



# FCC TEST REPORT

According to

## CFR47 §15.247 & RSS 247 Issue 2

Applicant	:	NINGBO DIYA ELECTRIC APPLIANCE CO.,LTD.
Address	:	SIMEN TOWN YUYAO CITY ZHEJIANG CHINA
Manufacturer	:	Hangzhou AiXiangJi Technology Co., Ltd
Address	:	Room 701, Building 3, More Center, No.87 GuDun Road, Hangzhou, China
Equipment	:	Relocatable Power Tap
Model No.	:	DR-V05,VPVPS-WH01
FCC ID	:	2AC2CDR-015
Test Period	:	Nov.13,2017~Nov.21, 2017

- The test result refers exclusively to the test presented test model / sample.
- Without written approval of **Cerpass Technology Corporation Test Laboratory** the test report shall not be reproduced exc- ept in full.
- The test report must not be used by the clients to claim product certification approval by any agency of the Government.

I HEREBY CERTIFY THAT :

The measurements shown in this test report were made in accordance with the procedures given in **ANSI C63.10 – 2013& FCC Part15.247**and the energy emitted by this equipment was **passed**.

Approved by:

Laboratory Accreditation:

Mark Liao / Assistant Manager



Cerpass Technology Corporation Test Laboratory

**TAF LAB Code:**

**1439**



## Contents

<b>1. Report of Measurements and Examinations .....</b>	<b>5</b>
<b>2. General Info .....</b>	<b>6</b>
2.1 Description of EUT .....	6
2.2 Description of wireless module .....	7
2.3 Description of Antenna .....	7
2.4 Carrier Frequency of Channels .....	8
2.5 The Worst Case Configuration .....	8
2.6 EUT Exercise Software .....	8
2.7 Power Parameter Value of the test software .....	9
2.8 Duty cycle .....	10
2.9 Support equipment .....	11
<b>3. General Information of Test Site .....</b>	<b>12</b>
3.1 Information of Test Site .....	12
3.2 Measuring Equipment .....	13
3.3 Measurement Uncertainty .....	14
<b>4. AC Conducted Emission Measurement .....</b>	<b>15</b>
4.1 Test Limit .....	15
4.2 Test Standard .....	15
4.3 Test Procedures .....	15
4.4 Test Setup Layout .....	16
4.5 Test Result .....	17
<b>5. Radiated Emission Measurement .....</b>	<b>19</b>
5.1 Test Limit .....	19
5.2 Test Standard .....	19
5.3 Test Procedures .....	20
5.4 Test Setup Layout .....	21
5.5 Test Result .....	23
<b>6. 6dB Bandwidth Measurement .....</b>	<b>30</b>
6.1 Test Limit .....	30
6.2 Test Standard .....	30
6.3 Test Procedures .....	30
6.4 Test Setup Layout .....	30
6.5 Test Result .....	31
<b>7. Output Power Measurement .....</b>	<b>34</b>
7.1 Test Limit .....	34
7.2 Test Standard .....	34
7.3 Test Procedures .....	34
7.4 Test Setup Layout .....	34
7.5 Test Result .....	35
<b>8. Power Spectral Density Measurement .....</b>	<b>36</b>
8.1 Test Limit .....	36
8.2 Test Standard .....	36
8.3 Test Procedures .....	36



---

8.4 Test Setup Layout .....	36
8.5 Test Result .....	37
<b>9. Conducted Band Edge and Out-of-Band Emissions Measurement .....</b>	<b>41</b>
9.1 Test Limit .....	41
9.2 Test Standard .....	41
9.3 Test Procedures .....	42
9.4 Test Setup Layout .....	42
9.5 Test Result .....	43
<b>10. Radiated Emission Band Edge Measurement .....</b>	<b>50</b>
10.1 Test Limit .....	50
10.2 Test Standard .....	50
10.3 Test Procedure .....	50
10.4 Test Setup Layout .....	51
10.5 Test Result .....	52



### History of this Test Report

Report No.	Version	Issue Date	Description
TEFI1711001	Rev 01	Nov.22, 2017	Original.



## 1. Report of Measurements and Examinations

Performed Test Item	Normative References	Test Performed	Deviation	Result
Conducted Emission	FCC CFR Title 47 Part 15 Subpart C: 2014 Section 15.207 RSS-GEN Issue 4 Section 8.8	Yes	N/A	Pass
Radiated Emission	FCC CFR Title 47 Part 15 Subpart C: 2014 Section 15.209 RSS-Gen Issue 4 November 2014 Section 6.13	Yes	No	Pass
RF Antenna Conducted Spurious	FCC CFR Title 47 Part 15 Subpart C: 2014 Section 15.247(d) RSS-247 Issue 2 February 2017 Section 5.5	Yes	No	Pass
Radiated Emission Band Edge	FCC CFR Title 47 Part 15 Subpart C: 2014 15.247(d) RSS-247 Issue 2 February 2017 Section 5.5	Yes	No	Pass
Operation Frequency Range of 20dB Bandwidth	FCC CFR Title 47 Part 15 Subpart C: 2014 15.215(c)	Yes	No	Pass
Occupied Bandwidth	FCC CFR Title 47 Part 15 Subpart C: 2014 Section 15.247(a)(2) RSS-247 Issue 2 February 2017 Section 5.1(a)	Yes	No	Pass
Output Power	FCC CFR Title 47 Part 15 Subpart C: 2014 Section 15.247(b)(3) RSS-247 Issue 2 February 2017 Section 5.1(b)	Yes	No	Pass
Power Spectral Density	FCC CFR Title 47 Part 15 Subpart C: 2014 Section 15.247(e) RSS-247 Issue 2 February 2017 Section 5.2(b)	Yes	No	Pass



## 2. General Info

### 2.1 Description of EUT

Product name	Relocatable Power Tap
Model No.	DR-V05,VPVPS-WH01



## 2.2 Description of wireless module

WLAN	TYWE3S
Spreading	802.11b: CCK, DQPSK, DBPSK 802.11g: 64 QAM, 16 QAM, QPSK, BPSK 802.11n: BPSK, QPSK, 16-QAM, 64-QAM
Frequency Range	802.11b/g/n(20MHz): 2412-2462MHz
Number of Channels	802.11b/g/n (20MHz):11
Data Rate	802.11b: 1, 2, 5.5, 11Mbps 802.11g: 6, 9, 12, 18, 24, 36, 48, 54Mbps 802.11n: MCS0~MCS7

Note: For more details, please refer to the EUT User manual.

## 2.3 Description of Antenna

Antenna	Peak Gain
PCB Antenna	3dBi for 2.40~2.50GHz band



## 2.4 Carrier Frequency of Channels

802.11b, 802.11g, 802.11n(20MHz)			
Channel	Frequency(MHz)	Channel	Frequency(MHz)
01	2412	08	2447
02	2417	09	2452
03	2422	10	2457
04	2427	11	2462
05	2432		
06	2437		
07	2442	---	---

## 2.5 The Worst Case Configuration

### Data rate Configuration:

Modulation Mode	Worst Data Rate
802.11b	1Mbps
802.11g	6Mbps
802.11n(HT20)	MCS0

Note: Power output test was verified over all data rates of each mode, and then choose the maximum power output for final test of each channel shown as the table.

## 2.6 EUT Exercise Software

1	Turn on the power of equipment.
2	Run 'SecureCRTPortable', input RF test command and set the test mode and channel, then press Transmit to start continue transmit.



**2.7 Power Parameter Value of the test software**

Mode	Frequency (MHz)	Power Setting
802.11b	2412	0
	2437	0
	2462	0
802.11g	2412	0
	2437	0
	2462	0
802.11n(20MHz)	2412	0
	2437	0
	2462	0



## 2.8 Duty cycle

Test Item	Duty cycle
-----------	------------

Mode	Frequency (MHz)	Measurement (%)
802.11b	2437	89.4
802.11g	2437	85.7
802.11n(20MHz)	2437	85.8

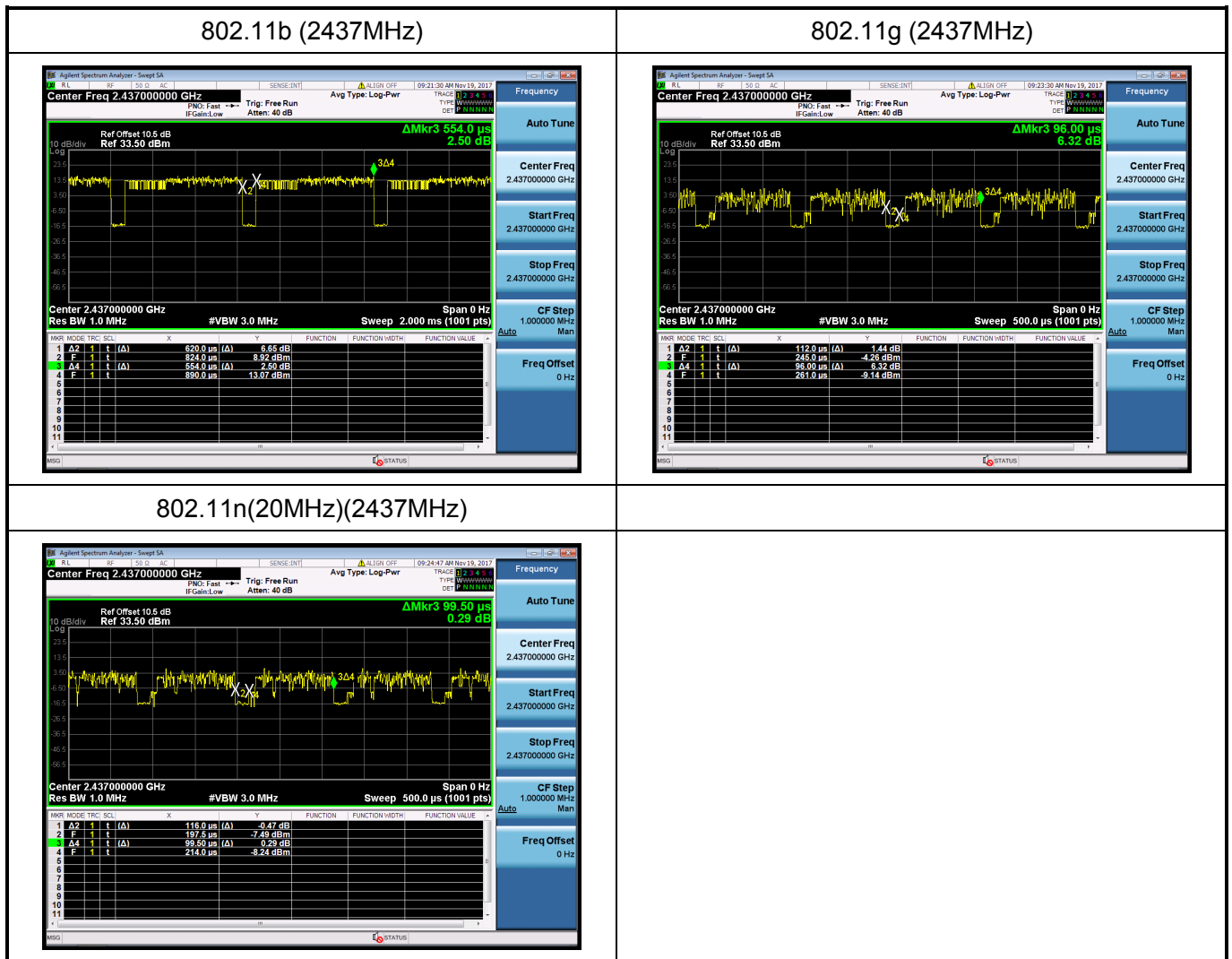



### 2.9 Support equipment

Product	Manufacturer	Model No.	Serial No.	Power Cord
N/A	N/A	N/A	N/A	N/A

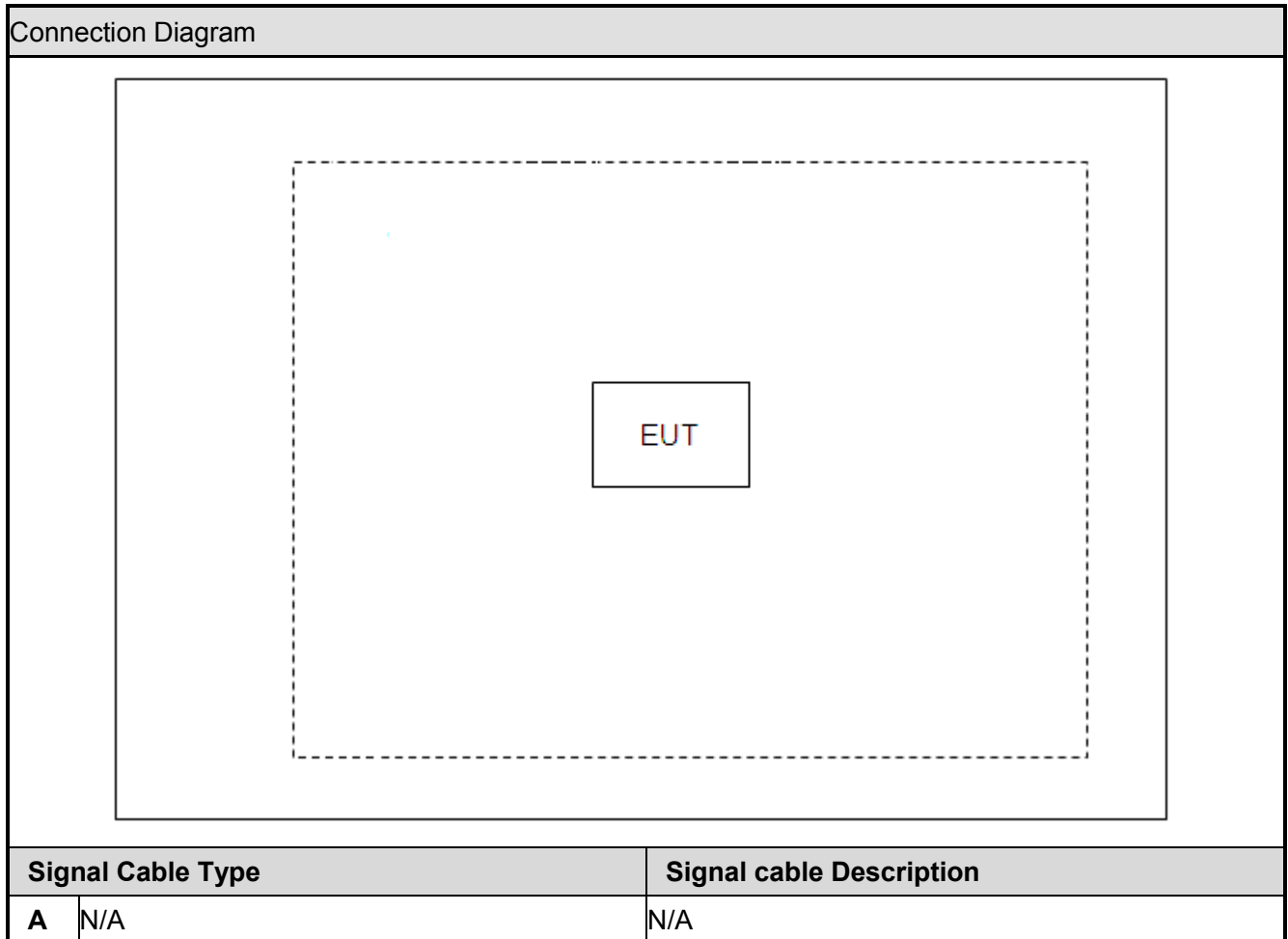



### 3. General Information of Test Site

#### 3.1 Information of Test Site

Test Site :	<b>Cerpass Technology Corporation Test Laboratory</b> Address: No.10, Ln. 2, Lianfu St., Luzhu Dist., Taoyuan City 33848, Taiwan (R.O.C.) Tel:+886-3-3226-888 Fax:+886-3-3226-881 Address: No.68-1, Shihbachongsi, Shihding Township, New Taipei City 223, Taiwan, R.O.C. Tel: +886-2-2663-8582
FCC Registration Number :	TW1439
IC Registration Number :	4934B-1, 4934E-1, 4934E-2
VCCI	T-2205 for Telecommunication Test C-4663 for Conducted emission test R-3428, R-4218 for Radiated emission test G-812, G-813 for radiated disturbance above 1GHz
Frequency Range Investigated :	Conducted Emission Test: from 150 kHz to 30 MHz Radiated Emission Test: from 30 MHz to 18,000 MHz
Test Distance :	The test distance of radiated emission below 1GHz from antenna to EUT is 3 M. The test distance of radiated emission above 1GHz from antenna to EUT is 3 M.



### 3.2 Measuring Equipment

Instrument/Ancillary	Manufacturer	Model No.	Serial No.	Calibration Date	Valid Date.
Test Receiver	R&S	ESCI	100565	2017.03.26	2018.03.25
AMN	R&S	ESH2-Z5	100182	2017.09.06	2018.09.05
Two-Line V-Network	R&S	ENV216	100325	/	/
Pulse Limiter	R&S	ESH3-Z2	100529	2017.03.26	2018.03.25
Temperature/ Humidity Meter	Zhicheng	ZC1-11	CEP-TH-004	2017.03.29	2018.03.28
EZ-EMC	Fala	Ver CT3A1	N/A	N/A	N/A

Instrument/Ancillary	Manufacturer	Model No.	Serial No.	Calibration Date	Valid Date.
EMI Test Receiver	R&S	ESCI	101183	2017.03.26	2018.03.25
Preamplifier	songyi	EM330	60618	2017.03.26	2018.03.25
Preamplifier	Agilent	8449B	3008A02342	2017.03.26	2018.03.25
Bilog Antenna	Sunol Science	JB1	A072414-1	2017.04.16	2018.04.15
Broad-Band Horn Antenna	Schwarzbeck	BBHA9120D	9120D-618	2017.04.16	2018.04.15
Broad-Band Horn Antenna	Schwarzbeck	BBHA9170	9170-347	2017.04.16	2018.04.15
Preamplifier	COM-POWER	PA-840	711885	2017.03.26	2018.03.25
Spectrum Analyzer	R&S	FSP40	100324	2017.03.26	2018.03.25
Spectrum Analyzer	KEYSIGHT	N9010A	MY54200207	2017.03.17	2018.03.16
Temperature/ Humidity Meter	Zhicheng	ZC1-11	CEP-TH-002	2017.03.29	2018.03.28
EZ-EMC	Fala	Ver CT3A1	N/A	N/A	N/A



### 3.3 Measurement Uncertainty

ISO/IEC 17025 requires that an estimate of the measurement uncertainties associated with the emissions test results be included in the report. The measurement uncertainties given below are based on a 95% confidence level (based on a coverage factor (k=2)).

Measurement Item	Measurement Frequency	Polarization	Uncertainty
Conducted Emission	9 kHz ~ 30 MHz	Line / Neutral	$\pm 2.9076$ dB
Radiated Emission	9 kHz ~ 40,000 MHz	Vertical / Horizontal	$\pm 0.948$ dB
Spurious Emission (Conducted)	-	-	$\pm 4.011$ dB
Maximum Peak and Average Output Power	-	-	$\pm 0.322$ dB
Power Spectral Density	-	-	$\pm 0.322$ dB
Bandwidth	-	-	74.224Hz



## 4. AC Conducted Emission Measurement

### 4.1 Test Limit

Conducted Emissions were measured from 150 kHz to 30 MHz with a bandwidth of 9 KHz on the 120 VAC power and return leads of the EUT according to the methods defined in ANSI C63.10-2013 Section 6.2. The EUT was placed on a nonmetallic stand in a shielded room 0.8 meters above the ground plane as shown in section 6.2.2. The interface cables and equipment positioning were varied within limits of reasonable applications to determine the position produced maximum conducted emissions.

FCC Part 15 Subpart C Paragraph 15.207 Limits		
Frequency (MHz)	Quasi Peak (dB $\mu$ V)	Average (dB $\mu$ V)
0.15 – 0.5	66-56*	56-46*
0.5 – 5.0	56	46
5.0 – 30.0	60	50

\*Decreases with the logarithm of the frequency.

### 4.2 Test Standard

Tested according to ANSI C63.10: 2013 Section 6.2 for compliance to FCC 47CFR 15.247 Part15.207 (a) requirements.

### 4.3 Test Procedures

The EUT was placed on a platform of nominal size, 1 m by 1.5 m, raised 80 cm above the conducting ground plane. The vertical conducting plane was located 40 cm to the rear of the EUT. All other surfaces of EUT were at least 80 cm from any other grounded conducting surface. The EUT and simulators are connected to the main power through a line impedance stabilization network (LISN). The LISN provides a 50 ohm /50uH coupling impedance for the measuring equipment. The peripheral devices are also connected to the main power through a LISN. (Please refer to the block diagram of the test setup and photographs) Each current-carrying conductor of the EUT power cord, except the ground (safety) conductor, was individually connected through a LISN to the input power source.

The excess length of the power cord between the EUT and the LISN receptacle were folded back and forth at the center of the lead to form a bundle not exceeding 40 cm in length.

Conducted emissions were investigated over the frequency range from 0.15MHz to 30MHz using a receiver bandwidth of 9 kHz.



### 4.4 Test Setup Layout

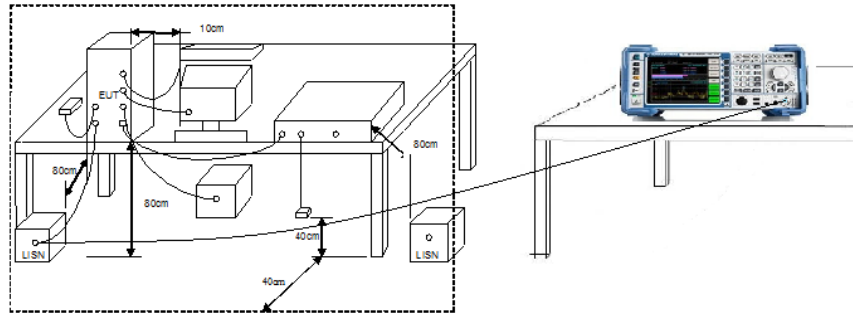





### 4.5 Test Result

Test Mode :	Mode 1: Normal Operation with WIFI on		
AC Power :	AC 120V/60Hz	Phase:	LINE
Temperature :	26°C	Humidity:	60%
Pressure(mbar) :	1002	Date:	2017/11/19

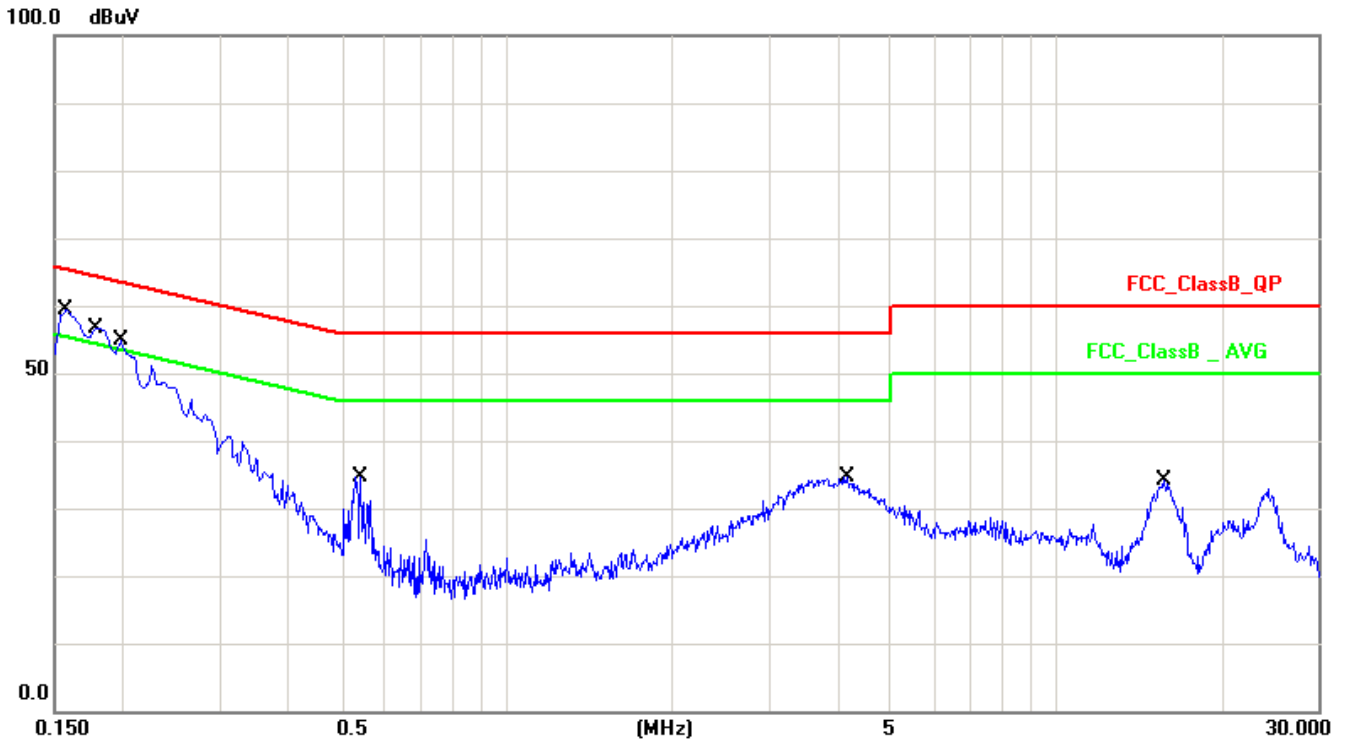

No.	Frequency (MHz)	Factor (dB)	Reading (dBuV)	Level (dBuV)	Limit (dBuV)	Margin (dB)	Detector
1	0.1580	10.13	46.40	56.53	65.56	-9.03	QP
2	0.1580	10.13	26.14	36.27	55.56	-19.29	AVG
3	0.1780	10.12	41.37	51.49	64.57	-13.08	QP
4	0.1780	10.12	17.34	27.46	54.57	-27.11	AVG
5	0.1980	10.12	41.22	51.34	63.69	-12.35	QP
6	0.1980	10.12	22.13	32.25	53.69	-21.44	AVG
7	0.5420	10.16	18.00	28.16	56.00	-27.84	QP
8	0.5420	10.16	6.76	16.92	46.00	-29.08	AVG
9	4.1700	10.21	20.10	30.31	56.00	-25.69	QP
10	4.1700	10.21	15.17	25.38	46.00	-20.62	AVG
11	15.7420	10.50	17.73	28.23	60.00	-31.77	QP
12	15.7420	10.50	11.72	22.22	50.00	-27.78	AVG

Note: Measurement Level = Reading Level + Correct Factor



Test Mode :	Mode 1: Normal Operation with WIFI on		
AC Power :	AC 120V/60Hz	Phase :	NEUTRAL
Temperature :	26°C	Humidity :	60%
Pressure(mbar) :	1002	Date:	2017/11/19

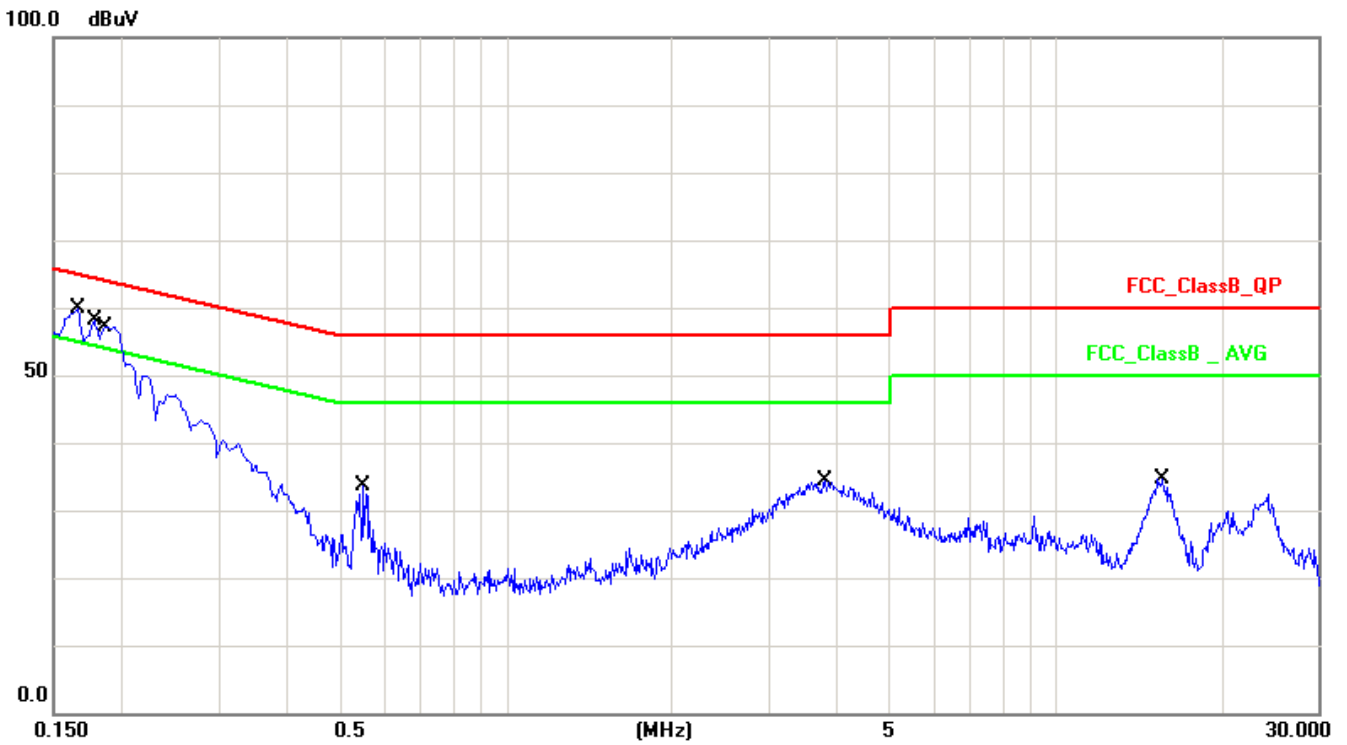

No.	Frequency (MHz)	Factor (dB)	Reading (dBuV)	Level (dBuV)	Limit (dBuV)	Margin (dB)	Detector
1	0.1660	10.13	43.44	53.57	65.15	-11.58	QP
2	0.1660	10.13	22.48	32.61	55.15	-22.54	AVG
3	0.1780	10.13	42.90	53.03	64.57	-11.54	QP
4	0.1780	10.13	23.19	33.32	54.57	-21.25	AVG
5	0.1864	10.13	40.59	50.72	64.19	-13.47	QP
6	0.1864	10.13	20.02	30.15	54.19	-24.04	AVG
7	0.5500	10.15	16.87	27.02	56.00	-28.98	QP
8	0.5500	10.15	6.81	16.96	46.00	-29.04	AVG
9	3.8060	10.22	19.63	29.85	56.00	-26.15	QP
10	3.8060	10.22	14.82	25.04	46.00	-20.96	AVG
11	15.6980	10.51	17.57	28.08	60.00	-31.92	QP
12	15.6980	10.51	11.29	21.80	50.00	-28.20	AVG

Note: Measurement Level = Reading Level + Correct Factor



## 5. Radiated Emission Measurement

### 5.1 Test Limit

In any 100kHz bandwidth outside the frequency band in which the spread spectrum or digitally modulated intentional radiator is operating, the radio frequency power that is produced by the intentional radiator shall be at least 20dB below that in the 100kHz bandwidth within the band that contains the highest level of the desired power, based on either an RF conducted or a radiated measurement. If the transmitter measurement is based on the maximum conducted output power, the attenuation required under this paragraph shall be 30dB instead of 20dB. In addition, radiated emissions which fall in section 15.205(a) the restricted bands must also comply with the radiated emission limit specified in section 15.209(a).

FCC Part 15 Subpart C Paragraph 15.209		
FREQUENCIES (MHz)	FIELD STRENGTH (micro volts/meter)	MEASUREMENT DISTANCE (meters)
0.009~0.490	2400/F(kHz)	300
0.490~1.705	24000/F(kHz)	30
1.705~30.0	30	30
30~88	100	3
88~216	150	3
216~960	200	3
Above 960	500	3

Note 1: The lower limit shall apply at the transition frequency.

Note 2: Distance refers to the distance in meters between the measuring instrument Antenna and the closed point of any part of the device or system.

Note 3: E field strength (dBuV/m) = 20 log E field strength (uV/m)

Note 4: \*\*Except as provided in paragraph (g), fundamental emissions from intentional radiators operating under this section shall not be located in the frequency bands 54-72 MHz, 76-88 MHz, 174-216 MHz or 470-806 MHz. However, operation within these frequency bands is permitted under other sections of this part, e.g., §§15.231 and 15.241.

### 5.2 Test Standard

KDB 558074 D01v04 - Section 12.2.3 (quasi-peak measurements)

KDB 558074 D01v04 - Section 12.2.4 (peak power measurements)

KDB 558074 D01v04- Section 12.2.5 (average power measurements)



### 5.3 Test Procedures

#### Quasi-Peak Field Strength Measurements:

The specifications for measurements using the CISPR quasi-peak detector can be found in Publication 16 of the International Special Committee on Radio Frequency Interference (CISPR) of the International Electrotechnical Commission.

As an alternative to CISPR quasi-peak measurement, compliance can be demonstrated to the applicable emission limits using a peak detector.

#### Peak Field Strength Measurements:

Analyzer center frequency was set to the frequency of the radiated spurious emission of interest

1. RBW=As specified in Table 1
2. VBW=3×RBW
3. Detector=Peak
4. Trace mode=Max hold
5. Sweep time=Auto couple
6. Allow the trace to stabilize

Table 1-RBW as a function of frequency

Frequency	RBW
9 ~ 150kHz	200 ~ 300Hz
0.15 ~ 30MHz	9 ~ 10kHz
30 ~ 1000MHz	100 ~ 120kHz
> 1000MHz	1MHz

#### AVE Field Strength Measurements:

Analyzer center frequency was set to the frequency of the radiated spurious emission of interest

1. RBW= 1MHz
2. VBW≥1/T
3. Detector=Peak
4. Trace mode=Max hold
5. Sweep time=Auto couple
6. Allow max hold to run for at least 50 times(1/duty cycle) trace

Do as an alternative, the instrument may be set to linear detector mode. Ensure that video filtering is applied in linear voltage domain (rather than in a log or dB domain). Some instruments require linear display mode in order to accomplish this. Others have a setting for Average-VBW Type, which can be set to "Voltage" regardless of the display mode



### 5.4 Test Setup Layout

9kHz~30MHz Test Setup

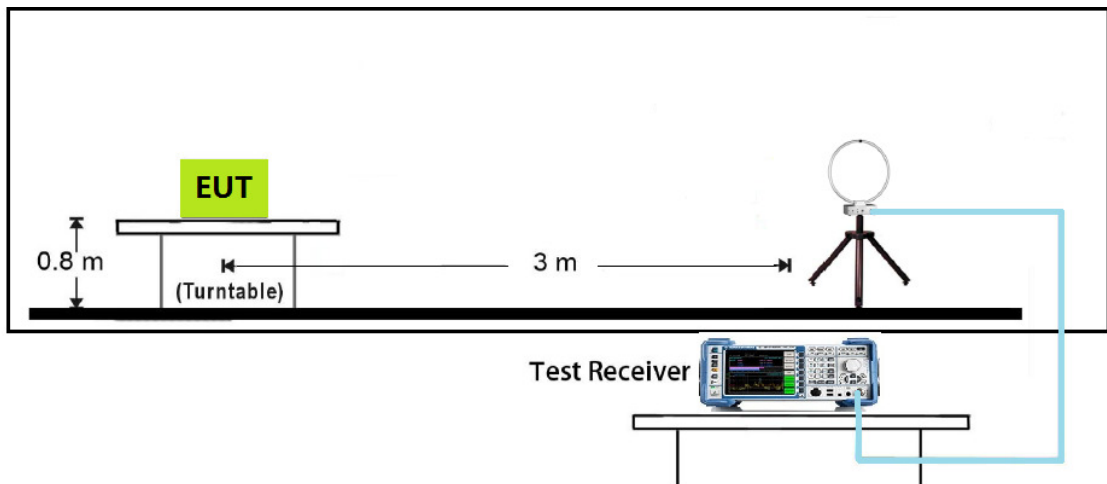

30MHz~1GHz Test Setup

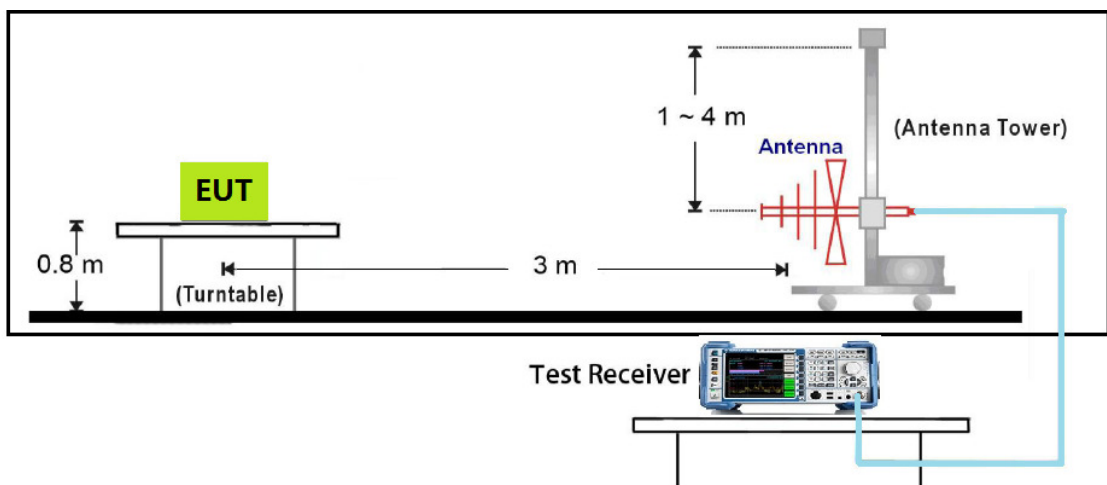



### 1GHz~18GHz Test Setup

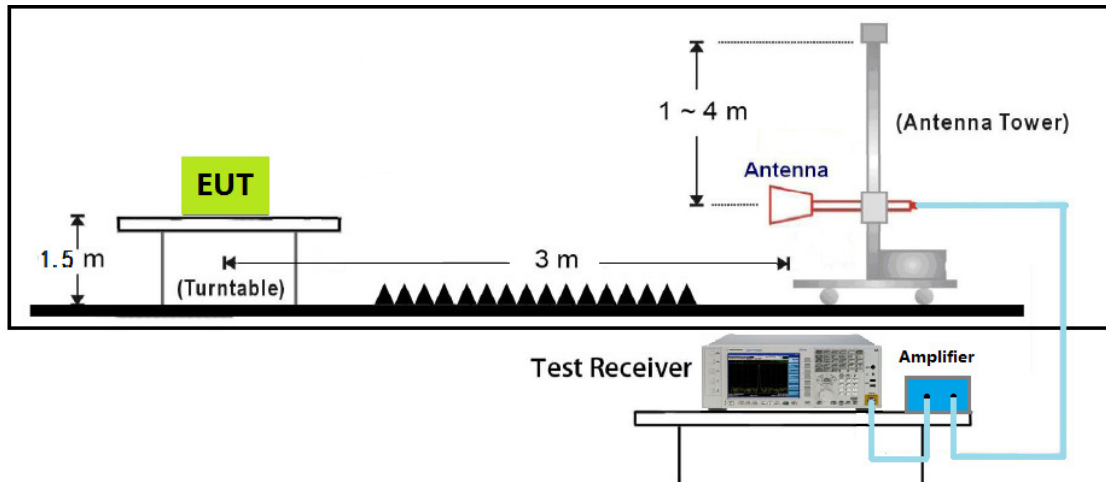

### 18GHz~40GHz Test Setup

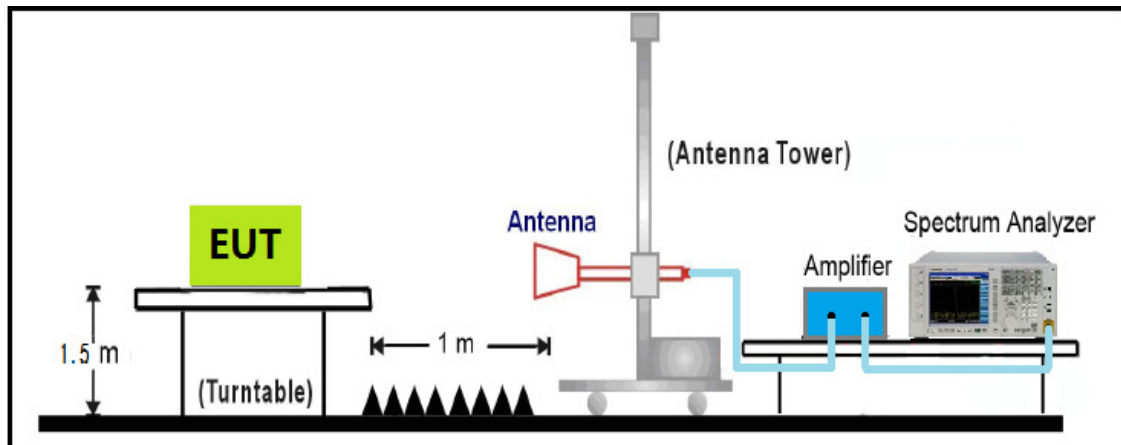



### 5.5 Test Result

Limit: FCC_Part15.209_RE(3m)	Margin: 0
Probe: CBL6112D (30-1000MHz)	Polarity: Horizontal
EUT: Relocatable Power Tapes	Power: AC 120V/60Hz
Note: Mode1: Transmit at channel 2437MHz by 802.11b	

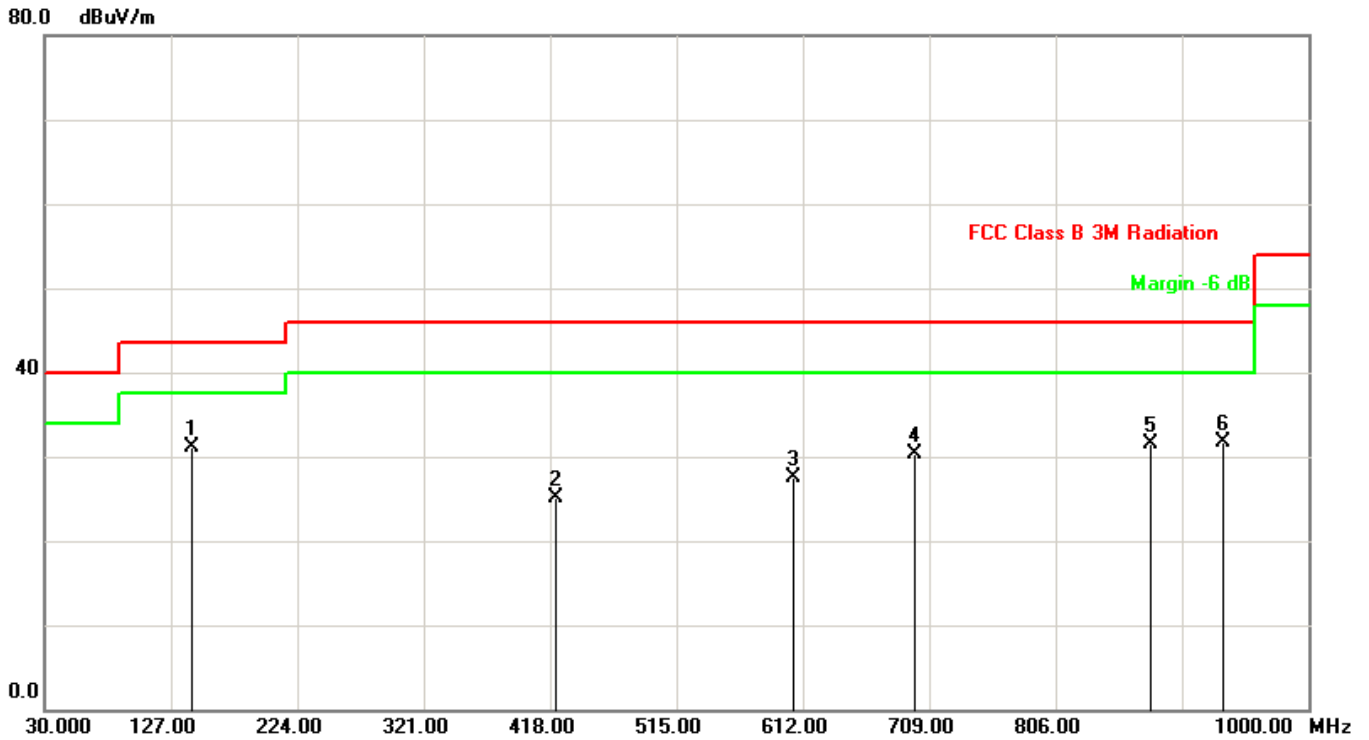

No.	Frequency (MHz)	Factor (dB/m)	Reading (dBuV)	Level (dBuV/m)	Limit (dBuV/m)	Margin (dB)	Det.
1	143.4900	-12.77	43.93	31.16	43.50	-12.34	QP
2	422.8500	-3.58	28.66	25.08	46.00	-20.92	QP
3	605.2100	-1.79	29.32	27.53	46.00	-18.47	QP
4	697.3600	0.88	29.37	30.25	46.00	-15.75	QP
5	878.7500	2.08	29.34	31.42	46.00	-14.58	QP
6	935.0099	2.49	29.16	31.65	46.00	-14.35	QP

Note: Measure Level (dBuV/m) = Reading Level (dBuV) + Factor(dB).

Factor (dB)=Cable Loss(dB) + Antenna Factor (dB/m) - Pre\_Amplifier Gain(dB)



Limit: FCC_Part15.209_RE(3m)	Margin: 0
Probe: CBL6112D (30-1000MHz)	Polarity: Vertical
EUT: Relocatable Power Tapes	Power: AC 120V/60Hz
Note: Mode1: Transmit at channel 2437MHz by 802.11b	

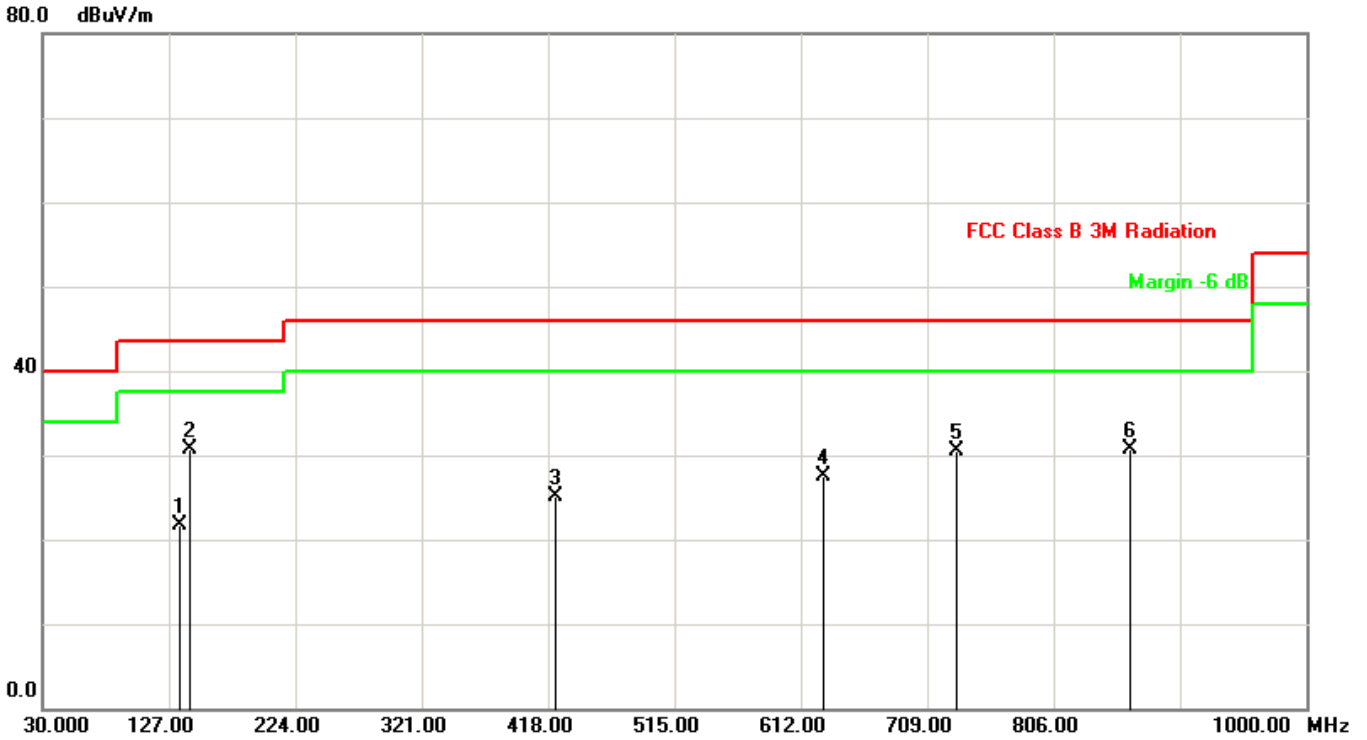

No.	Frequency (MHz)	Factor (dB/m)	Reading (dBuV)	Level (dBuV/m)	Limit (dBuV/m)	Margin (dB)	Det.
1	135.7298	-12.83	34.58	21.75	43.50	-21.75	QP
2	143.4900	-12.77	43.48	30.71	43.50	-12.79	QP
3	423.8199	-3.69	28.73	25.04	46.00	-20.96	QP
4	629.4600	-1.63	29.20	27.57	46.00	-18.43	QP
5	732.2799	1.54	28.96	30.50	46.00	-15.50	QP
6	865.1699	1.97	28.83	30.80	46.00	-15.20	QP

Note: Measure Level (dBuV/m) = Reading Level (dBuV) + Factor(dB).

Factor (dB)=Cable Loss(dB) + Antenna Factor (dB/m) - Pre\_Amplifier Gain(dB)



**Radiated Emission above 1GHz:**

Mode1: Transmit by 802.11b

CH	Antenna	Frequency (MHz)	Reading Level (dBuV/m)	Factor (dB)	Measure Level (dBuV/m)	Limit (dBuV/m)	Margin (dB)	Detector
1	H	4824.00	47.57	3.32	50.89	54(note3)	-3.11	PK
	H	7236.00	38.35	8.22	46.57	54(note3)	-7.43	PK
	V	4824.00	46.78	3.32	50.10	54(note3)	-3.90	PK
	V	7236.00	35.66	8.22	43.88	54(note3)	-10.12	PK
6	H	4874.00	49.54	3.42	52.96	54(note3)	-1.04	PK
	H	7311.00	38.51	8.27	46.78	54(note3)	-7.22	PK
	V	4874.00	48.75	3.42	52.17	54(note3)	-1.83	PK
	V	7311.00	36.14	8.27	44.41	54(note3)	-9.59	PK
11	H	4924.00	47.71	3.52	51.23	54(note3)	-2.77	PK
	H	7386.00	38.00	8.32	46.32	54(note3)	-7.68	PK
	V	4924.00	47.41	3.52	50.93	54(note3)	-3.07	PK
	V	7386.00	35.77	8.32	44.09	54(note3)	-9.91	PK

Note: 1. Measure Level = Reading Level + Factor.

2. The test trace is same as the ambient noise (the test frequency range: 9kHz~30MHz, 18GHz~25GHz), therefore no data appear in the report.

3. This limit applies for using average detector, if the test result on peak is lower than average limit, then average measurement needn't be performed.



Mode2: Transmit by 802.11g

CH	Antenna	Frequency (MHz)	Reading Level (dBuV/m)	Factor (dB)	Measure Level (dBuV/m)	Limit (dBuV/m)	Margin (dB)	Detector
1	H	4824.00	48.50	3.32	51.82	54(note3)	-2.18	PK
	H	7236.00	37.99	8.22	46.21	54(note3)	-7.79	PK
	V	4824.00	47.01	3.32	50.33	54(note3)	-3.67	PK
	V	7236.00	35.71	8.22	43.93	54(note3)	-10.07	PK
6	H	4874.00	48.12	3.42	51.54	54(note3)	-2.46	PK
	H	7311.00	38.18	8.27	46.45	54(note3)	-7.55	PK
	V	4874.00	47.53	3.42	50.95	54(note3)	-3.05	PK
	V	7311.00	35.83	8.27	44.10	54(note3)	-9.90	PK
11	H	4924.00	48.14	3.52	51.66	54(note3)	-2.34	PK
	H	7386.00	38.38	8.32	46.70	54(note3)	-7.30	PK
	V	4924.00	46.98	3.52	50.50	54(note3)	-3.50	PK
	V	7386.00	35.86	8.32	44.18	54(note3)	-9.82	PK

Note: 1. Measure Level = Reading Level + Factor.

2. The test trace is same as the ambient noise (the test frequency range: 9kHz~30MHz, 18GHz~25GHz), therefore no data appear in the report.

3. This limit applies for using average detector, if the test result on peak is lower than average limit, then average measurement needn't be performed.



Mode3: Transmit by 802.11n(20MHz)

CH	Antenna	Frequency (MHz)	Reading Level (dBuV/m)	Factor (dB)	Measure Level (dBuV/m)	Limit (dBuV/m)	Margin (dB)	Detector
1	H	4824.00	47.67	3.32	50.99	54(note3)	-3.01	PK
	H	7236.00	38.21	8.22	46.43	54(note3)	-7.57	PK
	V	4824.00	47.09	3.32	50.41	54(note3)	-3.59	PK
	V	7236.00	35.96	8.22	44.18	54(note3)	-9.82	PK
6	H	4874.00	48.16	3.42	51.58	54(note3)	-2.42	PK
	H	7311.00	38.34	8.27	46.61	54(note3)	-7.39	PK
	V	4874.00	46.83	3.42	50.25	54(note3)	-3.75	PK
	V	7311.00	35.90	8.27	44.17	54(note3)	-9.83	PK
11	H	4924.00	47.67	3.52	51.19	54(note3)	-2.81	PK
	H	7386.00	38.19	8.32	46.51	54(note3)	-7.49	PK
	V	4924.00	47.40	3.52	50.92	54(note3)	-3.08	PK
	V	7386.00	36.00	8.32	44.32	54(note3)	-9.68	PK

Note: 1. Measure Level = Reading Level + Factor.

2. The test trace is same as the ambient noise (the test frequency range: 9kHz~30MHz, 18GHz~25GHz), therefore no data appear in the report.

3. This limit applies for using average detector, if the test result on peak is lower than average limit, then average measurement needn't be performed.



**The worst case of Radiated Emission 1~18GHz:**

Site: AC102	Time: 2017/11/19
Limit: FCC_Part15.209_RE(3m)	Margin: 0
Probe: N/A	Polarity: Horizontal
EUT: Relocatable Power Tapes	Power: AC 120V/60Hz
Note: Mode: Transmit 802.11b at 2437MHz	

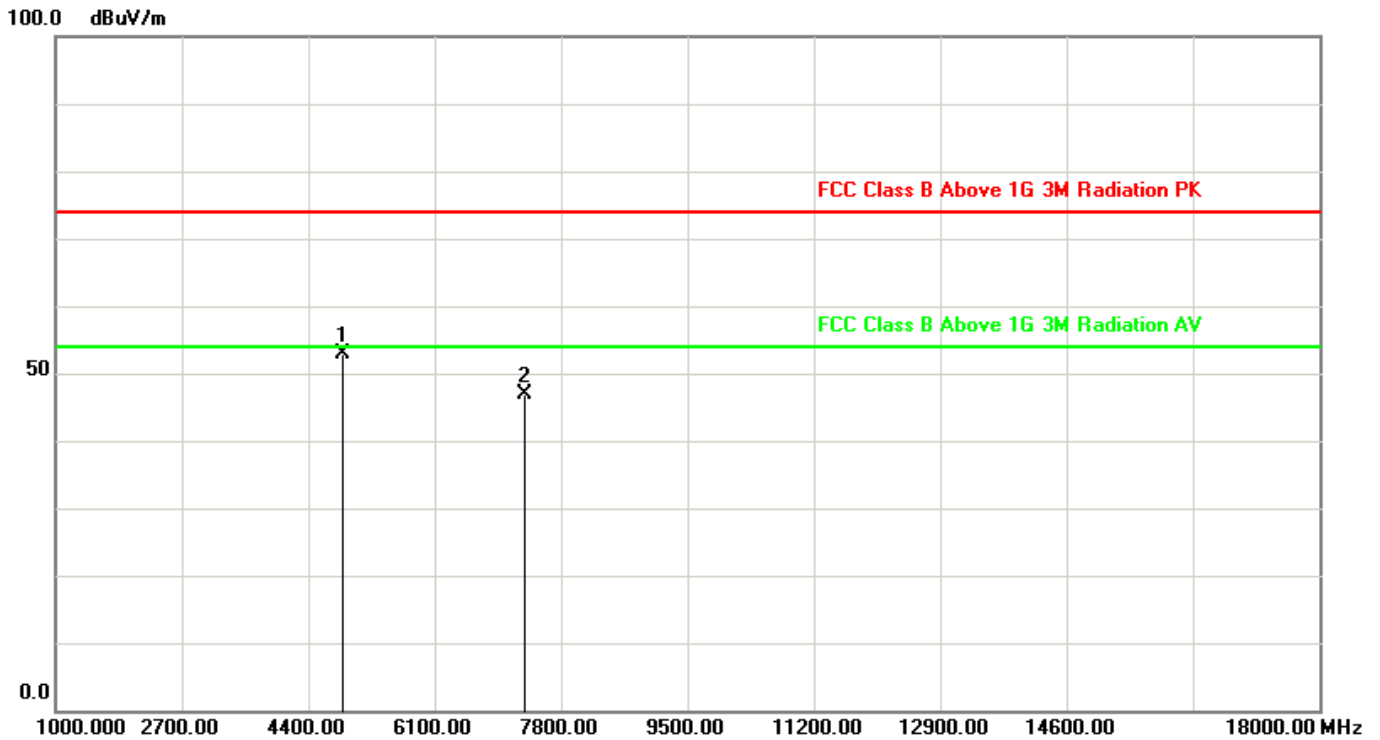

No.	Frequency (MHz)	Reading (dBuV)	Factor (dB/m)	Level (dBuV/m)	Limit (dBuV/m)	Margin (dB)	Det.
1	4874.00	49.54	3.42	52.96	54(note3)	-1.04	peak
2	7311.00	38.51	8.27	46.78	54(note3)	-7.22	peak

Note:

1. All Readings below 1GHz are Quasi-Peak, above are performed with peak and/or AVG measurements as necessary.
2. Measurement Level = Reading Level + Correct Factor
3. The test trace is same as the ambient noise (the test frequency range: 9kHz~30MHz, 18GHz~40GHz), therefore no data appear in the report.



Site: AC102	Time: 2017/11/19
Limit: FCC_Part15.209_RE(3m)	Margin: 0
Probe: N/A	Polarity: Vertical
EUT: Relocatable Power Tapes	Power: AC 120V/60Hz
Note: Mode: Transmit 802.11b at 2437MHz	

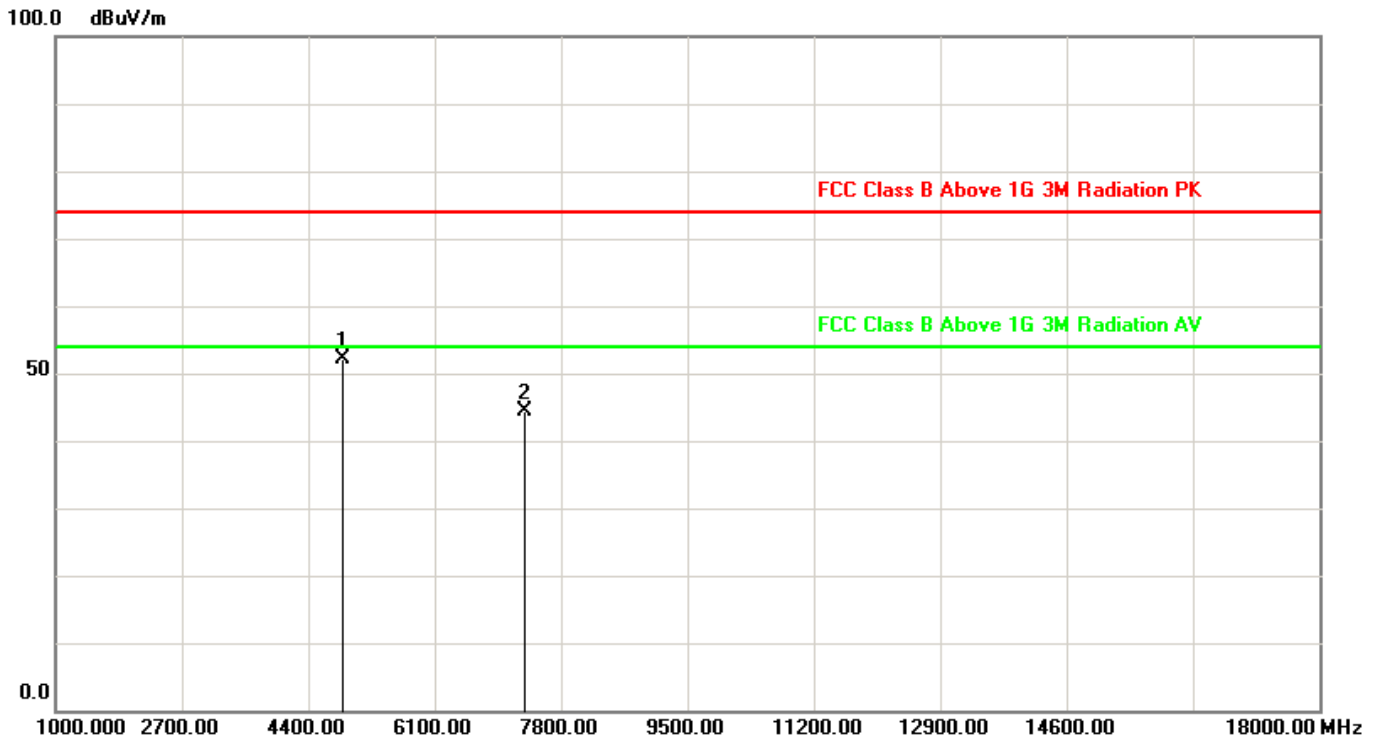

No.	Frequency (MHz)	Reading (dBuV)	Factor (dB/m)	Level (dBuV/m)	Limit (dBuV/m)	Margin (dB)	Det.
1	4874.00	48.75	3.42	52.17	54(note3)	-1.83	peak
2	7311.00	36.14	8.27	44.41	54(note3)	-9.59	peak

Note:

1. All Readings below 1GHz are Quasi-Peak, above are performed with peak and/or AVG measurements as necessary.
2. Measurement Level = Reading Level + Correct Factor
3. The test trace is same as the ambient noise (the test frequency range: 9kHz~30MHz, 18GHz~40GHz), therefore no data appear in the report.



## 6. 6dB Bandwidth Measurement

### 6.1 Test Limit

According to FCC part15.247 - Section (a)(2), the minimum 6dB bandwidth shall be at least 500 kHz.

### 6.2 Test Standard

KDB 558074 D01v04– Section 8.2 Option 2

### 6.3 Test Procedures

1. Set RBW=100KHz
2. VBW $\geq$ 3 $\times$ RBW
3. Detector=Peak
4. Trace mode=Max hold
5. Sweep time=Auto couple
6. Allow the trace to stabilize
7. The Spectrum's automatic bandwidth measurement capability was used to perform the 6dB bandwidth measurement. The "X" dB bandwidth parameter was set to X = 6. The bandwidth measurement was not influenced by any intermediate power nulls in the fundamental emission.

### 6.4 Test Setup Layout

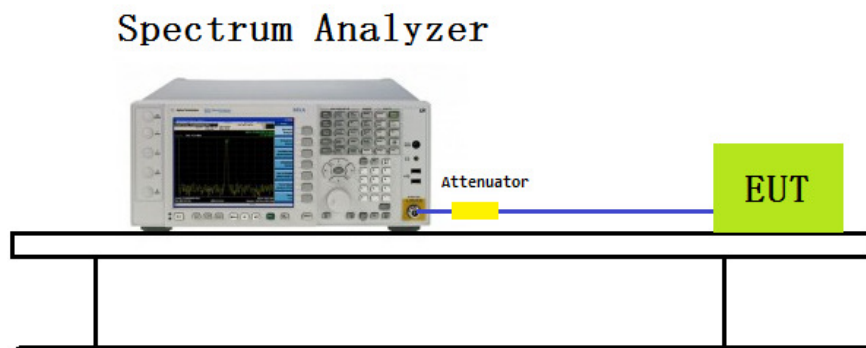



### 6.5 Test Result

Test Item	Occupied Bandwidth
Test Mode	Mode 1: Transmit by 802.11b

Channel No.	Frequency(MHz)	6dB Bandwidth(MHz)	99% Bandwidth(MHz)
1	2412	8.599	11.413
6	2437	8.569	11.330
11	2462	8.490	11.237

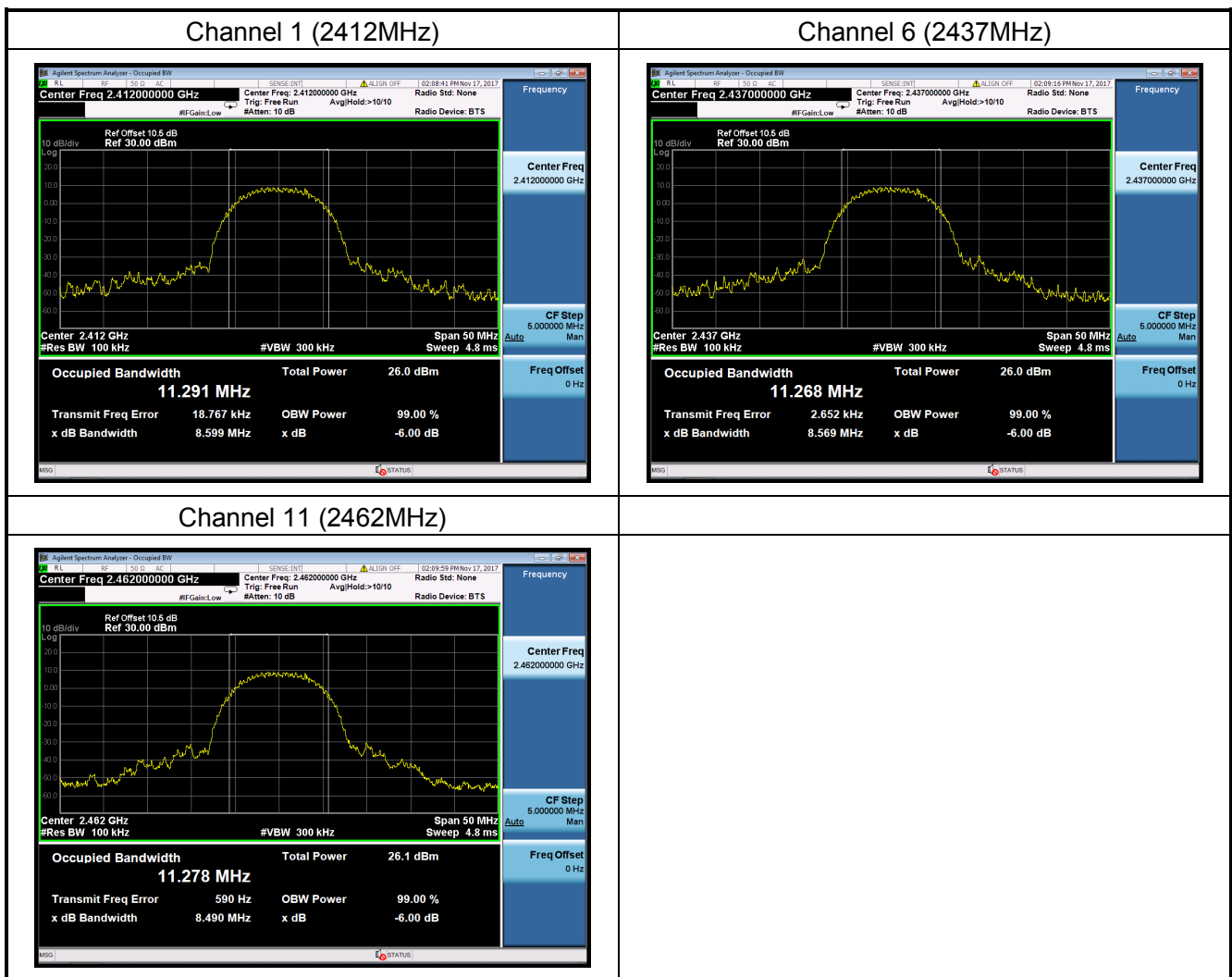



Test Item	Occupied Bandwidth
Test Mode	Mode 2: Transmit by 802.11g

Channel No.	Frequency(MHz)	6dB Bandwidth(MHz)	99% Bandwidth(MHz)
1	2412	16.27	16.470
6	2437	16.26	16.473
11	2462	16.26	16.470

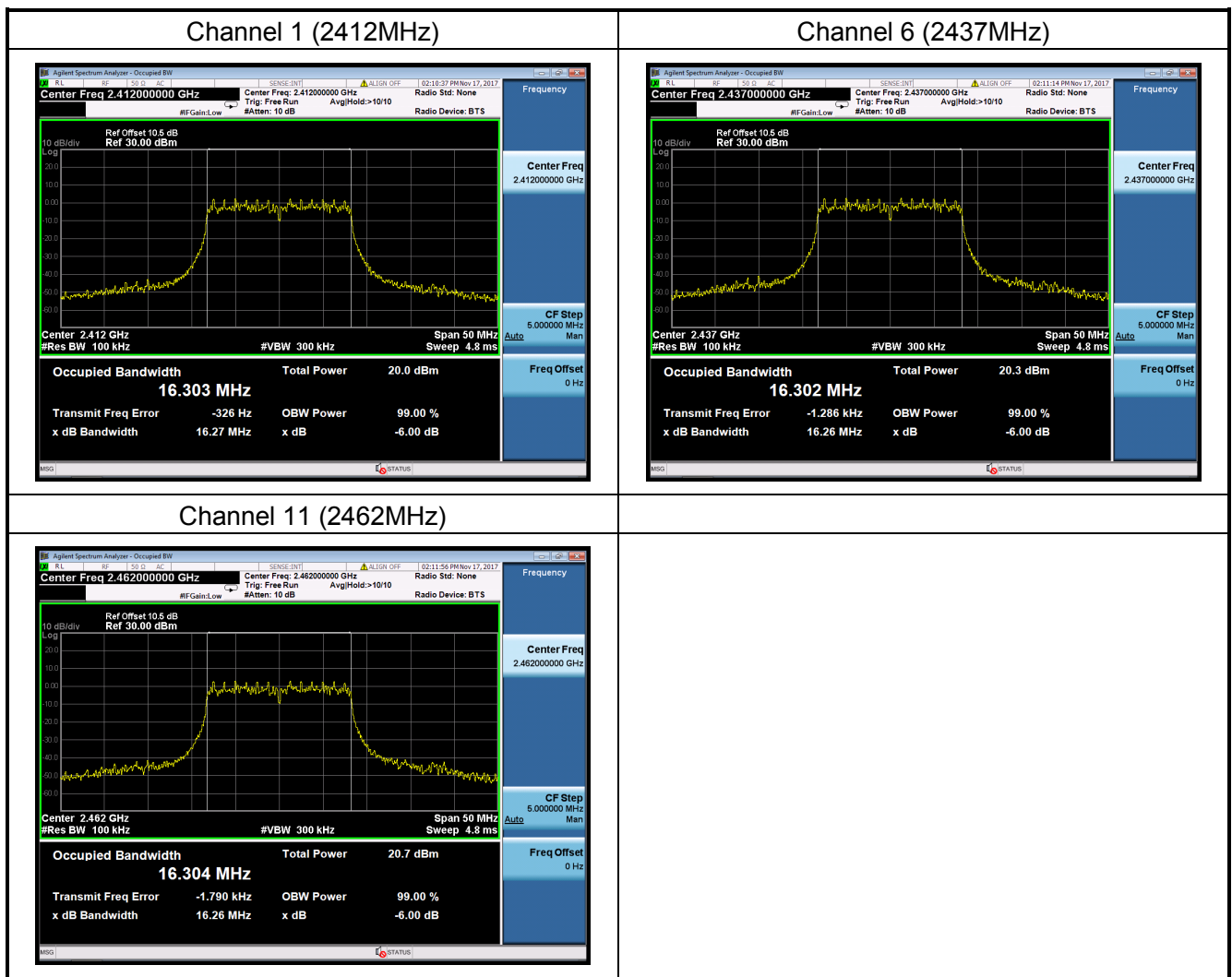





Test Item	Occupied Bandwidth
Test Mode	Mode 3: Transmit by 802.11n(20MHz)

Channel No.	Frequency(MHz)	6dB Bandwidth(MHz)	99% Bandwidth(MHz)
1	2412	16.24	17.687
6	2437	16.24	17.693
11	2462	16.23	17.693

Channel 1 (2412MHz)

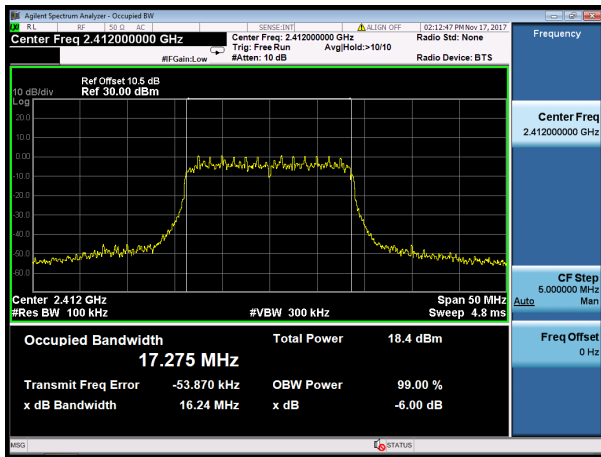

Channel 6 (2437MHz)

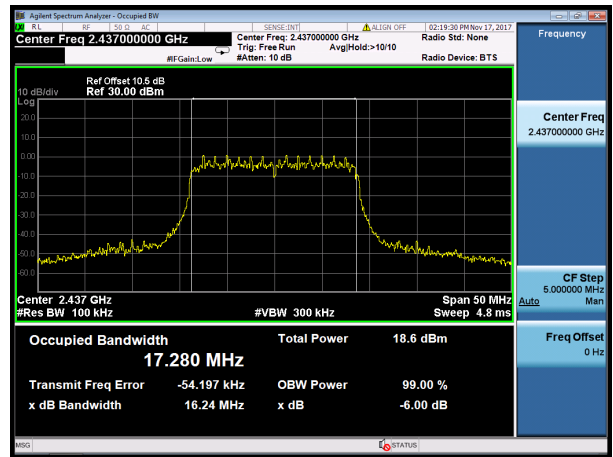

Channel 11 (2462MHz)

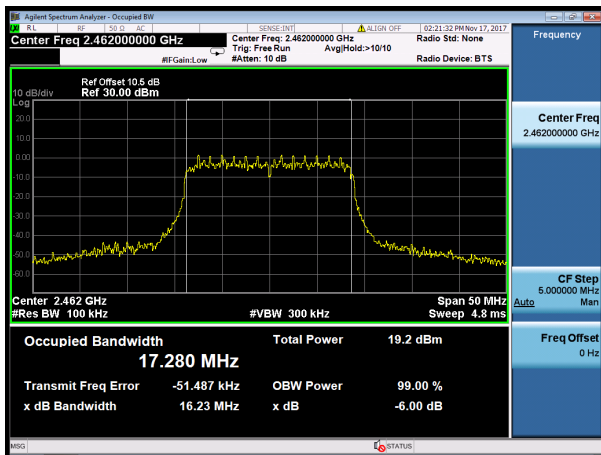



## 7. Output Power Measurement

### 7.1 Test Limit

According to FCC part15.247 (b) (3), for systems using digital modulation in the 902-928 MHz, 2400-2483.5 MHz, and 5725-5850MHz bands: 1 Watt. As an alternative to a peak power measurement, compliance with the one Watt limit can be based on a measurement of the maximum conducted output power. Maximum Conducted Output Power is defined as the total transmit power delivered to all antennas and antenna elements averaged across all symbols in the signaling alphabet when the transmitter is operating at its maximum power control level. Power must be summed across all antennas and antenna elements. The average must not include any time intervals during which the transmitter is off or is transmitting at a reduced power level. If multiple modes of operation are possible (e.g., alternative modulation methods), the maximum conducted output power is the highest total transmit power occurring in any mode.

Per RSS247 Issue 2 Section 5.4(d), for DTSs employing digital modulation techniques operating in the bands 902-928 MHz and 2400-2483.5 MHz, the maximum peak conducted output power shall not exceed 1W.

### 7.2 Test Standard

KDB 558074 D01v04 - Section 9.1.2 PKPM1 Peak Power Method (for signals with BW  $\leq$ 50MHz)

### 7.3 Test Procedures

Out power measurements were performed only when the EUT was transmitting at its maximum power control level using a broadband power meter with a pulse sensor. The pulse sensor employs a VBW = 50MHz so this method was only used for signals whose DTS bandwidth was less than or equal to 50MHz.

### 7.4 Test Setup Layout

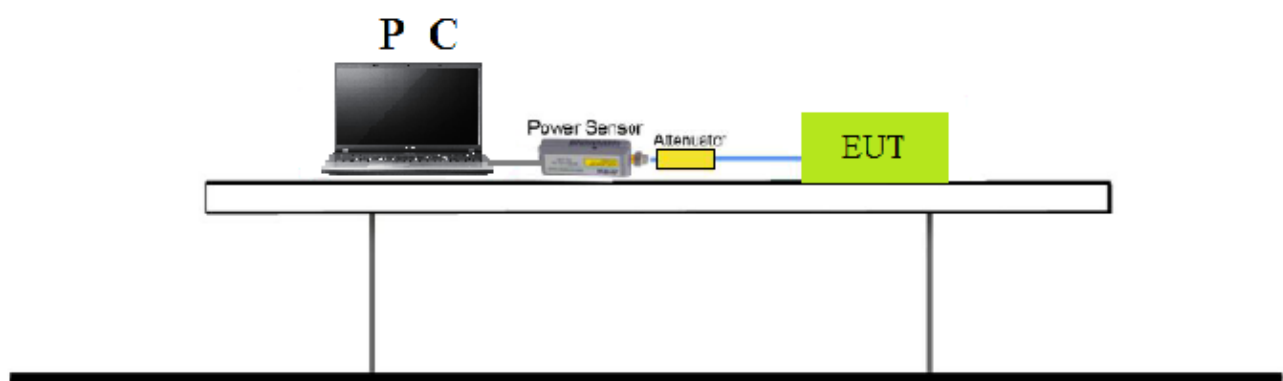



## 7.5 Test Result

### For Peak Power :

Test Mode	Channel No.	Frequency (MHz)	Peak Output Power (dBm)	Limit (dBm)	Result
802.11b	1	2412	22.05	30	Pass
	6	2437	21.50	30	Pass
	11	2462	21.06	30	Pass
802.11g	1	2412	21.99	30	Pass
	6	2437	22.12	30	Pass
	11	2462	22.19	30	Pass
802.11n(20MHz)	1	2412	20.98	30	Pass
	6	2437	21.24	30	Pass
	11	2462	21.07	30	Pass

### For Average Power :

Test Mode	Channel No.	Frequency (MHz)	Average Output Power (dBm)	Limit (dBm)	Result
802.11b	1	2412	15.18	30	Pass
	6	2437	15.24	30	Pass
	11	2462	14.88	30	Pass
802.11g	1	2412	10.21	30	Pass
	6	2437	10.29	30	Pass
	11	2462	10.37	30	Pass
802.11n(20MHz)	1	2412	8.64	30	Pass
	6	2437	8.65	30	Pass
	11	2462	8.81	30	Pass



## 8. Power Spectral Density Measurement

### 8.1 Test Limit

According to FCC part15.247 - Section (e), for digitally modulated systems, the power spectral density conducted from the intentional radiator to the antenna shall not be greater than 8 dBm in any 3 kHz band during any time interval of continuous transmission. This power spectral density shall be determined in accordance with the provisions of paragraph (b) of this section. The same method of determining the conducted output power shall be used to determine the power spectral density.

### 8.2 Test Standard

KDB 558074 D01v04- Section 10.2 Method PKPSD

### 8.3 Test Procedures

1. Set RBW=3kHz
2. Set RBW=10kHz
3. Span = 1.5 times the DTS channel bandwidth
4. Detector=Peak
5. Trace mode=Max hold
6. Sweep time=Auto couple
7. Allow the trace to stabilize
8. Analyzer was set to the center frequency of the DTS channel under investigation.

### 8.4 Test Setup Layout

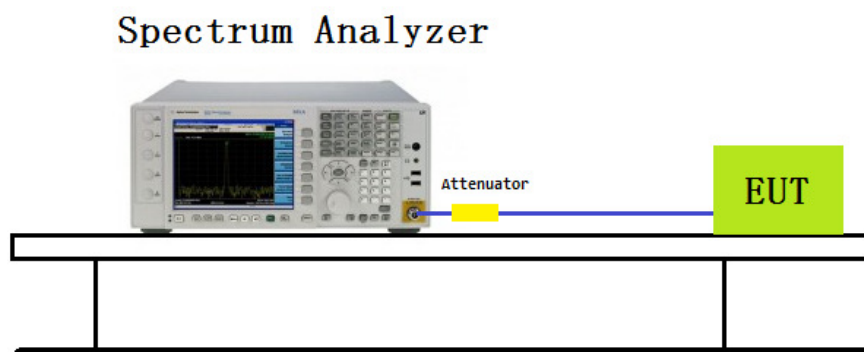



## 8.5 Test Result

Test Mode	Channel No.	Frequency(MHz)	Power Spectral Density (dBm/3kHz)	Limit (dBm/3kHz)	Result
802.11b	1	2412	-5.391	8	Pass
	6	2437	-5.296	8	Pass
	11	2462	-4.794	8	Pass
802.11g	1	2412	-9.719	8	Pass
	6	2437	-9.359	8	Pass
	11	2462	-9.379	8	Pass
802.11n(20M Hz)	1	2412	-10.654	8	Pass
	6	2437	-10.411	8	Pass
	11	2462	-10.320	8	Pass



Test Item	Power Spectral Density
Test Mode	Mode 1: Transmit by 802.11b

Channel 1 (2412MHz)

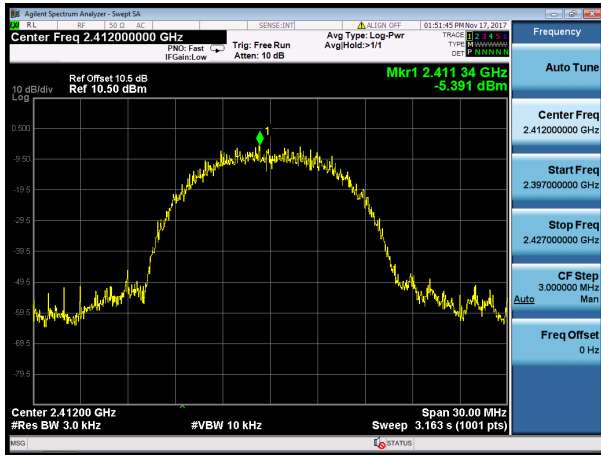

Channel 6 (2437MHz)

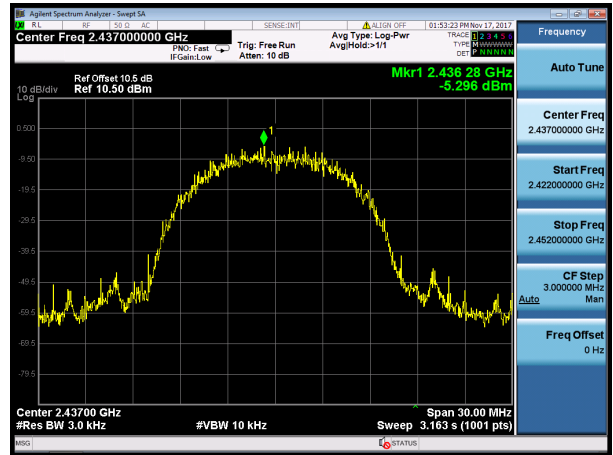

Channel 11 (2462MHz)

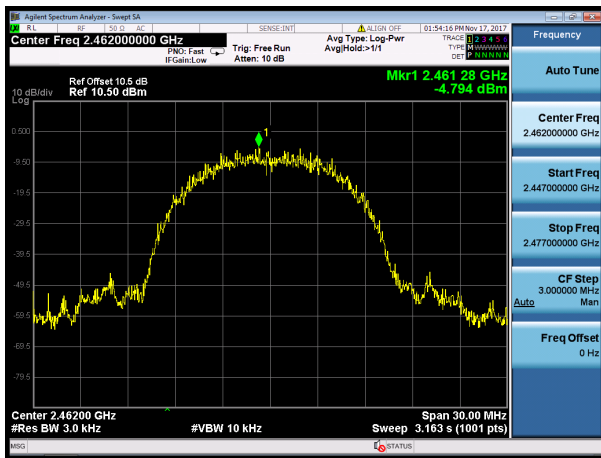



Test Item	Power Spectral Density
Test Mode	Mode 2: Transmit by 802.11g

Channel 1 (2412MHz)

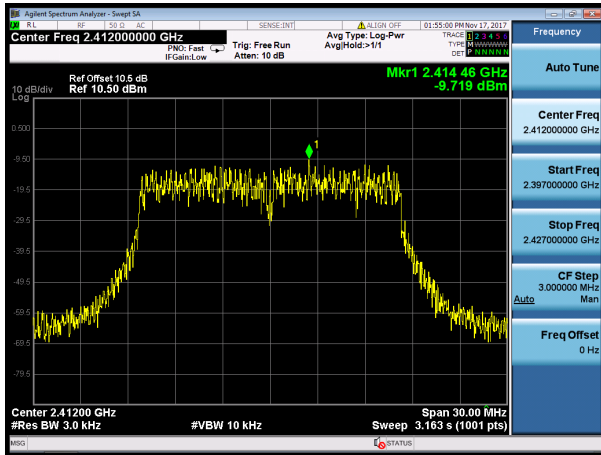

Channel 6 (2437MHz)

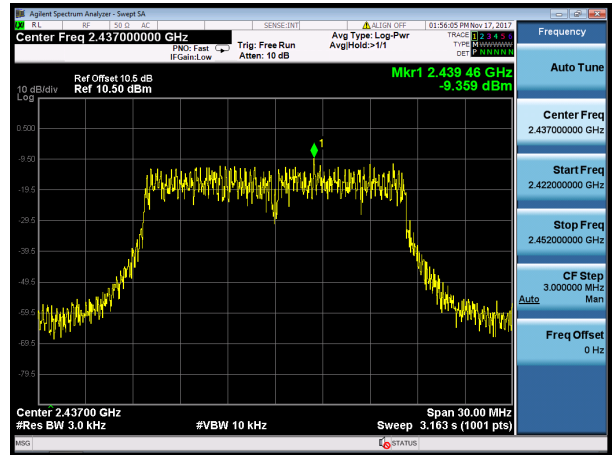

Channel 11 (2462MHz)

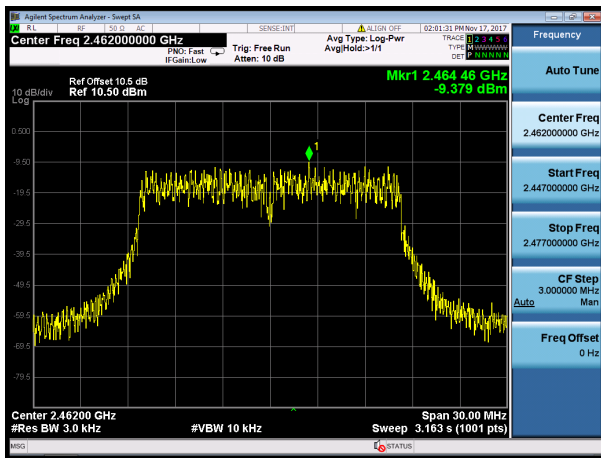



Test Item	Power Spectral Density
Test Mode	Mode 3: Transmit by 802.11n(20MHz)

Channel 1 (2412MHz)

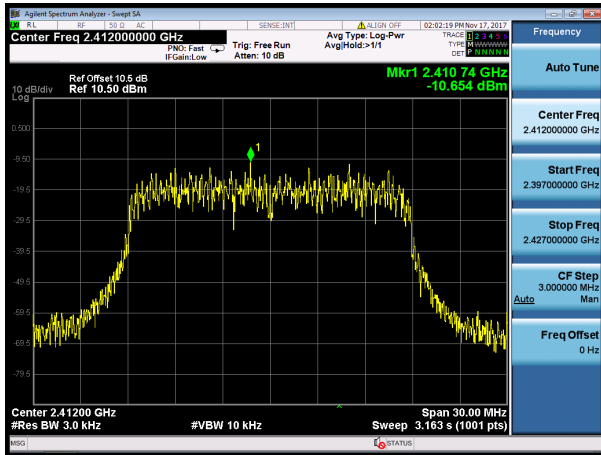

Channel 6 (2437MHz)

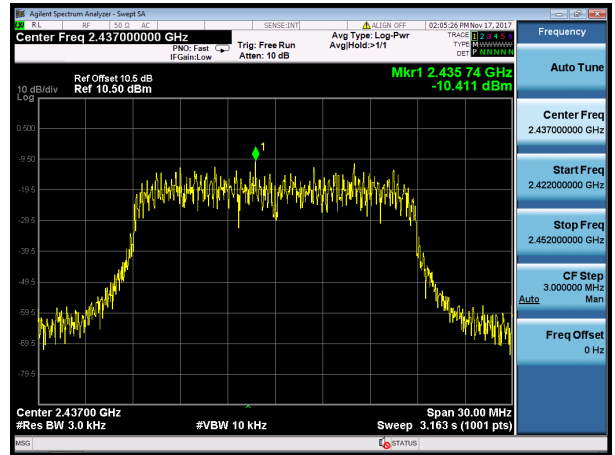

Channel 11 (2462MHz)

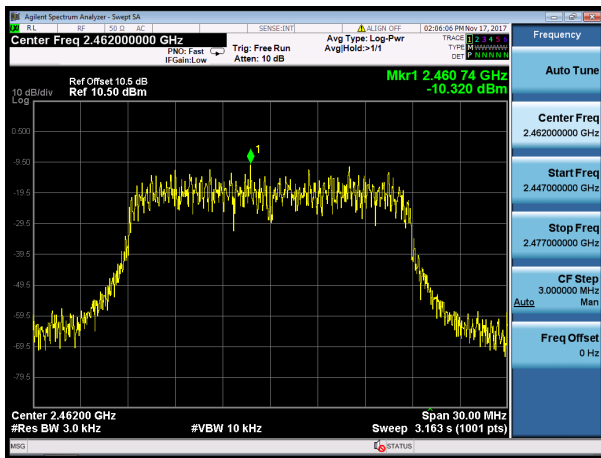





## 9. Conducted Band Edge and Out-of-Band Emissions Measurement

### 9.1 Test Limit

According to FCC part 15.247(d) , in any 100 kHz bandwidth outside the frequency band in which the spread spectrum or digitally modulated intentional radiator is operating, the radio frequency power that is produced by the intentional radiator shall be at least 20 dB below that in the 100 kHz bandwidth within the band that contains the highest level of the desired power, based on either an RF conducted or a radiated measurement, provided the transmitter demonstrates compliance with the peak conducted or a radiated measurement, provided the transmitter demonstrates compliance with the peak conducted power limits. If the transmitter complies with the conducted power limits based on the use of RMS averaging over a time interval, the attenuation required under this paragraph shall be 30 dB instead of 20 dB. Attenuation below the general limits specified in Section 15.209(a) of FCC part 15 is not required.

### 9.2 Test Standard

KDB 558074 D01v04 - Section 11.2 & Section 11.3



### 9.3 Test Procedures

#### Reference level measurement:

1. Set the RBW = 100 kHz
2. Set the VBW  $\geq 3 \times$  RBW
3. Set the span to  $\geq 1.5$  times the DTS bandwidth
4. Detector = peak
5. Trace mode = max hold
6. Sweep time = auto couple
7. Allow trace to fully stabilize
8. Set instrument center frequency to DTS channel center frequency

#### Emission level measurement:

1. RBW = 100kHz
2. VBW = 300kHz
3. Detector = Peak
4. Trace mode = max hold
5. Sweep time = auto couple
6. The trace was allowed to stabilize
7. Set the center frequency and span to encompass frequency range to be measured

### 9.4 Test Setup Layout

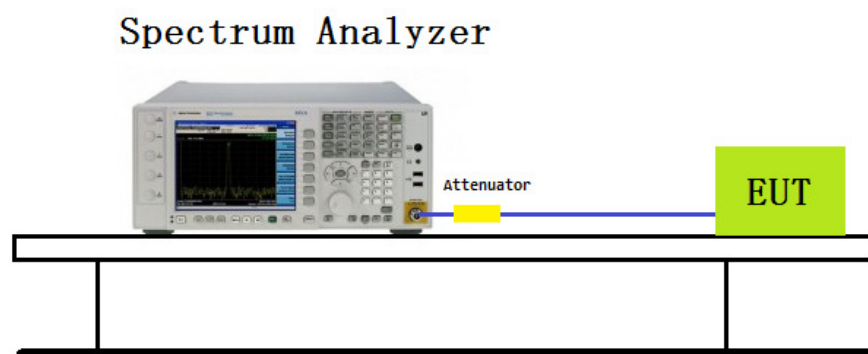



## 9.5 Test Result

Test Mode	Channel No.	Frequency (MHz)	Limit	Result
802.11b	1	2412	20dBc	Pass
	6	2437	20dBc	Pass
	11	2462	20dBc	Pass
802.11g	1	2412	20dBc	Pass
	6	2437	20dBc	Pass
	11	2462	20dBc	Pass
802.11n(20MHz)	1	2412	20dBc	Pass
	6	2437	20dBc	Pass
	11	2462	20dBc	Pass



Test Item	:	Conducted Band Edge and Out-of-Band Emissions
Test Mode	:	Mode 1: Transmit by 802.11b

Mode 1: Transmit by 802.11b (2412MHz)

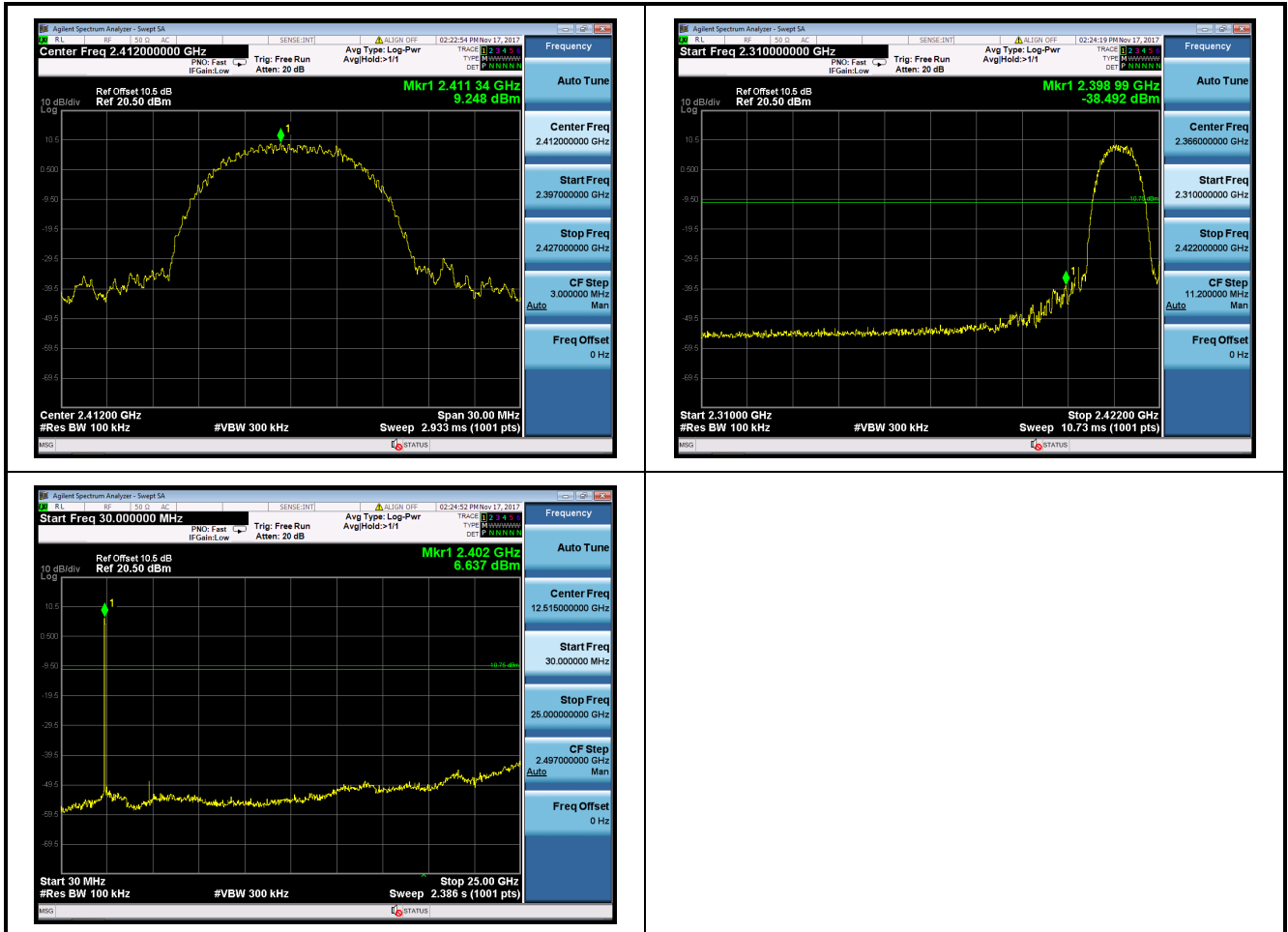



Mode 1: Transmit by 802.11b (2437MHz)

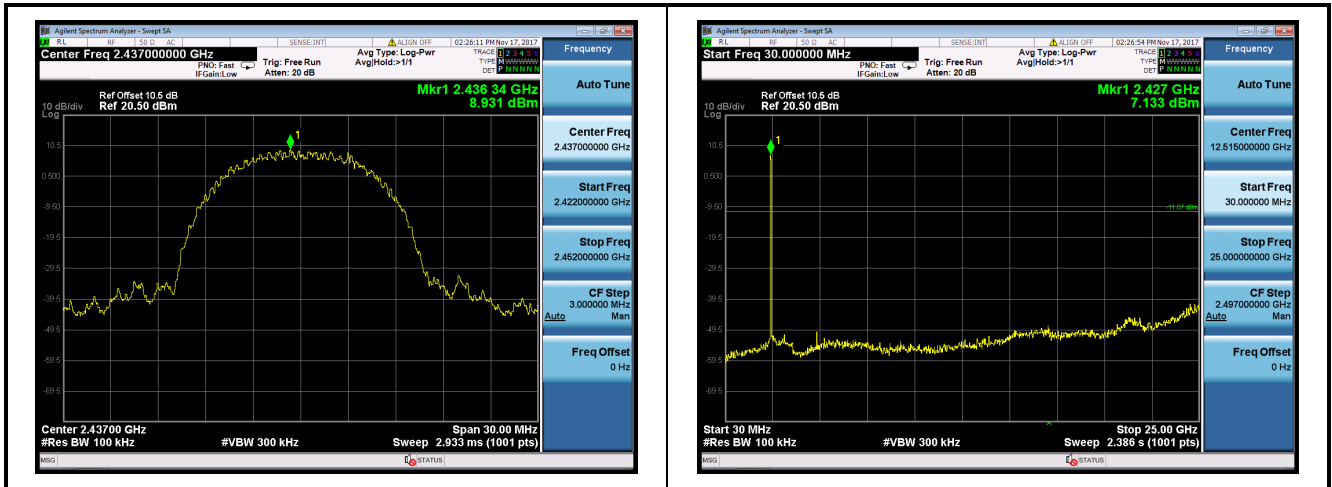

Mode 1: Transmit by 802.11b (2462MHz)

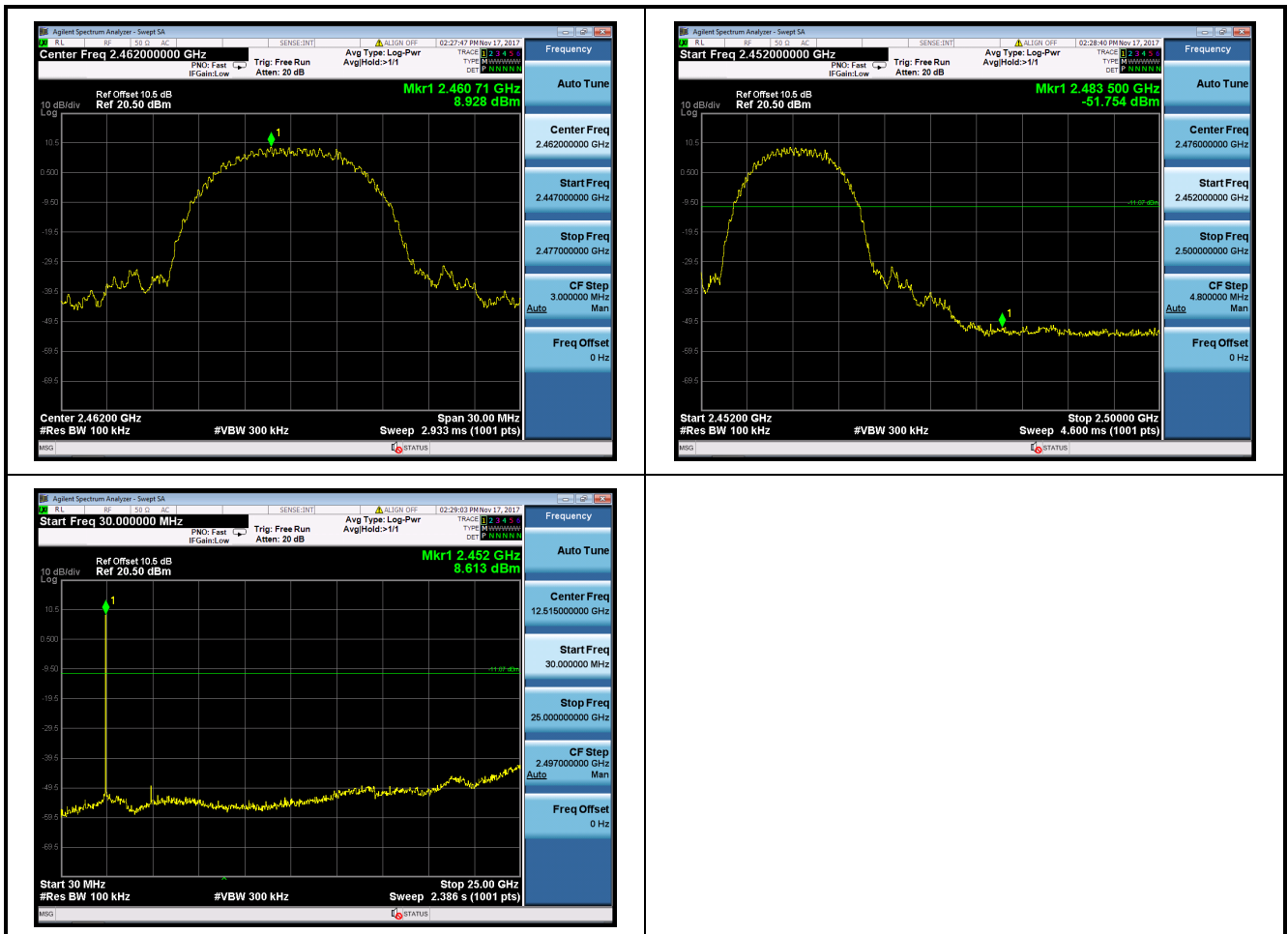



Test Item	:	Band-edge Compliance & Conducted Spurious Emissions
Test Mode	:	Mode 2: Transmit by 802.11g

Mode 2: Transmit by 802.11g (2412MHz)

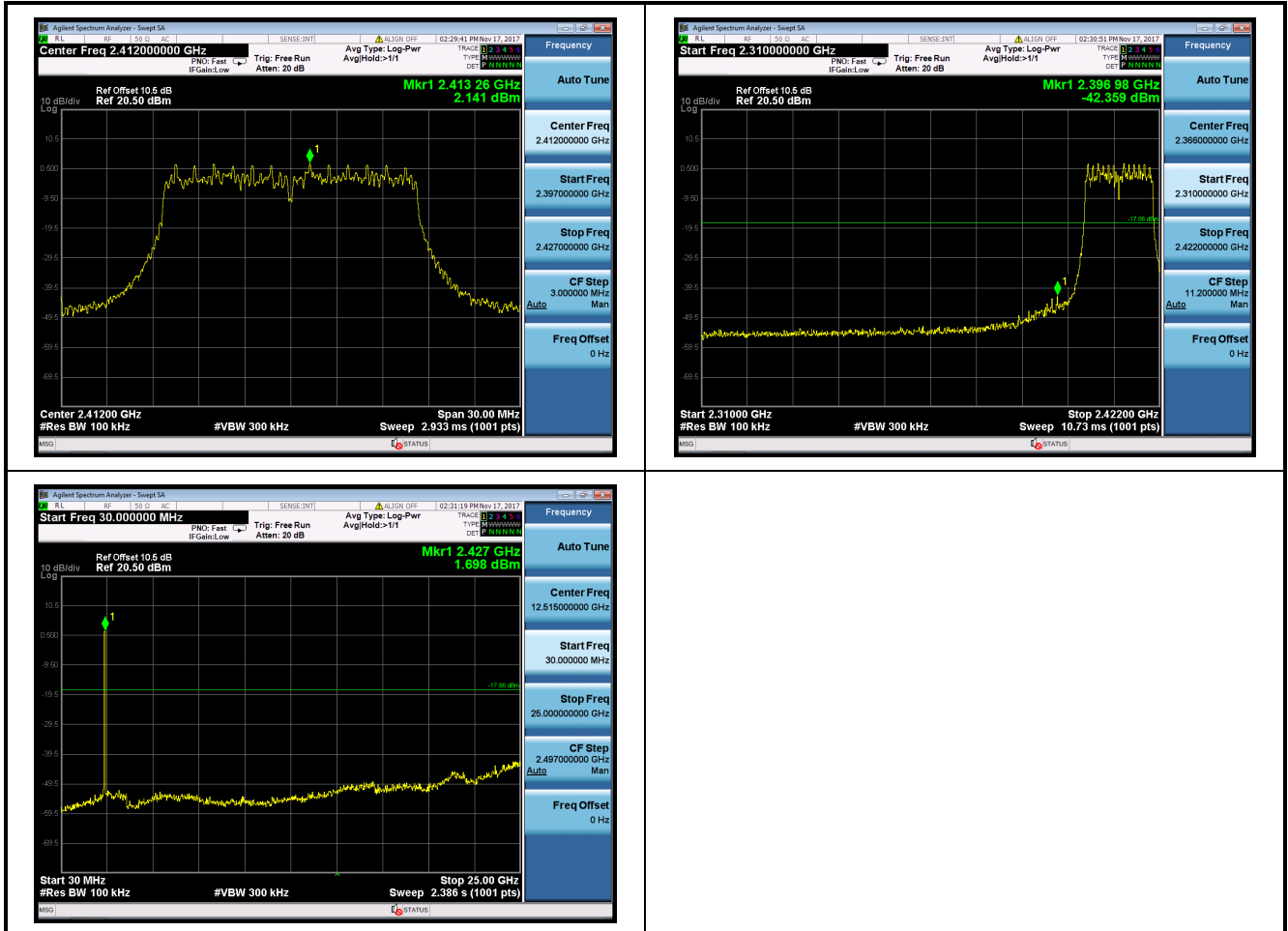



Mode 2: Transmit by 802.11g (2437MHz)

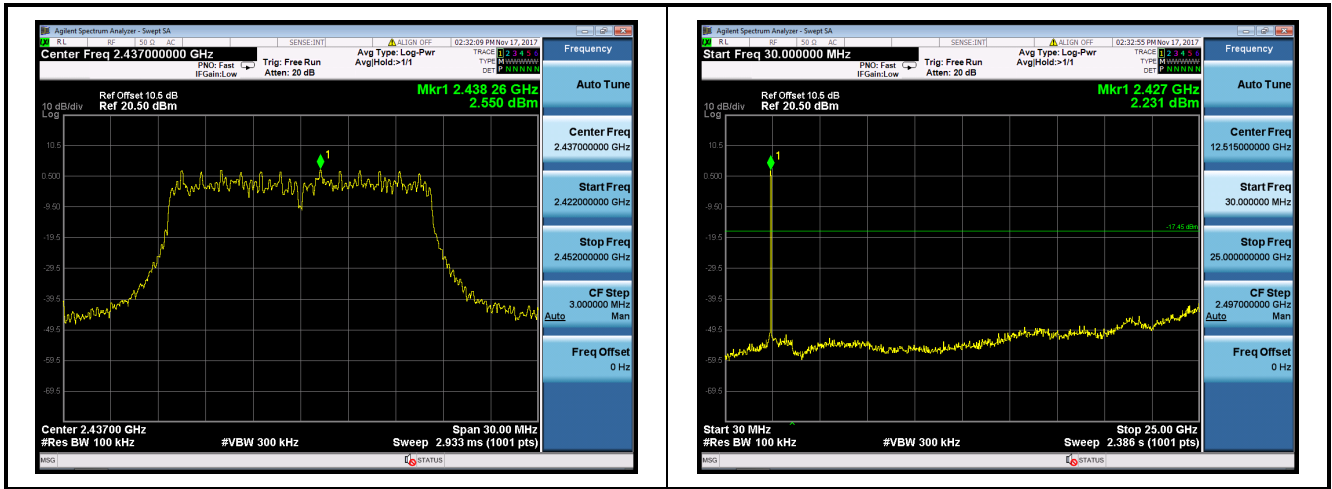

Mode 2: Transmit by 802.11g (2462MHz)

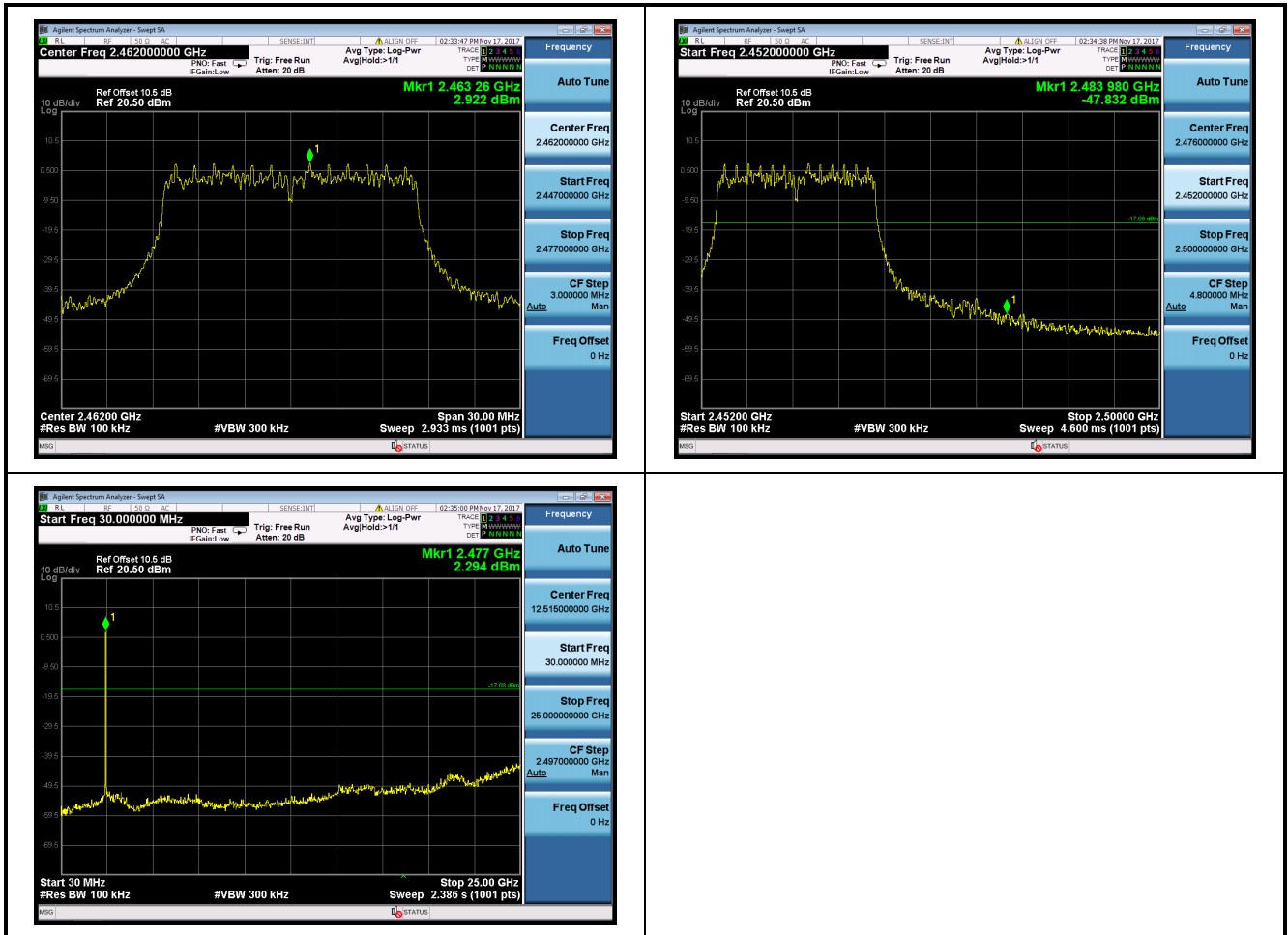



Test Item	:	Band-edge Compliance & Conducted Spurious Emissions
Test Mode	:	Mode 3: Transmit by 802.11n(20MHz)

Mode 3: Transmit by 802.11n(20MHz) (2412MHz)

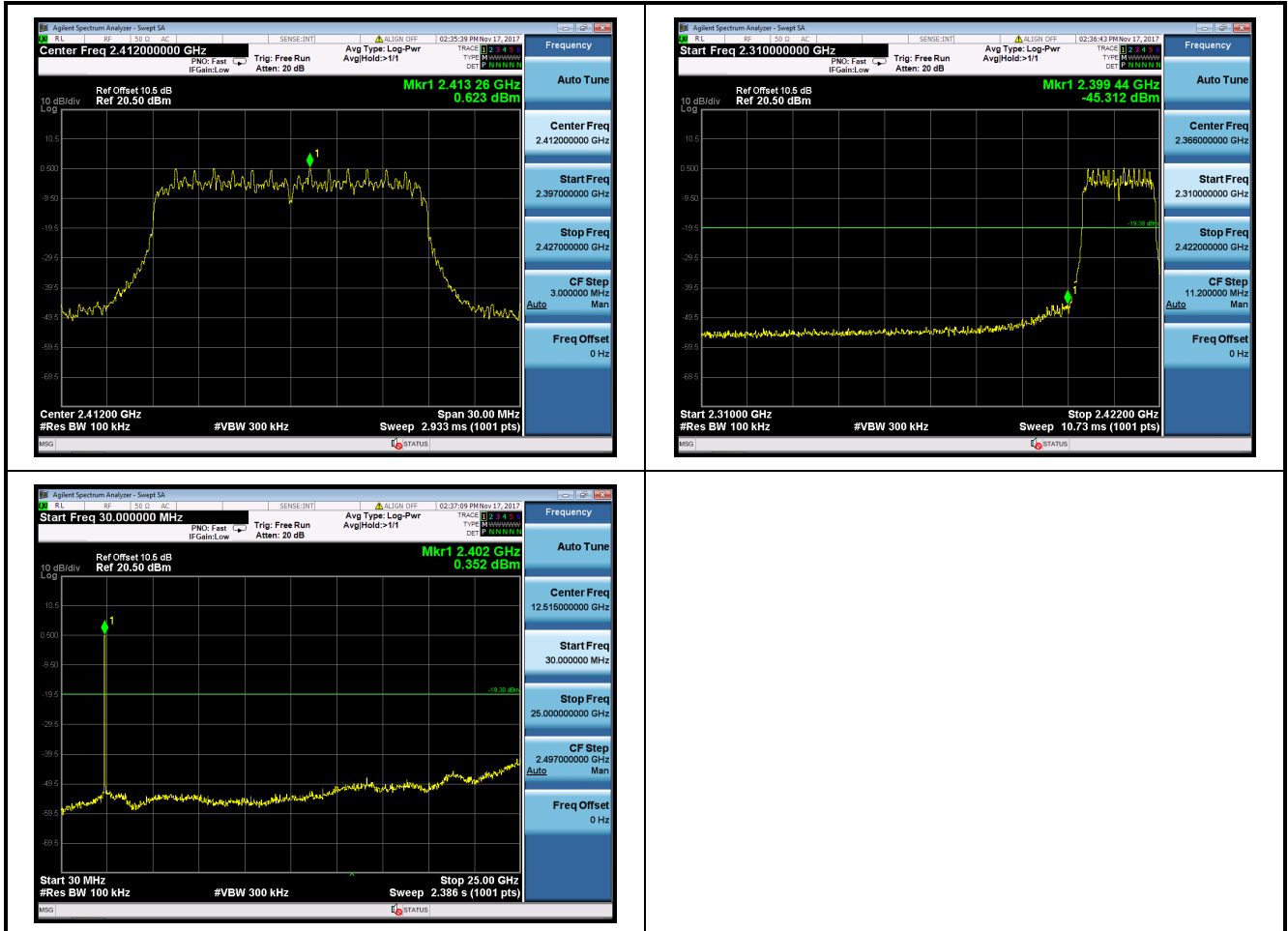





Mode 3: Transmit by 802.11n(20MHz) (2437MHz)

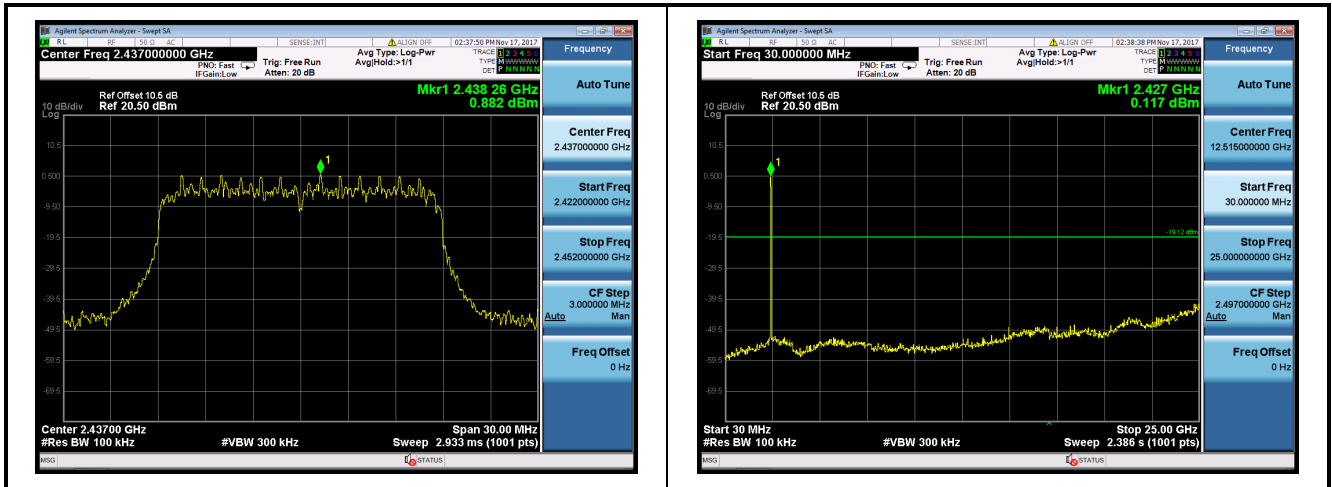

Mode 3: Transmit by 802.11n(20MHz) (2462MHz)

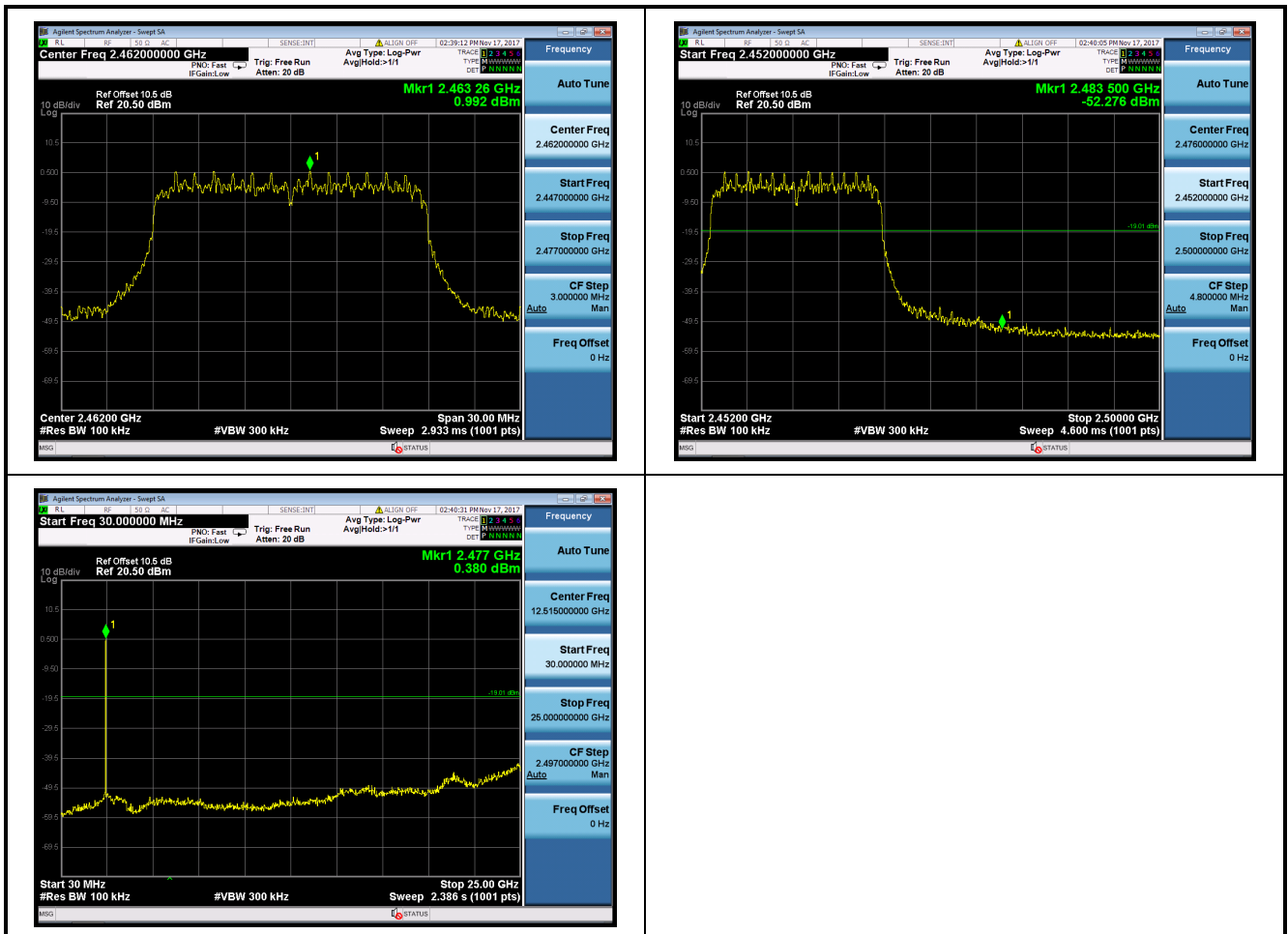



## 10. Radiated Emission Band Edge Measurement

### 10.1 Test Limit

Radiated emissions which fall in the restricted bands, as defined in Section 15.205(a) of FCC part 15, must also comply with the radiated emission limits specified in Section 15.209(a) of FCC part 15.

### 10.2 Test Standard

ANSI C63.10-2013 Section 6.10.5

### 10.3 Test Procedure

Peak Field Strength Measurements:

Analyzer center frequency was set to the frequency of the radiated spurious emission of interest

7. RBW=As specified in Table 1
8. VBW=3×RBW
9. Detector=Peak
10. Trace mode=Max hold
11. Sweep time=Auto couple
12. Allow the trace to stabilize

Table 1-RBW as a function of frequency

Frequency	RBW
9 ~ 150kHz	200 ~ 300Hz
0.15 ~ 30MHz	9 ~ 10kHz
30 ~ 1000MHz	100 ~ 120kHz
> 1000MHz	1MHz



#### AVE Field Strength Measurements:

Analyzer center frequency was set to the frequency of the radiated spurious emission of interest

7. RBW= 1MHz
8. VBW $\geq$ 1/T
9. Detector=Peak
10. Trace mode=Max hold
11. Sweep time=Auto couple
12. Allow max hold to run for at least 50 times(1/duty cycle) trace

Do as an alternative, the instrument may be set to linear detector mode. Ensure that video filtering is applied in linear voltage domain (rather than in a log or dB domain). Some instruments require linear display mode in order to accomplish this. Others have a setting for Average-VBW Type, which can be set to "Voltage" regardless of the display mode

#### 10.4 Test Setup Layout

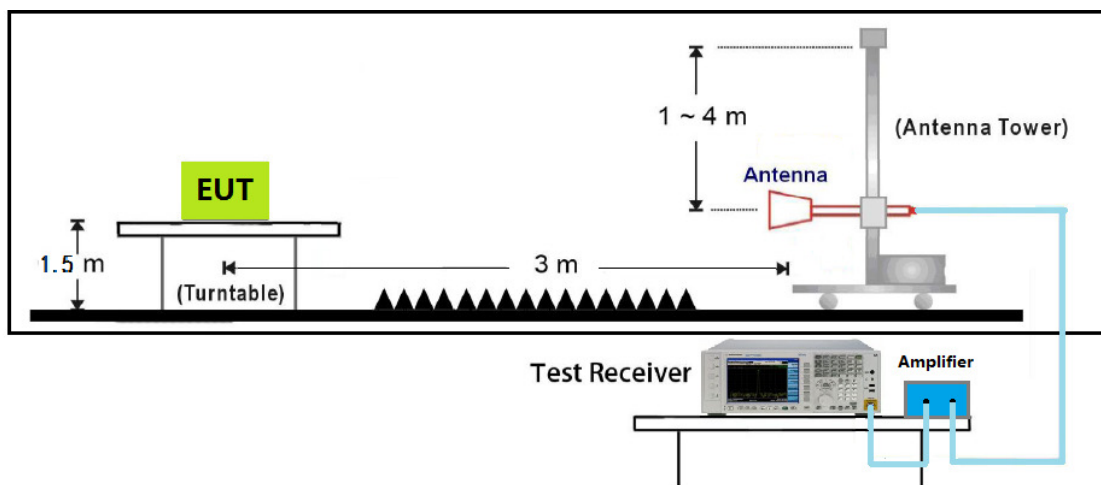



### 10.5 Test Result

Site: AC102	Time: 2017/11/20 - 18:38
Limit: FCC_Part15.209_RE(3m)	Margin: 0
Probe: N/A	Polarity: Horizontal
EUT: Relocatable Power Tapes	Power: 120V/60Hz
Note: Mode:Transmit 802.11b at 2412MHz	

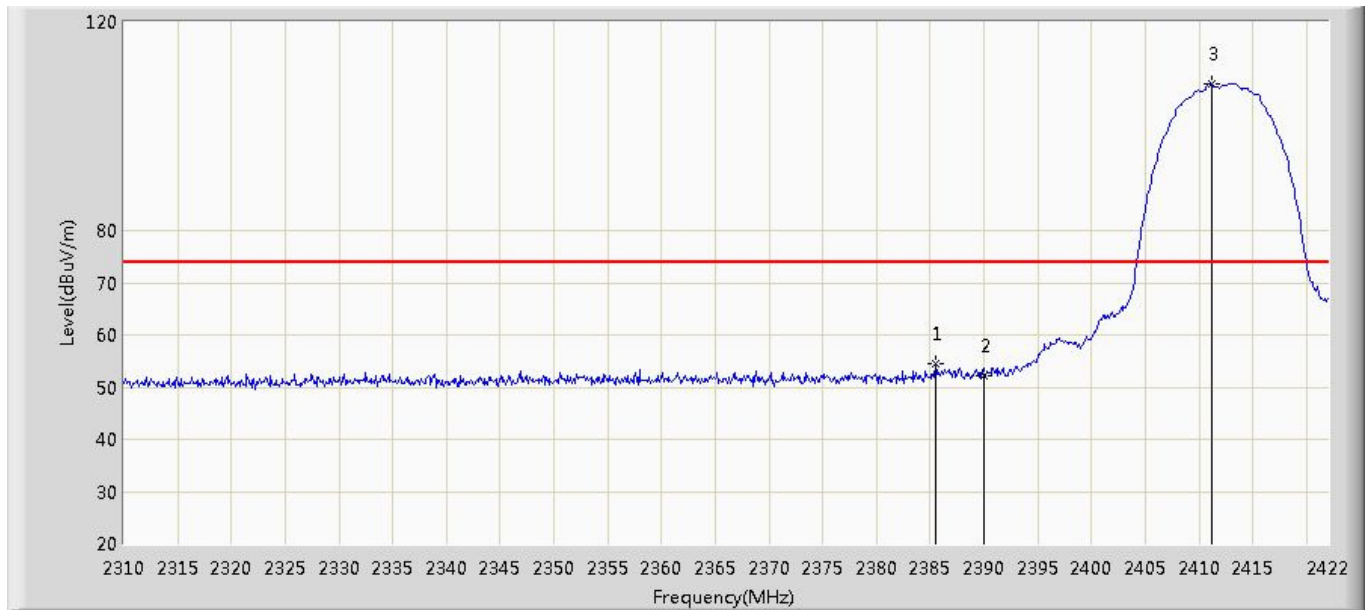

No	Mark	Frequency (MHz)	Measure Level (dBuV/m)	Reading Level (dBuV)	Over Limit (dB)	Limit (dBuV/m)	Factor (dB)	Type
1		2385.488	54.554	56.812	-19.446	74.000	-2.258	PK
2		2390.000	52.301	54.542	-21.699	74.000	-2.241	PK
3	*	2411.136	108.056	110.218	N/A	N/A	-2.162	PK

Note: Measure Level (dBuV/m) = Reading Level (dBuV) + Factor (dB)

Factor (dB) = Cable Loss (dB) + Antenna Factor (dB/m).



Site: AC102	Time: 2017/11/20 - 18:46
Limit: FCC_Part15.209_RE(3m)	Margin: 0
Probe: N/A	Polarity: Horizontal
EUT: Relocatable Power Tapes	Power: 120V/60Hz
Note: Mode:Transmit 802.11b at 2412MHz	

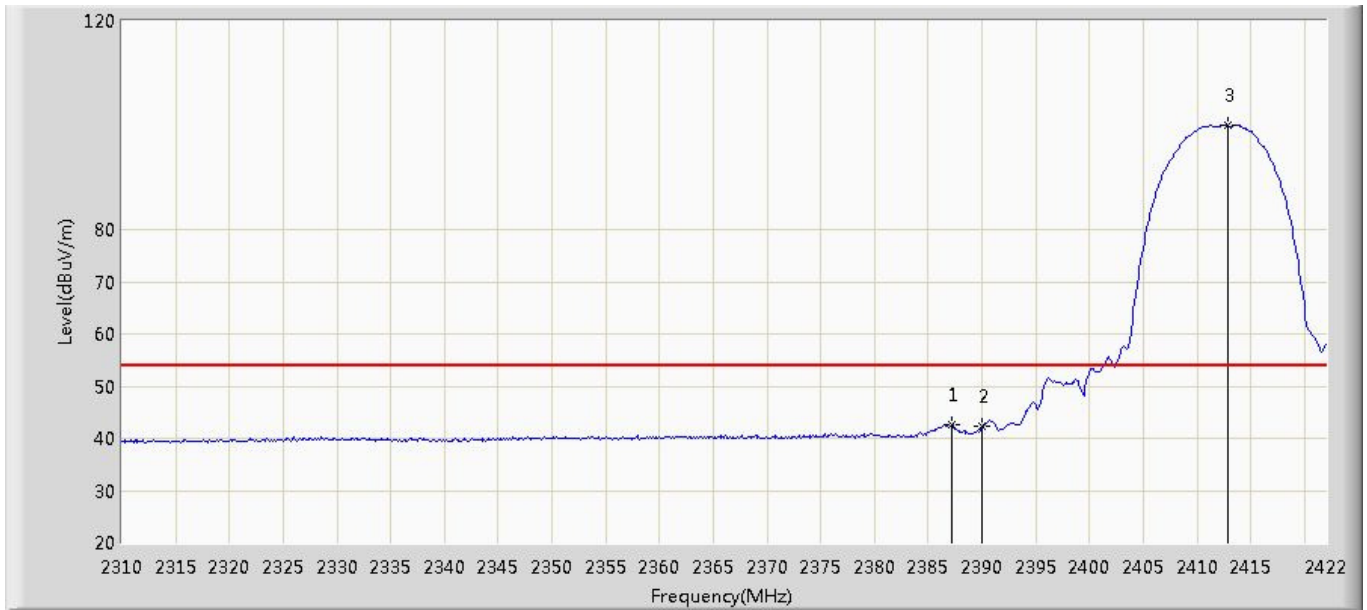

No	Mark	Frequency (MHz)	Measure Level (dBuV/m)	Reading Level (dBuV)	Over Limit (dB)	Limit (dBuV/m)	Factor (dB)	Type
1		2387.168	42.531	44.783	-11.469	54.000	-2.252	AV
2		2390.000	42.269	44.510	-11.731	54.000	-2.241	AV
3	*	2412.816	100.041	102.197	N/A	N/A	-2.156	AV

Note: Measure Level (dBuV/m) = Reading Level (dBuV) + Factor (dB)

Factor (dB) = Cable Loss (dB) + Antenna Factor (dB/m).



Site: AC102	Time: 2017/11/20 - 18:46
Limit: FCC_Part15.209_RE(3m)	Margin: 0
Probe: N/A	Polarity: Vertical
EUT: Relocatable Power Tapes	Power: 120V/60Hz
Note: Mode:Transmit 802.11b at 2412MHz	

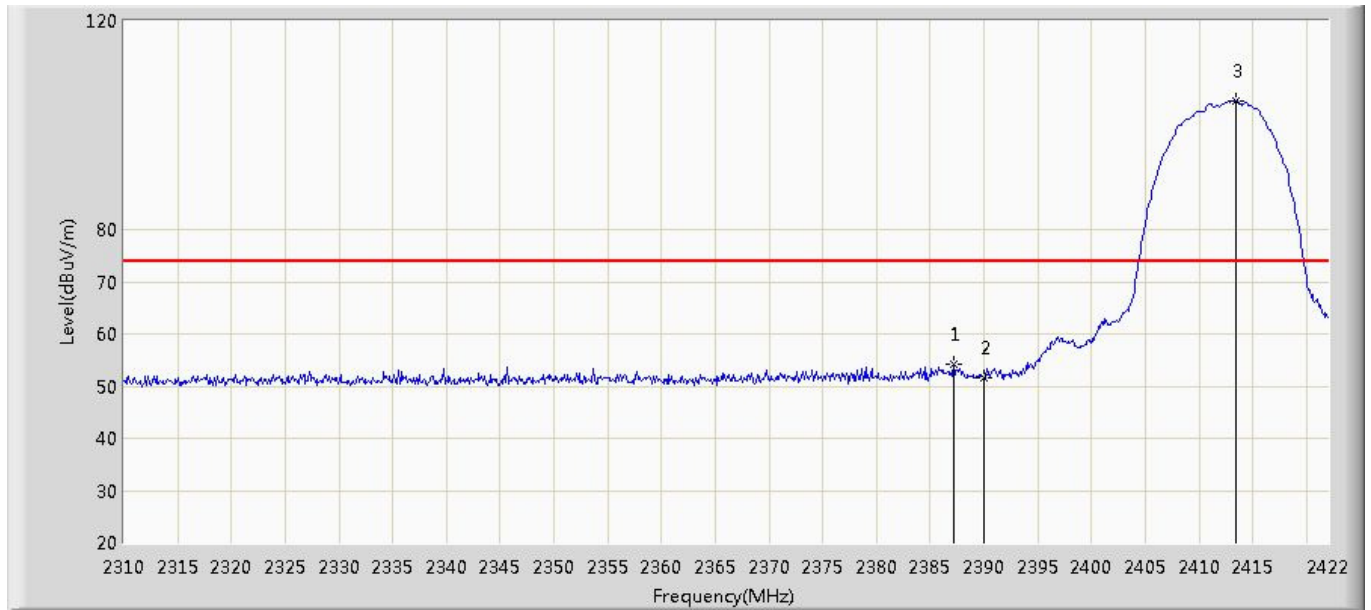

No	Mark	Frequency (MHz)	Measure Level (dBuV/m)	Reading Level (dBuV)	Over Limit (dB)	Limit (dBuV/m)	Factor (dB)	Type
1		2387.168	54.202	56.454	-19.798	74.000	-2.252	PK
2		2390.000	51.636	53.877	-22.364	74.000	-2.241	PK
3	*	2413.376	104.645	106.799	N/A	N/A	-2.154	PK

Note: Measure Level (dBuV/m) = Reading Level (dBuV) + Factor (dB)

Factor (dB) = Cable Loss (dB) + Antenna Factor (dB/m).



Site: AC102	Time: 2017/11/20 - 18:49
Limit: FCC_Part15.209_RE(3m)	Margin: 0
Probe: N/A	Polarity: Vertical
EUT: Relocatable Power Tapes	Power: 120V/60Hz
Note: Mode:Transmit 802.11b at 2412MHz	

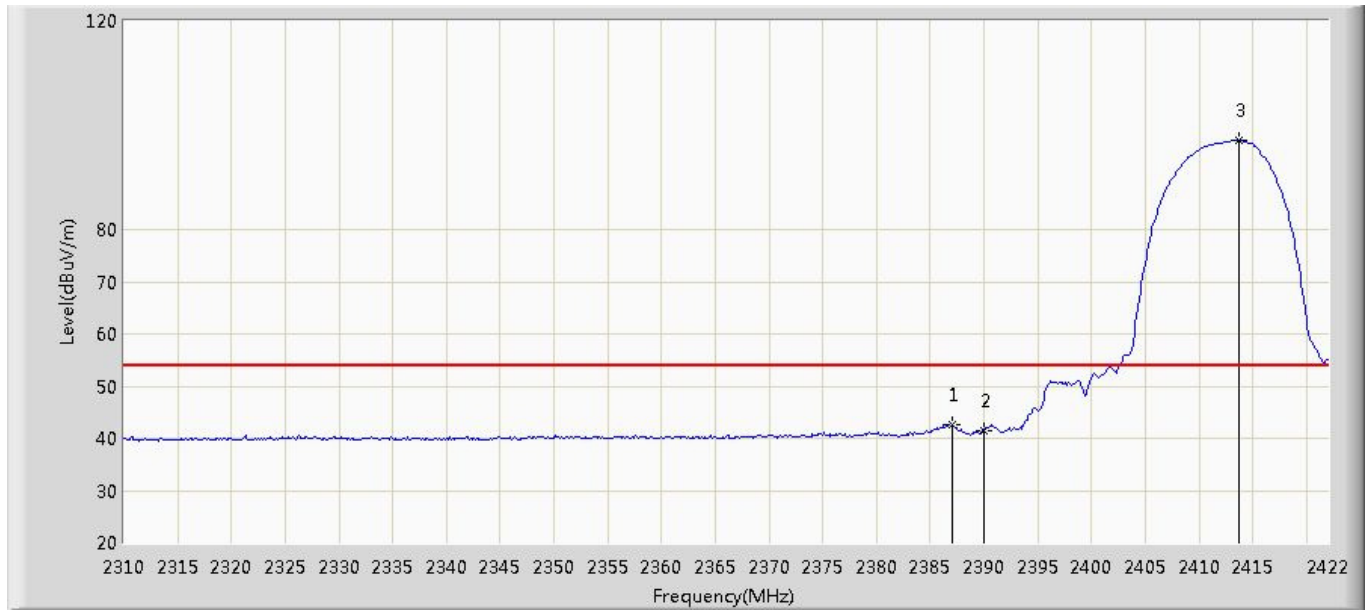

No	Mark	Frequency (MHz)	Measure Level (dBuV/m)	Reading Level (dBuV)	Over Limit (dB)	Limit (dBuV/m)	Factor (dB)	Type
1		2387.056	42.545	44.797	-11.455	54.000	-2.252	AV
2		2390.000	41.561	43.802	-12.439	54.000	-2.241	AV
3	*	2413.712	97.209	99.362	N/A	N/A	-2.153	AV

Note: Measure Level (dBuV/m) = Reading Level (dBuV) + Factor (dB)

Factor (dB) = Cable Loss (dB) + Antenna Factor (dB/m).



Site: AC102	Time: 2017/11/20 - 18:50
Limit: FCC_Part15.209_RE(3m)	Margin: 0
Probe: N/A	Polarity: Horizontal
EUT: Relocatable Power Tapes	Power: 120V/60Hz
Note: Mode:Transmit 802.11b at 2462MHz	

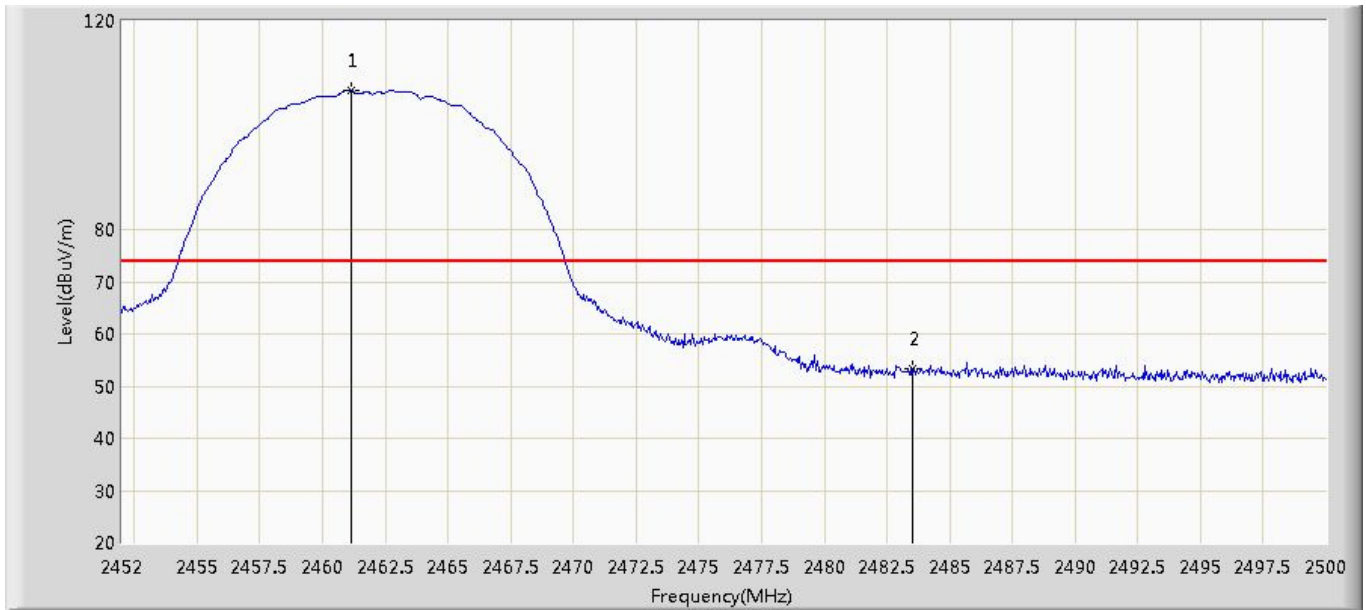

No	Mark	Frequency (MHz)	Measure Level (dBuV/m)	Reading Level (dBuV)	Over Limit (dB)	Limit (dBuV/m)	Factor (dB)	Type
1	*	2461.168	106.630	108.605	N/A	N/A	-1.975	PK
2		2483.500	53.277	55.169	-20.723	74.000	-1.892	PK

Note: Measure Level (dBuV/m) = Reading Level (dBuV) + Factor (dB)

Factor (dB) = Cable Loss (dB) + Antenna Factor (dB/m).





Site: AC102	Time: 2017/11/20 - 18:54
Limit: FCC_Part15.209_RE(3m)	Margin: 0
Probe: N/A	Polarity: Horizontal
EUT: Relocatable Power Tapes	Power: 120V/60Hz
Note: Mode:Transmit 802.11b at 2462MHz	



No	Mark	Frequency (MHz)	Measure Level (dBuV/m)	Reading Level (dBuV)	Over Limit (dB)	Limit (dBuV/m)	Factor (dB)	Type
1	*	2461.984	98.875	100.847	N/A	N/A	-1.972	AV
2		2483.500	42.146	44.038	-11.854	54.000	-1.892	AV

Note: Measure Level (dBuV/m) = Reading Level (dBuV) + Factor (dB)

Factor (dB) = Cable Loss (dB) + Antenna Factor (dB/m).



Site: AC102	Time: 2017/11/20 - 18:55
Limit: FCC_Part15.209_RE(3m)	Margin: 0
Probe: N/A	Polarity: Vertical
EUT: Relocatable Power Tapes	Power: 120V/60Hz
Note: Mode:Transmit 802.11b at 2462MHz	

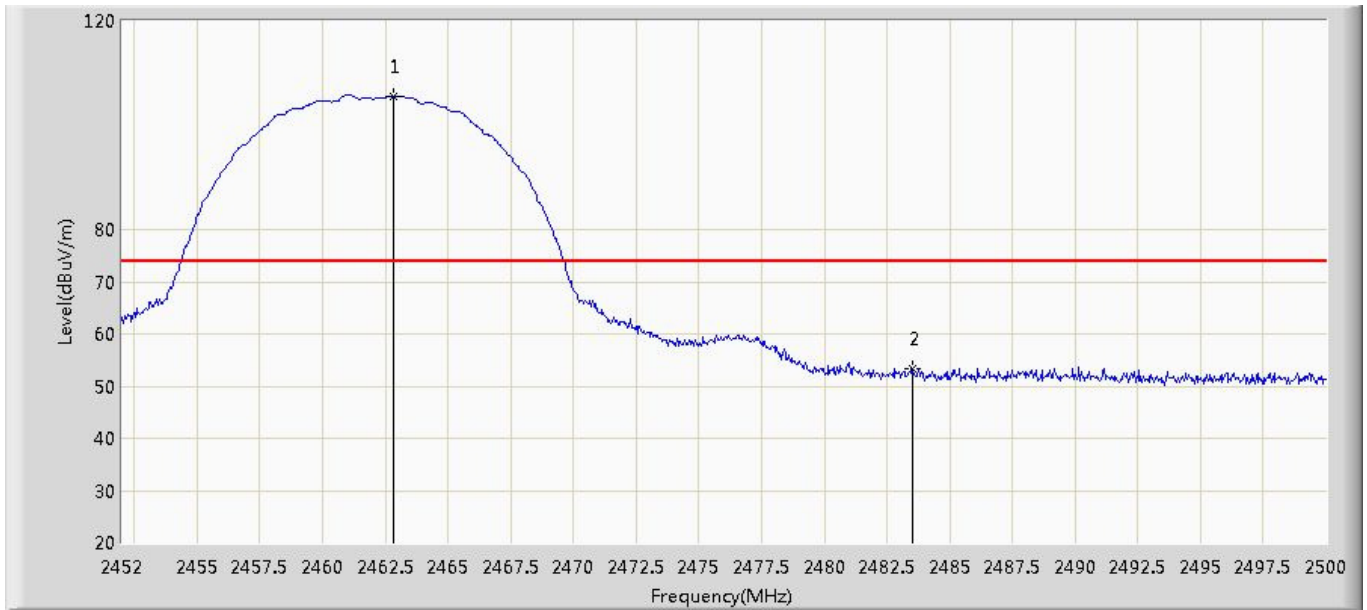

No	Mark	Frequency (MHz)	Measure Level (dBuV/m)	Reading Level (dBuV)	Over Limit (dB)	Limit (dBuV/m)	Factor (dB)	Type
1	*	2462.800	105.584	107.553	N/A	N/A	-1.969	PK
2		2483.500	53.194	55.086	-20.806	74.000	-1.892	PK

Note: Measure Level (dBuV/m) = Reading Level (dBuV) + Factor (dB)

Factor (dB) = Cable Loss (dB) + Antenna Factor (dB/m).



Site: AC102	Time: 2017/11/20 - 18:57
Limit: FCC_Part15.209_RE(3m)	Margin: 0
Probe: N/A	Polarity: Vertical
EUT: Relocatable Power Tapes	Power: 120V/60Hz
Note: Mode:Transmit 802.11b at 2462MHz	

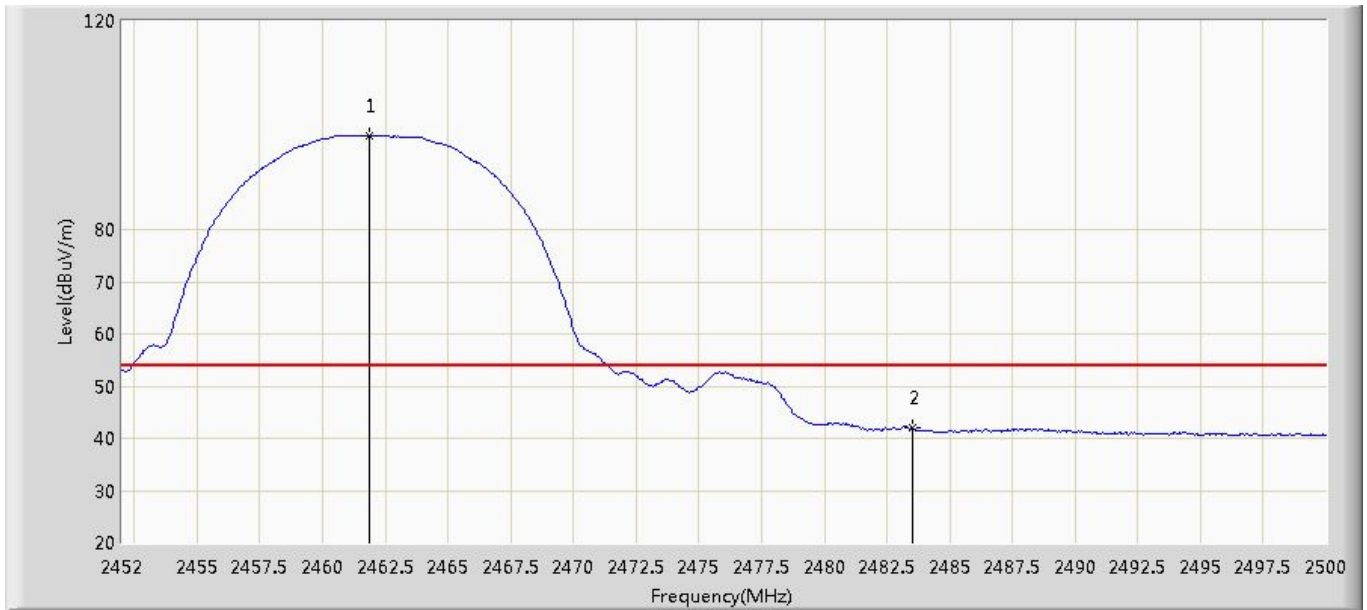

No	Mark	Frequency (MHz)	Measure Level (dBuV/m)	Reading Level (dBuV)	Over Limit (dB)	Limit (dBuV/m)	Factor (dB)	Type
1	*	2461.888	98.001	99.973	N/A	N/A	-1.972	AV
2		2483.500	41.979	43.871	-12.021	54.000	-1.892	AV

Note: Measure Level (dBuV/m) = Reading Level (dBuV) + Factor (dB)

Factor (dB) = Cable Loss (dB) + Antenna Factor (dB/m).



Site: AC102	Time: 2017/11/20 - 18:58
Limit: FCC_Part15.209_RE(3m)	Margin: 0
Probe: N/A	Polarity: Horizontal
EUT: Relocatable Power Tapes	Power: 120V/60Hz
Note: Mode:Transmit 802.11g at 2412MHz	



No	Mark	Frequency (MHz)	Measure Level (dBuV/m)	Reading Level (dBuV)	Over Limit (dB)	Limit (dBuV/m)	Factor (dB)	Type
1		2390.000	58.296	60.537	-15.704	74.000	-2.241	PK
2	*	2416.400	103.106	105.249	N/A	N/A	-2.143	PK

Note: Measure Level (dBuV/m) = Reading Level (dBuV) + Factor (dB)

Factor (dB) = Cable Loss (dB) + Antenna Factor (dB/m).



Site: AC102	Time: 2017/11/20 - 19:00
Limit: FCC_Part15.209_RE(3m)	Margin: 0
Probe: N/A	Polarity: Horizontal
EUT: Relocatable Power Tapes	Power: 120V/60Hz
Note: Mode:Transmit 802.11g at 2412MHz	

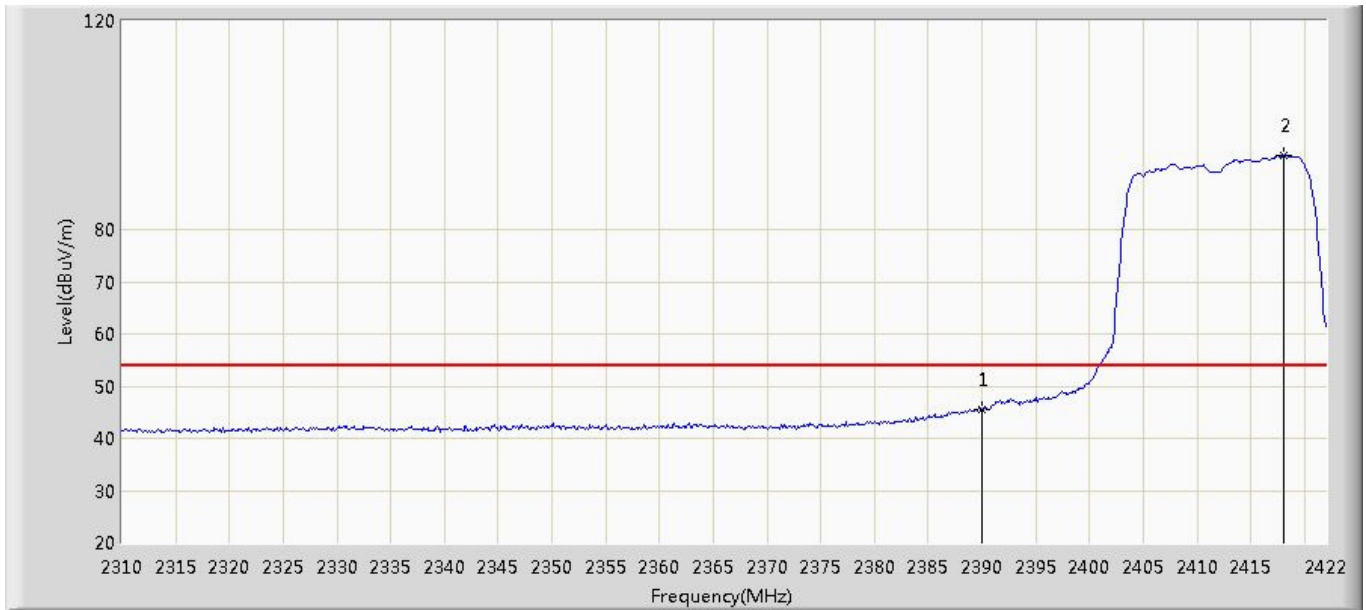

No	Mark	Frequency (MHz)	Measure Level (dBuV/m)	Reading Level (dBuV)	Over Limit (dB)	Limit (dBuV/m)	Factor (dB)	Type
1		2390.000	45.638	47.879	-8.362	54.000	-2.241	AV
2	*	2418.080	94.297	96.433	N/A	N/A	-2.136	AV

Note: Measure Level (dBuV/m) = Reading Level (dBuV) + Factor (dB)

Factor (dB) = Cable Loss (dB) + Antenna Factor (dB/m).



Site: AC102	Time: 2017/11/20 - 19:01
Limit: FCC_Part15.209_RE(3m)	Margin: 0
Probe: N/A	Polarity: Vertical
EUT: Relocatable Power Tapes	Power: 120V/60Hz
Note: Mode:Transmit 802.11g at 2412MHz	

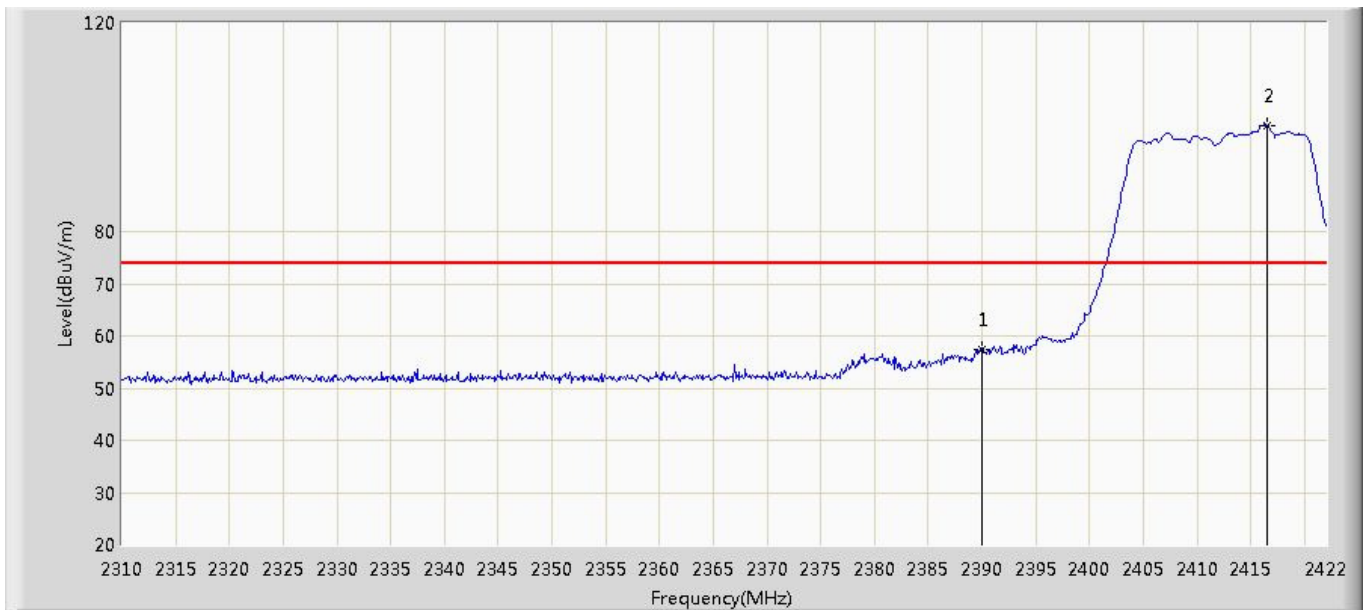

No	Mark	Frequency (MHz)	Measure Level (dBuV/m)	Reading Level (dBuV)	Over Limit (dB)	Limit (dBuV/m)	Factor (dB)	Type
1		2390.000	57.437	59.678	-16.563	74.000	-2.241	PK
2	*	2416.512	100.339	102.481	N/A	N/A	-2.142	PK

Note: Measure Level (dBuV/m) = Reading Level (dBuV) + Factor (dB)

Factor (dB) = Cable Loss (dB) + Antenna Factor (dB/m).



Site: AC102	Time: 2017/11/20 - 19:02
Limit: FCC_Part15.209_RE(3m)	Margin: 0
Probe: N/A	Polarity: Vertical
EUT: Relocatable Power Tapes	Power: 120V/60Hz
Note: Mode:Transmit 802.11g at 2412MHz	

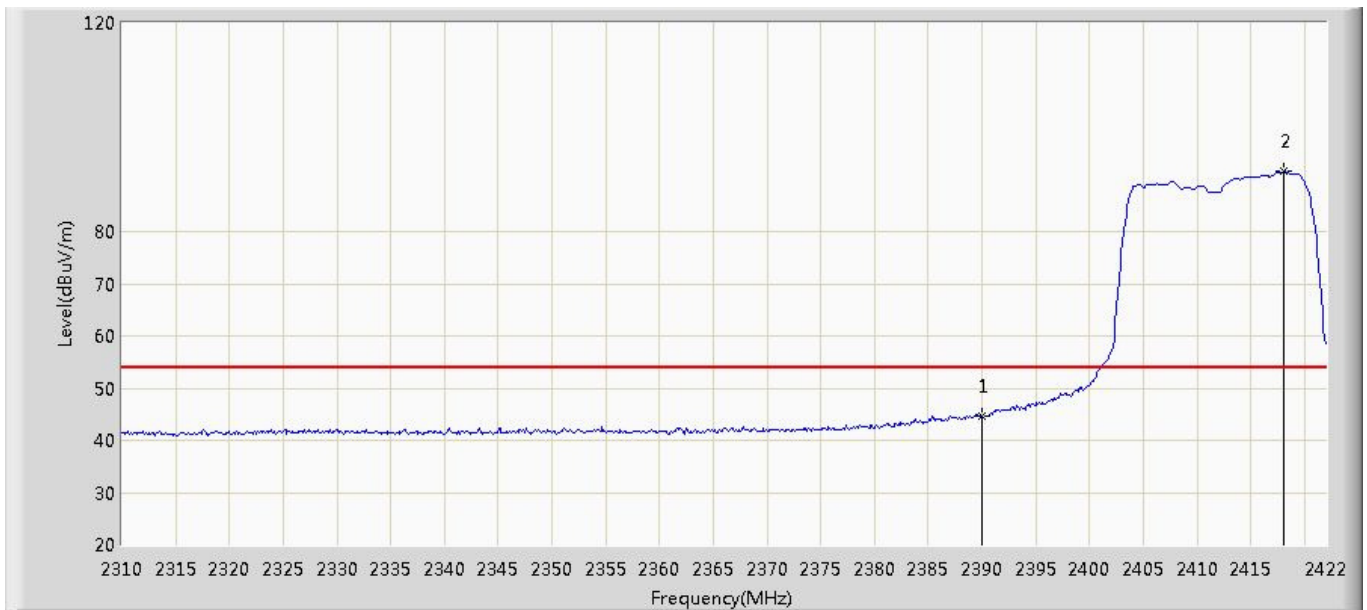

No	Mark	Frequency (MHz)	Measure Level (dBuV/m)	Reading Level (dBuV)	Over Limit (dB)	Limit (dBuV/m)	Factor (dB)	Type
1		2390.000	44.648	46.889	-9.352	54.000	-2.241	AV
2	*	2418.080	91.458	93.594	N/A	N/A	-2.136	AV

Note: Measure Level (dBuV/m) = Reading Level (dBuV) + Factor (dB)

Factor (dB) = Cable Loss (dB) + Antenna Factor (dB/m).



Site: AC102	Time: 2017/11/20 - 19:03
Limit: FCC_Part15.209_RE(3m)	Margin: 0
Probe: N/A	Polarity: Horizontal
EUT: Relocatable Power Tapes	Power: 120V/60Hz
Note: Mode:Transmit 802.11g at 2462MHz	

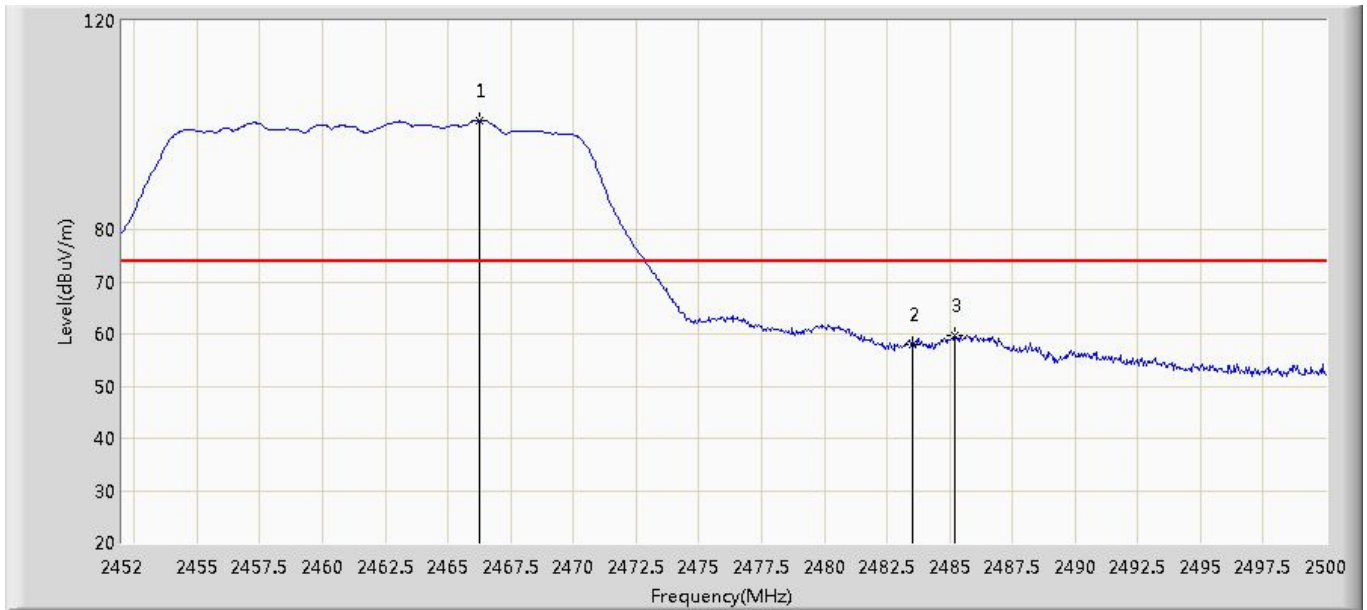

No	Mark	Frequency (MHz)	Measure Level (dBuV/m)	Reading Level (dBuV)	Over Limit (dB)	Limit (dBuV/m)	Factor (dB)	Type
1	*	2466.256	100.990	102.946	N/A	N/A	-1.956	PK
2		2483.500	57.943	59.835	-16.057	74.000	-1.892	PK
3		2485.216	59.786	61.672	-14.214	74.000	-1.886	PK

Note: Measure Level (dBuV/m) = Reading Level (dBuV) + Factor (dB)

Factor (dB) = Cable Loss (dB) + Antenna Factor (dB/m).





Site: AC102	Time: 2017/11/20 - 19:06
Limit: FCC_Part15.209_RE(3m)	Margin: 0
Probe: N/A	Polarity: Horizontal
EUT: Relocatable Power Tapes	Power: 120V/60Hz
Note: Mode:Transmit 802.11g at 2462MHz	

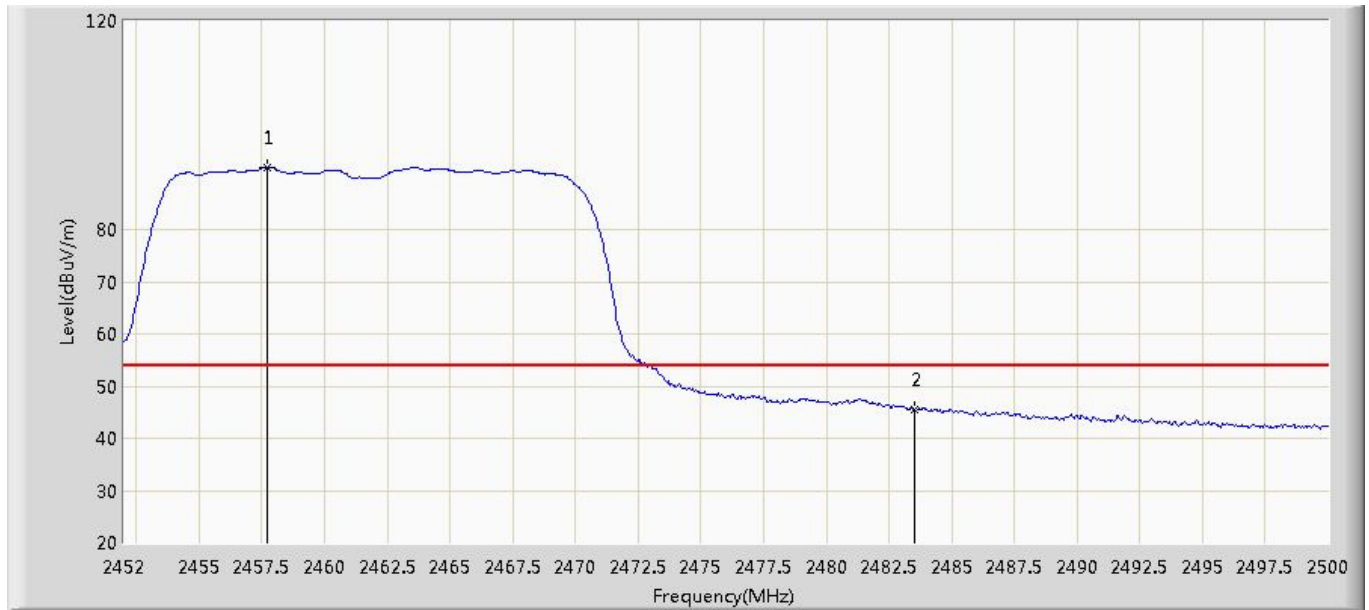

No	Mark	Frequency (MHz)	Measure Level (dBuV/m)	Reading Level (dBuV)	Over Limit (dB)	Limit (dBuV/m)	Factor (dB)	Type
1	*	2457.712	91.974	93.962	N/A	N/A	-1.988	AV
2		2483.500	45.382	47.274	-8.618	54.000	-1.892	AV

Note: Measure Level (dBuV/m) = Reading Level (dBuV) + Factor (dB)

Factor (dB) = Cable Loss (dB) + Antenna Factor (dB/m).



Site: AC102	Time: 2017/11/20 - 19:06
Limit: FCC_Part15.209_RE(3m)	Margin: 0
Probe: N/A	Polarity: Vertical
EUT: Relocatable Power Tapes	Power: 120V/60Hz
Note: Mode:Transmit 802.11g at 2462MHz	

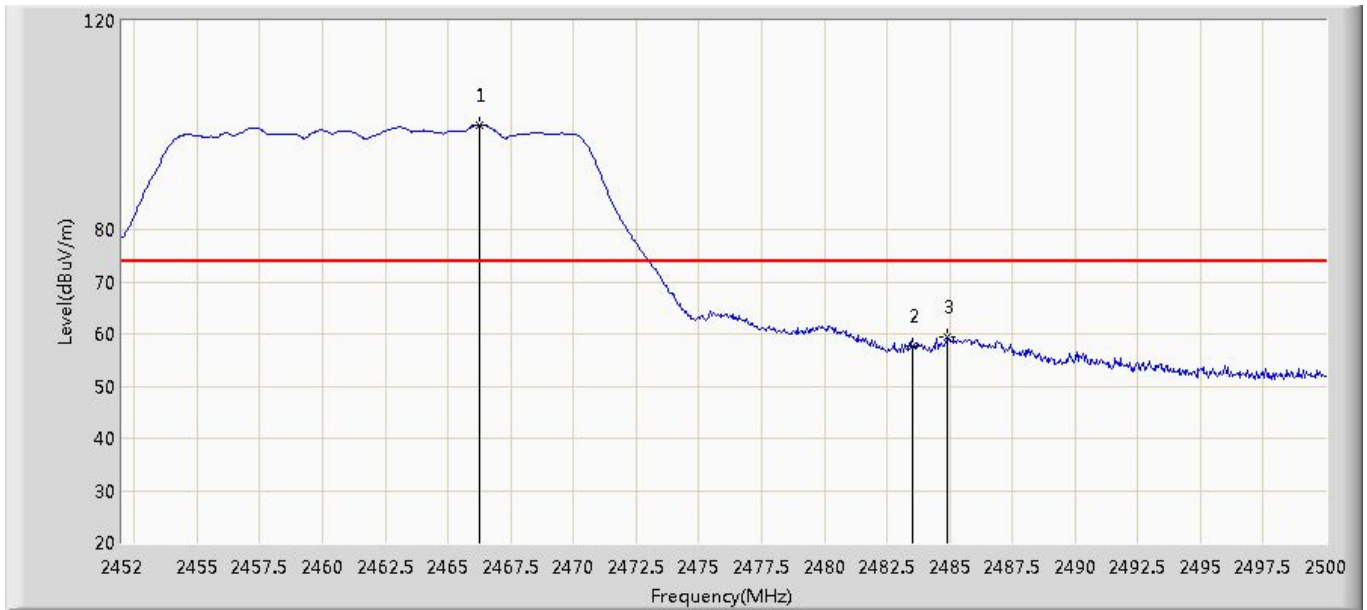

No	Mark	Frequency (MHz)	Measure Level (dBuV/m)	Reading Level (dBuV)	Over Limit (dB)	Limit (dBuV/m)	Factor (dB)	Type
1	*	2466.256	100.024	101.980	N/A	N/A	-1.956	PK
2		2483.500	57.728	59.620	-16.272	74.000	-1.892	PK
3		2484.928	59.463	61.350	-14.537	74.000	-1.887	PK

Note: Measure Level (dBuV/m) = Reading Level (dBuV) + Factor (dB)

Factor (dB) = Cable Loss (dB) + Antenna Factor (dB/m).



Site: AC102	Time: 2017/11/20 - 19:17
Limit: FCC_Part15.209_RE(3m)	Margin: 0
Probe: N/A	Polarity: Vertical
EUT: Relocatable Power Tapes	Power: 120V/60Hz
Note: Mode:Transmit 802.11g at 2462MHz	

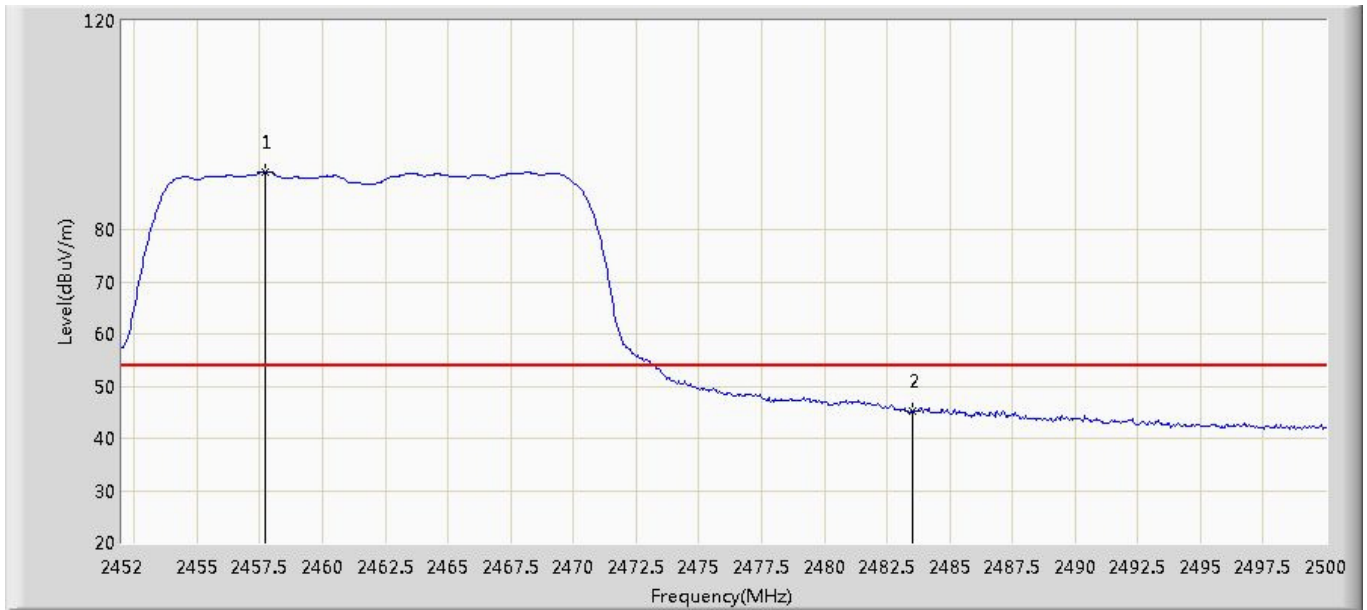

No	Mark	Frequency (MHz)	Measure Level (dBuV/m)	Reading Level (dBuV)	Over Limit (dB)	Limit (dBuV/m)	Factor (dB)	Type
1	*	2457.712	91.093	93.081	N/A	N/A	-1.988	AV
2		2483.500	45.154	47.046	-8.846	54.000	-1.892	AV

Note: Measure Level (dBuV/m) = Reading Level (dBuV) + Factor (dB)

Factor (dB) = Cable Loss (dB) + Antenna Factor (dB/m).



Site: AC102	Time: 2017/11/20 - 19:18
Limit: FCC_Part15.209_RE(3m)	Margin: 0
Probe: N/A	Polarity: Horizontal
EUT: Relocatable Power Tapes	Power: 120V/60Hz
Note: Mode:Transmit 802.11n(20MHz) at 2412MHz	

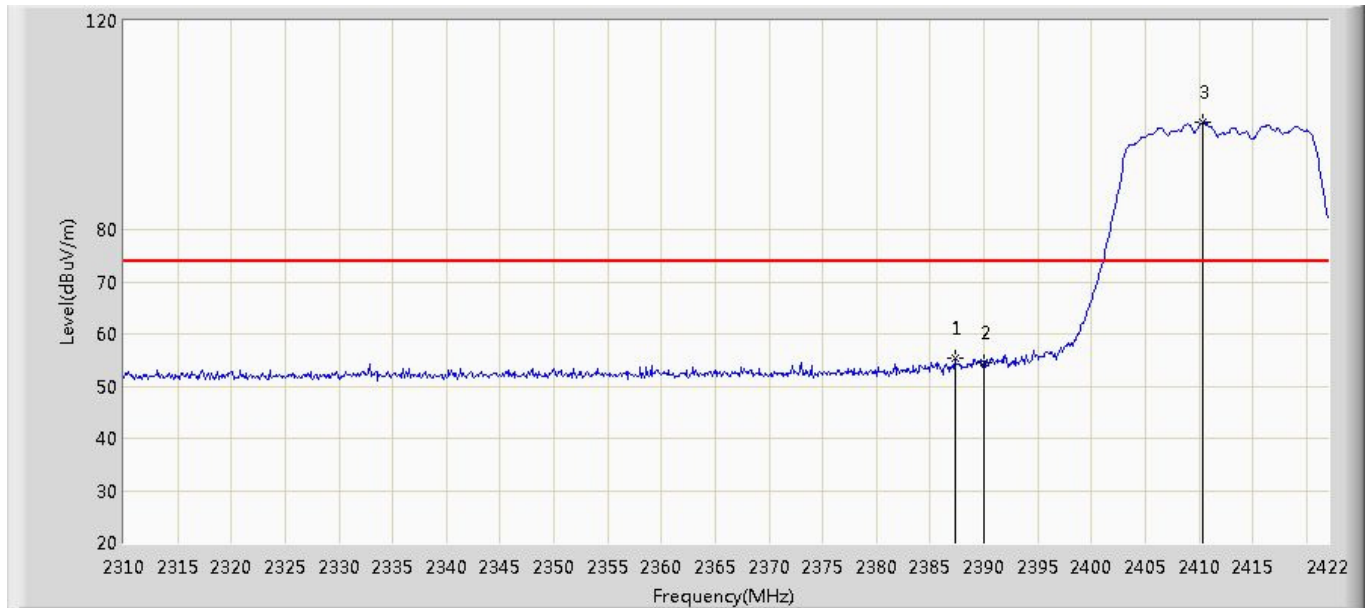

No	Mark	Frequency (MHz)	Measure Level (dBuV/m)	Reading Level (dBuV)	Over Limit (dB)	Limit (dBuV/m)	Factor (dB)	Type
1		2387.280	55.255	57.506	-18.745	74.000	-2.251	PK
2		2390.000	54.392	56.633	-19.608	74.000	-2.241	PK
3	*	2410.352	100.493	102.658	N/A	N/A	-2.165	PK

Note: Measure Level (dBuV/m) = Reading Level (dBuV) + Factor (dB)

Factor (dB) = Cable Loss (dB) + Antenna Factor (dB/m).



Site: AC102	Time: 2017/11/20 - 19:20
Limit: FCC_Part15.209_RE(3m)	Margin: 0
Probe: N/A	Polarity: Horizontal
EUT: Relocatable Power Tapes	Power: 120V/60Hz
Note: Mode:Transmit 802.11n(20MHz) at 2412MHz	

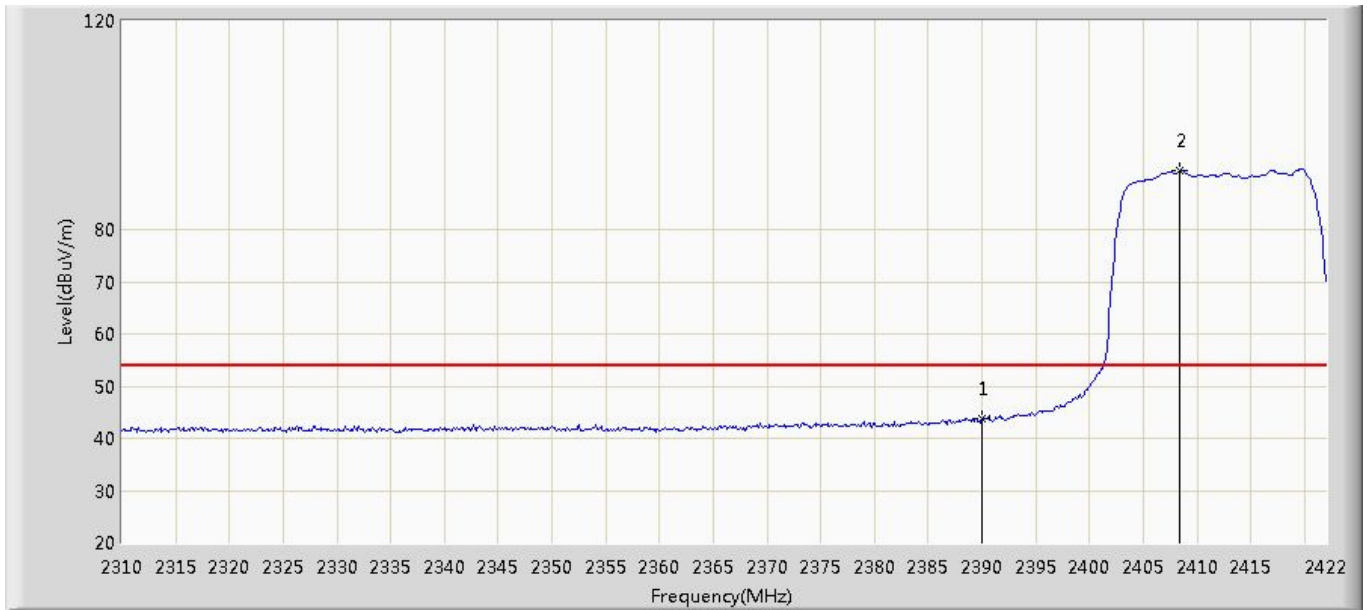

No	Mark	Frequency (MHz)	Measure Level (dBuV/m)	Reading Level (dBuV)	Over Limit (dB)	Limit (dBuV/m)	Factor (dB)	Type
1		2390.000	43.643	45.884	-10.357	54.000	-2.241	AV
2	*	2408.448	91.384	93.556	N/A	N/A	-2.172	AV

Note: Measure Level (dBuV/m) = Reading Level (dBuV) + Factor (dB)

Factor (dB) = Cable Loss (dB) + Antenna Factor (dB/m).



Site: AC102	Time: 2017/11/20 - 19:21
Limit: FCC_Part15.209_RE(3m)	Margin: 0
Probe: N/A	Polarity: Vertical
EUT: Relocatable Power Tapes	Power: 120V/60Hz
Note: Mode:Transmit 802.11n(20MHz) at 2412MHz	

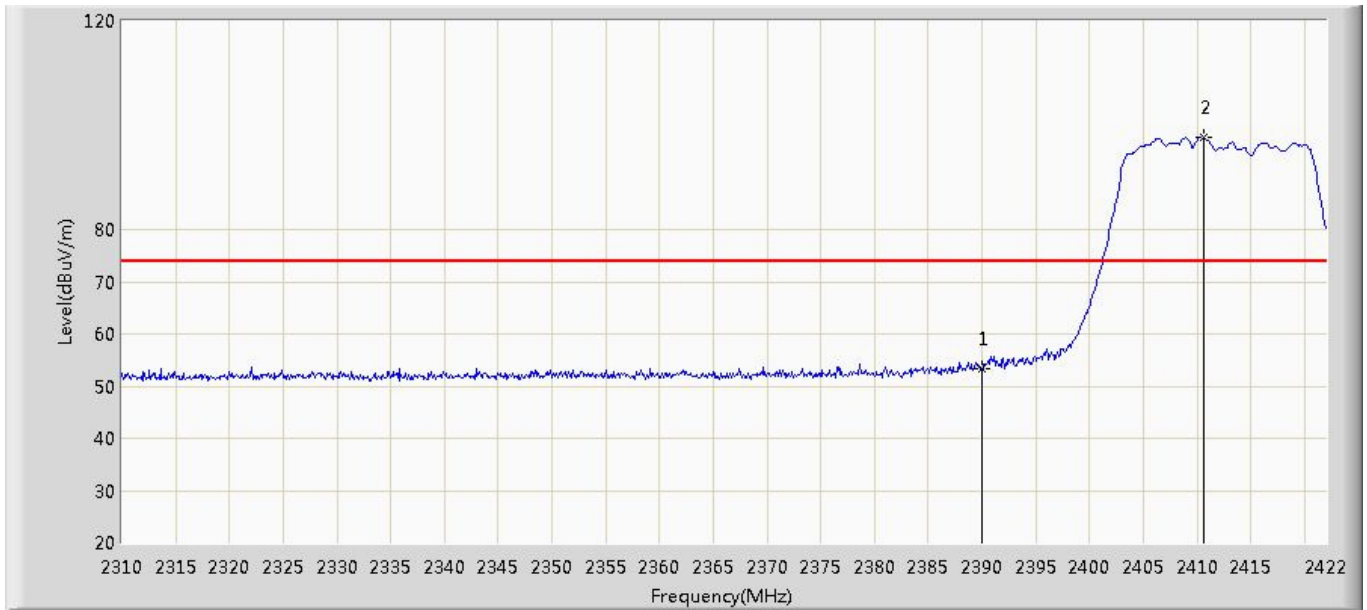

No	Mark	Frequency (MHz)	Measure Level (dBuV/m)	Reading Level (dBuV)	Over Limit (dB)	Limit (dBuV/m)	Factor (dB)	Type
1		2390.000	53.331	55.572	-20.669	74.000	-2.241	PK
2	*	2410.576	97.801	99.966	N/A	N/A	-2.165	PK

Note: Measure Level (dBuV/m) = Reading Level (dBuV) + Factor (dB)

Factor (dB) = Cable Loss (dB) + Antenna Factor (dB/m).



Site: AC102	Time: 2017/11/20 - 19:23
Limit: FCC_Part15.209_RE(3m)	Margin: 0
Probe: N/A	Polarity: Vertical
EUT: Relocatable Power Tapes	Power: 120V/60Hz
Note: Mode:Transmit 802.11n(20MHz) at 2412MHz	

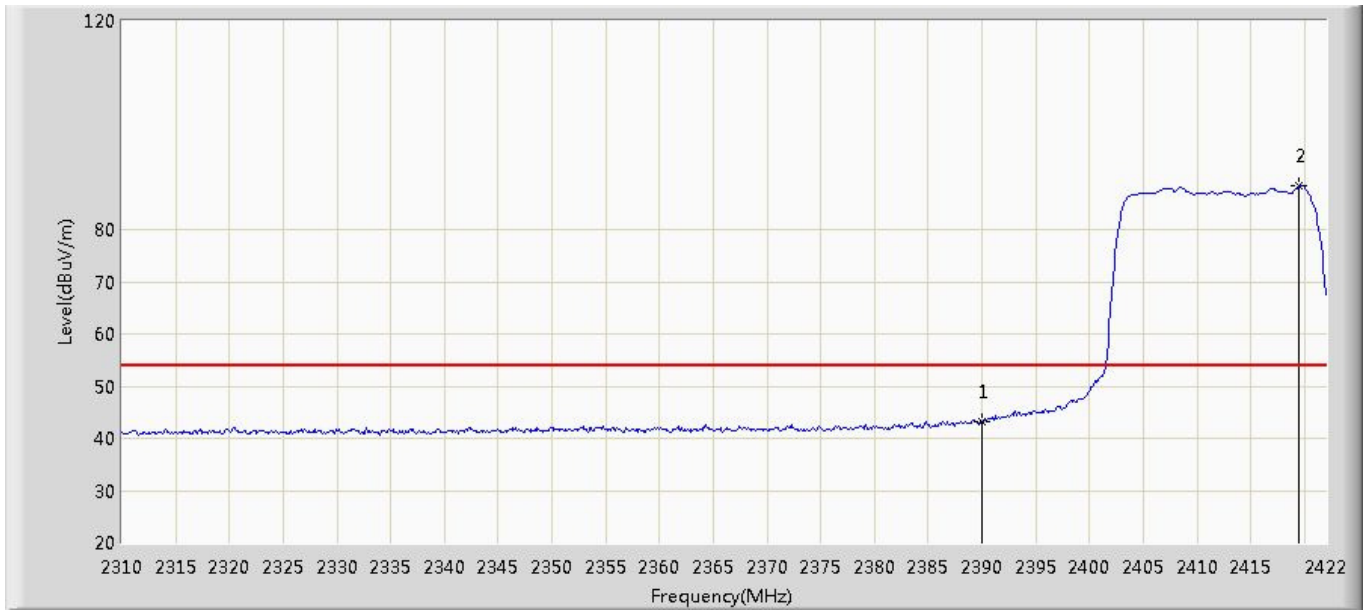

No	Mark	Frequency (MHz)	Measure Level (dBuV/m)	Reading Level (dBuV)	Over Limit (dB)	Limit (dBuV/m)	Factor (dB)	Type
1		2390.000	43.245	45.486	-10.755	54.000	-2.241	AV
2	*	2419.536	88.263	90.394	N/A	N/A	-2.131	AV

Note: Measure Level (dBuV/m) = Reading Level (dBuV) + Factor (dB)

Factor (dB) = Cable Loss (dB) + Antenna Factor (dB/m).



Site: AC102	Time: 2017/11/20 - 19:24
Limit: FCC_Part15.209_RE(3m)	Margin: 0
Probe: N/A	Polarity: Horizontal
EUT: Relocatable Power Tapes	Power: 120V/60Hz
Note: Mode:Transmit 802.11n(20MHz) at 2462MHz	

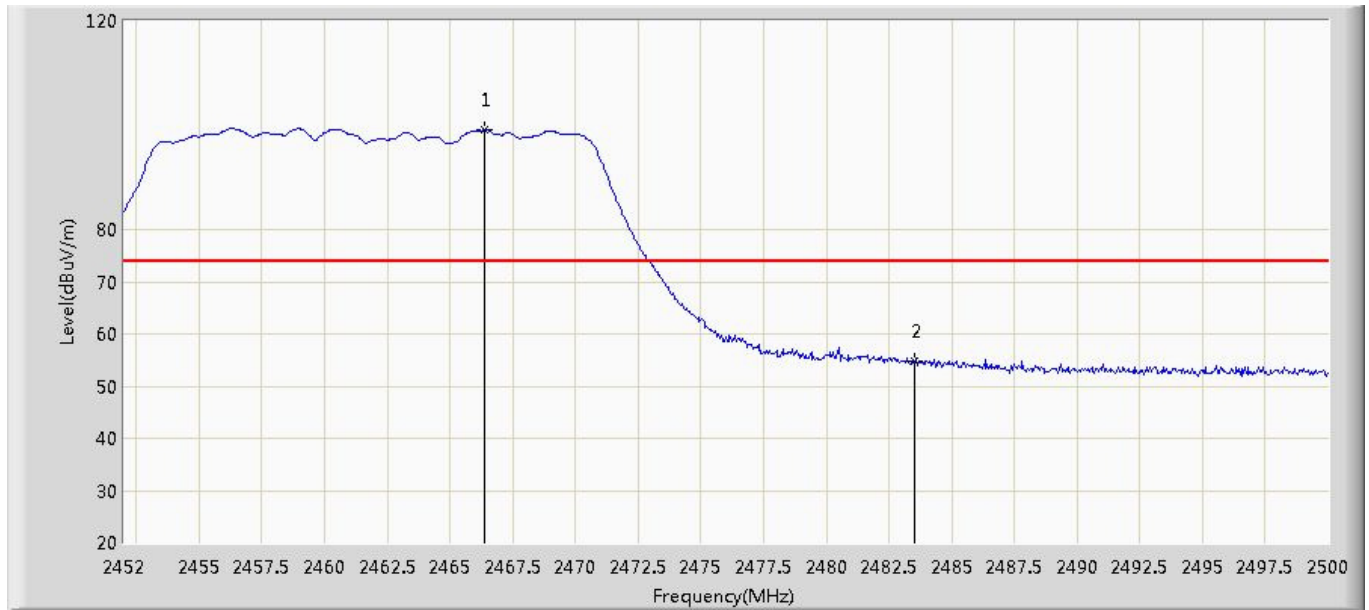

No	Mark	Frequency (MHz)	Measure Level (dBuV/m)	Reading Level (dBuV)	Over Limit (dB)	Limit (dBuV/m)	Factor (dB)	Type
1	*	2466.400	99.065	101.021	N/A	N/A	-1.956	PK
2		2483.500	54.850	56.742	-19.150	74.000	-1.892	PK

Note: Measure Level (dBuV/m) = Reading Level (dBuV) + Factor (dB)

Factor (dB) = Cable Loss (dB) + Antenna Factor (dB/m).





Site: AC102	Time: 2017/11/20 - 19:27
Limit: FCC_Part15.209_RE(3m)	Margin: 0
Probe: N/A	Polarity: Horizontal
EUT: Relocatable Power Tapes	Power: 120V/60Hz
Note: Mode:Transmit 802.11n(20MHz) at 2462MHz	

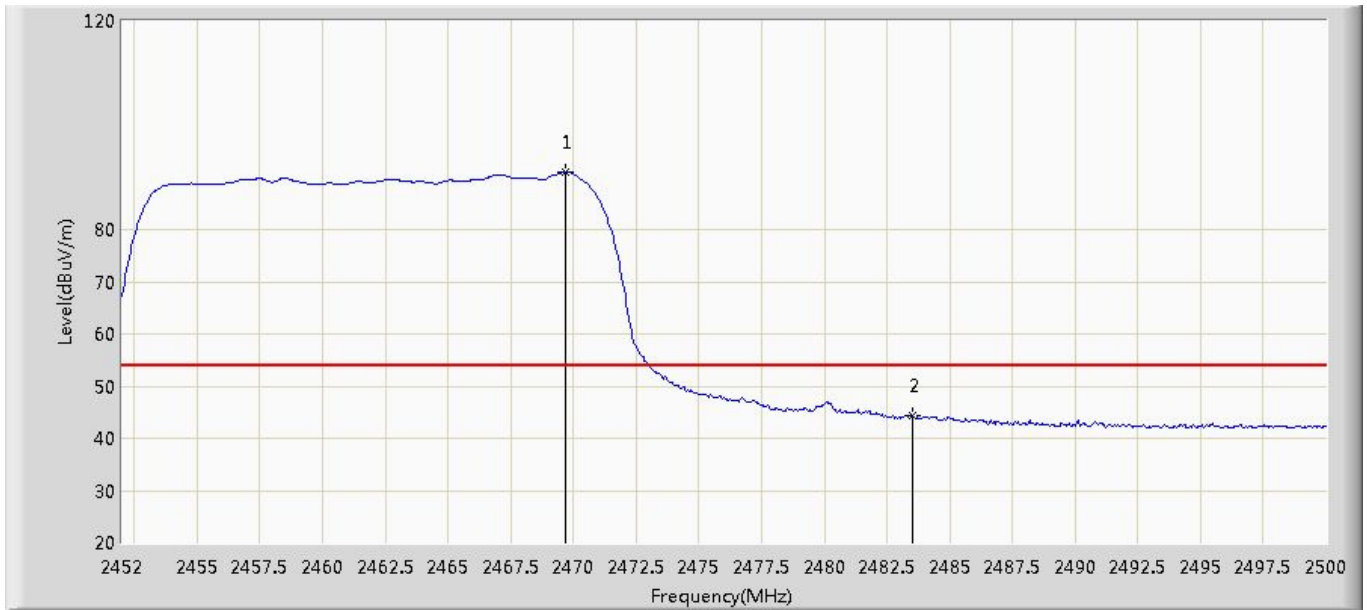

No	Mark	Frequency (MHz)	Measure Level (dBuV/m)	Reading Level (dBuV)	Over Limit (dB)	Limit (dBuV/m)	Factor (dB)	Type
1	*	2469.664	90.995	92.939	N/A	N/A	-1.944	AV
2		2483.500	44.244	46.136	-9.756	54.000	-1.892	AV

Note: Measure Level (dBuV/m) = Reading Level (dBuV) + Factor (dB)

Factor (dB) = Cable Loss (dB) + Antenna Factor (dB/m).



Site: AC102	Time: 2017/11/20 - 19:27
Limit: FCC_Part15.209_RE(3m)	Margin: 0
Probe: N/A	Polarity: Vertical
EUT: Relocatable Power Tapes	Power: 120V/60Hz
Note: Mode:Transmit 802.11n(20MHz) at 2462MHz	

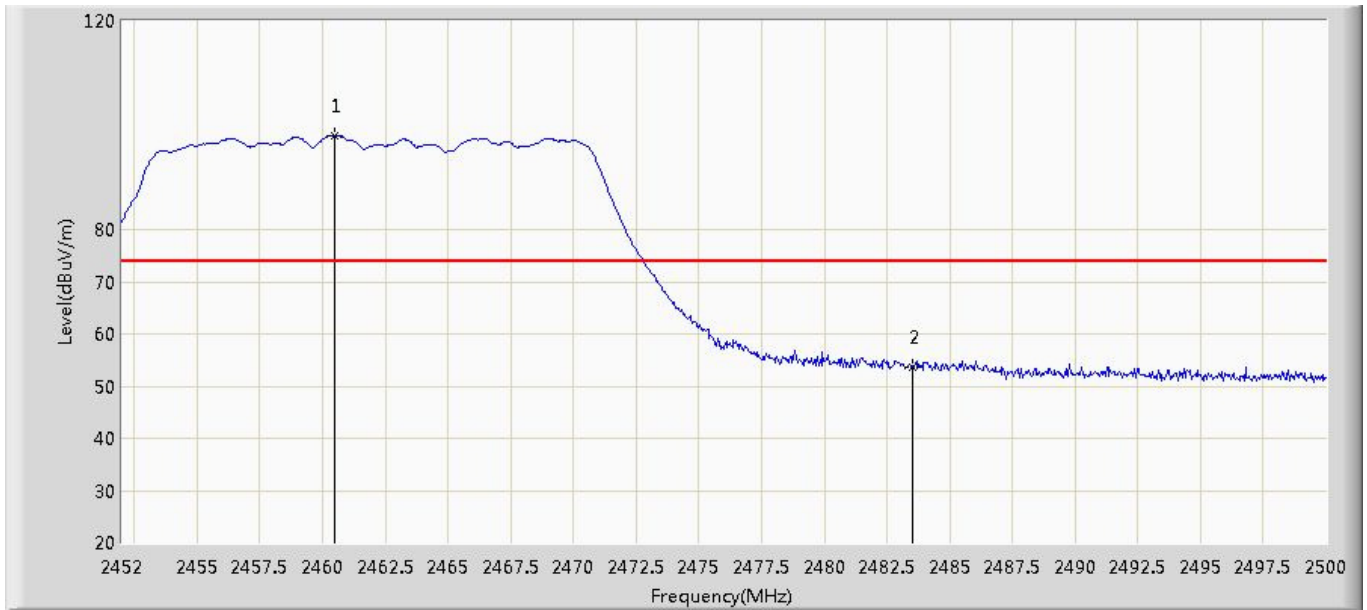

No	Mark	Frequency (MHz)	Measure Level (dBuV/m)	Reading Level (dBuV)	Over Limit (dB)	Limit (dBuV/m)	Factor (dB)	Type
1	*	2460.496	98.075	100.053	N/A	N/A	-1.978	PK
2		2483.500	53.599	55.491	-20.401	74.000	-1.892	PK

Note: Measure Level (dBuV/m) = Reading Level (dBuV) + Factor (dB)

Factor (dB) = Cable Loss (dB) + Antenna Factor (dB/m).



Site: AC102	Time: 2017/11/20 - 19:32
Limit: FCC_Part15.209_RE(3m)	Margin: 0
Probe: N/A	Polarity: Vertical
EUT: Relocatable Power Tapes	Power: 120V/60Hz
Note: Mode:Transmit 802.11n(20MHz) at 2462MHz	

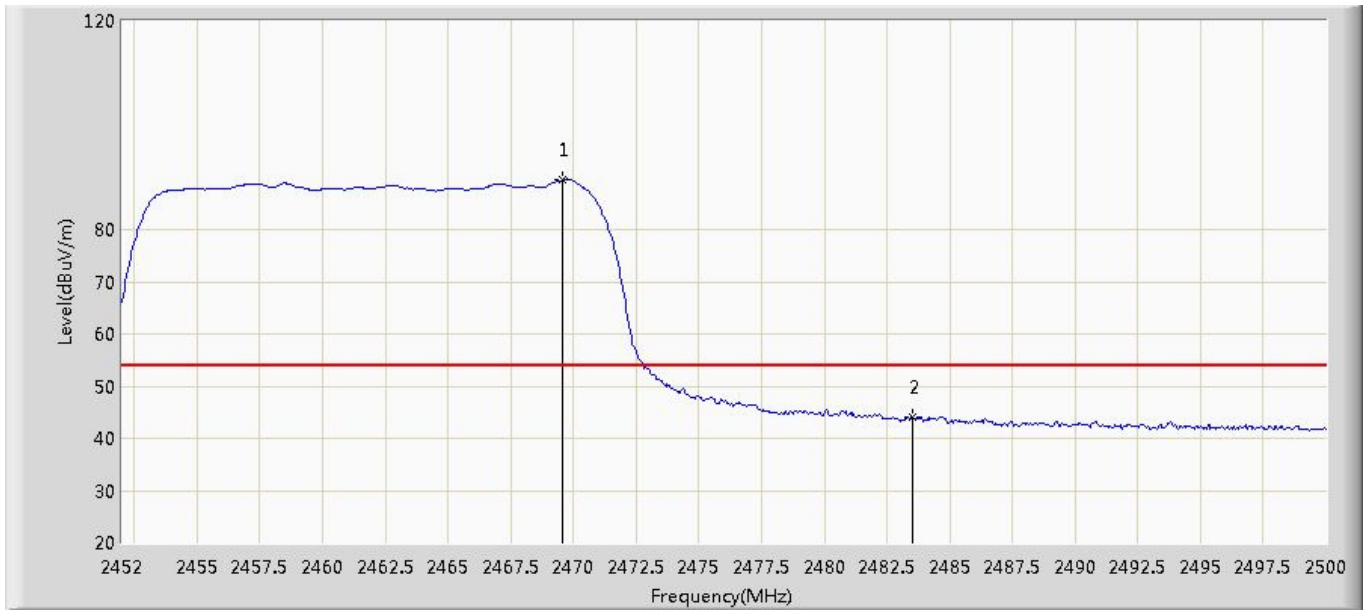

No	Mark	Frequency (MHz)	Measure Level (dBuV/m)	Reading Level (dBuV)	Over Limit (dB)	Limit (dBuV/m)	Factor (dB)	Type
1	*	2469.568	89.541	91.485	N/A	N/A	-1.944	AV
2		2483.500	43.985	45.877	-10.015	54.000	-1.892	AV

Note: Measure Level (dBuV/m) = Reading Level (dBuV) + Factor (dB)

Factor (dB) = Cable Loss (dB) + Antenna Factor (dB/m).

\_\_\_\_\_ The End \_\_\_\_\_