

**CFR 47 FCC PART 15 SUBPART C  
ISED RSS-247 Issue 3**

**TEST REPORT**

*For*

**WIFI+BT Module**

**MODEL NUMBER: WXT5LM2611**

**REPORT NUMBER: 4790962528-1-RF-3**

**ISSUE DATE: December 4, 2023**

**FCC ID:2AC23-WXT5L**

**IC:12290A-WXT5L**

*Prepared for*

**Hui Zhou Gaoshengda Technology Co.,LTD  
No.2,Jin-da Road,Huinan High-tech Industrial Park,Hui-ao Avenue,Huizhou  
City,Guangdong,China**

*Prepared by*

**UL Verification Services (Guangzhou) Co., Ltd, Song Shan Lake Branch**

**Building 10, Innovation Technology Park, No. 1, Li Bin Road, Song Shan Lake Hi-Tech Development Zone Dongguan, 523808, People's Republic of China**

**Tel: +86 769 22038881**

**Fax: +86 769 33244054**

**Website: [www.ul.com](http://www.ul.com)**

## Revision History

Rev.	Issue Date	Revisions	Revised By
V0	December 4, 2023	Initial Issue	

### Summary of Test Results

Test Item	Clause	Limit/Requirement	Result
Antenna Requirement	N/A	FCC Part 15.203/15.247 (c) RSS-GEN Clause 6.8	Pass
AC Power Line Conducted Emission	ANSI C63.10-2013, Clause 6.2	FCC Part 15.207 RSS-GEN Clause 8.8	Pass
Conducted Output Power	ANSI C63.10-2013, Clause 11.9.1.3	FCC Part 15.247 (b)(3) RSS-247 Clause 5.4 (d)	Pass
6dB Bandwidth and 99% Occupied Bandwidth	ANSI C63.10-2013, Clause 11.8.1	FCC Part 15.247 (a)(2) RSS-247 Clause 5.2 (a) ISED RSS-Gen Clause 6.7	Pass
Power Spectral Density	ANSI C63.10-2013, Clause 11.10.2	FCC Part 15.247 (e) RSS-247 Clause 5.2 (b)	Pass
Conducted Band edge and spurious emission	ANSI C63.10-2013, Clause 11.11	FCC Part 15.247(d) RSS-247 Clause 5.5	Pass
Radiated Band edge and Spurious Emission	ANSI C63.10-2013, Clause 11.12 & Clause 11.13	FCC Part 15.247 (d) FCC Part 15.205/15.209 RSS-247 Clause 5.5 RSS-GEN Clause 8.9	Pass
Duty Cycle	ANSI C63.10-2013, Clause 11.6	None; for reporting purposes only.	Pass

\*This test report is only published to and used by the applicant, and it is not for evidence purpose in China.

\*The measurement result for the sample received is <Pass> according to <CFR 47 FCC PART 15 SUBPART C><ISED RSS-247 Issue 3> when <Simple Acceptance> decision rule is applied.

## CONTENTS

<b>1.</b>	<b>ATTESTATION OF TEST RESULTS</b> .....	<b>6</b>
<b>2.</b>	<b>TEST METHODOLOGY</b> .....	<b>7</b>
<b>3.</b>	<b>FACILITIES AND ACCREDITATION</b> .....	<b>7</b>
<b>4.</b>	<b>CALIBRATION AND UNCERTAINTY</b> .....	<b>8</b>
4.1.	<i>MEASURING INSTRUMENT CALIBRATION</i> .....	8
4.2.	<i>MEASUREMENT UNCERTAINTY</i> .....	8
<b>5.</b>	<b>EQUIPMENT UNDER TEST</b> .....	<b>9</b>
5.1.	<i>DESCRIPTION OF EUT</i> .....	9
5.2.	<i>CHANNEL LIST</i> .....	9
5.3.	<i>MAXIMUM POWER</i> .....	9
5.4.	<i>TEST CHANNEL CONFIGURATION</i> .....	10
5.5.	<i>THE WORSE CASE POWER SETTING PARAMETER</i> .....	10
5.6.	<i>WORST-CASE CONFIGURATIONS</i> .....	11
5.7.	<i>DESCRIPTION OF AVAILABLE ANTENNAS</i> .....	12
5.8.	<i>SUPPORT UNITS FOR SYSTEM TEST</i> .....	13
<b>6.</b>	<b>MEASURING EQUIPMENT AND SOFTWARE USED</b> .....	<b>14</b>
<b>7.</b>	<b>ANTENNA PORT TEST RESULTS</b> .....	<b>17</b>
7.1.	<i>CONDUCTED OUTPUT POWER</i> .....	17
7.2.	<i>6DB BANDWIDTH AND 99% OCCUPIED BANDWIDTH</i> .....	18
7.3.	<i>POWER SPECTRAL DENSITY</i> .....	20
7.4.	<i>CONDUCTED BAND EDGE AND SPURIOUS EMISSION</i> .....	22
7.5.	<i>DUTY CYCLE</i> .....	24
<b>8.</b>	<b>RADIATED TEST RESULTS</b> .....	<b>25</b>
8.1.	<i>RESTRICTED BANDEDGE</i> .....	33
8.2.	<i>SPURIOUS EMISSIONS(1 GHZ~3 GHZ)</i> .....	57
8.3.	<i>SPURIOUS EMISSIONS(3 GHZ~18 GHZ)</i> .....	63
8.4.	<i>SPURIOUS EMISSIONS(9 KHZ~30 MHZ)</i> .....	99
8.5.	<i>SPURIOUS EMISSIONS(18 GHZ~26 GHZ)</i> .....	102
8.6.	<i>SPURIOUS EMISSIONS(30 MHZ~1 GHZ)</i> .....	104
<b>9.</b>	<b>ANTENNA REQUIREMENT</b> .....	<b>106</b>
<b>10.</b>	<b>AC POWER LINE CONDUCTED EMISSION</b> .....	<b>107</b>
<b>11.</b>	<b>TEST DATA</b> .....	<b>110</b>
11.1.	<i>APPENDIX A: DTS BANDWIDTH</i> .....	110

11.1.1.	Test Result .....	110
11.1.2.	Test Graphs .....	111
11.2.	<i>APPENDIX B: OCCUPIED CHANNEL BANDWIDTH</i> .....	122
11.2.1.	Test Result .....	122
11.2.2.	Test Graphs .....	123
11.3.	<i>APPENDIX C: MAXIMUM CONDUCTED OUTPUT POWER</i> .....	134
11.3.1.	Test Result .....	134
11.4.	<i>APPENDIX D: MAXIMUM POWER SPECTRAL DENSITY</i> .....	135
11.4.1.	Test Result .....	135
11.4.2.	Test Graphs .....	136
11.5.	<i>APPENDIX E: BAND EDGE MEASUREMENTS</i> .....	147
11.5.1.	Test Result .....	147
11.5.2.	Test Graphs .....	148
11.6.	<i>APPENDIX F: CONDUCTED SPURIOUS EMISSION</i> .....	155
11.6.1.	Test Result .....	155
11.6.2.	Test Graphs .....	157
11.7.	<i>APPENDIX G: DUTY CYCLE</i> .....	188
11.7.1.	Test Result .....	188
11.7.2.	Test Graphs .....	189

# 1. ATTESTATION OF TEST RESULTS

## Applicant Information

Company Name: Hui Zhou Gaoshengda Technology Co.,LTD  
 Address: No.2,Jin-da Road,Huinan High-tech Industrial Park,Hui-ao Avenue,Huizhou City,Guangdong,China

## Manufacturer Information

Company Name: Hui Zhou Gaoshengda Technology Co.,LTD  
 Address: No.2,Jin-da Road,Huinan High-tech Industrial Park,Hui-ao Avenue,Huizhou City,Guangdong,China

## EUT Information

EUT Name: WIFI+BT Module  
 Model: WXT5LM2611  
 Brand: GSD  
 Sample Received Date: October 8, 2023  
 Sample Status: Normal  
 Sample ID: 6550829  
 Date of Tested: October 19, 2023 to December 4, 2023

APPLICABLE STANDARDS	
STANDARD	TEST RESULTS
CFR 47 FCC PART 15 SUBPART C ISED RSS-247 Issue 3	Pass

Prepared By:

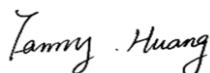

Fanny Huang  
 Engineer Project Associate

Checked By:

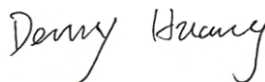

Denny Huang  
 Senior Project Engineer

Approved By:



Stephen Guo  
 Operations Manager

## 2. TEST METHODOLOGY

All tests were performed in accordance with the standard CFR 47 FCC PART 15 SUBPART C ISED RSS-247 Issue 3, KDB 558074 D01 15.247 Meas Guidance v05r02, KDB 414788 D01 Radiated Test Site v01r01, KDB 662911 D01 Multiple Transmitter Output v02r01, CFR 47 FCC Part 2, ANSI C63.10-2013 and ISED RSS-GEN Issue 5

## 3. FACILITIES AND ACCREDITATION

Accreditation Certificate	<p><b>A2LA (Certificate No.: 4102.01)</b>                  UL Verification Services (Guangzhou) Co., Ltd. Song Shan Lake Branch. has been assessed and proved to be in compliance with A2LA.</p> <p><b>FCC (FCC Designation No.: CN1187)</b>                  UL Verification Services (Guangzhou) Co., Ltd. Song Shan Lake Branch. Has been recognized to perform compliance testing on equipment subject to the Commission's Declaration of Conformity (DoC) and Certification rules</p> <p><b>ISED (Company No.: 21320)</b>                  UL Verification Services (Guangzhou) Co., Ltd. Song Shan Lake Branch. has been registered and fully described in a report filed with ISED. The Company Number is 21320 and the test lab Conformity Assessment Body Identifier (CABID) is CN0046.</p> <p><b>VCCI (Registration No.: G-20192, R-20202, C-20153 and T-20155)</b>                  UL Verification Services (Guangzhou) Co., Ltd. Song Shan Lake Branch. has been assessed and proved to be in compliance with VCCI, the Membership No. is 3793.                  Facility Name:                  Chamber D, the VCCI registration No. is G-20192 and R-20202                  Shielding Room B , the VCCI registration No. is C-20153 and T-20155</p>
---------------------------	--

**Note 1:**

All tests measurement facilities use to collect the measurement data are located at Building 10, Innovation Technology Park, No. 1, Li Bin Road, Song Shan Lake Hi-Tech Development Zone Dongguan, 523808, People's Republic of China.

**Note 2:**

The test anechoic chamber in UL Verification Services (Guangzhou) Co., Ltd. Song Shan Lake Branch had been calibrated and compared to the open field sites and the test anechoic chamber is shown to be equivalent to or worst case from the open field site.

**Note 3:**

For below 30 MHz, lab had performed measurements at test anechoic chamber and comparing to measurements obtained on an open field site. And these measurements below 30 MHz had been correlated to measurements performed on an OFS.

## 4. CALIBRATION AND UNCERTAINTY

### 4.1. MEASURING INSTRUMENT CALIBRATION

The measuring equipment utilized to perform the tests documented in this report has been calibrated in accordance with the manufacturer's recommendations and is traceable to recognized national standards.

### 4.2. MEASUREMENT UNCERTAINTY

Where relevant, the following measurement uncertainty levels have been estimated for tests performed on the apparatus:

Test Item	Uncertainty
Conduction emission	3.62 dB
Radiated Emission (Included Fundamental Emission) (9 kHz ~ 30 MHz)	2.2 dB
Radiated Emission (Included Fundamental Emission) (30 MHz ~ 1 GHz)	4.00 dB
Radiated Emission (Included Fundamental Emission) (1 GHz to 26 GHz)	5.78 dB (1 GHz ~ 18 GHz)
	5.23 dB (18 GHz ~ 26 GHz)
Duty Cycle	±0.028%
DTS and 99% Occupied Bandwidth	±0.0196%
Maximum Conducted Output Power	±0.686 dB
Maximum Power Spectral Density Level	±0.743 dB
Conducted Band-edge Compliance	±1.328 dB
Conducted Unwanted Emissions In Non-restricted Frequency Bands	±0.746 dB (9 kHz ~ 1 GHz)
	±1.328dB (1 GHz ~ 26 GHz)
Note: This uncertainty represents an expanded uncertainty expressed at approximately the 95% confidence level using a coverage factor of k=2.	



## 5. EQUIPMENT UNDER TEST

### 5.1. DESCRIPTION OF EUT

EUT Name	WIFI+BT Module
Model	WXT5LM2611

Frequency Range:	2412 MHz to 2462 MHz
Type of Modulation:	IEEE 802.11b: DSSS(CCK, DQPSK, DBPSK) IEEE 802.11g/n: OFDM(64-QAM, 16-QAM, QPSK, BPSK) IEEE 802.11ax: OFDM(1024-QAM, 64-QAM, 16-QAM, QPSK, BPSK)
Radio Technology:	IEEE 802.11b/g/n HT20/11n HT40/ax HE20/ax HE40
Normal Test Voltage:	DC 5 V

### 5.2. CHANNEL LIST

Channel List For Bandwidth=20 MHz							
Channel	Frequency (MHz)	Channel	Frequency (MHz)	Channel	Frequency (MHz)	Channel	Frequency (MHz)
1	2412	4	2427	7	2442	10	2457
2	2417	5	2432	8	2447	11	2462
3	2422	6	2437	9	2452	/	/

Channel List For Bandwidth=40 MHz							
Channel	Frequency (MHz)	Channel	Frequency (MHz)	Channel	Frequency (MHz)	Channel	Frequency (MHz)
3	2422	5	2432	7	2442	9	2452
4	2427	6	2437	8	2447	/	/

### 5.3. MAXIMUM POWER

IEEE Std. 802.11	Frequency (MHz)	Channel Number	Maximum Conducted AVG Output Power (dBm)	Maximum AVG EIRP (dBm)
b	2412 ~ 2462	1-11[11]	17.19	22.12
g	2412 ~ 2462	1-11[11]	15.70	20.63
n HT20	2412 ~ 2462	1-11[11]	17.33	22.26
n HT40	2422 ~ 2452	3-9[7]	16.85	21.78
ax HE20	2412 ~ 2462	1-11[11]	13.38	18.31
ax HE40	2422 ~ 2452	3-9[7]	12.66	17.59

#### 5.4. TEST CHANNEL CONFIGURATION

IEEE Std. 802.11	Test Channel Number	Frequency
b	CH 1(Low Channel), CH 6(MID Channel), CH 11(High Channel)	2412 MHz, 2437 MHz, 2462 MHz
g	CH 1(Low Channel), CH 6(MID Channel), CH 11(High Channel)	2412 MHz, 2437 MHz, 2462 MHz
n HT20	CH 1(Low Channel), CH 6(MID Channel), CH 11(High Channel)	2412 MHz, 2437 MHz, 2462 MHz
n HT40	CH 3(Low Channel), CH 6(MID Channel), CH 9(High Channel)	2422 MHz, 2437 MHz, 2452 MHz
ax HE20	CH 1(Low Channel), CH 6(MID Channel), CH 11(High Channel)	2412 MHz, 2437 MHz, 2462 MHz
ax HE40	CH 3(Low Channel), CH 6(MID Channel), CH 9(High Channel)	2422 MHz, 2437 MHz, 2452 MHz

#### 5.5. THE WORSE CASE POWER SETTING PARAMETER

The Worse Case Power Setting Parameter under 2400 ~ 2483.5MHz Band										
Test Software		QA Tool								
Modulation Mode	Transmit Antenna Number	Test Channel								
		NCB: 20MHz			NCB: 40MHz					
		CH 1	CH 6	CH 11	CH 3	CH 6	CH 9			
802.11b	0	15	15	15	/					
	1	15	15	15						
802.11g	0	11	12	12						
	1	11	12	12						
802.11n HT20	0	11	12	12						
	1	11	12	12						
802.11n HT40	0	/						12	12	12
	1	/						12	12	12
802.11ax HE20	0	7	8	8	/					
	1	7	8	8						
802.11ax HE40	0	/			8	7	7.5			
	1	/			8	7	7.5			

## 5.6. WORST-CASE CONFIGURATIONS

The EUT was tested in the following configuration(s):

Controlled in test mode using a software application on the EUT supplied by customer. The application was used to enable a continuous transmission and to select the mode, test channels, bandwidth, data rates as required.

Test channels referring to section 5.4.

Maximum power setting referring to section 5.5.

Worst-case data rates as provided by the client were:

802.11b mode: 1 Mbps  
802.11g mode: 6 Mbps  
802.11n HT20 mode: MCS0  
802.11n HT40 mode: MCS0  
802.11ax HE20 mode: MCS0  
802.11ax HE40 mode: MCS0

802.11b/g only support SISO mode.  
802.11n HT20/HT40/ax HE20/HE40 support SISO and MIMO mode.

802.11b/g SISO mode, Antenna 0 and Antenna 1 has the same power setting, and we have pre-tested for two antennas, only the worst data were recorded in the report.

802.11n/ax SISO mode and MIMO mode have the same power setting, so only the worst case power mode(MIMO) will be record in the report.

The EUT has 2 separate antennas which correspond to 2 separate antenna ports. Core 0 and Core 1 correspond to antenna 0 and antenna 1 respectively.

The measured additional path loss was included in any path loss calculations for all RF cable used during tested.

Conducted output power, power spectral density tests separately on each port with all supported SISO & MIMO port combinations.

Conducted bandedge and spurious emissions tests were performed with SISO mode, as this port was found to have the worst case in terms of power settings amongst all supported possible SISO & MIMO port combinations.

Radiated emissions tests were performed with the MIMO modes. These were found to be the worst modulation scheme with regards to emissions after preliminary investigations and, as this mode emits the highest conducted output power level, it was deemed to be the worst case.

The EUT support Cyclic Shift Diversity(CDD), Space Time Coding(STBC), Spartial Division Multiplexing(SDM) modes. They use the same conducted power per chain in any given mode, so we only chose the worst case mode CDD for final testing.

## 5.7. DESCRIPTION OF AVAILABLE ANTENNAS

Antenna	Frequency (MHz)	Antenna Type	MAX Antenna Gain (dBi)
0	2412-2462	PIFA Antenna	4.93
1	2412-2462	PIFA Antenna	4.93

The EUT support Cyclic Shift Diversity(CDD) mode.

MIMO output power port and MIMO PSD port summing were performed in accordance with KDB 662911 D01. For the CDD results the Directional Gain was calculated in accordance with the following method.

For output power measurements:

Directional gain=  $G_{ANT} + \text{Array Gain} = 4.93 \text{ dBi}$

$G_{ANT}$  : equal to the gain of the antenna having the highest gain

Array Gain = 0 dB (i.e., no array gain) for  $N_{ANT} \leq 4$

For power spectral density (PSD) measurements:

Directional gain=  $G_{ANT} + \text{Array Gain} = 7.94 \text{ dBi}$

Array Gain =  $10 \log(N_{ANT}/N_{SS}) \text{ dB}$ .

$N_{ANT}$  : number of transmit antennas

$N_{SS}$  : number of spatial streams, The worst case directional gain will occur when  $N_{SS} = 1$

Test Mode	Transmit and Receive Mode	Description
IEEE 802.11b	<input checked="" type="checkbox"/> 2TX, 2RX	ANT 0 and ANT 1 can be used as transmitting/receiving antenna.
IEEE 802.11g	<input checked="" type="checkbox"/> 2TX, 2RX	ANT 0 and ANT 1 can be used as transmitting/receiving antenna.
IEEE 802.11n HT20	<input checked="" type="checkbox"/> 2TX, 2RX	ANT 0 and ANT 1 can be used as transmitting/receiving antenna.
IEEE 802.11n HT40	<input checked="" type="checkbox"/> 2TX, 2RX	ANT 0 and ANT 1 can be used as transmitting/receiving antenna.
IEEE 802.11ax HE20	<input checked="" type="checkbox"/> 2TX, 2RX	ANT 0 and ANT 1 can be used as transmitting/receiving antenna.
IEEE 802.11ax HE40	<input checked="" type="checkbox"/> 2TX, 2RX	ANT 0 and ANT 1 can be used as transmitting/receiving antenna.
Note: 1.BT&WLAN 2.4G, BT & WLAN 5G, WLAN 2.4G & WLAN 5G can't transmit simultaneously. (declared by client)		

## 5.8. SUPPORT UNITS FOR SYSTEM TEST

### SUPPORT EQUIPMENT

Item	Equipment	Brand Name	Model Name	Remark
1	PC	Lenovo	E42-80	/
2	AC Adaptor	Lenovo	ADLX65YCC3D	Input: AC 100-240V, 1.8A, 50-60Hz Output: DC 20V, 3.25A,65.0W Max

### I/O CABLES

Cable No	Port	Connector Type	Cable Type	Cable Length(m)	Remarks
1	USB	/	/	1.0	/

### ACCESSORIES

Item	Accessory	Brand Name	Model Name	Description
/	/	/	/	/

### TEST SETUP

The EUT can work in engineering mode with a software through a Laptop.

### SETUP DIAGRAM FOR TESTS

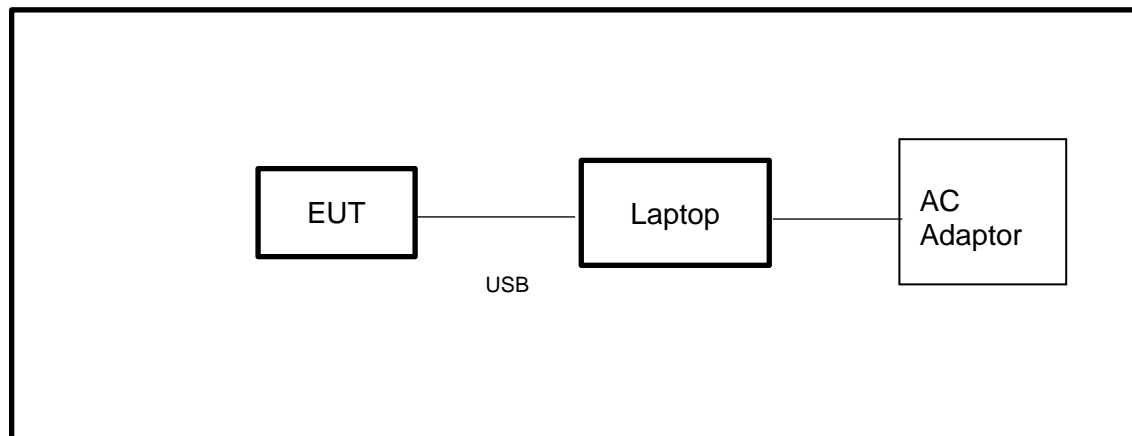

Note: AC Adaptor only use for AC POWER LINE CONDUCTED EMISSION test.

## 6. MEASURING EQUIPMENT AND SOFTWARE USED

R&S TS 8997 Test System					
Equipment	Manufacturer	Model No.	Serial No.	Last Cal.	Due. Date
Power sensor, Power Meter	R&S	OSP120	100921	Mar.31,2023	Mar.30,2024
Vector Signal Generator	R&S	SMBV100A	261637	Oct.12, 2023	Oct.11, 2024
Signal Generator	R&S	SMB100A	178553	Oct.12, 2023	Oct.11, 2024
Signal Analyzer	R&S	FSV40	101118	Oct.12, 2023	Oct.11, 2024
Software					
Description	Manufacturer	Name		Version	
For R&S TS 8997 Test System	Rohde & Schwarz	EMC 32		10.60.10	
Tonsend RF Test System					
Equipment	Manufacturer	Model No.	Serial No.	Last Cal.	Due. Date
Wideband Radio Communication Tester	R&S	CMW500	155523	Oct.12, 2023	Oct.11, 2024
Wireless Connectivity Tester	R&S	CMW270	1201.0002N75-102	Sep.25, 2023	Sep.24, 2024
PXA Signal Analyzer	Keysight	N9030A	MY55410512	Oct.12, 2023	Oct.11, 2024
MXG Vector Signal Generator	Keysight	N5182B	MY56200284	Oct.12, 2023	Oct.11, 2024
MXG Vector Signal Generator	Keysight	N5172B	MY56200301	Oct.12, 2023	Oct.11, 2024
DC power supply	Keysight	E3642A	MY55159130	Oct.12, 2023	Oct.11, 2024
Temperature & Humidity Chamber	SANMOOD	SG-80-CC-2	2088	Oct.12, 2023	Oct.11, 2024
Attenuator	Aglient	8495B	2814a12853	Oct.12, 2023	Oct.11, 2024
RF Control Unit	Tonscend	JS0806-2	23B80620666	April 18, 2023	April 17, 2024
Software					
Description	Manufacturer	Name		Version	
Tonsend SRD Test System	Tonsend	JS1120-3 RF Test System		V3.2.22	

Conducted Emissions					
Equipment	Manufacturer	Model No.	Serial No.	Last Cal.	Due Date
EMI Test Receiver	R&S	ESR3	101961	Oct.13, 2023	Oct.12, 2024
Two-Line V-Network	R&S	ENV216	101983	Oct.13, 2023	Oct.12, 2024
Artificial Mains Networks	Schwarzbeck	NSLK 8126	8126465	Oct.13, 2023	Oct.12, 2024
Software					
Description			Manufacturer	Name	Version
Test Software for Conducted Emissions			Farad	EZ-EMC	Ver. UL-3A1

Radiated Emissions					
Equipment	Manufacturer	Model No.	Serial No.	Last Cal.	Due Date
MXE EMI Receiver	KESIGHT	N9038A	MY56400036	Oct.12, 2023	Oct.11, 2024
Hybrid Log Periodic Antenna	TDK	HLP-3003C	130959	Aug.02, 2021	Aug.01, 2024
Preamplifier	HP	8447D	2944A09099	Oct.12, 2023	Oct.11, 2024
EMI Measurement Receiver	R&S	ESR26	101377	Oct.12, 2023	Oct.11, 2024
Horn Antenna	TDK	HRN-0118	130940	July 20, 2021	July 19, 2024
Preamplifier	TDK	PA-02-0118	TRS-305-00067	Oct.12, 2023	Oct.11, 2024
Horn Antenna	Schwarzbeck	BBHA9170	697	July 20, 2021	July 19, 2024
Preamplifier	TDK	PA-02-2	TRS-307-00003	Oct.12, 2023	Oct.11, 2024
Preamplifier	TDK	PA-02-3	TRS-308-00002	Oct.12, 2023	Oct.11, 2024
Loop antenna	Schwarzbeck	1519B	00008	Dec.14, 2021	Dec.13, 2024
Preamplifier	TDK	PA-02-001-3000	TRS-302-00050	Oct.12, 2023	Oct.11, 2024
High Pass Filter	Wi	WHKX10-2700-3000-18000-40SS	23	Oct.12, 2023	Oct.11, 2024
Highpass Filter	Wainwright	WHKX10-5850-6500-1800-40SS	4	Oct.12, 2023	Oct.11, 2024
Band Reject Filter	Wainwright	WRCJV12-5695-5725-5850-5880-40SS	4	Oct.12, 2023	Oct.11, 2024
Band Reject Filter	Wainwright	WRCJV20-5120-5150-5350-5380-60SS	2	Oct.12, 2023	Oct.11, 2024

Band Reject Filter	Wainwright	WRCJV20-5440-5470-5725-5755-60SS	1	Oct.12, 2023	Oct.11, 2024
Band Reject Filter	Wainwright	WRCJV8-2350-2400-2483.5-2533.5-40SS	4	Oct.12, 2023	Oct.11, 2024
Band Reject Filter	Wainwright	WRCD5-1879-1879.85-1880.15-1881-40SS	1	Oct.12, 2023	Oct.11, 2024
Notch Filter	Wainwright	WHJ10-882-980-7000-40SS	1	Oct.12, 2023	Oct.11, 2024
Highpass Filter	Xingbo	XBLBQ-GTA68	211115-2-1	Oct.12, 2023	Oct.11, 2024
Notch Filter (5905-6445 MHz)	Xingbo	XBLBQ-DZA175	210922-2-1	Oct.12, 2023	Oct.11, 2024
Notch Filter (6425-6525 MHz)	Xingbo	XBLBQ-DZA176	210922-2-2	Oct.12, 2023	Oct.11, 2024
Notch Filter (6825-7125 MHz)	Xingbo	XBLBQ-DZA177	210922-2-3	Oct.12, 2023	Oct.11, 2024
Notch Filter (6525-6875 MHz)	Xingbo	XBLBQ-DZA178	210922-2-4	Oct.12, 2023	Oct.11, 2024
Software					
Description			Manufacturer	Name	Version
Test Software for Radiated Emissions			Farad	EZ-EMC	Ver. UL-3A1

Other Instrument					
Equipment	Manufacturer	Model No.	Serial No.	Last Cal.	Due Date
Temperature humidity probe	OMEGA	ITHX-SD-5	18470007	Oct.21, 2023	Oct.20, 2024
Barometer	Yiyi	Baro	N/A	Oct.19, 2023	Oct.18, 2024
Attenuator	Agilent	8495B	2814a12853	Oct.12, 2023	Oct.11, 2024



## 7. ANTENNA PORT TEST RESULTS

### 7.1. CONDUCTED OUTPUT POWER

#### LIMITS

CFR 47 FCC Part15 (15.247) Subpart C ISED RSS-247 ISSUE 3			
Section	Test Item	Limit	Frequency Range (MHz)
CFR 47 FCC 15.247(b)(3) ISED RSS-247 5.4 (d)	AVG Output Power	1 watt or 30 dBm	2400-2483.5

#### TEST PROCEDURE

Refer to ANSI C63.10-2013 clause 11.9.2.3.1.

Connect the EUT to a low loss RF cable from the antenna port to the power sensor (video bandwidth is greater than the occupied bandwidth).

Measure peak emission level, the indicated level is the average output power, after any corrections for external attenuators and cables.

The test result in dBm by adding  $[10 \log (1 / D)]$ , where D is the duty cycle.

#### TEST SETUP

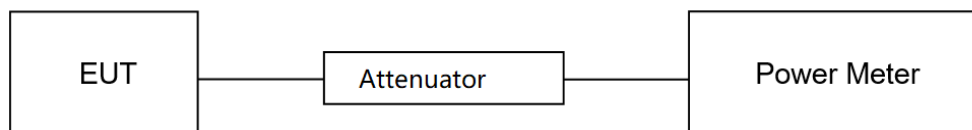

#### TEST ENVIRONMENT

Temperature	24.3°C	Relative Humidity	62.7%
Atmosphere Pressure	101kPa	Test Voltage	DC 5 V

#### TEST DATE / ENGINEER

Test Date	November 11, 2023	Test By	Johnson Liu
-----------	-------------------	---------	-------------

#### TEST RESULTS

Please refer to section "Test Data" - Appendix C

## 7.2. 6DB BANDWIDTH AND 99% OCCUPIED BANDWIDTH

### LIMITS

CFR 47 FCC Part15 (15.247) Subpart C ISED RSS-247 ISSUE 3			
Section	Test Item	Limit	Frequency Range (MHz)
CFR 47 FCC 15.247(a)(2) ISED RSS-247 5.2 (a)	6 dB Bandwidth	≥ 500 kHz	2400-2483.5
ISED RSS-Gen Clause 6.7	99 % Occupied Bandwidth	For reporting purposes only.	2400-2483.5

### TEST PROCEDURE

Refer to ANSI C63.10-2013 clause 11.8 for DTS bandwidth and clause 6.9 for Occupied Bandwidth.

Connect the EUT to the spectrum analyzer and use the following settings:

Center Frequency	The center frequency of the channel under test
Frequency Span	For 6 dB Bandwidth: Enough to capture all products of the modulation carrier emission For 99 % Occupied Bandwidth: Between 1.5 times and 5.0 times the OBW
Detector	Peak
RBW	For 6 dB Bandwidth: 100 kHz For 99 % Occupied Bandwidth: 1 % to 5 % of the occupied bandwidth
VBW	For 6 dB Bandwidth: ≥3 × RBW For 99 % Occupied Bandwidth: ≥3 × RBW
Trace	Max hold
Sweep	Auto couple

a) Use the 99 % power bandwidth function of the instrument, allow the trace to stabilize and report the measured bandwidth.

b) Allow the trace to stabilize and measure the maximum width of the emission that is constrained by the frequencies associated with the two outermost amplitude points (upper and lower frequencies) that are attenuated by 6 dB relative to the maximum level measured in the fundamental emission.

### TEST SETUP

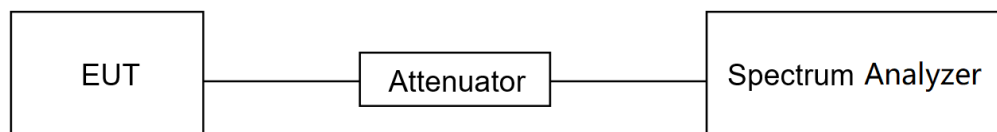

**TEST ENVIRONMENT**

Temperature	24.3°C	Relative Humidity	62.7%
Atmosphere Pressure	101kPa	Test Voltage	DC 5 V

**TEST DATE / ENGINEER**

Test Date	November 11, 2023	Test By	Johnson Liu
-----------	-------------------	---------	-------------

**TEST RESULTS**

Please refer to section "Test Data" - Appendix A&B

### 7.3. POWER SPECTRAL DENSITY

#### LIMITS

CFR 47 FCC Part15 (15.247) Subpart C ISED RSS-247 ISSUE 3			
Section	Test Item	Limit	Frequency Range (MHz)
CFR 47 FCC §15.247 (e) ISED RSS-247 5.2 (b)	Power Spectral Density	8 dBm in any 3 kHz band	2400-2483.5

#### TEST PROCEDURE

Refer to ANSI C63.10-2013 clause 11.10.5.

Connect the EUT to the spectrum analyzer and use the following settings:

Center Frequency	The center frequency of the channel under test
Detector	power averaging (rms)
RBW	$3 \text{ kHz} \leq \text{RBW} \leq 100 \text{ kHz}$
VBW	$\geq 3 \times \text{RBW}$
Span	1.5 x OBW bandwidth
Trace	Employ trace averaging(rms)mode over a minimum of 100 traces
Sweep time	Auto couple

Allow trace to fully stabilize and use the peak marker function to determine the maximum amplitude level within the RBW.

If measured value exceeds limit, reduce RBW (no less than 3 kHz) and repeat.

#### TEST SETUP

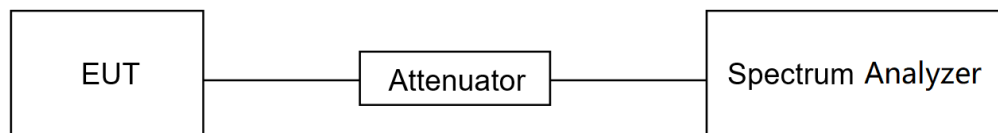

**TEST ENVIRONMENT**

Temperature	24.3°C	Relative Humidity	62.7%
Atmosphere Pressure	101kPa	Test Voltage	DC 5 V

**TEST DATE / ENGINEER**

Test Date	November 11, 2023	Test By	Johnson Liu
-----------	-------------------	---------	-------------

**TEST RESULTS**

Please refer to section "Test Data" - Appendix D

## 7.4. CONDUCTED BAND EDGE AND SPURIOUS EMISSION

### LIMITS

CFR 47 FCC Part15 (15.247) Subpart C ISED RSS-247 ISSUE 3		
Section	Test Item	Limit
CFR 47 FCC §15.247 (d) ISED RSS-247 5.5	Conducted Bandedge and Spurious Emissions	at least 30 dB below that in the 100 kHz bandwidth within the band that contains the highest level of the desired power

### TEST PROCEDURE

Refer to ANSI C63.10-2013 clause 11.11 and 11.13.

Connect the EUT to the spectrum analyzer and use the following settings for reference level measurement:

Center Frequency	The center frequency of the channel under test
Detector	Peak
RBW	100 kHz
VBW	$\geq 3 \times \text{RBW}$
Span	1.5 x DTS bandwidth
Trace	Max hold
Sweep time	Auto couple.

Allow trace to fully stabilize and use the peak marker function to determine the maximum PSD level.

Change the settings for emission level measurement:

Span	Set the center frequency and span to encompass frequency range to be measured
Detector	Peak
RBW	100 kHz
VBW	$\geq 3 \times \text{RBW}$
measurement points	$\geq \text{span}/\text{RBW}$
Trace	Max hold
Sweep time	Auto couple.

Allow trace to fully stabilize and use the peak marker function to determine the maximum PSD level. Ensure that the amplitude of all unwanted emissions outside of the authorized frequency band (excluding restricted frequency bands) is attenuated by at least the minimum requirements specified in 11.11.

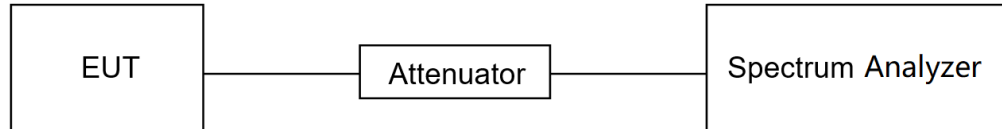
**TEST SETUP****TEST ENVIRONMENT**

Temperature	24.3°C	Relative Humidity	62.7%
Atmosphere Pressure	101kPa	Test Voltage	DC 5 V

**TEST DATE / ENGINEER**

Test Date	November 11, 2023	Test By	Johnson Liu
-----------	-------------------	---------	-------------

**TEST RESULTS**

Please refer to section "Test Data" - Appendix E&F

## 7.5. DUTY CYCLE

### LIMITS

None; for reporting purposes only.

### TEST PROCEDURE

Refer to ANSI C63.10-2013 clause 11.6 Zero – Span Spectrum Analyzer method.

### TEST SETUP

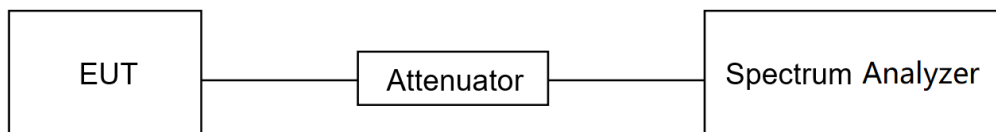

### TEST ENVIRONMENT

Temperature	24.3°C	Relative Humidity	62.7%
Atmosphere Pressure	101kPa	Test Voltage	DC 5 V

### TEST DATE / ENGINEER

Test Date	November 11, 2023	Test By	Johnson Liu
-----------	-------------------	---------	-------------

### TEST RESULTS

Please refer to section "Test Data" - Appendix G



## 8. RADIATED TEST RESULTS

### LIMITS

Please refer to CFR 47 FCC §15.205 and §15.209.

Please refer to ISED RSS-GEN Clause 8.9 and Clause 8.10.

Radiation Disturbance Test Limit for FCC (Class B) (9 kHz ~ 1 GHz)

Emissions radiated outside of the specified frequency bands above 30 MHz			
Frequency Range (MHz)	Field Strength Limit (uV/m) at 3 m	Field Strength Limit (dBuV/m) at 3 m	
		Quasi-Peak	
30 - 88	100	40	
88 - 216	150	43.5	
216 - 960	200	46	
Above 960	500	54	
Above 1000	500	Peak	Average
		74	54

FCC Emissions radiated outside of the specified frequency bands below 30 MHz		
Frequency (MHz)	Field strength (microvolts/meter)	Measurement distance (meters)
0.009-0.490	2400/F(kHz)	300
0.490-1.705	24000/F(kHz)	30
1.705-30.0	30	30

ISED General field strength limits at frequencies below 30 MHz

Table 6 – General field strength limits at frequencies below 30 MHz		
Frequency	Magnetic field strength (H-Field) (uA/m)	Measurement distance (m)
9 - 490 kHz <sup>Note 1</sup>	6.37/F (F in kHz)	300
490 - 1705 kHz	63.7/F (F in kHz)	30
1.705 - 30 MHz	0.08	30

**Note 1:** The emission limits for the ranges 9-90 kHz and 110-490 kHz are based on measurements employing a linear average detector.

ISED Restricted bands please refer to ISED RSS-GEN Clause 8.10

Table 7 – Restricted frequency bands <sup>Note 1</sup>		
MHz	MHz	GHz
0.090 - 0.110	149.9 - 150.05	9.0 - 9.2
0.495 - 0.505	156.52475 - 156.52525	9.3 - 9.5
2.1735 - 2.1905	156.7 - 156.9	10.6 - 12.7
3.020 - 3.026	162.0125 - 167.17	13.25 - 13.4
4.125 - 4.128	167.72 - 173.2	14.47 - 14.5
4.17725 - 4.17775	240 - 285	15.35 - 16.2
4.20725 - 4.20775	322 - 335.4	17.7 - 21.4
5.677 - 5.683	399.9 - 410	22.01 - 23.12
6.215 - 6.218	608 - 614	23.6 - 24.0
6.26775 - 6.26825	960 - 1427	31.2 - 31.8
6.31175 - 6.31225	1435 - 1626.5	36.43 - 36.5
8.291 - 8.294	1645.5 - 1646.5	Above 38.6
8.362 - 8.366	1660 - 1710	
8.37625 - 8.38675	1718.8 - 1722.2	
8.41425 - 8.41475	2200 - 2300	
12.29 - 12.293	2310 - 2390	
12.51975 - 12.52025	2483.5 - 2500	
12.57675 - 12.57725	2655 - 2900	
13.36 - 13.41	3260 - 3267	
16.42 - 16.423	3332 - 3339	
16.69475 - 16.69525	3345.8 - 3358	
16.80425 - 16.80475	3500 - 4400	
25.5 - 25.67	4500 - 5150	
37.5 - 38.25	5350 - 5460	
73 - 74.6	7250 - 7750	
74.8 - 75.2	8025 - 8500	
108 - 138		

**Note 1:** Certain frequency bands listed in table 7 and in bands above 38.6 GHz are designated for licence-exempt applications. These frequency bands and the requirements that apply to related devices are set out in the 200 and 300 series of RSSs.

FCC Restricted bands of operation refer to FCC §15.205 (a):

MHz	MHz	MHz	GHz
0.090-0.110	16.42-16.423	399.9-410	4.5-5.15
<sup>1</sup> 0.495-0.505	16.69475-16.69525	608-614	5.35-5.46
2.1735-2.1905	16.80425-16.80475	960-1240	7.25-7.75
4.125-4.128	25.5-25.67	1300-1427	8.025-8.5
4.17725-4.17775	37.5-38.25	1435-1626.5	9.0-9.2
4.20725-4.20775	73-74.6	1645.5-1646.5	9.3-9.5
6.215-6.218	74.8-75.2	1660-1710	10.6-12.7
6.26775-6.26825	108-121.94	1718.8-1722.2	13.25-13.4
6.31175-6.31225	123-138	2200-2300	14.47-14.5
8.291-8.294	149.9-150.05	2310-2390	15.35-16.2
8.362-8.366	156.52475-156.52525	2483.5-2500	17.7-21.4
8.37625-8.38675	156.7-156.9	2690-2900	22.01-23.12
8.41425-8.41475	162.0125-167.17	3260-3267	23.6-24.0
12.29-12.293	167.72-173.2	3332-3339	31.2-31.8
12.51975-12.52025	240-285	3345.8-3358	36.43-36.5
12.57675-12.57725	322-335.4	3600-4400	( <sup>2</sup> )
13.36-13.41			

Note: <sup>1</sup>Until February 1, 1999, this restricted band shall be 0.490-0.510 MHz.

<sup>2</sup>Above 38.6c

**TEST PROCEDURE**

Below 30 MHz

The setting of the spectrum analyzer

RBW	200 Hz (From 9 kHz to 0.15 MHz)/ 9 kHz (From 0.15 MHz to 30 MHz)
VBW	200 Hz (From 9 kHz to 0.15 MHz)/ 9 kHz (From 0.15 MHz to 30 MHz)
Sweep	Auto

1. The testing follows the guidelines in ANSI C63.10-2013 clause 6.4.
2. The EUT was arranged to its worst case and then turntable (from 0 degree to 360 degrees) to find the maximum reading. A pre-amp and a high pass filter are used for the test in order to get better signal level. Both Horizontal, Face-on and Face-off polarizations of the antenna are set to make the measurement.
3. The EUT was placed on a turntable with 80 cm above ground.
4. The EUT was set 3 meters from the interference receiving antenna, which was mounted on the top of a 1 m height antenna tower.
5. The radiated emission limits are based on measurements employing a CISPR quasi-peak detector except for the frequency bands 9-90 kHz, 110-490 kHz and above 1000 MHz Radiated emission limits in these three bands are based on measurements employing an average detector.
6. For measurement below 1 GHz, the initial step in collecting conducted emission data is a spectrum analyzer peak detector mode pre-scanning the measurement frequency range. Significant peaks are then marked and then Quasi Peak and average detector mode re-measured. If the emission level of the EUT measured by the peak detector is 3 dB lower than the applicable limit, the peak emission level will be reported. Otherwise, the emission measurement will be repeated using the quasi-peak and average detector and reported.
7. Although these tests were performed other than open field site, adequate comparison measurements were confirmed against 30m open field site. Therefore sufficient tests were made to demonstrate that the alternative site produces results that correlate with the ones of tests made in an open field site based on KDB 414788.
8. The limits in CFR 47, Part 15, Subpart C, paragraph 15.209 (a), are identical to those in RSS-GEN Section 8.9, Table 6, since the measurements are performed in terms of magnetic field strength and converted to electric field strength levels (as reported in the table) using the free space impedance of 377Ω. For example, the measurement frequency X kHz resulted in a level of Y dBuV/m, which is equivalent to  $Y-51.5 = Z$  dBuA/m, which has the same margin, W dB, to the corresponding RSS-GEN Table 6 limit as it has to be 15.209(a) limit.

Below 1 GHz and above 30 MHz

The setting of the spectrum analyzer

RBW	120 kHz
VBW	300 kHz
Sweep	Auto
Detector	Peak/QP
Trace	Max hold

1. The testing follows the guidelines in ANSI C63.10-2013 clause 6.5.
2. The EUT was arranged to its worst case and then tune the antenna tower (from 1 m to 4 m) and turntable (from 0 degree to 360 degrees) to find the maximum reading. A pre-amp and a high pass filter are used for the test in order to get better signal level. Both horizontal and vertical polarizations of the antenna are set to make the measurement.
3. The EUT was placed on a turntable with 80 cm above ground.
4. The EUT was set 3 meters from the interference receiving antenna, which was mounted on the top of a variable height antenna tower.
5. For measurement below 1 GHz, the initial step in collecting conducted emission data is a spectrum analyzer peak detector mode pre-scanning the measurement frequency range. Significant peaks are then marked and then Quasi Peak detector mode re-measured. If the emission level of the EUT measured by the peak detector is 3 dB lower than the applicable limit, the peak emission level will be reported. Otherwise, the emission measurement will be repeated using the quasi-peak detector and reported.

Above 1 GHz

The setting of the spectrum analyzer

RBW	1 MHz
VBW	PEAK: 3 MHz AVG: see note 6
Sweep	Auto
Detector	Peak
Trace	Max hold

1. The testing follows the guidelines in ANSI C63.10-2013 clause 6.6.
2. The EUT was arranged to its worst case and then tune the antenna tower (from 1 m to 4 m) and turntable (from 0 degree to 360 degrees) to find the maximum reading. A pre-amp and a high pass filter are used for the test in order to get better signal level. Both horizontal and vertical polarizations of the antenna are set to make the measurement.
3. The EUT was placed on a turntable with 1.5 m above ground.
4. The EUT was set 3 meters from the interference receiving antenna, which was mounted on the top of a variable height antenna tower.
5. For measurement above 1 GHz, the emission measurement will be measured by the peak detector. This peak level, once corrected, must comply with the limit specified in Section 15.209.
6. For measurements above 1 GHz the resolution bandwidth is set to 1 MHz, then the video bandwidth is set to 3 MHz for peak measurements and 1 MHz resolution bandwidth with 1/T video bandwidth with peak detector for average measurements. For the Duty Cycle please refer to clause 7.5. ON TIME AND DUTY CYCLE.

X axis, Y axis, Z axis positions:

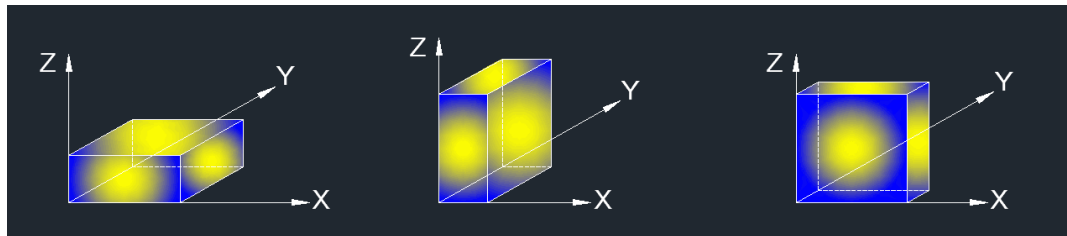

Note 1: For all radiated test, EUT in each of three orthogonal axis emissions had been tested, but only the worst case (X axis) data recorded in the report.

For Restricted Bandedge:

Note:

1. Measurement = Reading Level + Correct Factor.
2. If the peak values are less than the average limit of 54 dBuV/m, the average result is deemed to comply with average limit.
3. PK=Peak: Peak detector.
4. AV=Average: VBW=1/Ton, where: Ton is the transmitting duration.
5. For the transmitting duration, please refer to clause 7.5.
6. Only the worst data was recorded, if it complies with the limit, the other emissions deemed to comply with the limit.
7. Both horizontal and vertical have been tested, only the worst data was recorded in the report.
8. All modes have been tested, but only the worst data was recorded in the report.

For Radiate Spurious emission (9 kHz ~ 30 MHz):

Note:

1. Measurement = Reading Level + Correct Factor.
2. If the peak values are less than the QP limit, the QP result is deemed to comply with QP limit.
3. All 3 polarizations (Horizontal, Face-on and Face-off) of the loop antenna had been tested, but only the worst data recorded in the report.
4. All modes have been tested, but only the worst data was recorded in the report.
5.  $\text{dBuA/m} = \text{dBuV/m} - 20\text{Log}_{10}[120\pi] = \text{dBuV/m} - 51.5$

For Radiate Spurious Emission (30 MHz ~ 1 GHz):

Note:

1. Result Level = Read Level + Correct Factor.
2. If the peak values are less than the QP limit, the QP result is deemed to comply with QP limit.
3. All modes have been tested, but only the worst data was recorded in the report.

For Radiate Spurious Emission (1 GHz ~ 3 GHz):

Note:

1. Measurement = Reading Level + Correct Factor.
2. If the peak values are less than the average limit of 54 dBuV/m, the average result is deemed to comply with average limit.
3. Peak: Peak detector.
4. AVG: VBW=1/Ton, where: Ton is the transmitting duration.
5. For the transmitting duration, please refer to clause 7.5.
6. Filter losses were only considered in the spurious frequency bands and the authorized band was not corrected for Band reject filter losses.
7. Proper operation of the transmitter prior to adding the filter to the measurement chain.
8. All modes have been tested, but only the worst data was recorded in the report.

For Radiate Spurious Emission (3 GHz ~ 18 GHz):

Note:

1. Peak Result = Reading Level + Correct Factor.
2. If the peak values are less than the average limit of 54 dBuV/m, the average result is deemed to comply with average limit.
3. Peak: Peak detector.
4. AVG:  $VBW=1/T_{on}$ , where:  $T_{on}$  is the transmitting duration.
5. For the transmitting duration, please refer to clause 7.5.
6. Filter losses were only considered in the spurious frequency bands and the authorized band was not corrected for High Pass Filter losses.
7. Proper operation of the transmitter prior to adding the filter to the measurement chain.
8. All modes have been tested, but only the worst data was recorded in the report.

For Radiate Spurious emission (18 GHz ~ 26 GHz):

Note:

1. Measurement = Reading Level + Correct Factor.
2. If the peak values are less than the average limit of 54 dBuV/m, the average result is deemed to comply with average limit.
3. Peak: Peak detector.
4. All modes have been tested, but only the worst data was recorded in the report.

### TEST SETUP

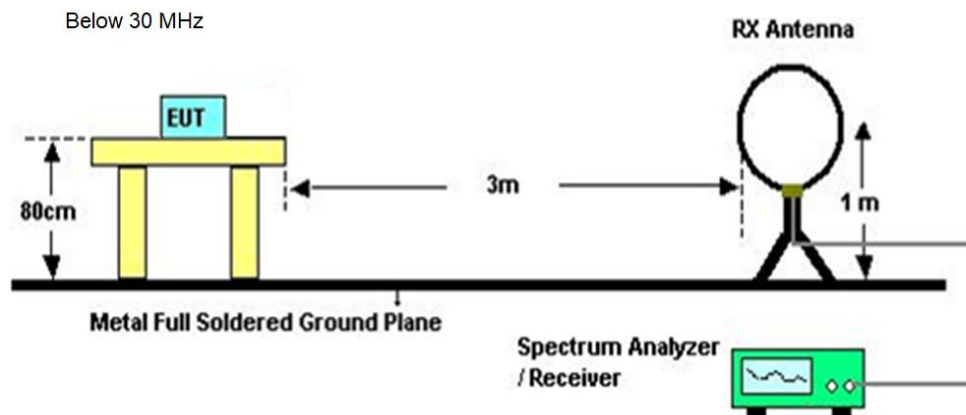

Below 1 GHz and above 30 MHz

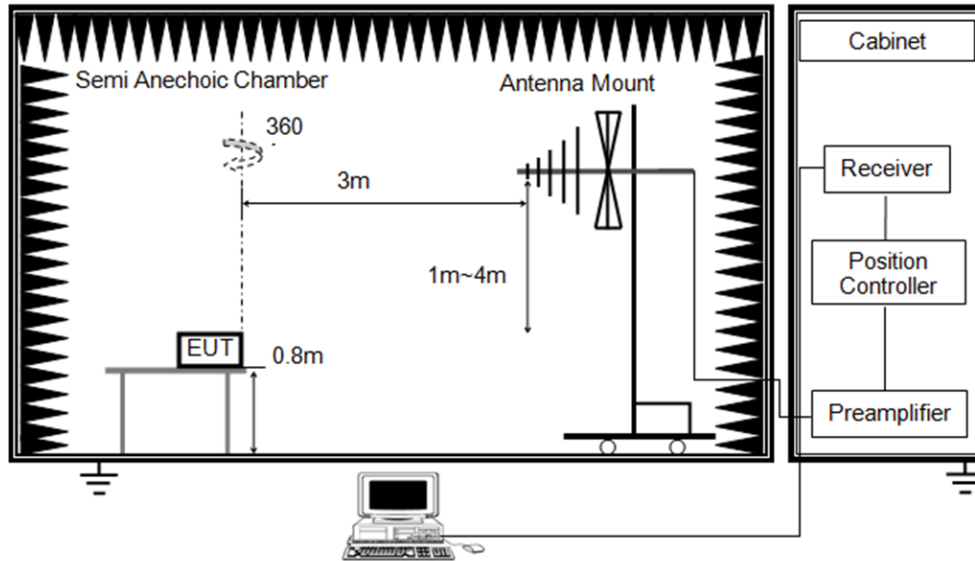

Above 1 GHz

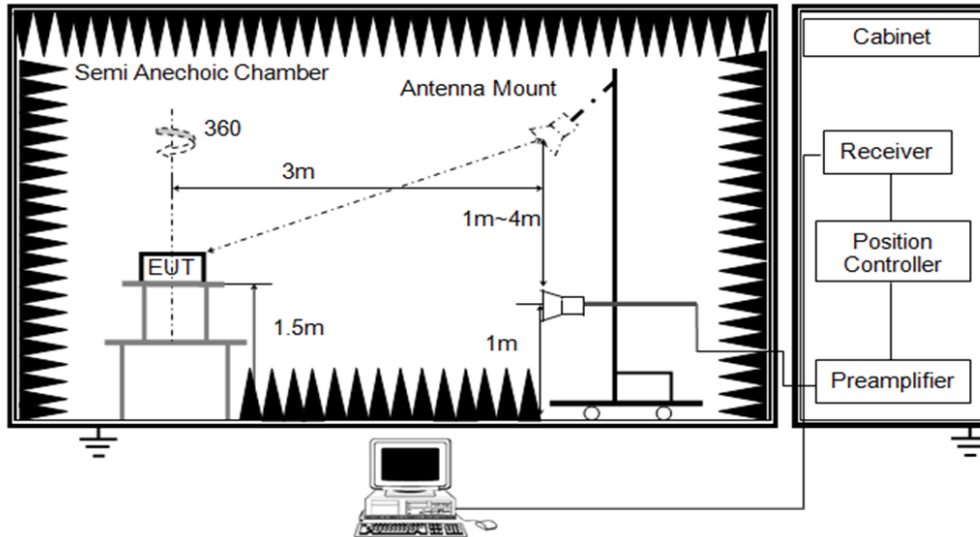

**TEST ENVIRONMENT**

Temperature	25.1°C	Relative Humidity	62%
Atmosphere Pressure	101kPa	Test Voltage	DC 5 V

**TEST DATE / ENGINEER**

Test Date	November 20, 2023	Test By	Rex Huang
-----------	-------------------	---------	-----------

**TEST RESULTS**



## 8.1. RESTRICTED BANDEDGE

Test Mode:	802.11b PK	Frequency(MHz):	2412
Polarity:	Horizontal	Test Voltage:	DC 5 V

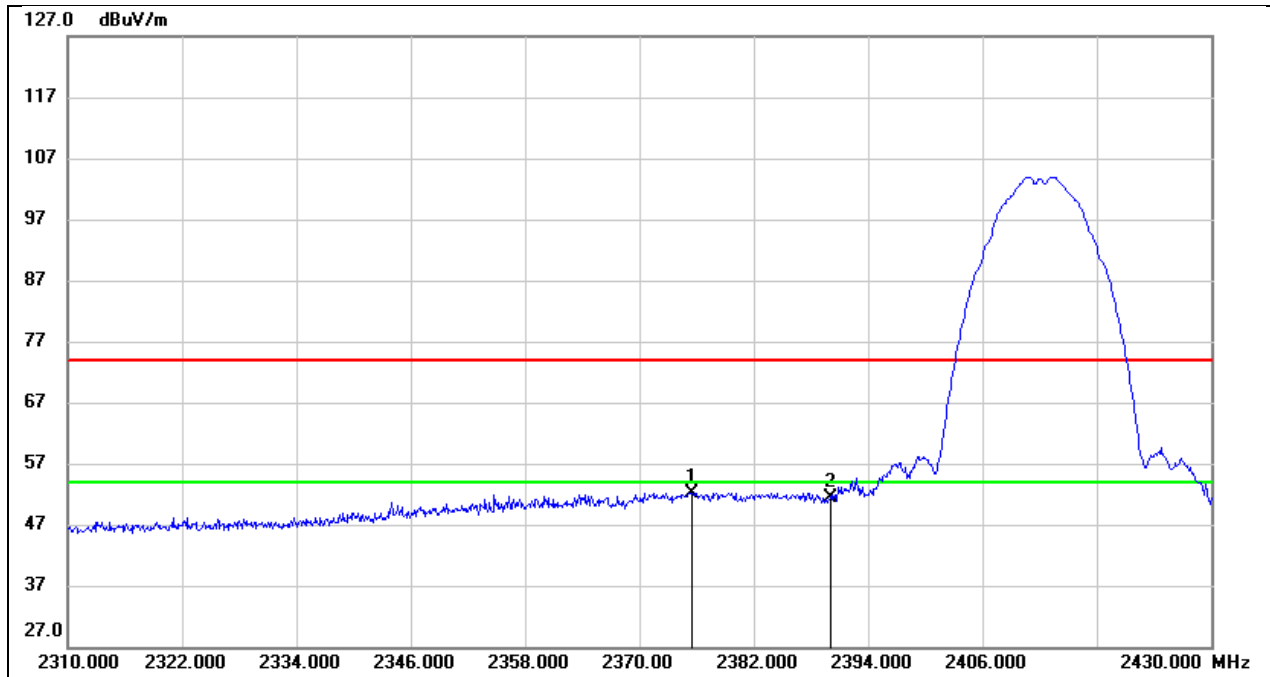

No.	Frequency (MHz)	Reading (dBuV)	Correct (dB/m)	Result (dBuV/m)	Limit (dBuV/m)	Margin (dB)	Remark
1	2375.520	20.11	32.12	52.23	74.00	-21.77	peak
2	2390.000	19.29	32.16	51.45	74.00	-22.55	peak

Test Mode:	802.11b PK	Frequency(MHz):	2412
Polarity:	Vertical	Test Voltage:	DC 5 V

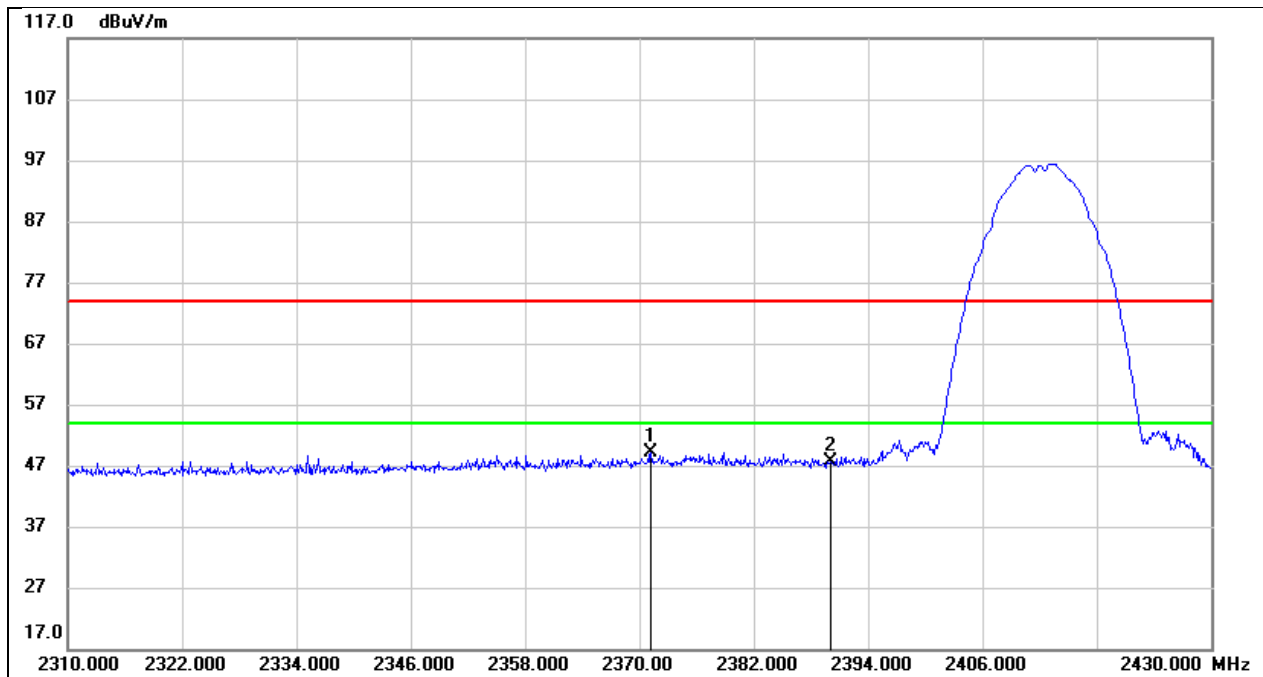

No.	Frequency (MHz)	Reading (dBuV)	Correct (dB/m)	Result (dBuV/m)	Limit (dBuV/m)	Margin (dB)	Remark
1	2371.200	17.10	32.11	49.21	74.00	-24.79	peak
2	2390.000	15.59	32.16	47.75	74.00	-26.25	peak

Test Mode:	802.11b PK	Frequency(MHz):	2462
Polarity:	Horizontal	Test Voltage:	DC 5 V

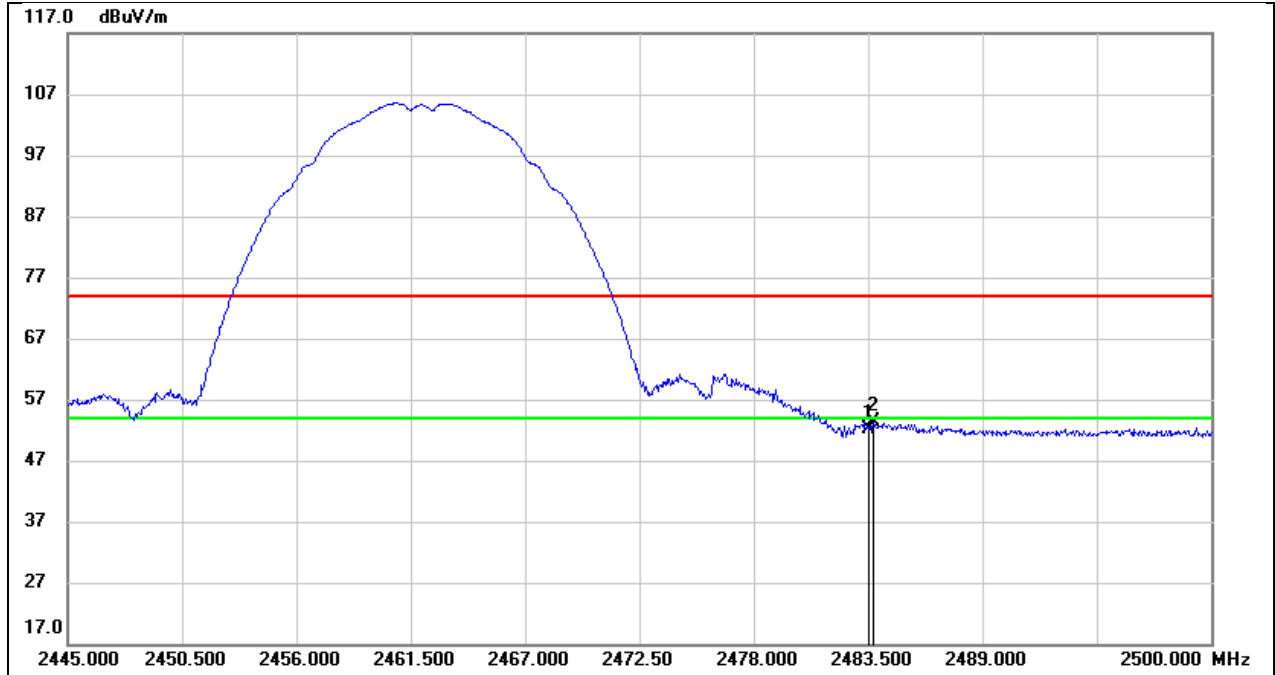

No.	Frequency (MHz)	Reading (dBuV)	Correct (dB/m)	Result (dBuV/m)	Limit (dBuV/m)	Margin (dB)	Remark
1	2483.500	19.58	32.44	52.02	74.00	-21.98	peak
2	2483.775	20.99	32.44	53.43	74.00	-20.57	peak

Test Mode:	802.11b AV	Frequency(MHz):	2462
Polarity:	Horizontal	Test Voltage:	DC 5 V

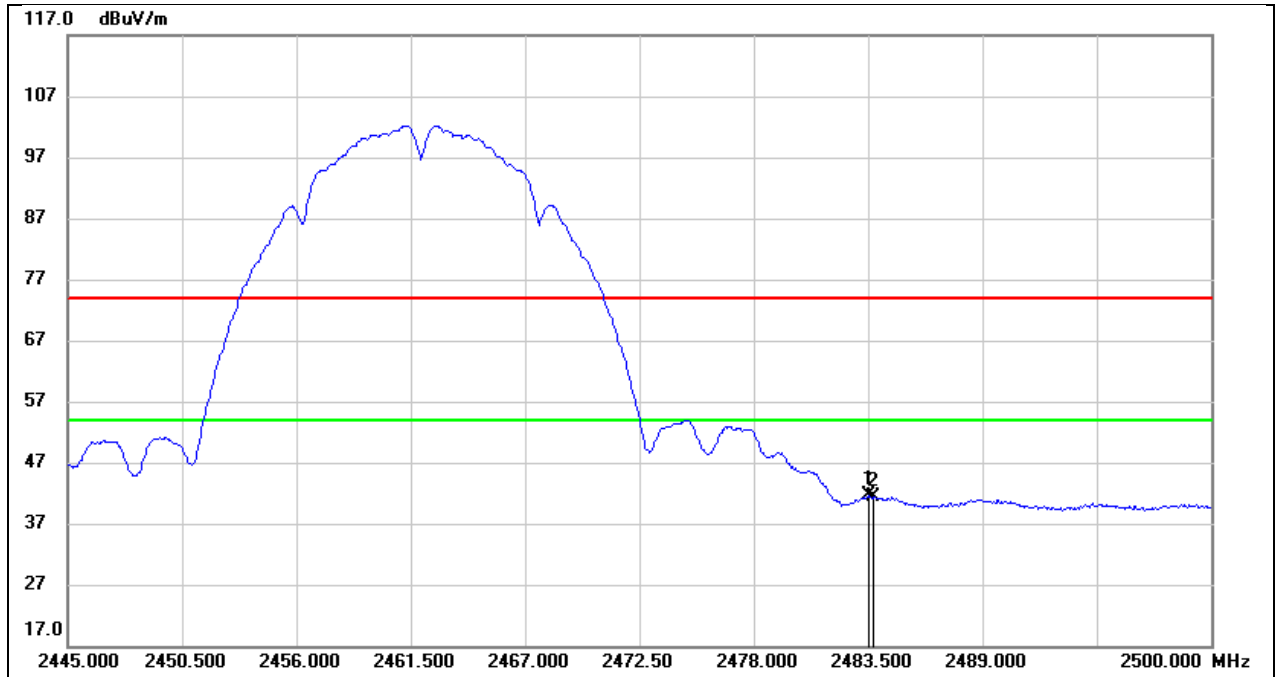

No.	Frequency (MHz)	Reading (dBuV)	Correct (dB/m)	Result (dBuV/m)	Limit (dBuV/m)	Margin (dB)	Remark
1	2483.500	9.11	32.44	41.55	54.00	-12.45	AVG
2	2483.775	8.87	32.44	41.31	54.00	-12.69	AVG

Test Mode:	802.11g PK	Frequency(MHz):	2412
Polarity:	Horizontal	Test Voltage:	DC 5 V

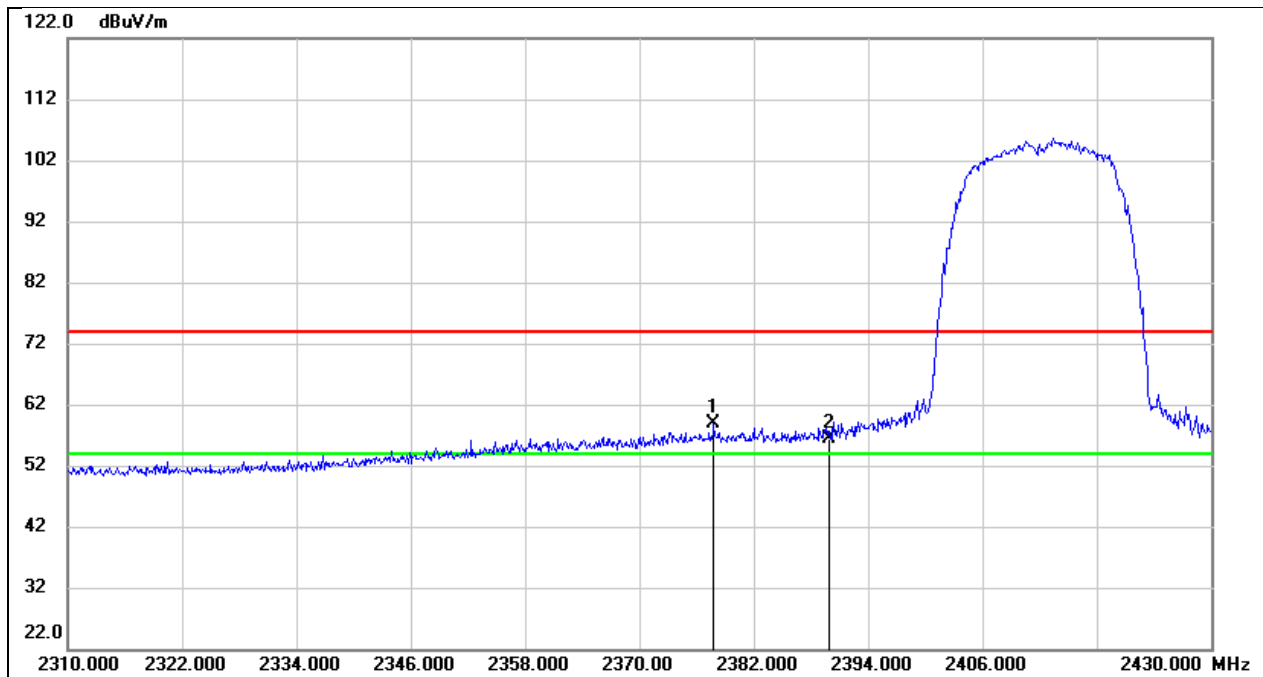

No.	Frequency (MHz)	Reading (dBuV)	Correct (dB/m)	Result (dBuV/m)	Limit (dBuV/m)	Margin (dB)	Remark
1	2377.800	26.76	32.12	58.88	74.00	-15.12	peak
2	2390.000	24.18	32.16	56.34	74.00	-17.66	peak

Test Mode:	802.11g AV	Frequency(MHz):	2412
Polarity:	Horizontal	Test Voltage:	DC 5 V

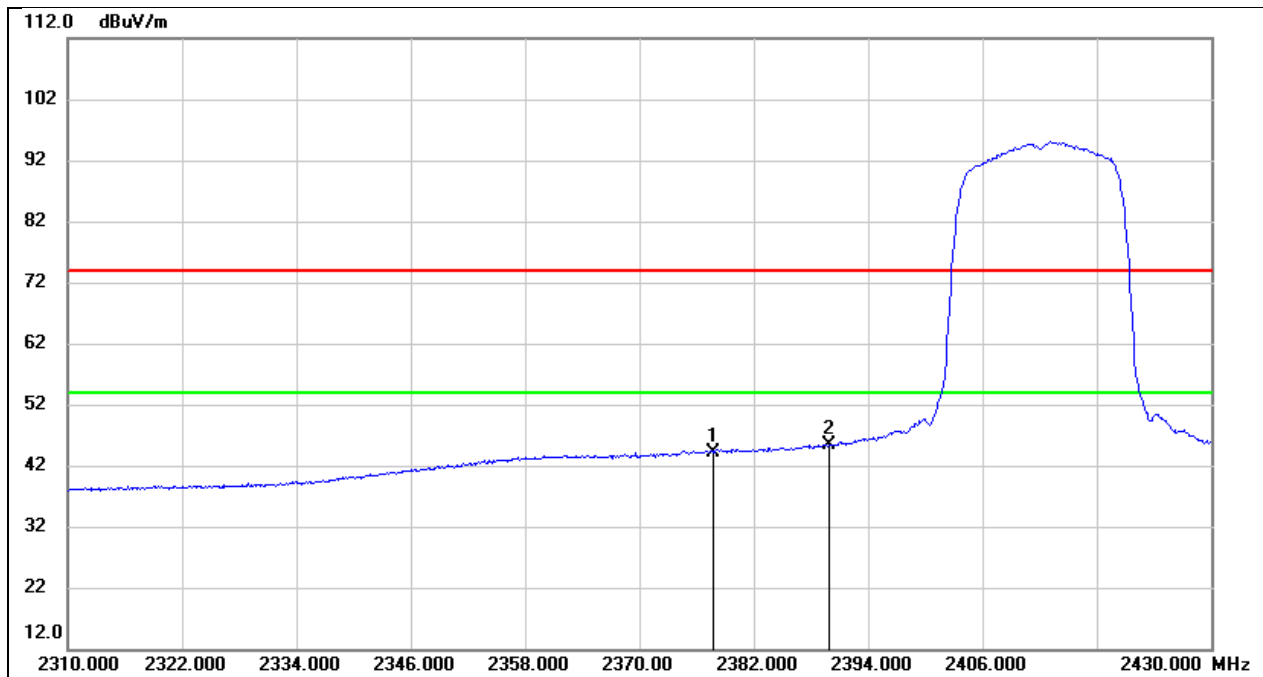

No.	Frequency (MHz)	Reading (dBuV)	Correct (dB/m)	Result (dBuV/m)	Limit (dBuV/m)	Margin (dB)	Remark
1	2377.800	12.10	32.12	44.22	54.00	-9.78	AVG
2	2390.000	13.14	32.16	45.30	54.00	-8.70	AVG

Test Mode:	802.11g PK	Frequency(MHz):	2462
Polarity:	Horizontal	Test Voltage:	DC 5 V

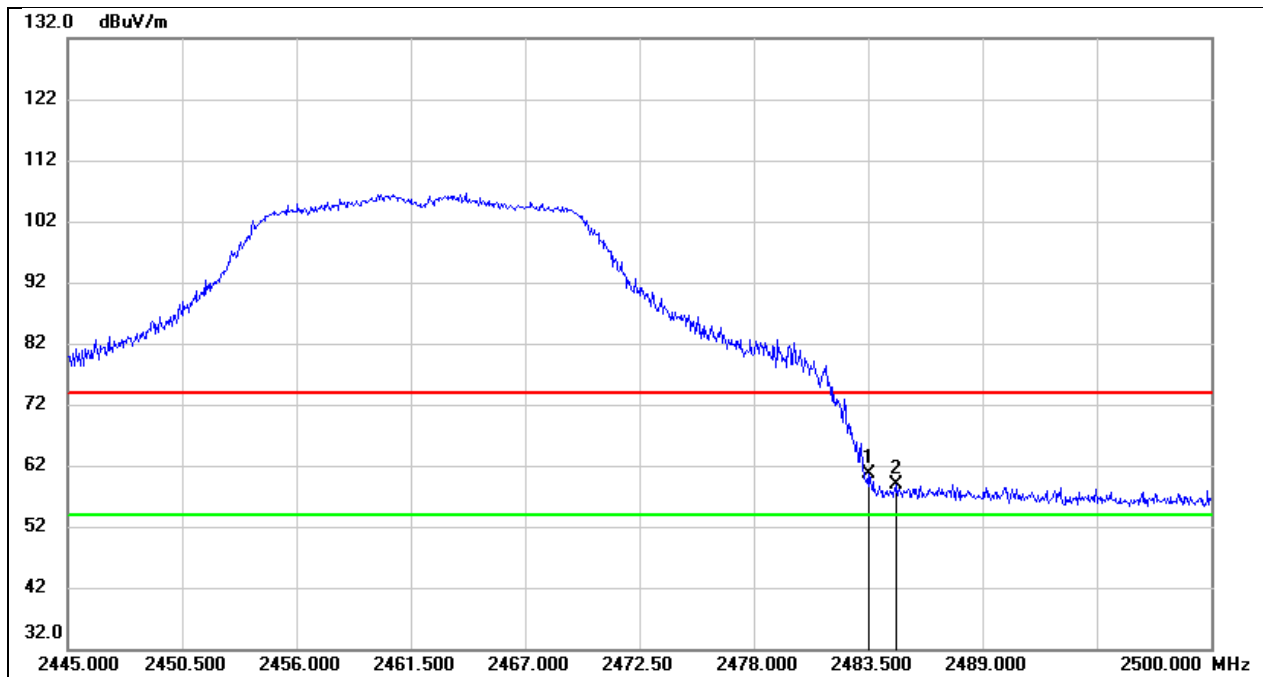

No.	Frequency (MHz)	Reading (dBuV)	Correct (dB/m)	Result (dBuV/m)	Limit (dBuV/m)	Margin (dB)	Remark
1	2483.500	28.07	32.44	60.51	74.00	-13.49	peak
2	2484.875	26.56	32.44	59.00	74.00	-15.00	peak

Test Mode:	802.11g AV	Frequency(MHz):	2462
Polarity:	Horizontal	Test Voltage:	DC 5 V

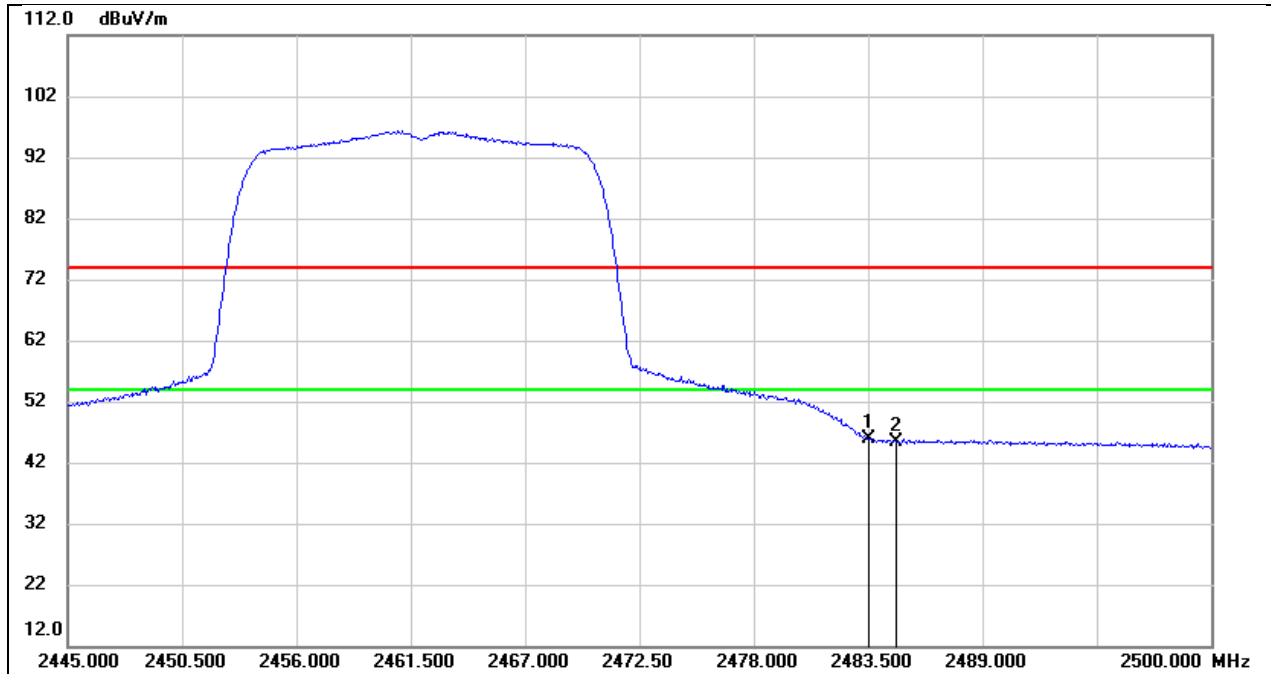

No.	Frequency (MHz)	Reading (dBuV)	Correct (dB/m)	Result (dBuV/m)	Limit (dBuV/m)	Margin (dB)	Remark
1	2483.500	13.42	32.44	45.86	54.00	-8.14	AVG
2	2484.875	13.02	32.44	45.46	54.00	-8.54	AVG



Test Mode:	802.11n HT20 PK	Frequency(MHz):	2412
Polarity:	Horizontal	Test Voltage:	DC 5 V

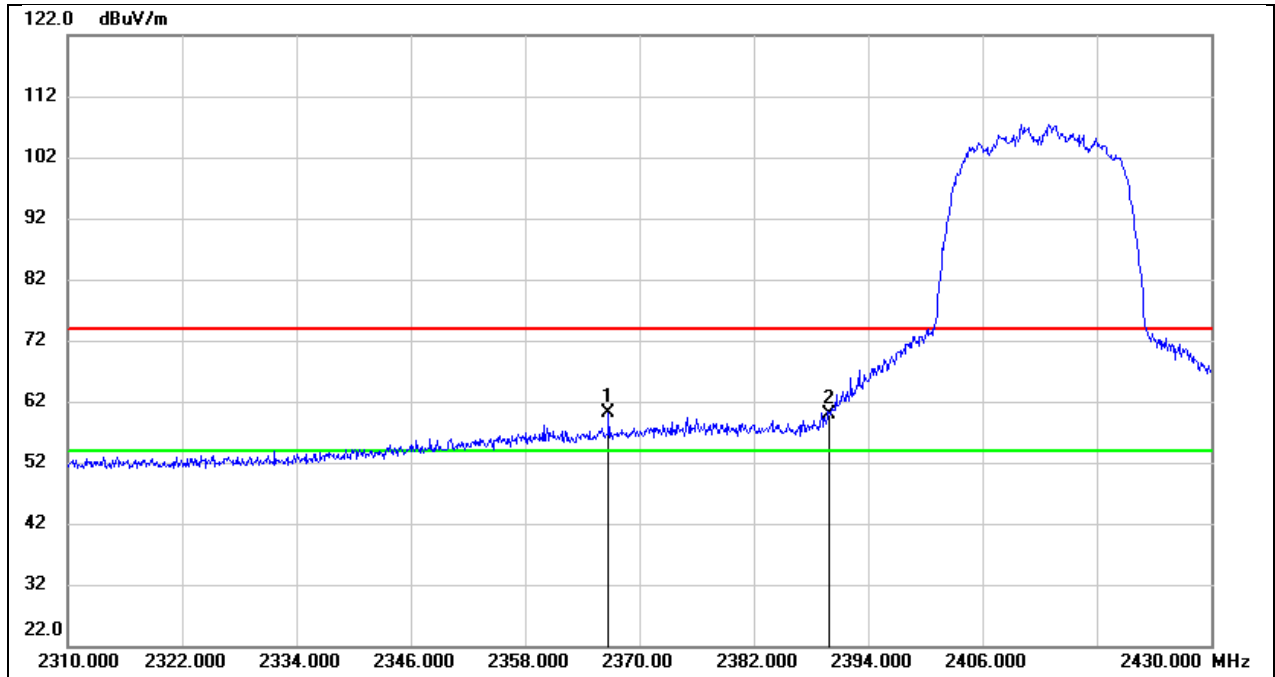

No.	Frequency (MHz)	Reading (dBuV)	Correct (dB/m)	Result (dBuV/m)	Limit (dBuV/m)	Margin (dB)	Remark
1	2366.760	28.05	32.09	60.14	74.00	-13.86	peak
2	2390.000	27.82	32.16	59.98	74.00	-14.02	peak

Test Mode:	802.11n HT20 AV	Frequency(MHz):	2412
Polarity:	Horizontal	Test Voltage:	DC 5 V

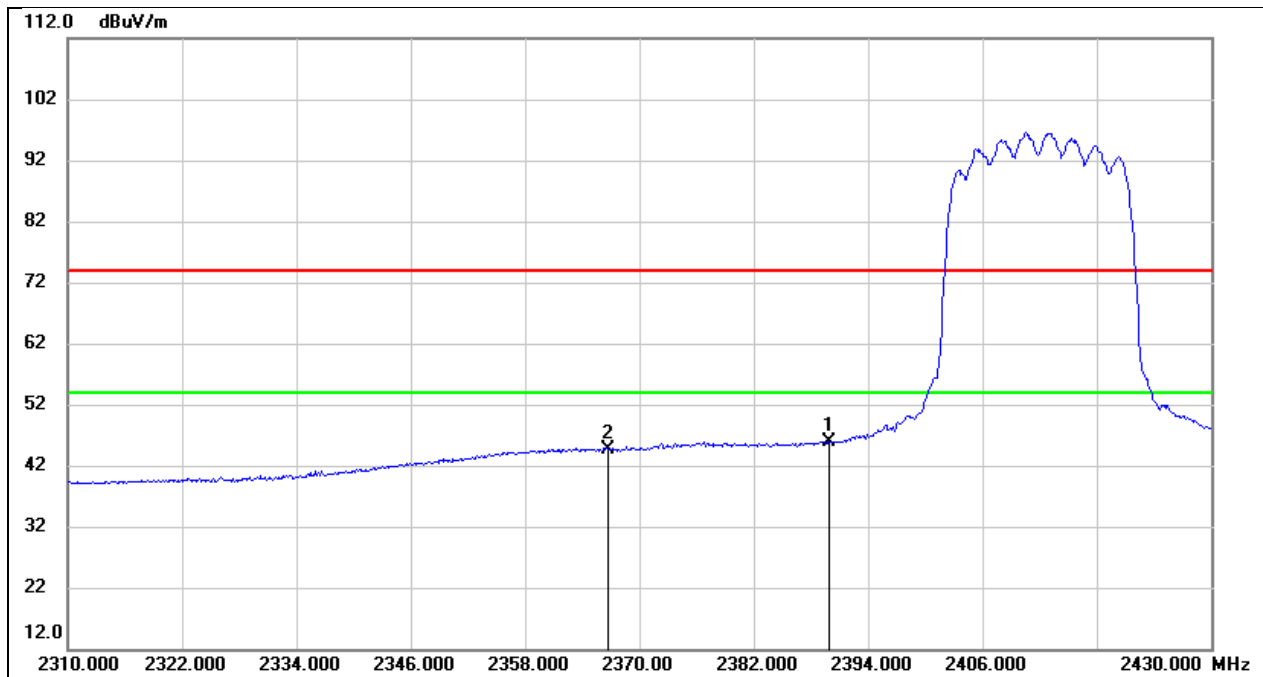

No.	Frequency (MHz)	Reading (dBuV)	Correct (dB/m)	Result (dBuV/m)	Limit (dBuV/m)	Margin (dB)	Remark
1	2390.000	13.62	32.16	45.78	54.00	-8.22	AVG
2	2366.760	12.52	32.09	44.61	54.00	-9.39	AVG

Test Mode:	802.11n HT20 PK	Frequency(MHz):	2462
Polarity:	Horizontal	Test Voltage:	DC 5 V

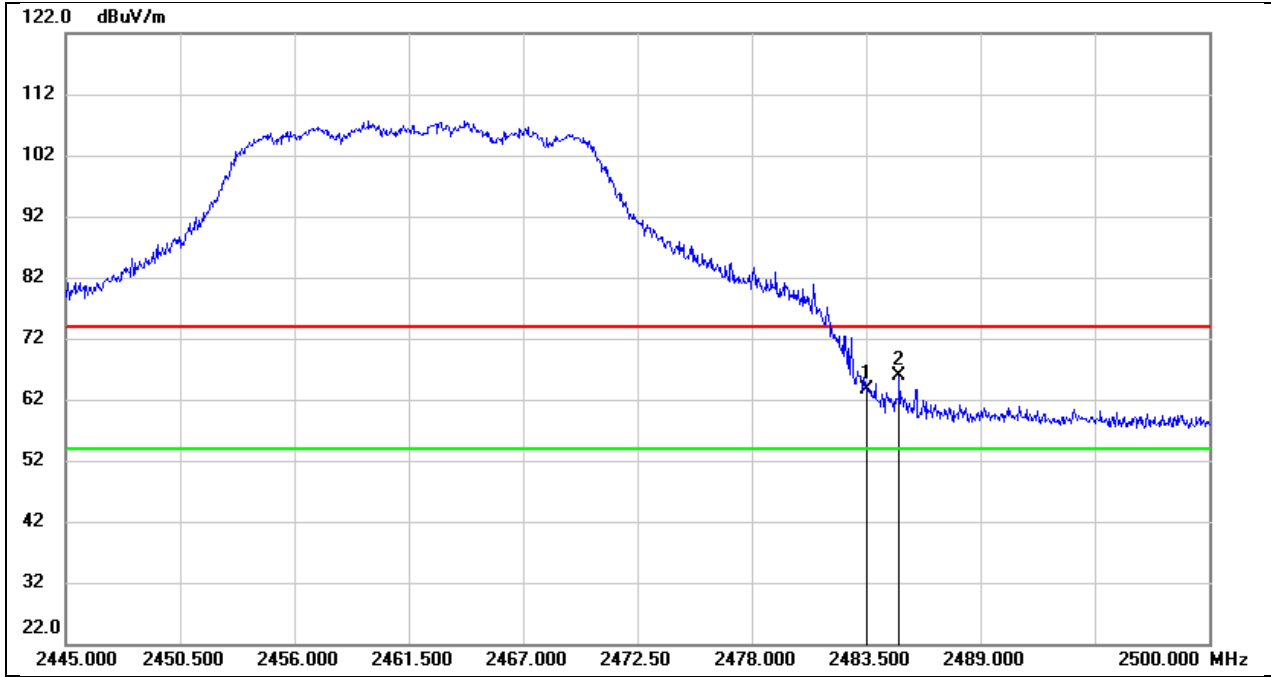

No.	Frequency (MHz)	Reading (dBuV)	Correct (dB/m)	Result (dBuV/m)	Limit (dBuV/m)	Margin (dB)	Remark
1	2483.500	31.13	32.44	63.57	74.00	-10.43	peak
2	2485.095	33.47	32.44	65.91	74.00	-8.09	peak

Test Mode:	802.11n HT20 AV	Frequency(MHz):	2462
Polarity:	Horizontal	Test Voltage:	DC 5 V

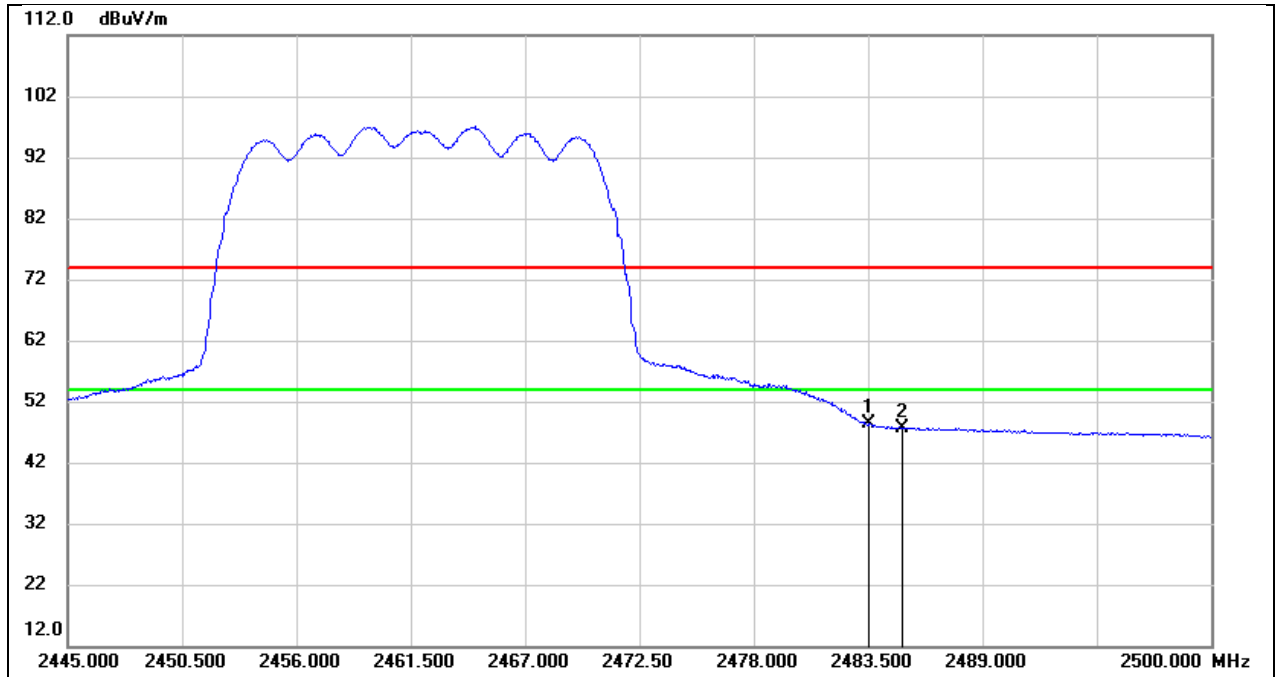

No.	Frequency (MHz)	Reading (dBuV)	Correct (dB/m)	Result (dBuV/m)	Limit (dBuV/m)	Margin (dB)	Remark
1	2483.500	15.92	32.44	48.36	54.00	-5.64	AVG
2	2485.095	15.26	32.44	47.70	54.00	-6.30	AVG

Test Mode:	802.11n HT40 PK	Frequency(MHz):	2422
Polarity:	Horizontal	Test Voltage:	DC 5 V

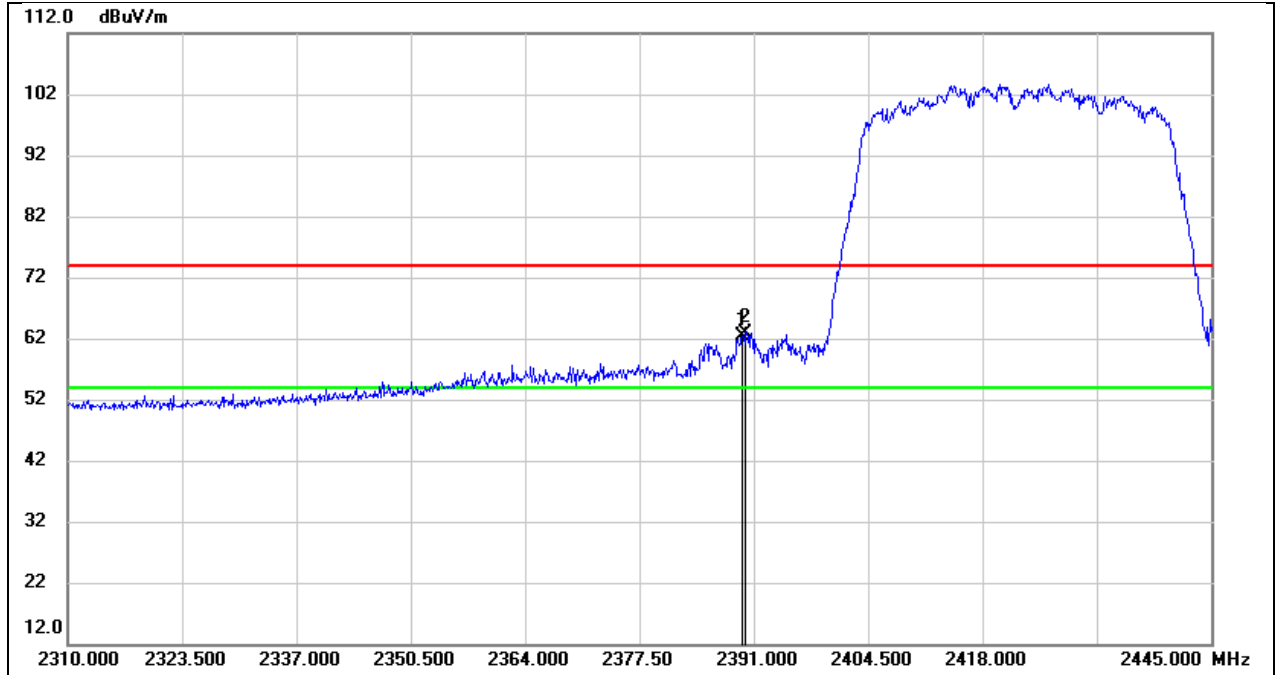

No.	Frequency (MHz)	Reading (dBuV)	Correct (dB/m)	Result (dBuV/m)	Limit (dBuV/m)	Margin (dB)	Remark
1	2389.650	30.34	32.16	62.50	74.00	-11.50	peak
2	2390.000	30.60	32.16	62.76	74.00	-11.24	peak

Test Mode:	802.11n HT40 AV	Frequency(MHz):	2422
Polarity:	Horizontal	Test Voltage:	DC 5 V

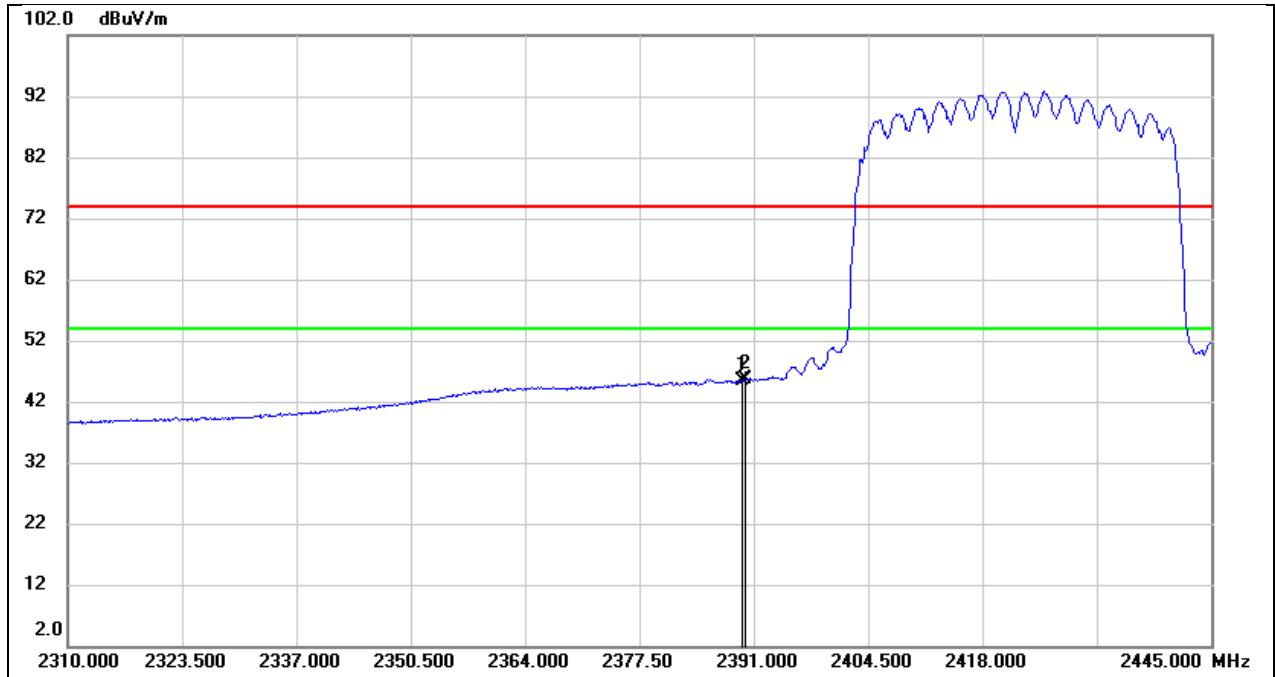

No.	Frequency (MHz)	Reading (dBuV)	Correct (dB/m)	Result (dBuV/m)	Limit (dBuV/m)	Margin (dB)	Remark
1	2389.650	13.32	32.16	45.48	54.00	-8.52	AVG
2	2390.000	13.53	32.16	45.69	54.00	-8.31	AVG

Test Mode:	802.11n HT40 PK	Frequency(MHz):	2452
Polarity:	Horizontal	Test Voltage:	DC 5 V

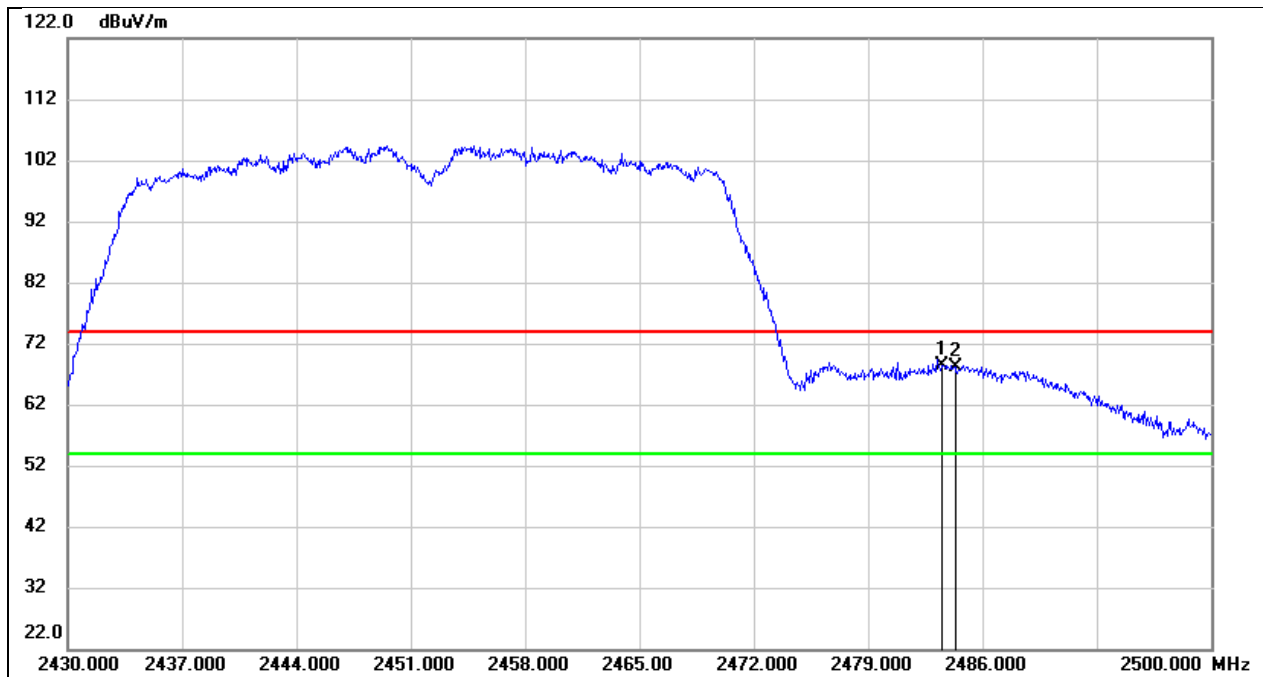

No.	Frequency (MHz)	Reading (dBuV)	Correct (dB/m)	Result (dBuV/m)	Limit (dBuV/m)	Margin (dB)	Remark
1	2483.500	36.02	32.44	68.46	74.00	-5.54	peak
2	2484.320	35.60	32.44	68.04	74.00	-5.96	peak

Test Mode:	802.11n HT40 AV	Frequency(MHz):	2452
Polarity:	Horizontal	Test Voltage:	DC 5 V

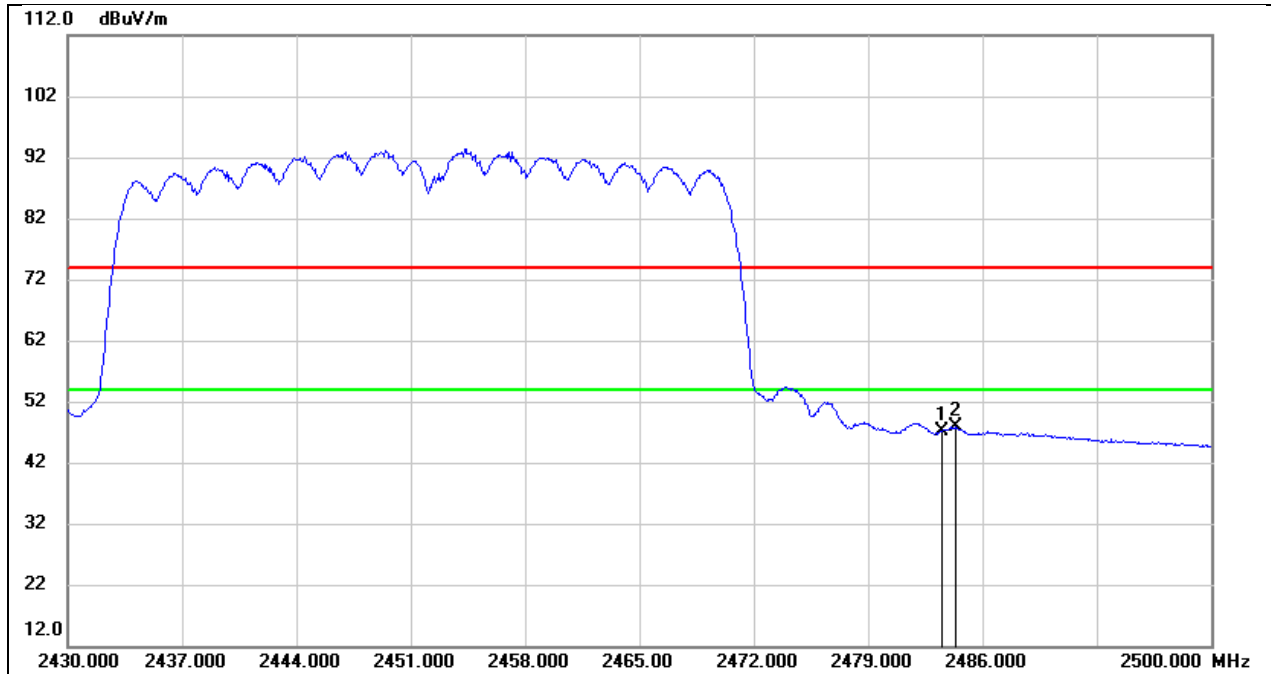

No.	Frequency (MHz)	Reading (dBuV)	Correct (dB/m)	Result (dBuV/m)	Limit (dBuV/m)	Margin (dB)	Remark
1	2483.500	14.60	32.44	47.04	54.00	-6.96	AVG
2	2484.320	15.56	32.44	48.00	54.00	-6.00	AVG



Test Mode:	802.11ax HE20 PK	Frequency(MHz):	2412
Polarity:	Horizontal	Test Voltage:	DC 5 V

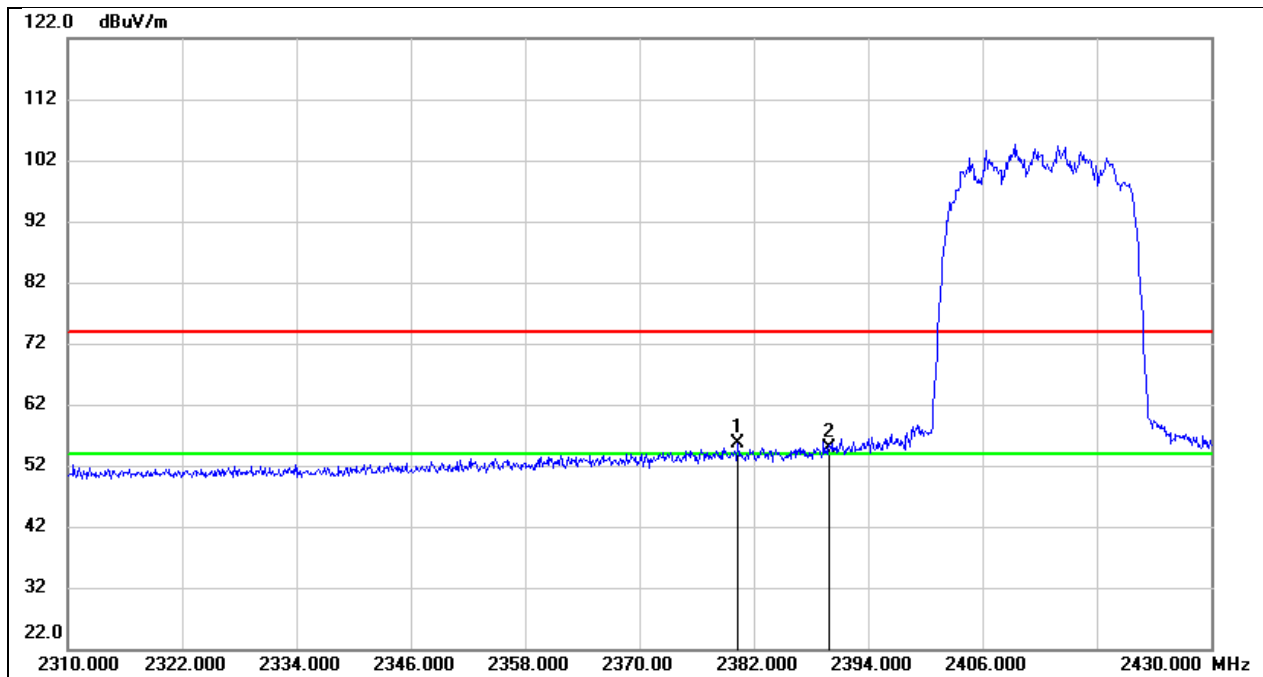

No.	Frequency (MHz)	Reading (dBuV)	Correct (dB/m)	Result (dBuV/m)	Limit (dBuV/m)	Margin (dB)	Remark
1	2380.320	23.45	32.13	55.58	74.00	-18.42	peak
2	2390.000	22.84	32.16	55.00	74.00	-19.00	peak

Test Mode:	802.11ax HE20 AV	Frequency(MHz):	2412
Polarity:	Horizontal	Test Voltage:	DC 5 V

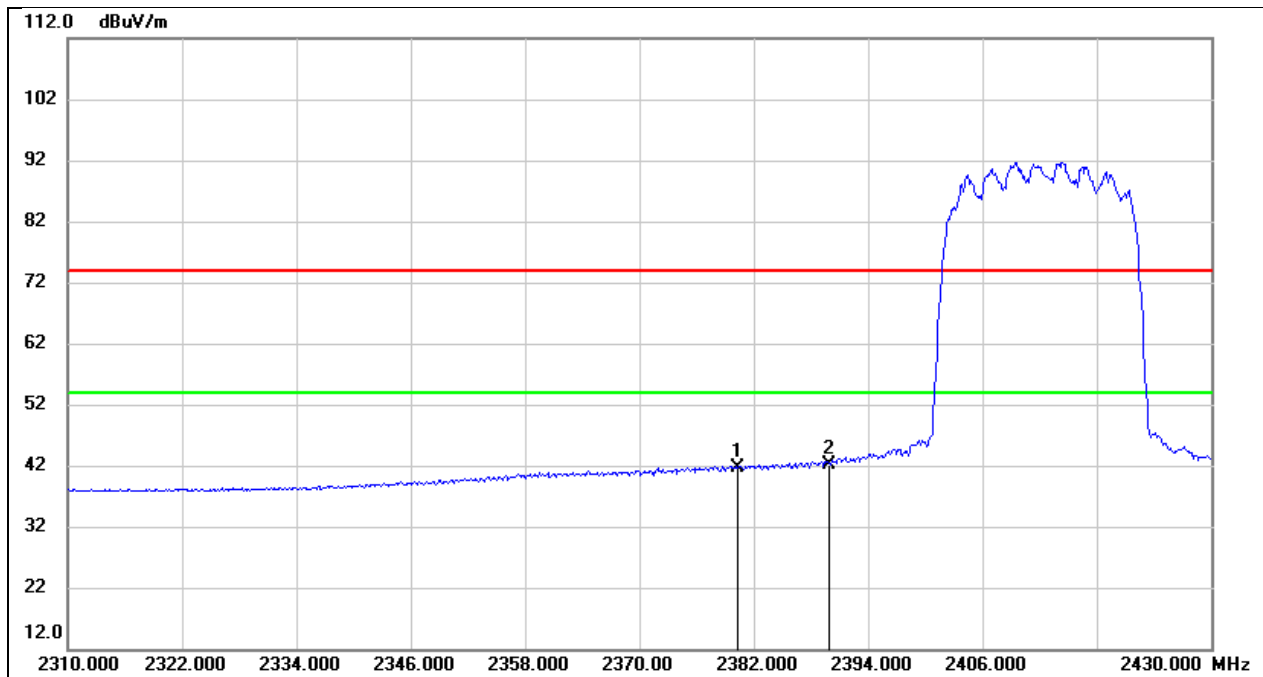

No.	Frequency (MHz)	Reading (dBuV)	Correct (dB/m)	Result (dBuV/m)	Limit (dBuV/m)	Margin (dB)	Remark
1	2380.320	9.50	32.13	41.63	54.00	-12.37	AVG
2	2390.000	10.09	32.16	42.25	54.00	-11.75	AVG

Test Mode:	802.11ax HE20 PK	Frequency(MHz):	2462
Polarity:	Horizontal	Test Voltage:	DC 5 V

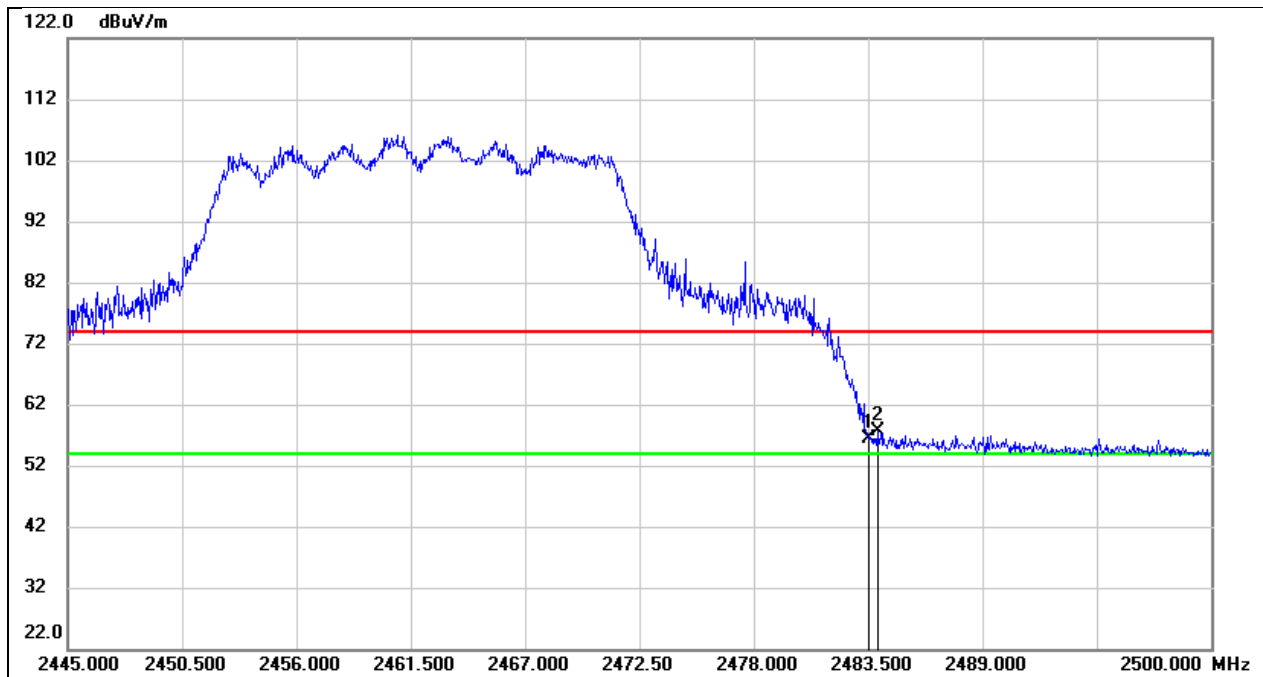

No.	Frequency (MHz)	Reading (dBuV)	Correct (dB/m)	Result (dBuV/m)	Limit (dBuV/m)	Margin (dB)	Remark
1	2483.500	24.00	32.44	56.44	74.00	-17.56	peak
2	2483.940	25.19	32.44	57.63	74.00	-16.37	peak

Test Mode:	802.11ax HE20 AV	Frequency(MHz):	2462
Polarity:	Horizontal	Test Voltage:	DC 5 V

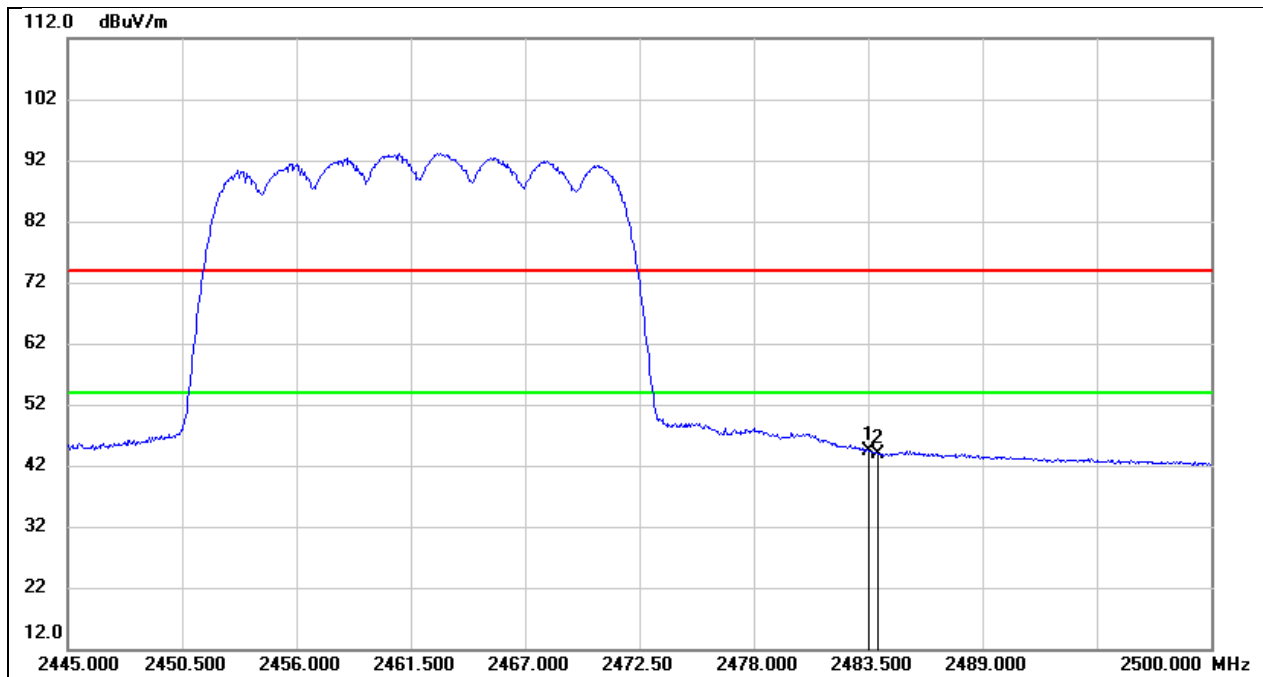

No.	Frequency (MHz)	Reading (dBuV)	Correct (dB/m)	Result (dBuV/m)	Limit (dBuV/m)	Margin (dB)	Remark
1	2483.500	11.95	32.44	44.39	54.00	-9.61	AVG
2	2483.940	11.51	32.44	43.95	54.00	-10.05	AVG

Test Mode:	802.11ax HE40 PK	Frequency(MHz):	2422
Polarity:	Horizontal	Test Voltage:	DC 5 V

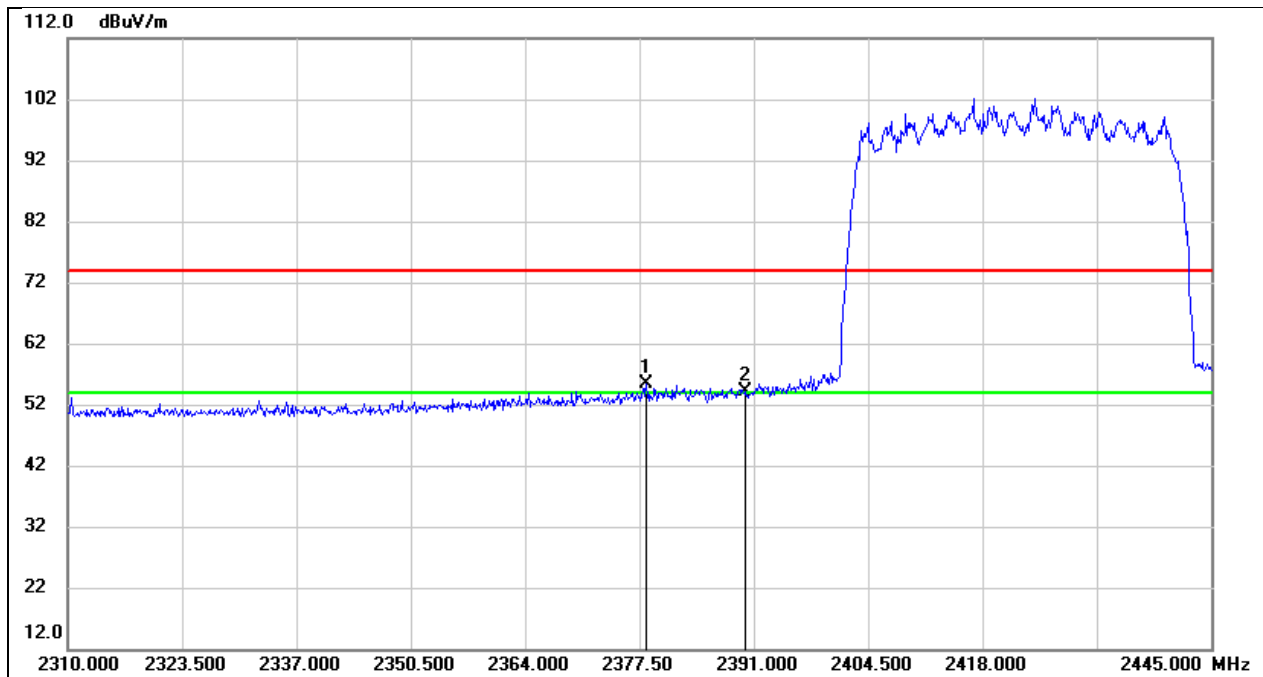

No.	Frequency (MHz)	Reading (dBuV)	Correct (dB/m)	Result (dBuV/m)	Limit (dBuV/m)	Margin (dB)	Remark
1	2378.310	23.24	32.12	55.36	74.00	-18.64	peak
2	2390.000	21.97	32.16	54.13	74.00	-19.87	peak

Test Mode:	802.11ax HE40 AV	Frequency(MHz):	2422
Polarity:	Horizontal	Test Voltage:	DC 5 V

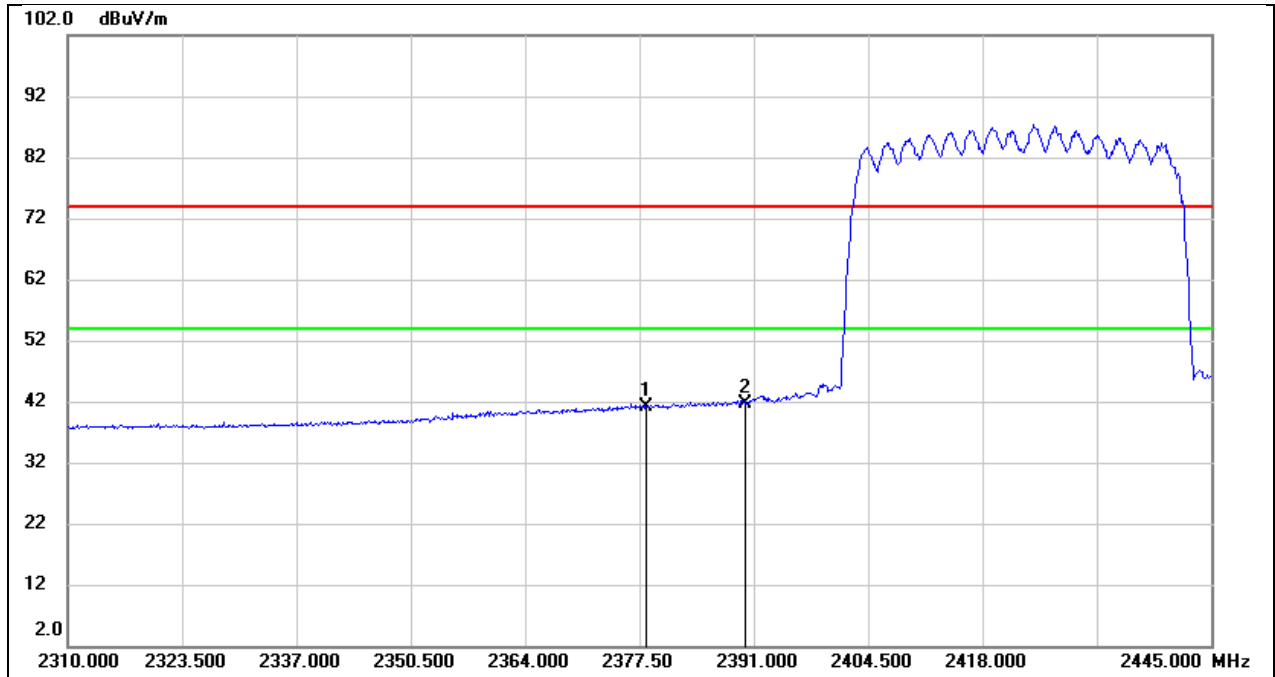

No.	Frequency (MHz)	Reading (dBuV)	Correct (dB/m)	Result (dBuV/m)	Limit (dBuV/m)	Margin (dB)	Remark
1	2378.310	9.00	32.12	41.12	54.00	-12.88	AVG
2	2390.000	9.57	32.16	41.73	54.00	-12.27	AVG

Test Mode:	802.11ax HE40 PK	Frequency(MHz):	2452
Polarity:	Horizontal	Test Voltage:	DC 5 V

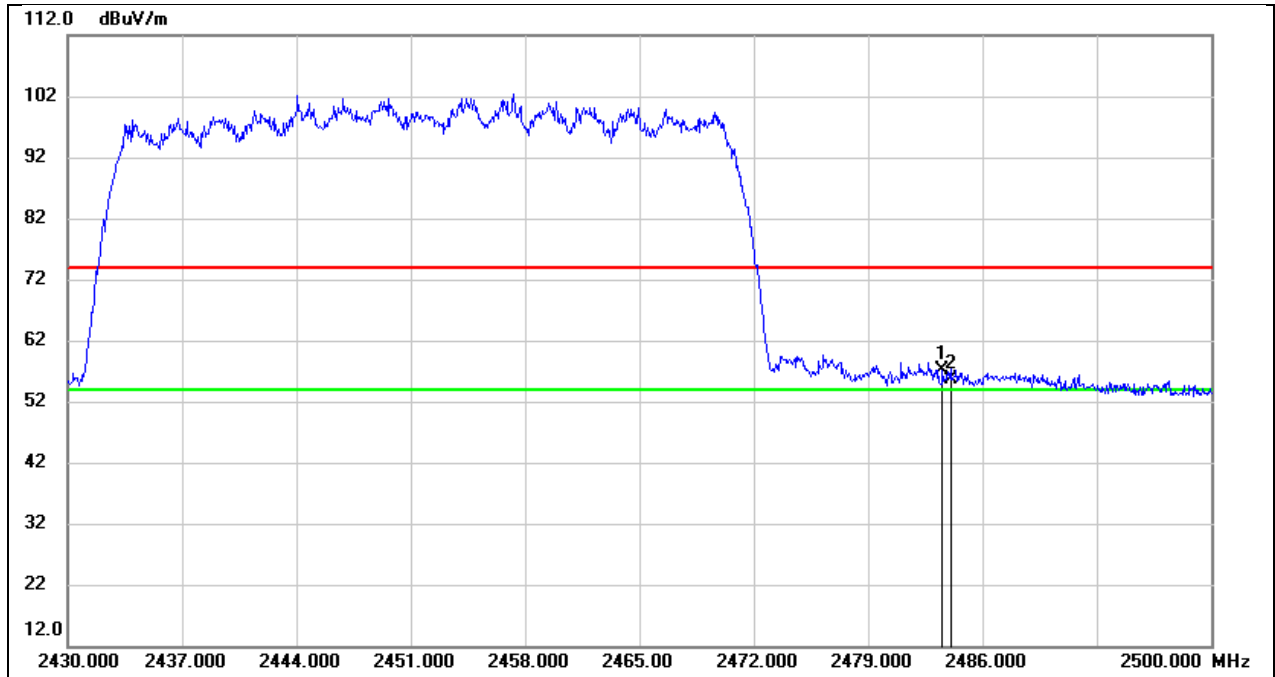

No.	Frequency (MHz)	Reading (dBuV)	Correct (dB/m)	Result (dBuV/m)	Limit (dBuV/m)	Margin (dB)	Remark
1	2483.500	24.59	32.44	57.03	74.00	-16.97	peak
2	2484.110	23.19	32.44	55.63	74.00	-18.37	peak

Test Mode:	802.11ax HE40 AV	Frequency(MHz):	2452
Polarity:	Horizontal	Test Voltage:	DC 5 V

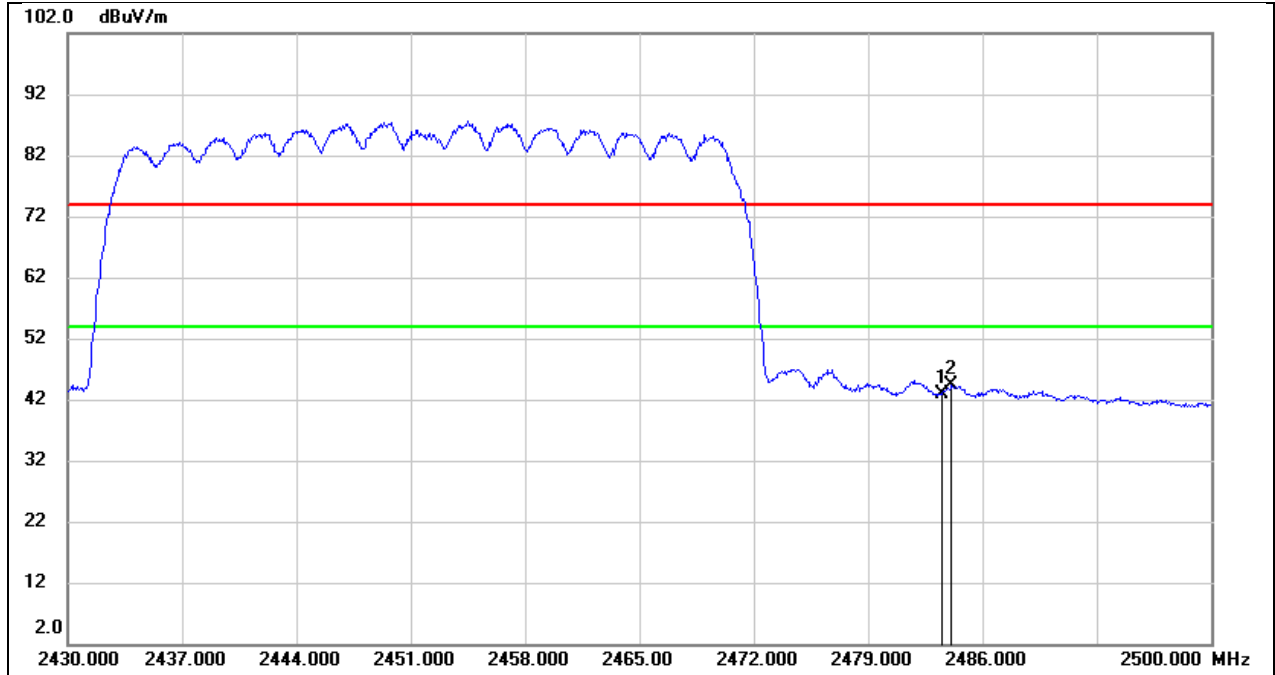

No.	Frequency (MHz)	Reading (dBuV)	Correct (dB/m)	Result (dBuV/m)	Limit (dBuV/m)	Margin (dB)	Remark
1	2483.500	10.51	32.44	42.95	54.00	-11.05	AVG
2	2484.110	11.93	32.44	44.37	54.00	-9.63	AVG



## 8.2. SPURIOUS EMISSIONS(1 GHZ~3 GHZ)

Test Mode:	802.11b	Frequency(MHz):	2412
Polarity:	Horizontal	Test Voltage:	DC 5 V

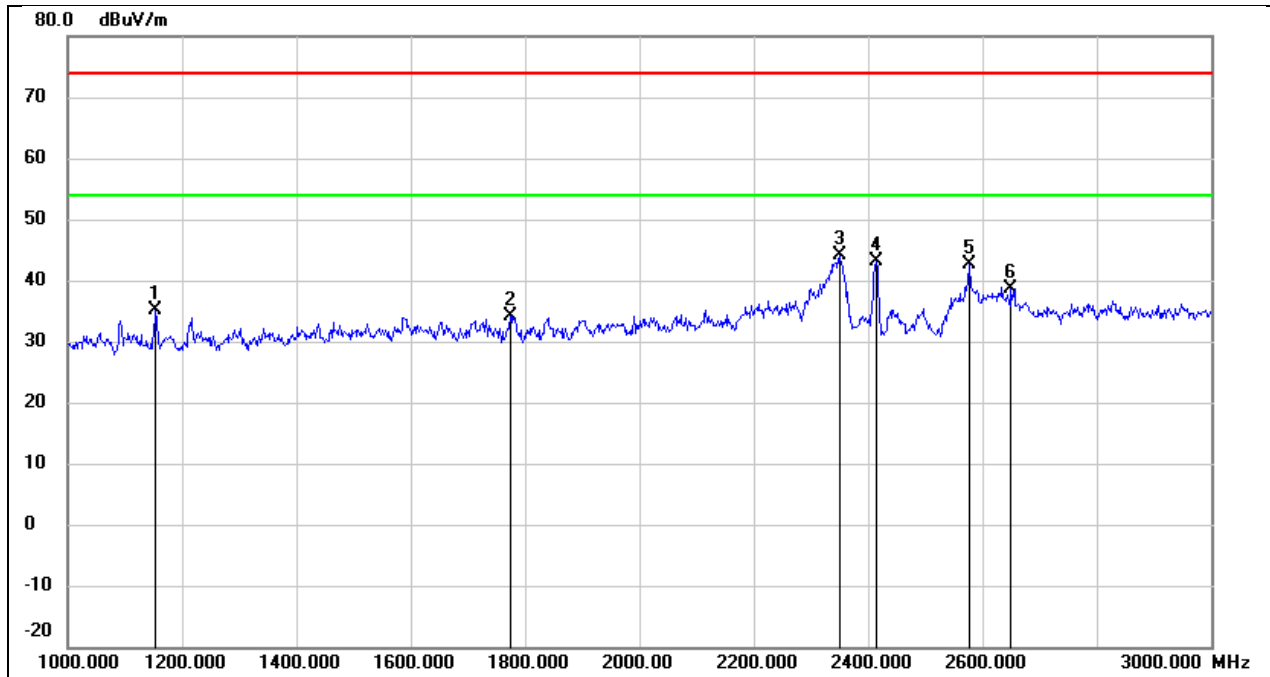

No.	Frequency (MHz)	Reading (dBuV)	Correct (dB/m)	Result (dBuV/m)	Limit (dBuV/m)	Margin (dB)	Remark
1	1154.000	49.38	-14.32	35.06	74.00	-38.94	peak
2	1774.000	45.86	-11.80	34.06	74.00	-39.94	peak
3	2350.000	53.33	-9.26	44.07	74.00	-29.93	peak
4	2412.000	52.06	-8.93	43.13	/	/	fundamental
5	2578.000	50.99	-8.26	42.73	74.00	-31.27	peak
6	2650.000	46.72	-8.03	38.69	74.00	-35.31	peak

Test Mode:	802.11b	Frequency(MHz):	2412
Polarity:	Vertical	Test Voltage:	DC 5 V

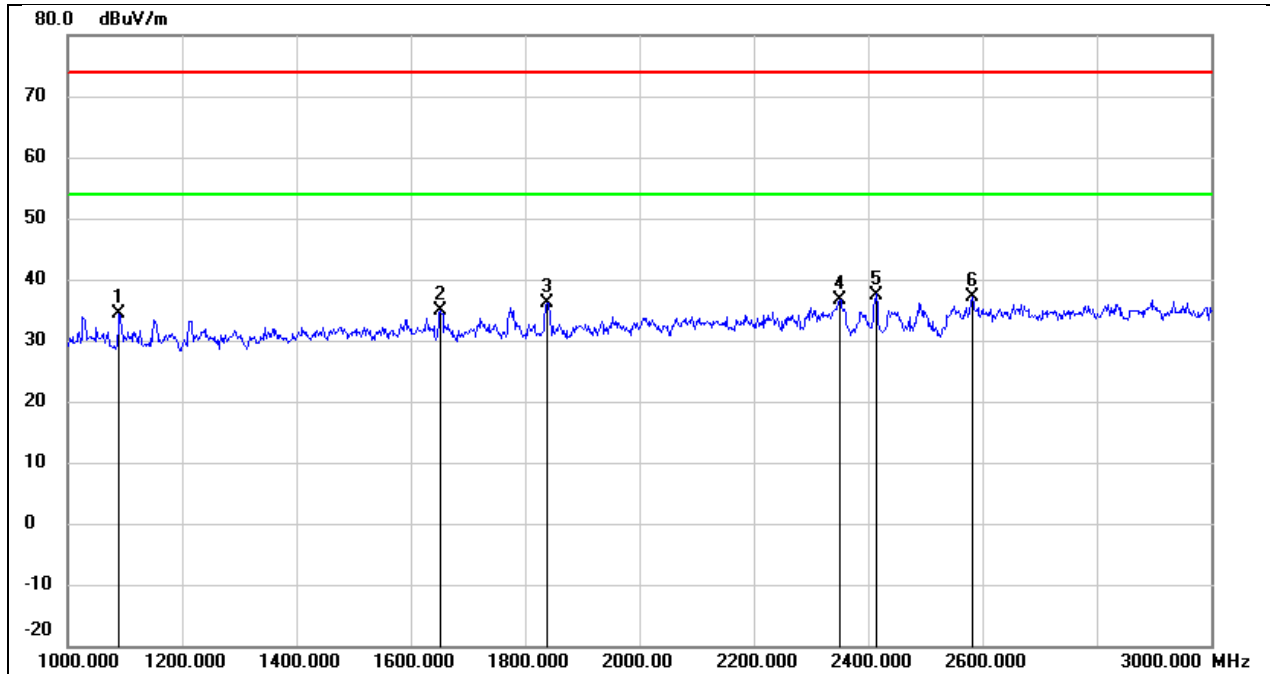

No.	Frequency (MHz)	Reading (dBuV)	Correct (dB/m)	Result (dBuV/m)	Limit (dBuV/m)	Margin (dB)	Remark
1	1090.000	49.09	-14.61	34.48	74.00	-39.52	peak
2	1652.000	47.07	-12.21	34.86	74.00	-39.14	peak
3	1838.000	47.75	-11.60	36.15	74.00	-37.85	peak
4	2350.000	45.81	-9.26	36.55	74.00	-37.45	peak
5	2412.000	46.43	-8.93	37.50	/	/	fundamental
6	2582.000	45.35	-8.24	37.11	74.00	-36.89	peak

Test Mode:	802.11b	Frequency(MHz):	2437
Polarity:	Horizontal	Test Voltage:	DC 5 V

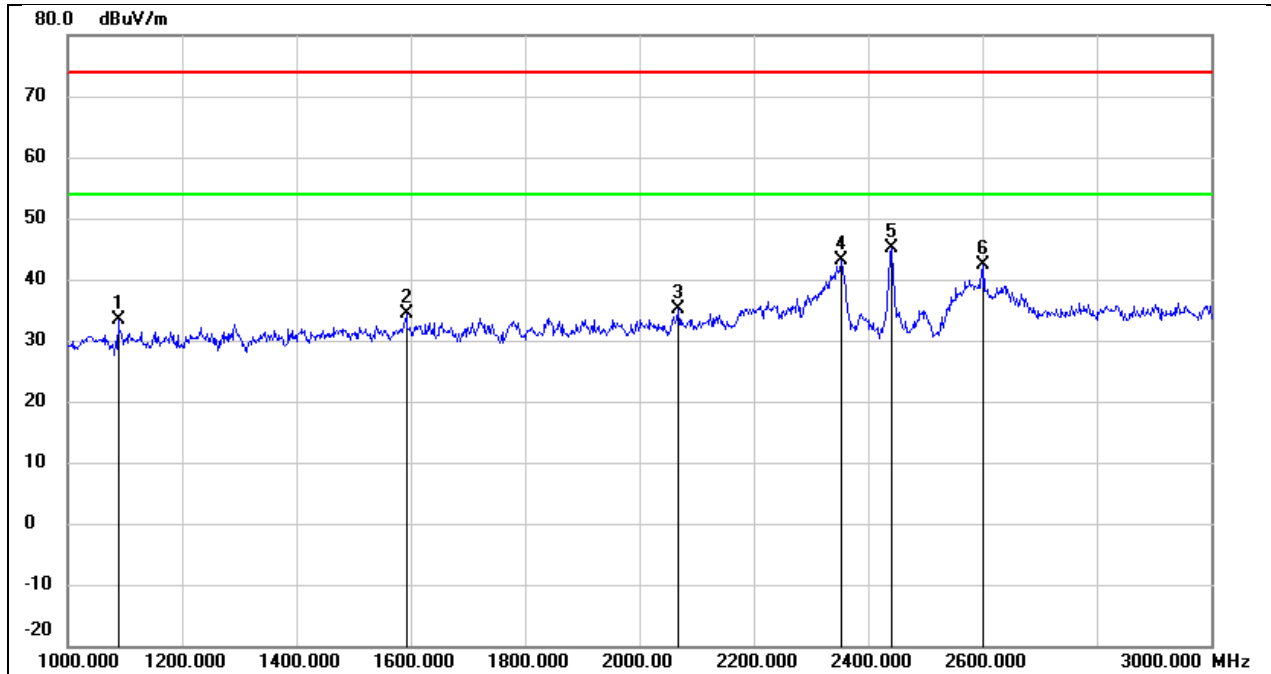

No.	Frequency (MHz)	Reading (dBuV)	Correct (dB/m)	Result (dBuV/m)	Limit (dBuV/m)	Margin (dB)	Remark
1	1088.000	47.94	-14.62	33.32	74.00	-40.68	peak
2	1592.000	46.73	-12.41	34.32	74.00	-39.68	peak
3	2068.000	45.86	-10.70	35.16	74.00	-38.84	peak
4	2354.000	52.41	-9.24	43.17	74.00	-30.83	peak
5	2437.000	53.97	-8.80	45.17	/	/	fundamental
6	2602.000	50.68	-8.19	42.49	74.00	-31.51	peak

Test Mode:	802.11b	Frequency(MHz):	2437
Polarity:	Vertical	Test Voltage:	DC 5 V

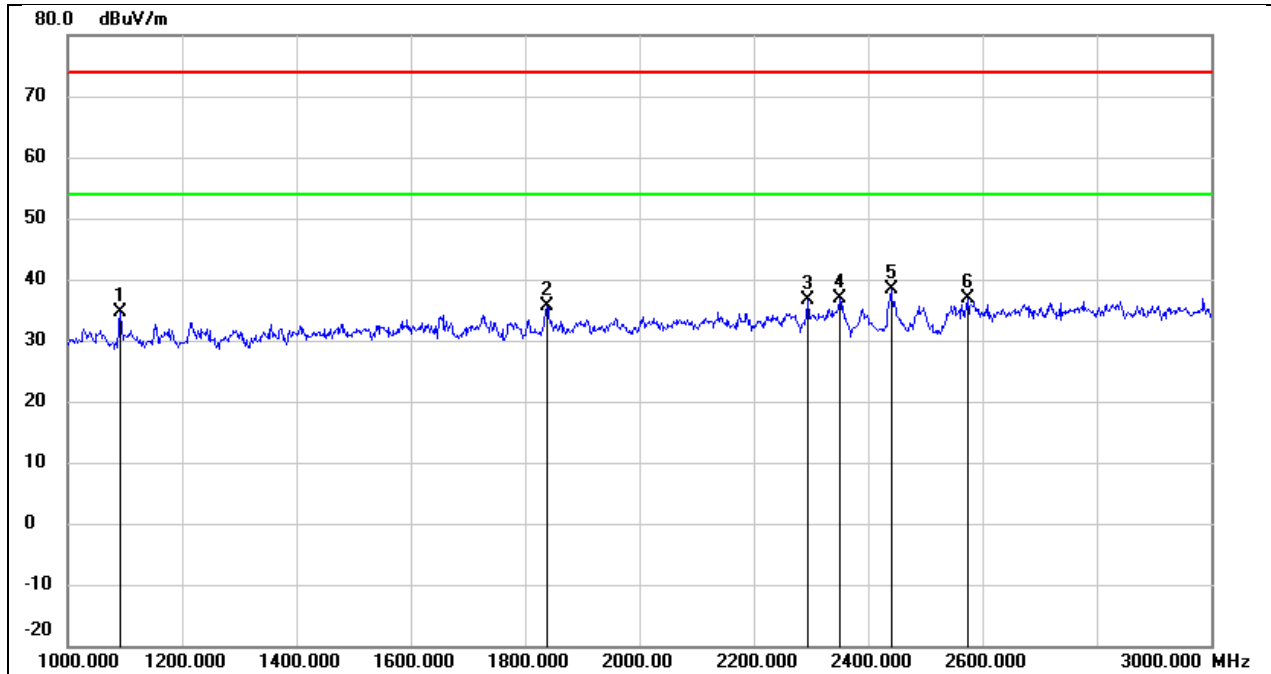

No.	Frequency (MHz)	Reading (dBuV)	Correct (dB/m)	Result (dBuV/m)	Limit (dBuV/m)	Margin (dB)	Remark
1	1092.000	49.19	-14.61	34.58	74.00	-39.42	peak
2	1838.000	47.32	-11.60	35.72	74.00	-38.28	peak
3	2294.000	46.20	-9.55	36.65	74.00	-37.35	peak
4	2350.000	46.18	-9.26	36.92	74.00	-37.08	peak
5	2437.000	47.06	-8.80	38.26	/	/	fundamental
6	2574.000	45.07	-8.27	36.80	74.00	-37.20	peak

Test Mode:	802.11b	Frequency(MHz):	2462
Polarity:	Horizontal	Test Voltage:	DC 5 V

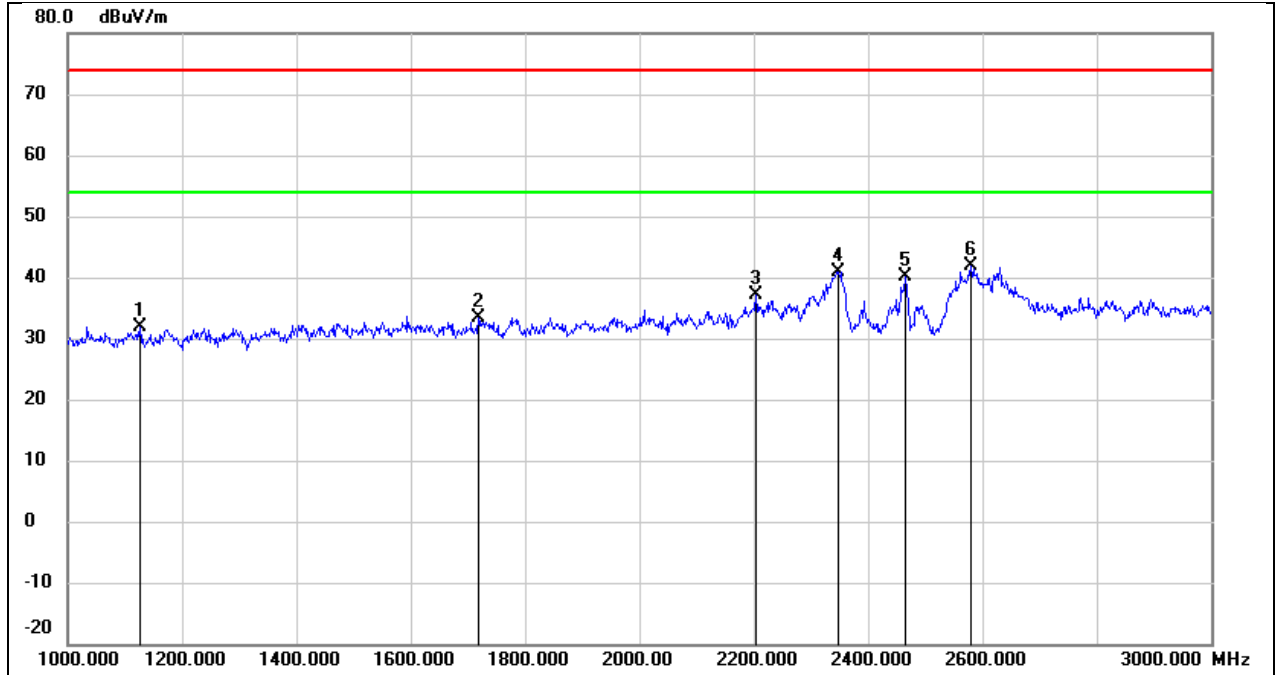

No.	Frequency (MHz)	Reading (dBuV)	Correct (dB/m)	Result (dBuV/m)	Limit (dBuV/m)	Margin (dB)	Remark
1	1126.000	46.35	-14.44	31.91	74.00	-42.09	peak
2	1718.000	45.33	-11.99	33.34	74.00	-40.66	peak
3	2204.000	47.17	-10.01	37.16	74.00	-36.84	peak
4	2348.000	50.27	-9.28	40.99	74.00	-33.01	peak
5	2462.000	48.79	-8.68	40.11	/	/	fundamental
6	2580.000	50.09	-8.25	41.84	74.00	-32.16	peak

Test Mode:	802.11b	Frequency(MHz):	2462
Polarity:	Vertical	Test Voltage:	DC 5 V

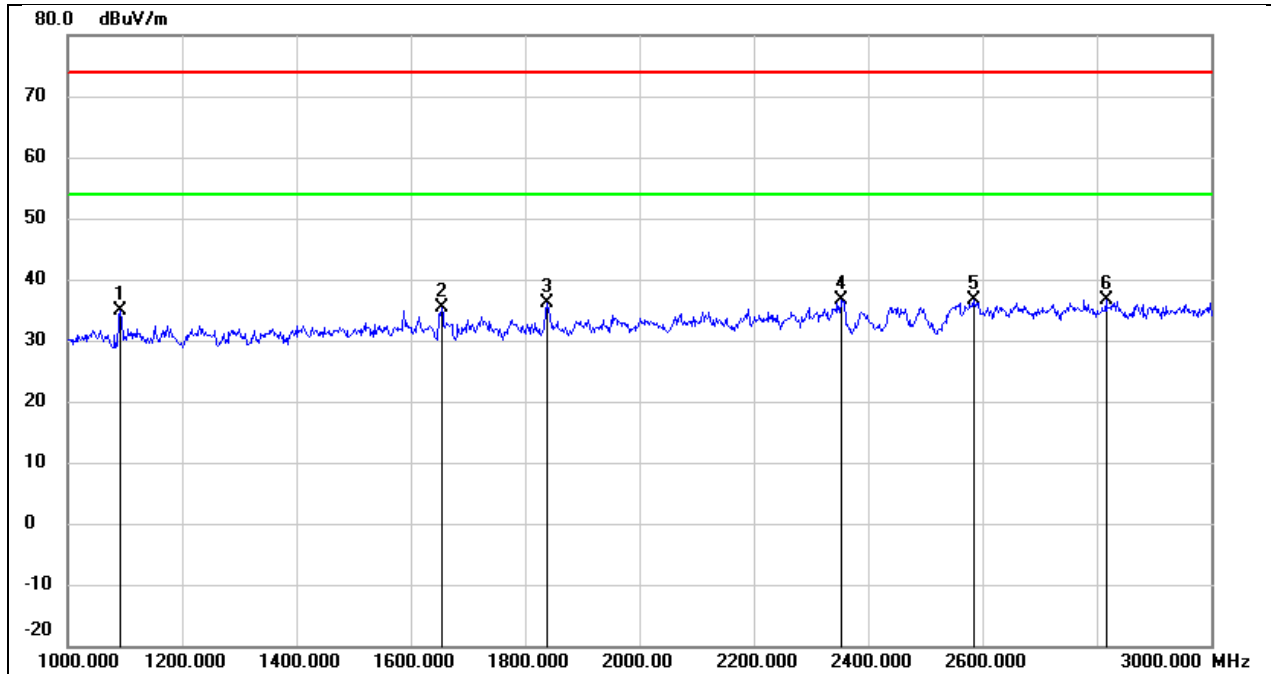

No.	Frequency (MHz)	Reading (dBuV)	Correct (dB/m)	Result (dBuV/m)	Limit (dBuV/m)	Margin (dB)	Remark
1	1092.000	49.53	-14.61	34.92	74.00	-39.08	peak
2	1654.000	47.69	-12.20	35.49	74.00	-38.51	peak
3	1838.000	47.68	-11.60	36.08	74.00	-37.92	peak
4	2354.000	45.91	-9.24	36.67	74.00	-37.33	peak
5	2584.000	44.78	-8.24	36.54	74.00	-37.46	peak
6	2816.000	44.17	-7.54	36.63	74.00	-37.37	peak

### 8.3. SPURIOUS EMISSIONS(3 GHZ~18 GHZ)

Test Mode:	802.11b	Frequency(MHz):	2412
Polarity:	Horizontal	Test Voltage:	DC 5 V

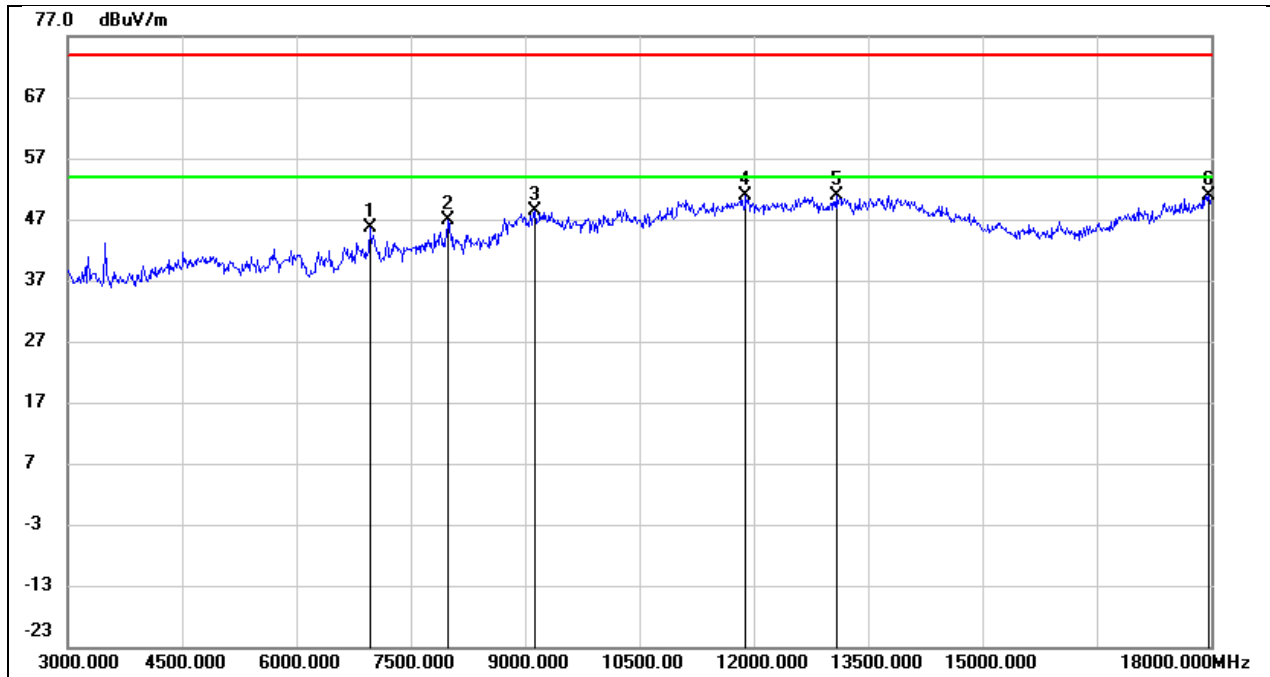

No.	Frequency (MHz)	Reading (dBuV)	Correct (dB/m)	Result (dBuV/m)	Limit (dBuV/m)	Margin (dB)	Remark
1	6960.000	39.13	6.50	45.63	74.00	-28.37	peak
2	7995.000	40.46	6.31	46.77	74.00	-27.23	peak
3	9135.000	37.74	10.55	48.29	74.00	-25.71	peak
4	11895.000	33.08	17.68	50.76	74.00	-23.24	peak
5	13080.000	31.93	19.07	51.00	74.00	-23.00	peak
6	17970.000	25.41	25.51	50.92	74.00	-23.08	peak

Test Mode:	802.11b	Frequency(MHz):	2412
Polarity:	Vertical	Test Voltage:	DC 5 V

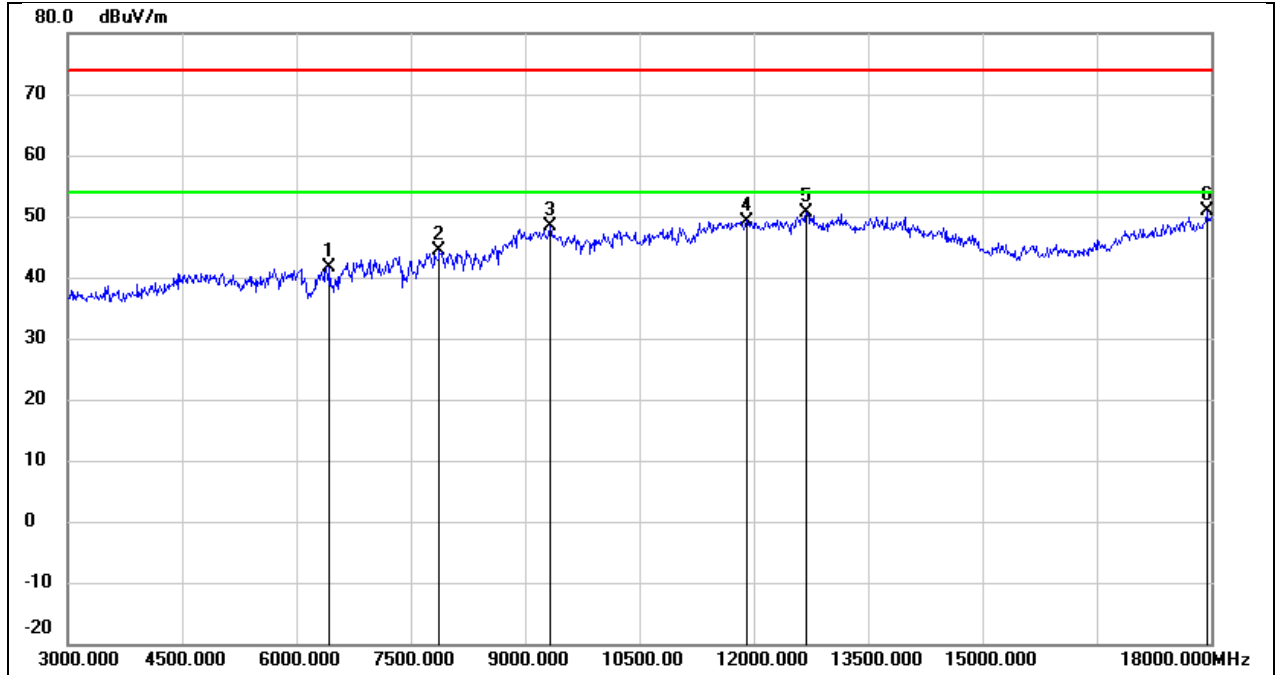

No.	Frequency (MHz)	Reading (dBuV)	Correct (dB/m)	Result (dBuV/m)	Limit (dBuV/m)	Margin (dB)	Remark
1	6435.000	37.78	3.96	41.74	74.00	-32.26	peak
2	7875.000	37.96	6.31	44.27	74.00	-29.73	peak
3	9330.000	37.71	10.62	48.33	74.00	-25.67	peak
4	11910.000	31.53	17.72	49.25	74.00	-24.75	peak
5	12690.000	32.54	18.02	50.56	74.00	-23.44	peak
6	17940.000	25.61	25.34	50.95	74.00	-23.05	peak



Test Mode:	802.11b	Frequency(MHz):	2437
Polarity:	Horizontal	Test Voltage:	DC 5 V

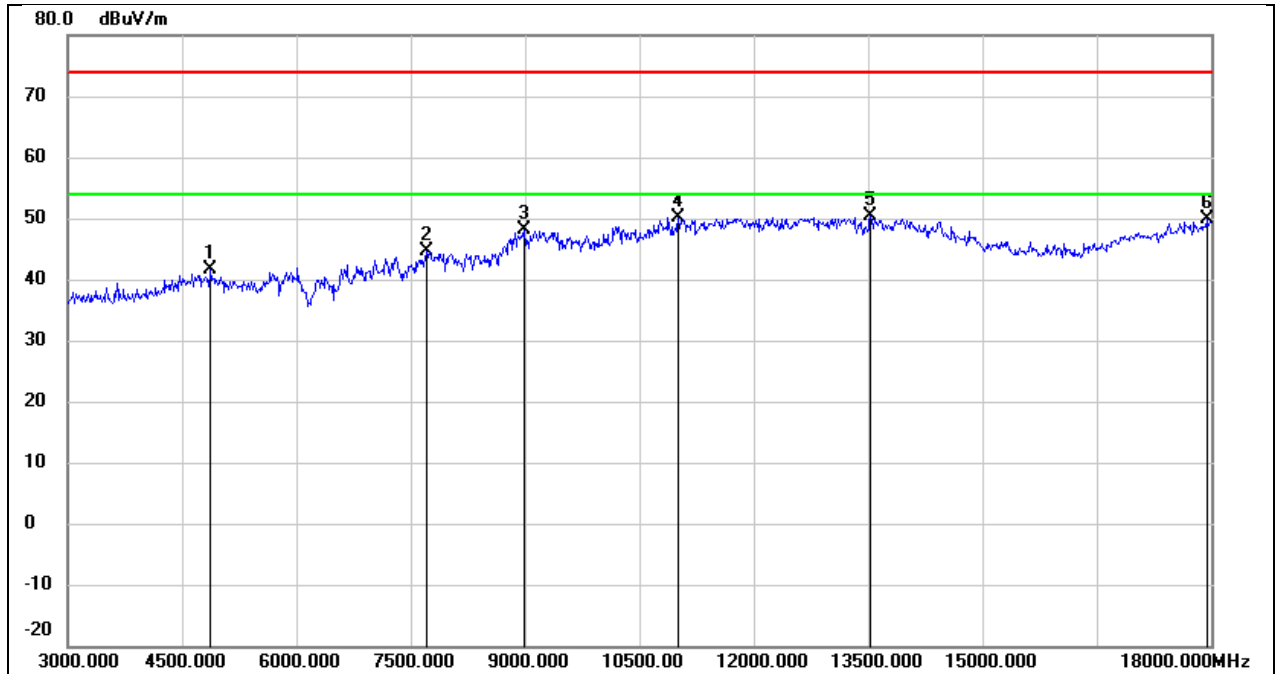

No.	Frequency (MHz)	Reading (dBuV)	Correct (dB/m)	Result (dBuV/m)	Limit (dBuV/m)	Margin (dB)	Remark
1	4875.000	41.67	-0.03	41.64	74.00	-32.36	peak
2	7710.000	38.36	6.33	44.69	74.00	-29.31	peak
3	8985.000	37.70	10.37	48.07	74.00	-25.93	peak
4	11010.000	35.32	14.81	50.13	74.00	-23.87	peak
5	13530.000	29.47	20.96	50.43	74.00	-23.57	peak
6	17940.000	24.55	25.34	49.89	74.00	-24.11	peak

Test Mode:	802.11b	Frequency(MHz):	2437
Polarity:	Vertical	Test Voltage:	DC 5 V

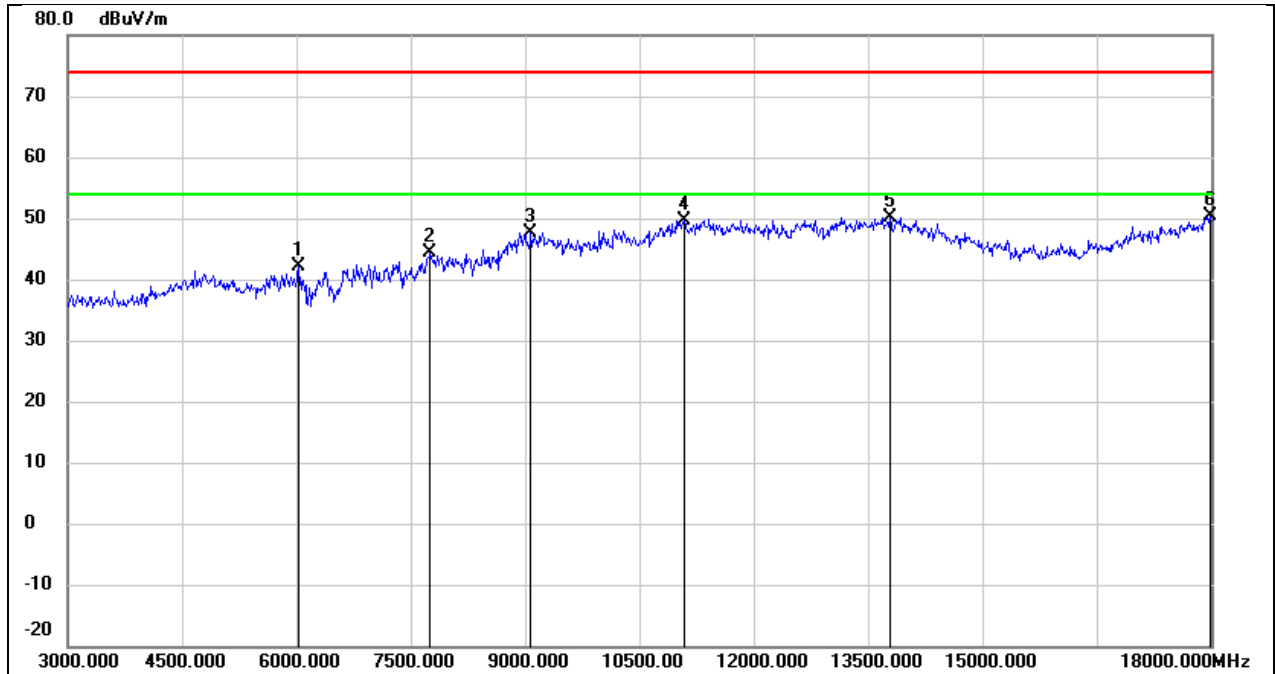

No.	Frequency (MHz)	Reading (dBuV)	Correct (dB/m)	Result (dBuV/m)	Limit (dBuV/m)	Margin (dB)	Remark
1	6030.000	39.68	2.37	42.05	74.00	-31.95	peak
2	7755.000	38.03	6.31	44.34	74.00	-29.66	peak
3	9075.000	37.18	10.52	47.70	74.00	-26.30	peak
4	11085.000	34.54	15.08	49.62	74.00	-24.38	peak
5	13785.000	28.57	21.51	50.08	74.00	-23.92	peak
6	17985.000	24.67	25.60	50.27	74.00	-23.73	peak

Test Mode:	802.11b	Frequency(MHz):	2462
Polarity:	Horizontal	Test Voltage:	DC 5 V

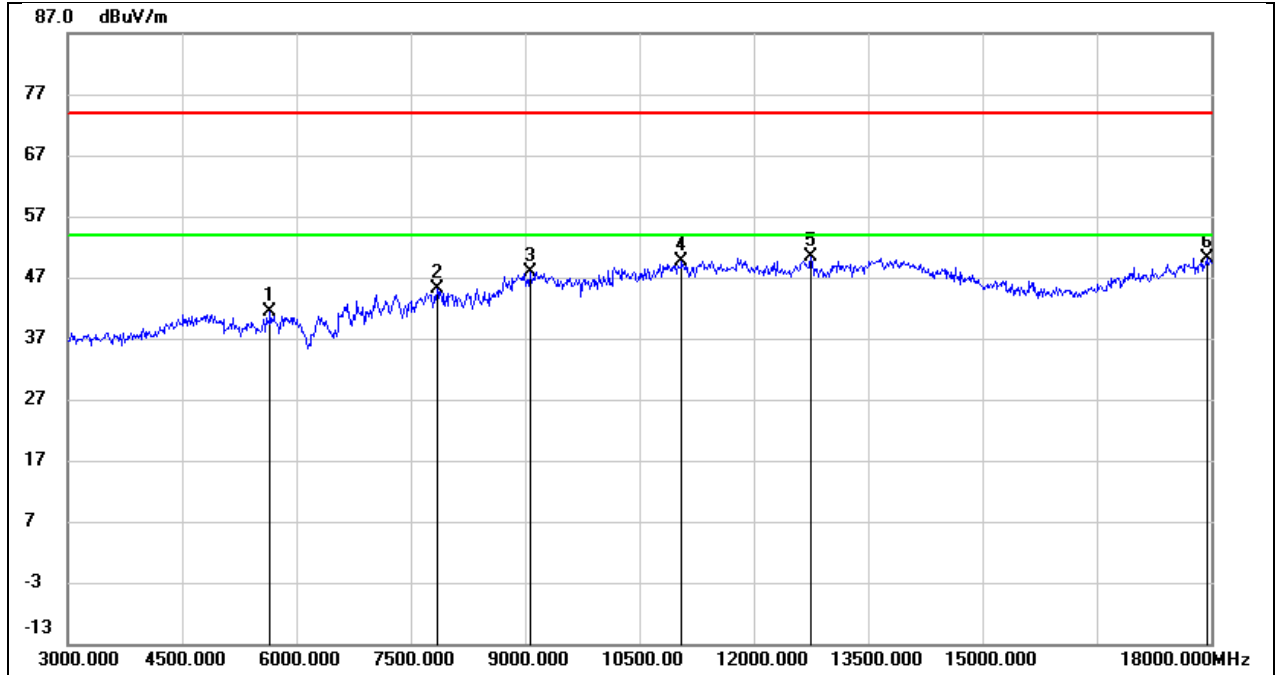

No.	Frequency (MHz)	Reading (dBuV)	Correct (dB/m)	Result (dBuV/m)	Limit (dBuV/m)	Margin (dB)	Remark
1	5655.000	40.09	1.29	41.38	74.00	-32.62	peak
2	7845.000	38.91	6.32	45.23	74.00	-28.77	peak
3	9060.000	37.37	10.51	47.88	74.00	-26.12	peak
4	11055.000	34.73	14.96	49.69	74.00	-24.31	peak
5	12750.000	32.34	18.16	50.50	74.00	-23.50	peak
6	17940.000	24.79	25.34	50.13	74.00	-23.87	peak

Test Mode:	802.11b	Frequency(MHz):	2462
Polarity:	Vertical	Test Voltage:	DC 5 V

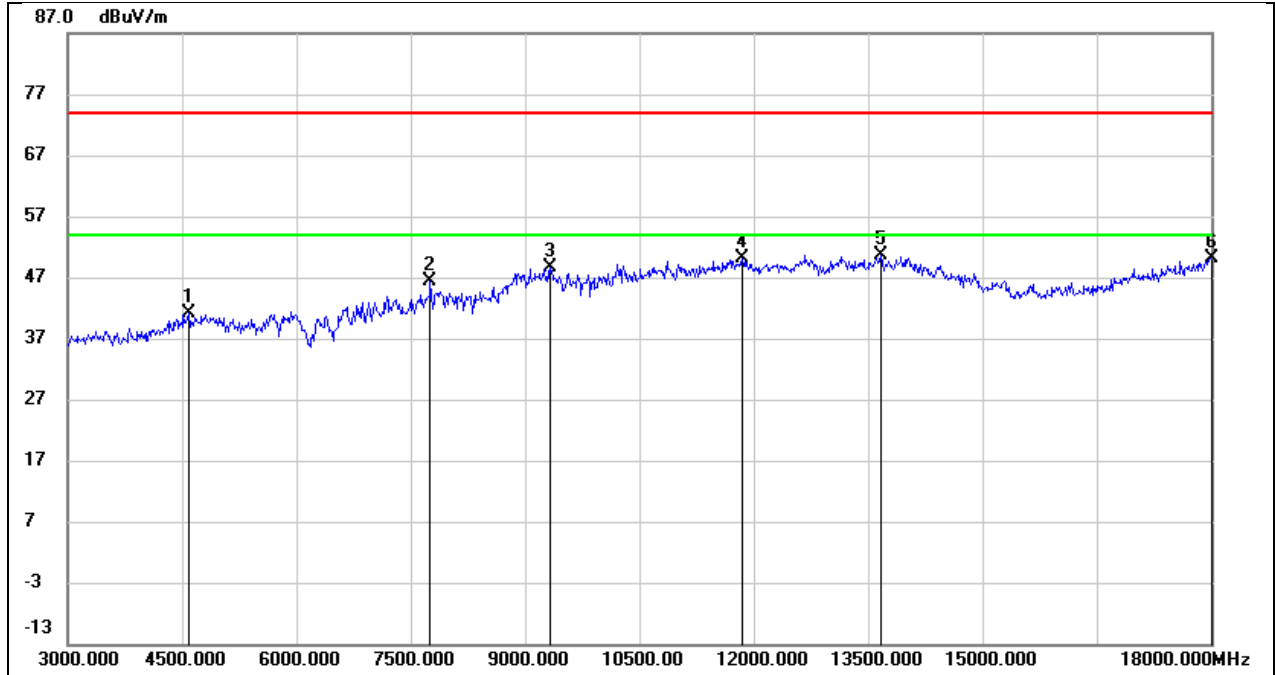

No.	Frequency (MHz)	Reading (dBuV)	Correct (dB/m)	Result (dBuV/m)	Limit (dBuV/m)	Margin (dB)	Remark
1	4590.000	42.28	-1.12	41.16	74.00	-32.84	peak
2	7755.000	39.95	6.31	46.26	74.00	-27.74	peak
3	9330.000	37.98	10.62	48.60	74.00	-25.40	peak
4	11850.000	32.58	17.56	50.14	74.00	-23.86	peak
5	13665.000	29.49	21.25	50.74	74.00	-23.26	peak
6	18000.000	24.54	25.69	50.23	74.00	-23.77	peak

Test Mode:	802.11g	Frequency(MHz):	2412
Polarity:	Horizontal	Test Voltage:	DC 5 V

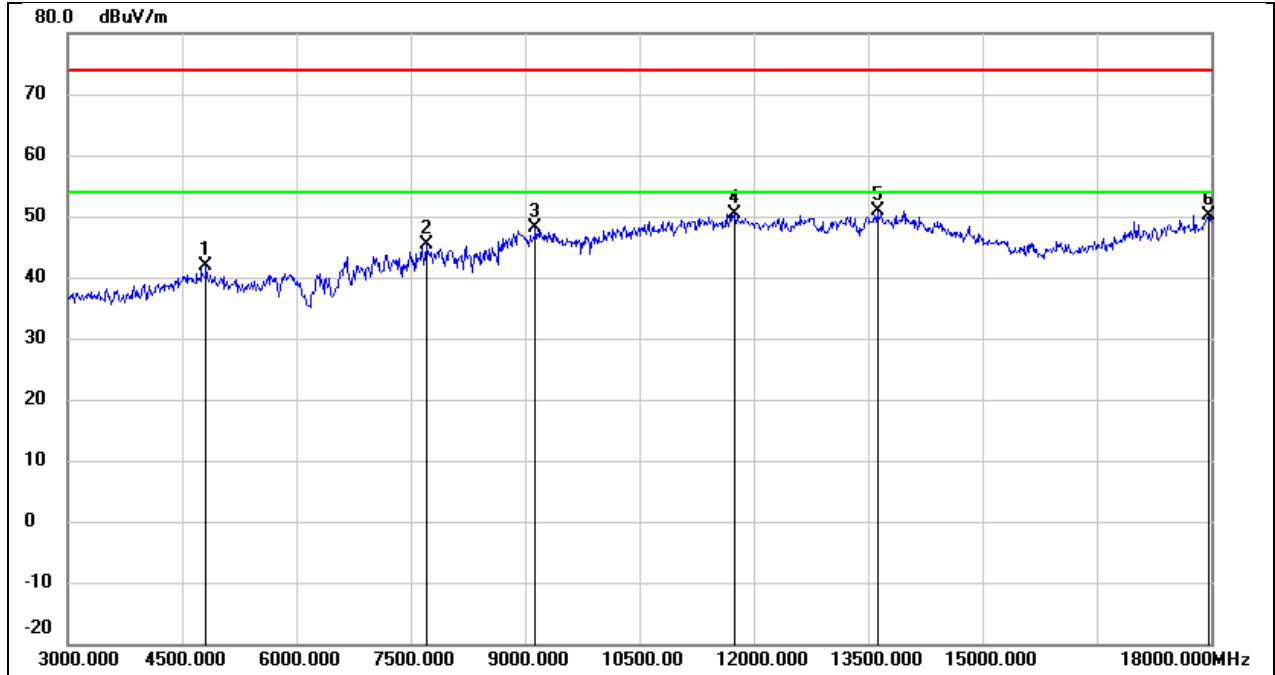

No.	Frequency (MHz)	Reading (dBuV)	Correct (dB/m)	Result (dBuV/m)	Limit (dBuV/m)	Margin (dB)	Remark
1	4815.000	42.08	-0.26	41.82	74.00	-32.18	peak
2	7710.000	39.08	6.33	45.41	74.00	-28.59	peak
3	9135.000	37.46	10.55	48.01	74.00	-25.99	peak
4	11745.000	33.15	17.27	50.42	74.00	-23.58	peak
5	13620.000	29.76	21.15	50.91	74.00	-23.09	peak
6	17970.000	24.53	25.51	50.04	74.00	-23.96	peak

Test Mode:	802.11g	Frequency(MHz):	2412
Polarity:	Vertical	Test Voltage:	DC 5 V

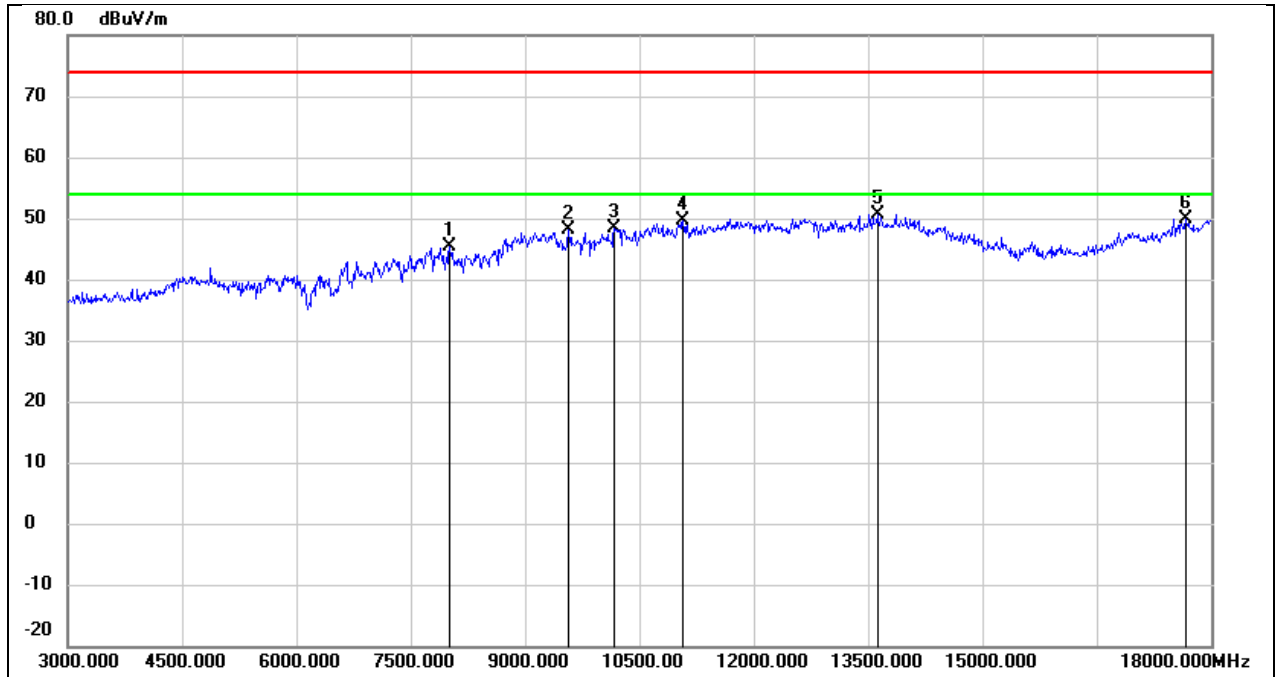

No.	Frequency (MHz)	Reading (dBuV)	Correct (dB/m)	Result (dBuV/m)	Limit (dBuV/m)	Margin (dB)	Remark
1	8010.000	38.99	6.32	45.31	74.00	-28.69	peak
2	9570.000	37.21	10.87	48.08	74.00	-25.92	peak
3	10170.000	35.97	12.34	48.31	74.00	-25.69	peak
4	11070.000	34.58	15.03	49.61	74.00	-24.39	peak
5	13620.000	29.59	21.15	50.74	74.00	-23.26	peak
6	17670.000	26.05	23.73	49.78	74.00	-24.22	peak

Test Mode:	802.11g	Frequency(MHz):	2437
Polarity:	Horizontal	Test Voltage:	DC 5 V

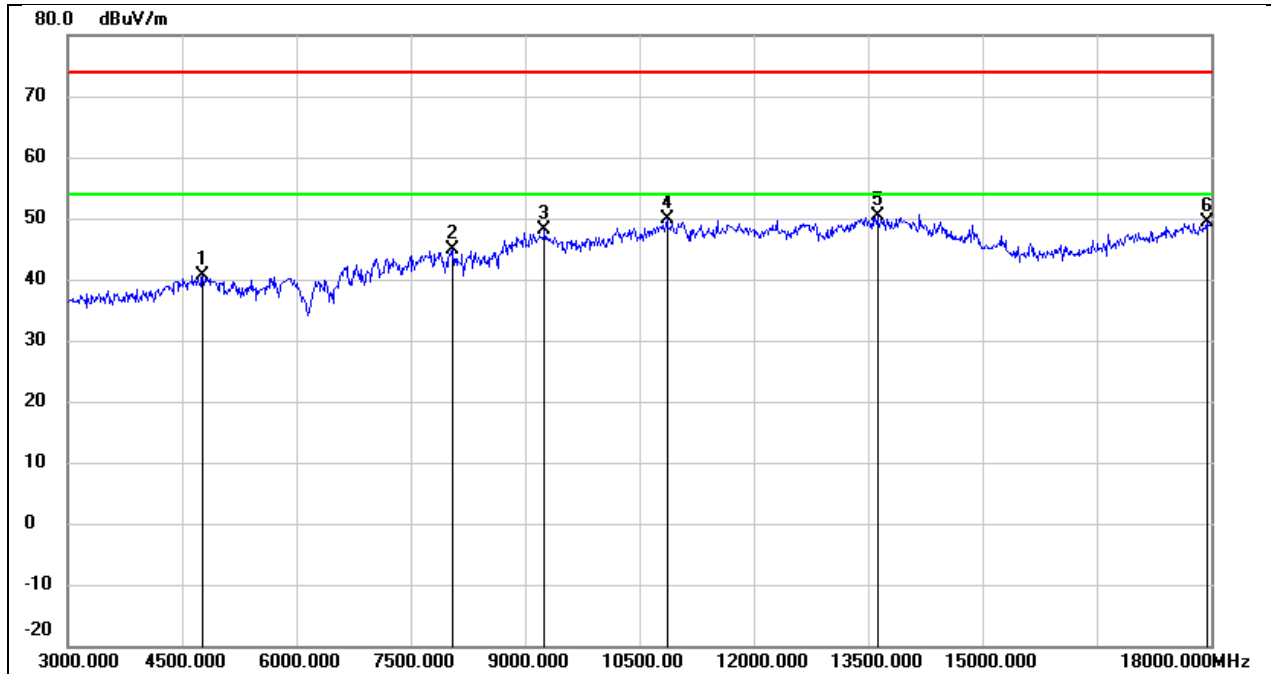

No.	Frequency (MHz)	Reading (dBuV)	Correct (dB/m)	Result (dBuV/m)	Limit (dBuV/m)	Margin (dB)	Remark
1	4770.000	41.02	-0.43	40.59	74.00	-33.41	peak
2	8055.000	38.47	6.37	44.84	74.00	-29.16	peak
3	9255.000	37.50	10.59	48.09	74.00	-25.91	peak
4	10860.000	35.70	14.27	49.97	74.00	-24.03	peak
5	13620.000	29.27	21.15	50.42	74.00	-23.58	peak
6	17940.000	24.03	25.34	49.37	74.00	-24.63	peak

Test Mode:	802.11g	Frequency(MHz):	2437
Polarity:	Vertical	Test Voltage:	DC 5 V

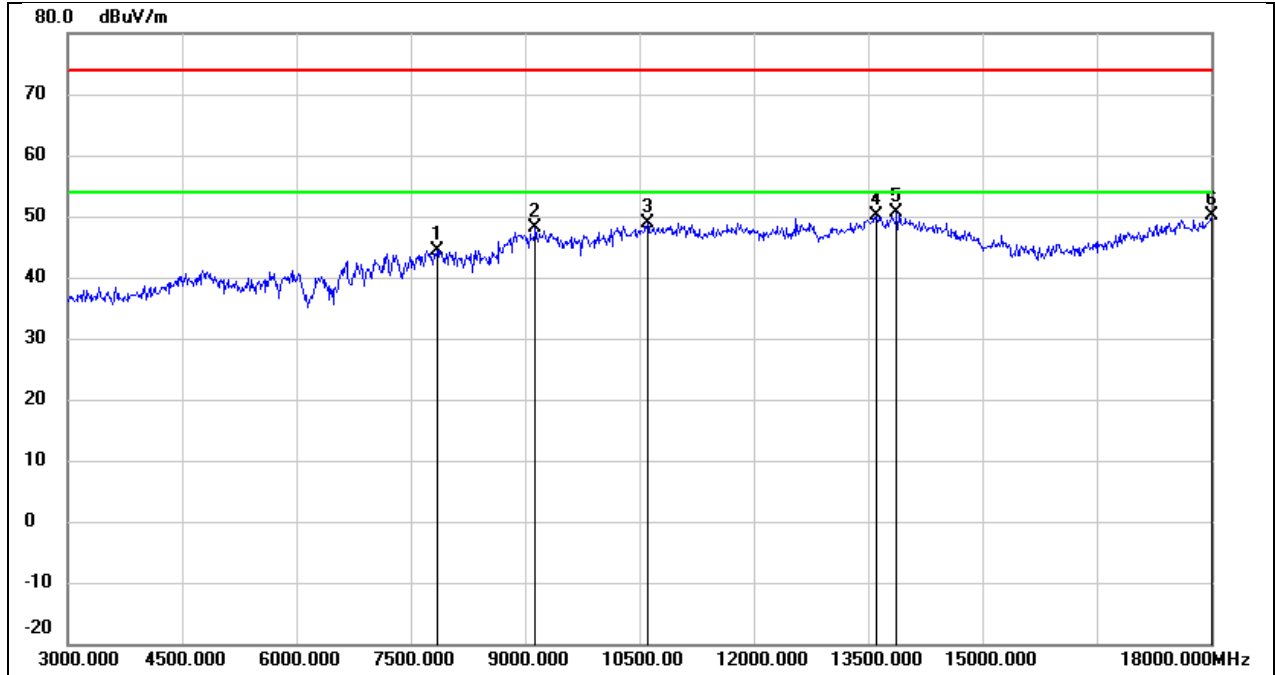

No.	Frequency (MHz)	Reading (dBuV)	Correct (dB/m)	Result (dBuV/m)	Limit (dBuV/m)	Margin (dB)	Remark
1	7845.000	38.14	6.32	44.46	74.00	-29.54	peak
2	9135.000	37.46	10.55	48.01	74.00	-25.99	peak
3	10605.000	35.51	13.37	48.88	74.00	-25.12	peak
4	13605.000	29.01	21.12	50.13	74.00	-23.87	peak
5	13875.000	29.03	21.70	50.73	74.00	-23.27	peak
6	18000.000	24.34	25.69	50.03	74.00	-23.97	peak



Test Mode:	802.11g	Frequency(MHz):	2462
Polarity:	Horizontal	Test Voltage:	DC 5 V

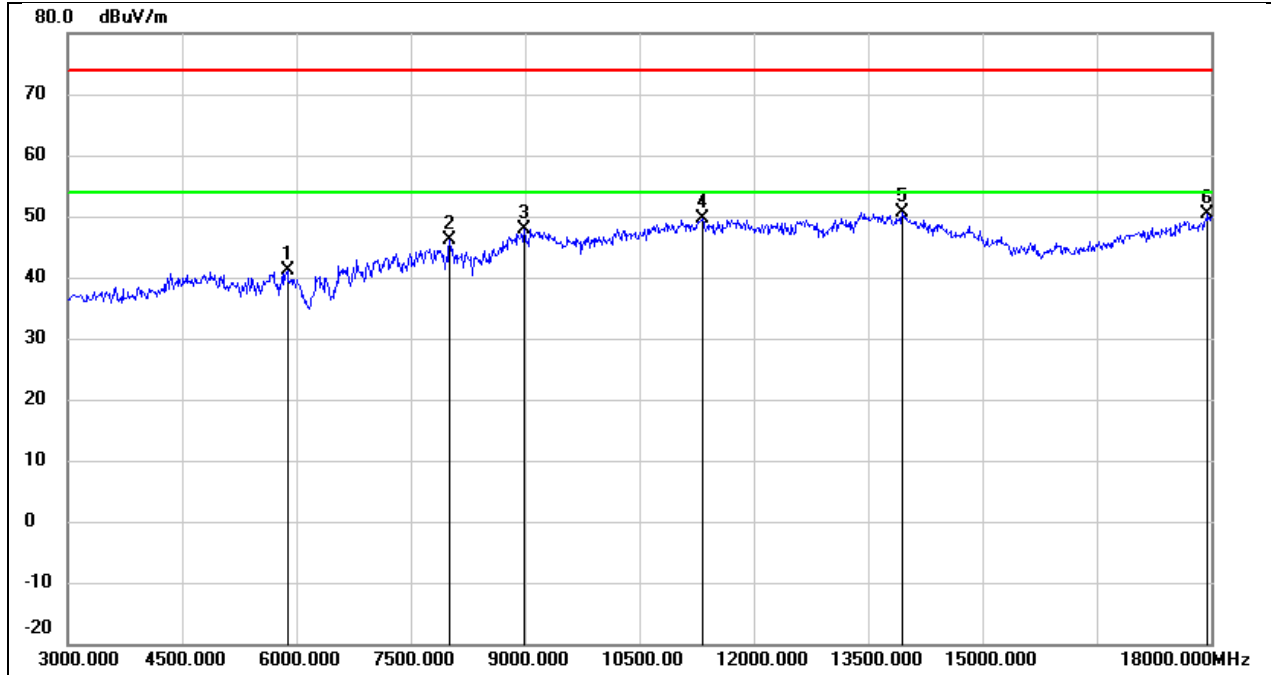

No.	Frequency (MHz)	Reading (dBuV)	Correct (dB/m)	Result (dBuV/m)	Limit (dBuV/m)	Margin (dB)	Remark
1	5880.000	39.26	1.92	41.18	74.00	-32.82	peak
2	8010.000	39.72	6.32	46.04	74.00	-27.96	peak
3	8985.000	37.42	10.37	47.79	74.00	-26.21	peak
4	11325.000	33.78	15.95	49.73	74.00	-24.27	peak
5	13950.000	28.84	21.86	50.70	74.00	-23.30	peak
6	17955.000	24.88	25.42	50.30	74.00	-23.70	peak

Test Mode:	802.11g	Frequency(MHz):	2462
Polarity:	Vertical	Test Voltage:	DC 5 V

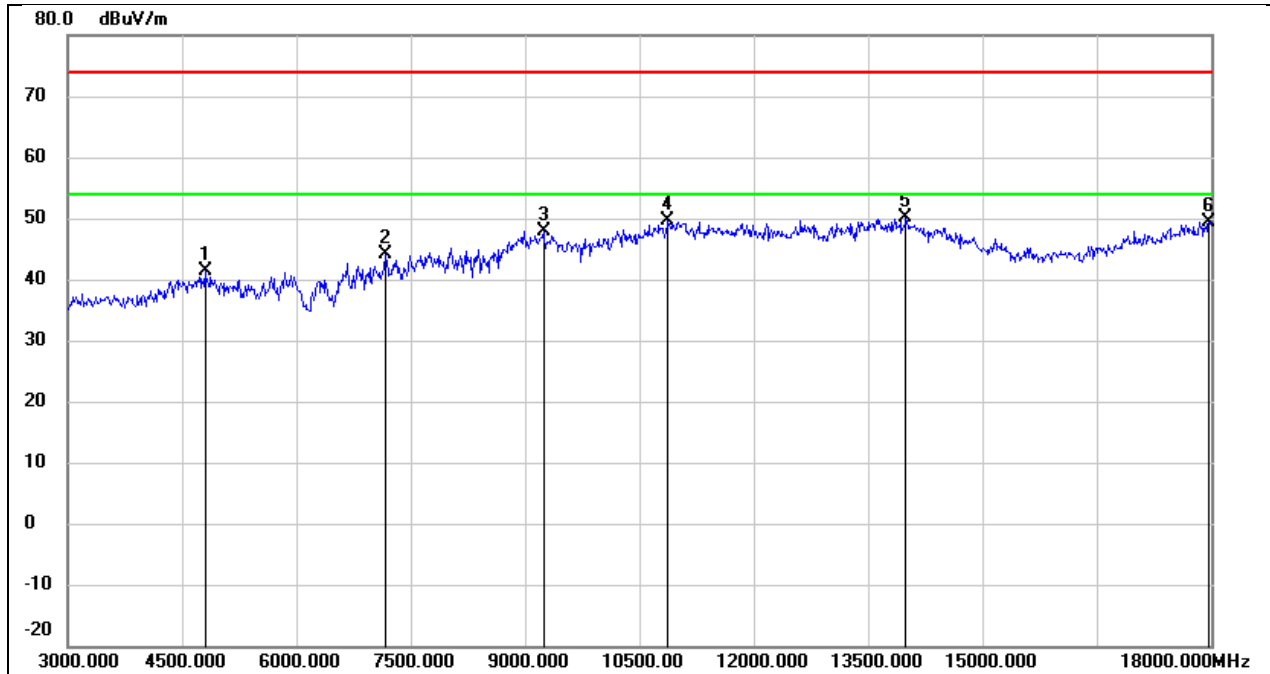

No.	Frequency (MHz)	Reading (dBuV)	Correct (dB/m)	Result (dBuV/m)	Limit (dBuV/m)	Margin (dB)	Remark
1	4800.000	41.57	-0.31	41.26	74.00	-32.74	peak
2	7170.000	37.48	6.56	44.04	74.00	-29.96	peak
3	9240.000	37.30	10.58	47.88	74.00	-26.12	peak
4	10875.000	35.31	14.32	49.63	74.00	-24.37	peak
5	13995.000	28.15	21.95	50.10	74.00	-23.90	peak
6	17970.000	23.86	25.51	49.37	74.00	-24.63	peak

Test Mode:	802.11n HT20	Frequency(MHz):	2412
Polarity:	Horizontal	Test Voltage:	DC 5 V

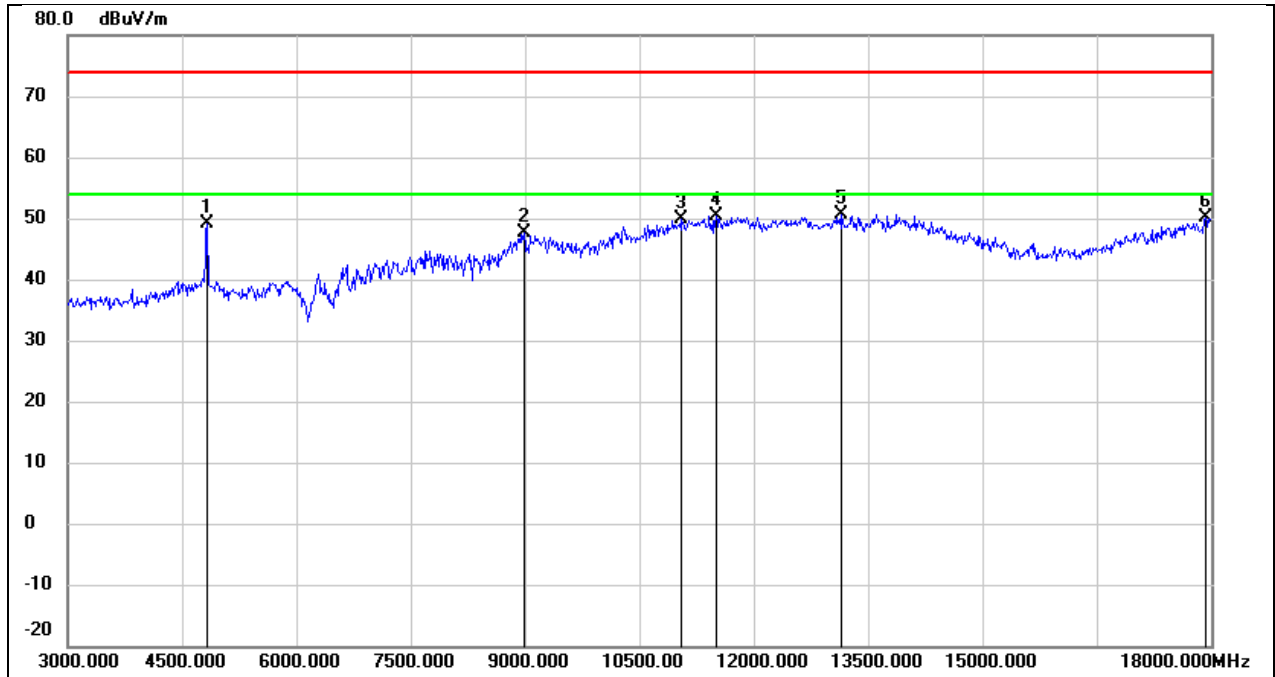

No.	Frequency (MHz)	Reading (dBuV)	Correct (dB/m)	Result (dBuV/m)	Limit (dBuV/m)	Margin (dB)	Remark
1	4830.000	49.29	-0.20	49.09	74.00	-24.91	peak
2	8985.000	37.15	10.37	47.52	74.00	-26.48	peak
3	11055.000	34.86	14.96	49.82	74.00	-24.18	peak
4	11505.000	33.71	16.61	50.32	74.00	-23.68	peak
5	13155.000	31.33	19.40	50.73	74.00	-23.27	peak
6	17925.000	24.97	25.25	50.22	74.00	-23.78	peak

Test Mode:	802.11n HT20	Frequency(MHz):	2412
Polarity:	Vertical	Test Voltage:	DC 5 V

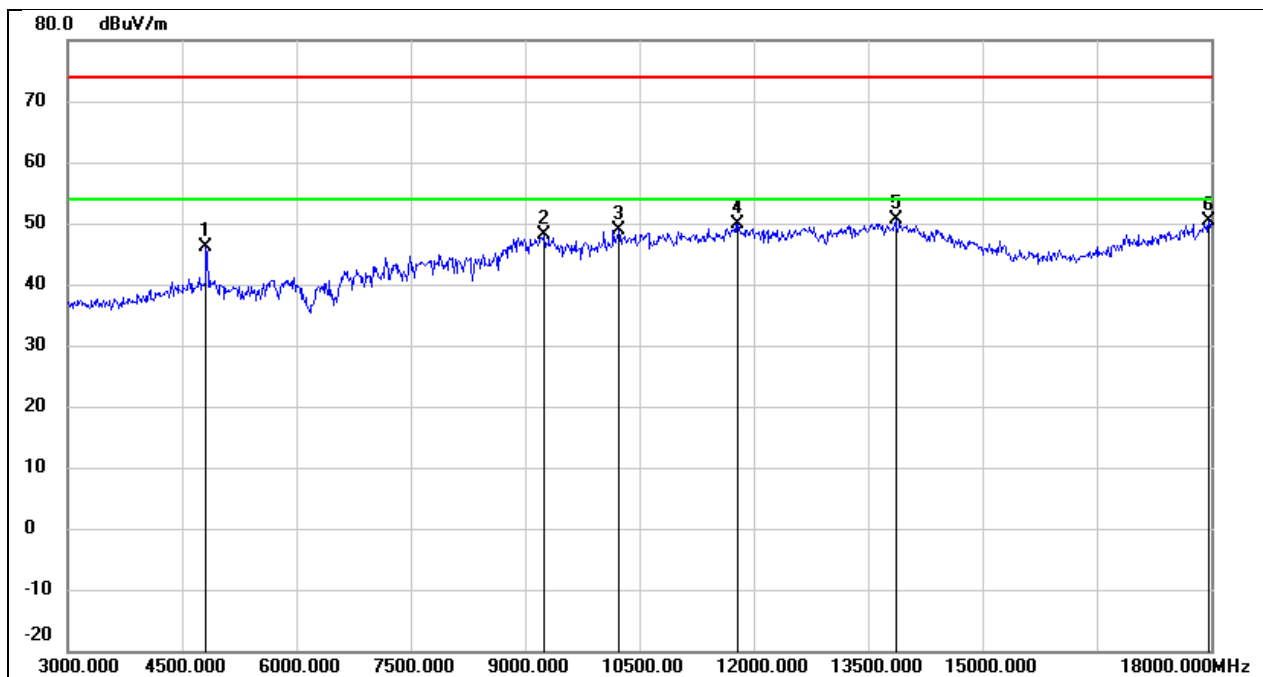

No.	Frequency (MHz)	Reading (dBuV)	Correct (dB/m)	Result (dBuV/m)	Limit (dBuV/m)	Margin (dB)	Remark
1	4815.000	46.40	-0.26	46.14	74.00	-27.86	peak
2	9255.000	37.57	10.59	48.16	74.00	-25.84	peak
3	10230.000	36.37	12.46	48.83	74.00	-25.17	peak
4	11790.000	32.41	17.38	49.79	74.00	-24.21	peak
5	13860.000	28.87	21.67	50.54	74.00	-23.46	peak
6	17970.000	24.90	25.51	50.41	74.00	-23.59	peak

Test Mode:	802.11n HT20	Frequency(MHz):	2437
Polarity:	Horizontal	Test Voltage:	DC 5 V

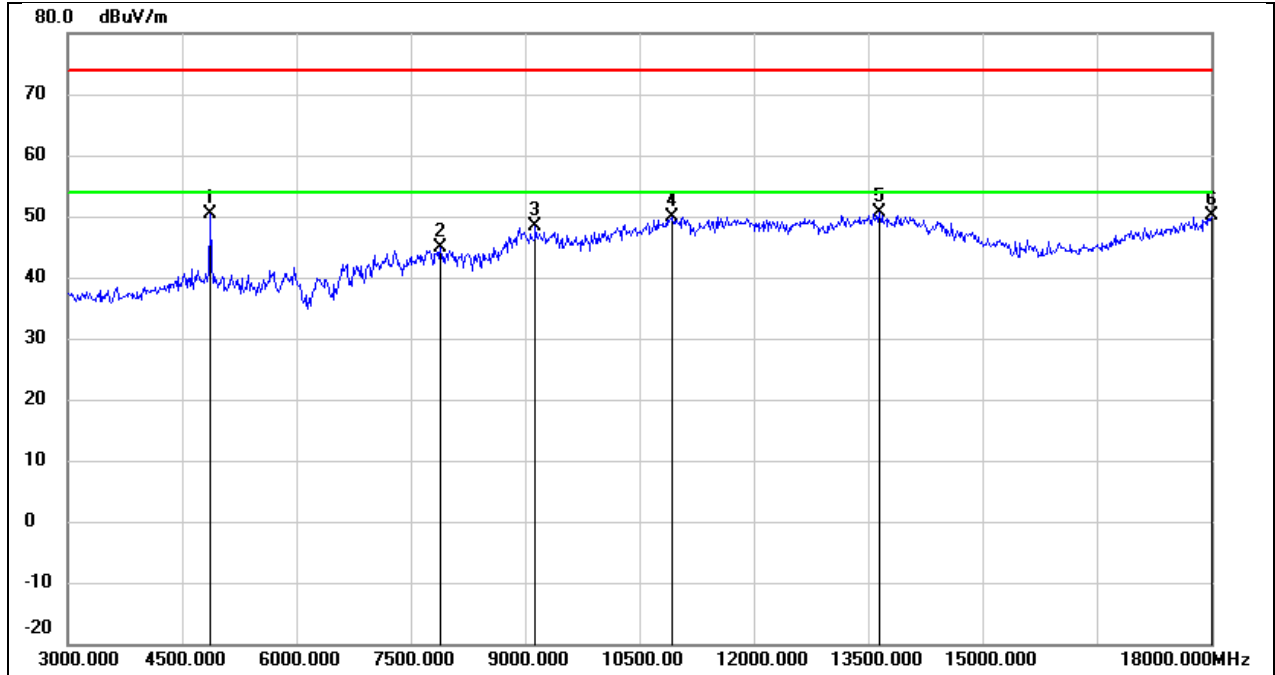

No.	Frequency (MHz)	Reading (dBuV)	Correct (dB/m)	Result (dBuV/m)	Limit (dBuV/m)	Margin (dB)	Remark
1	4875.000	50.36	-0.03	50.33	74.00	-23.67	peak
2	7890.000	38.68	6.31	44.99	74.00	-29.01	peak
3	9135.000	37.83	10.55	48.38	74.00	-25.62	peak
4	10920.000	35.48	14.49	49.97	74.00	-24.03	peak
5	13650.000	29.35	21.21	50.56	74.00	-23.44	peak
6	18000.000	24.35	25.69	50.04	74.00	-23.96	peak

Test Mode:	802.11n HT20	Frequency(MHz):	2437
Polarity:	Vertical	Test Voltage:	DC 5 V

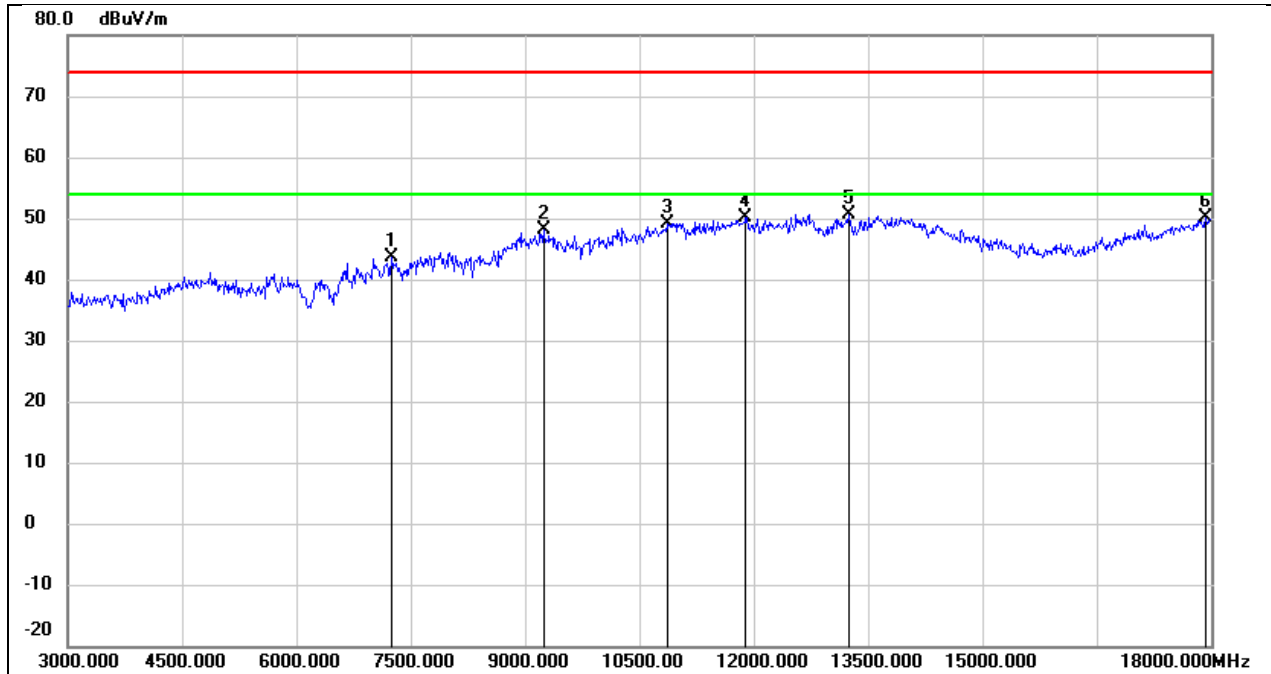

No.	Frequency (MHz)	Reading (dBuV)	Correct (dB/m)	Result (dBuV/m)	Limit (dBuV/m)	Margin (dB)	Remark
1	7245.000	37.09	6.51	43.60	74.00	-30.40	peak
2	9240.000	37.66	10.58	48.24	74.00	-25.76	peak
3	10860.000	34.79	14.27	49.06	74.00	-24.94	peak
4	11895.000	32.44	17.68	50.12	74.00	-23.88	peak
5	13245.000	30.78	19.78	50.56	74.00	-23.44	peak
6	17925.000	24.77	25.25	50.02	74.00	-23.98	peak

Test Mode:	802.11n HT20	Frequency(MHz):	2462
Polarity:	Horizontal	Test Voltage:	DC 5 V

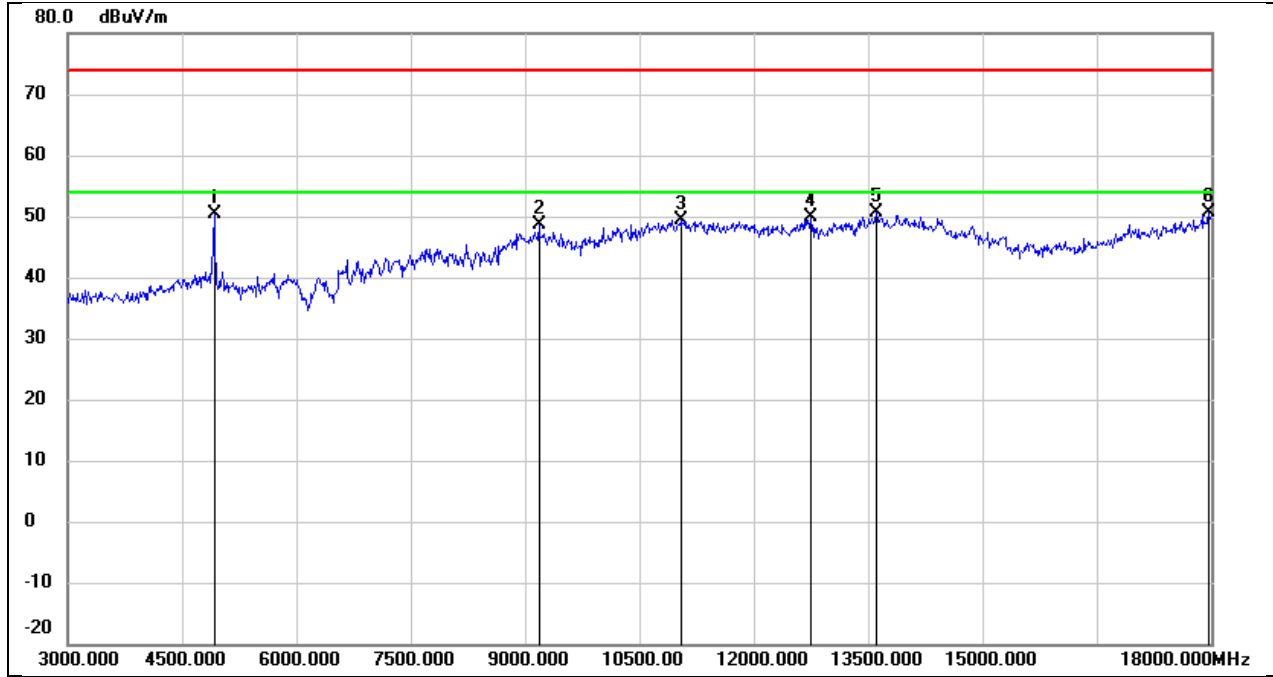

No.	Frequency (MHz)	Reading (dBuV)	Correct (dB/m)	Result (dBuV/m)	Limit (dBuV/m)	Margin (dB)	Remark
1	4920.000	50.21	0.14	50.35	74.00	-23.65	peak
2	9180.000	38.09	10.56	48.65	74.00	-25.35	peak
3	11055.000	34.48	14.96	49.44	74.00	-24.56	peak
4	12750.000	31.69	18.16	49.85	74.00	-24.15	peak
5	13605.000	29.58	21.12	50.70	74.00	-23.30	peak
6	17970.000	25.15	25.51	50.66	74.00	-23.34	peak

Test Mode:	802.11n HT20	Frequency(MHz):	2462
Polarity:	Vertical	Test Voltage:	DC 5 V

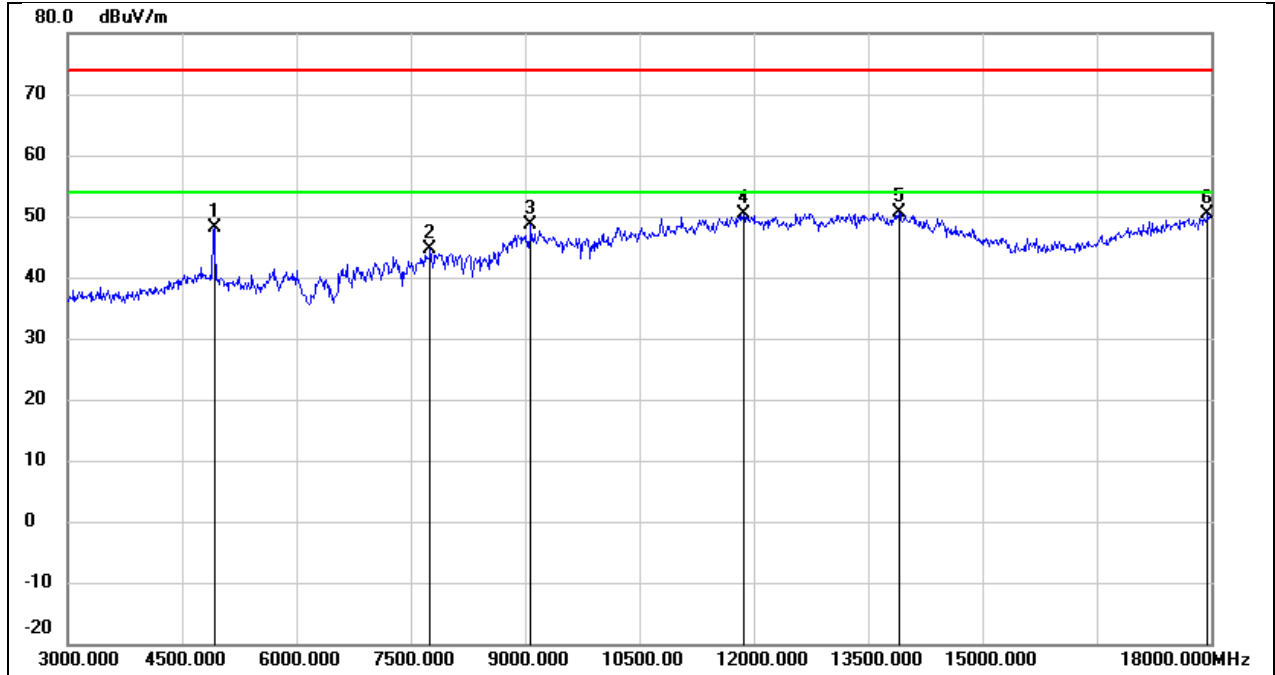

No.	Frequency (MHz)	Reading (dBuV)	Correct (dB/m)	Result (dBuV/m)	Limit (dBuV/m)	Margin (dB)	Remark
1	4920.000	48.04	0.14	48.18	74.00	-25.82	peak
2	7755.000	38.39	6.31	44.70	74.00	-29.30	peak
3	9075.000	38.16	10.52	48.68	74.00	-25.32	peak
4	11865.000	32.90	17.59	50.49	74.00	-23.51	peak
5	13905.000	28.92	21.76	50.68	74.00	-23.32	peak
6	17955.000	24.99	25.42	50.41	74.00	-23.59	peak



Test Mode:	802.11n HT40	Frequency(MHz):	2422
Polarity:	Horizontal	Test Voltage:	DC 5 V

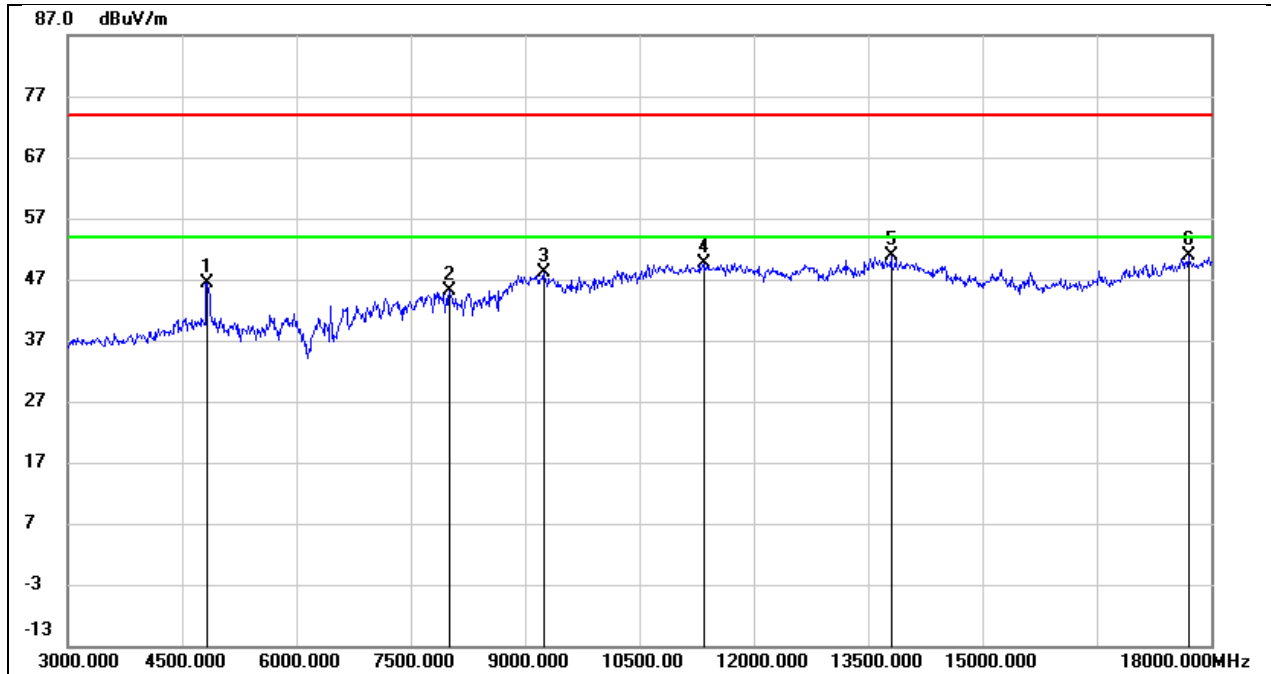

No.	Frequency (MHz)	Reading (dBuV)	Correct (dB/m)	Result (dBuV/m)	Limit (dBuV/m)	Margin (dB)	Remark
1	4830.000	46.65	-0.20	46.45	74.00	-27.55	peak
2	8010.000	38.92	6.32	45.24	74.00	-28.76	peak
3	9240.000	37.62	10.58	48.20	74.00	-25.80	peak
4	11340.000	33.57	16.01	49.58	74.00	-24.42	peak
5	13800.000	29.24	21.54	50.78	74.00	-23.22	peak
6	17700.000	26.97	23.91	50.88	74.00	-23.12	peak

Test Mode:	802.11n HT40	Frequency(MHz):	2422
Polarity:	Vertical	Test Voltage:	DC 5 V

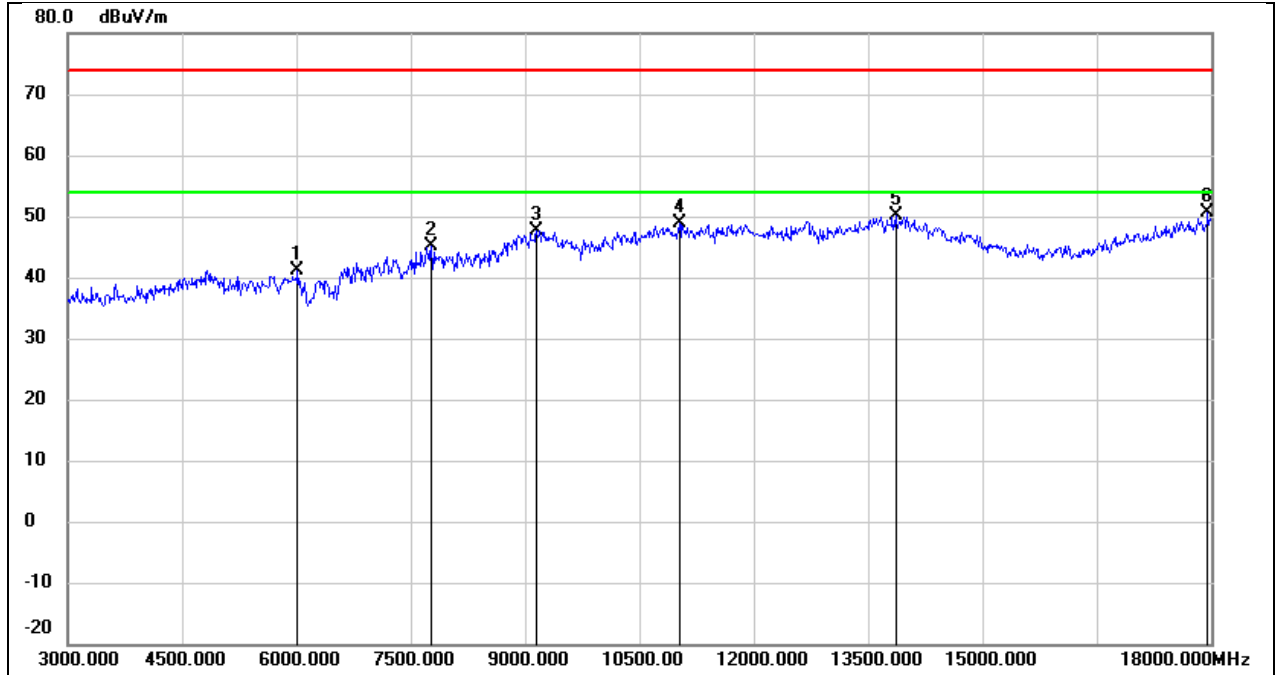

No.	Frequency (MHz)	Reading (dBuV)	Correct (dB/m)	Result (dBuV/m)	Limit (dBuV/m)	Margin (dB)	Remark
1	6015.000	38.86	2.31	41.17	74.00	-32.83	peak
2	7770.000	38.84	6.31	45.15	74.00	-28.85	peak
3	9150.000	37.10	10.54	47.64	74.00	-26.36	peak
4	11025.000	34.01	14.85	48.86	74.00	-25.14	peak
5	13860.000	28.53	21.67	50.20	74.00	-23.80	peak
6	17955.000	25.24	25.42	50.66	74.00	-23.34	peak

Test Mode:	802.11n HT40	Frequency(MHz):	2437
Polarity:	Horizontal	Test Voltage:	DC 5 V

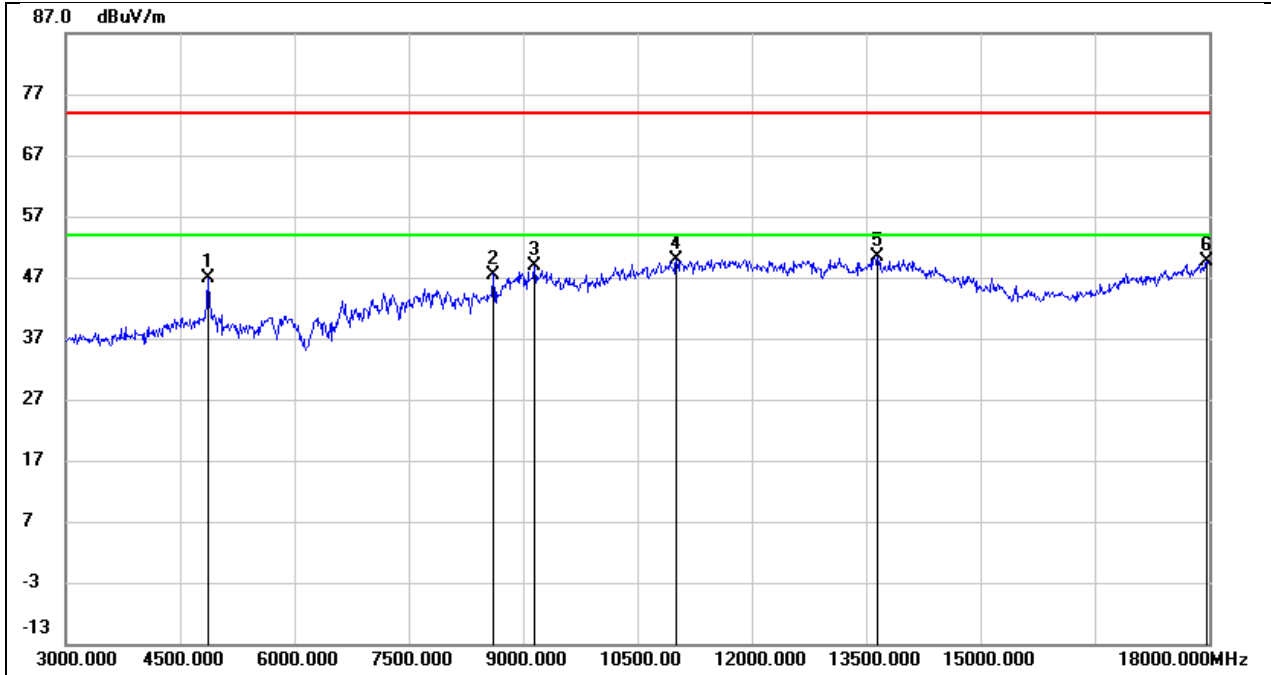

No.	Frequency (MHz)	Reading (dBuV)	Correct (dB/m)	Result (dBuV/m)	Limit (dBuV/m)	Margin (dB)	Remark
1	4860.000	47.06	-0.09	46.97	74.00	-27.03	peak
2	8610.000	39.86	7.64	47.50	74.00	-26.50	peak
3	9150.000	38.34	10.54	48.88	74.00	-25.12	peak
4	11010.000	34.99	14.81	49.80	74.00	-24.20	peak
5	13650.000	29.13	21.21	50.34	74.00	-23.66	peak
6	17970.000	24.07	25.51	49.58	74.00	-24.42	peak

Test Mode:	802.11n HT40	Frequency(MHz):	2437
Polarity:	Vertical	Test Voltage:	DC 5 V

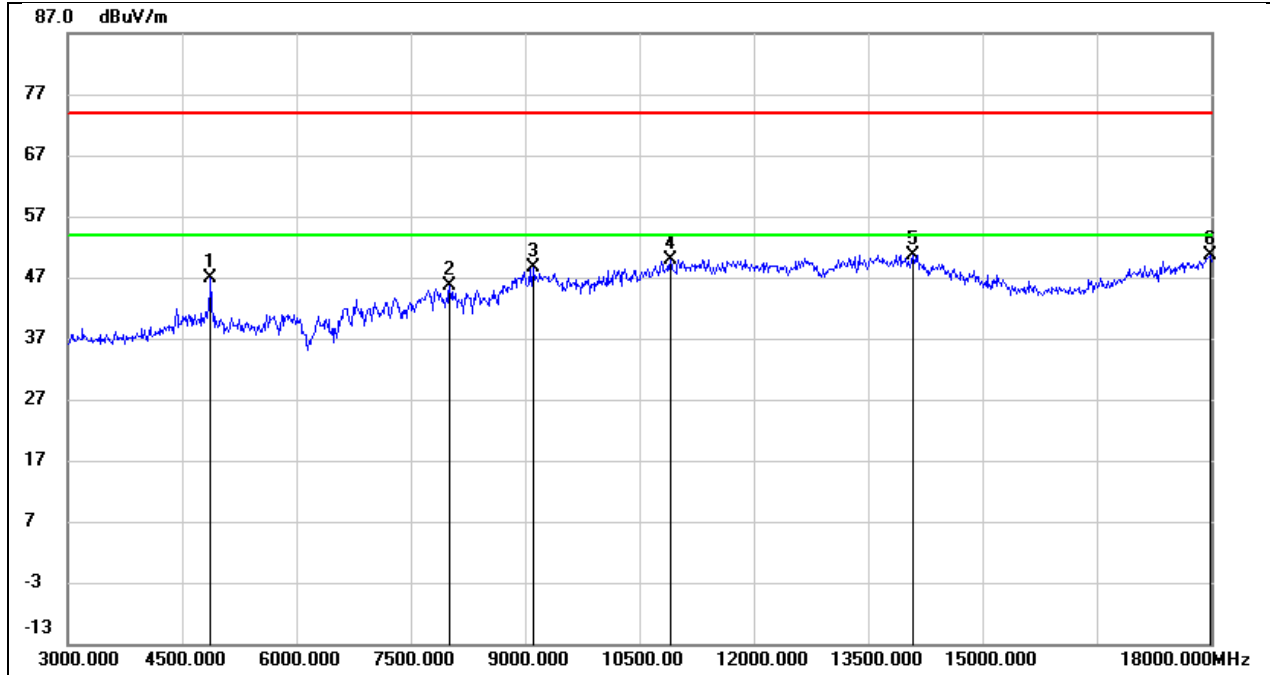

No.	Frequency (MHz)	Reading (dBuV)	Correct (dB/m)	Result (dBuV/m)	Limit (dBuV/m)	Margin (dB)	Remark
1	4875.000	46.87	-0.03	46.84	74.00	-27.16	peak
2	8010.000	39.20	6.32	45.52	74.00	-28.48	peak
3	9105.000	38.13	10.53	48.66	74.00	-25.34	peak
4	10905.000	35.55	14.43	49.98	74.00	-24.02	peak
5	14085.000	29.11	21.61	50.72	74.00	-23.28	peak
6	17985.000	25.09	25.60	50.69	74.00	-23.31	peak

Test Mode:	802.11n HT40	Frequency(MHz):	2452
Polarity:	Horizontal	Test Voltage:	DC 5 V

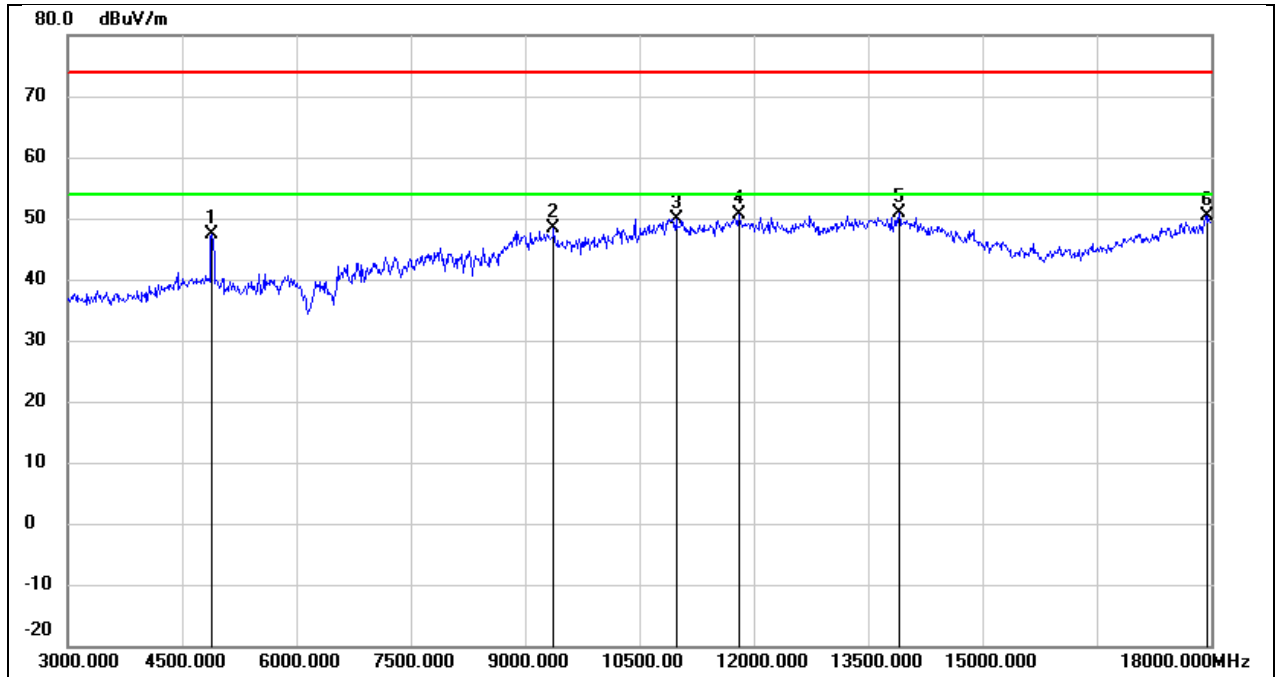

No.	Frequency (MHz)	Reading (dBuV)	Correct (dB/m)	Result (dBuV/m)	Limit (dBuV/m)	Margin (dB)	Remark
1	4890.000	47.28	0.03	47.31	74.00	-26.69	peak
2	9375.000	37.69	10.64	48.33	74.00	-25.67	peak
3	10980.000	35.24	14.69	49.93	74.00	-24.07	peak
4	11805.000	33.31	17.43	50.74	74.00	-23.26	peak
5	13905.000	29.08	21.76	50.84	74.00	-23.16	peak
6	17955.000	25.01	25.42	50.43	74.00	-23.57	peak

Test Mode:	802.11n HT40	Frequency(MHz):	2452
Polarity:	Vertical	Test Voltage:	DC 5 V

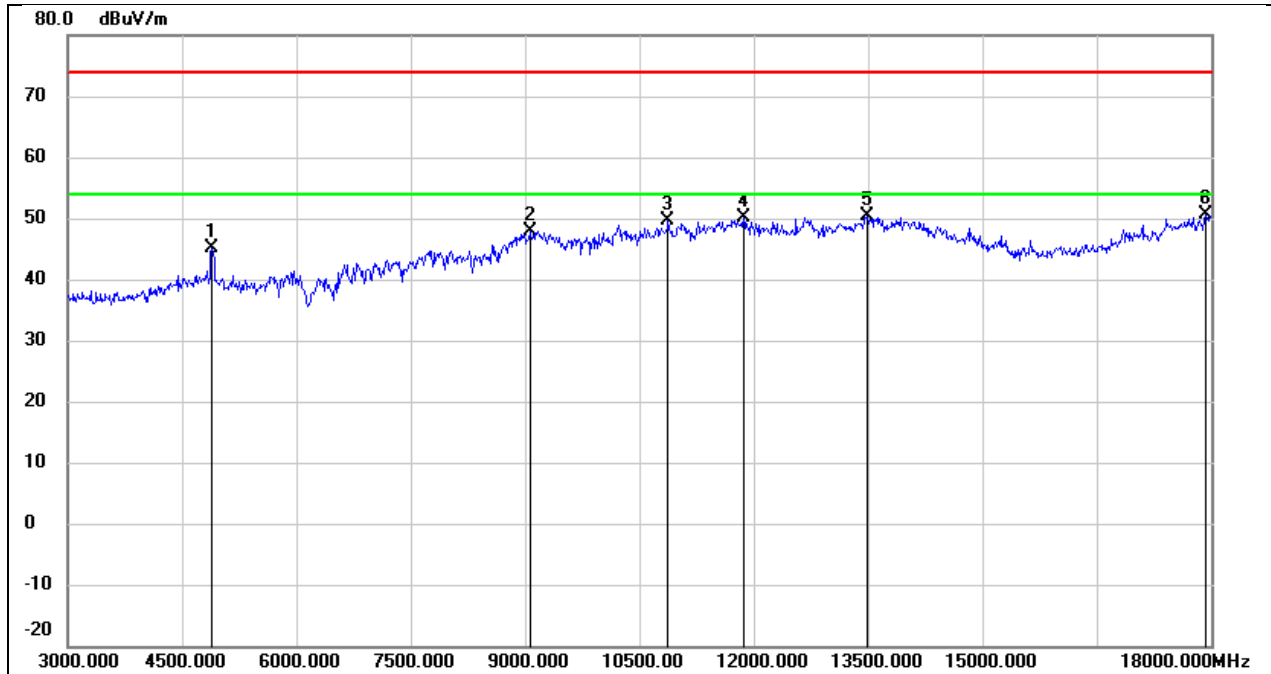

No.	Frequency (MHz)	Reading (dBuV)	Correct (dB/m)	Result (dBuV/m)	Limit (dBuV/m)	Margin (dB)	Remark
1	4890.000	45.02	0.03	45.05	74.00	-28.95	peak
2	9060.000	37.27	10.51	47.78	74.00	-26.22	peak
3	10875.000	35.35	14.32	49.67	74.00	-24.33	peak
4	11865.000	32.42	17.59	50.01	74.00	-23.99	peak
5	13485.000	29.45	20.84	50.29	74.00	-23.71	peak
6	17925.000	25.44	25.25	50.69	74.00	-23.31	peak

Test Mode:	802.11ax HE20	Frequency(MHz):	2412
Polarity:	Horizontal	Test Voltage:	DC 5 V

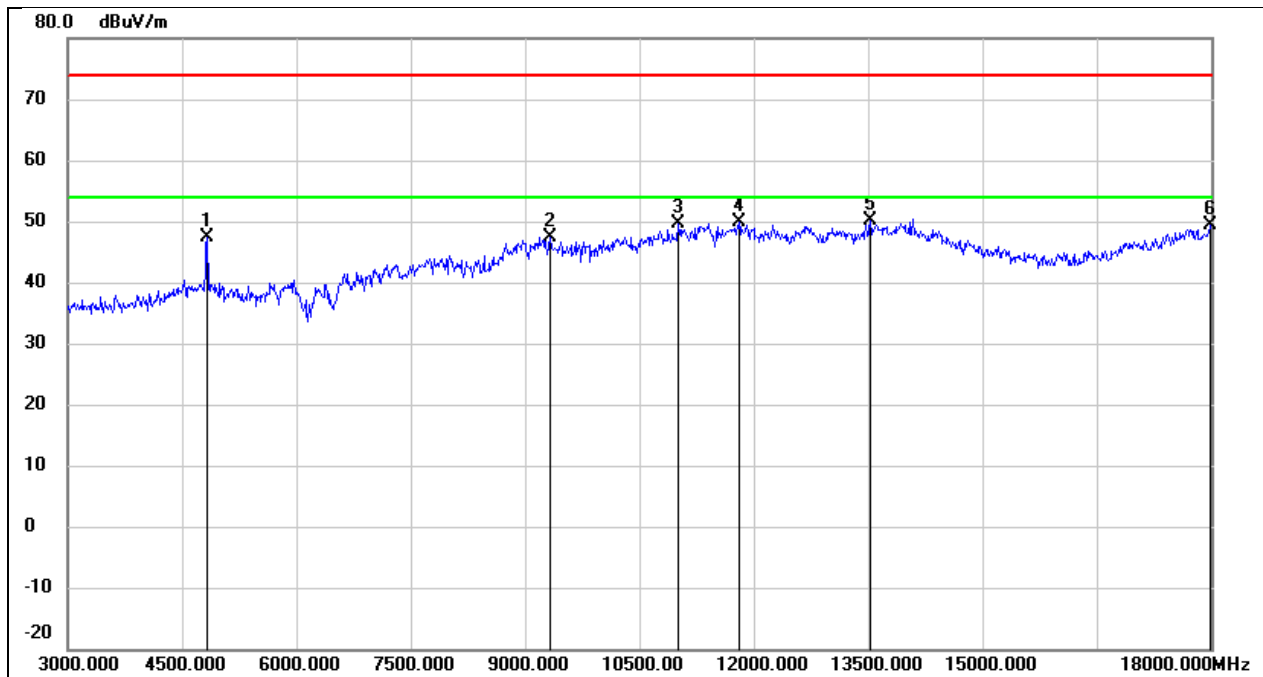

No.	Frequency (MHz)	Reading (dBuV)	Correct (dB/m)	Result (dBuV/m)	Limit (dBuV/m)	Margin (dB)	Remark
1	4830.000	47.68	-0.20	47.48	74.00	-26.52	peak
2	9330.000	36.85	10.62	47.47	74.00	-26.53	peak
3	11010.000	34.85	14.81	49.66	74.00	-24.34	peak
4	11805.000	32.54	17.43	49.97	74.00	-24.03	peak
5	13530.000	29.23	20.96	50.19	74.00	-23.81	peak
6	17985.000	23.85	25.60	49.45	74.00	-24.55	peak

Test Mode:	802.11ax HE20	Frequency(MHz):	2412
Polarity:	Vertical	Test Voltage:	DC 5 V

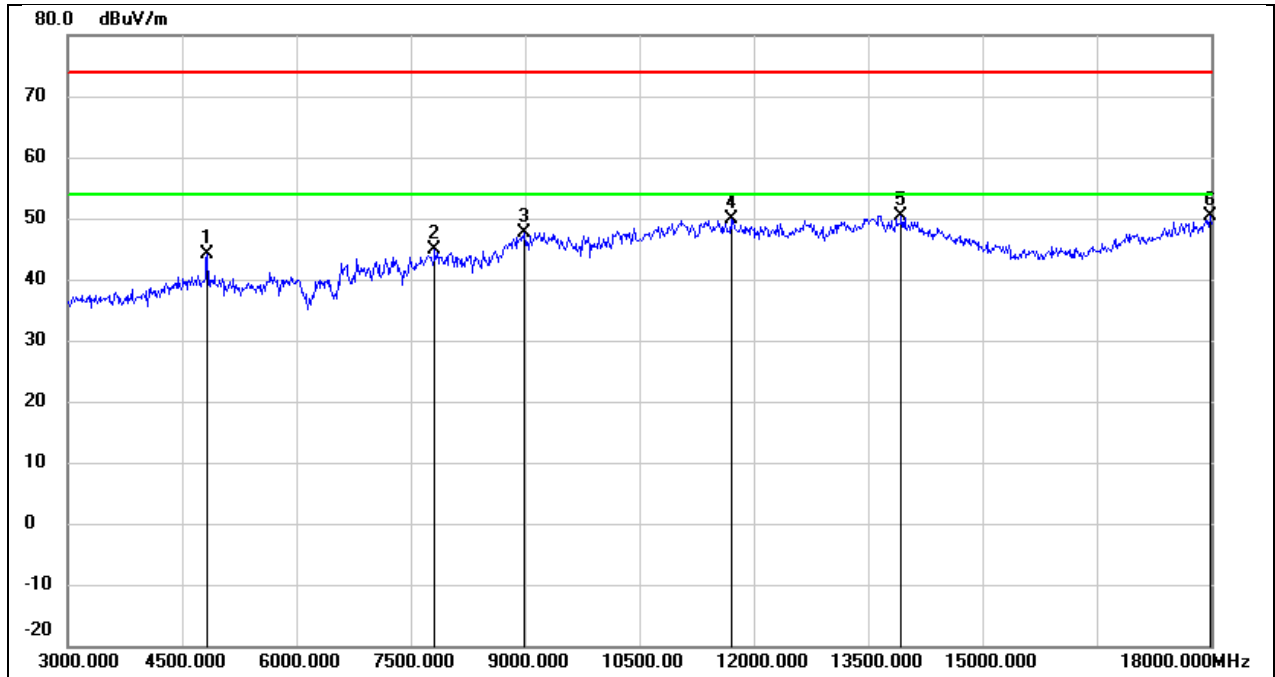

No.	Frequency (MHz)	Reading (dBuV)	Correct (dB/m)	Result (dBuV/m)	Limit (dBuV/m)	Margin (dB)	Remark
1	4830.000	44.42	-0.20	44.22	74.00	-29.78	peak
2	7815.000	38.62	6.32	44.94	74.00	-29.06	peak
3	8985.000	37.33	10.37	47.70	74.00	-26.30	peak
4	11700.000	32.72	17.14	49.86	74.00	-24.14	peak
5	13935.000	28.60	21.82	50.42	74.00	-23.58	peak
6	17985.000	24.71	25.60	50.31	74.00	-23.69	peak



Test Mode:	802.11ax HE20	Frequency(MHz):	2437
Polarity:	Horizontal	Test Voltage:	DC 5 V

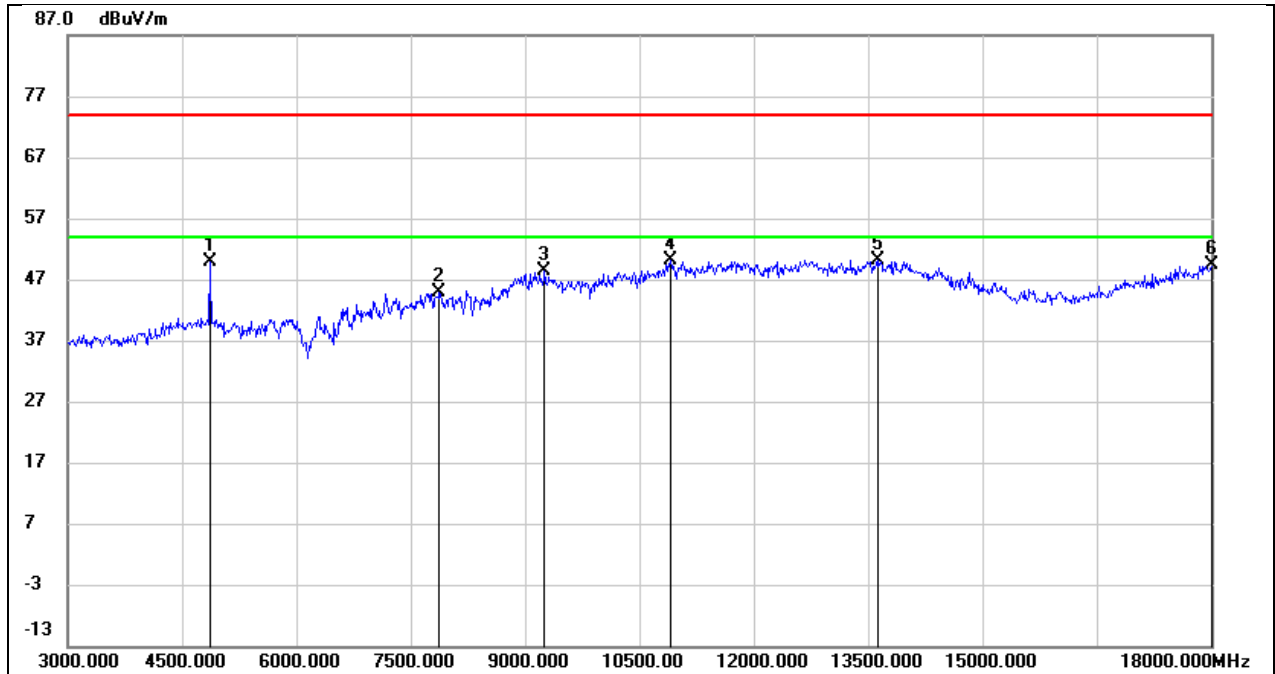

No.	Frequency (MHz)	Reading (dBuV)	Correct (dB/m)	Result (dBuV/m)	Limit (dBuV/m)	Margin (dB)	Remark
1	4860.000	49.89	-0.09	49.80	74.00	-24.20	peak
2	7875.000	38.54	6.31	44.85	74.00	-29.15	peak
3	9255.000	37.82	10.59	48.41	74.00	-25.59	peak
4	10905.000	35.66	14.43	50.09	74.00	-23.91	peak
5	13620.000	28.95	21.15	50.10	74.00	-23.90	peak
6	18000.000	23.78	25.69	49.47	74.00	-24.53	peak

Test Mode:	802.11ax HE20	Frequency(MHz):	2437
Polarity:	Vertical	Test Voltage:	DC 5 V

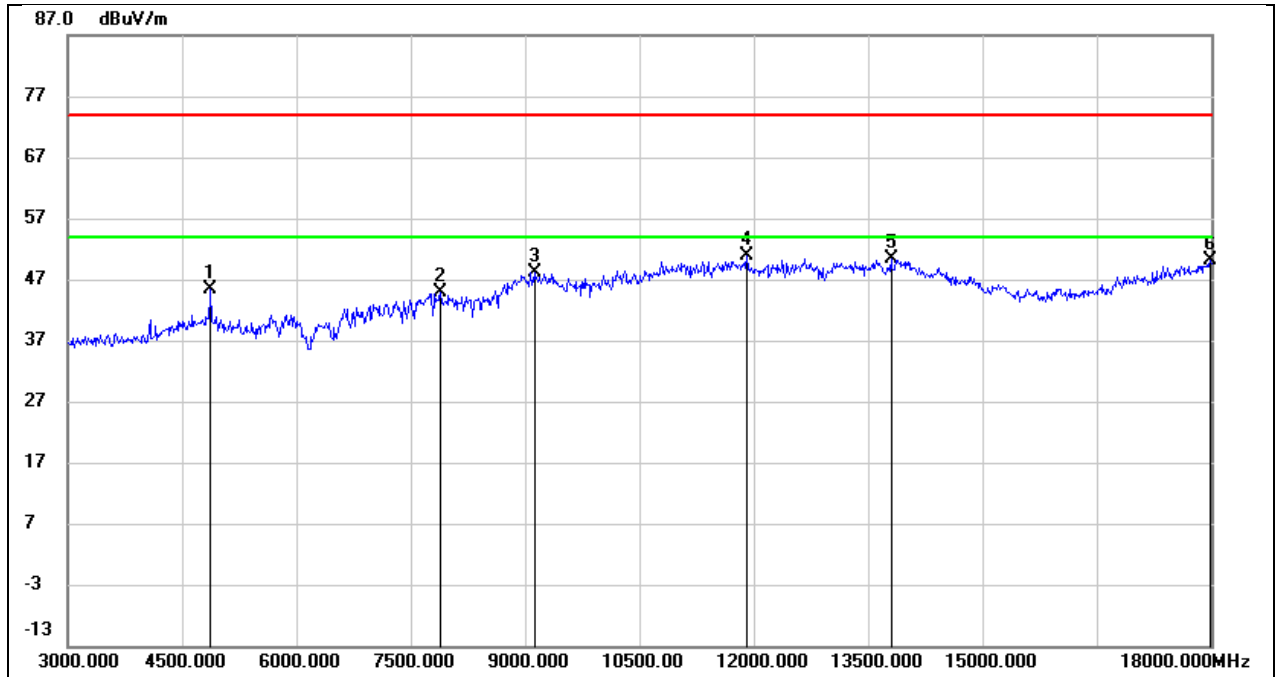

No.	Frequency (MHz)	Reading (dBuV)	Correct (dB/m)	Result (dBuV/m)	Limit (dBuV/m)	Margin (dB)	Remark
1	4875.000	45.32	-0.03	45.29	74.00	-28.71	peak
2	7890.000	38.47	6.31	44.78	74.00	-29.22	peak
3	9120.000	37.57	10.53	48.10	74.00	-25.90	peak
4	11910.000	33.12	17.72	50.84	74.00	-23.16	peak
5	13800.000	28.74	21.54	50.28	74.00	-23.72	peak
6	17985.000	24.44	25.60	50.04	74.00	-23.96	peak

Test Mode:	802.11ax HE20	Frequency(MHz):	2462
Polarity:	Horizontal	Test Voltage:	DC 5 V

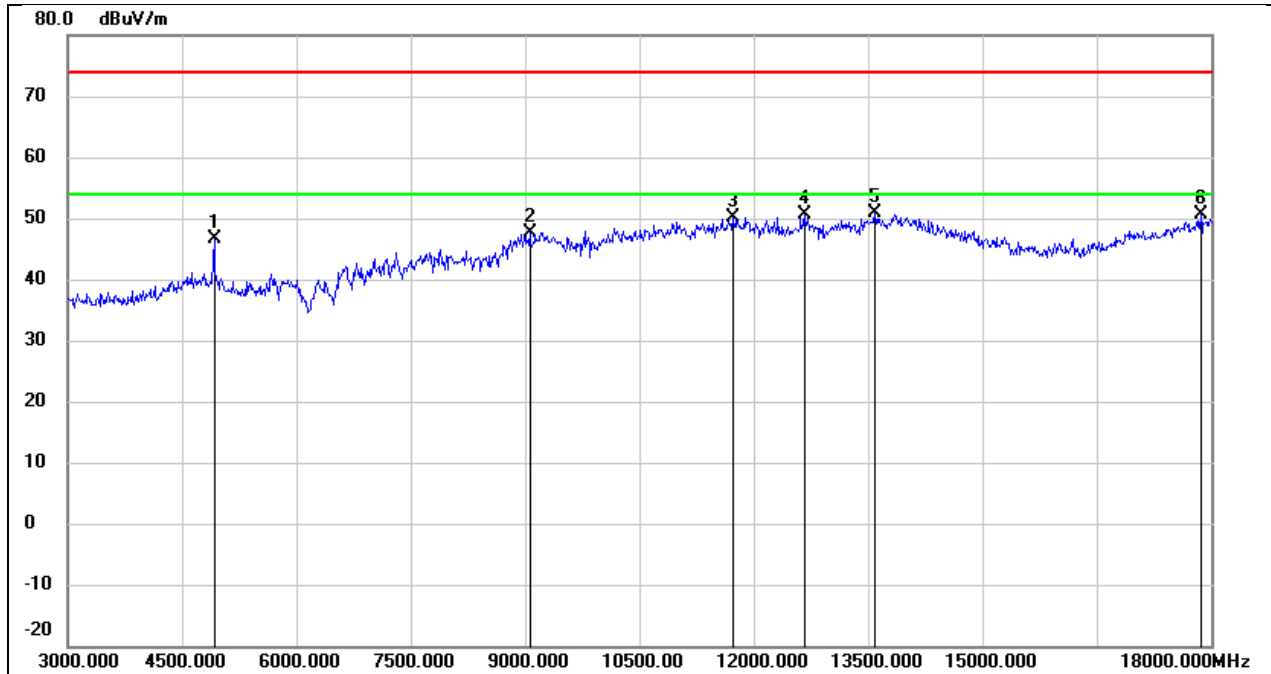

No.	Frequency (MHz)	Reading (dBuV)	Correct (dB/m)	Result (dBuV/m)	Limit (dBuV/m)	Margin (dB)	Remark
1	4920.000	46.56	0.14	46.70	74.00	-27.30	peak
2	9060.000	37.22	10.51	47.73	74.00	-26.27	peak
3	11730.000	32.97	17.22	50.19	74.00	-23.81	peak
4	12660.000	32.70	17.95	50.65	74.00	-23.35	peak
5	13590.000	29.89	21.09	50.98	74.00	-23.02	peak
6	17865.000	25.63	24.89	50.52	74.00	-23.48	peak

Test Mode:	802.11ax HE20	Frequency(MHz):	2462
Polarity:	Vertical	Test Voltage:	DC 5 V

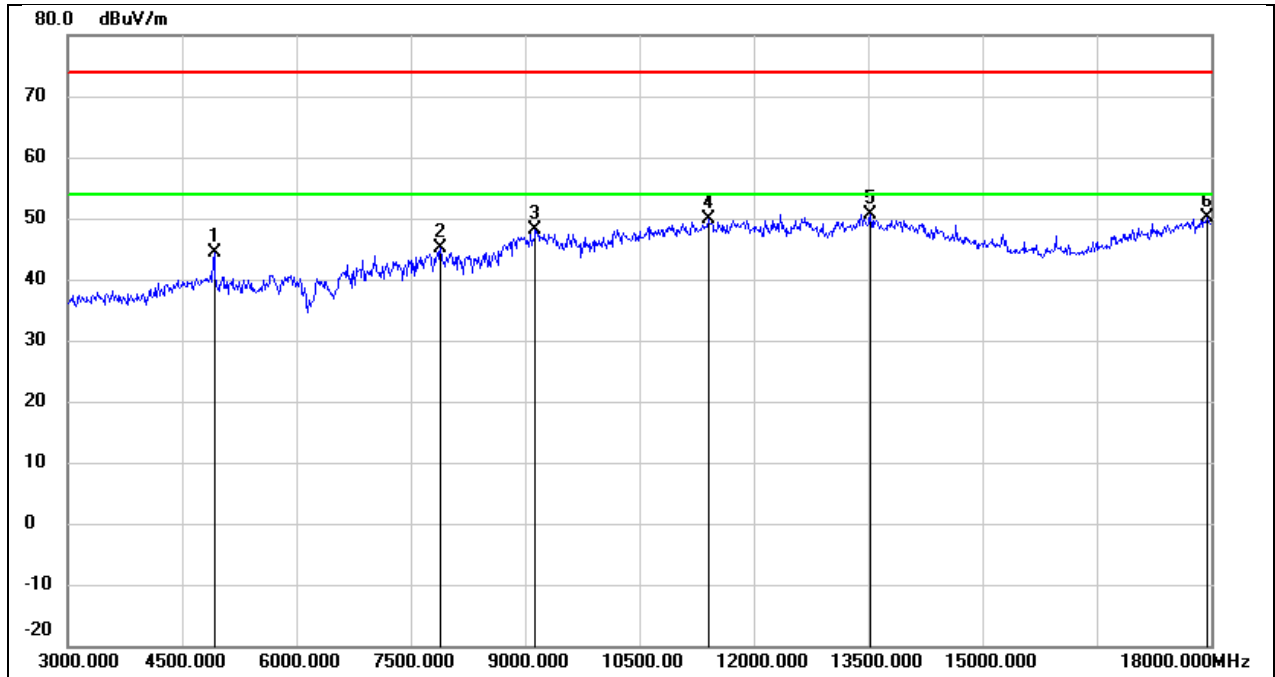

No.	Frequency (MHz)	Reading (dBuV)	Correct (dB/m)	Result (dBuV/m)	Limit (dBuV/m)	Margin (dB)	Remark
1	4920.000	44.16	0.14	44.30	74.00	-29.70	peak
2	7890.000	38.88	6.31	45.19	74.00	-28.81	peak
3	9135.000	37.49	10.55	48.04	74.00	-25.96	peak
4	11400.000	33.58	16.23	49.81	74.00	-24.19	peak
5	13530.000	29.78	20.96	50.74	74.00	-23.26	peak
6	17940.000	24.83	25.34	50.17	74.00	-23.83	peak

Test Mode:	802.11ax HE40	Frequency(MHz):	2422
Polarity:	Horizontal	Test Voltage:	DC 5 V

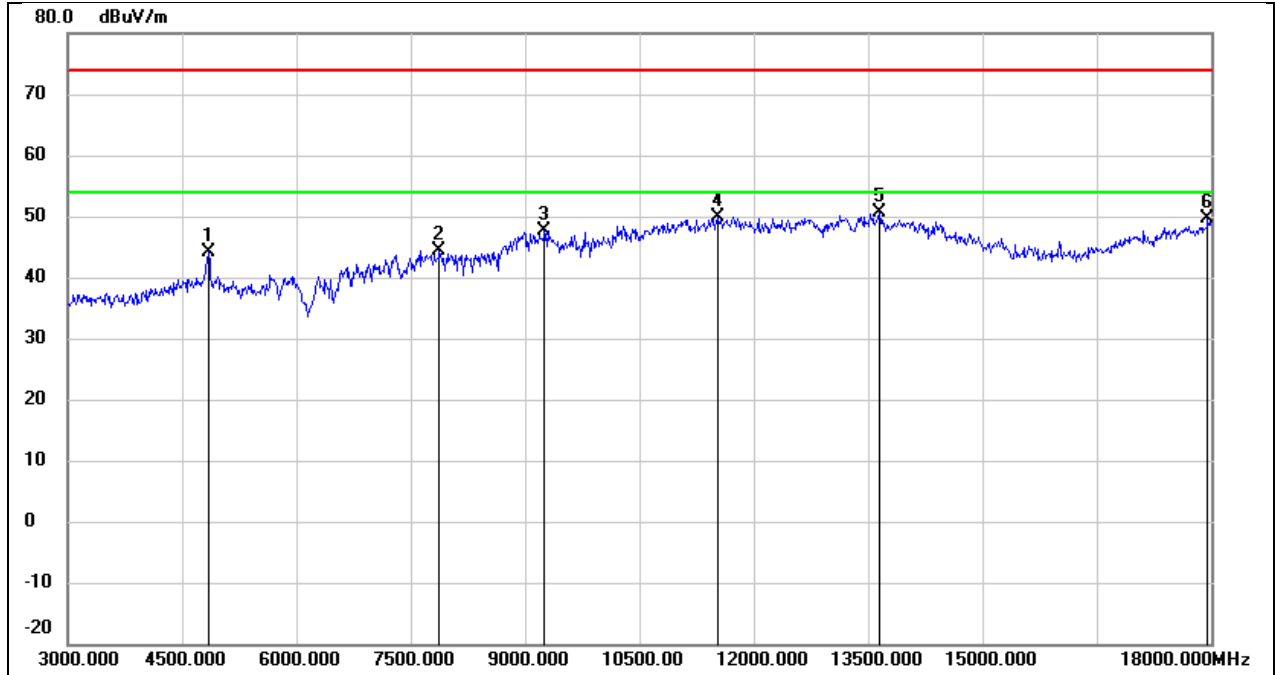

No.	Frequency (MHz)	Reading (dBuV)	Correct (dB/m)	Result (dBuV/m)	Limit (dBuV/m)	Margin (dB)	Remark
1	4845.000	44.34	-0.15	44.19	74.00	-29.81	peak
2	7875.000	38.07	6.31	44.38	74.00	-29.62	peak
3	9255.000	37.11	10.59	47.70	74.00	-26.30	peak
4	11535.000	33.27	16.70	49.97	74.00	-24.03	peak
5	13650.000	29.46	21.21	50.67	74.00	-23.33	peak
6	17955.000	24.20	25.42	49.62	74.00	-24.38	peak

Test Mode:	802.11ax HE40	Frequency(MHz):	2422
Polarity:	Vertical	Test Voltage:	DC 5 V

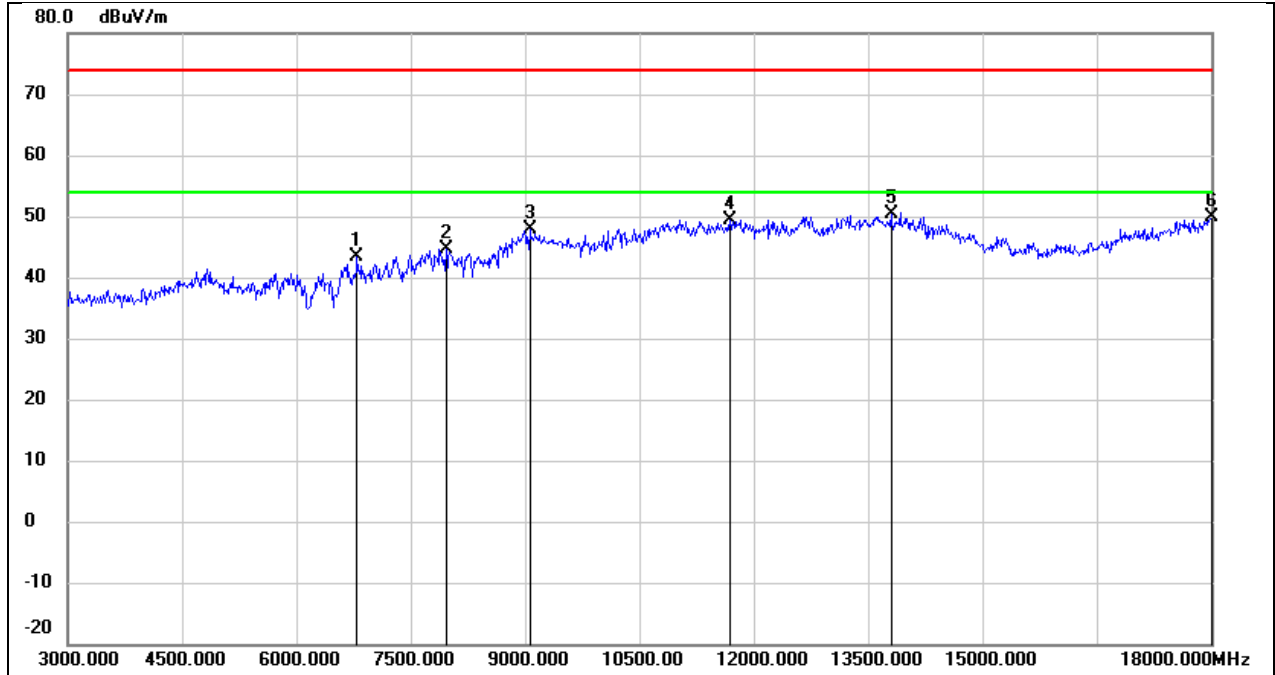

No.	Frequency (MHz)	Reading (dBuV)	Correct (dB/m)	Result (dBuV/m)	Limit (dBuV/m)	Margin (dB)	Remark
1	6795.000	37.62	5.68	43.30	74.00	-30.70	peak
2	7965.000	38.40	6.31	44.71	74.00	-29.29	peak
3	9060.000	37.48	10.51	47.99	74.00	-26.01	peak
4	11685.000	32.35	17.10	49.45	74.00	-24.55	peak
5	13800.000	28.86	21.54	50.40	74.00	-23.60	peak
6	18000.000	24.30	25.69	49.99	74.00	-24.01	peak

Test Mode:	802.11ax HE40	Frequency(MHz):	2437
Polarity:	Horizontal	Test Voltage:	DC 5 V

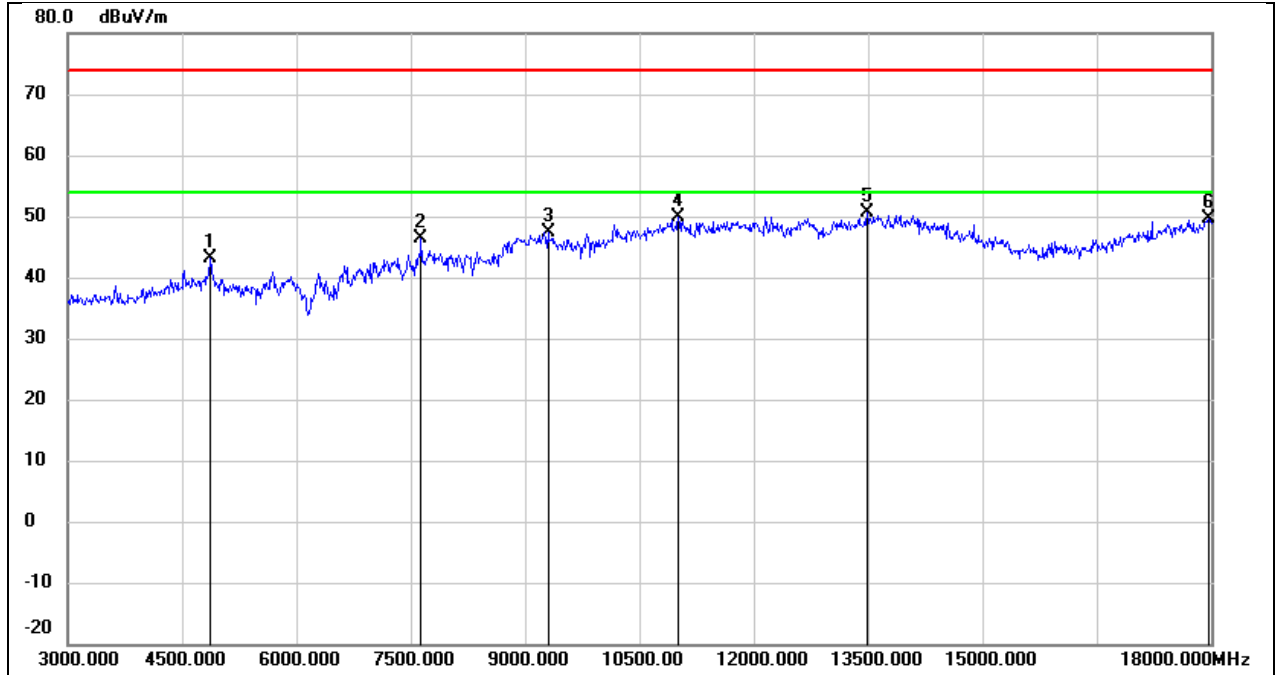

No.	Frequency (MHz)	Reading (dBuV)	Correct (dB/m)	Result (dBuV/m)	Limit (dBuV/m)	Margin (dB)	Remark
1	4875.000	43.11	-0.03	43.08	74.00	-30.92	peak
2	7635.000	40.09	6.33	46.42	74.00	-27.58	peak
3	9300.000	36.83	10.61	47.44	74.00	-26.56	peak
4	11010.000	35.15	14.81	49.96	74.00	-24.04	peak
5	13485.000	29.73	20.84	50.57	74.00	-23.43	peak
6	17970.000	24.22	25.51	49.73	74.00	-24.27	peak

Test Mode:	802.11ax HE40	Frequency(MHz):	2437
Polarity:	Vertical	Test Voltage:	DC 5 V

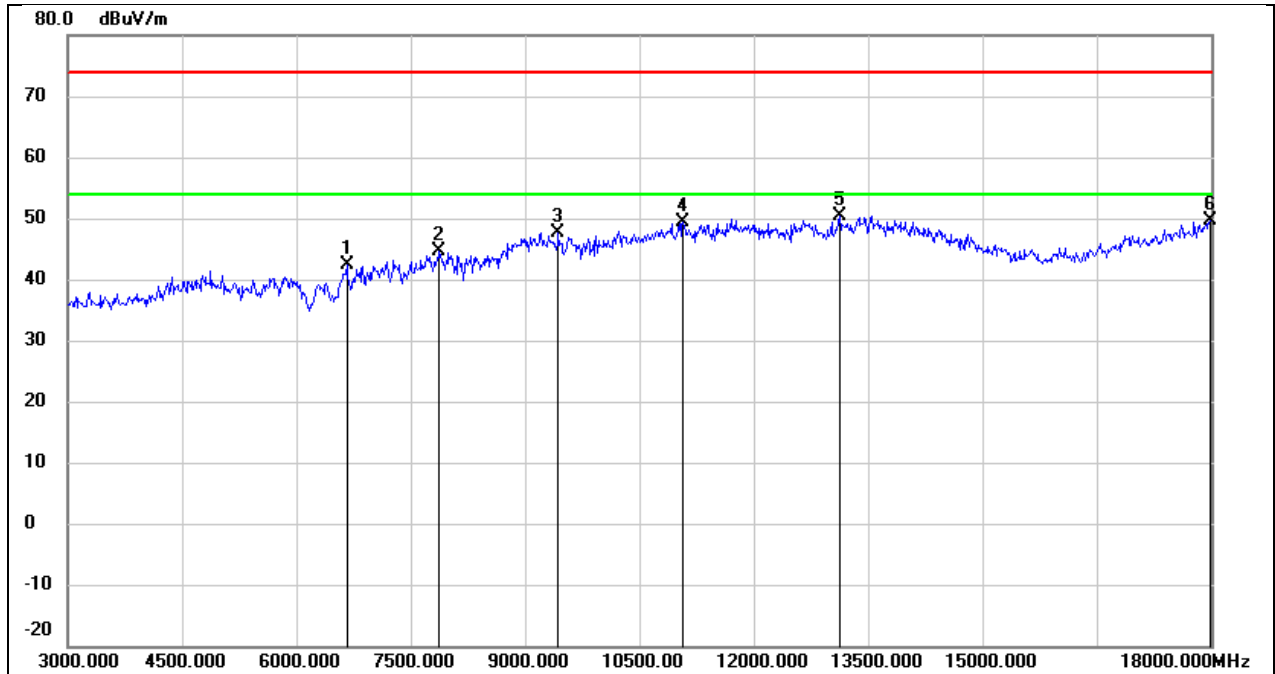

No.	Frequency (MHz)	Reading (dBuV)	Correct (dB/m)	Result (dBuV/m)	Limit (dBuV/m)	Margin (dB)	Remark
1	6660.000	37.27	5.02	42.29	74.00	-31.71	peak
2	7875.000	38.41	6.31	44.72	74.00	-29.28	peak
3	9435.000	36.87	10.67	47.54	74.00	-26.46	peak
4	11070.000	34.27	15.03	49.30	74.00	-24.70	peak
5	13125.000	31.21	19.26	50.47	74.00	-23.53	peak
6	17985.000	23.95	25.60	49.55	74.00	-24.45	peak



Test Mode:	802.11ax HE40	Frequency(MHz):	2452
Polarity:	Horizontal	Test Voltage:	DC 5 V

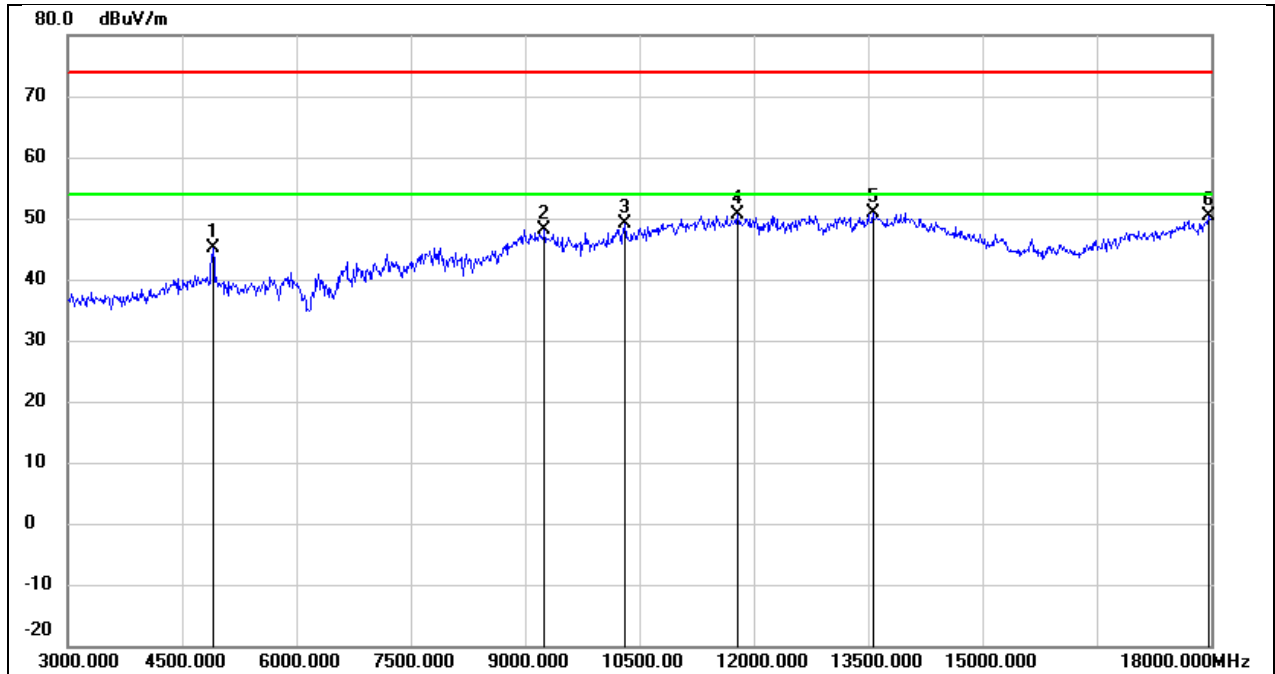

No.	Frequency (MHz)	Reading (dBuV)	Correct (dB/m)	Result (dBuV/m)	Limit (dBuV/m)	Margin (dB)	Remark
1	4905.000	45.04	0.09	45.13	74.00	-28.87	peak
2	9255.000	37.57	10.59	48.16	74.00	-25.84	peak
3	10305.000	36.49	12.61	49.10	74.00	-24.90	peak
4	11790.000	33.34	17.38	50.72	74.00	-23.28	peak
5	13560.000	29.77	21.04	50.81	74.00	-23.19	peak
6	17970.000	24.78	25.51	50.29	74.00	-23.71	peak

Test Mode:	802.11ax HE40	Frequency(MHz):	2452
Polarity:	Vertical	Test Voltage:	DC 5 V

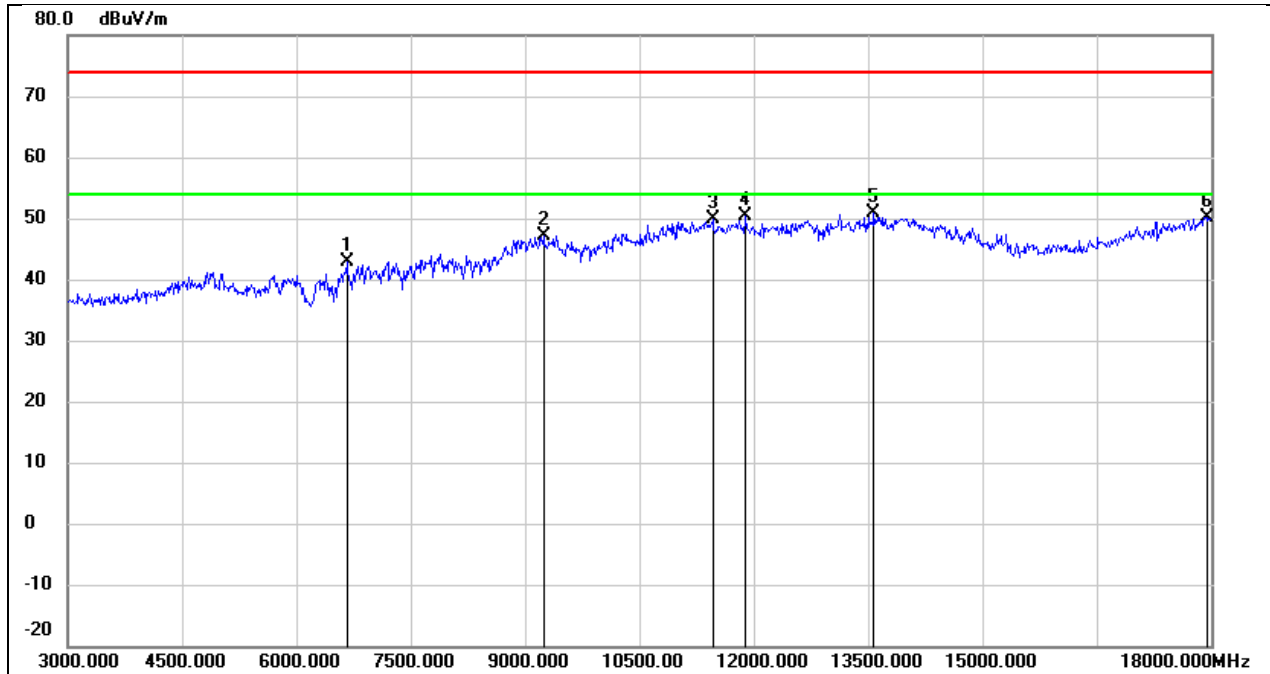

No.	Frequency (MHz)	Reading (dBuV)	Correct (dB/m)	Result (dBuV/m)	Limit (dBuV/m)	Margin (dB)	Remark
1	6660.000	37.93	5.02	42.95	74.00	-31.05	peak
2	9240.000	36.46	10.58	47.04	74.00	-26.96	peak
3	11460.000	33.52	16.46	49.98	74.00	-24.02	peak
4	11895.000	32.73	17.68	50.41	74.00	-23.59	peak
5	13575.000	29.81	21.06	50.87	74.00	-23.13	peak
6	17940.000	24.86	25.34	50.20	74.00	-23.80	peak

### 8.4. SPURIOUS EMISSIONS(9 KHZ~30 MHZ)

Test Mode:	802.11b	Frequency(MHz):	2412
Polarity:	Horizontal	Test Voltage:	DC 5 V

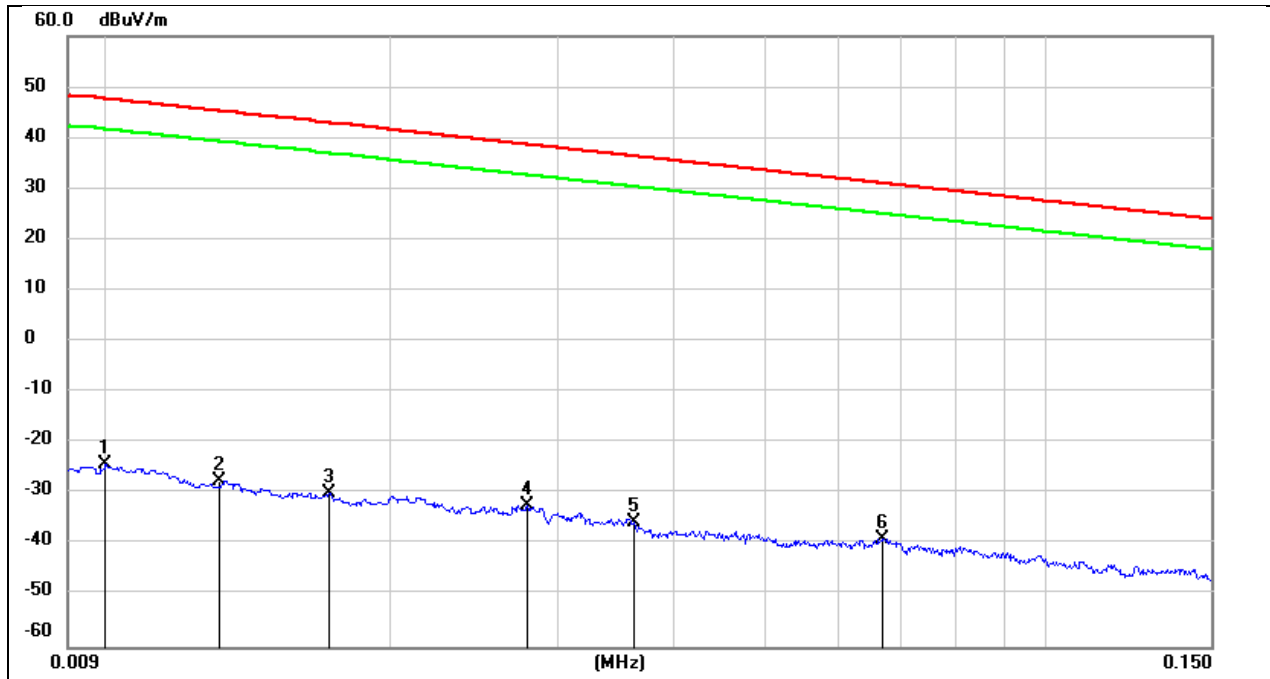

No.	Frequency (MHz)	Reading (dBuV)	Correct (dB/m)	FCC Result (dBuV/m)	FCC Limit (dBuV/m)	ISED Result (dBuA/m)	ISED Limit (dBuA/m)	Margin (dB)	Remark
1	0.0100	77.22	-101.40	-24.18	47.60	-75.68	-3.90	-71.78	peak
2	0.0131	73.97	-101.38	-27.41	45.25	-78.91	-6.25	-72.66	peak
3	0.0171	71.38	-101.36	-29.98	42.94	-81.48	-8.56	-72.92	peak
4	0.0279	69.17	-101.38	-32.21	38.69	-83.71	-12.81	-70.90	peak
5	0.0362	66.01	-101.42	-35.41	36.43	-86.91	-15.07	-71.84	peak
6	0.0670	62.72	-101.55	-38.83	31.08	-90.33	-20.42	-69.91	peak

Test Mode:	802.11b	Frequency(MHz):	2412
Polarity:	Horizontal	Test Voltage:	DC 5 V

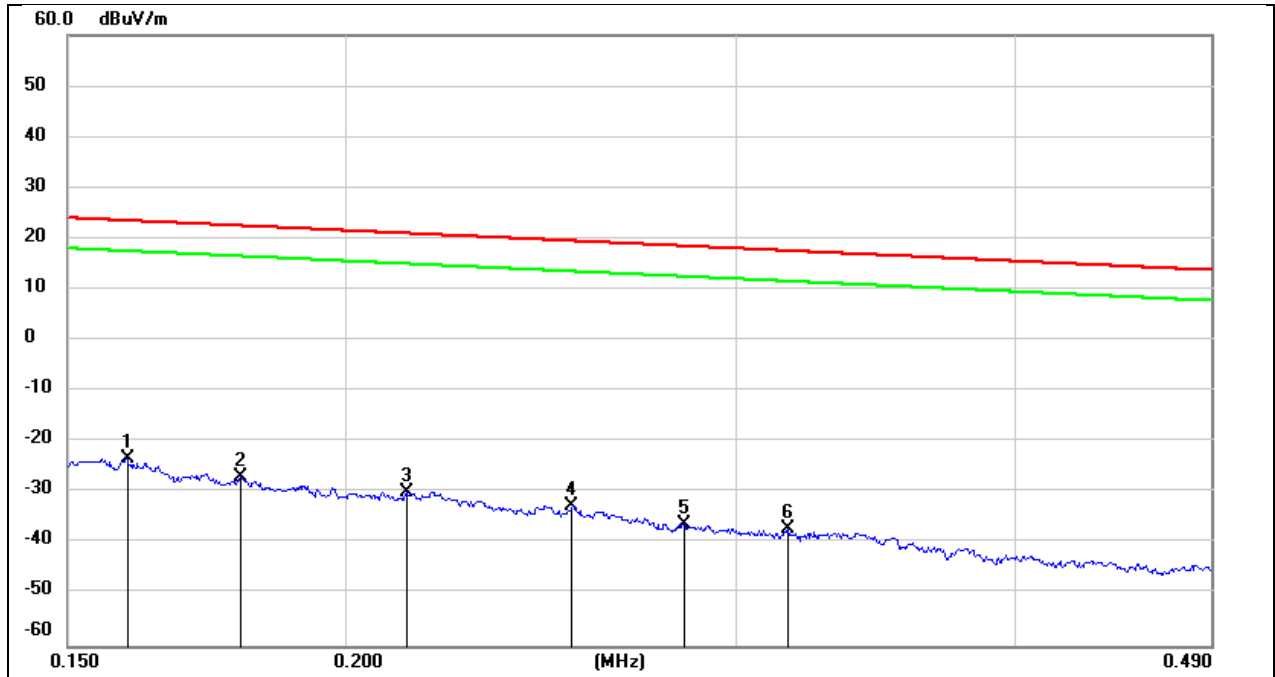

No.	Frequency (MHz)	Reading (dBuV)	Correct (dB/m)	FCC Result (dBuV/m)	FCC Limit (dBuV/m)	ISED Result (dBuA/m)	ISED Limit (dBuA/m)	Margin (dB)	Remark
1	0.1595	78.36	-101.65	-23.29	23.55	-74.79	-27.95	-46.84	peak
2	0.1794	74.77	-101.68	-26.91	22.53	-78.41	-28.97	-49.44	peak
3	0.2129	71.95	-101.74	-29.79	21.04	-81.29	-30.46	-50.83	peak
4	0.2530	69.14	-101.80	-32.66	19.54	-84.16	-31.96	-52.20	peak
5	0.2837	65.72	-101.83	-36.11	18.54	-87.61	-32.96	-54.65	peak
6	0.3163	64.70	-101.87	-37.17	17.60	-88.67	-33.90	-54.77	peak

Test Mode:	802.11b	Frequency(MHz):	2412
Polarity:	Horizontal	Test Voltage:	DC 5 V

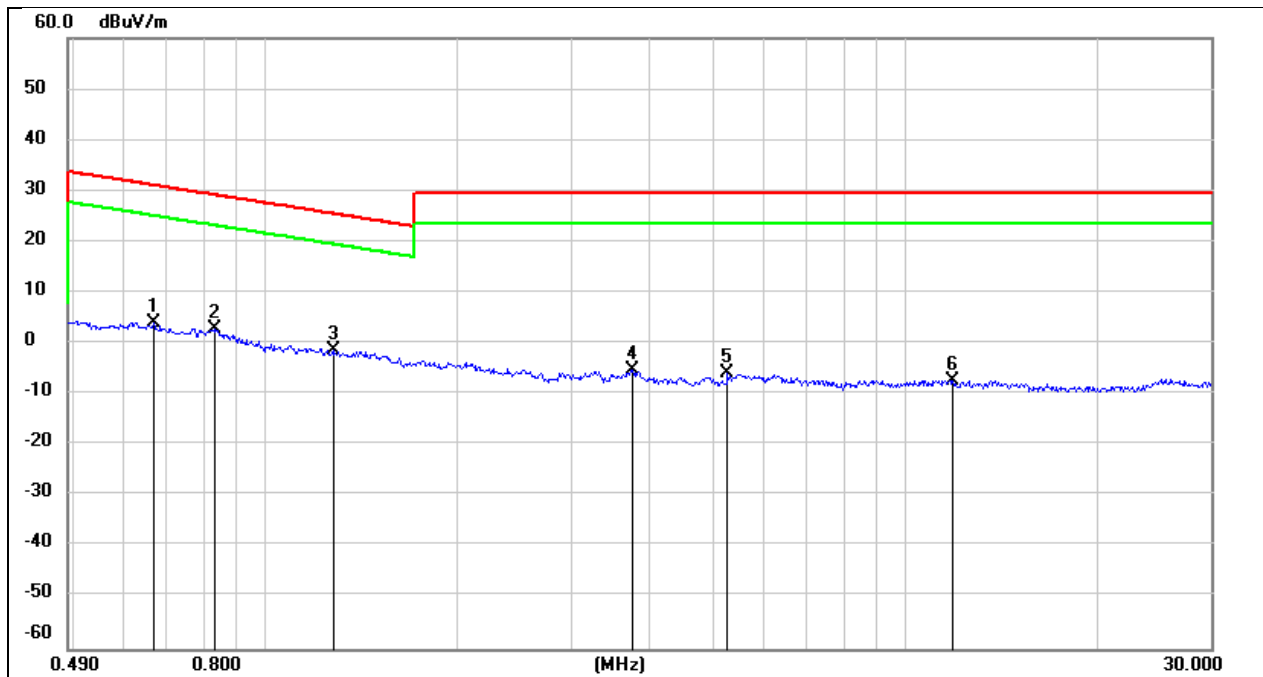

No.	Frequency (MHz)	Reading (dBuV)	Correct (dB/m)	FCC Result (dBuV/m)	FCC Limit (dBuV/m)	ISED Result (dBuA/m)	ISED Limit (dBuA/m)	Margin (dB)	Remark
1	0.6671	66.25	-62.10	4.15	31.12	-47.35	-20.38	-26.97	peak
2	0.8296	64.94	-62.17	2.77	29.23	-48.73	-22.27	-26.46	peak
3	1.2721	60.74	-62.15	-1.41	25.52	-52.91	-25.98	-26.93	peak
4	3.7406	56.30	-61.40	-5.10	29.54	-56.60	-21.96	-34.64	peak
5	5.2705	55.54	-61.45	-5.91	29.54	-57.41	-21.96	-35.45	peak
6	11.8513	53.56	-60.88	-7.32	29.54	-58.82	-21.96	-36.86	peak

### 8.5. SPURIOUS EMISSIONS(18 GHZ~26 GHZ)

Test Mode:	802.11b	Frequency(MHz):	2412
Polarity:	Horizontal	Test Voltage:	DC 5 V

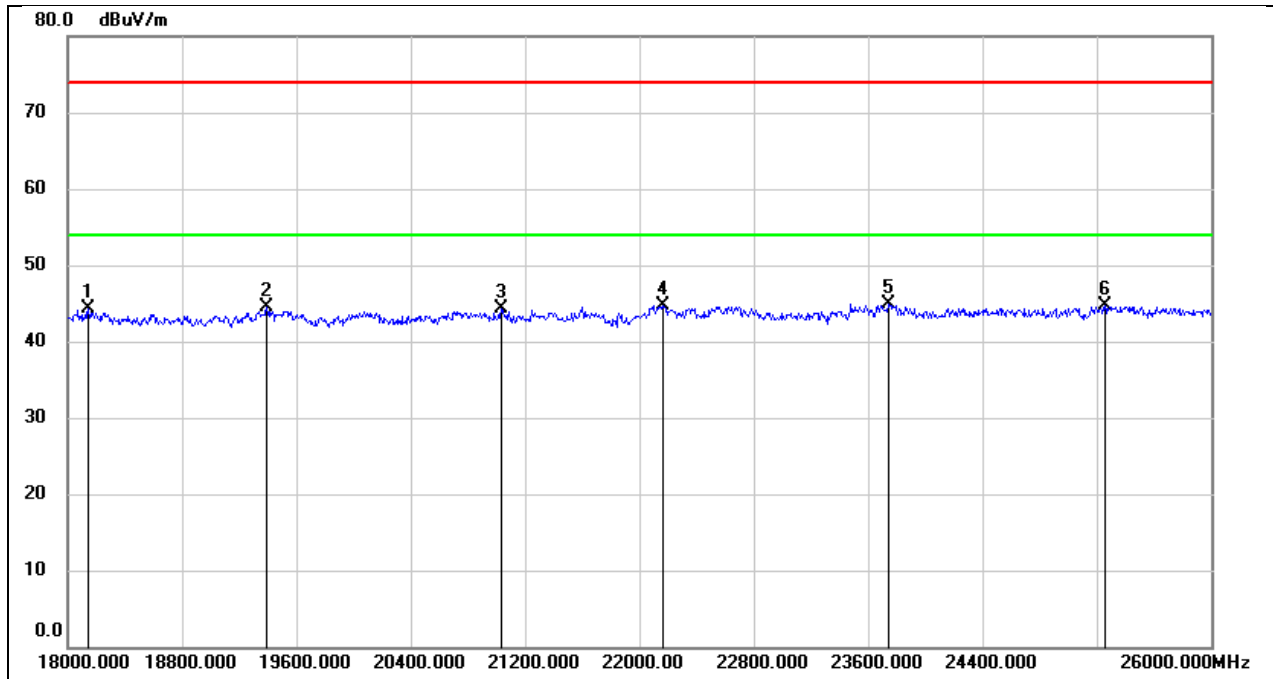

No.	Frequency (MHz)	Reading (dBuV)	Correct (dB/m)	Result (dBuV/m)	Limit (dBuV/m)	Margin (dB)	Remark
1	18144.000	49.77	-5.48	44.29	74.00	-29.71	peak
2	19392.000	50.12	-5.57	44.55	74.00	-29.45	peak
3	21032.000	49.15	-4.87	44.28	74.00	-29.72	peak
4	22160.000	49.08	-4.31	44.77	74.00	-29.23	peak
5	23744.000	48.15	-3.20	44.95	74.00	-29.05	peak
6	25256.000	46.29	-1.67	44.62	74.00	-29.38	peak

Test Mode:	802.11b	Frequency(MHz):	2412
Polarity:	Vertical	Test Voltage:	DC 5 V

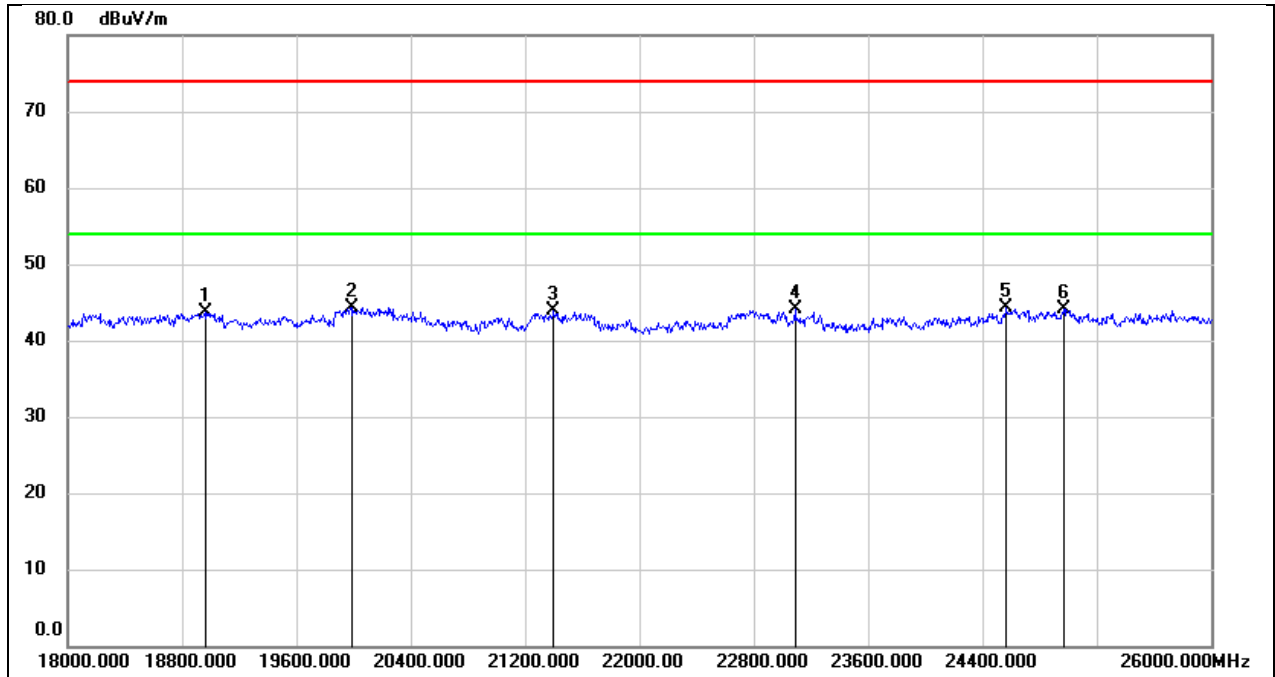

No.	Frequency (MHz)	Reading (dBuV)	Correct (dB/m)	Result (dBuV/m)	Limit (dBuV/m)	Margin (dB)	Remark
1	18960.000	49.01	-5.25	43.76	74.00	-30.24	peak
2	19984.000	49.71	-5.44	44.27	74.00	-29.73	peak
3	21400.000	48.54	-4.72	43.82	74.00	-30.18	peak
4	23088.000	47.52	-3.41	44.11	74.00	-29.89	peak
5	24568.000	46.60	-2.33	44.27	74.00	-29.73	peak
6	24968.000	46.26	-2.14	44.12	74.00	-29.88	peak

## 8.6. SPURIOUS EMISSIONS(30 MHZ~1 GHZ)

Test Mode:	802.11b	Frequency(MHz):	2412
Polarity:	Horizontal	Test Voltage:	DC 5 V

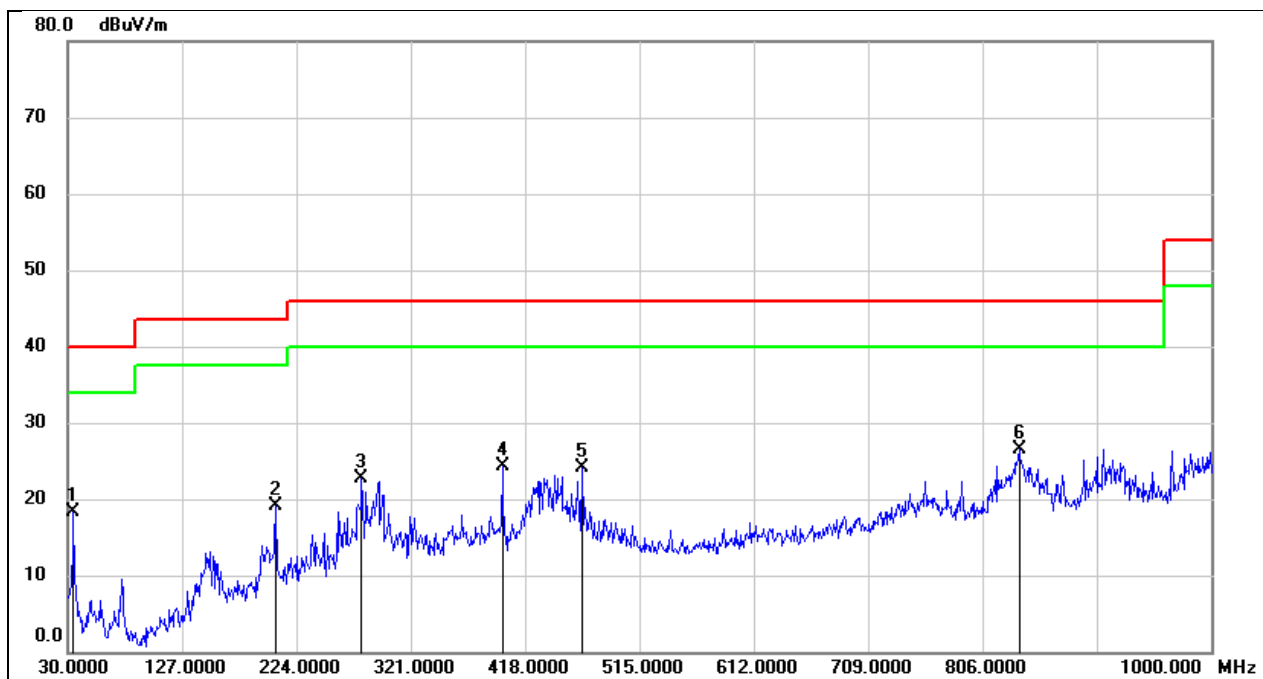

No.	Frequency (MHz)	Reading (dBuV)	Correct (dB/m)	Result (dBuV/m)	Limit (dBuV/m)	Margin (dB)	Remark
1	34.8500	37.21	-18.99	18.22	40.00	-21.78	QP
2	206.5399	36.03	-16.89	19.14	43.50	-24.36	QP
3	279.2900	39.33	-16.67	22.66	46.00	-23.34	QP
4	398.6000	37.29	-12.95	24.34	46.00	-21.66	QP
5	466.5000	35.56	-11.36	24.20	46.00	-21.80	QP
6	837.0400	32.93	-6.35	26.58	46.00	-19.42	QP



Test Mode:	802.11b	Frequency(MHz):	2412
Polarity:	Vertical	Test Voltage:	DC 5 V

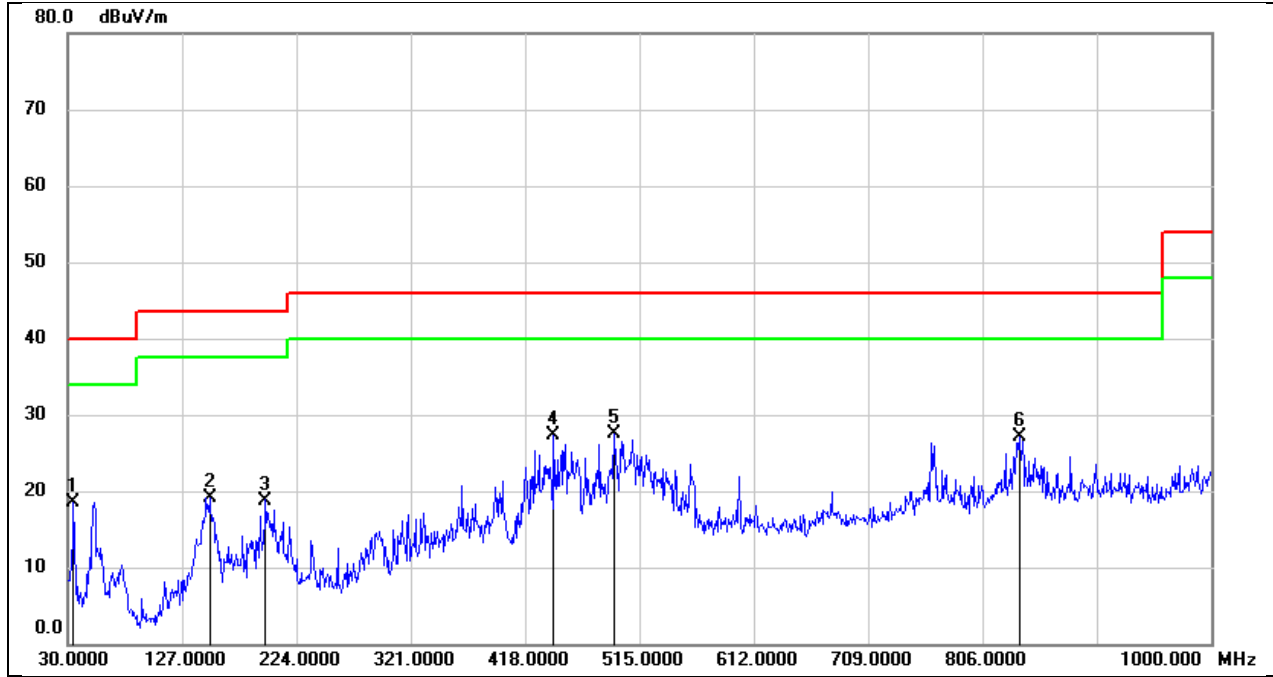

No.	Frequency (MHz)	Reading (dBuV)	Correct (dB/m)	Result (dBuV/m)	Limit (dBuV/m)	Margin (dB)	Remark
1	34.8500	37.52	-18.99	18.53	40.00	-21.47	QP
2	150.2800	37.52	-18.34	19.18	43.50	-24.32	QP
3	197.8100	35.39	-16.59	18.80	43.50	-24.70	QP
4	442.2500	39.21	-11.94	27.27	46.00	-18.73	QP
5	493.6600	38.31	-10.83	27.48	46.00	-18.52	QP
6	837.0400	33.36	-6.35	27.01	46.00	-18.99	QP

## 9. ANTENNA REQUIREMENT

### REQUIREMENT

Please refer to FCC part 15.203

An intentional radiator shall be designed to ensure that no antenna other than that furnished by the responsible party shall be used with the device. The use of a permanently attached antenna or of an antenna that uses a unique coupling to the intentional radiator shall be considered sufficient to comply with the provisions of this section. The manufacturer may design the unit so that a broken antenna can be replaced by the user, but the use of a standard antenna jack or electrical connector is prohibited.

Please refer to FCC part 15.247(b)(4)

The conducted output power limit specified in paragraph (b) of this section is based on the use of antennas with directional gains that do not exceed 6 dBi. Except as shown in paragraph (c) of this section, if transmitting antennas of directional gain greater than 6 dBi are used, the conducted output power from the intentional radiator shall be reduced below the stated values in paragraphs (b)(1), (b)(2), and (b)(3) of this section, as appropriate, by the amount in dB that the directional gain of the antenna exceeds 6 dBi.

### DESCRIPTION

Pass

## 10. AC POWER LINE CONDUCTED EMISSION

### LIMITS

Please refer to CFR 47 FCC §15.207 (a) and ISED RSS-Gen Clause 8.8

FREQUENCY (MHz)	Quasi-peak	Average
0.15 -0.5	66 - 56 *	56 - 46 *
0.50 -5.0	56.00	46.00
5.0 -30.0	60.00	50.00

### TEST PROCEDURE

The EUT is put on a table of non-conducting material that is 80 cm high. The vertical conducting wall of shielding is located 40 cm to the rear of the EUT. The power line of the EUT is connected to the AC mains through a Artificial Mains Network (A.M.N.). A EMI Measurement Receiver (R&S Test Receiver ESR3) is used to test the emissions from both sides of AC line. According to the requirements in Section 6.2 of ANSI C63.10-2013. Conducted emissions from the EUT measured in the frequency range between 0.15 MHz and 30 MHz using CISPR Quasi-Peak and average detector mode. The bandwidth of EMI test receiver is set at 9 kHz.

The arrangement of the equipment is installed to meet the standards and operating in a manner, which tends to maximize its emission characteristics in a normal application.

### TEST SETUP

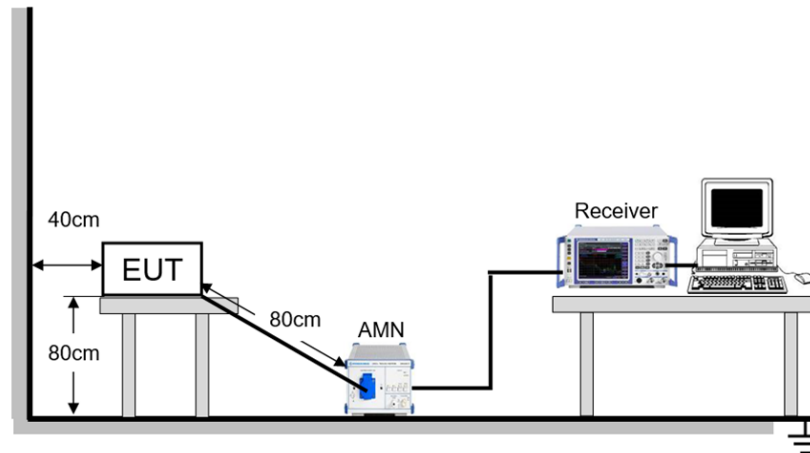

### TEST ENVIRONMENT

Temperature	23.5°C	Relative Humidity	56.8%
Atmosphere Pressure	101kPa	Test Voltage	AC 120 V, 60 Hz

### TEST DATE / ENGINEER

Test Date	November 20, 2023	Test By	Eason He
-----------	-------------------	---------	----------

**TEST RESULTS**

Test Mode:	802.11b	Frequency(MHz):	2412
Line:	Line		

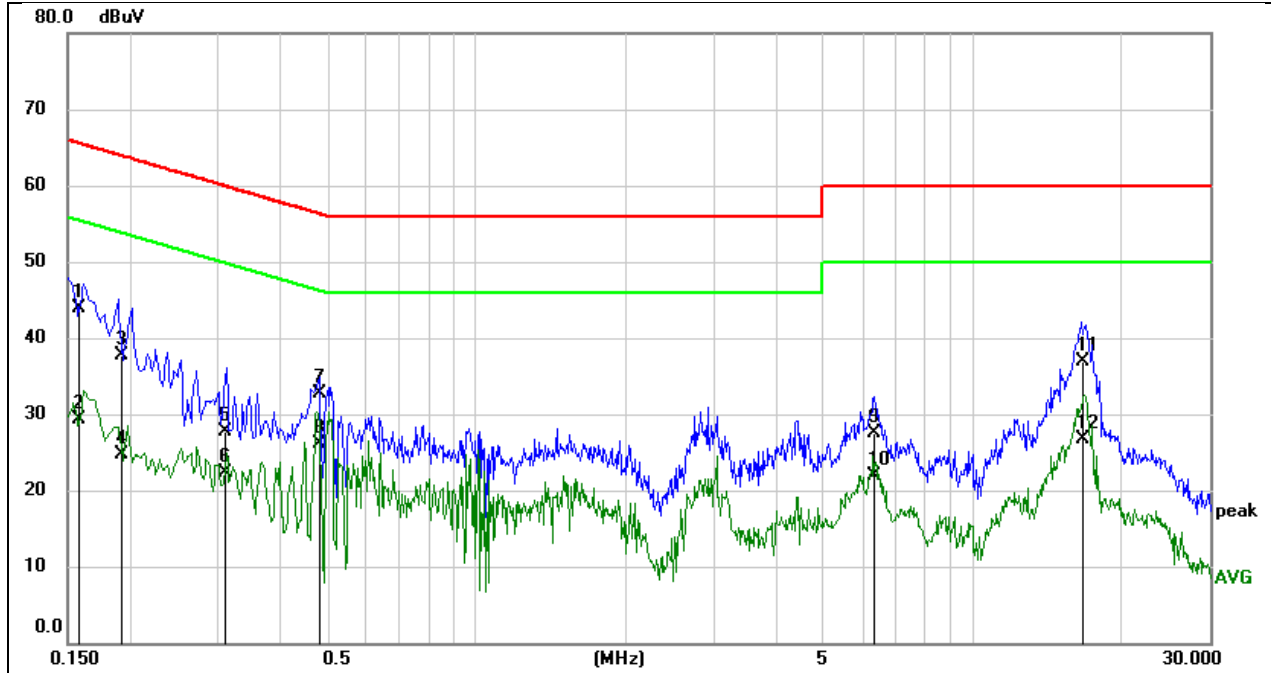

No.	Frequency (MHz)	Reading (dBuV)	Correct (dB)	Result (dBuV)	Limit (dBuV)	Margin (dB)	Remark
1	0.1581	34.35	9.59	43.94	65.56	-21.62	QP
2	0.1581	19.65	9.59	29.24	55.56	-26.32	AVG
3	0.1930	28.03	9.59	37.62	63.91	-26.29	QP
4	0.1930	15.14	9.59	24.73	53.91	-29.18	AVG
5	0.3109	18.07	9.59	27.66	59.95	-32.29	QP
6	0.3109	12.73	9.59	22.32	49.95	-27.63	AVG
7	0.4819	23.10	9.60	32.70	56.31	-23.61	QP
8	0.4819	16.53	9.60	26.13	46.31	-20.18	AVG
9	6.3386	17.83	9.74	27.57	60.00	-32.43	QP
10	6.3386	12.08	9.74	21.82	50.00	-28.18	AVG
11	16.6419	27.22	9.76	36.98	60.00	-23.02	QP
12	16.6419	17.03	9.76	26.79	50.00	-23.21	AVG

**Note:**

1. Result = Reading + Correct Factor.
2. If QP Result complies with AV limit, AV Result is deemed to comply with AV limit.
3. Test setup: RBW: 200 Hz (9 kHz ~ 150 kHz), 9 kHz (150 kHz ~ 30 MHz).
4. Step size: 80 Hz (0.009 MHz ~ 0.15 MHz), 4 kHz (0.15 MHz ~ 30 MHz), Scan time: auto.

Note: All the modes have been tested, only the worst data was recorded in the report.

Test Mode:	802.11b	Frequency(MHz):	2412
Line:	Neutral		

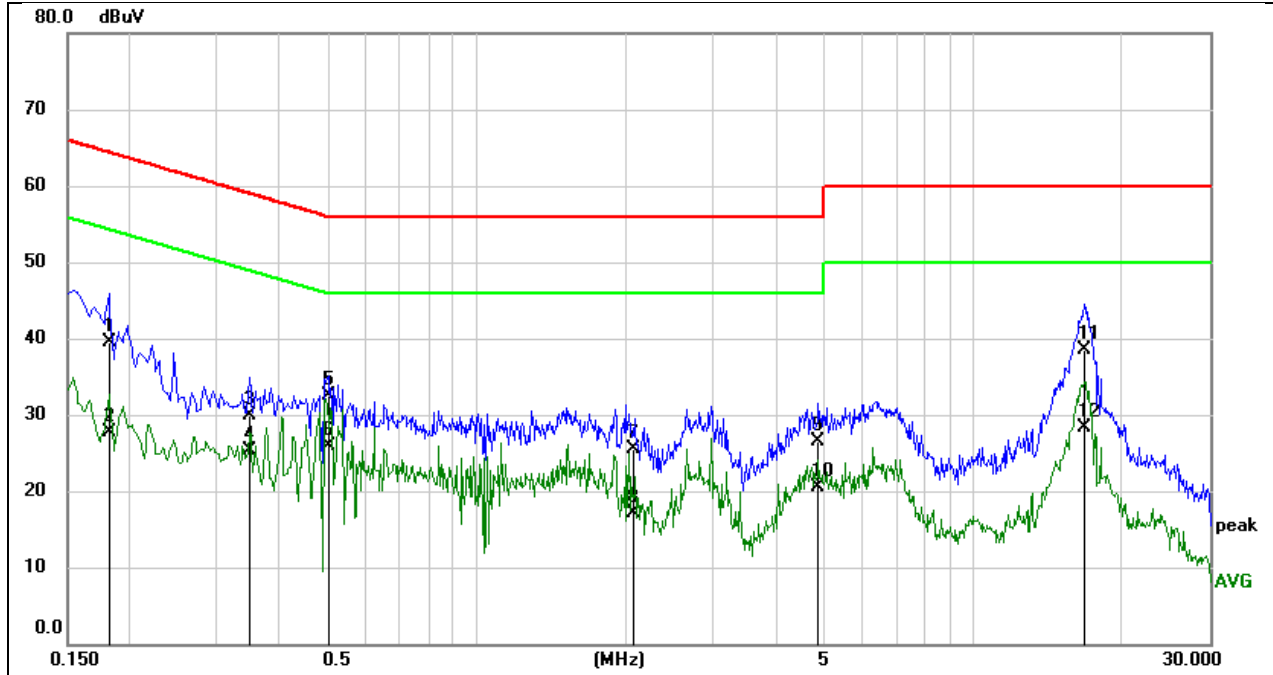

No.	Frequency (MHz)	Reading (dBuV)	Correct (dB)	Result (dBuV)	Limit (dBuV)	Margin (dB)	Remark
1	0.1822	29.96	9.55	39.51	64.38	-24.87	QP
2	0.1822	18.24	9.55	27.79	54.38	-26.59	AVG
3	0.3475	20.33	9.54	29.87	59.02	-29.15	QP
4	0.3475	15.67	9.54	25.21	49.02	-23.81	AVG
5	0.5006	23.04	9.50	32.54	56.00	-23.46	QP
6	0.5006	16.46	9.50	25.96	46.00	-20.04	AVG
7	2.0630	15.82	9.63	25.45	56.00	-30.55	QP
8	2.0630	7.53	9.63	17.16	46.00	-28.84	AVG
9	4.8856	16.85	9.61	26.46	56.00	-29.54	QP
10	4.8856	10.96	9.61	20.57	46.00	-25.43	AVG
11	16.7341	28.86	9.67	38.53	60.00	-21.47	QP
12	16.7341	18.61	9.67	28.28	50.00	-21.72	AVG

Note:

1. Result = Reading + Correct Factor.
2. If QP Result complies with AV limit, AV Result is deemed to comply with AV limit.
3. Test setup: RBW: 200 Hz (9 kHz ~ 150 kHz), 9 kHz (150 kHz ~ 30 MHz).
4. Step size: 80 Hz (0.009 MHz ~ 0.15 MHz), 4 kHz (0.15 MHz ~ 30 MHz), Scan time: auto.

Note: All the modes have been tested, only the worst data was recorded in the report.

## 11. TEST DATA

### 11.1. APPENDIX A: DTS BANDWIDTH

#### 11.1.1. Test Result

Test Mode	Antenna	Frequency[MHz]	DTS BW [MHz]	FL[MHz]	FH[MHz]	Limit[MHz]	Verdict
11B	Ant0	2412	7.56	2408.00	2415.56	≥0.5	PASS
	Ant1	2412	7.08	2408.44	2415.52	≥0.5	PASS
	Ant0	2437	7.08	2433.44	2440.52	≥0.5	PASS
	Ant1	2437	7.08	2433.44	2440.52	≥0.5	PASS
	Ant0	2462	7.08	2458.44	2465.52	≥0.5	PASS
	Ant1	2462	8.08	2457.48	2465.56	≥0.5	PASS
11G	Ant0	2412	13.20	2404.44	2417.64	≥0.5	PASS
	Ant1	2412	15.36	2404.40	2419.76	≥0.5	PASS
	Ant0	2437	15.08	2429.20	2444.28	≥0.5	PASS
	Ant1	2437	16.36	2428.80	2445.16	≥0.5	PASS
	Ant0	2462	15.76	2454.12	2469.88	≥0.5	PASS
	Ant1	2462	16.32	2453.84	2470.16	≥0.5	PASS
11N20MIMO	Ant0	2412	15.16	2404.08	2419.24	≥0.5	PASS
	Ant1	2412	15.12	2404.44	2419.56	≥0.5	PASS
	Ant0	2437	17.56	2428.20	2445.76	≥0.5	PASS
	Ant1	2437	17.56	2428.20	2445.76	≥0.5	PASS
	Ant0	2462	16.52	2453.84	2470.36	≥0.5	PASS
	Ant1	2462	16.36	2453.80	2470.16	≥0.5	PASS
11N40MIMO	Ant0	2422	35.12	2404.48	2439.60	≥0.5	PASS
	Ant1	2422	35.12	2404.48	2439.60	≥0.5	PASS
	Ant0	2437	35.12	2419.48	2454.60	≥0.5	PASS
	Ant1	2437	35.12	2419.48	2454.60	≥0.5	PASS
	Ant0	2452	35.12	2434.48	2469.60	≥0.5	PASS
	Ant1	2452	35.12	2434.48	2469.60	≥0.5	PASS
11AX20MIMO	Ant0	2412	16.00	2403.56	2419.56	≥0.5	PASS
	Ant1	2412	15.80	2403.76	2419.56	≥0.5	PASS
	Ant0	2437	18.32	2427.52	2445.84	≥0.5	PASS
	Ant1	2437	17.84	2428.20	2446.04	≥0.5	PASS
	Ant0	2462	18.28	2452.80	2471.08	≥0.5	PASS
	Ant1	2462	17.92	2452.96	2470.88	≥0.5	PASS
11AX40MIMO	Ant0	2422	36.88	2403.60	2440.48	≥0.5	PASS
	Ant1	2422	37.04	2403.76	2440.80	≥0.5	PASS
	Ant0	2437	36.64	2418.68	2455.32	≥0.5	PASS
	Ant1	2437	36.32	2419.48	2455.80	≥0.5	PASS
	Ant0	2452	36.72	2433.36	2470.08	≥0.5	PASS
	Ant1	2452	37.60	2433.20	2470.80	≥0.5	PASS

### 11.1.2. Test Graphs

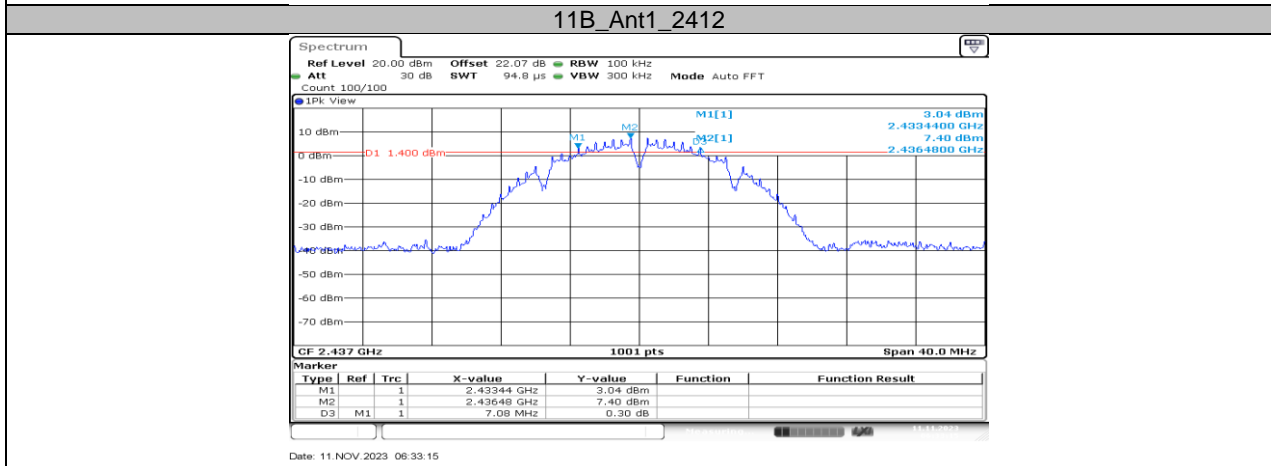
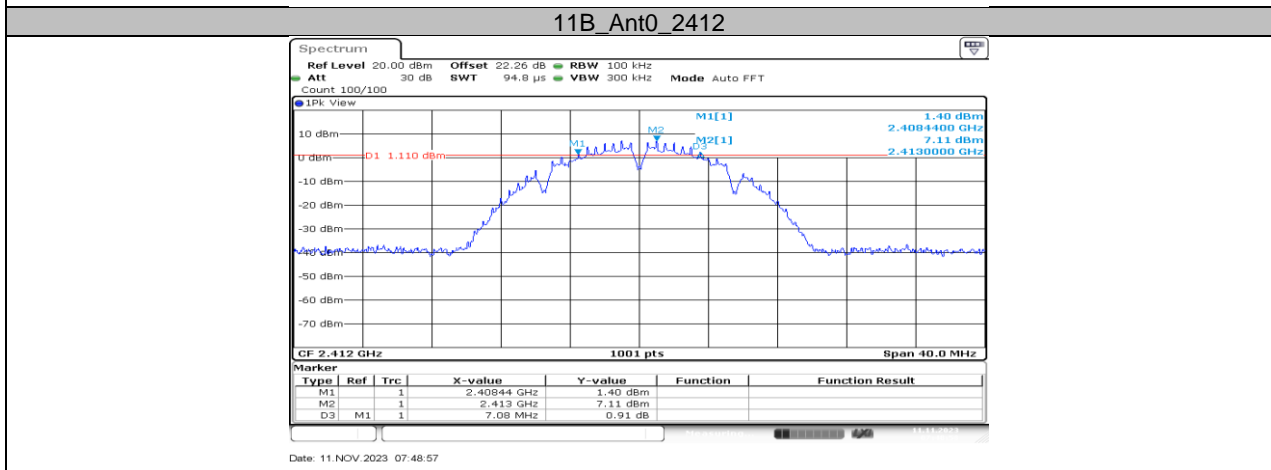
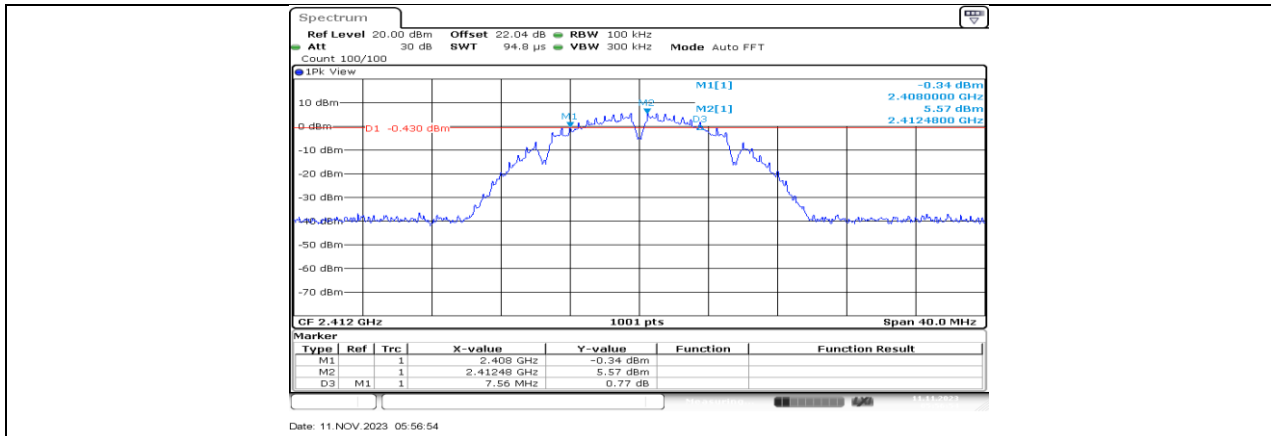

**11B\_Ant0\_2437**

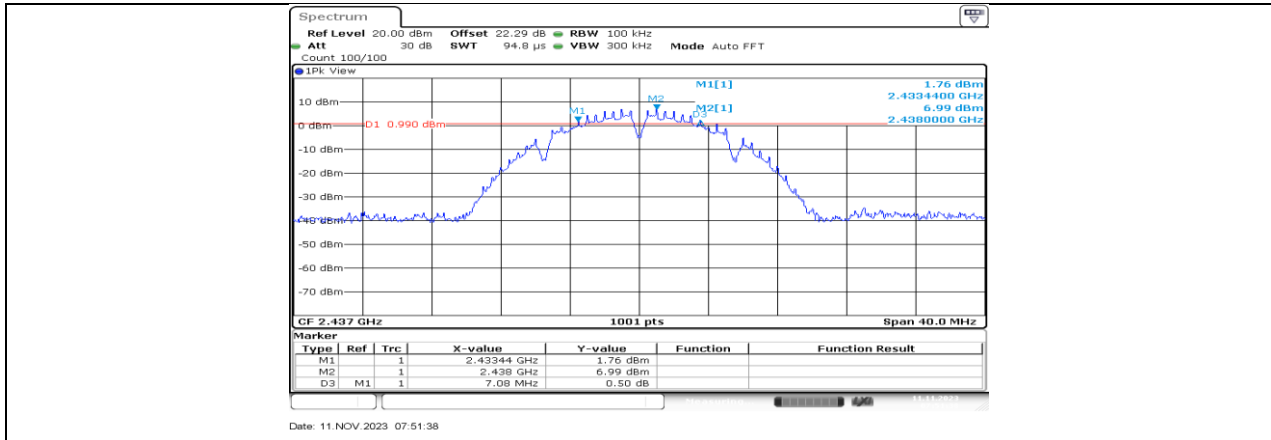

11B\_Ant1\_2437

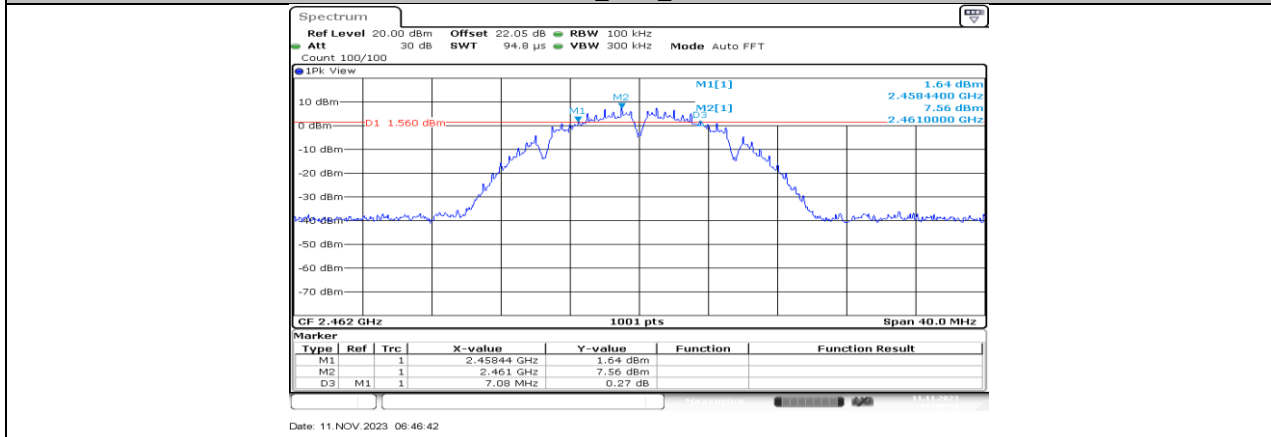

11B\_Ant0\_2462

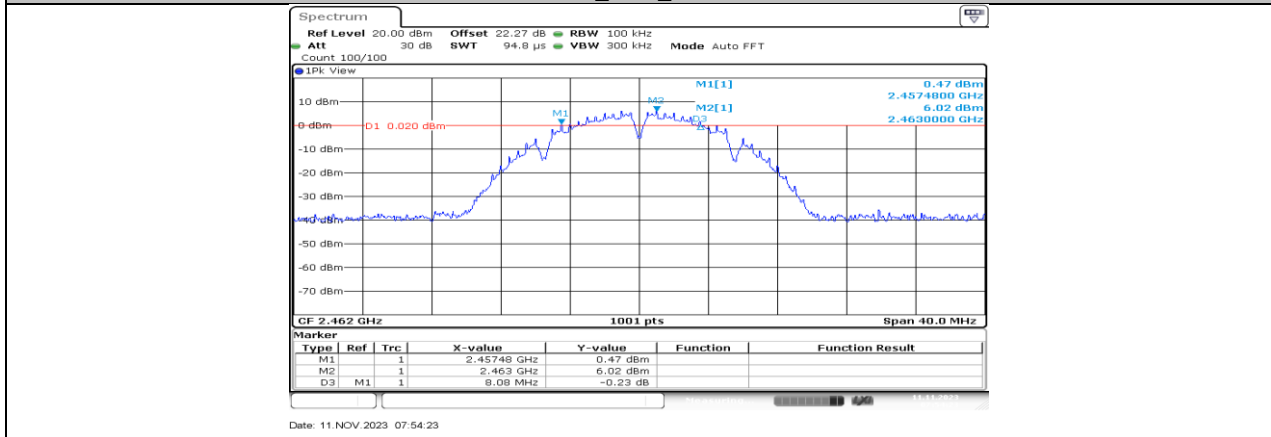

11B\_Ant1\_2462

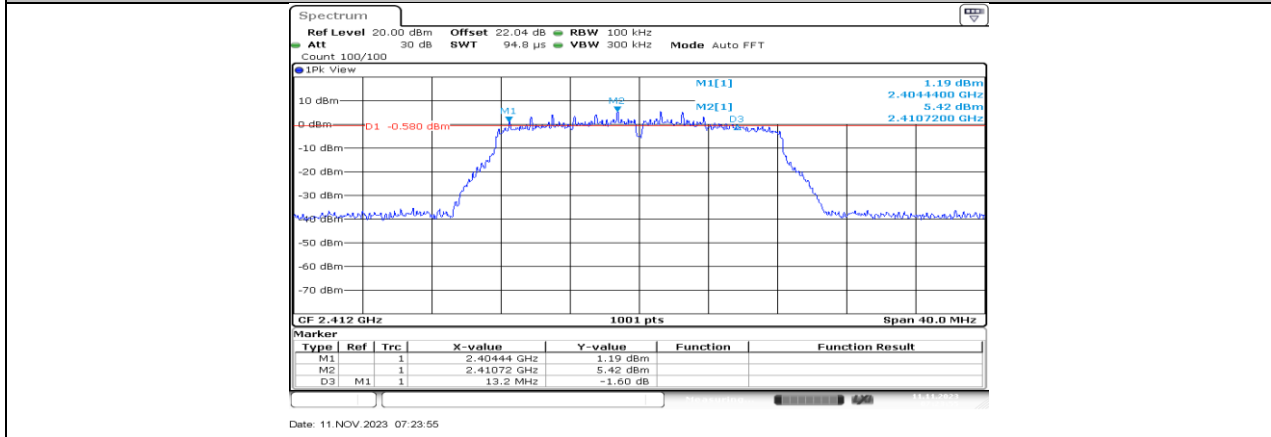



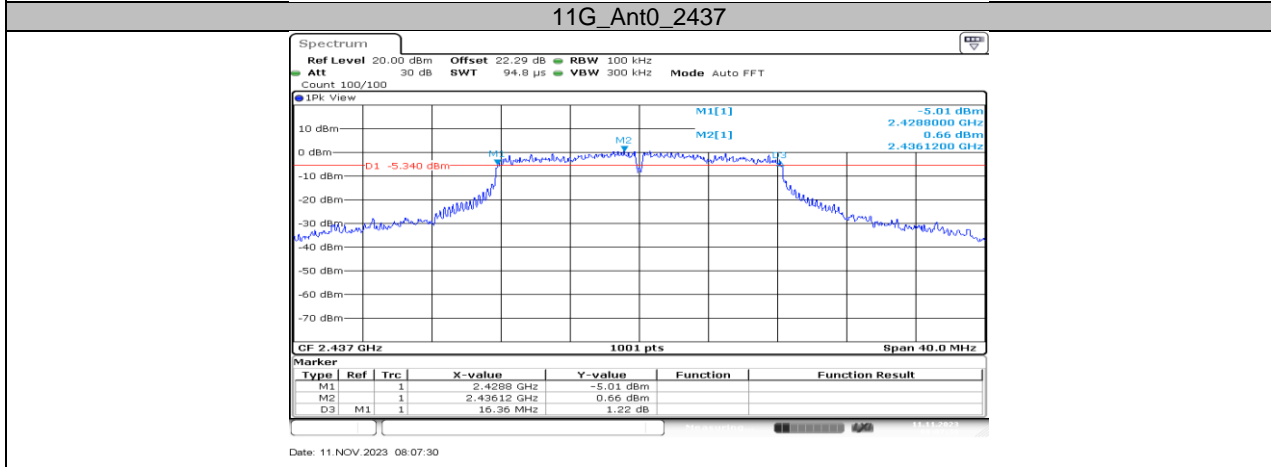
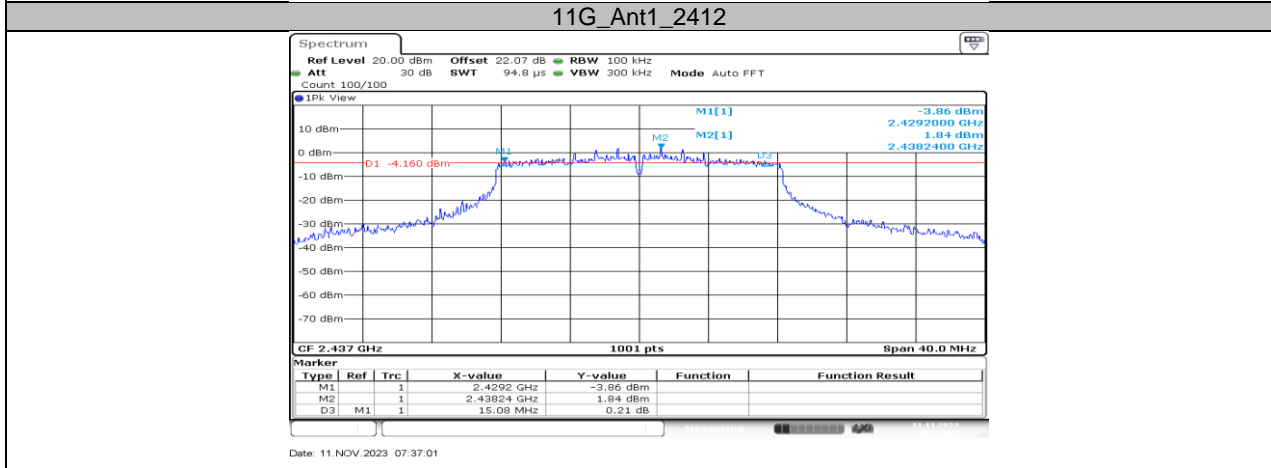
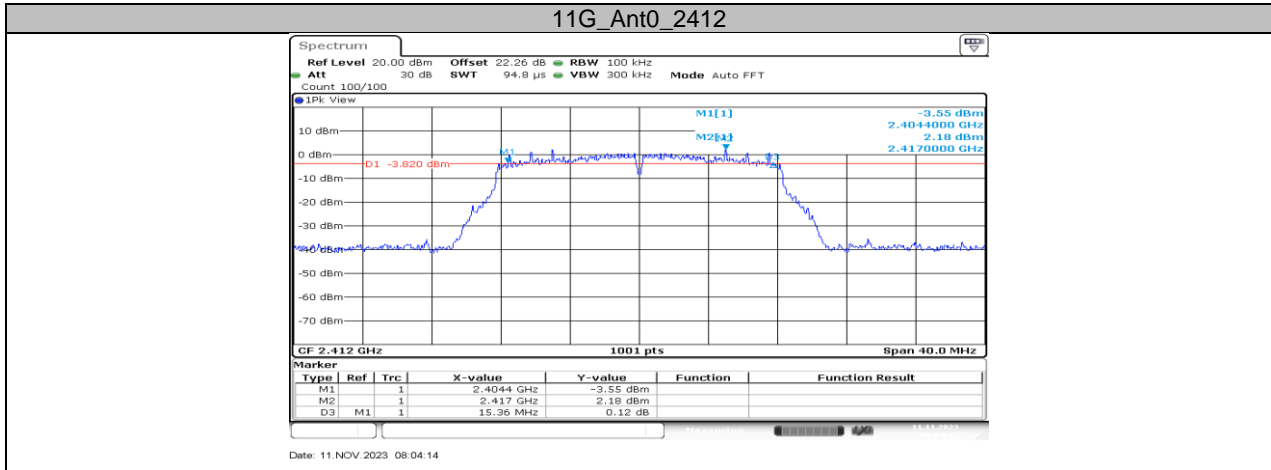

### 11G\_Ant1\_2437

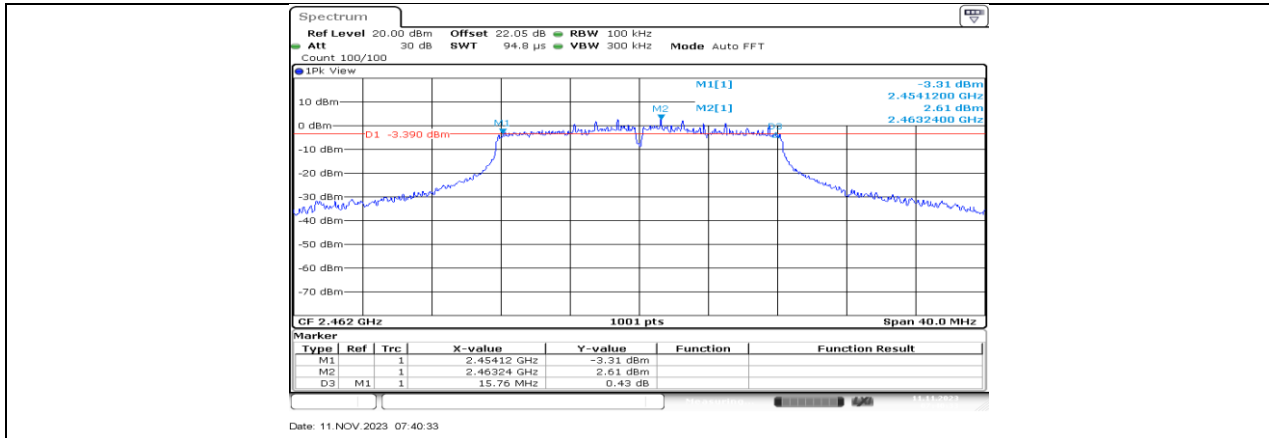

11G\_Ant0\_2462

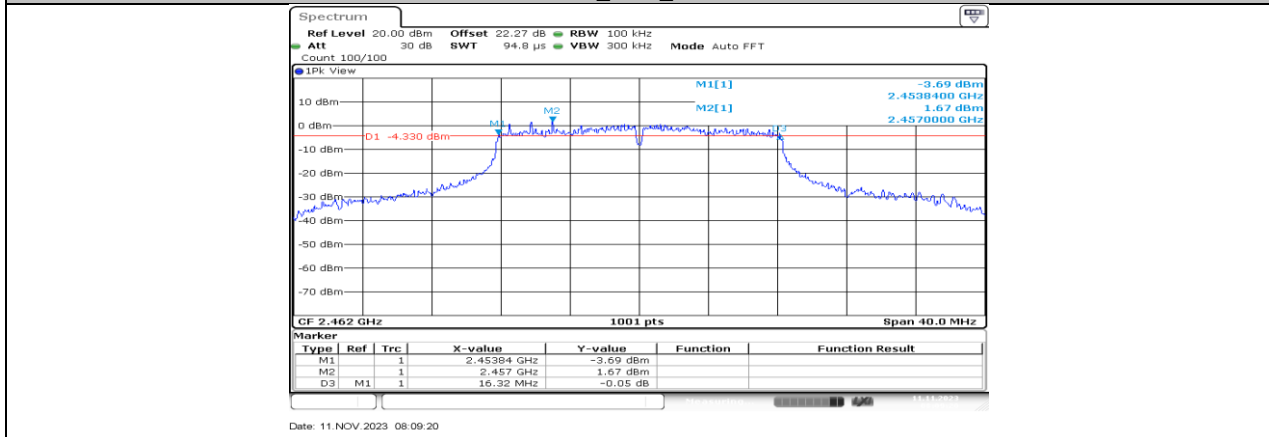

11G\_Ant1\_2462

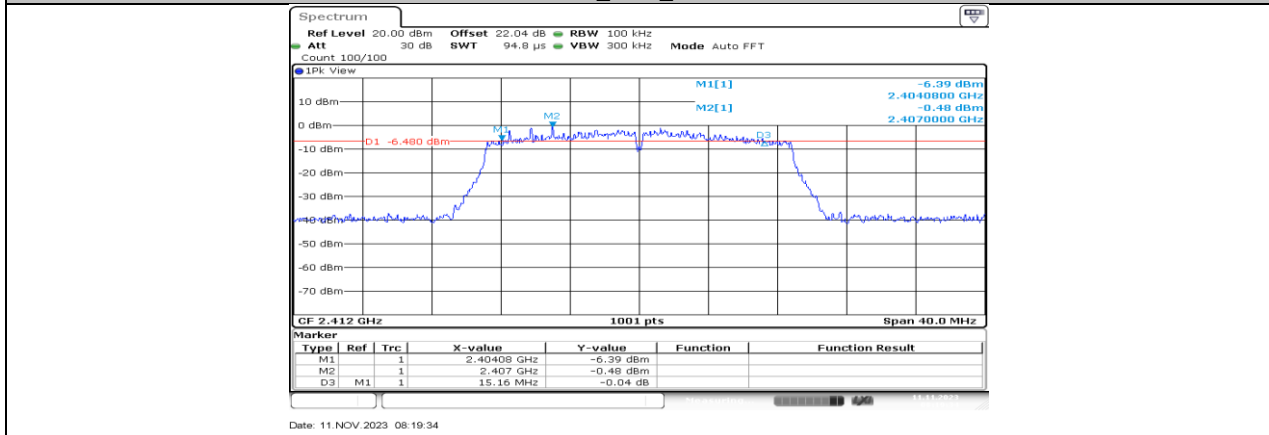

11N20MIMO\_Ant0\_2412

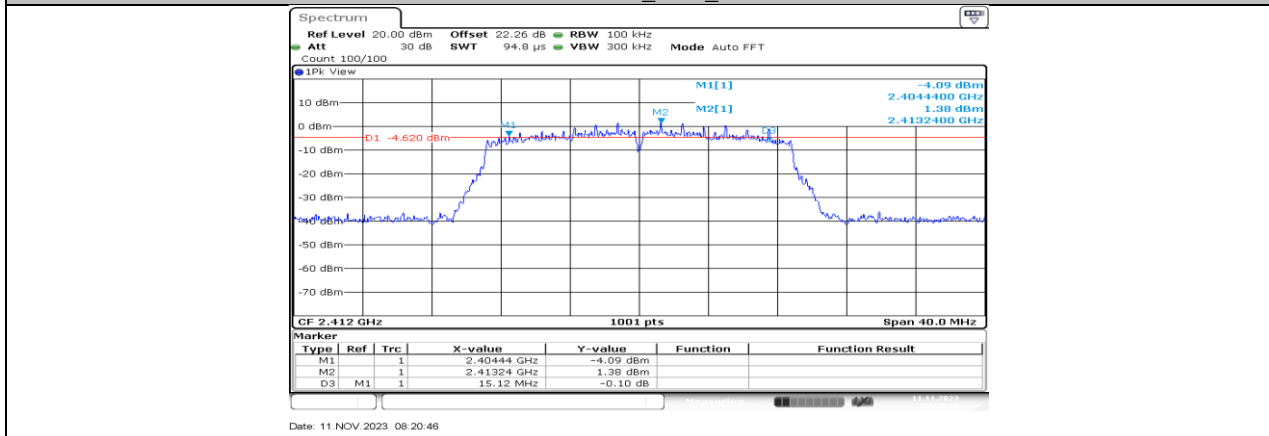

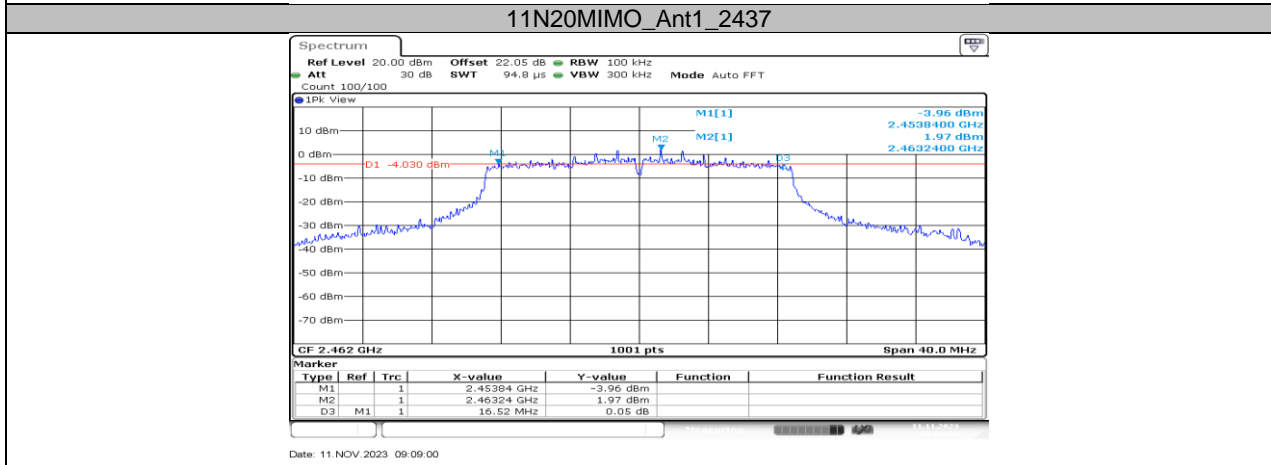
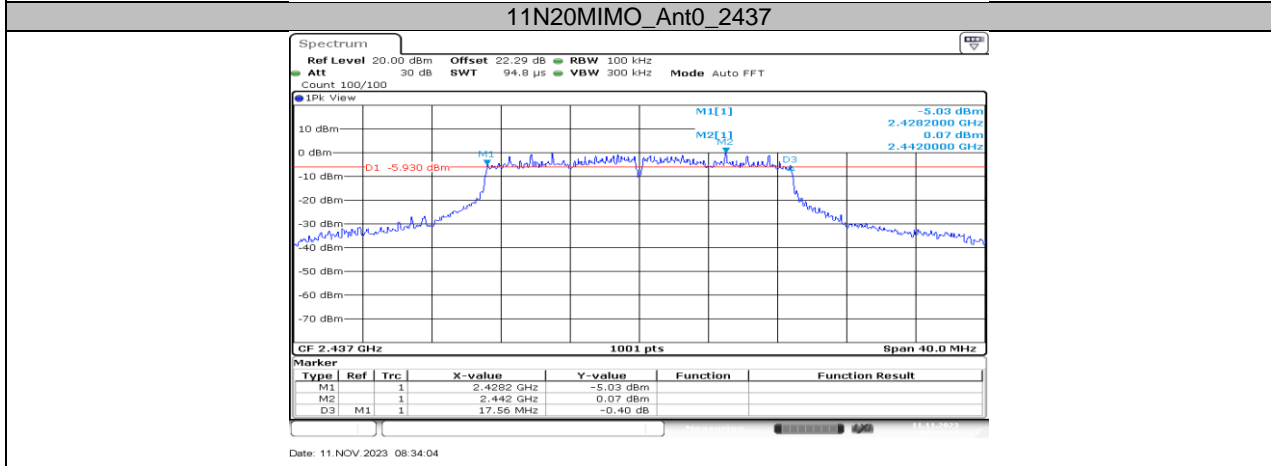
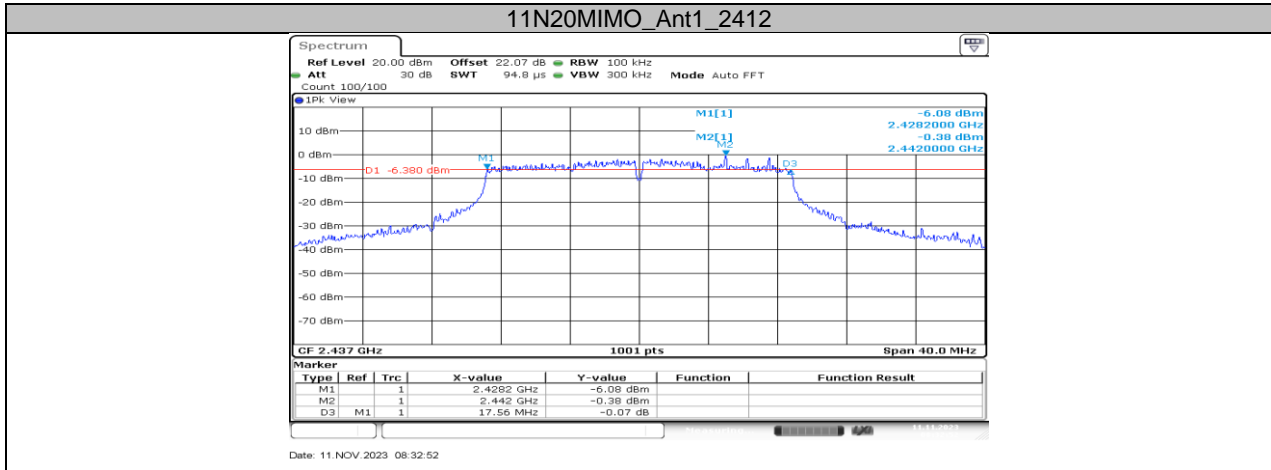

### 11N20MIMO\_Ant0\_2462

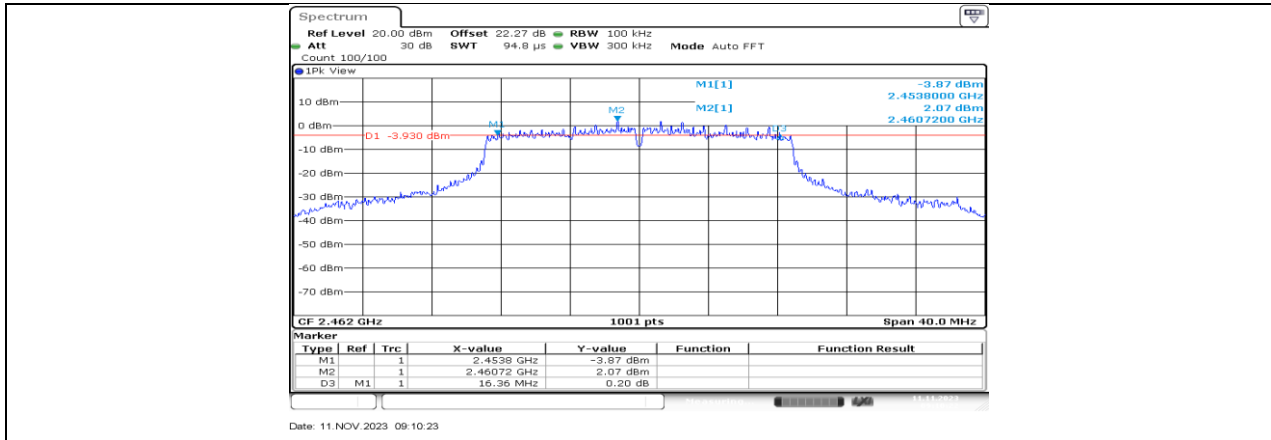

Date: 11.NOV.2023 09:10:23

11N20MIMO\_Ant1\_2462

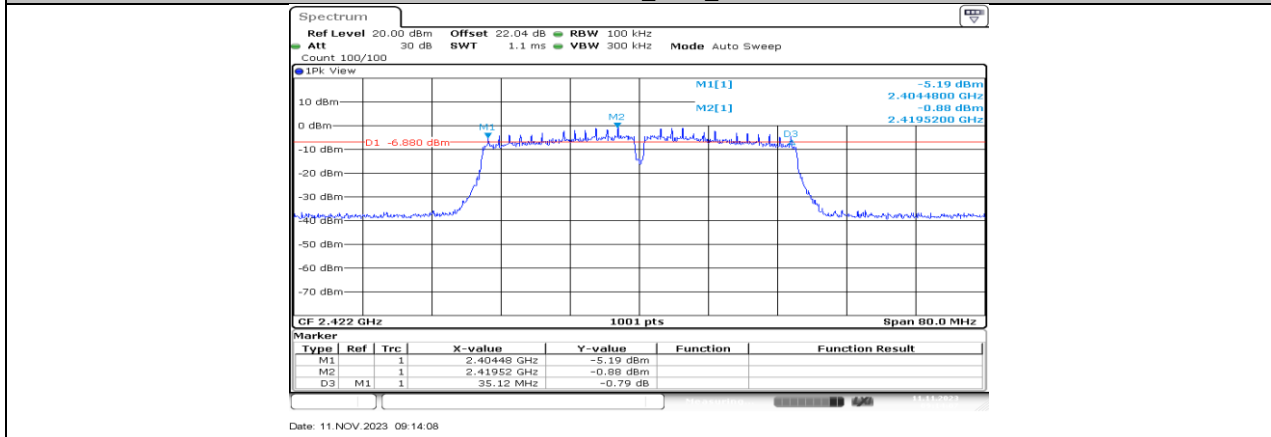

Date: 11.NOV.2023 09:14:08

11N40MIMO\_Ant0\_2422

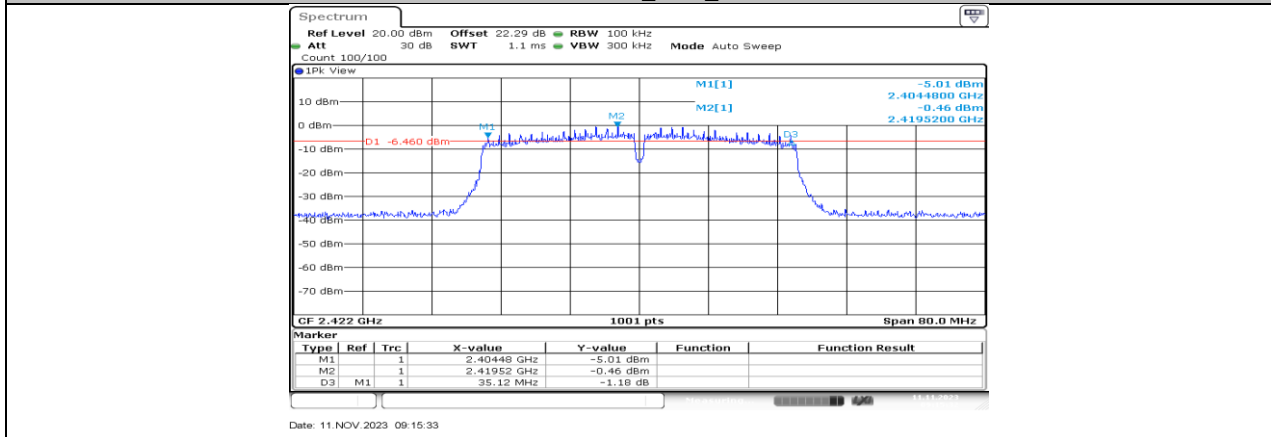

Date: 11.NOV.2023 09:15:33

11N40MIMO\_Ant1\_2422

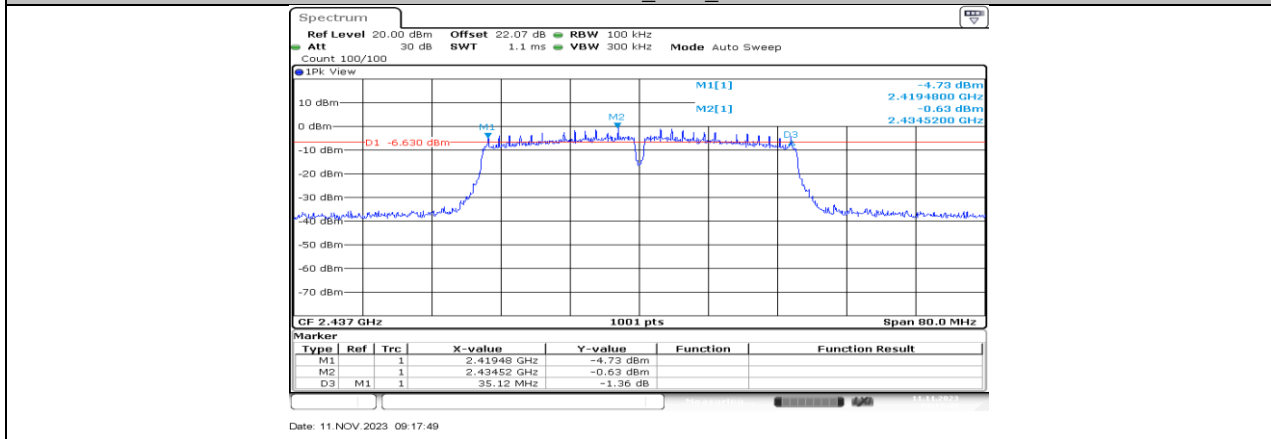

Date: 11.NOV.2023 09:17:49

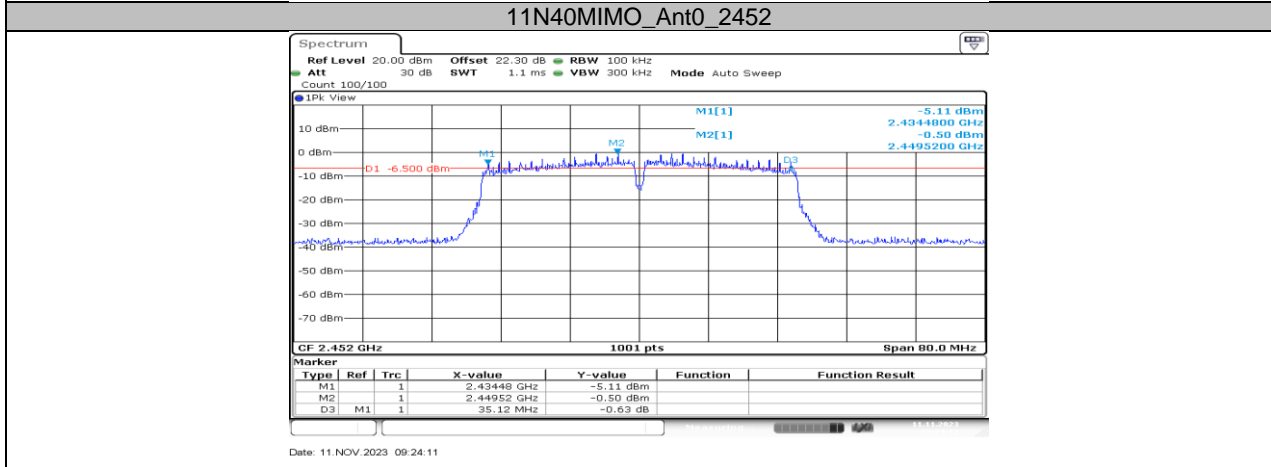
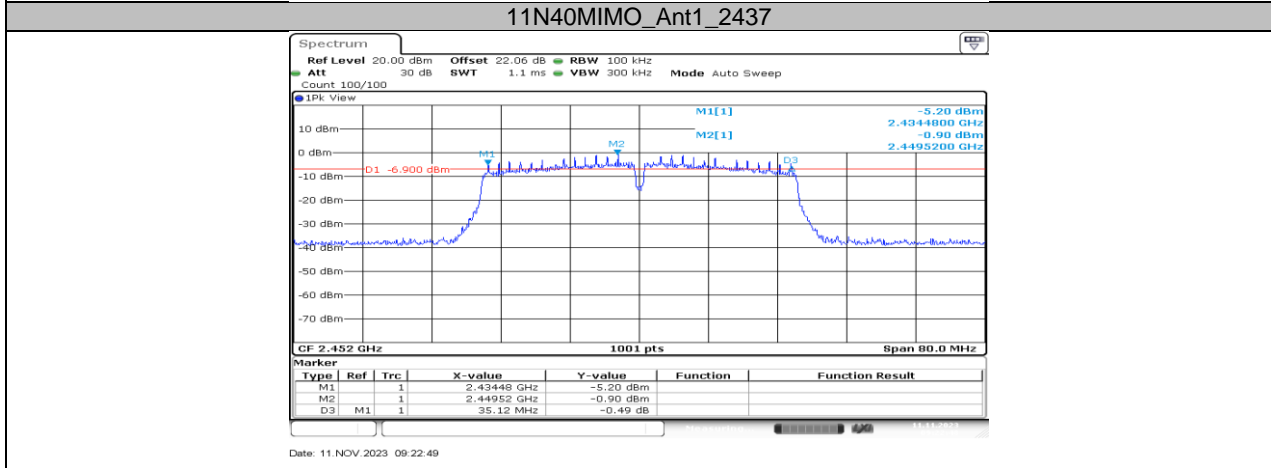
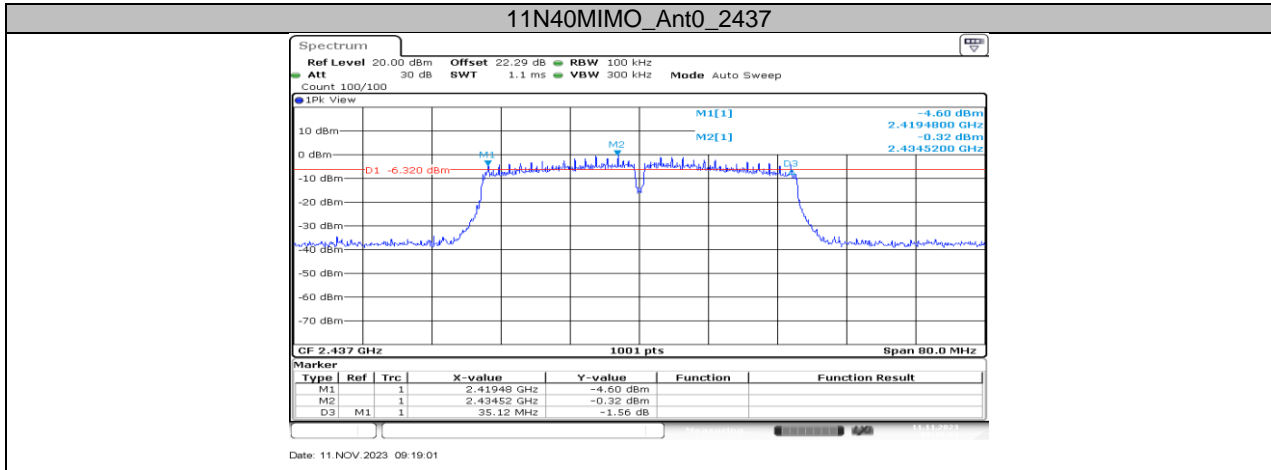

### 11N40MIMO\_Ant1\_2452

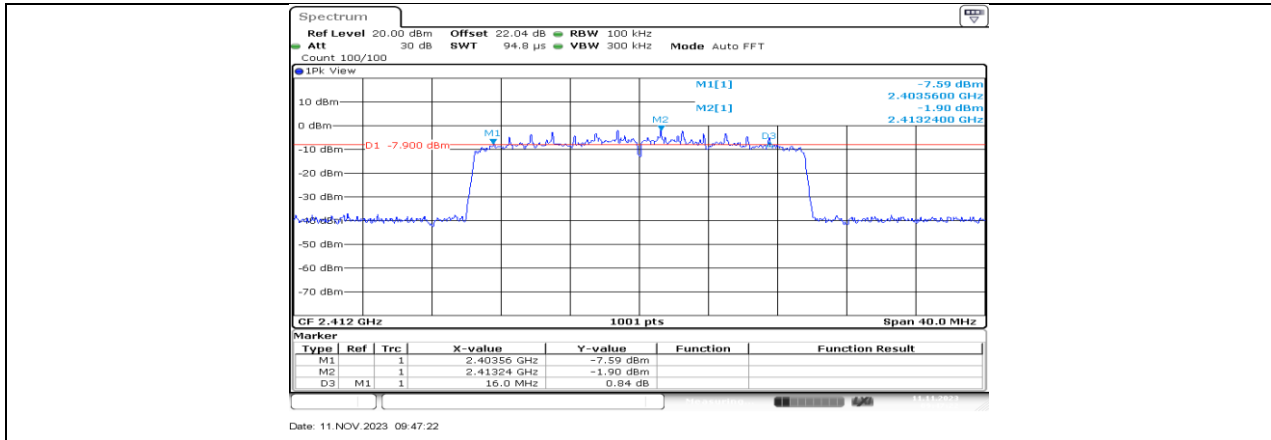

Date: 11.NOV.2023 09:47:22

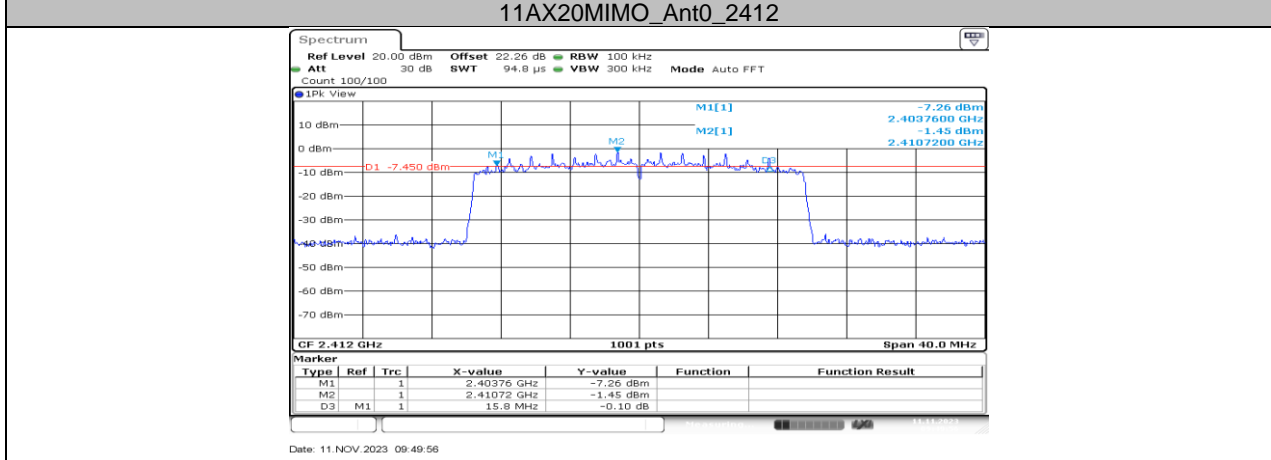

Date: 11.NOV.2023 09:49:56

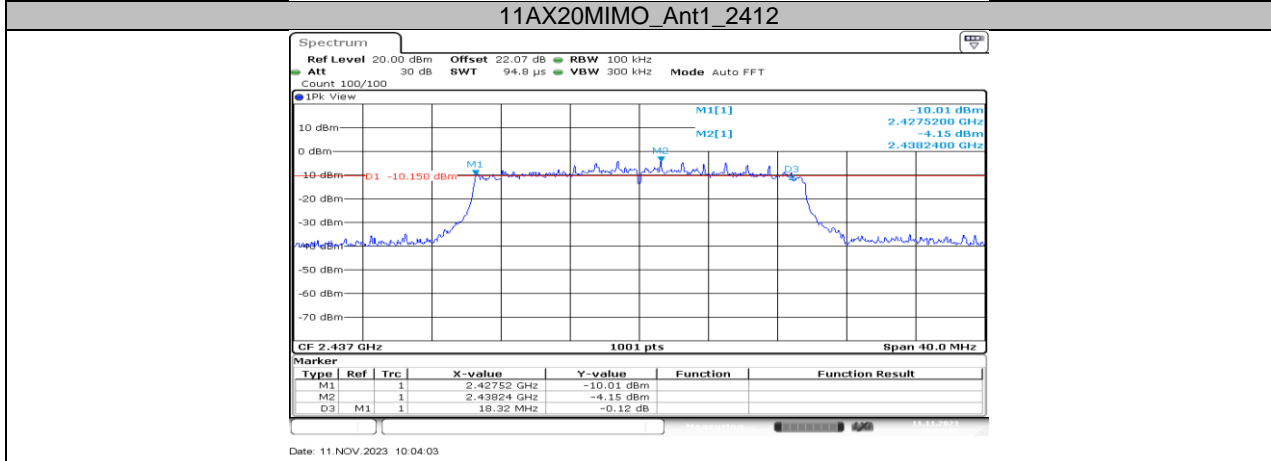

Date: 11.NOV.2023 10:04:03

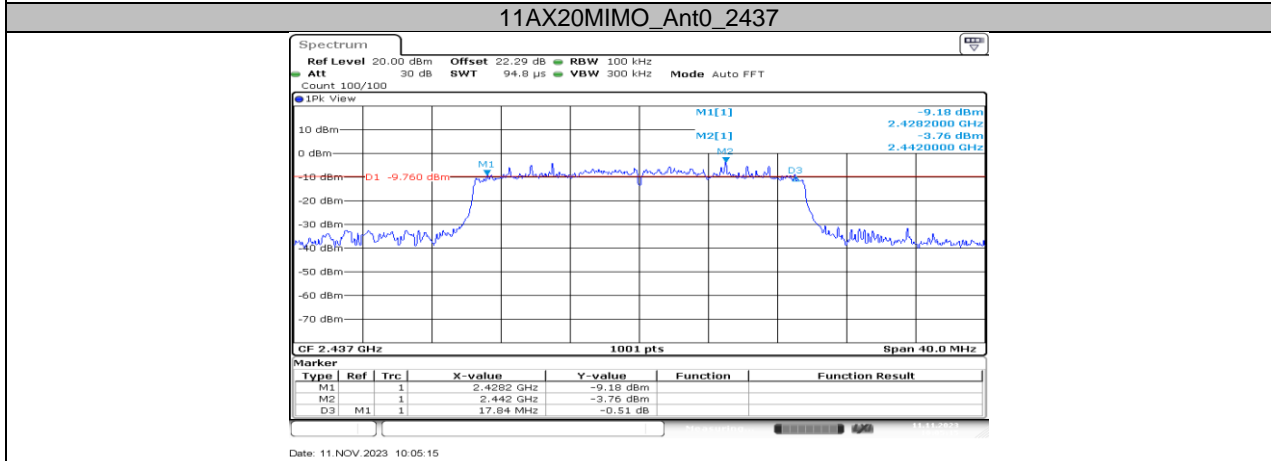

Date: 11.NOV.2023 10:05:15

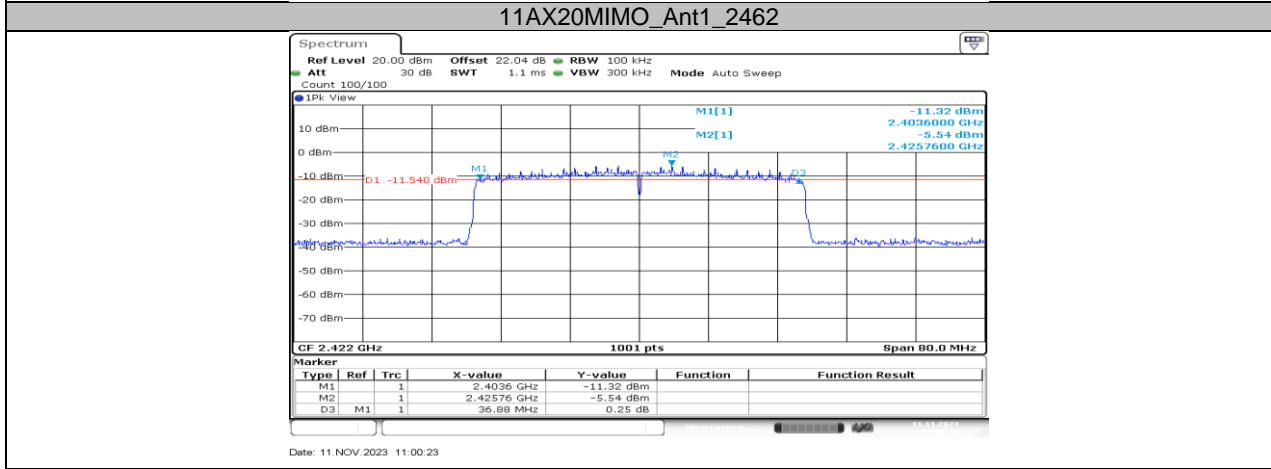
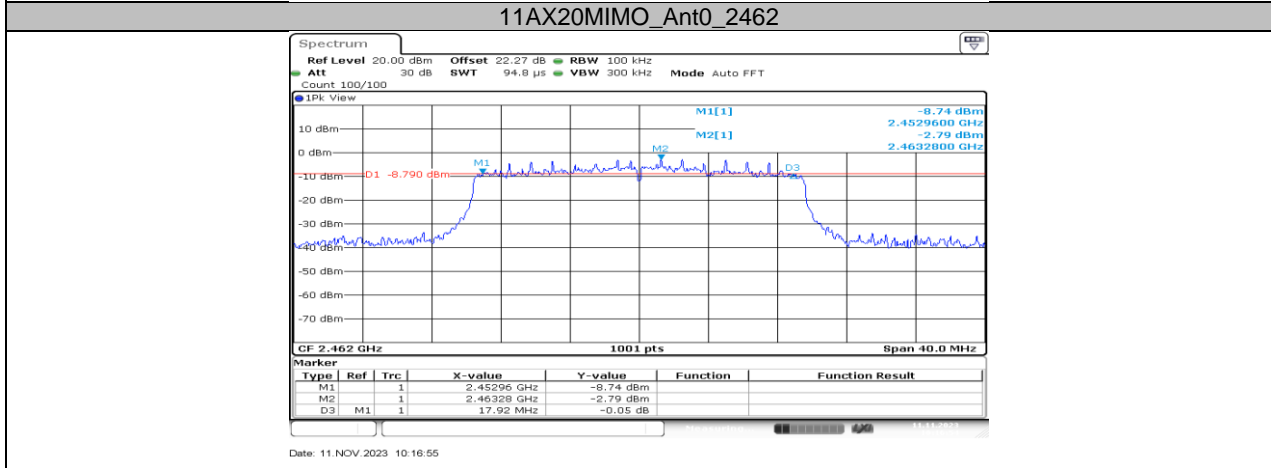
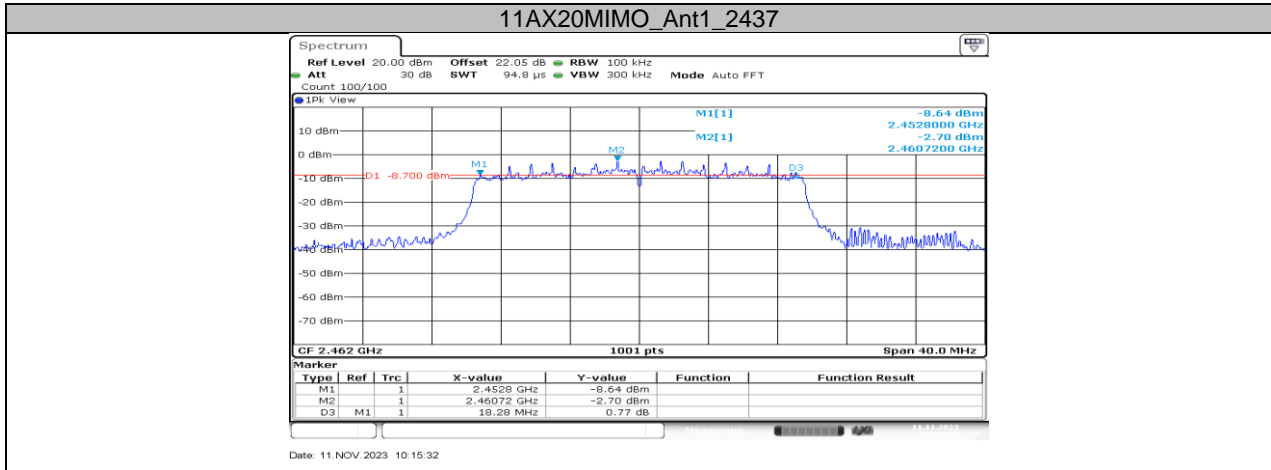

### 11AX40MIMO\_Ant0\_2422

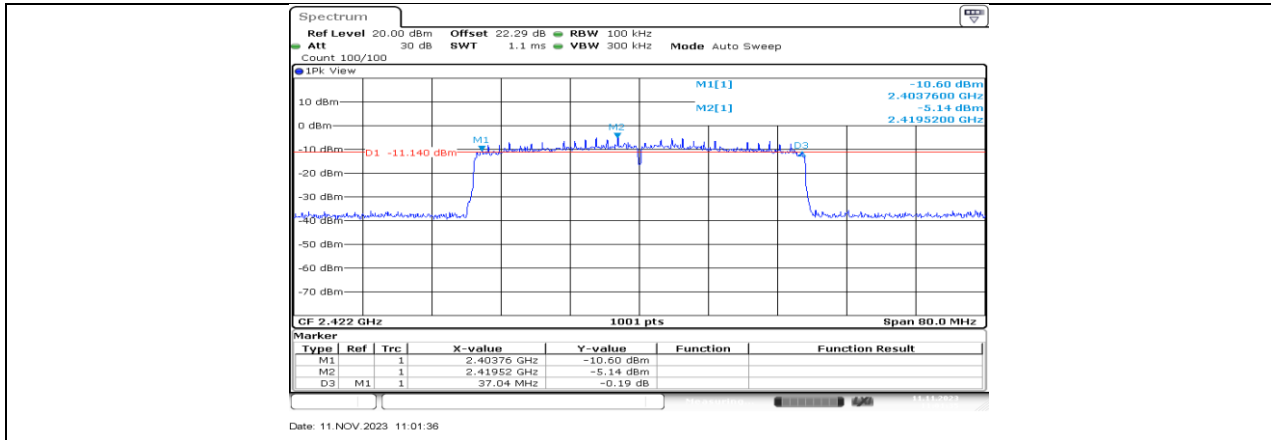

Date: 11.NOV.2023 11:01:36

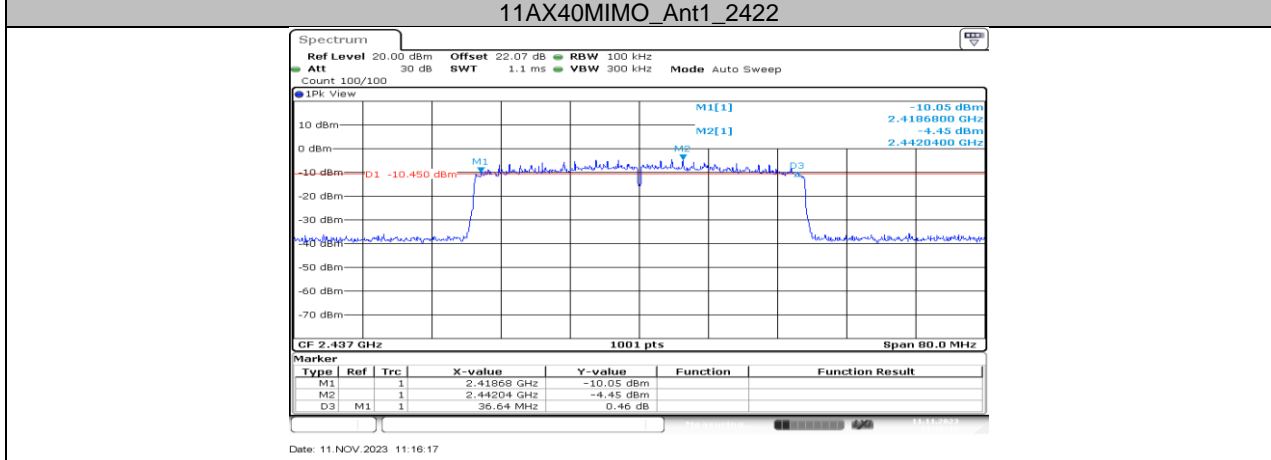

Date: 11.NOV.2023 11:16:17

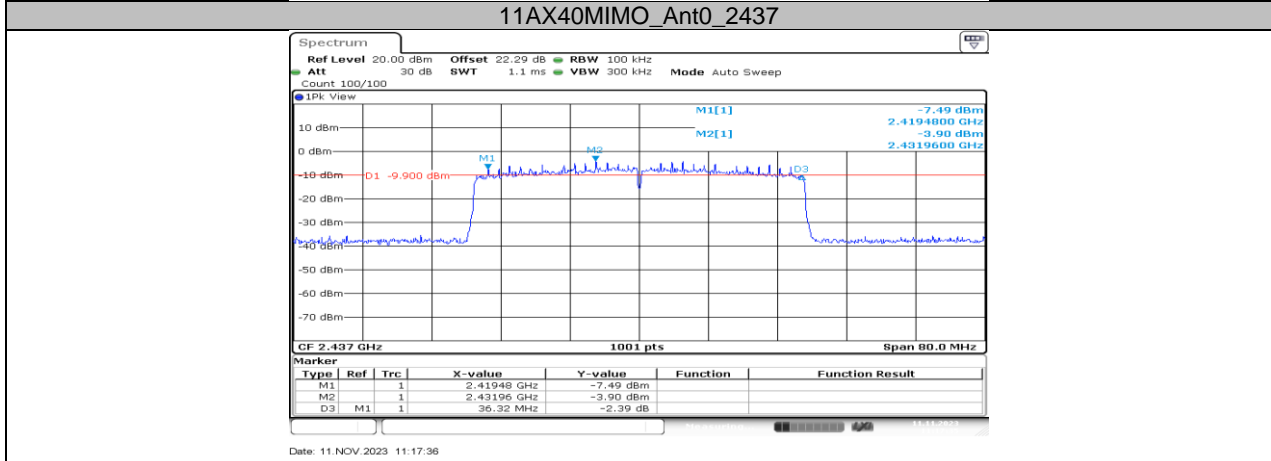

Date: 11.NOV.2023 11:17:36

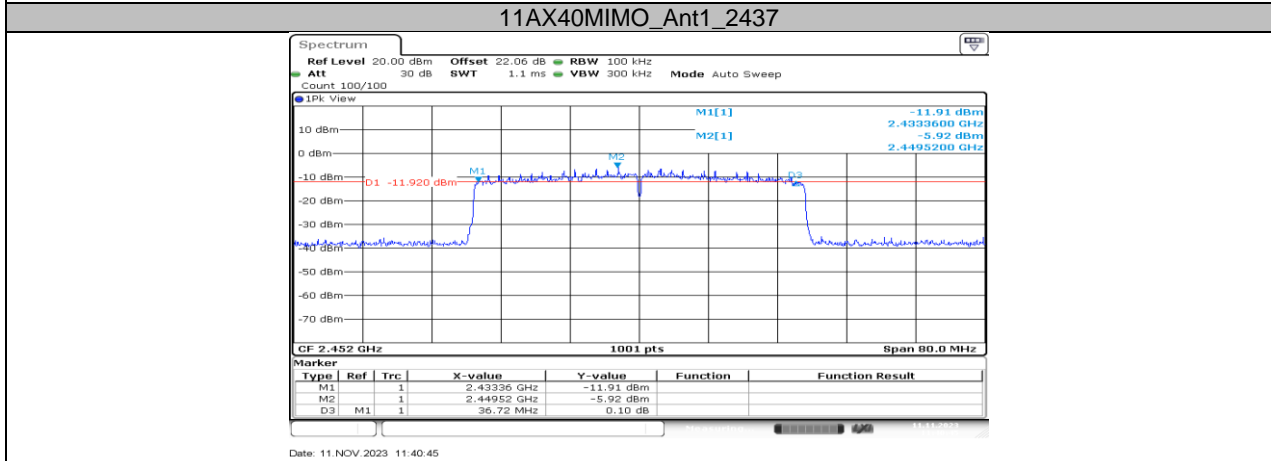

Date: 11.NOV.2023 11:40:45



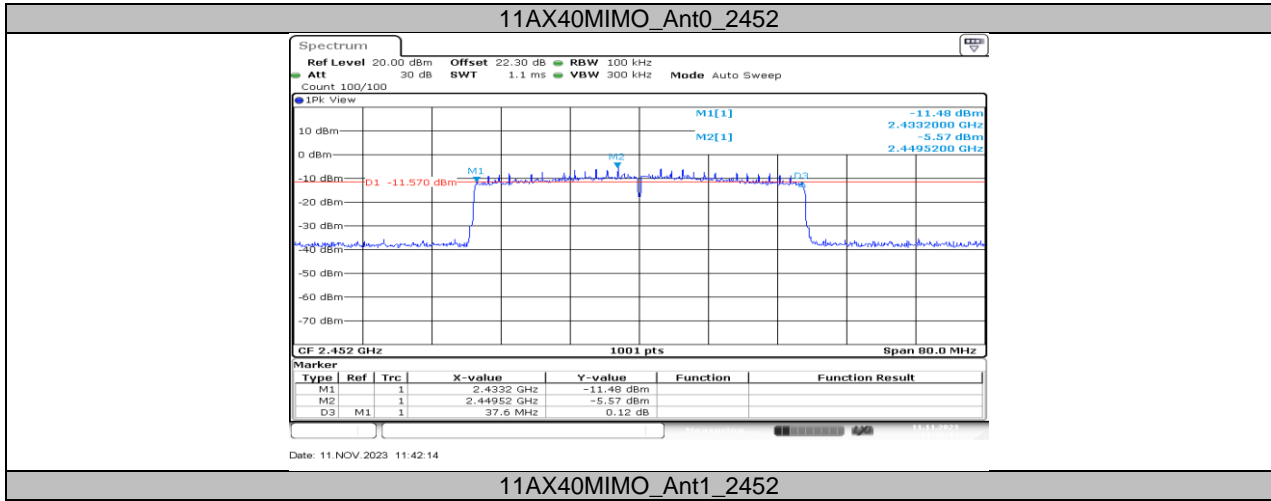

## 11.2. APPENDIX B: OCCUPIED CHANNEL BANDWIDTH

### 11.2.1. Test Result

Test Mode	Antenna	Frequency [MHz]	OCB [MHz]	FL[MHz]	FH[MHz]	Verdict
11B	Ant0	2412	12.787	2405.6464	2418.4336	PASS
	Ant1	2412	12.987	2405.5265	2418.5135	PASS
	Ant0	2437	12.987	2430.4865	2443.4735	PASS
	Ant1	2437	12.987	2430.5265	2443.5135	PASS
	Ant0	2462	13.027	2455.4865	2468.5135	PASS
	Ant1	2462	12.987	2455.5265	2468.5135	PASS
11G	Ant0	2412	17.143	2403.4086	2420.5514	PASS
	Ant1	2412	17.103	2403.4885	2420.5914	PASS
	Ant0	2437	18.941	2427.4496	2446.3906	PASS
	Ant1	2437	18.821	2427.5694	2446.3906	PASS
	Ant0	2462	18.981	2452.4895	2471.4705	PASS
	Ant1	2462	18.941	2452.4496	2471.3906	PASS
11N20MIMO	Ant0	2412	17.982	2403.0090	2420.9910	PASS
	Ant1	2412	17.742	2403.1289	2420.8711	PASS
	Ant0	2437	19.82	2427.0500	2446.8701	PASS
	Ant1	2437	18.621	2427.6893	2446.3107	PASS
	Ant0	2462	19.78	2452.1698	2471.9500	PASS
	Ant1	2462	18.621	2452.6893	2471.3107	PASS
11N40MIMO	Ant0	2422	36.364	2403.8581	2440.2218	PASS
	Ant1	2422	36.284	2403.8581	2440.1419	PASS
	Ant0	2437	36.444	2418.7782	2455.2218	PASS
	Ant1	2437	36.284	2418.8581	2455.1419	PASS
	Ant0	2452	36.444	2433.8581	2470.3017	PASS
	Ant1	2452	36.364	2433.8581	2470.2218	PASS
11AX20MIMO	Ant0	2412	18.901	2402.5694	2421.4705	PASS
	Ant1	2412	18.861	2402.6094	2421.4705	PASS
	Ant0	2437	19.341	2427.3696	2446.7103	PASS
	Ant1	2437	19.261	2427.3696	2446.6304	PASS
	Ant0	2462	19.341	2452.3696	2471.7103	PASS
	Ant1	2462	19.301	2452.3696	2471.6703	PASS
11AX40MIMO	Ant0	2422	37.802	2403.1389	2440.9411	PASS
	Ant1	2422	37.802	2403.1389	2440.9411	PASS
	Ant0	2437	37.802	2418.1389	2455.9411	PASS
	Ant1	2437	37.802	2418.1389	2455.9411	PASS
	Ant0	2452	37.802	2433.1389	2470.9411	PASS
	Ant1	2452	37.962	2433.0589	2471.0210	PASS