

WXT5G项目天线测试报告

Test Lab:	ZTX					
Address:	No. 34 Shilong Avenue, Shiyan Street, Bao'an District, Shenzhen, China					
Test Date:	16-Mar-23					
Engineer:	Zhao Feng					
Test Software:	Satimo.Spm					
Test Software version:	1.5.5					
Test Standard:	GB/T.9410-2008					
Calibration equipment table:	testing instrument	manufacturer	model	serial number	Calibration Date	Calibration expiration date
	network analyzer	Keysight	E5071C	MY47002902	2023.4.20	2023.4.19
	network analyzer	Agilent	E5071C	MY46521960	2023.4.20	2023.4.19
	SG24 antenna testing system	SATIMO	SG24		2023.4.20	2023.4.19

- 测试程序
- 模块实物图
- 测试环境
- 天线无源测试数据

测试程序

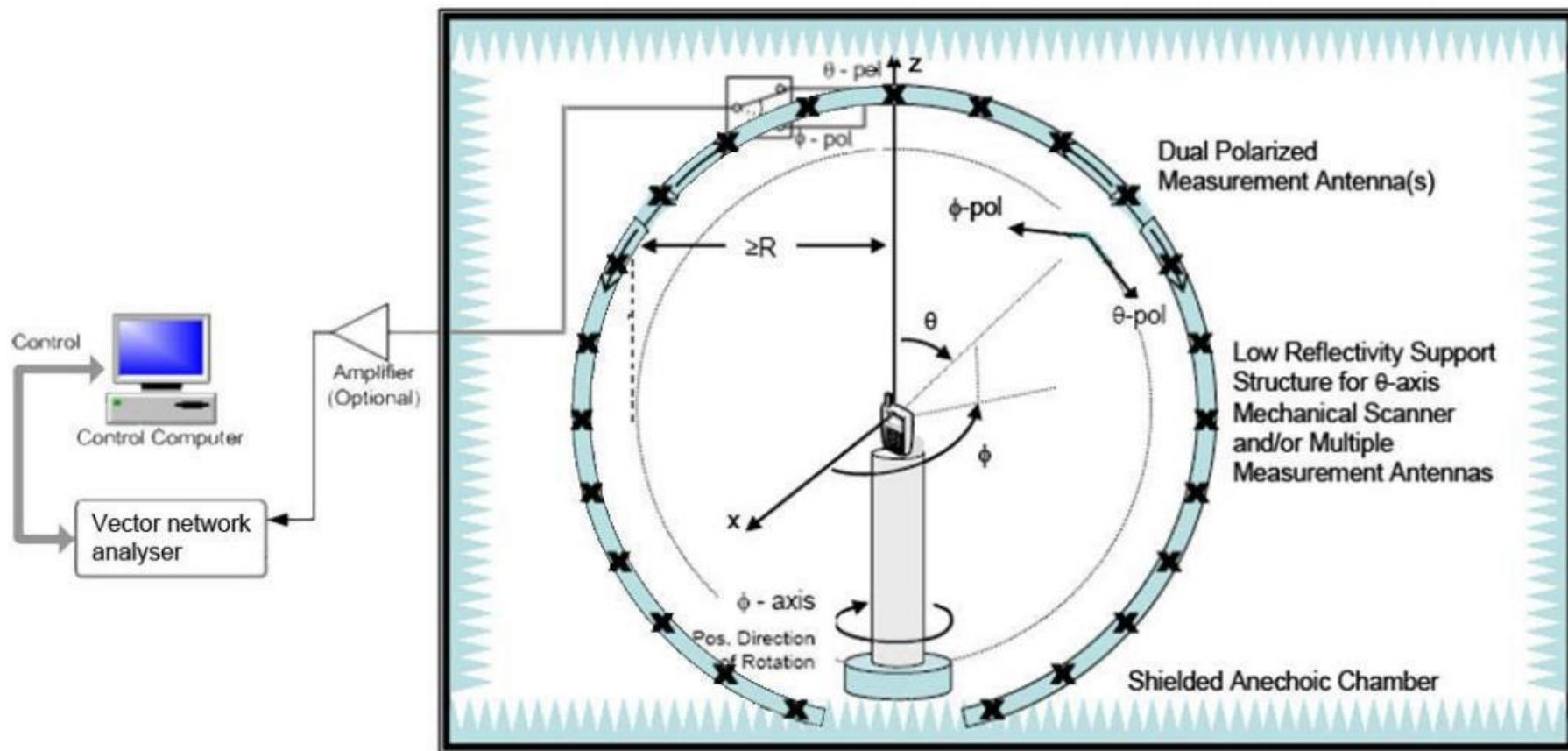

模块实物图

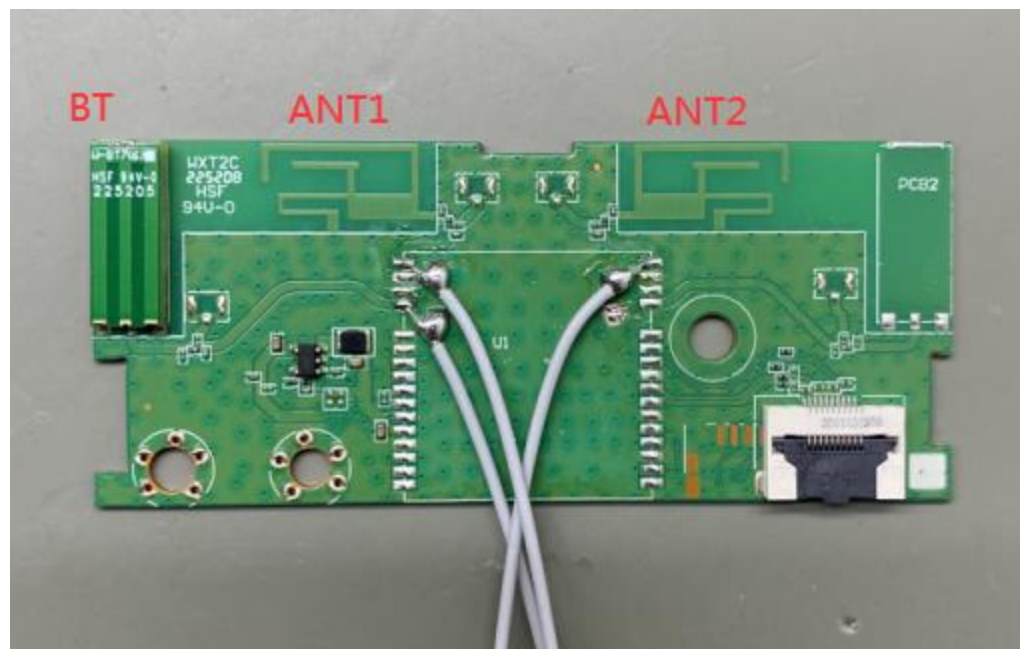

测试环境

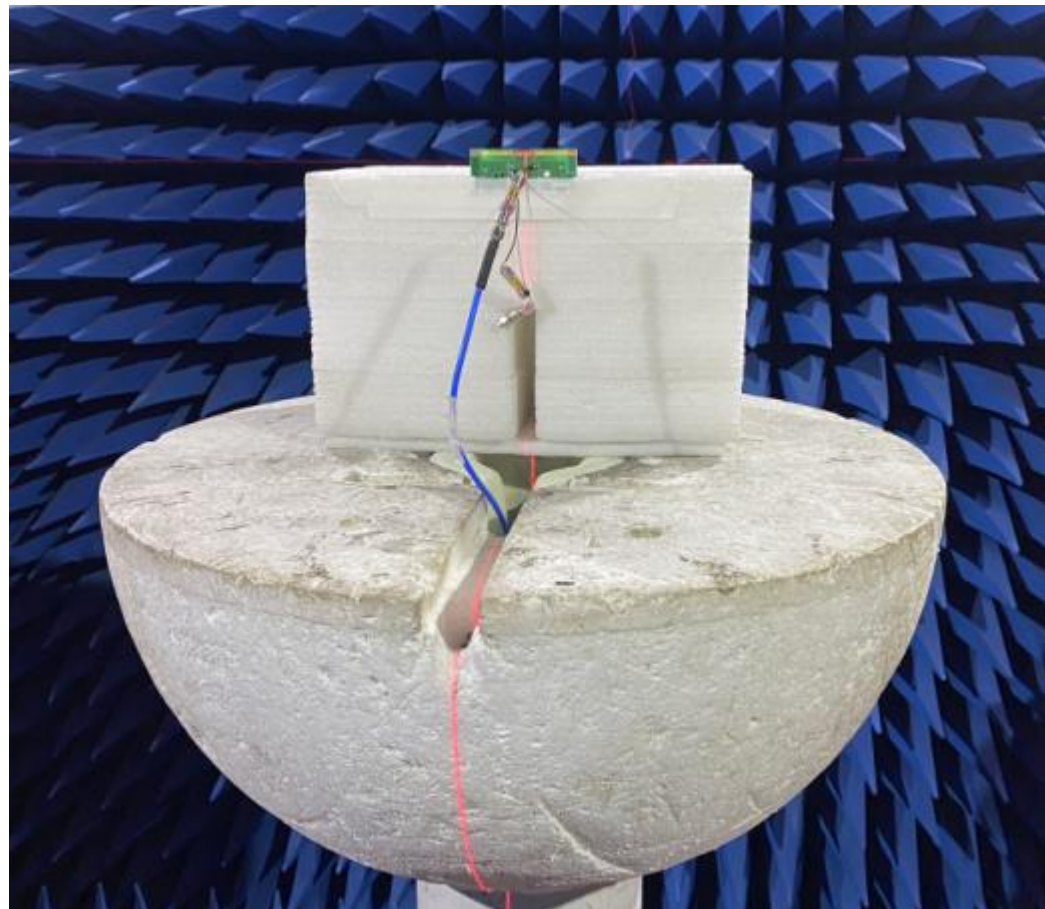

无源数据 (ANT1-驻波比)

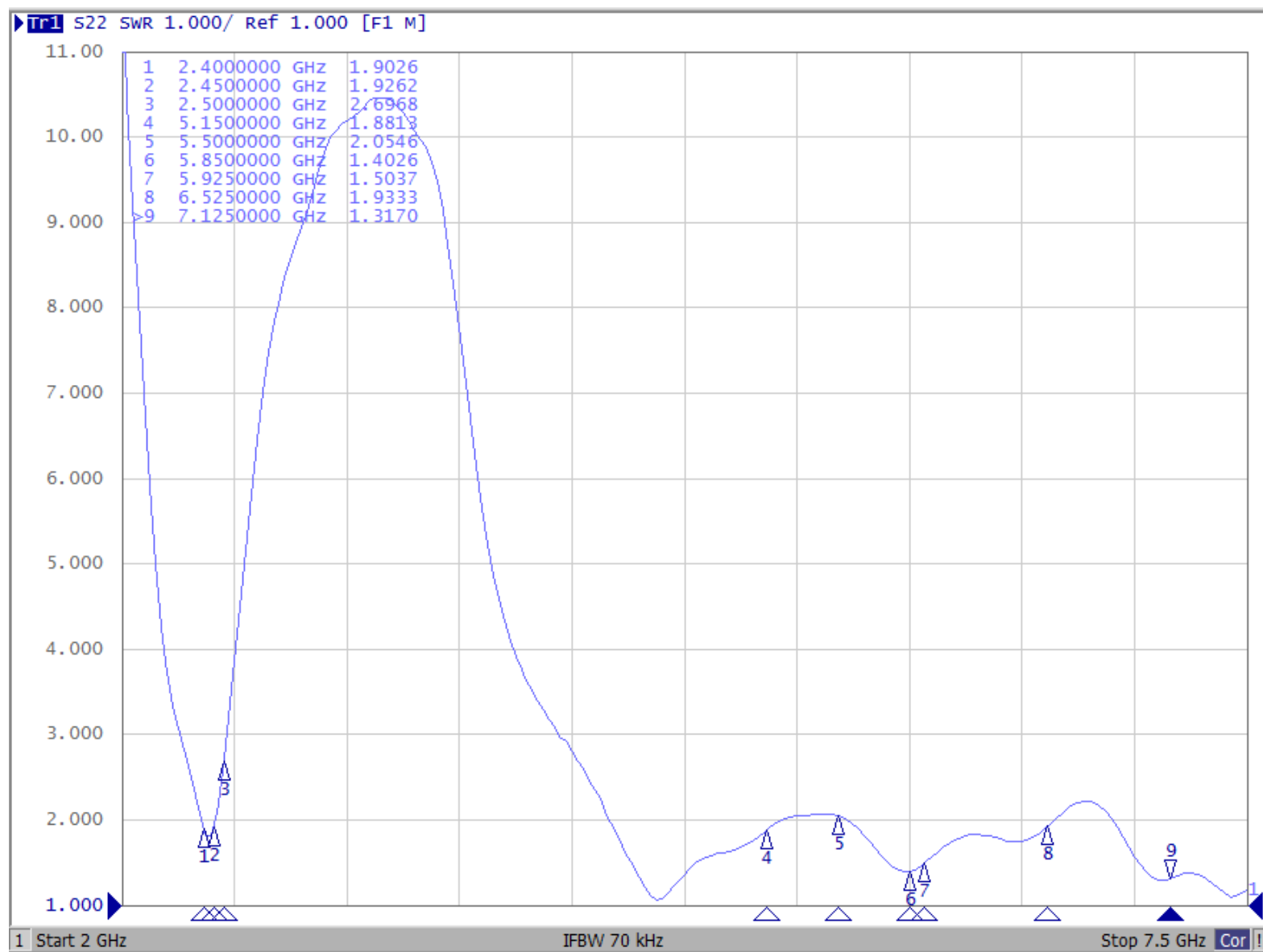

无源数据 (ANT1-效率/增益)

Frequency	Peak Gain	Efficiency	
		%	dB
Mhz	dB		
2400	0.49	40.71	-3.90
2410	0.67	41.58	-3.81
2420	1.02	42.62	-3.70
2430	1.36	44.92	-3.48
2440	1.25	43.88	-3.58
2450	1.32	42.59	-3.71
2460	0.82	39.22	-4.07
2470	1.02	37.87	-4.22
2480	1.40	39.70	-4.01
2490	1.44	37.69	-4.24
2500	1.33	37.73	-4.23
5150	2.01	47.82	-3.20
5250	2.24	52.41	-2.81
5350	2.55	55.05	-2.59
5450	2.03	51.41	-2.89
5550	2.96	56.69	-2.46
5650	2.43	53.52	-2.71
5750	2.86	54.11	-2.67
5850	3.13	55.39	-2.57

无源数据 (ANT1-2.4G方向图)

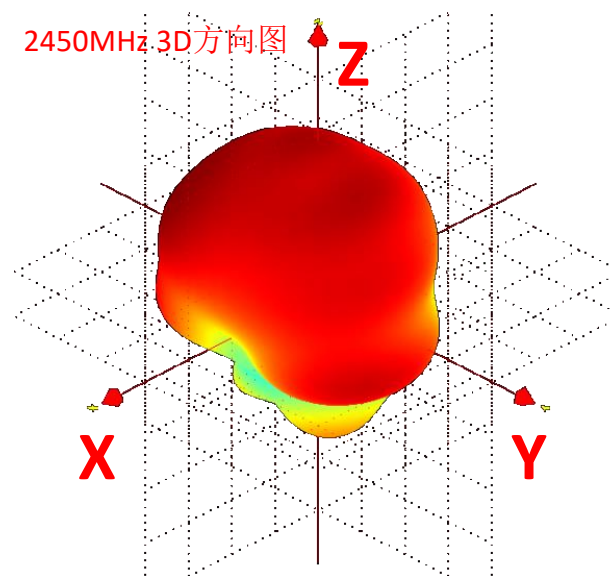
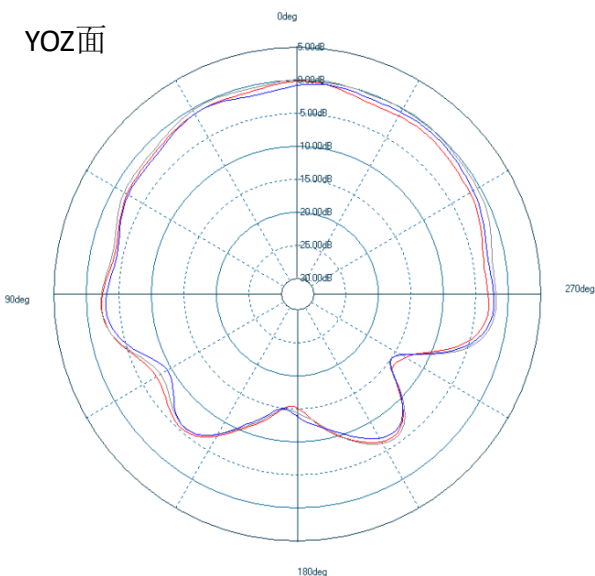
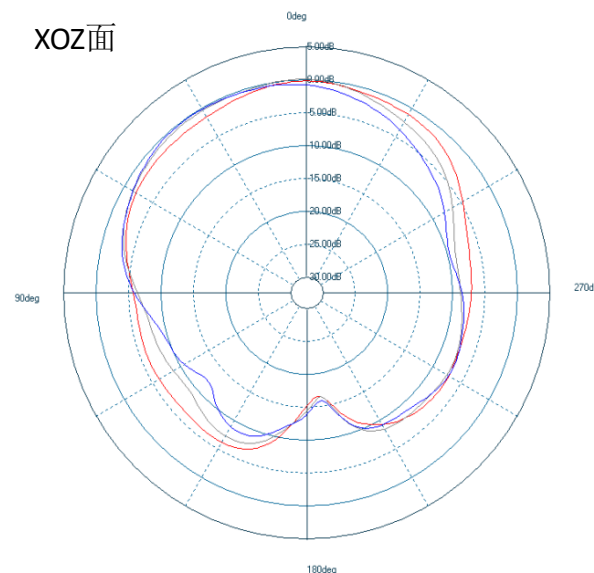
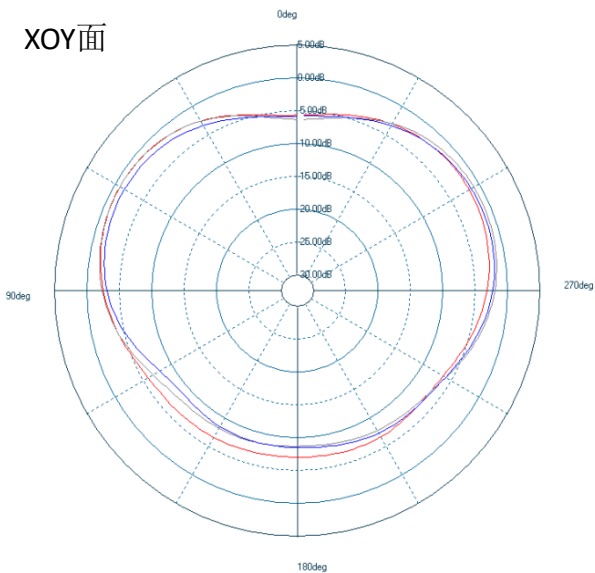

无源数据 (ANT1-5G方向图)

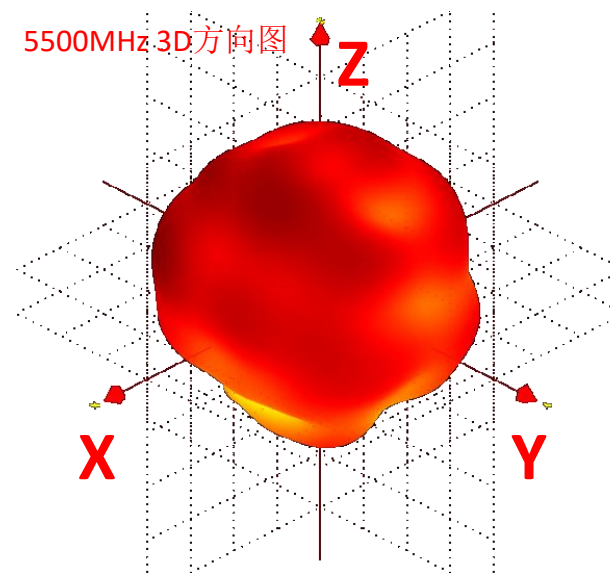
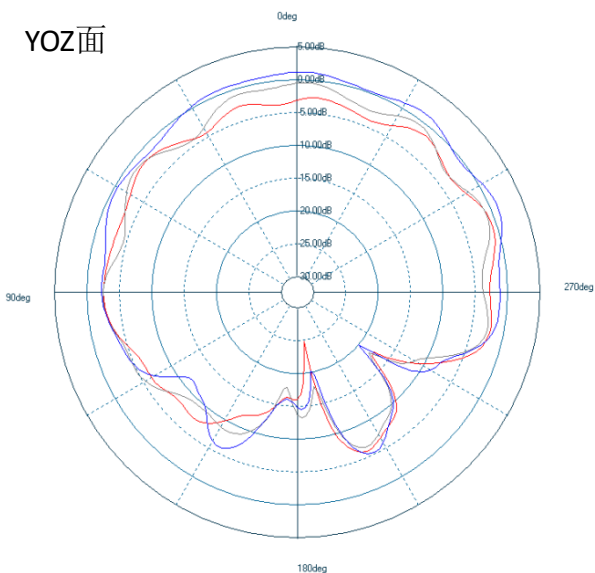
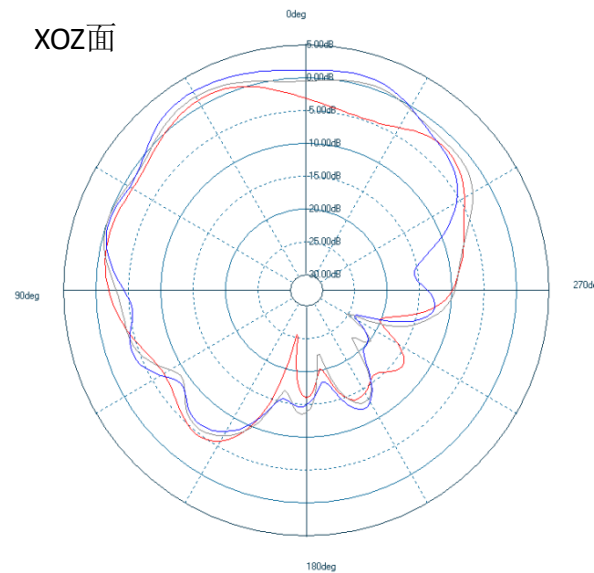
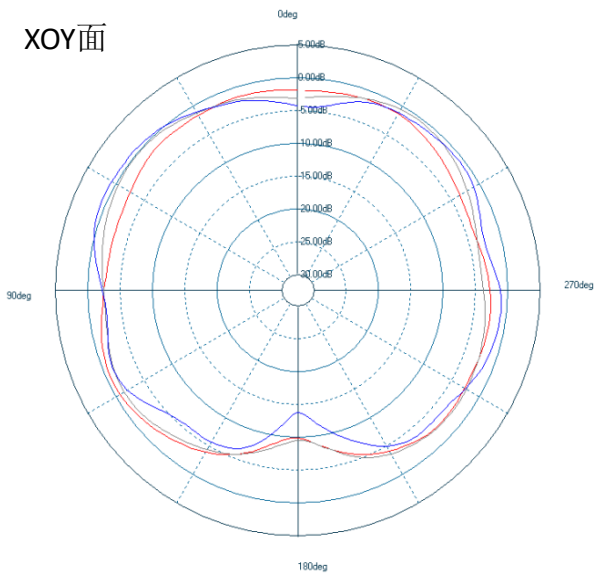

无源数据 (ANT2-驻波比)

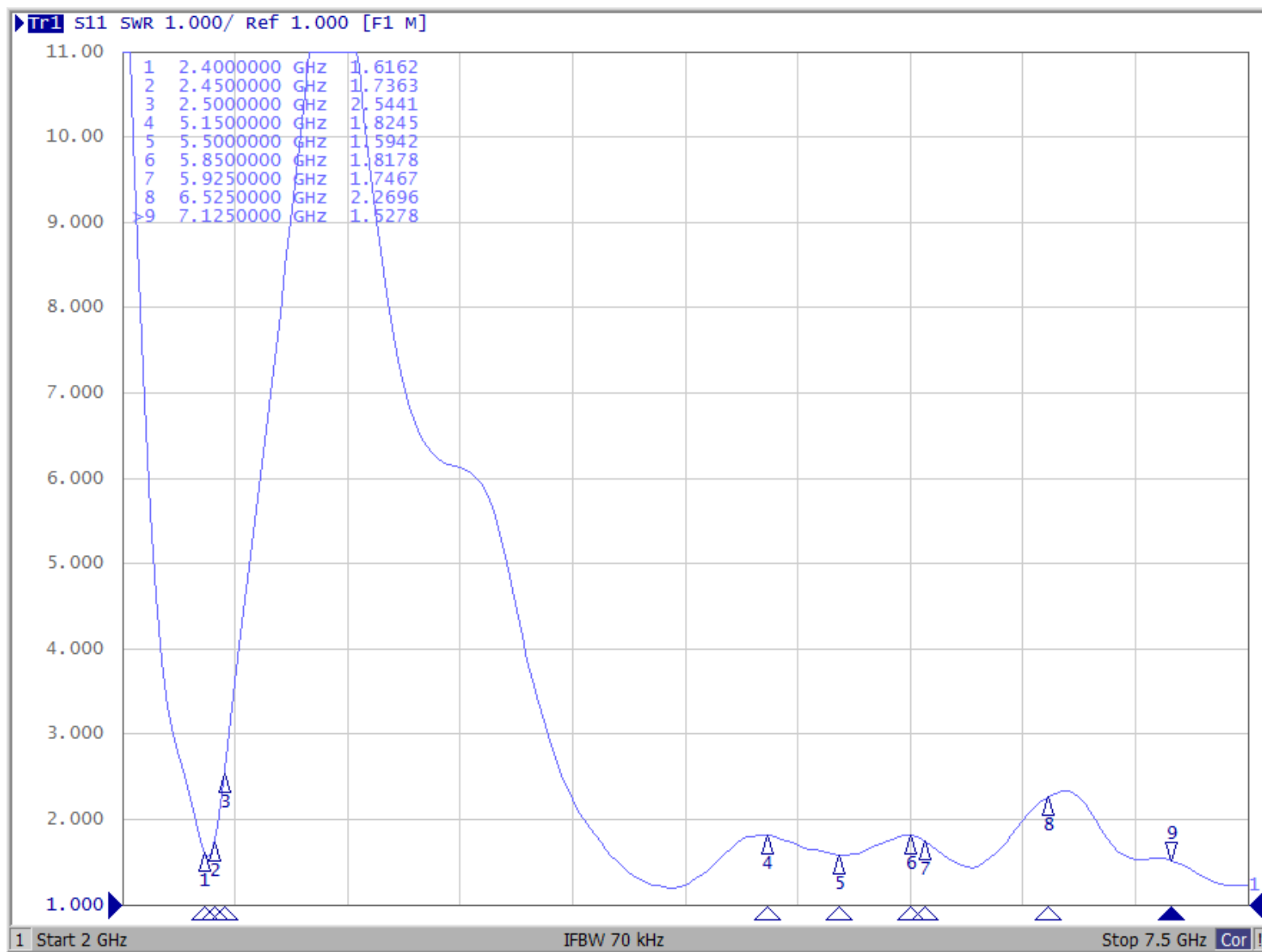

无源数据 (ANT2-效率/增益)

Frequency	Peak Gain	Efficiency	
		%	dB
Mhz	dB		
2400	1.26	41.37	-3.83
2410	1.16	42.73	-3.69
2420	1.09	42.57	-3.71
2430	1.40	43.80	-3.59
2440	1.62	44.20	-3.55
2450	1.60	41.83	-3.78
2460	1.41	41.41	-3.83
2470	0.96	36.25	-4.41
2480	1.05	36.78	-4.34
2490	0.82	35.47	-4.50
2500	1.00	35.63	-4.48
5150	2.28	56.21	-2.50
5250	2.09	58.29	-2.34
5350	2.17	52.95	-2.76
5450	2.01	50.32	-2.98
5550	2.81	52.63	-2.79
5650	3.07	52.22	-2.82
5750	3.01	55.08	-2.59
5850	3.45	58.71	-2.31

无源数据 (ANT2-2.4G方向图)

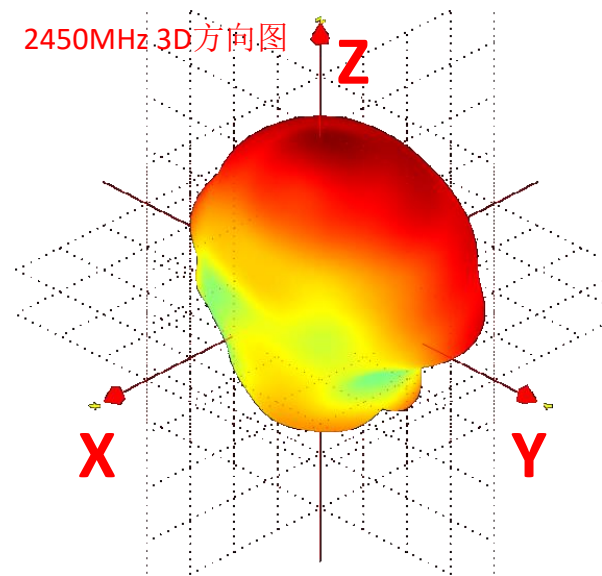
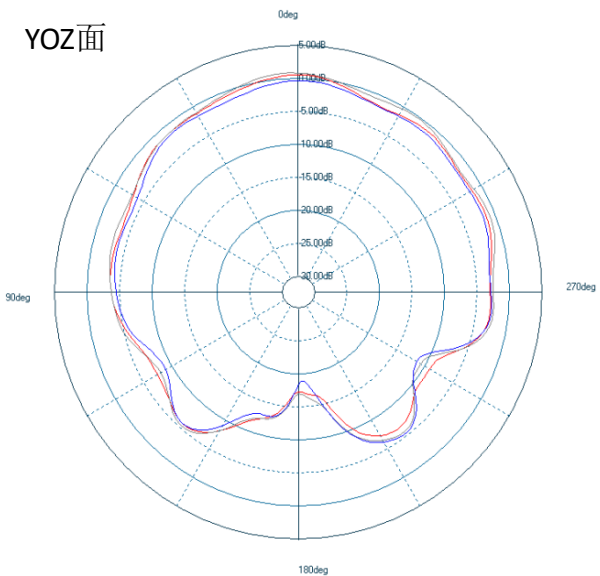
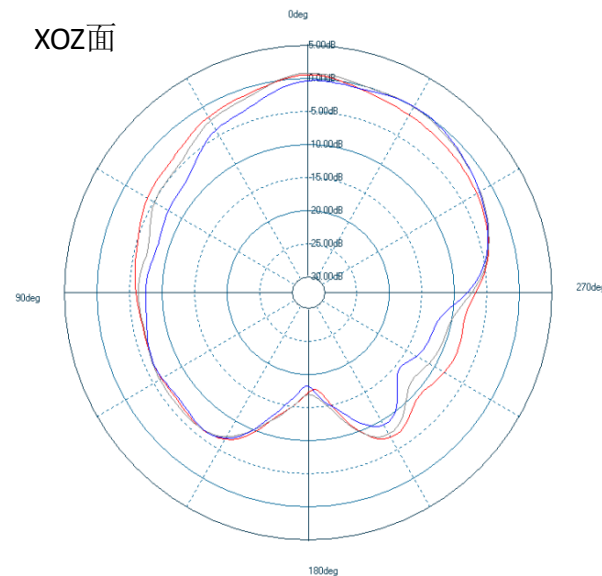
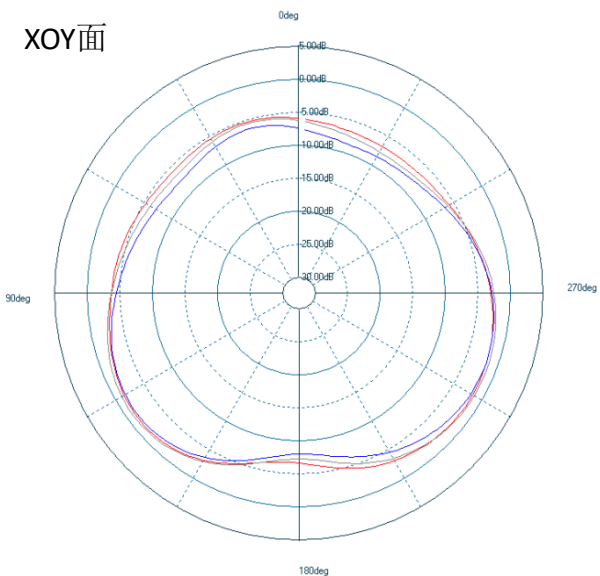

无源数据 (ANT2-5G方向图)

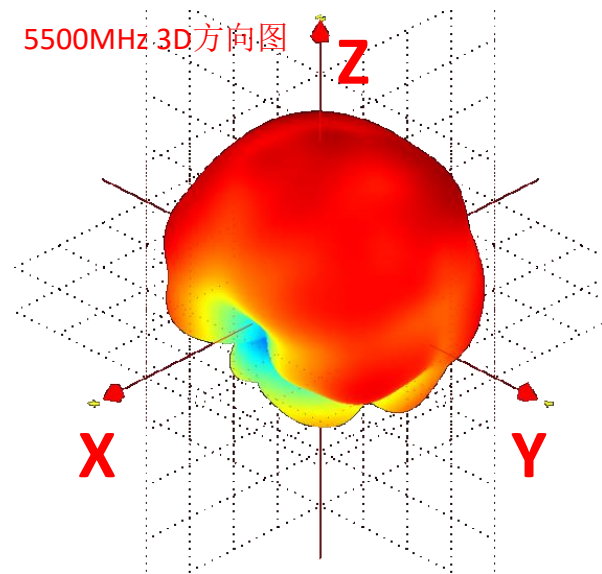
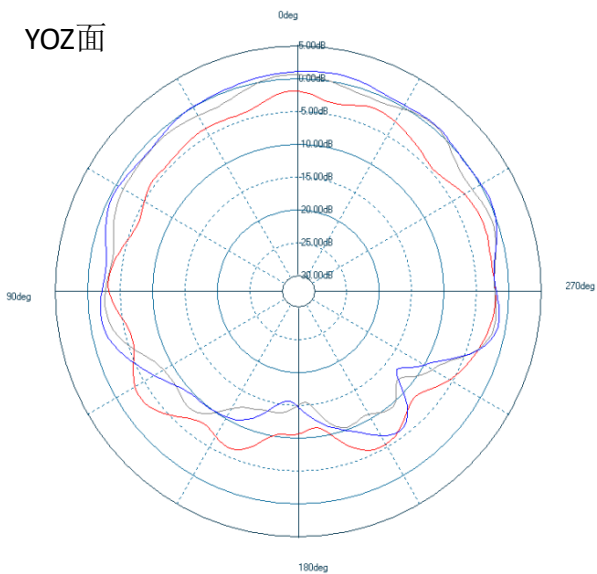
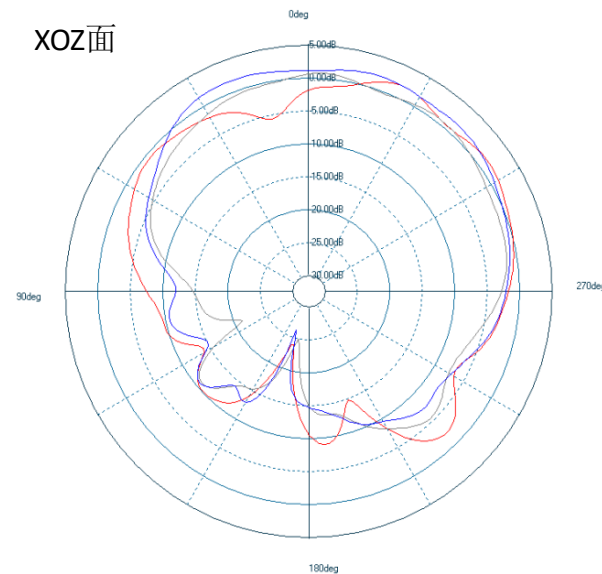
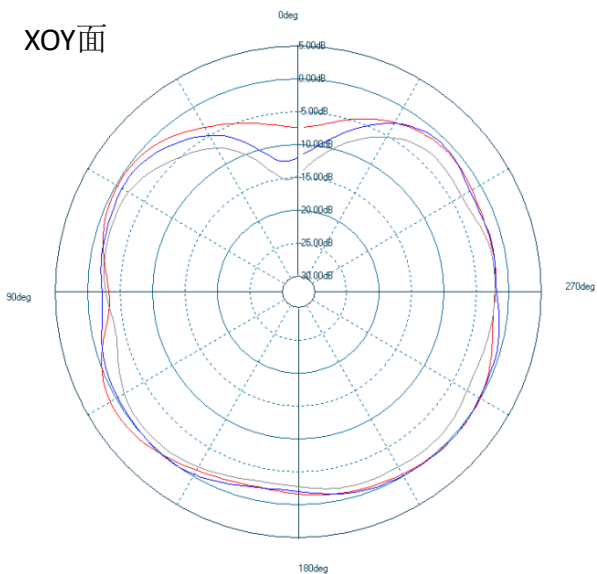

无源数据 (BT-驻波比)

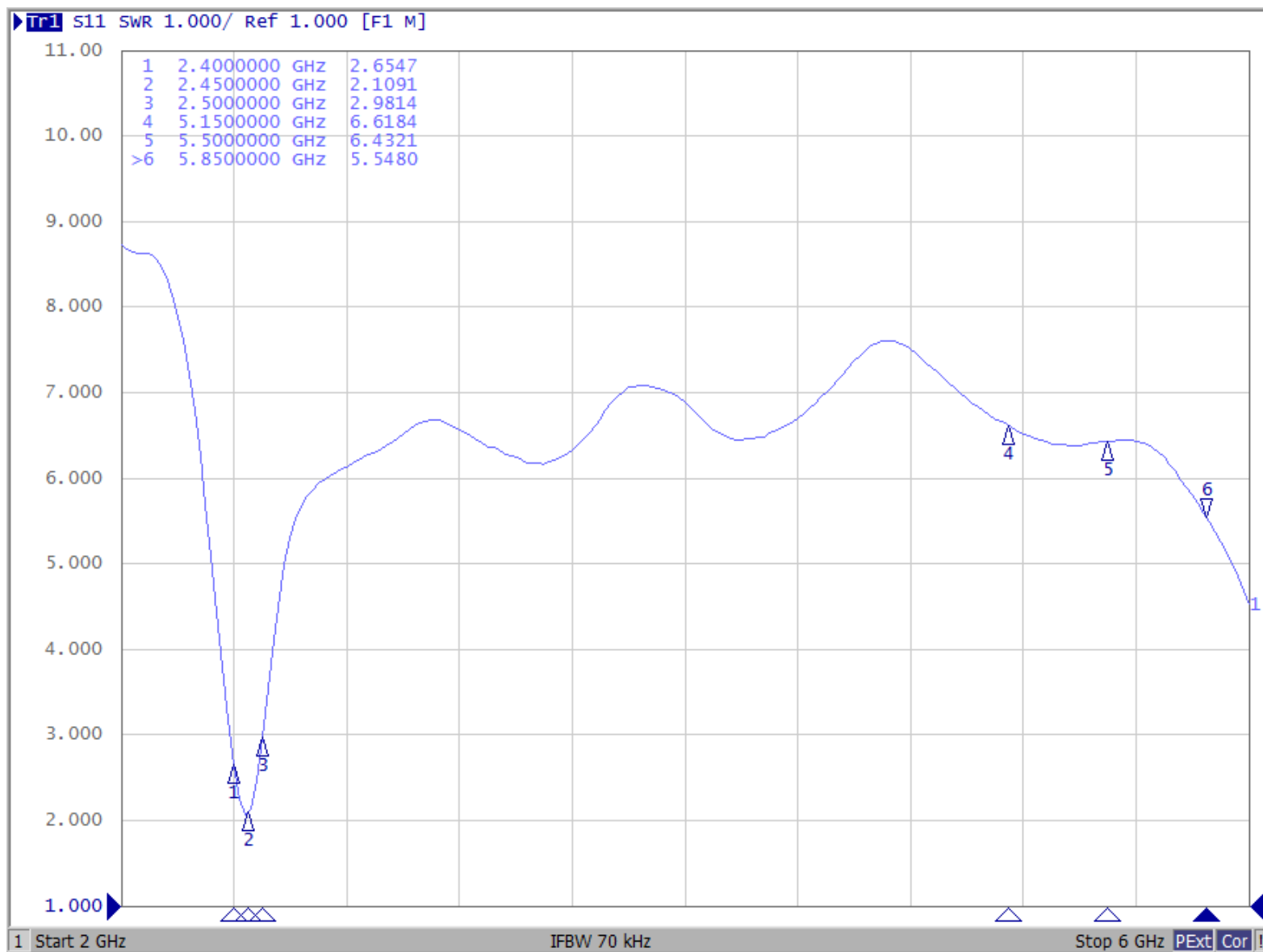

无源数据 (BT-效率/增益)

Frequency	Efficiency		Peak Gain
	Mhz	%	dB
2400	15.82	-8.01	0.98
2410	16.05	-7.95	1.08
2420	16.86	-7.73	1.17
2430	16.87	-7.73	1.23
2440	17.74	-7.51	1.36
2450	17.34	-7.61	1.31
2460	16.06	-7.94	1.27
2470	15.04	-8.23	0.98
2480	15.47	-8.11	1.04
2490	15.28	-8.16	0.86
2500	14.77	-8.31	0.73

无源数据 (BT-2.4G方向图)

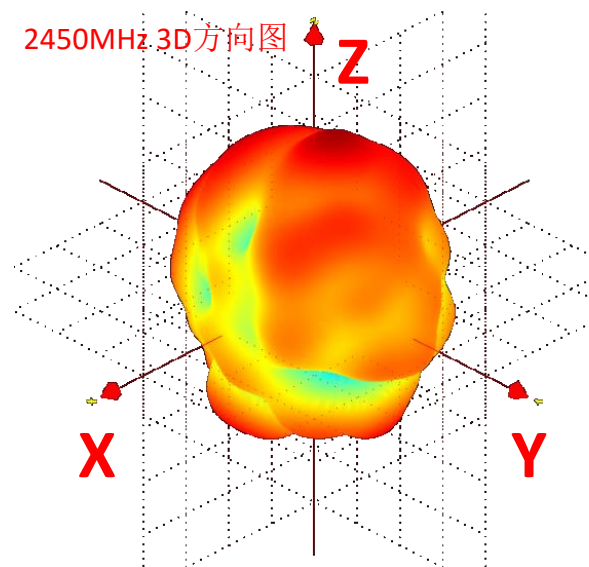
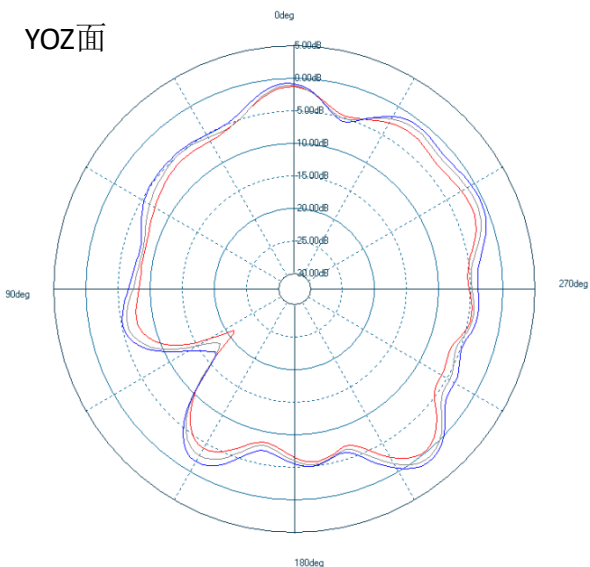
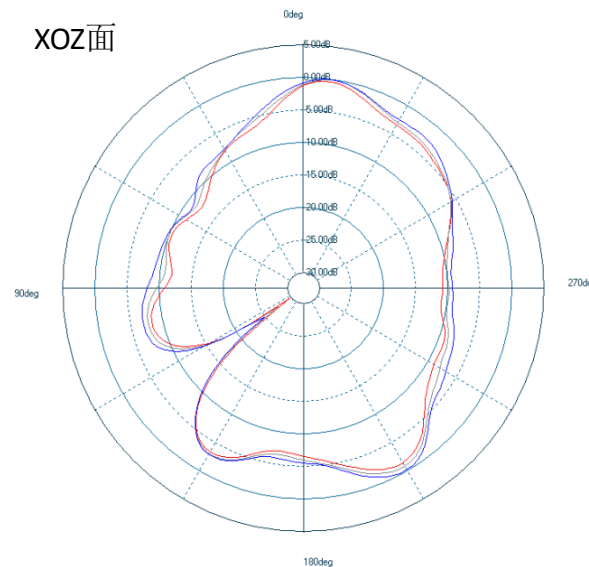
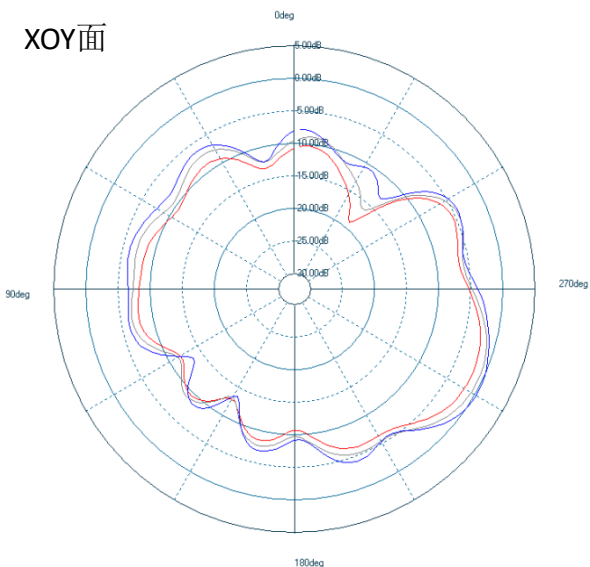

无源数据 (ANT1&ANT2天线隔离度)

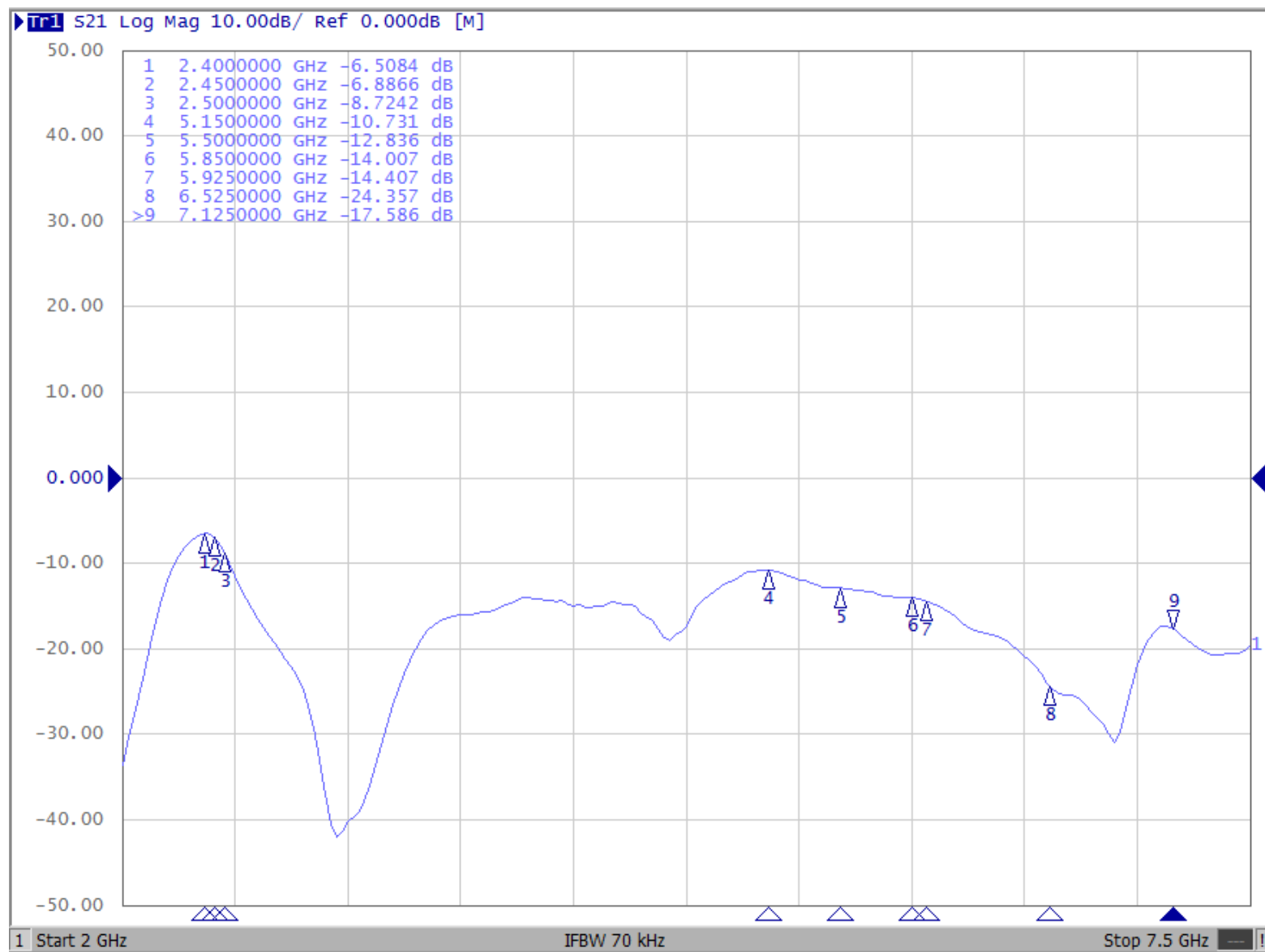

无源数据 (ANT1&BT天线隔离度)

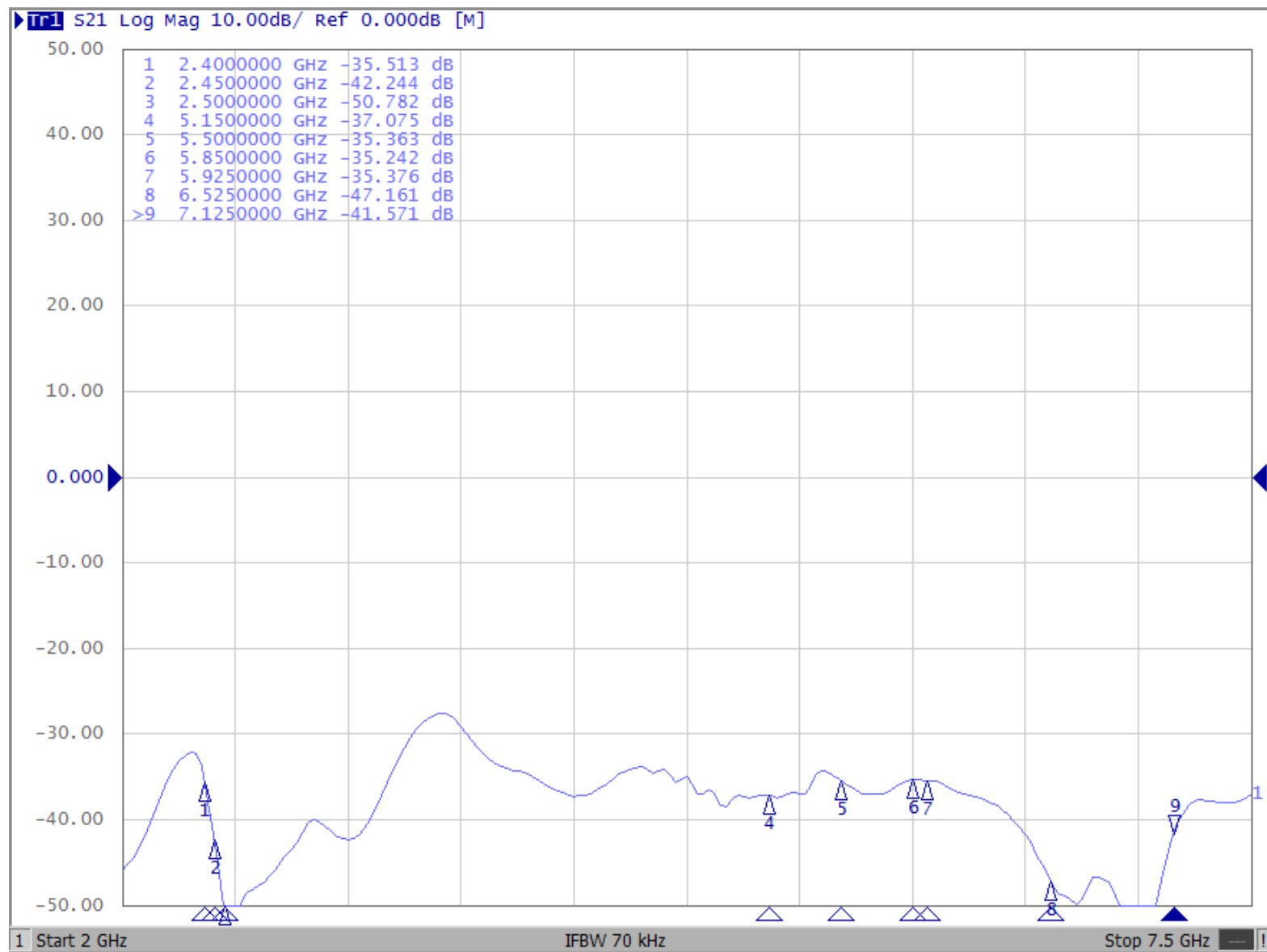

无源数据 (ANT2&BT天线隔离度)

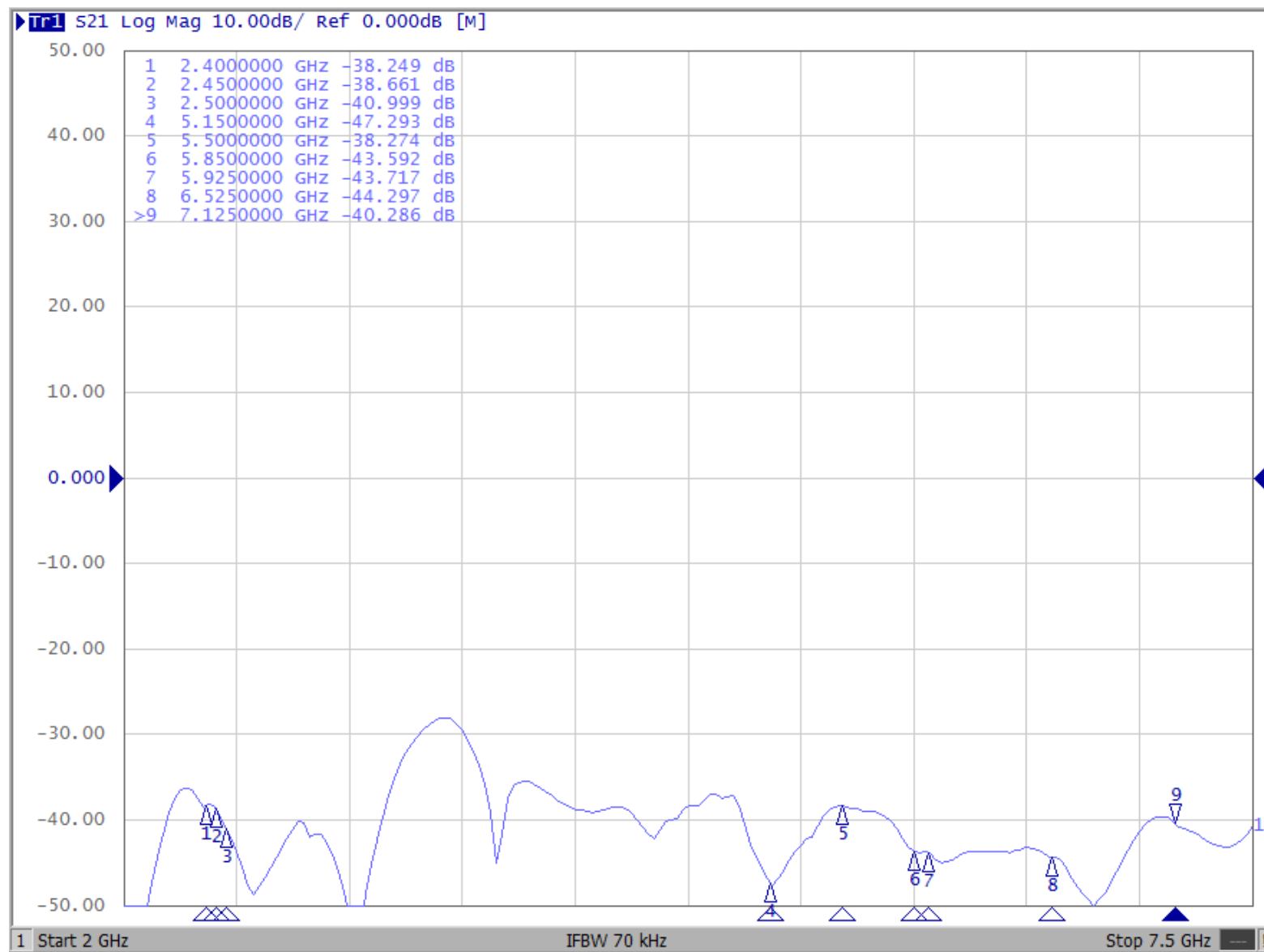

Thank You

