



**CFR 47 FCC PART 15 SUBPART E
ISED RSS-248 ISSUE 1**

CERTIFICATION TEST REPORT

For

WIFI+BT Module

MODEL NUMBER: WXT2CM2511

FCC ID: 2AC23-WXT2C

IC: 12290A-WXT2C

REPORT NUMBER: 4790175298-5

ISSUE DATE: March 8, 2022

Prepared for

**Hui Zhou Gaoshengda Technology Co.,LTD
NO.75 Zhongkai Development Area, Huizhou, Guangdong, China**

Prepared by

UL Verification Services (Guangzhou) Co., Ltd, Song Shan Lake Branch

Building 10, Innovation Technology Park, No. 1, Li Bin Road, Song Shan Lake Hi-Tech Development Zone Dongguan, 523808, People's Republic of China

Tel: +86 769 22038881

Fax: +86 769 33244054

Website: www.ul.com



Revision History

<u>Rev.</u>	<u>Issue Date</u>	<u>Revisions</u>	<u>Revised By</u>
V0	3/8/2022	Initial Issue	



Summary of Test Results			
Clause	Test Items	FCC/IC Rules	Test Results
1	6dB Bandwidth	FCC 15.407 (a)	PASS
2	99% Occupied Bandwidth	RSS-Gen Clause 6.7 RSS-248 Clause 4.4	PASS
3	Conducted Output Power	FCC 15.407 (a) RSS-248 Clause 4.6	PASS
4	Power Spectral Density	FCC 15.407 (a) RSS-248 Clause 4.6	PASS
5	Radiated Bandedge and Spurious Emission	FCC 15.407 (b) FCC 15.209 FCC 15.205 RSS-248 Clause 4.7 RSS-GEN Clause 8.9	PASS
6	Conducted Emission Test for AC Power Port	FCC 15.207 RSS-GEN Clause 8.8	PASS
7	Frequency Stability	FCC 15.407 (g) RSS-248 Clause 4.5	PASS
8	Contention-based Protocol	FCC 15.407 (d) RSS-248 Clause 4.8	PASS
9	Antenna Requirement	FCC 15.203 RSS-GEN Clause 6.8	PASS
Note: 1. This test report is only published to and used by the applicant, and it is not for evidence purpose in China. 2. The measurement result for the sample received is <Pass> according to < CFR 47 FCC PART 15 SUBPART E >< ISED RSS-248 > when <Accuracy Method> decision rule is applied.			



TABLE OF CONTENTS

1. ATTESTATION OF TEST RESULTS	7
2. TEST METHODOLOGY	8
3. FACILITIES AND ACCREDITATION	8
4. CALIBRATION AND UNCERTAINTY	9
4.1. <i>MEASURING INSTRUMENT CALIBRATION</i>	<i>9</i>
4.2. <i>MEASUREMENT UNCERTAINTY.....</i>	<i>9</i>
5. EQUIPMENT UNDER TEST	10
5.1. <i>DESCRIPTION OF EUT</i>	<i>10</i>
5.2. <i>MAXIMUM OUTPUT POWER.....</i>	<i>11</i>
5.3. <i>CHANNEL LIST.....</i>	<i>12</i>
5.4. <i>DESCRIPTION OF AVAILABLE ANTENNAS</i>	<i>15</i>
5.5. <i>THE WORSE CASE POWER SETTING PARAMETER.....</i>	<i>16</i>
5.6. <i>TEST CHANNEL CONFIGURATION.....</i>	<i>19</i>
5.7. <i>THE WORSE CASE CONFIGURATIONS</i>	<i>20</i>
5.8. <i>DESCRIPTION OF TEST SETUP.....</i>	<i>21</i>
6. MEASURING INSTRUMENT AND SOFTWARE USED	22
7. ANTENNA PORT TEST RESULTS	24
7.1. <i>ON TIME AND DUTY CYCLE.....</i>	<i>24</i>
7.2. <i>EMISSION BANDWIDTH AND 99 % OCCUPIED BANDWIDTH</i>	<i>25</i>
7.3. <i>CONDUCTED OUTPUT POWER.....</i>	<i>27</i>
7.4. <i>POWER SPECTRAL DENSITY.....</i>	<i>30</i>
7.5. <i>IN-BAND EMISSIONS (MASK).....</i>	<i>32</i>
8. RADIATED TEST RESULTS.....	34
8.1. <i>RESTRICTED BANDEDGE.....</i>	<i>41</i>
8.1.1. <i>802.11ax HE20 CDD MODE</i>	<i>41</i>
UNII-5 BAND	<i>41</i>
UNII-8 BAND	<i>45</i>
8.1.2. <i>802.11ax HE40 CDD MODE</i>	<i>47</i>
UNII-5 BAND	<i>47</i>
UNII-8 BAND	<i>49</i>
8.1.3. <i>802.11ax HE80 CDD MODE.....</i>	<i>51</i>
UNII-5 BAND	<i>51</i>
UNII-8 BAND	<i>53</i>
8.2. <i>SPURIOUS EMISSIONS (1 GHz ~ 9 GHz).....</i>	<i>55</i>
8.2.1. <i>802.11ax HE80 CDD MODE.....</i>	<i>55</i>



UNII-5 BAND	55
UNII-6 BAND	61
UNII-7 BAND	67
UNII-8 BAND	73
8.3. SPURIOUS EMISSIONS (9 GHz ~ 18 GHz)	79
8.3.1. 802.11ax HE20 CDD MODE	79
UNII-5 BAND	79
UNII-6 BAND	85
UNII-7 BAND	91
UNII-8 BAND	97
8.3.2. 802.11ax HE40 CDD MODE	103
UNII-5 BAND	103
UNII-6 BAND	109
UNII-7 BAND	113
UNII-8 BAND	119
8.3.3. 802.11ax HE80 CDD MODE	125
UNII-5 BAND	125
UNII-6 BAND	131
UNII-7 BAND	133
UNII-8 BAND	139
8.4. SPURIOUS EMISSIONS (18 GHz ~ 26 GHz)	143
8.4.1. 802.11ax HE80 CDD MODE	143
8.5. SPURIOUS EMISSIONS (26 GHz ~ 40 GHz)	145
8.5.1. 802.11ax HE80 CDD MODE	145
8.6. SPURIOUS EMISSIONS (30 MHz ~ 1 GHz)	147
8.6.1. 802.11ax HE80 CDD MODE	147
8.7. SPURIOUS EMISSIONS BELOW 30 MHz	149
8.7.1. 802.11ax HE80 CDD MODE	149
9. AC POWER LINE CONDUCTED EMISSIONS	152
9.1.1. 802.11ax HE80 CDD MODE	153
10. FREQUENCY STABILITY	155
11. CONTENTION BASED PROTOCOL	157
12. ANTENNA REQUIREMENTS	161
12.1. <i>Appendix A1: Emission Bandwidth</i>	162
12.1.1. Test Result	162
12.1.2. Test Graphs	164
12.2. <i>Appendix A2: Occupied channel bandwidth</i>	188
12.2.1. Test Result	188
12.2.2. Test Graphs	190
12.3. <i>Appendix B: Duty Cycle</i>	214
12.3.1. Test Result	214
12.3.2. Test Graphs	215
12.4. <i>Appendix C: Maximum Average Conducted Output Power</i>	216



12.4.1. STBC/SDM Mode Test Result216
12.4.1. CDD Mode Test Result.....218
12.5. *Appendix D: Maximum Power Spectral Density*.....220
12.5.1. STBC/SDM Mode Test Result220
12.5.2. STBC/SDM Test Graphs222
12.5.3. CDD Mode Test Result.....246
12.5.4. CDD Test Graphs.....248
12.6. *Appendix E: In-Band Emissions*272
12.6.1. Test Result272
12.6.2. Test Graphs275
12.7. *Appendix F: Frequency Stability*299
Test Result.....299
12.8. *Appendix G: Contention Based Protocol*301
12.8.1. Test Graphs305



1. ATTESTATION OF TEST RESULTS

Applicant Information

Company Name: Hui Zhou Gaoshengda Technology Co.,LTD
Address: NO.75 Zhongkai Development Area, Huizhou, Guangdong, China

Manufacturer Information

Company Name: Hui Zhou Gaoshengda Technology Co.,LTD
Address: NO.75 Zhongkai Development Area, Huizhou, Guangdong, China

EUT Information

EUT Name: WIFI+BT Module
Model: WXT2CM2511
Sample Received Date: November 22, 2021
Sample Status: Normal
Sample ID: 4425311
Date of Tested: November 22, 2021 ~ February 18, 2022

APPLICABLE STANDARDS	
STANDARD	TEST RESULTS
CFR 47 FCC PART 15 SUBPART E	PASS
ISED RSS-248 ISSUE 1	PASS
ISED RSS-GEN Issue 5	PASS

Prepared By:

Checked By:

Kebo Zhang
Project Engineer
Approved By:

Shawn Wen
Laboratory Leader

Stephen Guo
Laboratory Manager



2. TEST METHODOLOGY

The tests documented in this report were performed in accordance with ANSI C63.10-2013, CFR 47 FCC Part 2, CFR 47 FCC Part 15, KDB 789033 D02 v02r01, RSS-GEN Issue 5, RSS-248 Issue 1, KDB414788 D01 Radiated Test Site v01r01, KDB 662911 D01 Multiple Transmitter Output v02r01, KDB987594 D01 U-NII 6GHz General Requirements v01r02, KDB987594 D02 U-NII 6 GHz EMC Measurement v01v01.

3. FACILITIES AND ACCREDITATION

Accreditation Certificate	<p>A2LA (Certificate No.: 4102.01) UL Verification Services (Guangzhou) Co., Ltd. Song Shan Lake Branch. has been assessed and proved to be in compliance with A2LA.</p> <p>FCC (FCC Designation No.: CN1187) UL Verification Services (Guangzhou) Co., Ltd. Song Shan Lake Branch. Has been recognized to perform compliance testing on equipment subject to the Commission's Declaration of Conformity (DoC) and Certification rules</p> <p>ISED (Company No.: 21320) UL Verification Services (Guangzhou) Co., Ltd. Song Shan Lake Branch. has been registered and fully described in a report filed with ISED. The Company Number is 21320 and the test lab Conformity Assessment Body Identifier (CABID) is CN0046.</p> <p>VCCI (Registration No.: G-20019, R-20004, C-20012 and T-20011) UL Verification Services (Guangzhou) Co., Ltd. Song Shan Lake Branch. has been assessed and proved to be in compliance with VCCI, the Membership No. is 3793. Facility Name: Chamber D, the VCCI registration No. is G-20019 and R-20004 Shielding Room B , the VCCI registration No. is C-20012 and T-20011</p>
---------------------------	---

Note 1: All tests measurement facilities use to collect the measurement data are located at Building 10, Innovation Technology Park, Song Shan Lake Hi tech Development Zone, Dongguan, 523808, China

Note 2: The test anechoic chamber in UL Verification Services (Guangzhou) Co., Ltd. Song Shan Lake Branch had been calibrated and compared to the open field sites and the test anechoic chamber is shown to be equivalent to or worst case from the open field site.

Note 3: For below 30 MHz, lab had performed measurements at test anechoic chamber and comparing to measurements obtained on an open field site. And these measurements below 30 MHz had been correlated to measurements performed on an OFS.

4. CALIBRATION AND UNCERTAINTY

4.1. MEASURING INSTRUMENT CALIBRATION

The measuring equipment utilized to perform the tests documented in this report has been calibrated in accordance with the manufacturer's recommendations and is traceable to recognize national standards.

4.2. MEASUREMENT UNCERTAINTY

Where relevant, the following measurement uncertainty levels have been estimated for tests performed on the apparatus:

Test Item	Uncertainty
Conduction emission	3.62 dB
Radiated Emission (Included Fundamental Emission) (9 kHz ~ 30 MHz)	2.2 dB
Radiated Emission (Included Fundamental Emission) (30 MHz ~ 1 GHz)	4.00 dB
Radiated Emission (Included Fundamental Emission) (1 GHz to 40 GHz)	5.78 dB (1 GHz-18 GHz)
	5.23dB (18 GHz-26 GHz)
	5.64 dB (26 GHz-40 GHz)
Note: This uncertainty represents an expanded uncertainty expressed at approximately the 95 % confidence level using a coverage factor of k=2.	



5. EQUIPMENT UNDER TEST

5.1. DESCRIPTION OF EUT

EUT Name	WIFI+BT Module
Model	WXT2CM2511
Radio Technology	IEEE802.11ax HE20/HE40/HE80
Operation frequency	UNII-5 Band: 5.925 ~ 6.425 MHz UNII-6 Band: 6.425 ~ 6.525 MHz UNII-7 Band: 6.525 ~ 6.875 MHz UNII-8 Band: 6.875 ~ 7.125 MHz
Modulation	IEEE 802.11ax HE20: OFDMA (BPSK, QPSK,16QAM,64QAM, 256QAM, 1024QAM) IEEE 802.11ax HE40: OFDMA (BPSK, QPSK,16QAM,64QAM, 256QAM, 1024QAM) IEEE 802.11ax HE80: OFDMA (BPSK, QPSK,16QAM,64QAM, 256QAM, 1024QAM)
Power Supply	DC 5 V



5.2. MAXIMUM OUTPUT POWER

UNII-5 BAND

IEEE Std. 802.11	Frequency (MHz)	Maximum Average Conducted Power (dBm)	Max Average EIRP (dBm)
ax HE20	5.925-6.425	4.68	8.68
ax HE40		5.68	9.68
ax HE80		8.01	12.01

UNII-6 BAND

IEEE Std. 802.11	Frequency (MHz)	Maximum Average Conducted Power (dBm)	Max Average EIRP (dBm)
ax HE20	6.425-6.525	4.24	8.24
ax HE40		5.48	9.48
ax HE80		7.99	11.99

UNII-7 BAND

IEEE Std. 802.11	Frequency (MHz)	Maximum Average Conducted Power (dBm)	Max Average EIRP (dBm)
ax HE20	6.525-6.875	4.66	8.66
ax HE40		6.04	10.04
ax HE80		8.37	12.37

UNII-8 BAND

IEEE Std. 802.11	Frequency (MHz)	Maximum Average Conducted Power (dBm)	Max Average EIRP (dBm)
ax HE20	6.875 -7.125	4.42	8.42
ax HE40		5.54	9.54
ax HE80		8.04	12.04

**5.3. CHANNEL LIST**

UNII-5 (For Bandwidth=20MHz)					
Channel	Frequency (MHz)	Channel	Frequency (MHz)	Channel	Frequency (MHz)
1	5955	33	6115	65	6275
5	5975	37	6135	69	6295
9	5995	41	6155	73	6315
13	6015	45	6175	77	6335
17	6035	49	6195	81	6355
21	6055	53	6215	85	6375
25	6075	57	6235	89	6395
29	6095	61	6255	93	6415

UNII-6 (For Bandwidth=20MHz)					
Channel	Frequency (MHz)	Channel	Frequency (MHz)	Channel	Frequency (MHz)
97	6435	105	6475	113	6515
101	6455	109	6495	/	/

UNII-7 (For Bandwidth=20MHz)					
Channel	Frequency (MHz)	Channel	Frequency (MHz)	Channel	Frequency (MHz)
117	6535	141	6655	165	6775
121	6555	145	6675	169	6795
125	6575	149	6695	173	6815
129	6595	153	6715	177	6835
133	6615	157	6735	181	6855
137	6635	161	6755	/	/

UNII-8 (For Bandwidth=20MHz)					
Channel	Frequency (MHz)	Channel	Frequency (MHz)	Channel	Frequency (MHz)
185	6875	205	6975	225	7075
189	6895	209	6995	229	7095
193	6915	213	7015	233	7115
197	6935	217	7035	/	/
201	6955	221	7055	/	/



UNII-5 (For Bandwidth=40MHz)					
Channel	Frequency (MHz)	Channel	Frequency (MHz)	Channel	Frequency (MHz)
3	5965	35	6125	67	6285
11	6005	43	6165	75	6325
19	6045	51	6205	83	6365
27	6085	59	6245	91	6405

UNII-6 (For Bandwidth=40MHz)					
Channel	Frequency (MHz)	Channel	Frequency (MHz)	Channel	Frequency (MHz)
99	6445	107	6485	/	/

UNII-7 (For Bandwidth=40MHz)					
Channel	Frequency (MHz)	Channel	Frequency (MHz)	Channel	Frequency (MHz)
115	6525	139	6645	163	6765
123	6605	147	6685	171	6805
131	6645	155	6725	179	6845

UNII-8 (For Bandwidth=40MHz)					
Channel	Frequency (MHz)	Channel	Frequency (MHz)	Channel	Frequency (MHz)
187	6885	203	6965	219	7045
195	6925	211	7005	227	7085



UNII-5 (For Bandwidth=80MHz)					
Channel	Frequency (MHz)	Channel	Frequency (MHz)	Channel	Frequency (MHz)
7	5985	39	6145	71	6305
23	6065	55	6225	87	6385

UNII-6 (For Bandwidth=80MHz)					
Channel	Frequency (MHz)	Channel	Frequency (MHz)	Channel	Frequency (MHz)
103	6465	/	/	/	/

UNII-7 (For Bandwidth=80MHz)					
Channel	Frequency (MHz)	Channel	Frequency (MHz)	Channel	Frequency (MHz)
119	6545	151	6705	183	6865
135	6625	167	6785	/	/

UNII-8 (For Bandwidth=80MHz)					
Channel	Frequency (MHz)	Channel	Frequency (MHz)	Channel	Frequency (MHz)
199	6945	215	7025	/	/

5.4. DESCRIPTION OF AVAILABLE ANTENNAS

Antenna No.	Frequency Band	Antenna Type	Max Antenna Gain (dBi)
1	5925 ~ 7125	PCB	4
2	5925 ~ 7125	PCB	4

Note: The value of the antenna gain was declared by customer.

The EUT support Cyclic Shift Diversity (CDD) mode.

MIMO output power port and MIMO PSD port summing was performed in accordance with KDB 662911 D01. For the CDD mode results the Directional Gain was calculated in accordance with the following method.

For output power measurements:

Directional gain= $G_{ANT} + \text{Array Gain} = 4 \text{ dBi}$

G_{ANT} : equal to the gain of the antenna having the highest gain

Array Gain = 0 dB (i.e., no array gain) for $N_{ANT} \leq 4$

For power spectral density (PSD) measurements:

Directional gain= $G_{ANT} + \text{Array Gain} = 7 \text{ dBi}$

Array Gain = $10 \log (N_{ANT}/N_{SS}) \text{ dB}$.

N_{ANT} : number of transmit antennas

N_{SS} : number of spatial streams, the worst case directional gain will occur when $N_{SS} = 1$

The EUT support Space Time Block Codes (STBC), Spatial Division Multiplexing (SDM) modes mode.

MIMO output power port and MIMO PSD port summing was performed in accordance with KDB 662911 D01. For the STBC/SDM mode results the Directional Gain was calculated in accordance with the following method.

For output power measurements:

Directional gain= $G_{ANT} \text{ dBi} = 4 \text{ dBi}$

G_{ANT} : equal to the gain of the antenna having the highest gain

For power spectral density (PSD) measurements:

Directional gain= $G_{ANT} \text{ dBi} = 4 \text{ dBi}$

G_{ANT} : equal to the gain of the antenna having the highest gain

IEE Std. 802.11	Transmit and Receive Mode	Description
802.11ax HE20	<input checked="" type="checkbox"/> 2TX, 2RX	ANT 1 and ANT 2 can be used as transmitting/receiving antenna.
802.11ax HE40	<input checked="" type="checkbox"/> 2TX, 2RX	ANT 1 and ANT 2 can be used as transmitting/receiving antenna.
802.11ax HE80	<input checked="" type="checkbox"/> 2TX, 2RX	ANT 1 and ANT 2 can be used as transmitting/receiving antenna.

**5.5. THE WORSE CASE POWER SETTING PARAMETER**

The Worst Case Power Setting Parameter	
Test Software	QA tool

CDD Mode

UNII-5 BAND

IEE Std. 802.11	Rate	Channel	Soft set value	
			ANT 1	ANT 2
ax HE20	MCS0	1	4	4
		45	3.5	3.5
		93	4	4
ax HE40	MCS0	3	6.5	6.5
		43	5.5	5.5
		91	6	6
ax HE80	MCS0	7	10	10
		39	9.5	9.5
		87	9.5	9.5

UNII-6 BAND

IEE Std. 802.11	Rate	Channel	Soft set value	
			ANT 1	ANT 2
ax HE20	MCS0	97	4.5	4.5
		105	5	5
		113	5	5
ax HE40	MCS0	99	7	7
		107	7	7
ax HE80	MCS0	103	10	10

UNII-7 BAND

IEE Std. 802.11	Rate	Channel	Soft set value	
			ANT 1	ANT 2
ax HE20	MCS0	117	5	5
		153	3.5	3.5
		181	2.5	2.5
ax HE40	MCS0	115	6.5	6.5
		123	6.5	6.5
		155	5	5
		179	5	5
ax HE80	MCS0	119	10.5	10.5
		135	10	10
		151	9	9
		167	8.5	8.5
		183	8.5	8.5

**UNII-8 BAND**

IEE Std. 802.11	Rate	Channel	Soft set value	
			ANT 1	ANT 2
ax HE20	MCS0	185	3	3
		213	3	3
		233	4.5	4.5
ax HE40	MCS0	187	4.5	4.5
		211	5	5
		227	6	6
ax HE80	MCS0	199	8.5	8.5
		183	9.5	9.5

STBC/SDM Mode
CDD Mode

UNII-5 BAND

IEE Std. 802.11	Rate	Channel	Soft set value	
			ANT 1	ANT 2
ax HE20	MCS0	1	7.5	7.5
		45	6	6
		93	7	7
ax HE40	MCS0	3	9	9
		43	8	8
		91	8.5	8.5
ax HE80	MCS0	7	13	13
		39	12.5	12.5
		87	13	13

UNII-6 BAND

IEE Std. 802.11	Rate	Channel	Soft set value	
			ANT 1	ANT 2
ax HE20	MCS0	97	7.5	7.5
		105	7.5	7.5
		113	7.5	7.5
ax HE40	MCS0	99	9	9
		107	9	9
ax HE80	MCS0	103	14	14

**UNII-7 BAND**

IEE Std. 802.11	Rate	Channel	Soft set value	
			ANT 1	ANT 2
ax HE20	MCS0	117	7.5	7.5
		153	6	6
		181	5	5
ax HE40	MCS0	115	9	9
		123	9	9
		155	8	8
		179	7.5	7.5
ax HE80	MCS0	119	13.5	13.5
		135	13	13
		151	12.5	12.5
		167	12	12
		183	11.5	11.5

UNII-8 BAND

IEE Std. 802.11	Rate	Channel	Soft set value	
			ANT 1	ANT 2
ax HE20	MCS0	185	5.5	5.5
		213	6	6
		233	7.5	7.5
ax HE40	MCS0	187	7	7
		211	8	8
		227	9	9
ax HE80	MCS0	199	12	12
		183	12.5	12.5

**5.6. TEST CHANNEL CONFIGURATION**

UNII-5 Test Channel Configuration		
IEEE Std.	Test Channel Number	Frequency
802.11ax HE20	CH 1(Low Channel), CH 49(MID Channel), CH 93(High Channel)	5955 MHz, 6195 MHz, 6415 MHz
802.11ax HE40	CH 3(Low Channel), CH 43(MID Channel), CH 91(High Channel)	5965 MHz, 6165 MHz, 6405 MHz
802.11ax HE80	CH 7(Low Channel), CH 55(MID Channel), CH 87(High Channel)	5985 MHz, 6225 MHz, 6465 MHz

UNII-6 Test Channel Configuration		
IEEE Std.	Test Channel Number	Frequency
802.11ax HE20	CH 97(Low Channel), CH 105(MID Channel), CH 113(High Channel)	6435 MHz, 6475 MHz, 6515 MHz
802.11ax HE40	CH 99(Low Channel), CH 107(High Channel)	6445 MHz, 6485 MHz
802.11ax HE80	CH 103(Low Channel)	6465 MHz

UNII-7 Test Channel Configuration		
IEEE Std.	Test Channel Number	Frequency
802.11ax HE20	CH 117(Low Channel), CH 145(MID Channel), CH 181(High Channel)	6535 MHz, 6675 MHz, 6855 MHz
802.11ax HE40	CH 115(Low Channel), CH 147(MID Channel), CH 179(High Channel)	6525 MHz, 6685 MHz, 6845 MHz
802.11ax HE80	CH 119(Low Channel), CH 151(MID Channel), CH 183(High Channel)	6545 MHz, 6705 MHz, 6865 MHz

UNII-8 Test Channel Configuration		
IEEE Std.	Test Channel Number	Frequency
802.11ax HE20	CH 185(Low Channel), CH 209(MID Channel), CH 233(High Channel)	6875 MHz, 6995 MHz, 7115 MHz
802.11ax HE40	CH 187(Low Channel), CH 203(MID Channel), CH 227(High Channel)	6885 MHz, 6965 MHz, 7085 MHz
802.11ax HE80	CH 119(Low Channel), CH 183(High Channel)	6945 MHz, 7025 MHz

5.7. THE WORSE CASE CONFIGURATIONS

The EUT was tested in the following configuration(s):

Controlled in test mode using a software application on the EUT supplied by customer. The application was used to enable a continuous transmission and to select the mode, test channels, bandwidth, data rates as required.

Test channels referring to section 5.6.

Maximum power setting referring to section 5.5.

Worst case Data Rates declared by the customer:

802.11ax HE20 mode: MCS0

802.11ax HE40 mode: MCS0

802.11ax HE80 mode: MCS0

SISO mode and MIMO mode have the same power setting, so only the worst case power mode (MIMO) will be record in the report.

The EUT has 2 separate antennas which correspond to 2 separate antenna ports. Core 1 and Core 2 correspond to antenna 1 and antenna 2 respectively.

Antenna 1 and Antenna 2 have the same power setting, but the power test data are different. (Declared by customer.)

The measured additional path loss was included in any path loss calculations for all RF cable used during tested.

Conducted output power, power spectral density tests separately on each port with all supported SISO & MIMO port combinations.

5.8. DESCRIPTION OF TEST SETUP

SUPPORT EQUIPMENT

Item	Equipment	Brand Name	Model Name	Remarks
1	Laptop	Lenovo	XIAOXIN 5000	/
2	UART	/	/	/
3	AC Adapter	Lenovo	ADLX65YCC3D	Input: 100-240 Vac, 50/60 Hz Output: 20 Vdc, 3.25A

I/O CABLES

Cable No	Port	Connector Type	Cable Type	Cable Length(m)	Remarks
1	USB	N/A	N/A	1	N/A

ACCESSORIES

Item	Accessory	Brand Name	Model Name	Description
/	/	/	/	/

TEST SETUP

The EUT can work in engineering mode with a software through a Laptop.

SETUP DIAGRAM FOR TESTS

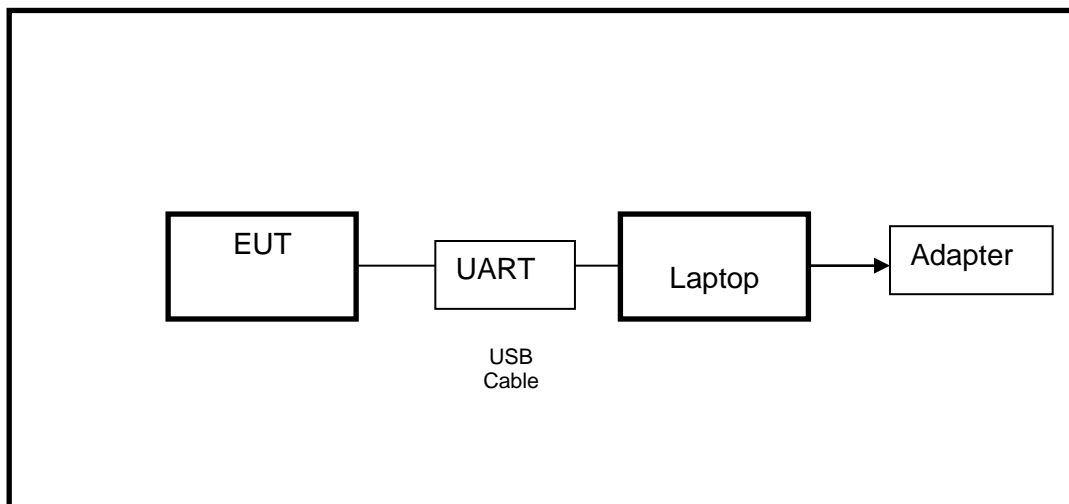

Note: AC adapter only use for AC POWER LINE CONDUCTED EMISSIONS testing.

**6. MEASURING INSTRUMENT AND SOFTWARE USED**

Conducted Emissions					
Equipment	Manufacturer	Model No.	Serial No.	Last Cal.	Due Date
EMI Test Receiver	R&S	ESR3	101961	Oct.30, 2021	Oct.29, 2022
Artificial Mains Networks	Schwarzbeck	NSLK 8126	8126465	Oct.30, 2021	Oct.29, 2022
Software					
Description			Manufacturer	Name	Version
Test Software for Conducted Emissions			Farad	EZ-EMC	Ver. UL-3A1

Radiated Emissions					
Equipment	Manufacturer	Model No.	Serial No.	Last Cal.	Due Date
MXE EMI Receiver	KESIGHT	N9038A	MY56400036	Oct.30, 2021	Oct.29, 2022
Hybrid Log Periodic Antenna	TDK	HLP-3003C	130959	Aug.02, 2021	Aug.01, 2024
Preamplifier	HP	8447D	2944A09099	Oct.30, 2021	Oct.29, 2022
EMI Measurement Receiver	R&S	ESR26	101377	Oct.30, 2021	Oct.29, 2022
Horn Antenna	TDK	HRN-0118	130940	July 20, 2021	July 19, 2024
Preamplifier	TDK	PA-02-0118	TRS-305-00067	Oct.30, 2021	Oct.29, 2022
Horn Antenna	Schwarzbeck	BBHA9170	697	July 20, 2021	July 19, 2024
Preamplifier	TDK	PA-02-2	TRS-307-00003	Oct.31, 2021	Oct.30, 2022
Preamplifier	TDK	PA-02-3	TRS-308-00002	Oct.31, 2021	Oct.30, 2022
Loop antenna	Schwarzbeck	1519B	00008	Dec.14, 2021	Dec.13, 2024
Preamplifier	TDK	PA-02-001-3000	TRS-302-00050	Oct.31, 2021	Oct.30, 2022
Preamplifier	Mini-Circuits	ZX60-83LN-S+	SUP01201941	Oct.31, 2021	Oct.30, 2022
High Pass Filter	Wi	WHKX10-2700-3000-18000-40SS	23	Oct.31, 2021	Oct.30, 2022
Highpass Filter	Wainwright	WHKX10-5850-6500-1800-40SS	4	Oct.31, 2021	Oct.30, 2022
Band Reject Filter	Wainwright	WRCJV8-2350-2400-2483.5-	4	Oct.31, 2021	Oct.30, 2022



		2533.5-40SS		
Software				
Description		Manufacturer	Name	Version
Test Software for Radiated Emissions		Farad	EZ-EMC	Ver. UL-3A1

Other instruments					
Equipment	Manufacturer	Model No.	Serial No.	Last Cal.	Next Cal.
Spectrum Analyzer	R&S	FSV40	101117	Oct.31, 2021	Oct.30, 2022
Dual Channel Power Meter	Keysight	N1912A	MY55416024	Oct.30, 2021	Oct.29, 2022
Power Sensor	Keysight	USB Wideband Power Sensor	MY5100022	Oct.30, 2021	Oct.29, 2022
Signal & Spectrum analyzer	R&S	FSW	1312.8000K26-103950-sj	Oct.31, 2021	Oct.30, 2022
Spectrum Analyzer	Keysight	N9020A	MY49100060	Oct.30, 2021	Oct.29, 2022
Vector Signal Generator	R&S	SMW200A	1412.0000K02-102983-sZ	Oct.31, 2021	Oct.30, 2022
Temperature & Humidity Chamber	SANMOOD	SG-80-CC-2	2088	Nov.10, 2021	Nov.09, 2022
DC power supply	Keysight	E3642A	MY55159130	Oct.30, 2021	Oct.29, 2022

7. ANTENNA PORT TEST RESULTS

7.1. ON TIME AND DUTY CYCLE

LIMITS

None; for reporting purposes only.

PROCEDURE

Refer to KDB 789033 D02 General U-NII Test Procedures New Rules v02r01 section II.B.

The zero-span mode on a spectrum analyzer or EMI receiver, if the response time and spacing between bins on the sweep are sufficient to permit accurate measurements of the on and off times of the transmitted signal. Set the center frequency of the instrument to the center frequency of the transmission. Set $RBW \geq EBW$ if possible; otherwise, set RBW to the largest available value. Set $VBW \geq RBW$. Set detector = peak or average. The zero-span measurement method shall not be used unless both RBW and VBW are $> 50/T$, where T is defined in II.B.1.a), and the number of sweep points across duration T exceeds 100. (For example, if VBW and/or RBW are limited to 3 MHz, then the zero-span method of measuring duty cycle shall not be used if $T \leq 16.7$ microseconds.)

TEST SETUP

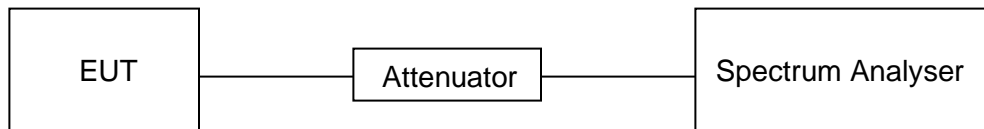

TEST ENVIRONMENT

Temperature	22.7 °C	Relative Humidity	51.5 %
Atmosphere Pressure	101 kPa	Test Voltage	DC 5 V

RESULTS

Please refer to appendix B.

7.2. EMISSION BANDWIDTH AND 99 % OCCUPIED BANDWIDTH

LIMITS

CFR 47 FCC Part15, Subpart E

The maximum transmitter channel bandwidth for U-NII devices in the 5.925-7.125 GHz band is 320 megahertz.

ISED RSS-248 ISSUE 1

The occupied bandwidth of the device shall not exceed 320 MHz.

TEST PROCEDURE

Refer to KDB 789033 D02 General U-NII Test Procedures New Rules v02r01 section II.C1. for 26 dB Emission Bandwidth; section II.D. for 99 % Occupied Bandwidth.

Connect the EUT to the spectrum analyser and use the following settings:

Center Frequency	The center frequency of the channel under test
Detector	Peak
RBW	For 26 dB Emission bandwidth: approximately 1 % of the EBW. For 99 % Occupied Bandwidth: approximately 1 % ~ 5 % of the OBW.
VBW	For 26 dB Bandwidth: $>3 \times \text{RBW}$ For 99 % Bandwidth: $>3 \times \text{RBW}$
Trace	Max hold
Sweep	Auto couple

- a) Use the 99 % power bandwidth function of the instrument, allow the trace to stabilize and report the measured bandwidth.
- b) Allow the trace to stabilize and measure the maximum width of the emission that is constrained by the frequencies associated with the two outermost amplitude points (upper and lower frequencies) that are attenuated by 6/26 dB relative to the maximum level measured in the fundamental emission.

TEST SETUP

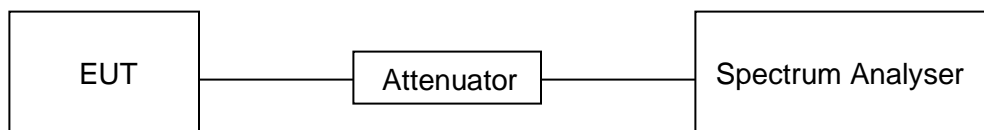



TEST ENVIRONMENT

Temperature	22.7 °C	Relative Humidity	51.5 %
Atmosphere Pressure	101 kPa	Test Voltage	DC 5 V

RESULTS

Please refer to Appendix A1&A2.



7.3. CONDUCTED OUTPUT POWER

LIMITS

CFR 47 FCC Part15, Subpart E

For a standard power access point and fixed client device operating in the 5.925-6.425 GHz and 6.525-6.875 GHz bands, the maximum power spectral density must not exceed 23 dBm e.i.r.p. in any 1-megahertz band. In addition, the maximum e.i.r.p. over the frequency band of operation must not exceed 36 dBm. For outdoor devices, the maximum e.i.r.p. at any elevation angle above 30 degrees as measured from the horizon must not exceed 125 mW (21 dBm).

For an indoor access point operating in the 5.925-7.125 GHz band, the maximum power spectral density must not exceed 5 dBm e.i.r.p. in any 1-megahertz band. In addition, the maximum e.i.r.p. over the frequency band of operation must not exceed 30 dBm.

ISED RSS-248 ISSUE 1

Power limits for devices other than client devices

The following limits shall apply to devices other than client devices:

The maximum e.i.r.p. over the 5925-7125 MHz frequency band shall not exceed 30 dBm.

Power limits for client devices

The following limits shall apply to client devices:

The maximum e.i.r.p. over the 5925-7125 MHz frequency band shall not exceed 24 dBm.

Note:

The above limits are based upon the maximum antenna gain does not exceed 6 dBi.

If transmitting antennas of directional gain greater than 6 dBi are used, the maximum conducted output power shall be reduced by the amount in dB that the directional gain of the antenna exceeds 6 dBi.

TEST PROCEDURE

Refer to KDB 789033 D02 General U-NII Test Procedures New Rules v02r01 section II.E.

Method SA-1 (trace averaging with the EUT transmitting at full power throughout each sweep):

- (i) Set span to encompass the entire emission bandwidth (EBW) (or, alternatively, the entire 99% occupied bandwidth) of the signal.
- (ii) Set RBW = 1 MHz.
- (iii) Set VBW \geq 3 MHz.
- (iv) Number of points in sweep $\geq 2 \times$ span / RBW. (This ensures that bin-to-bin spacing is \leq RBW/2, so that narrowband signals are not lost between frequency bins.)
- (v) Sweep time = auto.
- (vi) Detector = power averaging (rms), if available. Otherwise, use sample detector mode.
- (vii) If transmit duty cycle $<$ 98 %, use a video trigger with the trigger level set to enable triggering only on full power pulses. Transmitter must operate at maximum power control level for the entire duration of every sweep. If the EUT transmits continuously (i.e., with no off intervals) or at duty cycle \geq 98 %, and if each transmission is entirely at the maximum power control level, then the trigger shall be set to “free run.”
- (viii) Trace average at least 100 traces in power averaging (rms) mode.
- (ix) Compute power by integrating the spectrum across the EBW (or, alternatively, the entire 99% occupied bandwidth) of the signal using the instrument’s band power measurement function with band limits set equal to the EBW (or occupied bandwidth) band edges. If the instrument does not have a band power function, sum the spectrum levels (in power units) at 1 MHz intervals extending across the EBW (or, alternatively, the entire 99% occupied bandwidth) of the spectrum.

Method PM (Measurement using an RF average power meter):

- (i) Measurements may be performed using a wideband RF power meter with a thermocouple detector or equivalent if all of the following conditions are satisfied:
 - a. The EUT is configured to transmit continuously or to transmit with a constant duty cycle.
 - b. At all times when the EUT is transmitting, it must be transmitting at its maximum power control level.
 - c. The integration period of the power meter exceeds the repetition period of the transmitted signal by at least a factor of five.
- (ii) If the transmitter does not transmit continuously, measure the duty cycle, x , of the transmitter output signal as described in II.B.
- (iii) Measure the average power of the transmitter. This measurement is an average over both the on and off periods of the transmitter.
- (iv) Adjust the measurement in dBm by adding $10 \log (1/x)$ where x is the duty cycle (e.g., $10 \log (1/0.25)$ if the duty cycle is 25 %).

Method PM-G (Measurement using a gated RF average power meter):

Measurements may be performed using a wideband gated RF power meter provided that the gate parameters are adjusted such that the power is measured only when the EUT is transmitting at its maximum power control level. Since the measurement is made only during the ON time of the transmitter, no duty cycle correction factor is required.

Straddle channel power was measured using spectrum analyzer.

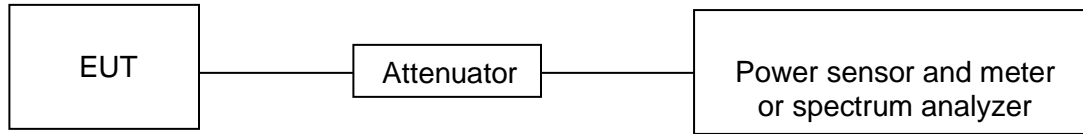
TEST SETUP**TEST ENVIRONMENT**

Temperature	22.7 °C	Relative Humidity	51.5 %
Atmosphere Pressure	101 kPa	Test Voltage	DC 5 V

RESULTS

Please refer to Appendix C



7.4. POWER SPECTRAL DENSITY

LIMITS

CFR 47 FCC Part15, Subpart E

For a subordinate device operating under the control of an indoor access point in the 5.925-7.125 GHz band, the maximum power spectral density must not exceed 5 dBm e.i.r.p. in any 1-megahertz band, and the maximum e.i.r.p. over the frequency band of operation must not exceed 30 dBm.

For client devices, except for fixed client devices as defined in this subpart, operating under the control of a standard power access point in 5.925-6.425 GHz and 6.525-6.875 GHz bands, the maximum power spectral density must not exceed 17 dBm e.i.r.p. in any 1-megahertz band, and the maximum e.i.r.p. over the frequency band of operation must not exceed 30 dBm and the device must limit its power to no more than 6 dB below its associated standard power access point's authorized transmit power.

ISED RSS-248 ISSUE 1

Power limits for devices other than client devices

The following limits shall apply to devices other than client devices:
The maximum e.i.r.p. spectral density shall not exceed 5 dBm/MHz; and

Power limits for client devices

The following limits shall apply to client devices:
The maximum e.i.r.p. spectral density shall not exceed -1 dBm/MHz; and

Note:

The above limits are based upon the maximum antenna gain does not exceed 6 dBi.
If transmitting antennas of directional gain greater than 6 dBi are used, maximum power spectral density shall be reduced by the amount in dB that the directional gain of the antenna exceeds 6 dBi.

TEST PROCEDURE

Refer to KDB 789033 D02 General U-NII Test Procedures New Rules v02r01 section II.F.

Connect the EUT to the spectrum analyser and use the following settings:

Center Frequency	The center frequency of the channel under test
Detector	RMS
RBW	1 MHz
VBW	$\geq 3 \times \text{RBW}$
Span	Encompass the entire emissions bandwidth (EBW) of the signal
Trace	Max hold
Sweep time	Auto

Allow trace to fully stabilize and Use the peak search function on the instrument to find the peak of the spectrum and record its value.

Add $10 \log (1/x)$, where x is the duty cycle, to the peak of the spectrum, the result is the Maximum PSD over 1 MHz reference bandwidth.

TEST SETUP

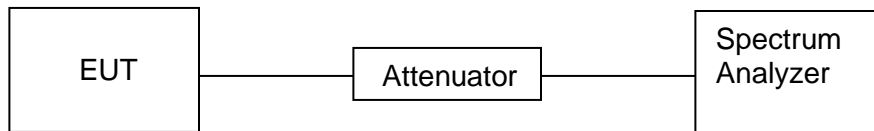

TEST ENVIRONMENT

Temperature	22.7 °C	Relative Humidity	51.5 %
Atmosphere Pressure	101 kPa	Test Voltage	DC 5 V

RESULTS

Please refer to Appendix D.

7.5. IN-BAND EMISSIONS (MASK)

LIMITS

CFR 47 FCC Part15, Subpart E and ISSED RSS-248 ISSUE 1

For transmitters operating within the 5.925-7.125 GHz bands: Power spectral density must be suppressed by 20 dB at 1 MHz outside of channel edge, by 28 dB at one channel bandwidth from the channel center, and by 40 dB at one- and one-half times the channel bandwidth away from channel center. At frequencies between one megahertz outside an unlicensed device's channel edge and one channel bandwidth from the center of the channel, the limits must be linearly interpolated between 20 dB and 28 dB suppression, and at frequencies between one and one- and one-half times an unlicensed device's channel bandwidth, the limits must be linearly interpolated between 28 dB and 40 dB suppression. Emissions removed from the channel center by more than one- and one-half times the channel bandwidth must be suppressed by at least 40 dB.

TEST PROCEDURE

Refer to 987594 D02 U-NII 6GHz EMC Measurement v01r01 J.

Connect output of the antenna port to a spectrum analyzer or EMI receiver, with appropriate attenuation, as to not damage the instrumentation.

2. Set the reference level of the measuring equipment in accordance with procedure 4.1.5.2 of ANSI C63.10-2013.
3. Measure the 26 dB EBW using the test procedure 12.4.1 of ANSI C63.10-2013. (This will be used to determine the channel edge.)
4. Measure the power spectral density (which will be used for emissions mask reference) using the following procedure:
 - a) Set the span to encompass the entire 26 dB EBW of the signal.
 - b) Set RBW = same RBW used for 26 dB EBW measurement.
 - c) Set VBW $\geq 3 \times$ RBW
 - d) Number of points in sweep $\geq [2 \times \text{span} / \text{RBW}]$.
 - e) Sweep time = auto.
 - f) Detector = RMS (i.e., power averaging)
 - g) Trace average at least 100 traces in power averaging (rms) mode.
 - h) Use the peak search function on the instrument to find the peak of the spectrum.
5. For the purposes of developing the emission mask, the channel bandwidth is defined as the 26 dB EBW.
6. Using the measuring equipment limit line function, develop the emissions mask based on the following requirements. The emissions power spectral density must be reduced below the peak power spectral density (in dB) as follows:
 - a. Suppressed by 20 dB at 1 MHz outside of the channel edge. (The channel edge is defined as the 26-dB point on either side of the carrier center frequency.)
 - b. Suppressed by 28 dB at one channel bandwidth from the channel center.
 - c. Suppressed by 40 dB at one- and one-half times the channel bandwidth from the channel center.
7. Adjust the span to encompass the entire mask as necessary.
8. Clear trace.
9. Trace average at least 100 traces in power averaging (rms) mode.

10. Adjust the reference level as necessary so that the crest of the channel touches the top of the emission mask.

TEST SETUP

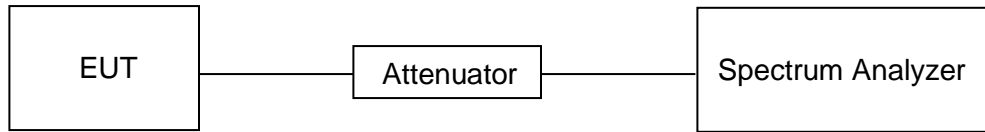

TEST ENVIRONMENT

Temperature	22.7 °C	Relative Humidity	51.5 %
Atmosphere Pressure	101 kPa	Test Voltage	DC 5 V

RESULTS

Please refer to appendix E.

8. RADIATED TEST RESULTS

LIMITS

Refer to CFR 47 FCC §15.205, §15.209 and §15.407 (b).

Refer to ISED RSS-GEN Clause 8.9, Clause 8.10 and ISED RSS-248 4.7.

Radiation Disturbance Test Limit for FCC (Class B) (9 kHz ~ 1 GHz)

Emissions radiated outside of the specified frequency bands above 30 MHz			
Frequency Range (MHz)	Field Strength Limit (uV/m) at 3 m	Field Strength Limit (dBuV/m) at 3 m	
		Quasi-Peak	
30 - 88	100	40	
88 - 216	150	43.5	
216 - 960	200	46	
Above 960	500	54	
Above 1000	500	Peak	Average
		74	54

FCC Emissions radiated outside of the specified frequency bands below 30 MHz		
Frequency (MHz)	Field strength (microvolts/meter)	Measurement distance (meters)
0.009-0.490	2400/F(kHz)	300
0.490-1.705	24000/F(kHz)	30
1.705-30.0	30	30

ISED General field strength limits at frequencies below 30 MHz

Table 6 – General field strength limits at frequencies below 30 MHz		
Frequency	Magnetic field strength (H-Field) (µA/m)	Measurement distance (m)
9 - 490 kHz ^{Note 1}	6.37/F (F in kHz)	300
490 - 1705 kHz	63.7/F (F in kHz)	30
1.705 - 30 MHz	0.08	30

Note 1: The emission limits for the ranges 9-90 kHz and 110-490 kHz are based on measurements employing a linear average detector.

ISED Restricted bands refer to ISED RSS-GEN Clause 8.10

Table 7 – Restricted frequency bands ^{Note 1}		
MHz	MHz	GHz
0.090 - 0.110	149.9 - 150.05	9.0 - 9.2
0.495 - 0.505	156.52475 - 156.52525	9.3 - 9.5
2.1735 - 2.1905	156.7 - 156.9	10.6 - 12.7
3.020 - 3.026	162.0125 - 167.17	13.25 - 13.4
4.125 - 4.128	167.72 - 173.2	14.47 - 14.5
4.17725 - 4.17775	240 - 285	15.35 - 16.2
4.20725 - 4.20775	322 - 335.4	17.7 - 21.4
5.677 - 5.683	399.9 - 410	22.01 - 23.12
6.215 - 6.218	608 - 614	23.6 - 24.0
6.26775 - 6.26825	960 - 1427	31.2 - 31.8
6.31175 - 6.31225	1435 - 1626.5	36.43 - 36.5
8.291 - 8.294	1645.5 - 1646.5	Above 38.6
8.362 - 8.366	1660 - 1710	
8.37625 - 8.38675	1718.8 - 1722.2	
8.41425 - 8.41475	2200 - 2300	
12.29 - 12.293	2310 - 2390	
12.51975 - 12.52025	2483.5 - 2500	
12.57675 - 12.57725	2655 - 2900	
13.36 - 13.41	3260 - 3267	
16.42 - 16.423	3332 - 3339	
16.89475 - 16.89525	3345.8 - 3358	
16.80425 - 16.80475	3500 - 4400	
25.5 - 25.67	4500 - 5150	
37.5 - 38.25	5350 - 5480	
73 - 74.6	7250 - 7750	
74.8 - 75.2	8025 - 8500	
108 - 138		

Note 1: Certain frequency bands listed in table 7 and in bands above 38.6 GHz are designated for licence-exempt applications. These frequency bands and the requirements that apply to related devices are set out in the 200 and 300 series of RSSs.

FCC Restricted bands of operation refer to FCC §15.205 (a):

MHz	MHz	MHz	GHz
0.090-0.110	16.42-16.423	399.9-410	4.5-5.15
¹ 0.495-0.505	16.69475-16.69525	608-614	5.35-5.46
2.1735-2.1905	16.80425-16.80475	960-1240	7.25-7.75
4.125-4.128	25.5-25.67	1300-1427	8.025-8.5
4.17725-4.17775	37.5-38.25	1435-1626.5	9.0-9.2
4.20725-4.20775	73-74.6	1645.5-1646.5	9.3-9.5
6.215-6.218	74.8-75.2	1660-1710	10.6-12.7
6.26775-6.26825	108-121.94	1718.8-1722.2	13.25-13.4
6.31175-6.31225	123-138	2200-2300	14.47-14.5
8.291-8.294	149.9-150.05	2310-2390	15.35-16.2
8.362-8.366	156.52475-156.52525	2483.5-2500	17.7-21.4
8.37625-8.38675	156.7-156.9	2690-2900	22.01-23.12
8.41425-8.41475	162.0125-167.17	3260-3267	23.6-24.0
12.29-12.293	167.72-173.2	3332-3339	31.2-31.8
12.51975-12.52025	240-285	3345.8-3358	36.43-36.5
12.57675-12.57725	322-335.4	3600-4400	(²)
13.36-13.41			

Note: ¹Until February 1, 1999, this restricted band shall be 0.490-0.510 MHz.

²Above 38.6c



Limits of unwanted/undesirable emission out of the restricted bands refer to CFR 47 FCC §15.407 (b) and ISED RSS-248 4.7.2.

For transmitters operating within the 5.925-7.125 GHz band: Any emissions outside of the 5.925-7.125 GHz band must not exceed an e.i.r.p. of -27 dBm/MHz.

TEST SETUP AND PROCEDURE

Below 30 MHz

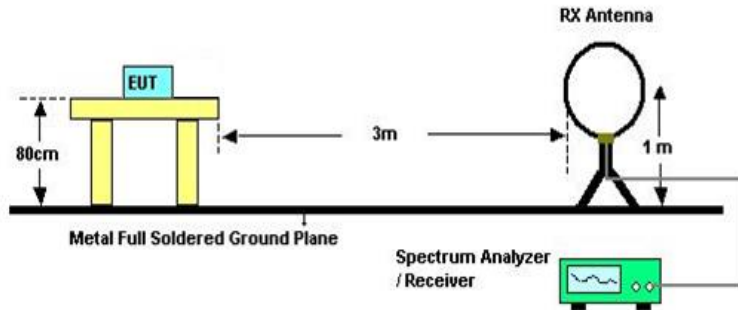

The setting of the spectrum analyser

RBW	200 Hz (From 9 kHz to 0.15 MHz)/ 9 kHz (From 0.15 MHz to 30 MHz)
VBW	200 Hz (From 9 kHz to 0.15 MHz)/ 9 kHz (From 0.15 MHz to 30 MHz)
Sweep	Auto
Trace	Max hold

1. The testing follows the guidelines in ANSI C63.10-2013 clause 11.11 & 11.12.
2. The EUT was arranged to its worst case and then turntable (from 0 degree to 360 degrees) to find the maximum reading. A pre-amp and a high pass filter are used for the test in order to get better signal level. Both Horizontal, Face-on and Face-off polarizations of the antenna are set to make the measurement.
3. The EUT was placed on a turntable with 80 cm above ground.
4. The EUT was set 3 meters from the interference receiving antenna, which was mounted on the top of a 1 m height antenna tower.
5. The radiated emission limits are based on measurements employing a CISPR quasi-peak detector except for the frequency bands 9-90 kHz, 110-490 kHz and above 1000 MHz. Radiated emission limits in these three bands are based on measurements employing an average detector.
6. For measurement below 1 GHz, the initial step in collecting conducted emission data is a spectrum analyzer peak detector mode pre-scanning the measurement frequency range. Significant peaks are then marked and then Quasi Peak and average detector mode re-measured. If the emission level of the EUT measured by the peak detector is 3 dB lower than the applicable limit, the peak emission level will be reported. Otherwise, the emission measurement will be repeated using the quasi-peak and average detector and reported.
7. Although these tests were performed other than open field site, adequate comparison measurements were confirmed against 30m open field site. Therefore sufficient tests were made to demonstrate that the alternative site produces results that correlate with the ones of tests made in an open field site based on KDB 414788.
8. The limits in CFR 47, Part 15, Subpart C, paragraph 15.209 (a), are identical to those in RSS-GEN Section 8.9, Table 6, since the measurements are performed in terms of magnetic field strength and converted to electric field strength levels (as reported in the table) using the free space impedance of 377 ohm; For example, the measurement frequency X kHz resulted in a level of Y dBuV/m, which is equivalent to $Y-51.5 = Z$ dBuA/m, which has the same margin, W dB, to the corresponding RSS-GEN Table 6 limit as it has to be 15.209(a) limit.

Below 1 GHz and above 30 MHz

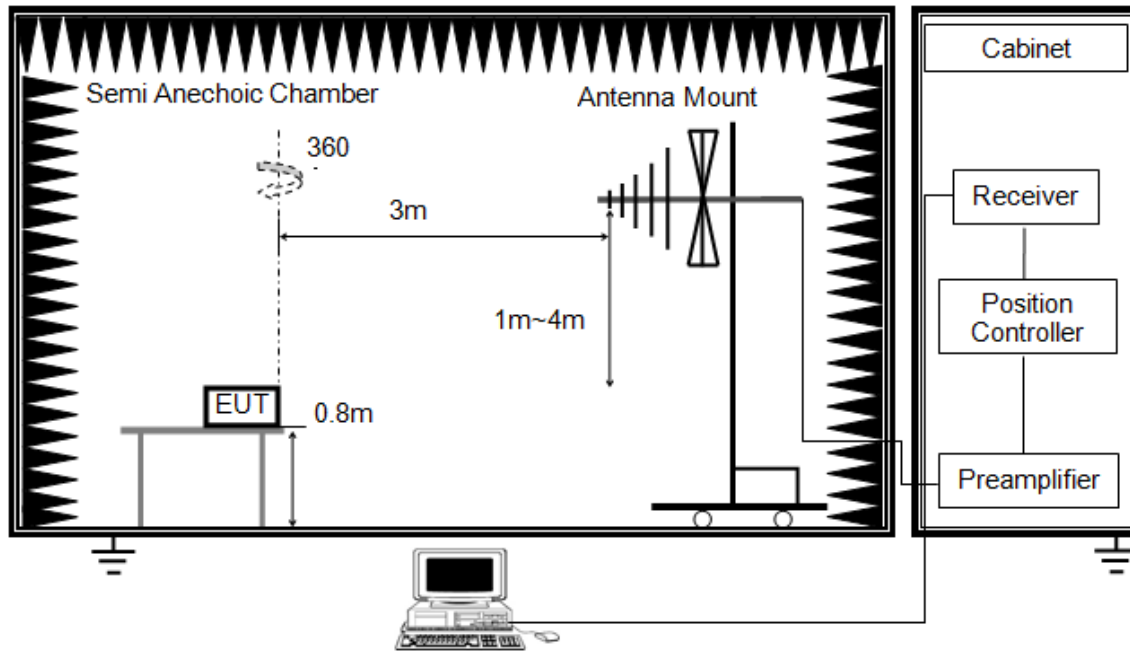

The setting of the spectrum analyser

RBW	120 kHz
VBW	300 kHz
Sweep	Auto
Detector	Peak/QP
Trace	Max hold

1. The testing follows the guidelines in ANSI C63.10-2013 clause 11.11 & 11.12.
2. The EUT was arranged to its worst case and then tune the antenna tower (from 1 m to 4 m) and turntable (from 0 degree to 360 degrees) to find the maximum reading. A pre-amp and a high pass filter are used for the test in order to get better signal level. Both horizontal and vertical polarizations of the antenna are set to make the measurement.
3. The EUT was placed on a turntable with 80 cm above ground.
4. The EUT was set 3 meters from the interference receiving antenna, which was mounted on the top of a variable height antenna tower.
5. For measurement below 1 GHz, the initial step in collecting conducted emission data is a spectrum analyzer peak detector mode pre-scanning the measurement frequency range. Significant peaks are then marked and then Quasi Peak detector mode re-measured. If the emission level of the EUT measured by the peak detector is 3 dB lower than the applicable limit, the peak emission level will be reported. Otherwise, the emission measurement will be repeated using the quasi-peak detector and reported.

Above 1 GHz

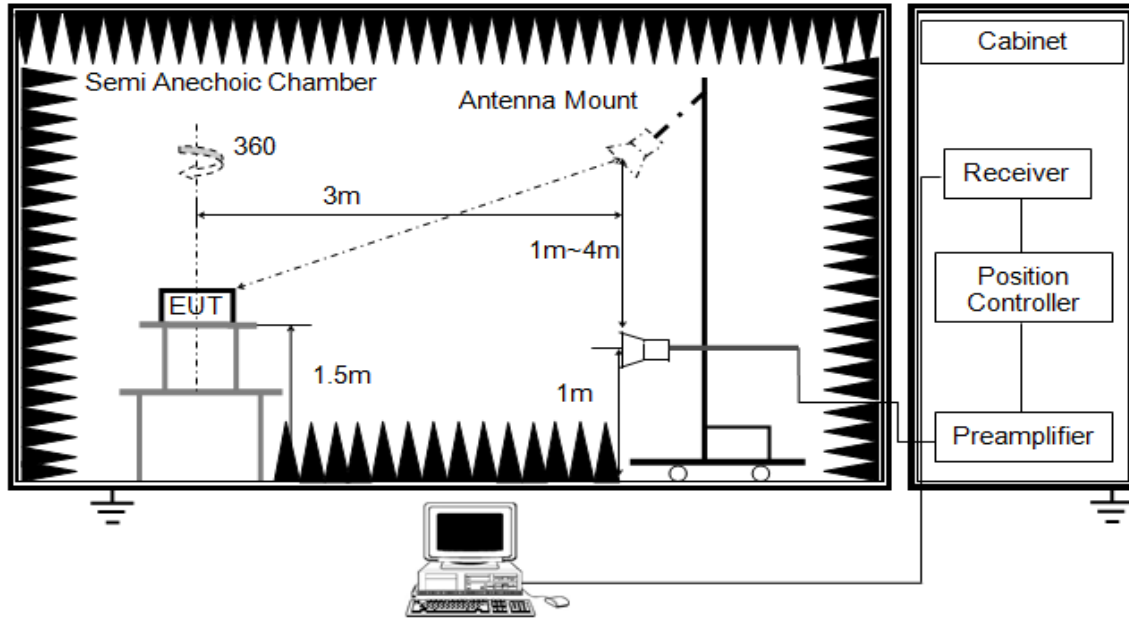

The setting of the spectrum analyser

RBW	1 MHz
VBW	PEAK: 3 MHz AVG: see note 6
Sweep	Auto
Detector	Peak
Trace	Max hold

1. The testing follows the guidelines in KDB 789033 D02 General U-NII Test Procedures New Rules v02r01 section II.G.3 ~ II.G.6.
2. The EUT was arranged to its worst case and then tune the antenna tower (from 1 m to 4 m) and turntable (from 0 degree to 360 degrees) to find the maximum reading. A pre-amp and a high pass filter are used for the test in order to get better signal level. Both horizontal and vertical polarizations of the antenna are set to make the measurement.
3. The EUT was placed on a turntable with 1.5 m above ground.
4. The EUT was set 3 meters from the interference receiving antenna, which was mounted on the top of a variable height antenna tower.
5. For measurement above 1 GHz, the emission measurement will be measured by the peak detector. This peak level, once corrected, must comply with the limit specified in Section 15.209.
6. For measurements above 1 GHz the resolution bandwidth is set to 1 MHz, then the video bandwidth is set to 3 MHz for peak measurements and 1 MHz resolution bandwidth with 1/T video bandwidth with peak detector for average measurements. For the Duty Cycle please refer to clause 7.1.ON TIME AND DUTY CYCLE.

X axis, Y axis, Z axis positions:

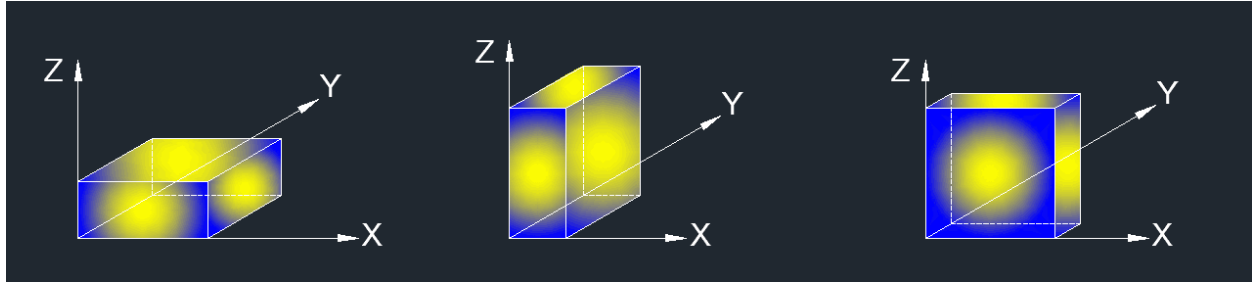

Note 1: For all radiated test, EUT in each of three orthogonal axis emissions had been tested, but only the worst case (X axis) data recorded in the report.

Note 2: The EUT was fully exercised with external accessories during the test. In the case of multiple accessory external ports, an external accessory shall be connected to one of each type of port.

TEST ENVIRONMENT

Temperature	24.3 °C	Relative Humidity	61 %
Atmosphere Pressure	101 kPa	Test Voltage	DC 5 V

RESULTS



8.1. RESTRICTED BANDEDGE

8.1.1. 802.11ax HE20 CDD MODE

UNII-5 BAND

RESTRICTED BANDEDGE (LOW CHANNEL, HORIZONTAL)

PEAK

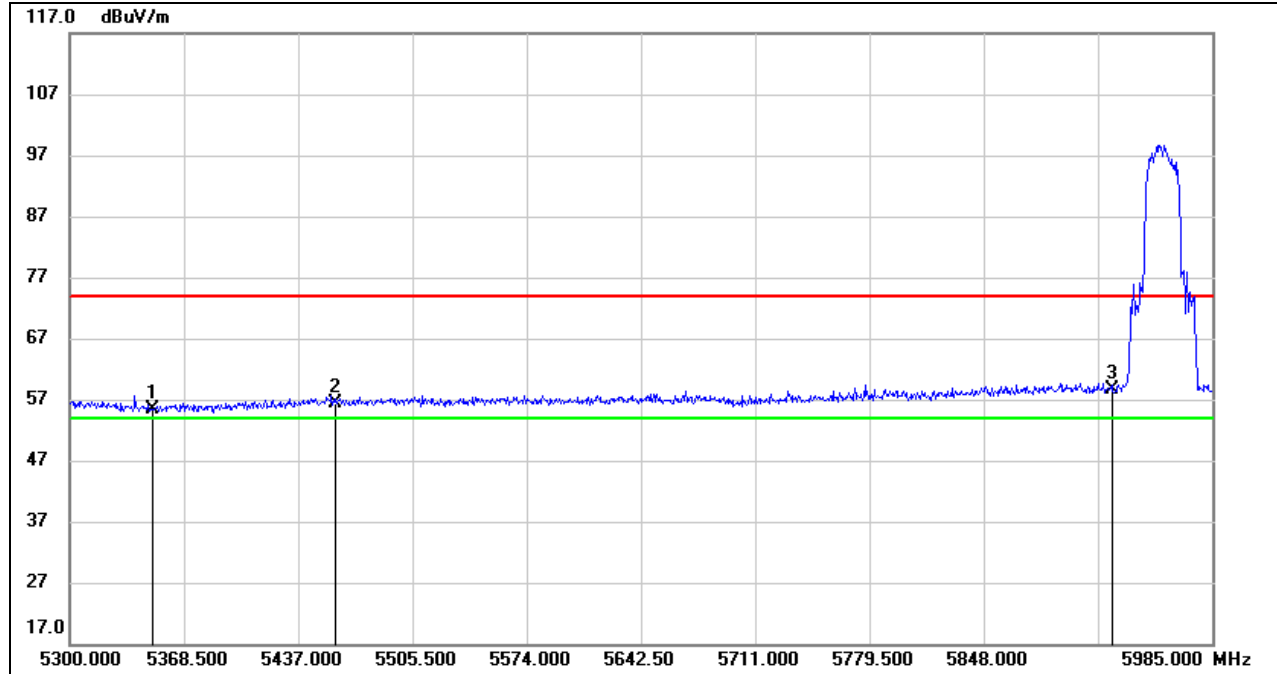

No.	Frequency (MHz)	Reading (dBuV)	Correct (dB/m)	Result (dBuV/m)	Limit (dBuV/m)	Margin (dB)	Remark
1	5350.000	15.26	40.08	55.34	74.00	-18.66	peak
2	5460.000	15.62	40.79	56.41	74.00	-17.59	peak
3	5925.000	16.79	41.83	58.62	74.00	-15.38	peak

Note: 1. Measurement = Reading Level + Correct Factor.
 2. If Peak Result complies with AV limit, AV Result is deemed to comply with AV limit.
 3. Only the worst data was recorded, if it complies with the limit, the other emissions deemed to comply with the limit.
 4. If the emissions less than the peak limit, it also complied with the -47dBm/MHz (88.2dBuV/m) limit.

AVG

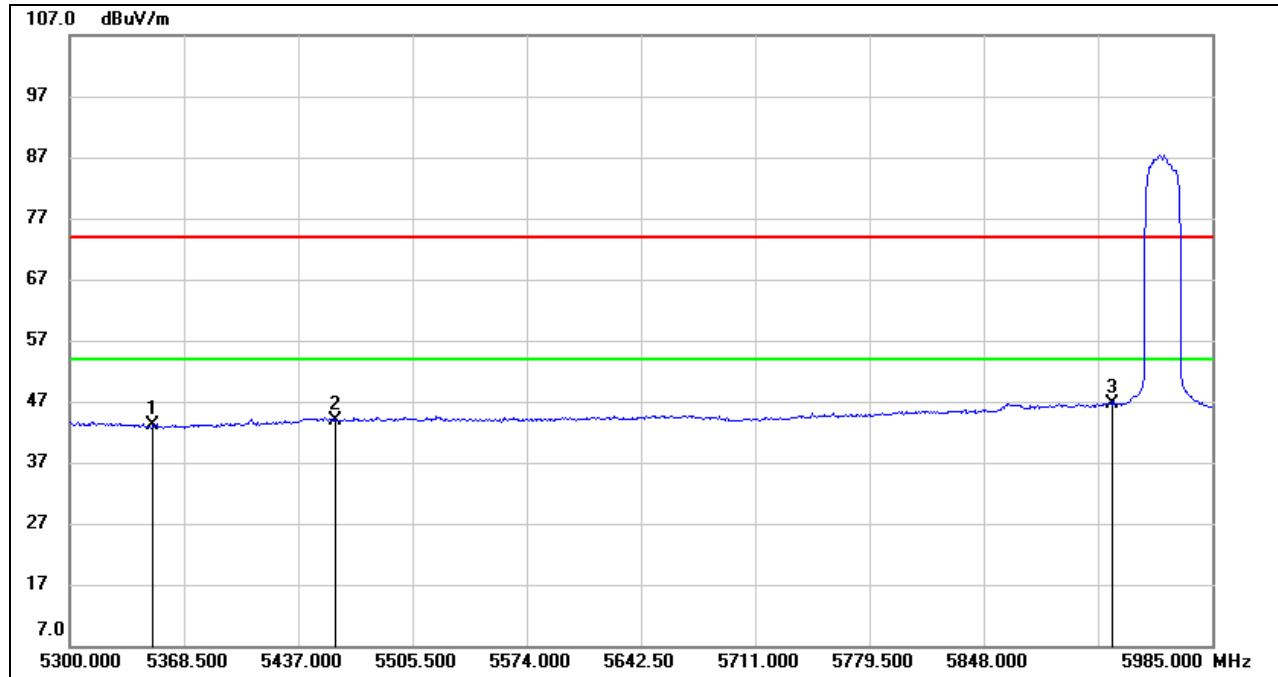

No.	Frequency (MHz)	Reading (dBuV)	Correct (dB/m)	Result (dBuV/m)	Limit (dBuV/m)	Margin (dB)	Remark
1	5350.000	3.00	40.08	43.08	54.00	-10.92	AVG
2	5460.000	3.15	40.79	43.94	54.00	-10.06	AVG
3	5925.000	4.82	41.83	46.65	54.00	-7.35	AVG

- Note:
1. Measurement = Reading Level + Correct Factor.
 2. If Peak Result complies with AV limit, AV Result is deemed to comply with AV limit.
 3. AVG: $VBW=1/T_{on}$, where: T_{on} is the transmitting duration.
 4. For the transmitting duration, please refer to clause 7.1.
 5. Only the worst data was recorded, if it complies with the limit, the other emissions deemed to comply with the limit.
 6. If the emissions less than the average limit, if also complied with the -27dBm/MHz (68.2dBuV/m) limit.

RESTRICTED BANDEDGE (LOW CHANNEL, VERTICAL)

PEAK

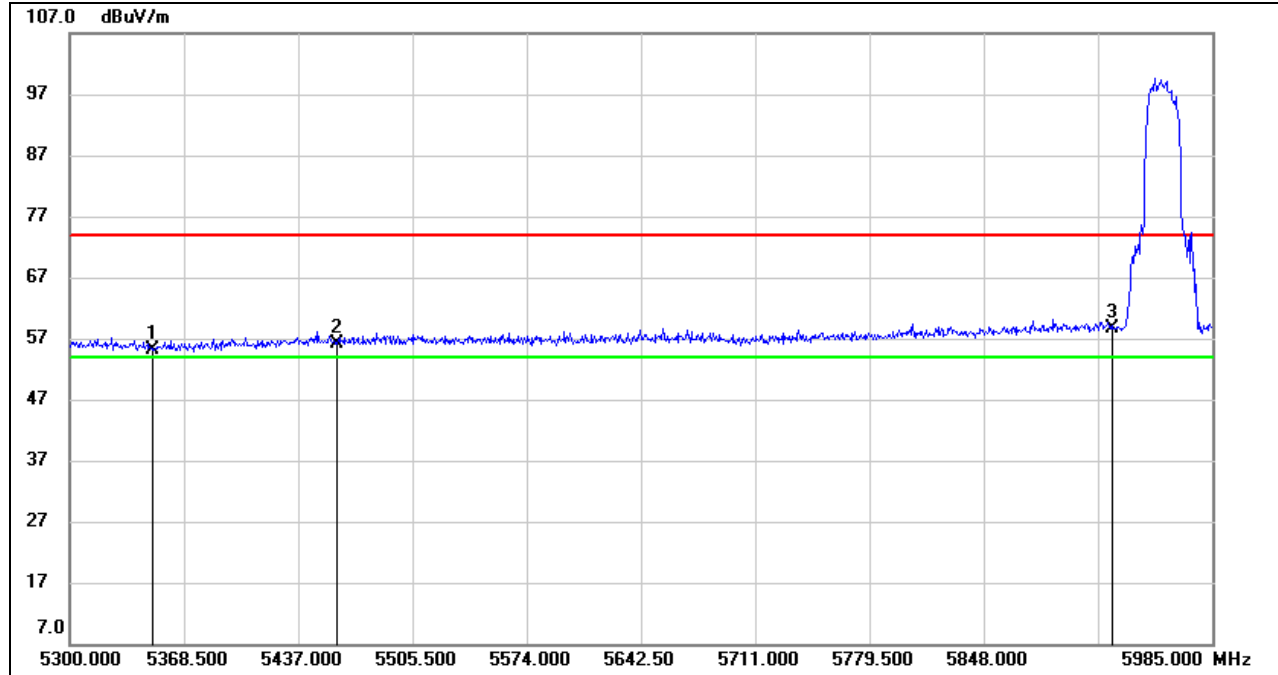

No.	Frequency (MHz)	Reading (dBuV)	Correct (dB/m)	Result (dBuV/m)	Limit (dBuV/m)	Margin (dB)	Remark
1	5350.000	14.99	40.08	55.07	74.00	-18.93	peak
2	5460.000	15.39	40.79	56.18	74.00	-17.82	peak
3	5925.000	16.79	41.83	58.62	74.00	-15.38	peak

Note: 1. Measurement = Reading Level + Correct Factor.

2. If Peak Result complies with AV limit, AV Result is deemed to comply with AV limit.

3. Only the worst data was recorded, if it complies with the limit, the other emissions deemed to comply with the limit.

4. If the emissions less than the peak limit, it also complied with the -47dBm/MHz (88.2dBuV/m) limit.

AVG

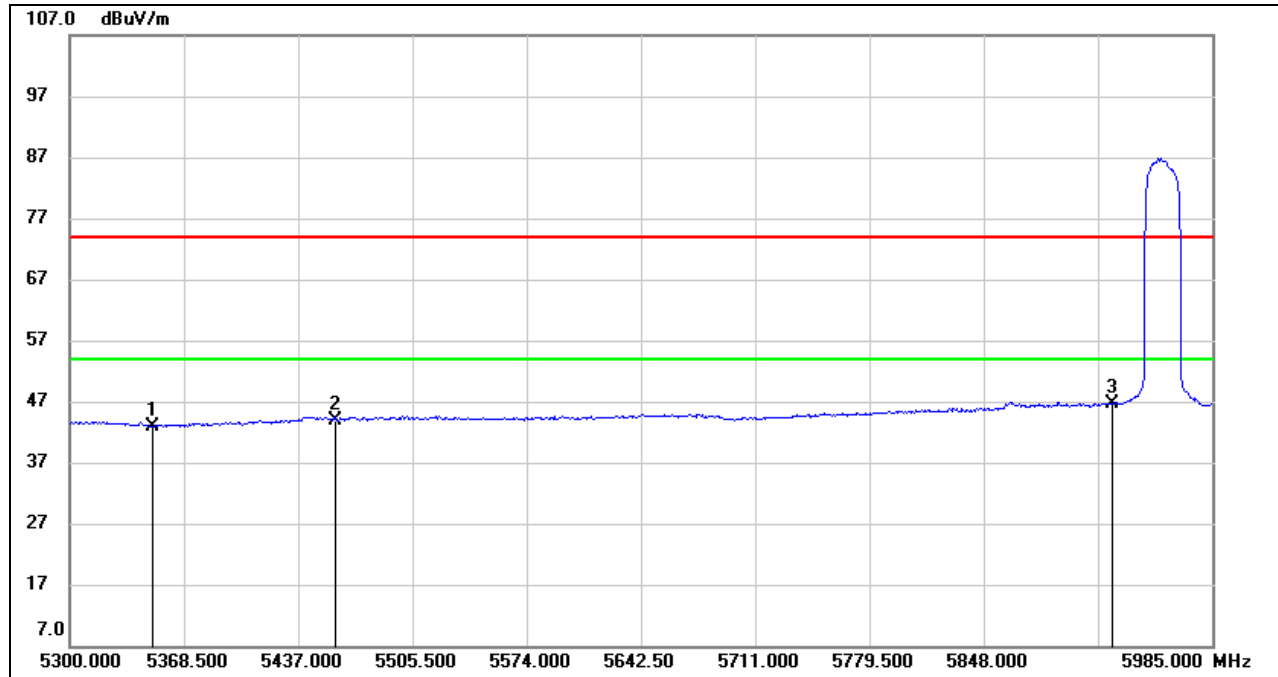

No.	Frequency (MHz)	Reading (dBuV)	Correct (dB/m)	Result (dBuV/m)	Limit (dBuV/m)	Margin (dB)	Remark
1	5350.000	2.77	40.08	42.85	54.00	-11.15	AVG
2	5460.000	3.15	40.79	43.94	54.00	-10.06	AVG
3	5925.000	4.85	41.83	46.68	54.00	-7.32	AVG

- Note:
1. Measurement = Reading Level + Correct Factor.
 2. If Peak Result complies with AV limit, AV Result is deemed to comply with AV limit.
 3. AVG: $VBW=1/T_{on}$, where: T_{on} is the transmitting duration.
 4. For the transmitting duration, please refer to clause 7.1.
 5. Only the worst data was recorded, if it complies with the limit, the other emissions deemed to comply with the limit.
 6. If the emissions less than the average limit, if also complied with the -27dBm/MHz (68.2dBuV/m) limit.

UNII-8 BAND

RESTRICTED BANDEDGE (HIGH CHANNEL, VERTICAL)

PEAK

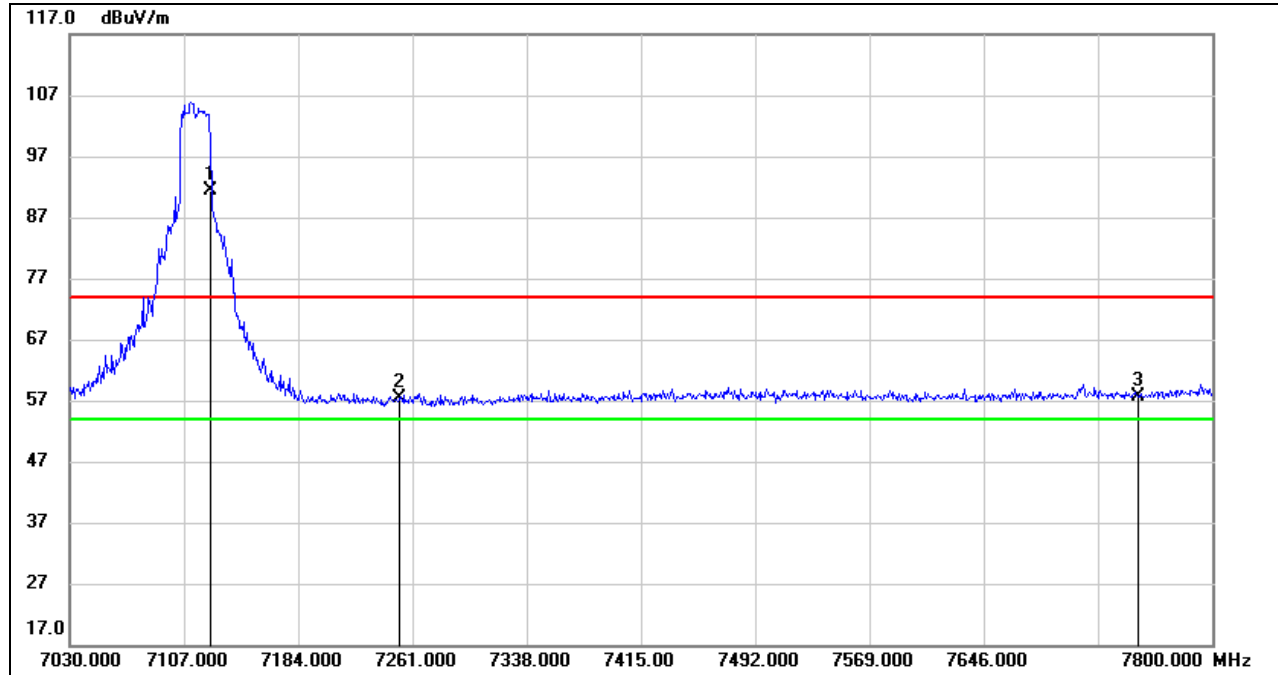

No.	Frequency (MHz)	Reading (dBuV)	Correct (dB/m)	Result (dBuV/m)	Limit (dBuV/m)	Margin (dB)	Remark
1	7125.000	46.97	44.35	91.32	74.00	17.32	peak
2	7252.000	13.31	44.01	57.32	74.00	-16.68	peak
3	7750.000	12.27	45.42	57.69	74.00	-16.31	peak

Note: 1. Measurement = Reading Level + Correct Factor.
 2. If Peak Result complies with AV limit, AV Result is deemed to comply with AV limit.
 3. Only the worst data was recorded, if it complies with the limit, the other emissions deemed to comply with the limit.
 4. If the emissions less than the peak limit, it also complied with the -47dBm/MHz (88.2dBuV/m) limit.

AVG

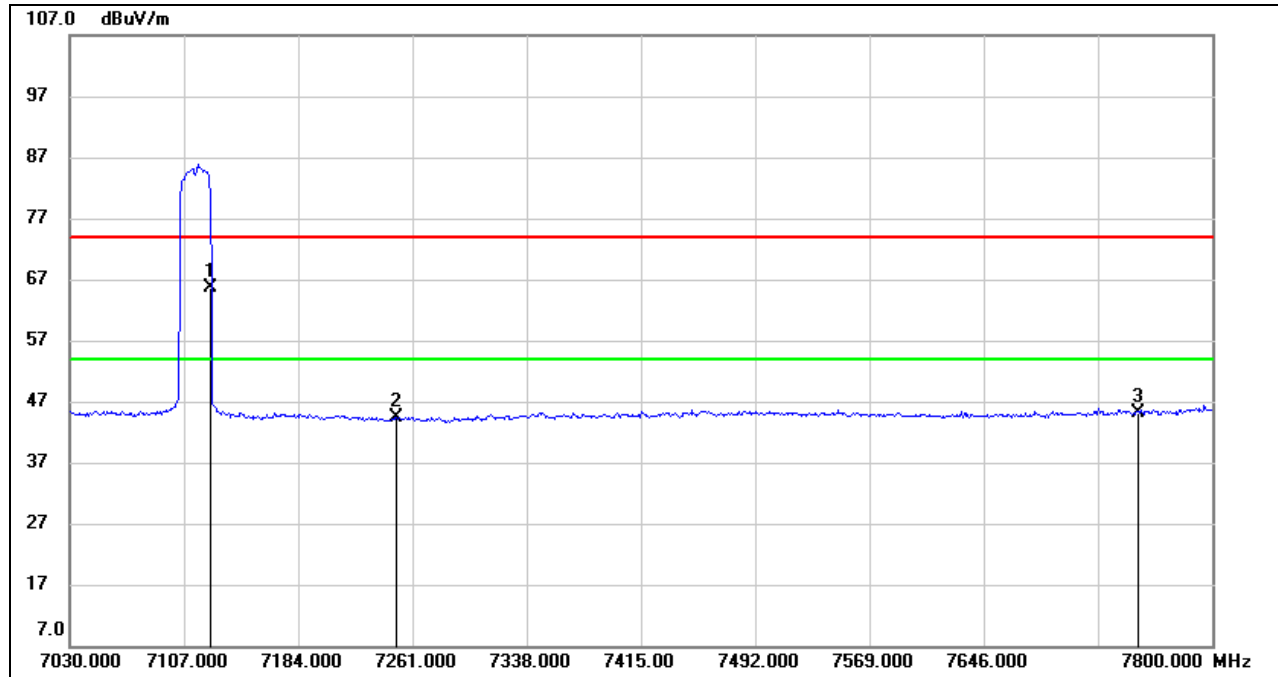

No.	Frequency (MHz)	Reading (dBuV)	Correct (dB/m)	Result (dBuV/m)	Limit (dBuV/m)	Margin (dB)	Remark
1	7125.000	21.32	44.35	65.67	54.00	11.67	AVG
2	7250.000	0.38	44.01	44.39	54.00	-9.61	AVG
3	7750.000	-0.31	45.42	45.11	54.00	-8.89	AVG

- Note: 1. Measurement = Reading Level + Correct Factor.
 2. If Peak Result complies with AV limit, AV Result is deemed to comply with AV limit.
 3. AVG: $VBW=1/T_{on}$, where: T_{on} is the transmitting duration.
 4. For the transmitting duration, please refer to clause 7.1.
 5. Only the worst data was recorded, if it complies with the limit, the other emissions deemed to comply with the limit.
 6. If the emissions less than the average limit, if also complied with the -27dBm/MHz (68.2dBuV/m) limit.

Note: All the polarities (Vertical & Horizontal) had been tested, only the worst data was recorded in the report.

Note: All the mode had been tested, but only the worst data was recorded in the report.

8.1.2. 802.11ax HE40 CDD MODE

UNII-5 BAND

RESTRICTED BANDEDGE (LOW CHANNEL, VERTICAL)

PEAK

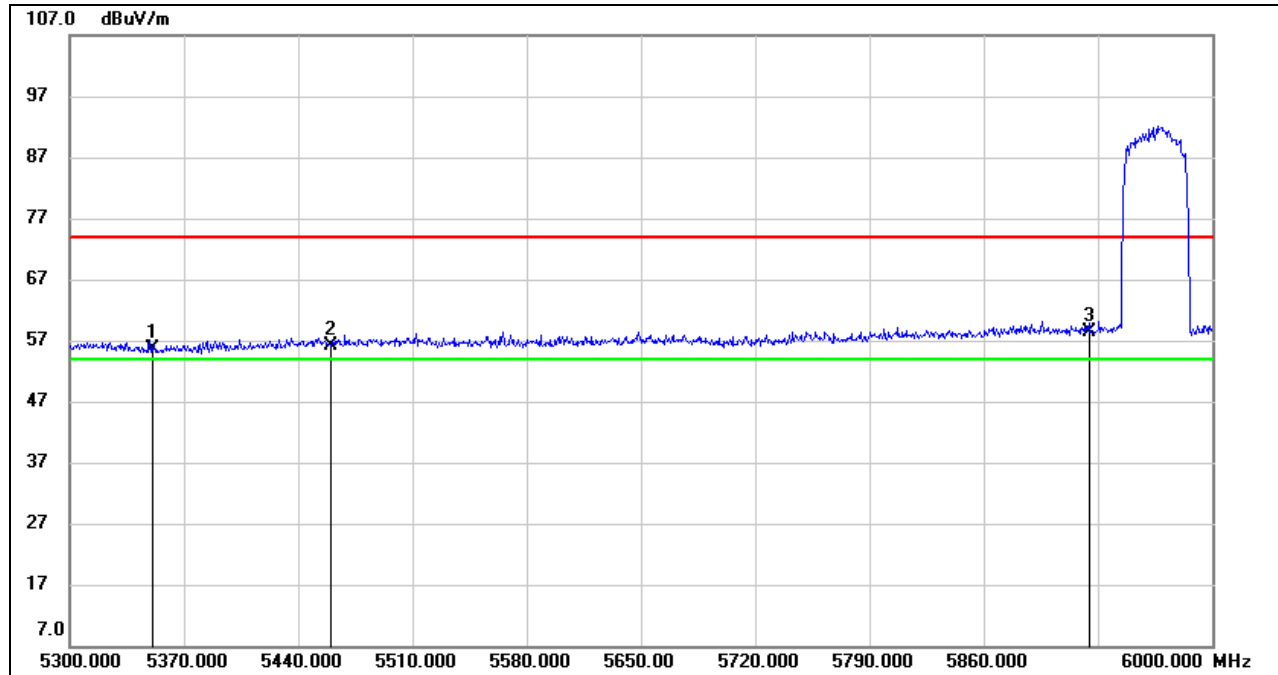

No.	Frequency (MHz)	Reading (dBuV)	Correct (dB/m)	Result (dBuV/m)	Limit (dBuV/m)	Margin (dB)	Remark
1	5350.000	15.52	40.08	55.60	74.00	-18.40	peak
2	5460.000	15.37	40.79	56.16	74.00	-17.84	peak
3	5925.000	16.47	41.83	58.30	74.00	-15.70	peak

Note: 1. Measurement = Reading Level + Correct Factor.
 2. If Peak Result complies with AV limit, AV Result is deemed to comply with AV limit.
 3. Only the worst data was recorded, if it complies with the limit, the other emissions deemed to comply with the limit.
 4. If the emissions less than the peak limit, it also complied with the -47dBm/MHz (88.2dBuV/m) limit.

AVG

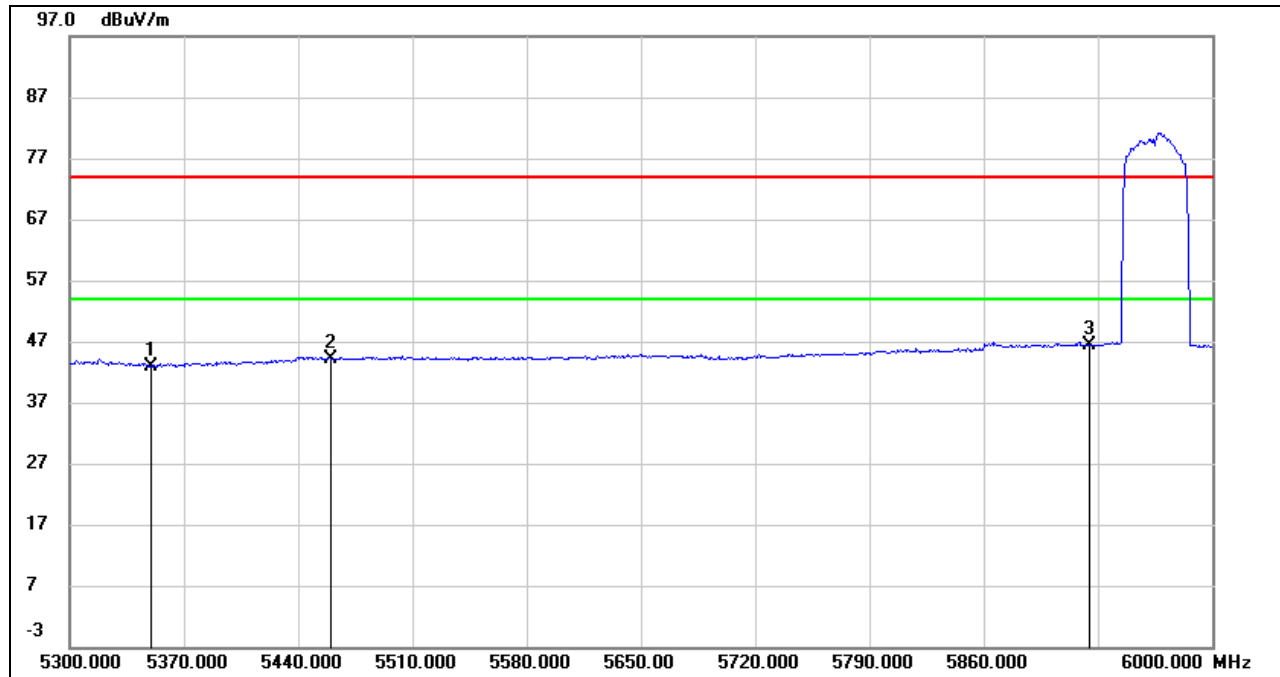

No.	Frequency (MHz)	Reading (dBuV)	Correct (dB/m)	Result (dBuV/m)	Limit (dBuV/m)	Margin (dB)	Remark
1	5350.000	2.85	40.08	42.93	54.00	-11.07	AVG
2	5460.000	3.27	40.79	44.06	54.00	-9.94	AVG
3	5925.000	4.59	41.83	46.42	54.00	-7.58	AVG

- Note:
1. Measurement = Reading Level + Correct Factor.
 2. If Peak Result complies with AV limit, AV Result is deemed to comply with AV limit.
 3. AVG: $VBW=1/T_{on}$, where: T_{on} is the transmitting duration.
 4. For the transmitting duration, please refer to clause 7.1.
 5. Only the worst data was recorded, if it complies with the limit, the other emissions deemed to comply with the limit.
 6. If the emissions less than the average limit, if also complied with the -27dBm/MHz (68.2dBuV/m) limit.

UNII-8 BAND

RESTRICTED BANDEDGE (HIGH CHANNEL, VERTICAL)

PEAK

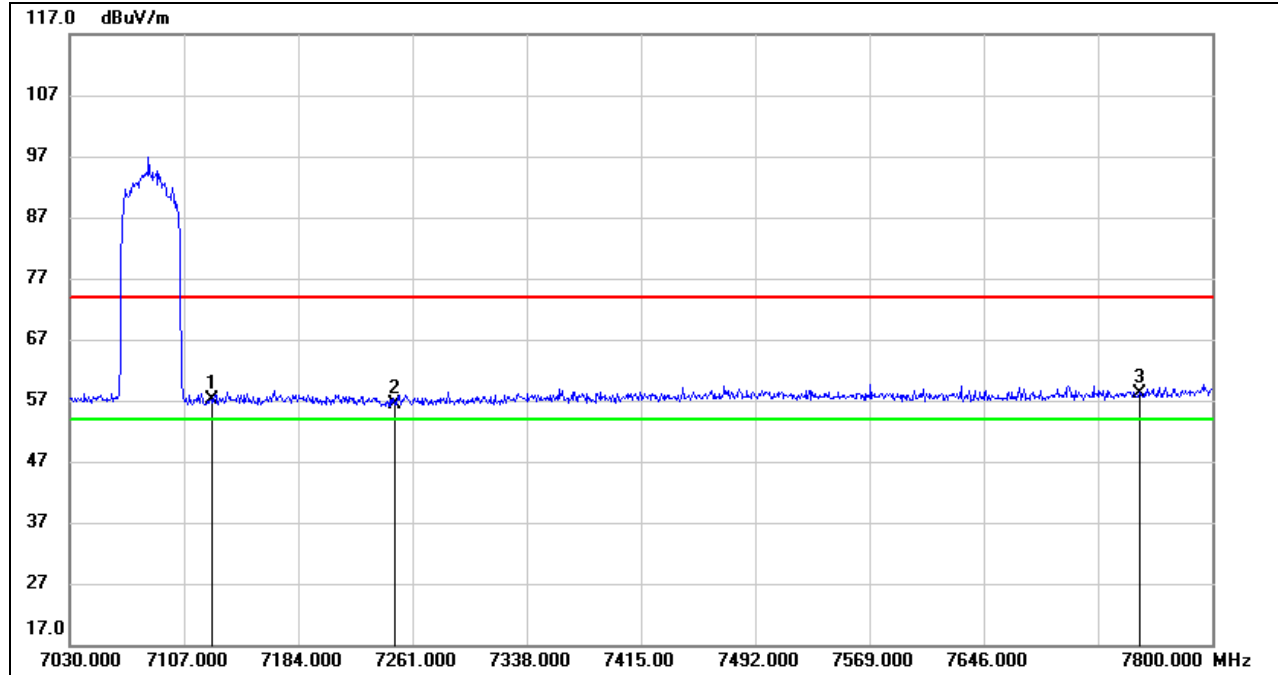

No.	Frequency (MHz)	Reading (dBuV)	Correct (dB/m)	Result (dBuV/m)	Limit (dBuV/m)	Margin (dB)	Remark
1	7125.000	12.81	44.35	57.16	74.00	-16.84	peak
2	7250.000	12.30	44.01	56.31	74.00	-17.69	peak
3	7750.000	12.83	45.42	58.25	74.00	-15.75	peak

- Note: 1. Measurement = Reading Level + Correct Factor.
 2. If Peak Result complies with AV limit, AV Result is deemed to comply with AV limit.
 3. Only the worst data was recorded, if it complies with the limit, the other emissions deemed to comply with the limit.
 4. If the emissions less than the peak limit, it also complied with the -47dBm/MHz (88.2dBuV/m) limit.



AVG

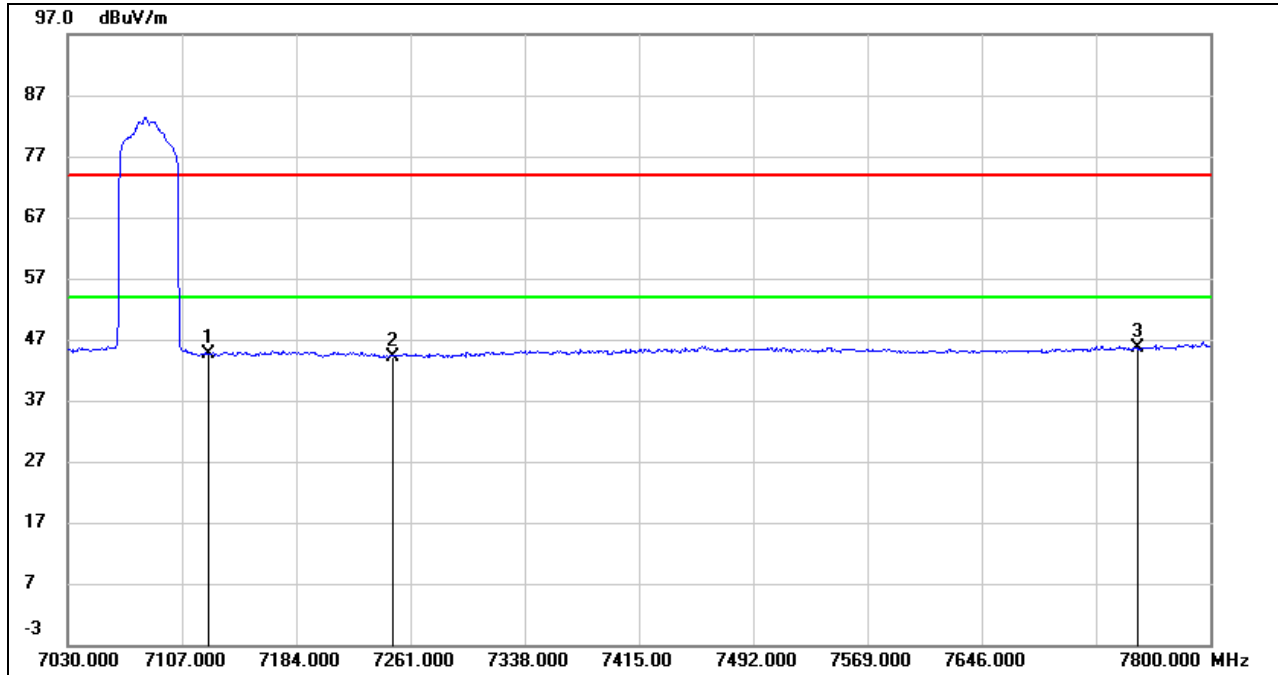

No.	Frequency (MHz)	Reading (dBuV)	Correct (dB/m)	Result (dBuV/m)	Limit (dBuV/m)	Margin (dB)	Remark
1	7125.000	0.29	44.35	44.64	54.00	-9.36	AVG
2	7250.000	0.24	44.01	44.25	54.00	-9.75	AVG
3	7750.000	0.18	45.42	45.60	54.00	-8.40	AVG

- Note: 1. Measurement = Reading Level + Correct Factor.
 2. If Peak Result complies with AV limit, AV Result is deemed to comply with AV limit.
 3. AVG: $VBW=1/Ton$, where: Ton is the transmitting duration.
 4. For the transmitting duration, please refer to clause 7.1.
 5. Only the worst data was recorded, if it complies with the limit, the other emissions deemed to comply with the limit.
 6. If the emissions less than the average limit, if also complied with the -27dBm/MHz (68.2dBuV/m) limit.

Note: All the polarities (Vertical & Horizontal) had been tested, only the worst data was recorded in the report.

Note: All the mode had been tested, but only the worst data was recorded in the report.

8.1.3. 802.11ax HE80 CDD MODE

UNII-5 BAND

RESTRICTED BANDEDGE (LOW CHANNEL, VERTICAL)

PEAK

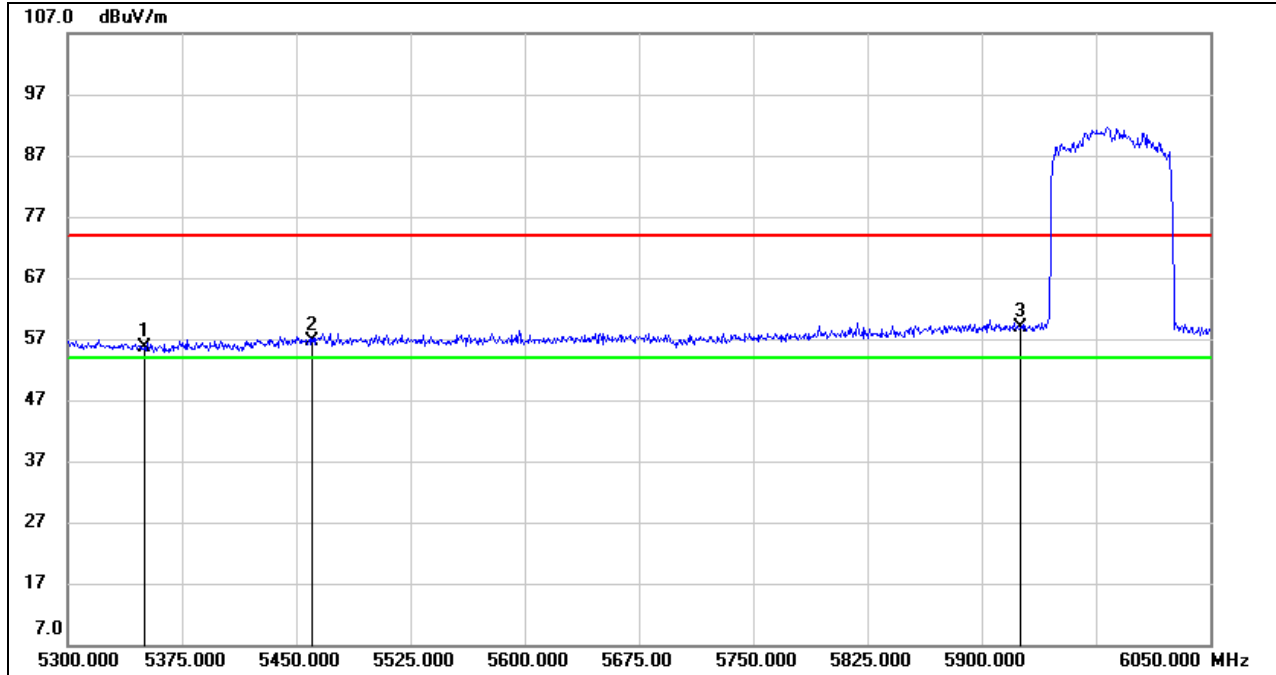

No.	Frequency (MHz)	Reading (dBuV)	Correct (dB/m)	Result (dBuV/m)	Limit (dBuV/m)	Margin (dB)	Remark
1	5350.000	15.44	40.08	55.52	74.00	-18.48	peak
2	5460.000	15.83	40.79	56.62	74.00	-17.38	peak
3	5925.000	17.06	41.83	58.89	74.00	-15.11	peak

- Note: 1. Measurement = Reading Level + Correct Factor.
 2. If Peak Result complies with AV limit, AV Result is deemed to comply with AV limit.
 3. Only the worst data was recorded, if it complies with the limit, the other emissions deemed to comply with the limit.
 4. If the emissions less than the peak limit, it also complied with the -47dBm/MHz (88.2dBuV/m) limit.

AVG

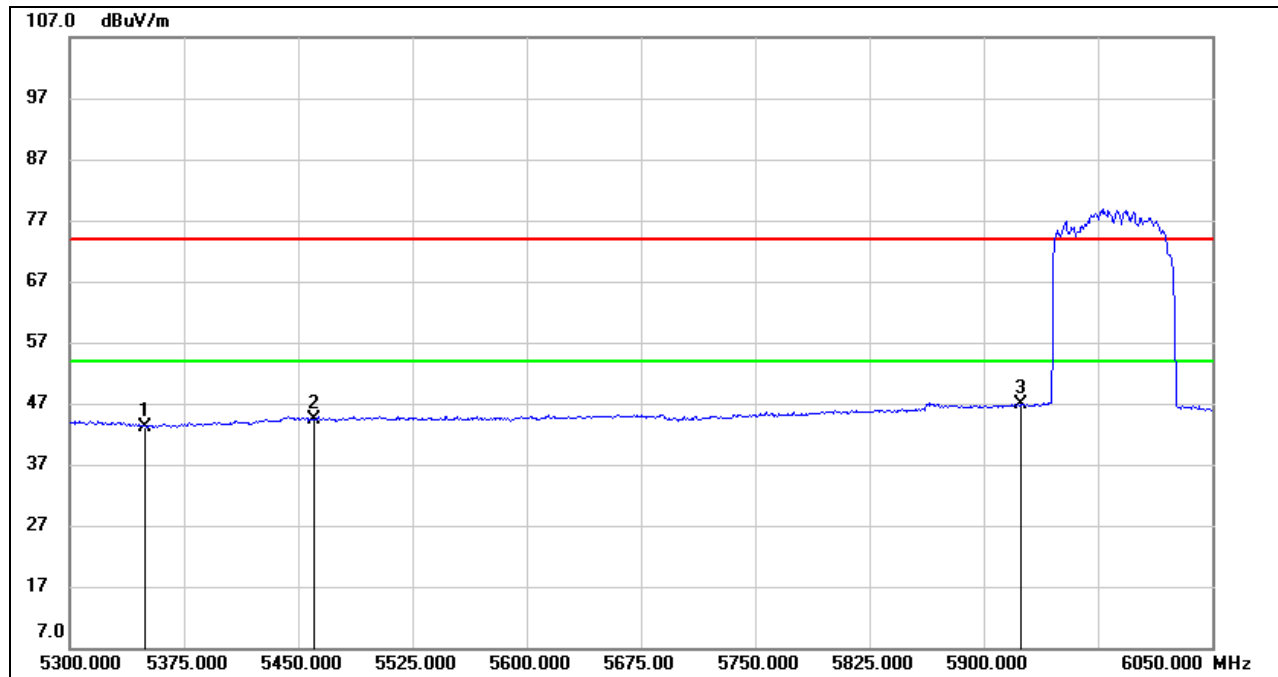

No.	Frequency (MHz)	Reading (dBuV)	Correct (dB/m)	Result (dBuV/m)	Limit (dBuV/m)	Margin (dB)	Remark
1	5350.000	3.16	40.08	43.24	54.00	-10.76	AVG
2	5460.000	3.69	40.79	44.48	54.00	-9.52	AVG
3	5925.000	5.00	41.83	46.83	54.00	-7.17	AVG

- Note: 1. Measurement = Reading Level + Correct Factor.
 2. If Peak Result complies with AV limit, AV Result is deemed to comply with AV limit.
 3. AVG: $VBW=1/Ton$, where: Ton is the transmitting duration.
 4. For the transmitting duration, please refer to clause 7.1.
 5. Only the worst data was recorded, if it complies with the limit, the other emissions deemed to comply with the limit.
 6. If the emissions less than the average limit, if also complied with the -27dBm/MHz (68.2dBuV/m) limit.

UNII-8 BAND

RESTRICTED BANDEDGE (HIGH CHANNEL, VERTICAL)

PEAK

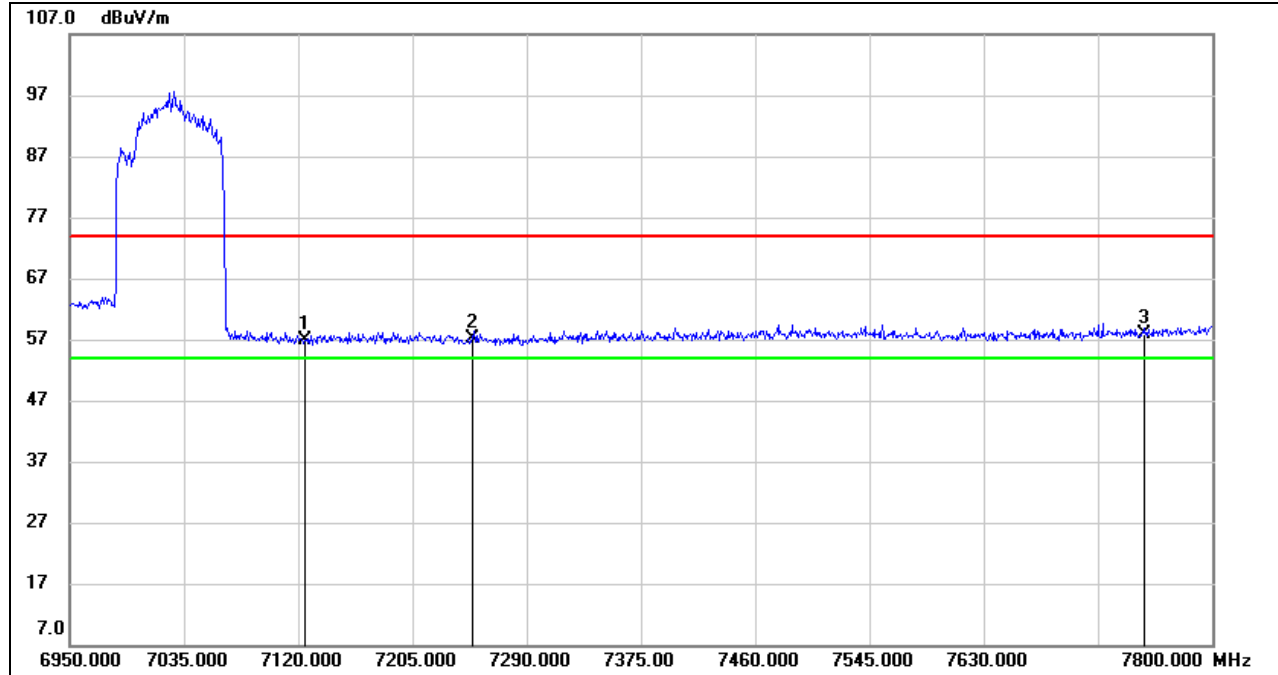

No.	Frequency (MHz)	Reading (dBuV)	Correct (dB/m)	Result (dBuV/m)	Limit (dBuV/m)	Margin (dB)	Remark
1	7125.000	12.45	44.35	56.80	74.00	-17.20	peak
2	7250.000	13.10	44.01	57.11	74.00	-16.89	peak
3	7750.000	12.43	45.42	57.85	74.00	-16.15	peak

- Note: 1. Measurement = Reading Level + Correct Factor.
 2. If Peak Result complies with AV limit, AV Result is deemed to comply with AV limit.
 3. Only the worst data was recorded, if it complies with the limit, the other emissions deemed to comply with the limit.
 4. If the emissions less than the peak limit, it also complied with the -47dBm/MHz (88.2dBuV/m) limit.

AVG

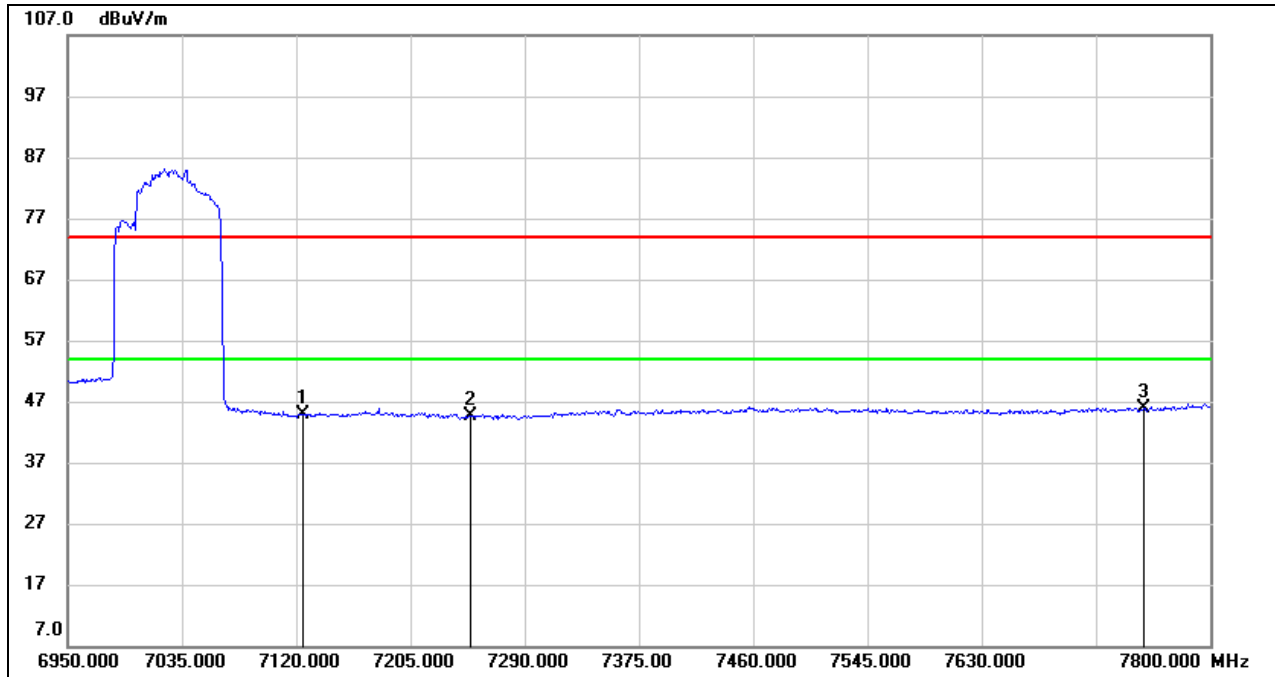

No.	Frequency (MHz)	Reading (dBuV)	Correct (dB/m)	Result (dBuV/m)	Limit (dBuV/m)	Margin (dB)	Remark
1	7125.000	0.48	44.35	44.83	54.00	-9.17	AVG
2	7250.000	0.56	44.01	44.57	54.00	-9.43	AVG
3	7750.000	0.35	45.42	45.77	54.00	-8.23	AVG

- Note: 1. Measurement = Reading Level + Correct Factor.
 2. If Peak Result complies with AV limit, AV Result is deemed to comply with AV limit.
 3. AVG: $VBW=1/Ton$, where: Ton is the transmitting duration.
 4. For the transmitting duration, please refer to clause 7.1.
 5. Only the worst data was recorded, if it complies with the limit, the other emissions deemed to comply with the limit.
 6. If the emissions less than the average limit, if also complied with the -27dBm/MHz (68.2dBuV/m) limit.

Note: All the polarities (Vertical & Horizontal) and Antennas had been tested, only the worst data was recorded in the report.

Note: All the mode had been tested, but only the worst data was recorded in the report.

8.2. SPURIOUS EMISSIONS (1 GHz ~ 9 GHz)

8.2.1. 802.11ax HE80 CDD MODE

UNII-5 BAND

HARMONICS AND SPURIOUS EMISSIONS (LOW CHANNEL, HORIZONTAL)

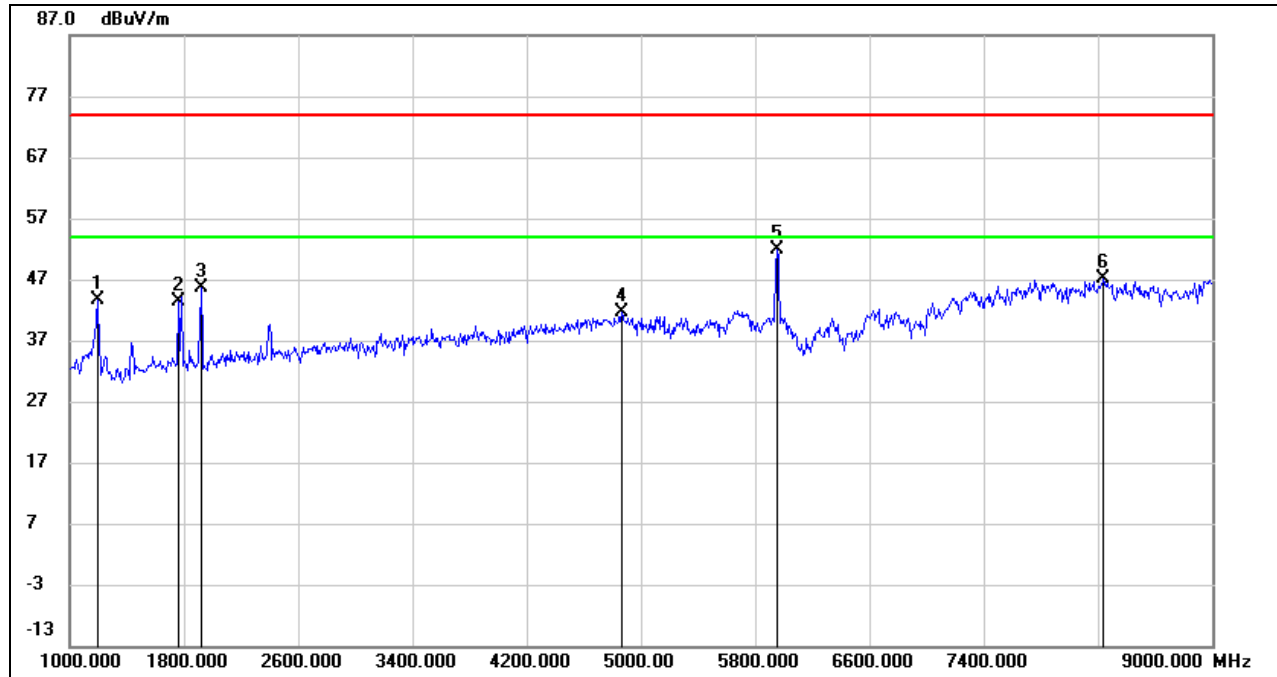

No.	Frequency (MHz)	Reading (dBuV)	Correct (dB/m)	Result (dBuV/m)	Limit (dBuV/m)	Margin (dB)	Remark
1	1192.000	56.64	-13.03	43.61	74.00	-30.39	peak
2	1760.000	53.74	-10.35	43.39	74.00	-30.61	peak
3	1920.000	55.87	-10.13	45.74	74.00	-28.26	peak
4	4864.000	40.92	0.69	41.61	74.00	-32.39	peak
5	5955.000	48.76	3.13	51.89	74.00	-22.11	peak
6	8240.000	37.90	9.20	47.10	74.00	-26.90	peak

Note: 1. Measurement = Reading Level + Correct Factor.

2. If Peak Result complies with AV limit, AV Result is deemed to comply with AV limit.

3. AVG: $VBW=1/Ton$, where: Ton is the transmitting duration.

4. For the transmitting duration, please refer to clause 7.1.

5. Only the worst data was recorded, if it complies with the limit, the other emissions deemed to comply with the limit.

6. If the emissions less than the average limit, if also complied with the -27dBm/MHz (68.2dBuV/m) limit.

HARMONICS AND SPURIOUS EMISSIONS (LOW CHANNEL, VERTICAL)

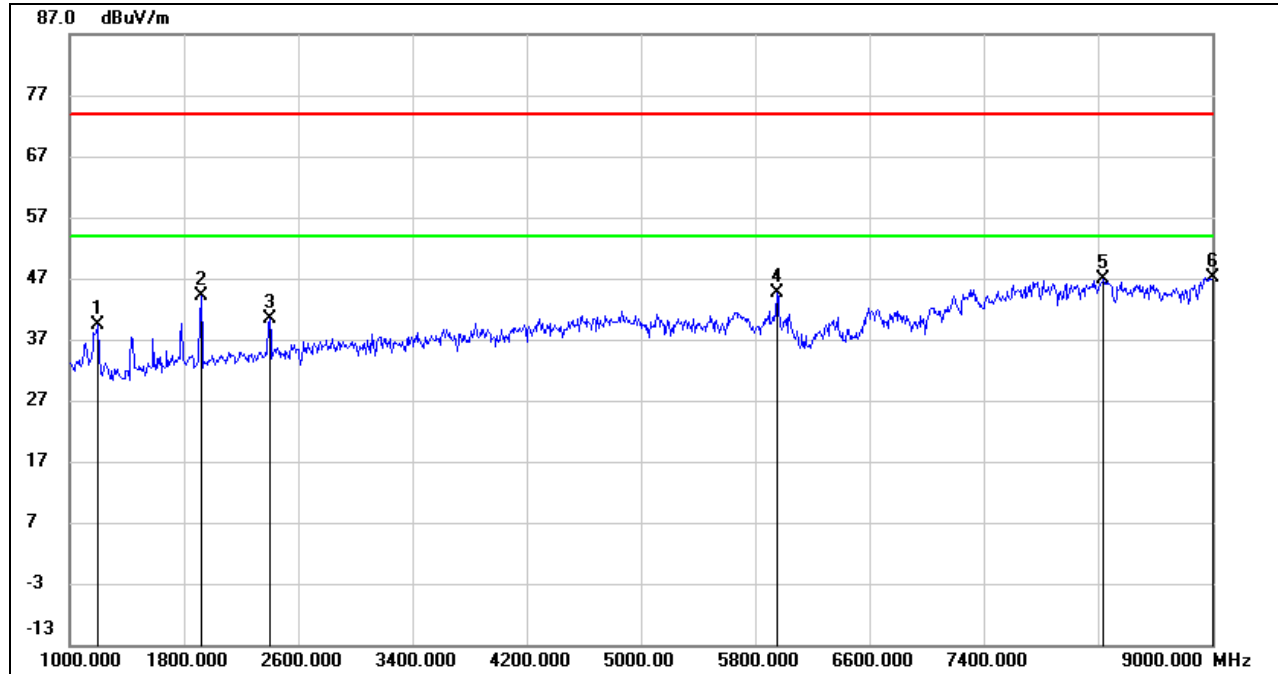

No.	Frequency (MHz)	Reading (dBuV)	Correct (dB/m)	Result (dBuV/m)	Limit (dBuV/m)	Margin (dB)	Remark
1	1192.000	52.38	-13.03	39.35	74.00	-34.65	peak
2	1920.000	54.28	-10.13	44.15	74.00	-29.85	peak
3	2400.000	48.83	-8.40	40.43	74.00	-33.57	peak
4	5955.000	41.46	3.13	44.59	74.00	-29.41	peak
5	8240.000	37.76	9.20	46.96	74.00	-27.04	peak
6	9000.000	36.46	10.63	47.09	74.00	-26.91	peak

- Note: 1. Measurement = Reading Level + Correct Factor.
 2. If Peak Result complies with AV limit, AV Result is deemed to comply with AV limit.
 3. Peak: Peak detector.
 4. Filter losses were only considered in the spurious frequency bands and the authorized band was not corrected for Band reject filter losses.
 5. Proper operation of the transmitter prior to adding the filter to the measurement chain.
 6. Since non-restricted band peak emissions are less than the average limit, they also comply with the -27dBm/MHz (68.2dBuV/m) limit.

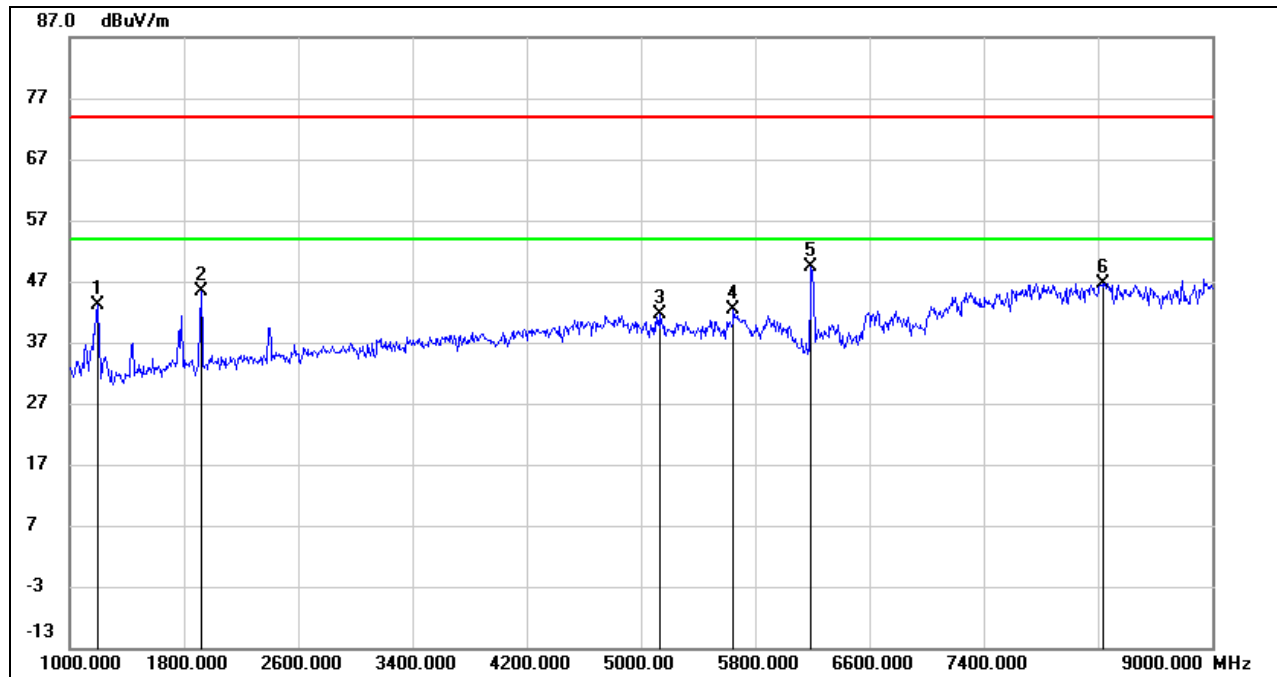
**HARMONICS AND SPURIOUS EMISSIONS (MID CHANNEL, HORIZONTAL)**

No.	Frequency (MHz)	Reading (dBuV)	Correct (dB/m)	Result (dBuV/m)	Limit (dBuV/m)	Margin (dB)	Remark
1	1192.000	56.21	-13.03	43.18	74.00	-30.82	peak
2	1920.000	55.48	-10.13	45.35	74.00	-28.65	peak
3	5128.000	40.01	1.67	41.68	74.00	-32.32	peak
4	5648.000	39.93	2.47	42.40	74.00	-31.60	peak
5	6192.000	46.03	3.26	49.29	74.00	-24.71	peak
6	8232.000	37.48	9.23	46.71	74.00	-27.29	peak

Note: 1. Measurement = Reading Level + Correct Factor.

2. If Peak Result complies with AV limit, AV Result is deemed to comply with AV limit.

3. Peak: Peak detector.

4. Filter losses were only considered in the spurious frequency bands and the authorized band was not corrected for Band reject filter losses.

5. Proper operation of the transmitter prior to adding the filter to the measurement chain.

6. Since non-restricted band peak emissions are less than the average limit, they also comply with the -27dBm/MHz (68.2dBuV/m) limit.

HARMONICS AND SPURIOUS EMISSIONS (MID CHANNEL, VERTICAL)

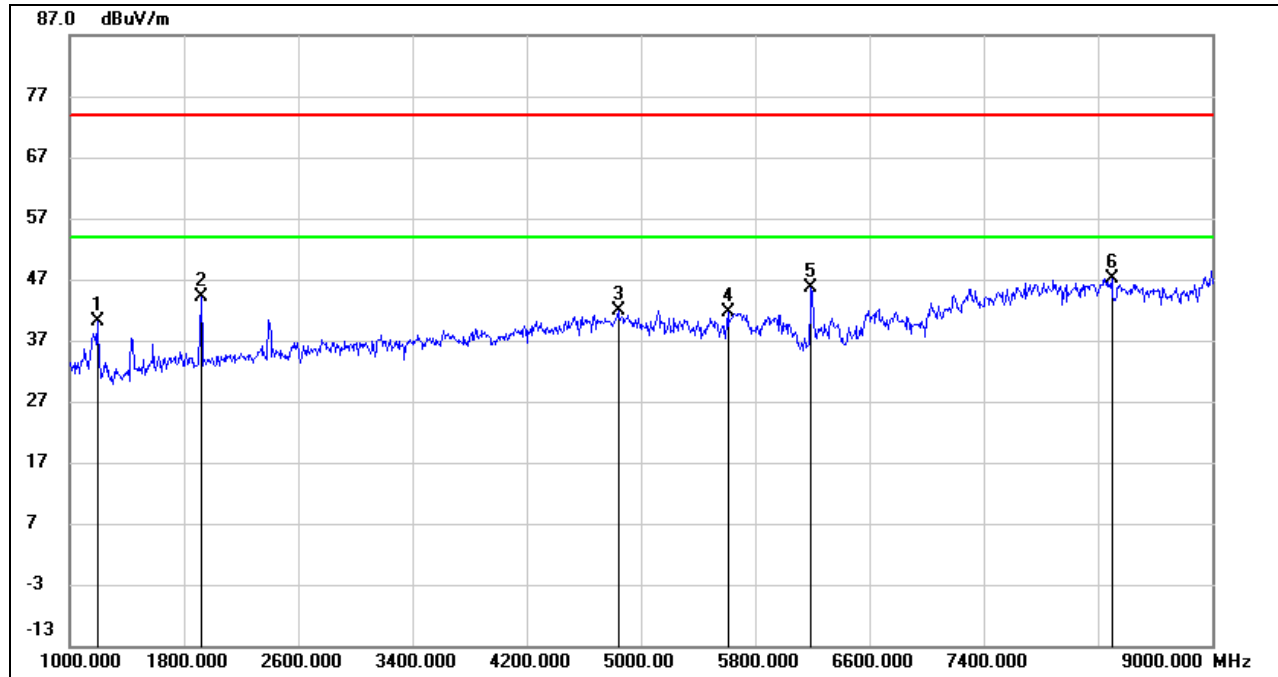

No.	Frequency (MHz)	Reading (dBuV)	Correct (dB/m)	Result (dBuV/m)	Limit (dBuV/m)	Margin (dB)	Remark
1	1192.000	53.10	-13.03	40.07	74.00	-33.93	peak
2	1920.000	54.25	-10.13	44.12	74.00	-29.88	peak
3	4840.000	41.34	0.65	41.99	74.00	-32.01	peak
4	5608.000	39.05	2.46	41.51	74.00	-32.49	peak
5	6195.000	42.32	3.25	45.57	74.00	-28.43	peak
6	8296.000	38.04	8.99	47.03	74.00	-26.97	peak

Note: 1. Measurement = Reading Level + Correct Factor.
 2. If Peak Result complies with AV limit, AV Result is deemed to comply with AV limit.
 3. Peak: Peak detector.
 4. Filter losses were only considered in the spurious frequency bands and the authorized band was not corrected for Band reject filter losses.
 5. Proper operation of the transmitter prior to adding the filter to the measurement chain.
 6. Since non-restricted band peak emissions are less than the average limit, they also comply with the -27dBm/MHz (68.2dBuV/m) limit.

HARMONICS AND SPURIOUS EMISSIONS (HIGH CHANNEL, HORIZONTAL)

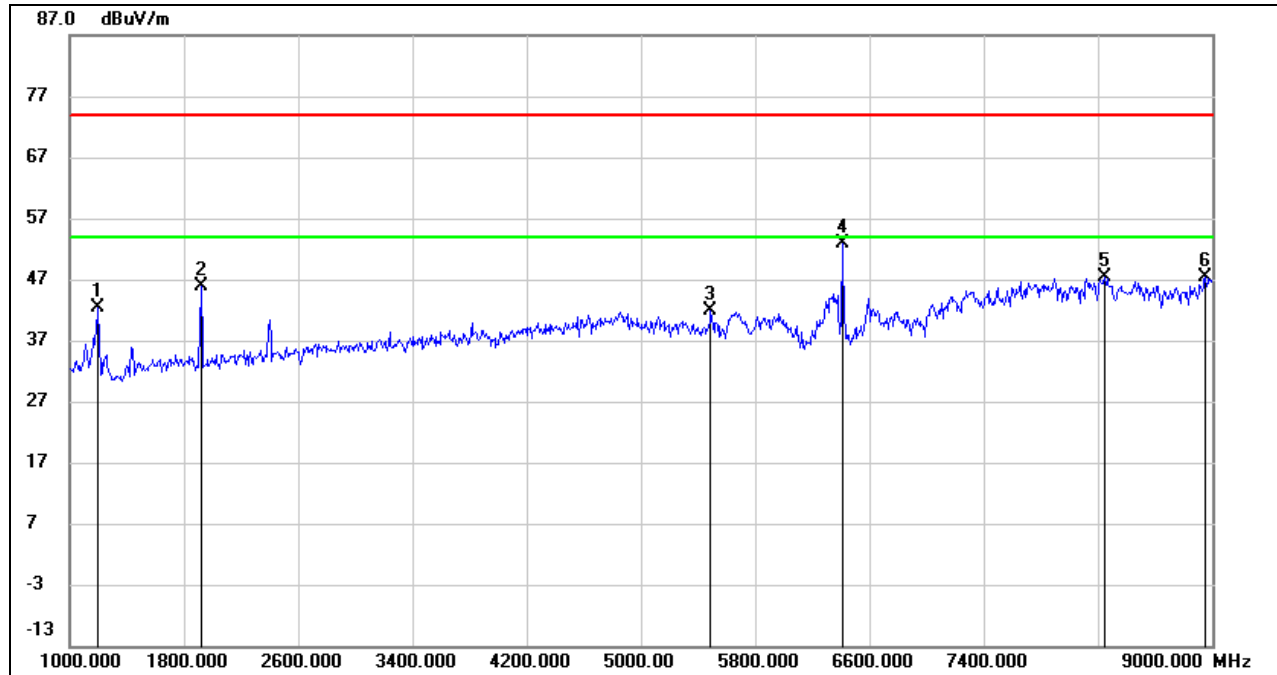

No.	Frequency (MHz)	Reading (dBuV)	Correct (dB/m)	Result (dBuV/m)	Limit (dBuV/m)	Margin (dB)	Remark
1	1200.000	55.28	-12.99	42.29	74.00	-31.71	peak
2	1920.000	56.09	-10.13	45.96	74.00	-28.04	peak
3	5488.000	39.85	2.13	41.98	74.00	-32.02	peak
4	6415.000	48.37	4.45	52.82	74.00	-21.18	peak
5	8248.000	38.26	9.17	47.43	74.00	-26.57	peak
6	8952.000	37.16	10.12	47.28	74.00	-26.72	peak

Note: 1. Measurement = Reading Level + Correct Factor.

2. If Peak Result complies with AV limit, AV Result is deemed to comply with AV limit.

3. Peak: Peak detector.

4. Filter losses were only considered in the spurious frequency bands and the authorized band was not corrected for Band reject filter losses.

5. Proper operation of the transmitter prior to adding the filter to the measurement chain.

6. Since non-restricted band peak emissions are less than the average limit, they also comply with the -27dBm/MHz (68.2dBuV/m) limit.

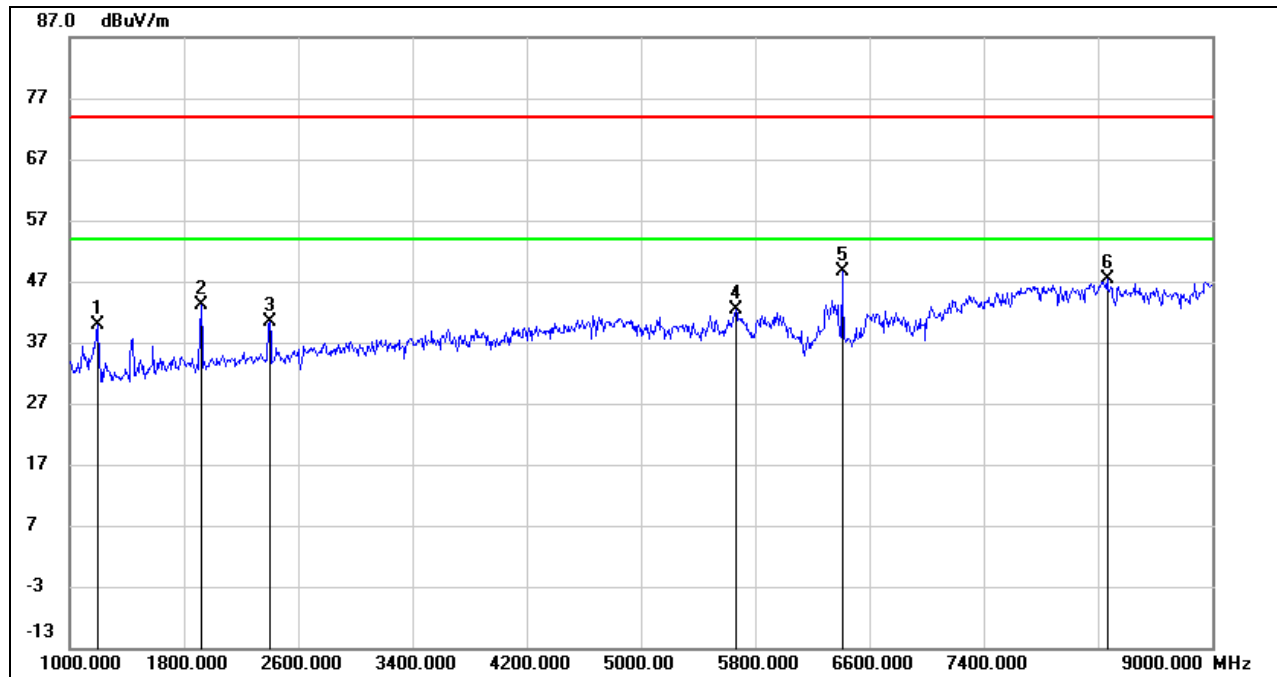
**HARMONICS AND SPURIOUS EMISSIONS (HIGH CHANNEL, VERTICAL)**

No.	Frequency (MHz)	Reading (dBuV)	Correct (dB/m)	Result (dBuV/m)	Limit (dBuV/m)	Margin (dB)	Remark
1	1192.000	52.92	-13.03	39.89	74.00	-34.11	peak
2	1920.000	53.25	-10.13	43.12	74.00	-30.88	peak
3	2400.000	48.88	-8.40	40.48	74.00	-33.52	peak
4	5664.000	39.91	2.48	42.39	74.00	-31.61	peak
5	6408.000	44.21	4.42	48.63	74.00	-25.37	peak
6	8264.000	38.23	9.12	47.35	74.00	-26.65	peak

Note: 1. Measurement = Reading Level + Correct Factor.

2. If Peak Result complies with AV limit, AV Result is deemed to comply with AV limit.

3. Peak: Peak detector.

4. Filter losses were only considered in the spurious frequency bands and the authorized band was not corrected for Band reject filter losses.

5. Proper operation of the transmitter prior to adding the filter to the measurement chain.

6. Since non-restricted band peak emissions are less than the average limit, they also comply with the -27dBm/MHz (68.2dBuV/m) limit.

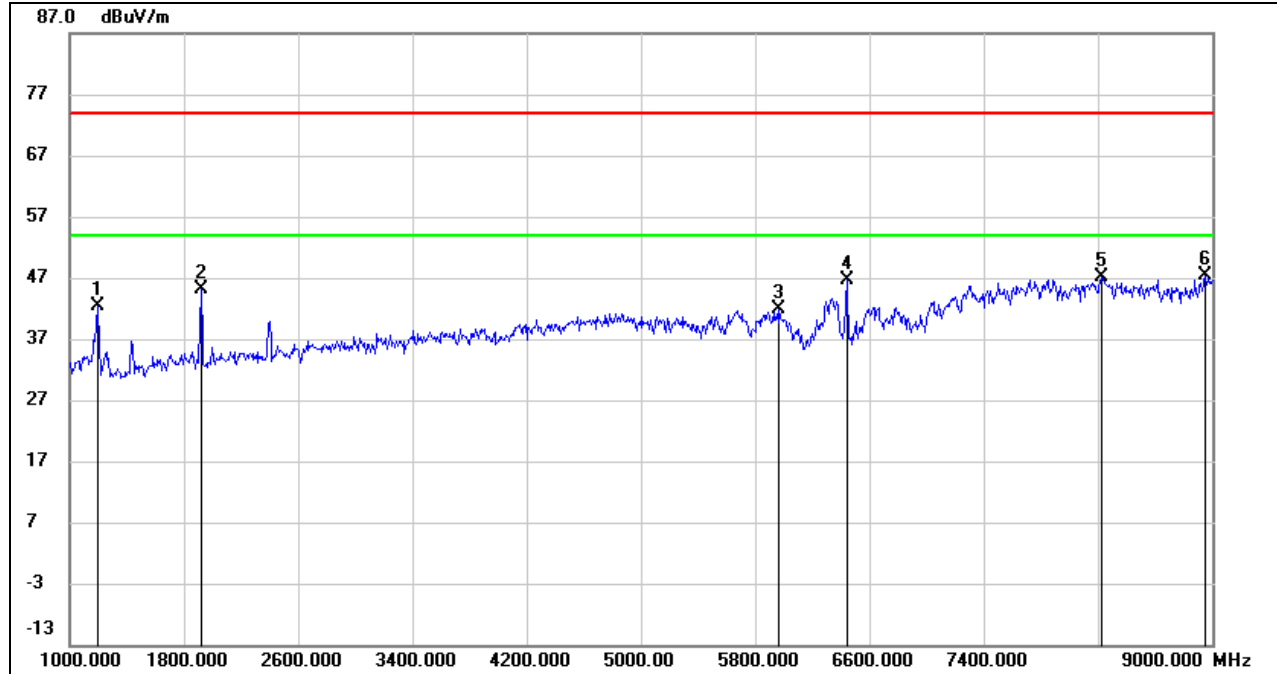
UNII-6 BAND
HARMONICS AND SPURIOUS EMISSIONS (LOW CHANNEL, HORIZONTAL)

No.	Frequency (MHz)	Reading (dBuV)	Correct (dB/m)	Result (dBuV/m)	Limit (dBuV/m)	Margin (dB)	Remark
1	1192.000	55.47	-13.03	42.44	74.00	-31.56	peak
2	1920.000	55.16	-10.13	45.03	74.00	-28.97	peak
3	5968.000	38.81	3.17	41.98	74.00	-32.02	peak
4	6435.000	42.17	4.57	46.74	74.00	-27.26	peak
5	8224.000	37.83	9.27	47.10	74.00	-26.90	peak
6	8952.000	37.31	10.12	47.43	74.00	-26.57	peak

Note: 1. Measurement = Reading Level + Correct Factor.

2. If Peak Result complies with AV limit, AV Result is deemed to comply with AV limit.

3. Peak: Peak detector.

4. Filter losses were only considered in the spurious frequency bands and the authorized band was not corrected for Band reject filter losses.

5. Proper operation of the transmitter prior to adding the filter to the measurement chain.

6. Since non-restricted band peak emissions are less than the average limit, they also comply with the -27dBm/MHz (68.2dBuV/m) limit.

HARMONICS AND SPURIOUS EMISSIONS (LOW CHANNEL, VERTICAL)

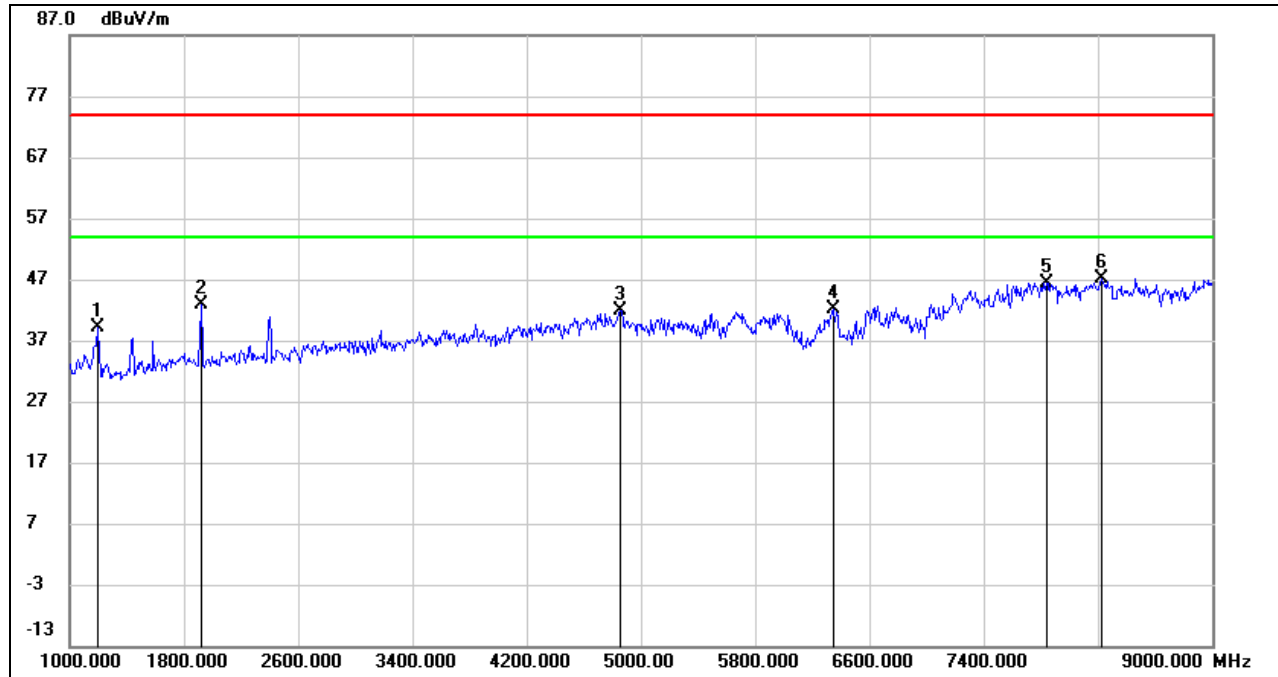

No.	Frequency (MHz)	Reading (dBuV)	Correct (dB/m)	Result (dBuV/m)	Limit (dBuV/m)	Margin (dB)	Remark
1	1192.000	52.25	-13.03	39.22	74.00	-34.78	peak
2	1920.000	53.00	-10.13	42.87	74.00	-31.13	peak
3	4856.000	41.31	0.67	41.98	74.00	-32.02	peak
4	6344.000	38.02	4.06	42.08	74.00	-31.92	peak
5	7840.000	38.34	8.13	46.47	74.00	-27.53	peak
6	8224.000	37.83	9.27	47.10	74.00	-26.90	peak

Note: 1. Measurement = Reading Level + Correct Factor.
 2. If Peak Result complies with AV limit, AV Result is deemed to comply with AV limit.
 3. Peak: Peak detector.
 4. Filter losses were only considered in the spurious frequency bands and the authorized band was not corrected for Band reject filter losses.
 5. Proper operation of the transmitter prior to adding the filter to the measurement chain.
 6. Since non-restricted band peak emissions are less than the average limit, they also comply with the -27dBm/MHz (68.2dBuV/m) limit.

HARMONICS AND SPURIOUS EMISSIONS (MID CHANNEL, HORIZONTAL)

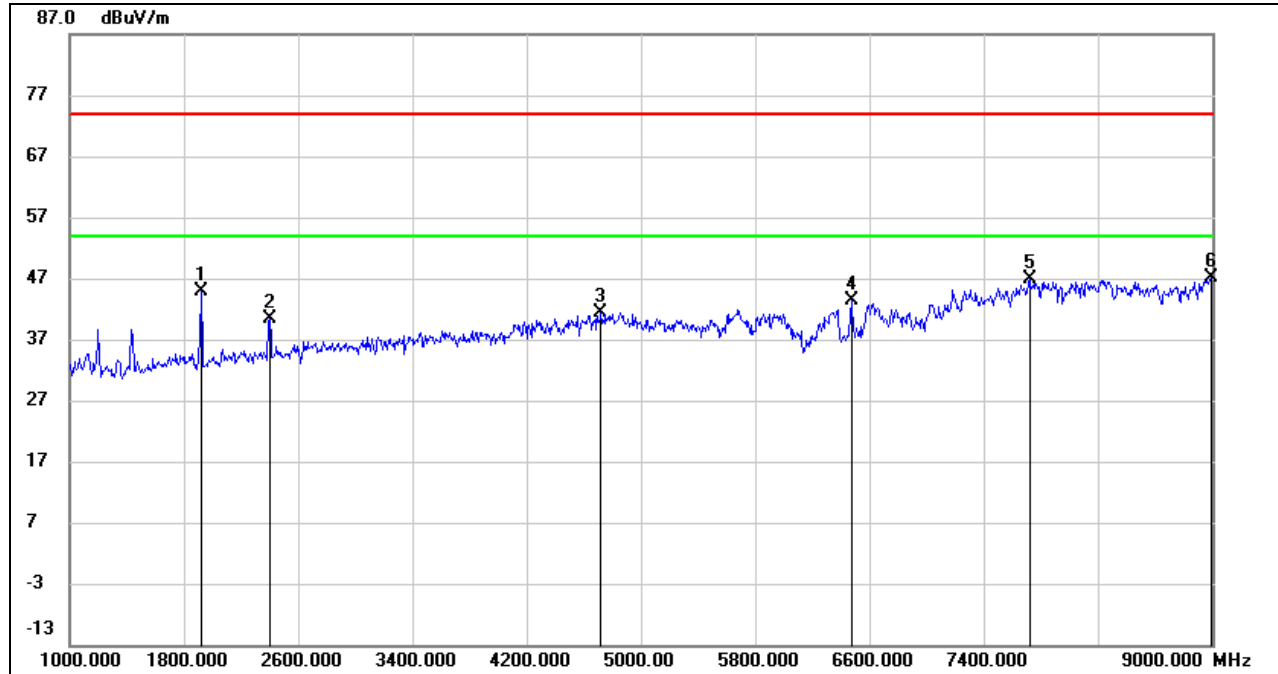

No.	Frequency (MHz)	Reading (dBuV)	Correct (dB/m)	Result (dBuV/m)	Limit (dBuV/m)	Margin (dB)	Remark
1	1920.000	55.11	-10.13	44.98	74.00	-29.02	peak
2	2400.000	48.82	-8.40	40.42	74.00	-33.58	peak
3	4720.000	41.19	0.12	41.31	74.00	-32.69	peak
4	6472.000	38.64	4.77	43.41	74.00	-30.59	peak
5	7720.000	38.90	7.94	46.84	74.00	-27.16	peak
6	8992.000	36.55	10.54	47.09	74.00	-26.91	peak

Note: 1. Measurement = Reading Level + Correct Factor.

2. If Peak Result complies with AV limit, AV Result is deemed to comply with AV limit.

3. Peak: Peak detector.

4. Filter losses were only considered in the spurious frequency bands and the authorized band was not corrected for Band reject filter losses.

5. Proper operation of the transmitter prior to adding the filter to the measurement chain.

6. Since non-restricted band peak emissions are less than the average limit, they also comply with the -27dBm/MHz (68.2dBuV/m) limit.

HARMONICS AND SPURIOUS EMISSIONS (MID CHANNEL, VERTICAL)

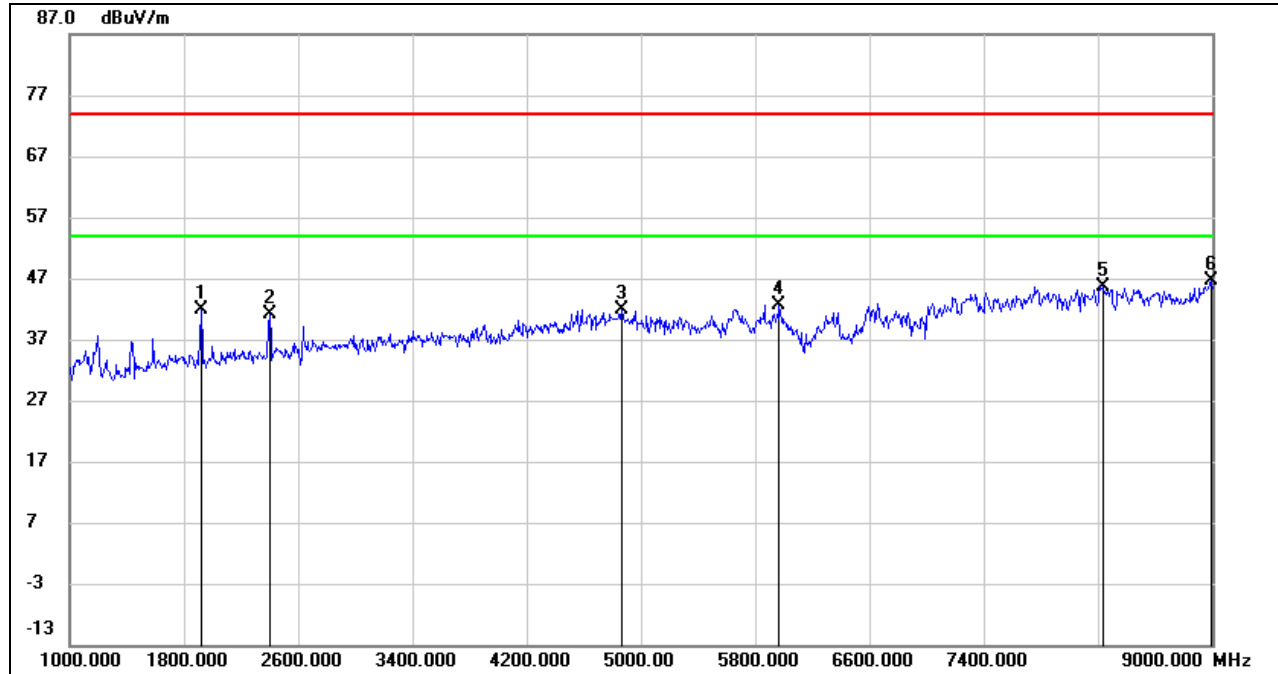

No.	Frequency (MHz)	Reading (dBuV)	Correct (dB/m)	Result (dBuV/m)	Limit (dBuV/m)	Margin (dB)	Remark
1	1920.000	52.01	-10.13	41.88	74.00	-32.12	peak
2	2400.000	49.45	-8.40	41.05	74.00	-32.95	peak
3	4864.000	41.11	0.69	41.80	74.00	-32.20	peak
4	5968.000	39.53	3.17	42.70	74.00	-31.30	peak
5	8232.000	36.50	9.23	45.73	74.00	-28.27	peak
6	8992.000	36.12	10.54	46.66	74.00	-27.34	peak

Note: 1. Measurement = Reading Level + Correct Factor.
 2. If Peak Result complies with AV limit, AV Result is deemed to comply with AV limit.
 3. Peak: Peak detector.
 4. Filter losses were only considered in the spurious frequency bands and the authorized band was not corrected for Band reject filter losses.
 5. Proper operation of the transmitter prior to adding the filter to the measurement chain.
 6. Since non-restricted band peak emissions are less than the average limit, they also comply with the -27dBm/MHz (68.2dBuV/m) limit.

HARMONICS AND SPURIOUS EMISSIONS (HIGH CHANNEL, HORIZONTAL)

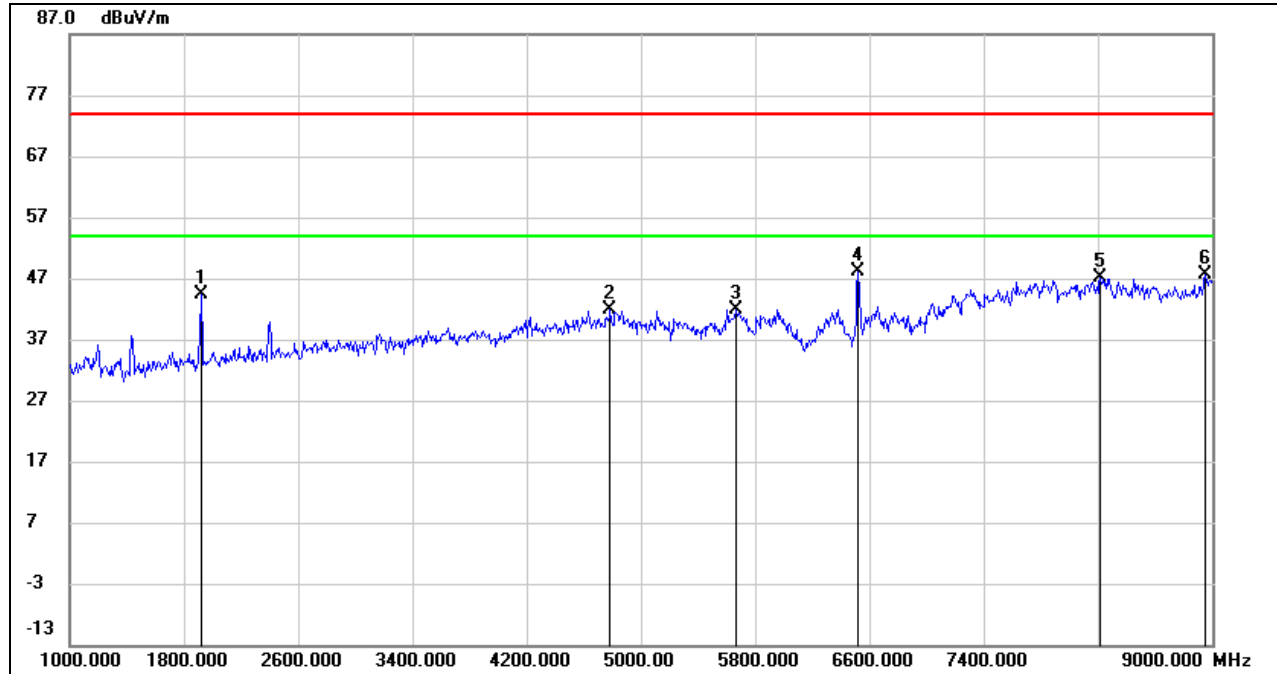

No.	Frequency (MHz)	Reading (dBuV)	Correct (dB/m)	Result (dBuV/m)	Limit (dBuV/m)	Margin (dB)	Remark
1	1920.000	54.56	-10.13	44.43	74.00	-29.57	peak
2	4784.000	41.28	0.49	41.77	74.00	-32.23	peak
3	5664.000	39.35	2.48	41.83	74.00	-32.17	peak
4	6520.000	42.99	5.04	48.03	74.00	-25.97	peak
5	8216.000	37.93	9.30	47.23	74.00	-26.77	peak
6	8952.000	37.60	10.12	47.72	74.00	-26.28	peak

Note: 1. Measurement = Reading Level + Correct Factor.

2. If Peak Result complies with AV limit, AV Result is deemed to comply with AV limit.

3. Peak: Peak detector.

4. Filter losses were only considered in the spurious frequency bands and the authorized band was not corrected for Band reject filter losses.

5. Proper operation of the transmitter prior to adding the filter to the measurement chain.

6. Since non-restricted band peak emissions are less than the average limit, they also comply with the -27dBm/MHz (68.2dBuV/m) limit.

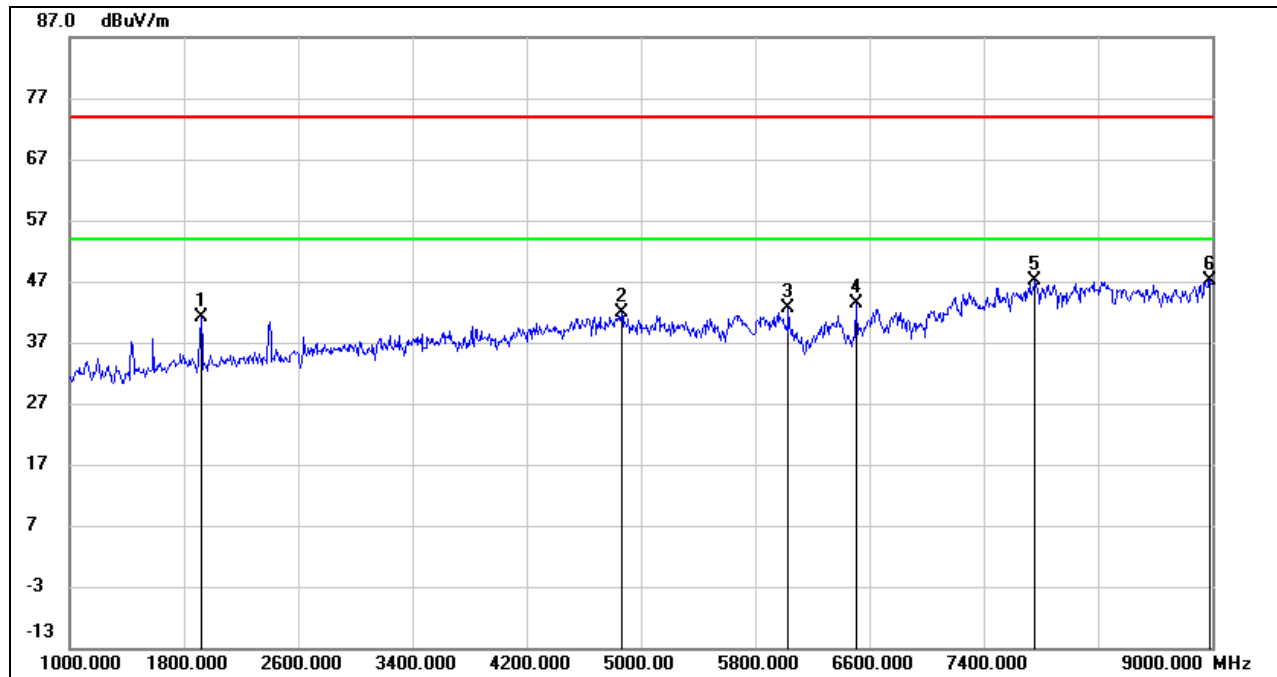
**HARMONICS AND SPURIOUS EMISSIONS (HIGH CHANNEL, VERTICAL)**

No.	Frequency (MHz)	Reading (dBuV)	Correct (dB/m)	Result (dBuV/m)	Limit (dBuV/m)	Margin (dB)	Remark
1	1920.000	51.30	-10.13	41.17	74.00	-32.83	peak
2	4864.000	41.09	0.69	41.78	74.00	-32.22	peak
3	6032.000	39.29	3.29	42.58	74.00	-31.42	peak
4	6504.000	38.41	4.95	43.36	74.00	-30.64	peak
5	7760.000	39.10	8.09	47.19	74.00	-26.81	peak
6	8984.000	36.63	10.46	47.09	74.00	-26.91	peak

Note: 1. Measurement = Reading Level + Correct Factor.

2. If Peak Result complies with AV limit, AV Result is deemed to comply with AV limit.

3. Peak: Peak detector.

4. Filter losses were only considered in the spurious frequency bands and the authorized band was not corrected for Band reject filter losses.

5. Proper operation of the transmitter prior to adding the filter to the measurement chain.

6. Since non-restricted band peak emissions are less than the average limit, they also comply with the -27dBm/MHz (68.2dBuV/m) limit.

UNII-7 BAND

HARMONICS AND SPURIOUS EMISSIONS (LOW CHANNEL, HORIZONTAL)

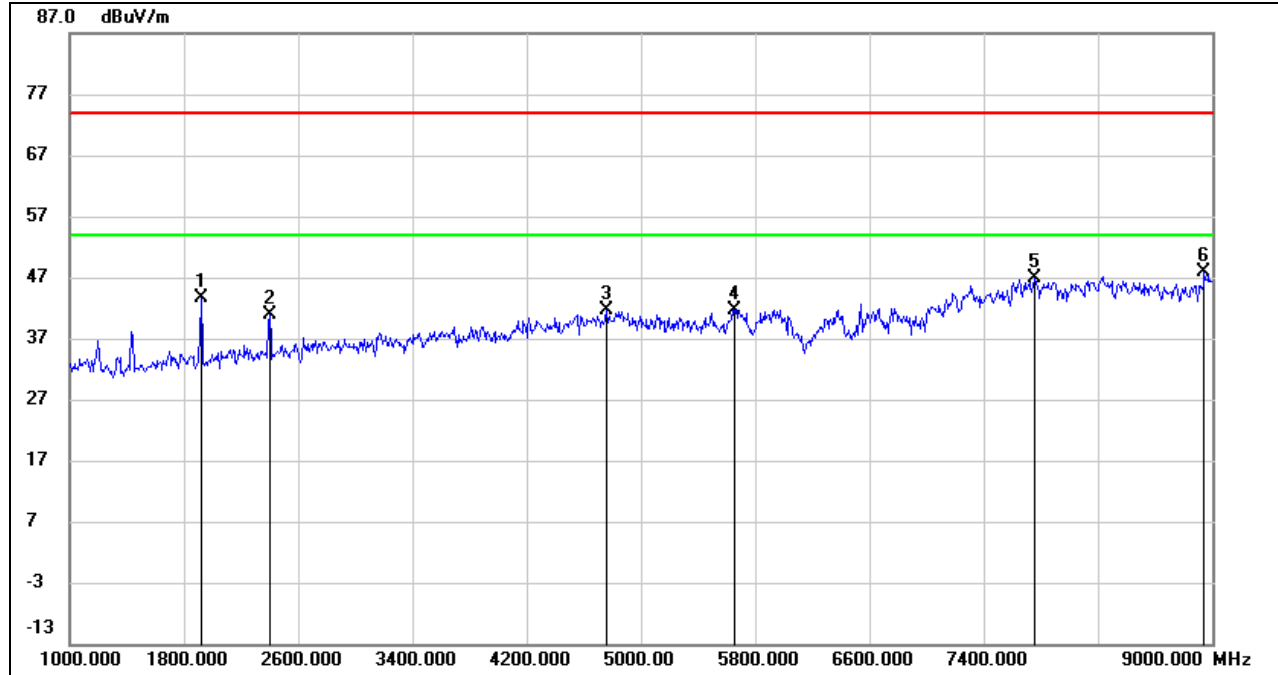

No.	Frequency (MHz)	Reading (dBuV)	Correct (dB/m)	Result (dBuV/m)	Limit (dBuV/m)	Margin (dB)	Remark
1	1920.000	53.67	-10.13	43.54	74.00	-30.46	peak
2	2400.000	49.35	-8.40	40.95	74.00	-33.05	peak
3	4760.000	41.17	0.35	41.52	74.00	-32.48	peak
4	5656.000	39.21	2.47	41.68	74.00	-32.32	peak
5	7760.000	38.90	8.09	46.99	74.00	-27.01	peak
6	8944.000	37.78	10.04	47.82	74.00	-26.18	peak

Note: 1. Measurement = Reading Level + Correct Factor.
 2. If Peak Result complies with AV limit, AV Result is deemed to comply with AV limit.
 3. Peak: Peak detector.
 4. Filter losses were only considered in the spurious frequency bands and the authorized band was not corrected for Band reject filter losses.
 5. Proper operation of the transmitter prior to adding the filter to the measurement chain.
 6. Since non-restricted band peak emissions are less than the average limit, they also comply with the -27dBm/MHz (68.2dBuV/m) limit.



HARMONICS AND SPURIOUS EMISSIONS (LOW CHANNEL, VERTICAL)

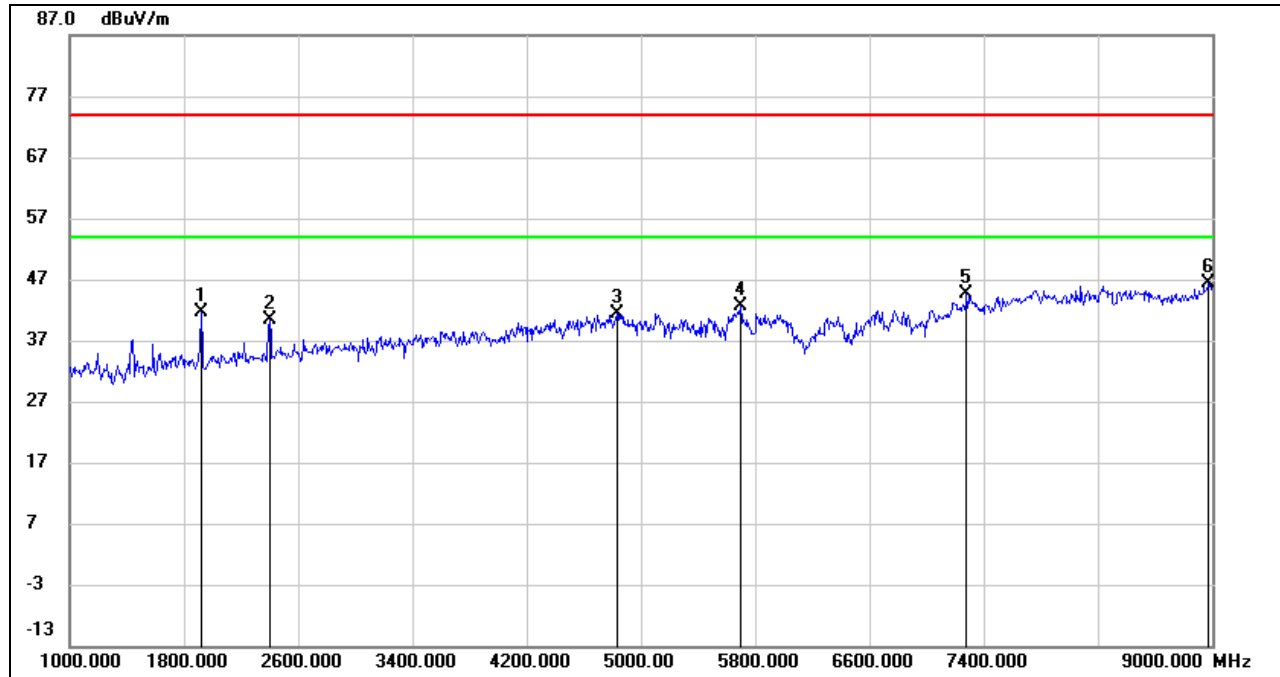

No.	Frequency (MHz)	Reading (dBuV)	Correct (dB/m)	Result (dBuV/m)	Limit (dBuV/m)	Margin (dB)	Remark
1	1920.000	51.75	-10.13	41.62	74.00	-32.38	peak
2	2400.000	48.81	-8.40	40.41	74.00	-33.59	peak
3	4832.000	40.69	0.64	41.33	74.00	-32.67	peak
4	5696.000	40.13	2.49	42.62	74.00	-31.38	peak
5	7280.000	37.39	7.28	44.67	74.00	-29.33	peak
6	8976.000	36.07	10.38	46.45	74.00	-27.55	peak

- Note: 1. Measurement = Reading Level + Correct Factor.
 2. If Peak Result complies with AV limit, AV Result is deemed to comply with AV limit.
 3. Peak: Peak detector.
 4. Filter losses were only considered in the spurious frequency bands and the authorized band was not corrected for Band reject filter losses.
 5. Proper operation of the transmitter prior to adding the filter to the measurement chain.
 6. Since non-restricted band peak emissions are less than the average limit, they also comply with the -27dBm/MHz (68.2dBuV/m) limit.

HARMONICS AND SPURIOUS EMISSIONS (MID CHANNEL, HORIZONTAL)

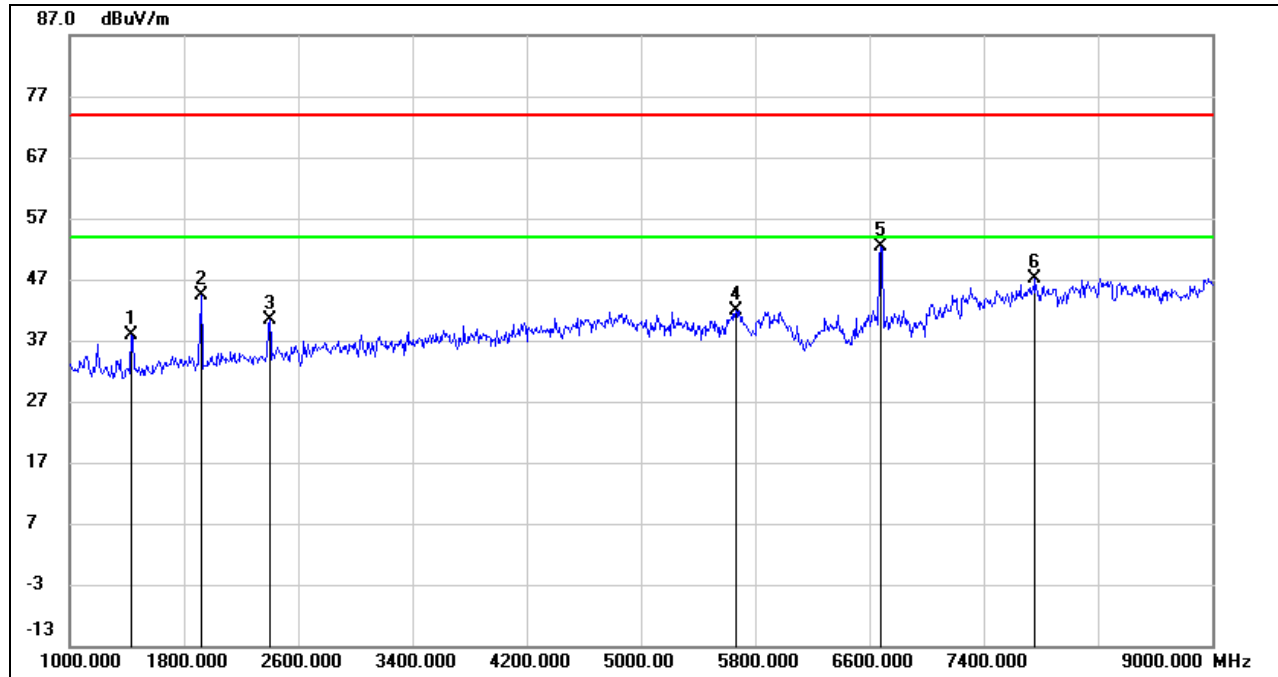

No.	Frequency (MHz)	Reading (dBuV)	Correct (dB/m)	Result (dBuV/m)	Limit (dBuV/m)	Margin (dB)	Remark
1	1432.000	50.54	-12.55	37.99	74.00	-36.01	peak
2	1920.000	54.53	-10.13	44.40	74.00	-29.60	peak
3	2400.000	48.86	-8.40	40.46	74.00	-33.54	peak
4	5664.000	39.33	2.48	41.81	74.00	-32.19	peak
5	6680.000	46.97	5.52	52.49	74.00	-21.51	peak
6	7760.000	39.02	8.09	47.11	74.00	-26.89	peak

- Note: 1. Measurement = Reading Level + Correct Factor.
 2. If Peak Result complies with AV limit, AV Result is deemed to comply with AV limit.
 3. Peak: Peak detector.
 4. Filter losses were only considered in the spurious frequency bands and the authorized band was not corrected for Band reject filter losses.
 5. Proper operation of the transmitter prior to adding the filter to the measurement chain.
 6. Since non-restricted band peak emissions are less than the average limit, they also comply with the -27dBm/MHz (68.2dBuV/m) limit.

HARMONICS AND SPURIOUS EMISSIONS (MID CHANNEL, VERTICAL)

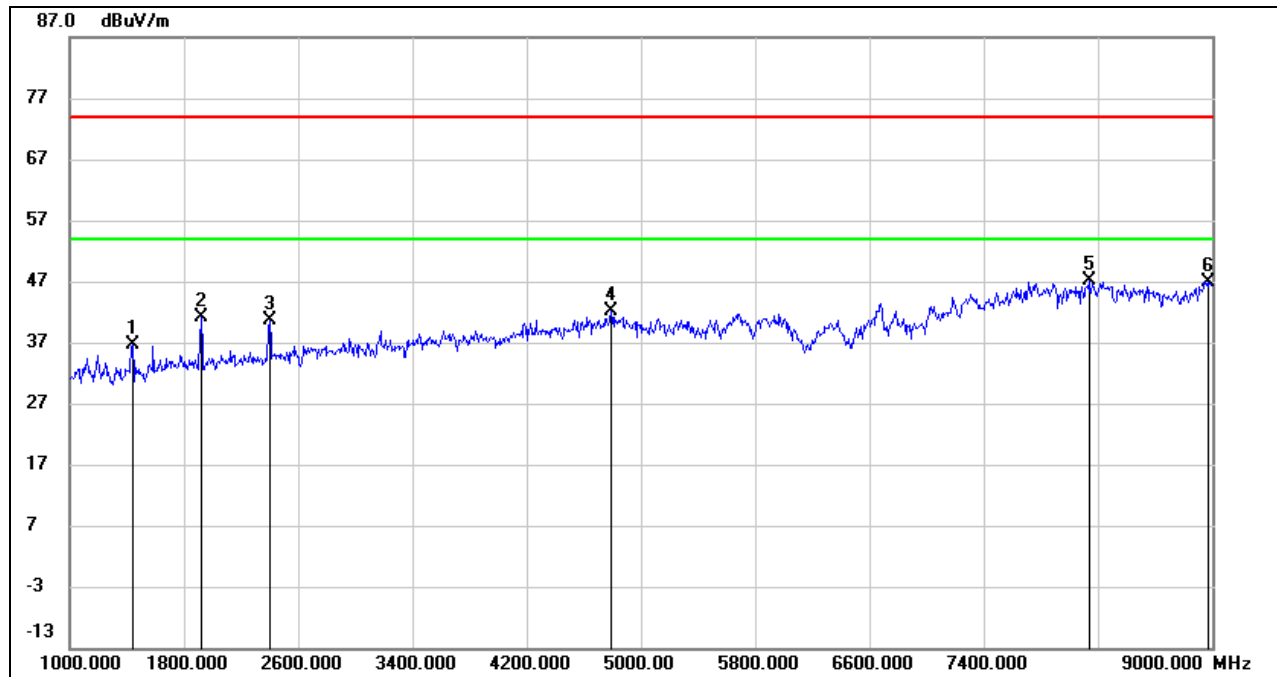

No.	Frequency (MHz)	Reading (dBuV)	Correct (dB/m)	Result (dBuV/m)	Limit (dBuV/m)	Margin (dB)	Remark
1	1440.000	49.16	-12.51	36.65	74.00	-37.35	peak
2	1920.000	51.27	-10.13	41.14	74.00	-32.86	peak
3	2400.000	49.06	-8.40	40.66	74.00	-33.34	peak
4	4792.000	41.54	0.54	42.08	74.00	-31.92	peak
5	8136.000	38.30	8.81	47.11	74.00	-26.89	peak
6	8968.000	36.70	10.29	46.99	74.00	-27.01	peak

Note: 1. Measurement = Reading Level + Correct Factor.

2. If Peak Result complies with AV limit, AV Result is deemed to comply with AV limit.

3. Peak: Peak detector.

4. Filter losses were only considered in the spurious frequency bands and the authorized band was not corrected for Band reject filter losses.

5. Proper operation of the transmitter prior to adding the filter to the measurement chain.

6. Since non-restricted band peak emissions are less than the average limit, they also comply with the -27dBm/MHz (68.2dBuV/m) limit.

HARMONICS AND SPURIOUS EMISSIONS (HIGH CHANNEL, HORIZONTAL)

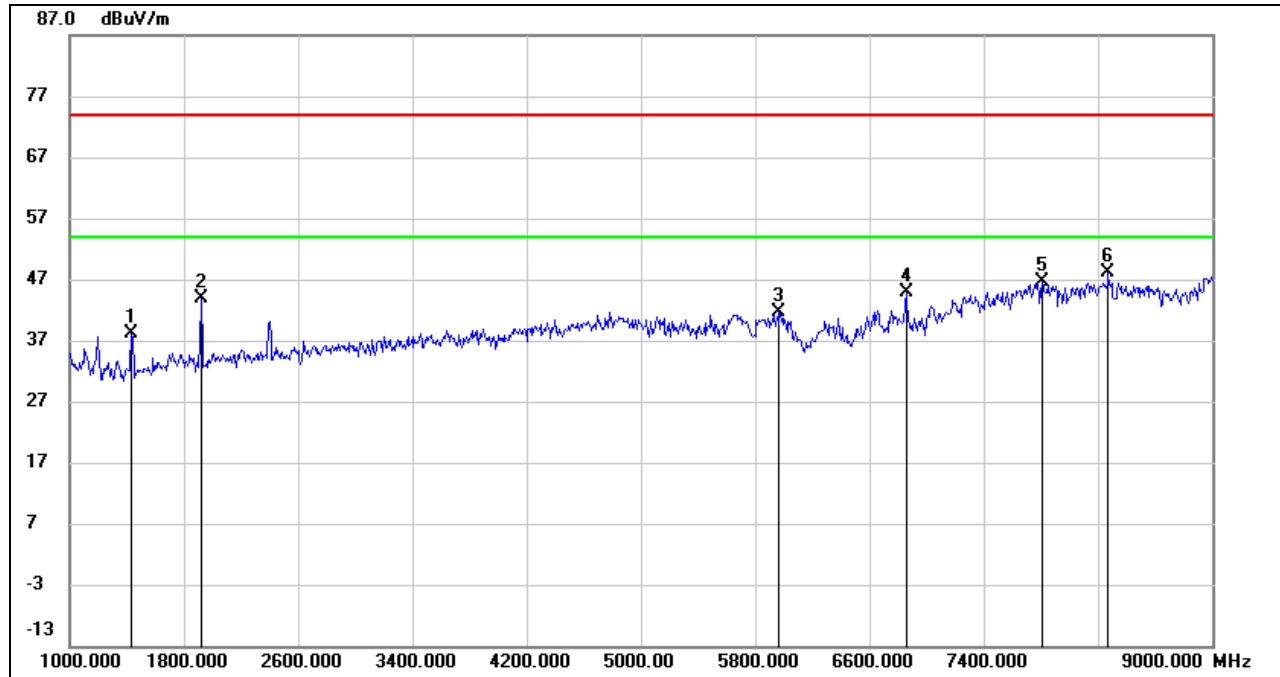

No.	Frequency (MHz)	Reading (dBuV)	Correct (dB/m)	Result (dBuV/m)	Limit (dBuV/m)	Margin (dB)	Remark
1	1432.000	50.64	-12.55	38.09	74.00	-35.91	peak
2	1920.000	54.09	-10.13	43.96	74.00	-30.04	peak
3	5968.000	38.40	3.17	41.57	74.00	-32.43	peak
4	6856.000	39.21	5.73	44.94	74.00	-29.06	peak
5	7808.000	38.31	8.23	46.54	74.00	-27.46	peak
6	8272.000	38.92	9.09	48.01	74.00	-25.99	peak

Note: 1. Measurement = Reading Level + Correct Factor.
 2. If Peak Result complies with AV limit, AV Result is deemed to comply with AV limit.
 3. Peak: Peak detector.
 4. Filter losses were only considered in the spurious frequency bands and the authorized band was not corrected for Band reject filter losses.
 5. Proper operation of the transmitter prior to adding the filter to the measurement chain.
 6. Since non-restricted band peak emissions are less than the average limit, they also comply with the -27dBm/MHz (68.2dBuV/m) limit.

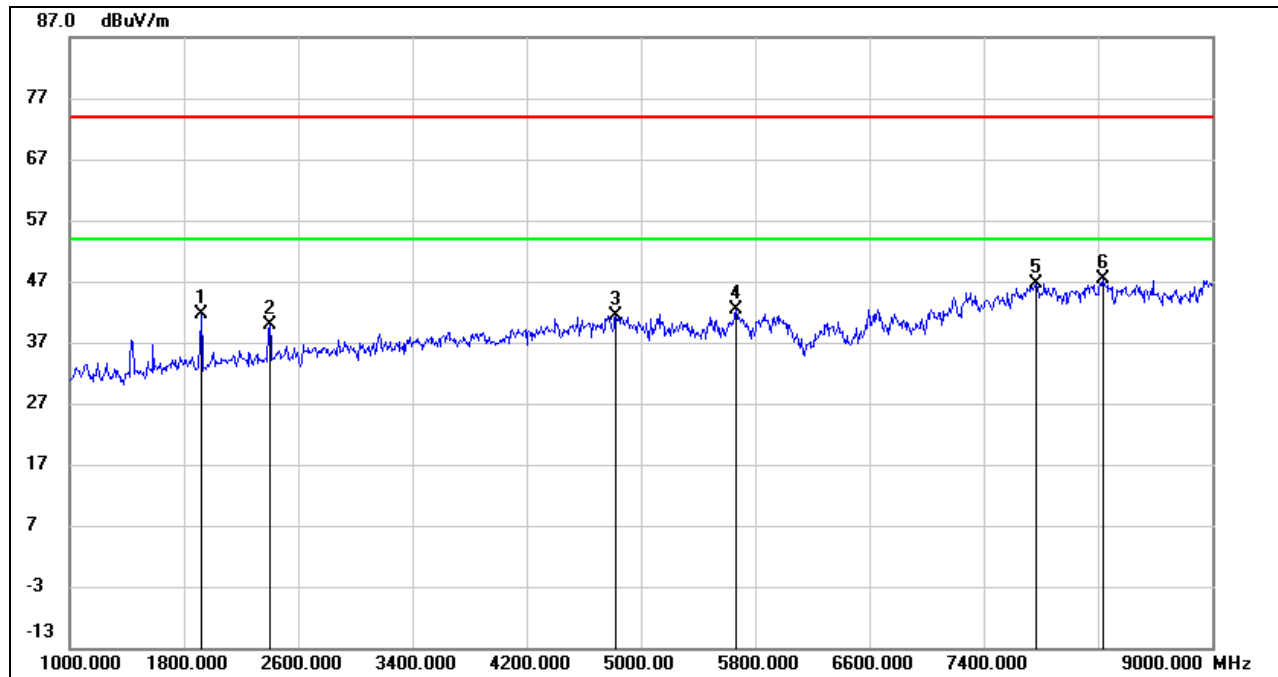
**HARMONICS AND SPURIOUS EMISSIONS (HIGH CHANNEL, VERTICAL)**

No.	Frequency (MHz)	Reading (dBuV)	Correct (dB/m)	Result (dBuV/m)	Limit (dBuV/m)	Margin (dB)	Remark
1	1920.000	51.78	-10.13	41.65	74.00	-32.35	peak
2	2400.000	48.22	-8.40	39.82	74.00	-34.18	peak
3	4824.000	40.84	0.62	41.46	74.00	-32.54	peak
4	5664.000	39.84	2.48	42.32	74.00	-31.68	peak
5	7768.000	38.45	8.12	46.57	74.00	-27.43	peak
6	8232.000	38.18	9.23	47.41	74.00	-26.59	peak

Note: 1. Measurement = Reading Level + Correct Factor.

2. If Peak Result complies with AV limit, AV Result is deemed to comply with AV limit.

3. Peak: Peak detector.

4. Filter losses were only considered in the spurious frequency bands and the authorized band was not corrected for Band reject filter losses.

5. Proper operation of the transmitter prior to adding the filter to the measurement chain.

6. Since non-restricted band peak emissions are less than the average limit, they also comply with the -27dBm/MHz (68.2dBuV/m) limit.

UNII-8 BAND

HARMONICS AND SPURIOUS EMISSIONS (LOW CHANNEL, HORIZONTAL)

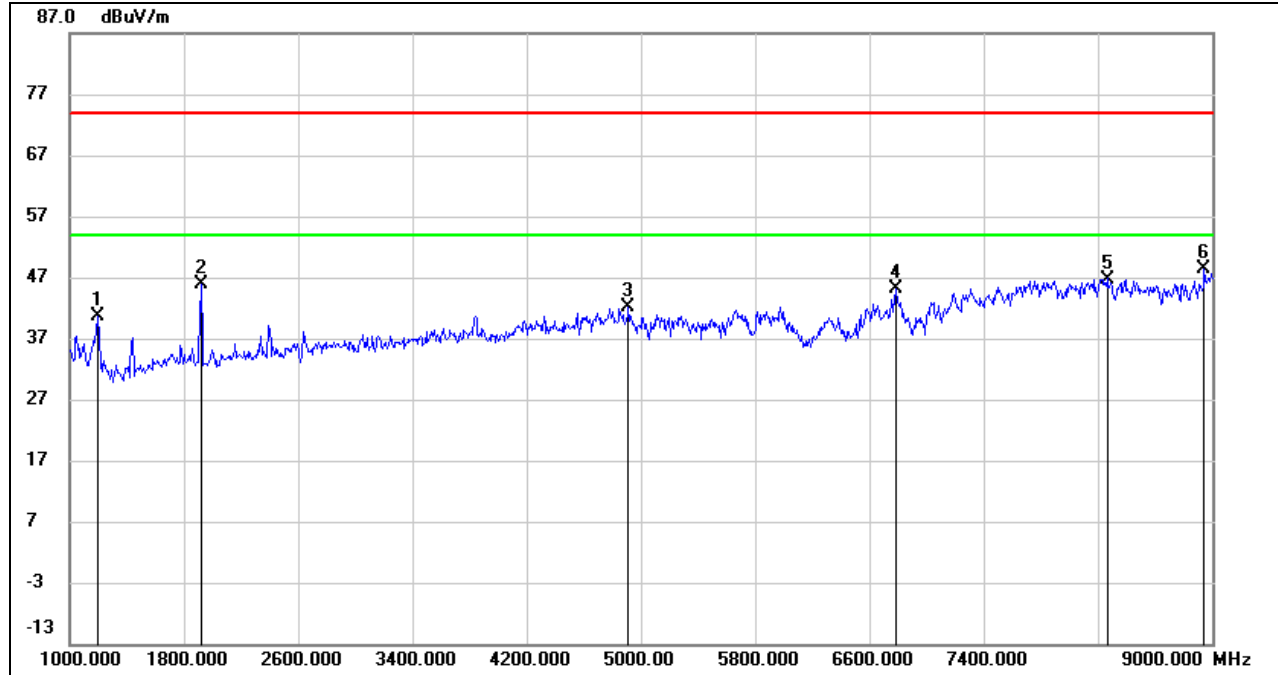

No.	Frequency (MHz)	Reading (dBuV)	Correct (dB/m)	Result (dBuV/m)	Limit (dBuV/m)	Margin (dB)	Remark
1	1192.000	53.63	-13.03	40.60	74.00	-33.40	peak
2	1920.000	56.07	-10.13	45.94	74.00	-28.06	peak
3	4912.000	41.36	0.77	42.13	74.00	-31.87	peak
4	6784.000	39.51	5.56	45.07	74.00	-28.93	peak
5	8264.000	37.63	9.12	46.75	74.00	-27.25	peak
6	8944.000	38.35	10.04	48.39	74.00	-25.61	peak

Note: 1. Measurement = Reading Level + Correct Factor.
 2. If Peak Result complies with AV limit, AV Result is deemed to comply with AV limit.
 3. Peak: Peak detector.
 4. Filter losses were only considered in the spurious frequency bands and the authorized band was not corrected for Band reject filter losses.
 5. Proper operation of the transmitter prior to adding the filter to the measurement chain.
 6. Since non-restricted band peak emissions are less than the average limit, they also comply with the -27dBm/MHz (68.2dBuV/m) limit.

HARMONICS AND SPURIOUS EMISSIONS (LOW CHANNEL, VERTICAL)

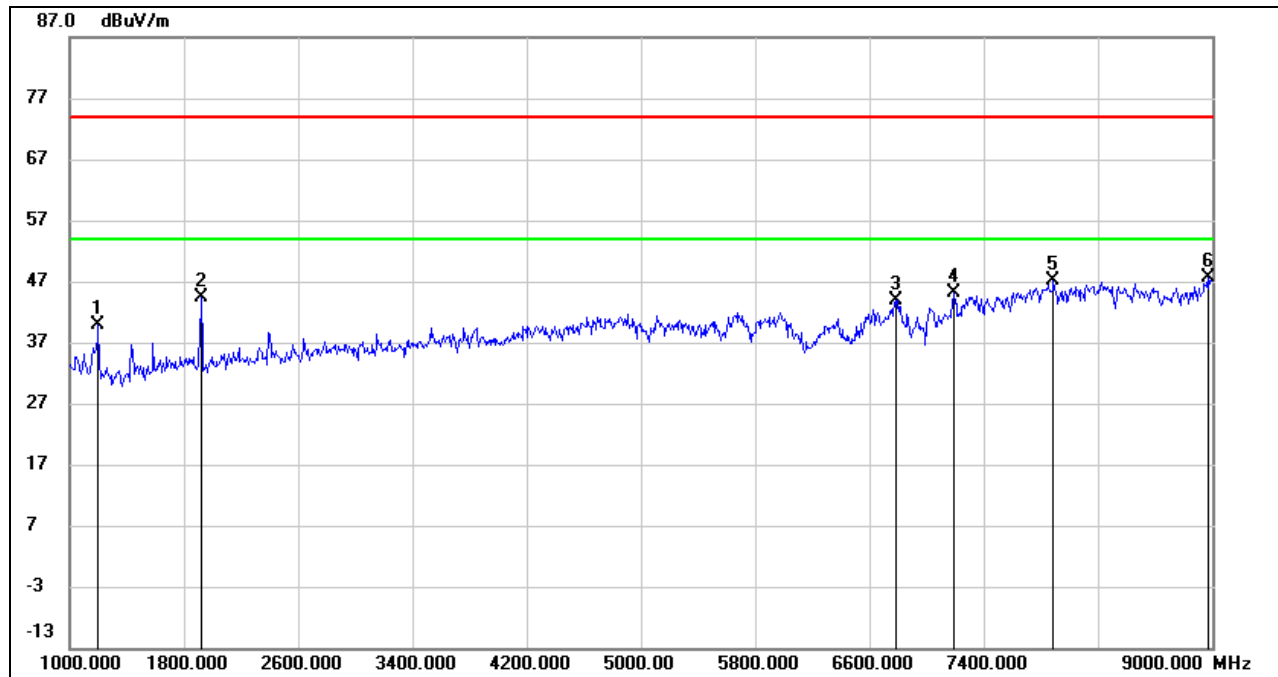

No.	Frequency (MHz)	Reading (dBuV)	Correct (dB/m)	Result (dBuV/m)	Limit (dBuV/m)	Margin (dB)	Remark
1	1200.000	52.98	-12.99	39.99	74.00	-34.01	peak
2	1920.000	54.53	-10.13	44.40	74.00	-29.60	peak
3	6784.000	38.38	5.56	43.94	74.00	-30.06	peak
4	7192.000	38.10	6.94	45.04	74.00	-28.96	peak
5	7888.000	39.05	7.99	47.04	74.00	-26.96	peak
6	8968.000	37.38	10.29	47.67	74.00	-26.33	peak

Note: 1. Measurement = Reading Level + Correct Factor.

2. If Peak Result complies with AV limit, AV Result is deemed to comply with AV limit.

3. Peak: Peak detector.

4. Filter losses were only considered in the spurious frequency bands and the authorized band was not corrected for Band reject filter losses.

5. Proper operation of the transmitter prior to adding the filter to the measurement chain.

6. Since non-restricted band peak emissions are less than the average limit, they also comply with the -27dBm/MHz (68.2dBuV/m) limit.

HARMONICS AND SPURIOUS EMISSIONS (MID CHANNEL, HORIZONTAL)

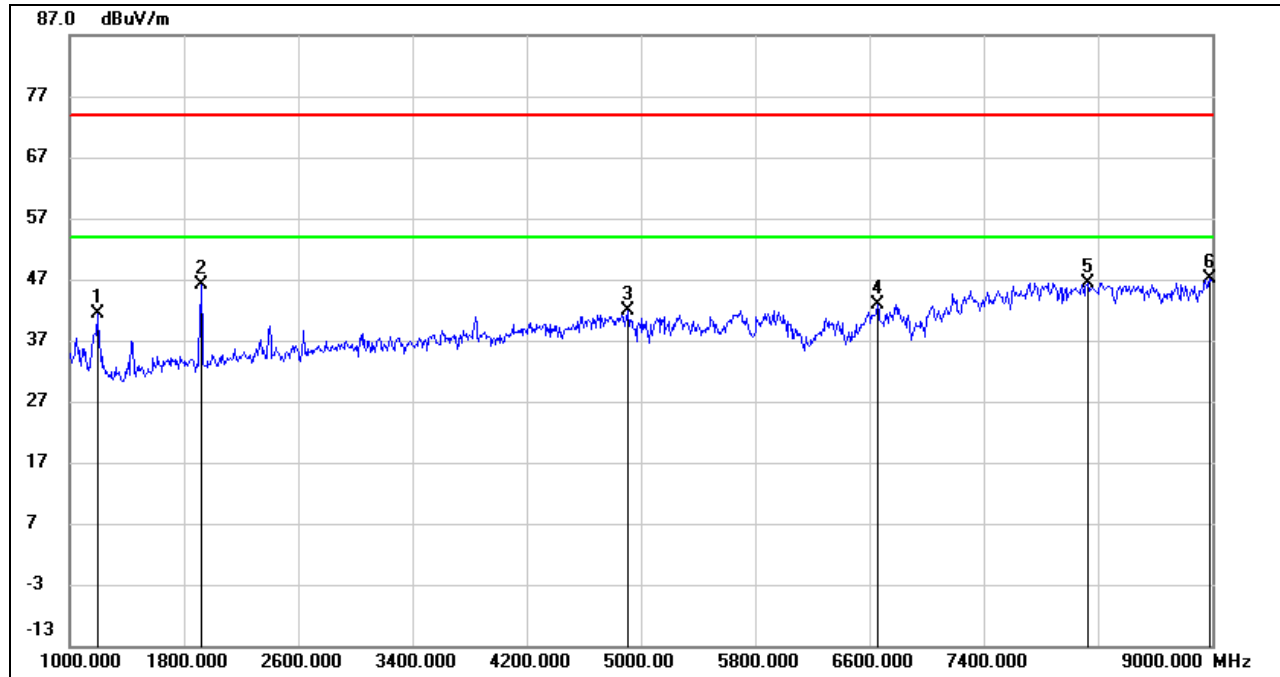

No.	Frequency (MHz)	Reading (dBuV)	Correct (dB/m)	Result (dBuV/m)	Limit (dBuV/m)	Margin (dB)	Remark
1	1192.000	54.44	-13.03	41.41	74.00	-32.59	peak
2	1920.000	56.37	-10.13	46.24	74.00	-27.76	peak
3	4912.000	41.12	0.77	41.89	74.00	-32.11	peak
4	6656.000	37.25	5.52	42.77	74.00	-31.23	peak
5	8128.000	37.71	8.74	46.45	74.00	-27.55	peak
6	8984.000	36.66	10.46	47.12	74.00	-26.88	peak

Note: 1. Measurement = Reading Level + Correct Factor.
 2. If Peak Result complies with AV limit, AV Result is deemed to comply with AV limit.
 3. Peak: Peak detector.
 4. Filter losses were only considered in the spurious frequency bands and the authorized band was not corrected for Band reject filter losses.
 5. Proper operation of the transmitter prior to adding the filter to the measurement chain.
 6. Since non-restricted band peak emissions are less than the average limit, they also comply with the -27dBm/MHz (68.2dBuV/m) limit.

HARMONICS AND SPURIOUS EMISSIONS (MID CHANNEL, VERTICAL)

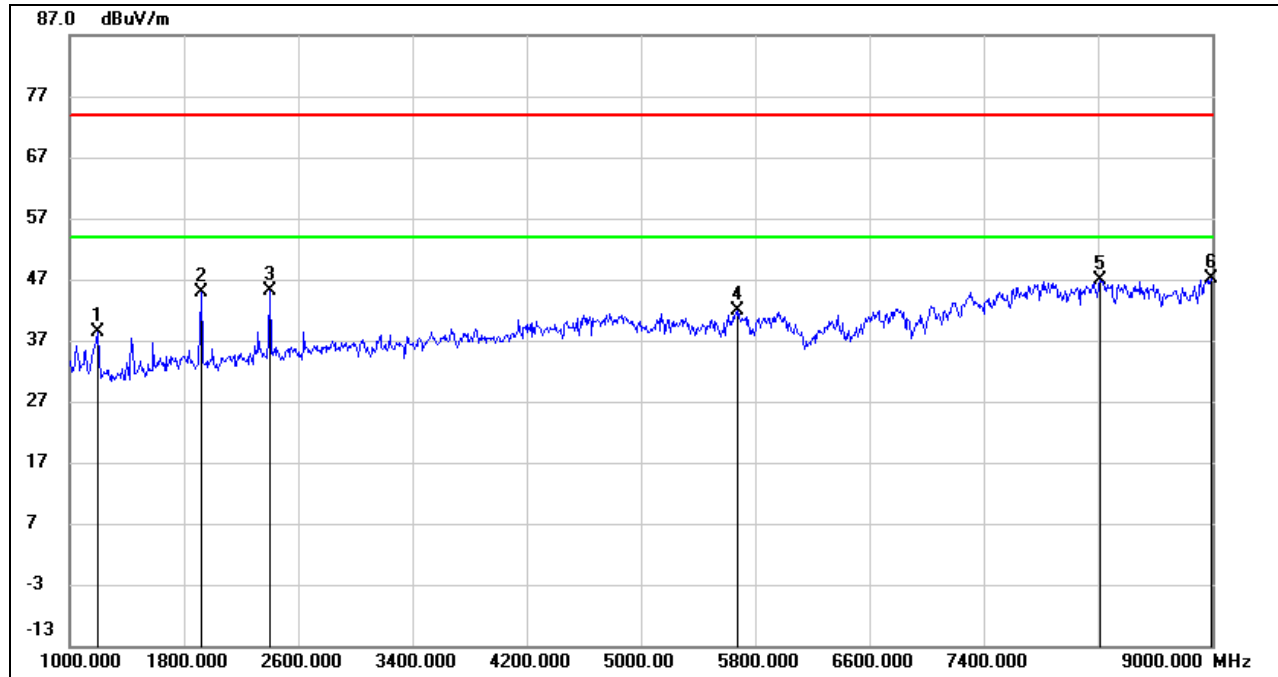

No.	Frequency (MHz)	Reading (dBuV)	Correct (dB/m)	Result (dBuV/m)	Limit (dBuV/m)	Margin (dB)	Remark
1	1192.000	51.50	-13.03	38.47	74.00	-35.53	peak
2	1920.000	54.97	-10.13	44.84	74.00	-29.16	peak
3	2400.000	53.57	-8.40	45.17	74.00	-28.83	peak
4	5680.000	39.29	2.48	41.77	74.00	-32.23	peak
5	8216.000	37.69	9.30	46.99	74.00	-27.01	peak
6	8992.000	36.50	10.54	47.04	74.00	-26.96	peak

Note: 1. Measurement = Reading Level + Correct Factor.
 2. If Peak Result complies with AV limit, AV Result is deemed to comply with AV limit.
 3. Peak: Peak detector.
 4. Filter losses were only considered in the spurious frequency bands and the authorized band was not corrected for Band reject filter losses.
 5. Proper operation of the transmitter prior to adding the filter to the measurement chain.
 6. Since non-restricted band peak emissions are less than the average limit, they also comply with the -27dBm/MHz (68.2dBuV/m) limit.



HARMONICS AND SPURIOUS EMISSIONS (HIGH CHANNEL, HORIZONTAL)

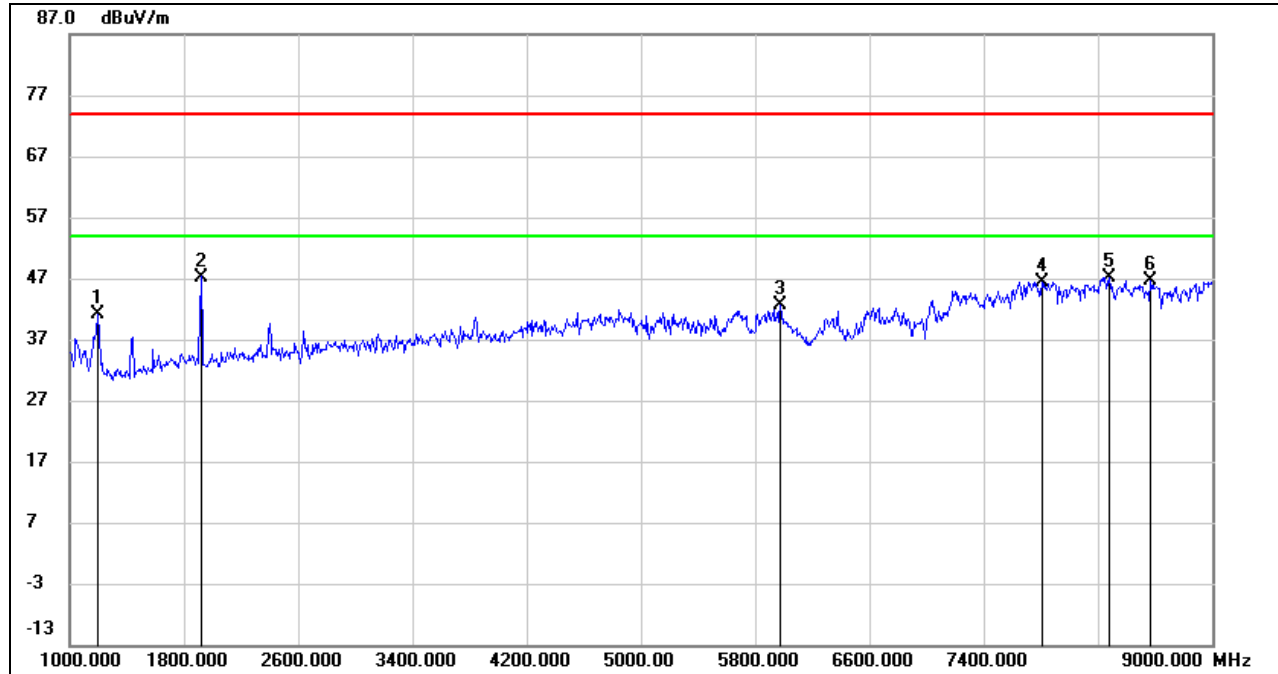

No.	Frequency (MHz)	Reading (dBuV)	Correct (dB/m)	Result (dBuV/m)	Limit (dBuV/m)	Margin (dB)	Remark
1	1200.000	54.16	-12.99	41.17	74.00	-32.83	peak
2	1920.000	57.38	-10.13	47.25	74.00	-26.75	peak
3	5976.000	39.45	3.20	42.65	74.00	-31.35	peak
4	7808.000	38.23	8.23	46.46	74.00	-27.54	peak
5	8280.000	38.08	9.05	47.13	74.00	-26.87	peak
6	8568.000	38.10	8.54	46.64	74.00	-27.36	peak

Note: 1. Measurement = Reading Level + Correct Factor.
 2. If Peak Result complies with AV limit, AV Result is deemed to comply with AV limit.
 3. Peak: Peak detector.
 4. Filter losses were only considered in the spurious frequency bands and the authorized band was not corrected for Band reject filter losses.
 5. Proper operation of the transmitter prior to adding the filter to the measurement chain.
 6. Since non-restricted band peak emissions are less than the average limit, they also comply with the -27dBm/MHz (68.2dBuV/m) limit.

HARMONICS AND SPURIOUS EMISSIONS (HIGH CHANNEL, VERTICAL)

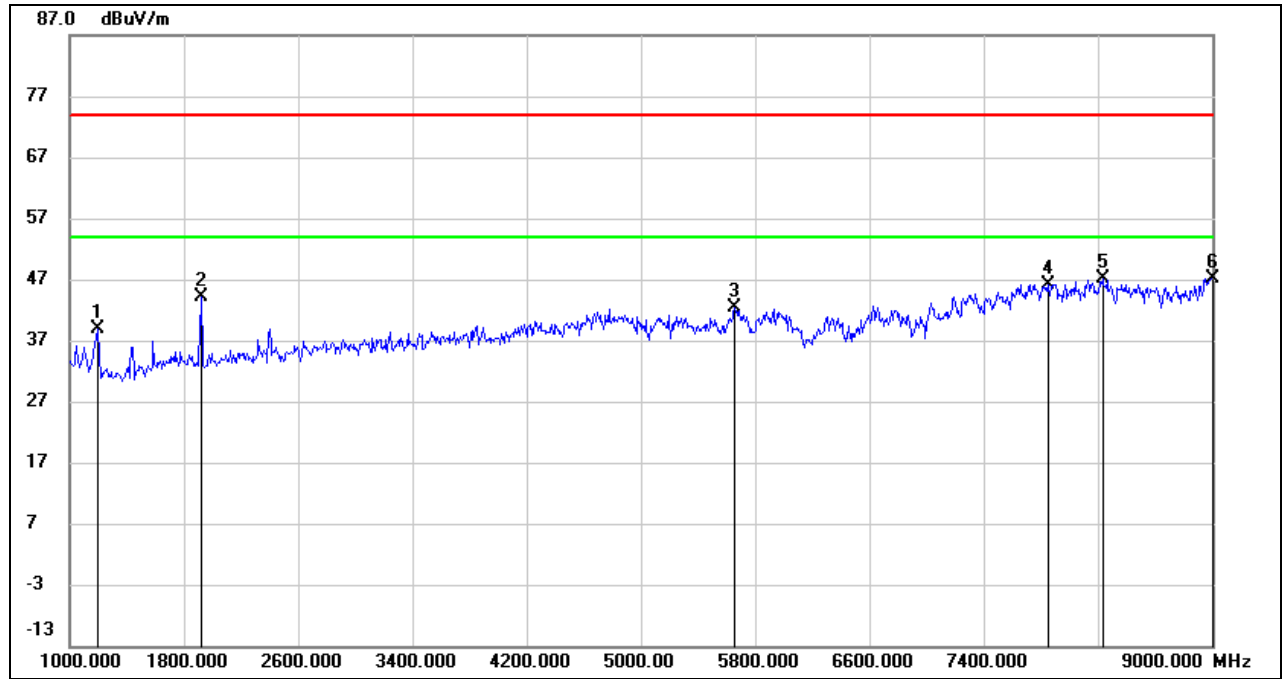

No.	Frequency (MHz)	Reading (dBuV)	Correct (dB/m)	Result (dBuV/m)	Limit (dBuV/m)	Margin (dB)	Remark
1	1200.000	51.90	-12.99	38.91	74.00	-35.09	peak
2	1920.000	54.34	-10.13	44.21	74.00	-29.79	peak
3	5656.000	39.96	2.47	42.43	74.00	-31.57	peak
4	7848.000	38.04	8.11	46.15	74.00	-27.85	peak
5	8232.000	37.87	9.23	47.10	74.00	-26.90	peak
6	9000.000	36.53	10.63	47.16	74.00	-26.84	peak

- Note: 1. Measurement = Reading Level + Correct Factor.
 2. If Peak Result complies with AV limit, AV Result is deemed to comply with AV limit.
 3. Peak: Peak detector.
 4. Filter losses were only considered in the spurious frequency bands and the authorized band was not corrected for Band reject filter losses.
 5. Proper operation of the transmitter prior to adding the filter to the measurement chain.
 6. Since non-restricted band peak emissions are less than the average limit, they also comply with the -27dBm/MHz (68.2dBuV/m) limit.

Note: All the modes had been tested, but only the worst data was recorded in the report.

8.3. SPURIOUS EMISSIONS (9 GHz ~ 18 GHz)

8.3.1. 802.11ax HE20 CDD MODE

UNII-5 BAND

HARMONICS AND SPURIOUS EMISSIONS (LOW CHANNEL, HORIZONTAL)

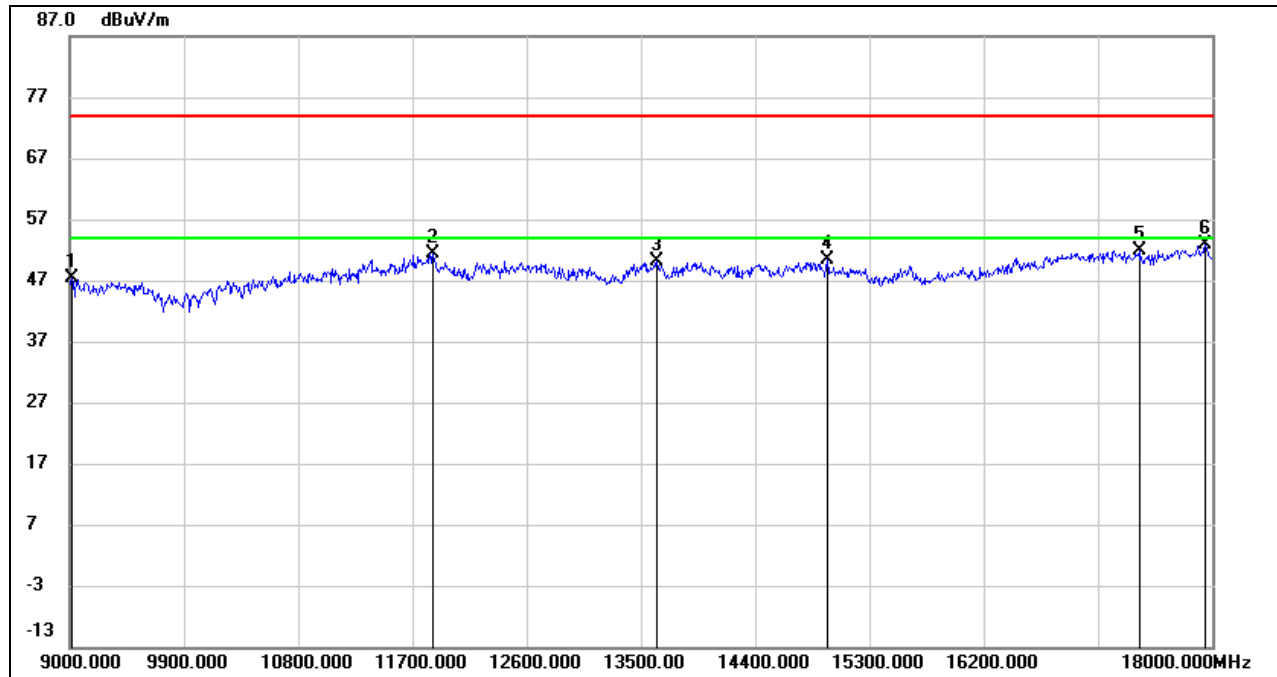

No.	Frequency (MHz)	Reading (dBuV)	Correct (dB/m)	Result (dBuV/m)	Limit (dBuV/m)	Margin (dB)	Remark
1	9018.000	37.00	10.50	47.50	74.00	-26.50	peak
2	11862.000	35.81	15.52	51.33	74.00	-22.67	peak
3	13626.000	33.56	16.50	50.06	74.00	-23.94	peak
4	14967.000	33.56	16.88	50.44	74.00	-23.56	peak
5	17424.000	31.20	20.75	51.95	74.00	-22.05	peak
6	17946.000	30.25	22.69	52.94	74.00	-21.06	peak

- Note: 1. Measurement = Reading Level + Correct Factor.
 2. If Peak Result complies with AV limit, AV Result is deemed to comply with AV limit.
 3. Peak: Peak detector.
 4. Filter losses were only considered in the spurious frequency bands and the authorized band was not corrected for High Pass Filter losses.
 5. Proper operation of the transmitter prior to adding the filter to the measurement chain.
 6. Since non-restricted band peak emissions are less than the average limit, they also comply with the -27dBm/MHz (68.2dBuV/m) limit.

HARMONICS AND SPURIOUS EMISSIONS (LOW CHANNEL, VERTICAL)

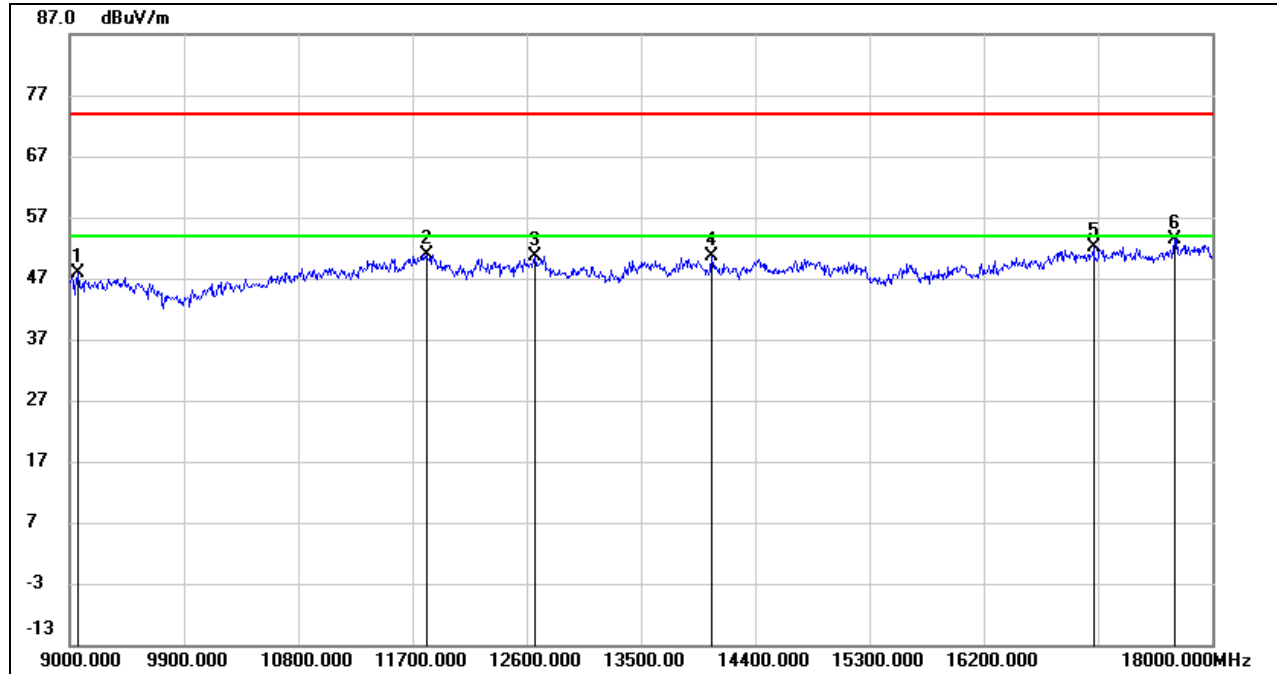

No.	Frequency (MHz)	Reading (dBuV)	Correct (dB/m)	Result (dBuV/m)	Limit (dBuV/m)	Margin (dB)	Remark
1	9063.000	37.79	10.21	48.00	74.00	-26.00	peak
2	11808.000	35.37	15.61	50.98	74.00	-23.02	peak
3	12663.000	35.30	15.40	50.70	74.00	-23.30	peak
4	14058.000	33.87	16.81	50.68	74.00	-23.32	peak
5	17064.000	31.54	20.49	52.03	74.00	-21.97	peak
6	17703.000	31.49	21.96	53.45	74.00	-20.55	peak

Note: 1. Measurement = Reading Level + Correct Factor.

2. If Peak Result complies with AV limit, AV Result is deemed to comply with AV limit.

3. Peak: Peak detector.

4. Filter losses were only considered in the spurious frequency bands and the authorized band was not corrected for High Pass Filter losses.

5. Proper operation of the transmitter prior to adding the filter to the measurement chain.

6. Since non-restricted band peak emissions are less than the average limit, they also comply with the -27dBm/MHz (68.2dBuV/m) limit.

HARMONICS AND SPURIOUS EMISSIONS (MID CHANNEL, HORIZONTAL)

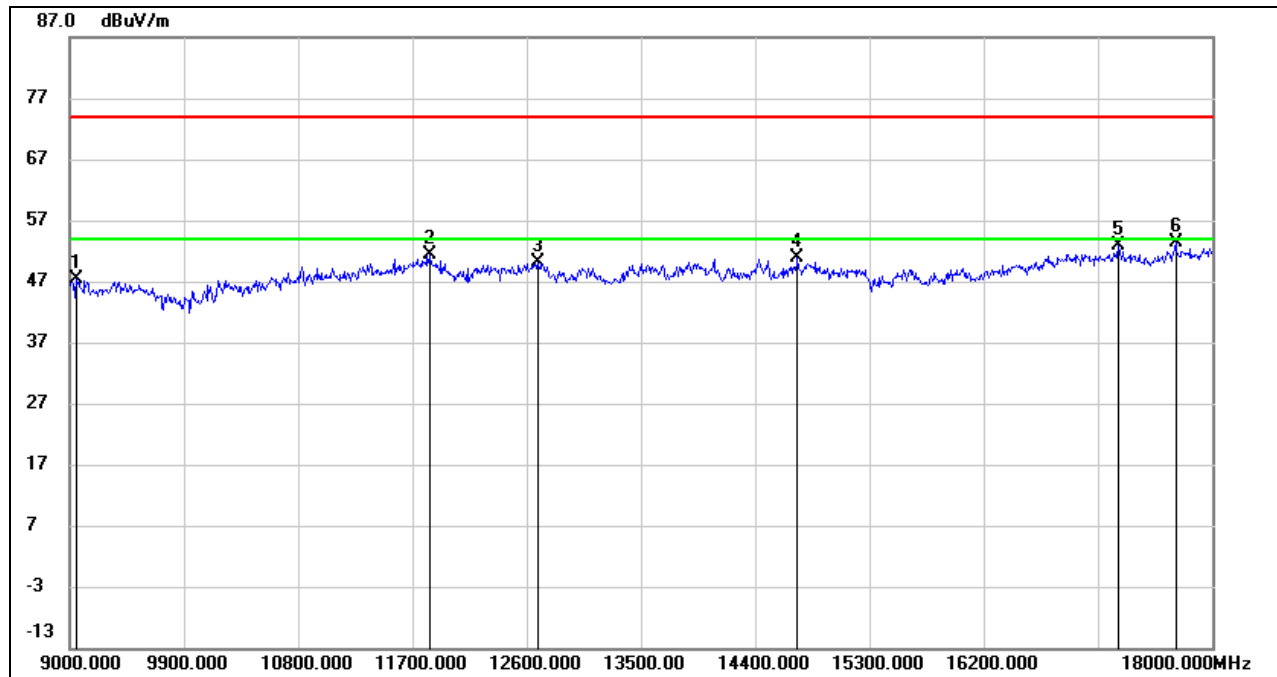

No.	Frequency (MHz)	Reading (dBuV)	Correct (dB/m)	Result (dBuV/m)	Limit (dBuV/m)	Margin (dB)	Remark
1	9054.000	37.15	10.26	47.41	74.00	-26.59	peak
2	11835.000	35.88	15.56	51.44	74.00	-22.56	peak
3	12690.000	34.57	15.45	50.02	74.00	-23.98	peak
4	14733.000	34.07	16.69	50.76	74.00	-23.24	peak
5	17262.000	31.90	20.95	52.85	74.00	-21.15	peak
6	17712.000	31.29	22.03	53.32	74.00	-20.68	peak

Note: 1. Measurement = Reading Level + Correct Factor.

2. If Peak Result complies with AV limit, AV Result is deemed to comply with AV limit.

3. Peak: Peak detector.

4. Filter losses were only considered in the spurious frequency bands and the authorized band was not corrected for High Pass Filter losses.

5. Proper operation of the transmitter prior to adding the filter to the measurement chain.

6. Since non-restricted band peak emissions are less than the average limit, they also comply with the -27dBm/MHz (68.2dBuV/m) limit.

HARMONICS AND SPURIOUS EMISSIONS (MID CHANNEL, VERTICAL)

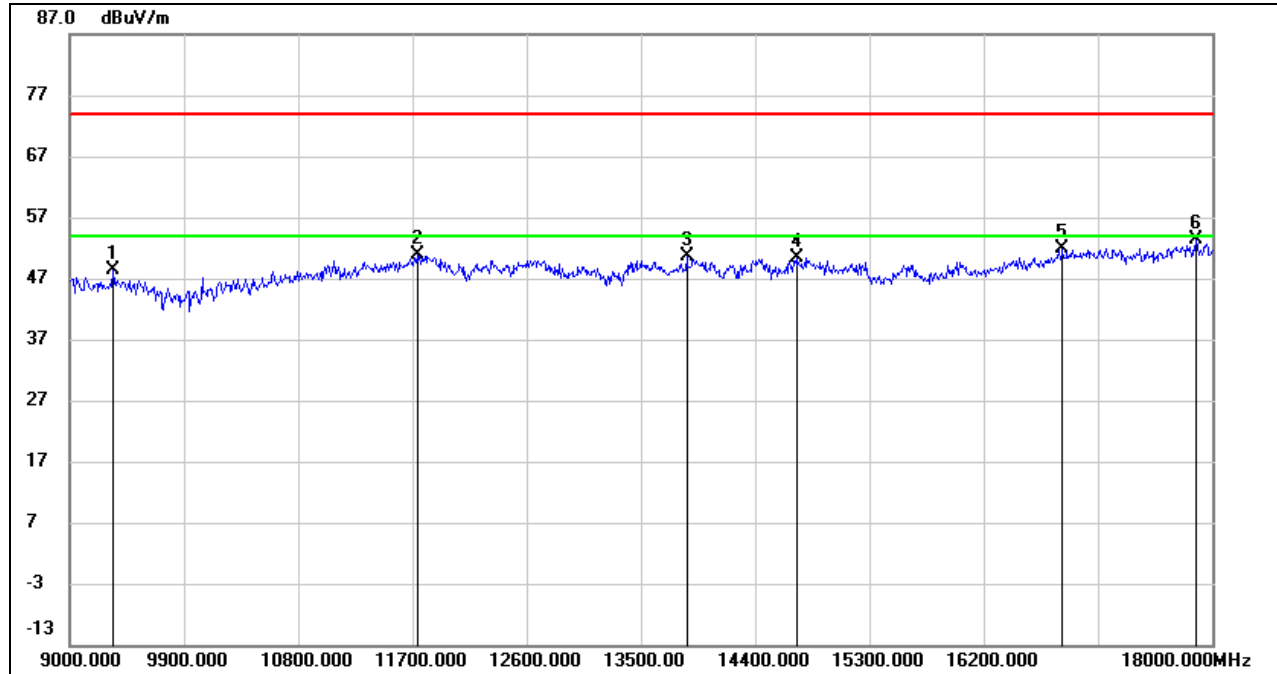

No.	Frequency (MHz)	Reading (dBuV)	Correct (dB/m)	Result (dBuV/m)	Limit (dBuV/m)	Margin (dB)	Remark
1	9342.000	38.32	10.02	48.34	74.00	-25.66	peak
2	11736.000	35.67	15.26	50.93	74.00	-23.07	peak
3	13860.000	33.71	16.92	50.63	74.00	-23.37	peak
4	14733.000	33.80	16.69	50.49	74.00	-23.51	peak
5	16821.000	32.16	19.79	51.95	74.00	-22.05	peak
6	17874.000	30.66	22.70	53.36	74.00	-20.64	peak

Note: 1. Measurement = Reading Level + Correct Factor.

2. If Peak Result complies with AV limit, AV Result is deemed to comply with AV limit.

3. Peak: Peak detector.

4. Filter losses were only considered in the spurious frequency bands and the authorized band was not corrected for High Pass Filter losses.

5. Proper operation of the transmitter prior to adding the filter to the measurement chain.

6. Since non-restricted band peak emissions are less than the average limit, they also comply with the -27dBm/MHz (68.2dBuV/m) limit.

HARMONICS AND SPURIOUS EMISSIONS (HIGH CHANNEL, HORIZONTAL)

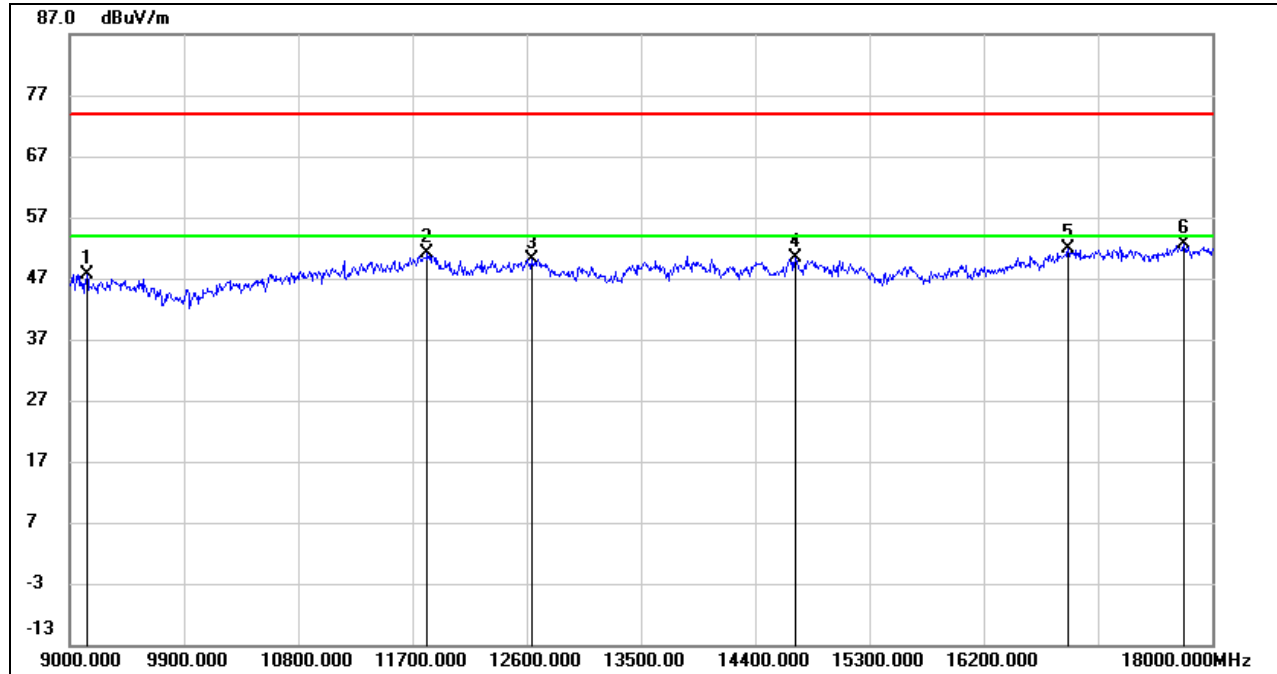

No.	Frequency (MHz)	Reading (dBuV)	Correct (dB/m)	Result (dBuV/m)	Limit (dBuV/m)	Margin (dB)	Remark
1	9135.000	37.96	9.73	47.69	74.00	-26.31	peak
2	11817.000	35.63	15.59	51.22	74.00	-22.78	peak
3	12636.000	34.77	15.35	50.12	74.00	-23.88	peak
4	14715.000	33.80	16.65	50.45	74.00	-23.55	peak
5	16866.000	31.98	19.90	51.88	74.00	-22.12	peak
6	17775.000	30.16	22.53	52.69	74.00	-21.31	peak

Note: 1. Measurement = Reading Level + Correct Factor.

2. If Peak Result complies with AV limit, AV Result is deemed to comply with AV limit.

3. Peak: Peak detector.

4. Filter losses were only considered in the spurious frequency bands and the authorized band was not corrected for High Pass Filter losses.

5. Proper operation of the transmitter prior to adding the filter to the measurement chain.

6. Since non-restricted band peak emissions are less than the average limit, they also comply with the -27dBm/MHz (68.2dBuV/m) limit.

HARMONICS AND SPURIOUS EMISSIONS (HIGH CHANNEL, VERTICAL)

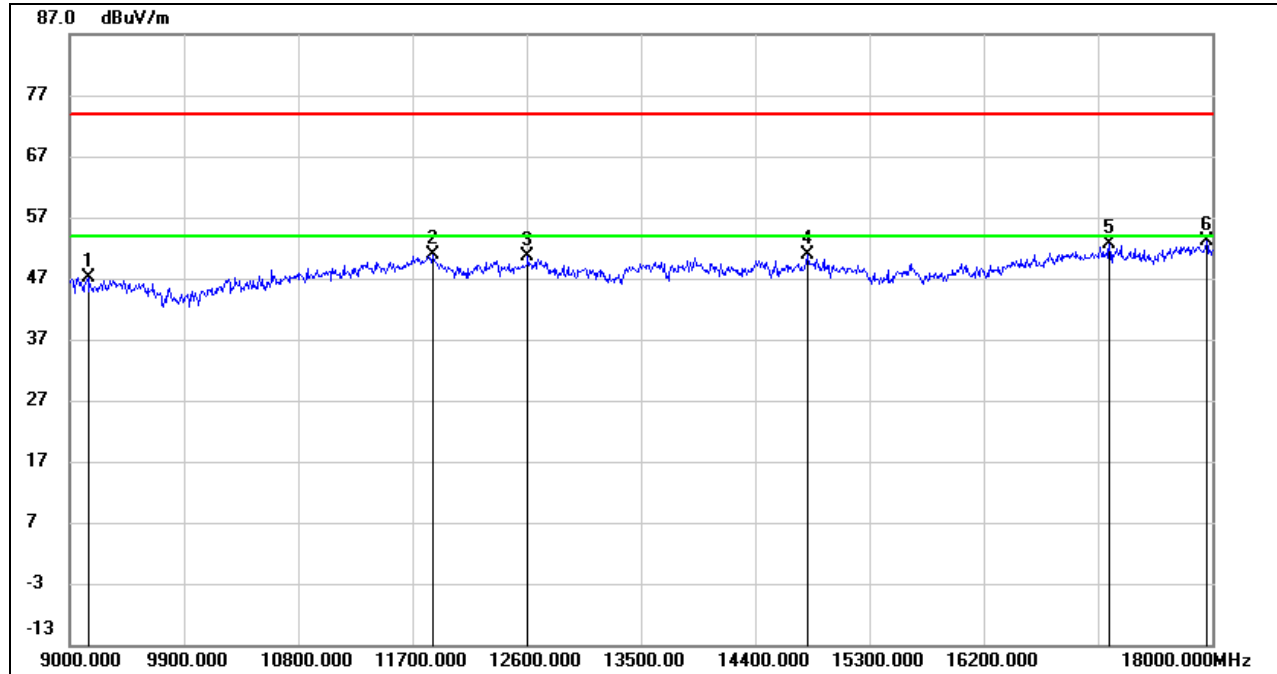

No.	Frequency (MHz)	Reading (dBuV)	Correct (dB/m)	Result (dBuV/m)	Limit (dBuV/m)	Margin (dB)	Remark
1	9144.000	37.37	9.67	47.04	74.00	-26.96	peak
2	11862.000	35.26	15.52	50.78	74.00	-23.22	peak
3	12609.000	35.36	15.30	50.66	74.00	-23.34	peak
4	14814.000	34.17	16.81	50.98	74.00	-23.02	peak
5	17190.000	31.55	21.00	52.55	74.00	-21.45	peak
6	17955.000	30.42	22.69	53.11	74.00	-20.89	peak

Note: 1. Measurement = Reading Level + Correct Factor.

2. If Peak Result complies with AV limit, AV Result is deemed to comply with AV limit.

3. Peak: Peak detector.

4. Filter losses were only considered in the spurious frequency bands and the authorized band was not corrected for High Pass Filter losses.

5. Proper operation of the transmitter prior to adding the filter to the measurement chain.

6. Since non-restricted band peak emissions are less than the average limit, they also comply with the -27dBm/MHz (68.2dBuV/m) limit.

UNII-6 BAND

HARMONICS AND SPURIOUS EMISSIONS (LOW CHANNEL, HORIZONTAL)

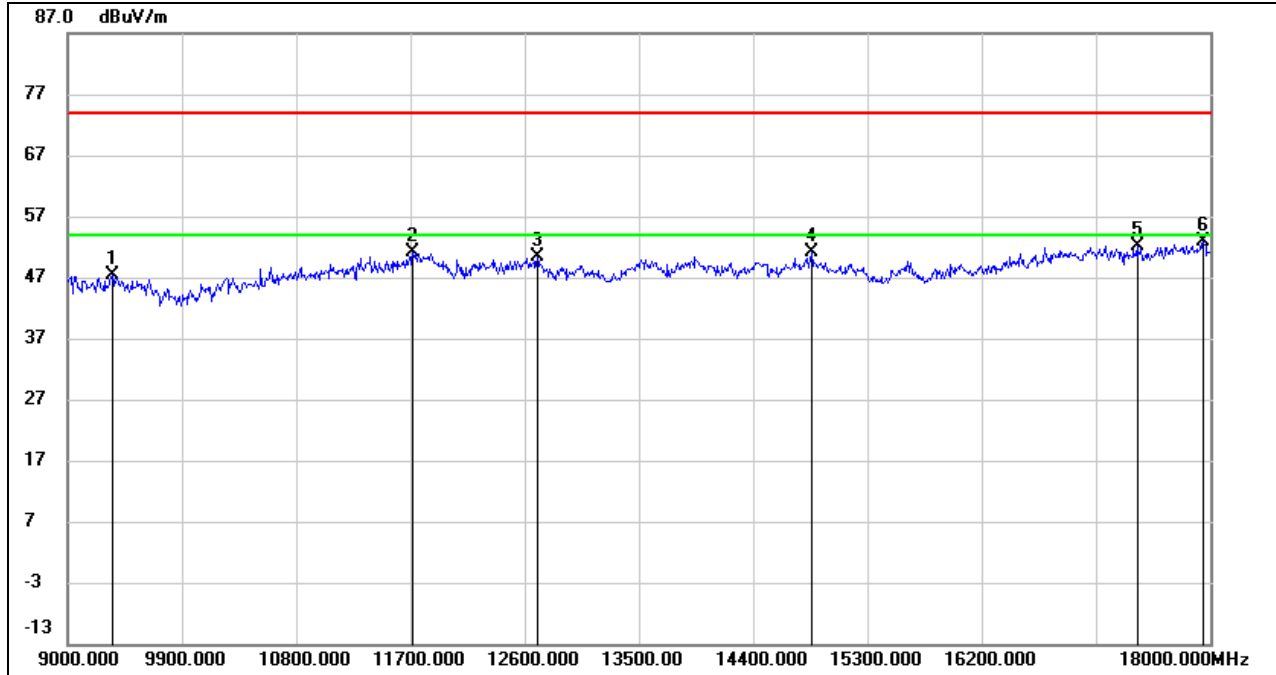

No.	Frequency (MHz)	Reading (dBuV)	Correct (dB/m)	Result (dBuV/m)	Limit (dBuV/m)	Margin (dB)	Remark
1	9351.000	37.36	10.06	47.42	74.00	-26.58	peak
2	11718.000	35.85	15.16	51.01	74.00	-22.99	peak
3	12699.000	34.86	15.47	50.33	74.00	-23.67	peak
4	14859.000	34.40	16.83	51.23	74.00	-22.77	peak
5	17424.000	31.50	20.75	52.25	74.00	-21.75	peak
6	17946.000	30.09	22.69	52.78	74.00	-21.22	peak

- Note: 1. Measurement = Reading Level + Correct Factor.
 2. If Peak Result complies with AV limit, AV Result is deemed to comply with AV limit.
 3. Peak: Peak detector.
 4. Filter losses were only considered in the spurious frequency bands and the authorized band was not corrected for High Pass Filter losses.
 5. Proper operation of the transmitter prior to adding the filter to the measurement chain.
 6. Since non-restricted band peak emissions are less than the average limit, they also comply with the -27dBm/MHz (68.2dBuV/m) limit.

HARMONICS AND SPURIOUS EMISSIONS (LOW CHANNEL, VERTICAL)

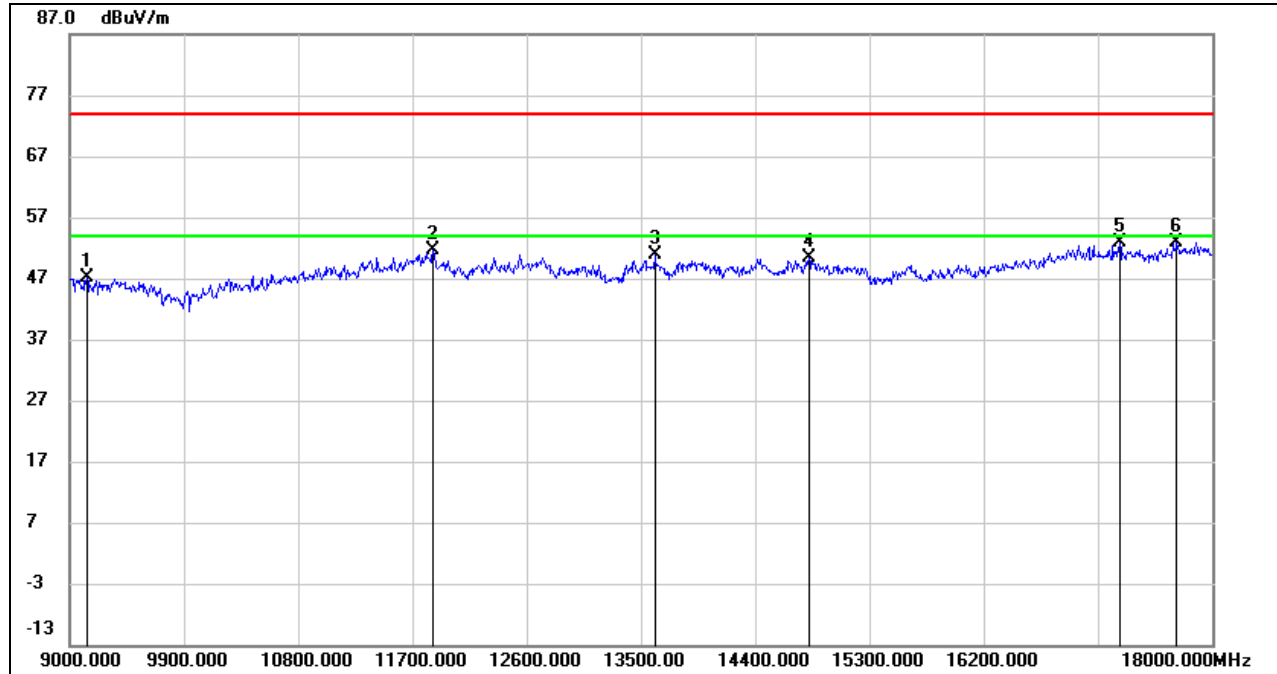

No.	Frequency (MHz)	Reading (dBuV)	Correct (dB/m)	Result (dBuV/m)	Limit (dBuV/m)	Margin (dB)	Remark
1	9135.000	37.39	9.73	47.12	74.00	-26.88	peak
2	11862.000	36.08	15.52	51.60	74.00	-22.40	peak
3	13608.000	34.40	16.45	50.85	74.00	-23.15	peak
4	14823.000	33.52	16.81	50.33	74.00	-23.67	peak
5	17271.000	31.89	20.94	52.83	74.00	-21.17	peak
6	17721.000	30.74	22.10	52.84	74.00	-21.16	peak

Note: 1. Measurement = Reading Level + Correct Factor.

2. If Peak Result complies with AV limit, AV Result is deemed to comply with AV limit.

3. Peak: Peak detector.

4. Filter losses were only considered in the spurious frequency bands and the authorized band was not corrected for High Pass Filter losses.

5. Proper operation of the transmitter prior to adding the filter to the measurement chain.

6. Since non-restricted band peak emissions are less than the average limit, they also comply with the -27dBm/MHz (68.2dBuV/m) limit.

HARMONICS AND SPURIOUS EMISSIONS (MID CHANNEL, HORIZONTAL)

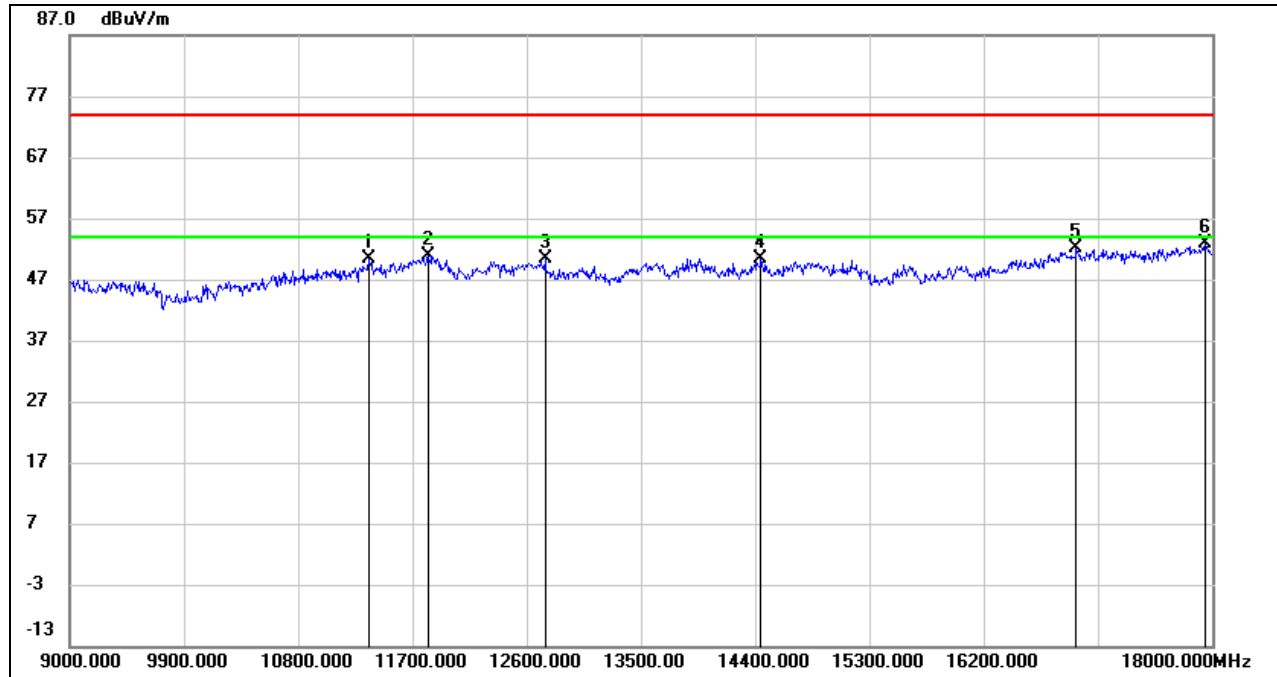

No.	Frequency (MHz)	Reading (dBuV)	Correct (dB/m)	Result (dBuV/m)	Limit (dBuV/m)	Margin (dB)	Remark
1	11358.000	36.22	14.10	50.32	74.00	-23.68	peak
2	11826.000	35.23	15.58	50.81	74.00	-23.19	peak
3	12744.000	34.79	15.56	50.35	74.00	-23.65	peak
4	14445.000	33.60	16.77	50.37	74.00	-23.63	peak
5	16929.000	31.98	20.06	52.04	74.00	-21.96	peak
6	17946.000	30.17	22.69	52.86	74.00	-21.14	peak

Note: 1. Measurement = Reading Level + Correct Factor.
 2. If Peak Result complies with AV limit, AV Result is deemed to comply with AV limit.
 3. Peak: Peak detector.
 4. Filter losses were only considered in the spurious frequency bands and the authorized band was not corrected for High Pass Filter losses.
 5. Proper operation of the transmitter prior to adding the filter to the measurement chain.
 6. Since non-restricted band peak emissions are less than the average limit, they also comply with the -27dBm/MHz (68.2dBuV/m) limit.

HARMONICS AND SPURIOUS EMISSIONS (MID CHANNEL, VERTICAL)

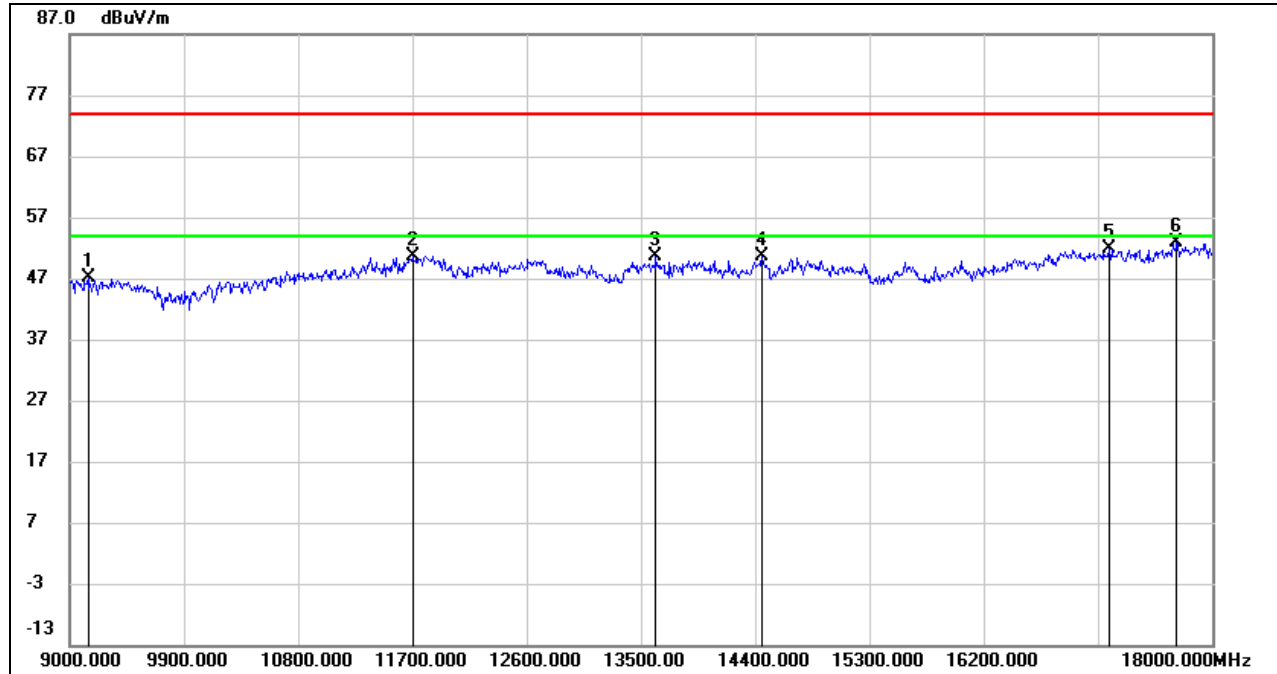

No.	Frequency (MHz)	Reading (dBuV)	Correct (dB/m)	Result (dBuV/m)	Limit (dBuV/m)	Margin (dB)	Remark
1	9144.000	37.43	9.67	47.10	74.00	-26.90	peak
2	11700.000	35.53	15.06	50.59	74.00	-23.41	peak
3	13617.000	34.19	16.47	50.66	74.00	-23.34	peak
4	14454.000	33.76	16.76	50.52	74.00	-23.48	peak
5	17190.000	30.76	21.00	51.76	74.00	-22.24	peak
6	17721.000	30.70	22.10	52.80	74.00	-21.20	peak

Note: 1. Measurement = Reading Level + Correct Factor.

2. If Peak Result complies with AV limit, AV Result is deemed to comply with AV limit.

3. Peak: Peak detector.

4. Filter losses were only considered in the spurious frequency bands and the authorized band was not corrected for High Pass Filter losses.

5. Proper operation of the transmitter prior to adding the filter to the measurement chain.

6. Since non-restricted band peak emissions are less than the average limit, they also comply with the -27dBm/MHz (68.2dBuV/m) limit.

HARMONICS AND SPURIOUS EMISSIONS (HIGH CHANNEL, HORIZONTAL)

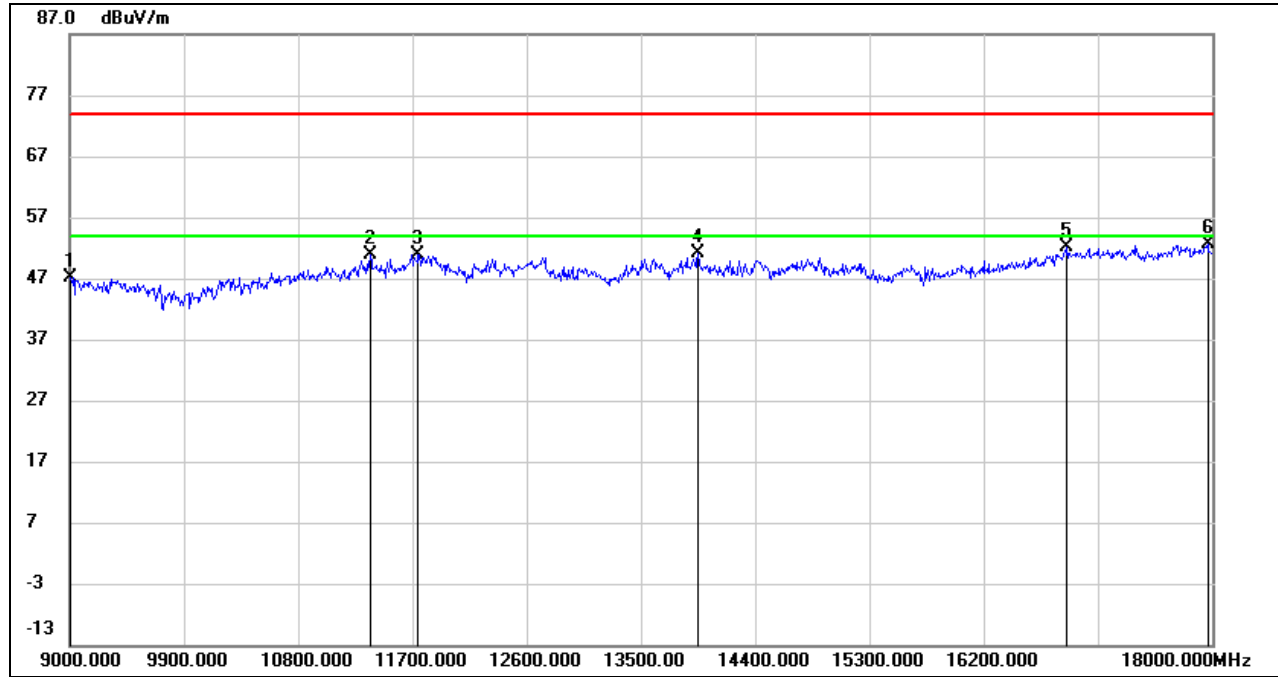

No.	Frequency (MHz)	Reading (dBuV)	Correct (dB/m)	Result (dBuV/m)	Limit (dBuV/m)	Margin (dB)	Remark
1	9009.000	36.63	10.58	47.21	74.00	-26.79	peak
2	11367.000	36.66	14.11	50.77	74.00	-23.23	peak
3	11745.000	35.66	15.31	50.97	74.00	-23.03	peak
4	13950.000	34.27	16.88	51.15	74.00	-22.85	peak
5	16857.000	32.32	19.88	52.20	74.00	-21.80	peak
6	17964.000	29.98	22.67	52.65	74.00	-21.35	peak

- Note: 1. Measurement = Reading Level + Correct Factor.
 2. If Peak Result complies with AV limit, AV Result is deemed to comply with AV limit.
 3. Peak: Peak detector.
 4. Filter losses were only considered in the spurious frequency bands and the authorized band was not corrected for High Pass Filter losses.
 5. Proper operation of the transmitter prior to adding the filter to the measurement chain.
 6. Since non-restricted band peak emissions are less than the average limit, they also comply with the -27dBm/MHz (68.2dBuV/m) limit.

HARMONICS AND SPURIOUS EMISSIONS (HIGH CHANNEL, VERTICAL)

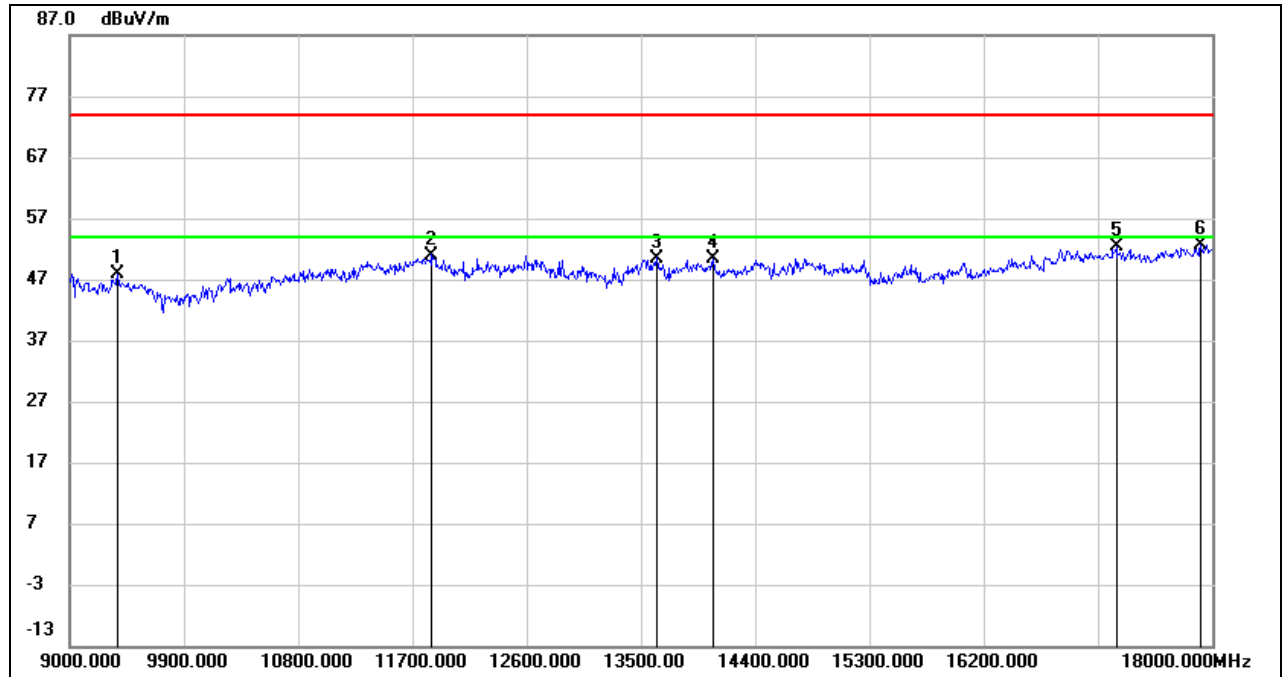

No.	Frequency (MHz)	Reading (dBuV)	Correct (dB/m)	Result (dBuV/m)	Limit (dBuV/m)	Margin (dB)	Remark
1	9378.000	37.78	10.20	47.98	74.00	-26.02	peak
2	11853.000	35.46	15.54	51.00	74.00	-23.00	peak
3	13626.000	34.00	16.50	50.50	74.00	-23.50	peak
4	14067.000	33.67	16.80	50.47	74.00	-23.53	peak
5	17244.000	31.33	20.97	52.30	74.00	-21.70	peak
6	17910.000	29.98	22.69	52.67	74.00	-21.33	peak

Note: 1. Measurement = Reading Level + Correct Factor.

2. If Peak Result complies with AV limit, AV Result is deemed to comply with AV limit.

3. Peak: Peak detector.

4. Filter losses were only considered in the spurious frequency bands and the authorized band was not corrected for High Pass Filter losses.

5. Proper operation of the transmitter prior to adding the filter to the measurement chain.

6. Since non-restricted band peak emissions are less than the average limit, they also comply with the -27dBm/MHz (68.2dBuV/m) limit.

UNII-7 BAND

HARMONICS AND SPURIOUS EMISSIONS (LOW CHANNEL, HORIZONTAL)

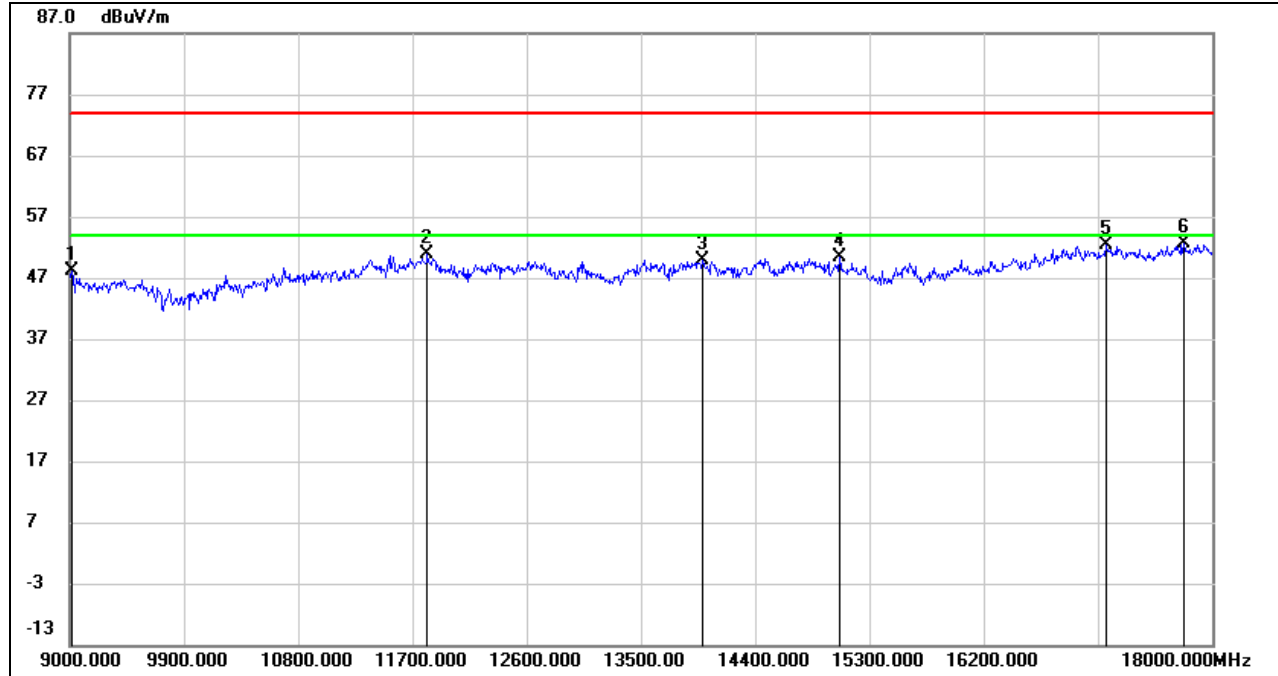

No.	Frequency (MHz)	Reading (dBuV)	Correct (dB/m)	Result (dBuV/m)	Limit (dBuV/m)	Margin (dB)	Remark
1	9018.000	37.51	10.50	48.01	74.00	-25.99	peak
2	11817.000	35.20	15.59	50.79	74.00	-23.21	peak
3	13986.000	33.05	16.86	49.91	74.00	-24.09	peak
4	15066.000	33.76	16.66	50.42	74.00	-23.58	peak
5	17163.000	31.50	20.89	52.39	74.00	-21.61	peak
6	17775.000	30.02	22.53	52.55	74.00	-21.45	peak

Note: 1. Measurement = Reading Level + Correct Factor.
 2. If Peak Result complies with AV limit, AV Result is deemed to comply with AV limit.
 3. Peak: Peak detector.
 4. Filter losses were only considered in the spurious frequency bands and the authorized band was not corrected for High Pass Filter losses.
 5. Proper operation of the transmitter prior to adding the filter to the measurement chain.
 6. Since non-restricted band peak emissions are less than the average limit, they also comply with the -27dBm/MHz (68.2dBuV/m) limit.

HARMONICS AND SPURIOUS EMISSIONS (LOW CHANNEL, VERTICAL)

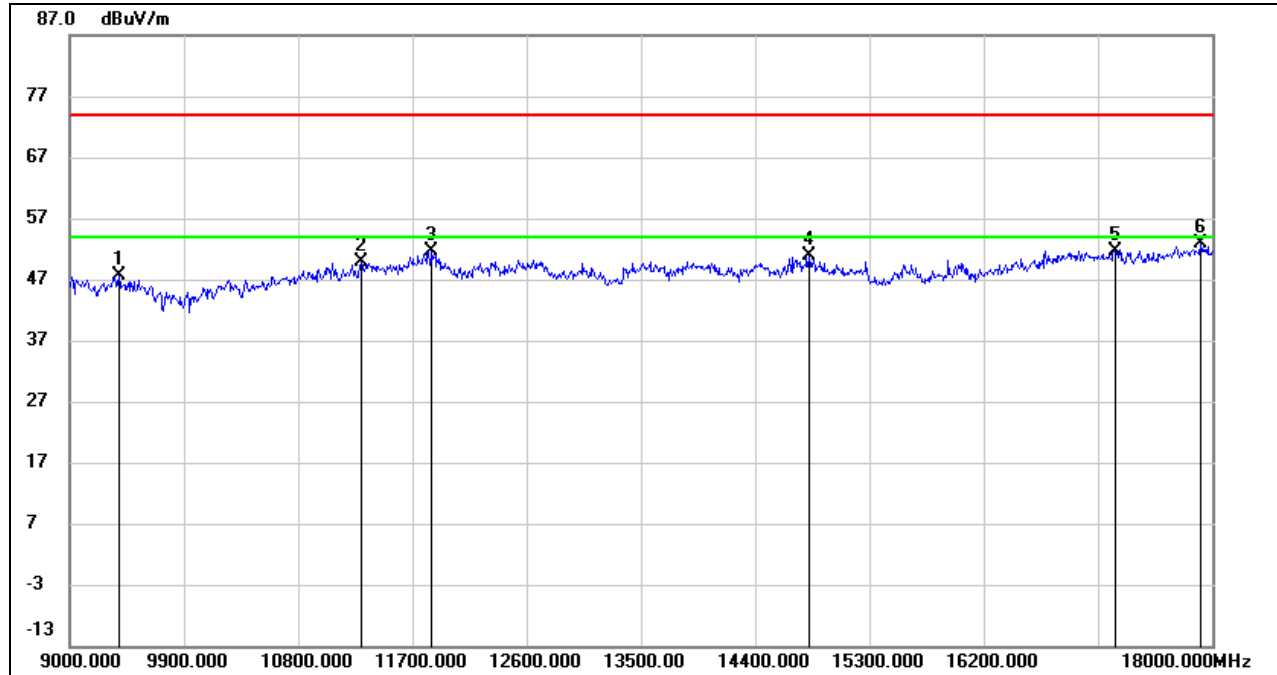

No.	Frequency (MHz)	Reading (dBuV)	Correct (dB/m)	Result (dBuV/m)	Limit (dBuV/m)	Margin (dB)	Remark
1	9387.000	37.49	10.24	47.73	74.00	-26.27	peak
2	11295.000	35.95	13.92	49.87	74.00	-24.13	peak
3	11853.000	35.99	15.54	51.53	74.00	-22.47	peak
4	14823.000	34.04	16.81	50.85	74.00	-23.15	peak
5	17235.000	30.72	20.99	51.71	74.00	-22.29	peak
6	17910.000	30.18	22.69	52.87	74.00	-21.13	peak

Note: 1. Measurement = Reading Level + Correct Factor.

2. If Peak Result complies with AV limit, AV Result is deemed to comply with AV limit.

3. Peak: Peak detector.

4. Filter losses were only considered in the spurious frequency bands and the authorized band was not corrected for High Pass Filter losses.

5. Proper operation of the transmitter prior to adding the filter to the measurement chain.

6. Since non-restricted band peak emissions are less than the average limit, they also comply with the -27dBm/MHz (68.2dBuV/m) limit.

HARMONICS AND SPURIOUS EMISSIONS (MID CHANNEL, HORIZONTAL)

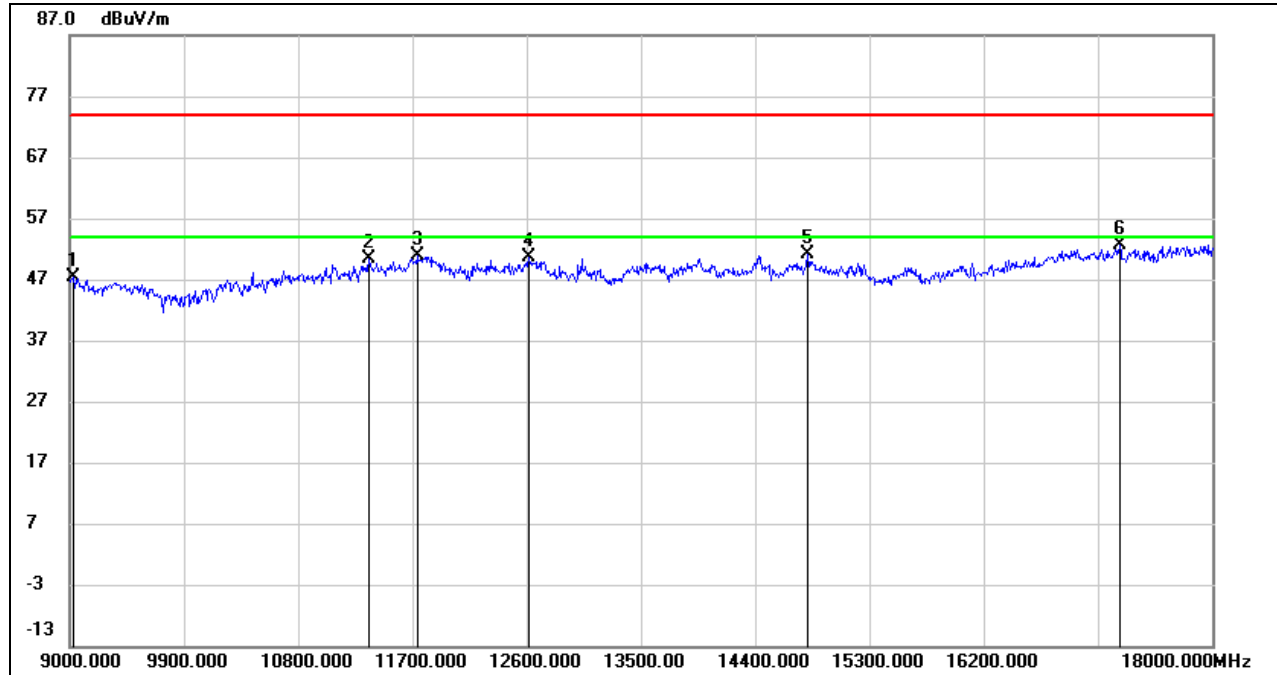

No.	Frequency (MHz)	Reading (dBuV)	Correct (dB/m)	Result (dBuV/m)	Limit (dBuV/m)	Margin (dB)	Remark
1	9027.000	36.88	10.45	47.33	74.00	-26.67	peak
2	11358.000	36.27	14.10	50.37	74.00	-23.63	peak
3	11736.000	35.61	15.26	50.87	74.00	-23.13	peak
4	12618.000	35.31	15.32	50.63	74.00	-23.37	peak
5	14814.000	34.21	16.81	51.02	74.00	-22.98	peak
6	17271.000	31.62	20.94	52.56	74.00	-21.44	peak

Note: 1. Measurement = Reading Level + Correct Factor.

2. If Peak Result complies with AV limit, AV Result is deemed to comply with AV limit.

3. Peak: Peak detector.

4. Filter losses were only considered in the spurious frequency bands and the authorized band was not corrected for High Pass Filter losses.

5. Proper operation of the transmitter prior to adding the filter to the measurement chain.

6. Since non-restricted band peak emissions are less than the average limit, they also comply with the -27dBm/MHz (68.2dBuV/m) limit.

HARMONICS AND SPURIOUS EMISSIONS (MID CHANNEL, VERTICAL)

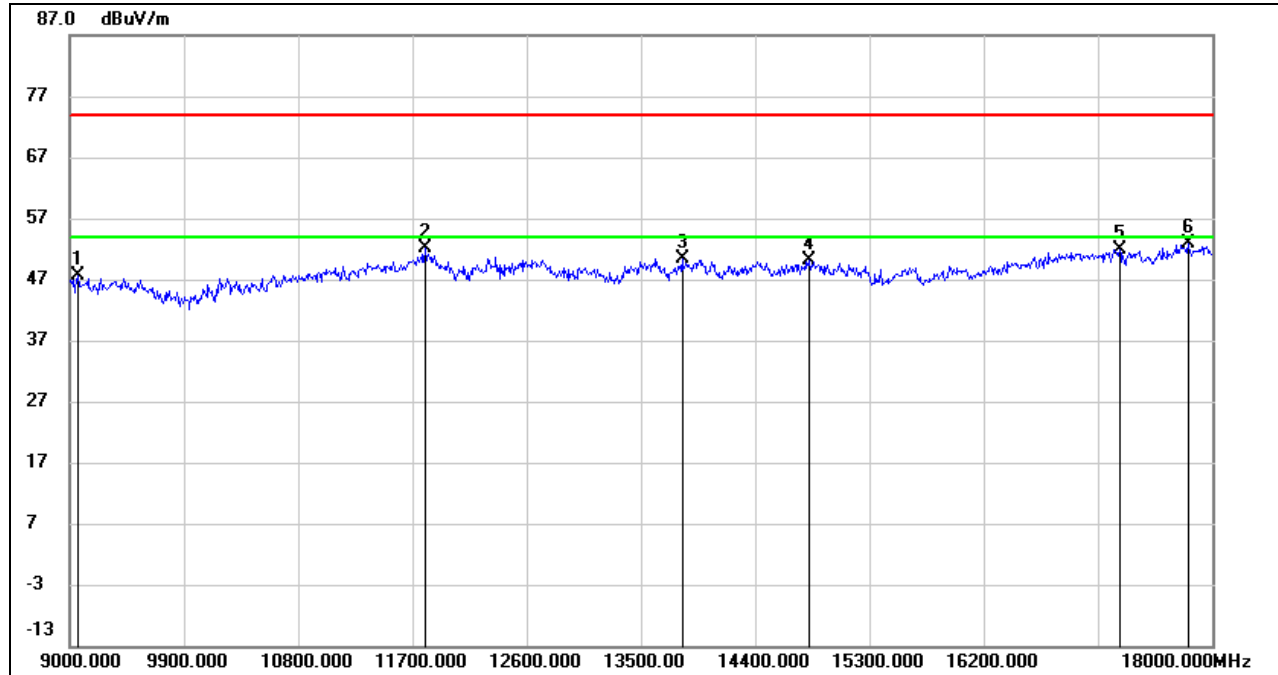

No.	Frequency (MHz)	Reading (dBuV)	Correct (dB/m)	Result (dBuV/m)	Limit (dBuV/m)	Margin (dB)	Remark
1	9063.000	37.47	10.21	47.68	74.00	-26.32	peak
2	11799.000	36.55	15.61	52.16	74.00	-21.84	peak
3	13824.000	33.51	16.94	50.45	74.00	-23.55	peak
4	14823.000	33.40	16.81	50.21	74.00	-23.79	peak
5	17271.000	31.01	20.94	51.95	74.00	-22.05	peak
6	17811.000	30.22	22.72	52.94	74.00	-21.06	peak

Note: 1. Measurement = Reading Level + Correct Factor.

2. If Peak Result complies with AV limit, AV Result is deemed to comply with AV limit.

3. Peak: Peak detector.

4. Filter losses were only considered in the spurious frequency bands and the authorized band was not corrected for High Pass Filter losses.

5. Proper operation of the transmitter prior to adding the filter to the measurement chain.

6. Since non-restricted band peak emissions are less than the average limit, they also comply with the -27dBm/MHz (68.2dBuV/m) limit.



HARMONICS AND SPURIOUS EMISSIONS (HIGH CHANNEL, HORIZONTAL)

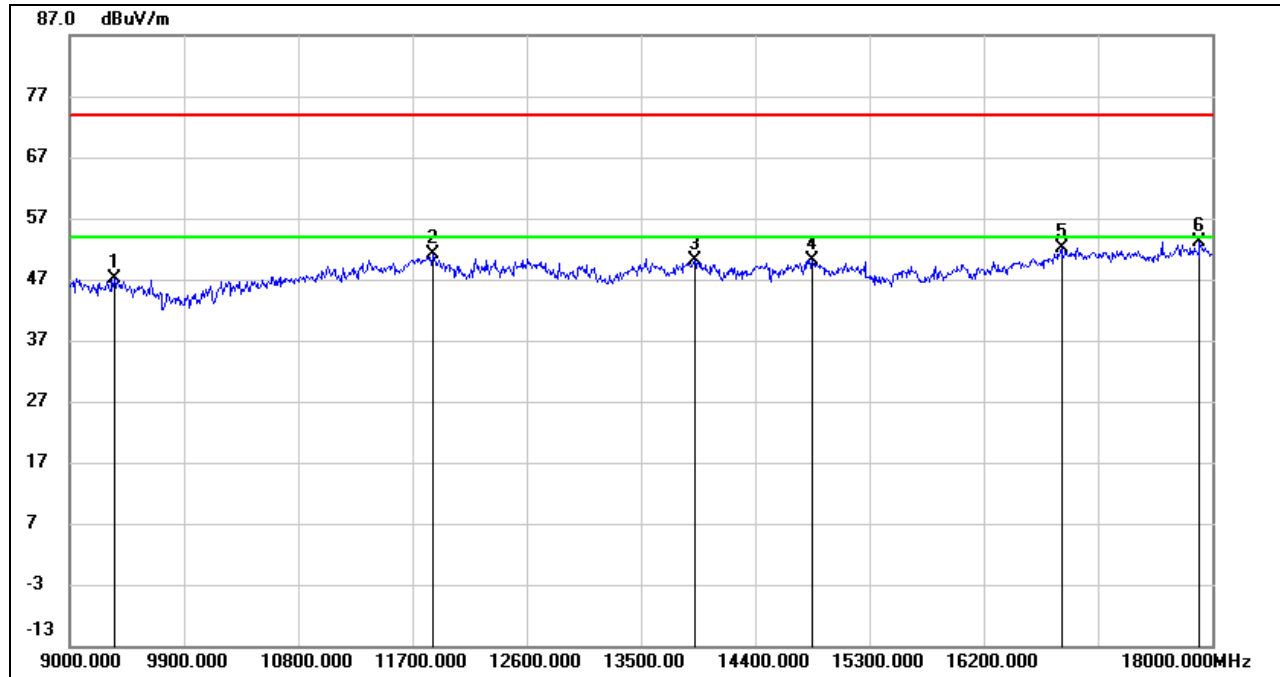

No.	Frequency (MHz)	Reading (dBuV)	Correct (dB/m)	Result (dBuV/m)	Limit (dBuV/m)	Margin (dB)	Remark
1	9351.000	37.08	10.06	47.14	74.00	-26.86	peak
2	11862.000	35.53	15.52	51.05	74.00	-22.95	peak
3	13923.000	33.21	16.89	50.10	74.00	-23.90	peak
4	14850.000	33.42	16.82	50.24	74.00	-23.76	peak
5	16812.000	32.29	19.77	52.06	74.00	-21.94	peak
6	17901.000	30.53	22.69	53.22	74.00	-20.78	peak

Note: 1. Measurement = Reading Level + Correct Factor.
 2. If Peak Result complies with AV limit, AV Result is deemed to comply with AV limit.
 3. Peak: Peak detector.
 4. Filter losses were only considered in the spurious frequency bands and the authorized band was not corrected for High Pass Filter losses.
 5. Proper operation of the transmitter prior to adding the filter to the measurement chain.
 6. Since non-restricted band peak emissions are less than the average limit, they also comply with the -27dBm/MHz (68.2dBuV/m) limit.

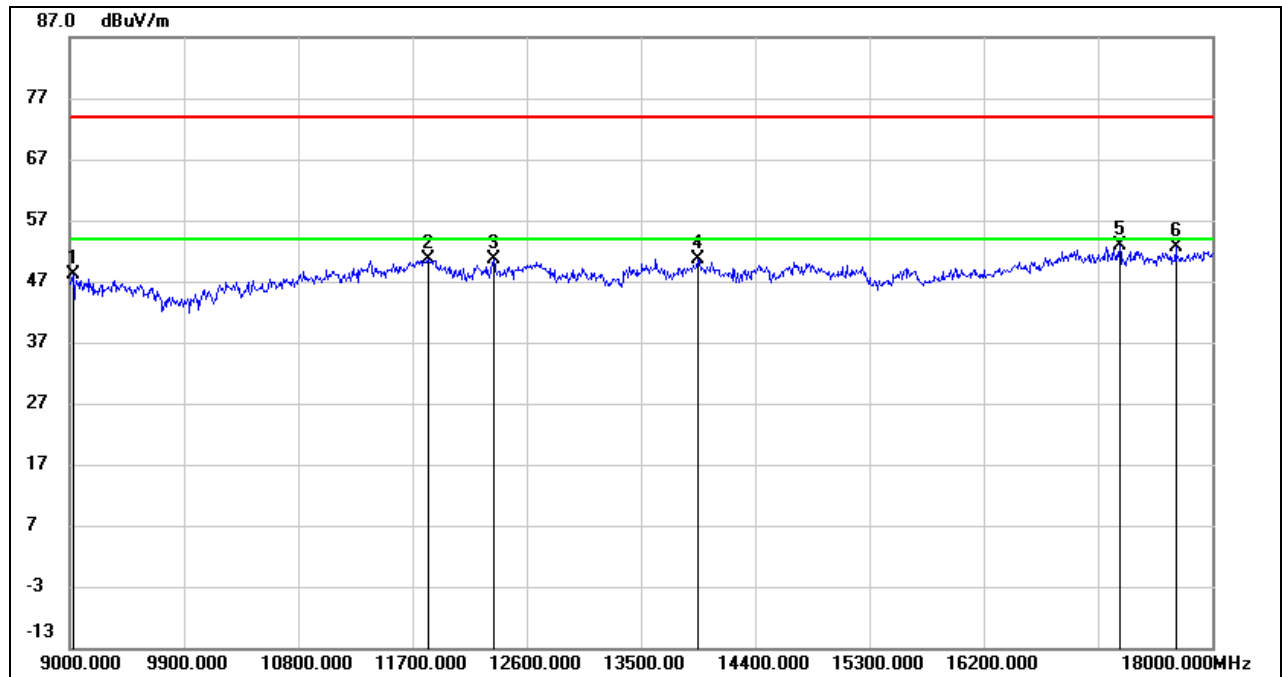
**HARMONICS AND SPURIOUS EMISSIONS (HIGH CHANNEL, VERTICAL)**

No.	Frequency (MHz)	Reading (dBuV)	Correct (dB/m)	Result (dBuV/m)	Limit (dBuV/m)	Margin (dB)	Remark
1	9027.000	37.58	10.45	48.03	74.00	-25.97	peak
2	11826.000	35.14	15.58	50.72	74.00	-23.28	peak
3	12339.000	35.16	15.39	50.55	74.00	-23.45	peak
4	13950.000	33.85	16.88	50.73	74.00	-23.27	peak
5	17271.000	32.04	20.94	52.98	74.00	-21.02	peak
6	17712.000	30.62	22.03	52.65	74.00	-21.35	peak

Note: 1. Measurement = Reading Level + Correct Factor.

2. If Peak Result complies with AV limit, AV Result is deemed to comply with AV limit.

3. Peak: Peak detector.

4. Filter losses were only considered in the spurious frequency bands and the authorized band was not corrected for High Pass Filter losses.

5. Proper operation of the transmitter prior to adding the filter to the measurement chain.

6. Since non-restricted band peak emissions are less than the average limit, they also comply with the -27dBm/MHz (68.2dBuV/m) limit.

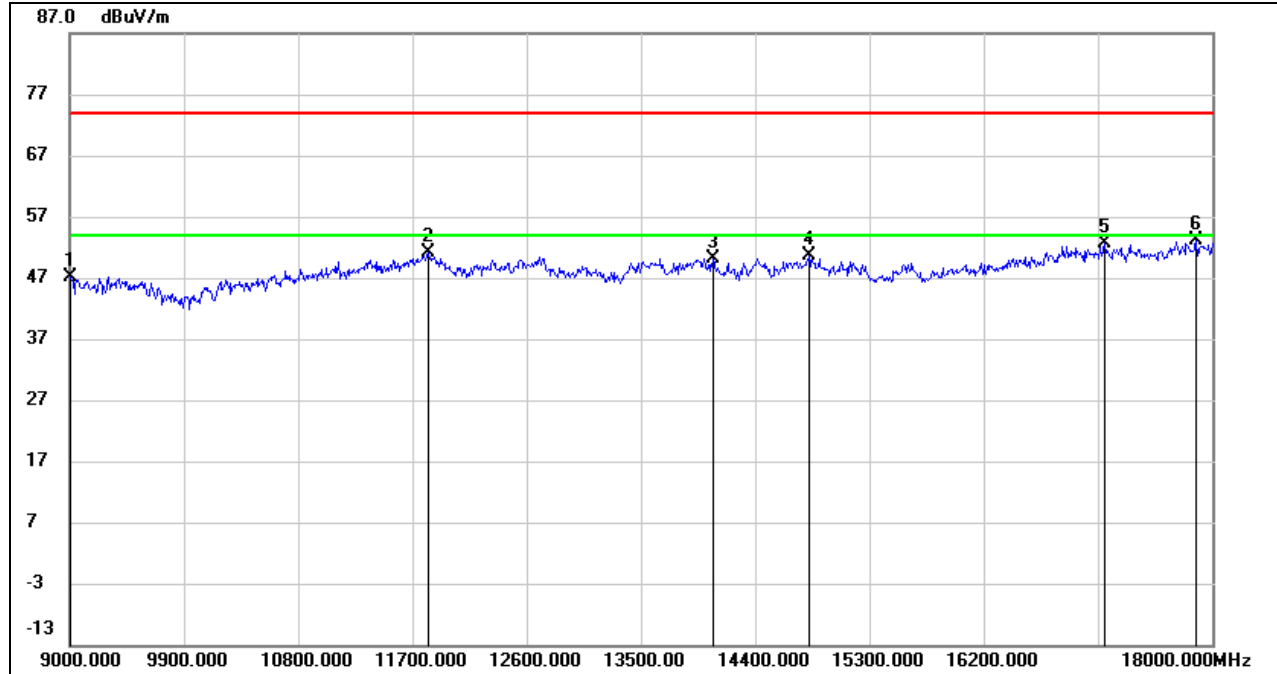
**UNII-8 BAND****HARMONICS AND SPURIOUS EMISSIONS (LOW CHANNEL, HORIZONTAL)**

No.	Frequency (MHz)	Reading (dBuV)	Correct (dB/m)	Result (dBuV/m)	Limit (dBuV/m)	Margin (dB)	Remark
1	9009.000	36.60	10.58	47.18	74.00	-26.82	peak
2	11826.000	35.43	15.58	51.01	74.00	-22.99	peak
3	14067.000	33.32	16.80	50.12	74.00	-23.88	peak
4	14823.000	33.82	16.81	50.63	74.00	-23.37	peak
5	17154.000	31.75	20.85	52.60	74.00	-21.40	peak
6	17874.000	30.33	22.70	53.03	74.00	-20.97	peak

Note: 1. Measurement = Reading Level + Correct Factor.

2. If Peak Result complies with AV limit, AV Result is deemed to comply with AV limit.

3. Peak: Peak detector.

4. Filter losses were only considered in the spurious frequency bands and the authorized band was not corrected for High Pass Filter losses.

5. Proper operation of the transmitter prior to adding the filter to the measurement chain.

6. Since non-restricted band peak emissions are less than the average limit, they also comply with the -27dBm/MHz (68.2dBuV/m) limit.

HARMONICS AND SPURIOUS EMISSIONS (LOW CHANNEL, VERTICAL)

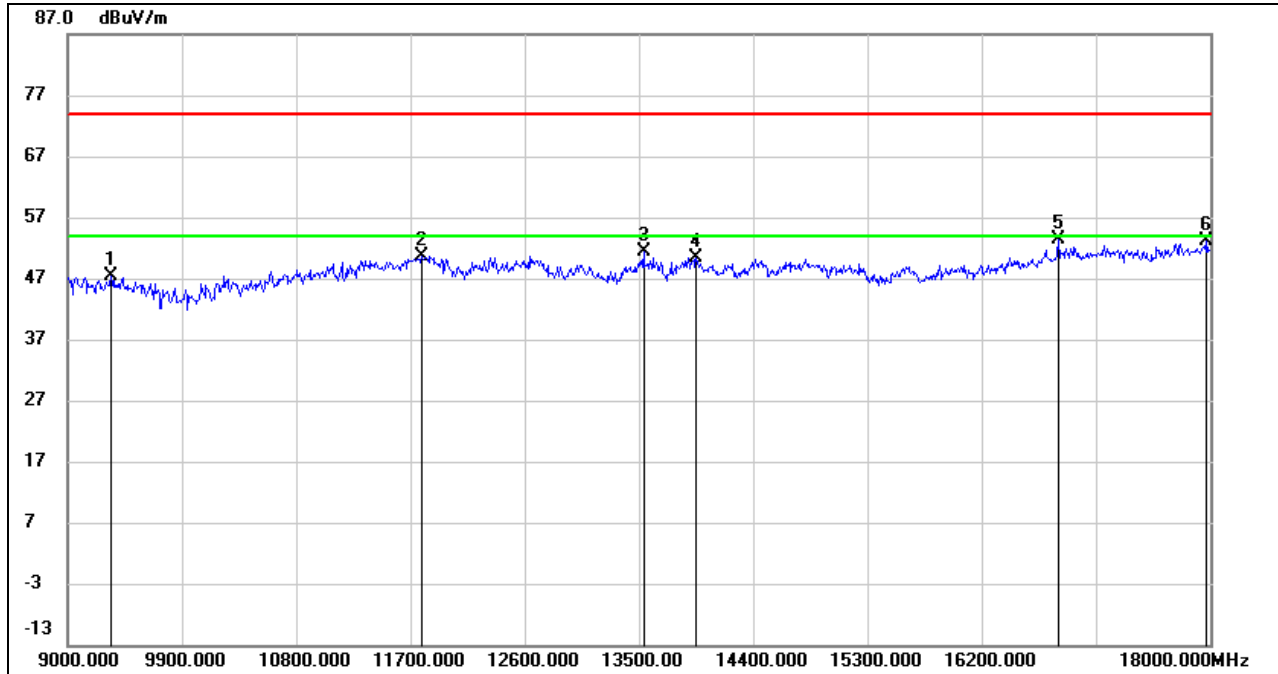

No.	Frequency (MHz)	Reading (dBuV)	Correct (dB/m)	Result (dBuV/m)	Limit (dBuV/m)	Margin (dB)	Remark
1	9342.000	37.46	10.02	47.48	74.00	-26.52	peak
2	11790.000	35.14	15.56	50.70	74.00	-23.30	peak
3	13536.000	34.95	16.42	51.37	74.00	-22.63	peak
4	13950.000	33.42	16.88	50.30	74.00	-23.70	peak
5	16803.000	33.71	19.75	53.46	74.00	-20.54	peak
6	17973.000	30.41	22.67	53.08	74.00	-20.92	peak

Note: 1. Measurement = Reading Level + Correct Factor.
 2. If Peak Result complies with AV limit, AV Result is deemed to comply with AV limit.
 3. Peak: Peak detector.
 4. Filter losses were only considered in the spurious frequency bands and the authorized band was not corrected for High Pass Filter losses.
 5. Proper operation of the transmitter prior to adding the filter to the measurement chain.
 6. Since non-restricted band peak emissions are less than the average limit, they also comply with the -27dBm/MHz (68.2dBuV/m) limit.

HARMONICS AND SPURIOUS EMISSIONS (MID CHANNEL, HORIZONTAL)

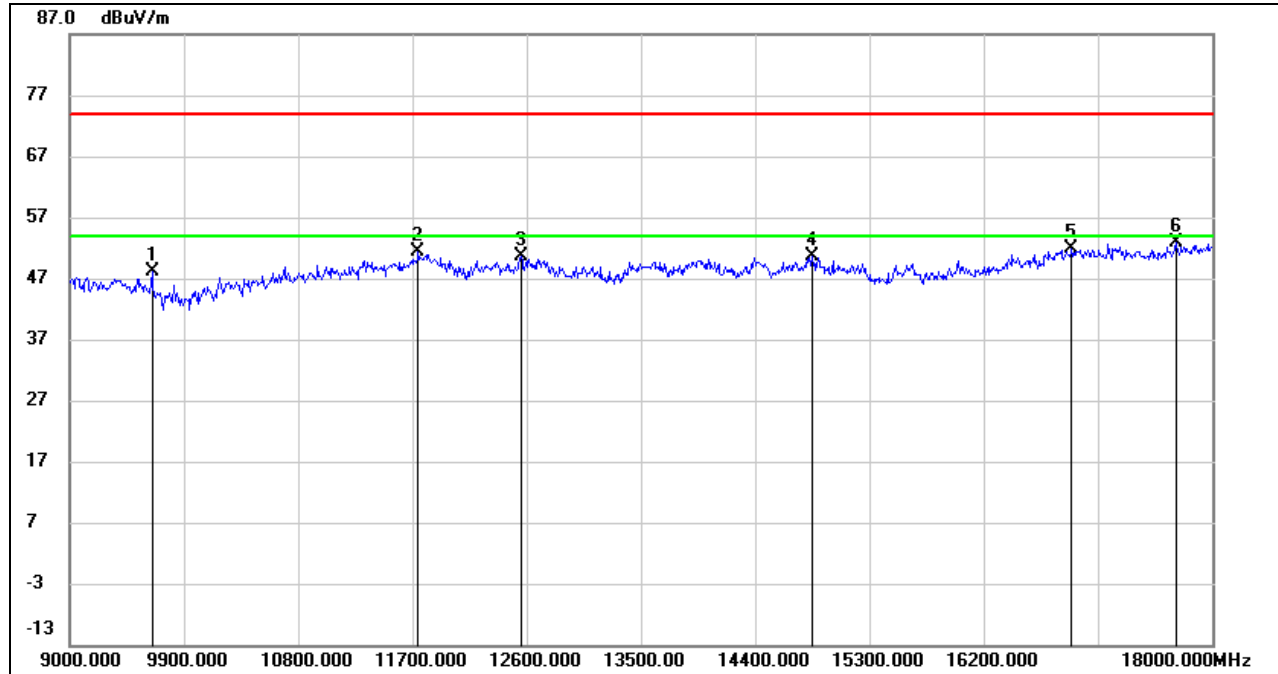

No.	Frequency (MHz)	Reading (dBuV)	Correct (dB/m)	Result (dBuV/m)	Limit (dBuV/m)	Margin (dB)	Remark
1	9648.000	37.75	10.35	48.10	74.00	-25.90	peak
2	11745.000	36.02	15.31	51.33	74.00	-22.67	peak
3	12555.000	35.31	15.32	50.63	74.00	-23.37	peak
4	14850.000	33.70	16.82	50.52	74.00	-23.48	peak
5	16893.000	31.88	19.96	51.84	74.00	-22.16	peak
6	17712.000	30.93	22.03	52.96	74.00	-21.04	peak

- Note: 1. Measurement = Reading Level + Correct Factor.
 2. If Peak Result complies with AV limit, AV Result is deemed to comply with AV limit.
 3. Peak: Peak detector.
 4. Filter losses were only considered in the spurious frequency bands and the authorized band was not corrected for High Pass Filter losses.
 5. Proper operation of the transmitter prior to adding the filter to the measurement chain.
 6. Since non-restricted band peak emissions are less than the average limit, they also comply with the -27dBm/MHz (68.2dBuV/m) limit.

HARMONICS AND SPURIOUS EMISSIONS (MID CHANNEL, VERTICAL)

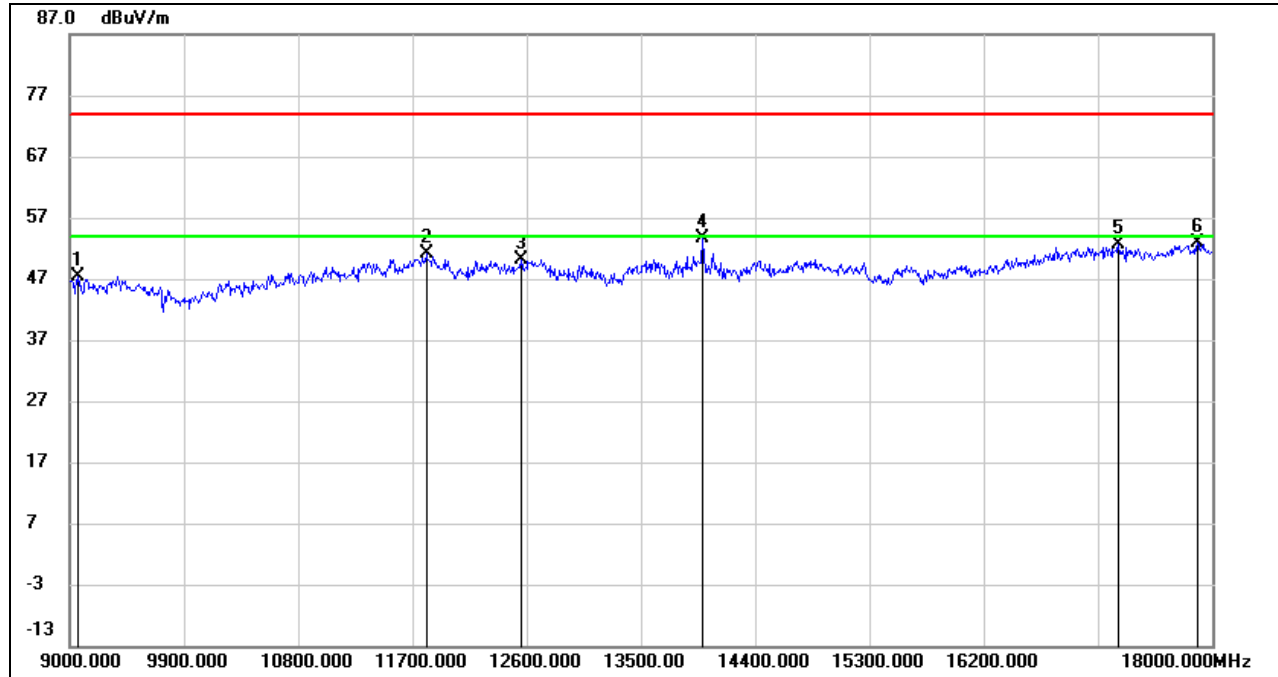

No.	Frequency (MHz)	Reading (dBuV)	Correct (dB/m)	Result (dBuV/m)	Limit (dBuV/m)	Margin (dB)	Remark
1	9063.000	37.25	10.21	47.46	74.00	-26.54	peak
2	11808.000	35.42	15.61	51.03	74.00	-22.97	peak
3	12555.000	34.82	15.32	50.14	74.00	-23.86	peak
4	13986.000	36.68	16.86	53.54	74.00	-20.46	peak
5	17262.000	31.77	20.95	52.72	74.00	-21.28	peak
6	17883.000	30.09	22.70	52.79	74.00	-21.21	peak

Note: 1. Measurement = Reading Level + Correct Factor.
 2. If Peak Result complies with AV limit, AV Result is deemed to comply with AV limit.
 3. Peak: Peak detector.
 4. Filter losses were only considered in the spurious frequency bands and the authorized band was not corrected for High Pass Filter losses.
 5. Proper operation of the transmitter prior to adding the filter to the measurement chain.
 6. Since non-restricted band peak emissions are less than the average limit, they also comply with the -27dBm/MHz (68.2dBuV/m) limit.

HARMONICS AND SPURIOUS EMISSIONS (HIGH CHANNEL, HORIZONTAL)

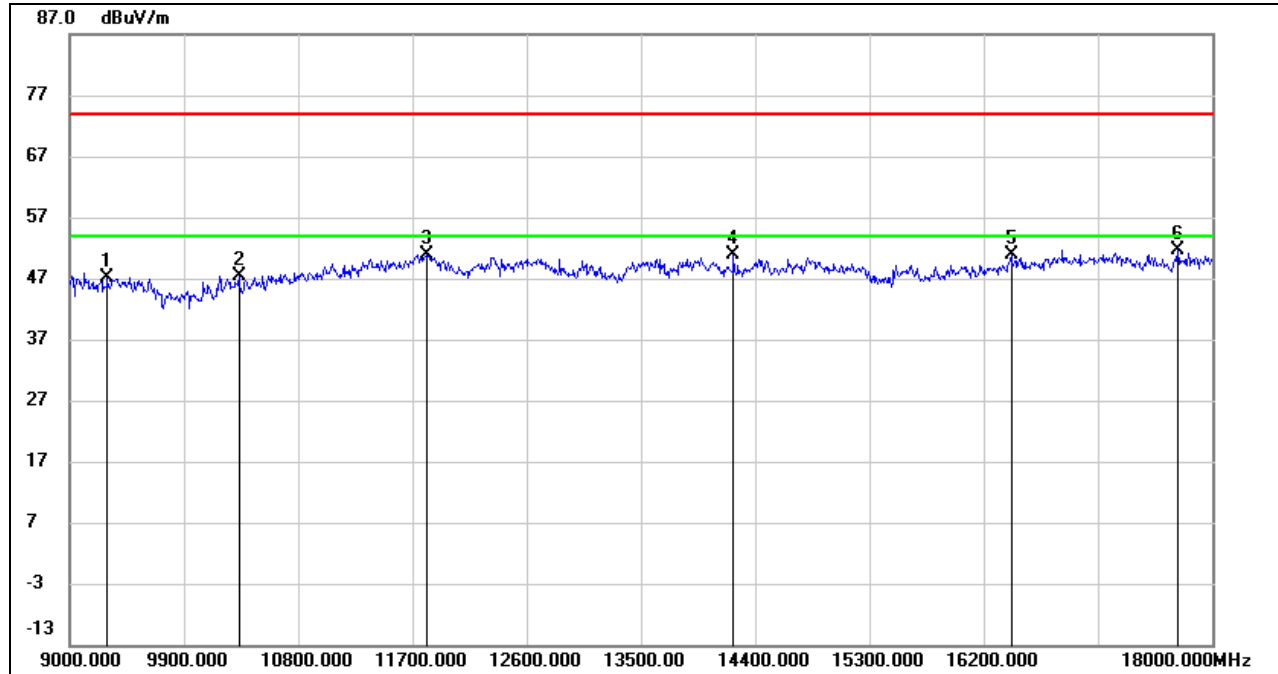

No.	Frequency (MHz)	Reading (dBuV)	Correct (dB/m)	Result (dBuV/m)	Limit (dBuV/m)	Margin (dB)	Remark
1	9297.000	37.35	9.79	47.14	74.00	-26.86	peak
2	10332.000	36.26	11.21	47.47	74.00	-26.53	peak
3	11808.000	35.28	15.61	50.89	74.00	-23.11	peak
4	14229.000	34.14	16.73	50.87	74.00	-23.13	peak
5	16416.000	32.21	18.77	50.98	74.00	-23.02	peak
6	17730.000	29.50	22.17	51.67	74.00	-22.33	peak

Note: 1. Measurement = Reading Level + Correct Factor.
 2. If Peak Result complies with AV limit, AV Result is deemed to comply with AV limit.
 3. Peak: Peak detector.
 4. Filter losses were only considered in the spurious frequency bands and the authorized band was not corrected for High Pass Filter losses.
 5. Proper operation of the transmitter prior to adding the filter to the measurement chain.
 6. Since non-restricted band peak emissions are less than the average limit, they also comply with the -27dBm/MHz (68.2dBuV/m) limit.

HARMONICS AND SPURIOUS EMISSIONS (HIGH CHANNEL, VERTICAL)

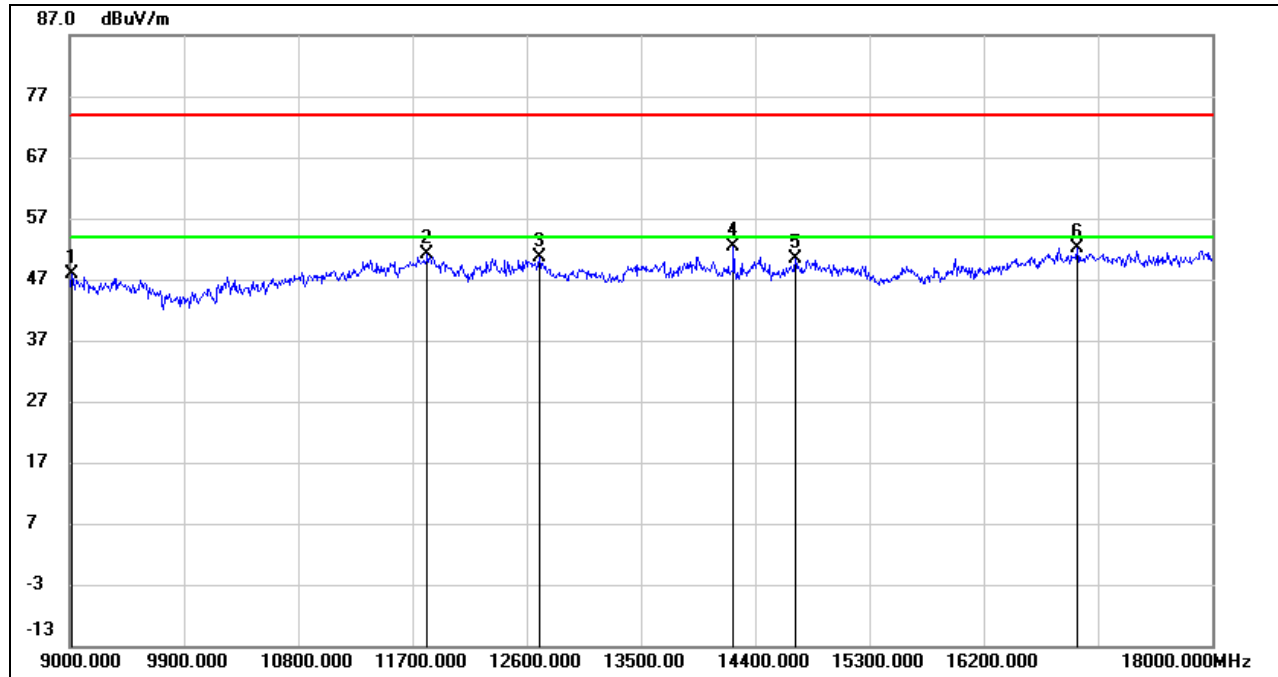

No.	Frequency (MHz)	Reading (dBuV)	Correct (dB/m)	Result (dBuV/m)	Limit (dBuV/m)	Margin (dB)	Remark
1	9018.000	37.28	10.50	47.78	74.00	-26.22	peak
2	11817.000	35.50	15.59	51.09	74.00	-22.91	peak
3	12699.000	35.04	15.47	50.51	74.00	-23.49	peak
4	14229.000	35.62	16.73	52.35	74.00	-21.65	peak
5	14715.000	33.66	16.65	50.31	74.00	-23.69	peak
6	16938.000	32.12	20.08	52.20	74.00	-21.80	peak

- Note: 1. Measurement = Reading Level + Correct Factor.
 2. If Peak Result complies with AV limit, AV Result is deemed to comply with AV limit.
 3. Peak: Peak detector.
 4. Filter losses were only considered in the spurious frequency bands and the authorized band was not corrected for High Pass Filter losses.
 5. Proper operation of the transmitter prior to adding the filter to the measurement chain.
 6. Since non-restricted band peak emissions are less than the average limit, they also comply with the -27dBm/MHz (68.2dBuV/m) limit.

Note: All the mode had been tested, but only the worst data was recorded in the report.

8.3.2. 802.11ax HE40 CDD MODE

UNII-5 BAND

HARMONICS AND SPURIOUS EMISSIONS (LOW CHANNEL, HORIZONTAL)

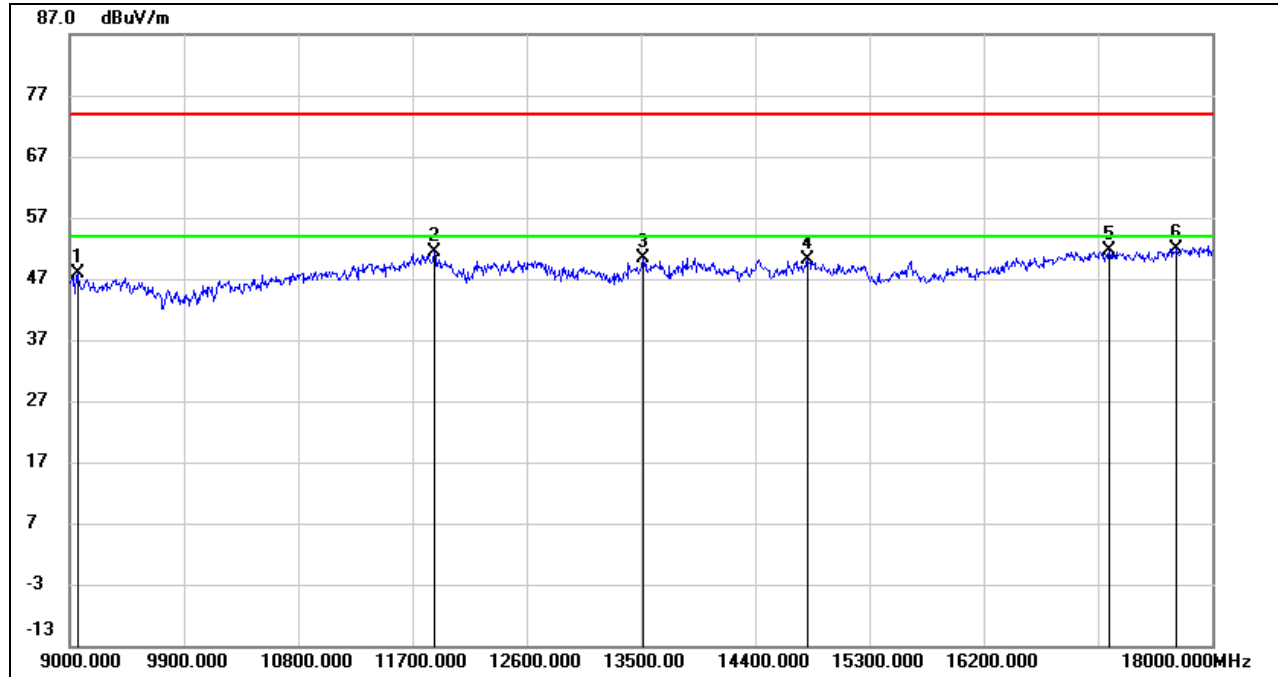

No.	Frequency (MHz)	Reading (dBuV)	Correct (dB/m)	Result (dBuV/m)	Limit (dBuV/m)	Margin (dB)	Remark
1	9063.000	37.70	10.21	47.91	74.00	-26.09	peak
2	11871.000	35.81	15.51	51.32	74.00	-22.68	peak
3	13518.000	33.99	16.41	50.40	74.00	-23.60	peak
4	14814.000	33.21	16.81	50.02	74.00	-23.98	peak
5	17190.000	30.73	21.00	51.73	74.00	-22.27	peak
6	17721.000	29.89	22.10	51.99	74.00	-22.01	peak

Note: 1. Measurement = Reading Level + Correct Factor.
 2. If Peak Result complies with AV limit, AV Result is deemed to comply with AV limit.
 3. Peak: Peak detector.
 4. Filter losses were only considered in the spurious frequency bands and the authorized band was not corrected for High Pass Filter losses.
 5. Proper operation of the transmitter prior to adding the filter to the measurement chain.
 6. Since non-restricted band peak emissions are less than the average limit, they also comply with the -27dBm/MHz (68.2dBuV/m) limit.

HARMONICS AND SPURIOUS EMISSIONS (LOW CHANNEL, VERTICAL)

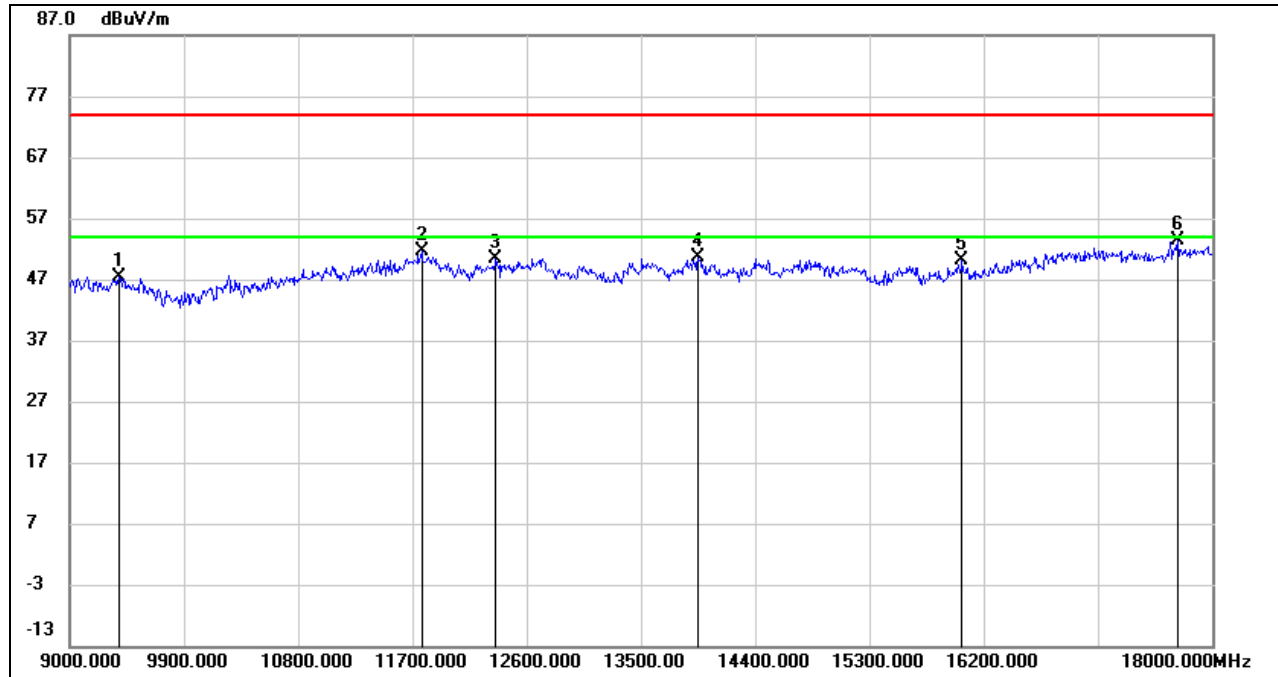

No.	Frequency (MHz)	Reading (dBuV)	Correct (dB/m)	Result (dBuV/m)	Limit (dBuV/m)	Margin (dB)	Remark
1	9387.000	37.03	10.24	47.27	74.00	-26.73	peak
2	11772.000	36.29	15.45	51.74	74.00	-22.26	peak
3	12357.000	35.04	15.42	50.46	74.00	-23.54	peak
4	13950.000	33.84	16.88	50.72	74.00	-23.28	peak
5	16029.000	32.78	17.33	50.11	74.00	-23.89	peak
6	17730.000	31.28	22.17	53.45	74.00	-20.55	peak

Note: 1. Measurement = Reading Level + Correct Factor.
 2. If Peak Result complies with AV limit, AV Result is deemed to comply with AV limit.
 3. Peak: Peak detector.
 4. Filter losses were only considered in the spurious frequency bands and the authorized band was not corrected for High Pass Filter losses.
 5. Proper operation of the transmitter prior to adding the filter to the measurement chain.
 6. Since non-restricted band peak emissions are less than the average limit, they also comply with the -27dBm/MHz (68.2dBuV/m) limit.

HARMONICS AND SPURIOUS EMISSIONS (MID CHANNEL, HORIZONTAL)

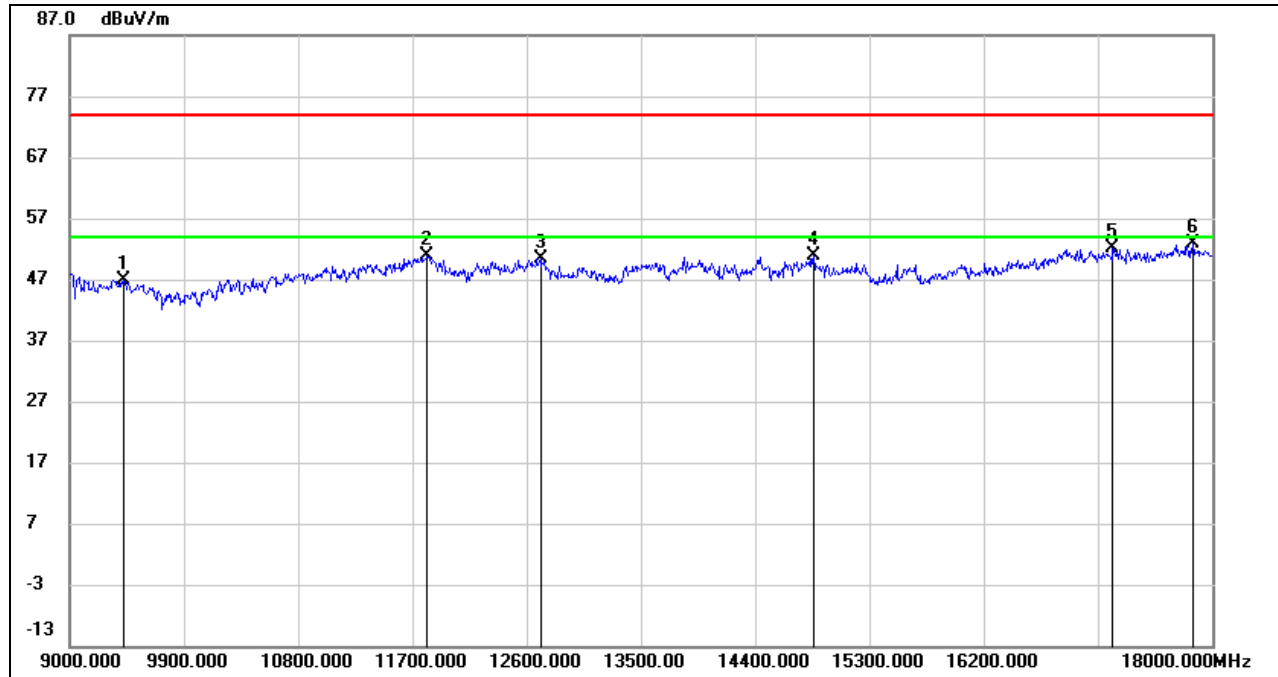

No.	Frequency (MHz)	Reading (dBuV)	Correct (dB/m)	Result (dBuV/m)	Limit (dBuV/m)	Margin (dB)	Remark
1	9423.000	36.62	10.35	46.97	74.00	-27.03	peak
2	11817.000	35.37	15.59	50.96	74.00	-23.04	peak
3	12708.000	34.99	15.49	50.48	74.00	-23.52	peak
4	14859.000	34.11	16.83	50.94	74.00	-23.06	peak
5	17217.000	31.13	21.01	52.14	74.00	-21.86	peak
6	17847.000	30.12	22.71	52.83	74.00	-21.17	peak

Note: 1. Measurement = Reading Level + Correct Factor.
 2. If Peak Result complies with AV limit, AV Result is deemed to comply with AV limit.
 3. Peak: Peak detector.
 4. Filter losses were only considered in the spurious frequency bands and the authorized band was not corrected for High Pass Filter losses.
 5. Proper operation of the transmitter prior to adding the filter to the measurement chain.
 6. Since non-restricted band peak emissions are less than the average limit, they also comply with the -27dBm/MHz (68.2dBuV/m) limit.

HARMONICS AND SPURIOUS EMISSIONS (MID CHANNEL, VERTICAL)

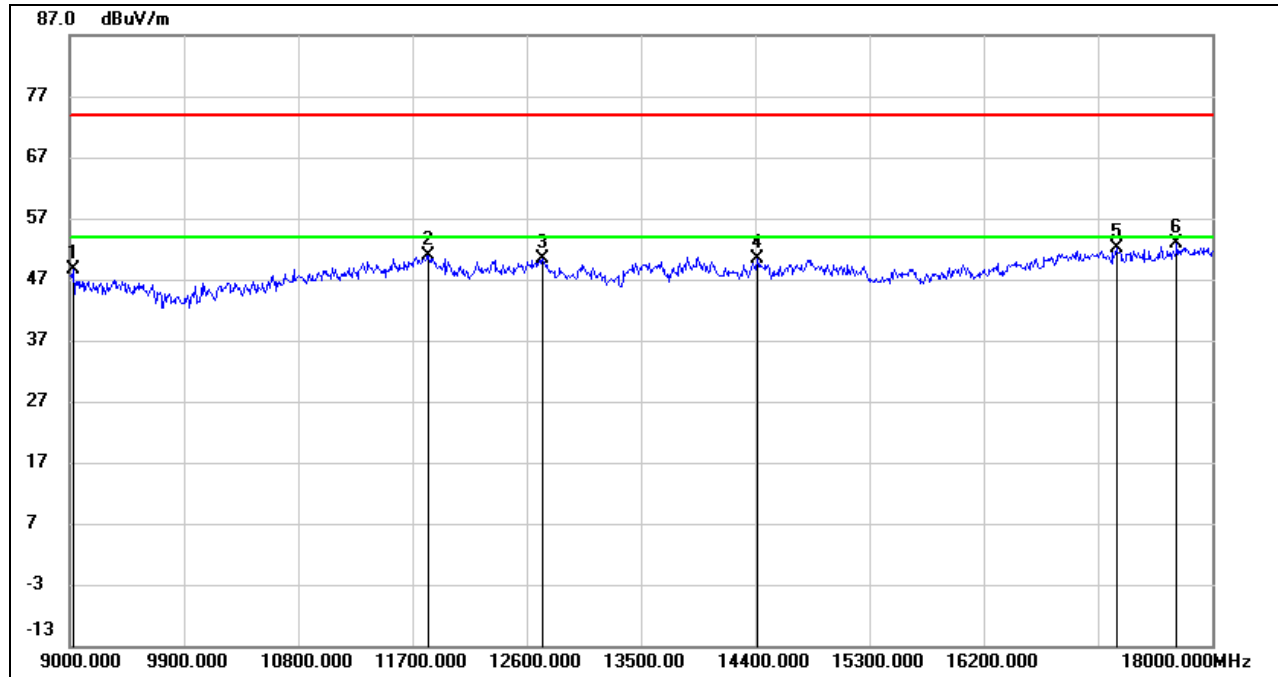

No.	Frequency (MHz)	Reading (dBuV)	Correct (dB/m)	Result (dBuV/m)	Limit (dBuV/m)	Margin (dB)	Remark
1	9027.000	38.13	10.45	48.58	74.00	-25.42	peak
2	11826.000	35.36	15.58	50.94	74.00	-23.06	peak
3	12726.000	34.79	15.52	50.31	74.00	-23.69	peak
4	14418.000	33.59	16.82	50.41	74.00	-23.59	peak
5	17244.000	31.08	20.97	52.05	74.00	-21.95	peak
6	17721.000	30.75	22.10	52.85	74.00	-21.15	peak

Note: 1. Measurement = Reading Level + Correct Factor.
 2. If Peak Result complies with AV limit, AV Result is deemed to comply with AV limit.
 3. Peak: Peak detector.
 4. Filter losses were only considered in the spurious frequency bands and the authorized band was not corrected for High Pass Filter losses.
 5. Proper operation of the transmitter prior to adding the filter to the measurement chain.
 6. Since non-restricted band peak emissions are less than the average limit, they also comply with the -27dBm/MHz (68.2dBuV/m) limit.

HARMONICS AND SPURIOUS EMISSIONS (HIGH CHANNEL, HORIZONTAL)

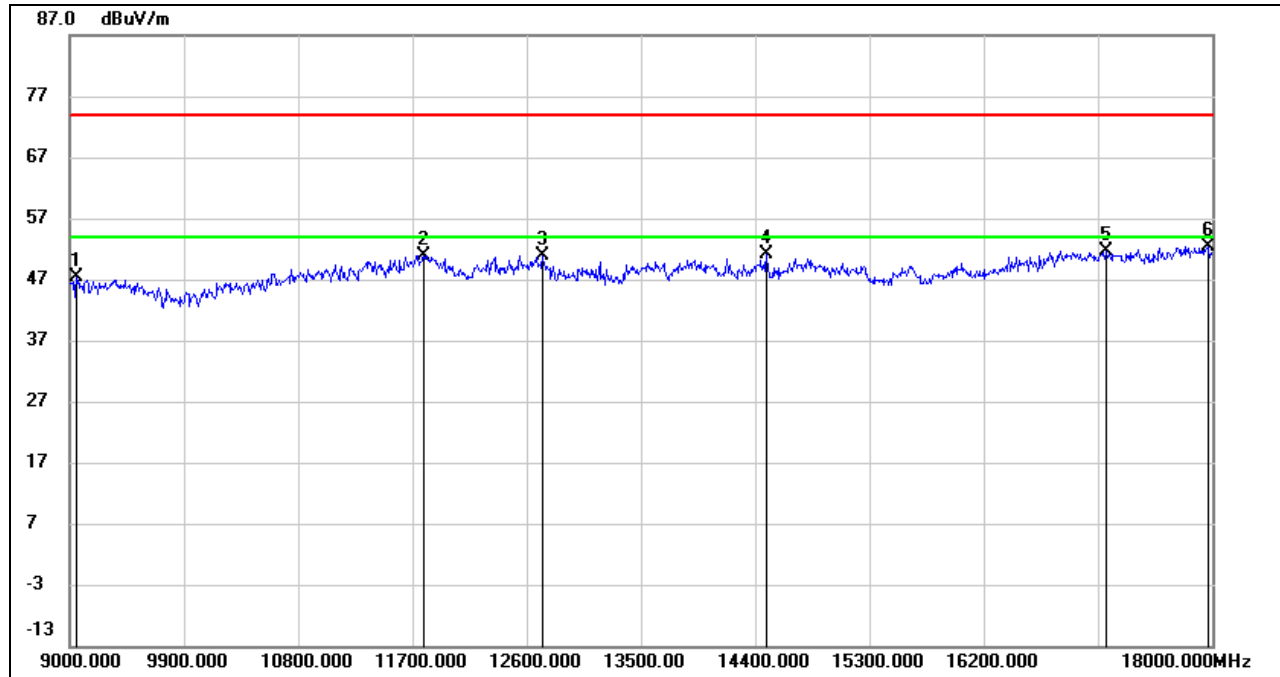

No.	Frequency (MHz)	Reading (dBuV)	Correct (dB/m)	Result (dBuV/m)	Limit (dBuV/m)	Margin (dB)	Remark
1	9054.000	37.07	10.26	47.33	74.00	-26.67	peak
2	11790.000	35.39	15.56	50.95	74.00	-23.05	peak
3	12726.000	35.44	15.52	50.96	74.00	-23.04	peak
4	14490.000	34.33	16.70	51.03	74.00	-22.97	peak
5	17163.000	30.70	20.89	51.59	74.00	-22.41	peak
6	17964.000	29.69	22.67	52.36	74.00	-21.64	peak

- Note: 1. Measurement = Reading Level + Correct Factor.
 2. If Peak Result complies with AV limit, AV Result is deemed to comply with AV limit.
 3. Peak: Peak detector.
 4. Filter losses were only considered in the spurious frequency bands and the authorized band was not corrected for High Pass Filter losses.
 5. Proper operation of the transmitter prior to adding the filter to the measurement chain.
 6. Since non-restricted band peak emissions are less than the average limit, they also comply with the -27dBm/MHz (68.2dBuV/m) limit.

HARMONICS AND SPURIOUS EMISSIONS (HIGH CHANNEL, VERTICAL)

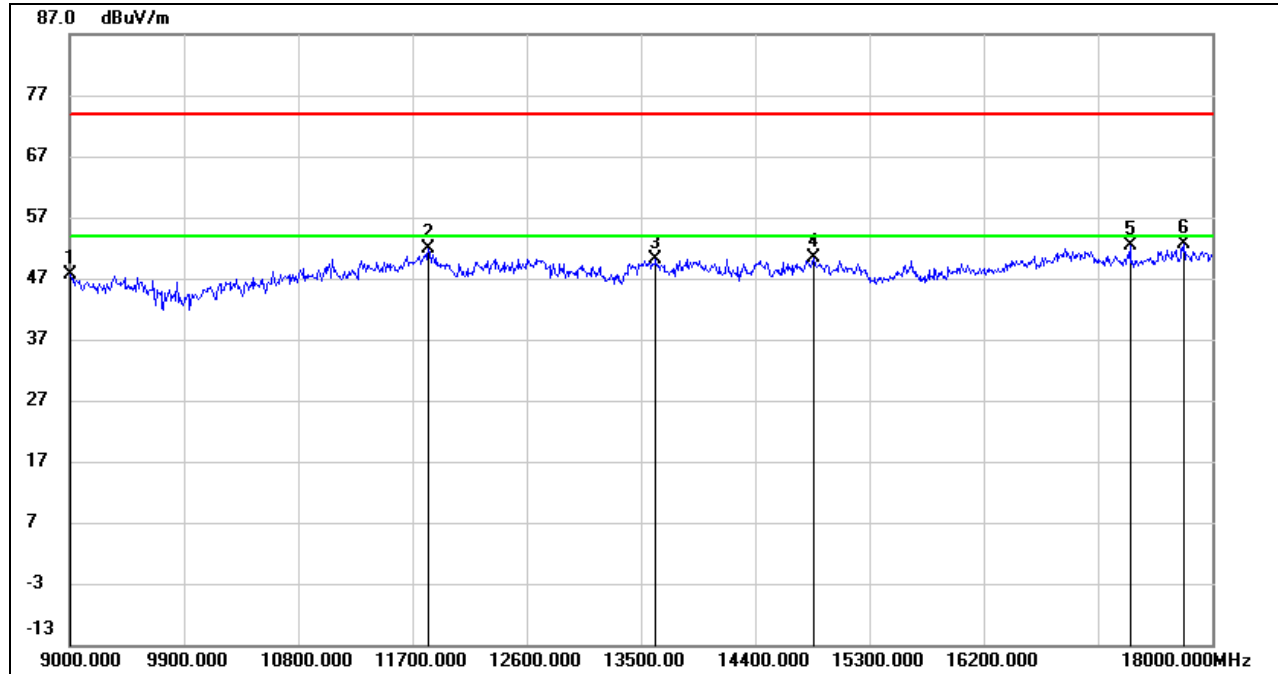

No.	Frequency (MHz)	Reading (dBuV)	Correct (dB/m)	Result (dBuV/m)	Limit (dBuV/m)	Margin (dB)	Remark
1	9009.000	36.97	10.58	47.55	74.00	-26.45	peak
2	11826.000	36.32	15.58	51.90	74.00	-22.10	peak
3	13617.000	33.67	16.47	50.14	74.00	-23.86	peak
4	14859.000	33.57	16.83	50.40	74.00	-23.60	peak
5	17352.000	31.61	20.81	52.42	74.00	-21.58	peak
6	17775.000	30.14	22.53	52.67	74.00	-21.33	peak

Note: 1. Measurement = Reading Level + Correct Factor.
 2. If Peak Result complies with AV limit, AV Result is deemed to comply with AV limit.
 3. Peak: Peak detector.
 4. Filter losses were only considered in the spurious frequency bands and the authorized band was not corrected for High Pass Filter losses.
 5. Proper operation of the transmitter prior to adding the filter to the measurement chain.
 6. Since non-restricted band peak emissions are less than the average limit, they also comply with the -27dBm/MHz (68.2dBuV/m) limit.



UNII-6 BAND

HARMONICS AND SPURIOUS EMISSIONS (LOW CHANNEL, HORIZONTAL)

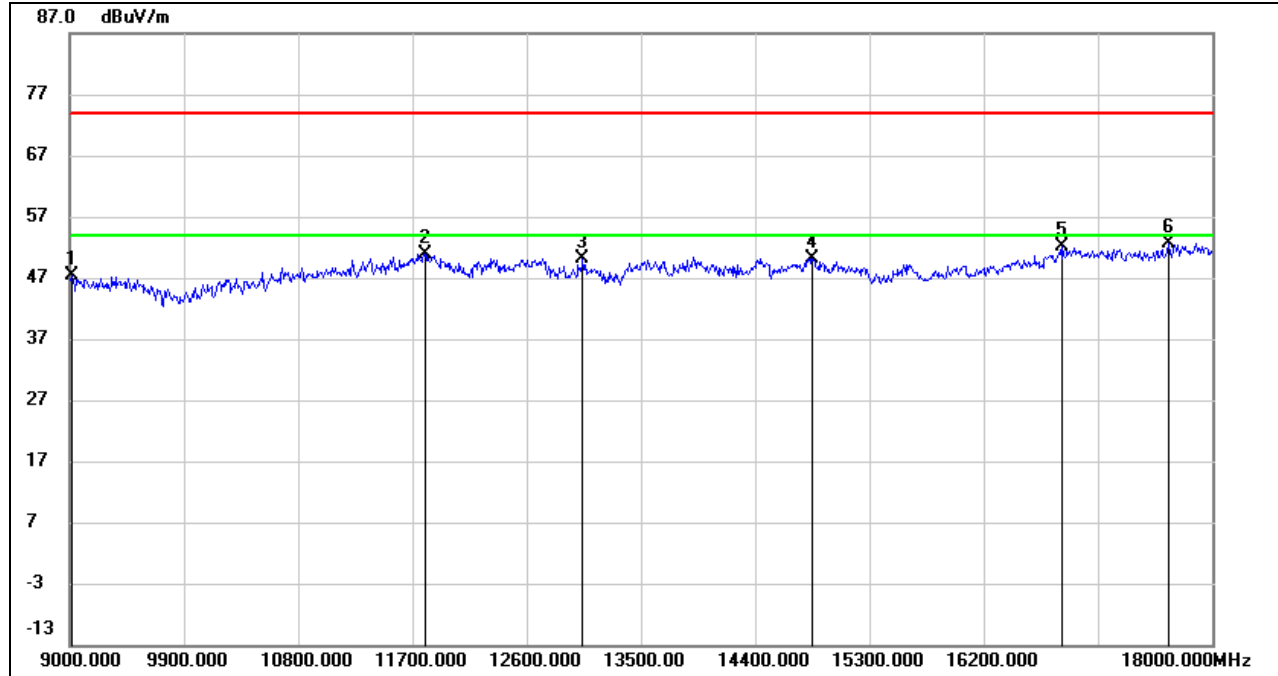

No.	Frequency (MHz)	Reading (dBuV)	Correct (dB/m)	Result (dBuV/m)	Limit (dBuV/m)	Margin (dB)	Remark
1	9018.000	36.83	10.50	47.33	74.00	-26.67	peak
2	11799.000	35.36	15.61	50.97	74.00	-23.03	peak
3	13041.000	34.75	15.45	50.20	74.00	-23.80	peak
4	14850.000	33.33	16.82	50.15	74.00	-23.85	peak
5	16821.000	32.30	19.79	52.09	74.00	-21.91	peak
6	17658.000	31.13	21.62	52.75	74.00	-21.25	peak

Note: 1. Measurement = Reading Level + Correct Factor.
 2. If Peak Result complies with AV limit, AV Result is deemed to comply with AV limit.
 3. Peak: Peak detector.
 4. Filter losses were only considered in the spurious frequency bands and the authorized band was not corrected for High Pass Filter losses.
 5. Proper operation of the transmitter prior to adding the filter to the measurement chain.
 6. Since non-restricted band peak emissions are less than the average limit, they also comply with the -27dBm/MHz (68.2dBuV/m) limit.

HARMONICS AND SPURIOUS EMISSIONS (LOW CHANNEL, VERTICAL)

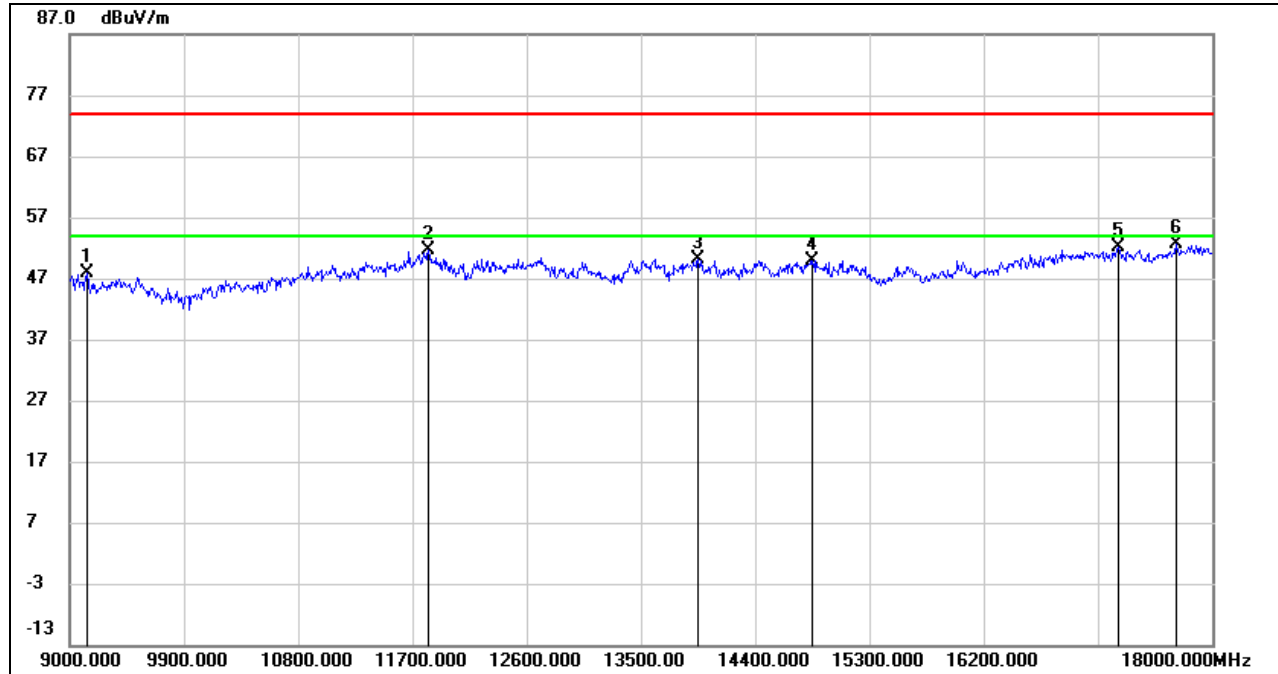

No.	Frequency (MHz)	Reading (dBuV)	Correct (dB/m)	Result (dBuV/m)	Limit (dBuV/m)	Margin (dB)	Remark
1	9135.000	38.14	9.73	47.87	74.00	-26.13	peak
2	11826.000	36.09	15.58	51.67	74.00	-22.33	peak
3	13950.000	33.28	16.88	50.16	74.00	-23.84	peak
4	14850.000	33.03	16.82	49.85	74.00	-24.15	peak
5	17262.000	31.23	20.95	52.18	74.00	-21.82	peak
6	17712.000	30.49	22.03	52.52	74.00	-21.48	peak

Note: 1. Measurement = Reading Level + Correct Factor.
 2. If Peak Result complies with AV limit, AV Result is deemed to comply with AV limit.
 3. Peak: Peak detector.
 4. Filter losses were only considered in the spurious frequency bands and the authorized band was not corrected for High Pass Filter losses.
 5. Proper operation of the transmitter prior to adding the filter to the measurement chain.
 6. Since non-restricted band peak emissions are less than the average limit, they also comply with the -27dBm/MHz (68.2dBuV/m) limit.

HARMONICS AND SPURIOUS EMISSIONS (HIGH CHANNEL, HORIZONTAL)

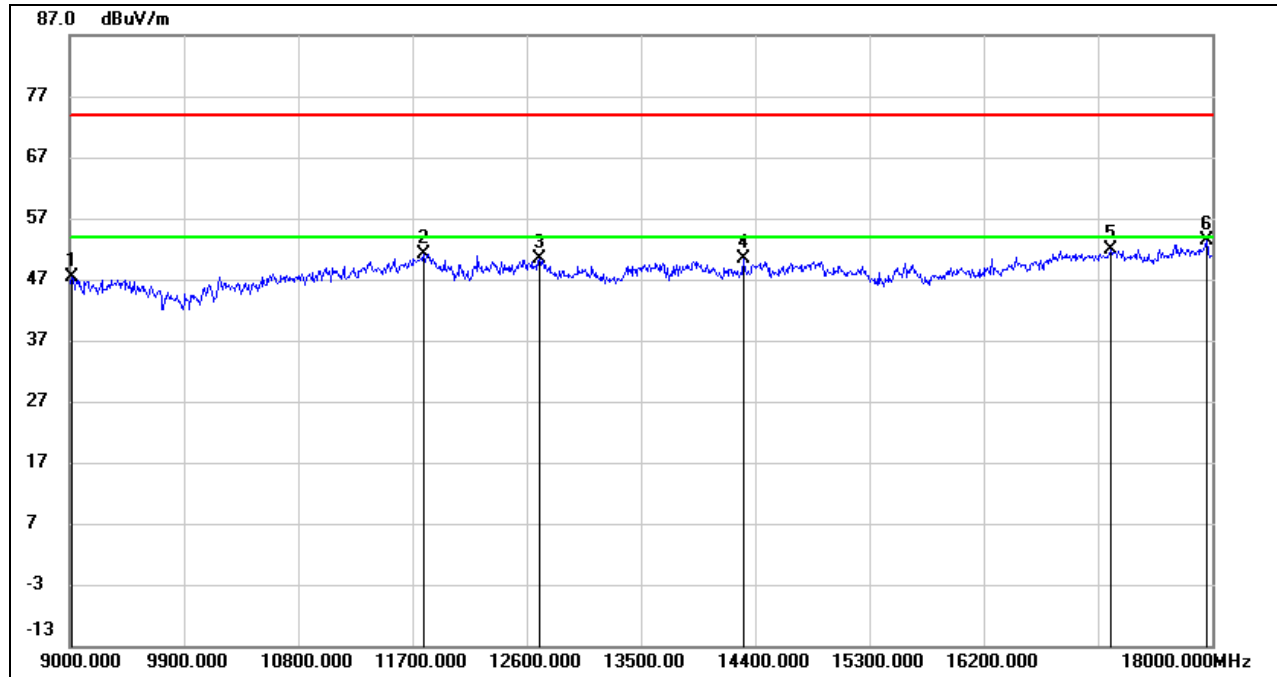

No.	Frequency (MHz)	Reading (dBuV)	Correct (dB/m)	Result (dBuV/m)	Limit (dBuV/m)	Margin (dB)	Remark
1	9018.000	36.77	10.50	47.27	74.00	-26.73	peak
2	11790.000	35.58	15.56	51.14	74.00	-22.86	peak
3	12699.000	34.91	15.47	50.38	74.00	-23.62	peak
4	14310.000	33.60	16.79	50.39	74.00	-23.61	peak
5	17199.000	30.91	21.04	51.95	74.00	-22.05	peak
6	17955.000	30.59	22.69	53.28	74.00	-20.72	peak

Note: 1. Measurement = Reading Level + Correct Factor.
 2. If Peak Result complies with AV limit, AV Result is deemed to comply with AV limit.
 3. Peak: Peak detector.
 4. Filter losses were only considered in the spurious frequency bands and the authorized band was not corrected for High Pass Filter losses.
 5. Proper operation of the transmitter prior to adding the filter to the measurement chain.
 6. Since non-restricted band peak emissions are less than the average limit, they also comply with the -27dBm/MHz (68.2dBuV/m) limit.

HARMONICS AND SPURIOUS EMISSIONS (HIGH CHANNEL, VERTICAL)

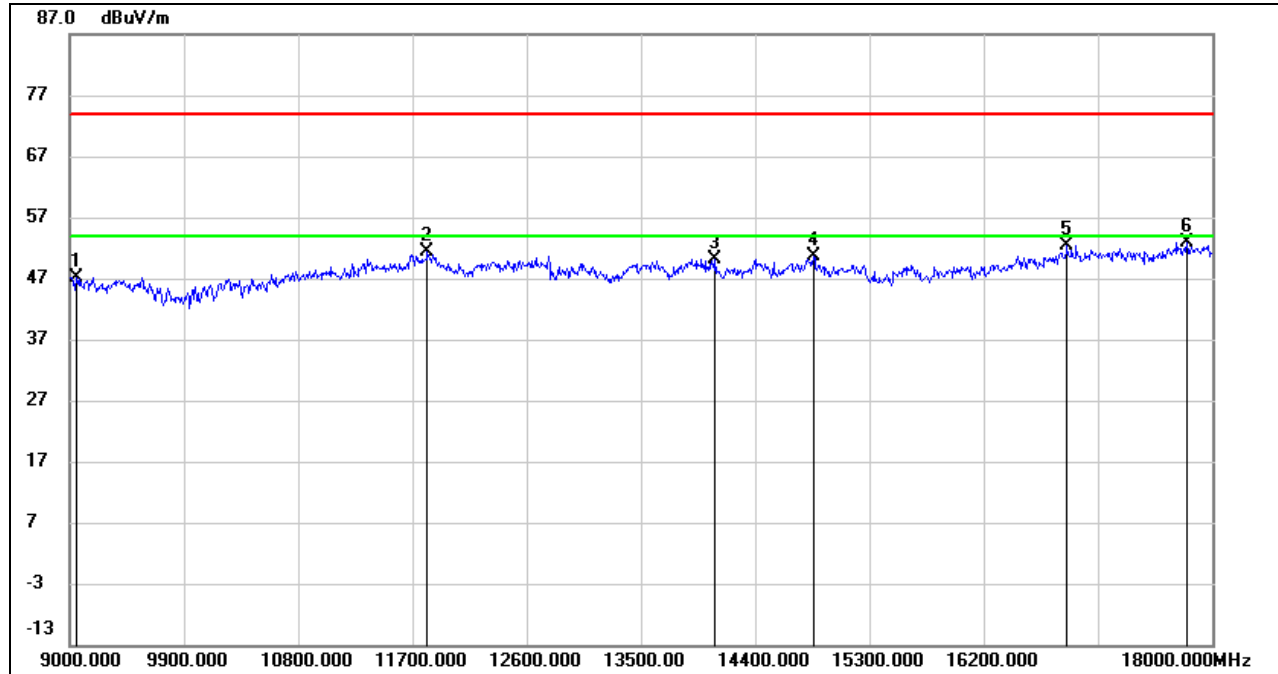

No.	Frequency (MHz)	Reading (dBuV)	Correct (dB/m)	Result (dBuV/m)	Limit (dBuV/m)	Margin (dB)	Remark
1	9054.000	36.96	10.26	47.22	74.00	-26.78	peak
2	11817.000	35.79	15.59	51.38	74.00	-22.62	peak
3	14085.000	33.32	16.79	50.11	74.00	-23.89	peak
4	14859.000	33.70	16.83	50.53	74.00	-23.47	peak
5	16857.000	32.57	19.88	52.45	74.00	-21.55	peak
6	17802.000	30.22	22.72	52.94	74.00	-21.06	peak

Note: 1. Measurement = Reading Level + Correct Factor.
 2. If Peak Result complies with AV limit, AV Result is deemed to comply with AV limit.
 3. Peak: Peak detector.
 4. Filter losses were only considered in the spurious frequency bands and the authorized band was not corrected for High Pass Filter losses.
 5. Proper operation of the transmitter prior to adding the filter to the measurement chain.
 6. Since non-restricted band peak emissions are less than the average limit, they also comply with the -27dBm/MHz (68.2dBuV/m) limit.



UNII-7 BAND

HARMONICS AND SPURIOUS EMISSIONS (LOW CHANNEL, HORIZONTAL)

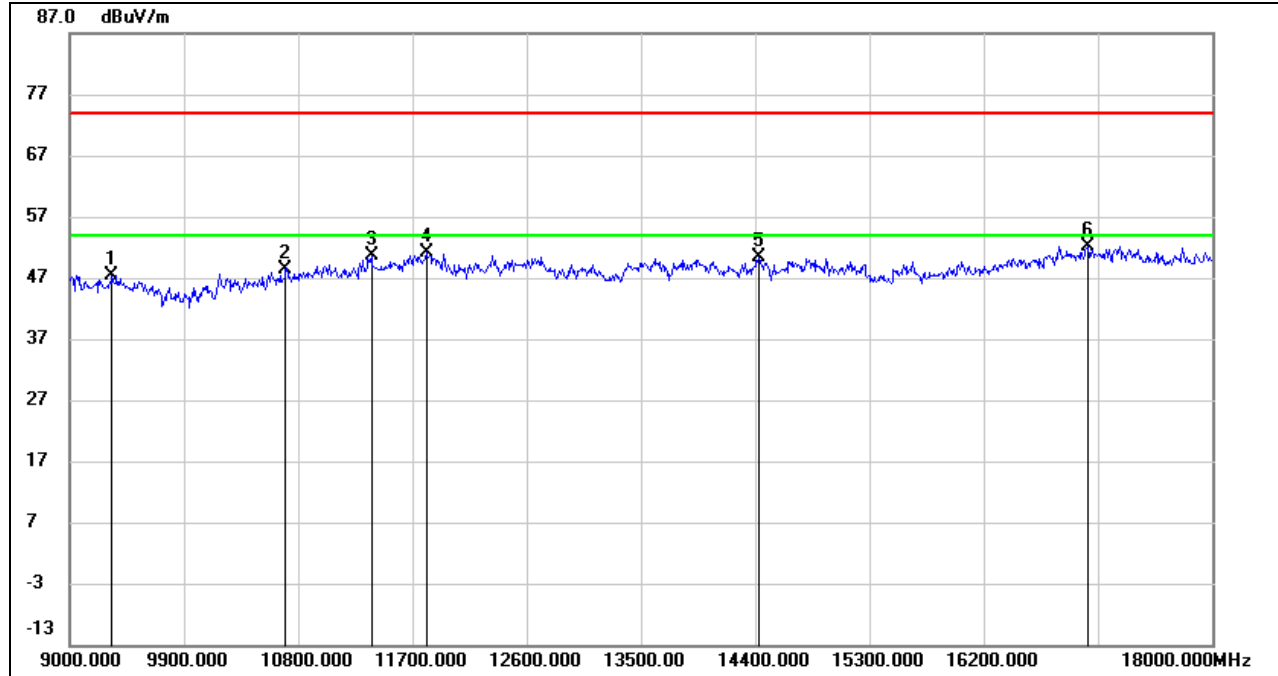

No.	Frequency (MHz)	Reading (dBuV)	Correct (dB/m)	Result (dBuV/m)	Limit (dBuV/m)	Margin (dB)	Remark
1	9333.000	37.47	9.97	47.44	74.00	-26.56	peak
2	10701.000	35.74	12.52	48.26	74.00	-25.74	peak
3	11376.000	36.53	14.15	50.68	74.00	-23.32	peak
4	11808.000	35.44	15.61	51.05	74.00	-22.95	peak
5	14427.000	33.49	16.80	50.29	74.00	-23.71	peak
6	17019.000	31.84	20.31	52.15	74.00	-21.85	peak

Note: 1. Measurement = Reading Level + Correct Factor.
 2. If Peak Result complies with AV limit, AV Result is deemed to comply with AV limit.
 3. Peak: Peak detector.
 4. Filter losses were only considered in the spurious frequency bands and the authorized band was not corrected for High Pass Filter losses.
 5. Proper operation of the transmitter prior to adding the filter to the measurement chain.
 6. Since non-restricted band peak emissions are less than the average limit, they also comply with the -27dBm/MHz (68.2dBuV/m) limit.

HARMONICS AND SPURIOUS EMISSIONS (LOW CHANNEL, VERTICAL)

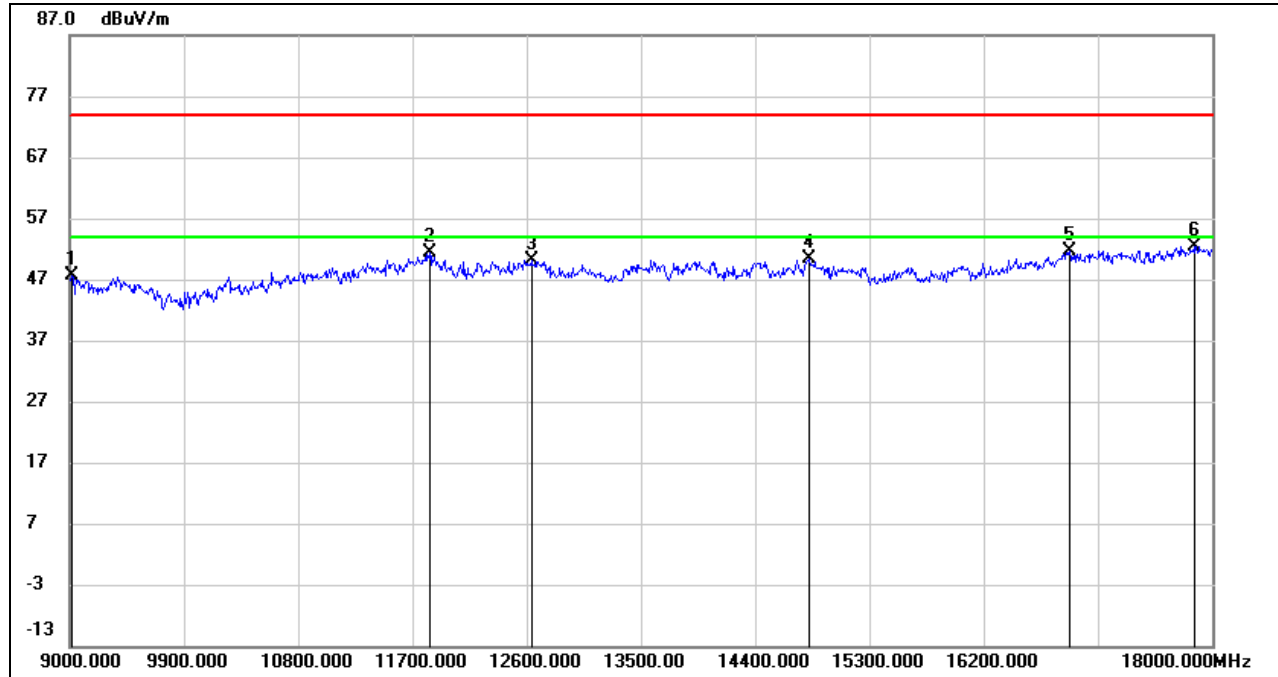

No.	Frequency (MHz)	Reading (dBuV)	Correct (dB/m)	Result (dBuV/m)	Limit (dBuV/m)	Margin (dB)	Remark
1	9018.000	37.04	10.50	47.54	74.00	-26.46	peak
2	11835.000	35.88	15.56	51.44	74.00	-22.56	peak
3	12636.000	34.84	15.35	50.19	74.00	-23.81	peak
4	14823.000	33.49	16.81	50.30	74.00	-23.70	peak
5	16875.000	31.83	19.92	51.75	74.00	-22.25	peak
6	17865.000	29.79	22.71	52.50	74.00	-21.50	peak

- Note: 1. Measurement = Reading Level + Correct Factor.
 2. If Peak Result complies with AV limit, AV Result is deemed to comply with AV limit.
 3. Peak: Peak detector.
 4. Filter losses were only considered in the spurious frequency bands and the authorized band was not corrected for High Pass Filter losses.
 5. Proper operation of the transmitter prior to adding the filter to the measurement chain.
 6. Since non-restricted band peak emissions are less than the average limit, they also comply with the -27dBm/MHz (68.2dBuV/m) limit.

HARMONICS AND SPURIOUS EMISSIONS (MID CHANNEL, HORIZONTAL)

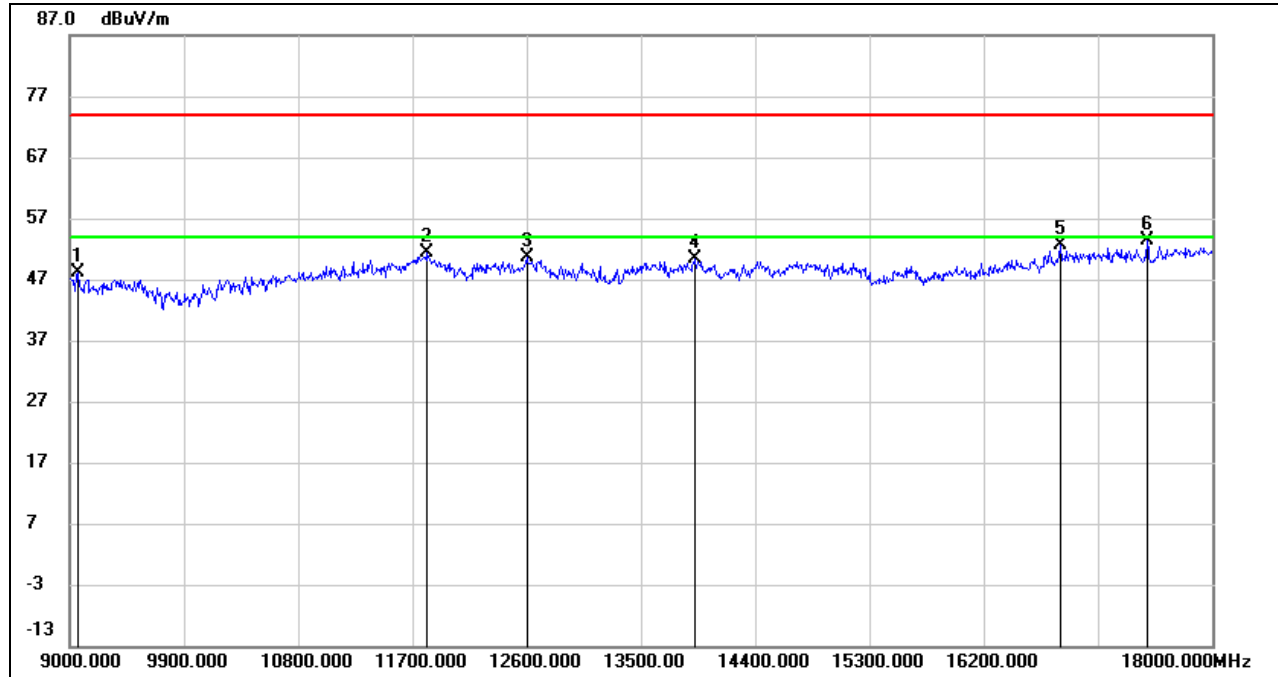

No.	Frequency (MHz)	Reading (dBuV)	Correct (dB/m)	Result (dBuV/m)	Limit (dBuV/m)	Margin (dB)	Remark
1	9063.000	37.96	10.21	48.17	74.00	-25.83	peak
2	11817.000	35.81	15.59	51.40	74.00	-22.60	peak
3	12600.000	35.34	15.29	50.63	74.00	-23.37	peak
4	13923.000	33.54	16.89	50.43	74.00	-23.57	peak
5	16803.000	32.81	19.75	52.56	74.00	-21.44	peak
6	17487.000	32.48	20.82	53.30	74.00	-20.70	peak

- Note: 1. Measurement = Reading Level + Correct Factor.
 2. If Peak Result complies with AV limit, AV Result is deemed to comply with AV limit.
 3. Peak: Peak detector.
 4. Filter losses were only considered in the spurious frequency bands and the authorized band was not corrected for High Pass Filter losses.
 5. Proper operation of the transmitter prior to adding the filter to the measurement chain.
 6. Since non-restricted band peak emissions are less than the average limit, they also comply with the -27dBm/MHz (68.2dBuV/m) limit.

HARMONICS AND SPURIOUS EMISSIONS (MID CHANNEL, VERTICAL)

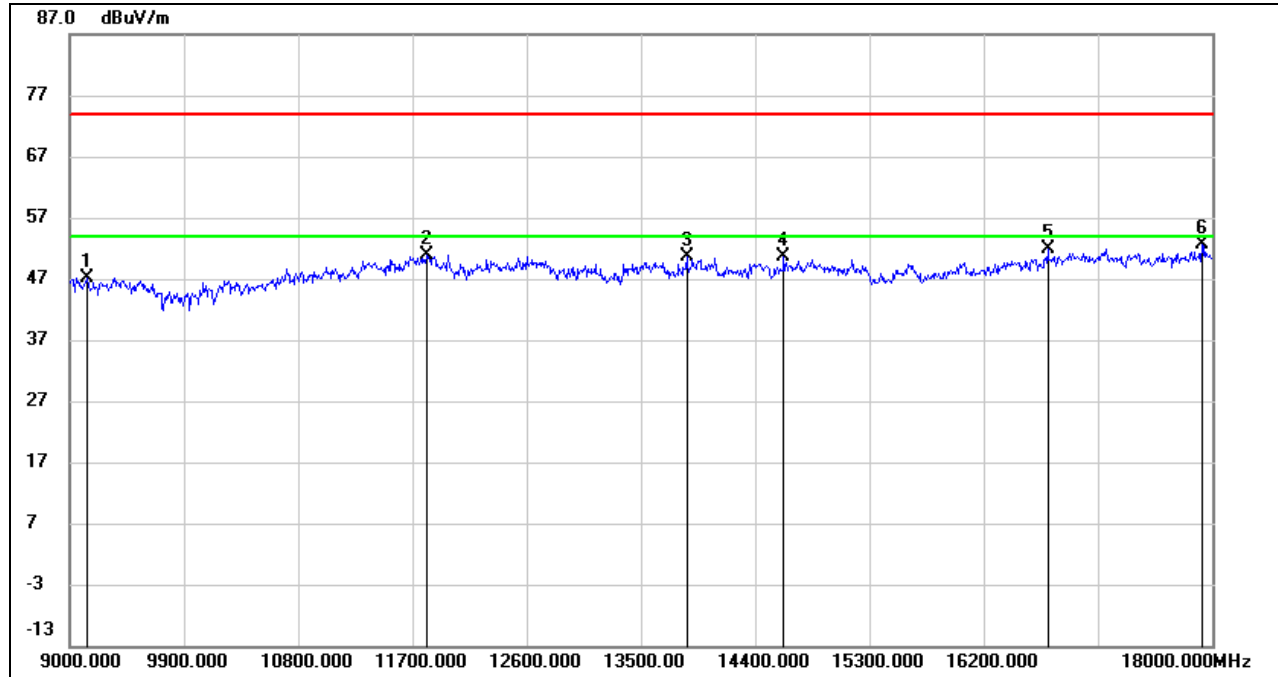

No.	Frequency (MHz)	Reading (dBuV)	Correct (dB/m)	Result (dBuV/m)	Limit (dBuV/m)	Margin (dB)	Remark
1	9135.000	37.47	9.73	47.20	74.00	-26.80	peak
2	11808.000	35.33	15.61	50.94	74.00	-23.06	peak
3	13860.000	33.61	16.92	50.53	74.00	-23.47	peak
4	14625.000	34.21	16.50	50.71	74.00	-23.29	peak
5	16704.000	32.23	19.63	51.86	74.00	-22.14	peak
6	17919.000	29.85	22.69	52.54	74.00	-21.46	peak

- Note: 1. Measurement = Reading Level + Correct Factor.
 2. If Peak Result complies with AV limit, AV Result is deemed to comply with AV limit.
 3. Peak: Peak detector.
 4. Filter losses were only considered in the spurious frequency bands and the authorized band was not corrected for High Pass Filter losses.
 5. Proper operation of the transmitter prior to adding the filter to the measurement chain.
 6. Since non-restricted band peak emissions are less than the average limit, they also comply with the -27dBm/MHz (68.2dBuV/m) limit.

HARMONICS AND SPURIOUS EMISSIONS (HIGH CHANNEL, HORIZONTAL)

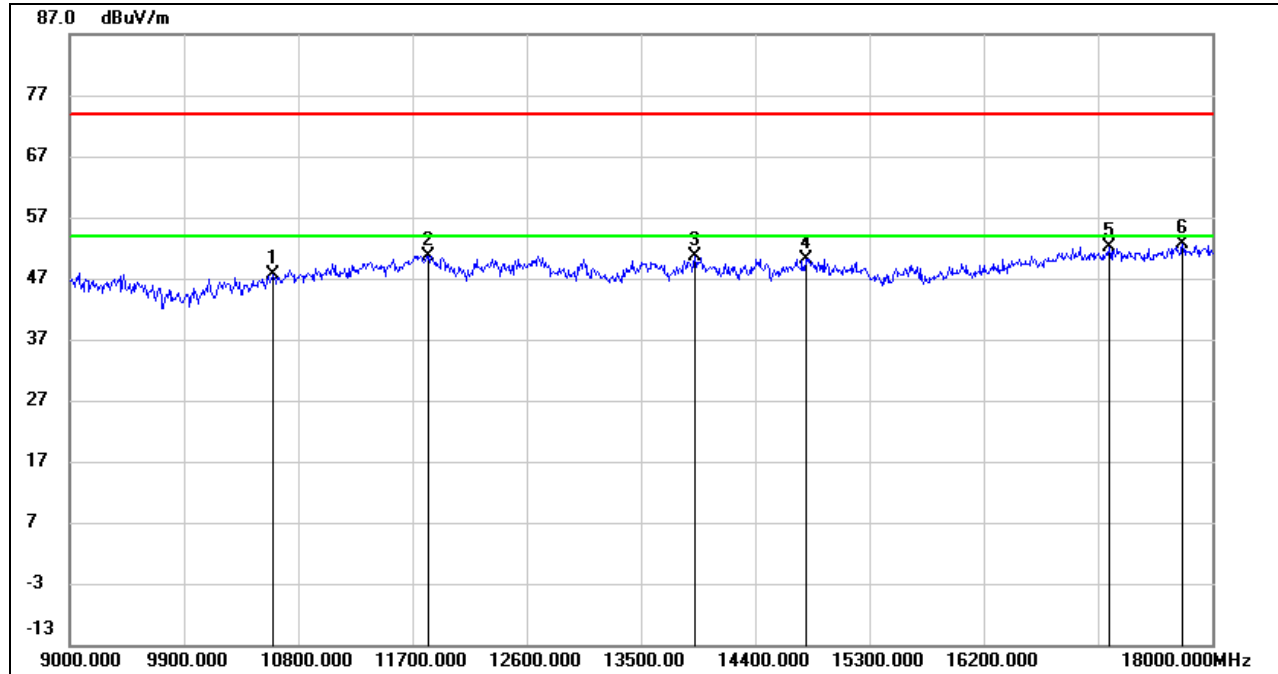

No.	Frequency (MHz)	Reading (dBuV)	Correct (dB/m)	Result (dBuV/m)	Limit (dBuV/m)	Margin (dB)	Remark
1	10602.000	35.24	12.36	47.60	74.00	-26.40	peak
2	11826.000	35.11	15.58	50.69	74.00	-23.31	peak
3	13923.000	33.74	16.89	50.63	74.00	-23.37	peak
4	14796.000	33.43	16.79	50.22	74.00	-23.78	peak
5	17190.000	31.18	21.00	52.18	74.00	-21.82	peak
6	17766.000	30.17	22.46	52.63	74.00	-21.37	peak

Note: 1. Measurement = Reading Level + Correct Factor.
 2. If Peak Result complies with AV limit, AV Result is deemed to comply with AV limit.
 3. Peak: Peak detector.
 4. Filter losses were only considered in the spurious frequency bands and the authorized band was not corrected for High Pass Filter losses.
 5. Proper operation of the transmitter prior to adding the filter to the measurement chain.
 6. Since non-restricted band peak emissions are less than the average limit, they also comply with the -27dBm/MHz (68.2dBuV/m) limit.

HARMONICS AND SPURIOUS EMISSIONS (HIGH CHANNEL, VERTICAL)

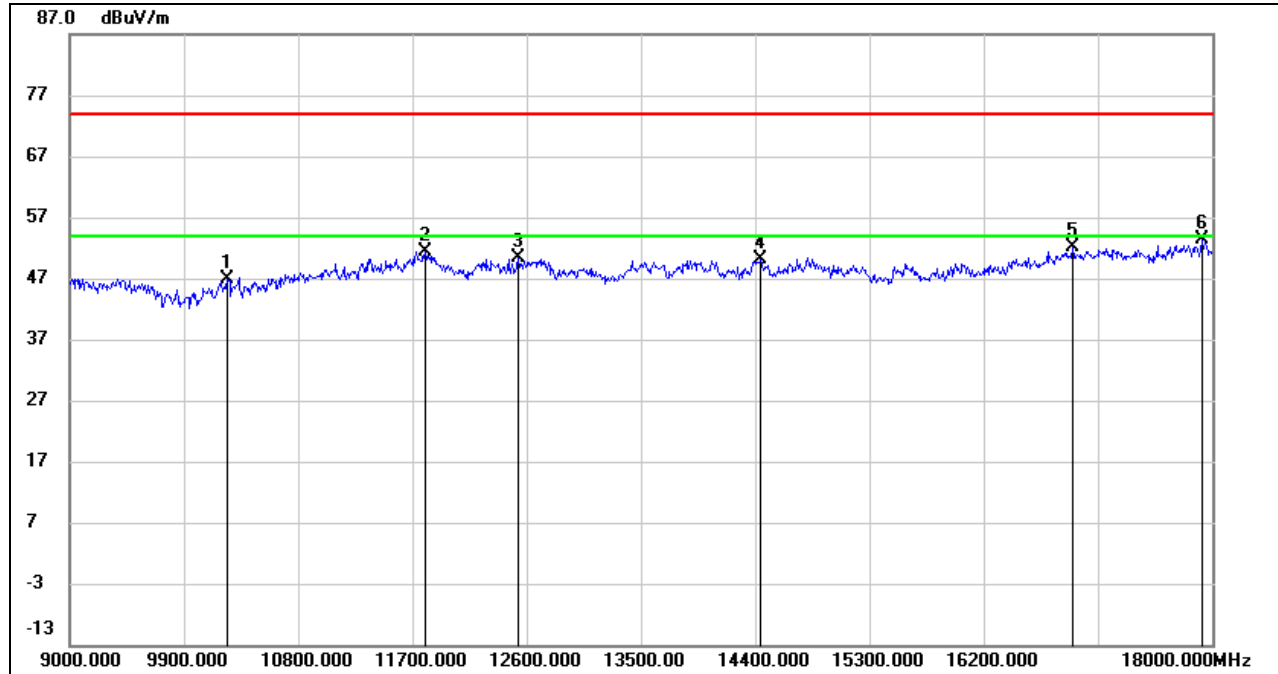

No.	Frequency (MHz)	Reading (dBuV)	Correct (dB/m)	Result (dBuV/m)	Limit (dBuV/m)	Margin (dB)	Remark
1	10242.000	35.98	10.89	46.87	74.00	-27.13	peak
2	11799.000	35.69	15.61	51.30	74.00	-22.70	peak
3	12528.000	34.96	15.34	50.30	74.00	-23.70	peak
4	14445.000	33.32	16.77	50.09	74.00	-23.91	peak
5	16902.000	32.04	19.99	52.03	74.00	-21.97	peak
6	17919.000	30.69	22.69	53.38	74.00	-20.62	peak

Note: 1. Measurement = Reading Level + Correct Factor.
 2. If Peak Result complies with AV limit, AV Result is deemed to comply with AV limit.
 3. Peak: Peak detector.
 4. Filter losses were only considered in the spurious frequency bands and the authorized band was not corrected for High Pass Filter losses.
 5. Proper operation of the transmitter prior to adding the filter to the measurement chain.
 6. Since non-restricted band peak emissions are less than the average limit, they also comply with the -27dBm/MHz (68.2dBuV/m) limit.

UNII-8 BAND

HARMONICS AND SPURIOUS EMISSIONS (LOW CHANNEL, HORIZONTAL)

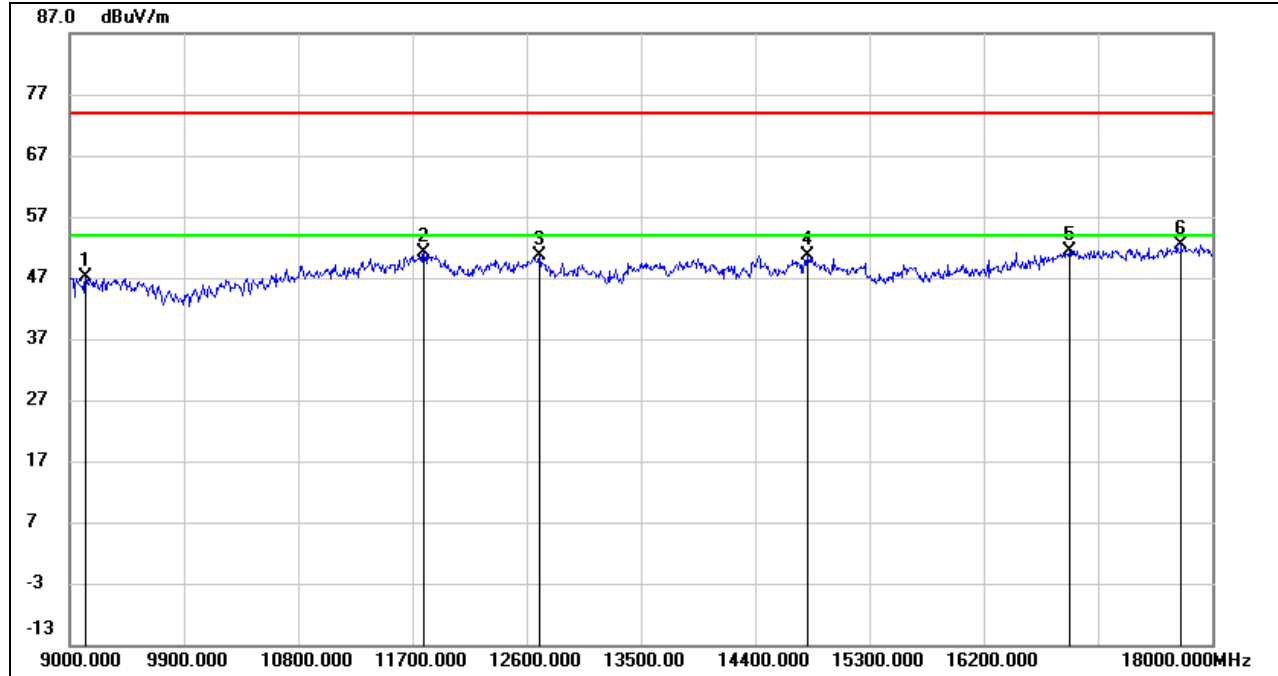

No.	Frequency (MHz)	Reading (dBuV)	Correct (dB/m)	Result (dBuV/m)	Limit (dBuV/m)	Margin (dB)	Remark
1	9126.000	37.36	9.78	47.14	74.00	-26.86	peak
2	11790.000	35.49	15.56	51.05	74.00	-22.95	peak
3	12699.000	35.25	15.47	50.72	74.00	-23.28	peak
4	14814.000	33.81	16.81	50.62	74.00	-23.38	peak
5	16875.000	31.56	19.92	51.48	74.00	-22.52	peak
6	17757.000	30.03	22.39	52.42	74.00	-21.58	peak

Note: 1. Measurement = Reading Level + Correct Factor.
 2. If Peak Result complies with AV limit, AV Result is deemed to comply with AV limit.
 3. Peak: Peak detector.
 4. Filter losses were only considered in the spurious frequency bands and the authorized band was not corrected for High Pass Filter losses.
 5. Proper operation of the transmitter prior to adding the filter to the measurement chain.
 6. Since non-restricted band peak emissions are less than the average limit, they also comply with the -27dBm/MHz (68.2dBuV/m) limit.

HARMONICS AND SPURIOUS EMISSIONS (LOW CHANNEL, VERTICAL)

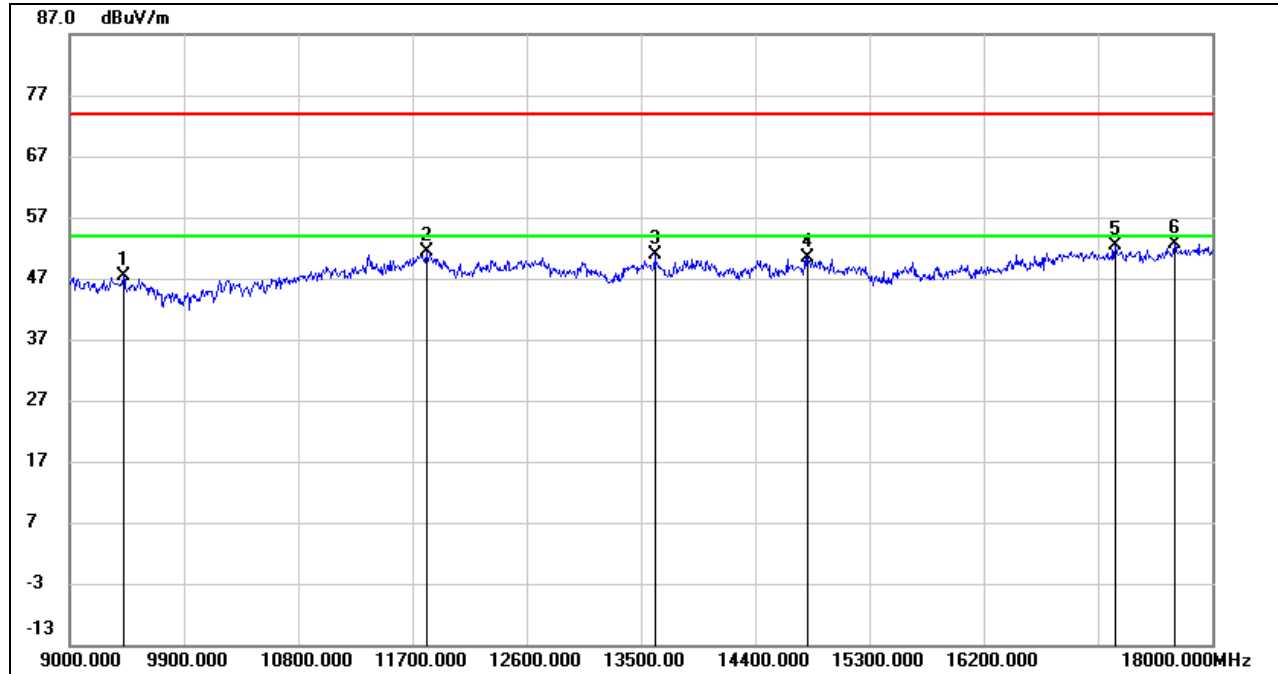

No.	Frequency (MHz)	Reading (dBuV)	Correct (dB/m)	Result (dBuV/m)	Limit (dBuV/m)	Margin (dB)	Remark
1	9423.000	37.10	10.35	47.45	74.00	-26.55	peak
2	11808.000	35.67	15.61	51.28	74.00	-22.72	peak
3	13608.000	34.31	16.45	50.76	74.00	-23.24	peak
4	14814.000	33.58	16.81	50.39	74.00	-23.61	peak
5	17235.000	31.44	20.99	52.43	74.00	-21.57	peak
6	17703.000	30.67	21.96	52.63	74.00	-21.37	peak

- Note: 1. Measurement = Reading Level + Correct Factor.
 2. If Peak Result complies with AV limit, AV Result is deemed to comply with AV limit.
 3. Peak: Peak detector.
 4. Filter losses were only considered in the spurious frequency bands and the authorized band was not corrected for High Pass Filter losses.
 5. Proper operation of the transmitter prior to adding the filter to the measurement chain.
 6. Since non-restricted band peak emissions are less than the average limit, they also comply with the -27dBm/MHz (68.2dBuV/m) limit.

HARMONICS AND SPURIOUS EMISSIONS (MID CHANNEL, HORIZONTAL)

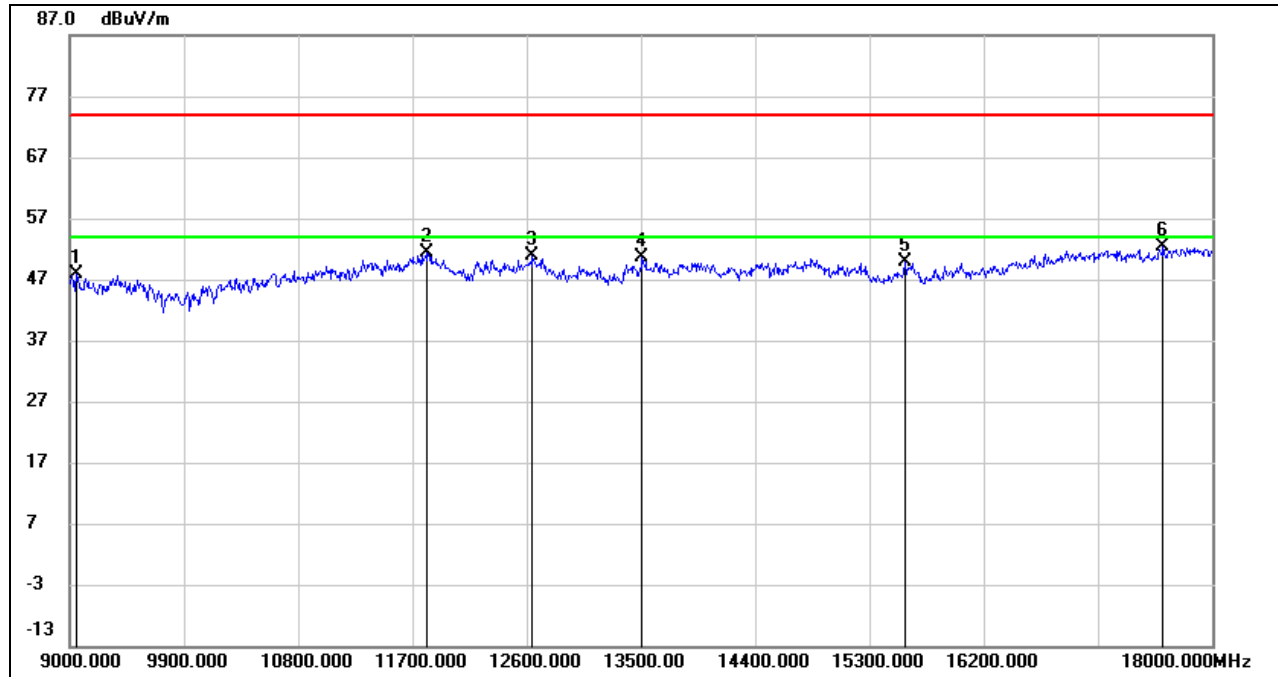

No.	Frequency (MHz)	Reading (dBuV)	Correct (dB/m)	Result (dBuV/m)	Limit (dBuV/m)	Margin (dB)	Remark
1	9054.000	37.63	10.26	47.89	74.00	-26.11	peak
2	11808.000	35.79	15.61	51.40	74.00	-22.60	peak
3	12645.000	35.47	15.38	50.85	74.00	-23.15	peak
4	13509.000	34.14	16.41	50.55	74.00	-23.45	peak
5	15579.000	33.12	16.65	49.77	74.00	-24.23	peak
6	17613.000	31.22	21.27	52.49	74.00	-21.51	peak

Note: 1. Measurement = Reading Level + Correct Factor.
 2. If Peak Result complies with AV limit, AV Result is deemed to comply with AV limit.
 3. Peak: Peak detector.
 4. Filter losses were only considered in the spurious frequency bands and the authorized band was not corrected for High Pass Filter losses.
 5. Proper operation of the transmitter prior to adding the filter to the measurement chain.
 6. Since non-restricted band peak emissions are less than the average limit, they also comply with the -27dBm/MHz (68.2dBuV/m) limit.



HARMONICS AND SPURIOUS EMISSIONS (MID CHANNEL, VERTICAL)

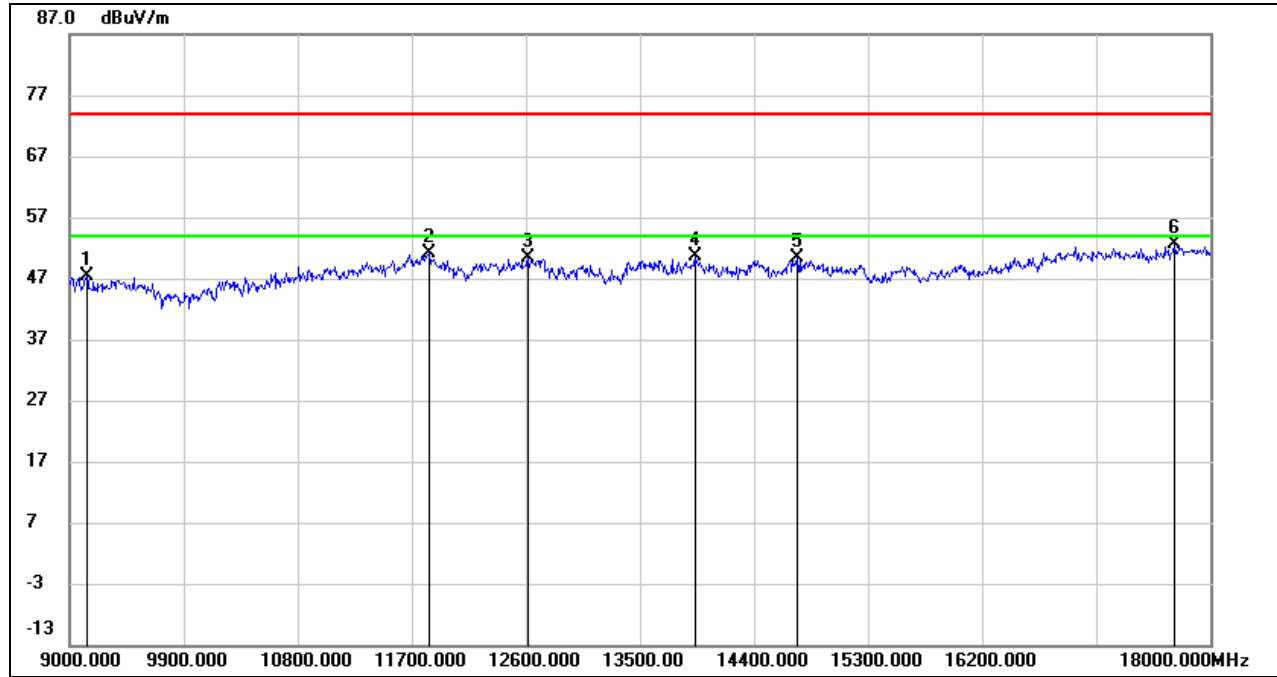

No.	Frequency (MHz)	Reading (dBuV)	Correct (dB/m)	Result (dBuV/m)	Limit (dBuV/m)	Margin (dB)	Remark
1	9135.000	37.70	9.73	47.43	74.00	-26.57	peak
2	11835.000	35.55	15.56	51.11	74.00	-22.89	peak
3	12618.000	35.13	15.32	50.45	74.00	-23.55	peak
4	13932.000	33.66	16.89	50.55	74.00	-23.45	peak
5	14742.000	33.65	16.70	50.35	74.00	-23.65	peak
6	17721.000	30.55	22.10	52.65	74.00	-21.35	peak

Note: 1. Measurement = Reading Level + Correct Factor.
 2. If Peak Result complies with AV limit, AV Result is deemed to comply with AV limit.
 3. Peak: Peak detector.
 4. Filter losses were only considered in the spurious frequency bands and the authorized band was not corrected for High Pass Filter losses.
 5. Proper operation of the transmitter prior to adding the filter to the measurement chain.
 6. Since non-restricted band peak emissions are less than the average limit, they also comply with the -27dBm/MHz (68.2dBuV/m) limit.



HARMONICS AND SPURIOUS EMISSIONS (HIGH CHANNEL, HORIZONTAL)

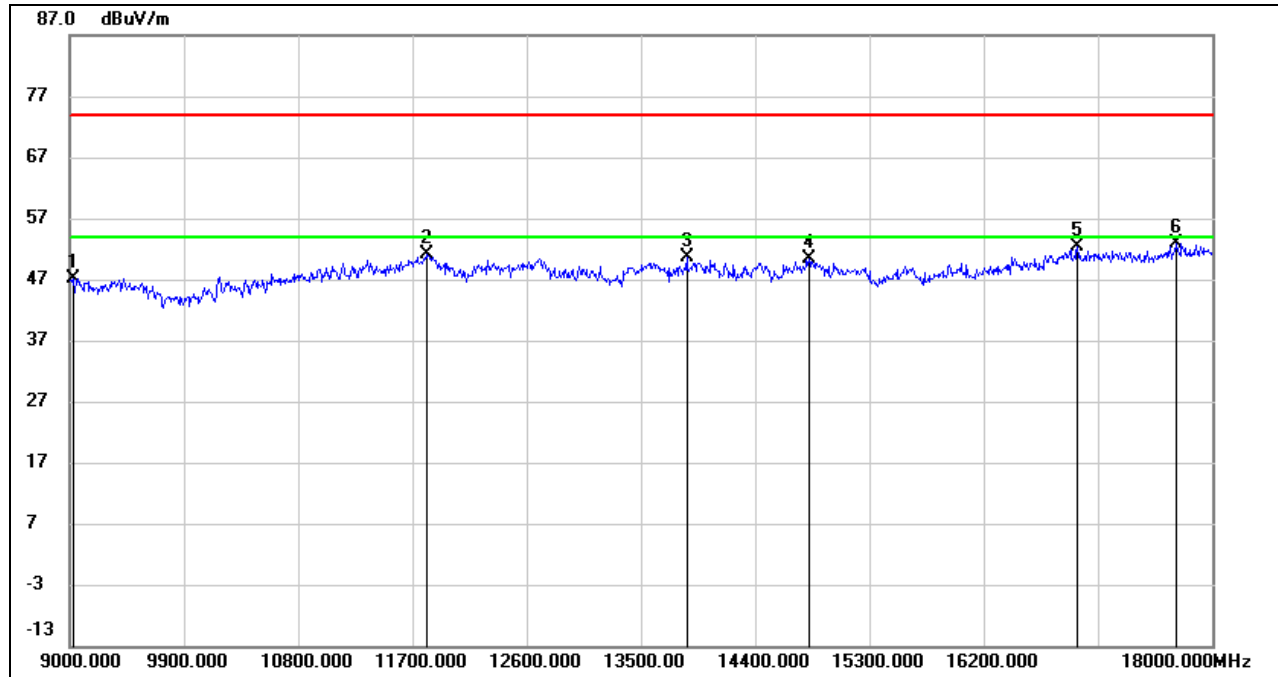

No.	Frequency (MHz)	Reading (dBuV)	Correct (dB/m)	Result (dBuV/m)	Limit (dBuV/m)	Margin (dB)	Remark
1	9027.000	36.76	10.45	47.21	74.00	-26.79	peak
2	11808.000	35.45	15.61	51.06	74.00	-22.94	peak
3	13860.000	33.78	16.92	50.70	74.00	-23.30	peak
4	14823.000	33.65	16.81	50.46	74.00	-23.54	peak
5	16938.000	32.29	20.08	52.37	74.00	-21.63	peak
6	17712.000	30.89	22.03	52.92	74.00	-21.08	peak

Note: 1. Measurement = Reading Level + Correct Factor.
 2. If Peak Result complies with AV limit, AV Result is deemed to comply with AV limit.
 3. Peak: Peak detector.
 4. Filter losses were only considered in the spurious frequency bands and the authorized band was not corrected for High Pass Filter losses.
 5. Proper operation of the transmitter prior to adding the filter to the measurement chain.
 6. Since non-restricted band peak emissions are less than the average limit, they also comply with the -27dBm/MHz (68.2dBuV/m) limit.

HARMONICS AND SPURIOUS EMISSIONS (HIGH CHANNEL, VERTICAL)

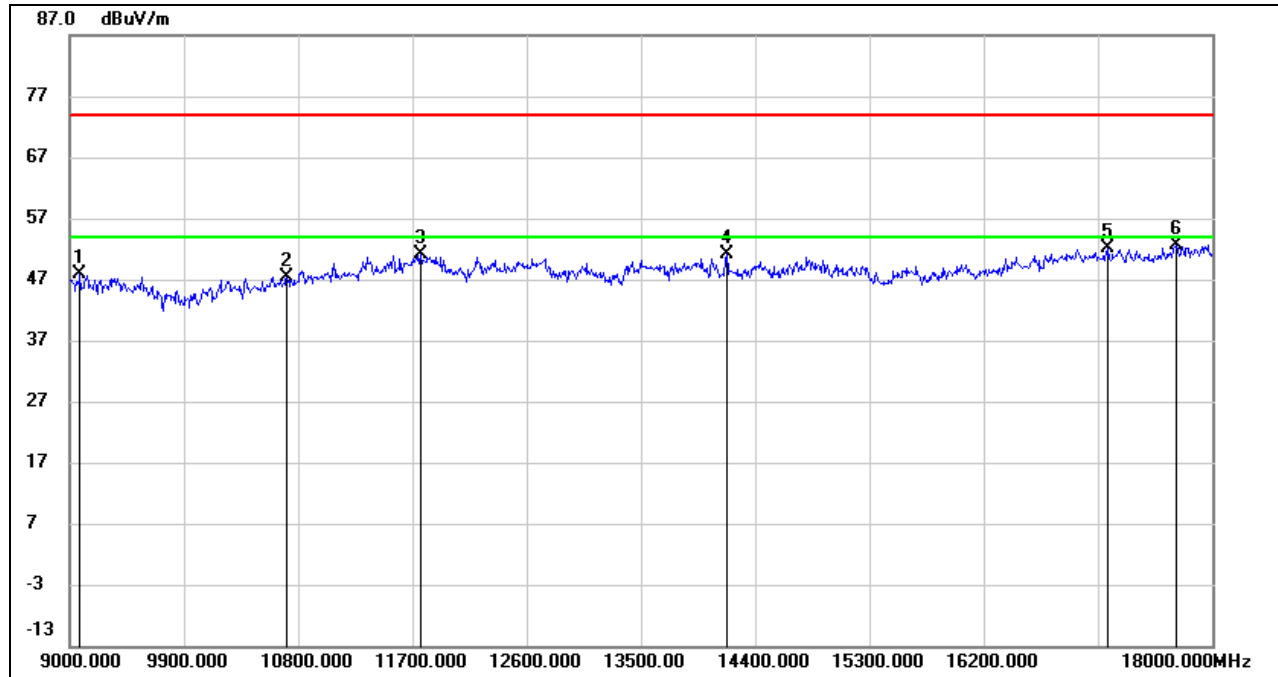

No.	Frequency (MHz)	Reading (dBuV)	Correct (dB/m)	Result (dBuV/m)	Limit (dBuV/m)	Margin (dB)	Remark
1	9081.000	37.78	10.08	47.86	74.00	-26.14	peak
2	10710.000	34.74	12.54	47.28	74.00	-26.72	peak
3	11763.000	35.72	15.41	51.13	74.00	-22.87	peak
4	14175.000	34.49	16.72	51.21	74.00	-22.79	peak
5	17181.000	31.12	20.96	52.08	74.00	-21.92	peak
6	17721.000	30.58	22.10	52.68	74.00	-21.32	peak

Note: 1. Measurement = Reading Level + Correct Factor.
 2. If Peak Result complies with AV limit, AV Result is deemed to comply with AV limit.
 3. Peak: Peak detector.
 4. Filter losses were only considered in the spurious frequency bands and the authorized band was not corrected for High Pass Filter losses.
 5. Proper operation of the transmitter prior to adding the filter to the measurement chain.
 6. Since non-restricted band peak emissions are less than the average limit, they also comply with the -27dBm/MHz (68.2dBuV/m) limit.

Note: All the mode had been tested, but only the worst data was recorded in the report.



8.3.3. 802.11ax HE80 CDD MODE

UNII-5 BAND

HARMONICS AND SPURIOUS EMISSIONS (LOW CHANNEL, HORIZONTAL)

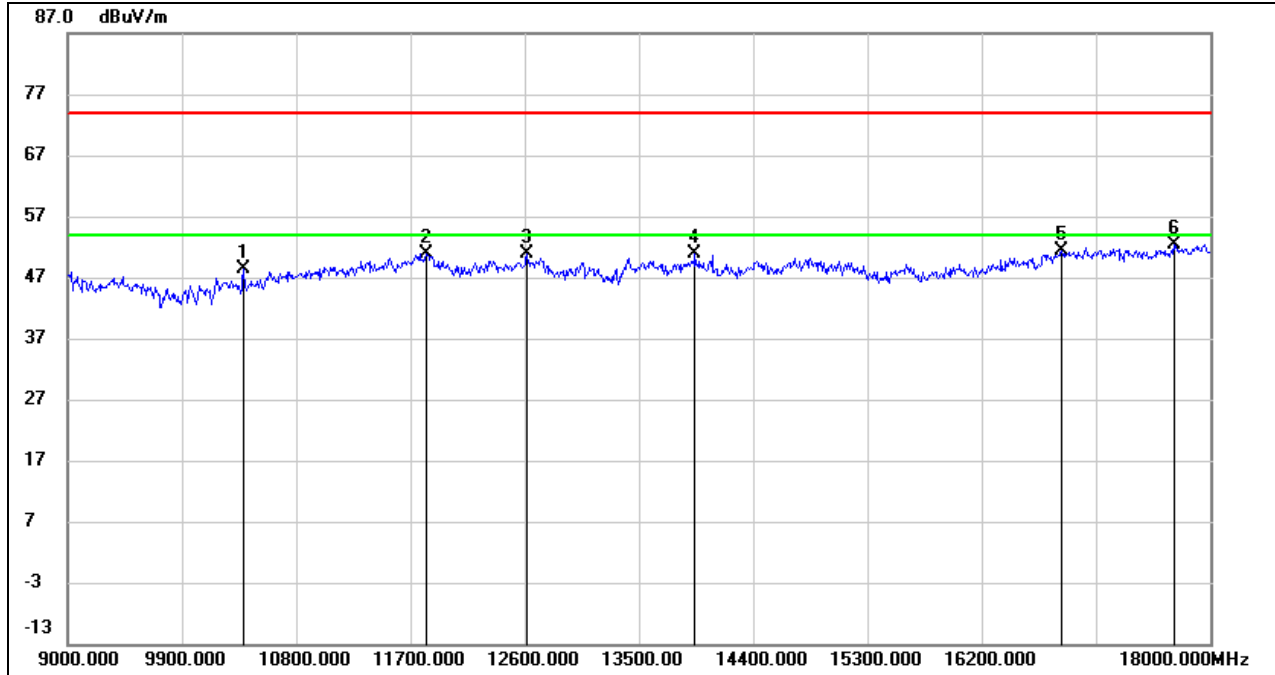

No.	Frequency (MHz)	Reading (dBuV)	Correct (dB/m)	Result (dBuV/m)	Limit (dBuV/m)	Margin (dB)	Remark
1	10386.000	36.85	11.41	48.26	74.00	-25.74	peak
2	11826.000	35.21	15.58	50.79	74.00	-23.21	peak
3	12618.000	35.65	15.32	50.97	74.00	-23.03	peak
4	13941.000	33.89	16.88	50.77	74.00	-23.23	peak
5	16830.000	31.55	19.81	51.36	74.00	-22.64	peak
6	17712.000	30.44	22.03	52.47	74.00	-21.53	peak

- Note: 1. Measurement = Reading Level + Correct Factor.
 2. If Peak Result complies with AV limit, AV Result is deemed to comply with AV limit.
 3. Peak: Peak detector.
 4. Filter losses were only considered in the spurious frequency bands and the authorized band was not corrected for High Pass Filter losses.
 5. Proper operation of the transmitter prior to adding the filter to the measurement chain.
 6. Since non-restricted band peak emissions are less than the average limit, they also comply with the -27dBm/MHz (68.2dBuV/m) limit.



HARMONICS AND SPURIOUS EMISSIONS (LOW CHANNEL, VERTICAL)

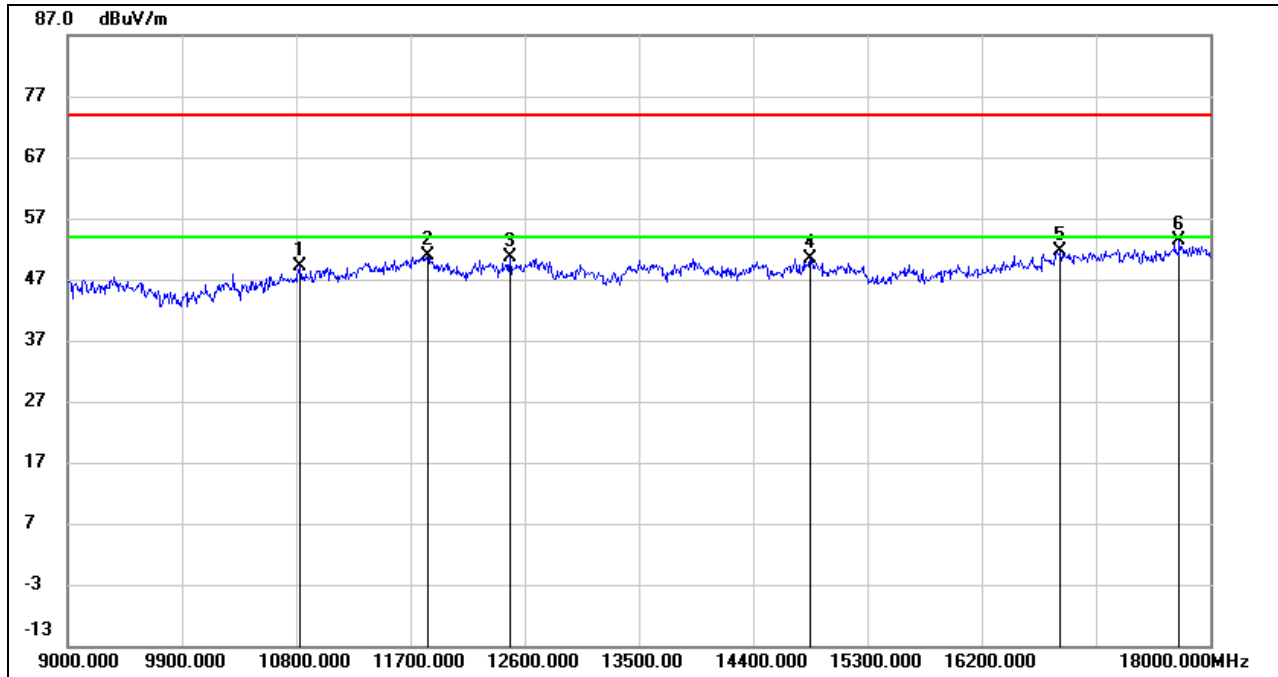

No.	Frequency (MHz)	Reading (dBuV)	Correct (dB/m)	Result (dBuV/m)	Limit (dBuV/m)	Margin (dB)	Remark
1	10827.000	36.30	12.76	49.06	74.00	-24.94	peak
2	11835.000	35.22	15.56	50.78	74.00	-23.22	peak
3	12483.000	35.21	15.39	50.60	74.00	-23.40	peak
4	14850.000	33.65	16.82	50.47	74.00	-23.53	peak
5	16821.000	31.80	19.79	51.59	74.00	-22.41	peak
6	17757.000	31.05	22.39	53.44	74.00	-20.56	peak

Note: 1. Measurement = Reading Level + Correct Factor.
 2. If Peak Result complies with AV limit, AV Result is deemed to comply with AV limit.
 3. Peak: Peak detector.
 4. Filter losses were only considered in the spurious frequency bands and the authorized band was not corrected for High Pass Filter losses.
 5. Proper operation of the transmitter prior to adding the filter to the measurement chain.
 6. Since non-restricted band peak emissions are less than the average limit, they also comply with the -27dBm/MHz (68.2dBuV/m) limit.

HARMONICS AND SPURIOUS EMISSIONS (MID CHANNEL, HORIZONTAL)

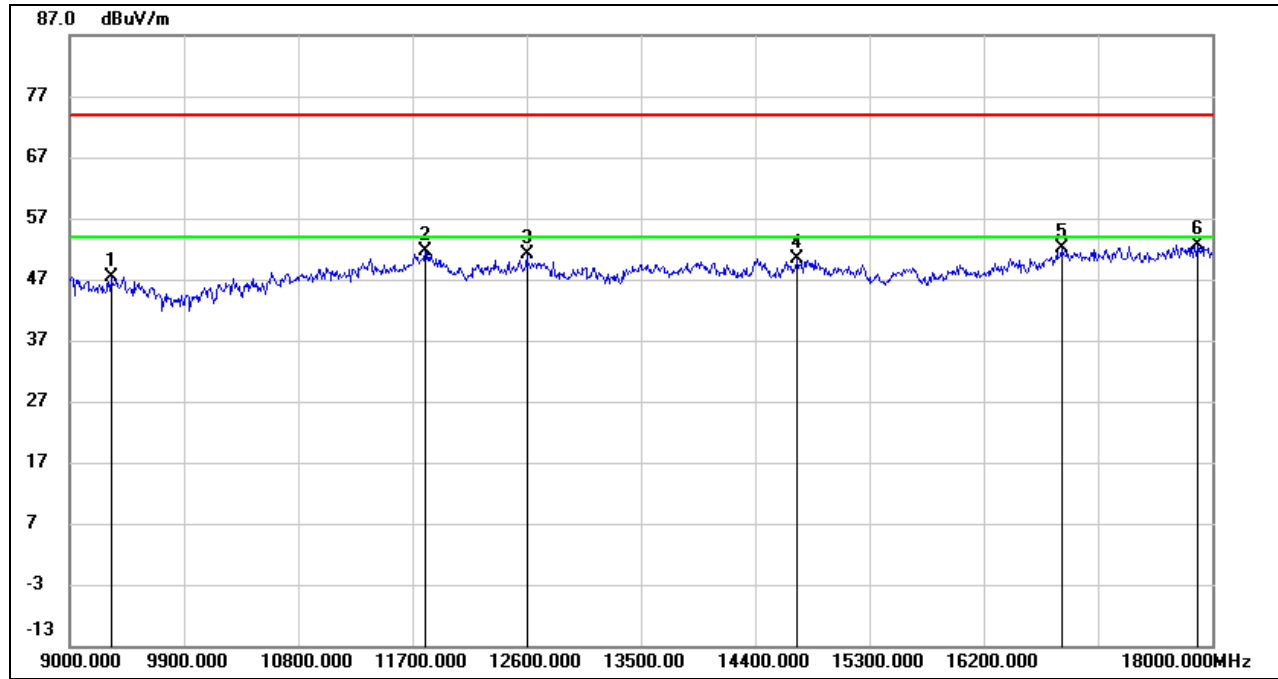

No.	Frequency (MHz)	Reading (dBuV)	Correct (dB/m)	Result (dBuV/m)	Limit (dBuV/m)	Margin (dB)	Remark
1	9324.000	37.41	9.92	47.33	74.00	-26.67	peak
2	11799.000	35.93	15.61	51.54	74.00	-22.46	peak
3	12600.000	35.91	15.29	51.20	74.00	-22.80	peak
4	14733.000	33.79	16.69	50.48	74.00	-23.52	peak
5	16812.000	32.37	19.77	52.14	74.00	-21.86	peak
6	17883.000	29.92	22.70	52.62	74.00	-21.38	peak

Note: 1. Measurement = Reading Level + Correct Factor.
 2. If Peak Result complies with AV limit, AV Result is deemed to comply with AV limit.
 3. Peak: Peak detector.
 4. Filter losses were only considered in the spurious frequency bands and the authorized band was not corrected for High Pass Filter losses.
 5. Proper operation of the transmitter prior to adding the filter to the measurement chain.
 6. Since non-restricted band peak emissions are less than the average limit, they also comply with the -27dBm/MHz (68.2dBuV/m) limit.

HARMONICS AND SPURIOUS EMISSIONS (MID CHANNEL, VERTICAL)

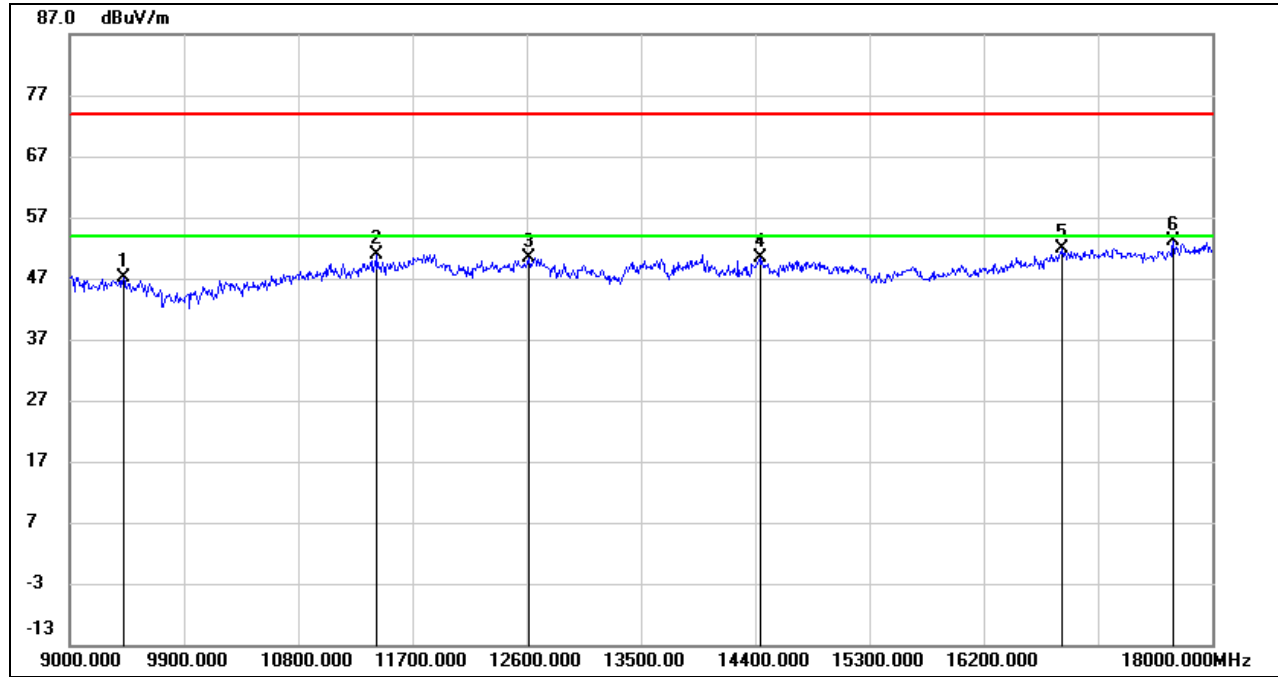

No.	Frequency (MHz)	Reading (dBuV)	Correct (dB/m)	Result (dBuV/m)	Limit (dBuV/m)	Margin (dB)	Remark
1	9423.000	36.74	10.35	47.09	74.00	-26.91	peak
2	11421.000	36.55	14.25	50.80	74.00	-23.20	peak
3	12618.000	35.10	15.32	50.42	74.00	-23.58	peak
4	14445.000	33.59	16.77	50.36	74.00	-23.64	peak
5	16821.000	32.16	19.79	51.95	74.00	-22.05	peak
6	17694.000	31.21	21.89	53.10	74.00	-20.90	peak

Note: 1. Measurement = Reading Level + Correct Factor.
 2. If Peak Result complies with AV limit, AV Result is deemed to comply with AV limit.
 3. Peak: Peak detector.
 4. Filter losses were only considered in the spurious frequency bands and the authorized band was not corrected for High Pass Filter losses.
 5. Proper operation of the transmitter prior to adding the filter to the measurement chain.
 6. Since non-restricted band peak emissions are less than the average limit, they also comply with the -27dBm/MHz (68.2dBuV/m) limit.



HARMONICS AND SPURIOUS EMISSIONS (HIGH CHANNEL, HORIZONTAL)

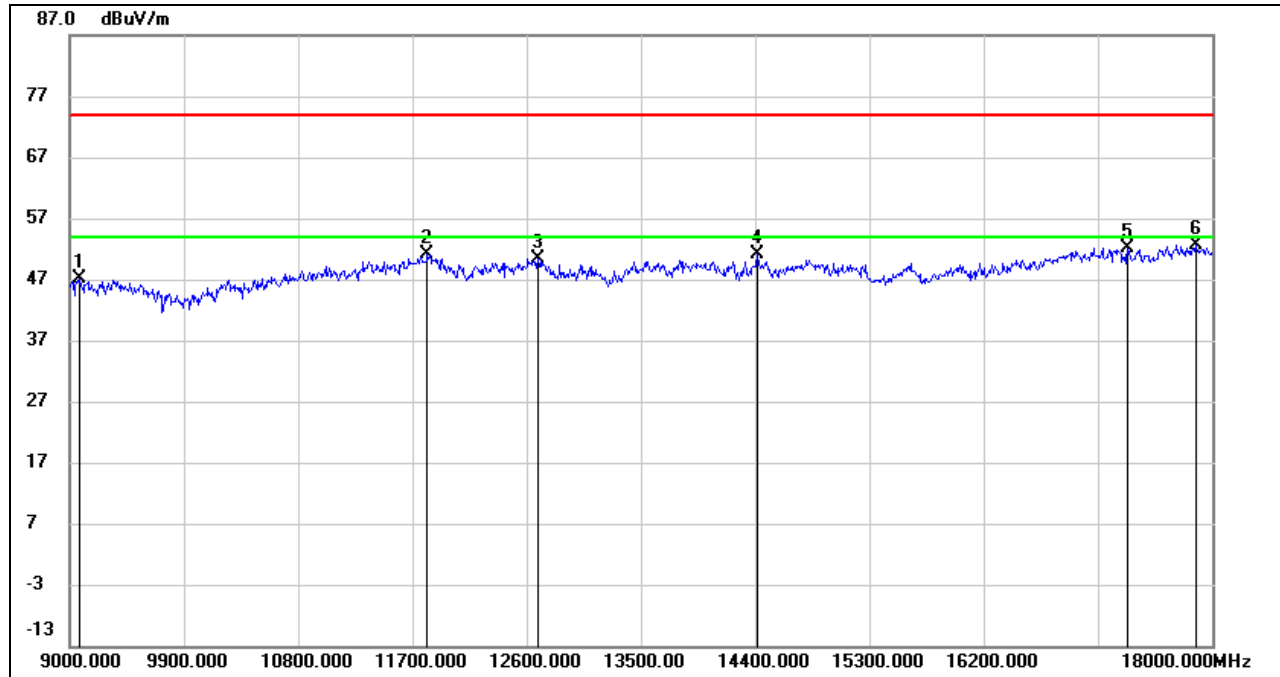

No.	Frequency (MHz)	Reading (dBuV)	Correct (dB/m)	Result (dBuV/m)	Limit (dBuV/m)	Margin (dB)	Remark
1	9081.000	36.93	10.08	47.01	74.00	-26.99	peak
2	11817.000	35.58	15.59	51.17	74.00	-22.83	peak
3	12690.000	34.82	15.45	50.27	74.00	-23.73	peak
4	14418.000	34.25	16.82	51.07	74.00	-22.93	peak
5	17334.000	31.39	20.84	52.23	74.00	-21.77	peak
6	17874.000	30.05	22.70	52.75	74.00	-21.25	peak

Note: 1. Measurement = Reading Level + Correct Factor.
 2. If Peak Result complies with AV limit, AV Result is deemed to comply with AV limit.
 3. Peak: Peak detector.
 4. Filter losses were only considered in the spurious frequency bands and the authorized band was not corrected for High Pass Filter losses.
 5. Proper operation of the transmitter prior to adding the filter to the measurement chain.
 6. Since non-restricted band peak emissions are less than the average limit, they also comply with the -27dBm/MHz (68.2dBuV/m) limit.

HARMONICS AND SPURIOUS EMISSIONS (HIGH CHANNEL, VERTICAL)

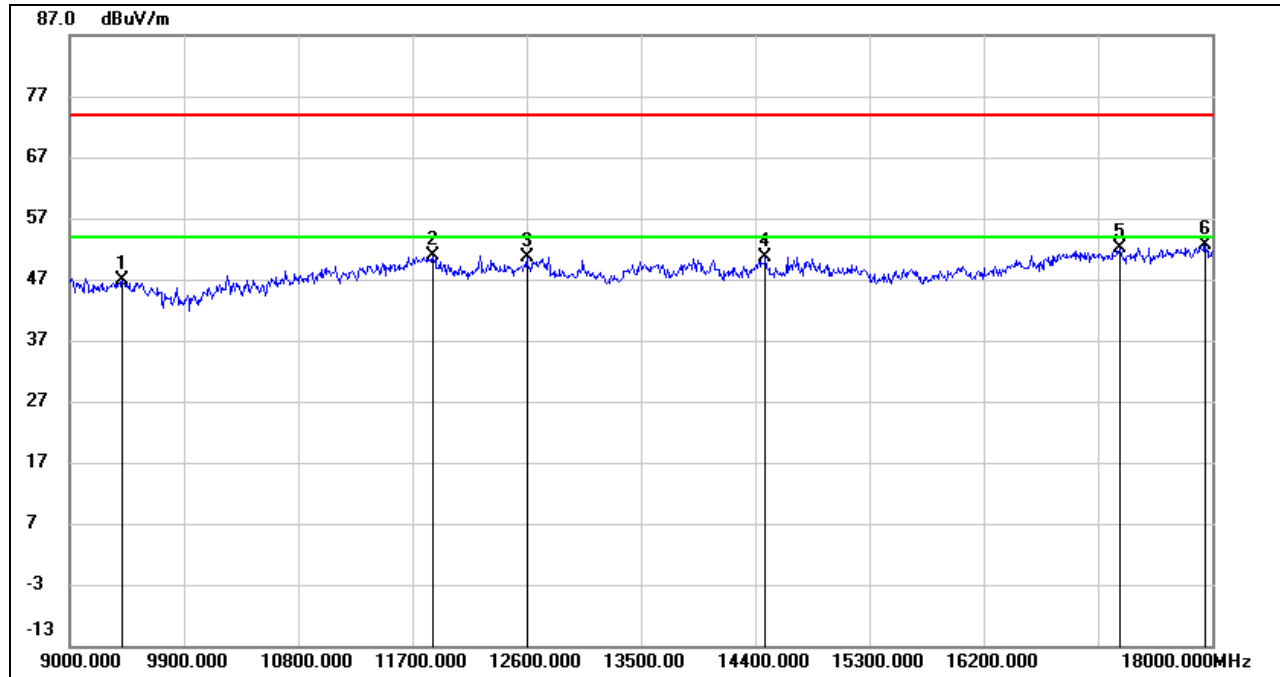

No.	Frequency (MHz)	Reading (dBuV)	Correct (dB/m)	Result (dBuV/m)	Limit (dBuV/m)	Margin (dB)	Remark
1	9414.000	36.44	10.33	46.77	74.00	-27.23	peak
2	11862.000	35.38	15.52	50.90	74.00	-23.10	peak
3	12600.000	35.41	15.29	50.70	74.00	-23.30	peak
4	14481.000	33.94	16.71	50.65	74.00	-23.35	peak
5	17271.000	31.23	20.94	52.17	74.00	-21.83	peak
6	17946.000	29.97	22.69	52.66	74.00	-21.34	peak

Note: 1. Measurement = Reading Level + Correct Factor.
 2. If Peak Result complies with AV limit, AV Result is deemed to comply with AV limit.
 3. Peak: Peak detector.
 4. Filter losses were only considered in the spurious frequency bands and the authorized band was not corrected for High Pass Filter losses.
 5. Proper operation of the transmitter prior to adding the filter to the measurement chain.
 6. Since non-restricted band peak emissions are less than the average limit, they also comply with the -27dBm/MHz (68.2dBuV/m) limit.

UNII-6 BAND

HARMONICS AND SPURIOUS EMISSIONS (LOW CHANNEL, HORIZONTAL)

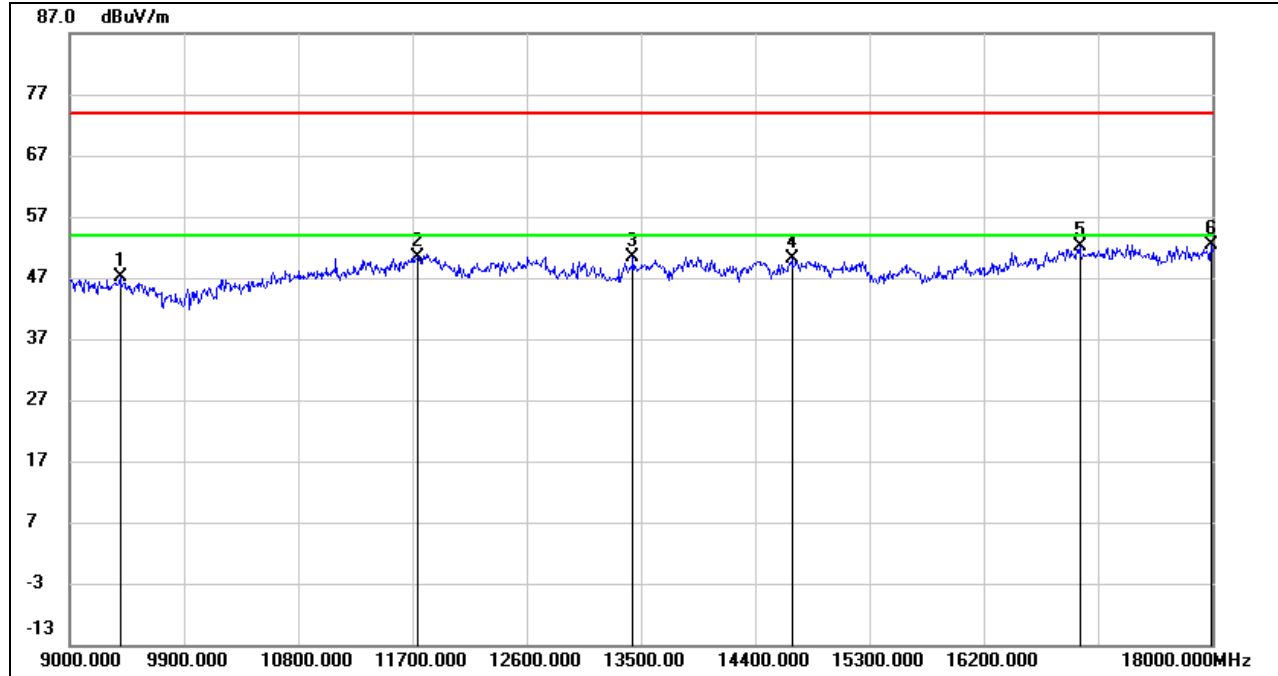

No.	Frequency (MHz)	Reading (dBuV)	Correct (dB/m)	Result (dBuV/m)	Limit (dBuV/m)	Margin (dB)	Remark
1	9396.000	36.89	10.30	47.19	74.00	-26.81	peak
2	11745.000	35.12	15.31	50.43	74.00	-23.57	peak
3	13437.000	34.16	16.34	50.50	74.00	-23.50	peak
4	14688.000	33.45	16.61	50.06	74.00	-23.94	peak
5	16956.000	31.97	20.12	52.09	74.00	-21.91	peak
6	17991.000	29.65	22.67	52.32	74.00	-21.68	peak

Note: 1. Measurement = Reading Level + Correct Factor.
 2. If Peak Result complies with AV limit, AV Result is deemed to comply with AV limit.
 3. Peak: Peak detector.
 4. Filter losses were only considered in the spurious frequency bands and the authorized band was not corrected for High Pass Filter losses.
 5. Proper operation of the transmitter prior to adding the filter to the measurement chain.
 6. Since non-restricted band peak emissions are less than the average limit, they also comply with the -27dBm/MHz (68.2dBuV/m) limit.

HARMONICS AND SPURIOUS EMISSIONS (LOW CHANNEL, VERTICAL)

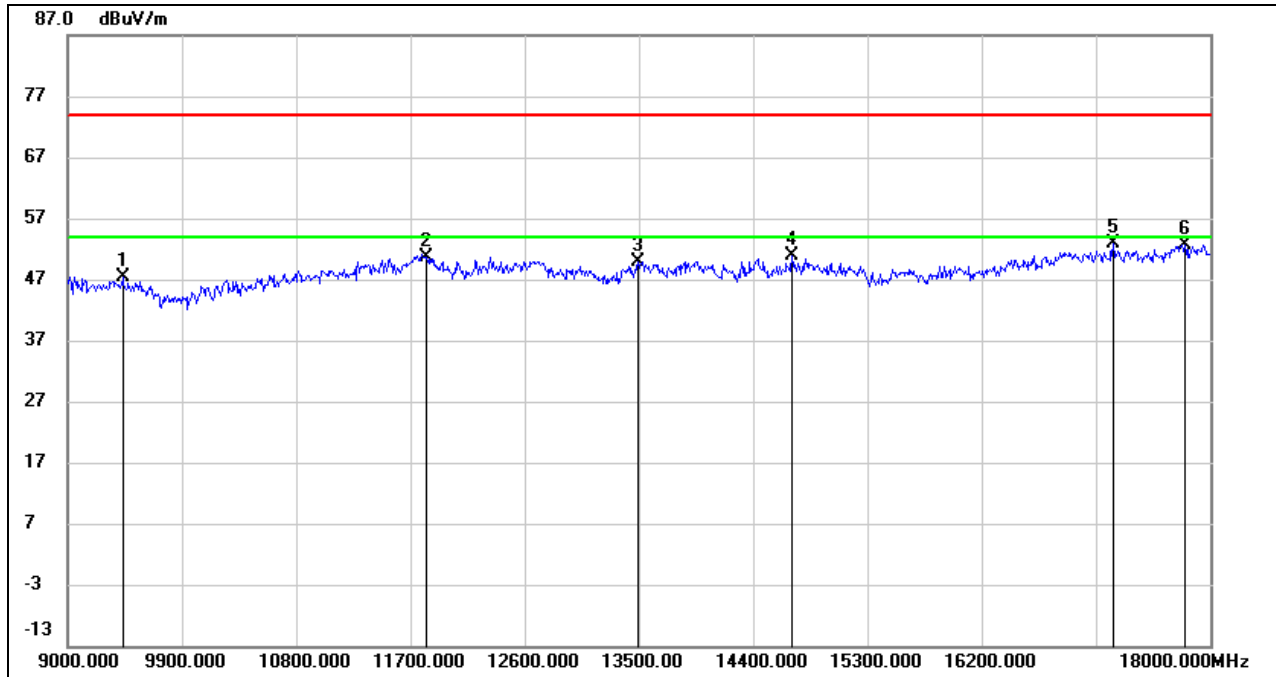

No.	Frequency (MHz)	Reading (dBuV)	Correct (dB/m)	Result (dBuV/m)	Limit (dBuV/m)	Margin (dB)	Remark
1	9432.000	37.00	10.36	47.36	74.00	-26.64	peak
2	11826.000	35.12	15.58	50.70	74.00	-23.30	peak
3	13491.000	33.56	16.41	49.97	74.00	-24.03	peak
4	14706.000	34.28	16.64	50.92	74.00	-23.08	peak
5	17235.000	31.84	20.99	52.83	74.00	-21.17	peak
6	17802.000	29.94	22.72	52.66	74.00	-21.34	peak

- Note: 1. Measurement = Reading Level + Correct Factor.
 2. If Peak Result complies with AV limit, AV Result is deemed to comply with AV limit.
 3. Peak: Peak detector.
 4. Filter losses were only considered in the spurious frequency bands and the authorized band was not corrected for High Pass Filter losses.
 5. Proper operation of the transmitter prior to adding the filter to the measurement chain.
 6. Since non-restricted band peak emissions are less than the average limit, they also comply with the -27dBm/MHz (68.2dBuV/m) limit.

UNII-7 BAND

HARMONICS AND SPURIOUS EMISSIONS (LOW CHANNEL, HORIZONTAL)

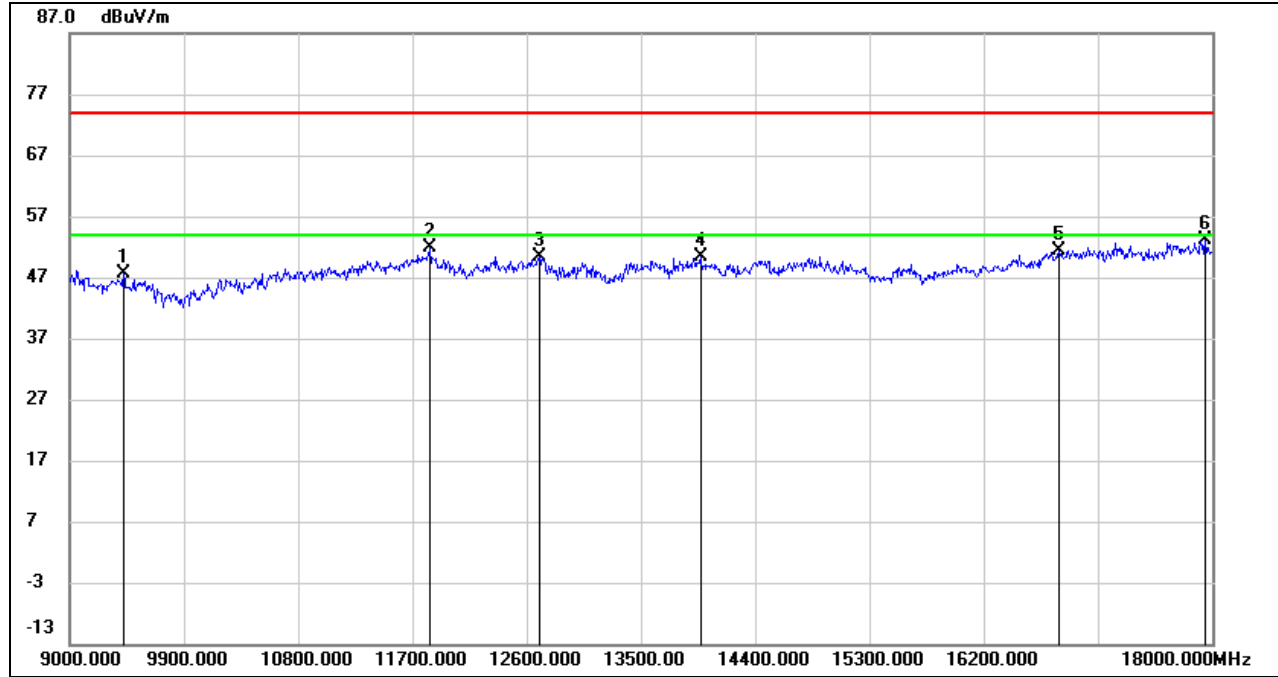

No.	Frequency (MHz)	Reading (dBuV)	Correct (dB/m)	Result (dBuV/m)	Limit (dBuV/m)	Margin (dB)	Remark
1	9423.000	37.22	10.35	47.57	74.00	-26.43	peak
2	11835.000	36.20	15.56	51.76	74.00	-22.24	peak
3	12699.000	34.84	15.47	50.31	74.00	-23.69	peak
4	13968.000	33.51	16.86	50.37	74.00	-23.63	peak
5	16794.000	31.73	19.74	51.47	74.00	-22.53	peak
6	17946.000	30.36	22.69	53.05	74.00	-20.95	peak

Note: 1. Measurement = Reading Level + Correct Factor.
 2. If Peak Result complies with AV limit, AV Result is deemed to comply with AV limit.
 3. Peak: Peak detector.
 4. Filter losses were only considered in the spurious frequency bands and the authorized band was not corrected for High Pass Filter losses.
 5. Proper operation of the transmitter prior to adding the filter to the measurement chain.
 6. Since non-restricted band peak emissions are less than the average limit, they also comply with the -27dBm/MHz (68.2dBuV/m) limit.

HARMONICS AND SPURIOUS EMISSIONS (LOW CHANNEL, VERTICAL)

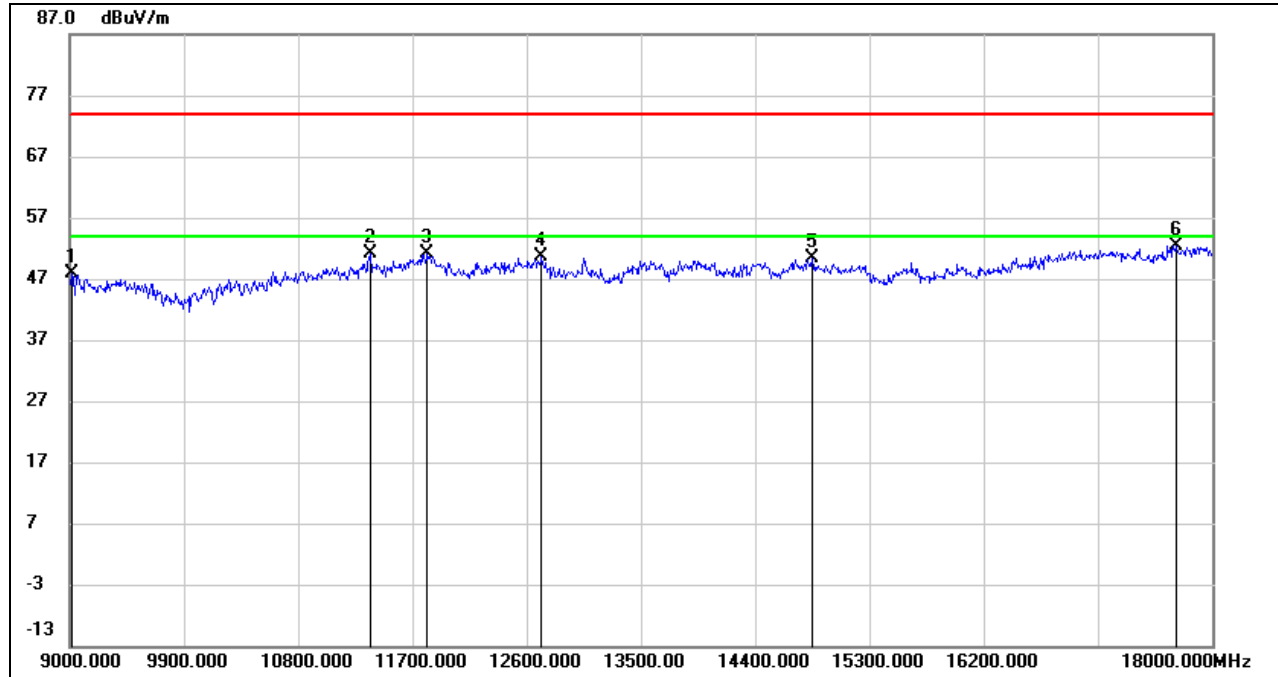

No.	Frequency (MHz)	Reading (dBuV)	Correct (dB/m)	Result (dBuV/m)	Limit (dBuV/m)	Margin (dB)	Remark
1	9018.000	37.44	10.50	47.94	74.00	-26.06	peak
2	11367.000	37.00	14.11	51.11	74.00	-22.89	peak
3	11817.000	35.57	15.59	51.16	74.00	-22.84	peak
4	12717.000	35.11	15.50	50.61	74.00	-23.39	peak
5	14850.000	33.55	16.82	50.37	74.00	-23.63	peak
6	17721.000	30.37	22.10	52.47	74.00	-21.53	peak

Note: 1. Measurement = Reading Level + Correct Factor.
 2. If Peak Result complies with AV limit, AV Result is deemed to comply with AV limit.
 3. Peak: Peak detector.
 4. Filter losses were only considered in the spurious frequency bands and the authorized band was not corrected for High Pass Filter losses.
 5. Proper operation of the transmitter prior to adding the filter to the measurement chain.
 6. Since non-restricted band peak emissions are less than the average limit, they also comply with the -27dBm/MHz (68.2dBuV/m) limit.

HARMONICS AND SPURIOUS EMISSIONS (MID CHANNEL, HORIZONTAL)

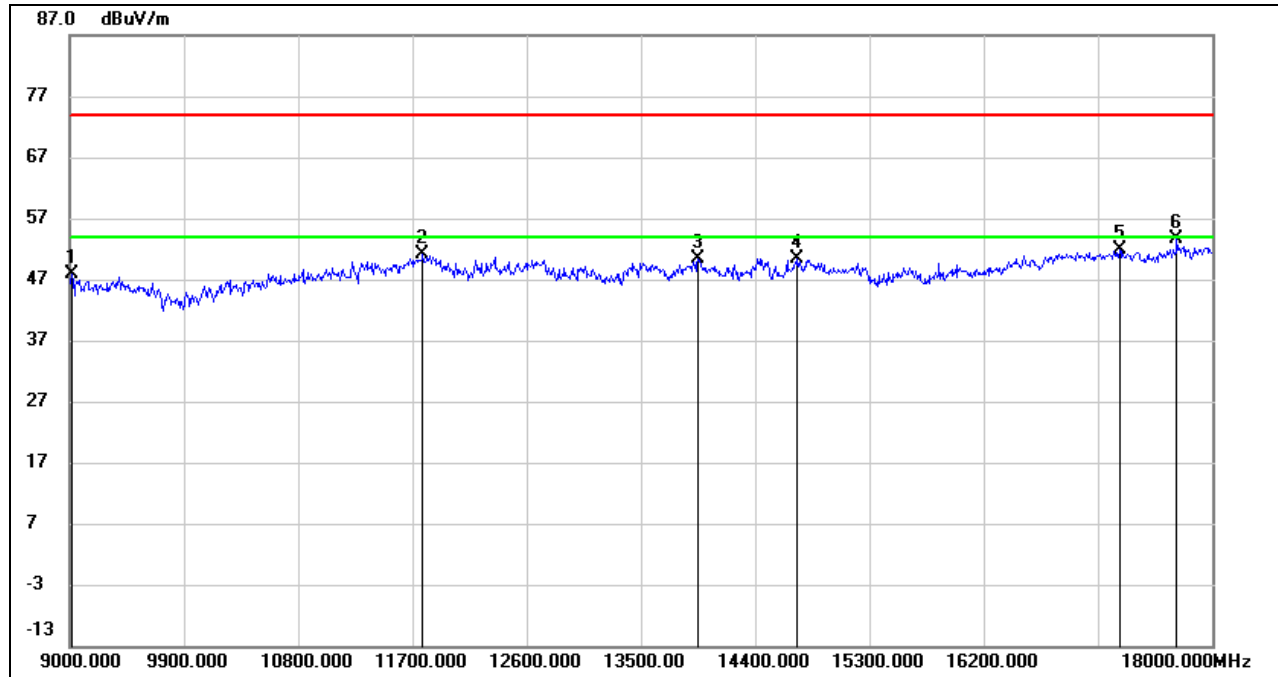

No.	Frequency (MHz)	Reading (dBuV)	Correct (dB/m)	Result (dBuV/m)	Limit (dBuV/m)	Margin (dB)	Remark
1	9018.000	37.38	10.50	47.88	74.00	-26.12	peak
2	11781.000	35.68	15.51	51.19	74.00	-22.81	peak
3	13950.000	33.48	16.88	50.36	74.00	-23.64	peak
4	14733.000	33.66	16.69	50.35	74.00	-23.65	peak
5	17271.000	30.91	20.94	51.85	74.00	-22.15	peak
6	17721.000	31.53	22.10	53.63	74.00	-20.37	peak

Note: 1. Measurement = Reading Level + Correct Factor.
 2. If Peak Result complies with AV limit, AV Result is deemed to comply with AV limit.
 3. Peak: Peak detector.
 4. Filter losses were only considered in the spurious frequency bands and the authorized band was not corrected for High Pass Filter losses.
 5. Proper operation of the transmitter prior to adding the filter to the measurement chain.
 6. Since non-restricted band peak emissions are less than the average limit, they also comply with the -27dBm/MHz (68.2dBuV/m) limit.



HARMONICS AND SPURIOUS EMISSIONS (MID CHANNEL, VERTICAL)

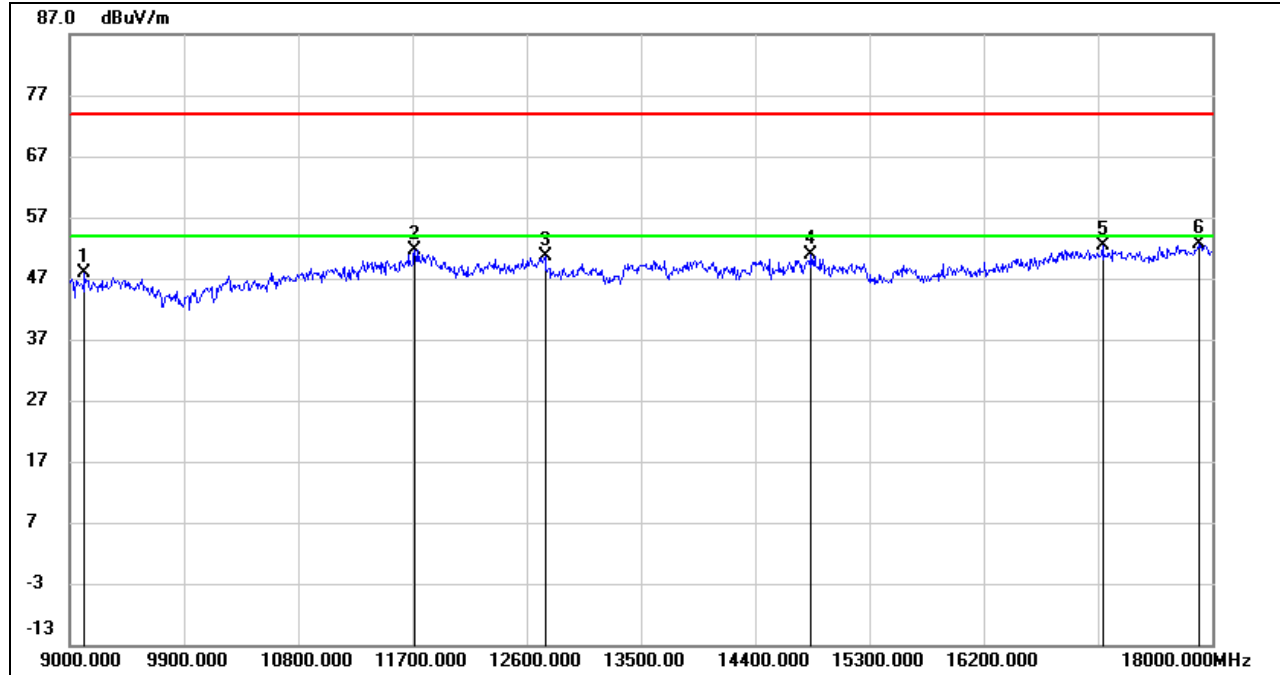

No.	Frequency (MHz)	Reading (dBuV)	Correct (dB/m)	Result (dBuV/m)	Limit (dBuV/m)	Margin (dB)	Remark
1	9117.000	37.97	9.84	47.81	74.00	-26.19	peak
2	11718.000	36.52	15.16	51.68	74.00	-22.32	peak
3	12744.000	35.14	15.56	50.70	74.00	-23.30	peak
4	14841.000	34.08	16.82	50.90	74.00	-23.10	peak
5	17136.000	31.51	20.78	52.29	74.00	-21.71	peak
6	17892.000	29.90	22.69	52.59	74.00	-21.41	peak

Note: 1. Measurement = Reading Level + Correct Factor.
 2. If Peak Result complies with AV limit, AV Result is deemed to comply with AV limit.
 3. Peak: Peak detector.
 4. Filter losses were only considered in the spurious frequency bands and the authorized band was not corrected for High Pass Filter losses.
 5. Proper operation of the transmitter prior to adding the filter to the measurement chain.
 6. Since non-restricted band peak emissions are less than the average limit, they also comply with the -27dBm/MHz (68.2dBuV/m) limit.

HARMONICS AND SPURIOUS EMISSIONS (HIGH CHANNEL, HORIZONTAL)

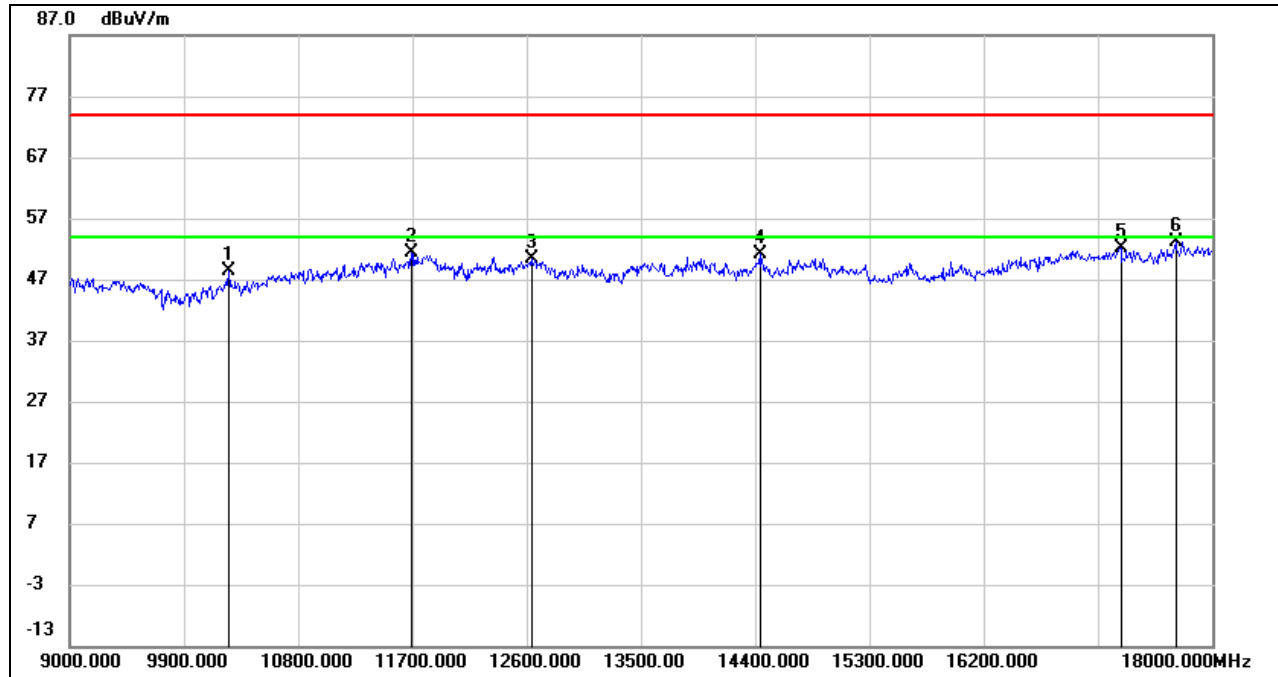

No.	Frequency (MHz)	Reading (dBuV)	Correct (dB/m)	Result (dBuV/m)	Limit (dBuV/m)	Margin (dB)	Remark
1	10251.000	37.34	10.92	48.26	74.00	-25.74	peak
2	11691.000	36.42	15.01	51.43	74.00	-22.57	peak
3	12636.000	35.06	15.35	50.41	74.00	-23.59	peak
4	14436.000	34.31	16.79	51.10	74.00	-22.90	peak
5	17280.000	31.17	20.92	52.09	74.00	-21.91	peak
6	17712.000	31.09	22.03	53.12	74.00	-20.88	peak

- Note: 1. Measurement = Reading Level + Correct Factor.
 2. If Peak Result complies with AV limit, AV Result is deemed to comply with AV limit.
 3. Peak: Peak detector.
 4. Filter losses were only considered in the spurious frequency bands and the authorized band was not corrected for High Pass Filter losses.
 5. Proper operation of the transmitter prior to adding the filter to the measurement chain.
 6. Since non-restricted band peak emissions are less than the average limit, they also comply with the -27dBm/MHz (68.2dBuV/m) limit.

HARMONICS AND SPURIOUS EMISSIONS (HIGH CHANNEL, VERTICAL)

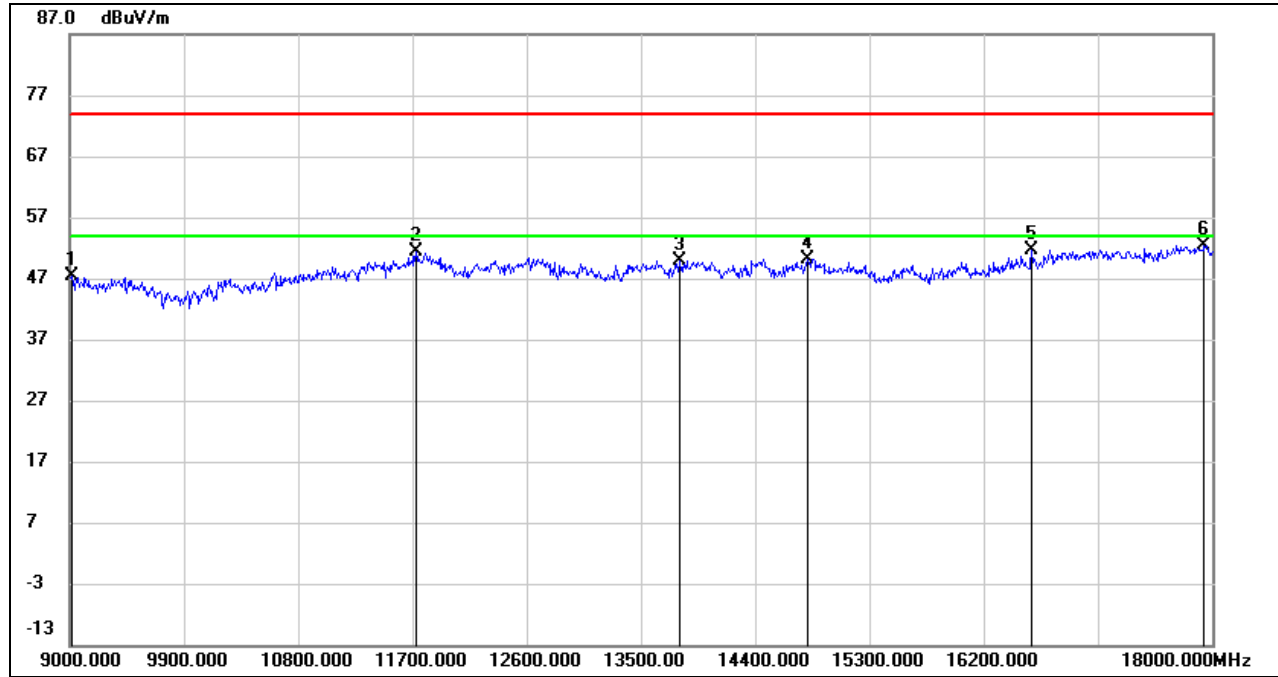

No.	Frequency (MHz)	Reading (dBuV)	Correct (dB/m)	Result (dBuV/m)	Limit (dBuV/m)	Margin (dB)	Remark
1	9018.000	36.89	10.50	47.39	74.00	-26.61	peak
2	11727.000	36.13	15.22	51.35	74.00	-22.65	peak
3	13806.000	32.95	16.95	49.90	74.00	-24.10	peak
4	14814.000	33.40	16.81	50.21	74.00	-23.79	peak
5	16578.000	32.15	19.44	51.59	74.00	-22.41	peak
6	17937.000	29.81	22.69	52.50	74.00	-21.50	peak

Note: 1. Measurement = Reading Level + Correct Factor.
 2. If Peak Result complies with AV limit, AV Result is deemed to comply with AV limit.
 3. Peak: Peak detector.
 4. Filter losses were only considered in the spurious frequency bands and the authorized band was not corrected for High Pass Filter losses.
 5. Proper operation of the transmitter prior to adding the filter to the measurement chain.
 6. Since non-restricted band peak emissions are less than the average limit, they also comply with the -27dBm/MHz (68.2dBuV/m) limit.

UNII-8 BAND

HARMONICS AND SPURIOUS EMISSIONS (LOW CHANNEL, HORIZONTAL)

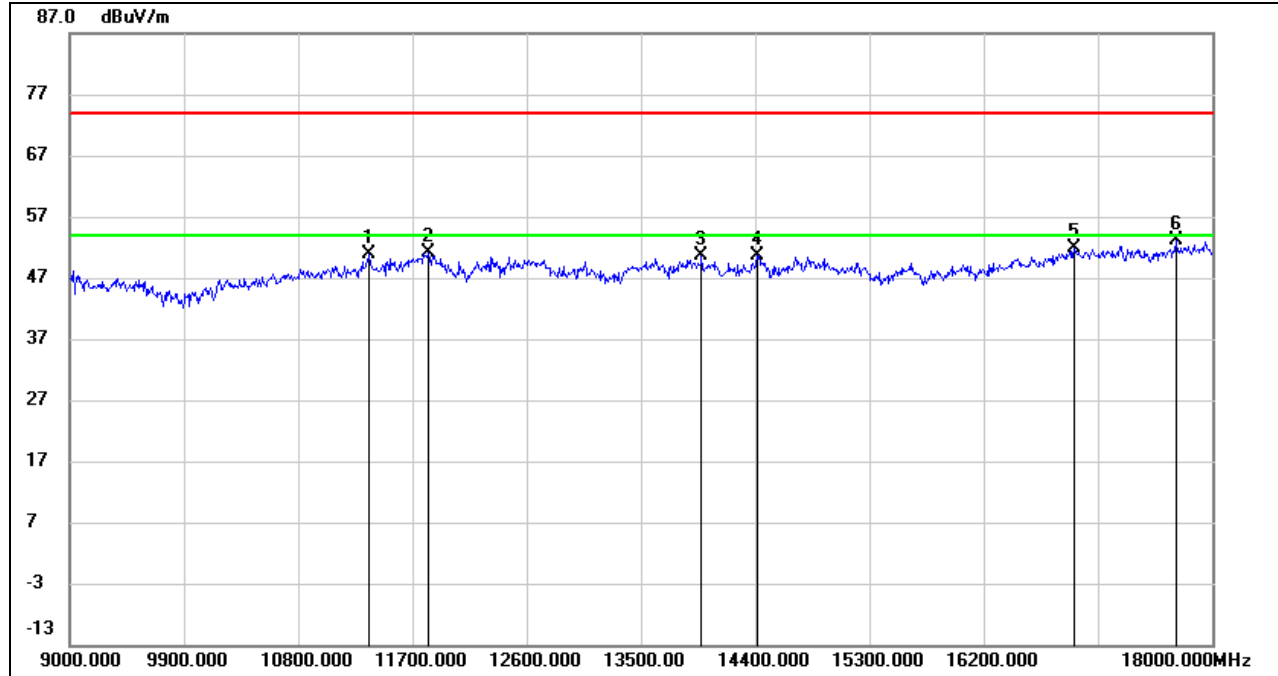

No.	Frequency (MHz)	Reading (dBuV)	Correct (dB/m)	Result (dBuV/m)	Limit (dBuV/m)	Margin (dB)	Remark
1	11358.000	36.80	14.10	50.90	74.00	-23.10	peak
2	11826.000	35.47	15.58	51.05	74.00	-22.95	peak
3	13977.000	33.84	16.86	50.70	74.00	-23.30	peak
4	14418.000	33.89	16.82	50.71	74.00	-23.29	peak
5	16911.000	31.75	20.02	51.77	74.00	-22.23	peak
6	17712.000	31.00	22.03	53.03	74.00	-20.97	peak

Note: 1. Measurement = Reading Level + Correct Factor.
 2. If Peak Result complies with AV limit, AV Result is deemed to comply with AV limit.
 3. Peak: Peak detector.
 4. Filter losses were only considered in the spurious frequency bands and the authorized band was not corrected for High Pass Filter losses.
 5. Proper operation of the transmitter prior to adding the filter to the measurement chain.
 6. Since non-restricted band peak emissions are less than the average limit, they also comply with the -27dBm/MHz (68.2dBuV/m) limit.

HARMONICS AND SPURIOUS EMISSIONS (LOW CHANNEL, VERTICAL)

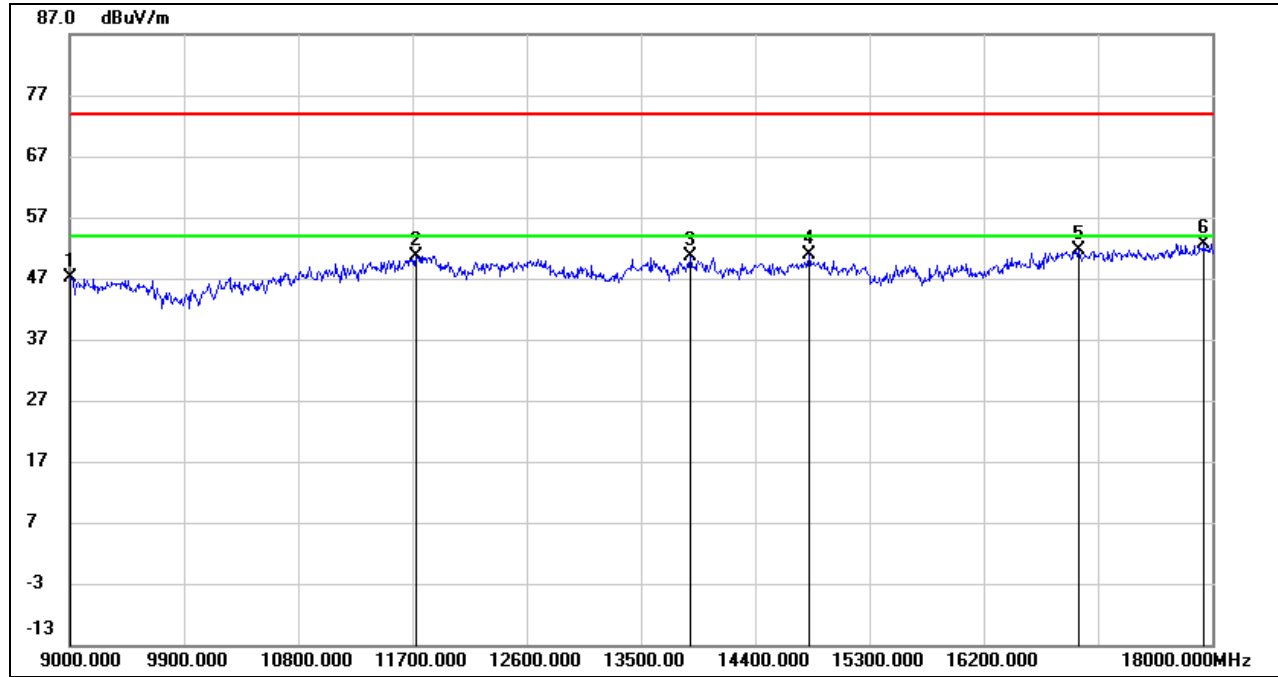

No.	Frequency (MHz)	Reading (dBuV)	Correct (dB/m)	Result (dBuV/m)	Limit (dBuV/m)	Margin (dB)	Remark
1	9009.000	36.48	10.58	47.06	74.00	-26.94	peak
2	11727.000	35.50	15.22	50.72	74.00	-23.28	peak
3	13887.000	33.68	16.91	50.59	74.00	-23.41	peak
4	14823.000	34.09	16.81	50.90	74.00	-23.10	peak
5	16947.000	31.46	20.10	51.56	74.00	-22.44	peak
6	17937.000	29.96	22.69	52.65	74.00	-21.35	peak

Note: 1. Measurement = Reading Level + Correct Factor.
 2. If Peak Result complies with AV limit, AV Result is deemed to comply with AV limit.
 3. Peak: Peak detector.
 4. Filter losses were only considered in the spurious frequency bands and the authorized band was not corrected for High Pass Filter losses.
 5. Proper operation of the transmitter prior to adding the filter to the measurement chain.
 6. Since non-restricted band peak emissions are less than the average limit, they also comply with the -27dBm/MHz (68.2dBuV/m) limit.



HARMONICS AND SPURIOUS EMISSIONS (HIGH CHANNEL, HORIZONTAL)

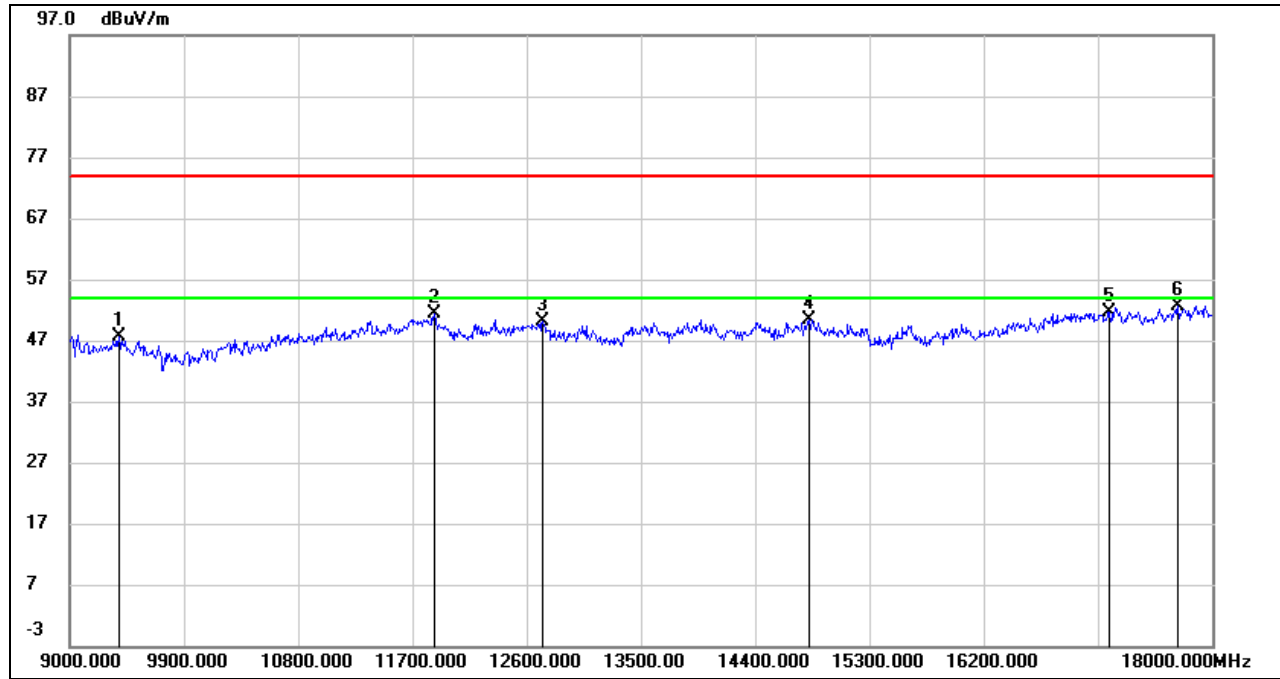

No.	Frequency (MHz)	Reading (dBuV)	Correct (dB/m)	Result (dBuV/m)	Limit (dBuV/m)	Margin (dB)	Remark
1	9387.000	37.48	10.24	47.72	74.00	-26.28	peak
2	11871.000	35.87	15.51	51.38	74.00	-22.62	peak
3	12726.000	34.53	15.52	50.05	74.00	-23.95	peak
4	14823.000	33.49	16.81	50.30	74.00	-23.70	peak
5	17190.000	30.71	21.00	51.71	74.00	-22.29	peak
6	17730.000	30.56	22.17	52.73	74.00	-21.27	peak

Note: 1. Measurement = Reading Level + Correct Factor.
 2. If Peak Result complies with AV limit, AV Result is deemed to comply with AV limit.
 3. Peak: Peak detector.
 4. Filter losses were only considered in the spurious frequency bands and the authorized band was not corrected for High Pass Filter losses.
 5. Proper operation of the transmitter prior to adding the filter to the measurement chain.
 6. Since non-restricted band peak emissions are less than the average limit, they also comply with the -27dBm/MHz (68.2dBuV/m) limit.

HARMONICS AND SPURIOUS EMISSIONS (HIGH CHANNEL, VERTICAL)

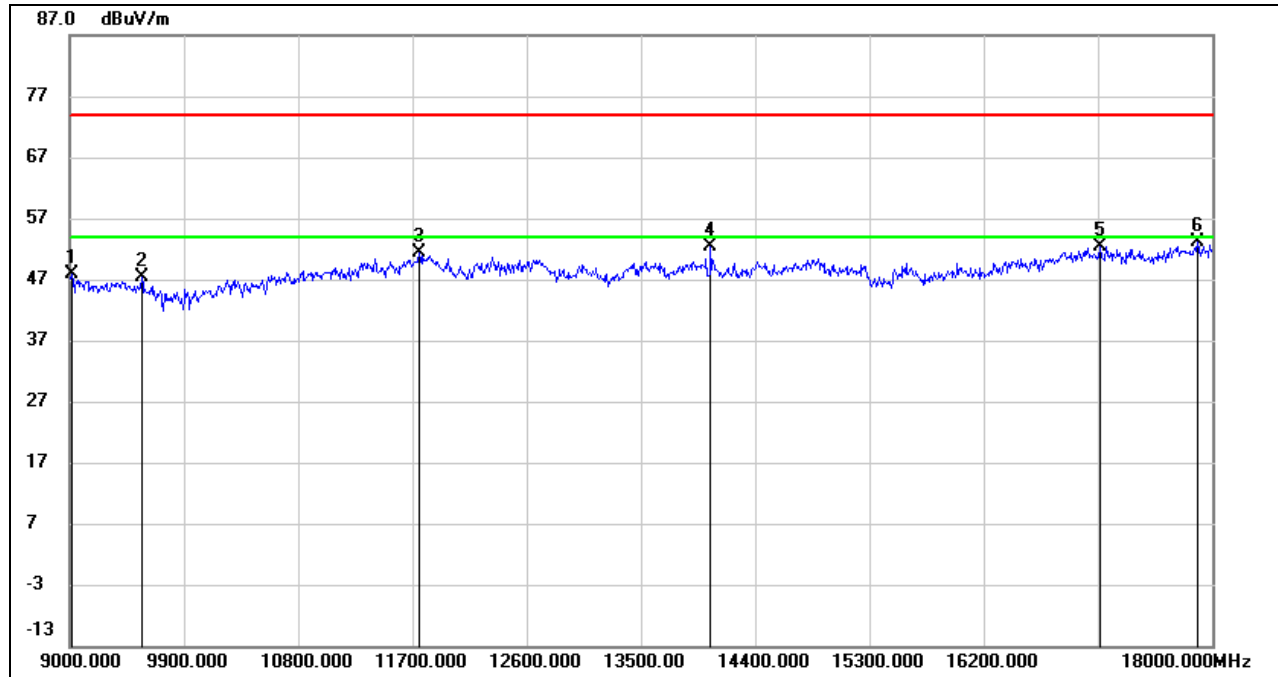

No.	Frequency (MHz)	Reading (dBuV)	Correct (dB/m)	Result (dBuV/m)	Limit (dBuV/m)	Margin (dB)	Remark
1	9018.000	37.33	10.50	47.83	74.00	-26.17	peak
2	9567.000	36.85	10.46	47.31	74.00	-26.69	peak
3	11754.000	35.99	15.35	51.34	74.00	-22.66	peak
4	14049.000	35.49	16.82	52.31	74.00	-21.69	peak
5	17118.000	31.62	20.70	52.32	74.00	-21.68	peak
6	17883.000	30.52	22.70	53.22	74.00	-20.78	peak

- Note: 1. Measurement = Reading Level + Correct Factor.
 2. If Peak Result complies with AV limit, AV Result is deemed to comply with AV limit.
 3. Peak: Peak detector.
 4. Filter losses were only considered in the spurious frequency bands and the authorized band was not corrected for High Pass Filter losses.
 5. Proper operation of the transmitter prior to adding the filter to the measurement chain.
 6. Since non-restricted band peak emissions are less than the average limit, they also comply with the -27dBm/MHz (68.2dBuV/m) limit.

Note: All the mode had been tested, but only the worst data was recorded in the report.

8.4. SPURIOUS EMISSIONS (18 GHz ~ 26 GHz)

8.4.1. 802.11ax HE80 CDD MODE

SPURIOUS EMISSIONS (UNII-8 BAND LOW CHANNEL, HORIZONTAL, WORST-CASE CONFIGURATION)

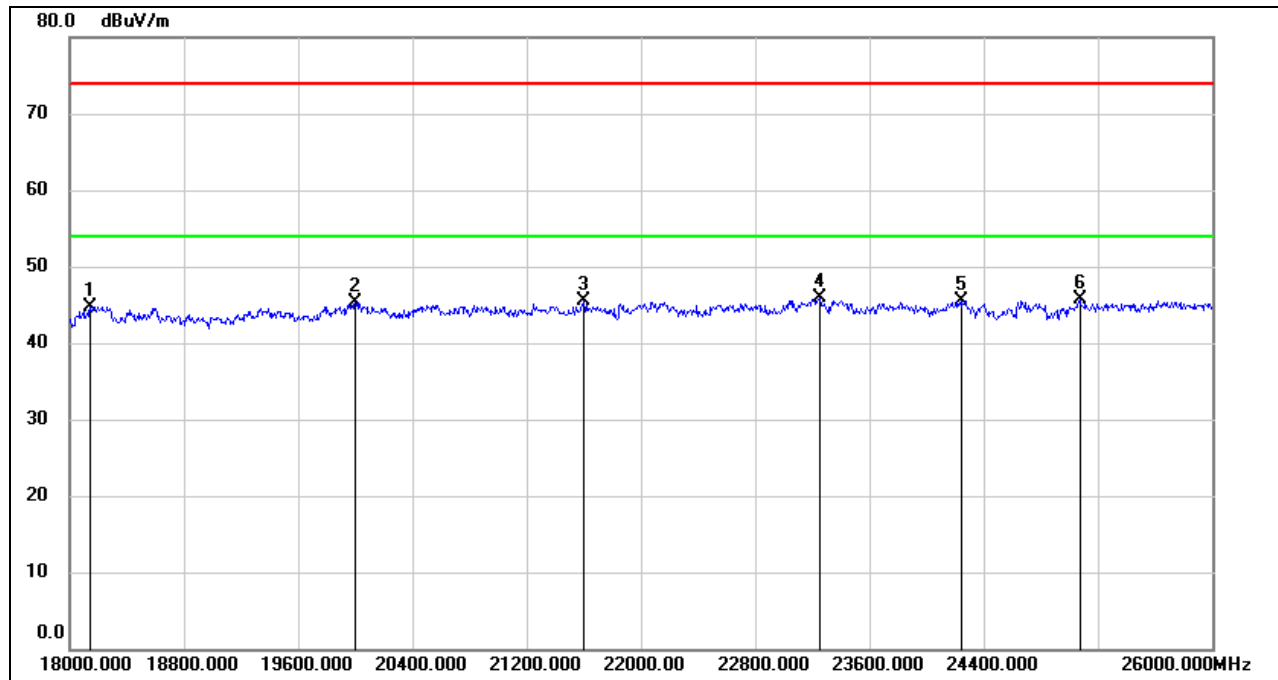

No.	Frequency (MHz)	Reading (dBuV)	Correct (dB/m)	Result (dBuV/m)	Limit (dBuV/m)	Margin (dB)	Remark
1	18144.000	50.27	-5.48	44.79	74.00	-29.21	peak
2	20000.000	50.81	-5.45	45.36	74.00	-28.64	peak
3	21600.000	50.02	-4.54	45.48	74.00	-28.52	peak
4	23256.000	49.22	-3.35	45.87	74.00	-28.13	peak
5	24248.000	48.32	-2.83	45.49	74.00	-28.51	peak
6	25072.000	47.67	-1.97	45.70	74.00	-28.30	peak

- Note: 1. Measurement = Reading Level + Correct Factor.
 2. If Peak Result complies with AV limit, AV Result is deemed to comply with AV limit.
 3. Peak: Peak detector.

SPURIOUS EMISSIONS (UNII-3 BAND MID CHANNEL, VERTICAL, WORST-CASE CONFIGURATION)

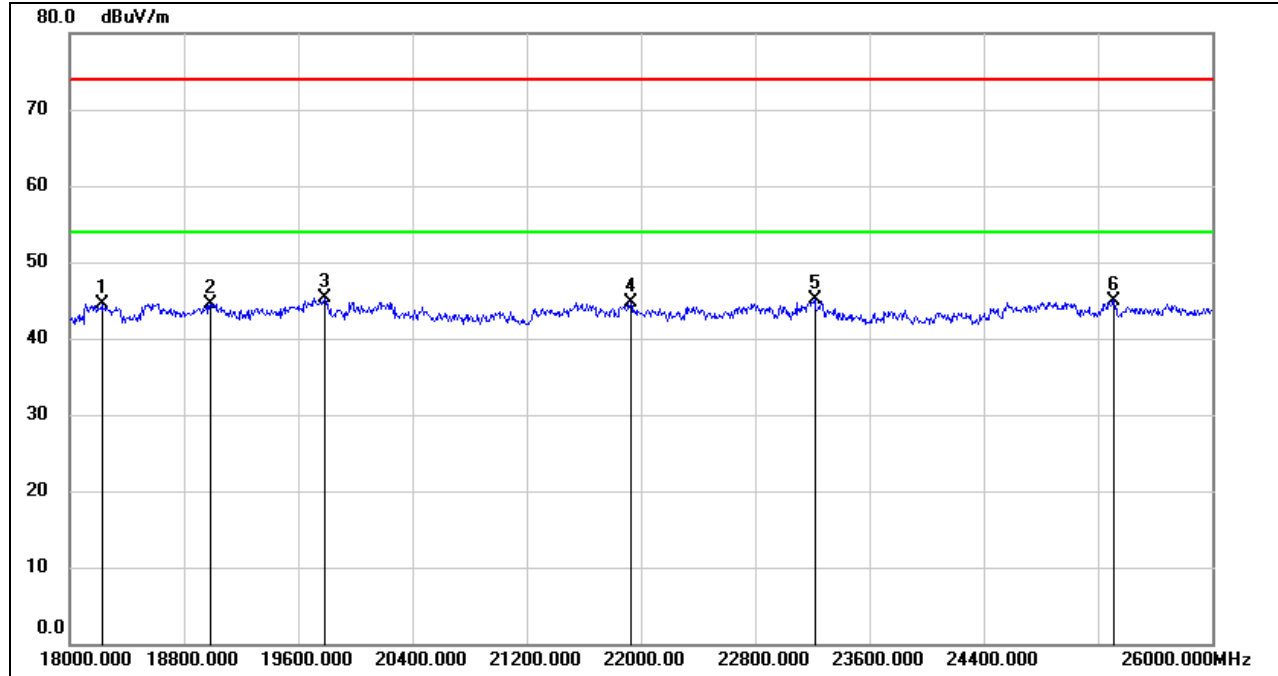

No.	Frequency (MHz)	Reading (dBuV)	Correct (dB/m)	Result (dBuV/m)	Limit (dBuV/m)	Margin (dB)	Remark
1	18224.000	50.08	-5.53	44.55	74.00	-29.45	peak
2	18984.000	49.79	-5.23	44.56	74.00	-29.44	peak
3	19784.000	50.57	-5.28	45.29	74.00	-28.71	peak
4	21928.000	49.05	-4.43	44.62	74.00	-29.38	peak
5	23216.000	48.51	-3.38	45.13	74.00	-28.87	peak
6	25312.000	46.70	-1.70	45.00	74.00	-29.00	peak

- Note: 1. Measurement = Reading Level + Correct Factor.
 2. If Peak Result complies with AV limit, AV Result is deemed to comply with AV limit.
 3. Peak: Peak detector.

Note: All the modes had been tested, but only the worst data was recorded in the report.

8.5. SPURIOUS EMISSIONS (26 GHz ~ 40 GHz)

8.5.1. 802.11ax HE80 CDD MODE

SPURIOUS EMISSIONS (UNII-8 BAND LOW CHANNEL, HORIZONTAL, WORST-CASE CONFIGURATION)

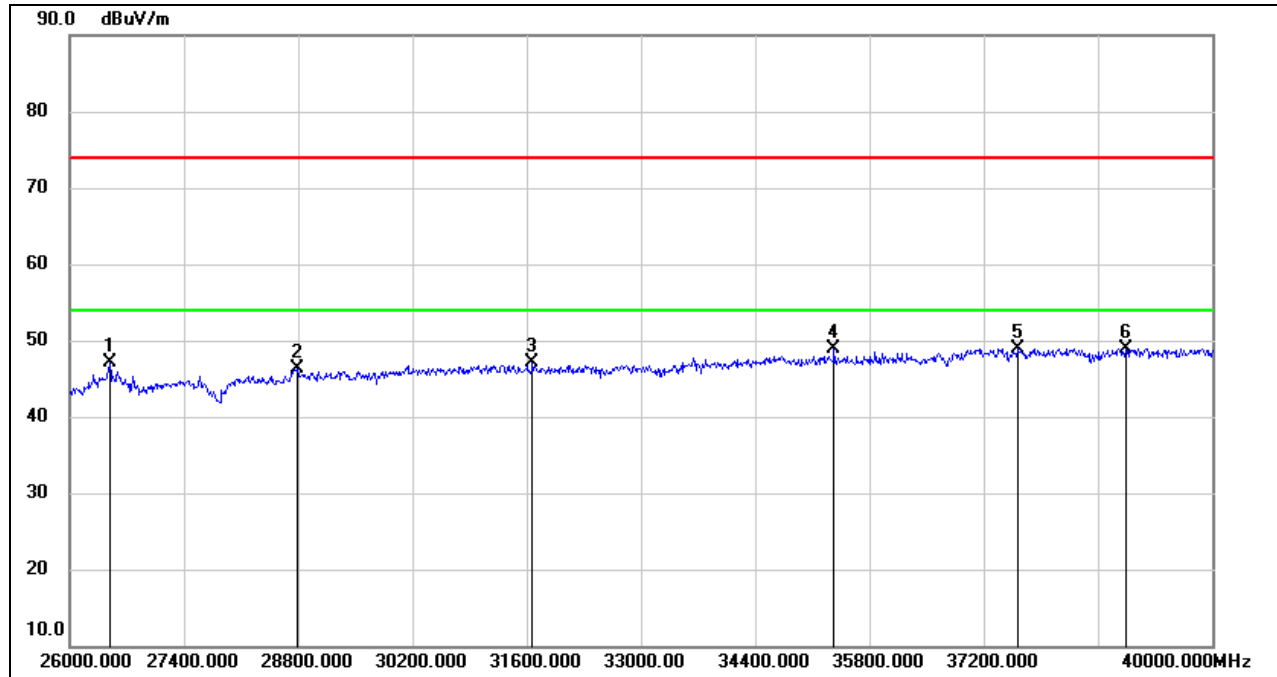

No.	Frequency (MHz)	Reading (dBuV)	Correct (dB/m)	Result (dBuV/m)	Limit (dBuV/m)	Margin (dB)	Remark
1	26490.000	51.79	-4.74	47.05	74.00	-26.95	peak
2	28786.000	46.99	-0.64	46.35	74.00	-27.65	peak
3	31670.000	48.36	-1.21	47.15	74.00	-26.85	peak
4	35366.000	46.40	2.59	48.99	74.00	-25.01	peak
5	37620.000	45.47	3.43	48.90	74.00	-25.10	peak
6	38936.000	44.61	4.29	48.90	74.00	-25.10	peak

- Note: 1. Measurement = Reading Level + Correct Factor.
 2. If Peak Result complies with AV limit, AV Result is deemed to comply with AV limit.
 3. Peak: Peak detector.



SPURIOUS EMISSIONS (UNII-3 BAND MID CHANNEL, VERTICAL, WORST-CASE CONFIGURATION)

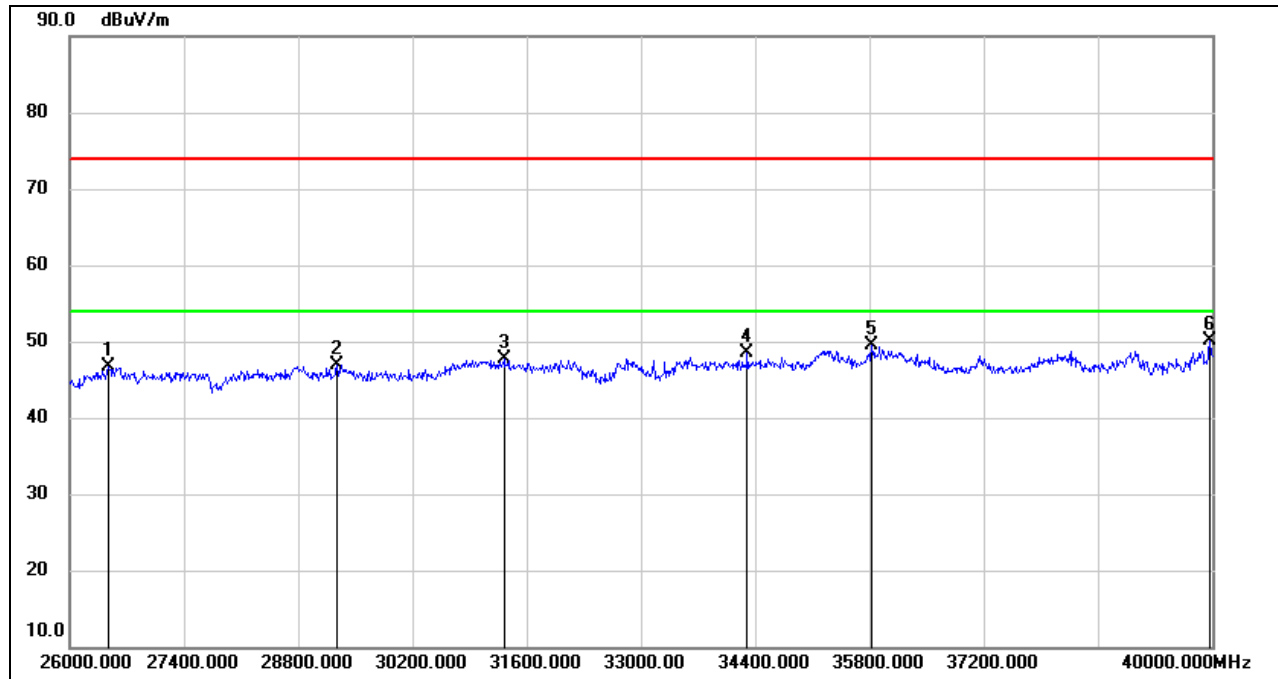

No.	Frequency (MHz)	Reading (dBuV)	Correct (dB/m)	Result (dBuV/m)	Limit (dBuV/m)	Margin (dB)	Remark
1	26476.000	51.53	-4.78	46.75	74.00	-27.25	peak
2	29276.000	48.01	-1.01	47.00	74.00	-27.00	peak
3	31320.000	48.61	-0.93	47.68	74.00	-26.32	peak
4	34302.000	47.45	1.10	48.55	74.00	-25.45	peak
5	35828.000	45.75	3.67	49.42	74.00	-24.58	peak
6	39972.000	44.95	5.13	50.08	74.00	-23.92	peak

- Note: 1. Measurement = Reading Level + Correct Factor.
 2. If Peak Result complies with AV limit, AV Result is deemed to comply with AV limit.
 3. Peak: Peak detector.

Note: All the modes had been tested, but only the worst data was recorded in the report.

8.6. SPURIOUS EMISSIONS (30 MHz ~ 1 GHz)

8.6.1. 802.11ax HE80 CDD MODE

SPURIOUS EMISSIONS (UNII-8 BAND LOW CHANNEL, HORIZONTAL, WORST-CASE CONFIGURATION)

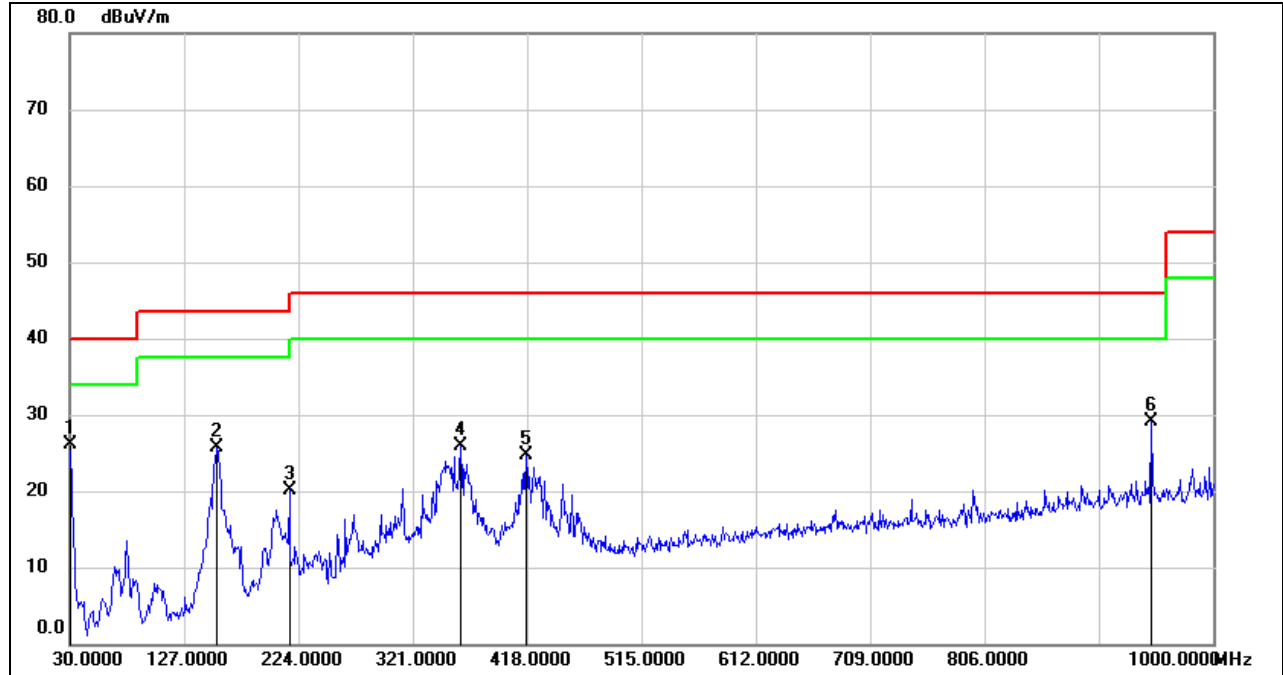

No.	Frequency (MHz)	Reading (dBuV)	Correct (dB/m)	Result (dBuV/m)	Limit (dBuV/m)	Margin (dB)	Remark
1	30.0000	45.03	-18.94	26.09	40.00	-13.91	QP
2	155.1300	43.78	-18.01	25.77	43.50	-17.73	QP
3	216.2400	37.91	-17.84	20.07	46.00	-25.93	QP
4	361.7400	39.91	-14.08	25.83	46.00	-20.17	QP
5	417.0300	37.64	-13.03	24.61	46.00	-21.39	QP
6	947.6200	33.48	-4.43	29.05	46.00	-16.95	QP

- Note: 1. Result Level = Read Level + Correct Factor.
 2. If Peak Result complies with QP limit, QP Result is deemed to comply with QP limit.
 3. Test setup: RBW: 120 kHz, VBW: 300 kHz, Sweep time: auto.

SPURIOUS EMISSIONS (UNII-3 BAND MID CHANNEL, VERTICAL, WORST-CASE CONFIGURATION)

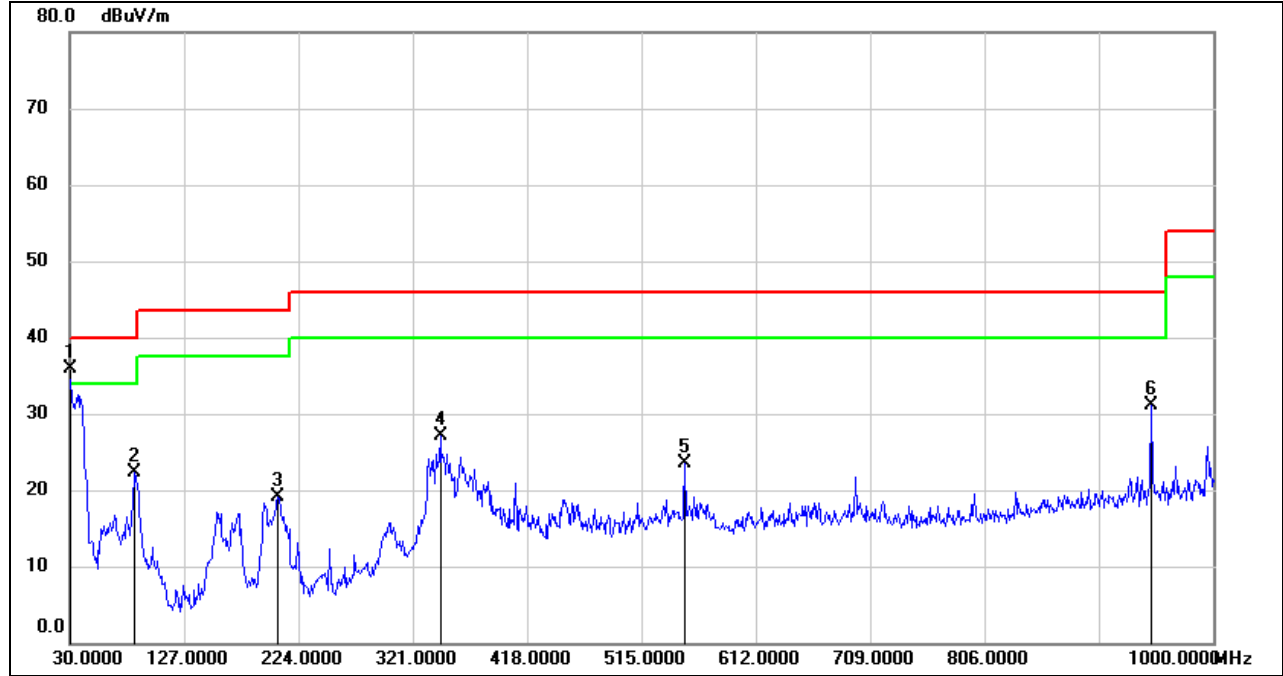

No.	Frequency (MHz)	Reading (dBuV)	Correct (dB/m)	Result (dBuV/m)	Limit (dBuV/m)	Margin (dB)	Remark
1	30.0000	54.90	-18.94	35.96	40.00	-4.04	QP
2	85.2900	44.01	-21.69	22.32	40.00	-17.68	QP
3	206.5399	36.03	-16.97	19.06	43.50	-24.44	QP
4	344.2800	41.46	-14.39	27.07	46.00	-18.93	QP
5	551.8600	34.03	-10.46	23.57	46.00	-22.43	QP
6	947.6200	35.50	-4.43	31.07	46.00	-14.93	QP

- Note: 1. Result Level = Read Level + Correct Factor.
 2. If Peak Result complies with QP limit, QP Result is deemed to comply with QP limit.
 3. Test setup: RBW: 120 kHz, VBW: 300 kHz, Sweep time: auto

Note: All the modes had been tested, but only the worst data was recorded in the report.

8.7. SPURIOUS EMISSIONS BELOW 30 MHz

8.7.1. 802.11ax HE80 CDD MODE

SPURIOUS EMISSIONS (UNII-8 BAND LOW CHANNEL, LOOP ANTENNA FACE ON TO THE EUT, WORST-CASE CONFIGURATION)

9 kHz ~ 150 kHz

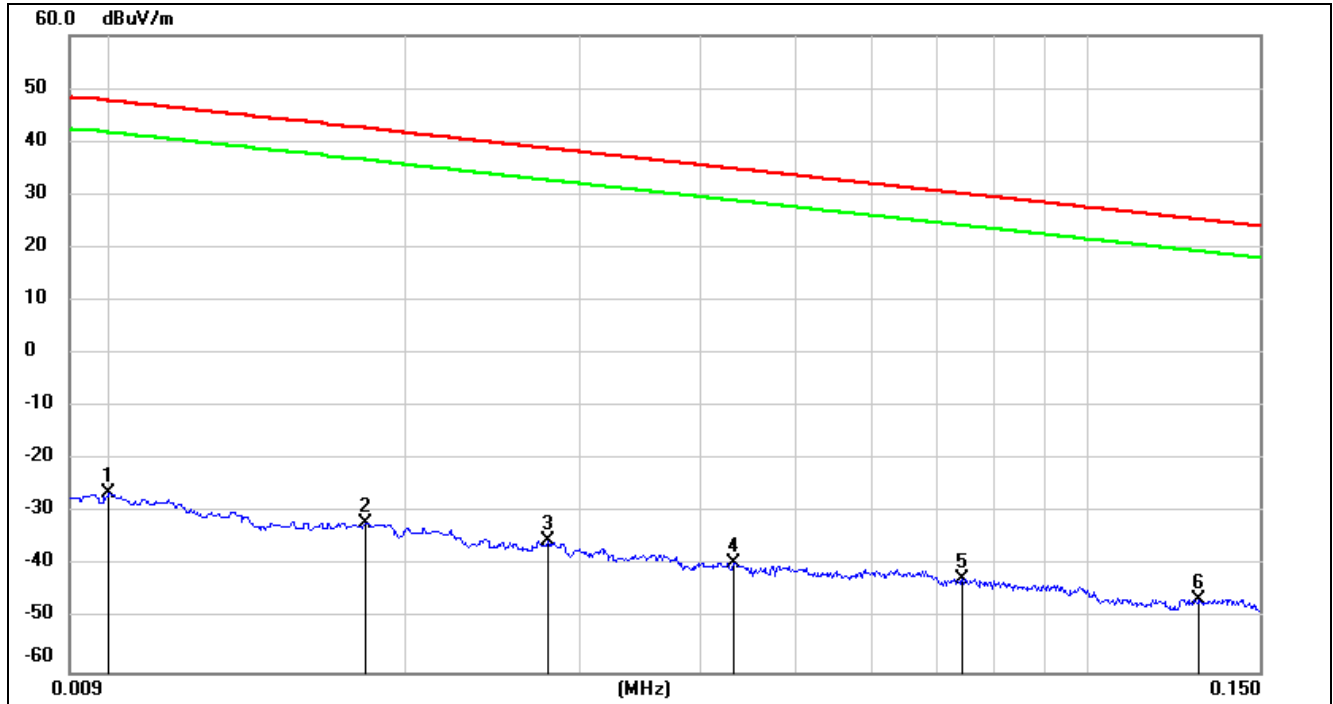

No.	Frequency (MHz)	Reading (dBuV)	Correct (dB/m)	FCC Result (dBuV/m)	FCC Limit (dBuV/m)	ISED Result (dBuA/m)	ISED Limit (dBuA/m)	Margin (dB)	Remark
1	0.0100	75.22	-101.40	-26.18	47.6	-77.68	-3.90	-73.78	peak
2	0.0181	69.35	-101.36	-32.01	42.45	-83.51	-9.05	-74.46	peak
3	0.0279	66.17	-101.38	-35.21	38.69	-86.71	-12.81	-73.90	peak
4	0.0432	62.07	-101.45	-39.38	34.89	-90.88	-16.61	-74.27	peak
5	0.0743	59.08	-101.59	-42.51	30.18	-94.01	-21.32	-72.69	peak
6	0.1300	55.43	-101.70	-46.27	25.33	-97.77	-26.17	-71.60	peak

Note: 1. Measurement = Reading Level + Correct Factor.

2. If Peak Result complies with AV and QP limit, AV and QP Result are deemed to comply with AV limit.

3. All 3 polarizations (Horizontal, Face-on and Face-off) of the loop antenna had been tested, but only the worst data recorded in the report.

4. $\text{dBuA/m} = \text{dBuV/m} - 20\log_{10}(120\pi) = \text{dBuV/m} - 51.5$.

150 kHz ~ 490 kHz

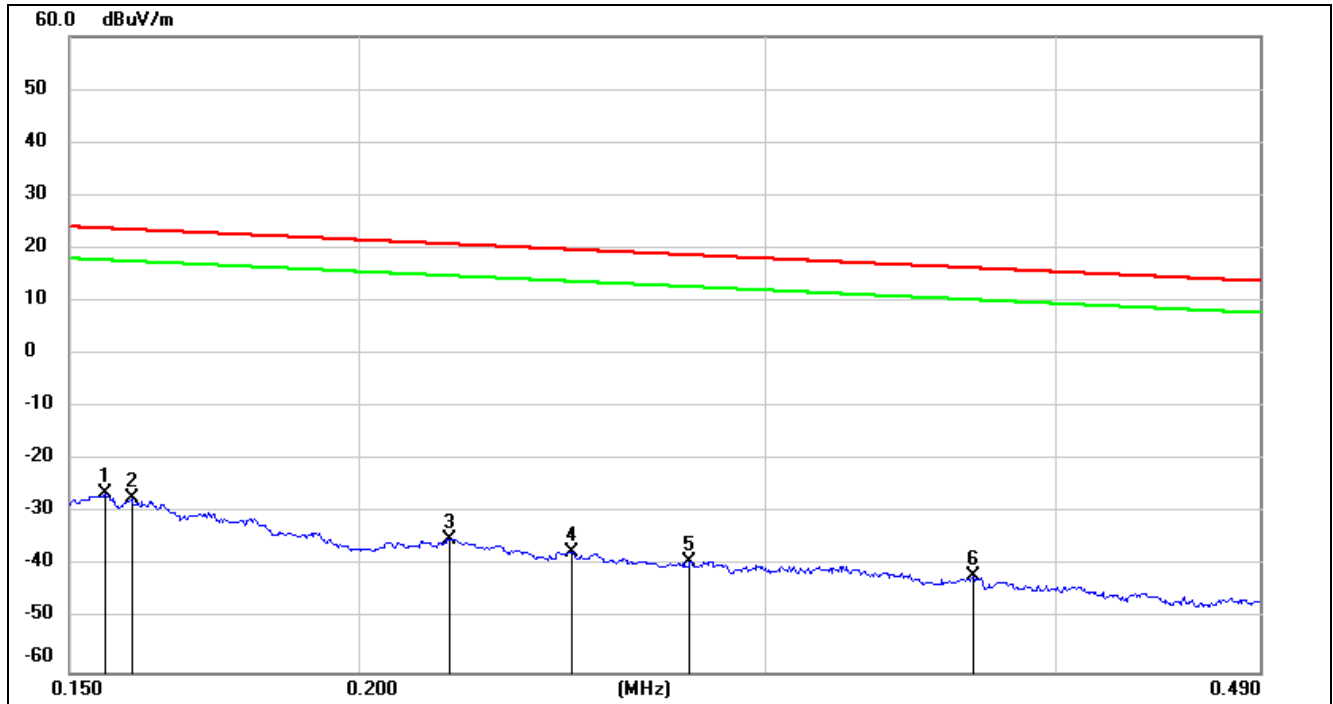

No.	Frequency (MHz)	Reading (dBuV)	Correct (dB/m)	FCC Result (dBuV/m)	FCC Limit (dBuV/m)	ISED Result (dBuA/m)	ISED Limit (dBuA/m)	Margin (dB)	Remark
1	0.1554	75.27	-101.65	-26.38	23.77	-77.88	-27.73	-50.15	peak
2	0.1595	74.36	-101.65	-27.29	23.55	-78.79	-27.95	-50.84	peak
3	0.2190	66.77	-101.75	-34.98	20.79	-86.48	-30.71	-55.77	peak
4	0.2472	64.45	-101.80	-37.35	19.74	-88.85	-31.76	-57.09	peak
5	0.2782	62.79	-101.83	-39.04	18.71	-90.54	-32.79	-57.75	peak
6	0.3684	59.98	-101.93	-41.95	16.27	-93.45	-35.23	-58.22	peak

- Note: 1. Measurement = Reading Level + Correct Factor.
 2. If Peak Result complies with AV and QP limit, AV and QP Result are deemed to comply with AV limit.
 3. All 3 polarizations (Horizontal, Face-on and Face-off) of the loop antenna had been tested, but only the worst data recorded in the report.
 4. $\text{dBuA/m} = \text{dBuV/m} - 20\log_{10}(120\pi) = \text{dBuV/m} - 51.5$.

490 kHz ~ 30 MHz

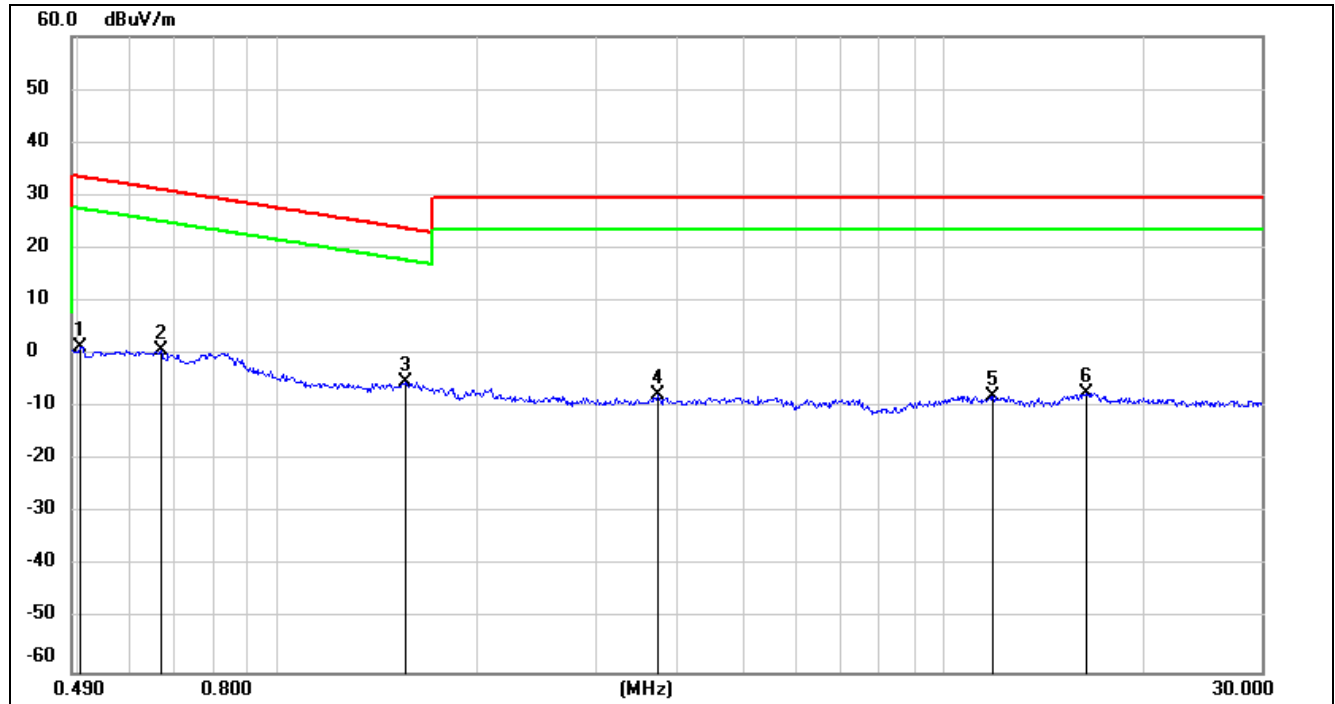

No.	Frequency (MHz)	Reading (dBuV)	Correct (dB/m)	FCC Result (dBuV/m)	FCC Limit (dBuV/m)	ISED Result (dBuA/m)	ISED Limit (dBuA/m)	Margin (dB)	Remark
1	0.5039	63.43	-62.07	1.36	33.56	-50.14	-17.94	-32.20	peak
2	0.6671	62.75	-62.10	0.65	31.12	-50.85	-20.38	-30.47	peak
3	1.5564	56.68	-62.02	-5.34	23.76	-56.84	-27.74	-29.10	peak
4	3.7100	53.70	-61.41	-7.71	29.54	-59.21	-21.96	-37.25	peak
5	11.8513	53.06	-60.88	-7.82	29.54	-59.32	-21.96	-37.36	peak
6	16.3959	53.67	-60.96	-7.29	29.54	-58.79	-21.96	-36.83	peak

Note: 1. Measurement = Reading Level + Correct Factor.

2. If Peak Result complies with AV and QP limit, AV and QP Result are deemed to comply with AV limit.

3. All 3 polarizations (Horizontal, Face-on and Face-off) of the loop antenna had been tested, but only the worst data recorded in the report.

4. $\text{dBuA/m} = \text{dBuV/m} - 20\log_{10}(120\pi) = \text{dBuV/m} - 51.5$.

Note: All the modes had been tested, but only the worst data was recorded in the report.

9. AC POWER LINE CONDUCTED EMISSIONS

LIMITS

Please refer to CFR 47 FCC §15.207 (a).

FREQUENCY (MHz)	Quasi-peak	Average
0.15 -0.5	66 - 56 *	56 - 46 *
0.50 -5.0	56.00	46.00
5.0 -30.0	60.00	50.00

TEST SETUP AND PROCEDURE

Refer to ANSI C63.10-2013 clause 6.2.

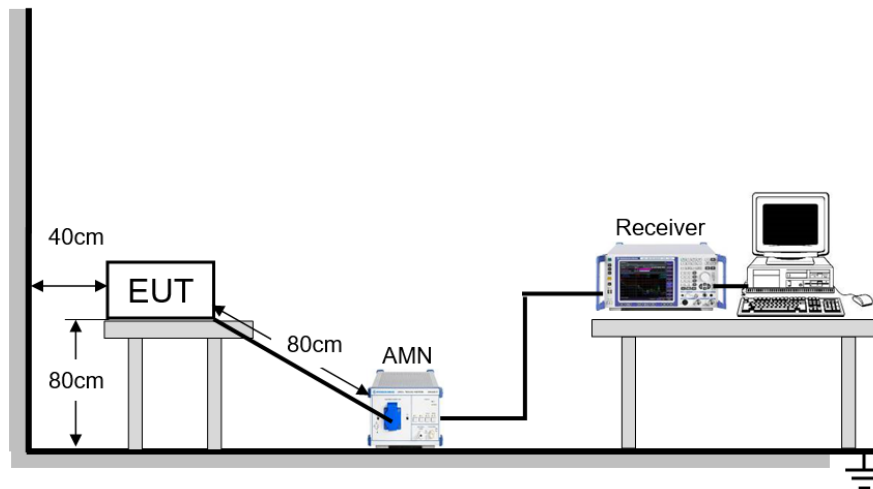

The EUT is put on a table of non-conducting material that is 80 cm high. The vertical conducting wall of shielding is located 40 cm to the rear of the EUT. The power line of the EUT is connected to the AC mains through a Artificial Mains Network (A.M.N.). A EMI Measurement Receiver (R&S Test Receiver ESR3) is used to test the emissions from both sides of AC line. According to the requirements in Section 6.2 of ANSI C63.10-2013. Conducted emissions from the EUT measured in the frequency range between 0.15 MHz and 30 MHz using CISPR Quasi-Peak and average detector mode. The bandwidth of EMI test receiver is set at 9 kHz.

The arrangement of the equipment is installed to meet the standards and operating in a manner, which tends to maximize its emission characteristics in a normal application.

TEST ENVIRONMENT

Temperature	20.5 °C	Relative Humidity	51.7 %
Atmosphere Pressure	101 kPa	Test Voltage	AC 120 V, 60 Hz

RESULTS

9.1.1. 802.11ax HE80 CDD MODE

LINE N RESULTS (UNII-7 BAND MID CHANNEL, WORST-CASE CONFIGURATION)

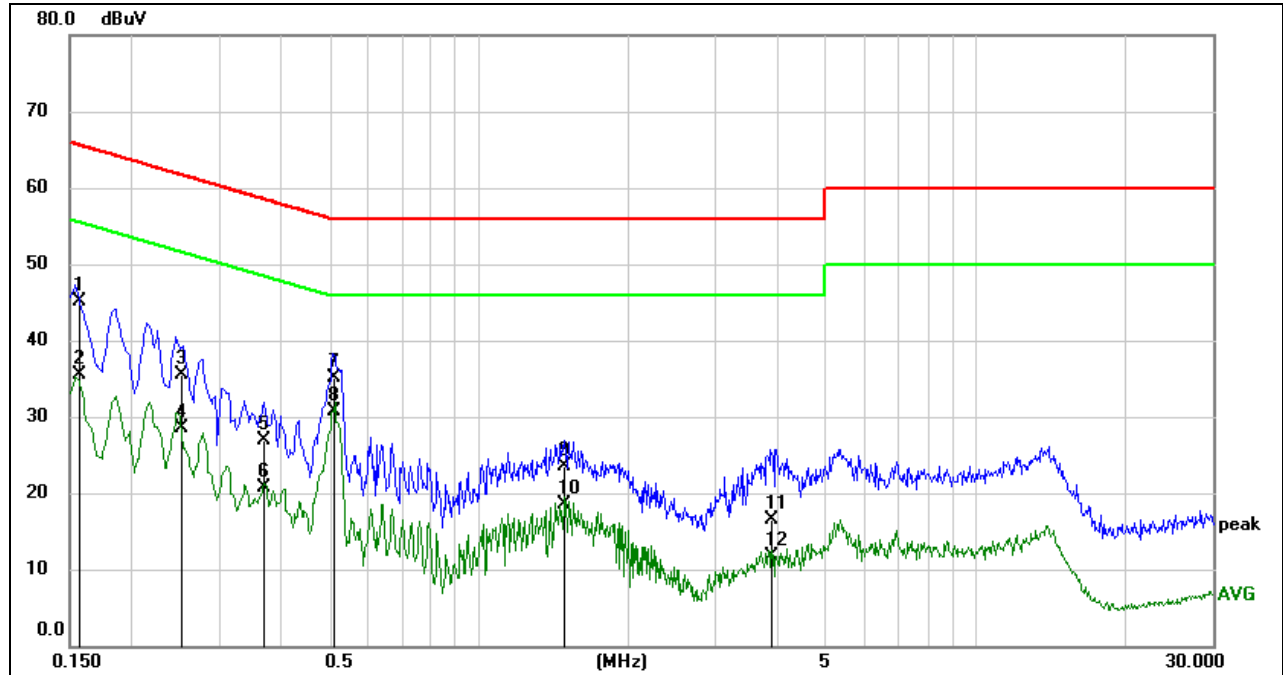

No.	Frequency (MHz)	Reading (dBuV)	Correct (dB)	Result (dBuV)	Limit (dBuV)	Margin (dB)	Remark
1	0.1568	35.54	9.59	45.13	65.63	-20.50	QP
2	0.1568	25.93	9.59	35.52	55.63	-20.11	AVG
3	0.2519	26.02	9.54	35.56	61.69	-26.13	QP
4	0.2519	18.96	9.54	28.50	51.69	-23.19	AVG
5	0.3710	17.39	9.42	26.81	58.48	-31.67	QP
6	0.3710	11.34	9.42	20.76	48.48	-27.72	AVG
7	0.5138	25.80	9.32	35.12	56.00	-20.88	QP
8	0.5138	21.31	9.32	30.63	46.00	-15.37	AVG
9	1.4868	13.96	9.62	23.58	56.00	-32.42	QP
10	1.4868	8.84	9.62	18.46	46.00	-27.54	AVG
11	3.8947	6.85	9.60	16.45	56.00	-39.55	QP
12	3.8947	2.14	9.60	11.74	46.00	-34.26	AVG

Note: 1. Result = Reading + Correct Factor.

2. If QP Result complies with AV limit, AV Result is deemed to comply with AV limit.

3. Test setup: RBW: 200 Hz (9 kHz ~ 150 kHz), 9 kHz (150 kHz ~ 30 MHz).

4. Step size: 80 Hz (0.009 MHz ~ 0.15 MHz), 4 kHz (0.15 MHz ~ 30 MHz), Scan time: auto.

LINE L RESULTS (UNII-2C BAND MID CHANNEL, WORST-CASE CONFIGURATION)

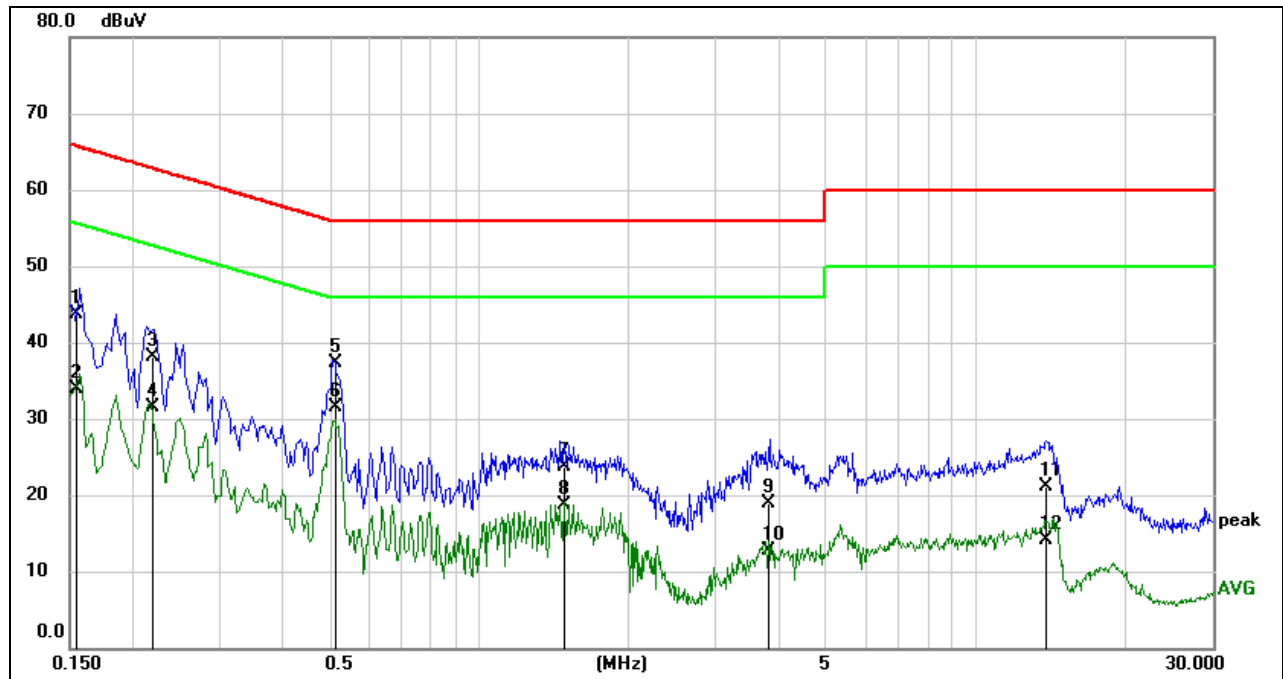

No.	Frequency (MHz)	Reading (dBuV)	Correct (dB)	Result (dBuV)	Limit (dBuV)	Margin (dB)	Remark
1	0.1543	34.11	9.59	43.70	65.77	-22.07	QP
2	0.1543	24.24	9.59	33.83	55.77	-21.94	AVG
3	0.2186	28.51	9.57	38.08	62.87	-24.79	QP
4	0.2186	21.84	9.57	31.41	52.87	-21.46	AVG
5	0.5144	28.01	9.32	37.33	56.00	-18.67	QP
6	0.5144	22.10	9.32	31.42	46.00	-14.58	AVG
7	1.4869	14.18	9.62	23.80	56.00	-32.20	QP
8	1.4869	9.18	9.62	18.80	46.00	-27.20	AVG
9	3.8257	9.34	9.60	18.94	56.00	-37.06	QP
10	3.8257	3.06	9.60	12.66	46.00	-33.34	AVG
11	13.8890	11.26	9.76	21.02	60.00	-38.98	QP
12	13.8890	4.32	9.76	14.08	50.00	-35.92	AVG

Note: 1. Result = Reading + Correct Factor.

2. If QP Result complies with AV limit, AV Result is deemed to comply with AV limit.

3. Test setup: RBW: 200 Hz (9 kHz ~ 150 kHz), 9 kHz (150 kHz ~ 30 MHz).

4. Step size: 80 Hz (0.009 MHz ~ 0.15 MHz), 4 kHz (0.15 MHz ~ 30 MHz), Scan time: auto.

Note: All the modes had been tested, but only the worst data was recorded in the report.

10. FREQUENCY STABILITY

LIMITS

The frequency of the carrier signal shall be maintained within band of operation.

TEST PROCEDURE

1. The EUT was placed inside an environmental chamber as the temperature in the chamber was varied between 0 °C ~ 70 °C (declared by customer).
2. The temperature was incremented by 10 °C intervals and the unit allowed to stabilize at each temperature before each measurement. The center frequency of the transmitting channel was evaluated at each temperature and the frequency deviation from the channel's center frequency was recorded.
3. The primary supply voltage is varied from 85 % to 115 % of the nominal value for non hand-carried battery and AC powered equipment. For hand-carried, battery-powered equipment, primary supply voltage is reduced to the battery operating end point which shall be specified by the manufacturer.

Connect the EUT to the spectrum analyser and use the following settings:

Center Frequency	The center frequency of the channel under test
Detector	Peak
RBW	10 kHz
VBW	$\geq 3 \times \text{RBW}$
Span	Encompass the entire emissions bandwidth (EBW) of the signal
Trace	Max hold
Sweep time	Auto

4. While maintaining a constant temperature inside the environmental chamber, turn the EUT on and record the operating frequency at startup, and at 2 minutes, 5 minutes, and 10 minutes after the EUT is energized.
5. Allow the trace to stabilize, find the peak value of the power envelope and record the frequency, then calculated the frequency drift.

TEST SETUP

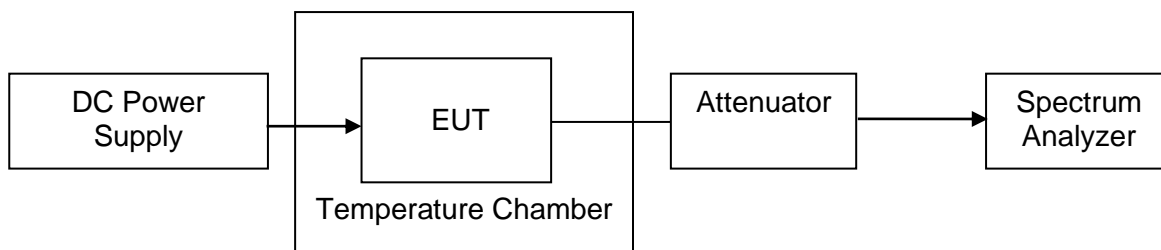



TEST ENVIRONMENT

	Normal Test Conditions	Extreme Test Conditions
Relative Humidity	20 % - 75 %	/
Atmospheric Pressure	100 kPa ~102 kPa	/
Temperature	T _N (Normal Temperature): 25.1 °C	T _L (Low Temperature): 0 °C
		T _H (High Temperature): 70 °C
Supply Voltage	V _N (Normal Voltage): AC 120 V	V _L (Low Voltage): AC 102 V
		V _H (High Voltage): DC 138 V

RESULTS

Please refer to Appendix F.

11. CONTENTION BASED PROTOCOL

APPLICABILITY OF DFS REQUIREMENTS

Indoor access points, subordinate devices and client devices operating in the 5.925-7.125 GHz band (herein referred to as unlicensed devices) are required to use technologies that include a contention-based protocol to avoid co-channel interference with incumbent devices sharing the band. To ensure incumbent co-channel operations are detected in a technology-agnostic manner, unlicensed devices are required to detect co-channel radio frequency energy (energy detect) and avoid simultaneous transmission.

Unlicensed low-power indoor devices must detect co-channel radio frequency power that is at least -62 dBm or lower. Upon detection of energy in the band, unlicensed low power indoor devices must vacate the channel (in which incumbent signal is transmitted) and stay off the incumbent channel as long as detected radio frequency power is equal to or greater than the threshold (-62 dBm)¹. The -62 dBm (or lower) threshold is referenced to a 0 dBi antenna gain. To ensure incumbent operations are reliably detected in the band, low power indoor devices must detect RF energy throughout their intended operating channel. For example, an 802.11 device that plans to transmit a 40 MHz- wide signal (on a primary 20 MHz channel and a secondary 20 MHz channel) must detect energy throughout the entire 40 MHz channel. Additionally, low-power indoor devices must detect co-channel energy with 90% or greater certainty.

a) Simulating Incumbent Signal

The incumbent signal is assumed to be noise-like. One example of such transmission could be Digital Video Broadcasting (DVB) systems that use Orthogonal Frequency Division Multiplexing (OFDM). Incumbent systems may also use different bandwidths for their transmissions. A 10 MHz-wide additive white Gaussian noise (AWGN) signal is selected to simulate and represent incumbent transmission.

b) Required number of tests

Incumbent and EUT (access point, subordinate or client) signals may occupy different portions of the channel. Depending on the EUT transmission bandwidth and incumbent signal center frequency (simulated by a 10 MHz-wide AWGN signal), the center frequency of the EUT signal f_{fcc1} may fall within the incumbent's occupied bandwidth (Figure 1.a), or outside of it (Figure 1.b).

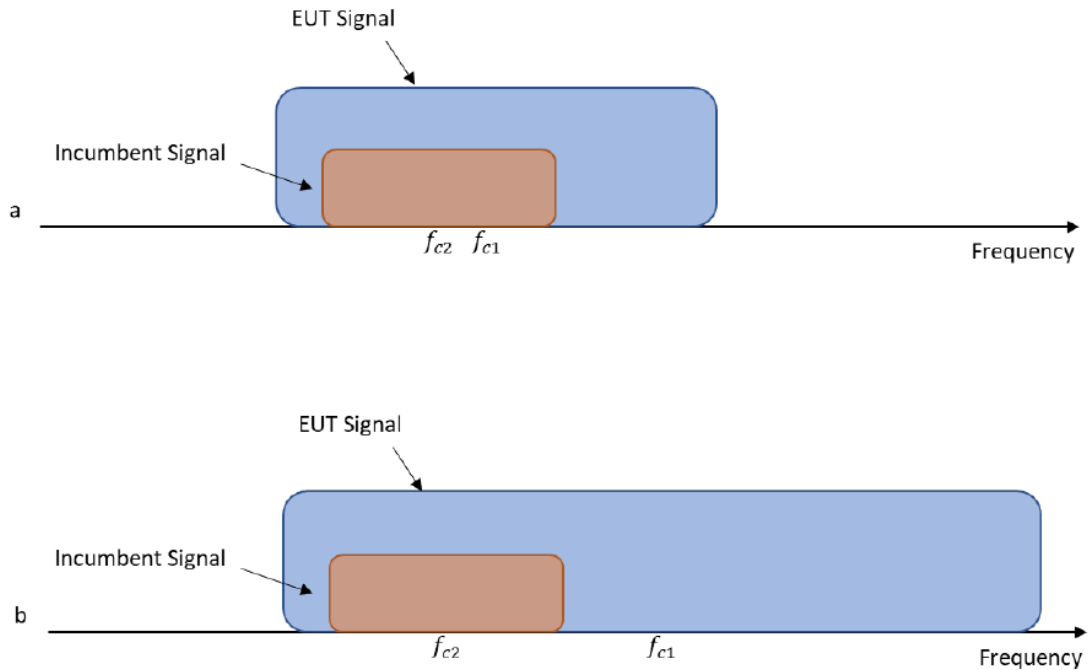

Figure 1. Two possible scenarios where a) center frequency of EUT transmission falls within incumbent's bandwidth, or b) outside of it

To ensure EUT reliably detects an incumbent signal in both scenarios shown in Figure 1, the detection threshold test may be repeated more than once with the incumbent signal (having center frequency f_{c2}) tuned to different center frequencies within the EUT transmission bandwidth. The criteria specified in Table 1 determine how many times the detection threshold test must be performed;

Table 1. Criteria to determine number of times detection threshold test may be performed

If	Number of Tests	Placement of Incumbent Transmission
$BW_{EUT} \leq BW_{Inc}$	Once	Tune incumbent and EUT transmissions ($f_{c1} = f_{c2}$)
$BW_{Inc} < BW_{EUT} \leq 2BW_{Inc}$	Once	Incumbent transmission is contained within BW_{EUT}
$2BW_{Inc} < BW_{EUT} \leq 4BW_{Inc}$	Twice. Incumbent transmission is contained within BW_{EUT}	Incumbent transmission is located as closely as possible to the lower edge and upper edge, respectively, of the EUT channel
$BW_{EUT} > 4BW_{Inc}$	Three times	Incumbent transmission is located as closely as possible to the lower edge of the EUT channel, in the middle of EUT channel, and as closely as possible to the upper edge of the EUT channel

where:

BW_{EUT} : Transmission bandwidth of EUT signal

BW_{Inc} : Transmission bandwidth of the simulated incumbent signal (10 MHz wide AWGN signal)

f_{c1} : Center frequency of EUT transmission

f_{c2} : Center frequency of simulated incumbent signal

TEST SETUP AND PROCEDURE

To ensure the EUT is capable of detecting co-channel energy, the first step is to configure the EUT to transmit with a constant duty cycle.² To simulate an incumbent signal, a signal generator (or similar source) that is capable of generating band-limited additive white Gaussian noise (AWGN) is required. Depending on the EUT antenna configuration, the AWGN signal can be provided to the EUT receiver via a conducted method (Figure 2) or a radiated method (Figure 3). Figure 2 shows the conducted test setup where a band-limited AWGN signal is generated at a very low power level and injected into the EUT's antenna port. The AWGN signal power level is then incrementally increased while the EUT transmission is monitored on a signal analyzer 2 to verify if the EUT can sense the AWGN signal and can subsequently cease its transmission. A triggered measurement, as shown in Figure 2, is optional, and assists with determining the time it takes the EUT to cease transmission (or vacate the channel) upon detecting RF energy. If the EUT has only one antenna port, then an AWGN signal source can be connected to the same antenna port.

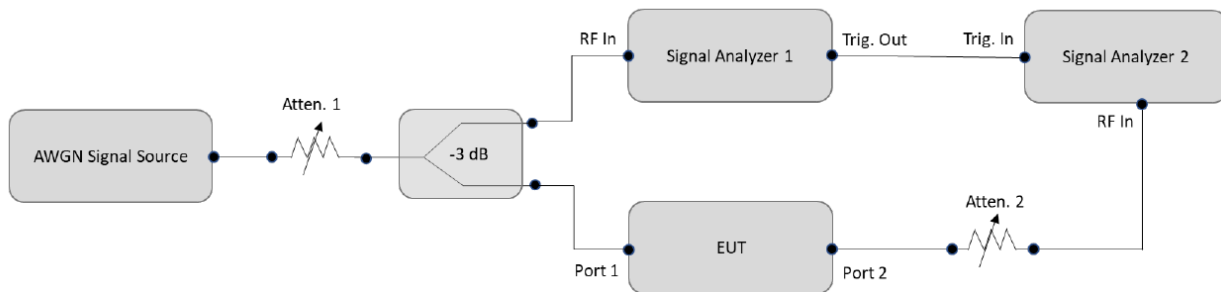

1. Configure the EUT to transmit with a constant duty cycle.
2. Set the operating parameters of the EUT including power level, operating frequency, modulation and bandwidth.
3. Set the signal analyzer center frequency to the nominal EUT channel center frequency. The span range of the signal analyzer shall be between two times and five times the OBW of the EUT.

Connect the output port of the EUT to the signal analyzer 2, as shown in Figure 2. Ensure that the attenuator 2 provides enough attenuation to not overload the signal analyzer 2 receiver.

4. Monitoring the signal analyzer 2, verify the EUT is operating and transmitting with the parameters set at step two.
5. Using an AWGN signal source, generate (but do not transmit, i.e., RF OFF) a 10 MHz-wide AWGN signal. Use Table 1 to determine the center frequency of the 10 MHz AWGN signal relative to the EUT's channel bandwidth and center frequency.
6. Set the AWGN signal power to an extremely low level (more than 20 dB below the -62 dBm threshold). Connect the AWGN signal source, via a 3-dB splitter, to the signal analyzer 1 and the EUT as shown in Figure 2.
7. Transmit the AWGN signal (RF ON) and verify its characteristics on the signal analyzer 1.



8. Monitor the signal analyzer 2 to verify if the AWGN signal has been detected and the EUT has ceased transmission. If the EUT continues to transmit, then incrementally increase the AWGN signal power level until the EUT stops transmitting.
9. (Including all losses in the RF paths) Determine and record the AWGN signal power level (at the EUT's antenna port) at which the EUT ceased transmission. Repeat the procedure at least 10 times to verify the EUT can detect an AWGN signal with 90% (or better) level of certainty.
10. Refer to Table 1 to determine number of times the detection threshold testing needs to be repeated. If testing is required more than once, then go back to step 5, choose a different center frequency for the AWGN signal and repeat the process.

TEST ENVIRONMENT

Temperature	24.1 °C	Relative Humidity	60.5 %
Atmosphere Pressure	101 kPa	Test Voltage	DC 5 V

RESULTS

Please refer to Appendix G.

12. ANTENNA REQUIREMENTS

APPLICABLE REQUIREMENTS

Please refer to FCC §15.203

An intentional radiator shall be designed to ensure that no antenna other than that furnished by the responsible party shall be used with the device. The use of a permanently attached antenna or of an antenna that uses a unique coupling to the intentional radiator shall be considered sufficient to comply with the provisions of this section. The manufacturer may design the unit so that a broken antenna can be replaced by the user, but the use of a standard antenna jack or electrical connector is prohibited.

Please refer to FCC §15.247(b)(4)

The conducted output power limit specified in paragraph (b) of this section is based on the use of antennas with directional gains that do not exceed 6 dBi. Except as shown in paragraph (c) of this section, if transmitting antennas of directional gain greater than 6 dBi are used, the conducted output power from the intentional radiator shall be reduced below the stated values in paragraphs (b)(1), (b)(2), and (b)(3) of this section, as appropriate, by the amount in dB that the directional gain of the antenna exceeds 6 dBi.

RESULTS

Complies

**12.1. Appendix A1: Emission Bandwidth****12.1.1. Test Result**

Test Mode	Antenna	Channel	26db EBW [MHz]	FL[MHz]	FH[MHz]	Verdict
11AX20MIMO	Ant1	5955	21.200	5944.240	5965.440	PASS
	Ant2	5955	21.960	5944.080	5966.040	PASS
	Ant1	6175	21.000	6164.560	6185.560	PASS
	Ant2	6175	22.080	6164.000	6186.080	PASS
	Ant1	6415	20.640	6404.680	6425.320	PASS
	Ant2	6415	21.120	6404.520	6425.640	PASS
	Ant1	6435	22.160	6423.800	6445.960	PASS
	Ant2	6435	20.760	6424.400	6445.160	PASS
	Ant1	6475	21.480	6464.600	6486.080	PASS
	Ant2	6475	21.600	6464.200	6485.800	PASS
	Ant1	6515	21.320	6504.200	6525.520	PASS
	Ant2	6515	21.960	6504.320	6526.280	PASS
	Ant1	6535	21.440	6524.240	6545.680	PASS
	Ant2	6535	21.760	6524.320	6546.080	PASS
	Ant1	6715	21.760	6704.320	6726.080	PASS
	Ant2	6715	21.320	6704.480	6725.800	PASS
	Ant1	6855	21.040	6844.520	6865.560	PASS
	Ant2	6855	21.040	6844.280	6865.320	PASS
	Ant1	6875	21.440	6864.200	6885.640	PASS
	Ant2	6875	24.120	6861.640	6885.760	PASS
11AX40MIMO	Ant1	7015	21.160	7004.520	7025.680	PASS
	Ant2	7015	21.200	7004.360	7025.560	PASS
	Ant1	7115	21.880	7104.080	7125.960	PASS
	Ant2	7115	21.320	7104.600	7125.920	PASS
	Ant1	5965	39.120	5945.480	5984.600	PASS
	Ant2	5965	39.360	5945.320	5984.680	PASS
	Ant1	6165	39.360	6145.400	6184.760	PASS
	Ant2	6165	39.360	6145.400	6184.760	PASS
	Ant1	6405	39.200	6385.480	6424.680	PASS
	Ant2	6405	38.960	6385.560	6424.520	PASS
	Ant1	6445	39.680	6425.160	6464.840	PASS
	Ant2	6445	39.120	6425.480	6464.600	PASS
	Ant1	6485	39.280	6465.480	6504.760	PASS
	Ant2	6485	39.120	6465.480	6504.600	PASS
	Ant1	6525	39.440	6505.320	6544.760	PASS
	Ant2	6525	39.120	6505.560	6544.680	PASS
	Ant1	6565	39.120	6545.480	6584.600	PASS
	Ant2	6565	39.280	6545.400	6584.680	PASS
	Ant1	6725	39.360	6705.400	6744.760	PASS
	Ant2	6725	39.200	6705.480	6744.680	PASS
11AX80MIMO	Ant1	6845	39.280	6825.480	6864.760	PASS
	Ant2	6845	39.360	6825.400	6864.760	PASS
	Ant1	6885	39.040	6865.560	6904.600	PASS
	Ant2	6885	39.280	6865.480	6904.760	PASS
	Ant1	7005	39.200	6985.480	7024.680	PASS
	Ant2	7005	39.440	6985.320	7024.760	PASS
	Ant1	7085	39.360	7065.480	7104.840	PASS
	Ant2	7085	39.440	7065.320	7104.760	PASS
	Ant1	5985	79.360	5945.160	6024.520	PASS
	Ant2	5985	79.360	5945.480	6024.840	PASS
Ant1	6145	79.520	6105.480	6185.000	PASS	
Ant2	6145	79.040	6105.800	6184.840	PASS	
Ant1	6385	79.520	6345.320	6424.840	PASS	
Ant2	6385	78.880	6345.960	6424.840	PASS	



	Ant1	6465	78.880	6425.800	6504.680	PASS
	Ant2	6465	78.720	6425.800	6504.520	PASS
	Ant1	6545	79.680	6505.320	6585.000	PASS
	Ant2	6545	78.720	6505.800	6584.520	PASS
	Ant1	6625	79.200	6585.480	6664.680	PASS
	Ant2	6625	78.560	6585.640	6664.200	PASS
	Ant1	6705	79.520	6665.480	6745.000	PASS
	Ant2	6705	79.040	6665.640	6744.680	PASS
	Ant1	6785	79.680	6745.320	6825.000	PASS
	Ant2	6785	79.040	6745.640	6824.680	PASS
	Ant1	6865	79.360	6825.480	6904.840	PASS
	Ant2	6865	78.880	6825.640	6904.520	PASS
	Ant1	6945	79.680	6905.320	6985.000	PASS
	Ant2	6945	80.160	6905.160	6985.320	PASS
	Ant1	7025	80.000	6985.160	7065.160	PASS
	Ant2	7025	80.160	6985.160	7065.320	PASS

12.1.2. Test Graphs



