

HARMONICS AND SPURIOUS EMISSIONS (MID CHANNEL, HORIZONTAL)

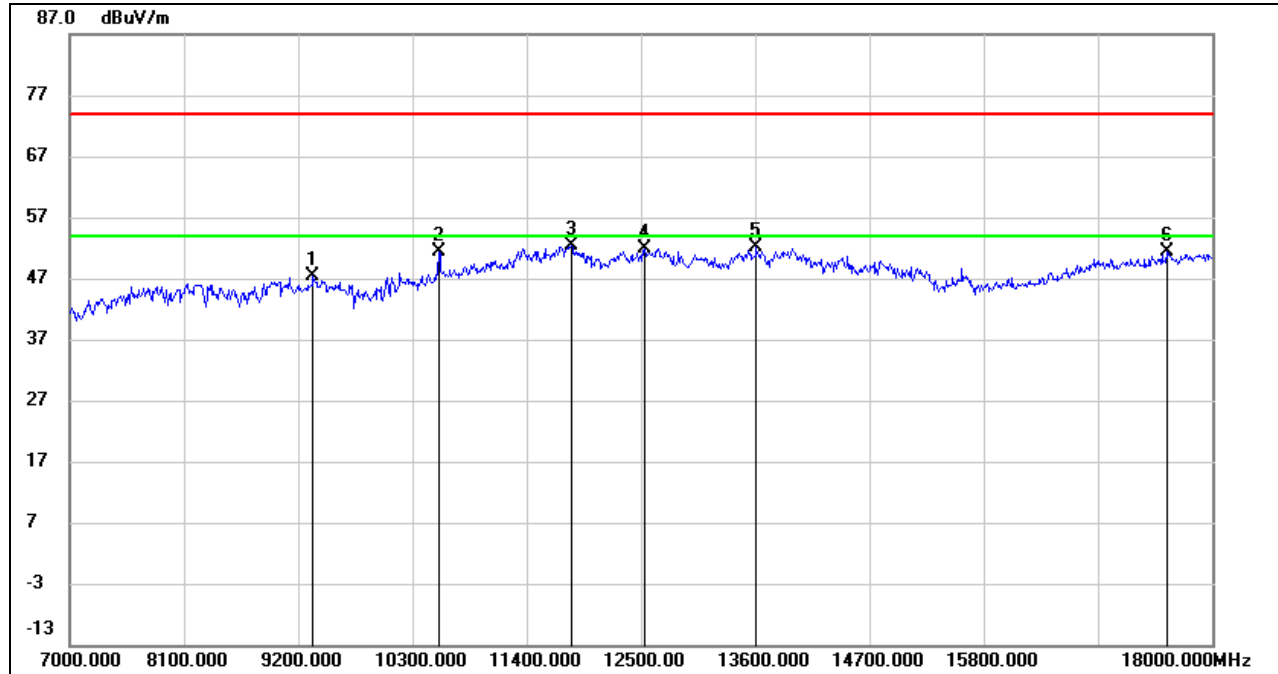

No.	Frequency (MHz)	Reading (dBuV)	Correct (dB/m)	Result (dBuV/m)	Limit (dBuV/m)	Margin (dB)	Remark
1	9343.000	37.50	9.80	47.30	74.00	-26.70	peak
2	10553.000	38.56	12.71	51.27	74.00	-22.73	peak
3	11829.000	35.01	17.30	52.31	74.00	-21.69	peak
4	12533.000	35.24	16.66	51.90	74.00	-22.10	peak
5	13611.000	33.73	18.39	52.12	74.00	-21.88	peak
6	17560.000	30.93	20.50	51.43	74.00	-22.57	peak

Note: 1. Measurement = Reading Level + Correct Factor.
 2. If Peak Result complies with AV limit, AV Result is deemed to comply with AV limit.
 3. Peak: Peak detector.
 4. Filter losses were only considered in the spurious frequency bands and the authorized band was not corrected for High Pass Filter losses.
 5. Proper operation of the transmitter prior to adding the filter to the measurement chain.
 6. Since non-restricted band peak emissions are less than the average limit, they also comply with the -27dBm/MHz (68.2dBuV/m) limit.

HARMONICS AND SPURIOUS EMISSIONS (MID CHANNEL, VERTICAL)

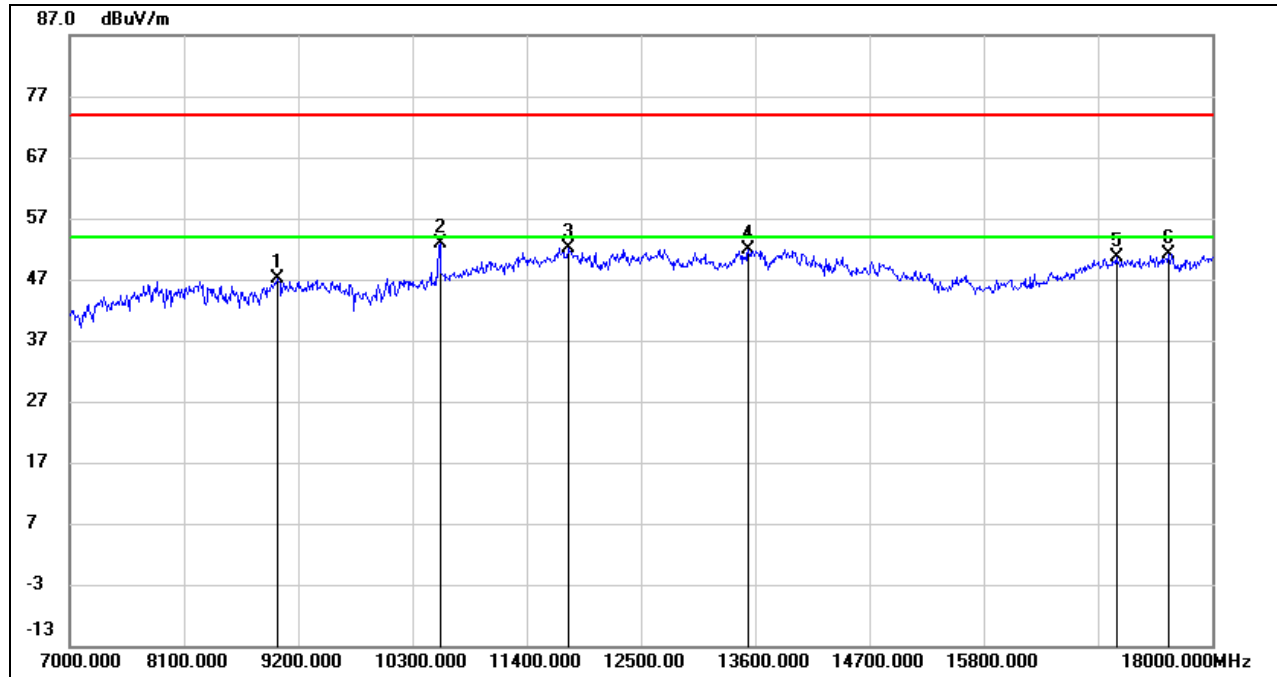

No.	Frequency (MHz)	Reading (dBuV)	Correct (dB/m)	Result (dBuV/m)	Limit (dBuV/m)	Margin (dB)	Remark
1	9002.000	37.09	10.11	47.20	74.00	-26.80	peak
2	10564.000	40.23	12.76	52.99	74.00	-21.01	peak
3	11807.000	34.82	17.35	52.17	74.00	-21.83	peak
4	13534.000	33.41	18.40	51.81	74.00	-22.19	peak
5	17076.000	31.63	18.99	50.62	74.00	-23.38	peak
6	17582.000	30.48	20.64	51.12	74.00	-22.88	peak

Note: 1. Measurement = Reading Level + Correct Factor.

2. If Peak Result complies with AV limit, AV Result is deemed to comply with AV limit.

3. Peak: Peak detector.

4. Filter losses were only considered in the spurious frequency bands and the authorized band was not corrected for High Pass Filter losses.

5. Proper operation of the transmitter prior to adding the filter to the measurement chain.

6. Since non-restricted band peak emissions are less than the average limit, they also comply with the -27dBm/MHz (68.2dBuV/m) limit.

HARMONICS AND SPURIOUS EMISSIONS (HIGH CHANNEL, HORIZONTAL)

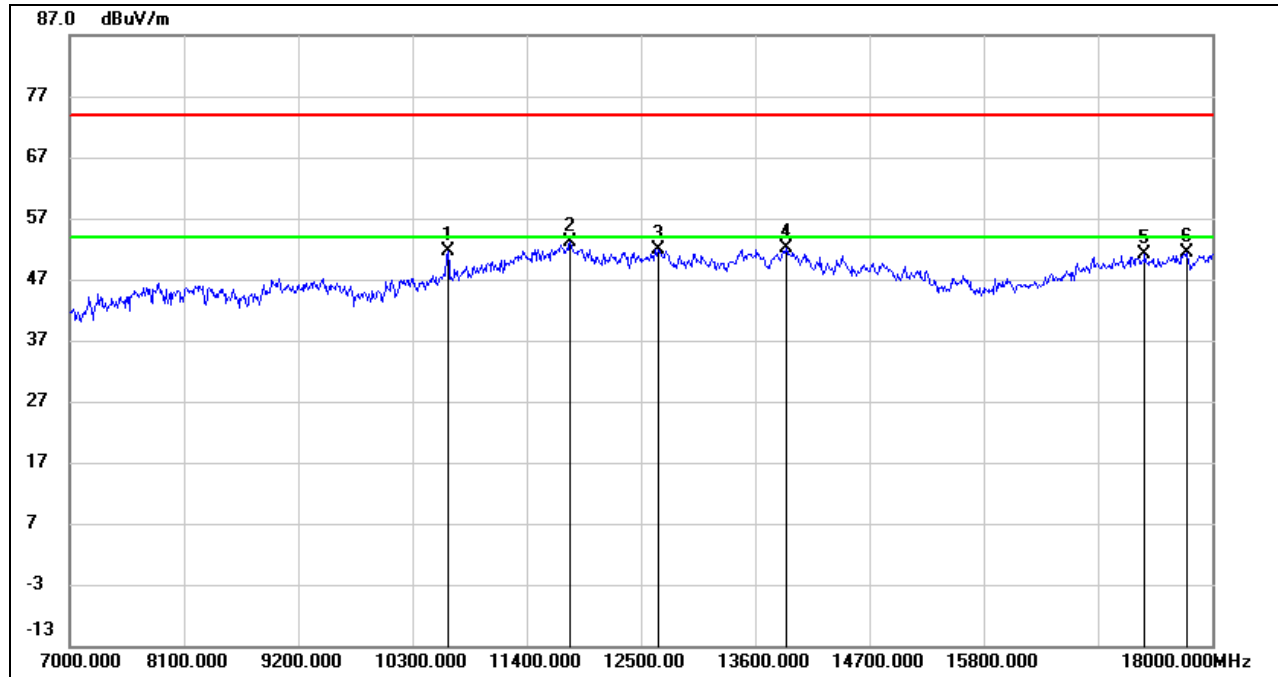

No.	Frequency (MHz)	Reading (dBuV)	Correct (dB/m)	Result (dBuV/m)	Limit (dBuV/m)	Margin (dB)	Remark
1	10641.000	38.69	13.04	51.73	74.00	-22.27	peak
2	11818.000	35.81	17.31	53.12	74.00	-20.88	peak
3	12665.000	35.15	16.78	51.93	74.00	-22.07	peak
4	13897.000	33.44	18.66	52.10	74.00	-21.90	peak
5	17351.000	31.28	19.81	51.09	74.00	-22.91	peak
6	17758.000	28.98	22.42	51.40	74.00	-22.60	peak

Note: 1. Measurement = Reading Level + Correct Factor.
 2. If Peak Result complies with AV limit, AV Result is deemed to comply with AV limit.
 3. Peak: Peak detector.
 4. Filter losses were only considered in the spurious frequency bands and the authorized band was not corrected for High Pass Filter losses.
 5. Proper operation of the transmitter prior to adding the filter to the measurement chain.
 6. Since non-restricted band peak emissions are less than the average limit, they also comply with the -27dBm/MHz (68.2dBuV/m) limit.

HARMONICS AND SPURIOUS EMISSIONS (HIGH CHANNEL, VERTICAL)

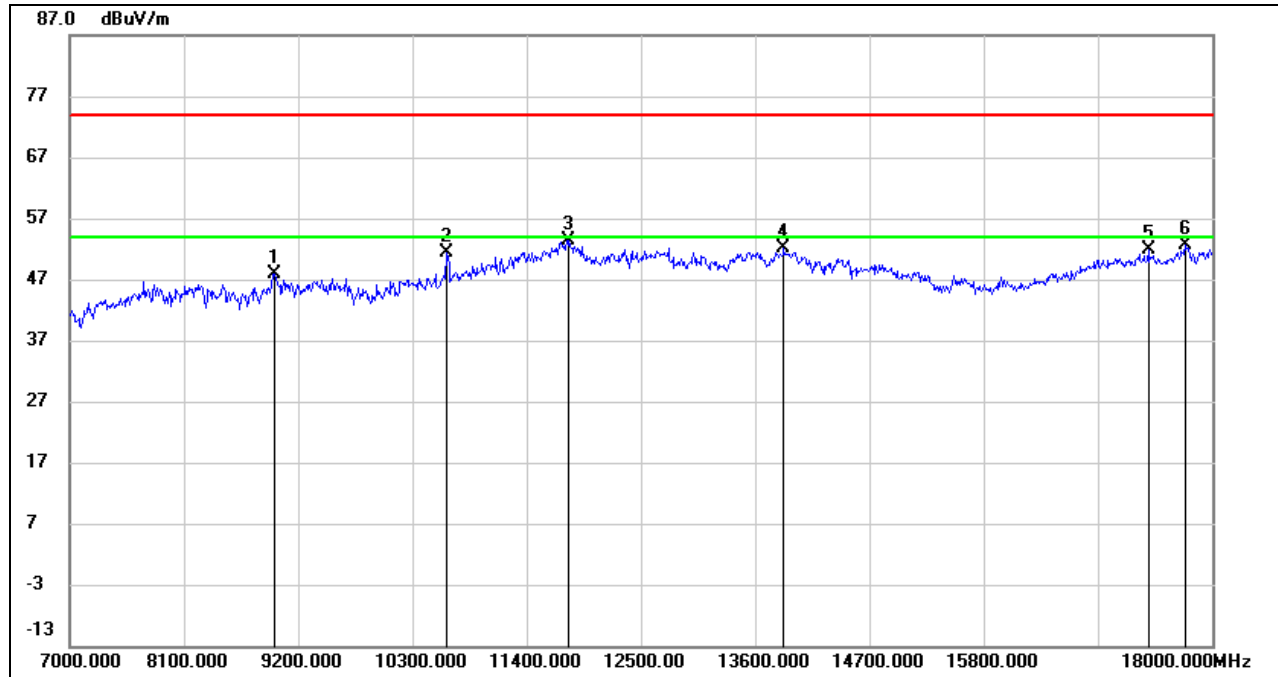

No.	Frequency (MHz)	Reading (dBuV)	Correct (dB/m)	Result (dBuV/m)	Limit (dBuV/m)	Margin (dB)	Remark
1	8969.000	38.07	9.79	47.86	74.00	-26.14	peak
2	10630.000	38.40	13.01	51.41	74.00	-22.59	peak
3	11807.000	36.02	17.35	53.37	74.00	-20.63	peak
4	13875.000	33.45	18.69	52.14	74.00	-21.86	peak
5	17384.000	31.97	19.83	51.80	74.00	-22.20	peak
6	17736.000	30.43	22.18	52.61	74.00	-21.39	peak

Note: 1. Measurement = Reading Level + Correct Factor.
 2. If Peak Result complies with AV limit, AV Result is deemed to comply with AV limit.
 3. Peak: Peak detector.
 4. Filter losses were only considered in the spurious frequency bands and the authorized band was not corrected for High Pass Filter losses.
 5. Proper operation of the transmitter prior to adding the filter to the measurement chain.
 6. Since non-restricted band peak emissions are less than the average limit, they also comply with the -27dBm/MHz (68.2dBuV/m) limit.

UNII-2C BAND

HARMONICS AND SPURIOUS EMISSIONS (LOW CHANNEL, HORIZONTAL)

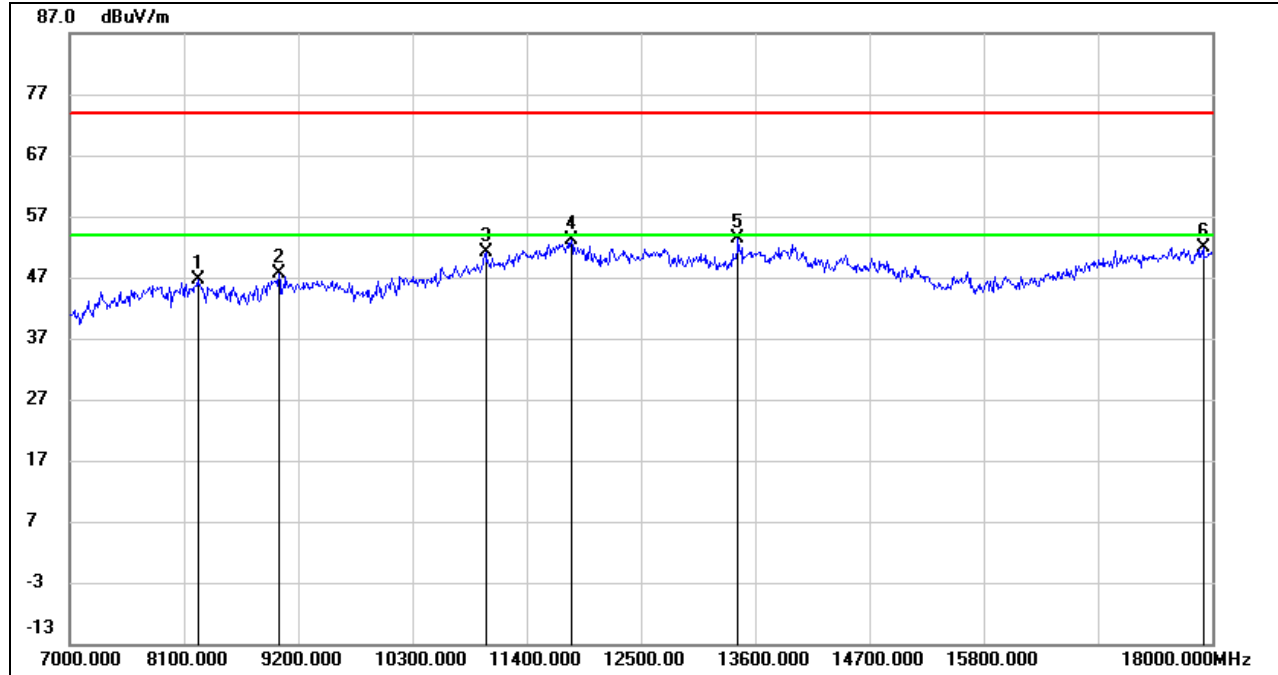

No.	Frequency (MHz)	Reading (dBuV)	Correct (dB/m)	Result (dBuV/m)	Limit (dBuV/m)	Margin (dB)	Remark
1	8232.000	38.03	8.59	46.62	74.00	-27.38	peak
2	9013.000	37.48	10.05	47.53	74.00	-26.47	peak
3	11004.000	36.92	14.17	51.09	74.00	-22.91	peak
4	11829.000	35.72	17.30	53.02	74.00	-20.98	peak
5	13435.000	35.07	18.28	53.35	74.00	-20.65	peak
6	17912.000	28.85	23.14	51.99	74.00	-22.01	peak

Note: 1. Measurement = Reading Level + Correct Factor.
 2. If Peak Result complies with AV limit, AV Result is deemed to comply with AV limit.
 3. Peak: Peak detector.
 4. Filter losses were only considered in the spurious frequency bands and the authorized band was not corrected for High Pass Filter losses.
 5. Proper operation of the transmitter prior to adding the filter to the measurement chain.
 6. Since non-restricted band peak emissions are less than the average limit, they also comply with the -27dBm/MHz (68.2dBuV/m) limit.



HARMONICS AND SPURIOUS EMISSIONS (LOW CHANNEL, VERTICAL)

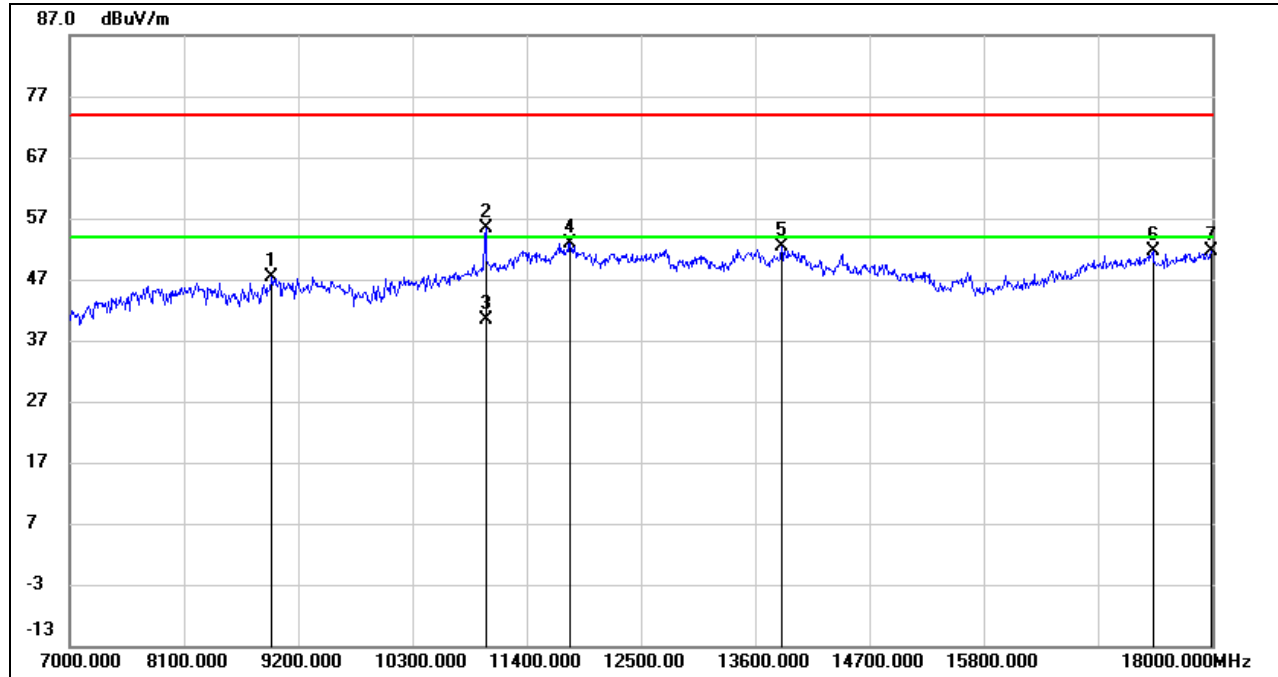

No.	Frequency (MHz)	Reading (dBuV)	Correct (dB/m)	Result (dBuV/m)	Limit (dBuV/m)	Margin (dB)	Remark
1	8947.000	37.82	9.55	47.37	74.00	-26.63	peak
2	11004.000	41.15	14.17	55.32	74.00	-18.68	peak
3	11004.000	26.12	14.17	40.29	54.00	-13.71	AVG
4	11818.000	35.50	17.31	52.81	74.00	-21.19	peak
5	13853.000	33.69	18.72	52.41	74.00	-21.59	peak
6	17428.000	31.63	19.92	51.55	74.00	-22.45	peak
7	17989.000	28.34	23.34	51.68	74.00	-22.32	peak

Note: 1. Measurement = Reading Level + Correct Factor.
 2. If Peak Result complies with AV limit, AV Result is deemed to comply with AV limit.
 3. Peak: Peak detector.
 4. Filter losses were only considered in the spurious frequency bands and the authorized band was not corrected for High Pass Filter losses.
 5. Proper operation of the transmitter prior to adding the filter to the measurement chain.
 6. Since non-restricted band peak emissions are less than the average limit, they also comply with the -27dBm/MHz (68.2dBuV/m) limit.

HARMONICS AND SPURIOUS EMISSIONS (MID CHANNEL, HORIZONTAL)

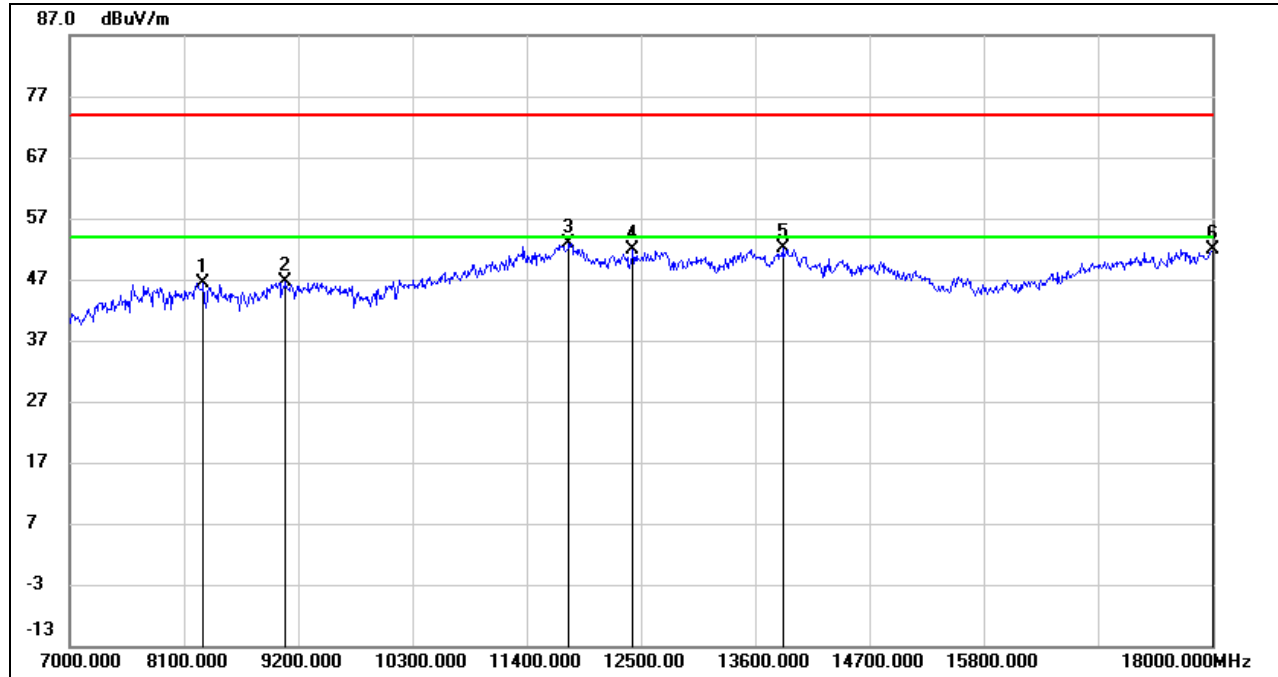

No.	Frequency (MHz)	Reading (dBuV)	Correct (dB/m)	Result (dBuV/m)	Limit (dBuV/m)	Margin (dB)	Remark
1	8287.000	37.95	8.37	46.32	74.00	-27.68	peak
2	9079.000	36.92	9.67	46.59	74.00	-27.41	peak
3	11807.000	35.51	17.35	52.86	74.00	-21.14	peak
4	12423.000	34.95	16.84	51.79	74.00	-22.21	peak
5	13864.000	33.46	18.70	52.16	74.00	-21.84	peak
6	18000.000	28.49	23.37	51.86	74.00	-22.14	peak

- Note: 1. Measurement = Reading Level + Correct Factor.
 2. If Peak Result complies with AV limit, AV Result is deemed to comply with AV limit.
 3. Peak: Peak detector.
 4. Filter losses were only considered in the spurious frequency bands and the authorized band was not corrected for High Pass Filter losses.
 5. Proper operation of the transmitter prior to adding the filter to the measurement chain.
 6. Since non-restricted band peak emissions are less than the average limit, they also comply with the -27dBm/MHz (68.2dBuV/m) limit.

HARMONICS AND SPURIOUS EMISSIONS (MID CHANNEL, VERTICAL)

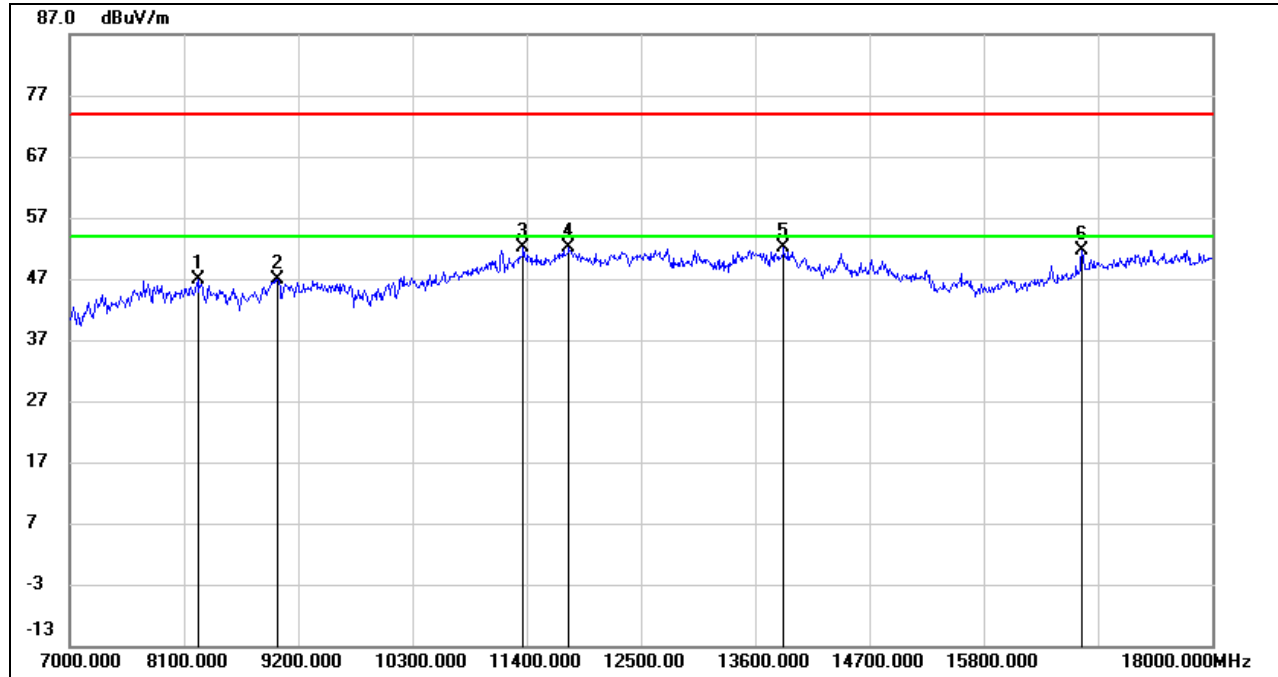

No.	Frequency (MHz)	Reading (dBuV)	Correct (dB/m)	Result (dBuV/m)	Limit (dBuV/m)	Margin (dB)	Remark
1	8232.000	38.38	8.59	46.97	74.00	-27.03	peak
2	9002.000	36.69	10.11	46.80	74.00	-27.20	peak
3	11367.000	36.36	15.67	52.03	74.00	-21.97	peak
4	11807.000	34.89	17.35	52.24	74.00	-21.76	peak
5	13875.000	33.38	18.69	52.07	74.00	-21.93	peak
6	16746.000	34.00	17.62	51.62	74.00	-22.38	peak

- Note: 1. Measurement = Reading Level + Correct Factor.
 2. If Peak Result complies with AV limit, AV Result is deemed to comply with AV limit.
 3. Peak: Peak detector.
 4. Filter losses were only considered in the spurious frequency bands and the authorized band was not corrected for High Pass Filter losses.
 5. Proper operation of the transmitter prior to adding the filter to the measurement chain.
 6. Since non-restricted band peak emissions are less than the average limit, they also comply with the -27dBm/MHz (68.2dBuV/m) limit.

HARMONICS AND SPURIOUS EMISSIONS (HIGH CHANNEL, HORIZONTAL)

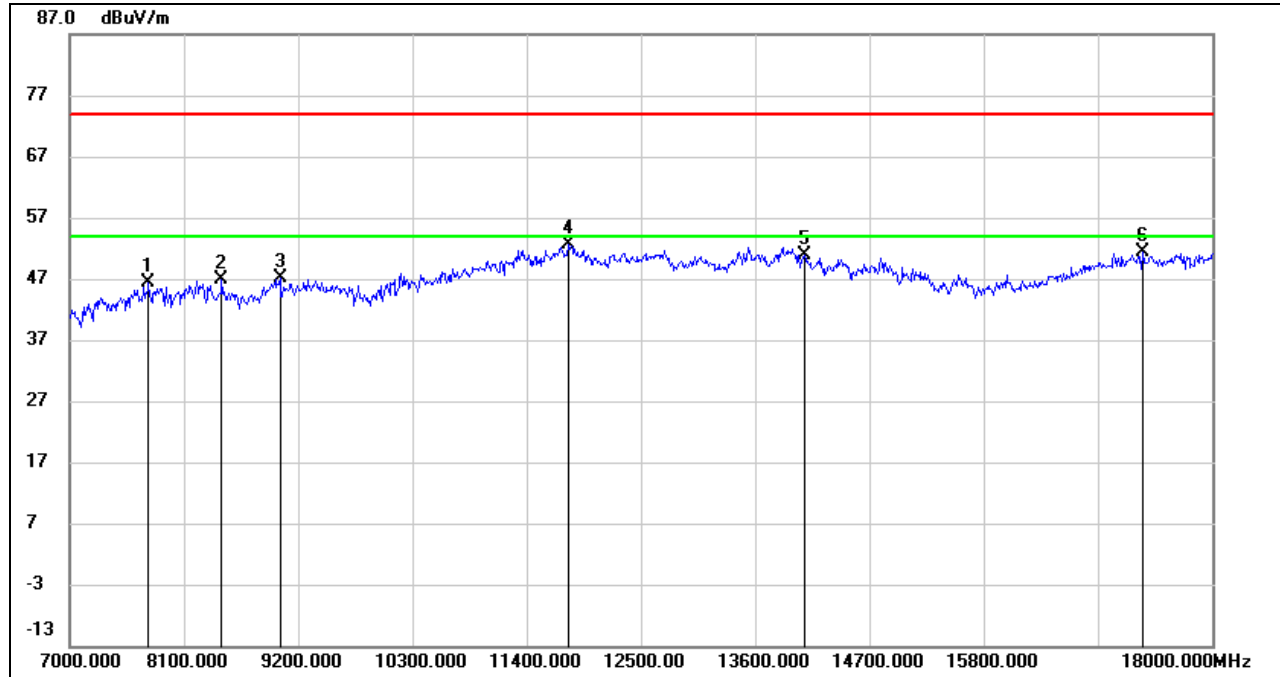

No.	Frequency (MHz)	Reading (dBuV)	Correct (dB/m)	Result (dBuV/m)	Limit (dBuV/m)	Margin (dB)	Remark
1	7759.000	39.03	7.45	46.48	74.00	-27.52	peak
2	8463.000	39.15	7.85	47.00	74.00	-27.00	peak
3	9024.000	37.07	9.99	47.06	74.00	-26.94	peak
4	11807.000	35.19	17.35	52.54	74.00	-21.46	peak
5	14073.000	32.55	18.29	50.84	74.00	-23.16	peak
6	17329.000	31.68	19.80	51.48	74.00	-22.52	peak

Note: 1. Measurement = Reading Level + Correct Factor.
 2. If Peak Result complies with AV limit, AV Result is deemed to comply with AV limit.
 3. Peak: Peak detector.
 4. Filter losses were only considered in the spurious frequency bands and the authorized band was not corrected for High Pass Filter losses.
 5. Proper operation of the transmitter prior to adding the filter to the measurement chain.
 6. Since non-restricted band peak emissions are less than the average limit, they also comply with the -27dBm/MHz (68.2dBuV/m) limit.

HARMONICS AND SPURIOUS EMISSIONS (HIGH CHANNEL, VERTICAL)

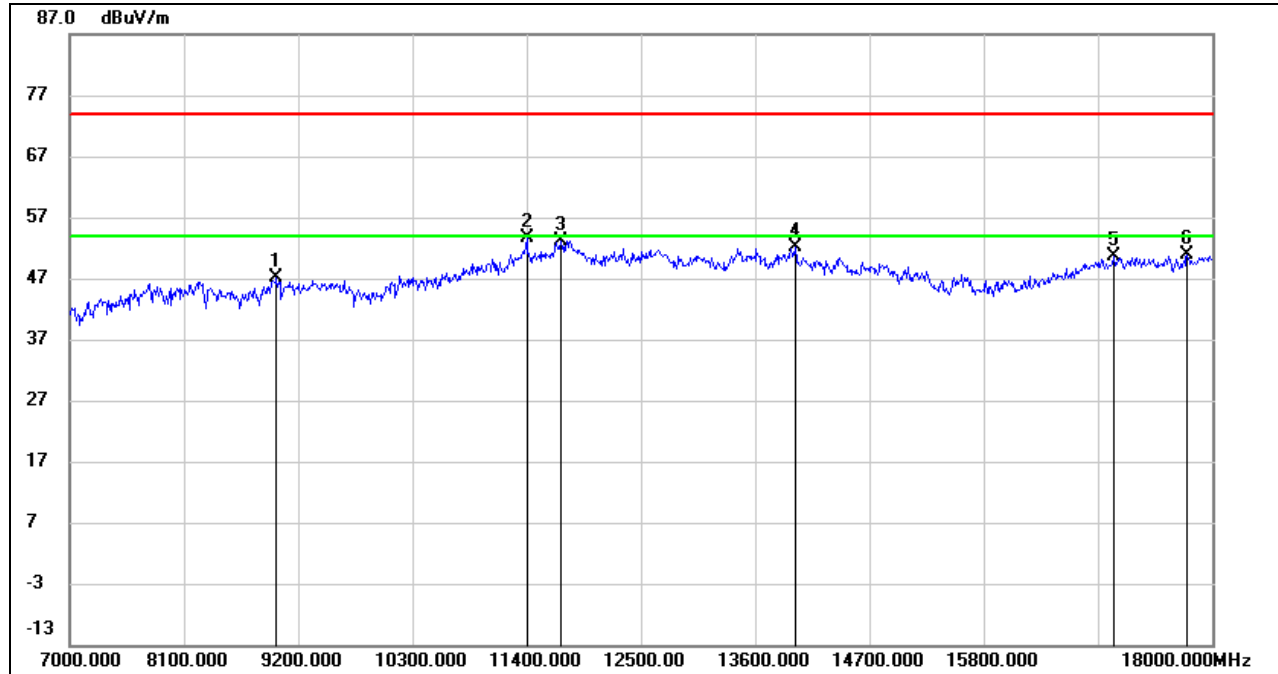

No.	Frequency (MHz)	Reading (dBuV)	Correct (dB/m)	Result (dBuV/m)	Limit (dBuV/m)	Margin (dB)	Remark
1	8991.000	37.02	10.03	47.05	74.00	-26.95	peak
2	11400.000	37.68	15.84	53.52	74.00	-20.48	peak
3	11730.000	36.20	16.98	53.18	74.00	-20.82	peak
4	13985.000	33.55	18.57	52.12	74.00	-21.88	peak
5	17054.000	31.67	18.86	50.53	74.00	-23.47	peak
6	17758.000	28.56	22.42	50.98	74.00	-23.02	peak

- Note: 1. Measurement = Reading Level + Correct Factor.
 2. If Peak Result complies with AV limit, AV Result is deemed to comply with AV limit.
 3. Peak: Peak detector.
 4. Filter losses were only considered in the spurious frequency bands and the authorized band was not corrected for High Pass Filter losses.
 5. Proper operation of the transmitter prior to adding the filter to the measurement chain.
 6. Since non-restricted band peak emissions are less than the average limit, they also comply with the -27dBm/MHz (68.2dBuV/m) limit.

STRADDLE CHANNEL 144

HARMONICS AND SPURIOUS EMISSIONS (HORIZONTAL)

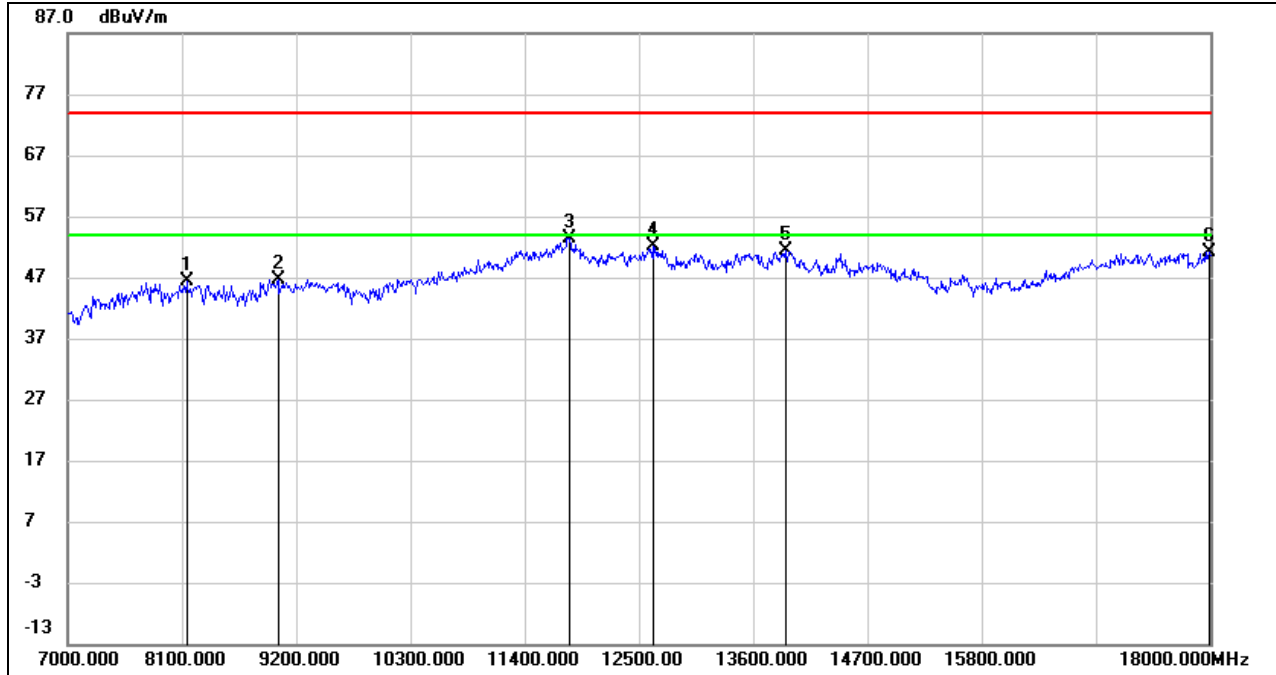

No.	Frequency (MHz)	Reading (dBuV)	Correct (dB/m)	Result (dBuV/m)	Limit (dBuV/m)	Margin (dB)	Remark
1	8144.000	38.13	8.25	46.38	74.00	-27.62	peak
2	9024.000	36.73	9.99	46.72	74.00	-27.28	peak
3	11829.000	36.13	17.30	53.43	74.00	-20.57	peak
4	12632.000	35.46	16.70	52.16	74.00	-21.84	peak
5	13908.000	32.61	18.66	51.27	74.00	-22.73	peak
6	17989.000	27.81	23.34	51.15	74.00	-22.85	peak

Note: 1. Measurement = Reading Level + Correct Factor.
 2. If Peak Result complies with AV limit, AV Result is deemed to comply with AV limit.
 3. Peak: Peak detector.
 4. Filter losses were only considered in the spurious frequency bands and the authorized band was not corrected for High Pass Filter losses.
 5. Proper operation of the transmitter prior to adding the filter to the measurement chain.
 6. Since non-restricted band peak emissions are less than the average limit, they also comply with the -27dBm/MHz (68.2dBuV/m) limit.

HARMONICS AND SPURIOUS EMISSIONS (VERTICAL)

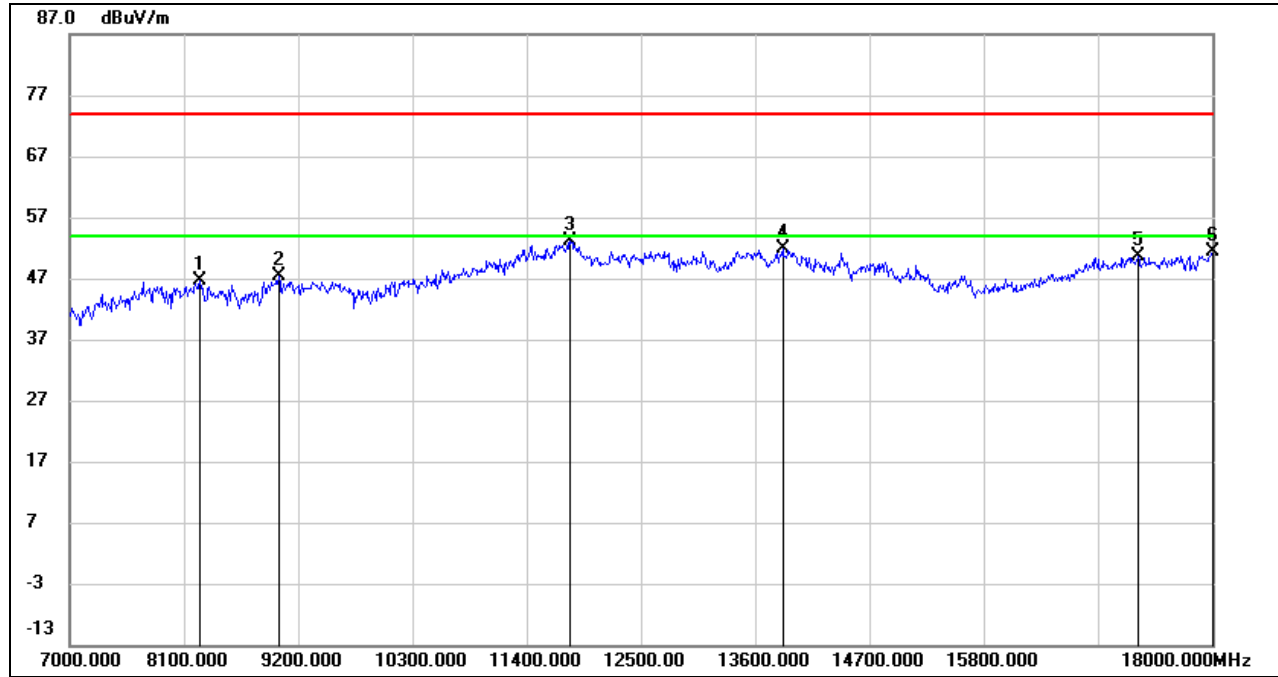

No.	Frequency (MHz)	Reading (dBuV)	Correct (dB/m)	Result (dBuV/m)	Limit (dBuV/m)	Margin (dB)	Remark
1	8254.000	38.25	8.50	46.75	74.00	-27.25	peak
2	9013.000	37.21	10.05	47.26	74.00	-26.74	peak
3	11818.000	35.84	17.31	53.15	74.00	-20.85	peak
4	13864.000	33.11	18.70	51.81	74.00	-22.19	peak
5	17285.000	30.92	19.79	50.71	74.00	-23.29	peak
6	18000.000	28.12	23.37	51.49	74.00	-22.51	peak

Note: 1. Measurement = Reading Level + Correct Factor.
 2. If Peak Result complies with AV limit, AV Result is deemed to comply with AV limit.
 3. Peak: Peak detector.
 4. Filter losses were only considered in the spurious frequency bands and the authorized band was not corrected for High Pass Filter losses.
 5. Proper operation of the transmitter prior to adding the filter to the measurement chain.
 6. Since non-restricted band peak emissions are less than the average limit, they also comply with the -27dBm/MHz (68.2dBuV/m) limit.



UNII-3 BAND

HARMONICS AND SPURIOUS EMISSIONS (LOW CHANNEL, HORIZONTAL)

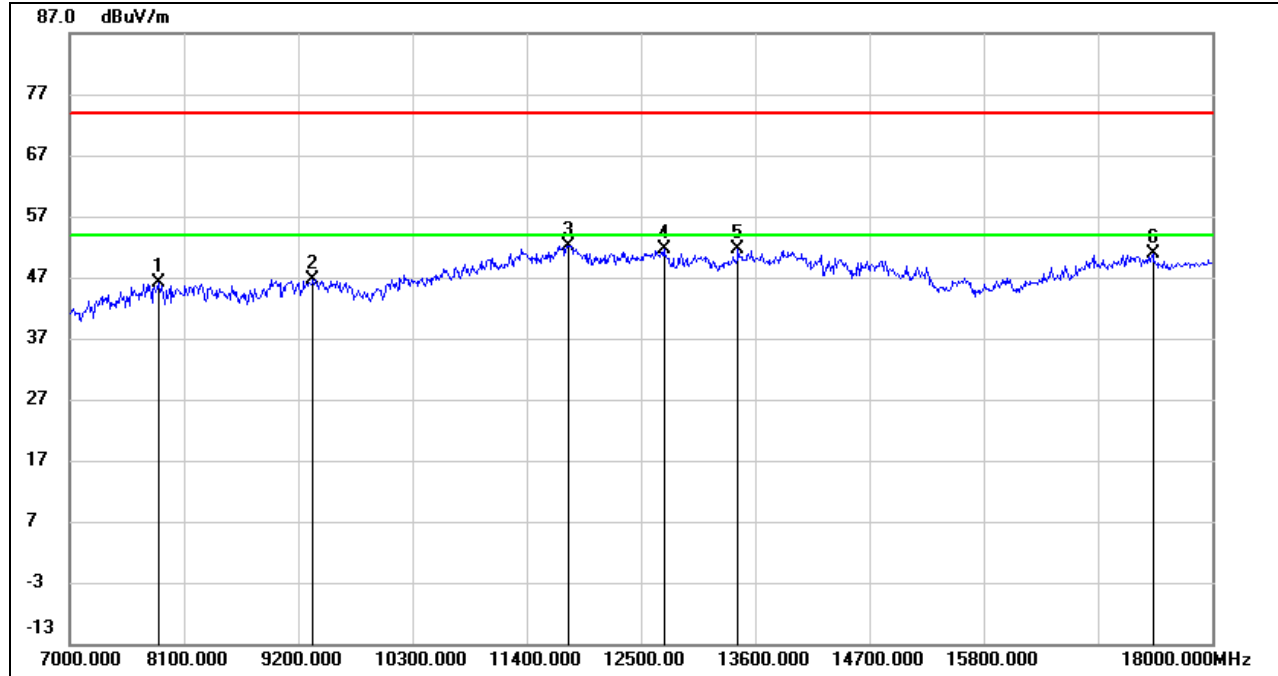

No.	Frequency (MHz)	Reading (dBuV)	Correct (dB/m)	Result (dBuV/m)	Limit (dBuV/m)	Margin (dB)	Remark
1	7858.000	38.59	7.45	46.04	74.00	-27.96	peak
2	9343.000	36.81	9.80	46.61	74.00	-27.39	peak
3	11796.000	34.90	17.33	52.23	74.00	-21.77	peak
4	12720.000	34.72	16.89	51.61	74.00	-22.39	peak
5	13435.000	33.31	18.28	51.59	74.00	-22.41	peak
6	17428.000	31.00	19.92	50.92	74.00	-23.08	peak

- Note: 1. Measurement = Reading Level + Correct Factor.
 2. If Peak Result complies with AV limit, AV Result is deemed to comply with AV limit.
 3. Peak: Peak detector.
 4. Filter losses were only considered in the spurious frequency bands and the authorized band was not corrected for High Pass Filter losses.
 5. Proper operation of the transmitter prior to adding the filter to the measurement chain.
 6. Since non-restricted band peak emissions are less than the average limit, they also comply with the -27dBm/MHz (68.2dBuV/m) limit.

HARMONICS AND SPURIOUS EMISSIONS (LOW CHANNEL, VERTICAL)

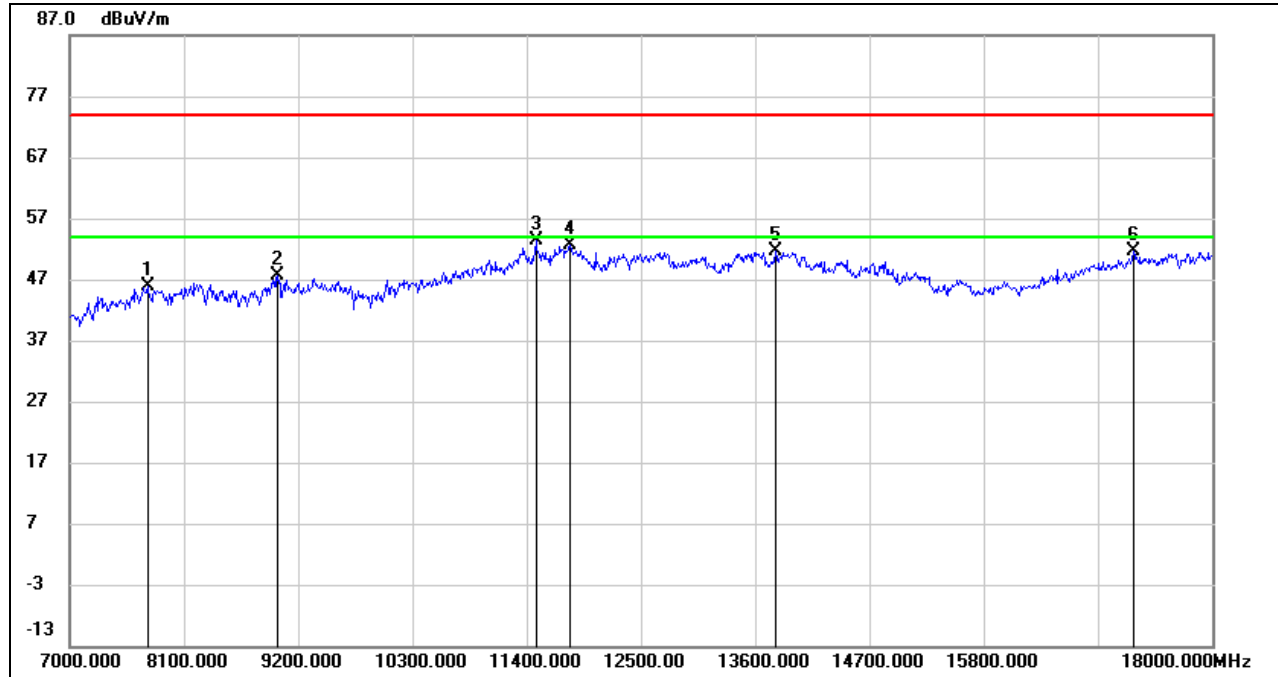

No.	Frequency (MHz)	Reading (dBuV)	Correct (dB/m)	Result (dBuV/m)	Limit (dBuV/m)	Margin (dB)	Remark
1	7748.000	38.40	7.40	45.80	74.00	-28.20	peak
2	9002.000	37.40	10.11	47.51	74.00	-26.49	peak
3	11488.000	37.36	16.12	53.48	74.00	-20.52	peak
4	11818.000	35.20	17.31	52.51	74.00	-21.49	peak
5	13798.000	32.75	18.78	51.53	74.00	-22.47	peak
6	17241.000	31.88	19.75	51.63	74.00	-22.37	peak

Note: 1. Measurement = Reading Level + Correct Factor.
 2. If Peak Result complies with AV limit, AV Result is deemed to comply with AV limit.
 3. Peak: Peak detector.
 4. Filter losses were only considered in the spurious frequency bands and the authorized band was not corrected for High Pass Filter losses.
 5. Proper operation of the transmitter prior to adding the filter to the measurement chain.
 6. Since non-restricted band peak emissions are less than the average limit, they also comply with the -27dBm/MHz (68.2dBuV/m) limit.

HARMONICS AND SPURIOUS EMISSIONS (MID CHANNEL, HORIZONTAL)

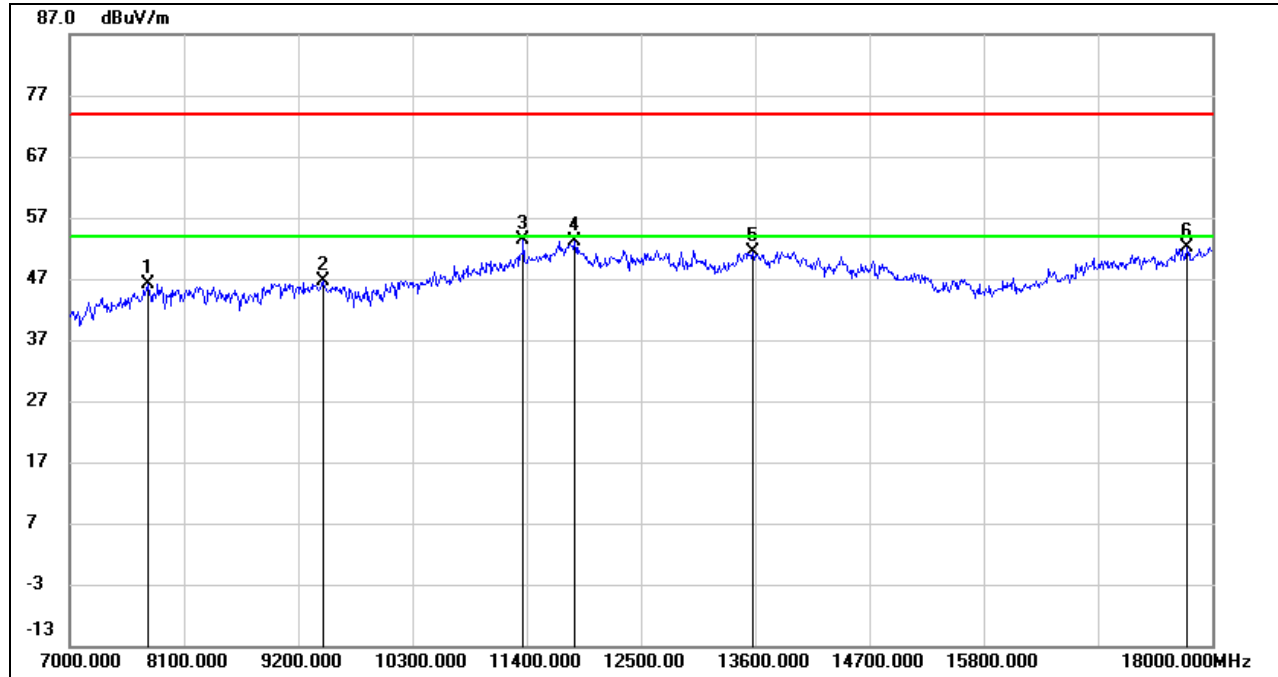

No.	Frequency (MHz)	Reading (dBuV)	Correct (dB/m)	Result (dBuV/m)	Limit (dBuV/m)	Margin (dB)	Remark
1	7748.000	38.66	7.40	46.06	74.00	-27.94	peak
2	9442.000	36.39	10.23	46.62	74.00	-27.38	peak
3	11367.000	37.64	15.67	53.31	74.00	-20.69	peak
4	11862.000	35.95	17.25	53.20	74.00	-20.80	peak
5	13578.000	32.92	18.38	51.30	74.00	-22.70	peak
6	17758.000	29.73	22.42	52.15	74.00	-21.85	peak

Note: 1. Measurement = Reading Level + Correct Factor.
 2. If Peak Result complies with AV limit, AV Result is deemed to comply with AV limit.
 3. Peak: Peak detector.
 4. Filter losses were only considered in the spurious frequency bands and the authorized band was not corrected for High Pass Filter losses.
 5. Proper operation of the transmitter prior to adding the filter to the measurement chain.
 6. Since non-restricted band peak emissions are less than the average limit, they also comply with the -27dBm/MHz (68.2dBuV/m) limit.

HARMONICS AND SPURIOUS EMISSIONS (MID CHANNEL, VERTICAL)

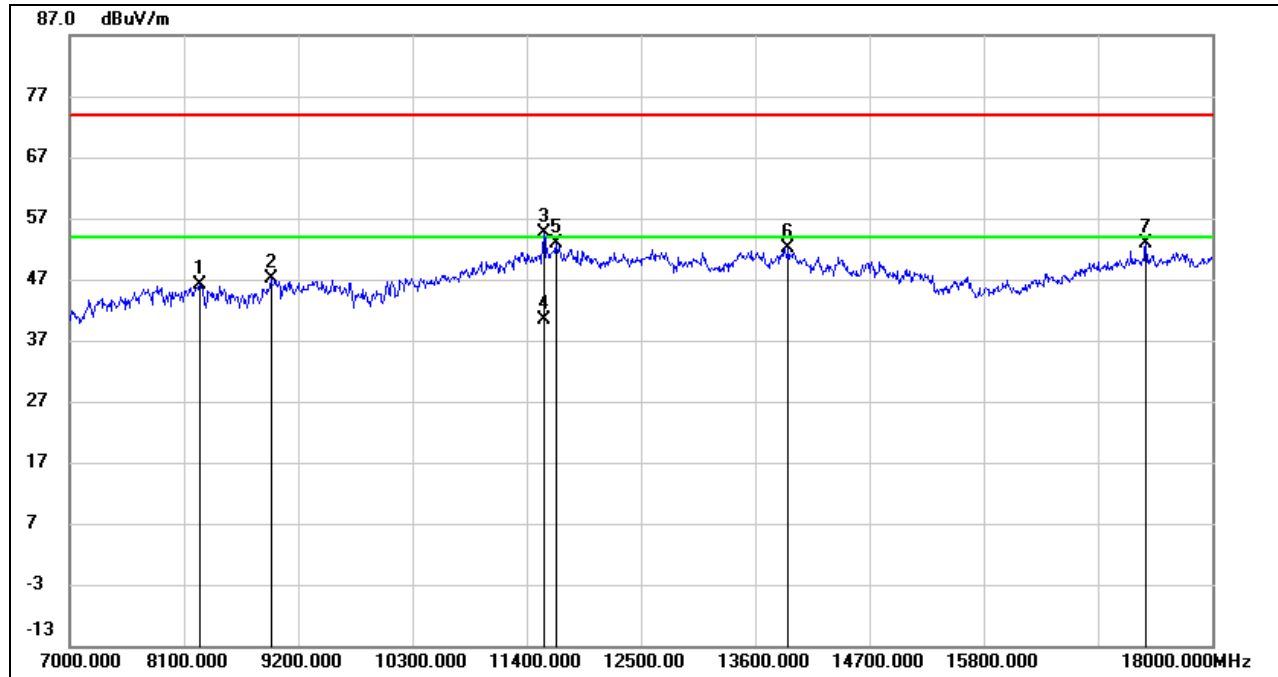

No.	Frequency (MHz)	Reading (dBuV)	Correct (dB/m)	Result (dBuV/m)	Limit (dBuV/m)	Margin (dB)	Remark
1	8254.000	37.58	8.50	46.08	74.00	-27.92	peak
2	8936.000	37.73	9.43	47.16	74.00	-26.84	peak
3	11565.000	38.47	16.24	54.71	74.00	-19.29	peak
4	11565.000	24.03	16.24	40.27	54.00	-13.73	AVG
5	11686.000	36.07	16.75	52.82	74.00	-21.18	peak
6	13919.000	33.39	18.64	52.03	74.00	-21.97	peak
7	17362.000	33.15	19.81	52.96	74.00	-21.04	peak

Note: 1. Measurement = Reading Level + Correct Factor.
 2. If Peak Result complies with AV limit, AV Result is deemed to comply with AV limit.
 3. Peak: Peak detector.
 4. Filter losses were only considered in the spurious frequency bands and the authorized band was not corrected for High Pass Filter losses.
 5. Proper operation of the transmitter prior to adding the filter to the measurement chain.
 6. Since non-restricted band peak emissions are less than the average limit, they also comply with the -27dBm/MHz (68.2dBuV/m) limit.

HARMONICS AND SPURIOUS EMISSIONS (HIGH CHANNEL, HORIZONTAL)

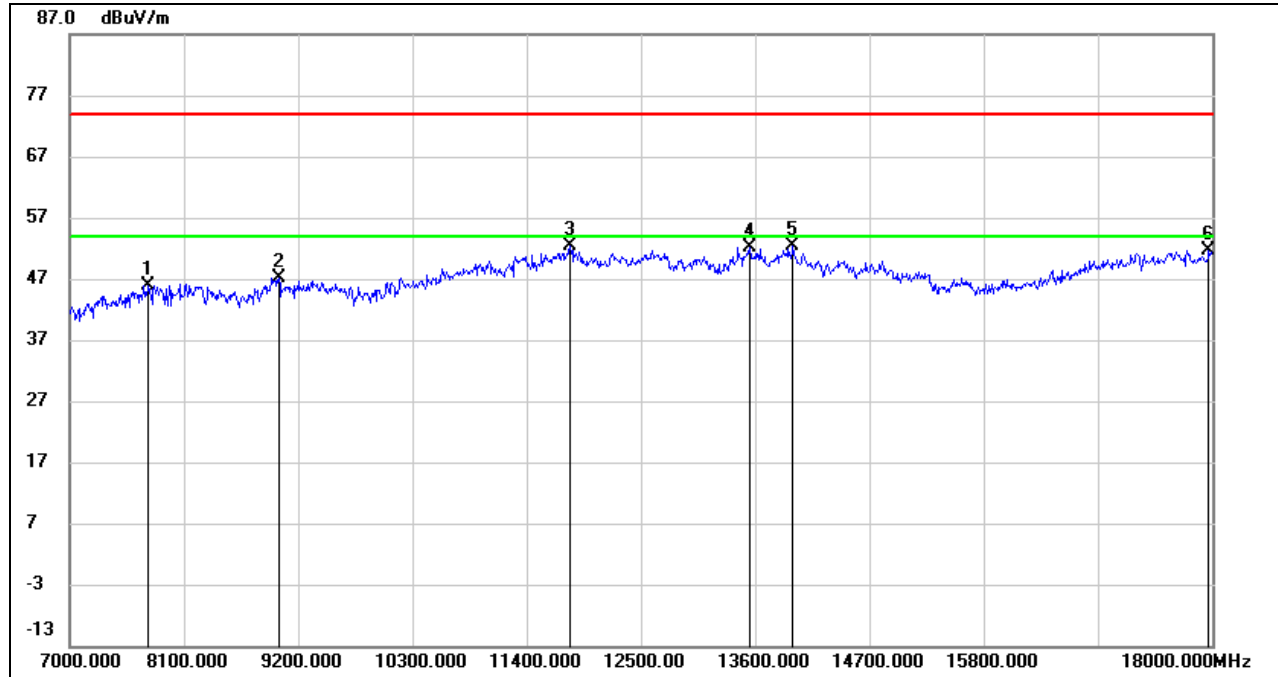

No.	Frequency (MHz)	Reading (dBuV)	Correct (dB/m)	Result (dBuV/m)	Limit (dBuV/m)	Margin (dB)	Remark
1	7759.000	38.53	7.45	45.98	74.00	-28.02	peak
2	9013.000	37.06	10.05	47.11	74.00	-26.89	peak
3	11818.000	35.05	17.31	52.36	74.00	-21.64	peak
4	13545.000	33.69	18.39	52.08	74.00	-21.92	peak
5	13963.000	33.74	18.59	52.33	74.00	-21.67	peak
6	17967.000	28.25	23.28	51.53	74.00	-22.47	peak

- Note: 1. Measurement = Reading Level + Correct Factor.
 2. If Peak Result complies with AV limit, AV Result is deemed to comply with AV limit.
 3. Peak: Peak detector.
 4. Filter losses were only considered in the spurious frequency bands and the authorized band was not corrected for High Pass Filter losses.
 5. Proper operation of the transmitter prior to adding the filter to the measurement chain.
 6. Since non-restricted band peak emissions are less than the average limit, they also comply with the -27dBm/MHz (68.2dBuV/m) limit.

HARMONICS AND SPURIOUS EMISSIONS (HIGH CHANNEL, VERTICAL)

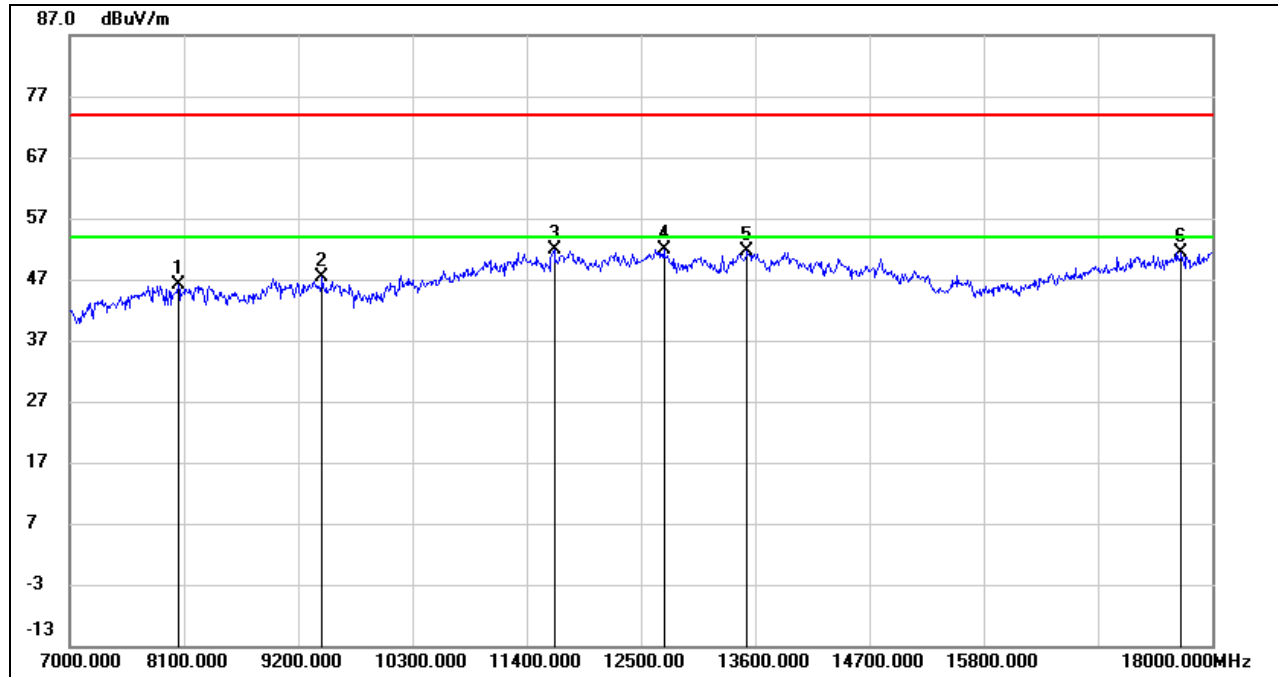

No.	Frequency (MHz)	Reading (dBuV)	Correct (dB/m)	Result (dBuV/m)	Limit (dBuV/m)	Margin (dB)	Remark
1	8045.000	38.66	7.43	46.09	74.00	-27.91	peak
2	9431.000	37.29	10.20	47.49	74.00	-26.51	peak
3	11664.000	35.33	16.64	51.97	74.00	-22.03	peak
4	12720.000	34.97	16.89	51.86	74.00	-22.14	peak
5	13523.000	33.10	18.41	51.51	74.00	-22.49	peak
6	17703.000	29.51	21.83	51.34	74.00	-22.66	peak

Note: 1. Measurement = Reading Level + Correct Factor.
 2. If Peak Result complies with AV limit, AV Result is deemed to comply with AV limit.
 3. Peak: Peak detector.
 4. Filter losses were only considered in the spurious frequency bands and the authorized band was not corrected for High Pass Filter losses.
 5. Proper operation of the transmitter prior to adding the filter to the measurement chain.
 6. Since non-restricted band peak emissions are less than the average limit, they also comply with the -27dBm/MHz (68.2dBuV/m) limit.

8.3.3. 802.11ac VHT40 MIMO MODE

UNII-1 BAND

HARMONICS AND SPURIOUS EMISSIONS (LOW CHANNEL, HORIZONTAL)

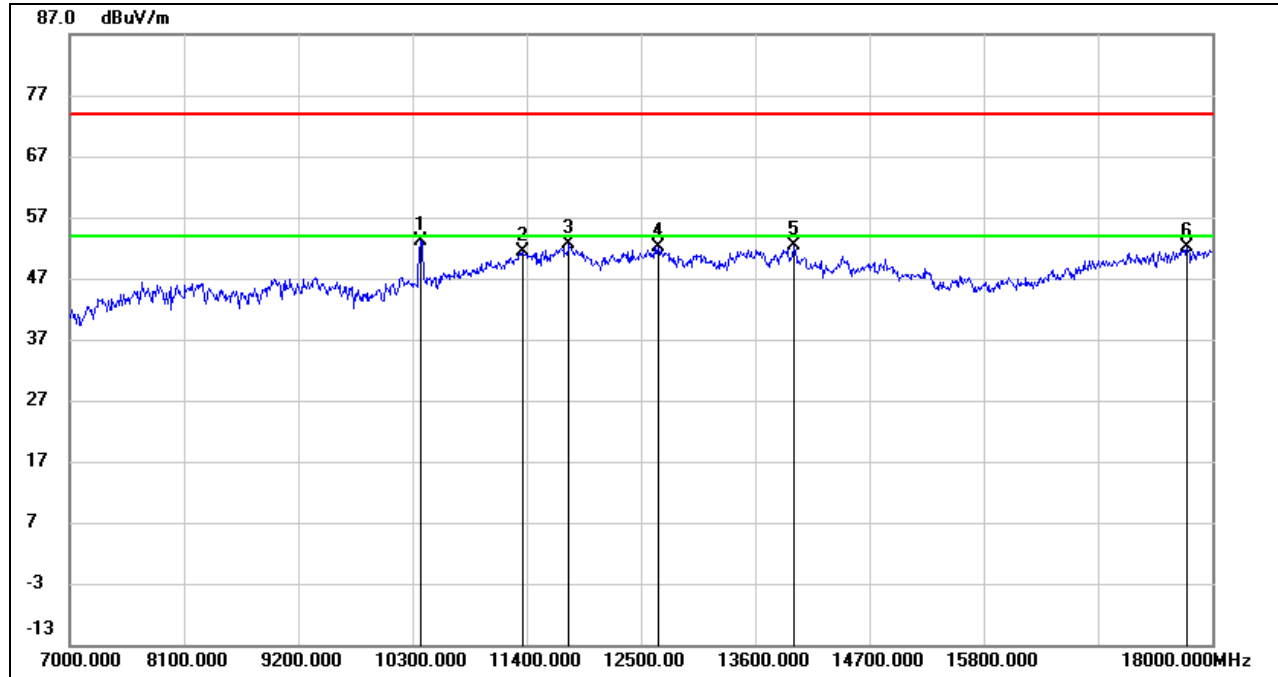

No.	Frequency (MHz)	Reading (dBuV)	Correct (dB/m)	Result (dBuV/m)	Limit (dBuV/m)	Margin (dB)	Remark
1	10377.000	41.29	11.90	53.19	74.00	-20.81	peak
2	11356.000	35.71	15.64	51.35	74.00	-22.65	peak
3	11807.000	35.32	17.35	52.67	74.00	-21.33	peak
4	12665.000	35.34	16.78	52.12	74.00	-21.88	peak
5	13974.000	33.83	18.58	52.41	74.00	-21.59	peak
6	17758.000	29.68	22.42	52.10	74.00	-21.90	peak

- Note: 1. Measurement = Reading Level + Correct Factor.
 2. If Peak Result complies with AV limit, AV Result is deemed to comply with AV limit.
 3. Peak: Peak detector.
 4. Filter losses were only considered in the spurious frequency bands and the authorized band was not corrected for High Pass Filter losses.
 5. Proper operation of the transmitter prior to adding the filter to the measurement chain.
 6. Since non-restricted band peak emissions are less than the average limit, they also comply with the -27dBm/MHz (68.2dBuV/m) limit.

HARMONICS AND SPURIOUS EMISSIONS (LOW CHANNEL, VERTICAL)

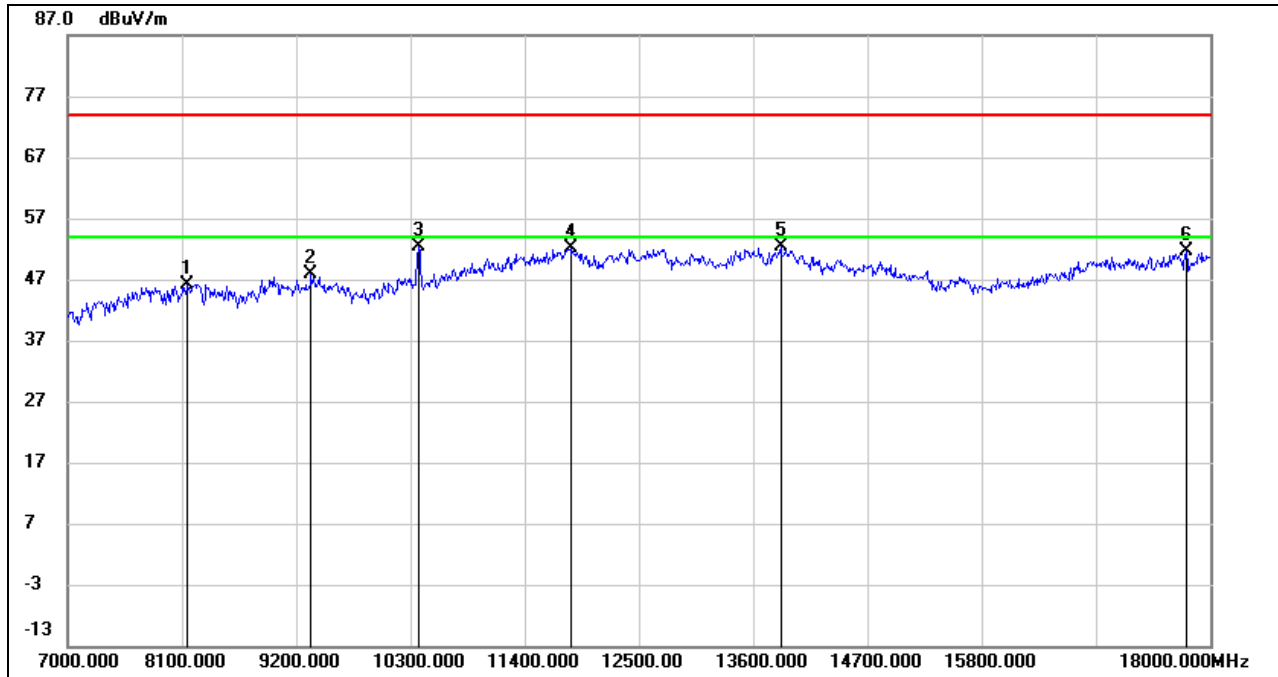

No.	Frequency (MHz)	Reading (dBuV)	Correct (dB/m)	Result (dBuV/m)	Limit (dBuV/m)	Margin (dB)	Remark
1	8155.000	37.86	8.35	46.21	74.00	-27.79	peak
2	9343.000	38.07	9.80	47.87	74.00	-26.13	peak
3	10377.000	40.52	11.90	52.42	74.00	-21.58	peak
4	11840.000	34.76	17.29	52.05	74.00	-21.95	peak
5	13864.000	33.57	18.70	52.27	74.00	-21.73	peak
6	17769.000	29.03	22.53	51.56	74.00	-22.44	peak

Note: 1. Measurement = Reading Level + Correct Factor.
 2. If Peak Result complies with AV limit, AV Result is deemed to comply with AV limit.
 3. Peak: Peak detector.
 4. Filter losses were only considered in the spurious frequency bands and the authorized band was not corrected for High Pass Filter losses.
 5. Proper operation of the transmitter prior to adding the filter to the measurement chain.
 6. Since non-restricted band peak emissions are less than the average limit, they also comply with the -27dBm/MHz (68.2dBuV/m) limit.

HARMONICS AND SPURIOUS EMISSIONS (HIGH CHANNEL, HORIZONTAL)

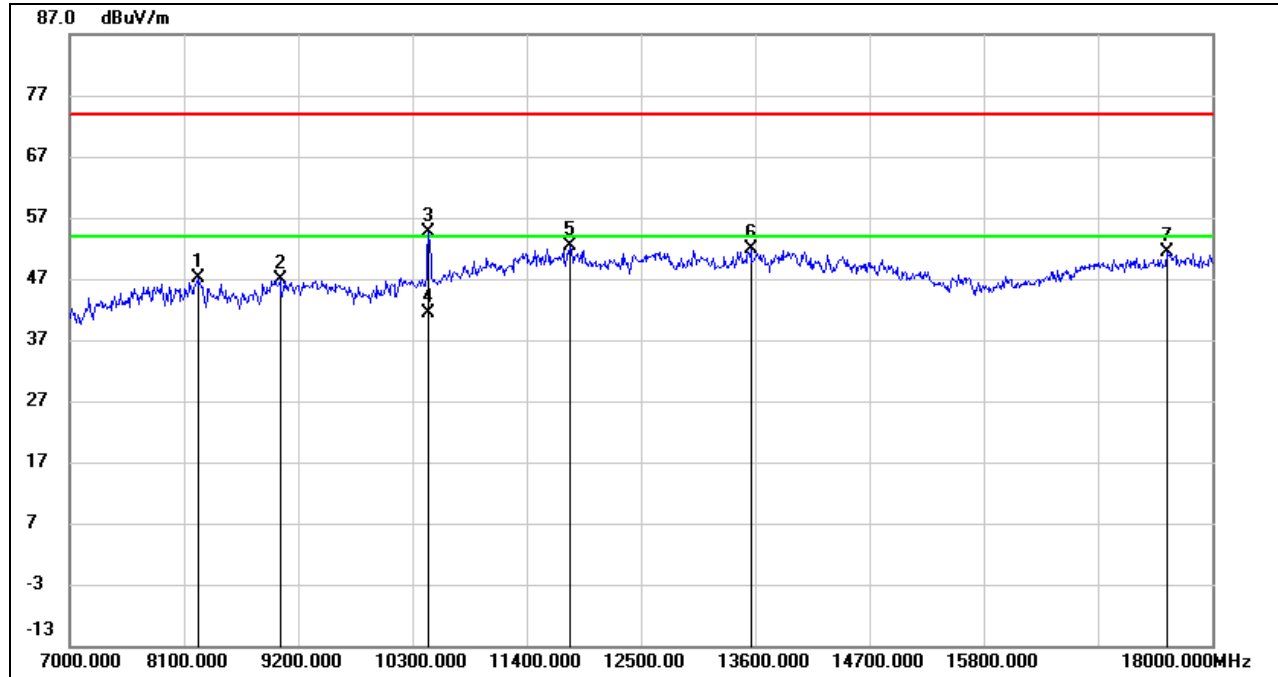

No.	Frequency (MHz)	Reading (dBuV)	Correct (dB/m)	Result (dBuV/m)	Limit (dBuV/m)	Margin (dB)	Remark
1	8232.000	38.44	8.59	47.03	74.00	-26.97	peak
2	9024.000	36.94	9.99	46.93	74.00	-27.07	peak
3	10454.000	42.36	12.24	54.60	74.00	-19.40	peak
4	10454.000	29.21	12.24	41.45	54.00	-12.55	AVG
5	11818.000	35.13	17.31	52.44	74.00	-21.56	peak
6	13556.000	33.56	18.39	51.95	74.00	-22.05	peak
7	17560.000	30.76	20.50	51.26	74.00	-22.74	peak

Note: 1. Measurement = Reading Level + Correct Factor.
 2. If Peak Result complies with AV limit, AV Result is deemed to comply with AV limit.
 3. Peak: Peak detector.
 4. Filter losses were only considered in the spurious frequency bands and the authorized band was not corrected for High Pass Filter losses.
 5. Proper operation of the transmitter prior to adding the filter to the measurement chain.
 6. Since non-restricted band peak emissions are less than the average limit, they also comply with the -27dBm/MHz (68.2dBuV/m) limit.

HARMONICS AND SPURIOUS EMISSIONS (HIGH CHANNEL, VERTICAL)

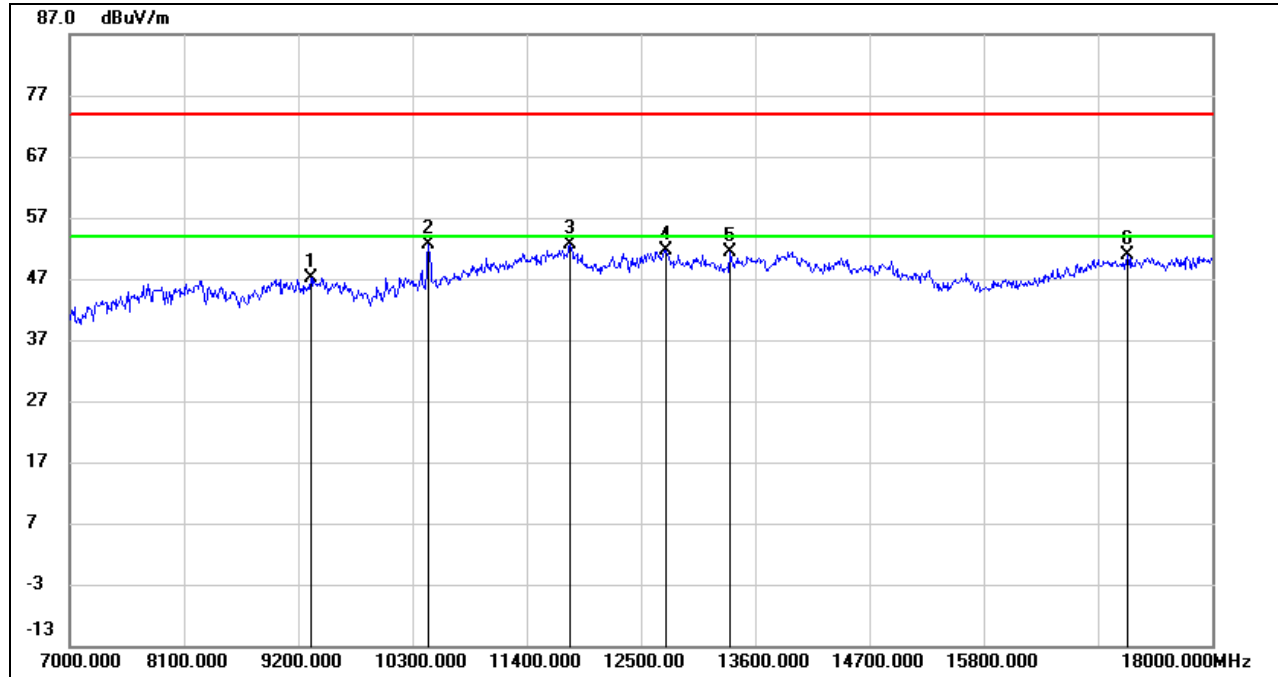

No.	Frequency (MHz)	Reading (dBuV)	Correct (dB/m)	Result (dBuV/m)	Limit (dBuV/m)	Margin (dB)	Remark
1	9321.000	37.46	9.66	47.12	74.00	-26.88	peak
2	10454.000	40.46	12.24	52.70	74.00	-21.30	peak
3	11818.000	35.31	17.31	52.62	74.00	-21.38	peak
4	12742.000	34.69	16.94	51.63	74.00	-22.37	peak
5	13358.000	33.26	18.03	51.29	74.00	-22.71	peak
6	17186.000	31.12	19.65	50.77	74.00	-23.23	peak

- Note: 1. Measurement = Reading Level + Correct Factor.
 2. If Peak Result complies with AV limit, AV Result is deemed to comply with AV limit.
 3. Peak: Peak detector.
 4. Filter losses were only considered in the spurious frequency bands and the authorized band was not corrected for High Pass Filter losses.
 5. Proper operation of the transmitter prior to adding the filter to the measurement chain.
 6. Since non-restricted band peak emissions are less than the average limit, they also comply with the -27dBm/MHz (68.2dBuV/m) limit.

UNII-2A BAND

HARMONICS AND SPURIOUS EMISSIONS (LOW CHANNEL, HORIZONTAL)

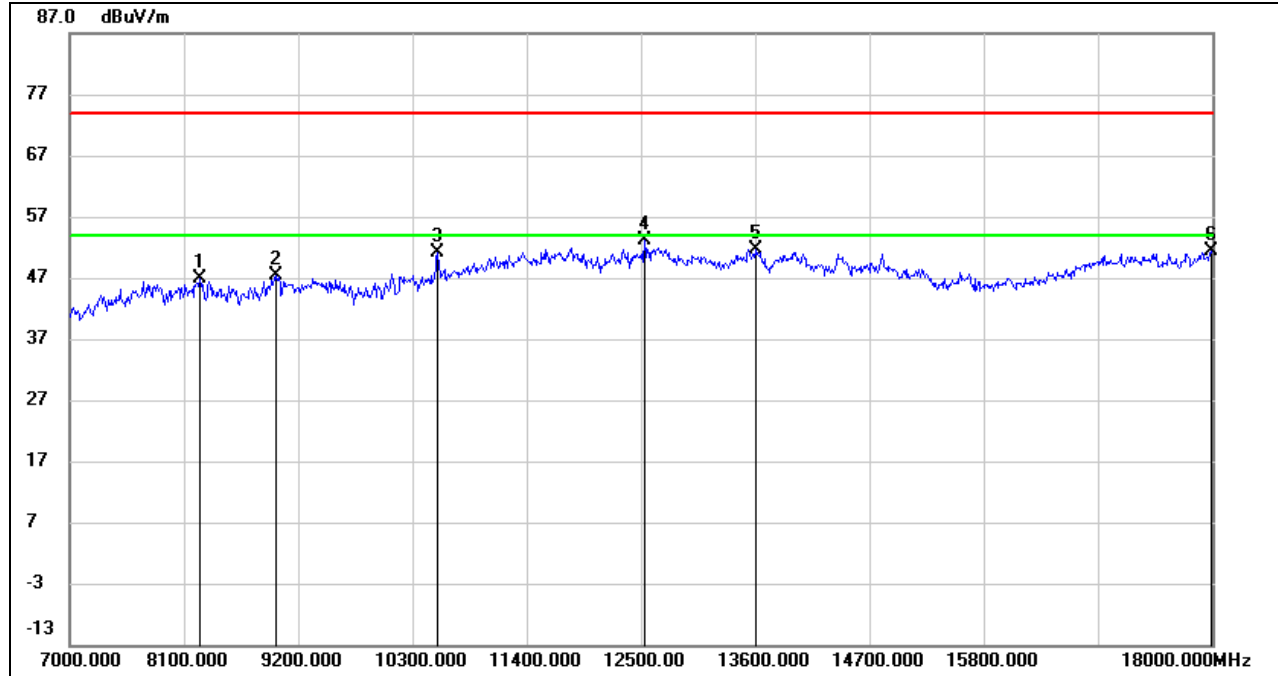

No.	Frequency (MHz)	Reading (dBuV)	Correct (dB/m)	Result (dBuV/m)	Limit (dBuV/m)	Margin (dB)	Remark
1	8254.000	38.32	8.50	46.82	74.00	-27.18	peak
2	8980.000	37.57	9.91	47.48	74.00	-26.52	peak
3	10542.000	38.42	12.66	51.08	74.00	-22.92	peak
4	12533.000	36.50	16.66	53.16	74.00	-20.84	peak
5	13600.000	33.27	18.37	51.64	74.00	-22.36	peak
6	17989.000	28.01	23.34	51.35	74.00	-22.65	peak

Note: 1. Measurement = Reading Level + Correct Factor.
 2. If Peak Result complies with AV limit, AV Result is deemed to comply with AV limit.
 3. Peak: Peak detector.
 4. Filter losses were only considered in the spurious frequency bands and the authorized band was not corrected for High Pass Filter losses.
 5. Proper operation of the transmitter prior to adding the filter to the measurement chain.
 6. Since non-restricted band peak emissions are less than the average limit, they also comply with the -27dBm/MHz (68.2dBuV/m) limit.

HARMONICS AND SPURIOUS EMISSIONS (LOW CHANNEL, VERTICAL)

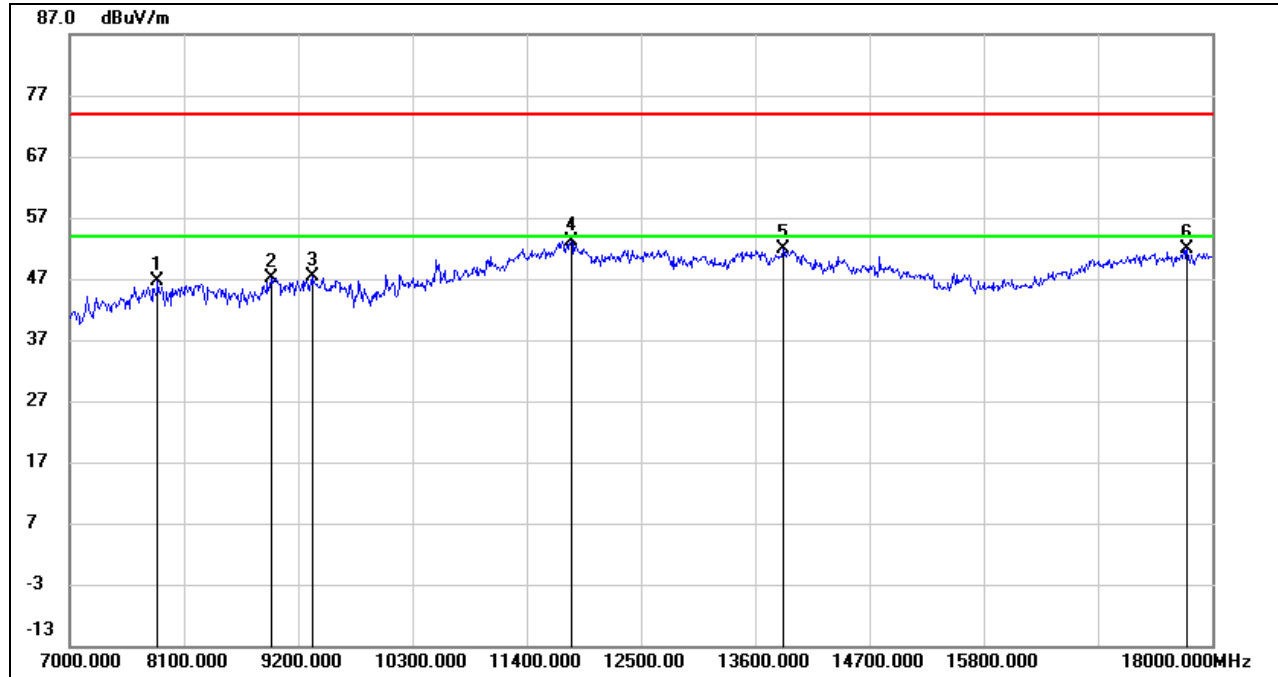

No.	Frequency (MHz)	Reading (dBuV)	Correct (dB/m)	Result (dBuV/m)	Limit (dBuV/m)	Margin (dB)	Remark
1	7847.000	39.09	7.48	46.57	74.00	-27.43	peak
2	8936.000	37.79	9.43	47.22	74.00	-26.78	peak
3	9343.000	37.61	9.80	47.41	74.00	-26.59	peak
4	11829.000	35.81	17.30	53.11	74.00	-20.89	peak
5	13875.000	33.30	18.69	51.99	74.00	-22.01	peak
6	17758.000	29.36	22.42	51.78	74.00	-22.22	peak

Note: 1. Measurement = Reading Level + Correct Factor.
 2. If Peak Result complies with AV limit, AV Result is deemed to comply with AV limit.
 3. Peak: Peak detector.
 4. Filter losses were only considered in the spurious frequency bands and the authorized band was not corrected for High Pass Filter losses.
 5. Proper operation of the transmitter prior to adding the filter to the measurement chain.
 6. Since non-restricted band peak emissions are less than the average limit, they also comply with the -27dBm/MHz (68.2dBuV/m) limit.

HARMONICS AND SPURIOUS EMISSIONS (HIGH CHANNEL, HORIZONTAL)

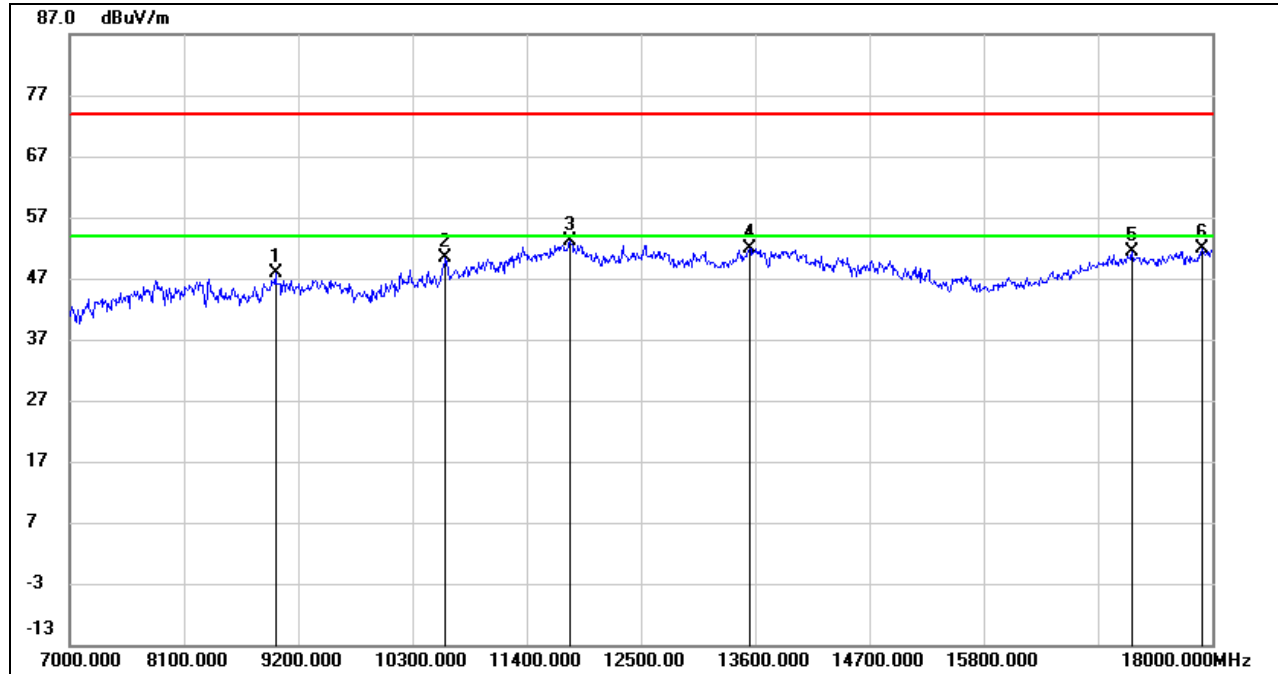

No.	Frequency (MHz)	Reading (dBuV)	Correct (dB/m)	Result (dBuV/m)	Limit (dBuV/m)	Margin (dB)	Remark
1	8980.000	37.86	9.91	47.77	74.00	-26.23	peak
2	10619.000	37.48	12.99	50.47	74.00	-23.53	peak
3	11818.000	35.93	17.31	53.24	74.00	-20.76	peak
4	13545.000	33.59	18.39	51.98	74.00	-22.02	peak
5	17230.000	31.58	19.75	51.33	74.00	-22.67	peak
6	17901.000	28.86	23.12	51.98	74.00	-22.02	peak

Note: 1. Measurement = Reading Level + Correct Factor.
 2. If Peak Result complies with AV limit, AV Result is deemed to comply with AV limit.
 3. Peak: Peak detector.
 4. Filter losses were only considered in the spurious frequency bands and the authorized band was not corrected for High Pass Filter losses.
 5. Proper operation of the transmitter prior to adding the filter to the measurement chain.
 6. Since non-restricted band peak emissions are less than the average limit, they also comply with the -27dBm/MHz (68.2dBuV/m) limit.

HARMONICS AND SPURIOUS EMISSIONS (HIGH CHANNEL, VERTICAL)

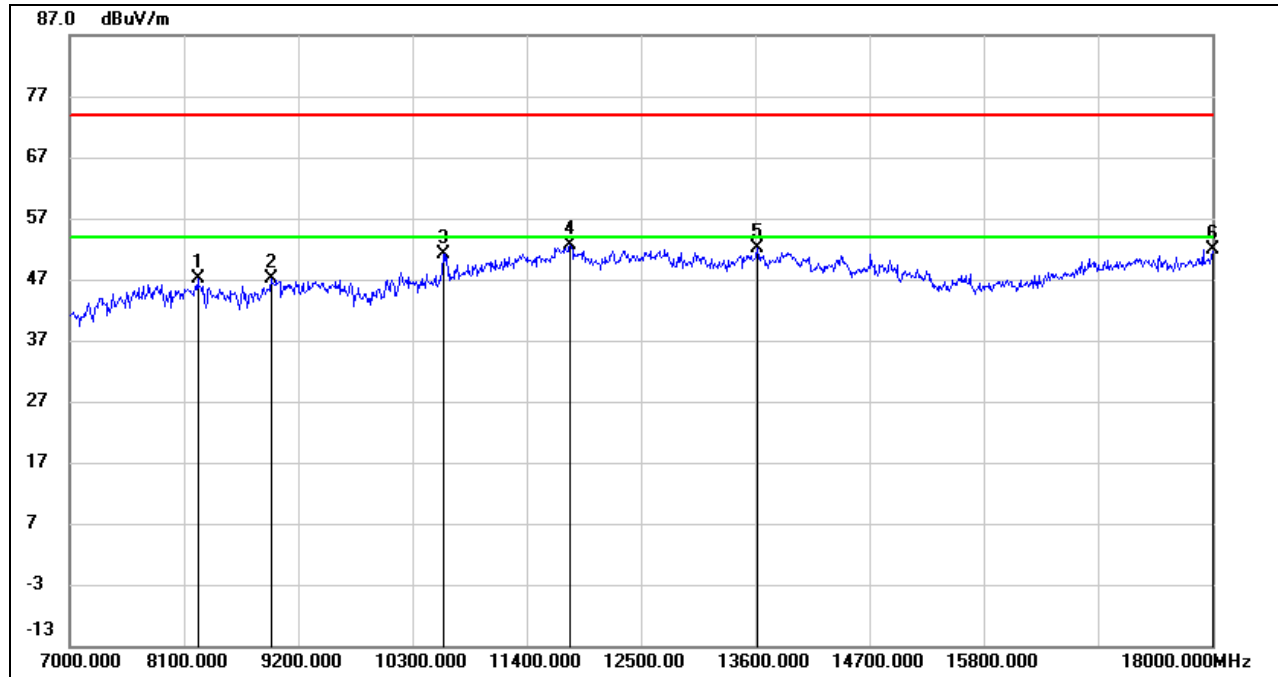

No.	Frequency (MHz)	Reading (dBuV)	Correct (dB/m)	Result (dBuV/m)	Limit (dBuV/m)	Margin (dB)	Remark
1	8232.000	38.48	8.59	47.07	74.00	-26.93	peak
2	8936.000	37.61	9.43	47.04	74.00	-26.96	peak
3	10597.000	38.24	12.93	51.17	74.00	-22.83	peak
4	11818.000	35.27	17.31	52.58	74.00	-21.42	peak
5	13622.000	33.64	18.41	52.05	74.00	-21.95	peak
6	18000.000	28.48	23.37	51.85	74.00	-22.15	peak

Note: 1. Measurement = Reading Level + Correct Factor.
 2. If Peak Result complies with AV limit, AV Result is deemed to comply with AV limit.
 3. Peak: Peak detector.
 4. Filter losses were only considered in the spurious frequency bands and the authorized band was not corrected for High Pass Filter losses.
 5. Proper operation of the transmitter prior to adding the filter to the measurement chain.
 6. Since non-restricted band peak emissions are less than the average limit, they also comply with the -27dBm/MHz (68.2dBuV/m) limit.

UNII-2C BAND

HARMONICS AND SPURIOUS EMISSIONS (LOW CHANNEL, HORIZONTAL)

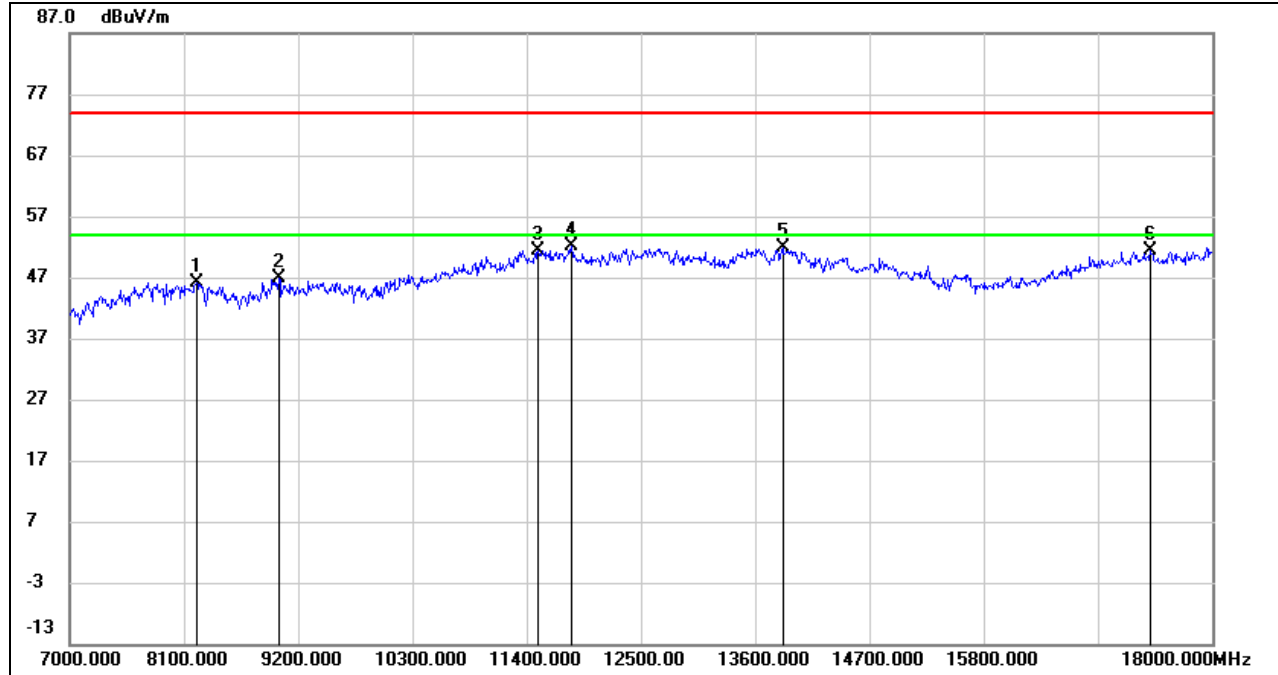

No.	Frequency (MHz)	Reading (dBuV)	Correct (dB/m)	Result (dBuV/m)	Limit (dBuV/m)	Margin (dB)	Remark
1	8221.000	37.61	8.63	46.24	74.00	-27.76	peak
2	9013.000	36.83	10.05	46.88	74.00	-27.12	peak
3	11510.000	35.17	16.17	51.34	74.00	-22.66	peak
4	11829.000	34.76	17.30	52.06	74.00	-21.94	peak
5	13864.000	33.25	18.70	51.95	74.00	-22.05	peak
6	17406.000	31.53	19.85	51.38	74.00	-22.62	peak

Note: 1. Measurement = Reading Level + Correct Factor.
 2. If Peak Result complies with AV limit, AV Result is deemed to comply with AV limit.
 3. Peak: Peak detector.
 4. Filter losses were only considered in the spurious frequency bands and the authorized band was not corrected for High Pass Filter losses.
 5. Proper operation of the transmitter prior to adding the filter to the measurement chain.
 6. Since non-restricted band peak emissions are less than the average limit, they also comply with the -27dBm/MHz (68.2dBuV/m) limit.

HARMONICS AND SPURIOUS EMISSIONS (LOW CHANNEL, VERTICAL)

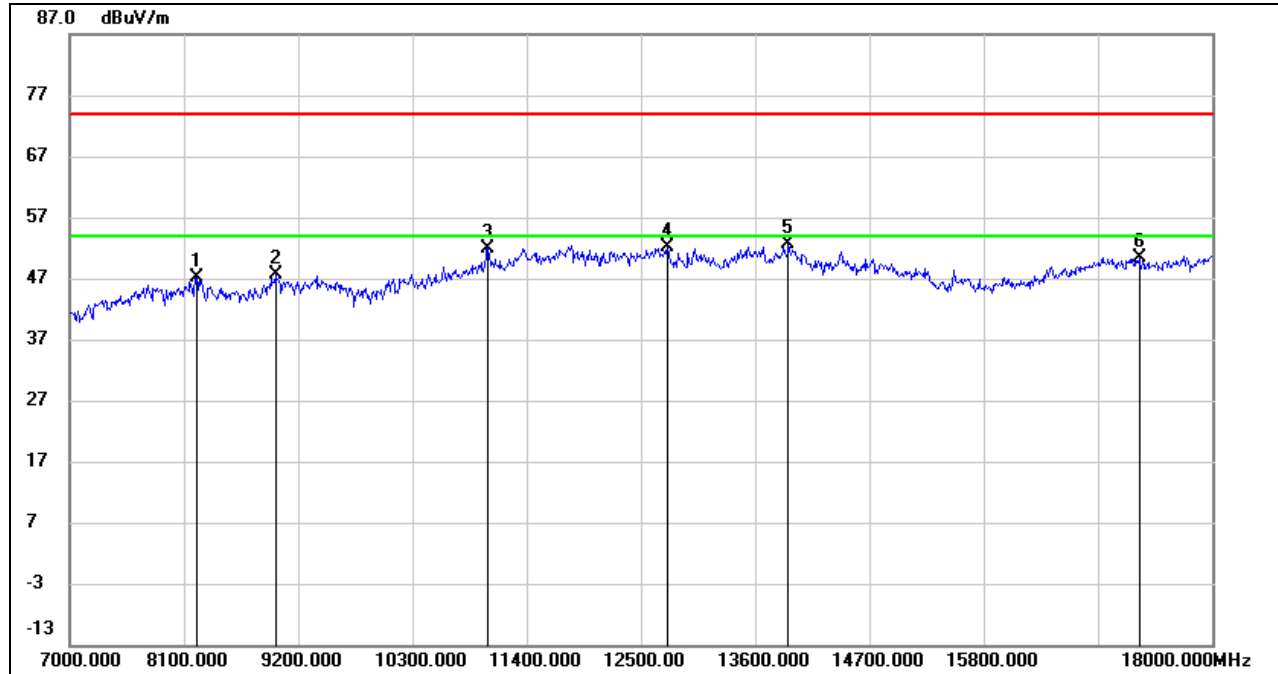

No.	Frequency (MHz)	Reading (dBuV)	Correct (dB/m)	Result (dBuV/m)	Limit (dBuV/m)	Margin (dB)	Remark
1	8221.000	38.57	8.63	47.20	74.00	-26.80	peak
2	8980.000	37.61	9.91	47.52	74.00	-26.48	peak
3	11026.000	37.65	14.26	51.91	74.00	-22.09	peak
4	12753.000	35.10	16.97	52.07	74.00	-21.93	peak
5	13919.000	33.97	18.64	52.61	74.00	-21.39	peak
6	17296.000	30.68	19.79	50.47	74.00	-23.53	peak

- Note: 1. Measurement = Reading Level + Correct Factor.
 2. If Peak Result complies with AV limit, AV Result is deemed to comply with AV limit.
 3. Peak: Peak detector.
 4. Filter losses were only considered in the spurious frequency bands and the authorized band was not corrected for High Pass Filter losses.
 5. Proper operation of the transmitter prior to adding the filter to the measurement chain.
 6. Since non-restricted band peak emissions are less than the average limit, they also comply with the -27dBm/MHz (68.2dBuV/m) limit.

HARMONICS AND SPURIOUS EMISSIONS (MID CHANNEL, HORIZONTAL)

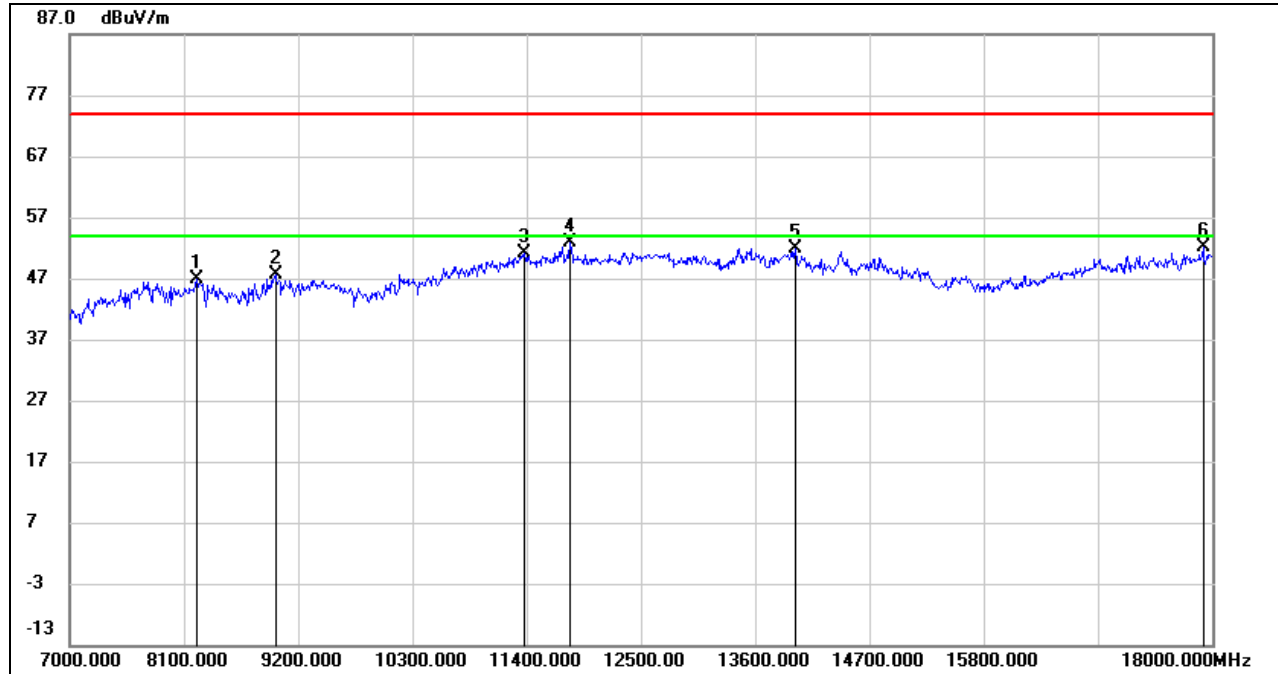

No.	Frequency (MHz)	Reading (dBuV)	Correct (dB/m)	Result (dBuV/m)	Limit (dBuV/m)	Margin (dB)	Remark
1	8221.000	38.21	8.63	46.84	74.00	-27.16	peak
2	8980.000	37.72	9.91	47.63	74.00	-26.37	peak
3	11378.000	35.30	15.73	51.03	74.00	-22.97	peak
4	11818.000	35.68	17.31	52.99	74.00	-21.01	peak
5	13985.000	33.43	18.57	52.00	74.00	-22.00	peak
6	17912.000	28.95	23.14	52.09	74.00	-21.91	peak

- Note: 1. Measurement = Reading Level + Correct Factor.
 2. If Peak Result complies with AV limit, AV Result is deemed to comply with AV limit.
 3. Peak: Peak detector.
 4. Filter losses were only considered in the spurious frequency bands and the authorized band was not corrected for High Pass Filter losses.
 5. Proper operation of the transmitter prior to adding the filter to the measurement chain.
 6. Since non-restricted band peak emissions are less than the average limit, they also comply with the -27dBm/MHz (68.2dBuV/m) limit.

HARMONICS AND SPURIOUS EMISSIONS (MID CHANNEL, VERTICAL)

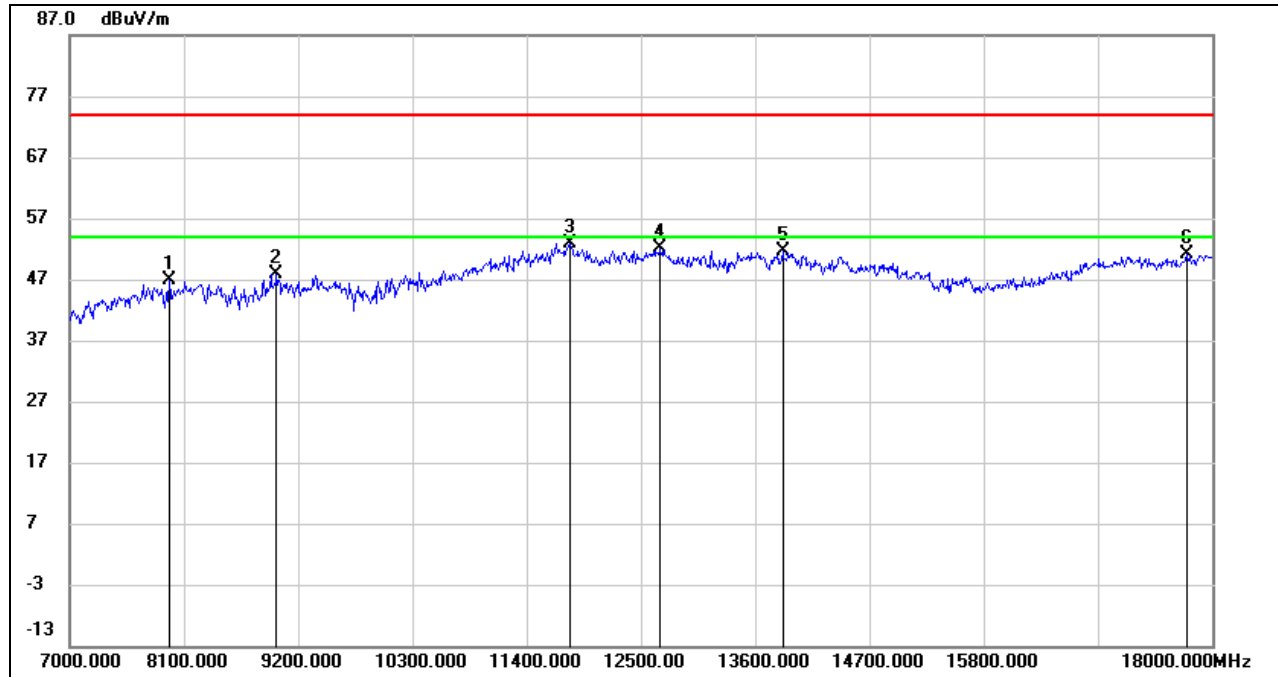

No.	Frequency (MHz)	Reading (dBuV)	Correct (dB/m)	Result (dBuV/m)	Limit (dBuV/m)	Margin (dB)	Remark
1	7957.000	39.70	7.18	46.88	74.00	-27.12	peak
2	8991.000	37.85	10.03	47.88	74.00	-26.12	peak
3	11818.000	35.57	17.31	52.88	74.00	-21.12	peak
4	12687.000	35.20	16.82	52.02	74.00	-21.98	peak
5	13864.000	32.85	18.70	51.55	74.00	-22.45	peak
6	17758.000	28.66	22.42	51.08	74.00	-22.92	peak

Note: 1. Measurement = Reading Level + Correct Factor.
 2. If Peak Result complies with AV limit, AV Result is deemed to comply with AV limit.
 3. Peak: Peak detector.
 4. Filter losses were only considered in the spurious frequency bands and the authorized band was not corrected for High Pass Filter losses.
 5. Proper operation of the transmitter prior to adding the filter to the measurement chain.
 6. Since non-restricted band peak emissions are less than the average limit, they also comply with the -27dBm/MHz (68.2dBuV/m) limit.



HARMONICS AND SPURIOUS EMISSIONS (HIGH CHANNEL, HORIZONTAL)

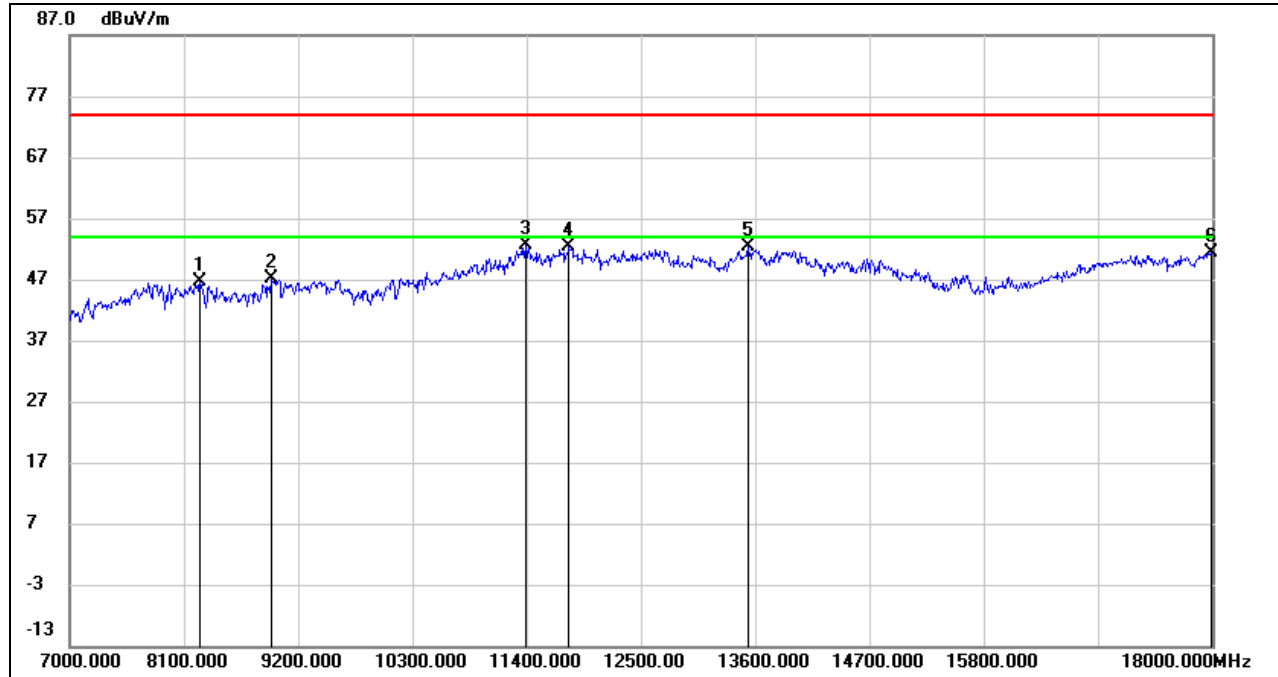

No.	Frequency (MHz)	Reading (dBuV)	Correct (dB/m)	Result (dBuV/m)	Limit (dBuV/m)	Margin (dB)	Remark
1	8254.000	38.24	8.50	46.74	74.00	-27.26	peak
2	8936.000	37.63	9.43	47.06	74.00	-26.94	peak
3	11389.000	36.88	15.78	52.66	74.00	-21.34	peak
4	11807.000	35.05	17.35	52.40	74.00	-21.60	peak
5	13534.000	33.91	18.40	52.31	74.00	-21.69	peak
6	17989.000	28.05	23.34	51.39	74.00	-22.61	peak

- Note: 1. Measurement = Reading Level + Correct Factor.
 2. If Peak Result complies with AV limit, AV Result is deemed to comply with AV limit.
 3. Peak: Peak detector.
 4. Filter losses were only considered in the spurious frequency bands and the authorized band was not corrected for High Pass Filter losses.
 5. Proper operation of the transmitter prior to adding the filter to the measurement chain.
 6. Since non-restricted band peak emissions are less than the average limit, they also comply with the -27dBm/MHz (68.2dBuV/m) limit.

HARMONICS AND SPURIOUS EMISSIONS (HIGH CHANNEL, VERTICAL)

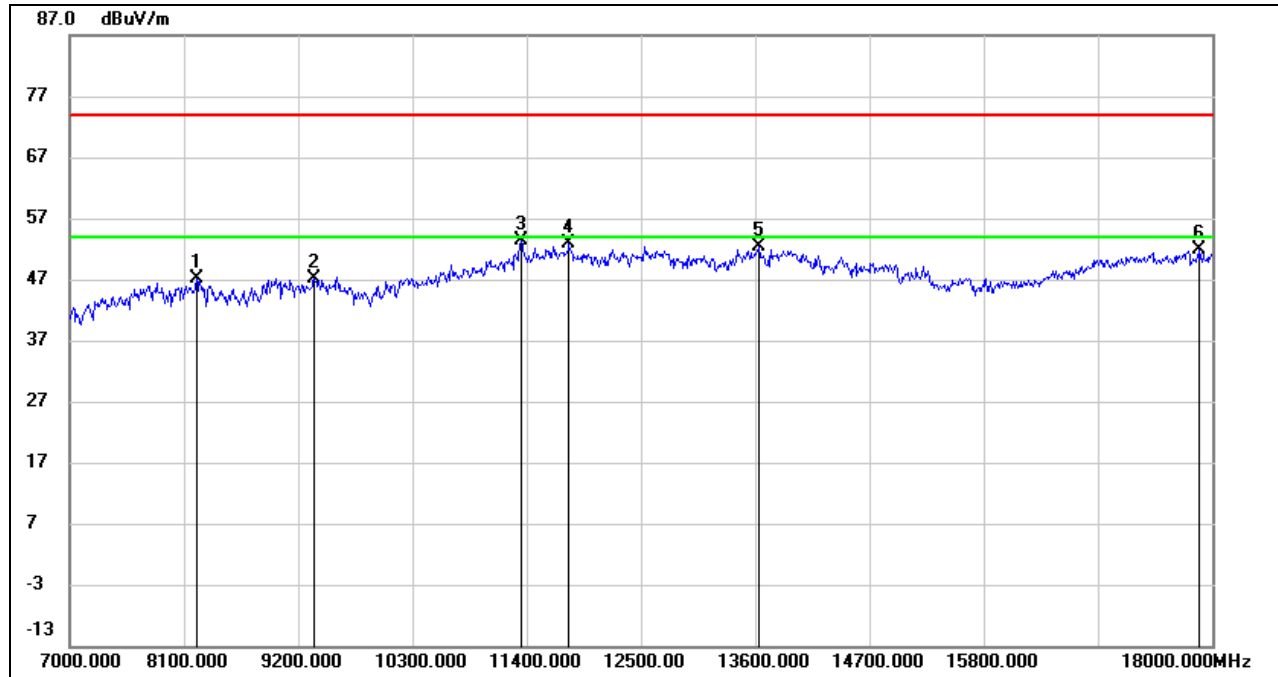

No.	Frequency (MHz)	Reading (dBuV)	Correct (dB/m)	Result (dBuV/m)	Limit (dBuV/m)	Margin (dB)	Remark
1	8221.000	38.42	8.63	47.05	74.00	-26.95	peak
2	9354.000	37.37	9.86	47.23	74.00	-26.77	peak
3	11345.000	37.84	15.58	53.42	74.00	-20.58	peak
4	11807.000	35.47	17.35	52.82	74.00	-21.18	peak
5	13633.000	34.02	18.43	52.45	74.00	-21.55	peak
6	17879.000	28.92	23.06	51.98	74.00	-22.02	peak

Note: 1. Measurement = Reading Level + Correct Factor.
 2. If Peak Result complies with AV limit, AV Result is deemed to comply with AV limit.
 3. Peak: Peak detector.
 4. Filter losses were only considered in the spurious frequency bands and the authorized band was not corrected for High Pass Filter losses.
 5. Proper operation of the transmitter prior to adding the filter to the measurement chain.
 6. Since non-restricted band peak emissions are less than the average limit, they also comply with the -27dBm/MHz (68.2dBuV/m) limit.

STRADDLE CHANNEL 142

HARMONICS AND SPURIOUS EMISSIONS (HORIZONTAL)

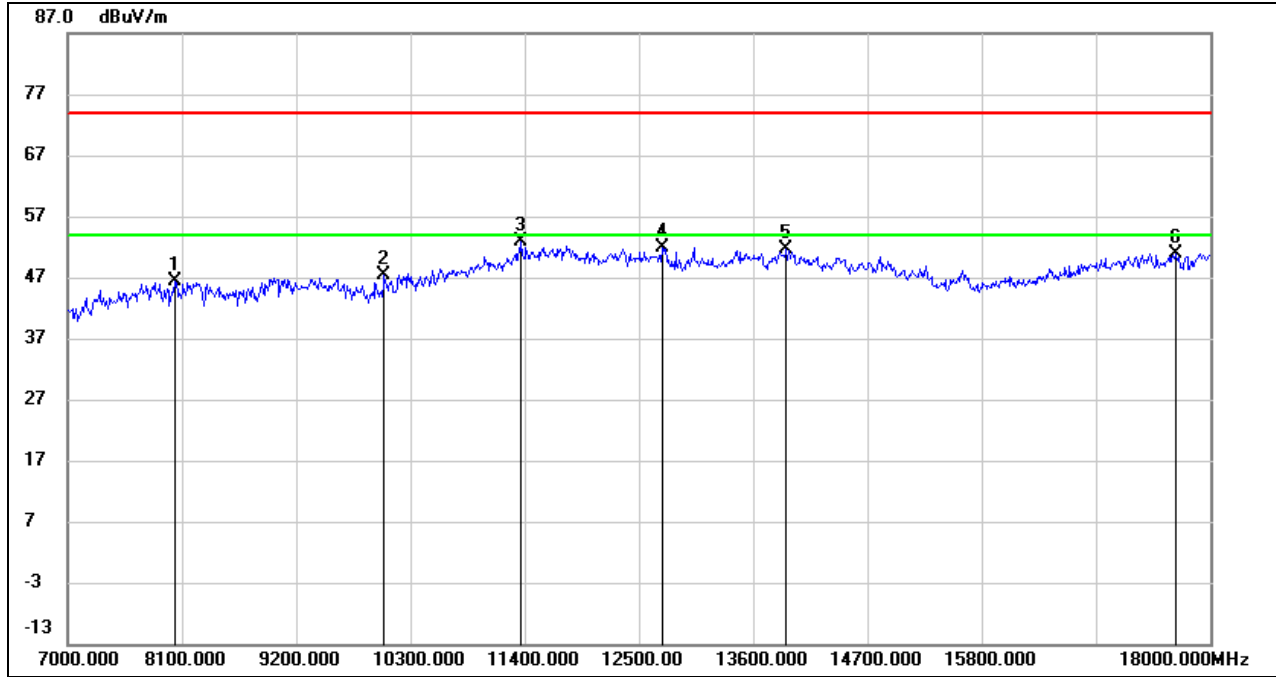

No.	Frequency (MHz)	Reading (dBuV)	Correct (dB/m)	Result (dBuV/m)	Limit (dBuV/m)	Margin (dB)	Remark
1	8034.000	39.08	7.35	46.43	74.00	-27.57	peak
2	10047.000	36.47	10.95	47.42	74.00	-26.58	peak
3	11367.000	37.16	15.67	52.83	74.00	-21.17	peak
4	12720.000	34.95	16.89	51.84	74.00	-22.16	peak
5	13919.000	33.00	18.64	51.64	74.00	-22.36	peak
6	17670.000	29.47	21.48	50.95	74.00	-23.05	peak

Note: 1. Measurement = Reading Level + Correct Factor.
 2. If Peak Result complies with AV limit, AV Result is deemed to comply with AV limit.
 3. Peak: Peak detector.
 4. Filter losses were only considered in the spurious frequency bands and the authorized band was not corrected for High Pass Filter losses.
 5. Proper operation of the transmitter prior to adding the filter to the measurement chain.
 6. Since non-restricted band peak emissions are less than the average limit, they also comply with the -27dBm/MHz (68.2dBuV/m) limit.

HARMONICS AND SPURIOUS EMISSIONS (VERTICAL)

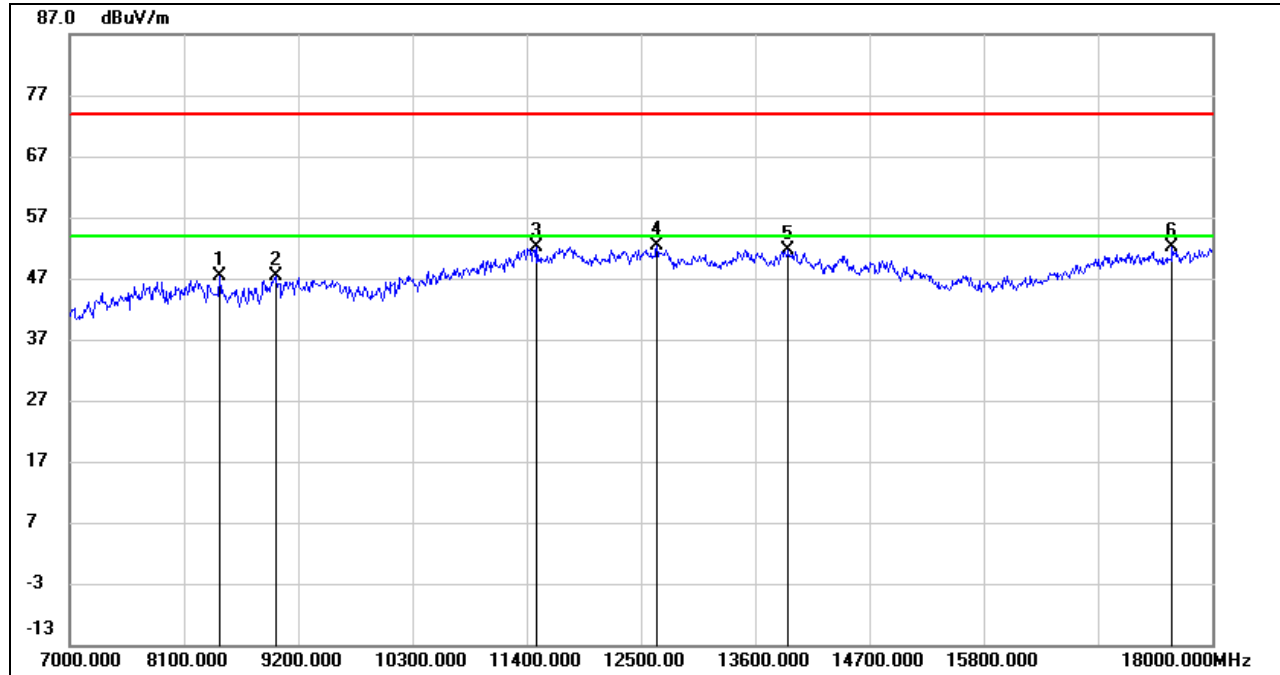

No.	Frequency (MHz)	Reading (dBuV)	Correct (dB/m)	Result (dBuV/m)	Limit (dBuV/m)	Margin (dB)	Remark
1	8441.000	39.50	7.87	47.37	74.00	-26.63	peak
2	8980.000	37.39	9.91	47.30	74.00	-26.70	peak
3	11499.000	36.04	16.16	52.20	74.00	-21.80	peak
4	12654.000	35.62	16.74	52.36	74.00	-21.64	peak
5	13919.000	32.92	18.64	51.56	74.00	-22.44	peak
6	17615.000	31.18	20.91	52.09	74.00	-21.91	peak

Note: 1. Measurement = Reading Level + Correct Factor.
 2. If Peak Result complies with AV limit, AV Result is deemed to comply with AV limit.
 3. Peak: Peak detector.
 4. Filter losses were only considered in the spurious frequency bands and the authorized band was not corrected for High Pass Filter losses.
 5. Proper operation of the transmitter prior to adding the filter to the measurement chain.
 6. Since non-restricted band peak emissions are less than the average limit, they also comply with the -27dBm/MHz (68.2dBuV/m) limit.



UNII-3 BAND

HARMONICS AND SPURIOUS EMISSIONS (LOW CHANNEL, HORIZONTAL)

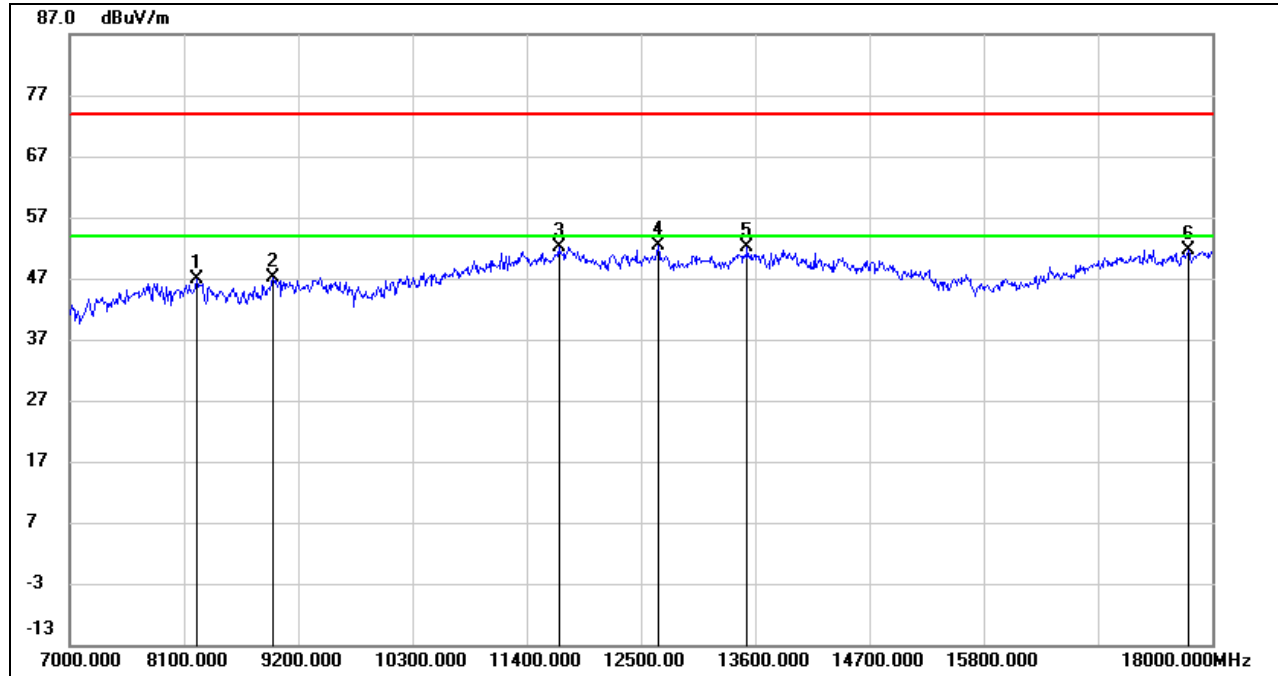

No.	Frequency (MHz)	Reading (dBuV)	Correct (dB/m)	Result (dBuV/m)	Limit (dBuV/m)	Margin (dB)	Remark
1	8221.000	38.17	8.63	46.80	74.00	-27.20	peak
2	8958.000	37.56	9.67	47.23	74.00	-26.77	peak
3	11708.000	35.29	16.87	52.16	74.00	-21.84	peak
4	12665.000	35.48	16.78	52.26	74.00	-21.74	peak
5	13523.000	33.69	18.41	52.10	74.00	-21.90	peak
6	17769.000	29.13	22.53	51.66	74.00	-22.34	peak

Note: 1. Measurement = Reading Level + Correct Factor.
 2. If Peak Result complies with AV limit, AV Result is deemed to comply with AV limit.
 3. Peak: Peak detector.
 4. Filter losses were only considered in the spurious frequency bands and the authorized band was not corrected for High Pass Filter losses.
 5. Proper operation of the transmitter prior to adding the filter to the measurement chain.
 6. Since non-restricted band peak emissions are less than the average limit, they also comply with the -27dBm/MHz (68.2dBuV/m) limit.



HARMONICS AND SPURIOUS EMISSIONS (LOW CHANNEL, VERTICAL)

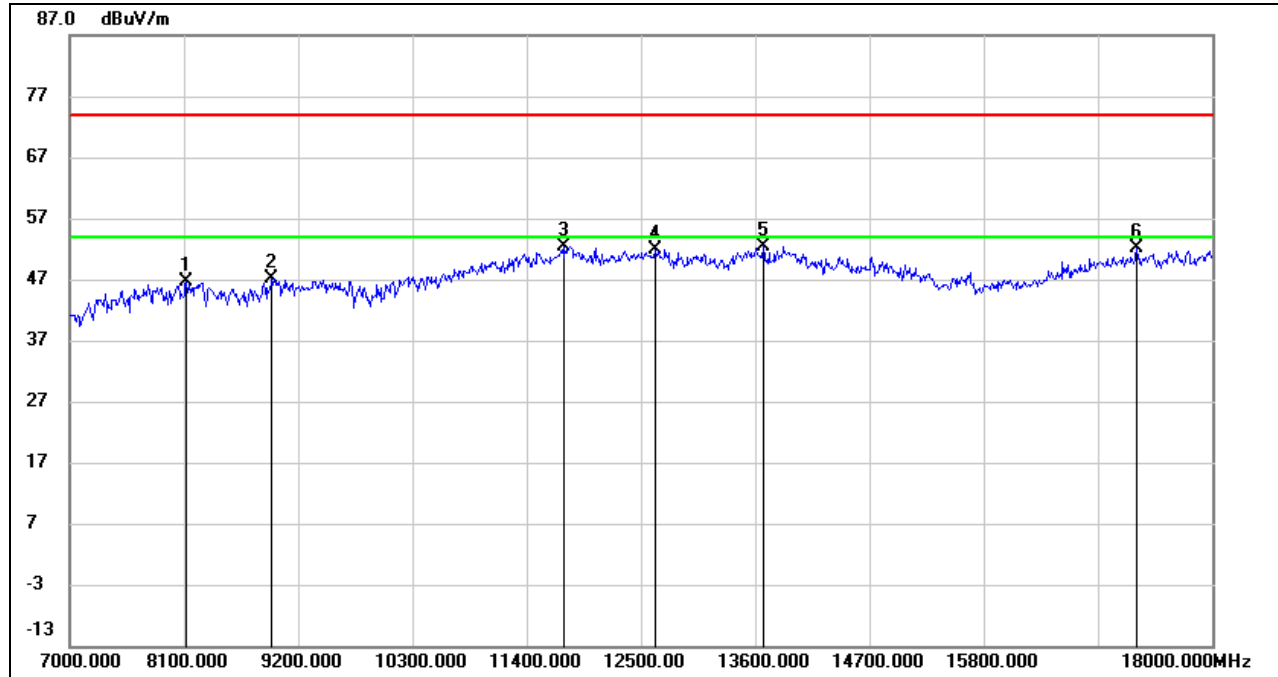

No.	Frequency (MHz)	Reading (dBuV)	Correct (dB/m)	Result (dBuV/m)	Limit (dBuV/m)	Margin (dB)	Remark
1	8122.000	38.44	8.07	46.51	74.00	-27.49	peak
2	8947.000	37.68	9.55	47.23	74.00	-26.77	peak
3	11752.000	35.19	17.10	52.29	74.00	-21.71	peak
4	12643.000	35.08	16.72	51.80	74.00	-22.20	peak
5	13677.000	33.92	18.53	52.45	74.00	-21.55	peak
6	17274.000	32.26	19.78	52.04	74.00	-21.96	peak

- Note: 1. Measurement = Reading Level + Correct Factor.
 2. If Peak Result complies with AV limit, AV Result is deemed to comply with AV limit.
 3. Peak: Peak detector.
 4. Filter losses were only considered in the spurious frequency bands and the authorized band was not corrected for High Pass Filter losses.
 5. Proper operation of the transmitter prior to adding the filter to the measurement chain.
 6. Since non-restricted band peak emissions are less than the average limit, they also comply with the -27dBm/MHz (68.2dBuV/m) limit.

HARMONICS AND SPURIOUS EMISSIONS (HIGH CHANNEL, HORIZONTAL)

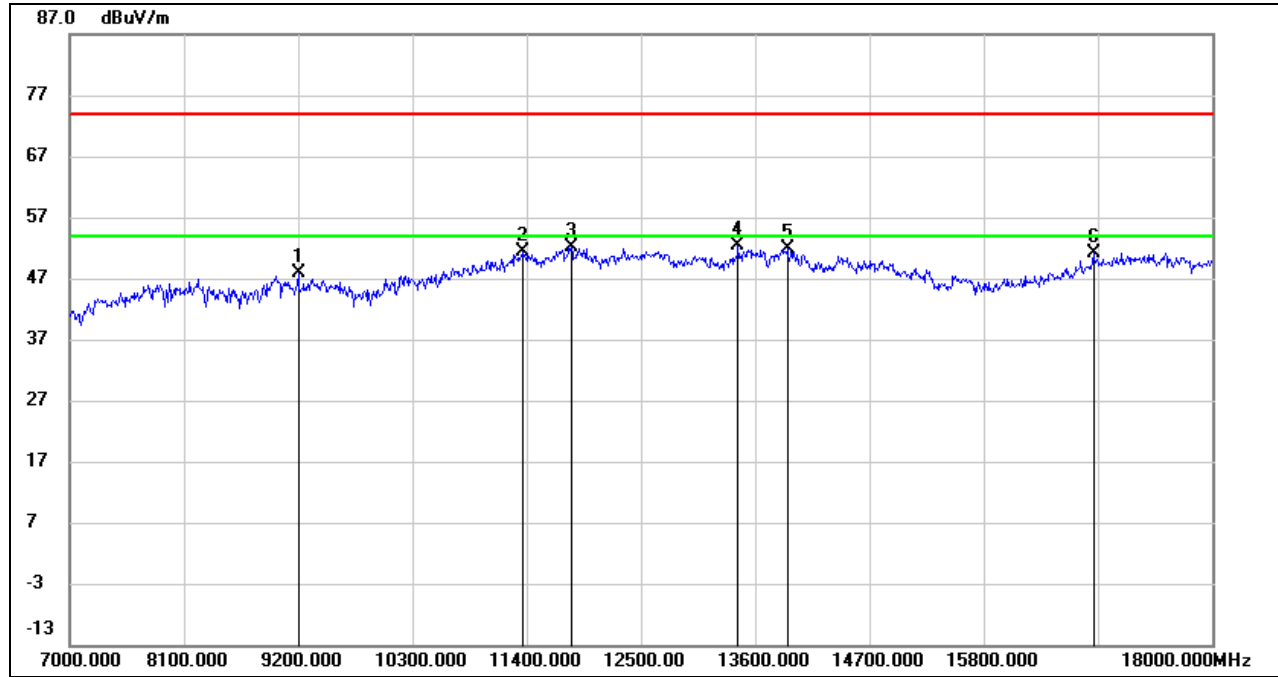

No.	Frequency (MHz)	Reading (dBuV)	Correct (dB/m)	Result (dBuV/m)	Limit (dBuV/m)	Margin (dB)	Remark
1	9200.000	38.82	8.95	47.77	74.00	-26.23	peak
2	11367.000	35.70	15.67	51.37	74.00	-22.63	peak
3	11829.000	34.95	17.30	52.25	74.00	-21.75	peak
4	13435.000	34.07	18.28	52.35	74.00	-21.65	peak
5	13908.000	33.16	18.66	51.82	74.00	-22.18	peak
6	16856.000	33.27	17.97	51.24	74.00	-22.76	peak

- Note: 1. Measurement = Reading Level + Correct Factor.
 2. If Peak Result complies with AV limit, AV Result is deemed to comply with AV limit.
 3. Peak: Peak detector.
 4. Filter losses were only considered in the spurious frequency bands and the authorized band was not corrected for High Pass Filter losses.
 5. Proper operation of the transmitter prior to adding the filter to the measurement chain.
 6. Since non-restricted band peak emissions are less than the average limit, they also comply with the -27dBm/MHz (68.2dBuV/m) limit.

HARMONICS AND SPURIOUS EMISSIONS (HIGH CHANNEL, VERTICAL)

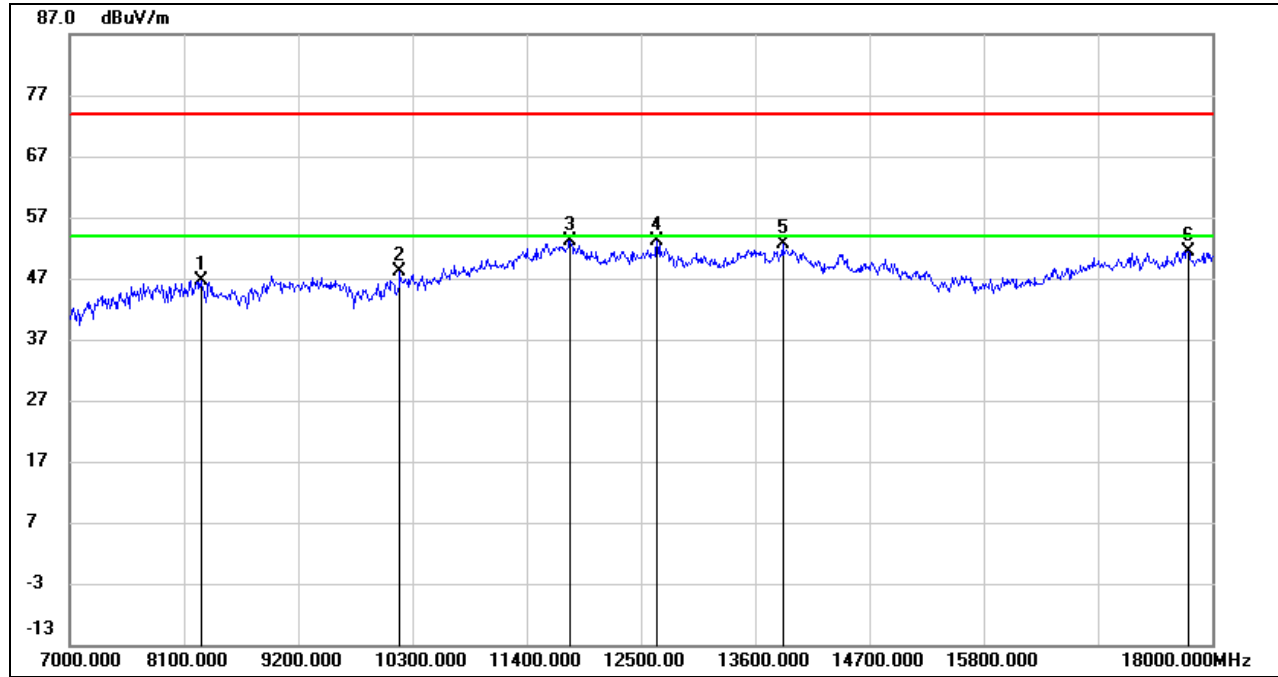

No.	Frequency (MHz)	Reading (dBuV)	Correct (dB/m)	Result (dBuV/m)	Limit (dBuV/m)	Margin (dB)	Remark
1	8265.000	38.27	8.45	46.72	74.00	-27.28	peak
2	10179.000	36.89	11.25	48.14	74.00	-25.86	peak
3	11818.000	35.85	17.31	53.16	74.00	-20.84	peak
4	12654.000	36.39	16.74	53.13	74.00	-20.87	peak
5	13864.000	33.83	18.70	52.53	74.00	-21.47	peak
6	17769.000	28.90	22.53	51.43	74.00	-22.57	peak

Note: 1. Measurement = Reading Level + Correct Factor.
 2. If Peak Result complies with AV limit, AV Result is deemed to comply with AV limit.
 3. Peak: Peak detector.
 4. Filter losses were only considered in the spurious frequency bands and the authorized band was not corrected for High Pass Filter losses.
 5. Proper operation of the transmitter prior to adding the filter to the measurement chain.
 6. Since non-restricted band peak emissions are less than the average limit, they also comply with the -27dBm/MHz (68.2dBuV/m) limit.

8.3.4. 802.11ac VHT80 MIMO MODE

UNII-1 BAND

HARMONICS AND SPURIOUS EMISSIONS (LOW CHANNEL, HORIZONTAL)

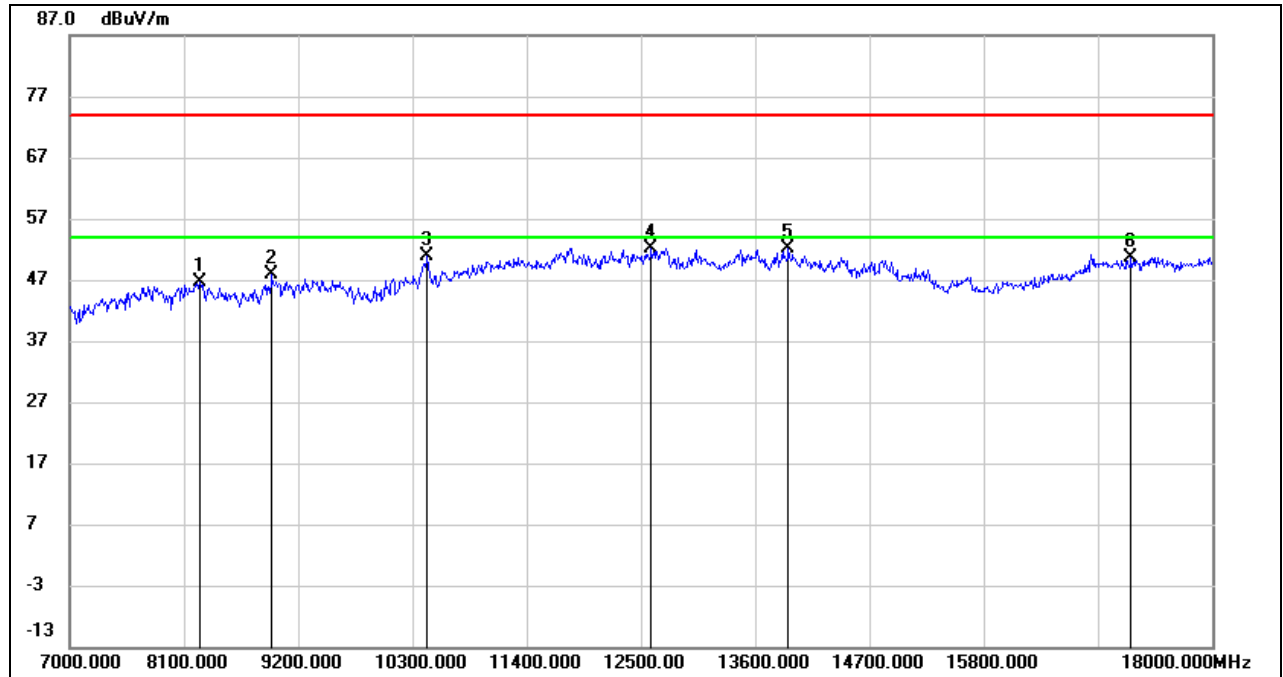

No.	Frequency (MHz)	Reading (dBuV)	Correct (dB/m)	Result (dBuV/m)	Limit (dBuV/m)	Margin (dB)	Remark
1	8254.000	38.24	8.50	46.74	74.00	-27.26	peak
2	8947.000	38.32	9.55	47.87	74.00	-26.13	peak
3	10443.000	38.70	12.18	50.88	74.00	-23.12	peak
4	12599.000	35.54	16.63	52.17	74.00	-21.83	peak
5	13919.000	33.51	18.64	52.15	74.00	-21.85	peak
6	17219.000	30.99	19.74	50.73	74.00	-23.27	peak

- Note:
1. Measurement = Reading Level + Correct Factor.
 2. If Peak Result complies with AV limit, AV Result is deemed to comply with AV limit.
 3. Peak: Peak detector.
 4. AVG: $VBW=1/Ton$, where: Ton is the transmitting duration.
 5. For the transmitting duration, please refer to clause 7.1.
 6. Filter losses were only considered in the spurious frequency bands and the authorized band was not corrected for High Pass Filter losses.
 7. Proper operation of the transmitter prior to adding the filter to the measurement chain.
 8. Since non-restricted band peak emissions are less than the average limit, they also comply with the -27dBm/MHz (68.2dBuV/m) limit.

HARMONICS AND SPURIOUS EMISSIONS (LOW CHANNEL, VERTICAL)

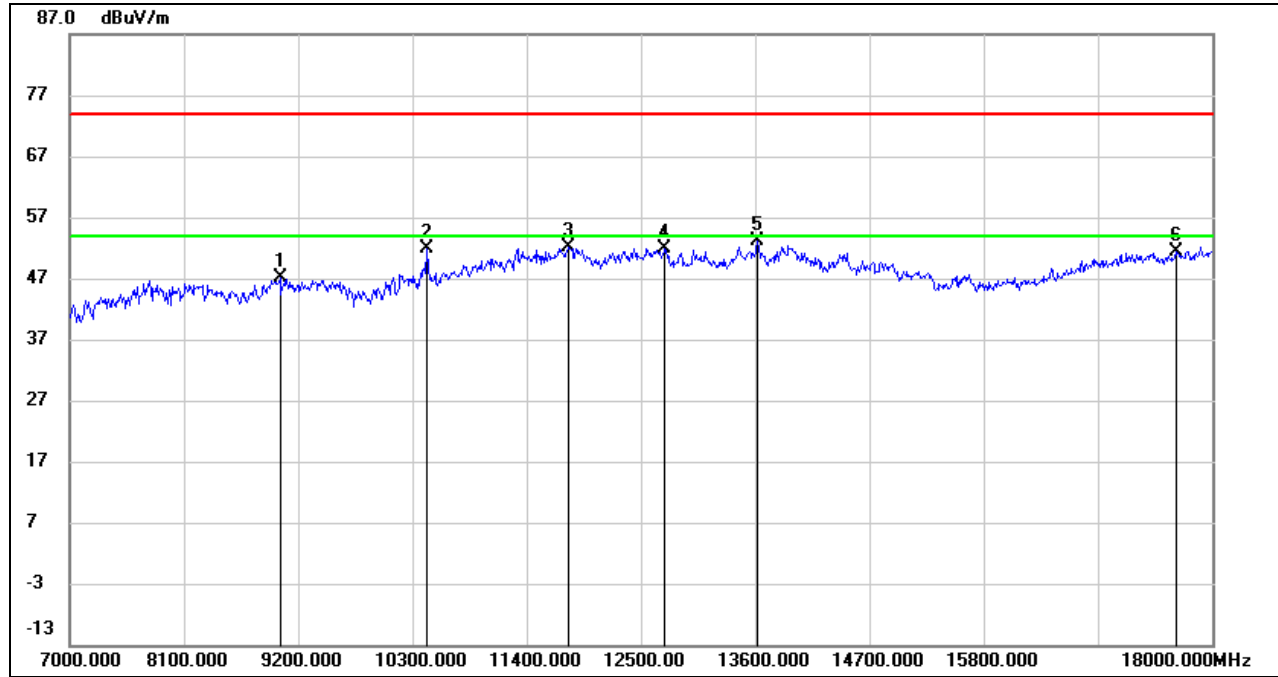

No.	Frequency (MHz)	Reading (dBuV)	Correct (dB/m)	Result (dBuV/m)	Limit (dBuV/m)	Margin (dB)	Remark
1	9024.000	37.26	9.99	47.25	74.00	-26.75	peak
2	10443.000	39.68	12.18	51.86	74.00	-22.14	peak
3	11807.000	34.89	17.35	52.24	74.00	-21.76	peak
4	12731.000	35.06	16.93	51.99	74.00	-22.01	peak
5	13622.000	34.63	18.41	53.04	74.00	-20.96	peak
6	17648.000	30.21	21.26	51.47	74.00	-22.53	peak

- Note: 1. Measurement = Reading Level + Correct Factor.
 2. If Peak Result complies with AV limit, AV Result is deemed to comply with AV limit.
 3. Peak: Peak detector.
 4. AVG: $VBW=1/Ton$, where: Ton is the transmitting duration.
 5. For the transmitting duration, please refer to clause 7.1.
 6. Filter losses were only considered in the spurious frequency bands and the authorized band was not corrected for High Pass Filter losses.
 7. Proper operation of the transmitter prior to adding the filter to the measurement chain.
 8. Since non-restricted band peak emissions are less than the average limit, they also comply with the -27dBm/MHz (68.2dBuV/m) limit.

UNII-2A BAND

HARMONICS AND SPURIOUS EMISSIONS (LOW CHANNEL, HORIZONTAL)

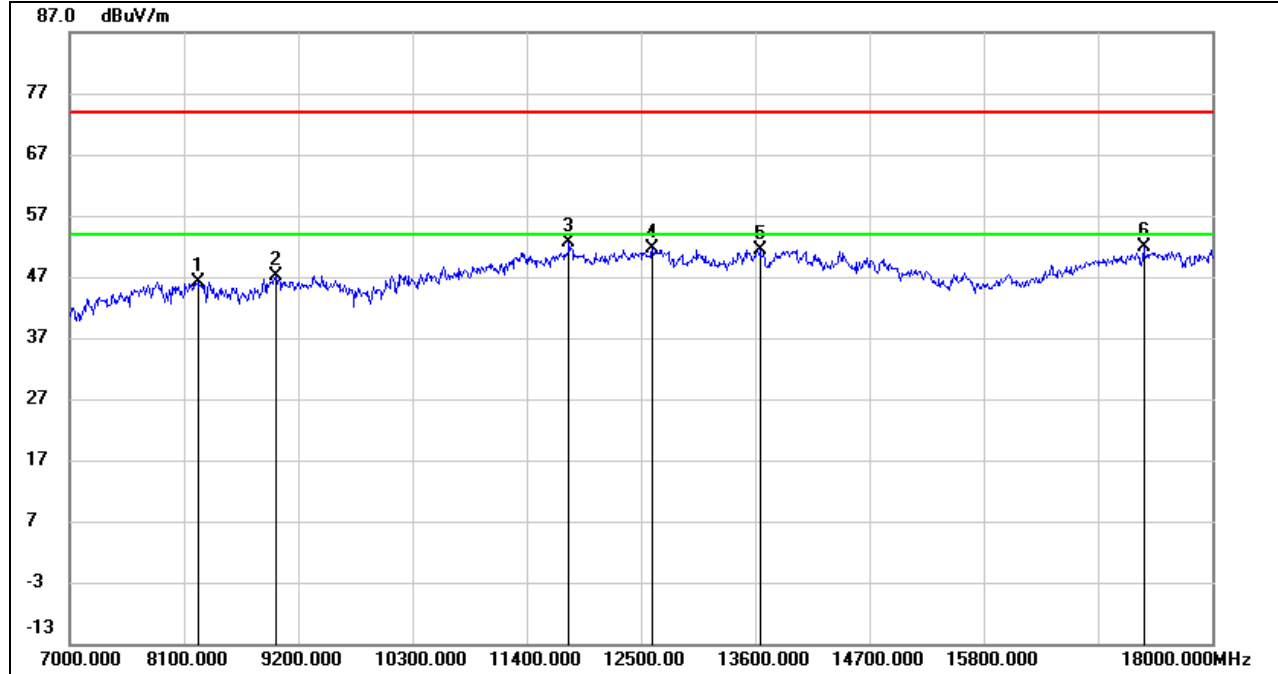

No.	Frequency (MHz)	Reading (dBuV)	Correct (dB/m)	Result (dBuV/m)	Limit (dBuV/m)	Margin (dB)	Remark
1	8232.000	37.64	8.59	46.23	74.00	-27.77	peak
2	8980.000	37.29	9.91	47.20	74.00	-26.80	peak
3	11807.000	35.20	17.35	52.55	74.00	-21.45	peak
4	12610.000	34.90	16.64	51.54	74.00	-22.46	peak
5	13644.000	32.93	18.46	51.39	74.00	-22.61	peak
6	17340.000	31.99	19.80	51.79	74.00	-22.21	peak

Note: 1. Measurement = Reading Level + Correct Factor.
 2. If Peak Result complies with AV limit, AV Result is deemed to comply with AV limit.
 3. Peak: Peak detector.
 4. Filter losses were only considered in the spurious frequency bands and the authorized band was not corrected for High Pass Filter losses.
 5. Proper operation of the transmitter prior to adding the filter to the measurement chain.
 6. Since non-restricted band peak emissions are less than the average limit, they also comply with the -27dBm/MHz (68.2dBuV/m) limit.

HARMONICS AND SPURIOUS EMISSIONS (LOW CHANNEL, VERTICAL)

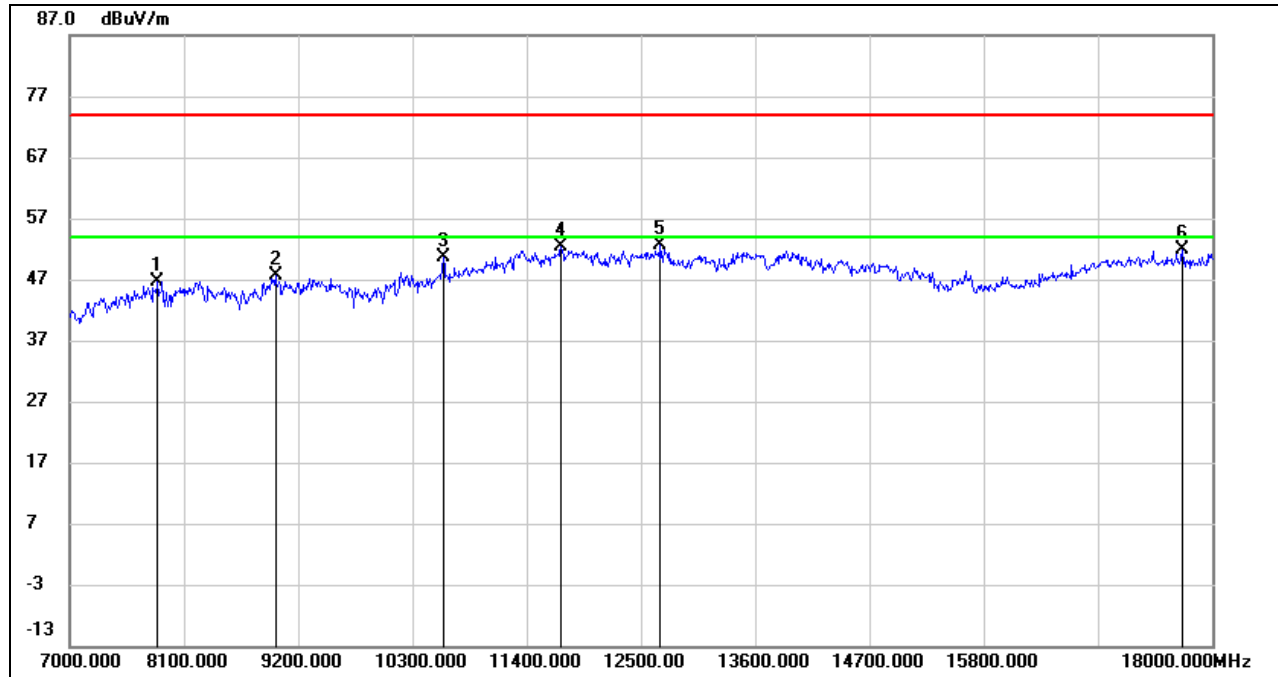

No.	Frequency (MHz)	Reading (dBuV)	Correct (dB/m)	Result (dBuV/m)	Limit (dBuV/m)	Margin (dB)	Remark
1	7847.000	39.14	7.48	46.62	74.00	-27.38	peak
2	8980.000	37.66	9.91	47.57	74.00	-26.43	peak
3	10597.000	37.75	12.93	50.68	74.00	-23.32	peak
4	11730.000	35.36	16.98	52.34	74.00	-21.66	peak
5	12687.000	35.91	16.82	52.73	74.00	-21.27	peak
6	17714.000	29.94	21.94	51.88	74.00	-22.12	peak

- Note:
1. Measurement = Reading Level + Correct Factor.
 2. If Peak Result complies with AV limit, AV Result is deemed to comply with AV limit.
 3. Peak: Peak detector.
 4. AVG: $VBW=1/Ton$, where: Ton is the transmitting duration.
 5. For the transmitting duration, please refer to clause 7.1.
 6. Filter losses were only considered in the spurious frequency bands and the authorized band was not corrected for High Pass Filter losses.
 7. Proper operation of the transmitter prior to adding the filter to the measurement chain.
 8. Since non-restricted band peak emissions are less than the average limit, they also comply with the -27dBm/MHz (68.2dBuV/m) limit.

UNII-2C BAND

HARMONICS AND SPURIOUS EMISSIONS (LOW CHANNEL, HORIZONTAL)

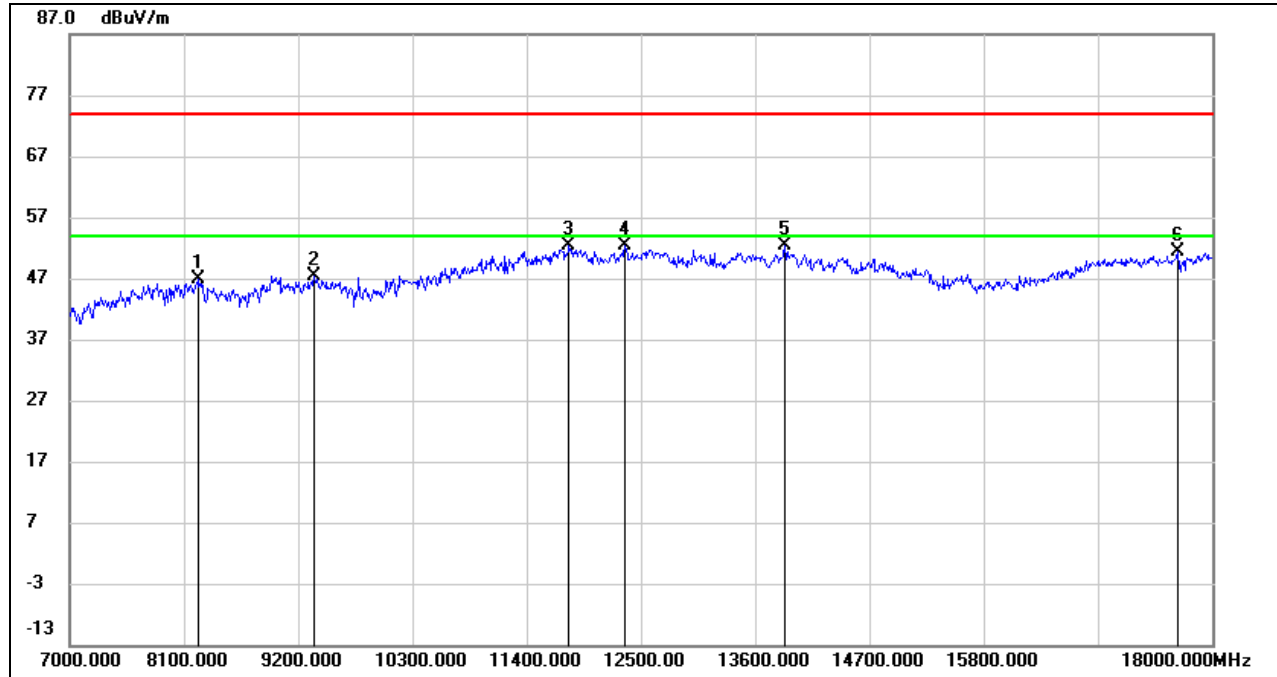

No.	Frequency (MHz)	Reading (dBuV)	Correct (dB/m)	Result (dBuV/m)	Limit (dBuV/m)	Margin (dB)	Remark
1	8243.000	38.30	8.54	46.84	74.00	-27.16	peak
2	9354.000	37.53	9.86	47.39	74.00	-26.61	peak
3	11807.000	34.95	17.35	52.30	74.00	-21.70	peak
4	12346.000	35.62	16.83	52.45	74.00	-21.55	peak
5	13886.000	33.75	18.68	52.43	74.00	-21.57	peak
6	17670.000	29.99	21.48	51.47	74.00	-22.53	peak

- Note:
1. Measurement = Reading Level + Correct Factor.
 2. If Peak Result complies with AV limit, AV Result is deemed to comply with AV limit.
 3. Peak: Peak detector.
 4. AVG: $VBW=1/Ton$, where: Ton is the transmitting duration.
 5. For the transmitting duration, please refer to clause 7.1.
 6. Filter losses were only considered in the spurious frequency bands and the authorized band was not corrected for High Pass Filter losses.
 7. Proper operation of the transmitter prior to adding the filter to the measurement chain.
 8. Since non-restricted band peak emissions are less than the average limit, they also comply with the -27dBm/MHz (68.2dBuV/m) limit.



HARMONICS AND SPURIOUS EMISSIONS (LOW CHANNEL, VERTICAL)

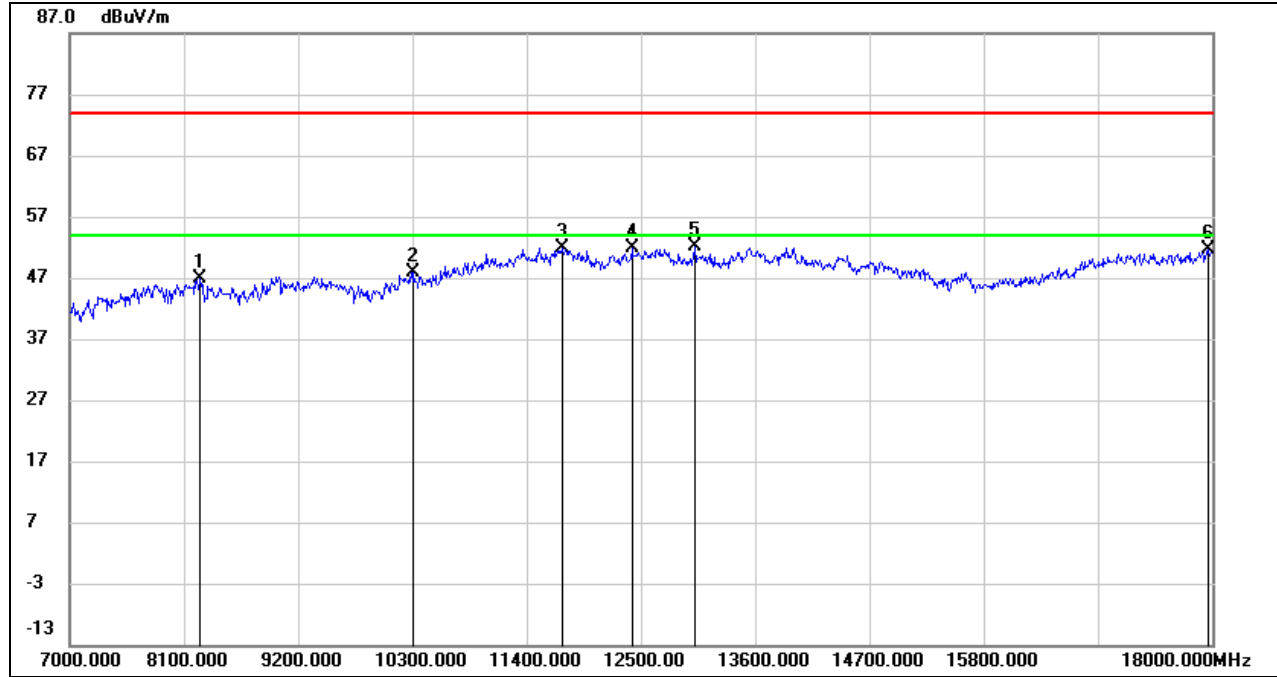

No.	Frequency (MHz)	Reading (dBuV)	Correct (dB/m)	Result (dBuV/m)	Limit (dBuV/m)	Margin (dB)	Remark
1	8254.000	38.35	8.50	46.85	74.00	-27.15	peak
2	10311.000	36.28	11.68	47.96	74.00	-26.04	peak
3	11741.000	34.87	17.03	51.90	74.00	-22.10	peak
4	12412.000	35.08	16.87	51.95	74.00	-22.05	peak
5	13017.000	35.32	16.93	52.25	74.00	-21.75	peak
6	17956.000	28.26	23.26	51.52	74.00	-22.48	peak

- Note: 1. Measurement = Reading Level + Correct Factor.
 2. If Peak Result complies with AV limit, AV Result is deemed to comply with AV limit.
 3. Peak: Peak detector.
 4. AVG: $VBW=1/Ton$, where: Ton is the transmitting duration.
 5. For the transmitting duration, please refer to clause 7.1.
 6. Filter losses were only considered in the spurious frequency bands and the authorized band was not corrected for High Pass Filter losses.
 7. Proper operation of the transmitter prior to adding the filter to the measurement chain.
 8. Since non-restricted band peak emissions are less than the average limit, they also comply with the -27dBm/MHz (68.2dBuV/m) limit.

HARMONICS AND SPURIOUS EMISSIONS (HIGH CHANNEL, HORIZONTAL)

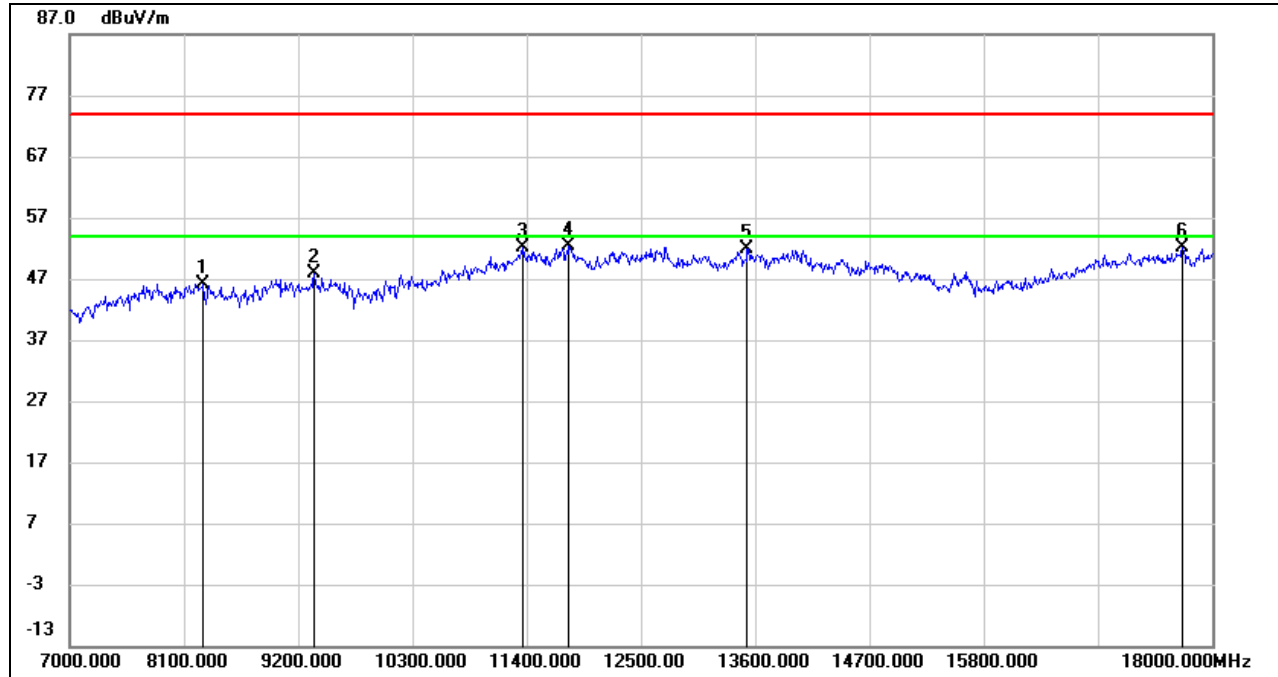

No.	Frequency (MHz)	Reading (dBuV)	Correct (dB/m)	Result (dBuV/m)	Limit (dBuV/m)	Margin (dB)	Remark
1	8287.000	37.83	8.37	46.20	74.00	-27.80	peak
2	9354.000	37.99	9.86	47.85	74.00	-26.15	peak
3	11367.000	36.43	15.67	52.10	74.00	-21.90	peak
4	11807.000	35.13	17.35	52.48	74.00	-21.52	peak
5	13523.000	33.40	18.41	51.81	74.00	-22.19	peak
6	17714.000	30.26	21.94	52.20	74.00	-21.80	peak

- Note:
1. Measurement = Reading Level + Correct Factor.
 2. If Peak Result complies with AV limit, AV Result is deemed to comply with AV limit.
 3. Peak: Peak detector.
 4. AVG: $VBW=1/Ton$, where: Ton is the transmitting duration.
 5. For the transmitting duration, please refer to clause 7.1.
 6. Filter losses were only considered in the spurious frequency bands and the authorized band was not corrected for High Pass Filter losses.
 7. Proper operation of the transmitter prior to adding the filter to the measurement chain.
 8. Since non-restricted band peak emissions are less than the average limit, they also comply with the -27dBm/MHz (68.2dBuV/m) limit.

HARMONICS AND SPURIOUS EMISSIONS (HIGH CHANNEL, VERTICAL)

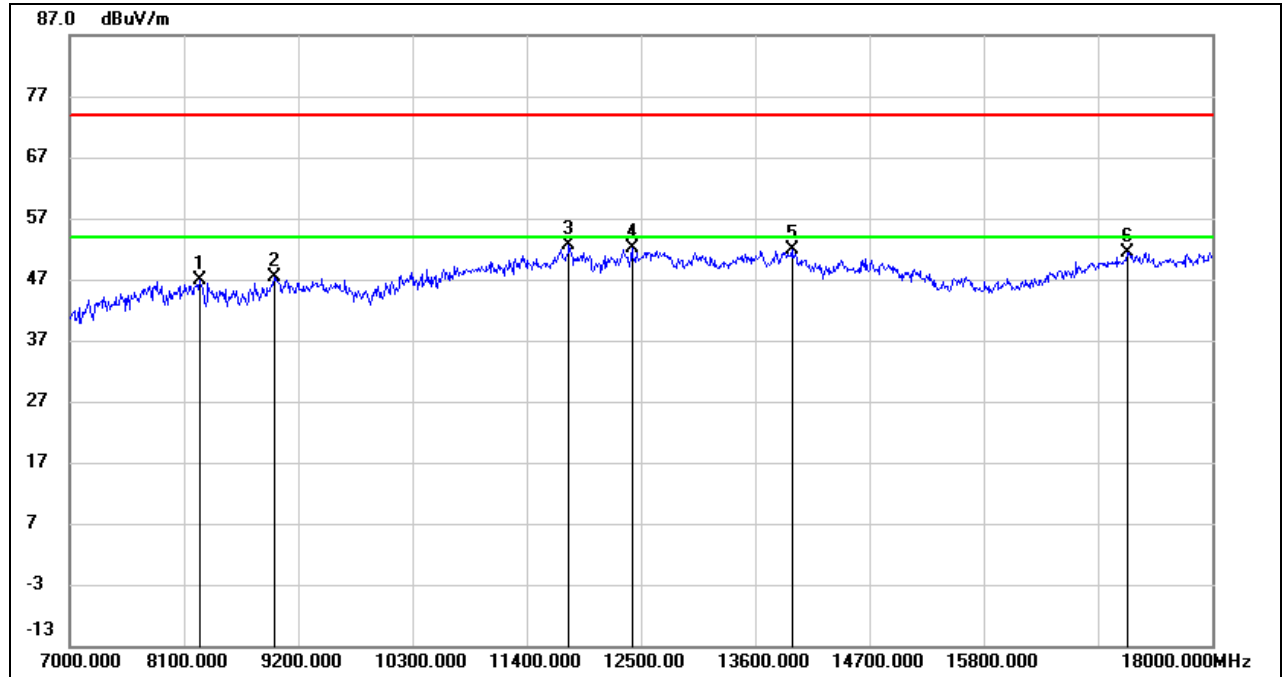

No.	Frequency (MHz)	Reading (dBuV)	Correct (dB/m)	Result (dBuV/m)	Limit (dBuV/m)	Margin (dB)	Remark
1	8254.000	38.50	8.50	47.00	74.00	-27.00	peak
2	8969.000	37.48	9.79	47.27	74.00	-26.73	peak
3	11807.000	35.26	17.35	52.61	74.00	-21.39	peak
4	12412.000	35.35	16.87	52.22	74.00	-21.78	peak
5	13952.000	33.34	18.61	51.95	74.00	-22.05	peak
6	17186.000	31.68	19.65	51.33	74.00	-22.67	peak

- Note: 1. Measurement = Reading Level + Correct Factor.
 2. If Peak Result complies with AV limit, AV Result is deemed to comply with AV limit.
 3. Peak: Peak detector.
 4. AVG: $VBW=1/Ton$, where: Ton is the transmitting duration.
 5. For the transmitting duration, please refer to clause 7.1.
 6. Filter losses were only considered in the spurious frequency bands and the authorized band was not corrected for High Pass Filter losses.
 7. Proper operation of the transmitter prior to adding the filter to the measurement chain.
 8. Since non-restricted band peak emissions are less than the average limit, they also comply with the -27dBm/MHz (68.2dBuV/m) limit.

STRADDLE CHANNEL 138

HARMONICS AND SPURIOUS EMISSIONS (HIGH CHANNEL, HORIZONTAL)

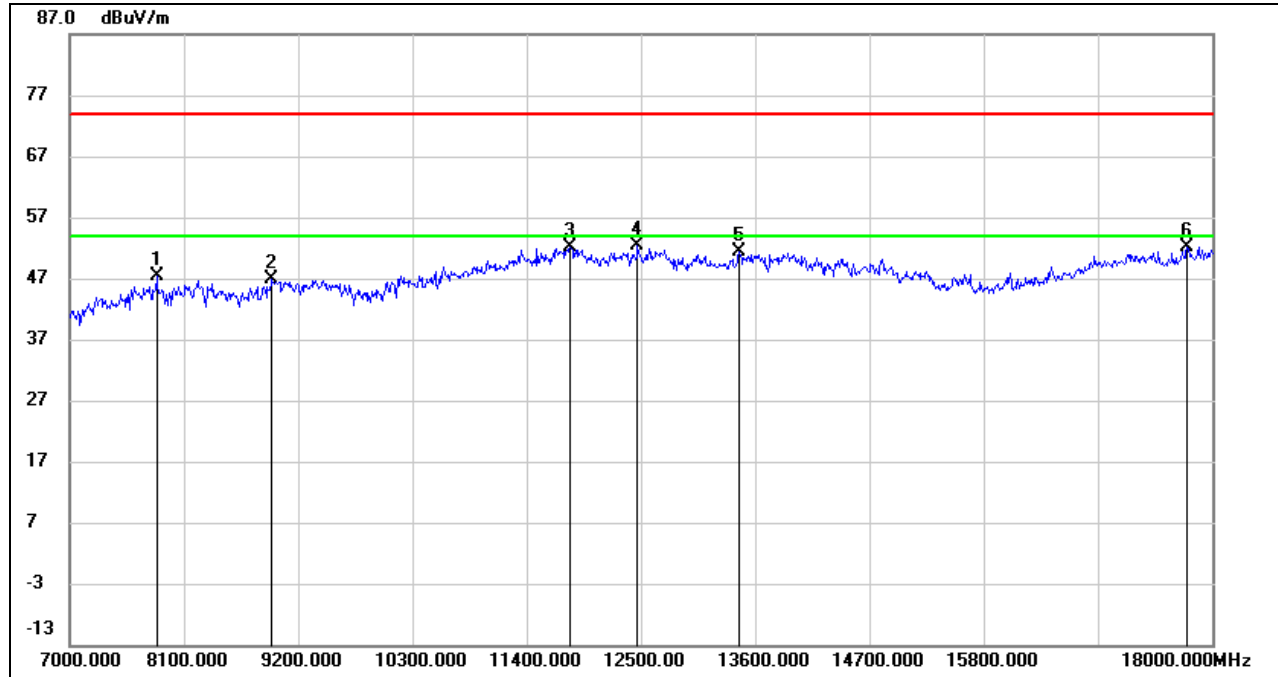

No.	Frequency (MHz)	Reading (dBuV)	Correct (dB/m)	Result (dBuV/m)	Limit (dBuV/m)	Margin (dB)	Remark
1	7836.000	39.86	7.51	47.37	74.00	-26.63	peak
2	8947.000	37.24	9.55	46.79	74.00	-27.21	peak
3	11818.000	34.88	17.31	52.19	74.00	-21.81	peak
4	12467.000	35.63	16.74	52.37	74.00	-21.63	peak
5	13446.000	33.02	18.30	51.32	74.00	-22.68	peak
6	17758.000	29.61	22.42	52.03	74.00	-21.97	peak

- Note: 1. Measurement = Reading Level + Correct Factor.
 2. If Peak Result complies with AV limit, AV Result is deemed to comply with AV limit.
 3. Peak: Peak detector.
 4. AVG: VBW=1/Ton, where: Ton is the transmitting duration.
 5. For the transmitting duration, please refer to clause 7.1.
 6. Filter losses were only considered in the spurious frequency bands and the authorized band was not corrected for High Pass Filter losses.
 7. Proper operation of the transmitter prior to adding the filter to the measurement chain.
 8. Since non-restricted band peak emissions are less than the average limit, they also comply with the -27dBm/MHz (68.2dBuV/m) limit.

HARMONICS AND SPURIOUS EMISSIONS (HIGH CHANNEL, VERTICAL)

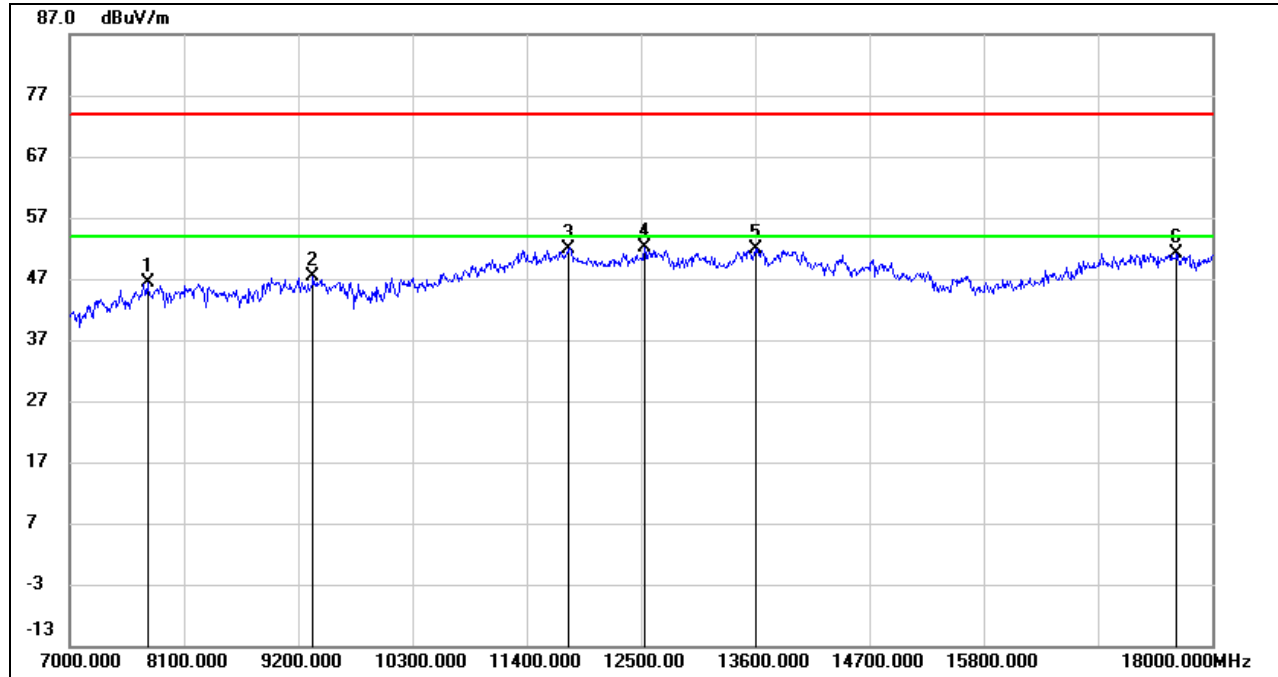

No.	Frequency (MHz)	Reading (dBuV)	Correct (dB/m)	Result (dBuV/m)	Limit (dBuV/m)	Margin (dB)	Remark
1	7748.000	39.00	7.40	46.40	74.00	-27.60	peak
2	9343.000	37.47	9.80	47.27	74.00	-26.73	peak
3	11796.000	34.66	17.33	51.99	74.00	-22.01	peak
4	12533.000	35.58	16.66	52.24	74.00	-21.76	peak
5	13600.000	33.42	18.37	51.79	74.00	-22.21	peak
6	17659.000	29.73	21.37	51.10	74.00	-22.90	peak

- Note: 1. Measurement = Reading Level + Correct Factor.
 2. If Peak Result complies with AV limit, AV Result is deemed to comply with AV limit.
 3. Peak: Peak detector.
 4. AVG: $VBW=1/Ton$, where: Ton is the transmitting duration.
 5. For the transmitting duration, please refer to clause 7.1.
 6. Filter losses were only considered in the spurious frequency bands and the authorized band was not corrected for High Pass Filter losses.
 7. Proper operation of the transmitter prior to adding the filter to the measurement chain.
 8. Since non-restricted band peak emissions are less than the average limit, they also comply with the -27dBm/MHz (68.2dBuV/m) limit.

UNII-3 BAND

HARMONICS AND SPURIOUS EMISSIONS (LOW CHANNEL, HORIZONTAL)

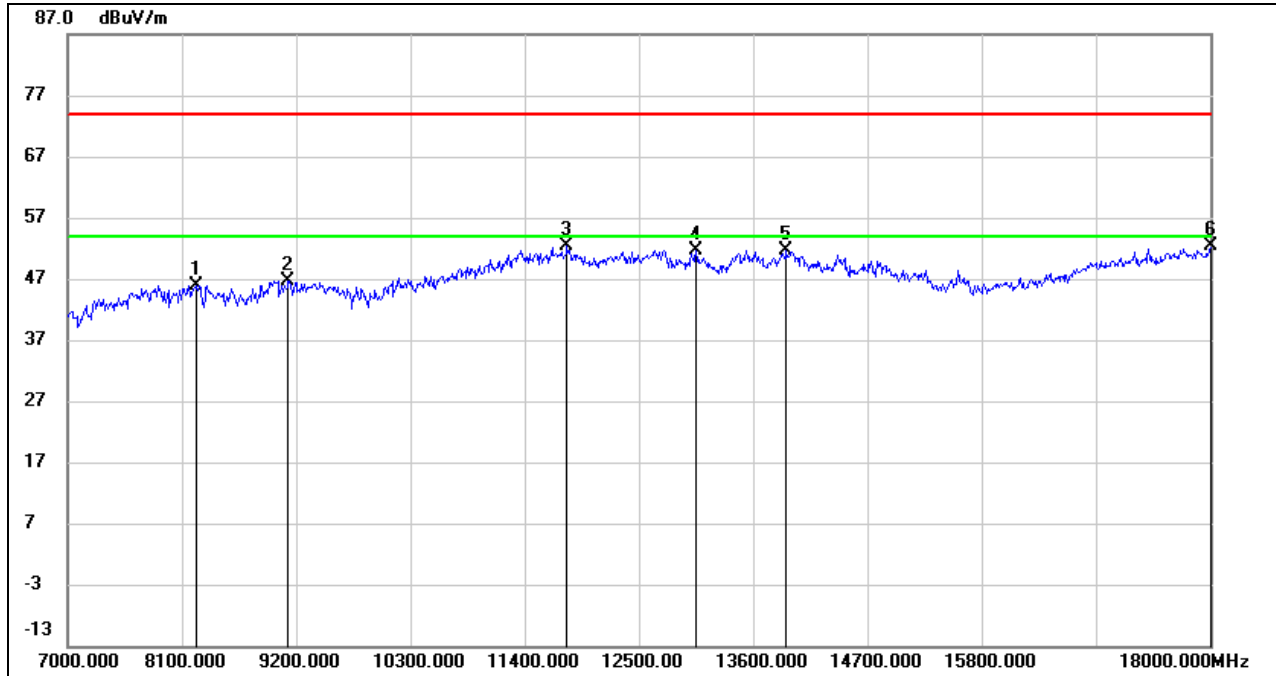

No.	Frequency (MHz)	Reading (dBuV)	Correct (dB/m)	Result (dBuV/m)	Limit (dBuV/m)	Margin (dB)	Remark
1	8232.000	37.40	8.59	45.99	74.00	-28.01	peak
2	9123.000	37.26	9.41	46.67	74.00	-27.33	peak
3	11807.000	34.95	17.35	52.30	74.00	-21.70	peak
4	13050.000	34.67	17.00	51.67	74.00	-22.33	peak
5	13919.000	32.92	18.64	51.56	74.00	-22.44	peak
6	18000.000	28.89	23.37	52.26	74.00	-21.74	peak

Note: 1. Measurement = Reading Level + Correct Factor.
 2. If Peak Result complies with AV limit, AV Result is deemed to comply with AV limit.
 3. Peak: Peak detector.
 4. Filter losses were only considered in the spurious frequency bands and the authorized band was not corrected for High Pass Filter losses.
 5. Proper operation of the transmitter prior to adding the filter to the measurement chain.
 6. Since non-restricted band peak emissions are less than the average limit, they also comply with the -27dBm/MHz (68.2dBuV/m) limit.

HARMONICS AND SPURIOUS EMISSIONS (LOW CHANNEL, VERTICAL)

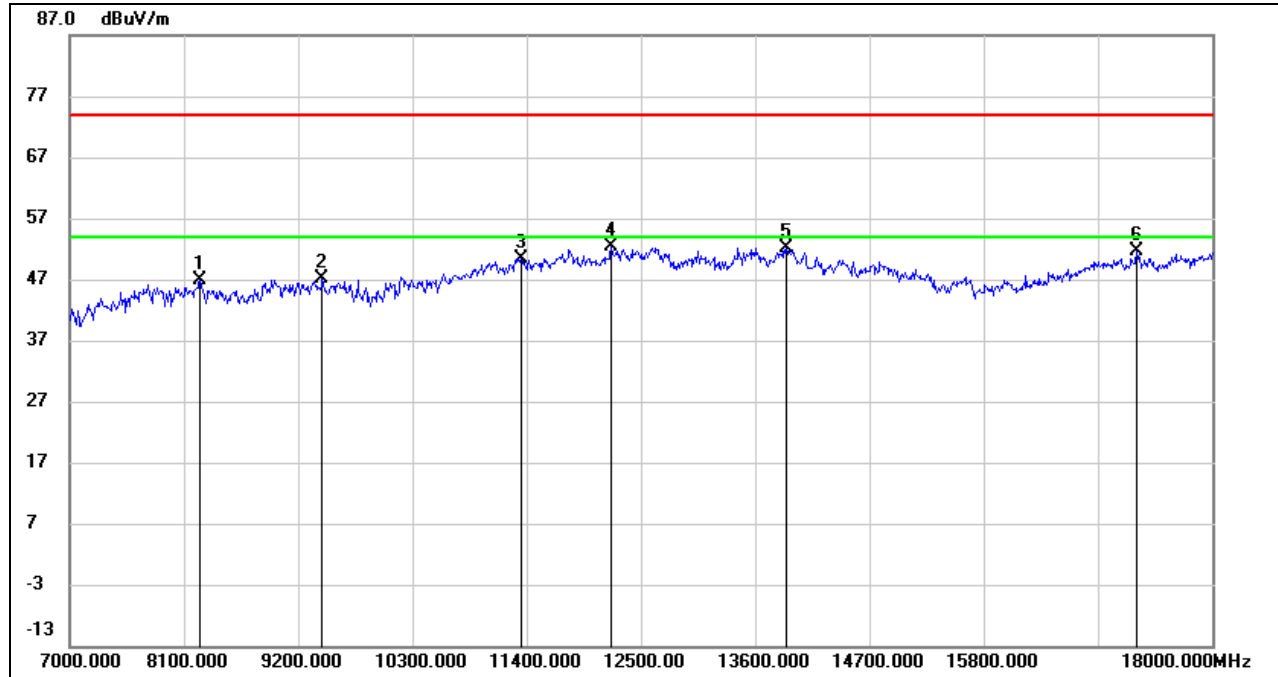

No.	Frequency (MHz)	Reading (dBuV)	Correct (dB/m)	Result (dBuV/m)	Limit (dBuV/m)	Margin (dB)	Remark
1	8254.000	38.34	8.50	46.84	74.00	-27.16	peak
2	9431.000	36.85	10.20	47.05	74.00	-26.95	peak
3	11345.000	34.85	15.58	50.43	74.00	-23.57	peak
4	12214.000	35.72	16.66	52.38	74.00	-21.62	peak
5	13897.000	33.44	18.66	52.10	74.00	-21.90	peak
6	17274.000	31.91	19.78	51.69	74.00	-22.31	peak

- Note: 1. Measurement = Reading Level + Correct Factor.
 2. If Peak Result complies with AV limit, AV Result is deemed to comply with AV limit.
 3. Peak: Peak detector.
 4. AVG: $VBW=1/T_{on}$, where: T_{on} is the transmitting duration.
 5. For the transmitting duration, please refer to clause 7.1.
 6. Filter losses were only considered in the spurious frequency bands and the authorized band was not corrected for High Pass Filter losses.
 7. Proper operation of the transmitter prior to adding the filter to the measurement chain.
 8. Since non-restricted band peak emissions are less than the average limit, they also comply with the -27dBm/MHz (68.2dBuV/m) limit.

8.3.5. 802.11ax HE20 MIMO MODE

UNII-1 BAND

HARMONICS AND SPURIOUS EMISSIONS (LOW CHANNEL, HORIZONTAL)

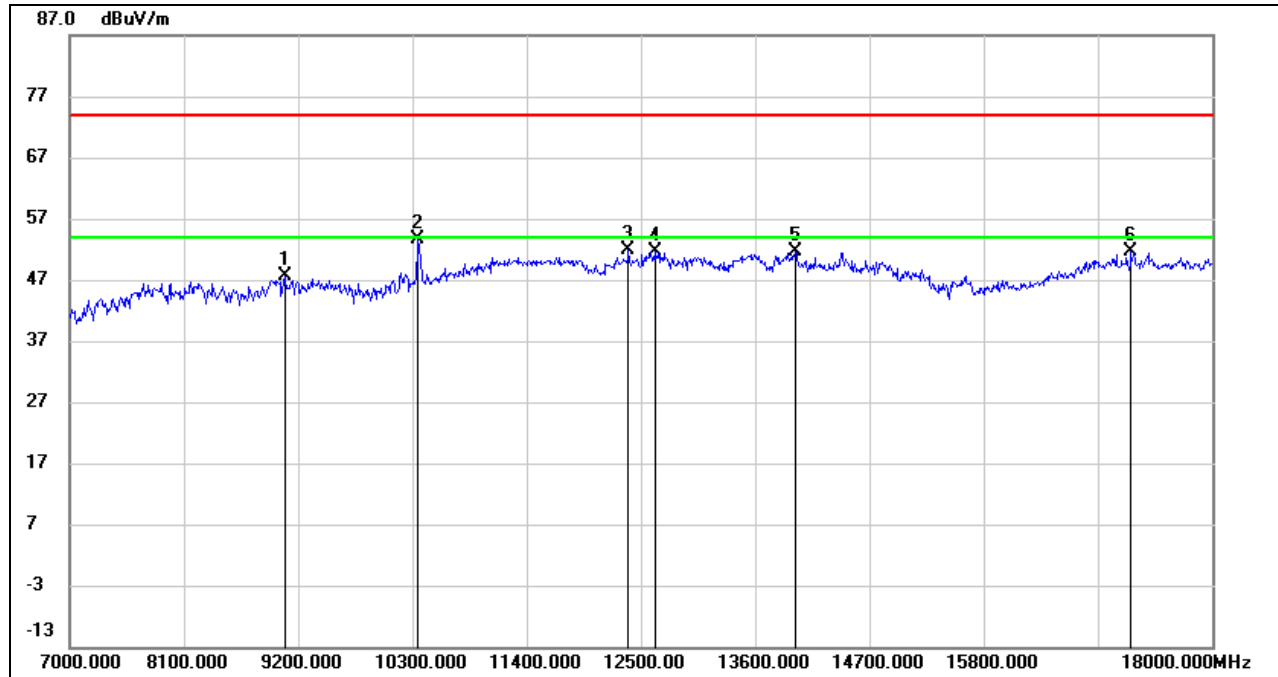

No.	Frequency (MHz)	Reading (dBuV)	Correct (dB/m)	Result (dBuV/m)	Limit (dBuV/m)	Margin (dB)	Remark
1	9068.000	37.87	9.73	47.60	74.00	-26.40	peak
2	10355.000	41.76	11.82	53.58	74.00	-20.42	peak
3	12379.000	34.96	16.86	51.82	74.00	-22.18	peak
4	12637.500	34.84	16.71	51.55	74.00	-22.45	peak
5	13985.000	33.05	18.57	51.62	74.00	-22.38	peak
6	17224.500	31.91	19.75	51.66	74.00	-22.34	peak

Note: 1. Measurement = Reading Level + Correct Factor.
 2. If Peak Result complies with AV limit, AV Result is deemed to comply with AV limit.
 3. Peak: Peak detector.
 4. Filter losses were only considered in the spurious frequency bands and the authorized band was not corrected for High Pass Filter losses.
 5. Proper operation of the transmitter prior to adding the filter to the measurement chain.
 6. Since non-restricted band peak emissions are less than the average limit, they also comply with the -27dBm/MHz (68.2dBuV/m) limit.



HARMONICS AND SPURIOUS EMISSIONS (LOW CHANNEL, VERTICAL)

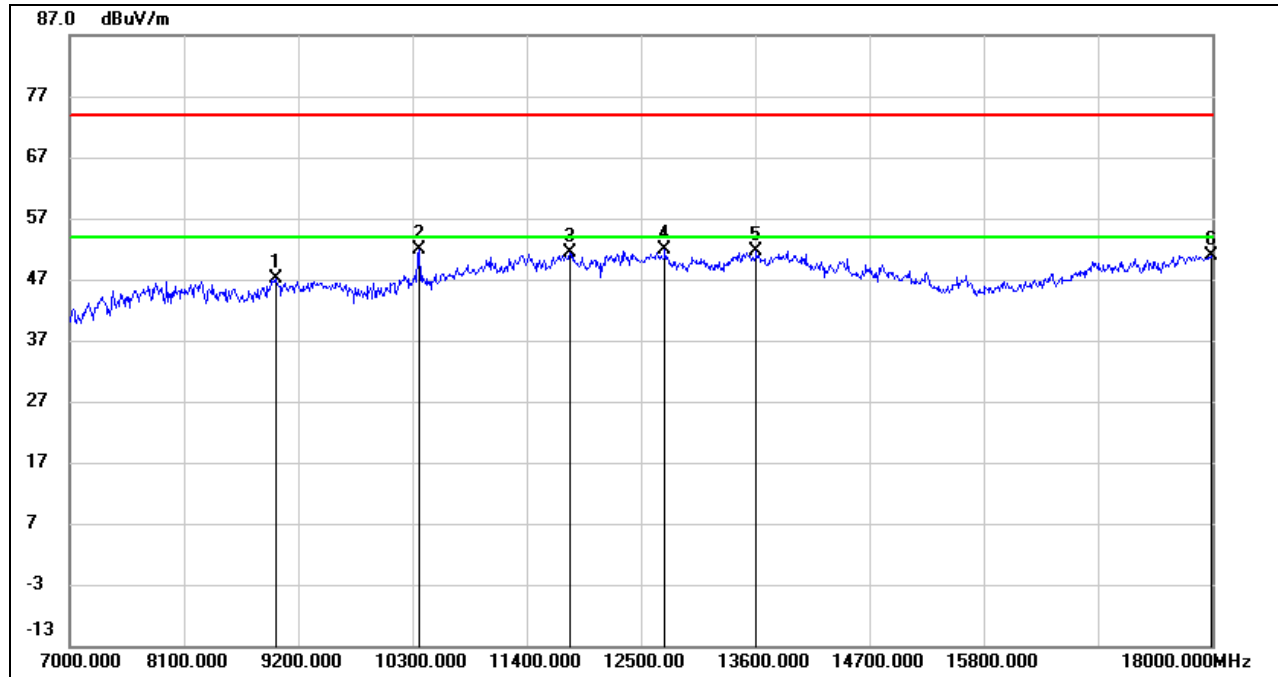

No.	Frequency (MHz)	Reading (dBuV)	Correct (dB/m)	Result (dBuV/m)	Limit (dBuV/m)	Margin (dB)	Remark
1	8980.000	37.18	9.91	47.09	74.00	-26.91	peak
2	10366.000	40.01	11.85	51.86	74.00	-22.14	peak
3	11818.000	34.06	17.31	51.37	74.00	-22.63	peak
4	12731.000	34.99	16.93	51.92	74.00	-22.08	peak
5	13611.000	33.28	18.39	51.67	74.00	-22.33	peak
6	17989.000	27.63	23.34	50.97	74.00	-23.03	peak

- Note: 1. Measurement = Reading Level + Correct Factor.
 2. If Peak Result complies with AV limit, AV Result is deemed to comply with AV limit.
 3. Peak: Peak detector.
 4. Filter losses were only considered in the spurious frequency bands and the authorized band was not corrected for High Pass Filter losses.
 5. Proper operation of the transmitter prior to adding the filter to the measurement chain.
 6. Since non-restricted band peak emissions are less than the average limit, they also comply with the -27dBm/MHz (68.2dBuV/m) limit.

HARMONICS AND SPURIOUS EMISSIONS (MID CHANNEL, HORIZONTAL)

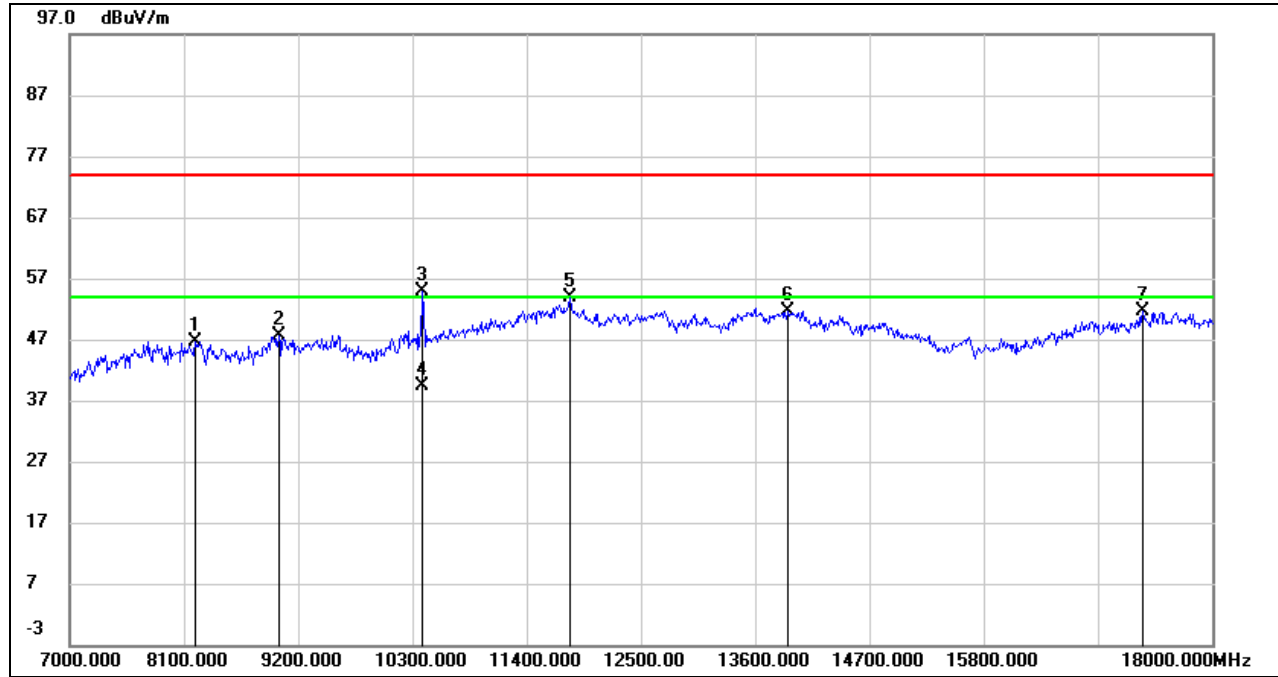

No.	Frequency (MHz)	Reading (dBuV)	Correct (dB/m)	Result (dBuV/m)	Limit (dBuV/m)	Margin (dB)	Remark
1	8215.500	38.05	8.65	46.70	74.00	-27.30	peak
2	9018.500	37.62	10.02	47.64	74.00	-26.36	peak
3	10404.500	42.86	11.99	54.85	74.00	-19.15	peak
4	10404.500	27.33	11.99	39.32	54.00	-14.68	AVG
5	11823.500	36.45	17.32	53.77	74.00	-20.23	peak
6	13913.500	33.01	18.65	51.66	74.00	-22.34	peak
7	17334.500	31.76	19.81	51.57	74.00	-22.43	peak

Note: 1. Measurement = Reading Level + Correct Factor.
 2. If Peak Result complies with AV limit, AV Result is deemed to comply with AV limit.
 3. Peak: Peak detector.
 4. Filter losses were only considered in the spurious frequency bands and the authorized band was not corrected for High Pass Filter losses.
 5. Proper operation of the transmitter prior to adding the filter to the measurement chain.
 6. Since non-restricted band peak emissions are less than the average limit, they also comply with the -27dBm/MHz (68.2dBuV/m) limit.

HARMONICS AND SPURIOUS EMISSIONS (MID CHANNEL, VERTICAL)

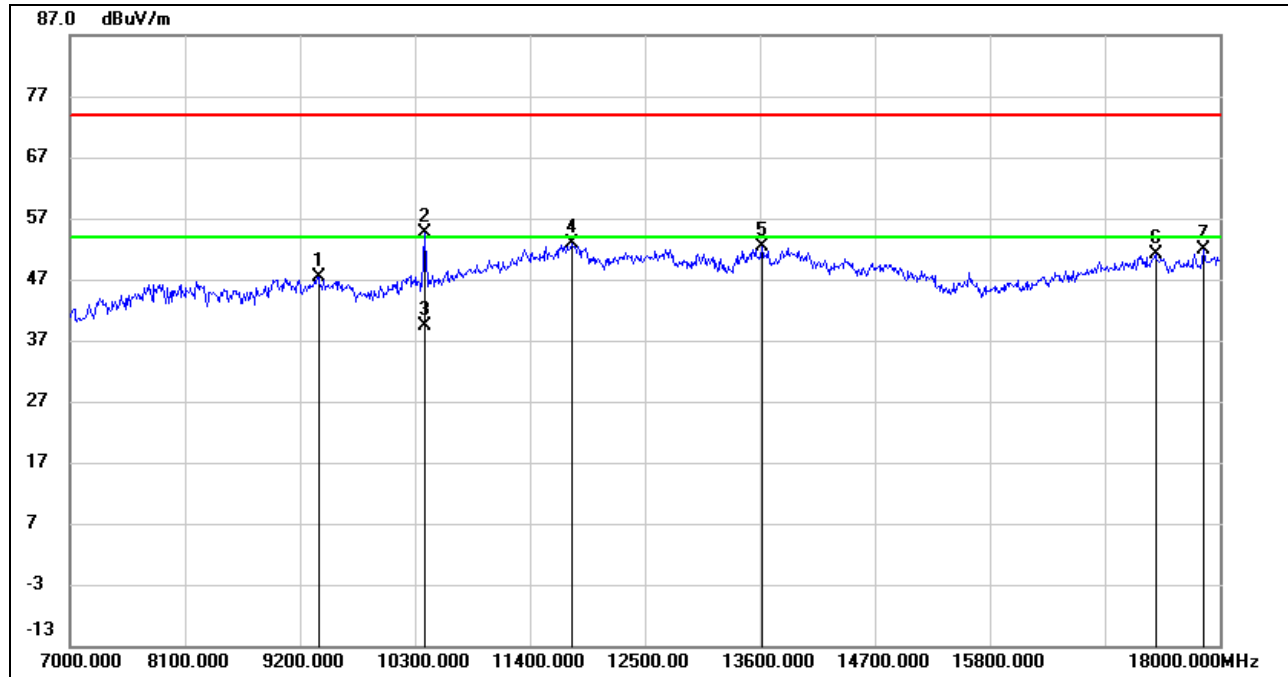

No.	Frequency (MHz)	Reading (dBuV)	Correct (dB/m)	Result (dBuV/m)	Limit (dBuV/m)	Margin (dB)	Remark
1	9381.500	37.33	10.02	47.35	74.00	-26.65	peak
2	10393.500	42.57	11.94	54.51	74.00	-19.49	peak
3	10393.500	27.38	11.94	39.32	54.00	-14.68	AVG
4	11812.500	35.50	17.33	52.83	74.00	-21.17	peak
5	13622.000	34.09	18.41	52.50	74.00	-21.50	peak
6	17389.500	31.22	19.83	51.05	74.00	-22.95	peak
7	17851.500	28.87	22.99	51.86	74.00	-22.14	peak

Note: 1. Measurement = Reading Level + Correct Factor.
 2. If Peak Result complies with AV limit, AV Result is deemed to comply with AV limit.
 3. Peak: Peak detector.
 4. Filter losses were only considered in the spurious frequency bands and the authorized band was not corrected for High Pass Filter losses.
 5. Proper operation of the transmitter prior to adding the filter to the measurement chain.
 6. Since non-restricted band peak emissions are less than the average limit, they also comply with the -27dBm/MHz (68.2dBuV/m) limit.

HARMONICS AND SPURIOUS EMISSIONS (HIGH CHANNEL, HORIZONTAL)

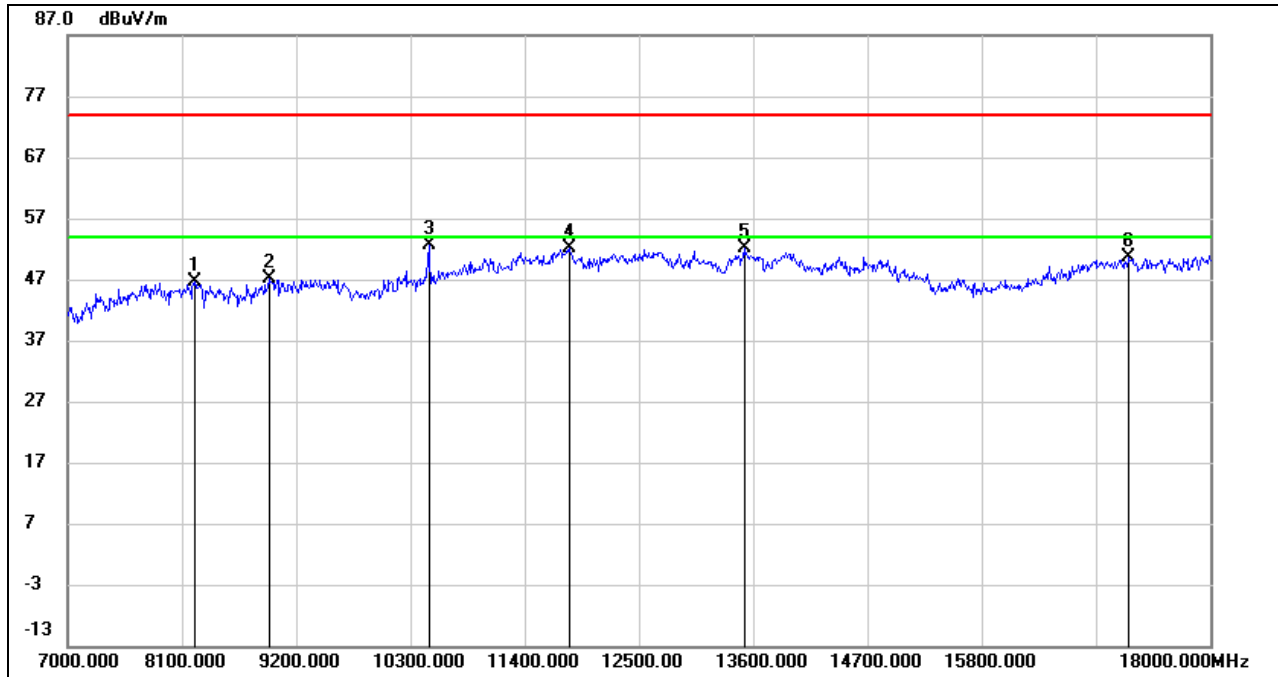

No.	Frequency (MHz)	Reading (dBuV)	Correct (dB/m)	Result (dBuV/m)	Limit (dBuV/m)	Margin (dB)	Remark
1	8226.500	38.14	8.61	46.75	74.00	-27.25	peak
2	8936.000	37.64	9.43	47.07	74.00	-26.93	peak
3	10476.000	40.32	12.34	52.66	74.00	-21.34	peak
4	11829.000	34.75	17.30	52.05	74.00	-21.95	peak
5	13517.500	33.66	18.40	52.06	74.00	-21.94	peak
6	17224.500	30.98	19.75	50.73	74.00	-23.27	peak

Note: 1. Measurement = Reading Level + Correct Factor.
 2. If Peak Result complies with AV limit, AV Result is deemed to comply with AV limit.
 3. Peak: Peak detector.
 4. Filter losses were only considered in the spurious frequency bands and the authorized band was not corrected for High Pass Filter losses.
 5. Proper operation of the transmitter prior to adding the filter to the measurement chain.
 6. Since non-restricted band peak emissions are less than the average limit, they also comply with the -27dBm/MHz (68.2dBuV/m) limit.

HARMONICS AND SPURIOUS EMISSIONS (HIGH CHANNEL, VERTICAL)

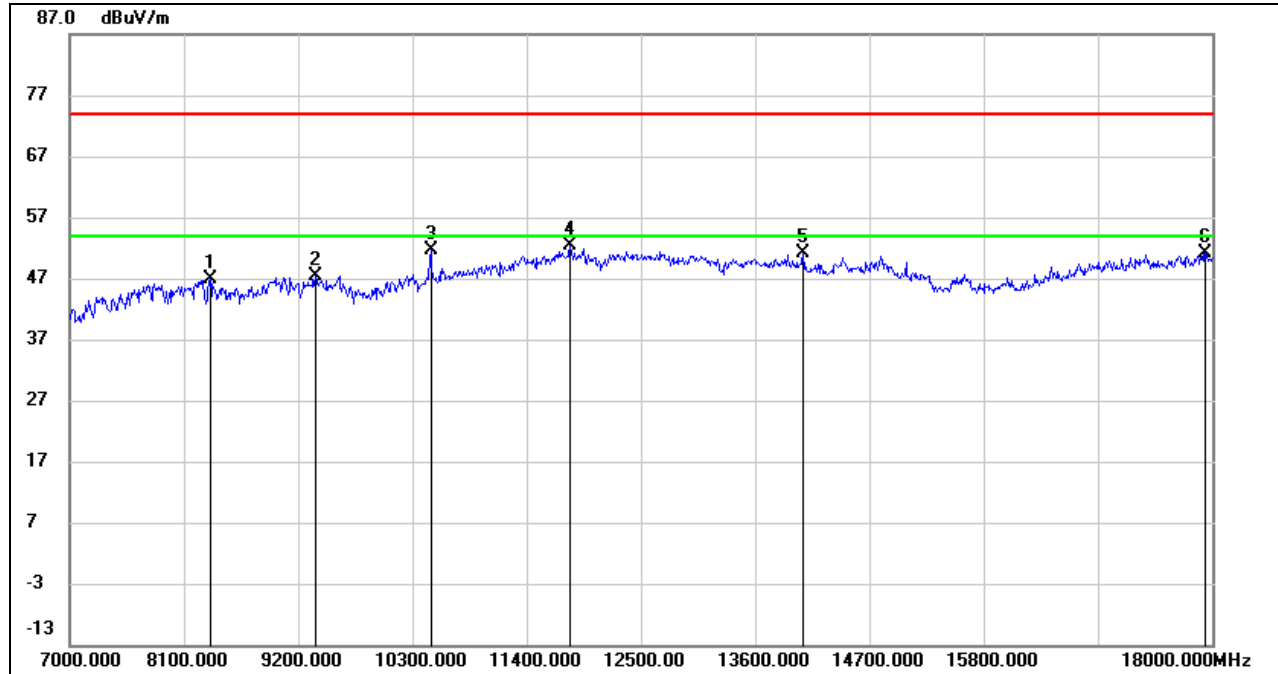

No.	Frequency (MHz)	Reading (dBuV)	Correct (dB/m)	Result (dBuV/m)	Limit (dBuV/m)	Margin (dB)	Remark
1	8353.000	38.73	8.10	46.83	74.00	-27.17	peak
2	9365.000	37.50	9.92	47.42	74.00	-26.58	peak
3	10476.000	39.26	12.34	51.60	74.00	-22.40	peak
4	11823.500	34.99	17.32	52.31	74.00	-21.69	peak
5	14062.000	32.80	18.33	51.13	74.00	-22.87	peak
6	17934.000	28.01	23.20	51.21	74.00	-22.79	peak

Note: 1. Measurement = Reading Level + Correct Factor.
 2. If Peak Result complies with AV limit, AV Result is deemed to comply with AV limit.
 3. Peak: Peak detector.
 4. Filter losses were only considered in the spurious frequency bands and the authorized band was not corrected for High Pass Filter losses.
 5. Proper operation of the transmitter prior to adding the filter to the measurement chain.
 6. Since non-restricted band peak emissions are less than the average limit, they also comply with the -27dBm/MHz (68.2dBuV/m) limit.

UNII-2A BAND

HARMONICS AND SPURIOUS EMISSIONS (LOW CHANNEL, HORIZONTAL)

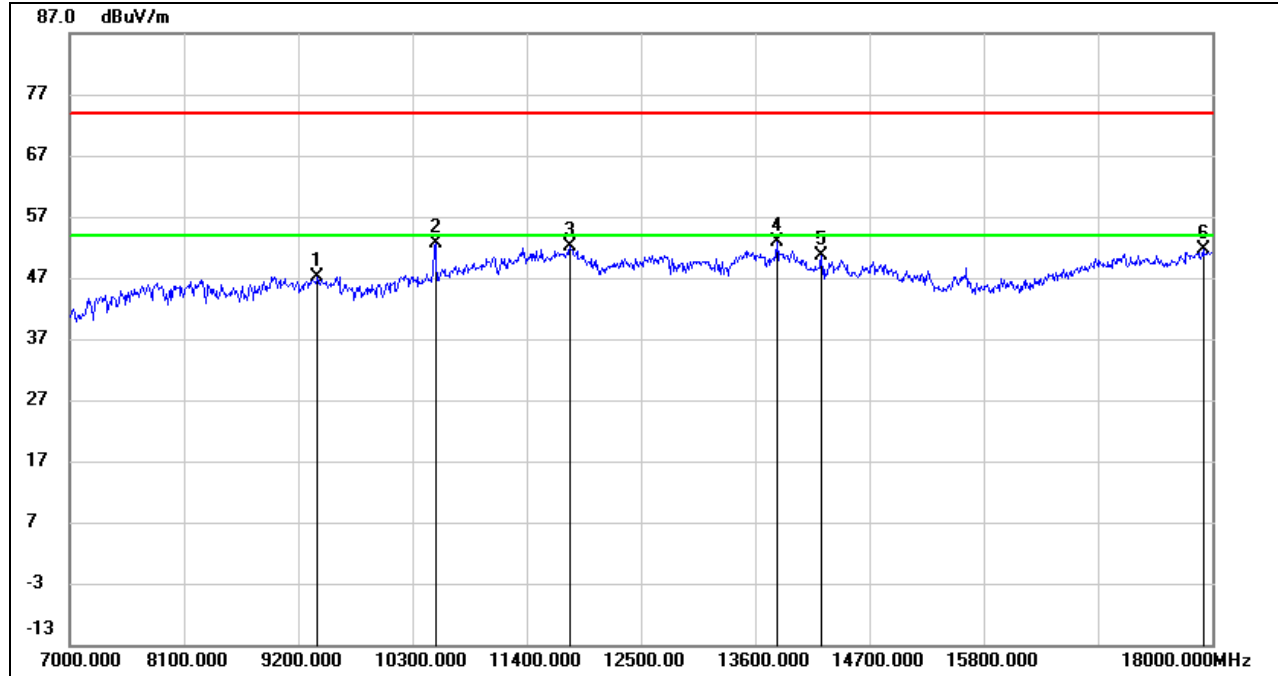

No.	Frequency (MHz)	Reading (dBuV)	Correct (dB/m)	Result (dBuV/m)	Limit (dBuV/m)	Margin (dB)	Remark
1	9392.500	37.10	10.09	47.19	74.00	-26.81	peak
2	10520.000	39.97	12.56	52.53	74.00	-21.47	peak
3	11823.500	34.84	17.32	52.16	74.00	-21.84	peak
4	13809.000	34.05	18.77	52.82	74.00	-21.18	peak
5	14238.000	32.78	17.77	50.55	74.00	-23.45	peak
6	17912.000	28.55	23.14	51.69	74.00	-22.31	peak

Note: 1. Measurement = Reading Level + Correct Factor.
 2. If Peak Result complies with AV limit, AV Result is deemed to comply with AV limit.
 3. Peak: Peak detector.
 4. Filter losses were only considered in the spurious frequency bands and the authorized band was not corrected for High Pass Filter losses.
 5. Proper operation of the transmitter prior to adding the filter to the measurement chain.
 6. Since non-restricted band peak emissions are less than the average limit, they also comply with the -27dBm/MHz (68.2dBuV/m) limit.

HARMONICS AND SPURIOUS EMISSIONS (LOW CHANNEL, VERTICAL)

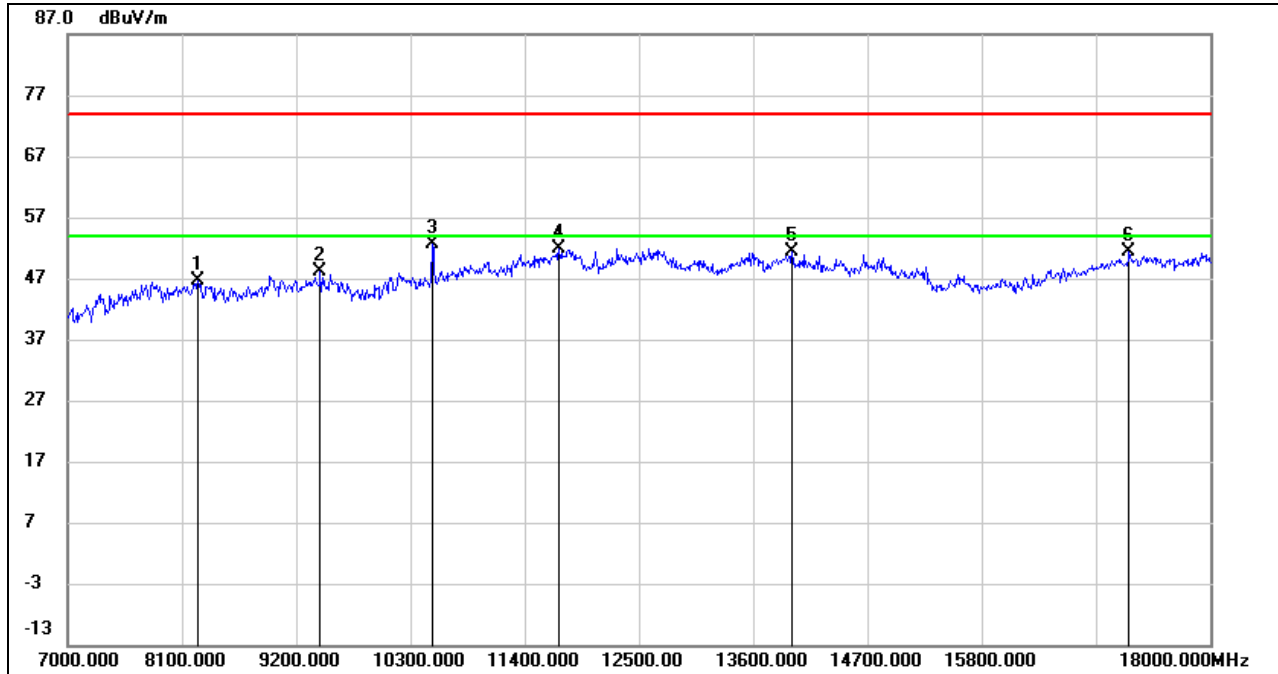

No.	Frequency (MHz)	Reading (dBuV)	Correct (dB/m)	Result (dBuV/m)	Limit (dBuV/m)	Margin (dB)	Remark
1	8254.000	38.09	8.50	46.59	74.00	-27.41	peak
2	9431.000	37.85	10.20	48.05	74.00	-25.95	peak
3	10514.500	40.06	12.52	52.58	74.00	-21.42	peak
4	11735.500	34.93	17.01	51.94	74.00	-22.06	peak
5	13974.000	32.80	18.58	51.38	74.00	-22.62	peak
6	17219.000	31.52	19.74	51.26	74.00	-22.74	peak

- Note: 1. Measurement = Reading Level + Correct Factor.
 2. If Peak Result complies with AV limit, AV Result is deemed to comply with AV limit.
 3. Peak: Peak detector.
 4. Filter losses were only considered in the spurious frequency bands and the authorized band was not corrected for High Pass Filter losses.
 5. Proper operation of the transmitter prior to adding the filter to the measurement chain.
 6. Since non-restricted band peak emissions are less than the average limit, they also comply with the -27dBm/MHz (68.2dBuV/m) limit.

HARMONICS AND SPURIOUS EMISSIONS (MID CHANNEL, HORIZONTAL)

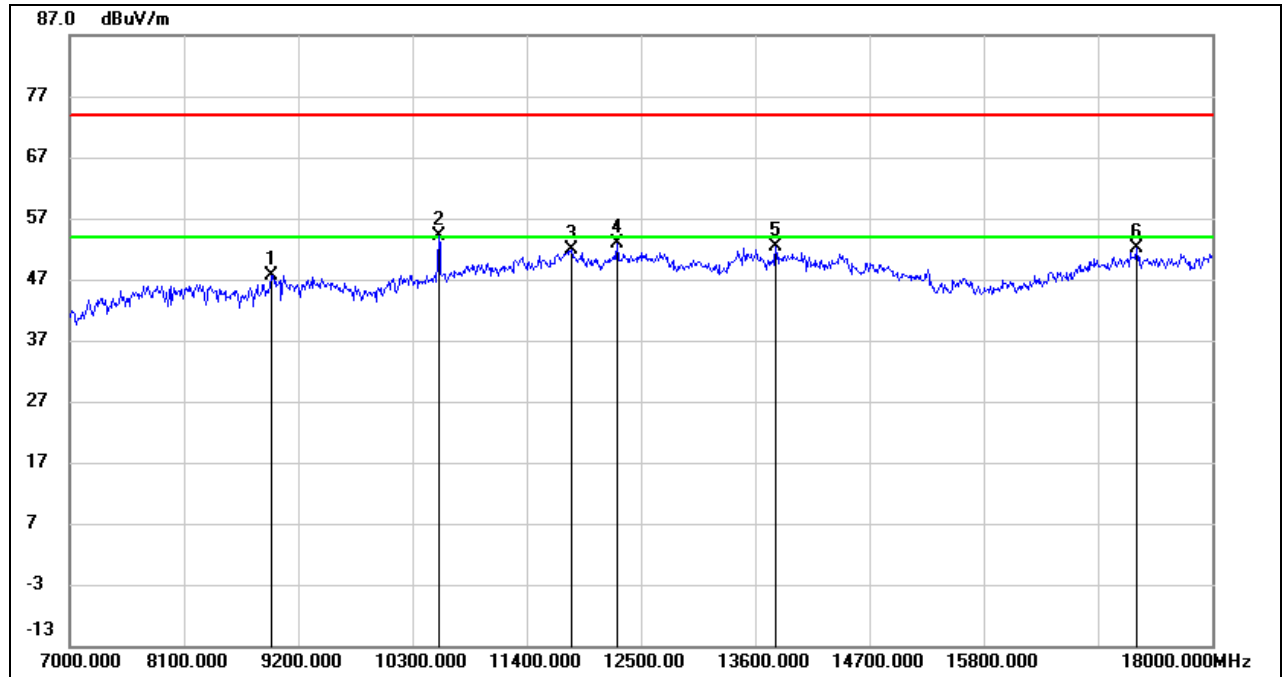

No.	Frequency (MHz)	Reading (dBuV)	Correct (dB/m)	Result (dBuV/m)	Limit (dBuV/m)	Margin (dB)	Remark
1	8941.500	38.22	9.49	47.71	74.00	-26.29	peak
2	10558.500	41.29	12.74	54.03	74.00	-19.97	peak
3	11829.000	34.51	17.30	51.81	74.00	-22.19	peak
4	12274.500	36.05	16.74	52.79	74.00	-21.21	peak
5	13798.000	33.54	18.78	52.32	74.00	-21.68	peak
6	17279.500	32.37	19.78	52.15	74.00	-21.85	peak

Note: 1. Measurement = Reading Level + Correct Factor.
 2. If Peak Result complies with AV limit, AV Result is deemed to comply with AV limit.
 3. Peak: Peak detector.
 4. Filter losses were only considered in the spurious frequency bands and the authorized band was not corrected for High Pass Filter losses.
 5. Proper operation of the transmitter prior to adding the filter to the measurement chain.
 6. Since non-restricted band peak emissions are less than the average limit, they also comply with the -27dBm/MHz (68.2dBuV/m) limit.

HARMONICS AND SPURIOUS EMISSIONS (MID CHANNEL, VERTICAL)

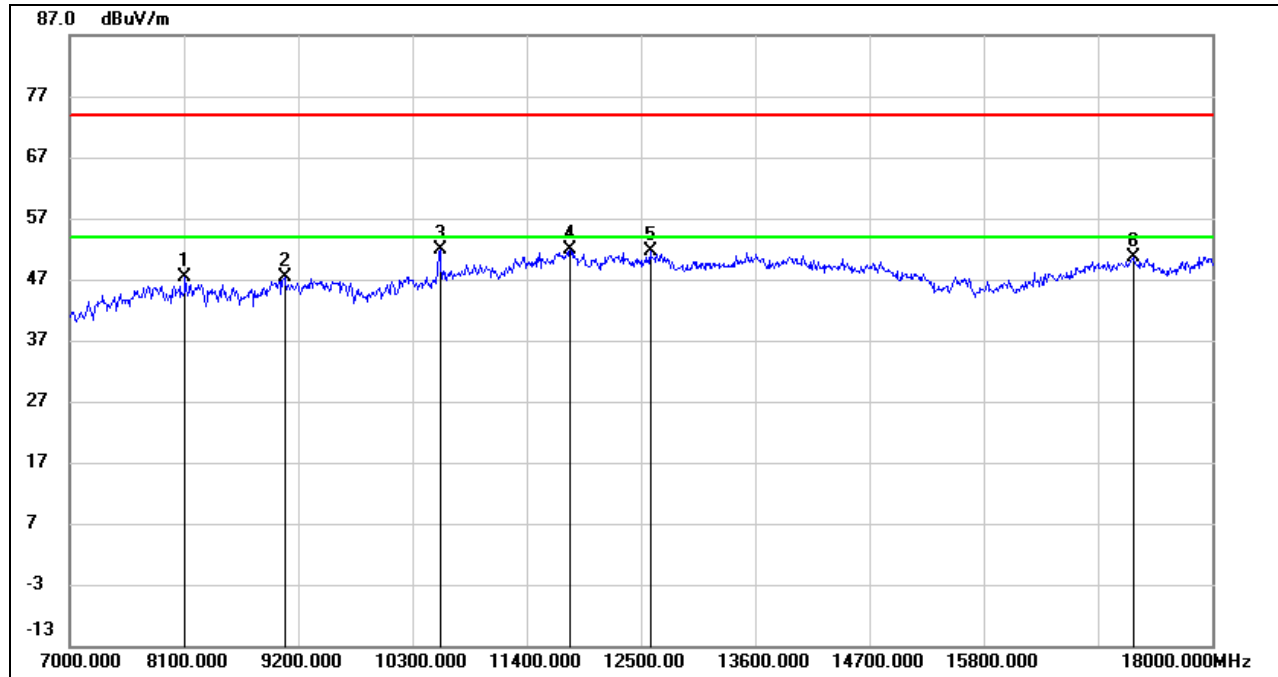

No.	Frequency (MHz)	Reading (dBuV)	Correct (dB/m)	Result (dBuV/m)	Limit (dBuV/m)	Margin (dB)	Remark
1	8111.000	39.30	7.99	47.29	74.00	-26.71	peak
2	9068.000	37.75	9.73	47.48	74.00	-26.52	peak
3	10564.000	39.23	12.76	51.99	74.00	-22.01	peak
4	11818.000	34.48	17.31	51.79	74.00	-22.21	peak
5	12593.500	35.00	16.63	51.63	74.00	-22.37	peak
6	17246.500	30.91	19.76	50.67	74.00	-23.33	peak

Note: 1. Measurement = Reading Level + Correct Factor.
 2. If Peak Result complies with AV limit, AV Result is deemed to comply with AV limit.
 3. Peak: Peak detector.
 4. Filter losses were only considered in the spurious frequency bands and the authorized band was not corrected for High Pass Filter losses.
 5. Proper operation of the transmitter prior to adding the filter to the measurement chain.
 6. Since non-restricted band peak emissions are less than the average limit, they also comply with the -27dBm/MHz (68.2dBuV/m) limit.

HARMONICS AND SPURIOUS EMISSIONS (HIGH CHANNEL, HORIZONTAL)

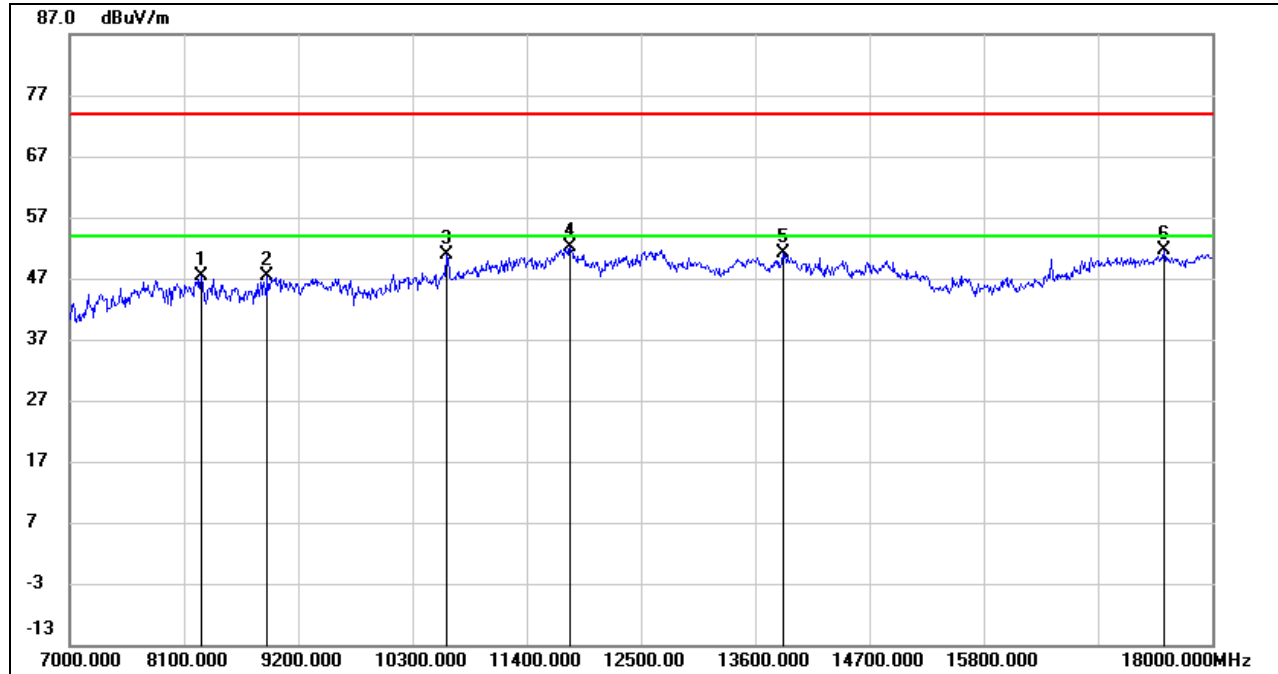

No.	Frequency (MHz)	Reading (dBuV)	Correct (dB/m)	Result (dBuV/m)	Limit (dBuV/m)	Margin (dB)	Remark
1	8270.500	38.84	8.43	47.27	74.00	-26.73	peak
2	8908.500	38.23	9.13	47.36	74.00	-26.64	peak
3	10635.500	37.96	13.03	50.99	74.00	-23.01	peak
4	11818.000	34.77	17.31	52.08	74.00	-21.92	peak
5	13864.000	32.37	18.70	51.07	74.00	-22.93	peak
6	17538.000	31.29	20.37	51.66	74.00	-22.34	peak

Note: 1. Measurement = Reading Level + Correct Factor.
 2. If Peak Result complies with AV limit, AV Result is deemed to comply with AV limit.
 3. Peak: Peak detector.
 4. Filter losses were only considered in the spurious frequency bands and the authorized band was not corrected for High Pass Filter losses.
 5. Proper operation of the transmitter prior to adding the filter to the measurement chain.
 6. Since non-restricted band peak emissions are less than the average limit, they also comply with the -27dBm/MHz (68.2dBuV/m) limit.

HARMONICS AND SPURIOUS EMISSIONS (HIGH CHANNEL, VERTICAL)

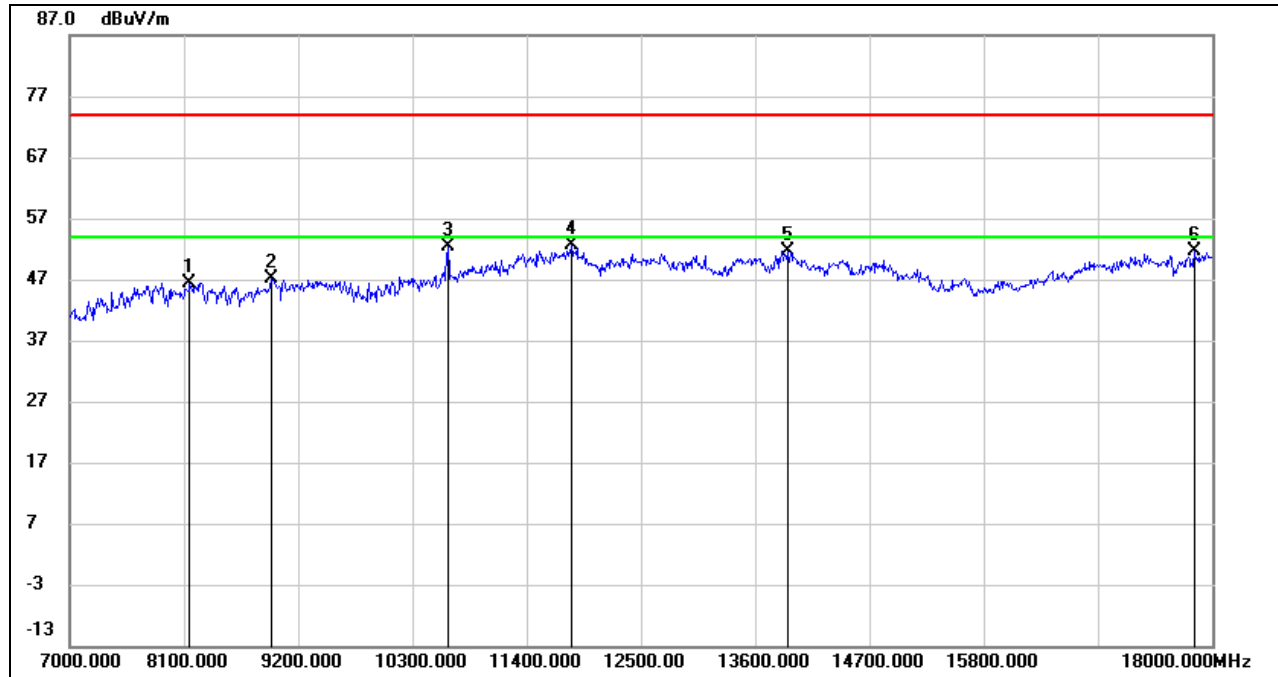

No.	Frequency (MHz)	Reading (dBuV)	Correct (dB/m)	Result (dBuV/m)	Limit (dBuV/m)	Margin (dB)	Remark
1	8160.500	38.10	8.40	46.50	74.00	-27.50	peak
2	8941.500	37.69	9.49	47.18	74.00	-26.82	peak
3	10641.000	39.24	13.04	52.28	74.00	-21.72	peak
4	11834.500	35.27	17.29	52.56	74.00	-21.44	peak
5	13908.000	32.97	18.66	51.63	74.00	-22.37	peak
6	17829.500	28.61	22.94	51.55	74.00	-22.45	peak

Note: 1. Measurement = Reading Level + Correct Factor.
 2. If Peak Result complies with AV limit, AV Result is deemed to comply with AV limit.
 3. Peak: Peak detector.
 4. Filter losses were only considered in the spurious frequency bands and the authorized band was not corrected for High Pass Filter losses.
 5. Proper operation of the transmitter prior to adding the filter to the measurement chain.
 6. Since non-restricted band peak emissions are less than the average limit, they also comply with the -27dBm/MHz (68.2dBuV/m) limit.

UNII-2C BAND

HARMONICS AND SPURIOUS EMISSIONS (LOW CHANNEL, HORIZONTAL)

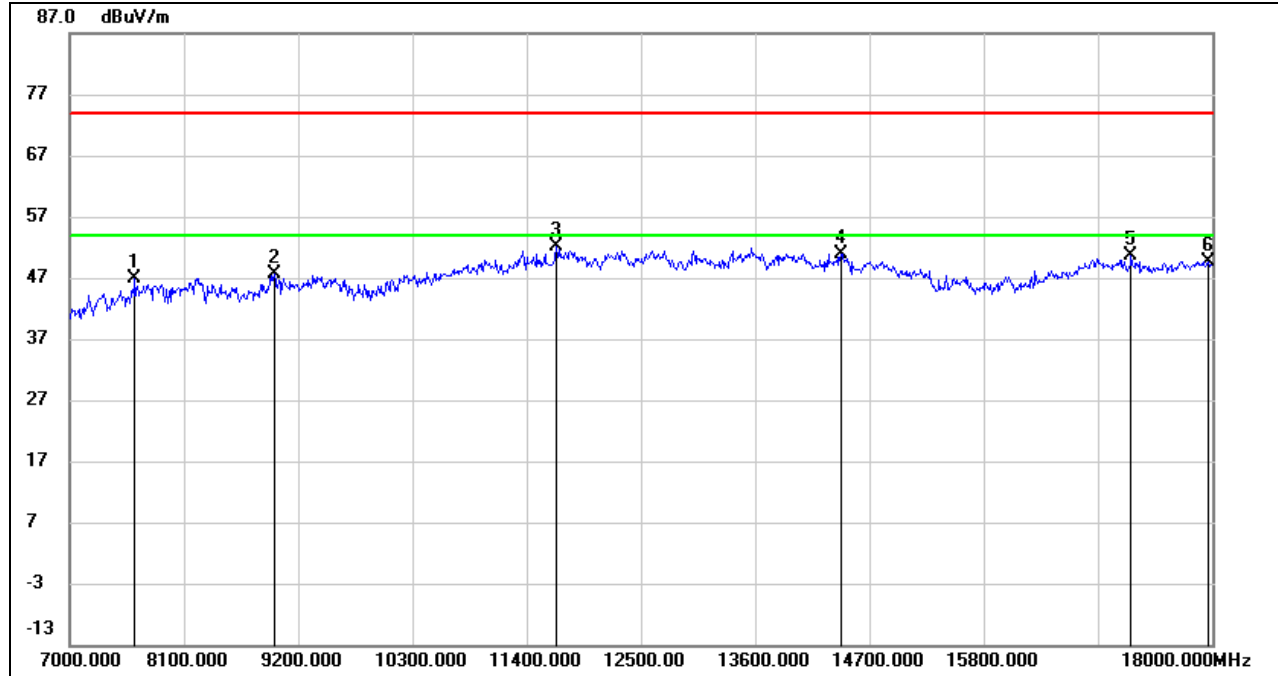

No.	Frequency (MHz)	Reading (dBuV)	Correct (dB/m)	Result (dBuV/m)	Limit (dBuV/m)	Margin (dB)	Remark
1	7632.500	39.92	6.93	46.85	74.00	-27.15	peak
2	8969.000	37.74	9.79	47.53	74.00	-26.47	peak
3	11686.000	35.32	16.75	52.07	74.00	-21.93	peak
4	14430.500	33.68	17.30	50.98	74.00	-23.02	peak
5	17224.500	30.85	19.75	50.60	74.00	-23.40	peak
6	17956.000	26.49	23.26	49.75	74.00	-24.25	peak

Note: 1. Measurement = Reading Level + Correct Factor.
 2. If Peak Result complies with AV limit, AV Result is deemed to comply with AV limit.
 3. Peak: Peak detector.
 4. Filter losses were only considered in the spurious frequency bands and the authorized band was not corrected for High Pass Filter losses.
 5. Proper operation of the transmitter prior to adding the filter to the measurement chain.
 6. Since non-restricted band peak emissions are less than the average limit, they also comply with the -27dBm/MHz (68.2dBuV/m) limit.



HARMONICS AND SPURIOUS EMISSIONS (LOW CHANNEL, VERTICAL)

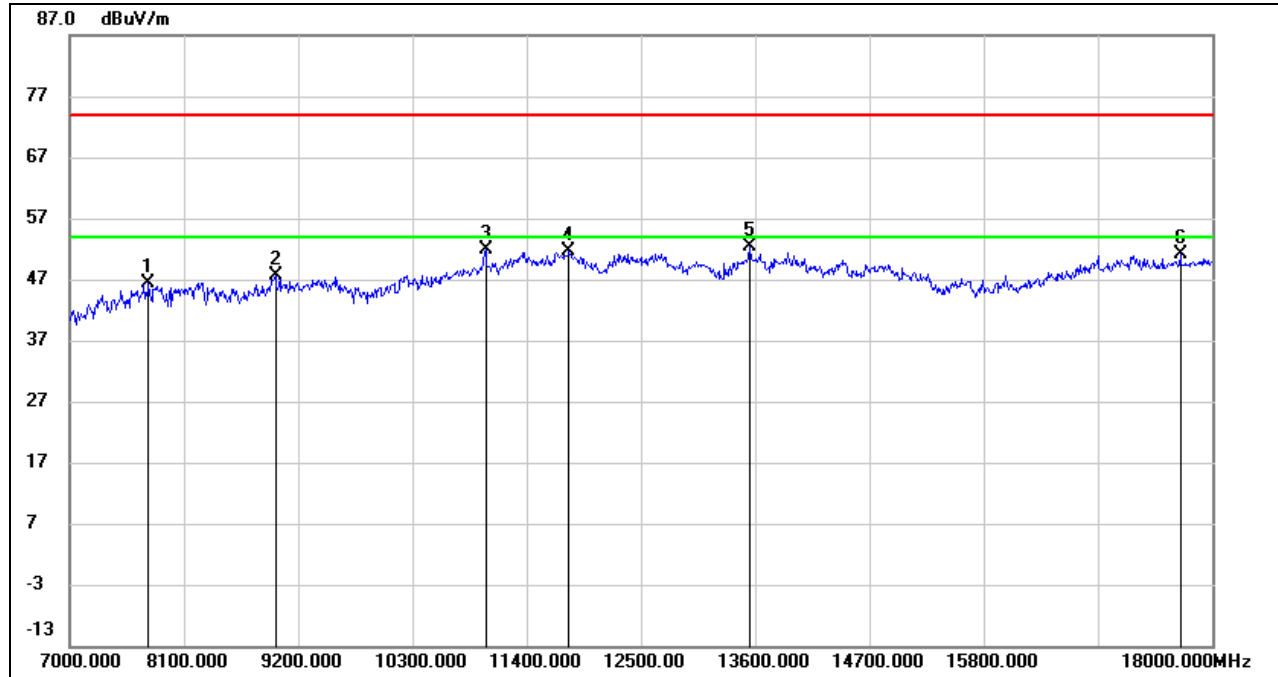

No.	Frequency (MHz)	Reading (dBuV)	Correct (dB/m)	Result (dBuV/m)	Limit (dBuV/m)	Margin (dB)	Remark
1	7759.000	38.81	7.45	46.26	74.00	-27.74	peak
2	8985.500	37.56	9.97	47.53	74.00	-26.47	peak
3	11004.000	37.63	14.17	51.80	74.00	-22.20	peak
4	11812.500	34.31	17.33	51.64	74.00	-22.36	peak
5	13545.000	34.01	18.39	52.40	74.00	-21.60	peak
6	17697.500	29.37	21.78	51.15	74.00	-22.85	peak

- Note: 1. Measurement = Reading Level + Correct Factor.
 2. If Peak Result complies with AV limit, AV Result is deemed to comply with AV limit.
 3. Peak: Peak detector.
 4. Filter losses were only considered in the spurious frequency bands and the authorized band was not corrected for High Pass Filter losses.
 5. Proper operation of the transmitter prior to adding the filter to the measurement chain.
 6. Since non-restricted band peak emissions are less than the average limit, they also comply with the -27dBm/MHz (68.2dBuV/m) limit.

HARMONICS AND SPURIOUS EMISSIONS (MID CHANNEL, HORIZONTAL)

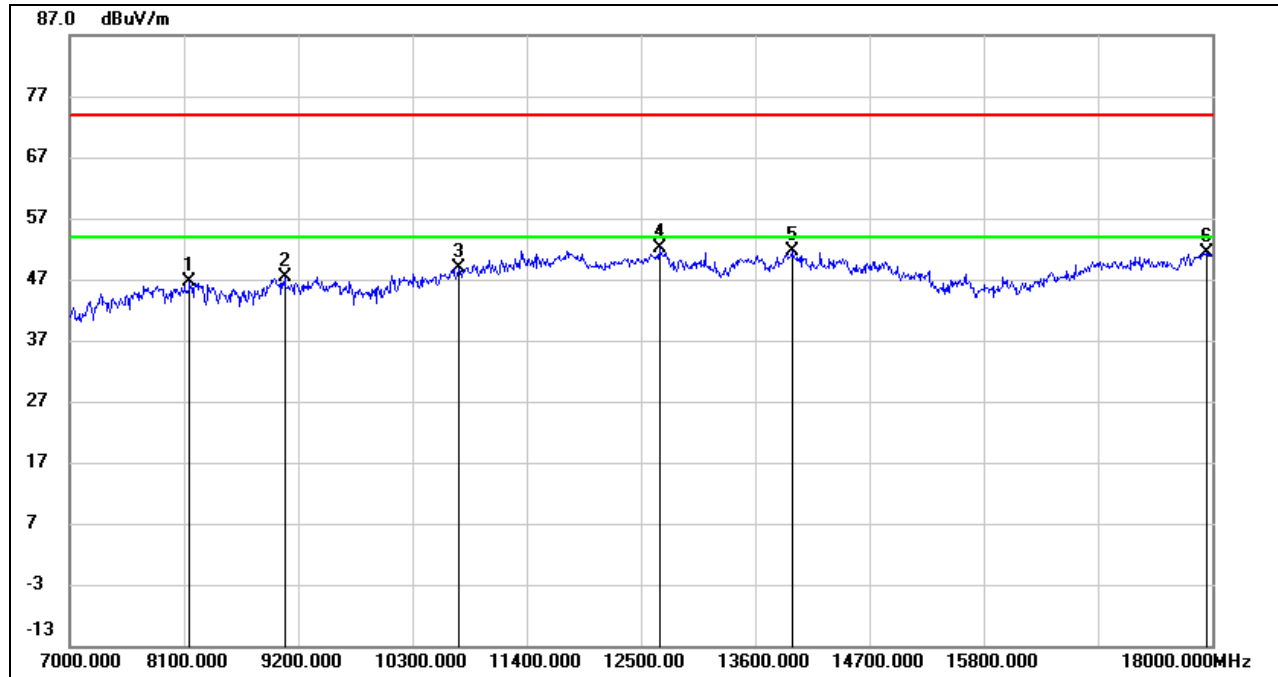

No.	Frequency (MHz)	Reading (dBuV)	Correct (dB/m)	Result (dBuV/m)	Limit (dBuV/m)	Margin (dB)	Remark
1	8155.000	38.24	8.35	46.59	74.00	-27.41	peak
2	9068.000	37.55	9.73	47.28	74.00	-26.72	peak
3	10751.000	35.68	13.30	48.98	74.00	-25.02	peak
4	12676.000	35.22	16.79	52.01	74.00	-21.99	peak
5	13952.000	32.98	18.61	51.59	74.00	-22.41	peak
6	17945.000	28.26	23.23	51.49	74.00	-22.51	peak

Note: 1. Measurement = Reading Level + Correct Factor.
 2. If Peak Result complies with AV limit, AV Result is deemed to comply with AV limit.
 3. Peak: Peak detector.
 4. Filter losses were only considered in the spurious frequency bands and the authorized band was not corrected for High Pass Filter losses.
 5. Proper operation of the transmitter prior to adding the filter to the measurement chain.
 6. Since non-restricted band peak emissions are less than the average limit, they also comply with the -27dBm/MHz (68.2dBuV/m) limit.



HARMONICS AND SPURIOUS EMISSIONS (MID CHANNEL, VERTICAL)

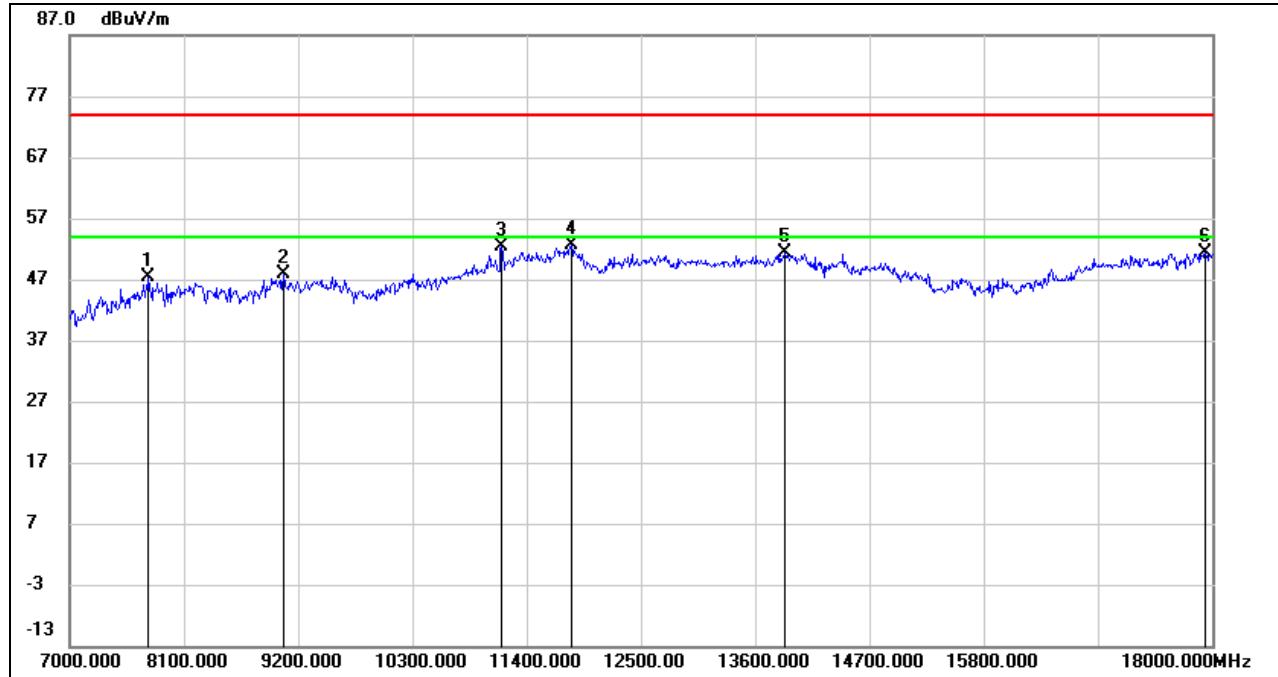

No.	Frequency (MHz)	Reading (dBuV)	Correct (dB/m)	Result (dBuV/m)	Limit (dBuV/m)	Margin (dB)	Remark
1	7759.000	40.05	7.45	47.50	74.00	-26.50	peak
2	9062.500	38.17	9.76	47.93	74.00	-26.07	peak
3	11158.000	37.54	14.74	52.28	74.00	-21.72	peak
4	11829.000	35.26	17.30	52.56	74.00	-21.44	peak
5	13891.500	32.64	18.67	51.31	74.00	-22.69	peak
6	17939.500	28.16	23.22	51.38	74.00	-22.62	peak

- Note: 1. Measurement = Reading Level + Correct Factor.
 2. If Peak Result complies with AV limit, AV Result is deemed to comply with AV limit.
 3. Peak: Peak detector.
 4. Filter losses were only considered in the spurious frequency bands and the authorized band was not corrected for High Pass Filter losses.
 5. Proper operation of the transmitter prior to adding the filter to the measurement chain.
 6. Since non-restricted band peak emissions are less than the average limit, they also comply with the -27dBm/MHz (68.2dBuV/m) limit.

HARMONICS AND SPURIOUS EMISSIONS (HIGH CHANNEL, HORIZONTAL)

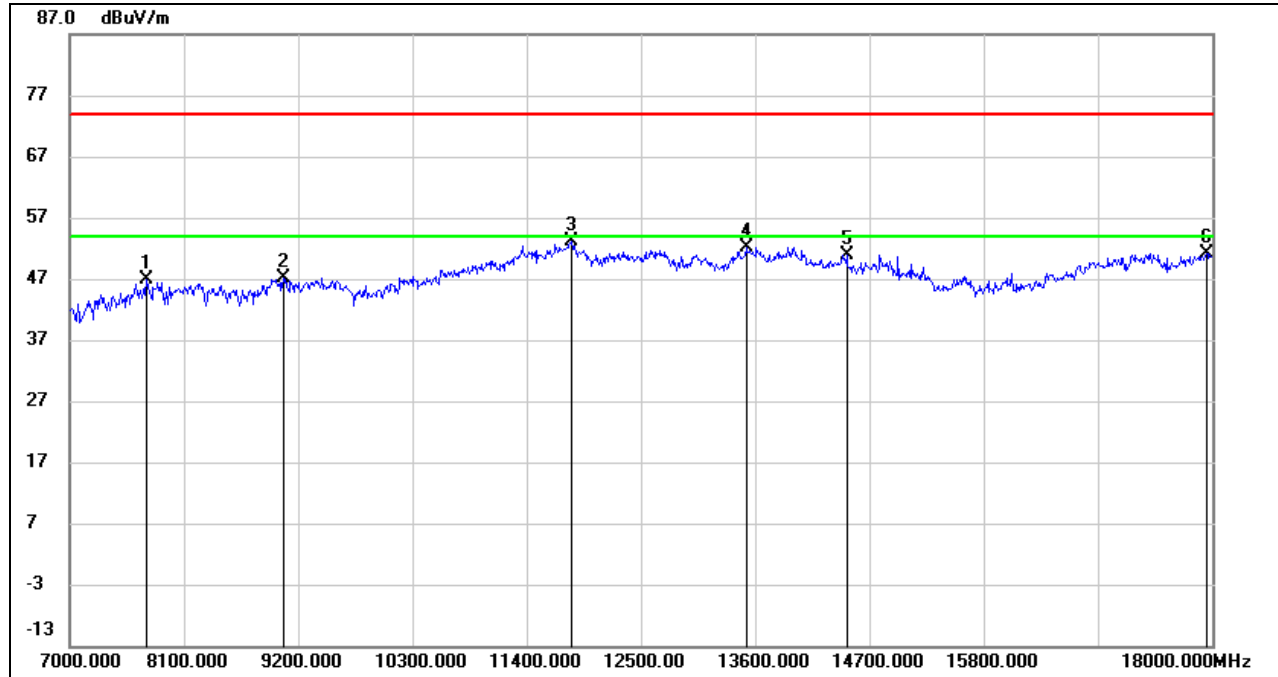

No.	Frequency (MHz)	Reading (dBuV)	Correct (dB/m)	Result (dBuV/m)	Limit (dBuV/m)	Margin (dB)	Remark
1	7737.000	39.42	7.35	46.77	74.00	-27.23	peak
2	9057.000	37.26	9.80	47.06	74.00	-26.94	peak
3	11829.000	35.89	17.30	53.19	74.00	-20.81	peak
4	13512.000	33.83	18.41	52.24	74.00	-21.76	peak
5	14480.000	33.90	17.07	50.97	74.00	-23.03	peak
6	17945.000	27.82	23.23	51.05	74.00	-22.95	peak

- Note: 1. Measurement = Reading Level + Correct Factor.
 2. If Peak Result complies with AV limit, AV Result is deemed to comply with AV limit.
 3. Peak: Peak detector.
 4. Filter losses were only considered in the spurious frequency bands and the authorized band was not corrected for High Pass Filter losses.
 5. Proper operation of the transmitter prior to adding the filter to the measurement chain.
 6. Since non-restricted band peak emissions are less than the average limit, they also comply with the -27dBm/MHz (68.2dBuV/m) limit.

HARMONICS AND SPURIOUS EMISSIONS (HIGH CHANNEL, VERTICAL)

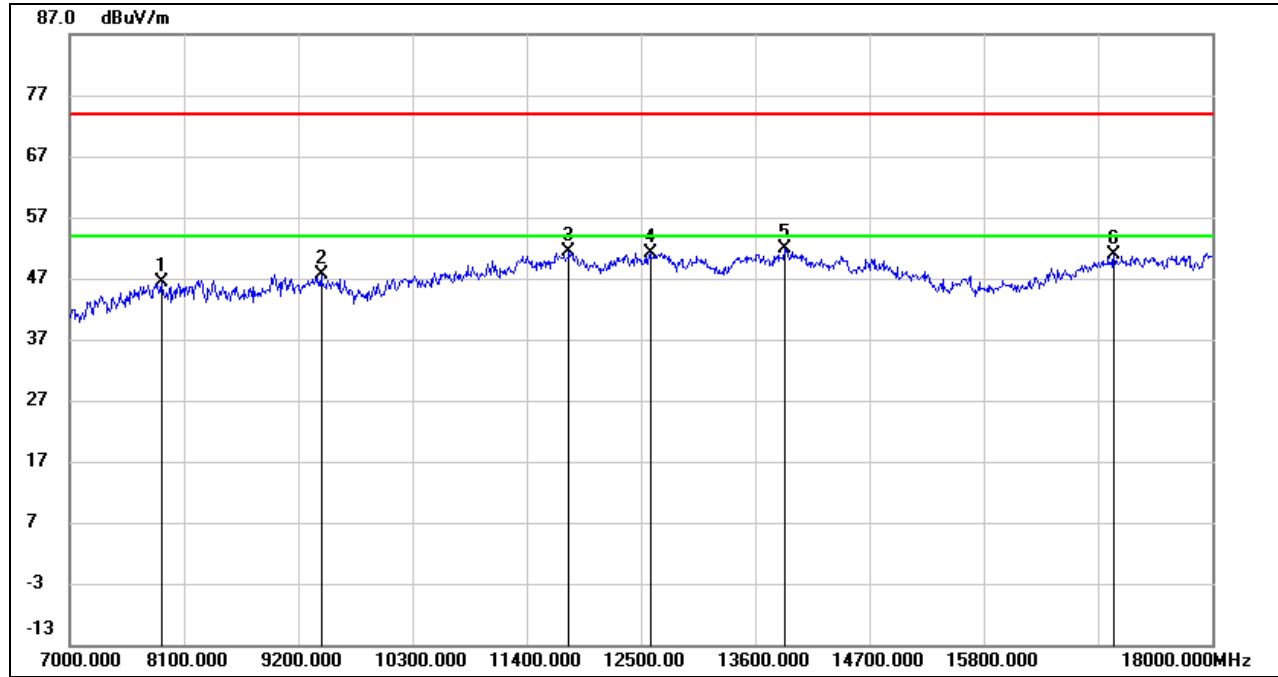

No.	Frequency (MHz)	Reading (dBuV)	Correct (dB/m)	Result (dBuV/m)	Limit (dBuV/m)	Margin (dB)	Remark
1	7880.000	38.98	7.39	46.37	74.00	-27.63	peak
2	9420.000	37.50	10.17	47.67	74.00	-26.33	peak
3	11807.000	33.91	17.35	51.26	74.00	-22.74	peak
4	12588.000	34.52	16.63	51.15	74.00	-22.85	peak
5	13886.000	33.30	18.68	51.98	74.00	-22.02	peak
6	17054.000	31.98	18.86	50.84	74.00	-23.16	peak

Note: 1. Measurement = Reading Level + Correct Factor.
 2. If Peak Result complies with AV limit, AV Result is deemed to comply with AV limit.
 3. Peak: Peak detector.
 4. Filter losses were only considered in the spurious frequency bands and the authorized band was not corrected for High Pass Filter losses.
 5. Proper operation of the transmitter prior to adding the filter to the measurement chain.
 6. Since non-restricted band peak emissions are less than the average limit, they also comply with the -27dBm/MHz (68.2dBuV/m) limit.



STRADDLE CHANNEL 144

HARMONICS AND SPURIOUS EMISSIONS (HORIZONTAL)

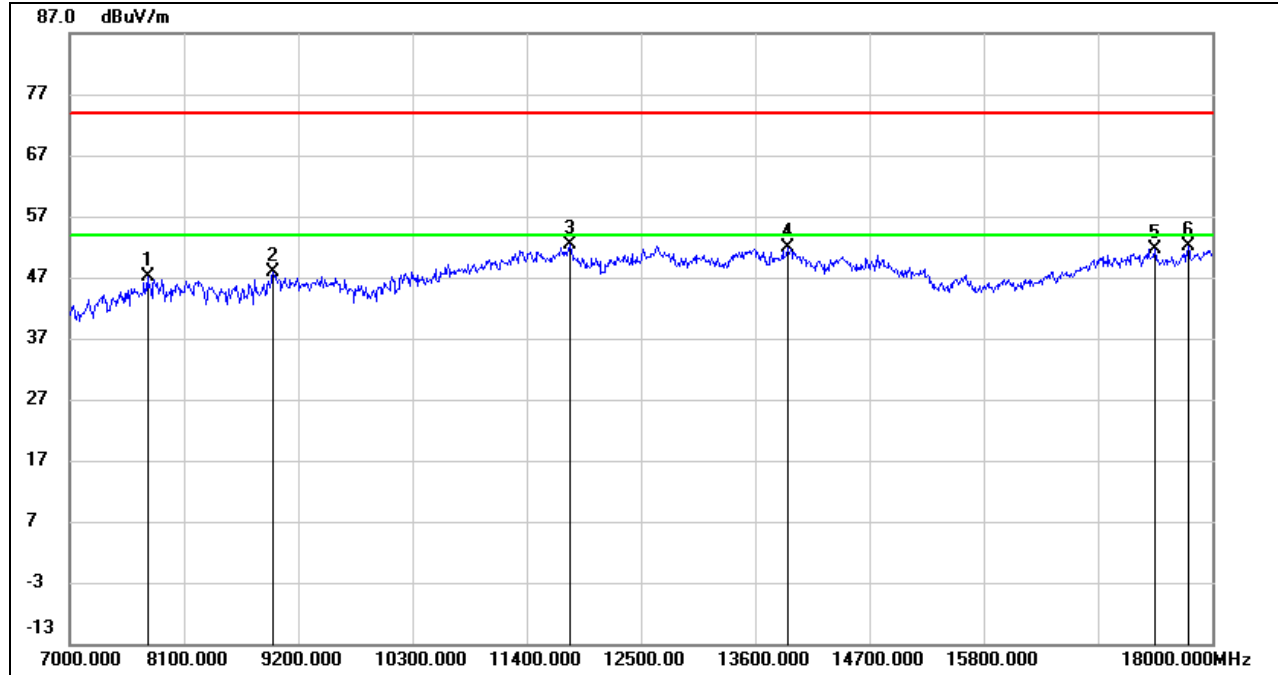

No.	Frequency (MHz)	Reading (dBuV)	Correct (dB/m)	Result (dBuV/m)	Limit (dBuV/m)	Margin (dB)	Remark
1	7748.000	39.76	7.40	47.16	74.00	-26.84	peak
2	8958.000	38.26	9.67	47.93	74.00	-26.07	peak
3	11818.000	35.06	17.31	52.37	74.00	-21.63	peak
4	13919.000	33.14	18.64	51.78	74.00	-22.22	peak
5	17450.000	31.69	19.98	51.67	74.00	-22.33	peak
6	17769.000	29.56	22.53	52.09	74.00	-21.91	peak

Note: 1. Measurement = Reading Level + Correct Factor.
 2. If Peak Result complies with AV limit, AV Result is deemed to comply with AV limit.
 3. Peak: Peak detector.
 4. Filter losses were only considered in the spurious frequency bands and the authorized band was not corrected for High Pass Filter losses.
 5. Proper operation of the transmitter prior to adding the filter to the measurement chain.
 6. Since non-restricted band peak emissions are less than the average limit, they also comply with the -27dBm/MHz (68.2dBuV/m) limit.



HARMONICS AND SPURIOUS EMISSIONS (VERTICAL)

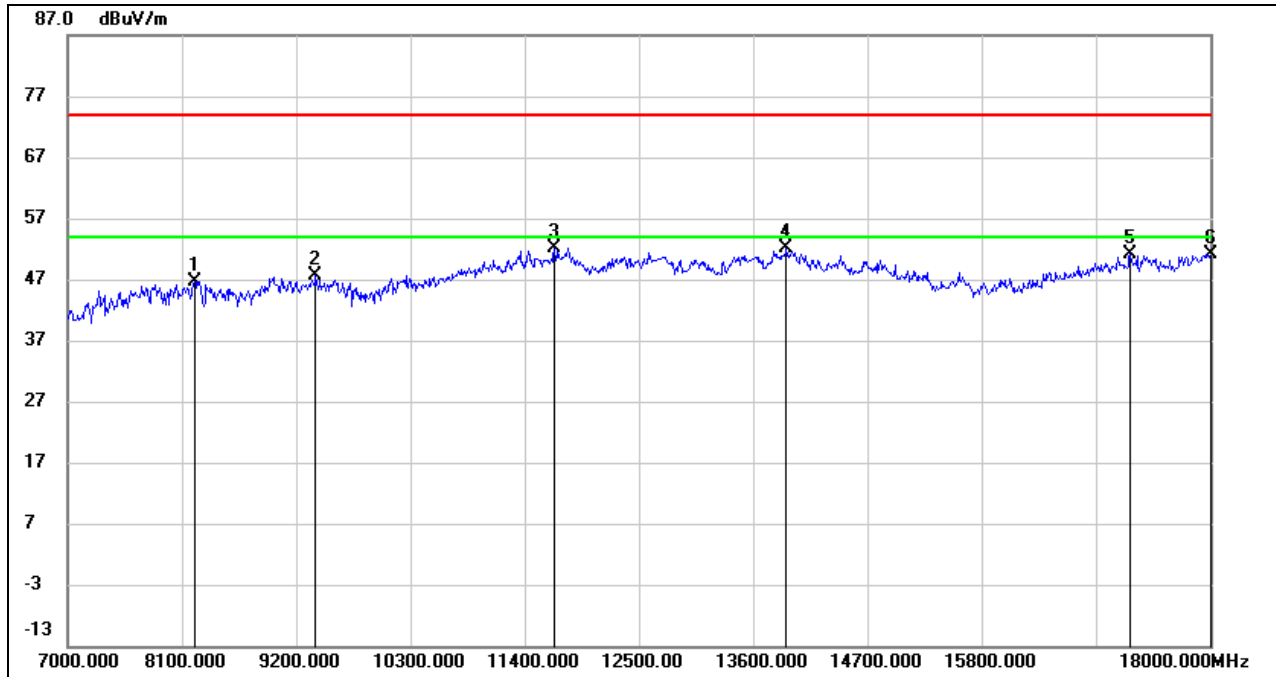

No.	Frequency (MHz)	Reading (dBuV)	Correct (dB/m)	Result (dBuV/m)	Limit (dBuV/m)	Margin (dB)	Remark
1	8221.000	38.01	8.63	46.64	74.00	-27.36	peak
2	9387.000	37.65	10.05	47.70	74.00	-26.30	peak
3	11686.000	35.44	16.75	52.19	74.00	-21.81	peak
4	13919.000	33.46	18.64	52.10	74.00	-21.90	peak
5	17230.000	31.40	19.75	51.15	74.00	-22.85	peak
6	18000.000	27.83	23.37	51.20	74.00	-22.80	peak

Note: 1. Measurement = Reading Level + Correct Factor.
 2. If Peak Result complies with AV limit, AV Result is deemed to comply with AV limit.
 3. Peak: Peak detector.
 4. Filter losses were only considered in the spurious frequency bands and the authorized band was not corrected for High Pass Filter losses.
 5. Proper operation of the transmitter prior to adding the filter to the measurement chain.
 6. Since non-restricted band peak emissions are less than the average limit, they also comply with the -27dBm/MHz (68.2dBuV/m) limit.

UNII-3 BAND

HARMONICS AND SPURIOUS EMISSIONS (LOW CHANNEL, HORIZONTAL)

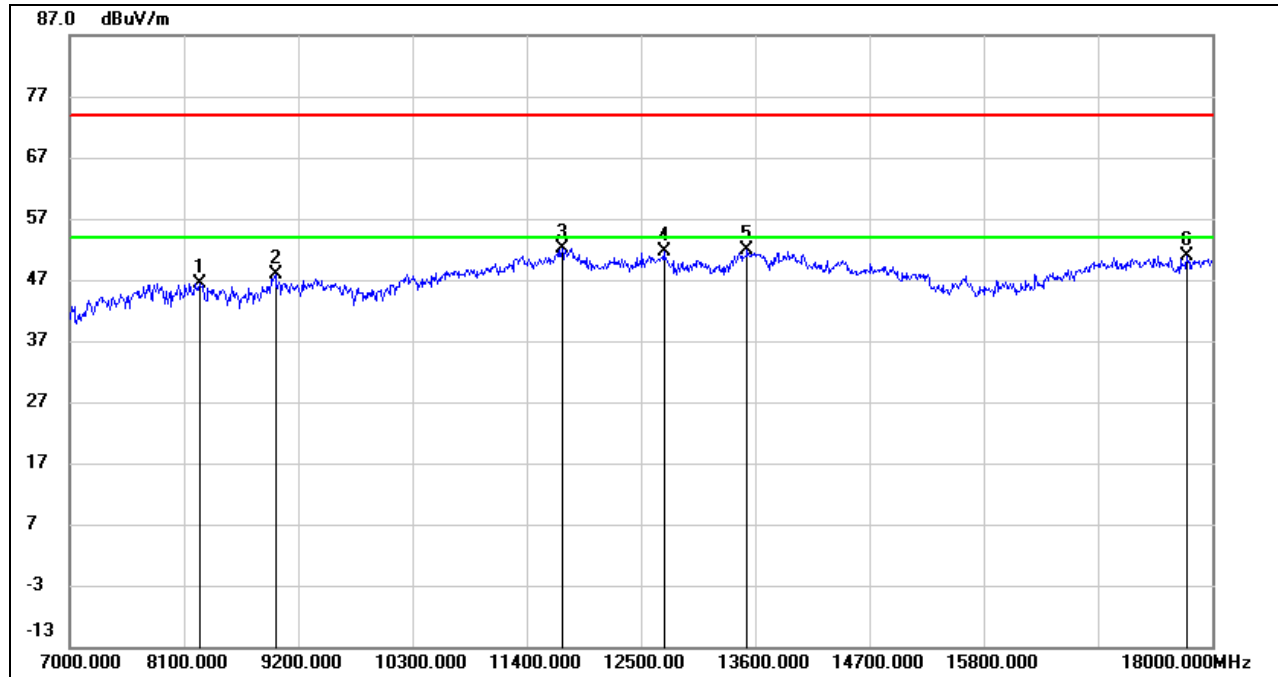

No.	Frequency (MHz)	Reading (dBuV)	Correct (dB/m)	Result (dBuV/m)	Limit (dBuV/m)	Margin (dB)	Remark
1	8254.000	37.99	8.50	46.49	74.00	-27.51	peak
2	8980.000	37.89	9.91	47.80	74.00	-26.20	peak
3	11741.000	35.04	17.03	52.07	74.00	-21.93	peak
4	12720.000	34.80	16.89	51.69	74.00	-22.31	peak
5	13523.000	33.55	18.41	51.96	74.00	-22.04	peak
6	17758.000	28.44	22.42	50.86	74.00	-23.14	peak

Note: 1. Measurement = Reading Level + Correct Factor.
 2. If Peak Result complies with AV limit, AV Result is deemed to comply with AV limit.
 3. Peak: Peak detector.
 4. Filter losses were only considered in the spurious frequency bands and the authorized band was not corrected for High Pass Filter losses.
 5. Proper operation of the transmitter prior to adding the filter to the measurement chain.
 6. Since non-restricted band peak emissions are less than the average limit, they also comply with the -27dBm/MHz (68.2dBuV/m) limit.

HARMONICS AND SPURIOUS EMISSIONS (LOW CHANNEL, VERTICAL)

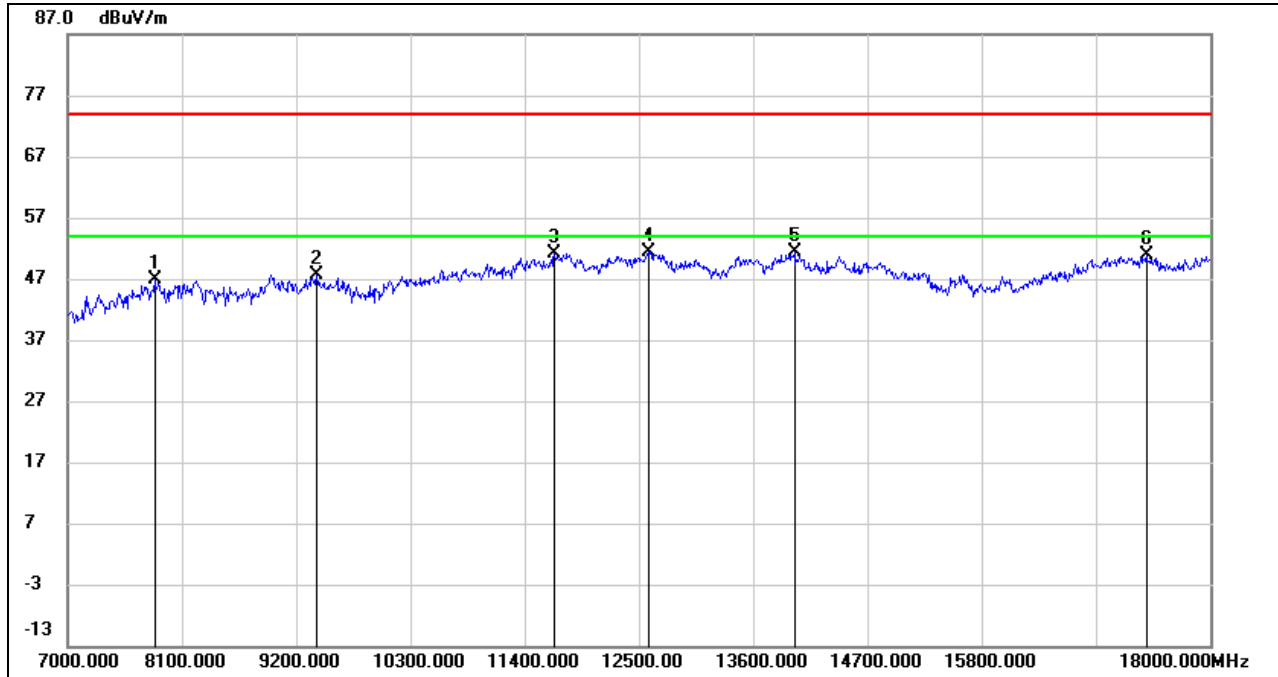

No.	Frequency (MHz)	Reading (dBuV)	Correct (dB/m)	Result (dBuV/m)	Limit (dBuV/m)	Margin (dB)	Remark
1	7836.000	39.34	7.51	46.85	74.00	-27.15	peak
2	9398.000	37.63	10.12	47.75	74.00	-26.25	peak
3	11686.000	34.26	16.75	51.01	74.00	-22.99	peak
4	12588.000	34.77	16.63	51.40	74.00	-22.60	peak
5	13996.000	32.91	18.55	51.46	74.00	-22.54	peak
6	17384.000	31.17	19.83	51.00	74.00	-23.00	peak

- Note: 1. Measurement = Reading Level + Correct Factor.
 2. If Peak Result complies with AV limit, AV Result is deemed to comply with AV limit.
 3. Peak: Peak detector.
 4. Filter losses were only considered in the spurious frequency bands and the authorized band was not corrected for High Pass Filter losses.
 5. Proper operation of the transmitter prior to adding the filter to the measurement chain.
 6. Since non-restricted band peak emissions are less than the average limit, they also comply with the -27dBm/MHz (68.2dBuV/m) limit.

HARMONICS AND SPURIOUS EMISSIONS (MID CHANNEL, HORIZONTAL)

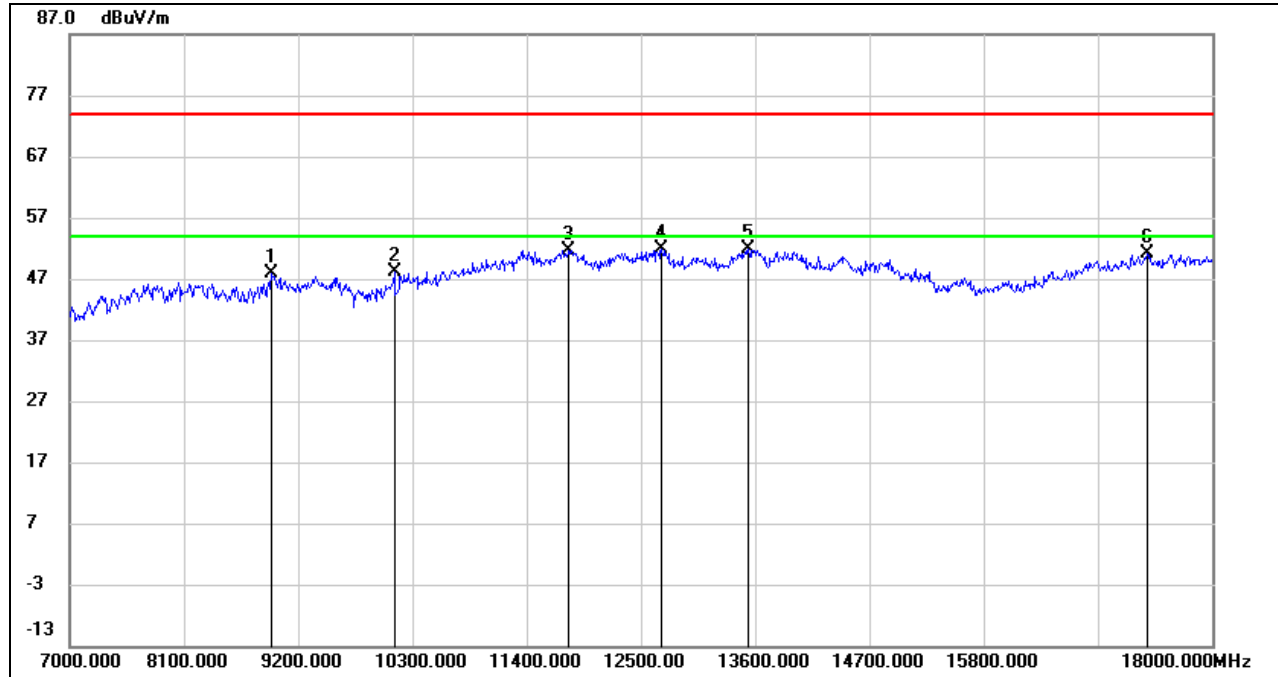

No.	Frequency (MHz)	Reading (dBuV)	Correct (dB/m)	Result (dBuV/m)	Limit (dBuV/m)	Margin (dB)	Remark
1	8936.000	38.57	9.43	48.00	74.00	-26.00	peak
2	10124.000	36.98	11.12	48.10	74.00	-25.90	peak
3	11807.000	34.32	17.35	51.67	74.00	-22.33	peak
4	12698.000	35.10	16.85	51.95	74.00	-22.05	peak
5	13534.000	33.37	18.40	51.77	74.00	-22.23	peak
6	17373.000	31.42	19.81	51.23	74.00	-22.77	peak

Note: 1. Measurement = Reading Level + Correct Factor.
 2. If Peak Result complies with AV limit, AV Result is deemed to comply with AV limit.
 3. Peak: Peak detector.
 4. Filter losses were only considered in the spurious frequency bands and the authorized band was not corrected for High Pass Filter losses.
 5. Proper operation of the transmitter prior to adding the filter to the measurement chain.
 6. Since non-restricted band peak emissions are less than the average limit, they also comply with the -27dBm/MHz (68.2dBuV/m) limit.

HARMONICS AND SPURIOUS EMISSIONS (MID CHANNEL, VERTICAL)

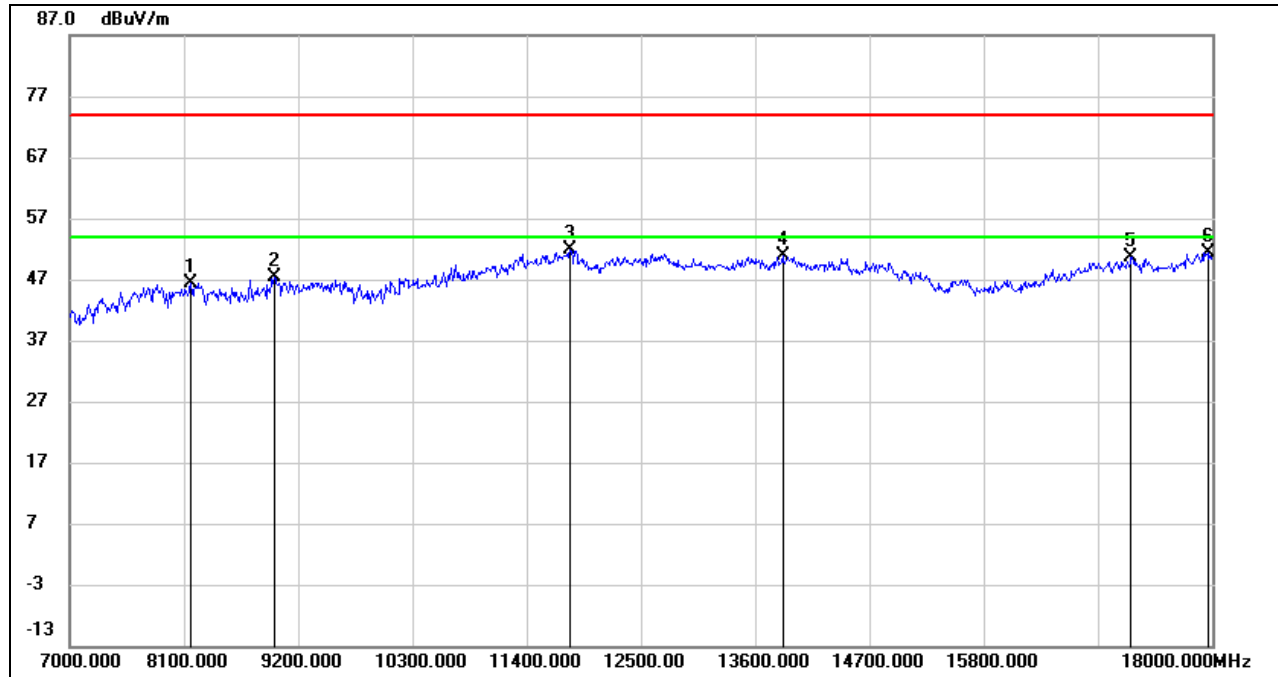

No.	Frequency (MHz)	Reading (dBuV)	Correct (dB/m)	Result (dBuV/m)	Limit (dBuV/m)	Margin (dB)	Remark
1	8166.000	38.01	8.43	46.44	74.00	-27.56	peak
2	8969.000	37.70	9.79	47.49	74.00	-26.51	peak
3	11818.000	34.63	17.31	51.94	74.00	-22.06	peak
4	13864.000	32.15	18.70	50.85	74.00	-23.15	peak
5	17219.000	30.87	19.74	50.61	74.00	-23.39	peak
6	17956.000	28.19	23.26	51.45	74.00	-22.55	peak

Note: 1. Measurement = Reading Level + Correct Factor.
 2. If Peak Result complies with AV limit, AV Result is deemed to comply with AV limit.
 3. Peak: Peak detector.
 4. Filter losses were only considered in the spurious frequency bands and the authorized band was not corrected for High Pass Filter losses.
 5. Proper operation of the transmitter prior to adding the filter to the measurement chain.
 6. Since non-restricted band peak emissions are less than the average limit, they also comply with the -27dBm/MHz (68.2dBuV/m) limit.

HARMONICS AND SPURIOUS EMISSIONS (HIGH CHANNEL, HORIZONTAL)

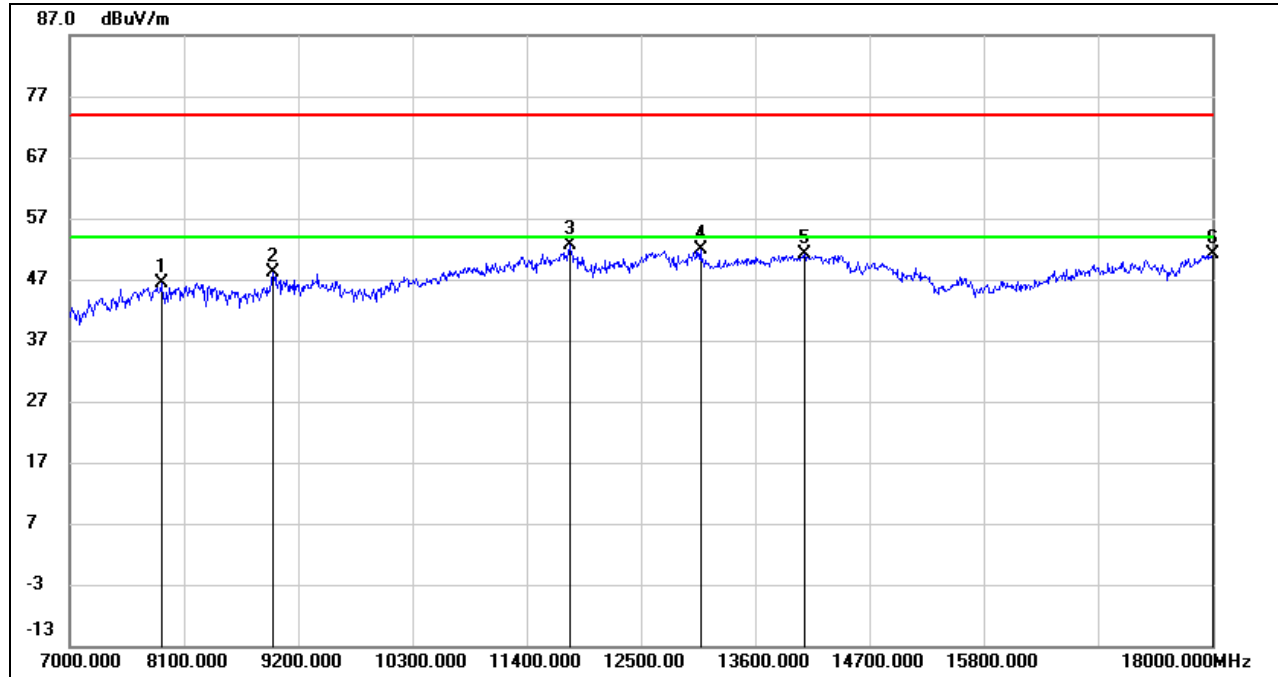

No.	Frequency (MHz)	Reading (dBuV)	Correct (dB/m)	Result (dBuV/m)	Limit (dBuV/m)	Margin (dB)	Remark
1	7880.000	38.95	7.39	46.34	74.00	-27.66	peak
2	8958.000	38.44	9.67	48.11	74.00	-25.89	peak
3	11818.000	35.24	17.31	52.55	74.00	-21.45	peak
4	13072.000	34.70	17.06	51.76	74.00	-22.24	peak
5	14073.000	32.90	18.29	51.19	74.00	-22.81	peak
6	18000.000	27.87	23.37	51.24	74.00	-22.76	peak

- Note: 1. Measurement = Reading Level + Correct Factor.
 2. If Peak Result complies with AV limit, AV Result is deemed to comply with AV limit.
 3. Peak: Peak detector.
 4. Filter losses were only considered in the spurious frequency bands and the authorized band was not corrected for High Pass Filter losses.
 5. Proper operation of the transmitter prior to adding the filter to the measurement chain.
 6. Since non-restricted band peak emissions are less than the average limit, they also comply with the -27dBm/MHz (68.2dBuV/m) limit.

HARMONICS AND SPURIOUS EMISSIONS (HIGH CHANNEL, VERTICAL)

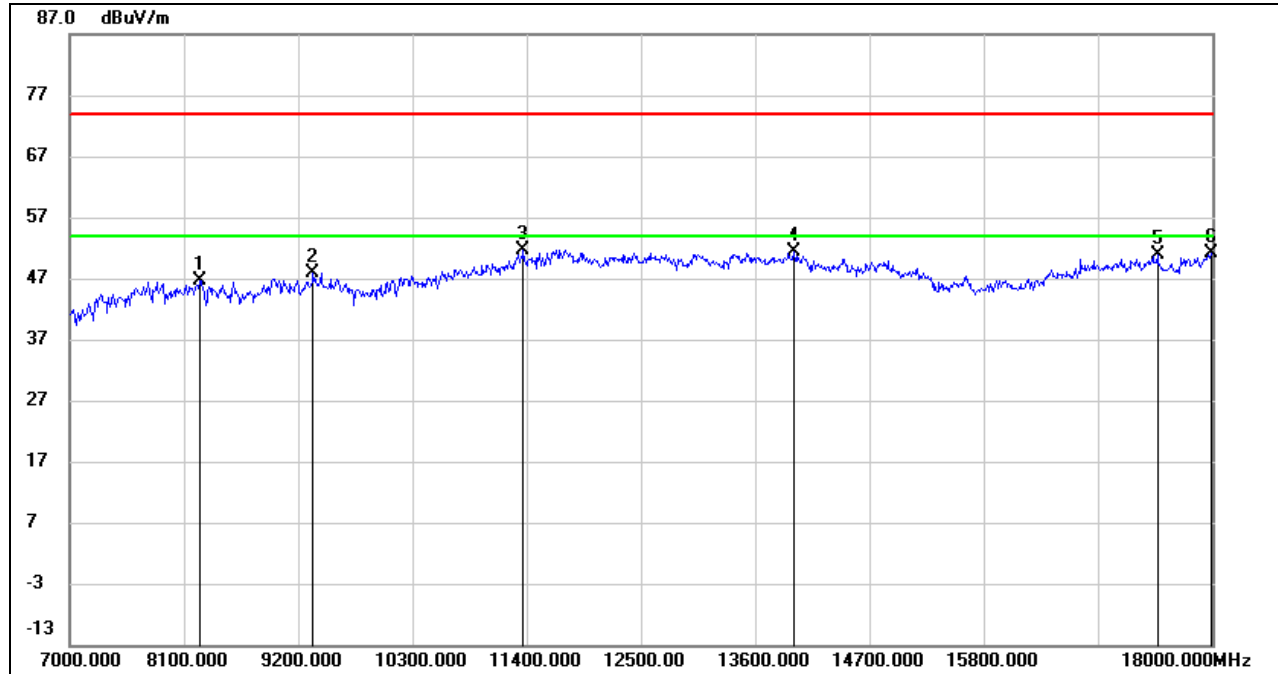

No.	Frequency (MHz)	Reading (dBuV)	Correct (dB/m)	Result (dBuV/m)	Limit (dBuV/m)	Margin (dB)	Remark
1	8254.000	38.13	8.50	46.63	74.00	-27.37	peak
2	9343.000	38.07	9.80	47.87	74.00	-26.13	peak
3	11367.000	36.03	15.67	51.70	74.00	-22.30	peak
4	13974.000	32.69	18.58	51.27	74.00	-22.73	peak
5	17472.000	30.84	20.04	50.88	74.00	-23.12	peak
6	17989.000	27.83	23.34	51.17	74.00	-22.83	peak

Note: 1. Measurement = Reading Level + Correct Factor.
 2. If Peak Result complies with AV limit, AV Result is deemed to comply with AV limit.
 3. Peak: Peak detector.
 4. Filter losses were only considered in the spurious frequency bands and the authorized band was not corrected for High Pass Filter losses.
 5. Proper operation of the transmitter prior to adding the filter to the measurement chain.
 6. Since non-restricted band peak emissions are less than the average limit, they also comply with the -27dBm/MHz (68.2dBuV/m) limit.

8.3.6. 802.11ax HE40 MIMO MODE

UNII-1 BAND

HARMONICS AND SPURIOUS EMISSIONS (LOW CHANNEL, HORIZONTAL)

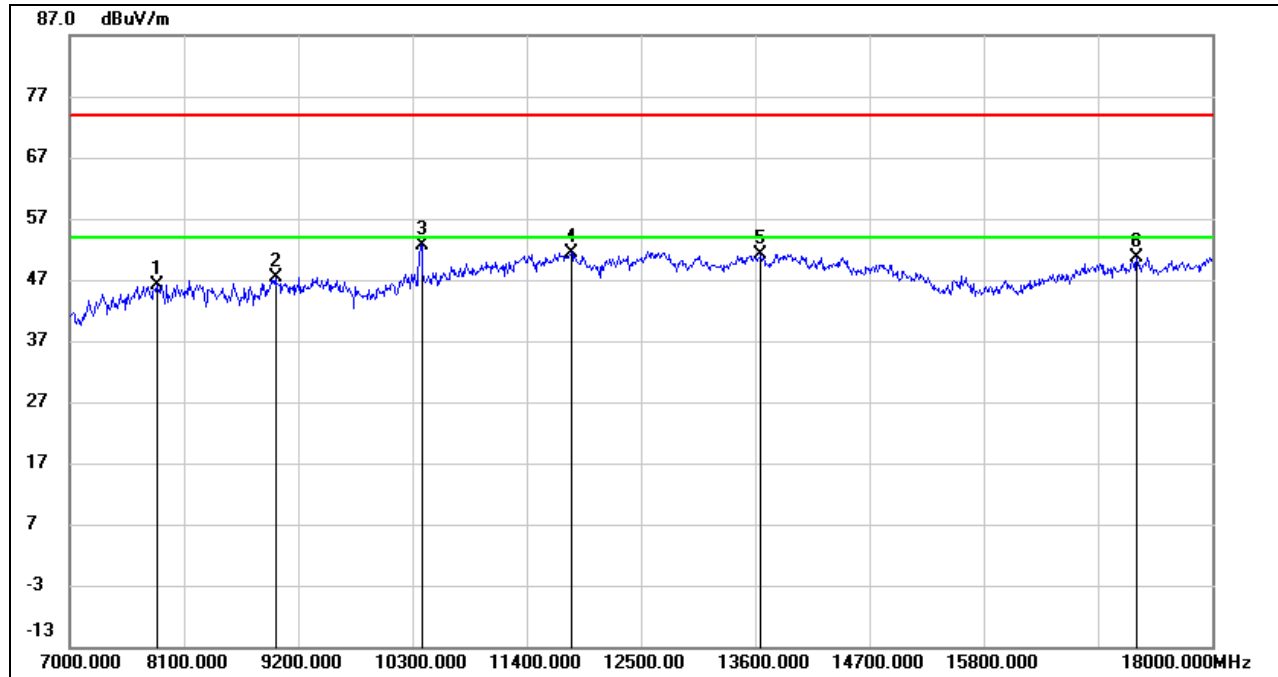

No.	Frequency (MHz)	Reading (dBuV)	Correct (dB/m)	Result (dBuV/m)	Limit (dBuV/m)	Margin (dB)	Remark
1	7836.000	38.57	7.51	46.08	74.00	-27.92	peak
2	8980.000	37.48	9.91	47.39	74.00	-26.61	peak
3	10388.000	40.64	11.93	52.57	74.00	-21.43	peak
4	11829.000	34.18	17.30	51.48	74.00	-22.52	peak
5	13655.000	32.71	18.48	51.19	74.00	-22.81	peak
6	17274.000	30.89	19.78	50.67	74.00	-23.33	peak

- Note: 1. Measurement = Reading Level + Correct Factor.
 2. If Peak Result complies with AV limit, AV Result is deemed to comply with AV limit.
 3. Peak: Peak detector.
 4. Filter losses were only considered in the spurious frequency bands and the authorized band was not corrected for High Pass Filter losses.
 5. Proper operation of the transmitter prior to adding the filter to the measurement chain.
 6. Since non-restricted band peak emissions are less than the average limit, they also comply with the -27dBm/MHz (68.2dBuV/m) limit.

HARMONICS AND SPURIOUS EMISSIONS (LOW CHANNEL, VERTICAL)

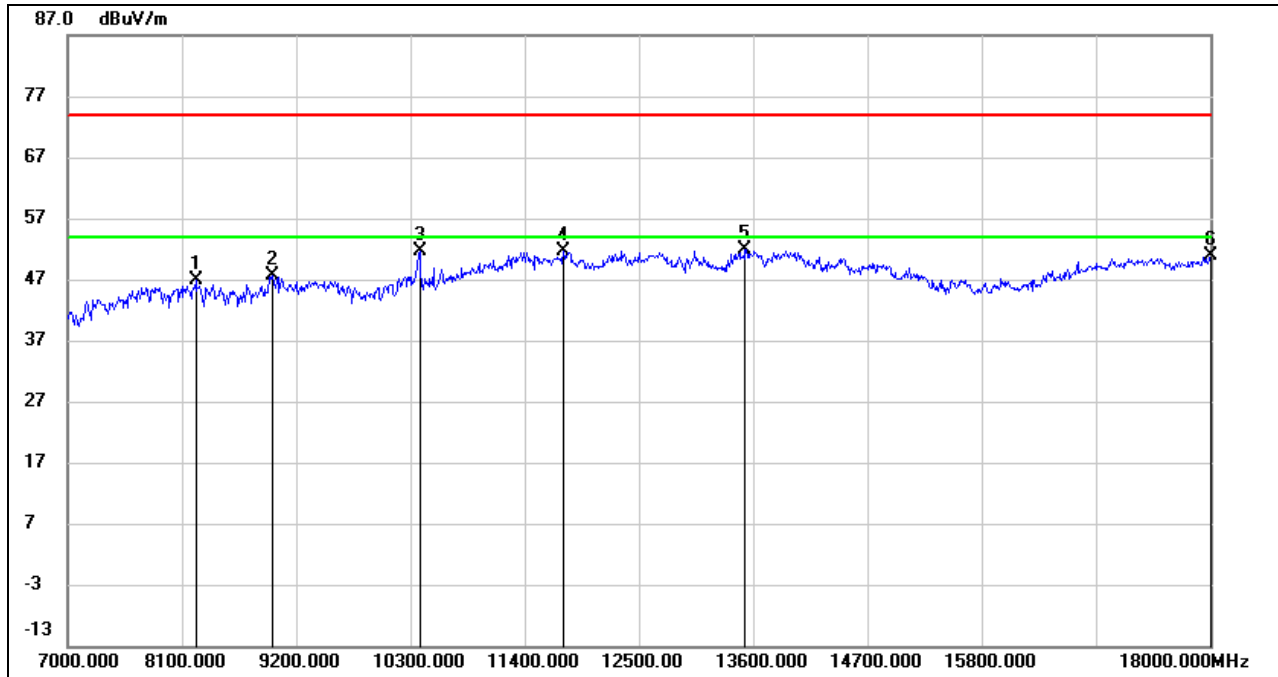

No.	Frequency (MHz)	Reading (dBuV)	Correct (dB/m)	Result (dBuV/m)	Limit (dBuV/m)	Margin (dB)	Remark
1	8232.000	38.36	8.59	46.95	74.00	-27.05	peak
2	8969.000	37.85	9.79	47.64	74.00	-26.36	peak
3	10388.000	39.75	11.93	51.68	74.00	-22.32	peak
4	11774.000	34.53	17.22	51.75	74.00	-22.25	peak
5	13523.000	33.48	18.41	51.89	74.00	-22.11	peak
6	18000.000	27.51	23.37	50.88	74.00	-23.12	peak

Note: 1. Measurement = Reading Level + Correct Factor.
 2. If Peak Result complies with AV limit, AV Result is deemed to comply with AV limit.
 3. Peak: Peak detector.
 4. Filter losses were only considered in the spurious frequency bands and the authorized band was not corrected for High Pass Filter losses.
 5. Proper operation of the transmitter prior to adding the filter to the measurement chain.
 6. Since non-restricted band peak emissions are less than the average limit, they also comply with the -27dBm/MHz (68.2dBuV/m) limit.



HARMONICS AND SPURIOUS EMISSIONS (HIGH CHANNEL, HORIZONTAL)

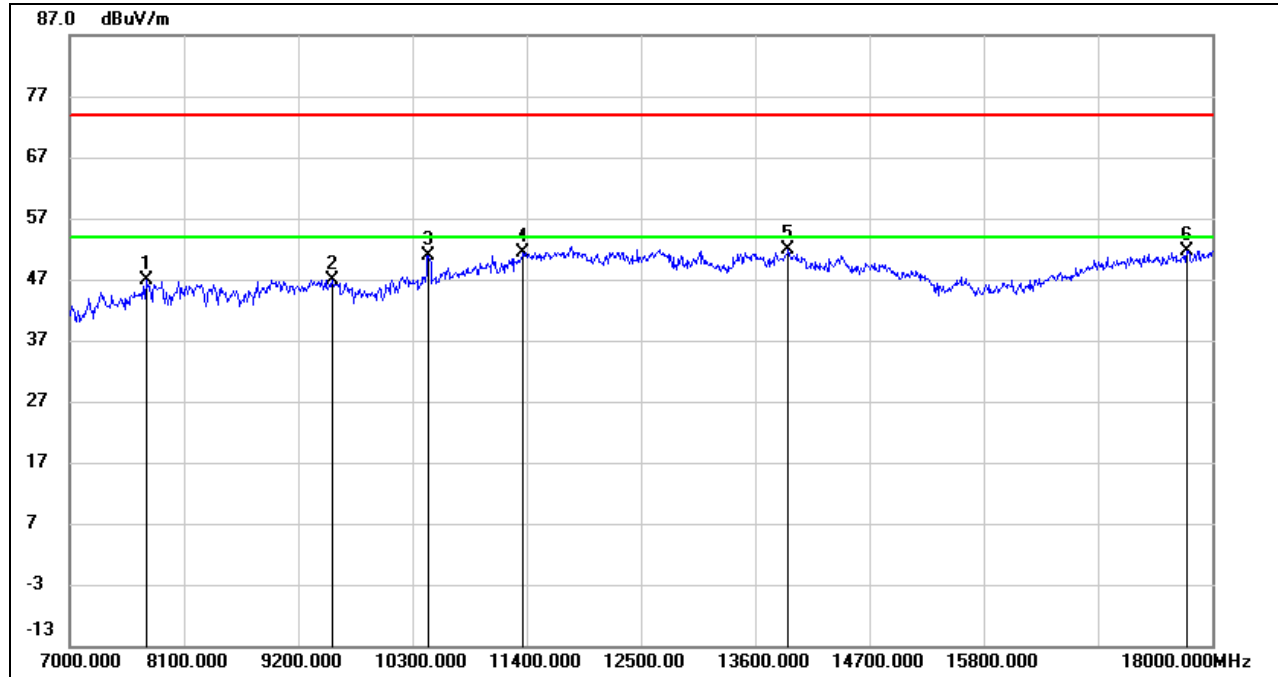

No.	Frequency (MHz)	Reading (dBuV)	Correct (dB/m)	Result (dBuV/m)	Limit (dBuV/m)	Margin (dB)	Remark
1	7737.000	39.51	7.35	46.86	74.00	-27.14	peak
2	9530.000	36.58	10.39	46.97	74.00	-27.03	peak
3	10454.000	38.75	12.24	50.99	74.00	-23.01	peak
4	11367.000	35.77	15.67	51.44	74.00	-22.56	peak
5	13919.000	33.26	18.64	51.90	74.00	-22.10	peak
6	17758.000	29.27	22.42	51.69	74.00	-22.31	peak

- Note: 1. Measurement = Reading Level + Correct Factor.
 2. If Peak Result complies with AV limit, AV Result is deemed to comply with AV limit.
 3. Peak: Peak detector.
 4. Filter losses were only considered in the spurious frequency bands and the authorized band was not corrected for High Pass Filter losses.
 5. Proper operation of the transmitter prior to adding the filter to the measurement chain.
 6. Since non-restricted band peak emissions are less than the average limit, they also comply with the -27dBm/MHz (68.2dBuV/m) limit.

HARMONICS AND SPURIOUS EMISSIONS (HIGH CHANNEL, VERTICAL)

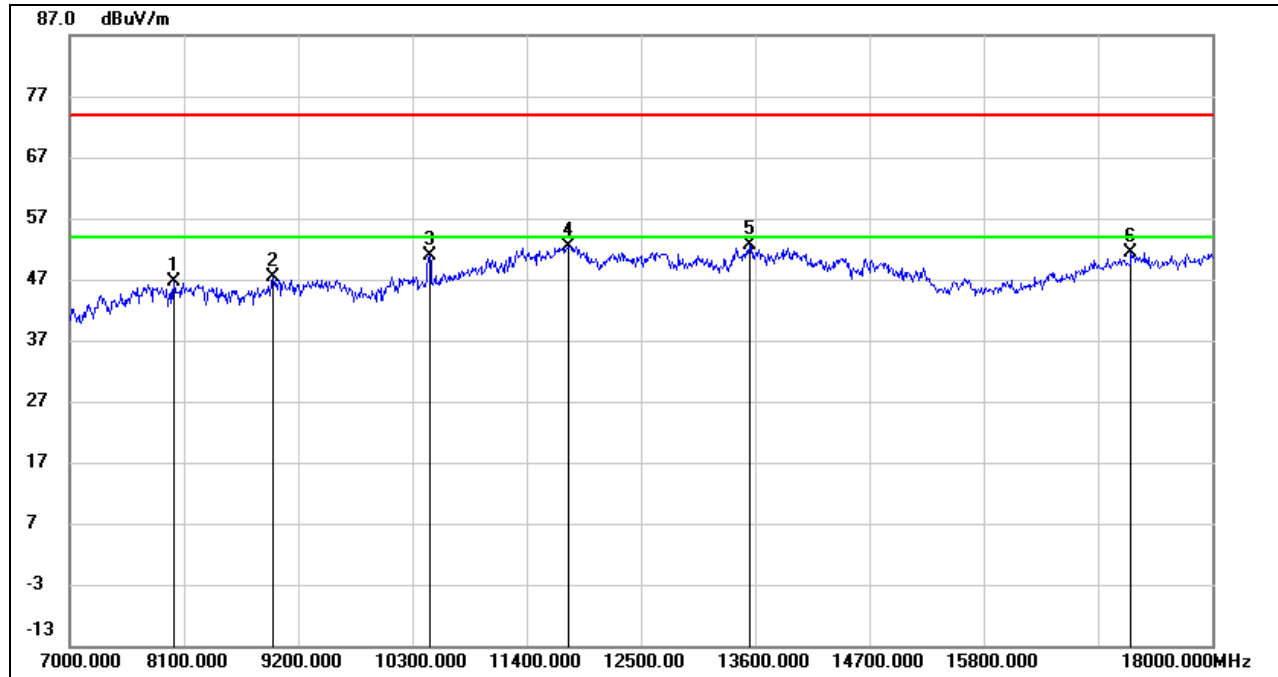

No.	Frequency (MHz)	Reading (dBuV)	Correct (dB/m)	Result (dBuV/m)	Limit (dBuV/m)	Margin (dB)	Remark
1	8001.000	39.60	7.07	46.67	74.00	-27.33	peak
2	8958.000	37.60	9.67	47.27	74.00	-26.73	peak
3	10465.000	38.57	12.29	50.86	74.00	-23.14	peak
4	11807.000	35.04	17.35	52.39	74.00	-21.61	peak
5	13545.000	34.27	18.39	52.66	74.00	-21.34	peak
6	17219.000	31.68	19.74	51.42	74.00	-22.58	peak

Note: 1. Measurement = Reading Level + Correct Factor.
 2. If Peak Result complies with AV limit, AV Result is deemed to comply with AV limit.
 3. Peak: Peak detector.
 4. Filter losses were only considered in the spurious frequency bands and the authorized band was not corrected for High Pass Filter losses.
 5. Proper operation of the transmitter prior to adding the filter to the measurement chain.
 6. Since non-restricted band peak emissions are less than the average limit, they also comply with the -27dBm/MHz (68.2dBuV/m) limit.

UNII-2A BAND

HARMONICS AND SPURIOUS EMISSIONS (LOW CHANNEL, HORIZONTAL)

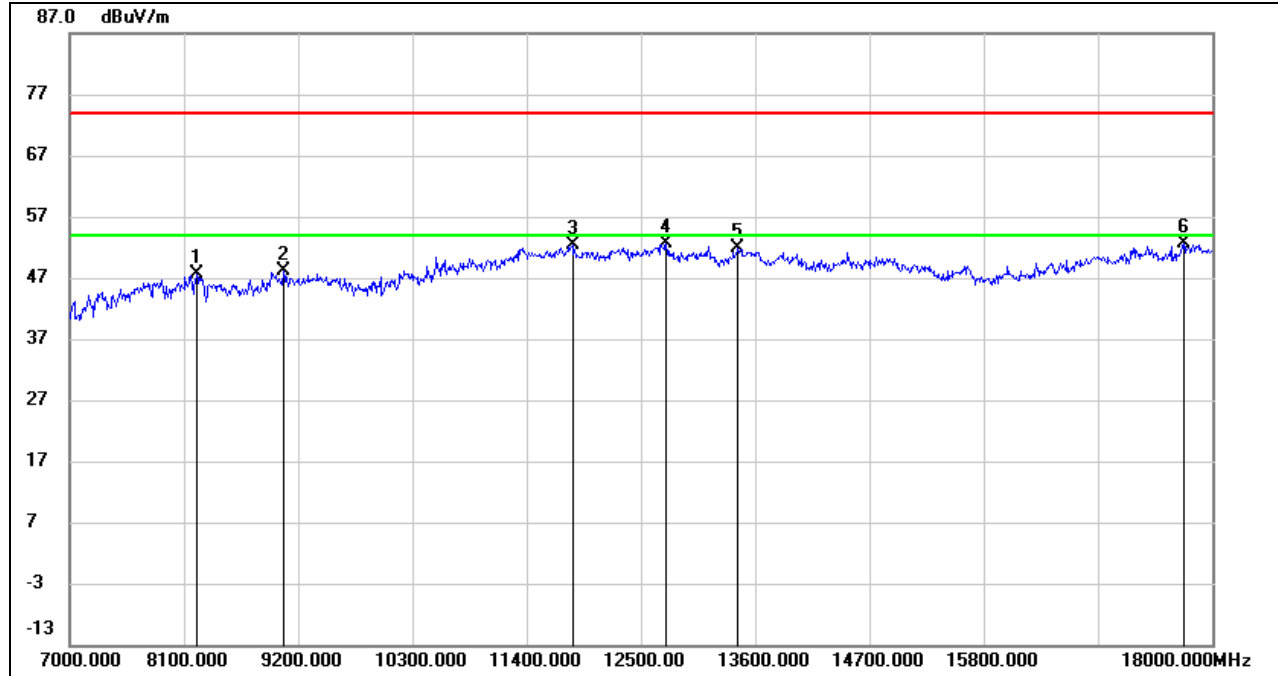

No.	Frequency (MHz)	Reading (dBuV)	Correct (dB/m)	Result (dBuV/m)	Limit (dBuV/m)	Margin (dB)	Remark
1	8221.000	38.90	8.63	47.53	74.00	-26.47	peak
2	9057.000	38.43	9.80	48.23	74.00	-25.77	peak
3	11840.000	35.18	17.29	52.47	74.00	-21.53	peak
4	12742.000	35.61	16.94	52.55	74.00	-21.45	peak
5	13435.000	33.69	18.28	51.97	74.00	-22.03	peak
6	17725.000	30.60	22.06	52.66	74.00	-21.34	peak

Note: 1. Measurement = Reading Level + Correct Factor.
 2. If Peak Result complies with AV limit, AV Result is deemed to comply with AV limit.
 3. Peak: Peak detector.
 4. Filter losses were only considered in the spurious frequency bands and the authorized band was not corrected for High Pass Filter losses.
 5. Proper operation of the transmitter prior to adding the filter to the measurement chain.
 6. Since non-restricted band peak emissions are less than the average limit, they also comply with the -27dBm/MHz (68.2dBuV/m) limit.

HARMONICS AND SPURIOUS EMISSIONS (LOW CHANNEL, VERTICAL)

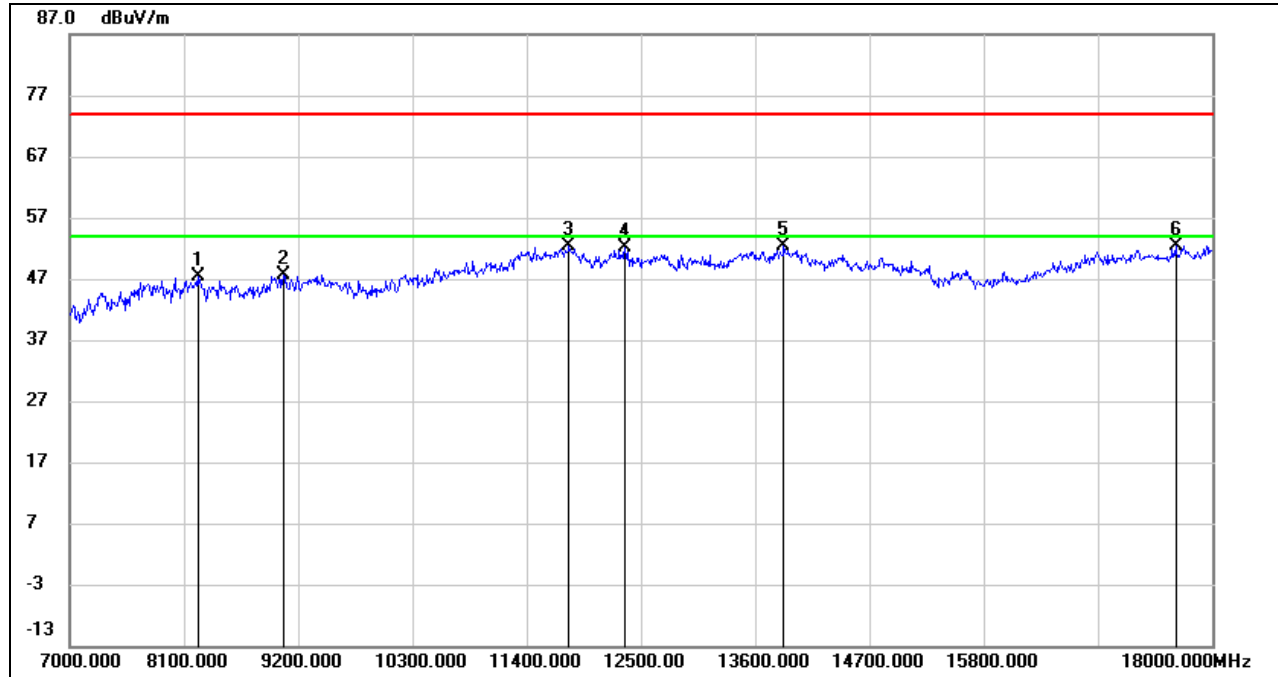

No.	Frequency (MHz)	Reading (dBuV)	Correct (dB/m)	Result (dBuV/m)	Limit (dBuV/m)	Margin (dB)	Remark
1	8232.000	38.79	8.59	47.38	74.00	-26.62	peak
2	9057.000	37.74	9.80	47.54	74.00	-26.46	peak
3	11807.000	35.12	17.35	52.47	74.00	-21.53	peak
4	12346.000	35.19	16.83	52.02	74.00	-21.98	peak
5	13875.000	33.65	18.69	52.34	74.00	-21.66	peak
6	17648.000	31.07	21.26	52.33	74.00	-21.67	peak

- Note: 1. Measurement = Reading Level + Correct Factor.
 2. If Peak Result complies with AV limit, AV Result is deemed to comply with AV limit.
 3. Peak: Peak detector.
 4. Filter losses were only considered in the spurious frequency bands and the authorized band was not corrected for High Pass Filter losses.
 5. Proper operation of the transmitter prior to adding the filter to the measurement chain.
 6. Since non-restricted band peak emissions are less than the average limit, they also comply with the -27dBm/MHz (68.2dBuV/m) limit.

HARMONICS AND SPURIOUS EMISSIONS (HIGH CHANNEL, HORIZONTAL)

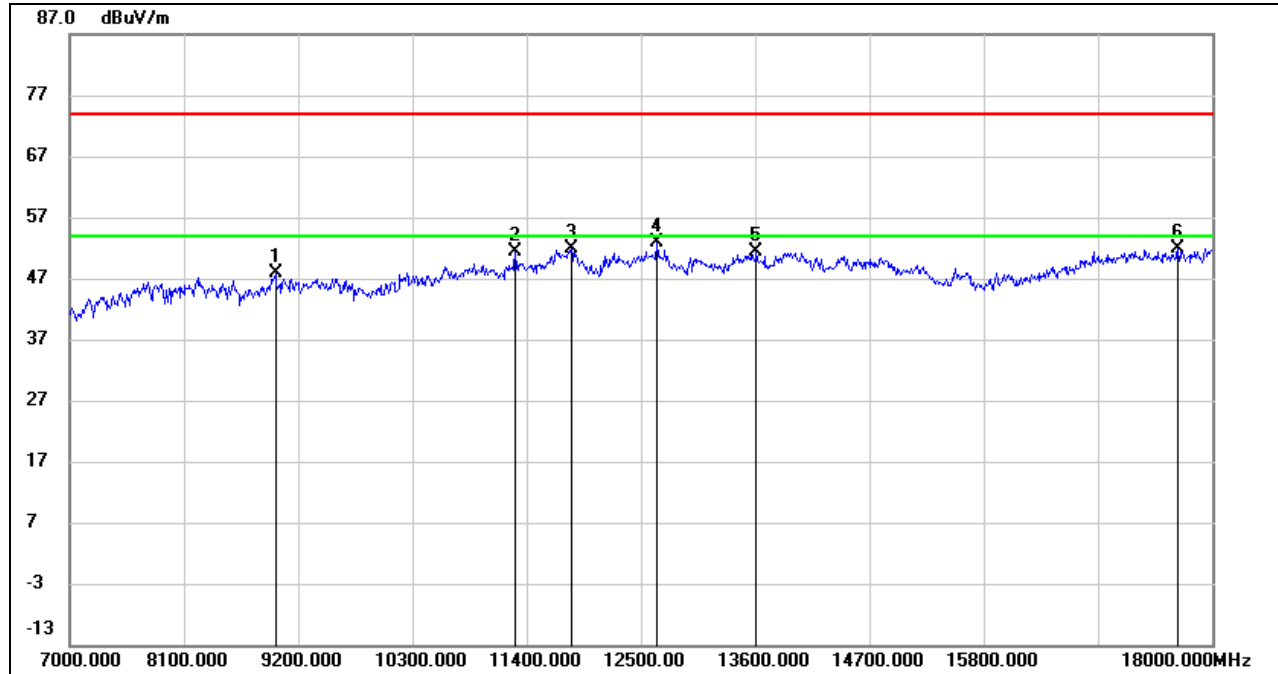

No.	Frequency (MHz)	Reading (dBuV)	Correct (dB/m)	Result (dBuV/m)	Limit (dBuV/m)	Margin (dB)	Remark
1	8980.000	38.02	9.91	47.93	74.00	-26.07	peak
2	11290.000	35.95	15.32	51.27	74.00	-22.73	peak
3	11829.000	34.46	17.30	51.76	74.00	-22.24	peak
4	12654.000	36.08	16.74	52.82	74.00	-21.18	peak
5	13611.000	32.90	18.39	51.29	74.00	-22.71	peak
6	17670.000	30.52	21.48	52.00	74.00	-22.00	peak

Note: 1. Measurement = Reading Level + Correct Factor.
 2. If Peak Result complies with AV limit, AV Result is deemed to comply with AV limit.
 3. Peak: Peak detector.
 4. Filter losses were only considered in the spurious frequency bands and the authorized band was not corrected for High Pass Filter losses.
 5. Proper operation of the transmitter prior to adding the filter to the measurement chain.
 6. Since non-restricted band peak emissions are less than the average limit, they also comply with the -27dBm/MHz (68.2dBuV/m) limit.

HARMONICS AND SPURIOUS EMISSIONS (HIGH CHANNEL, VERTICAL)

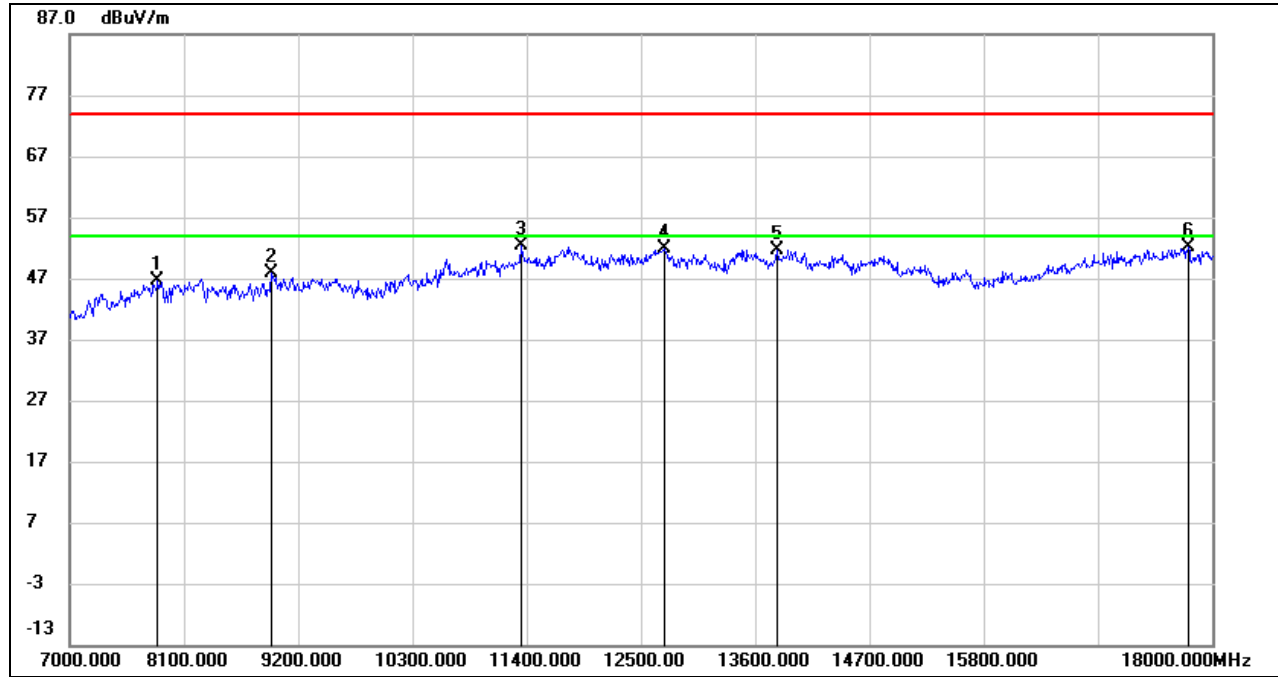

No.	Frequency (MHz)	Reading (dBuV)	Correct (dB/m)	Result (dBuV/m)	Limit (dBuV/m)	Margin (dB)	Remark
1	7847.000	39.25	7.48	46.73	74.00	-27.27	peak
2	8936.000	38.46	9.43	47.89	74.00	-26.11	peak
3	11345.000	36.69	15.58	52.27	74.00	-21.73	peak
4	12731.000	34.87	16.93	51.80	74.00	-22.20	peak
5	13809.000	32.91	18.77	51.68	74.00	-22.32	peak
6	17769.000	29.66	22.53	52.19	74.00	-21.81	peak

Note: 1. Measurement = Reading Level + Correct Factor.
 2. If Peak Result complies with AV limit, AV Result is deemed to comply with AV limit.
 3. Peak: Peak detector.
 4. Filter losses were only considered in the spurious frequency bands and the authorized band was not corrected for High Pass Filter losses.
 5. Proper operation of the transmitter prior to adding the filter to the measurement chain.
 6. Since non-restricted band peak emissions are less than the average limit, they also comply with the -27dBm/MHz (68.2dBuV/m) limit.

UNII-2C BAND

HARMONICS AND SPURIOUS EMISSIONS (LOW CHANNEL, HORIZONTAL)

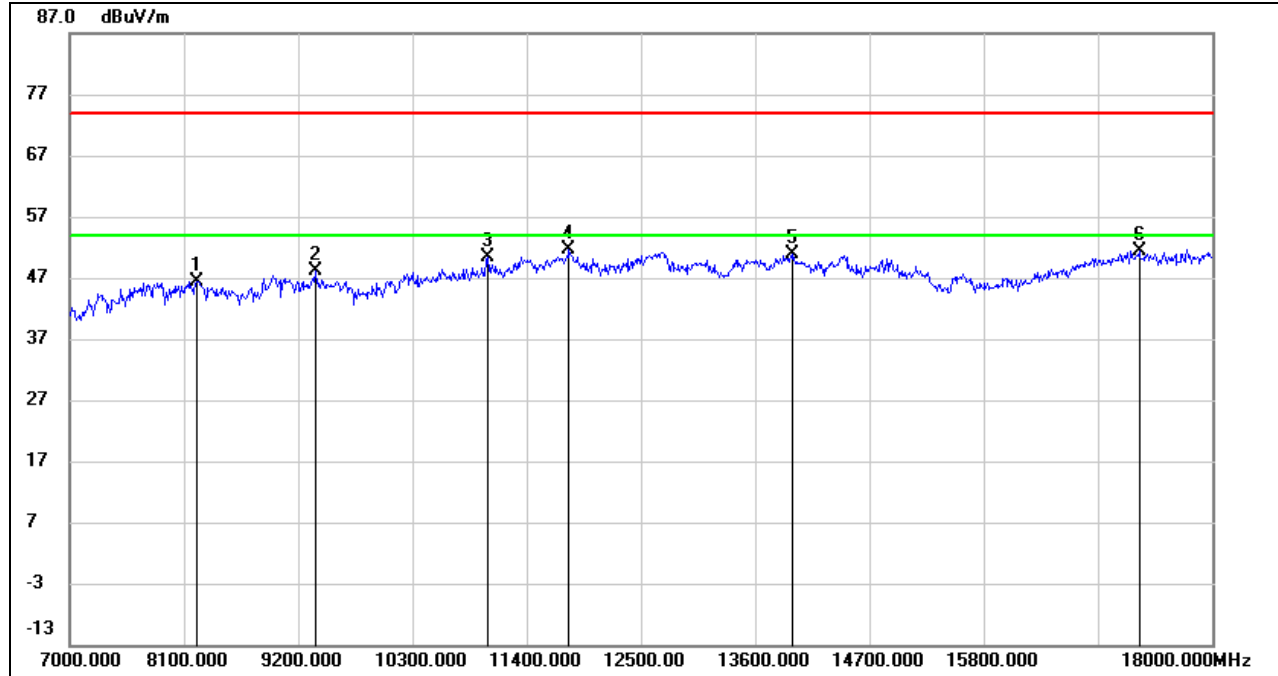

No.	Frequency (MHz)	Reading (dBuV)	Correct (dB/m)	Result (dBuV/m)	Limit (dBuV/m)	Margin (dB)	Remark
1	8226.500	37.81	8.61	46.42	74.00	-27.58	peak
2	9370.500	38.10	9.95	48.05	74.00	-25.95	peak
3	11031.500	36.21	14.27	50.48	74.00	-23.52	peak
4	11812.500	34.42	17.33	51.75	74.00	-22.25	peak
5	13957.500	32.19	18.60	50.79	74.00	-23.21	peak
6	17296.000	31.67	19.79	51.46	74.00	-22.54	peak

Note: 1. Measurement = Reading Level + Correct Factor.
 2. If Peak Result complies with AV limit, AV Result is deemed to comply with AV limit.
 3. Peak: Peak detector.
 4. Filter losses were only considered in the spurious frequency bands and the authorized band was not corrected for High Pass Filter losses.
 5. Proper operation of the transmitter prior to adding the filter to the measurement chain.
 6. Since non-restricted band peak emissions are less than the average limit, they also comply with the -27dBm/MHz (68.2dBuV/m) limit.

HARMONICS AND SPURIOUS EMISSIONS (LOW CHANNEL, VERTICAL)

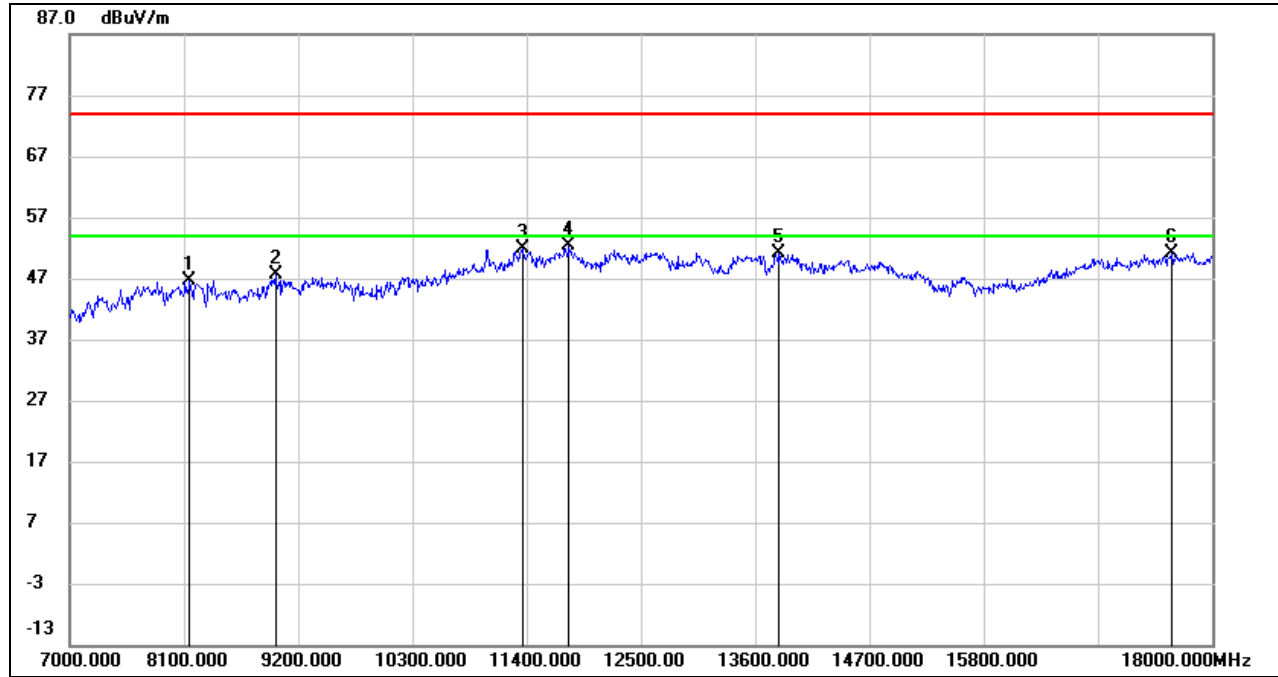

No.	Frequency (MHz)	Reading (dBuV)	Correct (dB/m)	Result (dBuV/m)	Limit (dBuV/m)	Margin (dB)	Remark
1	8160.500	38.31	8.40	46.71	74.00	-27.29	peak
2	8985.500	37.70	9.97	47.67	74.00	-26.33	peak
3	11356.000	36.30	15.64	51.94	74.00	-22.06	peak
4	11812.500	35.02	17.33	52.35	74.00	-21.65	peak
5	13836.500	32.28	18.74	51.02	74.00	-22.98	peak
6	17615.000	30.26	20.91	51.17	74.00	-22.83	peak

- Note: 1. Measurement = Reading Level + Correct Factor.
 2. If Peak Result complies with AV limit, AV Result is deemed to comply with AV limit.
 3. Peak: Peak detector.
 4. Filter losses were only considered in the spurious frequency bands and the authorized band was not corrected for High Pass Filter losses.
 5. Proper operation of the transmitter prior to adding the filter to the measurement chain.
 6. Since non-restricted band peak emissions are less than the average limit, they also comply with the -27dBm/MHz (68.2dBuV/m) limit.



HARMONICS AND SPURIOUS EMISSIONS (MID CHANNEL, HORIZONTAL)

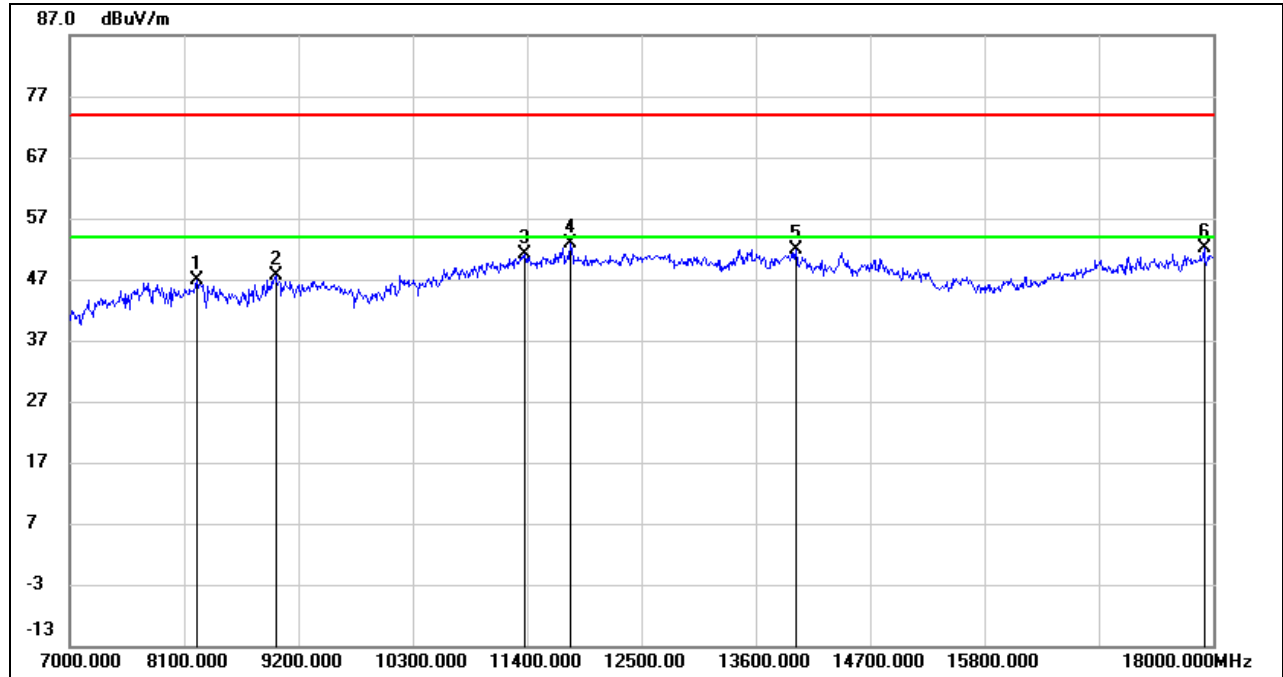

No.	Frequency (MHz)	Reading (dBuV)	Correct (dB/m)	Result (dBuV/m)	Limit (dBuV/m)	Margin (dB)	Remark
1	8221.000	38.21	8.63	46.84	74.00	-27.16	peak
2	8980.000	37.72	9.91	47.63	74.00	-26.37	peak
3	11378.000	35.30	15.73	51.03	74.00	-22.97	peak
4	11818.000	35.68	17.31	52.99	74.00	-21.01	peak
5	13985.000	33.43	18.57	52.00	74.00	-22.00	peak
6	17912.000	28.95	23.14	52.09	74.00	-21.91	peak

- Note: 1. Measurement = Reading Level + Correct Factor.
 2. If Peak Result complies with AV limit, AV Result is deemed to comply with AV limit.
 3. Peak: Peak detector.
 4. Filter losses were only considered in the spurious frequency bands and the authorized band was not corrected for High Pass Filter losses.
 5. Proper operation of the transmitter prior to adding the filter to the measurement chain.
 6. Since non-restricted band peak emissions are less than the average limit, they also comply with the -27dBm/MHz (68.2dBuV/m) limit.



HARMONICS AND SPURIOUS EMISSIONS (MID CHANNEL, VERTICAL)

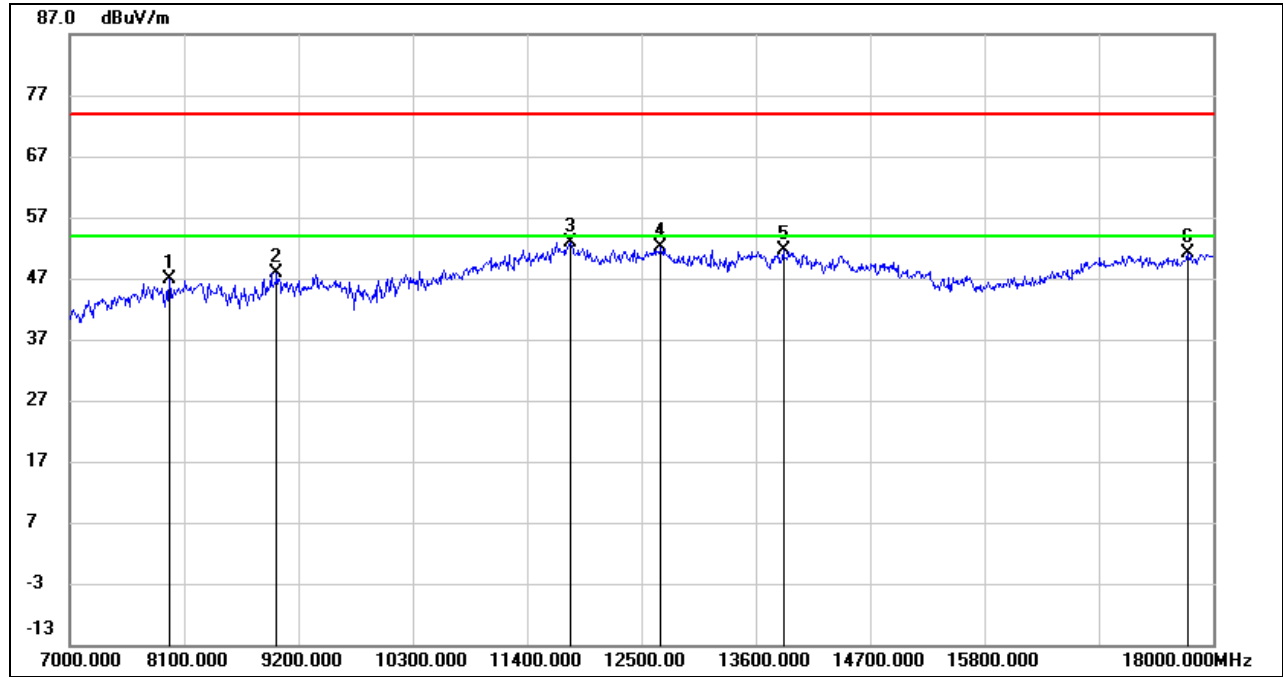

No.	Frequency (MHz)	Reading (dBuV)	Correct (dB/m)	Result (dBuV/m)	Limit (dBuV/m)	Margin (dB)	Remark
1	7957.000	39.70	7.18	46.88	74.00	-27.12	peak
2	8991.000	37.85	10.03	47.88	74.00	-26.12	peak
3	11818.000	35.57	17.31	52.88	74.00	-21.12	peak
4	12687.000	35.20	16.82	52.02	74.00	-21.98	peak
5	13864.000	32.85	18.70	51.55	74.00	-22.45	peak
6	17758.000	28.66	22.42	51.08	74.00	-22.92	peak

Note: 1. Measurement = Reading Level + Correct Factor.
 2. If Peak Result complies with AV limit, AV Result is deemed to comply with AV limit.
 3. Peak: Peak detector.
 4. Filter losses were only considered in the spurious frequency bands and the authorized band was not corrected for High Pass Filter losses.
 5. Proper operation of the transmitter prior to adding the filter to the measurement chain.
 6. Since non-restricted band peak emissions are less than the average limit, they also comply with the -27dBm/MHz (68.2dBuV/m) limit.



HARMONICS AND SPURIOUS EMISSIONS (HIGH CHANNEL, HORIZONTAL)

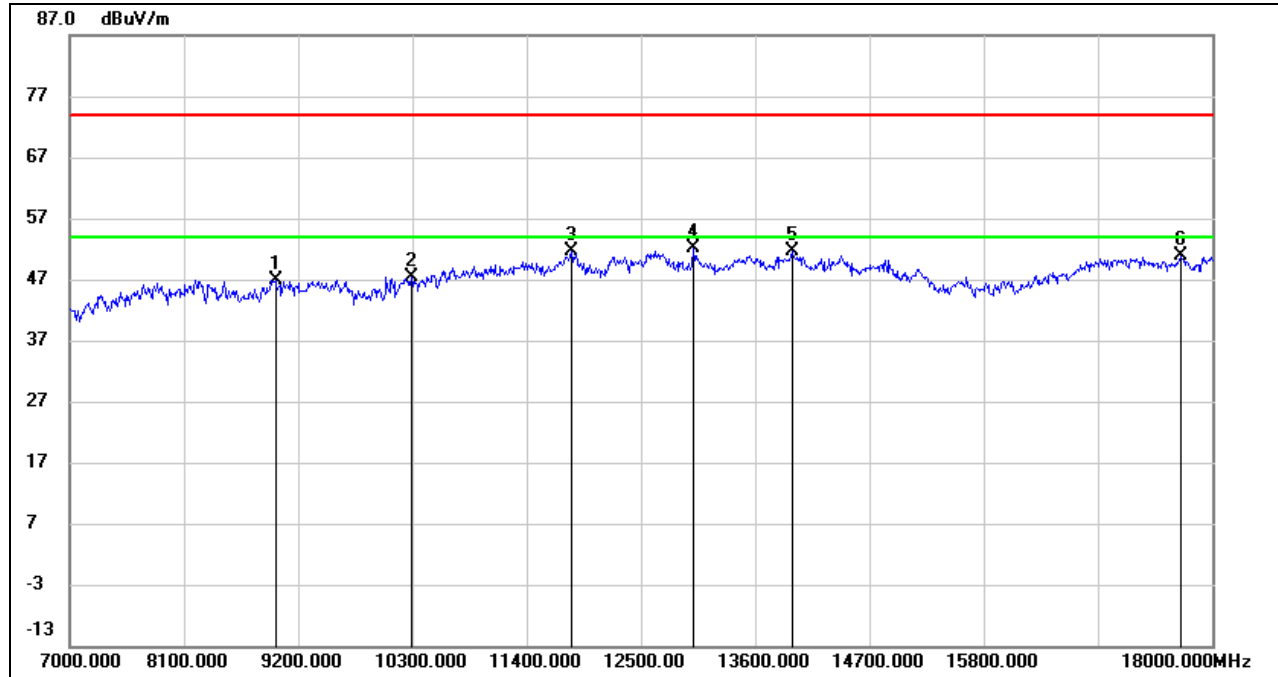

No.	Frequency (MHz)	Reading (dBuV)	Correct (dB/m)	Result (dBuV/m)	Limit (dBuV/m)	Margin (dB)	Remark
1	8985.500	36.95	9.97	46.92	74.00	-27.08	peak
2	10294.500	35.78	11.62	47.40	74.00	-26.60	peak
3	11834.500	34.38	17.29	51.67	74.00	-22.33	peak
4	13011.500	35.09	16.92	52.01	74.00	-21.99	peak
5	13952.000	33.14	18.61	51.75	74.00	-22.25	peak
6	17697.500	29.04	21.78	50.82	74.00	-23.18	peak

- Note: 1. Measurement = Reading Level + Correct Factor.
 2. If Peak Result complies with AV limit, AV Result is deemed to comply with AV limit.
 3. Peak: Peak detector.
 4. Filter losses were only considered in the spurious frequency bands and the authorized band was not corrected for High Pass Filter losses.
 5. Proper operation of the transmitter prior to adding the filter to the measurement chain.
 6. Since non-restricted band peak emissions are less than the average limit, they also comply with the -27dBm/MHz (68.2dBuV/m) limit.

HARMONICS AND SPURIOUS EMISSIONS (HIGH CHANNEL, VERTICAL)

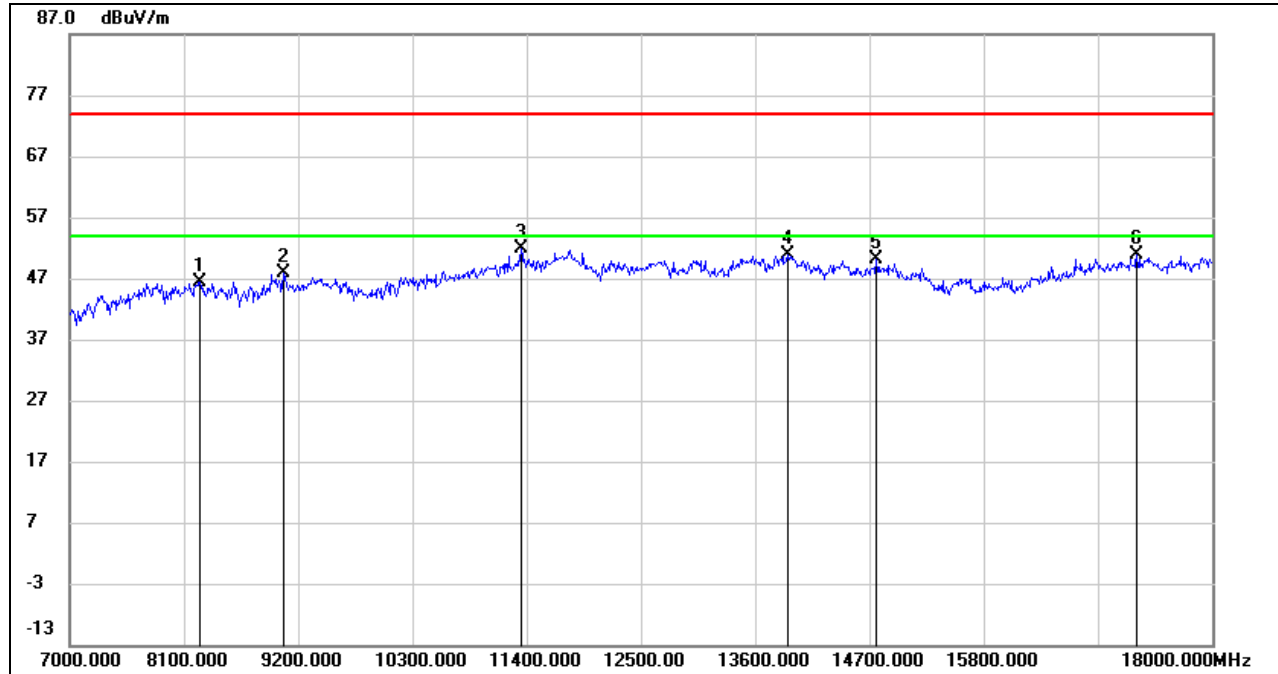

No.	Frequency (MHz)	Reading (dBuV)	Correct (dB/m)	Result (dBuV/m)	Limit (dBuV/m)	Margin (dB)	Remark
1	8259.500	37.91	8.48	46.39	74.00	-27.61	peak
2	9062.500	38.01	9.76	47.77	74.00	-26.23	peak
3	11350.500	36.32	15.60	51.92	74.00	-22.08	peak
4	13913.500	32.27	18.65	50.92	74.00	-23.08	peak
5	14766.000	33.68	16.35	50.03	74.00	-23.97	peak
6	17279.500	31.21	19.78	50.99	74.00	-23.01	peak

Note: 1. Measurement = Reading Level + Correct Factor.
 2. If Peak Result complies with AV limit, AV Result is deemed to comply with AV limit.
 3. Peak: Peak detector.
 4. Filter losses were only considered in the spurious frequency bands and the authorized band was not corrected for High Pass Filter losses.
 5. Proper operation of the transmitter prior to adding the filter to the measurement chain.
 6. Since non-restricted band peak emissions are less than the average limit, they also comply with the -27dBm/MHz (68.2dBuV/m) limit.

STRADDLE CHANNEL 142

HARMONICS AND SPURIOUS EMISSIONS (HORIZONTAL)

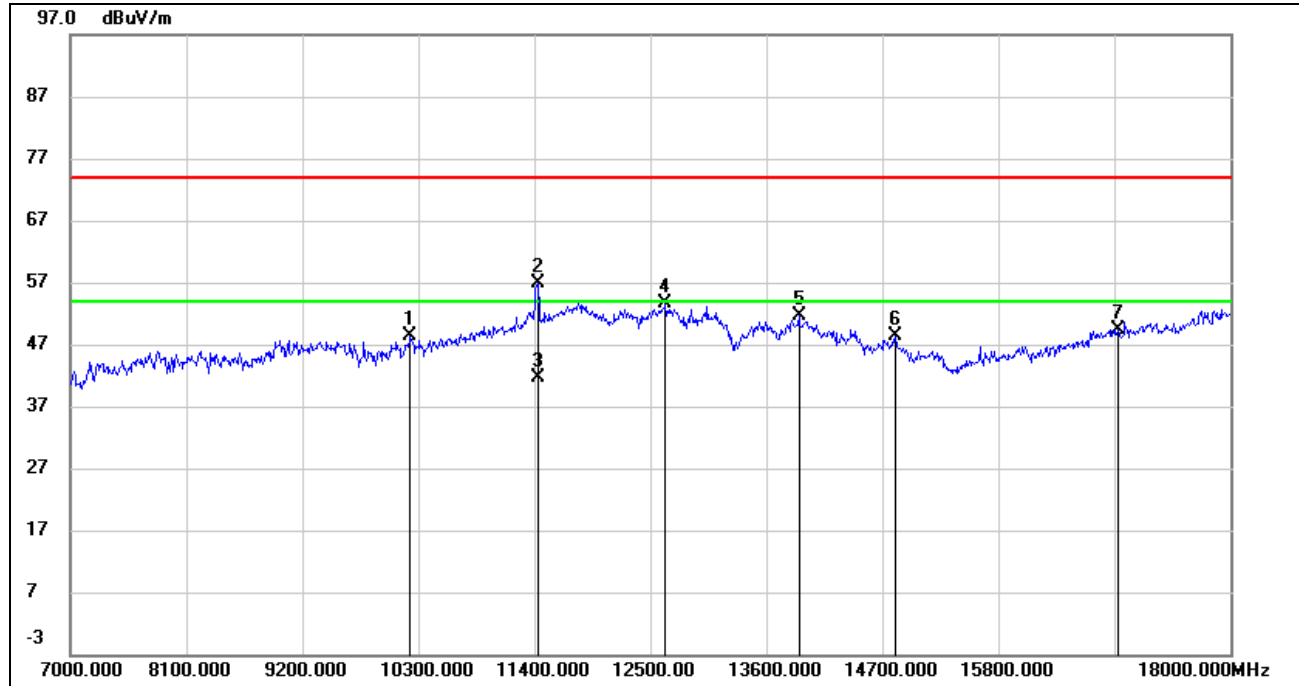

No.	Frequency (MHz)	Reading (dBuV)	Correct (dB/m)	Result (dBuV/m)	Limit (dBuV/m)	Margin (dB)	Remark
1	10223.000	36.25	12.03	48.28	74.00	-25.72	peak
2	11433.000	40.18	16.65	56.83	74.00	-17.17	peak
3	11433.000	24.86	16.65	41.51	54.00	-12.49	AVG
4	12643.000	35.19	18.37	53.56	74.00	-20.44	peak
5	13908.000	29.86	21.67	51.53	74.00	-22.47	peak
6	14821.000	30.28	18.20	48.48	74.00	-25.52	peak
7	16933.000	29.46	19.92	49.38	74.00	-24.62	peak

Note: 1. Measurement = Reading Level + Correct Factor.
 2. If Peak Result complies with AV limit, AV Result is deemed to comply with AV limit.
 3. Peak: Peak detector.
 4. Filter losses were only considered in the spurious frequency bands and the authorized band was not corrected for High Pass Filter losses.
 5. Proper operation of the transmitter prior to adding the filter to the measurement chain.
 6. Since non-restricted band peak emissions are less than the average limit, they also comply with the -27dBm/MHz (68.2dBuV/m) limit.



HARMONICS AND SPURIOUS EMISSIONS (VERTICAL)

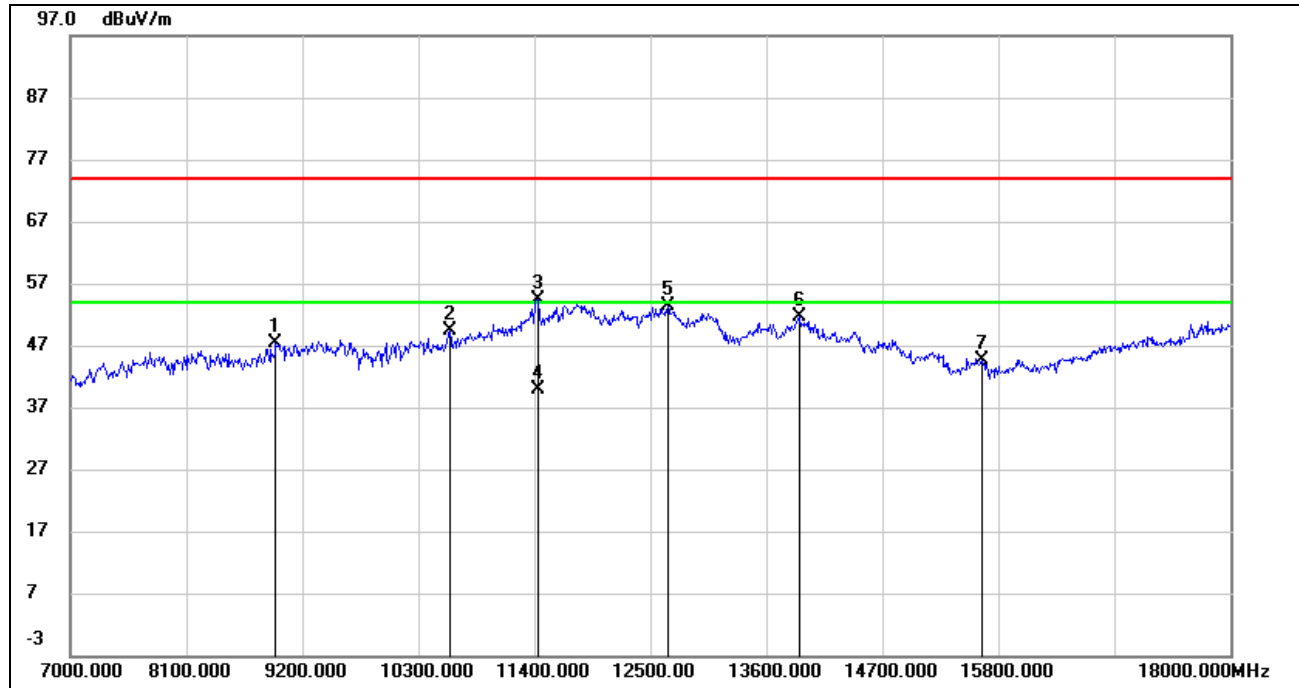

No.	Frequency (MHz)	Reading (dBuV)	Correct (dB/m)	Result (dBuV/m)	Limit (dBuV/m)	Margin (dB)	Remark
1	8947.000	37.27	10.03	47.30	74.00	-26.70	peak
2	10597.000	35.91	13.35	49.26	74.00	-24.74	peak
3	11433.000	37.77	16.65	54.42	74.00	-19.58	peak
4	11433.000	23.13	16.65	39.78	54.00	-14.22	AVG
5	12665.000	34.95	18.38	53.33	74.00	-20.67	peak
6	13919.000	29.95	21.66	51.61	74.00	-22.39	peak
7	15646.000	28.13	16.57	44.70	74.00	-29.30	peak

Note: 1. Measurement = Reading Level + Correct Factor.
 2. If Peak Result complies with AV limit, AV Result is deemed to comply with AV limit.
 3. Peak: Peak detector.
 4. Filter losses were only considered in the spurious frequency bands and the authorized band was not corrected for High Pass Filter losses.
 5. Proper operation of the transmitter prior to adding the filter to the measurement chain.
 6. Since non-restricted band peak emissions are less than the average limit, they also comply with the -27dBm/MHz (68.2dBuV/m) limit.

UNII-3 BAND

HARMONICS AND SPURIOUS EMISSIONS (LOW CHANNEL, HORIZONTAL)

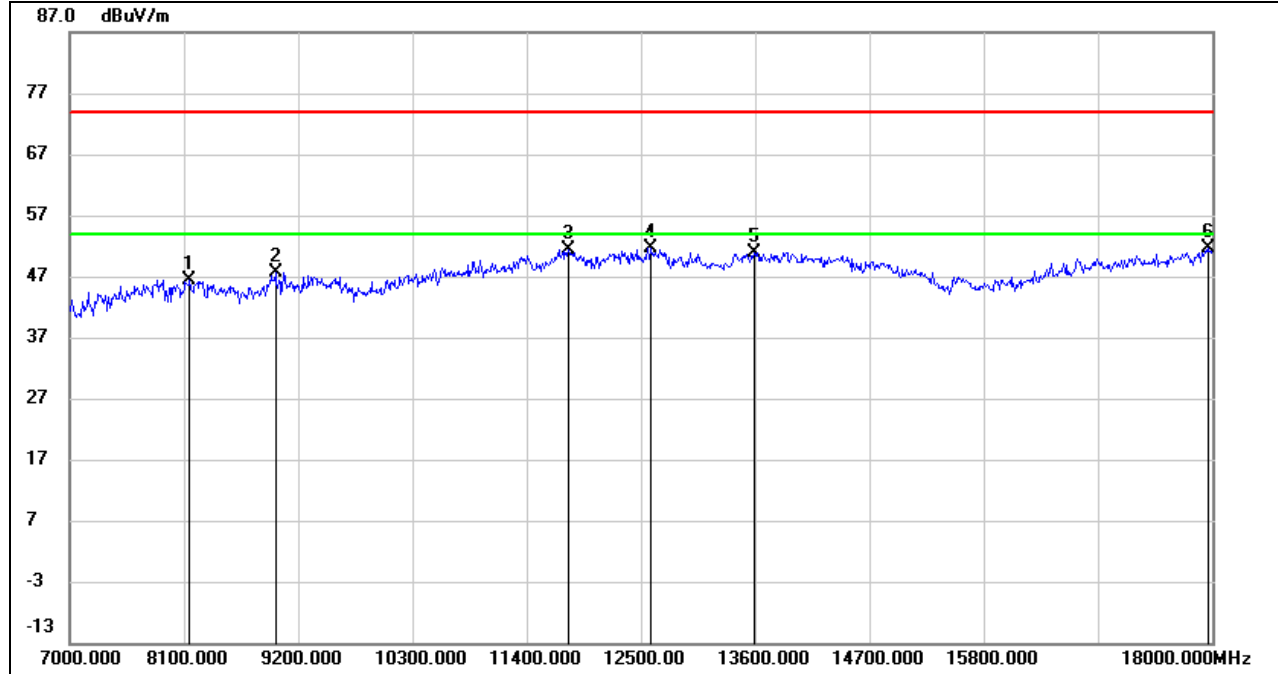

No.	Frequency (MHz)	Reading (dBuV)	Correct (dB/m)	Result (dBuV/m)	Limit (dBuV/m)	Margin (dB)	Remark
1	8155.000	38.03	8.35	46.38	74.00	-27.62	peak
2	8985.500	37.70	9.97	47.67	74.00	-26.33	peak
3	11807.000	33.99	17.35	51.34	74.00	-22.66	peak
4	12588.000	35.02	16.63	51.65	74.00	-22.35	peak
5	13594.500	32.61	18.36	50.97	74.00	-23.03	peak
6	17961.500	28.28	23.27	51.55	74.00	-22.45	peak

Note: 1. Measurement = Reading Level + Correct Factor.
 2. If Peak Result complies with AV limit, AV Result is deemed to comply with AV limit.
 3. Peak: Peak detector.
 4. Filter losses were only considered in the spurious frequency bands and the authorized band was not corrected for High Pass Filter losses.
 5. Proper operation of the transmitter prior to adding the filter to the measurement chain.
 6. Since non-restricted band peak emissions are less than the average limit, they also comply with the -27dBm/MHz (68.2dBuV/m) limit.

HARMONICS AND SPURIOUS EMISSIONS (LOW CHANNEL, VERTICAL)

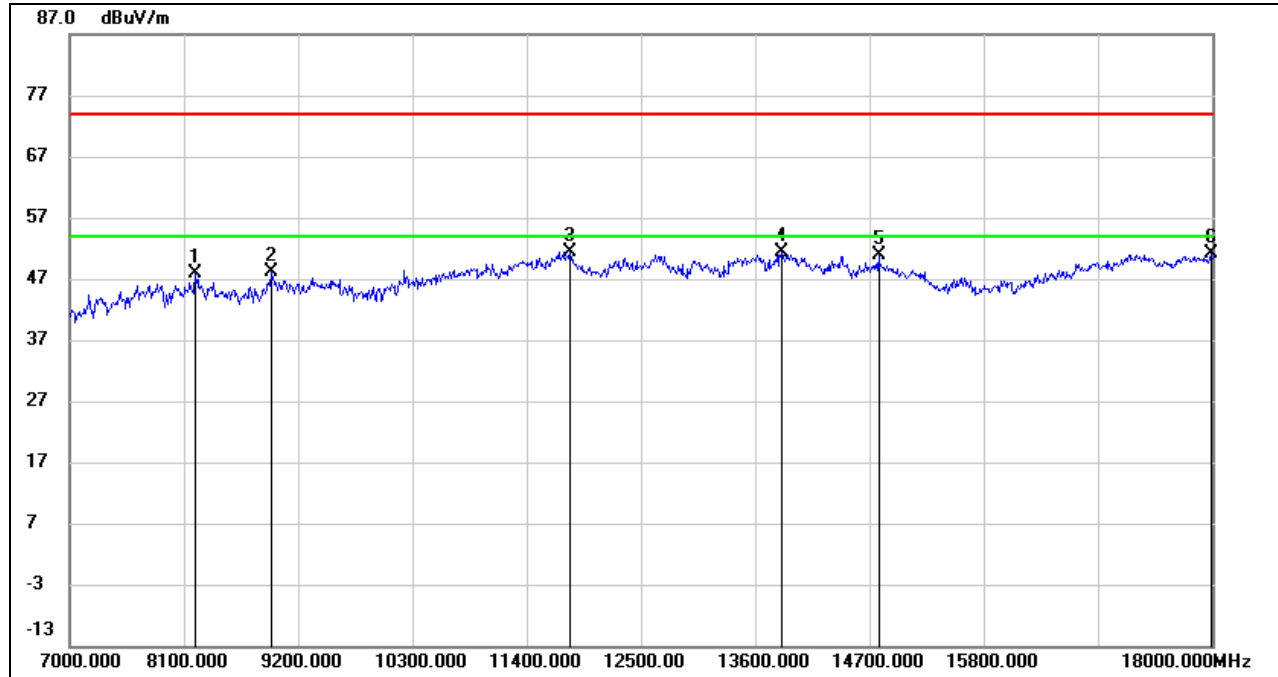

No.	Frequency (MHz)	Reading (dBuV)	Correct (dB/m)	Result (dBuV/m)	Limit (dBuV/m)	Margin (dB)	Remark
1	8215.500	39.17	8.65	47.82	74.00	-26.18	peak
2	8936.000	38.59	9.43	48.02	74.00	-25.98	peak
3	11818.000	34.07	17.31	51.38	74.00	-22.62	peak
4	13858.500	32.65	18.71	51.36	74.00	-22.64	peak
5	14793.500	34.53	16.32	50.85	74.00	-23.15	peak
6	17994.500	27.74	23.36	51.10	74.00	-22.90	peak

- Note: 1. Measurement = Reading Level + Correct Factor.
 2. If Peak Result complies with AV limit, AV Result is deemed to comply with AV limit.
 3. Peak: Peak detector.
 4. Filter losses were only considered in the spurious frequency bands and the authorized band was not corrected for High Pass Filter losses.
 5. Proper operation of the transmitter prior to adding the filter to the measurement chain.
 6. Since non-restricted band peak emissions are less than the average limit, they also comply with the -27dBm/MHz (68.2dBuV/m) limit.

HARMONICS AND SPURIOUS EMISSIONS (HIGH CHANNEL, HORIZONTAL)

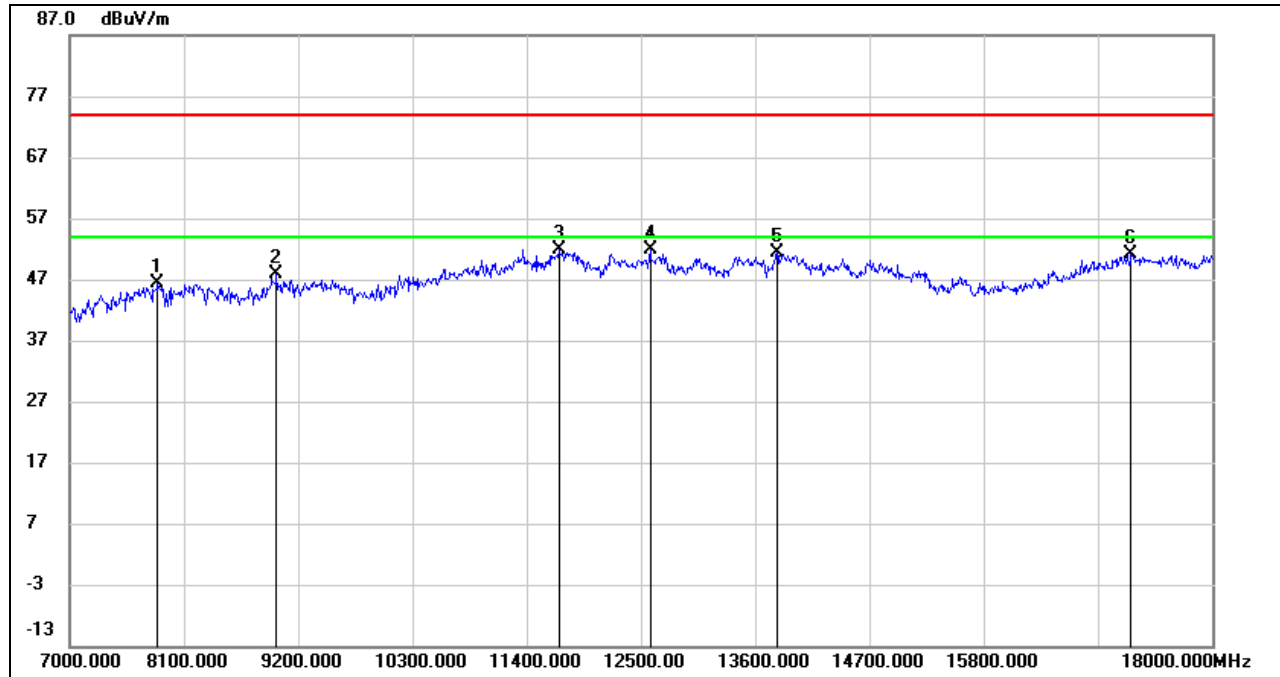

No.	Frequency (MHz)	Reading (dBuV)	Correct (dB/m)	Result (dBuV/m)	Limit (dBuV/m)	Margin (dB)	Remark
1	7852.500	38.84	7.46	46.30	74.00	-27.70	peak
2	8991.000	37.74	10.03	47.77	74.00	-26.23	peak
3	11713.500	34.91	16.90	51.81	74.00	-22.19	peak
4	12593.500	35.13	16.63	51.76	74.00	-22.24	peak
5	13809.000	32.65	18.77	51.42	74.00	-22.58	peak
6	17219.000	31.42	19.74	51.16	74.00	-22.84	peak

- Note: 1. Measurement = Reading Level + Correct Factor.
 2. If Peak Result complies with AV limit, AV Result is deemed to comply with AV limit.
 3. Peak: Peak detector.
 4. Filter losses were only considered in the spurious frequency bands and the authorized band was not corrected for High Pass Filter losses.
 5. Proper operation of the transmitter prior to adding the filter to the measurement chain.
 6. Since non-restricted band peak emissions are less than the average limit, they also comply with the -27dBm/MHz (68.2dBuV/m) limit.

HARMONICS AND SPURIOUS EMISSIONS (HIGH CHANNEL, VERTICAL)

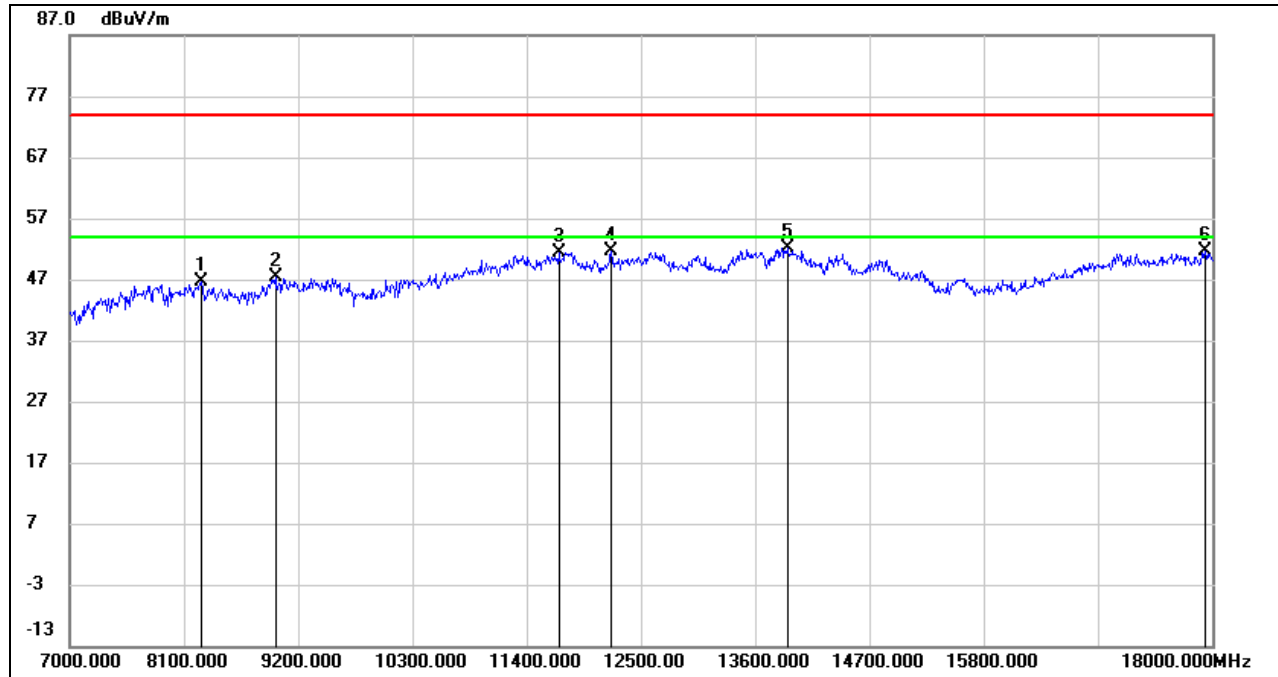

No.	Frequency (MHz)	Reading (dBuV)	Correct (dB/m)	Result (dBuV/m)	Limit (dBuV/m)	Margin (dB)	Remark
1	8270.500	38.29	8.43	46.72	74.00	-27.28	peak
2	8985.500	37.37	9.97	47.34	74.00	-26.66	peak
3	11713.500	34.58	16.90	51.48	74.00	-22.52	peak
4	12214.000	34.86	16.66	51.52	74.00	-22.48	peak
5	13913.500	33.44	18.65	52.09	74.00	-21.91	peak
6	17939.500	28.44	23.22	51.66	74.00	-22.34	peak

Note: 1. Measurement = Reading Level + Correct Factor.
 2. If Peak Result complies with AV limit, AV Result is deemed to comply with AV limit.
 3. Peak: Peak detector.
 4. Filter losses were only considered in the spurious frequency bands and the authorized band was not corrected for High Pass Filter losses.
 5. Proper operation of the transmitter prior to adding the filter to the measurement chain.
 6. Since non-restricted band peak emissions are less than the average limit, they also comply with the -27dBm/MHz (68.2dBuV/m) limit.

8.3.7. 802.11ax HE80 MIMO MODE

UNII-1 BAND

HARMONICS AND SPURIOUS EMISSIONS (LOW CHANNEL, HORIZONTAL)

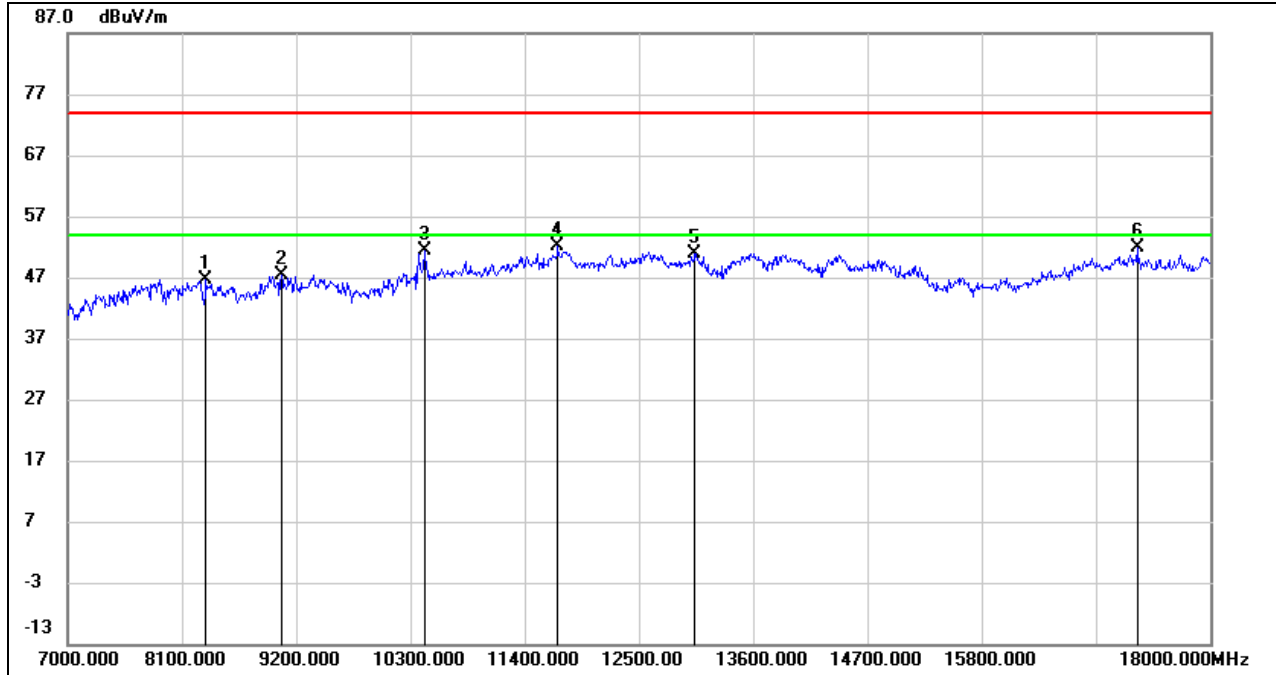

No.	Frequency (MHz)	Reading (dBuV)	Correct (dB/m)	Result (dBuV/m)	Limit (dBuV/m)	Margin (dB)	Remark
1	8336.500	38.37	8.17	46.54	74.00	-27.46	peak
2	9062.500	37.62	9.76	47.38	74.00	-26.62	peak
3	10437.500	39.28	12.15	51.43	74.00	-22.57	peak
4	11724.500	35.12	16.95	52.07	74.00	-21.93	peak
5	13039.000	33.98	16.99	50.97	74.00	-23.03	peak
6	17296.000	32.03	19.79	51.82	74.00	-22.18	peak

- Note: 1. Measurement = Reading Level + Correct Factor.
 2. If Peak Result complies with AV limit, AV Result is deemed to comply with AV limit.
 3. Peak: Peak detector.
 4. AVG: $VBW=1/Ton$, where: Ton is the transmitting duration.
 5. For the transmitting duration, please refer to clause 7.1.
 6. Filter losses were only considered in the spurious frequency bands and the authorized band was not corrected for High Pass Filter losses.
 7. Proper operation of the transmitter prior to adding the filter to the measurement chain.
 8. Since non-restricted band peak emissions are less than the average limit, they also comply with the -27dBm/MHz (68.2dBuV/m) limit.

HARMONICS AND SPURIOUS EMISSIONS (LOW CHANNEL, VERTICAL)

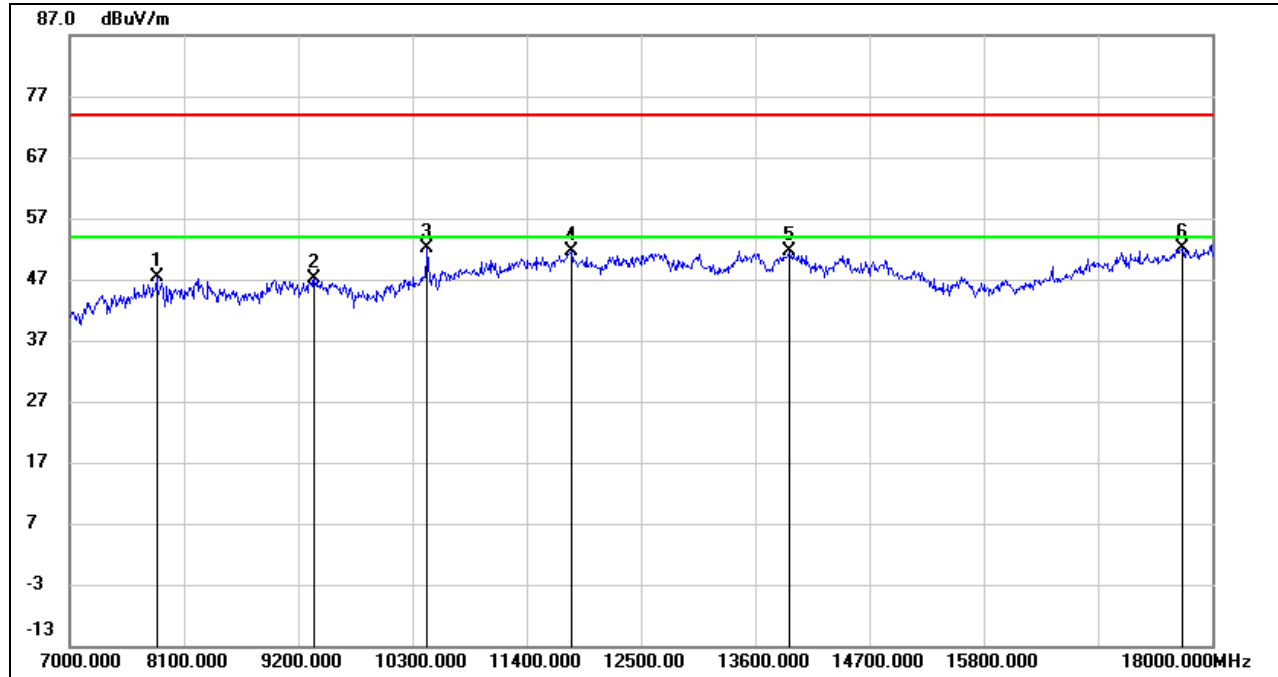

No.	Frequency (MHz)	Reading (dBuV)	Correct (dB/m)	Result (dBuV/m)	Limit (dBuV/m)	Margin (dB)	Remark
1	7836.000	39.78	7.51	47.29	74.00	-26.71	peak
2	9354.000	37.27	9.86	47.13	74.00	-26.87	peak
3	10443.000	40.05	12.18	52.23	74.00	-21.77	peak
4	11829.000	34.33	17.30	51.63	74.00	-22.37	peak
5	13930.000	33.00	18.63	51.63	74.00	-22.37	peak
6	17719.500	30.23	22.01	52.24	74.00	-21.76	peak

- Note: 1. Measurement = Reading Level + Correct Factor.
 2. If Peak Result complies with AV limit, AV Result is deemed to comply with AV limit.
 3. Peak: Peak detector.
 4. AVG: $VBW=1/Ton$, where: Ton is the transmitting duration.
 5. For the transmitting duration, please refer to clause 7.1.
 6. Filter losses were only considered in the spurious frequency bands and the authorized band was not corrected for High Pass Filter losses.
 7. Proper operation of the transmitter prior to adding the filter to the measurement chain.
 8. Since non-restricted band peak emissions are less than the average limit, they also comply with the -27dBm/MHz (68.2dBuV/m) limit.

UNII-2A BAND

HARMONICS AND SPURIOUS EMISSIONS (LOW CHANNEL, HORIZONTAL)

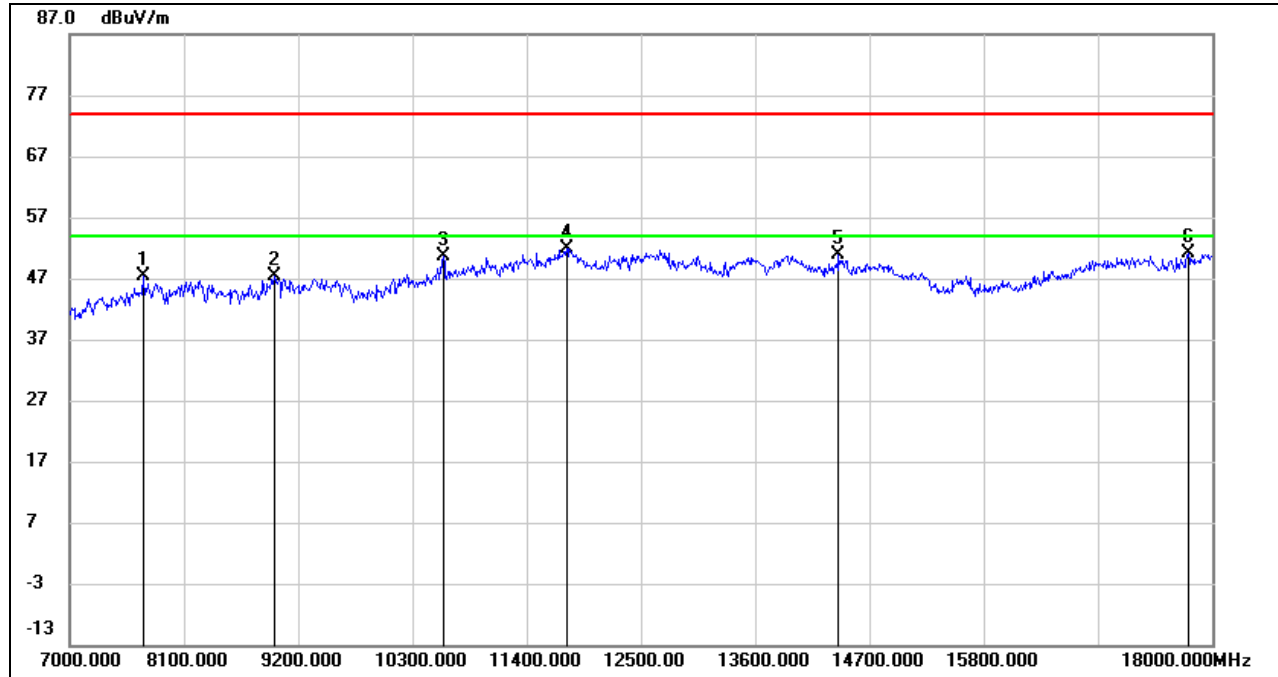

No.	Frequency (MHz)	Reading (dBuV)	Correct (dB/m)	Result (dBuV/m)	Limit (dBuV/m)	Margin (dB)	Remark
1	7709.500	40.07	7.25	47.32	74.00	-26.68	peak
2	8969.000	37.58	9.79	47.37	74.00	-26.63	peak
3	10602.500	37.77	12.94	50.71	74.00	-23.29	peak
4	11790.500	34.61	17.30	51.91	74.00	-22.09	peak
5	14403.000	33.35	17.42	50.77	74.00	-23.23	peak
6	17774.500	28.48	22.60	51.08	74.00	-22.92	peak

Note: 1. Measurement = Reading Level + Correct Factor.
 2. If Peak Result complies with AV limit, AV Result is deemed to comply with AV limit.
 3. Peak: Peak detector.
 4. Filter losses were only considered in the spurious frequency bands and the authorized band was not corrected for High Pass Filter losses.
 5. Proper operation of the transmitter prior to adding the filter to the measurement chain.
 6. Since non-restricted band peak emissions are less than the average limit, they also comply with the -27dBm/MHz (68.2dBuV/m) limit.

HARMONICS AND SPURIOUS EMISSIONS (LOW CHANNEL, VERTICAL)

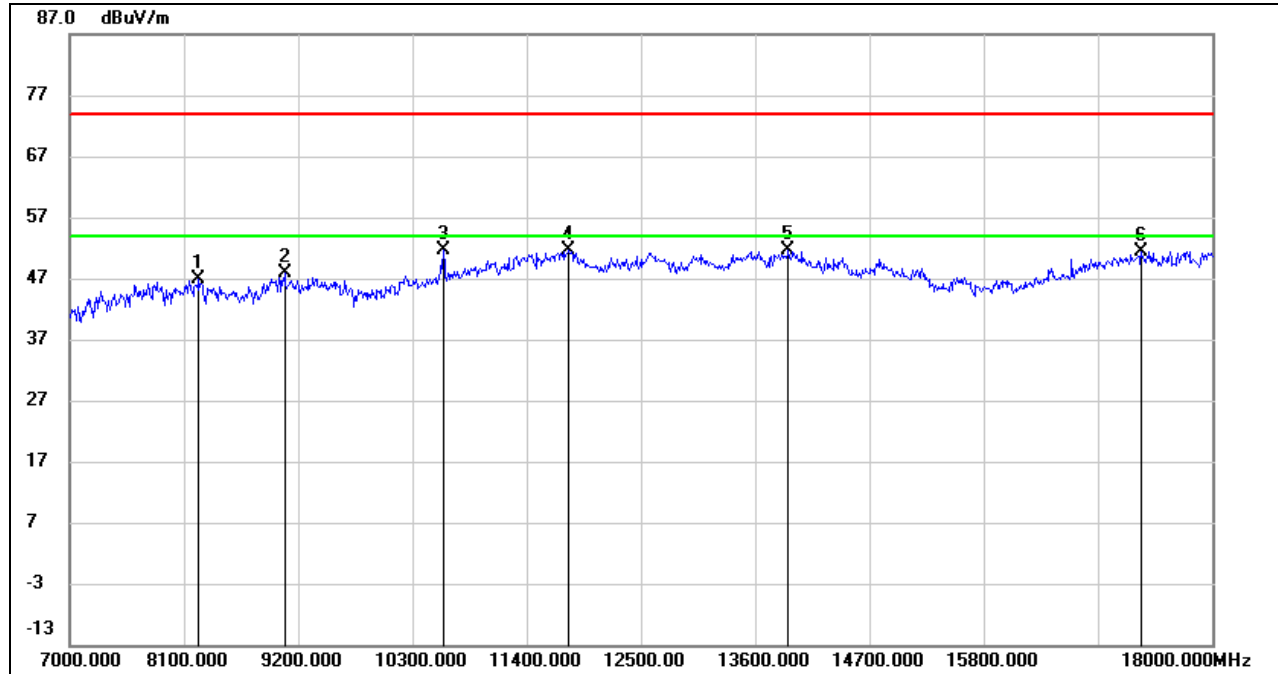

No.	Frequency (MHz)	Reading (dBuV)	Correct (dB/m)	Result (dBuV/m)	Limit (dBuV/m)	Margin (dB)	Remark
1	8243.000	38.24	8.54	46.78	74.00	-27.22	peak
2	9068.000	38.11	9.73	47.84	74.00	-26.16	peak
3	10602.500	38.57	12.94	51.51	74.00	-22.49	peak
4	11807.000	34.31	17.35	51.66	74.00	-22.34	peak
5	13919.000	32.96	18.64	51.60	74.00	-22.40	peak
6	17323.500	31.62	19.80	51.42	74.00	-22.58	peak

- Note:
1. Measurement = Reading Level + Correct Factor.
 2. If Peak Result complies with AV limit, AV Result is deemed to comply with AV limit.
 3. Peak: Peak detector.
 4. AVG: $VBW=1/Ton$, where: Ton is the transmitting duration.
 5. For the transmitting duration, please refer to clause 7.1.
 6. Filter losses were only considered in the spurious frequency bands and the authorized band was not corrected for High Pass Filter losses.
 7. Proper operation of the transmitter prior to adding the filter to the measurement chain.
 8. Since non-restricted band peak emissions are less than the average limit, they also comply with the -27dBm/MHz (68.2dBuV/m) limit.



UNII-2C BAND

HARMONICS AND SPURIOUS EMISSIONS (LOW CHANNEL, HORIZONTAL)

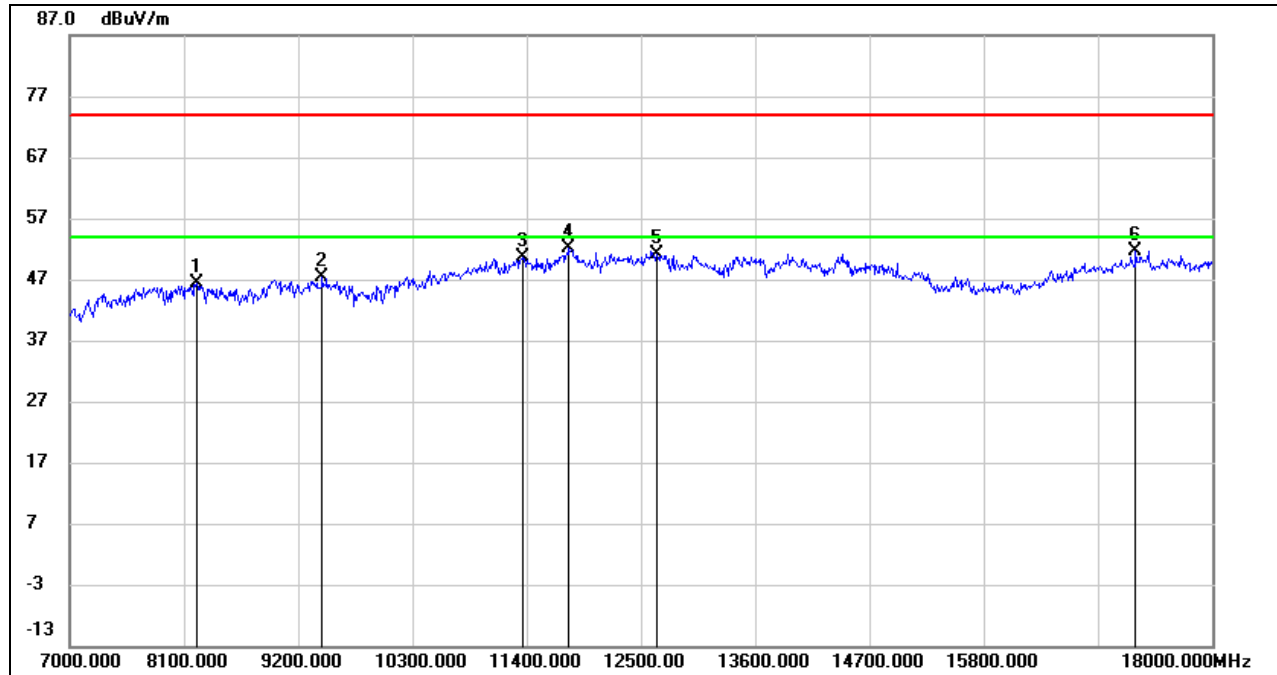

No.	Frequency (MHz)	Reading (dBuV)	Correct (dB/m)	Result (dBuV/m)	Limit (dBuV/m)	Margin (dB)	Remark
1	8221.000	37.64	8.63	46.27	74.00	-27.73	peak
2	9431.000	37.15	10.20	47.35	74.00	-26.65	peak
3	11356.000	34.95	15.64	50.59	74.00	-23.41	peak
4	11812.500	34.84	17.33	52.17	74.00	-21.83	peak
5	12654.000	34.37	16.74	51.11	74.00	-22.89	peak
6	17263.000	31.87	19.78	51.65	74.00	-22.35	peak

- Note:
1. Measurement = Reading Level + Correct Factor.
 2. If Peak Result complies with AV limit, AV Result is deemed to comply with AV limit.
 3. Peak: Peak detector.
 4. AVG: $VBW=1/Ton$, where: Ton is the transmitting duration.
 5. For the transmitting duration, please refer to clause 7.1.
 6. Filter losses were only considered in the spurious frequency bands and the authorized band was not corrected for High Pass Filter losses.
 7. Proper operation of the transmitter prior to adding the filter to the measurement chain.
 8. Since non-restricted band peak emissions are less than the average limit, they also comply with the -27dBm/MHz (68.2dBuV/m) limit.

HARMONICS AND SPURIOUS EMISSIONS (LOW CHANNEL, VERTICAL)

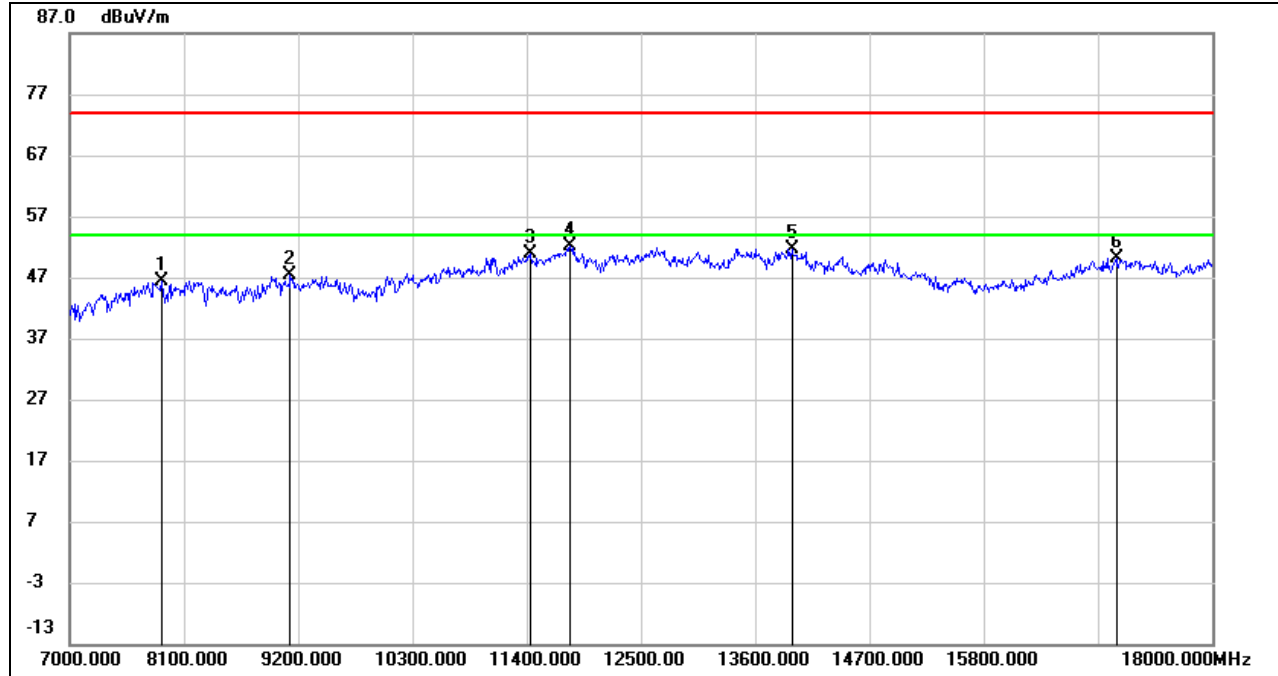

No.	Frequency (MHz)	Reading (dBuV)	Correct (dB/m)	Result (dBuV/m)	Limit (dBuV/m)	Margin (dB)	Remark
1	7885.500	39.00	7.37	46.37	74.00	-27.63	peak
2	9128.500	37.96	9.37	47.33	74.00	-26.67	peak
3	11438.500	34.93	15.96	50.89	74.00	-23.11	peak
4	11818.000	34.82	17.31	52.13	74.00	-21.87	peak
5	13952.000	33.07	18.61	51.68	74.00	-22.32	peak
6	17076.000	31.26	18.99	50.25	74.00	-23.75	peak

- Note: 1. Measurement = Reading Level + Correct Factor.
 2. If Peak Result complies with AV limit, AV Result is deemed to comply with AV limit.
 3. Peak: Peak detector.
 4. AVG: $VBW=1/Ton$, where: Ton is the transmitting duration.
 5. For the transmitting duration, please refer to clause 7.1.
 6. Filter losses were only considered in the spurious frequency bands and the authorized band was not corrected for High Pass Filter losses.
 7. Proper operation of the transmitter prior to adding the filter to the measurement chain.
 8. Since non-restricted band peak emissions are less than the average limit, they also comply with the -27dBm/MHz (68.2dBuV/m) limit.



HARMONICS AND SPURIOUS EMISSIONS (HIGH CHANNEL, HORIZONTAL)

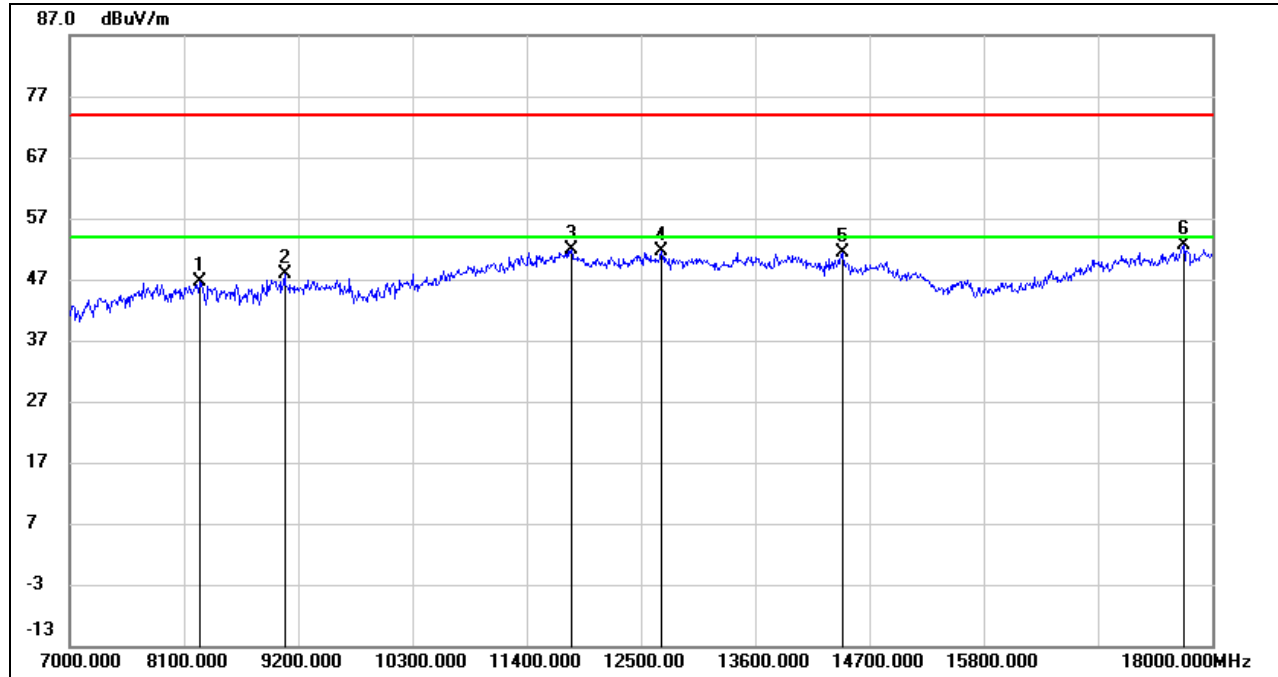

No.	Frequency (MHz)	Reading (dBuV)	Correct (dB/m)	Result (dBuV/m)	Limit (dBuV/m)	Margin (dB)	Remark
1	8259.500	38.11	8.48	46.59	74.00	-27.41	peak
2	9068.000	38.13	9.73	47.86	74.00	-26.14	peak
3	11829.000	34.48	17.30	51.78	74.00	-22.22	peak
4	12698.000	34.84	16.85	51.69	74.00	-22.31	peak
5	14452.500	34.13	17.19	51.32	74.00	-22.68	peak
6	17725.000	30.62	22.06	52.68	74.00	-21.32	peak

- Note:
1. Measurement = Reading Level + Correct Factor.
 2. If Peak Result complies with AV limit, AV Result is deemed to comply with AV limit.
 3. Peak: Peak detector.
 4. AVG: $VBW=1/Ton$, where: Ton is the transmitting duration.
 5. For the transmitting duration, please refer to clause 7.1.
 6. Filter losses were only considered in the spurious frequency bands and the authorized band was not corrected for High Pass Filter losses.
 7. Proper operation of the transmitter prior to adding the filter to the measurement chain.
 8. Since non-restricted band peak emissions are less than the average limit, they also comply with the -27dBm/MHz (68.2dBuV/m) limit.

HARMONICS AND SPURIOUS EMISSIONS (HIGH CHANNEL, VERTICAL)

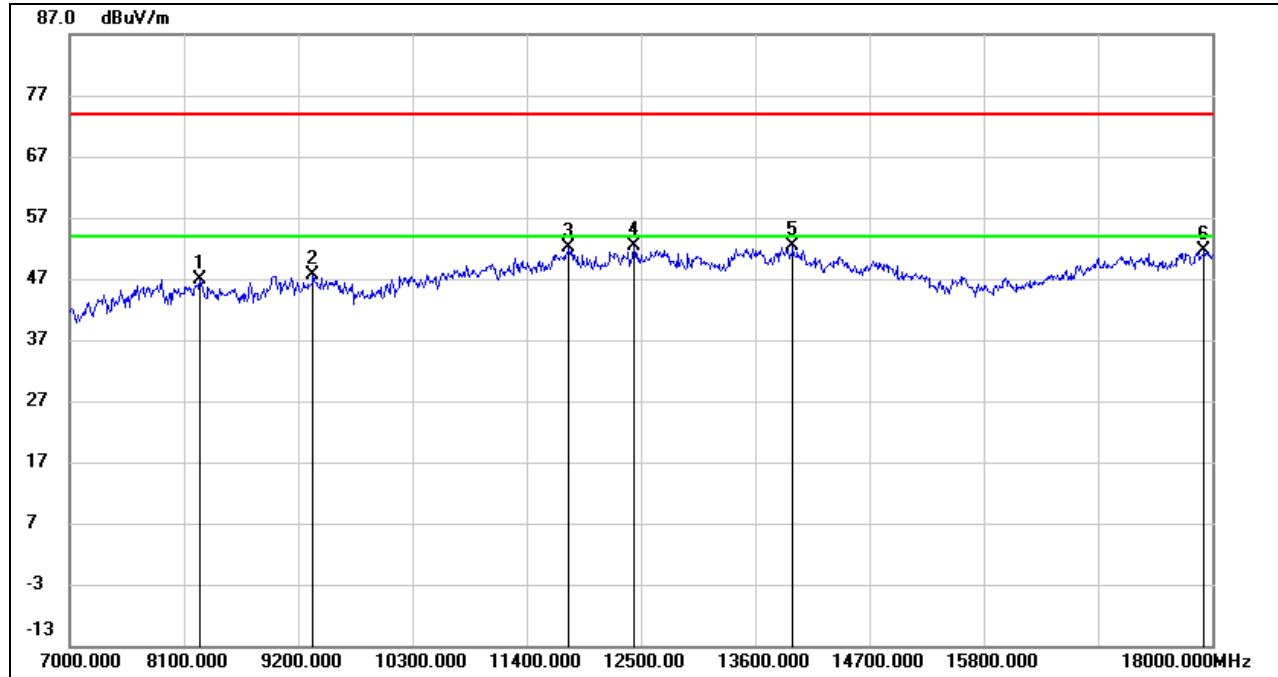

No.	Frequency (MHz)	Reading (dBuV)	Correct (dB/m)	Result (dBuV/m)	Limit (dBuV/m)	Margin (dB)	Remark
1	8259.500	38.40	8.48	46.88	74.00	-27.12	peak
2	9343.000	37.82	9.80	47.62	74.00	-26.38	peak
3	11807.000	34.73	17.35	52.08	74.00	-21.92	peak
4	12434.000	35.59	16.82	52.41	74.00	-21.59	peak
5	13968.500	33.87	18.58	52.45	74.00	-21.55	peak
6	17923.000	28.38	23.18	51.56	74.00	-22.44	peak

- Note: 1. Measurement = Reading Level + Correct Factor.
 2. If Peak Result complies with AV limit, AV Result is deemed to comply with AV limit.
 3. Peak: Peak detector.
 4. AVG: $VBW=1/Ton$, where: Ton is the transmitting duration.
 5. For the transmitting duration, please refer to clause 7.1.
 6. Filter losses were only considered in the spurious frequency bands and the authorized band was not corrected for High Pass Filter losses.
 7. Proper operation of the transmitter prior to adding the filter to the measurement chain.
 8. Since non-restricted band peak emissions are less than the average limit, they also comply with the -27dBm/MHz (68.2dBuV/m) limit.

STRADDLE CHANNEL 138

HARMONICS AND SPURIOUS EMISSIONS (HIGH CHANNEL, HORIZONTAL)

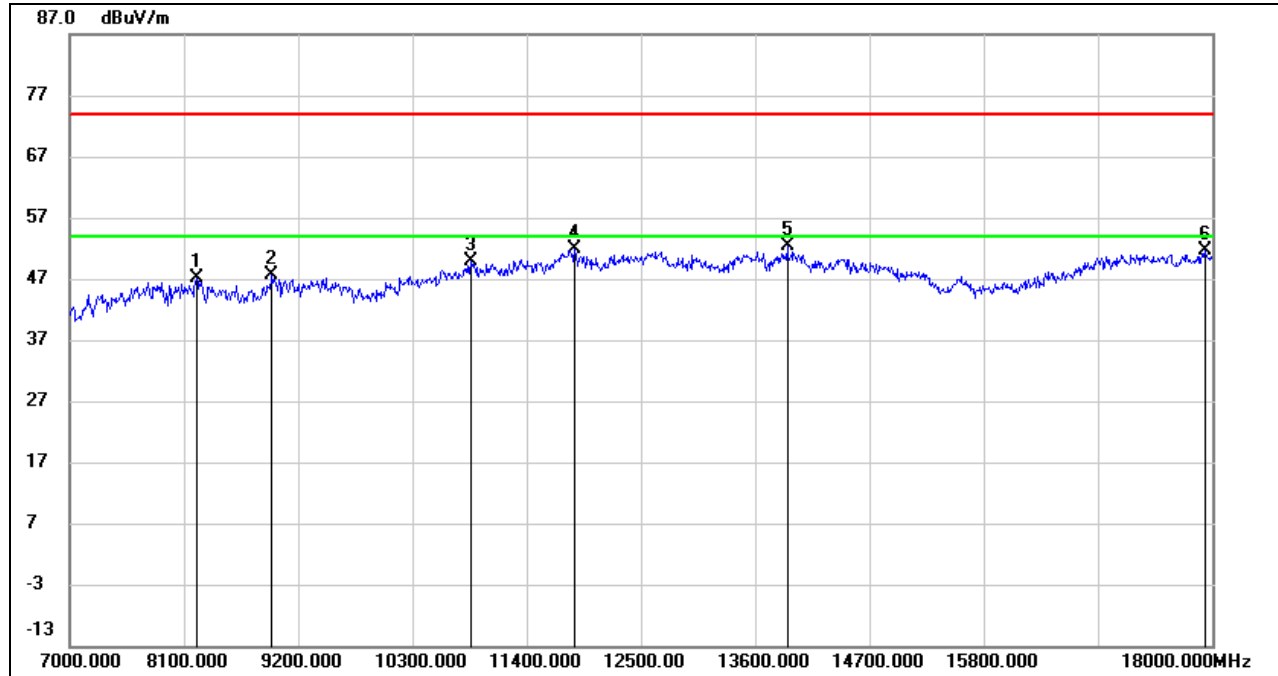

No.	Frequency (MHz)	Reading (dBuV)	Correct (dB/m)	Result (dBuV/m)	Limit (dBuV/m)	Margin (dB)	Remark
1	8226.500	38.55	8.61	47.16	74.00	-26.84	peak
2	8947.000	38.02	9.55	47.57	74.00	-26.43	peak
3	10866.500	36.11	13.66	49.77	74.00	-24.23	peak
4	11862.000	34.71	17.25	51.96	74.00	-22.04	peak
5	13913.500	33.76	18.65	52.41	74.00	-21.59	peak
6	17934.000	28.31	23.20	51.51	74.00	-22.49	peak

- Note: 1. Measurement = Reading Level + Correct Factor.
 2. If Peak Result complies with AV limit, AV Result is deemed to comply with AV limit.
 3. Peak: Peak detector.
 4. AVG: $VBW=1/Ton$, where: Ton is the transmitting duration.
 5. For the transmitting duration, please refer to clause 7.1.
 6. Filter losses were only considered in the spurious frequency bands and the authorized band was not corrected for High Pass Filter losses.
 7. Proper operation of the transmitter prior to adding the filter to the measurement chain.
 8. Since non-restricted band peak emissions are less than the average limit, they also comply with the -27dBm/MHz (68.2dBuV/m) limit.

HARMONICS AND SPURIOUS EMISSIONS (HIGH CHANNEL, VERTICAL)

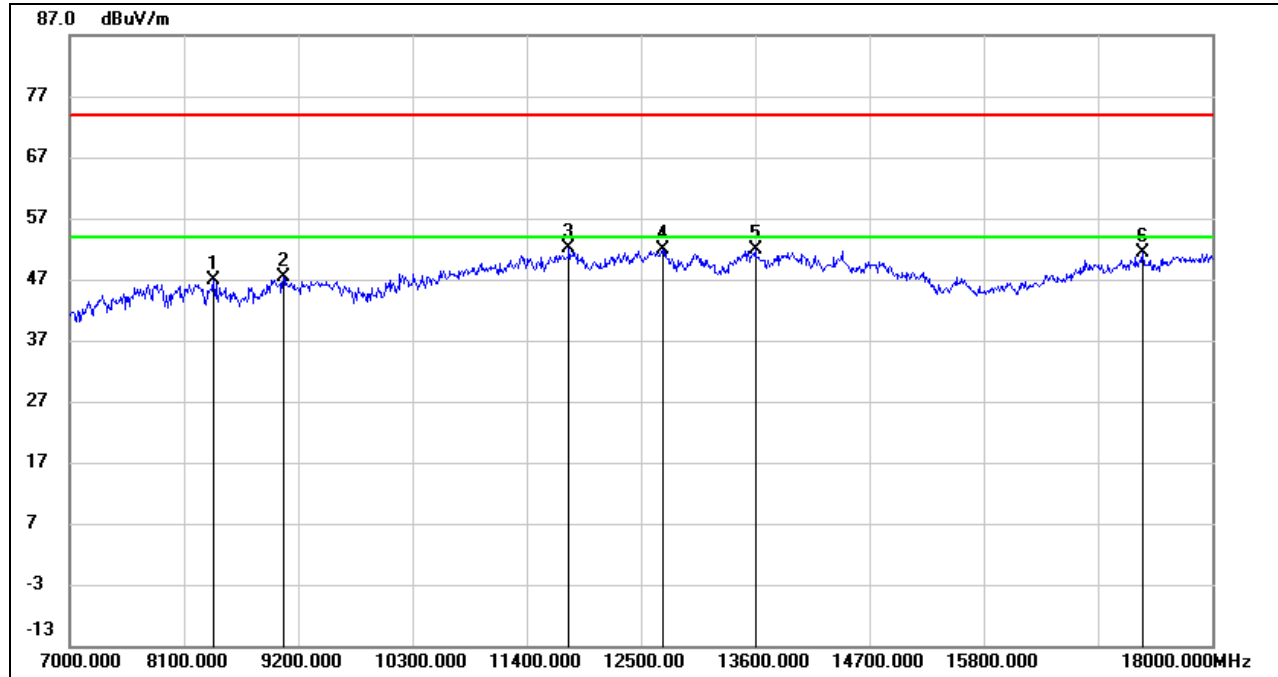

No.	Frequency (MHz)	Reading (dBuV)	Correct (dB/m)	Result (dBuV/m)	Limit (dBuV/m)	Margin (dB)	Remark
1	8386.000	38.87	7.97	46.84	74.00	-27.16	peak
2	9062.500	37.50	9.76	47.26	74.00	-26.74	peak
3	11812.500	34.89	17.33	52.22	74.00	-21.78	peak
4	12714.500	34.99	16.88	51.87	74.00	-22.13	peak
5	13605.500	33.45	18.38	51.83	74.00	-22.17	peak
6	17329.000	31.47	19.80	51.27	74.00	-22.73	peak

Note: 1. Measurement = Reading Level + Correct Factor.
 2. If Peak Result complies with AV limit, AV Result is deemed to comply with AV limit.
 3. Peak: Peak detector.
 4. AVG: $VBW=1/Ton$, where: Ton is the transmitting duration.
 5. For the transmitting duration, please refer to clause 7.1.
 6. Filter losses were only considered in the spurious frequency bands and the authorized band was not corrected for High Pass Filter losses.
 7. Proper operation of the transmitter prior to adding the filter to the measurement chain.
 8. Since non-restricted band peak emissions are less than the average limit, they also comply with the -27dBm/MHz (68.2dBuV/m) limit.

UNII-3 BAND

HARMONICS AND SPURIOUS EMISSIONS (LOW CHANNEL, HORIZONTAL)

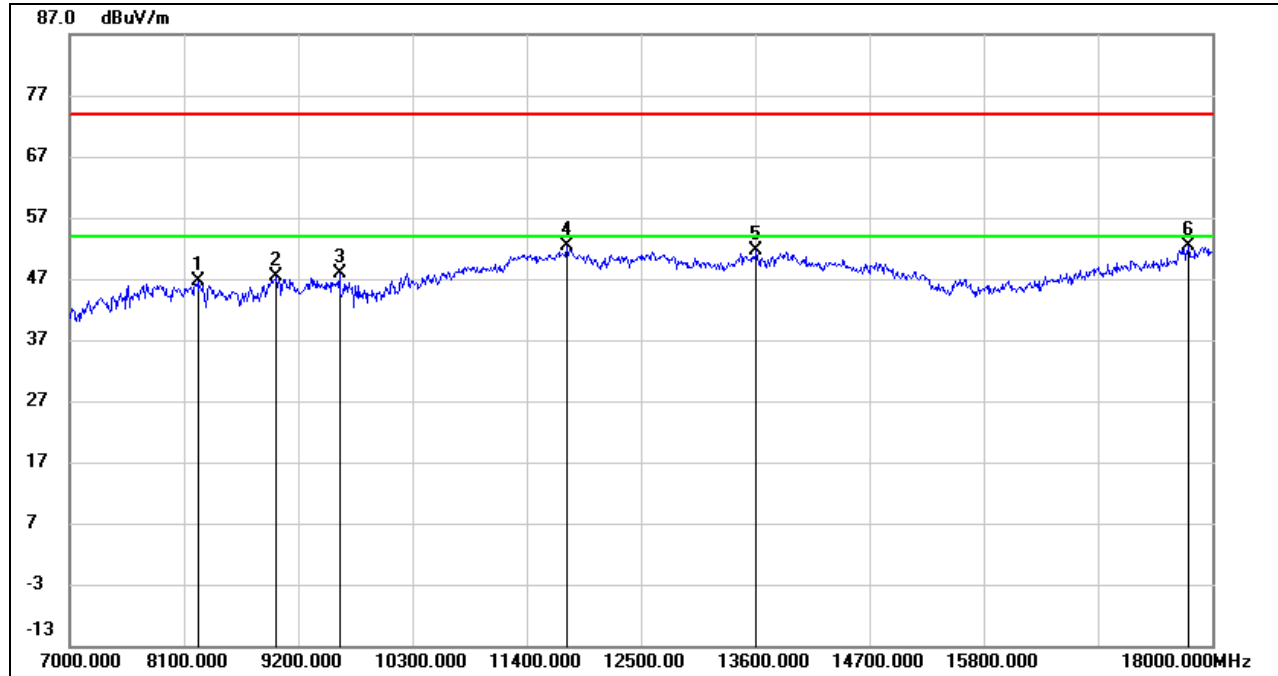

No.	Frequency (MHz)	Reading (dBuV)	Correct (dB/m)	Result (dBuV/m)	Limit (dBuV/m)	Margin (dB)	Remark
1	8237.500	37.98	8.56	46.54	74.00	-27.46	peak
2	8991.000	37.28	10.03	47.31	74.00	-26.69	peak
3	9596.000	37.38	10.51	47.89	74.00	-26.11	peak
4	11785.000	35.10	17.27	52.37	74.00	-21.63	peak
5	13616.500	33.32	18.40	51.72	74.00	-22.28	peak
6	17769.000	29.93	22.53	52.46	74.00	-21.54	peak

Note: 1. Measurement = Reading Level + Correct Factor.
 2. If Peak Result complies with AV limit, AV Result is deemed to comply with AV limit.
 3. Peak: Peak detector.
 4. Filter losses were only considered in the spurious frequency bands and the authorized band was not corrected for High Pass Filter losses.
 5. Proper operation of the transmitter prior to adding the filter to the measurement chain.
 6. Since non-restricted band peak emissions are less than the average limit, they also comply with the -27dBm/MHz (68.2dBuV/m) limit.



HARMONICS AND SPURIOUS EMISSIONS (LOW CHANNEL, VERTICAL)

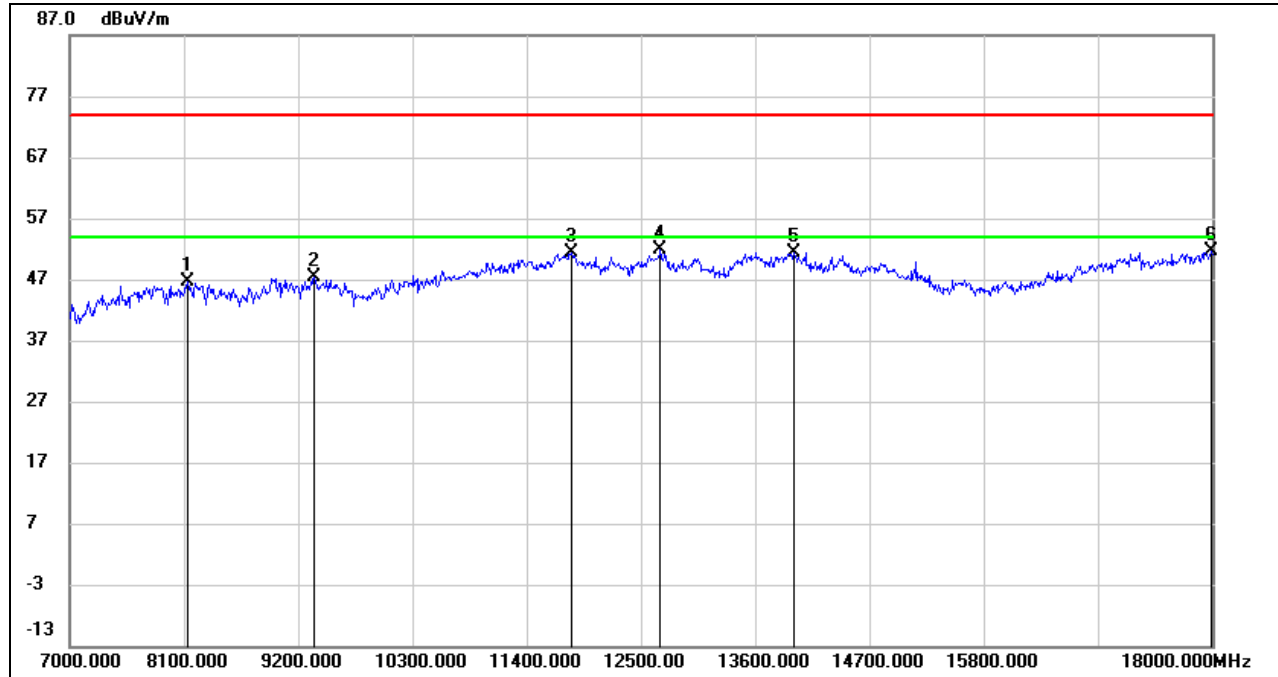

No.	Frequency (MHz)	Reading (dBuV)	Correct (dB/m)	Result (dBuV/m)	Limit (dBuV/m)	Margin (dB)	Remark
1	8138.500	38.51	8.20	46.71	74.00	-27.29	peak
2	9354.000	37.53	9.86	47.39	74.00	-26.61	peak
3	11829.000	34.10	17.30	51.40	74.00	-22.60	peak
4	12687.000	34.97	16.82	51.79	74.00	-22.21	peak
5	13974.000	32.84	18.58	51.42	74.00	-22.58	peak
6	17994.500	28.19	23.36	51.55	74.00	-22.45	peak

- Note: 1. Measurement = Reading Level + Correct Factor.
 2. If Peak Result complies with AV limit, AV Result is deemed to comply with AV limit.
 3. Peak: Peak detector.
 4. AVG: $VBW=1/Ton$, where: Ton is the transmitting duration.
 5. For the transmitting duration, please refer to clause 7.1.
 6. Filter losses were only considered in the spurious frequency bands and the authorized band was not corrected for High Pass Filter losses.
 7. Proper operation of the transmitter prior to adding the filter to the measurement chain.
 8. Since non-restricted band peak emissions are less than the average limit, they also comply with the -27dBm/MHz (68.2dBuV/m) limit.

8.4. SPURIOUS EMISSIONS (18 GHz ~ 26 GHz)

8.4.1. 802.11ac VHT20 MIMO MODE

SPURIOUS EMISSIONS (UNII-3 BAND LOW CHANNEL, HORIZONTAL, WORST-CASE CONFIGURATION)

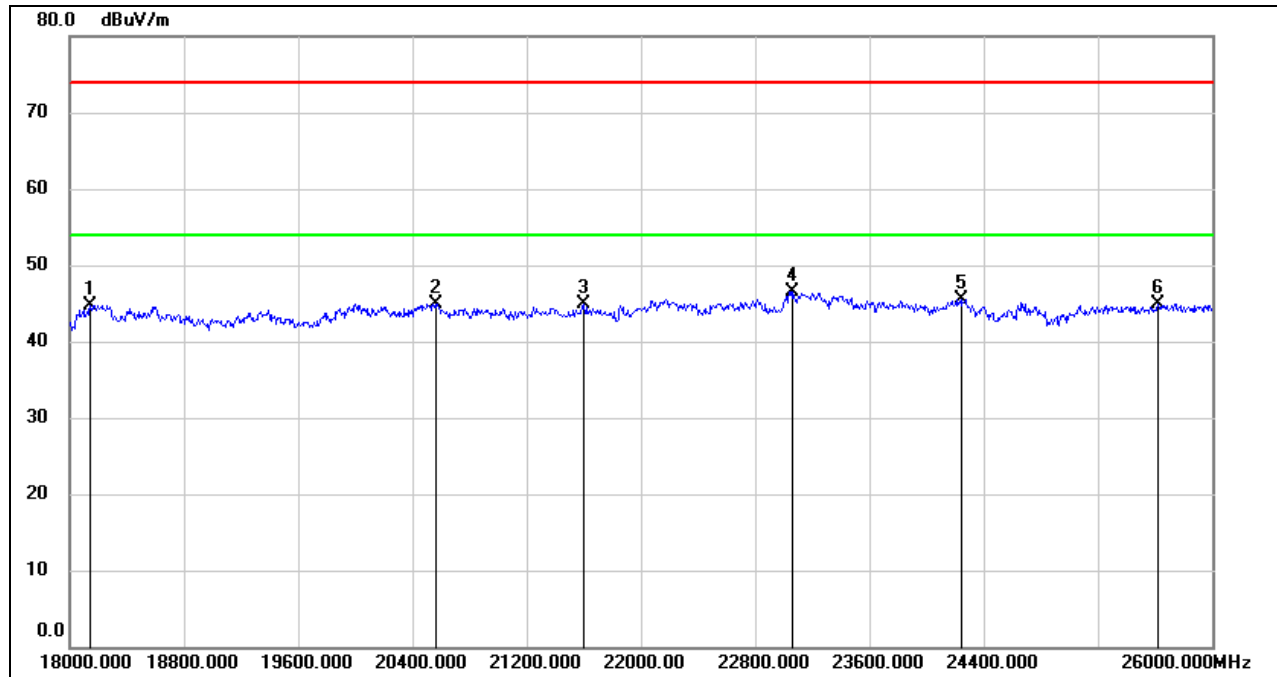

No.	Frequency (MHz)	Reading (dBuV)	Correct (dB/m)	Result (dBuV/m)	Limit (dBuV/m)	Margin (dB)	Remark
1	18144.000	50.27	-5.48	44.79	74.00	-29.21	peak
2	20560.000	50.23	-5.30	44.93	74.00	-29.07	peak
3	21600.000	49.52	-4.54	44.98	74.00	-29.02	peak
4	23064.000	49.99	-3.42	46.57	74.00	-27.43	peak
5	24248.000	48.32	-2.83	45.49	74.00	-28.51	peak
6	25616.000	46.18	-1.24	44.94	74.00	-29.06	peak

- Note: 1. Measurement = Reading Level + Correct Factor.
 2. If Peak Result complies with AV limit, AV Result is deemed to comply with AV limit.
 3. Peak: Peak detector.

SPURIOUS EMISSIONS (UNII-3 BAND LOW CHANNEL, VERTICAL, WORST-CASE CONFIGURATION)

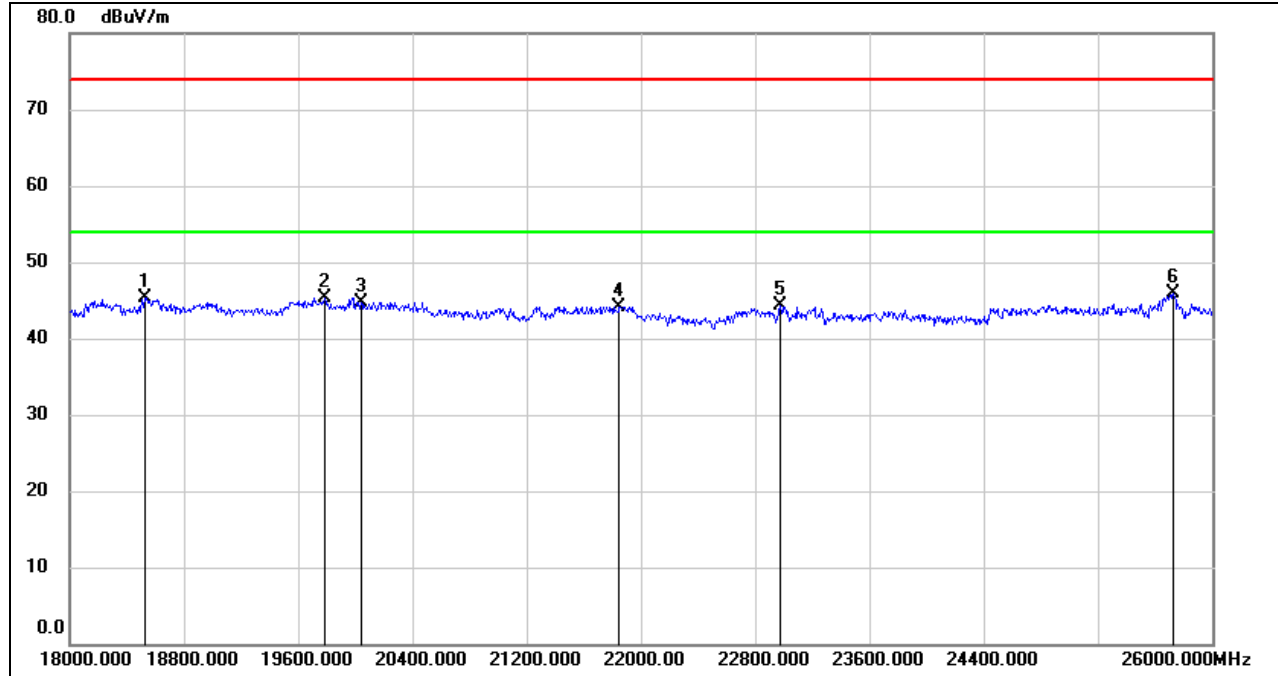

No.	Frequency (MHz)	Reading (dBuV)	Correct (dB/m)	Result (dBuV/m)	Limit (dBuV/m)	Margin (dB)	Remark
1	18528.000	50.61	-5.26	45.35	74.00	-28.65	peak
2	19784.000	50.57	-5.28	45.29	74.00	-28.71	peak
3	20040.000	50.21	-5.48	44.73	74.00	-29.27	peak
4	21848.000	48.58	-4.39	44.19	74.00	-29.81	peak
5	22976.000	47.76	-3.46	44.30	74.00	-29.70	peak
6	25728.000	46.61	-0.72	45.89	74.00	-28.11	peak

- Note: 1. Measurement = Reading Level + Correct Factor.
 2. If Peak Result complies with AV limit, AV Result is deemed to comply with AV limit.
 3. Peak: Peak detector.

Note: All the modes had been tested, but only the worst data was recorded in the report.

8.5. SPURIOUS EMISSIONS (26 GHz ~ 40 GHz)

8.5.1. 802.11 ac VHT20 MIMO MODE

SPURIOUS EMISSIONS (UNII-3 BAND LOW CHANNEL, HORIZONTAL, WORST-CASE CONFIGURATION)

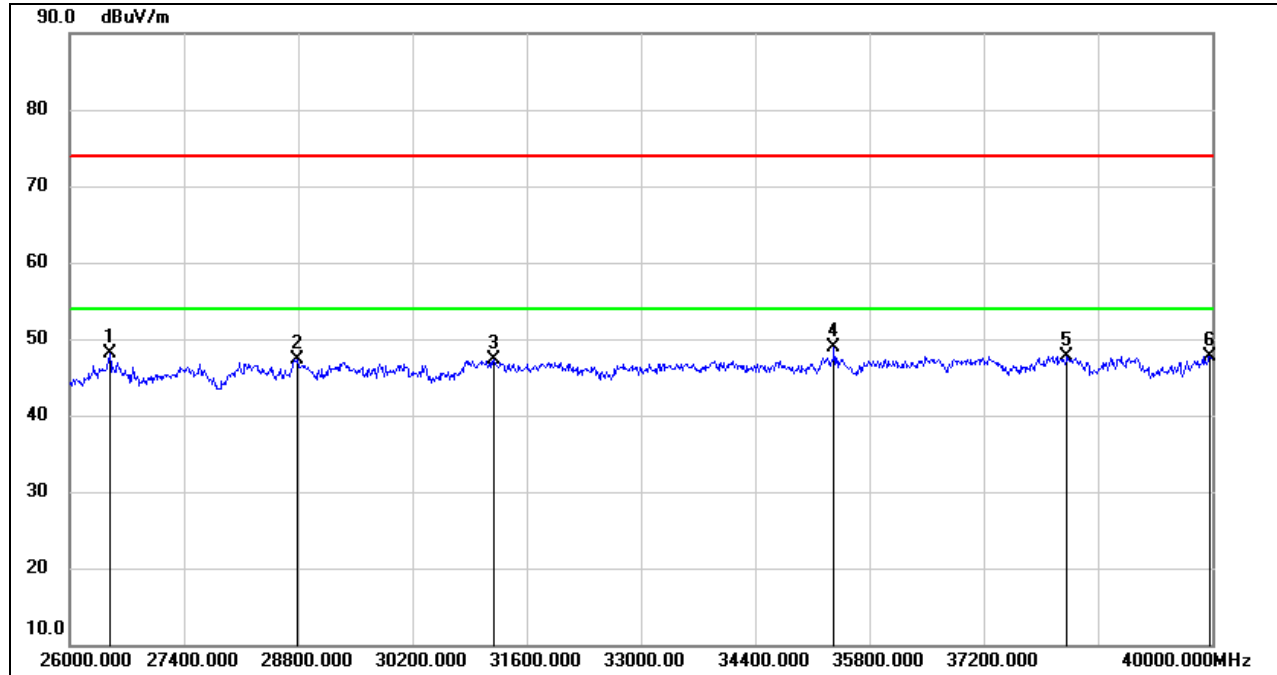

No.	Frequency (MHz)	Reading (dBuV)	Correct (dB/m)	Result (dBuV/m)	Limit (dBuV/m)	Margin (dB)	Remark
1	26490.000	52.79	-4.74	48.05	74.00	-25.95	peak
2	28786.000	47.99	-0.64	47.35	74.00	-26.65	peak
3	31194.000	48.04	-0.80	47.24	74.00	-26.76	peak
4	35366.000	46.40	2.59	48.99	74.00	-25.01	peak
5	38222.000	43.88	3.80	47.68	74.00	-26.32	peak
6	39972.000	42.58	5.13	47.71	74.00	-26.29	peak

- Note: 1. Measurement = Reading Level + Correct Factor.
 2. If Peak Result complies with AV limit, AV Result is deemed to comply with AV limit.
 3. Peak: Peak detector.



SPURIOUS EMISSIONS (UNII-3 BAND LOW CHANNEL, VERTICAL, WORST-CASE CONFIGURATION)

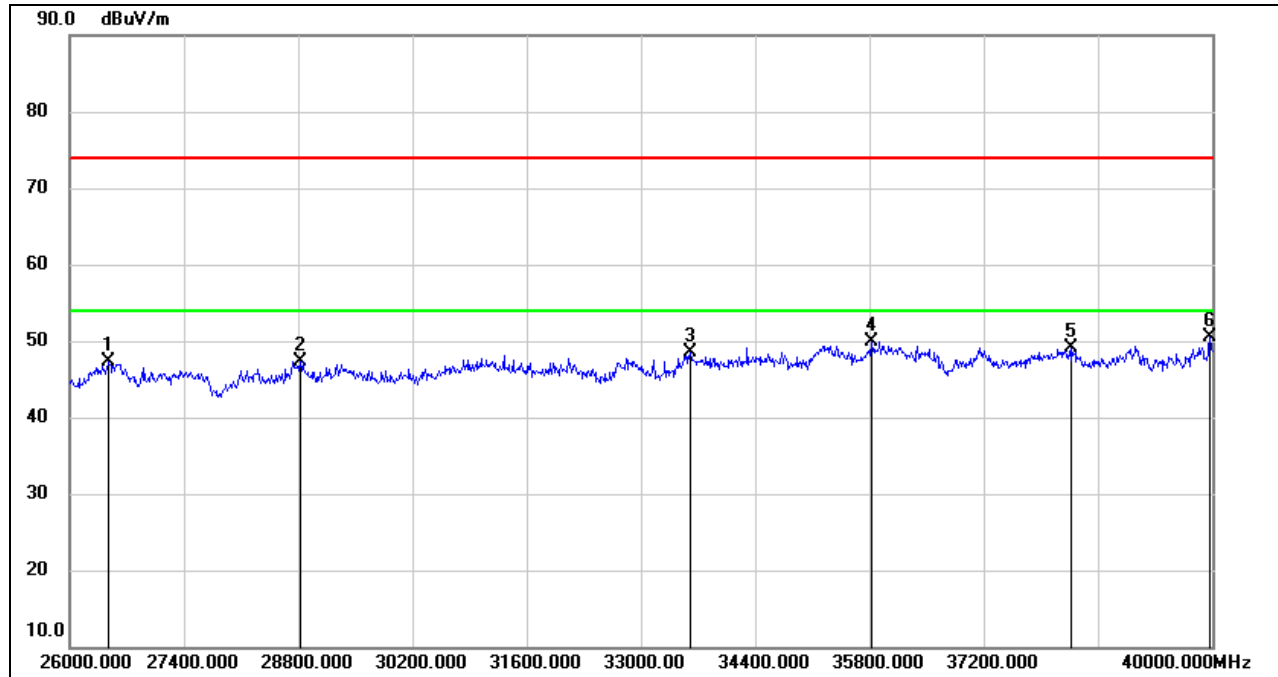

No.	Frequency (MHz)	Reading (dBuV)	Correct (dB/m)	Result (dBuV/m)	Limit (dBuV/m)	Margin (dB)	Remark
1	26476.000	52.03	-4.78	47.25	74.00	-26.75	peak
2	28828.000	48.13	-0.79	47.34	74.00	-26.66	peak
3	33602.000	48.01	0.46	48.47	74.00	-25.53	peak
4	35828.000	46.25	3.67	49.92	74.00	-24.08	peak
5	38278.000	45.32	3.82	49.14	74.00	-24.86	peak
6	39972.000	45.45	5.13	50.58	74.00	-23.42	peak

- Note: 1. Measurement = Reading Level + Correct Factor.
 2. If Peak Result complies with AV limit, AV Result is deemed to comply with AV limit.
 3. Peak: Peak detector.

Note: All the modes had been tested, but only the worst data was recorded in the report.

8.6. SPURIOUS EMISSIONS (30 MHz ~ 1 GHz)

8.6.1. 802.11ac VHT20 MIMO MODE

SPURIOUS EMISSIONS (UNII-3 BAND LOW CHANNEL, HORIZONTAL, WORST-CASE CONFIGURATION)

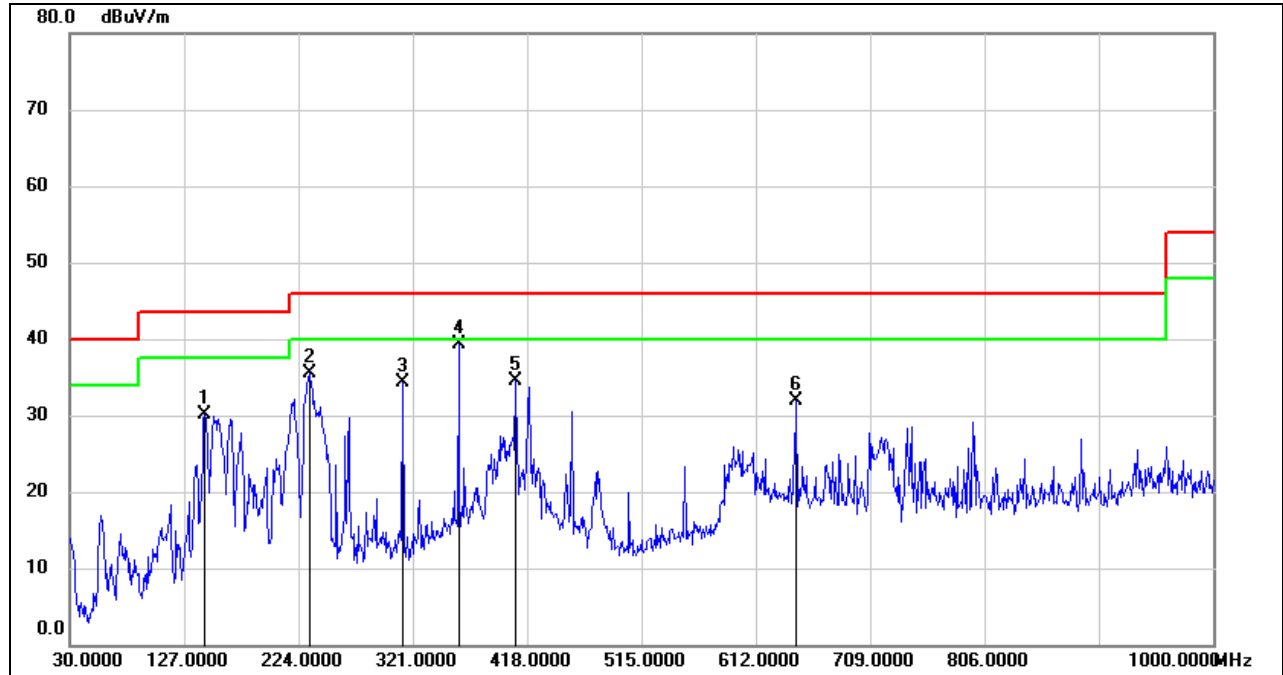

No.	Frequency (MHz)	Reading (dBuV)	Correct (dB/m)	Result (dBuV/m)	Limit (dBuV/m)	Margin (dB)	Remark
1	144.4600	48.79	-18.60	30.19	43.50	-13.31	QP
2	233.7000	54.32	-18.85	35.47	46.00	-10.53	QP
3	312.2700	49.39	-15.01	34.38	46.00	-11.62	QP
4	359.8000	53.38	-14.10	39.28	46.00	-6.72	QP
5	408.3000	47.58	-13.17	34.41	46.00	-11.59	QP
6	645.9500	40.88	-9.05	31.83	46.00	-14.17	QP

- Note: 1. Result Level = Read Level + Correct Factor.
 2. If Peak Result complies with QP limit, QP Result is deemed to comply with QP limit.
 3. Test setup: RBW: 120 kHz, VBW: 300 kHz, Sweep time: auto.

SPURIOUS EMISSIONS (UNII-3 BAND LOW CHANNEL, VERTICAL, WORST-CASE CONFIGURATION)

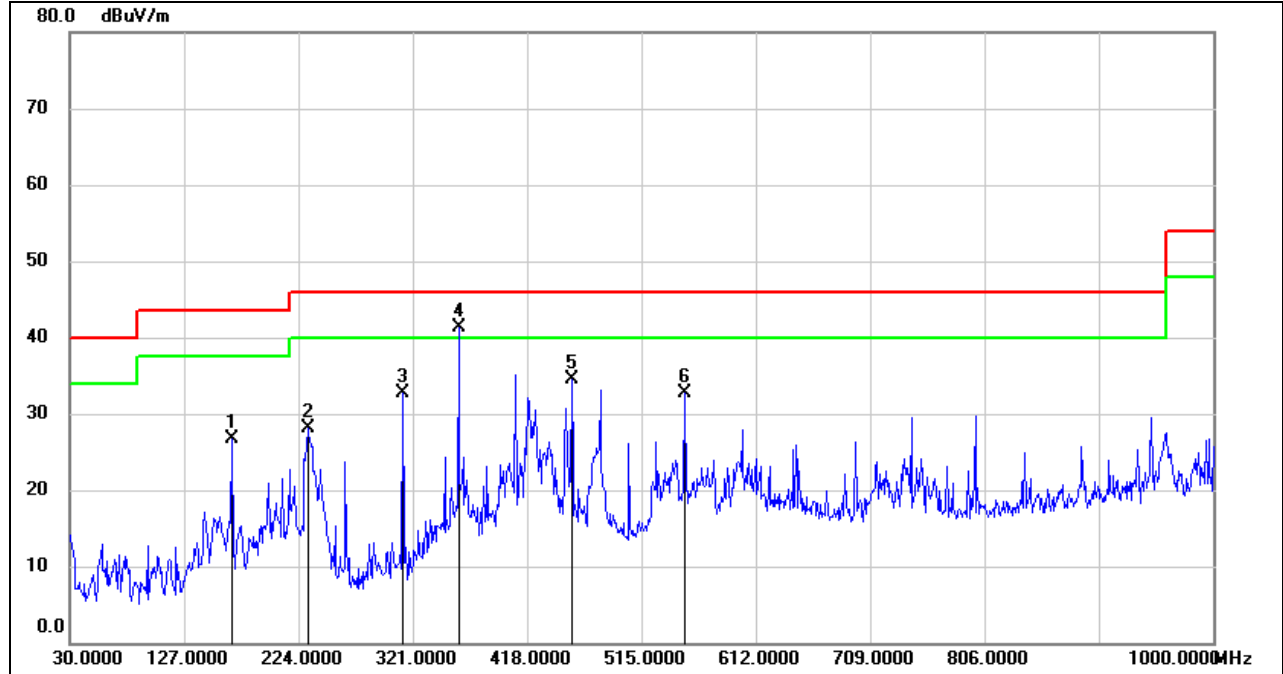

No.	Frequency (MHz)	Reading (dBuV)	Correct (dB/m)	Result (dBuV/m)	Limit (dBuV/m)	Margin (dB)	Remark
1	167.7400	44.09	-17.41	26.68	43.50	-16.82	QP
2	231.7600	46.93	-18.76	28.17	46.00	-17.83	QP
3	312.2700	47.80	-15.01	32.79	46.00	-13.21	QP
4	359.8000	55.45	-14.10	41.35	46.00	-4.65	QP
5	455.8300	46.75	-12.27	34.48	46.00	-11.52	QP
6	551.8600	43.18	-10.46	32.72	46.00	-13.28	QP

- Note: 1. Result Level = Read Level + Correct Factor.
 2. If Peak Result complies with QP limit, QP Result is deemed to comply with QP limit.
 3. Test setup: RBW: 120 kHz, VBW: 300 kHz, Sweep time: auto

Note: All the modes had been tested, but only the worst data was recorded in the report.

8.7. SPURIOUS EMISSIONS BELOW 30 MHz

8.7.1. 802.11ac VHT20 MIMO MODE

SPURIOUS EMISSIONS (UNII-3 BAND LOW CHANNEL, LOOP ANTENNA FACE ON TO THE EUT, WORST-CASE CONFIGURATION)

9 kHz ~ 150 kHz

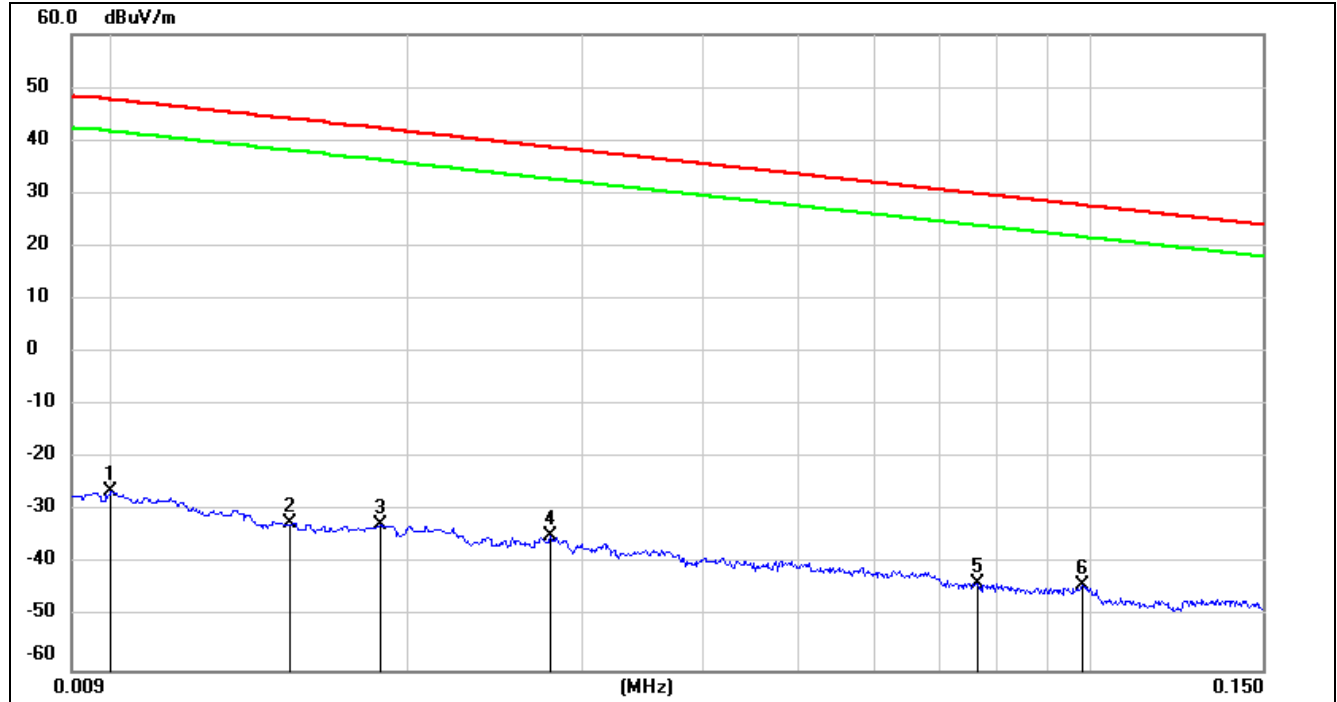

No.	Frequency (MHz)	Reading (dBuV)	Correct (dB/m)	FCC Result (dBuV/m)	FCC Limit (dBuV/m)	ISED Result (dBuA/m)	ISED Limit (dBuA/m)	Margin (dB)	Remark
1	0.0100	75.22	-101.40	-26.18	47.6	-77.68	-3.90	-73.78	peak
2	0.0151	69.21	-101.37	-32.16	44.02	-83.66	-7.48	-76.18	peak
3	0.0187	68.70	-101.35	-32.65	42.16	-84.15	-9.34	-74.81	peak
4	0.0279	66.67	-101.38	-34.71	38.69	-86.21	-12.81	-73.40	peak
5	0.0767	58.09	-101.61	-43.52	29.91	-95.02	-21.59	-73.43	peak
6	0.0981	57.77	-101.78	-44.01	27.77	-95.51	-23.73	-71.78	peak

Note: 1. Measurement = Reading Level + Correct Factor.

2. If Peak Result complies with AV and QP limit, AV and QP Result are deemed to comply with AV limit.

3. All 3 polarizations (Horizontal, Face-on and Face-off) of the loop antenna had been tested, but only the worst data recorded in the report.

4. $\text{dBuA/m} = \text{dBuV/m} - 20\log_{10}(120\pi) = \text{dBuV/m} - 51.5$.

150 kHz ~ 490 kHz

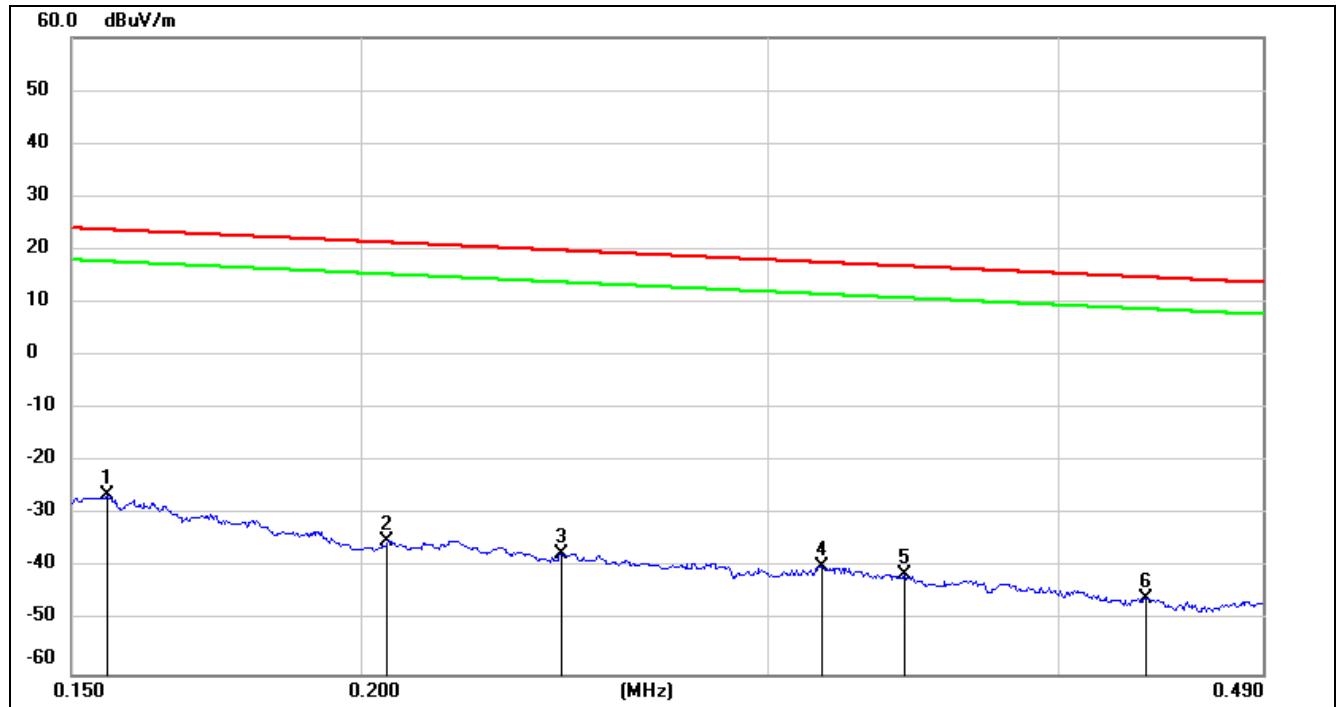

No.	Frequency (MHz)	Reading (dBuV)	Correct (dB/m)	FCC Result (dBuV/m)	FCC Limit (dBuV/m)	ISED Result (dBuA/m)	ISED Limit (dBuA/m)	Margin (dB)	Remark
1	0.1554	75.27	-101.65	-26.38	23.77	-77.88	-27.73	-50.15	peak
2	0.2053	66.79	-101.73	-34.94	21.35	-86.44	-30.15	-56.29	peak
3	0.2442	64.53	-101.79	-37.26	19.85	-88.76	-31.65	-57.11	peak
4	0.3163	62.20	-101.87	-39.67	17.6	-91.17	-33.90	-57.27	peak
5	0.3431	60.67	-101.90	-41.23	16.89	-92.73	-34.61	-58.12	peak
6	0.4364	56.36	-101.99	-45.63	14.8	-97.13	-36.70	-60.43	peak

Note: 1. Measurement = Reading Level + Correct Factor.

2. If Peak Result complies with AV and QP limit, AV and QP Result are deemed to comply with AV limit.

3. All 3 polarizations (Horizontal, Face-on and Face-off) of the loop antenna had been tested, but only the worst data recorded in the report.

4. $\text{dBuA/m} = \text{dBuV/m} - 20\log_{10}(120\pi) = \text{dBuV/m} - 51.5$.

490 kHz ~ 30 MHz

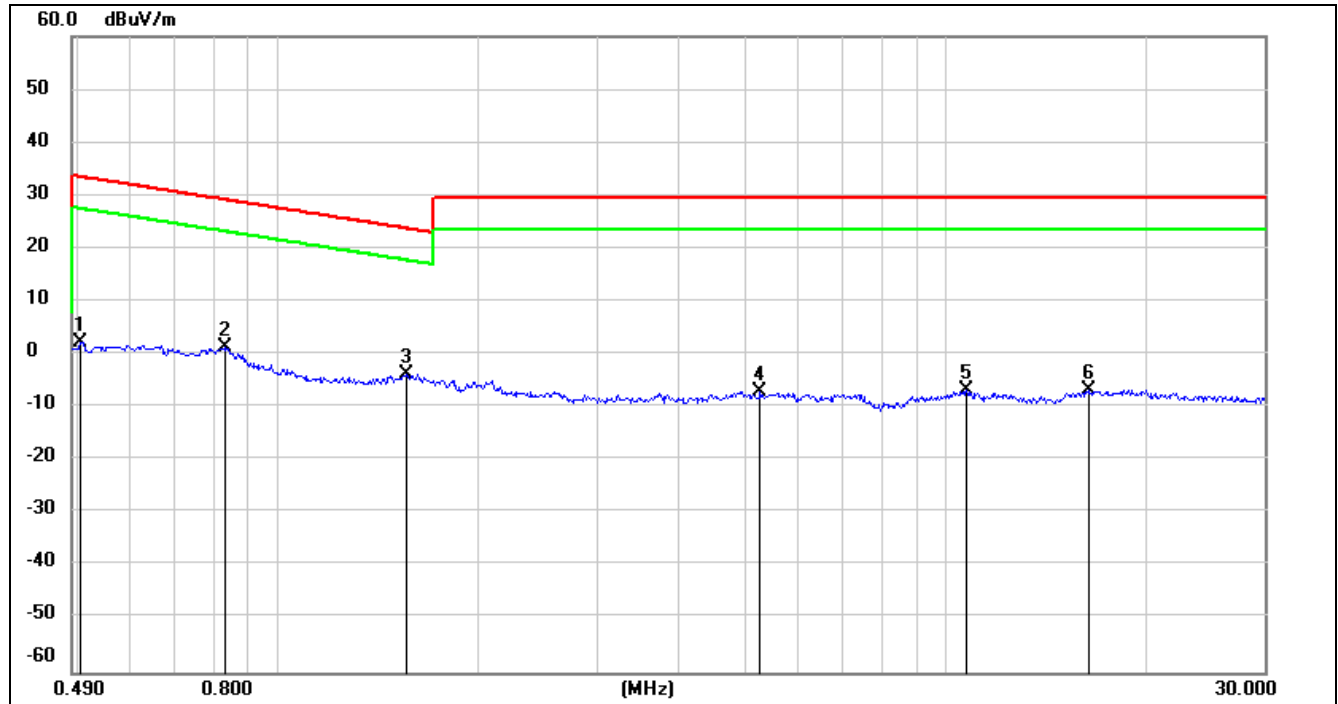

No.	Frequency (MHz)	Reading (dBuV)	Correct (dB/m)	FCC Result (dBuV/m)	FCC Limit (dBuV/m)	ISED Result (dBuA/m)	ISED Limit (dBuA/m)	Margin (dB)	Remark
1	0.5039	64.44	-62.07	2.37	33.56	-49.13	-17.94	-31.19	peak
2	0.8296	63.44	-62.17	1.27	29.23	-50.23	-22.27	-27.96	peak
3	1.5564	58.18	-62.02	-3.84	23.76	-55.34	-27.74	-27.60	peak
4	5.2705	54.54	-61.45	-6.91	29.54	-58.41	-21.96	-36.45	peak
5	10.7299	53.98	-60.83	-6.85	29.54	-58.35	-21.96	-36.39	peak
6	16.3959	54.17	-60.96	-6.79	29.54	-58.29	-21.96	-36.33	peak

- Note: 1. Measurement = Reading Level + Correct Factor.
 2. If Peak Result complies with AV and QP limit, AV and QP Result are deemed to comply with AV limit.
 3. All 3 polarizations (Horizontal, Face-on and Face-off) of the loop antenna had been tested, but only the worst data recorded in the report.
 4. $\text{dBuA/m} = \text{dBuV/m} - 20\log_{10}(120\pi) = \text{dBuV/m} - 51.5$.

Note: All the modes had been tested, but only the worst data was recorded in the report.

9. AC POWER LINE CONDUCTED EMISSIONS

LIMITS

Please refer to CFR 47 FCC §15.207 (a).

FREQUENCY (MHz)	Quasi-peak	Average
0.15 -0.5	66 - 56 *	56 - 46 *
0.50 -5.0	56.00	46.00
5.0 -30.0	60.00	50.00

TEST SETUP AND PROCEDURE

Refer to ANSI C63.10-2013 clause 6.2.

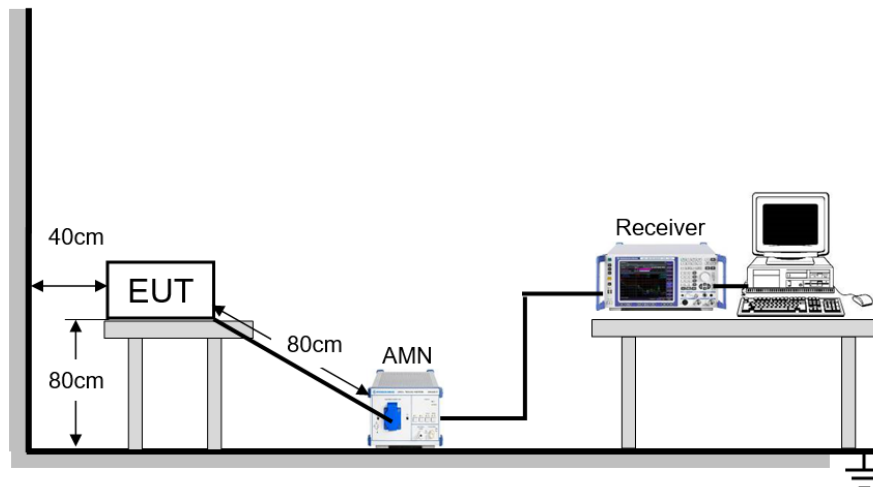

The EUT is put on a table of non-conducting material that is 80 cm high. The vertical conducting wall of shielding is located 40 cm to the rear of the EUT. The power line of the EUT is connected to the AC mains through a Artificial Mains Network (A.M.N.). A EMI Measurement Receiver (R&S Test Receiver ESR3) is used to test the emissions from both sides of AC line. According to the requirements in Section 6.2 of ANSI C63.10-2013. Conducted emissions from the EUT measured in the frequency range between 0.15 MHz and 30 MHz using CISPR Quasi-Peak and average detector mode. The bandwidth of EMI test receiver is set at 9 kHz.

The arrangement of the equipment is installed to meet the standards and operating in a manner, which tends to maximize its emission characteristics in a normal application.

TEST ENVIRONMENT

Temperature	20.6 °C	Relative Humidity	62.1 %
Atmosphere Pressure	101 kPa	Test Voltage	AC 120 V, 60 Hz

RESULTS

9.1.1. 802.11ac VHT20 MIMO MODE

LINE N RESULTS (UNII-3 BAND LOW CHANNEL, WORST-CASE CONFIGURATION)

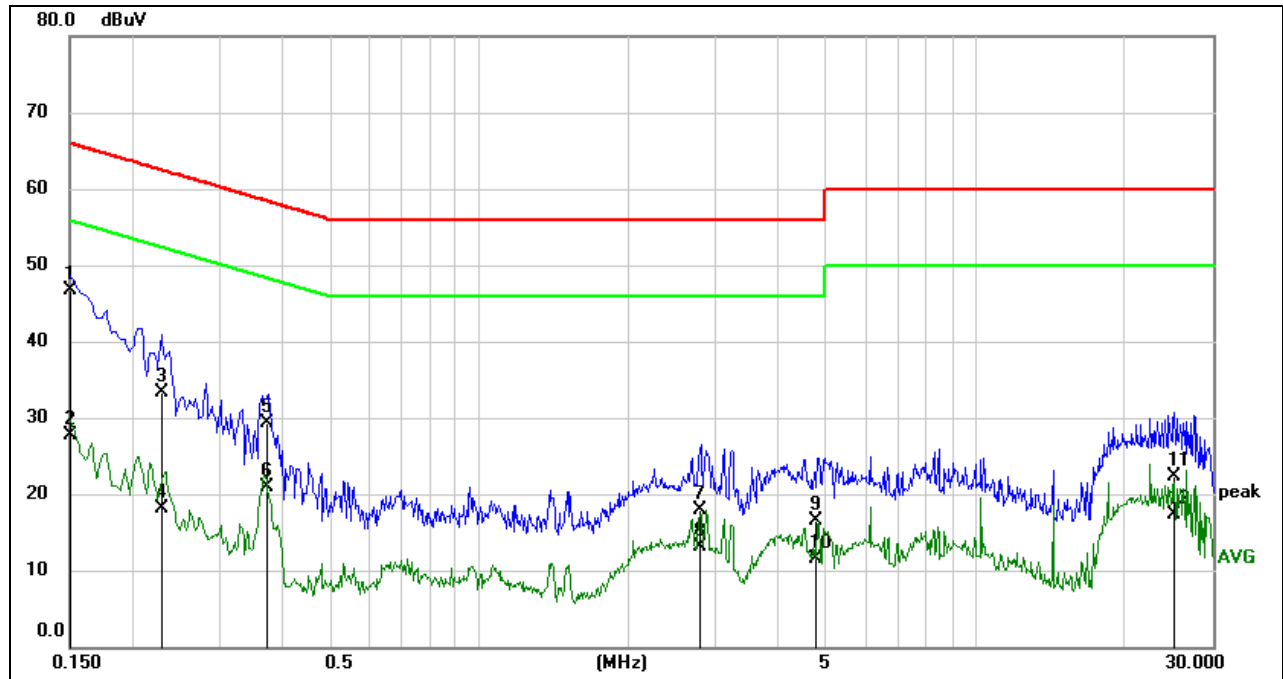

No.	Frequency (MHz)	Reading (dBuV)	Correct (dB)	Result (dBuV)	Limit (dBuV)	Margin (dB)	Remark
1	0.1507	37.13	9.59	46.72	65.96	-19.24	QP
2	0.1507	18.15	9.59	27.74	55.96	-28.22	AVG
3	0.2284	23.73	9.56	33.29	62.51	-29.22	QP
4	0.2284	8.57	9.56	18.13	52.51	-34.38	AVG
5	0.3743	19.89	9.42	29.31	58.40	-29.09	QP
6	0.3743	11.45	9.42	20.87	48.40	-27.53	AVG
7	2.7931	8.31	9.62	17.93	56.00	-38.07	QP
8	2.7931	3.58	9.62	13.20	46.00	-32.80	AVG
9	4.7926	6.81	9.61	16.42	56.00	-39.58	QP
10	4.7926	1.88	9.61	11.49	46.00	-34.51	AVG
11	25.0498	12.64	9.70	22.34	60.00	-37.66	QP
12	25.0498	7.56	9.70	17.26	50.00	-32.74	AVG

- Note: 1. Result = Reading + Correct Factor.
 2. If QP Result complies with AV limit, AV Result is deemed to comply with AV limit.
 3. Test setup: RBW: 200 Hz (9 kHz ~ 150 kHz), 9 kHz (150 kHz ~ 30 MHz).
 4. Step size: 80 Hz (0.009 MHz ~ 0.15 MHz), 4 kHz (0.15 MHz ~ 30 MHz), Scan time: auto.

LINE L RESULTS (UNII-3 BAND LOW CHANNEL, WORST-CASE CONFIGURATION)

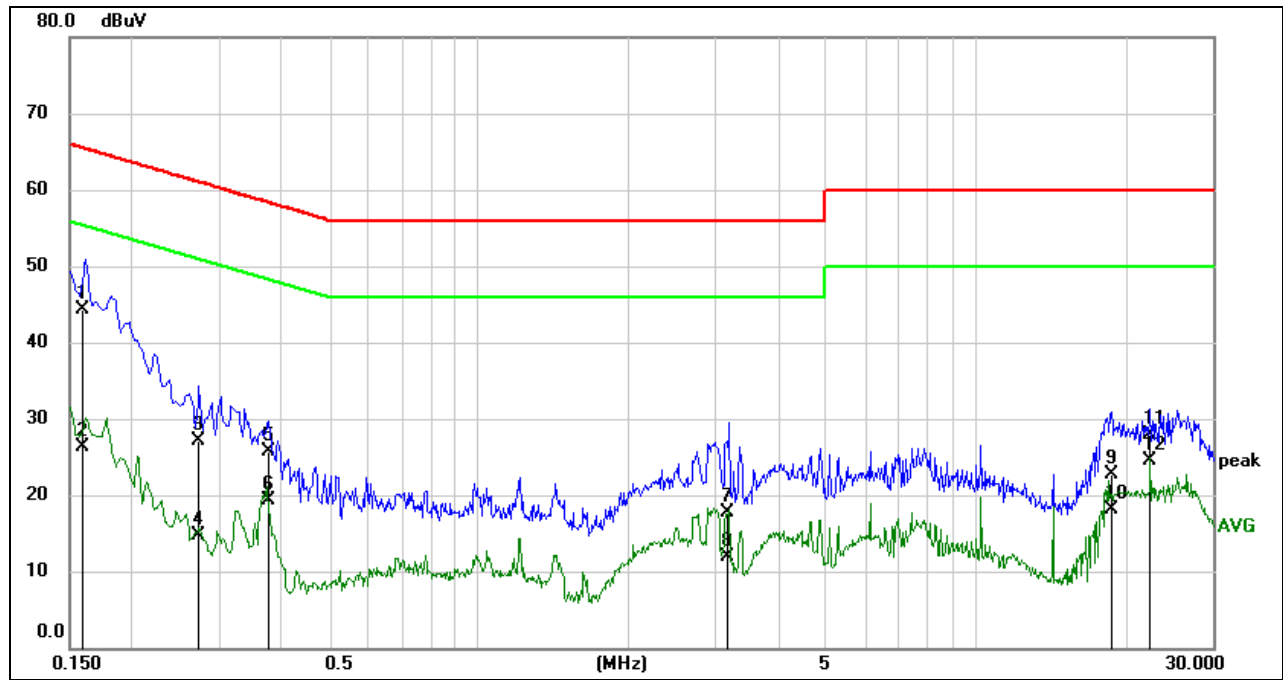

No.	Frequency (MHz)	Reading (dBuV)	Correct (dB)	Result (dBuV)	Limit (dBuV)	Margin (dB)	Remark
1	0.1583	34.79	9.59	44.38	65.55	-21.17	QP
2	0.1583	16.71	9.59	26.30	55.55	-29.25	AVG
3	0.2712	17.54	9.52	27.06	61.08	-34.02	QP
4	0.2712	5.21	9.52	14.73	51.08	-36.35	AVG
5	0.3751	16.29	9.41	25.70	58.39	-32.69	QP
6	0.3751	9.97	9.41	19.38	48.39	-29.01	AVG
7	3.1700	8.12	9.61	17.73	56.00	-38.27	QP
8	3.1700	2.31	9.61	11.92	46.00	-34.08	AVG
9	18.7858	12.96	9.74	22.70	60.00	-37.30	QP
10	18.7858	8.37	9.74	18.11	50.00	-31.89	AVG
11	22.5277	18.27	9.73	28.00	60.00	-32.00	QP
12	22.5277	14.87	9.73	24.60	50.00	-25.40	AVG

- Note: 1. Result = Reading + Correct Factor.
 2. If QP Result complies with AV limit, AV Result is deemed to comply with AV limit.
 3. Test setup: RBW: 200 Hz (9 kHz ~ 150 kHz), 9 kHz (150 kHz ~ 30 MHz).
 4. Step size: 80 Hz (0.009 MHz ~ 0.15 MHz), 4 kHz (0.15 MHz ~ 30 MHz), Scan time: auto.

Note: All the modes had been tested, but only the worst data was recorded in the report.

10. FREQUENCY STABILITY

LIMITS

The frequency of the carrier signal shall be maintained within band of operation.

TEST PROCEDURE

1. The EUT was placed inside an environmental chamber as the temperature in the chamber was varied between 0 °C ~ 60 °C (declared by customer).
2. The temperature was incremented by 10 °C intervals and the unit allowed to stabilize at each temperature before each measurement. The center frequency of the transmitting channel was evaluated at each temperature and the frequency deviation from the channel's center frequency was recorded.
3. The primary supply voltage is varied from 85 % to 115 % of the nominal value for non hand-carried battery and AC powered equipment. For hand-carried, battery-powered equipment, primary supply voltage is reduced to the battery operating end point which shall be specified by the manufacturer.

Connect the EUT to the spectrum analyser and use the following settings:

Center Frequency	The center frequency of the channel under test
Detector	Peak
RBW	10 kHz
VBW	$\geq 3 \times \text{RBW}$
Span	Encompass the entire emissions bandwidth (EBW) of the signal
Trace	Max hold
Sweep time	Auto

4. While maintaining a constant temperature inside the environmental chamber, turn the EUT on and record the operating frequency at startup, and at 2 minutes, 5 minutes, and 10 minutes after the EUT is energized.
5. Allow the trace to stabilize, find the peak value of the power envelope and record the frequency, then calculated the frequency drift.

TEST SETUP

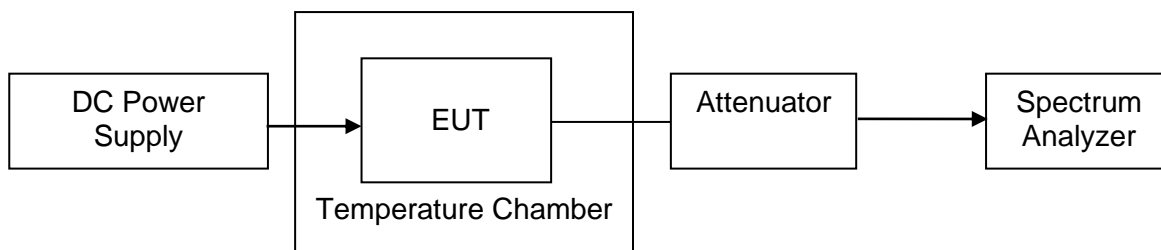



TEST ENVIRONMENT

	Normal Test Conditions	Extreme Test Conditions
Relative Humidity	20 % - 75 %	/
Atmospheric Pressure	100 kPa ~102 kPa	/
Temperature	T _N (Normal Temperature): 25.1 °C	T _L (Low Temperature): 0 °C
		T _H (High Temperature): 60 °C
Supply Voltage	V _N (Normal Voltage): DC 5 V	V _L (Low Voltage): DC 4.5 V
		V _H (High Voltage): DC 5.5 V

RESULTS

Please refer to Appendix H.

11. DYNAMIC FREQUENCY SELECTION

APPLICABILITY OF DFS REQUIREMENTS

A U-NII network will employ a DFS function to detect signals from radar systems and to avoid co-channel operation with these systems. This applies to the 5250-5350 MHz and/or 5470-5725 MHz bands.

Within the context of the operation of the DFS function, a U-NII device will operate in either Master Mode or Client Mode. U-NII devices operating in Client Mode can only operate in a network controlled by a U-NII device operating in Master Mode.

Table 1: Applicability of DFS Requirements Prior to Use of a Channel

Requirement	Operational Mode		
	<input type="checkbox"/> Master	<input checked="" type="checkbox"/> Client Without Radar Detection	<input type="checkbox"/> Client With Radar Detection
Non-Occupancy Period	Yes	Not required	Yes
DFS Detection Threshold	Yes	Not required	Yes
Channel Availability Check Time	Yes	Not required	Not required
U-NII Detection Bandwidth	Yes	Not required	Yes

Table 2: Applicability of DFS requirements during normal operation

Requirement	Operational Mode	
	<input type="checkbox"/> Master Device or Client with Radar Detection	<input checked="" type="checkbox"/> Client Without Radar Detection
DFS Detection Threshold	Yes	Not required
Channel Closing Transmission Time	Yes	Yes
Channel Move Time	Yes	Yes
U-NII Detection Bandwidth	Yes	Not required

Additional requirements for devices with multiple bandwidth modes	<input type="checkbox"/> Master Device or Client with Radar Detection	<input checked="" type="checkbox"/> Client Without Radar Detection
U-NII Detection Bandwidth and Statistical Performance Check	All BW modes must be tested	Not required
Channel Move Time and Channel Closing Transmission Time	Test using widest BW mode available	Test using the widest BW mode available for the link
All other tests	Any single BW mode	Not required

Note: Frequencies selected for statistical performance check should include several frequencies within the radar detection bandwidth and frequencies near the edge of the radar detection bandwidth. For 802.11 devices it is suggested to select frequencies in each of the bonded 20 MHz channels and the channel center frequency.

LIMITS

(1) DFS Detection Thresholds

Table 3: DFS Detection Thresholds for Master Devices and Client Devices With Radar Detection

Maximum Transmit Power	Value (See Notes 1, 2, and 3)
EIRP \geq 200 milliwatt	-64 dBm
EIRP < 200 milliwatt and power spectral density < 10 dBm/MHz	-62 dBm
EIRP < 200 milliwatt that do not meet the power spectral density requirement	-64 dBm

Note 1: This is the level at the input of the receiver assuming a 0 dBi receive antenna.
 Note 2: Throughout these test procedures an additional 1 dB has been added to the amplitude of the test transmission waveforms to account for variations in measurement equipment. This will ensure that the test signal is at or above the detection threshold level to trigger a DFS response.
 Note3: EIRP is based on the highest antenna gain. For MIMO devices refer to KDB Publication 662911 D01.

(2) DFS Response Requirements

Table 4: DFS Response Requirement Values

Parameter	Value
Non-occupancy period	Minimum 30 minutes
Channel Availability Check Time	60 seconds
Channel Move Time	10 seconds See Note 1.
Channel Closing Transmission Time	200 milliseconds + an aggregate of 60 milliseconds over remaining 10 second period. See Notes 1 and 2.
U-NII Detection Bandwidth	Minimum 100% of the U-NII 99% transmission power bandwidth. See Note 3.

Note 1: Channel Move Time and the Channel Closing Transmission Time should be performed with Radar Type 0. The measurement timing begins at the end of the Radar Type 0 burst.
 Note 2: The Channel Closing Transmission Time is comprised of 200 milliseconds starting at the beginning of the Channel Move Time plus any additional intermittent control signals required facilitating a Channel move (an aggregate of 60 milliseconds) during the remainder of the 10 second period. The aggregate duration of control signals will not count quiet periods in between transmissions.
 Note 3: During the U-NII Detection Bandwidth detection test, radar type 0 should be used. For each frequency step the minimum percentage of detection is 90 percent. Measurements are performed with no data traffic.

PARAMETERS OF RADAR TEST WAVEFORMS

This section provides the parameters for required test waveforms, minimum percentage of successful detections, and the minimum number of trials that must be used for determining DFS conformance. Step intervals of 0.1 microsecond for Pulse Width, 1 microsecond for PRI, 1 MHz for chirp width and 1 for the number of pulses will be utilized for the random determination of specific test waveforms.

Table 5 Short Pulse Radar Test Waveforms

Radar Type	Pulse Width (μsec)	PRI (μsec)	Number of Pulses	Minimum Percentage of Successful Detection	Minimum Number of Trials
0	1	1428	18	See Note 1	See Note 1
1	1	Test A	Roundup $\left\{ \frac{1}{360} \right\}$	60%	30
		Test B			
2	1-5	150-230	23-29	60%	30
3	6-10	200-500	16-18	60%	30
4	11-20	200-500	12-16	60%	30
Aggregate (Radar Types 1-4)				80%	120
<p>Note 1: Short Pulse Radar Type 0 should be used for the detection bandwidth test, channel move time, and channel closing time tests.</p> <p>Test A: 15 unique PRI values randomly selected from the list of 23 PRI values in Table 5a</p> <p>Test B: 15 unique PRI values randomly selected within the range of 518-3066 μsec, with a minimum increment of 1 μsec, excluding PRI values selected in Test A</p>					

A minimum of 30 unique waveforms are required for each of the Short Pulse Radar Types 2 through 4. If more than 30 waveforms are used for Short Pulse Radar Types 2 through 4, then each additional waveform must also be unique and not repeated from the previous waveforms. If more than 30 waveforms are used for Short Pulse Radar Type 1, then each additional waveform is generated with Test B and must also be unique and not repeated from the previous waveforms in Tests A or B. Test aggregate is average of the percentage of successful detections of short pulse radar types 1-4.

TEST SETUP

Setup for Client with injection at the Master

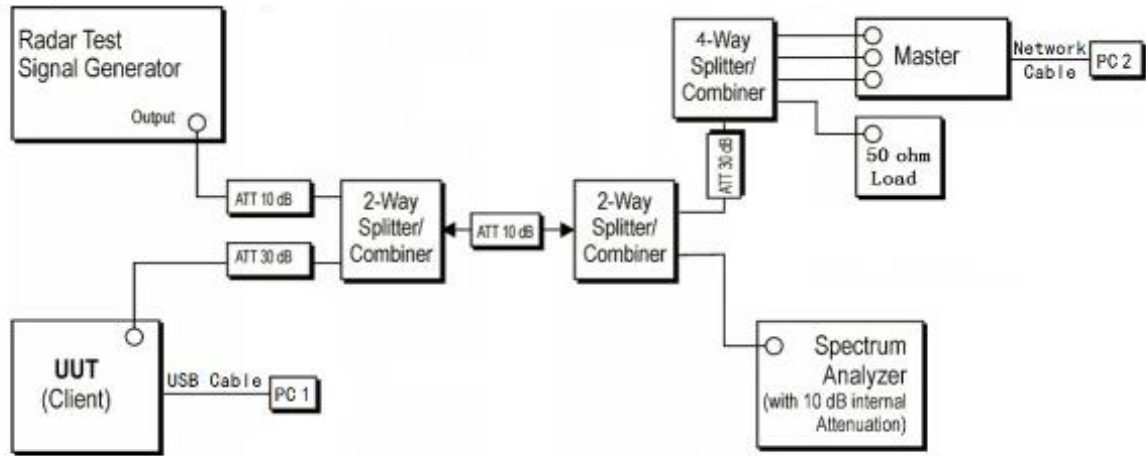

TEST ENVIRONMENT

Temperature	24.1 °C	Relative Humidity	60.5 %
Atmosphere Pressure	101 kPa	Test Voltage	DC 5 V

RESULTS

Please refer to Appendix E & F & G.

12. ANTENNA REQUIREMENTS

APPLICABLE REQUIREMENTS

Please refer to FCC §15.203

An intentional radiator shall be designed to ensure that no antenna other than that furnished by the responsible party shall be used with the device. The use of a permanently attached antenna or of an antenna that uses a unique coupling to the intentional radiator shall be considered sufficient to comply with the provisions of this section. The manufacturer may design the unit so that a broken antenna can be replaced by the user, but the use of a standard antenna jack or electrical connector is prohibited.

Please refer to FCC §15.247(b)(4)

The conducted output power limit specified in paragraph (b) of this section is based on the use of antennas with directional gains that do not exceed 6 dBi. Except as shown in paragraph (c) of this section, if transmitting antennas of directional gain greater than 6 dBi are used, the conducted output power from the intentional radiator shall be reduced below the stated values in paragraphs (b)(1), (b)(2), and (b)(3) of this section, as appropriate, by the amount in dB that the directional gain of the antenna exceeds 6 dBi.

RESULTS

Complies

**12.1. Appendix A1: Emission Bandwidth****12.1.1. Test Result**

Test Mode	Antenna	Channel	26db EBW [MHz]	FL[MHz]	FH[MHz]	Verdict
11A	Ant1	5180	23.280	5168.200	5191.480	PASS
	Ant2	5180	22.440	5168.560	5191.000	PASS
	Ant1	5200	23.480	5188.280	5211.760	PASS
	Ant2	5200	23.360	5187.440	5210.800	PASS
	Ant1	5240	19.720	5230.120	5249.840	PASS
	Ant2	5240	19.840	5230.080	5249.920	PASS
	Ant1	5260	22.640	5248.320	5270.960	PASS
	Ant2	5260	23.720	5248.840	5272.560	PASS
	Ant1	5280	23.440	5268.320	5291.760	PASS
	Ant2	5280	22.040	5268.800	5290.840	PASS
	Ant1	5320	24.320	5307.200	5331.520	PASS
	Ant2	5320	22.600	5308.360	5330.960	PASS
	Ant1	5500	23.520	5488.280	5511.800	PASS
	Ant2	5500	22.360	5488.600	5510.960	PASS
	Ant1	5580	22.640	5568.960	5591.600	PASS
	Ant2	5580	22.880	5568.640	5591.520	PASS
	Ant1	5700	23.120	5688.280	5711.400	PASS
	Ant2	5700	22.880	5688.800	5711.680	PASS
	Ant1	5720	22.320	5708.160	5730.480	PASS
	Ant2	5720	22.560	5708.680	5731.240	PASS
	Ant1	5720_UNII-2C	16.84	5708.160	5725	PASS
	Ant2	5720_UNII-2C	16.32	5708.680	5725	PASS
	Ant1	5720_UNII-3	5.48	5725	5730.480	PASS
	Ant2	5720_UNII-3	6.24	5725	5731.240	PASS
	Ant1	5745	23.440	5733.360	5756.800	PASS
	Ant2	5745	23.320	5733.280	5756.600	PASS
	Ant1	5785	22.880	5773.400	5796.280	PASS
	Ant2	5785	23.480	5773.240	5796.720	PASS
	Ant1	5825	23.160	5813.720	5836.880	PASS
	Ant2	5825	23.440	5813.240	5836.680	PASS
11AC20MIMO	Ant1	5180	22.520	5168.720	5191.240	PASS
	Ant2	5180	23.280	5168.200	5191.480	PASS
	Ant1	5200	23.880	5187.520	5211.400	PASS
	Ant2	5200	23.600	5188.240	5211.840	PASS
	Ant1	5240	19.960	5229.960	5249.920	PASS
	Ant2	5240	19.960	5229.920	5249.880	PASS
	Ant1	5260	23.320	5248.520	5271.840	PASS
	Ant2	5260	22.120	5248.920	5271.040	PASS
	Ant1	5280	23.400	5268.440	5291.840	PASS
	Ant2	5280	22.760	5268.680	5291.440	PASS
	Ant1	5320	22.400	5308.640	5331.040	PASS
	Ant2	5320	22.360	5308.760	5331.120	PASS
	Ant1	5500	23.560	5488.240	5511.800	PASS
	Ant2	5500	24.840	5488.320	5513.160	PASS
	Ant1	5580	24.200	5568.280	5592.480	PASS
	Ant2	5580	22.360	5568.680	5591.040	PASS
	Ant1	5700	23.560	5688.120	5711.680	PASS
	Ant2	5700	22.440	5688.560	5711.000	PASS
	Ant1	5720	23.280	5708.160	5731.440	PASS
	Ant2	5720	23.280	5708.320	5731.600	PASS
	Ant1	5720_UNII-2C	16.84	5708.160	5725	PASS
	Ant2	5720_UNII-2C	16.68	5708.320	5725	PASS
	Ant1	5720_UNII-3	6.44	5725	5731.440	PASS
	Ant2	5720_UNII-3	6.6	5725	5731.600	PASS



	Ant1	5745	23.160	5733.320	5756.480	PASS
	Ant2	5745	22.760	5733.480	5756.240	PASS
	Ant1	5785	24.000	5772.360	5796.360	PASS
	Ant2	5785	22.640	5773.840	5796.480	PASS
	Ant1	5825	23.280	5813.480	5836.760	PASS
	Ant2	5825	23.000	5813.480	5836.480	PASS
11AC40MIMO	Ant1	5190	40.320	5169.680	5210.000	PASS
	Ant2	5190	40.000	5170.000	5210.000	PASS
	Ant1	5230	40.880	5209.520	5250.400	PASS
	Ant2	5230	39.920	5210.080	5250.000	PASS
	Ant1	5270	40.560	5249.760	5290.320	PASS
	Ant2	5270	40.000	5250.000	5290.000	PASS
	Ant1	5310	40.560	5289.600	5330.160	PASS
	Ant2	5310	40.160	5289.840	5330.000	PASS
	Ant1	5510	40.720	5489.760	5530.480	PASS
	Ant2	5510	39.920	5490.160	5530.080	PASS
	Ant1	5550	40.480	5529.680	5570.160	PASS
	Ant2	5550	40.160	5530.080	5570.240	PASS
	Ant1	5670	40.880	5649.600	5690.480	PASS
	Ant2	5670	40.160	5649.920	5690.080	PASS
	Ant1	5710	40.960	5689.600	5730.560	PASS
	Ant2	5710	40.080	5690.000	5730.080	PASS
	Ant1	5710_UNII-2C	35.4	5689.600	5725	PASS
	Ant2	5710_UNII-2C	35	5690.000	5725	PASS
	Ant1	5710_UNII-3	5.56	5725	5730.560	PASS
	Ant2	5710_UNII-3	5.08	5725	5730.080	PASS
Ant1	5755	40.640	5734.680	5775.320	PASS	
Ant2	5755	40.000	5735.000	5775.000	PASS	
Ant1	5795	41.120	5774.440	5815.560	PASS	
Ant2	5795	40.000	5775.080	5815.080	PASS	
11AC80MIMO	Ant1	5210	80.320	5169.680	5250.000	PASS
	Ant2	5210	80.000	5170.160	5250.160	PASS
	Ant1	5290	79.840	5250.160	5330.000	PASS
	Ant2	5290	79.520	5250.320	5329.840	PASS
	Ant1	5530	80.000	5490.160	5570.160	PASS
	Ant2	5530	80.160	5490.000	5570.160	PASS
	Ant1	5610	80.160	5570.000	5650.160	PASS
	Ant2	5610	79.840	5570.160	5650.000	PASS
	Ant1	5690	80.480	5649.840	5730.320	PASS
	Ant2	5690	80.160	5650.000	5730.160	PASS
	Ant1	5690_UNII-2C	75.16	5649.840	5725	PASS
	Ant2	5690_UNII-2C	75	5650.000	5725	PASS
	Ant1	5690_UNII-3	5.32	5725	5730.320	PASS
	Ant2	5690_UNII-3	5.16	5725	5730.160	PASS
	Ant1	5775	80.320	5734.840	5815.160	PASS
	Ant2	5775	80.160	5734.840	5815.000	PASS
11AX20MIMO	Ant1	5180	21.560	5169.320	5190.880	PASS
	Ant2	5180	22.160	5168.960	5191.120	PASS
	Ant1	5200	22.040	5189.080	5211.120	PASS
	Ant2	5200	21.240	5189.360	5210.600	PASS
	Ant1	5240	19.880	5230.000	5249.880	PASS
	Ant2	5240	19.920	5230.000	5249.920	PASS
	Ant1	5260	21.760	5248.880	5270.640	PASS
	Ant2	5260	21.880	5248.960	5270.840	PASS
	Ant1	5280	21.800	5269.160	5290.960	PASS
	Ant2	5280	21.080	5269.360	5290.440	PASS
	Ant1	5320	21.560	5309.240	5330.800	PASS
	Ant2	5320	21.680	5309.000	5330.680	PASS
	Ant1	5500	21.840	5489.040	5510.880	PASS
	Ant2	5500	21.840	5489.040	5510.880	PASS
Ant1	5580	21.840	5569.280	5591.120	PASS	



	Ant2	5580	21.720	5569.280	5591.000	PASS	
	Ant1	5700	21.800	5689.040	5710.840	PASS	
	Ant2	5700	21.120	5689.360	5710.480	PASS	
	Ant1	5720	21.000	5709.320	5730.320	PASS	
	Ant2	5720	21.840	5709.000	5730.840	PASS	
	Ant1	5720_UNII-2C	15.68	5709.320	5725	PASS	
	Ant2	5720_UNII-2C	16	5709.000	5725	PASS	
	Ant1	5720_UNII-3	5.32	5725	5730.320	PASS	
	Ant2	5720_UNII-3	5.84	5725	5730.840	PASS	
	Ant1	5745	21.520	5734.160	5755.680	PASS	
	Ant2	5745	21.200	5734.320	5755.520	PASS	
	Ant1	5785	21.920	5774.080	5796.000	PASS	
	Ant2	5785	21.520	5774.080	5795.600	PASS	
	Ant1	5825	22.280	5814.160	5836.440	PASS	
	Ant2	5825	21.560	5814.240	5835.800	PASS	
11AX40MIMO	Ant1	5190	39.680	5170.160	5209.840	PASS	
	Ant2	5190	39.760	5170.080	5209.840	PASS	
	Ant1	5230	39.840	5210.080	5249.920	PASS	
	Ant2	5230	39.840	5210.160	5250.000	PASS	
	Ant1	5270	39.600	5250.240	5289.840	PASS	
	Ant2	5270	39.680	5250.160	5289.840	PASS	
	Ant1	5310	39.760	5290.080	5329.840	PASS	
	Ant2	5310	39.680	5290.160	5329.840	PASS	
	Ant1	5510	39.600	5490.160	5529.760	PASS	
	Ant2	5510	39.840	5490.080	5529.920	PASS	
	Ant1	5550	39.920	5530.080	5570.000	PASS	
	Ant2	5550	39.760	5530.160	5569.920	PASS	
	Ant1	5670	39.760	5650.160	5689.920	PASS	
	Ant2	5670	39.840	5650.080	5689.920	PASS	
	Ant1	5710	39.680	5690.160	5729.840	PASS	
	Ant2	5710	39.920	5690.080	5730.000	PASS	
		Ant1	5710_UNII-2C	34.84	5690.160	5725	PASS
		Ant2	5710_UNII-2C	34.92	5690.080	5725	PASS
		Ant1	5710_UNII-3	4.84	5725	5729.840	PASS
		Ant2	5710_UNII-3	5	5725	5730.000	PASS
11AX80MIMO	Ant1	5755	39.600	5735.160	5774.760	PASS	
	Ant2	5755	39.760	5735.000	5774.760	PASS	
	Ant1	5795	39.760	5775.240	5815.000	PASS	
	Ant2	5795	39.840	5775.160	5815.000	PASS	
	Ant1	5210	80.640	5169.680	5250.320	PASS	
	Ant2	5210	80.640	5169.680	5250.320	PASS	
	Ant1	5290	80.320	5250.000	5330.320	PASS	
	Ant2	5290	80.480	5249.840	5330.320	PASS	
	Ant1	5530	80.640	5489.680	5570.320	PASS	
	Ant2	5530	80.480	5489.840	5570.320	PASS	
	Ant1	5610	80.320	5569.840	5650.160	PASS	
	Ant2	5610	80.480	5569.840	5650.320	PASS	
	Ant1	5690	80.800	5649.680	5730.480	PASS	
	Ant2	5690	80.640	5649.680	5730.320	PASS	
		Ant1	5690_UNII-2C	75.32	5649.680	5725	PASS
		Ant2	5690_UNII-2C	75.32	5649.680	5725	PASS
	Ant1	5690_UNII-3	5.48	5725	5730.480	PASS	
	Ant2	5690_UNII-3	5.32	5725	5730.320	PASS	
	Ant1	5775	80.800	5734.680	5815.480	PASS	
	Ant2	5775	80.640	5734.680	5815.320	PASS	



12.1.2. Test Graphs

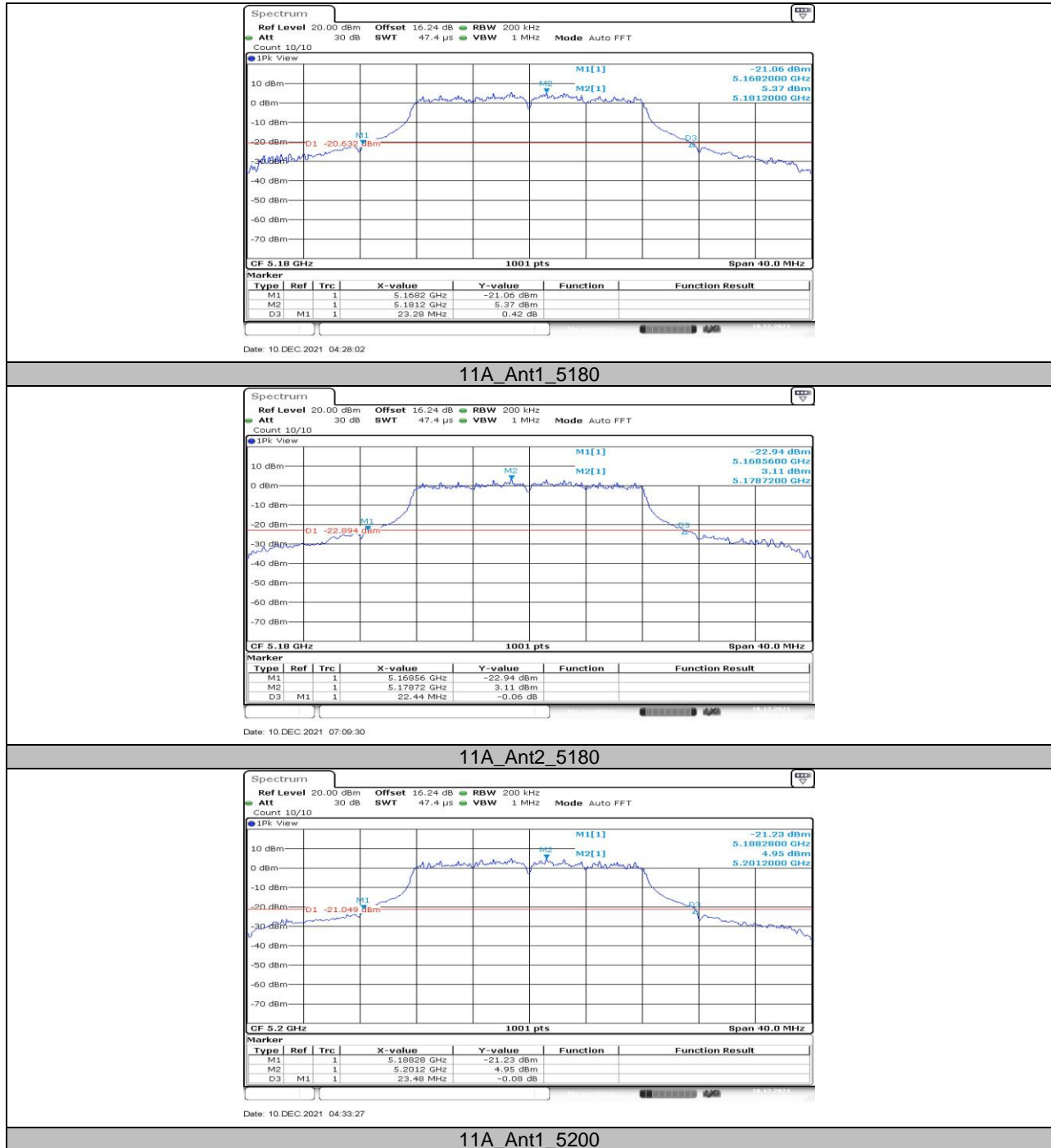

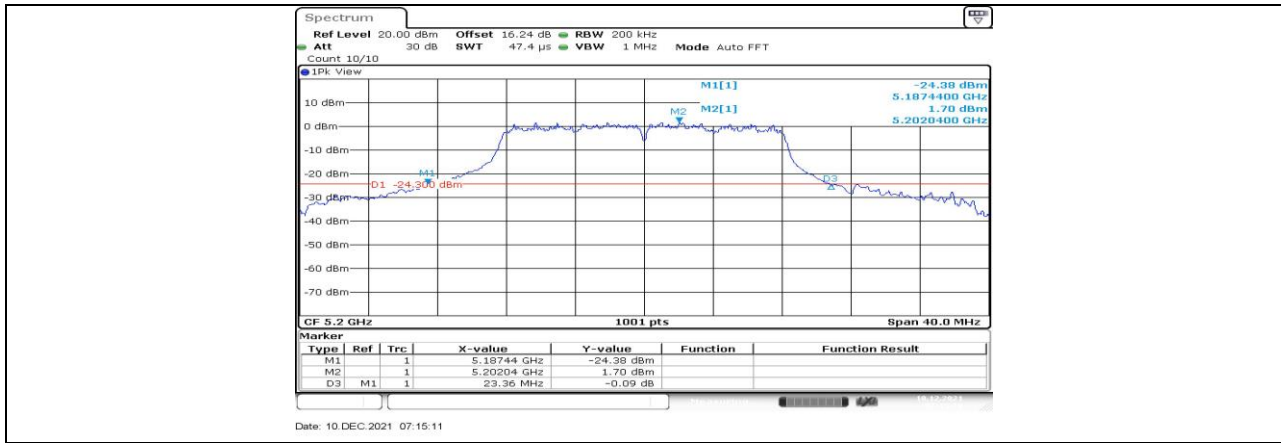

11A_Ant2_5200

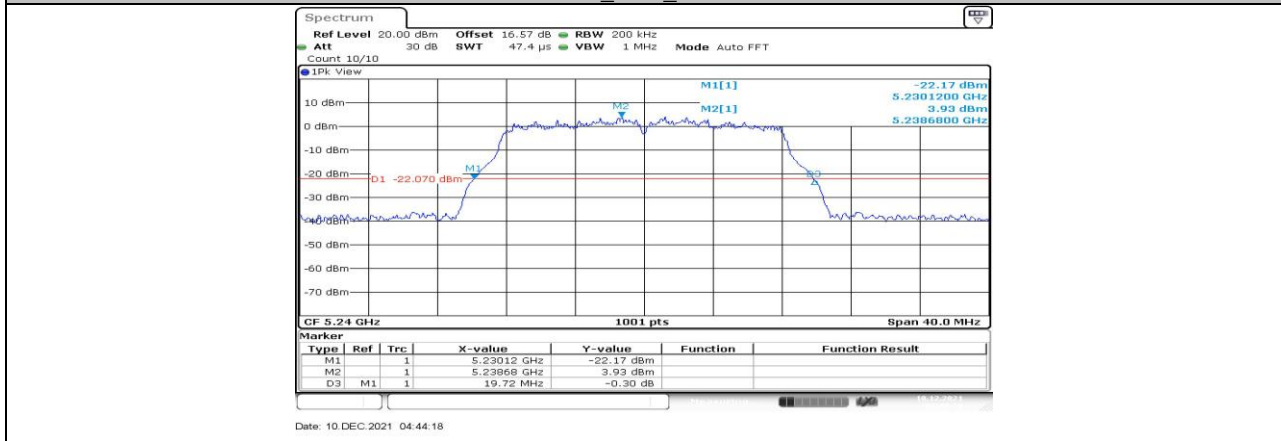

11A_Ant1_5240

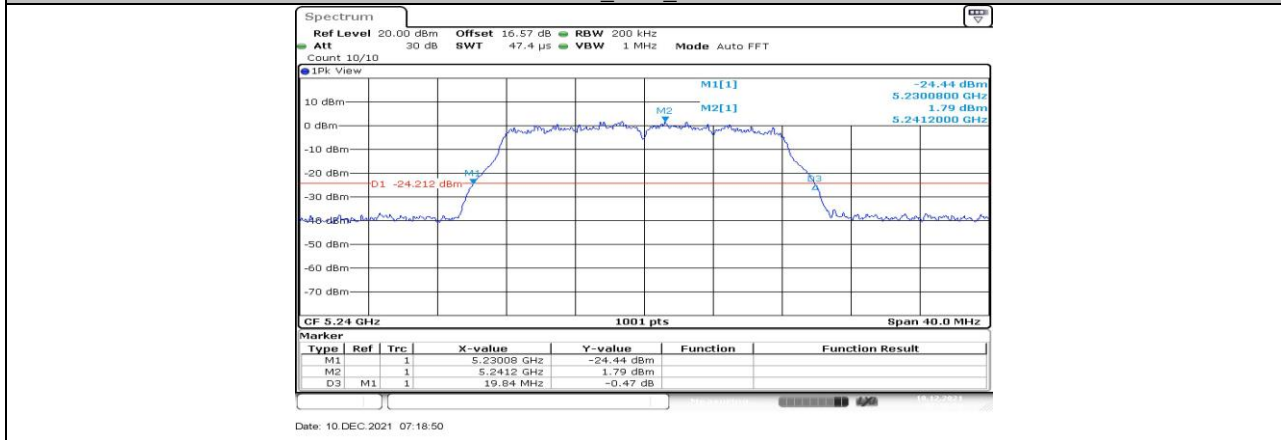

11A_Ant2_5240

