



CFR 47 FCC PART 15 SUBPART C

CERTIFICATION TEST REPORT

For

WIFI+BT Module

MODEL NUMBER: WT54M2000

FCC ID: 2AC23-WT54

REPORT NUMBER: 4788989204-2

ISSUE DATE: June 17, 2018

Prepared for

**Hui Zhou Gaoshengda Technology Co.,LTD
NO.75 Zhongkai Development Area Huizhou, Guangdong China**

Prepared by

**UL Verification Services (Guangzhou) Co., Ltd, Song Shan Lake Branch
Building 10, Innovation Technology Park, No. 1, Li Bin Road, Song Shan Lake
Hi-Tech Development Zone Dongguan, People's Republic of China**

Tel: +86 769 22038881

Fax: +86 769 33244054

Website: www.ul.com



Revision History

<u>Rev.</u>	<u>Issue Date</u>	<u>Revisions</u>	<u>Revised By</u>
V0	06/17/2019	Initial Issue	



Summary of Test Results			
Clause	Test Items	FCC Rules	Test Results
1	20dB Bandwidth and 99% Occupied Bandwidth	FCC 15.247 (a) (1)	Pass
2	Conducted Output Power	FCC 15.247 (b) (1)	Pass
3	Carrier Hopping Channel Separation	FCC 15.247 (a) (1)	Pass
4	Number of Hopping Frequency	15.247 (a) (1) III	Pass
5	Time of Occupancy (Dwell Time)	15.247 (a) (1) III	Pass
6	Conducted Bandedge	FCC 15.247 (d)	Pass
7	Radiated Bandedge and Spurious	FCC 15.247 (d) FCC 15.209 FCC 15.205	Pass
8	Conducted Emission Test For AC Power Port	FCC 15.207	Pass
9	Antenna Requirement	FCC 15.203	Pass



TABLE OF CONTENTS

1. ATTESTATION OF TEST RESULTS	6
2. TEST METHODOLOGY	7
3. FACILITIES AND ACCREDITATION	7
4. CALIBRATION AND UNCERTAINTY	8
4.1. <i>MEASURING INSTRUMENT CALIBRATION</i>	<i>8</i>
4.2. <i>MEASUREMENT UNCERTAINTY.....</i>	<i>8</i>
5. EQUIPMENT UNDER TEST	9
5.1. <i>DESCRIPTION OF EUT</i>	<i>9</i>
5.2. <i>MAXIMUM OUTPUT POWER.....</i>	<i>9</i>
5.3. <i>PACKET TYPE CONFIGURATION</i>	<i>9</i>
5.4. <i>CHANNEL LIST.....</i>	<i>10</i>
5.5. <i>TEST CHANNEL CONFIGURATION.....</i>	<i>10</i>
5.6. <i>THE WORSE CASE POWER SETTING PARAMETER.....</i>	<i>10</i>
5.7. <i>DESCRIPTION OF AVAILABLE ANTENNAS</i>	<i>11</i>
5.8. <i>WORST-CASE CONFIGURATIONS.....</i>	<i>11</i>
5.9. <i>TEST ENVIRONMENT</i>	<i>11</i>
5.10. <i>DESCRIPTION OF TEST SETUP</i>	<i>12</i>
5.11. <i>MEASURING INSTRUMENT AND SOFTWARE USED</i>	<i>13</i>
6. ANTENNA PORT TEST RESULTS	15
6.1. <i>ON TIME AND DUTY CYCLE.....</i>	<i>15</i>
6.2. <i>20dB BANDWIDTH AND 99% OCCUPIED BANDWIDTH</i>	<i>17</i>
6.2.1. <i>GFSK MODE</i>	<i>18</i>
6.2.2. <i>8DPSK MODE</i>	<i>20</i>
6.3. <i>CONDUCTED OUTPUT POWER.....</i>	<i>22</i>
6.3.1. <i>GFSK MODE</i>	<i>23</i>
6.3.2. <i>8DPSK MODE</i>	<i>23</i>
6.4. <i>CARRIER HOPPING CHANNEL SEPARATION.....</i>	<i>24</i>
6.4.1. <i>GFSK MODE</i>	<i>25</i>
6.4.2. <i>8DPSK MODE</i>	<i>26</i>
6.5. <i>NUMBER OF HOPPING FREQUENCY.....</i>	<i>27</i>
6.5.1. <i>GFSK MODE</i>	<i>28</i>
6.5.2. <i>8DPSK MODE</i>	<i>29</i>
6.6. <i>TIME OF OCCUPANCY (DWELL TIME).....</i>	<i>30</i>
6.6.1. <i>GFSK MODE</i>	<i>31</i>
6.6.2. <i>8DPSK MODE</i>	<i>34</i>



6.7. CONDUCTED SPURIOUS EMISSION36
6.7.1. GFSK MODE37
6.7.2. 8DPSK MODE44

7. RADIATED TEST RESULTS.....51
7.1. LIMITS AND PROCEDURE51
7.2. RESTRICTED BANDEDGE58
7.2.1. GFSK MODE58
7.2.2. 8DPSK MODE62
7.3. SPURIOUS EMISSIONS (1~3GHz)66
7.3.1. GFSK MODE66
7.3.2. 8DPSK MODE72
7.4. SPURIOUS EMISSIONS (3~18GHz)78
7.4.1. GFSK MODE78
7.4.2. 8DPSK MODE84
7.5. SPURIOUS EMISSIONS 18G ~ 26GHz.....90
7.5.1. GFSK MODE90
7.6. SPURIOUS EMISSIONS 30M ~ 1 GHz92
7.6.1. GFSK MODE92
7.7. SPURIOUS EMISSIONS BELOW 30M.....94
7.7.1. GFSK MODE94

8. AC POWER LINE CONDUCTED EMISSIONS97
8.1.1. GFSK MODE98

9. ANTENNA REQUIREMENTS.....100



1. ATTESTATION OF TEST RESULTS

Applicant Information

Company Name: Hui Zhou Gaoshengda Technology Co.,LTD
Address: NO.75 Zhongkai Development Area Huizhou, Guangdong China

Manufacturer Information

Company Name: Hui Zhou Gaoshengda Technology Co.,LTD
Address: NO.75 Zhongkai Development Area Huizhou, Guangdong China

EUT Description

EUT Name: WIFI+BT Module
Model: WT54M2000
Sample Status: Normal
Brand Name: GSD
Sample Received Date: April 28, 2019
Date of Tested: April 29 ~ June 17, 2019

APPLICABLE STANDARDS	
STANDARD	TEST RESULTS
CFR 47 FCC PART 15 SUBPART C	PASS

Prepared By:

Kebo Zhang
Engineer Project Associate

Checked By:

Shawn Wen
Laboratory Leader

Approved By:

Stephen Guo
Laboratory Manager



2. TEST METHODOLOGY

The tests documented in this report were performed in accordance with KDB 558074 D01 DTS Meas Guidance v05r02, KDB 414788 D01 Radiated Test Site v01r01, CFR 47 FCC Part 2, CFR 47 FCC Part 15, ANSI C63.10-2013, ISED RSS-247 Issue 2 and ISED RSS-GEN Issue 5.

3. FACILITIES AND ACCREDITATION

Accreditation Certificate	<p>A2LA (Certificate No.: 4102.01) UL Verification Services (Guangzhou) Co., Ltd. Song Shan Lake Branch. has been assessed and proved to be in compliance with A2LA.</p> <p>FCC (FCC Designation No.: CN1187) UL Verification Services (Guangzhou) Co., Ltd. Song Shan Lake Branch. Has been recognized to perform compliance testing on equipment subject to the Commission's Declaration of Conformity (DoC) and Certification rules</p> <p>ISED(Company No.: 21320) UL Verification Services (Guangzhou) Co., Ltd. Song Shan Lake Branch. has been registered and fully described in a report filed with ISED. The Company Number is 21320.</p> <p>VCCI (Registration No.: G-20019, R-20004, C-20012 and T-20011) UL Verification Services (Guangzhou) Co., Ltd. Song Shan Lake Branch. has been assessed and proved to be in compliance with VCCI, the Membership No. is 3793. Facility Name: Chamber D, the VCCI registration No. is G-20019 and R-20004 Shielding Room B , the VCCI registration No. is C-20012 and T-20011</p>
---------------------------	---

Note:

1. All tests measurement facilities use to collect the measurement data are located at Building 10, Innovation Technology Park, Song Shan Lake Hi tech Development Zone, Dongguan, 523808, China
2. The test anechoic chamber in UL Verification Services (Guangzhou) Co., Ltd. Song Shan Lake Branch had been calibrated and compared to the open field sites and the test anechoic chamber is shown to be equivalent to or worst case from the open field site.
3. For below 30MHz, lab had performed measurements at test anechoic chamber and comparing to measurements obtained on an open field site. And these measurements below 30MHz had been correlated to measurements performed on an OFS.



4. CALIBRATION AND UNCERTAINTY

4.1. MEASURING INSTRUMENT CALIBRATION

The measuring equipment utilized to perform the tests documented in this report has been calibrated in accordance with the manufacturer's recommendations, and is traceable to recognized national standards.

4.2. MEASUREMENT UNCERTAINTY

Where relevant, the following measurement uncertainty levels have been estimated for tests performed on the apparatus:

Test Item	Uncertainty
Conduction emission	3.62dB
Radiation Emission test(include Fundamental emission) (9kHz-30MHz)	2.2dB
Radiation Emission test(include Fundamental emission) (30MHz-1GHz)	4.00dB
Radiation Emission test (1GHz to 26GHz)(include Fundamental emission)	5.78dB (1GHz-18Gz)
	5.23dB (18GHz-26Gz)
Note: This uncertainty represents an expanded uncertainty expressed at approximately the 95% confidence level using a coverage factor of k=2.	



5. EQUIPMENT UNDER TEST

5.1. DESCRIPTION OF EUT

Equipment	WIFI+BT Module		
Model	WT54M2000		
Product Description (Bluetooth)	Operation Frequency	2402 MHz ~ 2480 MHz	
	Modulation Type	Data Rate	
	GFSK	1Mbps	
	π/4-DQPSK	2Mbps	
	8DPSK	3Mbps	
Bluetooth Version	BT5.0+EDR		
Rated Input	DC 3.3V		

5.2. MAXIMUM OUTPUT POWER

Bluetooth Mode	Frequency (MHz)	Channel Number	Max Output Power (dBm)	EIRP (dBm)
GFSK	2402-2480	0-78[79]	4.873	9.613
8DPSK	2402-2480	0-78[79]	4.765	9.505

5.3. PACKET TYPE CONFIGURATION

Test Mode	Packet Type	Setting(Packet Length)
GFSK	DH1	27
	DH3	183
	DH5	339
π/4-DQPSK	2-DH1	54
	2-DH3	367
	2-DH5	679
8DPSK	3-DH1	83
	3-DH3	552
	3-DH5	1021



5.4. CHANNEL LIST

Channel	Frequency (MHz)	Channel	Frequency (MHz)	Channel	Frequency (MHz)	Channel	Frequency (MHz)
00	2402	20	2422	40	2442	60	2462
01	2403	21	2423	41	2443	61	2463
02	2404	22	2424	42	2444	62	2464
03	2405	23	2425	43	2445	63	2465
04	2406	24	2426	44	2446	64	2466
05	2407	25	2427	45	2447	65	2467
06	2408	26	2428	46	2448	66	2468
07	2409	27	2429	47	2449	67	2469
08	2410	28	2430	48	2450	68	2470
09	2411	29	2431	49	2451	69	2471
10	2412	30	2432	50	2452	70	2472
11	2413	31	2433	51	2453	71	2473
12	2414	32	2434	52	2454	72	2474
13	2415	33	2435	53	2455	73	2475
14	2416	34	2436	54	2456	74	2476
15	2417	35	2437	55	2457	75	2477
16	2418	36	2438	56	2458	76	2478
17	2419	37	2439	57	2459	77	2479
18	2420	38	2440	58	2460	78	2480
19	2421	39	2441	59	2461	/	/

5.5. TEST CHANNEL CONFIGURATION

Test Mode	Test Channel Number	Test Channel
GFSK	CH 00, CH 39, CH 78	Low, Middle, High
8DPSK	CH 00, CH 39, CH 78	Low, Middle, High

5.6. THE WORSE CASE POWER SETTING PARAMETER

The Worst Case Power Setting Parameter under 2400 ~ 2483.5MHz Band				
Test Software		WCN_Combio_Tool		
Modulation Type	Transmit Antenna Number	Test Channel		
		CH 00	CH 39	CH 78
GFSK	1	Default	Default	Default
8DPSK	1	Default	Default	Default



5.7. DESCRIPTION OF AVAILABLE ANTENNAS

Ant.	Frequency (MHz)	Antenna Type	Antenna Gain (dBi)
1	2402-2480	IPEX Connector	4.74

Test Mode	Transmit and Receive Mode	Description
GFSK	1TX, 1RX	Chain 1 can be used as transmitting/receiving antenna.
8DPSK	1TX, 1RX	Chain 1 can be used as transmitting/receiving antenna.

5.8. WORST-CASE CONFIGURATIONS

Bluetooth Mode	Modulation Technology	Modulation Type	Data Rate (Mbps)
BR	FHSS	GFSK	1Mbit/s
EDR	FHSS	8DPSK	3Mbit/s

Note: Pre-Scan has been conducted to determine the worst-case mode from all possible combinations between available modulations, data rates.

5.9. TEST ENVIRONMENT

Environment Parameter	Selected Values During Tests	
Relative Humidity	45 ~ 70%	
Atmospheric Pressure:	1025Pa	
Temperature	TN	23 ~ 28 °C
Voltage :	VL	N/A
	VN	DC 3.3V
	VH	N/A

Note: VL= Lower Extreme Test Voltage
VN= Nominal Voltage.
VH= Upper Extreme Test Voltage
TN= Normal Temperature

5.10. DESCRIPTION OF TEST SETUP

SUPPORT EQUIPMENT

Item	Equipment	Brand Name	Model Name	P/N
1	Laptop	ThinkPad	T460S	SL10K24796 JS
2	USB TO UART	/	/	/

I/O CABLES

Cable No	Port	Connector Type	Cable Type	Cable Length(m)	Remarks
1	USB	/	/	0.5	/

Note: The USB cable is for debugging only.

ACCESSORY

Item	Accessory	Brand Name	Model Name	Description
1	N/A	/	/	/

TEST SETUP

The EUT can work in an engineer mode with software through a Laptop.

SETUP DIAGRAM FOR TESTS

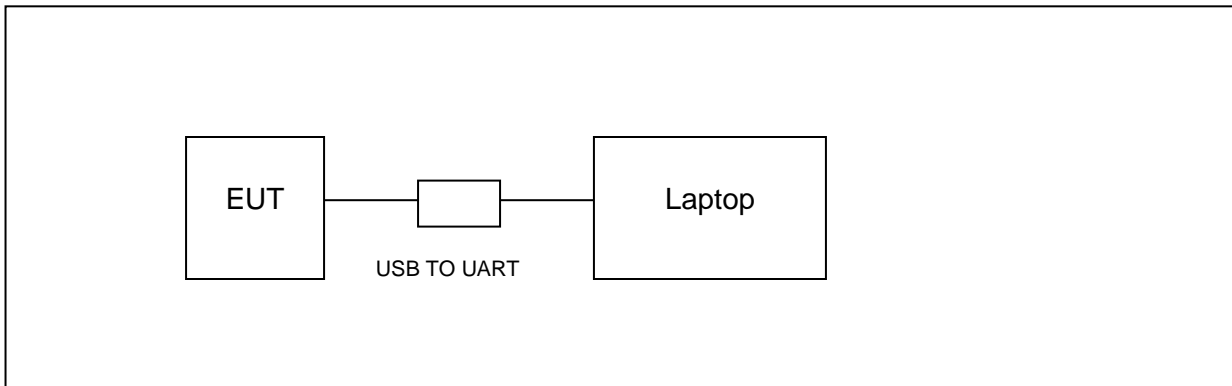



5.11. MEASURING INSTRUMENT AND SOFTWARE USED

Conducted Emissions						
Instrument						
Used	Equipment	Manufacturer	Model No.	Serial No.	Last Cal.	Next Cal.
<input checked="" type="checkbox"/>	EMI Test Receiver	R&S	ESR3	101961	Dec.10,2018	Dec.10,2019
<input checked="" type="checkbox"/>	Two-Line V-Network	R&S	ENV216	101983	Dec.10,2018	Dec.10,2019
<input checked="" type="checkbox"/>	Artificial Mains Networks	Schwarzbeck	NSLK 8126	8126465	Dec.10,2018	Dec.10,2019
Software						
Used	Description	Manufacturer	Name	Version		
<input checked="" type="checkbox"/>	Test Software for Conducted disturbance	Farad	EZ-EMC	Ver. UL-3A1		
Radiated Emissions						
Instrument						
Used	Equipment	Manufacturer	Model No.	Serial No.	Last Cal.	Next Cal.
<input checked="" type="checkbox"/>	MXE EMI Receiver	KESIGHT	N9038A	MY56400036	Dec.10,2018	Dec.10,2019
<input checked="" type="checkbox"/>	Hybrid Log Periodic Antenna	TDK	HLP-3003C	130960	Sep.17, 2018	Sep.17, 2021
<input checked="" type="checkbox"/>	Preamplifier	HP	8447D	2944A09099	Dec.10,2018	Dec.10,2019
<input checked="" type="checkbox"/>	EMI Measurement Receiver	R&S	ESR26	101377	Dec.10,2018	Dec.10,2019
<input checked="" type="checkbox"/>	Horn Antenna	TDK	HRN-0118	130939	Sep.17, 2018	Sep.17, 2021
<input checked="" type="checkbox"/>	High Gain Horn Antenna	Schwarzbeck	BBHA-9170	691	Aug.11, 2018	Aug.11, 2021
<input checked="" type="checkbox"/>	Preamplifier	TDK	PA-02-0118	TRS-305-00066	Dec.10,2018	Dec.10,2019
<input checked="" type="checkbox"/>	Preamplifier	TDK	PA-02-2	TRS-307-00003	Dec.10,2018	Dec.10,2019
<input checked="" type="checkbox"/>	Loop antenna	Schwarzbeck	1519B	00008	Jan.07, 2019	Jan.07, 2022
<input checked="" type="checkbox"/>	Band Reject Filter	Wainwright	WRCJV8-2350-2400-2483.5-2533.5-40SS	4	Dec.10, 2018	Dec.10, 2019
<input checked="" type="checkbox"/>	High Pass Filter	Wi	WHKX10-2700-3000-18000-40SS	23	Dec.10,2018	Dec.10,2019
Software						
Used	Description	Manufacturer	Name	Version		
<input checked="" type="checkbox"/>	Test Software for Radiated disturbance	Farad	EZ-EMC	Ver. UL-3A1		



Other instruments						
Used	Equipment	Manufacturer	Model No.	Serial No.	Last Cal.	Next Cal.
<input checked="" type="checkbox"/>	Spectrum Analyzer	Keysight	N9030A	MY55410512	Dec.10,2018	Dec.10,2019
<input checked="" type="checkbox"/>	Power Meter	Keysight	N9031A	MY55416024	Dec.10,2018	Dec.10,2019
<input checked="" type="checkbox"/>	Power Sensor	Keysight	N9323A	MY55440013	Dec.10,2018	Dec.10,2019



6. ANTENNA PORT TEST RESULTS

6.1. ON TIME AND DUTY CYCLE

LIMITS

None; for reporting purposes only

PROCEDURE

KDB 558074 Zero-Span Spectrum Analyzer Method

TEST SETUP

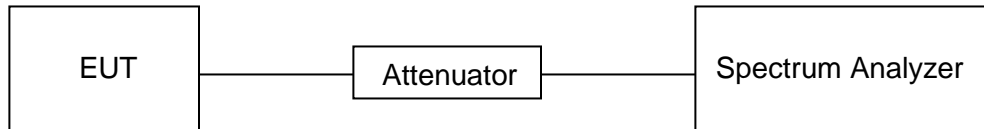

TEST ENVIRONMENT

Temperature	23.2°C	Relative Humidity	56%
Atmosphere Pressure	101kPa	Test Voltage	DC 3.3V

RESULTS

Mode	On Time (msec)	Period (msec)	Duty Cycle x (Linear)	Duty Cycle (%)	Duty Cycle Correction Factor (dB)	1/T Minimum VBW (kHz)	Final setting For VBW (kHz)
GFSK	2.880	5.000	0.576	67.6	2.396	0.347	0.5
8DPSK	2.880	5.000	0.576	67.6	2.396	0.347	0.5

Note:

Duty Cycle Correction Factor=10log (1/x).

Where: x is Duty Cycle (Linear)

Where: T is On Time

If that calculated VBW is not available on the analyzer then the next higher value should be used.

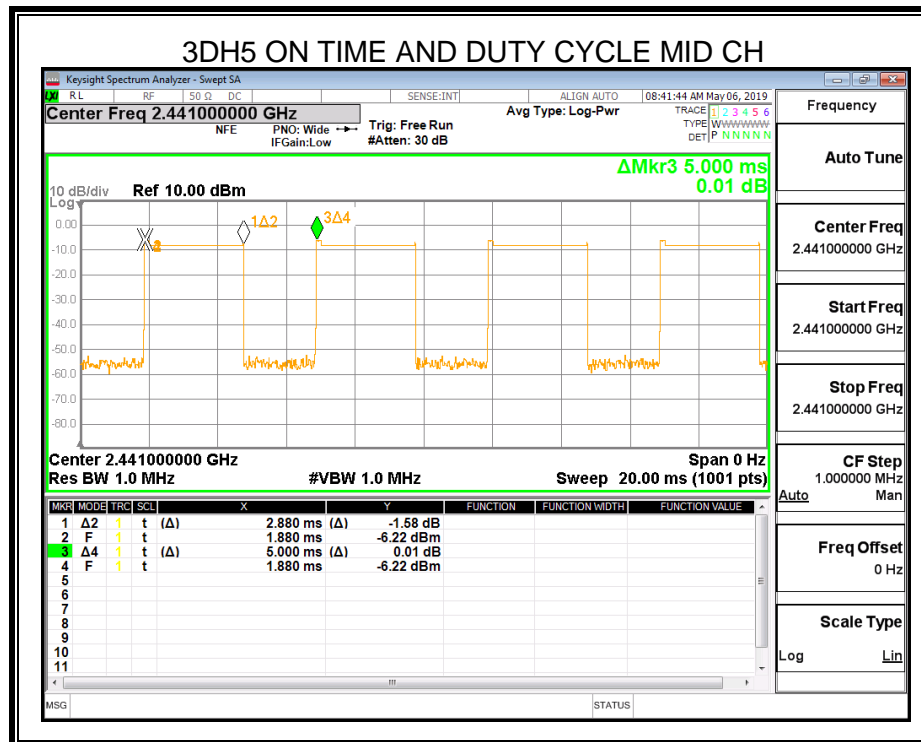
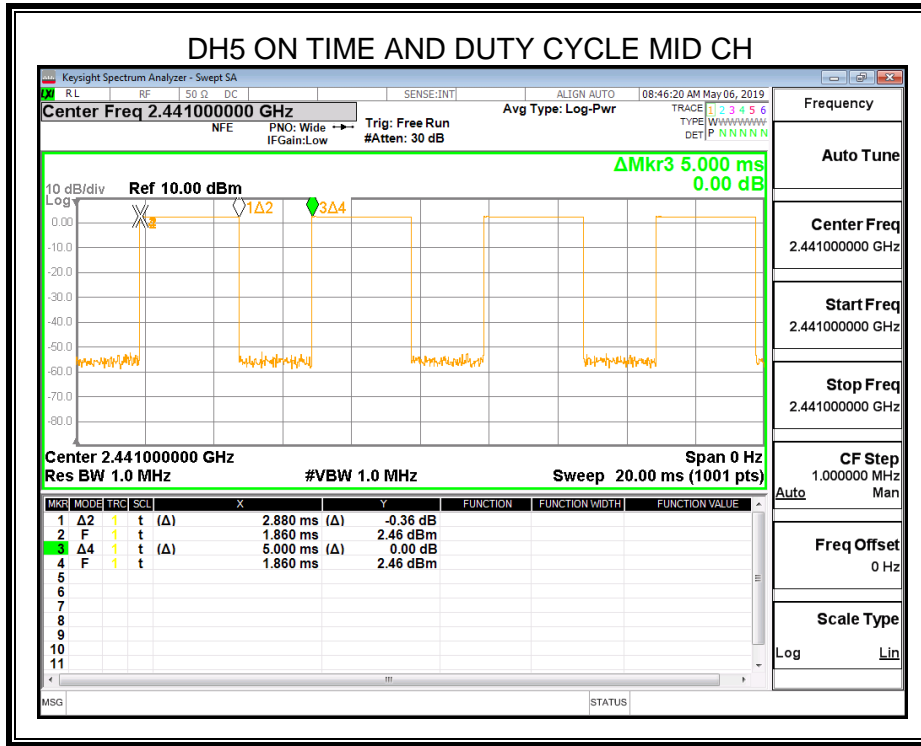

6.2. 20dB BANDWIDTH AND 99% OCCUPIED BANDWIDTH

LIMITS

CFR 47FCC Part15 (15.247) Subpart C ISED RSS-247 ISSUE 2			
Section	Test Item	Limit	Frequency Range (MHz)
CFR 47 FCC 15.247 (a) (1) RSS-247 Clause 5.1 (a)	20dB Occupied Bandwidth	/	2400-2483.5
ISED RSS-Gen Clause 6.6	99% Occupied Bandwidth	/	2400-2483.5

TEST PROCEDURE

Connect the UUT to the spectrum analyser and use the following settings:

Center Frequency	The centre frequency of the channel under test
Detector	Peak
RBW	1% to 5% of the OBW
VBW	approximately 3×RBW
Span	approximately 2 to 3 times the OBW
Trace	Max hold
Sweep	Auto couple

Allow the trace to stabilize and measure the maximum width of the emission that is constrained by the frequencies associated with the two outermost amplitude points (upper and lower frequencies) that are attenuated by 20 dB and 99% relative to the maximum level measured in the fundamental emission.

TEST SETUP

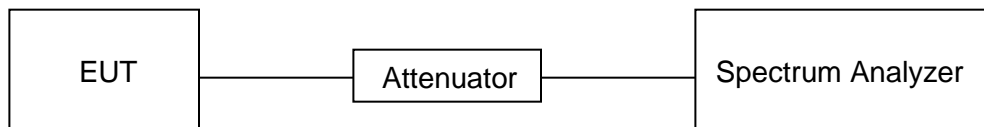



TEST ENVIRONMENT

Temperature	23.2°C	Relative Humidity	56%
Atmosphere Pressure	101kPa	Test Voltage	DC 3.3V

RESULTS

6.2.1. GFSK MODE

Channel	Frequency (MHz)	20dB Occupied bandwidth (MHz)	99% Occupied bandwidth (MHz)	Result
Low	2402	0.8419	0.81799	PASS
Middle	2441	0.8277	0.80977	PASS
High	2480	0.8351	0.80920	PASS

Test Graph

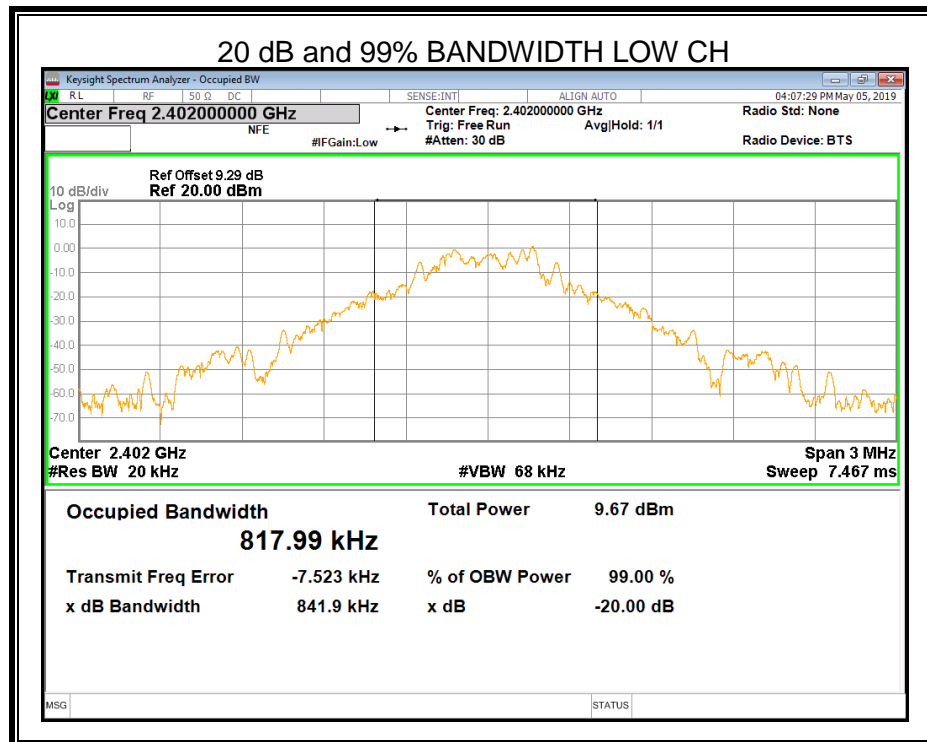

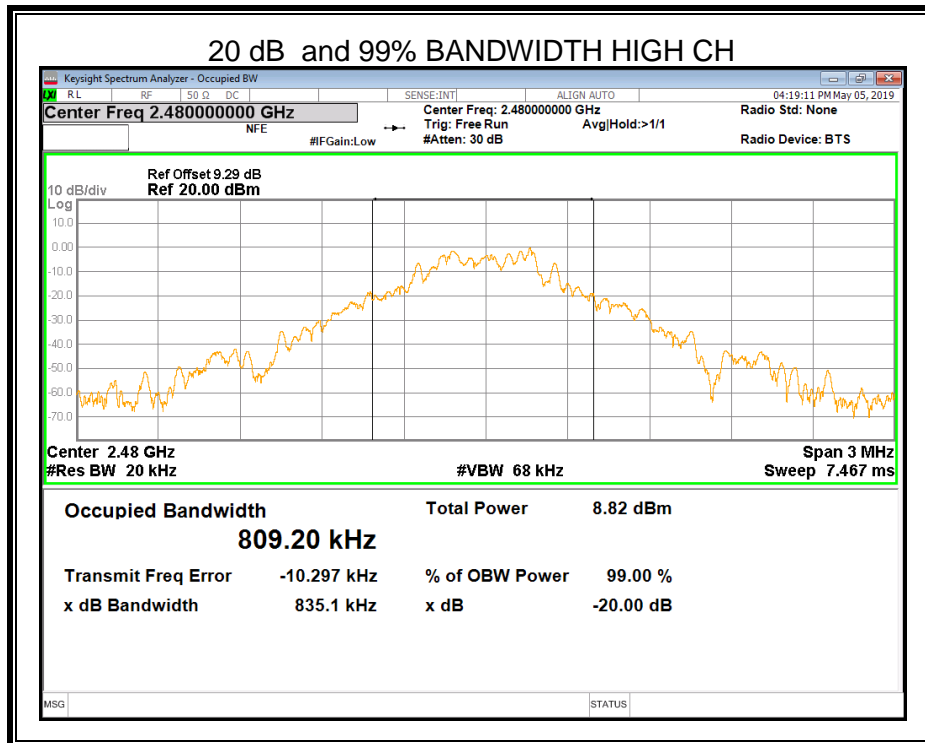
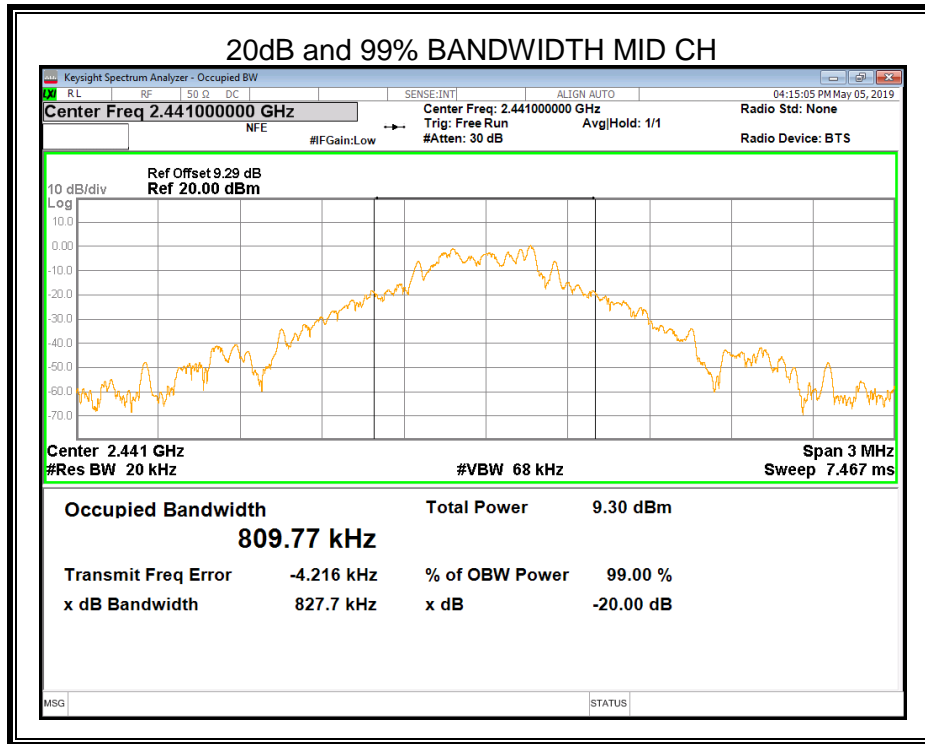



6.2.2. 8DPSK MODE

Channel	Frequency (MHz)	20dB Occupied bandwidth (MHz)	99% Occupied bandwidth (MHz)	Result
Low	2402	1.078	1.0446	PASS
Middle	2441	1.194	1.0672	PASS
High	2480	1.078	1.0446	PASS

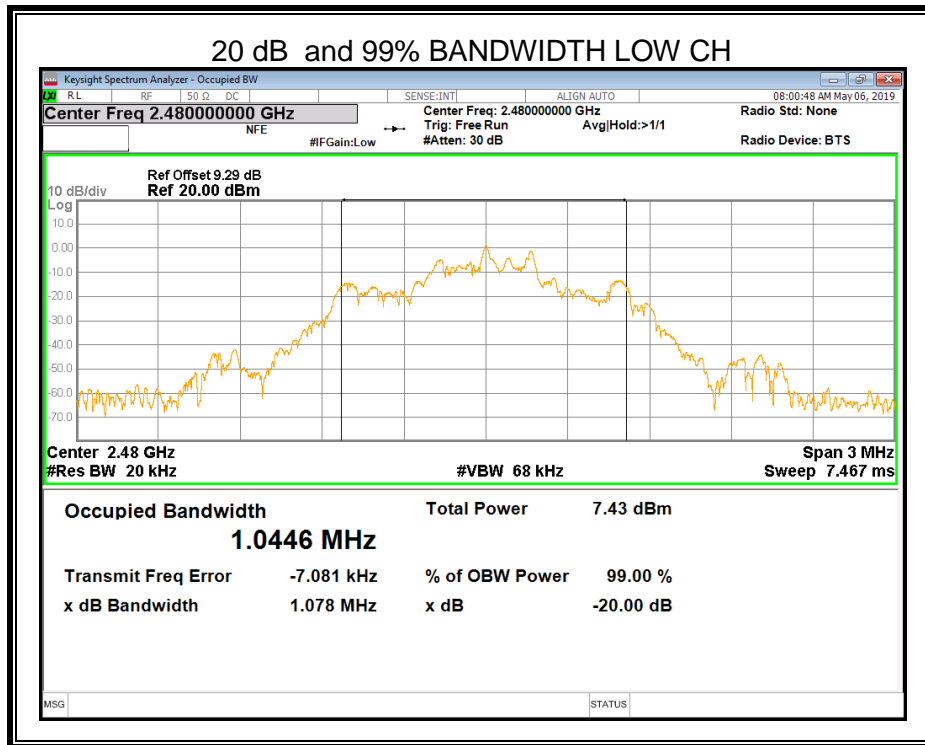

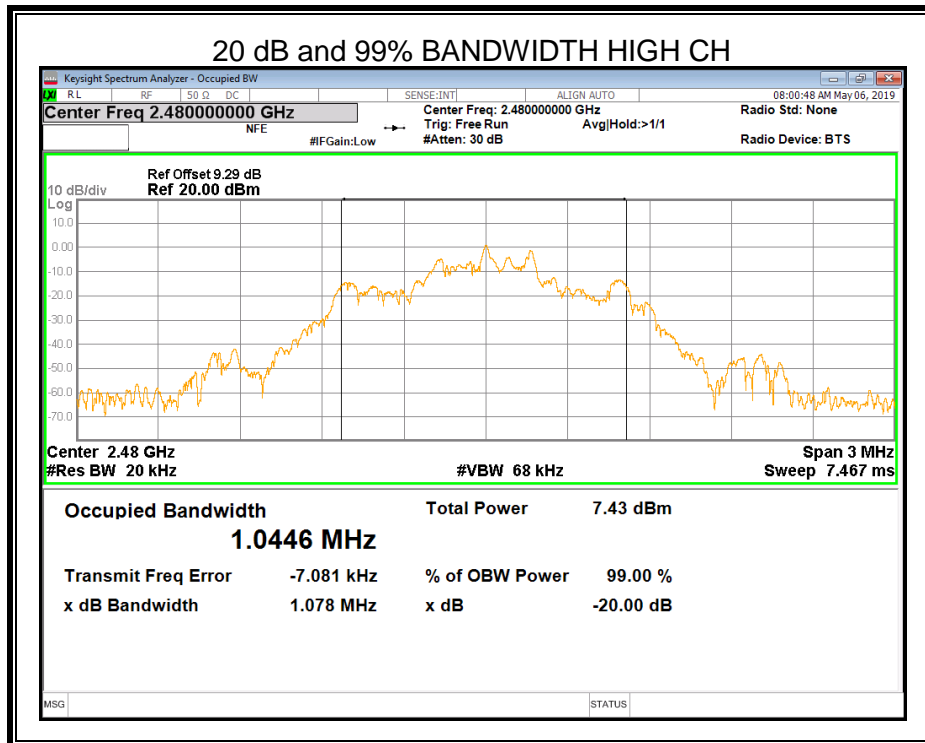
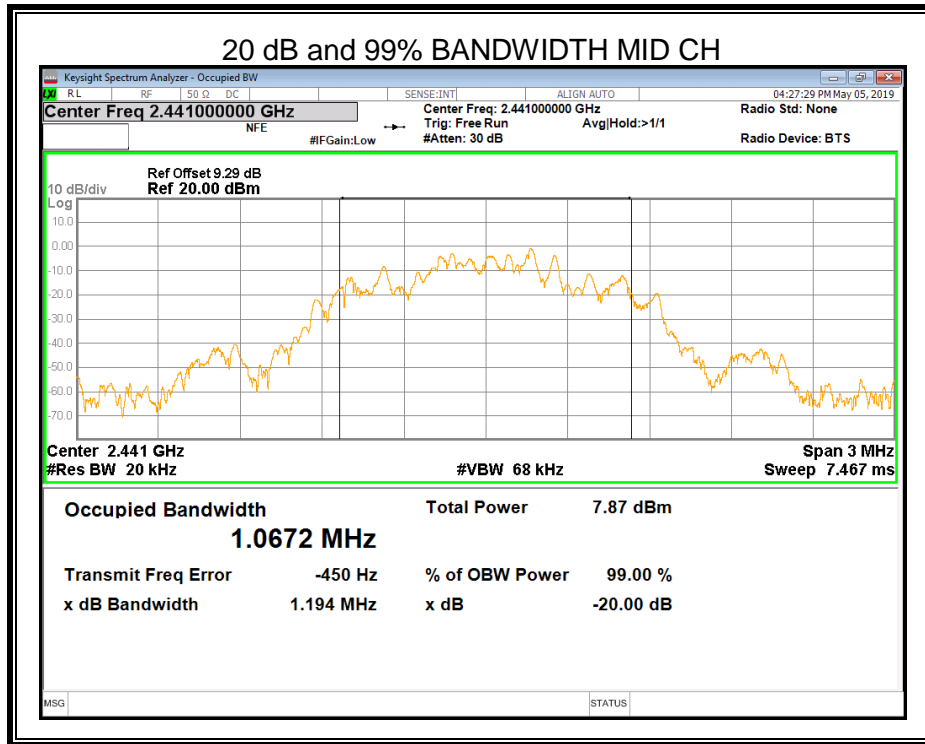

6.3. CONDUCTED OUTPUT POWER

LIMITS

CFR 47 FCC Part15 (15.247) , Subpart C ISED RSS-247 ISSUE 2			
Section	Test Item	Limit	Frequency Range (MHz)
CFR 47 FCC 15.247 (b) (1) ISED RSS-247 Clause 5.4 (b)	Peak Conducted Output Power	Hopping channel carrier frequencies separated by a minimum of 25 kHz or the 20 dB bandwidth of the hopping channel : 1 watt or 30dBm; Hopping channel carrier frequencies that are separated by 25 kHz or two-thirds of the 20 dB bandwidth of the hopping channel : 125 mW or 21dBm	2400-2483.5

TEST PROCEDURE

Place the EUT on the table and set it in the transmitting mode.
Remove the antenna from the EUT and then connect a low loss RF cable from the antenna port to the Power sensor.
Measure peak power of each channel.

TEST SETUP

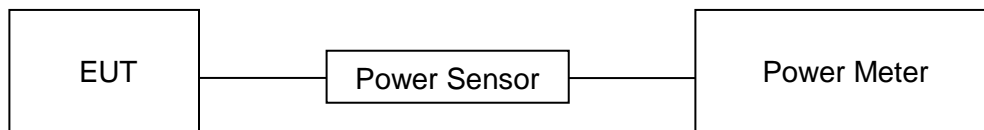



TEST ENVIRONMENT

Temperature	23.2°C	Relative Humidity	56%
Atmosphere Pressure	101kPa	Test Voltage	DC 3.3V

RESULTS

6.3.1. GFSK MODE

Channel	Frequency	Maximum Conducted Output Power(PK)	EIRP	Limit	Result
	(MHz)	(dBm)	(dBm)	(dBm)	
Low	2402	4.873	9.613	30	Pass
Middle	2441	4.432	9.172	30	Pass
High	2480	4.102	8.842	30	Pass

Note: EIRP= Maximum Conducted Output Power + Antenna Gain

Note: The channel separation is 1MHz and the 20dB Bandwidth is less than 1MHz.

6.3.2. 8DPSK MODE

Channel	Frequency	Maximum Conducted Output Power(PK)	EIRP	Limit	Result
	(MHz)	(dBm)	(dBm)	(dBm)	
Low	2402	4.765	9.505	21	Pass
Middle	2441	4.300	9.040	21	Pass
High	2480	4.121	8.861	21	Pass

Note: EIRP= Maximum Conducted Output Power + Antenna Gain

Note: The channel separation is 1MHz and the 20dB Bandwidth is bigger than 1MHz.

6.4. CARRIER HOPPING CHANNEL SEPARATION

LIMITS

CFR 47 FCC Part15 (15.247) , Subpart C ISED RSS-247 ISSUE 2			
Section	Test Item	Limit	Frequency Range (MHz)
CFR 47 FCC 15.247 (a) (1) ISED RSS-247 Clause 5.1 (b)	Carrier Hopping Channel Separation	Frequency hopping systems shall have hopping channel carrier frequencies separated by a minimum of 25 kHz or the 20 dB bandwidth of the hopping channel, whichever is greater. Alternatively, frequency hopping systems operating in the 2400-2483.5 MHz band may have hopping channel carrier frequencies that are separated by 25 kHz or two-thirds of the 20 dB bandwidth of the hopping channel.	2400-2483.5

TEST PROCEDURE

Connect the UUT to the spectrum Analyzer and use the following settings:

Center Frequency	The center frequency of the channel under test
Span	wide enough to capture the peaks of two adjacent channels
Detector	Peak
RBW	Start with the RBW set to approximately 30% of the channel spacing; adjust as necessary to best identify the center of each individual channel.
VBW	\geq RBW
Trace	Max hold
Sweep time	Auto couple

Allow the trace to stabilize. Use the marker-delta function to determine the separation between the peaks of the adjacent channels.

Compliance of an EUT with the appropriate regulatory limit shall be determined.

A plot of the data shall be included in the test report.

TEST SETUP

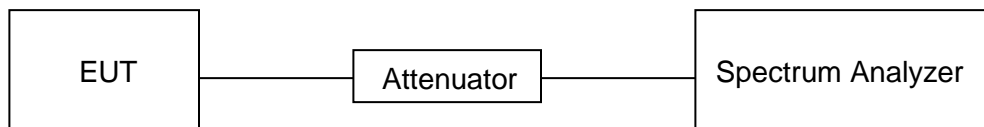

TEST ENVIRONMENT

Temperature	23.2°C	Relative Humidity	56%
Atmosphere Pressure	101kPa	Test Voltage	DC 3.3V

RESULTS

6.4.1. GFSK MODE

Channel	Carrier Hopping Channel Separation (MHz)	Limit (MHz)	Result
Middle	1.0	≥ 20 dB Bandwidth Of The Hopping Channel	PASS

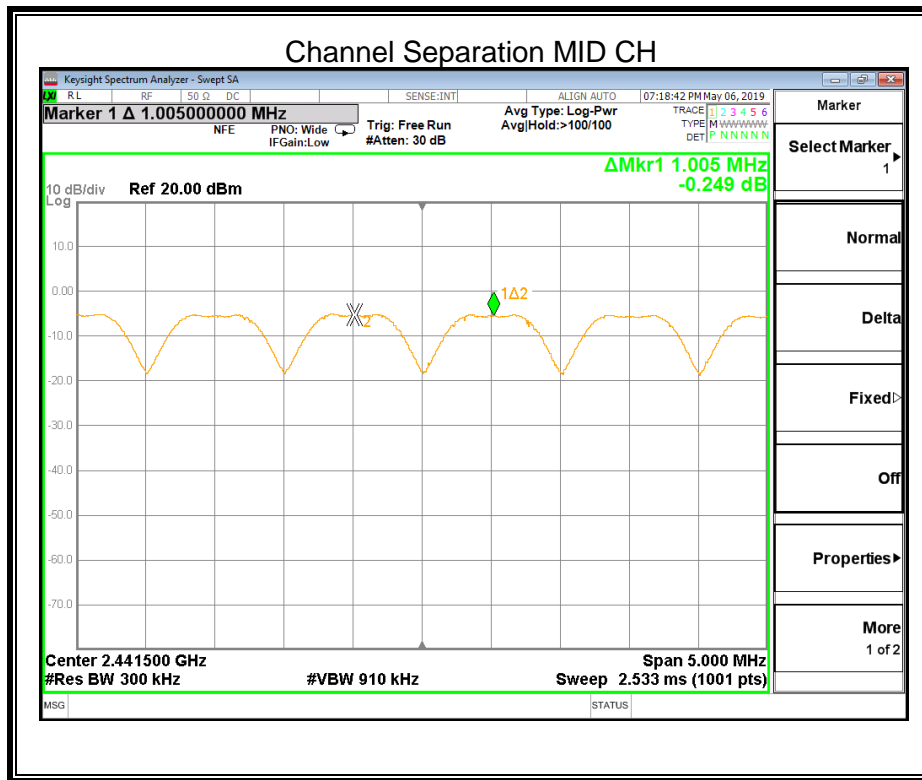

Note: For 20 dB Bandwidth of The Hopping Channel, please refer to clause 6.2.1.

6.4.2. 8DPSK MODE

Channel	Carrier Hopping Channel Separation (MHz)	Limit (MHz)	Result
Middle	1.0	≥ two-thirds of the 20 dB Bandwidth Of The Hopping Channel	PASS

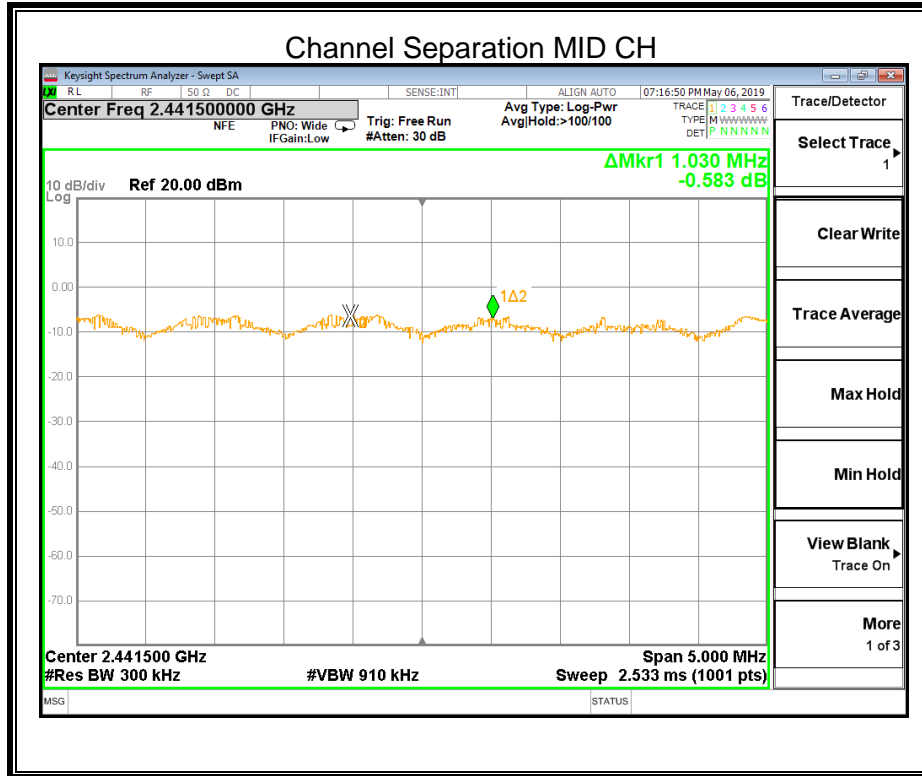

Note: For 20 dB Bandwidth of The Hopping Channel, please refer to clause 6.2.2.



6.5. NUMBER OF HOPPING FREQUENCY

LIMITS

CFR 47 FCC Part15 (15.247) , Subpart C ISED RSS-247 ISSUE 2		
Section	Test Item	Limit
CFR 47 15.247 (a) (1) III ISED RSS-247 Clause 5.1 (d)	Number of Hopping Frequency	at least 15 hopping channels

TEST PROCEDURE

Connect the EUT to the spectrum Analyzer and use the following settings:

Detector	Peak
RBW	To identify clearly the individual channels, set the RBW to less than 30% of the channel spacing or the 20 dB bandwidth, whichever is smaller.
VBW	≥RBW
Span	The frequency band of operation
Trace	Max hold
Sweep time	Auto couple

Set EUT to transmit maximum output power and switch on frequency hopping function. then set enough count time (larger than 5000 times) to get all the hopping frequency channel displayed on the screen of spectrum analyzer.

Count the quantity of peaks to get the number of hopping channels.

FHSS Mode: 79 Channels observed.

AFHSS Mode: 20 Channels declared.

TEST SETUP

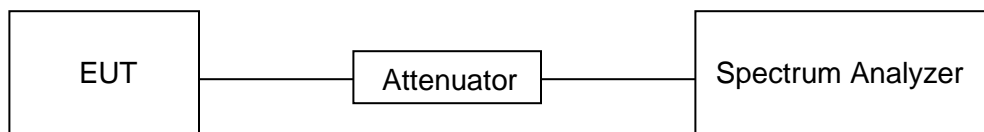

TEST ENVIRONMENT

Temperature	23.2°C	Relative Humidity	56%
Atmosphere Pressure	101kPa	Test Voltage	DC 3.3V



RESULTS

6.5.1. GFSK MODE

Hopping numbers	Limit	Results
79	>15	Pass

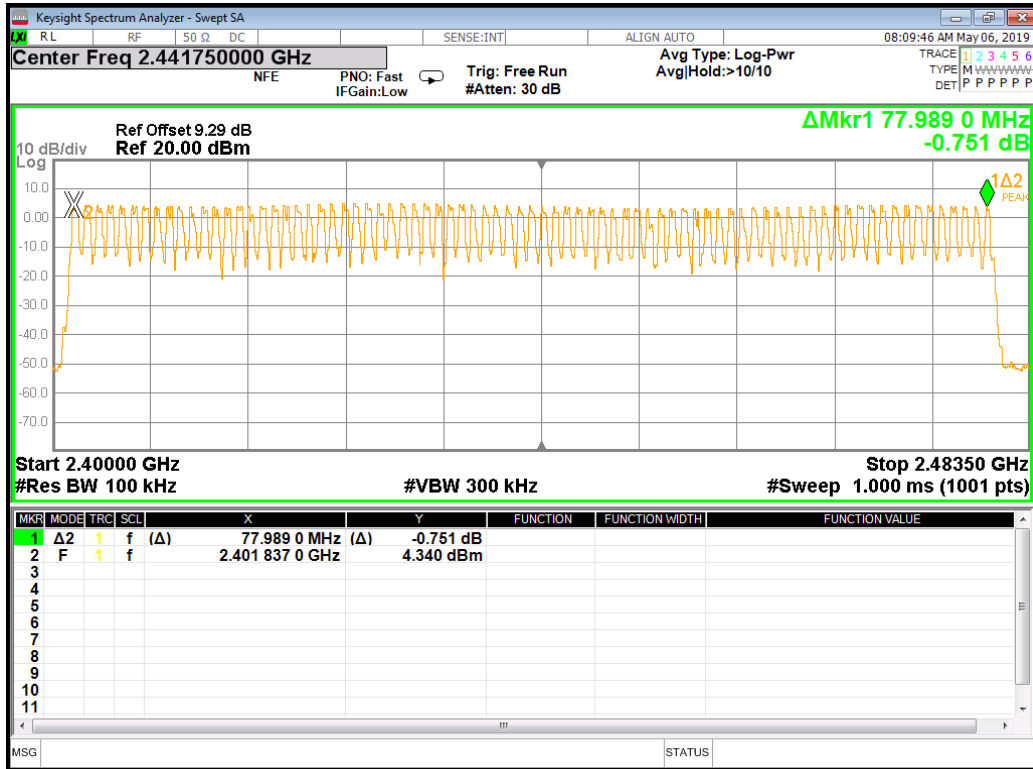



6.5.2. 8DPSK MODE

Hopping numbers	Limit	Results
79	>15	Pass

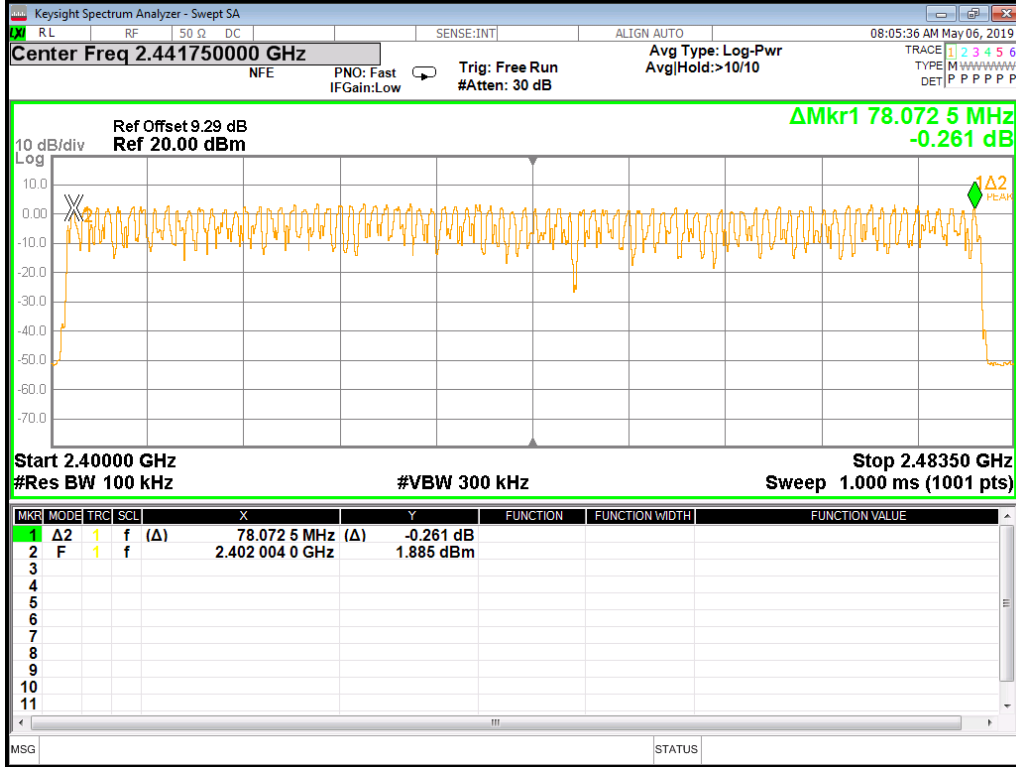



6.6. TIME OF OCCUPANCY (DWELL TIME)

LIMITS

CFR 47 FCC Part15 (15.247) , Subpart C ISED RSS-247 ISSUE 2		
Section	Test Item	Limit
CFR 47 15.247 (a) (1) III ISED RSS-247 Clause 5.1 (d)	Time of Occupancy (Dwell Time)	The average time of occupancy on any channel shall not be greater than 0.4 seconds within a period of 0.4 seconds, multiplied by the number of hopping channels employed.

TEST PROCEDURE

Connect the UUT to the spectrum Analyzer and use the following settings:

Center Frequency	The center frequency of the channel under test
Detector	Peak
RBW	1 MHz
VBW	≥RBW
Span	zero span
Trace	Max hold
Sweep time	As necessary to capture the entire dwell time per hopping channel

- The transmitter output (antenna port) was connected to the spectrum analyzer
- Set RBW of spectrum analyzer to 1MHz and VBW to 1MHz.
- Use a video trigger with the trigger level set to enable triggering only on full pulses.
- Sweep Time is more than once pulse time.
- Set the center frequency on any frequency would be measure and set the frequency span to zero span.
- Measure the maximum time duration of one single pulse.
- Set the EUT for DH5, DH3 and DH1 packet transmitting.
- Measure the maximum time duration of one single pulse.
A Period Time = (channel number)*0.4

For FHSS Mode (79 Channel):

DH1 Time Slot: Reading * (1600/2)*31.6/(channel number)

DH3 Time Slot: Reading * (1600/4)*31.6/(channel number)

DH5 Time Slot: Reading * (1600/6)*31.6/(channel number)

For AFHSS Mode (20 Channel):

DH1 Time Slot: Reading * (800/2)*8/(channel number)

DH3 Time Slot: Reading * (800/4)*8/(channel number)



DH5 Time Slot: Reading * (800/6)*8/(channel number)

TEST SETUP

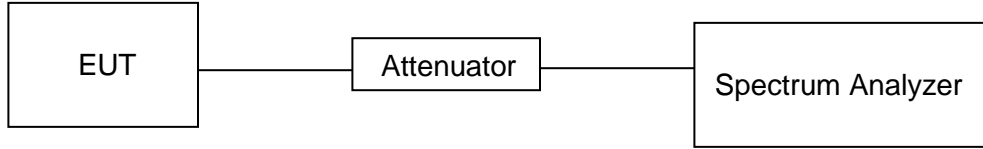

TEST ENVIRONMENT

Temperature	23.2°C	Relative Humidity	56%
Atmosphere Pressure	101kPa	Test Voltage	DC 3.3V

RESULTS

6.6.1. GFSK MODE

FHSS Mode				
Packet	Channel	Burst Width [ms/hop/ch]	Dwell Time [s]	Results
DH1	MCH	0.380	0.122	PASS
DH3	MCH	1.630	0.261	PASS
DH5	MCH	2.880	0.307	PASS
AFHSS Mode				
DH1	MCH	0.380	0.061	PASS
DH3	MCH	1.630	0.130	PASS
DH5	MCH	2.880	0.154	PASS



Test Graph

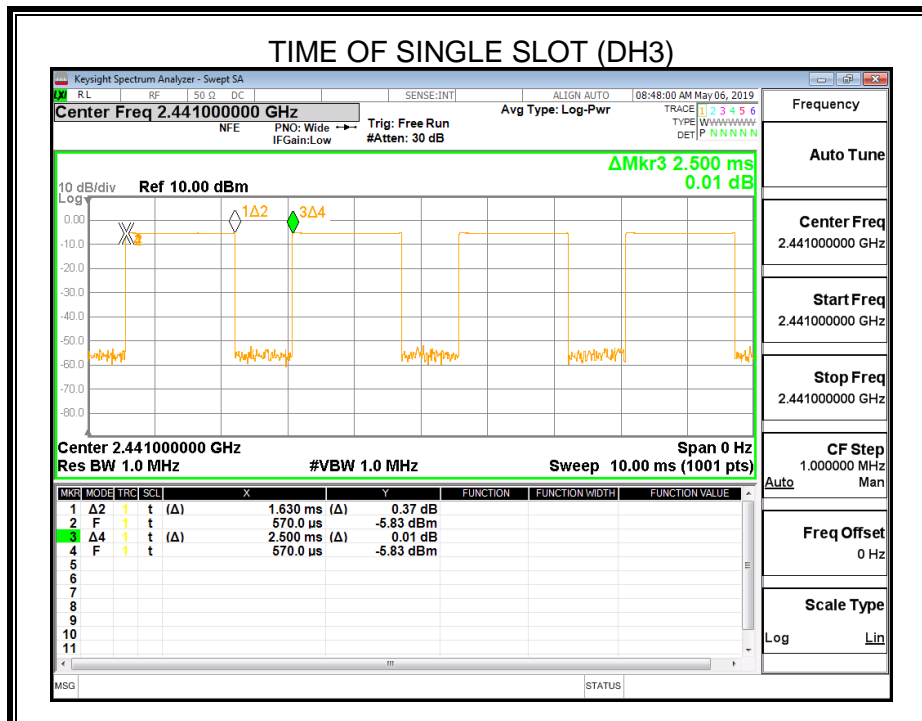
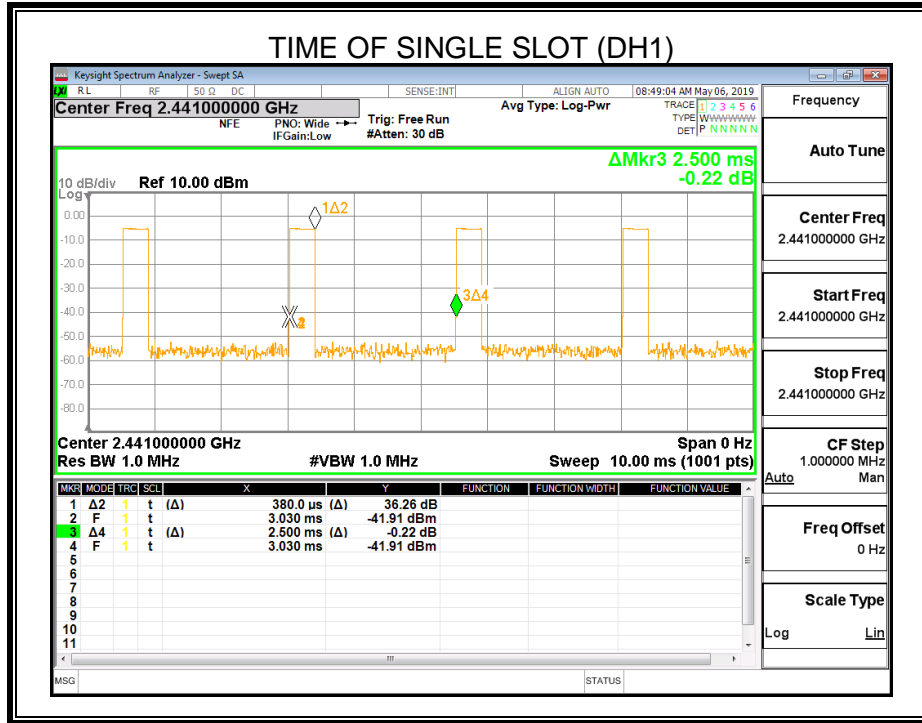

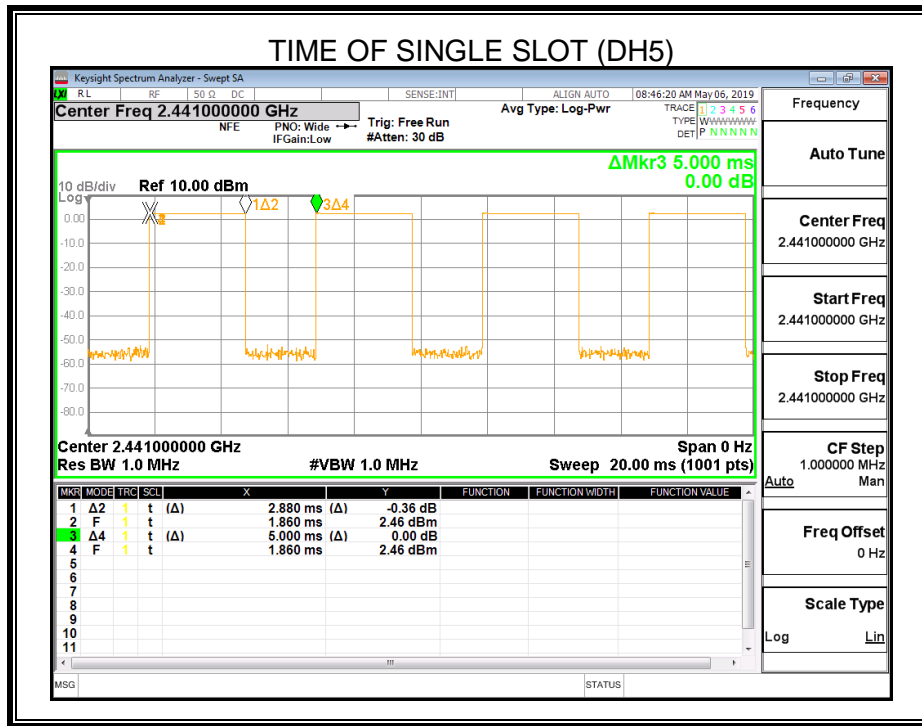



6.6.2. 8DPSK MODE

FHSS Mode				
Packet	Channel	Burst Width [ms/hop/ch]	Dwell Time [s]	Results
3DH1	MCH	0.380	0.122	PASS
3DH3	MCH	1.640	0.262	PASS
3DH5	MCH	2.880	0.307	PASS
AFHSS Mode				
3DH1	MCH	0.380	0.061	PASS
3DH3	MCH	1.640	0.131	PASS
3DH5	MCH	2.880	0.154	PASS

Test Graph

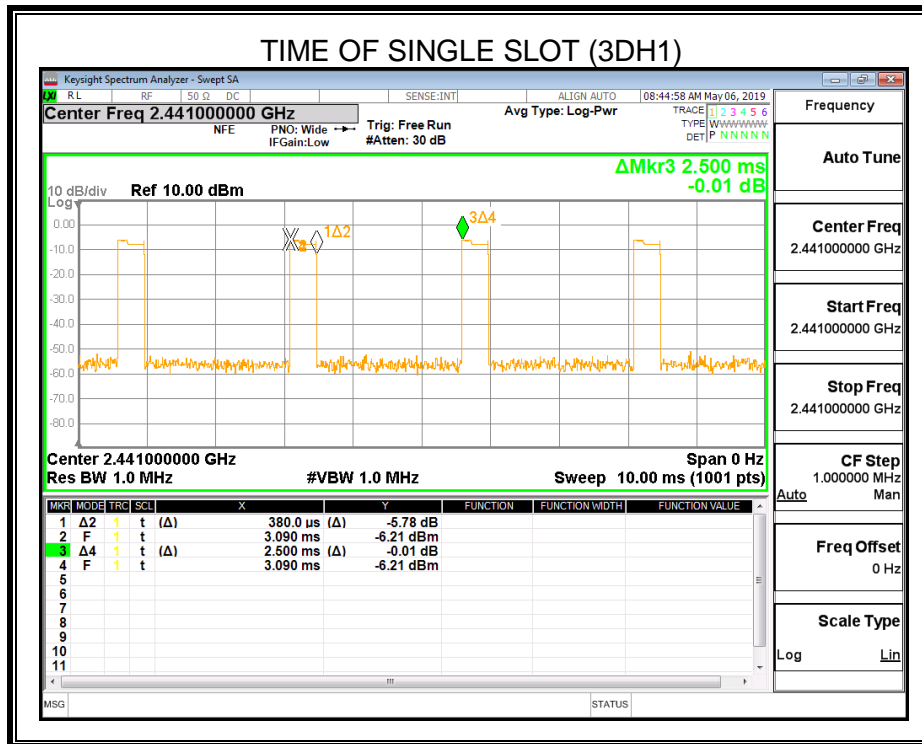

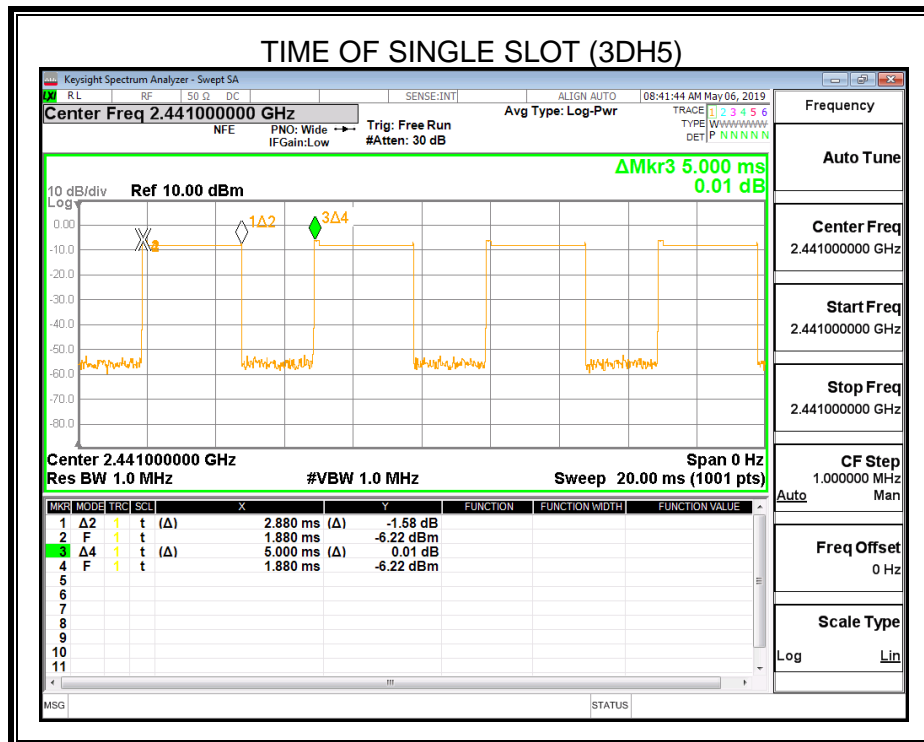
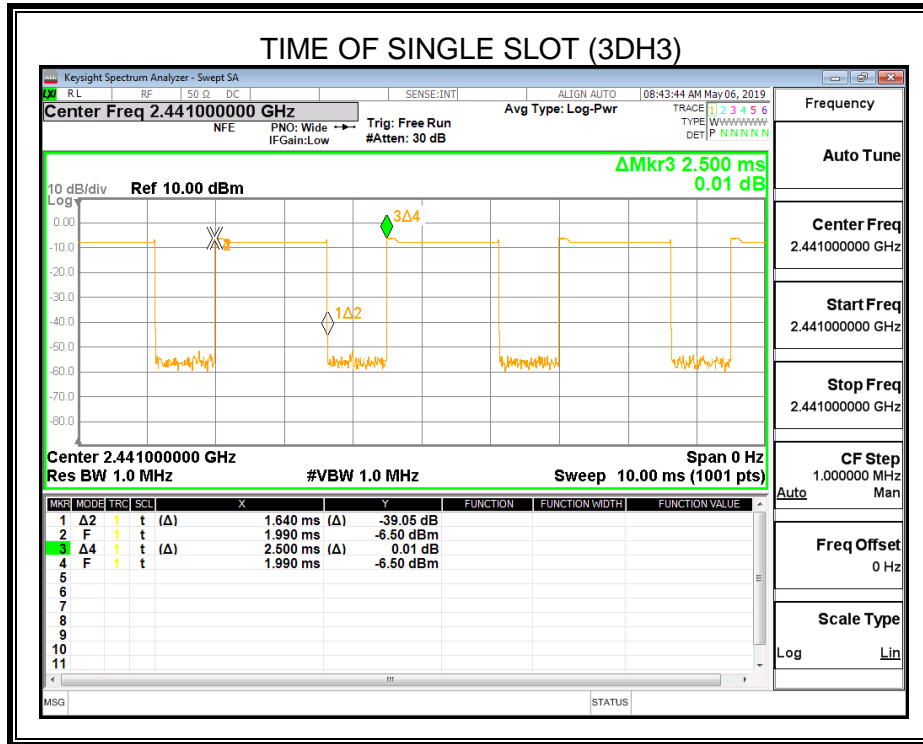



6.7. CONDUCTED SPURIOUS EMISSION

LIMITS

CFR 47 FCC Part15 (15.247) , Subpart C ISED RSS-247 ISSUE 2		
Section	Test Item	Limit
CFR 47 FCC §15.247 (d) ISED RSS-247 5.5	Conducted Spurious Emission	at least 20 dB below that in the 100 kHz bandwidth within the band that contains the highest level of the desired power

TEST PROCEDURE

Please refer to the ANSI C63.10 section 6.10.

For Bandedge use the following settings:

Detector	Peak
RBW	100kHz
VBW	300kHz
Span	wide enough to fully capture the emission being measured
Trace	Max hold
Sweep time	Auto couple.

For Spurious Emission use the following settings:

Detector	Peak
RBW	100kHz
VBW	300kHz
Span	wide enough to fully capture the emission being measured
Trace	Max hold
Sweep time	Auto couple.

Use the peak marker function to determine the maximum amplitude level.

TEST SETUP

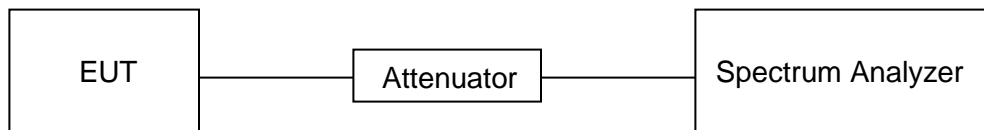

TEST ENVIRONMENT

Temperature	23.2°C	Relative Humidity	56%
Atmosphere Pressure	101kPa	Test Voltage	DC 3.3V



RESULTS

6.7.1. GFSK MODE

LOW CH BANDEDGE

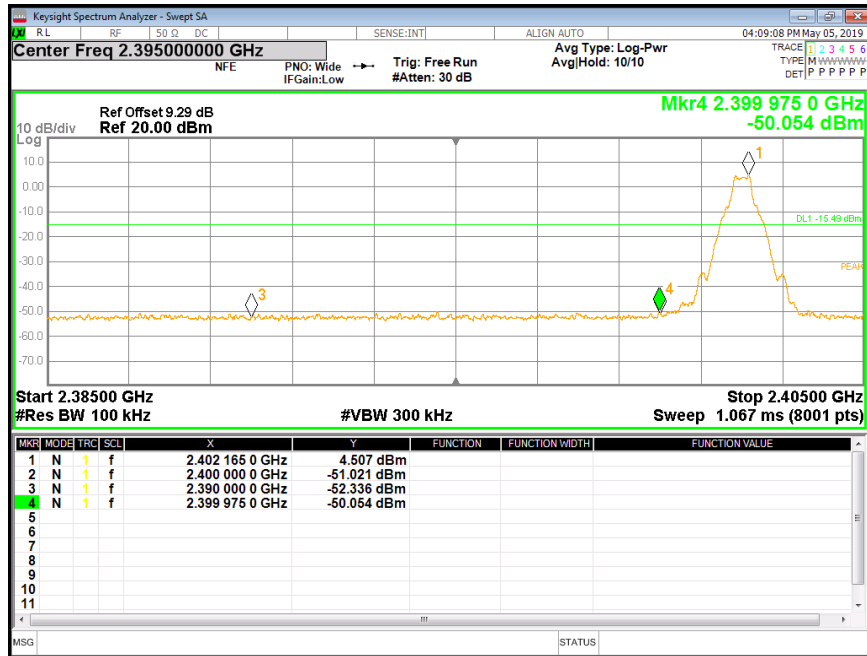

LOW CH SPURIOUS EMISSIONS REFERENCE

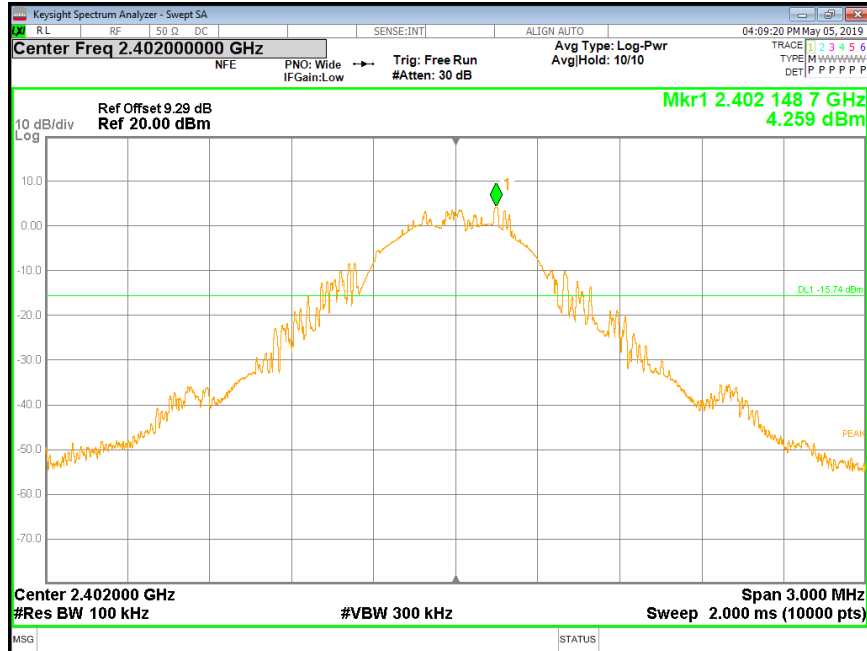



LOW CH SPURIOUS EMISSIONS 30M-10G

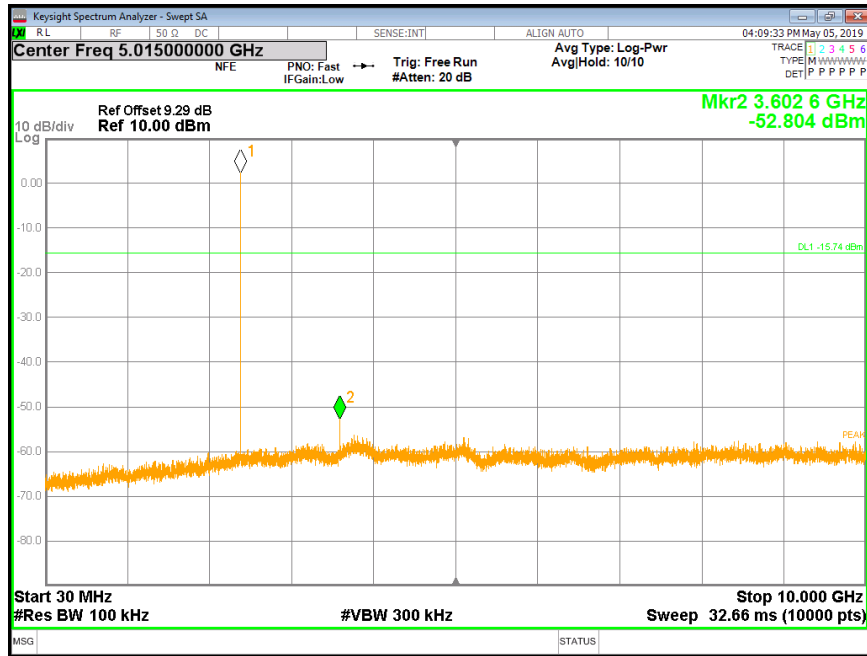

LOW CH SPURIOUS EMISSIONS 10G-26G

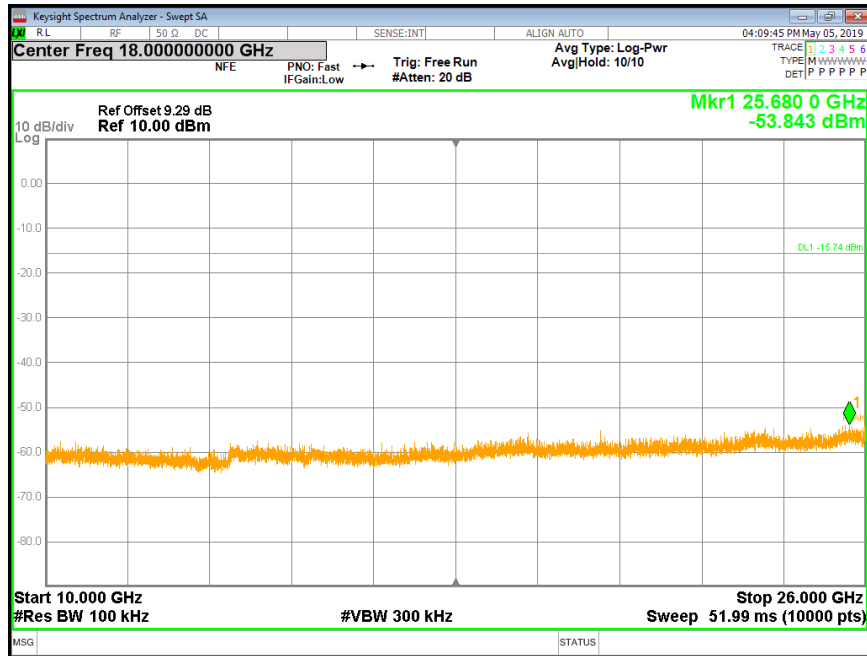



MID CH SPURIOUS EMISSIONS REFERENCE

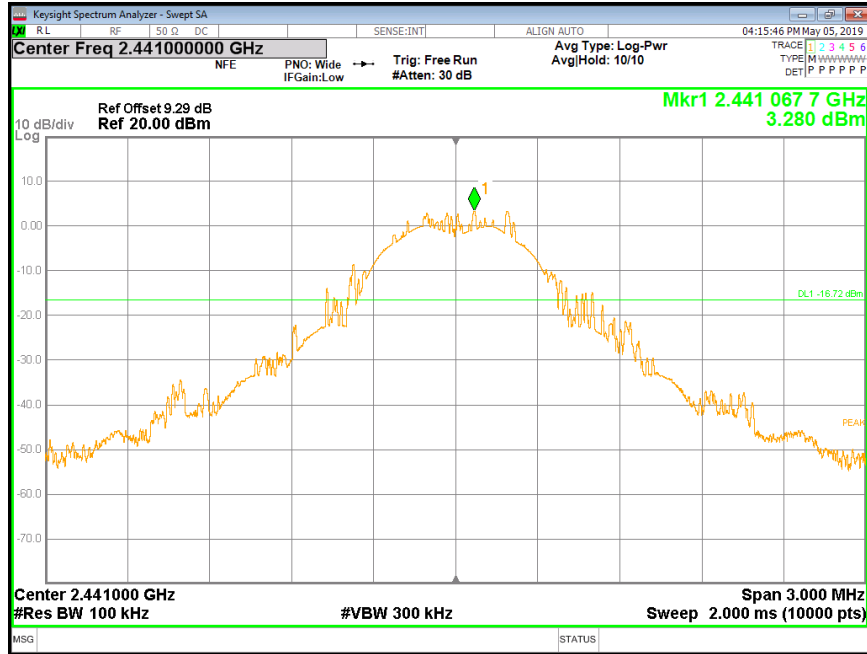

MID CH SPURIOUS EMISSIONS 30M-10G

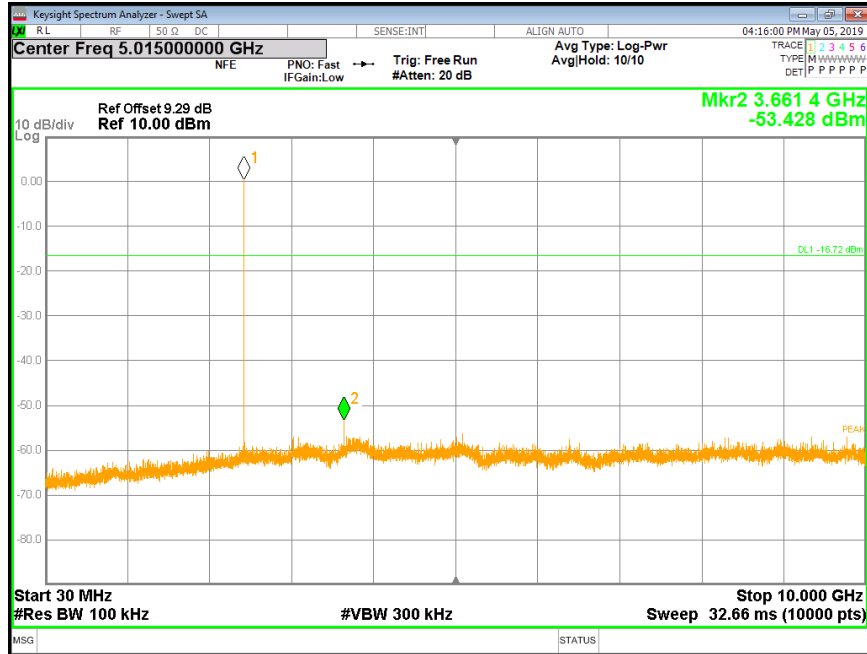



MID CH SPURIOUS EMISSIONS 10G-26G

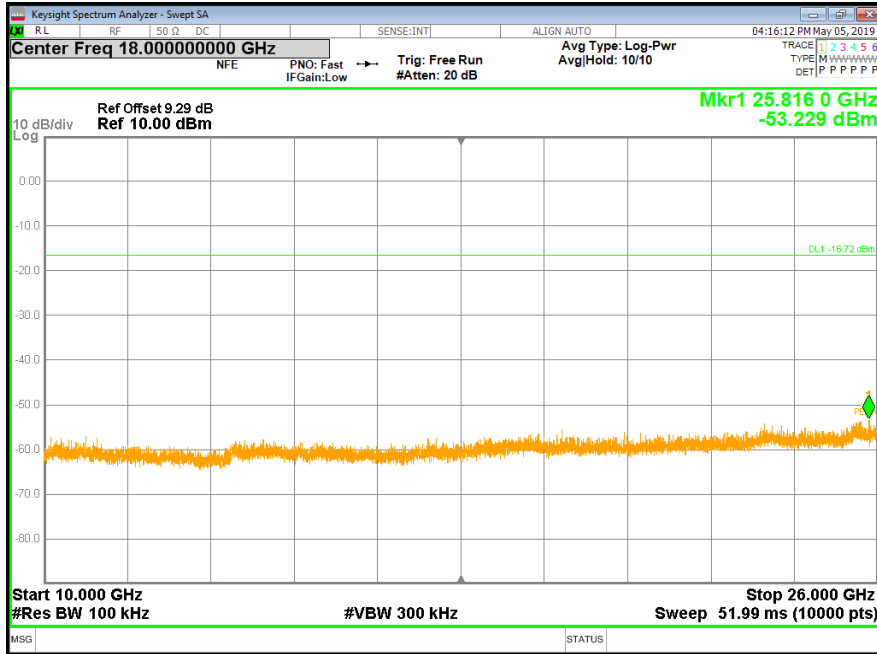

HIGH CH BANDEDAGE

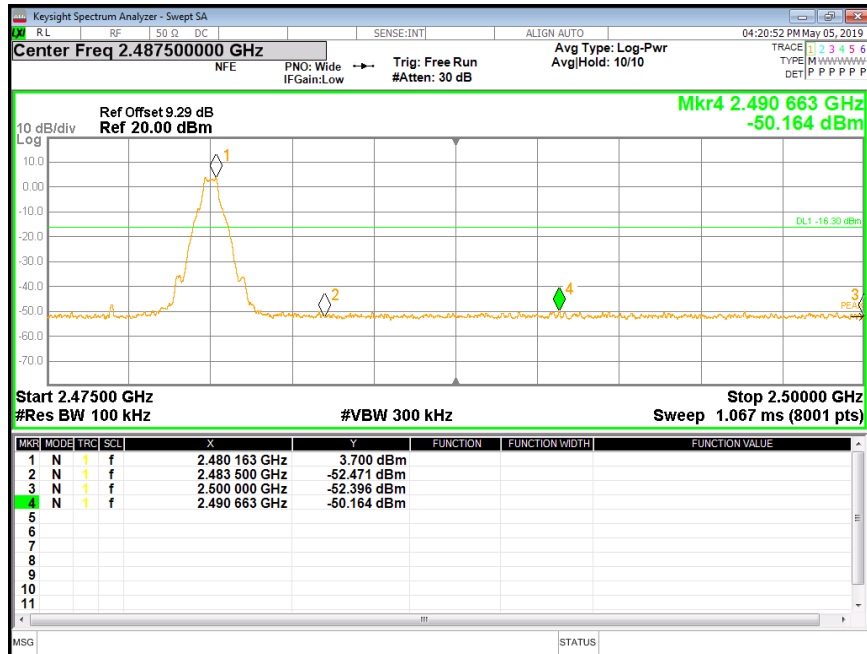



HIGH CH SPURIOUS EMISSIONS REFERENCE

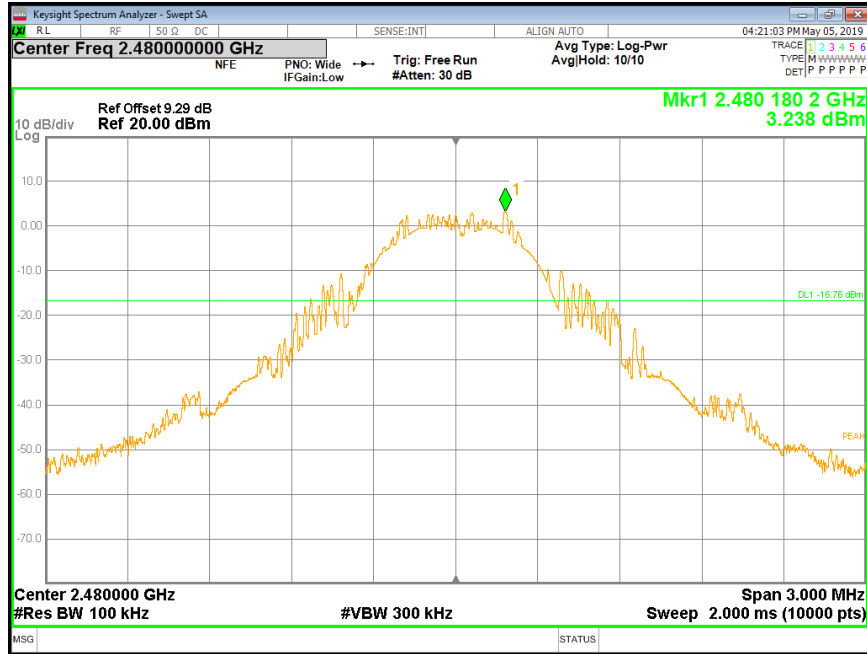

HIGH CH SPURIOUS EMISSIONS 30M-10G

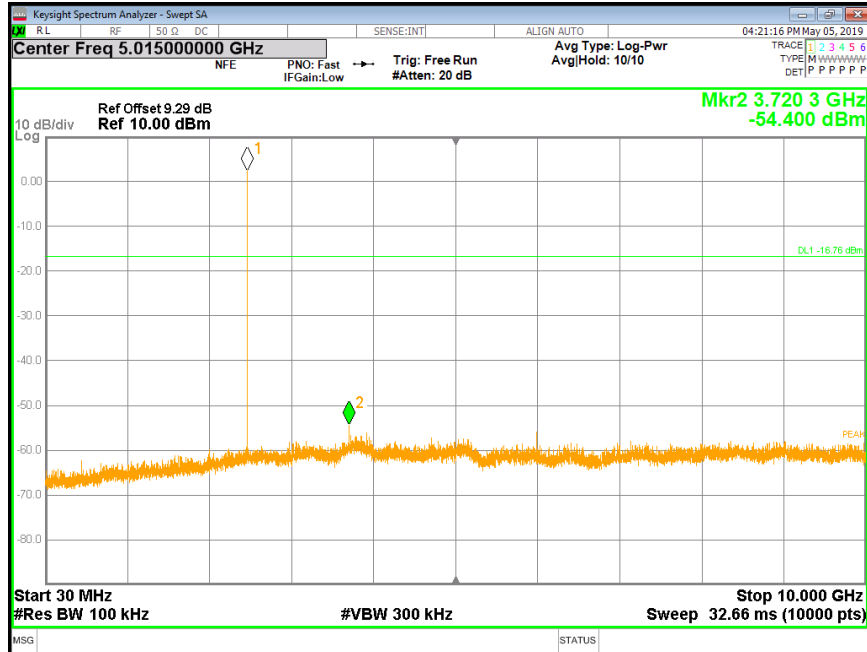



HIGH CH SPURIOUS EMISSIONS 10G-26G

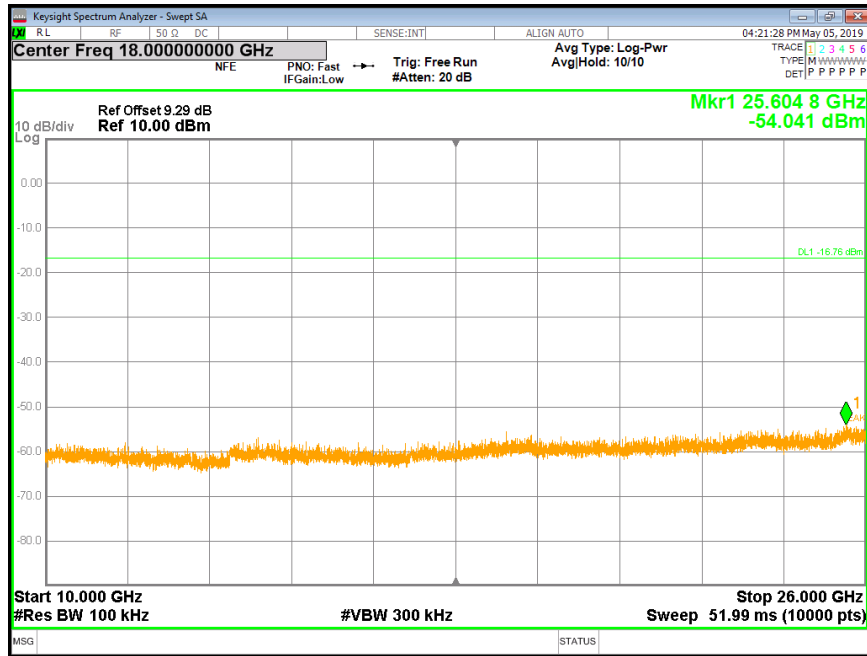



SPURIOUS BANDEDGE EMISSIONS WITH HOPPING ON

LOW CH BANDEDGE WITH HOPPING ON

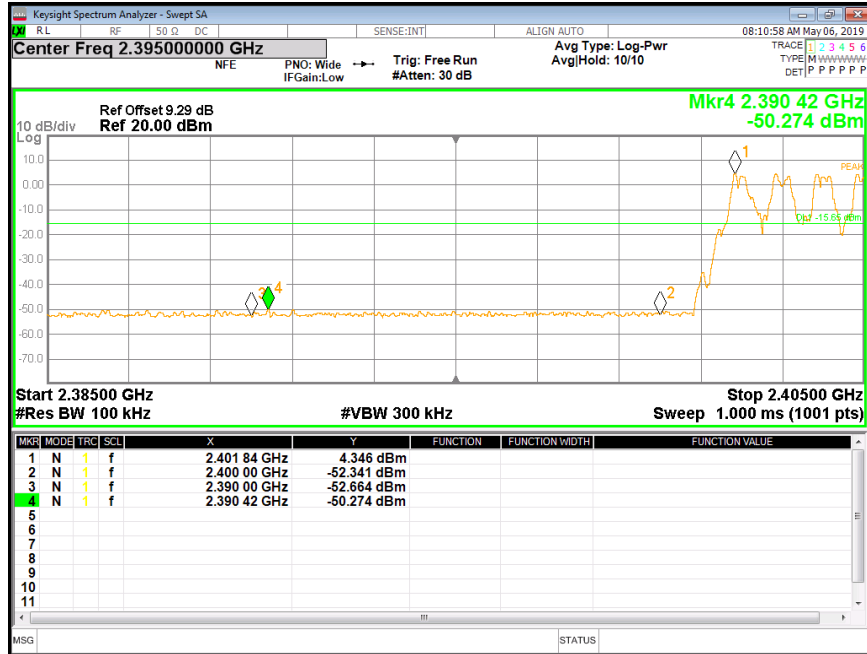

HIGH CH BANDEDGE WITH HOPPING ON

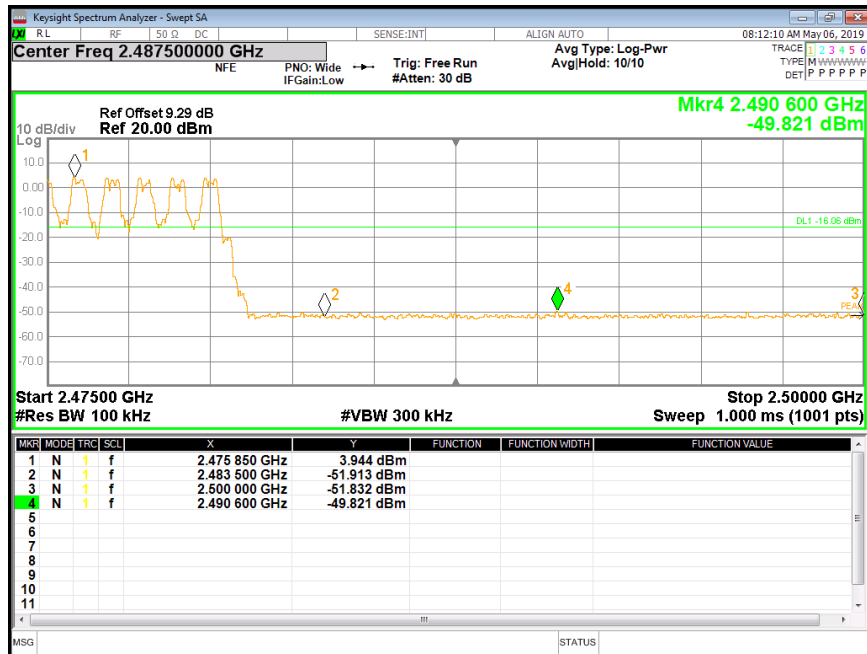



6.7.2. 8DPSK MODE

LOW CH BANDEDGE

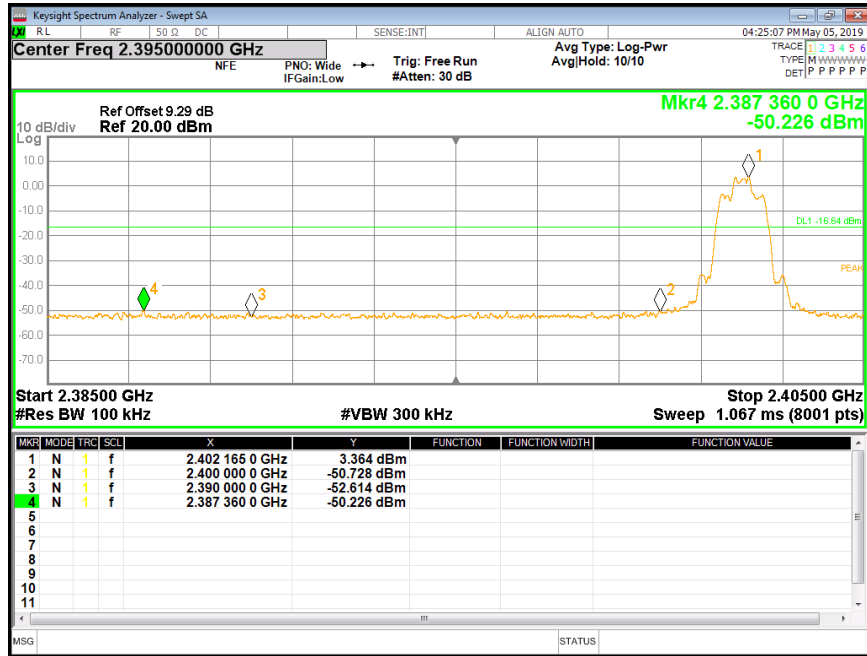

LOW CH SPURIOUS EMISSIONS REFERENCE

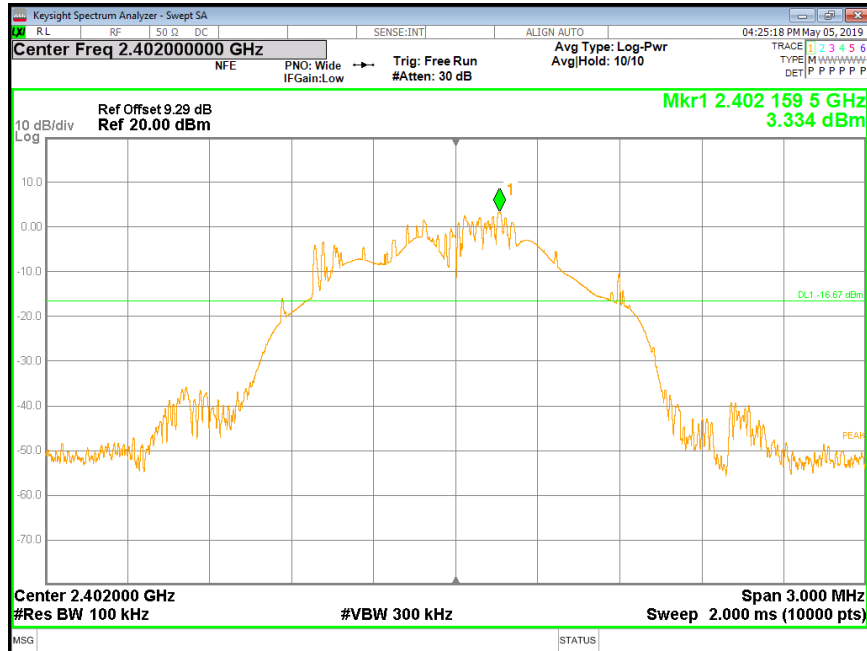



LOW CH SPURIOUS EMISSIONS 30M-10G

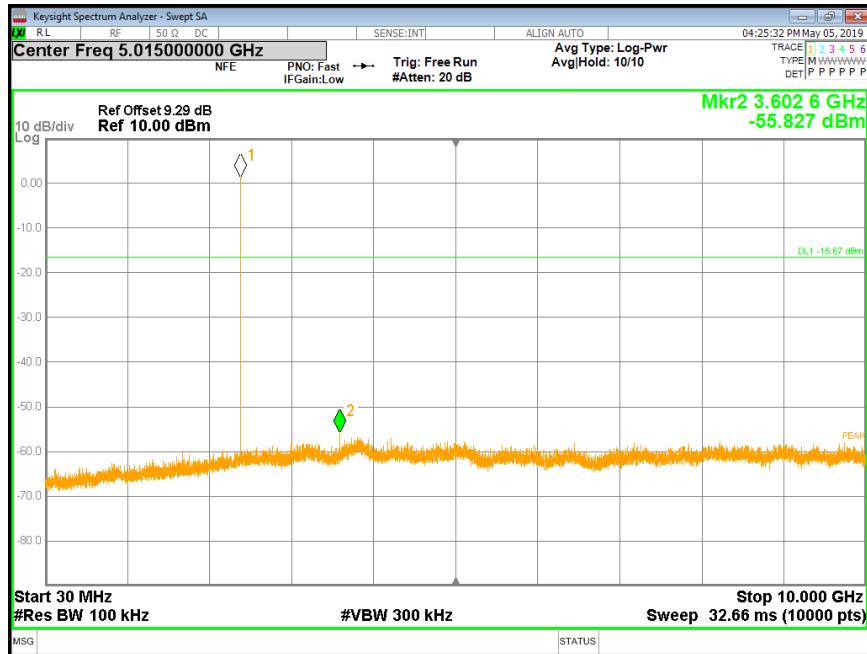

LOW CH SPURIOUS EMISSIONS 10G-26G

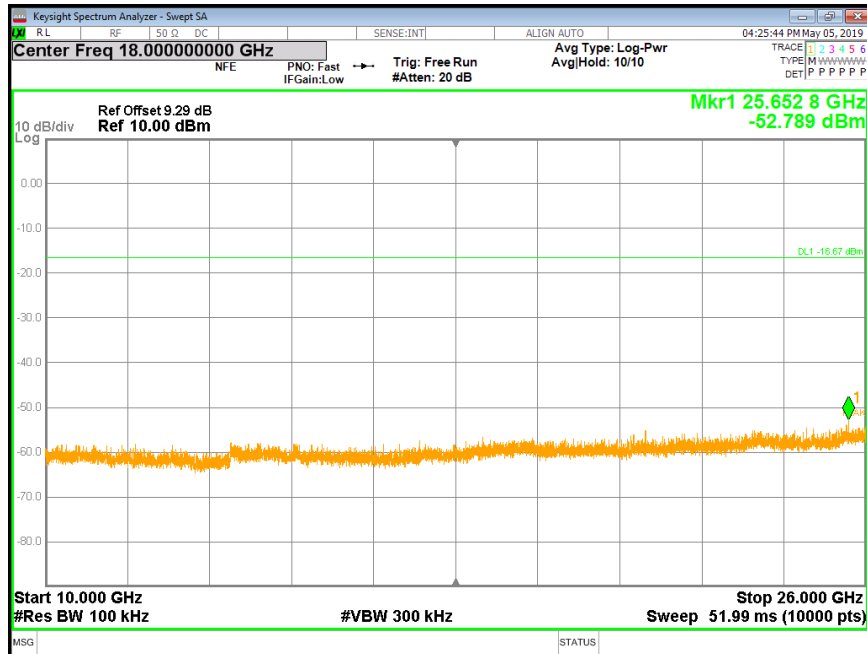



MID CH SPURIOUS EMISSIONS REFERENCE

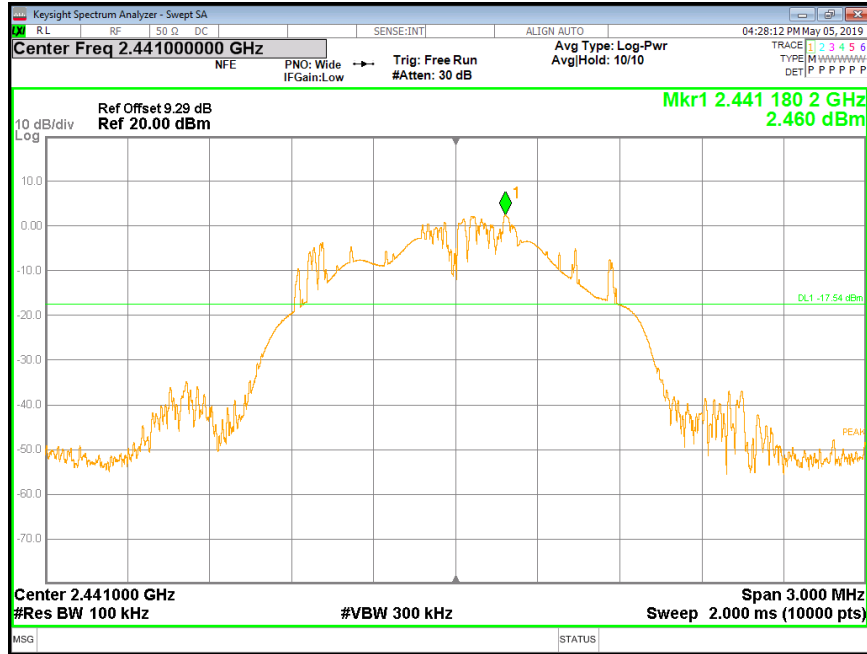

MID CH SPURIOUS EMISSIONS 30M-10G

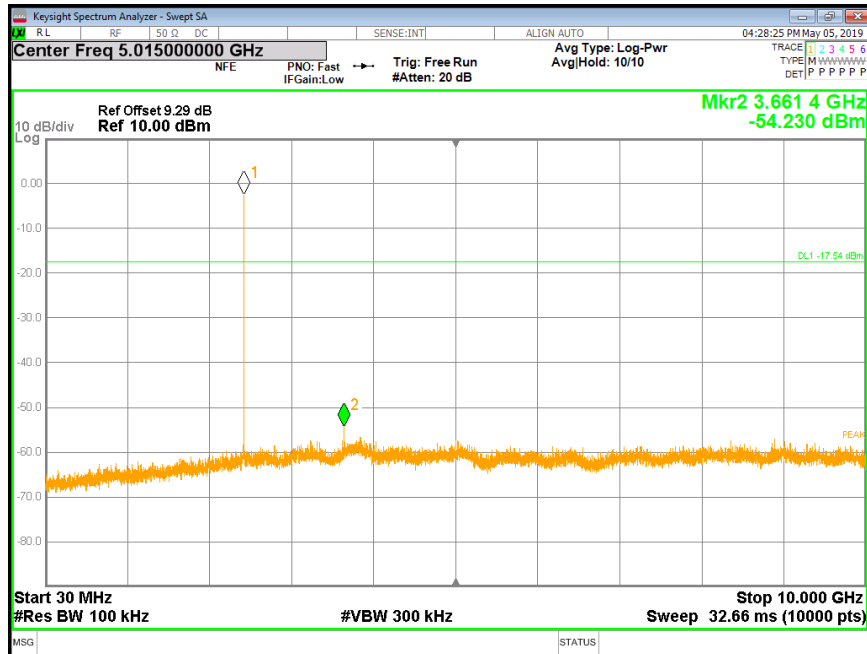



MID CH SPURIOUS EMISSIONS 10G-26G

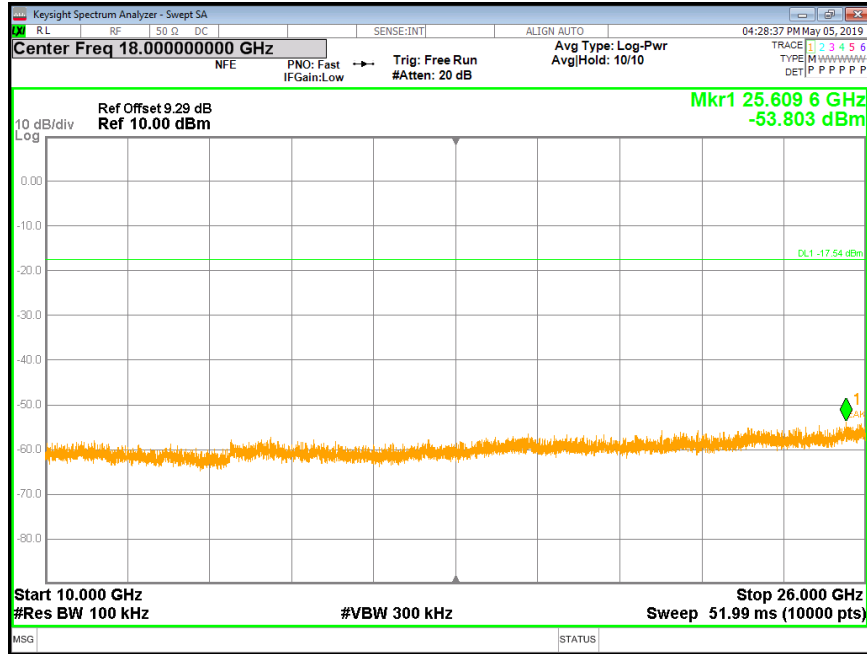

HIGH CH BANDEDAGE

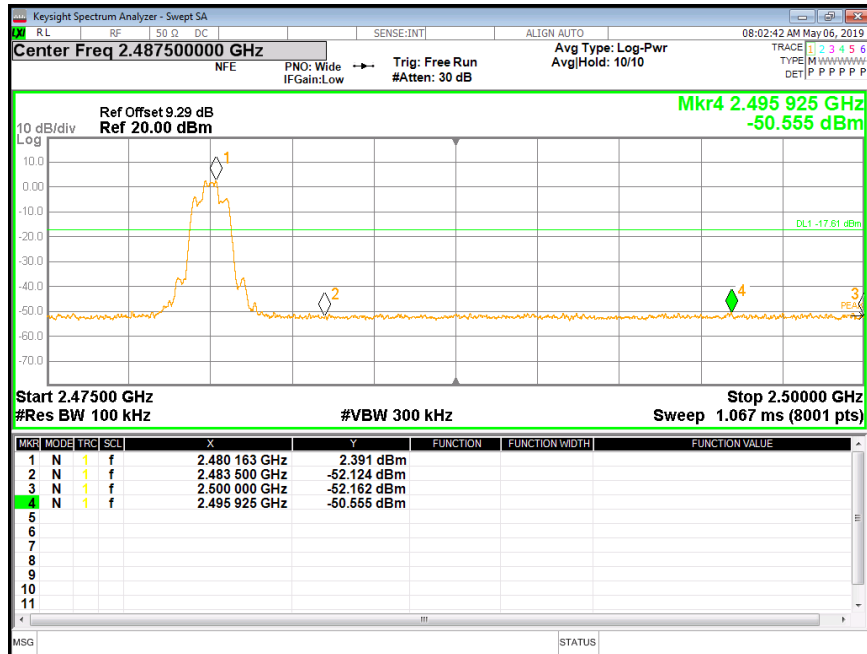



HIGH CH SPURIOUS EMISSIONS REFERENCE

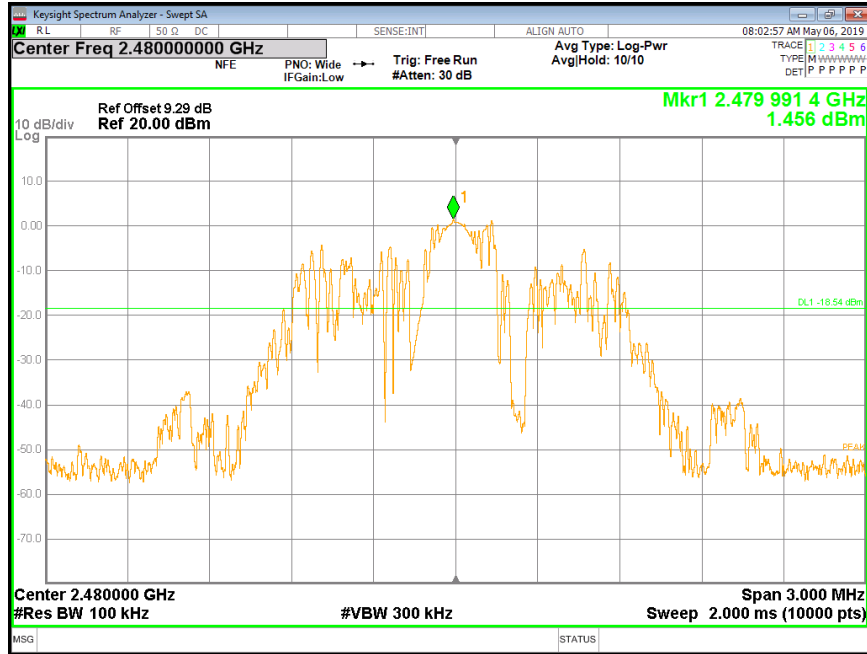

HIGH CH SPURIOUS EMISSIONS 30M-10G

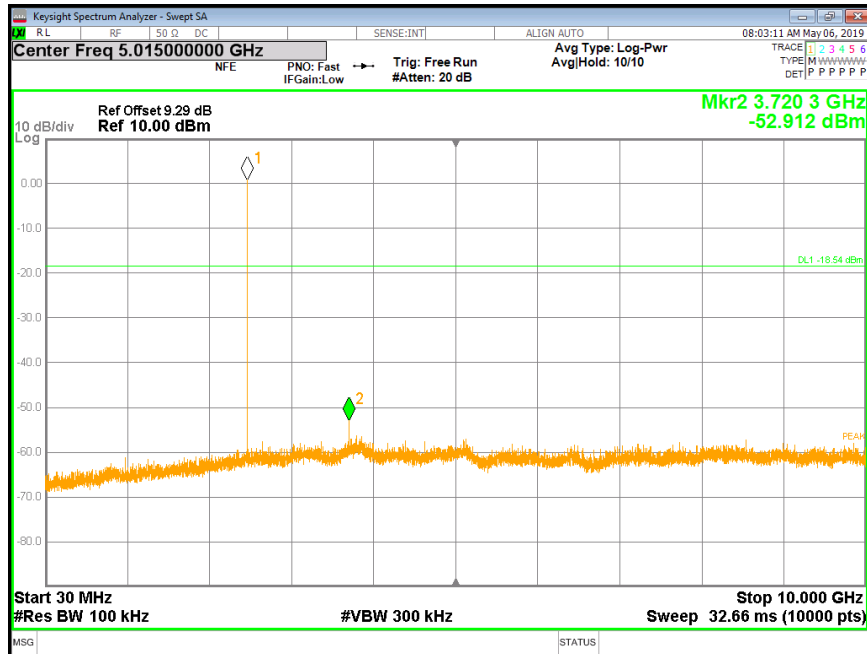



HIGH CH SPURIOUS EMISSIONS 10G-26G

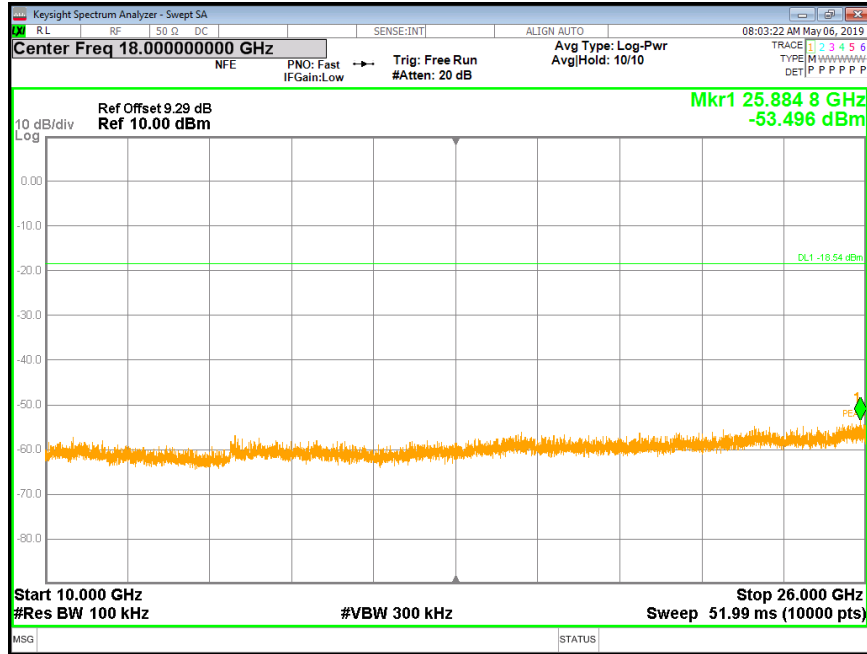



SPURIOUS BANDEDGE EMISSIONS WITH HOPPING ON

LOW CH BANDEDGE WITH HOPPING ON

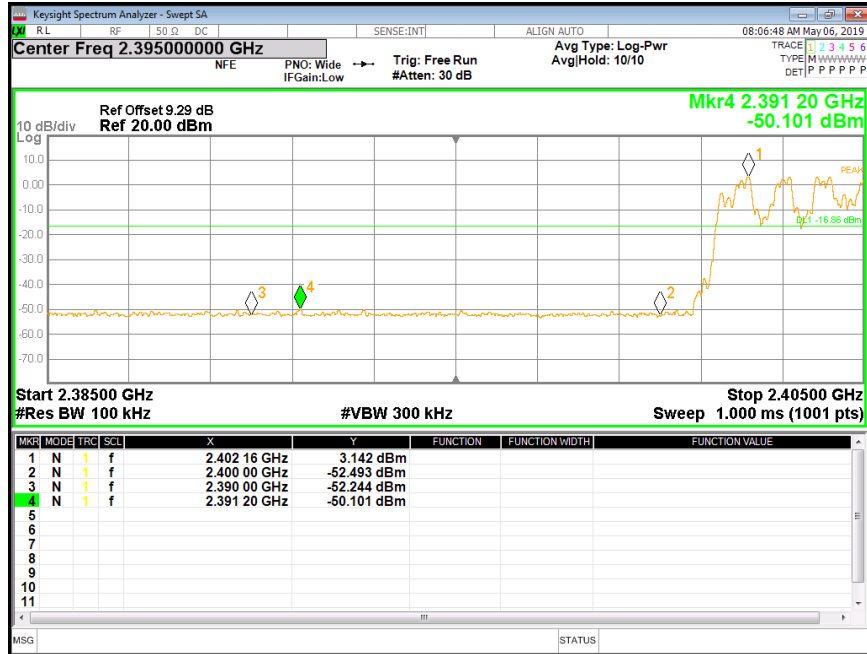

HIGH CH BANDEDGE WITH HOPPING ON

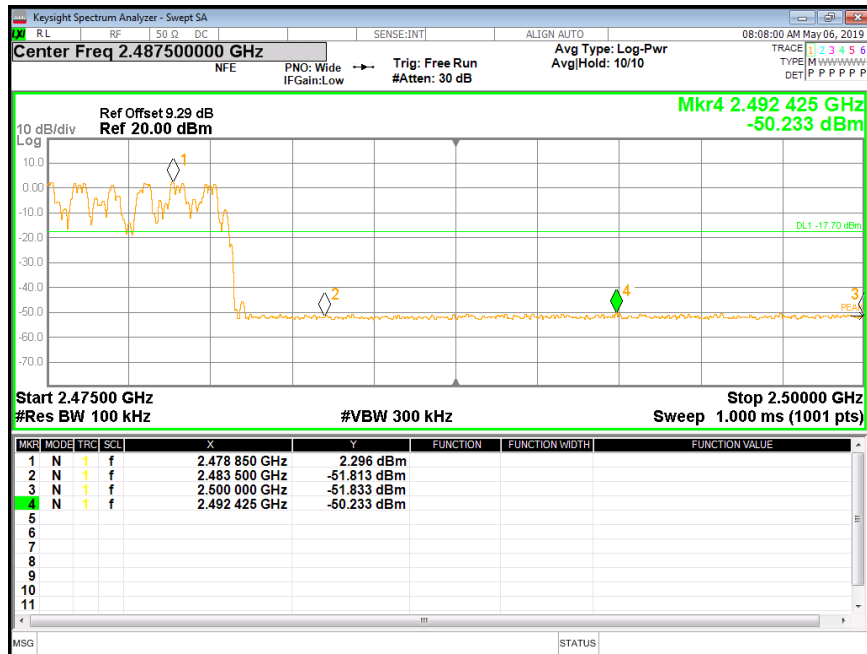



7. RADIATED TEST RESULTS

7.1. LIMITS AND PROCEDURE

LIMITS

Please refer to CFR 47 FCC §15.205 and §15.209

Please refer to ISED RSS-GEN Clause 8.9 and Clause 8.10

Radiation Disturbance Test Limit for FCC (Class B)(9kHz-1GHz)

Frequency (MHz)	Field Strength (microvolts/meter)	Measurement Distance (meters)
0.009~0.490	2400/F(kHz)	300
0.490~1.705	24000/F(kHz)	30
1.705~30.0	30	30
30~88	100	3
88~216	150	3
216~960	200	3
960~1000	500	3

Note: 1) At frequencies at or above 30 MHz, measurements may be performed at a distance other than what is specified provided: measurements are not made in the near field except where it can be shown that near field measurements are appropriate due to the characteristics of the device; and it can be demonstrated that the signal levels needed to be measured at the distance employed can be detected by the measurement equipment. Measurements shall not be performed at a distance greater than 30 meters unless it can be further demonstrated that measurements at a distance of 30 meters or less are impractical. When performing measurements at a distance other than that specified, the results shall be extrapolated to the specified distance using an extrapolation factor of 20 dB/decade (inverse linear-distance for field strength measurements; inverse-linear-distance-squared for power density measurements).

(2) At frequencies below 30 MHz, measurements may be performed at a distance closer than that specified in the regulations; however, an attempt should be made to avoid making measurements in the near field. Pending the development of an appropriate measurement procedure for measurements performed below 30 MHz, when performing measurements at a closer distance than specified, the results shall be extrapolated to the specified distance by either making measurements at a minimum of two distances on at least one radial to determine the proper extrapolation factor or by using the square of an inverse linear distance extrapolation factor (40 dB/decade). This paragraph (f) shall not apply to Access BPL devices operating below 30 MHz.

Radiation Disturbance Test Limit for FCC (Above 1G)

Frequency (MHz)	dB(uV/m) (at 3 meters)	
	Peak	Average
Above 1000	74	54



IC Restricted bands please refer to ISED RSS-GEN Clause 8.10

Table 7 – Restricted frequency bands ^{Notes 1}		
MHz	MHz	GHz
0.090 - 0.110	149.9 - 150.05	9.0 - 9.2
0.495 - 0.505	156.52475 - 156.52525	9.3 - 9.5
2.1735 - 2.1905	156.7 - 156.9	10.6 - 12.7
3.020 - 3.026	162.0125 - 167.17	13.25 - 13.4
4.125 - 4.128	167.72 - 173.2	14.47 - 14.5
4.17725 - 4.17775	240 - 285	15.35 - 16.2
4.20725 - 4.20775	322 - 335.4	17.7 - 21.4
5.677 - 5.683	399.9 - 410	22.01 - 23.12
6.215 - 6.218	608 - 614	23.6 - 24.0
6.26775 - 6.26825	960 - 1427	31.2 - 31.8
6.31175 - 6.31225	1435 - 1626.5	36.43 - 36.5
8.291 - 8.294	1645.5 - 1646.5	Above 38.6
8.362 - 8.366	1660 - 1710	
8.37625 - 8.38675	1718.8 - 1722.2	
8.41425 - 8.41475	2200 - 2300	
12.29 - 12.293	2310 - 2390	
12.51975 - 12.52025	2483.5 - 2500	
12.57675 - 12.57725	2655 - 2900	
13.36 - 13.41	3260 - 3267	
16.42 - 16.423	3332 - 3339	
16.69475 - 16.69525	3345.8 - 3358	
16.80425 - 16.80475	3500 - 4400	
25.5 - 25.67	4500 - 5150	
37.5 - 38.25	5350 - 5460	
73 - 74.6	7250 - 7750	
74.8 - 75.2	8025 - 8500	
108 - 138		

Note 1: Certain frequency bands listed in table 7 and in bands above 38.6 GHz are designated for licence-exempt applications. These frequency bands and the requirements that apply to related devices are set out in the 200 and 300 series of RSSs.



FCC Restricted bands of operation:

MHz	MHz	MHz	GHz
0.090-0.110	16.42-16.423	399.9-410	4.5-5.15
¹ 0.495-0.505	16.69475-16.69525	608-614	5.35-5.46
2.1735-2.1905	16.80425-16.80475	960-1240	7.25-7.75
4.125-4.128	25.5-25.67	1300-1427	8.025-8.5
4.17725-4.17775	37.5-38.25	1435-1626.5	9.0-9.2
4.20725-4.20775	73-74.6	1645.5-1646.5	9.3-9.5
6.215-6.218	74.8-75.2	1660-1710	10.6-12.7
6.26775-6.26825	108-121.94	1718.8-1722.2	13.25-13.4
6.31175-6.31225	123-138	2200-2300	14.47-14.5
8.291-8.294	149.9-150.05	2310-2390	15.35-16.2
8.362-8.366	156.52475-156.52525	2483.5-2500	17.7-21.4
8.37625-8.38675	156.7-156.9	2690-2900	22.01-23.12
8.41425-8.41475	162.0125-167.17	3260-3267	23.6-24.0
12.29-12.293	167.72-173.2	3332-3339	31.2-31.8
12.51975-12.52025	240-285	3345.8-3358	36.43-36.5
12.57675-12.57725	322-335.4	3600-4400	(²)
13.36-13.41			

Note: ¹Until February 1, 1999, this restricted band shall be 0.490-0.510 MHz.
²Above 38.6c

TEST SETUP AND PROCEDURE
Below 30MHz

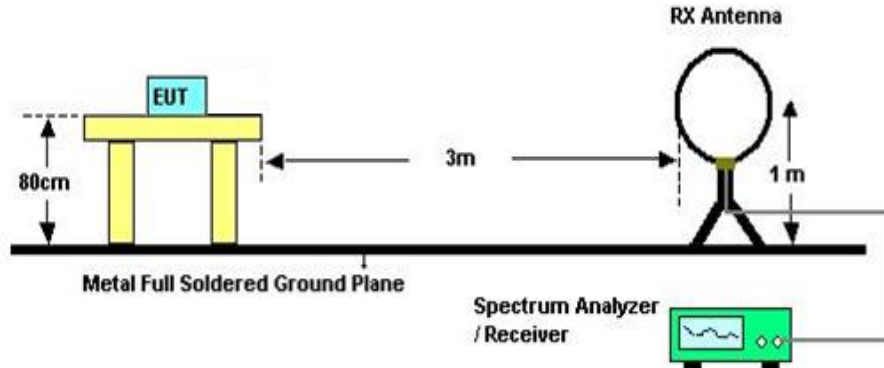

The setting of the spectrum Analyzer

RBW	200Hz (From 9kHz to 0.15MHz)/ 9kHz (From 0.15MHz to 30MHz)
VBW	200Hz (From 9kHz to 0.15MHz)/ 9kHz (From 0.15MHz to 30MHz)
Sweep	Auto
Detector	Peak/QP/ Average
Trace	Max hold

1. The testing follows the guidelines in ANSI C63.10-2013
2. The EUT was arranged to its worst case and then turntable (from 0 degree to 360 degrees) to find the maximum reading. A pre-amp and a high pass filter are used for the test in order to get better signal level. Both horizontal and vertical polarizations of the antenna are set to make the measurement.
3. The EUT was placed on a turntable with 80cm meter above ground.
4. The EUT was set 3 meters from the interference receiving antenna, which was mounted on the top of a variable height antenna tower.
5. The radiated emission limits are based on measurements employing a CISPR quasi-peak detector except for the frequency bands 9-90 kHz, 110-490 kHz and above 1000 MHz. Radiated emission limits in these three bands are based on measurements employing an average detector.
6. For measurement below 1GHz, the initial step in collecting conducted emission data is a spectrum analyzer peak detector mode pre-scanning the measurement frequency range. Significant peaks are then marked and then Quasi Peak detector mode re-measured. If the emission level of the EUT measured by the peak detector is 3 dB lower than the applicable limit, the peak emission level will be reported. Otherwise, the emission measurement will be repeated using the quasi-peak detector and reported.
7. Although these tests were performed other than open area test site, adequate comparison measurements were confirmed against 30m OFS. Therefore sufficient tests were made to demonstrate that the alternative site produces results that correlate with the ones of tests made in an open field based on KDB 414788.

Below 1G and above 30MHz

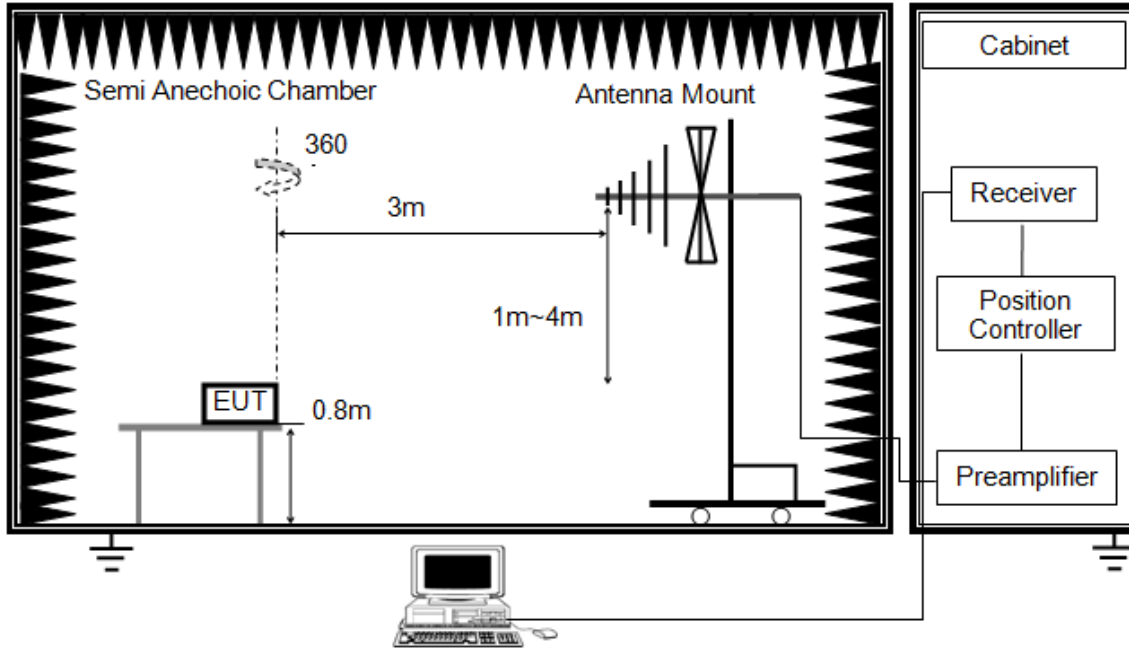

The setting of the spectrum Analyzer

RBW	120K
VBW	300K
Sweep	Auto
Detector	Peak/QP
Trace	Max hold

1. The testing follows the guidelines in ANSI C63.10-2013.
2. The EUT was arranged to its worst case and then tune the antenna tower (from 1 m to 4 m) and turntable (from 0 degree to 360 degrees) to find the maximum reading. A pre-amp and a high pass filter are used for the test in order to get better signal level. Both horizontal and vertical polarizations of the antenna are set to make the measurement.
3. The EUT was placed on a turntable with 80cm above ground.
4. The EUT was set 3 meters from the interference receiving antenna, which was mounted on the top of a variable height antenna tower.
5. For measurement below 1GHz, the initial step in collecting conducted emission data is a spectrum analyzer peak detector mode pre-scanning the measurement frequency range. Significant peaks are then marked and then Quasi Peak detector mode re-measured. If the emission level of the EUT measured by the peak detector is 3 dB lower than the applicable limit, the peak emission level will be reported. Otherwise, the emission measurement will be repeated using the quasi-peak detector and reported.

Above 1G

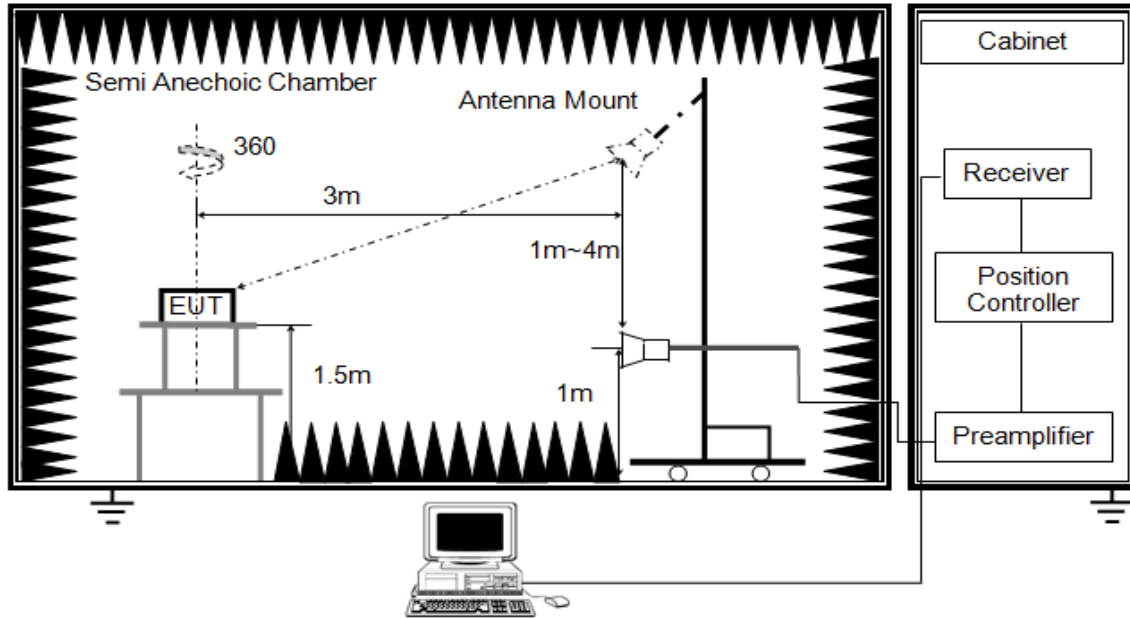

RBW	1M
VBW	PEAK: 3M AVG: see note 6
Sweep	Auto
Detector	Peak
Trace	Max hold

1. The testing follows the guidelines in ANSI C63.10-2013.
2. The EUT was arranged to its worst case and then tune the antenna tower (from 1 m to 4 m) and turntable (from 0 degree to 360 degrees) to find the maximum reading. A pre-amp and a high pass filter are used for the test in order to get better signal level. Both horizontal and vertical polarizations of the antenna are set to make the measurement.
3. The EUT was placed on a turntable with 150cm above ground.
4. The EUT was set 3 meters from the interference receiving antenna, which was mounted on the top of a variable height antenna tower.
5. For measurement above 1GHz, the emission measurement will be measured by the peak detector. This peak level, once corrected, must comply with the limit specified in Section 15.209.
6. For measurements above 1 GHz the resolution bandwidth is set to 1 MHz, then the video bandwidth is set to 3 MHz for peak measurements and 1 MHz resolution bandwidth with 1/T video bandwidth with peak detector. For the Duty Cycle please refer to clause 6.1.ON TIME AND DUTY CYCLE.

X axis, Y axis, Z axis positions:

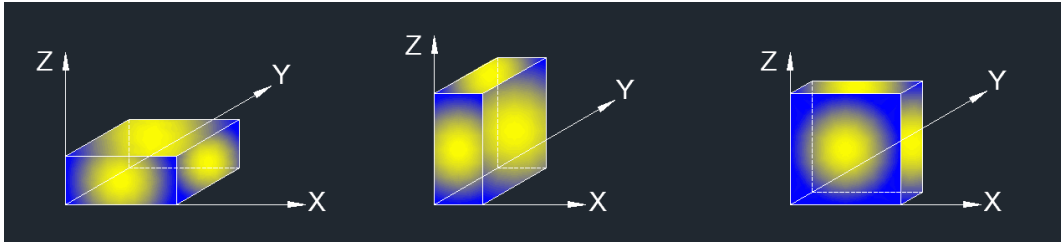

Note 1: For all radiated test, EUT in each of three orthogonal axis emissions had been tested, but only the worst case (X axis) data recorded in the report.

Note 2: The EUT was fully exercised with external accessories during the test. In the case of multiple accessory external ports, an external accessory shall be connected to one of each type of port.

TEST ENVIRONMENT

Temperature	23.5°C	Relative Humidity	54%
Atmosphere Pressure	101kPa	Test Voltage	DC 3.3V



7.2. RESTRICTED BANDEDGE

7.2.1. GFSK MODE

RESTRICTED BANDEDGE (LOW CHANNEL, HORIZONTAL)

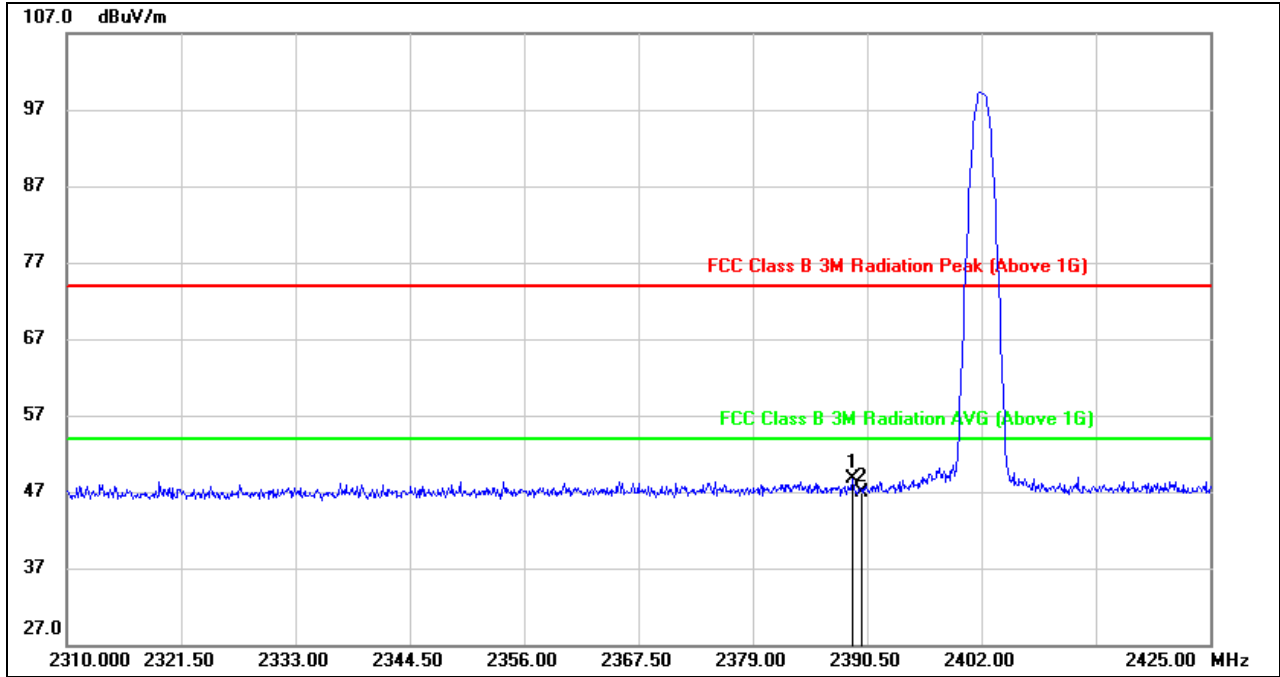

No.	Frequency (MHz)	Reading (dBuV)	Correct (dB/m)	Result (dBuV/m)	Limit (dBuV/m)	Margin (dB)	Remark
1	2389.005	15.67	32.94	48.61	74.00	-25.39	peak
2	2390.000	14.02	32.94	46.96	74.00	-27.04	peak

Note: 1. Measurement = Reading Level + Correct Factor.
 2. If Peak Result complies with AV limit, AV Result is deemed to comply with AV limit.
 3. Peak: Peak detector.
 4. Only the worst case emission was recorded, if it complies with the limit, the other emissions deemed to comply with the limit.



RESTRICTED BANDEDGE (LOW CHANNEL, VERTICAL)

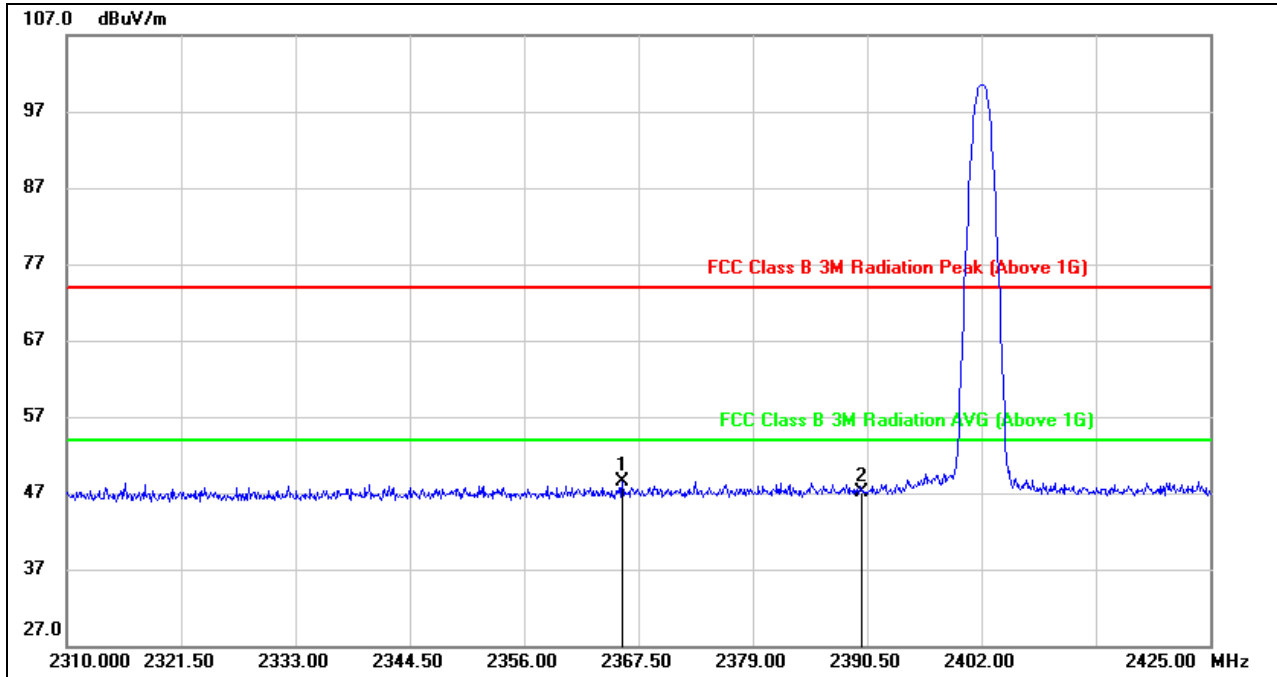

No.	Frequency (MHz)	Reading (dBuV)	Correct (dB/m)	Result (dBuV/m)	Limit (dBuV/m)	Margin (dB)	Remark
1	2365.890	15.71	32.87	48.58	74.00	-25.42	peak
2	2390.000	14.21	32.94	47.15	74.00	-26.85	peak

- Note: 1. Measurement = Reading Level + Correct Factor.
 2. If Peak Result complies with AV limit, AV Result is deemed to comply with AV limit.
 3. Peak: Peak detector.
 4. Only the worst case emission was recorded, if it complies with the limit, the other emissions deemed to comply with the limit.



RESTRICTED BANDEDGE (HIGH CHANNEL, HORIZONTAL)

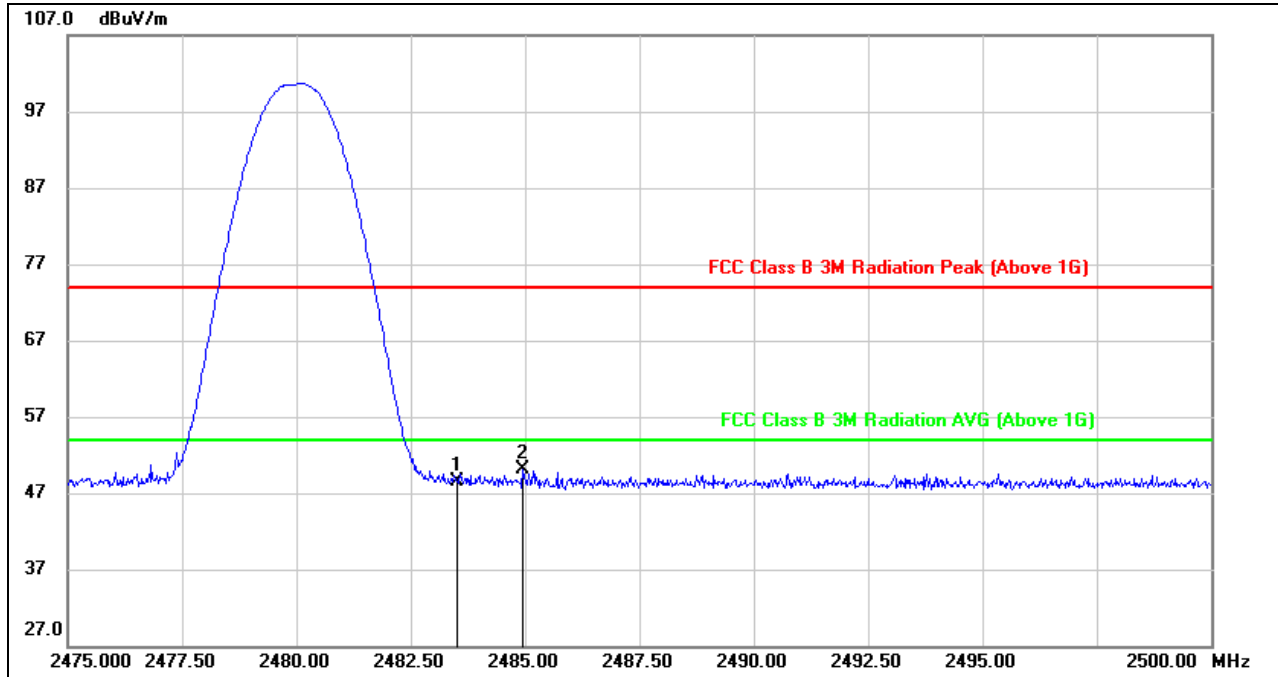

No.	Frequency (MHz)	Reading (dBuV)	Correct (dB/m)	Result (dBuV/m)	Limit (dBuV/m)	Margin (dB)	Remark
1	2483.500	14.94	33.58	48.52	74.00	-25.48	peak
2	2484.950	16.46	33.59	50.05	74.00	-23.95	peak

Note: 1. Measurement = Reading Level + Correct Factor.
 2. If Peak Result complies with AV limit, AV Result is deemed to comply with AV limit.
 3. Peak: Peak detector.
 4. Only the worst case emission was recorded, if it complies with the limit, the other emissions deemed to comply with the limit.



RESTRICTED BANDEDGE (HIGH CHANNEL, VERTICAL)

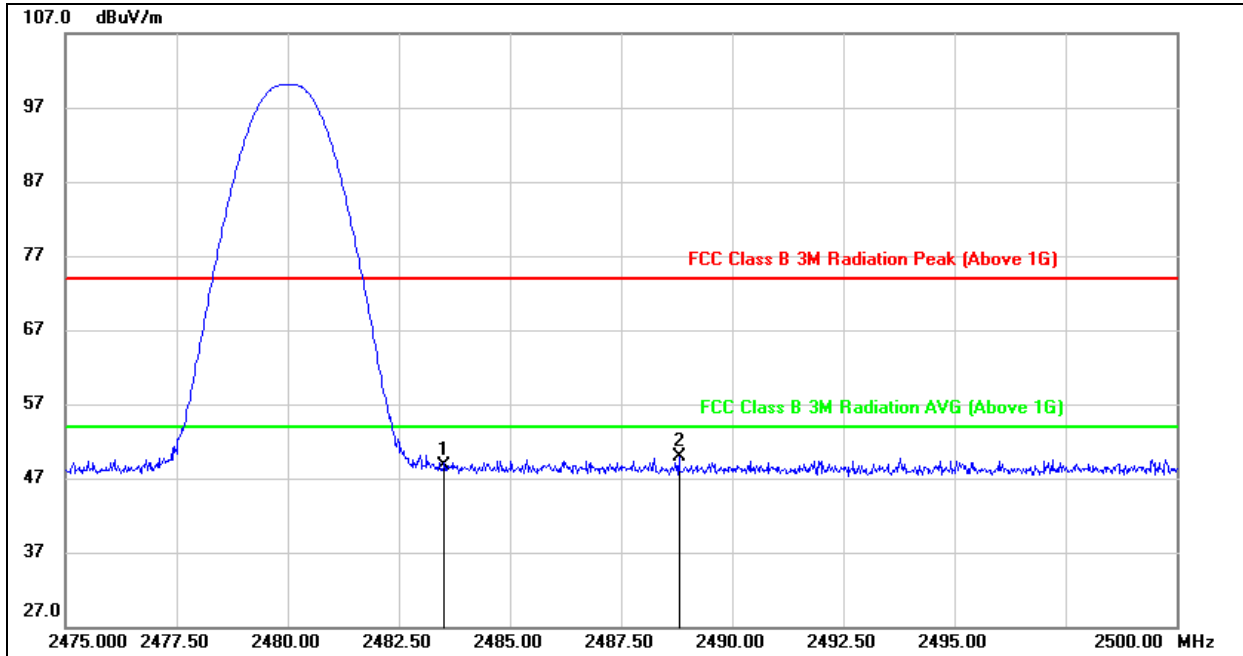

No.	Frequency (MHz)	Reading (dBuV)	Correct (dB/m)	Result (dBuV/m)	Limit (dBuV/m)	Margin (dB)	Remark
1	2483.500	15.09	33.58	48.67	74.00	-25.33	peak
2	2488.800	16.24	33.62	49.86	74.00	-24.14	peak

- Note:
1. Measurement = Reading Level + Correct Factor.
 2. If Peak Result complies with AV limit, AV Result is deemed to comply with AV limit.
 3. Peak: Peak detector.
 4. Only the worst case emission was recorded, if it complies with the limit, the other emissions deemed to comply with the limit.



7.2.2 8DPSK MODE

RESTRICTED BANDEDGE (LOW CHANNEL, HORIZONTAL)

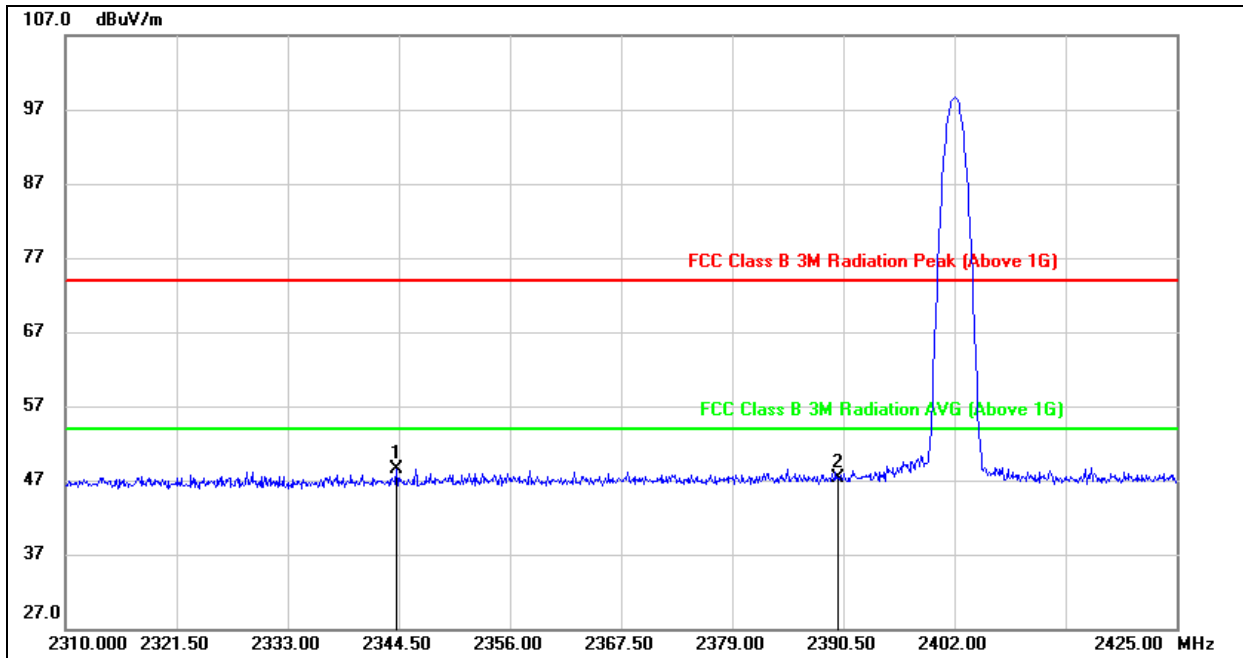

No.	Frequency (MHz)	Reading (dBuV)	Correct (dB/m)	Result (dBuV/m)	Limit (dBuV/m)	Margin (dB)	Remark
1	2344.270	15.73	32.79	48.52	74.00	-25.48	peak
2	2390.000	14.31	32.94	47.25	74.00	-26.75	peak

Note: 1. Measurement = Reading Level + Correct Factor.
 2. If Peak Result complies with AV limit, AV Result is deemed to comply with AV limit.
 3. Peak: Peak detector.
 4. Only the worst case emission was recorded, if it complies with the limit, the other emissions deemed to comply with the limit.



RESTRICTED BANDEDGE (LOW CHANNEL, VERTICAL)

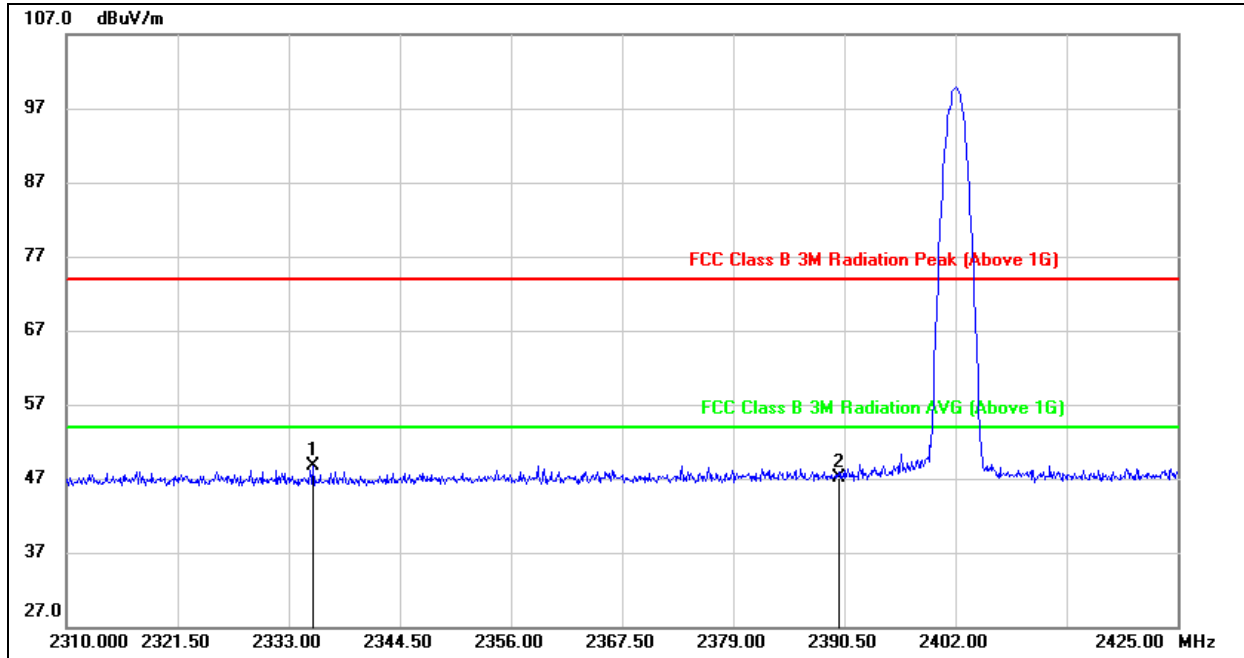

No.	Frequency (MHz)	Reading (dBuV)	Correct (dB/m)	Result (dBuV/m)	Limit (dBuV/m)	Margin (dB)	Remark
1	2335.530	16.01	32.76	48.77	74.00	-25.23	peak
2	2390.000	14.22	32.94	47.16	74.00	-26.84	peak

Note: 1. Measurement = Reading Level + Correct Factor.
 2. If Peak Result complies with AV limit, AV Result is deemed to comply with AV limit.
 3. Peak: Peak detector.
 4. Only the worst case emission was recorded, if it complies with the limit, the other emissions deemed to comply with the limit.



RESTRICTED BANDEDGE (HIGH CHANNEL, HORIZONTAL)

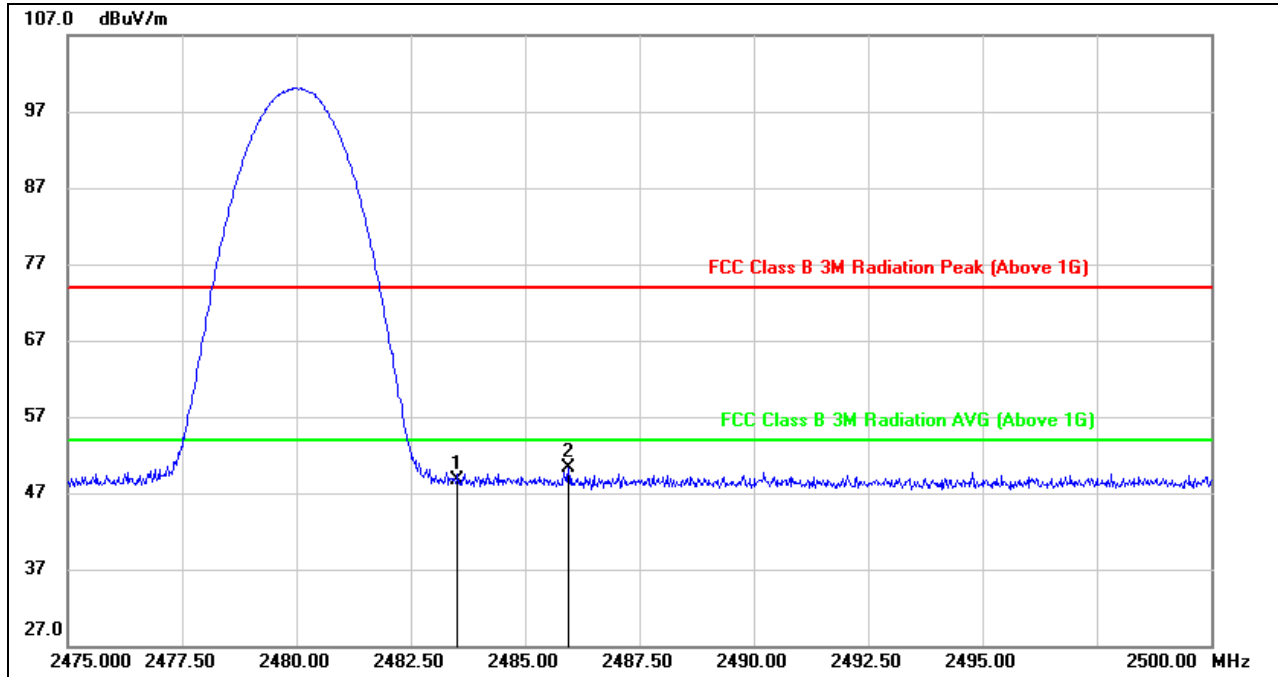

No.	Frequency (MHz)	Reading (dBuV)	Correct (dB/m)	Result (dBuV/m)	Limit (dBuV/m)	Margin (dB)	Remark
1	2483.500	15.11	33.58	48.69	74.00	-25.31	peak
2	2485.950	16.61	33.59	50.20	74.00	-23.80	peak

- Note: 1. Measurement = Reading Level + Correct Factor.
 2. If Peak Result complies with AV limit, AV Result is deemed to comply with AV limit.
 3. Peak: Peak detector.
 4. Only the worst case emission was recorded, if it complies with the limit, the other emissions deemed to comply with the limit.



RESTRICTED BANDEDGE (HIGH CHANNEL, VERTICAL)

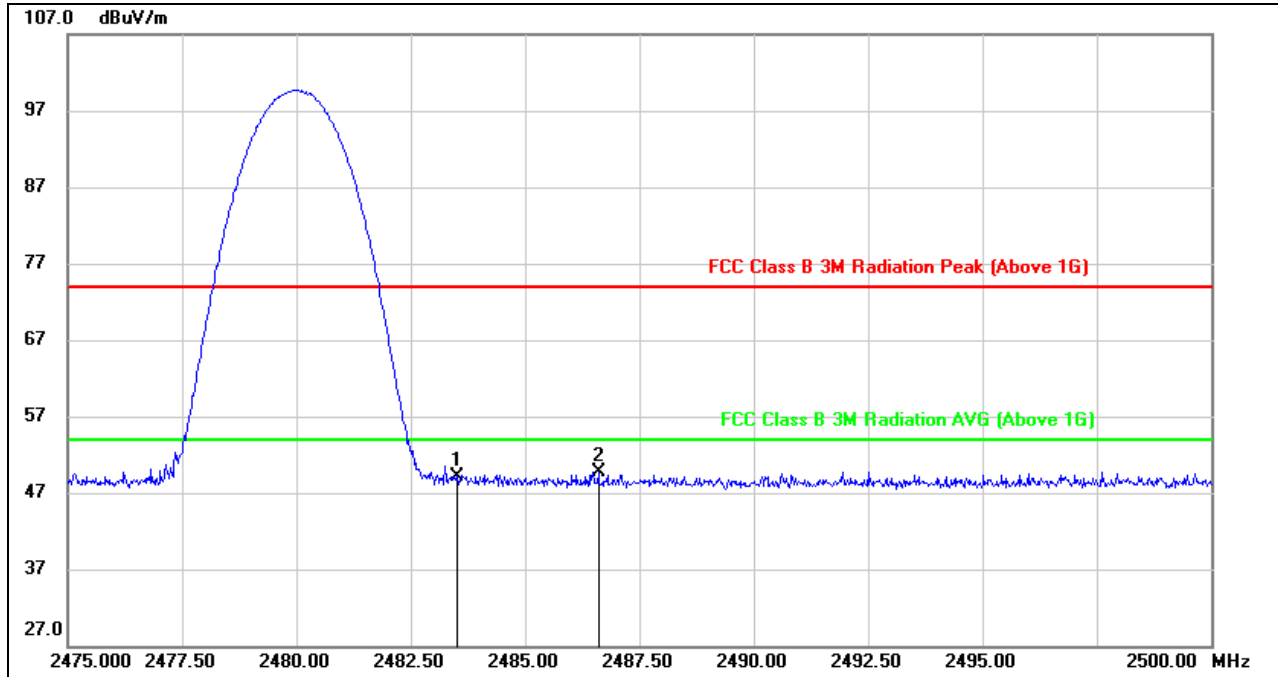

No.	Frequency (MHz)	Reading (dBuV)	Correct (dB/m)	Result (dBuV/m)	Limit (dBuV/m)	Margin (dB)	Remark
1	2483.500	15.45	33.58	49.03	74.00	-24.97	peak
2	2486.600	16.17	33.61	49.78	74.00	-24.22	peak

- Note: 1. Measurement = Reading Level + Correct Factor.
 2. If Peak Result complies with AV limit, AV Result is deemed to comply with AV limit.
 3. Peak: Peak detector.
 4. Only the worst case emission was recorded, if it complies with the limit, the other emissions deemed to comply with the limit.



7.3. SPURIOUS EMISSIONS (1~3GHz)

7.3.1. GFSK MODE

HARMONICS AND SPURIOUS EMISSIONS (LOW CHANNEL, HORIZONTAL)

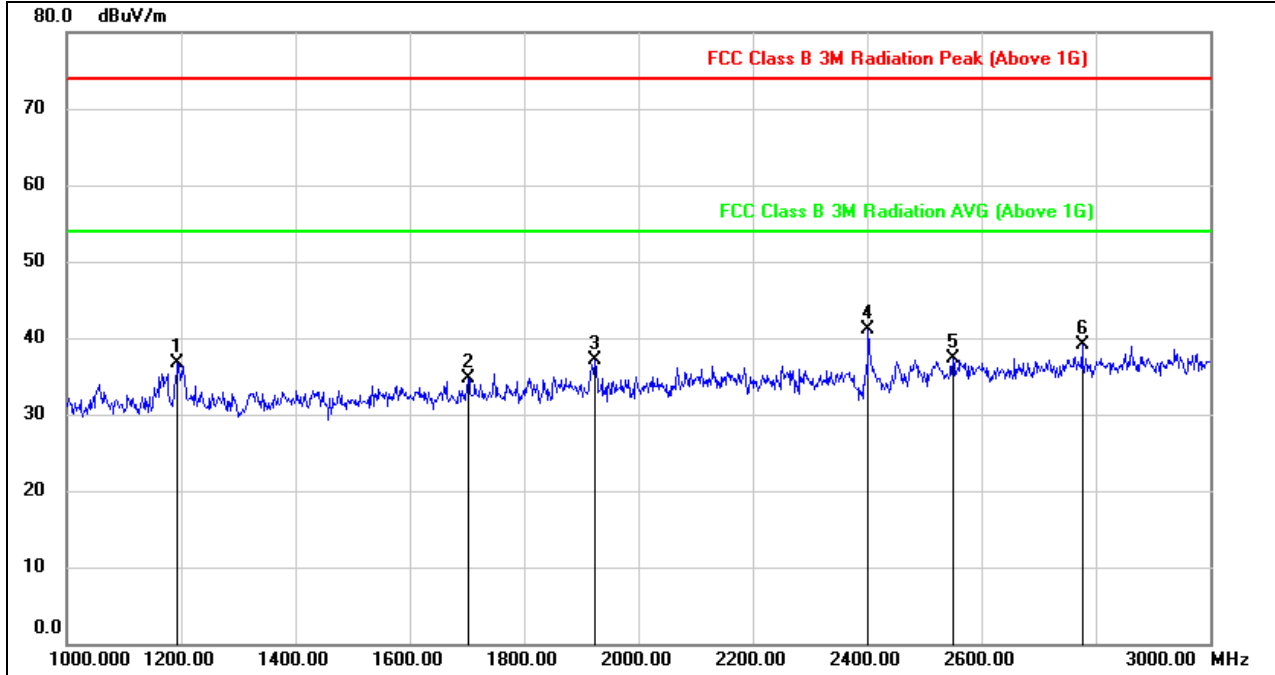

No.	Frequency (MHz)	Reading (dBuV)	Correct (dB/m)	Result (dBuV/m)	Limit (dBuV/m)	Margin (dB)	Remark
1	1194.000	48.89	-12.26	36.63	74.00	-37.37	peak
2	1702.000	45.21	-10.58	34.63	74.00	-39.37	peak
3	1924.000	46.38	-9.37	37.01	74.00	-36.99	peak
4	2402.000	48.05	-7.00	41.05	74.00	-32.95	peak
5	2550.000	43.76	-6.38	37.38	74.00	-36.62	peak
6	2776.000	44.64	-5.45	39.19	74.00	-34.81	peak

- Note: 1. Peak Result = Reading Level + Correct Factor.
 2. If Peak Result complies with AV limit, AV Result is deemed to comply with AV limit.
 3. Peak: Peak detector.
 4. The Band Reject filter loss factor already add into the correct factor.
 5. Proper operation of the transmitter prior to adding the filter to the measurement chain.



HARMONICS AND SPURIOUS EMISSIONS (LOW CHANNEL, VERTICAL)

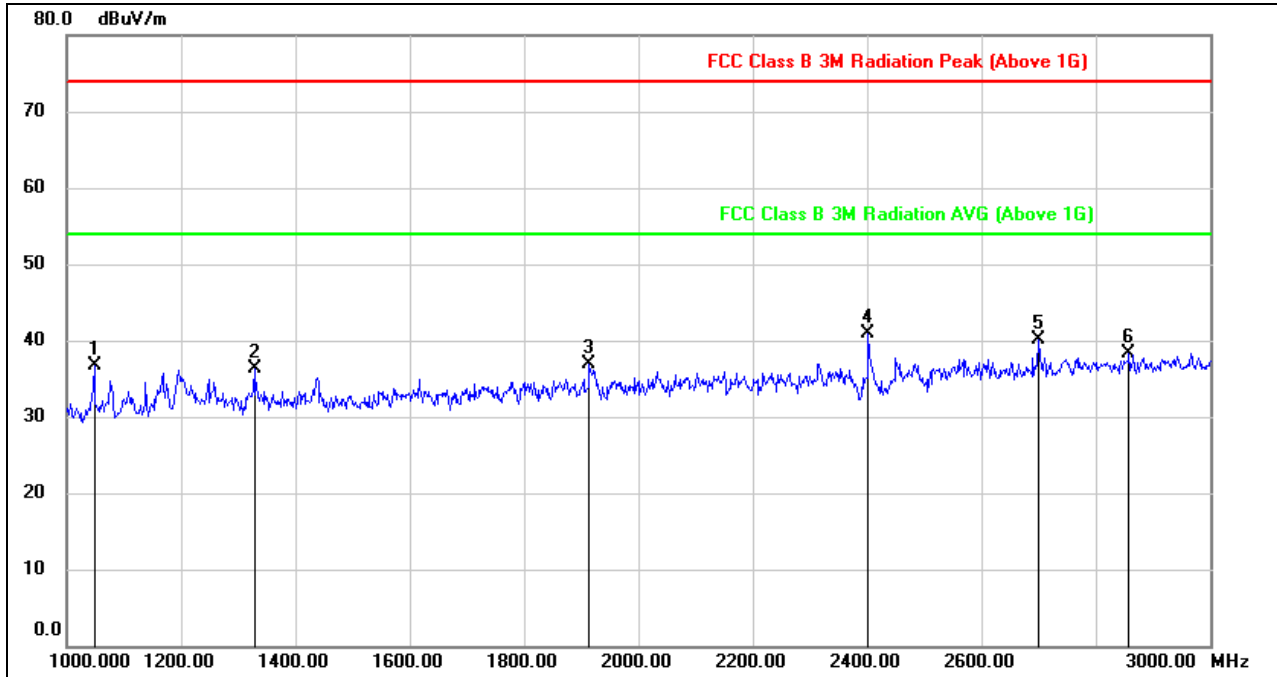

No.	Frequency (MHz)	Reading (dBuV)	Correct (dB/m)	Result (dBuV/m)	Limit (dBuV/m)	Margin (dB)	Remark
1	1048.000	49.91	-13.24	36.67	74.00	-37.33	peak
2	1328.000	48.18	-11.86	36.32	74.00	-37.68	peak
3	1914.000	46.18	-9.36	36.82	74.00	-37.18	peak
4	2402.000	47.90	-7.00	40.90	74.00	-33.10	peak
5	2700.000	46.18	-5.98	40.20	74.00	-33.80	peak
6	2858.000	43.32	-4.97	38.35	74.00	-35.65	peak

- Note: 1. Peak Result = Reading Level + Correct Factor.
 2. If Peak Result complies with AV limit, AV Result is deemed to comply with AV limit.
 3. Peak: Peak detector.
 4. The Band Reject filter loss factor already add into the correct factor.
 5. Proper operation of the transmitter prior to adding the filter to the measurement chain.



HARMONICS AND SPURIOUS EMISSIONS (MID CHANNEL, HORIZONTAL)

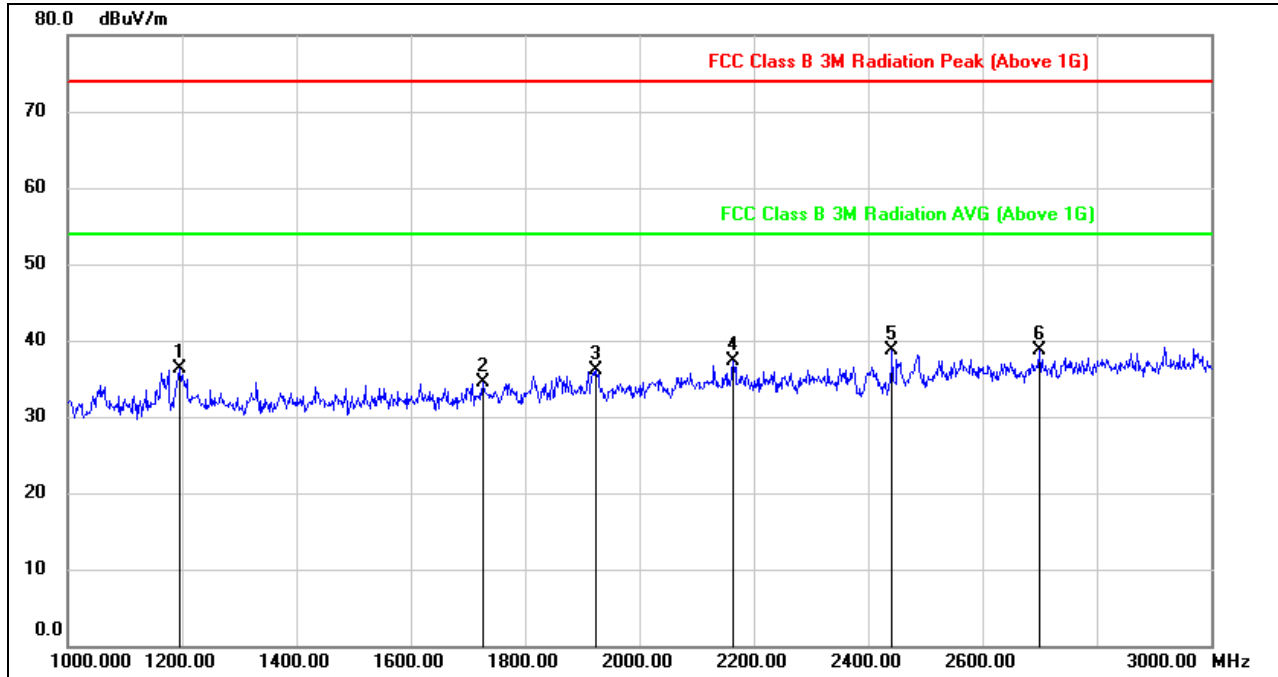

No.	Frequency (MHz)	Reading (dBuV)	Correct (dB/m)	Result (dBuV/m)	Limit (dBuV/m)	Margin (dB)	Remark
1	1196.000	48.45	-12.24	36.21	74.00	-37.79	peak
2	1726.000	44.91	-10.34	34.57	74.00	-39.43	peak
3	1924.000	45.56	-9.37	36.19	74.00	-37.81	peak
4	2164.000	45.56	-8.27	37.29	74.00	-36.71	peak
5	2442.000	45.29	-6.65	38.64	74.00	-35.36	peak
6	2700.000	44.66	-5.98	38.68	74.00	-35.32	peak

- Note: 1. Peak Result = Reading Level + Correct Factor.
 2. If Peak Result complies with AV limit, AV Result is deemed to comply with AV limit.
 3. Peak: Peak detector.
 4. The Band Reject filter loss factor already add into the correct factor.
 5. Proper operation of the transmitter prior to adding the filter to the measurement chain.



HARMONICS AND SPURIOUS EMISSIONS (MID CHANNEL, VERTICAL)

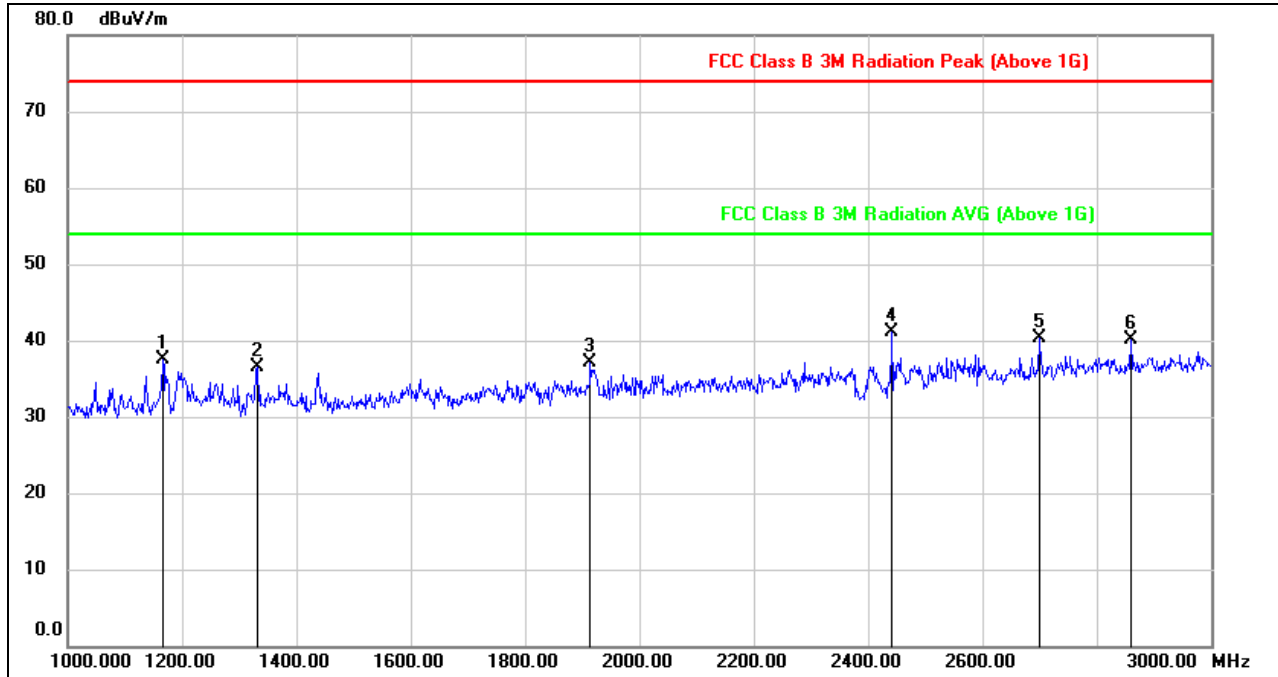

No.	Frequency (MHz)	Reading (dBuV)	Correct (dB/m)	Result (dBuV/m)	Limit (dBuV/m)	Margin (dB)	Remark
1	1166.000	49.98	-12.52	37.46	74.00	-36.54	peak
2	1332.000	48.34	-11.86	36.48	74.00	-37.52	peak
3	1914.000	46.53	-9.36	37.17	74.00	-36.83	peak
4	2442.000	47.75	-6.65	41.10	74.00	-32.90	peak
5	2700.000	46.32	-5.98	40.34	74.00	-33.66	peak
6	2860.000	44.96	-4.95	40.01	74.00	-33.99	peak

- Note: 1. Peak Result = Reading Level + Correct Factor.
 2. If Peak Result complies with AV limit, AV Result is deemed to comply with AV limit.
 3. Peak: Peak detector.
 4. The Band Reject filter loss factor already add into the correct factor.
 5. Proper operation of the transmitter prior to adding the filter to the measurement chain.



HARMONICS AND SPURIOUS EMISSIONS (HIGH CHANNEL, HORIZONTAL)

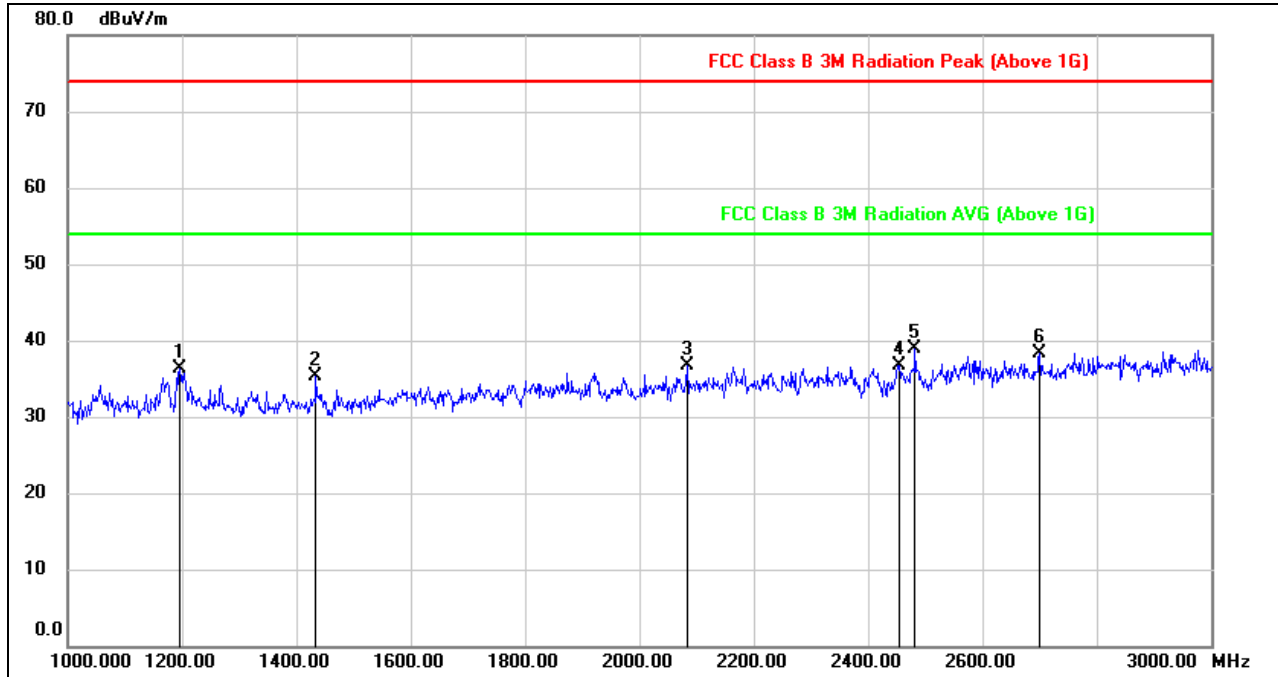

No.	Frequency (MHz)	Reading (dBuV)	Correct (dB/m)	Result (dBuV/m)	Limit (dBuV/m)	Margin (dB)	Remark
1	1196.000	48.60	-12.24	36.36	74.00	-37.64	peak
2	1434.000	47.14	-11.86	35.28	74.00	-38.72	peak
3	2084.000	45.40	-8.72	36.68	74.00	-37.32	peak
4	2454.000	43.28	-6.55	36.73	74.00	-37.27	peak
5	2482.000	45.27	-6.32	38.95	74.00	-35.05	peak
6	2700.000	44.35	-5.98	38.37	74.00	-35.63	peak

- Note: 1. Peak Result = Reading Level + Correct Factor.
 2. If Peak Result complies with AV limit, AV Result is deemed to comply with AV limit.
 3. Peak: Peak detector.
 4. The Band Reject filter loss factor already add into the correct factor.
 5. Proper operation of the transmitter prior to adding the filter to the measurement chain.



HARMONICS AND SPURIOUS EMISSIONS (HIGH CHANNEL, VERTICAL)

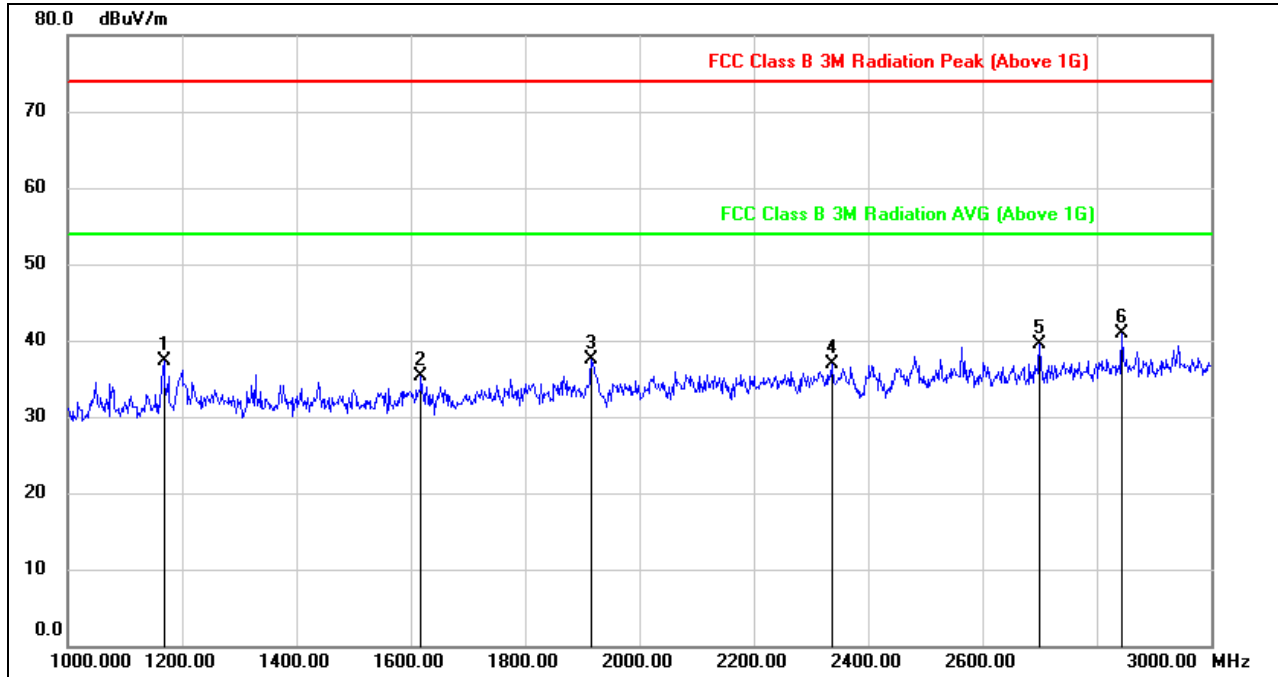

No.	Frequency (MHz)	Reading (dBuV)	Correct (dB/m)	Result (dBuV/m)	Limit (dBuV/m)	Margin (dB)	Remark
1	1168.000	49.89	-12.51	37.38	74.00	-36.62	peak
2	1618.000	46.05	-10.79	35.26	74.00	-38.74	peak
3	1916.000	46.77	-9.36	37.41	74.00	-36.59	peak
4	2336.000	44.23	-7.30	36.93	74.00	-37.07	peak
5	2700.000	45.45	-5.98	39.47	74.00	-34.53	peak
6	2844.000	45.87	-5.04	40.83	74.00	-33.17	peak

- Note: 1. Peak Result = Reading Level + Correct Factor.
 2. If Peak Result complies with AV limit, AV Result is deemed to comply with AV limit.
 3. Peak: Peak detector.
 4. The Band Reject filter loss factor already add into the correct factor.
 5. Proper operation of the transmitter prior to adding the filter to the measurement chain.



7.3.2. 8DPSK MODE

HARMONICS AND SPURIOUS EMISSIONS (LOW CHANNEL, HORIZONTAL)

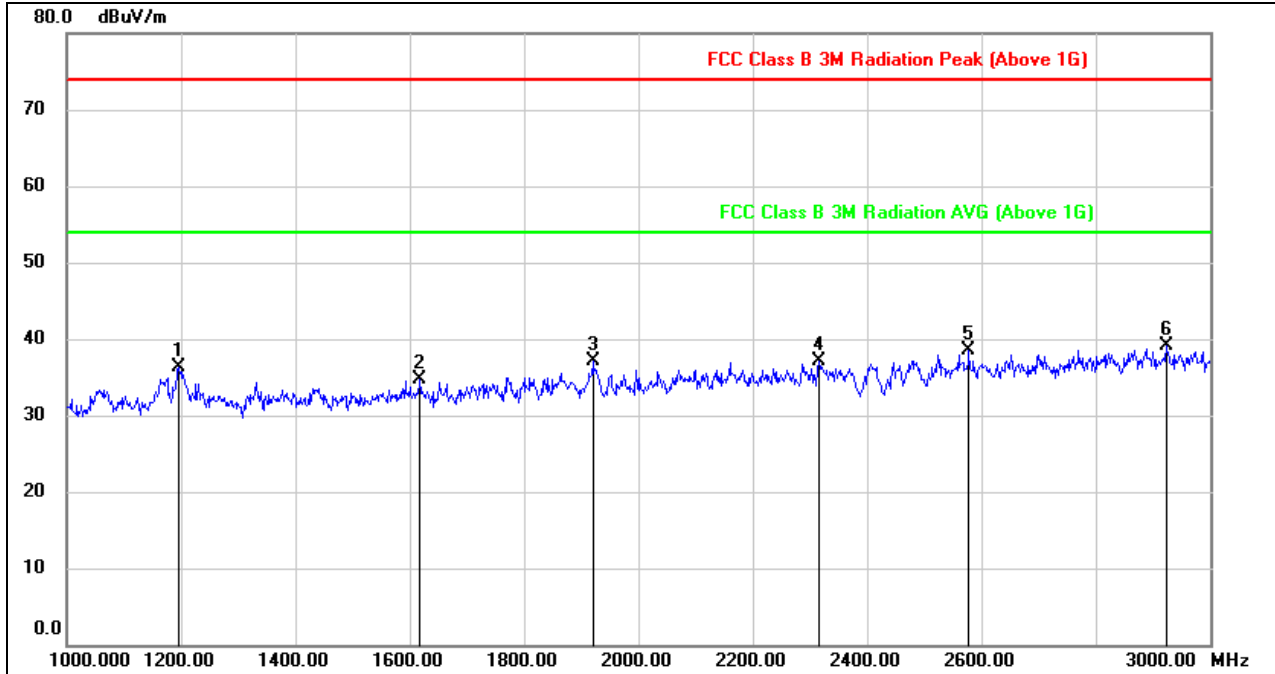

No.	Frequency (MHz)	Reading (dBuV)	Correct (dB/m)	Result (dBuV/m)	Limit (dBuV/m)	Margin (dB)	Remark
1	1196.000	48.52	-12.24	36.28	74.00	-37.72	peak
2	1618.000	45.44	-10.79	34.65	74.00	-39.35	peak
3	1920.000	46.39	-9.36	37.03	74.00	-36.97	peak
4	2316.000	44.50	-7.40	37.10	74.00	-36.90	peak
5	2578.000	44.95	-6.49	38.46	74.00	-35.54	peak
6	2924.000	43.65	-4.64	39.01	74.00	-34.99	peak

- Note:
1. Peak Result = Reading Level + Correct Factor.
 2. If Peak Result complies with AV limit, AV Result is deemed to comply with AV limit.
 3. Peak: Peak detector.
 4. The Band Reject filter loss factor already add into the correct factor.
 5. Proper operation of the transmitter prior to adding the filter to the measurement chain.



HARMONICS AND SPURIOUS EMISSIONS (LOW CHANNEL, VERTICAL)

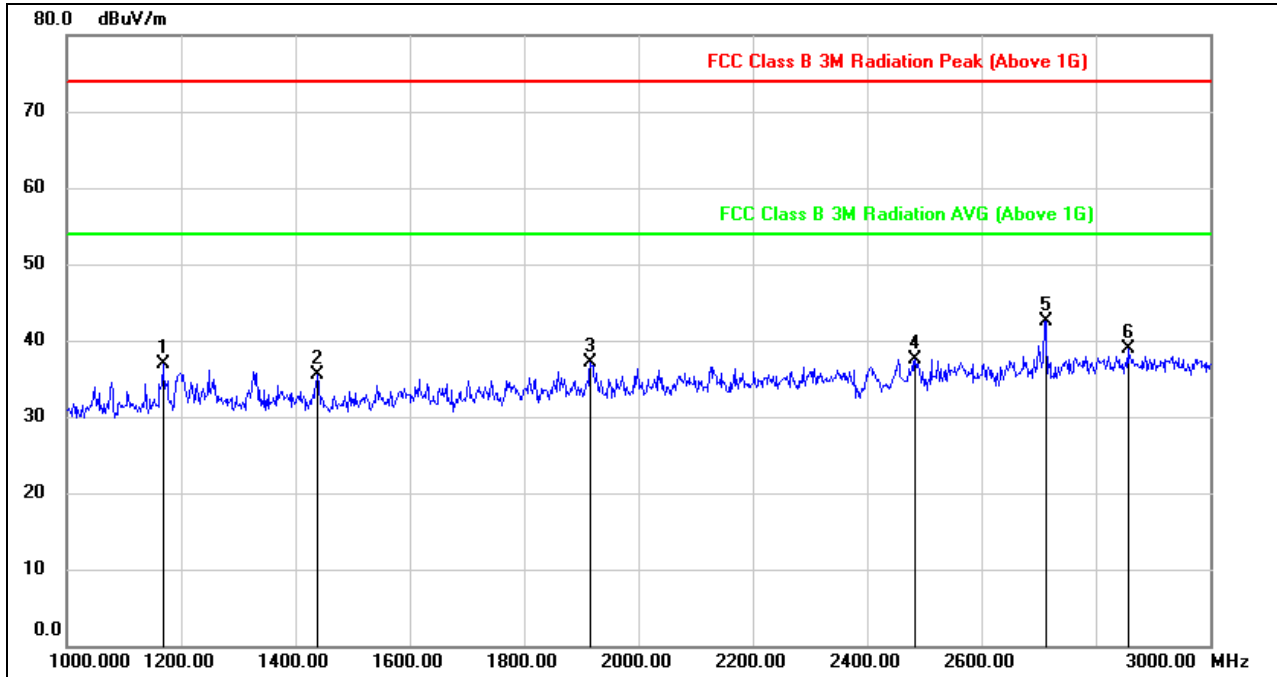

No.	Frequency (MHz)	Reading (dBuV)	Correct (dB/m)	Result (dBuV/m)	Limit (dBuV/m)	Margin (dB)	Remark
1	1168.000	49.43	-12.51	36.92	74.00	-37.08	peak
2	1438.000	47.27	-11.85	35.42	74.00	-38.58	peak
3	1916.000	46.43	-9.36	37.07	74.00	-36.93	peak
4	2484.000	43.89	-6.30	37.59	74.00	-36.41	peak
5	2712.000	48.45	-5.90	42.55	74.00	-31.45	peak
6	2856.000	43.95	-4.99	38.96	74.00	-35.04	peak

- Note: 1. Peak Result = Reading Level + Correct Factor.
 2. If Peak Result complies with AV limit, AV Result is deemed to comply with AV limit.
 3. Peak: Peak detector.
 4. The Band Reject filter loss factor already add into the correct factor.
 5. Proper operation of the transmitter prior to adding the filter to the measurement chain.



HARMONICS AND SPURIOUS EMISSIONS (MID CHANNEL, HORIZONTAL)

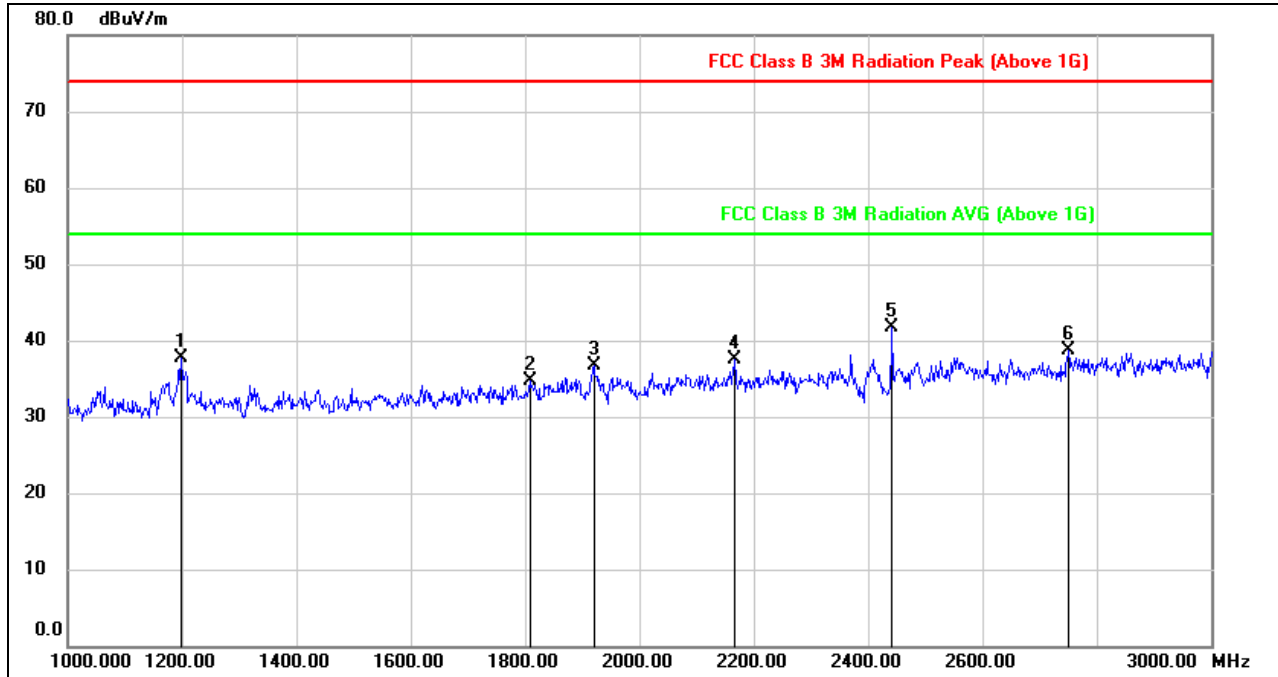

No.	Frequency (MHz)	Reading (dBuV)	Correct (dB/m)	Result (dBuV/m)	Limit (dBuV/m)	Margin (dB)	Remark
1	1198.000	49.84	-12.22	37.62	74.00	-36.38	peak
2	1808.000	44.28	-9.60	34.68	74.00	-39.32	peak
3	1920.000	46.06	-9.36	36.70	74.00	-37.30	peak
4	2166.000	45.81	-8.26	37.55	74.00	-36.45	peak
5	2442.000	48.30	-6.65	41.65	74.00	-32.35	peak
6	2750.000	44.27	-5.63	38.64	74.00	-35.36	peak

- Note: 1. Peak Result = Reading Level + Correct Factor.
 2. If Peak Result complies with AV limit, AV Result is deemed to comply with AV limit.
 3. Peak: Peak detector.
 4. The Band Reject filter loss factor already add into the correct factor.
 5. Proper operation of the transmitter prior to adding the filter to the measurement chain.



HARMONICS AND SPURIOUS EMISSIONS (MID CHANNEL, VERTICAL)

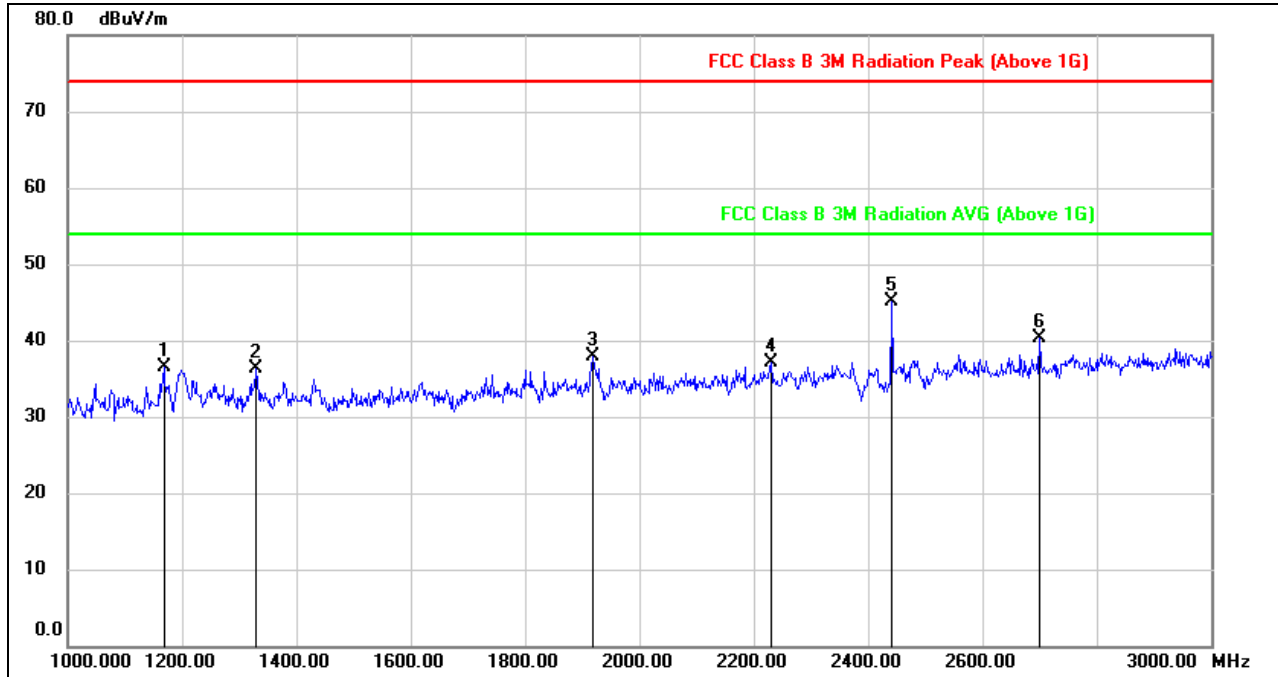

No.	Frequency (MHz)	Reading (dBuV)	Correct (dB/m)	Result (dBuV/m)	Limit (dBuV/m)	Margin (dB)	Remark
1	1168.000	48.93	-12.51	36.42	74.00	-37.58	peak
2	1330.000	48.21	-11.87	36.34	74.00	-37.66	peak
3	1918.000	47.21	-9.36	37.85	74.00	-36.15	peak
4	2230.000	44.95	-7.91	37.04	74.00	-36.96	peak
5	2442.000	51.83	-6.65	45.18	74.00	-28.82	peak
6	2700.000	46.33	-5.98	40.35	74.00	-33.65	peak

- Note: 1. Peak Result = Reading Level + Correct Factor.
 2. If Peak Result complies with AV limit, AV Result is deemed to comply with AV limit.
 3. Peak: Peak detector.
 4. The Band Reject filter loss factor already add into the correct factor.
 5. Proper operation of the transmitter prior to adding the filter to the measurement chain.



HARMONICS AND SPURIOUS EMISSIONS (HIGH CHANNEL, HORIZONTAL)

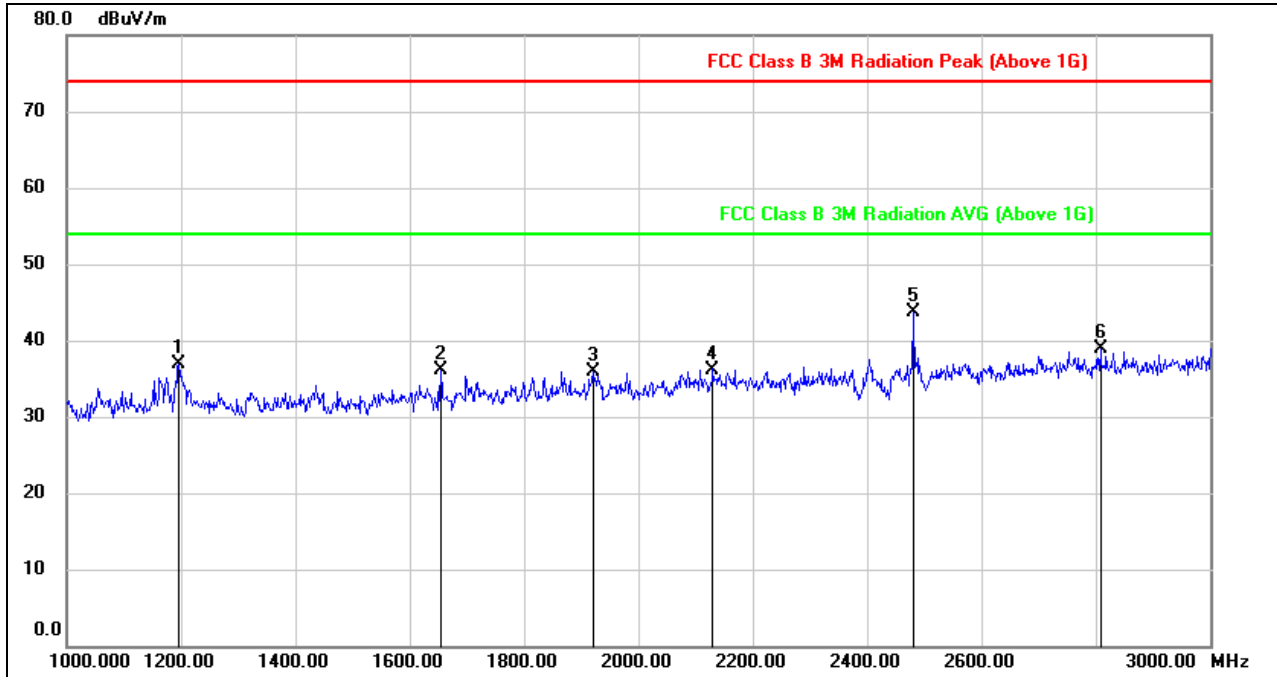

No.	Frequency (MHz)	Reading (dBuV)	Correct (dB/m)	Result (dBuV/m)	Limit (dBuV/m)	Margin (dB)	Remark
1	1196.000	49.20	-12.24	36.96	74.00	-37.04	peak
2	1654.000	46.75	-10.71	36.04	74.00	-37.96	peak
3	1920.000	45.34	-9.36	35.98	74.00	-38.02	peak
4	2130.000	44.65	-8.45	36.20	74.00	-37.80	peak
5	2480.000	50.04	-6.34	43.70	74.00	-30.30	peak
6	2808.000	44.07	-5.24	38.83	74.00	-35.17	peak

- Note: 1. Peak Result = Reading Level + Correct Factor.
 2. If Peak Result complies with AV limit, AV Result is deemed to comply with AV limit.
 3. Peak: Peak detector.
 4. The Band Reject filter loss factor already add into the correct factor.
 5. Proper operation of the transmitter prior to adding the filter to the measurement chain.



HARMONICS AND SPURIOUS EMISSIONS (HIGH CHANNEL, VERTICAL)

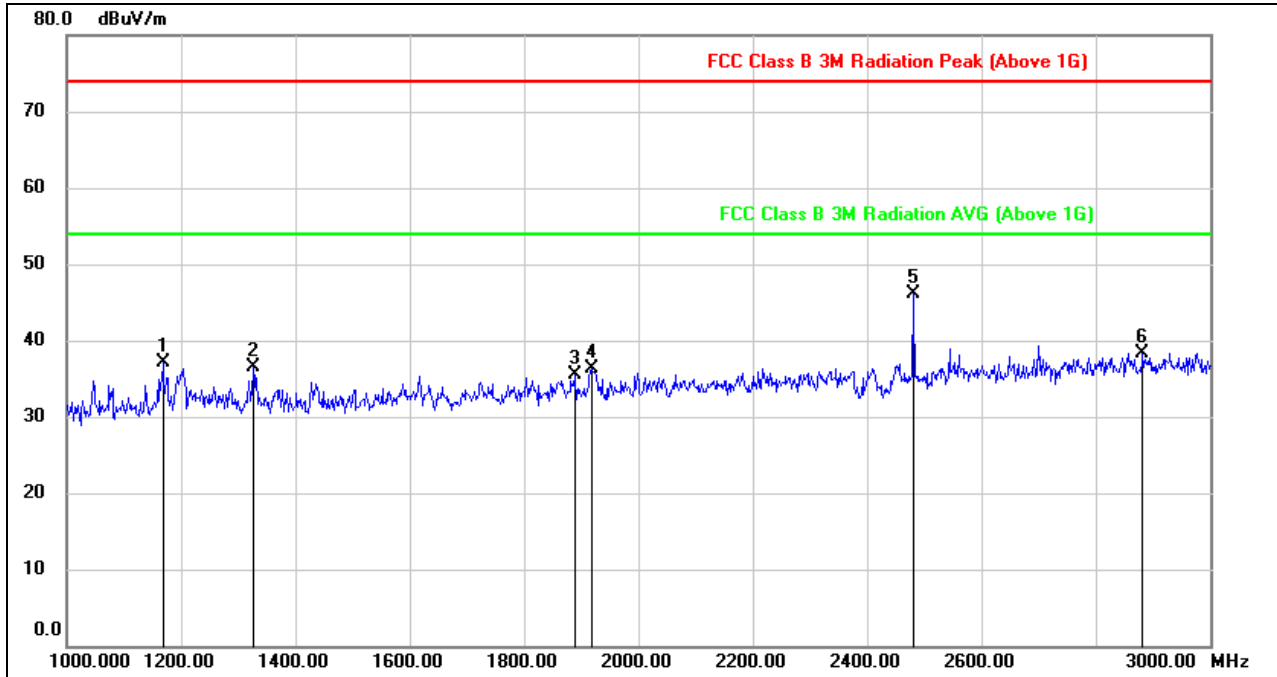

No.	Frequency (MHz)	Reading (dBuV)	Correct (dB/m)	Result (dBuV/m)	Limit (dBuV/m)	Margin (dB)	Remark
1	1168.000	49.60	-12.51	37.09	74.00	-36.91	peak
2	1326.000	48.27	-11.86	36.41	74.00	-37.59	peak
3	1888.000	44.91	-9.39	35.52	74.00	-38.48	peak
4	1918.000	45.71	-9.36	36.35	74.00	-37.65	peak
5	2480.000	52.47	-6.34	46.13	74.00	-27.87	peak
6	2882.000	43.21	-4.84	38.37	74.00	-35.63	peak

- Note: 1. Peak Result = Reading Level + Correct Factor.
 2. If Peak Result complies with AV limit, AV Result is deemed to comply with AV limit.
 3. Peak: Peak detector.
 4. The Band Reject filter loss factor already add into the correct factor.
 5. Proper operation of the transmitter prior to adding the filter to the measurement chain.



7.4. SPURIOUS EMISSIONS (3~18GHz)

7.4.1. GFSK MODE

HARMONICS AND SPURIOUS EMISSIONS (LOW CHANNEL, HORIZONTAL)

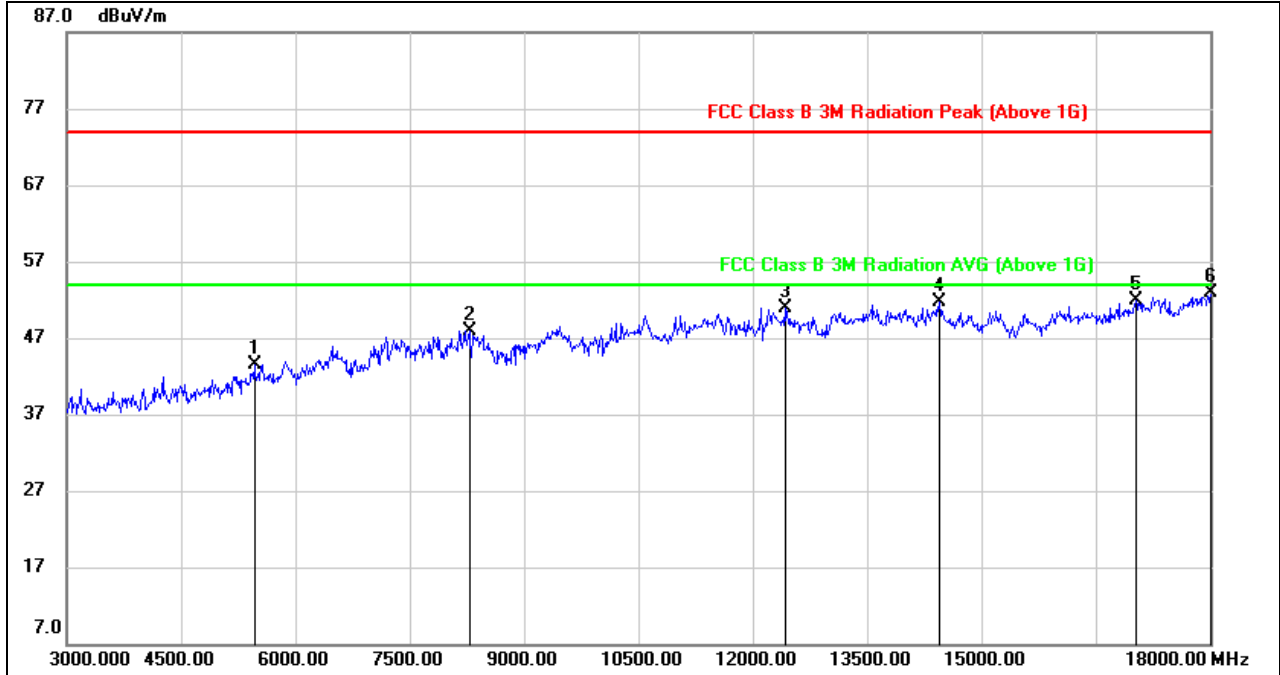

No.	Frequency (MHz)	Reading (dBuV)	Correct (dB/m)	Result (dBuV/m)	Limit (dBuV/m)	Margin (dB)	Remark
1	5460.000	41.23	2.27	43.50	74.00	-30.50	peak
2	8280.000	39.14	8.74	47.88	74.00	-26.12	peak
3	12420.000	36.53	14.41	50.94	74.00	-23.06	peak
4	14445.000	35.39	16.37	51.76	74.00	-22.24	peak
5	17025.000	31.54	20.45	51.99	74.00	-22.01	peak
6	18000.000	29.68	23.27	52.95	74.00	-21.05	peak

- Note: 1. Peak Result = Reading Level + Correct Factor.
 2. If Peak Result complies with AV limit, AV Result is deemed to comply with AV limit.
 3. Peak: Peak detector.
 4. The High Pass filter loss factor already add into the correct factor.
 5. Proper operation of the transmitter prior to adding the filter to the measurement chain.



HARMONICS AND SPURIOUS EMISSIONS (LOW CHANNEL, VERTICAL)

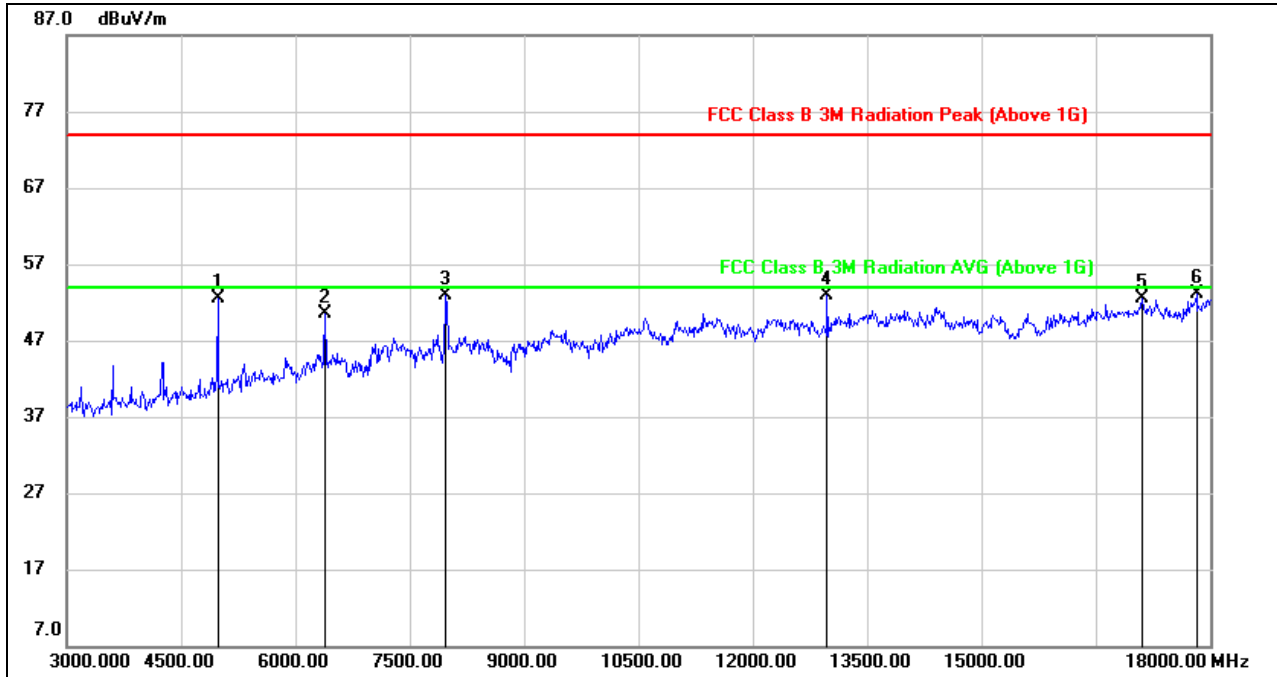

No.	Frequency (MHz)	Reading (dBuV)	Correct (dB/m)	Result (dBuV/m)	Limit (dBuV/m)	Margin (dB)	Remark
1	4980.000	52.14	0.37	52.51	74.00	-21.49	peak
2	6390.000	45.50	4.97	50.47	74.00	-23.53	peak
3	7965.000	44.62	8.26	52.88	74.00	-21.12	peak
4	12975.000	38.10	14.71	52.81	74.00	-21.19	peak
5	17115.000	31.72	20.81	52.53	74.00	-21.47	peak
6	17820.000	29.89	23.21	53.10	74.00	-20.90	peak

- Note: 1. Peak Result = Reading Level + Correct Factor.
 2. If Peak Result complies with AV limit, AV Result is deemed to comply with AV limit.
 3. Peak: Peak detector.
 4. The High Pass filter loss factor already add into the correct factor.
 5. Proper operation of the transmitter prior to adding the filter to the measurement chain.



HARMONICS AND SPURIOUS EMISSIONS (MID CHANNEL, HORIZONTAL)

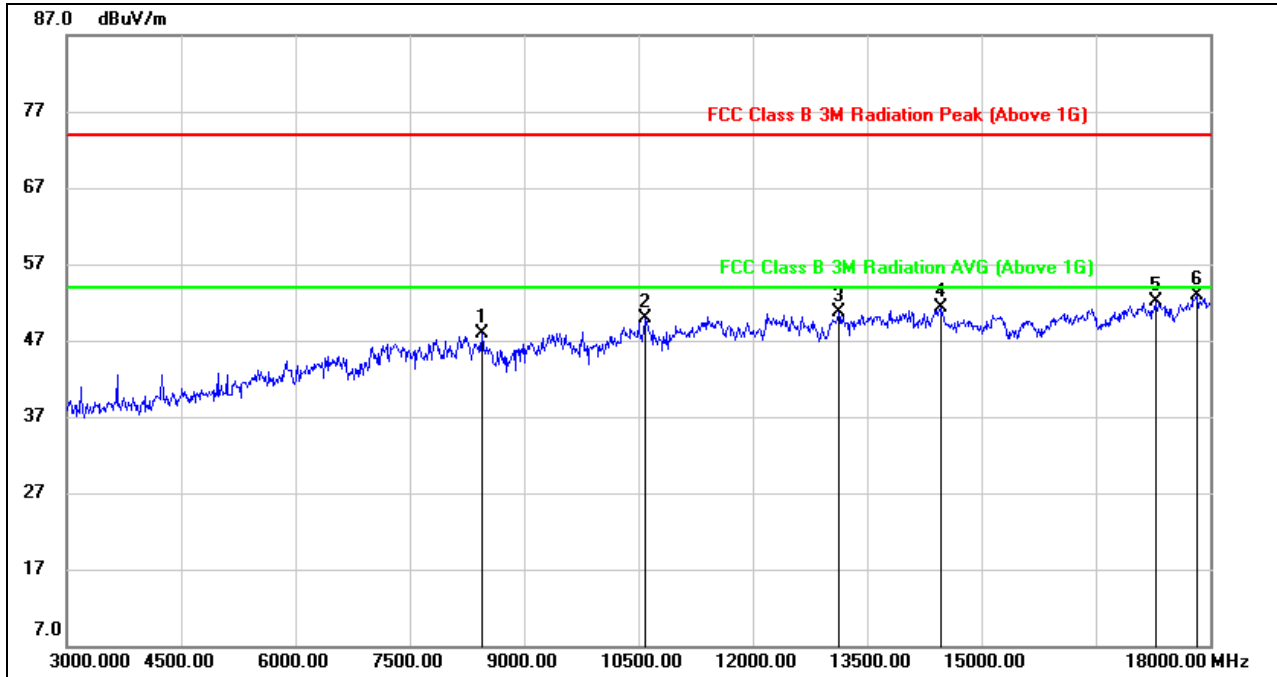

No.	Frequency (MHz)	Reading (dBuV)	Correct (dB/m)	Result (dBuV/m)	Limit (dBuV/m)	Margin (dB)	Remark
1	8445.000	39.17	8.65	47.82	74.00	-26.18	peak
2	10590.000	37.30	12.68	49.98	74.00	-24.02	peak
3	13125.000	35.68	14.99	50.67	74.00	-23.33	peak
4	14460.000	35.02	16.35	51.37	74.00	-22.63	peak
5	17280.000	30.35	21.72	52.07	74.00	-21.93	peak
6	17820.000	29.61	23.21	52.82	74.00	-21.18	peak

- Note: 1. Peak Result = Reading Level + Correct Factor.
 2. If Peak Result complies with AV limit, AV Result is deemed to comply with AV limit.
 3. Peak: Peak detector.
 4. High pass filter losses had already added into the correct factor.



HARMONICS AND SPURIOUS EMISSIONS (MID CHANNEL, VERTICAL)

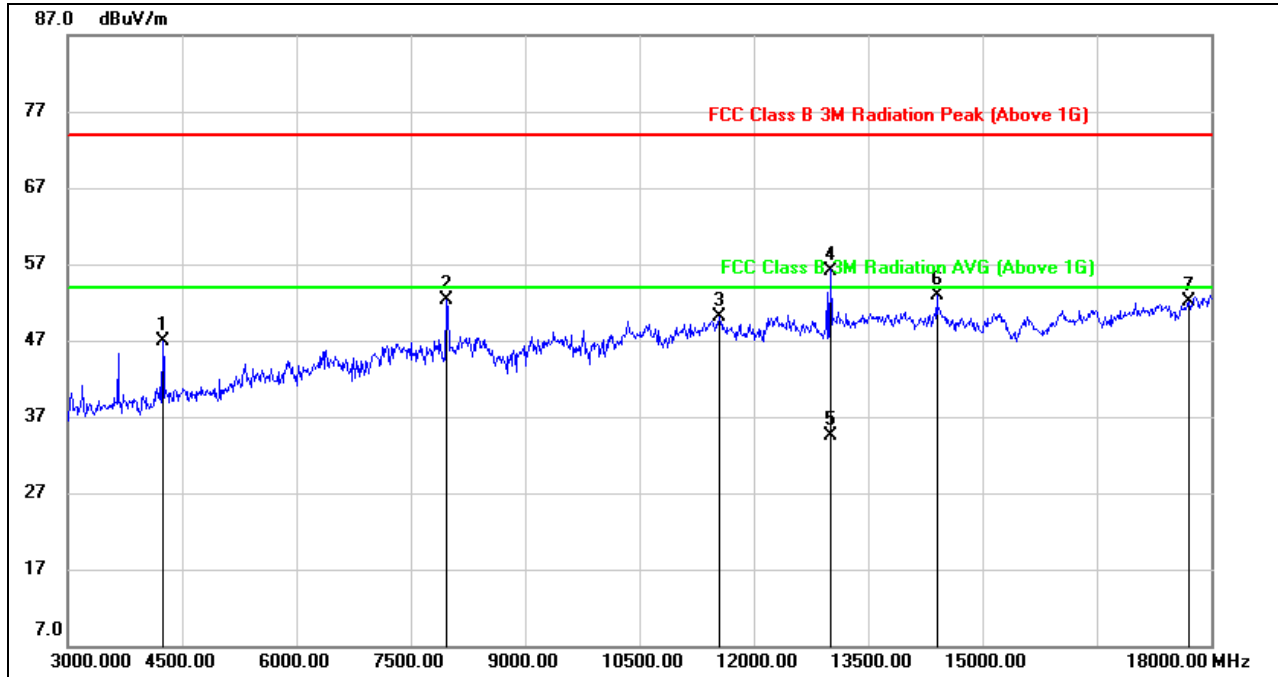

No.	Frequency (MHz)	Reading (dBuV)	Correct (dB/m)	Result (dBuV/m)	Limit (dBuV/m)	Margin (dB)	Remark
1	4245.000	48.83	-2.02	46.81	74.00	-27.19	peak
2	7965.000	43.97	8.26	52.23	74.00	-21.77	peak
3	11550.000	35.96	14.13	50.09	74.00	-23.91	peak
4	13005.000	41.47	14.73	56.20	74.00	-17.80	peak
5	13005.000	19.72	14.73	34.45	54.00	-19.55	AVG
6	14400.000	36.56	16.43	52.99	74.00	-21.01	peak
7	17700.000	29.80	22.24	52.04	74.00	-21.96	peak

- Note:
1. Peak Result = Reading Level + Correct Factor.
 2. If Peak Result complies with AV limit, AV Result is deemed to comply with AV limit.
 3. Peak: Peak detector.
 4. AVG: $VBW=1/Ton$ where: ton is transmit duration.
 5. For duty cycle, please refer to clause 7.1.
 6. The High Pass filter loss factor already add into the correct factor.
 7. Proper operation of the transmitter prior to adding the filter to the measurement chain.



HARMONICS AND SPURIOUS EMISSIONS (HIGH CHANNEL, HORIZONTAL)

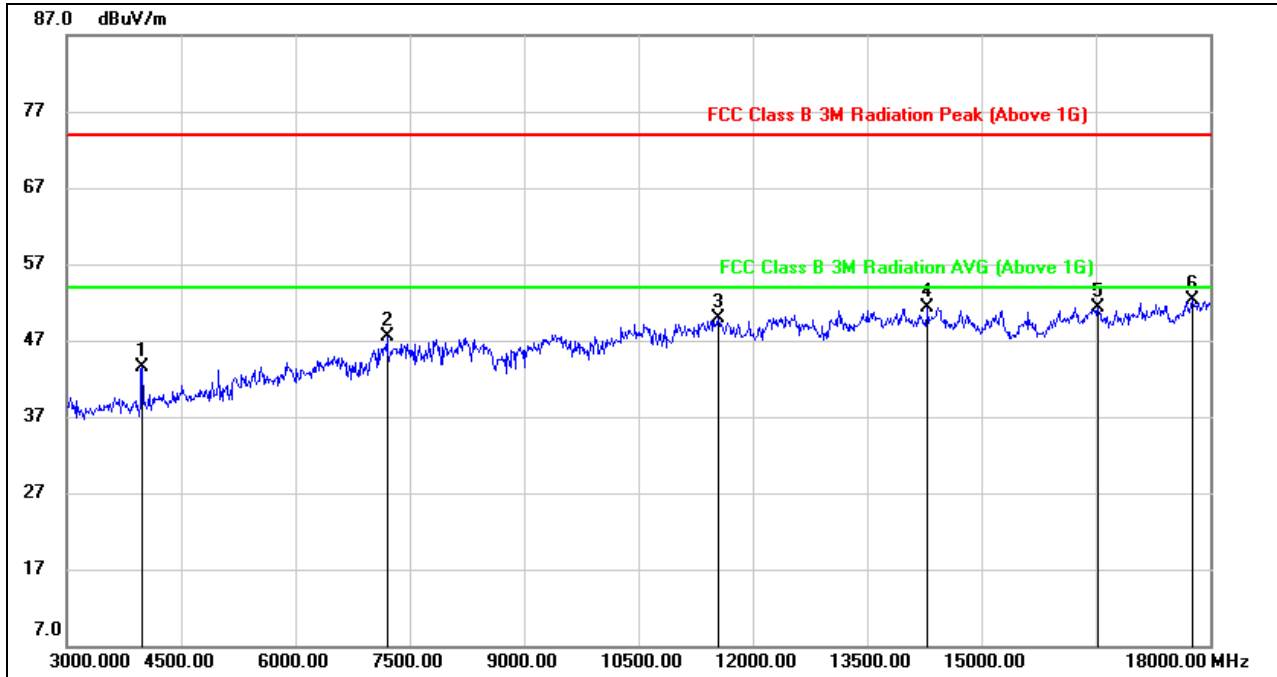

No.	Frequency (MHz)	Reading (dBuV)	Correct (dB/m)	Result (dBuV/m)	Limit (dBuV/m)	Margin (dB)	Remark
1	3990.000	46.39	-2.95	43.44	74.00	-30.56	peak
2	7200.000	40.64	6.88	47.52	74.00	-26.48	peak
3	11550.000	35.70	14.13	49.83	74.00	-24.17	peak
4	14295.000	34.98	16.31	51.29	74.00	-22.71	peak
5	16530.000	32.33	19.03	51.36	74.00	-22.64	peak
6	17775.000	29.31	22.97	52.28	74.00	-21.72	peak

- Note: 1. Peak Result = Reading Level + Correct Factor.
 2. If Peak Result complies with AV limit, AV Result is deemed to comply with AV limit.
 3. Peak: Peak detector.
 4. The High Pass filter loss factor already add into the correct factor.
 5. Proper operation of the transmitter prior to adding the filter to the measurement chain.



HARMONICS AND SPURIOUS EMISSIONS (HIGH CHANNEL, VERTICAL)

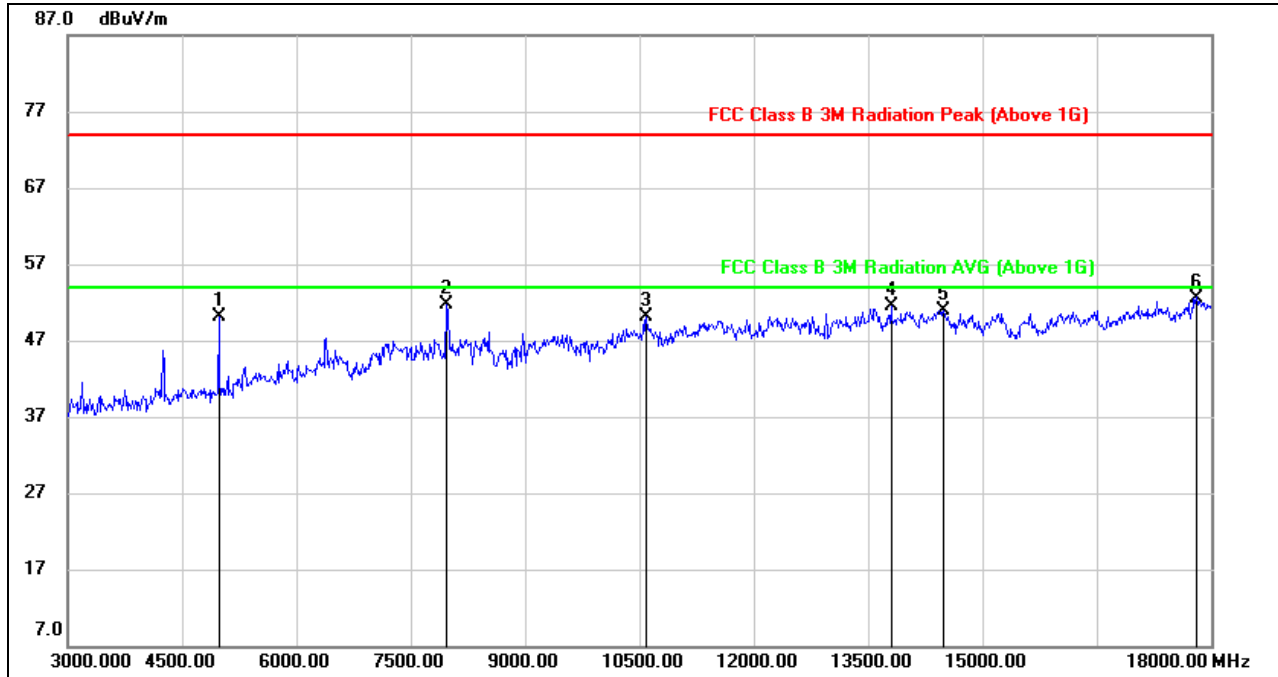

No.	Frequency (MHz)	Reading (dBuV)	Correct (dB/m)	Result (dBuV/m)	Limit (dBuV/m)	Margin (dB)	Remark
1	4980.000	49.82	0.37	50.19	74.00	-23.81	peak
2	7965.000	43.39	8.26	51.65	74.00	-22.35	peak
3	10590.000	37.52	12.68	50.20	74.00	-23.80	peak
4	13800.000	34.61	16.81	51.42	74.00	-22.58	peak
5	14490.000	34.63	16.32	50.95	74.00	-23.05	peak
6	17805.000	29.38	23.22	52.60	74.00	-21.40	peak

- Note: 1. Peak Result = Reading Level + Correct Factor.
 2. If Peak Result complies with AV limit, AV Result is deemed to comply with AV limit.
 3. Peak: Peak detector.
 4. The High Pass filter loss factor already add into the correct factor.
 5. Proper operation of the transmitter prior to adding the filter to the measurement chain.



7.4.2. 8DPSK MODE

HARMONICS AND SPURIOUS EMISSIONS (LOW CHANNEL, HORIZONTAL)

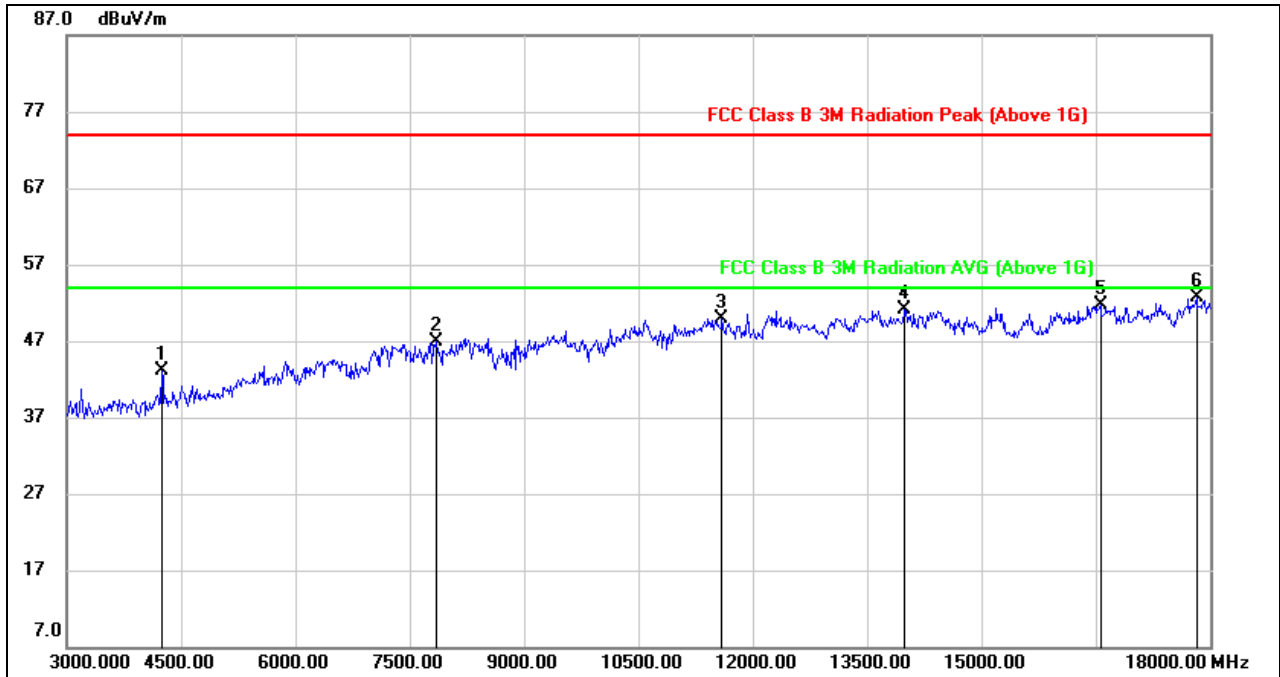

No.	Frequency (MHz)	Reading (dBuV)	Correct (dB/m)	Result (dBuV/m)	Limit (dBuV/m)	Margin (dB)	Remark
1	4245.000	45.10	-2.02	43.08	74.00	-30.92	peak
2	7845.000	38.21	8.68	46.89	74.00	-27.11	peak
3	11595.000	35.83	14.17	50.00	74.00	-24.00	peak
4	13995.000	34.78	16.35	51.13	74.00	-22.87	peak
5	16560.000	32.43	19.18	51.61	74.00	-22.39	peak
6	17820.000	29.49	23.21	52.70	74.00	-21.30	peak

- Note:
1. Peak Result = Reading Level + Correct Factor.
 2. If Peak Result complies with AV limit, AV Result is deemed to comply with AV limit.
 3. Peak: Peak detector.
 4. The High Pass filter loss factor already add into the correct factor.
 5. Proper operation of the transmitter prior to adding the filter to the measurement chain.



HARMONICS AND SPURIOUS EMISSIONS (LOW CHANNEL, VERTICAL)

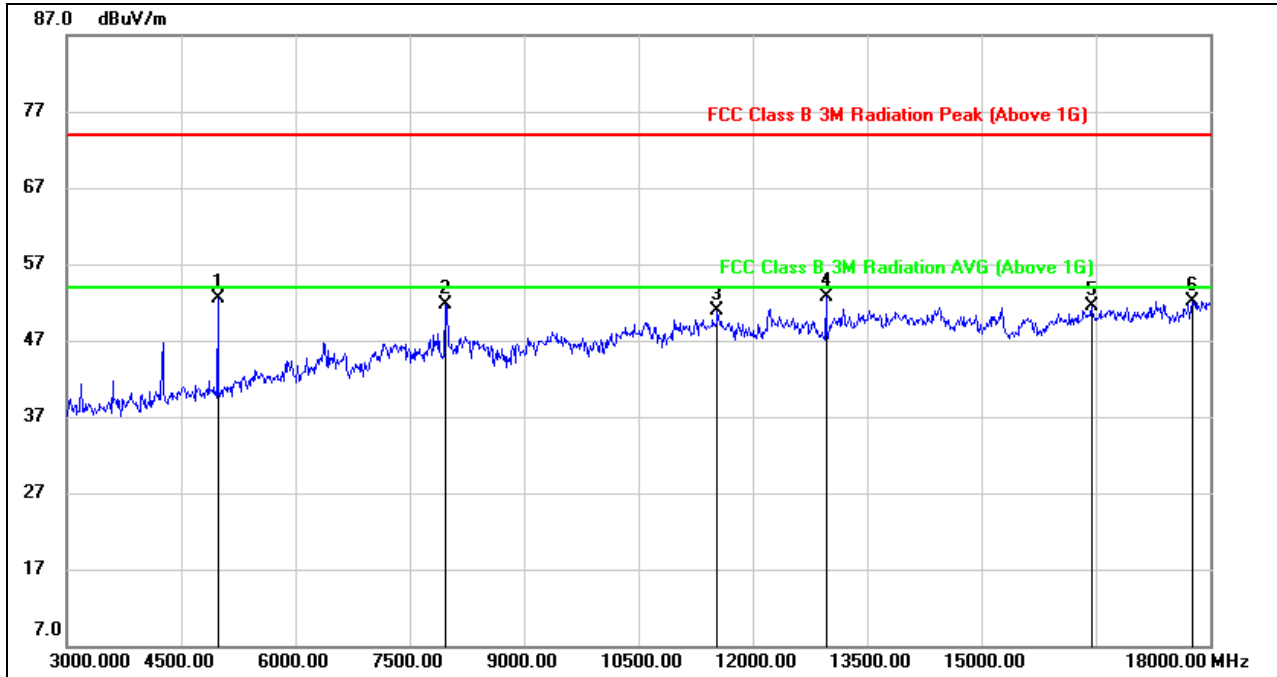

No.	Frequency (MHz)	Reading (dBuV)	Correct (dB/m)	Result (dBuV/m)	Limit (dBuV/m)	Margin (dB)	Remark
1	4980.000	52.19	0.37	52.56	74.00	-21.44	peak
2	7965.000	43.39	8.26	51.65	74.00	-22.35	peak
3	11535.000	36.89	14.10	50.99	74.00	-23.01	peak
4	12960.000	38.03	14.71	52.74	74.00	-21.26	peak
5	16440.000	32.74	18.69	51.43	74.00	-22.57	peak
6	17775.000	29.22	22.97	52.19	74.00	-21.81	peak

- Note: 1. Peak Result = Reading Level + Correct Factor.
 2. If Peak Result complies with AV limit, AV Result is deemed to comply with AV limit.
 3. Peak: Peak detector.
 4. The High Pass filter loss factor already add into the correct factor.
 5. Proper operation of the transmitter prior to adding the filter to the measurement chain.



HARMONICS AND SPURIOUS EMISSIONS (MID CHANNEL, HORIZONTAL)

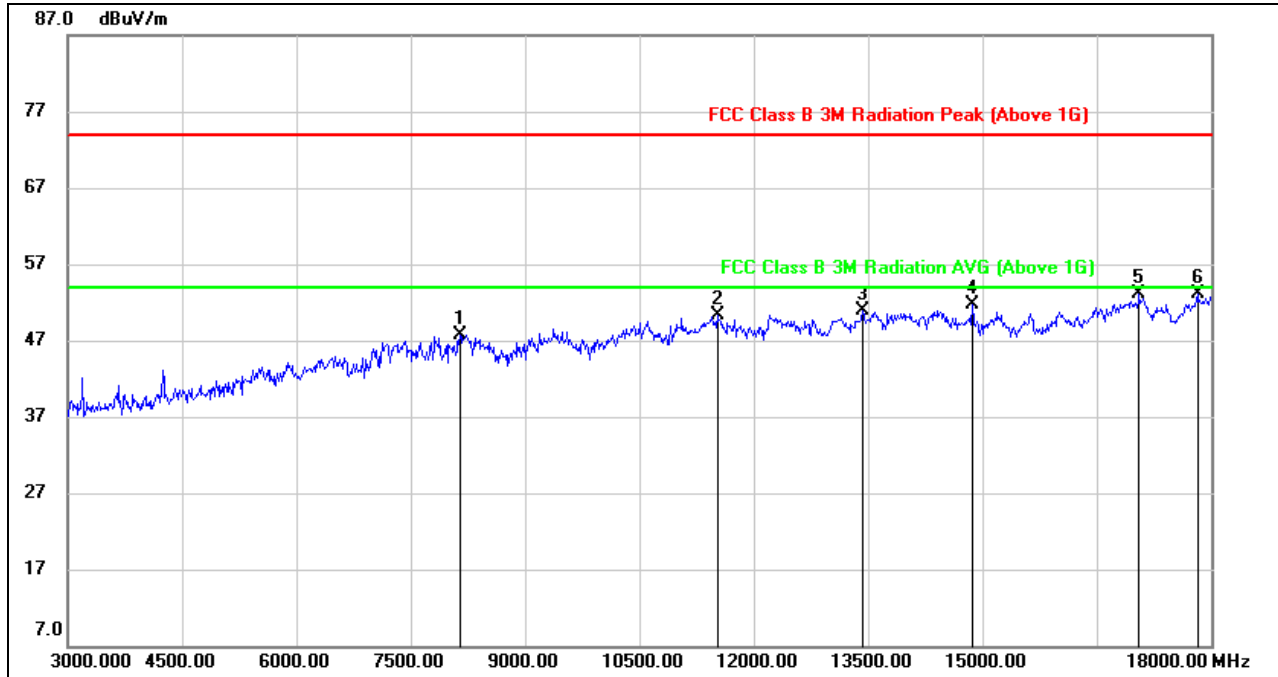

No.	Frequency (MHz)	Reading (dBuV)	Correct (dB/m)	Result (dBuV/m)	Limit (dBuV/m)	Margin (dB)	Remark
1	8145.000	38.43	9.30	47.73	74.00	-26.27	peak
2	11520.000	36.25	14.10	50.35	74.00	-23.65	peak
3	13425.000	35.12	15.83	50.95	74.00	-23.05	peak
4	14865.000	36.09	15.56	51.65	74.00	-22.35	peak
5	17055.000	32.46	20.57	53.03	74.00	-20.97	peak
6	17820.000	29.84	23.21	53.05	74.00	-20.95	peak

- Note:
1. Peak Result = Reading Level + Correct Factor.
 2. If Peak Result complies with AV limit, AV Result is deemed to comply with AV limit.
 3. Peak: Peak detector.
 4. The High Pass filter loss factor already add into the correct factor.
 5. Proper operation of the transmitter prior to adding the filter to the measurement chain.



HARMONICS AND SPURIOUS EMISSIONS (MID CHANNEL, VERTICAL)

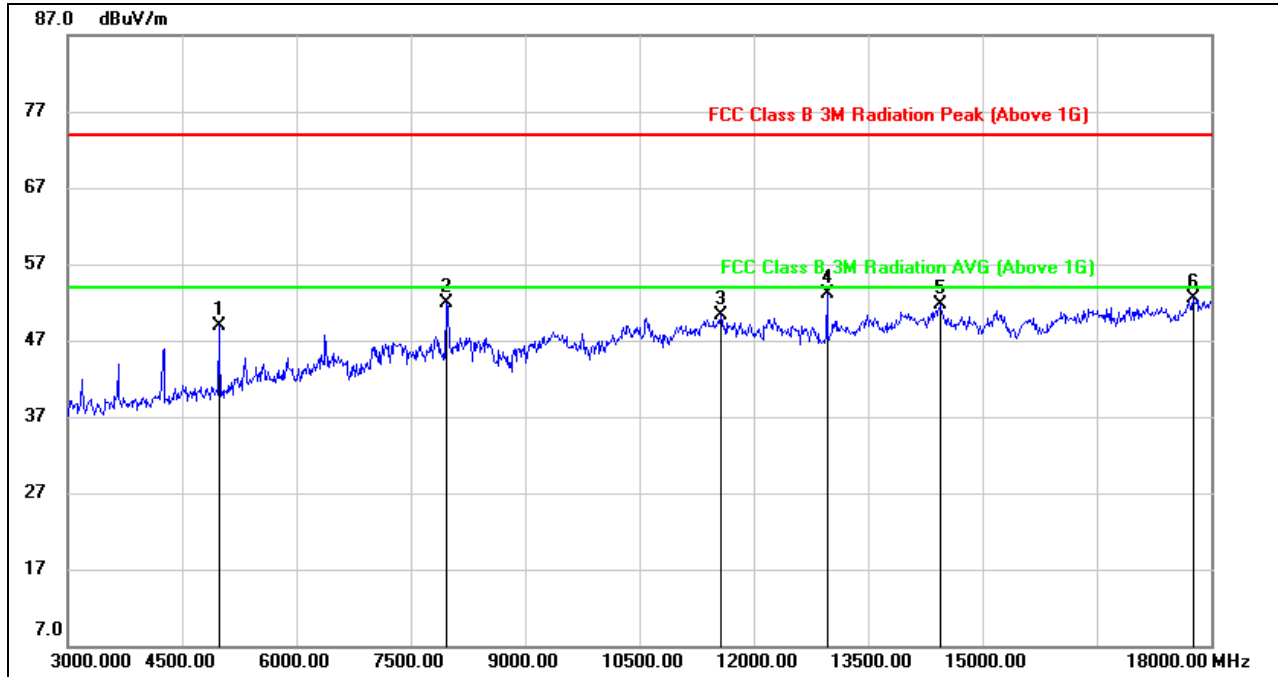

No.	Frequency (MHz)	Reading (dBuV)	Correct (dB/m)	Result (dBuV/m)	Limit (dBuV/m)	Margin (dB)	Remark
1	4980.000	48.58	0.37	48.95	74.00	-25.05	peak
2	7965.000	43.58	8.26	51.84	74.00	-22.16	peak
3	11565.000	36.17	14.14	50.31	74.00	-23.69	peak
4	12960.000	38.45	14.71	53.16	74.00	-20.84	peak
5	14445.000	35.26	16.37	51.63	74.00	-22.37	peak
6	17760.000	29.77	22.83	52.60	74.00	-21.40	peak

- Note: 1. Peak Result = Reading Level + Correct Factor.
 2. If Peak Result complies with AV limit, AV Result is deemed to comply with AV limit.
 3. Peak: Peak detector.
 4. The High Pass filter loss factor already add into the correct factor.
 5. Proper operation of the transmitter prior to adding the filter to the measurement chain.



HARMONICS AND SPURIOUS EMISSIONS (HIGH CHANNEL, HORIZONTAL)

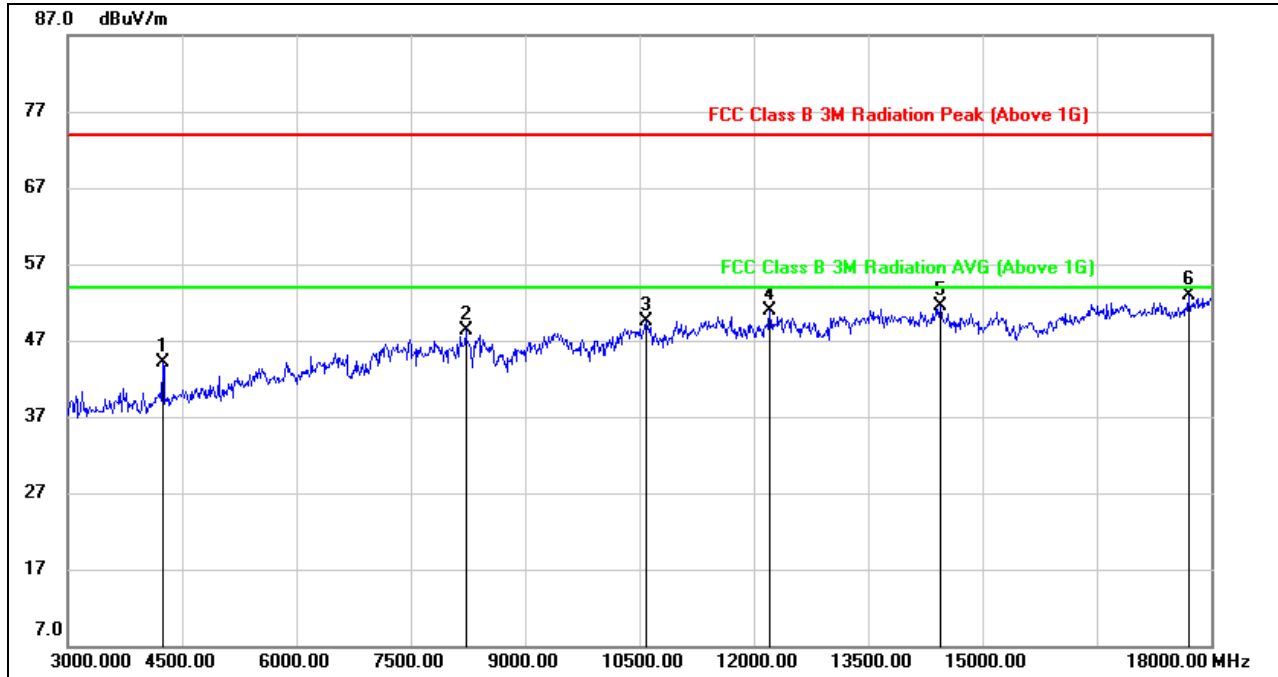

No.	Frequency (MHz)	Reading (dBuV)	Correct (dB/m)	Result (dBuV/m)	Limit (dBuV/m)	Margin (dB)	Remark
1	4245.000	46.07	-2.02	44.05	74.00	-29.95	peak
2	8220.000	38.99	9.40	48.39	74.00	-25.61	peak
3	10590.000	36.73	12.68	49.41	74.00	-24.59	peak
4	12210.000	36.62	14.25	50.87	74.00	-23.13	peak
5	14445.000	35.14	16.37	51.51	74.00	-22.49	peak
6	17700.000	30.66	22.24	52.90	74.00	-21.10	peak

- Note:
1. Peak Result = Reading Level + Correct Factor.
 2. If Peak Result complies with AV limit, AV Result is deemed to comply with AV limit.
 3. Peak: Peak detector.
 4. The High Pass filter loss factor already add into the correct factor.
 5. Proper operation of the transmitter prior to adding the filter to the measurement chain.



HARMONICS AND SPURIOUS EMISSIONS (HIGH CHANNEL, VERTICAL)

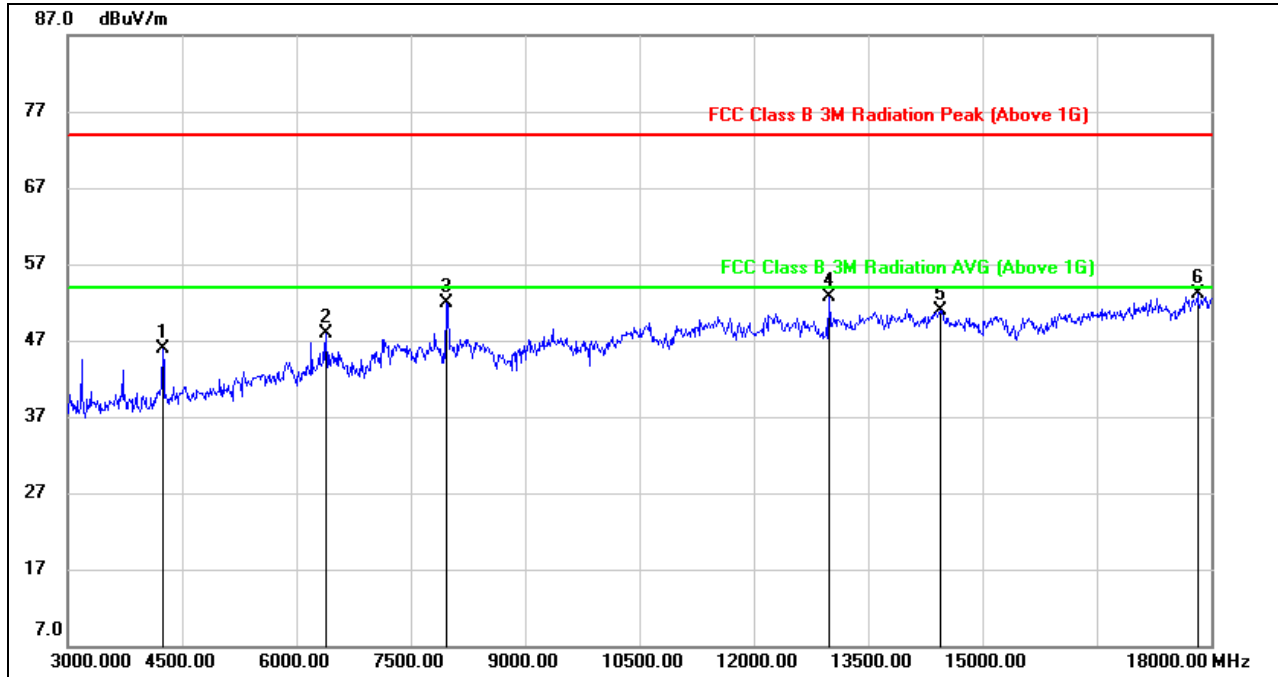

No.	Frequency (MHz)	Reading (dBuV)	Correct (dB/m)	Result (dBuV/m)	Limit (dBuV/m)	Margin (dB)	Remark
1	4245.000	47.90	-2.02	45.88	74.00	-28.12	peak
2	6390.000	43.03	4.97	48.00	74.00	-26.00	peak
3	7965.000	43.68	8.26	51.94	74.00	-22.06	peak
4	12990.000	37.94	14.71	52.65	74.00	-21.35	peak
5	14445.000	34.59	16.37	50.96	74.00	-23.04	peak
6	17820.000	29.83	23.21	53.04	74.00	-20.96	peak

- Note: 1. Peak Result = Reading Level + Correct Factor.
 2. If Peak Result complies with AV limit, AV Result is deemed to comply with AV limit.
 3. Peak: Peak detector.
 4. The High Pass filter loss factor already add into the correct factor.
 5. Proper operation of the transmitter prior to adding the filter to the measurement chain.



7.5. SPURIOUS EMISSIONS 18G ~ 26GHZ

7.5.1. GFSK MODE

SPURIOUS EMISSIONS (LOW CHANNEL, WORST-CASE CONFIGURATION, HORIZONTAL)

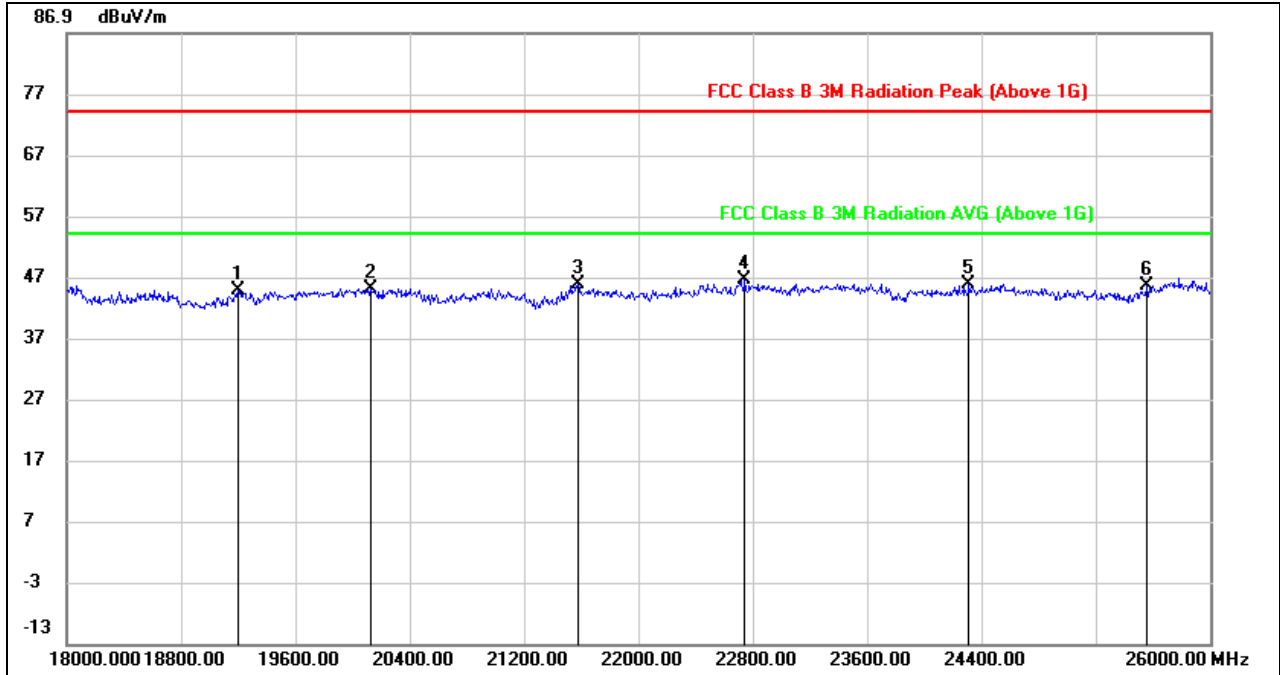

No.	Frequency (MHz)	Reading (dBuV)	Correct (dB/m)	Result (dBuV)	Limit (dBuV)	Margin (dB)	Remark
1	19200.000	49.78	-5.02	44.76	74.00	-29.24	peak
2	20128.000	49.76	-4.64	45.12	74.00	-28.88	peak
3	21576.000	51.48	-5.77	45.71	74.00	-28.29	peak
4	22744.000	52.18	-5.74	46.44	74.00	-27.56	peak
5	24312.000	49.10	-3.35	45.75	74.00	-28.25	peak
6	25560.000	47.27	-1.70	45.57	74.00	-28.43	peak

- Note: 1. Peak Result = Reading Level + Correct Factor.
 2. If Peak Result complies with AV limit, AV Result is deemed to comply with AV limit.
 3. Peak: Peak detector.
 4. High pass filter losses had already added into the correct factor.



SPURIOUS EMISSIONS (LOW CHANNEL, WORST-CASE CONFIGURATION, VERTICAL)

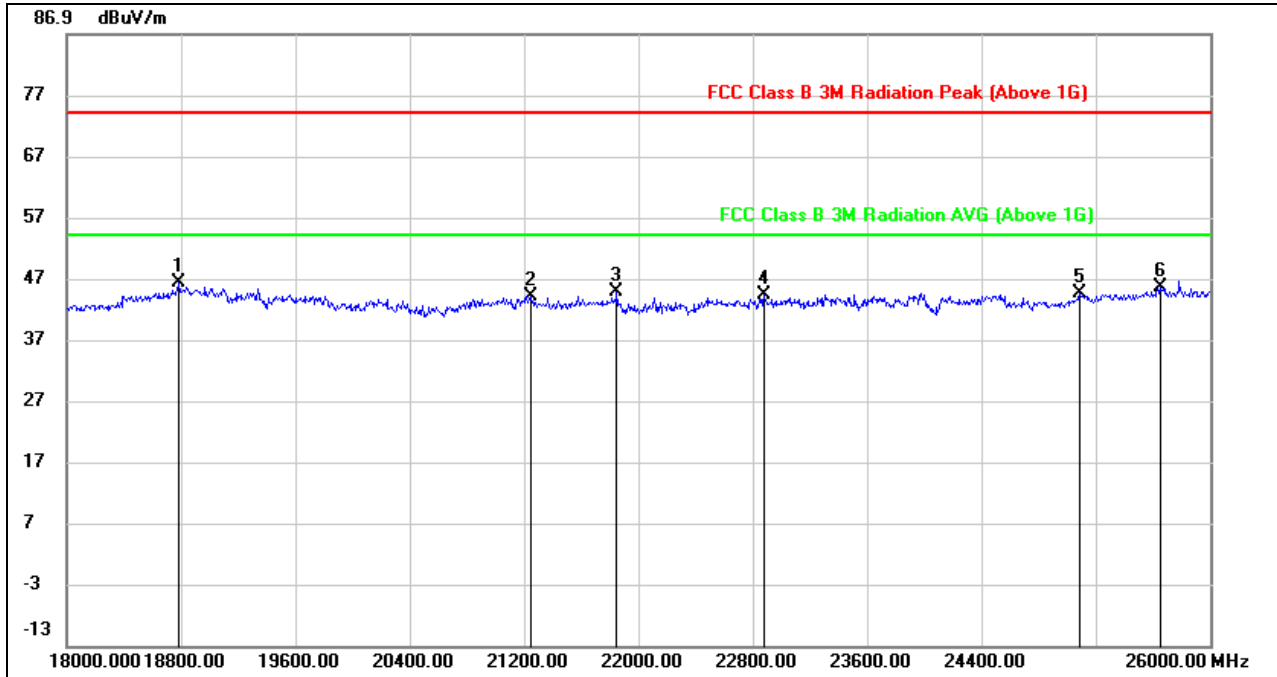

No.	Frequency (MHz)	Reading (dBuV)	Correct (dB/m)	Result (dBuV)	Limit (dBuV)	Margin (dB)	Remark
1	18784.000	51.05	-4.84	46.21	74.00	-27.79	peak
2	21248.000	49.48	-5.51	43.97	74.00	-30.03	peak
3	21848.000	50.76	-5.95	44.81	74.00	-29.19	peak
4	22880.000	49.92	-5.67	44.25	74.00	-29.75	peak
5	25088.000	45.63	-1.12	44.51	74.00	-29.49	peak
6	25648.000	47.12	-1.53	45.59	74.00	-28.41	peak

- Note: 1. Peak Result = Reading Level + Correct Factor.
 2. If Peak Result complies with AV limit, AV Result is deemed to comply with AV limit.
 3. Peak: Peak detector.
 4. High pass filter losses had already added into the correct factor.

Note: All test mode has been tested, only the worst data record in the report.



7.6. SPURIOUS EMISSIONS 30M ~ 1 GHz

7.6.1. GFSK MODE

SPURIOUS EMISSIONS (LOW CHANNEL, WORST-CASE CONFIGURATION, HORIZONTAL)

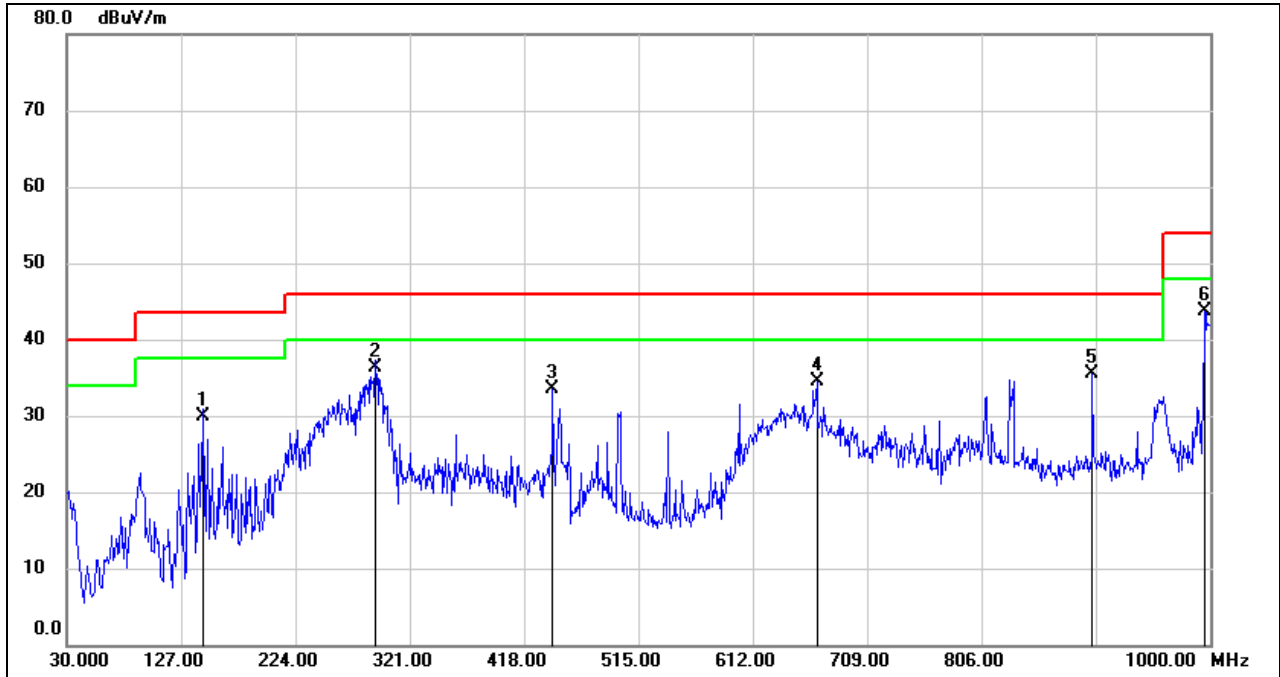

No.	Frequency (MHz)	Reading (dBuV)	Correct (dB/m)	Result (dBuV/m)	Limit (dBuV/m)	Margin (dB)	Remark
1	145.4299	48.54	-18.70	29.84	43.50	-13.66	QP
2	291.9000	50.55	-14.34	36.21	46.00	-9.79	QP
3	442.2500	45.08	-11.56	33.52	46.00	-12.48	QP
4	666.3200	41.79	-7.23	34.56	46.00	-11.44	QP
5	900.0900	39.61	-4.11	35.50	46.00	-10.50	QP
6	995.1500	46.74	-2.95	43.79	54.00	-10.21	QP

- Note: 1. Result Level = Read Level + Antenna Factor + Cable loss.
 2. If Peak Result complies with QP limit, QP Result is deemed to comply with QP limit.
 3. Test setup: RBW: 120 kHz, VBW: 300 kHz, Sweep time: auto.



SPURIOUS EMISSIONS (LOW CHANNEL, WORST-CASE CONFIGURATION, VERTICAL)

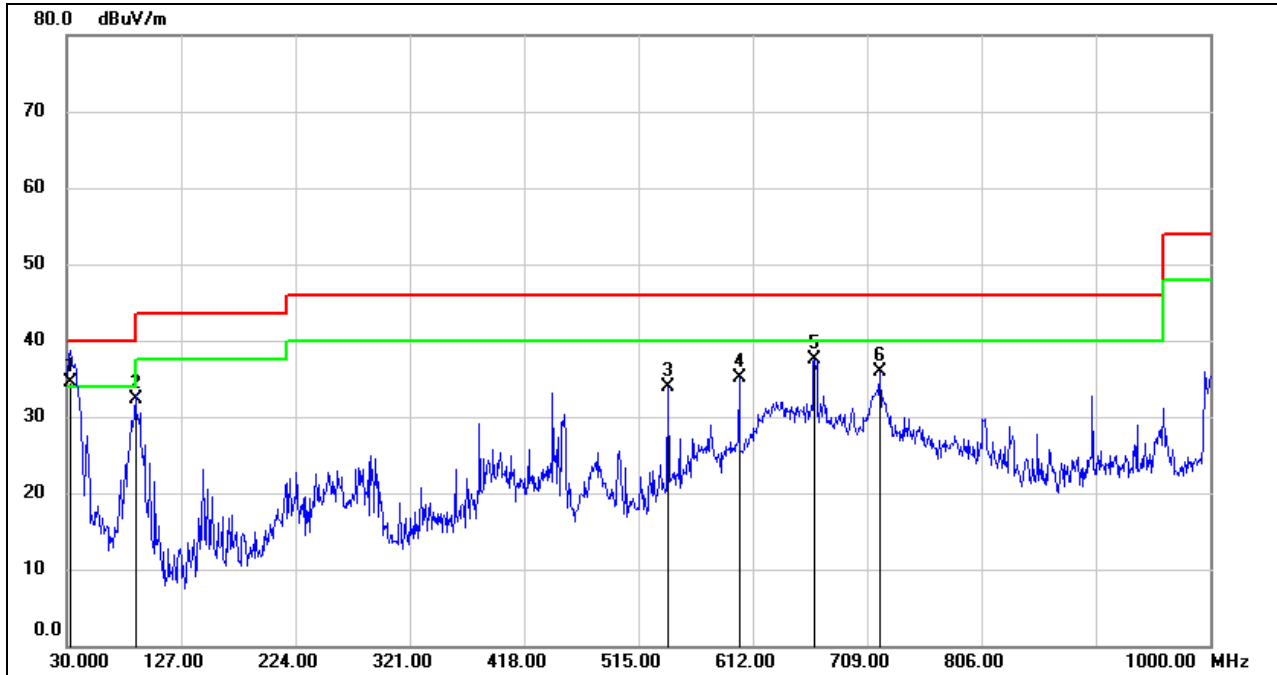

No.	Frequency (MHz)	Reading (dBuV)	Correct (dB/m)	Result (dBuV/m)	Limit (dBuV/m)	Margin (dB)	Remark
1	32.9100	51.86	-17.39	34.47	40.00	-5.53	QP
2	88.2000	53.31	-21.03	32.28	43.50	-11.22	QP
3	540.2199	43.49	-9.59	33.90	46.00	-12.10	QP
4	600.3600	43.47	-8.42	35.05	46.00	-10.95	QP
5	664.3800	44.75	-7.26	37.49	46.00	-8.51	QP
6	719.6700	42.07	-6.09	35.98	46.00	-10.02	QP

- Note: 1. Result Level = Read Level + Antenna Factor + Cable loss.
 2. If Peak Result complies with QP limit, QP Result is deemed to comply with QP limit.
 3. Test setup: RBW: 120 kHz, VBW: 300 kHz, Sweep time: auto

Note: All test mode has been tested, only the worst data record in the report.



7.7. SPURIOUS EMISSIONS BELOW 30M

7.7.1. GFSK MODE

SPURIOUS EMISSIONS (HIGH CHANNEL, LOOP ANTENNA FACE ON TO THE EUT, WORST-CASE CONFIGURATION)

9kHz~ 150kHz

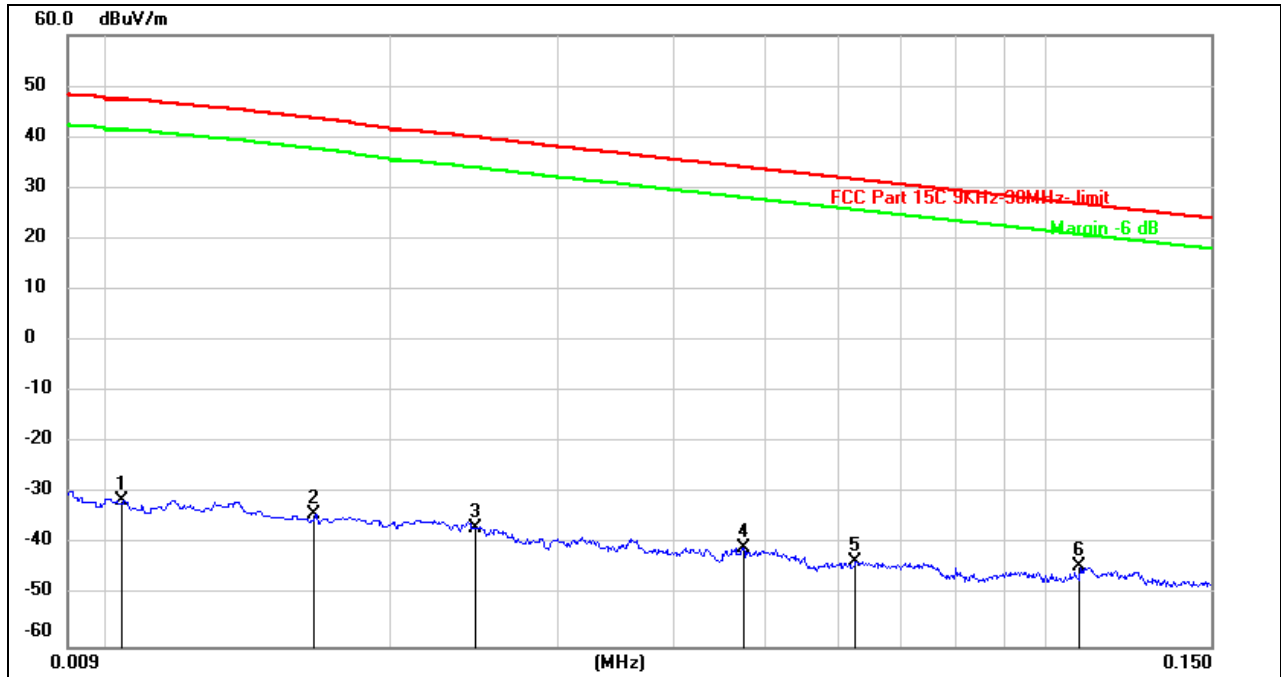

No.	Frequency (MHz)	Reading (dBuV)	Correct (dB/m)	Result (dBuV)	Limit (dBuV)	Margin (dB)	Remark
1	0.0103	70.14	-101.40	-31.26	47.42	-78.68	peak
2	0.0165	67.34	-101.37	-34.03	43.69	-77.72	peak
3	0.0246	64.70	-101.36	-36.66	39.96	-76.62	peak
4	0.0475	60.94	-101.47	-40.53	34.10	-74.63	peak
5	0.0626	58.31	-101.53	-43.22	31.69	-74.91	peak
6	0.1087	57.38	-101.78	-44.40	26.89	-71.29	peak

Note: 1. Measurement = Reading Level + Correct Factor.

2. If Peak Result complies with AV and QP limit, AV and QP Result are deemed to comply with AV limit.

3. All 3 polarizations(Horizontal, Face-on and Face-off) of the loop antenna had been tested, but only the worst data recorded in the report.



150kHz ~ 0.49MHz

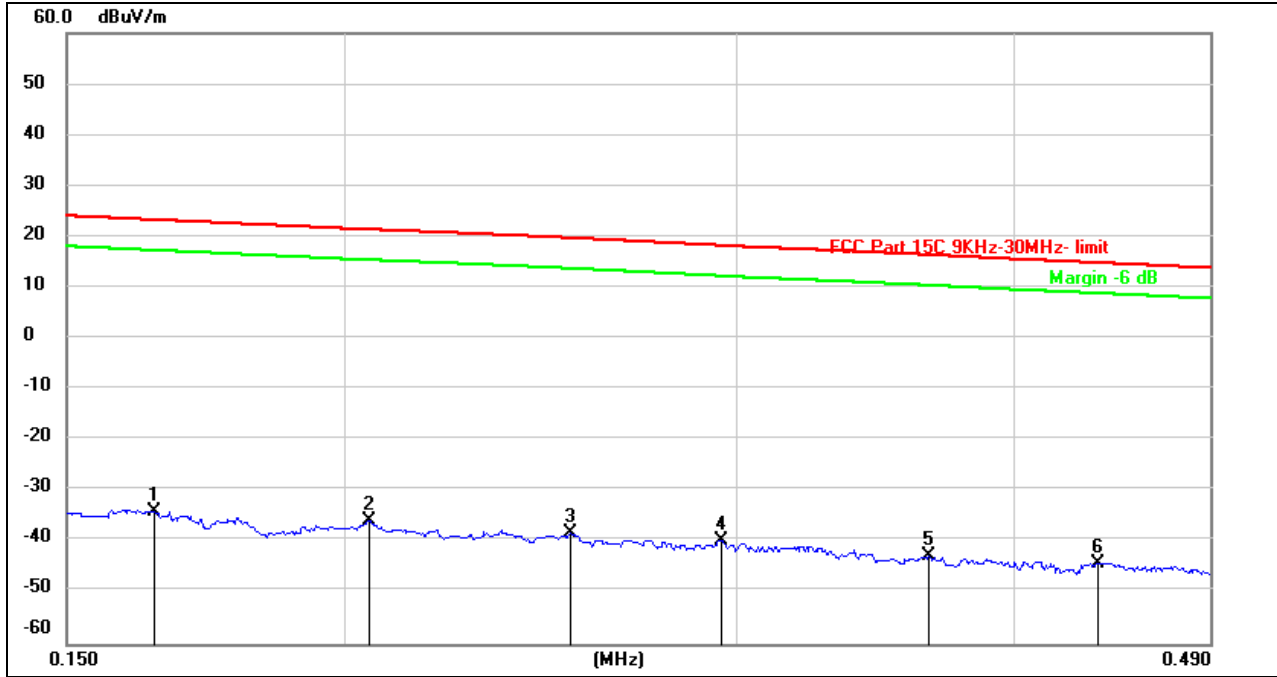

No.	Frequency (MHz)	Reading (dBuV)	Correct (dB/m)	Result (dBuV)	Limit (dBuV)	Margin (dB)	Remark
1	0.1643	67.67	-101.65	-33.98	23.30	-57.28	peak
2	0.2051	65.81	-101.73	-35.92	21.40	-57.32	peak
3	0.2530	63.59	-101.80	-38.21	19.71	-57.92	peak
4	0.2953	62.13	-101.85	-39.72	18.23	-57.95	peak
5	0.3662	59.08	-101.93	-42.85	16.40	-59.25	peak
6	0.4364	57.86	-101.99	-44.13	14.85	-58.98	peak

Note: 1. Measurement = Reading Level + Correct Factor.
 2. If Peak Result complies with AV and QP limit, AV and QP Result are deemed to comply with AV limit.
 3. All 3 polarizations(Horizontal, Face-on and Face-off) of the loop antenna had been tested, but only the worst data recorded in the report.



0.49MHz ~ 30MHz

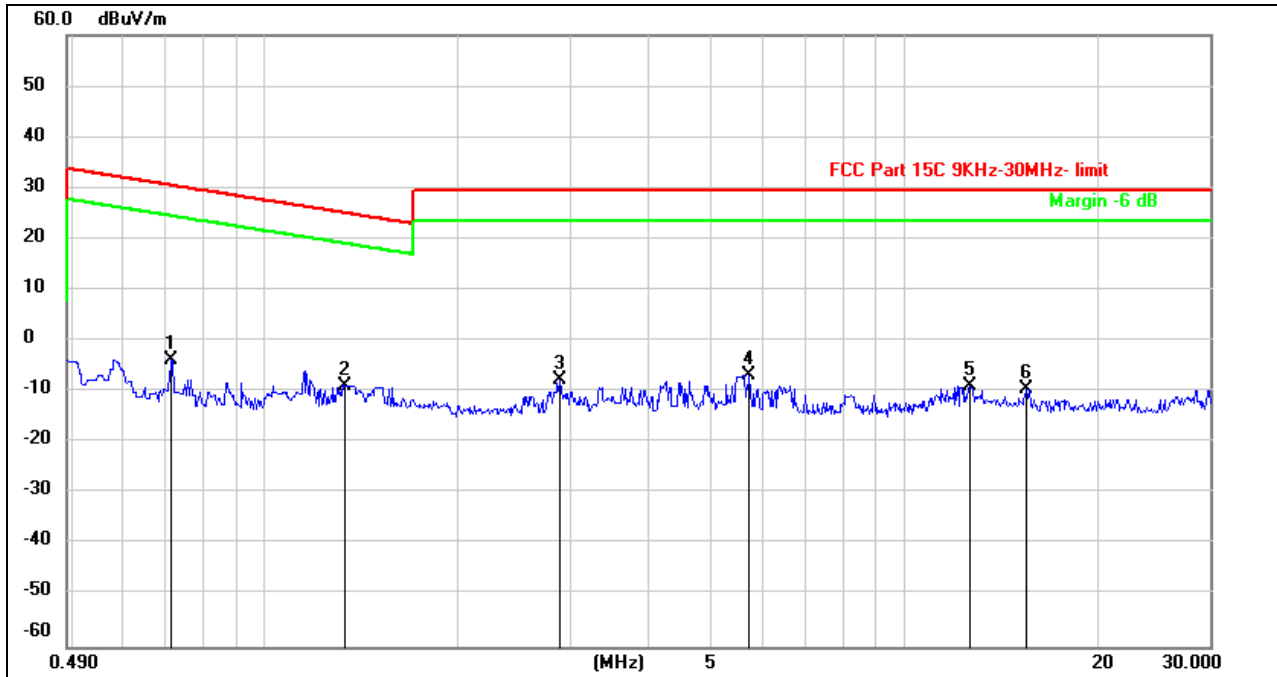

No.	Frequency (MHz)	Reading (dBuV)	Correct (dB/m)	Result (dBuV)	Limit (dBuV)	Margin (dB)	Remark
1	0.7125	58.32	-62.12	-3.80	30.55	-34.35	peak
2	1.3317	53.38	-62.11	-8.73	25.12	-33.85	peak
3	2.8864	54.03	-61.60	-7.57	29.54	-37.11	peak
4	5.7145	54.67	-61.39	-6.72	29.54	-36.26	peak
5	12.6775	51.96	-60.92	-8.96	29.54	-38.50	peak
6	15.4809	51.70	-61.00	-9.30	29.54	-38.84	peak

- Note: 1. Measurement = Reading Level + Correct Factor.
 2. If Peak Result complies with AV and QP limit, AV and QP Result are deemed to comply with AV limit.
 3. All 3 polarizations(Horizontal, Face-on and Face-off) of the loop antenna had been tested, but only the worst data recorded in the report.

Note: All test mode has been tested, only the worst data record in the report.

8. AC POWER LINE CONDUCTED EMISSIONS

LIMITS

Please refer to CFR 47 FCC §15.207 (a) and ISED RSS-Gen Clause 8.8.

FREQUENCY (MHz)	Quasi-peak	Average
0.15 -0.5	66 - 56 *	56 - 46 *
0.50 -5.0	56.00	46.00
5.0 -30.0	60.00	50.00

TEST SETUP AND PROCEDURE

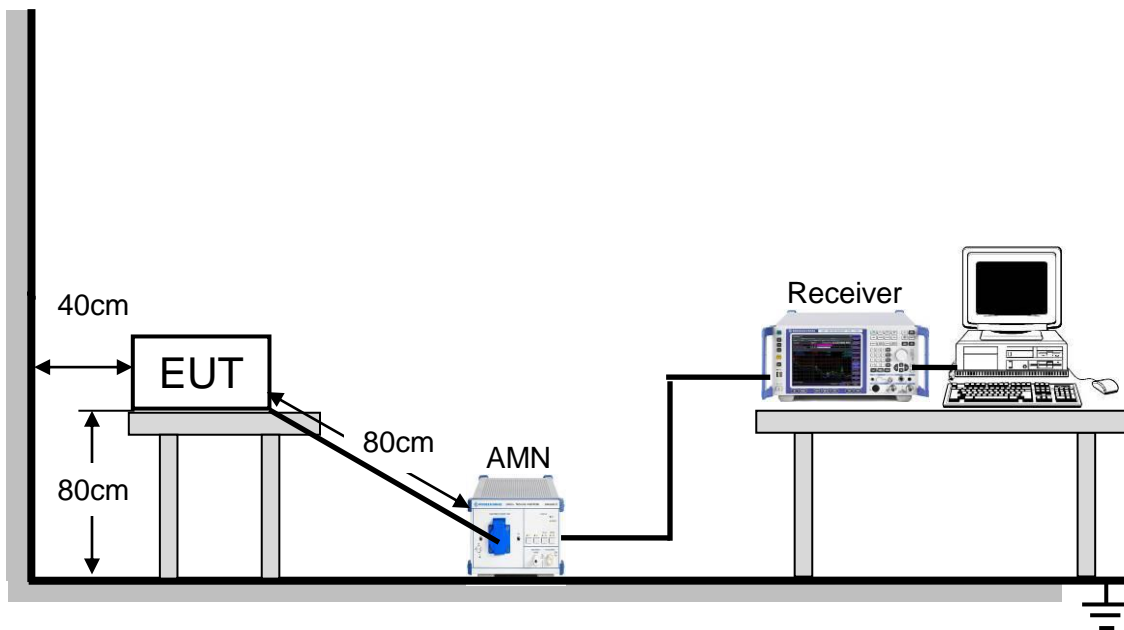

The EUT is put on a table of non-conducting material that is 80cm high. The vertical conducting wall of shielding is located 40cm to the rear of the EUT. The power line of the EUT is connected to the AC mains through a Artificial Mains Network (A.M.N.). A EMI Measurement Receiver (R&S Test Receiver ESR3) is used to test the emissions from both sides of AC line. According to the requirements in Section 6.2 of ANSI C63.10-2013. Conducted emissions from the EUT measured in the frequency range between 0.15 MHz and 30MHz using CISPR Quasi-Peak and average detector mode. The bandwidth of EMI test receiver is set at 9kHz.

The arrangement of the equipment is installed to meet the standards and operating in a manner, which tends to maximize its emission characteristics in a normal application.



8.1.1. GFSK MODE

TEST RESULTS (HIGH CHANNEL, WORST-CASE CONFIGURATION)

LINE N RESULTS

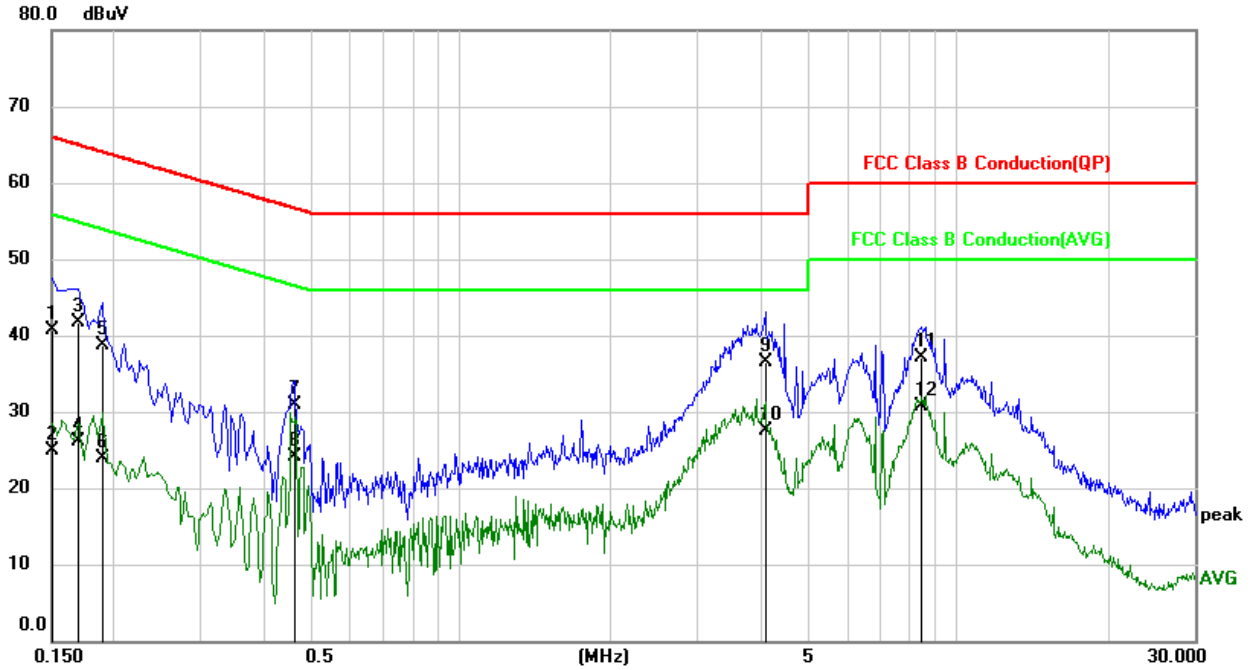

No.	Frequency (MHz)	Reading (dBuV)	Correct (dB)	Result (dBuV)	Limit (dBuV)	Margin (dB)	Remark
1	0.1500	31.02	9.60	40.62	66.00	-25.38	QP
2	0.1500	15.21	9.60	24.81	56.00	-31.19	AVG
3	0.1698	32.03	9.60	41.63	64.97	-23.34	QP
4	0.1698	16.54	9.60	26.14	54.97	-28.83	AVG
5	0.1909	29.08	9.60	38.68	64.00	-25.32	QP
6	0.1909	14.38	9.60	23.98	54.00	-30.02	AVG
7	0.4654	21.25	9.60	30.85	56.60	-25.75	QP
8	0.4654	14.49	9.60	24.09	46.60	-22.51	AVG
9	4.0938	26.92	9.66	36.58	56.00	-19.42	QP
10	4.0938	17.75	9.66	27.41	46.00	-18.59	AVG
11	8.4980	27.35	9.73	37.08	60.00	-22.92	QP
12	8.4980	21.01	9.73	30.74	50.00	-19.26	AVG

- Note: 1. Result = Reading +Correct Factor.
 2. If QP Result complies with AV limit, AV Result is deemed to comply with AV limit.
 3. Test setup: RBW: 200 Hz (9 kHz—150 kHz), 9 kHz (150 kHz—30 MHz).
 4. Step size: 80Hz (0.009MHz-0.15MHz), 4 kHz (0.15MHz-30MHz), Scan time: auto.



LINE L RESULTS

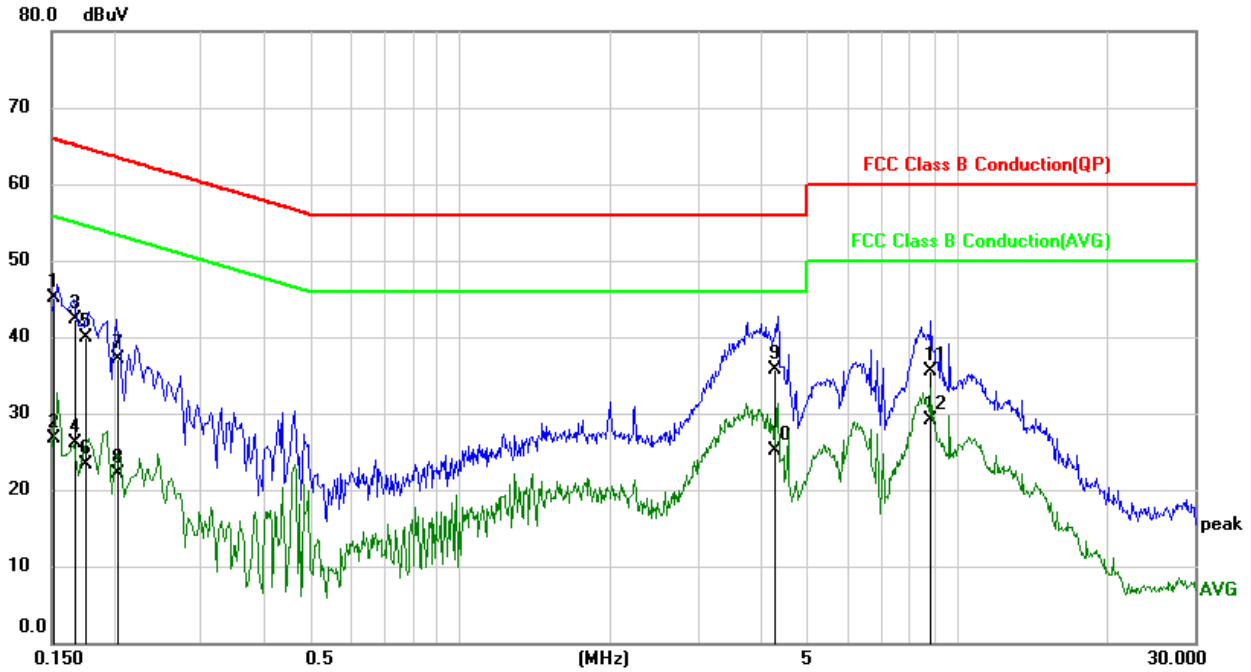

No.	Frequency (MHz)	Reading (dBuV)	Correct (dB)	Result (dBuV)	Limit (dBuV)	Margin (dB)	Remark
1	0.1516	35.44	9.61	45.05	65.91	-20.86	QP
2	0.1516	17.02	9.61	26.63	55.91	-29.28	AVG
3	0.1672	32.78	9.61	42.39	65.10	-22.71	QP
4	0.1672	16.52	9.61	26.13	55.10	-28.97	AVG
5	0.1751	30.37	9.61	39.98	64.71	-24.73	QP
6	0.1751	13.71	9.61	23.32	54.71	-31.39	AVG
7	0.2043	27.42	9.60	37.02	63.43	-26.41	QP
8	0.2043	12.60	9.60	22.20	53.43	-31.23	AVG
9	4.2851	26.06	9.66	35.72	56.00	-20.28	QP
10	4.2851	15.51	9.66	25.17	46.00	-20.83	AVG
11	8.8225	25.81	9.73	35.54	60.00	-24.46	QP
12	8.8225	19.44	9.73	29.17	50.00	-20.83	AVG

- Note: 1. Result = Reading +Correct Factor.
 2. If QP Result complies with AV limit, AV Result is deemed to comply with AV limit.
 3. Test setup: RBW: 200 Hz (9 kHz—150 kHz), 9 kHz (150 kHz—30 MHz).
 4. Step size: 80Hz (0.009MHz-0.15MHz), 4 kHz (0.15MHz-30MHz), Scan time: auto.

Note: All test mode has been tested, only the worst data record in the report.



9. ANTENNA REQUIREMENTS

APPLICABLE REQUIREMENTS

Please refer to FCC §15.203

An intentional radiator shall be designed to ensure that no antenna other than that furnished by the responsible party shall be used with the device. The use of a permanently attached antenna or of an antenna that uses a unique coupling to the intentional radiator shall be considered sufficient to comply with the provisions of this section. The manufacturer may design the unit so that a broken antenna can be replaced by the user, but the use of a standard antenna jack or electrical connector is prohibited.

Please refer to FCC §15.247(b)(4)

The conducted output power limit specified in paragraph (b) of this section is based on the use of antennas with directional gains that do not exceed 6 dBi. Except as shown in paragraph (c) of this section, if transmitting antennas of directional gain greater than 6 dBi are used, the conducted output power from the intentional radiator shall be reduced below the stated values in paragraphs (b)(1), (b)(2), and (b)(3) of this section, as appropriate, by the amount in dB that the directional gain of the antenna exceeds 6 dBi.

RESULTS

Complies

END OF REPORT