

FCC Radio Test Report

FCC ID: 2AC23-WT39M2011

**FCC 47 CFR Part 15 Subpart C
RSS 247 Issue 1:2015**

Product : WIFI+BT Module

Trade Name : GSD

Model Number : WT39M2011

Firmware Version Identification Number (FVIN): 1.0

Issued for

Hui Zhou Gaoshengda Technology Co.,LTD

NO.75 Zhongkai Development Area, Huizhou, Guangdong, China

Issued by

Shenzhen ATL Testing Technology Co., Ltd.

F/4, Building 10, Dayuan Industrial Zone, Xili Town, Nanshan District, Shenzhen,
China

Tel.: +86-0755-26909822 Fax.: +86-0755-61605504

Website: www.atllab.org

Note: This report shall not be reproduced except in full, without the written approval of Shenzhen ATL Testing Technology Co., Ltd.. This document may be altered or revised by Shenzhen ATL Testing Technology Co., Ltd. personnel only, and shall be noted in the revision section of the document. The test results in the report only apply to the tested sample

TEST RESULT CERTIFICATION

Product : WIFI+BT Module
Applicant..... : Hui Zhou Gaoshengda Technology Co.,LTD
Address : NO.75 Zhongkai Development Area, Huizhou, Guangdong, China
Manufacturer..... : Hui Zhou Gaoshengda Technology Co.,LTD
Address : NO.75 Zhongkai Development Area, Huizhou, Guangdong, China
Model No. : WT39M2011
Standards : FCC Part 15 Subpart C (15.247)
 : RSS 247 Issue 1: 2015
Test Method..... : ANSI C63.10: 2014

The above equipment has been tested by Shenzhen ATL Testing Technology Co., Ltd. and found compliance with the requirements set forth in the technical standards mentioned above. The results of testing in this report apply only to the product/system, which was tested. Other similar equipment will not necessarily produce the same results due to production tolerance and measurement uncertainties.

Test..... :

Date of receipt of test item 2015-12-28
Date(s) of performance of test 2016-01-04 to 2016-01-25
Test Result..... : Pass

Testing by	:		Date	:	2016-01-25
		(Si feifei)			_____
Check by	:		Date	:	2016-01-25
		(Xie Lingling)			_____
Approved by	:		Date	:	2016-01-26
		(Xu Peng)			_____

Table of Contents	Page
1 . TEST SUMMARY	6
1.1 TEST FACILITY	7
1.2 MEASUREMENT UNCERTAINTY	7
2 . GENERAL INFORMATION	8
2.1 GENERAL DESCRIPTION OF EUT	8
2.2 DESCRIPTION OF TEST MODES	9
2.3 DESCRIPTION OF TEST SETUP	10
2.4 DESCRIPTION TEST PERIPHERAL AND EUT PERIPHERAL	11
2.5 EUT Exercise Software	11
3 . CONDUCTED EMISSION TEST	12
3.1 CONDUCTED EMISSION MEASUREMENT (Frequency Range 150KHz-30MHz)	12
3.2 TEST PROCEDURE	12
3.3 TEST SETUP	13
3.4 TEST INSTRUMENTS	13
3.5 EUT OPERATING CONDITIONS	13
3.6 TEST RESULTS	14
4 . RADIATED EMISSION MEASUREMENT	17
4.1 RADIATED EMISSION LIMIT (Frequency Range 9KHz-1000MHz)	17
4.2 TEST PROCEDURE	17
4.3 TEST SETUP	18
4.4 TEST INSTRUMENTS	19
4.5 EUT OPERATING CONDITIONS	19
4.6 TEST RESULTS	20
5 . CONDUCTED OUTPUT POWER MEASUREMENT	28
5.1 LIMITS	28
5.2 TEST PROCEDURE	28
5.3 TEST SETUP	28
5.4 TEST INSTRUMENTS	28
5.5 EUT OPERATING CONDITIONS	28
5.6 TEST RESULTS	28

Table of Contents	Page
6 . OCCUPIED BANDWIDTH MEASUREMENT	33
6.1 LIMITS	33
6.2 TEST PROCEDURE	33
6.3 TEST SETUP	33
6.4 TEST INSTRUMENTS	33
6.5 EUT OPERATING CONDITIONS	33
6.6 TEST RESULTS	33
7 . CARRIER FREQUENCY SEPARATION MEASUREMENT	38
7.1 LIMITS	38
7.2 TEST PROCEDURE	38
7.3 TEST SETUP	38
7.4 TEST INSTRUMENTS	38
7.5 EUT OPERATING CONDITIONS	38
7.6 TEST RESULTS	38
8 . NUMBER OF HOPPING	43
8.1 LIMITS	43
8.2 TEST PROCEDURE	43
8.3 TEST SETUP	43
8.4 TEST INSTRUMENTS	43
8.5 EUT OPERATING CONDITIONS	43
8.6 TEST RESULTS	43
9 . DWELL TIME	46
9.1 LIMITS	46
9.2 TEST PROCEDURE	46
9.3 TEST SETUP	46
9.4 TEST INSTRUMENTS	46
9.5 EUT OPERATING CONDITIONS	46
9.6 TEST RESULTS	46
10 . BAND EDGES MEASUREMENT	59
10.1 LIMITS	59
10.2 TEST PROCEDURE	59

Table of Contents	Page
10.3 TEST SETUP	59
10.4 TEST INSTRUMENTS	60
10.5 EUT OPERATING CONDITIONS	60
10.6 TEST RESULTS	60
11 . OUT OF BAND CONDUCTED EMISSIONS MEASUREMENT	65
11.1 LIMITS	65
11.2 TEST PROCEDURE	65
11.3 TEST SETUP	65
11.4 TEST INSTRUMENTS	65
11.5 EUT OPERATING CONDITIONS	65
11.6 TEST RESULTS	65
12 . ANTENNA REQUIREMENT	69
12.1 REQUIREMENT	69
12.2 ANTENNA CONNECTOR CONSTRUCTION	69

1. TEST SUMMARY

Test procedures according to the technical standards:

FCC Part 15 Subpart C (15.247)				
Standard Section		Test Item	Judgment	Remark
15.207	RSS Gen 7.2.4	AC Power Conducted Emission	PASS	
15.247(c)	RSS 247 5.5	Transmitter Radiated Emissions	PASS	
15.247(b)(1)	RSS 247 5.1	Output Power	PASS	
15.247(a)(1)	RSS 247 5.1	20dB RF Bandwidth	PASS	
15.247(a)(1)(iii)	RSS 247 5.1	Carrier Frequency Separation	PASS	
15.247(a)(1)(iii)	RSS 247 5.1	Hopping Number	PASS	
15.247(a)(1)(iii)	RSS 247 5.1	Dwell Time	PASS	
15.247(c)	RSS 247 5.1	Occupied Bandwidth Measurement	PASS	
15.247(c)	RSS 247 5.5	Out of Band Conducted Spurious Emission	PASS	
15.247(c)	RSS 247 5.5	Band Edge Measurement	PASS	
15.203		Antenna Requirement	PASS	

NOTE:

(1) "N/A" denotes test is not applicable in this Test Report

(2) The test results of this report relate only to the tested sample(s) identified in this report.

1.1 TEST FACILITY

Shenzhen ATL Testing Technology Co., Ltd.

Add. : F/4, Building 10, Dayuan Industrial Zone, Xili Town, Nanshan District, Shenzhen, China

1.2 MEASUREMENT UNCERTAINTY

The reported uncertainty of measurement $y \pm U$, where expanded uncertainty U is based on a standard uncertainty multiplied by a coverage factor of $k=2$, providing a level of confidence of approximately **95** %.

A. Conducted Emission :

The measurement uncertainty is evaluated as ± 3.2 dB.

B. Radiated Measurement :

The measurement uncertainty is evaluated as ± 3.7 dB.

2. GENERAL INFORMATION

2.1 GENERAL DESCRIPTION OF EUT

Equipment	WIFI+BT Module
Model Name	WT39M2011
Additional Model Number(s)	N/A
Model Difference	N/A
Frequency Range	Bluetooth 4.0 Bluetooth V2.0+EDR: 2402~2480 MHz
Modulation Type	Bluetooth: GFSK/ $\pi/4$ -DQPSK/8-DPSK
RF Output Power	Bluetooth: GFSK: 3.80 dBm 8-DPSK: 2.09 dBm
Antenna Type	FPC Antenna (Gain: 3.96 dBi)
Power Source	DC Powered by host system.
Power Rating	DC 5V from USB interference.
Remark	More details EUT technical specifications, please refer to the User's Manual.

Note:

- (1) This Test Report is FCC Part 15 Subpart C, 15.247 for Bluetooth. And the Test procedure follows the FCC Public Notice DA 00-705-Filing and Measurement Guidance for Frequency Hopping Spectrum Systems.
- (2) More information about the Wifi, please refer to other test report.
- (3) Transmitting mode with antennas

Mode	TX Antenna (s)
Bluetooth	1

2.2 DESCRIPTION OF TEST MODES

To investigate the maximum EMI emission characteristics generated from EUT, the test system was pre-scanning tested based on the consideration of following EUT operation mode or test configuration mode which possibly have effect on EMI emission level. Each of these EUT operation mode(s) or test configuration mode(s) mentioned above was evaluated respectively.

Pretest Mode	Description
Mode 1	BT TX(GFSK) Mode
Mode 2	BT TX($\pi/4$ -DQPSK) Mode
Mode 3	BT TX(8-DPSK) Mode

For Conducted Test	
Final Test Mode	Description
Mode 1	BT TX(GFSK) Mode

For Radiated Test	
Final Test Mode	Description
Mode 1	BT TX(GFSK) Mode
Mode 2	BT TX(8-DPSK) Mode

Note:

- (1) Software used to control the EUT for staying in continuous transmitting mode was programmed. After verification, all tests were carried out with the worst case test modes as shown below.
- (2) GFSK Mode:
Channel (2402/2441/2480 MHz) with DH1 data packet were chosen for full testing.
- (3) 8-DPSK Mode:
Channel (2402/2441/2480 MHz) with DH1 data packet were chosen for full testing.
- (4) By preliminary testing and verifying three axis (X, Y and Z) position of EUT transmitted status, it was found that "X axis" position was the worst, then the final test was executed the worst condition and test data were recorded in this report.

2.3 DESCRIPTION OF TEST SETUP

Radiated Emission

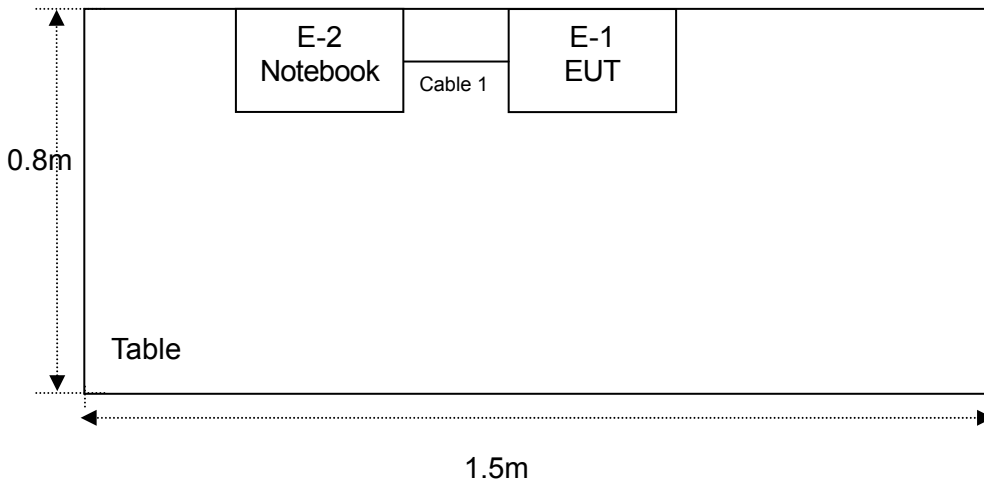

2.4 DESCRIPTION TEST PERIPHERAL AND EUT PERIPHERAL

The EUT has been tested as an independent unit together with other necessary accessories or support units. The following support units or accessories were used to form a representative test configuration during the tests.

Item	Equipment	Mfr/Brand	Model/Type No.	Series No.	Note
E-1	WIFI Module	GSD	WT39M2011	N/A	EUT
E-2	Notebook	LENOVO	P405	DOC	

Item	Shielded Type	Ferrite Core	Length	Note
1	NO	NO	15cm	

Note:

- (1) The support equipment was authorized by Declaration of Confirmation.
- (2) For detachable type I/O cable should be specified the length in cm in 『Length』 column.
- (3) “YES” means “shielded” “with core”; “NO” means “unshielded” “without core”.

2.5 EUT Exercise Software

Test Software: Media Tek BT Tool.exe

GFSK: The command set for RF power-DEF
 8-DPSK: The command set for RF power-DEF

3. CONDUCTED EMISSION TEST

3.1 CONDUCTED EMISSION MEASUREMENT (Frequency Range 150KHz-30MHz)

FREQUENCY (MHz)	Quasi-peak	Average
	dBuV	dBuV
0.15 -0.5	66 - 56 *	56 - 46 *
0.50 -5.0	56.00	46.00
5.0 -30.0	60.00	50.00

Note:

- (1) The tighter limit applies at the band edges.
- (2) The limit of " * " marked band means the limitation decreases linearly with the logarithm of the frequency in the range.

The following table is the setting of the receiver

Receiver Parameters	Setting
Attenuation	10 dB
Start Frequency	0.15 MHz
Stop Frequency	30 MHz
IF Bandwidth	9 kHz

3.2 TEST PROCEDURE

- a. The EUT was placed 0.8 meters from the horizontal ground plane with EUT being connected to the power mains through a line impedance stabilization network (LISN). All other support equipments powered from additional LISN(s). The LISN provide 50 Ohm/ 50uH of coupling impedance for the measuring instrument.
- b. Interconnecting cables that hang closer than 40 cm to the ground plane shall be folded back and forth in the center forming a bundle 30 to 40 cm long.
- c. I/O cables that are not connected to a peripheral shall be bundled in the center. The end of the cable may be terminated, if required, using the correct terminating impedance. The overall length shall not exceed 1 m.
- d. LISN at least 80 cm from nearest part of EUT chassis.
- e. For the actual test configuration, please refer to the related Item –EUT Test Photos.

3.3 TEST SETUP

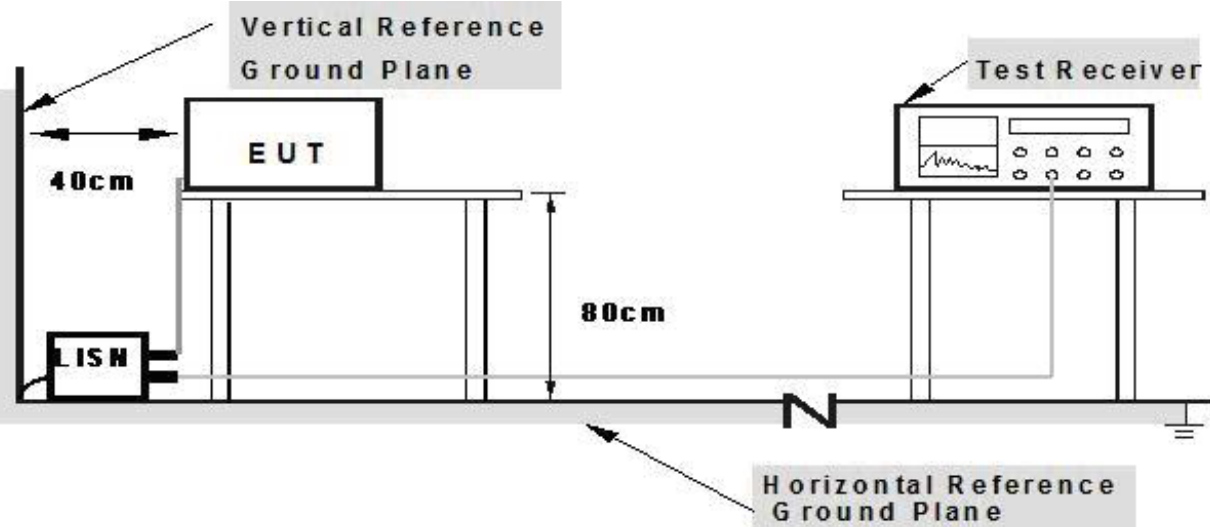

- Note: 1. Support units were connected to second LISN.**
2. Both of LISNs (AMN) are 80 cm from EUT and at least 80 cm from other units and other metal planes

3.4 TEST INSTRUMENTS

Equipment	Manufacturer	Type No.	Serial No.	Last calibration	Calibrated until	Calibration period
LISN	R&S	NSLK81	8126466	Jul. 05, 2015	Jul. 04. 2016	1 year
LISN	R&S	NSLK81	8126487	Dec. 23, 2015	Dec. 22, 2016	1 year
50Ω Switch	ANRITSU CORP	MP59B	6200983704	Jul. 05, 2015	Jul. 04. 2016	1 year
Test Cable	N/A	C01	N/A	Jul. 05, 2015	Jul. 04. 2016	1 year
Test Cable	N/A	C02	N/A	Jul. 05, 2015	Jul. 04. 2016	1 year
Test Cable	N/A	C03	N/A	Jul. 05, 2015	Jul. 04. 2016	1 year
EMI Test Receiver	R&S	ESCI	1166.595	Jul. 05, 2015	Jul. 04. 2016	1 year
Passive Voltage Probe	ESH2-Z3	R&S	100196	Jul. 05, 2015	Jul. 04. 2016	1 year

3.5 EUT OPERATING CONDITIONS

The EUT tested system was configured as the statements of 2.3 Unless otherwise a special operating condition is specified in the follows during the testing.

3.6 TEST RESULTS

EUT :	WiFi+BT Module	Model Name. :	WT39M2011
Temperature :	26 °C	Relative Humidity :	56%
Pressure :	1010hPa	Test Date :	2016-01-16
Test Mode :	Mode 1	Phase :	Line
Test Voltage :	120V/ 60Hz		

No.	Mk.	Freq. MHz	Reading Level dBuV	Correct Factor dB	Measure- ment dBuV	Limit dBuV	Over dB	Detector
1		0.1516	30.15	9.92	40.07	65.91	-25.84	peak
2	*	0.4020	26.81	10.02	36.83	57.81	-20.98	peak
3		0.6820	18.81	10.11	28.92	56.00	-27.08	peak
4		1.2660	18.58	10.06	28.64	56.00	-27.36	peak
5		1.6580	18.01	10.06	28.07	56.00	-27.93	peak
6		3.6340	18.06	10.01	28.07	56.00	-27.93	peak

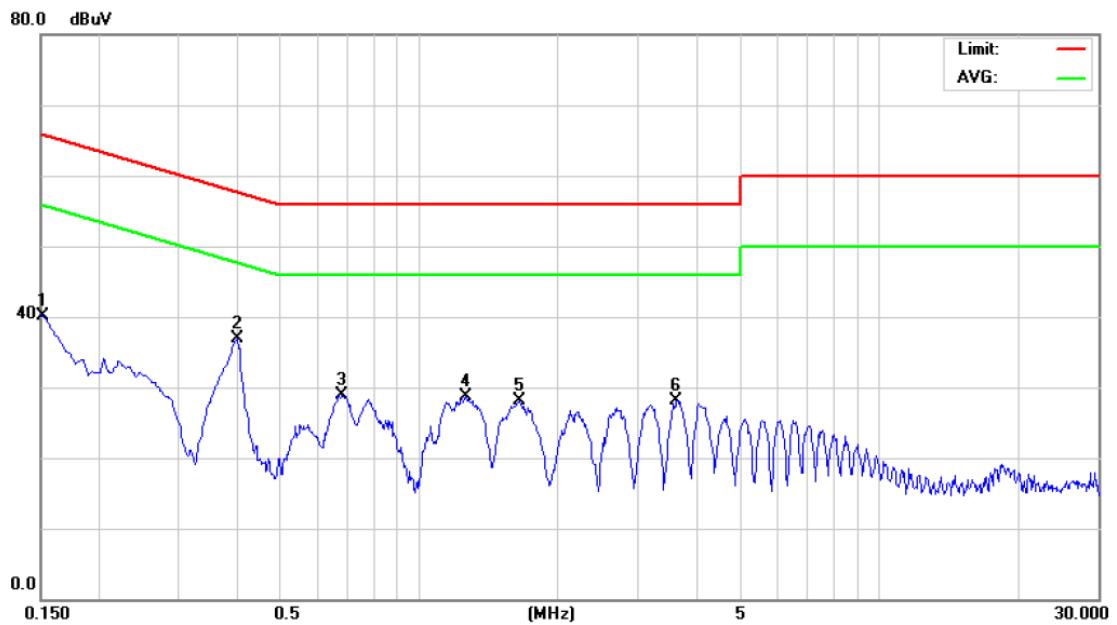

EUT :	WIFI+BT Module	Model Name. :	WT39M2011
Temperature :	26 °C	Relative Humidity :	56%
Pressure :	1010hPa	Test Date :	2016-01-16
Test Mode :	Mode 1	Phase :	Neutral
Test Voltage :	120V/ 60Hz		

No. Mk.	Freq. MHz	Reading Level dBuV	Correct Factor dB	Measure- ment dBuV	Limit dBuV	Over dB	Detector
1	0.1500	30.69	10.12	40.81	66.00	-25.19	peak
2 *	0.3980	26.79	10.05	36.84	57.90	-21.06	peak
3	0.6700	19.02	10.02	29.04	56.00	-26.96	peak
4	1.2420	18.50	10.14	28.64	56.00	-27.36	peak
5	1.6900	16.76	10.09	26.85	56.00	-29.15	peak
6	3.1420	17.21	10.06	27.27	56.00	-28.73	peak

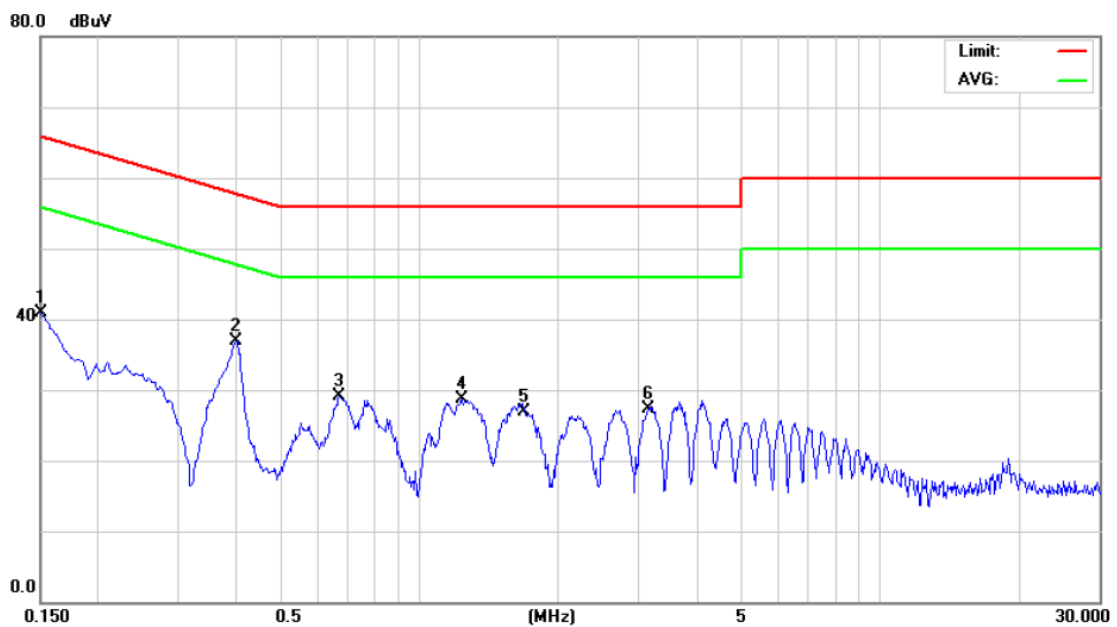

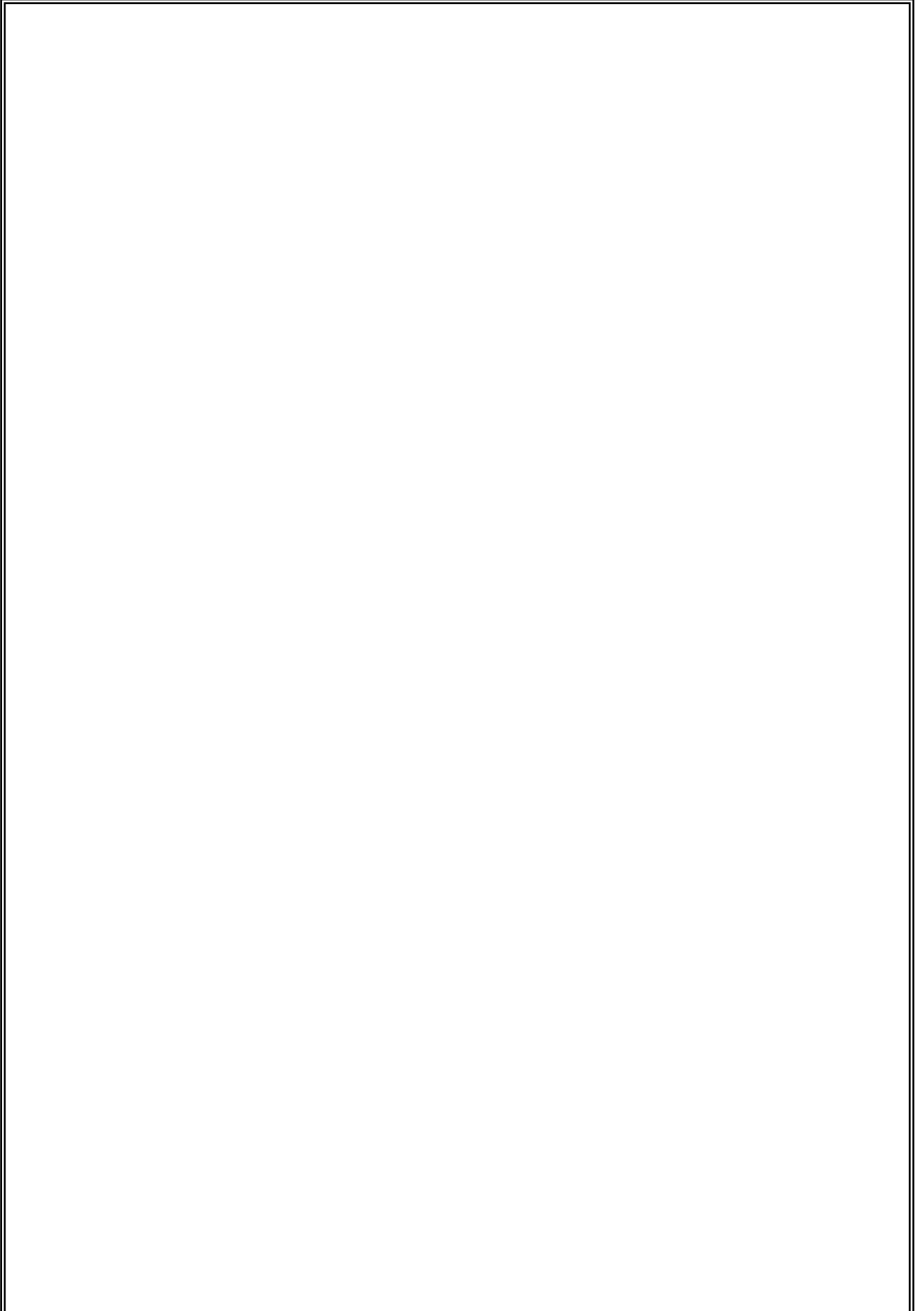

4. RADIATED EMISSION MEASUREMENT

4.1 RADIATED EMISSION LIMIT (Frequency Range 9KHz-1000MHz)

20 dBc in any 100 kHz bandwidth outside the operating frequency band. In case the emission fall within the restricted band specified on 15.205(a), then the 15.209(a) limit in the table bellow has to be followed.

FREQUENCY (MHz)	Field Strength (uV/m at meter)	Measurement Distance (meters)
0.009 -0.490	2400/F(KHz)	300
0.490 -1.705	24000/F(KHz)	30
1.705 -30.0	30	30
30 -88	100	3
88 -216	150	3
216~960	200	3
Above 960	500	3

RADIATED EMISSION LIMITS (Above 1000MHz)

FREQUENCY (MHz)	Class A (dBuV/m)(at 3 M)		Class B (dBuV/m)(at 3 M)	
	Peak	Average		Peak
Above 1000	80	60	74	54

Note:

- (1) The limit for radiated test was performed according to FCC PART 15C.
- (2) The tighter limit applies at the band edges.
- (2) Emission Level(dBuV/m)=20log Emission Level(uV/m)

The following table is the setting of the receiver

Receiver Parameter	Setting
Attenuation	Auto
Start Frequency~ Stop Frequency	9kHz~150kHz/ RB 200Hz for QP
Start Frequency~ Stop Frequency	150kHz~30MHz/ RB 9kHz for QP
Start Frequency~ Stop Frequency	30MHz~1000MHz/ RB120kHz for QP

The following table is the setting of the spectrum

Spectrum Parameter	Setting
Attenuation	Auto
Start Frequency	1000 MHz
Stop Frequency	10 th carrier harmonic
RB/ VB (emission in restricted band)	1MHz/ 3 MHz for Peak, 1MHz/ 10Hz for Average

4.2 TEST PROCEDURE

- a. The measuring distance of at 3 m shall be used for measurements at frequency up to 1GHz. For frequencies above 1GHz, any suitable measuring distance may be used.

- b. The EUT was placed on the top of a rotating table 0.8 meters above the ground at a 3 meter open area test site. The table was rotated 360 degrees to determine the position of the highest radiation.
- c. The height of the equipment or of the substitution antenna shall be 0.8 m; the height of the test antenna shall vary between 1 m to 4 m. Both horizontal and vertical polarizations of the antenna are set to make the measurement.
- d. The initial step in collecting conducted emission data is a spectrum analyzer peak detector mode pre-scanning the measurement frequency range. Significant peaks are then marked and then Quasi Peak detector mode re-measured, above 1G Average detector mode will be instead.
- e. If the Peak Mode measured value compliance with and lower than Quasi Peak Mode Limit, the EUT shall be deemed to meet QP Limits and then no additional QP Mode measurement performed.
- f. For the actual test configuration, please refer to the related Item –EUT Test Photos.

Note:

Both horizontal and vertical antenna polarities were tested.

And performed pretest to three orthogonal axis. The worst case emissions were reported.

4.3 TEST SETUP

(A) Radiated Emission Test Set-Up Frequency Below 1 GHz

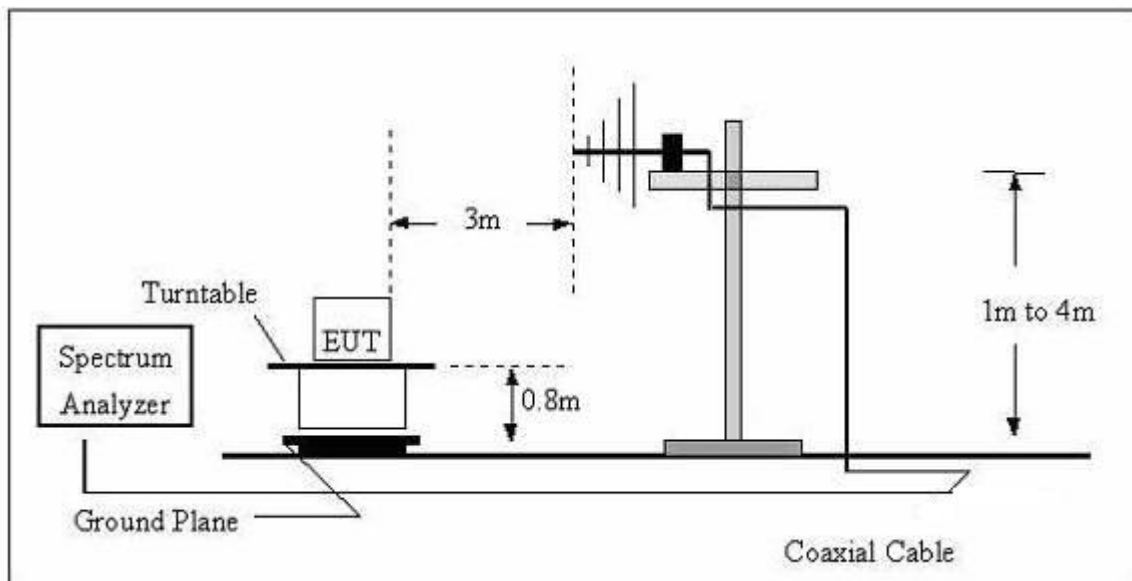

(B) Radiated Emission Test Set-Up Frequency Above 1GHz

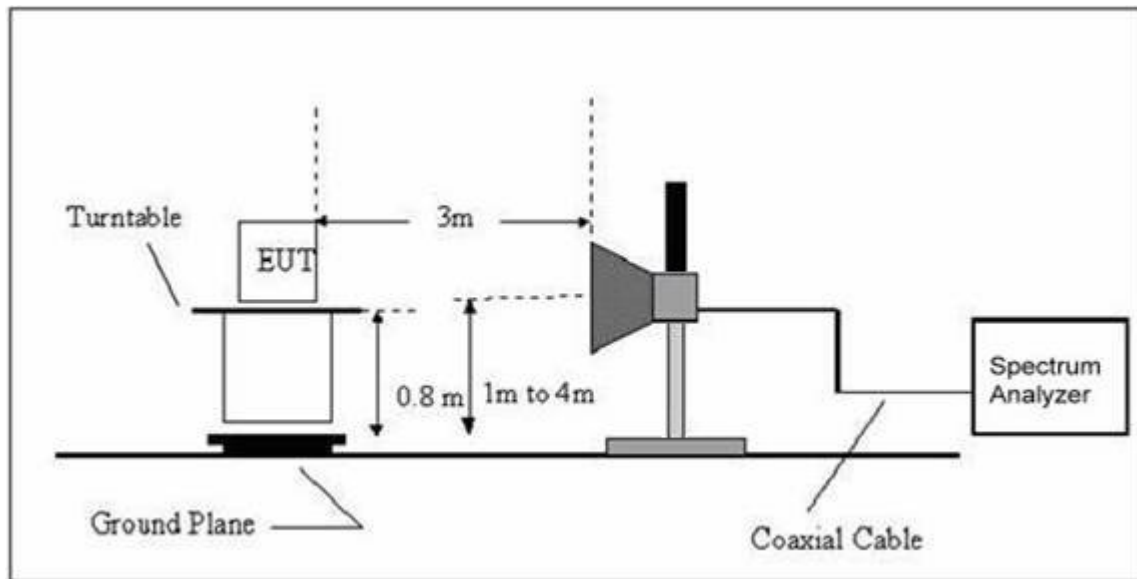

4.4 TEST INSTRUMENTS

Equipment	Manufacturer	Type No.	Serial No.	Last calibration	Calibrated until	Calibration period
Broadband Antenna	R&S	VULB 9168	VULB 9168-456	Jul. 05, 2015	Jul. 04. 2016	1 year
Test Cable	N/A	R-01	N/A	Dec. 23, 2015	Dec. 22, 2016	1 year
Test Cable	N/A	R-02	N/A	Dec. 23, 2015	Dec. 22, 2016	1 year
EMI Test Receiver	R&S	ESCI	101324	Jul. 05, 2015	Jul. 04. 2016	1 year
Antenna Mast	EM	SC100_1	N/A	N/A	N/A	N/A
Turn Table	EM	SC100	060531	N/A	N/A	N/A
50Ω Switch	Anritsu Corp	MP59B	6200983705	Jul. 05, 2015	Jul. 04. 2016	1 year
Spectrum Analyzer	R&S	FSP40	100154	Jul. 05, 2015	Jul. 04. 2016	1 year
Horn Antenna	R&S	HF906	10029	Jul. 05, 2015	Jul. 04. 2016	1 year
Amplifier	EM	EM-30180	060538	Jul. 05, 2015	Jul. 04. 2016	1 year

4.5 EUT OPERATING CONDITIONS

The EUT tested system was configured as the statements of 2.3 Unless otherwise a special operating condition is specified in the follows during the testing.

4.6 TEST RESULTS

4.6.1 TEST RESULTS (Bellow 1GHz)

EUT :	WIFI+BT Module	Model Name. :	WT39M2011
Temperature :	26 °C	Relative Humidity :	56%
Pressure :	1010 hPa	Test Date :	2016-01-16
Test Mode :	BT TX Mode	Polarization :	Horizontal
Test Power :	DC 5V		

No.	Mk.	Freq. MHz	Reading Level dBuV	Correct Factor dB	Measure- ment dBuV/m	Limit dBuV/m	Over dB	Detector
1	*	87.4400	54.74	-22.86	31.88	40.00	-8.12	QP
2		245.7600	51.18	-18.51	32.67	46.00	-13.33	QP
3		296.0900	51.98	-16.67	35.31	46.00	-10.69	QP
4		399.5700	50.36	-15.74	34.62	46.00	-11.38	QP
5		465.5300	49.79	-14.70	35.09	46.00	-10.91	QP
6		836.0700	43.38	-11.26	32.12	46.00	-13.88	QP

Remark:

Factor = Antenna Factor + Cable Loss.

EUT :	WIFI+BT Module	Model Name. :	WT39M2011
Temperature :	26 °C	Relative Humidity :	56%
Pressure :	1010 hPa	Test Date :	2016-01-16
Test Mode :	BT TX Mode	Polarization :	Vertical
Test Power :	DC 5V		

No.	Mk.	Freq.	Reading Level	Correct Factor	Measurement	Limit	Over	
		MHz	dBuV	dB	dBuV/m	dBuV/m	dB	Detector
1		54.2500	49.94	-20.86	29.08	40.00	-10.92	QP
2		81.4100	52.71	-22.60	30.11	40.00	-9.89	QP
3		108.5700	52.65	-20.11	32.54	43.50	-10.96	QP
4	*	378.2300	53.56	-15.91	37.65	46.00	-8.35	QP
5		461.6500	50.05	-14.78	35.27	46.00	-10.73	QP
6		595.5100	43.92	-12.38	31.54	46.00	-14.46	QP

Remark:

Factor = Antenna Factor + Cable Loss.

4.6.2 TEST RESULTS (Above 1GHz)

EUT :	WIFI+BT Module	Model Name. :	WT39M2011
Temperature :	26 °C	Relative Humidity :	56%
Pressure :	1010 hPa	Test Date :	2016-01-16
Test Mode :	GFSK TX 2402MHz	Polarization :	Horizontal
Test Power :	DC 5V		

No. Mk.	Freq.	Reading Level	Correct Factor	Measurement	Limit	Over	Detector	Comment
	MHz	dBuV	dB	dBuV/m	dBuV/m	dB		
1	2390.000	45.93	-1.49	44.44	74.00	-29.56	peak	
2	2390.000	42.06	-1.49	40.57	54.00	-13.43	AVG	
3 X	2402.100	100.8	-1.50	99.34	74.00	25.34	peak	Fundamental Frequency
4 *	2402.100	99.02	-1.50	97.52	54.00	43.52	AVG	Fundamental Frequency

No. Mk.	Freq.	Reading Level	Correct Factor	Measurement	Limit	Over	Detector	Comment
	MHz	dBuV	dB	dBuV/m	dBuV/m	dB		
1	4804.120	47.11	5.65	52.76	74.00	-21.24	peak	
2 *	4804.120	41.58	5.65	47.23	54.00	-6.77	AVG	

EUT :	WIFI+BT Module	Model Name. :	WT39M2011
Temperature :	26 °C	Relative Humidity :	56%
Pressure :	1010 hPa	Test Date :	2016-01-16
Test Mode :	GFSK TX 2402MHz	Polarization :	Vertical
Test Power :	DC 5V		

No. Mk.	Freq.	Reading Level	Correct Factor	Measurement	Limit	Over	Detector	Comment
	MHz	dBuV	dB	dBuV/m	dBuV/m	dB		
1	2390.000	47.31	-1.49	45.82	74.00	-28.18	peak	
2	2390.000	42.92	-1.49	41.43	54.00	-12.57	AVG	
3 X	2402.200	101.1	-1.50	99.61	74.00	25.61	peak	Fundamental Frequency
4 *	2402.200	99.39	-1.50	97.89	54.00	43.89	AVG	Fundamental Frequency

No. Mk.	Freq.	Reading Level	Correct Factor	Measurement	Limit	Over	Detector	Comment
	MHz	dBuV	dB	dBuV/m	dBuV/m	dB		
1	4804.120	44.92	5.65	50.57	74.00	-23.43	peak	
2 *	4804.120	39.69	5.65	45.34	54.00	-8.66	AVG	

EUT :	WIFI+BT Module	Model Name. :	WT39M2011
Temperature :	26 °C	Relative Humidity :	56%
Pressure :	1010 hPa	Test Date :	2016-01-16
Test Mode :	GFSK TX 2441MHz	Polarization :	Horizontal
Test Power :	DC 5V		

No.	Mk.	Freq.	Reading Level	Correct Factor	Measurement	Limit	Over	Detector	Comment
		MHz	dBuV	dB	dBuV/m	dBuV/m	dB		
1		4882.110	46.17	5.91	52.08	74.00	-21.92	peak	
2	*	4882.110	40.97	5.91	46.88	54.00	-7.12	AVG	

EUT :	WIFI+BT Module	Model Name. :	WT39M2011
Temperature :	26 °C	Relative Humidity :	56%
Pressure :	1010 hPa	Test Date :	2016-01-16
Test Mode :	GFSK TX 2441MHz	Polarization :	Vertical
Test Power :	DC 5V		

No.	Mk.	Freq.	Reading Level	Correct Factor	Measurement	Limit	Over	Detector	Comment
		MHz	dBuV	dB	dBuV/m	dBuV/m	dB		
1		4882.110	44.73	5.91	50.64	74.00	-23.36	peak	
2	*	4882.110	39.06	5.91	44.97	54.00	-9.03	AVG	

EUT :	WIFI+BT Module	Model Name. :	WT39M2011
Temperature :	26 °C	Relative Humidity :	56%
Pressure :	1010 hPa	Test Date :	2016-01-16
Test Mode :	GFSK TX 2480MHz	Polarization :	Horizontal
Test Power :	DC 5V		

No. Mk.	Freq.	Reading Level	Correct Factor	Measurement	Limit	Over	Detector	Comment
	MHz	dBuV	dB	dBuV/m	dBuV/m	dB		
1 *	2480.000	98.36	-1.58	96.78	54.00	42.78	AVG	Fundamental Frequency
2 X	2480.100	100.0	-1.58	98.47	74.00	24.47	peak	Fundamental Frequency
3	2483.500	59.33	-1.58	57.75	74.00	-16.25	peak	
4	2483.500	51.66	-1.58	50.08	54.00	-3.92	AVG	

No. Mk.	Freq.	Reading Level	Correct Factor	Measurement	Limit	Over	Detector	Comment
	MHz	dBuV	dB	dBuV/m	dBuV/m	dB		
1	4960.100	46.28	6.15	52.43	74.00	-21.57	peak	
2 *	4960.100	41.12	6.15	47.27	54.00	-6.73	AVG	

EUT :	WIFI+BT Module	Model Name. :	WT39M2011
Temperature :	26 °C	Relative Humidity :	56%
Pressure :	1010 hPa	Test Date :	2016-01-16
Test Mode :	GFSK TX 2480MHz	Polarization :	Vertical
Test Power :	DC 5V		

No. Mk.	Freq.	Reading Level	Correct Factor	Measurement	Limit	Over	Detector	Comment
	MHz	dBuV	dB	dBuV/m	dBuV/m	dB		
1 X	2480.200	98.99	-1.58	97.41	74.00	23.41	peak	Fundamental Frequency
2 *	2480.200	97.44	-1.58	95.86	54.00	41.86	AVG	Fundamental Frequency
3	2483.500	58.16	-1.58	56.58	74.00	-17.42	peak	
4	2483.500	53.45	-1.58	51.87	54.00	-2.13	AVG	

No. Mk.	Freq.	Reading Level	Correct Factor	Measurement	Limit	Over	Detector	Comment
	MHz	dBuV	dB	dBuV/m	dBuV/m	dB		
1	4960.100	44.53	6.15	50.68	74.00	-23.32	peak	
2 *	4960.100	39.24	6.15	45.39	54.00	-8.61	AVG	

EUT :	WIFI+BT Module	Model Name. :	WT39M2011
Temperature :	26 °C	Relative Humidity :	56%
Pressure :	1010 hPa	Test Date :	2016-01-16
Test Mode :	8DPSK TX 2402MHz	Polarization :	Horizontal
Test Power :	DC 5V		

No. Mk.	Freq.	Reading Level	Correct Factor	Measurement	Limit	Over	Detector	Comment
	MHz	dBuV	dB	dBuV/m	dBuV/m	dB		
1	2390.000	46.13	-1.49	44.64	74.00	-29.36	peak	
2	2390.000	42.27	-1.49	40.78	54.00	-13.22	AVG	
3 X	2402.200	99.66	-1.50	98.16	74.00	24.16	peak	Fundamental Frequency
4 *	2402.300	98.29	-1.50	96.79	54.00	42.79	AVG	Fundamental Frequency

No. Mk.	Freq.	Reading Level	Correct Factor	Measurement	Limit	Over	Detector	Comment
	MHz	dBuV	dB	dBuV/m	dBuV/m	dB		
1	4804.100	45.11	5.65	50.76	74.00	-23.24	peak	
2 *	4804.100	39.16	5.65	44.81	54.00	-9.19	AVG	

EUT :	WIFI+BT Module	Model Name. :	WT39M2011
Temperature :	26 °C	Relative Humidity :	56%
Pressure :	1010 hPa	Test Date :	2016-01-16
Test Mode :	8DPSK TX 2402MHz	Polarization :	Vertical
Test Power :	DC 5V		

No. Mk.	Freq.	Reading Level	Correct Factor	Measurement	Limit	Over	Detector	Comment
	MHz	dBuV	dB	dBuV/m	dBuV/m	dB		
1	2390.000	46.96	-1.49	45.47	74.00	-28.53	peak	
2	2390.000	43.70	-1.49	42.21	54.00	-11.79	AVG	
3 X	2402.200	96.51	-1.50	95.01	74.00	21.01	peak	Fundamental Frequency
4 *	2402.200	95.37	-1.50	93.87	54.00	39.87	AVG	Fundamental Frequency

No. Mk.	Freq.	Reading Level	Correct Factor	Measurement	Limit	Over	Detector	Comment
	MHz	dBuV	dB	dBuV/m	dBuV/m	dB		
1	4804.100	43.23	5.65	48.88	74.00	-25.12	peak	
2 *	4804.100	37.32	5.65	42.97	54.00	-11.03	AVG	

EUT :	WIFI+BT Module	Model Name. :	WT39M2011
Temperature :	26 °C	Relative Humidity :	56%
Pressure :	1010 hPa	Test Date :	2016-01-16
Test Mode :	8DPSK TX 2441MHz	Polarization :	Horizontal
Test Power :	DC 5V		

No. Mk.	Freq.	Reading Level	Correct Factor	Measurement	Limit	Over	Detector	Comment
	MHz	dBuV	dB	dBuV/m	dBuV/m	dB		
1	4882.120	44.27	5.91	50.18	74.00	-23.82	peak	
2 *	4882.120	38.86	5.91	44.77	54.00	-9.23	AVG	

EUT :	WIFI+BT Module	Model Name. :	WT39M2011
Temperature :	26 °C	Relative Humidity :	56%
Pressure :	1010 hPa	Test Date :	2016-01-16
Test Mode :	8DPSK TX 2441MHz	Polarization :	Vertical
Test Power :	DC 5V		

No. Mk.	Freq.	Reading Level	Correct Factor	Measurement	Limit	Over	Detector	Comment
	MHz	dBuV	dB	dBuV/m	dBuV/m	dB		
1	4882.120	42.85	5.91	48.76	74.00	-25.24	peak	
2 *	4882.120	36.49	5.91	42.40	54.00	-11.60	AVG	

EUT :	WIFI+BT Module	Model Name. :	WT39M2011
Temperature :	26 °C	Relative Humidity :	56%
Pressure :	1010 hPa	Test Date :	2016-01-16
Test Mode :	8DPSK TX 2480MHz	Polarization :	Horizontal
Test Power :	DC 5V		

No. Mk.	Freq.	Reading Level	Correct Factor	Measurement	Limit	Over	Detector	Comment
	MHz	dBuV	dB	dBuV/m	dBuV/m	dB		
1 X	2480.100	98.64	-1.58	97.06	74.00	23.06	peak	Fundamental Frequency
2 *	2480.100	97.34	-1.58	95.76	54.00	41.76	AVG	Fundamental Frequency
3	2483.500	57.38	-1.58	55.80	74.00	-18.20	peak	
4	2483.500	52.66	-1.58	51.08	54.00	-2.92	AVG	

No. Mk.	Freq.	Reading Level	Correct Factor	Measurement	Limit	Over	Detector	Comment
	MHz	dBuV	dB	dBuV/m	dBuV/m	dB		
1	4960.110	44.40	6.15	50.55	74.00	-23.45	peak	
2 *	4960.110	38.52	6.15	44.67	54.00	-9.33	AVG	

EUT :	WIFI+BT Module	Model Name. :	WT39M2011
Temperature :	26 °C	Relative Humidity :	56%
Pressure :	1010 hPa	Test Date :	2016-01-16
Test Mode :	8DPSK TX 2480MHz	Polarization :	Vertical
Test Power :	DC 5V		

No. Mk.	Freq.	Reading Level	Correct Factor	Measurement	Limit	Over	Detector	Comment
	MHz	dBuV	dB	dBuV/m	dBuV/m	dB		
1 X	2480.000	96.71	-1.58	95.13	74.00	21.13	peak	Fundamental Frequency
2 *	2480.100	95.43	-1.58	93.85	54.00	39.85	AVG	Fundamental Frequency
3	2483.500	56.15	-1.58	54.57	74.00	-19.43	peak	
4	2483.500	51.84	-1.58	50.26	54.00	-3.74	AVG	

No. Mk.	Freq.	Reading Level	Correct Factor	Measurement	Limit	Over	Detector	Comment
	MHz	dBuV	dB	dBuV/m	dBuV/m	dB		
1	4960.110	42.70	6.15	48.85	74.00	-25.15	peak	
2 *	4960.110	36.93	6.15	43.08	54.00	-10.92	AVG	

5. CONDUCTED OUTPUT POWER MEASUREMENT

5.1 LIMITS

Peak Output Power	For frequency Hopping systems in 2400~2483.5MHz band and employing at least 75 non-overlapping hopping channels < 1 watt (30 dBm).
-------------------	--

5.2 TEST PROCEDURE

The EUT was directly connected to the power meter and antenna output port as show in the block diagram as bellow.

5.3 TEST SETUP

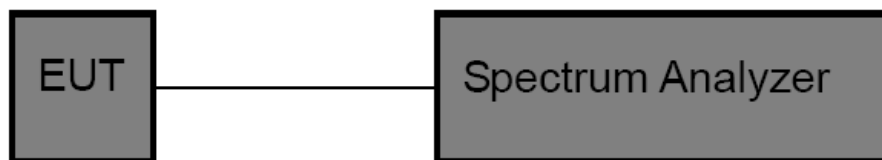

5.4 TEST INSTRUMENTS

Equipment	Manufacturer	Type No.	Serial No.	Last calibration	Calibrated until	Calibration period
Spectrum Analyzer	R&S	FSP40	100154	Jul. 05, 2015	Jul. 04. 2016	1 year

5.5 EUT OPERATING CONDITIONS

The EUT was set to continuously transmitting in the maximum power during the test.

5.6 TEST RESULTS

GFSK (1Mbps)		
Frequency (MHz)	Peak Output Power (dBm)	Limit (dBm)
2402	3.69	<30
2441	3.55	
2480	3.80	

2402 MHz

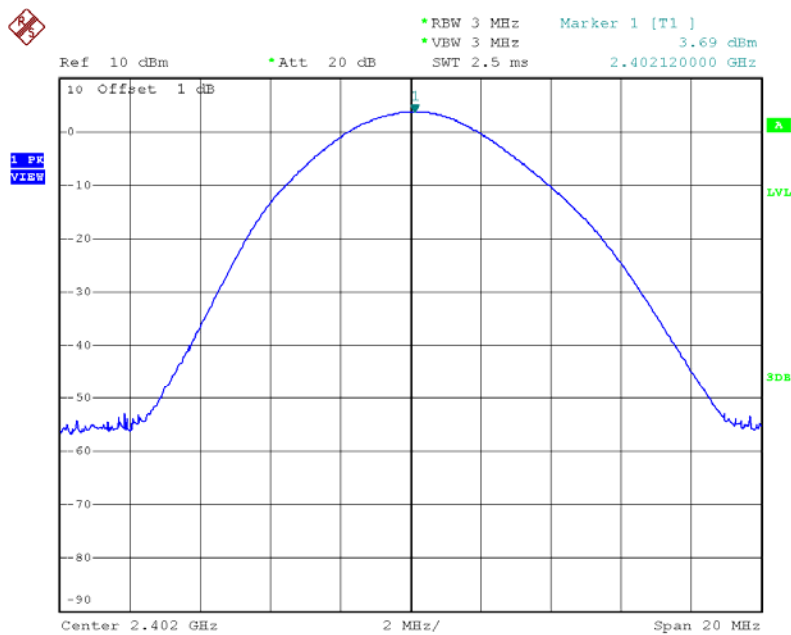

Date: 18.JAN.2016 16:36:29

2441 MHz

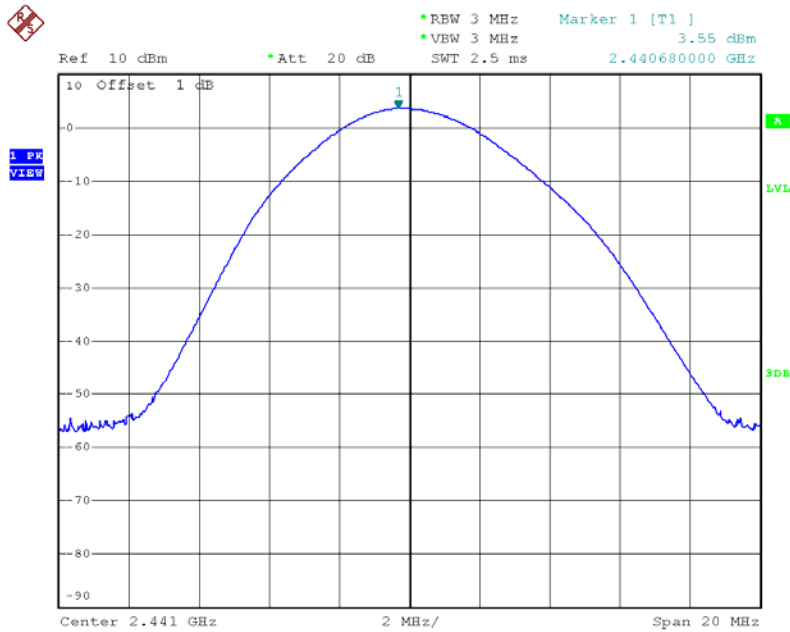

Date: 18.JAN.2016 16:37:20

2480 MHz

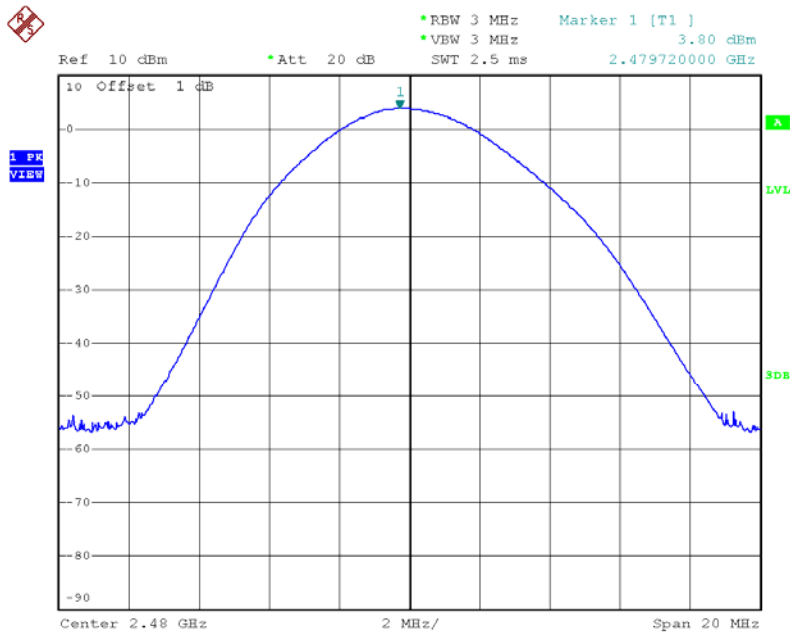

Date: 18.JAN.2016 16:38:00

8-DPSK (3Mbps)		
Frequency (MHz)	Peak Output Power (dBm)	Limit (dBm)
2402	1.95	<30
2441	2.09	
2480	1.91	

2402 MHz

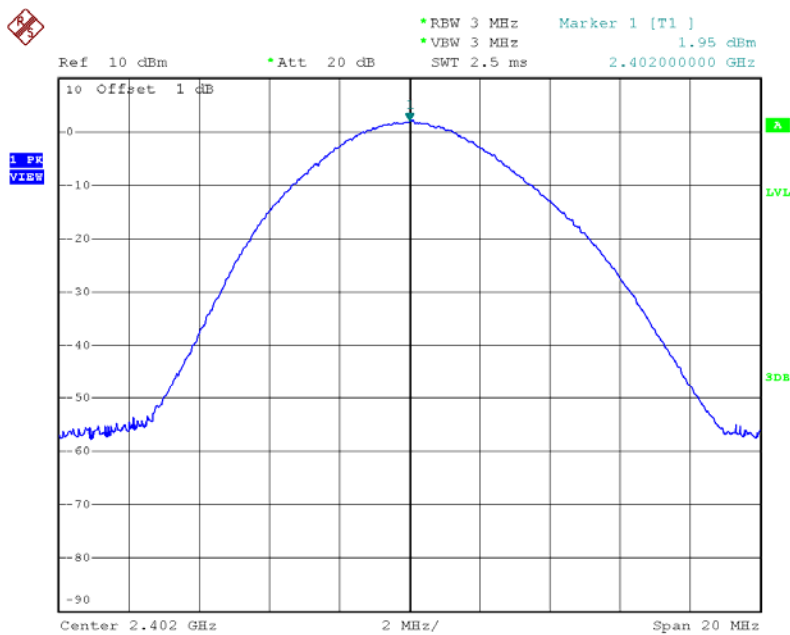

Date: 18.JAN.2016 18:03:09

2441 MHz

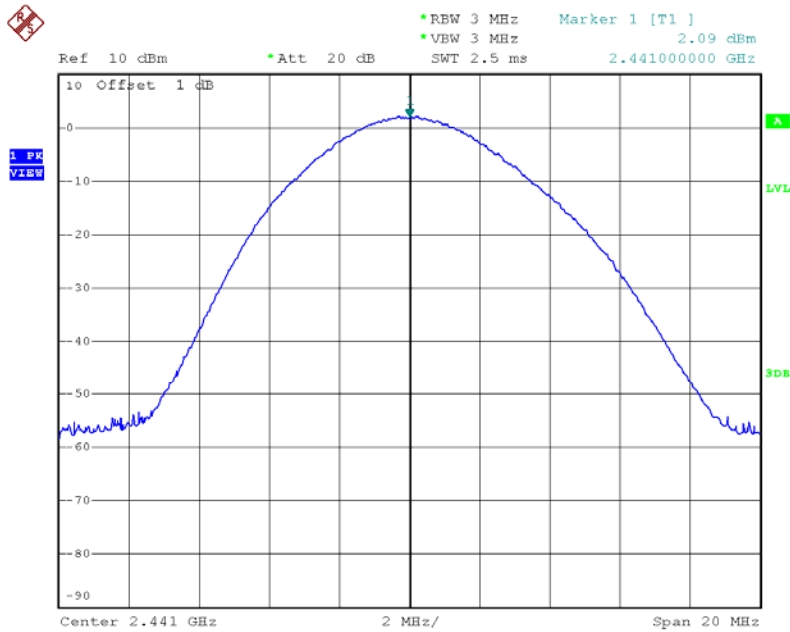

Date: 18.JAN.2016 18:04:43

2480 MHz

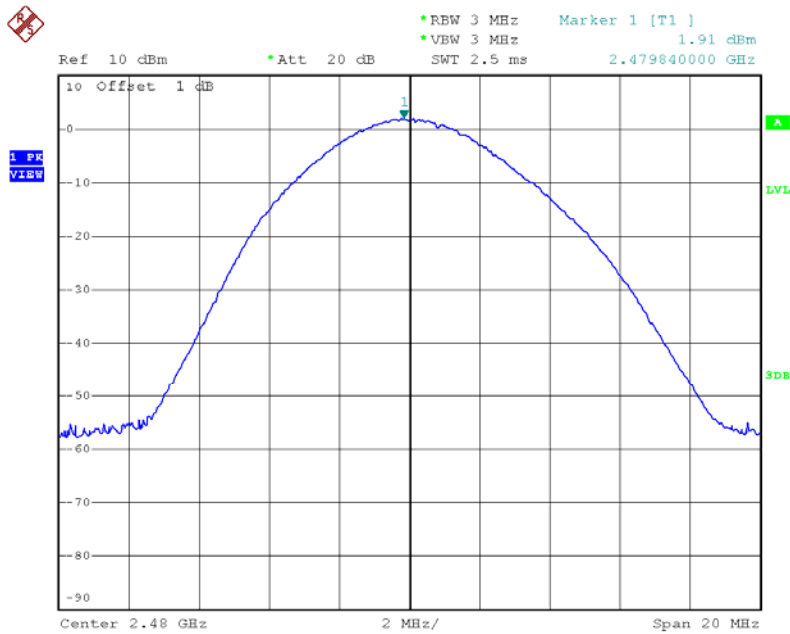

Date: 18.JAN.2016 18:06:33

6. OCCUPIED BANDWIDTH MEASUREMENT

6.1 LIMITS

20dB Bandwidth	N/A
99% Occupied Bandwidth	N/A

6.2 TEST PROCEDURE

The EUT was directly connected to the power meter and antenna output port as show in the block diagram as bellow.

6.3 TEST SETUP

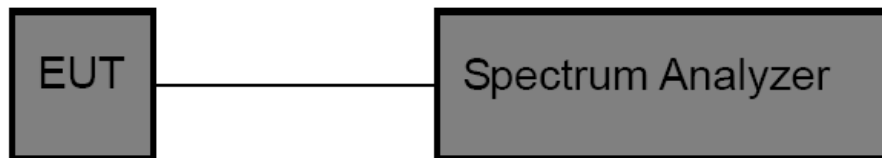

6.4 TEST INSTRUMENTS

Equipment	Manufacturer	Type No.	Serial No.	Last calibration	Calibrated until	Calibration period
Spectrum Analyzer	R&S	FSP40	100154	Jul. 05, 2015	Jul. 04. 2016	1 year

6.5 EUT OPERATING CONDITIONS

The EUT was set to continuously transmitting in the maximum power during the test.

6.6 TEST RESULTS

GFSK Mode (1Mbps)			
Frequency (MHz)	20dB Bandwidth (kHz)	99% OBW (kHz)	Limit
2402	919.35	864.00	N/A
2441	856.00	848.00	
2480	948.00	876.00	
8-DPSK Mode (3Mbps)			
Frequency (MHz)	20dB Bandwidth (kHz)	99% OBW (kHz)	Limit
2402	1213.80	1148.00	N/A
2441	1214.00	1152.00	
2480	1208.00	1152.00	
Note: Test plots please refer following pages.			

2402 MHz(GFSK) Bandwidth

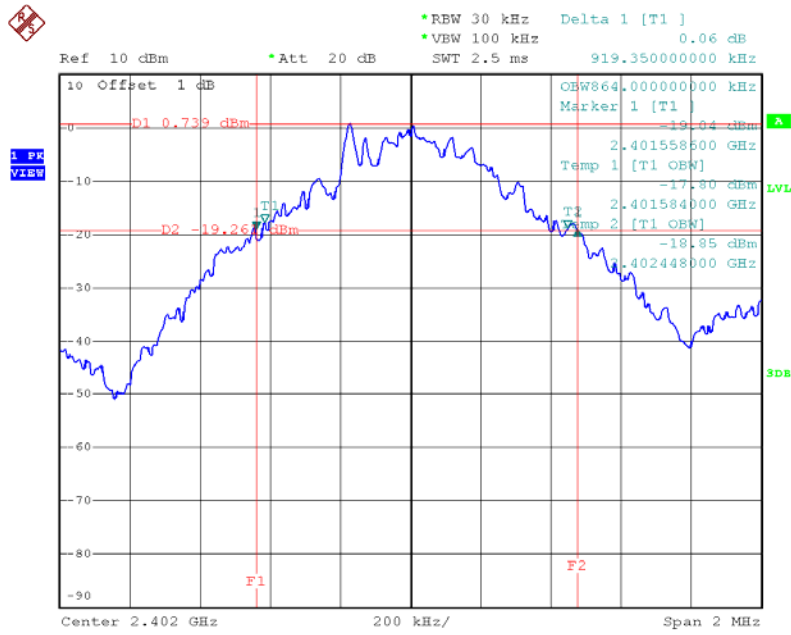

Date: 18.JAN.2016 16:50:13

2441 MHz(GFSK) Bandwidth

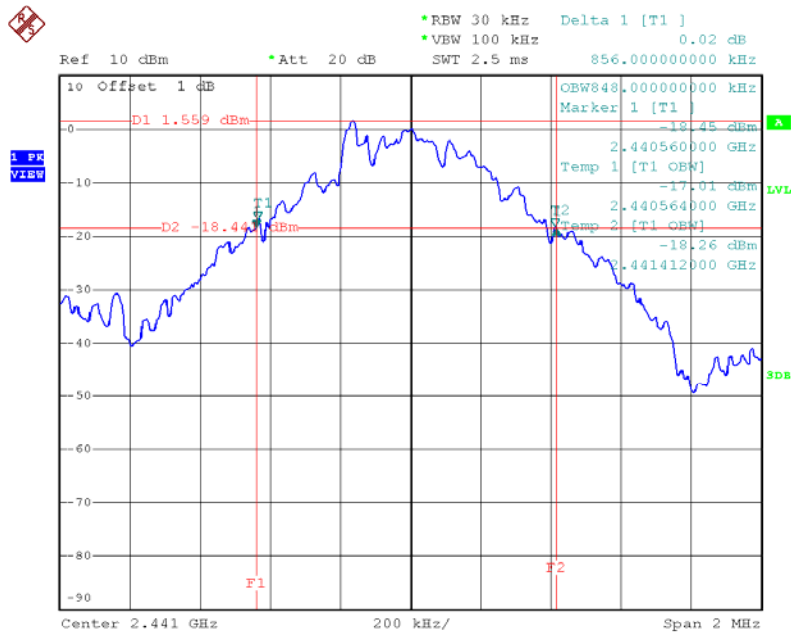

Date: 18.JAN.2016 16:52:15

2480 MHz(GFSK) Bandwidth

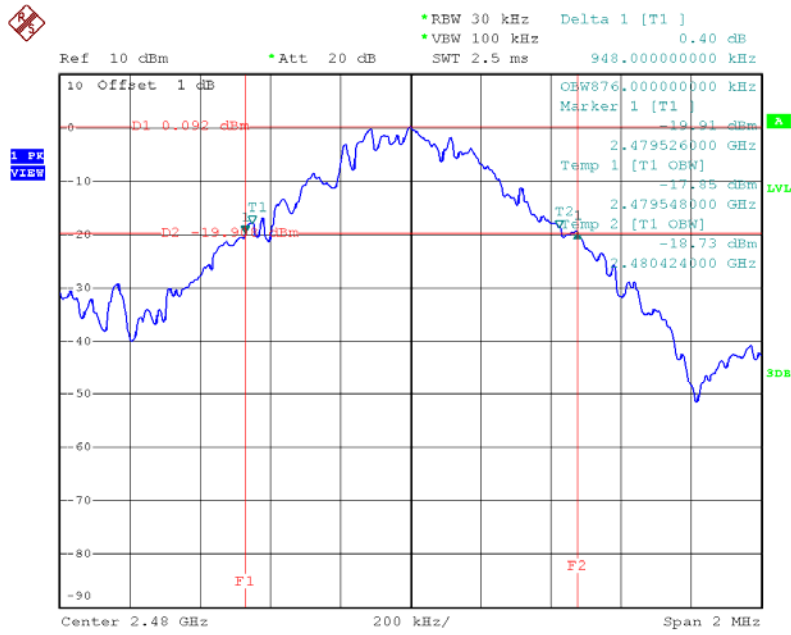

Date: 18.JAN.2016 16:53:23

2402 MHz(8-DPSK) Bandwidth

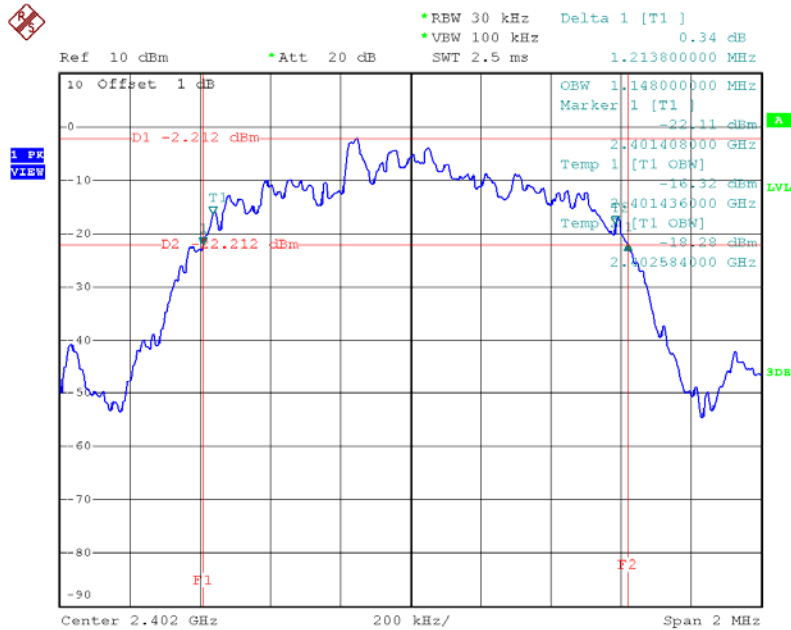

Date: 18.JAN.2016 18:02:49

2441 MHz(8-DPSK) Bandwidth

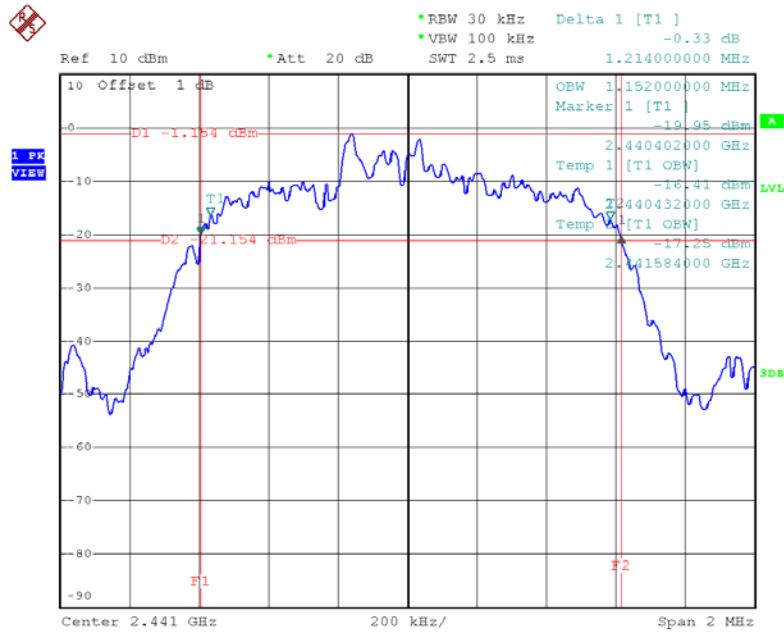

Date: 18.JAN.2016 18:04:36

2480 MHz(8-DPSK) Bandwidth

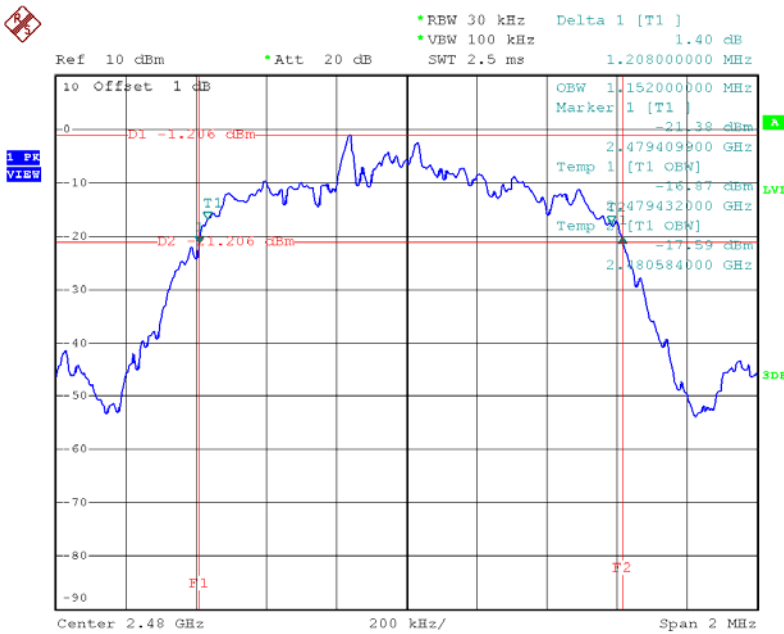

Date: 18.JAN.2016 18:06:10

7. CARRIER FREQUENCY SEPARATION MEASUREMENT

7.1 LIMITS

Frequency Separation	The channel spacing shall be a minimum of 25 kHz or two-thirds of the 20 dB Bandwidth
----------------------	---

7.2 TEST PROCEDURE

The EUT was directly connected to the power meter and antenna output port as show in the block diagram as bellow.

- a. Set span= wide enough to capture the peaks of two adjacent channels.
- b. Set the RBW \geq 1% of the span
- c. Set the VBW \geq 3 RBW (30kHz/ 100kHz)
- d. Detector= Peak.
- e. Sweep time= auto couple
- f. Trace mode= max hold.
- g. Allow trace to fully stabilize.
- h. Use the marker-delta function to determine the separation between the peaks of the adjacent channels.

7.3 TEST SETUP

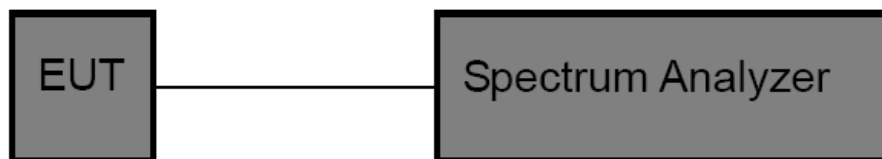

7.4 TEST INSTRUMENTS

Equipment	Manufacturer	Type No.	Serial No.	Last calibration	Calibrated until	Calibration period
Spectrum Analyzer	R&S	FSP40	100154	Jul. 05, 2015	Jul. 04. 2016	1 year

7.5 EUT OPERATING CONDITIONS

The EUT was set to continuously transmitting in the maximum power during the test.

7.6 TEST RESULTS

GFSK Mode (1Mbps)		
Frequency (MHz)	Channel Separation (kHz)	Limit (kHz)
2402	1007.00	>632
2441	1174.50	
2480	813.50	
GFSK Mode (1Mbps)		
Frequency (MHz)	Frequency (kHz)	Frequency (kHz)
2402	816.00	>809.3
2441	1207.50	
2480	1006.00	
Note: Test plots please refer following pages.		

2402 MHz(GFSK)-Channel Separation

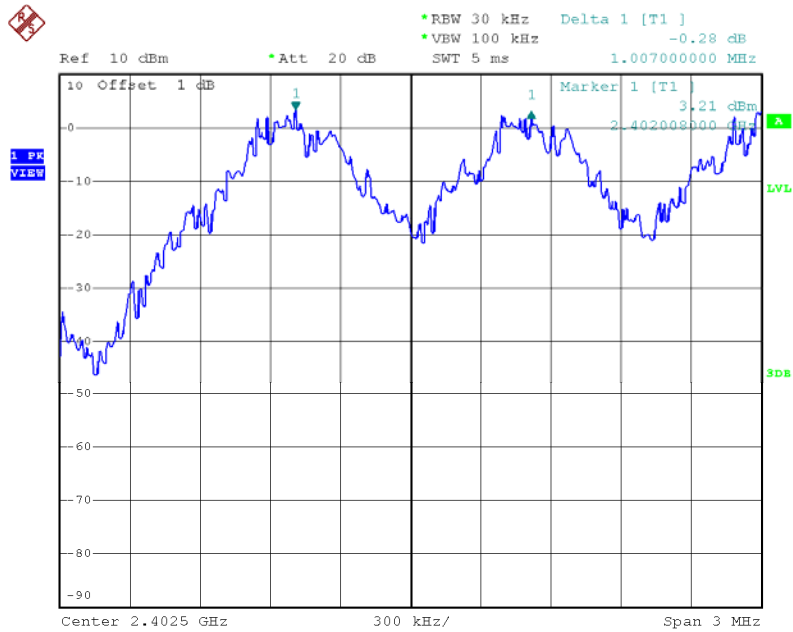

Date: 18.JAN.2016 16:55:41

2441 MHz(GFSK)-Channel Separation

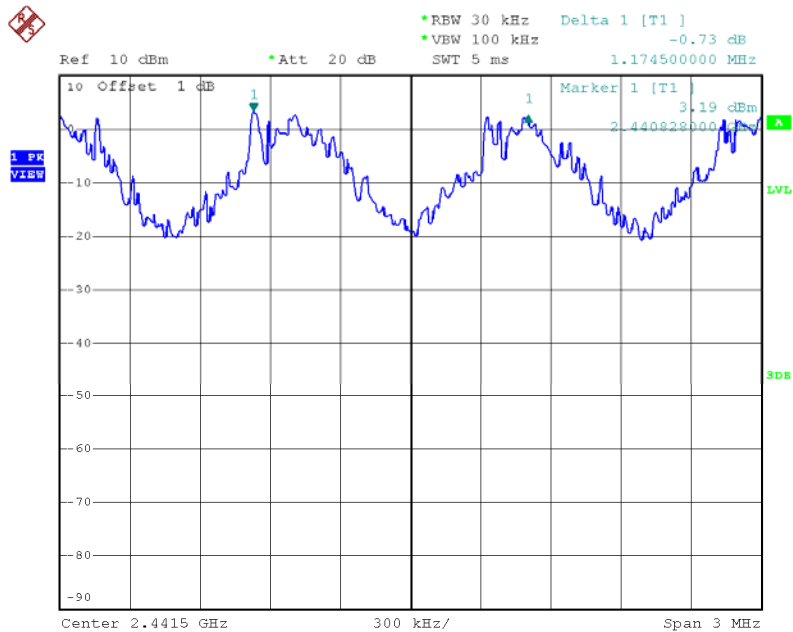

Date: 18.JAN.2016 16:56:52

2480 MHz(GFSK)-Channel Separation

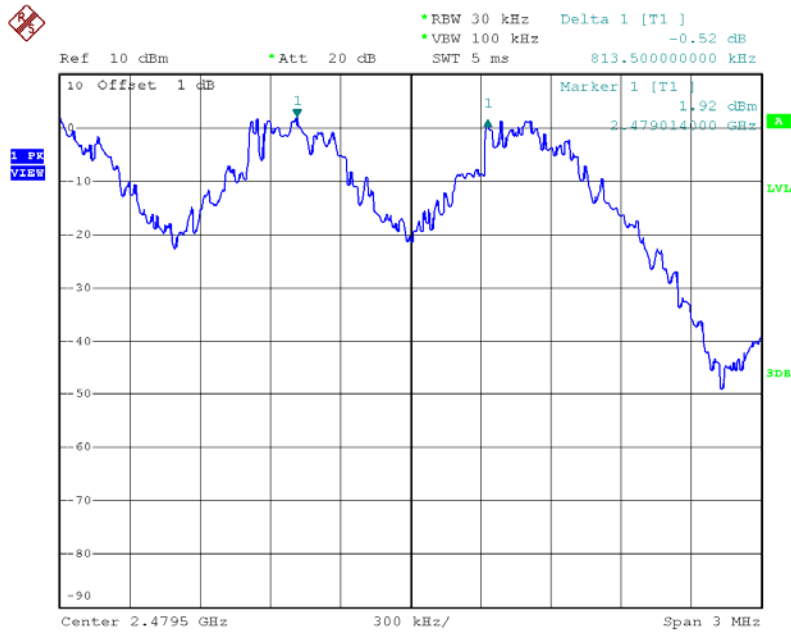

Date: 18.JAN.2016 16:58:02

2402 MHz(8-DPSK)-Channel Separation

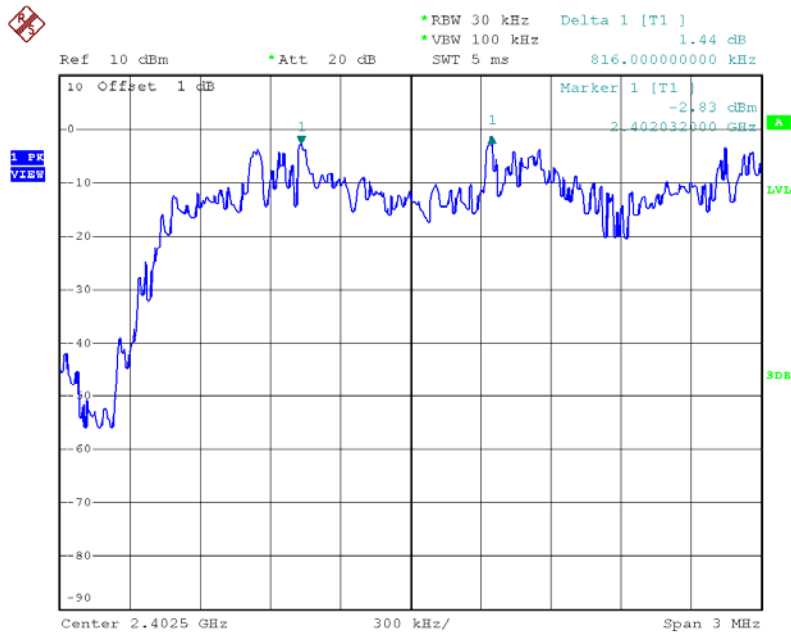

Date: 18.JAN.2016 18:15:31

2441 MHz(8-DPSK)-Channel Separation

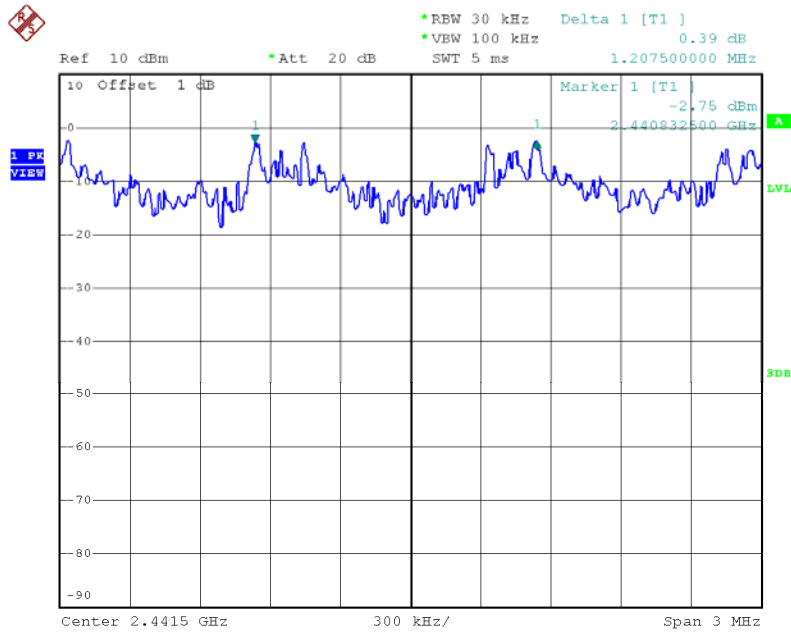

Date: 18.JAN.2016 18:16:38

2480 MHz(8-DPSK)-Channel Separation

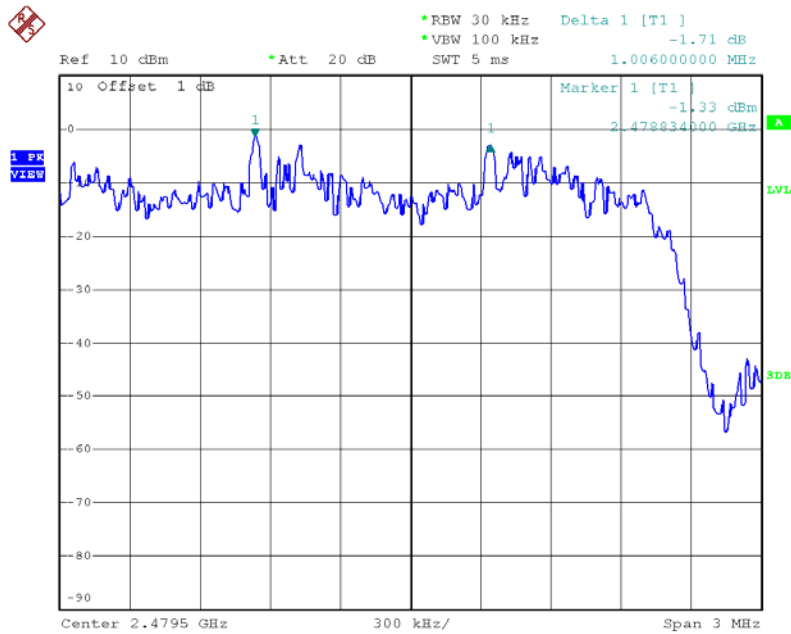

Date: 18.JAN.2016 18:17:46

8. NUMBER OF HOPPING

8.1 LIMITS

Hopping Number	Frequency hopping systems in 2400-2483.5 MHz band shall use at least 15 channels.
----------------	---

8.2 TEST PROCEDURE

The EUT was directly connected to the power meter and antenna output port as show in the block diagram as bellow.

- a. Set span= the frequency band of operation.
- b. Set the RBW \geq 1% of the span
- c. Set the VBW \geq 3 RBW (100kHz/ 300kHz)
- d. Detector= Peak.
- e. Sweep time= auto couple
- f. Trace mode= max hold.
- g. Allow trace to fully stabilize.

8.3 TEST SETUP

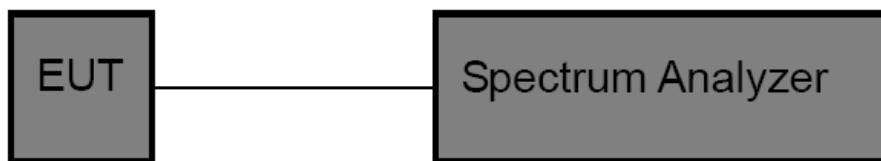

8.4 TEST INSTRUMENTS

Equipment	Manufacturer	Type No.	Serial No.	Last calibration	Calibrated until	Calibration period
Spectrum Analyzer	R&S	FSP40	100154	Jul. 05, 2015	Jul. 04. 2016	1 year

8.5 EUT OPERATING CONDITIONS

The EUT was set to continuously transmitting in the maximum power during the test.

8.6 TEST RESULTS

GFSK Mode (1Mbps)	
Measurement Number	Limit
79	>15

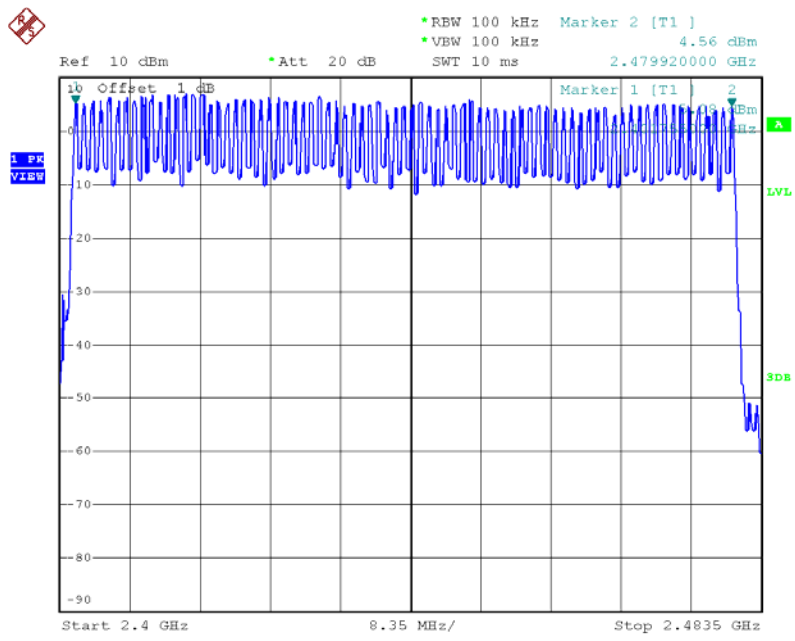

Date: 18.JAN.2016 16:59:52

8-DPSK Mode (3Mbps)	
Measurement Number	Limit
79	>15

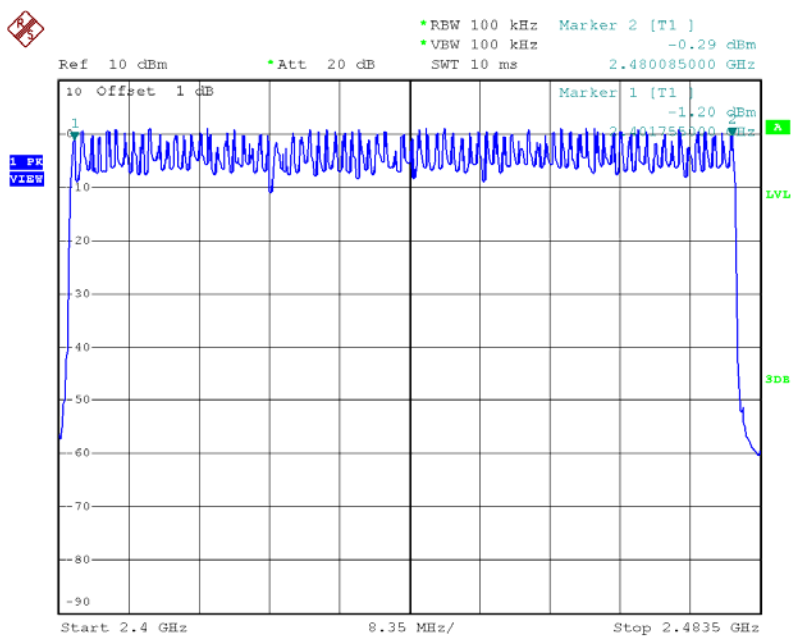

Date: 18.JAN.2016 18:30:59

9. DWELL TIME

9.1 LIMITS

Dwell Time	The average time of occupancy on any channel shall not be greater than 0.4 seconds within a period of 0.4 seconds multiplied the number of hopping channels employed.
------------	---

9.2 TEST PROCEDURE

The EUT was directly connected to the power meter and antenna output port as show in the block diagram as bellow.

- a. Set span= zero
- b. Set the RBW= 1 MHz
- c. Set the VBW \geq RBW
- d. Detector= Peak.
- e. Sweep time= as necessary to capture the entire dwell time per hopping channel
- f. Trace mode= max hold
- g. Use the marker-delta function to determine the dwell time

9.3 TEST SETUP

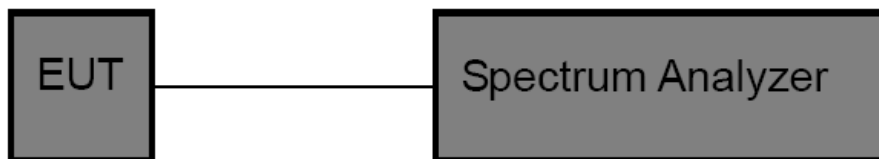

9.4 TEST INSTRUMENTS

Equipment	Manufacturer	Type No.	Serial No.	Last calibration	Calibrated until	Calibration period
Spectrum Analyzer	R&S	FSP40	100154	Jul. 05, 2015	Jul. 04. 2016	1 year

9.5 EUT OPERATING CONDITIONS

The EUT was set to continuously transmitting in the maximum power during the test.

9.6 TEST RESULTS

GFSK Mode (1Mbps)				
Frequency: 2402 MHz				
Packet Type	Pulse Time (ms)	Total of Dwell (ms)	Period Time (s)	Limit (ms)
DH1	0.38	121.60	31.60	<400
DH3	1.64	262.40	31.60	
DH5	2.88	307.20	31.60	
Frequency: 2441 MHz				
Packet Type	Pulse Time (ms)	Total of Dwell (ms)	Period Time (s)	Limit (ms)
DH1	0.38	121.60	31.60	<400
DH3	1.64	262.40	31.60	
DH5	2.88	307.20	31.60	
Frequency: 2480 MHz				
Packet Type	Pulse Time (ms)	Total of Dwell (ms)	Period Time (s)	Limit (ms)
DH1	0.385	123.20	31.60	<400
DH3	1.64	262.40	31.60	
DH5	2.88	307.20	31.60	

2402 MHz (GFSK DH1)- Pulse Time

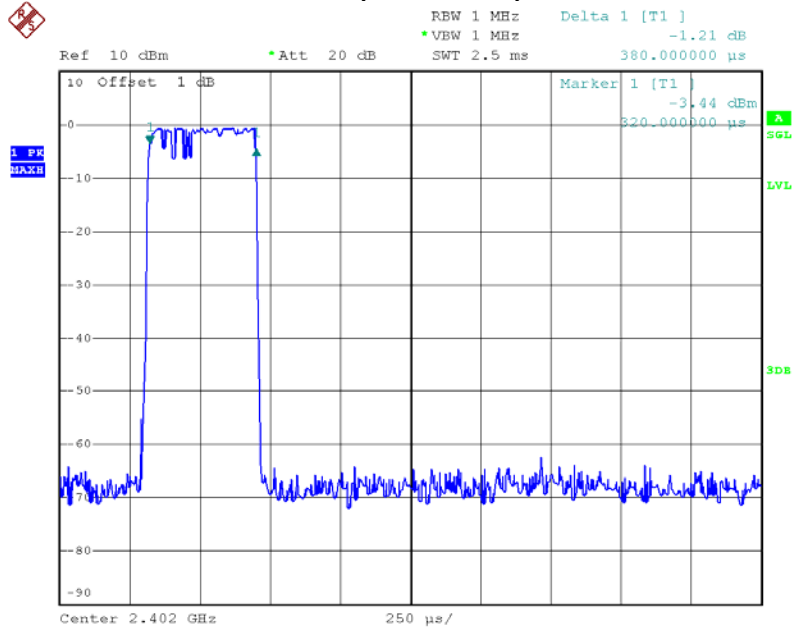

Date: 18.JAN.2016 16:54:15

2402 MHz (GFSK DH3)- Pulse Time

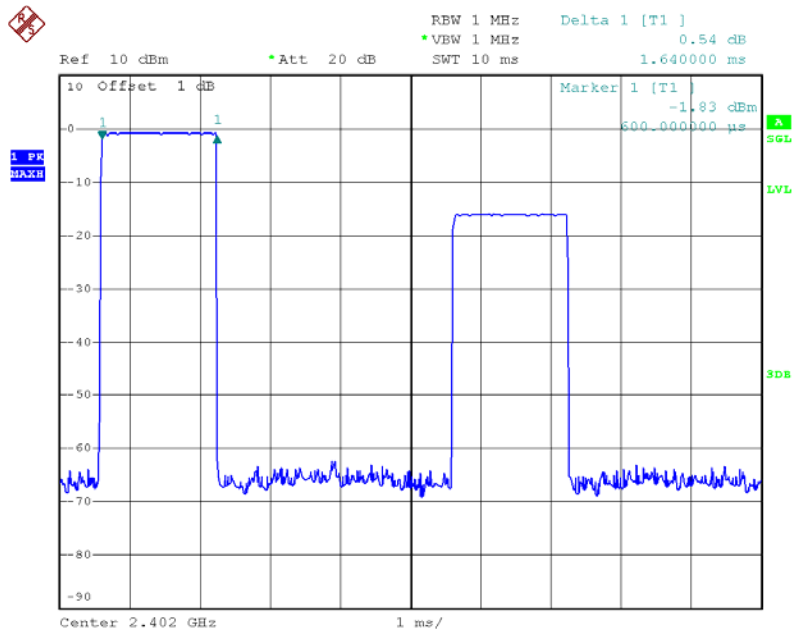

Date: 18.JAN.2016 17:04:03

2402 MHz (GFSK DH5)- Pulse Time

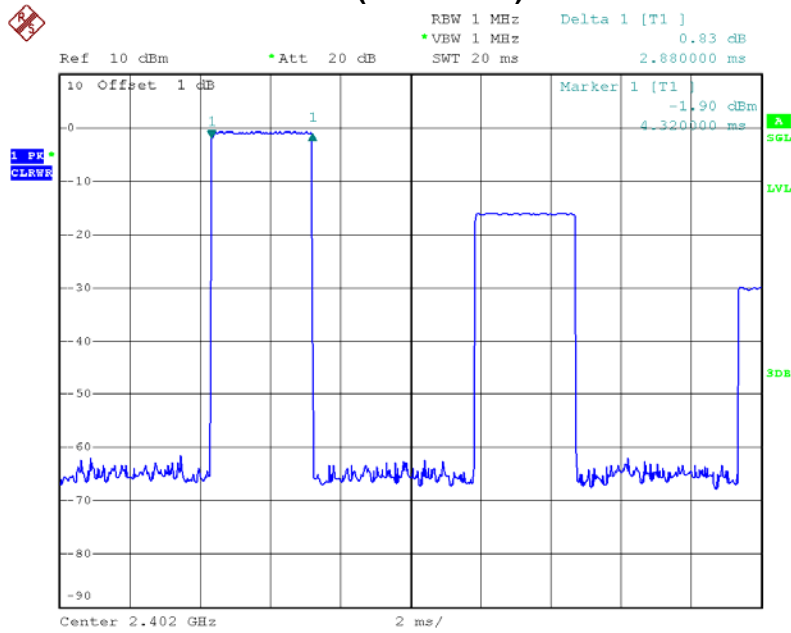

Date: 18.JAN.2016 17:05:06

2441 MHz (GFSK DH1)- Pulse Time

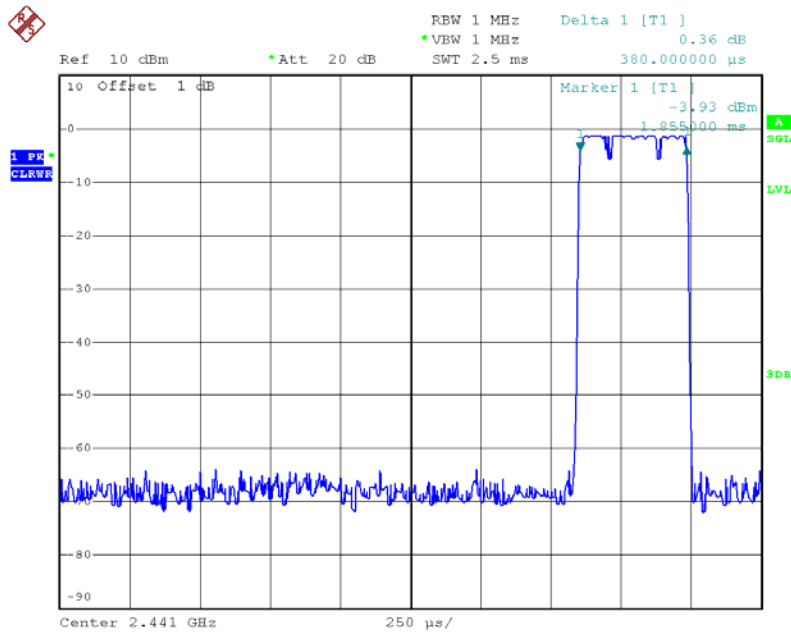

Date: 18.JAN.2016 16:54:22

2441 MHz (GFSK DH3)- Pulse Time

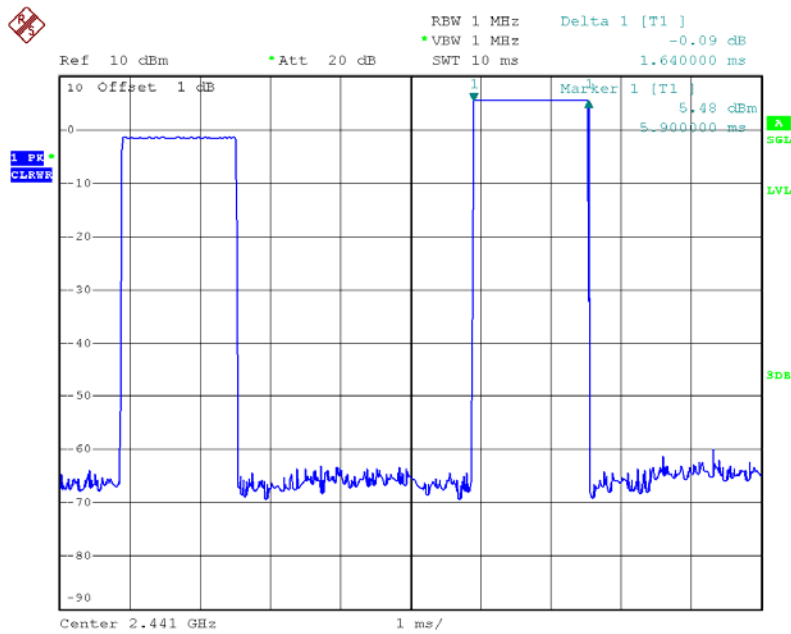

Date: 18.JAN.2016 17:04:08

2441 MHz (GFSK DH5)- Pulse Time

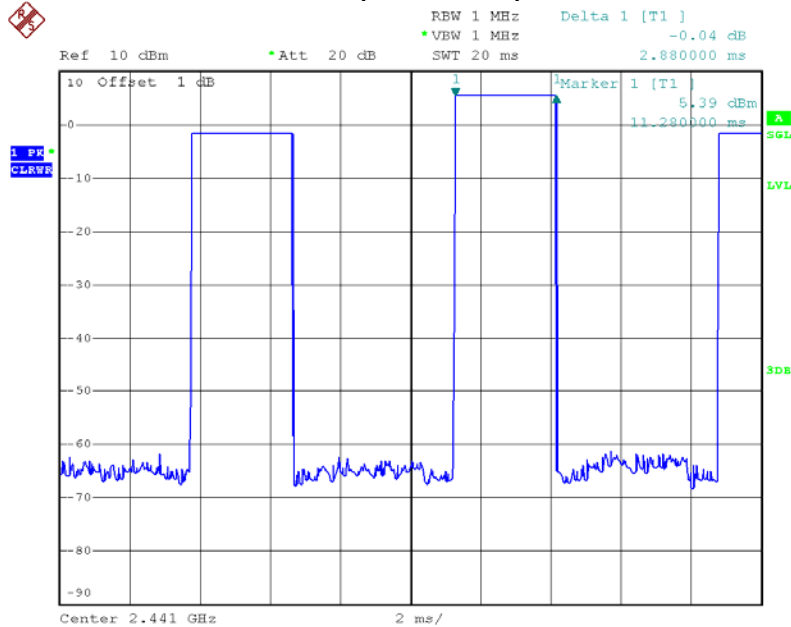

Date: 18.JAN.2016 17:05:11

2480 MHz (GFSK DH1)- Pulse Time

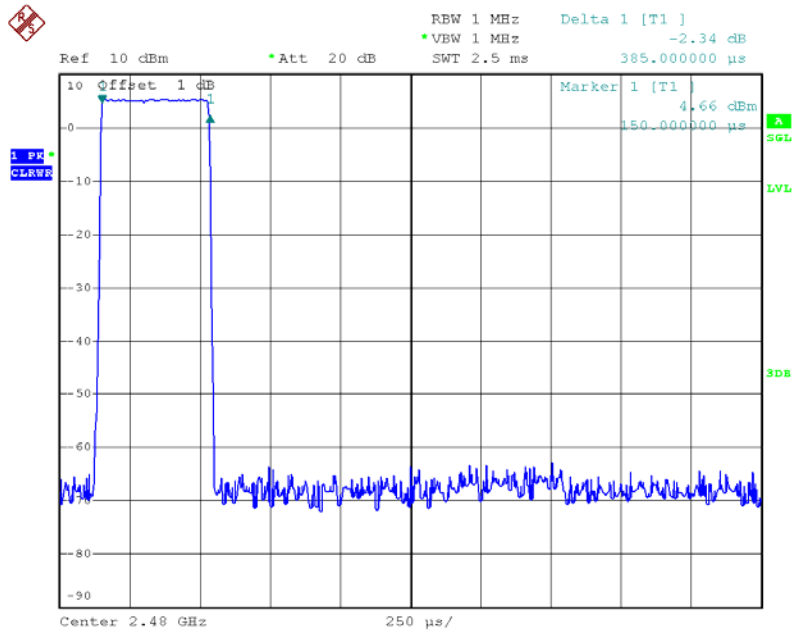

Date: 18.JAN.2016 16:54:28

2480 MHz (GFSK DH3)- Pulse Time

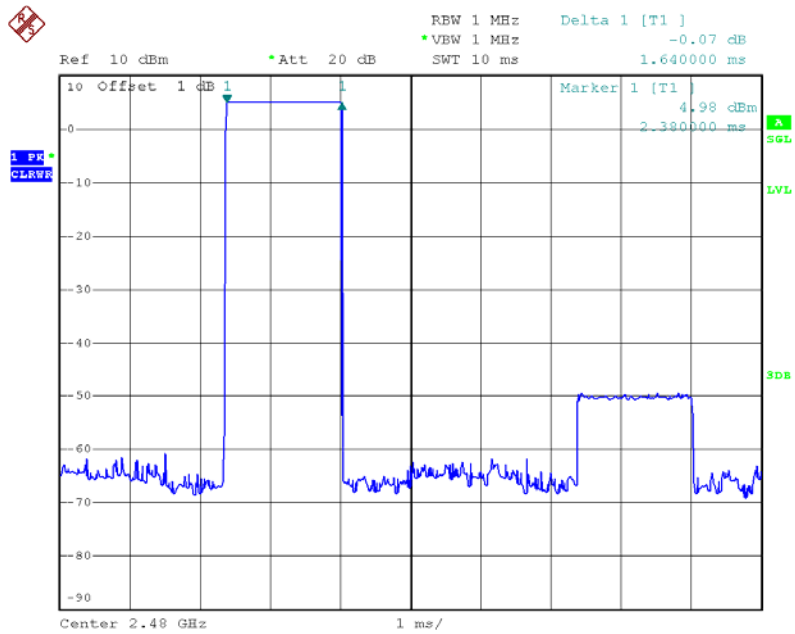

Date: 18.JAN.2016 17:04:19

2480 MHz (GFSK DH5)- Pulse Time

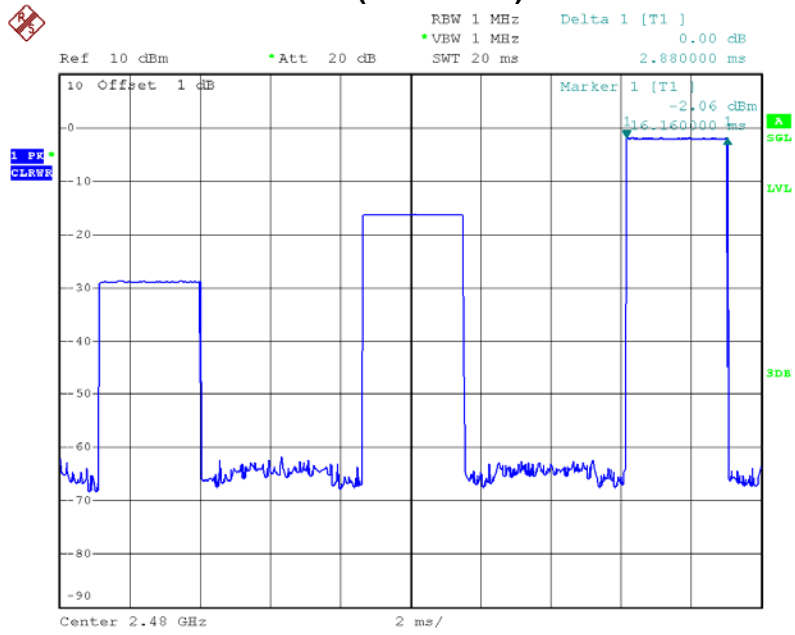

Date: 18.JAN.2016 17:05:20

8-DPSK Mode (3Mbps)				
Frequency: 2402 MHz				
Packet Type	Pulse Time (ms)	Total of Dwell (ms)	Period Time (s)	Limit (ms)
DH1	0.38	121.60	31.60	<400
DH3	1.64	262.40	31.60	
DH5	2.88	307.20	31.60	
Frequency: 2441 MHz				
Packet Type	Pulse Time (ms)	Total of Dwell (ms)	Period Time (s)	Limit (ms)
DH1	0.38	121.60	31.60	<400
DH3	1.64	262.40	31.60	
DH5	2.88	307.20	31.60	
Frequency: 2480 MHz				
Packet Type	Pulse Time (ms)	Total of Dwell (ms)	Period Time (s)	Limit (ms)
DH1	0.375	120.00	31.60	<400
DH3	1.62	259.20	31.60	
DH5	2.92	311.47	31.60	

2402 MHz (8-DPSK DH1)- Pulse Time

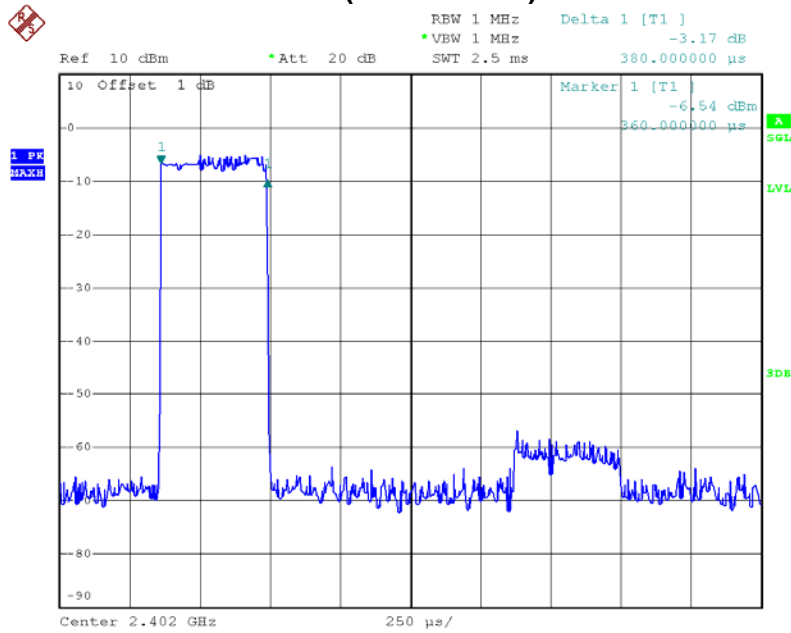

Date: 18.JAN.2016 18:14:12

2402 MHz (8-DPSK DH3)- Pulse Time

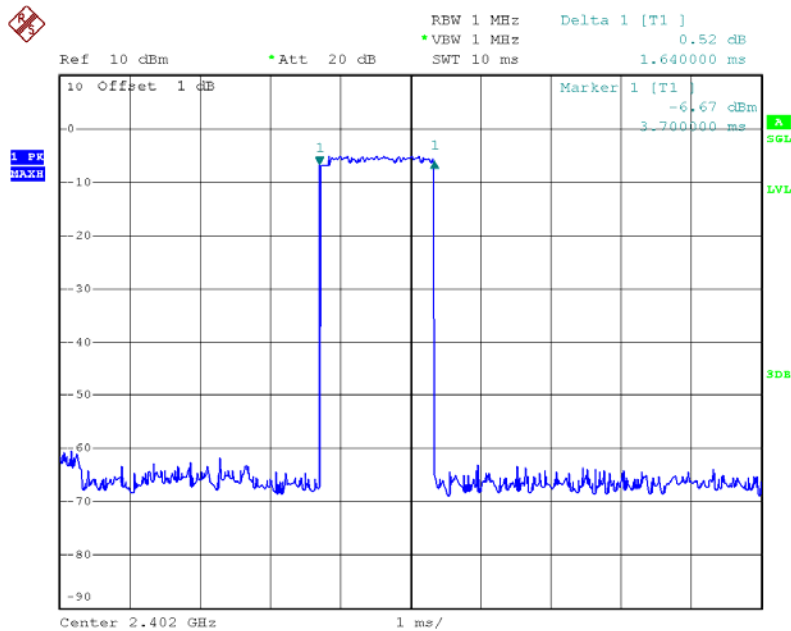

Date: 18.JAN.2016 18:25:11

2402 MHz (8-DPSK DH5)- Pulse Time

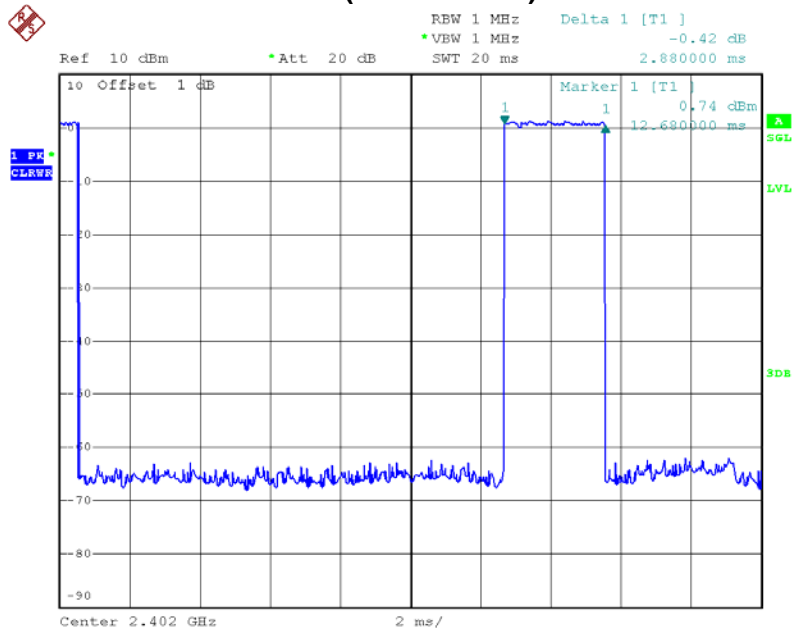

Date: 18.JAN.2016 18:25:39

2441 MHz (8-DPSK DH1)- Pulse Time

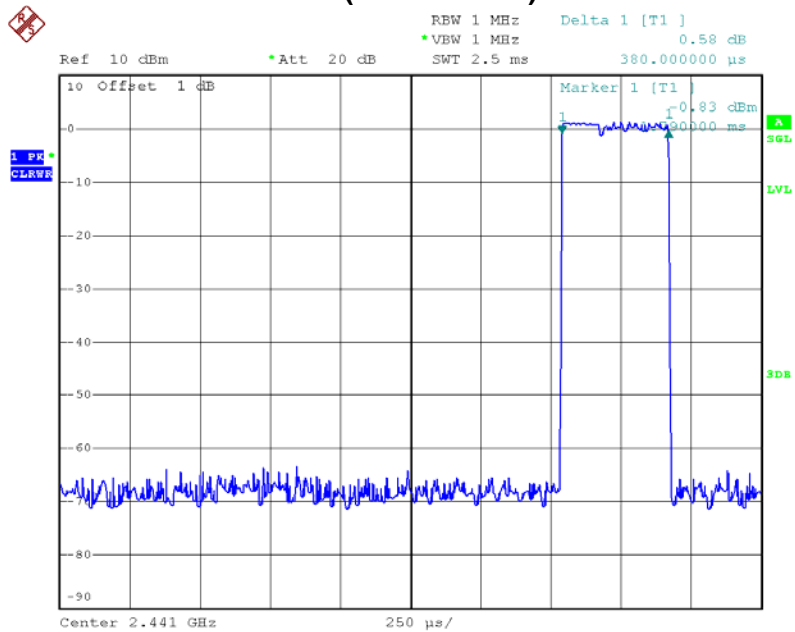

Date: 18.JAN.2016 18:14:19

2441 MHz (8-DPSK DH3)- Pulse Time

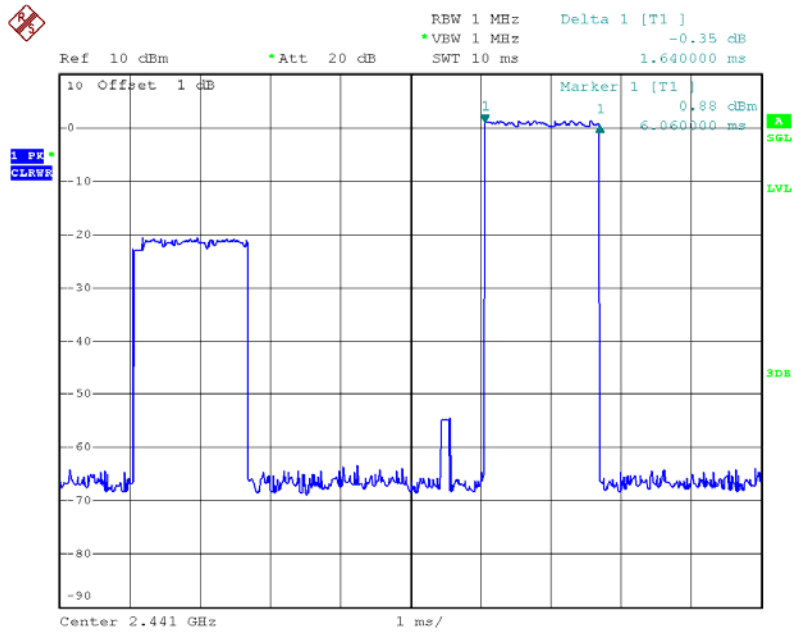

Date: 18.JAN.2016 18:25:18

2441 MHz (8-DPSK DH5)- Pulse Time

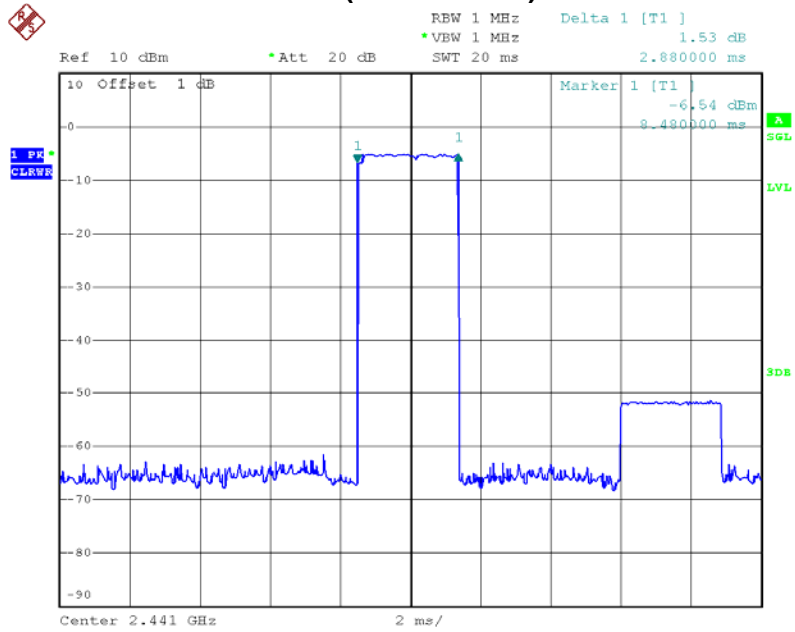

Date: 18.JAN.2016 18:25:44

2480 MHz (8-DPSK DH1)- Pulse Time

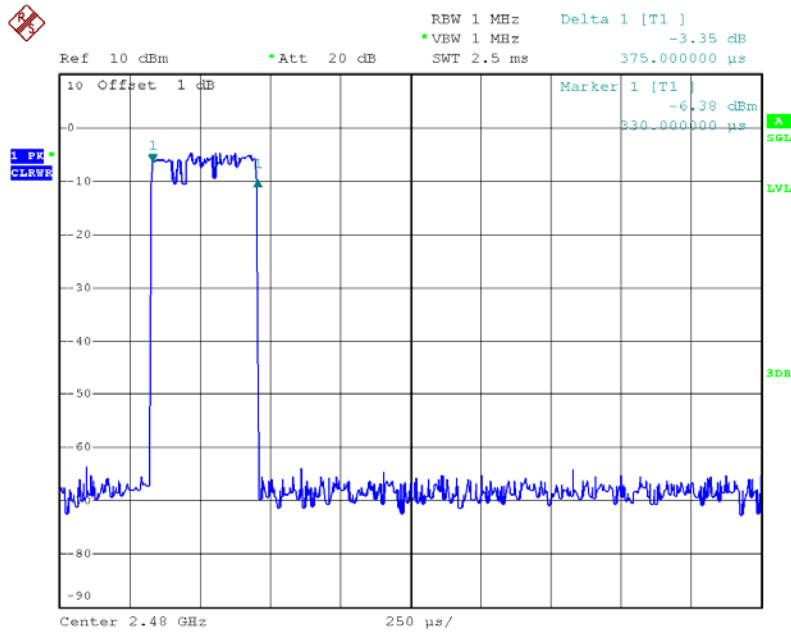

Date: 18.JAN.2016 18:14:26

2480 MHz (8-DPSK DH3)- Pulse Time

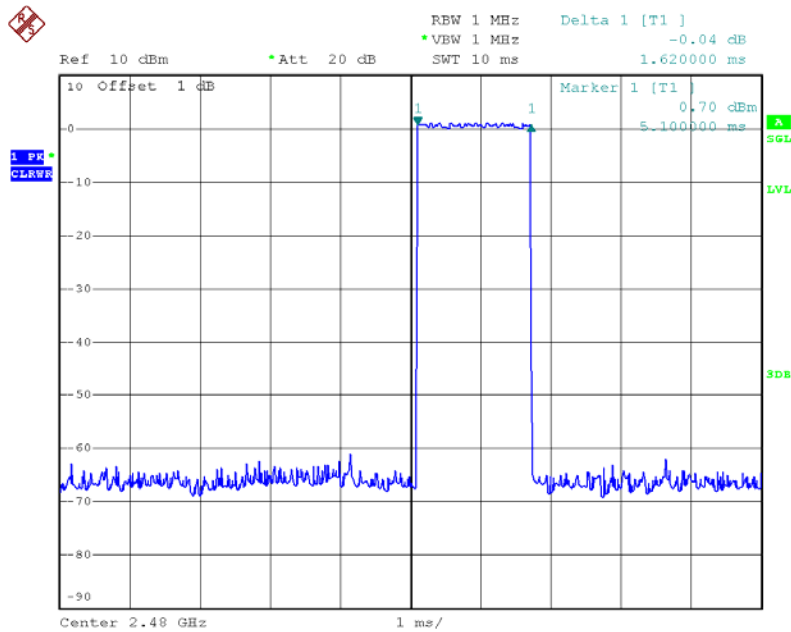

Date: 18.JAN.2016 18:25:23

2480 MHz (8-DPSK DH5)- Pulse Time

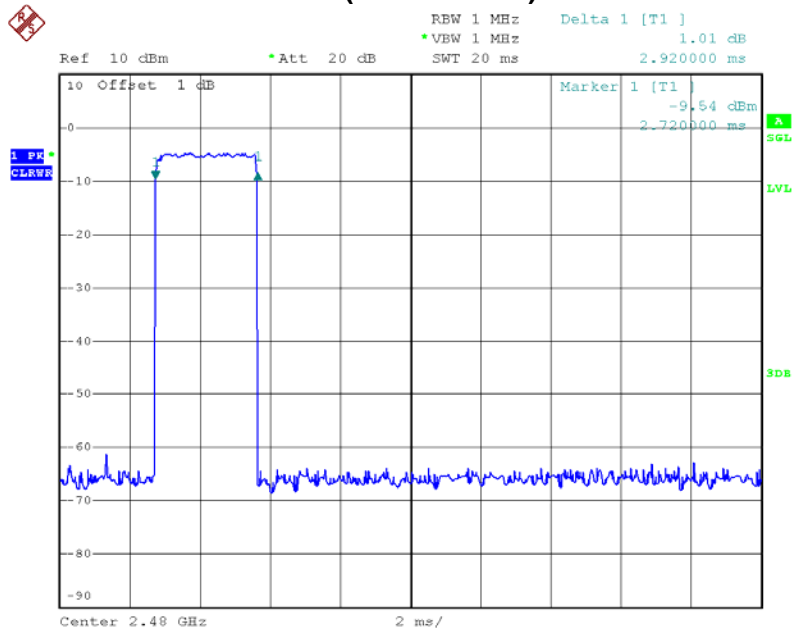

Date: 18.JAN.2016 18:25:48

10. BAND EDGES MEASUREMENT

10.1 LIMITS

Band Edges Requirement	In any 100 kHz bandwidth outside the intentional radiation frequency band, the radio frequency power shall be at least 20 dB below the highest level of the radiated power. In addition, radiated emissions which fall in the restricted bands must also comply with the radiated emission limits.
------------------------	--

10.2 TEST PROCEDURE

The EUT was directly connected to the power meter and antenna output port as show in the block diagram as bellow.

- a. Set frequency range to capture low band-edge from 2310 MHz up to 2390 MHz, and for up band-edge from 2483.5 MHz up to 2500 MHz
- b. For low band-edge set the equipment transmit at the lowest channel, and for up band-edge set the equipment transmit at the highest channel
- c. Set the VBW ≥ 3 RBW (100kHz/ 300kHz) for conducted measurement
- d. For radiated measurements the RBW set to 1 MHz, and the VBW set to 1 MHz for peak measurements and 10 Hz for average measurement

10.3 TEST SETUP

(A) Radiated Emission Test Set-Up

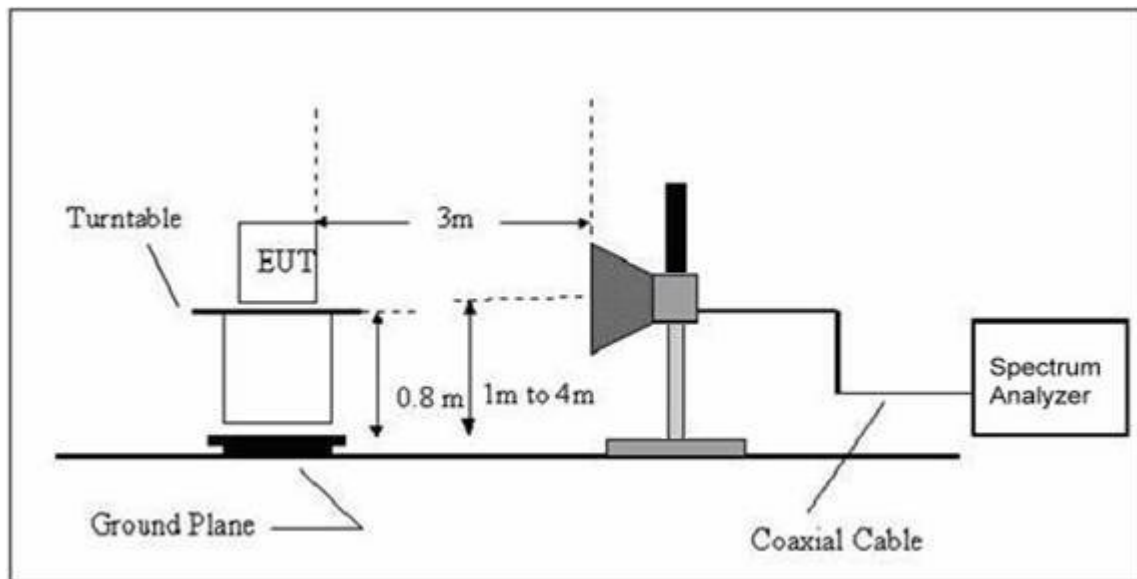

(B) Conducted Emission Test Setup

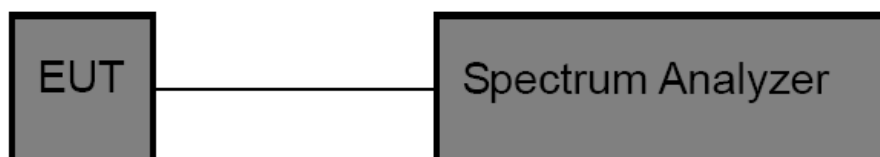

10.4 TEST INSTRUMENTS

Equipment	Manufacturer	Type No.	Serial No.	Last calibration	Calibrated until	Calibration period
Spectrum Analyzer	R&S	FSP40	100154	Jul. 05, 2015	Jul. 04. 2016	1 year

10.5 EUT OPERATING CONDITIONS

The EUT was set to continuously transmitting in the maximum power during the test.

10.6 TEST RESULTS

Fixed GFSK Mode Low

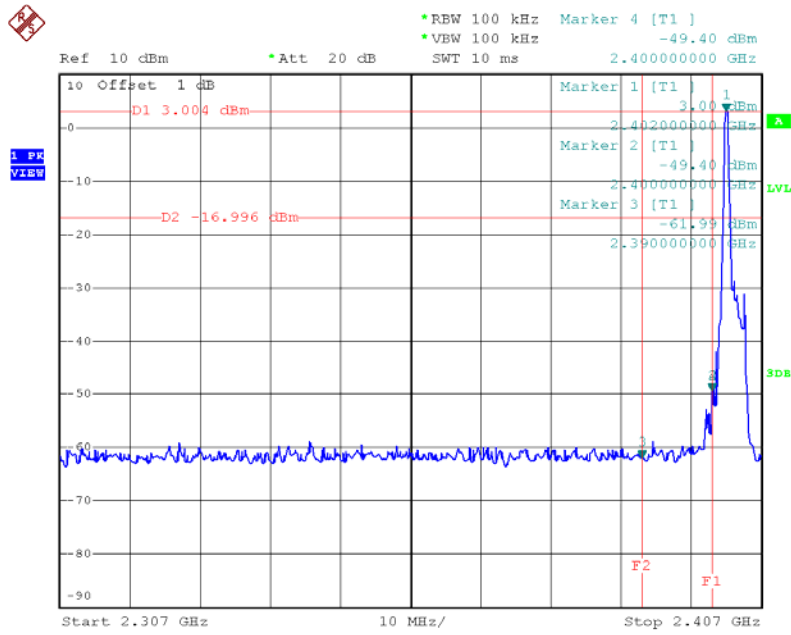

Date: 18.JAN.2016 16:49:40

Fixed GFSK Mode Up

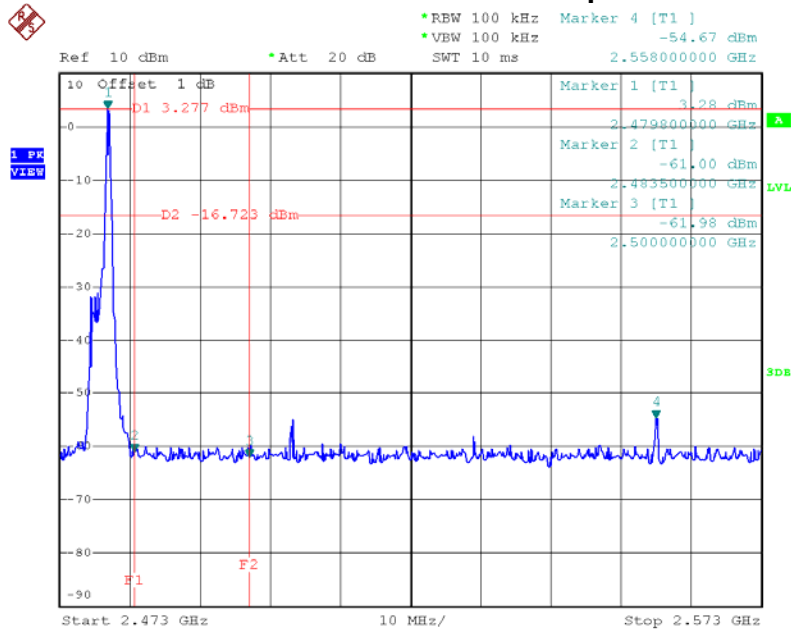

Date: 18.JAN.2016 16:52:51

Hopping GFSK Mode Low

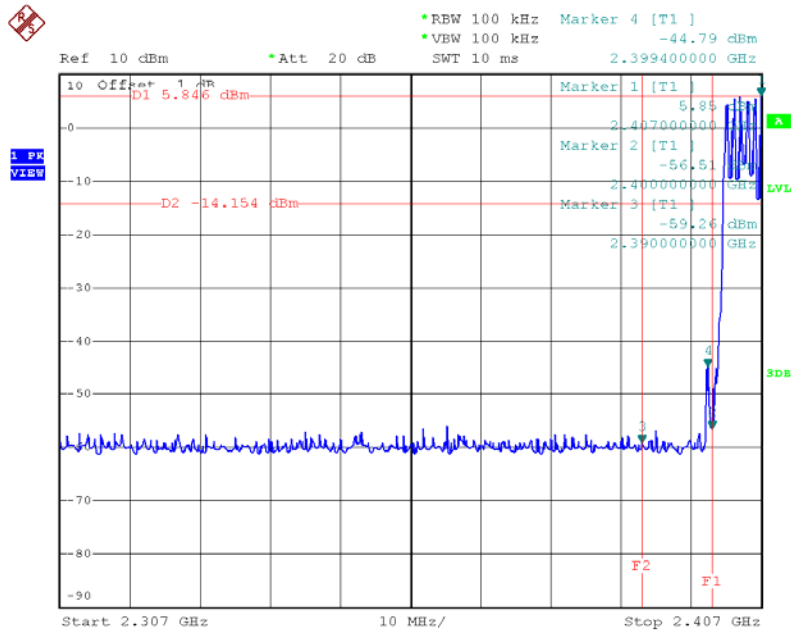

Date: 18.JAN.2016 17:00:27

Hopping GFSK Mode Up

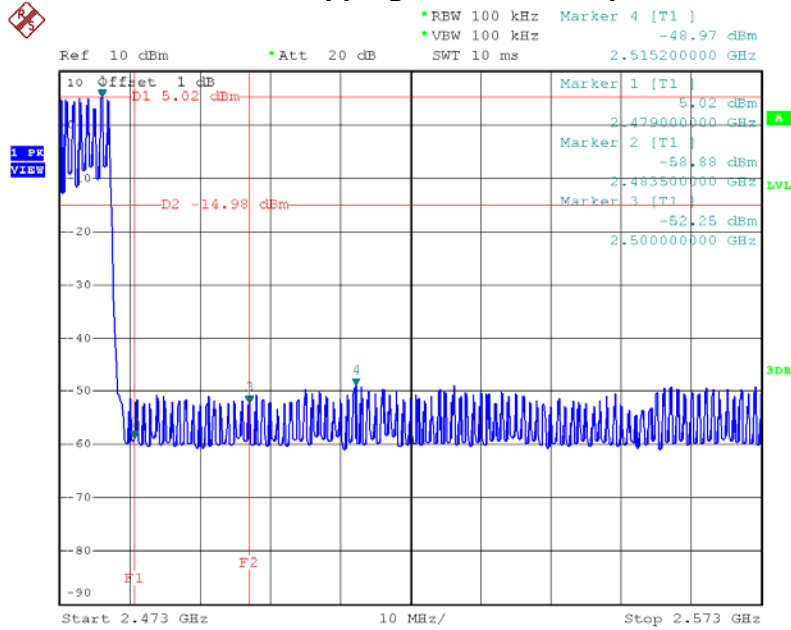

Date: 18.JAN.2016 17:03:30

Fixed 8-DPSK Mode Low

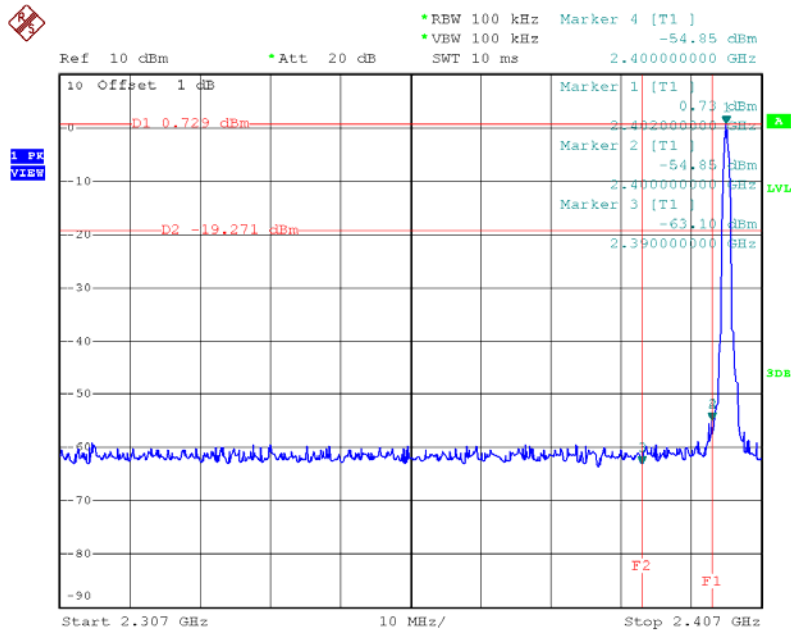

Date: 18.JAN.2016 18:02:27

Fixed 8-DPSK Mode Up

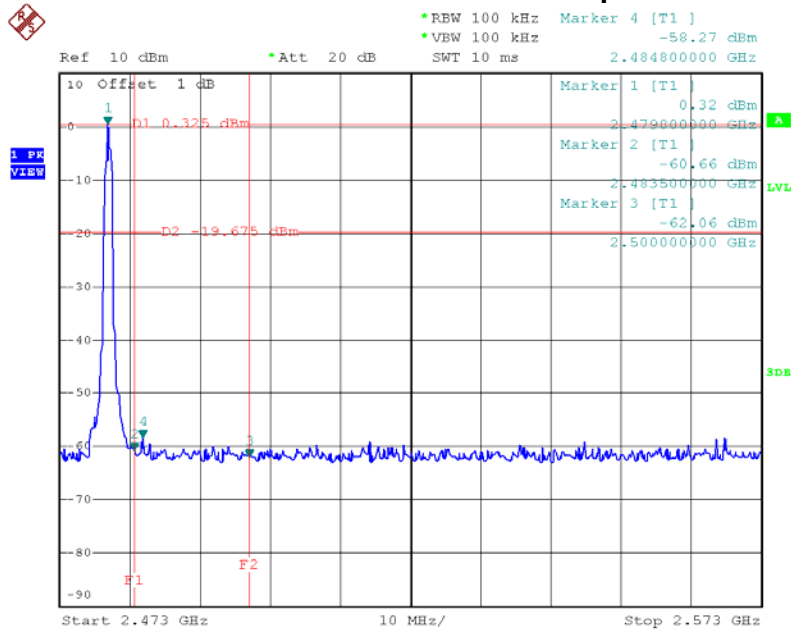

Date: 18.JAN.2016 18:05:47

Hopping 8-DPSK Mode Low

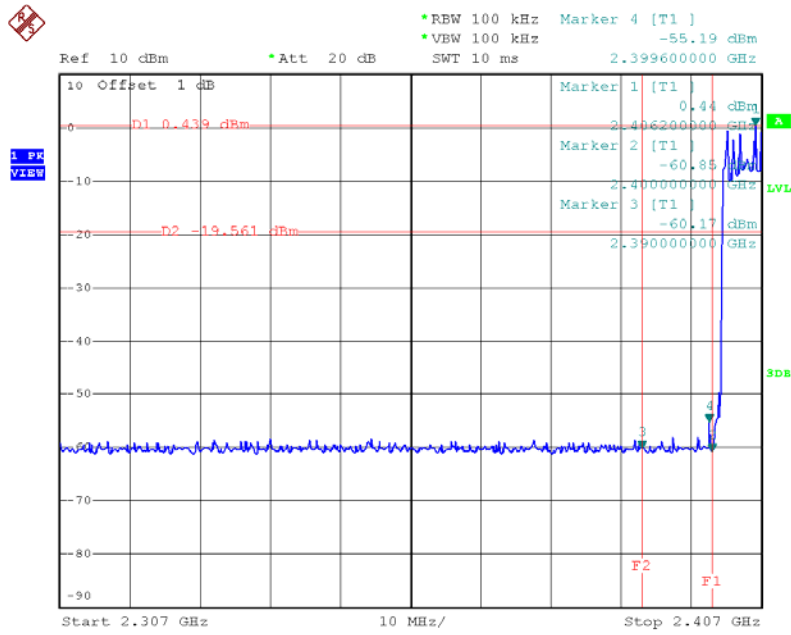

Date: 18.JAN.2016 18:24:10

Hopping GFSK Mode Up

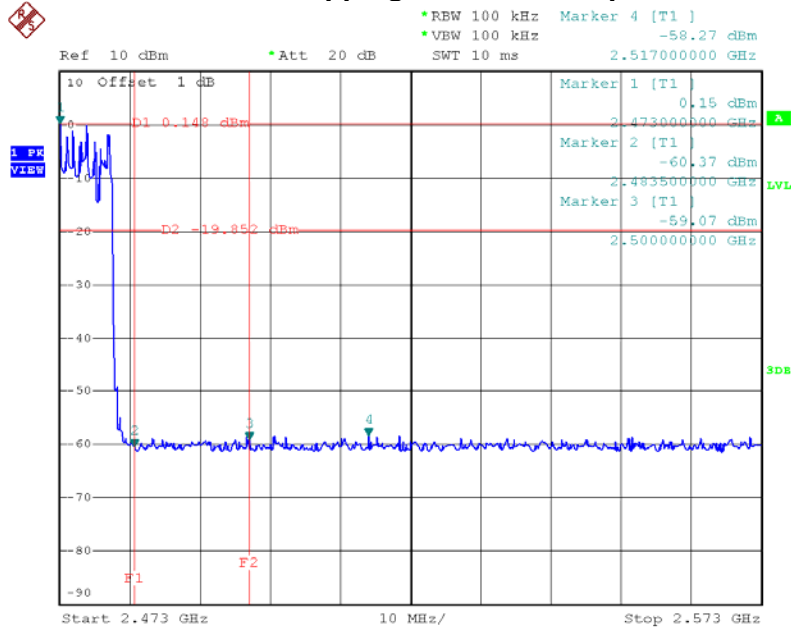

Date: 18.JAN.2016 18:24:44

11. OUT OF BAND CONDUCTED EMISSIONS MEASUREMENT

11.1 LIMITS

Requirement	In any 100 kHz bandwidth outside the frequency band in which the spread spectrum or digitally modulated intentional radiator is operating, the radio frequency power that is produced by the intentional radiator shall be at least 20 dB below that in the 100 kHz bandwidth within the band that contains the highest level of the desired power
-------------	--

11.2 TEST PROCEDURE

The EUT was directly connected to the power meter and antenna output port as show in the block diagram as bellow.

- a. Set spectrum frequency range from 30 MHz~26.5 GHz.
- b. Set spectrum RBW=100 kHz, RBW=300 kHz.
- c. Detector= Peak.
- d. Sweep time= auto couple
- e. Trace mode= maxhold.
- f. Allow trace to fully stabilize.
- g. Use the peak marker function to determine the maximum amplitude level within the RBW.

11.3 TEST SETUP

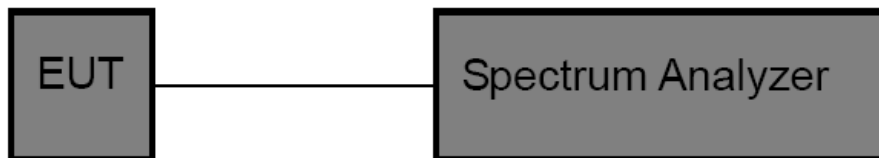

11.4 TEST INSTRUMENTS

Equipment	Manufacturer	Type No.	Serial No.	Last calibration	Calibrated until	Calibration period
Spectrum Analyzer	R&S	FSP40	MY45108040	Jul. 05, 2015	Jul. 04. 2016	1 year

11.5 EUT OPERATING CONDITIONS

The EUT was set to continuously transmitting in the maximum power during the test.

11.6 TEST RESULTS

GFSK 2402 MHz

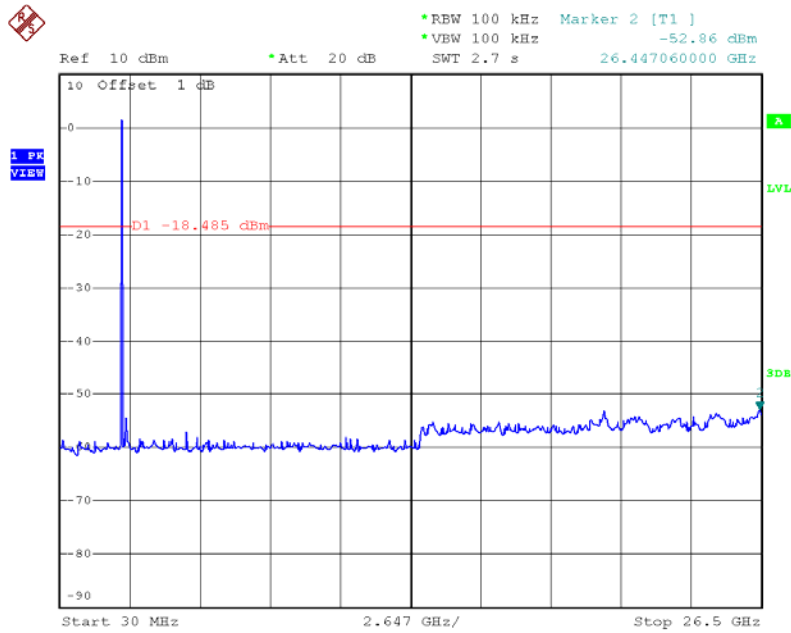

Date: 18.JAN.2016 16:50:35

GFSK 2441 MHz

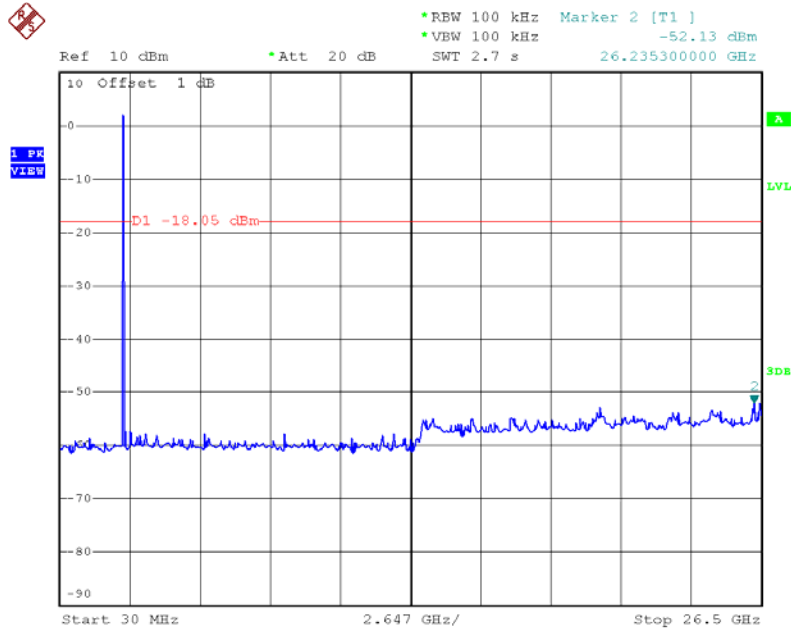

Date: 18.JAN.2016 16:51:37

GFSK 2480 MHz

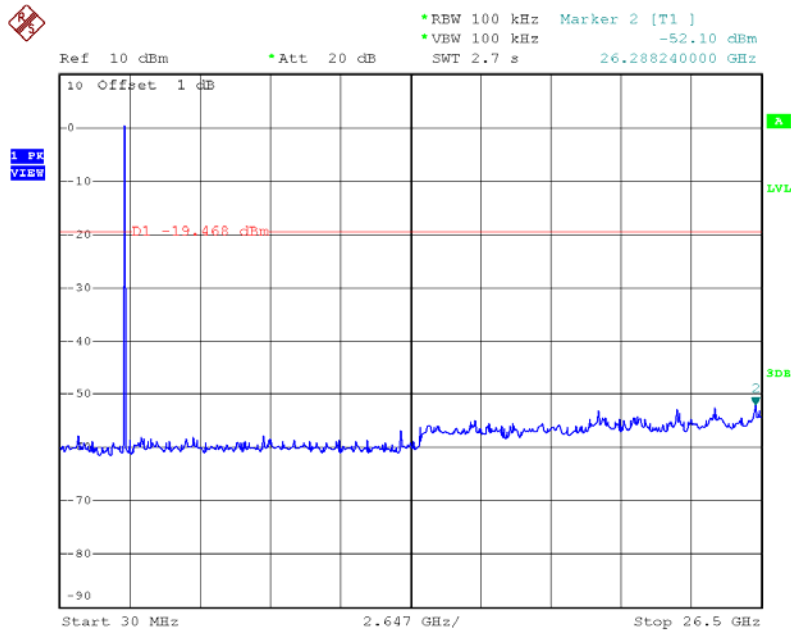

Date: 18.JAN.2016 16:53:40

8-DPSK 2402 MHz

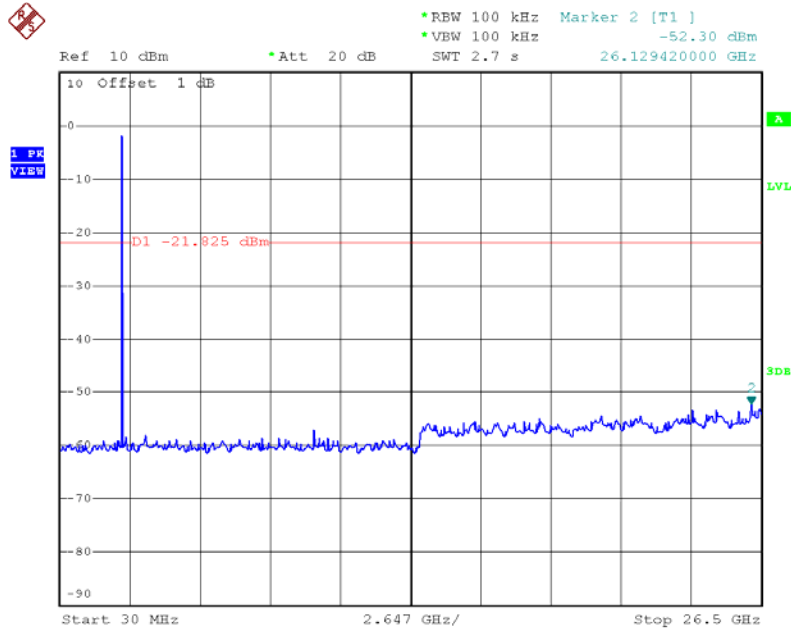

Date: 18.JAN.2016 18:03:02

8-DPSK 2441 MHz

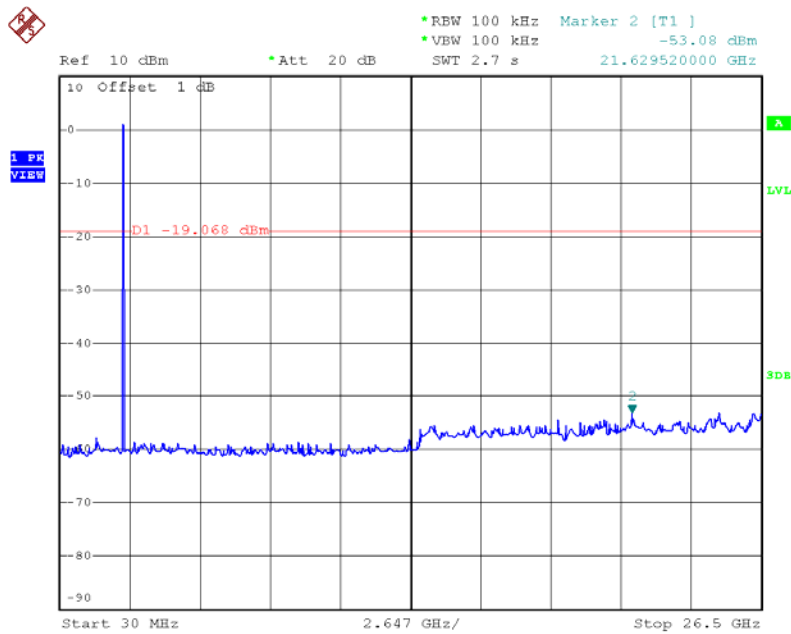

Date: 18.JAN.2016 18:04:14

8-DPSK 2480 MHz

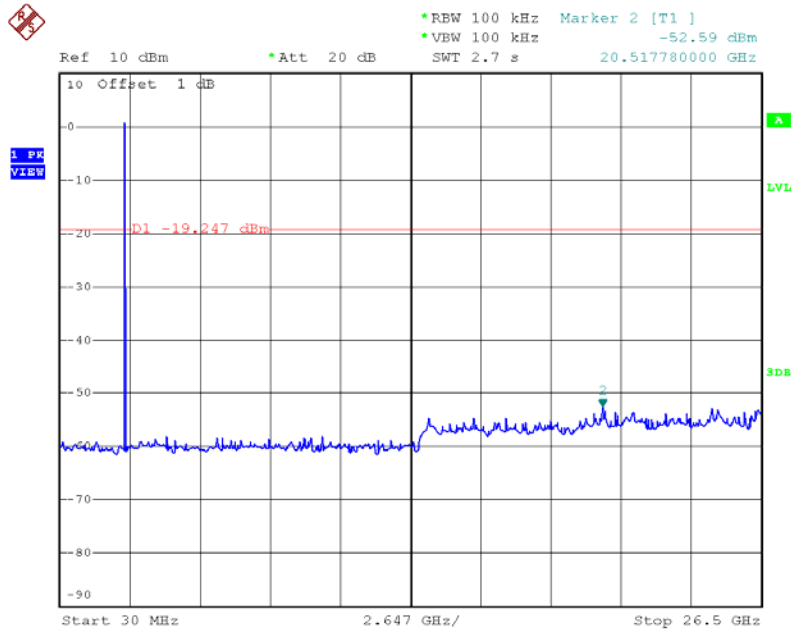

Date: 18.JAN.2016 18:06:27

12. ANTENNA REQUIREMENT

12.1 REQUIREMENT

Antenna Requirement (15.203)	An intentional radiator shall be designed to ensure that no antenna other than that furnished by the responsible party shall be used with the device. The use of a permanently attached antenna or of an antenna that uses a unique coupling to the intentional radiator shall be considered sufficient to comply with the provisions of this Section. The manufacturer may design the unit so that a broken antenna can be replaced by the user, but the use of a standard antenna jack or electrical connector is prohibited.
Antenna Requirement (15.247)	If transmitting antennas of directional gain greater than 6 dBi are used, the power shall be reduced by the amount in dB that the directional gain of the antenna exceeds 6 dBi.

12.2 ANTENNA CONNECTOR CONSTRUCTION

The EUT antenna is a FPC Antenna. And the maximum gain of this antenna is 3.96 dBi. It complies with the standard requirement.