

CFR 47 FCC PART 15 SUBPART C

TEST REPORT

For

WIFI+BT Module

MODEL NUMBER: WL3HR1500

REPORT NUMBER: 4790897717.1-RF-2

ISSUE DATE: June 26, 2023

FCC ID: 2AC23-WL3H

Prepared for

**Hui Zhou Gaoshengda Technology Co.,LTD
No.2, Jin-da Road, Huinan High-tech Industrial Park, Huizhou, Guangdong, China**

Prepared by

UL Verification Services (Guangzhou) Co., Ltd, Song Shan Lake Branch

Building 10, Innovation Technology Park, No. 1, Li Bin Road, Song Shan Lake Hi-Tech Development Zone Dongguan, 523808, People's Republic of China

Tel: +86 769 22038881

Fax: +86 769 33244054

Website: www.ul.com

Revision History

Rev.	Issue Date	Revisions	Revised By
V0	June 26, 2023	Initial Issue	

Summary of Test Results

Test Item	Clause	Limit/Requirement	Result
Antenna Requirement	N/A	FCC Part 15.203/15.247 (c)	Pass
AC Power Line Conducted Emission	ANSI C63.10-2013, Clause 6.2	FCC Part 15.207	Pass
Conducted Output Power	ANSI C63.10-2013, Clause 11.9.1.3	FCC Part 15.247 (b)(3)	Pass
6dB Bandwidth and 99% Occupied Bandwidth	ANSI C63.10-2013, Clause 11.8.1	FCC Part 15.247 (a)(2)	Pass
Power Spectral Density	ANSI C63.10-2013, Clause 11.10.2	FCC Part 15.247 (e)	Pass
Conducted Band edge and spurious emission	ANSI C63.10-2013, Clause 11.11	FCC Part 15.247(d)	Pass
Radiated Band edge and Spurious Emission	ANSI C63.10-2013, Clause 11.12 & Clause 11.13	FCC Part 15.247 (d) FCC Part 15.205/15.209	Pass
Duty Cycle	ANSI C63.10-2013, Clause 11.6	None; for reporting purposes only.	Pass

*This test report is only published to and used by the applicant, and it is not for evidence purpose in China.

*The measurement result for the sample received is <Pass> according to <CFR 47 FCC PART 15 SUBPART C> when <Accuracy Method> decision rule is applied.

CONTENTS

1. ATTESTATION OF TEST RESULTS.....	6
2. TEST METHODOLOGY.....	7
3. FACILITIES AND ACCREDITATION.....	7
4. CALIBRATION AND UNCERTAINTY	8
4.1. <i>MEASURING INSTRUMENT CALIBRATION</i>	<i>8</i>
4.2. <i>MEASUREMENT UNCERTAINTY.....</i>	<i>8</i>
5. EQUIPMENT UNDER TEST	9
5.1. <i>DESCRIPTION OF EUT</i>	<i>9</i>
5.2. <i>CHANNEL LIST</i>	<i>9</i>
5.3. <i>MAXIMUM EIRP</i>	<i>9</i>
5.4. <i>TEST CHANNEL CONFIGURATION.....</i>	<i>9</i>
5.5. <i>THE WORSE CASE POWER SETTING PARAMETER.....</i>	<i>10</i>
5.6. <i>WORST-CASE CONFIGURATIONS.....</i>	<i>10</i>
5.7. <i>DESCRIPTION OF AVAILABLE ANTENNAS</i>	<i>11</i>
5.8. <i>SUPPORT UNITS FOR SYSTEM TEST</i>	<i>12</i>
6. MEASURING EQUIPMENT AND SOFTWARE USED.....	13
7. ANTENNA PORT TEST RESULTS	16
7.1. <i>CONDUCTED OUTPUT POWER</i>	<i>16</i>
7.2. <i>6DB BANDWIDTH AND 99% OCCUPIED BANDWIDTH.....</i>	<i>17</i>
7.3. <i>POWER SPECTRAL DENSITY</i>	<i>19</i>
7.4. <i>CONDUCTED BAND EDGE AND SPURIOUS EMISSION.....</i>	<i>21</i>
7.5. <i>DUTY CYCLE</i>	<i>23</i>
8. RADIATED TEST RESULTS.....	24
8.1. <i>RESTRICTED BANDEDGE</i>	<i>32</i>
8.2. <i>SPURIOUS EMISSIONS(1 GHZ~3 GHZ)</i>	<i>44</i>
8.3. <i>SPURIOUS EMISSIONS(3 GHZ~18 GHZ)</i>	<i>50</i>
8.4. <i>SPURIOUS EMISSIONS(9 KHZ~30 MHZ)</i>	<i>68</i>
8.5. <i>SPURIOUS EMISSIONS(18 GHZ~26 GHZ)</i>	<i>71</i>
8.6. <i>SPURIOUS EMISSIONS(30 MHZ~1 GHZ).....</i>	<i>73</i>
9. ANTENNA REQUIREMENT	75
10. AC POWER LINE CONDUCTED EMISSION	76

11.	TEST DATA.....	80
11.1.	<i>APPENDIX A: DTS BANDWIDTH.....</i>	<i>80</i>
11.1.1.	Test Result.....	80
11.1.2.	Test Graphs	81
11.2.	<i>APPENDIX B: OCCUPIED CHANNEL BANDWIDTH.....</i>	<i>84</i>
11.2.1.	Test Result.....	84
11.2.2.	Test Graphs	85
11.3.	<i>APPENDIX C: MAXIMUM CONDUCTED OUTPUT POWER.....</i>	<i>88</i>
11.3.1.	Test Result.....	88
11.4.	<i>APPENDIX D: MAXIMUM POWER SPECTRAL DENSITY.....</i>	<i>89</i>
11.4.1.	Test Result.....	89
11.4.2.	Test Graphs	90
11.5.	<i>APPENDIX E: BAND EDGE MEASUREMENTS.....</i>	<i>93</i>
11.5.1.	Test Result.....	93
11.5.2.	Test Graphs	94
11.6.	<i>APPENDIX F: CONDUCTED SPURIOUS EMISSION</i>	<i>96</i>
11.6.1.	Test Result.....	96
11.6.2.	Test Graphs	97
11.7.	<i>APPENDIX G: DUTY CYCLE.....</i>	<i>106</i>
11.7.1.	Test Result.....	106
11.7.2.	Test Graphs	107

1. ATTESTATION OF TEST RESULTS

Applicant Information

Company Name: Hui Zhou Gaoshengda Technology Co.,LTD
 Address: No.2, Jin-da Road, Huinan High-tech Industrial Park, Huizhou, Guangdong, China

Manufacturer Information

Company Name: Hui Zhou Gaoshengda Technology Co.,LTD
 Address: No.2, Jin-da Road, Huinan High-tech Industrial Park, Huizhou, Guangdong, China

EUT Information

EUT Name: WIFI+BT Module
 Model: WL3HR1500
 Brand: GSD
 Sample Received Date: June 16, 2023
 Sample Status: Normal
 Sample ID: 6188147
 Date of Tested: June 16, 2023 to June 26, 2023

APPLICABLE STANDARDS	
STANDARD	TEST RESULTS
CFR 47 FCC PART 15 SUBPART C	Pass

Prepared By:



Fanny Huang
 Engineer Project Associate

Checked By:

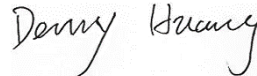

Denny Huang
 Senior Project Engineer

Approved By:



Stephen Guo
 Operations Manager

2. TEST METHODOLOGY

All tests were performed in accordance with the standard CFR 47 FCC PART 15 SUBPART C , KDB 558074 D01 15.247 Meas Guidance v05r02, KDB 414788 D01 Radiated Test Site v01r01, KDB 662911 D01 Multiple Transmitter Output v02r01, CFR 47 FCC Part 2, ANSI C63.10-2013.

3. FACILITIES AND ACCREDITATION

Accreditation Certificate	<p>A2LA (Certificate No.: 4102.01) UL Verification Services (Guangzhou) Co., Ltd. Song Shan Lake Branch. has been assessed and proved to be in compliance with A2LA.</p> <p>FCC (FCC Designation No.: CN1187) UL Verification Services (Guangzhou) Co., Ltd. Song Shan Lake Branch. Has been recognized to perform compliance testing on equipment subject to the Commission's Declaration of Conformity (DoC) and Certification rules</p> <p>ISED (Company No.: 21320) UL Verification Services (Guangzhou) Co., Ltd. Song Shan Lake Branch. has been registered and fully described in a report filed with ISED. The Company Number is 21320 and the test lab Conformity Assessment Body Identifier (CABID) is CN0046.</p> <p>VCCI (Registration No.: G-20019, R-20004, C-20012 and T-20011) UL Verification Services (Guangzhou) Co., Ltd. Song Shan Lake Branch. has been assessed and proved to be in compliance with VCCI, the Membership No. is 3793. Facility Name: Chamber D, the VCCI registration No. is G-20019 and R-20004 Shielding Room B , the VCCI registration No. is C-20012 and T-20011</p>
---------------------------	--

Note 1:

All tests measurement facilities use to collect the measurement data are located at Building 10, Innovation Technology Park, No. 1, Li Bin Road, Song Shan Lake Hi-Tech Development Zone Dongguan, 523808, People’s Republic of China.

Note 2:

The test anechoic chamber in UL Verification Services (Guangzhou) Co., Ltd. Song Shan Lake Branch had been calibrated and compared to the open field sites and the test anechoic chamber is shown to be equivalent to or worst case from the open field site.

Note 3:

For below 30 MHz, lab had performed measurements at test anechoic chamber and comparing to measurements obtained on an open field site. And these measurements below 30 MHz had been correlated to measurements performed on an OFS.

4. CALIBRATION AND UNCERTAINTY

4.1. MEASURING INSTRUMENT CALIBRATION

The measuring equipment utilized to perform the tests documented in this report has been calibrated in accordance with the manufacturer's recommendations and is traceable to recognized national standards.

4.2. MEASUREMENT UNCERTAINTY

Where relevant, the following measurement uncertainty levels have been estimated for tests performed on the apparatus:

Test Item	Uncertainty
Conduction emission	3.62 dB
Radiated Emission (Included Fundamental Emission) (9 kHz ~ 30 MHz)	2.2 dB
Radiated Emission (Included Fundamental Emission) (30 MHz ~ 1 GHz)	4.00 dB
Radiated Emission (Included Fundamental Emission) (1 GHz to 26 GHz)	5.78 dB (1 GHz ~ 18 GHz)
	5.23 dB (18 GHz ~ 26 GHz)
Duty Cycle	±0.028%
DTS and 99% Occupied Bandwidth	±0.0196%
Maximum Conducted Output Power	±0.686 dB
Maximum Power Spectral Density Level	±0.743 dB
Conducted Band-edge Compliance	±1.328 dB
Conducted Unwanted Emissions In Non-restricted Frequency Bands	±0.746 dB (9 kHz ~ 1 GHz)
	±1.328dB (1 GHz ~ 26 GHz)
Note: This uncertainty represents an expanded uncertainty expressed at approximately the 95% confidence level using a coverage factor of k=2.	

5. EQUIPMENT UNDER TEST

5.1. DESCRIPTION OF EUT

EUT Name	WIFI+BT Module
Model	WL3HR1500
Frequency Range:	2412 MHz to 2462 MHz
Type of Modulation:	IEEE 802.11b: DSSS(CCK, DQPSK, DBPSK) IEEE 802.11g/n: OFDM(64-QAM, 16-QAM, QPSK, BPSK)
Radio Technology:	IEEE 802.11b/g/n-HT20
Normal Test Voltage:	DC 3.3 V

5.2. CHANNEL LIST

Channel List for 802.11b/g/n (20 MHz)							
Channel	Frequency (MHz)	Channel	Frequency (MHz)	Channel	Frequency (MHz)	Channel	Frequency (MHz)
1	2412	4	2427	7	2442	10	2457
2	2417	5	2432	8	2447	11	2462
3	2422	6	2437	9	2452	/	/

5.3. MAXIMUM EIRP

IEEE Std. 802.11	Frequency (MHz)	Channel Number	Maximum Conducted AVG Output Power (dBm)	Maximum AVG EIRP (dBm)
b	2412 ~ 2462	1-11[11]	17.49	20.29
g	2412 ~ 2462	1-11[11]	15.30	18.10
n HT20	2412 ~ 2462	1-11[11]	14.16	16.96

5.4. TEST CHANNEL CONFIGURATION

IEEE Std. 802.11	Test Channel Number	Frequency
b	CH 1(Low Channel), CH 6(MID Channel), CH 11(High Channel)	2412 MHz, 2437 MHz, 2462 MHz
g	CH 1(Low Channel), CH 6(MID Channel), CH 11(High Channel)	2412 MHz, 2437 MHz, 2462 MHz
n HT20	CH 1(Low Channel), CH 6(MID Channel), CH 11(High Channel)	2412 MHz, 2437 MHz, 2462 MHz

5.5. THE WORSE CASE POWER SETTING PARAMETER

The Worse Case Power Setting Parameter under 2400 ~ 2483.5MHz Band							
Test Software		UI_mptool					
Modulation Mode	Transmit Antenna Number	Test Channel					
		NCB: 20MHz			NCB: 40MHz		
		CH 1	CH 6	CH 11	CH 3	CH 6	CH 9
802.11b	1	84	84	84	/		
802.11g	1	88	88	88			
802.11n HT20	1	84	84	84			

5.6. WORST-CASE CONFIGURATIONS

The EUT was tested in the following configuration(s):

Controlled in test mode using a software application on the EUT supplied by customer. The application was used to enable a continuous transmission and to select the mode, test channels, bandwidth, data rates as required.

Test channels referring to section 5.4.

Maximum power setting referring to section 5.5.

Worst-case data rates as provided by the client were:

802.11b mode: 1 Mbps
 802.11g mode: 6 Mbps
 802.11n HT20 mode: MCS0

The measured additional path loss was included in any path loss calculations for all RF cable used during tested.

5.7. DESCRIPTION OF AVAILABLE ANTENNAS

Antenna	Frequency (MHz)	Antenna Type	MAX Antenna Gain (dBi)
1	2412-2462	PCB Antenna	2.80

The EUT support Cyclic Shift Diversity(CDD) mode.

Test Mode	Transmit and Receive Mode	Description
IEEE 802.11b	<input checked="" type="checkbox"/> 1TX, 1RX	Antenna 1 can be used as transmitting/receiving antenna.
IEEE 802.11g	<input checked="" type="checkbox"/> 1TX, 1RX	Antenna 1 can be used as transmitting/receiving antenna.
IEEE 802.11n HT20	<input checked="" type="checkbox"/> 1TX, 1RX	Antenna 1 can be used as transmitting/receiving antenna.
Note: 1.BT&WLAN 2.4G can't transmit simultaneously. (declared by client)		

Note: The value of the antenna gain was declared by customer.

5.8. SUPPORT UNITS FOR SYSTEM TEST

SUPPORT EQUIPMENT

Item	Equipment	Brand Name	Model Name	Remark
1	PC	Lenovo	E42-80	/
2	UART	/	/	/

I/O CABLES

Cable No	Port	Connector Type	Cable Type	Cable Length(m)	Remarks
1	USB	/	/	1.0	/

ACCESSORIES

Item	Accessory	Brand Name	Model Name	Description
/	/	/	/	/

TEST SETUP

The EUT can work in engineering mode with a software through a Laptop.

SETUP DIAGRAM FOR TESTS

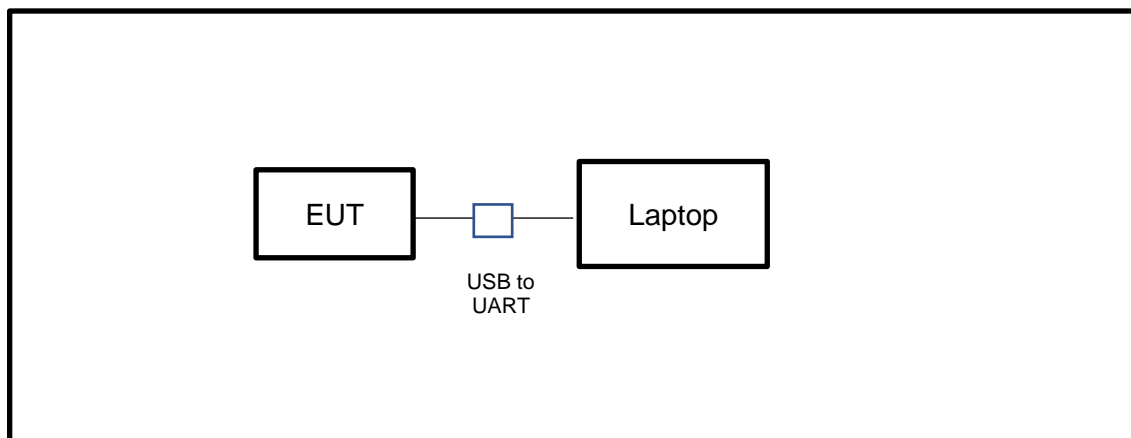

6. MEASURING EQUIPMENT AND SOFTWARE USED

R&S TS 8997 Test System					
Equipment	Manufacturer	Model No.	Serial No.	Last Cal.	Due. Date
Power sensor, Power Meter	R&S	OSP120	100921	Mar.31,2023	Mar.30,2024
Vector Signal Generator	R&S	SMBV100A	261637	Oct.17, 2022	Oct.16, 2023
Signal Generator	R&S	SMB100A	178553	Oct.17, 2022	Oct.16, 2023
Signal Analyzer	R&S	FSV40	101118	Oct.17, 2022	Oct.16, 2023
Software					
Description	Manufacturer	Name		Version	
For R&S TS 8997 Test System	Rohde & Schwarz	EMC 32		10.60.10	
Tonsend RF Test System					
Equipment	Manufacturer	Model No.	Serial No.	Last Cal.	Due. Date
Wideband Radio Communication Tester	R&S	CMW500	155523	Oct.17, 2022	Oct.16, 2023
Wireless Connectivity Tester	R&S	CMW270	1201.0002N75-102	Sep.28, 2022	Sep.27, 2023
PXA Signal Analyzer	Keysight	N9030A	MY55410512	Oct.17, 2022	Oct.16, 2023
MXG Vector Signal Generator	Keysight	N5182B	MY56200284	Oct.17, 2022	Oct.16, 2023
MXG Vector Signal Generator	Keysight	N5172B	MY56200301	Oct.17, 2022	Oct.16, 2023
DC power supply	Keysight	E3642A	MY55159130	Oct.17, 2022	Oct.16, 2023
Temperature & Humidity Chamber	SANMOOD	SG-80-CC-2	2088	Oct.17, 2022	Oct.16, 2023
Attenuator	Aglient	8495B	2814a12853	Oct.18, 2022	Oct.17, 2023
RF Control Unit	Tonscend	JS0806-2	23B80620666	April 18,2023	April 17,2024
Software					
Description	Manufacturer	Name		Version	
Tonsend SRD Test System	Tonsend	JS1120-3 RF Test System		V3.2.22	

Conducted Emissions					
Equipment	Manufacturer	Model No.	Serial No.	Last Cal.	Due Date
EMI Test Receiver	R&S	ESR3	101961	Oct.17, 2022	Oct.16, 2023
Two-Line V-Network	R&S	ENV216	101983	Oct.17, 2022	Oct.16, 2023
Artificial Mains Networks	Schwarzbeck	NSLK 8126	8126465	Oct.17, 2022	Oct.16, 2023
Software					
Description			Manufacturer	Name	Version
Test Software for Conducted Emissions			Farad	EZ-EMC	Ver. UL-3A1

Radiated Emissions					
Equipment	Manufacturer	Model No.	Serial No.	Last Cal.	Due Date
MXE EMI Receiver	KESIGHT	N9038A	MY56400036	Oct.17, 2022	Oct.16, 2023
Hybrid Log Periodic Antenna	TDK	HLP-3003C	130959	Aug.02, 2021	Aug.01, 2024
Preamplifier	HP	8447D	2944A09099	Oct.17, 2022	Oct.16, 2023
EMI Measurement Receiver	R&S	ESR26	101377	Oct.17, 2022	Oct.16, 2023
Horn Antenna	TDK	HRN-0118	130940	July 20, 2021	July 19, 2024
Preamplifier	TDK	PA-02-0118	TRS-305-00067	Oct.17, 2022	Oct.16, 2023
Horn Antenna	Schwarzbeck	BBHA9170	697	July 20, 2021	July 19, 2024
Preamplifier	TDK	PA-02-2	TRS-307-00003	Oct.17, 2022	Oct.16, 2023
Preamplifier	TDK	PA-02-3	TRS-308-00002	Oct.17, 2022	Oct.16, 2023
Loop antenna	Schwarzbeck	1519B	00008	Dec.14, 2021	Dec.13, 2024
Preamplifier	TDK	PA-02-001-3000	TRS-302-00050	Oct.17, 2022	Oct.16, 2023
Preamplifier	Mini-Circuits	ZX60-83LN-S+	SUP01202035	Oct.17, 2022	Oct.16, 2023
High Pass Filter	Wi	WHKX10-2700-3000-18000-40SS	23	Oct.17, 2022	Oct.16, 2023
Highpass Filter	Wainwright	WHKX10-5850-6500-1800-40SS	4	Oct.17, 2022	Oct.16, 2023
Band Reject Filter	Wainwright	WRCJV12-5695-5725-5850-5880-40SS	4	Oct.17, 2022	Oct.16, 2023

Band Reject Filter	Wainwright	WRCJV20-5120-5150-5350-5380-60SS	2	Oct.17, 2022	Oct.16, 2023
Band Reject Filter	Wainwright	WRCJV20-5440-5470-5725-5755-60SS	1	Oct.17, 2022	Oct.16, 2023
Band Reject Filter	Wainwright	WRCJV8-2350-2400-2483.5-2533.5-40SS	4	Oct.17, 2022	Oct.16, 2023
Band Reject Filter	Wainwright	WRCD5-1879-1879.85-1880.15-1881-40SS	1	Oct.17, 2022	Oct.16, 2023
Notch Filter	Wainwright	WHJ10-882-980-7000-40SS	1	Oct.17, 2022	Oct.16, 2023
Software					
Description		Manufacturer	Name	Version	
Test Software for Radiated Emissions		Farad	EZ-EMC	Ver. UL-3A1	

Other Instrument					
Equipment	Manufacturer	Model No.	Serial No.	Last Cal.	Due Date
Temperature humidity probe	OMEGA	ITHX-SD-5	18470007	Oct.22, 2022	Oct.21, 2023
Barometer	Yiyi	Baro	N/A	Oct.24, 2022	Oct.23, 2023
Attenuator	Agilent	8495B	2814a12853	Oct.18, 2022	Oct.17, 2023

7. ANTENNA PORT TEST RESULTS

7.1. CONDUCTED OUTPUT POWER

LIMITS

CFR 47 FCC Part15 (15.247) Subpart C			
Section	Test Item	Limit	Frequency Range (MHz)
CFR 47 FCC 15.247(b)(3)	AVG Output Power	1 watt or 30 dBm	2400-2483.5

TEST PROCEDURE

Refer to ANSI C63.10-2013 clause 11.9.2.3.1.

Connect the EUT to a low loss RF cable from the antenna port to the power sensor (video bandwidth is greater than the occupied bandwidth).

Measure peak emission level, the indicated level is the average output power, after any corrections for external attenuators and cables.

The test result in dBm by adding $[10 \log (1 / D)]$, where D is the duty cycle.

TEST SETUP

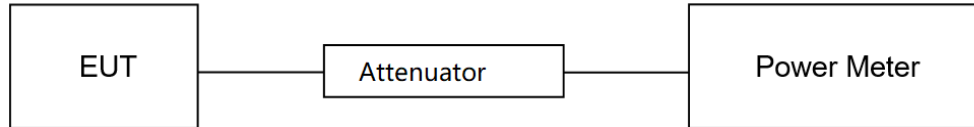

TEST ENVIRONMENT

Temperature	25°C	Relative Humidity	57%
Atmosphere Pressure	101kPa	Test Voltage	DC 3.3 V

TEST DATE / ENGINEER

Test Date	June 19, 2023	Test By	Walker Yuan
-----------	---------------	---------	-------------

TEST RESULTS

Please refer to section "Test Data" - Appendix C

7.2. 6DB BANDWIDTH AND 99% OCCUPIED BANDWIDTH

LIMITS

CFR 47 FCC Part15 (15.247) Subpart C			
Section	Test Item	Limit	Frequency Range (MHz)
CFR 47 FCC 15.247(a)(2)	6 dB Bandwidth	≥ 500 kHz	2400-2483.5
ISED RSS-Gen Clause 6.7	99 % Occupied Bandwidth	For reporting purposes only.	2400-2483.5

TEST PROCEDURE

Refer to ANSI C63.10-2013 clause 11.8 for DTS bandwidth and clause 6.9 for Occupied Bandwidth.

Connect the EUT to the spectrum analyser and use the following settings:

Center Frequency	The center frequency of the channel under test
Frequency Span	For 6 dB Bandwidth: Enough to capture all products of the modulation carrier emission For 99 % Occupied Bandwidth: Between 1.5 times and 5.0 times the OBW
Detector	Peak
RBW	For 6 dB Bandwidth: 100 kHz For 99 % Occupied Bandwidth: 1 % to 5 % of the occupied bandwidth
VBW	For 6 dB Bandwidth: ≥3 × RBW For 99 % Occupied Bandwidth: ≥3 × RBW
Trace	Max hold
Sweep	Auto couple

a) Use the 99 % power bandwidth function of the instrument, allow the trace to stabilize and report the measured bandwidth.

b) Allow the trace to stabilize and measure the maximum width of the emission that is constrained by the frequencies associated with the two outermost amplitude points (upper and lower frequencies) that are attenuated by 6 dB relative to the maximum level measured in the fundamental emission.

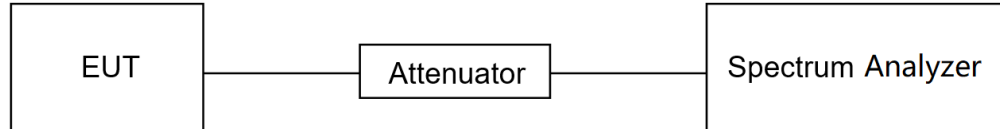
TEST SETUP**TEST ENVIRONMENT**

Temperature	25°C	Relative Humidity	57%
Atmosphere Pressure	101kPa	Test Voltage	DC 3.3 V

TEST DATE / ENGINEER

Test Date	June 19, 2023	Test By	Walker Yuan
-----------	---------------	---------	-------------

TEST RESULTS

Please refer to section "Test Data" - Appendix A&B

7.3. POWER SPECTRAL DENSITY

LIMITS

CFR 47 FCC Part15 (15.247) Subpart C			
Section	Test Item	Limit	Frequency Range (MHz)
CFR 47 FCC §15.247 (e)	Power Spectral Density	8 dBm in any 3 kHz band	2400-2483.5

TEST PROCEDURE

Refer to ANSI C63.10-2013 clause 11.10.5.

Connect the EUT to the spectrum analyser and use the following settings:

Center Frequency	The center frequency of the channel under test
Detector	power averaging (rms)
RBW	$3 \text{ kHz} \leq \text{RBW} \leq 100 \text{ kHz}$
VBW	$\geq 3 \times \text{RBW}$
Span	1.5 x OBW bandwidth
Trace	Average
Sweep time	Auto couple

Allow trace to fully stabilize and use the peak marker function to determine the maximum amplitude level within the RBW.

If measured value exceeds limit, reduce RBW (no less than 3 kHz) and repeat.

TEST SETUP

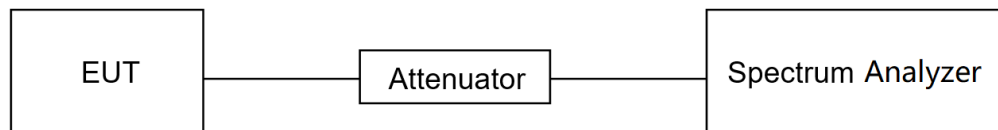

TEST ENVIRONMENT

Temperature	25°C	Relative Humidity	57%
Atmosphere Pressure	101kPa	Test Voltage	DC 3.3 V

TEST DATE / ENGINEER

Test Date	June 19, 2023	Test By	Walker Yuan
-----------	---------------	---------	-------------

TEST RESULTS

Please refer to section "Test Data" - Appendix D

7.4. CONDUCTED BAND EDGE AND SPURIOUS EMISSION

LIMITS

CFR 47 FCC Part15 (15.247) Subpart C		
Section	Test Item	Limit
CFR 47 FCC §15.247 (d)	Conducted Bandedge and Spurious Emissions	at least 30 dB below that in the 100 kHz bandwidth within the band that contains the highest level of the desired power

TEST PROCEDURE

Refer to ANSI C63.10-2013 clause 11.11 and 11.13.

Connect the EUT to the spectrum analyser and use the following settings for reference level measurement:

Center Frequency	The center frequency of the channel under test
Detector	Peak
RBW	100 kHz
VBW	$\geq 3 \times \text{RBW}$
Span	1.5 x DTS bandwidth
Trace	Max hold
Sweep time	Auto couple.

Allow trace to fully stabilize and use the peak marker function to determine the maximum PSD level.

Change the settings for emission level measurement:

Span	Set the center frequency and span to encompass frequency range to be measured
Detector	Peak
RBW	100 kHz
VBW	$\geq 3 \times \text{RBW}$
measurement points	$\geq \text{span}/\text{RBW}$
Trace	Max hold
Sweep time	Auto couple.

Allow trace to fully stabilize and use the peak marker function to determine the maximum PSD level. Ensure that the amplitude of all unwanted emissions outside of the authorized frequency band (excluding restricted frequency bands) is attenuated by at least the minimum requirements specified in 11.11.

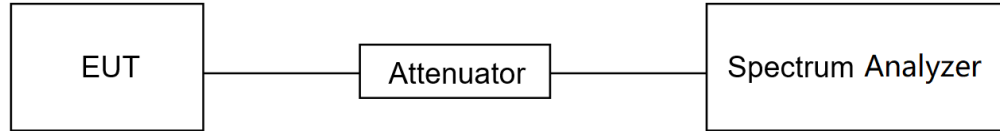
TEST SETUP**TEST ENVIRONMENT**

Temperature	25°C	Relative Humidity	57%
Atmosphere Pressure	101kPa	Test Voltage	DC 3.3 V

TEST DATE / ENGINEER

Test Date	June 19, 2023	Test By	Walker Yuan
-----------	---------------	---------	-------------

TEST RESULTS

Please refer to section "Test Data" - Appendix E&F

7.5. DUTY CYCLE

LIMITS

None; for reporting purposes only.

TEST PROCEDURE

Refer to ANSI C63.10-2013 clause 11.6 Zero – Span Spectrum Analyzer method.

TEST SETUP

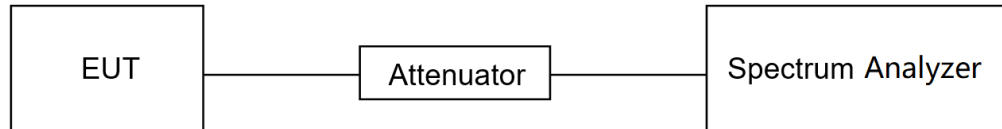

TEST ENVIRONMENT

Temperature	25°C	Relative Humidity	57%
Atmosphere Pressure	101kPa	Test Voltage	DC 3.3 V

TEST DATE / ENGINEER

Test Date	June 19, 2023	Test By	Walker Yuan
-----------	---------------	---------	-------------

TEST RESULTS

Please refer to section "Test Data" - Appendix G

8. RADIATED TEST RESULTS

LIMITS

Please refer to CFR 47 FCC §15.205 and §15.209.

Radiation Disturbance Test Limit for FCC (Class B) (9 kHz ~ 1 GHz)

Emissions radiated outside of the specified frequency bands above 30 MHz			
Frequency Range (MHz)	Field Strength Limit (uV/m) at 3 m	Field Strength Limit (dBuV/m) at 3 m	
		Quasi-Peak	
30 - 88	100	40	
88 - 216	150	43.5	
216 - 960	200	46	
Above 960	500	54	
Above 1000	500	Peak	Average
		74	54

FCC Emissions radiated outside of the specified frequency bands below 30 MHz		
Frequency (MHz)	Field strength (microvolts/meter)	Measurement distance (meters)
0.009-0.490	2400/F(kHz)	300
0.490-1.705	24000/F(kHz)	30
1.705-30.0	30	30

FCC Restricted bands of operation refer to FCC §15.205 (a):

MHz	MHz	MHz	GHz
0.090-0.110	16.42-16.423	399.9-410	4.5-5.15
¹ 0.495-0.505	16.69475-16.69525	608-614	5.35-5.46
2.1735-2.1905	16.80425-16.80475	960-1240	7.25-7.75
4.125-4.128	25.5-25.67	1300-1427	8.025-8.5
4.17725-4.17775	37.5-38.25	1435-1626.5	9.0-9.2
4.20725-4.20775	73-74.6	1645.5-1646.5	9.3-9.5
6.215-6.218	74.8-75.2	1660-1710	10.6-12.7
6.26775-6.26825	108-121.94	1718.8-1722.2	13.25-13.4
6.31175-6.31225	123-138	2200-2300	14.47-14.5
8.291-8.294	149.9-150.05	2310-2390	15.35-16.2
8.362-8.366	156.52475-156.52525	2483.5-2500	17.7-21.4
8.37625-8.38675	156.7-156.9	2690-2900	22.01-23.12
8.41425-8.41475	162.0125-167.17	3260-3267	23.6-24.0
12.29-12.293	167.72-173.2	3332-3339	31.2-31.8
12.51975-12.52025	240-285	3345.8-3358	36.43-36.5
12.57675-12.57725	322-335.4	3600-4400	(²)
13.36-13.41			

Note: ¹Until February 1, 1999, this restricted band shall be 0.490-0.510 MHz.

²Above 38.6c

TEST PROCEDURE

Below 30 MHz

The setting of the spectrum analyser

RBW	200 Hz (From 9 kHz to 0.15 MHz)/ 9 kHz (From 0.15 MHz to 30 MHz)
VBW	200 Hz (From 9 kHz to 0.15 MHz)/ 9 kHz (From 0.15 MHz to 30 MHz)
Sweep	Auto

1. The testing follows the guidelines in ANSI C63.10-2013 clause 6.4.
2. The EUT was arranged to its worst case and then turntable (from 0 degree to 360 degrees) to find the maximum reading. A pre-amp and a high pass filter are used for the test in order to get better signal level. Both Horizontal, Face-on and Face-off polarizations of the antenna are set to make the measurement.
3. The EUT was placed on a turntable with 80 cm above ground.
4. The EUT was set 3 meters from the interference receiving antenna, which was mounted on the top of a 1 m height antenna tower.
5. The radiated emission limits are based on measurements employing a CISPR quasi-peak detector except for the frequency bands 9-90 kHz, 110-490 kHz and above 1000 MHz Radiated emission limits in these three bands are based on measurements employing an average detector.
6. For measurement below 1 GHz, the initial step in collecting conducted emission data is a spectrum analyzer peak detector mode pre-scanning the measurement frequency range. Significant peaks are then marked and then Quasi Peak and average detector mode re-measured. If the emission level of the EUT measured by the peak detector is 3 dB lower than the applicable limit, the peak emission level will be reported. Otherwise, the emission measurement will be repeated using the quasi-peak and average detector and reported.

7. Although these tests were performed other than open field site, adequate comparison measurements were confirmed against 30m open field site. Therefore sufficient tests were made to demonstrate that the alternative site produces results that correlate with the ones of tests made in an open field site based on KDB 414788.

8. The limits in CFR 47, Part 15, Subpart C, paragraph 15.209 (a), are identical to those in RSS-GEN Section 8.9, Table 6, since the measurements are performed in terms of magnetic field strength and converted to electric field strength levels (as reported in the table) using the free space impedance of 377Ω . For example, the measurement frequency X KHz resulted in a level of Y dBuV/m, which is equivalent to $Y-51.5 = Z$ dBuA/m, which has the same margin, W dB, to the corresponding RSS-GEN Table 6 limit as it has to be 15.209(a) limit.

Below 1 GHz and above 30 MHz

The setting of the spectrum analyser

RBW	120 kHz
VBW	300 kHz
Sweep	Auto
Detector	Peak/QP
Trace	Max hold

1. The testing follows the guidelines in ANSI C63.10-2013 clause 6.5.
2. The EUT was arranged to its worst case and then tune the antenna tower (from 1 m to 4 m) and turntable (from 0 degree to 360 degrees) to find the maximum reading. A pre-amp and a high pass filter are used for the test in order to get better signal level. Both horizontal and vertical polarizations of the antenna are set to make the measurement.
3. The EUT was placed on a turntable with 80 cm above ground.
4. The EUT was set 3 meters from the interference receiving antenna, which was mounted on the top of a variable height antenna tower.
5. For measurement below 1 GHz, the initial step in collecting conducted emission data is a spectrum analyzer peak detector mode pre-scanning the measurement frequency range. Significant peaks are then marked and then Quasi Peak detector mode re-measured. If the emission level of the EUT measured by the peak detector is 3 dB lower than the applicable limit, the peak emission level will be reported. Otherwise, the emission measurement will be repeated using the quasi-peak detector and reported.

Above 1G

The setting of the spectrum analyser

RBW	1 MHz
VBW	PEAK: 3 MHz AVG: see note 6
Sweep	Auto
Detector	Peak
Trace	Max hold

1. The testing follows the guidelines in ANSI C63.10-2013 clause 6.6.
2. The EUT was arranged to its worst case and then tune the antenna tower (from 1 m to 4 m) and turntable (from 0 degree to 360 degrees) to find the maximum reading. A pre-amp and a high pass filter are used for the test in order to get better signal level. Both horizontal and vertical polarizations of the antenna are set to make the measurement.
3. The EUT was placed on a turntable with 1.5 m above ground.
4. The EUT was set 3 meters from the interference receiving antenna, which was mounted on the top of a variable height antenna tower.
5. For measurement above 1 GHz, the emission measurement will be measured by the peak detector. This peak level, once corrected, must comply with the limit specified in Section 15.209.
6. For measurements above 1 GHz the resolution bandwidth is set to 1 MHz, then the video bandwidth is set to 3 MHz for peak measurements and 1 MHz resolution bandwidth with 1/T video bandwidth with peak detector for average measurements. For the Duty Cycle please refer to clause 7.5.ON TIME AND DUTY CYCLE.

X axis, Y axis, Z axis positions:

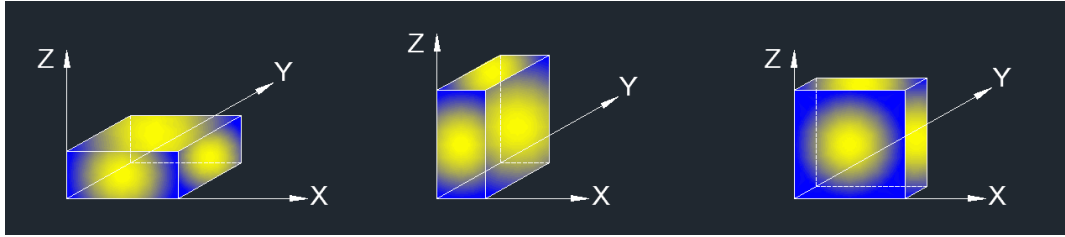

Note 1: For all radiated test, EUT in each of three orthogonal axis emissions had been tested, but only the worst case (X axis) data recorded in the report.

For Band edge:

Note:

1. Measurement = Reading Level + Correct Factor.
2. If the peak values are less than the average limit of 54 dBuV/m, the average result is deemed to comply with average limit.
3. Peak: Peak detector.
4. AVG: $VBW=1/Ton$, where: Ton is the transmitting duration.
5. For the transmitting duration, please refer to clause 7.5.
6. Only the worst data was recorded, if it complies with the limit, the other emissions deemed to comply with the limit.
7. Horizontal and Vertical have been tested, only the worst data was recorded in the report.
8. All modes and channels have been tested, only the worst data was recorded in the report.

For Radiate Spurious emission 1GHz-3GHz:

Note:

1. Measurement = Reading Level + Correct Factor.
2. If the Peak values are less than the Average limit of 54 dBuV/m, the Average result is deemed to comply with Average limit.
3. Peak: Peak detector.
4. AVG: $VBW=1/Ton$, where: Ton is the transmitting duration.
5. For the transmitting duration, please refer to clause 7.5.
6. Filter losses were only considered in the spurious frequency bands and the authorized band was not corrected for Band reject filter losses.
7. Proper operation of the transmitter prior to adding the filter to the measurement chain.
8. All modes and channels have been tested, only the worst data was recorded in the report.

For Radiate Spurious emission 3GHz-18GHz:

Note:

1. Peak Result = Reading Level + Correct Factor.
2. If the Peak values are less than the Average limit of 54 dBuV/m, the Average result is deemed to comply with Average limit.
3. Peak: Peak detector.
4. AVG: $VBW=1/Ton$, where: Ton is the transmitting duration.
5. For the transmitting duration, please refer to clause 7.5.
6. Filter losses were only considered in the spurious frequency bands and the authorized band was not corrected for High Pass Filter losses.
7. Proper operation of the transmitter prior to adding the filter to the measurement chain.
8. All modes and channels have been tested, only the worst data was recorded in the report.

For Radiate Spurious emission 9kHz-30MHz:

Note:

1. Measurement = Reading Level + Correct Factor.
2. If the Peak values are less than the QP limit, the QP result is deemed to comply with QP limit.
3. All 3 polarizations (Horizontal, Face-on and Face-off) of the loop antenna had been tested, but only the worst data recorded in the report.
4. All modes and channels have been tested, only the worst data was recorded in the report.

For Radiate Spurious emission 18GHz-26GHz:

Note:

1. Measurement = Reading Level + Correct Factor.
2. If the Peak values are less than the Average limit of 54 dBuV/m, the Average result is deemed to comply with Average limit.
3. Peak: Peak detector.
4. All modes and channels have been tested, only the worst data was recorded in the report.

For Radiate Spurious emission 30MHz-1GHz:

Note:

1. Result Level = Read Level + Correct Factor.
2. If the Peak values are less than the QP limit, the QP result is deemed to comply with QP limit.
3. Test setup: RBW: 120 kHz, VBW: 300 kHz, Sweep time: auto.
4. All modes and channels have been tested, only the worst data was recorded in the report.

TEST SETUP

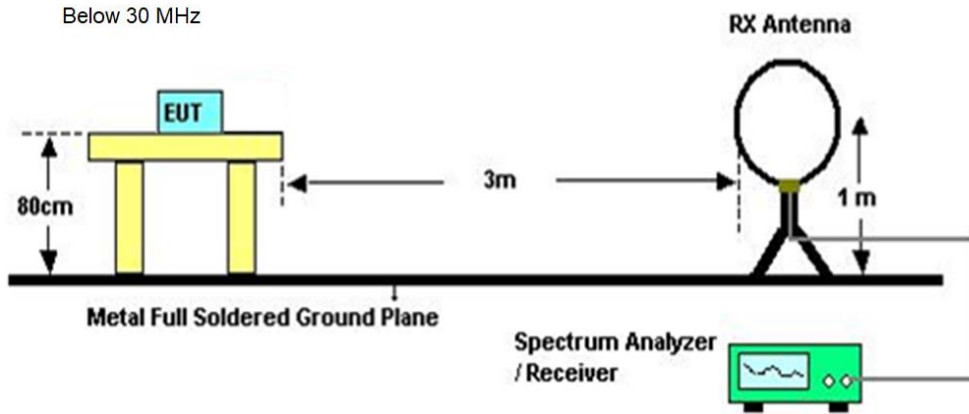

Below 1 GHz and above 30 MHz

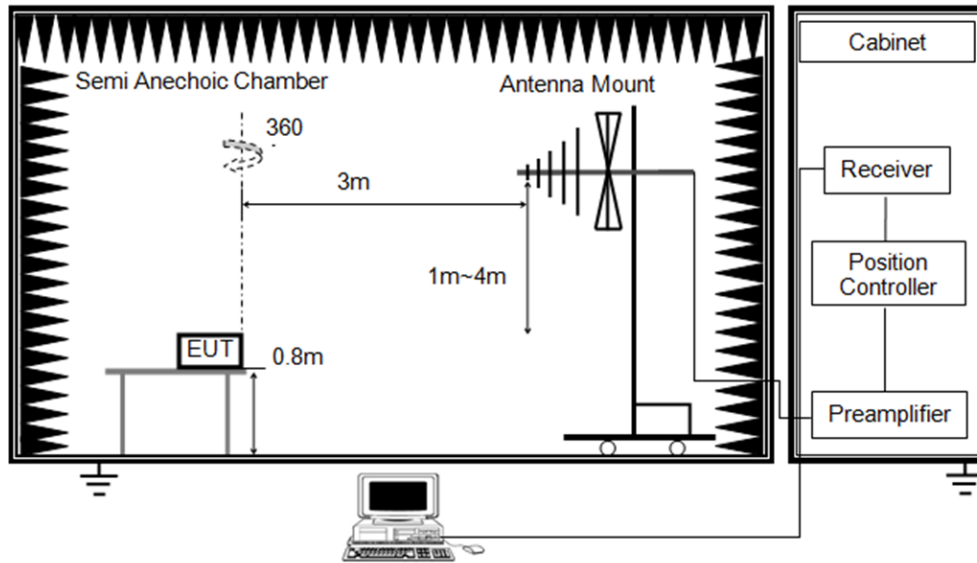

Above 1 GHz

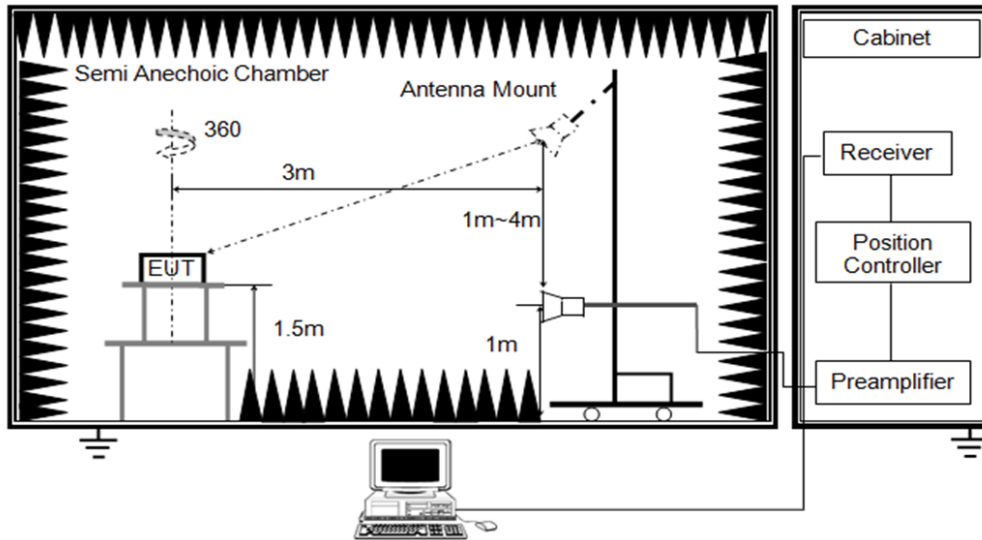

TEST ENVIRONMENT

Temperature	24.8°C	Relative Humidity	59%
Atmosphere Pressure	101kPa	Test Voltage	DC 3.3 V

TEST DATE / ENGINEER

Test Date	June 26, 2023	Test By	Rex Huang
-----------	---------------	---------	-----------

TEST RESULTS

8.1. RESTRICTED BANDEDGE

Test Mode:	802.11b PK	Channel:	2412
Polarity:	Horizontal	Test Voltage:	DC 3.3 V

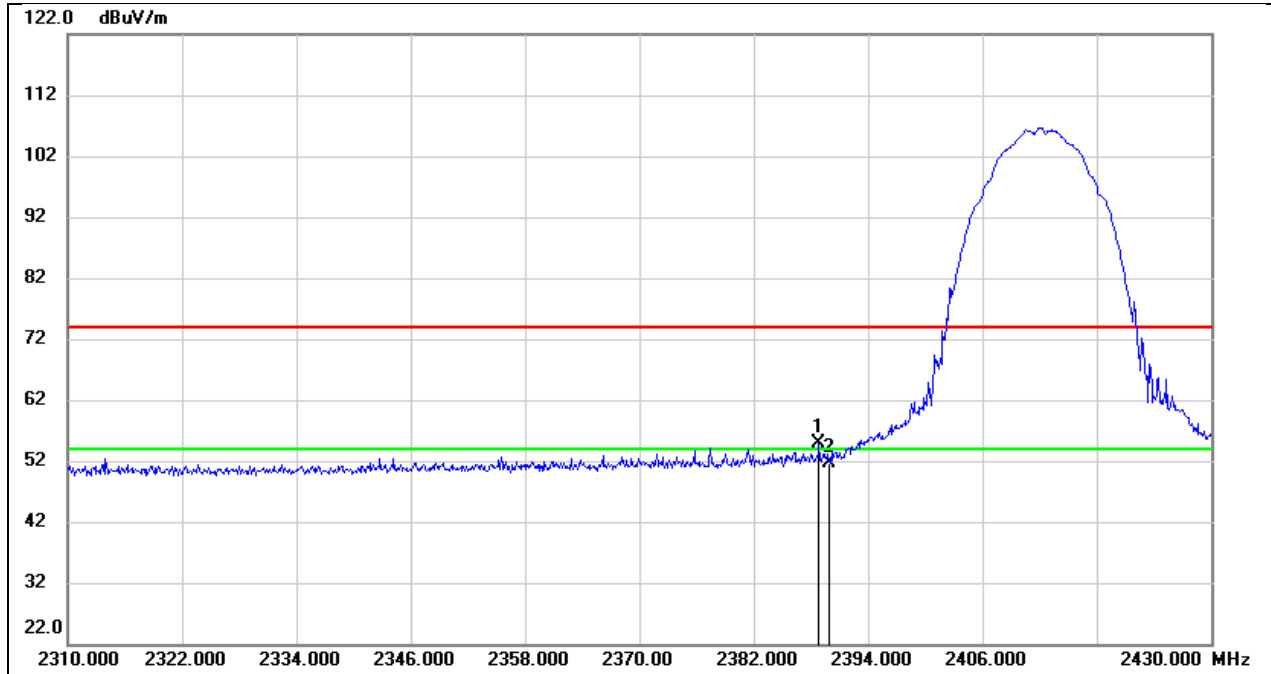

No.	Frequency (MHz)	Reading (dBuV)	Correct (dB/m)	Result (dBuV/m)	Limit (dBuV/m)	Margin (dB)	Remark
1	2388.840	22.65	32.16	54.81	74.00	-19.19	peak
2	2390.000	19.56	32.16	51.72	74.00	-22.28	peak

Test Mode:	802.11b AV	Channel:	2412
Polarity:	Horizontal	Test Voltage:	DC 3.3 V

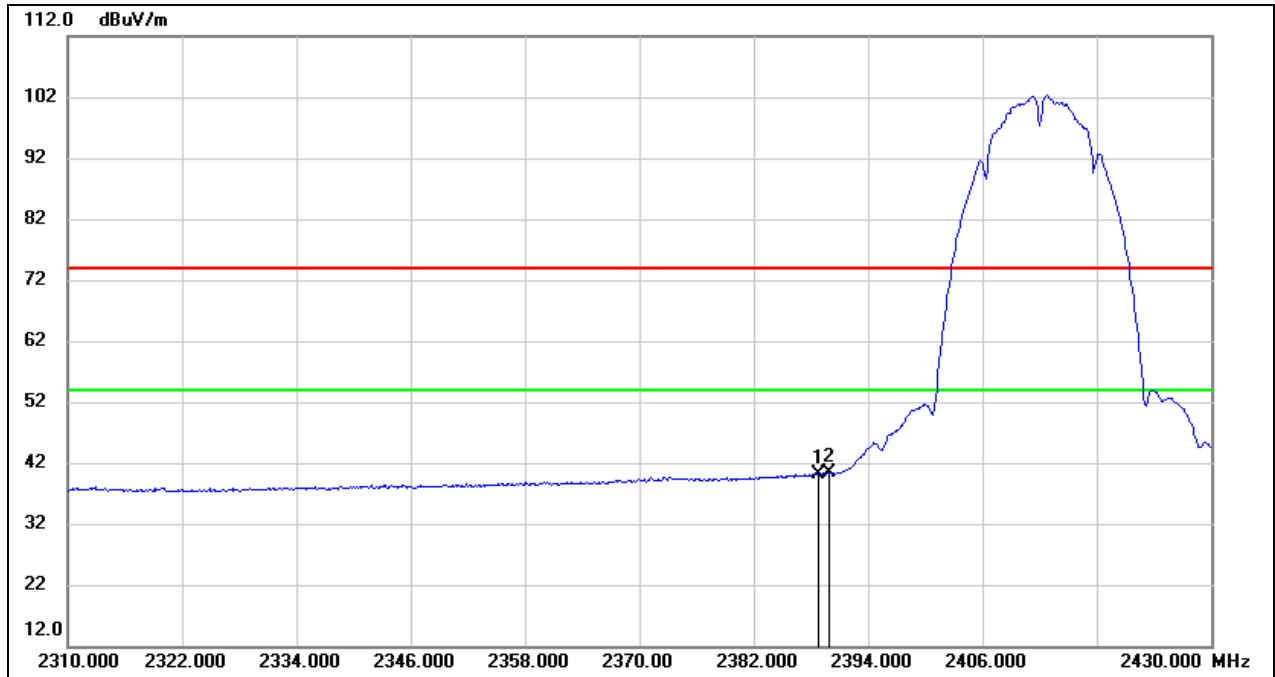

No.	Frequency (MHz)	Reading (dBuV)	Correct (dB/m)	Result (dBuV/m)	Limit (dBuV/m)	Margin (dB)	Remark
1	2388.840	7.97	32.16	40.13	54.00	-13.87	AVG
2	2390.000	8.21	32.16	40.37	54.00	-13.63	AVG

Test Mode:	802.11b PK	Channel:	2462
Polarity:	Horizontal	Test Voltage:	DC 3.3 V

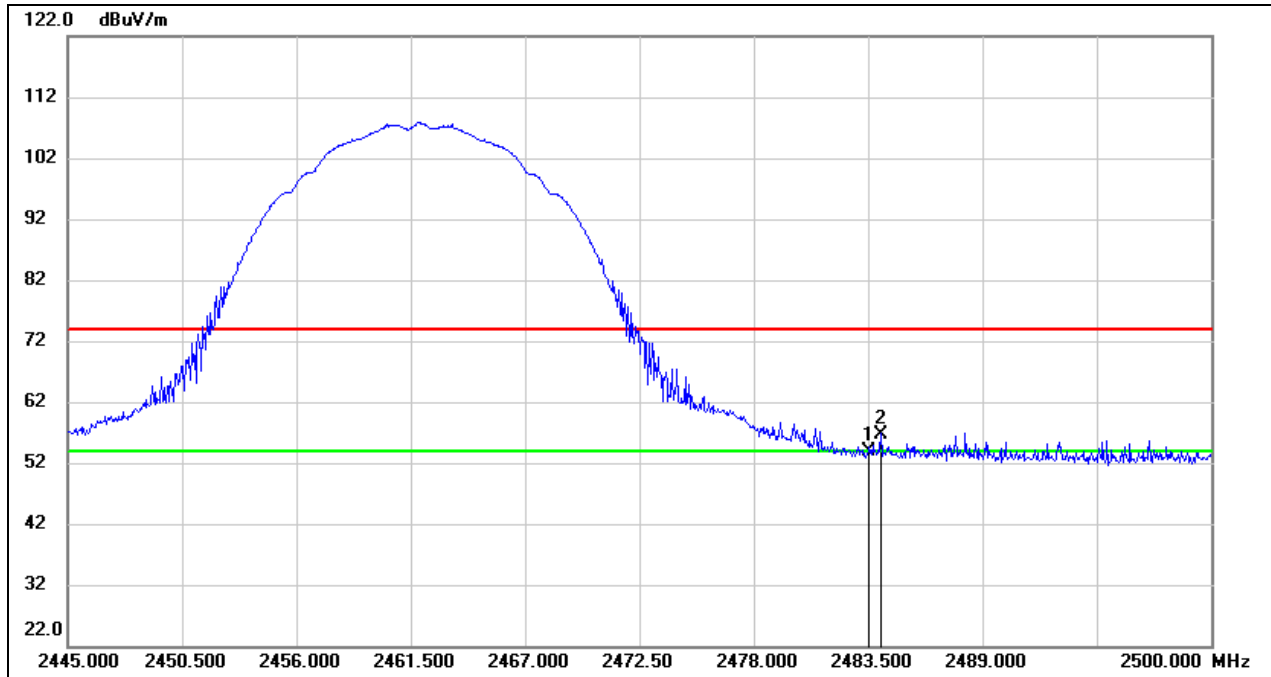

No.	Frequency (MHz)	Reading (dBuV)	Correct (dB/m)	Result (dBuV/m)	Limit (dBuV/m)	Margin (dB)	Remark
1	2483.500	21.37	32.44	53.81	74.00	-20.19	peak
2	2484.105	24.31	32.44	56.75	74.00	-17.25	peak

Test Mode:	802.11b AV	Channel:	2462
Polarity:	Horizontal	Test Voltage:	DC 3.3 V

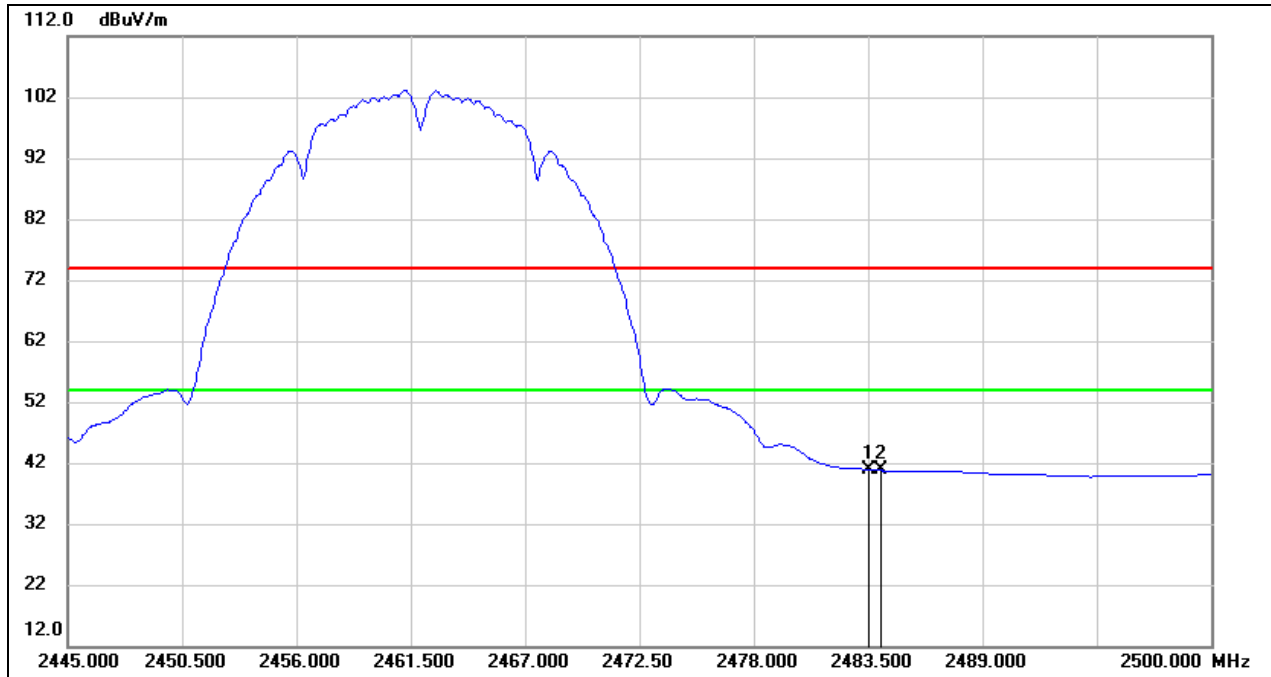

No.	Frequency (MHz)	Reading (dBuV)	Correct (dB/m)	Result (dBuV/m)	Limit (dBuV/m)	Margin (dB)	Remark
1	2483.500	8.39	32.44	40.83	54.00	-13.17	AVG
2	2484.105	8.34	32.44	40.78	54.00	-13.22	AVG

Test Mode:	802.11g PK	Channel:	2412
Polarity:	Horizontal	Test Voltage:	DC 3.3 V

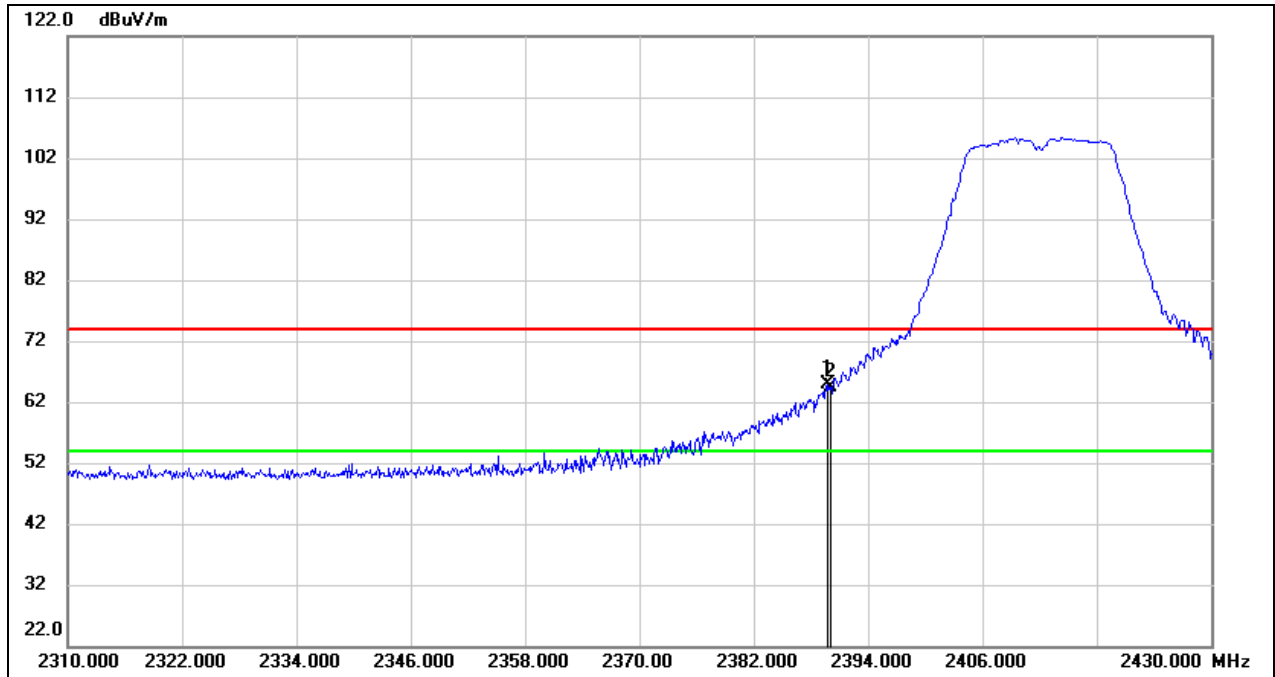

No.	Frequency (MHz)	Reading (dBuV)	Correct (dB/m)	Result (dBuV/m)	Limit (dBuV/m)	Margin (dB)	Remark
1	2389.800	32.77	32.16	64.93	74.00	-9.07	peak
2	2390.000	32.14	32.16	64.30	74.00	-9.70	peak

Test Mode:	802.11g AV	Channel:	2412
Polarity:	Horizontal	Test Voltage:	DC 3.3 V

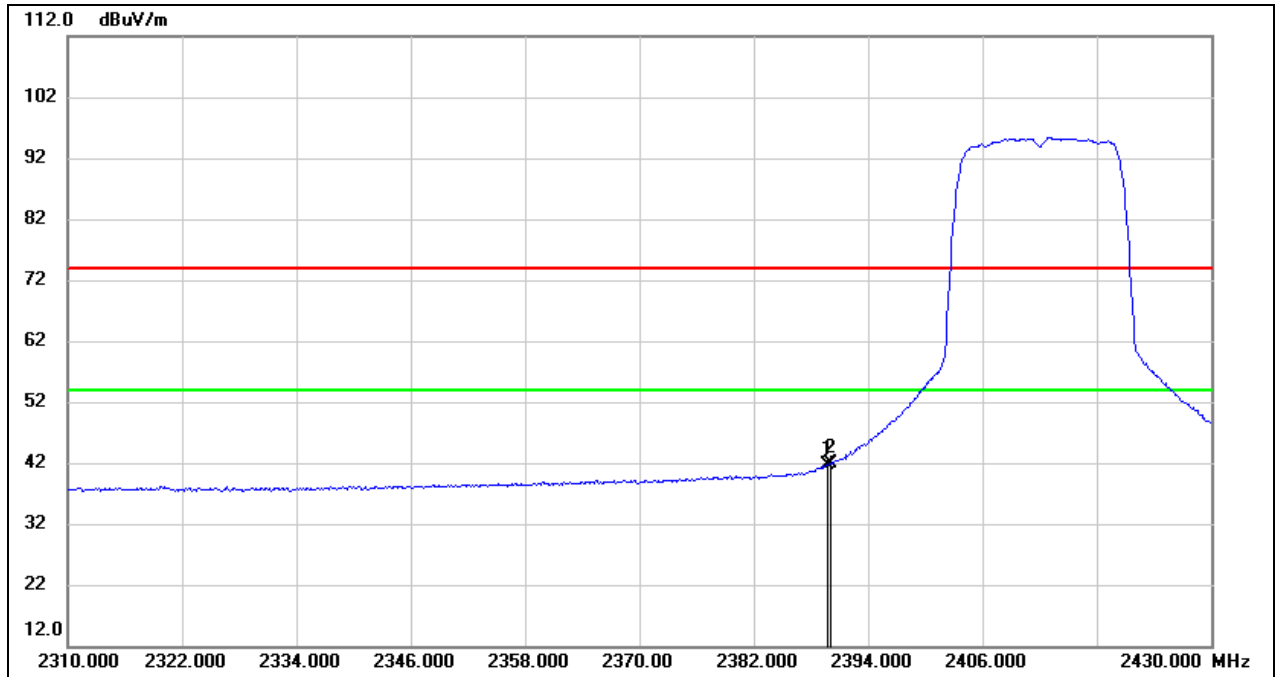

No.	Frequency (MHz)	Reading (dBuV)	Correct (dB/m)	Result (dBuV/m)	Limit (dBuV/m)	Margin (dB)	Remark
1	2389.800	9.54	32.16	41.70	54.00	-12.30	AVG
2	2390.000	9.72	32.16	41.88	54.00	-12.12	AVG

Test Mode:	802.11g PK	Channel:	2462
Polarity:	Horizontal	Test Voltage:	DC 3.3 V

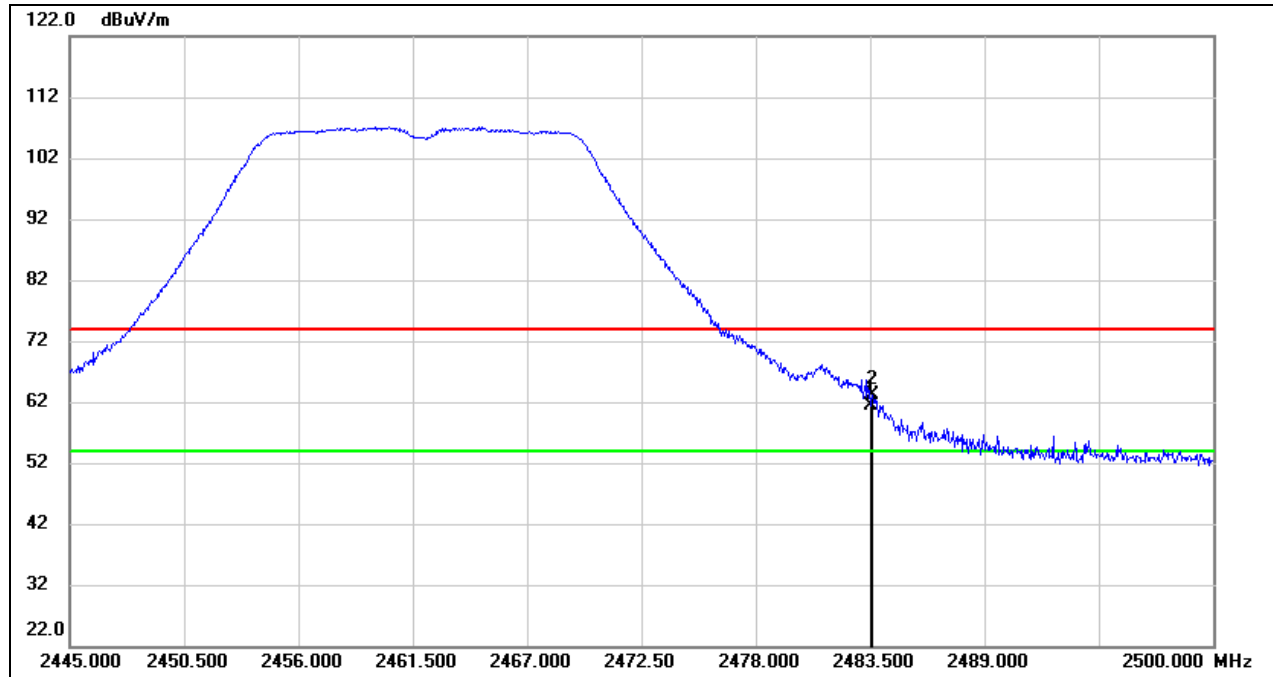

No.	Frequency (MHz)	Reading (dBuV)	Correct (dB/m)	Result (dBuV/m)	Limit (dBuV/m)	Margin (dB)	Remark
1	2483.500	28.89	32.44	61.33	74.00	-12.67	peak
2	2483.610	30.57	32.44	63.01	74.00	-10.99	peak

Test Mode:	802.11g AV	Channel:	2462
Polarity:	Horizontal	Test Voltage:	DC 3.3 V

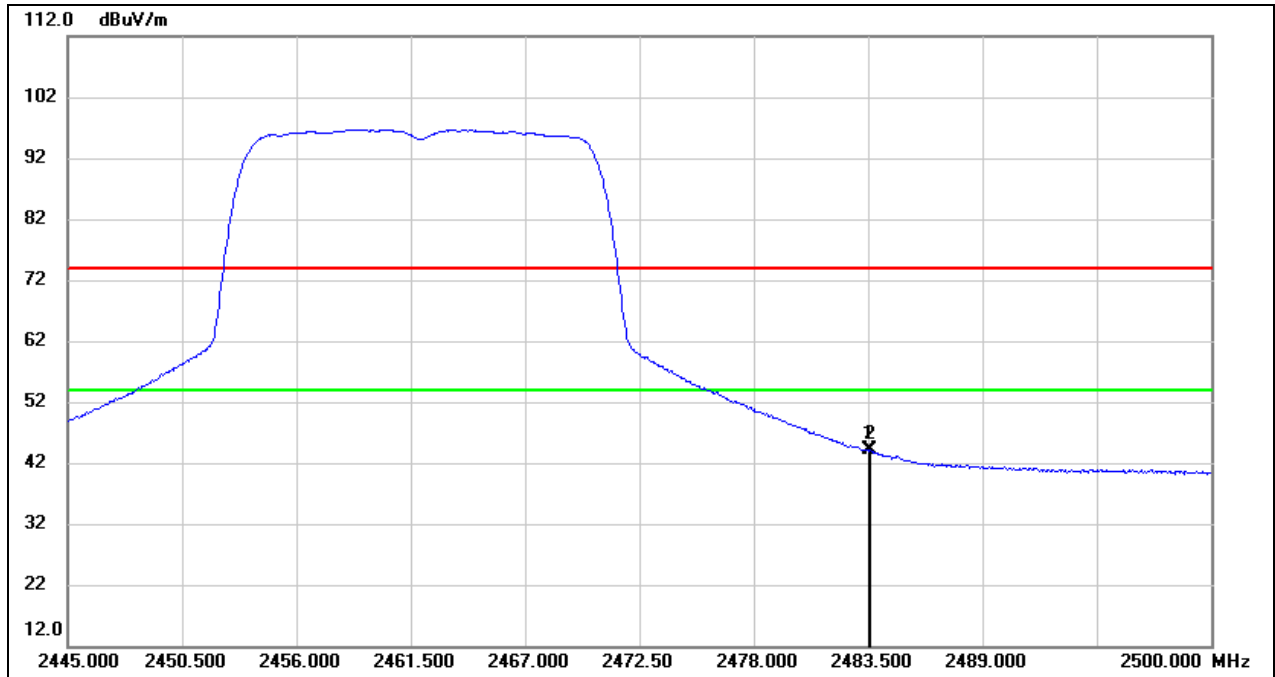

No.	Frequency (MHz)	Reading (dBuV)	Correct (dB/m)	Result (dBuV/m)	Limit (dBuV/m)	Margin (dB)	Remark
1	2483.500	11.58	32.44	44.02	54.00	-9.98	AVG
2	2483.610	11.59	32.44	44.03	54.00	-9.97	AVG

Test Mode:	802.11n HT20 PK	Channel:	2412
Polarity:	Horizontal	Test Voltage:	DC 3.3 V

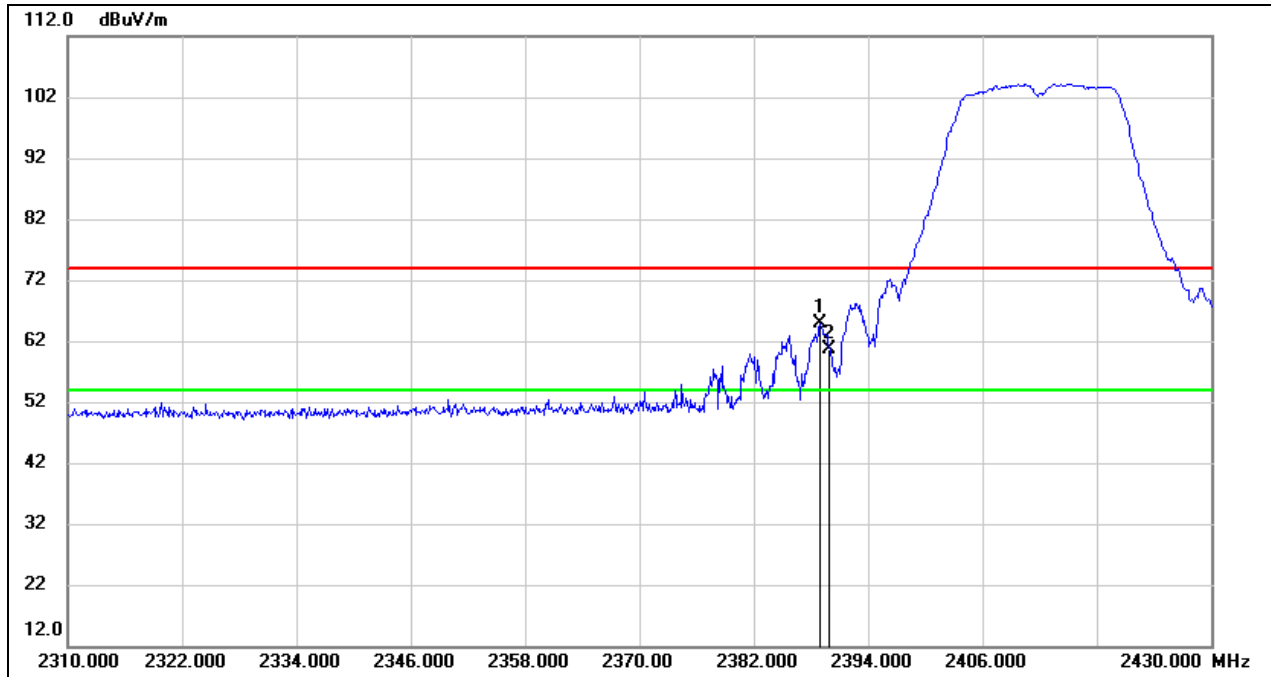

No.	Frequency (MHz)	Reading (dBuV)	Correct (dB/m)	Result (dBuV/m)	Limit (dBuV/m)	Margin (dB)	Remark
1	2388.960	32.68	32.16	64.84	74.00	-9.16	peak
2	2390.000	28.49	32.16	60.65	74.00	-13.35	peak

Test Mode:	802.11n HT20 AV	Channel:	2412
Polarity:	Horizontal	Test Voltage:	DC 3.3 V

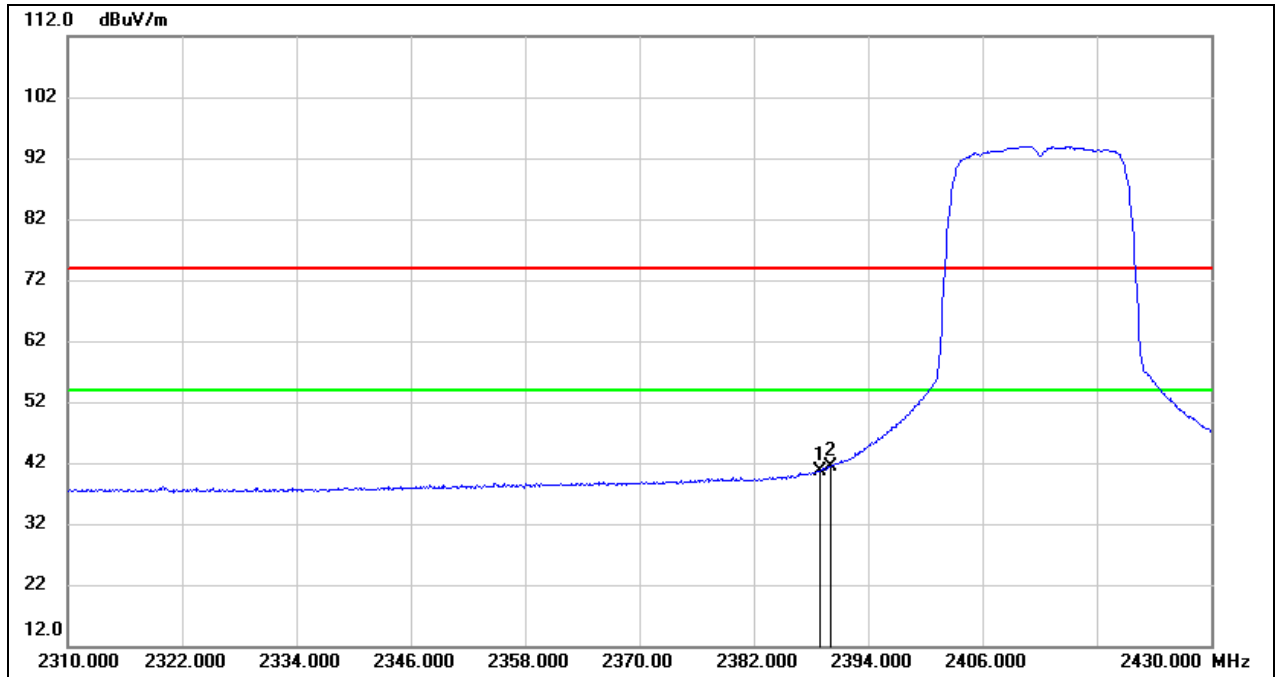

No.	Frequency (MHz)	Reading (dBuV)	Correct (dB/m)	Result (dBuV/m)	Limit (dBuV/m)	Margin (dB)	Remark
1	2388.960	8.57	32.16	40.73	54.00	-13.27	AVG
2	2390.000	9.23	32.16	41.39	54.00	-12.61	AVG

Test Mode:	802.11n HT20 PK	Channel:	2462
Polarity:	Horizontal	Test Voltage:	DC 3.3 V

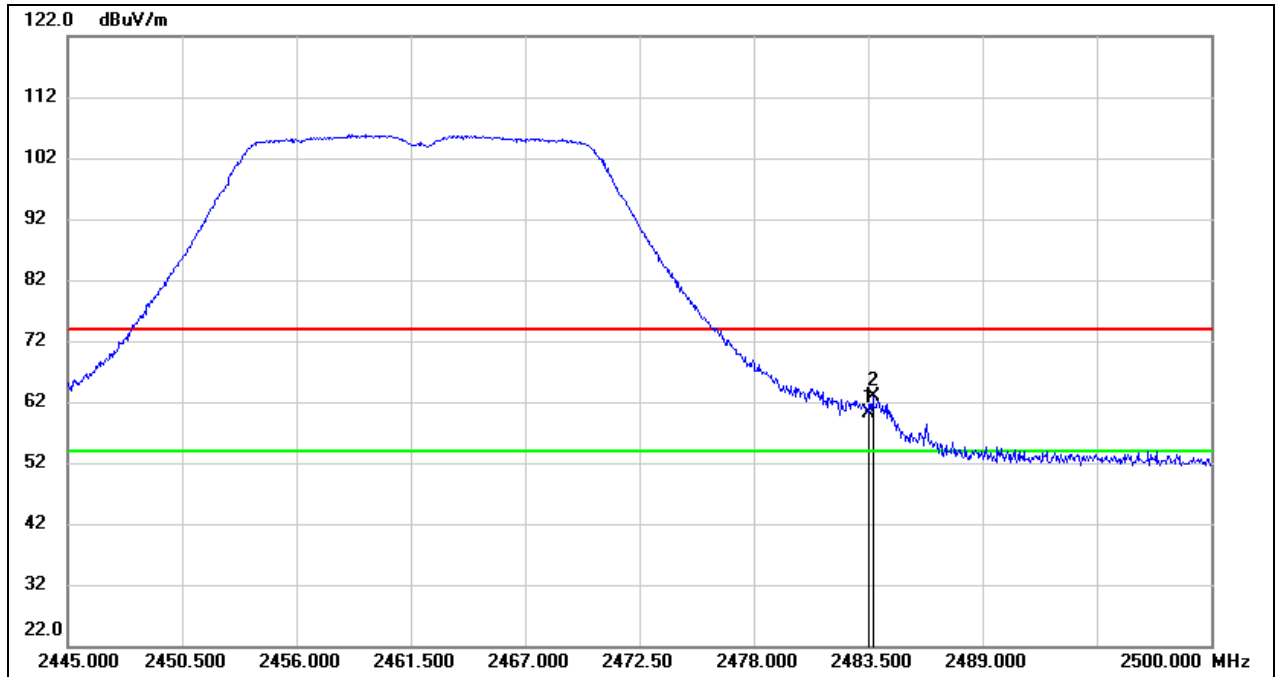

No.	Frequency (MHz)	Reading (dBuV)	Correct (dB/m)	Result (dBuV/m)	Limit (dBuV/m)	Margin (dB)	Remark
1	2483.500	27.80	32.44	60.24	74.00	-13.76	peak
2	2483.720	30.34	32.44	62.78	74.00	-11.22	peak

Test Mode:	802.11n HT20 AV	Channel:	2462
Polarity:	Horizontal	Test Voltage:	DC 3.3 V

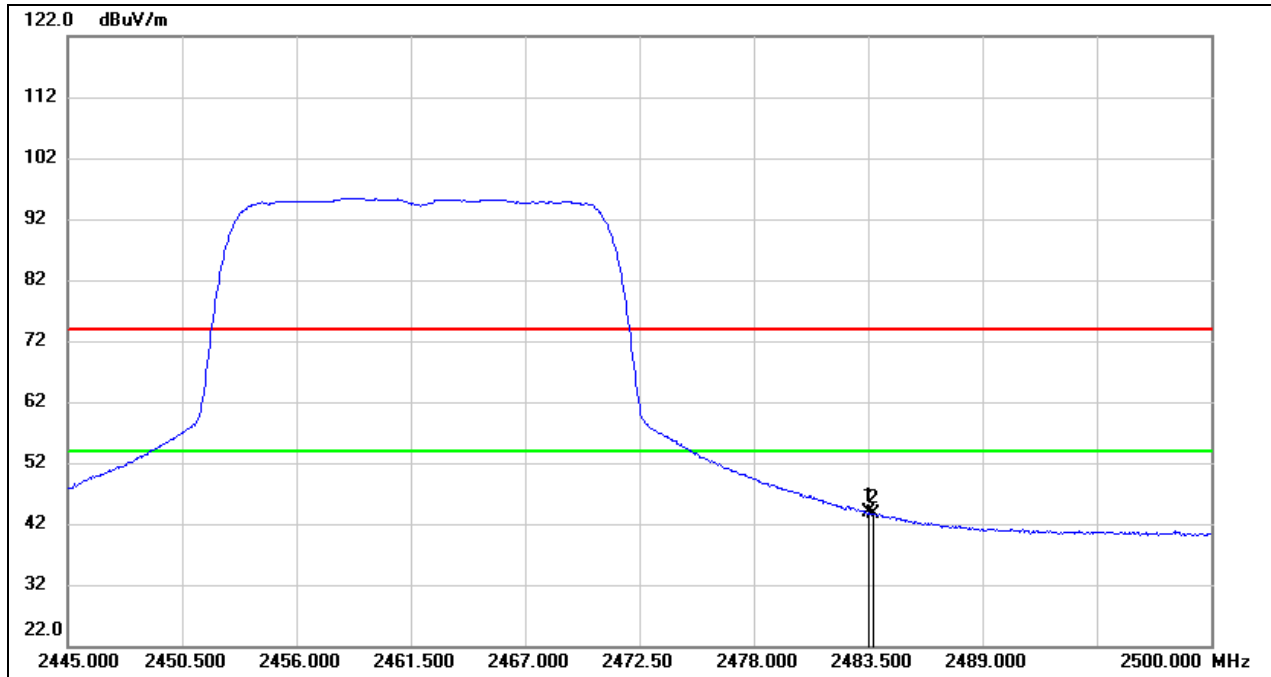

No.	Frequency (MHz)	Reading (dBuV)	Correct (dB/m)	Result (dBuV/m)	Limit (dBuV/m)	Margin (dB)	Remark
1	2483.500	11.33	32.44	43.77	54.00	-10.23	AVG
2	2483.720	11.09	32.44	43.53	54.00	-10.47	AVG

8.2. SPURIOUS EMISSIONS(1 GHZ~3 GHZ)

Test Mode:	802.11b	Channel:	2412
Polarity:	Horizontal	Test Voltage:	DC 3.3 V

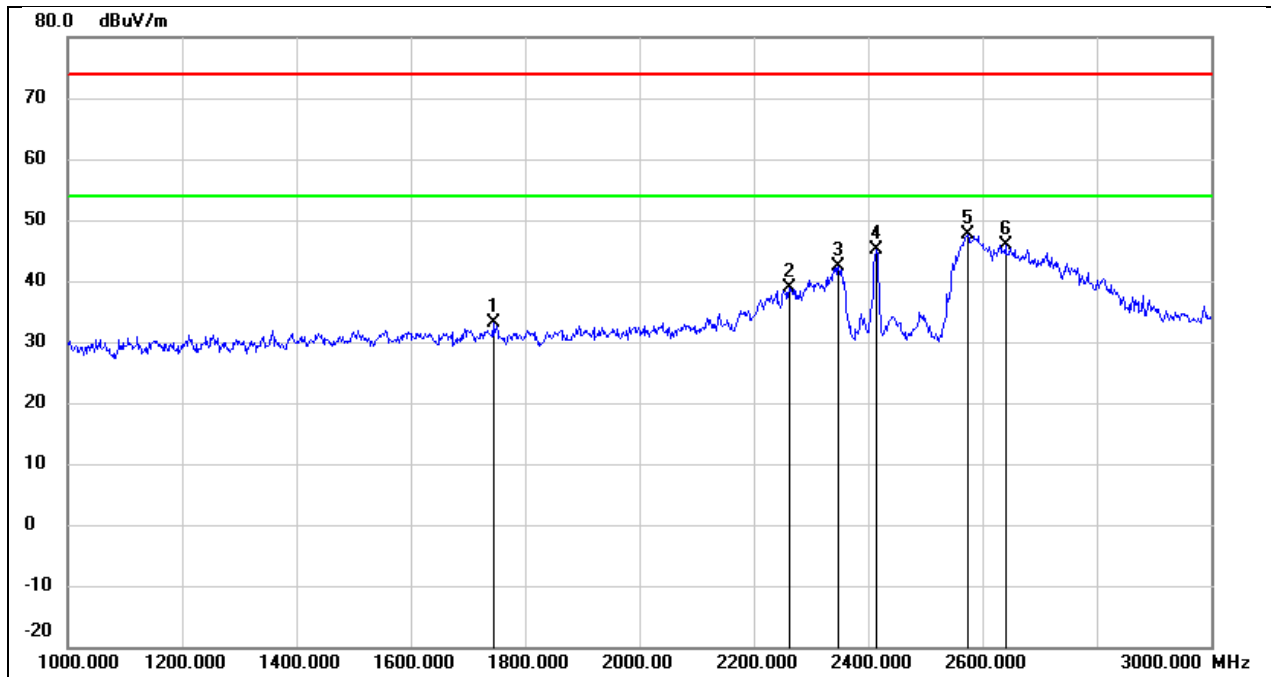

No.	Frequency (MHz)	Reading (dBuV)	Correct (dB/m)	Result (dBuV/m)	Limit (dBuV/m)	Margin (dB)	Remark
1	1744.000	44.94	-11.90	33.04	74.00	-40.96	peak
2	2262.000	48.68	-9.72	38.96	74.00	-35.04	peak
3	2348.000	51.64	-9.28	42.36	74.00	-31.64	peak
4	2412.000	54.09	-8.93	45.16	/	/	fundamental
5	2574.000	55.92	-8.27	47.65	74.00	-26.35	peak
6	2640.000	53.96	-8.07	45.89	74.00	-28.11	peak

Test Mode:	802.11b	Channel:	2412
Polarity:	Vertical	Test Voltage:	DC 3.3 V

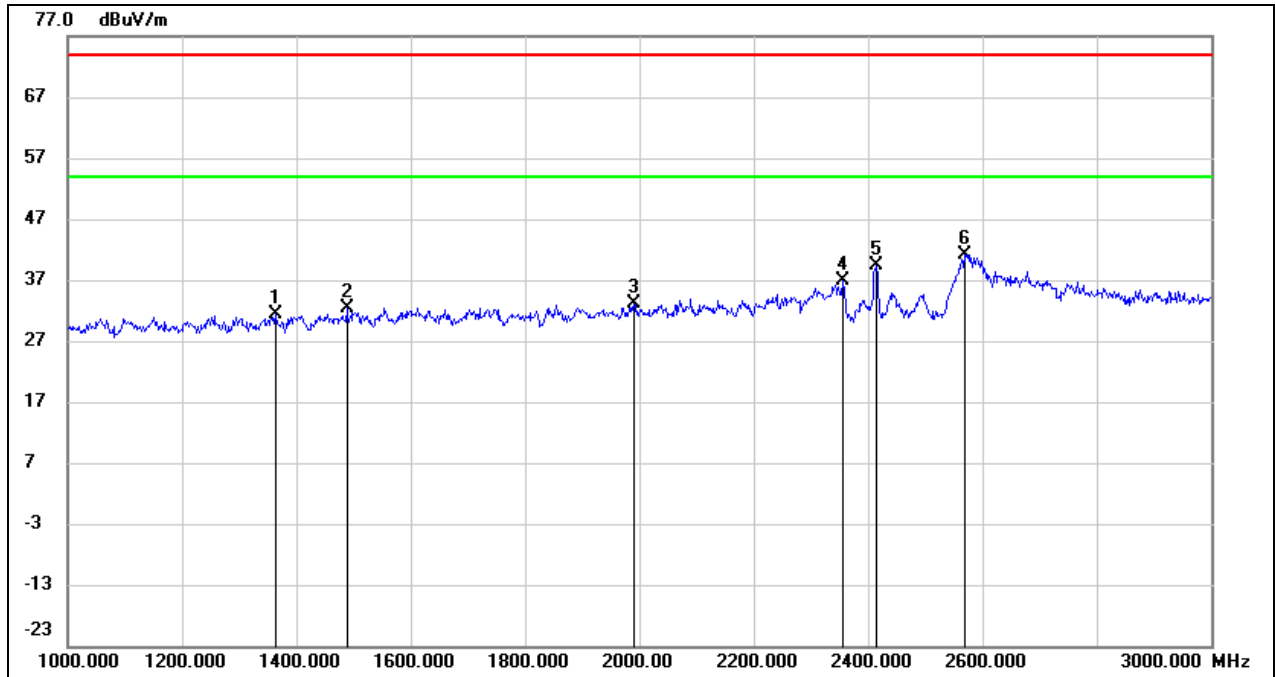

No.	Frequency (MHz)	Reading (dBuV)	Correct (dB/m)	Result (dBuV/m)	Limit (dBuV/m)	Margin (dB)	Remark
1	1364.000	44.63	-13.34	31.29	74.00	-42.71	peak
2	1488.000	45.13	-12.76	32.37	74.00	-41.63	peak
3	1990.000	44.16	-11.09	33.07	74.00	-40.93	peak
4	2356.000	46.16	-9.22	36.94	74.00	-37.06	peak
5	2412.000	48.20	-8.93	39.27	/	/	fundamental
6	2568.000	49.49	-8.28	41.21	74.00	-32.79	peak

Test Mode:	802.11b	Channel:	2437
Polarity:	Horizontal	Test Voltage:	DC 3.3 V

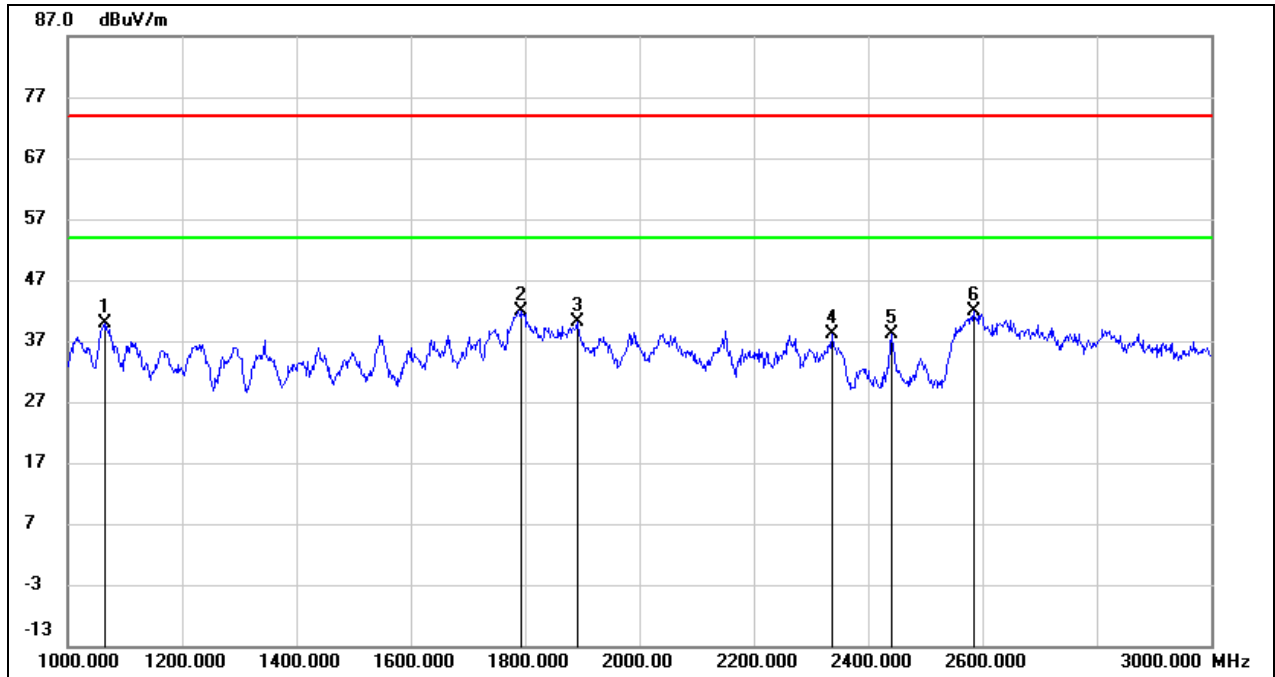

No.	Frequency (MHz)	Reading (dBuV)	Correct (dB/m)	Result (dBuV/m)	Limit (dBuV/m)	Margin (dB)	Remark
1	1066.000	54.62	-14.73	39.89	74.00	-34.11	peak
2	1794.000	53.52	-11.74	41.78	74.00	-32.22	peak
3	1892.000	51.52	-11.42	40.10	74.00	-33.90	peak
4	2336.000	47.50	-9.33	38.17	74.00	-35.83	peak
5	2437.000	46.97	-8.80	38.17	/	/	fundamental
6	2584.000	50.07	-8.24	41.83	74.00	-32.17	peak

Test Mode:	802.11b	Channel:	2437
Polarity:	Vertical	Test Voltage:	DC 3.3 V

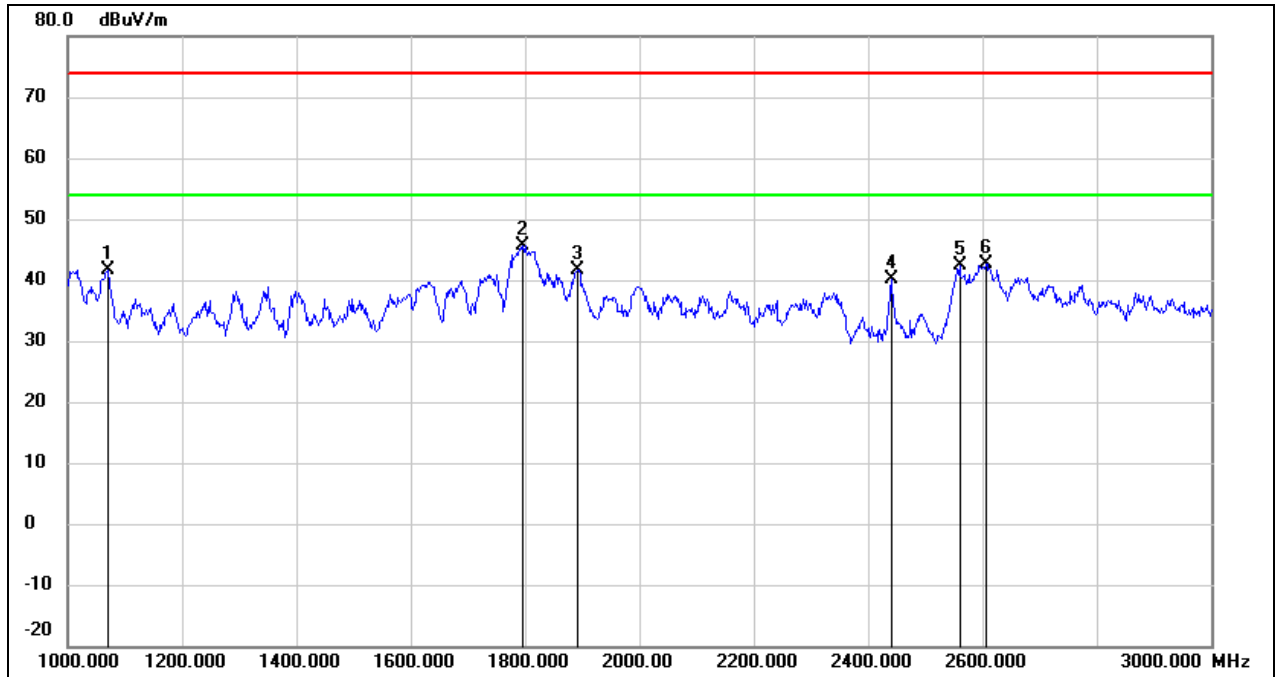

No.	Frequency (MHz)	Reading (dBuV)	Correct (dB/m)	Result (dBuV/m)	Limit (dBuV/m)	Margin (dB)	Remark
1	1070.000	56.22	-14.70	41.52	74.00	-32.48	peak
2	1796.000	57.43	-11.73	45.70	74.00	-28.30	peak
3	1892.000	53.11	-11.42	41.69	74.00	-32.31	peak
4	2437.000	48.83	-8.80	40.03	/	/	fundamental
5	2560.000	50.62	-8.31	42.31	74.00	-31.69	peak
6	2606.000	50.78	-8.17	42.61	74.00	-31.39	peak

Test Mode:	802.11b	Channel:	2462
Polarity:	Horizontal	Test Voltage:	DC 3.3 V

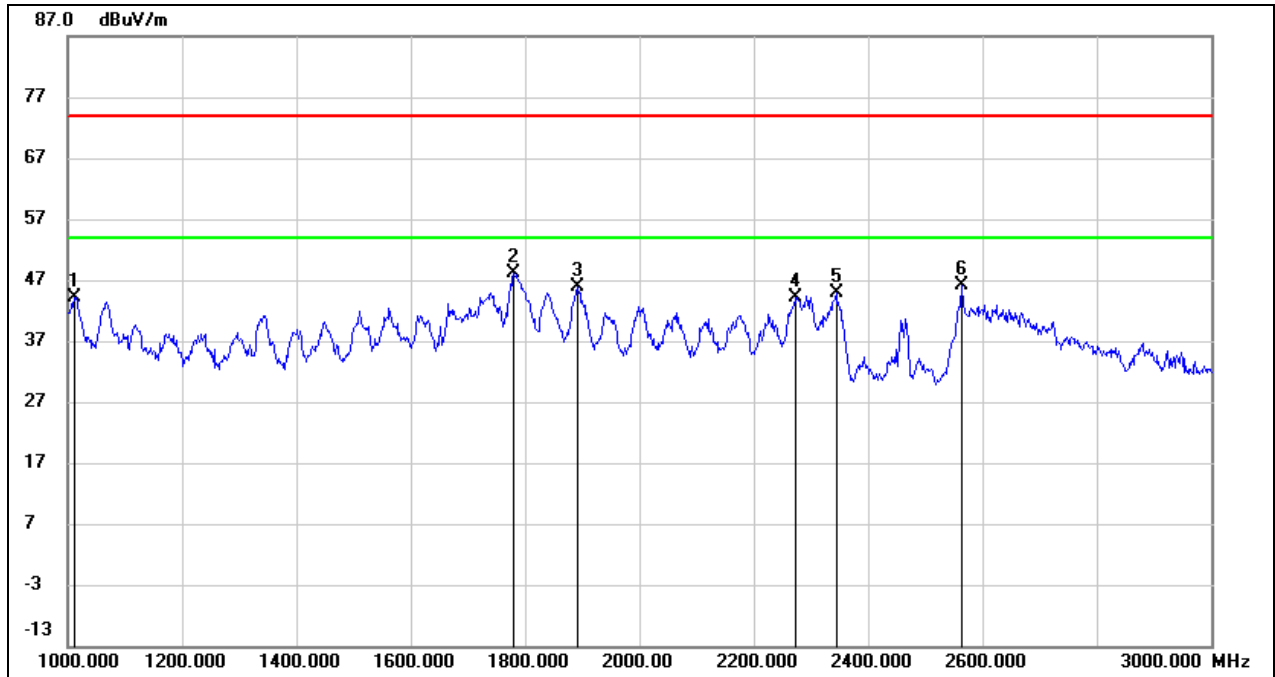

No.	Frequency (MHz)	Reading (dBuV)	Correct (dB/m)	Result (dBuV/m)	Limit (dBuV/m)	Margin (dB)	Remark
1	1012.000	59.20	-14.98	44.22	74.00	-29.78	peak
2	1780.000	60.01	-11.79	48.22	74.00	-25.78	peak
3	1892.000	57.29	-11.42	45.87	74.00	-28.13	peak
4	2272.000	53.81	-9.66	44.15	74.00	-29.85	peak
5	2344.000	54.08	-9.30	44.78	74.00	-29.22	peak
6	2564.000	54.39	-8.30	46.09	74.00	-27.91	peak

Test Mode:	802.11b	Channel:	2462
Polarity:	Vertical	Test Voltage:	DC 3.3 V

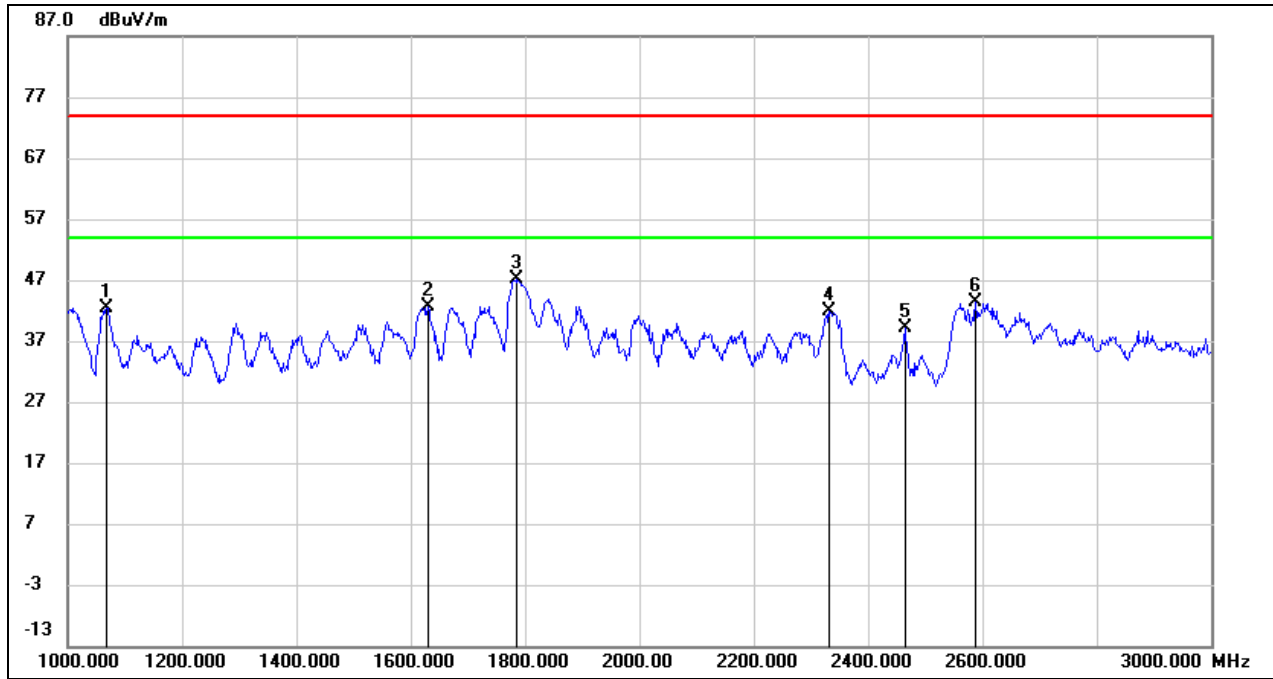

No.	Frequency (MHz)	Reading (dBuV)	Correct (dB/m)	Result (dBuV/m)	Limit (dBuV/m)	Margin (dB)	Remark
1	1068.000	57.17	-14.72	42.45	74.00	-31.55	peak
2	1630.000	54.92	-12.28	42.64	74.00	-31.36	peak
3	1786.000	58.81	-11.76	47.05	74.00	-26.95	peak
4	2332.000	51.31	-9.36	41.95	74.00	-32.05	peak
5	2462.000	47.75	-8.68	39.07	/	/	fundamental
6	2588.000	51.50	-8.22	43.28	74.00	-30.72	peak

8.3. SPURIOUS EMISSIONS(3 GHZ~18 GHZ)

Test Mode:	802.11b	Channel:	2412
Polarity:	Horizontal	Test Voltage:	DC 3.3 V

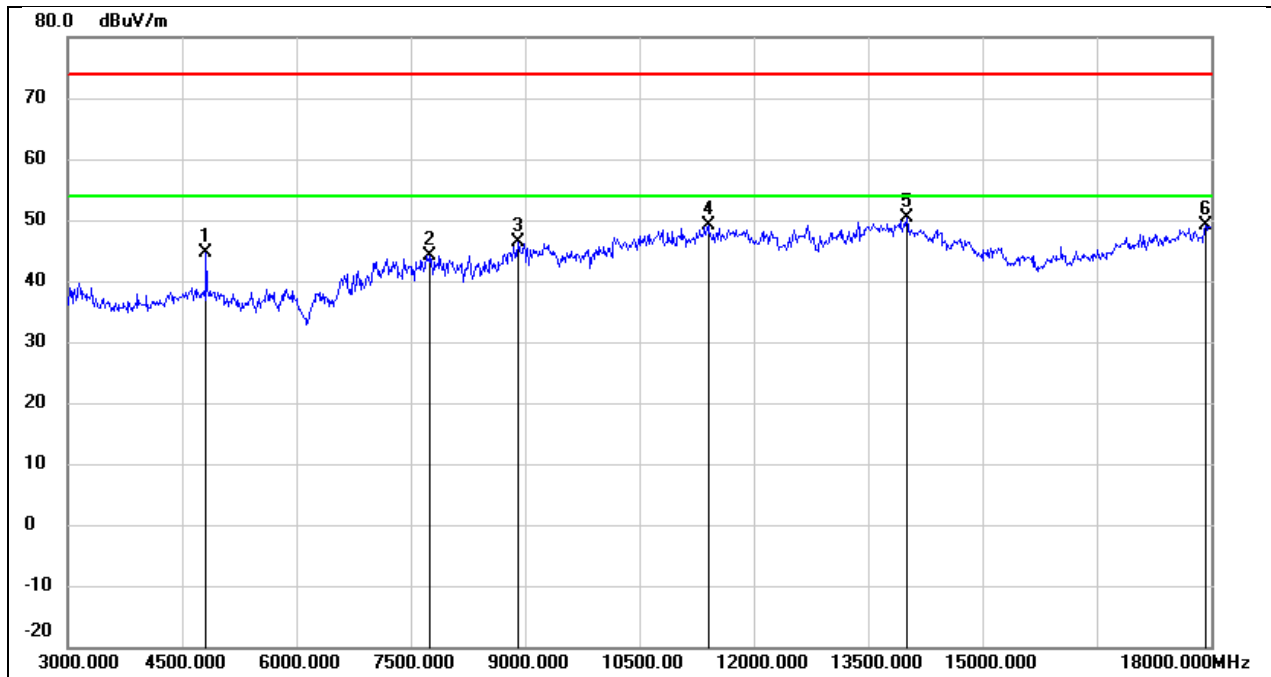

No.	Frequency (MHz)	Reading (dBuV)	Correct (dB/m)	Result (dBuV/m)	Limit (dBuV/m)	Margin (dB)	Remark
1	4815.000	45.00	-0.26	44.74	74.00	-29.26	peak
2	7755.000	37.92	6.31	44.23	74.00	-29.77	peak
3	8910.000	36.49	9.82	46.31	74.00	-27.69	peak
4	11400.000	33.00	16.23	49.23	74.00	-24.77	peak
5	14010.000	28.38	21.93	50.31	74.00	-23.69	peak
6	17925.000	23.90	25.25	49.15	74.00	-24.85	peak

Test Mode:	802.11b	Channel:	2412
Polarity:	Vertical	Test Voltage:	DC 3.3 V

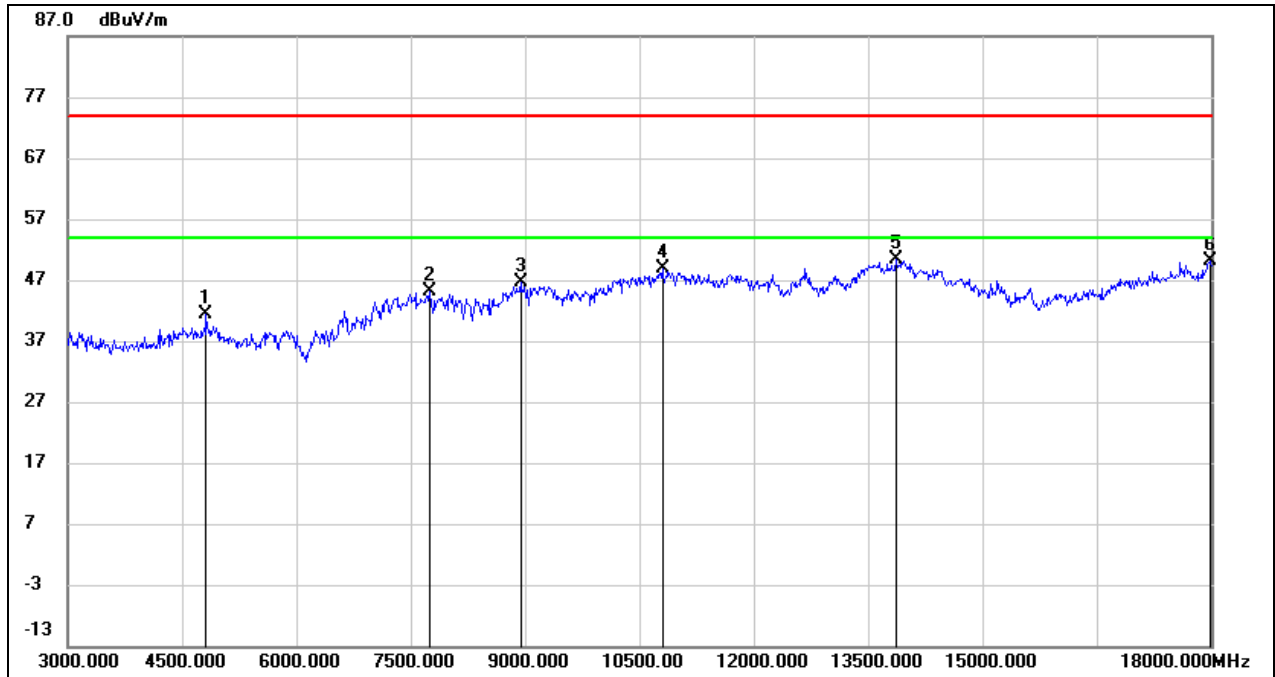

No.	Frequency (MHz)	Reading (dBuV)	Correct (dB/m)	Result (dBuV/m)	Limit (dBuV/m)	Margin (dB)	Remark
1	4815.000	41.65	-0.26	41.39	74.00	-32.61	peak
2	7740.000	38.70	6.32	45.02	74.00	-28.98	peak
3	8940.000	36.47	10.04	46.51	74.00	-27.49	peak
4	10800.000	34.82	14.06	48.88	74.00	-25.12	peak
5	13860.000	28.74	21.67	50.41	74.00	-23.59	peak
6	17985.000	24.54	25.60	50.14	74.00	-23.86	peak

Test Mode:	802.11b	Channel:	2437
Polarity:	Horizontal	Test Voltage:	DC 3.3 V

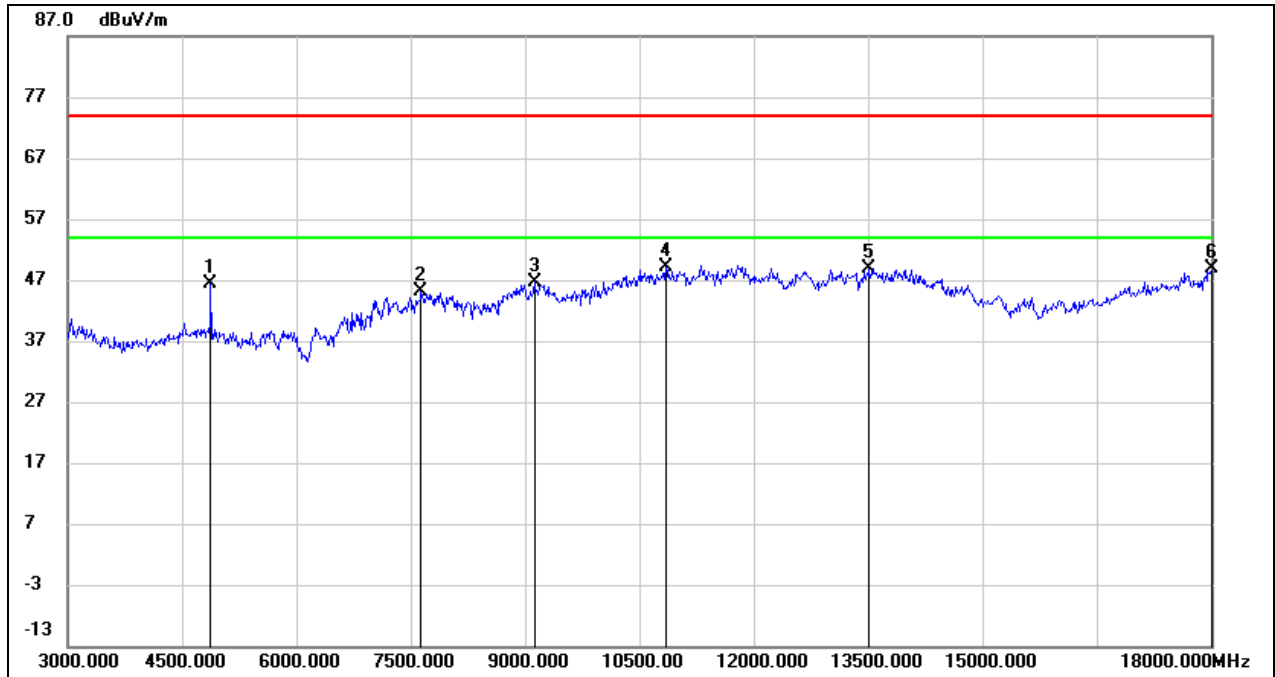

No.	Frequency (MHz)	Reading (dBuV)	Correct (dB/m)	Result (dBuV/m)	Limit (dBuV/m)	Margin (dB)	Remark
1	4875.000	46.31	-0.03	46.28	74.00	-27.72	peak
2	7635.000	38.80	6.33	45.13	74.00	-28.87	peak
3	9120.000	36.20	10.53	46.73	74.00	-27.27	peak
4	10845.000	34.84	14.21	49.05	74.00	-24.95	peak
5	13515.000	28.06	20.93	48.99	74.00	-25.01	peak
6	18000.000	23.13	25.69	48.82	74.00	-25.18	peak

Test Mode:	802.11b	Channel:	2437
Polarity:	Vertical	Test Voltage:	DC 3.3 V

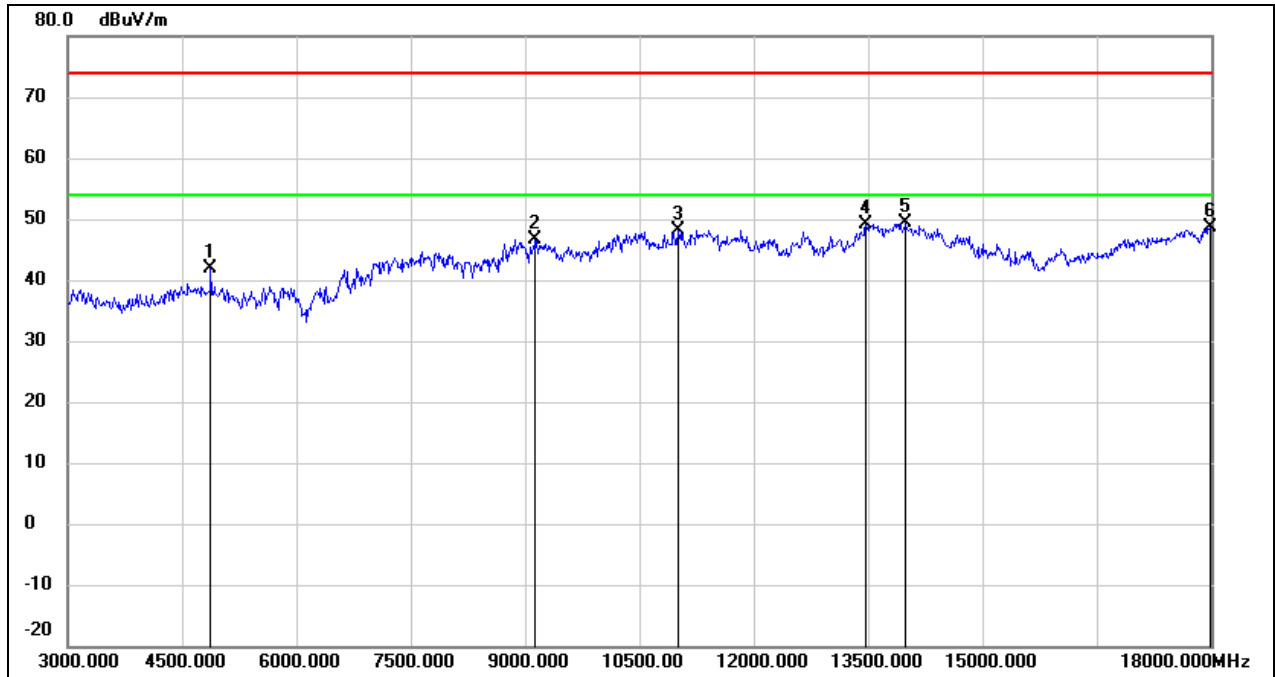

No.	Frequency (MHz)	Reading (dBuV)	Correct (dB/m)	Result (dBuV/m)	Limit (dBuV/m)	Margin (dB)	Remark
1	4875.000	41.90	-0.03	41.87	74.00	-32.13	peak
2	9135.000	36.00	10.55	46.55	74.00	-27.45	peak
3	11010.000	33.44	14.81	48.25	74.00	-25.75	peak
4	13470.000	28.28	20.77	49.05	74.00	-24.95	peak
5	13995.000	27.39	21.95	49.34	74.00	-24.66	peak
6	17985.000	23.14	25.60	48.74	74.00	-25.26	peak

Test Mode:	802.11b	Channel:	2462
Polarity:	Horizontal	Test Voltage:	DC 3.3 V

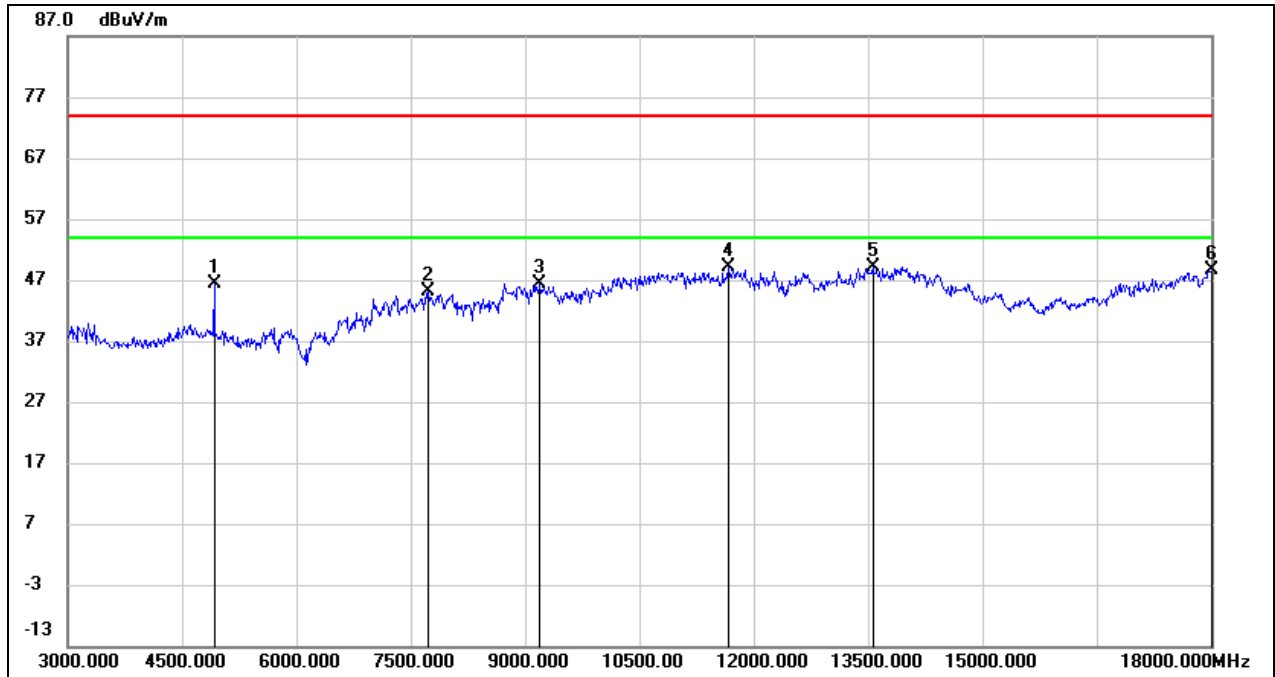

No.	Frequency (MHz)	Reading (dBuV)	Correct (dB/m)	Result (dBuV/m)	Limit (dBuV/m)	Margin (dB)	Remark
1	4920.000	46.17	0.14	46.31	74.00	-27.69	peak
2	7725.000	38.72	6.32	45.04	74.00	-28.96	peak
3	9195.000	35.87	10.56	46.43	74.00	-27.57	peak
4	11670.000	32.12	17.07	49.19	74.00	-24.81	peak
5	13560.000	28.21	21.04	49.25	74.00	-24.75	peak
6	18000.000	22.98	25.69	48.67	74.00	-25.33	peak

Test Mode:	802.11b	Channel:	2462
Polarity:	Vertical	Test Voltage:	DC 3.3 V

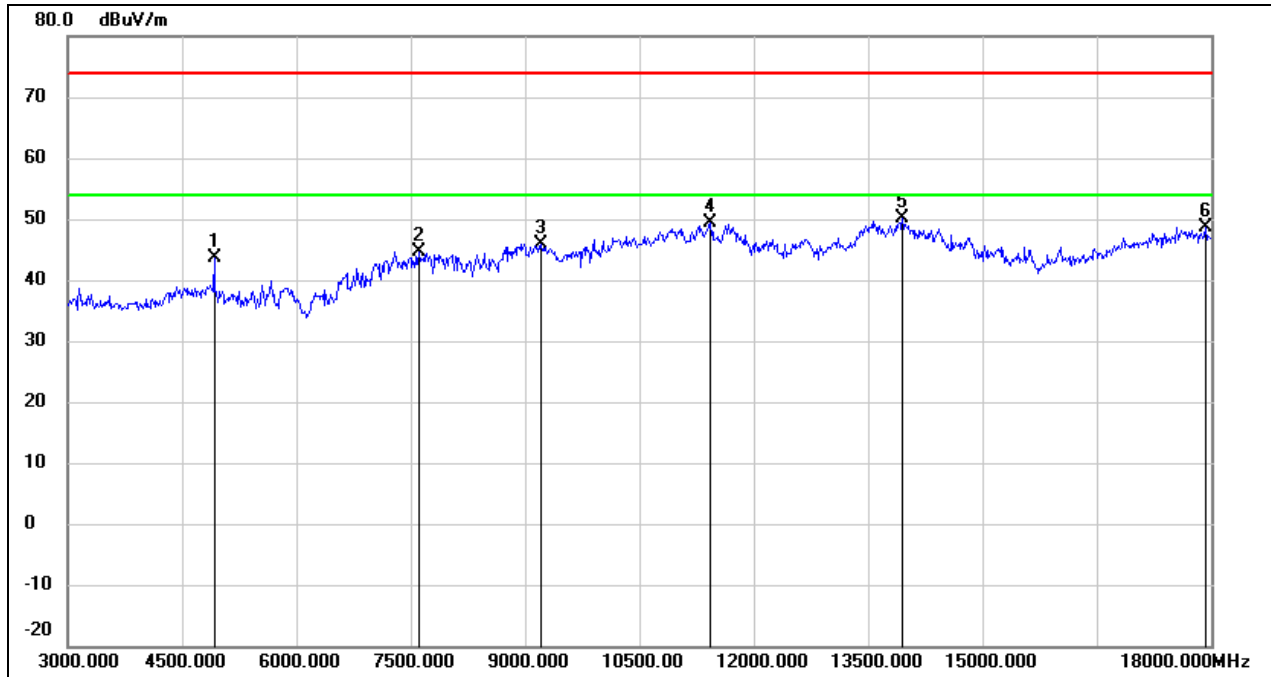

No.	Frequency (MHz)	Reading (dBuV)	Correct (dB/m)	Result (dBuV/m)	Limit (dBuV/m)	Margin (dB)	Remark
1	4920.000	43.54	0.14	43.68	74.00	-30.32	peak
2	7605.000	38.26	6.32	44.58	74.00	-29.42	peak
3	9210.000	35.42	10.57	45.99	74.00	-28.01	peak
4	11430.000	33.02	16.34	49.36	74.00	-24.64	peak
5	13950.000	28.29	21.86	50.15	74.00	-23.85	peak
6	17925.000	23.47	25.25	48.72	74.00	-25.28	peak

Test Mode:	802.11g	Channel:	2412
Polarity:	Horizontal	Test Voltage:	DC 3.3 V

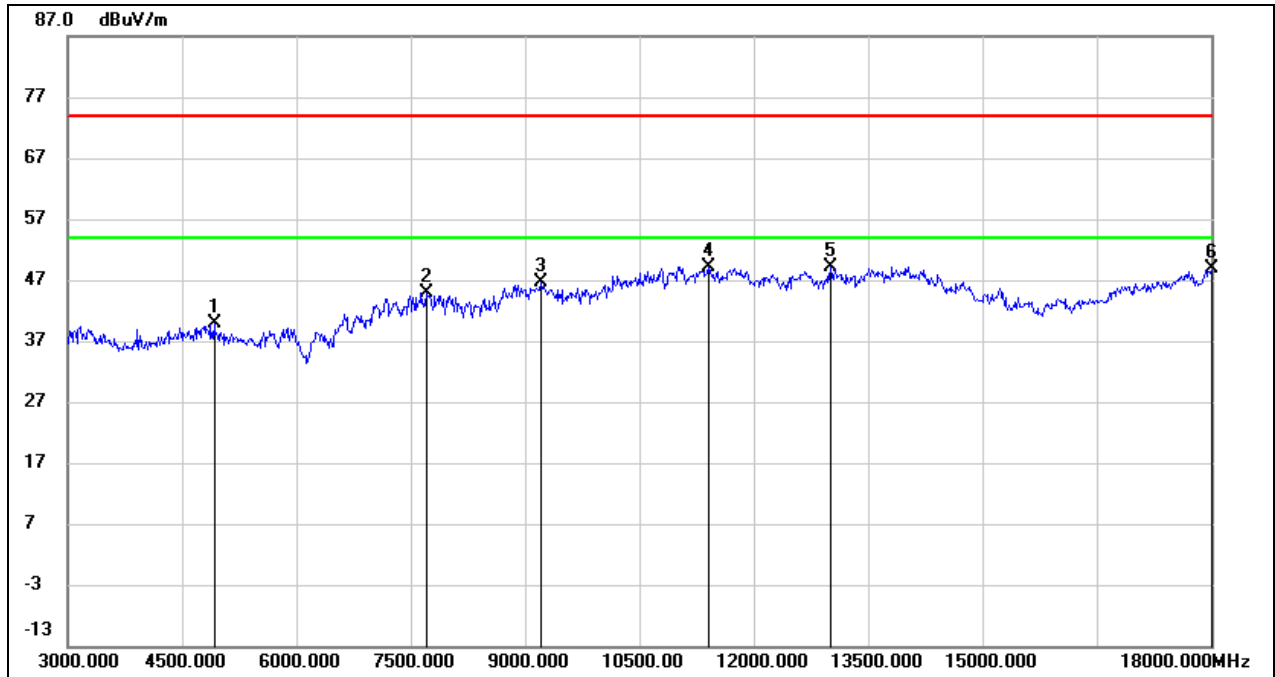

No.	Frequency (MHz)	Reading (dBuV)	Correct (dB/m)	Result (dBuV/m)	Limit (dBuV/m)	Margin (dB)	Remark
1	4920.000	39.67	0.14	39.81	74.00	-34.19	peak
2	7710.000	38.66	6.33	44.99	74.00	-29.01	peak
3	9210.000	36.03	10.57	46.60	74.00	-27.40	peak
4	11400.000	33.02	16.23	49.25	74.00	-24.75	peak
5	13005.000	30.42	18.74	49.16	74.00	-24.84	peak
6	18000.000	23.08	25.69	48.77	74.00	-25.23	peak

Test Mode:	802.11g	Channel:	2412
Polarity:	Vertical	Test Voltage:	DC 3.3 V

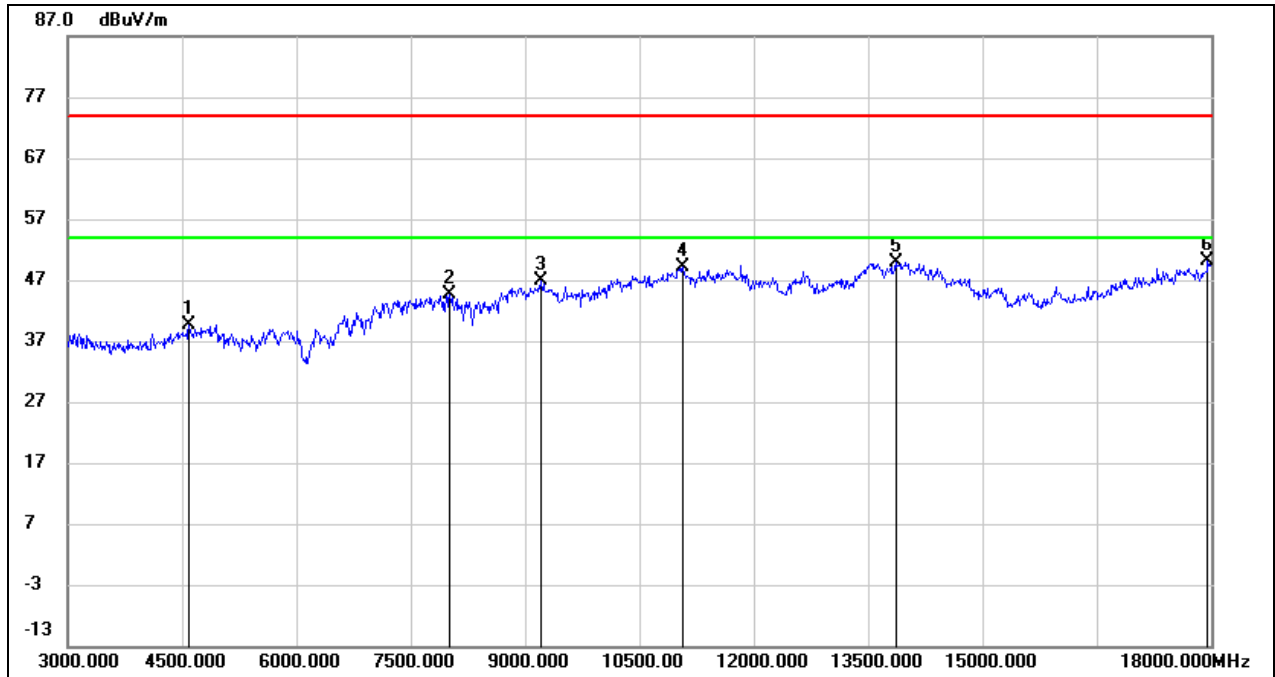

No.	Frequency (MHz)	Reading (dBuV)	Correct (dB/m)	Result (dBuV/m)	Limit (dBuV/m)	Margin (dB)	Remark
1	4590.000	40.68	-1.12	39.56	74.00	-34.44	peak
2	8010.000	38.37	6.32	44.69	74.00	-29.31	peak
3	9210.000	36.43	10.57	47.00	74.00	-27.00	peak
4	11070.000	34.04	15.03	49.07	74.00	-24.93	peak
5	13860.000	28.23	21.67	49.90	74.00	-24.10	peak
6	17955.000	24.69	25.42	50.11	74.00	-23.89	peak

Test Mode:	802.11g	Channel:	2437
Polarity:	Horizontal	Test Voltage:	DC 3.3 V

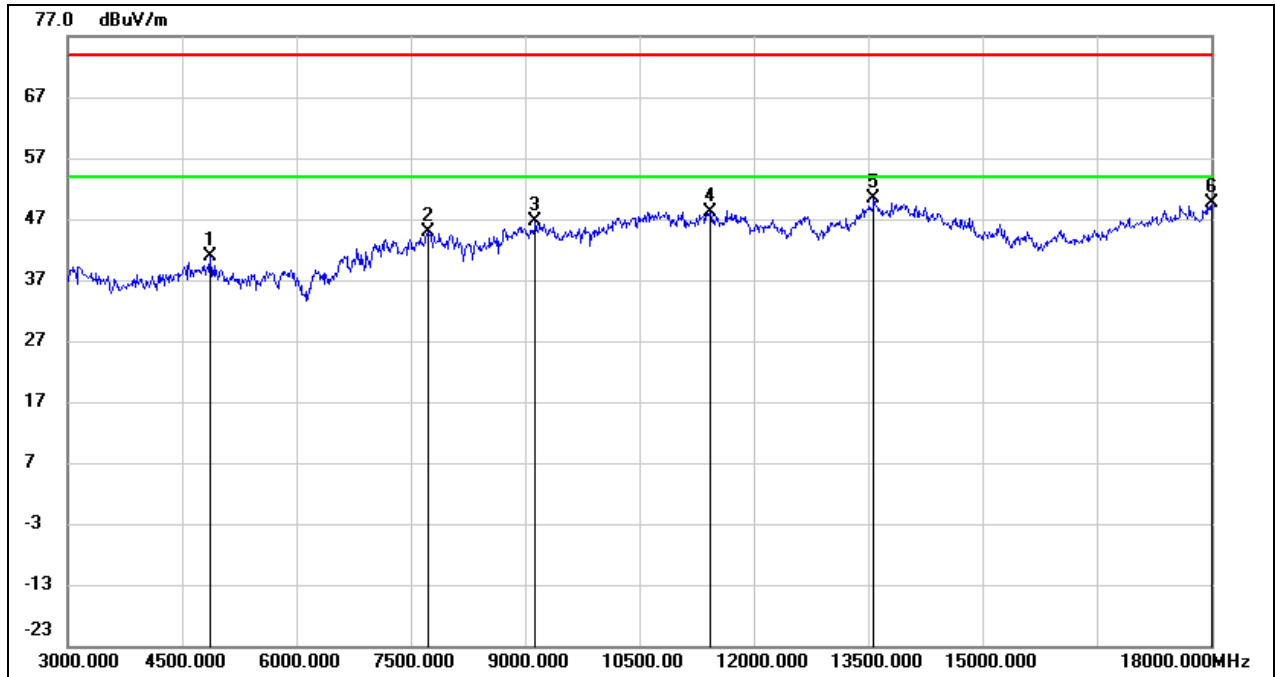

No.	Frequency (MHz)	Reading (dBuV)	Correct (dB/m)	Result (dBuV/m)	Limit (dBuV/m)	Margin (dB)	Remark
1	4875.000	40.82	-0.03	40.79	74.00	-33.21	peak
2	7725.000	38.63	6.32	44.95	74.00	-29.05	peak
3	9135.000	36.13	10.55	46.68	74.00	-27.32	peak
4	11430.000	31.86	16.34	48.20	74.00	-25.80	peak
5	13575.000	29.31	21.06	50.37	74.00	-23.63	peak
6	18000.000	23.91	25.69	49.60	74.00	-24.40	peak

Test Mode:	802.11g	Channel:	2437
Polarity:	Vertical	Test Voltage:	DC 3.3 V

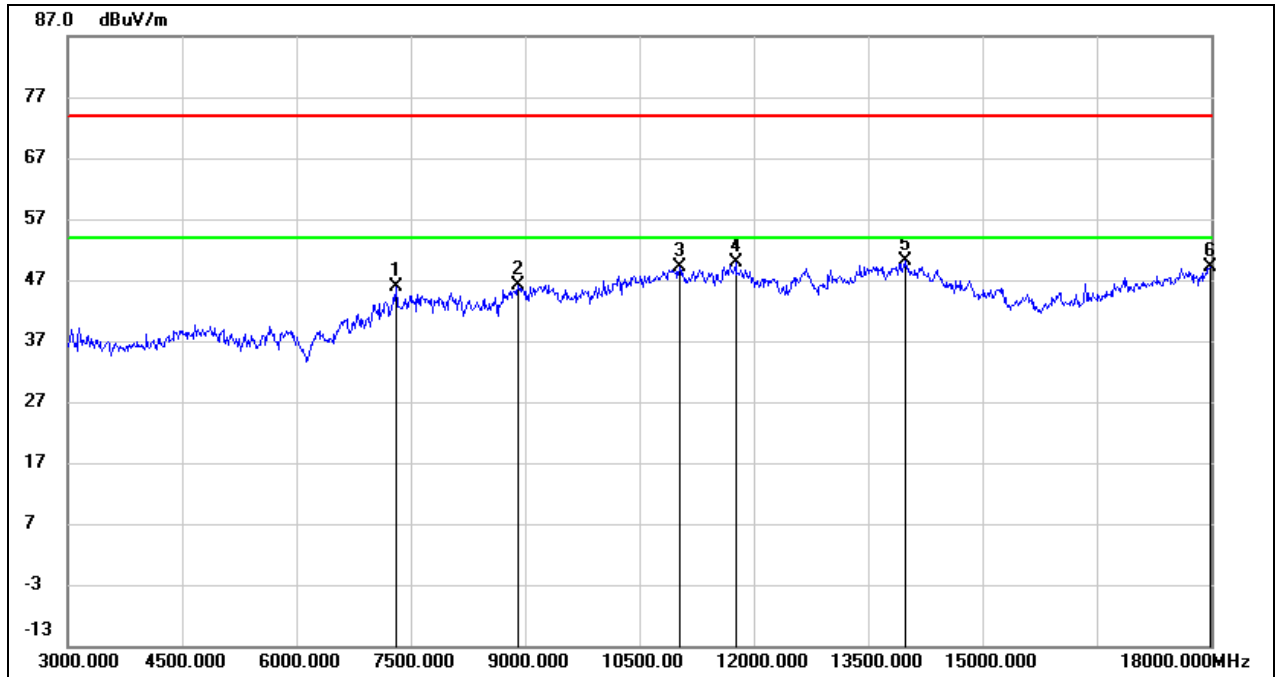

No.	Frequency (MHz)	Reading (dBuV)	Correct (dB/m)	Result (dBuV/m)	Limit (dBuV/m)	Margin (dB)	Remark
1	7305.000	39.43	6.47	45.90	74.00	-28.10	peak
2	8910.000	36.25	9.82	46.07	74.00	-27.93	peak
3	11025.000	34.20	14.85	49.05	74.00	-24.95	peak
4	11760.000	32.50	17.31	49.81	74.00	-24.19	peak
5	13995.000	28.17	21.95	50.12	74.00	-23.88	peak
6	17985.000	23.64	25.60	49.24	74.00	-24.76	peak

Test Mode:	802.11g	Channel:	2462
Polarity:	Horizontal	Test Voltage:	DC 3.3 V

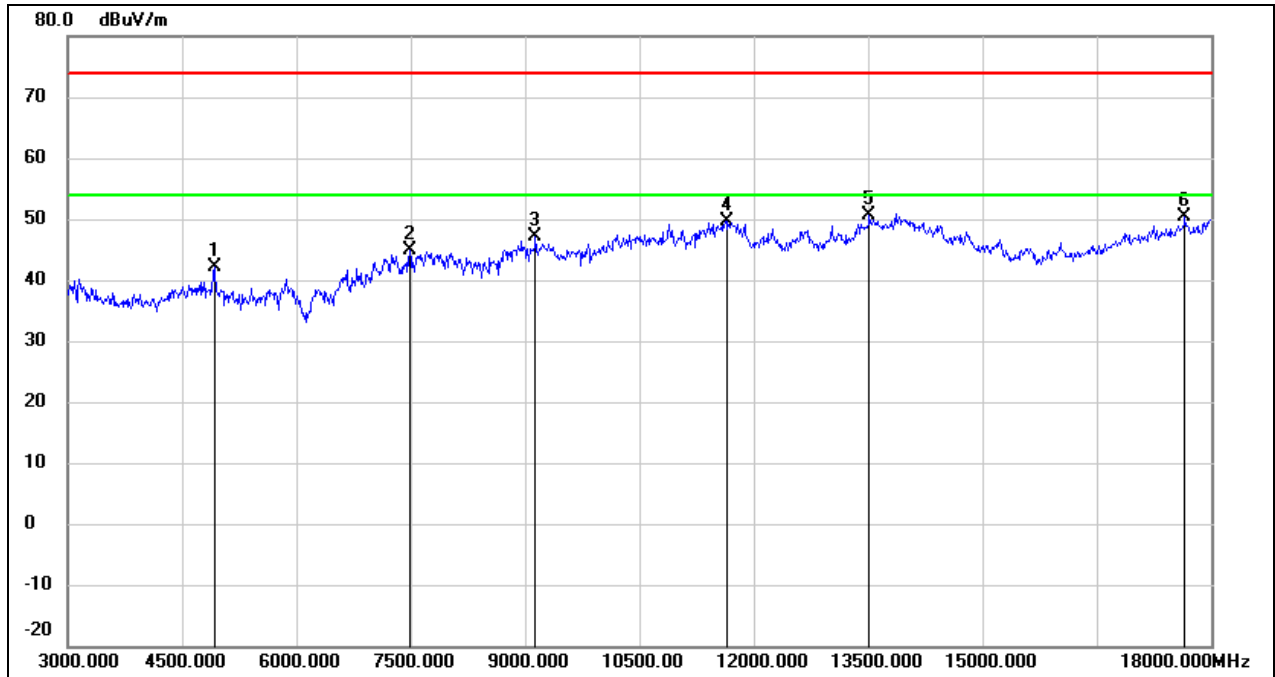

No.	Frequency (MHz)	Reading (dBuV)	Correct (dB/m)	Result (dBuV/m)	Limit (dBuV/m)	Margin (dB)	Remark
1	4920.000	42.11	0.14	42.25	74.00	-31.75	peak
2	7485.000	38.57	6.34	44.91	74.00	-29.09	peak
3	9135.000	36.46	10.55	47.01	74.00	-26.99	peak
4	11640.000	32.76	16.98	49.74	74.00	-24.26	peak
5	13515.000	29.67	20.93	50.60	74.00	-23.40	peak
6	17655.000	26.81	23.64	50.45	74.00	-23.55	peak

Test Mode:	802.11g	Channel:	2462
Polarity:	Vertical	Test Voltage:	DC 3.3 V

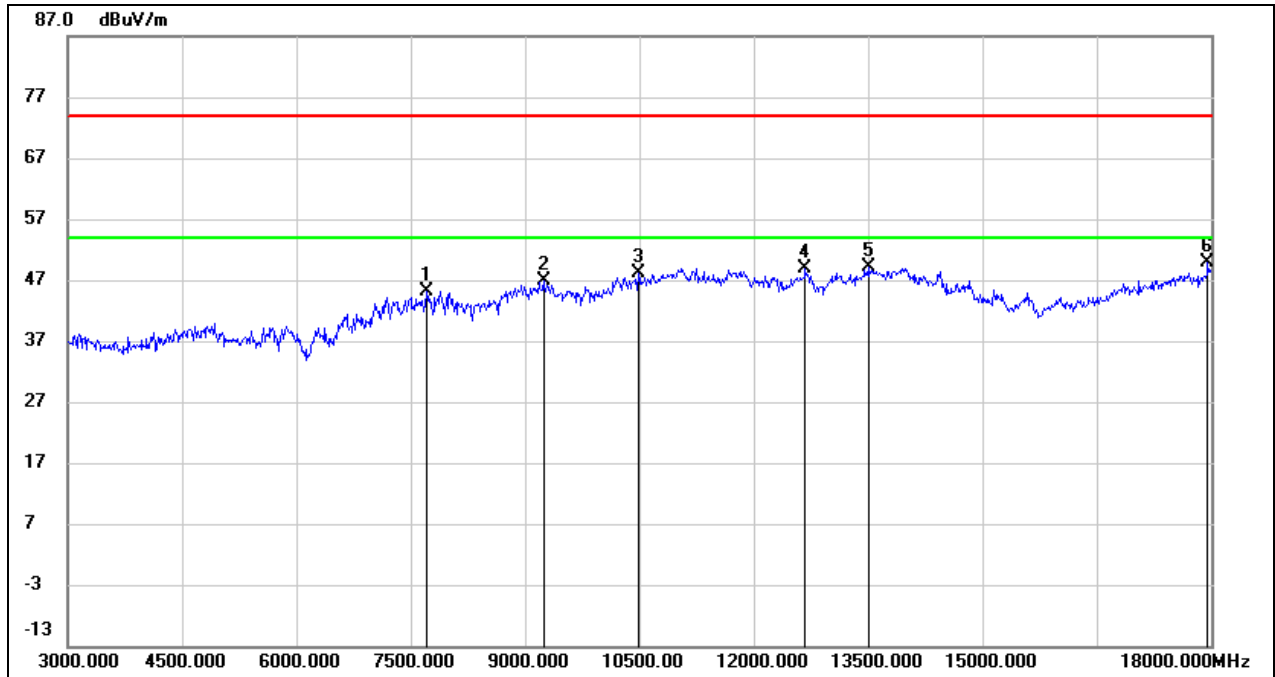

No.	Frequency (MHz)	Reading (dBuV)	Correct (dB/m)	Result (dBuV/m)	Limit (dBuV/m)	Margin (dB)	Remark
1	7710.000	38.74	6.33	45.07	74.00	-28.93	peak
2	9240.000	36.32	10.58	46.90	74.00	-27.10	peak
3	10485.000	35.06	12.97	48.03	74.00	-25.97	peak
4	12675.000	30.97	17.99	48.96	74.00	-25.04	peak
5	13500.000	28.25	20.90	49.15	74.00	-24.85	peak
6	17955.000	24.45	25.42	49.87	74.00	-24.13	peak

Test Mode:	802.11n HT20	Channel:	2412
Polarity:	Horizontal	Test Voltage:	DC 3.3 V

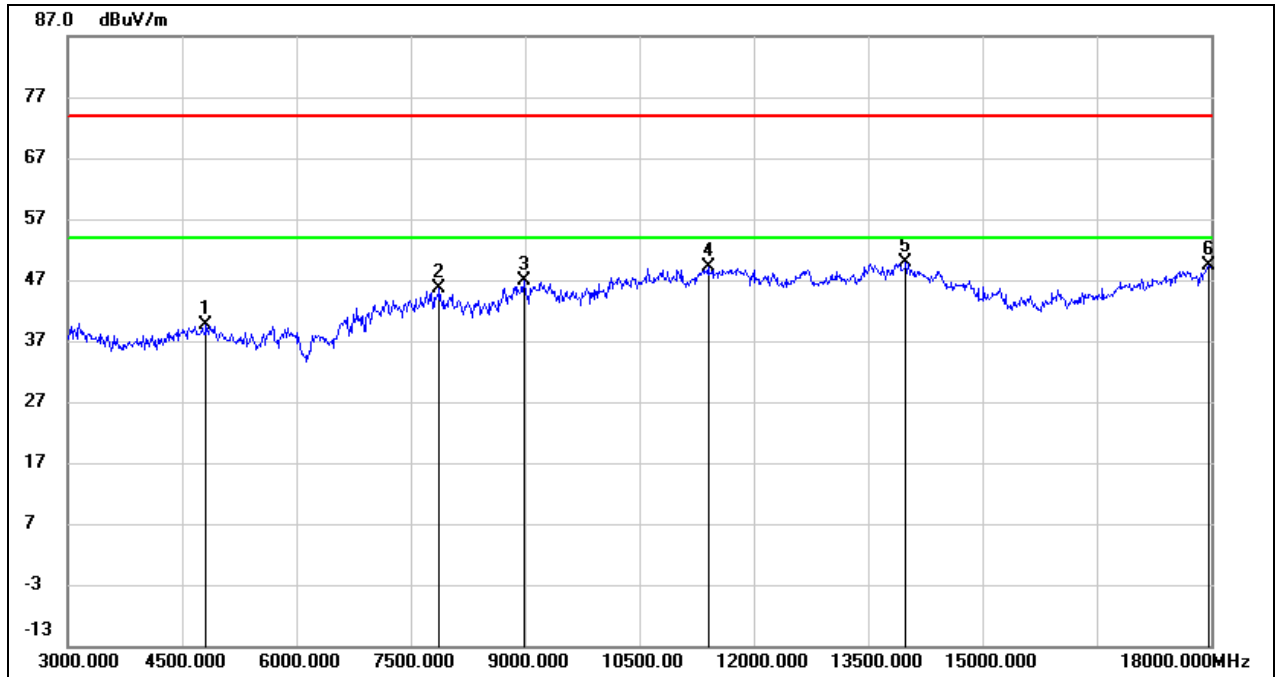

No.	Frequency (MHz)	Reading (dBuV)	Correct (dB/m)	Result (dBuV/m)	Limit (dBuV/m)	Margin (dB)	Remark
1	4815.000	39.99	-0.26	39.73	74.00	-34.27	peak
2	7875.000	39.39	6.31	45.70	74.00	-28.30	peak
3	8985.000	36.49	10.37	46.86	74.00	-27.14	peak
4	11400.000	32.79	16.23	49.02	74.00	-24.98	peak
5	13995.000	27.84	21.95	49.79	74.00	-24.21	peak
6	17970.000	23.83	25.51	49.34	74.00	-24.66	peak

Test Mode:	802.11n HT20	Channel:	2412
Polarity:	Vertical	Test Voltage:	DC 3.3 V

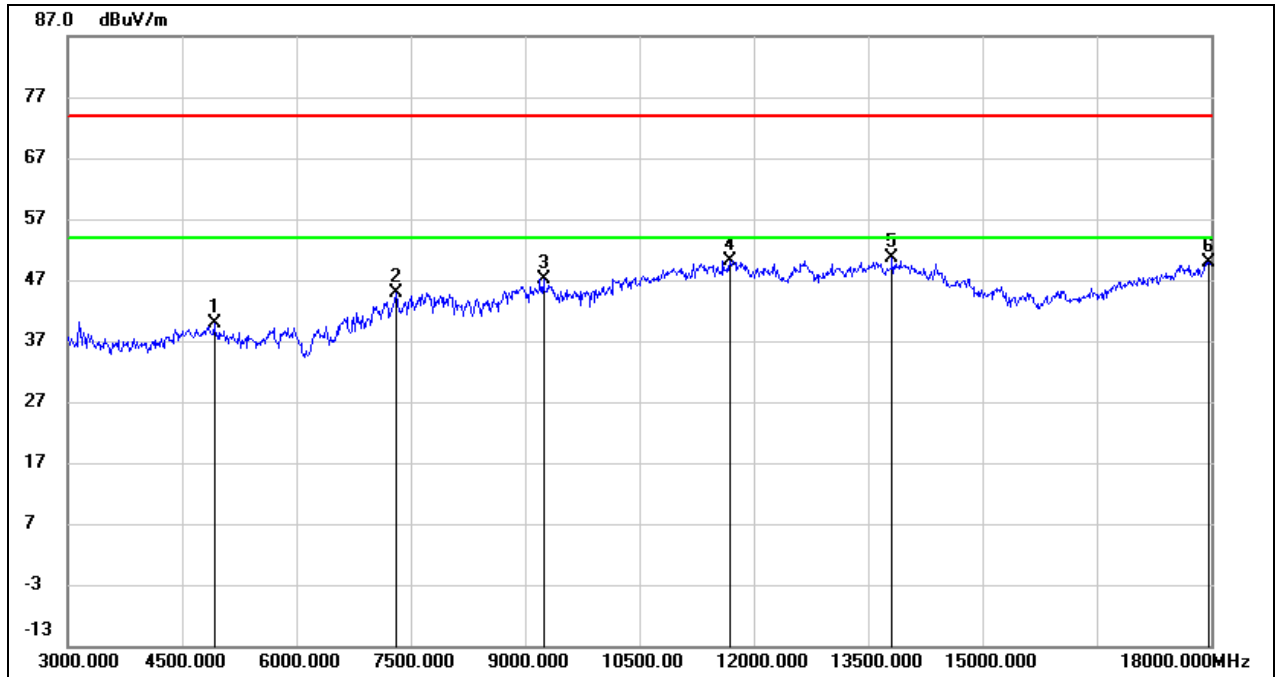

No.	Frequency (MHz)	Reading (dBuV)	Correct (dB/m)	Result (dBuV/m)	Limit (dBuV/m)	Margin (dB)	Remark
1	4920.000	39.72	0.14	39.86	74.00	-34.14	peak
2	7305.000	38.51	6.47	44.98	74.00	-29.02	peak
3	9240.000	36.52	10.58	47.10	74.00	-26.90	peak
4	11685.000	33.12	17.10	50.22	74.00	-23.78	peak
5	13815.000	29.09	21.56	50.65	74.00	-23.35	peak
6	17970.000	24.45	25.51	49.96	74.00	-24.04	peak

Test Mode:	802.11n HT20	Channel:	2437
Polarity:	Horizontal	Test Voltage:	DC 3.3 V

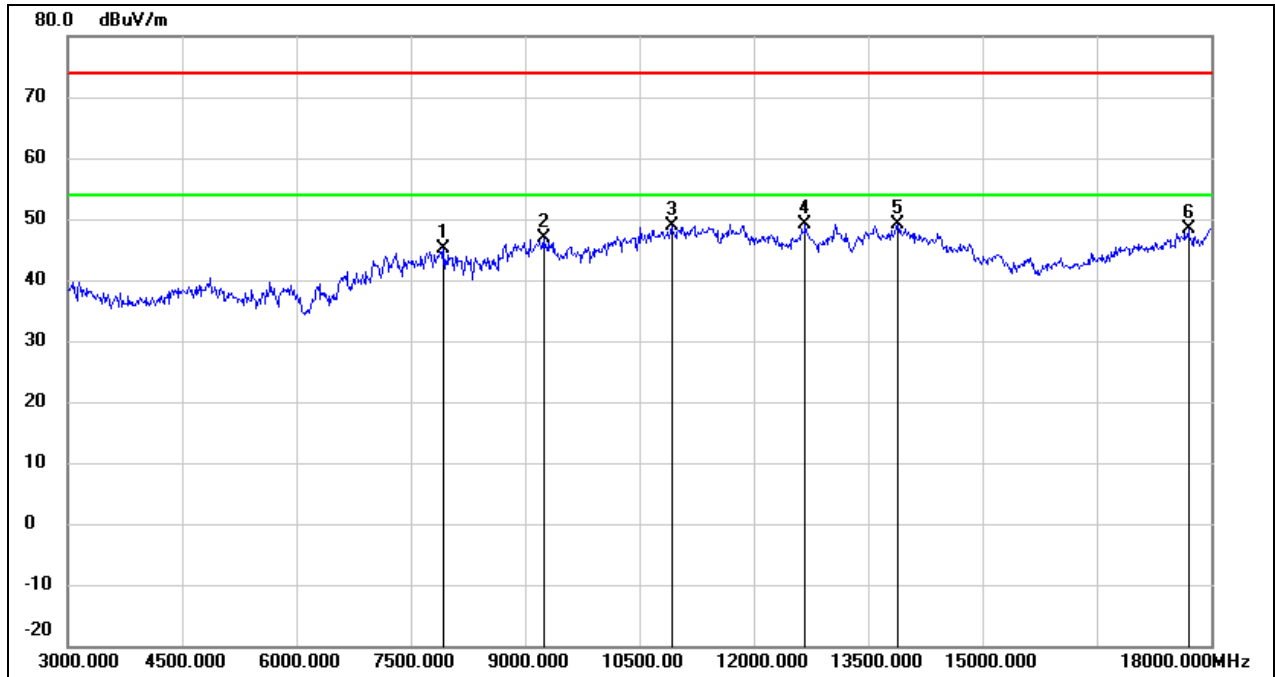

No.	Frequency (MHz)	Reading (dBuV)	Correct (dB/m)	Result (dBuV/m)	Limit (dBuV/m)	Margin (dB)	Remark
1	7935.000	38.90	6.32	45.22	74.00	-28.78	peak
2	9240.000	36.18	10.58	46.76	74.00	-27.24	peak
3	10920.000	34.47	14.49	48.96	74.00	-25.04	peak
4	12675.000	31.18	17.99	49.17	74.00	-24.83	peak
5	13890.000	27.37	21.72	49.09	74.00	-24.91	peak
6	17700.000	24.58	23.91	48.49	74.00	-25.51	peak

Test Mode:	802.11n HT20	Channel:	2437
Polarity:	Vertical	Test Voltage:	DC 3.3 V

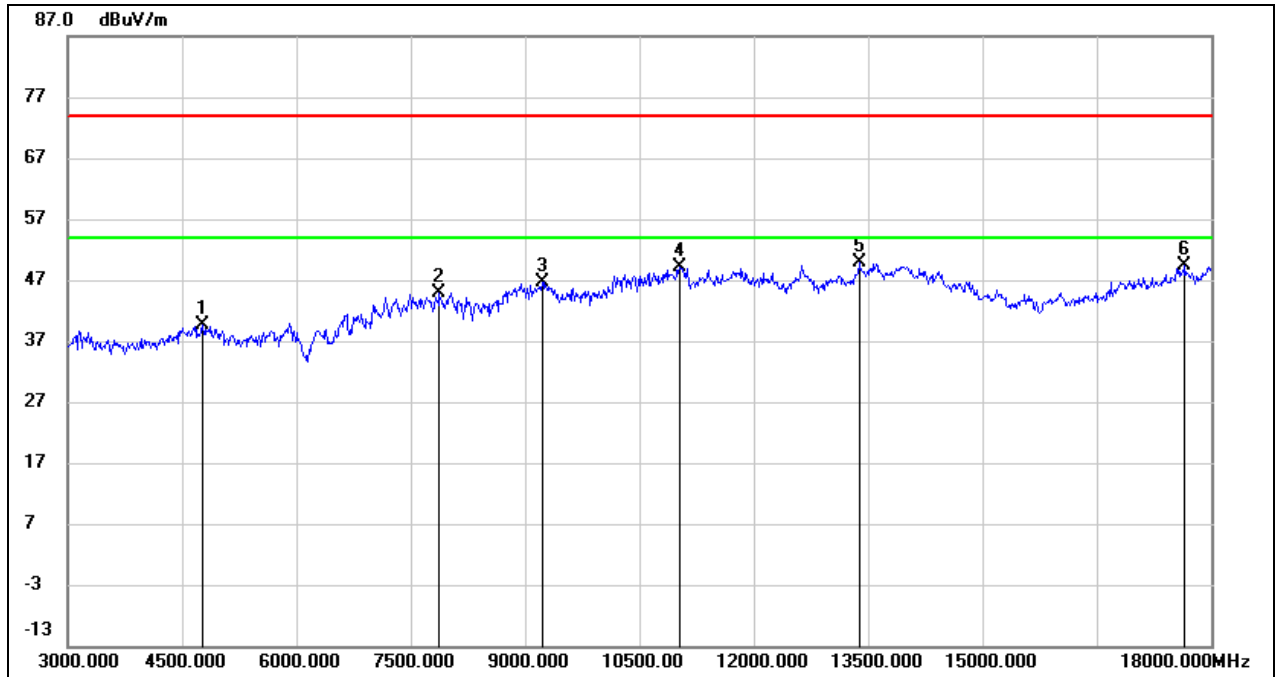

No.	Frequency (MHz)	Reading (dBuV)	Correct (dB/m)	Result (dBuV/m)	Limit (dBuV/m)	Margin (dB)	Remark
1	4770.000	39.95	-0.43	39.52	74.00	-34.48	peak
2	7875.000	38.55	6.31	44.86	74.00	-29.14	peak
3	9225.000	36.17	10.58	46.75	74.00	-27.25	peak
4	11025.000	34.24	14.85	49.09	74.00	-24.91	peak
5	13380.000	29.50	20.38	49.88	74.00	-24.12	peak
6	17655.000	25.66	23.64	49.30	74.00	-24.70	peak

Test Mode:	802.11n HT20	Channel:	2462
Polarity:	Horizontal	Test Voltage:	DC 3.3 V

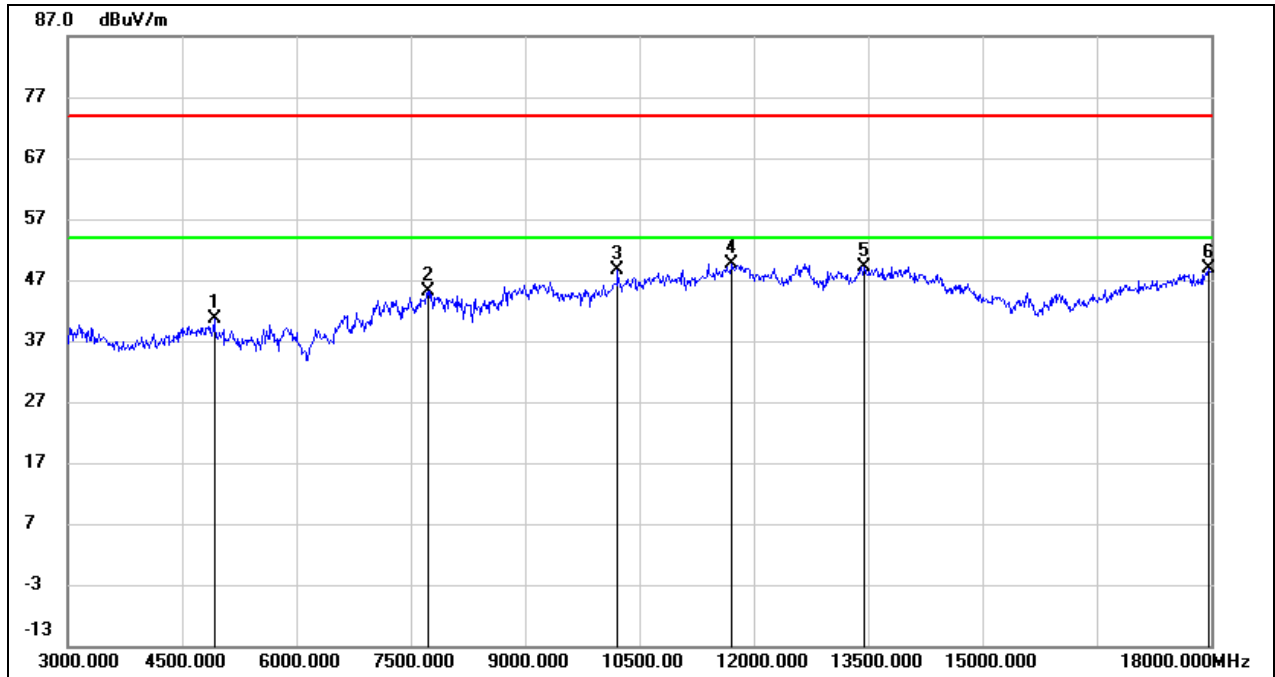

No.	Frequency (MHz)	Reading (dBuV)	Correct (dB/m)	Result (dBuV/m)	Limit (dBuV/m)	Margin (dB)	Remark
1	4920.000	40.61	0.14	40.75	74.00	-33.25	peak
2	7725.000	38.82	6.32	45.14	74.00	-28.86	peak
3	10215.000	36.29	12.43	48.72	74.00	-25.28	peak
4	11715.000	32.46	17.19	49.65	74.00	-24.35	peak
5	13455.000	28.54	20.71	49.25	74.00	-24.75	peak
6	17970.000	23.35	25.51	48.86	74.00	-25.14	peak

Test Mode:	802.11n HT20	Channel:	2462
Polarity:	Vertical	Test Voltage:	DC 3.3 V

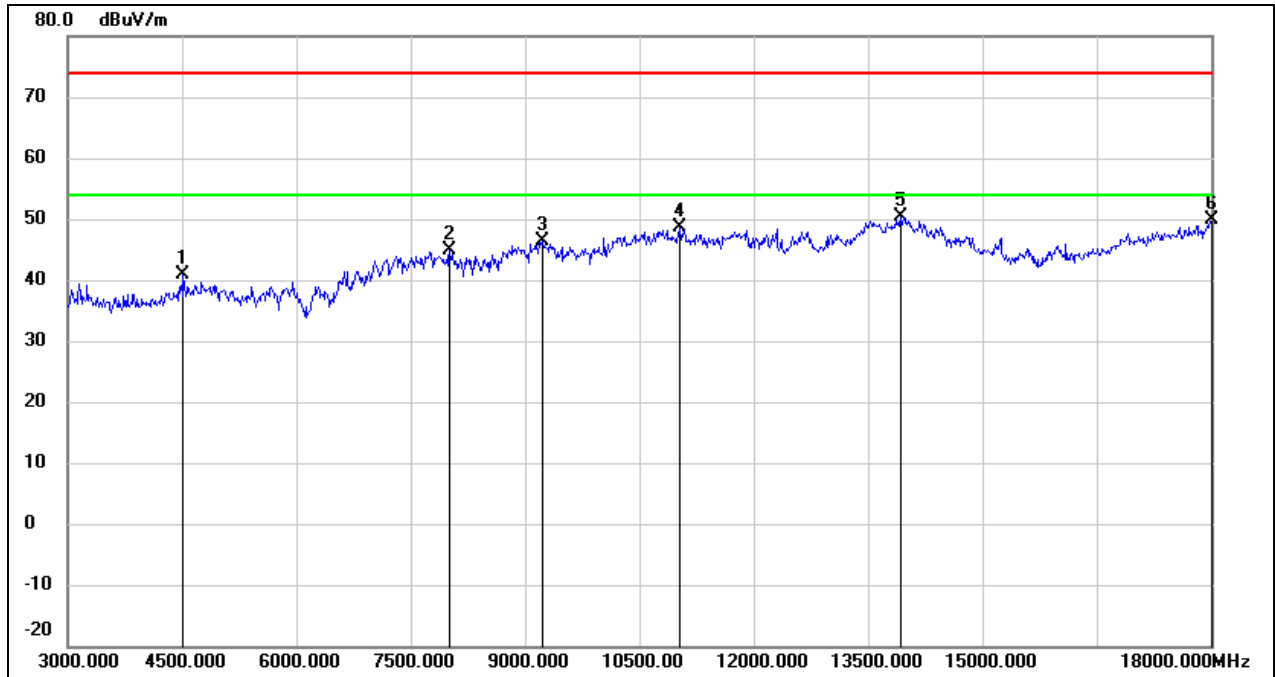

No.	Frequency (MHz)	Reading (dBuV)	Correct (dB/m)	Result (dBuV/m)	Limit (dBuV/m)	Margin (dB)	Remark
1	4515.000	42.36	-1.40	40.96	74.00	-33.04	peak
2	8010.000	38.58	6.32	44.90	74.00	-29.10	peak
3	9225.000	35.75	10.58	46.33	74.00	-27.67	peak
4	11025.000	33.72	14.85	48.57	74.00	-25.43	peak
5	13920.000	28.63	21.79	50.42	74.00	-23.58	peak
6	18000.000	24.30	25.69	49.99	74.00	-24.01	peak

8.4. SPURIOUS EMISSIONS(9 KHZ~30 MHZ)

Test Mode:	802.11b	Channel:	2412
Polarity:	FACE ON	Test Voltage:	DC 3.3 V

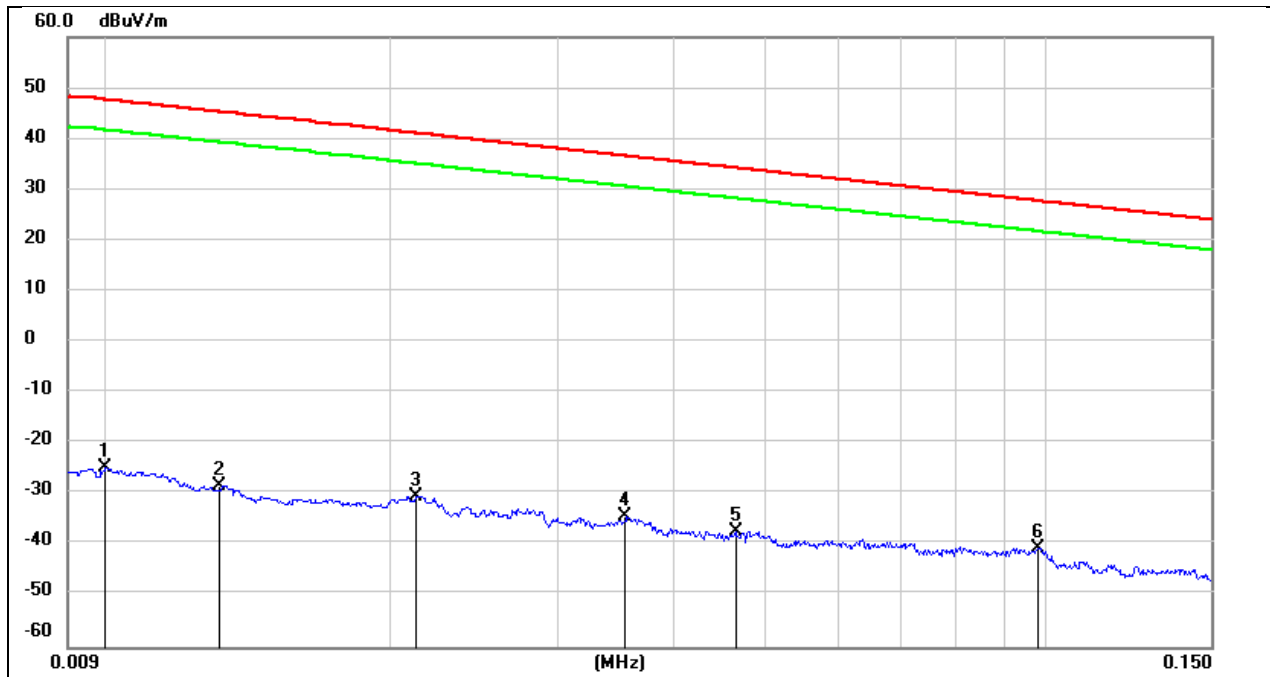

No.	Frequency (MHz)	Reading (dBuV)	Correct (dB/m)	Result (dBuV/m)	Limit (dBuV/m)	Margin (dB)	Remark
1	0.0100	76.72	-101.40	-24.68	47.60	-72.28	peak
2	0.0131	72.97	-101.38	-28.41	45.25	-73.66	peak
3	0.0212	71.04	-101.35	-30.31	41.07	-71.38	peak
4	0.0354	66.97	-101.41	-34.44	36.62	-71.06	peak
5	0.0466	64.17	-101.46	-37.29	34.23	-71.52	peak
6	0.0981	61.27	-101.78	-40.51	27.77	-68.28	peak

Test Mode:	802.11b	Channel:	2412
Polarity:	FACE ON	Test Voltage:	DC 3.3 V

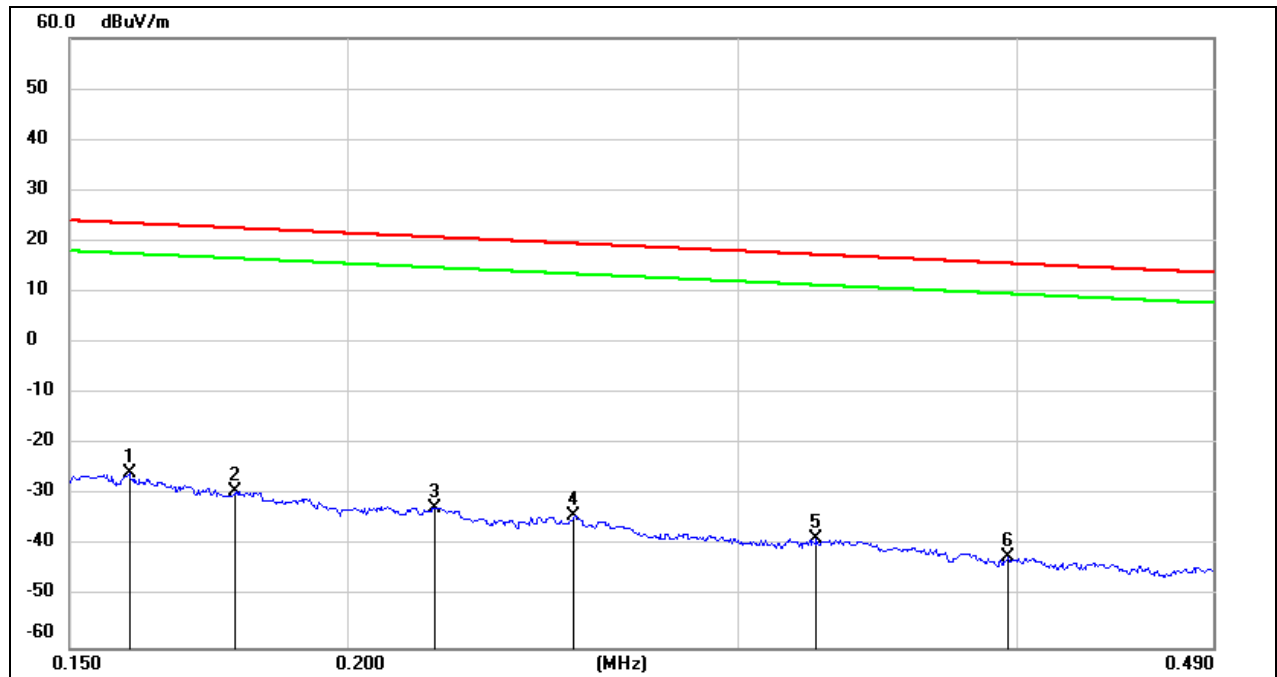

No.	Frequency (MHz)	Reading (dBuV)	Correct (dB/m)	Result (dBuV/m)	Limit (dBuV/m)	Margin (dB)	Remark
1	0.1595	75.86	-101.65	-25.79	23.55	-49.34	peak
2	0.1781	72.35	-101.68	-29.33	22.59	-51.92	peak
3	0.2190	69.27	-101.75	-32.48	20.79	-53.27	peak
4	0.2530	67.64	-101.80	-34.16	19.54	-53.70	peak
5	0.3251	63.21	-101.88	-38.67	17.36	-56.03	peak
6	0.3966	59.68	-101.96	-42.28	15.63	-57.91	peak

Test Mode:	802.11b	Channel:	2412
Polarity:	FACE ON	Test Voltage:	DC 3.3 V

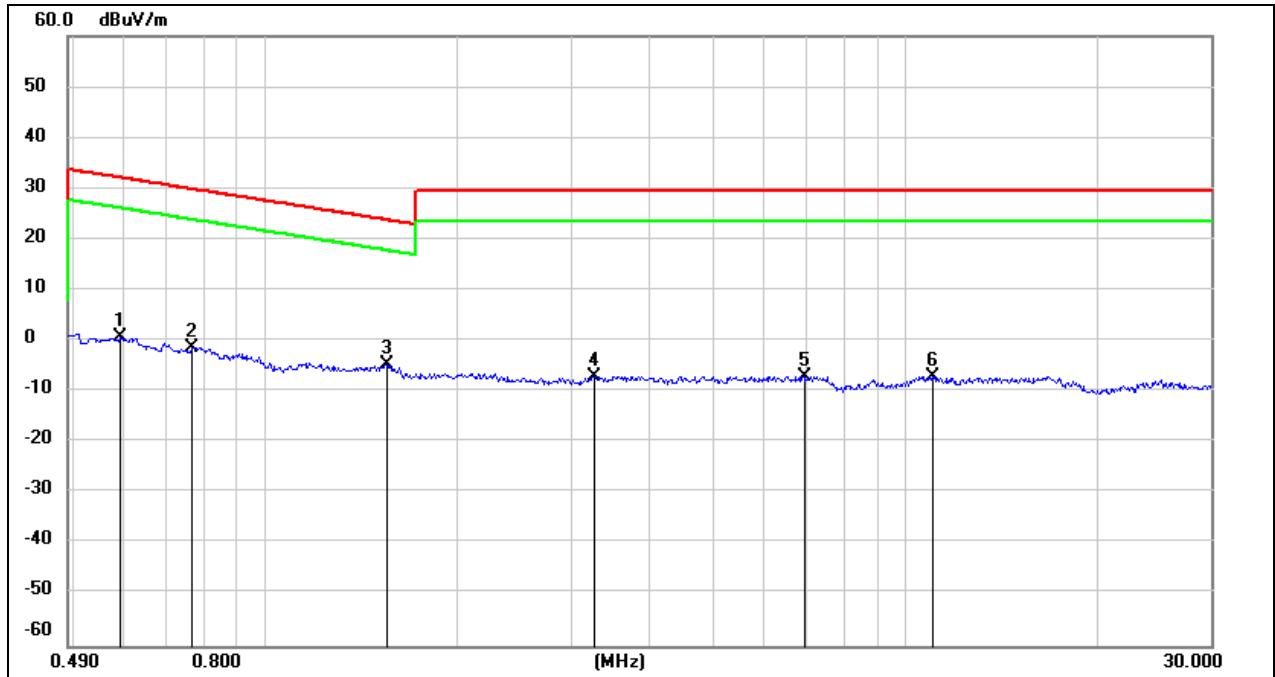

No.	Frequency (MHz)	Reading (dBuV)	Correct (dB/m)	Result (dBuV/m)	Limit (dBuV/m)	Margin (dB)	Remark
1	0.5917	62.74	-62.08	0.66	32.16	-31.50	peak
2	0.7671	60.91	-62.12	-1.21	29.90	-31.11	peak
3	1.5443	57.35	-62.03	-4.68	23.83	-28.51	peak
4	3.2639	54.59	-61.51	-6.92	29.54	-36.46	peak
5	6.9527	54.32	-61.22	-6.90	29.54	-36.44	peak
6	10.9954	53.84	-60.84	-7.00	29.54	-36.54	peak

8.5. SPURIOUS EMISSIONS(18 GHZ~26 GHZ)

Test Mode:	802.11b	Channel:	2412
Polarity:	Horizontal	Test Voltage:	DC 3.3 V

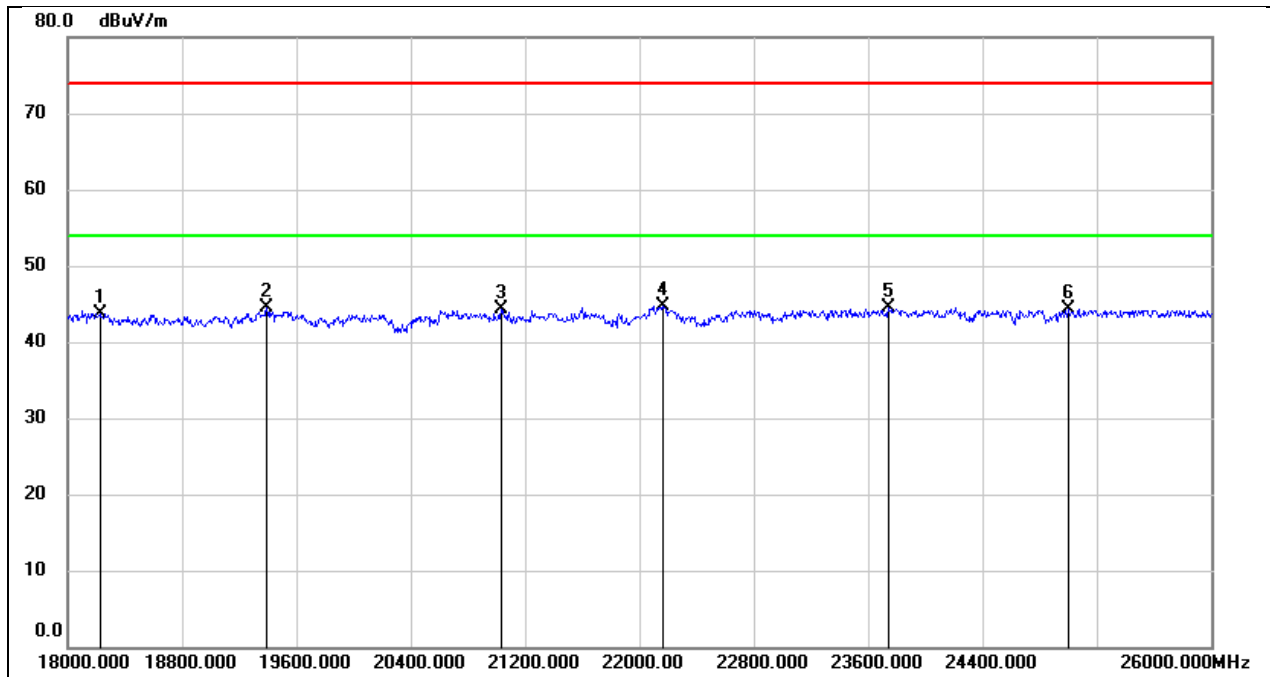

No.	Frequency (MHz)	Reading (dBuV)	Correct (dB/m)	Result (dBuV/m)	Limit (dBuV/m)	Margin (dB)	Remark
1	18232.000	49.25	-5.54	43.71	74.00	-30.29	peak
2	19392.000	50.12	-5.57	44.55	74.00	-29.45	peak
3	21032.000	49.15	-4.87	44.28	74.00	-29.72	peak
4	22160.000	49.08	-4.31	44.77	74.00	-29.23	peak
5	23744.000	47.65	-3.20	44.45	74.00	-29.55	peak
6	25000.000	46.36	-2.10	44.26	74.00	-29.74	peak

Test Mode:	802.11b	Channel:	2412
Polarity:	Vertical	Test Voltage:	DC 3.3 V

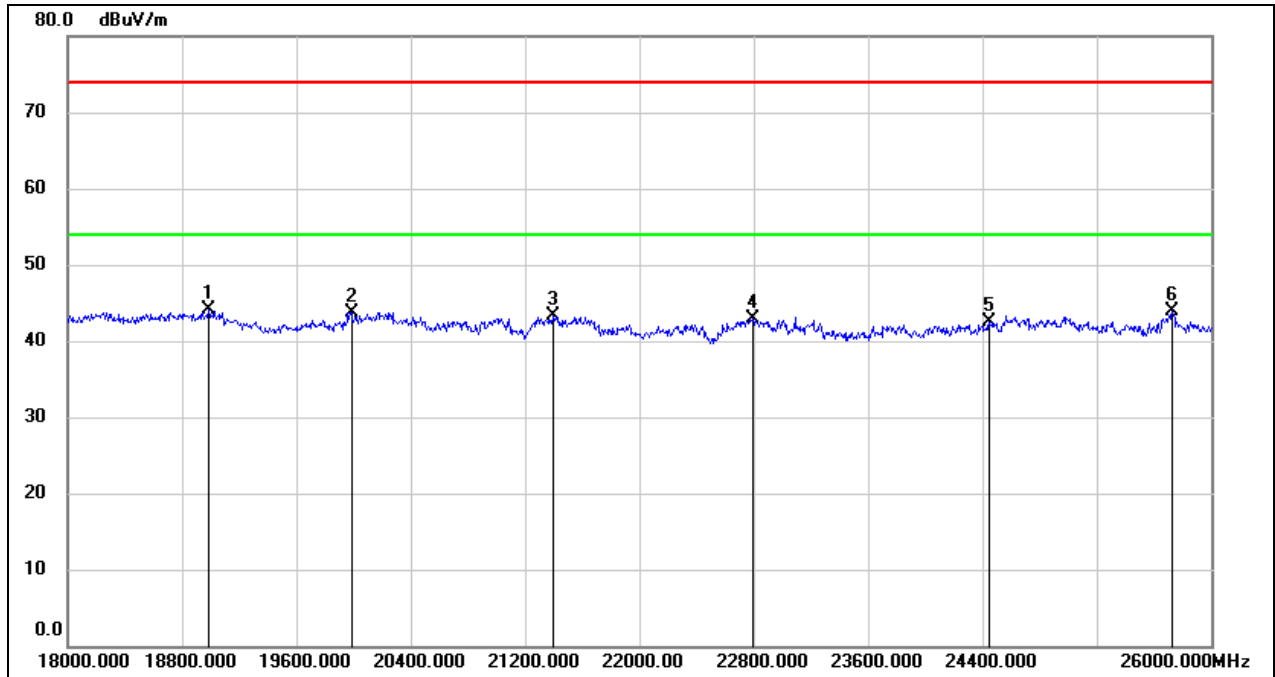

No.	Frequency (MHz)	Reading (dBuV)	Correct (dB/m)	Result (dBuV/m)	Limit (dBuV/m)	Margin (dB)	Remark
1	18984.000	49.29	-5.23	44.06	74.00	-29.94	peak
2	19984.000	49.21	-5.44	43.77	74.00	-30.23	peak
3	21400.000	48.04	-4.72	43.32	74.00	-30.68	peak
4	22792.000	46.61	-3.65	42.96	74.00	-31.04	peak
5	24448.000	44.92	-2.42	42.50	74.00	-31.50	peak
6	25728.000	44.61	-0.72	43.89	74.00	-30.11	peak

8.6. SPURIOUS EMISSIONS(30 MHZ~1 GHZ)

Test Mode:	802.11b	Channel:	2412
Polarity:	Horizontal	Test Voltage:	DC 3.3 V

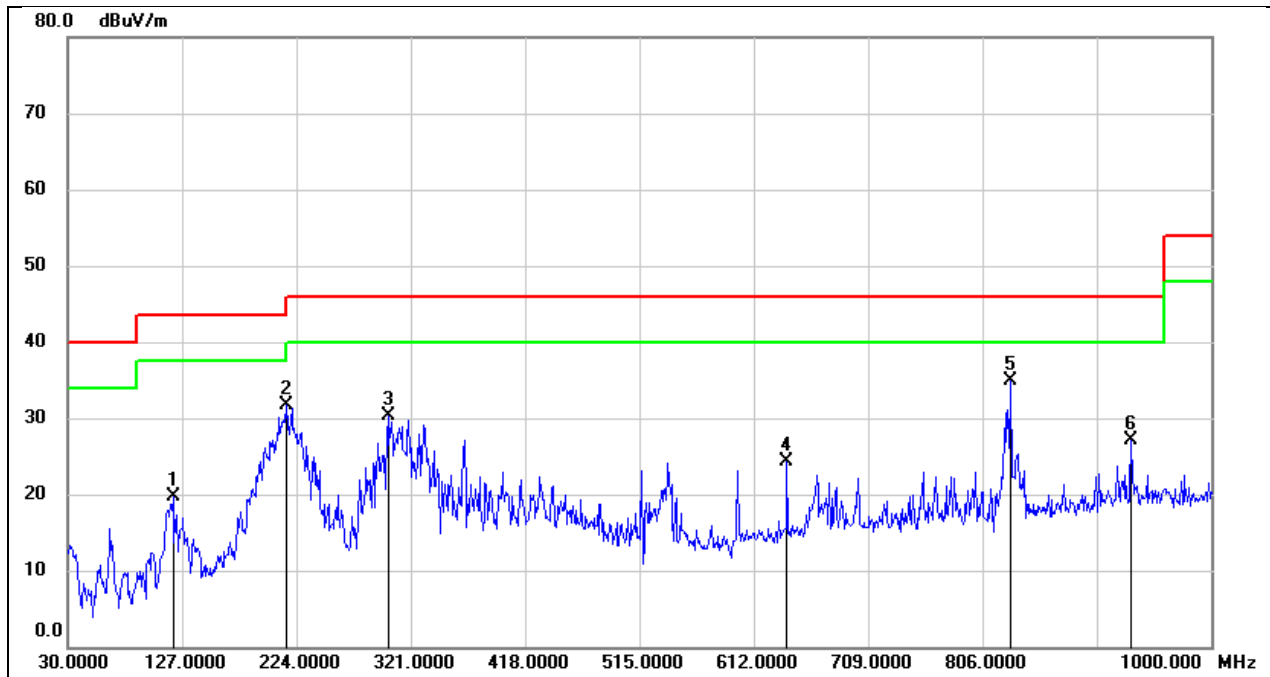

No.	Frequency (MHz)	Reading (dBuV)	Correct (dB/m)	Result (dBuV/m)	Limit (dBuV/m)	Margin (dB)	Remark
1	119.2400	39.68	-19.90	19.78	43.50	-23.72	peak
2	215.2700	49.39	-17.76	31.63	43.50	-11.87	peak
3	302.5700	45.63	-15.25	30.38	46.00	-15.62	peak
4	640.1300	33.37	-9.03	24.34	46.00	-21.66	peak
5	830.2500	41.63	-6.68	34.95	46.00	-11.05	peak
6	932.1000	31.74	-4.72	27.02	46.00	-18.98	peak

Test Mode:	802.11b	Channel:	2412
Polarity:	Vertical	Test Voltage:	DC 3.3 V

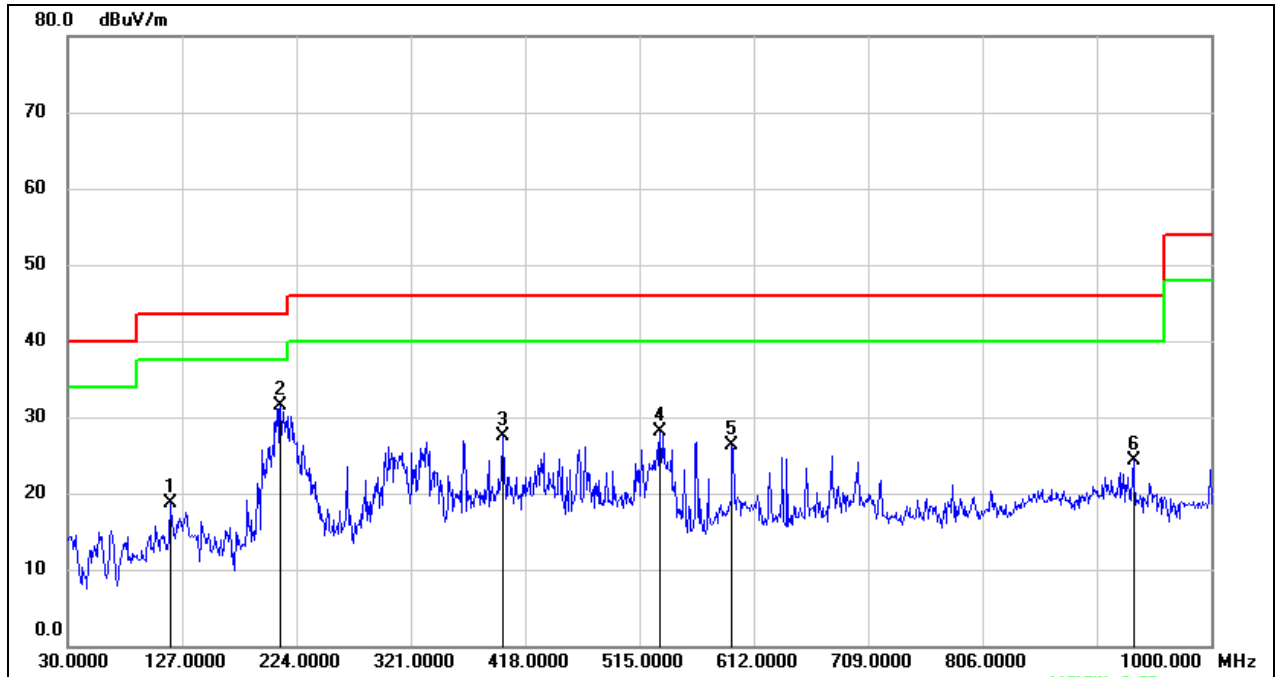

No.	Frequency (MHz)	Reading (dBuV)	Correct (dB/m)	Result (dBuV/m)	Limit (dBuV/m)	Margin (dB)	Remark
1	117.3000	38.70	-20.03	18.67	43.50	-24.83	peak
2	210.4200	48.91	-17.32	31.59	43.50	-11.91	peak
3	398.6000	40.88	-13.37	27.51	46.00	-18.49	peak
4	532.4600	38.82	-10.73	28.09	46.00	-17.91	peak
5	593.5700	35.99	-9.72	26.27	46.00	-19.73	peak
6	934.0400	29.03	-4.67	24.36	46.00	-21.64	peak

9. ANTENNA REQUIREMENT

REQUIREMENT

Please refer to FCC part 15.203

An intentional radiator shall be designed to ensure that no antenna other than that furnished by the responsible party shall be used with the device. The use of a permanently attached antenna or of an antenna that uses a unique coupling to the intentional radiator shall be considered sufficient to comply with the provisions of this section. The manufacturer may design the unit so that a broken antenna can be replaced by the user, but the use of a standard antenna jack or electrical connector is prohibited.

Please refer to FCC part 15.247(b)(4)

The conducted output power limit specified in paragraph (b) of this section is based on the use of antennas with directional gains that do not exceed 6 dBi. Except as shown in paragraph (c) of this section, if transmitting antennas of directional gain greater than 6 dBi are used, the conducted output power from the intentional radiator shall be reduced below the stated values in paragraphs (b)(1), (b)(2), and (b)(3) of this section, as appropriate, by the amount in dB that the directional gain of the antenna exceeds 6 dBi.

DESCRIPTION

Pass

10. AC POWER LINE CONDUCTED EMISSION

LIMITS

Please refer to CFR 47 FCC §15.207 (a).

FREQUENCY (MHz)	Quasi-peak	Average
0.15 -0.5	66 - 56 *	56 - 46 *
0.50 -5.0	56.00	46.00
5.0 -30.0	60.00	50.00

TEST PROCEDURE

The EUT is put on a table of non-conducting material that is 80 cm high. The vertical conducting wall of shielding is located 40 cm to the rear of the EUT. The power line of the EUT is connected to the AC mains through a Artificial Mains Network (A.M.N.). A EMI Measurement Receiver (R&S Test Receiver ESR3) is used to test the emissions from both sides of AC line. According to the requirements in Section 6.2 of ANSI C63.10-2013. Conducted emissions from the EUT measured in the frequency range between 0.15 MHz and 30 MHz using CISPR Quasi-Peak and average detector mode. The bandwidth of EMI test receiver is set at 9 kHz.

The arrangement of the equipment is installed to meet the standards and operating in a manner, which tends to maximize its emission characteristics in a normal application.

TEST SETUP

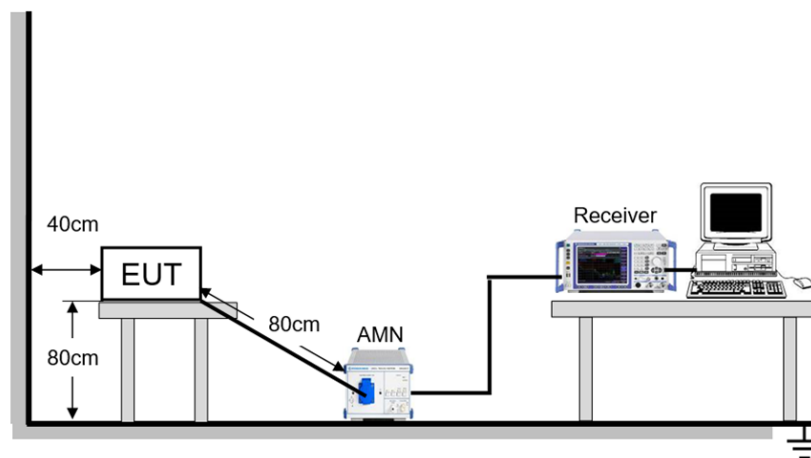

TEST ENVIRONMENT

Temperature	25.7°C	Relative Humidity	65.8%
Atmosphere Pressure	101kPa	Test Voltage	AC 120 V, 60 Hz

TEST DATE / ENGINEER

Test Date	June 25, 2023	Test By	Wite Chen
-----------	---------------	---------	-----------

TEST RESULTS

Test Mode:	802.11b	Channel:	2412
Line:	Line	Test Voltage:	AC 120 V, 60 Hz

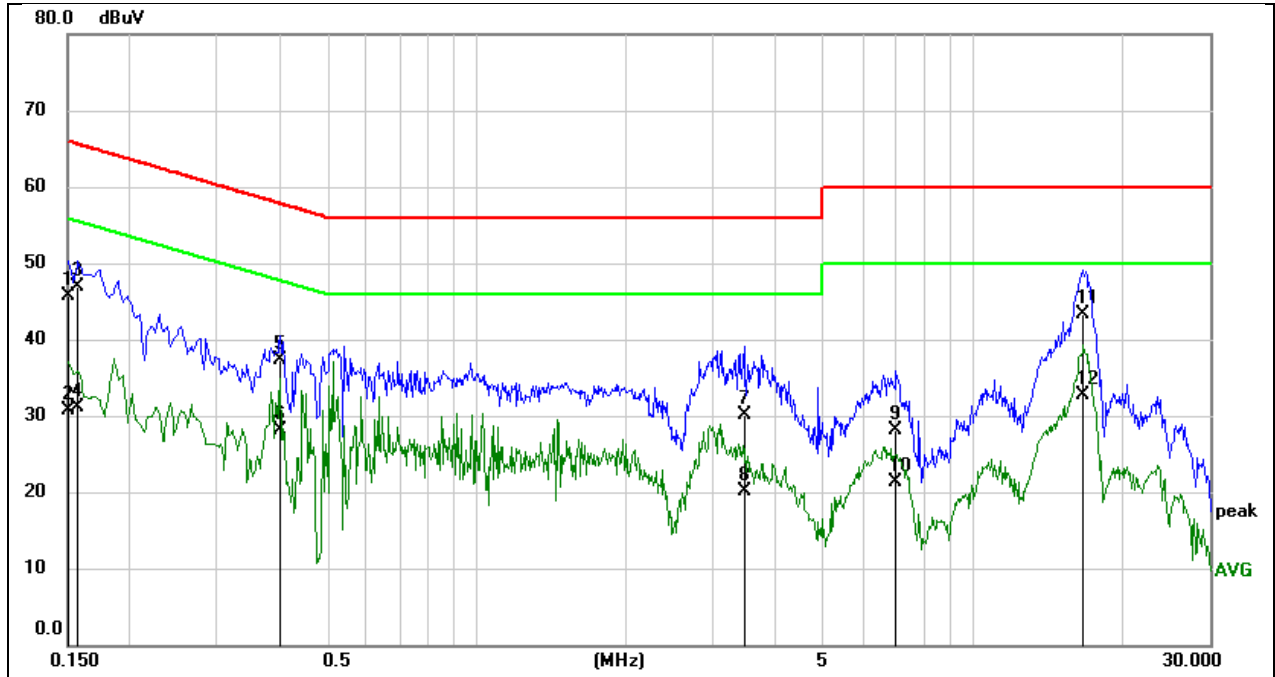

No.	Frequency (MHz)	Reading (dBuV)	Correct (dB)	Result (dBuV)	Limit (dBuV)	Margin (dB)	Remark
1	0.1500	36.14	9.59	45.73	66.00	-20.27	QP
2	0.1500	21.10	9.59	30.69	56.00	-25.31	AVG
3	0.1575	37.36	9.59	46.95	65.59	-18.64	QP
4	0.1575	21.61	9.59	31.20	55.59	-24.39	AVG
5	0.4038	27.75	9.60	37.35	57.77	-20.42	QP
6	0.4038	18.46	9.60	28.06	47.77	-19.71	AVG
7	3.4382	20.33	9.68	30.01	56.00	-25.99	QP
8	3.4382	10.42	9.68	20.10	46.00	-25.90	AVG
9	7.0265	18.29	9.73	28.02	60.00	-31.98	QP
10	7.0265	11.61	9.73	21.34	50.00	-28.66	AVG
11	16.6555	33.61	9.77	43.38	60.00	-16.62	QP
12	16.6555	22.89	9.77	32.66	50.00	-17.34	AVG

Note:

1. Result = Reading + Correct Factor.
2. If QP Result complies with AV limit, AV Result is deemed to comply with AV limit.
3. Test setup: RBW: 200 Hz (9 kHz ~ 150 kHz), 9 kHz (150 kHz ~ 30 MHz).
4. Step size: 80 Hz (0.009 MHz ~ 0.15 MHz), 4 kHz (0.15 MHz ~ 30 MHz), Scan time: auto.

Note: All the modes have been tested, only the worst data was recorded in the report.

Test Mode:	802.11b	Channel:	2412
Line:	Neutral	Test Voltage:	AC 120 V, 60 Hz

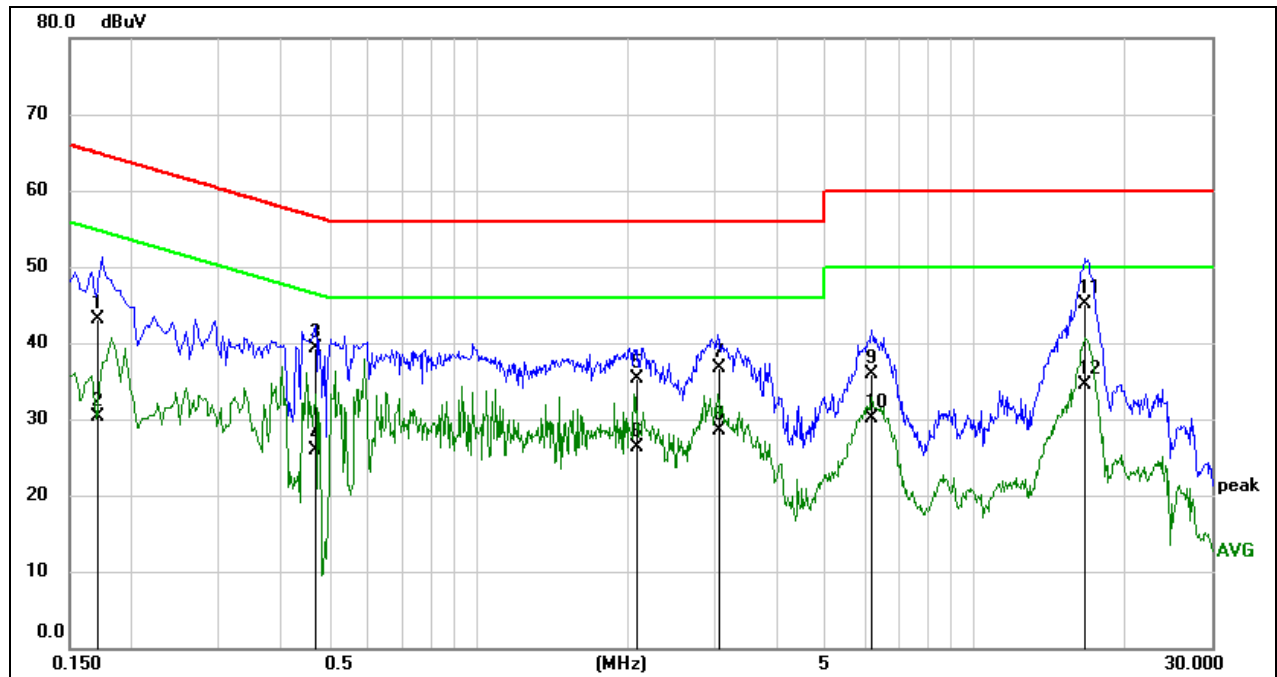

No.	Frequency (MHz)	Reading (dBuV)	Correct (dB)	Result (dBuV)	Limit (dBuV)	Margin (dB)	Remark
1	0.1702	33.65	9.53	43.18	64.95	-21.77	QP
2	0.1702	20.77	9.53	30.30	54.95	-24.65	AVG
3	0.4704	29.85	9.51	39.36	56.51	-17.15	QP
4	0.4704	16.43	9.51	25.94	46.51	-20.57	AVG
5	2.0789	25.73	9.63	35.36	56.00	-20.64	QP
6	2.0789	16.73	9.63	26.36	46.00	-19.64	AVG
7	3.0522	27.01	9.62	36.63	56.00	-19.37	QP
8	3.0522	18.84	9.62	28.46	46.00	-17.54	AVG
9	6.1868	26.22	9.64	35.86	60.00	-24.14	QP
10	6.1868	20.40	9.64	30.04	50.00	-19.96	AVG
11	16.6014	35.42	9.66	45.08	60.00	-14.92	QP
12	16.6014	24.90	9.66	34.56	50.00	-15.44	AVG

Note:

1. Result = Reading + Correct Factor.
2. If QP Result complies with AV limit, AV Result is deemed to comply with AV limit.
3. Test setup: RBW: 200 Hz (9 kHz ~ 150 kHz), 9 kHz (150 kHz ~ 30 MHz).
4. Step size: 80 Hz (0.009 MHz ~ 0.15 MHz), 4 kHz (0.15 MHz ~ 30 MHz), Scan time: auto.

Note: All the modes have been tested, only the worst data was recorded in the report.

11. TEST DATA

11.1. APPENDIX A: DTS BANDWIDTH

11.1.1. Test Result

Test Mode	Antenna	Channel	DTS BW [MHz]	FL[MHz]	FH[MHz]	Limit[MHz]	Verdict
11B	Ant1	2412	9.08	2407.40	2416.48	≥0.5	PASS
		2437	9.08	2432.40	2441.48	≥0.5	PASS
		2462	9.08	2457.40	2466.48	≥0.5	PASS
11G	Ant1	2412	16.36	2403.76	2420.12	≥0.5	PASS
		2437	16.36	2428.76	2445.12	≥0.5	PASS
		2462	16.36	2453.76	2470.12	≥0.5	PASS
11N20SISO	Ant1	2412	17.56	2403.16	2420.72	≥0.5	PASS
		2437	17.56	2428.16	2445.72	≥0.5	PASS
		2462	17.56	2453.16	2470.72	≥0.5	PASS

11.1.2. Test Graphs

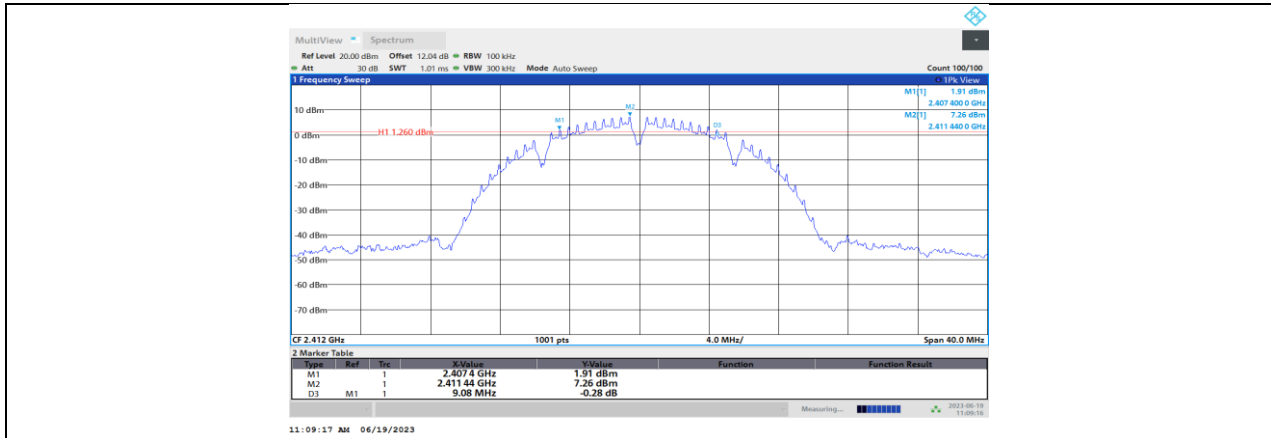

11B_Ant1_2412

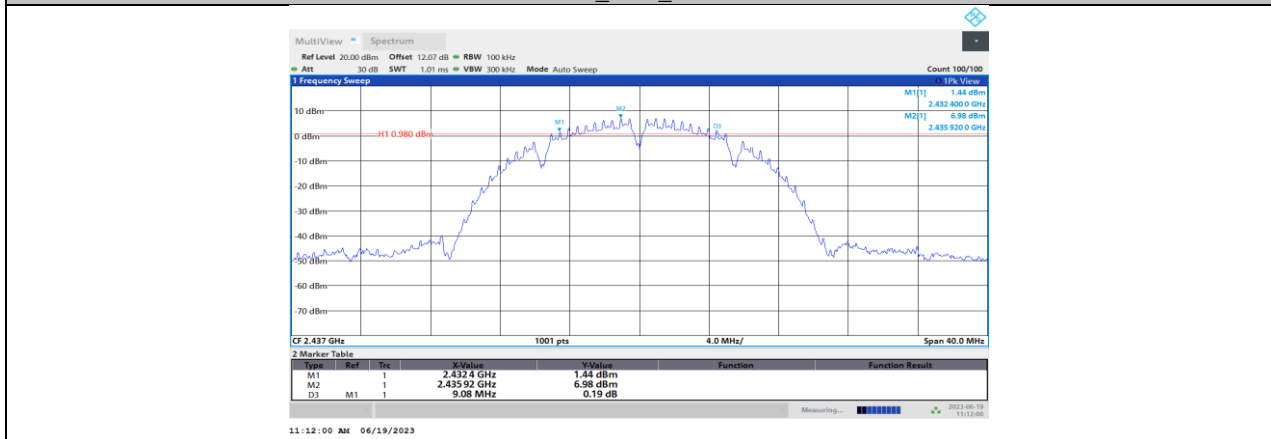

11B_Ant1_2437

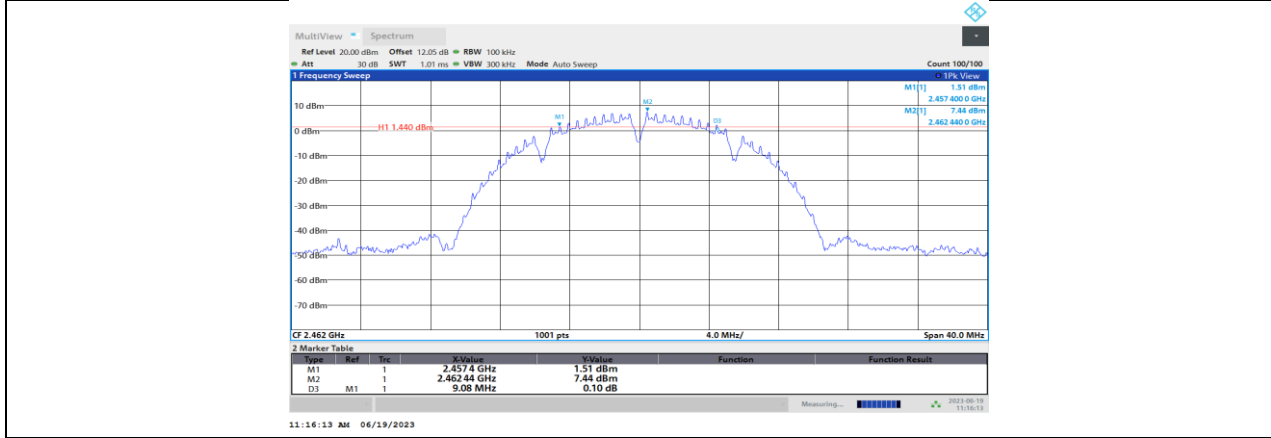

11B_Ant1_2462

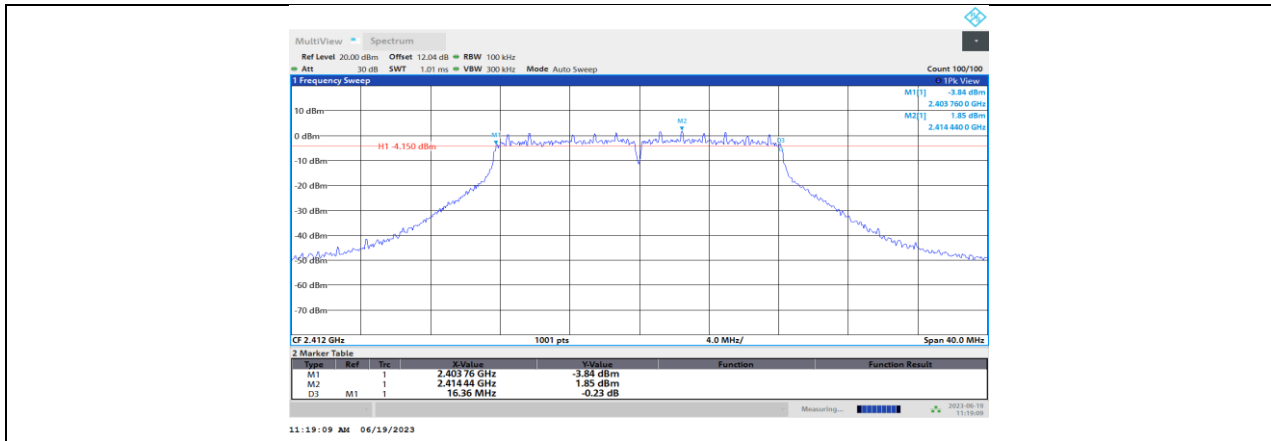

11G_Ant1_2412

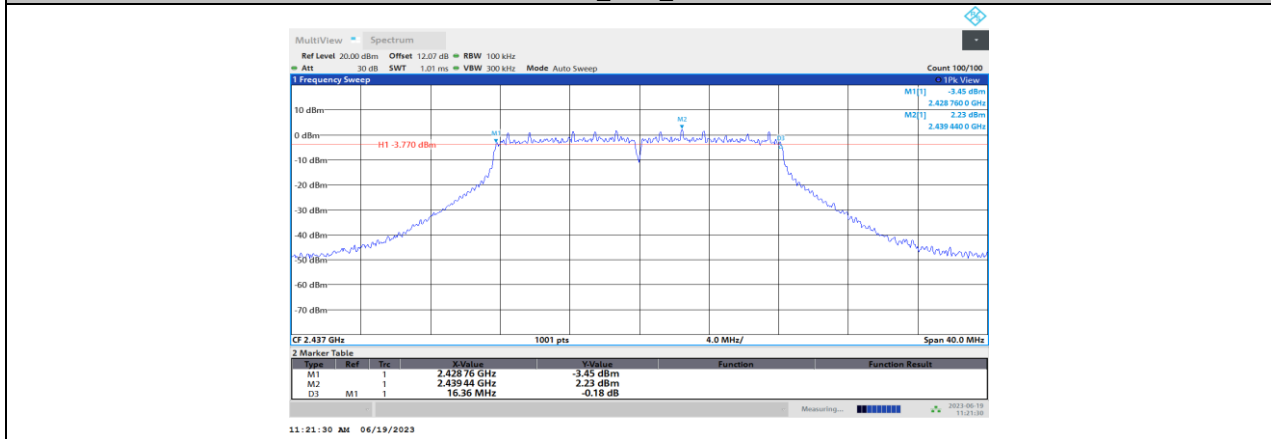

11G_Ant1_2437

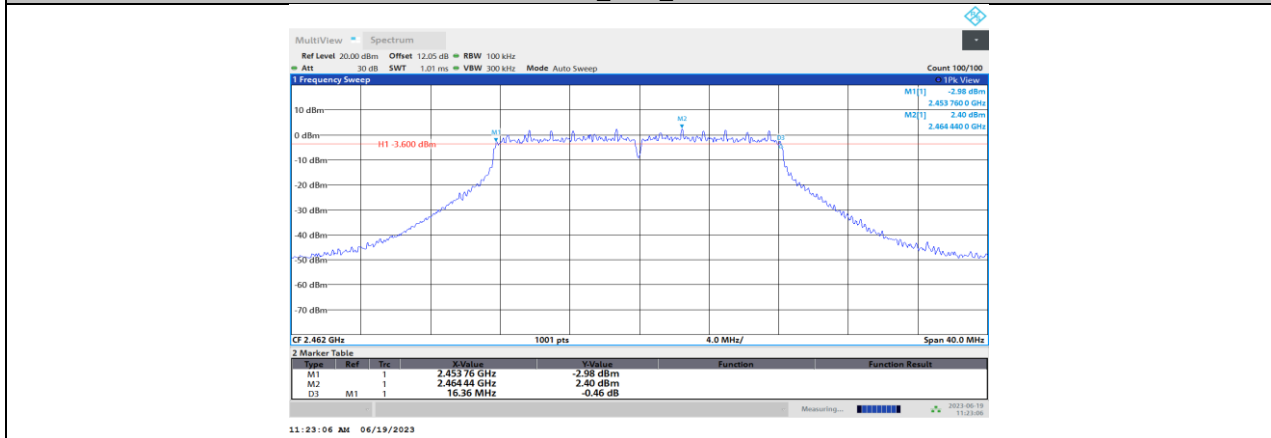

11G_Ant1_2462

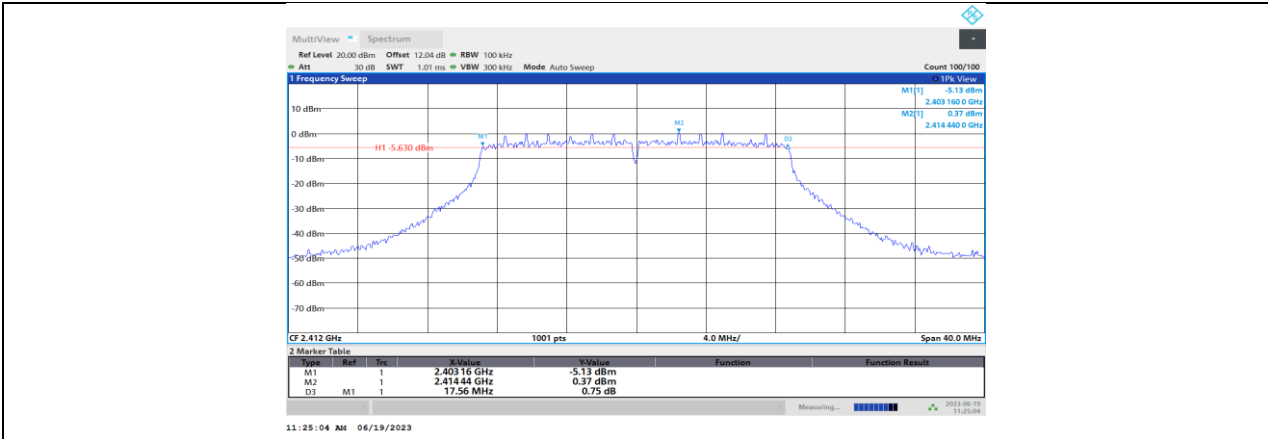

11N20SISO_Ant1_2412

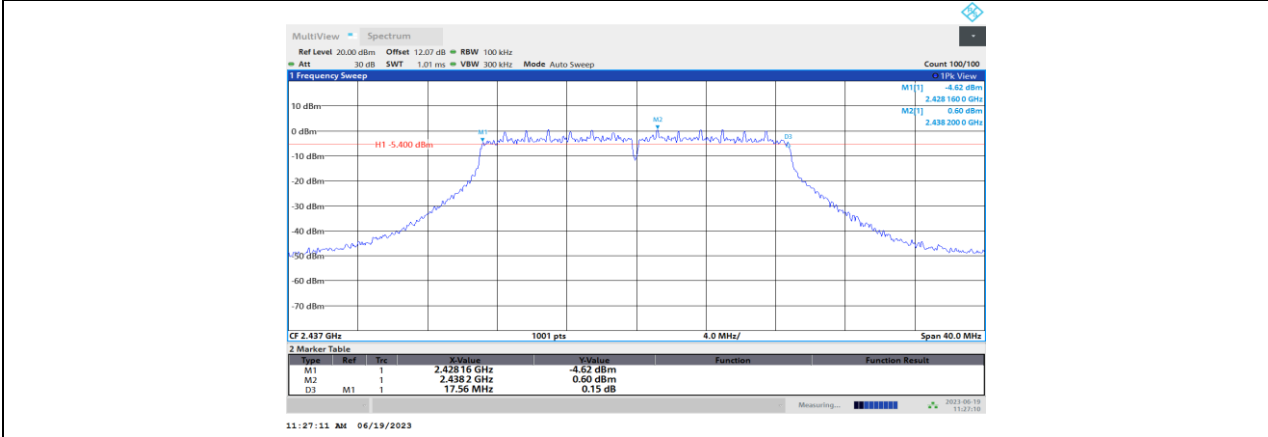

11N20SISO_Ant1_2437

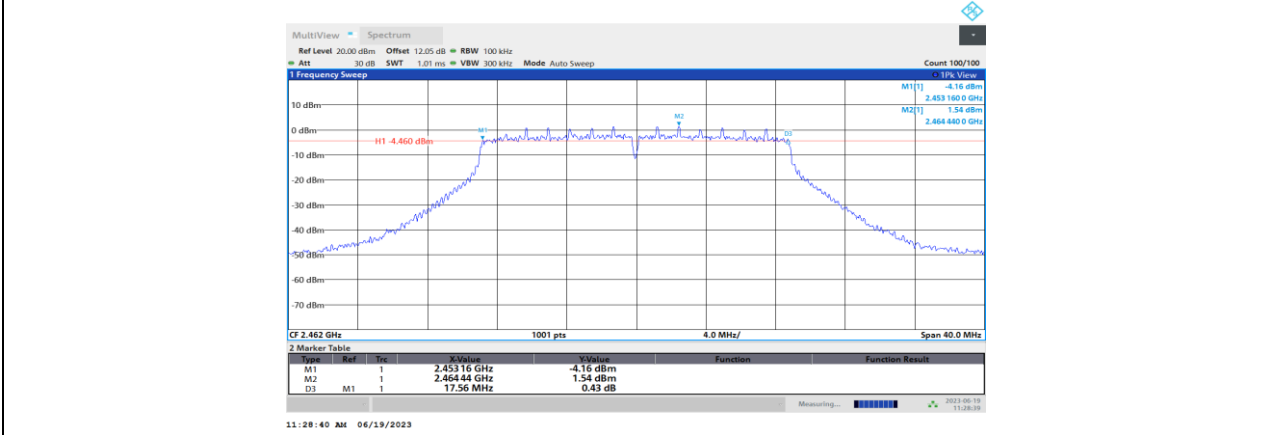

11N20SISO_Ant1_2462

11.2. APPENDIX B: OCCUPIED CHANNEL BANDWIDTH

11.2.1. Test Result

Test Mode	Antenna	Channel	OCB [MHz]	FL[MHz]	FH[MHz]	Verdict
11B	Ant1	2412	14.025	2404.9443	2418.9690	PASS
		2437	14.027	2429.9482	2443.9755	PASS
		2462	14.016	2454.9434	2468.9592	PASS
11G	Ant1	2412	17.838	2403.1479	2420.9855	PASS
		2437	17.723	2428.1463	2445.8689	PASS
		2462	17.64	2453.1214	2470.7616	PASS
11N20SISO	Ant1	2412	18.6	2402.7311	2421.3309	PASS
		2437	18.661	2427.6737	2446.3348	PASS
		2462	18.694	2452.6599	2471.3540	PASS

11.2.2. Test Graphs

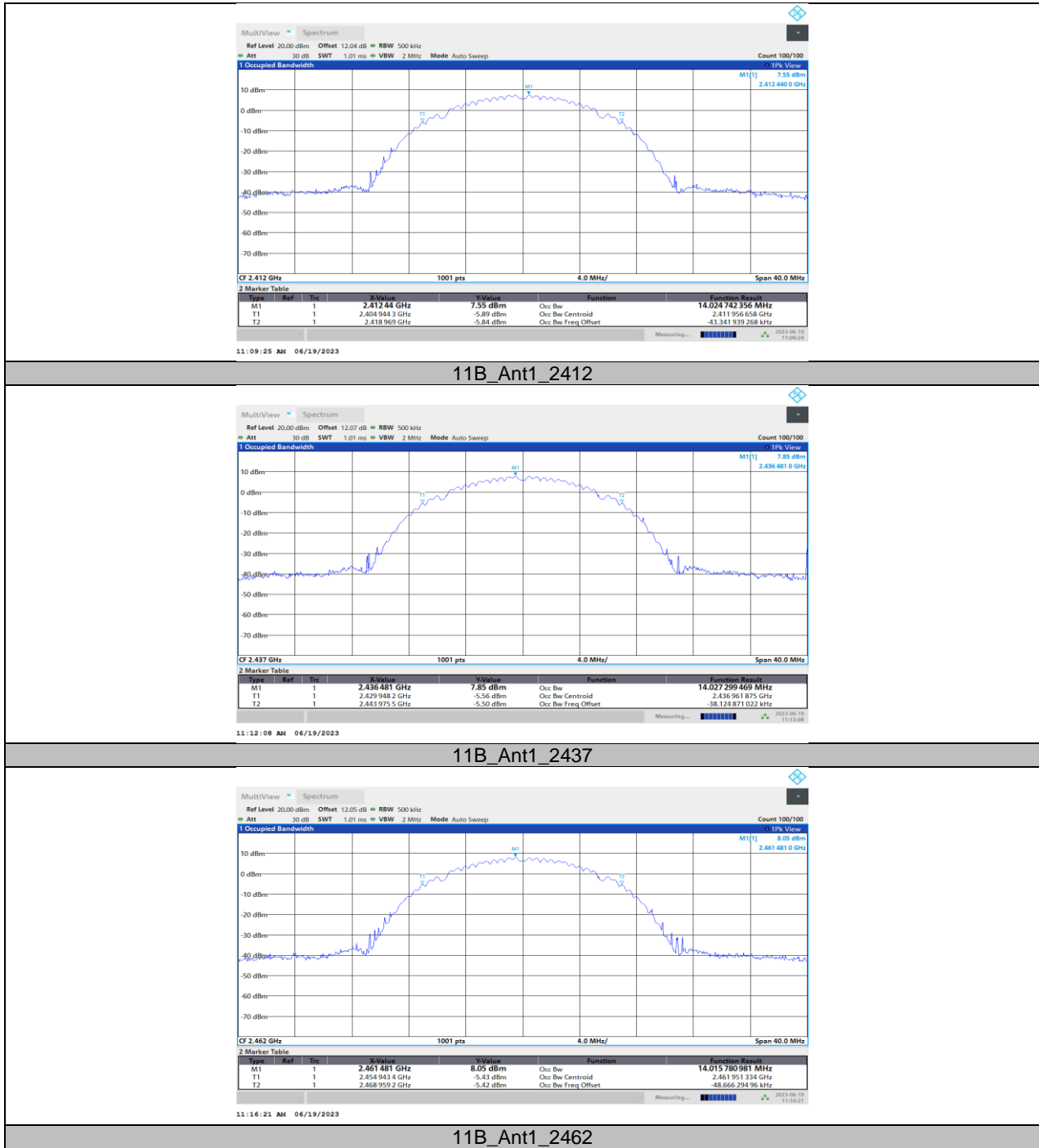

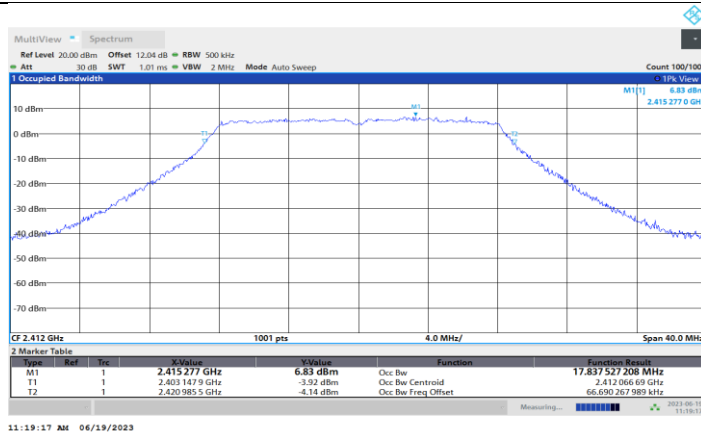

11G_Ant1_2412

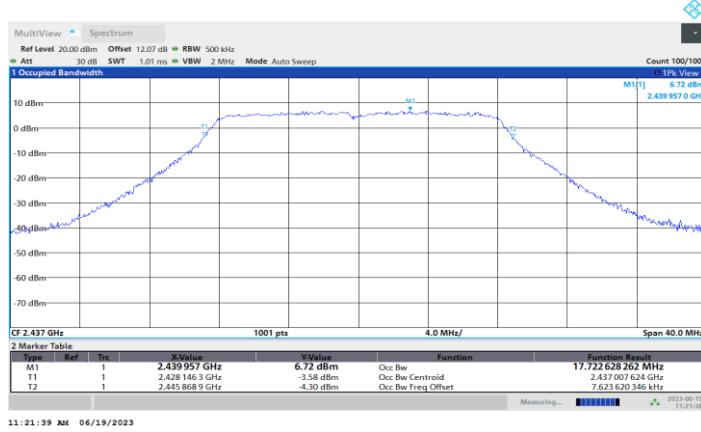

11G_Ant1_2437

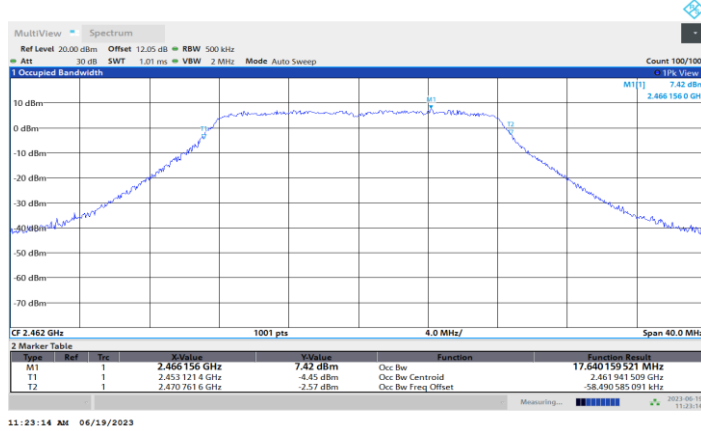

11G_Ant1_2462

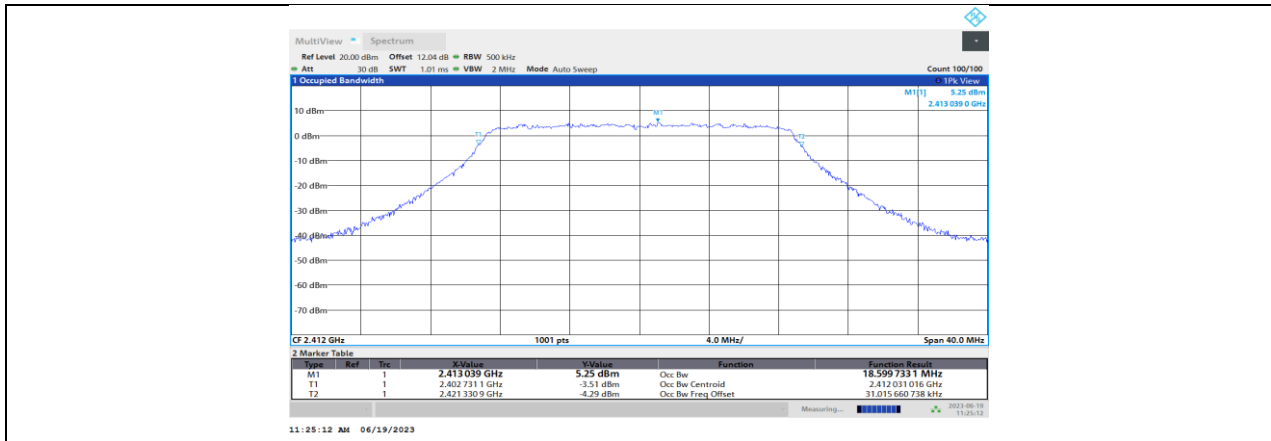

11N20SISO_Ant1_2412

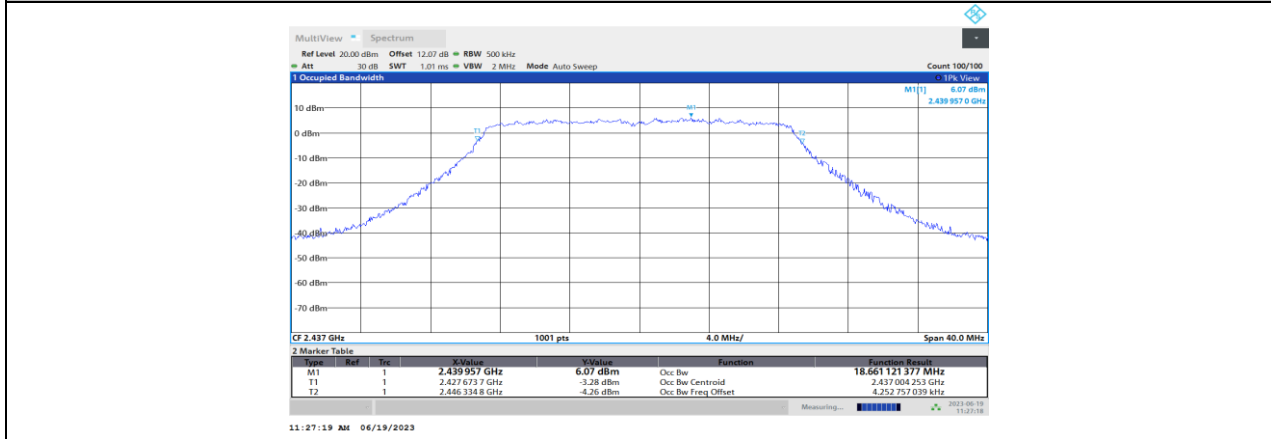

11N20SISO_Ant1_2437

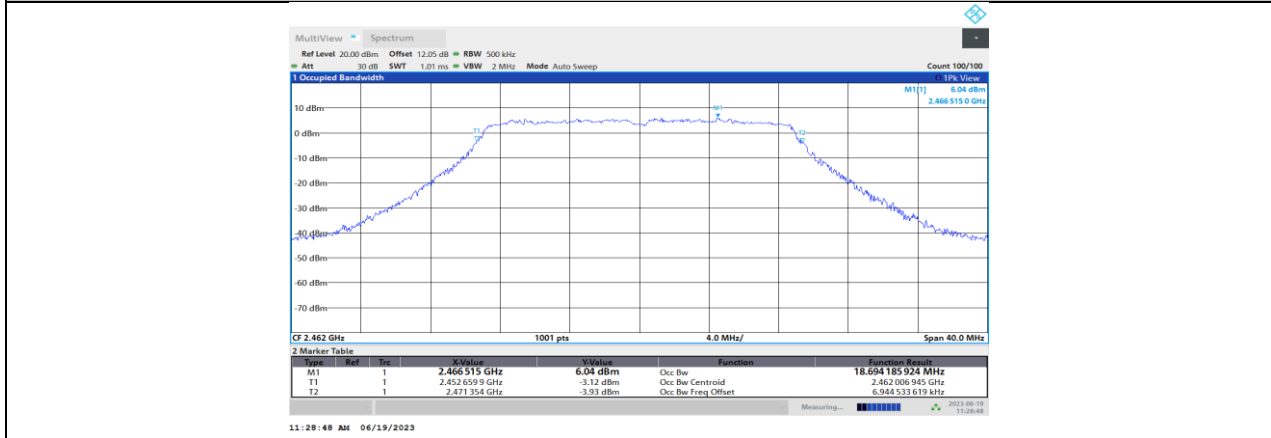

11N20SISO_Ant1_2462

11.3. APPENDIX C: MAXIMUM CONDUCTED OUTPUT POWER

11.3.1. Test Result

Test Mode	Antenna	Channel	Result[dBm]	Limit[dBm]	Verdict
11B	Ant1	2412	16.83	≤30.00	PASS
		2437	17.37	≤30.00	PASS
		2462	17.49	≤30.00	PASS
11G	Ant1	2412	14.47	≤30.00	PASS
		2437	14.92	≤30.00	PASS
		2462	15.30	≤30.00	PASS
11N20SISO	Ant1	2412	13.43	≤30.00	PASS
		2437	13.78	≤30.00	PASS
		2462	14.16	≤30.00	PASS

Note: 1. Conducted Power=Meas. Level+ Correction Factor

2. The Duty Cycle Factor (refer to section 7.5) had already compensated to the test data.

11.4. APPENDIX D: MAXIMUM POWER SPECTRAL DENSITY

11.4.1. Test Result

Test Mode	Antenna	Channel	Result[dBm/3kHz]	Limit[dBm/3kHz]	Verdict
11B	Ant1	2412	-16.29	≤8.00	PASS
		2437	-15.53	≤8.00	PASS
		2462	-15.77	≤8.00	PASS
11G	Ant1	2412	-18.1	≤8.00	PASS
		2437	-18.14	≤8.00	PASS
		2462	-17.56	≤8.00	PASS
11N20SISO	Ant1	2412	-19.94	≤8.00	PASS
		2437	-19.65	≤8.00	PASS
		2462	-18.62	≤8.00	PASS

11.4.2. Test Graphs

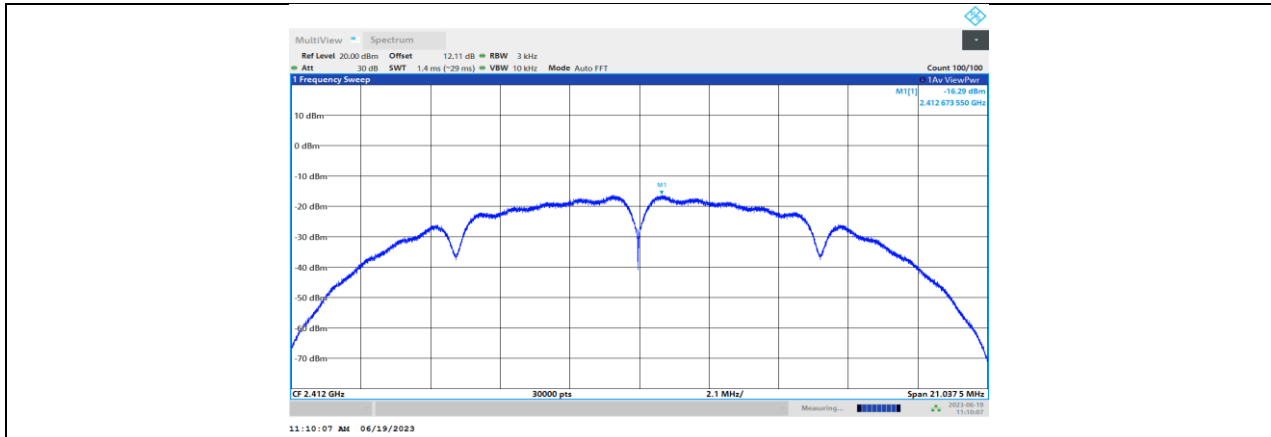

11B_Ant1_2412

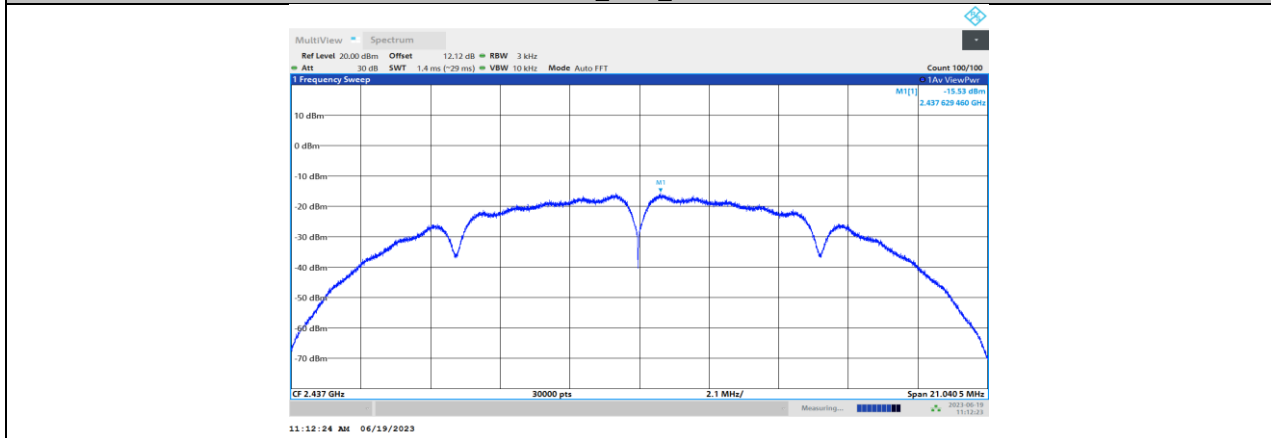

11B_Ant1_2437

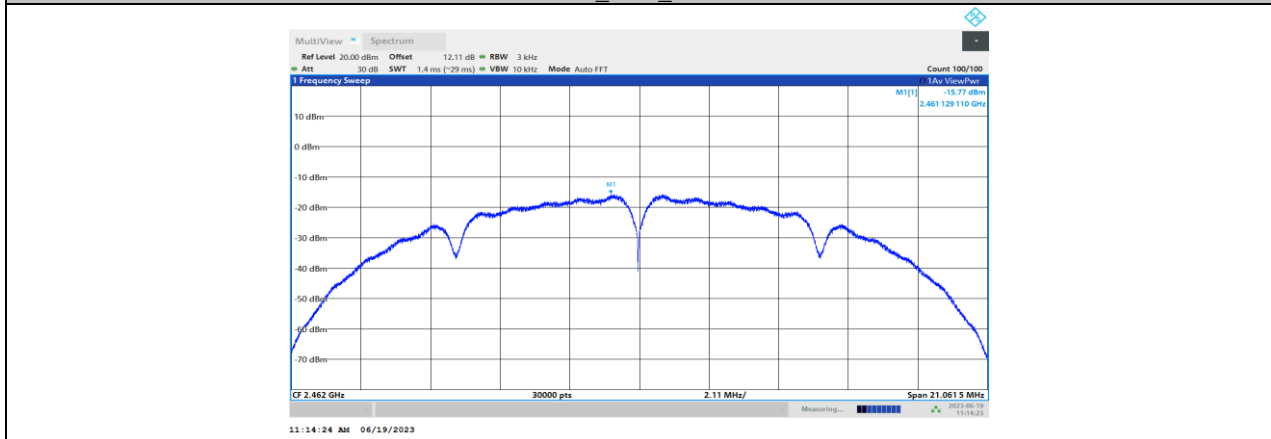

11B_Ant1_2462

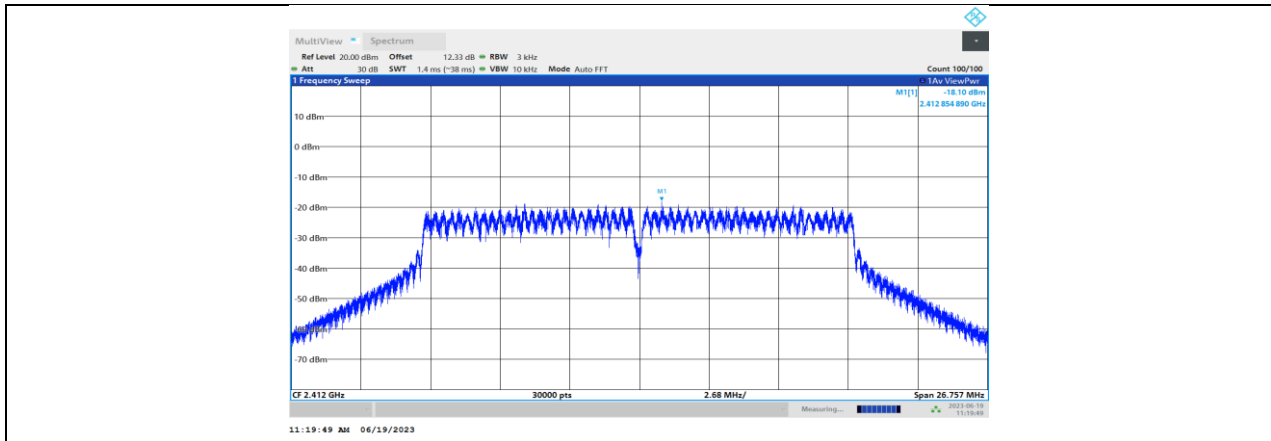

11G_Ant1_2412

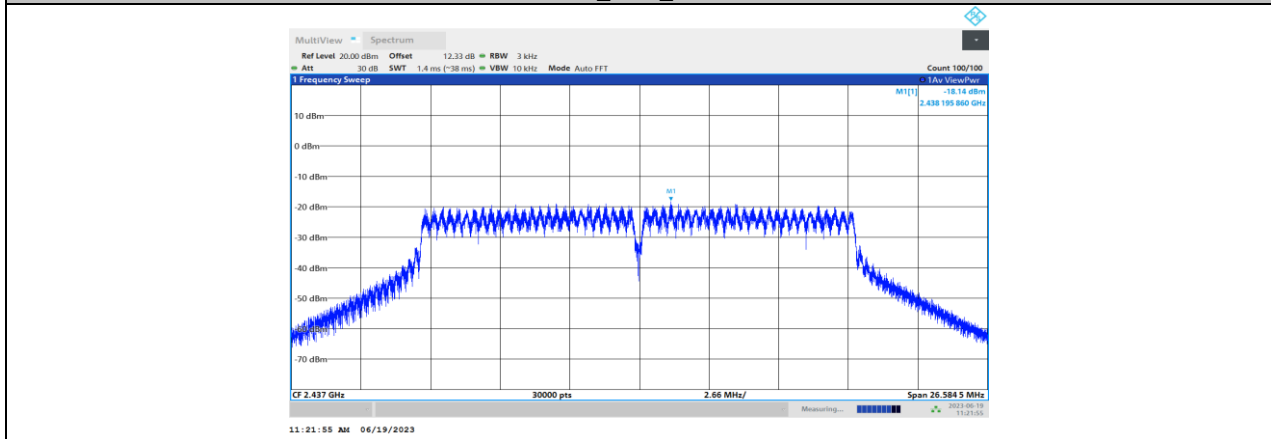

11G_Ant1_2437

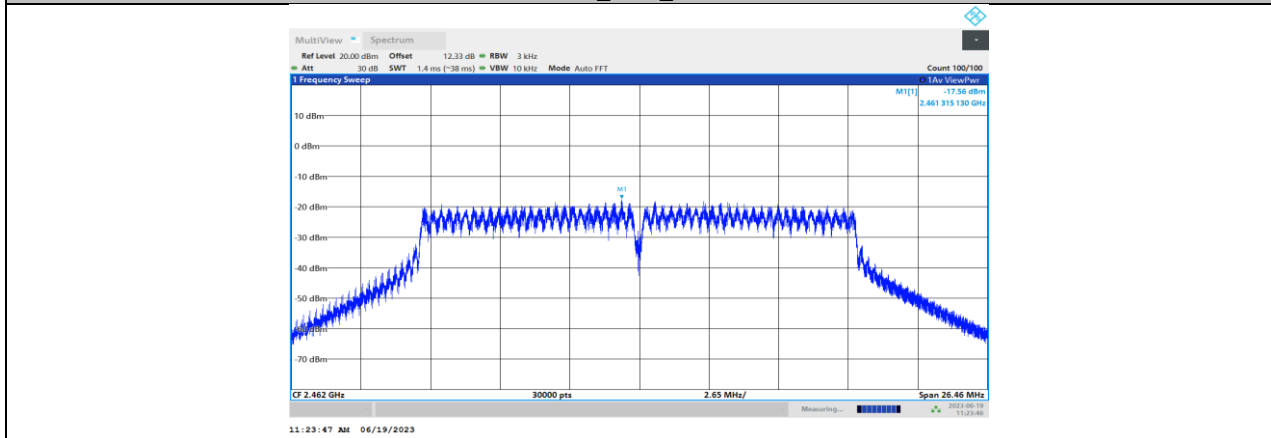

11G_Ant1_2462

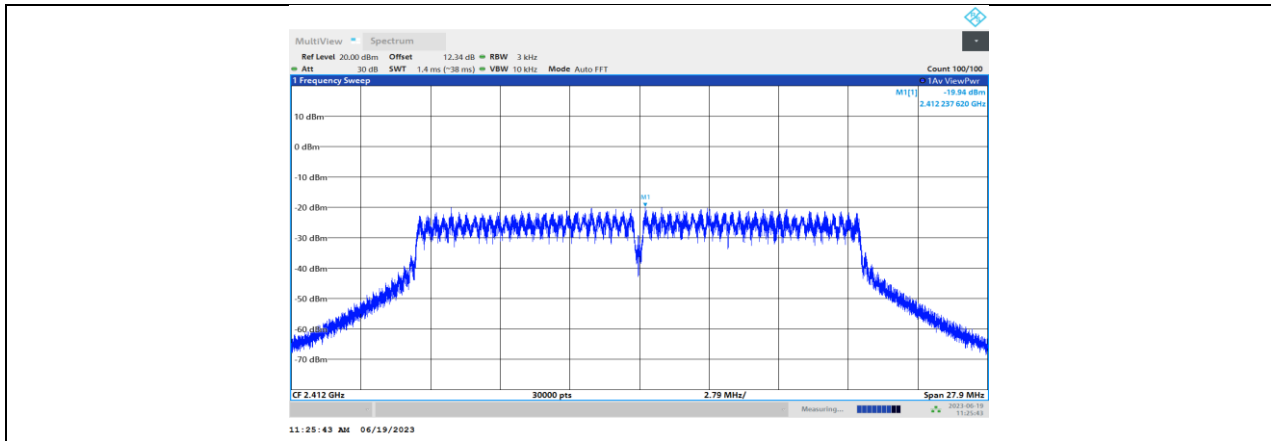

11N20SISO_Ant1_2412

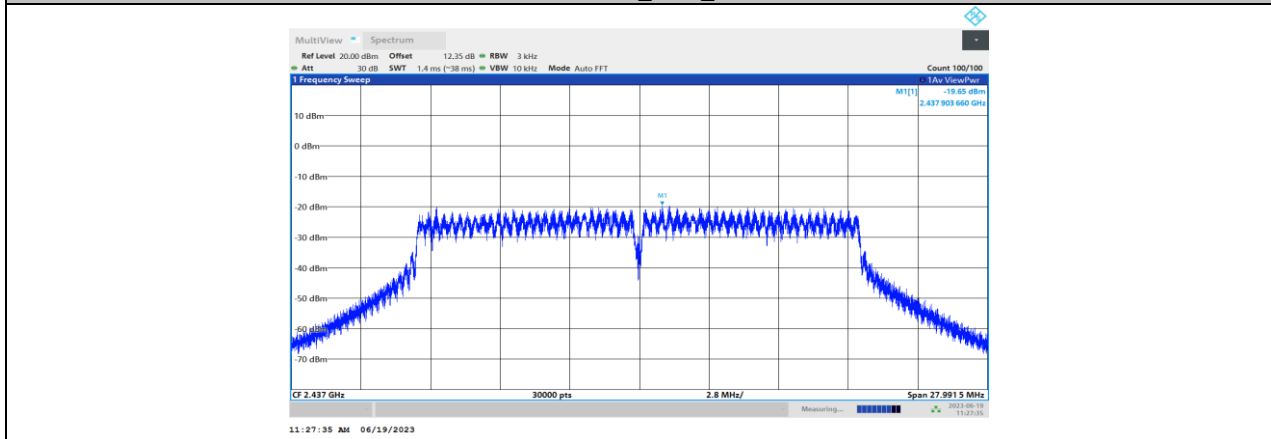

11N20SISO_Ant1_2437

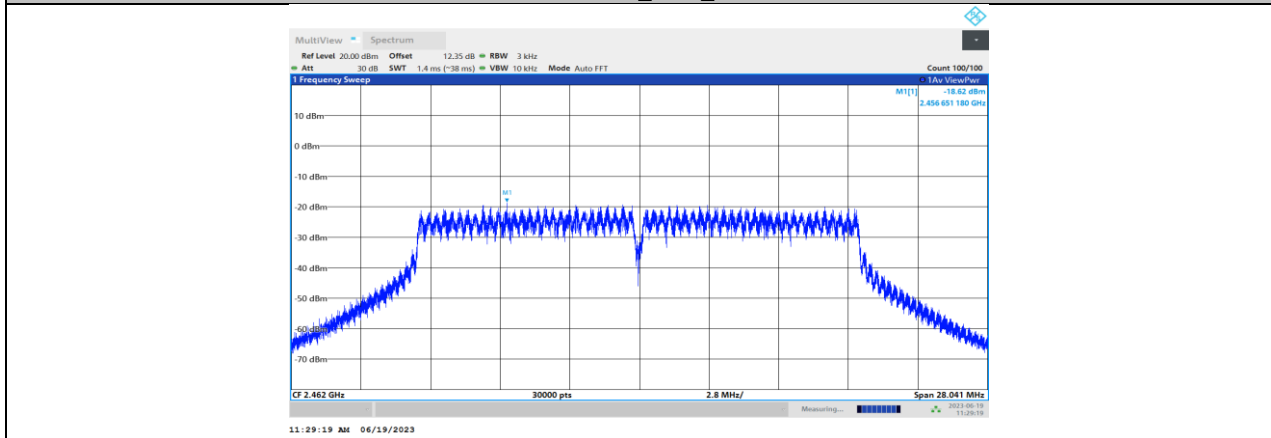

11N20SISO_Ant1_2462

11.5. APPENDIX E: BAND EDGE MEASUREMENTS

11.5.1. Test Result

Test Mode	Antenna	ChName	Channel	RefLevel[dBm]	Result[dBm]	Limit[dBm]	Verdict
11B	Ant1	Low	2412	7.10	-41.28	≤-22.9	PASS
		High	2462	7.38	-47.79	≤-22.62	PASS
11G	Ant1	Low	2412	1.83	-32.27	≤-28.17	PASS
		High	2462	2.49	-46.9	≤-27.51	PASS
11N20SISO	Ant1	Low	2412	0.82	-33.66	≤-29.18	PASS
		High	2462	1.28	-47.78	≤-28.72	PASS

11.5.2. Test Graphs

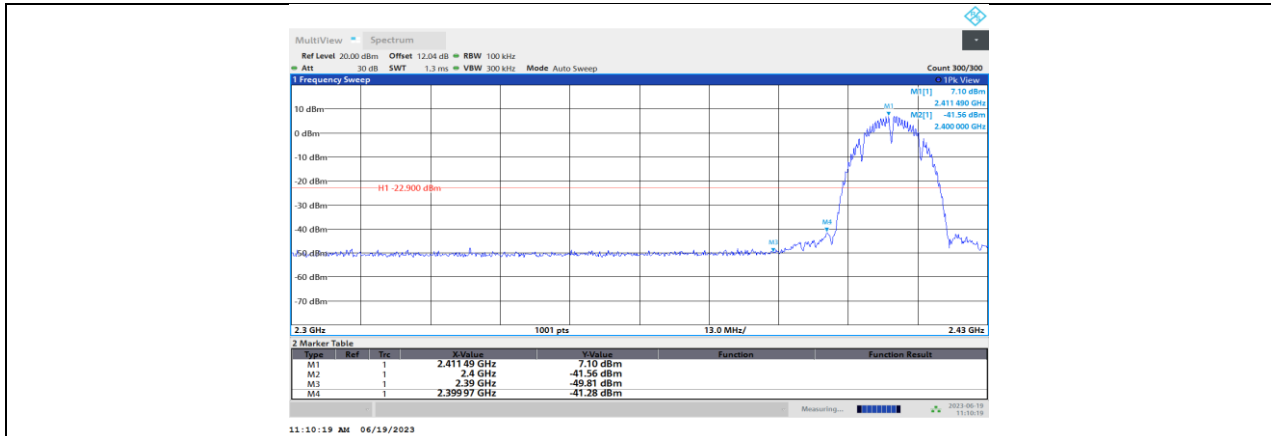

11B_Ant1_Low_2412

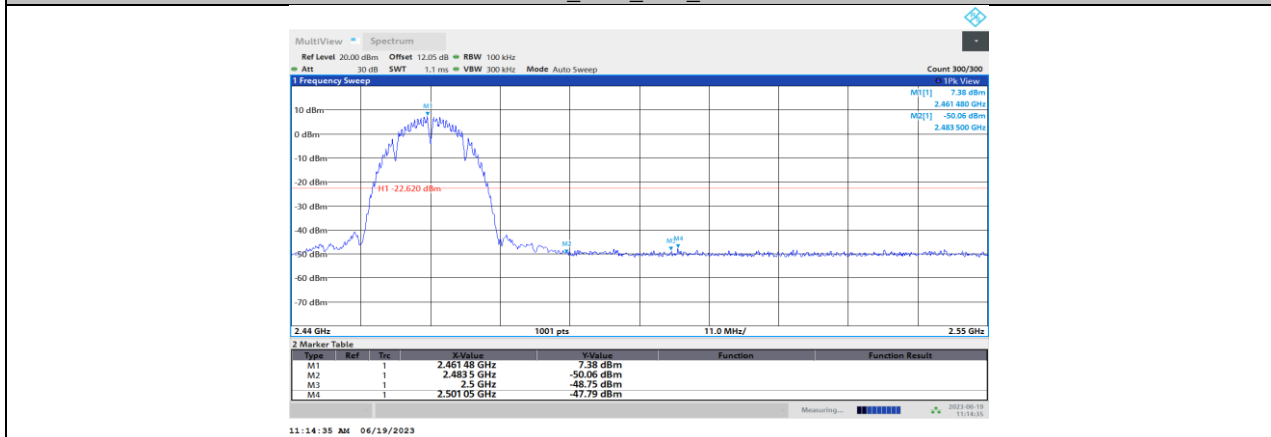

11B_Ant1_High_2462

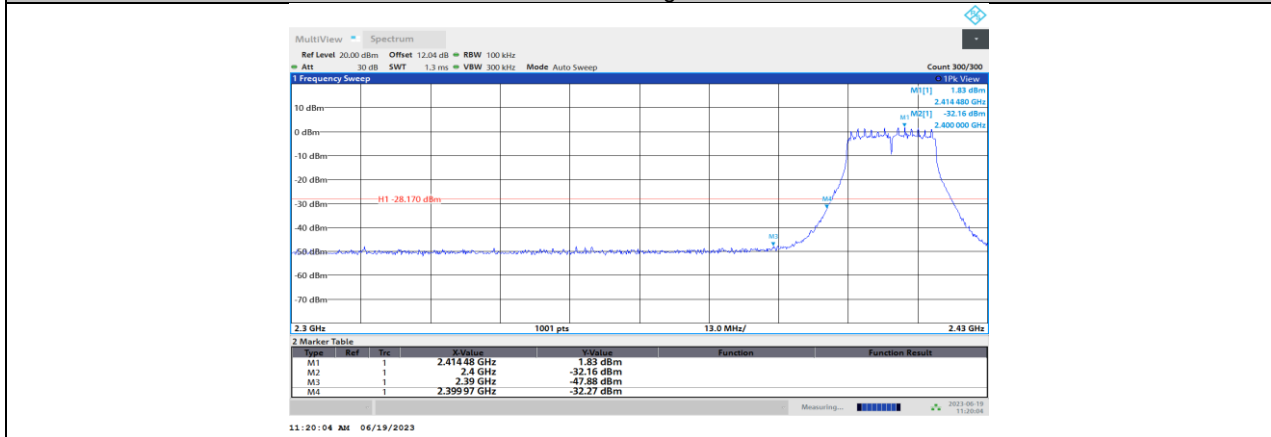

11G_Ant1_Low_2412

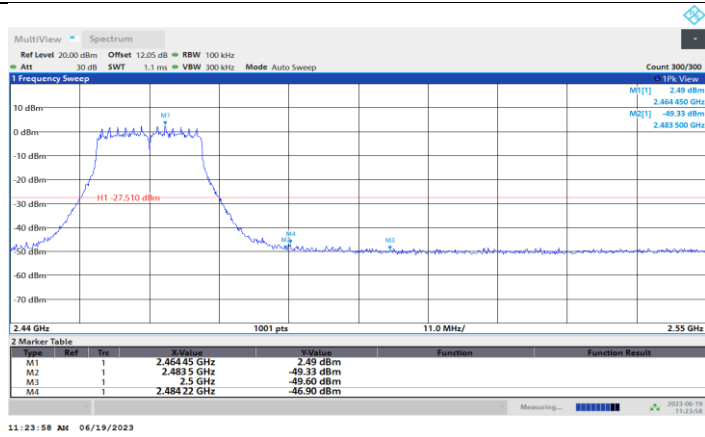

11G_Ant1_High_2462

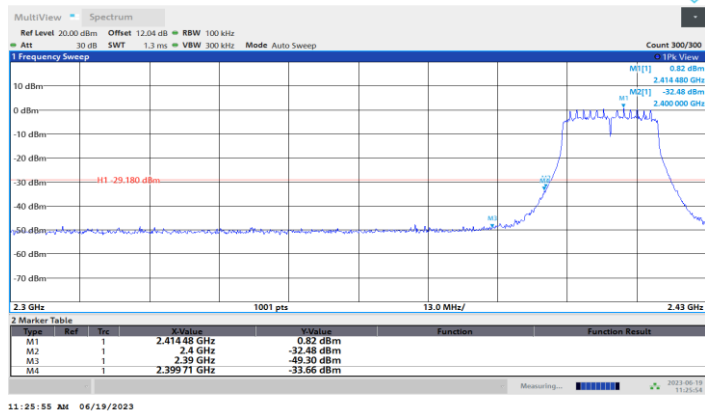

11N20SISO_Ant1_Low_2412

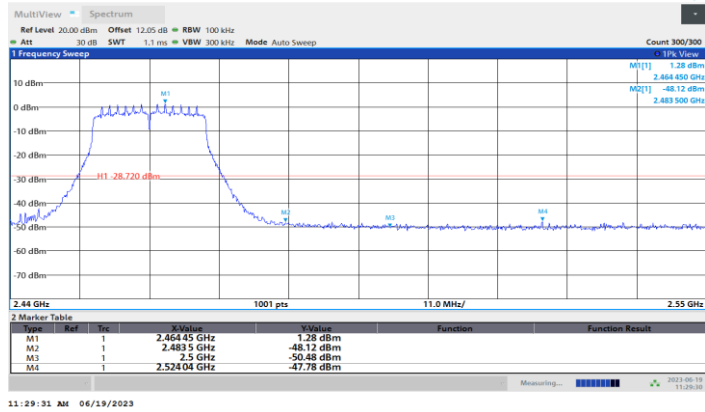

11N20SISO_Ant1_High_2462

11.6. APPENDIX F: CONDUCTED SPURIOUS EMISSION

11.6.1. Test Result

Test Mode	Antenna	Channel	FreqRange [Mhz]	Result [dBm]	Limit [dBm]	Verdict
11B	Ant1	2412	Reference	6.87	---	PASS
			30~1000	-56.92	≤-23.13	PASS
			1000~26500	-41.29	≤-23.13	PASS
		2437	Reference	7.23	---	PASS
			30~1000	-57.83	≤-22.77	PASS
			1000~26500	-40.4	≤-22.77	PASS
		2462	Reference	7.66	---	PASS
			30~1000	-56.85	≤-22.34	PASS
			1000~26500	-41.78	≤-22.34	PASS
11G	Ant1	2412	Reference	1.80	---	PASS
			30~1000	-57.62	≤-28.2	PASS
			1000~26500	-41.81	≤-28.2	PASS
		2437	Reference	2.21	---	PASS
			30~1000	-57.87	≤-27.79	PASS
			1000~26500	-41.84	≤-27.79	PASS
		2462	Reference	2.49	---	PASS
			30~1000	-57.31	≤-27.51	PASS
			1000~26500	-42.07	≤-27.51	PASS
11N20SISO	Ant1	2412	Reference	0.81	---	PASS
			30~1000	-58.15	≤-29.19	PASS
			1000~26500	-41.71	≤-29.19	PASS
		2437	Reference	1.09	---	PASS
			30~1000	-57.65	≤-28.91	PASS
			1000~26500	-41.35	≤-28.91	PASS
		2462	Reference	1.36	---	PASS
			30~1000	-57.54	≤-28.64	PASS
			1000~26500	-41.57	≤-28.64	PASS

11.6.2. Test Graphs

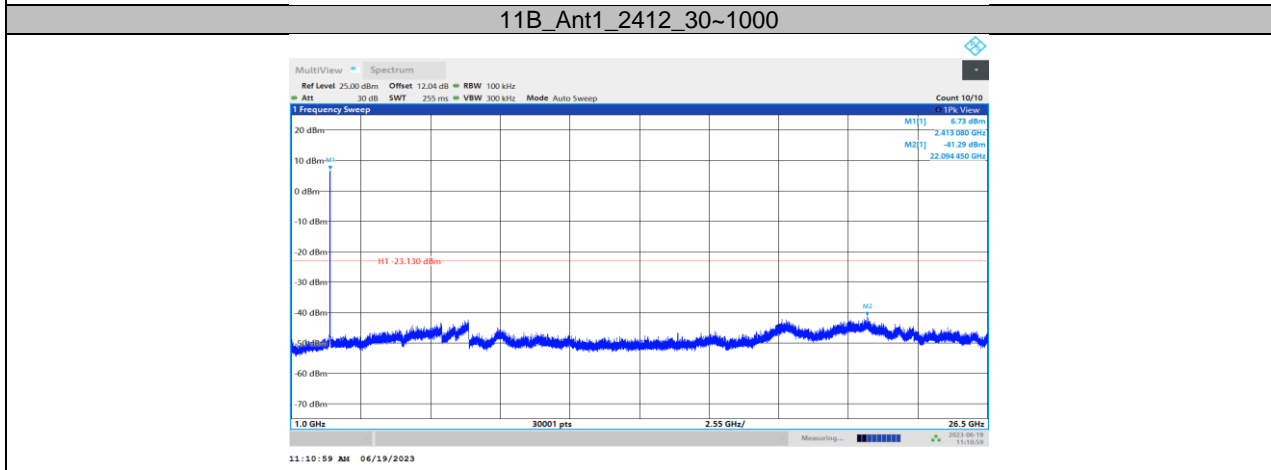
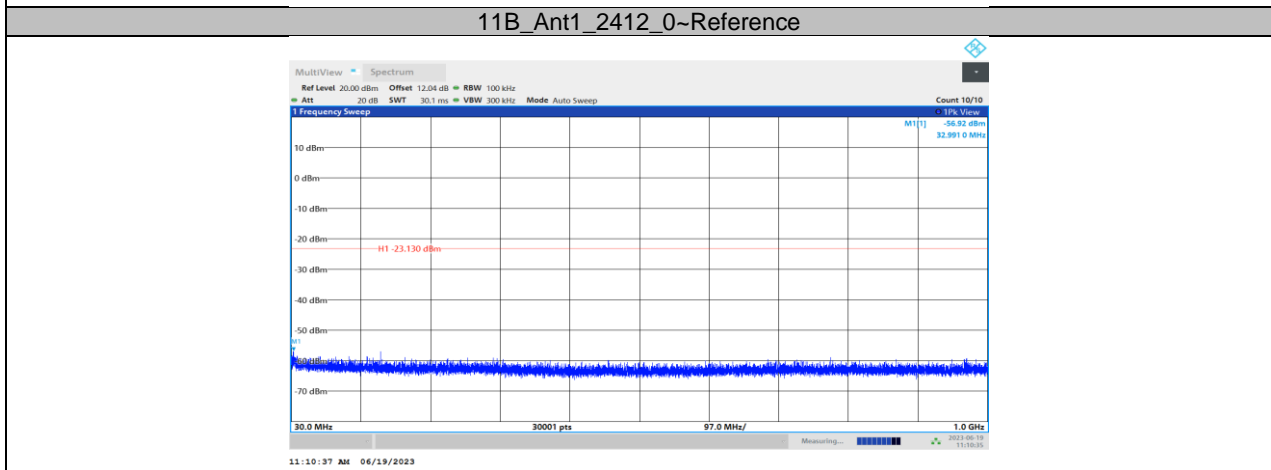
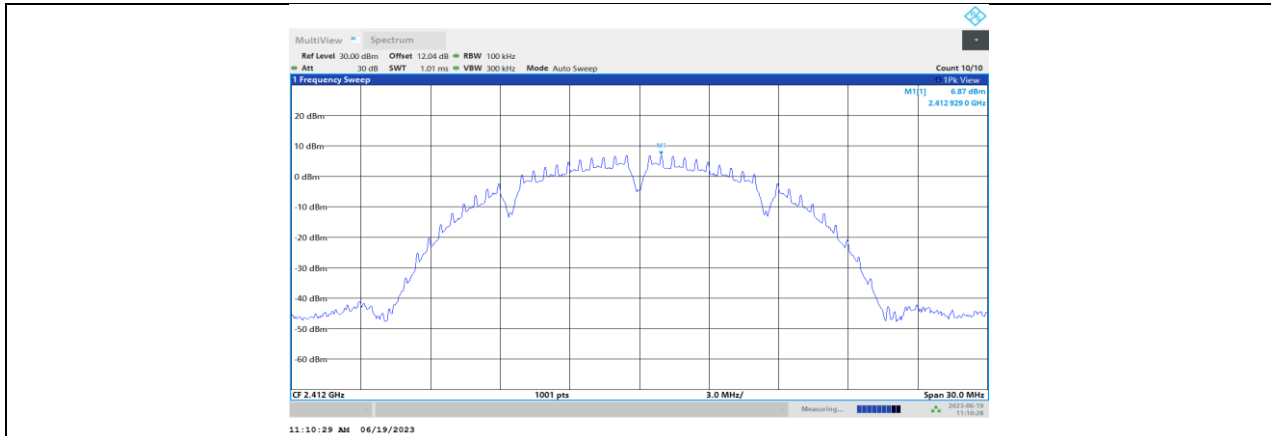

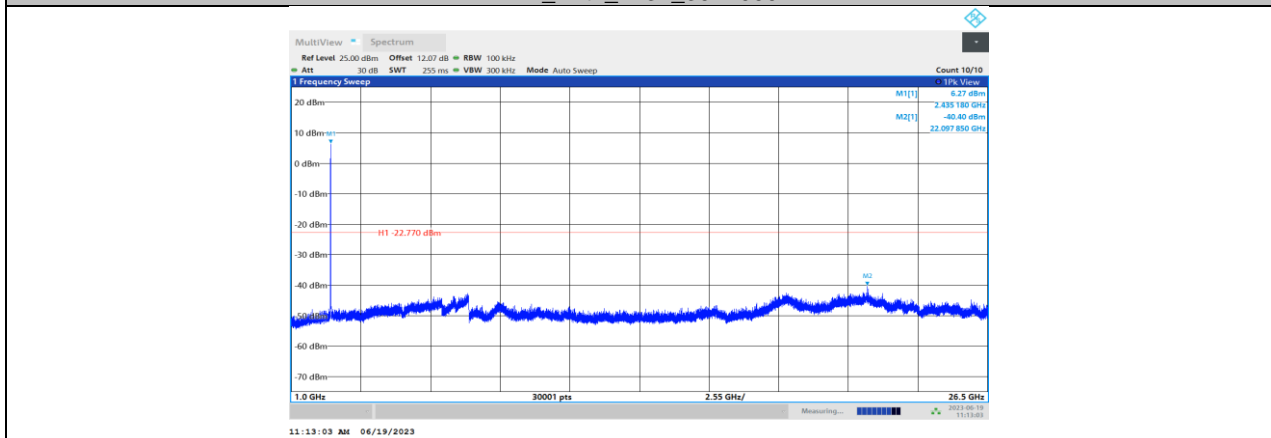
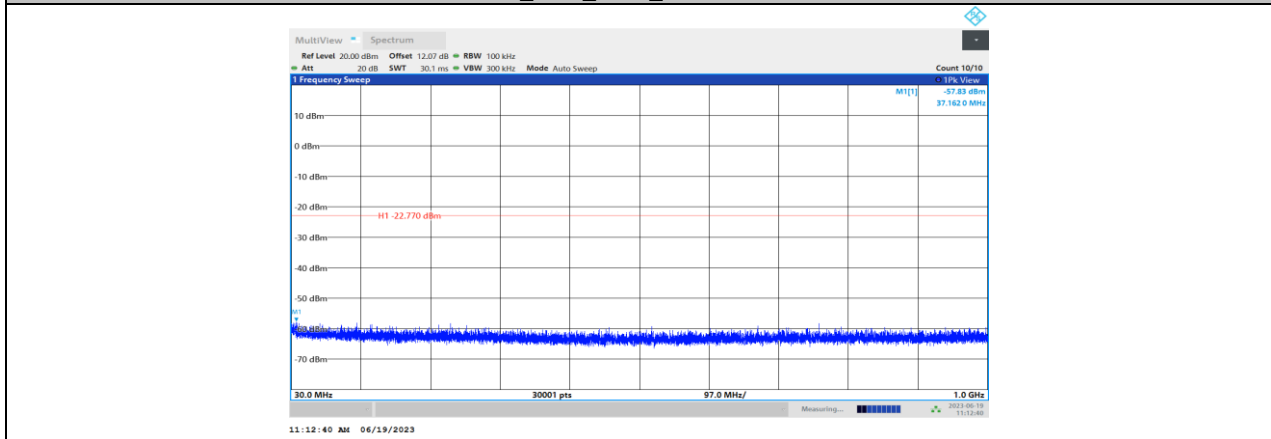
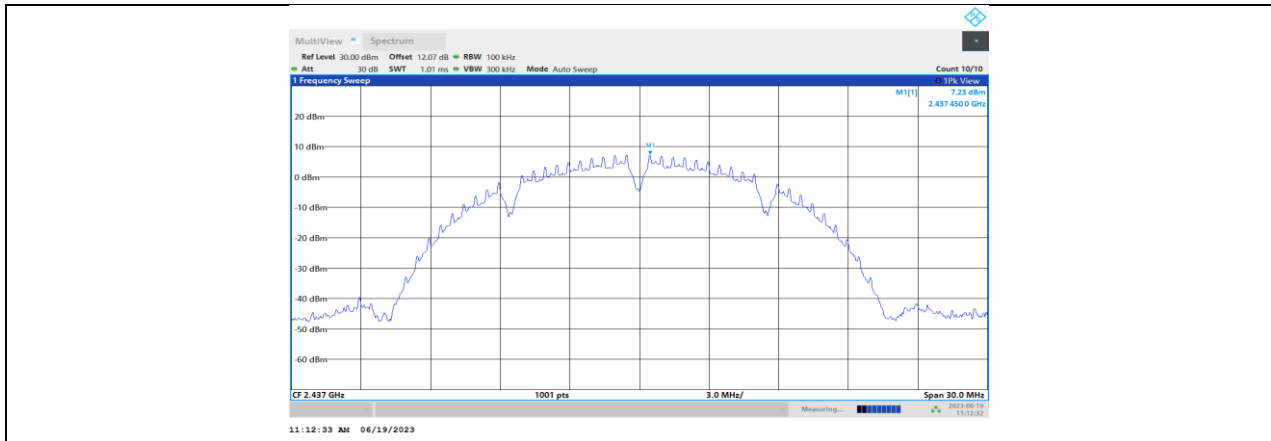

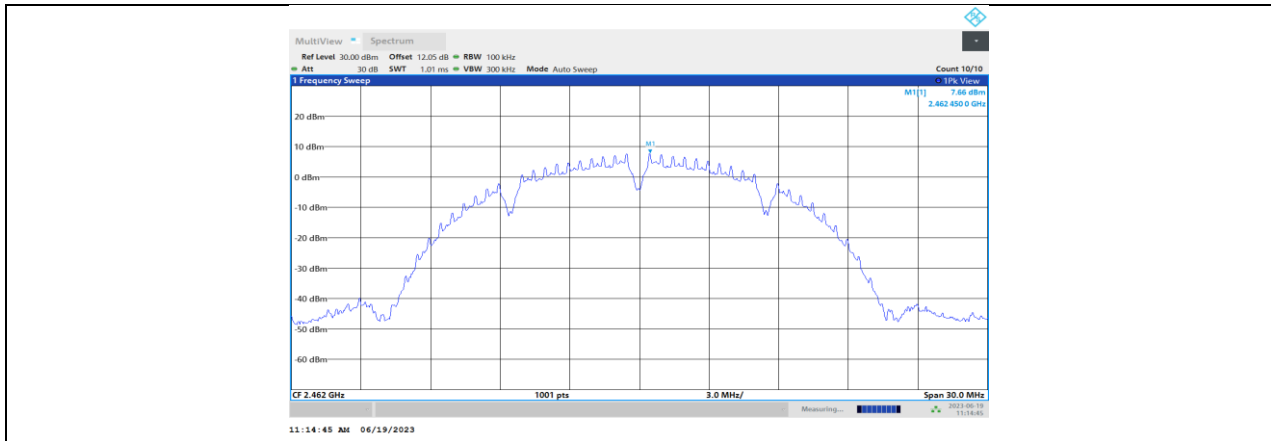

11B_Ant1_2462_0~Reference

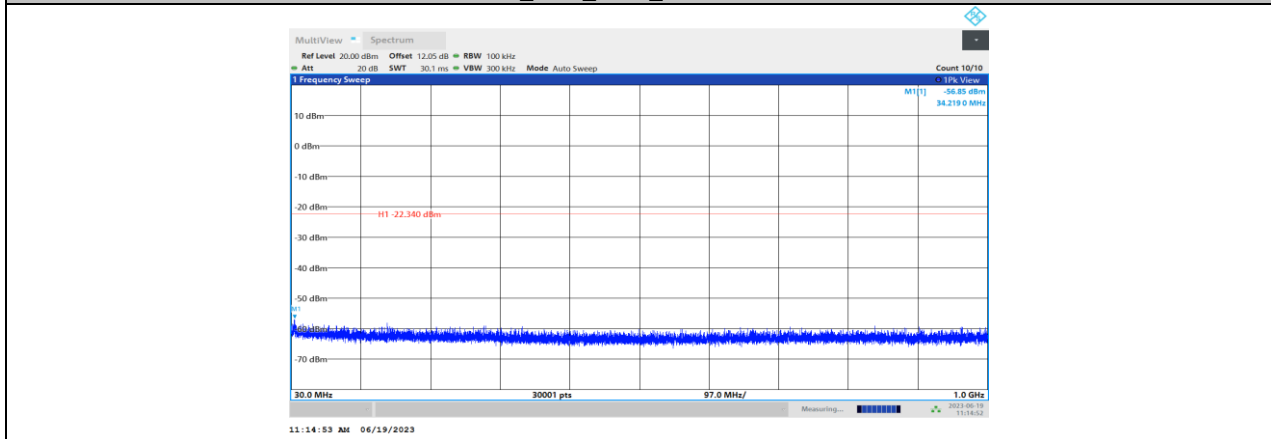

11B_Ant1_2462_30~1000

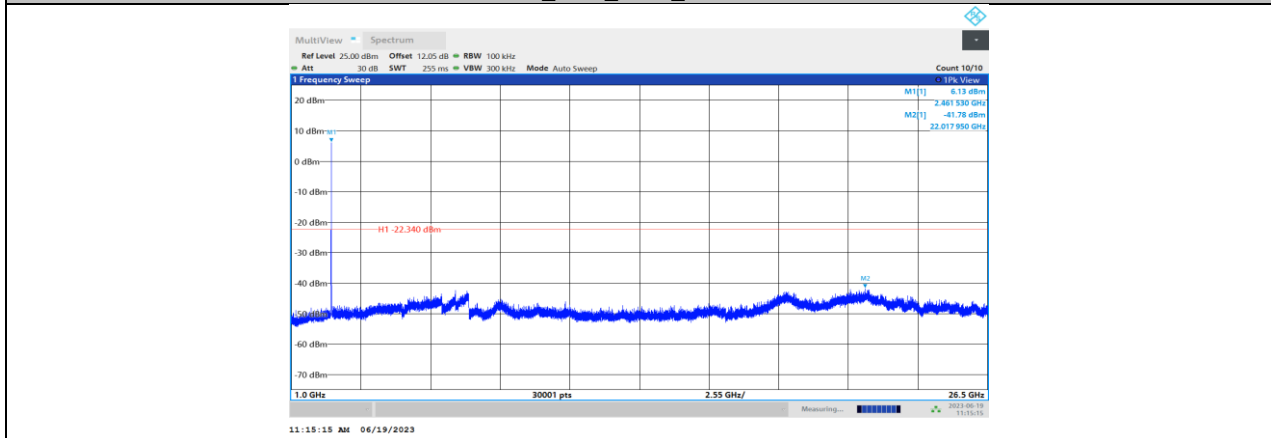

11B_Ant1_2462_1000~26500

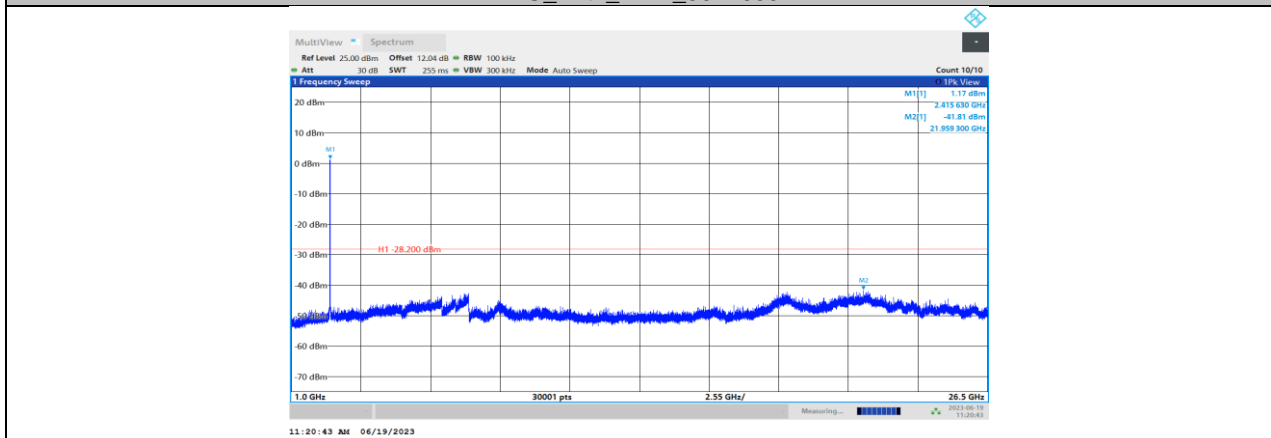
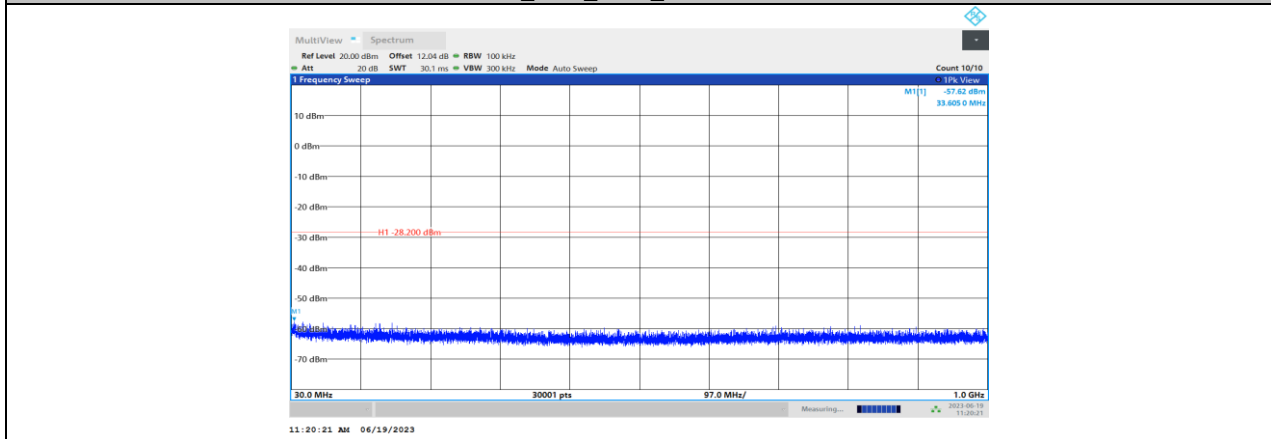
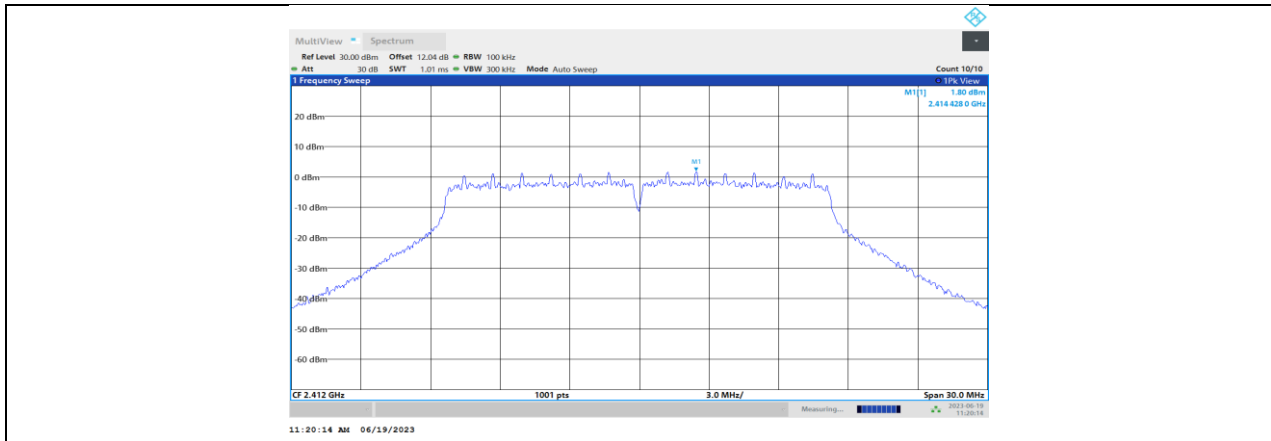

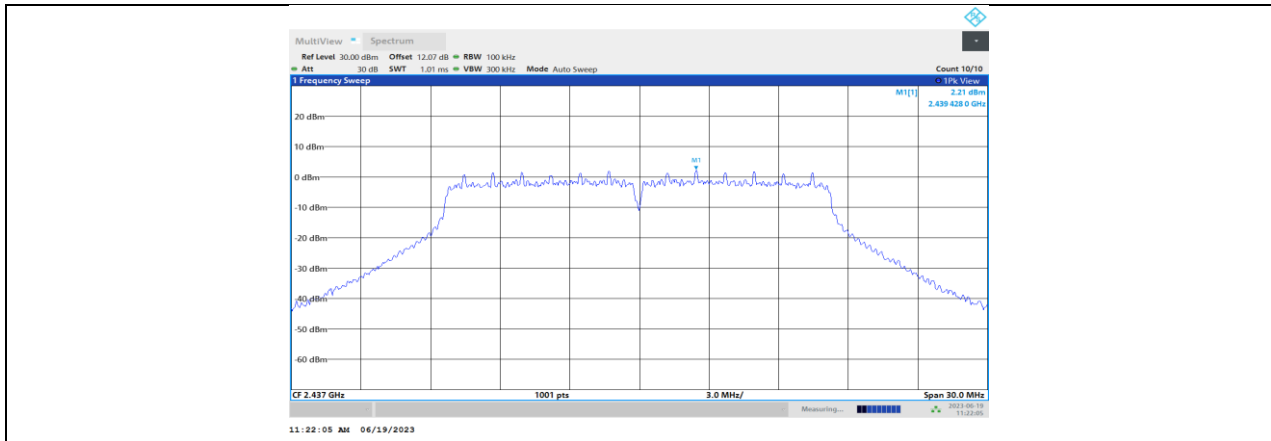

11G_Ant1_2437_0~Reference

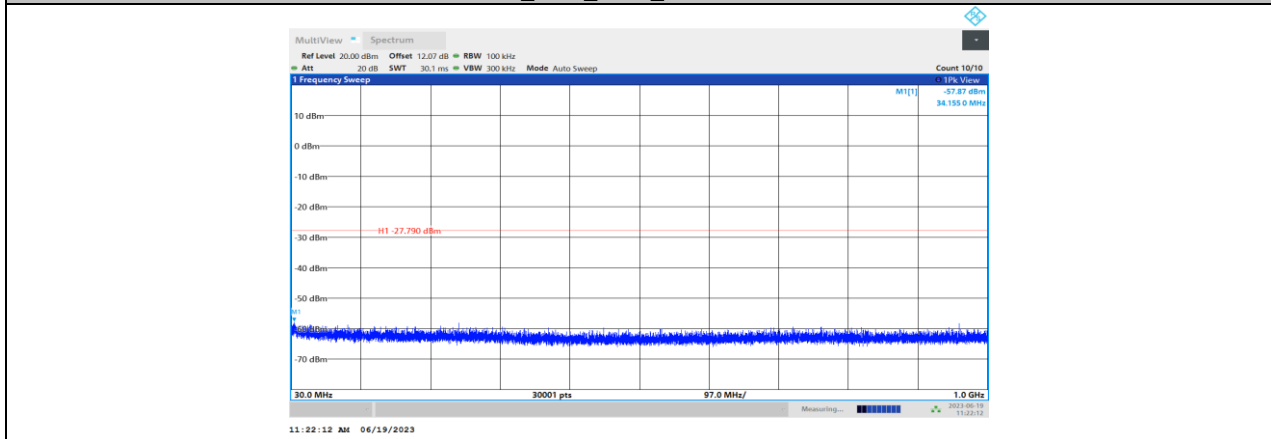

11G_Ant1_2437_30~1000

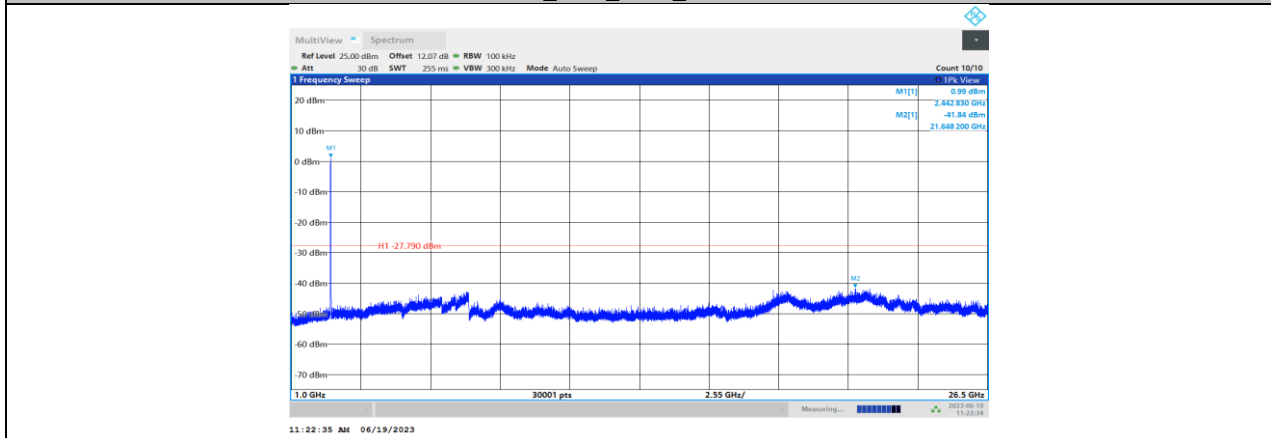

11G_Ant1_2437_1000~26500

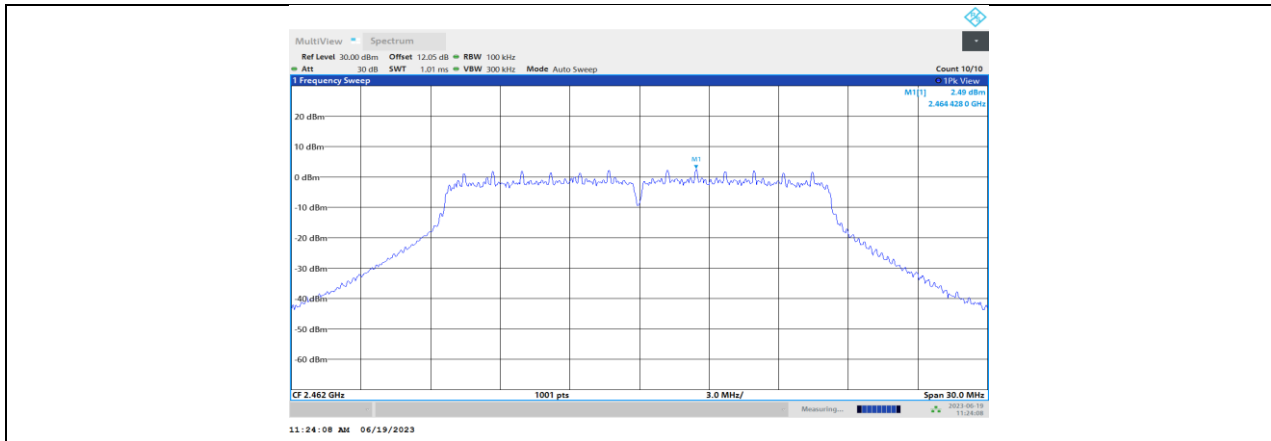

11G_Ant1_2462_0~Reference

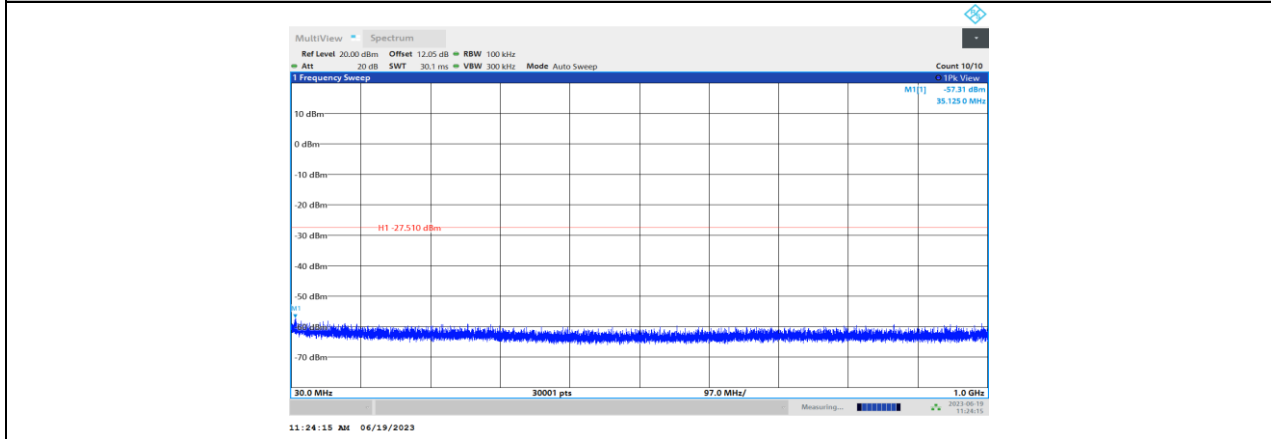

11G_Ant1_2462_30~1000

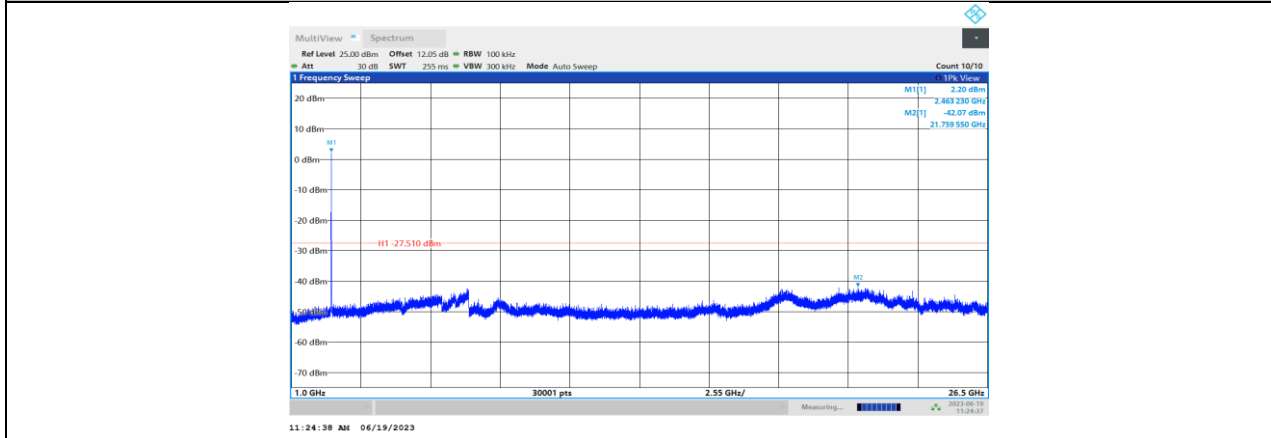

11G_Ant1_2462_1000~26500

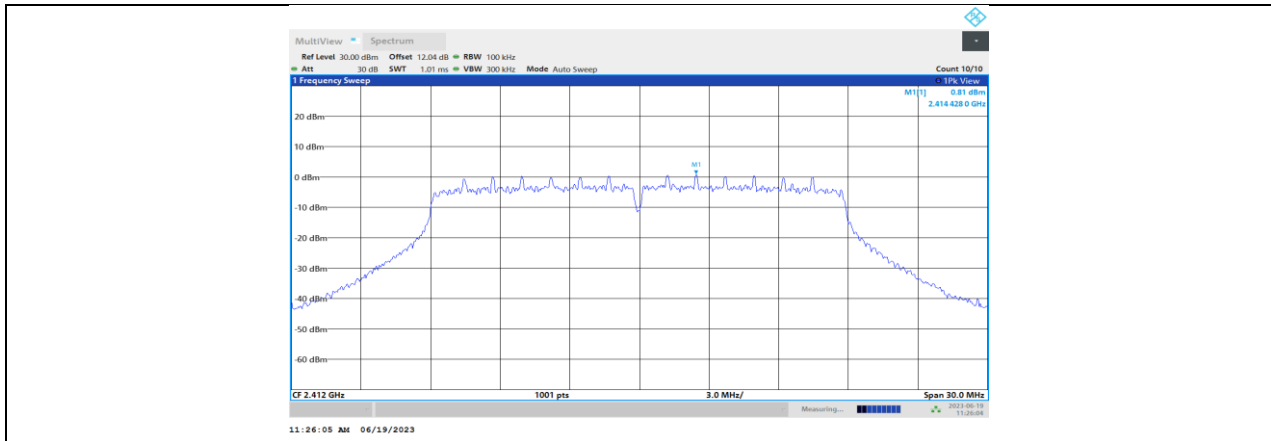

11N20SISO_Ant1_2412_0~Reference

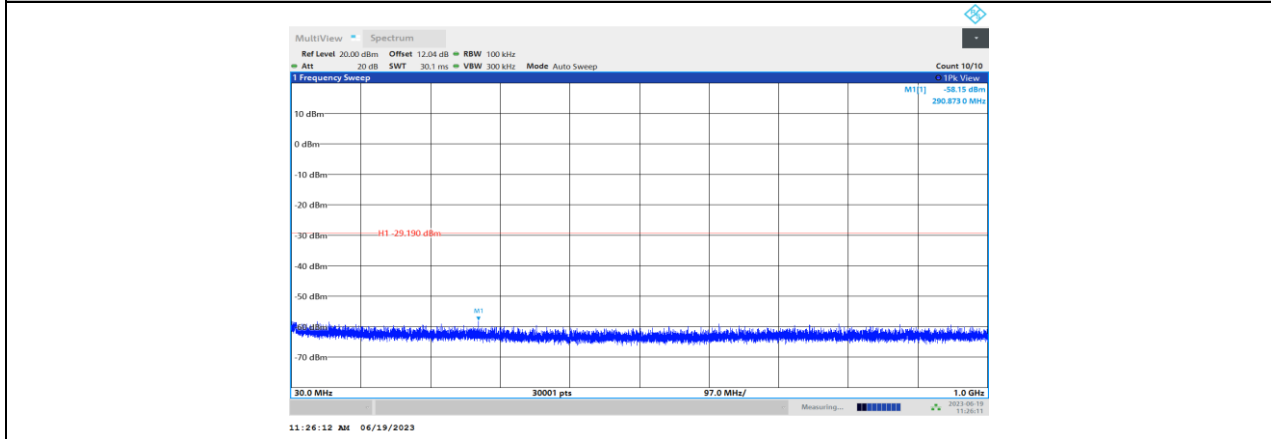

11N20SISO_Ant1_2412_30~1000

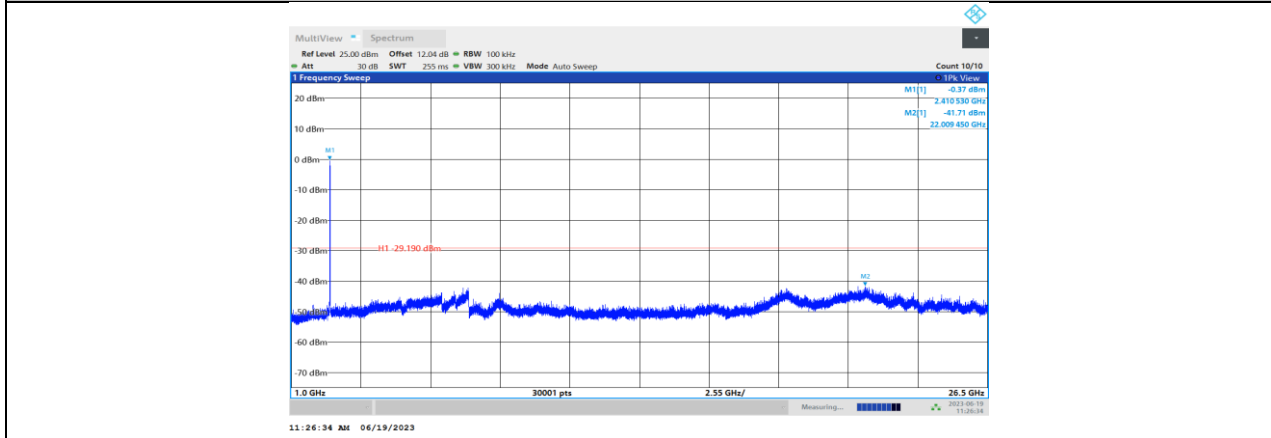

11N20SISO_Ant1_2412_1000~26500

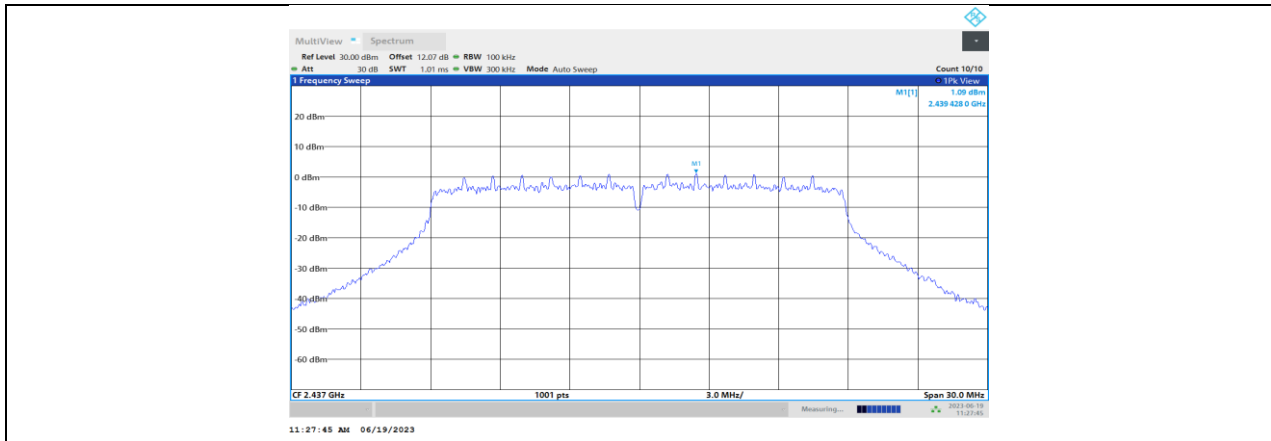

11N20SISO_Ant1_2437_0~Reference

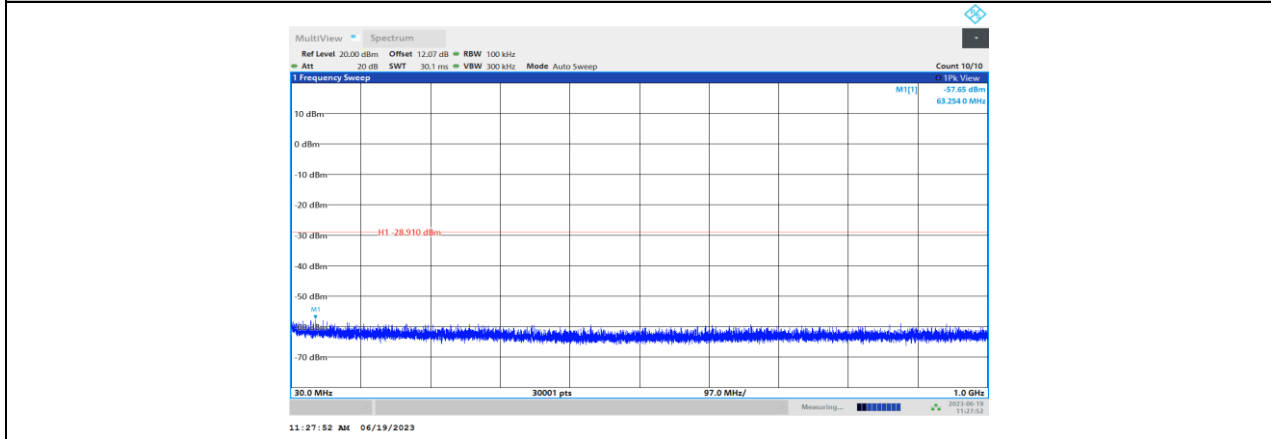

11N20SISO_Ant1_2437_30~1000

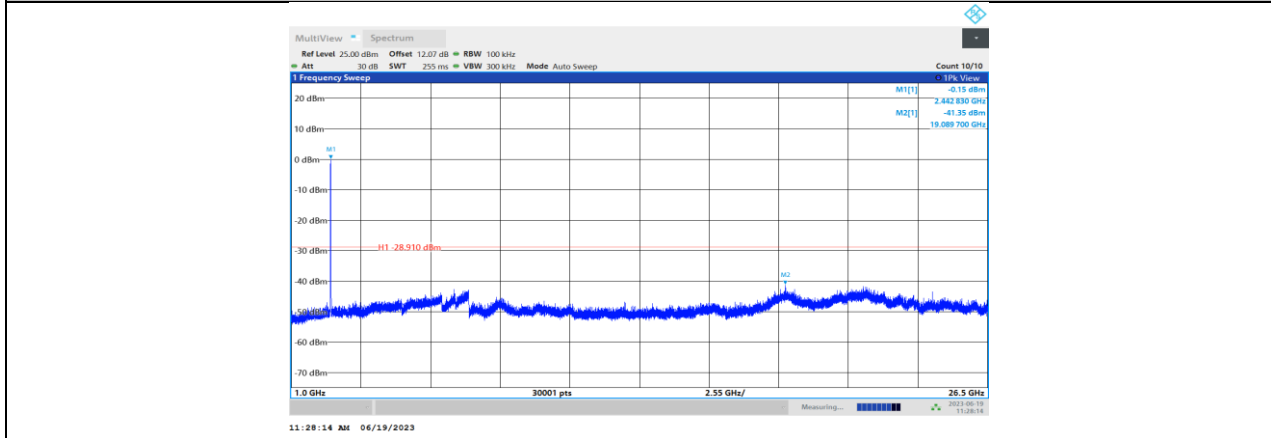

11N20SISO_Ant1_2437_1000~26500

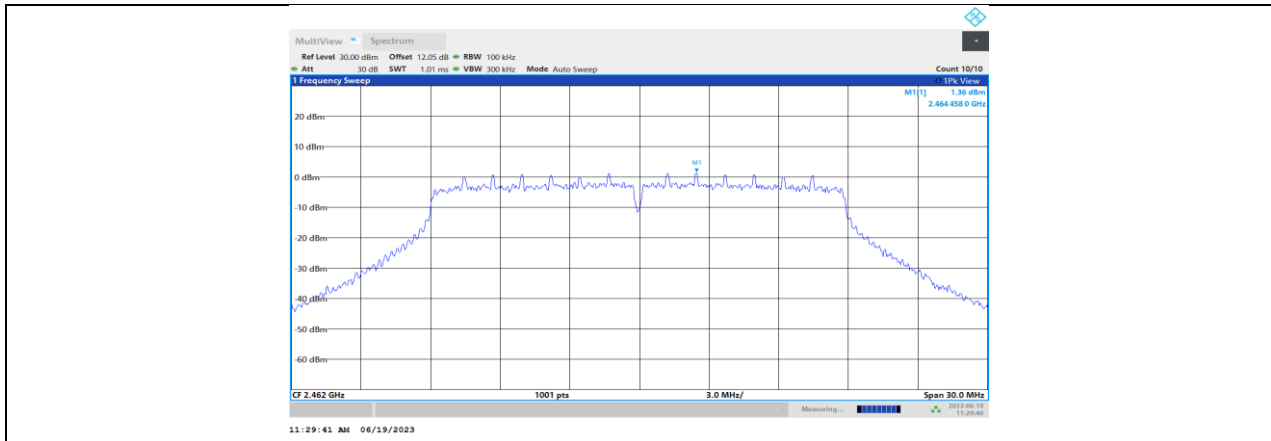

11N20SISO_Ant1_2462_0~Reference

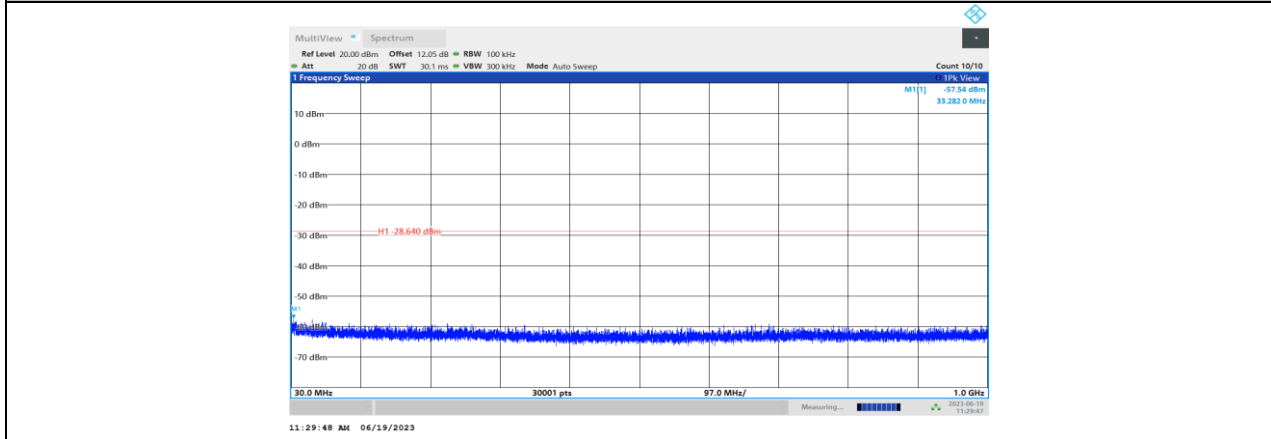

11N20SISO_Ant1_2462_30~1000

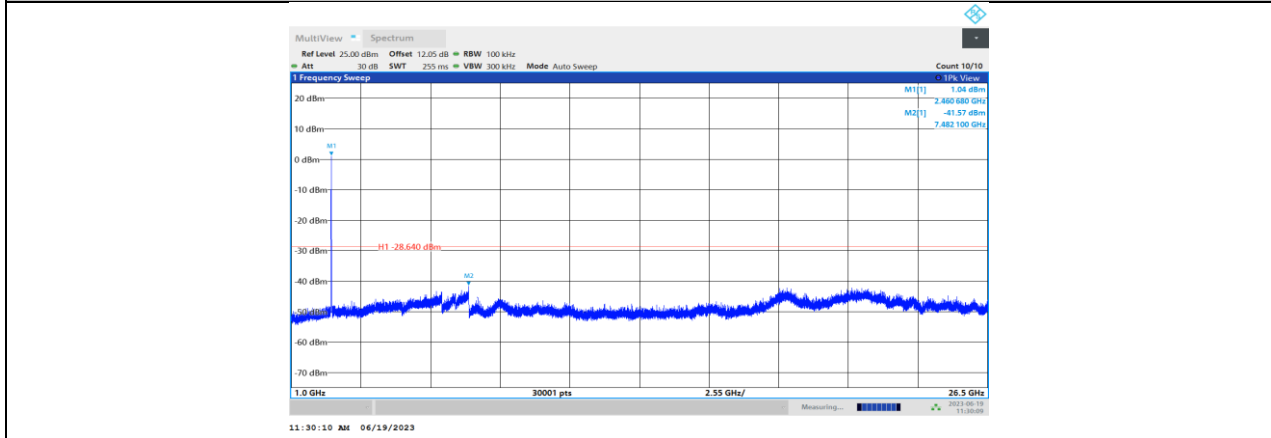

11N20SISO_Ant1_2462_1000~26500

11.7. APPENDIX G: DUTY CYCLE

11.7.1. Test Result

Test Mode	On Time (msec)	Period (msec)	Duty Cycle x (Linear)	Duty Cycle (%)	Duty Cycle Correction Factor (dB)	1/T Minimum VBW (kHz)	Final setting For VBW (kHz)
11B	12.42	12.55	0.9896	98.96	0.05	0.08	0.01
11G	2.07	2.2	0.9409	94.09	0.26	0.48	1
11N20SISO	1.92	2.05	0.9366	93.66	0.28	0.52	1

Note:

Duty Cycle Correction Factor=10log (1/x).

Where: x is Duty Cycle (Linear)

Where: T is On Time

If that calculated VBW is not available on the analyzer then the next higher value should be used.

11.7.2. Test Graphs



END OF REPORT