

深圳汉阳天线设计有限公司

SHENZHEN HANYANG ANTENNA DESIGN CO.LTD.

客户：高盛达

**Antenna Test Report**

项目名称： /

**Date : 2023-11-21**

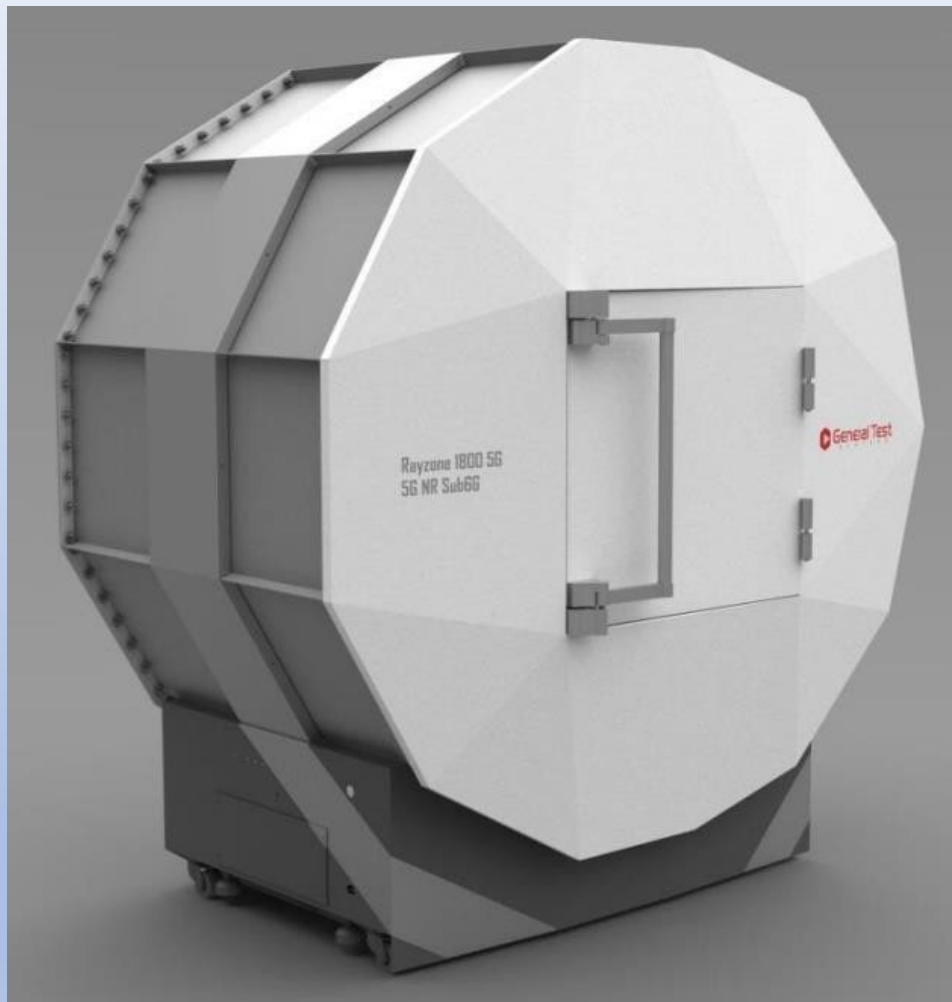

- 无线通信标准: 2G/3G/4G/5G(FR1)/GNSS/A-GNSS/Wi-Fi/Bluetooth
- 物联网通信标准: LTE Cat NB1(NB-IoT)/Cat-M1(e-MTC)
- SISO测试TRP/TIS/EIRP/EIS, 2x2 MIMO吞吐率测试;
- 无源天线测试、Desense测试、ICS
- 支持600MHz-7.5GHz频段
- GTS MaxSign 100 测试软件支持天线/OTA测试, 提供可视化数据分析
- 新型EPP硬质环保吸波材料、低RCS高增益测量天线组、透波转台和夹具
- 快速MIMO测试; 认证级测试精度
- 一体化设计, 即插即用, 维护简单



## RayZone1800 Test Setup

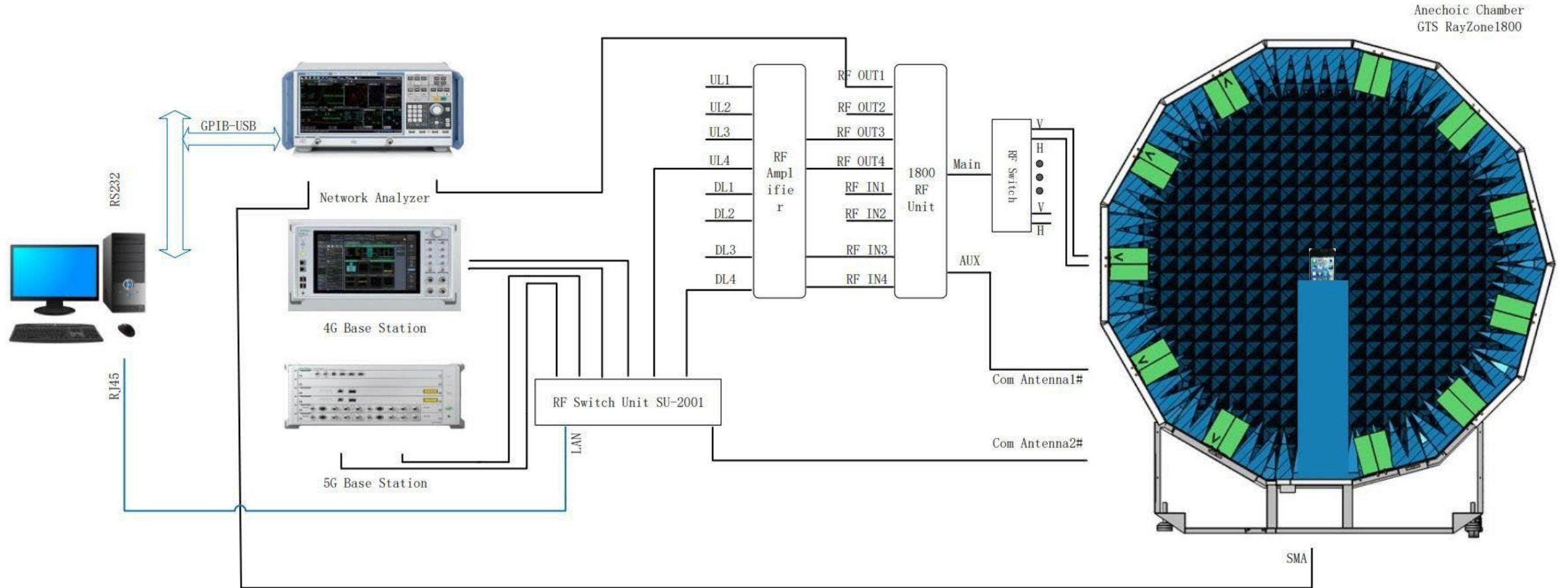



Address of the testing laboratory :Shenzhen Baoan District Qianjin 2 Road BaoYunda logistics information building 12A11

Test Date: 11/21/2023

Test Engineer: Liu Deng

Software name and version: GTS\_MAX SIGN Libra1.2.7

Cal Date:11/5/2023

Test Standard:Generic standard

Test set-up:

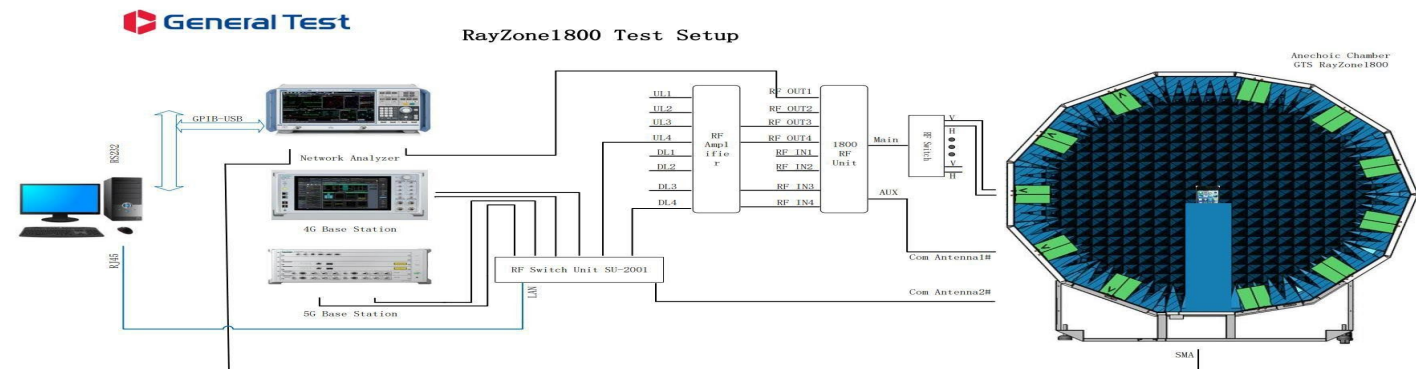
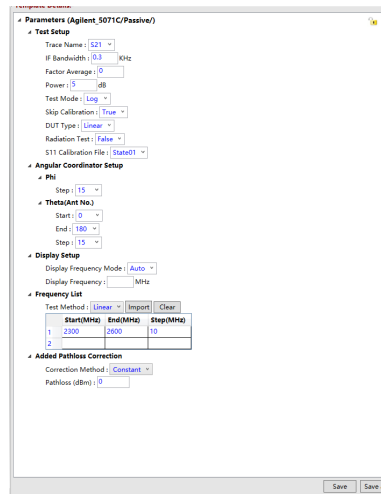

Test flow:





## 测试设备表

	测试仪器	制造商	型号	系列号	校准日期	校准过期日期
校准设备表	网络分析仪	Keysight	E5071C	MY47002902	2023.04.01	2024.03.30
	CMW500天线测试系统	GTS	1800	/	2023.04.01	2024.03.30

## 测试照片

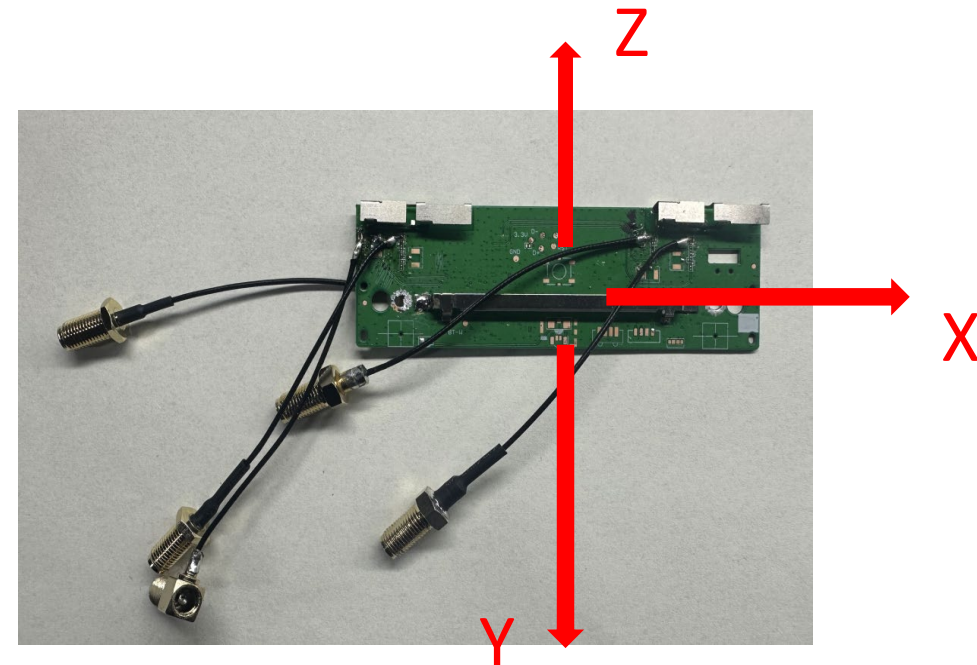
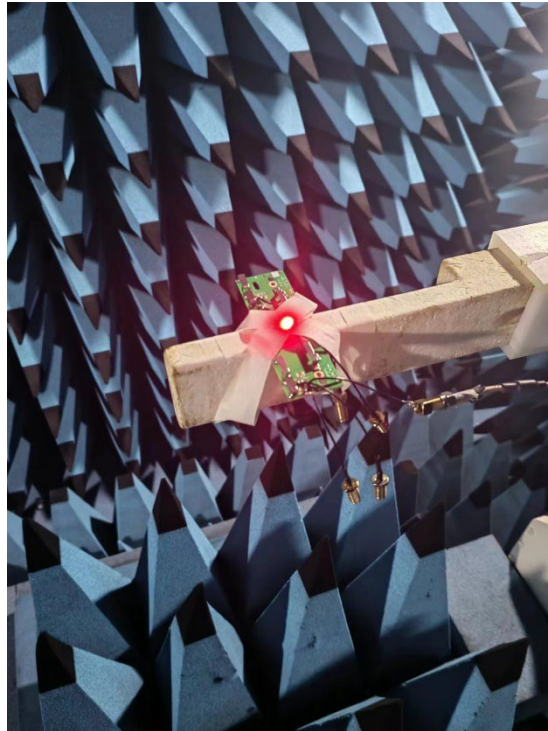

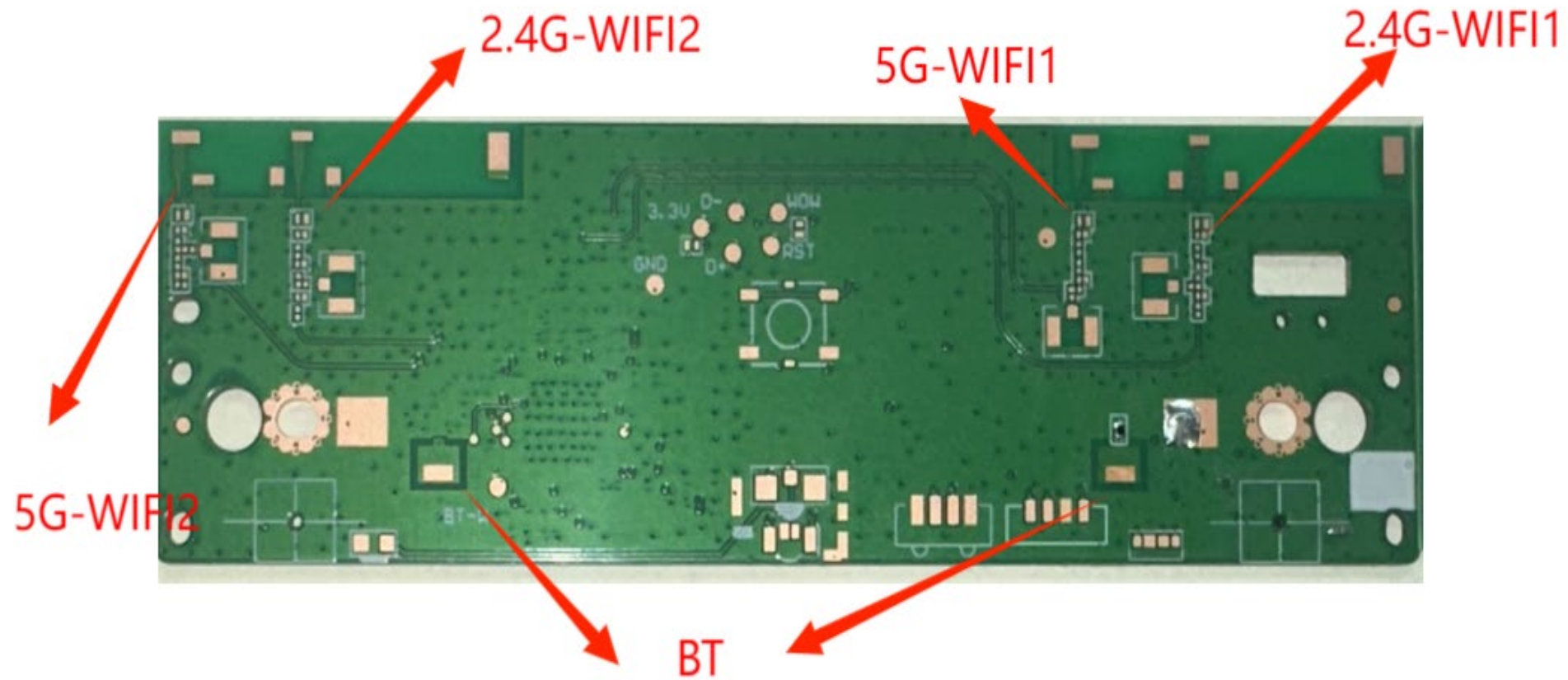

Passive Test For 2400-2500			
Freq (MHz)	Effi (dB)	Gain (dBi)	Effi (%)
2400	-5.47	-2.42	28.37
2410	-5.14	-1.72	30.65
2420	-4.84	-1.18	32.81
2430	-4.57	-0.66	34.89
2440	-4.31	-0.14	37.04
2450	-4.19	0.13	38.12
2460	-4.11	0.3	38.81
2470	-4.11	0.3	38.78
2480	-4.18	0.1	38.22
2490	-4.31	-0.31	37.09
2500	-4.41	-0.75	36.19

2450MHZ

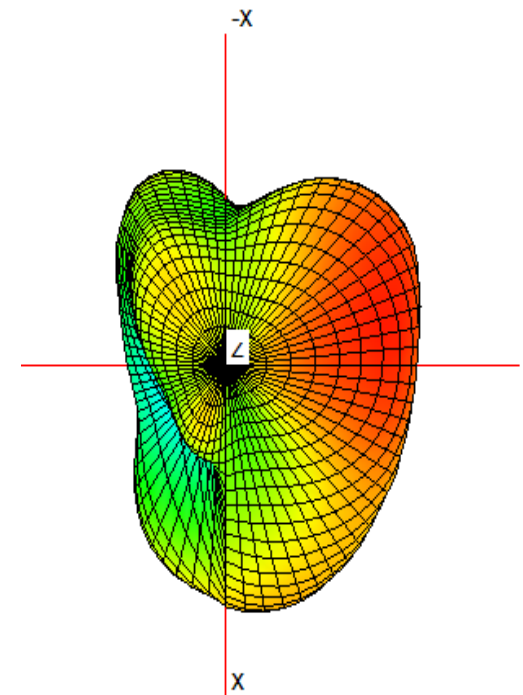
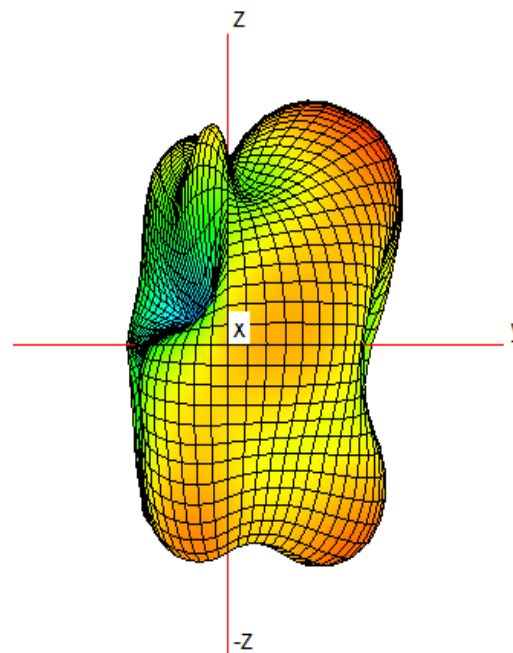
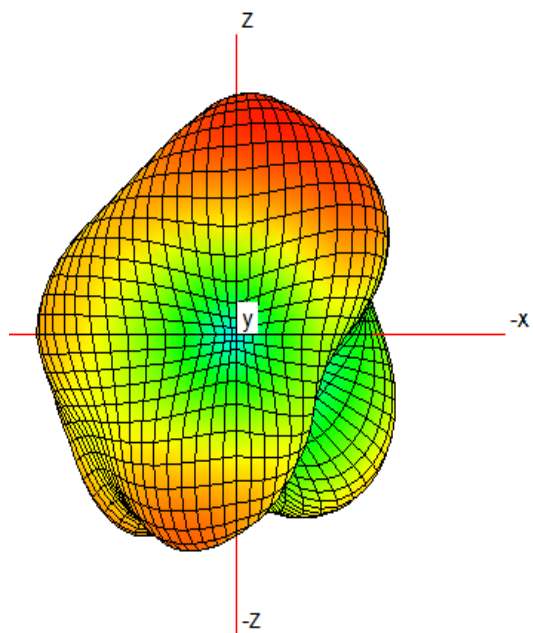



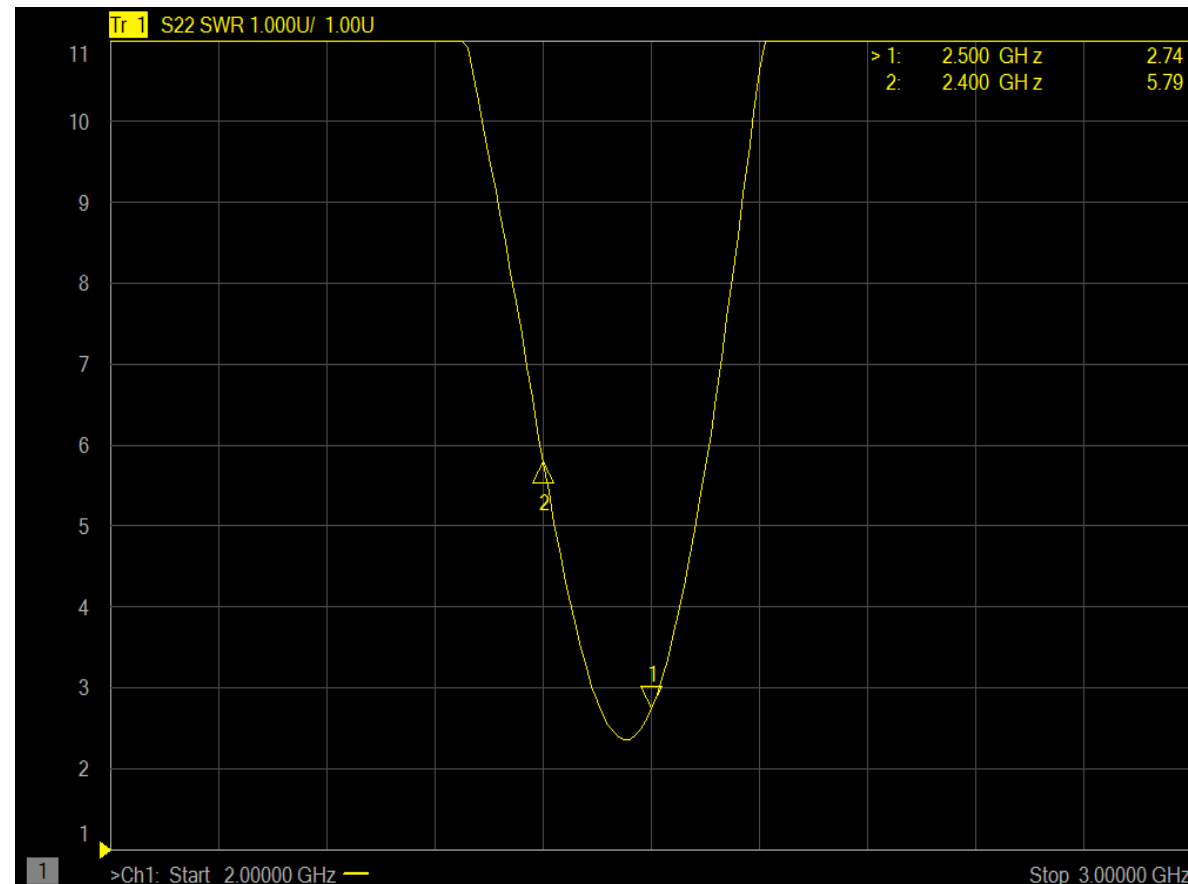
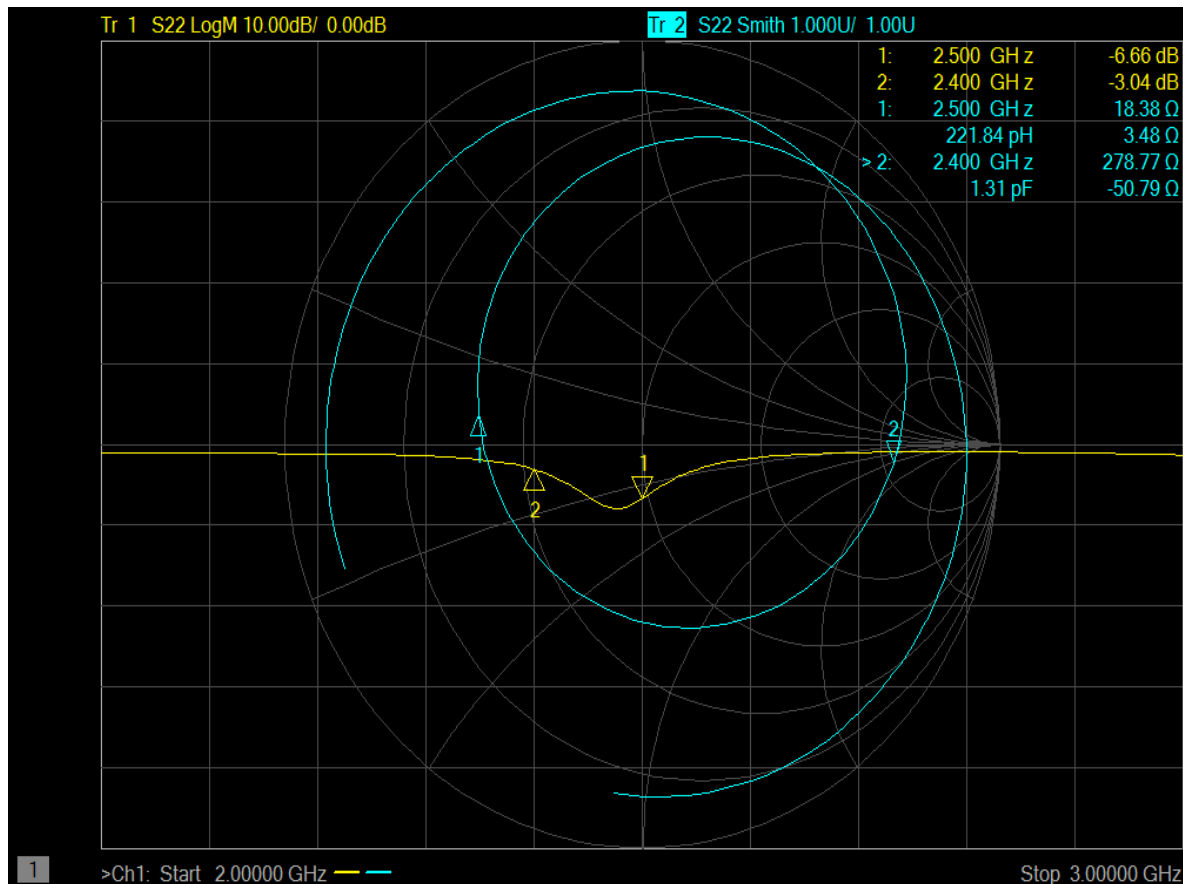

## WiFi-1 天线 2.4G

Passive Test For 2400-2500

Freq (MHz)	Effi (dB)	Gain (dBi)	Effi (%)
2400	-4.64	1.83	34.33
2410	-4.56	1.88	34.96
2420	-4.47	1.91	35.7
2430	-4.29	1.47	37.27
2440	-4.29	2.04	37.21
2450	-4.23	2.03	37.79
2460	-4.62	1.07	34.55
2470	-4.62	1.74	34.55
2480	-4.66	1.76	34.16
2490	-4.65	2.88	34.25
2500	-4.71	1.76	33.77

## WiFi-1 天线 5.8G

Passive Test For 5150-5850

Freq (MHz)	Effi (dB)	Gain (dBi)	Effi (%)
5150	-4.09	1.09	38.97
5220	-4.37	0.51	36.58
5290	-4.45	0.2	35.88
5360	-4.08	1.25	39.09
5430	-3.91	1.86	40.67
5500	-3.66	2.44	43.02
5570	-3.08	3.48	49.18
5640	-2.7	4.01	53.76
5710	-2.61	3.81	54.84
5780	-2.63	3.51	54.54
5850	-2.68	3.07	54

## 2450MHZ

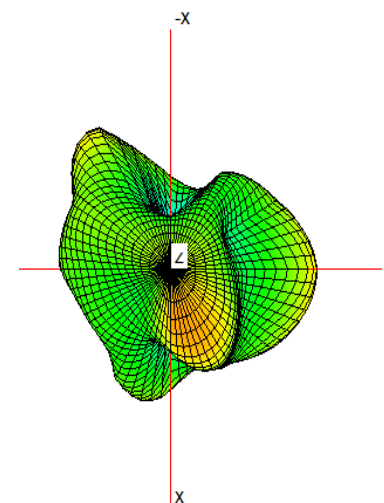
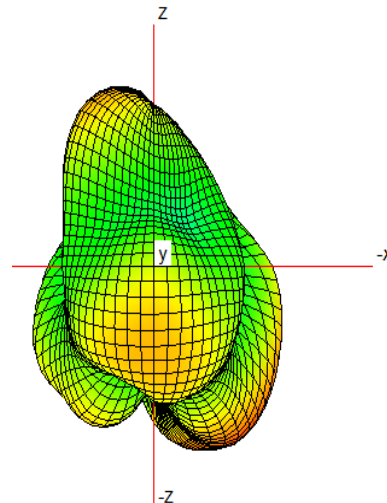
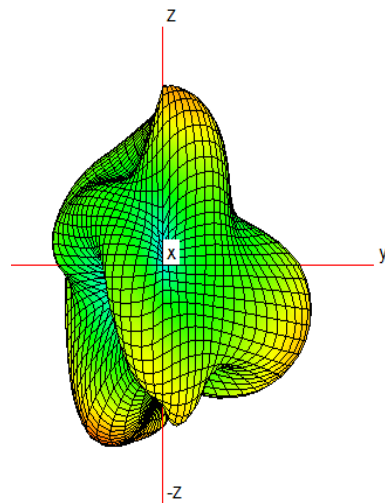

## 5650MHZ

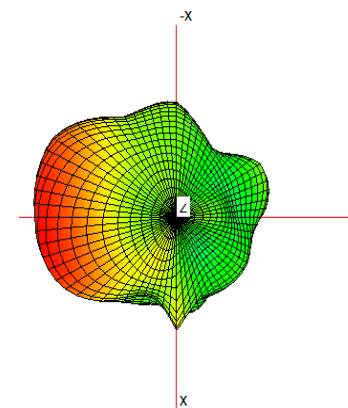
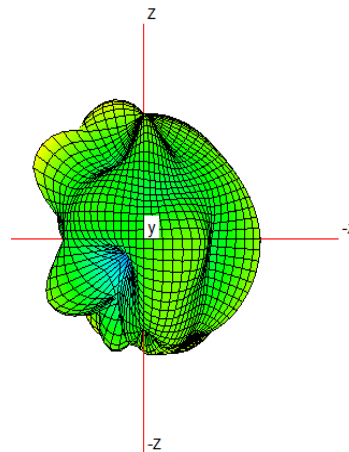
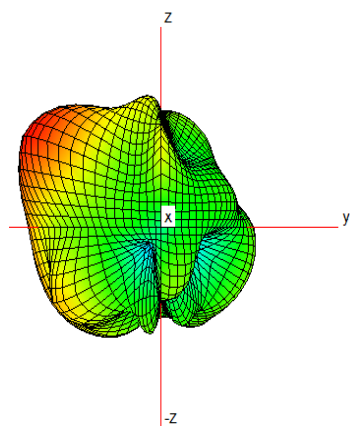

## WiFi-1 2.4G

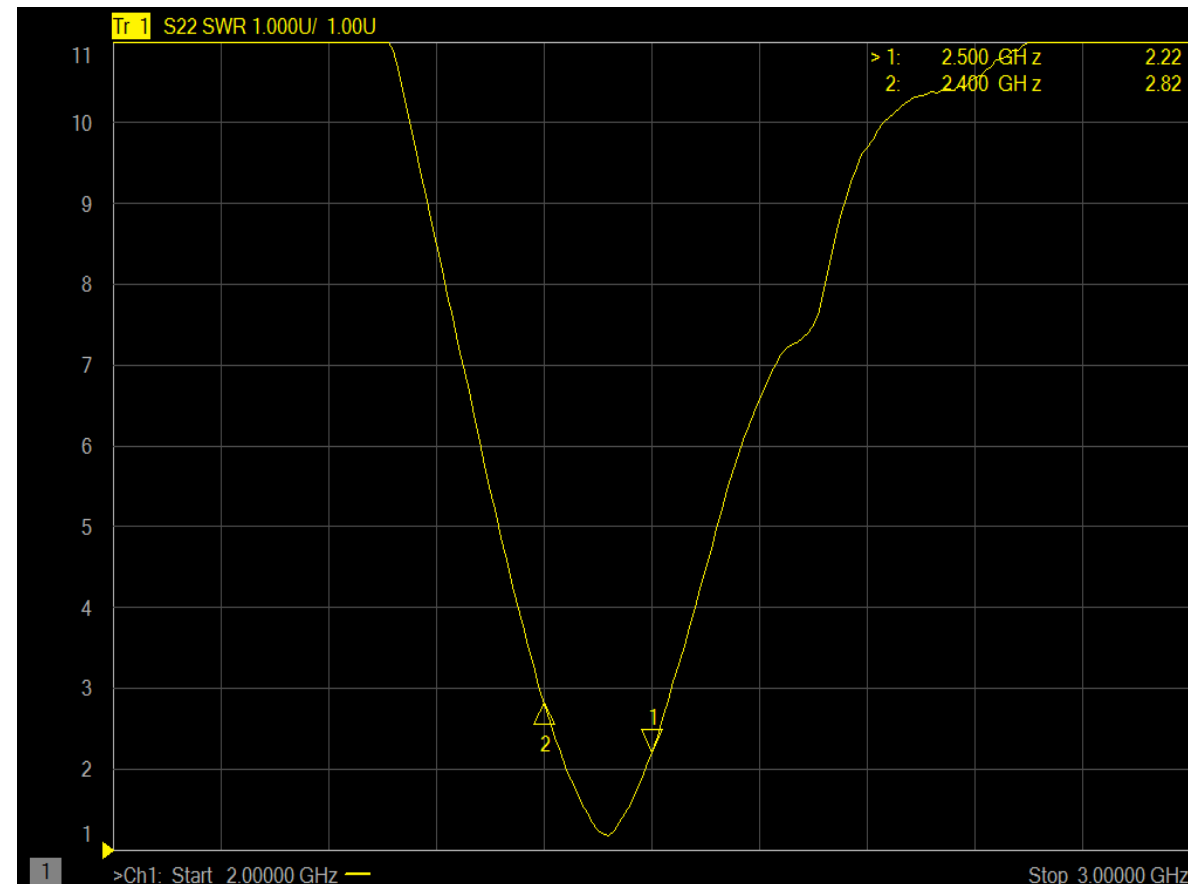
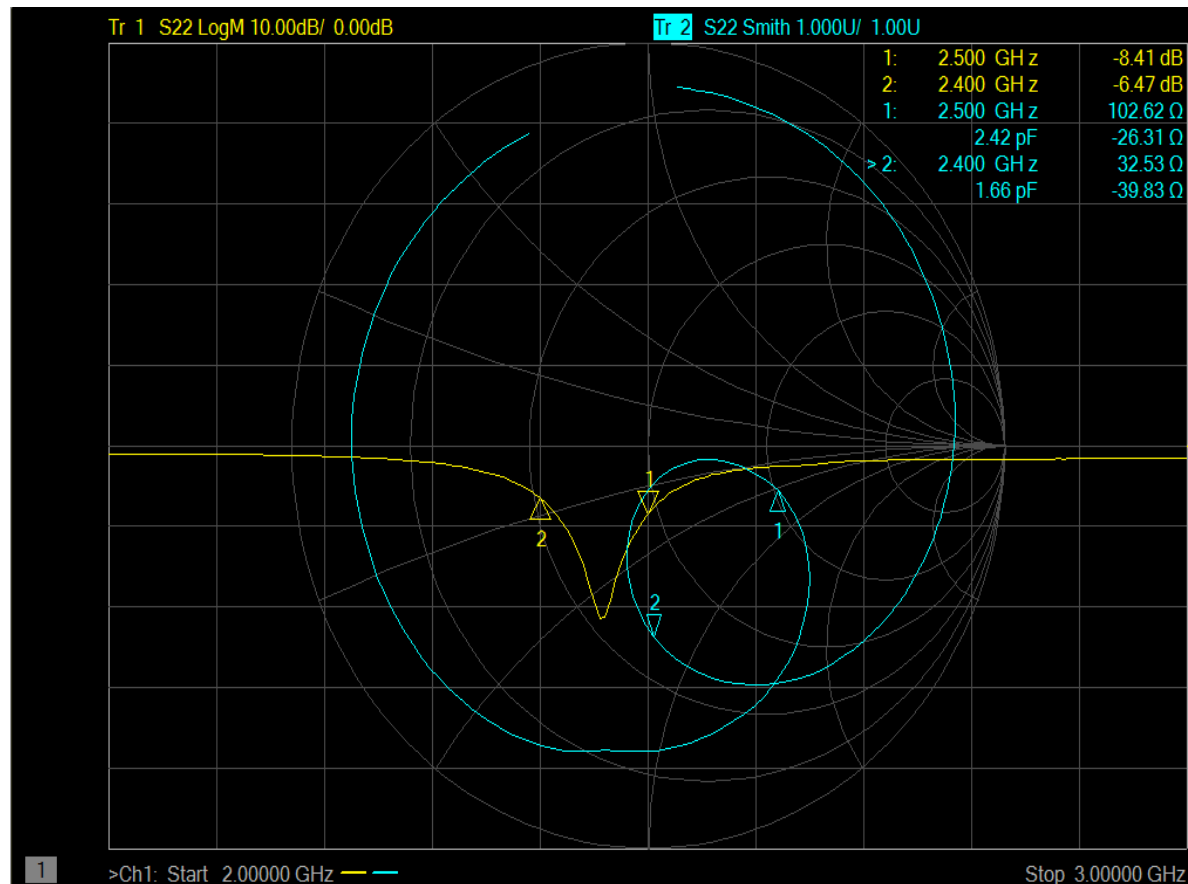





## WiFi-1 5.8G

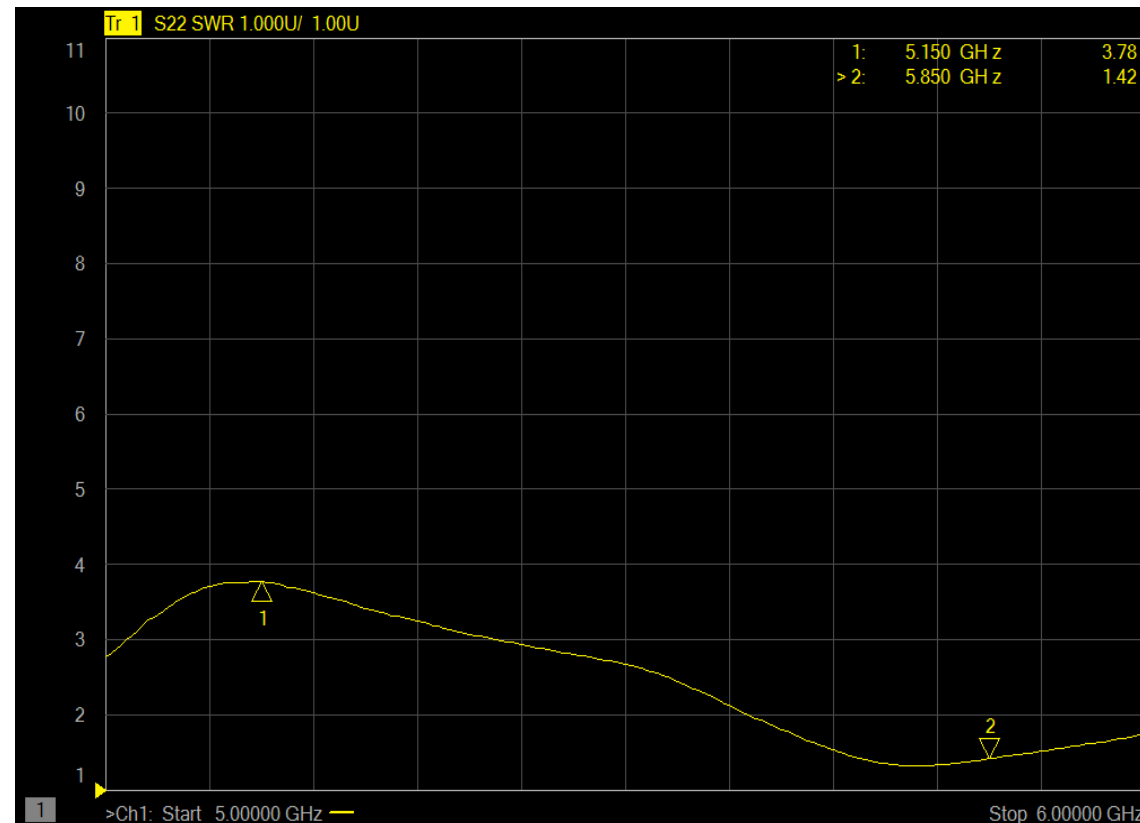
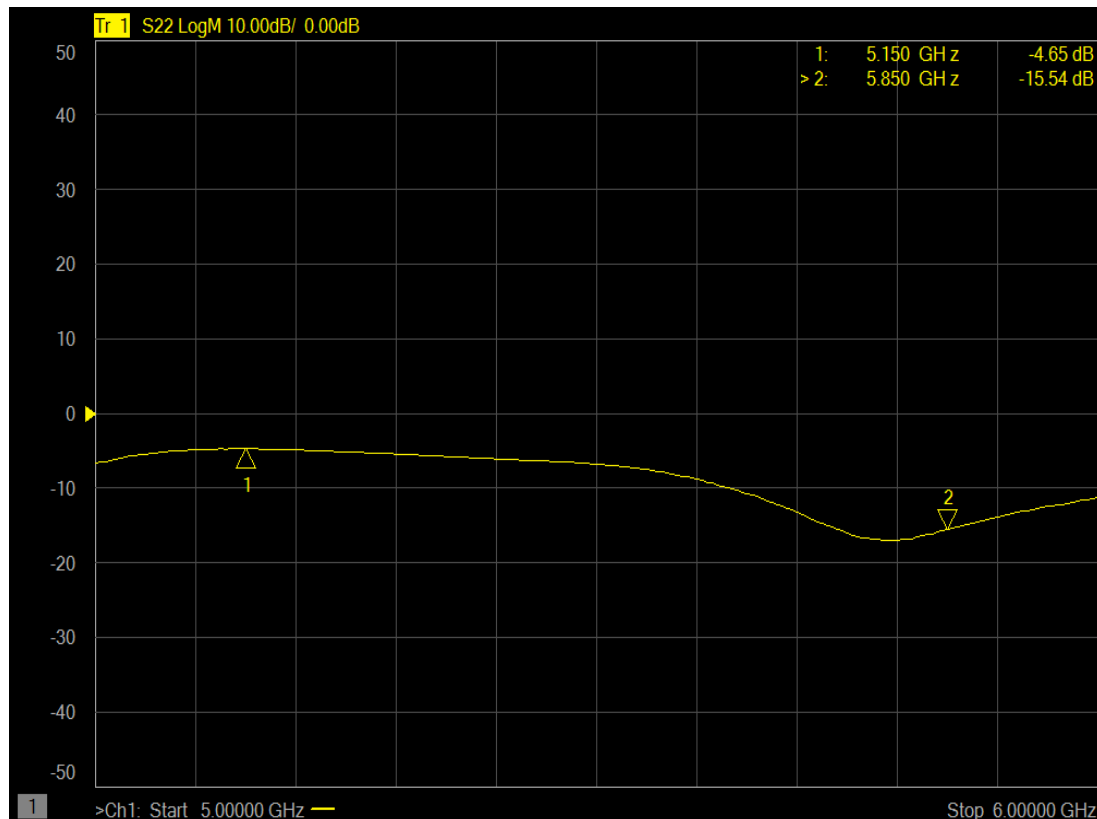

## WiFi-2 天线 2.4G

Passive Test For 2400-2500

Freq (MHz)	Effi (dB)	Gain (dBi)	Effi (%)
2400	-5.7	-2.22	31.93
2410	-5.24	-1.71	34.93
2420	-4.83	-1.23	37.85
2430	-4.49	-0.89	40.59
2440	-4.19	-0.67	43.07
2450	-4.05	-0.55	44.31
2460	-3.98	-0.34	44.95
2470	-4.02	-0.26	44.64
2480	-4.16	-0.33	43.35
2490	-4.38	-0.49	41.44
2500	-4.57	-0.58	39.9

## WiFi-2 天线 5.8G

Passive Test For 5150-5850

Freq (MHz)	Effi (dB)	Gain (dBi)	Effi (%)
5150	-4	1.79	39.83
5220	-3.18	2.39	48.06
5290	-2.9	2.92	51.32
5360	-2.49	3.13	56.39
5430	-2.75	2.77	53.11
5500	-3.14	2.41	48.55
5570	-3.44	2.29	45.25
5640	-3.7	1.9	42.66
5710	-3.76	1.41	42.03
5780	-3.9	0.88	40.77
5850	-4.27	0.59	37.45

## 2450MHZ

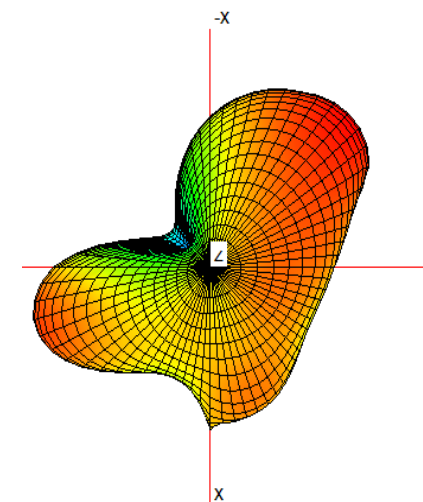
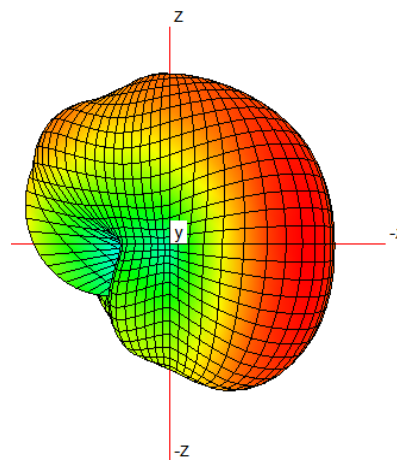
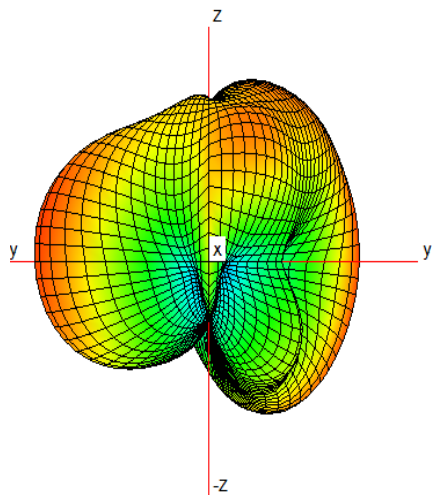

## 5650MHZ

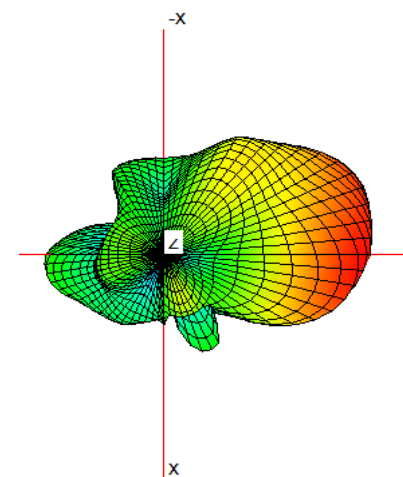
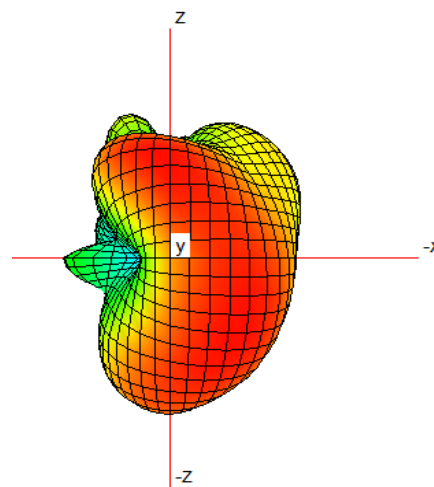
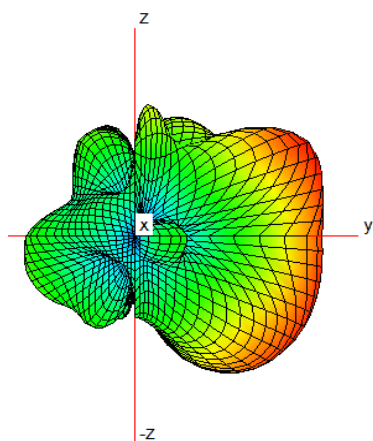

## WiFi-1 2.4G

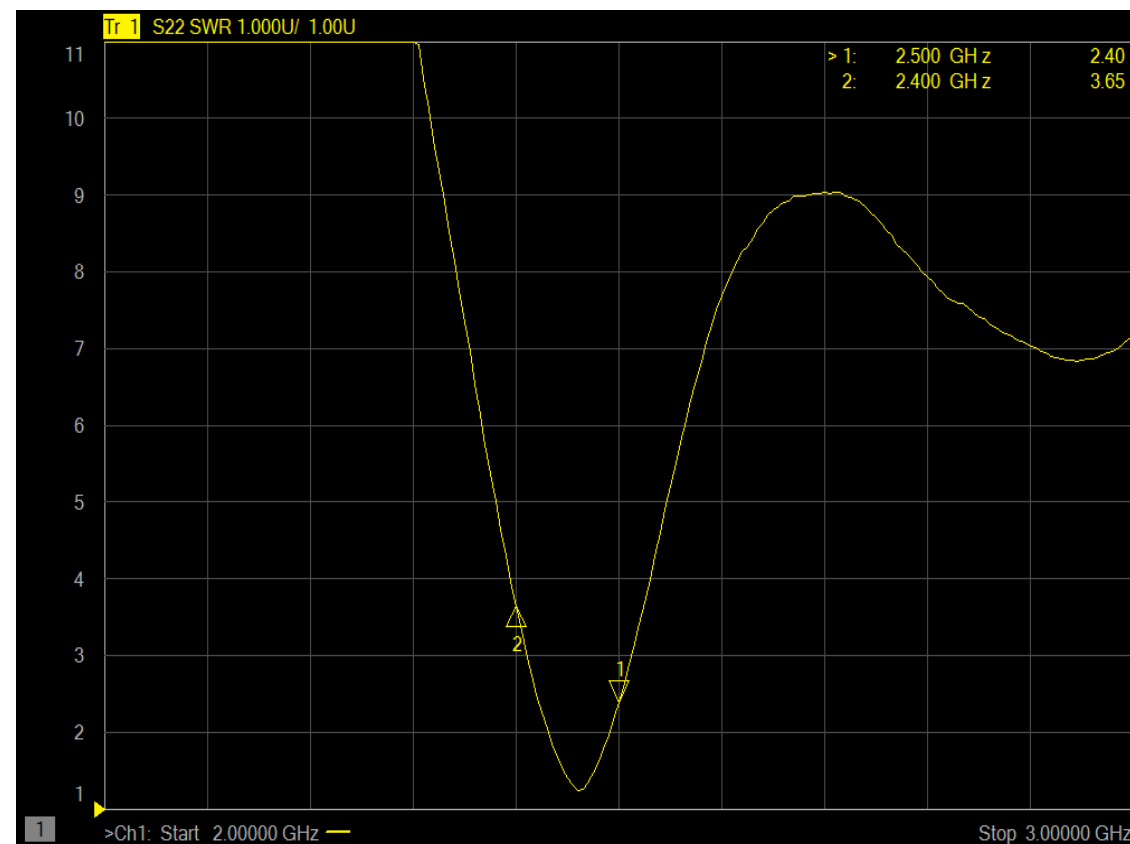
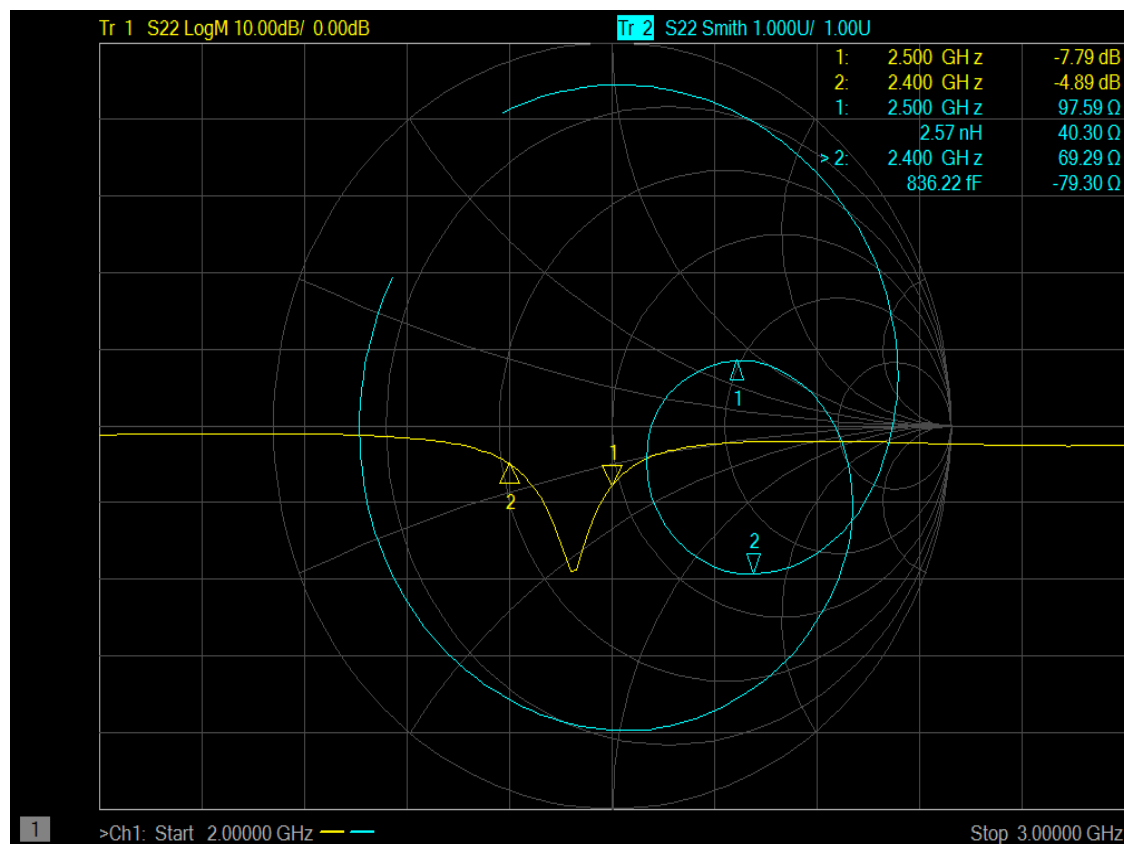



## WiFi-1 5.8G

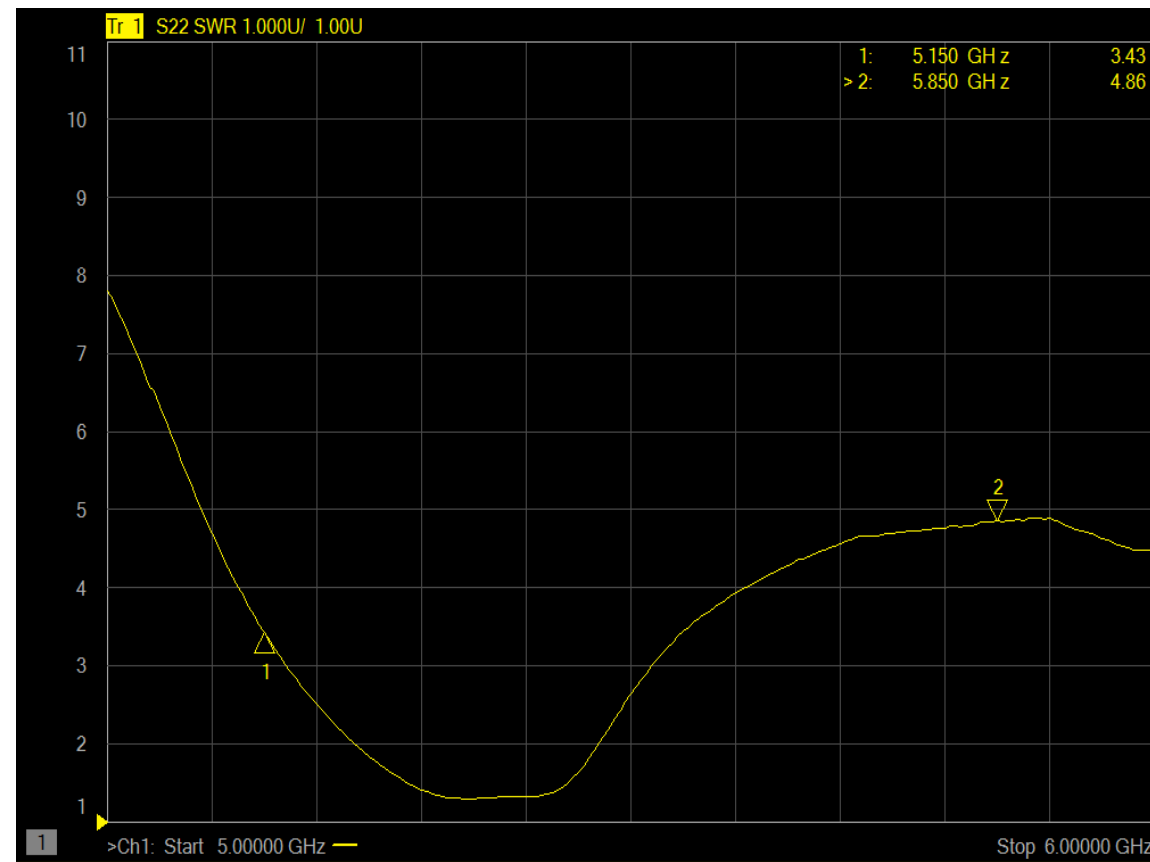
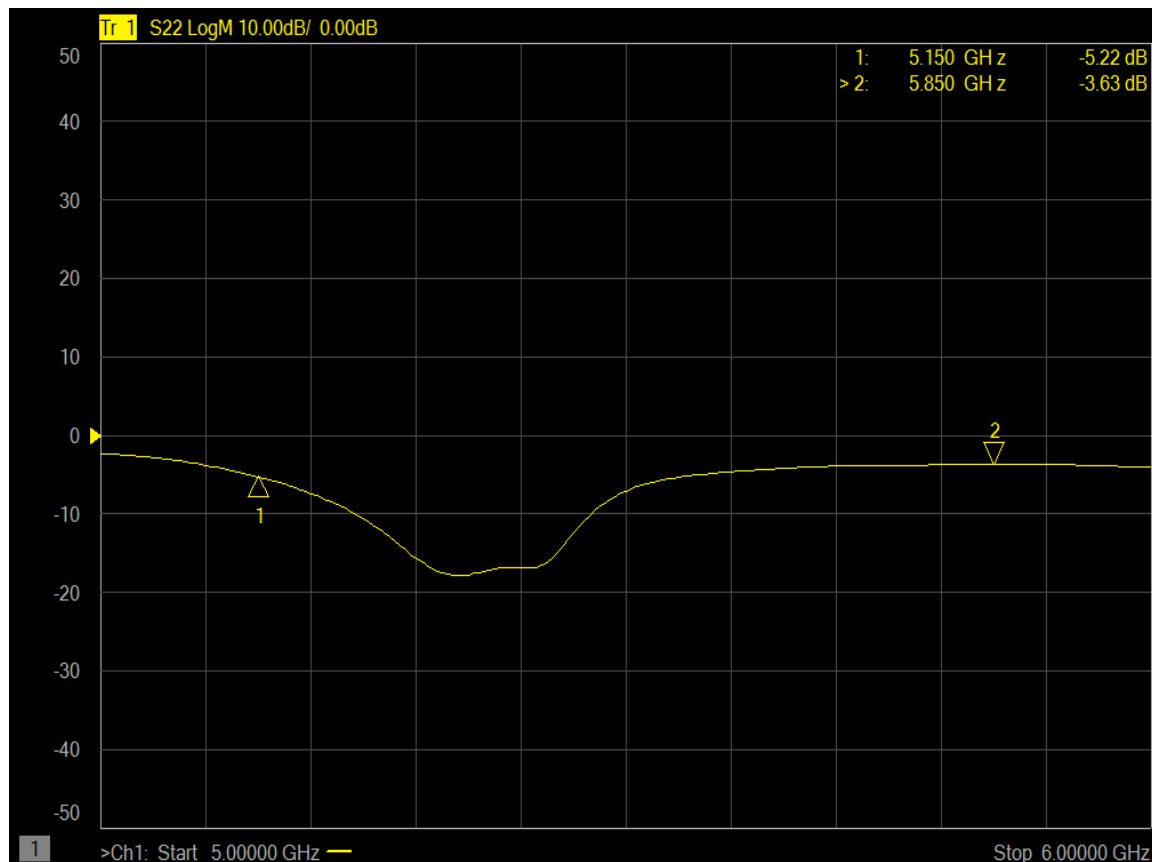

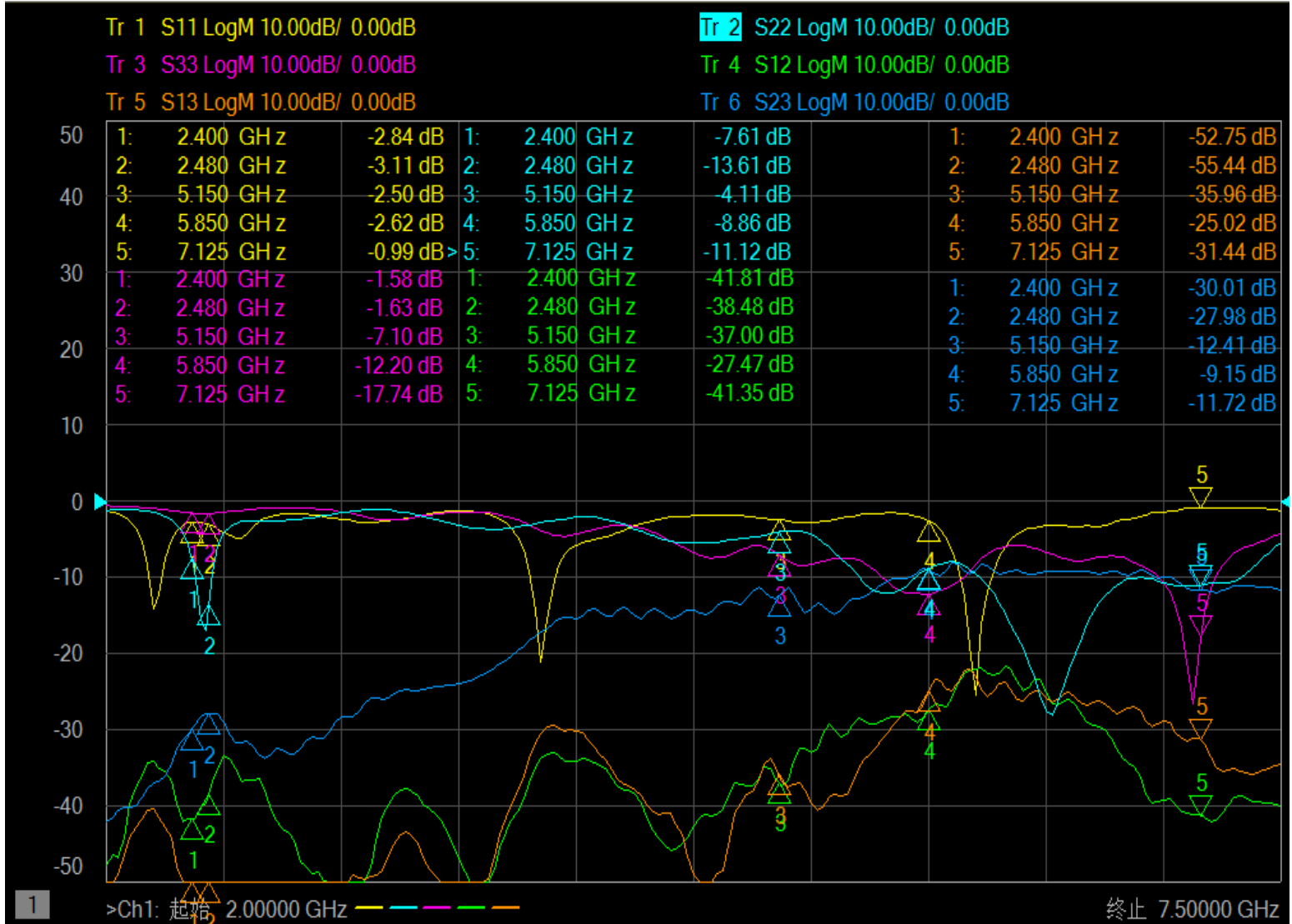

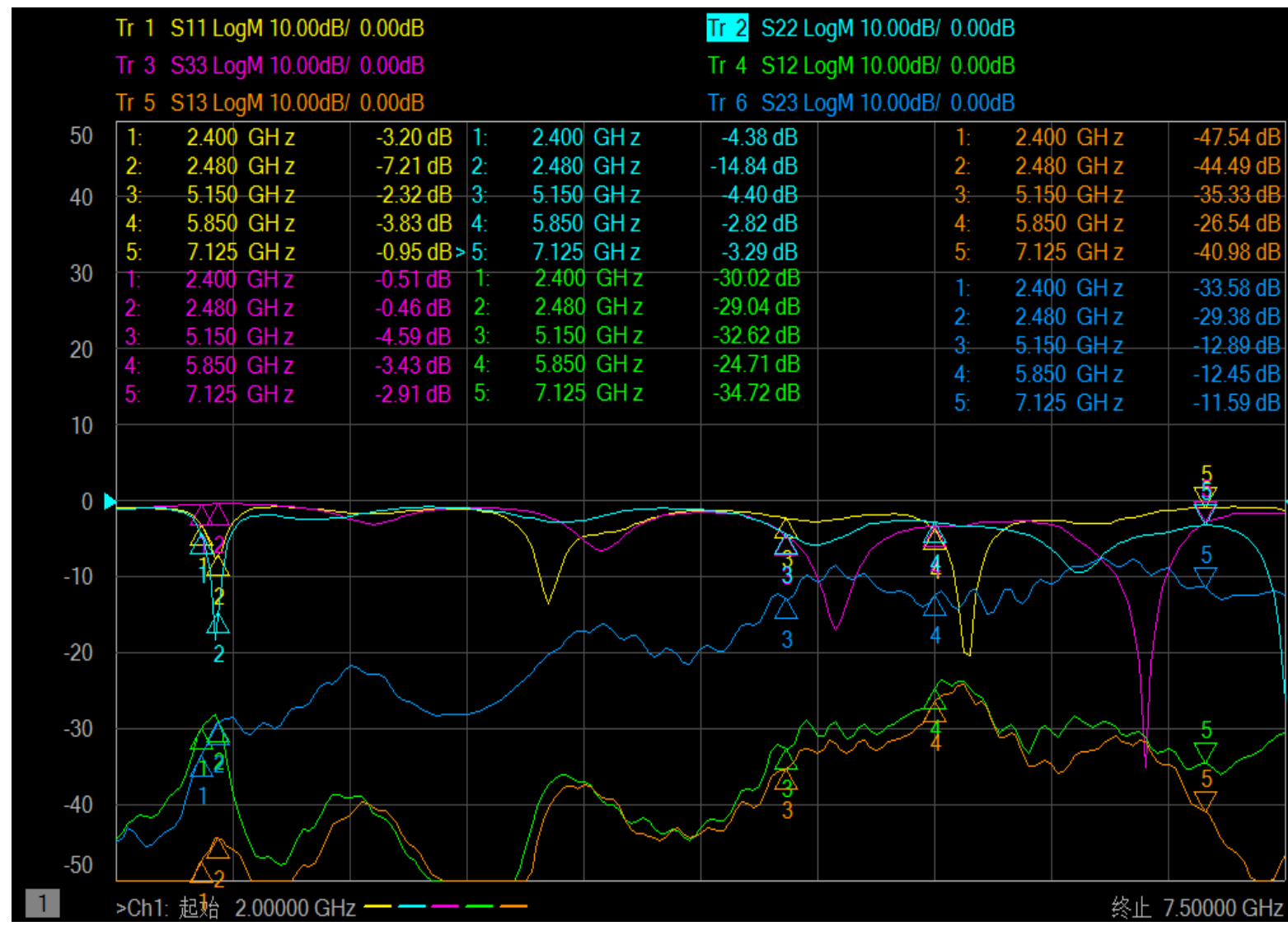

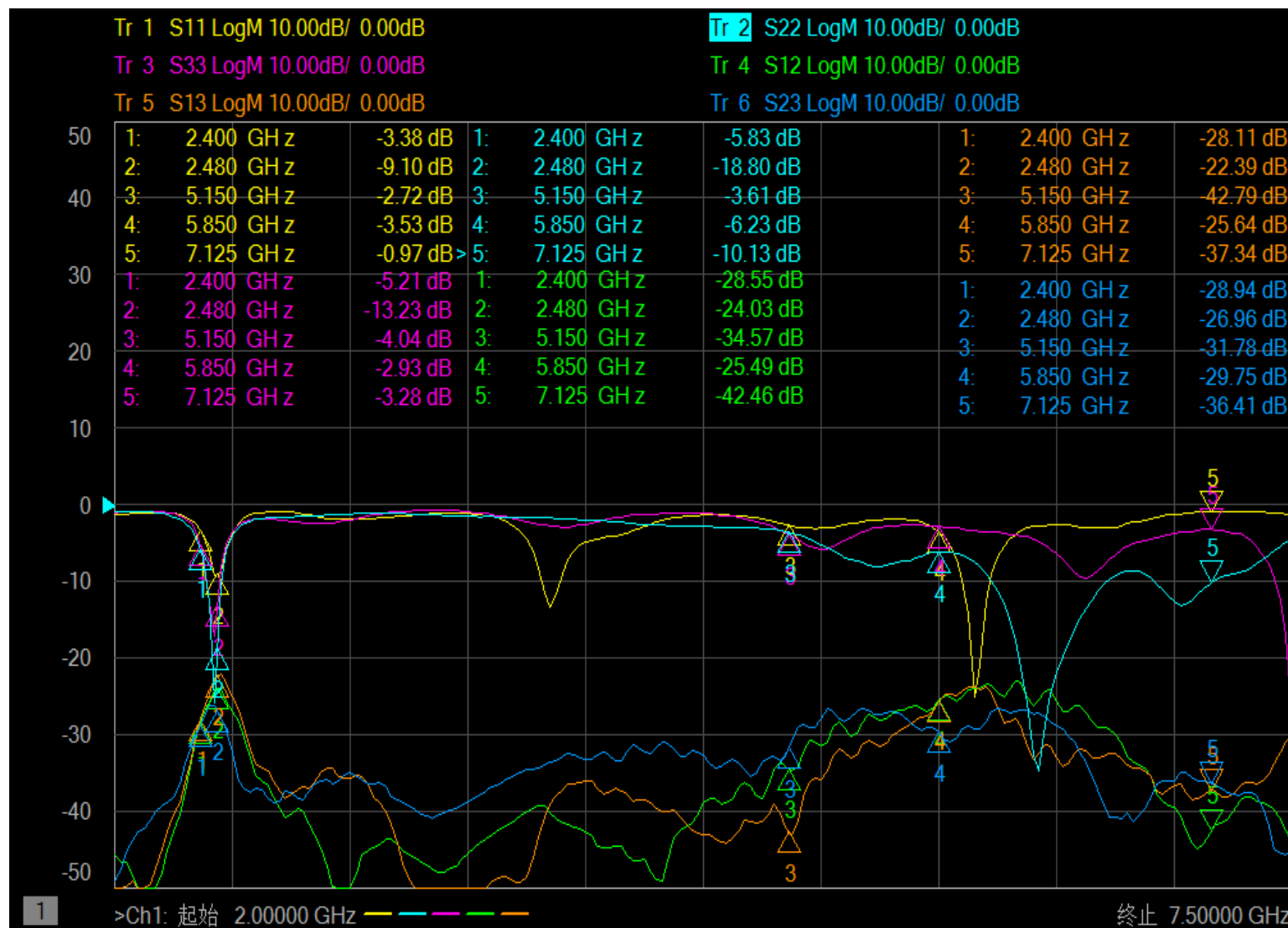



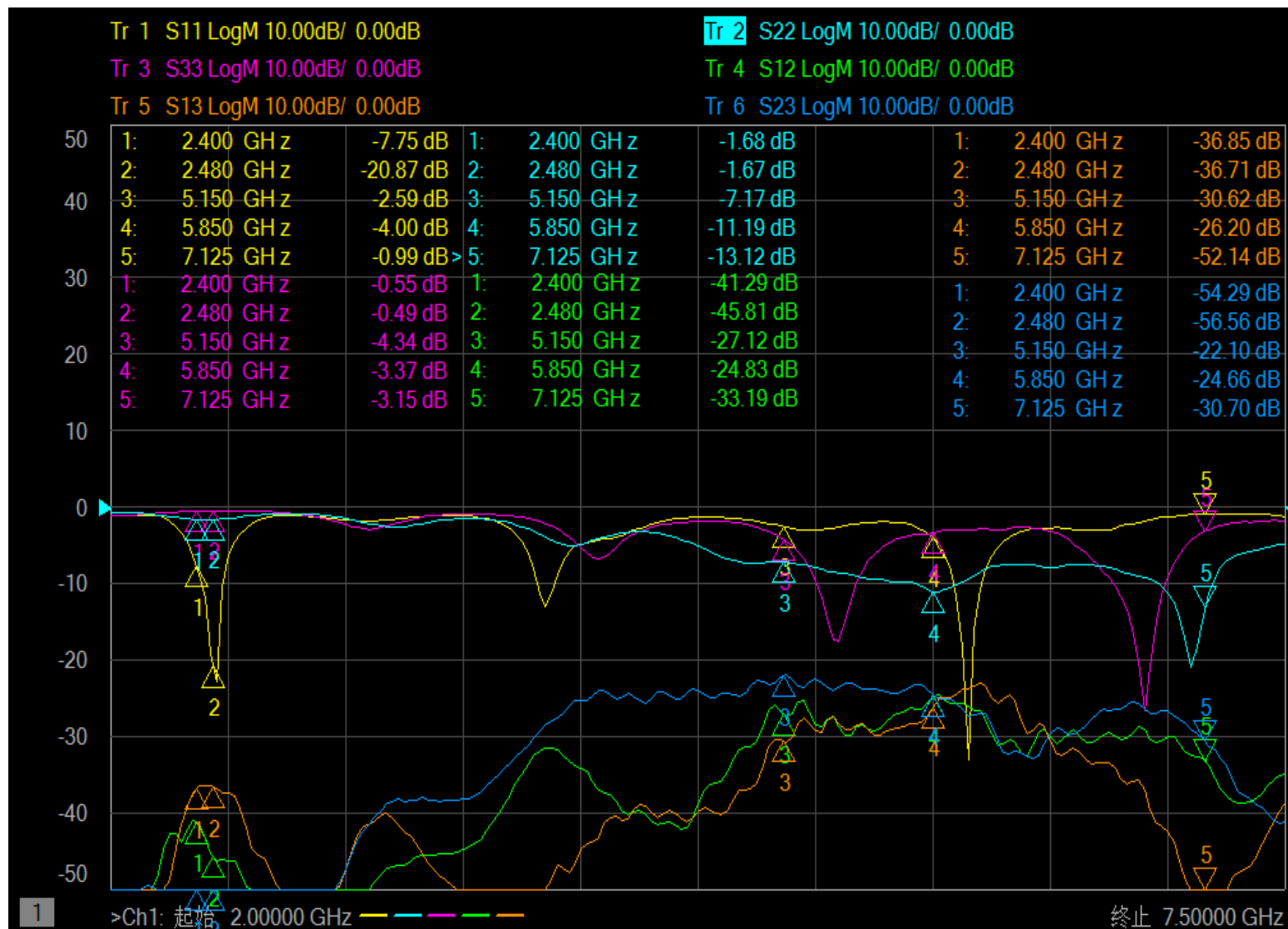





深圳汉阳天线设计有限公司

SHENZHEN HANYANG ANTENNA DESIGN CO., LTD.

# 5G

Welcome calls consultations, negotiations and guidance come!

# Thank you

地址：深圳市宝安区前进路宝运达物 流信息大厦**12A**层。

电话：**0755-23069700**

汉阳天线 版权所有 Copyright ©2014-2024 Shenzhen Hanyang Antenna Design Co., Ltd. All rights reserved.