



深圳汉阳天线设计有限公司

SHENZHEN HANYANG ANTENNA DESIGN CO.LTD.

Customer: GSD

Antenna report

Project name: WKCT15

Date: 2023-06-06

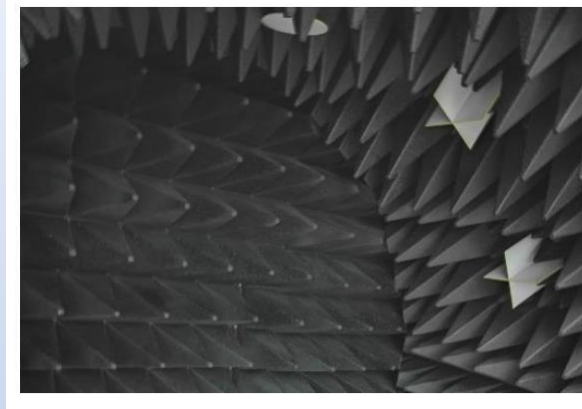
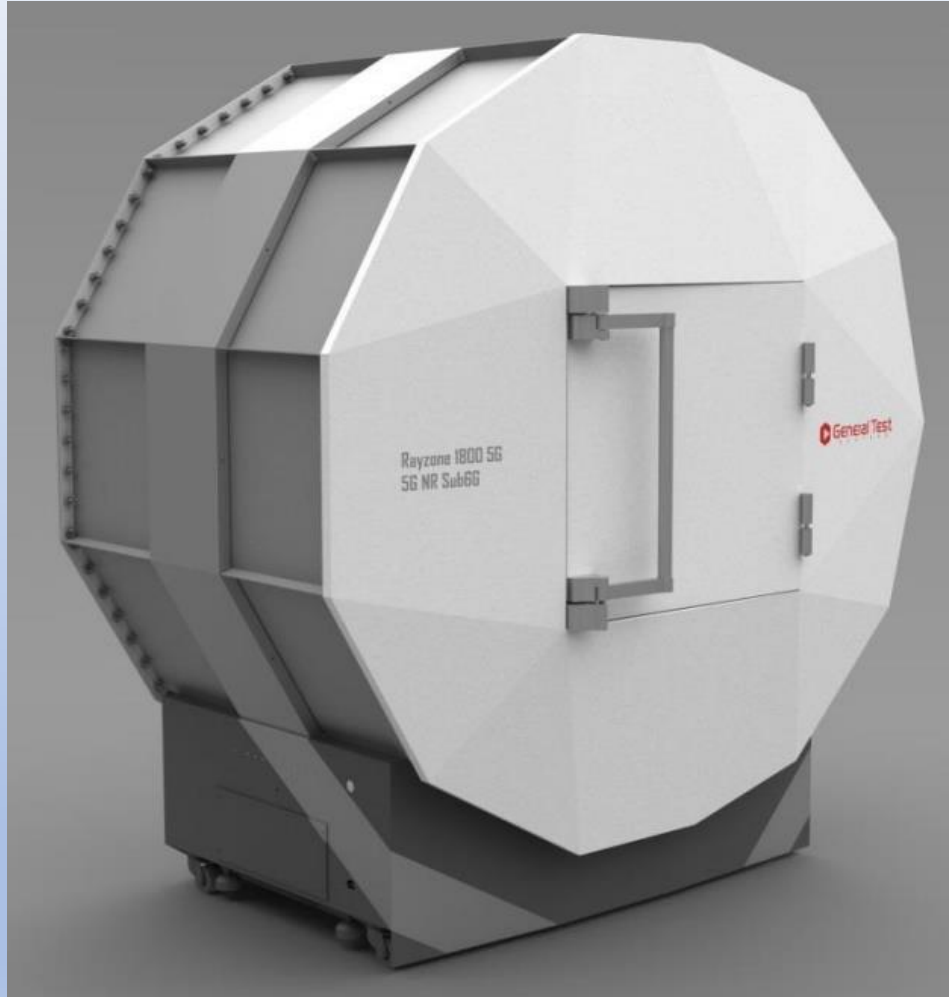

Wireless communication standard:2G/3G/4G/5G(FR1)/GNSS/Wi-Fi/Bluetooth
Internet of Things communication standards:LTE Cat NB1(NB-IoT)/Cat-M1(e-MTC)
SISO test TRP/TIS/EIRP/EIS,2x2 MIMO Throughput test
Passive antenna test,Desense ,test ICS
Support 600MHz-7.5GHz frequency
GTS MaxSign 100 test software support antenna/OTA test, Provide visual data analysis
New EPP rigid and environmentally friendly absorbing material.
Low RCS high gain measurement antenna set , Transparent turntable and fixture
MIMO test fastly. Certification level test accuracy.
Integrated design,use and maintenance is simply.

Address of the testing laboratory :Shenzhen Baoan District Qianjin 2 Road BaoYunda logistics information building 12A11

Test Date: 6/6/2023

Test Engineer: Liu Deng

Software name and version: GTS_MAX SIGN Libra1.2.7

Cal Date:6/6/2023

Test Standard:Generic standard

Test set-up:

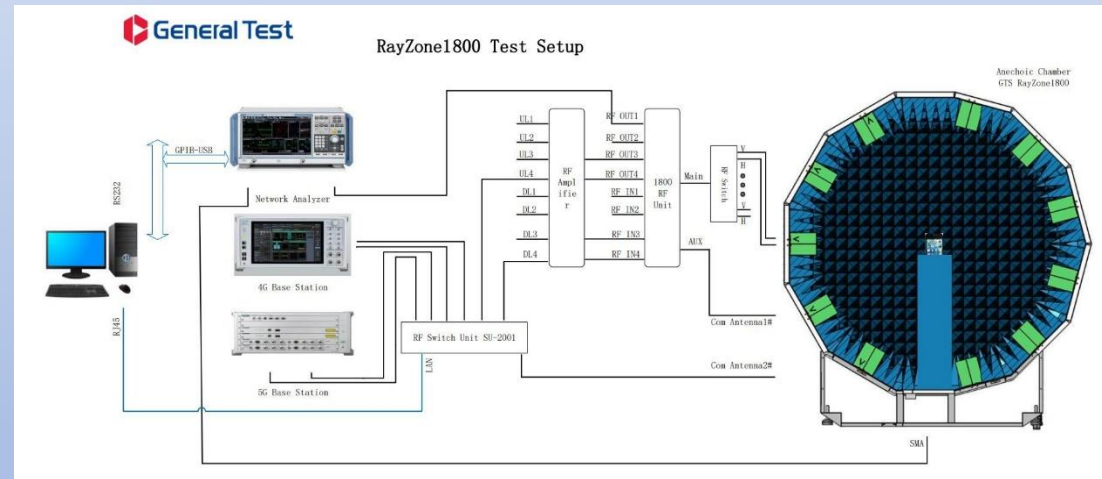
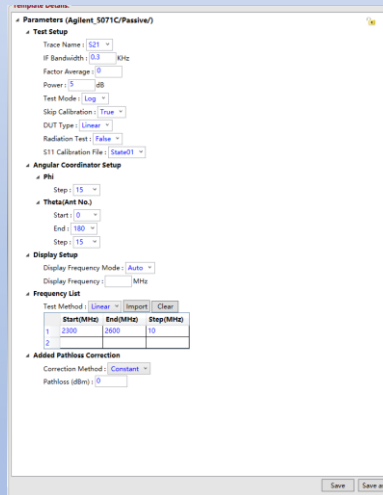

Test flow:

Equipment list	Equipment	Manufacturer	model	SN	Last cal.	Dul Date
	Network analyzer	Keysight	E5071C	MY47002902	2023.04.01	2024.03.30
	CMW antenna system	GTS	1800	/	2023.04.01	2024.03.30

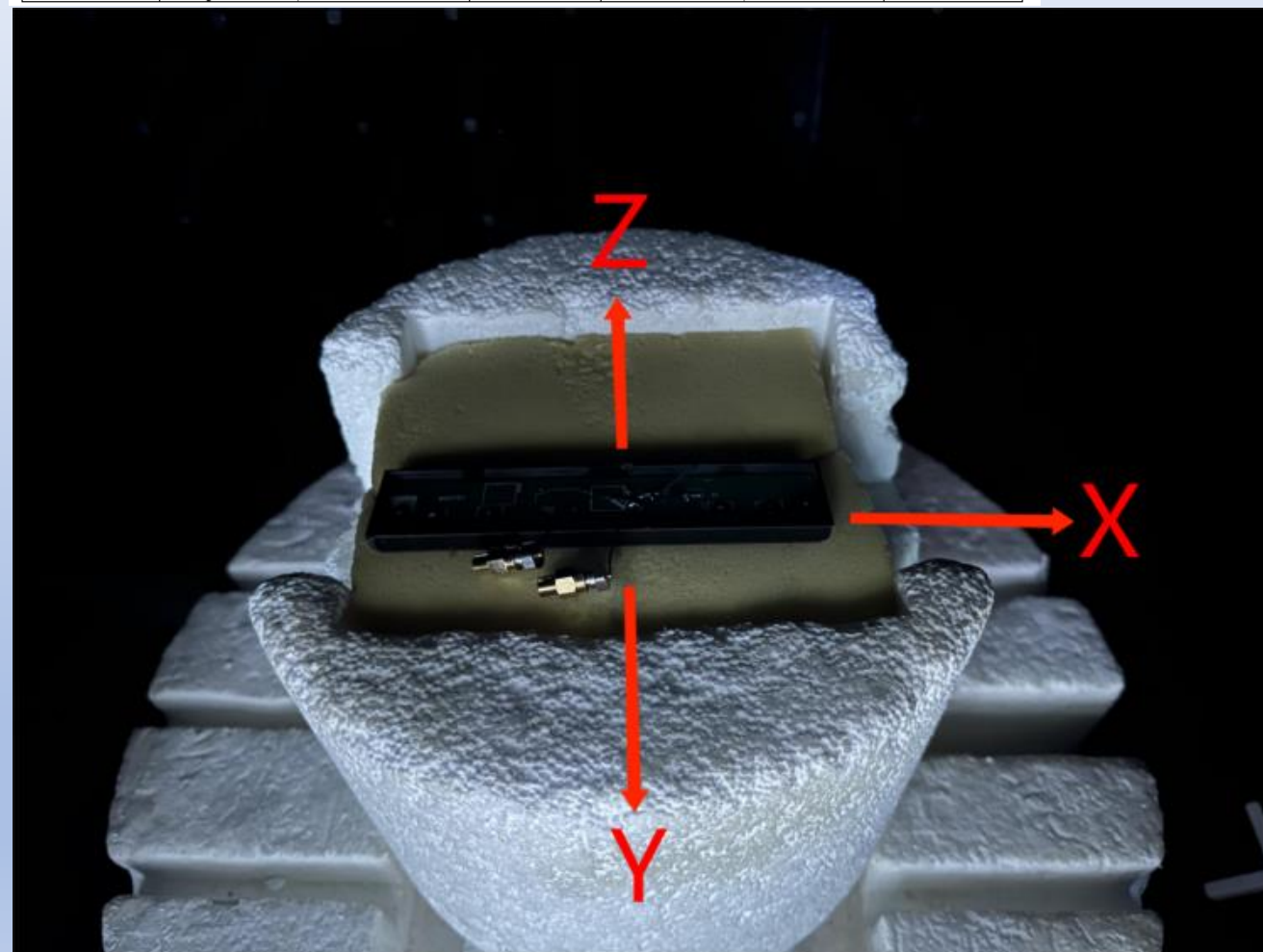



WIFI-0 2.4G				WIFI-0 5.8G			
Freq	EfficiencydB	EfficiencyPcent	Gain	Freq	EfficiencydB	EfficiencyPcent	Gain
2300	-8.02	15.76	-3.9	5150	-5.41	28.75	-1.78
2310	-7.89	16.25	-3.86	5175	-5.15	30.52	-1.41
2320	-7.47	17.91	-3.37	5200	-4.86	32.65	-1.06
2330	-7.19	19.11	-3.04	5225	-4.63	34.47	-0.77
2340	-6.9	20.4	-2.76	5250	-4.5	35.52	-0.37
2350	-6.61	21.84	-2.37	5275	-4.58	34.86	-0.15
2360	-6.3	23.46	-2.05	5300	-4.55	35.06	0.18
2370	-5.94	25.44	-1.78	5325	-4.48	35.68	0.5
2380	-5.56	27.79	-1.37	5350	-4.27	37.39	0.93
2390	-5.33	29.31	-1.06	5375	-4.07	39.19	1.16
2400	-5.05	31.27	-0.83	5400	-4.03	39.58	1.46
2410	-4.8	33.11	-0.62	5425	-4.1	38.88	1.5
2420	-4.47	35.74	-0.24	5450	-4.39	36.42	1.21
2430	-4.11	38.78	0.11	5475	-4.71	33.82	0.78
2440	-3.91	40.64	0.27	5500	-4.93	32.14	0.33
2450	-3.74	42.31	0.46	5525	-5	31.6	0.27
2460	-3.57	43.93	0.56	5550	-5.1	30.9	0.35
2470	-3.43	45.36	0.66	5575	-5.02	31.47	0.34
2480	-3.34	46.35	0.66	5600	-5.07	31.1	0.21
2490	-3.36	46.13	0.65	5625	-4.92	32.23	0.42
2500	-3.39	45.78	0.5	5650	-4.83	32.85	0.45
2510	-3.47	45	0.38	5675	-4.9	32.38	0.17
2520	-3.61	43.59	0.26	5700	-4.84	32.84	0.26
2530	-3.82	41.5	-0.05	5725	-4.81	33.04	0.25
2540	-4.12	38.75	-0.5	5750	-4.66	34.17	0.31
2550	-4.43	36.07	-0.86	5775	-4.61	34.56	0.37
2560	-4.76	33.45	-1.22	5800	-4.54	35.19	0.51
2570	-5.09	30.96	-1.61	5825	-4.49	35.52	0.58
2580	-5.52	28.03	-2.07	5850	-4.46	35.79	0.6
2590	-5.97	25.3	-2.55				
2600	-6.36	23.13	-2.85				

2450MHZ

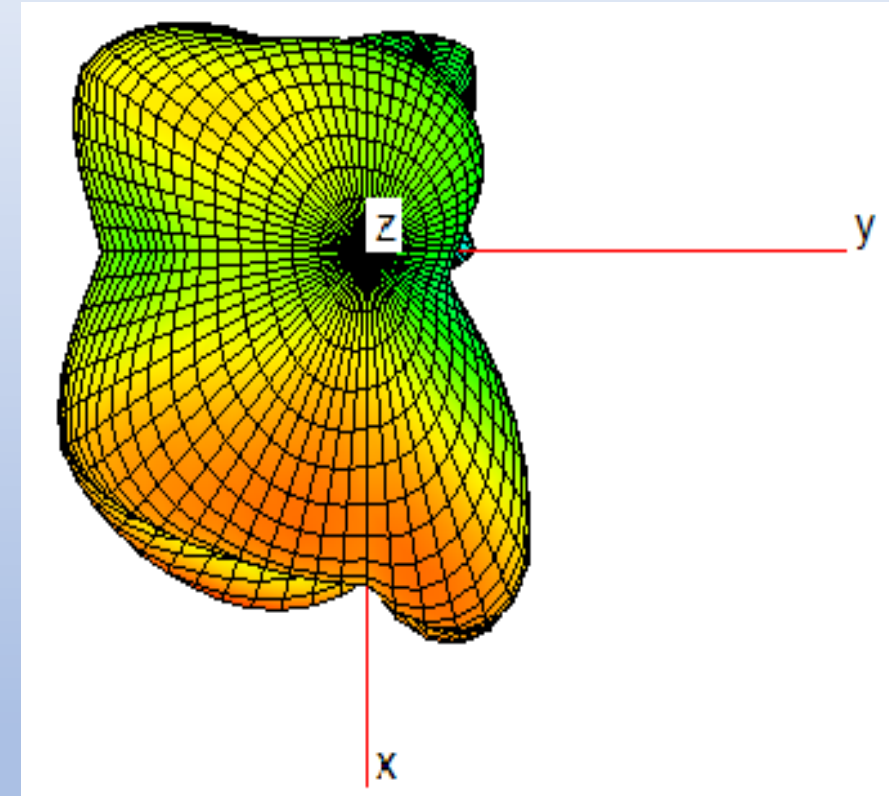
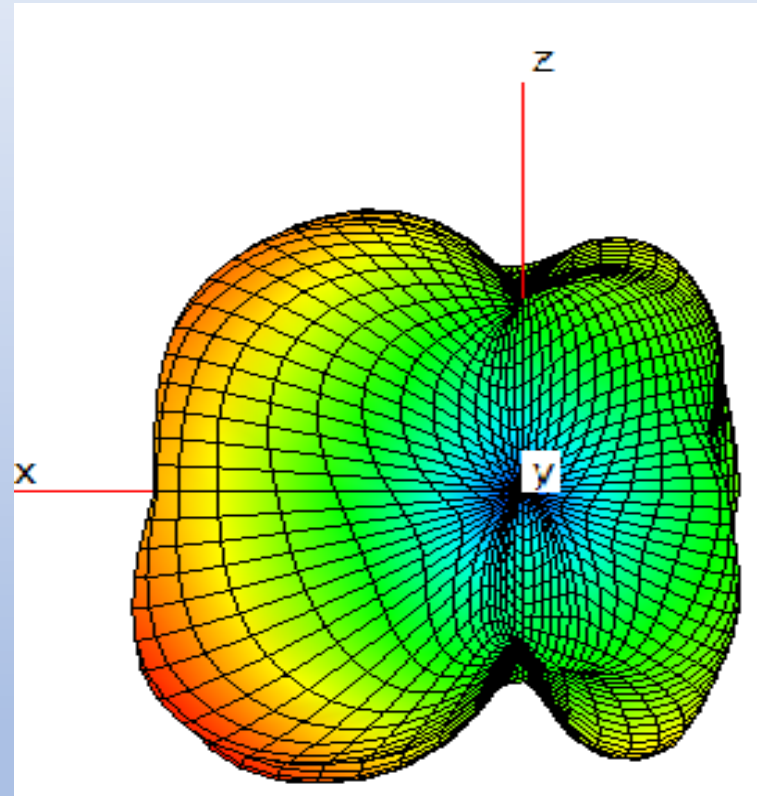
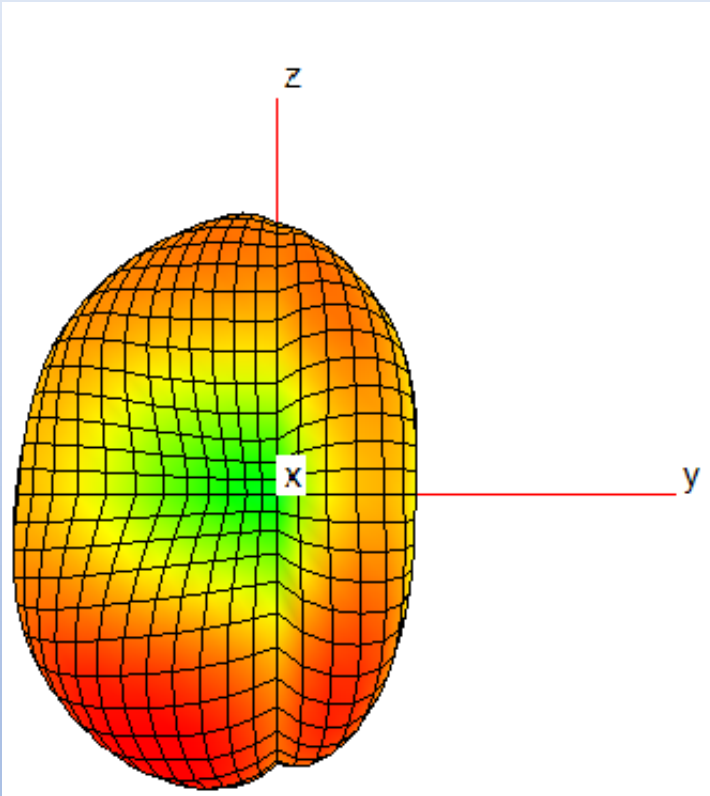

5650MHZ

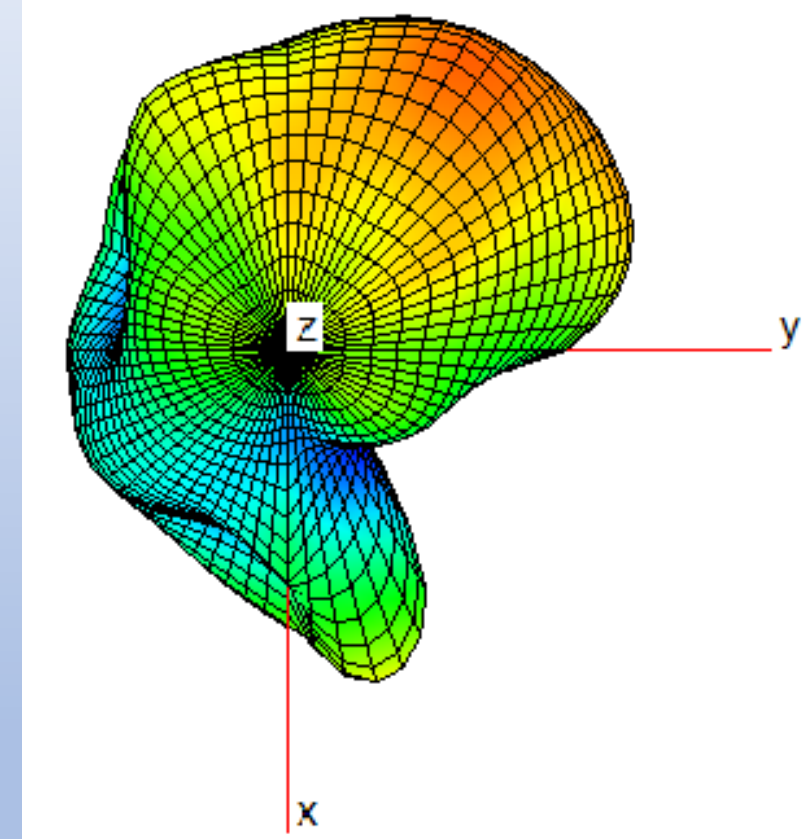
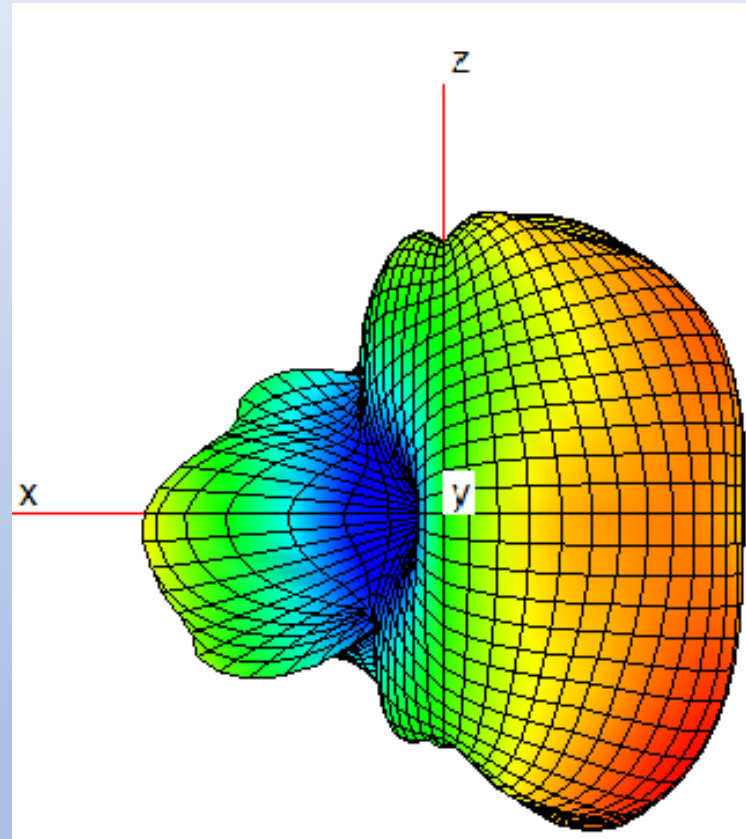
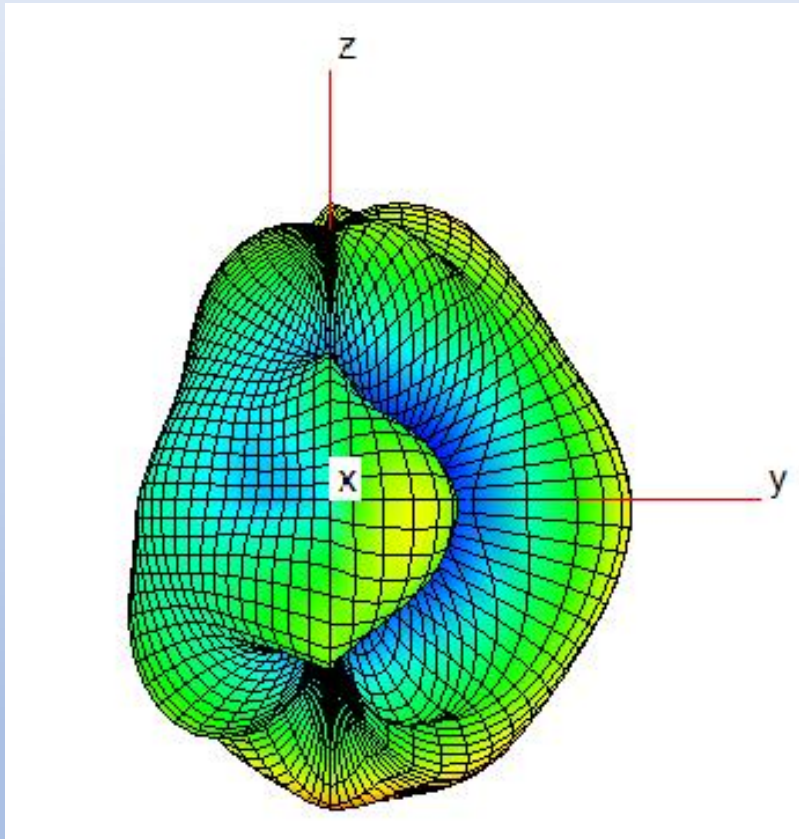

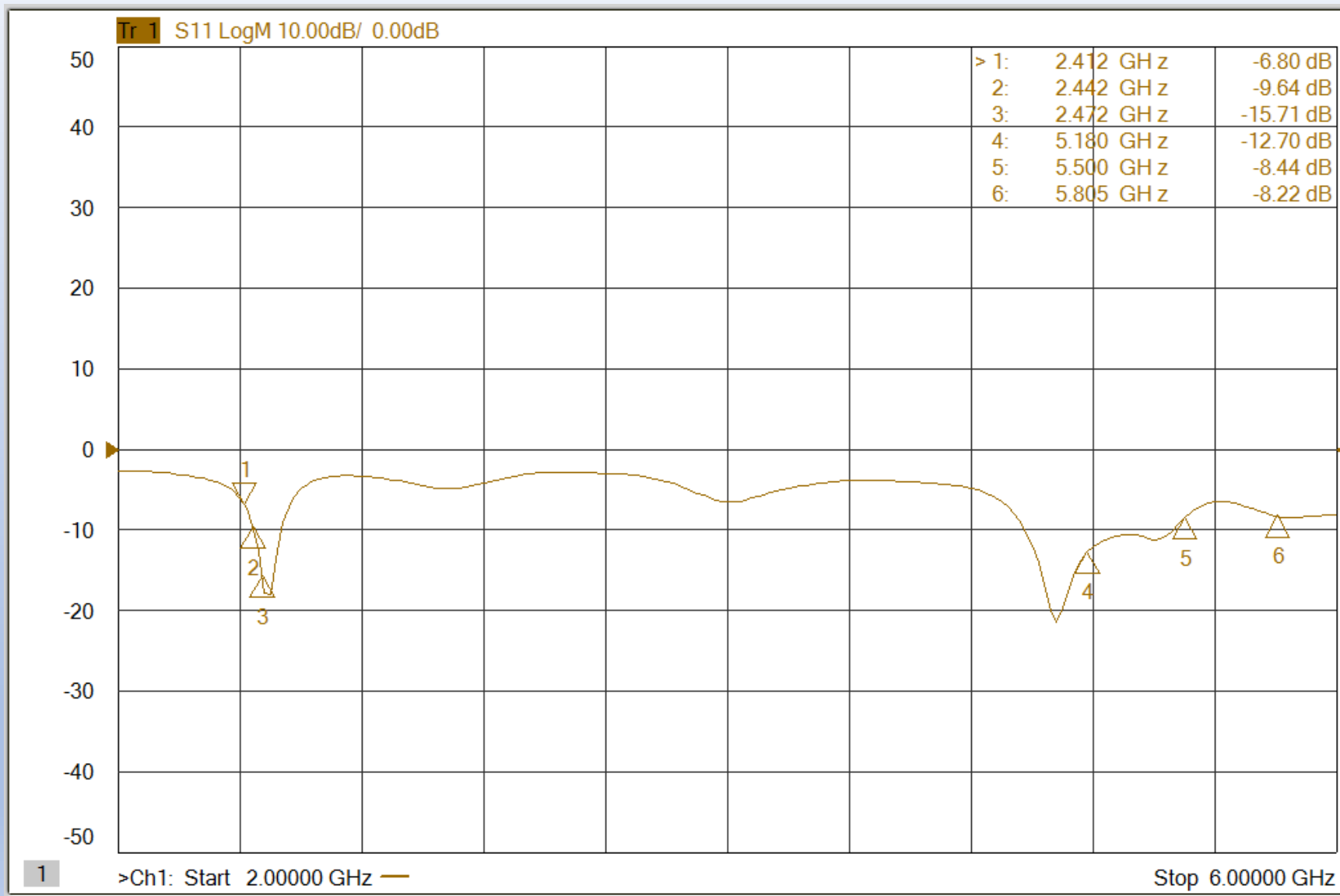

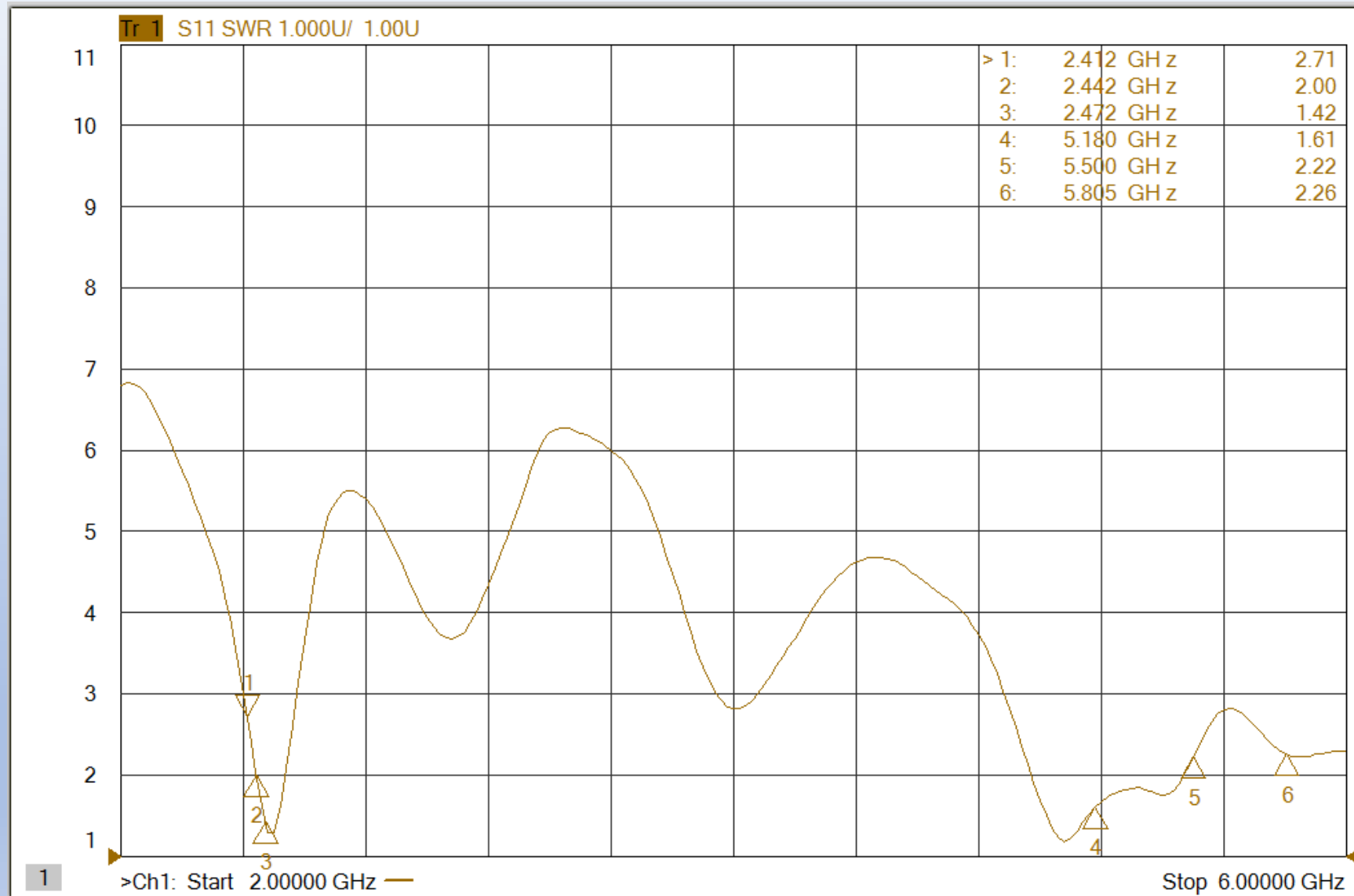



WIFI-1 2.4G			
Freq	EfficiencydB	EfficiencyPcent	Gain
2300	-6.73	21.25	-2.46
2310	-6.65	21.61	-2.25
2320	-6.36	23.12	-1.98
2330	-6.02	24.99	-1.54
2340	-5.77	26.46	-1.31
2350	-5.5	28.21	-1.03
2360	-5.26	29.79	-0.68
2370	-5.03	31.44	-0.58
2380	-4.64	34.33	-0.13
2390	-4.41	36.24	0.08
2400	-4.2	38.01	0.22
2410	-4.01	39.73	0.39
2420	-3.84	41.33	0.56
2430	-3.59	43.73	0.69
2440	-3.38	45.88	0.8
2450	-3.28	46.98	0.79
2460	-3.17	48.16	0.87
2470	-3.11	48.9	0.94
2480	-3	50.11	0.96
2490	-2.92	51.04	0.94
2500	-2.9	51.26	0.93
2510	-2.87	51.69	0.96
2520	-2.89	51.44	0.85
2530	-2.9	51.3	0.81
2540	-2.96	50.63	0.68
2550	-3.07	49.34	0.61
2560	-3.2	47.83	0.41
2570	-3.36	46.13	0.28
2580	-3.6	43.65	-0.08
2590	-3.87	41.06	-0.33
2600	-4.17	38.28	-0.77

WIFI-1 5.8G			
Freq	EfficiencydB	EfficiencyPcent	Gain
5150	-4.82	32.92	-0.81
5175	-4.32	37	-0.11
5200	-3.83	41.41	0.46
5225	-3.5	44.63	0.88
5250	-3.45	45.17	1.07
5275	-3.65	43.18	1.06
5300	-3.73	42.32	1.26
5325	-3.77	41.95	1.16
5350	-3.61	43.5	1.41
5375	-3.43	45.44	1.73
5400	-3.39	45.84	1.73
5425	-3.43	45.41	1.52
5450	-3.58	43.88	1.24
5475	-3.73	42.33	1.12
5500	-3.79	41.8	1.42
5525	-3.65	43.19	1.57
5550	-3.52	44.46	1.95
5575	-3.22	47.67	2.4
5600	-3.05	49.5	2.62
5625	-2.82	52.29	2.98
5650	-2.66	54.22	3.21
5675	-2.69	53.84	3.25
5700	-2.63	54.62	3.37
5725	-2.65	54.38	3.41
5750	-2.58	55.23	3.53
5775	-2.6	54.94	3.43
5800	-2.64	54.47	3.29
5825	-2.71	53.56	3.12
5850	-2.75	53.11	3.1

2450MHZ

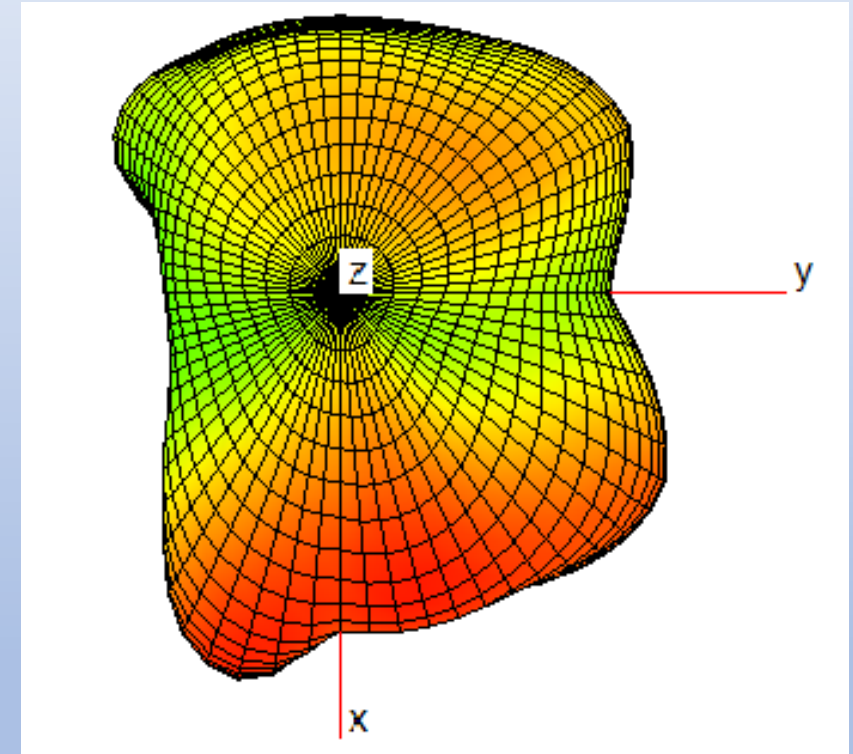
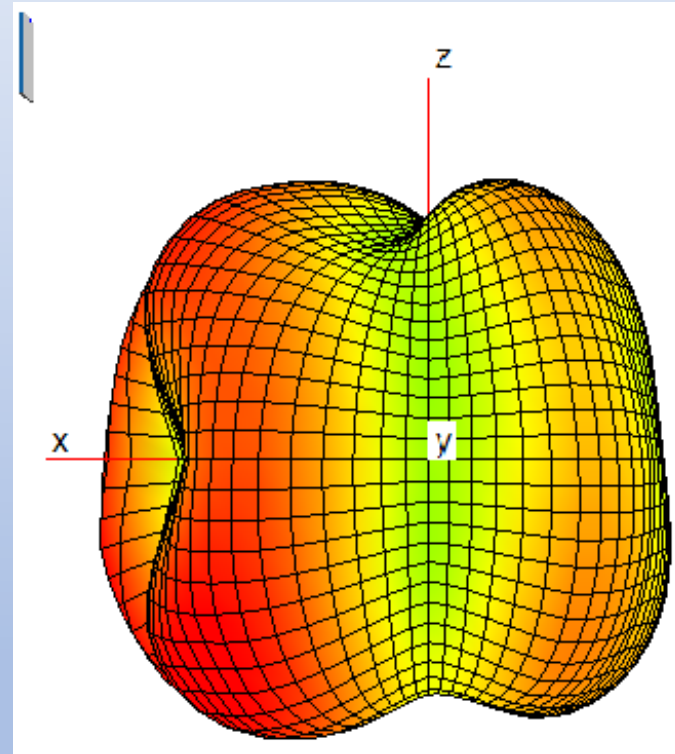
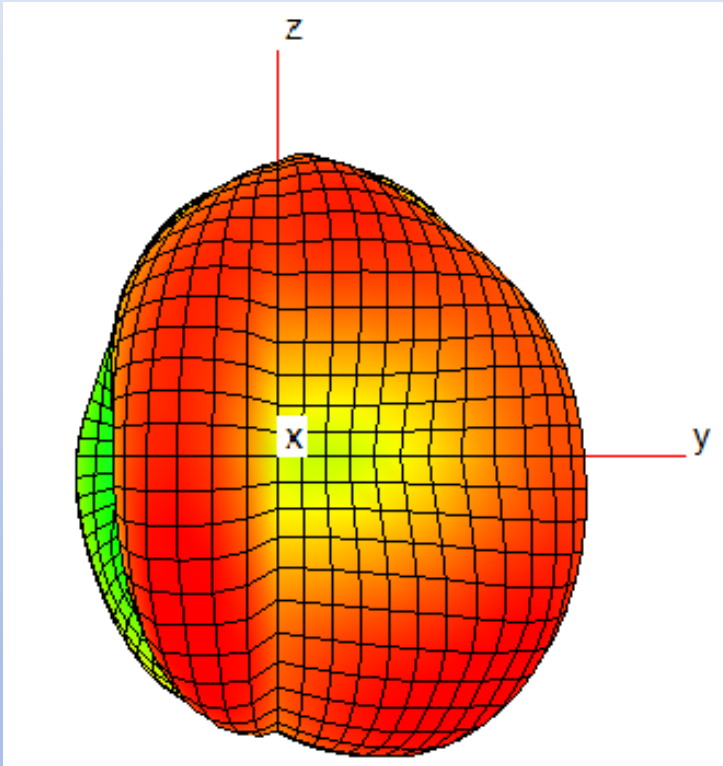

5650MHZ

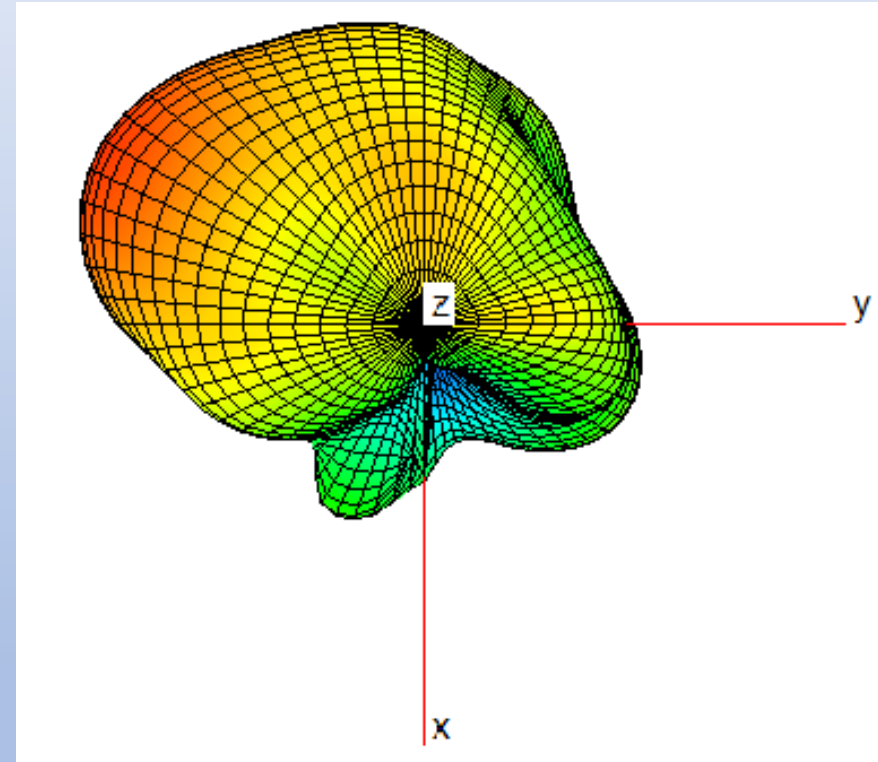
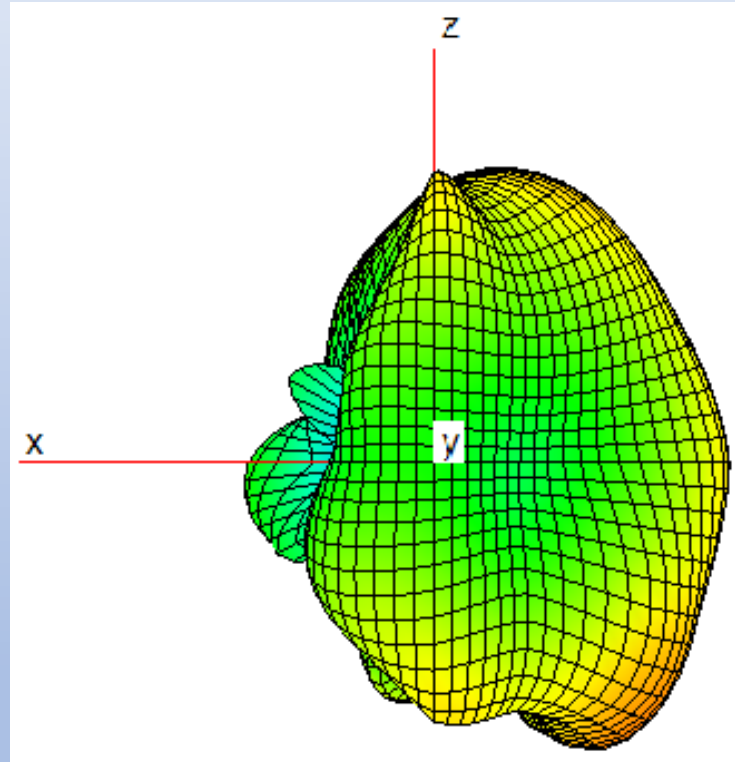
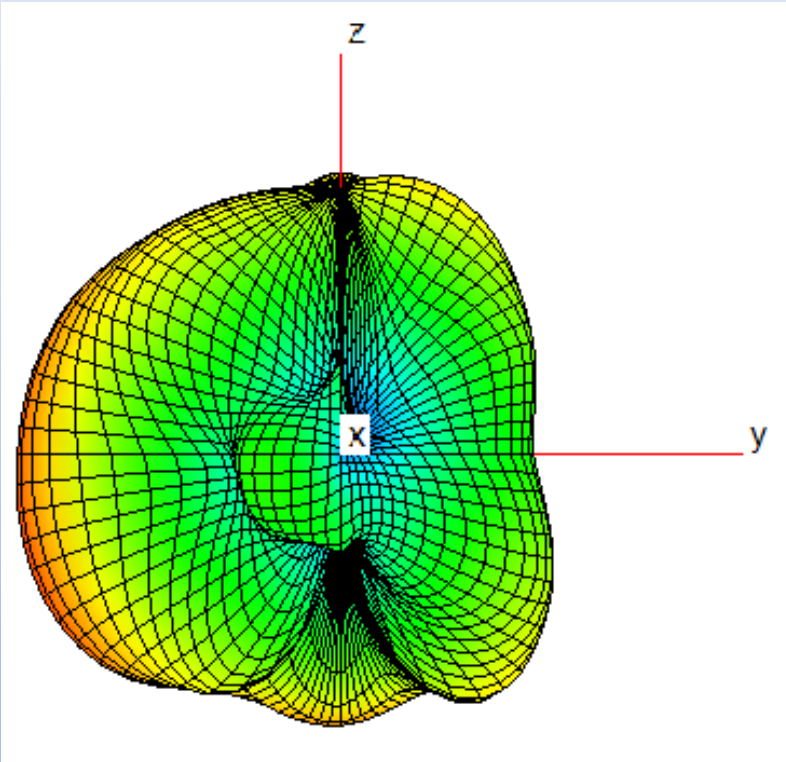

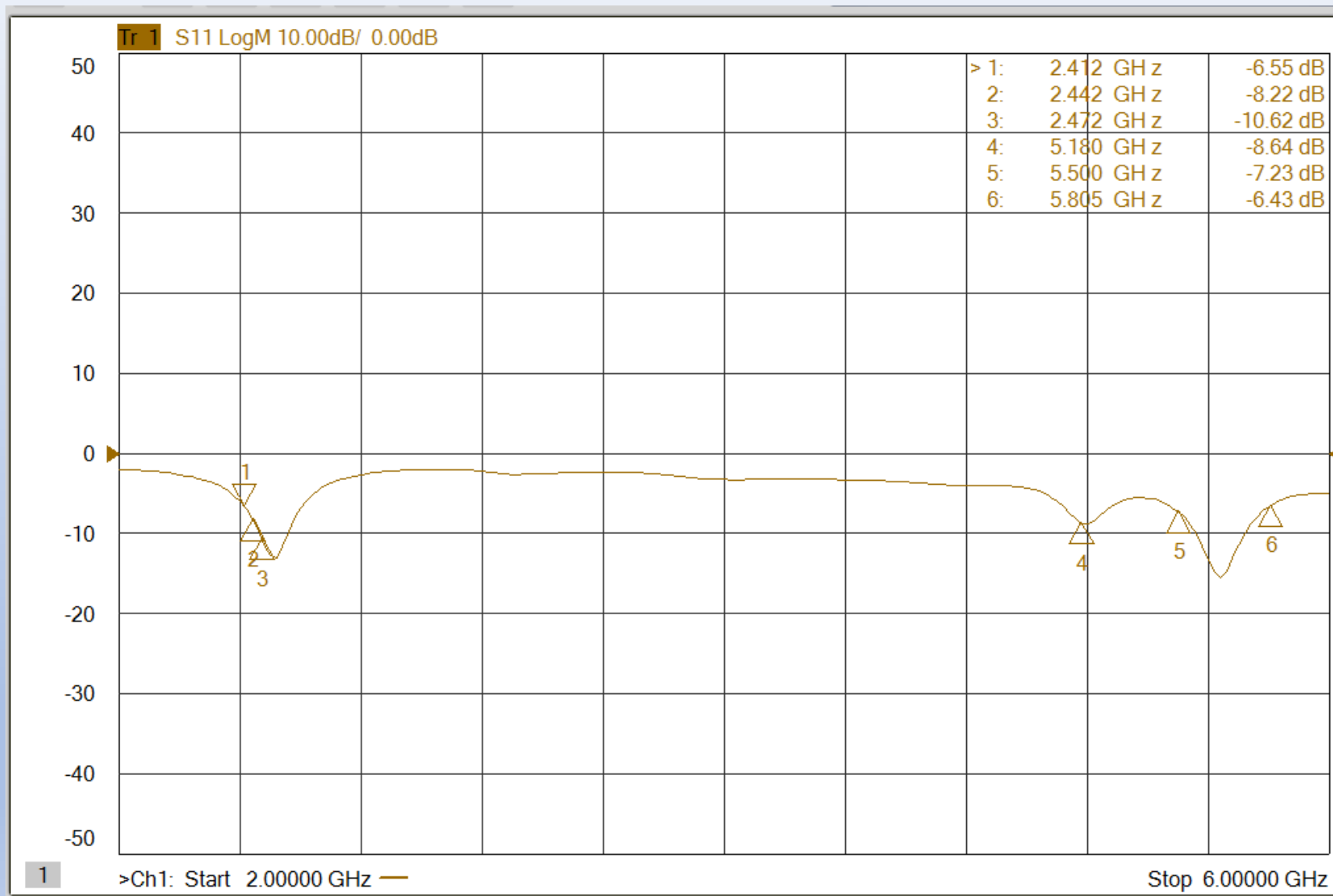

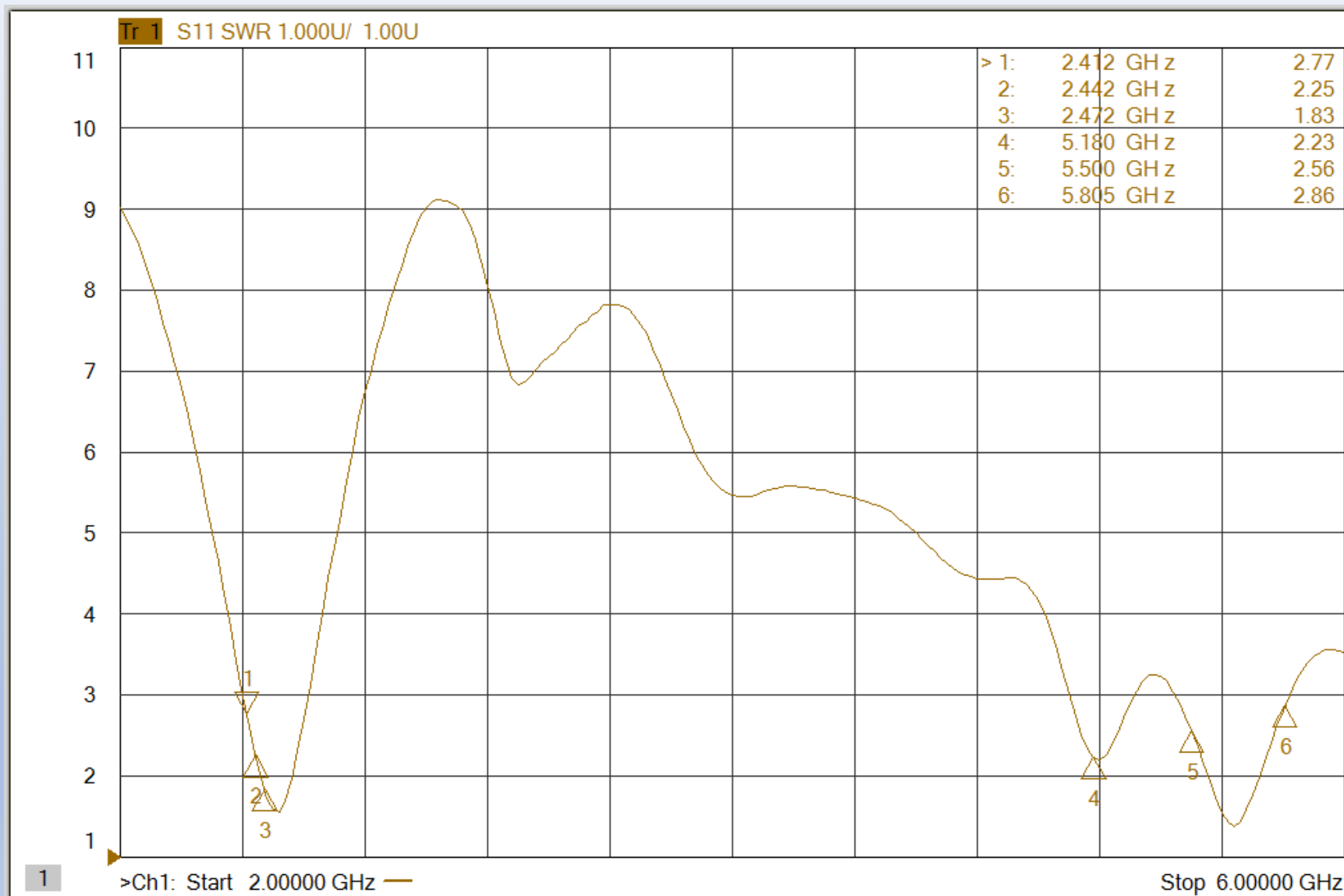



BT			
Freq	EfficiencydB	EfficiencyPcent	Gain
2300	-4.75	33.53	-0.1
2310	-4.47	35.72	0.24
2320	-4.26	37.48	0.42
2330	-3.95	40.31	0.79
2340	-3.63	43.37	1.07
2350	-3.35	46.26	1.31
2360	-2.99	50.19	1.73
2370	-2.8	52.42	1.73
2380	-2.56	55.53	1.98
2390	-2.3	58.87	2.26
2400	-2.09	61.83	2.46
2410	-1.91	64.48	2.73
2420	-1.74	67.02	2.97
2430	-1.68	67.96	3.18
2440	-1.66	68.24	3.32
2450	-1.72	67.23	3.44
2460	-1.86	65.13	3.38
2470	-2.04	62.53	3.27
2480	-2.24	59.66	3.21
2490	-2.5	56.18	2.96
2500	-2.79	52.57	2.78
2510	-3.07	49.33	2.51
2520	-3.39	45.78	2.19
2530	-3.7	42.69	1.92
2540	-3.99	39.94	1.63
2550	-4.35	36.73	1.23
2560	-4.69	33.96	0.77
2570	-5.05	31.29	0.47
2580	-5.45	28.54	-0.08
2590	-5.8	26.32	-0.55
2600	-6.21	23.91	-0.93

2450MHZ

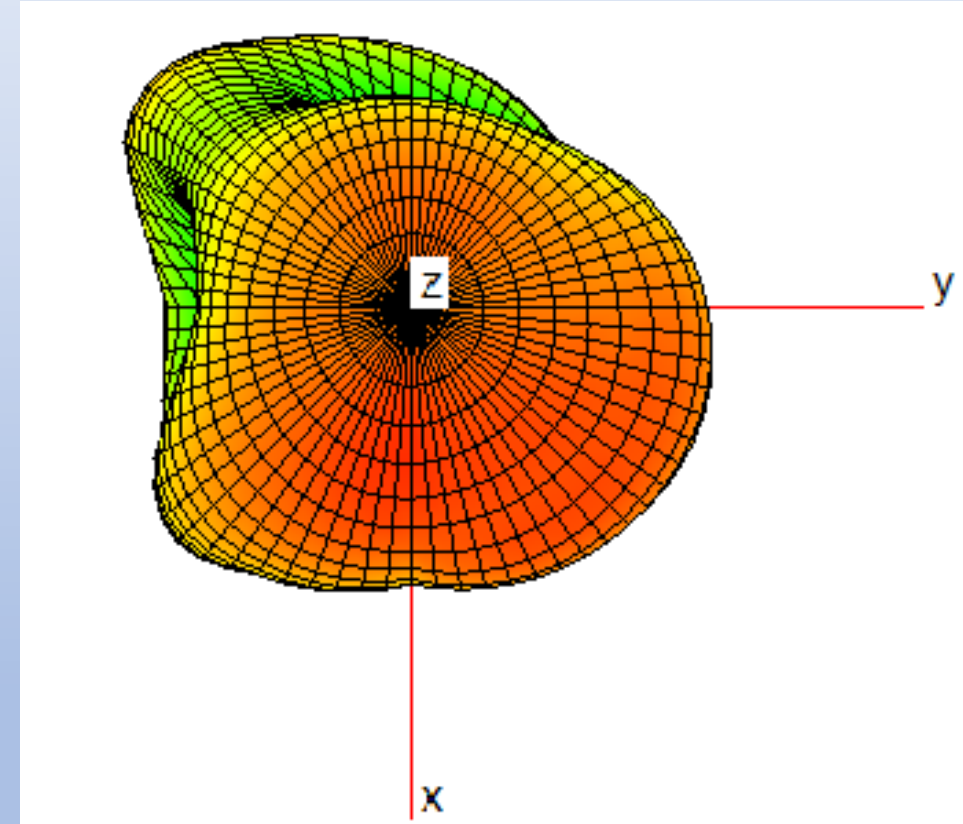
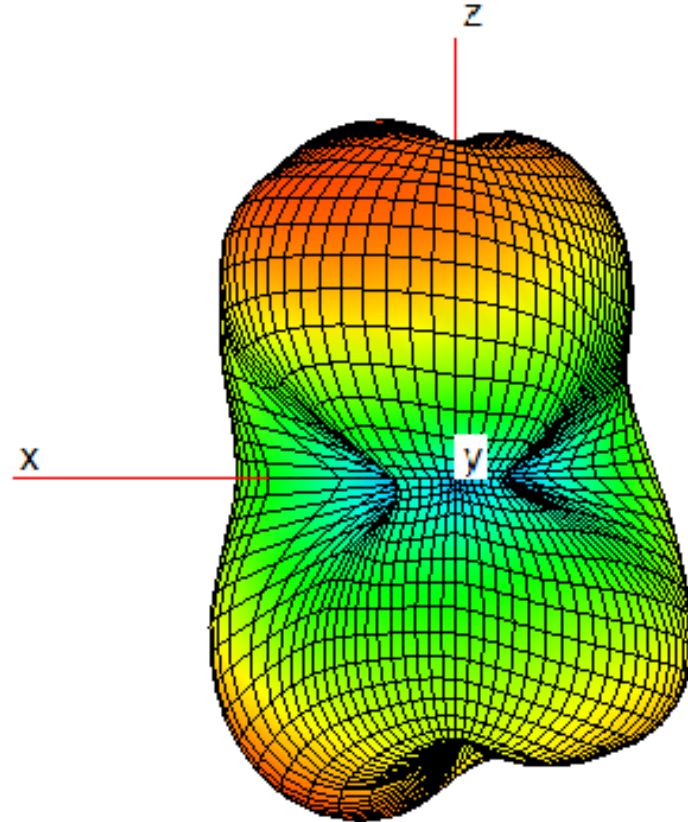
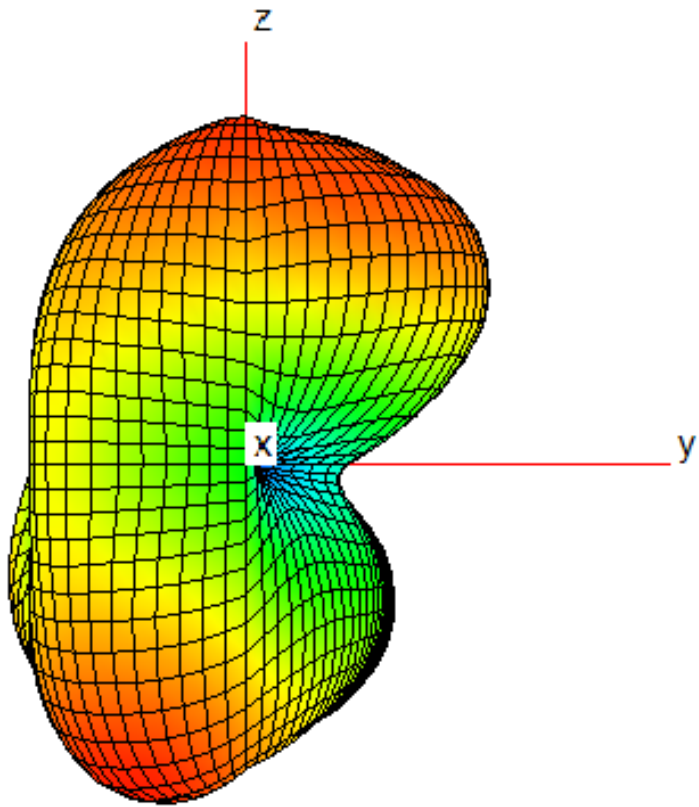

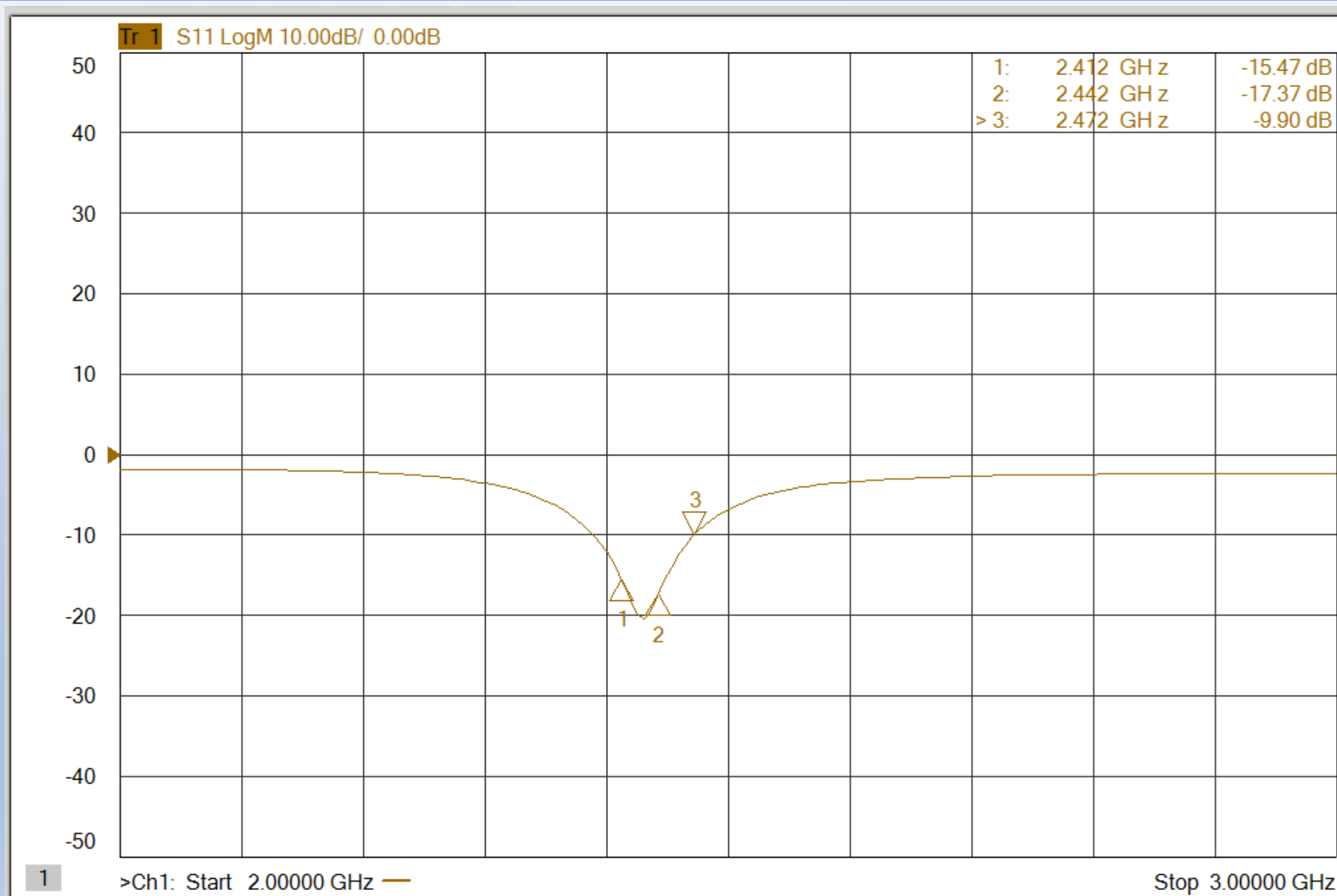

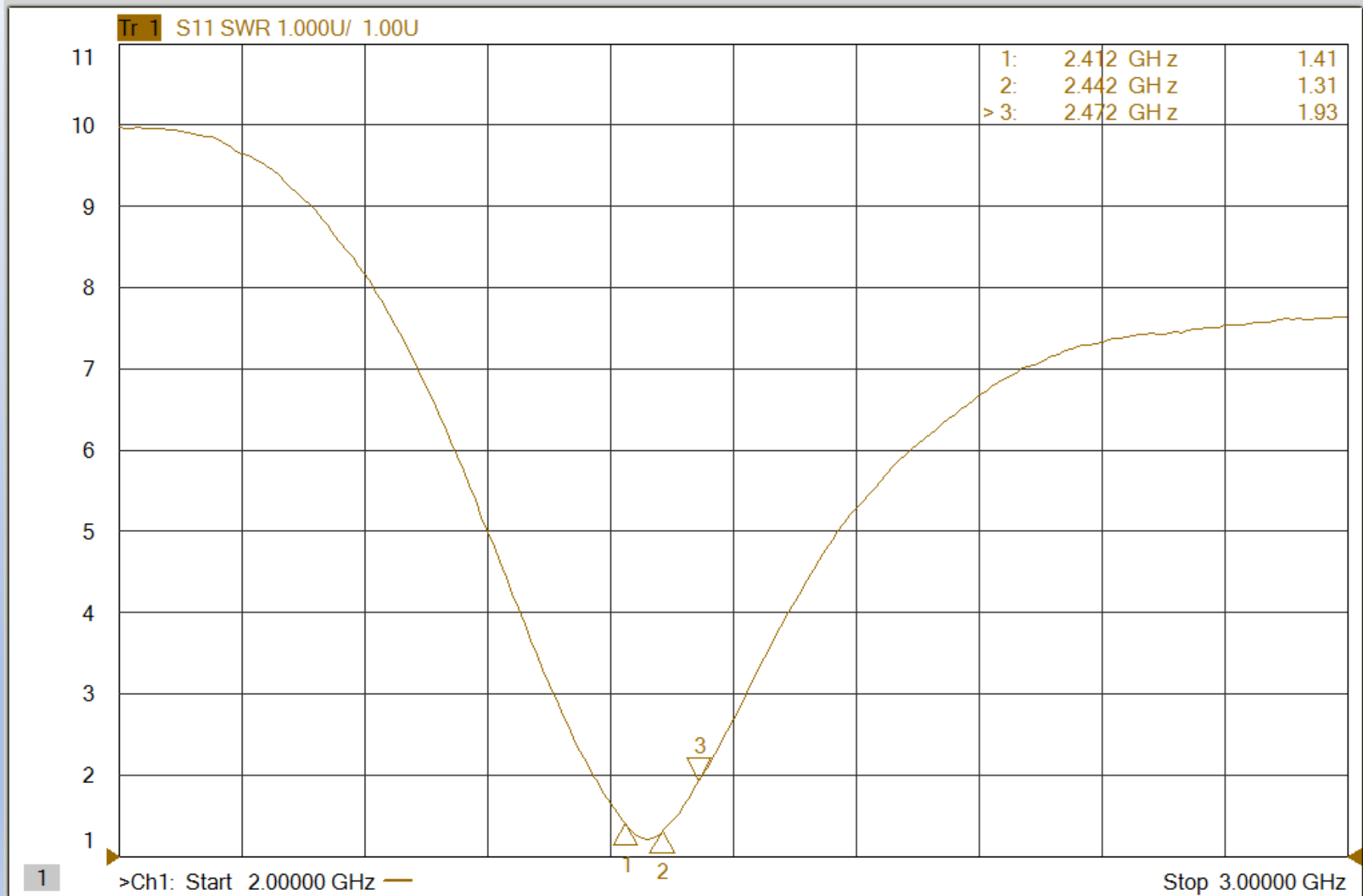

WIFI-0-Tr 1 S11 WIFI-1-Tr 2 S22 BT-Tr 3 S33

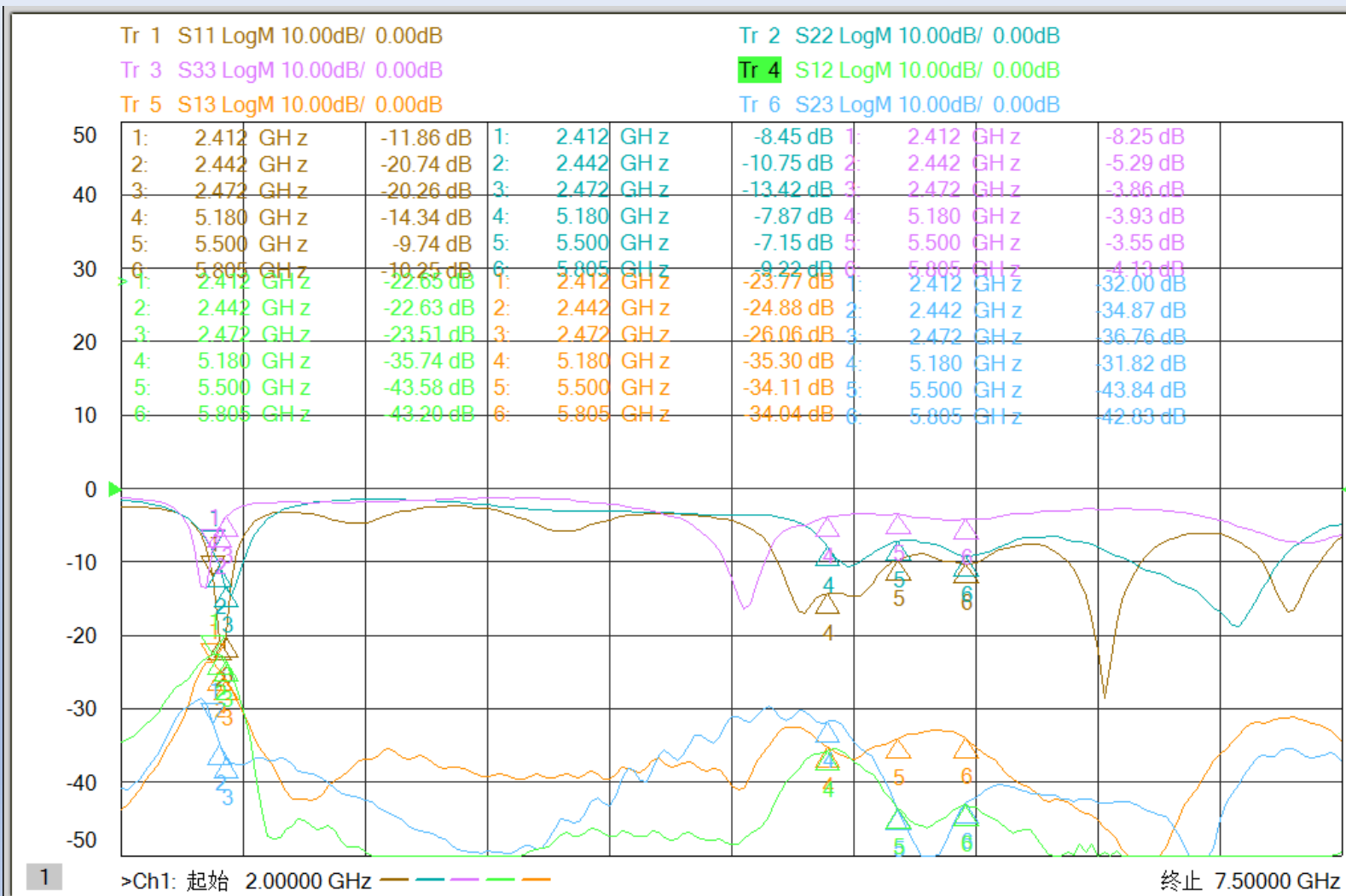



深圳汉阳天线设计有限公司

SHENZHEN HANYANG ANTENNA DESIGN CO., LTD.

5G

Welcome calls consultations, negotiations and guidance come!

Thank you

地址：深圳市宝安区前进路宝运达物流信息大厦12A层。

电话：0755-23069700

汉阳天线 版权所有 Copyright ©2014-2024 Shenzhen Hanyang Antenna Design Co., Ltd. All rights reserved.