

SPECIFICATION

SHEET FOR APPROVAL

(Revision: R: A1)

CUSTOMER(客户名称)	高盛达	
CS P/N(客户机种)	WCT5J-20 (黑线)	
PART NAME(品名)	PIFA antenna	L=201mm
FREQUENCY(频率)	2.4G~2.5G / 5.15G~5.85G	
ZTX NO.(物料编号)	2.00004301	
DATE(日期)	2020-02-26	

Connector type:IPEX connector

CUSTOMER			
QA CHECKED	ME CHECKED	RF CHECKED	MANAGER CHECKED

Remark(备注):

Sign(客户确认签字盖章): _____

ZHONG TIAN XUN TECHNOLOGY CO., LTD				
MANAGER CHECKED	MANAGER CHECKED	ME CHECKED	RF CHECKED	LISTER
		邹一麟	刘蒋军	



深圳市中天迅通信技术股份有限公司

SHENZHEN ZHONGTIAN XUN Communication Technology Co.,Ltd.

地址: 深圳市宝安区石岩镇石龙大道 34 号(腾达工业园) 邮编: 518000

Address: No. 34, Shilong Avenue, Shiyan Town, Bao'an District, Shenzhen
(Tengda Industrial Park)

电话: 0755-27588320

传真: 0755-27588045

<http://www.chinaztx.com>

ANTENNA SPECIFICATION

CUS P/N :WCT5J-20 (黑线) WIFI 天线
ZTX P/N :WCT5J-20 (黑线) WIFI 天线

ApplicationDate:Feb.26,2020
Editor:

Rev: R:A1
Page 1 of 9

Revision history

版本	日期	状态
A1	2020-02-26	首版



ANTENNA SPECIFICATION

CUS P/N :WCT5J-20 (黑线) WIFI 天线
ZTX P/N :WCT5J-20 (黑线) WIFI 天线

ApplicationDate:Feb.26,2020
Editor:

Rev: R:A1
Page 2 of 9

Index

		Revision history	1
		Index	2
1		Mechanical Specification	3
	1-1	Mechanical Specification (WIFI 组件)	3
2		Test equipment	4
3		Antenna test data	5
	3-1	VSWR	5
	3-2	Matching circuit	5
	3-3	No-source test data	5
	3-4	Environment treatment	6
	3-5	产品实物图片	6
4		Environment Characteristic	7
5		Material list	7
6		The packing way	8
		附页： 出货标签模板	9



ANTENNA SPECIFICATION

CUS P/N :WCT5J-20 (黑线) WIFI 天线
ZTX P/N :WCT5J-20 (黑线) WIFI 天线

ApplicationDate:Feb.26,2020
Editor:

Rev: R:A1
Page 3 of 9

1. Mechanical Specification

1-1 Mechanical Configuration (WIFI 组件)

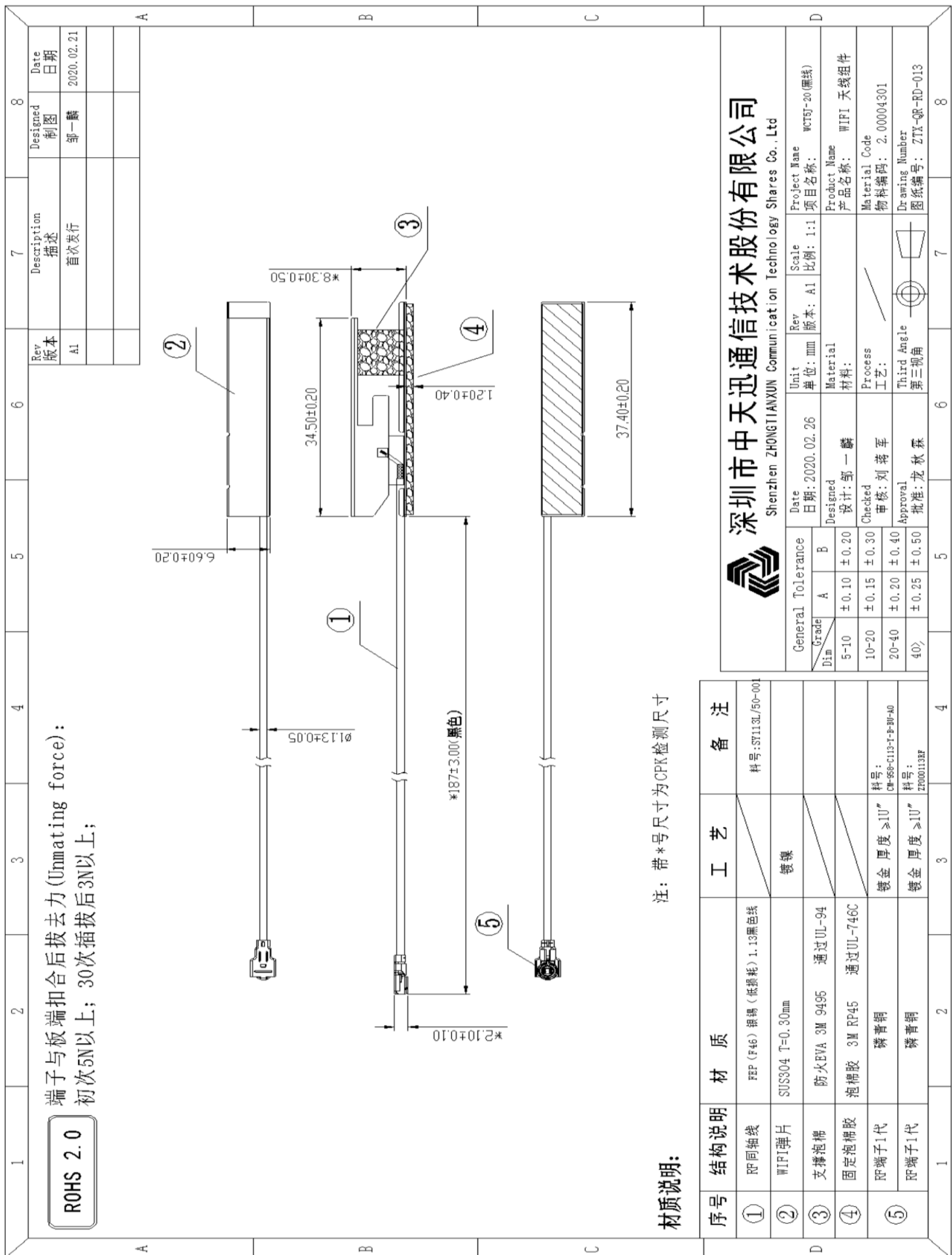

ANTENNA SPECIFICATION

CUS P/N :WCT5J-20 (黑线) WIFI 天线
ZTX P/N :WCT5J-20 (黑线) WIFI 天线

ApplicationDate:Feb.26,2020
Editor:

Rev: R:A1
Page 4 of 9

2. Test equipment

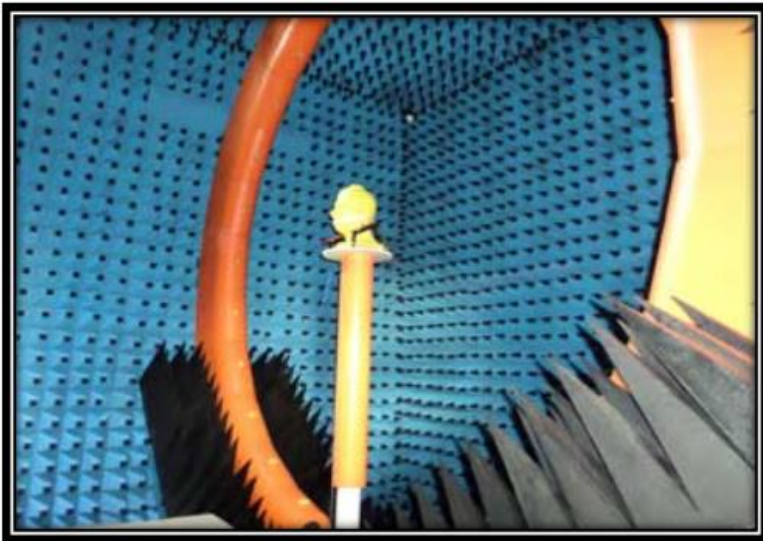

Owned 6 microwave dark room, equipped 2 sets world leading France Satimo SG24 OTA certification test systems (one in SHENZHEN, another one in Shanghai), ETS OTA Standard test system, Blue test reverberation test system which is High repeatability, high accuracy and high resolution. It can quickly provide accurate test reports, fully meet the CITA standards.

Testing range:

Support active, passive testing of
GSM/CDMA/WCDMA/TD-
SCDMA/LTE/WIFI/WLAN/WiMax/BT
/GPS/MIMO/UWB within0.4-6G.

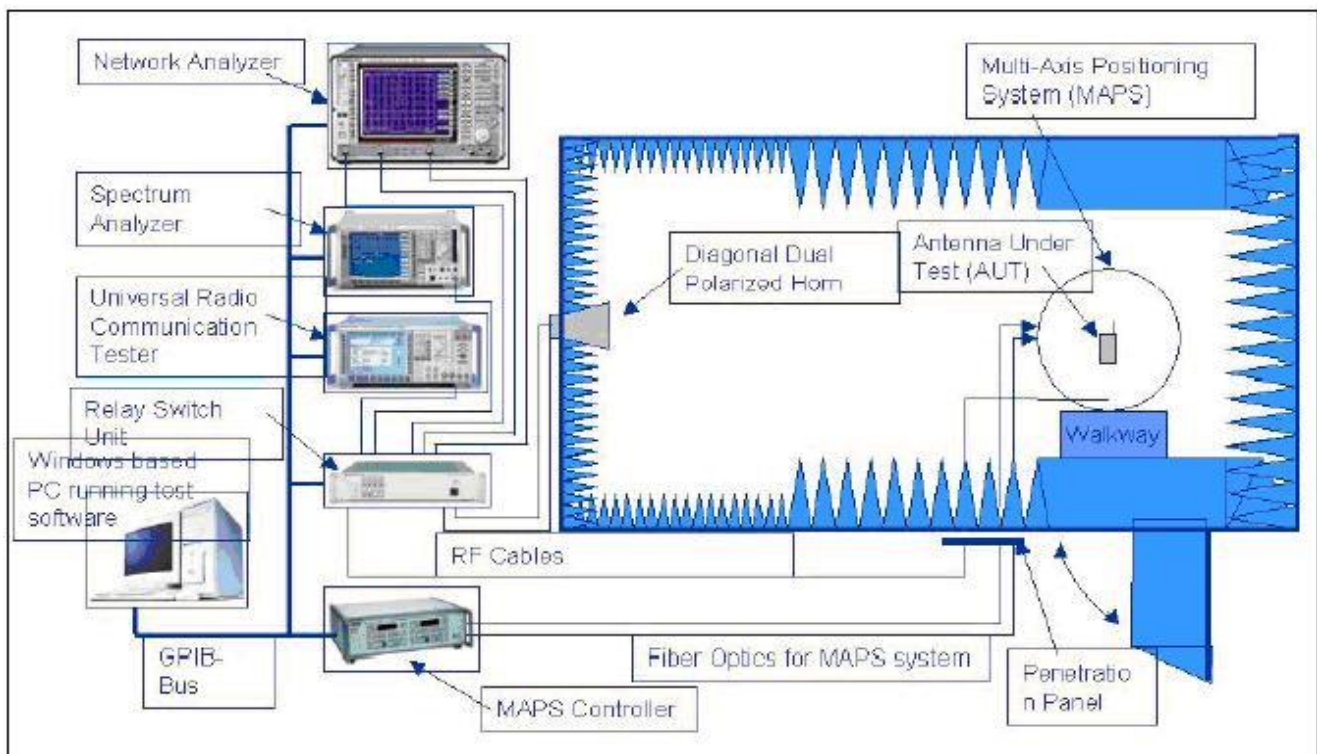

ANTENNA SPECIFICATION

CUS P/N :WCT5J-20 (黑线) WIFI 天线
ZTX P/N :WCT5J-20 (黑线) WIFI 天线

ApplicationDate:Feb.26,2020
Editor:

Rev: R:A1
Page 5 of 9

3. Antenna test data

3-1 VSWR

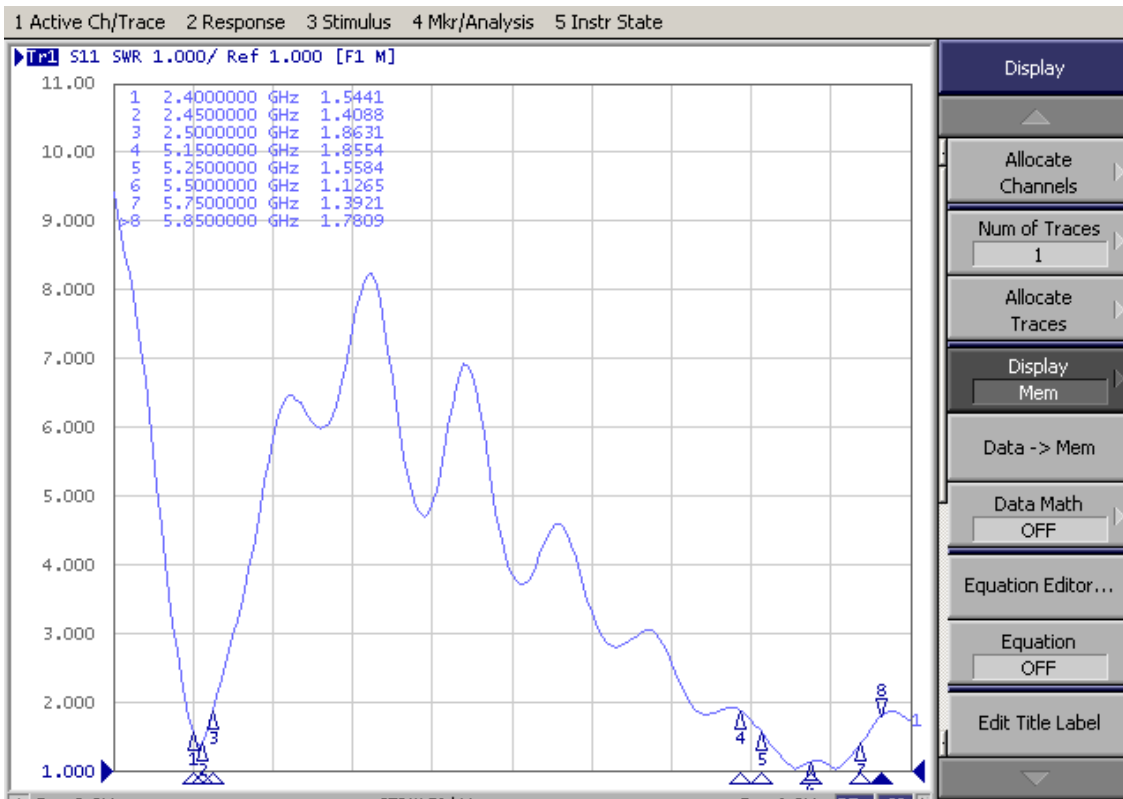

3-2 Matching circuit

N/A

3-3 No-source test data

Frequency(GHz)	2.45	5.15	5.5	5.85
Line Loss(dB/m)	2.85	4.1	4.2	4.3
Line Loss(200mm)	0.57dB	0.82dB	0.84dB	0.86dB

Frequency	Peak Gain	Efficiency	
		%	dB
Mhz	dB		
2400	2.65	71.73	-1.44
2410	2.28	73.51	-1.34
2420	2.62	68.78	-1.63
2430	2.70	70.19	-1.54
2440	2.88	73.16	-1.36
2450	2.82	71.98	-1.43
2460	2.63	69.43	-1.58
2470	2.60	68.77	-1.63

ANTENNA SPECIFICATION

CUS P/N :WCT5J-20 (黑线) WIFI 天线
ZTX P/N :WCT5J-20 (黑线) WIFI 天线

ApplicationDate:Feb.26,2020
Editor:

Rev: R:A1
Page 6 of 9

2480	2.73	67.92	-1.68
2490	2.81	69.39	-1.59
2500	2.73	68.52	-1.64
5150	3.67	65.82	-1.82
5200	3.89	69.19	-1.60
5250	3.89	69.17	-1.60
5300	3.75	71.06	-1.48
5350	3.61	69.55	-1.58
5400	3.49	72.74	-1.38
5450	3.77	69.12	-1.60
5500	3.72	69.20	-1.60
5550	3.70	67.78	-1.69
5600	3.72	68.96	-1.61
5650	3.47	68.96	-1.61
5700	3.47	70.48	-1.52
5750	3.86	69.22	-1.60
5800	3.87	69.38	-1.59
5850	3.86	70.34	-1.53

3-4 Environment treatment

N/A

3-5 产品实物图片

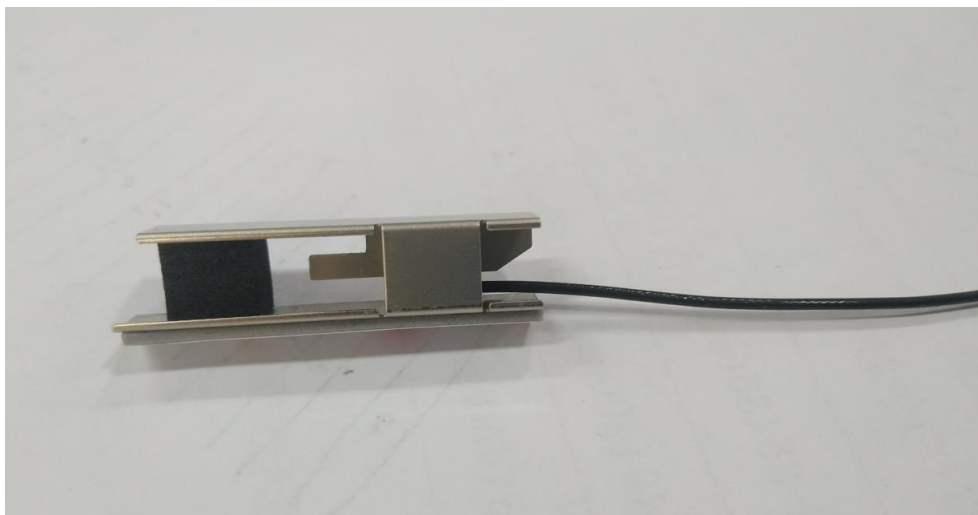

ANTENNA SPECIFICATION

CUS P/N :WCT5J-20 (黑线) WIFI 天线
ZTX P/N :WCT5J-20 (黑线) WIFI 天线









ApplicationDate:Feb.26,2020
Editor:

Rev: R:A1
Page 7 of 9

4. Environment Characteristic

NO.	ITEM	TEST CONDITION	SPECIFICATION
4-1	High Temperature/Humidity Storage Test(non operating)	1.Temperature: +80 ±2°C 2.Humidity: 90~95%RH 3.Time: 48hrs	No material deformation is allowed.
4-2	Low Temperature/Humidity Storage Test(non operating)	1.Temperature: -30±2°C 2.Humidity: 0%RH 3.Time: 48hrs	The VSWR, Gain, Radiation Pattern must be met specifications after these test.

5. Material list

序号	材料(原料)名称	第三方公证化学报告测试编号	第三方公证化学报告测试单位	第三方公证化学报告测试日期	状态	文档
1	SUS304	SZXEC1901037403	SGS	2019-05-22	有效	 SUS304 SZXEC1901037403
2	EVA 泡棉	SZXEC1900416304	SGS	2019-03-13	有效	 ROH2.0英文 SZXEC1900416304
3	3M 9448A	SHAEC1927934601	SGS	2019-12-20	有效	 93010LE(93005L E,93010LE,93015
4	RF 端子 1 代	CANEC1907229906	SGS	2019-05-06	有效	 紫金C5210中文 CANEC19072299
		A2190318223101001E	CTI	2019-11-25	有效	 镀镍层中英文版 A2190318223101
		A2190318585101001E	CTI	2019-11-25	有效	 金镀层中英文版 A2190318585101
		CE-2019-82288	SGS	2019-08-21	有效	 PBT 黑 CE-2019-82288 z
5	镀锡铜线	A2190138284101E	CTI	2019-06-06	有效	 镀锡铜线 A21901 38284101E 2019
		SHAEC1904071101	SGS	2019-03-13	有效	 FEP-BLACK SHAEC190407111





ANTENNA SPECIFICATION

CUS P/N :WCT5J-20 (黑线) WIFI 天线
ZTX P/N :WCT5J-20 (黑线) WIFI 天线

ApplicationDate:Feb.26,2020
Editor:

Rev: R:A1
Page 8 of 9

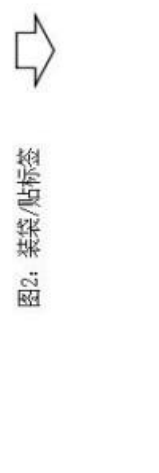
6.The packing way

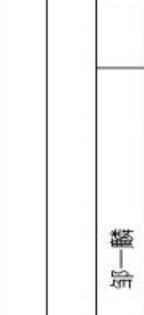
深圳市中天迅通信股份有限公司 SHENZHEN ZHONGTIAN XUN Communication Technology Co.,Ltd.		包装规范			文件编号	版本	工序号/名称	工序工时	日产量																																				
产品名称	WIFI天线	产品型号	WCT5J-20	ZTX-QD-WI-	A1	包装/装箱	/	/																																					
<p>作业方法 (自检验工序作业合格后,方能流入下一道工序)</p> <ol style="list-style-type: none"> 每40pcs产品整齐、橡皮筋包扎,用PE开口胶袋包装,贴小标签,填写产品名称、物料号、数量、周期等信息; 将独立包装好的产品,每9袋(360PCS)装入(36*28cm)PE封口胶袋中,贴标签,填写产品名称、物料号、数量、周期等信息; 装箱,纸箱规格(38*26*9cm)每小箱装1袋+尾数4PCS(364pcs),贴标签,填写产品名称、物料号、数量、周期等信息; 装箱,纸箱规格(45*32.5*42cm)每大箱装5小箱(1820pcs)尾数除外; 外箱的右上角贴现品票,标签内容包括(物料名称,Box ID,物料编码,数量,生产日期,供应名称,供应商代码,原产地,批次/Bin值,二维码等)不可有漏写,写错现象; 箱子用胶纸以“工”字型封箱。 																																													
<p>图1: 确认数量/橡皮筋包扎/贴标签</p>  <p>图2: 装袋/贴标签</p> 																																													
<p>图3: 装箱/贴标签</p> 																																													
<p>图4: 贴现品票/封箱</p> 																																													
<table border="1"> <thead> <tr> <th>物料名称</th> <th>物料编码</th> <th>用量</th> <th>使用工具</th> </tr> </thead> <tbody> <tr> <td>PE开口袋</td> <td></td> <td>50</td> <td>240*160mm</td> </tr> <tr> <td>PE封口袋</td> <td></td> <td>5</td> <td>360*280mm</td> </tr> <tr> <td>橡皮筋</td> <td></td> <td>50</td> <td></td> </tr> <tr> <td>纸箱</td> <td></td> <td>5</td> <td>38*26*9cm</td> </tr> <tr> <td>纸箱</td> <td></td> <td>1</td> <td>45*32.5*42cm</td> </tr> <tr> <td>标签</td> <td></td> <td></td> <td></td> </tr> </tbody> </table>										物料名称	物料编码	用量	使用工具	PE开口袋		50	240*160mm	PE封口袋		5	360*280mm	橡皮筋		50		纸箱		5	38*26*9cm	纸箱		1	45*32.5*42cm	标签											
物料名称	物料编码	用量	使用工具																																										
PE开口袋		50	240*160mm																																										
PE封口袋		5	360*280mm																																										
橡皮筋		50																																											
纸箱		5	38*26*9cm																																										
纸箱		1	45*32.5*42cm																																										
标签																																													
<table border="1"> <thead> <tr> <th colspan="2">修订内容</th> <th>修订日期</th> <th>修订人</th> </tr> </thead> <tbody> <tr> <td>版本</td> <td></td> <td></td> <td></td> </tr> <tr> <td>制订</td> <td>邹一麟</td> <td></td> <td></td> </tr> <tr> <td></td> <td>审核</td> <td></td> <td></td> </tr> <tr> <td></td> <td>易爱玲</td> <td></td> <td></td> </tr> <tr> <td></td> <td>品质确认</td> <td></td> <td></td> </tr> <tr> <td></td> <td>胡善梅</td> <td></td> <td></td> </tr> <tr> <td></td> <td>批准</td> <td></td> <td></td> </tr> <tr> <td></td> <td>龙秋霖</td> <td></td> <td></td> </tr> </tbody> </table>										修订内容		修订日期	修订人	版本				制订	邹一麟				审核				易爱玲				品质确认				胡善梅				批准				龙秋霖		
修订内容		修订日期	修订人																																										
版本																																													
制订	邹一麟																																												
	审核																																												
	易爱玲																																												
	品质确认																																												
	胡善梅																																												
	批准																																												
	龙秋霖																																												

ANTENNA SPECIFICATION

CUS P/N :WCT5J-20 (黑线) WIFI 天线

ApplicationDate:Feb.26,2020

Rev: R:A1

ZTX P/N :WCT5J-20 (黑线) WIFI 天线

Editor:

Page 9 of 9

附页：出货标签模板

N/A



深圳市中天迅通信技术股份有限公司

SHENZHEN ZHONGTIAN XUN Communication Technology Co.,Ltd.