



**CFR 47 FCC PART 15 SUBPART E
ISED RSS-247 ISSUE 2**

TEST REPORT

For

WIFI+BT Module

MODEL NUMBER: WCT5JM2611

FCC ID: 2AC23- WCT5J

IC: 12290A- WCT5J

REPORT NUMBER: 4789403417-3

ISSUE DATE: March 31, 2020

Prepared for

**Hui Zhou Gaoshengda Technology Co.,LTD
NO.75 Zhongkai Development Area Huizhou, Guangdong China**

Prepared by

**UL Verification Services (Guangzhou) Co., Ltd, Song Shan Lake Branch
Building 10, Innovation Technology Park, No. 1, Li Bin Road, Song Shan Lake
Hi-Tech Development Zone Dongguan, People's Republic of China**

Tel: +86 769 22038881

Fax: +86 769 33244054

Website: www.ul.com



Revision History

<u>Rev.</u>	<u>Issue Date</u>	<u>Revisions</u>	<u>Revised By</u>
V0	3/31/2020	Initial Issue	



Summary of Test Results			
Clause	Test Items	FCC/IC Rules	Test Results
1	6dB/26dB Bandwidth	FCC 15.407 (a)&(e) RSS-247 Clause 6.2	PASS
2	99% Occupied Bandwidth	RSS-Gen Clause 6.7	PASS
3	Maximum Conducted Output Power	FCC 15.407 (a) RSS-247 Clause 6.2	PASS
4	Power Spectral Density	FCC 15.407 (a) RSS-247 Clause 6.2	PASS
5	Radiated Bandedge and Spurious Emission	FCC 15.407 (b) FCC 15.209 FCC 15.205 RSS-247 Clause 6.2 RSS-GEN Clause 8.9	PASS
6	Conducted Emission Test For AC Power Port	FCC 15.207 RSS-GEN Clause 8.8	PASS
7	Frequency Stability	FCC 15.407 (g)	PASS
8	Antenna Requirement	FCC 15.203 RSS-GEN Clause 8.3	PASS
Note: This test report is only published to and used by the applicant, and it is not for evidence purpose in China.			



TABLE OF CONTENTS

1. ATTESTATION OF TEST RESULTS	6
2. TEST METHODOLOGY	7
3. FACILITIES AND ACCREDITATION	7
4. CALIBRATION AND UNCERTAINTY	8
4.1. <i>MEASURING INSTRUMENT CALIBRATION</i>	<i>8</i>
4.2. <i>MEASUREMENT UNCERTAINTY.....</i>	<i>8</i>
5. EQUIPMENT UNDER TEST	9
5.1. <i>DESCRIPTION OF EUT</i>	<i>9</i>
5.2. <i>MAXIMUM EIRP</i>	<i>9</i>
5.3. <i>CHANNEL LIST.....</i>	<i>10</i>
5.4. <i>THE WORSE CASE POWER SETTING PARAMETER.....</i>	<i>11</i>
5.5. <i>THE WORSE CASE CONFIGURATIONS</i>	<i>12</i>
5.6. <i>DESCRIPTION OF AVAILABLE ANTENNAS</i>	<i>13</i>
5.7. <i>DESCRIPTION OF TEST SETUP.....</i>	<i>14</i>
6. MEASURING INSTRUMENT AND SOFTWARE USED	15
7. ANTENNA PORT TEST RESULTS	17
7.1. <i>ON TIME AND DUTY CYCLE.....</i>	<i>17</i>
7.2. <i>6/26/99% dB BANDWIDTH.....</i>	<i>19</i>
7.2.1. <i>802.11a 20 MODE</i>	<i>21</i>
7.2.2. <i>802.11n HT20 MODE</i>	<i>24</i>
7.2.3. <i>802.11n HT40 MODE</i>	<i>27</i>
7.2.4. <i>802.11ac VHT80 MODE</i>	<i>30</i>
7.3. <i>MAXIMUM CONDUCTED OUTPUT POWER.....</i>	<i>32</i>
7.3.1. <i>UNII-1 BAND</i>	<i>33</i>
7.3.2. <i>UNII-3 BAND</i>	<i>34</i>
7.4. <i>POWER SPECTRAL DENSITY.....</i>	<i>35</i>
7.4.1. <i>802.11a 20 MODE</i>	<i>37</i>
7.4.2. <i>802.11n HT20 MODE</i>	<i>39</i>
7.4.3. <i>802.11n HT40 MODE</i>	<i>43</i>
7.4.4. <i>802.11ac VHT80 MODE</i>	<i>45</i>
8. RADIATED TEST RESULTS.....	47
8.1. <i>802.11a 20 MODE.....</i>	<i>53</i>
8.1.1. <i>UNII-1 BAND</i>	<i>53</i>
8.1.2. <i>UNII-3 BAND</i>	<i>85</i>
8.2. <i>802.11n HT20 MIMO MODE.....</i>	<i>117</i>
8.2.1. <i>UNII-1 BAND</i>	<i>117</i>



8.2.2.	UNII-3 BAND	149
8.3.	802.11n HT40 MIMO MODE.....	181
8.3.1.	UNII-1 BAND	181
8.3.2.	UNII-3 BAND	205
8.4.	802.11ac VHT80 MIMO MODE.....	229
8.4.1.	UNII-1 BAND	229
8.4.2.	UNII-3 BAND	245
8.5.	SPURIOUS EMISSIONS 18~26GHz	257
8.5.1.	802.11a 20 MODE	257
8.6.	SPURIOUS EMISSIONS 26~40GHz	259
8.6.1.	802.11a 20 MODE	259
8.7.	SPURIOUS EMISSIONS 30M ~ 1 GHz	261
8.7.1.	802.11a 20 MODE	261
8.8.	SPURIOUS EMISSIONS BELOW 30M.....	263
8.8.1.	802.11a 20 MODE	263
9.	AC POWER LINE CONDUCTED EMISSIONS	266
9.1.	802.11a 20 MODE	267
10.	FREQUENCY STABILITY.....	269
11.	ANTENNA REQUIREMENTS	272



1. ATTESTATION OF TEST RESULTS

Applicant Information

Company Name: Hui Zhou Gaoshengda Technology Co.,LTD
Address: NO.75 Zhongkai Development Area Huizhou, Guangdong China

Manufacturer Information

Company Name: Hui Zhou Gaoshengda Technology Co.,LTD
Address: NO.75 Zhongkai Development Area Huizhou, Guangdong China

EUT Description

EUT Name: WIFI+BT Module
Model: WCT5JM2611
Brand: GSD
Sample Status: Normal
Sample ID: 2930557
Sample Received Date: March 05, 2020
Date of Tested: March 05, 2020~ March 31, 2020

APPLICABLE STANDARDS	
STANDARD	TEST RESULTS
CFR 47 FCC PART 15 SUBPART E	PASS
ISED RSS-247 Issue 2	PASS
ISED RSS-GEN Issue 5	PASS

Prepared By:

Kebo Zhang
Project Engineer
Approved By:

Stephen Guo
Laboratory Manager

Checked By:

Shawn Wen
Laboratory Leader



2. TEST METHODOLOGY

The tests documented in this report were performed in accordance with ANSI C63.10-2013, CFR 47 FCC Part 2, CFR 47 FCC Part 15, KDB 789033 D02 v02r01, RSS-GEN Issue 5, RSS-247 Issue 2, KDB414788 D01 Radiated Test Site v01.

3. FACILITIES AND ACCREDITATION

Accreditation Certificate	<p>A2LA (Certificate No.: 4102.01) UL Verification Services (Guangzhou) Co., Ltd. Song Shan Lake Branch. has been assessed and proved to be in compliance with A2LA.</p> <p>FCC (FCC Designation No.: CN1187) UL Verification Services (Guangzhou) Co., Ltd. Song Shan Lake Branch. Has been recognized to perform compliance testing on equipment subject to the Commission's Declaration of Conformity (DoC) and Certification rules</p> <p>ISED(Company No.: 21320) UL Verification Services (Guangzhou) Co., Ltd. Song Shan Lake Branch. has been registered and fully described in a report filed with ISED. The Company Number is 21320.</p> <p>VCCI (Registration No.: G-20019, R-20004, C-20012 and T-20011) UL Verification Services (Guangzhou) Co., Ltd. Song Shan Lake Branch. has been assessed and proved to be in compliance with VCCI, the Membership No. is 3793. Facility Name: Chamber D, the VCCI registration No. is G-20019 and R-20004 Shielding Room B , the VCCI registration No. is C-20012 and T-20011</p>
---------------------------	---

Note 1: All tests measurement facilities use to collect the measurement data are located at Building 10, Innovation Technology Park, Song Shan Lake Hi tech Development Zone, Dongguan, 523808, China

Note 2: The test anechoic chamber in UL Verification Services (Guangzhou) Co., Ltd. Song Shan Lake Branch had been calibrated and compared to the open field sites and the test anechoic chamber is shown to be equivalent to or worst case from the open field site.

Note 3: For below 30MHz, lab had performed measurements at test anechoic chamber and comparing to measurements obtained on an open field site. And these measurements below 30MHz had been correlated to measurements performed on an OFS.



4. CALIBRATION AND UNCERTAINTY

4.1. MEASURING INSTRUMENT CALIBRATION

The measuring equipment utilized to perform the tests documented in this report has been calibrated in accordance with the manufacturer's recommendations, and is traceable to recognize national standards.

4.2. MEASUREMENT UNCERTAINTY

Where relevant, the following measurement uncertainty levels have been estimated for tests performed on the apparatus:

Test Item	Uncertainty
Uncertainty for Conduction emission test	3.62dB
Uncertainty for Radiation Emission test(include Fundamental emission) (9KHz-30MHz)	2.2dB
Uncertainty for Radiation Emission test(include Fundamental emission) (30MHz-1GHz)	4.00dB
Uncertainty for Radiation Emission test (1GHz to 26GHz)(include Fundamental emission)	5.78dB (1GHz-18Gz)
	5.23dB (18GHz-26Gz)
	5.64dB (26GHz-40Gz)
Note: This uncertainty represents an expanded uncertainty expressed at approximately the 95% confidence level using a coverage factor of k=2.	



5. EQUIPMENT UNDER TEST

5.1. DESCRIPTION OF EUT

EUT Name	WIFI+BT Module
Model	WCT5JM2611
Radio Technology	IEEE802.11a 20 IEEE802.11n HT20/n HT40 IEEE802.11ac VHT20/VHT40/VHT80
Operation frequency	UNII-1/UNII-3
Modulation	OFDM(BPSK,QPSK,16QAM,64QAM,256QAM in ac mode only.)
Supply Voltage	DC 5V

5.2. MAXIMUM EIRP

UNII-1 BAND

IEE Std.	Frequency (MHz)	Max Power (dBm)	Max EIRP (dBm)
802.11a 20	5150-5250	15.04	18.93
802.11n HT20	5150-5250	17.48	21.37
802.11n HT40	5150-5250	16.68	20.57
802.11ac VHT20	5150-5250	16.04	19.93
802.11ac VHT40	5150-5250	15.80	19.69
802.11ac VHT80	5150-5250	16.95	20.84

UNII-3 BAND

IEE Std. 802.11	Frequency (MHz)	Max Power (dBm)
802.11a 20	5725-5850	14.67
802.11n HT20	5725-5850	17.42
802.11n HT40	5725-5850	17.46
802.11ac VHT20	5725-5850	16.43
802.11ac VHT40	5725-5850	16.47
802.11ac VHT80	5725-5850	16.44



5.3. CHANNEL LIST

UNII-1 (For Bandwidth=20MHz)		UNII-1 (For Bandwidth=40MHz)		UNII-1 (For Bandwidth=80MHz)	
Channel	Frequency (MHz)	Channel	Frequency (MHz)	Channel	Frequency (MHz)
36	5180	38	5190	42	5210
40	5200	46	5230		
44	5220				
48	5240				

UNII-3 (For Bandwidth=20MHz)		UNII-3 (For Bandwidth=40MHz)		UNII-3 (For Bandwidth=80MHz)	
Channel	Frequency (MHz)	Channel	Frequency (MHz)	Channel	Frequency (MHz)
149	5745	151	5755	155	5775
153	5765	159	5795		
157	5785				
161	5805				
165	5825				



5.4. THE WORSE CASE POWER SETTING PARAMETER

The Worst Case Power Setting Parameter			
Test Software	QATool_Dbg		
Frequency Band	mode	channel	setting
UNII-1	802.11a(20M)	5180	1B
		5200	1B
		5240	1B
	802.11n (20M)	5180	1A
		5200	1B
		5240	1B
	802.11ac (20M)	5180	19
		5200	19
		5240	19
	802.11n (40M)	5190	14
		5230	1A
		5190	13
		5230	17
		5210	1A
UNII-3	802.11a(20M)	5745	1D
		5785	1E
		5825	1F
	802.11n (20M)	5745	1E
		5785	1F
		5825	1F
	802.11ac (20M)	5745	1C
		5785	1D
		5825	1D
	802.11n (40M)	5755	1E
		5795	1E
		5755	1B
802.11ac (40M)	5755	1B	
	5795	1B	
802.11ac (80M)	5775	1C	



5.5. THE WORSE CASE CONFIGURATIONS

For SISO modes, there are two transmission antennas. The antenna used in any given time can be either ANTENNA 0 or ANTENNA 1. The output power measurement for SISO modes on both antennas are reported.

For 2TX MIMO modes, ANTENNA 0 and ANTENNA 1, used at the same time.

SISO mode and MIMO mode have the same power setting, so only the worst case MIMO mode will be record in the report.

Worst-case data rates as provided by the client were:

802.11a 20 mode: 6 Mbps
802.11n HT20 mode: MCS0
802.11n HT40 mode: MCS0
802.11ac VHT20 mode: MCS0
802.11ac VHT40 mode: MCS0
802.11ac VHT80 mode: MCS0

802.11ac VHT20 and VHT40 mode are different from 802.11nHT20 and HT40 only in control messages, so for these 4 modes, only 802.11nHT20 and 802.11nHT40 worst case power modes data are recorded in the report .

802.11n HT20/HT40 SISO mode and MIMO mode have the same power setting, so only the worst case MIMO mode will be record in the report.

802.11a 20 support SISO mode, two antenna have the same power setting, so only the worst data for antenna 0 are recorded in the report.



5.6. DESCRIPTION OF AVAILABLE ANTENNAS

Antenna model	Frequency (MHz)	Antenna Type	Antenna Gain (dBi)
WCT5H-20	5150-5850	PIFA Antenna	3.79
WCT5H-40	5150-5850	PIFA Antenna	3.83
WCT5H-60	5150-5850	PIFA Antenna	3.64
WCT5J-20	5150-5850	PIFA Antenna	3.89
WCT5J-40	5150-5850	PIFA Antenna	3.86
WCT5J-60	5150-5850	PIFA Antenna	3.78

Note: 1. The EUT has 2 kinds of antennas WCT5H and WCT5J. For WCT5H-20/ WCT5H-40/ WCT5H-60, they differ only in line length. For WCT5J-20/ WCT5J-40/ WCT5J-60, they differ only in line length. So for the Radiated Bandedge and Spurious Emission, we use the worst kind WCT5H-40 and WCT5J-20 to test. Other test items we use the worst kind WCT5J-20 to test.

2. ANT 0,1 use the same antenna. So Directional gain= GANT + 10 log(NANT)
dBi=6.90dBi, GANT : Antenna Gain(3.89dBi), NANT : Antenna numbers(2).

IEE Std. 802.11	Transmit and Receive Mode	Description
802.11a 20	☒2TX, 2RX	ANT 0,1 can be used as transmitting/receiving antenna.
802.11n HT20	☒2TX, 2RX	ANT 0,1 can be used as transmitting/receiving antenna.
802.11n HT40	☒2TX, 2RX	ANT 0,1 can be used as transmitting/receiving antenna.
802.11ac VHT20	☒2TX, 2RX	ANT 0,1 can be used as transmitting/receiving antenna.
802.11ac VHT40	☒2TX, 2RX	ANT 0,1 can be used as transmitting/receiving antenna.
802.11ac VHT80	☒2TX, 2RX	ANT 0,1 can be used as transmitting/receiving antenna.
Note: 1. The EUT does not support simultaneous transmission. 2. 802.11a 20 only support SISO mode. 802.11n HT20/HT40 and 802.11ac VHT20/VHT40/VHT80 support SISO mode and MIMO mode.		



5.7. DESCRIPTION OF TEST SETUP

SUPPORT EQUIPMENT

Item	Equipment	Brand Name	Model Name	Remarks
1	PC	Dell	Vostro 3902	8KNDDDB2
2	USB TO UART	/	/	/

I/O CABLES

Cable No	Port	Connector Type	Cable Type	Cable Length(m)	Remarks
1	USB	/	/	1.0	/

ACCESSORIES

Item	Accessory	Brand Name	Model Name	Description
1	/	/	/	/

TEST SETUP

The EUT can work in engineering mode with a software.

SETUP DIAGRAM FOR TESTS

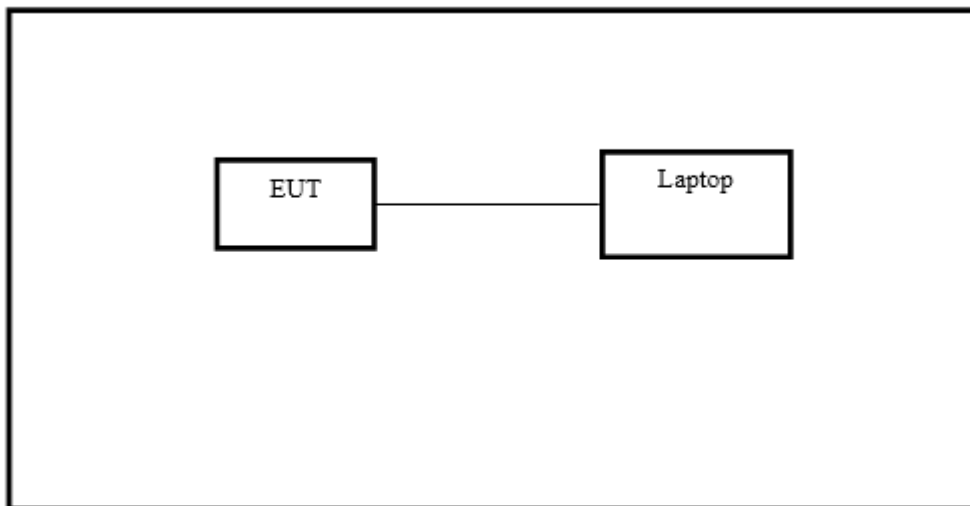



6. MEASURING INSTRUMENT AND SOFTWARE USED

Conducted Emissions						
Instrument						
Used	Equipment	Manufacturer	Model No.	Serial No.	Last Cal.	Next Cal.
<input checked="" type="checkbox"/>	EMI Test Receiver	R&S	ESR3	101961	Dec.05,2019	Dec.05,2020
<input checked="" type="checkbox"/>	Two-Line V-Network	R&S	ENV216	101983	Dec.05,2019	Dec.05,2020
<input checked="" type="checkbox"/>	Artificial Mains Networks	Schwarzbeck	NSLK 8126	8126465	Dec.05,2019	Dec.05,2020
Software						
Used	Description		Manufacturer	Name	Version	
<input checked="" type="checkbox"/>	Test Software for Conducted disturbance		Farad	EZ-EMC	Ver. UL-3A1	
Radiated Emissions						
Instrument						
Used	Equipment	Manufacturer	Model No.	Serial No.	Last Cal.	Next Cal.
<input checked="" type="checkbox"/>	MXE EMI Receiver	KESIGHT	N9038A	MY56400036	Dec.06,2019	Dec.06,2020
<input checked="" type="checkbox"/>	Hybrid Log Periodic Antenna	TDK	HLP-3003C	130960	Sep.17, 2018	Sep.17, 2021
<input checked="" type="checkbox"/>	Preamplifier	HP	8447D	2944A09099	Dec.05,2019	Dec.05,2020
<input checked="" type="checkbox"/>	EMI Measurement Receiver	R&S	ESR26	101377	Dec.05,2019	Dec.05,2020
<input checked="" type="checkbox"/>	Horn Antenna	TDK	HRN-0118	130939	Sep.17, 2018	Sep.17, 2021
<input checked="" type="checkbox"/>	High Gain Horn Antenna	Schwarzbeck	BBHA-9170	691	Aug.11, 2018	Aug.11, 2021
<input checked="" type="checkbox"/>	Preamplifier	TDK	PA-02-0118	TRS-305-00066	Dec.05,2019	Dec.05,2020
<input checked="" type="checkbox"/>	Preamplifier	TDK	PA-02-2	TRS-307-00003	Dec.05,2019	Dec.05,2020
<input checked="" type="checkbox"/>	Preamplifier	TDK	PA-02-3	TRS-308-00002	Dec.05,2019	Dec.05,2020
<input checked="" type="checkbox"/>	Loop antenna	Schwarzbeck	1519B	00008	Jan.07, 2019	Jan.07, 2022
<input checked="" type="checkbox"/>	Band Reject Filter	Wainwright	WRCJV12-5695-5725-5850-5880-40SS	4	Dec.05,2019	Dec.05,2020
<input checked="" type="checkbox"/>	Band Reject Filter	Wainwright	WRCJV20-5120-5150-5350-5380-60SS	2	Dec.05,2019	Dec.05,2020



<input checked="" type="checkbox"/>	Band Reject Filter	Wainwright	WRCJV20-5440-5470-5725-5755-60SS	1	Dec.05,2019	Dec.05,2020
<input checked="" type="checkbox"/>	High Pass Filter	Wainwright	WHKX10-5850-6500-1800-40SS	4	Dec.05,2019	Dec.05,2020
Software						
Used	Description		Manufacturer	Name		Version
<input checked="" type="checkbox"/>	Test Software for Radiated disturbance		Farad	EZ-EMC		Ver. UL-3A1
Other instruments						
Used	Equipment	Manufacturer	Model No.	Serial No.	Last Cal.	Next Cal.
<input checked="" type="checkbox"/>	Spectrum Analyzer	Keysight	N9030A	MY55410512	Dec.06,2019	Dec.06,2020
<input checked="" type="checkbox"/>	Power sensor, Power Meter	R&S	OSP120	100921	Dec.06,2019	Dec.06,2020



7. ANTENNA PORT TEST RESULTS

7.1. ON TIME AND DUTY CYCLE

LIMITS

None; for reporting purposes only

TEST SETUP

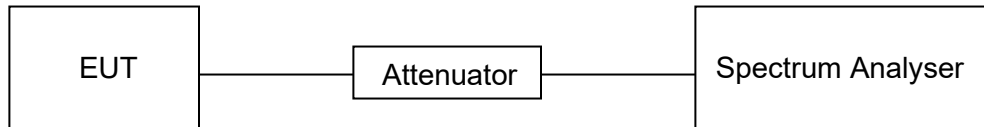

TEST ENVIRONMENT

Temperature	24.7°C	Relative Humidity	58%
Atmosphere Pressure	101kPa	Test Voltage	DC 5V

RESULTS

Mode	ON Time (ms)	Period (ms)	Duty Cycle x (Linear)	Duty Cycle (%)	Duty Cycle Correction Factor (dB)	1/T Minimum VBW (KHz)	Final setting For VBW (kHz)
802.11a 20	1.385	1.420	0.9754	97.54%	0.11	0.722	1
802.11n HT20	1.300	1.335	0.9738	97.38%	0.12	0.769	1
802.11ac VHT20	0.681	0.717	0.9498	94.98%	0.22	1.468	2
802.11n HT40	0.648	0.684	0.9474	94.74%	0.23	1.543	2
802.11ac VHT40	0.352	0.388	0.9072	90.72%	0.42	2.841	3
802.11ac VHT80	0.925	1.555	0.5949	59.49%	2.26	1.081	2

Note:

Duty Cycle Correction Factor=10log (1/x).

Where: x is Duty Cycle (Linear)

Where: T is On Time

If that calculated VBW is not available on the analyzer then the next higher value should be used.

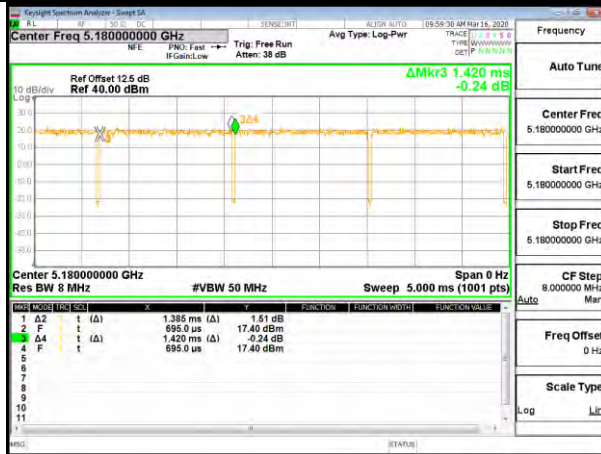

802.11a 20



802.11n HT20

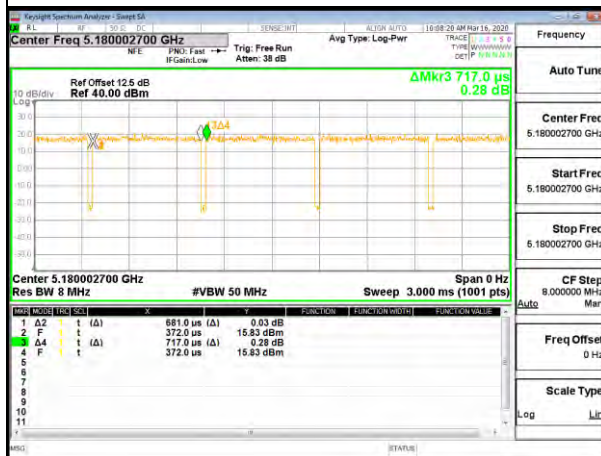

802.11ac VHT20



802.11ac VHT40



802.11n HT40



802.11ac VHT80

7.2. 6/26/99% dB BANDWIDTH

LIMITS

CFR 47 FCC Part15, Subpart E ISED RSS-247		
Test Item	Limit	Frequency Range (MHz)
Bandwidth	26 dB Bandwidth	5150-5250
	26 dB Bandwidth	5250-5350
	26 dB Bandwidth	For FCC:5470-5725 For IC:5470-5600 5650-5725
	Minimum 500kHz 6dB Bandwidth	5725-5850

ISED RSS-247		
RSS-Gen Clause 6.7	99% Bandwidth	For reporting purposes only.

TEST PROCEDURE

Connect the UUT to the spectrum analyser and use the following settings:

Center Frequency	The center frequency of the channel under test
Detector	Peak
RBW	For 6dB Bandwidth: RBW=100kHz For 26dB Bandwidth: approximately 1%~5% of the emission bandwidth. For 99% Occupied Bandwidth: approximately 1%~5% of the emission bandwidth.
VBW	For 6dB Bandwidth : $\geq 3 \times \text{RBW}$ For 26dB Bandwidth : approximately $3 \times \text{RBW}$ For 99% Occupied Bandwidth: $\geq 3 \times \text{RBW}$
Trace	Max hold
Sweep	Auto couple

Allow the trace to stabilize and measure the maximum width of the emission that is constrained by the frequencies associated with the two outermost amplitude points (upper and lower frequencies) that are attenuated by 6dB/26dB&99% Occupied Bandwidth relative to the maximum level measured in the fundamental emission.

TEST SETUP

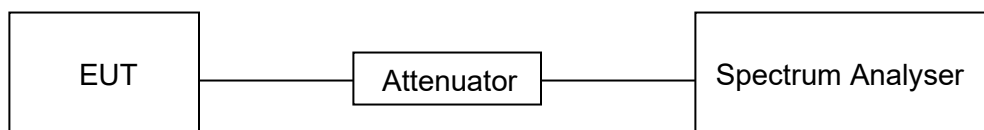



TEST ENVIRONMENT

Temperature	24.7°C	Relative Humidity	58%
Atmosphere Pressure	101kPa	Test Voltage	DC 5V

RESULTS



7.2.1. 802.11a 20 MODE

ANT0 WORST CASE

UNII-1 BAND

Channel	Frequency (MHz)	26 dB BW (MHz)	99% BW (MHz)
Low	5180	19.18	16.406
Mid	5200	19.35	16.361
High	5240	19.68	16.388

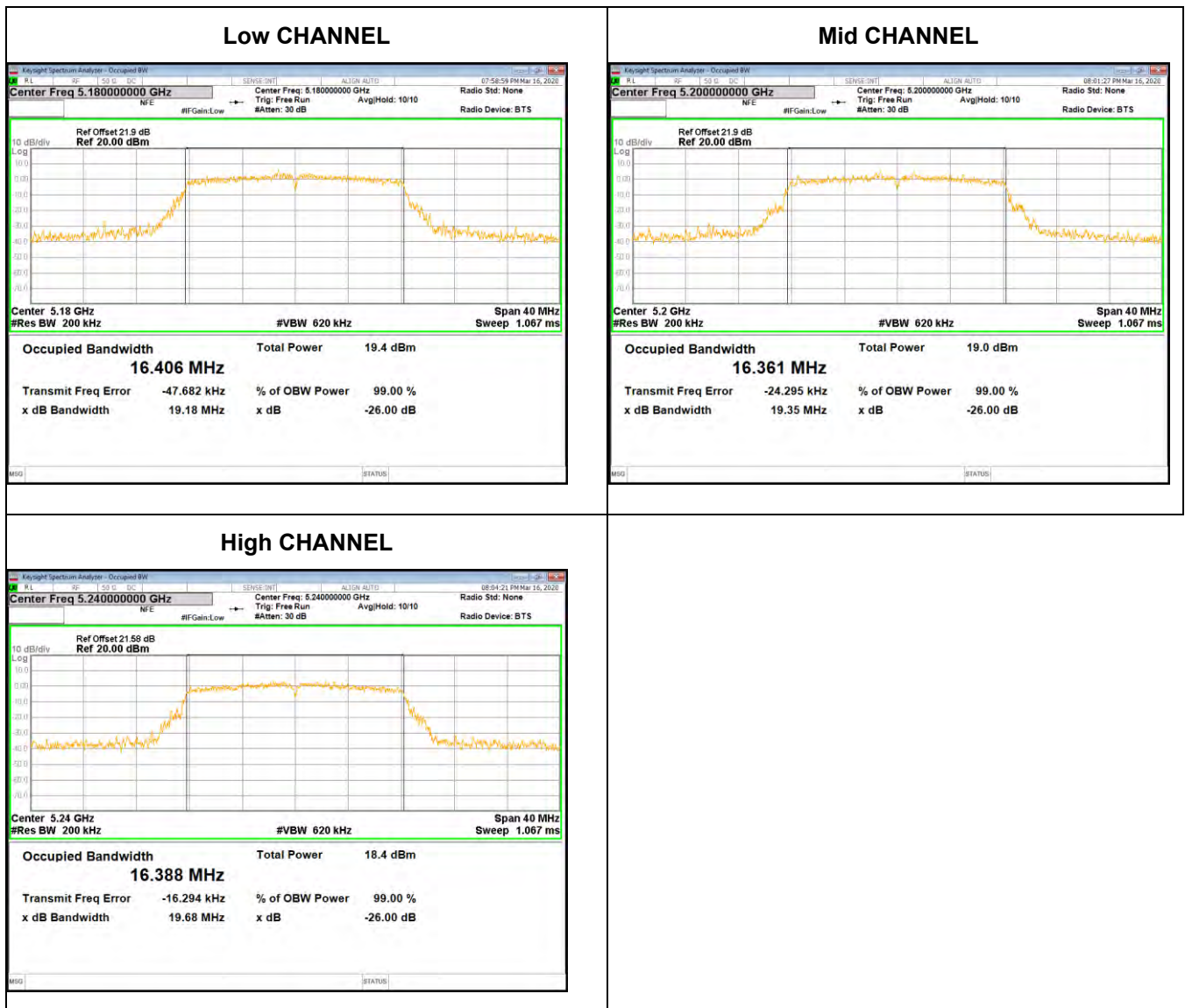



UNII-3 BAND

Channel	Frequency (MHz)	6 dB BW (MHz)	99% BW (MHz)	Limit For 6dB BW (KHz)	Result
Low	5745	16.30	16.455	500	PASS
Mid	5785	16.29	16.490	500	PASS
High	5825	16.28	16.484	500	PASS

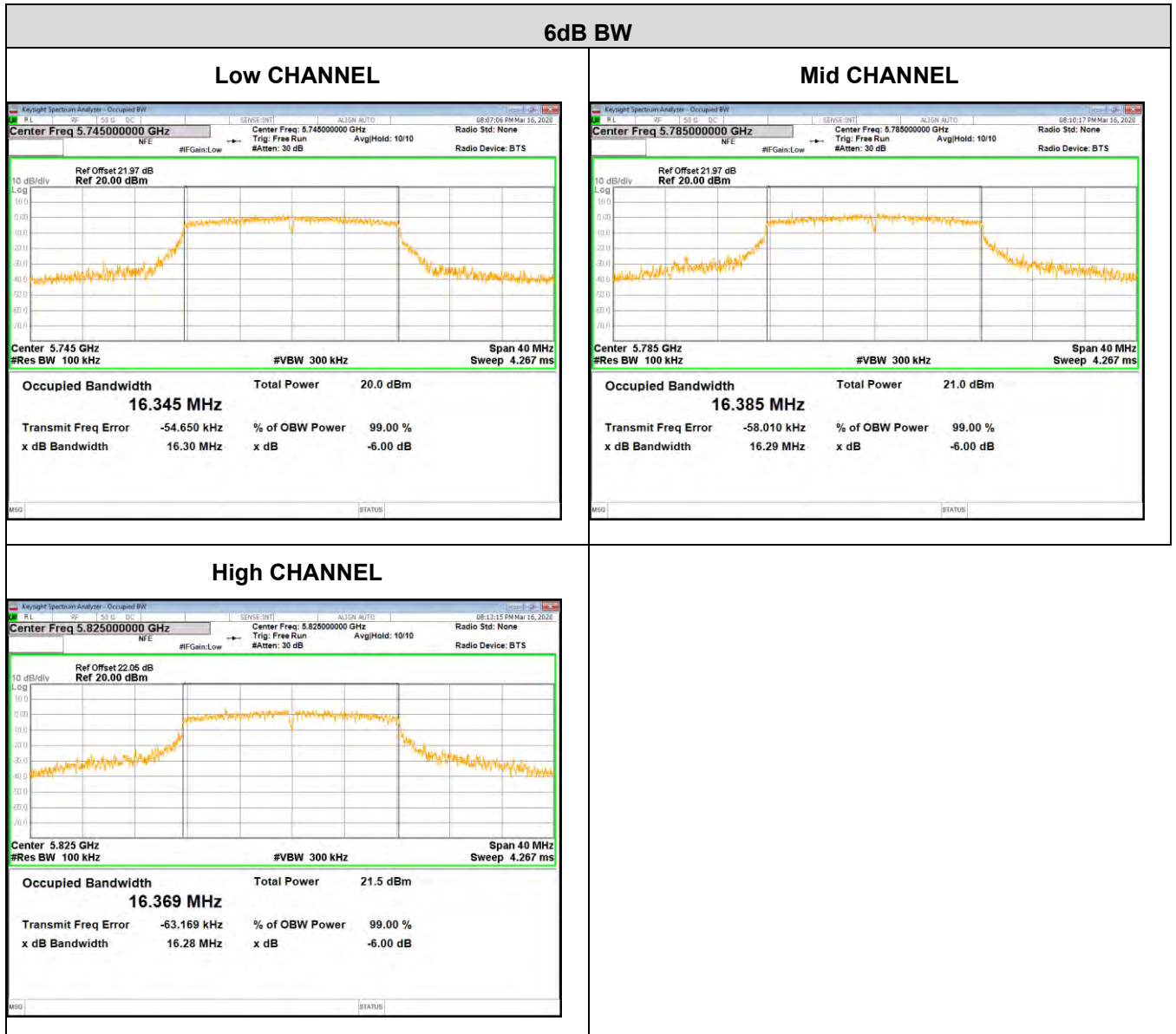



Note: All the modes and antenna ports had been tested, only the worst data recorded in the report.



7.2.2. 802.11n HT20 MODE

ANT0 WORST CASE

UNII-1 BAND

Channel	Frequency (MHz)	26 dB BW (MHz)	99% BW (MHz)
Low	5180	19.96	17.551
Mid	5200	20.17	17.608
High	5240	20.10	17.583





UNII-3 BAND

Channel	Frequency (MHz)	6 dB BW (MHz)	99% BW (MHz)	Limit For 6dB BW (KHz)	Result
Low	5745	16.74	17.631	500	PASS
Mid	5785	17.57	17.604	500	PASS
High	5825	17.51	17.638	500	PASS

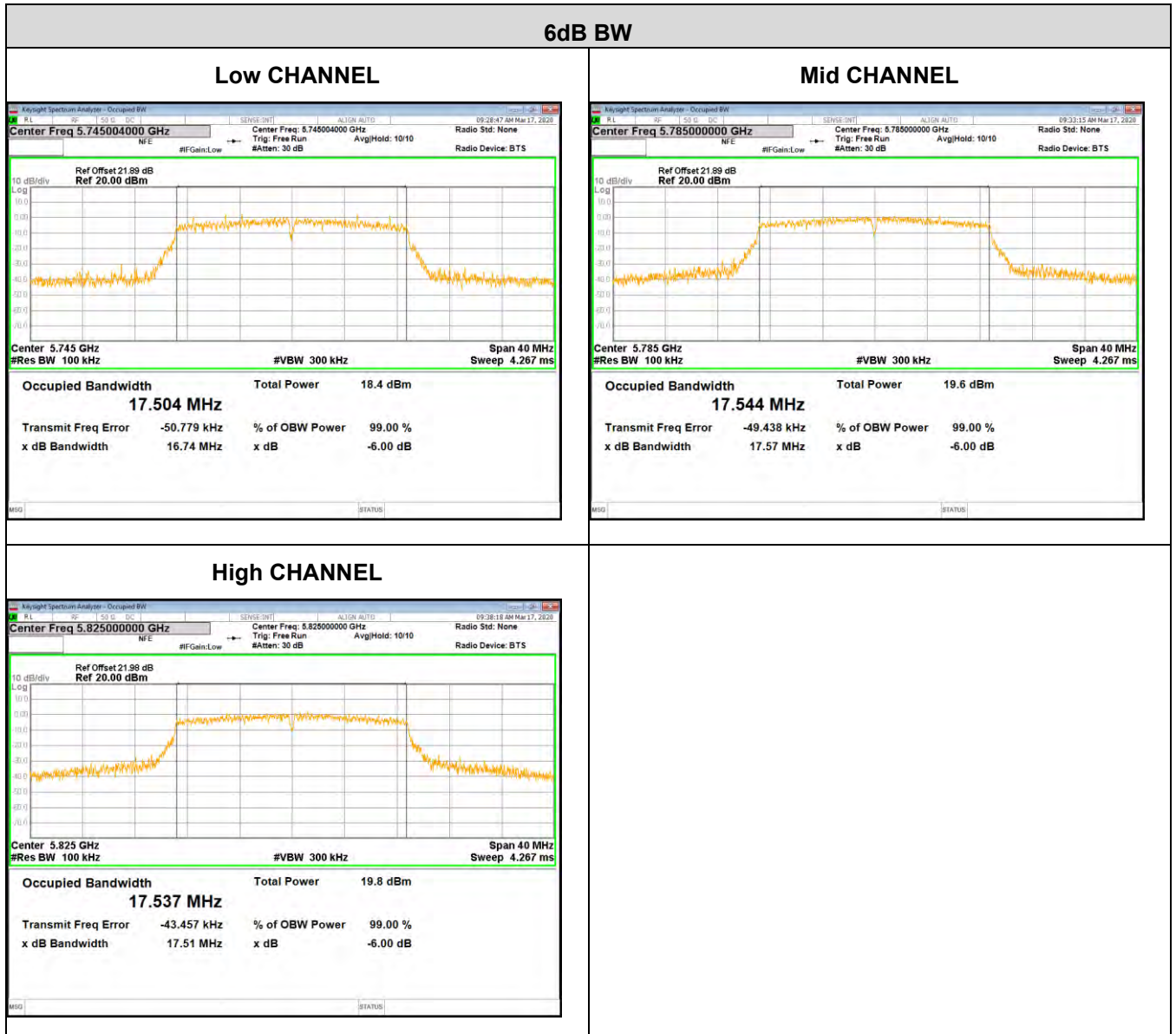



Note: All the modes and antenna ports had been tested, only the worst data recorded in the report.



7.2.3. 802.11n HT40 MODE

ANT0 WORST CASE

UNII-1 BAND

Channel	Frequency (MHz)	26 dB BW (MHz)	99% BW (MHz)
Low	5190	40.13	36.102
High	5230	40.26	36.109

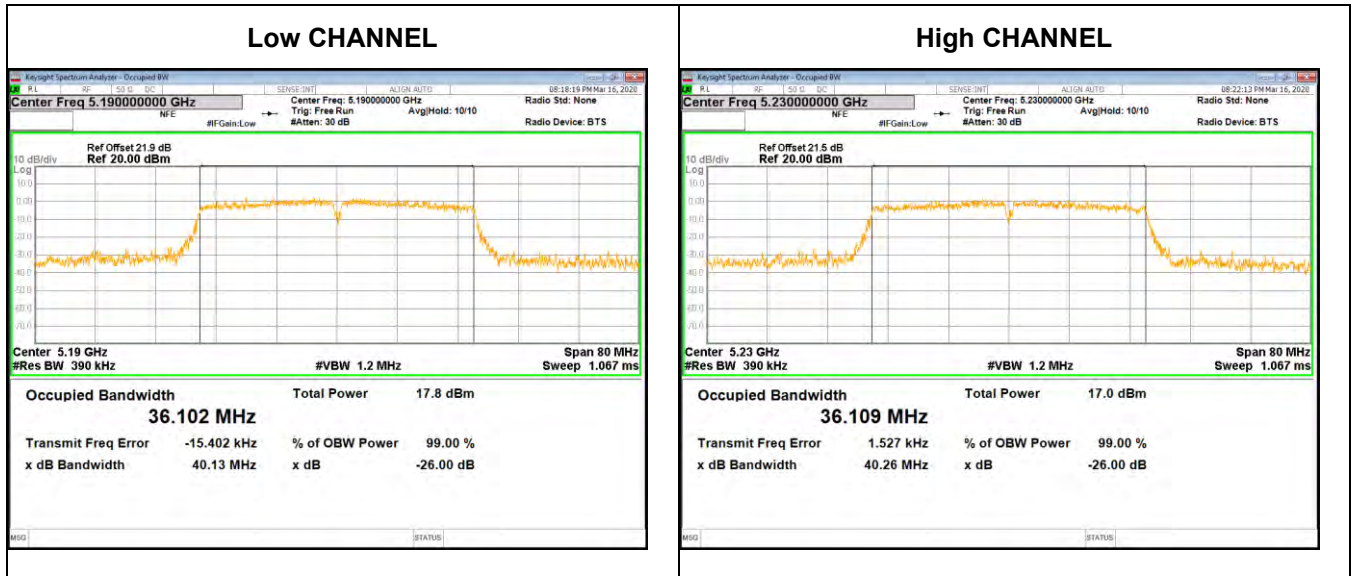



UNII-3 BAND

Channel	Frequency (MHz)	6 dB BW (MHz)	99% BW (MHz)	Limit (KHz)	Result
Low	5755	35.05	36.335	500	PASS
High	5795	35.10	36.305	500	PASS

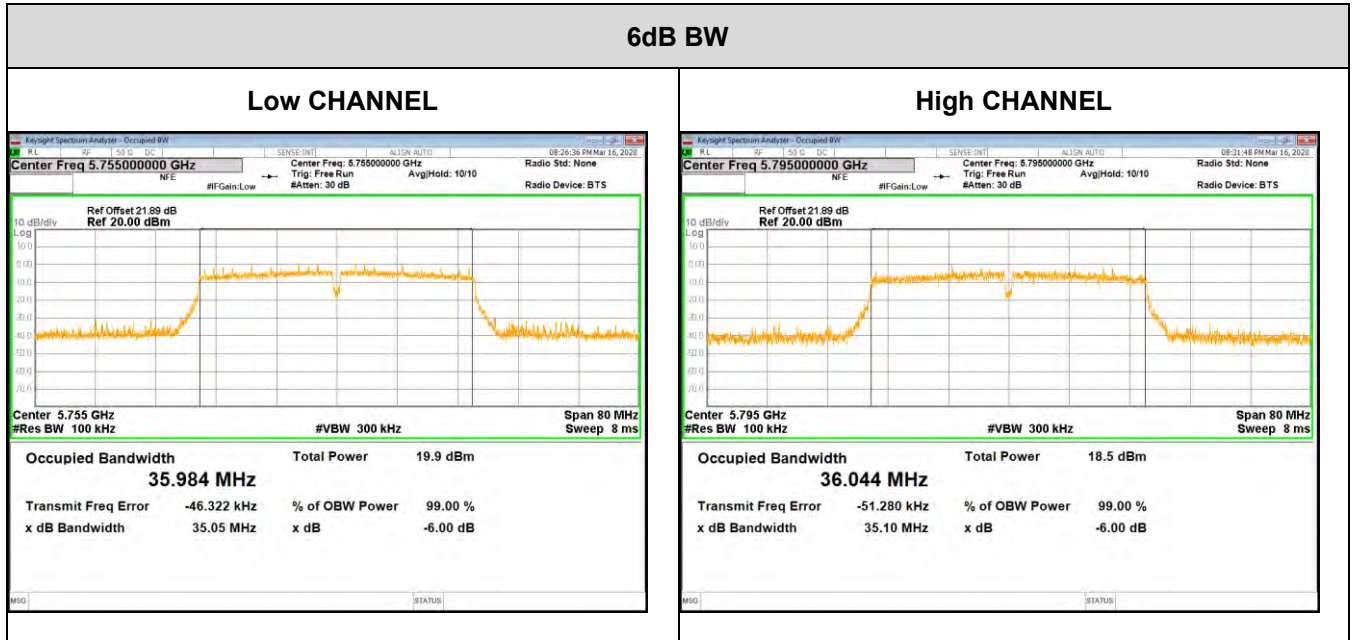

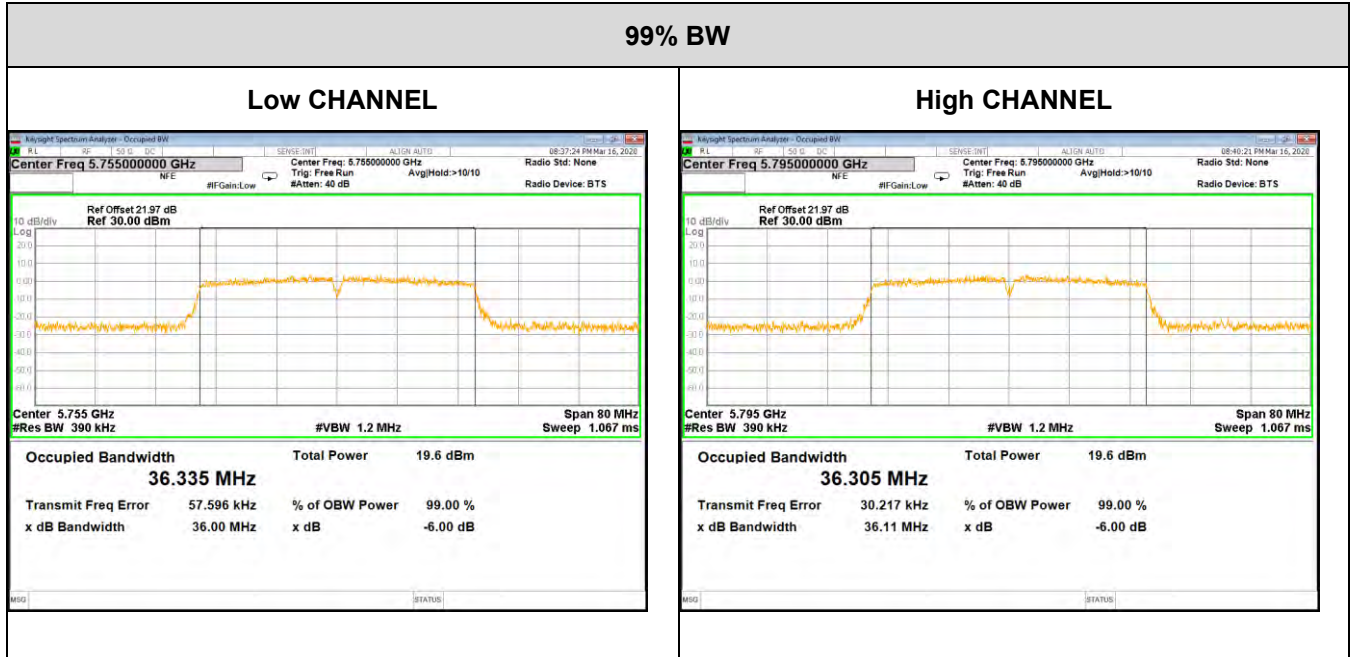

Note: All the modes and antenna ports had been tested, only the worst data recorded in the report.



7.2.4. 802.11ac VHT80 MODE

ANT0 WORST CASE

UNII-1 BAND

Channel	Frequency (MHz)	26 dB BW (MHz)	99% BW (MHz)
Mid	5210	79.84	75.793

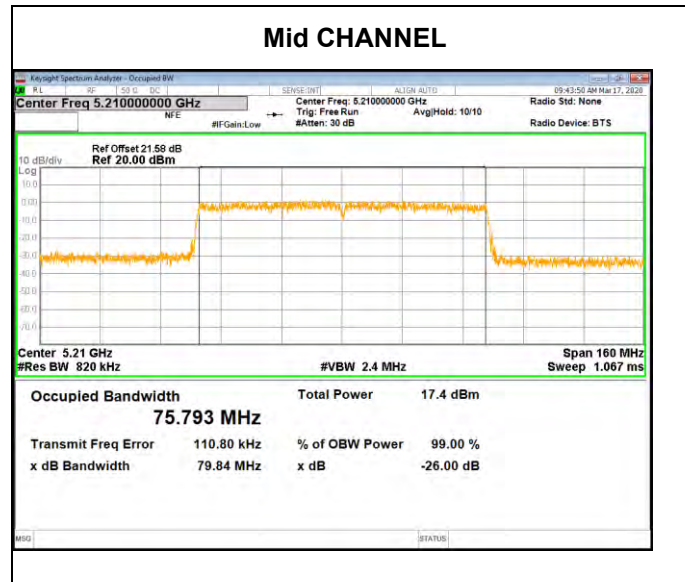



UNII-3 BAND

Channel	Frequency (MHz)	6 dB BW (MHz)	99% BW (MHz)	Limit For 6dB BW (KHz)	Result
Mid	5775	75.07	76.545	500	PASS

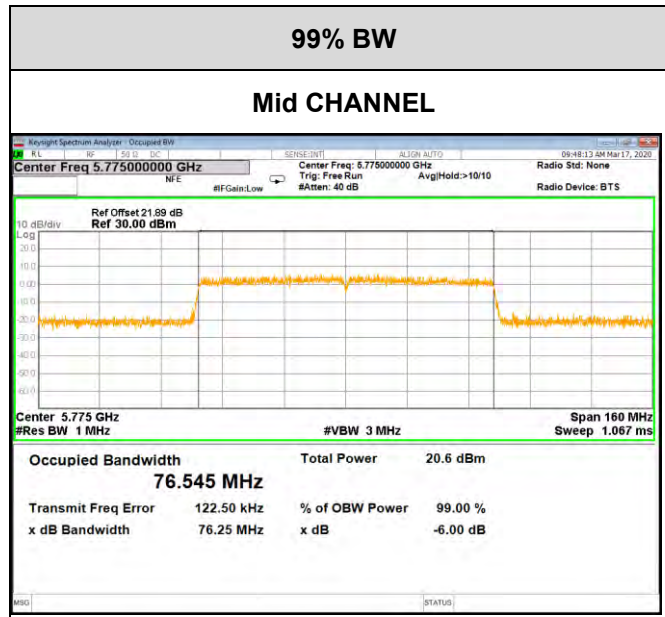
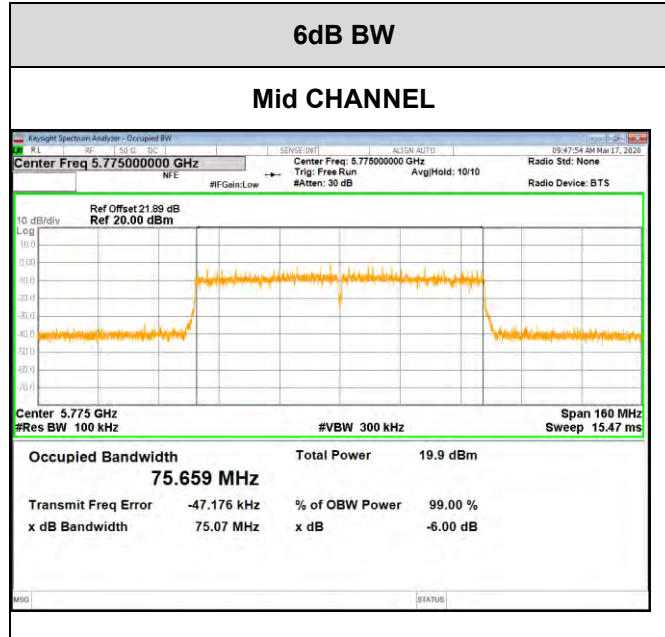

Note: All the modes and antenna ports had been tested, only the worst data recorded in the report.



7.3. MAXIMUM CONDUCTED OUTPUT POWER

LIMITS

CFR 47 FCC Part15, Subpart E		
Test Item	Limit	Frequency Range (MHz)
Conducted Output Power	For FCC client devices:250mW (24dBm)	5150-5250
	1 Watt (30dBm)	5725-5850

ISED RSS-247		
Test Item	Limit	Frequency Range (MHz)
Conducted Output Power	Maximum e.i.r.p. shall not exceed 200 mW or $10 + 10 \log_{10} B$, dBm, whichever is less where B is the 99% emission bandwidth in megahertz	5150-5250
	1 Watt (30dBm)	5725-5850

Note: If transmitting antennas of directional gain greater than 6 dBi are used, the maximum conducted output power shall be reduced by the amount in dB that the directional gain of the antenna exceeds 6dBi. Directional gain= GANT + 10 log(NANT) dBi=6.90dBi, GANT : Antenna Gain(3.89dBi), NANT : Antenna numbers(2).

TEST PROCEDURE

Refer to KDB 789033 D02 General UNII Test Procedures New Rules v02r01
Connect the EUT to the a broadband average RF power meter, the power meter shall have a video bandwidth that is greater than or equal to the bandwidth and shall utilize a fast-responding diode detector.

TEST SETUP

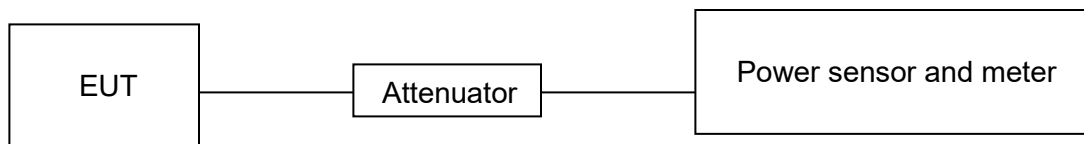

TEST ENVIRONMENT

Temperature	24.7°C	Relative Humidity	58%
Atmosphere Pressure	101kPa	Test Voltage	DC 5V



RESULTS

7.3.1. UNII-1 BAND

Mode	Frequency (MHz)	Chain	CONDUCTED POWER (dBm)		Limit (dBm)	EIRP (dBm)	EIRP Limit (dBm)
			Single	Total			
a	5180	0	15.04		24	18.93	22.14
		1	14.55			18.44	
	5200	0	14.86		24	18.75	22.14
		1	14.32			18.21	
	5240	0	14.97		24	18.86	22.14
		1	14.29			18.18	
n HT20	5180	0	13.82	16.69	23.1	20.58	22.44
		1	13.54				
	5200	0	14.17	17.48	23.1	21.37	22.44
		1	14.75				
	5240	0	14.25	16.99	23.1	20.88	22.44
		1	13.69				
ac VHT20	5180	0	13.31	16.04	23.1	19.93	22.44
		1	12.73				
	5200	0	13.22	15.86	23.1	19.75	22.44
		1	12.45				
	5240	0	13.24	15.89	23.1	19.78	22.44
		1	12.48				
n HT40	5190	0	12.15	15.22	23.1	19.11	24
		1	12.27				
	5230	0	14.10	16.68	23.1	20.57	24
		1	13.20				
ac VHT40	5190	0	12.03	14.90	23.1	18.79	24
		1	11.74				
	5230	0	13.25	15.80	23.1	19.69	24
		1	12.28				
ac VHT80	5210	0	13.90	16.95	23.1	20.84	24
		1	13.98				

Note: 1. Conducted Power=Meas. Level+ Correction Factor
 2. EIRP=conducted Power + Antenna Gain
 3. The test results have already included the duty cycle correction factor. About correction Factor please refer to section 7.1



7.3.2. UNII-3 BAND

Mode	Frequency (MHz)	Chain	CONDUCTED POWER (dBm)		Limit (dBm)
			Single	Total	
a	5745	0	14.28		30
		1	14.26		
	5785	0	14.62		30
		1	14.38		
	5825	0	14.67		30
		1	14.44		
n HT20	5745	0	14.12	17.22	29.1
		1	14.29		
	5785	0	14.43	17.42	29.1
		1	14.39		
	5825	0	13.97	17.06	29.1
		1	14.12		
ac VHT20	5745	0	13.01	16.16	29.1
		1	13.29		
	5785	0	13.40	16.43	29.1
		1	13.44		
	5825	0	13.01	16.03	29.1
		1	13.03		
n HT40	5755	0	14.39	17.46	29.1
		1	14.50		
	5795	0	14.10	17.12	29.1
		1	14.11		
ac VHT40	5755	0	13.40	16.47	29.1
		1	13.52		
	5795	0	13.15	16.13	29.1
		1	13.08		
ac VHT80	5775	0	13.28	16.44	29.1
		1	13.57		

Note: 1. Conducted Power=Meas. Level+ Correction Factor

2. The test results have already included the duty cycle correction factor. About correction Factor please refer to section 7.1



7.4. POWER SPECTRAL DENSITY

LIMITS

CFR 47 FCC Part15, Subpart E ISED RSS-247		
Test Item	Limit	Frequency Range (MHz)
Power Spectral Density	For FCC: Other than Mobile and portable:17dBm/MHz Mobile and portable:11dBm/MHz	5150-5250
	For RSS: e.i.r.p. 10dBm/MHz	
	11dBm/MHz	5250-5350
	11dBm/MHz	For FCC:5470-5725 For IC:5470-5600 5650-5725
	30dBm/500kHz	5725-5850
<p>Note: 1. If transmitting antennas of directional gain greater than 6 dBi are used, both the maximum conducted output power and the maximum power spectral density shall be reduced by the amount in dB that the directional gain of the antenna exceeds 6dBi. Directional gain= GANT + 10 log(NANT) dBi=6.90dBi, GANT : Antenna Gain(3.89dBi), NANT : Antenna numbers(2).</p>		

TEST PROCEDURE

Connect the UUT to the spectrum analyser and use the following settings:

For U-NII-1, U-NII-2A and U-NII-2C band:

Center Frequency	The center frequency of the channel under test
Detector	RMS
RBW	1MHz
VBW	$\geq 3 \times$ RBW
Span	Encompass the entire emissions bandwidth (EBW) of the signal
Trace	Max hold
Sweep time	Auto

For U-NII-3:

Center Frequency	The center frequency of the channel under test
Detector	RMS
RBW	500kHz
VBW	$\geq 3 \times$ RBW
Span	Encompass the entire emissions bandwidth (EBW) of the signal
Trace	Max hold
Sweep time	Auto



Allow trace to fully stabilize and use the peak marker function to determine the maximum amplitude level within the RBW.

TEST SETUP

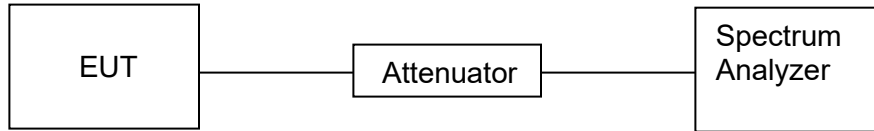

TEST ENVIRONMENT

Temperature	24.7°C	Relative Humidity	58%
Atmosphere Pressure	101kPa	Test Voltage	DC 5V

RESULTS



7.4.1. 802.11a 20 MODE

UNII-1 BAND

Test Channel	Frequency (MHz)	ANT	DCCF (dB)	PSD Result (dBm/MHz)	FCC Limit (dBm/MHz)	EIRP Result (dBm/MHz)	ISED EIRP Limit (dBm/MHz)
Low	5180	0	0.11	5.278	11	9.168	10
Mid	5200	0	0.11	4.767		8.657	
High	5240	0	0.11	4.461		8.351	

Note:

1. For test plots, it does not include the duty cycle correction factor.
2. PSD result=Test plots result+ Duty Cycle Correction Factor
3. The test results have already included the duty cycle correction factor. About correction Factor please refer to section 7.1.

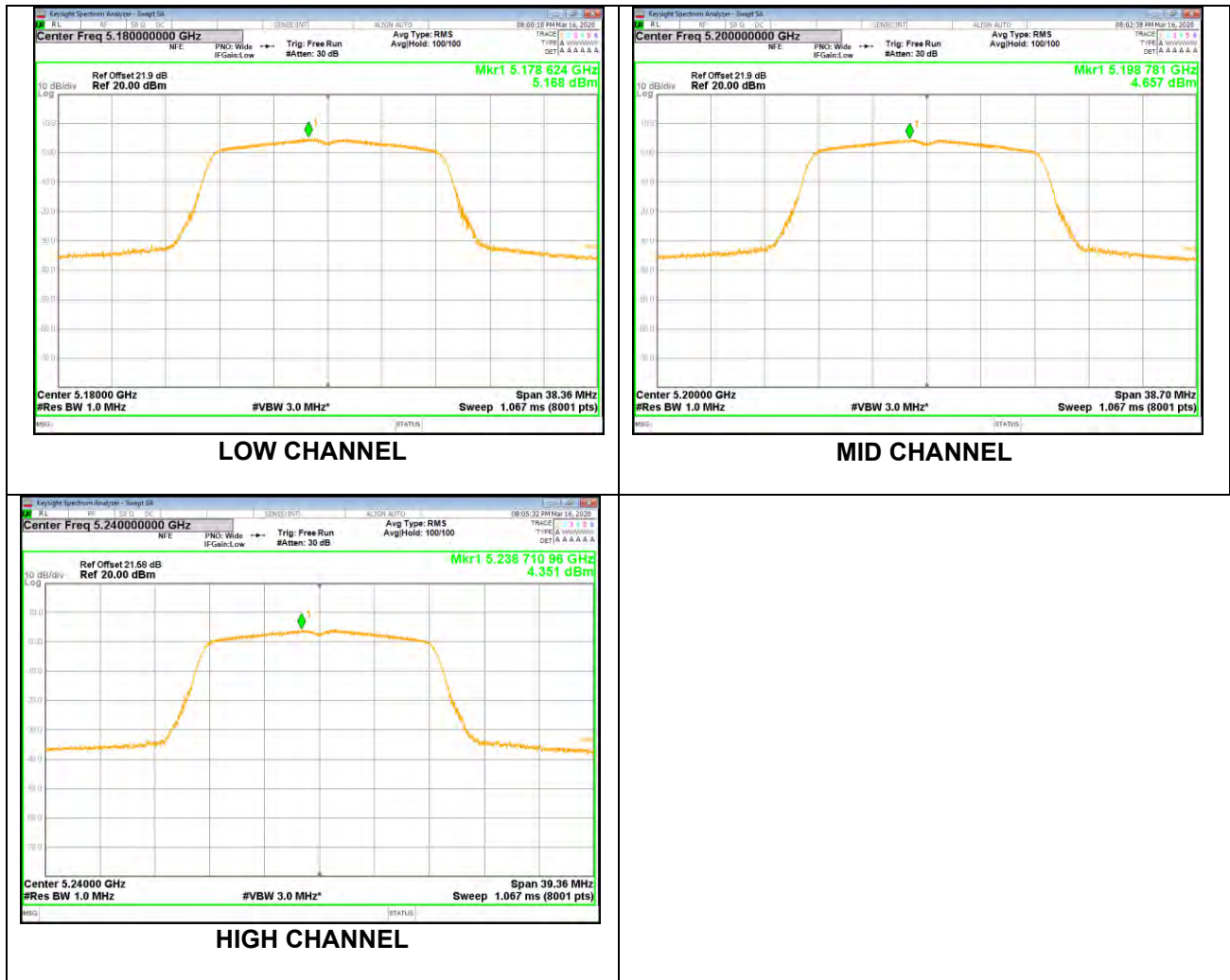



UNII-3 BAND

Test Channel	Frequency (MHz)	ANT	DCCF (dB)	PSD Result (dBm/500KHz)	Limit (dBm/500KHz)
Low	5745	0	0.11	3.282	30
Mid	5785	0	0.11	4.243	
High	5825	0	0.11	4.759	

Note:

1. For test plots, it does not include the duty cycle correction factor.
2. PSD result=Test plots result+ Correction Factor
3. The test results have already included the duty cycle correction factor. About correction Factor please refer to section 7.1.



LOW CHANNEL

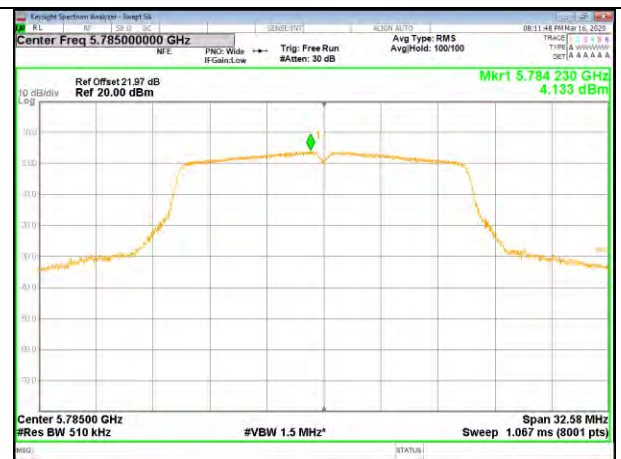

MID CHANNEL



HIGH CHANNEL



7.4.2. 802.11n HT20 MODE

UNII-1 BAND

Test Channel	Frequency (MHz)	ANT	DCCF (dB)	PSD Result (dBm/M Hz)	PSD Result (dBm/M Hz) Total	FCC Limit (dBm/M Hz)	EIRP Result (dBm/M Hz)	EIRP Limit (dBm/M Hz)
Low	5180	0	0.12	2.614	5.88	10.1	9.77	10
		1	0.12	3.103				
Mid	5200	0	0.12	2.644	5.84			
		1	0.12	3.006				
High	5240	0	0.12	2.124	5.17			
		1	0.12	2.186				

Note:

1. For test plots, it does not include the duty cycle correction factor.
2. PSD result=Test plots result+ Correction Factor
3. The PSD test results have already included the duty cycle correction factor. About correction Factor please refer to section 7.1.

ANT 0

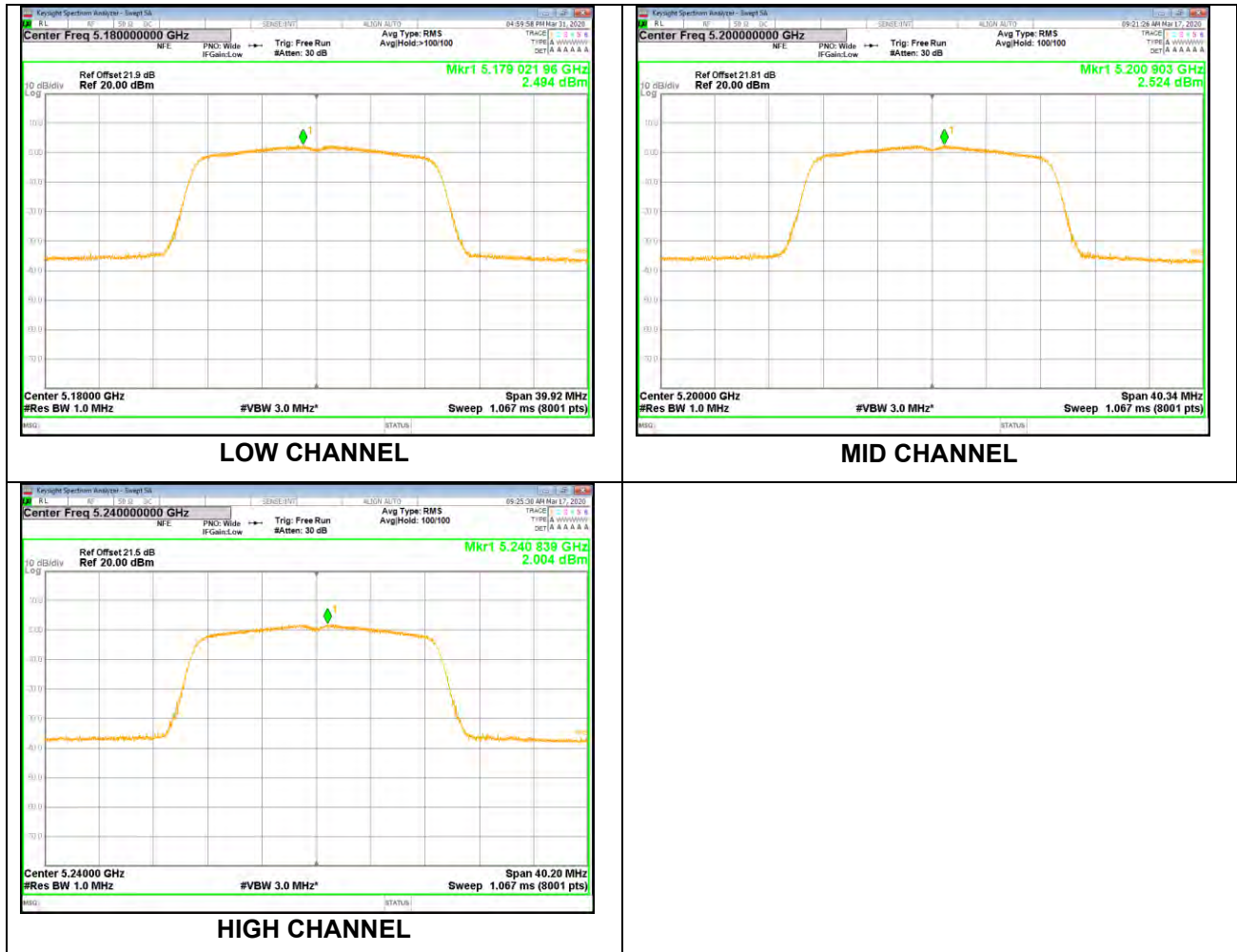



ANT 1



LOW CHANNEL

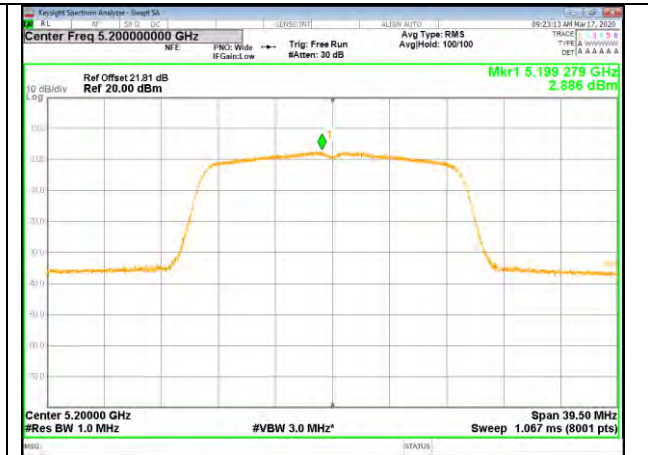

MID CHANNEL

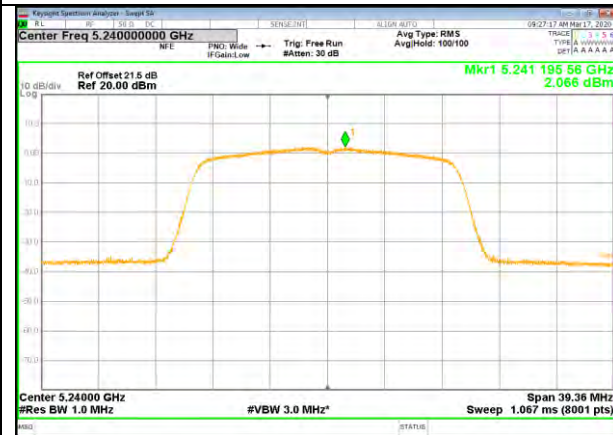

HIGH CHANNEL



UNII-3 BAND

Test Channel	Frequency (MHz)	ANT	DCCF (dB)	PSD Result (dBm/500K Hz)	PSD Result (dBm/500KHz) Total	Limit (dBm/500 KHz)
Low	5745	0	0.12	1.216	4.35	29.1
		1	0.12	1.461		
Mid	5785	0	0.12	2.570	5.49	
		1	0.12	2.378		
High	5825	0	0.12	2.870	5.81	
		1	0.12	2.722		

Note:

1. For test plots, it does not include the duty cycle correction factor.
2. PSD result=Test plots result+ Correction Factor
3. The PSD test results have already included the duty cycle correction factor. About correction Factor please refer to section 7.1.

ANT 0

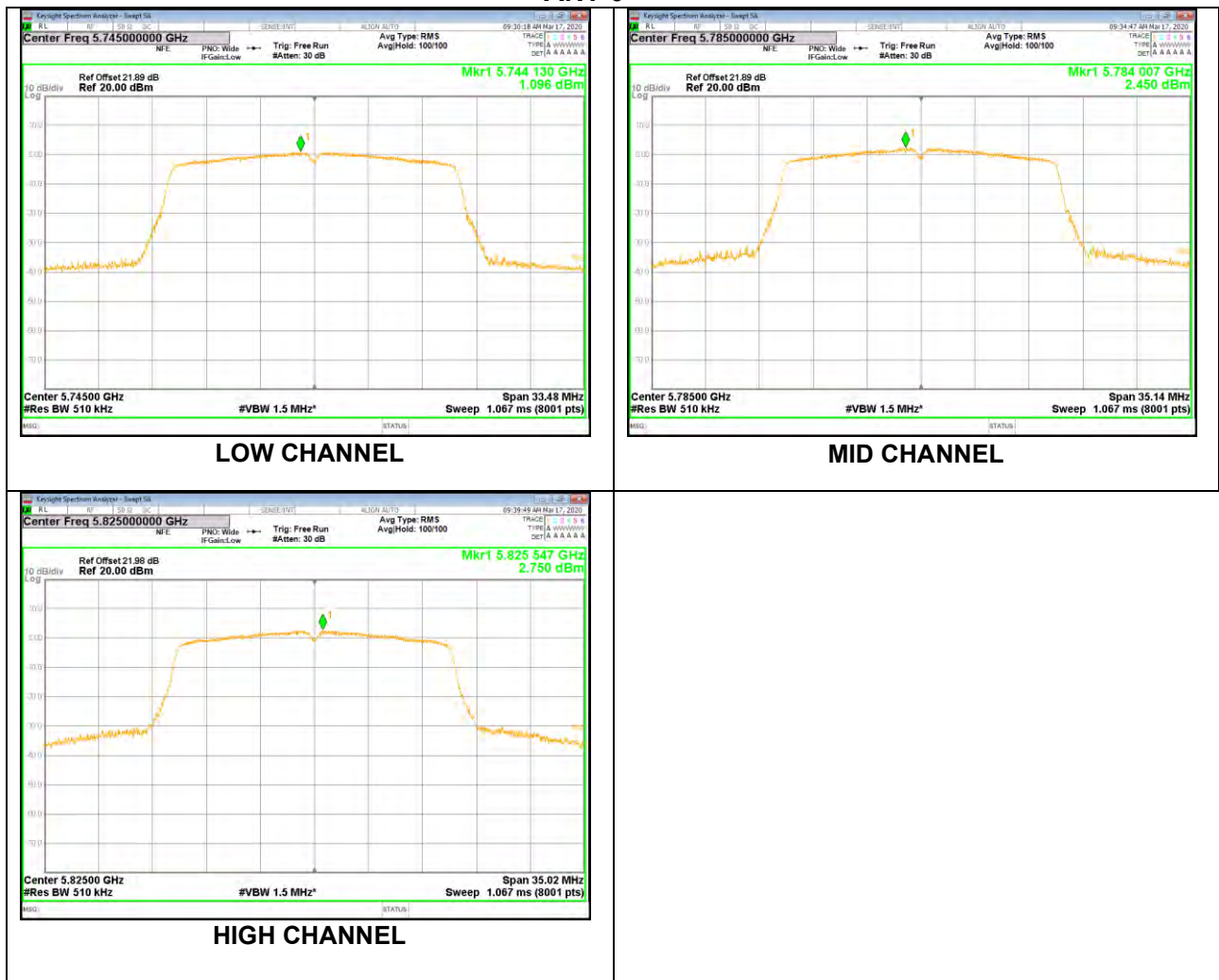



ANT 1



LOW CHANNEL

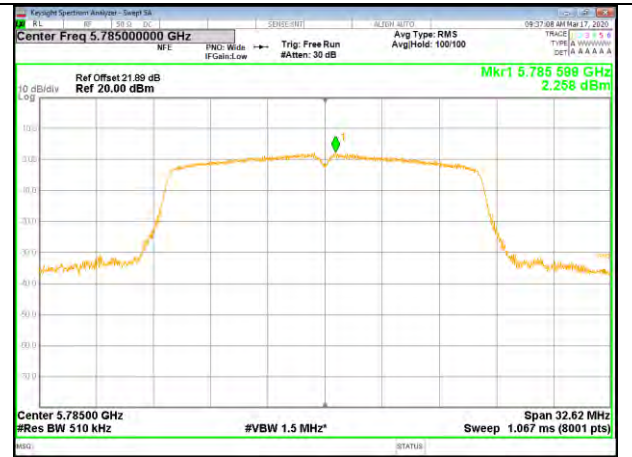

MID CHANNEL



HIGH CHANNEL



7.4.3. 802.11n HT40 MODE

UNII-1 BAND

Test Channel	Frequency (MHz)	ANT	DCCF (dB)	PSD Result (dBm/M Hz)	PSD Result (dBm/M Hz) Total	FCC Limit (dBm/M Hz)	EIRP Result (dBm/M Hz)	EIRP Limit (dBm/M Hz)
Low	5190	0	0.23	0.189	3.19	10.1	7.08	10
		1	0.23	0.178				
High	5230	0	0.23	-0.619	2.40		6.29	
		1	0.23	-0.594				

Note:

1. For test plots, it does not include the duty cycle correction factor.
2. PSD result=Test plots result+ Correction Factor
3. The PSD test results have already included the duty cycle correction factor. About correction Factor please refer to section 7.1.

ANT 0

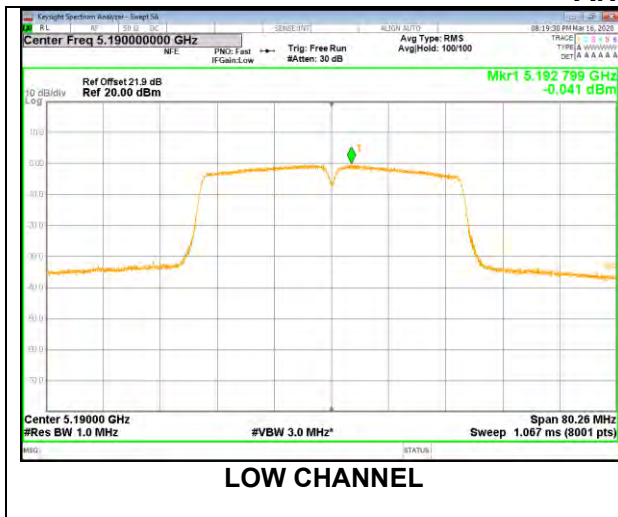

LOW CHANNEL

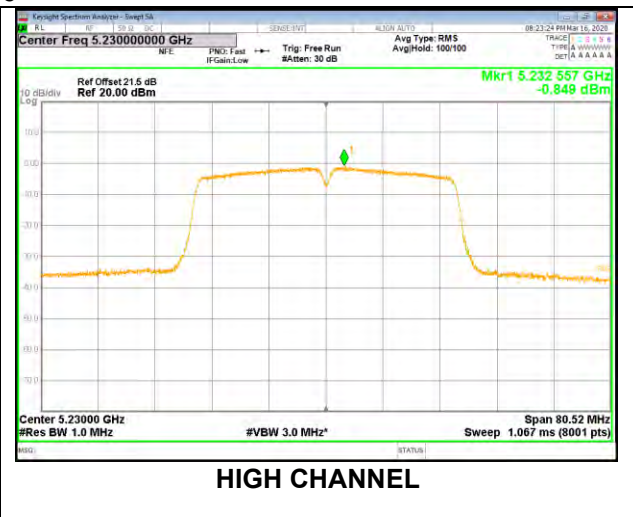

HIGH CHANNEL

ANT 1

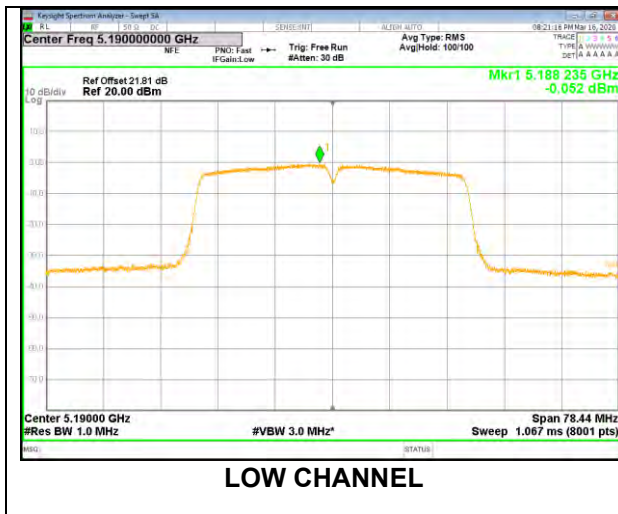

LOW CHANNEL

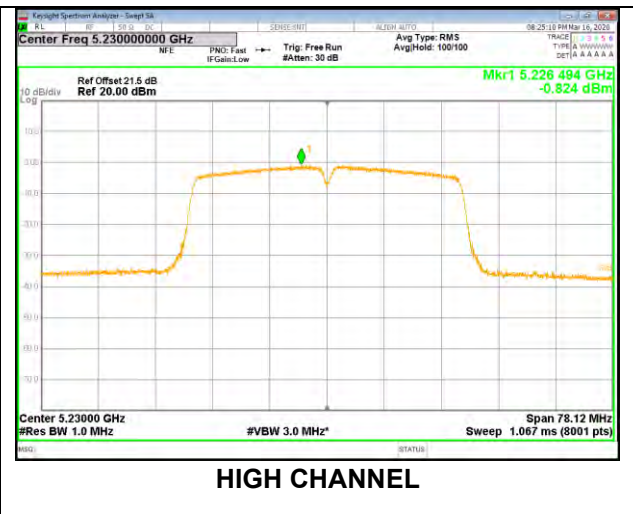

HIGH CHANNEL



UNII-3 BAND

Test Channel	Frequency (MHz)	ANT	DCCF (dB)	PSD Result (dBm/500K Hz)	PSD Result (dBm/500KHz) Total	Limit (dBm/500 KHz)
Low	5755	0	0.23	-1.634	1.24	29.1
		1	0.23	-1.911		
High	5795	0	0.23	-1.645	0.98	
		1	0.23	-2.458		

Note:

1. For test plots, it does not include the duty cycle correction factor.
2. PSD result=Test plots result+ Correction Factor
3. The PSD test results have already included the duty cycle correction factor. About correction Factor please refer to section 7.1.

ANT 0

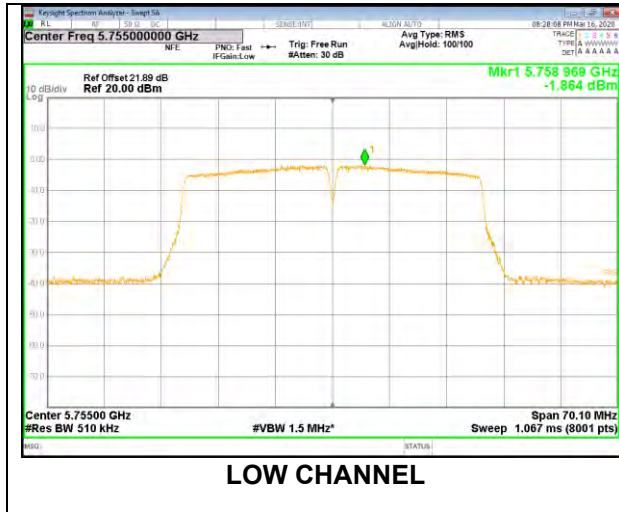

ANT 1

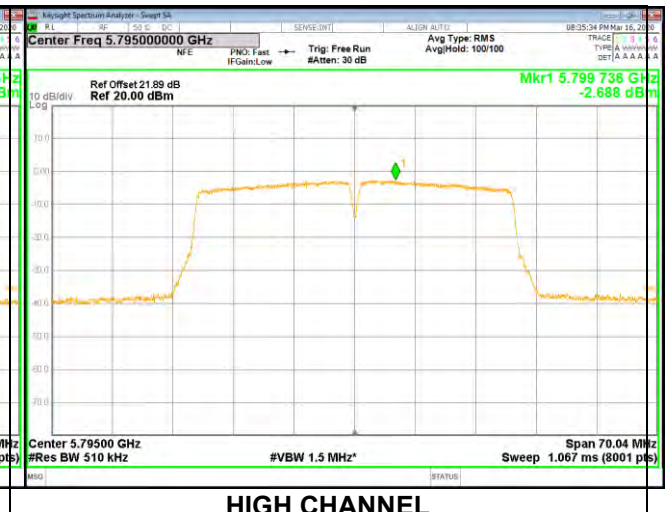



7.4.4. 802.11ac VHT80 MODE

UNII-1 BAND

Test Channel	Frequency (MHz)	ANT	DCCF (dB)	PSD Result (dBm/MHz)	PSD Result (dBm/MHz) Total	FCC Limit (dBm/MHz)	EIRP Result (dBm/MHz)	EIRP Limit (dBm/MHz)
Mid	5210	0	2.26	-3.903	-0.60	10.1	3.29	10
		1	2.26	-3.341				

Note:

1. For test plots, it does not include the duty cycle correction factor.
2. PSD result=Test plots result+ Correction Factor
3. The PSD test results have already included the duty cycle correction factor. About correction Factor please refer to section 7.1.

ANT 0

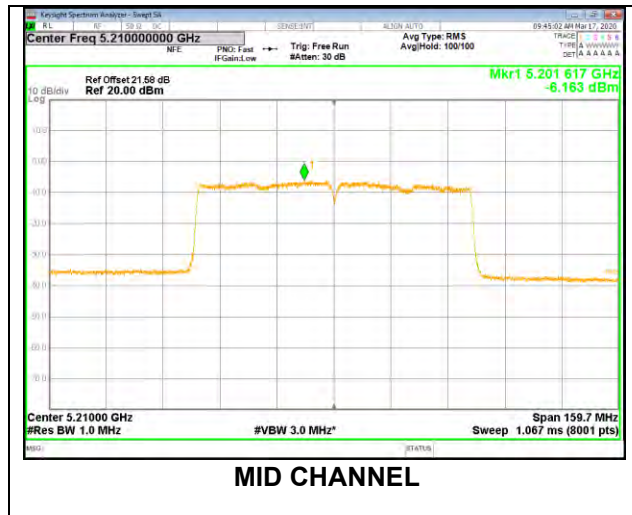

ANT 1

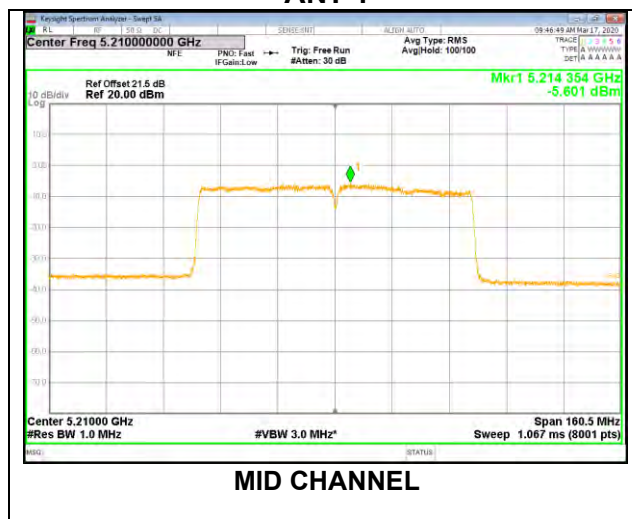



UNII-3 BAND

Test Channel	Frequency (MHz)	ANT	DCCF (dB)	PSD Result (dBm/500K Hz)	PSD Result (dBm/500KHz) Total	Limit (dBm/500 KHz)
Mid	5775	0	2.26	-3.919	-0.95	29.1
		1	2.26	-4.008		

Note:

1. For test plots, it does not include the duty cycle correction factor.
2. PSD result=Test plots result+ Correction Factor
3. The PSD test results have already included the duty cycle correction factor. About correction Factor please refer to section 7.1.

ANT 0

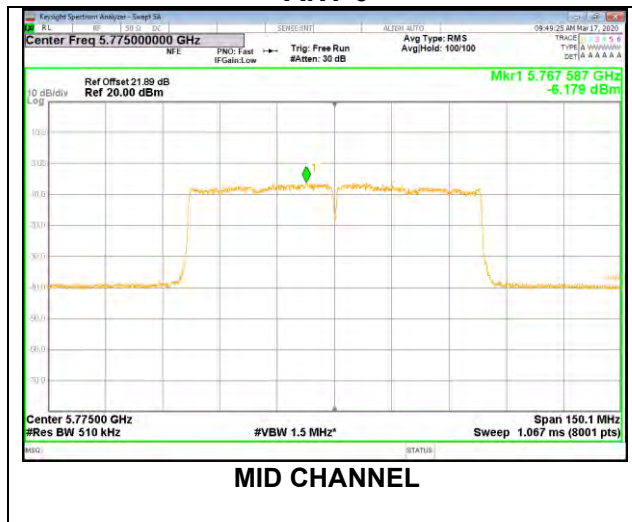

MID CHANNEL

ANT 1

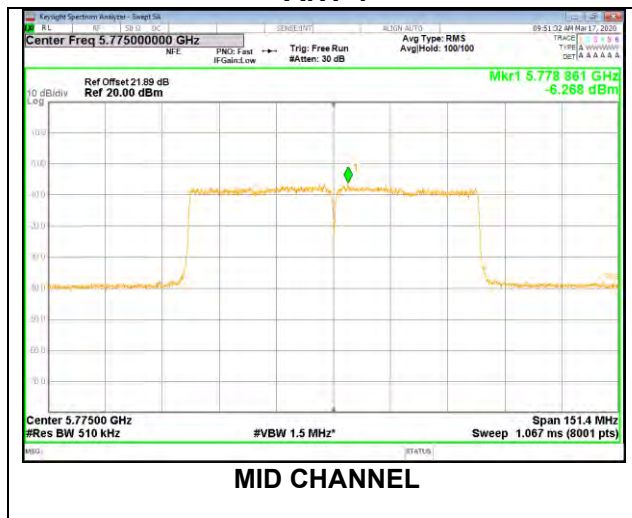

MID CHANNEL

Note: All the modes and antenna ports had been tested, only the worst data recorded in the report.



8. RADIATED TEST RESULTS

LIMITS

Please refer to CFR 47 FCC §15.205, §15.209 and §15.407(b) (4)

Please refer to ISED RSS-GEN Clause 8.9

Radiation Disturbance Test Limit for FCC (Class B)(9kHz-1GHz)

Frequency (MHz)	Field Strength (microvolts/meter)	Measurement Distance (meters)
0.009~0.490	2400/F(kHz)	300
0.490~1.705	24000/F(kHz)	30
1.705~30.0	30	30
30~88	100	3
88~216	150	3
216~960	200	3
960~1000	500	3

Note: 1) At frequencies at or above 30 MHz, measurements may be performed at a distance other than what is specified provided: measurements are not made in the near field except where it can be shown that near field measurements are appropriate due to the characteristics of the device; and it can be demonstrated that the signal levels needed to be measured at the distance employed can be detected by the measurement equipment. Measurements shall not be performed at a distance greater than 30 meters unless it can be further demonstrated that measurements at a distance of 30 meters or less are impractical. When performing measurements at a distance other than that specified, the results shall be extrapolated to the specified distance using an extrapolation factor of 20 dB/decade (inverse linear-distance for field strength measurements; inverse-linear-distance-squared for power density measurements).

(2) At frequencies below 30 MHz, measurements may be performed at a distance closer than that specified in the regulations; however, an attempt should be made to avoid making measurements in the near field. Pending the development of an appropriate measurement procedure for measurements performed below 30 MHz, when performing measurements at a closer distance than specified, the results shall be extrapolated to the specified distance by either making measurements at a minimum of two distances on at least one radial to determine the proper extrapolation factor or by using the square of an inverse linear distance extrapolation factor (40 dB/decade). This paragraph (f) shall not apply to Access BPL devices operating below 30 MHz.



IC Restricted bands please refer to ISED RSS-GEN Clause 8.10.
FCC Restricted bands please refer to CFR 47 FCC 15.209.

Radiated emissions which fall in the restricted bands must comply with the radiated emission limits specified as below table.

LIMITS OF RADIATED EMISSION MEASUREMENT (Below 1GHz)			
Frequency Range (MHz)	Field Strength Limit (uV/m) at 3 m	Field Strength Limit (dBuV/m) at 3 m	
		Quasi-Peak	
30 - 88	100	40	
88 - 216	150	43.5	
216 - 960	200	46	
Above 960	500	54	
Above 1000	500	Peak	Average
		74	54

Limits of unwanted emission out of the restricted bands

LIMITS OF RADIATED EMISSION MEASUREMENT (Above 1GHz)			
Frequency Range (MHz)	EIRP Limit	Field Strength Limit (dBuV/m) at 3 m	
5150~5250 MHz	PK:-27 (dBm/MHz)	PK:68.2(dBμV/m)	
5250~5350 MHz			
5470~5725 MHz			
5725~5850 MHz	PK:-27 (dBm/MHz) *1 PK:10 (dBm/MHz) *2 PK:15.6 (dBm/MHz) *3 PK:27 (dBm/MHz) *4	PK: 68.2(dBμV/m) *1 PK:105.2 (dBμV/m) *2 PK: 110.8(dBμV/m) *3 PK:122.2 (dBμV/m) *4	
<p>Note:</p> <p>*1 beyond 75 MHz or more above of the band edge.</p> <p>*2 below the band edge increasing linearly to 10 dBm/MHz at 25 MHz above.</p> <p>*3 below the band edge increasing linearly to a level of 15.6 dBm/MHz at 5 MHz above.</p> <p>*4 from 5 MHz above or below the band edge increasing linearly to a level of 27 dBm/MHz at the band edge.</p>			

TEST SETUP AND PROCEDURE

Below 30MHz

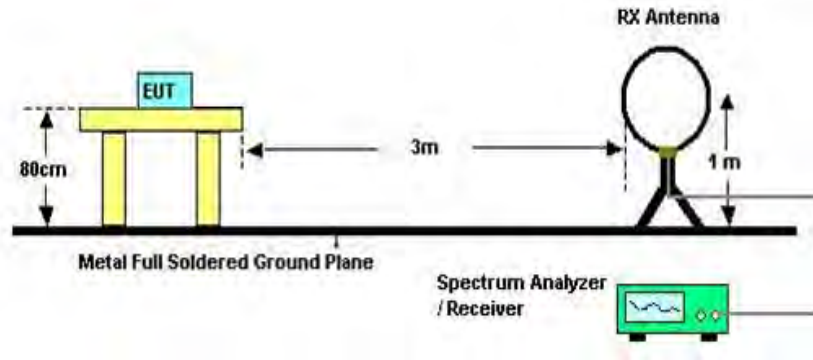

The setting of the spectrum analyser

RBW	200Hz (From 9kHz to 0.15MHz)/ 9kHz (From 0.15MHz to 30MHz)
VBW	200Hz (From 9kHz to 0.15MHz)/ 9kHz (From 0.15MHz to 30MHz)
Sweep	Auto
Detector	Peak/QP/ Average
Trace	Max hold

1. The testing follows the guidelines in ANSI C63.10-2013
2. The EUT was arranged to its worst case and then turntable (from 0 degree to 360 degrees) to find the maximum reading. A pre-amp and a high pass filter are used for the test in order to get better signal level. Both Horizontal, Face-on and Face-off polarizations of the antenna are set to make the measurement.
3. The EUT was placed on a turntable with 0.8 meter above ground.
4. The EUT was set 3 meters from the interference receiving antenna, which was mounted on the top of a variable height antenna tower.
5. For measurement below 1GHz, the initial step in collecting conducted emission data is a spectrum analyzer peak detector mode pre-scanning the measurement frequency range. Significant peaks are then marked and then Quasi Peak detector mode re-measured. If the emission level of the EUT measured by the peak detector is 3 dB lower than the applicable limit, the peak emission level will be reported. Otherwise, the emission measurement will be repeated using the quasi-peak detector and reported.
6. Although these tests were performed other than open field site, adequate comparison measurements were confirmed against 30m open field site. Therefore sufficient tests were made to demonstrate that the alternative site produces results that correlate with the ones of tests made in an open field site based on KDB 414788.

Below 1G

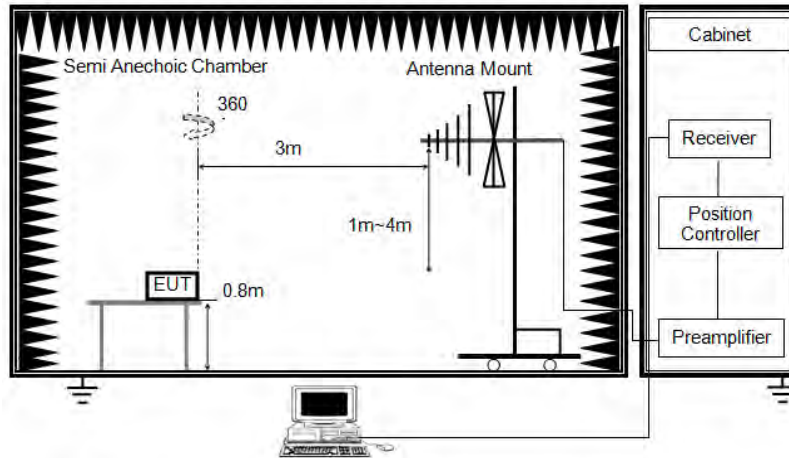

The setting of the spectrum analyser

RBW	120kHz
VBW	300kHz
Sweep	Auto
Detector	Peak/QP
Trace	Max hold

1. The testing follows the guidelines in ANSI C63.10-2013.
2. The EUT was arranged to its worst case and then tune the antenna tower (from 1 m to 4 m) and turntable (from 0 degree to 360 degrees) to find the maximum reading. A pre-amp and a high pass filter are used for the test in order to get better signal level. Both horizontal and vertical polarizations of the antenna are set to make the measurement.
3. The EUT was placed on a turntable with 0.8 meter above ground.
4. The EUT was set 3 meters from the interference receiving antenna, which was mounted on the top of a variable height antenna tower.
5. For measurement below 1GHz, the initial step in collecting conducted emission data is a spectrum analyzer peak detector mode pre-scanning the measurement frequency range. Significant peaks are then marked and then Quasi Peak detector mode re-measured. If the emission level of the EUT measured by the peak detector is 3 dB lower than the applicable limit, the peak emission level will be reported. Otherwise, the emission measurement will be repeated using the quasi-peak detector and reported.

Above 1G

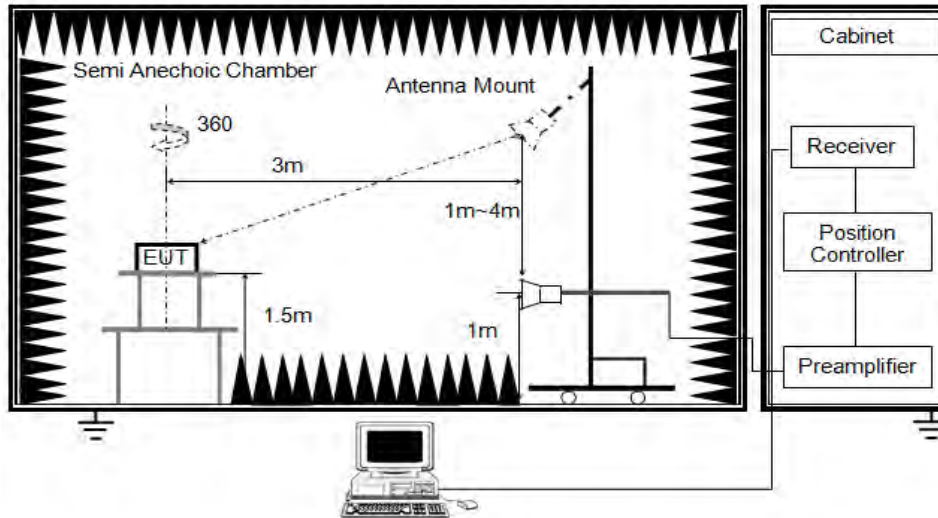

The setting of the spectrum analyser

RBW	1MHz
VBW	PEAK: 3MHz AVG: see note 6
Sweep	Auto
Detector	Peak
Trace	Max hold

1. The testing follows the guidelines in ANSI C63.10-2013.
2. The EUT was arranged to its worst case and then tune the antenna tower (from 1 m to 4 m) and turntable (from 0 degree to 360 degrees) to find the maximum reading. A pre-amp and a high pass filter are used for the test in order to get better signal level. Both horizontal and vertical polarizations of the antenna are set to make the measurement.
3. The EUT was placed on a turntable with 1.5m above ground.
4. The EUT was set 3 meters from the interference receiving antenna, which was mounted on the top of a variable height antenna tower.
5. For measurement above 1GHz, the emission measurement will be measured by the peak detector. This peak level, once corrected, must comply with the limit specified in Section 15.209.
6. For measurements above 1 GHz the resolution bandwidth is set to 1 MHz, then the video bandwidth is set to 3 MHz for peak measurements and 1 MHz resolution bandwidth with 1/T video bandwidth with peak detector for average measurements. For the Duty Cycle please refer to clause 7.1.ON TIME AND DUTY CYCLE.

X axis, Y axis, Z axis positions:

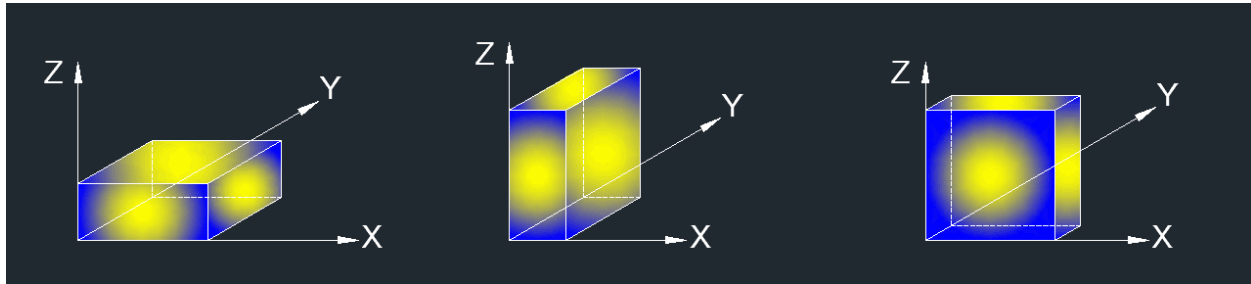

Note 1: For all radiated test, EUT in each of three orthogonal axis emissions had been tested, but only the worst case (Y axis) data recorded in the report.

Note 2: The EUT was fully exercised with external accessories during the test. In the case of multiple accessory external ports, an external accessory shall be connected to one of each type of port.

Note 3: The EUT does not support simultaneous transmission.

TEST ENVIRONMENT

Temperature	23.4°C	Relative Humidity	54%
Atmosphere Pressure	101kPa	Test Voltage	DC 5V



8.1. 802.11a 20 MODE

8.1.1. UNII-1 BAND

**1TX MODE ANT0:WCT5J-20
RESTRICTED BANDEGE LOW CHANNEL**

HORIZONTAL RESULTS
PEAK

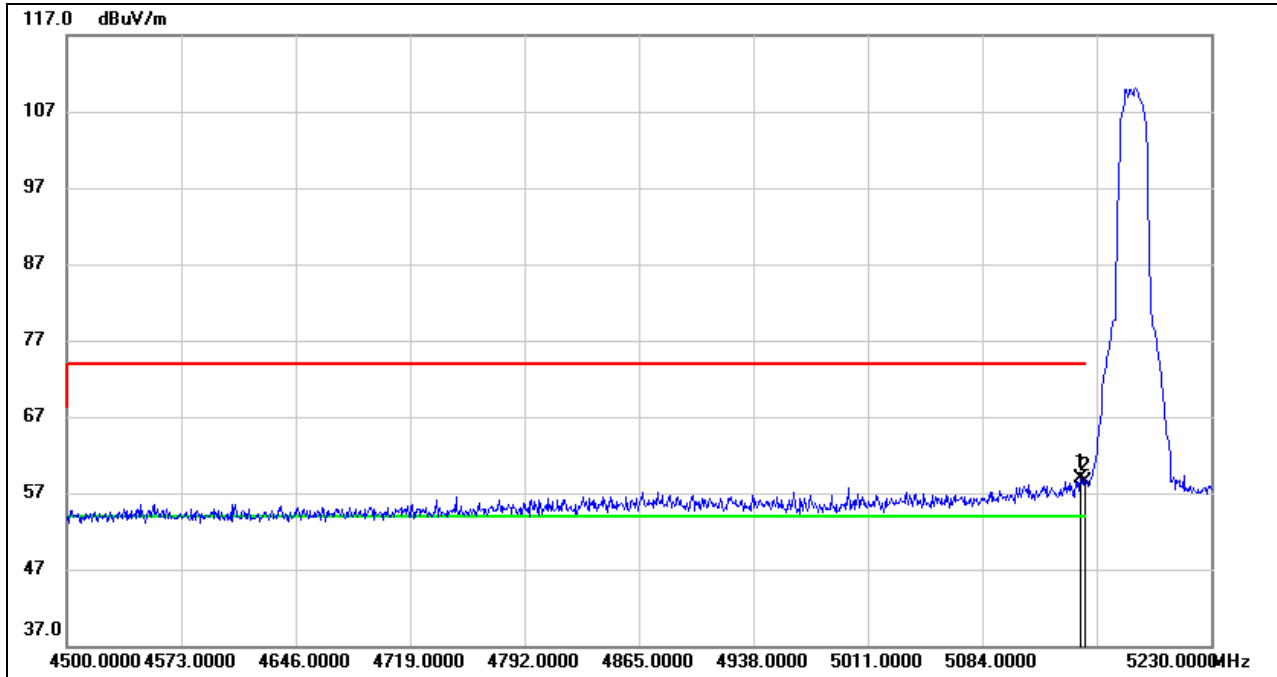

No.	Frequency (MHz)	Reading (dBuV)	Correct (dB/m)	Result (dBuV/m)	Limit (dBuV/m)	Margin (dB)	Remark
1	5146.780	18.43	40.45	58.88	74.00	-15.12	peak
2	5150.000	18.04	40.46	58.50	74.00	-15.50	peak

- Note: 1. Measurement = Reading Level + Correct Factor.
 2. If Peak Result complies with AV limit, AV Result is deemed to comply with AV limit.
 3. Peak: Peak detector.
 4. Only the worst case emission will be recorder, if it complies with the limit, the other emissions deemed to comply with the limit.



AVG

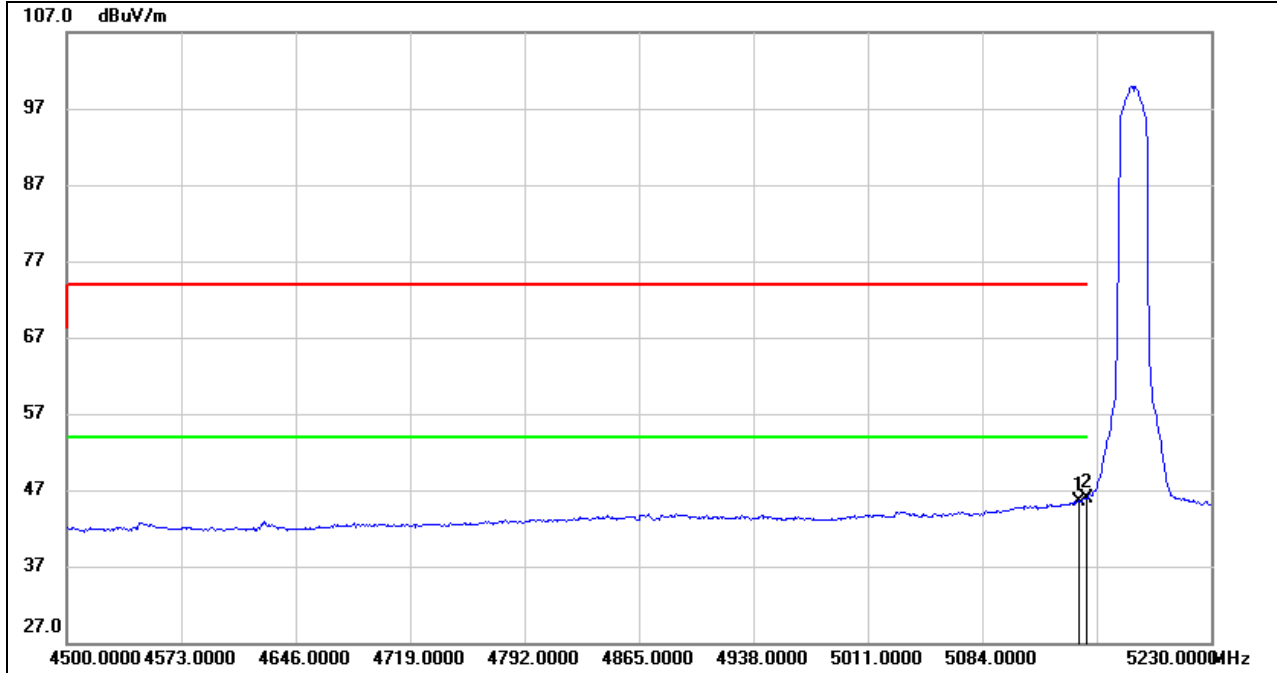

No.	Frequency (MHz)	Reading (dBuV)	Correct (dB/m)	Result (dBuV/m)	Limit (dBuV/m)	Margin (dB)	Remark
1	5146.780	5.01	40.45	45.46	54.00	-8.54	AVG
2	5150.000	5.41	40.46	45.87	54.00	-8.13	AVG

- Note: 1. Measurement = Reading Level + Correct Factor.
 2. AVG: $VBW=1/Ton$ where: ton is transmit duration.
 3. For duty cycle, please refer to clause 7.1.
 4. Only the worst case emission will be recorder, if it complies with the limit, the other emissions deemed to comply with the limit.



VERTICAL RESULTS
PEAK

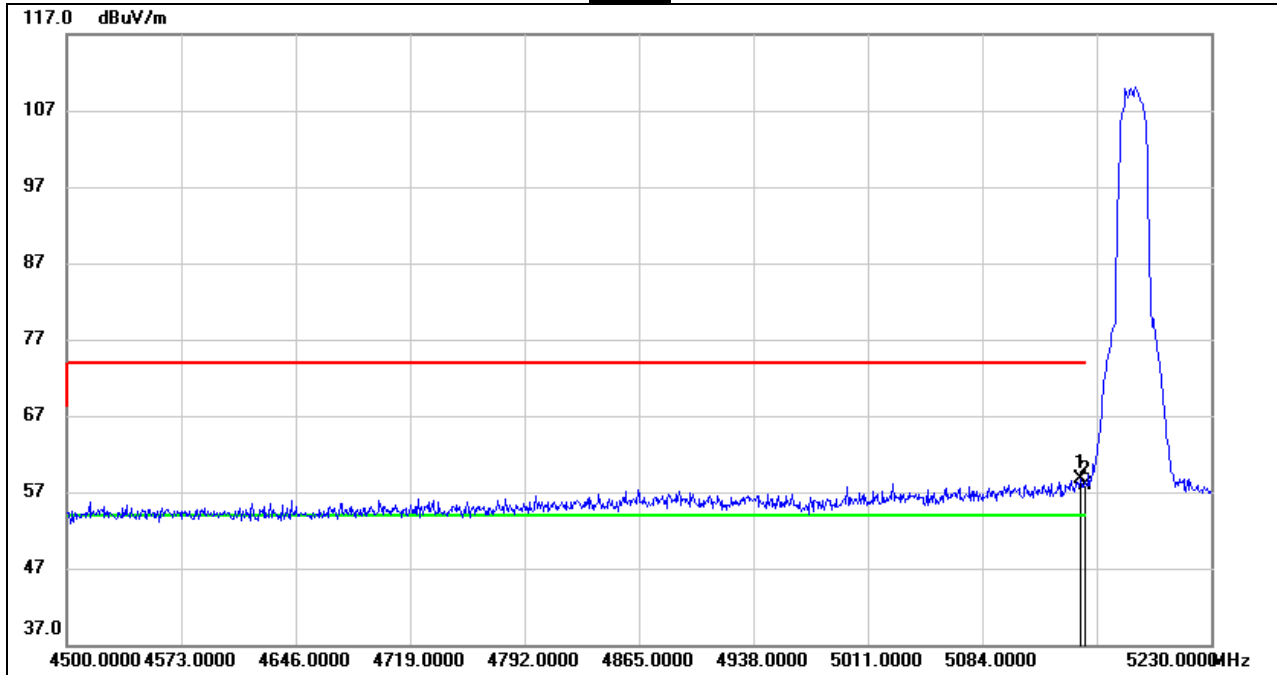

No.	Frequency (MHz)	Reading (dBuV)	Correct (dB/m)	Result (dBuV/m)	Limit (dBuV/m)	Margin (dB)	Remark
1	5146.780	18.35	40.45	58.80	74.00	-15.20	peak
2	5150.000	17.47	40.46	57.93	74.00	-16.07	peak

- Note: 1. Measurement = Reading Level + Correct Factor.
 2. If Peak Result complies with AV limit, AV Result is deemed to comply with AV limit.
 3. Peak: Peak detector.
 4. Only the worst case emission will be recorder, if it complies with the limit, the other emissions deemed to comply with the limit.



AVG

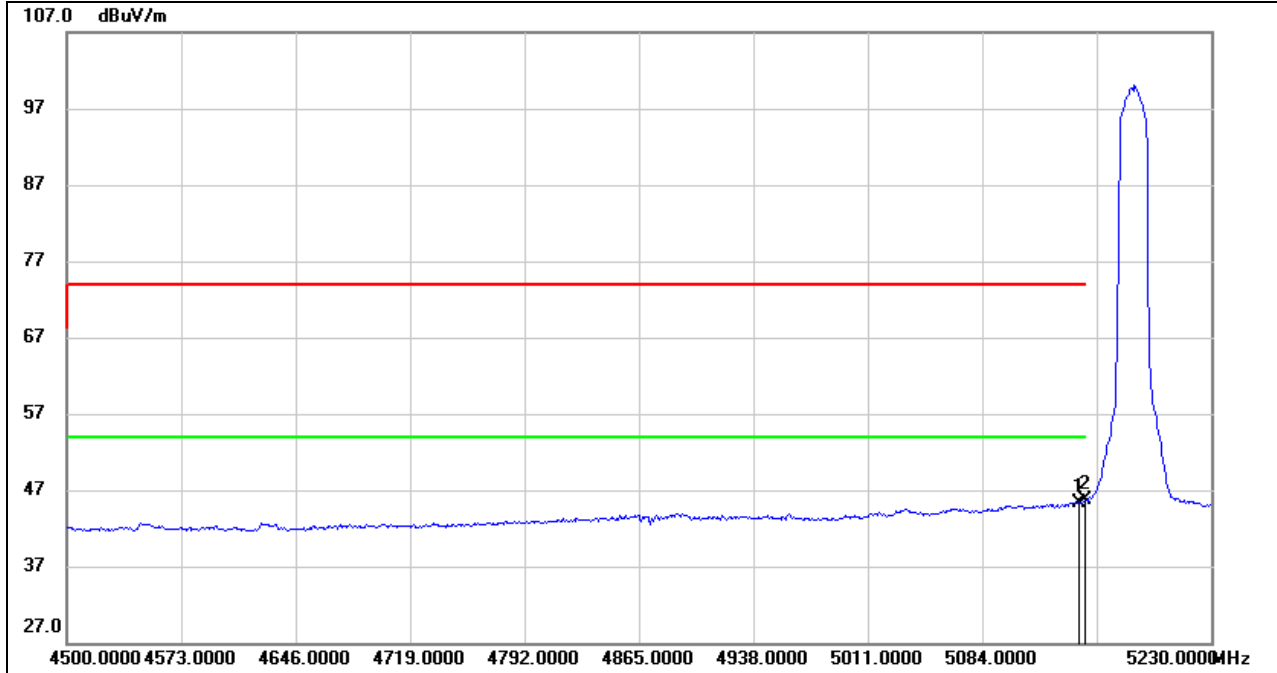

No.	Frequency (MHz)	Reading (dBuV)	Correct (dB/m)	Result (dBuV/m)	Limit (dBuV/m)	Margin (dB)	Remark
1	5146.780	4.76	40.45	45.21	54.00	-8.79	AVG
2	5150.000	5.24	40.46	45.70	54.00	-8.30	AVG

- Note: 1. Measurement = Reading Level + Correct Factor.
 2. AVG: VBW=1/Ton where: ton is transmit duration.
 3. For duty cycle, please refer to clause 7.1.
 4. Only the worst case emission will be recorder, if it complies with the limit, the other emissions deemed to comply with the limit.



HARMONICS AND SPURIOUS EMISSIONS LOW CHANNEL

**HORIZONTAL RESULTS
1-7GHz**

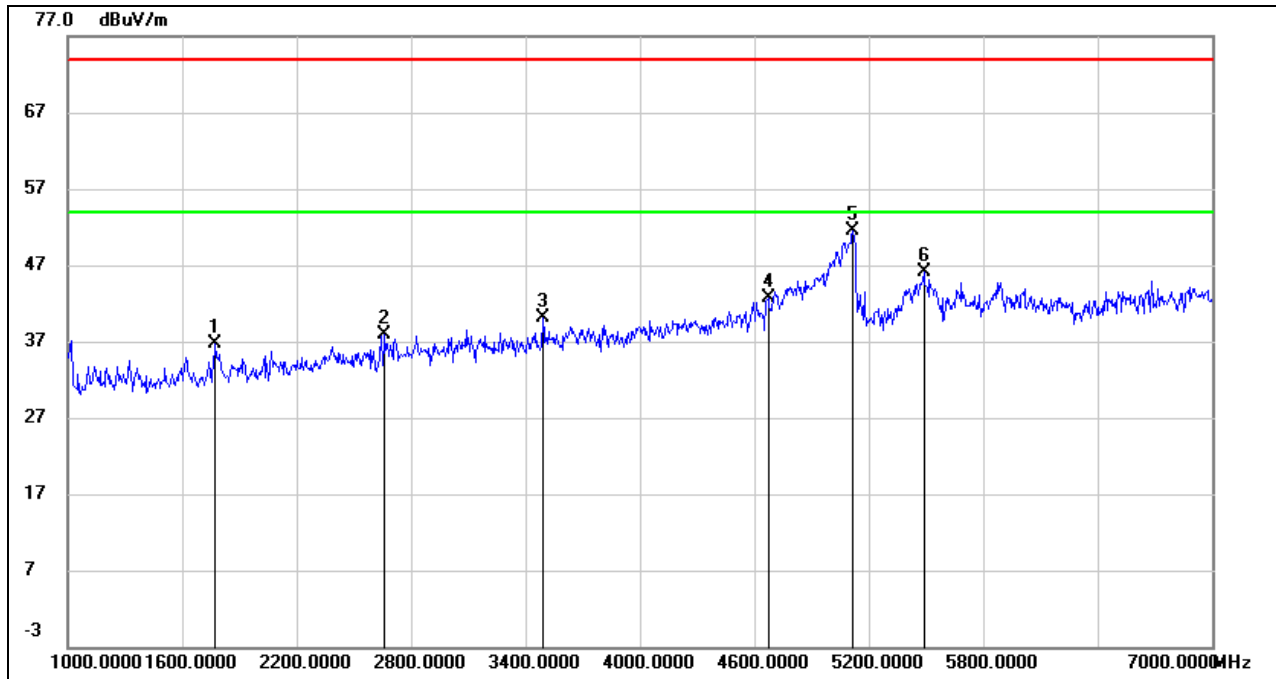

No.	Frequency (MHz)	Reading (dBuV)	Correct (dB/m)	Result (dBuV/m)	Limit (dBuV/m)	Margin (dB)	Remark
1	1774.000	47.08	-10.33	36.75	74.00	-37.25	peak
2	2662.000	44.81	-6.96	37.85	74.00	-36.15	peak
3	3490.000	44.03	-3.95	40.08	74.00	-33.92	peak
4	4672.000	41.54	1.09	42.63	74.00	-31.37	peak
5	5116.000	48.54	2.87	51.41	74.00	-22.59	peak
6	5488.000	41.88	4.28	46.16	74.00	-27.84	peak

Note: 1. Measurement = Reading Level + Correct Factor.
 2. If Peak Result complies with AV limit, AV Result is deemed to comply with AV limit.
 3. Peak: Peak detector.
 4. Filter losses were only considered in the spurious frequency bands and the authorized band was not corrected for Band reject filter losses.
 5. Proper operation of the transmitter prior to adding the filter to the measurement chain.
 6. Owing to the highest peak level of unwanted emission out of the restricted bands complies with the lowest limit(54dBuV/m), so all the test point were deemed to comply with the limits list in the standard.



HORIZONTAL RESULTS
7-18GHz

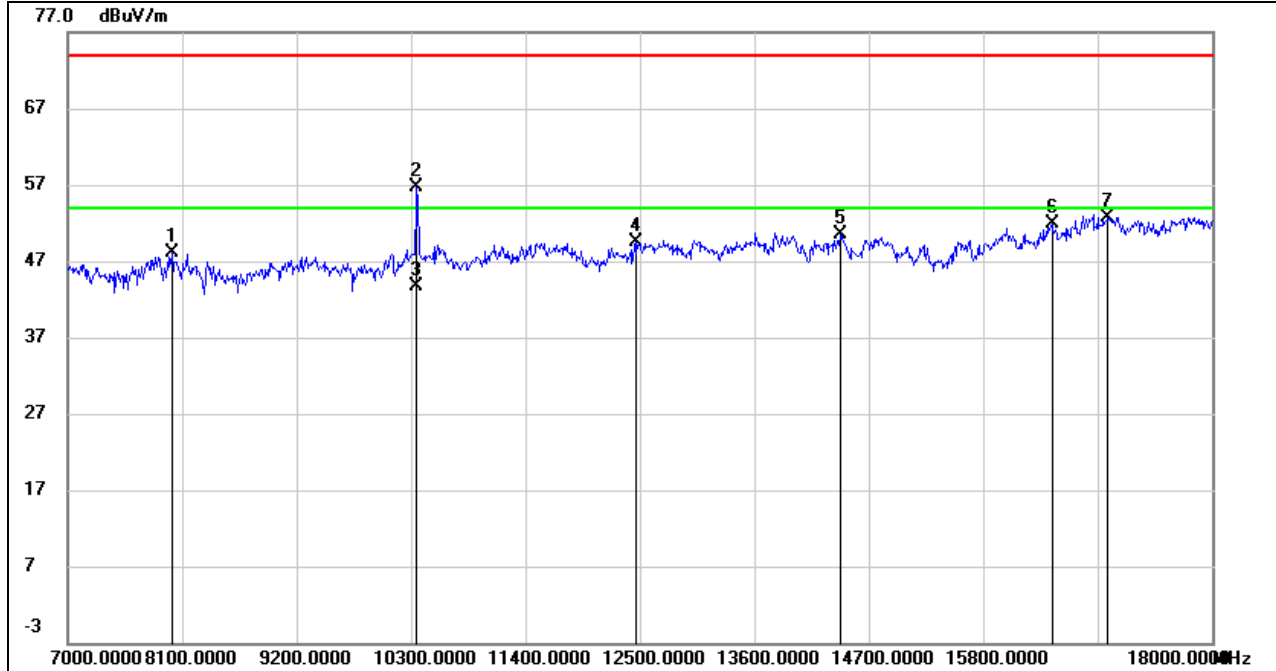

No.	Frequency (MHz)	Reading (dBuV)	Correct (dB/m)	Result (dBuV/m)	Limit (dBuV/m)	Margin (dB)	Remark
1	8001.000	40.57	7.44	48.01	74.00	-25.99	peak
2	10357.700	45.46	11.22	56.68	74.00	-17.32	peak
3	10357.700	32.52	11.22	43.74	54.00	-10.26	AVG
4	12456.000	34.87	14.54	49.41	74.00	-24.59	peak
5	14425.000	33.87	16.65	50.52	74.00	-23.48	peak
6	16460.000	32.39	19.49	51.88	74.00	-22.12	peak
7	16999.000	32.16	20.64	52.80	74.00	-21.20	peak

Note: 1. Measurement = Reading Level + Correct Factor.
 2. If Peak Result complies with AV limit, AV Result is deemed to comply with AV limit.
 3. Peak: Peak detector.
 4. AVG: $VBW=1/Ton$ where: ton is transmit duration.
 5. For transmit duration, please refer to clause 7.1.
 6. Filter losses were only considered in the spurious frequency bands and the authorized band was not corrected for High Pass Filter losses.
 7. Proper operation of the transmitter prior to adding the filter to the measurement chain.
 8. Owing to the highest peak level of unwanted emission out of the restricted bands complies with the lowest limit(54dBuV/m), so all the test point were deemed to comply with the limits list in the standard.



VERTICAL RESULTS
1-7GHz

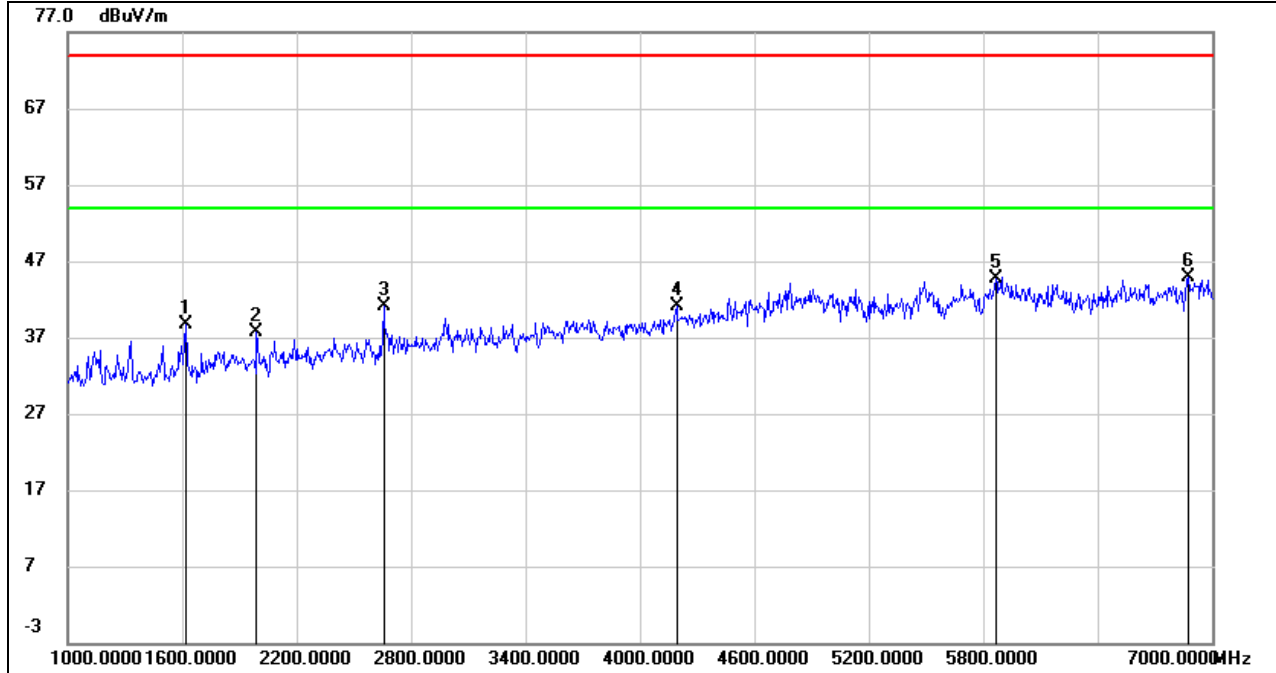

No.	Frequency (MHz)	Reading (dBuV)	Correct (dB/m)	Result (dBuV/m)	Limit (dBuV/m)	Margin (dB)	Remark
1	1618.000	49.72	-11.09	38.63	74.00	-35.37	peak
2	1990.000	47.57	-9.86	37.71	74.00	-36.29	peak
3	2656.000	48.06	-7.01	41.05	74.00	-32.95	peak
4	4192.000	42.07	-0.94	41.13	74.00	-32.87	peak
5	5866.000	39.91	4.82	44.73	74.00	-29.27	peak
6	6874.000	38.02	6.86	44.88	74.00	-29.12	peak

Note: 1. Measurement = Reading Level + Correct Factor.
 2. If Peak Result complies with AV limit, AV Result is deemed to comply with AV limit.
 3. Peak: Peak detector.
 4. Filter losses were only considered in the spurious frequency bands and the authorized band was not corrected for Band reject filter losses.
 5. Proper operation of the transmitter prior to adding the filter to the measurement chain.
 6. Owing to the highest peak level of unwanted emission out of the restricted bands complies with the lowest limit(54dBuV/m), so all the test point were deemed to comply with the limits list in the standard.



7-18GHz

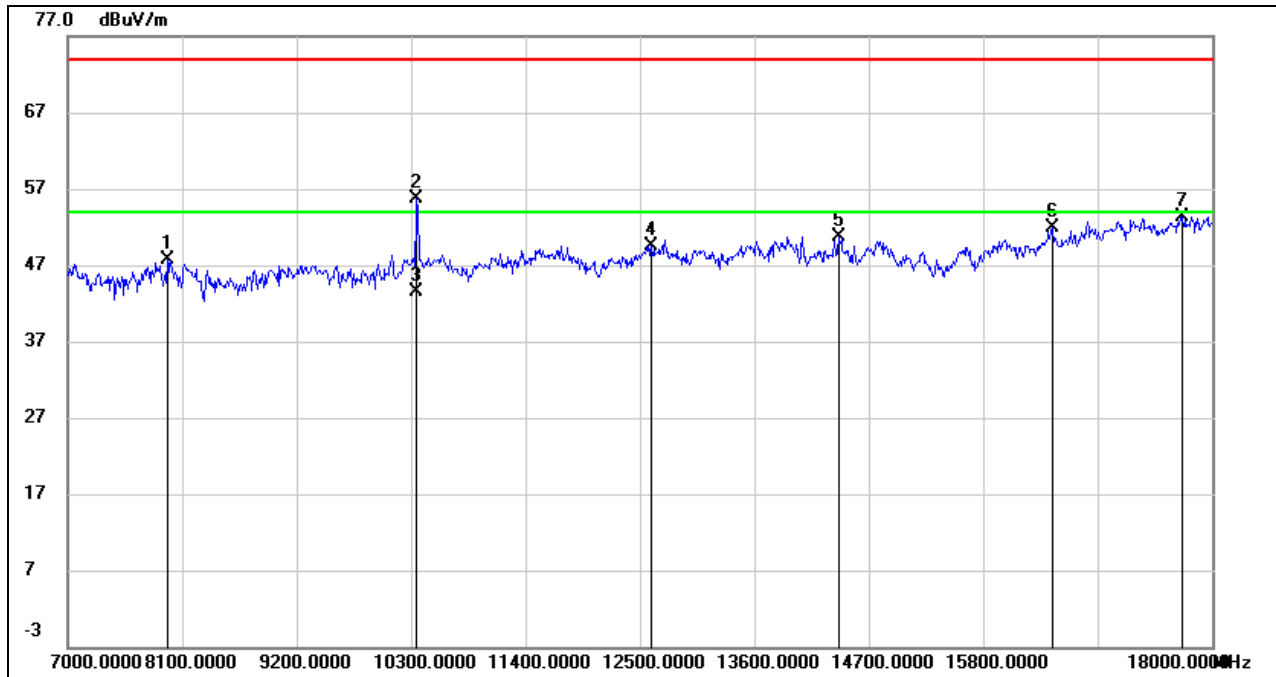

No.	Frequency (MHz)	Reading (dBuV)	Correct (dB/m)	Result (dBuV/m)	Limit (dBuV/m)	Margin (dB)	Remark
1	7957.000	40.20	7.50	47.70	74.00	-26.30	peak
2	10361.444	44.54	11.22	55.76	74.00	-18.24	peak
3	10361.444	32.22	11.22	43.44	54.00	-10.56	AVG
4	12610.000	35.28	14.21	49.49	74.00	-24.51	peak
5	14414.000	34.04	16.66	50.70	74.00	-23.30	peak
6	16460.000	32.45	19.49	51.94	74.00	-22.06	peak
7	17714.000	30.77	22.62	53.39	74.00	-20.61	peak

Note: 1. Measurement = Reading Level + Correct Factor.
 2. If Peak Result complies with AV limit, AV Result is deemed to comply with AV limit.
 3. Peak: Peak detector.
 4. AVG: $VBW=1/T_{on}$ where: t_{on} is transmit duration.
 5. For transmit duration, please refer to clause 7.1.
 6. Filter losses were only considered in the spurious frequency bands and the authorized band was not corrected for High Pass Filter losses.
 7. Proper operation of the transmitter prior to adding the filter to the measurement chain.
 8. Owing to the highest peak level of unwanted emission out of the restricted bands complies with the lowest limit(54dBuV/m), so all the test point were deemed to comply with the limits list in the standard.



HARMONICS AND SPURIOUS EMISSIONS MID CHANNEL

HORIZONTAL RESULTS
1-7GHz

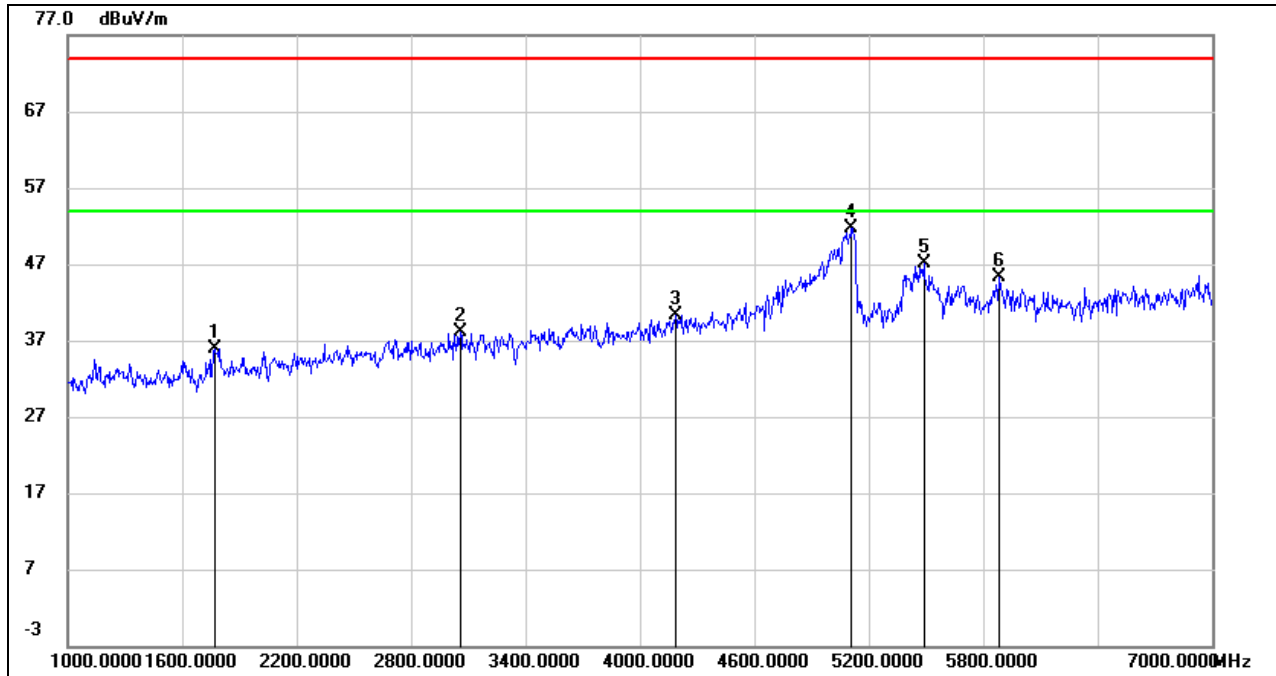

No.	Frequency (MHz)	Reading (dBuV)	Correct (dB/m)	Result (dBuV/m)	Limit (dBuV/m)	Margin (dB)	Remark
1	1768.000	46.29	-10.38	35.91	74.00	-38.09	peak
2	3058.000	42.83	-4.64	38.19	74.00	-35.81	peak
3	4186.000	41.31	-1.02	40.29	74.00	-33.71	peak
4	5110.000	48.81	2.85	51.66	74.00	-22.34	peak
5	5488.000	42.88	4.28	47.16	74.00	-26.84	peak
6	5884.000	40.08	5.14	45.22	74.00	-28.78	peak

Note: 1. Measurement = Reading Level + Correct Factor.
 2. If Peak Result complies with AV limit, AV Result is deemed to comply with AV limit.
 3. Peak: Peak detector.
 4. Filter losses were only considered in the spurious frequency bands and the authorized band was not corrected for Band reject filter losses.
 5. Proper operation of the transmitter prior to adding the filter to the measurement chain.
 6. Owing to the highest peak level of unwanted emission out of the restricted bands complies with the lowest limit(54dBuV/m), so all the test point were deemed to comply with the limits list in the standard.



HORIZONTAL RESULTS
7-18GHz

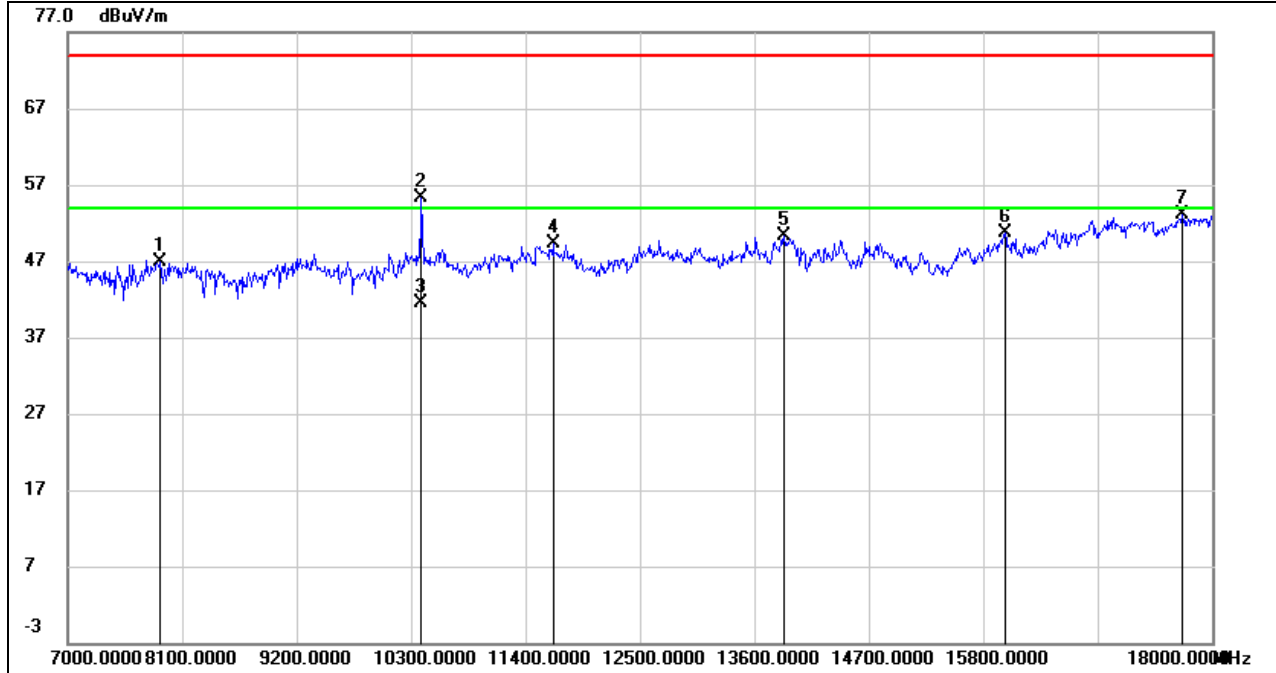

No.	Frequency (MHz)	Reading (dBuV)	Correct (dB/m)	Result (dBuV/m)	Limit (dBuV/m)	Margin (dB)	Remark
1	7891.000	39.26	7.66	46.92	74.00	-27.08	peak
2	10397.500	44.08	11.18	55.26	74.00	-18.74	peak
3	10397.500	30.41	11.18	41.59	54.00	-12.41	AVG
4	11664.000	36.05	13.22	49.27	74.00	-24.73	peak
5	13886.000	34.04	16.30	50.34	74.00	-23.66	peak
6	16009.000	32.85	17.85	50.70	74.00	-23.30	peak
7	17714.000	30.40	22.62	53.02	74.00	-20.98	peak

Note: 1. Measurement = Reading Level + Correct Factor.
 2. If Peak Result complies with AV limit, AV Result is deemed to comply with AV limit.
 3. Peak: Peak detector.
 4. AVG: $VBW=1/Ton$ where: ton is transmit duration.
 5. For transmit duration, please refer to clause 7.1.
 6. Filter losses were only considered in the spurious frequency bands and the authorized band was not corrected for High Pass Filter losses.
 7. Proper operation of the transmitter prior to adding the filter to the measurement chain.
 8. Owing to the highest peak level of unwanted emission out of the restricted bands complies with the lowest limit(54dBuV/m), so all the test point were deemed to comply with the limits list in the standard.



VERTICAL RESULTS
1-7GHz

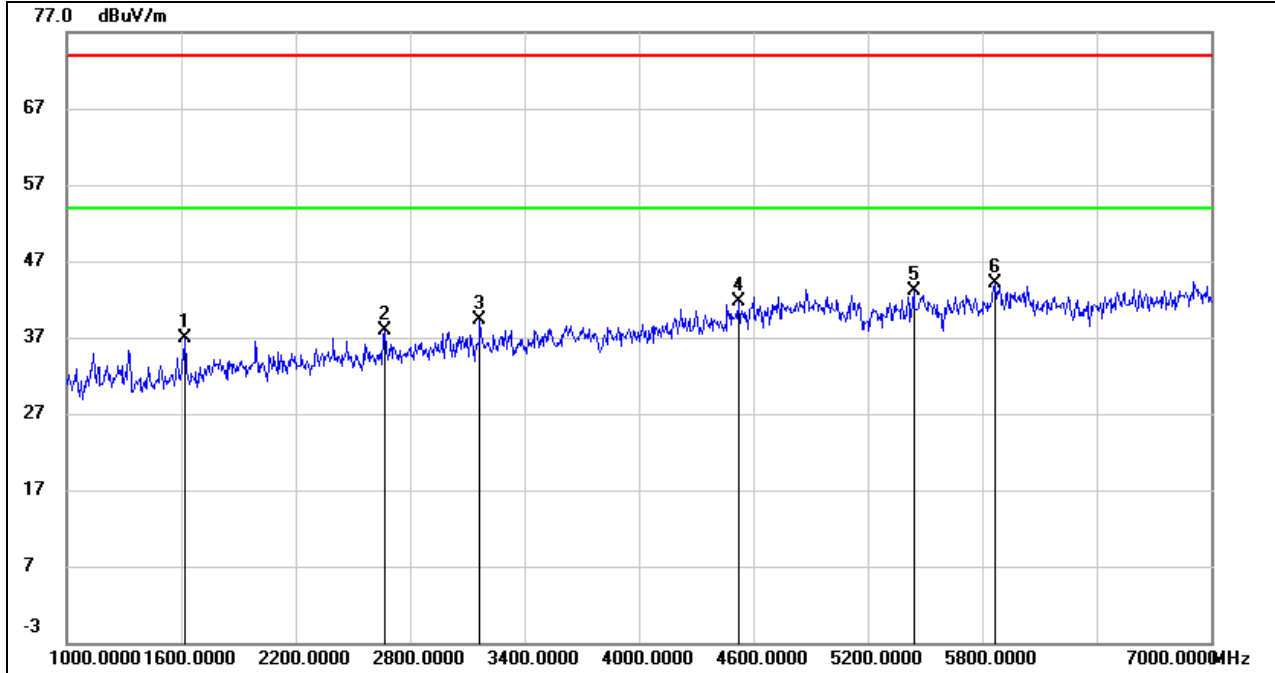

No.	Frequency (MHz)	Reading (dBuV)	Correct (dB/m)	Result (dBuV/m)	Limit (dBuV/m)	Margin (dB)	Remark
1	1618.000	48.03	-11.09	36.94	74.00	-37.06	peak
2	2668.000	44.78	-6.91	37.87	74.00	-36.13	peak
3	3166.000	43.87	-4.60	39.27	74.00	-34.73	peak
4	4522.000	41.43	0.35	41.78	74.00	-32.22	peak
5	5440.000	39.41	3.61	43.02	74.00	-30.98	peak
6	5866.000	39.19	4.82	44.01	74.00	-29.99	peak

Note: 1. Measurement = Reading Level + Correct Factor.
 2. If Peak Result complies with AV limit, AV Result is deemed to comply with AV limit.
 3. Peak: Peak detector.
 4. Filter losses were only considered in the spurious frequency bands and the authorized band was not corrected for Band reject filter losses.
 5. Proper operation of the transmitter prior to adding the filter to the measurement chain.
 6. Owing to the highest peak level of unwanted emission out of the restricted bands complies with the lowest limit(54dBuV/m), so all the test point were deemed to comply with the limits list in the standard.



7-18GHz

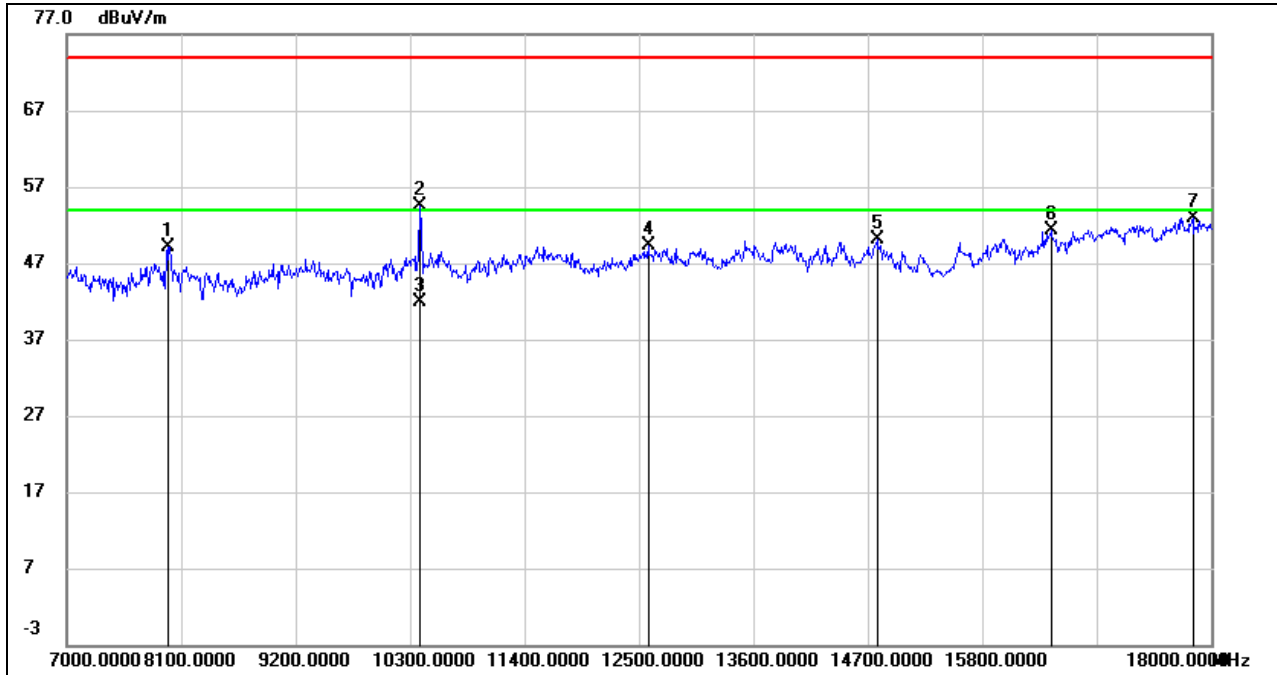

No.	Frequency (MHz)	Reading (dBuV)	Correct (dB/m)	Result (dBuV/m)	Limit (dBuV/m)	Margin (dB)	Remark
1	7968.000	41.66	7.49	49.15	74.00	-24.85	peak
2	10401.470	43.42	11.17	54.59	74.00	-19.41	peak
3	10401.470	30.64	11.17	41.81	54.00	-12.19	AVG
4	12588.000	35.08	14.27	49.35	74.00	-24.65	peak
5	14788.000	34.08	16.08	50.16	74.00	-23.84	peak
6	16460.000	31.73	19.49	51.22	74.00	-22.78	peak
7	17824.000	29.44	23.42	52.86	74.00	-21.14	peak

Note: 1. Measurement = Reading Level + Correct Factor.
 2. If Peak Result complies with AV limit, AV Result is deemed to comply with AV limit.
 3. Peak: Peak detector.
 4. AVG: $VBW=1/T_{on}$ where: t_{on} is transmit duration.
 5. For transmit duration, please refer to clause 7.1.
 6. Filter losses were only considered in the spurious frequency bands and the authorized band was not corrected for High Pass Filter losses.
 7. Proper operation of the transmitter prior to adding the filter to the measurement chain.
 8. Owing to the highest peak level of unwanted emission out of the restricted bands complies with the lowest limit(54dBuV/m), so all the test point were deemed to comply with the limits list in the standard.



HARMONICS AND SPURIOUS EMISSIONS HIGH CHANNEL

HORIZONTAL RESULTS
1-7GHz

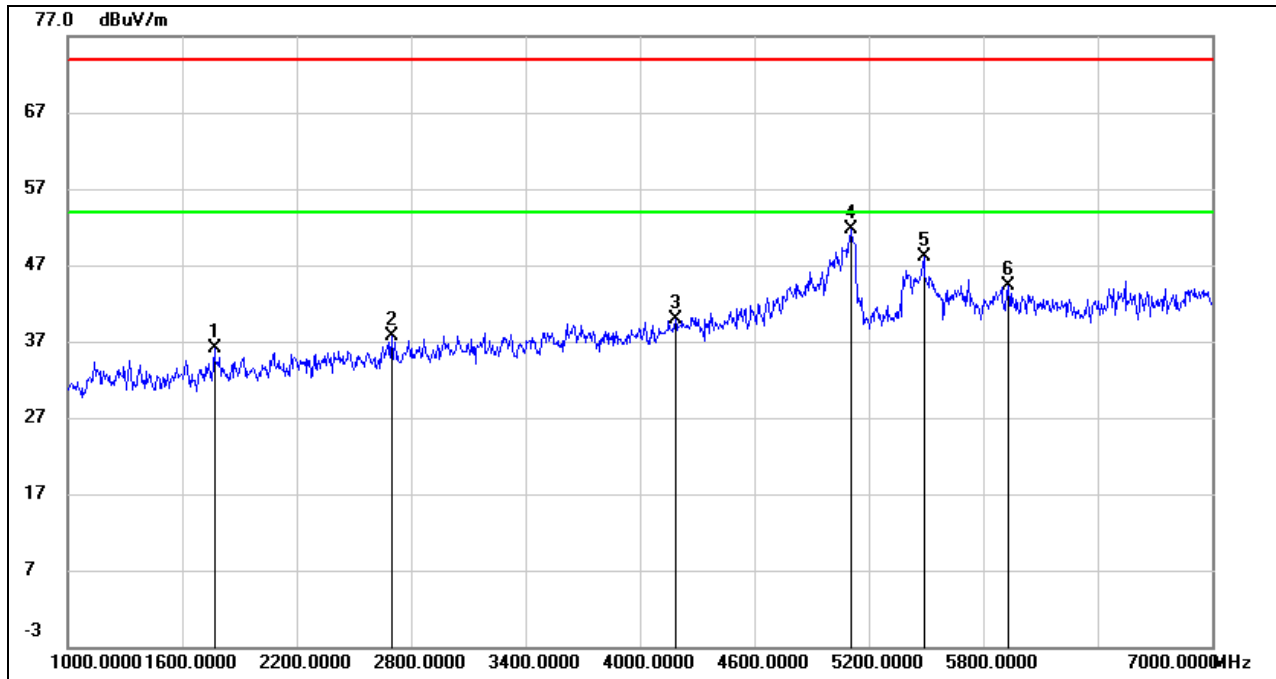

No.	Frequency (MHz)	Reading (dBuV)	Correct (dB/m)	Result (dBuV/m)	Limit (dBuV/m)	Margin (dB)	Remark
1	1768.000	46.48	-10.38	36.10	74.00	-37.90	peak
2	2698.000	44.28	-6.65	37.63	74.00	-36.37	peak
3	4186.000	40.83	-1.02	39.81	74.00	-34.19	peak
4	5110.000	48.92	2.85	51.77	74.00	-22.23	peak
5	5488.000	43.86	4.28	48.14	74.00	-25.86	peak
6	5932.000	39.14	5.10	44.24	74.00	-29.76	peak

Note: 1. Measurement = Reading Level + Correct Factor.
 2. If Peak Result complies with AV limit, AV Result is deemed to comply with AV limit.
 3. Peak: Peak detector.
 4. Filter losses were only considered in the spurious frequency bands and the authorized band was not corrected for Band reject filter losses.
 5. Proper operation of the transmitter prior to adding the filter to the measurement chain.
 6. Owing to the highest peak level of unwanted emission out of the restricted bands complies with the lowest limit(54dBuV/m), so all the test point were deemed to comply with the limits list in the standard.



HORIZONTAL RESULTS
7-18GHz

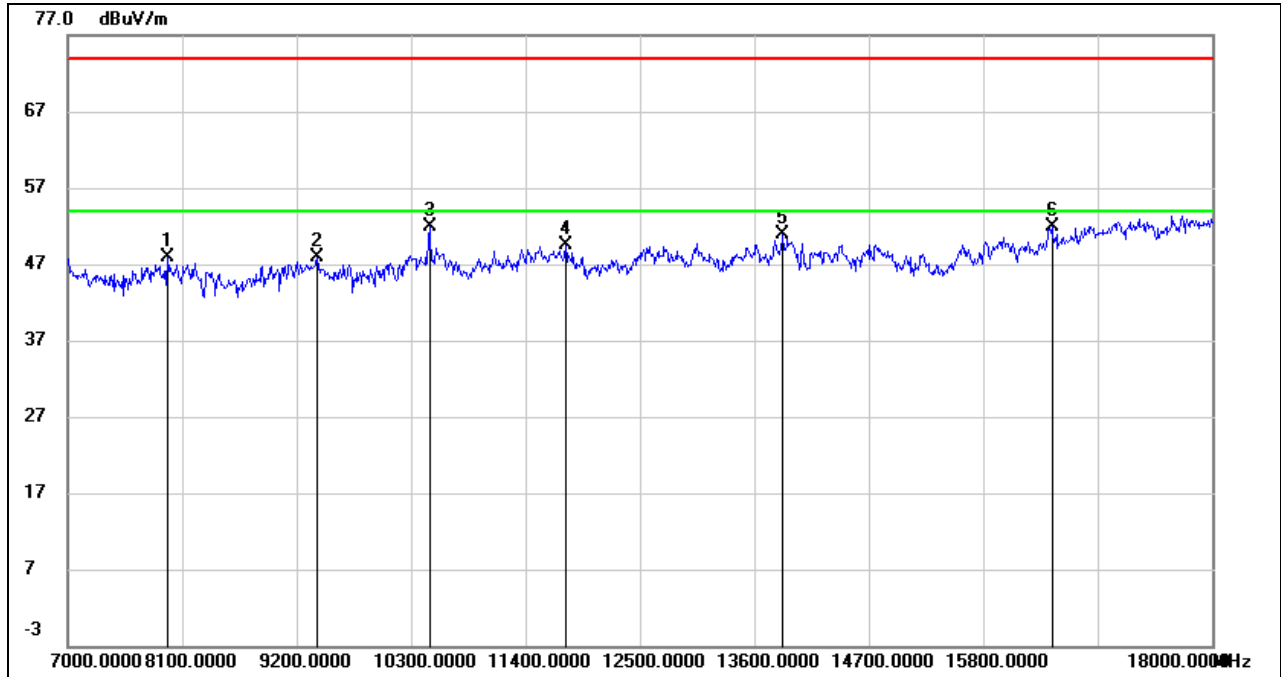

No.	Frequency (MHz)	Reading (dBuV)	Correct (dB/m)	Result (dBuV/m)	Limit (dBuV/m)	Margin (dB)	Remark
1	7957.000	40.33	7.50	47.83	74.00	-26.17	peak
2	9398.000	37.98	9.93	47.91	74.00	-26.09	peak
3	10476.000	40.56	11.31	51.87	74.00	-22.13	peak
4	11785.000	36.27	13.22	49.49	74.00	-24.51	peak
5	13875.000	34.61	16.39	51.00	74.00	-23.00	peak
6	16460.000	32.48	19.49	51.97	74.00	-22.03	peak

Note: 1. Measurement = Reading Level + Correct Factor.
 2. If Peak Result complies with AV limit, AV Result is deemed to comply with AV limit.
 3. Peak: Peak detector.
 4. Filter losses were only considered in the spurious frequency bands and the authorized band was not corrected for High Pass Filter losses.
 5. Proper operation of the transmitter prior to adding the filter to the measurement chain.
 6. Owing to the highest peak level of unwanted emission out of the restricted bands complies with the lowest limit(54dBuV/m), so all the test point were deemed to comply with the limits list in the standard.



VERTICAL RESULTS
1-7GHz

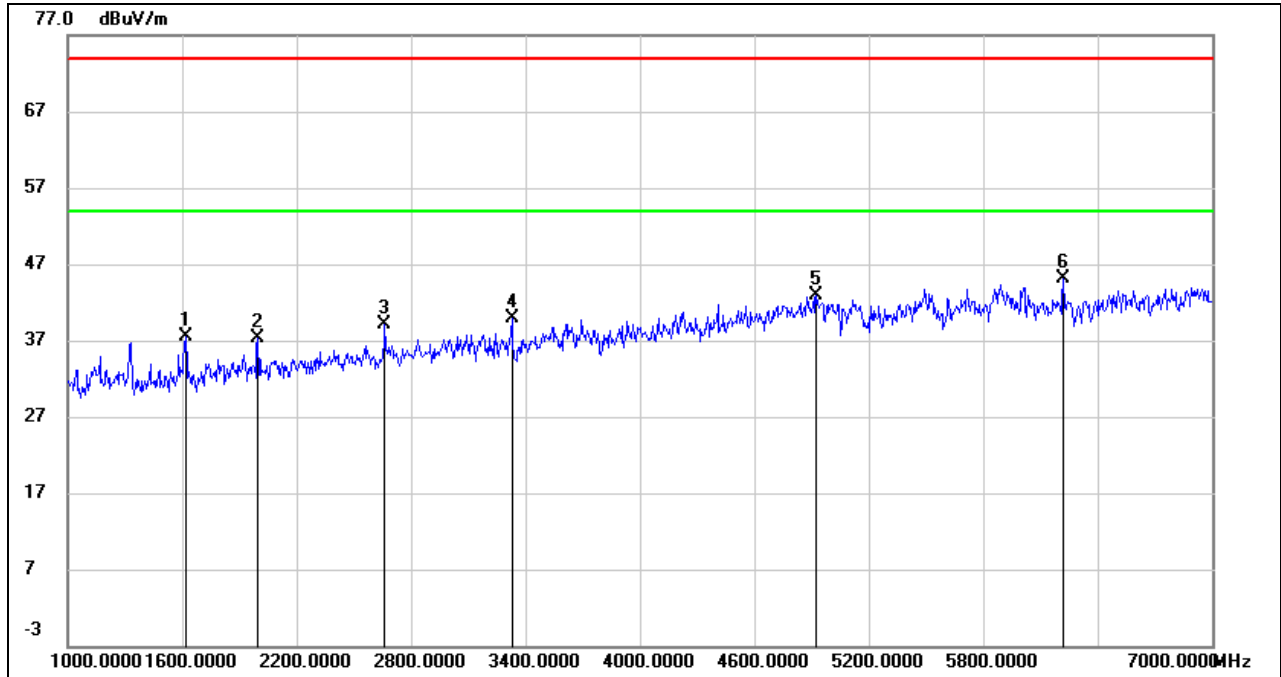

No.	Frequency (MHz)	Reading (dBuV)	Correct (dB/m)	Result (dBuV/m)	Limit (dBuV/m)	Margin (dB)	Remark
1	1618.000	48.51	-11.09	37.42	74.00	-36.58	peak
2	1996.000	47.13	-9.87	37.26	74.00	-36.74	peak
3	2662.000	46.10	-6.96	39.14	74.00	-34.86	peak
4	3328.000	44.36	-4.44	39.92	74.00	-34.08	peak
5	4924.000	40.48	2.50	42.98	74.00	-31.02	peak
6	6220.000	40.88	4.29	45.17	74.00	-28.83	peak

Note: 1. Measurement = Reading Level + Correct Factor.
 2. If Peak Result complies with AV limit, AV Result is deemed to comply with AV limit.
 3. Peak: Peak detector.
 4. Filter losses were only considered in the spurious frequency bands and the authorized band was not corrected for Band reject filter losses.
 5. Proper operation of the transmitter prior to adding the filter to the measurement chain.
 6. Owing to the highest peak level of unwanted emission out of the restricted bands complies with the lowest limit(54dBuV/m), so all the test point were deemed to comply with the limits list in the standard.



7-18GHz

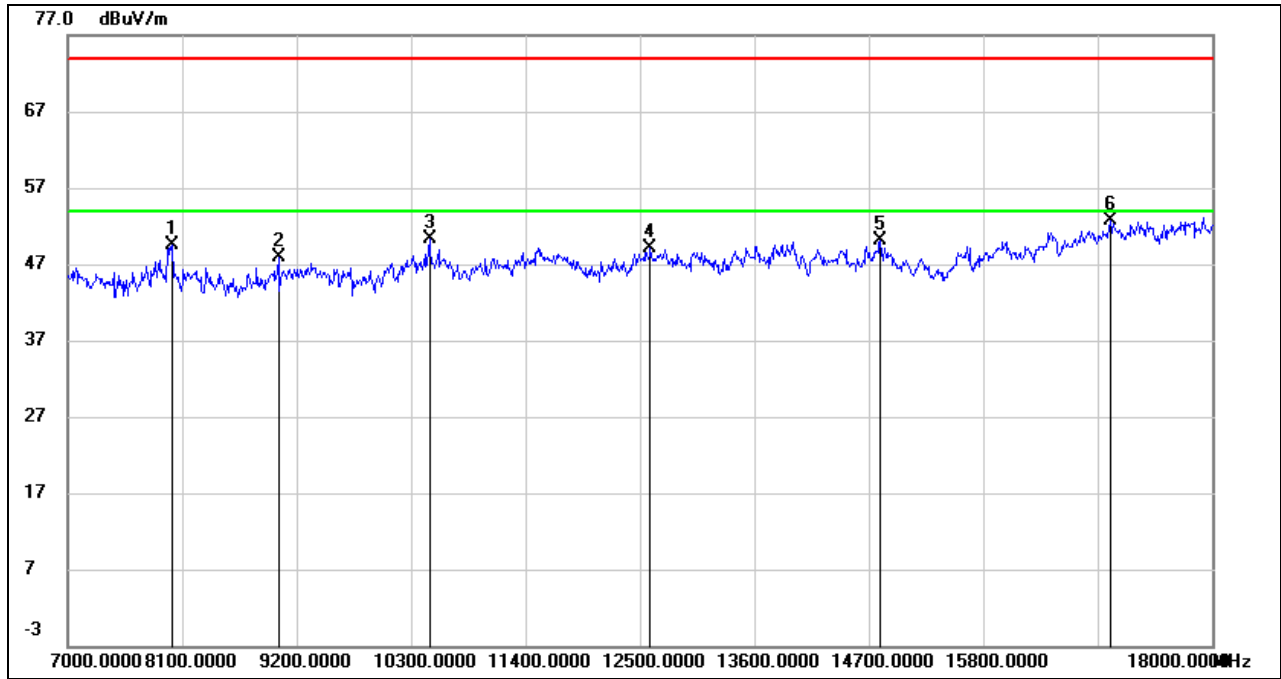

No.	Frequency (MHz)	Reading (dBuV)	Correct (dB/m)	Result (dBuV/m)	Limit (dBuV/m)	Margin (dB)	Remark
1	8001.000	42.09	7.44	49.53	74.00	-24.47	peak
2	9024.000	38.44	9.40	47.84	74.00	-26.16	peak
3	10476.000	39.02	11.31	50.33	74.00	-23.67	peak
4	12599.000	34.92	14.19	49.11	74.00	-24.89	peak
5	14810.000	33.95	16.07	50.02	74.00	-23.98	peak
6	17021.000	32.01	20.69	52.70	74.00	-21.30	peak

Note: 1. Measurement = Reading Level + Correct Factor.
 2. If Peak Result complies with AV limit, AV Result is deemed to comply with AV limit.
 3. Peak: Peak detector.
 4. Filter losses were only considered in the spurious frequency bands and the authorized band was not corrected for High Pass Filter losses.
 5. Proper operation of the transmitter prior to adding the filter to the measurement chain.
 6. Owing to the highest peak level of unwanted emission out of the restricted bands complies with the lowest limit(54dBuV/m), so all the test point were deemed to comply with the limits list in the standard.



1TX MODE ANT0:WCT5H-40

RESTRICTED BANDEDGE LOW CHANNEL

HORIZONTAL RESULTS
PEAK

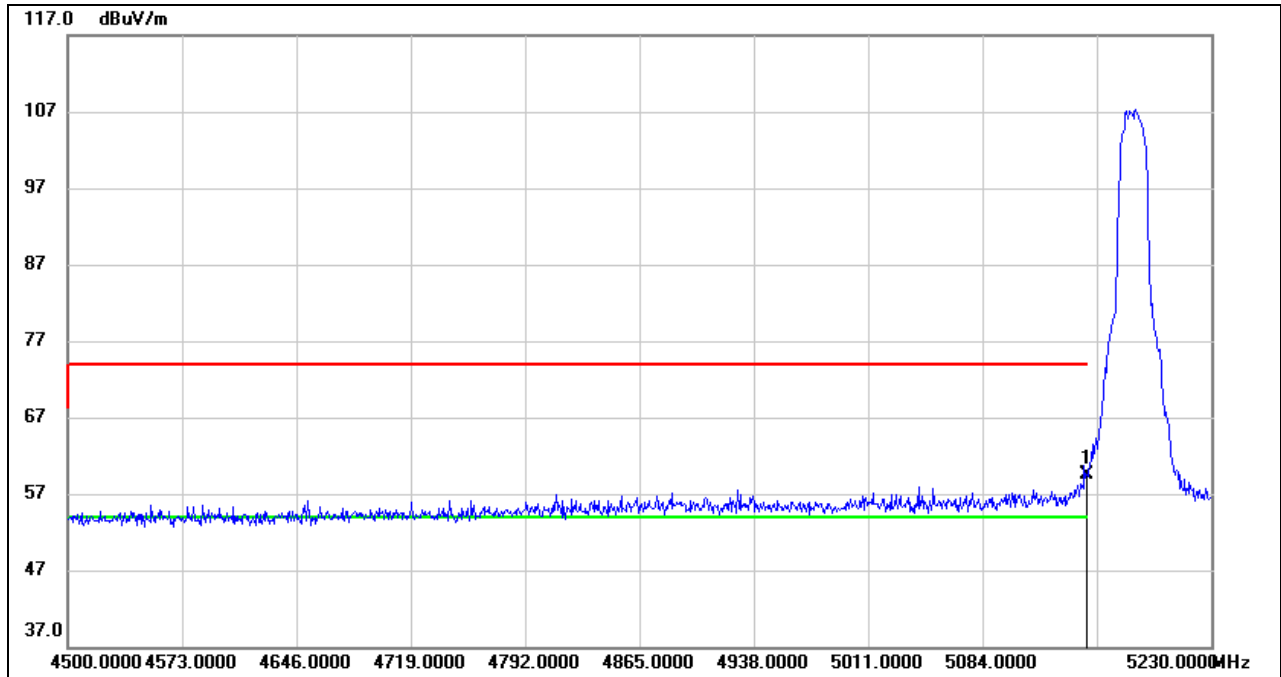

No.	Frequency (MHz)	Reading (dBuV)	Correct (dB/m)	Result (dBuV/m)	Limit (dBuV/m)	Margin (dB)	Remark
1	5150.000	19.01	40.46	59.47	74.00	-14.53	peak

Note: 1. Measurement = Reading Level + Correct Factor.
 2. If Peak Result complies with AV limit, AV Result is deemed to comply with AV limit.
 3. Peak: Peak detector.
 4. Only the worst case emission will be recorder, if it complies with the limit, the other emissions deemed to comply with the limit.



AVG

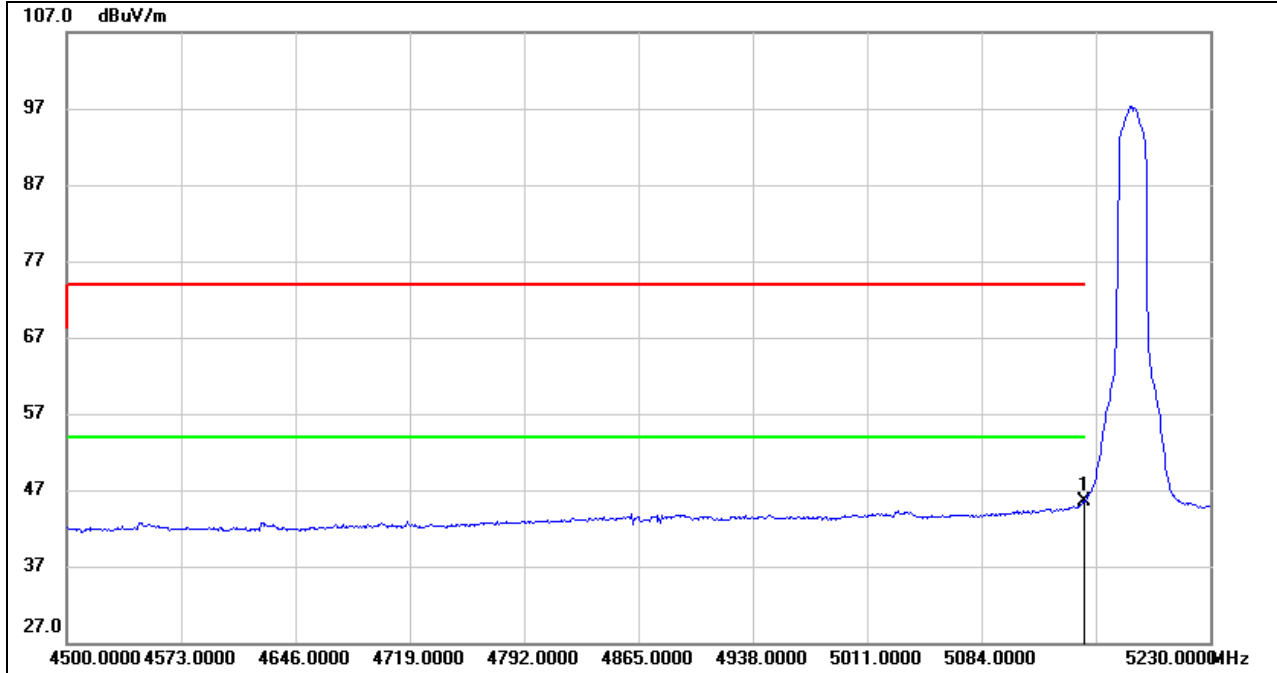

No.	Frequency (MHz)	Reading (dBuV)	Correct (dB/m)	Result (dBuV/m)	Limit (dBuV/m)	Margin (dB)	Remark
1	5150.000	5.04	40.46	45.50	54.00	-8.50	AVG

- Note: 1. Measurement = Reading Level + Correct Factor.
 2. AVG: $VBW=1/Ton$ where: ton is transmit duration.
 3. For duty cycle, please refer to clause 7.1.
 4. Only the worst case emission will be recorder, if it complies with the limit, the other emissions deemed to comply with the limit.



VERTICAL RESULTS
PEAK

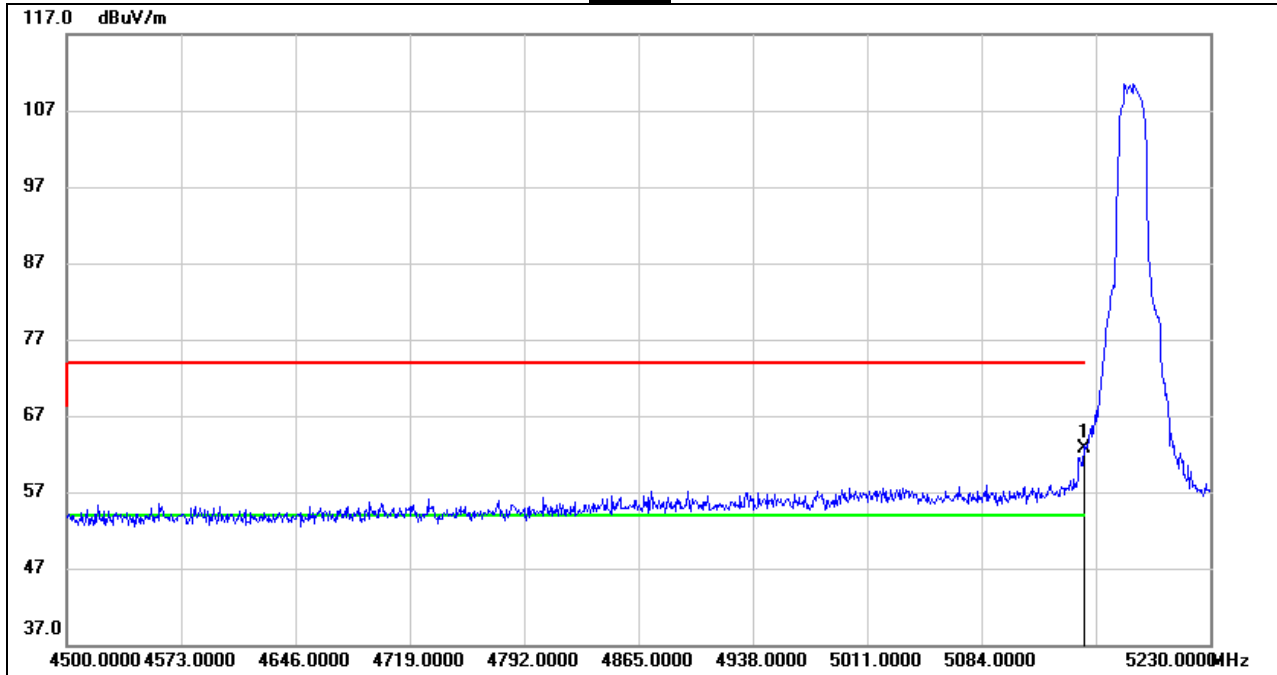

No.	Frequency (MHz)	Reading (dBuV)	Correct (dB/m)	Result (dBuV/m)	Limit (dBuV/m)	Margin (dB)	Remark
1	5150.000	22.26	40.46	62.72	74.00	-11.28	peak

- Note: 1. Measurement = Reading Level + Correct Factor.
 2. If Peak Result complies with AV limit, AV Result is deemed to comply with AV limit.
 3. Peak: Peak detector.
 4. Only the worst case emission will be recorder, if it complies with the limit, the other emissions deemed to comply with the limit.



AVG

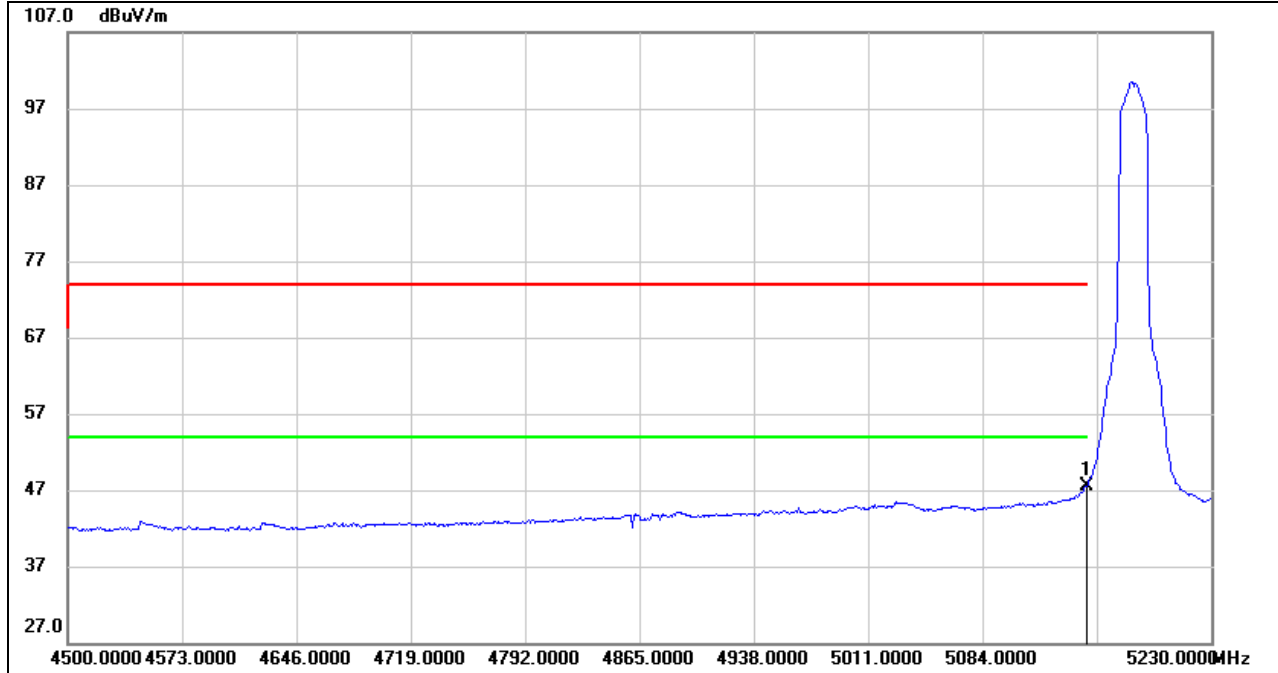

No.	Frequency (MHz)	Reading (dBuV)	Correct (dB/m)	Result (dBuV/m)	Limit (dBuV/m)	Margin (dB)	Remark
1	5150.000	6.98	40.46	47.44	54.00	-6.56	AVG

- Note: 1. Measurement = Reading Level + Correct Factor.
 2. AVG: $VBW=1/Ton$ where: ton is transmit duration.
 3. For duty cycle, please refer to clause 7.1.
 4. Only the worst case emission will be recorder, if it complies with the limit, the other emissions deemed to comply with the limit.



HARMONICS AND SPURIOUS EMISSIONS LOW CHANNEL

HORIZONTAL RESULTS
1-7GHz

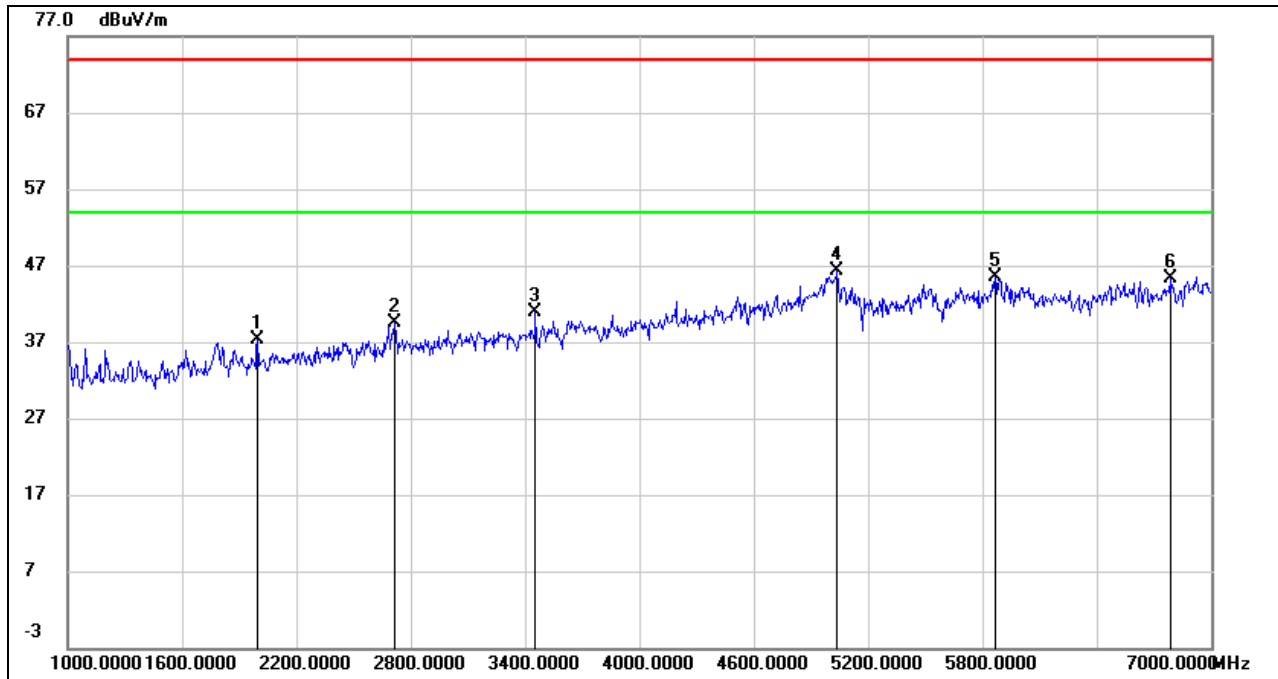

No.	Frequency (MHz)	Reading (dBuV)	Correct (dB/m)	Result (dBuV/m)	Limit (dBuV/m)	Margin (dB)	Remark
1	1996.000	47.26	-9.87	37.39	74.00	-36.61	peak
2	2716.000	46.13	-6.53	39.60	74.00	-34.40	peak
3	3454.000	45.06	-4.19	40.87	74.00	-33.13	peak
4	5038.000	43.56	2.76	46.32	74.00	-27.68	peak
5	5866.000	40.65	4.82	45.47	74.00	-28.53	peak
6	6784.000	39.17	6.10	45.27	74.00	-28.73	peak

Note: 1. Measurement = Reading Level + Correct Factor.
 2. If Peak Result complies with AV limit, AV Result is deemed to comply with AV limit.
 3. Peak: Peak detector.
 4. Filter losses were only considered in the spurious frequency bands and the authorized band was not corrected for Band reject filter losses.
 5. Proper operation of the transmitter prior to adding the filter to the measurement chain.
 6. Owing to the highest peak level of unwanted emission out of the restricted bands complies with the lowest limit(54dBuV/m), so all the test point were deemed to comply with the limits list in the standard.



HORIZONTAL RESULTS
7-18GHz

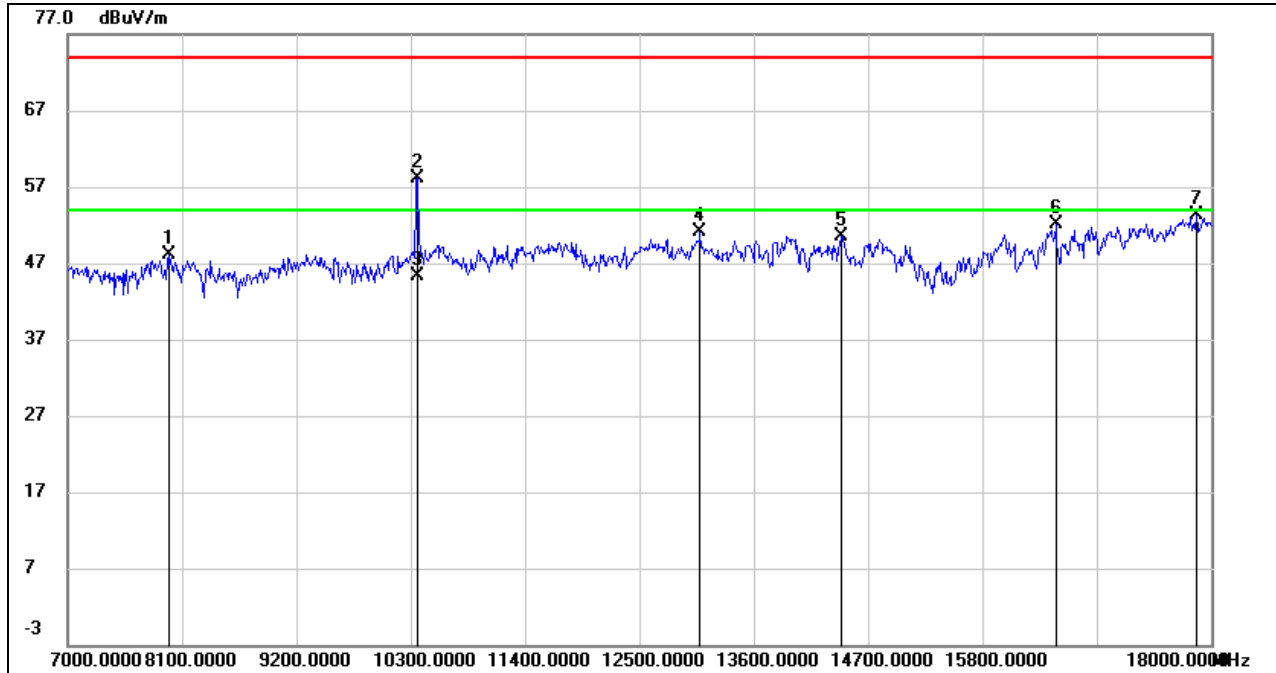

No.	Frequency (MHz)	Reading (dBuV)	Correct (dB/m)	Result (dBuV/m)	Limit (dBuV/m)	Margin (dB)	Remark
1	7968.000	40.55	7.49	48.04	74.00	-25.96	peak
2	10361.510	46.93	11.22	58.15	74.00	-15.85	peak
3	10361.510	34.04	11.22	45.26	54.00	-8.74	AVG
4	13083.000	35.69	15.32	51.01	74.00	-22.99	peak
5	14436.000	33.89	16.64	50.53	74.00	-23.47	peak
6	16504.000	32.40	19.61	52.01	74.00	-21.99	peak
7	17857.000	29.99	23.41	53.40	74.00	-20.60	peak

- Note: 1. Measurement = Reading Level + Correct Factor.
 2. If Peak Result complies with AV limit, AV Result is deemed to comply with AV limit.
 3. Peak: Peak detector.
 4. AVG: VBW=1/Ton where: ton is transmit duration.
 5. For transmit duration, please refer to clause 7.1.
 6. Filter losses were only considered in the spurious frequency bands and the authorized band was not corrected for High Pass Filter losses.
 7. Proper operation of the transmitter prior to adding the filter to the measurement chain.
 8. Owing to the highest peak level of unwanted emission out of the restricted bands complies with the lowest limit(54dBuV/m), so all the test point were deemed to comply with the limits list in the standard.



VERTICAL RESULTS
1-7GHz

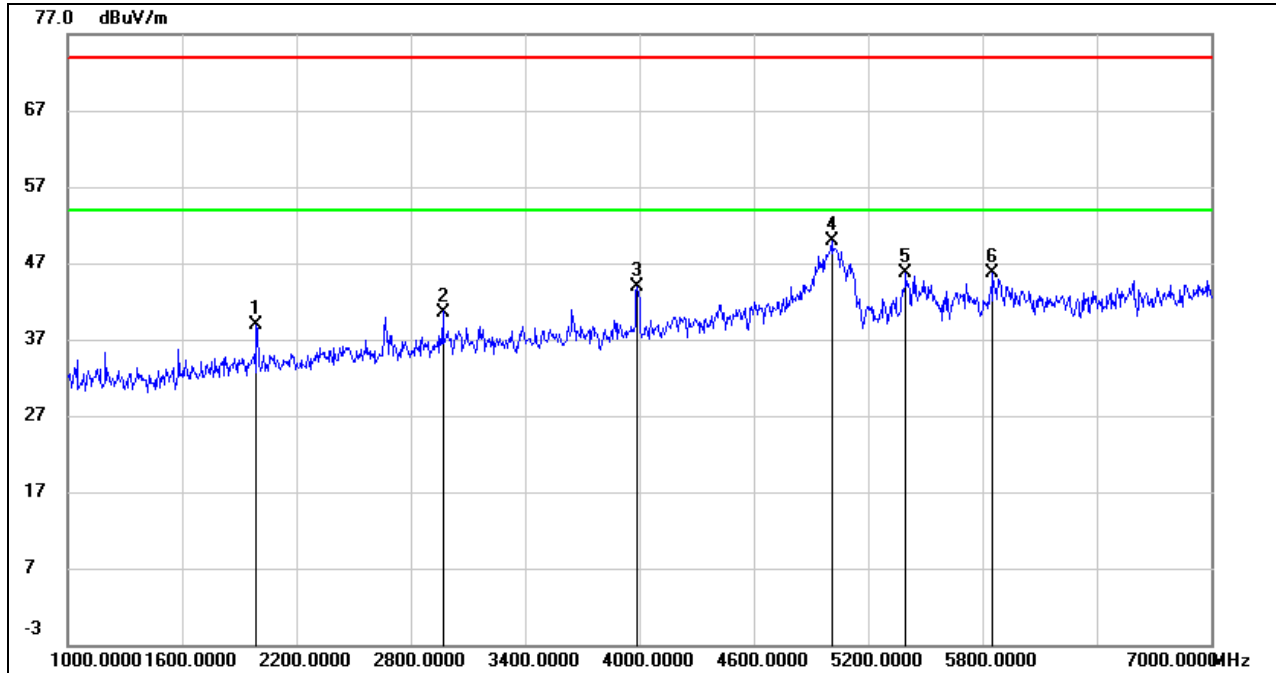

No.	Frequency (MHz)	Reading (dBuV)	Correct (dB/m)	Result (dBuV/m)	Limit (dBuV/m)	Margin (dB)	Remark
1	1990.000	48.74	-9.86	38.88	74.00	-35.12	peak
2	2968.000	45.92	-5.32	40.60	74.00	-33.40	peak
3	3988.000	46.24	-2.39	43.85	74.00	-30.15	peak
4	5008.000	47.11	2.71	49.82	74.00	-24.18	peak
5	5398.000	42.64	3.06	45.70	74.00	-28.30	peak
6	5854.000	41.09	4.60	45.69	74.00	-28.31	peak

Note: 1. Measurement = Reading Level + Correct Factor.
 2. If Peak Result complies with AV limit, AV Result is deemed to comply with AV limit.
 3. Peak: Peak detector.
 4. Filter losses were only considered in the spurious frequency bands and the authorized band was not corrected for Band reject filter losses.
 5. Proper operation of the transmitter prior to adding the filter to the measurement chain.
 6. Owing to the highest peak level of unwanted emission out of the restricted bands complies with the lowest limit(54dBuV/m), so all the test point were deemed to comply with the limits list in the standard.



7-18GHz

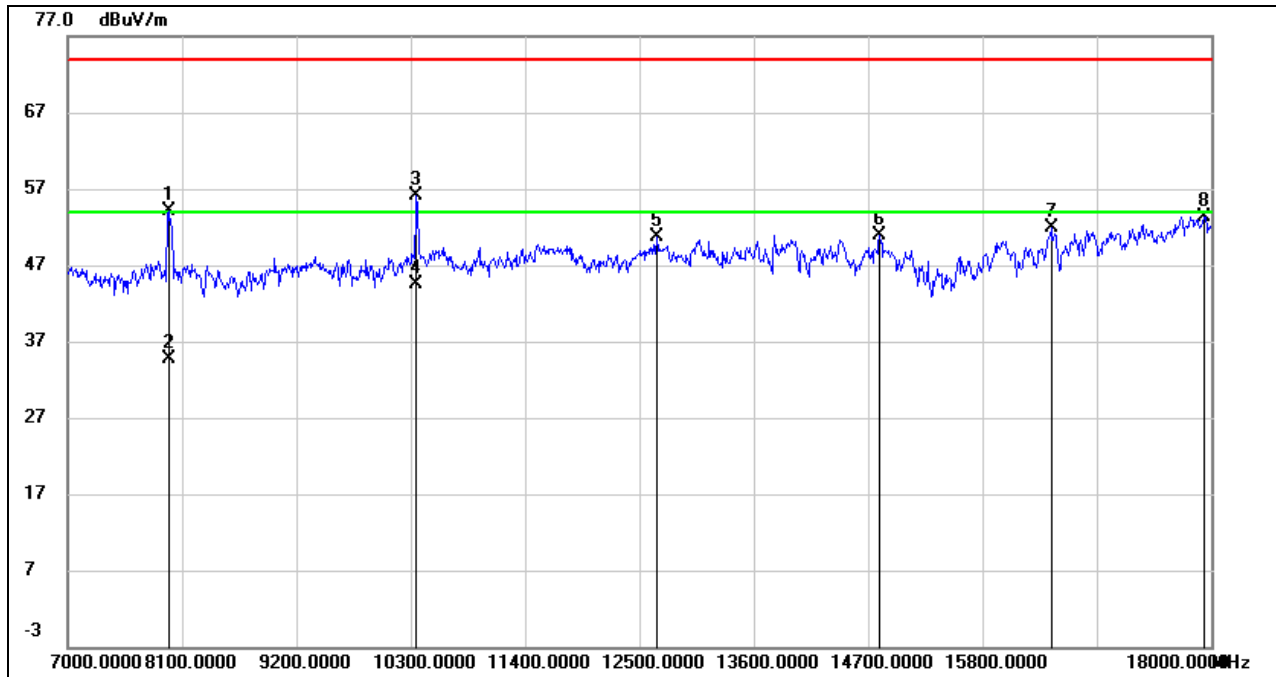

No.	Frequency (MHz)	Reading (dBuV)	Correct (dB/m)	Result (dBuV/m)	Limit (dBuV/m)	Margin (dB)	Remark
1	7969.736	46.70	7.49	54.19	74.00	-19.81	peak
2	7969.736	27.23	7.49	34.72	54.00	-19.28	AVG
3	10361.590	44.88	11.22	56.10	74.00	-17.90	peak
4	10361.590	33.22	11.22	44.44	54.00	-9.56	AVG
5	12665.000	36.37	14.35	50.72	74.00	-23.28	peak
6	14810.000	34.77	16.07	50.84	74.00	-23.16	peak
7	16460.000	32.44	19.49	51.93	74.00	-22.07	peak
8	17934.000	29.95	23.45	53.40	74.00	-20.60	peak

Note: 1. Measurement = Reading Level + Correct Factor.
 2. If Peak Result complies with AV limit, AV Result is deemed to comply with AV limit.
 3. Peak: Peak detector.
 4. AVG: VBW=1/Ton where: ton is transmit duration.
 5. For transmit duration, please refer to clause 7.1.
 6. Filter losses were only considered in the spurious frequency bands and the authorized band was not corrected for High Pass Filter losses.
 7. Proper operation of the transmitter prior to adding the filter to the measurement chain.
 8. Owing to the highest peak level of unwanted emission out of the restricted bands complies with the lowest limit(54dBuV/m), so all the test point were deemed to comply with the limits list in the standard.



HARMONICS AND SPURIOUS EMISSIONS MID CHANNEL

HORIZONTAL RESULTS
1-7GHz

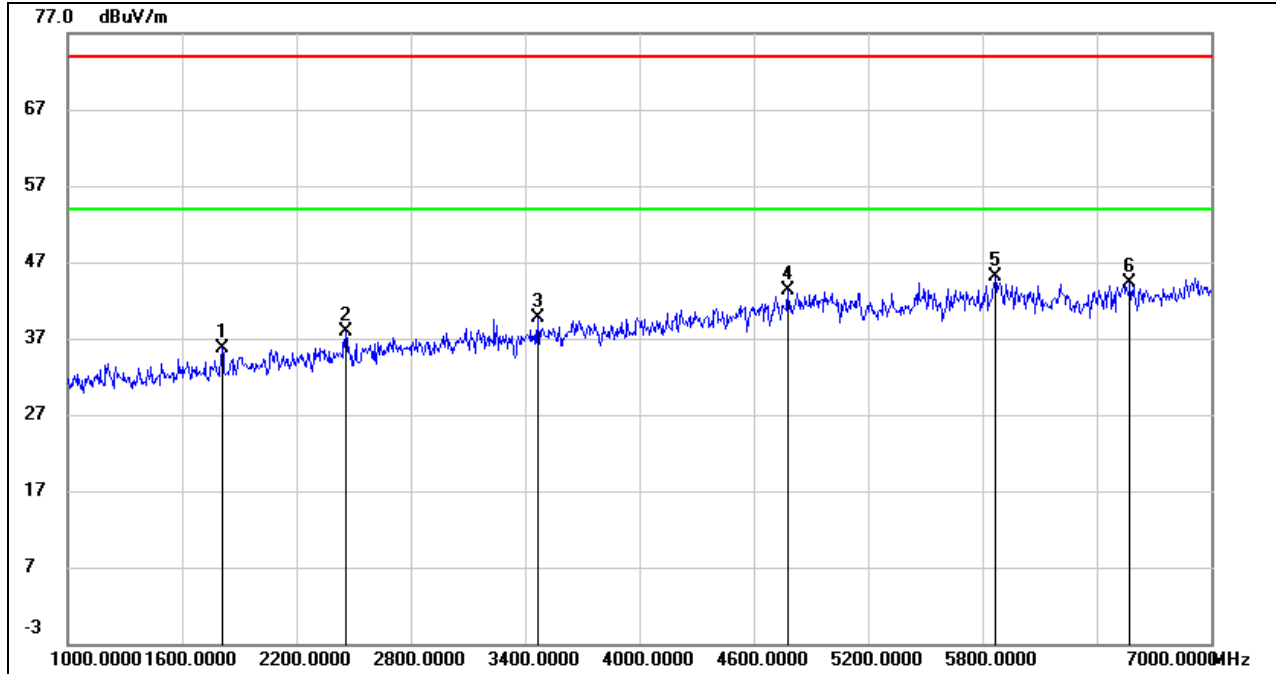

No.	Frequency (MHz)	Reading (dBuV)	Correct (dB/m)	Result (dBuV/m)	Limit (dBuV/m)	Margin (dB)	Remark
1	1810.000	45.77	-10.06	35.71	74.00	-38.29	peak
2	2458.000	45.43	-7.46	37.97	74.00	-36.03	peak
3	3466.000	43.87	-4.11	39.76	74.00	-34.24	peak
4	4780.000	41.86	1.54	43.40	74.00	-30.60	peak
5	5866.000	40.21	4.82	45.03	74.00	-28.97	peak
6	6574.000	37.64	6.60	44.24	74.00	-29.76	peak

Note: 1. Measurement = Reading Level + Correct Factor.
 2. If Peak Result complies with AV limit, AV Result is deemed to comply with AV limit.
 3. Peak: Peak detector.
 4. Filter losses were only considered in the spurious frequency bands and the authorized band was not corrected for Band reject filter losses.
 5. Proper operation of the transmitter prior to adding the filter to the measurement chain.
 6. Owing to the highest peak level of unwanted emission out of the restricted bands complies with the lowest limit(54dBuV/m), so all the test point were deemed to comply with the limits list in the standard.



HORIZONTAL RESULTS
7-18GHz

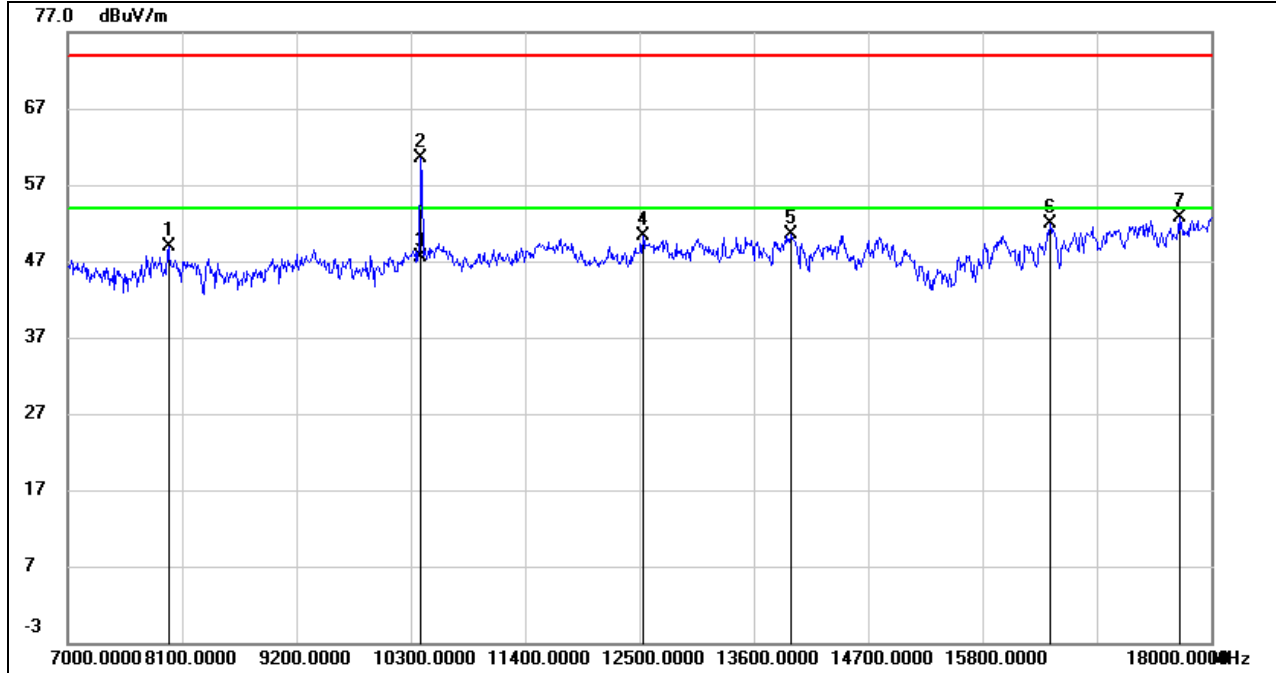

No.	Frequency (MHz)	Reading (dBuV)	Correct (dB/m)	Result (dBuV/m)	Limit (dBuV/m)	Margin (dB)	Remark
1	7968.000	41.37	7.49	48.86	74.00	-25.14	peak
2	10401.760	49.42	11.17	60.59	74.00	-13.41	peak
3	10401.760	36.36	11.17	47.53	54.00	-6.47	AVG
4	12533.000	35.58	14.65	50.23	74.00	-23.77	peak
5	13952.000	34.31	16.16	50.47	74.00	-23.53	peak
6	16449.000	32.48	19.45	51.93	74.00	-22.07	peak
7	17692.000	30.28	22.44	52.72	74.00	-21.28	peak

Note: 1. Measurement = Reading Level + Correct Factor.
 2. If Peak Result complies with AV limit, AV Result is deemed to comply with AV limit.
 3. Peak: Peak detector.
 4. AVG: $VBW=1/Ton$ where: ton is transmit duration.
 5. For transmit duration, please refer to clause 7.1.
 6. Filter losses were only considered in the spurious frequency bands and the authorized band was not corrected for High Pass Filter losses.
 7. Proper operation of the transmitter prior to adding the filter to the measurement chain.
 8. Owing to the highest peak level of unwanted emission out of the restricted bands complies with the lowest limit(54dBuV/m), so all the test point were deemed to comply with the limits list in the standard.



VERTICAL RESULTS
1-7GHz

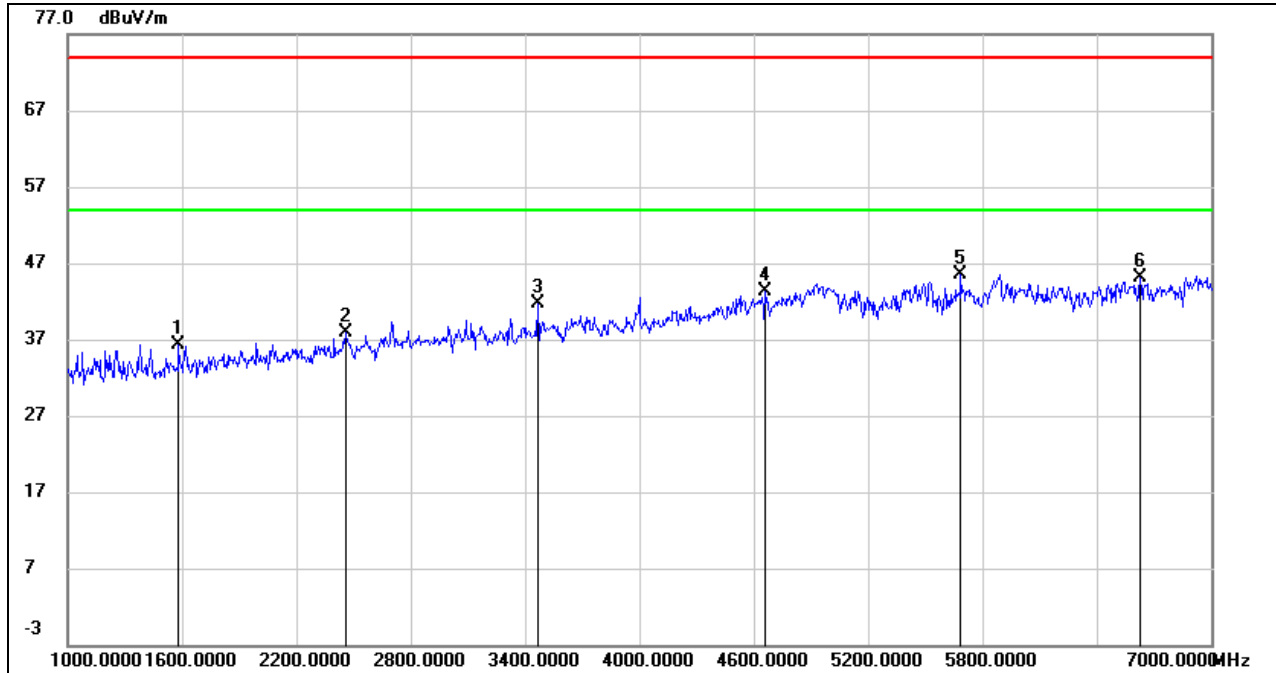

No.	Frequency (MHz)	Reading (dBuV)	Correct (dB/m)	Result (dBuV/m)	Limit (dBuV/m)	Margin (dB)	Remark
1	1582.000	47.62	-11.28	36.34	74.00	-37.66	peak
2	2458.000	45.38	-7.46	37.92	74.00	-36.08	peak
3	3466.000	45.87	-4.11	41.76	74.00	-32.24	peak
4	4660.000	42.29	1.04	43.33	74.00	-30.67	peak
5	5686.000	41.66	3.79	45.45	74.00	-28.55	peak
6	6628.000	38.62	6.48	45.10	74.00	-28.90	peak

Note: 1. Measurement = Reading Level + Correct Factor.
 2. If Peak Result complies with AV limit, AV Result is deemed to comply with AV limit.
 3. Peak: Peak detector.
 4. Filter losses were only considered in the spurious frequency bands and the authorized band was not corrected for Band reject filter losses.
 5. Proper operation of the transmitter prior to adding the filter to the measurement chain.
 6. Owing to the highest peak level of unwanted emission out of the restricted bands complies with the lowest limit(54dBuV/m), so all the test point were deemed to comply with the limits list in the standard.



7-18GHz

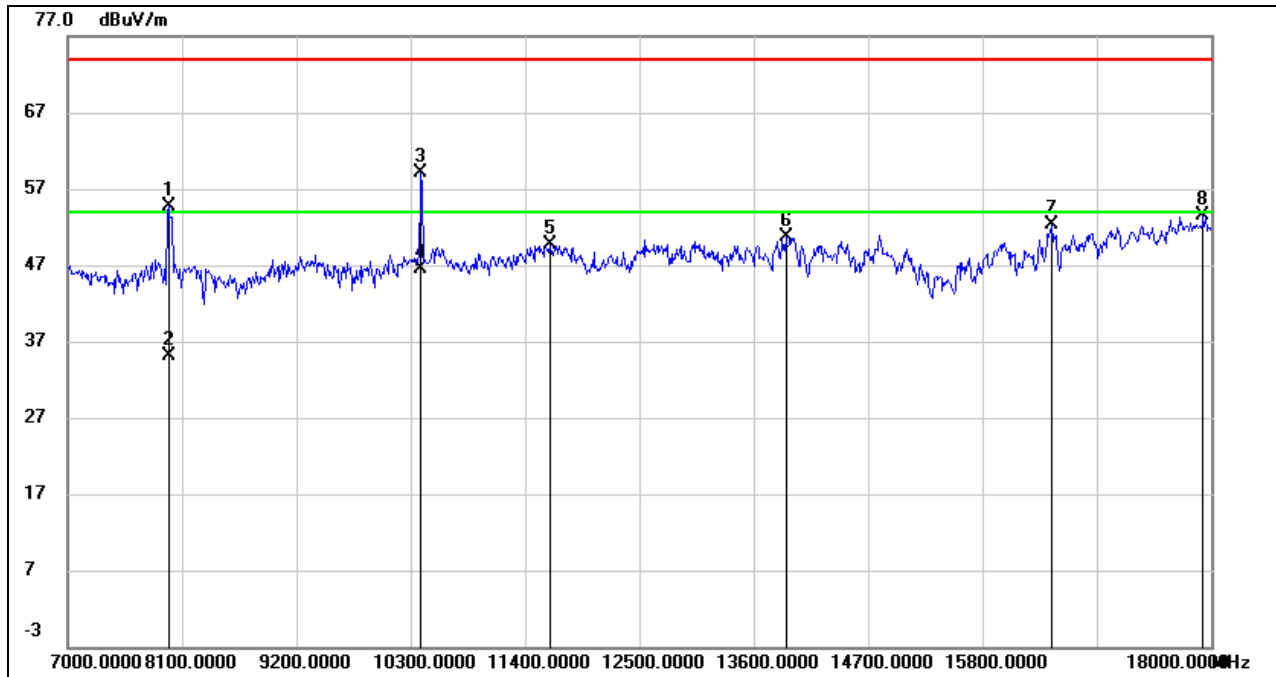

No.	Frequency (MHz)	Reading (dBuV)	Correct (dB/m)	Result (dBuV/m)	Limit (dBuV/m)	Margin (dB)	Remark
1	7969.120	47.14	7.49	54.63	74.00	-19.37	peak
2	7969.120	27.65	7.49	35.14	54.00	-18.86	AVG
3	10401.720	47.91	11.17	59.08	74.00	-14.92	peak
4	10401.720	35.40	11.17	46.57	54.00	-7.43	AVG
5	11642.000	36.33	13.33	49.66	74.00	-24.34	peak
6	13908.000	34.50	16.16	50.66	74.00	-23.34	peak
7	16471.000	32.81	19.52	52.33	74.00	-21.67	peak
8	17923.000	30.00	23.42	53.42	74.00	-20.58	peak

Note: 1. Measurement = Reading Level + Correct Factor.
 2. If Peak Result complies with AV limit, AV Result is deemed to comply with AV limit.
 3. Peak: Peak detector.
 4. AVG: $VBW=1/Ton$ where: ton is transmit duration.
 5. For transmit duration, please refer to clause 7.1.
 6. Filter losses were only considered in the spurious frequency bands and the authorized band was not corrected for High Pass Filter losses.
 7. Proper operation of the transmitter prior to adding the filter to the measurement chain.
 8. Owing to the highest peak level of unwanted emission out of the restricted bands complies with the lowest limit(54dBuV/m), so all the test point were deemed to comply with the limits list in the standard.



HARMONICS AND SPURIOUS EMISSIONS HIGH CHANNEL

HORIZONTAL RESULTS
1-7GHz

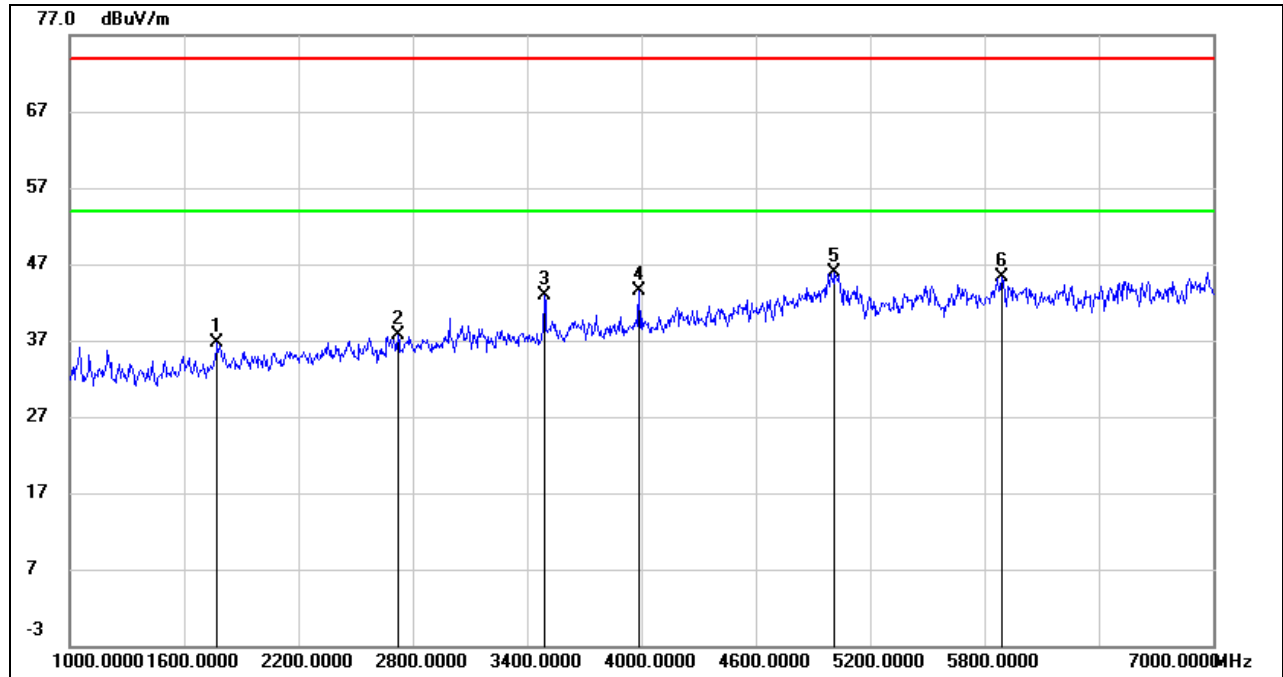

No.	Frequency (MHz)	Reading (dBuV)	Correct (dB/m)	Result (dBuV/m)	Limit (dBuV/m)	Margin (dB)	Remark
1	1774.000	47.10	-10.33	36.77	74.00	-37.23	peak
2	2722.000	44.13	-6.50	37.63	74.00	-36.37	peak
3	3490.000	46.93	-3.95	42.98	74.00	-31.02	peak
4	3988.000	45.98	-2.39	43.59	74.00	-30.41	peak
5	5014.000	43.20	2.73	45.93	74.00	-28.07	peak
6	5890.000	40.07	5.26	45.33	74.00	-28.67	peak

Note: 1. Measurement = Reading Level + Correct Factor.
 2. If Peak Result complies with AV limit, AV Result is deemed to comply with AV limit.
 3. Peak: Peak detector.
 4. Filter losses were only considered in the spurious frequency bands and the authorized band was not corrected for Band reject filter losses.
 5. Proper operation of the transmitter prior to adding the filter to the measurement chain.
 6. Owing to the highest peak level of unwanted emission out of the restricted bands complies with the lowest limit(54dBuV/m), so all the test point were deemed to comply with the limits list in the standard.



HORIZONTAL RESULTS
7-18GHz

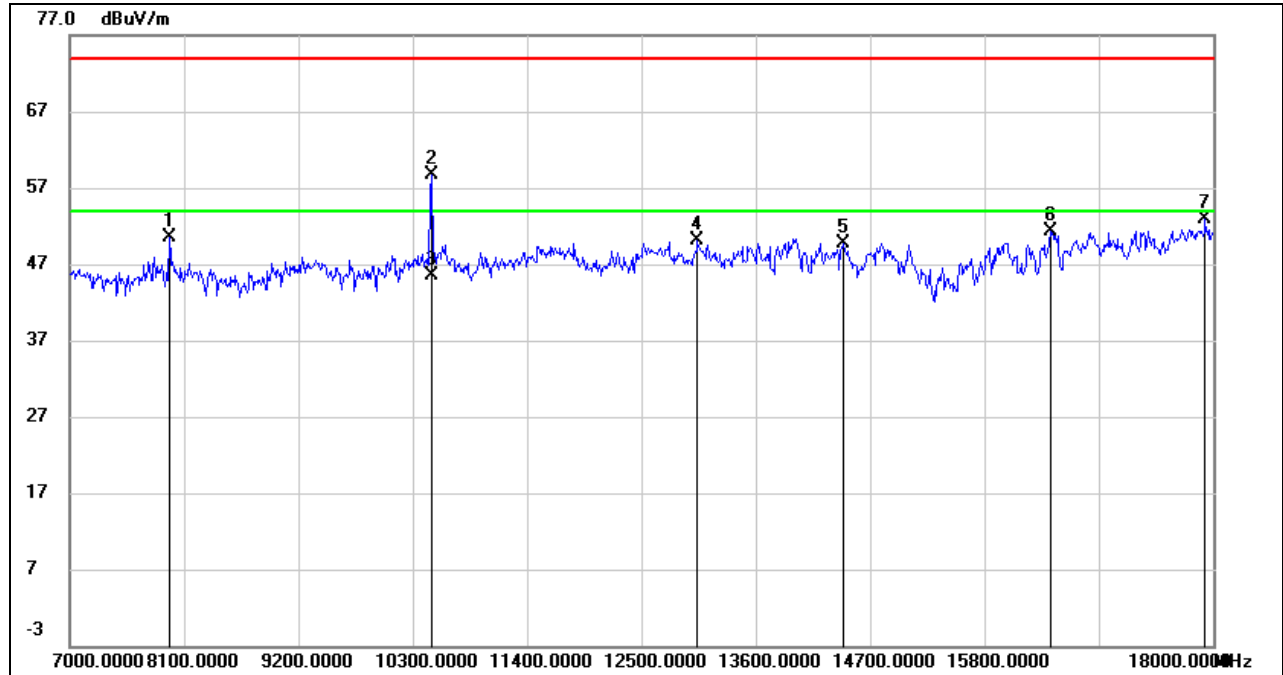

No.	Frequency (MHz)	Reading (dBuV)	Correct (dB/m)	Result (dBuV/m)	Limit (dBuV/m)	Margin (dB)	Remark
1	7957.000	43.01	7.50	50.51	74.00	-23.49	peak
2	10477.900	47.48	11.31	58.79	74.00	-15.21	peak
3	10477.900	34.16	11.31	45.47	54.00	-8.53	AVG
4	13039.000	34.91	15.16	50.07	74.00	-23.93	peak
5	14436.000	33.03	16.64	49.67	74.00	-24.33	peak
6	16438.000	31.86	19.41	51.27	74.00	-22.73	peak
7	17923.000	29.53	23.42	52.95	74.00	-21.05	peak

- Note: 1. Measurement = Reading Level + Correct Factor.
 2. If Peak Result complies with AV limit, AV Result is deemed to comply with AV limit.
 3. Peak: Peak detector.
 4. AVG: $VBW=1/Ton$ where: ton is transmit duration.
 5. For transmit duration, please refer to clause 7.1.
 6. Filter losses were only considered in the spurious frequency bands and the authorized band was not corrected for High Pass Filter losses.
 7. Proper operation of the transmitter prior to adding the filter to the measurement chain.
 8. Owing to the highest peak level of unwanted emission out of the restricted bands complies with the lowest limit(54dBuV/m), so all the test point were deemed to comply with the limits list in the standard.



VERTICAL RESULTS
1-7GHz

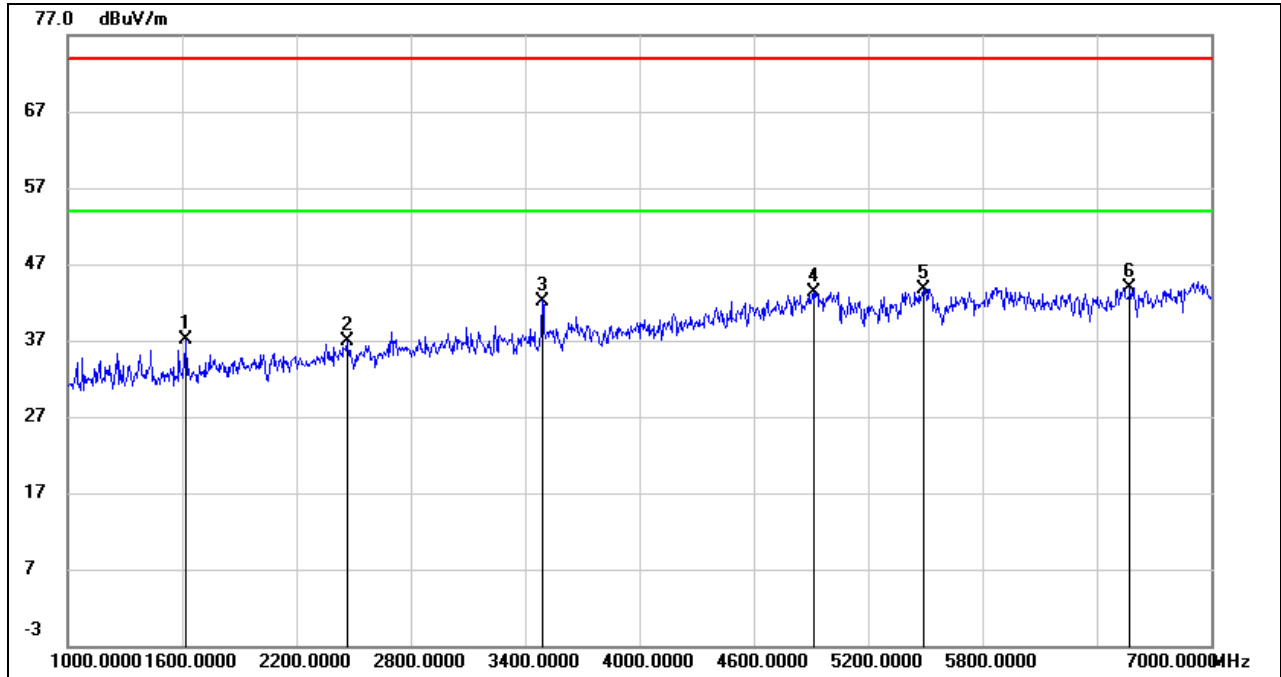

No.	Frequency (MHz)	Reading (dBuV)	Correct (dB/m)	Result (dBuV/m)	Limit (dBuV/m)	Margin (dB)	Remark
1	1618.000	48.21	-11.09	37.12	74.00	-36.88	peak
2	2464.000	44.41	-7.43	36.98	74.00	-37.02	peak
3	3490.000	46.15	-3.95	42.20	74.00	-31.80	peak
4	4912.000	40.81	2.47	43.28	74.00	-30.72	peak
5	5488.000	39.51	4.28	43.79	74.00	-30.21	peak
6	6574.000	37.35	6.60	43.95	74.00	-30.05	peak

Note: 1. Measurement = Reading Level + Correct Factor.
 2. If Peak Result complies with AV limit, AV Result is deemed to comply with AV limit.
 3. Peak: Peak detector.
 4. Filter losses were only considered in the spurious frequency bands and the authorized band was not corrected for Band reject filter losses.
 5. Proper operation of the transmitter prior to adding the filter to the measurement chain.
 6. Owing to the highest peak level of unwanted emission out of the restricted bands complies with the lowest limit(54dBuV/m), so all the test point were deemed to comply with the limits list in the standard.



7-18GHz

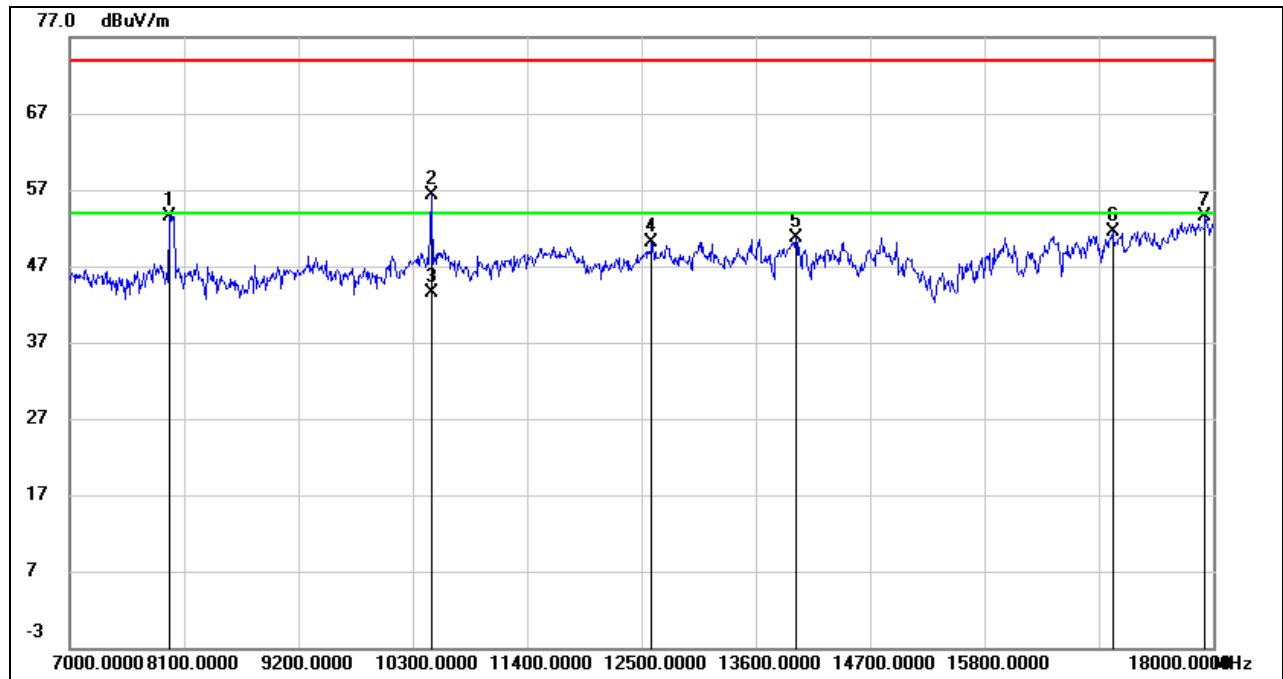

No.	Frequency (MHz)	Reading (dBuV)	Correct (dB/m)	Result (dBuV/m)	Limit (dBuV/m)	Margin (dB)	Remark
1	7957.000	46.08	7.50	53.58	74.00	-20.42	peak
2	10481.900	45.05	11.32	56.37	74.00	-17.63	peak
3	10481.900	32.13	11.32	43.45	54.00	-10.55	AVG
4	12599.000	35.84	14.19	50.03	74.00	-23.97	peak
5	13985.000	34.60	16.16	50.76	74.00	-23.24	peak
6	17032.000	30.79	20.72	51.51	74.00	-22.49	peak
7	17923.000	30.06	23.42	53.48	74.00	-20.52	peak

- Note: 1. Measurement = Reading Level + Correct Factor.
 2. If Peak Result complies with AV limit, AV Result is deemed to comply with AV limit.
 3. Peak: Peak detector.
 4. AVG: $VBW=1/Ton$ where: ton is transmit duration.
 5. For transmit duration, please refer to clause 7.1.
 6. Filter losses were only considered in the spurious frequency bands and the authorized band was not corrected for High Pass Filter losses.
 7. Proper operation of the transmitter prior to adding the filter to the measurement chain.
 8. Owing to the highest peak level of unwanted emission out of the restricted bands complies with the lowest limit(54dBuV/m), so all the test point were deemed to comply with the limits list in the standard.



8.1.2. UNII-3 BAND
1TX MODE ANT0:WCT5J-20

RESTRICTED BANDEDGE LOW CHANNEL

HORIZONTAL RESULTS
PEAK

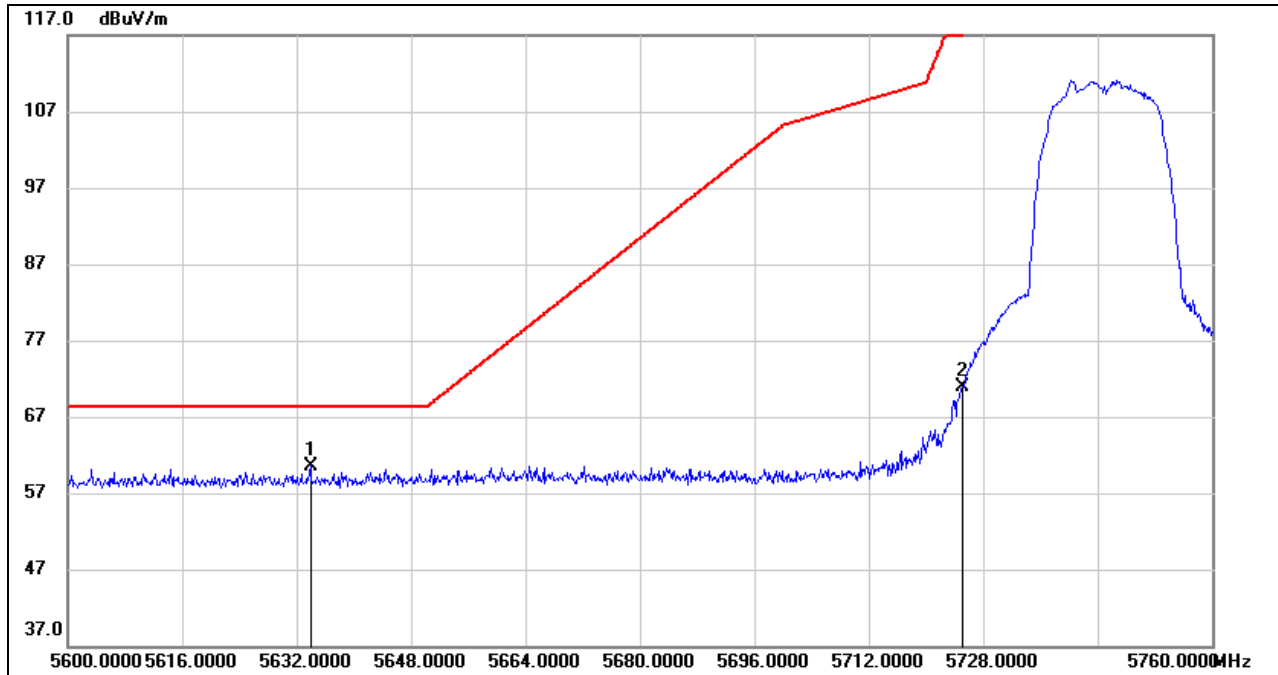

No.	Frequency (MHz)	Reading (dBuV)	Correct (dB/m)	Result (dBuV/m)	Limit (dBuV/m)	Margin (dB)	Remark
1	5633.920	19.13	41.47	60.60	68.20	-7.60	peak
2	5725.000	29.22	41.61	70.83	122.20	-51.37	peak

Note: 1. Measurement = Reading Level + Correct Factor.



VERTICAL RESULTS
PEAK

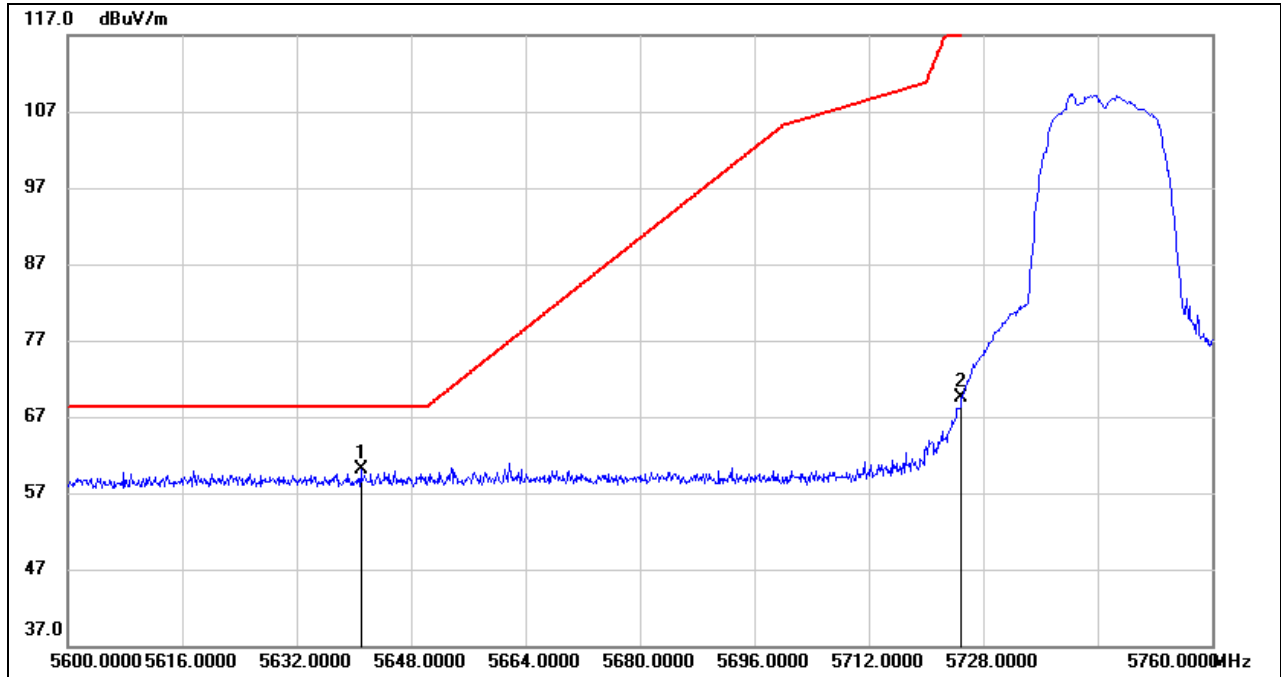

No.	Frequency (MHz)	Reading (dBuV)	Correct (dB/m)	Result (dBuV/m)	Limit (dBuV/m)	Margin (dB)	Remark
1	5640.960	18.67	41.48	60.15	68.20	-8.05	peak
2	5725.000	27.82	41.61	69.43	122.20	-52.77	peak

Note: 1. Measurement = Reading Level + Correct Factor.



RESTRICTED BANDEGE HIGH CHANNEL

HORIZONTAL RESULTS
PEAK

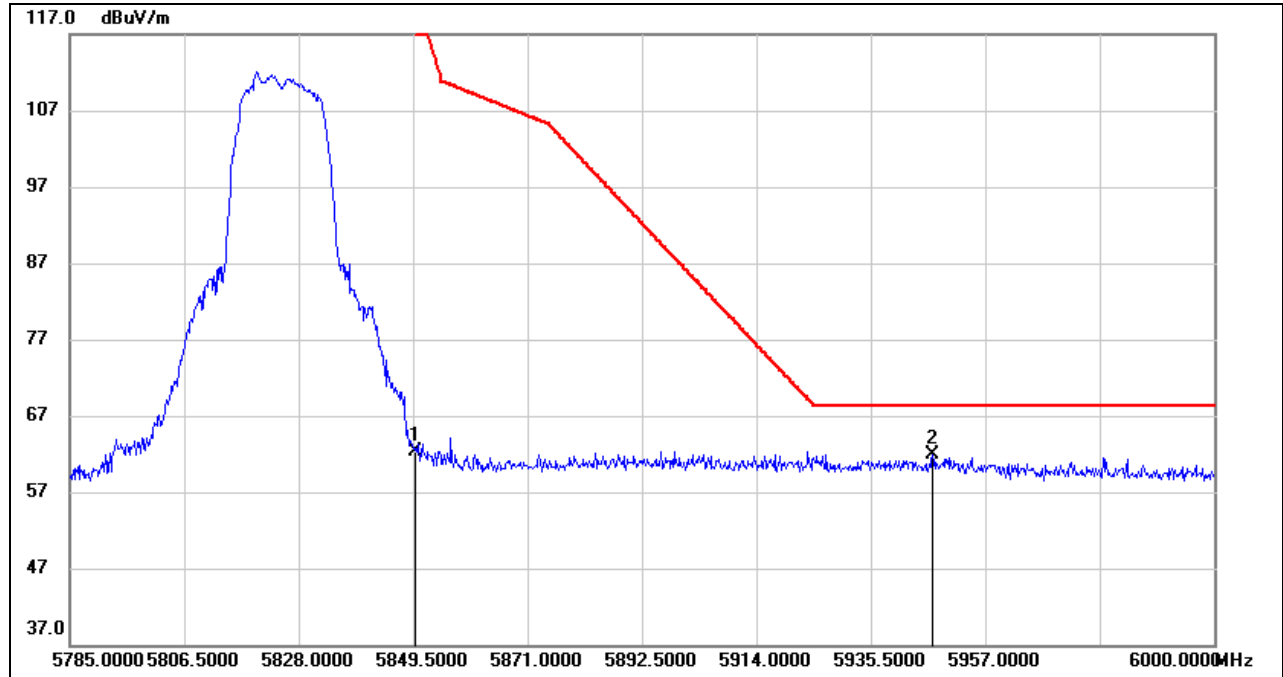

No.	Frequency (MHz)	Reading (dBuV)	Correct (dB/m)	Result (dBuV/m)	Limit (dBuV/m)	Margin (dB)	Remark
1	5850.000	19.38	42.89	62.27	122.20	-59.93	peak
2	5947.110	18.93	43.05	61.98	68.20	-6.22	peak

Note: 1. Measurement = Reading Level + Correct Factor.



VERTICAL RESULTS
PEAK

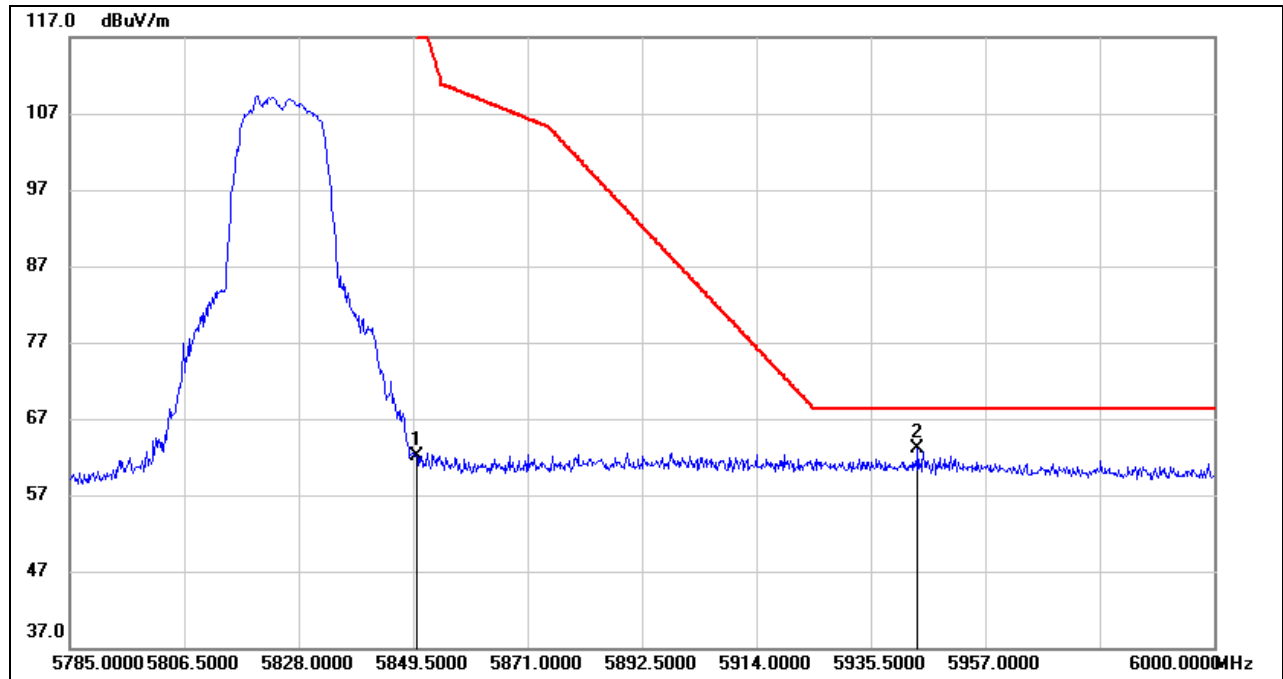

No.	Frequency (MHz)	Reading (dBuV)	Correct (dB/m)	Result (dBuV/m)	Limit (dBuV/m)	Margin (dB)	Remark
1	5850.000	19.22	42.89	62.11	122.20	-60.09	peak
2	5944.315	19.97	43.09	63.06	68.20	-5.14	peak

Note: 1. Measurement = Reading Level + Correct Factor.



HARMONICS AND SPURIOUS EMISSIONS LOW CHANNEL

HORIZONTAL RESULTS
1-7GHz

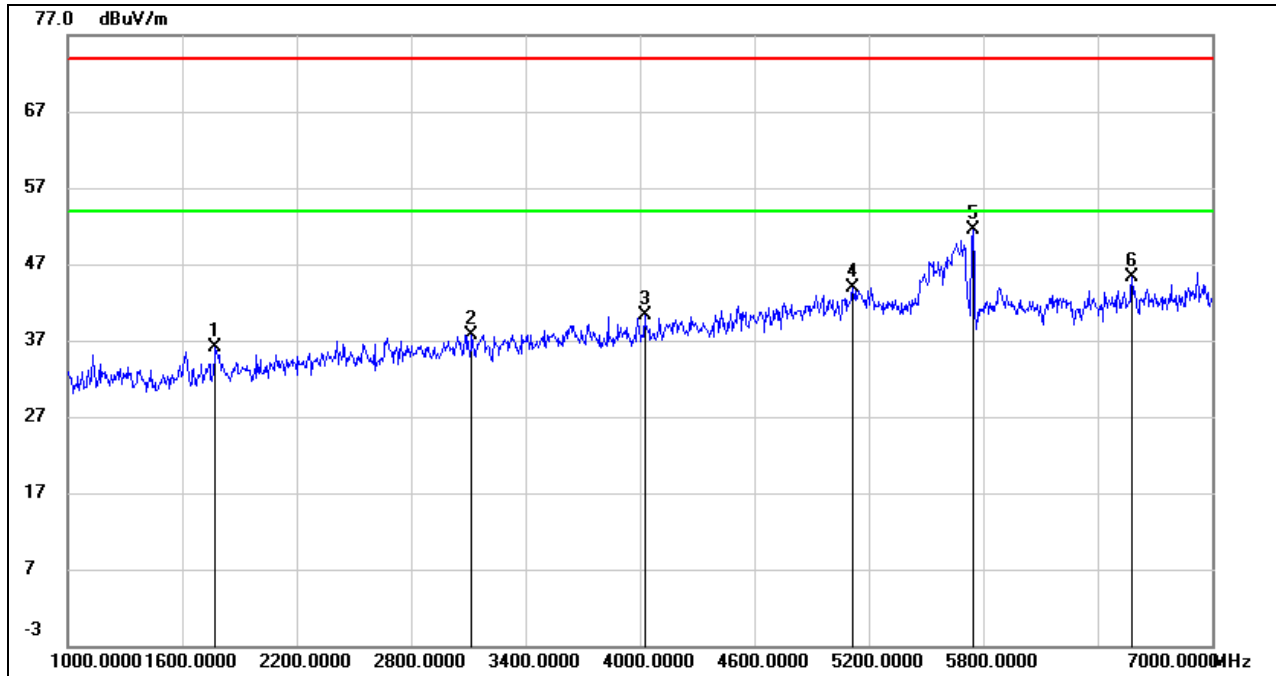

No.	Frequency (MHz)	Reading (dBuV)	Correct (dB/m)	Result (dBuV/m)	Limit (dBuV/m)	Margin (dB)	Remark
1	1774.000	46.37	-10.33	36.04	74.00	-37.96	peak
2	3118.000	42.14	-4.40	37.74	74.00	-36.26	peak
3	4024.000	42.57	-2.32	40.25	74.00	-33.75	peak
4	5116.000	41.11	2.87	43.98	74.00	-30.02	peak
5	5746.000	47.81	3.76	51.57	74.00	-22.43	peak
6	6580.000	38.66	6.56	45.22	74.00	-28.78	peak

Note: 1. Measurement = Reading Level + Correct Factor.
 2. If Peak Result complies with AV limit, AV Result is deemed to comply with AV limit.
 3. Peak: Peak detector.
 4. Filter losses were only considered in the spurious frequency bands and the authorized band was not corrected for Band reject filter losses.
 5. Proper operation of the transmitter prior to adding the filter to the measurement chain.
 6. Owing to the highest peak level of unwanted emission out of the restricted bands complies with the lowest limit(54dBuV/m), so all the test point were deemed to comply with the limits list in the standard.



HORIZONTAL RESULTS
7-18GHz

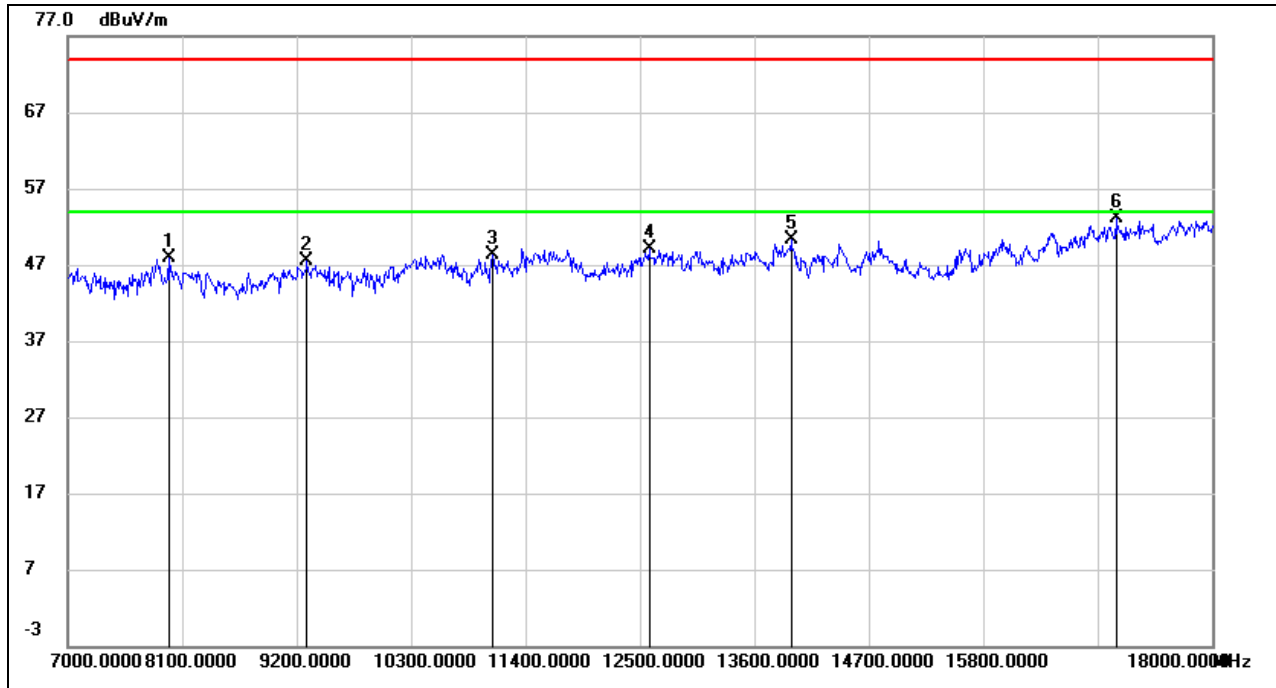

No.	Frequency (MHz)	Reading (dBuV)	Correct (dB/m)	Result (dBuV/m)	Limit (dBuV/m)	Margin (dB)	Remark
1	7968.000	40.37	7.49	47.86	74.00	-26.14	peak
2	9299.000	38.11	9.31	47.42	74.00	-26.58	peak
3	11081.000	35.73	12.64	48.37	74.00	-25.63	peak
4	12588.000	34.86	14.27	49.13	74.00	-24.87	peak
5	13952.000	34.13	16.16	50.29	74.00	-23.71	peak
6	17076.000	32.22	20.82	53.04	74.00	-20.96	peak

Note: 1. Measurement = Reading Level + Correct Factor.
 2. If Peak Result complies with AV limit, AV Result is deemed to comply with AV limit.
 3. Peak: Peak detector.
 4. Filter losses were only considered in the spurious frequency bands and the authorized band was not corrected for High Pass Filter losses.
 5. Proper operation of the transmitter prior to adding the filter to the measurement chain.
 6. Owing to the highest peak level of unwanted emission out of the restricted bands complies with the lowest limit(54dBuV/m), so all the test point were deemed to comply with the limits list in the standard.



VERTICAL RESULTS
1-7GHz

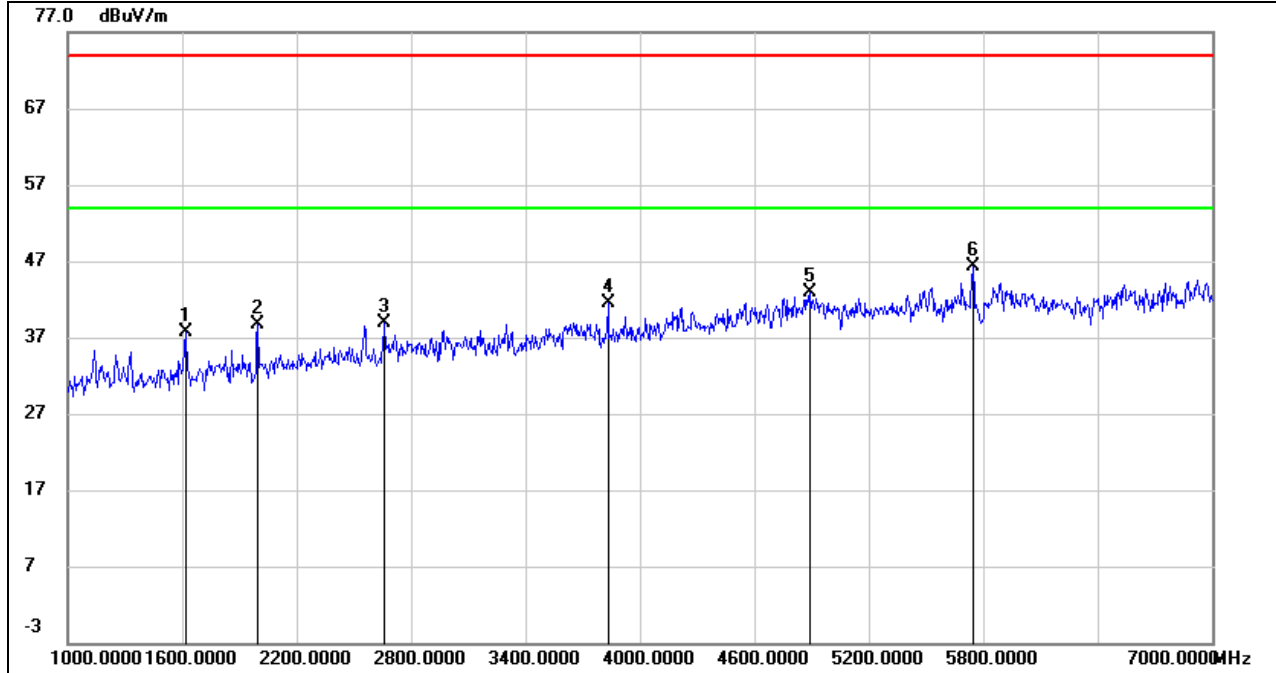

No.	Frequency (MHz)	Reading (dBuV)	Correct (dB/m)	Result (dBuV/m)	Limit (dBuV/m)	Margin (dB)	Remark
1	1618.000	48.87	-11.09	37.78	74.00	-36.22	peak
2	1996.000	48.67	-9.87	38.80	74.00	-35.20	peak
3	2662.000	45.96	-6.96	39.00	74.00	-35.00	peak
4	3832.000	44.30	-2.79	41.51	74.00	-32.49	peak
5	4894.000	40.43	2.39	42.82	74.00	-31.18	peak
6	5746.000	42.49	3.76	46.25	74.00	-27.75	peak

Note: 1. Measurement = Reading Level + Correct Factor.
 2. If Peak Result complies with AV limit, AV Result is deemed to comply with AV limit.
 3. Peak: Peak detector.
 4. Filter losses were only considered in the spurious frequency bands and the authorized band was not corrected for Band reject filter losses.
 5. Proper operation of the transmitter prior to adding the filter to the measurement chain.
 6. Owing to the highest peak level of unwanted emission out of the restricted bands complies with the lowest limit(54dBuV/m), so all the test point were deemed to comply with the limits list in the standard.



7-18GHz

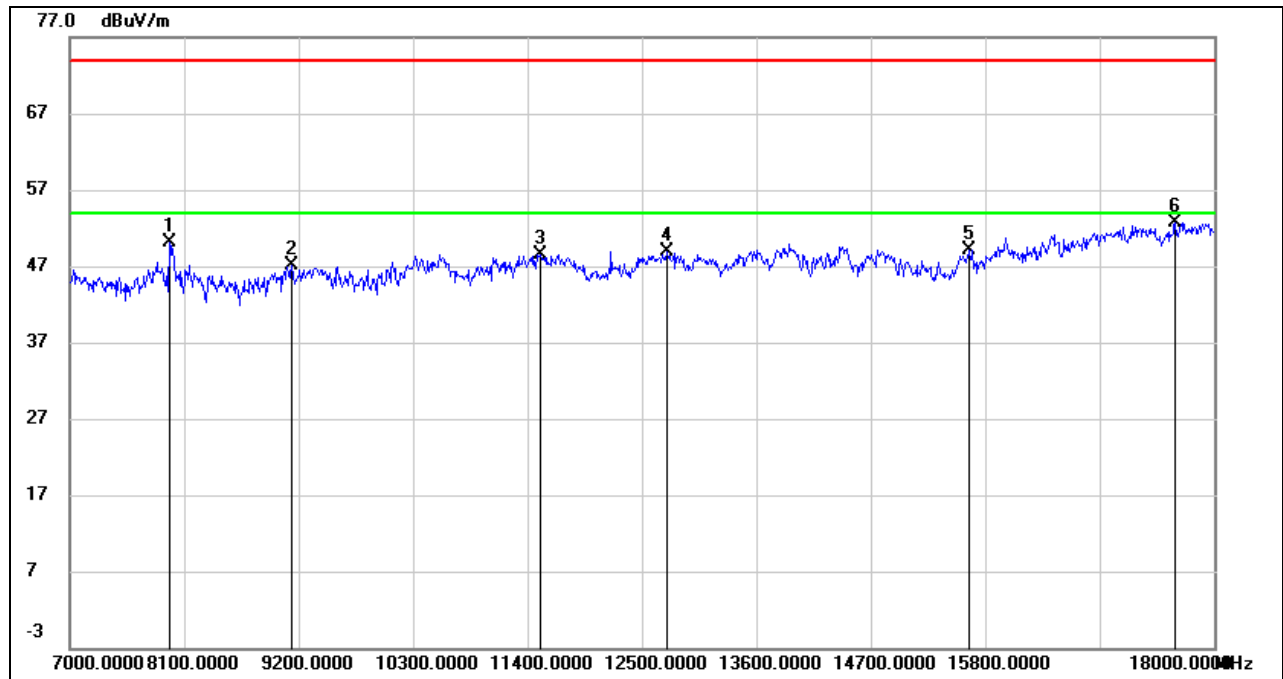

No.	Frequency (MHz)	Reading (dBuV)	Correct (dB/m)	Result (dBuV/m)	Limit (dBuV/m)	Margin (dB)	Remark
1	7957.000	42.58	7.50	50.08	74.00	-23.92	peak
2	9134.000	37.77	9.28	47.05	74.00	-26.95	peak
3	11521.000	35.12	13.40	48.52	74.00	-25.48	peak
4	12742.000	33.80	15.16	48.96	74.00	-25.04	peak
5	15646.000	32.12	16.97	49.09	74.00	-24.91	peak
6	17626.000	30.77	22.02	52.79	74.00	-21.21	peak

Note: 1. Measurement = Reading Level + Correct Factor.
 2. If Peak Result complies with AV limit, AV Result is deemed to comply with AV limit.
 3. Peak: Peak detector.
 4. Filter losses were only considered in the spurious frequency bands and the authorized band was not corrected for High Pass Filter losses.
 5. Proper operation of the transmitter prior to adding the filter to the measurement chain.
 6. Owing to the highest peak level of unwanted emission out of the restricted bands complies with the lowest limit(54dBuV/m), so all the test point were deemed to comply with the limits list in the standard.



HARMONICS AND SPURIOUS EMISSIONS MID CHANNEL

HORIZONTAL RESULTS
1-7GHz

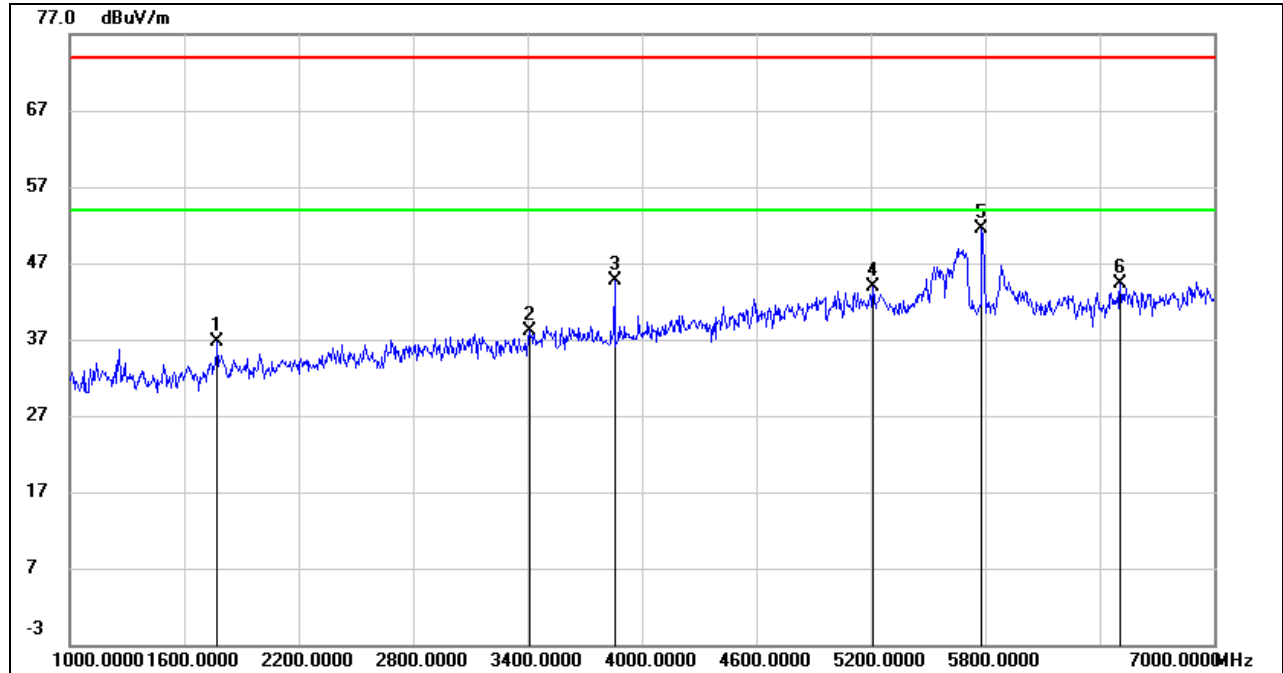

No.	Frequency (MHz)	Reading (dBuV)	Correct (dB/m)	Result (dBuV/m)	Limit (dBuV/m)	Margin (dB)	Remark
1	1774.000	47.00	-10.33	36.67	74.00	-37.33	peak
2	3412.000	42.54	-4.46	38.08	74.00	-35.92	peak
3	3856.000	47.45	-2.68	44.77	74.00	-29.23	peak
4	5212.000	40.77	3.04	43.81	74.00	-30.19	peak
5	5782.000	47.74	3.67	51.41	74.00	-22.59	peak
6	6508.000	37.21	7.06	44.27	74.00	-29.73	peak

Note: 1. Measurement = Reading Level + Correct Factor.
 2. If Peak Result complies with AV limit, AV Result is deemed to comply with AV limit.
 3. Peak: Peak detector.
 4. Filter losses were only considered in the spurious frequency bands and the authorized band was not corrected for Band reject filter losses.
 5. Proper operation of the transmitter prior to adding the filter to the measurement chain.
 6. Owing to the highest peak level of unwanted emission out of the restricted bands complies with the lowest limit(54dBuV/m), so all the test point were deemed to comply with the limits list in the standard.



HORIZONTAL RESULTS
7-18GHz

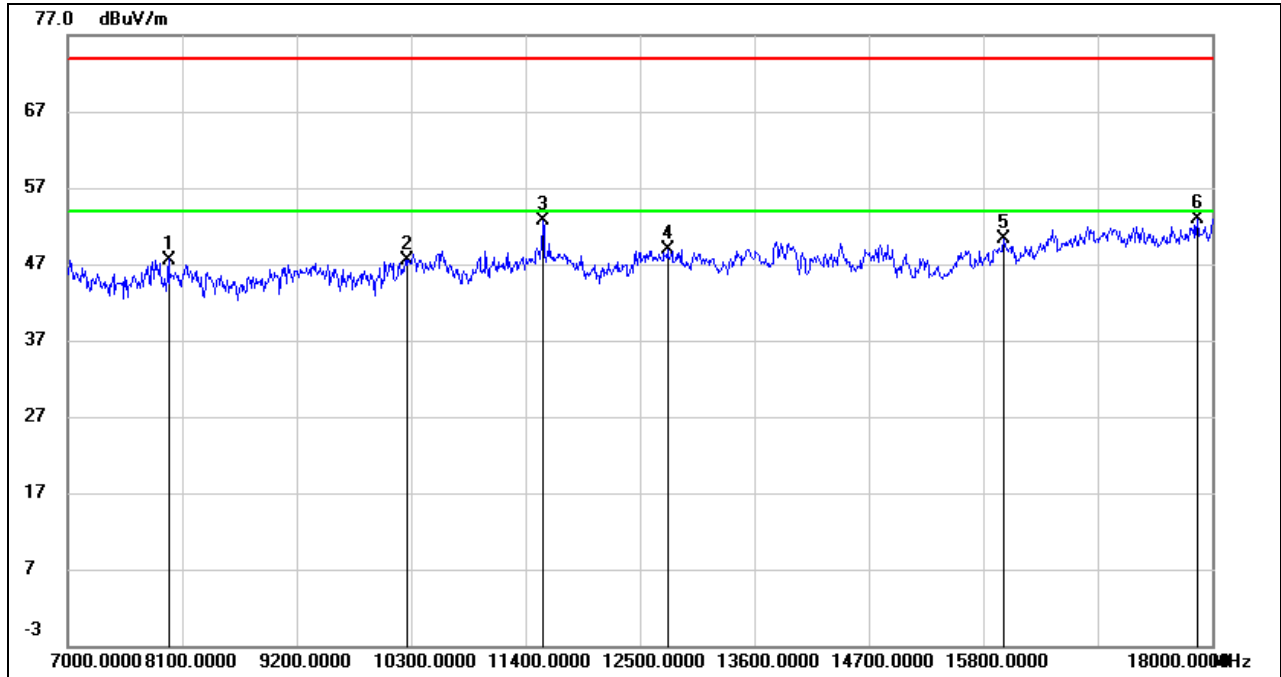

No.	Frequency (MHz)	Reading (dBuV)	Correct (dB/m)	Result (dBuV/m)	Limit (dBuV/m)	Margin (dB)	Remark
1	7968.000	40.11	7.49	47.60	74.00	-26.40	peak
2	10256.000	36.56	10.91	47.47	74.00	-26.53	peak
3	11565.000	39.18	13.47	52.65	74.00	-21.35	peak
4	12764.000	33.37	15.54	48.91	74.00	-25.09	peak
5	15998.000	32.52	17.80	50.32	74.00	-23.68	peak
6	17857.000	29.49	23.41	52.90	74.00	-21.10	peak

Note: 1. Measurement = Reading Level + Correct Factor.
 2. If Peak Result complies with AV limit, AV Result is deemed to comply with AV limit.
 3. Peak: Peak detector.
 4. Filter losses were only considered in the spurious frequency bands and the authorized band was not corrected for High Pass Filter losses.
 5. Proper operation of the transmitter prior to adding the filter to the measurement chain.
 6. Owing to the highest peak level of unwanted emission out of the restricted bands complies with the lowest limit(54dBuV/m), so all the test point were deemed to comply with the limits list in the standard.



VERTICAL RESULTS
1-7GHz

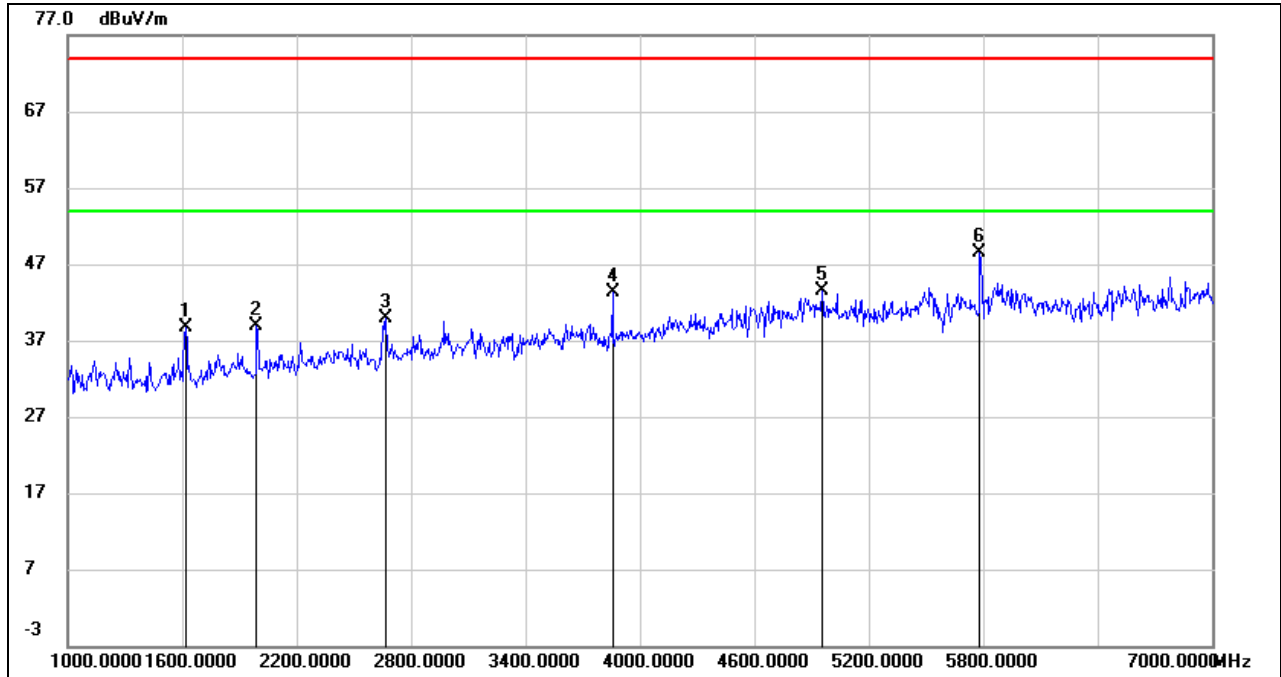

No.	Frequency (MHz)	Reading (dBuV)	Correct (dB/m)	Result (dBuV/m)	Limit (dBuV/m)	Margin (dB)	Remark
1	1618.000	49.75	-11.09	38.66	74.00	-35.34	peak
2	1990.000	48.67	-9.86	38.81	74.00	-35.19	peak
3	2668.000	46.83	-6.91	39.92	74.00	-34.08	peak
4	3856.000	45.99	-2.68	43.31	74.00	-30.69	peak
5	4954.000	41.01	2.58	43.59	74.00	-30.41	peak
6	5782.000	44.82	3.67	48.49	74.00	-25.51	peak

Note: 1. Measurement = Reading Level + Correct Factor.
 2. If Peak Result complies with AV limit, AV Result is deemed to comply with AV limit.
 3. Peak: Peak detector.
 4. Filter losses were only considered in the spurious frequency bands and the authorized band was not corrected for Band reject filter losses.
 5. Proper operation of the transmitter prior to adding the filter to the measurement chain.
 6. Owing to the highest peak level of unwanted emission out of the restricted bands complies with the lowest limit(54dBuV/m), so all the test point were deemed to comply with the limits list in the standard.



7-18GHz

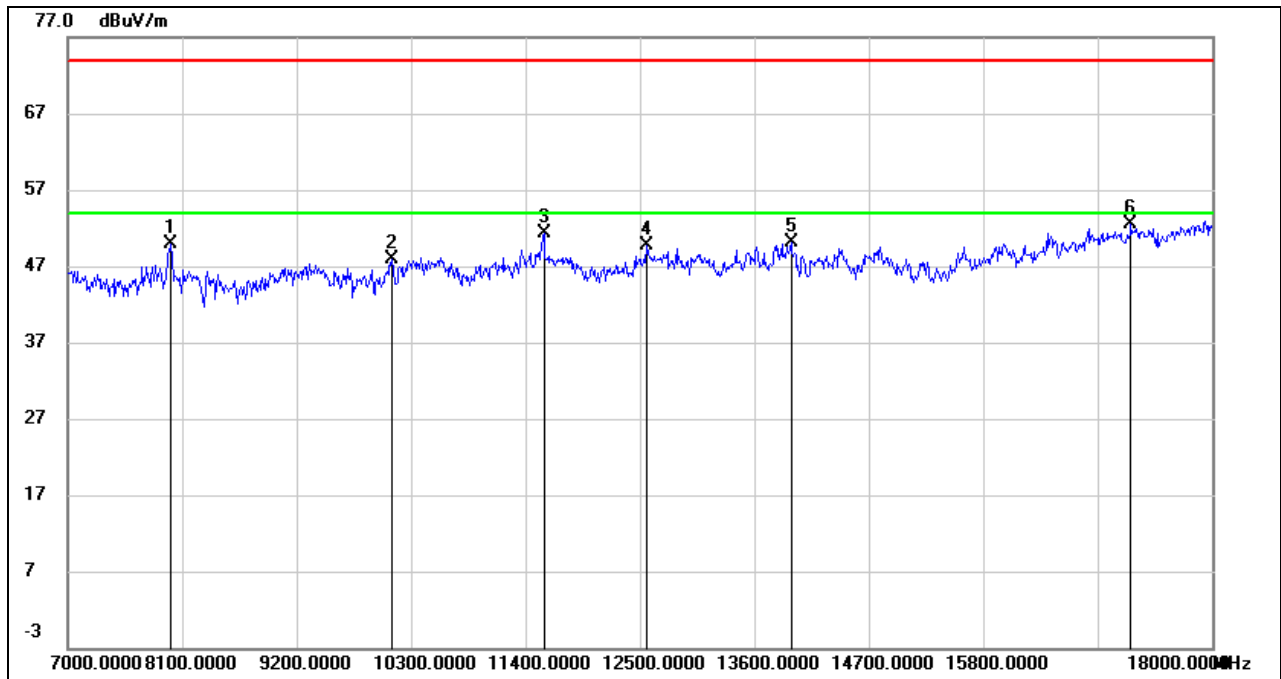

No.	Frequency (MHz)	Reading (dBuV)	Correct (dB/m)	Result (dBuV/m)	Limit (dBuV/m)	Margin (dB)	Remark
1	7990.000	42.37	7.45	49.82	74.00	-24.18	peak
2	10113.000	37.24	10.74	47.98	74.00	-26.02	peak
3	11576.000	37.74	13.51	51.25	74.00	-22.75	peak
4	12566.000	35.30	14.42	49.72	74.00	-24.28	peak
5	13952.000	33.98	16.16	50.14	74.00	-23.86	peak
6	17219.000	31.09	21.34	52.43	74.00	-21.57	peak

Note: 1. Measurement = Reading Level + Correct Factor.
 2. If Peak Result complies with AV limit, AV Result is deemed to comply with AV limit.
 3. Peak: Peak detector.
 4. Filter losses were only considered in the spurious frequency bands and the authorized band was not corrected for High Pass Filter losses.
 5. Proper operation of the transmitter prior to adding the filter to the measurement chain.
 6. Owing to the highest peak level of unwanted emission out of the restricted bands complies with the lowest limit(54dBuV/m), so all the test point were deemed to comply with the limits list in the standard.



HARMONICS AND SPURIOUS EMISSIONS HIGH CHANNEL

HORIZONTAL RESULTS
1-7GHz

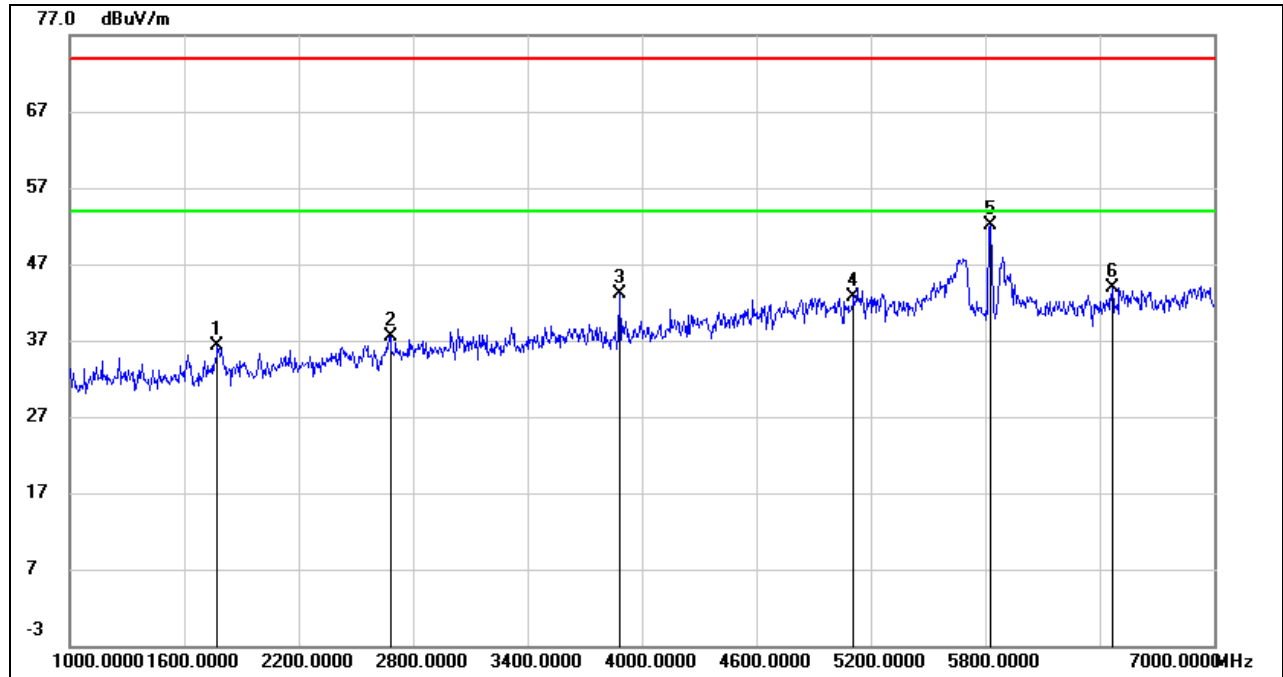

No.	Frequency (MHz)	Reading (dBuV)	Correct (dB/m)	Result (dBuV/m)	Limit (dBuV/m)	Margin (dB)	Remark
1	1774.000	46.56	-10.33	36.23	74.00	-37.77	peak
2	2680.000	44.31	-6.80	37.51	74.00	-36.49	peak
3	3880.000	45.73	-2.58	43.15	74.00	-30.85	peak
4	5110.000	39.92	2.85	42.77	74.00	-31.23	peak
5	5830.000	47.90	4.18	52.08	74.00	-21.92	peak
6	6466.000	37.47	6.40	43.87	74.00	-30.13	peak

Note: 1. Measurement = Reading Level + Correct Factor.
 2. If Peak Result complies with AV limit, AV Result is deemed to comply with AV limit.
 3. Peak: Peak detector.
 4. Filter losses were only considered in the spurious frequency bands and the authorized band was not corrected for Band reject filter losses.
 5. Proper operation of the transmitter prior to adding the filter to the measurement chain.
 6. Owing to the highest peak level of unwanted emission out of the restricted bands complies with the lowest limit(54dBuV/m), so all the test point were deemed to comply with the limits list in the standard.



HORIZONTAL RESULTS
7-18GHz

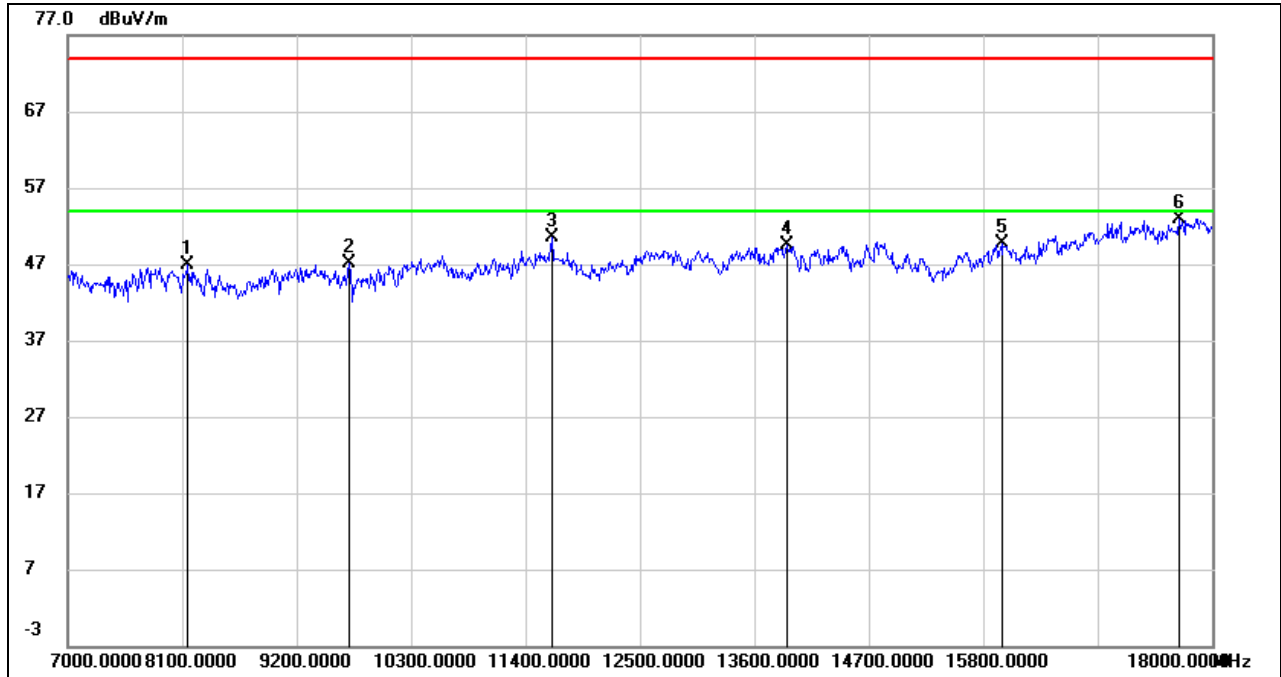

No.	Frequency (MHz)	Reading (dBuV)	Correct (dB/m)	Result (dBuV/m)	Limit (dBuV/m)	Margin (dB)	Remark
1	8155.000	38.29	8.52	46.81	74.00	-27.19	peak
2	9706.000	37.21	9.85	47.06	74.00	-26.94	peak
3	11653.000	37.16	13.28	50.44	74.00	-23.56	peak
4	13908.000	33.29	16.16	49.45	74.00	-24.55	peak
5	15987.000	31.84	17.79	49.63	74.00	-24.37	peak
6	17681.000	30.62	22.37	52.99	74.00	-21.01	peak

Note: 1. Measurement = Reading Level + Correct Factor.
 2. If Peak Result complies with AV limit, AV Result is deemed to comply with AV limit.
 3. Peak: Peak detector.
 4. Filter losses were only considered in the spurious frequency bands and the authorized band was not corrected for High Pass Filter losses.
 5. Proper operation of the transmitter prior to adding the filter to the measurement chain.
 6. Owing to the highest peak level of unwanted emission out of the restricted bands complies with the lowest limit(54dBuV/m), so all the test point were deemed to comply with the limits list in the standard.



VERTICAL RESULTS
1-7GHz

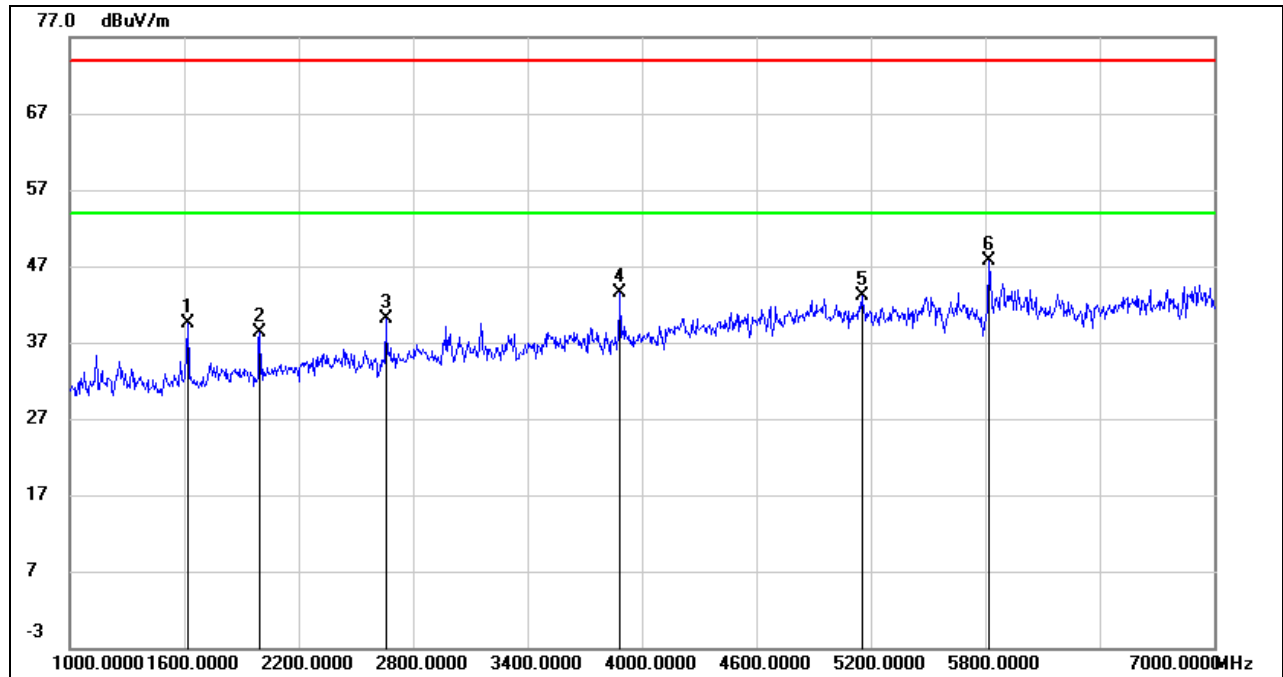

No.	Frequency (MHz)	Reading (dBuV)	Correct (dB/m)	Result (dBuV/m)	Limit (dBuV/m)	Margin (dB)	Remark
1	1618.000	50.52	-11.09	39.43	74.00	-34.57	peak
2	1996.000	48.17	-9.87	38.30	74.00	-35.70	peak
3	2656.000	47.20	-7.01	40.19	74.00	-33.81	peak
4	3886.000	46.01	-2.56	43.45	74.00	-30.55	peak
5	5152.000	40.14	2.95	43.09	74.00	-30.91	peak
6	5818.000	43.81	3.95	47.76	74.00	-26.24	peak

Note: 1. Measurement = Reading Level + Correct Factor.
 2. If Peak Result complies with AV limit, AV Result is deemed to comply with AV limit.
 3. Peak: Peak detector.
 4. Filter losses were only considered in the spurious frequency bands and the authorized band was not corrected for Band reject filter losses.
 5. Proper operation of the transmitter prior to adding the filter to the measurement chain.
 6. Owing to the highest peak level of unwanted emission out of the restricted bands complies with the lowest limit(54dBuV/m), so all the test point were deemed to comply with the limits list in the standard.



7-18GHz

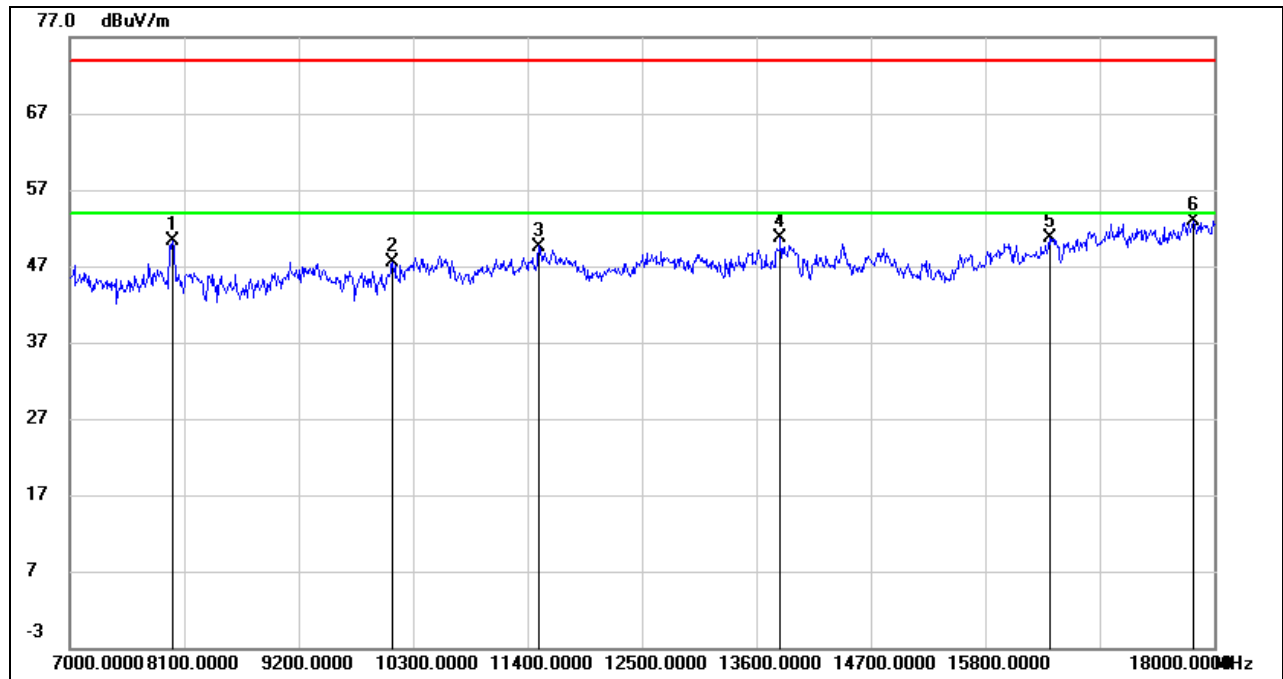

No.	Frequency (MHz)	Reading (dBuV)	Correct (dB/m)	Result (dBuV/m)	Limit (dBuV/m)	Margin (dB)	Remark
1	7990.000	42.92	7.45	50.37	74.00	-23.63	peak
2	10102.000	36.65	10.78	47.43	74.00	-26.57	peak
3	11510.000	36.21	13.39	49.60	74.00	-24.40	peak
4	13831.000	33.96	16.79	50.75	74.00	-23.25	peak
5	16416.000	31.35	19.33	50.68	74.00	-23.32	peak
6	17802.000	29.50	23.41	52.91	74.00	-21.09	peak

Note: 1. Measurement = Reading Level + Correct Factor.
 2. If Peak Result complies with AV limit, AV Result is deemed to comply with AV limit.
 3. Peak: Peak detector.
 4. Filter losses were only considered in the spurious frequency bands and the authorized band was not corrected for High Pass Filter losses.
 5. Proper operation of the transmitter prior to adding the filter to the measurement chain.
 6. Owing to the highest peak level of unwanted emission out of the restricted bands complies with the lowest limit(54dBuV/m), so all the test point were deemed to comply with the limits list in the standard.