



**CFR 47 FCC PART 15 SUBPART C
ISED RSS-247 ISSUE 2**

CERTIFICATION TEST REPORT

For

WIFI+BT Module

MODEL NUMBER: WCT5JM2611

FCC ID: 2AC23-WCT5J

IC: 12290A-WCT5J

REPORT NUMBER: 4789403417-2

ISSUE DATE: March 25, 2020

Prepared for

**Hui Zhou Gaoshengda Technology Co.,LTD
NO.75 Zhongkai Development Area Huizhou, Guangdong China**

Prepared by

**UL Verification Services (Guangzhou) Co., Ltd, Song Shan Lake Branch
Building 10, Innovation Technology Park, No. 1, Li Bin Road, Song Shan Lake
Hi-Tech Development Zone Dongguan, People's Republic of China**

Tel: +86 769 22038881

Fax: +86 769 33244054

Website: www.ul.com

The results reported herein have been performed in accordance with the laboratory's terms of accreditation. This report shall not be reproduced except in full without the written approval of the Laboratory. The results in this report apply to the test sample(s) mentioned above at the time of the testing period only and are not to be used to indicate applicability to other similar products. This report does not imply that the product(s) has met the criteria for certification.



Revision History

<u>Rev.</u>	<u>Issue Date</u>	<u>Revisions</u>	<u>Revised By</u>
V0	03/25/2020	Initial Issue	



Summary of Test Results			
Clause	Test Items	FCC/ISED Rules	Test Results
1	20dB Bandwidth and 99% Occupied Bandwidth	FCC 15.247 (a) (1) RSS-247 Clause 5.1 (a) RSS-Gen Clause 6.7	Pass
2	Conducted Output Power	FCC 15.247 (b) (1) RSS-247 Clause 5.1 (b)	Pass
3	Carrier Hopping Channel Separation	FCC 15.247 (a) (1) RSS-247 Clause 5.1 (b)	Pass
4	Number of Hopping Frequency	15.247 (a) (1) III RSS-247 Clause 5.1 (d)	Pass
5	Time of Occupancy (Dwell Time)	15.247 (a) (1) III RSS-247 Clause 5.1 (d)	Pass
6	Conducted Bandedge	FCC 15.247 (d) RSS-247 Clause 5.5	Pass
7	Radiated Bandedge and Spurious	FCC 15.247 (d) FCC 15.209 FCC 15.205 RSS-247 Clause 5.5 RSS-GEN Clause 8.9 RSS-GEN Clause 8.10	Pass
8	Conducted Emission Test For AC Power Port	FCC 15.207 RSS-GEN Clause 8.8	Pass
9	Antenna Requirement	FCC 15.203 RSS-GEN Clause 6.8	Pass
This test report is only published to and used by the applicant, and it is not for evidence purpose in China			



TABLE OF CONTENTS

1. ATTESTATION OF TEST RESULTS	6
2. TEST METHODOLOGY	7
3. FACILITIES AND ACCREDITATION	7
4. CALIBRATION AND UNCERTAINTY	8
4.1. <i>MEASURING INSTRUMENT CALIBRATION.....</i>	<i>8</i>
4.2. <i>MEASUREMENT UNCERTAINTY.....</i>	<i>8</i>
5. EQUIPMENT UNDER TEST	9
5.1. <i>DESCRIPTION OF EUT</i>	<i>9</i>
5.2. <i>MAXIMUM OUTPUT POWER.....</i>	<i>9</i>
5.3. <i>PACKET TYPE CONFIGURATION.....</i>	<i>9</i>
5.4. <i>CHANNEL LIST</i>	<i>10</i>
5.5. <i>TEST CHANNEL CONFIGURATION.....</i>	<i>10</i>
5.6. <i>THE WORSE CASE POWER SETTING PARAMETER.....</i>	<i>10</i>
5.7. <i>DESCRIPTION OF AVAILABLE ANTENNAS</i>	<i>11</i>
5.8. <i>WORST-CASE CONFIGURATIONS.....</i>	<i>11</i>
5.9. <i>TEST ENVIRONMENT</i>	<i>11</i>
5.10. <i>DESCRIPTION OF TEST SETUP.....</i>	<i>12</i>
6. MEASURING INSTRUMENT AND SOFTWARE USED	13
7. ANTENNA PORT TEST RESULTS	15
7.1. <i>ON TIME AND DUTY CYCLE.....</i>	<i>15</i>
7.2. <i>20dB BANDWIDTH AND 99% OCCUPIED BANDWIDTH</i>	<i>17</i>
7.2.1. <i>GFSK MODE</i>	<i>18</i>
7.2.2. <i>8DPSK MODE</i>	<i>22</i>
7.3. <i>CONDUCTED OUTPUT POWER.....</i>	<i>26</i>
7.3.1. <i>GFSK MODE</i>	<i>27</i>
7.3.2. <i>8DPSK MODE</i>	<i>27</i>
7.4. <i>CARRIER HOPPING CHANNEL SEPARATION.....</i>	<i>28</i>
7.4.1. <i>GFSK MODE</i>	<i>29</i>
7.4.2. <i>8DPSK MODE</i>	<i>30</i>
7.5. <i>NUMBER OF HOPPING FREQUENCY.....</i>	<i>31</i>
7.5.1. <i>GFSK MODE</i>	<i>32</i>
7.5.2. <i>8DPSK MODE</i>	<i>33</i>
7.6. <i>TIME OF OCCUPANCY (DWELL TIME).....</i>	<i>34</i>
6.6.1. <i>GFSK MODE</i>	<i>35</i>



6.6.2.	8DPSK MODE	38
7.7.	CONDUCTED SPURIOUS EMISSION	40
6.6.3.	GFSK MODE	41
6.6.4.	8DPSK MODE	48
8.	RADIATED TEST RESULTS.....	55
8.1.	LIMITS AND PROCEDURE	55
8.2.	RESTRICTED BANDEDGE	60
8.2.1.	GFSK MODE	60
8.2.2.	8DPSK MODE	68
8.3.	SPURIOUS EMISSIONS (1~3GHz)	76
8.3.1.	GFSK MODE	76
8.3.2.	8DPSK MODE	88
8.4.	SPURIOUS EMISSIONS (3~18GHz)	100
8.4.1.	GFSK MODE	100
8.4.2.	8DPSK MODE	112
8.5.	SPURIOUS EMISSIONS 18G ~ 26GHz.....	124
8.5.1.	GFSK MODE	124
8.6.	SPURIOUS EMISSIONS 26G ~ 40GHz.....	126
8.6.1.	GFSK MODE	126
8.7.	SPURIOUS EMISSIONS 30M ~ 1 GHz.....	128
8.7.1.	GFSK MODE	128
8.8.	SPURIOUS EMISSIONS BELOW 30M.....	130
8.8.1.	GFSK MODE	130
9.	AC POWER LINE CONDUCTED EMISSIONS.....	133
9.1.	8DPSK MODE	134
10.	ANTENNA REQUIREMENTS.....	136



1. ATTESTATION OF TEST RESULTS

Applicant Information

Company Name: Hui Zhou Gaoshengda Technology Co.,LTD
Address: NO.75 Zhongkai Development Area Huizhou, Guangdong China

Manufacturer Information

Company Name: Hui Zhou Gaoshengda Technology Co.,LTD
Address: NO.75 Zhongkai Development Area Huizhou, Guangdong China

EUT Description

Product Name: WIFI+BT Module
Model Name: WCT5JM2611
Brand: GSD
Sample Status: Normal
Sample ID: 2930557
Sample Received date: March 05, 2020
Date Tested: March 05, 2020~March 23, 2020

APPLICABLE STANDARDS	
STANDARD	TEST RESULTS
CFR 47 FCC PART 15 SUBPART C	PASS
ISED RSS-247 Issue 2	PASS
ISED RSS-GEN Issue 5	PASS

Prepared By:

Checked By:

Kebo Zhang
Engineer Project Associate

Shawn Wen
Laboratory Leader

Approved By:

Stephen Guo
Laboratory Manager



2. TEST METHODOLOGY

The tests documented in this report were performed in accordance with KDB 558074 D01 15.247 Meas Guidance v05r02, KDB 414788 D01 Radiated Test Site v01r01, CFR 47 FCC Part2, CFR 47 FCC Part 15, ANSI C63.10-2013, ISED RSS-247 Issue 2 and ISED RSS-GEN Issue 5.

3. FACILITIES AND ACCREDITATION

Accreditation Certificate	<p>A2LA (Certificate No.: 4102.01) UL Verification Services (Guangzhou) Co., Ltd. Song Shan Lake Branch. has been assessed and proved to be in compliance with A2LA.</p> <p>FCC (FCC Designation No.: CN1187) UL Verification Services (Guangzhou) Co., Ltd. Song Shan Lake Branch. Has been recognized to perform compliance testing on equipment subject to the Commission's Delcaration of Conformity (DoC) and Certification rules</p> <p>ISED(Company No.: 21320) UL Verification Services (Guangzhou) Co., Ltd. Song Shan Lake Branch. has been registered and fully described in a report filed with ISED. The Company Number is 21320.</p> <p>VCCI (Registration No.: G-20019, R-20004, C-20012 and T-20011) UL Verification Services (Guangzhou) Co., Ltd. Song Shan Lake Branch. has been assessed and proved to be in compliance with VCCI, the Membership No. is 3793. Facility Name: Chamber D, the VCCI registration No. is G-20019 and R-20004 Shielding Room B , the VCCI registration No. is C-20012 and T-20011</p>
---------------------------	---

Note:

1. All tests measurement facilities use to collect the measurement data are located at Building 10, Innovation Technology Park, Song Shan Lake Hi tech Development Zone, Dongguan, 523808, China.
2. The test anechoic chamber in UL Verification Services (Guangzhou) Co., Ltd. Song Shan Lake Branch had been calibrated and compared to the open field sites and the test anechoic chamber is shown to be equivalent to or worst case from the open field site.
3. For below 30MHz, lab had performed measurements at test anechoic chamber and comparing to measurements obtained on an open field site. And these measurements below 30MHz had been correlated to measurements performed on an OFS.



4. CALIBRATION AND UNCERTAINTY

4.1. MEASURING INSTRUMENT CALIBRATION

The measuring equipment utilized to perform the tests documented in this report has been calibrated in accordance with the manufacturer's recommendations, and is traceable to recognized national standards.

4.2. MEASUREMENT UNCERTAINTY

Where relevant, the following measurement uncertainty levels have been estimated for tests performed on the apparatus:

Test Item	Uncertainty
Conduction emission	3.62dB
Radiation Emission test(include Fundamental emission) (9kHz-30MHz)	2.2dB
Radiation Emission test(include Fundamental emission) (30MHz-1GHz)	4.00dB
Radiation Emission test (1GHz to 26GHz)(include Fundamental emission)	5.78dB (1GHz-18Gz)
	5.23dB (18GHz-26Gz)
Note: This uncertainty represents an expanded uncertainty expressed at approximately the 95% confidence level using a coverage factor of k=2.	



5. EQUIPMENT UNDER TEST

5.1. DESCRIPTION OF EUT

EUT Name	WIFI+BT Module				
Model	WCT5JM2611				
Product Description (Bluetooth)	Operation Frequency	2402 MHz ~ 2480 MHz			
	Modulation Type	Data Rate			
	GFSK	1Mbps			
	$\pi/4$ -DQPSK	2Mbps			
	8DPSK	3Mbps			
Supply Voltage	<input type="checkbox"/> AC mains State	AC 120V, 60Hz			
	<input checked="" type="checkbox"/> DC State	<input type="checkbox"/> Internal Power Supply			
		<input checked="" type="checkbox"/> External Power Supply or AC/DC adapter	Rate Input:	DC 5V	
			Rate Output:		
	<input type="checkbox"/> Battery				

5.2. MAXIMUM OUTPUT POWER

Bluetooth Mode	Frequency (MHz)	Channel Number	Max PEAK Output Power (dBm)	EIRP (dBm)
GFSK	2402-2480	0-78[79]	5.317	8.197
8DPSK	2402-2480	0-78[79]	8.276	11.156

5.3. PACKET TYPE CONFIGURATION

Test Mode	Packet Type	Setting(Packet Length)
GFSK	DH1	27
	DH3	183
	DH5	339
$\pi/4$ -DQPSK	2-DH1	54
	2-DH3	367
	2-DH5	679
8DPSK	3-DH1	83
	3-DH3	552
	3-DH5	1021



5.4. CHANNEL LIST

Channel	Frequency (MHz)	Channel	Frequency (MHz)	Channel	Frequency (MHz)	Channel	Frequency (MHz)
0	2402	20	2422	40	2442	60	2462
1	2403	21	2423	41	2443	61	2463
2	2404	22	2424	42	2444	62	2464
3	2405	23	2425	43	2445	63	2465
4	2406	24	2426	44	2446	64	2466
5	2407	25	2427	45	2447	65	2467
6	2408	26	2428	46	2448	66	2468
7	2409	27	2429	47	2449	67	2469
8	2410	28	2430	48	2450	68	2470
9	2411	29	2431	49	2451	69	2471
10	2412	30	2432	50	2452	70	2472
11	2413	31	2433	51	2453	71	2473
12	2414	32	2434	52	2454	72	2474
13	2415	33	2435	53	2455	73	2475
14	2416	34	2436	54	2456	74	2476
15	2417	35	2437	55	2457	75	2477
16	2418	36	2438	56	2458	76	2478
17	2419	37	2439	57	2459	77	2479
18	2420	38	2440	58	2460	78	2480
19	2421	39	2441	59	2461	/	/

5.5. TEST CHANNEL CONFIGURATION

Test Mode	Test Channel	Frequency
GFSK	CH0, CH39, CH78/ Low, Middle, High	2402MHz, 2441MHz, 2480MHz
□/4-DQPSK	CH0, CH39, CH78/ Low, Middle, High	2402MHz, 2441MHz, 2480MHz
8DPSK	CH0, CH39, CH78/ Low, Middle, High	2402MHz, 2441MHz, 2480MHz

5.6. THE WORSE CASE POWER SETTING PARAMETER

The Worse Case Power Setting Parameter under 2400 ~ 2483.5MHz Band				
Test Software		WCN_Combo_Tool		
Modulation Type	Transmit Antenna Number	Test Channel Power Setting		
		CH 00	CH 39	CH 78
GFSK	0	Default	Default	Default
8DPSK	0	Default	Default	Default



5.7. DESCRIPTION OF AVAILABLE ANTENNAS

Antenna model	Frequency (MHz)	Antenna Type	Antenna Gain (dBi)
WCT5H-20	2402-2480	PIFA Antenna	2.77
WCT5H-40	2402-2480	PIFA Antenna	2.60
WCT5H-60	2402-2480	PIFA Antenna	2.71
WCT5J-20	2402-2480	PIFA Antenna	2.88
WCT5J-40	2402-2480	PIFA Antenna	2.73
WCT5J-60	2402-2480	PIFA Antenna	2.79

Note: The EUT has 2 kinds of antennas WCT5H and WCT5J. For WCT5H-20/ WCT5H-40/ WCT5H-60, they differ only in line length. For WCT5J-20/ WCT5J-40/ WCT5J-60, they differ only in line length. So for the Radiated Bandedge and Spurious Emission, we use the worst kind WCT5H-20 and WCT5J-20 to test. Other test items we use the worst kind WCT5J-20 to test.

Test Mode	Transmit and Receive Mode	Description
GFSK	1TX, 1RX	Chain 0 can be used as transmitting/receiving antenna.
π/4-DQPSK	1TX, 1RX	Chain 0 can be used as transmitting/receiving antenna.
8DPSK	1TX, 1RX	Chain 0 can be used as transmitting/receiving antenna.

5.8. WORST-CASE CONFIGURATIONS

Bluetooth Mode	Modulation Technology	Modulation Type	Data Rate (Mbps)
BR	FHSS	GFSK	1Mbit/s
EDR	FHSS	8DPSK	3Mbit/s

Note: Pre-Scan has been conducted to determine the worst-case mode from all possible combinations between available modulations, data rates.

5.9. TEST ENVIRONMENT

Environment Parameter	Selected Values During Tests	
Relative Humidity	45 ~ 70%	
Atmospheric Pressure:	101kPa	
Temperature	TN	22 ~ 28 °C
Voltage:	VL	N/A
	VN	DC 5V
	VH	N/A

Note: VL= Lower Extreme Test Voltage
VN= Nominal Voltage.
VH= Upper Extreme Test Voltage
TN= Normal Temperature

5.10. DESCRIPTION OF TEST SETUP

SUPPORT EQUIPMENT

Item	Equipment	Brand Name	Model Name	P/N
1	PC	Dell	Vostro 3902	8KNDDDB2
2	USB TO UART	/	/	/

I/O CABLES

Cable No	Port	Connector Type	Cable Type	Cable Length(m)	Remarks
1	USB	/	/	1.0	/

ACCESSORY

Item	Accessory	Brand Name	Model Name	Description
1	/	/	/	/

TEST SETUP

The EUT can work in an engineer mode with software.

SETUP DIAGRAM FOR TESTS

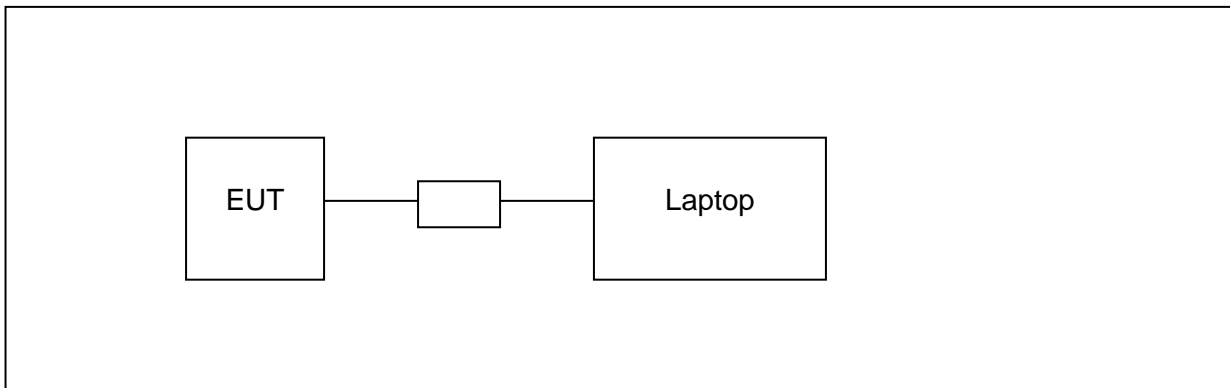



6. MEASURING INSTRUMENT AND SOFTWARE USED

Conducted Emissions						
Instrument						
Used	Equipment	Manufacturer	Model No.	Serial No.	Last Cal.	Next Cal.
<input checked="" type="checkbox"/>	EMI Test Receiver	R&S	ESR3	101961	Dec.05,2019	Dec.05,2020
<input checked="" type="checkbox"/>	Two-Line V- Network	R&S	ENV216	101983	Dec.05,2019	Dec.05,2020
<input checked="" type="checkbox"/>	Artificial Mains Networks	Schwarzbeck	NSLK 8126	8126465	Dec.05,2019	Dec.05,2020
Software						
Used	Description	Manufacturer	Name	Version		
<input checked="" type="checkbox"/>	Test Software for Conducted disturbance	Farad	EZ-EMC	Ver. UL-3A1		
Radiated Emissions						
Instrument						
Used	Equipment	Manufacturer	Model No.	Serial No.	Last Cal.	Next Cal.
<input checked="" type="checkbox"/>	MXE EMI Receiver	KESIGHT	N9038A	MY56400 036	Dec.06,2019	Dec.06,2020
<input checked="" type="checkbox"/>	Hybrid Log Periodic Antenna	TDK	HLP-3003C	130960	Sep.17, 2018	Sep.17, 2021
<input checked="" type="checkbox"/>	Preamplifier	HP	8447D	2944A090 99	Dec.05,2019	Dec.05,2020
<input checked="" type="checkbox"/>	EMI Measurement Receiver	R&S	ESR26	101377	Dec.05,2019	Dec.05,2020
<input checked="" type="checkbox"/>	Horn Antenna	TDK	HRN-0118	130939	Sep.17, 2018	Sep.17, 2021
<input checked="" type="checkbox"/>	High Gain Horn Antenna	Schwarzbeck	BBHA-9170	691	Aug.11, 2018	Aug.11, 2021
<input checked="" type="checkbox"/>	Preamplifier	TDK	PA-02-0118	TRS-305- 00066	Dec.05,2019	Dec.05,2020
<input checked="" type="checkbox"/>	Preamplifier	TDK	PA-02-2	TRS-307- 00003	Dec.05,2019	Dec.05,2020
<input checked="" type="checkbox"/>	Loop antenna	Schwarzbeck	1519B	00008	Jan.07, 2019	Jan.07, 2022
<input checked="" type="checkbox"/>	Band Reject Filter	Wainwright	WRCJV8- 2350-2400- 2483.5- 2533.5-40SS	4	Dec.05,2019	Dec.05,2020
<input checked="" type="checkbox"/>	High Pass Filter	Wi	WHKX10- 2700-3000- 18000-40SS	23	Dec.05,2019	Dec.05,2020
Software						
Used	Description	Manufacturer	Name	Version		
<input checked="" type="checkbox"/>	Test Software for Radiated disturbance	Farad	EZ-EMC	Ver. UL-3A1		
Other instruments						



Used	Equipment	Manufacturer	Model No.	Serial No.	Last Cal.	Next Cal.
<input checked="" type="checkbox"/>	Spectrum Analyzer	Keysight	N9030A	MY55410512	Dec.06,2019	Dec.06,2020
<input checked="" type="checkbox"/>	Power Meter	Keysight	N1911A	MY55416024	Dec.06,2019	Dec.06,2020
<input checked="" type="checkbox"/>	Power Sensor	Keysight	U2021XA	MY5100022	Dec.06,2019	Dec.06,2020



7. ANTENNA PORT TEST RESULTS

7.1. ON TIME AND DUTY CYCLE

LIMITS

None; for reporting purposes only

TEST SETUP

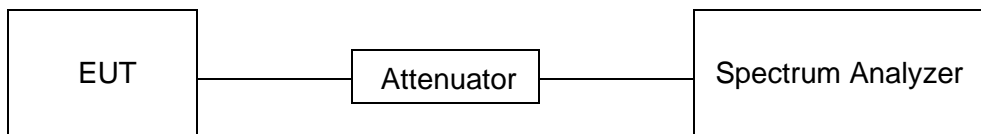

TEST ENVIRONMENT

Temperature	25.1°C	Relative Humidity	58%
Atmosphere Pressure	101kPa	Test Voltage	DC 5V

RESULTS

Mode	On Time (msec)	Period (msec)	Duty Cycle x (Linear)	Duty Cycle (%)	Duty Cycle Correction Factor (dB)	1/T Minimum VBW (kHz)	Final setting For VBW (kHz)
GFSK	1.635	2.505	0.653	65.3%	1.85	0.61	1
8DPSK	1.635	2.505	0.653	65.3%	1.85	0.61	1

Note:

Duty Cycle Correction Factor=10log (1/x).

Where: x is Duty Cycle (Linear)

Where: T is On Time

If that calculated VBW is not available on the analyzer then the next higher value should be used.

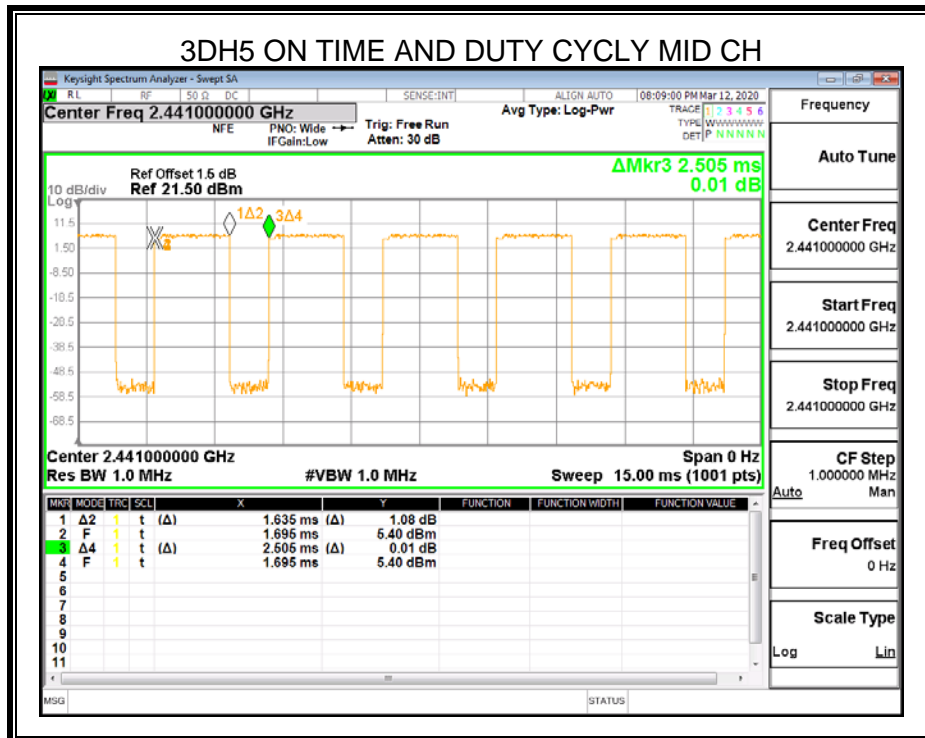
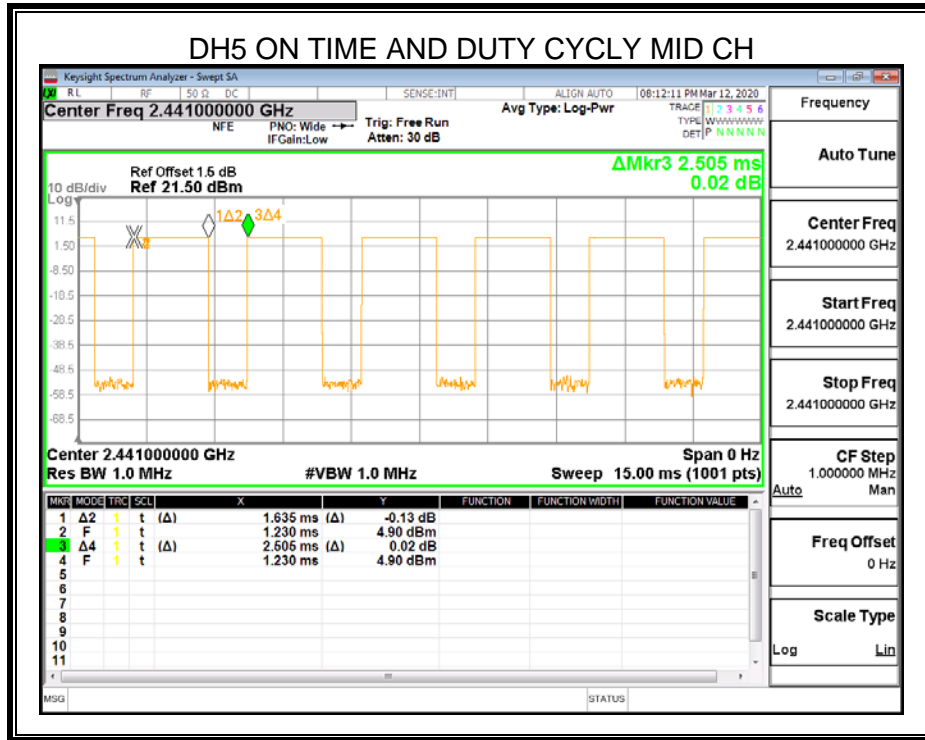

7.2. 20dB BANDWIDTH AND 99% OCCUPIED BANDWIDTH

LIMITS

CFR 47FCC Part15 (15.247) Subpart C ISED RSS-247 ISSUE 2			
Section	Test Item	Limit	Frequency Range (MHz)
CFR 47 FCC 15.247 (a) (1) RSS-247 Clause 5.1 (a)	20dB Occupied Bandwidth	/	2400-2483.5
ISED RSS-Gen Clause 6.7	99% Occupied Bandwidth	/	2400-2483.5

TEST PROCEDURE

Connect the UUT to the spectrum analyser and use the following settings:

Center Frequency	The centre frequency of the channel under test
Detector	Peak
RBW	For 20dB:Occupied Bandwidth:1% to 5% of the 20 dB bandwidth For 99%:Occupied Bandwidth: 1% to 5% of the occupied bandwidth
VBW	For 20dB Occupied Bandwidth: approximately 3×RBW For 99% Occupied Bandwidth: ≥ 3×RBW
Span	For 20dB: between 2 times and 5 times the OBW. For 99dB: between 1.5 times and 5.0 times the OBW.
Trace	Max hold
Sweep	Auto couple

Allow the trace to stabilize and measure the maximum width of the emission that is constrained by the frequencies associated with the two outermost amplitude points (upper and lower frequencies) that are attenuated by 20 dB and 99% relative to the maximum level measured in the fundamental emission.

TEST SETUP

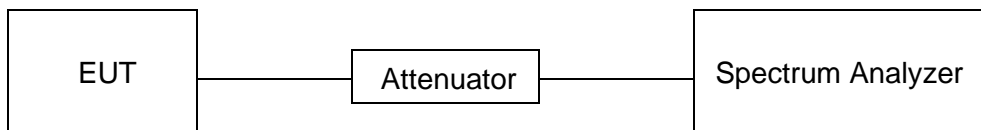



TEST ENVIRONMENT

Temperature	25.1°C	Relative Humidity	58%
Atmosphere Pressure	101kPa	Test Voltage	DC 5V

RESULTS

7.2.1. GFSK MODE

Channel	Frequency (MHz)	20dB Occupied bandwidth (MHz)	99% Occupied bandwidth (MHz)	Result
Low	2402	0.9377	0.86679	PASS
Middle	2441	0.9376	0.86600	PASS
High	2480	0.9377	0.86827	PASS

Test Graph

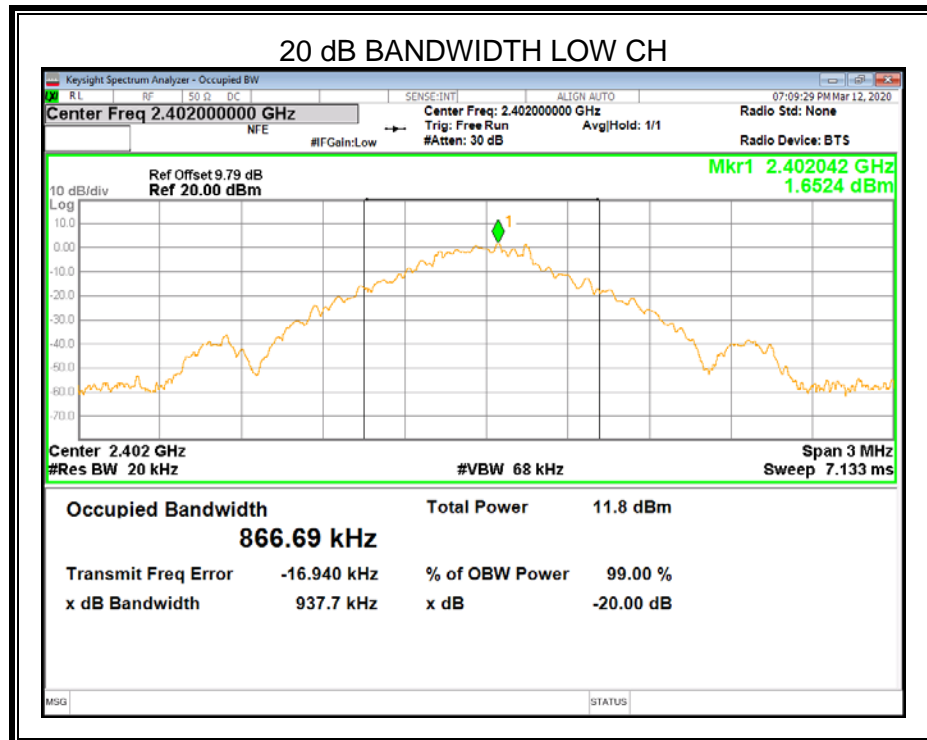

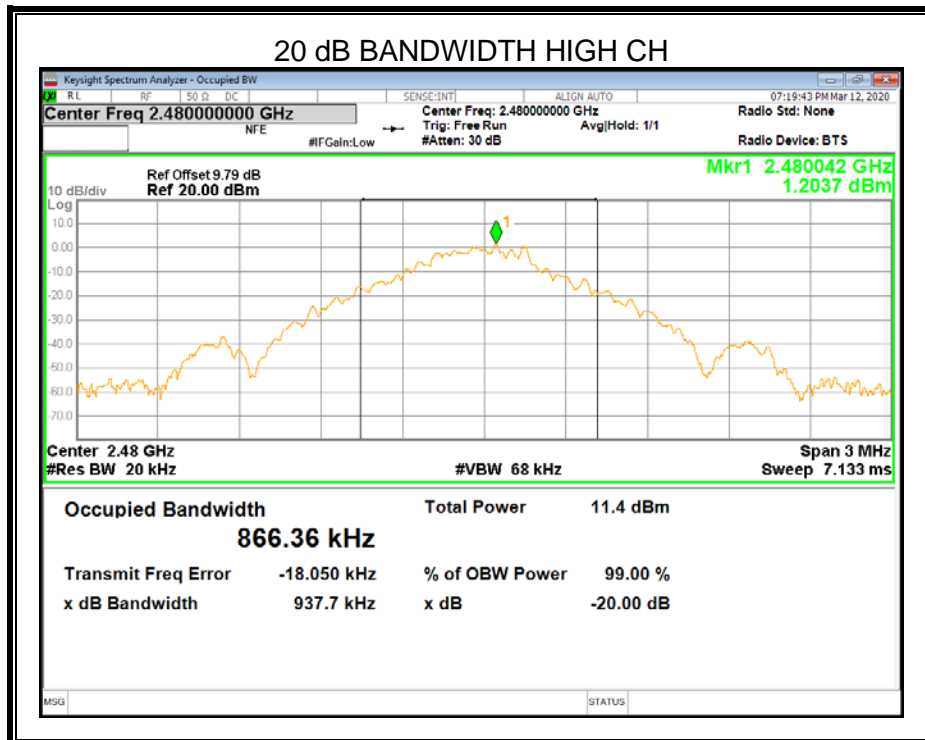
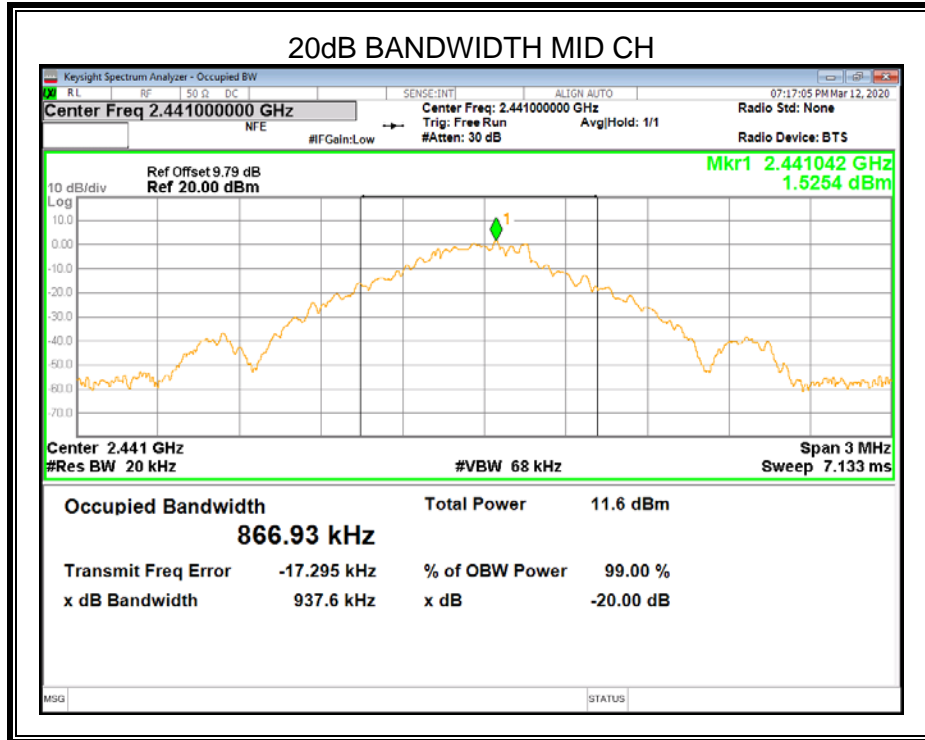

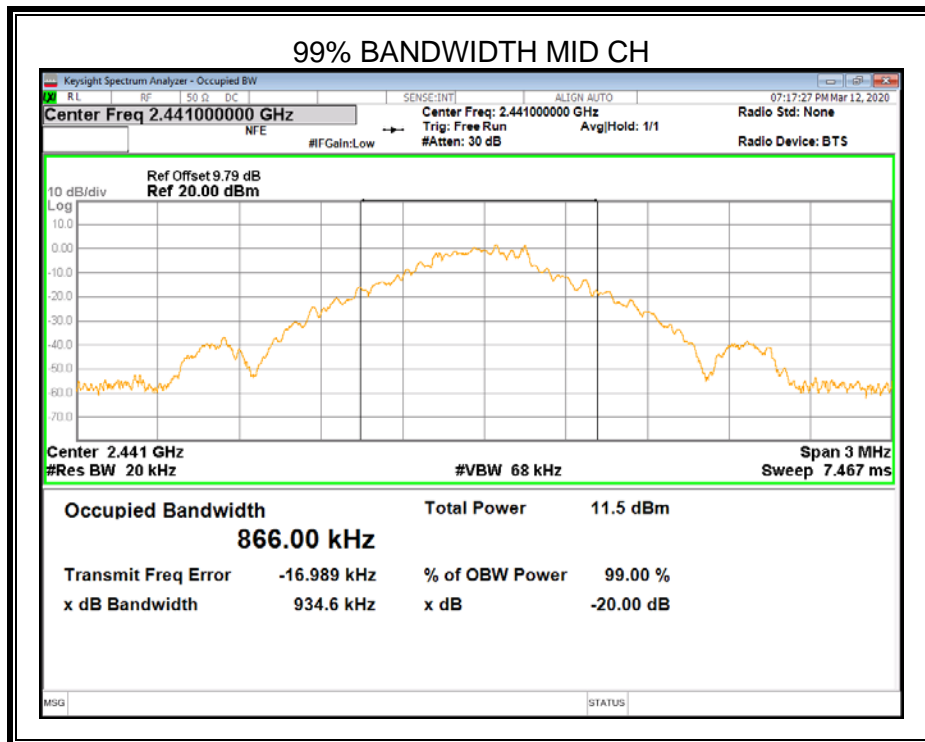
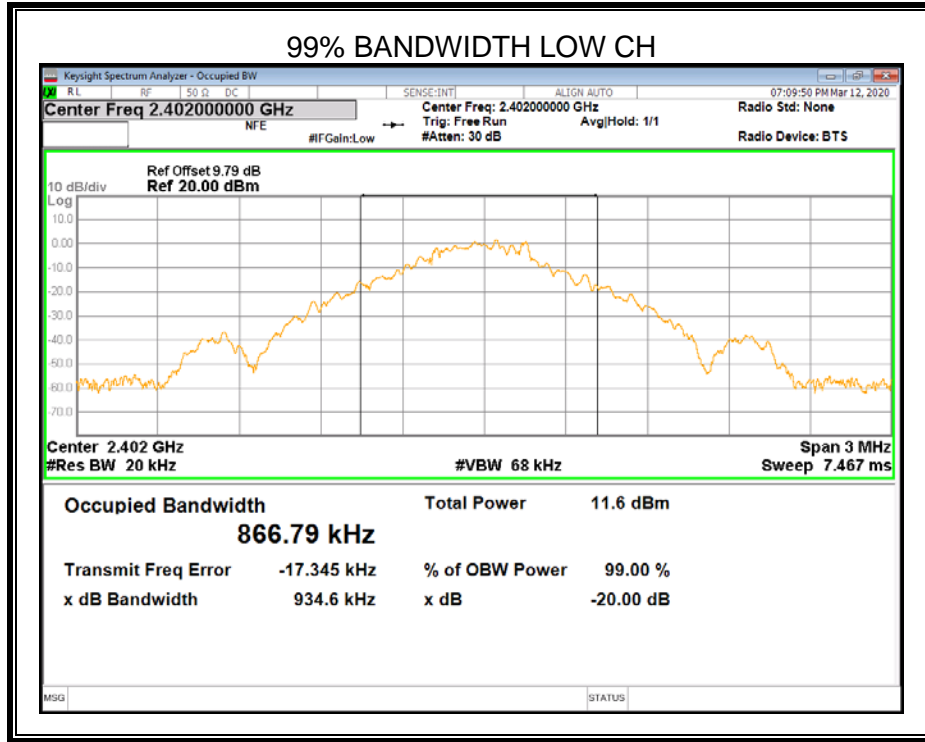

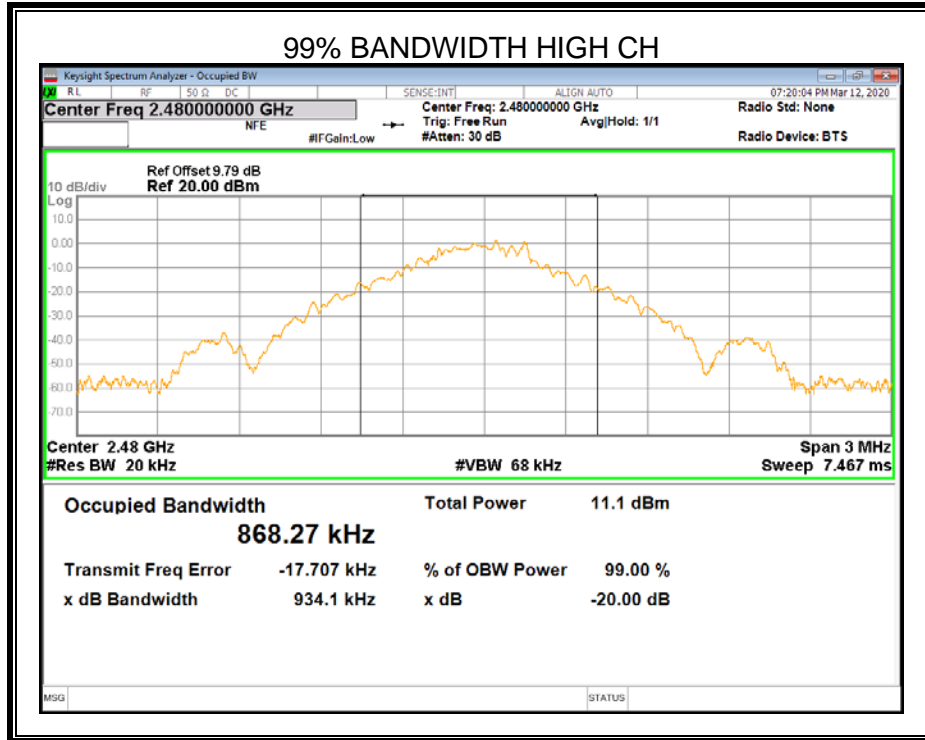



7.2.2. 8DPSK MODE

Channel	Frequency (MHz)	20dB Occupied bandwidth (MHz)	99% Occupied bandwidth (MHz)	Result
Low	2402	1.268	1.1743	PASS
Middle	2441	1.268	1.1777	PASS
High	2480	1.287	1.1789	PASS

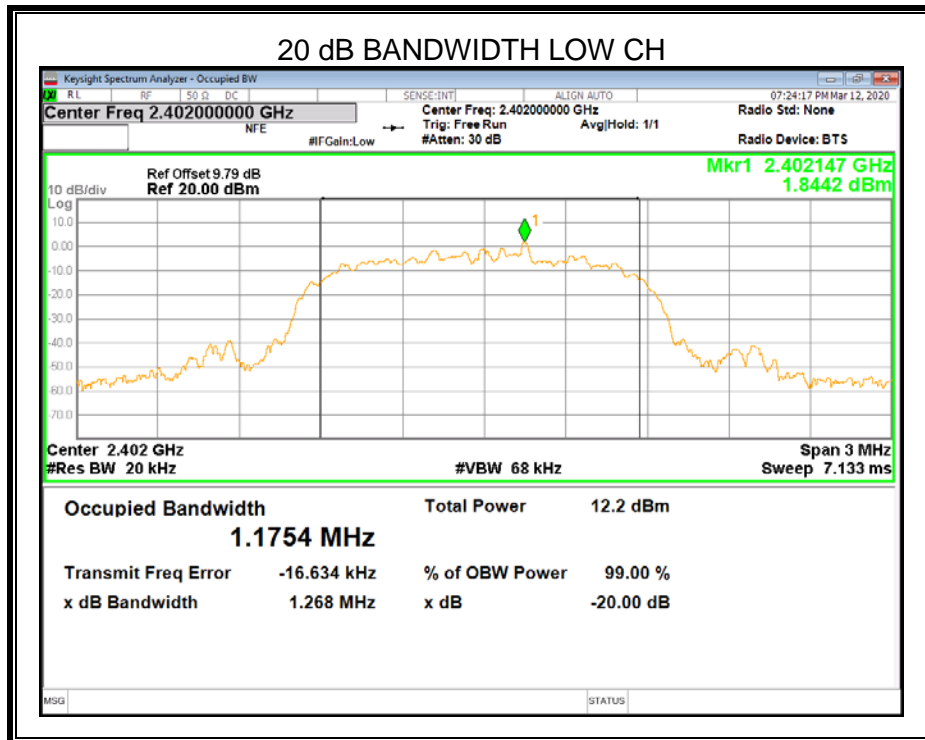

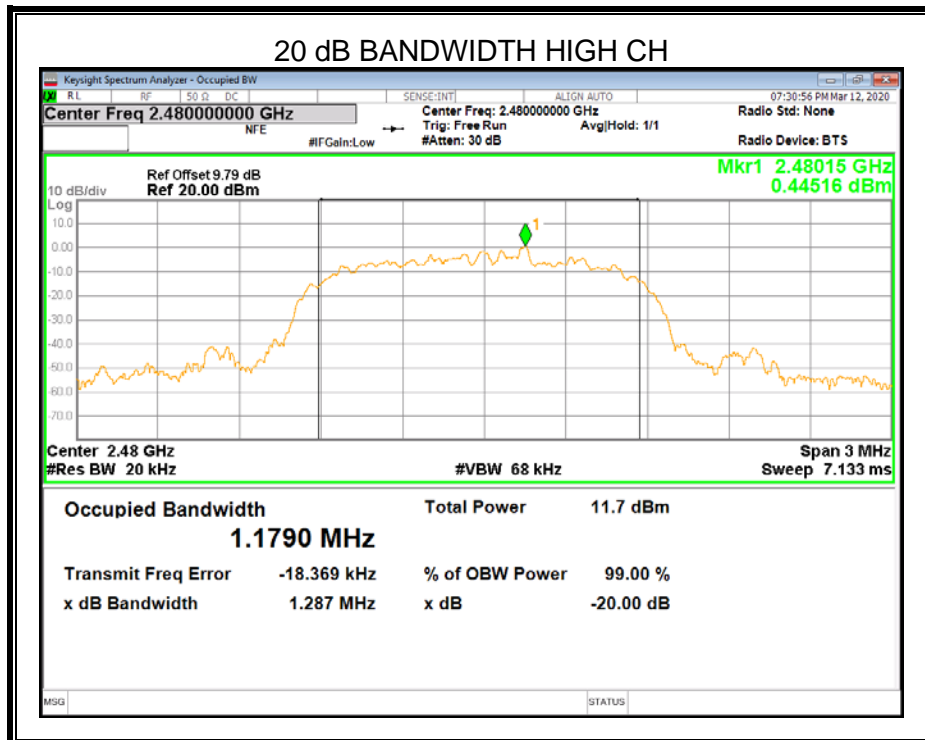
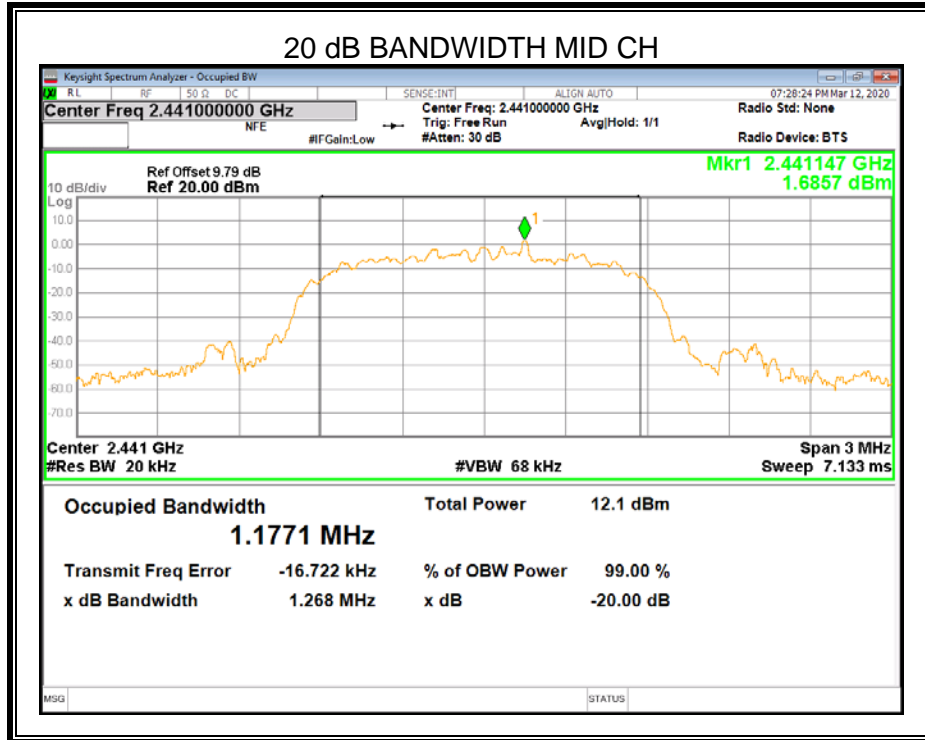

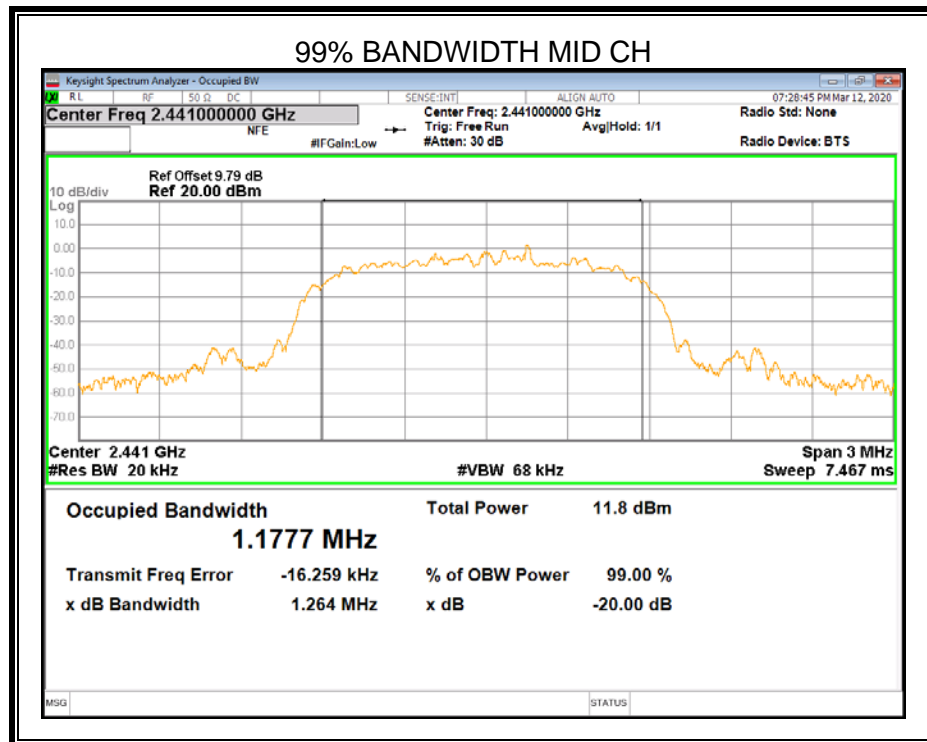
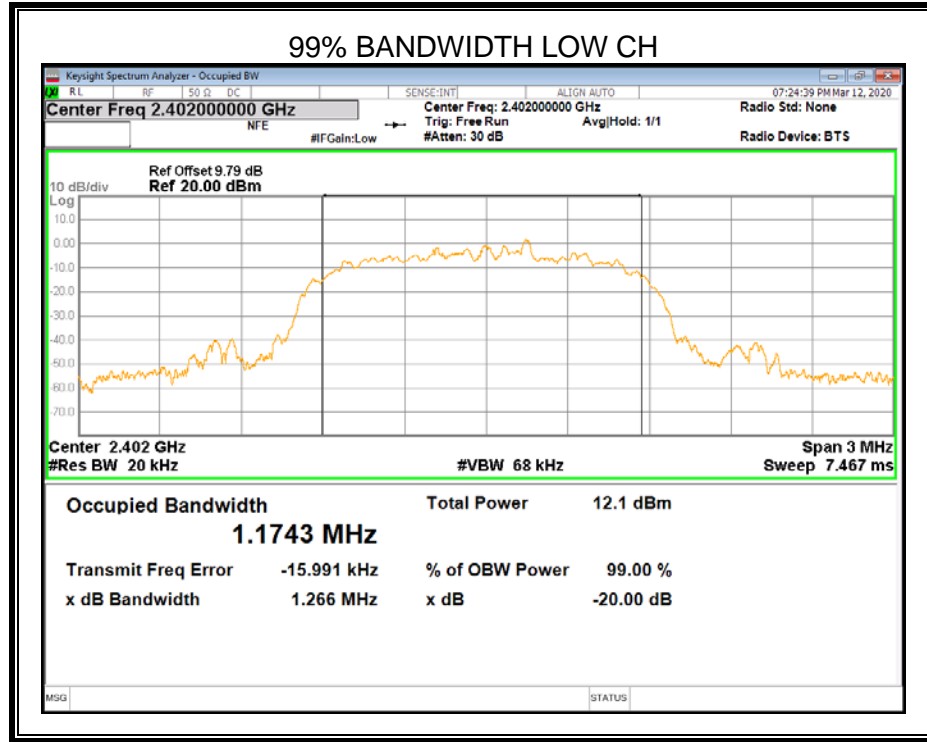

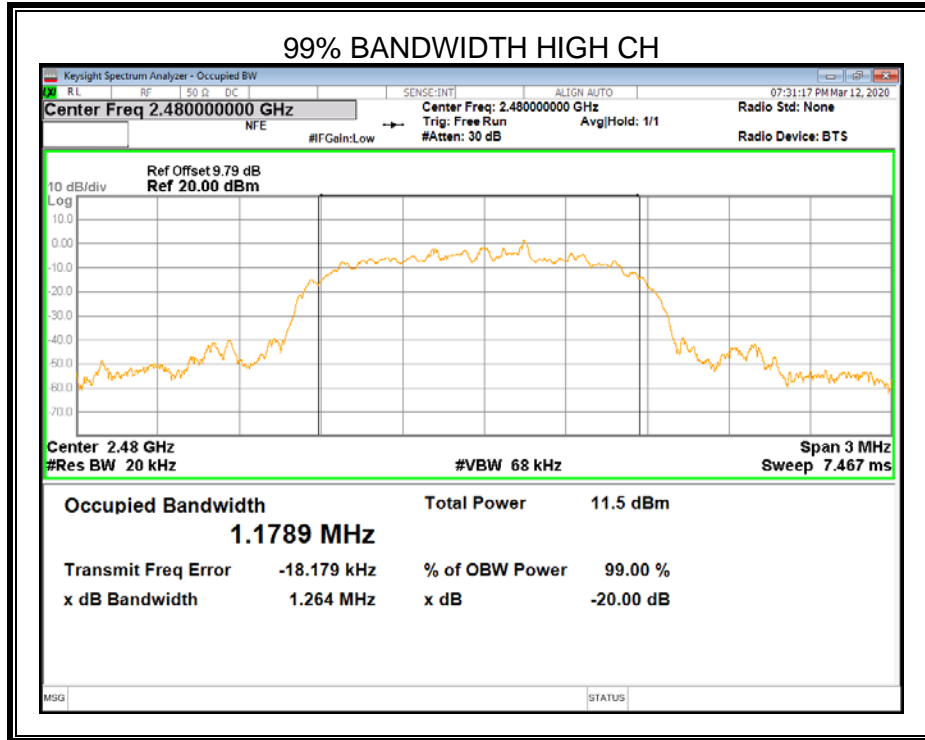

7.3. CONDUCTED OUTPUT POWER

LIMITS

CFR 47 FCC Part15 (15.247) , Subpart C ISED RSS-247 ISSUE 2			
Section	Test Item	Limit	Frequency Range (MHz)
CFR 47 FCC 15.247 (b) (1) ISED RSS-247 Clause 5.4 (b)	Peak Conducted Output Power	Hopping channel carrier frequencies separated by a minimum of 25 kHz or the 20 dB bandwidth of the hopping channel : 1 watt or 30dBm; Hopping channel carrier frequencies that are separated by 25 kHz or two-thirds of the 20 dB bandwidth of the hopping channel : 125 mW or 21dBm	2400-2483.5

TEST PROCEDURE

Place the EUT on the table and set it in the transmitting mode.
Remove the antenna from the EUT and then connect a low loss RF cable from the antenna port to the Power sensor.
Measure peak power of each channel.

TEST SETUP

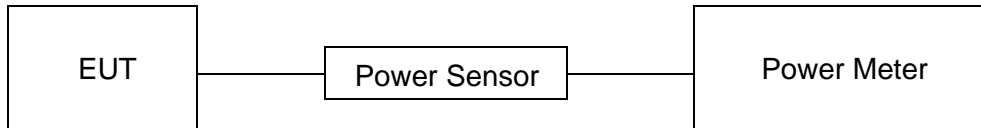



TEST ENVIRONMENT

Temperature	25.1°C	Relative Humidity	58%
Atmosphere Pressure	101kPa	Test Voltage	DC 5V

RESULTS

7.3.1. GFSK MODE

Channel	Frequency	Maximum Conducted Output Power(PK)	EIRP	Limit	Result
	(MHz)	(dBm)	(dBm)	(dBm)	
Low	2402	5.317	8.197	30	Pass
Middle	2441	5.179	8.059	30	Pass
High	2480	4.876	7.756	30	Pass

Note: EIRP= Maximum Conducted Output Power + Antenna Gain

Note: The channel separation is 1MHz and the 20dB Bandwidth is less than 1MHz.

7.3.2. 8DPSK MODE

Channel	Frequency	Maximum Conducted Output Power(PK)	EIRP	Limit	Result
	(MHz)	(dBm)	(dBm)	(dBm)	
Low	2402	8.276	11.156	21	Pass
Middle	2441	8.091	10.971	21	Pass
High	2480	7.685	10.565	21	Pass

Note: EIRP= Maximum Conducted Output Power + Antenna Gain

Note: The channel separation is 1MHz and the 20dB Bandwidth is bigger than 1MHz.



7.4. CARRIER HOPPING CHANNEL SEPARATION

LIMITS

CFR 47 FCC Part15 (15.247) , Subpart C ISED RSS-247 ISSUE 2			
Section	Test Item	Limit	Frequency Range (MHz)
CFR 47 FCC 15.247 (a) (1) ISED RSS-247 Clause 5.1 (b)	Carrier Hopping Channel Separation	Frequency hopping systems shall have hopping channel carrier frequencies separated by a minimum of 25 kHz or the 20 dB bandwidth of the hopping channel, whichever is greater. Alternatively, frequency hopping systems operating in the 2400-2483.5 MHz band may have hopping channel carrier frequencies that are separated by 25 kHz or two-thirds of the 20 dB bandwidth of the hopping channel.	2400-2483.5

TEST PROCEDURE

Connect the UUT to the spectrum Analyzer and use the following settings:

Center Frequency	The center frequency of the channel under test
Span	wide enough to capture the peaks of two adjacent channels
Detector	Peak
RBW	Start with the RBW set to approximately 30% of the channel spacing; adjust as necessary to best identify the center of each individual channel.
VBW	\geq RBW
Trace	Max hold
Sweep time	Auto couple

Allow the trace to stabilize. Use the marker-delta function to determine the separation between the peaks of the adjacent channels.

Compliance of an EUT with the appropriate regulatory limit shall be determined.

A plot of the data shall be included in the test report.

TEST SETUP

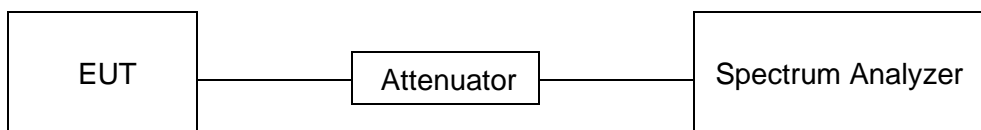

TEST ENVIRONMENT

Temperature	25.1°C	Relative Humidity	58%
Atmosphere Pressure	101kPa	Test Voltage	DC 5V

RESULTS

7.4.1. GFSK MODE

Channel	Carrier Hopping Channel Separation (MHz)	Limit (MHz)	Result
Middle	1.010	≥ 20 dB Bandwidth Of The Hopping Channel	PASS

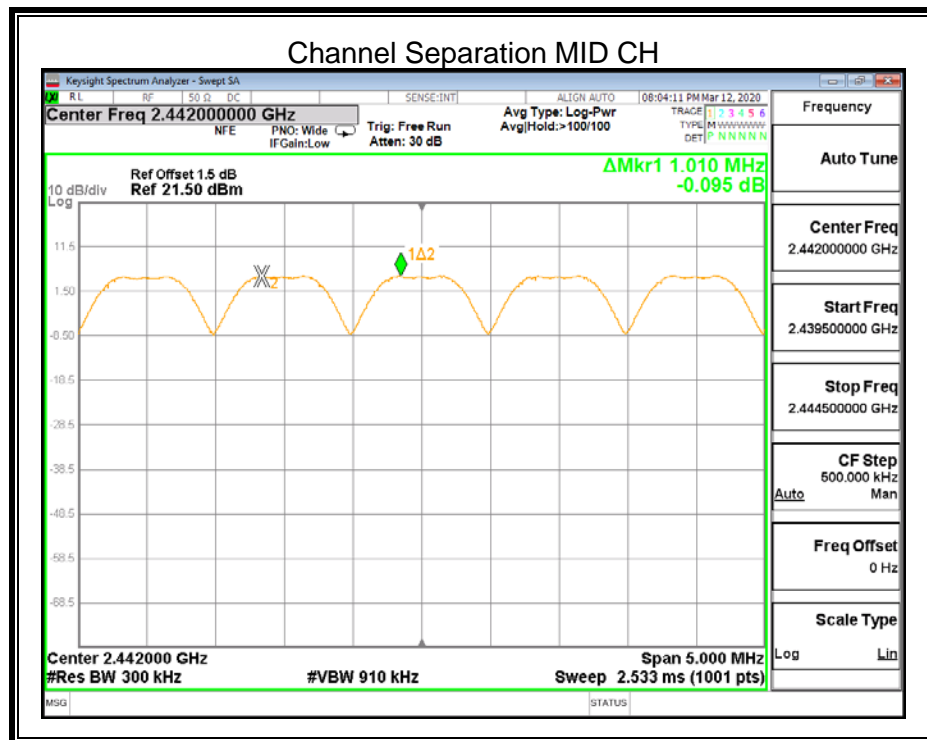

Note: For 20 dB Bandwidth of The Hopping Channel, please refer to clause 6.2.

7.4.2. 8DPSK MODE

Channel	Carrier Hopping Channel Separation (MHz)	Limit (MHz)	Result
Middle	1.020	≥ two-thirds of the 20 dB Bandwidth Of The Hopping Channel	PASS

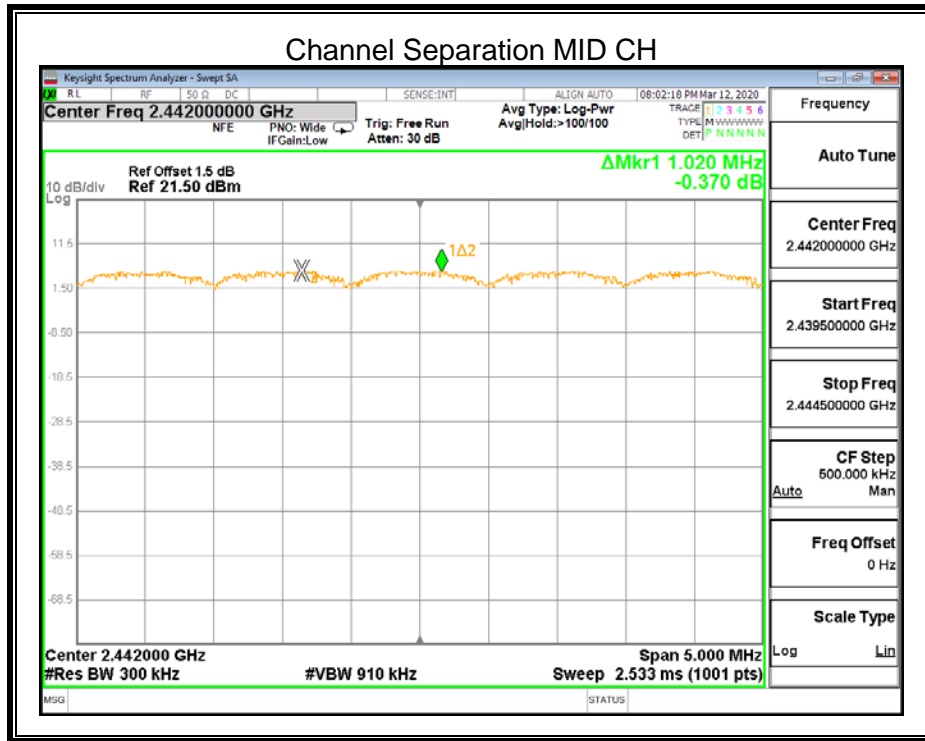

Note: For 20 dB Bandwidth of The Hopping Channel, please refer to clause 6.2.



7.5. NUMBER OF HOPPING FREQUENCY

LIMITS

CFR 47 FCC Part15 (15.247) , Subpart C ISED RSS-247 ISSUE 2		
Section	Test Item	Limit
CFR 47 15.247 (a) (1) III ISED RSS-247 Clause 5.1 (d)	Number of Hopping Frequency	at least 15 hopping channels

TEST PROCEDURE

Connect the EUT to the spectrum Analyzer and use the following settings:

Detector	Peak
RBW	To identify clearly the individual channels, set the RBW to less than 30% of the channel spacing or the 20 dB bandwidth, whichever is smaller.
VBW	≥RBW
Span	The frequency band of operation
Trace	Max hold
Sweep time	Auto couple

Set EUT to transmit maximum output power and switch on frequency hopping function. then set enough count time (larger than 5000 times) to get all the hopping frequency channel displayed on the screen of spectrum analyzer.

Count the quantity of peaks to get the number of hopping channels.

FHSS Mode: 79 Channels observed.

AFHSS Mode: 20 Channels declared.

TEST SETUP

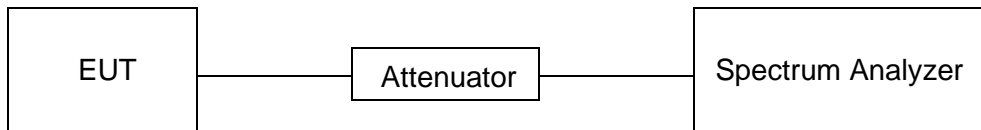

TEST ENVIRONMENT

Temperature	25.1°C	Relative Humidity	58%
Atmosphere Pressure	101kPa	Test Voltage	DC 5V



RESULTS

7.5.1. GFSK MODE

Hopping numbers	Limit	Results
79	>=15	Pass

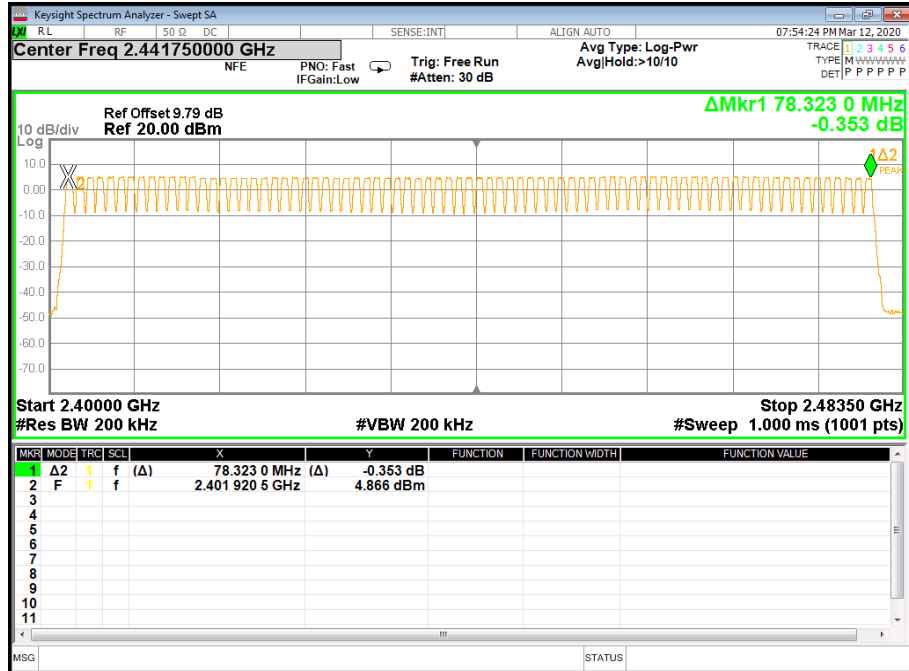



7.5.2. 8DPSK MODE

Hopping numbers	Limit	Results
79	≥ 15	Pass

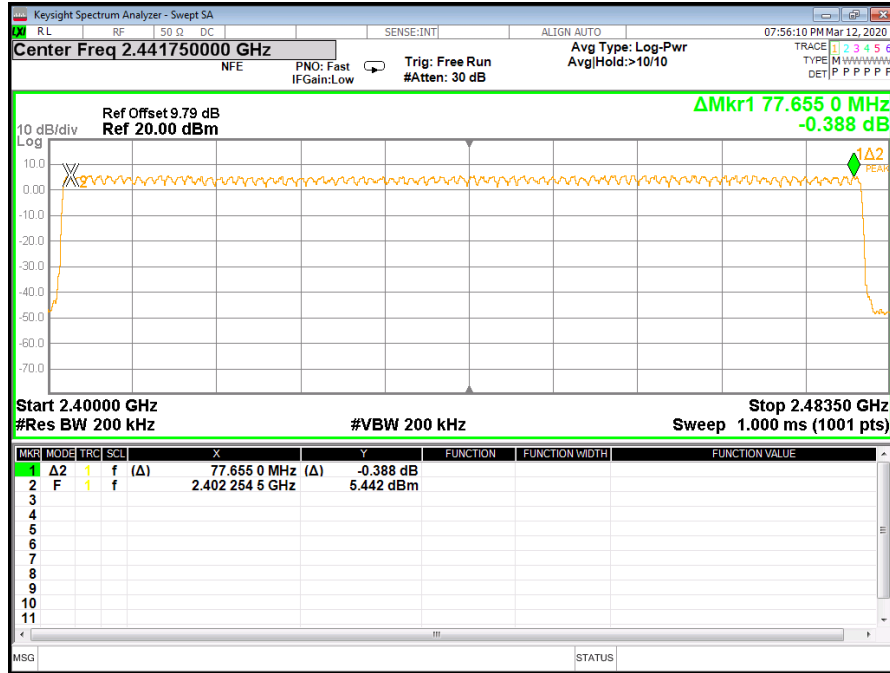



7.6. TIME OF OCCUPANCY (DWELL TIME)

LIMITS

CFR 47 FCC Part15 (15.247) , Subpart C ISED RSS-247 ISSUE 2		
Section	Test Item	Limit
CFR 47 15.247 (a) (1) III ISED RSS-247 Clause 5.1 (d)	Time of Occupancy (Dwell Time)	The average time of occupancy on any channel shall not be greater than 0.4 seconds within a period of 0.4 seconds, multiplied by the number of hopping channels employed.

TEST PROCEDURE

Connect the UUT to the spectrum Analyzer and use the following settings:

Center Frequency	The center frequency of the channel under test
Detector	Average
RBW	1MHz
VBW	≥RBW
Span	zero span
Trace	Clear Write
Sweep time	As necessary to capture the entire dwell time per hopping channel

- The transmitter output (antenna port) was connected to the spectrum analyzer
- Set RBW of spectrum analyzer to 1MHz and VBW to 1MHz.
- Use a video trigger with the trigger level set to enable triggering only on full pulses.
- Sweep Time is more than once pulse time.
- Set the center frequency on any frequency would be measure and set the frequency span to zero span.
- Measure the maximum time duration of one single pulse.
- Set the EUT for DH5, DH3 and DH1 packet transmitting.
- Measure the maximum time duration of one single pulse.
A Period Time = (channel number)*0.4

For FHSS Mode (79 Channel):

DH1 Time Slot: Reading * (1600/2)*31.6/(channel number)
DH3 Time Slot: Reading * (1600/4)*31.6/(channel number)
DH5 Time Slot: Reading * (1600/6)*31.6/(channel number)

For AFHSS Mode (20 Channel):

DH1 Time Slot: Reading * (800/2)*8/(channel number)
DH3 Time Slot: Reading * (800/4)*8/(channel number)
DH5 Time Slot: Reading * (800/6)*8/(channel number)



TEST SETUP

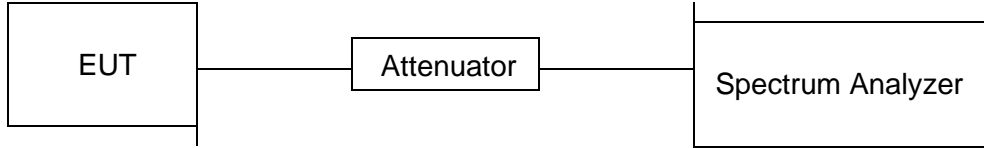

TEST ENVIRONMENT

Temperature	25.1°C	Relative Humidity	58%
Atmosphere Pressure	101kPa	Test Voltage	DC 5V

RESULTS

6.6.1. GFSK MODE

FHSS Mode				
Packet	Channel	Burst Width [ms/hop/ch]	Dwell Time [s]	Results
DH1	MCH	0.360	0.1152	PASS
DH3	MCH	1.635	0.2616	PASS
DH5	MCH	2.880	0.3072	PASS
AFHSS Mode				
DH1	MCH	0.360	0.0576	PASS
DH3	MCH	1.635	0.1308	PASS
DH5	MCH	2.880	0.1536	PASS



Test Graph

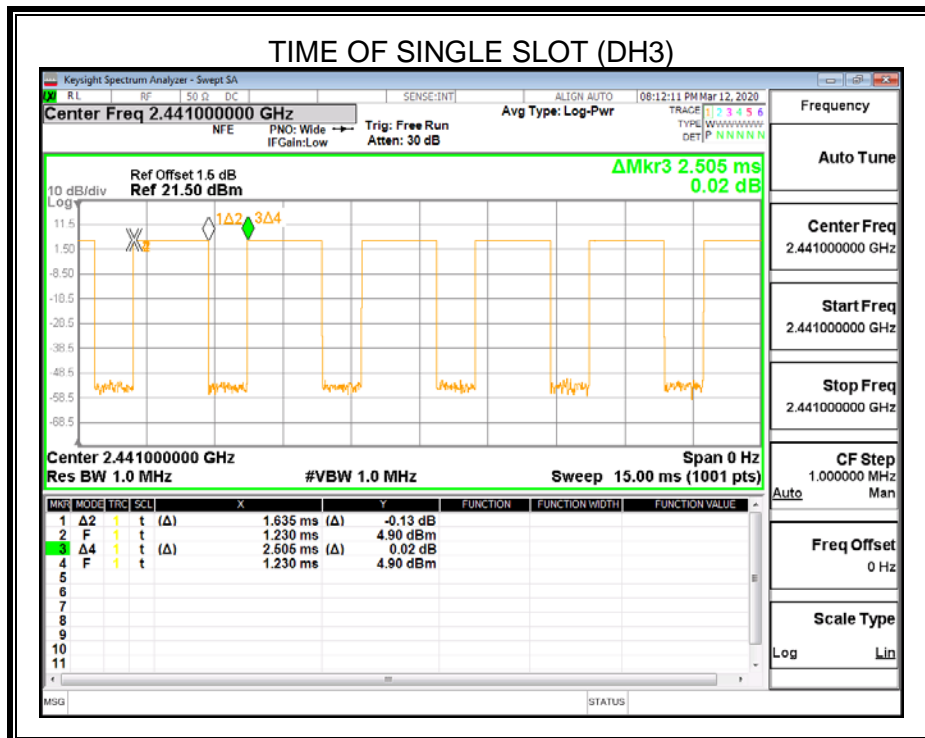
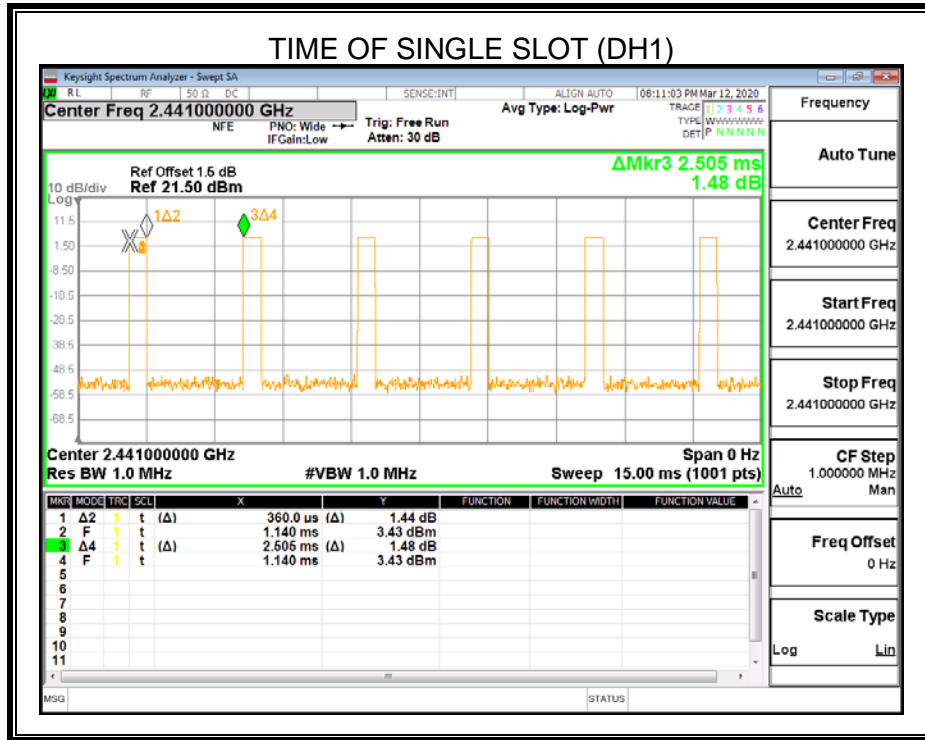



6.6.2. 8DPSK MODE

FHSS Mode				
Packet	Channel	Burst Width [ms/hop/ch]	Dwell Time [s]	Results
3DH1	MCH	0.390	0.1248	PASS
3DH3	MCH	1.635	0.2616	PASS
3DH5	MCH	2.880	0.3072	PASS
AFHSS Mode				
3DH1	MCH	0.390	0.0624	PASS
3DH3	MCH	1.635	0.1308	PASS
3DH5	MCH	2.880	0.1536	PASS

Test Graph

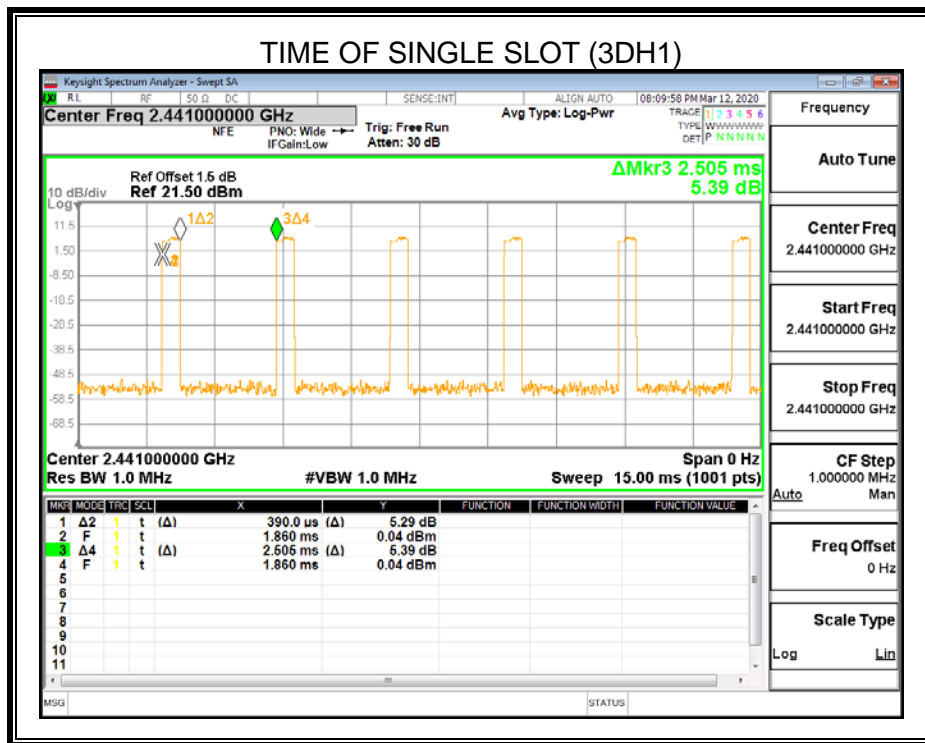

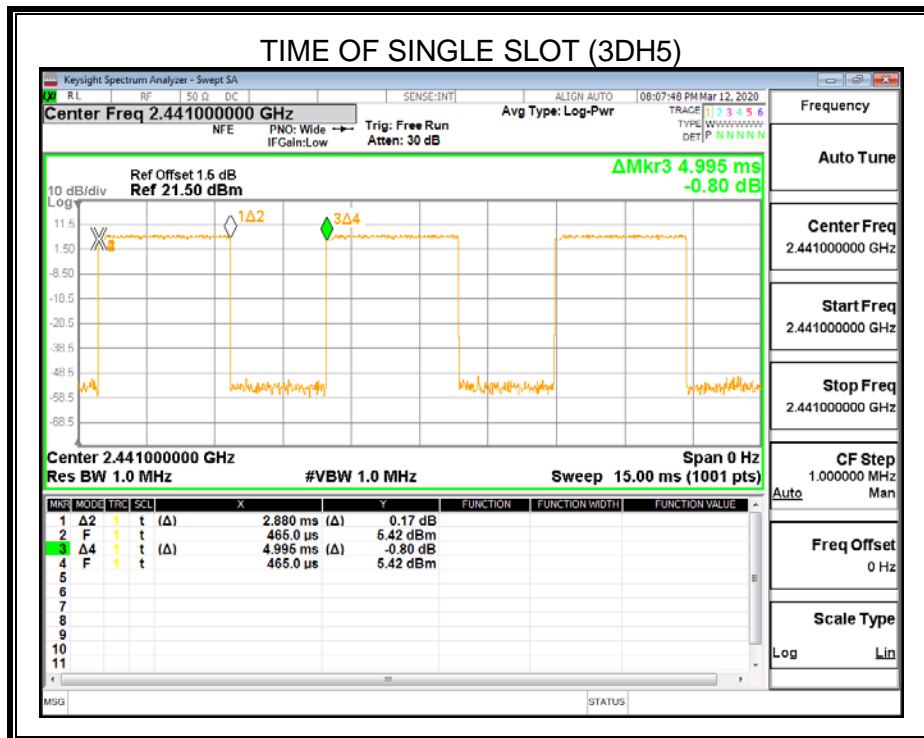
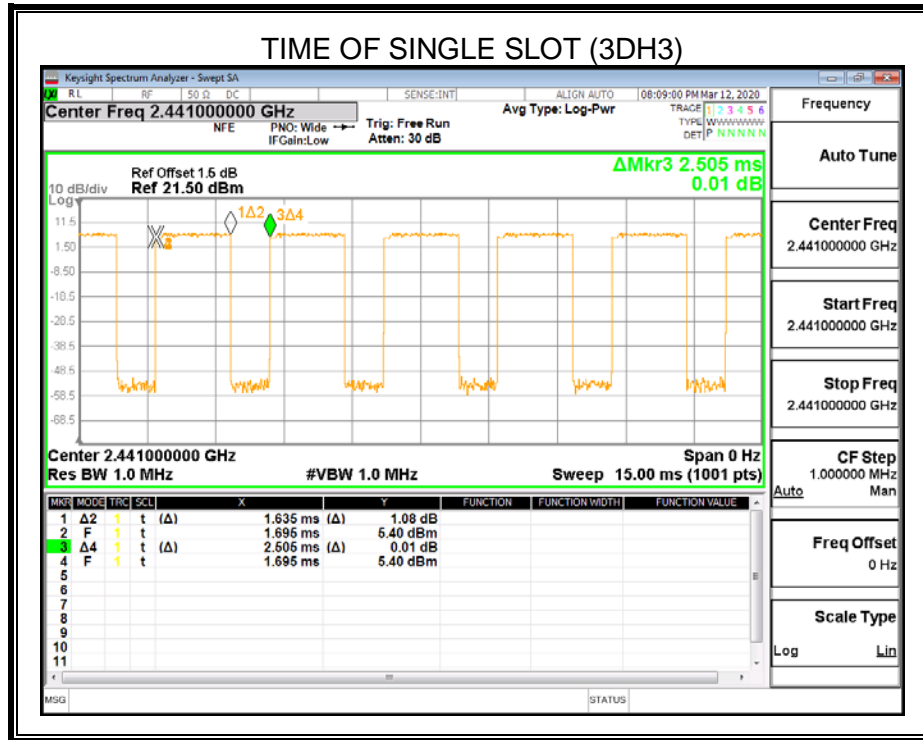



7.7. CONDUCTED SPURIOUS EMISSION

LIMITS

CFR 47 FCC Part15 (15.247) , Subpart C ISED RSS-247 ISSUE 2		
Section	Test Item	Limit
CFR 47 FCC §15.247 (d) ISED RSS-247 5.5	Conducted Spurious Emission	at least 20 dB below that in the 100 kHz bandwidth within the band that contains the highest level of the desired power

TEST PROCEDURE

For Bandedge use the following settings:

Detector	Peak
RBW	100kHz
VBW	300kHz
Span	wide enough to fully capture the emission being measured
Trace	Max hold
Sweep time	Auto couple.

For Spurious Emission use the following settings:

Detector	Peak
RBW	100kHz
VBW	300kHz
Span	wide enough to fully capture the emission being measured
Trace	Max hold
Sweep time	Auto couple.

Use the peak marker function to determine the maximum amplitude level.

TEST SETUP

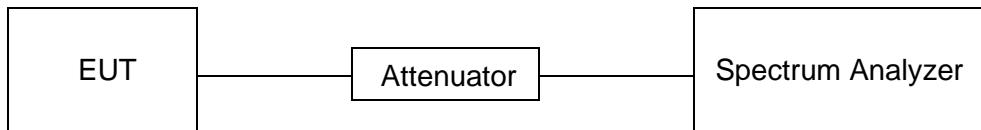

TEST ENVIRONMENT

Temperature	25.1°C	Relative Humidity	58%
Atmosphere Pressure	101kPa	Test Voltage	DC 5V



RESULTS

6.6.3. GFSK MODE

LOW CH BANDEDAGE

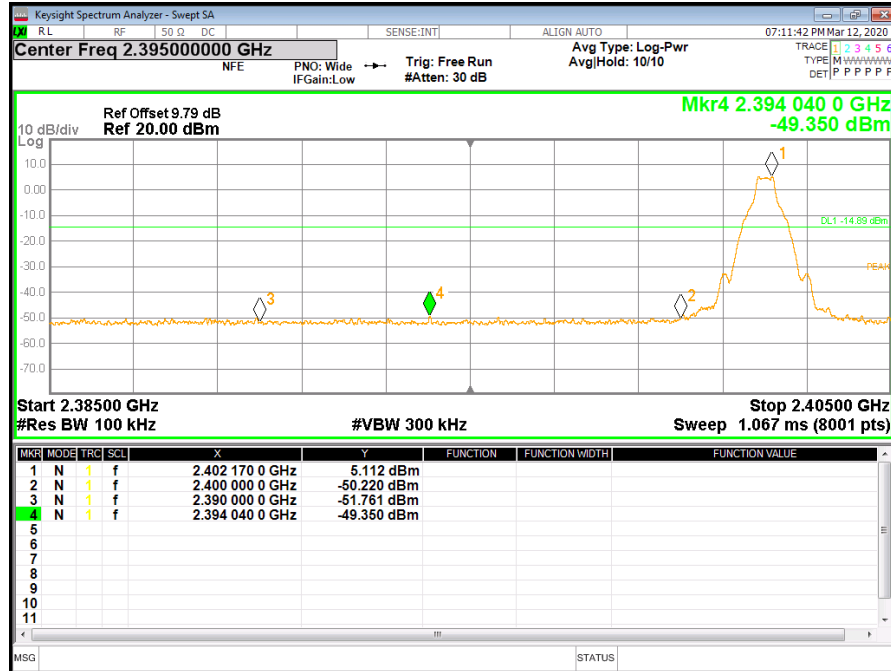

LOW CH REFERENCE

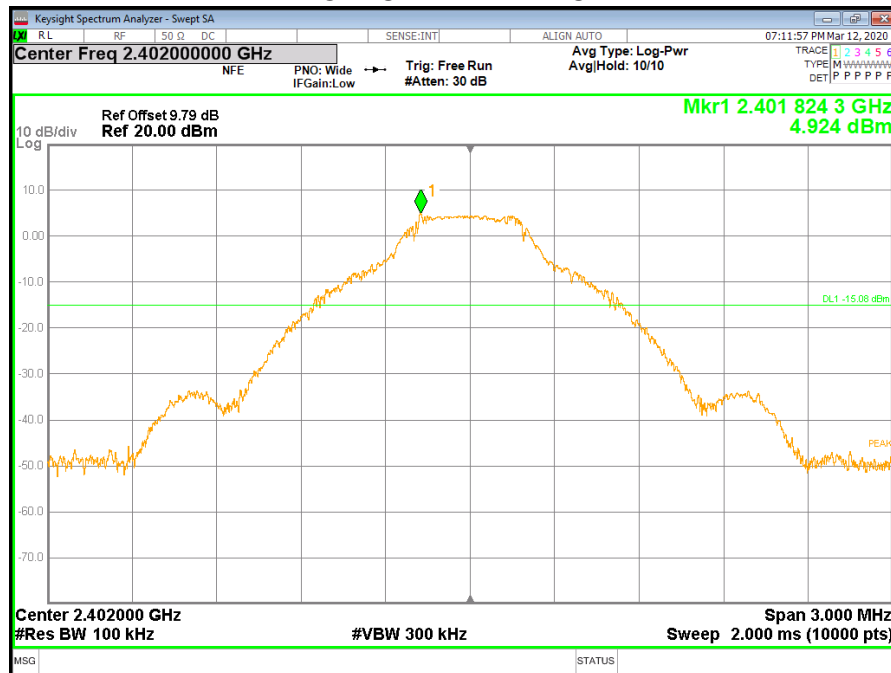



LOW CH SPURIOUS EMISSIONS 30M-10G

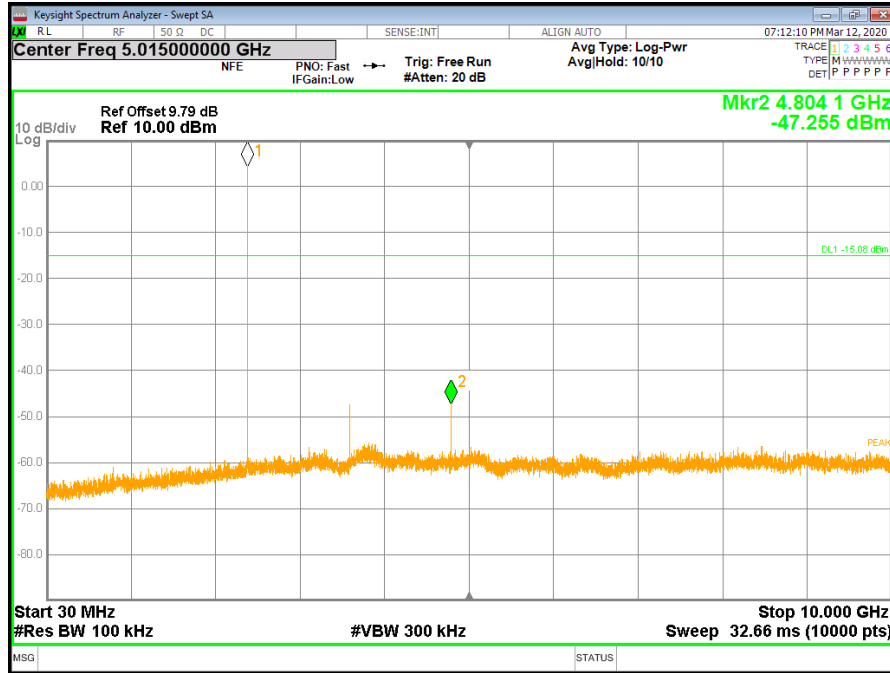

LOW CH SPURIOUS EMISSIONS 10G-26G

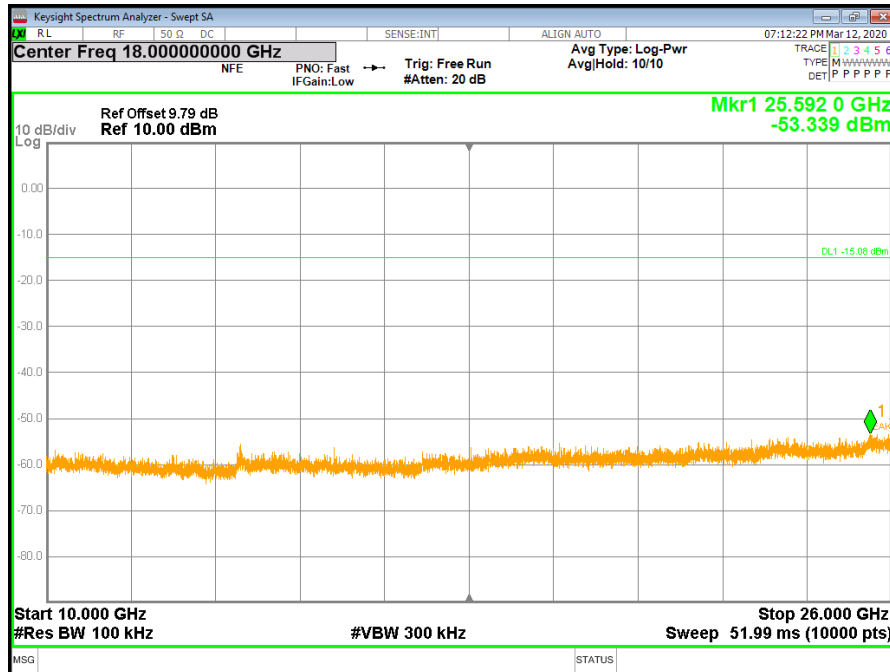



MID CH REFERENCE

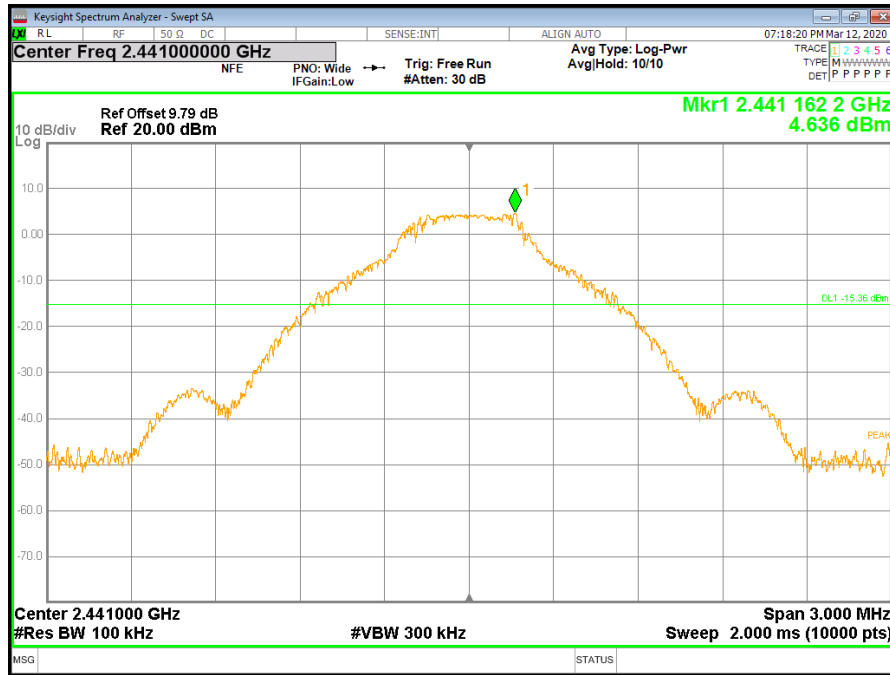

MID CH SPURIOUS EMISSIONS 30M-10G

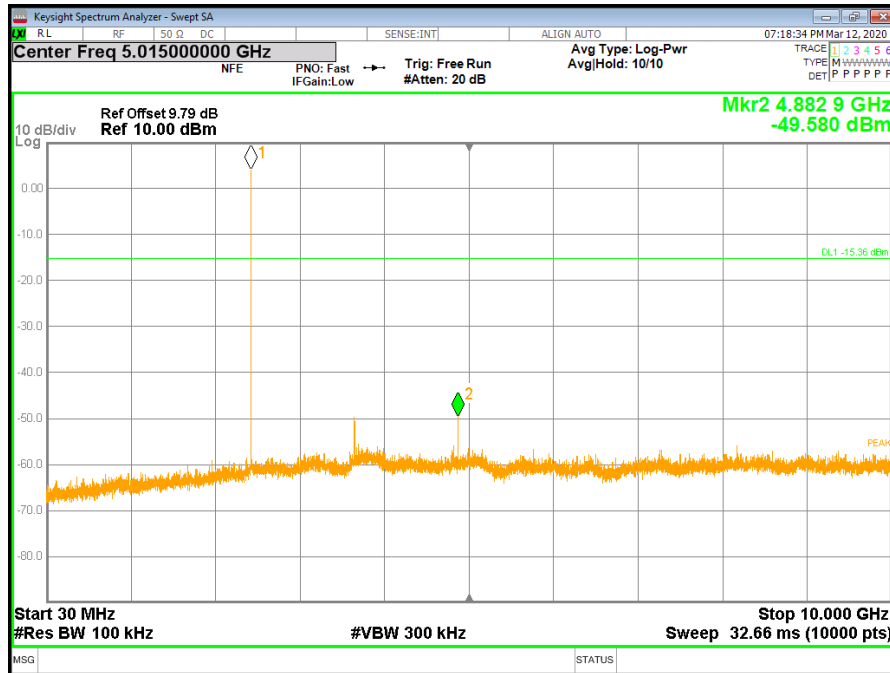



MID CH SPURIOUS EMISSIONS 10G-26G

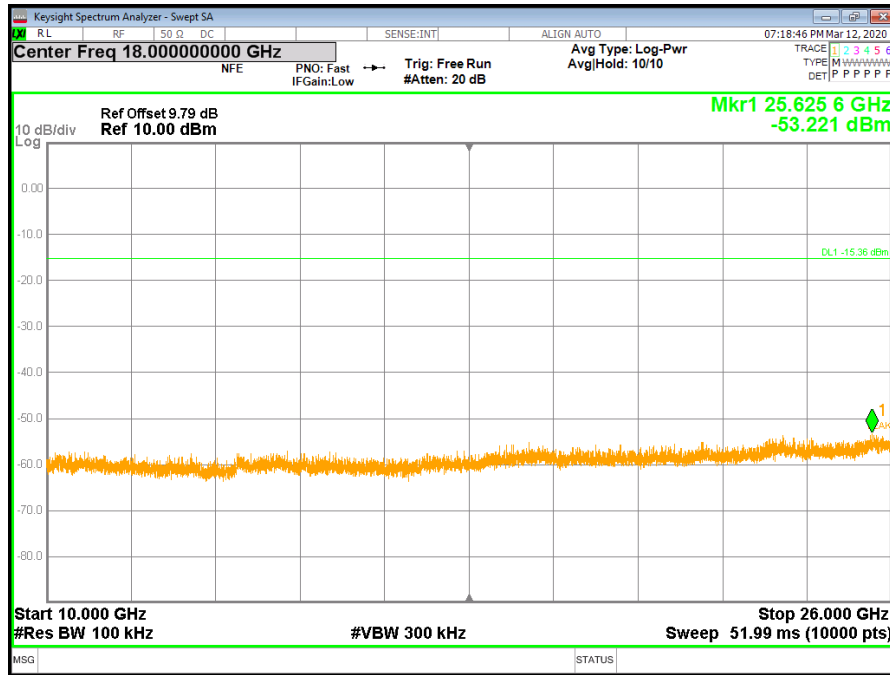

HIGH CH BANDEDGE

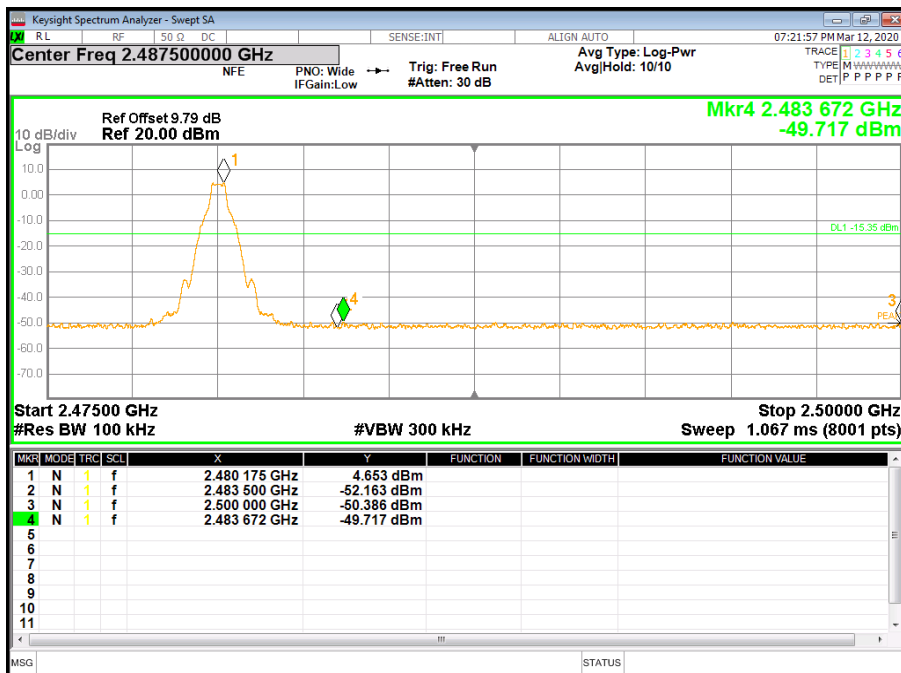



HIGH CH REFERENCE

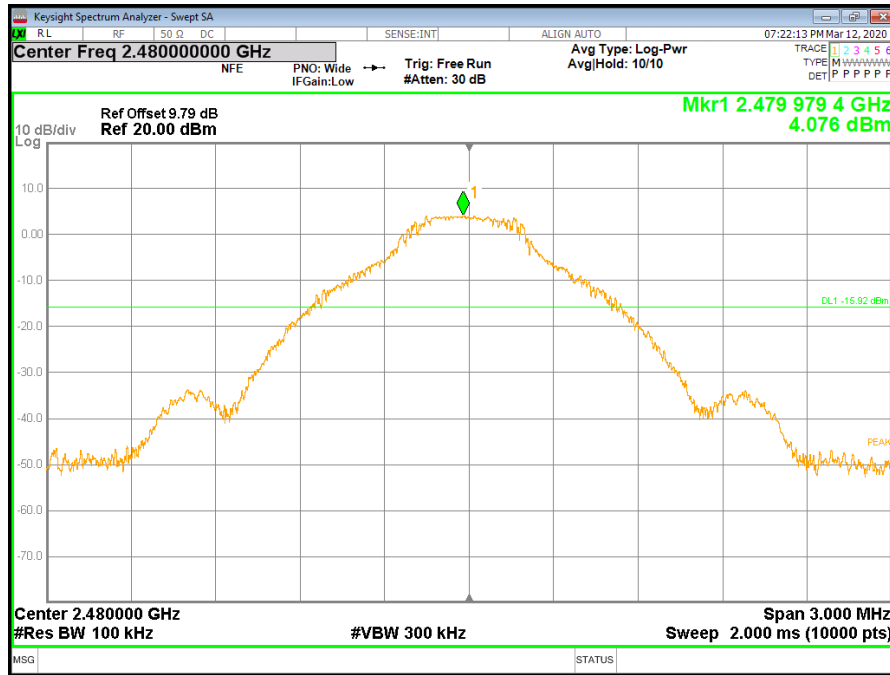

HIGH CH SPURIOUS EMISSIONS 30M-10G

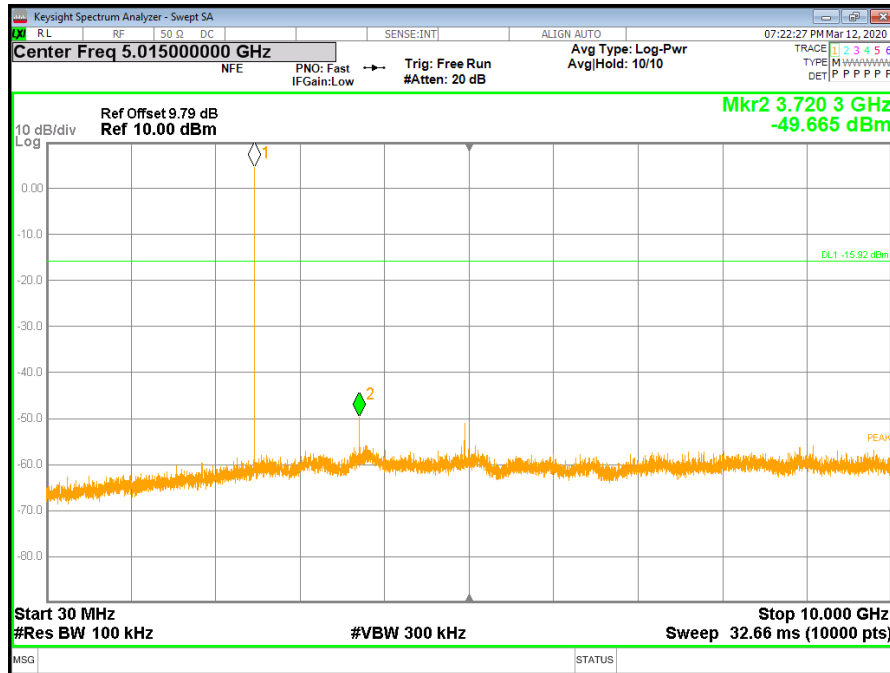



HIGH CH SPURIOUS EMISSIONS 10G-26G

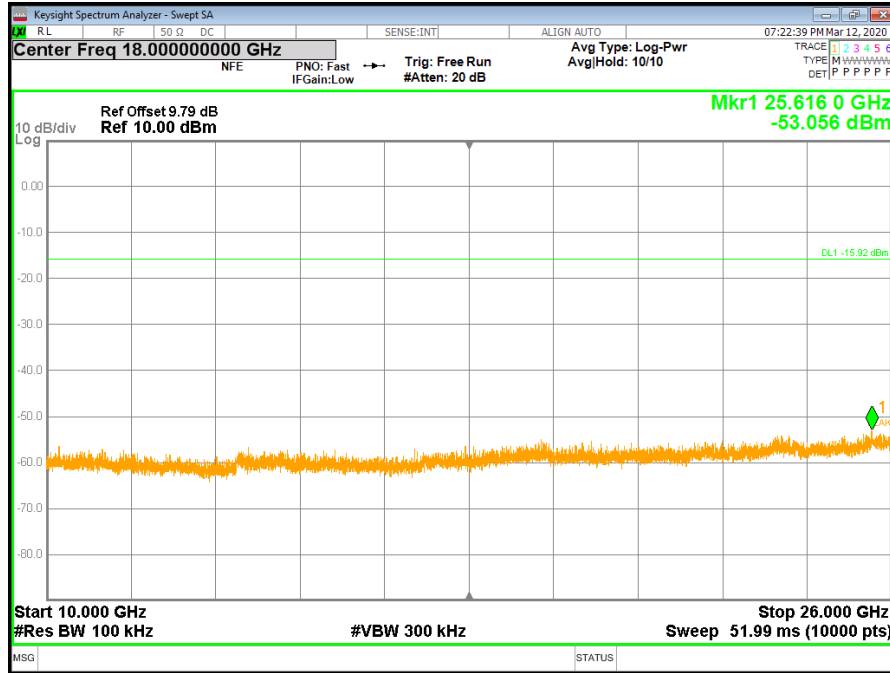

SPURIOUS BANDEDGE EMISSIONS WITH HOPPING ON

LOW CH BANDEDGE WITH HOPPING ON

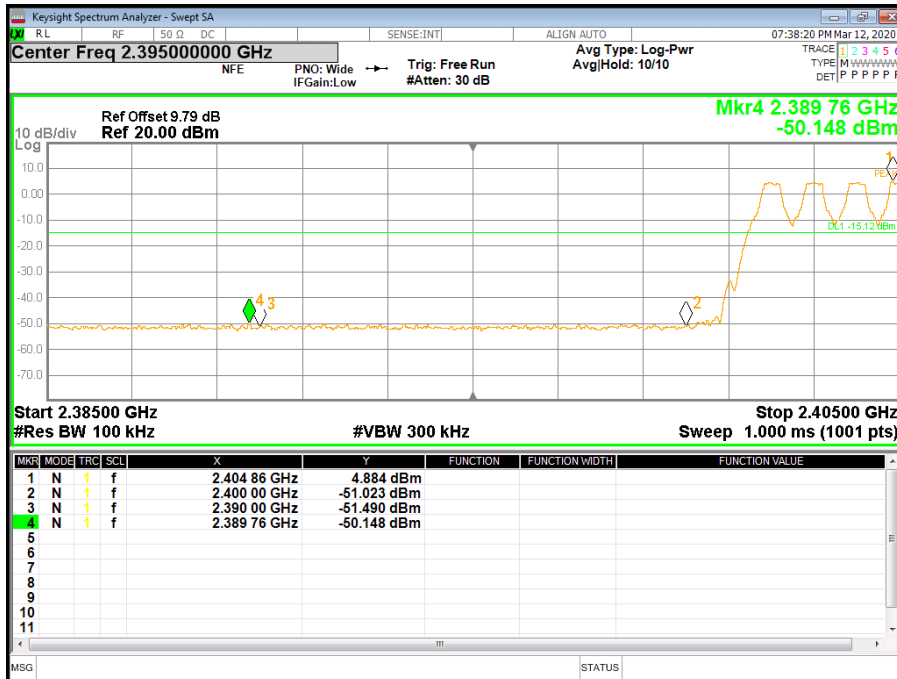



HIGH CH BANDEDGE WITH HOPPING ON

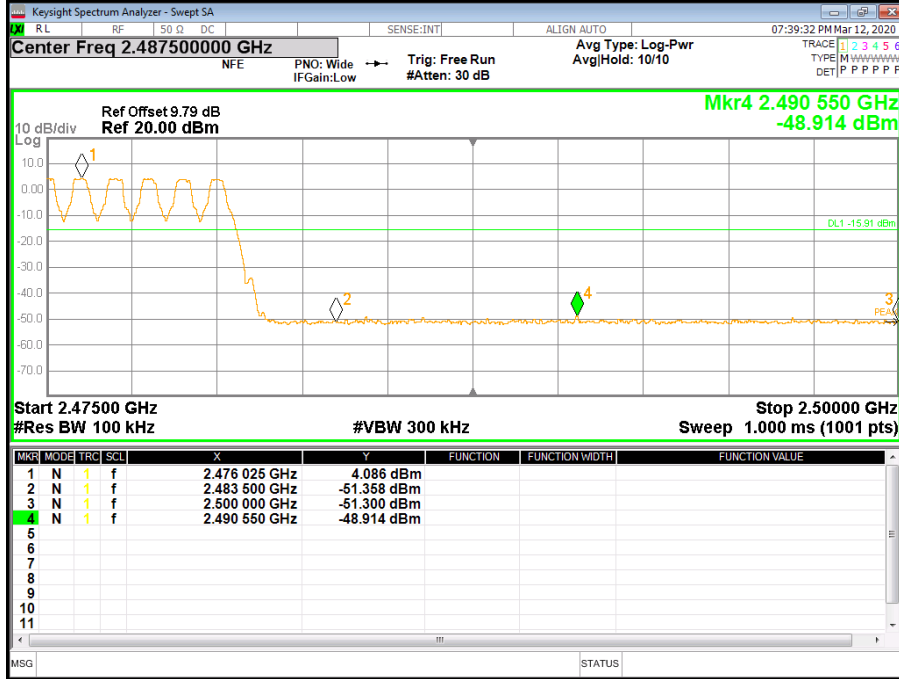



6.6.4. 8DPSK MODE

LOW CH BANDEDGE

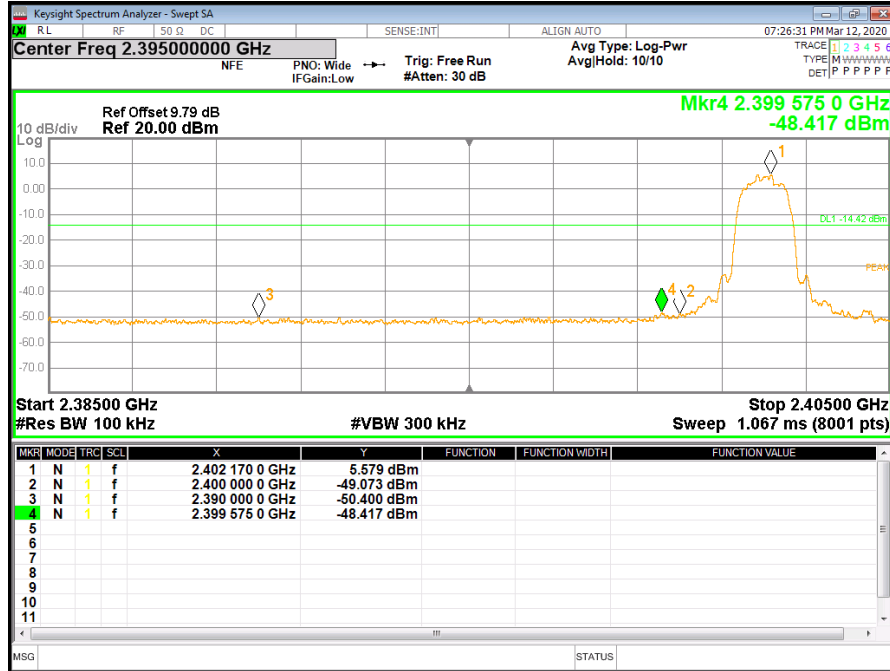

LOW CH REFERENCE

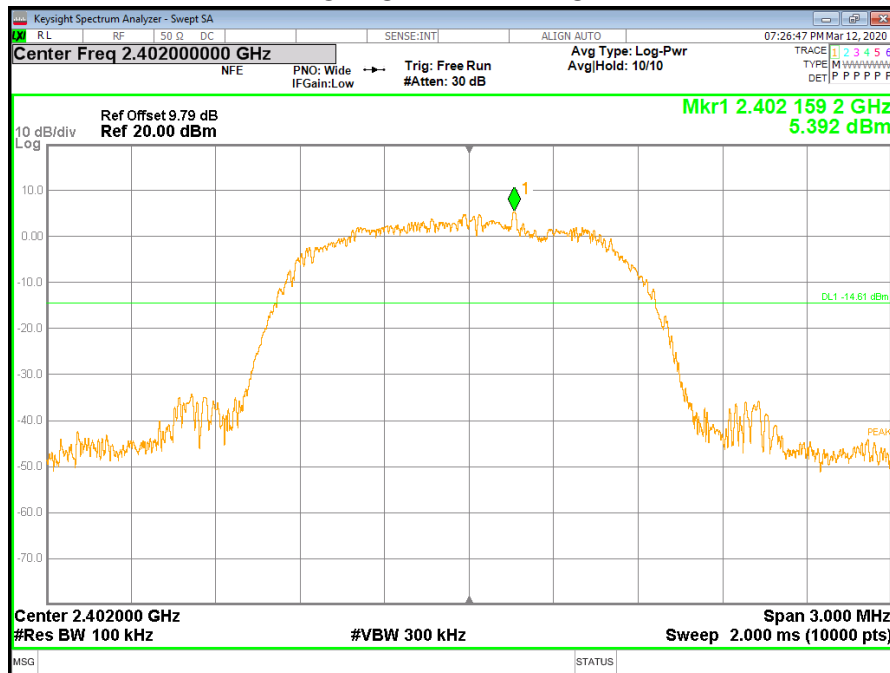



LOW CH SPURIOUS EMISSIONS 30M-10G

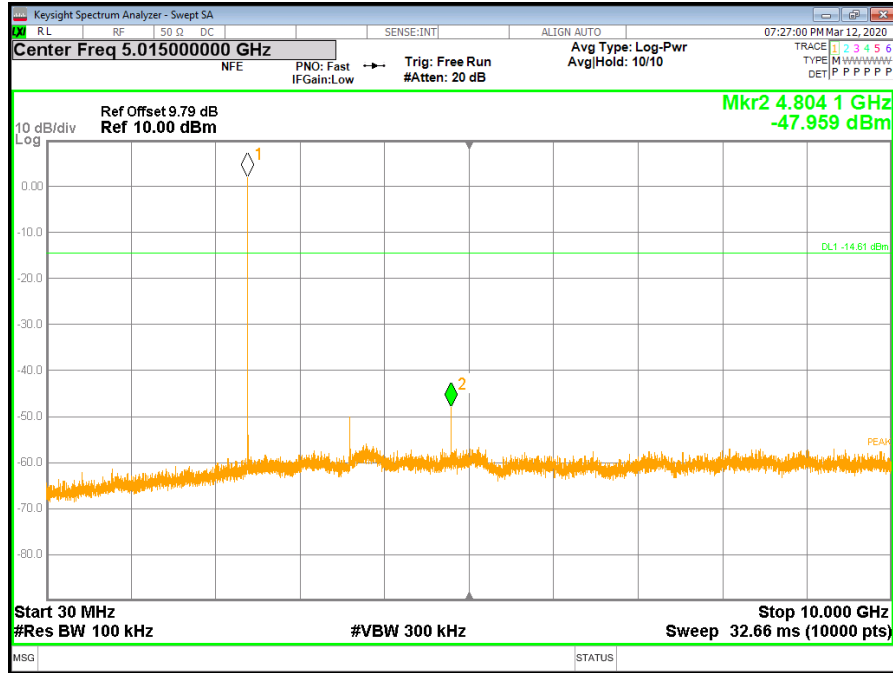

LOW CH SPURIOUS EMISSIONS 10G-26G

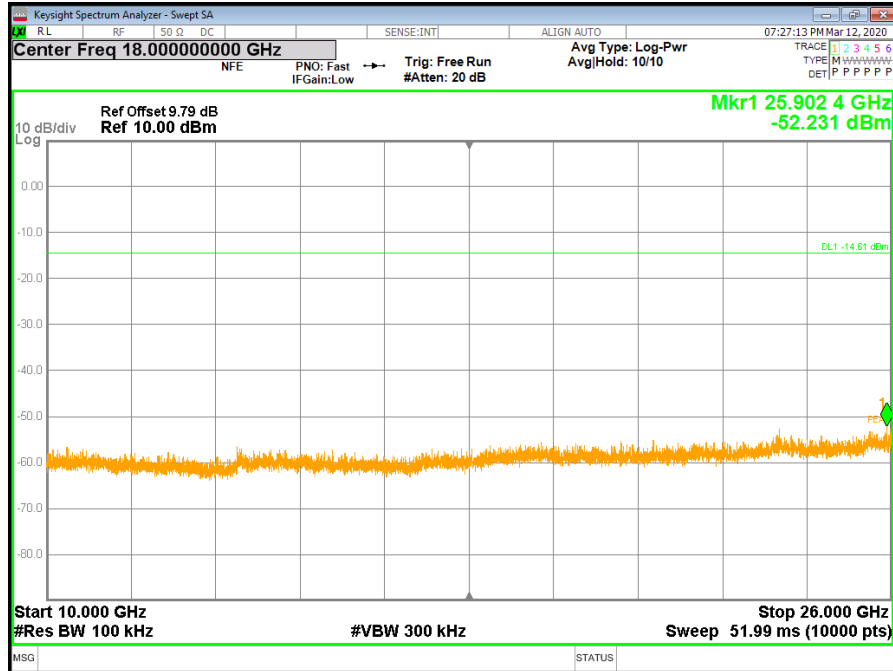



MID CH SPURIOUS EMISSIONS

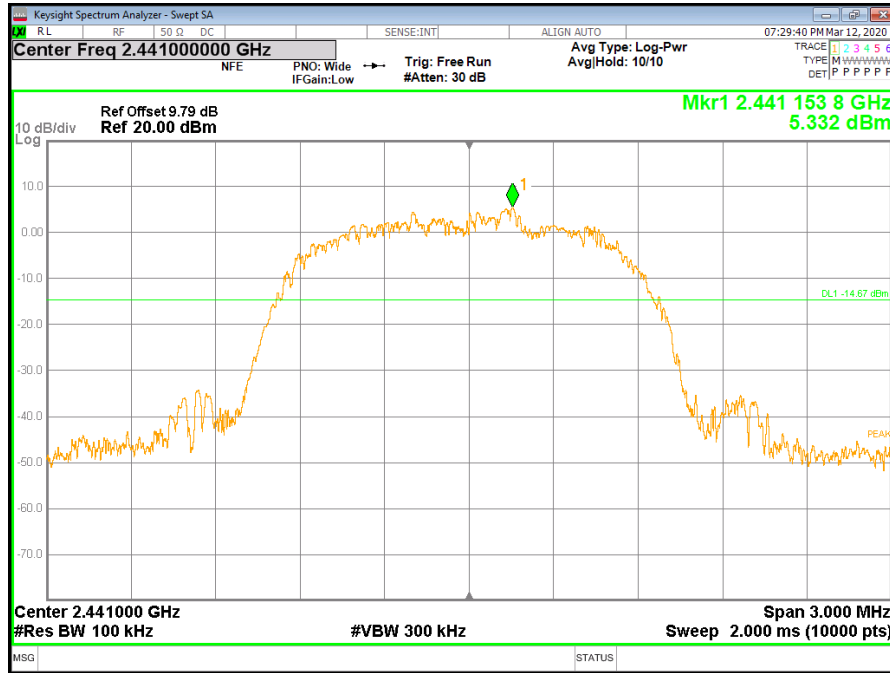

MID CH SPURIOUS EMISSIONS 30M-10G

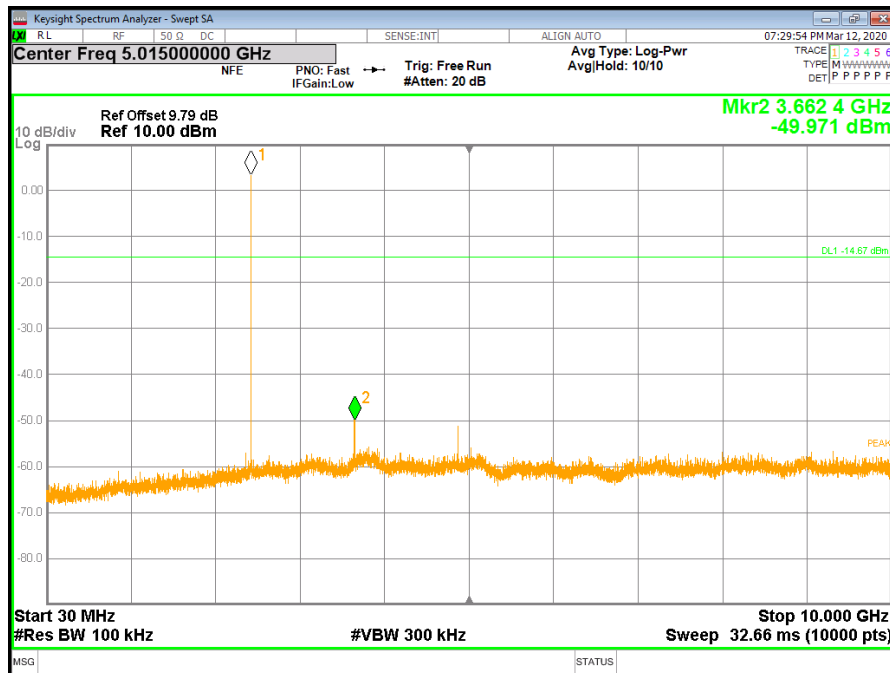



MID CH SPURIOUS EMISSIONS 10G-26G

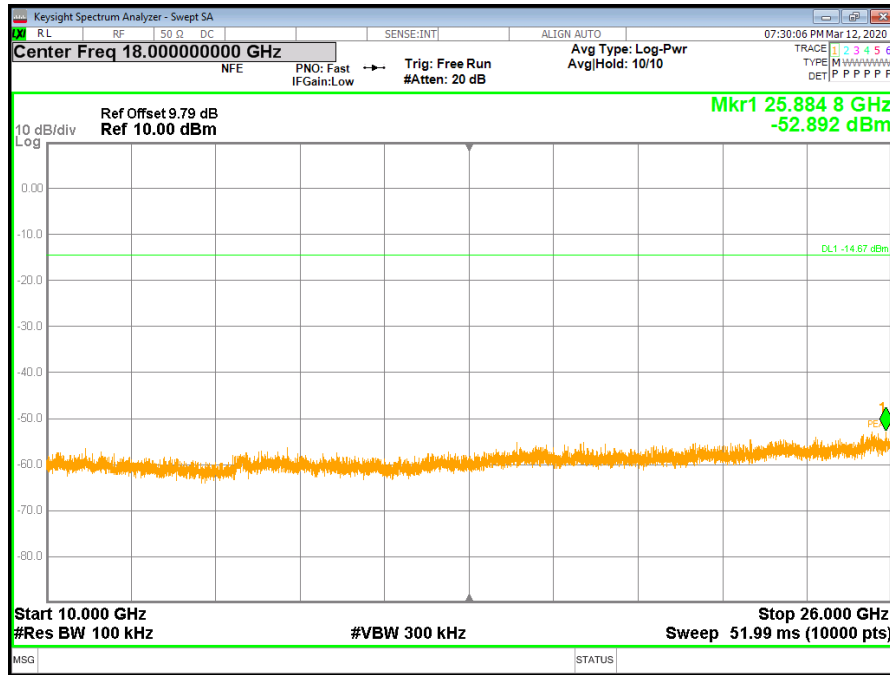

HIGH CH BANDEDAGE

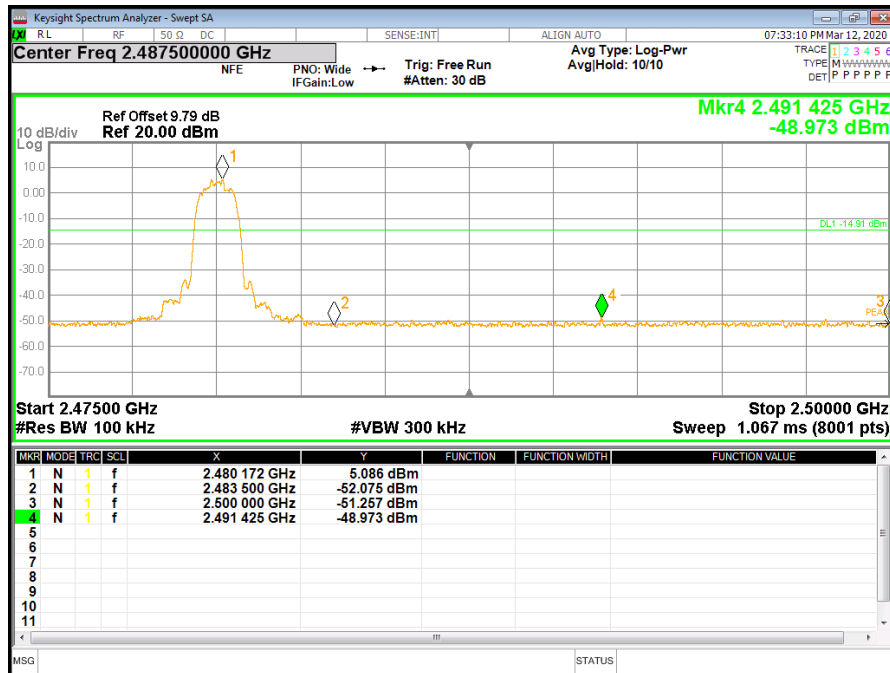



HIGH CH SPURIOUS EMISSIONS

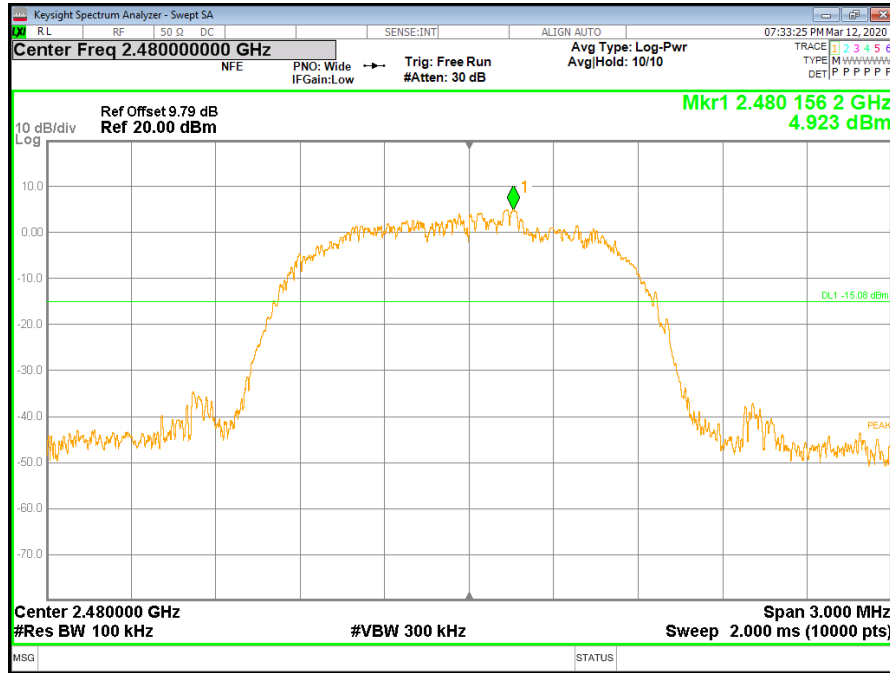

HIGH CH SPURIOUS EMISSIONS 30M-10G

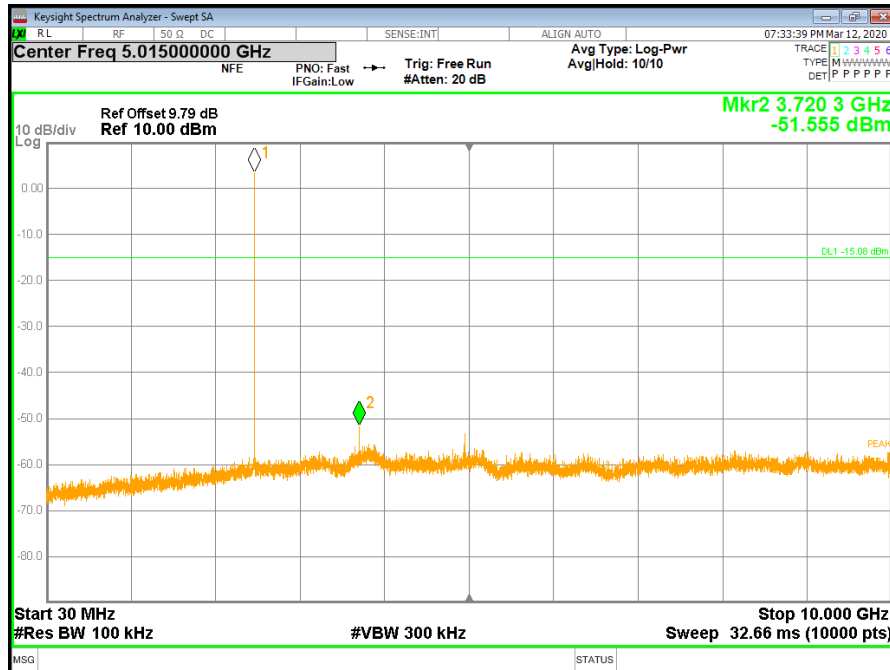



HIGH CH SPURIOUS EMISSIONS 10G-26G

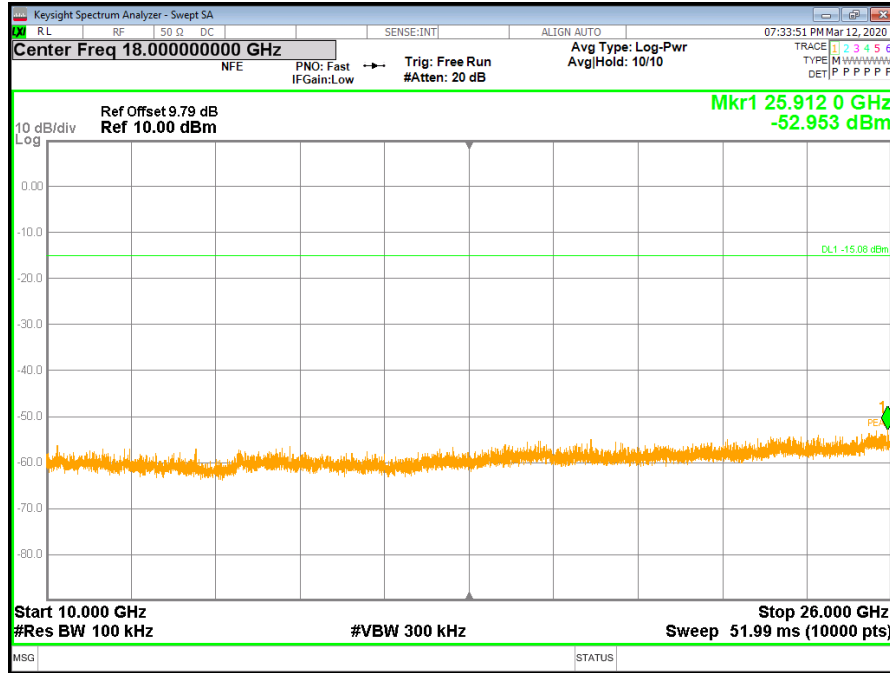

SPURIOUS BANDEDGE EMISSIONS WITH HOPPING ON

LOW CH BANDEDGE WITH HOPPING ON

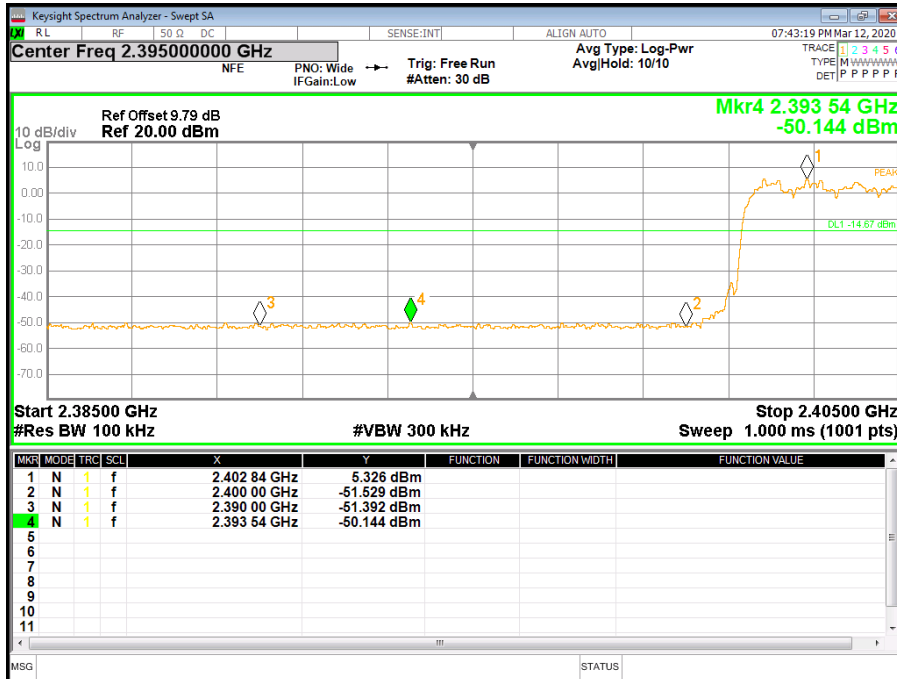



HIGH CH BANDEDGE WITH HOPPING ON

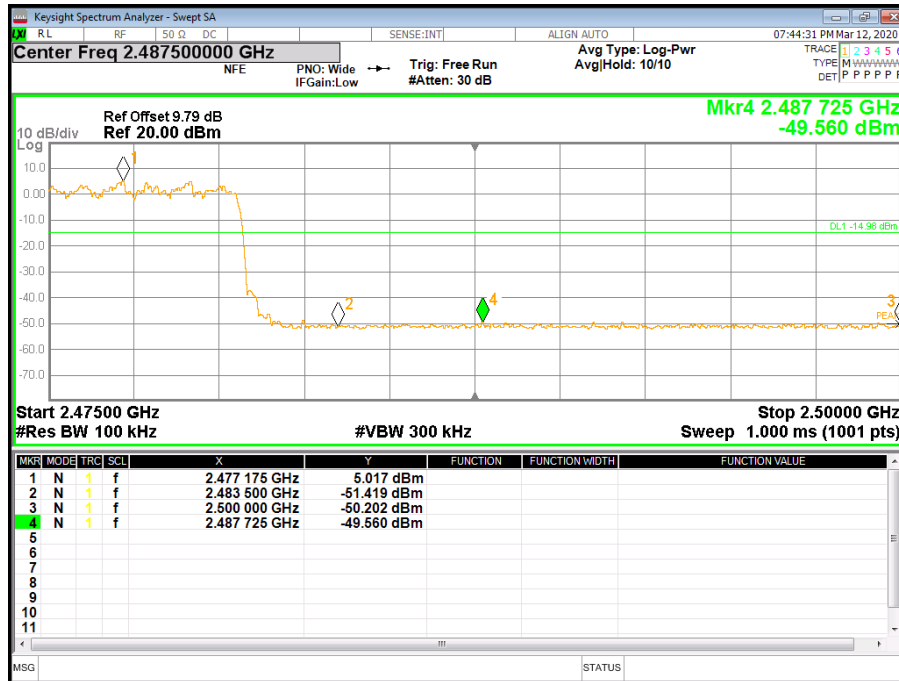



8. RADIATED TEST RESULTS

8.1. LIMITS AND PROCEDURE

LIMITS

Please refer to CFR 47 FCC §15.205 and §15.209

Please refer to ISED RSS-GEN Clause 8.9 and Clause 8.10

Radiation Disturbance Test Limit for FCC (Class B)(9kHz-1GHz)

Frequency (MHz)	Field Strength (microvolts/meter)	Measurement Distance (meters)
0.009~0.490	2400/F(kHz)	300
0.490~1.705	24000/F(kHz)	30
1.705~30.0	30	30
30~88	100	3
88~216	150	3
216~960	200	3
960~1000	500	3

Note: 1) At frequencies at or above 30 MHz, measurements may be performed at a distance other than what is specified provided: measurements are not made in the near field except where it can be shown that near field measurements are appropriate due to the characteristics of the device; and it can be demonstrated that the signal levels needed to be measured at the distance employed can be detected by the measurement equipment. Measurements shall not be performed at a distance greater than 30 meters unless it can be further demonstrated that measurements at a distance of 30 meters or less are impractical. When performing measurements at a distance other than that specified, the results shall be extrapolated to the specified distance using an extrapolation factor of 20 dB/decade (inverse linear-distance for field strength measurements; inverse-linear-distance-squared for power density measurements).

(2) At frequencies below 30 MHz, measurements may be performed at a distance closer than that specified in the regulations; however, an attempt should be made to avoid making measurements in the near field. Pending the development of an appropriate measurement procedure for measurements performed below 30 MHz, when performing measurements at a closer distance than specified, the results shall be extrapolated to the specified distance by either making measurements at a minimum of two distances on at least one radial to determine the proper extrapolation factor or by using the square of an inverse linear distance extrapolation factor (40 dB/decade). This paragraph (f) shall not apply to Access BPL devices operating below 30 MHz.

Radiation Disturbance Test Limit for FCC (Above 1G)

Frequency (MHz)	dB(uV/m) (at 3 meters)	
	Peak	Average
Above 1000	74	54

About Restricted bands of operation please refer to RSS-Gen section 8.10 and FCC §15.205 (a)

TEST SETUP AND PROCEDURE
Below 30MHz

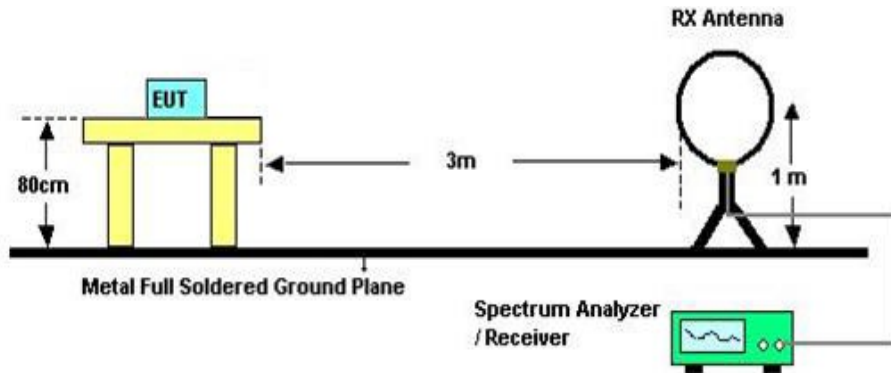

The setting of the spectrum Analyzer

RBW	200Hz (From 9kHz to 0.15MHz)/ 9kHz (From 0.15MHz to 30MHz)
VBW	200Hz (From 9kHz to 0.15MHz)/ 9kHz (From 0.15MHz to 30MHz)
Sweep	Auto
Detector	Peak/QP/ Average
Trace	Max hold

1. The testing follows the guidelines in ANSI C63.10-2013
2. The EUT was arranged to its worst case and then turntable (from 0 degree to 360 degrees) to find the maximum reading. A pre-amp and a high pass filter are used for the test in order to get better signal level. Both Horizontal, Face-on and Face-off polarizations of the antenna are set to make the measurement.
3. The EUT was placed on a turntable with 80cm meter above ground.
4. The EUT was set 3 meters from the interference receiving antenna, which was mounted on the top of a variable height antenna tower.
5. The radiated emission limits are based on measurements employing a CISPR quasi-peak detector except for the frequency bands 9-90 kHz, 110-490 kHz and above 1000 MHz. Radiated emission limits in these three bands are based on measurements employing an average detector.
6. For measurement below 1GHz, the initial step in collecting conducted emission data is a spectrum analyzer peak detector mode pre-scanning the measurement frequency range. Significant peaks are then marked and then Quasi Peak detector mode re-measured. If the emission level of the EUT measured by the peak detector is 3 dB lower than the applicable limit, the peak emission level will be reported. Otherwise, the emission measurement will be repeated using the quasi-peak detector and reported.
7. Although these tests were performed other than open area test site, adequate comparison measurements were confirmed against 30m OFS. Therefore sufficient tests were made to demonstrate that the alternative site produces results that correlate with the ones of tests made in an open field based on KDB 414788.

Below 1G and above 30MHz

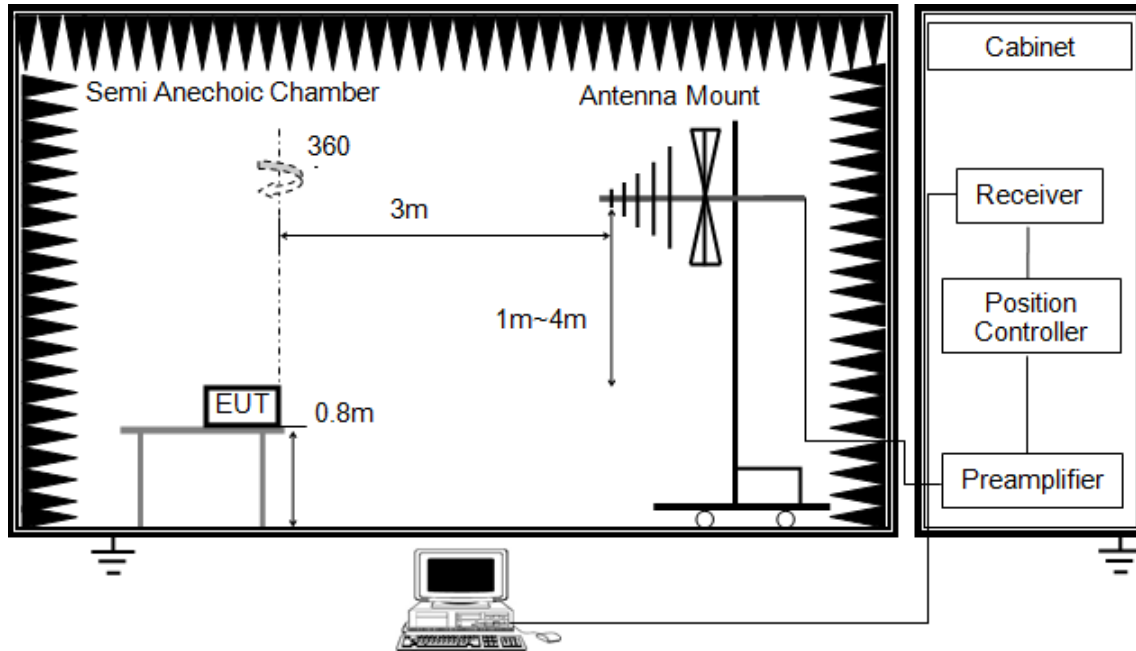

The setting of the spectrum Analyzer

RBW	120kHz
VBW	300kHz
Sweep	Auto
Detector	Peak/QP
Trace	Max hold

1. The testing follows the guidelines in ANSI C63.10-2013.
2. The EUT was arranged to its worst case and then tune the antenna tower (from 1 m to 4 m) and turntable (from 0 degree to 360 degrees) to find the maximum reading. A pre-amp and a high pass filter are used for the test in order to get better signal level. Both horizontal and vertical polarizations of the antenna are set to make the measurement.
3. The EUT was placed on a turntable with 80cm above ground.
4. The EUT was set 3 meters from the interference receiving antenna, which was mounted on the top of a variable height antenna tower.
5. For measurement below 1GHz, the initial step in collecting conducted emission data is a spectrum analyzer peak detector mode pre-scanning the measurement frequency range. Significant peaks are then marked and then Quasi Peak detector mode re-measured. If the emission level of the EUT measured by the peakdetector is 3 dB lower than the applicable limit, the peak emission level will be reported. Otherwise, the emission measurement will be repeated using the quasi-peak detector and reported.

Above 1G

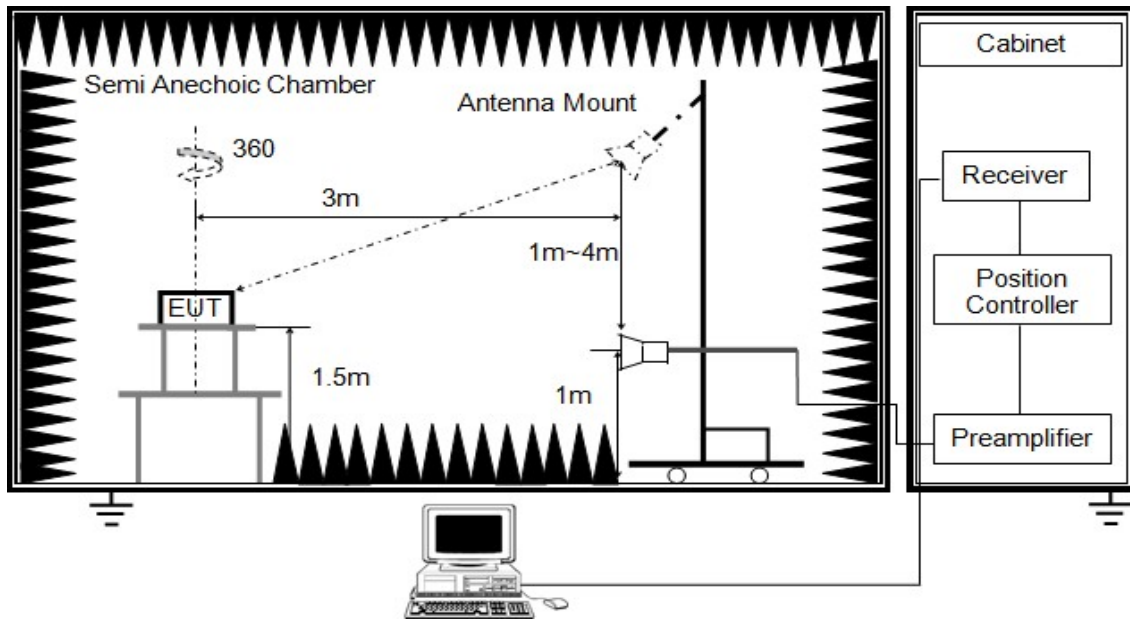

RBW	1MHz
VBW	PEAK: 3MHz AVG: see note 6
Sweep	Auto
Detector	Peak
Trace	Max hold

1. The testing follows the guidelines in ANSI C63.10-2013.
2. The EUT was arranged to its worst case and then tune the antenna tower (from 1 m to 4 m) and turntable (from 0 degree to 360 degrees) to find the maximum reading. A pre-amp and a high pass filter are used for the test in order to get better signal level. Both horizontal and vertical polarizations of the antenna are set to make the measurement.
3. The EUT was placed on a turntable with 150cm above ground.
4. The EUT was set 3 meters from the interference receiving antenna, which was mounted on the top of a variable height antenna tower.
5. For measurement above 1GHz, the emission measurement will be measured by the peak detector. This peak level, once corrected, must comply with the limit specified in Section 15.209.
6. For measurements above 1 GHz the resolution bandwidth is set to 1 MHz, then the video bandwidth is set to 3 MHz for peak measurements and 1 MHz resolution bandwidth with 1/T video bandwidth with peak detector. For the Duty Cycle please refer to clause 7.1.ON TIME AND DUTY CYCLE.

X axis, Y axis, Z axis positions:

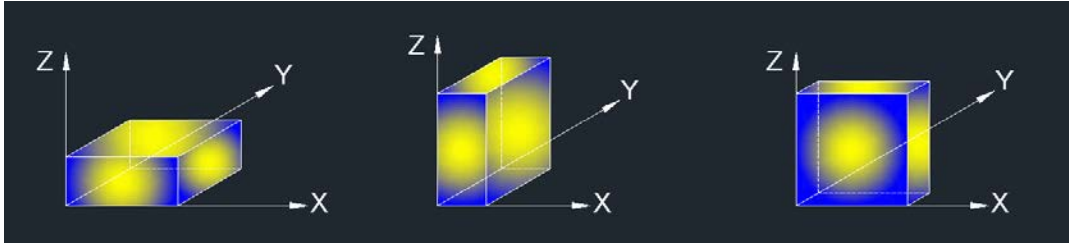

Note 1: For radiated test, EUT in each of three orthogonal axis emissions had been tested, but only the worst case (Y axis) data recorded in the report.

Note 2: The EUT was fully exercised with external accessories during the test. In the case of multiple accessory external ports, an external accessory shall be connected to one of each type of port.

Note 3: The EUT does not support simultaneous transmission.

TEST ENVIRONMENT

Temperature	23.4°C	Relative Humidity	54%
Atmosphere Pressure	101kPa	Test Voltage	DC 5V



8.2. RESTRICTED BANDEGE

8.2.1. GFSK MODE

Test Result for Antenna WCT5J-20

RESTRICTED BANDEGE (LOW CHANNEL, HORIZONTAL)

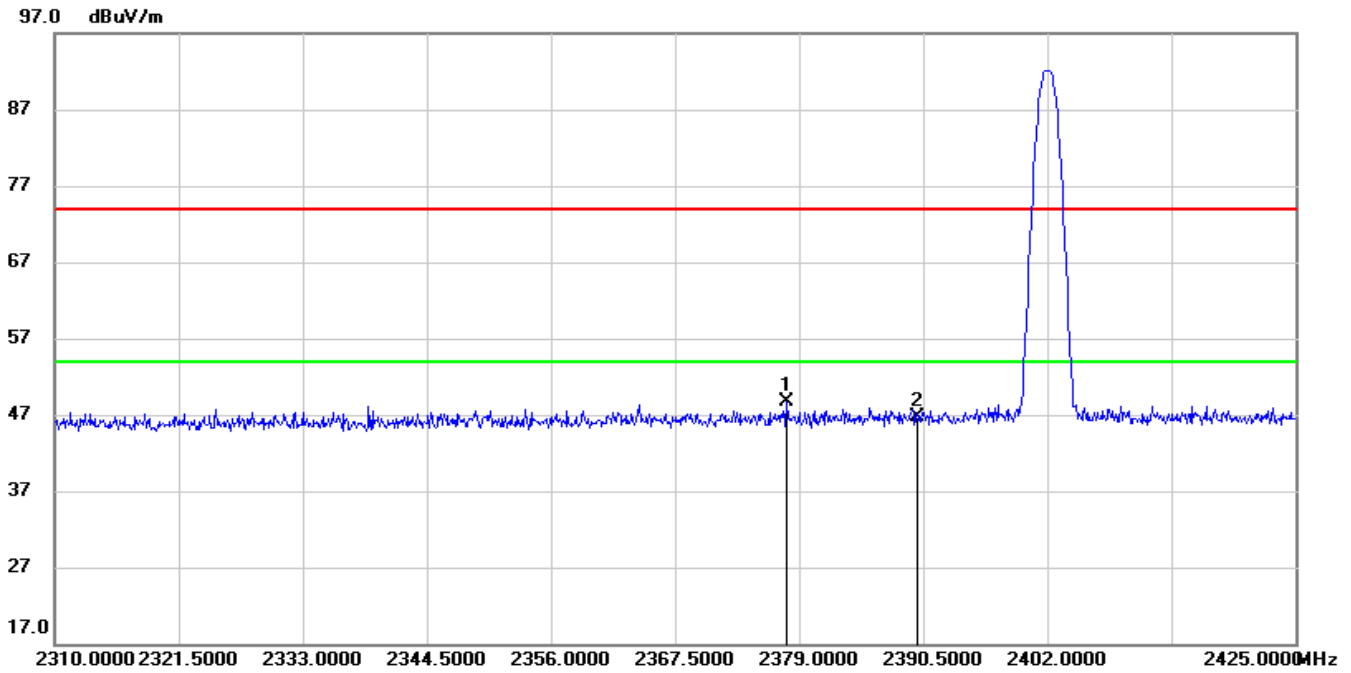

No.	Frequency (MHz)	Reading (dBuV)	Correct (dB/m)	Result (dBuV/m)	Limit (dBuV/m)	Margin (dB)	Remark
1	2377.850	15.78	32.90	48.68	74.00	-25.32	peak
2	2390.000	13.72	32.94	46.66	74.00	-27.34	peak

- Note: 1. Measurement = Reading Level + Correct Factor.
 2. If Peak Result complies with AV limit, AV Result is deemed to comply with AV limit.
 3. Peak: Peak detector.
 4. Only the worst case emission was recorded, if it complies with the limit, the other emissions deemed to comply with the limit.



RESTRICTED BANDEGE (LOW CHANNEL, VERTICAL)

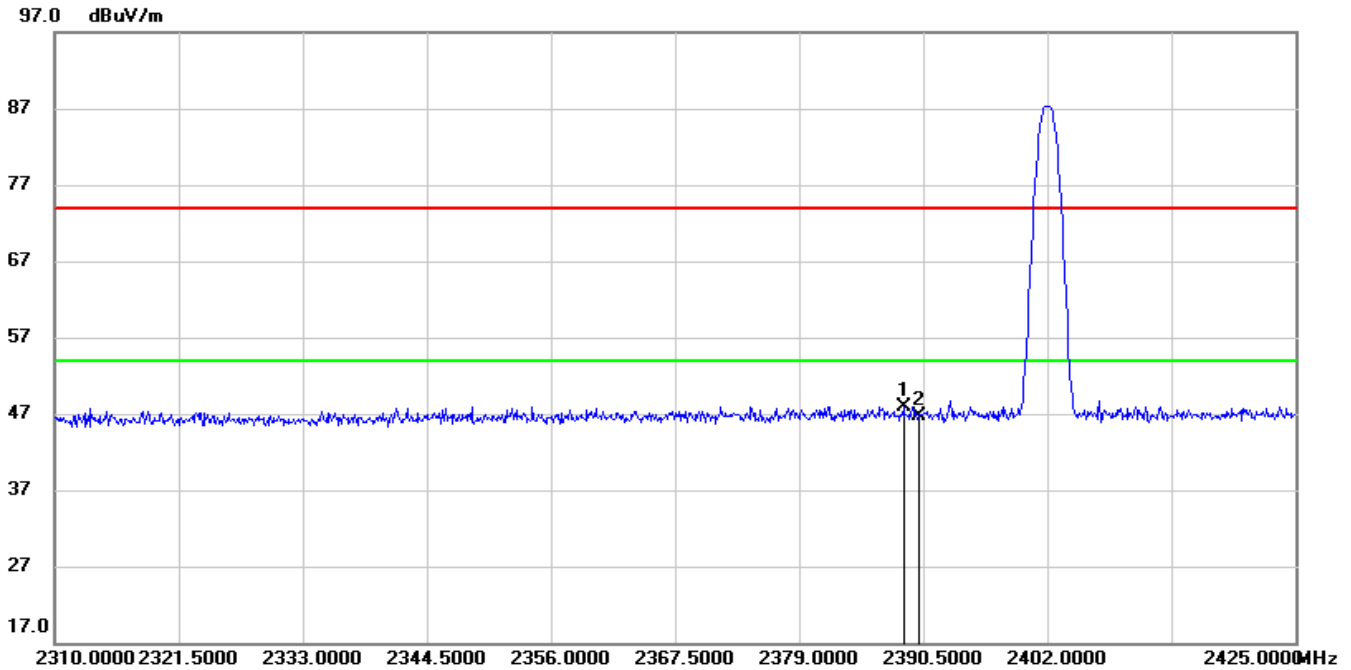

No.	Frequency (MHz)	Reading (dBuV)	Correct (dB/m)	Result (dBuV/m)	Limit (dBuV/m)	Margin (dB)	Remark
1	2388.660	15.02	32.94	47.96	74.00	-26.04	peak
2	2390.000	13.67	32.94	46.61	74.00	-27.39	peak

Note: 1. Measurement = Reading Level + Correct Factor.
 2.If Peak Result complies with AV limit, AV Result is deemed to comply with AV limit.
 3.Peak: Peak detector.
 4.Only the worst case emission was recorded, if it complies with the limit, the other emissions deemed to comply with the limit.



RESTRICTED BANDEDGE (HIGH CHANNEL, HORIZONTAL)

PEAK

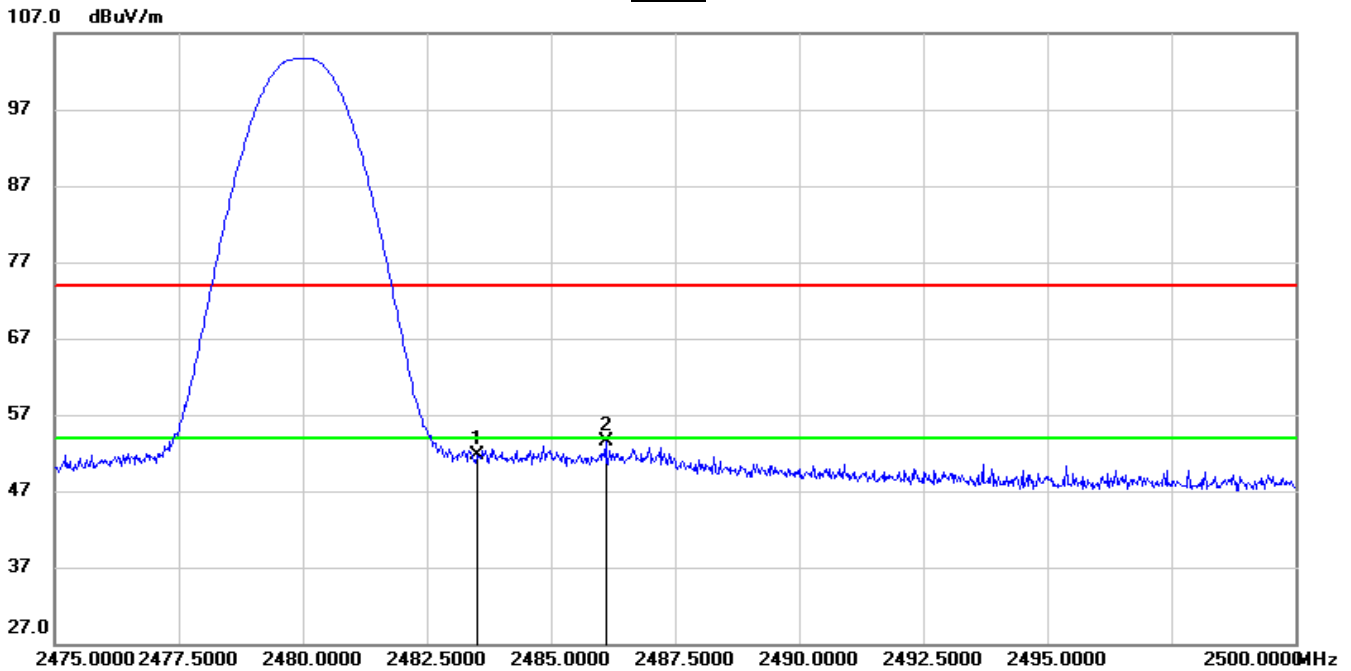

No.	Frequency (MHz)	Reading (dBuV)	Correct (dB/m)	Result (dBuV/m)	Limit (dBuV/m)	Margin (dB)	Remark
1	2483.500	18.22	33.58	51.80	74.00	-22.20	peak
2	2486.100	20.00	33.59	53.59	74.00	-20.41	peak

- Note: 1. Measurement = Reading Level + Correct Factor.
 2.If Peak Result complies with AV limit, AV Result is deemed to comply with AV limit.
 3.Peak: Peak detector.
 4.Only the worst case emission was recorded, if it complies with the limit, the other emissions deemed to comply with the limit.



RESTRICTED BANDEDGE (HIGH CHANNEL, VERTICAL)

PEAK

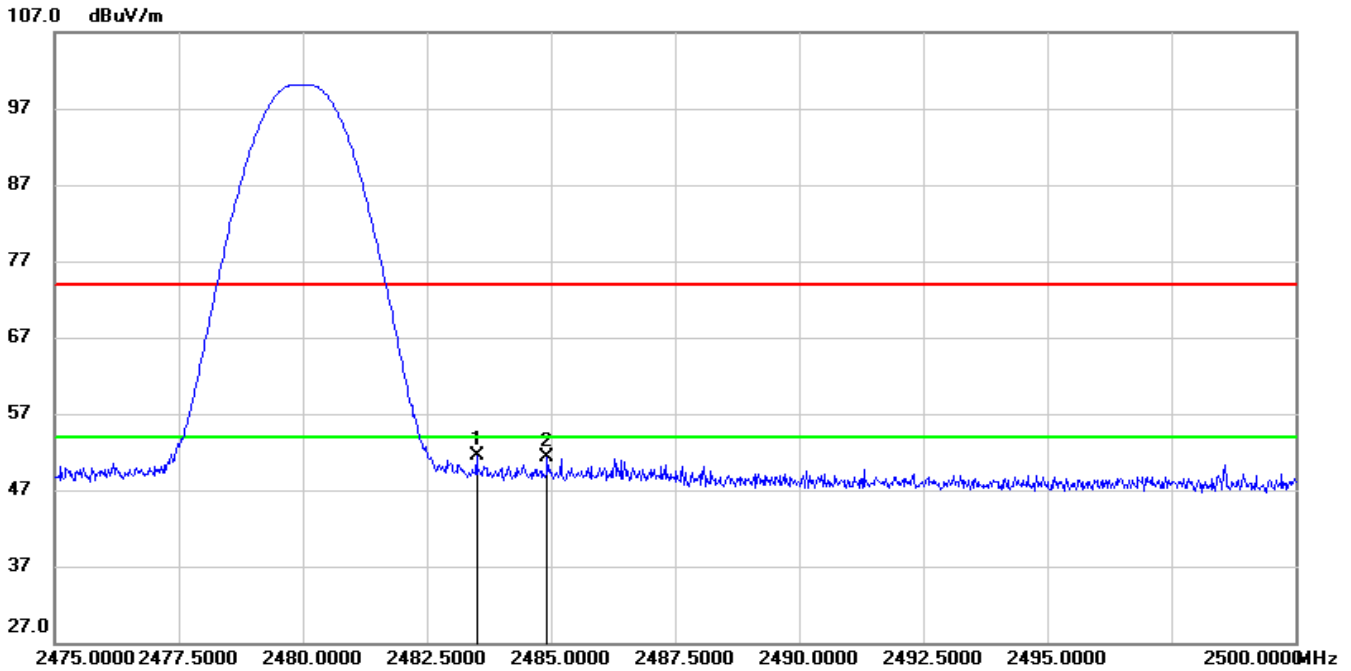

No.	Frequency (MHz)	Reading (dBuV)	Correct (dB/m)	Result (dBuV/m)	Limit (dBuV/m)	Margin (dB)	Remark
1	2483.500	17.91	33.58	51.49	74.00	-22.51	peak
2	2484.925	17.71	33.59	51.30	74.00	-22.70	peak

- Note: 1. Measurement = Reading Level + Correct Factor.
 2.If Peak Result complies with AV limit, AV Result is deemed to comply with AV limit.
 3.Peak: Peak detector.
 4.Only the worst case emission was recorded, if it complies with the limit, the other emissions deemed to comply with the limit.



Test Result for Antenna WCT5H-20

RESTRICTED BANDEDGE (LOW CHANNEL, HORIZONTAL)

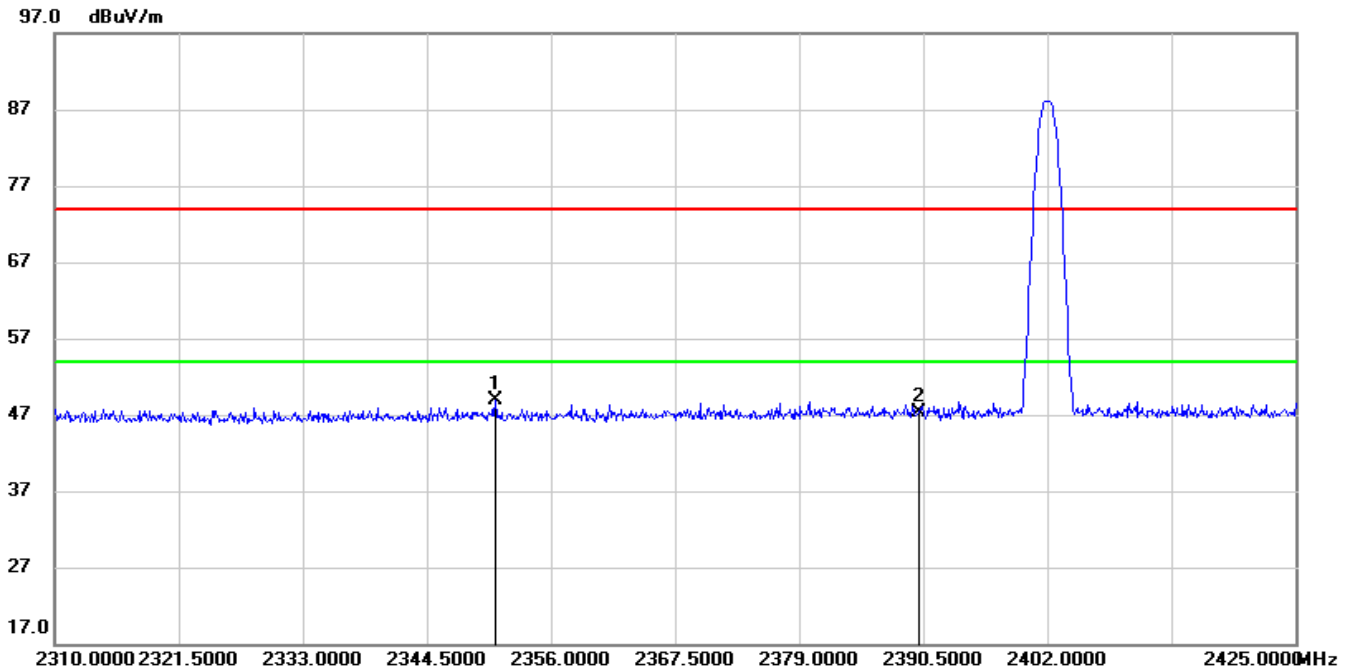

No.	Frequency (MHz)	Reading (dBuV)	Correct (dB/m)	Result (dBuV/m)	Limit (dBuV/m)	Margin (dB)	Remark
1	2350.825	16.19	32.81	49.00	74.00	-25.00	peak
2	2390.000	14.40	32.94	47.34	74.00	-26.66	peak

- Note:
1. Measurement = Reading Level + Correct Factor.
 2. If Peak Result complies with AV limit, AV Result is deemed to comply with AV limit.
 3. Peak: Peak detector.
 4. Only the worst case emission was recorded, if it complies with the limit, the other emissions deemed to comply with the limit.



RESTRICTED BANDEDGE (LOW CHANNEL, VERTICAL)

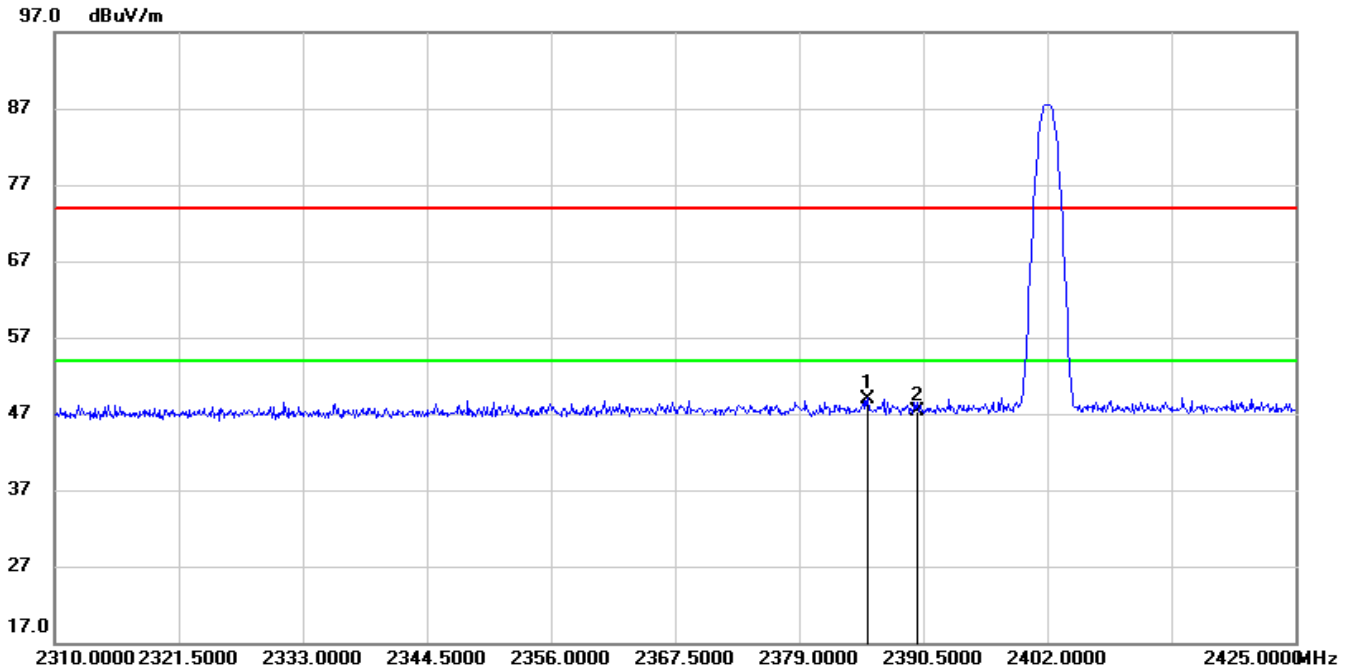

No.	Frequency (MHz)	Reading (dBuV)	Correct (dB/m)	Result (dBuV/m)	Limit (dBuV/m)	Margin (dB)	Remark
1	2385.325	16.07	32.93	49.00	74.00	-25.00	peak
2	2390.000	14.27	32.94	47.21	74.00	-26.79	peak

Note: 1. Measurement = Reading Level + Correct Factor.
 2.If Peak Result complies with AV limit, AV Result is deemed to comply with AV limit.
 3.Peak: Peak detector.
 4.Only the worst case emission was recorded, if it complies with the limit, the other emissions deemed to comply with the limit.



RESTRICTED BANDEDGE (HIGH CHANNEL, HORIZONTAL)

PEAK

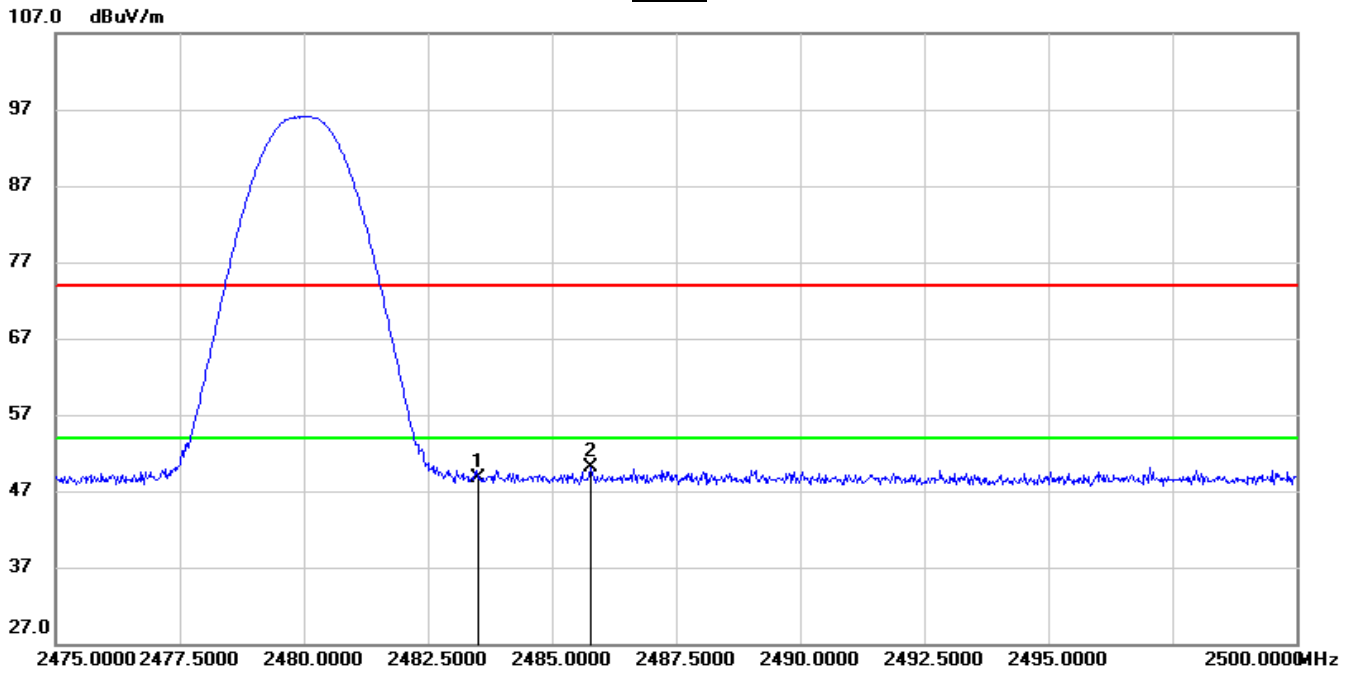

No.	Frequency (MHz)	Reading (dBuV)	Correct (dB/m)	Result (dBuV/m)	Limit (dBuV/m)	Margin (dB)	Remark
1	2483.500	15.15	33.58	48.73	74.00	-25.27	peak
2	2485.775	16.56	33.59	50.15	74.00	-23.85	peak

Note: 1. Measurement = Reading Level + Correct Factor.
 2.If Peak Result complies with AV limit, AV Result is deemed to comply with AV limit.
 3.Peak: Peak detector.
 4.Only the worst case emission was recorded, if it complies with the limit, the other emissions deemed to comply with the limit.



RESTRICTED BANDEDGE (HIGH CHANNEL, VERTICAL)

PEAK

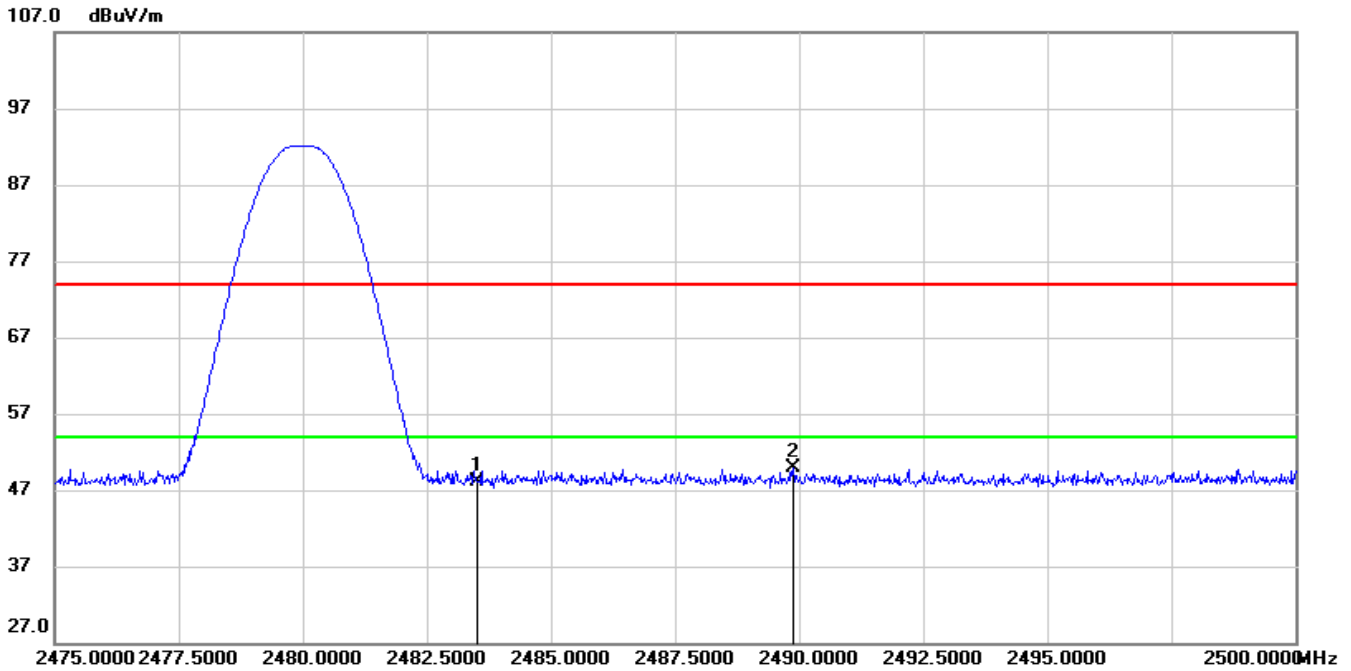

No.	Frequency (MHz)	Reading (dBuV)	Correct (dB/m)	Result (dBuV/m)	Limit (dBuV/m)	Margin (dB)	Remark
1	2483.500	14.51	33.58	48.09	74.00	-25.91	peak
2	2489.875	16.22	33.63	49.85	74.00	-24.15	peak

- Note: 1. Measurement = Reading Level + Correct Factor.
 2.If Peak Result complies with AV limit, AV Result is deemed to comply with AV limit.
 3.Peak: Peak detector.
 4.Only the worst case emission was recorded, if it complies with the limit, the other emissions deemed to comply with the limit.



8.2.2. 8DPSK MODE

Test Result for Antenna WCT5J-20

RESTRICTED BANDEDGE (LOW CHANNEL, HORIZONTAL)

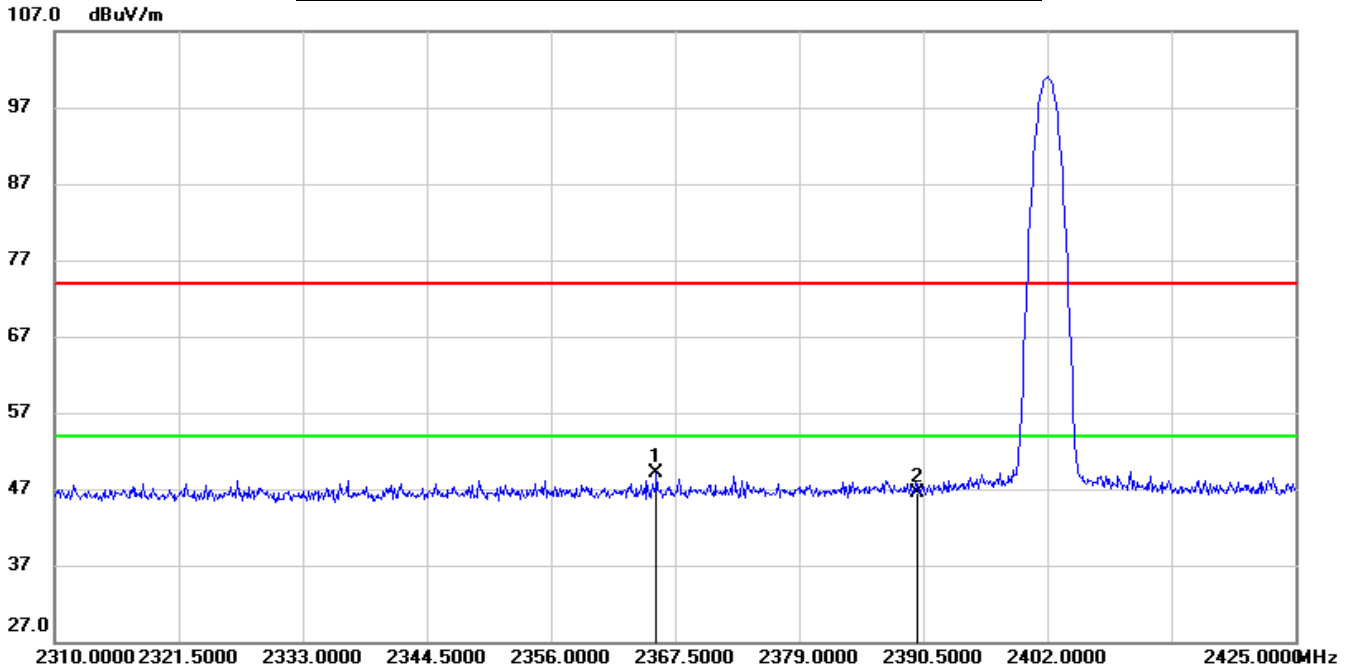

No.	Frequency (MHz)	Reading (dBuV)	Correct (dB/m)	Result (dBuV/m)	Limit (dBuV/m)	Margin (dB)	Remark
1	2365.775	16.22	32.87	49.09	74.00	-24.91	peak
2	2390.000	13.58	32.94	46.52	74.00	-27.48	peak

- Note: 1. Measurement = Reading Level + Correct Factor.
 2. If Peak Result complies with AV limit, AV Result is deemed to comply with AV limit.
 3. Peak: Peak detector.
 4. Only the worst case emission was recorded, if it complies with the limit, the other emissions deemed to comply with the limit.



RESTRICTED BANDEDGE (LOW CHANNEL, VERTICAL)

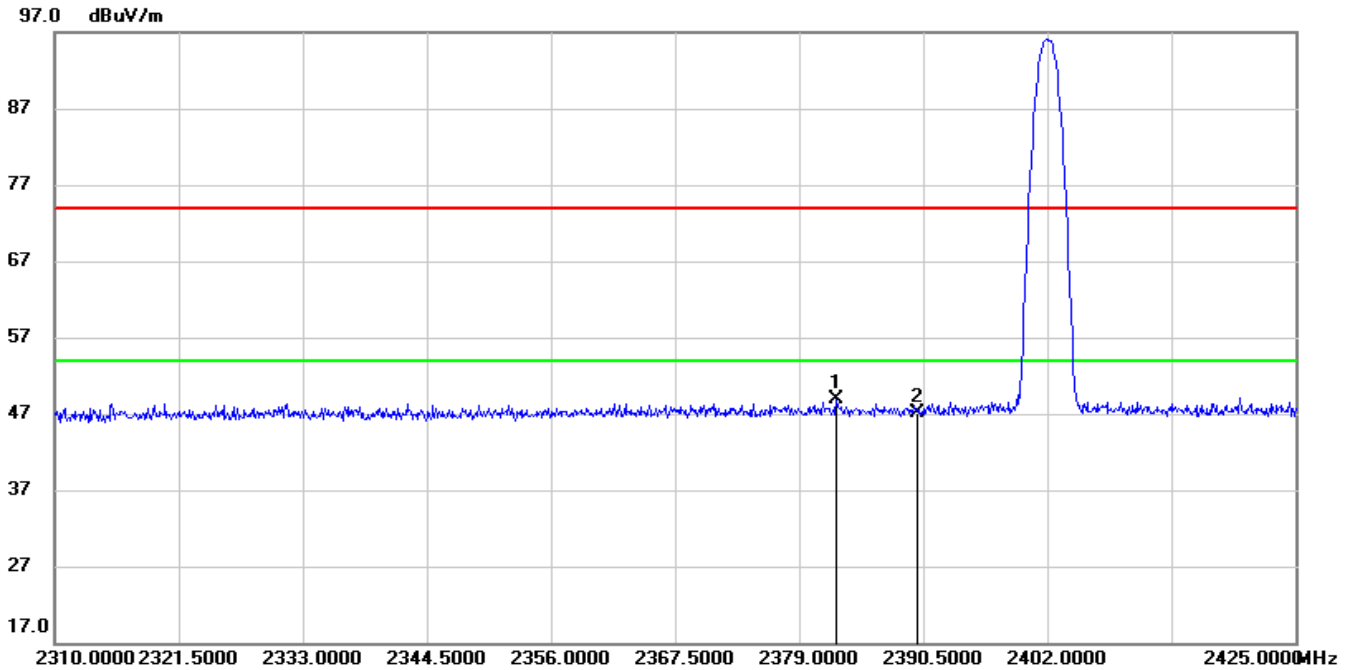

No.	Frequency (MHz)	Reading (dBuV)	Correct (dB/m)	Result (dBuV/m)	Limit (dBuV/m)	Margin (dB)	Remark
1	2382.450	16.04	32.92	48.96	74.00	-25.04	peak
2	2390.000	14.23	32.94	47.17	74.00	-26.83	peak

- Note: 1. Measurement = Reading Level + Correct Factor.
 2. If Peak Result complies with AV limit, AV Result is deemed to comply with AV limit.
 3. Peak: Peak detector.
 4. Only the worst case emission was recorded, if it complies with the limit, the other emissions deemed to comply with the limit.



RESTRICTED BANDEDGE (HIGH CHANNEL, HORIZONTAL)

PEAK

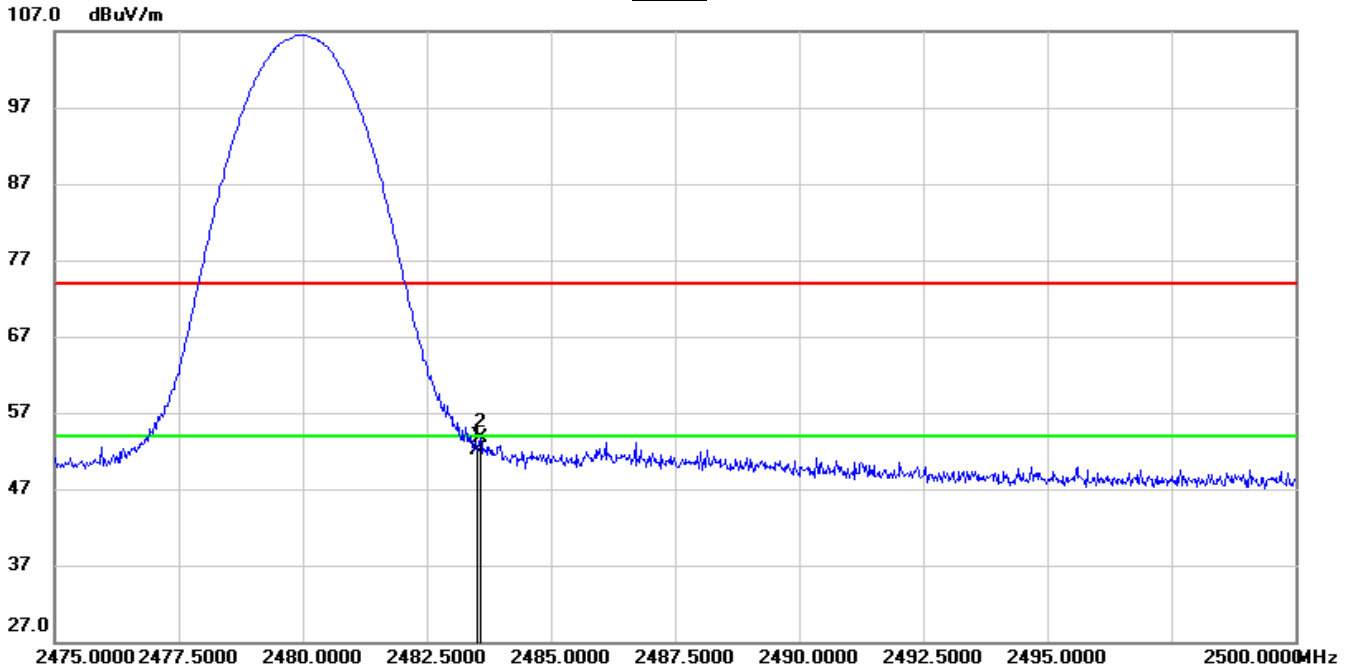

No.	Frequency (MHz)	Reading (dBuV)	Correct (dB/m)	Result (dBuV/m)	Limit (dBuV/m)	Margin (dB)	Remark
1	2483.500	18.43	33.58	52.01	74.00	-21.99	peak
2	2483.575	20.09	33.58	53.67	74.00	-20.33	peak

- Note: 1. Measurement = Reading Level + Correct Factor.
 2. If Peak Result complies with AV limit, AV Result is deemed to comply with AV limit.
 3. Peak: Peak detector.
 4. Only the worst case emission was recorded, if it complies with the limit, the other emissions deemed to comply with the limit.



RESTRICTED BANDEDGE (HIGH CHANNEL, VERTICAL)
PEAK

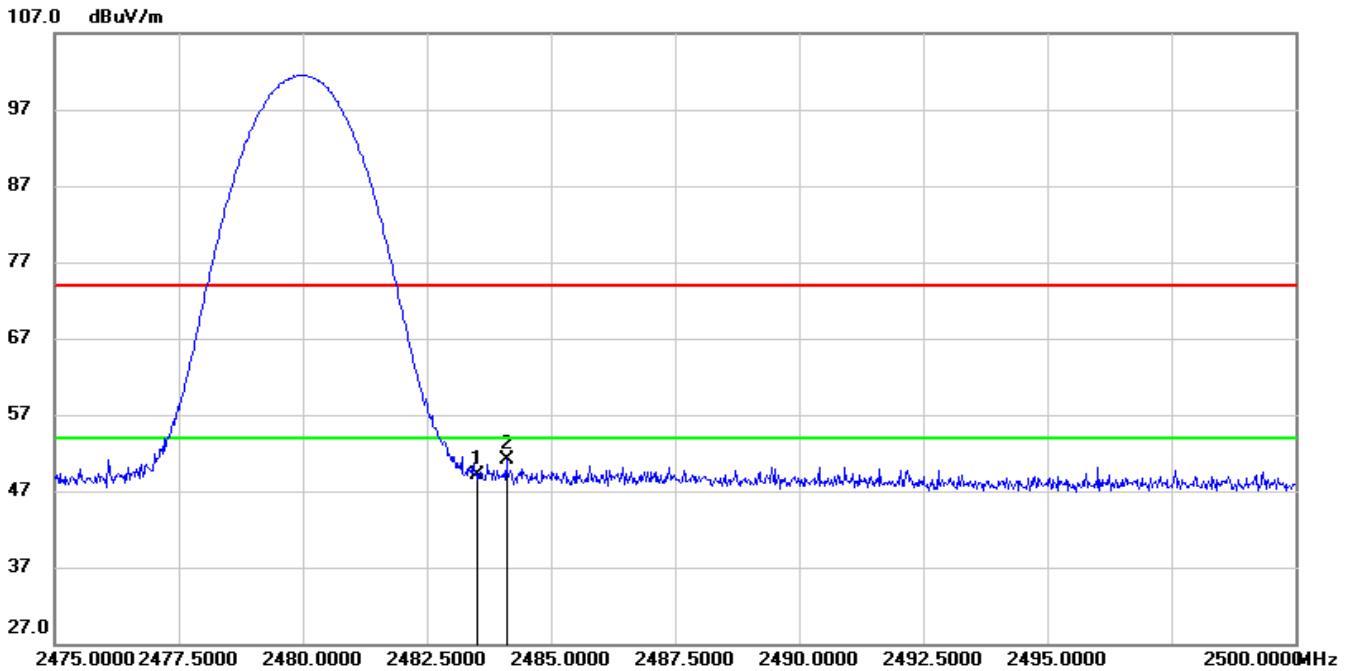

No.	Frequency (MHz)	Reading (dBuV)	Correct (dB/m)	Result (dBuV/m)	Limit (dBuV/m)	Margin (dB)	Remark
1	2483.500	15.59	33.58	49.17	74.00	-24.83	peak
2	2484.100	17.53	33.58	51.11	74.00	-22.89	peak

- Note: 1. Measurement = Reading Level + Correct Factor.
 2. If Peak Result complies with AV limit, AV Result is deemed to comply with AV limit.
 3. Peak: Peak detector.
 4. Only the worst case emission was recorded, if it complies with the limit, the other emissions deemed to comply with the limit.



Test Result for Antenna WCT5H-20

RESTRICTED BANDEDGE (LOW CHANNEL, HORIZONTAL)

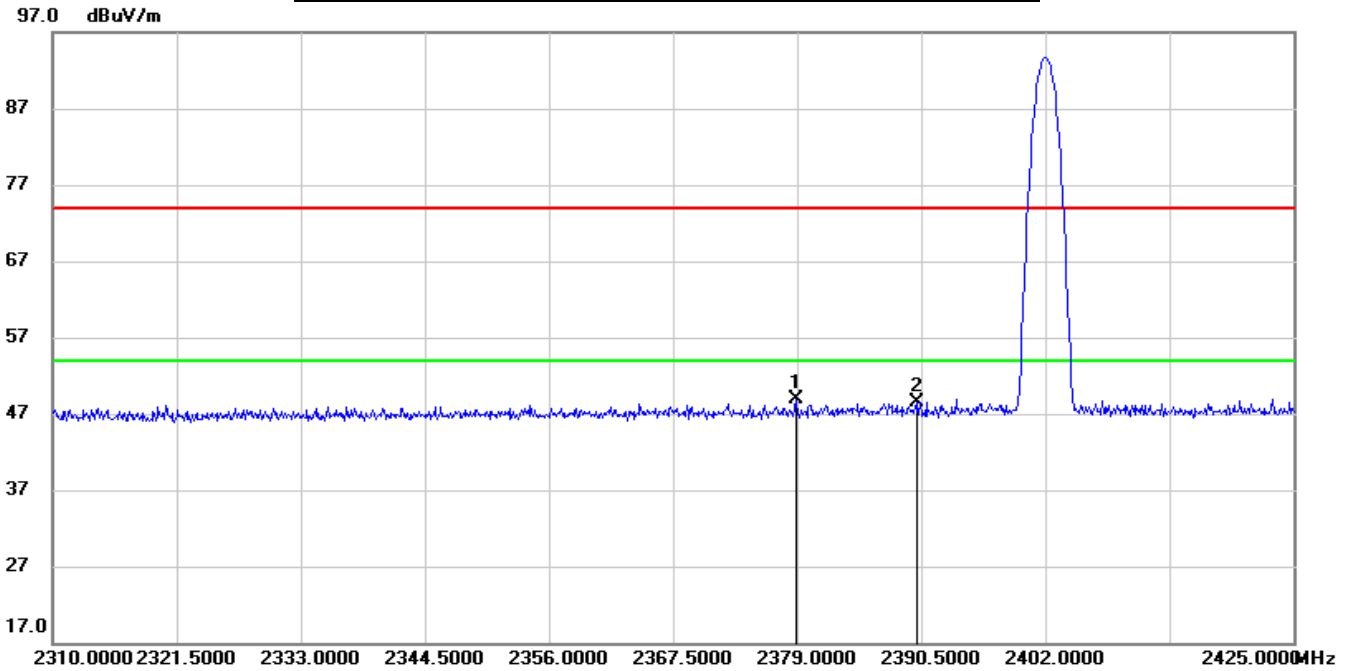

No.	Frequency (MHz)	Reading (dBuV)	Correct (dB/m)	Result (dBuV/m)	Limit (dBuV/m)	Margin (dB)	Remark
1	2378.885	15.97	32.91	48.88	74.00	-25.12	peak
2	2390.000	15.60	32.94	48.54	74.00	-25.46	peak

- Note: 1. Measurement = Reading Level + Correct Factor.
 2. If Peak Result complies with AV limit, AV Result is deemed to comply with AV limit.
 3. Peak: Peak detector.
 4. Only the worst case emission was recorded, if it complies with the limit, the other emissions deemed to comply with the limit.



RESTRICTED BANDEDGE (LOW CHANNEL, VERTICAL)

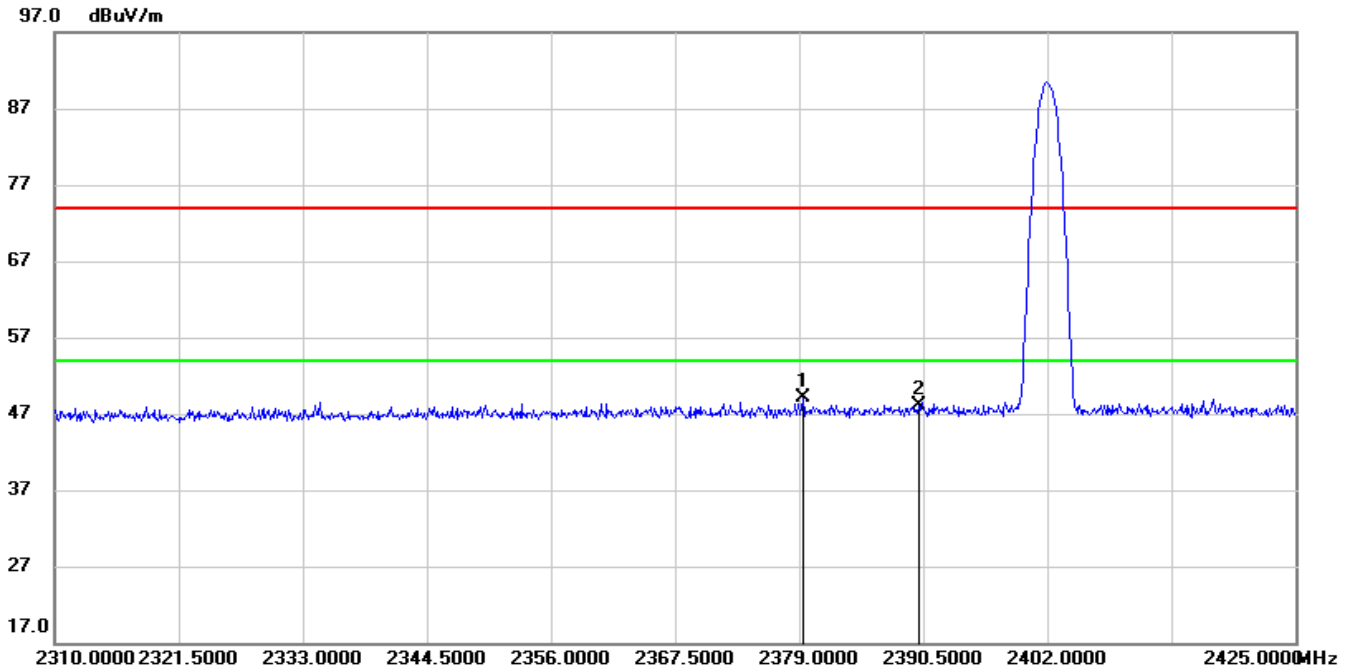

No.	Frequency (MHz)	Reading (dBuV)	Correct (dB/m)	Result (dBuV/m)	Limit (dBuV/m)	Margin (dB)	Remark
1	2379.345	16.19	32.91	49.10	74.00	-24.90	peak
2	2390.000	15.11	32.94	48.05	74.00	-25.95	peak

- Note: 1. Measurement = Reading Level + Correct Factor.
 2. If Peak Result complies with AV limit, AV Result is deemed to comply with AV limit.
 3. Peak: Peak detector.
 4. Only the worst case emission was recorded, if it complies with the limit, the other emissions deemed to comply with the limit.



RESTRICTED BANDEDGE (HIGH CHANNEL, HORIZONTAL)

PEAK

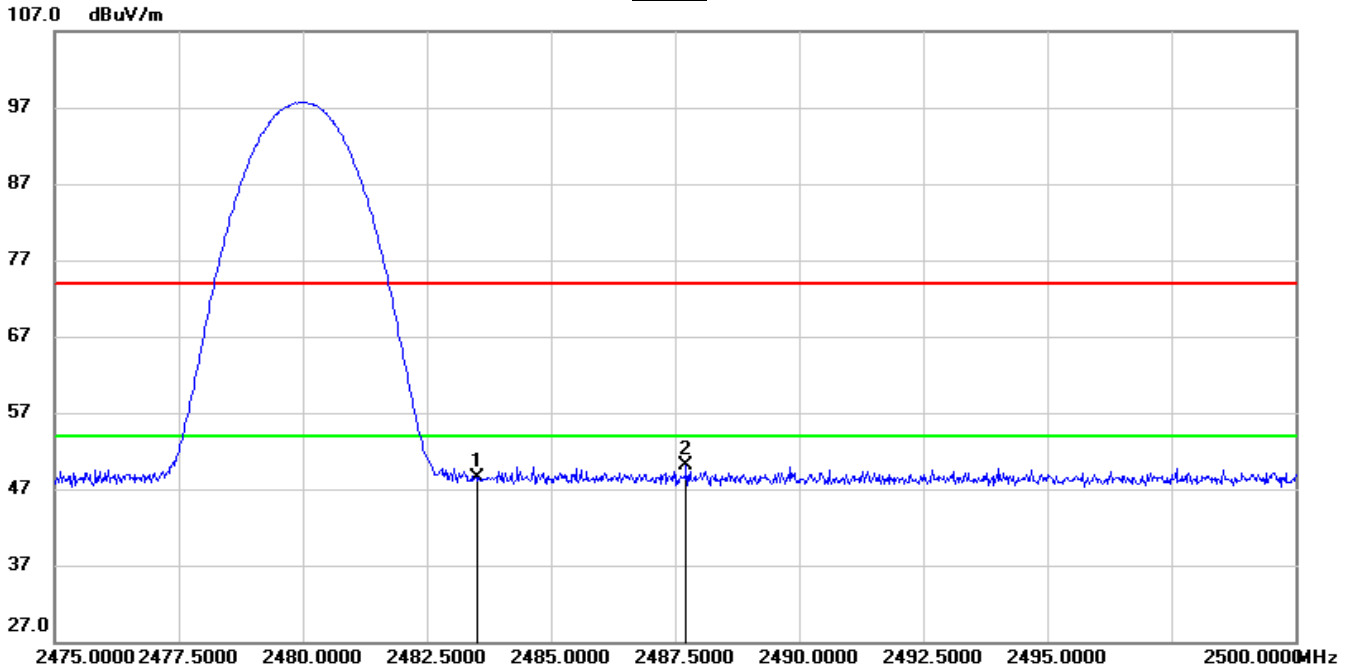

No.	Frequency (MHz)	Reading (dBuV)	Correct (dB/m)	Result (dBuV/m)	Limit (dBuV/m)	Margin (dB)	Remark
1	2483.500	14.94	33.58	48.52	74.00	-25.48	peak
2	2487.725	16.56	33.61	50.17	74.00	-23.83	peak

- Note: 1. Measurement = Reading Level + Correct Factor.
 2. If Peak Result complies with AV limit, AV Result is deemed to comply with AV limit.
 3. Peak: Peak detector.
 4. Only the worst case emission was recorded, if it complies with the limit, the other emissions deemed to comply with the limit.



RESTRICTED BANDEDGE (HIGH CHANNEL, VERTICAL)
PEAK

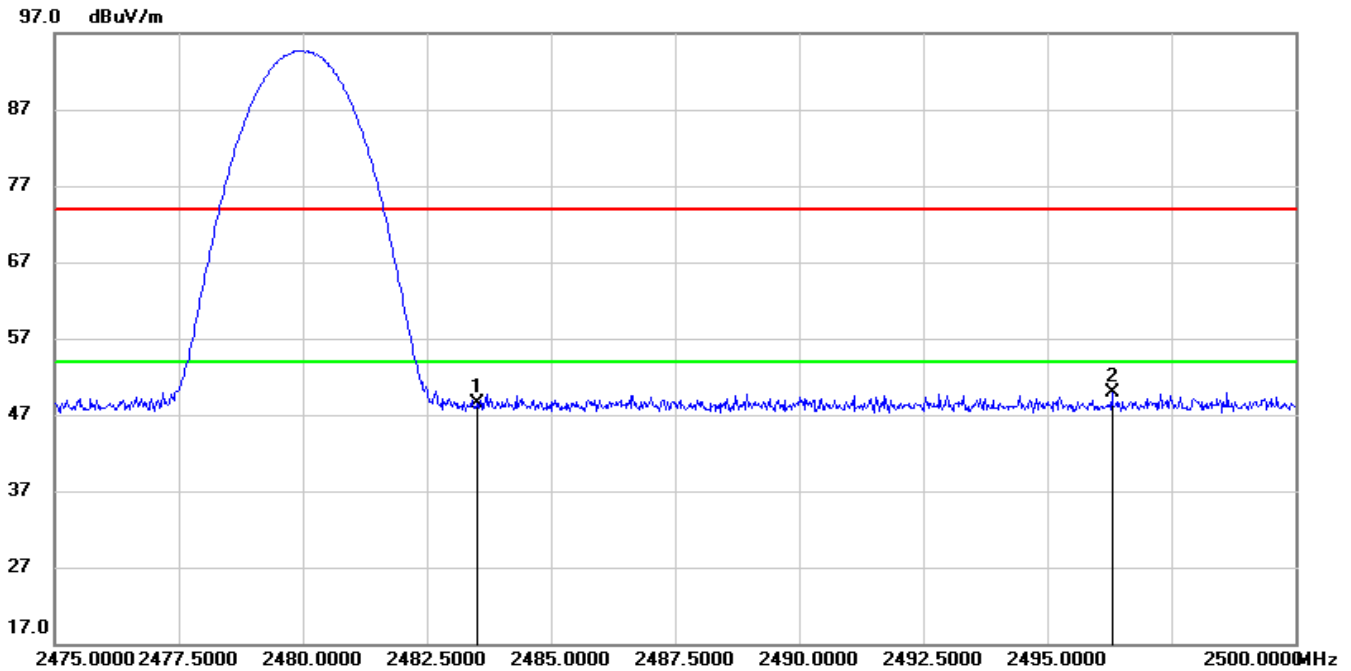

No.	Frequency (MHz)	Reading (dBuV)	Correct (dB/m)	Result (dBuV/m)	Limit (dBuV/m)	Margin (dB)	Remark
1	2483.500	14.96	33.58	48.54	74.00	-25.46	peak
2	2496.300	16.16	33.67	49.83	74.00	-24.17	peak

- Note: 1. Measurement = Reading Level + Correct Factor.
 2. If Peak Result complies with AV limit, AV Result is deemed to comply with AV limit.
 3. Peak: Peak detector.
 4. Only the worst case emission was recorded, if it complies with the limit, the other emissions deemed to comply with the limit.



8.3. SPURIOUS EMISSIONS (1~3GHz)

8.3.1. GFSK MODE

Test Result for Antenna WCT5J-20

HARMONICS AND SPURIOUS EMISSIONS (LOW CHANNEL, HORIZONTAL)

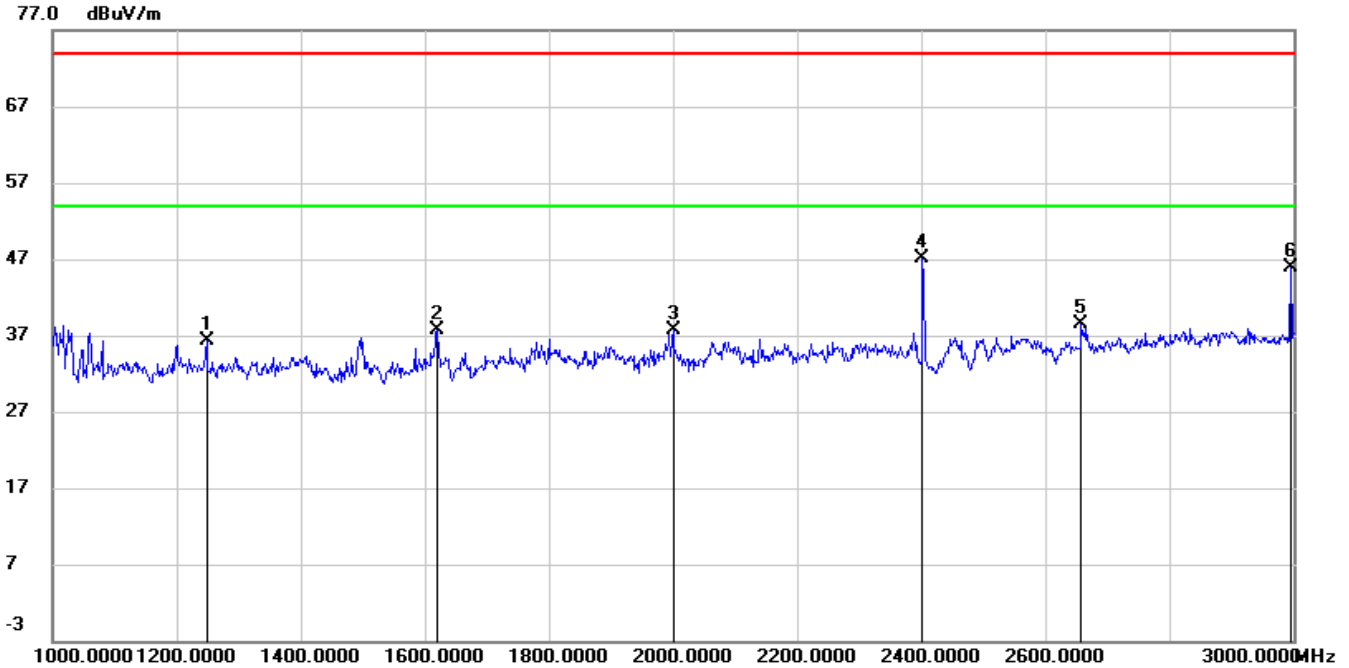

No.	Frequency (MHz)	Reading (dBuV)	Correct (dB/m)	Result (dBuV/m)	Limit (dBuV/m)	Margin (dB)	Remark
1	1248.000	48.87	-12.51	36.36	74.00	-37.64	peak
2	1620.000	48.94	-11.29	37.65	74.00	-36.35	peak
3	2000.000	47.57	-9.82	37.75	74.00	-36.25	peak
4	2402.000	54.95	-7.85	47.10	/	/	fundamental
5	2658.000	45.81	-7.37	38.44	74.00	-35.56	peak
6	2996.000	51.28	-5.30	45.98	74.00	-28.02	peak

- Note:
1. Peak Result = Reading Level + Correct Factor.
 2. If Peak Result complies with AV limit, AV Result is deemed to comply with AV limit.
 3. Peak: Peak detector.
 4. Filter losses were only considered in the spurious frequency bands and the authorized band was not corrected for Band reject filter losses
 5. Proper operation of the transmitter prior to adding the filter to the measurement chain.



HARMONICS AND SPURIOUS EMISSIONS (LOW CHANNEL, VERTICAL)

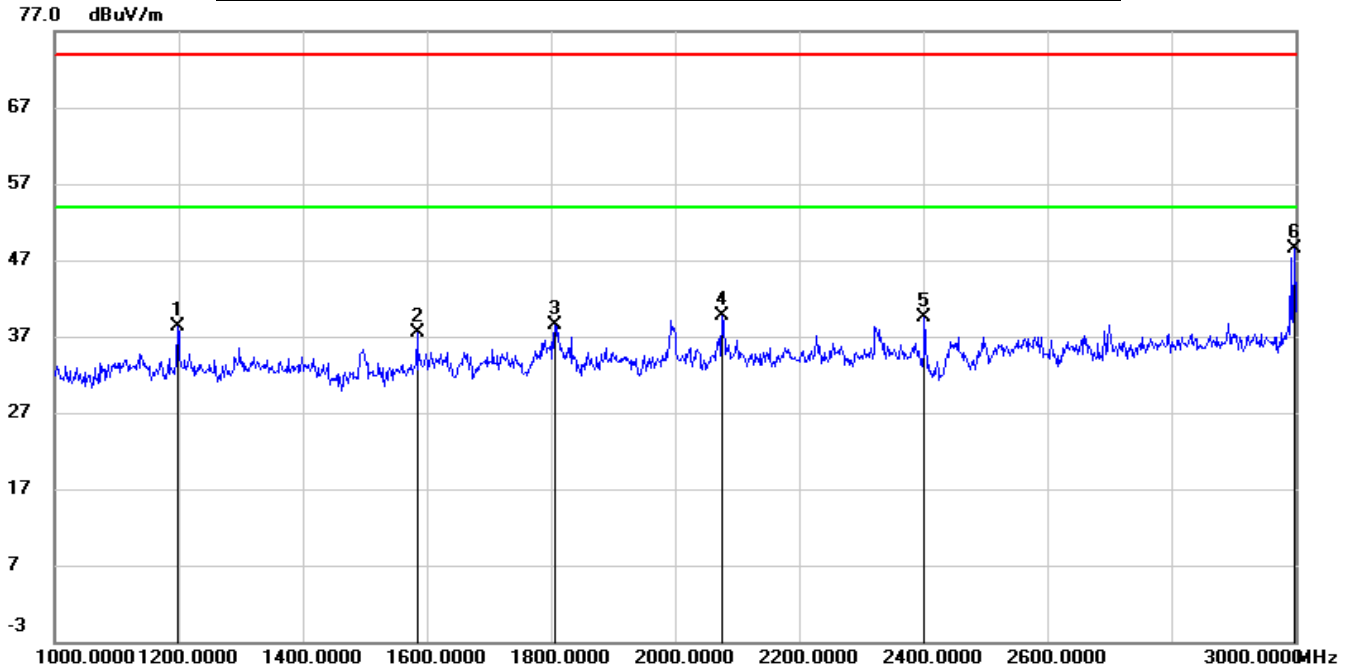

No.	Frequency (MHz)	Reading (dBuV)	Correct (dB/m)	Result (dBuV/m)	Limit (dBuV/m)	Margin (dB)	Remark
1	1198.000	51.07	-12.69	38.38	74.00	-35.62	peak
2	1584.000	49.10	-11.53	37.57	74.00	-36.43	peak
3	1806.000	48.35	-9.92	38.43	74.00	-35.57	peak
4	2076.000	48.99	-9.31	39.68	74.00	-34.32	peak
5	2402.000	47.30	-7.85	39.45	/	/	fundamental
6	2998.000	53.89	-5.31	48.58	74.00	-25.42	peak

- Note: 1. Peak Result = Reading Level + Correct Factor.
 2. If Peak Result complies with AV limit, AV Result is deemed to comply with AV limit.
 3. Peak: Peak detector.
 4. Filter losses were only considered in the spurious frequency bands and the authorized band was not corrected for Band reject filter losses
 5. Proper operation of the transmitter prior to adding the filter to the measurement chain.



HARMONICS AND SPURIOUS EMISSIONS (MID CHANNEL, HORIZONTAL)

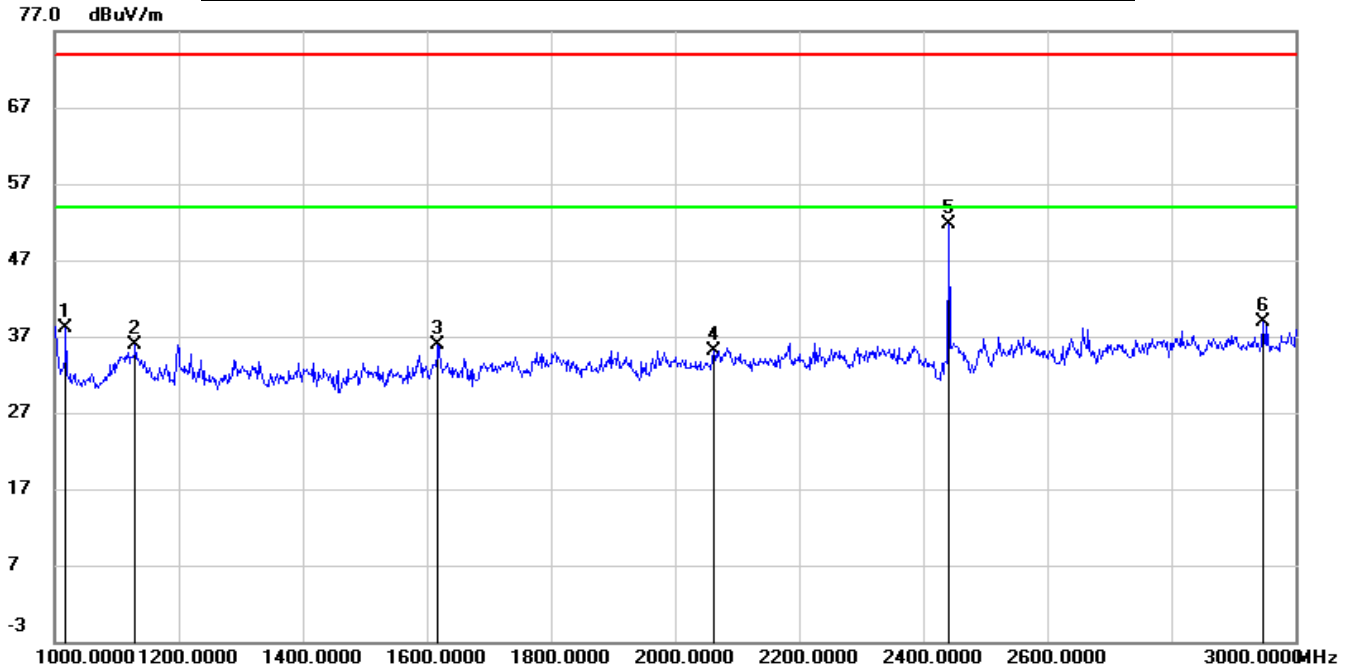

No.	Frequency (MHz)	Reading (dBuV)	Correct (dB/m)	Result (dBuV/m)	Limit (dBuV/m)	Margin (dB)	Remark
1	1018.000	51.68	-13.58	38.10	74.00	-35.90	peak
2	1130.000	49.22	-13.27	35.95	74.00	-38.05	peak
3	1618.000	47.12	-11.31	35.81	74.00	-38.19	peak
4	2062.000	44.56	-9.41	35.15	74.00	-38.85	peak
5	2441.000	59.30	-7.57	51.73	/	/	fundamental
6	2948.000	44.32	-5.42	38.90	74.00	-35.10	peak

- Note: 1. Peak Result = Reading Level + Correct Factor.
 2. If Peak Result complies with AV limit, AV Result is deemed to comply with AV limit.
 3. Peak: Peak detector.
 4. Filter losses were only considered in the spurious frequency bands and the authorized band was not corrected for Band reject filter losses
 5. Proper operation of the transmitter prior to adding the filter to the measurement chain.



HARMONICS AND SPURIOUS EMISSIONS (MID CHANNEL, VERTICAL)

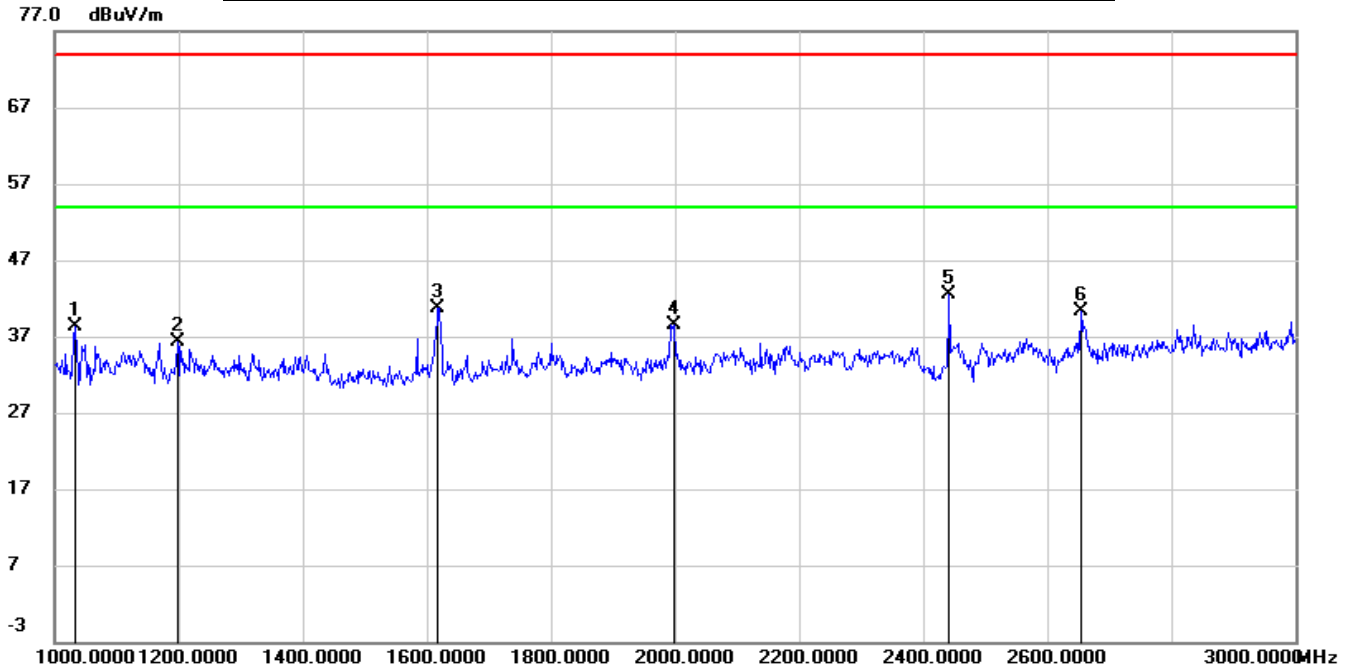

No.	Frequency (MHz)	Reading (dBuV)	Correct (dB/m)	Result (dBuV/m)	Limit (dBuV/m)	Margin (dB)	Remark
1	1032.000	51.85	-13.57	38.28	74.00	-35.72	peak
2	1198.000	49.00	-12.69	36.31	74.00	-37.69	peak
3	1618.000	51.95	-11.31	40.64	74.00	-33.36	peak
4	1998.000	48.42	-9.83	38.59	74.00	-35.41	peak
5	2441.000	50.01	-7.57	42.44	/	/	fundamental
6	2654.000	47.63	-7.39	40.24	74.00	-33.76	peak

- Note: 1. Peak Result = Reading Level + Correct Factor.
 2. If Peak Result complies with AV limit, AV Result is deemed to comply with AV limit.
 3. Peak: Peak detector.
 4. Filter losses were only considered in the spurious frequency bands and the authorized band was not corrected for Band reject filter losses
 5. Proper operation of the transmitter prior to adding the filter to the measurement chain.



HARMONICS AND SPURIOUS EMISSIONS (HIGH CHANNEL, HORIZONTAL)

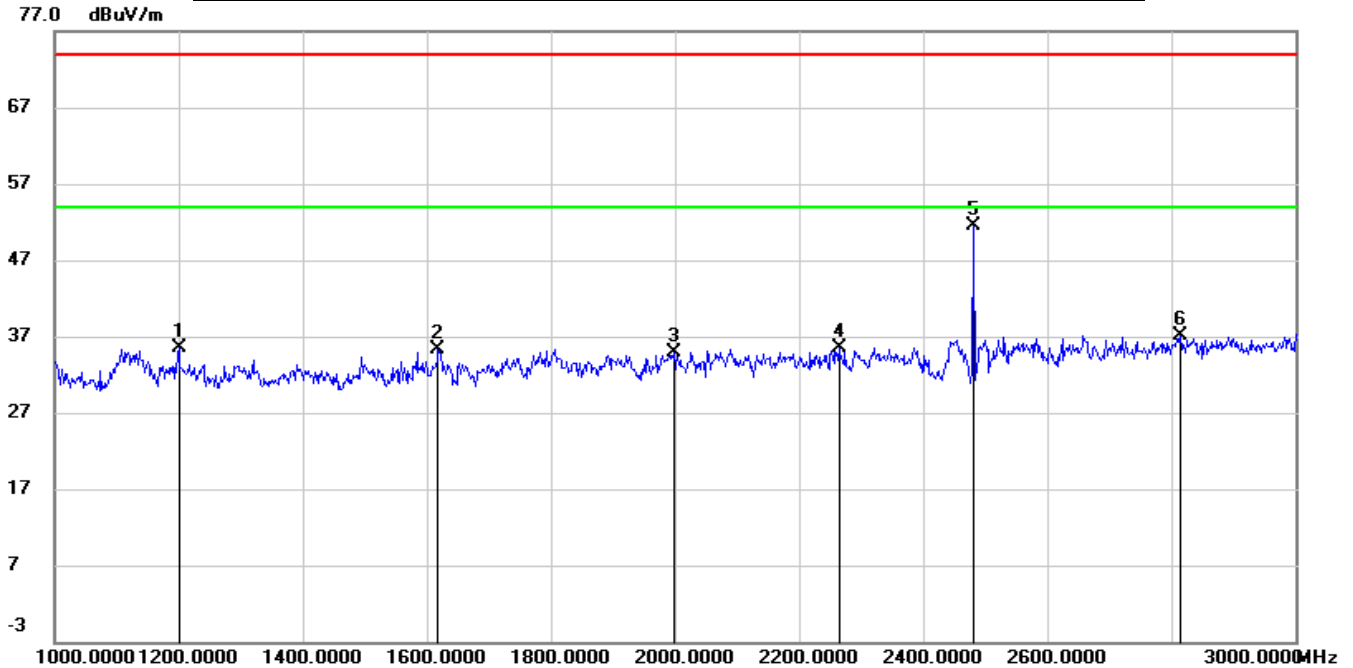

No.	Frequency (MHz)	Reading (dBuV)	Correct (dB/m)	Result (dBuV/m)	Limit (dBuV/m)	Margin (dB)	Remark
1	1200.000	48.11	-12.68	35.43	74.00	-38.57	peak
2	1618.000	46.66	-11.31	35.35	74.00	-38.65	peak
3	1998.000	44.66	-9.83	34.83	74.00	-39.17	peak
4	2264.000	43.79	-8.36	35.43	74.00	-38.57	peak
5	2480.000	58.84	-7.31	51.53	/	/	fundamental
6	2814.000	43.14	-5.98	37.16	74.00	-36.84	peak

- Note: 1. Peak Result = Reading Level + Correct Factor.
 2. If Peak Result complies with AV limit, AV Result is deemed to comply with AV limit.
 3. Peak: Peak detector.
 4. Filter losses were only considered in the spurious frequency bands and the authorized band was not corrected for Band reject filter losses
 5. Proper operation of the transmitter prior to adding the filter to the measurement chain.



HARMONICS AND SPURIOUS EMISSIONS (HIGH CHANNEL, VERTICAL)

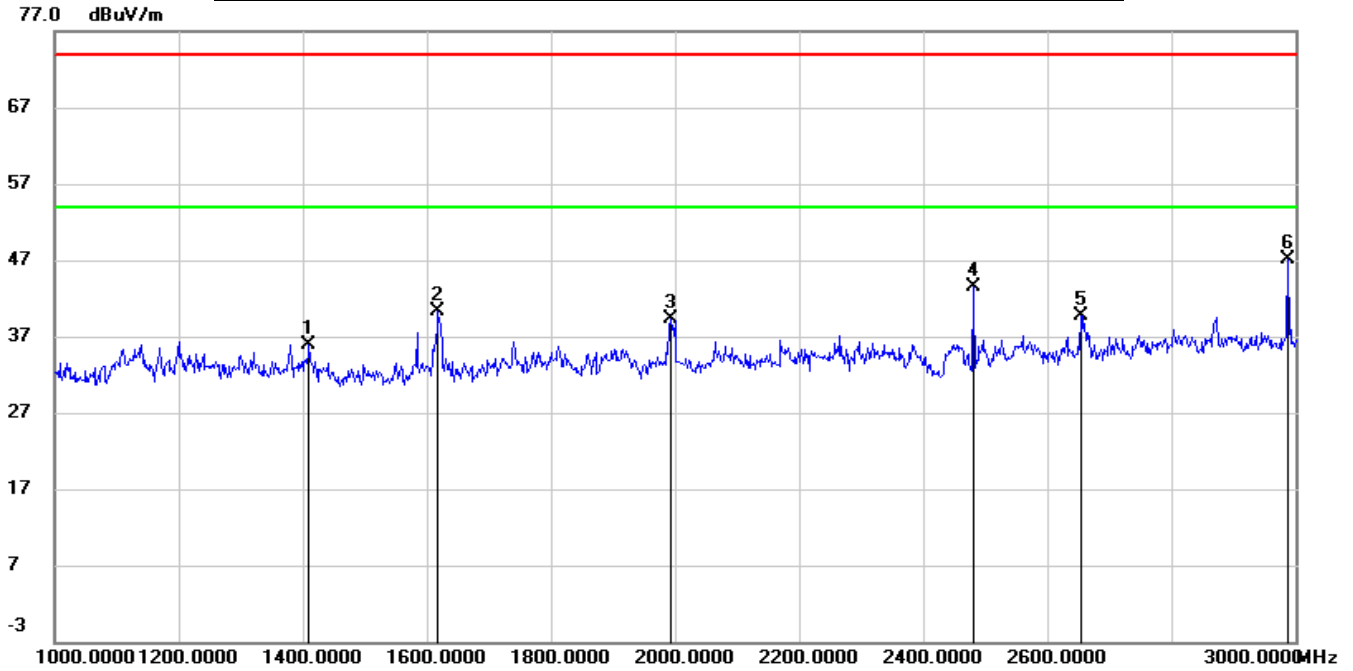

No.	Frequency (MHz)	Reading (dBuV)	Correct (dB/m)	Result (dBuV/m)	Limit (dBuV/m)	Margin (dB)	Remark
1	1410.000	48.33	-12.36	35.97	74.00	-38.03	peak
2	1618.000	51.70	-11.31	40.39	74.00	-33.61	peak
3	1992.000	49.18	-9.83	39.35	74.00	-34.65	peak
4	2480.000	50.91	-7.31	43.60	/	/	fundamental
5	2654.000	47.15	-7.39	39.76	74.00	-34.24	peak
6	2988.000	52.36	-5.33	47.03	74.00	-26.97	peak

- Note: 1. Peak Result = Reading Level + Correct Factor.
 2. If Peak Result complies with AV limit, AV Result is deemed to comply with AV limit.
 3. Peak: Peak detector.
 4. Filter losses were only considered in the spurious frequency bands and the authorized band was not corrected for Band reject filter losses
 5. Proper operation of the transmitter prior to adding the filter to the measurement chain.



Test Result for Antenna WCT5H-20

HARMONICS AND SPURIOUS EMISSIONS (LOW CHANNEL, HORIZONTAL)

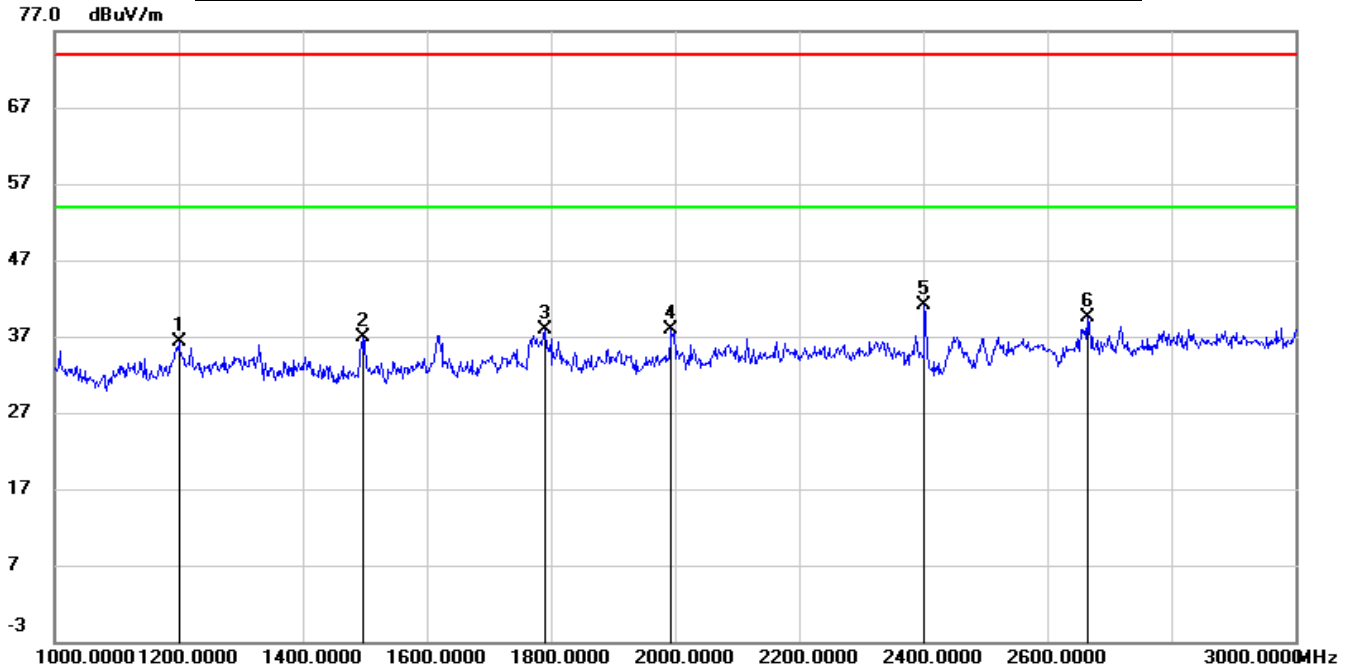

No.	Frequency (MHz)	Reading (dBuV)	Correct (dB/m)	Result (dBuV/m)	Limit (dBuV/m)	Margin (dB)	Remark
1	1200.000	48.92	-12.68	36.24	74.00	-37.76	peak
2	1498.000	49.12	-12.21	36.91	74.00	-37.09	peak
3	1790.000	47.99	-10.01	37.98	74.00	-36.02	peak
4	1994.000	47.71	-9.83	37.88	74.00	-36.12	peak
5	2402.000	49.04	-7.85	41.19	/	/	fundamental
6	2664.000	46.90	-7.34	39.56	74.00	-34.44	peak

- Note: 1. Peak Result = Reading Level + Correct Factor.
 2. If Peak Result complies with AV limit, AV Result is deemed to comply with AV limit.
 3. Peak: Peak detector.
 4. Filter losses were only considered in the spurious frequency bands and the authorized band was not corrected for Band reject filter losses
 5. Proper operation of the transmitter prior to adding the filter to the measurement chain.



HARMONICS AND SPURIOUS EMISSIONS (LOW CHANNEL, VERTICAL)

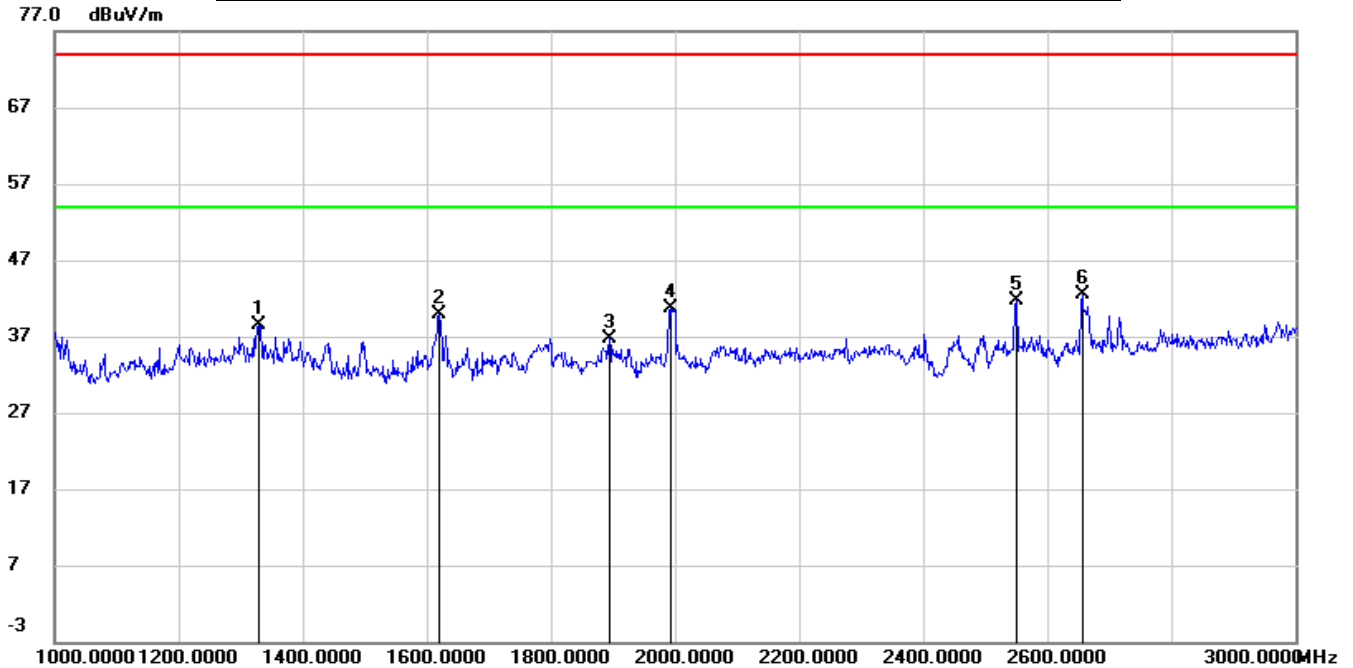

No.	Frequency (MHz)	Reading (dBuV)	Correct (dB/m)	Result (dBuV/m)	Limit (dBuV/m)	Margin (dB)	Remark
1	1328.000	50.77	-12.36	38.41	74.00	-35.59	peak
2	1620.000	51.24	-11.29	39.95	74.00	-34.05	peak
3	1894.000	46.75	-9.95	36.80	74.00	-37.20	peak
4	1992.000	50.54	-9.83	40.71	74.00	-33.29	peak
5	2550.000	49.05	-7.44	41.61	74.00	-32.39	peak
6	2656.000	49.82	-7.38	42.44	74.00	-31.56	peak

- Note: 1. Peak Result = Reading Level + Correct Factor.
 2. If Peak Result complies with AV limit, AV Result is deemed to comply with AV limit.
 3. Peak: Peak detector.
 4. Filter losses were only considered in the spurious frequency bands and the authorized band was not corrected for Band reject filter losses
 5. Proper operation of the transmitter prior to adding the filter to the measurement chain.



HARMONICS AND SPURIOUS EMISSIONS (MID CHANNEL, HORIZONTAL)

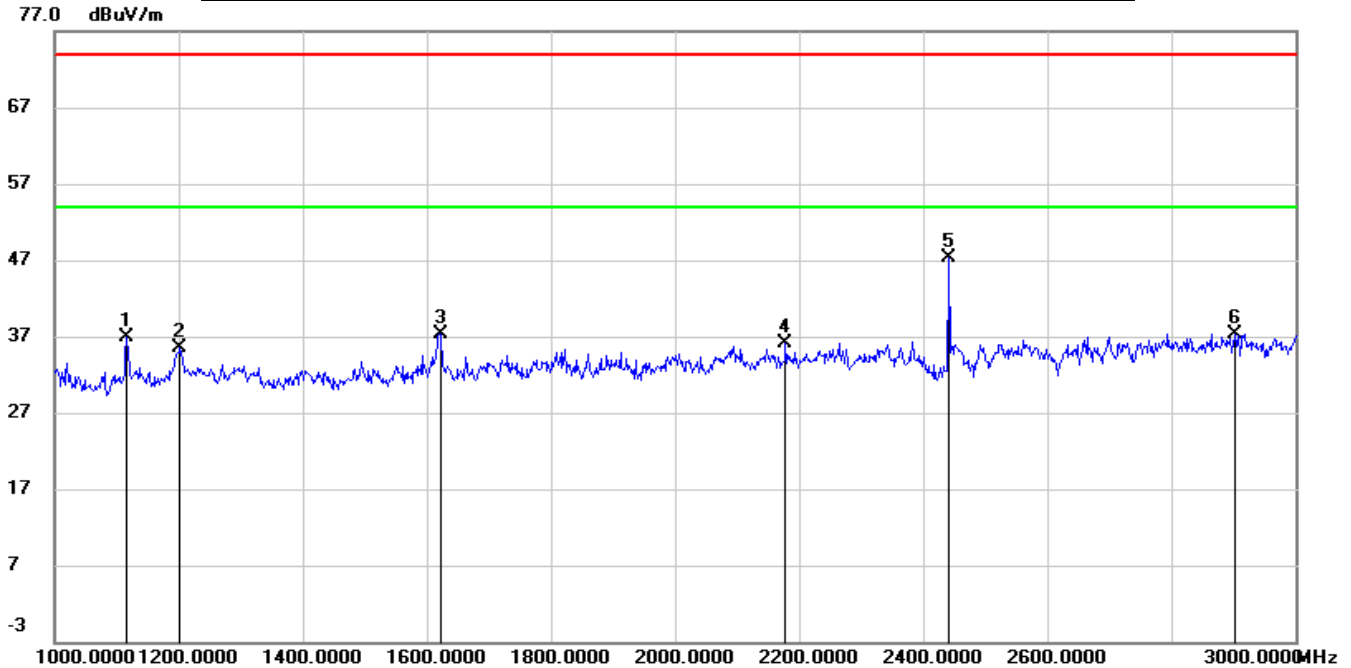

No.	Frequency (MHz)	Reading (dBuV)	Correct (dB/m)	Result (dBuV/m)	Limit (dBuV/m)	Margin (dB)	Remark
1	1116.000	50.20	-13.38	36.82	74.00	-37.18	peak
2	1202.000	48.15	-12.68	35.47	74.00	-38.53	peak
3	1622.000	48.63	-11.29	37.34	74.00	-36.66	peak
4	2178.000	44.80	-8.78	36.02	74.00	-37.98	peak
5	2441.000	54.93	-7.57	47.36	/	/	fundamental
6	2902.000	42.91	-5.51	37.40	74.00	-36.60	peak

- Note: 1. Peak Result = Reading Level + Correct Factor.
 2. If Peak Result complies with AV limit, AV Result is deemed to comply with AV limit.
 3. Peak: Peak detector.
 4. Filter losses were only considered in the spurious frequency bands and the authorized band was not corrected for Band reject filter losses
 5. Proper operation of the transmitter prior to adding the filter to the measurement chain.



HARMONICS AND SPURIOUS EMISSIONS (MID CHANNEL, VERTICAL)

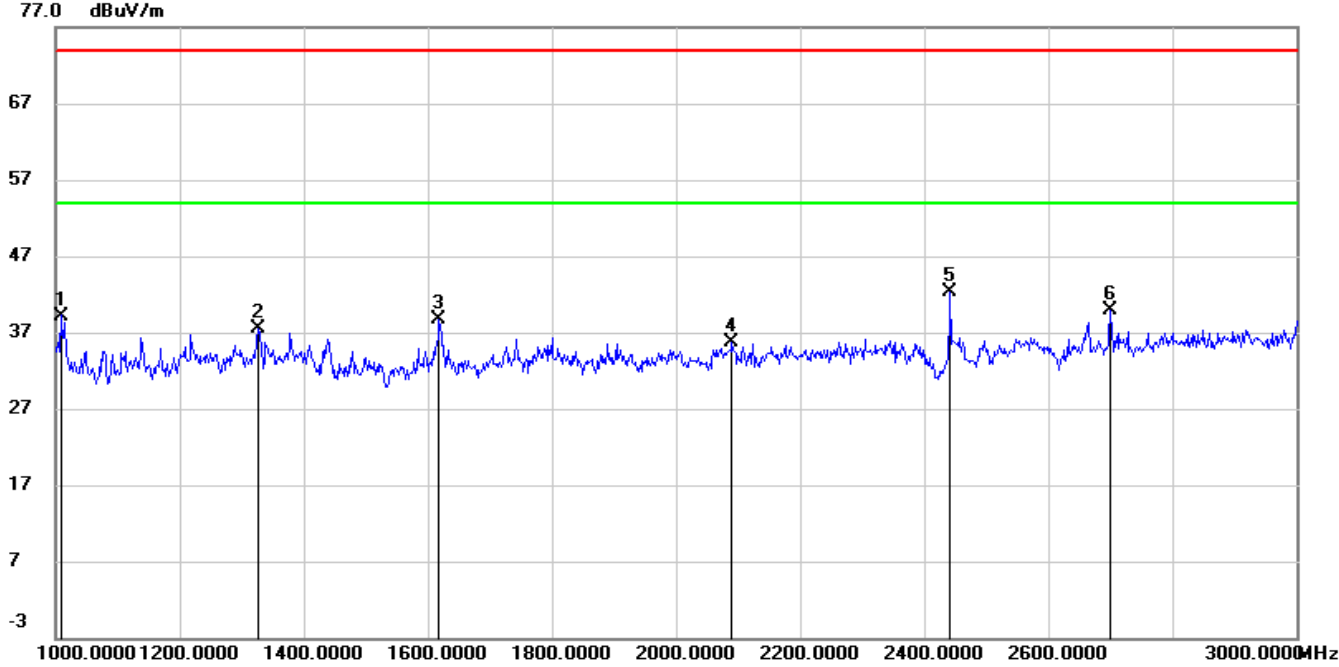

No.	Frequency (MHz)	Reading (dBuV)	Correct (dB/m)	Result (dBuV/m)	Limit (dBuV/m)	Margin (dB)	Remark
1	1008.000	52.79	-13.59	39.20	74.00	-34.80	peak
2	1326.000	49.77	-12.35	37.42	74.00	-36.58	peak
3	1618.000	50.01	-11.31	38.70	74.00	-35.30	peak
4	2090.000	44.97	-9.22	35.75	74.00	-38.25	peak
5	2441.000	49.78	-7.57	42.21	/	/	fundamental
6	2700.000	47.04	-7.13	39.91	74.00	-34.09	peak

- Note: 1. Peak Result = Reading Level + Correct Factor.
 2. If Peak Result complies with AV limit, AV Result is deemed to comply with AV limit.
 3. Peak: Peak detector.
 4. Filter losses were only considered in the spurious frequency bands and the authorized band was not corrected for Band reject filter losses
 5. Proper operation of the transmitter prior to adding the filter to the measurement chain.



HARMONICS AND SPURIOUS EMISSIONS (HIGH CHANNEL, HORIZONTAL)

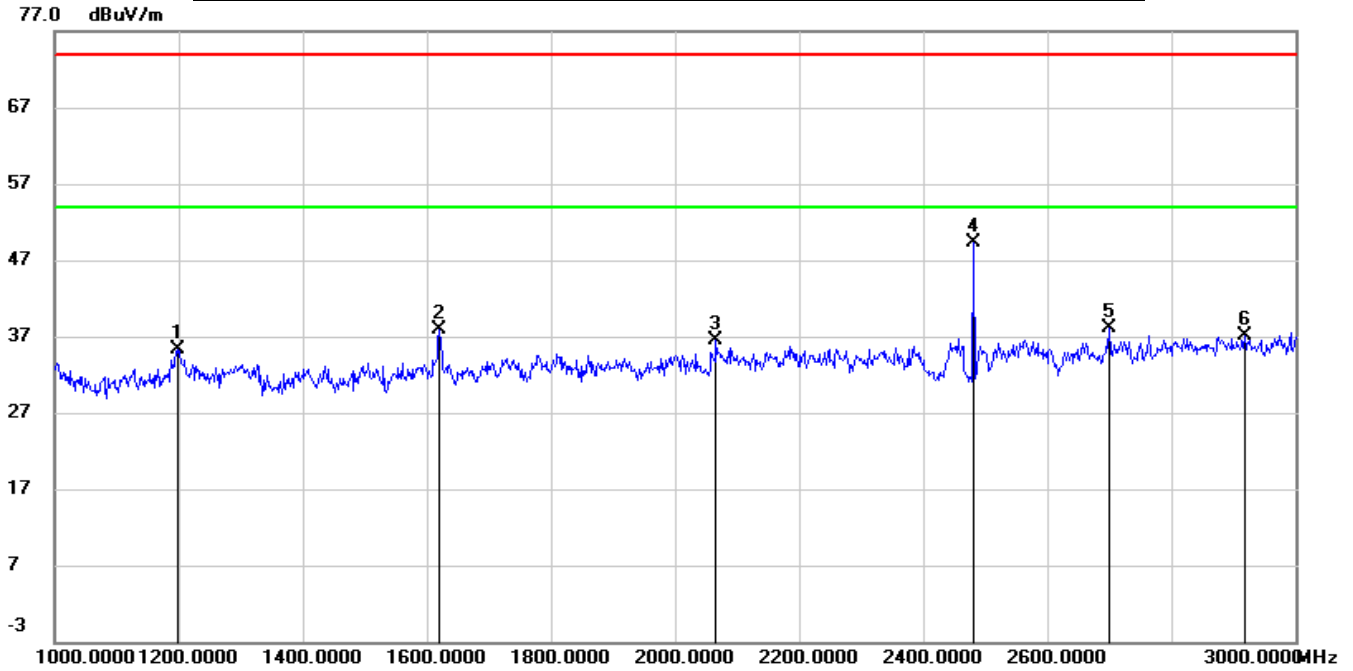

No.	Frequency (MHz)	Reading (dBuV)	Correct (dB/m)	Result (dBuV/m)	Limit (dBuV/m)	Margin (dB)	Remark
1	1198.000	47.98	-12.69	35.29	74.00	-38.71	peak
2	1620.000	49.16	-11.29	37.87	74.00	-36.13	peak
3	2066.000	45.98	-9.39	36.59	74.00	-37.41	peak
4	2480.000	56.66	-7.31	49.35	/	/	fundamental
5	2700.000	45.19	-7.13	38.06	74.00	-35.94	peak
6	2918.000	42.59	-5.48	37.11	74.00	-36.89	peak

- Note: 1. Peak Result = Reading Level + Correct Factor.
 2. If Peak Result complies with AV limit, AV Result is deemed to comply with AV limit.
 3. Peak: Peak detector.
 4. Filter losses were only considered in the spurious frequency bands and the authorized band was not corrected for Band reject filter losses
 5. Proper operation of the transmitter prior to adding the filter to the measurement chain.



HARMONICS AND SPURIOUS EMISSIONS (HIGH CHANNEL, VERTICAL)

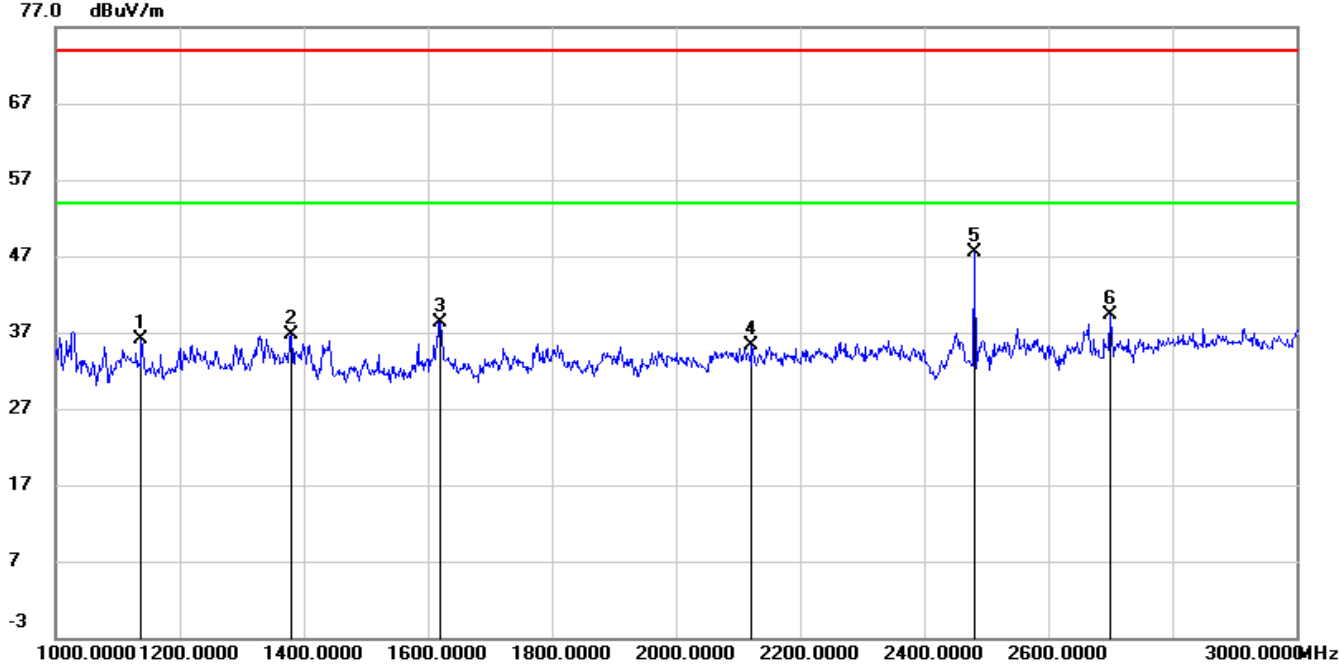

No.	Frequency (MHz)	Reading (dBuV)	Correct (dB/m)	Result (dBuV/m)	Limit (dBuV/m)	Margin (dB)	Remark
1	1138.000	49.21	-13.19	36.02	74.00	-37.98	peak
2	1380.000	49.14	-12.38	36.76	74.00	-37.24	peak
3	1620.000	49.65	-11.29	38.36	74.00	-35.64	peak
4	2122.000	44.35	-9.05	35.30	74.00	-38.70	peak
5	2480.000	54.84	-7.31	47.53	/	/	fundamental
6	2700.000	46.45	-7.13	39.32	74.00	-34.68	peak

- Note:
1. Peak Result = Reading Level + Correct Factor.
 2. If Peak Result complies with AV limit, AV Result is deemed to comply with AV limit.
 3. Peak: Peak detector.
 4. Filter losses were only considered in the spurious frequency bands and the authorized band was not corrected for Band reject filter losses
 5. Proper operation of the transmitter prior to adding the filter to the measurement chain.



8.3.2. 8DPSK MODE

Test Result for Antenna WCT5J-20

HARMONICS AND SPURIOUS EMISSIONS (LOW CHANNEL, HORIZONTAL)

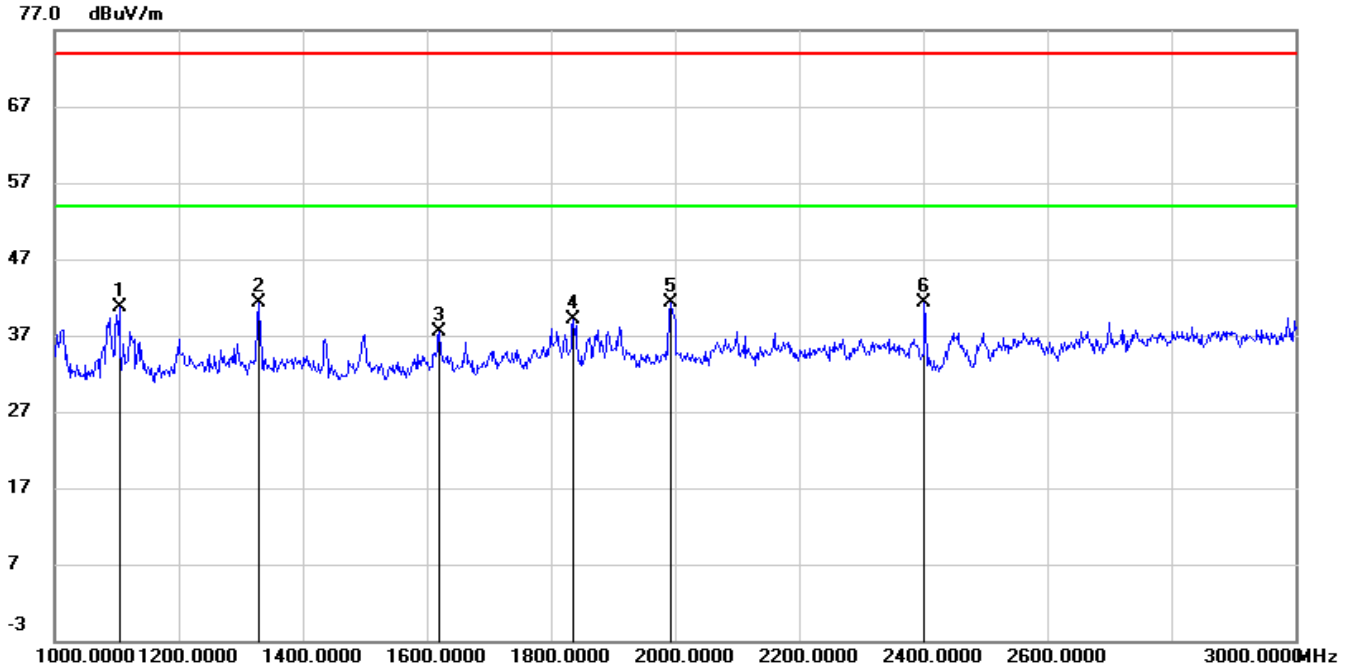

No.	Frequency (MHz)	Reading (dBuV)	Correct (dB/m)	Result (dBuV/m)	Limit (dBuV/m)	Margin (dB)	Remark
1	1104.000	54.10	-13.48	40.62	74.00	-33.38	peak
2	1328.000	53.66	-12.36	41.30	74.00	-32.70	peak
3	1620.000	48.70	-11.29	37.41	74.00	-36.59	peak
4	1836.000	48.96	-9.92	39.04	74.00	-34.96	peak
5	1992.000	51.06	-9.83	41.23	74.00	-32.77	peak
6	2402.000	49.11	-7.85	41.26	/	/	fundamental

- Note:
1. Peak Result = Reading Level + Correct Factor.
 2. If Peak Result complies with AV limit, AV Result is deemed to comply with AV limit.
 3. Peak: Peak detector.
 4. Filter losses were only considered in the spurious frequency bands and the authorized band was not corrected for Band reject filter losses
 5. Proper operation of the transmitter prior to adding the filter to the measurement chain.



HARMONICS AND SPURIOUS EMISSIONS (LOW CHANNEL, VERTICAL)

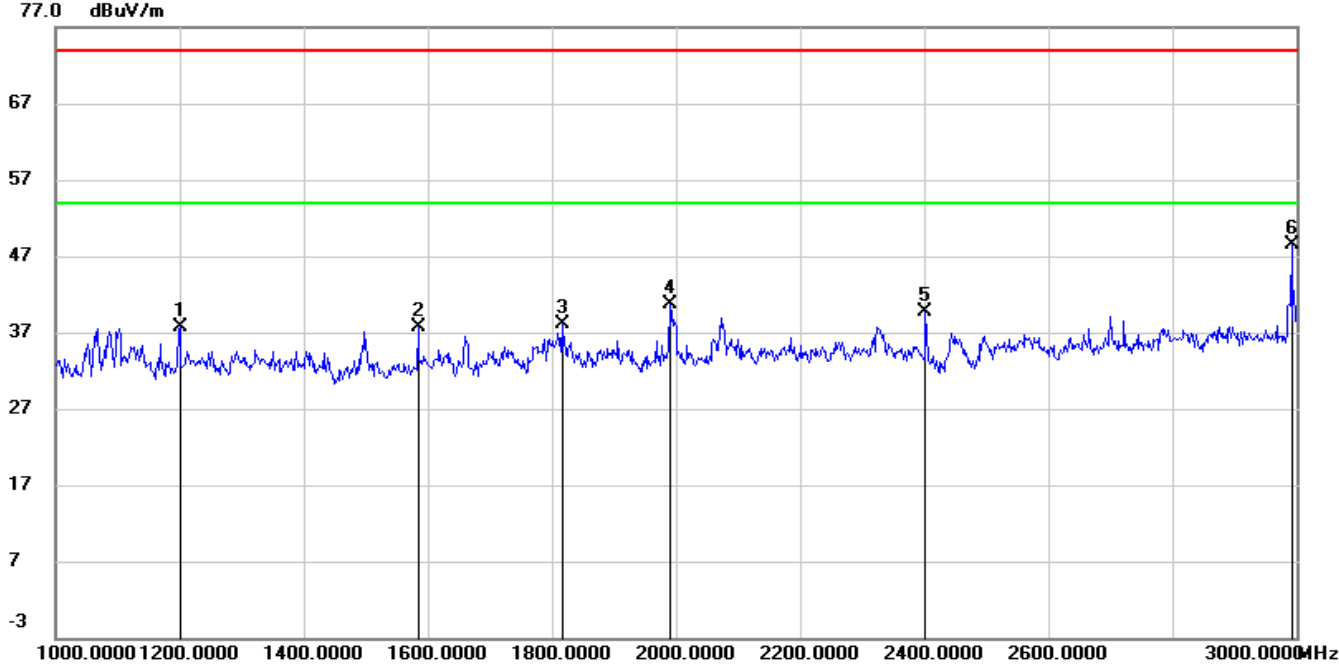

No.	Frequency (MHz)	Reading (dBuV)	Correct (dB/m)	Result (dBuV/m)	Limit (dBuV/m)	Margin (dB)	Remark
1	1200.000	50.46	-12.68	37.78	74.00	-36.22	peak
2	1584.000	49.18	-11.53	37.65	74.00	-36.35	peak
3	1816.000	48.07	-9.92	38.15	74.00	-35.85	peak
4	1990.000	50.57	-9.84	40.73	74.00	-33.27	peak
5	2402.000	47.55	-7.85	39.70	/	/	fundamental
6	2992.000	53.82	-5.31	48.51	74.00	-25.49	peak

- Note: 1. Peak Result = Reading Level + Correct Factor.
 2. If Peak Result complies with AV limit, AV Result is deemed to comply with AV limit.
 3. Peak: Peak detector.
 4. Filter losses were only considered in the spurious frequency bands and the authorized band was not corrected for Band reject filter losses
 5. Proper operation of the transmitter prior to adding the filter to the measurement chain.

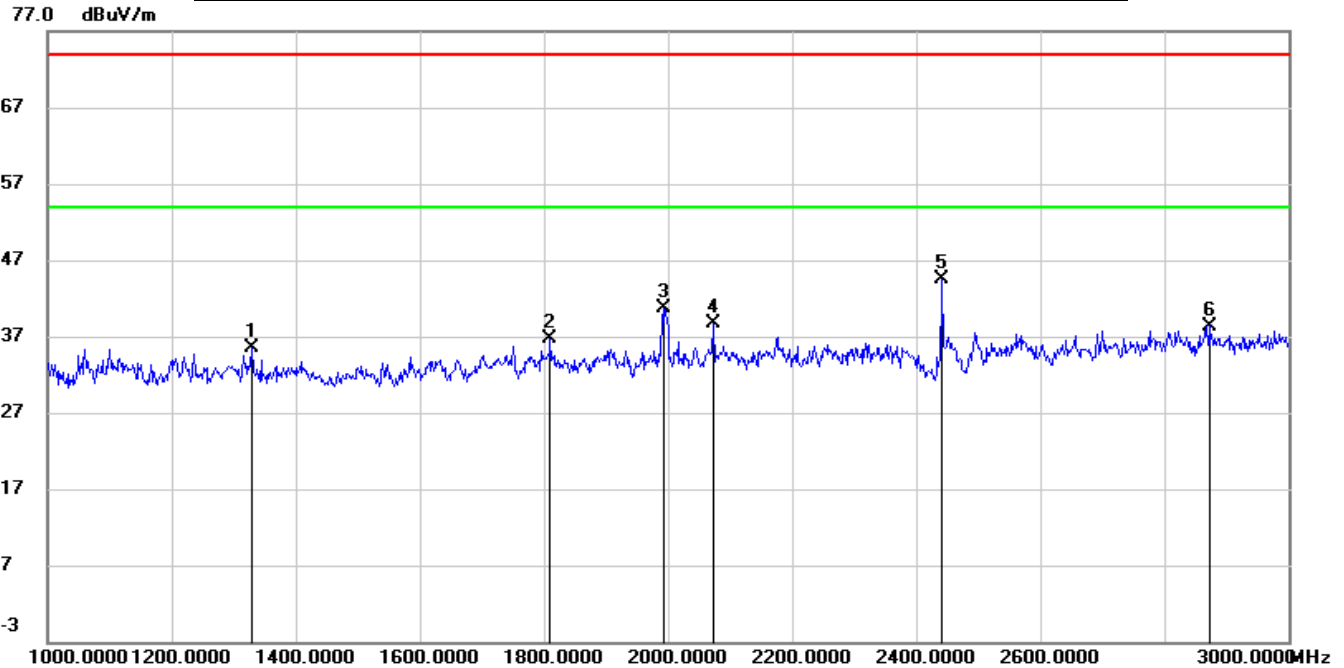
**HARMONICS AND SPURIOUS EMISSIONS (MID CHANNEL, HORIZONTAL)**

No.	Frequency (MHz)	Reading (dBuV)	Correct (dB/m)	Result (dBuV/m)	Limit (dBuV/m)	Margin (dB)	Remark
1	1328.000	47.88	-12.36	35.52	74.00	-38.48	peak
2	1810.000	46.68	-9.92	36.76	74.00	-37.24	peak
3	1992.000	50.57	-9.83	40.74	74.00	-33.26	peak
4	2072.000	48.02	-9.34	38.68	74.00	-35.32	peak
5	2441.000	52.13	-7.57	44.56	/	/	fundamental
6	2872.000	44.07	-5.67	38.40	74.00	-35.60	peak

- Note: 1. Peak Result = Reading Level + Correct Factor.
 2. If Peak Result complies with AV limit, AV Result is deemed to comply with AV limit.
 3. Peak: Peak detector.
 4. Filter losses were only considered in the spurious frequency bands and the authorized band was not corrected for Band reject filter losses
 5. Proper operation of the transmitter prior to adding the filter to the measurement chain.



HARMONICS AND SPURIOUS EMISSIONS (MID CHANNEL, VERTICAL)

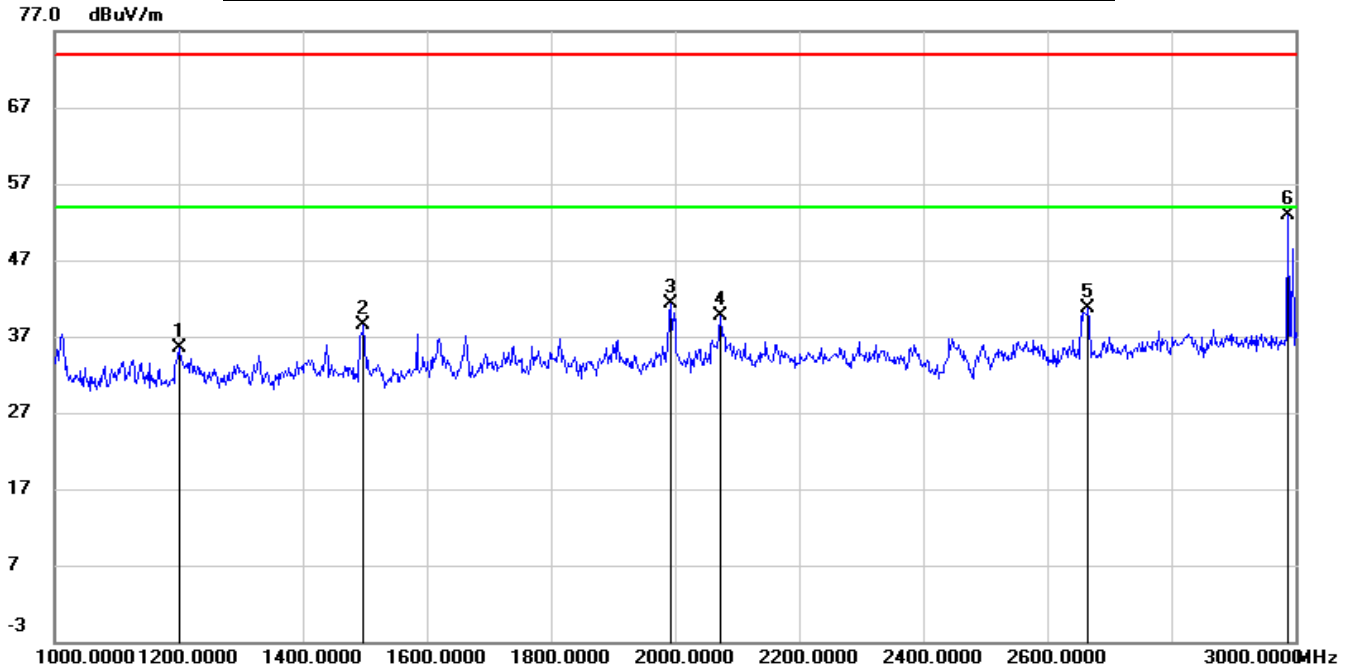

No.	Frequency (MHz)	Reading (dBuV)	Correct (dB/m)	Result (dBuV/m)	Limit (dBuV/m)	Margin (dB)	Remark
1	1200.000	48.16	-12.68	35.48	74.00	-38.52	peak
2	1498.000	50.79	-12.21	38.58	74.00	-35.42	peak
3	1992.000	51.23	-9.83	41.40	74.00	-32.60	peak
4	2072.000	49.06	-9.34	39.72	74.00	-34.28	peak
5	2666.000	47.97	-7.32	40.65	74.00	-33.35	peak
6	2988.000	58.31	-5.33	52.98	74.00	-21.02	peak

- Note: 1. Peak Result = Reading Level + Correct Factor.
 2. If Peak Result complies with AV limit, AV Result is deemed to comply with AV limit.
 3. Peak: Peak detector.
 4. Filter losses were only considered in the spurious frequency bands and the authorized band was not corrected for Band reject filter losses
 5. Proper operation of the transmitter prior to adding the filter to the measurement chain.



HARMONICS AND SPURIOUS EMISSIONS (HIGH CHANNEL, HORIZONTAL)

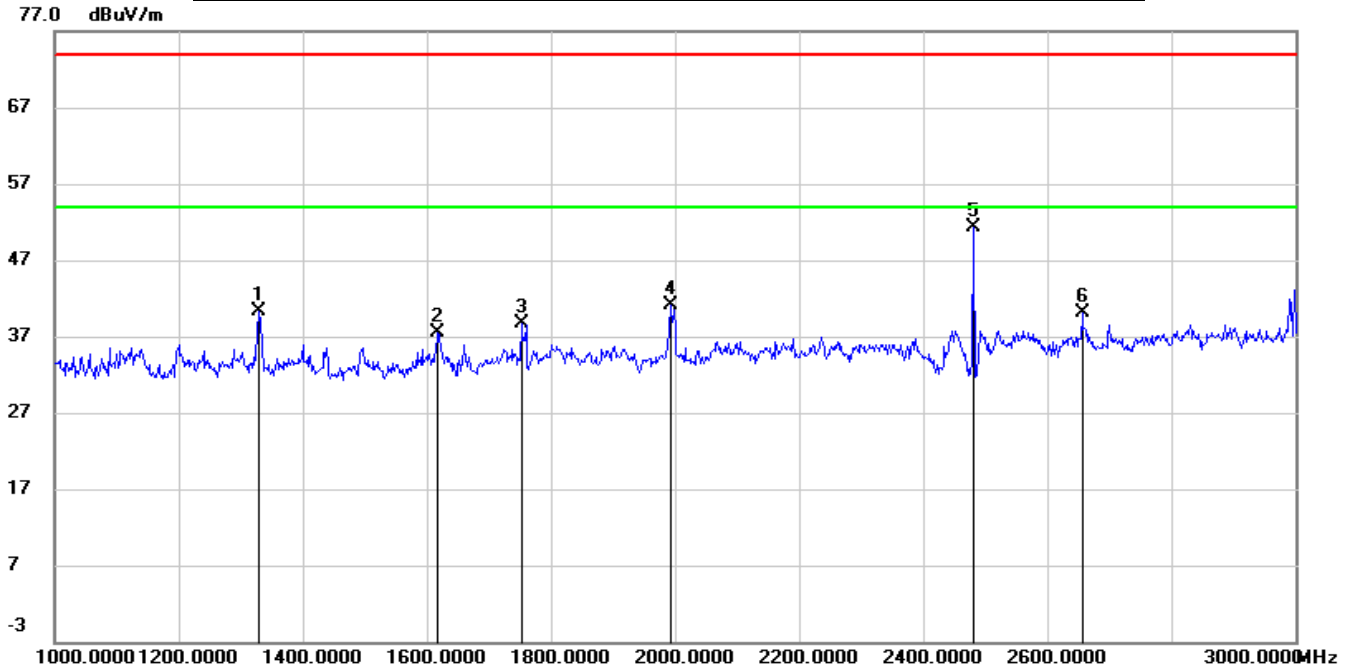

No.	Frequency (MHz)	Reading (dBuV)	Correct (dB/m)	Result (dBuV/m)	Limit (dBuV/m)	Margin (dB)	Remark
1	1328.000	52.57	-12.36	40.21	74.00	-33.79	peak
2	1618.000	48.86	-11.31	37.55	74.00	-36.45	peak
3	1752.000	49.12	-10.39	38.73	74.00	-35.27	peak
4	1992.000	50.85	-9.83	41.02	74.00	-32.98	peak
5	2480.000	58.70	-7.31	51.39	/	/	fundamental
6	2656.000	47.48	-7.38	40.10	74.00	-33.90	peak

- Note: 1. Peak Result = Reading Level + Correct Factor.
 2. If Peak Result complies with AV limit, AV Result is deemed to comply with AV limit.
 3. Peak: Peak detector.
 4. Filter losses were only considered in the spurious frequency bands and the authorized band was not corrected for Band reject filter losses
 5. Proper operation of the transmitter prior to adding the filter to the measurement chain.



HARMONICS AND SPURIOUS EMISSIONS (HIGH CHANNEL, VERTICAL)

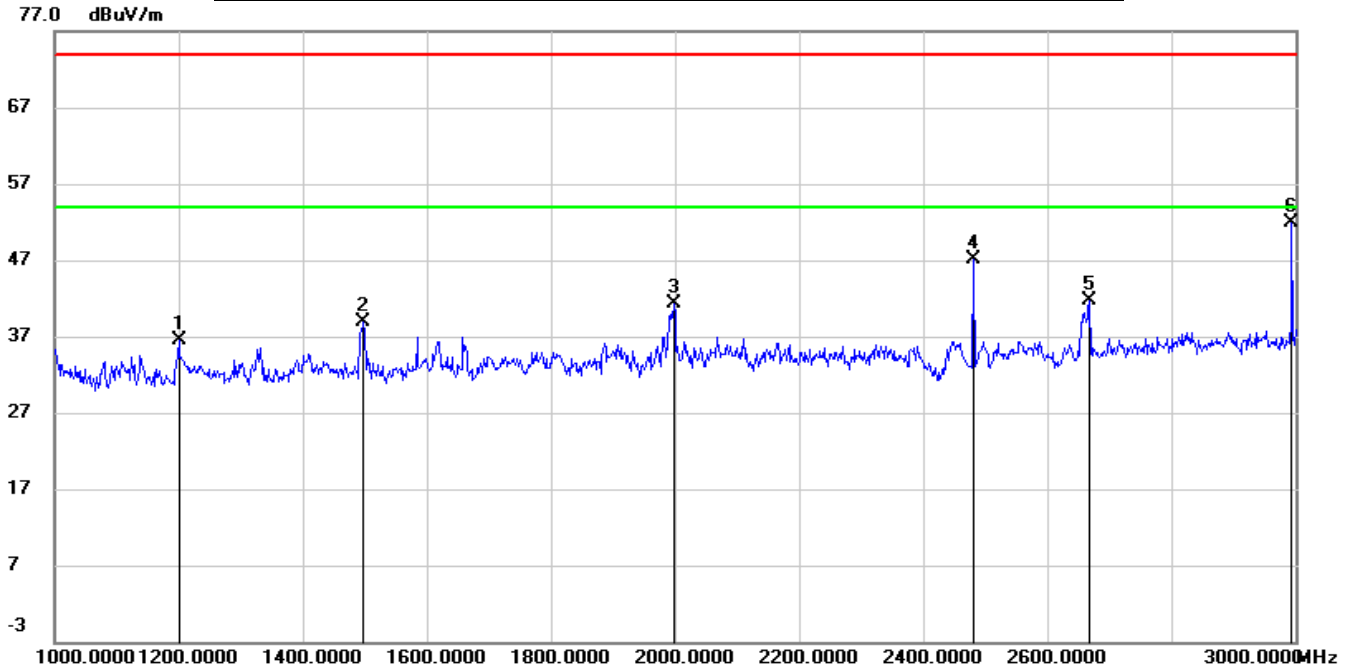

No.	Frequency (MHz)	Reading (dBuV)	Correct (dB/m)	Result (dBuV/m)	Limit (dBuV/m)	Margin (dB)	Remark
1	1200.000	49.18	-12.68	36.50	74.00	-37.50	peak
2	1498.000	51.20	-12.21	38.99	74.00	-35.01	peak
3	1998.000	51.10	-9.83	41.27	74.00	-32.73	peak
4	2480.000	54.47	-7.31	47.16	/	/	fundamental
5	2668.000	48.94	-7.32	41.62	74.00	-32.38	peak
6	2994.000	57.19	-5.31	51.88	74.00	-22.12	peak

- Note: 1. Peak Result = Reading Level + Correct Factor.
 2. If Peak Result complies with AV limit, AV Result is deemed to comply with AV limit.
 3. Peak: Peak detector.
 4. Filter losses were only considered in the spurious frequency bands and the authorized band was not corrected for Band reject filter losses
 5. Proper operation of the transmitter prior to adding the filter to the measurement chain.



Test Result for Antenna WCT5H-20

HARMONICS AND SPURIOUS EMISSIONS (LOW CHANNEL, HORIZONTAL)

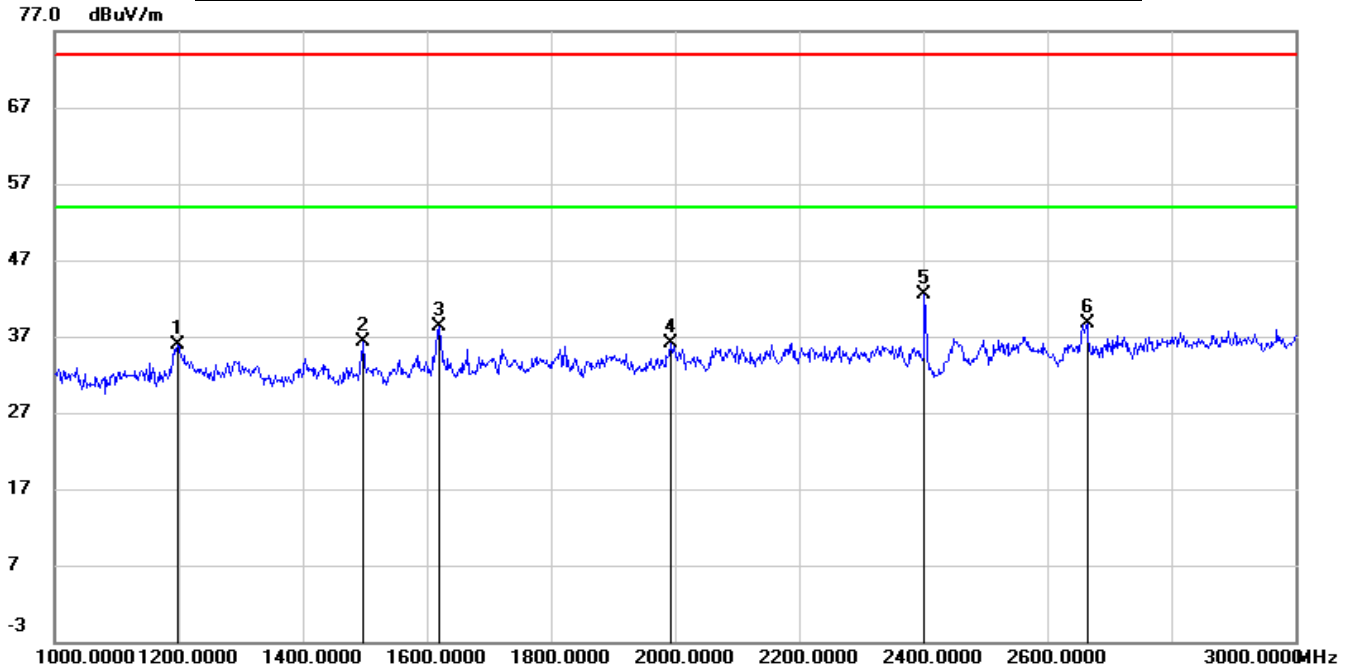

No.	Frequency (MHz)	Reading (dBuV)	Correct (dB/m)	Result (dBuV/m)	Limit (dBuV/m)	Margin (dB)	Remark
1	1198.000	48.64	-12.69	35.95	74.00	-38.05	peak
2	1498.000	48.55	-12.21	36.34	74.00	-37.66	peak
3	1620.000	49.52	-11.29	38.23	74.00	-35.77	peak
4	1992.000	46.02	-9.83	36.19	74.00	-37.81	peak
5	2402.000	50.34	-7.85	42.49	/	/	fundamental
6	2664.000	45.96	-7.34	38.62	74.00	-35.38	peak

- Note: 1. Peak Result = Reading Level + Correct Factor.
 2. If Peak Result complies with AV limit, AV Result is deemed to comply with AV limit.
 3. Peak: Peak detector.
 4. Filter losses were only considered in the spurious frequency bands and the authorized band was not corrected for Band reject filter losses
 5. Proper operation of the transmitter prior to adding the filter to the measurement chain.



HARMONICS AND SPURIOUS EMISSIONS (LOW CHANNEL, VERTICAL)

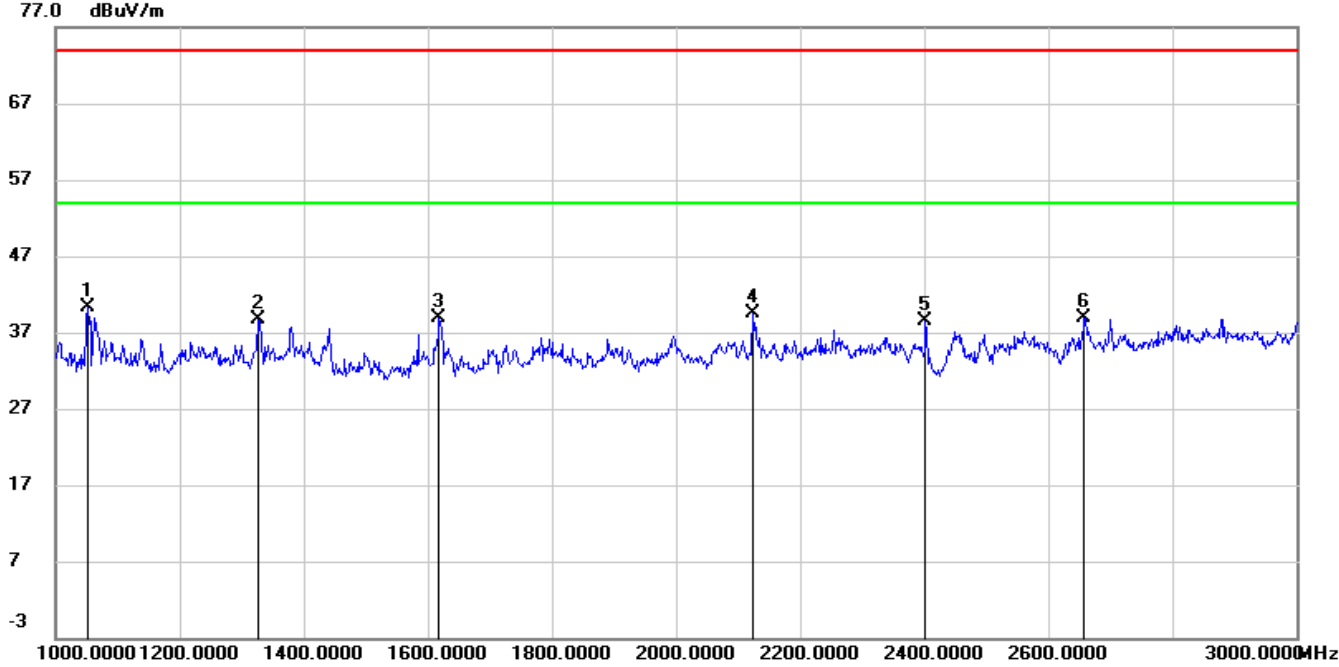

No.	Frequency (MHz)	Reading (dBuV)	Correct (dB/m)	Result (dBuV/m)	Limit (dBuV/m)	Margin (dB)	Remark
1	1052.000	53.83	-13.56	40.27	74.00	-33.73	peak
2	1326.000	51.01	-12.35	38.66	74.00	-35.34	peak
3	1618.000	50.16	-11.31	38.85	74.00	-35.15	peak
4	2124.000	48.56	-9.04	39.52	74.00	-34.48	peak
5	2402.000	46.29	-7.85	38.44	/	/	fundamental
6	2658.000	46.36	-7.37	38.99	74.00	-35.01	peak

- Note: 1. Peak Result = Reading Level + Correct Factor.
 2. If Peak Result complies with AV limit, AV Result is deemed to comply with AV limit.
 3. Peak: Peak detector.
 4. Filter losses were only considered in the spurious frequency bands and the authorized band was not corrected for Band reject filter losses
 5. Proper operation of the transmitter prior to adding the filter to the measurement chain.



HARMONICS AND SPURIOUS EMISSIONS (MID CHANNEL, HORIZONTAL)

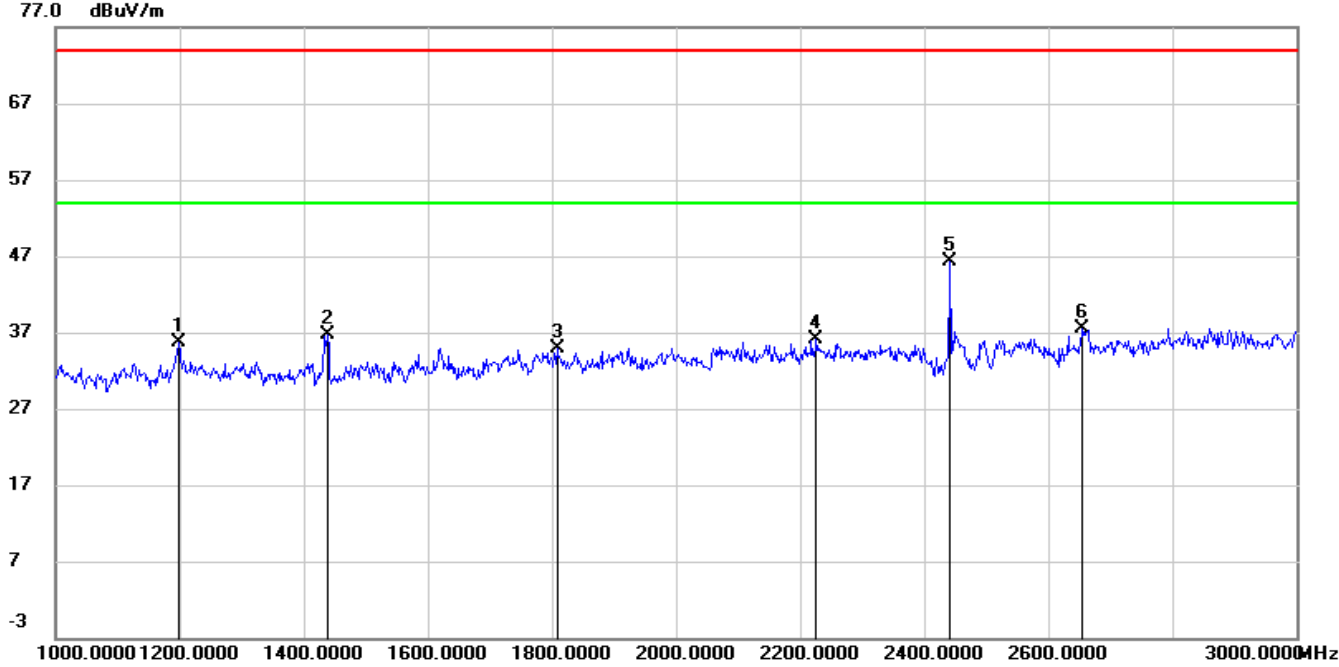

No.	Frequency (MHz)	Reading (dBuV)	Correct (dB/m)	Result (dBuV/m)	Limit (dBuV/m)	Margin (dB)	Remark
1	1198.000	48.32	-12.69	35.63	74.00	-38.37	peak
2	1438.000	49.08	-12.32	36.76	74.00	-37.24	peak
3	1808.000	44.81	-9.92	34.89	74.00	-39.11	peak
4	2226.000	44.61	-8.54	36.07	74.00	-37.93	peak
5	2441.000	53.89	-7.57	46.32	/	/	fundamental
6	2654.000	44.92	-7.39	37.53	74.00	-36.47	peak

- Note: 1. Peak Result = Reading Level + Correct Factor.
 2. If Peak Result complies with AV limit, AV Result is deemed to comply with AV limit.
 3. Peak: Peak detector.
 4. Filter losses were only considered in the spurious frequency bands and the authorized band was not corrected for Band reject filter losses
 5. Proper operation of the transmitter prior to adding the filter to the measurement chain.



HARMONICS AND SPURIOUS EMISSIONS (MID CHANNEL, VERTICAL)

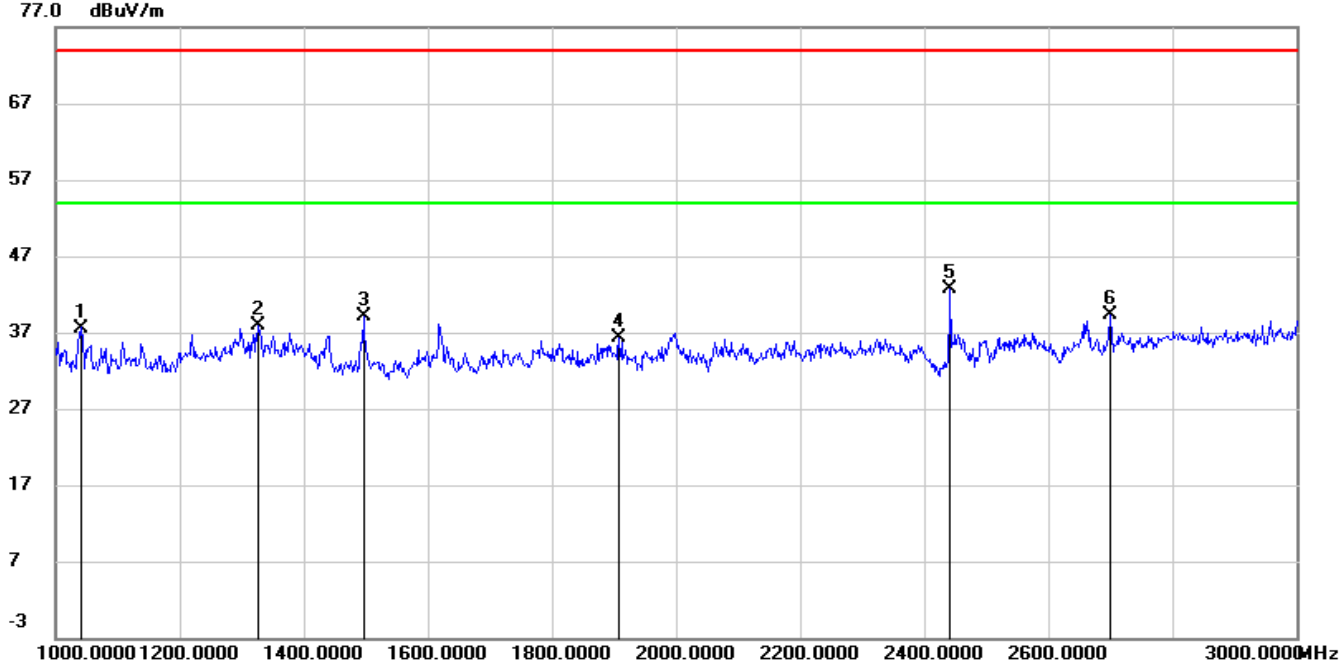

No.	Frequency (MHz)	Reading (dBuV)	Correct (dB/m)	Result (dBuV/m)	Limit (dBuV/m)	Margin (dB)	Remark
1	1040.000	51.17	-13.57	37.60	74.00	-36.40	peak
2	1326.000	50.23	-12.35	37.88	74.00	-36.12	peak
3	1496.000	51.27	-12.22	39.05	74.00	-34.95	peak
4	1908.000	46.26	-9.94	36.32	74.00	-37.68	peak
5	2441.000	50.25	-7.57	42.68	/	/	fundamental
6	2700.000	46.34	-7.13	39.21	74.00	-34.79	peak

- Note: 1. Peak Result = Reading Level + Correct Factor.
 2. If Peak Result complies with AV limit, AV Result is deemed to comply with AV limit.
 3. Peak: Peak detector.
 4. Filter losses were only considered in the spurious frequency bands and the authorized band was not corrected for Band reject filter losses
 5. Proper operation of the transmitter prior to adding the filter to the measurement chain.



HARMONICS AND SPURIOUS EMISSIONS (HIGH CHANNEL, HORIZONTAL)

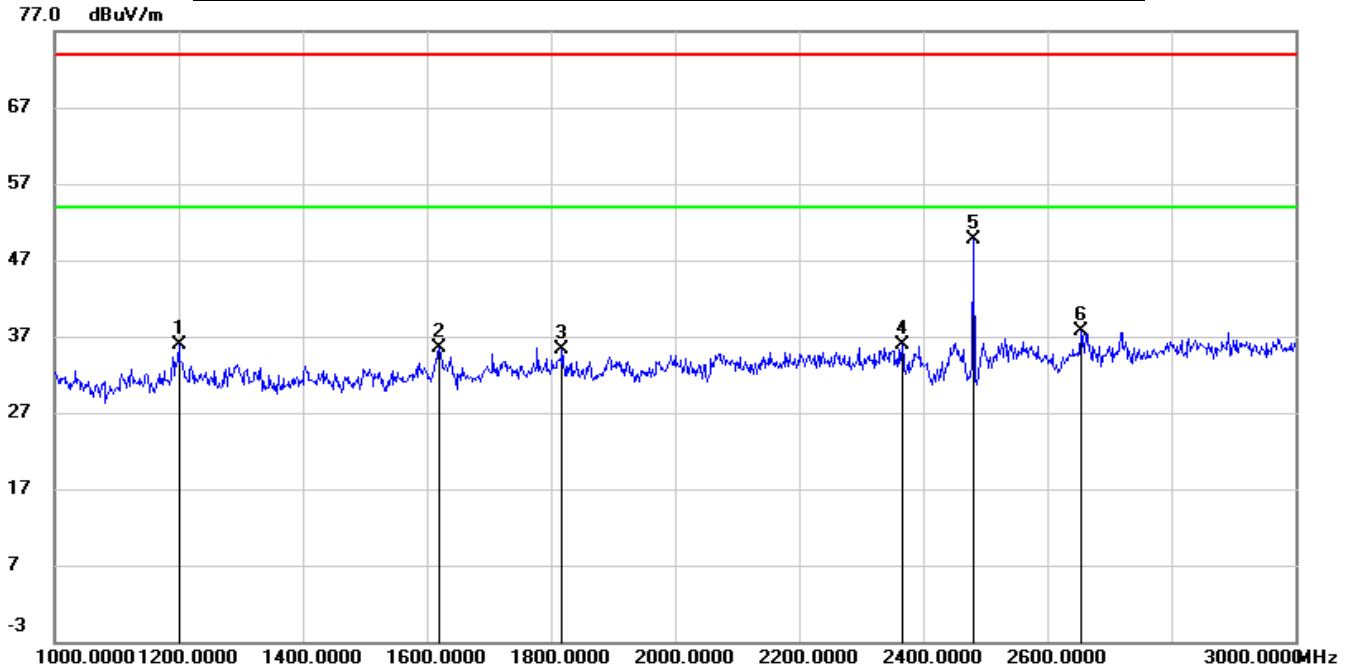

No.	Frequency (MHz)	Reading (dBuV)	Correct (dB/m)	Result (dBuV/m)	Limit (dBuV/m)	Margin (dB)	Remark
1	1200.000	48.53	-12.68	35.85	74.00	-38.15	peak
2	1620.000	46.70	-11.29	35.41	74.00	-38.59	peak
3	1818.000	45.24	-9.92	35.32	74.00	-38.68	peak
4	2366.000	43.83	-7.97	35.86	74.00	-38.14	peak
5	2480.000	57.01	-7.31	49.70	/	/	fundamental
6	2654.000	45.09	-7.39	37.70	74.00	-36.30	peak

- Note: 1. Peak Result = Reading Level + Correct Factor.
 2. If Peak Result complies with AV limit, AV Result is deemed to comply with AV limit.
 3. Peak: Peak detector.
 4. Filter losses were only considered in the spurious frequency bands and the authorized band was not corrected for Band reject filter losses
 5. Proper operation of the transmitter prior to adding the filter to the measurement chain.



HARMONICS AND SPURIOUS EMISSIONS (HIGH CHANNEL, VERTICAL)

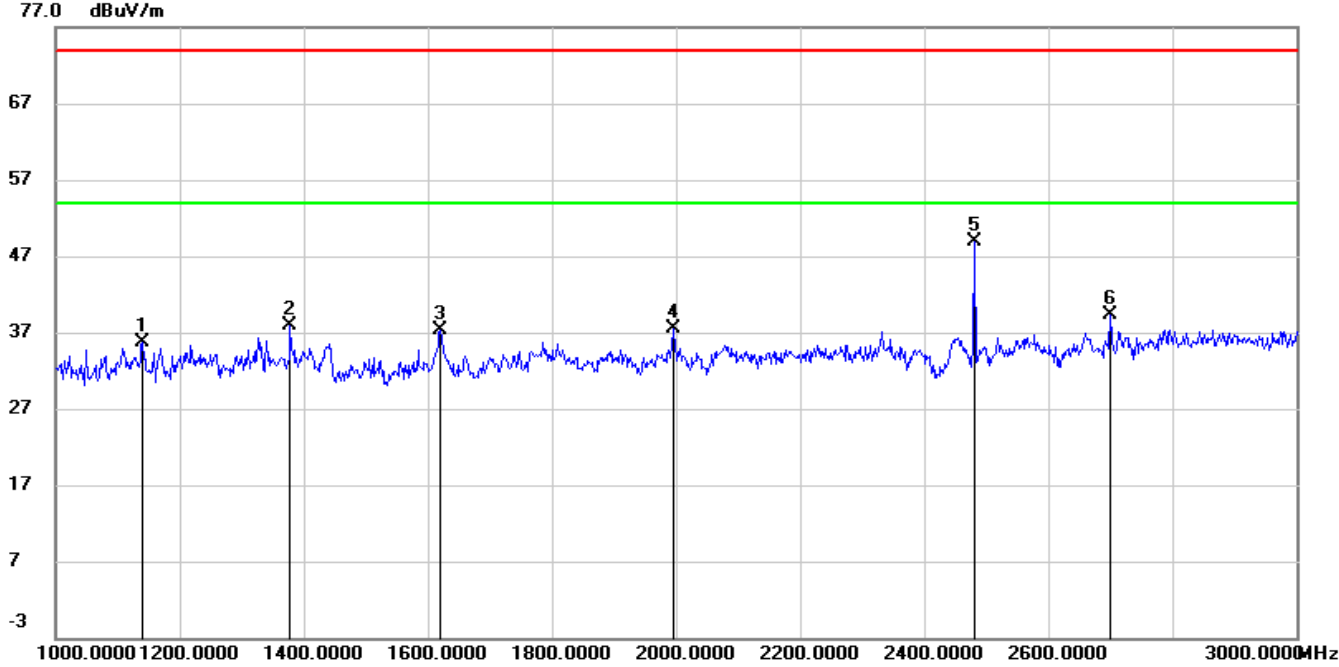

No.	Frequency (MHz)	Reading (dBuV)	Correct (dB/m)	Result (dBuV/m)	Limit (dBuV/m)	Margin (dB)	Remark
1	1140.000	48.90	-13.19	35.71	74.00	-38.29	peak
2	1378.000	50.24	-12.38	37.86	74.00	-36.14	peak
3	1620.000	48.51	-11.29	37.22	74.00	-36.78	peak
4	1996.000	47.28	-9.83	37.45	74.00	-36.55	peak
5	2480.000	56.25	-7.31	48.94	/	/	fundamental
6	2700.000	46.49	-7.13	39.36	74.00	-34.64	peak

- Note: 1. Peak Result = Reading Level + Correct Factor.
 2. If Peak Result complies with AV limit, AV Result is deemed to comply with AV limit.
 3. Peak: Peak detector.
 4. Filter losses were only considered in the spurious frequency bands and the authorized band was not corrected for Band reject filter losses
 5. Proper operation of the transmitter prior to adding the filter to the measurement chain.



8.4. SPURIOUS EMISSIONS (3~18GHz)

8.4.1. GFSK MODE

Test Result for Antenna WCT5J-20

HARMONICS AND SPURIOUS EMISSIONS (LOW CHANNEL, HORIZONTAL)

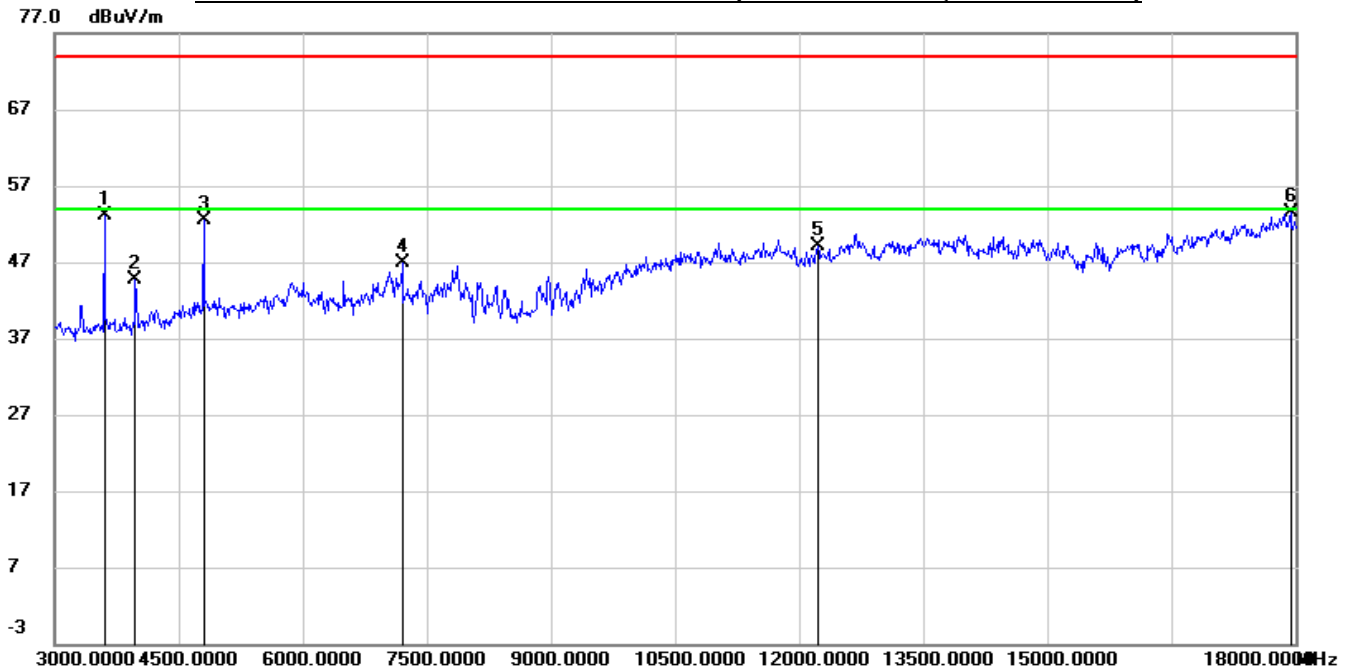

No.	Frequency (MHz)	Reading (dBuV)	Correct (dB/m)	Result (dBuV/m)	Limit (dBuV/m)	Margin (dB)	Remark
1	3600.000	56.57	-3.52	53.05	74.00	-20.95	peak
2	3975.000	47.68	-2.90	44.78	74.00	-29.22	peak
3	4800.000	52.06	0.46	52.52	74.00	-21.48	peak
4	7200.000	41.04	5.82	46.86	74.00	-27.14	peak
5	12225.000	35.31	13.81	49.12	74.00	-24.88	peak
6	17940.000	30.11	23.39	53.50	74.00	-20.50	peak

- Note: 1. Peak Result = Reading Level + Correct Factor.
 2. If Peak Result complies with AV limit, AV Result is deemed to comply with AV limit.
 3. Peak: Peak detector.
 4. Filter losses were only considered in the spurious frequency bands and the authorized band was not corrected for High Pass Filter losses.
 5. Proper operation of the transmitter prior to adding the filter to the measurement chain.



HARMONICS AND SPURIOUS EMISSIONS (LOW CHANNEL, VERTICAL)

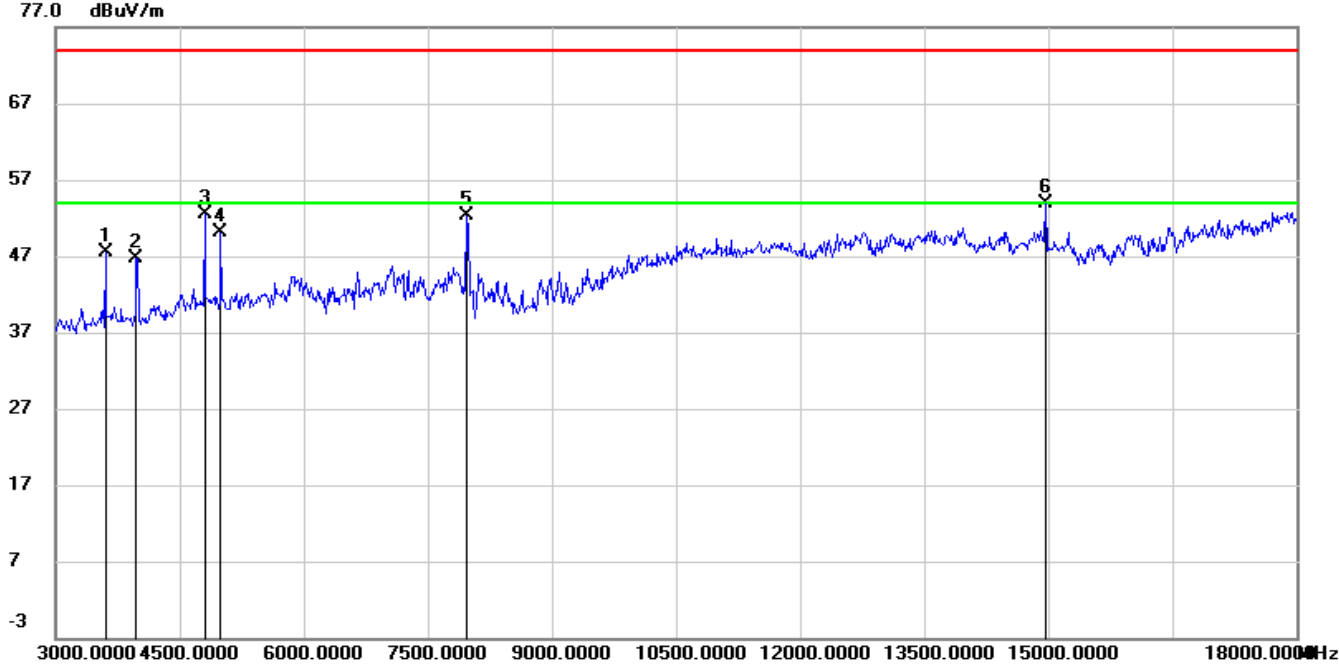

No.	Frequency (MHz)	Reading (dBuV)	Correct (dB/m)	Result (dBuV/m)	Limit (dBuV/m)	Margin (dB)	Remark
1	3600.000	50.93	-3.52	47.41	74.00	-26.59	peak
2	3975.000	49.66	-2.90	46.76	74.00	-27.24	peak
3	4800.000	52.11	0.46	52.57	74.00	-21.43	peak
4	4995.000	48.75	1.37	50.12	74.00	-23.88	peak
5	7965.000	45.35	7.00	52.35	74.00	-21.65	peak
6	14970.000	37.93	15.98	53.91	74.00	-20.09	peak

- Note: 1. Peak Result = Reading Level + Correct Factor.
 2. If Peak Result complies with AV limit, AV Result is deemed to comply with AV limit.
 3. Peak: Peak detector.
 4. Filter losses were only considered in the spurious frequency bands and the authorized band was not corrected for High Pass Filter losses.
 5. Proper operation of the transmitter prior to adding the filter to the measurement chain.



HARMONICS AND SPURIOUS EMISSIONS (MID CHANNEL, HORIZONTAL)

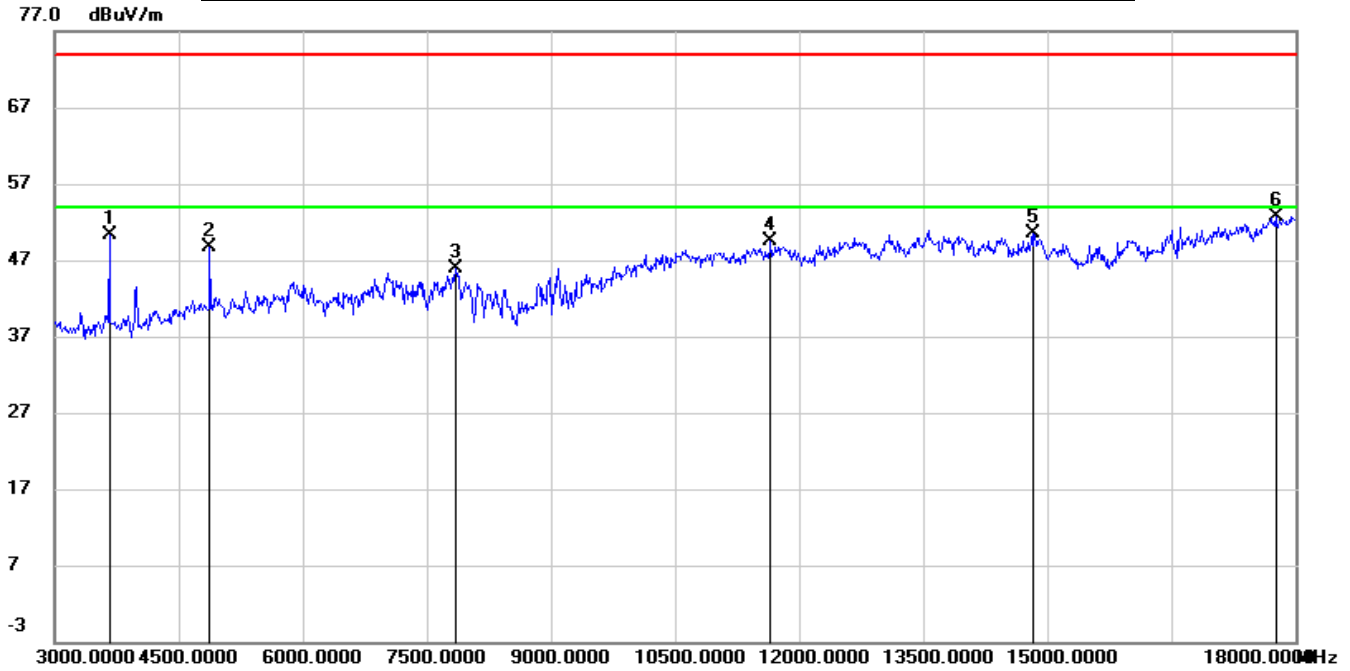

No.	Frequency (MHz)	Reading (dBuV)	Correct (dB/m)	Result (dBuV/m)	Limit (dBuV/m)	Margin (dB)	Remark
1	3660.000	53.28	-3.05	50.23	74.00	-23.77	peak
2	4875.000	47.89	0.76	48.65	74.00	-25.35	peak
3	7845.000	38.21	7.62	45.83	74.00	-28.17	peak
4	11655.000	36.42	13.06	49.48	74.00	-24.52	peak
5	14820.000	34.58	15.94	50.52	74.00	-23.48	peak
6	17760.000	29.81	22.95	52.76	74.00	-21.24	peak

- Note: 1. Peak Result = Reading Level + Correct Factor.
 2. If Peak Result complies with AV limit, AV Result is deemed to comply with AV limit.
 3. Peak: Peak detector.
 4. Filter losses were only considered in the spurious frequency bands and the authorized band was not corrected for High Pass Filter losses.
 5. Proper operation of the transmitter prior to adding the filter to the measurement chain.



HARMONICS AND SPURIOUS EMISSIONS (MID CHANNEL, VERTICAL)

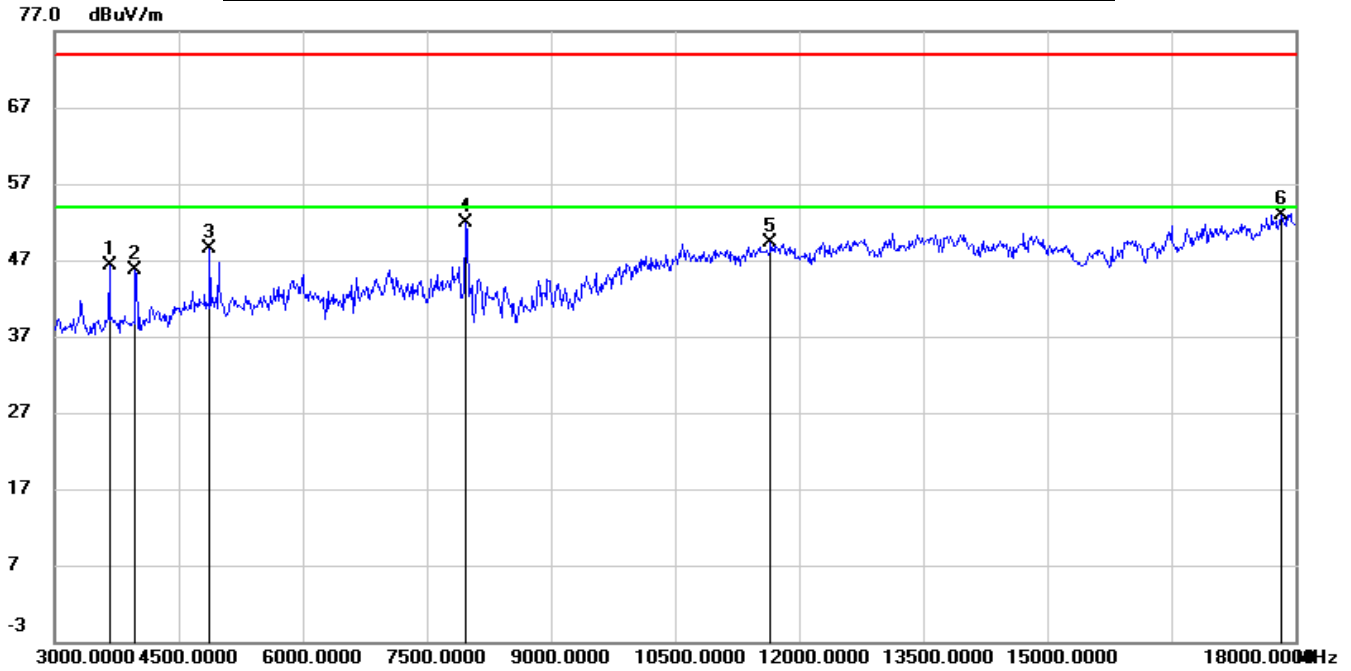

No.	Frequency (MHz)	Reading (dBuV)	Correct (dB/m)	Result (dBuV/m)	Limit (dBuV/m)	Margin (dB)	Remark
1	3660.000	49.45	-3.05	46.40	74.00	-27.60	peak
2	3975.000	48.69	-2.90	45.79	74.00	-28.21	peak
3	4875.000	47.68	0.76	48.44	74.00	-25.56	peak
4	7965.000	44.89	7.00	51.89	74.00	-22.11	peak
5	11655.000	36.18	13.06	49.24	74.00	-24.76	peak
6	17820.000	29.67	23.30	52.97	74.00	-21.03	peak

- Note: 1. Peak Result = Reading Level + Correct Factor.
 2. If Peak Result complies with AV limit, AV Result is deemed to comply with AV limit.
 3. Peak: Peak detector.
 4. Filter losses were only considered in the spurious frequency bands and the authorized band was not corrected for High Pass Filter losses.
 5. Proper operation of the transmitter prior to adding the filter to the measurement chain.



HARMONICS AND SPURIOUS EMISSIONS (HIGH CHANNEL, HORIZONTAL)

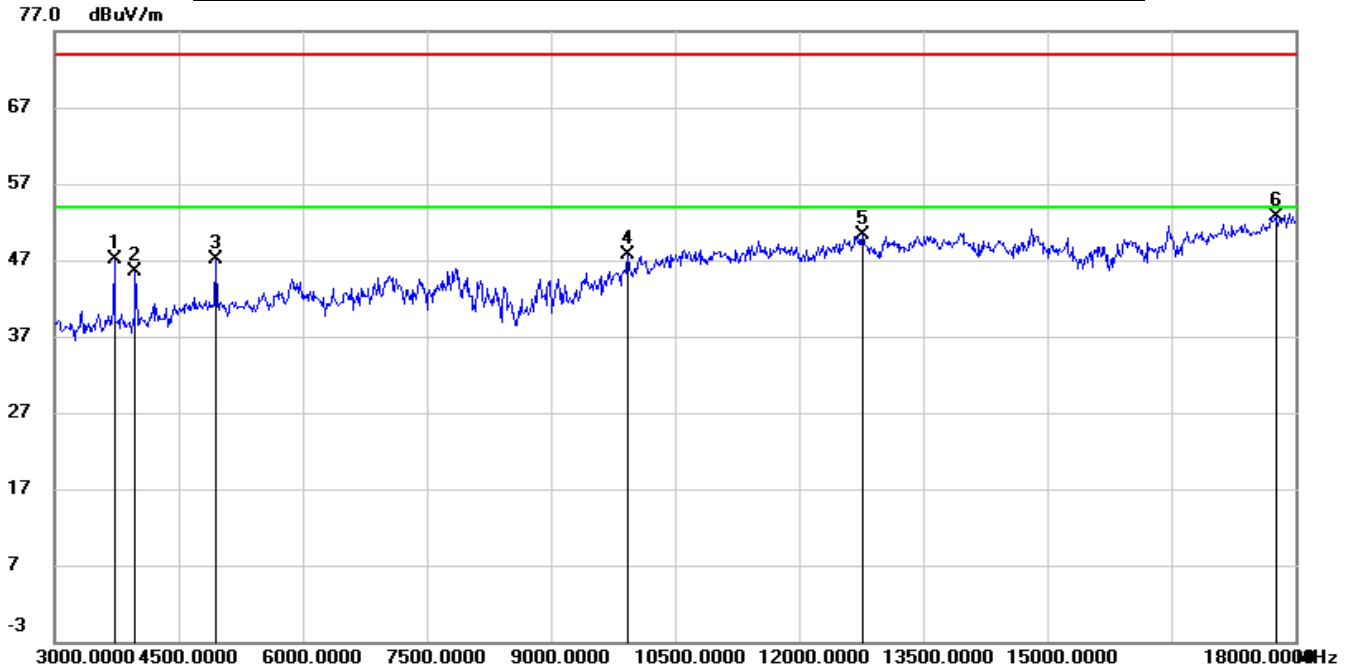

No.	Frequency (MHz)	Reading (dBuV)	Correct (dB/m)	Result (dBuV/m)	Limit (dBuV/m)	Margin (dB)	Remark
1	3720.000	49.83	-2.74	47.09	74.00	-26.91	peak
2	3975.000	48.31	-2.90	45.41	74.00	-28.59	peak
3	4950.000	45.92	1.13	47.05	74.00	-26.95	peak
4	9930.000	37.62	10.08	47.70	74.00	-26.30	peak
5	12765.000	35.08	15.18	50.26	74.00	-23.74	peak
6	17760.000	29.79	22.95	52.74	74.00	-21.26	peak

- Note: 1. Peak Result = Reading Level + Correct Factor.
 2. If Peak Result complies with AV limit, AV Result is deemed to comply with AV limit.
 3. Peak: Peak detector.
 4. Filter losses were only considered in the spurious frequency bands and the authorized band was not corrected for High Pass Filter losses.
 5. Proper operation of the transmitter prior to adding the filter to the measurement chain.



HARMONICS AND SPURIOUS EMISSIONS (HIGH CHANNEL, VERTICAL)

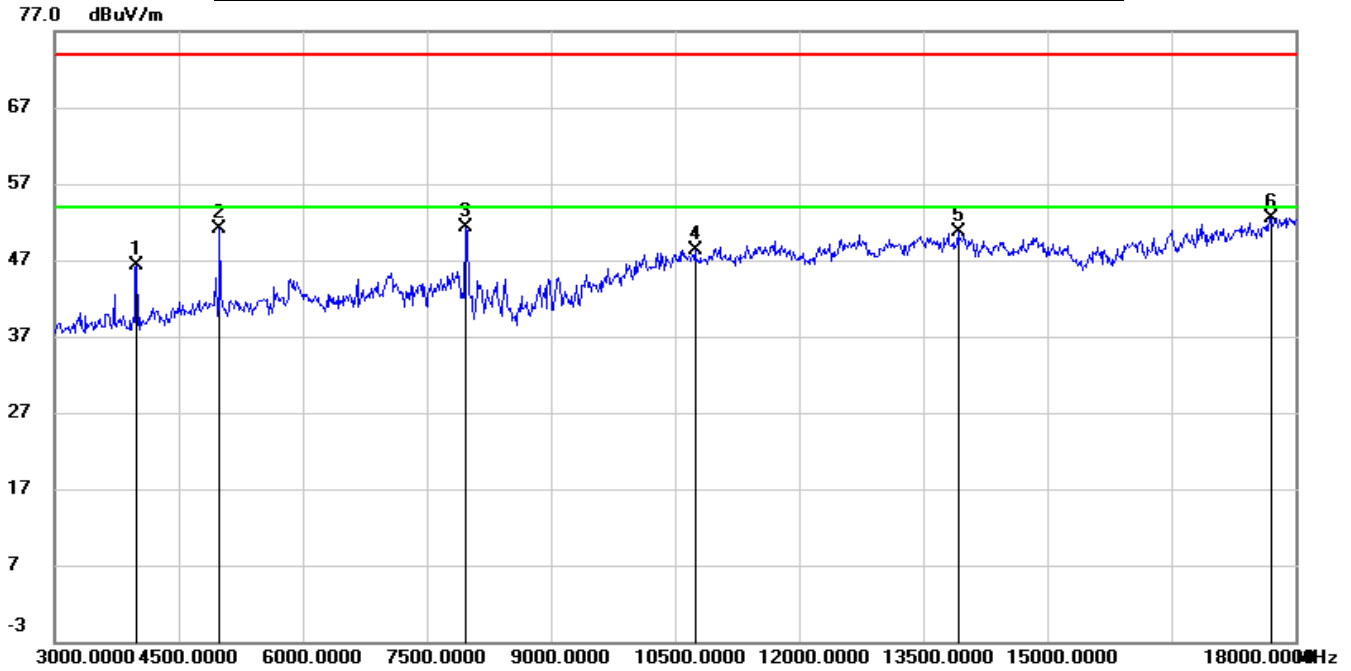

No.	Frequency (MHz)	Reading (dBuV)	Correct (dB/m)	Result (dBuV/m)	Limit (dBuV/m)	Margin (dB)	Remark
1	3990.000	49.26	-2.89	46.37	74.00	-27.63	peak
2	4995.000	49.77	1.37	51.14	74.00	-22.86	peak
3	7965.000	44.39	7.00	51.39	74.00	-22.61	peak
4	10740.000	36.63	11.64	48.27	74.00	-25.73	peak
5	13920.000	34.44	16.17	50.61	74.00	-23.39	peak
6	17700.000	30.14	22.43	52.57	74.00	-21.43	peak

- Note: 1. Peak Result = Reading Level + Correct Factor.
 2. If Peak Result complies with AV limit, AV Result is deemed to comply with AV limit.
 3. Peak: Peak detector.
 4. Filter losses were only considered in the spurious frequency bands and the authorized band was not corrected for High Pass Filter losses.
 5. Proper operation of the transmitter prior to adding the filter to the measurement chain.



Test Result for Antenna WCT5H-20

HARMONICS AND SPURIOUS EMISSIONS (LOW CHANNEL, HORIZONTAL)

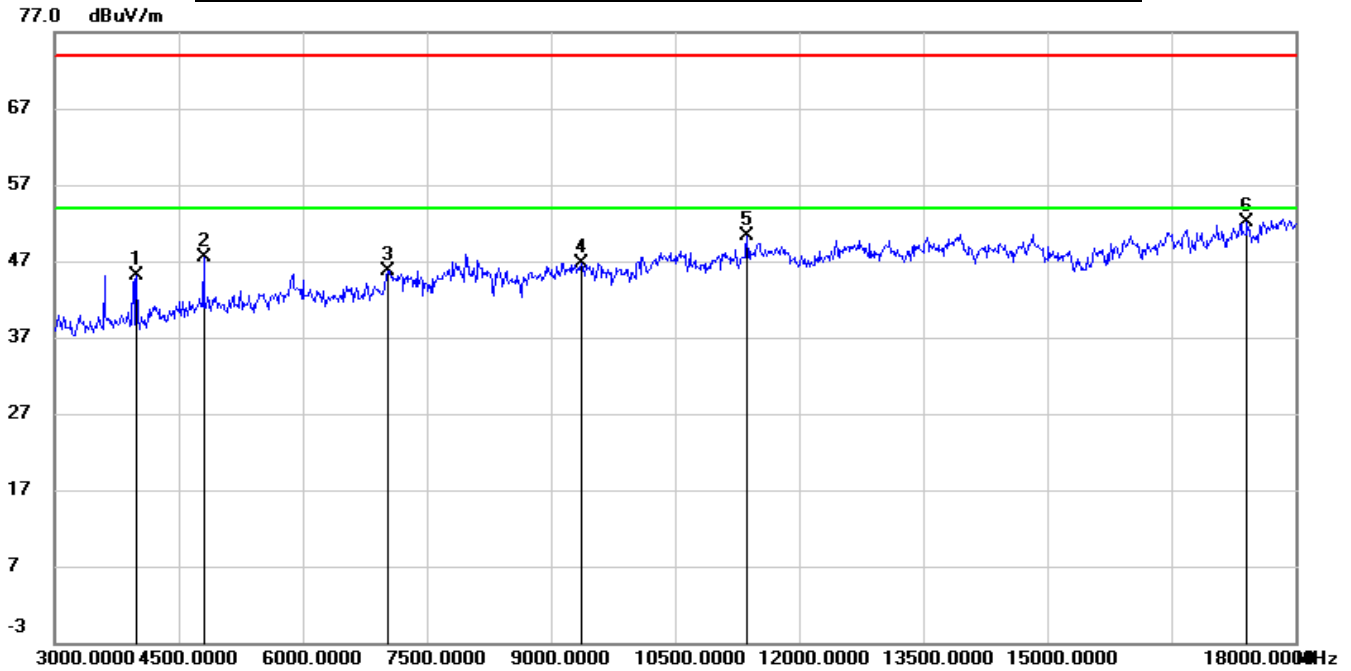

No.	Frequency (MHz)	Reading (dBuV)	Correct (dB/m)	Result (dBuV/m)	Limit (dBuV/m)	Margin (dB)	Remark
1	3990.000	47.94	-2.89	45.05	74.00	-28.95	peak
2	4800.000	47.03	0.46	47.49	74.00	-26.51	peak
3	7020.000	39.98	5.78	45.76	74.00	-28.24	peak
4	9375.000	37.28	9.45	46.73	74.00	-27.27	peak
5	11370.000	37.86	12.54	50.40	74.00	-23.60	peak
6	17415.000	30.75	21.39	52.14	74.00	-21.86	peak

- Note: 1. Peak Result = Reading Level + Correct Factor.
 2. If Peak Result complies with AV limit, AV Result is deemed to comply with AV limit.
 3. Peak: Peak detector.
 4. Filter losses were only considered in the spurious frequency bands and the authorized band was not corrected for High Pass Filter losses.
 5. Proper operation of the transmitter prior to adding the filter to the measurement chain.



HARMONICS AND SPURIOUS EMISSIONS (LOW CHANNEL, VERTICAL)

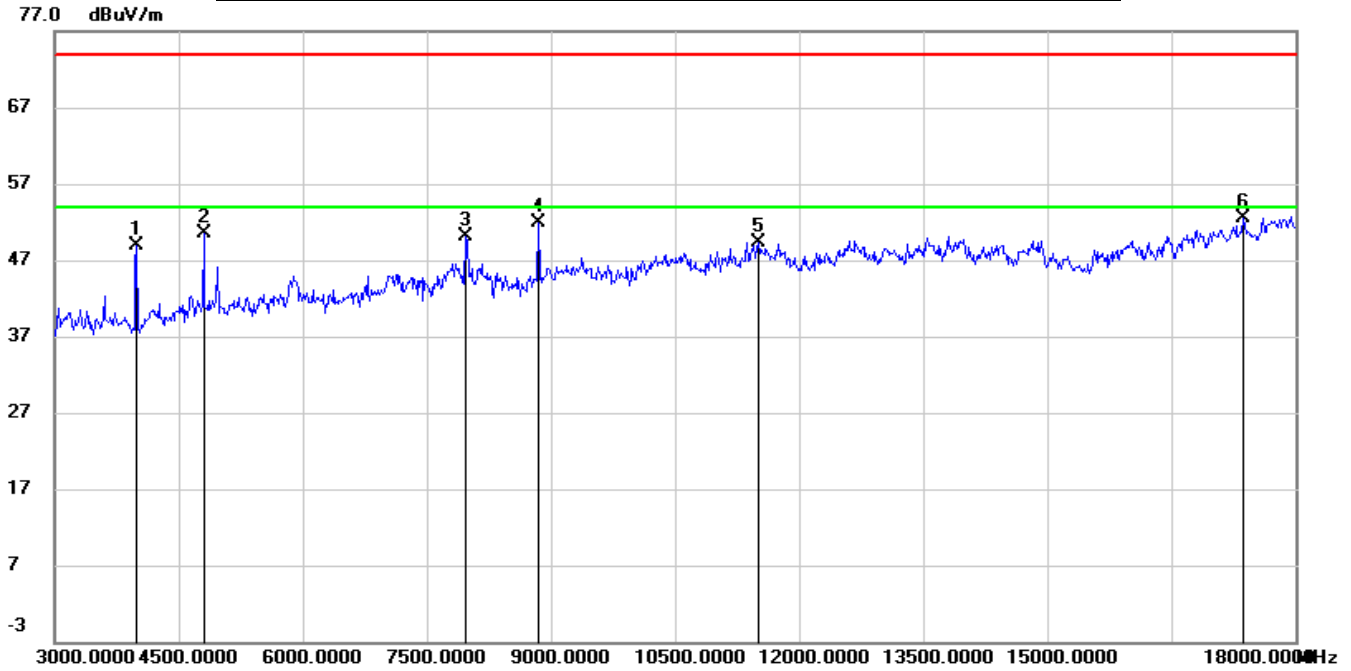

No.	Frequency (MHz)	Reading (dBuV)	Correct (dB/m)	Result (dBuV/m)	Limit (dBuV/m)	Margin (dB)	Remark
1	3990.000	51.71	-2.89	48.82	74.00	-25.18	peak
2	4800.000	50.11	0.46	50.57	74.00	-23.43	peak
3	7965.000	43.04	7.00	50.04	74.00	-23.96	peak
4	8850.000	43.65	8.17	51.82	74.00	-22.18	peak
5	11505.000	35.87	13.42	49.29	74.00	-24.71	peak
6	17370.000	30.90	21.52	52.42	74.00	-21.58	peak

- Note: 1. Peak Result = Reading Level + Correct Factor.
 2. If Peak Result complies with AV limit, AV Result is deemed to comply with AV limit.
 3. Peak: Peak detector.
 4. Filter losses were only considered in the spurious frequency bands and the authorized band was not corrected for High Pass Filter losses.
 5. Proper operation of the transmitter prior to adding the filter to the measurement chain.



HARMONICS AND SPURIOUS EMISSIONS (MID CHANNEL, HORIZONTAL)

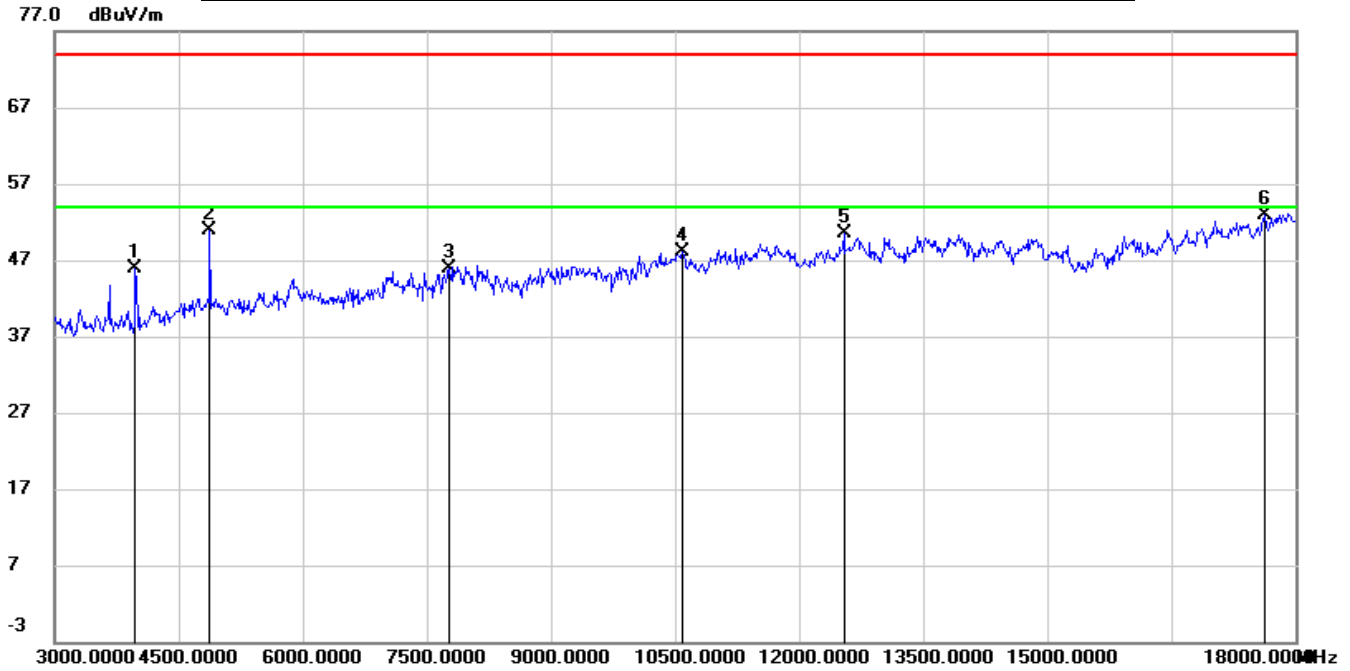

No.	Frequency (MHz)	Reading (dBuV)	Correct (dB/m)	Result (dBuV/m)	Limit (dBuV/m)	Margin (dB)	Remark
1	3975.000	48.87	-2.90	45.97	74.00	-28.03	peak
2	4875.000	50.08	0.76	50.84	74.00	-23.16	peak
3	7770.000	38.44	7.50	45.94	74.00	-28.06	peak
4	10590.000	36.15	11.88	48.03	74.00	-25.97	peak
5	12540.000	36.23	14.33	50.56	74.00	-23.44	peak
6	17625.000	30.87	21.95	52.82	74.00	-21.18	peak

Note: 1. Peak Result = Reading Level + Correct Factor.

4. If Peak Result complies with AV limit, AV Result is deemed to comply with AV limit.

5. Peak: Peak detector.

4. Filter losses were only considered in the spurious frequency bands and the authorized band was not corrected for High Pass Filter losses.

5. Proper operation of the transmitter prior to adding the filter to the measurement chain.



HARMONICS AND SPURIOUS EMISSIONS (MID CHANNEL, VERTICAL)

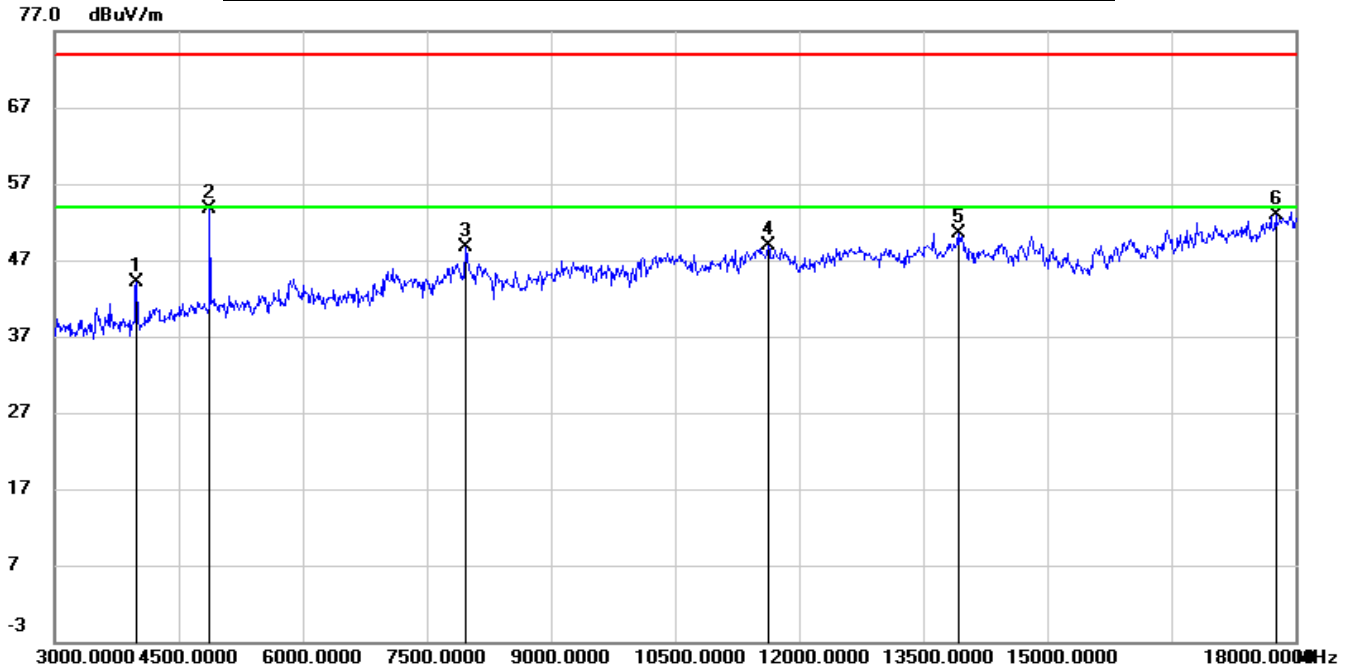

No.	Frequency (MHz)	Reading (dBuV)	Correct (dB/m)	Result (dBuV/m)	Limit (dBuV/m)	Margin (dB)	Remark
1	3990.000	46.95	-2.89	44.06	74.00	-29.94	peak
2	4875.000	52.86	0.76	53.62	74.00	-20.38	peak
3	7965.000	41.61	7.00	48.61	74.00	-25.39	peak
4	11625.000	35.75	13.12	48.87	74.00	-25.13	peak
5	13920.000	34.27	16.17	50.44	74.00	-23.56	peak
6	17760.000	29.95	22.95	52.90	74.00	-21.10	peak

- Note: 1. Peak Result = Reading Level + Correct Factor.
 2. If Peak Result complies with AV limit, AV Result is deemed to comply with AV limit.
 3. Peak: Peak detector.
 4. Filter losses were only considered in the spurious frequency bands and the authorized band was not corrected for High Pass Filter losses.
 5. Proper operation of the transmitter prior to adding the filter to the measurement chain.



HARMONICS AND SPURIOUS EMISSIONS (HIGH CHANNEL, HORIZONTAL)

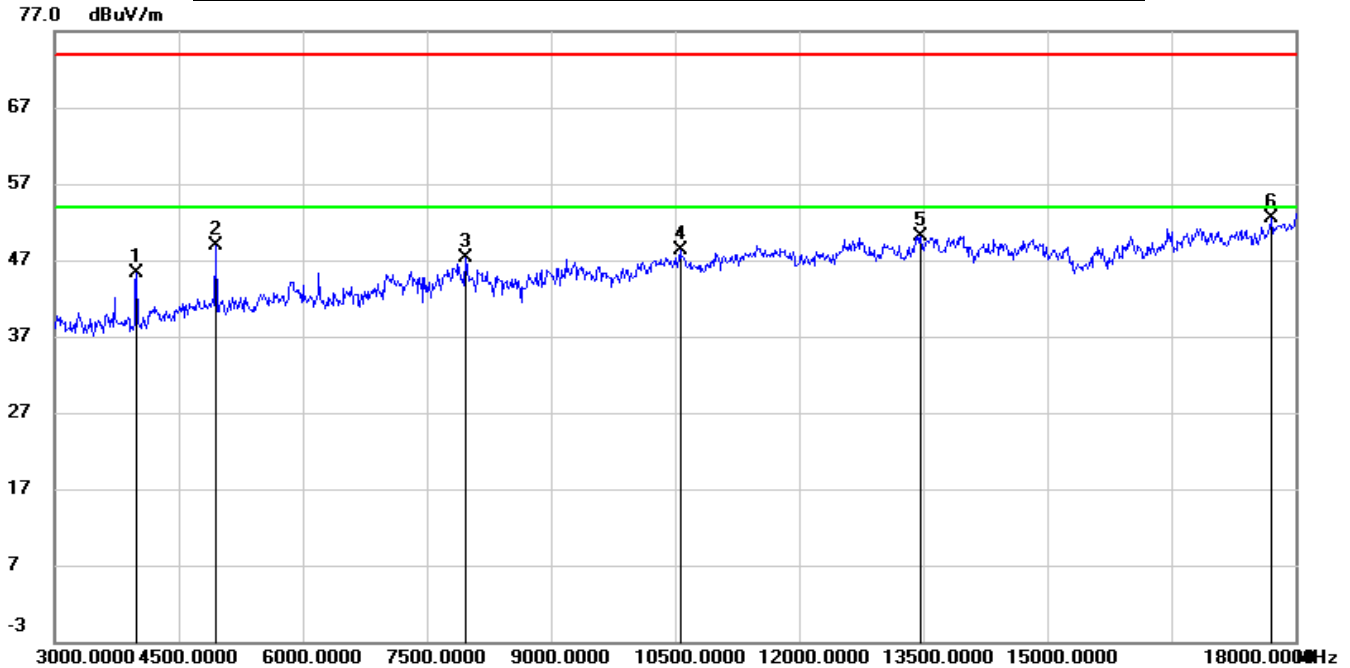

No.	Frequency (MHz)	Reading (dBuV)	Correct (dB/m)	Result (dBuV/m)	Limit (dBuV/m)	Margin (dB)	Remark
1	3990.000	48.11	-2.89	45.22	74.00	-28.78	peak
2	4950.000	47.86	1.13	48.99	74.00	-25.01	peak
3	7965.000	40.36	7.00	47.36	74.00	-26.64	peak
4	10560.000	36.48	11.73	48.21	74.00	-25.79	peak
5	13470.000	34.31	15.87	50.18	74.00	-23.82	peak
6	17715.000	29.90	22.56	52.46	74.00	-21.54	peak

- Note: 1. Peak Result = Reading Level + Correct Factor.
 2. If Peak Result complies with AV limit, AV Result is deemed to comply with AV limit.
 3. Peak: Peak detector.
 4. Filter losses were only considered in the spurious frequency bands and the authorized band was not corrected for High Pass Filter losses.
 5. Proper operation of the transmitter prior to adding the filter to the measurement chain.



HARMONICS AND SPURIOUS EMISSIONS (HIGH CHANNEL, VERTICAL)

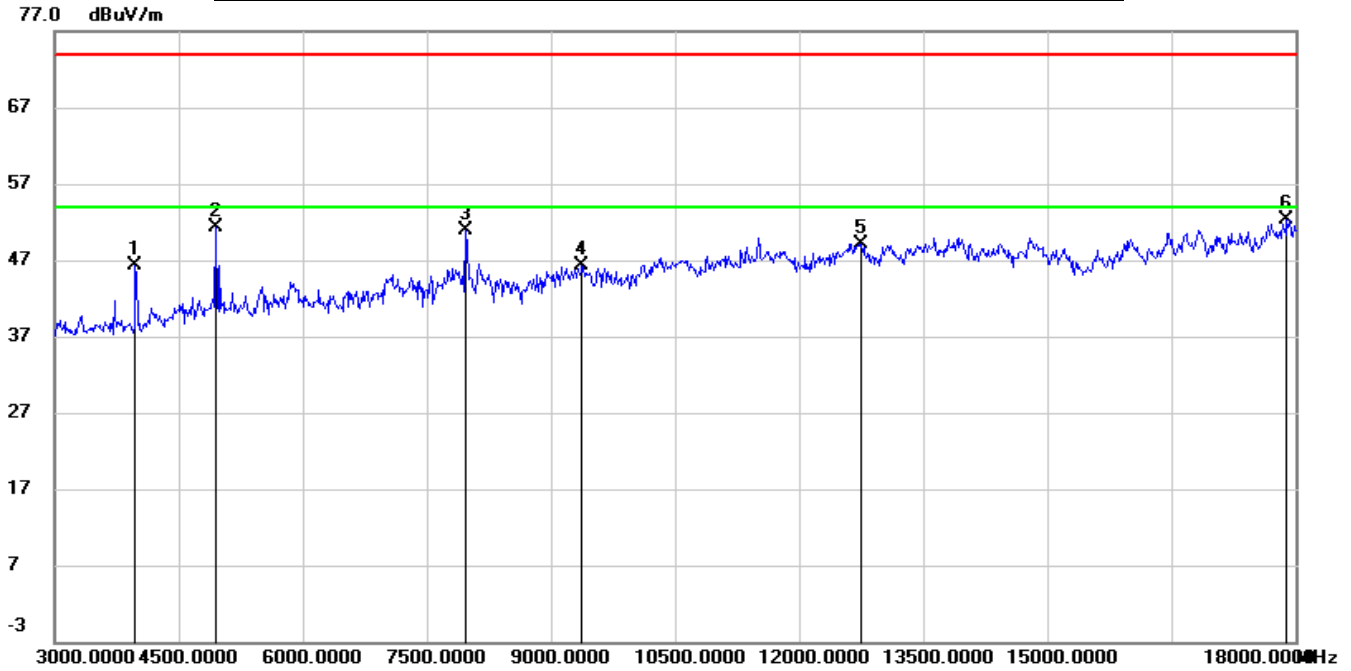

No.	Frequency (MHz)	Reading (dBuV)	Correct (dB/m)	Result (dBuV/m)	Limit (dBuV/m)	Margin (dB)	Remark
1	3975.000	49.15	-2.90	46.25	74.00	-27.75	peak
2	4950.000	50.13	1.13	51.26	74.00	-22.74	peak
3	7965.000	43.82	7.00	50.82	74.00	-23.18	peak
4	9375.000	36.88	9.45	46.33	74.00	-27.67	peak
5	12750.000	34.18	14.98	49.16	74.00	-24.84	peak
6	17895.000	28.93	23.34	52.27	74.00	-21.73	peak

- Note: 1. Peak Result = Reading Level + Correct Factor.
 2. If Peak Result complies with AV limit, AV Result is deemed to comply with AV limit.
 3. Peak: Peak detector.
 4. Filter losses were only considered in the spurious frequency bands and the authorized band was not corrected for High Pass Filter losses.
 5. Proper operation of the transmitter prior to adding the filter to the measurement chain.



8.4.2. 8DPSK MODE

Test Result for Antenna WCT5J-20

HARMONICS AND SPURIOUS EMISSIONS (LOW CHANNEL, HORIZONTAL)

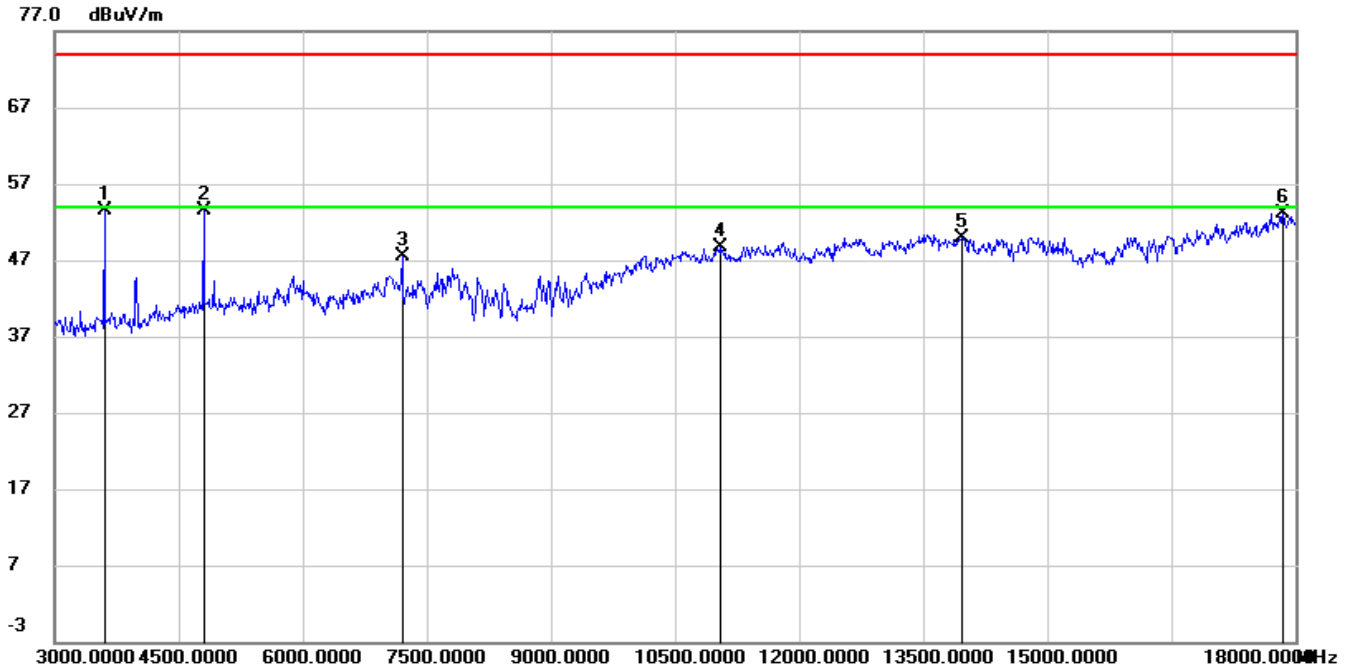

No.	Frequency (MHz)	Reading (dBuV)	Correct (dB/m)	Result (dBuV/m)	Limit (dBuV/m)	Margin (dB)	Remark
1	3600.000	56.98	-3.52	53.46	74.00	-20.54	peak
2	4800.000	53.09	0.46	53.55	74.00	-20.45	peak
3	7200.000	41.78	5.82	47.60	74.00	-26.40	peak
4	11055.000	36.10	12.59	48.69	74.00	-25.31	peak
5	13965.000	33.80	16.09	49.89	74.00	-24.11	peak
6	17850.000	29.77	23.32	53.09	74.00	-20.91	peak

- Note:
1. Peak Result = Reading Level + Correct Factor.
 2. If Peak Result complies with AV limit, AV Result is deemed to comply with AV limit.
 3. Peak: Peak detector.
 4. Filter losses were only considered in the spurious frequency bands and the authorized band was not corrected for High Pass Filter losses.
 5. Proper operation of the transmitter prior to adding the filter to the measurement chain.



HARMONICS AND SPURIOUS EMISSIONS (LOW CHANNEL, VERTICAL)

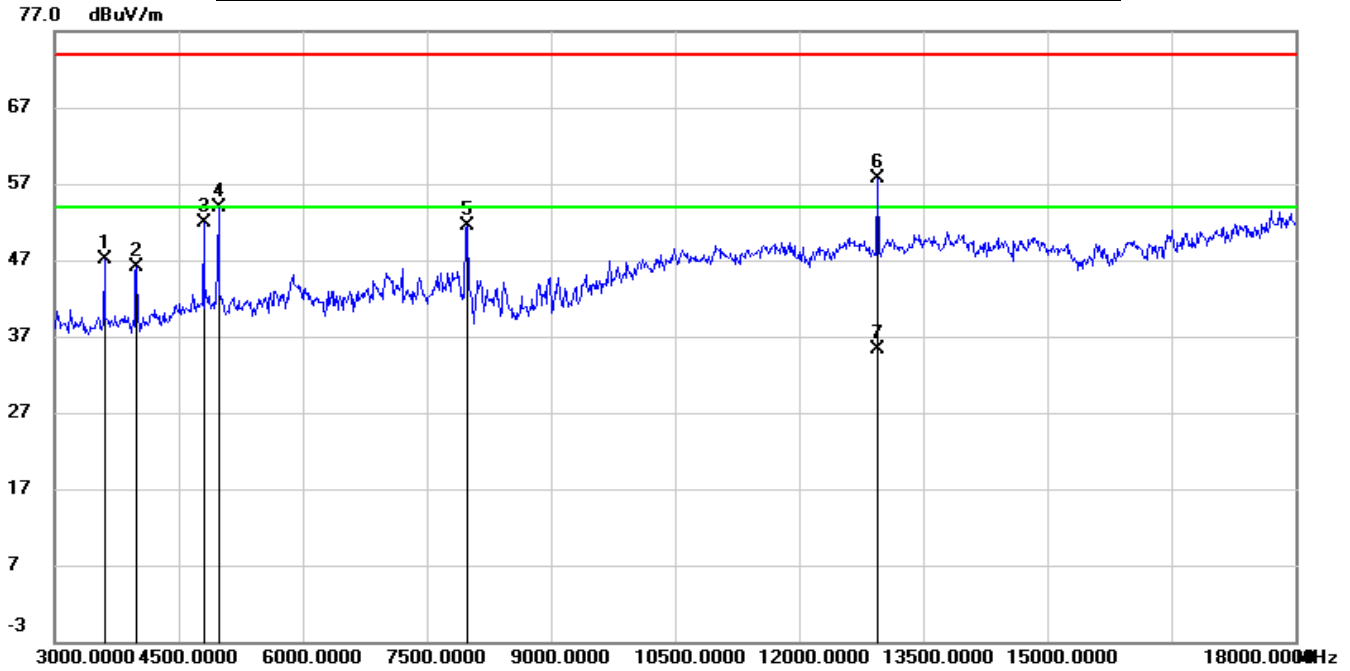

No.	Frequency (MHz)	Reading (dBuV)	Correct (dB/m)	Result (dBuV/m)	Limit (dBuV/m)	Margin (dB)	Remark
1	3600.000	50.59	-3.52	47.07	74.00	-26.93	peak
2	3990.000	49.09	-2.89	46.20	74.00	-27.80	peak
3	4800.000	51.48	0.46	51.94	74.00	-22.06	peak
4	4980.000	52.65	1.29	53.94	74.00	-20.06	peak
5	7995.000	44.61	6.89	51.50	74.00	-22.50	peak
6	12951.394	42.81	14.91	57.72	74.00	-16.28	peak
7	12951.394	20.35	14.91	35.26	54.00	-18.74	AVG

- Note: 1. Measurement = Reading Level + Correct Factor.
 2. If Peak Result complies with AV limit, AV Result is deemed to comply with AV limit.
 3. Peak: Peak detector.
 4. AVG: VBW=1/Ton where: ton is transmit duration.
 5. For transmit duration, please refer to clause 7.1.
 6. Filter losses were only considered in the spurious frequency bands and the authorized band was not corrected for High Pass Filter losses.
 7. Proper operation of the transmitter prior to adding the filter to the measurement chain.



HARMONICS AND SPURIOUS EMISSIONS (MID CHANNEL, HORIZONTAL)

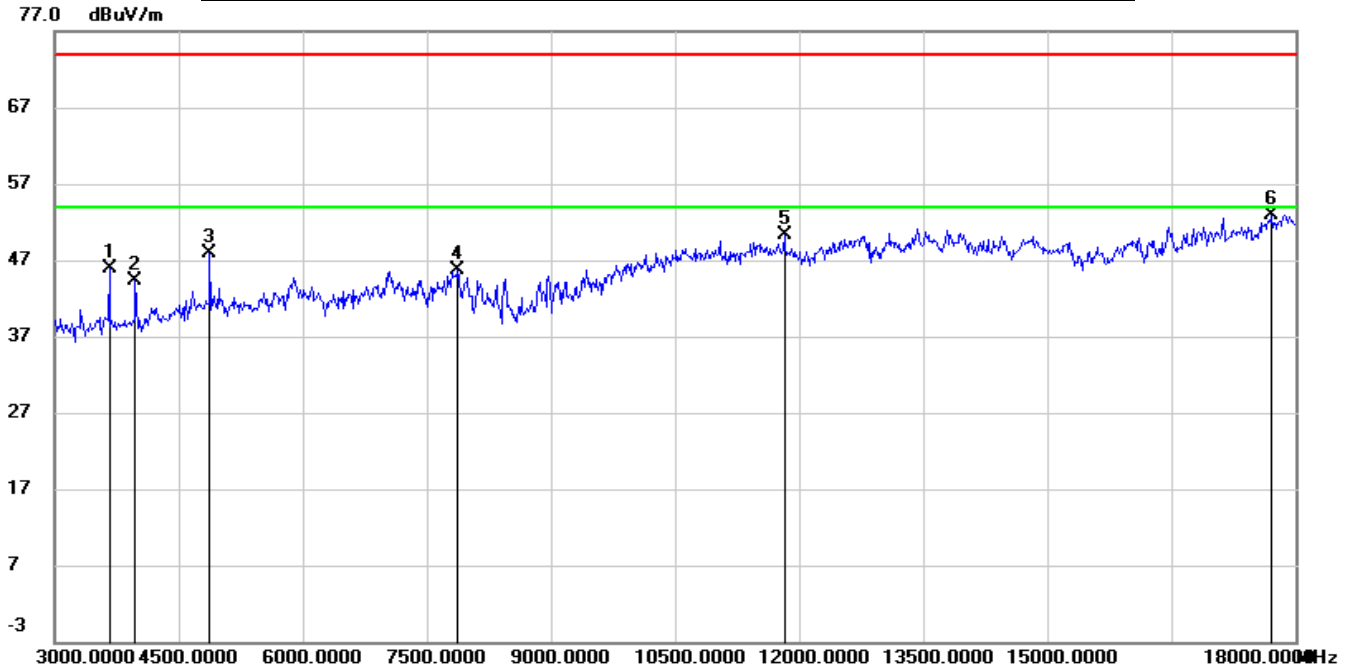

No.	Frequency (MHz)	Reading (dBuV)	Correct (dB/m)	Result (dBuV/m)	Limit (dBuV/m)	Margin (dB)	Remark
1	3660.000	48.93	-3.05	45.88	74.00	-28.12	peak
2	3975.000	47.15	-2.90	44.25	74.00	-29.75	peak
3	4875.000	47.08	0.76	47.84	74.00	-26.16	peak
4	7875.000	38.35	7.40	45.75	74.00	-28.25	peak
5	11820.000	37.21	13.19	50.40	74.00	-23.60	peak
6	17715.000	30.38	22.56	52.94	74.00	-21.06	peak

- Note: 1. Peak Result = Reading Level + Correct Factor.
 2. If Peak Result complies with AV limit, AV Result is deemed to comply with AV limit.
 3. Peak: Peak detector.
 4. Filter losses were only considered in the spurious frequency bands and the authorized band was not corrected for High Pass Filter losses.
 5. Proper operation of the transmitter prior to adding the filter to the measurement chain.



HARMONICS AND SPURIOUS EMISSIONS (MID CHANNEL, VERTICAL)

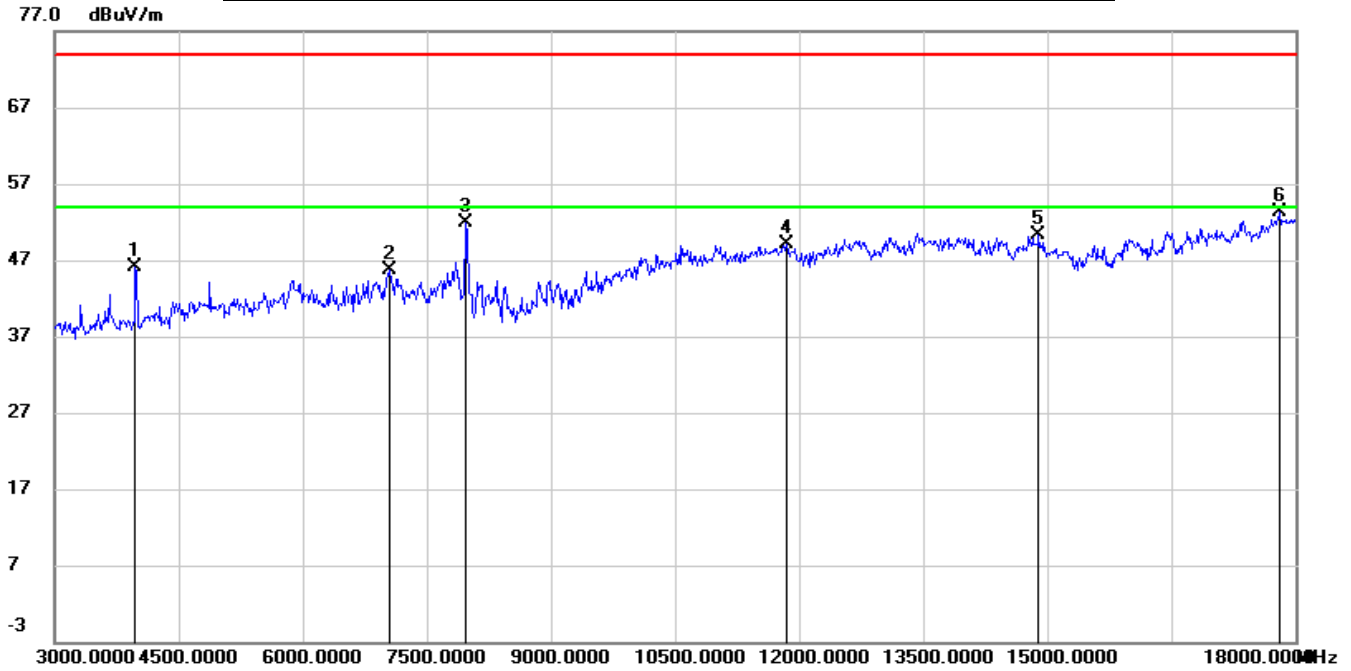

No.	Frequency (MHz)	Reading (dBuV)	Correct (dB/m)	Result (dBuV/m)	Limit (dBuV/m)	Margin (dB)	Remark
1	3975.000	48.96	-2.90	46.06	74.00	-27.94	peak
2	7050.000	39.82	5.84	45.66	74.00	-28.34	peak
3	7965.000	44.81	7.00	51.81	74.00	-22.19	peak
4	11850.000	35.89	13.20	49.09	74.00	-24.91	peak
5	14895.000	34.39	16.01	50.40	74.00	-23.60	peak
6	17805.000	30.00	23.31	53.31	74.00	-20.69	peak

- Note: 1. Peak Result = Reading Level + Correct Factor.
 2. If Peak Result complies with AV limit, AV Result is deemed to comply with AV limit.
 3. Peak: Peak detector.
 4. Filter losses were only considered in the spurious frequency bands and the authorized band was not corrected for High Pass Filter losses.
 5. Proper operation of the transmitter prior to adding the filter to the measurement chain.



HARMONICS AND SPURIOUS EMISSIONS (HIGH CHANNEL, HORIZONTAL)

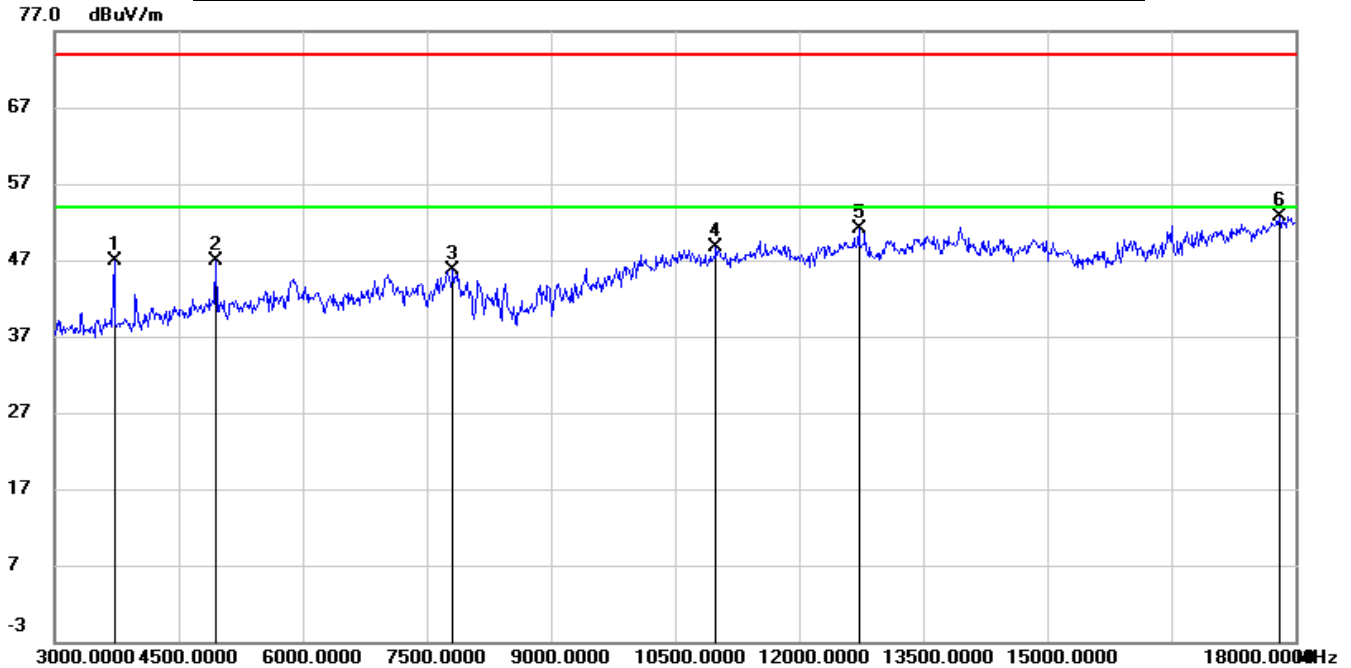

No.	Frequency (MHz)	Reading (dBuV)	Correct (dB/m)	Result (dBuV/m)	Limit (dBuV/m)	Margin (dB)	Remark
1	3720.000	49.71	-2.74	46.97	74.00	-27.03	peak
2	4950.000	45.69	1.13	46.82	74.00	-27.18	peak
3	7815.000	37.92	7.83	45.75	74.00	-28.25	peak
4	10995.000	36.03	12.60	48.63	74.00	-25.37	peak
5	12720.000	36.51	14.57	51.08	74.00	-22.92	peak
6	17805.000	29.36	23.31	52.67	74.00	-21.33	peak

- Note: 1. Peak Result = Reading Level + Correct Factor.
 2. If Peak Result complies with AV limit, AV Result is deemed to comply with AV limit.
 3. Peak: Peak detector.
 4. Filter losses were only considered in the spurious frequency bands and the authorized band was not corrected for High Pass Filter losses.
 5. Proper operation of the transmitter prior to adding the filter to the measurement chain.



HARMONICS AND SPURIOUS EMISSIONS (HIGH CHANNEL, VERTICAL)

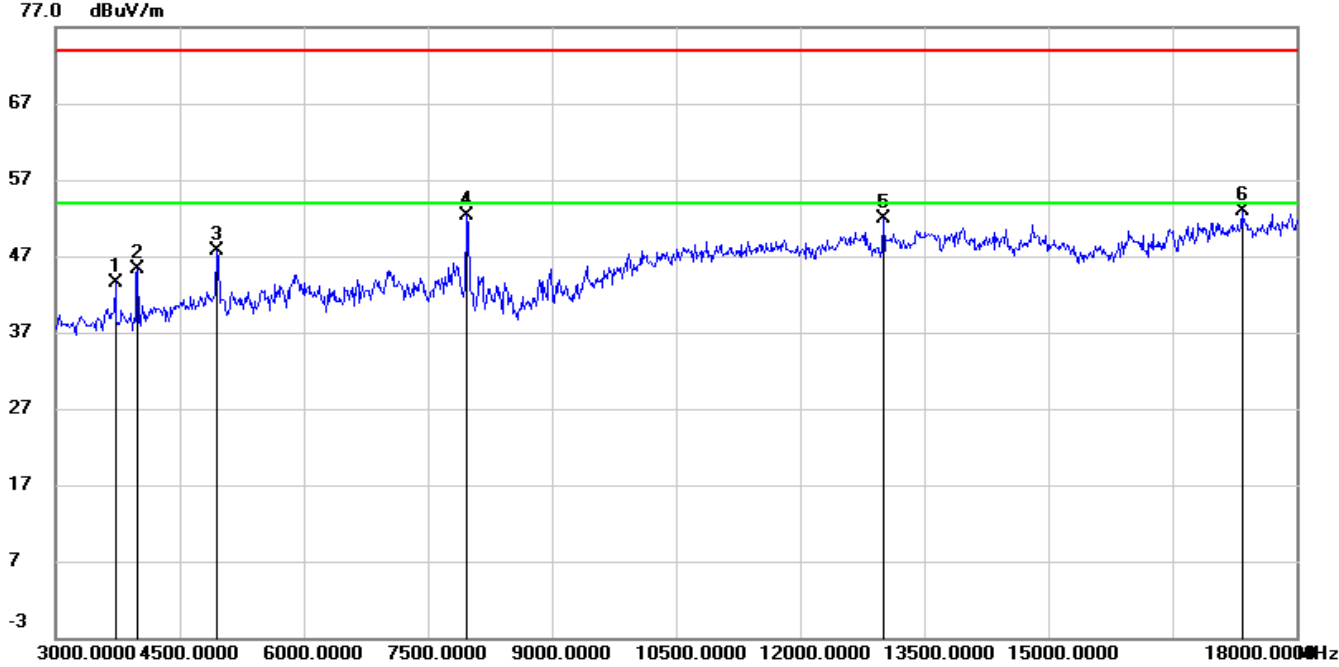

No.	Frequency (MHz)	Reading (dBuV)	Correct (dB/m)	Result (dBuV/m)	Limit (dBuV/m)	Margin (dB)	Remark
1	3720.000	46.17	-2.74	43.43	74.00	-30.57	peak
2	3990.000	48.11	-2.89	45.22	74.00	-28.78	peak
3	4950.000	46.50	1.13	47.63	74.00	-26.37	peak
4	7965.000	45.40	7.00	52.40	74.00	-21.60	peak
5	13005.000	36.90	14.95	51.85	74.00	-22.15	peak
6	17340.000	31.21	21.61	52.82	74.00	-21.18	peak

- Note: 1. Peak Result = Reading Level + Correct Factor.
 2. If Peak Result complies with AV limit, AV Result is deemed to comply with AV limit.
 3. Peak: Peak detector.
 4. Filter losses were only considered in the spurious frequency bands and the authorized band was not corrected for High Pass Filter losses.
 5. Proper operation of the transmitter prior to adding the filter to the measurement chain.



Test Result for Antenna WCT5H-20

HARMONICS AND SPURIOUS EMISSIONS (LOW CHANNEL, HORIZONTAL)

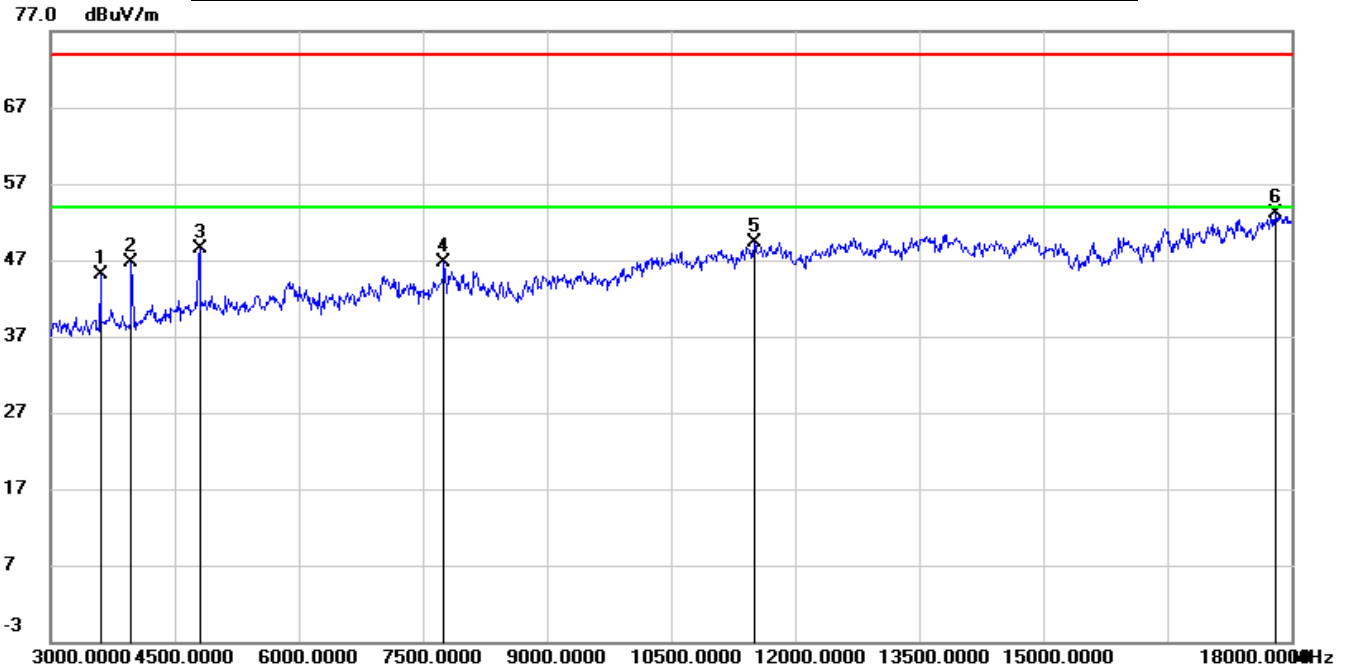

No.	Frequency (MHz)	Reading (dBuV)	Correct (dB/m)	Result (dBuV/m)	Limit (dBuV/m)	Margin (dB)	Remark
1	3600.000	48.60	-3.52	45.08	74.00	-28.92	peak
2	3975.000	49.53	-2.90	46.63	74.00	-27.37	peak
3	4800.000	47.99	0.46	48.45	74.00	-25.55	peak
4	7755.000	39.48	7.29	46.77	74.00	-27.23	peak
5	11505.000	35.98	13.42	49.40	74.00	-24.60	peak
6	17805.000	29.79	23.31	53.10	74.00	-20.90	peak

- Note: 1. Peak Result = Reading Level + Correct Factor.
 2. If Peak Result complies with AV limit, AV Result is deemed to comply with AV limit.
 3. Peak: Peak detector.
 4. Filter losses were only considered in the spurious frequency bands and the authorized band was not corrected for High Pass Filter losses.
 5. Proper operation of the transmitter prior to adding the filter to the measurement chain.



HARMONICS AND SPURIOUS EMISSIONS (LOW CHANNEL, VERTICAL)

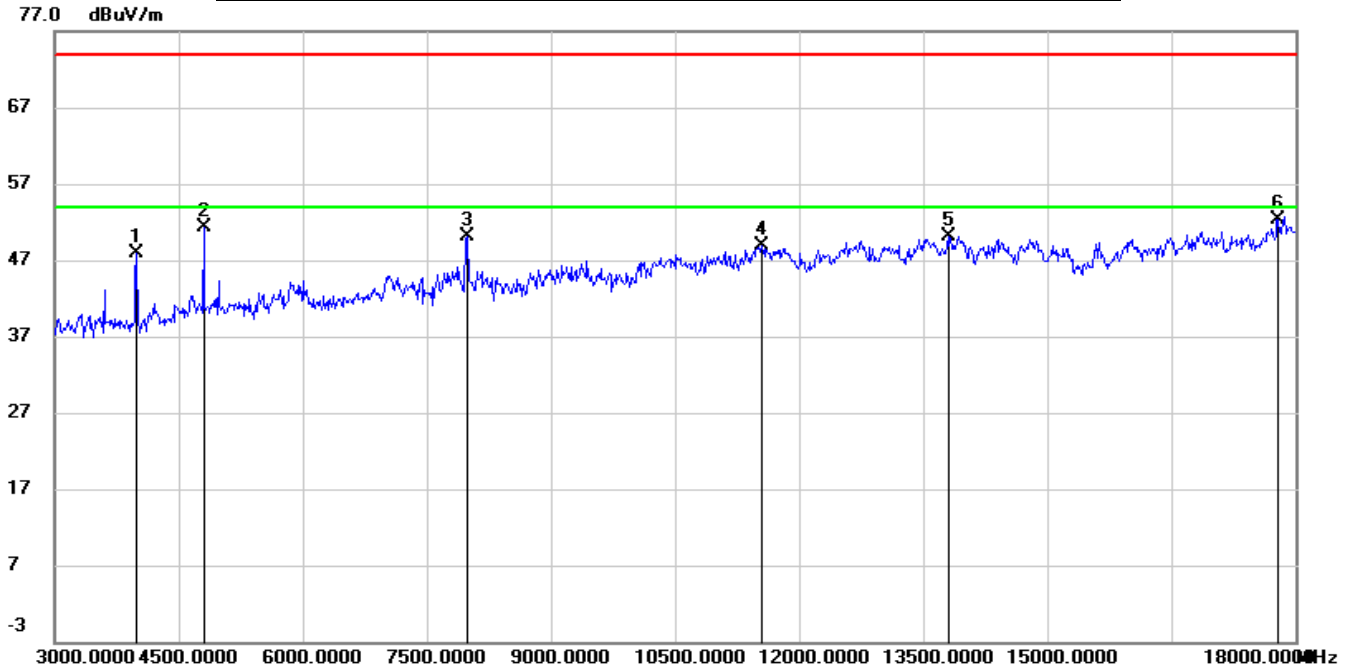

No.	Frequency (MHz)	Reading (dBuV)	Correct (dB/m)	Result (dBuV/m)	Limit (dBuV/m)	Margin (dB)	Remark
1	3990.000	50.86	-2.89	47.97	74.00	-26.03	peak
2	4800.000	50.93	0.46	51.39	74.00	-22.61	peak
3	7995.000	43.19	6.89	50.08	74.00	-23.92	peak
4	11550.000	35.69	13.30	48.99	74.00	-25.01	peak
5	13800.000	33.05	17.10	50.15	74.00	-23.85	peak
6	17790.000	29.13	23.22	52.35	74.00	-21.65	peak

- Note: 1. Peak Result = Reading Level + Correct Factor.
 2. If Peak Result complies with AV limit, AV Result is deemed to comply with AV limit.
 3. Peak: Peak detector.
 4. Filter losses were only considered in the spurious frequency bands and the authorized band was not corrected for High Pass Filter losses.
 5. Proper operation of the transmitter prior to adding the filter to the measurement chain.



HARMONICS AND SPURIOUS EMISSIONS (MID CHANNEL, HORIZONTAL)

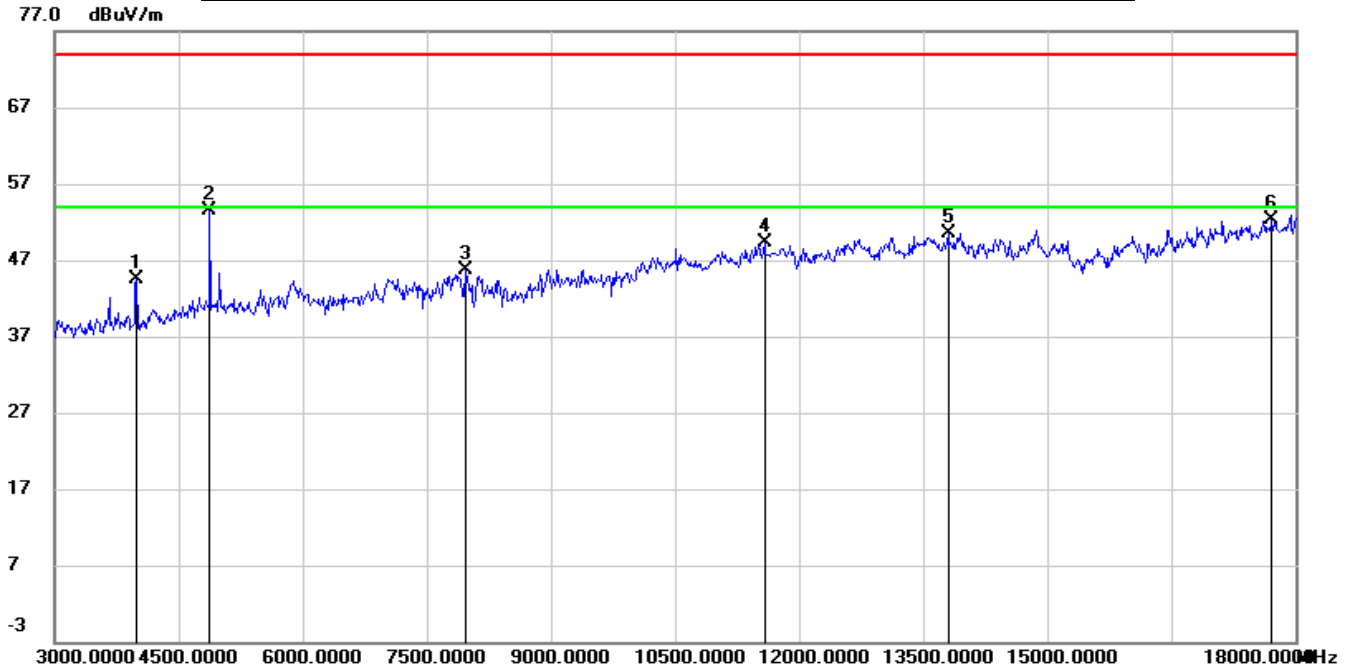

No.	Frequency (MHz)	Reading (dBuV)	Correct (dB/m)	Result (dBuV/m)	Limit (dBuV/m)	Margin (dB)	Remark
1	3990.000	47.37	-2.89	44.48	74.00	-29.52	peak
2	4875.000	52.81	0.76	53.57	74.00	-20.43	peak
3	7965.000	38.68	7.00	45.68	74.00	-28.32	peak
4	11580.000	36.16	13.23	49.39	74.00	-24.61	peak
5	13800.000	33.45	17.10	50.55	74.00	-23.45	peak
6	17715.000	29.83	22.56	52.39	74.00	-21.61	peak

- Note: 1. Peak Result = Reading Level + Correct Factor.
 2. If Peak Result complies with AV limit, AV Result is deemed to comply with AV limit.
 3. Peak: Peak detector.
 4. Filter losses were only considered in the spurious frequency bands and the authorized band was not corrected for High Pass Filter losses.
 5. Proper operation of the transmitter prior to adding the filter to the measurement chain.



HARMONICS AND SPURIOUS EMISSIONS (MID CHANNEL, VERTICAL)

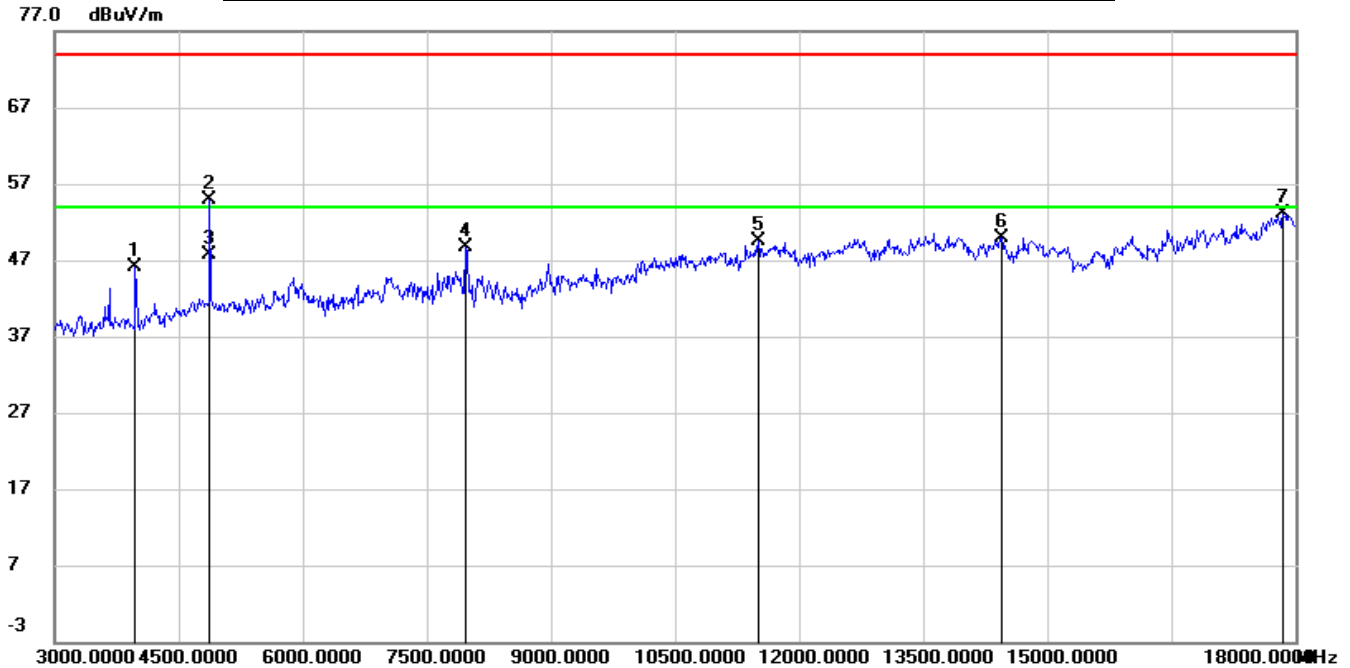

No.	Frequency (MHz)	Reading (dBuV)	Correct (dB/m)	Result (dBuV/m)	Limit (dBuV/m)	Margin (dB)	Remark
1	3975.000	49.04	-2.90	46.14	74.00	-27.86	peak
2	4882.010	54.14	0.78	54.92	74.00	-19.08	peak
3	4882.010	46.83	0.78	47.61	54.00	-6.39	AVG
4	7965.000	41.69	7.00	48.69	74.00	-25.31	peak
5	11505.000	36.10	13.42	49.52	74.00	-24.48	peak
6	14445.000	33.59	16.36	49.95	74.00	-24.05	peak
7	17850.000	29.82	23.32	53.14	74.00	-20.86	peak

- Note: 1. Peak Result = Reading Level + Correct Factor.
 2. If Peak Result complies with AV limit, AV Result is deemed to comply with AV limit.
 3. Peak: Peak detector.
 4. AVG: VBW=1/Ton where: ton is transmit duration.
 5. For duty cycle, please refer to clause 7.1.
 6. Filter losses were only considered in the spurious frequency bands and the authorized band was not corrected for High Pass Filter losses.
 7. Proper operation of the transmitter prior to adding the filter to the measurement chain.



HARMONICS AND SPURIOUS EMISSIONS (HIGH CHANNEL, HORIZONTAL)

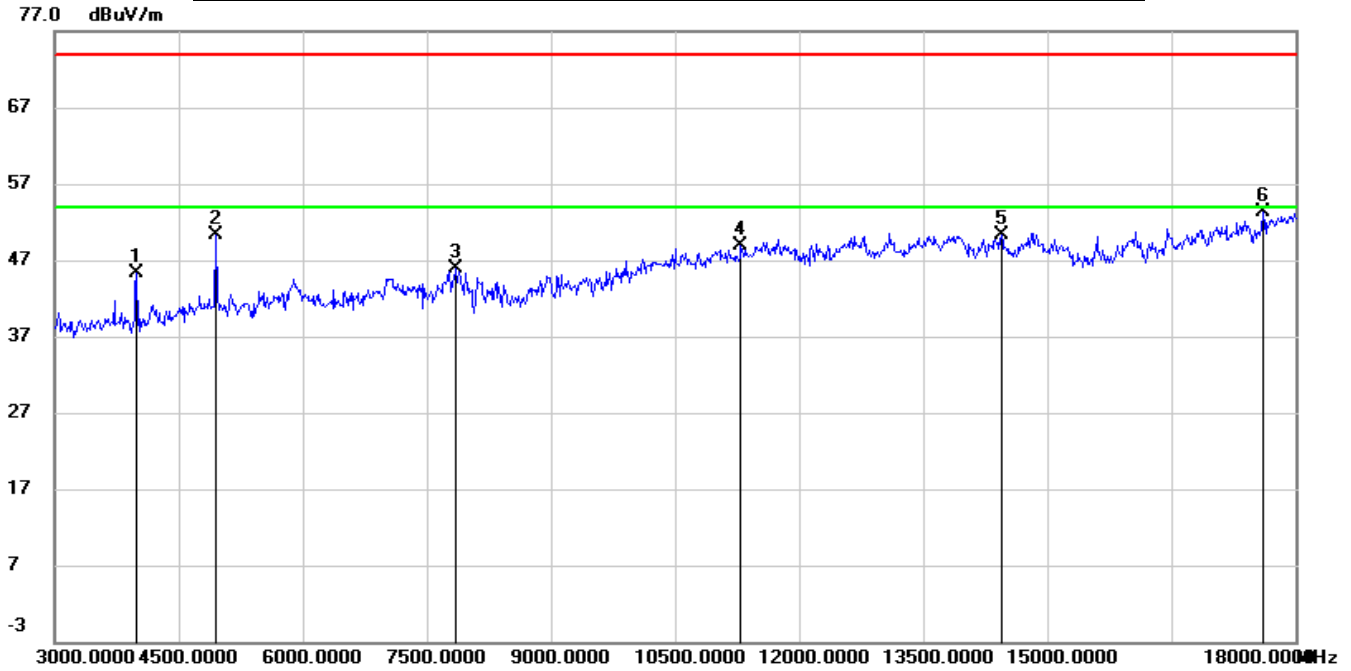

No.	Frequency (MHz)	Reading (dBuV)	Correct (dB/m)	Result (dBuV/m)	Limit (dBuV/m)	Margin (dB)	Remark
1	3990.000	48.18	-2.89	45.29	74.00	-28.71	peak
2	4950.000	49.11	1.13	50.24	74.00	-23.76	peak
3	7845.000	38.22	7.62	45.84	74.00	-28.16	peak
4	11295.000	36.57	12.34	48.91	74.00	-25.09	peak
5	14445.000	33.97	16.36	50.33	74.00	-23.67	peak
6	17610.000	31.38	21.86	53.24	74.00	-20.76	peak

- Note: 1. Peak Result = Reading Level + Correct Factor.
 2. If Peak Result complies with AV limit, AV Result is deemed to comply with AV limit.
 3. Peak: Peak detector.
 4. Filter losses were only considered in the spurious frequency bands and the authorized band was not corrected for High Pass Filter losses.
 5. Proper operation of the transmitter prior to adding the filter to the measurement chain.



HARMONICS AND SPURIOUS EMISSIONS (HIGH CHANNEL, VERTICAL)

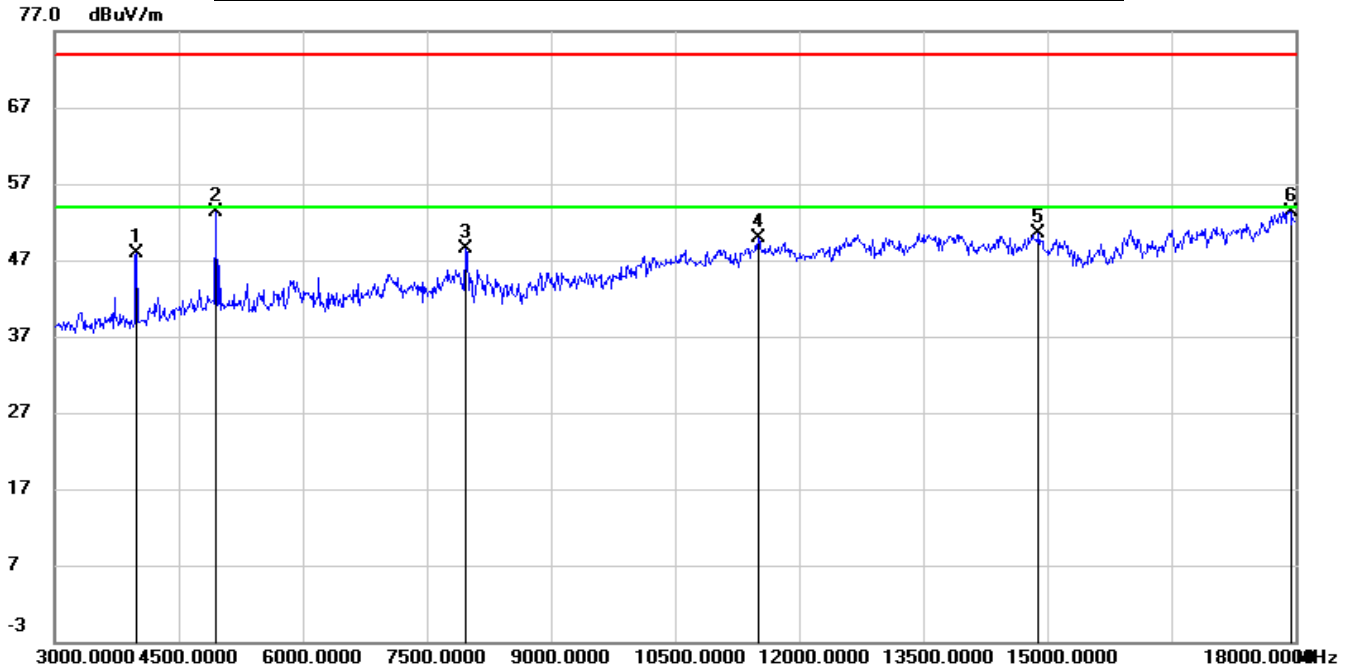

No.	Frequency (MHz)	Reading (dBuV)	Correct (dB/m)	Result (dBuV/m)	Limit (dBuV/m)	Margin (dB)	Remark
1	3990.000	50.85	-2.89	47.96	74.00	-26.04	peak
2	4950.000	52.23	1.13	53.36	74.00	-20.64	peak
3	7965.000	41.55	7.00	48.55	74.00	-25.45	peak
4	11505.000	36.45	13.42	49.87	74.00	-24.13	peak
5	14895.000	34.49	16.01	50.50	74.00	-23.50	peak
6	17940.000	30.01	23.39	53.40	74.00	-20.60	peak

- Note: 1. Peak Result = Reading Level + Correct Factor.
 2. If Peak Result complies with AV limit, AV Result is deemed to comply with AV limit.
 3. Peak: Peak detector.
 4. Filter losses were only considered in the spurious frequency bands and the authorized band was not corrected for High Pass Filter losses.
 5. Proper operation of the transmitter prior to adding the filter to the measurement chain.



8.5. SPURIOUS EMISSIONS 18G ~ 26GHz

8.5.1. GFSK MODE

Test Result for Antenna WCT5J-20

SPURIOUS EMISSIONS (MID CHANNEL, WORST-CASE CONFIGURATION, HORIZONTAL)

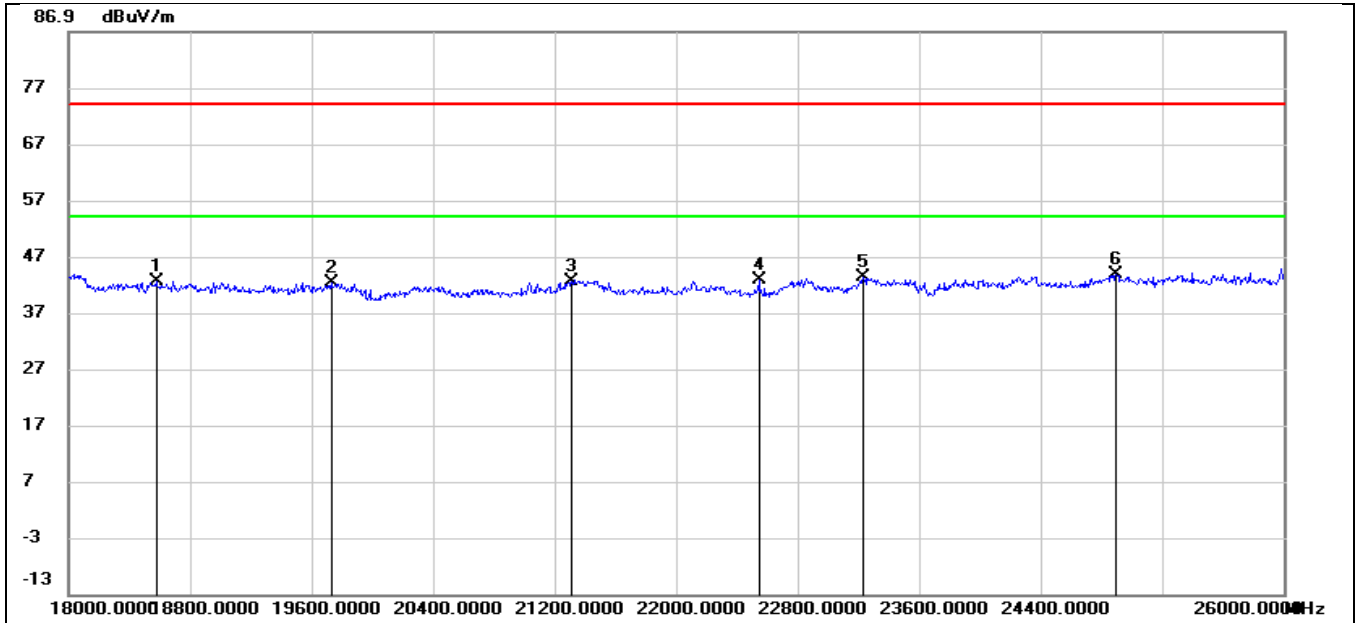

No.	Frequency (MHz)	Reading (dBuV)	Correct (dB/m)	Result (dBuV/m)	Limit (dBuV/m)	Margin (dB)	Remark
1	18576.000	46.97	-4.51	42.46	74.00	-31.54	peak
2	19728.000	46.65	-4.38	42.27	74.00	-31.73	peak
3	21312.000	48.12	-5.57	42.55	74.00	-31.45	peak
4	22544.000	48.48	-5.79	42.69	74.00	-31.31	peak
5	23232.000	48.45	-5.28	43.17	74.00	-30.83	peak
6	24896.000	45.27	-1.44	43.83	74.00	-30.17	peak

- Note: 1. Peak Result = Reading Level + Correct Factor.
 2. If Peak Result complies with AV limit, AV Result is deemed to comply with AV limit.
 3. Peak: Peak detector.



SPURIOUS EMISSIONS (MID CHANNEL, WORST-CASE CONFIGURATION, VERTICAL)

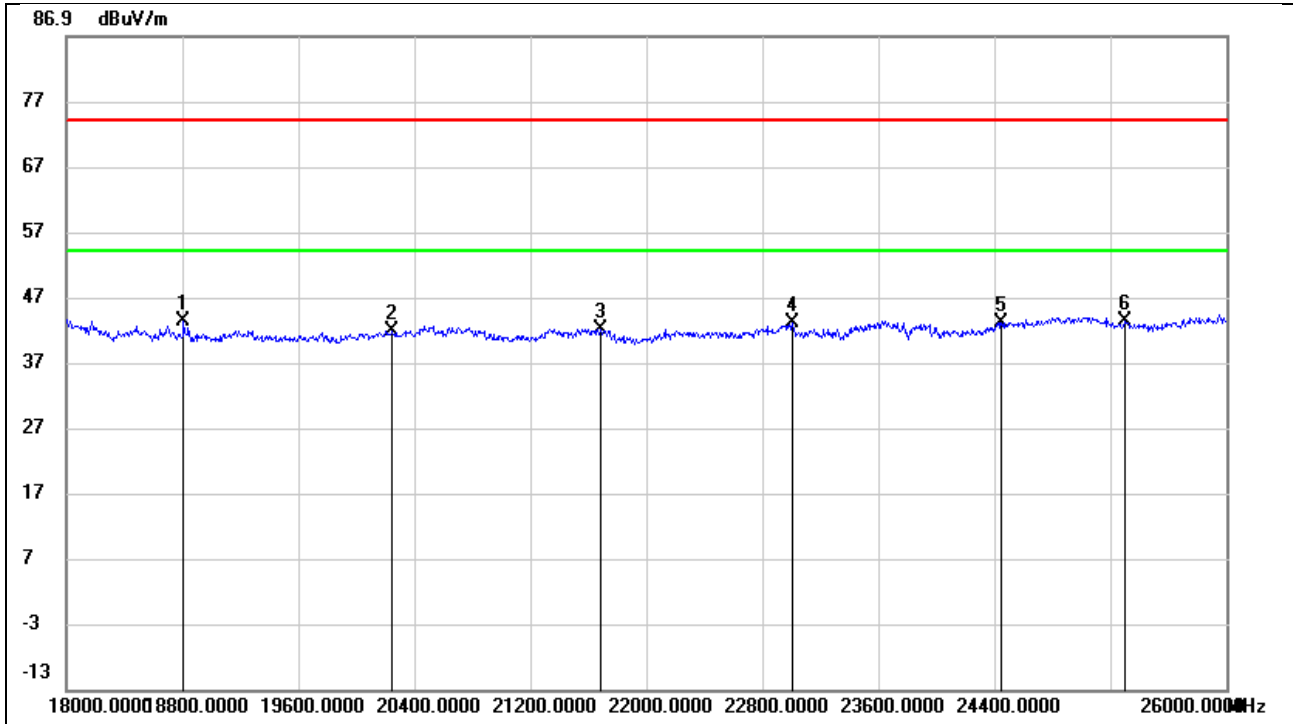

No.	Frequency (MHz)	Reading (dBuV)	Correct (dB/m)	Result (dBuV/m)	Limit (dBuV/m)	Margin (dB)	Remark
1	18808.000	48.05	-4.85	43.20	74.00	-30.80	peak
2	20248.000	46.78	-4.88	41.90	74.00	-32.10	peak
3	21688.000	47.89	-5.76	42.13	74.00	-31.87	peak
4	23008.000	48.52	-5.60	42.92	74.00	-31.08	peak
5	24448.000	45.88	-2.79	43.09	74.00	-30.91	peak
6	25296.000	44.70	-1.30	43.40	74.00	-30.60	peak

- Note: 1. Peak Result = Reading Level + Correct Factor.
 2. If Peak Result complies with AV limit, AV Result is deemed to comply with AV limit.
 3. Peak: Peak detector.

Note: All test mode has been tested, only the worst data record in the report.



8.6. SPURIOUS EMISSIONS 26G ~ 40GHz

8.6.1. GFSK MODE

Test Result for Antenna WCT5J-20

SPURIOUS EMISSIONS (MID CHANNEL, WORST-CASE CONFIGURATION, HORIZONTAL)

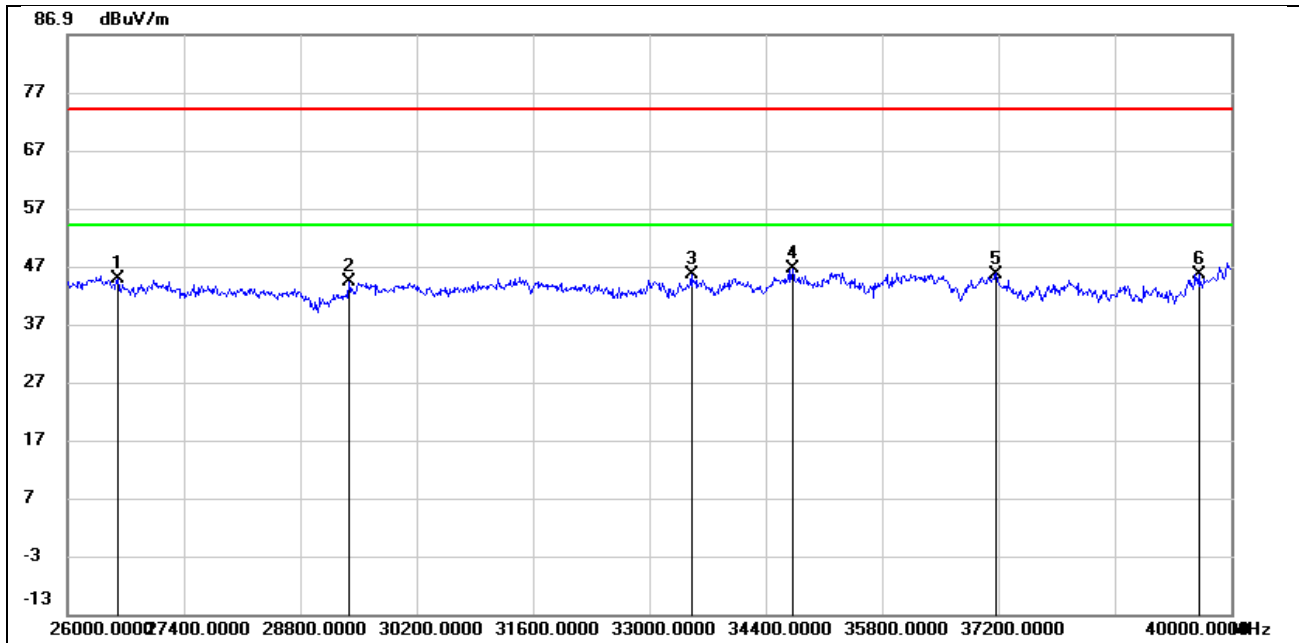

No.	Frequency (MHz)	Reading (dBuV)	Correct (dB/m)	Result (dBuV/m)	Limit (dBuV/m)	Margin (dB)	Remark
1	26602.000	49.59	-4.80	44.79	74.00	-29.21	peak
2	29388.000	45.23	-0.84	44.39	74.00	-29.61	peak
3	33504.000	44.95	0.58	45.53	74.00	-28.47	peak
4	34722.000	44.93	1.48	46.41	74.00	-27.59	peak
5	37172.000	42.49	3.16	45.65	74.00	-28.35	peak
6	39608.000	40.60	4.93	45.53	74.00	-28.47	peak

Note: 1. Peak Result = Reading Level + Correct Factor.

2. If Peak Result complies with AV limit, AV Result is deemed to comply with AV limit.

3. Peak: Peak detector.



SPURIOUS EMISSIONS (MID CHANNEL, WORST-CASE CONFIGURATION, VERTICAL)

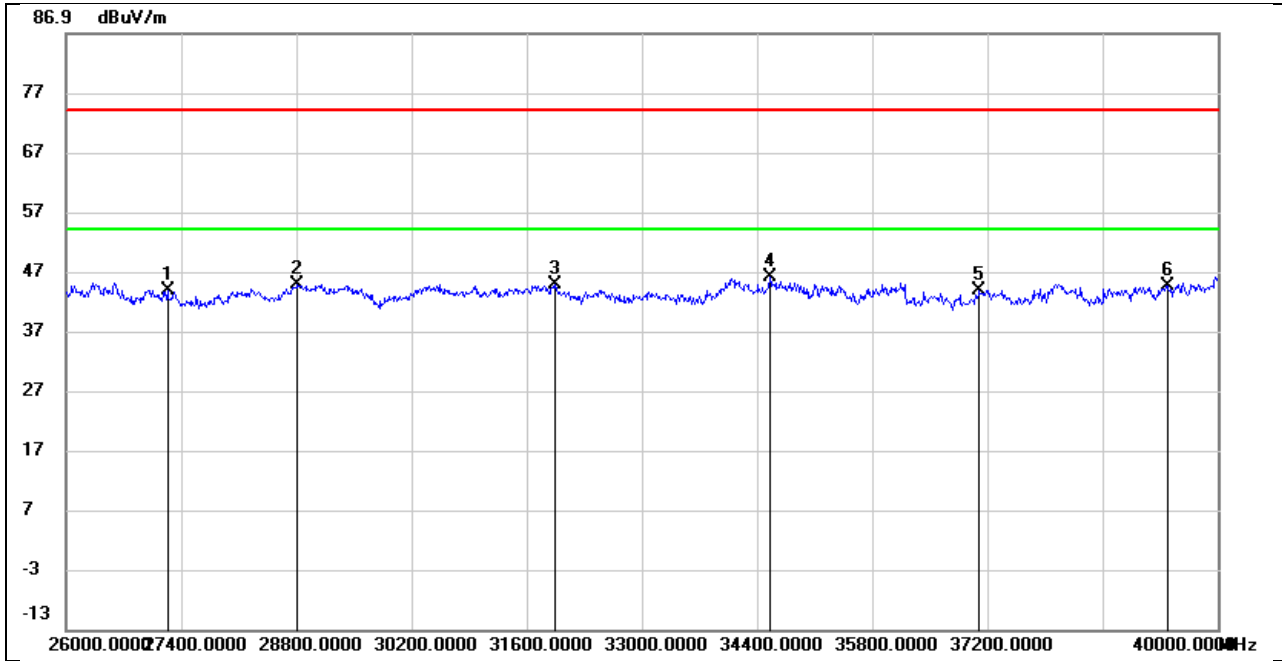

No.	Frequency (MHz)	Reading (dBuV)	Correct (dB/m)	Result (dBuV/m)	Limit (dBuV/m)	Margin (dB)	Remark
1	27232.000	48.17	-4.31	43.86	74.00	-30.14	peak
2	28814.000	45.56	-0.75	44.81	74.00	-29.19	peak
3	31936.000	46.74	-1.91	44.83	74.00	-29.17	peak
4	34554.000	44.95	1.07	46.02	74.00	-27.98	peak
5	37102.000	40.63	3.19	43.82	74.00	-30.18	peak
6	39384.000	40.00	4.61	44.61	74.00	-29.39	peak

- Note: 1. Peak Result = Reading Level + Correct Factor.
 2. If Peak Result complies with AV limit, AV Result is deemed to comply with AV limit.
 3. Peak: Peak detector.

Note: All test mode has been tested, only the worst data record in the report.



8.7. SPURIOUS EMISSIONS 30M ~ 1 GHz

8.7.1. GFSK MODE

Test Result for Antenna WCT5J-20

SPURIOUS EMISSIONS (MID CHANNEL, WORST-CASE CONFIGURATION, HORIZONTAL)

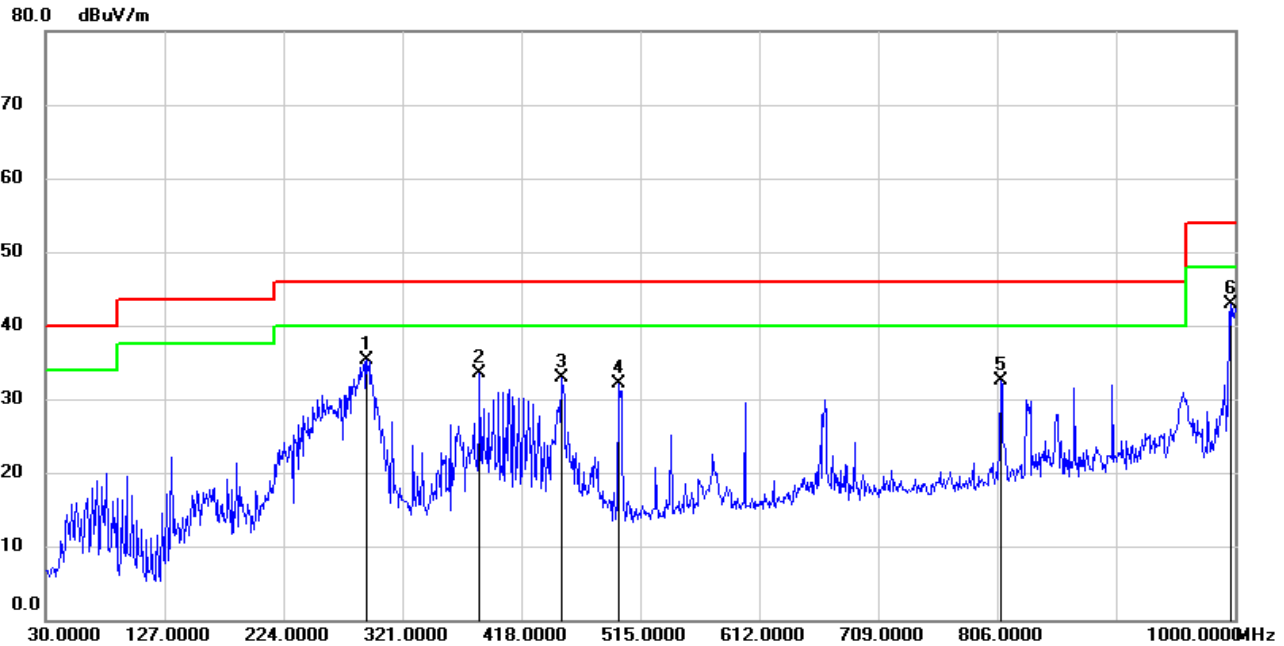

No.	Frequency (MHz)	Reading (dBuV)	Correct (dB/m)	Result (dBuV/m)	Limit (dBuV/m)	Margin (dB)	Remark
1	291.9000	49.96	-14.65	35.31	46.00	-10.69	QP
2	384.0500	46.42	-12.97	33.45	46.00	-12.55	QP
3	450.9800	44.77	-11.81	32.96	46.00	-13.04	QP
4	497.5400	43.05	-11.03	32.02	46.00	-13.98	QP
5	808.9099	37.98	-5.53	32.45	46.00	-13.55	QP
6	996.1200	45.83	-2.93	42.90	54.00	-11.10	QP

Note: 1. Result Level = Read Level + Antenna Factor + Cable loss.

2. If Peak Result complies with QP limit, QP Result is deemed to comply with QP limit.

3. Test setup: RBW: 120 kHz, VBW: 300 kHz, Sweep time: auto.



SPURIOUS EMISSIONS (MID CHANNEL, WORST-CASE CONFIGURATION, VERTICAL)

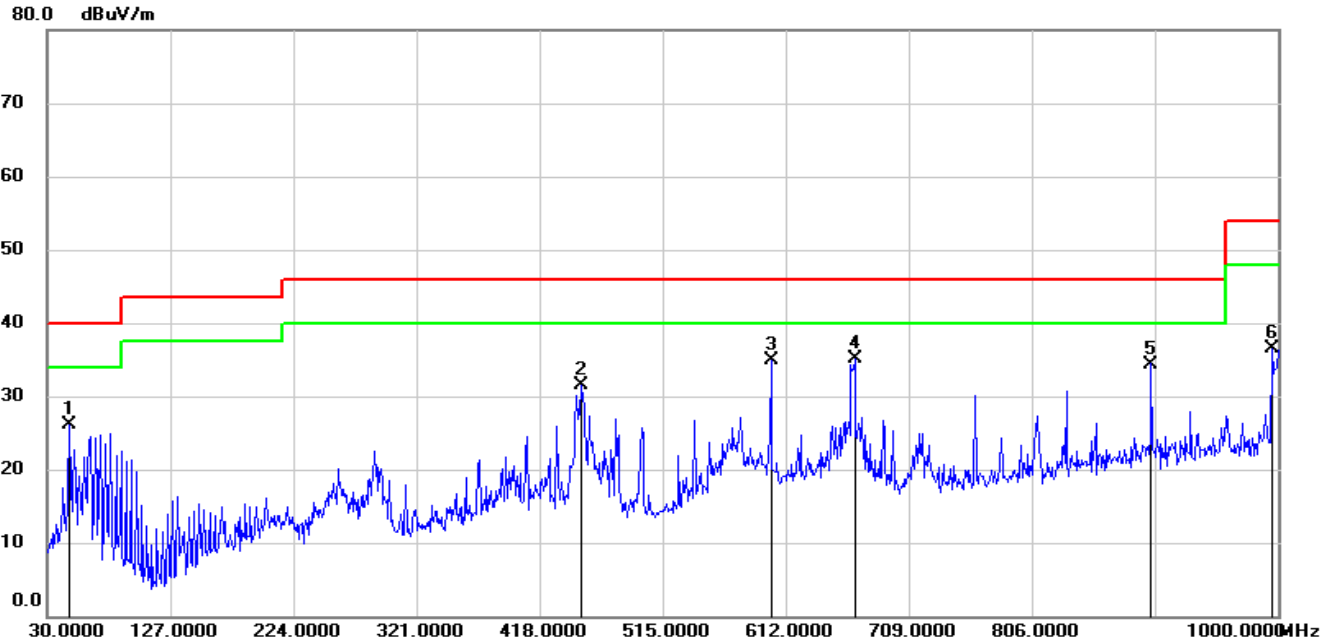

No.	Frequency (MHz)	Reading (dBuV)	Correct (dB/m)	Result (dBuV/m)	Limit (dBuV/m)	Margin (dB)	Remark
1	47.4600	44.37	-18.19	26.18	40.00	-13.82	QP
2	450.9800	43.22	-11.81	31.41	46.00	-14.59	QP
3	600.3600	43.80	-8.90	34.90	46.00	-11.10	QP
4	666.3200	42.69	-7.65	35.04	46.00	-10.96	QP
5	900.0900	38.65	-4.25	34.40	46.00	-11.60	QP
6	995.1500	39.51	-2.95	36.56	54.00	-17.44	QP

- Note: 1. Result Level = Read Level + Antenna Factor + Cable loss.
 2. If Peak Result complies with QP limit, QP Result is deemed to comply with QP limit.
 3. Test setup: RBW: 120 kHz, VBW: 300 kHz, Sweep time: auto

Note: All test mode has been tested, only the worst data record in the report.



8.8. SPURIOUS EMISSIONS BELOW 30M

8.8.1. GFSK MODE

- Test Result for Antenna WCT5J-20

SPURIOUS EMISSIONS (MID CHANNEL, LOOP ANTENNA FACE ON TO THE EUT, WORST-CASE CONFIGURATION)

9kHz~ 150kHz

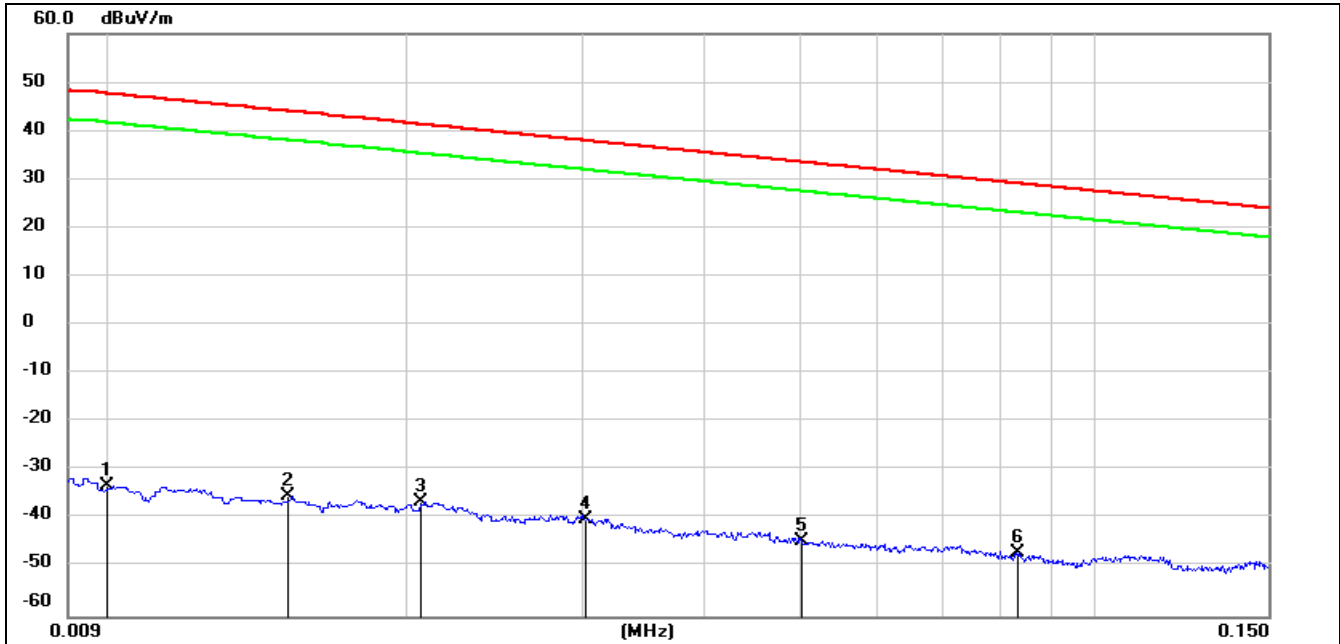

No.	Frequency (MHz)	Reading (dBuV)	Correct (dB/m)	FCC Result (dBuV/m)	FCC Limit (dBuV/m)	ISED Result (dBuA/m)	ISED Limit (dBuA/m)	Margin (dB)	Remark
1	0.0100	68.22	-101.40	-33.18	47.60	-84.68	-3.90	-80.78	peak
2	0.0151	66.11	-101.37	-35.26	44.02	-86.76	-7.48	-79.28	peak
3	0.0206	64.92	-101.35	-36.43	41.32	-87.93	-10.18	-77.75	peak
4	0.0303	61.45	-101.39	-39.94	37.97	-91.44	-13.53	-77.91	peak
5	0.0502	56.96	-101.48	-44.52	33.59	-96.02	-17.91	-78.11	peak
6	0.0834	54.78	-101.66	-46.88	29.18	-98.38	-22.32	-76.06	peak

Note: 1. Measurement = Reading Level + Correct Factor (dBuA/m= dBuV/m- 20Log10[120π] = dBuV/m- 51.5).

2. If Peak Result complies with AV and QP limit, AV and QP Result are deemed to comply with AV limit.

3. All 3 polarizations(Horizontal, Face-on and Face-off) of the loop antenna had been tested, but only the worst data recorded in the report.



150kHz ~ 490kHz

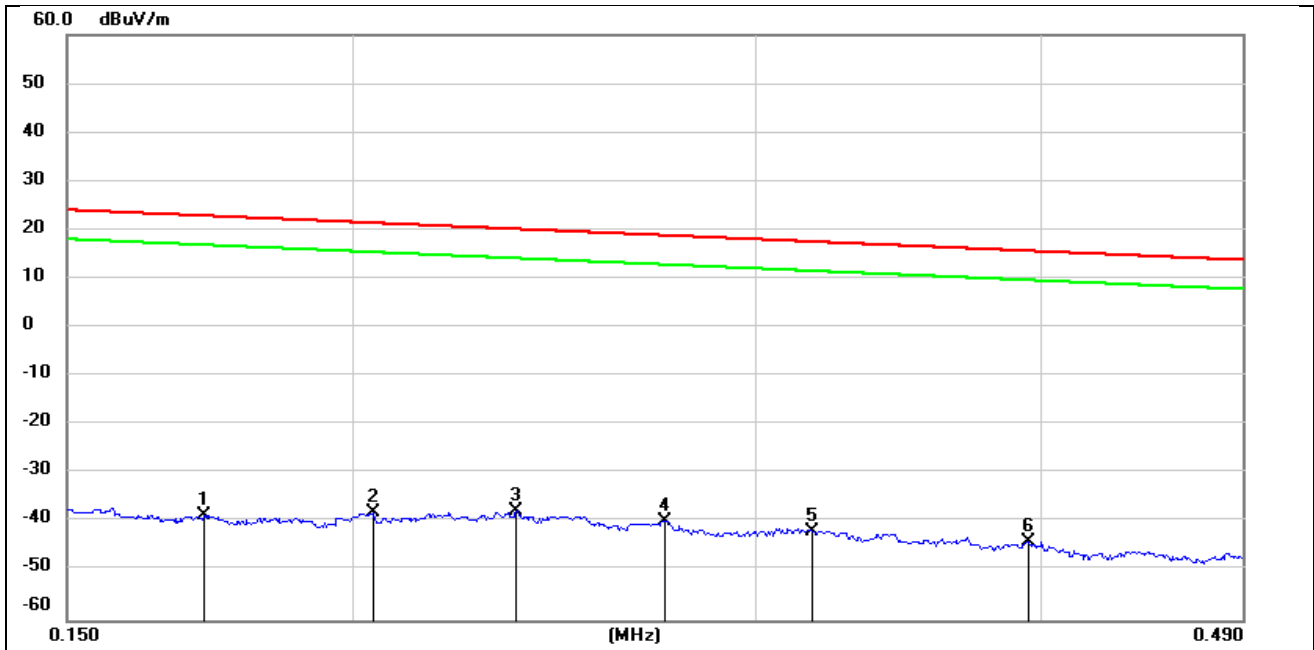

No.	Frequency (MHz)	Reading (dBuV)	Correct (dB/m)	FCC Result (dBuV/m)	FCC Limit (dBuV/m)	ISED Result (dBuA/m)	ISED Limit (dBuA/m)	Margin (dB)	Remark
1	0.1720	63.19	-101.67	-38.48	22.90	-89.98	-28.60	-61.38	peak
2	0.2041	63.65	-101.72	-38.07	21.40	-89.57	-30.10	-59.47	peak
3	0.2358	64.00	-101.78	-37.78	20.15	-89.28	-31.35	-57.93	peak
4	0.2736	62.08	-101.83	-39.75	18.86	-91.25	-32.64	-58.61	peak
5	0.3180	60.18	-101.88	-41.70	17.55	-93.20	-33.95	-59.25	peak
6	0.3951	57.98	-101.96	-43.98	15.67	-95.48	-35.83	-59.65	peak

Note: 1. Measurement = Reading Level + Correct Factor (dBuA/m= dBuV/m- 20Log10[120π] = dBuV/m- 51.5).

2. If Peak Result complies with AV and QP limit, AV and QP Result are deemed to comply with AV limit.

3. All 3 polarizations(Horizontal, Face-on and Face-off) of the loop antenna had been tested, but only the worst data recorded in the report.



490kHz ~ 30MHz

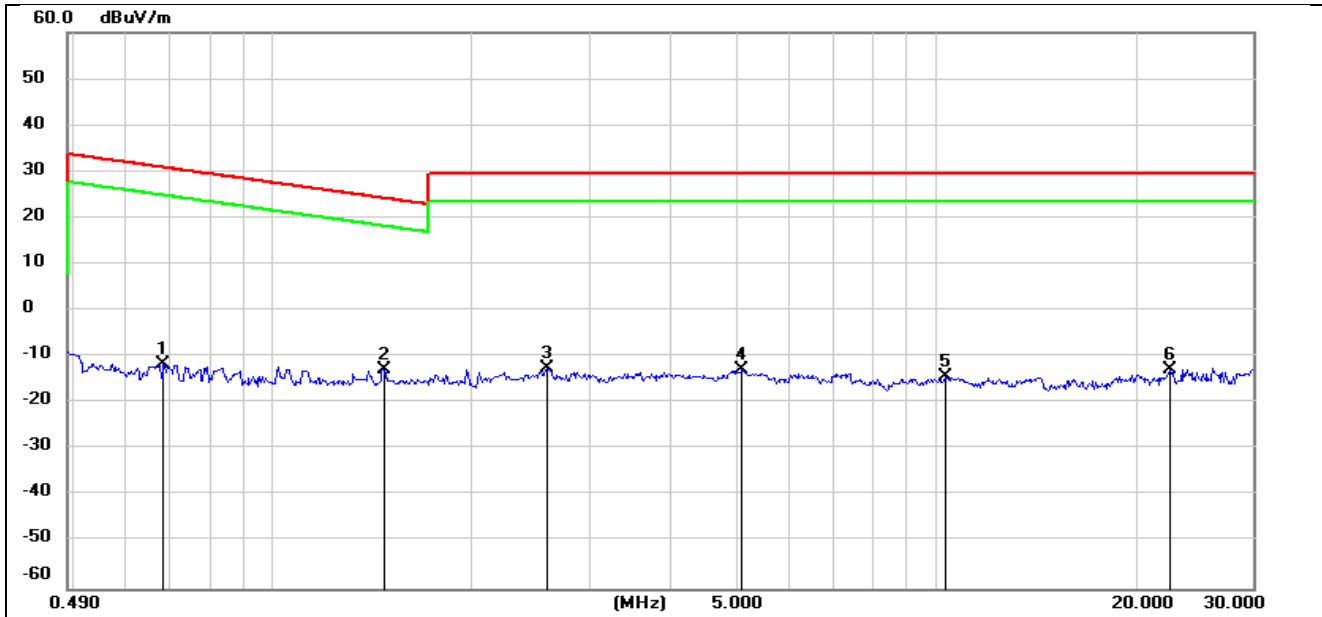

No.	Frequency (MHz)	Reading (dBuV)	Correct (dB/m)	FCC Result (dBuV/m)	FCC Limit (dBuV/m)	ISED Result (dBuA/m)	ISED Limit (dBuA/m)	Margin (dB)	Remark
1	0.6834	50.71	-62.11	-11.40	30.91	-62.90	-20.59	-42.31	peak
2	1.4700	49.39	-62.05	-12.66	24.26	-64.16	-27.24	-36.92	peak
3	2.5935	49.11	-61.68	-12.57	29.54	-64.07	-21.96	-42.11	peak
4	5.0936	48.70	-61.48	-12.78	29.54	-64.28	-21.96	-42.32	peak
5	10.3168	46.48	-60.81	-14.33	29.54	-65.83	-21.96	-43.87	peak
6	22.5045	47.88	-60.64	-12.76	29.54	-64.26	-21.96	-42.30	peak

Note: 1. Measurement = Reading Level + Correct Factor (dBuA/m= dBuV/m- 20Log10[120π] = dBuV/m- 51.5).

2. If Peak Result complies with AV and QP limit, AV and QP Result are deemed to comply with AV limit.

3. All 3 polarizations(Horizontal, Face-on and Face-off) of the loop antenna had been tested, but only the worst data recorded in the report.

Note: All test mode has been tested, only the worst data record in the report.

9. AC POWER LINE CONDUCTED EMISSIONS

LIMITS

Please refer to CFR 47 FCC §15.207 (a) and ISED RSS-Gen Clause 8.8.

FREQUENCY (MHz)	Quasi-peak	Average
0.15 -0.5	66 - 56 *	56 - 46 *
0.50 -5.0	56.00	46.00
5.0 -30.0	60.00	50.00

TEST SETUP AND PROCEDURE

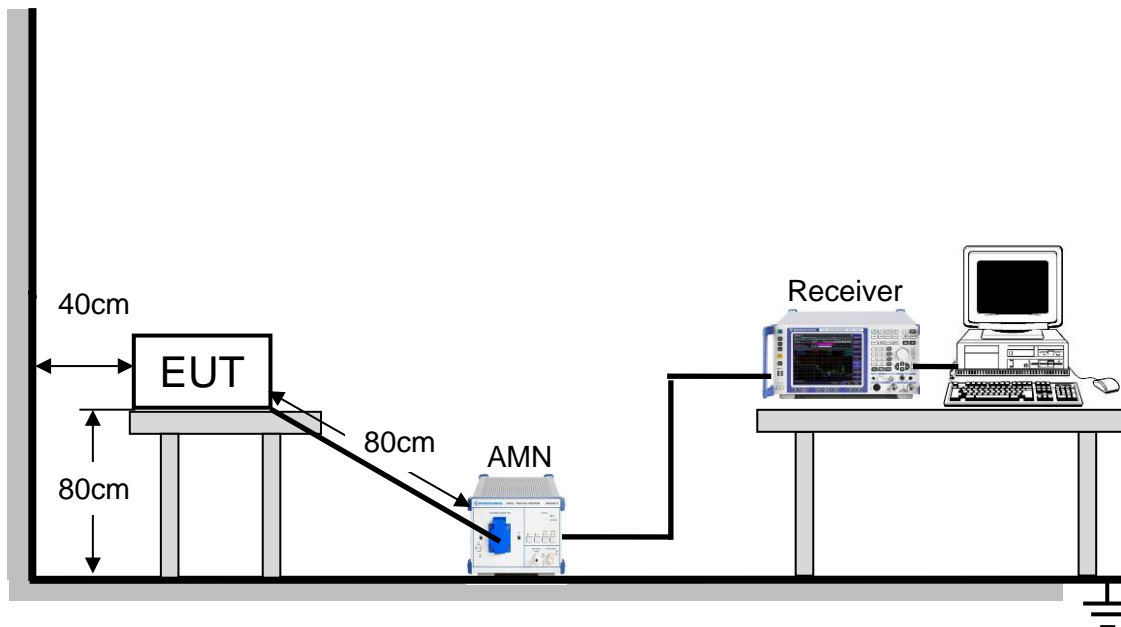

The EUT is put on a table of non-conducting material that is 80cm high. The vertical conducting wall of shielding is located 40cm to the rear of the EUT. The power line of the EUT is connected to the AC mains through a Artificial Mains Network (A.M.N.). A EMI Measurement Receiver (R&S Test Receiver ESR3) is used to test the emissions from both sides of AC line. According to the requirements in Section 6.2 of ANSI C63.10-2013. Conducted emissions from the EUT measured in the frequency range between 0.15 MHz and 30MHz using CISPR Quasi-Peak and average detector mode. The bandwidth of EMI test receiver is set at 9kHz.

The arrangement of the equipment is installed to meet the standards and operating in a manner, which tends to maximize its emission characteristics in a normal application.

TEST ENVIRONMENT

Temperature	25°C	Relative Humidity	58%
Atmosphere Pressure	101kPa	Test Voltage	DC 5V



9.1. 8DPSK MODE

Test Result for Antenna WCT5J-20

TEST RESULTS (HIGH CHANNEL, WORST-CASE CONFIGURATION)

LINE N RESULTS

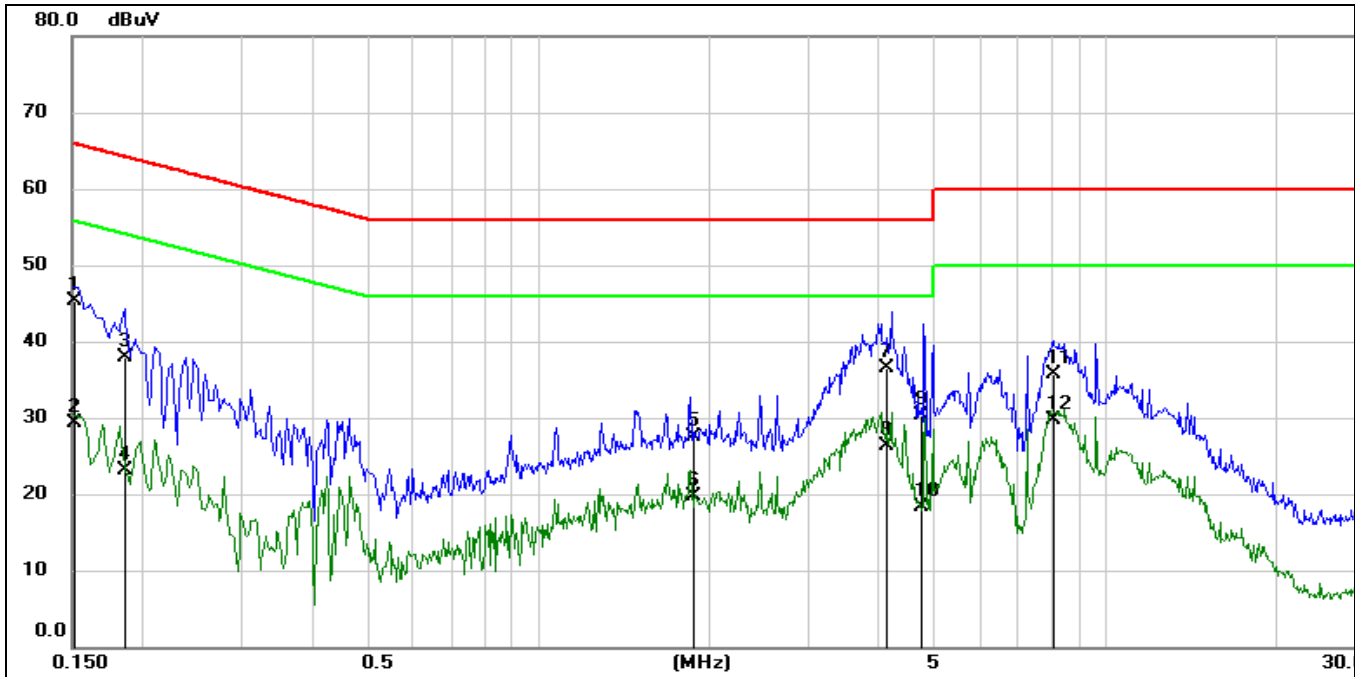

No.	Frequency (MHz)	Reading (dBuV)	Correct (dB)	Result (dBuV)	Limit (dBuV)	Margin (dB)	Remark
1	0.1513	35.73	9.60	45.33	65.93	-20.60	QP
2	0.1513	19.75	9.60	29.35	55.93	-26.58	AVG
3	0.1859	28.24	9.60	37.84	64.22	-26.38	QP
4	0.1859	13.53	9.60	23.13	54.22	-31.09	AVG
5	1.8931	17.79	9.63	27.42	56.00	-28.58	QP
6	1.8931	10.17	9.63	19.80	46.00	-26.20	AVG
7	4.1293	26.92	9.66	36.58	56.00	-19.42	QP
8	4.1293	16.56	9.66	26.22	46.00	-19.78	AVG
9	4.7334	20.73	9.67	30.40	56.00	-25.60	QP
10	4.7334	8.61	9.67	18.28	46.00	-27.72	AVG
11	8.0832	26.05	9.72	35.77	60.00	-24.23	QP
12	8.0832	19.95	9.72	29.67	50.00	-20.33	AVG

- Note: 1. Result = Reading +Correct Factor.
 2. If QP Result complies with AV limit, AV Result is deemed to comply with AV limit.
 3. Test setup: RBW: 200 Hz (9 kHz—150 kHz), 9 kHz (150 kHz—30 MHz).
 4. Step size: 80Hz (0.009MHz-0.15MHz), 4 kHz (0.15MHz-30MHz), Scan time: auto.



LINE L RESULTS

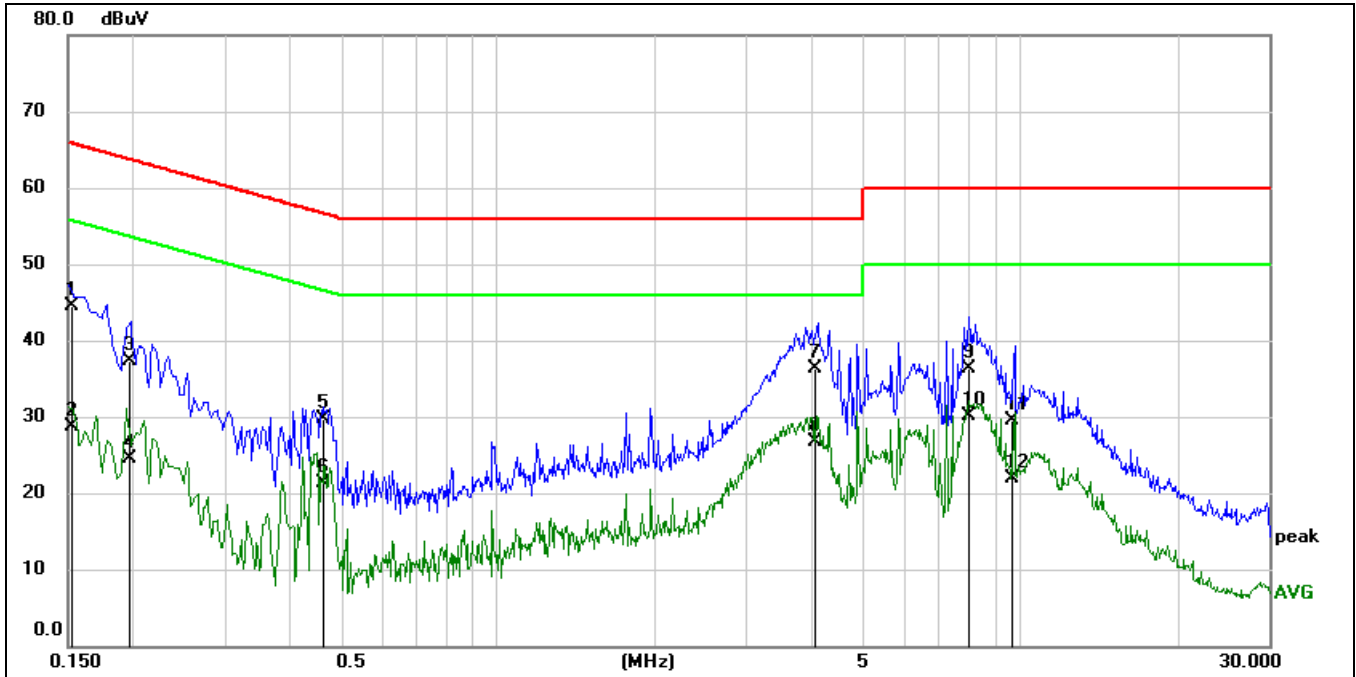

No.	Frequency (MHz)	Reading (dBuV)	Correct (dB)	Result (dBuV)	Limit (dBuV)	Margin (dB)	Remark
1	0.1528	34.97	9.61	44.58	65.85	-21.27	QP
2	0.1528	19.04	9.61	28.65	55.85	-27.20	AVG
3	0.1963	27.80	9.60	37.40	63.77	-26.37	QP
4	0.1963	14.88	9.60	24.48	53.77	-29.29	AVG
5	0.4634	20.05	9.60	29.65	56.63	-26.98	QP
6	0.4634	11.61	9.60	21.21	46.63	-25.42	AVG
7	4.0579	26.70	9.66	36.36	56.00	-19.64	QP
8	4.0579	17.07	9.66	26.73	46.00	-19.27	AVG
9	8.0440	26.56	9.72	36.28	60.00	-23.72	QP
10	8.0440	20.41	9.72	30.13	50.00	-19.87	AVG
11	9.6864	19.83	9.74	29.57	60.00	-30.43	QP
12	9.6864	12.10	9.74	21.84	50.00	-28.16	AVG

- Note: 1. Result = Reading +Correct Factor.
 2. If QP Result complies with AV limit, AV Result is deemed to comply with AV limit.
 3. Test setup: RBW: 200 Hz (9 kHz—150 kHz), 9 kHz (150 kHz—30 MHz).
 4. Step size: 80Hz (0.009MHz-0.15MHz), 4 kHz (0.15MHz-30MHz), Scan time: auto.

Note: All the modes and channels had been tested, but only the worst data recorded in the report.



10. ANTENNA REQUIREMENTS

APPLICABLE REQUIREMENTS

Please refer to FCC §15.203

An intentional radiator shall be designed to ensure that no antenna other than that furnished by the responsible party shall be used with the device. The use of a permanently attached antenna or of an antenna that uses a unique coupling to the intentional radiator shall be considered sufficient to comply with the provisions of this section. The manufacturer may design the unit so that a broken antenna can be replaced by the user, but the use of a standard antenna jack or electrical connector is prohibited.

Please refer to FCC §15.247(b)(4)

The conducted output power limit specified in paragraph (b) of this section is based on the use of antennas with directional gains that do not exceed 6 dBi. Except as shown in paragraph (c) of this section, if transmitting antennas of directional gain greater than 6 dBi are used, the conducted output power from the intentional radiator shall be reduced below the stated values in paragraphs (b)(1), (b)(2), and (b)(3) of this section, as appropriate, by the amount in dB that the directional gain of the antenna exceeds 6 dBi.

RESULTS

Complies

END OF REPORT