



CFR 47 FCC PART 15 SUBPART E

TEST REPORT

For

WIFI+BT Module

MODEL NUMBER: WCT54M2001

FCC ID:2AC23-WCT54

REPORT NUMBER: 4788997152-4

ISSUE DATE: June 17, 2019

Prepared for

**Hui Zhou Gaoshengda Technology Co.,LTD
NO.75 Zhongkai Development Area Huizhou, Guangdong China**

Prepared by

**UL Verification Services (Guangzhou) Co., Ltd, Song Shan Lake Branch
Building 10, Innovation Technology Park, No. 1, Li Bin Road, Song Shan Lake
Hi-Tech Development Zone Dongguan, People's Republic of China**

Tel: +86 769 22038881

Fax: +86 769 33244054

Website: www.ul.com



Revision History

<u>Rev.</u>	<u>Issue Date</u>	<u>Revisions</u>	<u>Revised By</u>
V0	06/17/2019	Initial Issue	



Summary of Test Results			
Clause	Test Items	FCC Rules	Test Results
1	6/26db/99% Bandwidth	FCC 15.407 (a)&(e)	PASS
2	Maximum Conducted Output Power	FCC 15.407 (a)	PASS
3	Power Spectral Density	FCC 15.407 (a)	PASS
4	Antenna Conducted Spurious Emission	FCC 15.407 (b)	PASS
5	Radiated Bandedge and Spurious Emission	FCC 15.407 (a) FCC 15.209 FCC 15.205	PASS
6	Conducted Emission Test For AC Power Port	FCC 15.207	PASS
7	Antenna Requirement	FCC 15.203	PASS
8	Frequency Stability	FCC 15.407 (g)	PASS
9	Dynamic Frequency Selection	FCC 15.407 (h)	No support



TABLE OF CONTENTS

1. ATTESTATION OF TEST RESULTS	6
2. TEST METHODOLOGY	7
3. FACILITIES AND ACCREDITATION	7
4. CALIBRATION AND UNCERTAINTY	8
4.1. <i>MEASURING INSTRUMENT CALIBRATION</i>	8
4.2. <i>MEASUREMENT UNCERTAINTY</i>	8
5. EQUIPMENT UNDER TEST	9
5.1. <i>DESCRIPTION OF EUT</i>	9
5.2. <i>MAXIMUM EIRP</i>	10
5.3. <i>CHANNEL LIST</i>	11
5.4. <i>THE WORSE CASE POWER SETTING PARAMETER</i>	12
5.5. <i>THE WORSE CASE CONFIGURATIONS</i>	13
5.6. <i>DESCRIPTION OF AVAILABLE ANTENNAS</i>	14
5.7. <i>DESCRIPTION OF TEST SETUP</i>	15
6. MEASURING INSTRUMENT AND SOFTWARE USED	16
7. ANTENNA PORT TEST RESULTS	18
7.1. <i>ON TIME AND DUTY CYCLE</i>	18
7.2. <i>6/26/99% dB BANDWIDTH</i>	20
7.2.1. 802.11a SISO MODE	22
7.2.2. 802.11n HT20 MIMO MODE	25
7.2.3. 802.11n HT40 MIMO MODE	28
7.2.4. 802.11ac VHT80 MIMO MODE	30
7.3. <i>MAXIMUM CONDUCTED OUTPUT POWER</i>	32
7.3.1. UNII-1 BAND	33
7.3.2. UNII-3 BAND	34
7.4. <i>POWER SPECTRAL DENSITY</i>	35
7.4.1. 802.11a SISO MODE	37
7.4.2. 802.11n HT20 MIMO MODE	41
7.4.3. 802.11n HT40 MIMO MODE	45
7.4.4. 802.11ac VHT80 MIMO MODE	47
8. RADIATED TEST RESULTS	49
8.1. <i>802.11a SISO MODE</i>	55
8.1.1. UNII-1 BAND	55
8.1.2. UNII-3 BAND	71
8.2. <i>802.11n HT20 MIMO MODE</i>	87
8.2.1. UNII-1 BAND	87



8.2.2.	UNII-3 BAND	103
8.3.	802.11n HT40 MIMO MODE	119
8.3.1.	UNII-1 BAND	119
8.3.2.	UNII-3 BAND	131
8.4.	802.11ac VHT80 MIMO MODE	143
8.4.1.	UNII-1 BAND	143
8.4.2.	UNII-3 BAND	151
8.1.	WORST-CASE CO-LOCATION	157
8.1.1.	BT GFSK AND 802.11n HT20 MIMO MODE	157
8.2.	SPURIOUS EMISSIONS 18~26GHz.....	161
8.2.1.	802.11n HT20 MIMO MODE	161
8.3.	SPURIOUS EMISSIONS 26~40GHz.....	163
8.3.1.	802.11n HT20 MIMO MODE	163
8.4.	SPURIOUS EMISSIONS 30M ~ 1 GHz.....	165
8.4.1.	802.11n HT20 MIMO MODE	165
8.5.	SPURIOUS EMISSIONS BELOW 30M.....	167
8.5.1.	802.11n HT20 MIMO MODE	167
9.	AC POWER LINE CONDUCTED EMISSIONS	170
9.1.	802.11n HT20 MIMO MODE	171
10.	FREQUENCY STABILITY	173
11.	ANTENNA REQUIREMENTS.....	175



1. ATTESTATION OF TEST RESULTS

Applicant Information

Company Name: Hui Zhou Gaoshengda Technology Co.,LTD
Address: NO.75 Zhongkai Development Area Huizhou, Guangdong China

Manufacturer Information

Company Name: Hui Zhou Gaoshengda Technology Co.,LTD
Address: NO.75 Zhongkai Development Area Huizhou, Guangdong China

EUT Description

EUT Name: WIFI+BT Module
Model: WCT54M2001
Brand: GSD
Sample Status: Normal
Sample ID: 1000690879
Sample Received Date: May 10, 2019
Date of Tested: May 10, 2019 ~ June 17, 2019

APPLICABLE STANDARDS	
STANDARD	TEST RESULTS
CFR 47 FCC PART 15 SUBPART E	PASS

Prepared By:

Checked By:

Kebo Zhang
Engineer Project Associate
Approved By:

Shawn Wen
Laboratory Leader

Stephen Guo
Laboratory Manager



2. TEST METHODOLOGY

The tests documented in this report were performed in accordance with ANSI C63.10-2013, CFR 47 FCC Part 2, CFR 47 FCC Part 15, KDB 789033 D02 v02r01 and KDB414788 D01 Radiated Test Site v01r01.

3. FACILITIES AND ACCREDITATION

Accreditation Certificate	<p>A2LA (Certificate No.: 4102.01) UL Verification Services (Guangzhou) Co., Ltd. Song Shan Lake Branch. has been assessed and proved to be in compliance with A2LA.</p> <p>FCC (FCC Designation No.: CN1187) UL Verification Services (Guangzhou) Co., Ltd. Song Shan Lake Branch. Has been recognized to perform compliance testing on equipment subject to the Commission's Declaration of Conformity (DoC) and Certification rules</p> <p>ISED(Company No.: 21320) UL Verification Services (Guangzhou) Co., Ltd. Song Shan Lake Branch. has been registered and fully described in a report filed with ISED. The Company Number is 21320.</p> <p>VCCI (Registration No.: G-20019, R-20004, C-20012 and T-20011) UL Verification Services (Guangzhou) Co., Ltd. Song Shan Lake Branch. has been assessed and proved to be in compliance with VCCI, the Membership No. is 3793. Facility Name: Chamber D, the VCCI registration No. is G-20019 and R-20004 Shielding Room B , the VCCI registration No. is C-20012 and T-20011</p>
---------------------------	---

Note 1: All tests measurement facilities use to collect the measurement data are located at Building 10, Innovation Technology Park, Song Shan Lake Hi tech Development Zone, Dongguan, 523808, China

Note 2: The test anechoic chamber in UL Verification Services (Guangzhou) Co., Ltd. Song Shan Lake Branch had been calibrated and compared to the open field sites and the test anechoic chamber is shown to be equivalent to or worst case from the open field site.

Note 3: For below 30MHz, lab had performed measurements at test anechoic chamber and comparing to measurements obtained on an open field site. And these measurements below 30MHz had been correlated to measurements performed on an OFS.



4. CALIBRATION AND UNCERTAINTY

4.1. MEASURING INSTRUMENT CALIBRATION

The measuring equipment utilized to perform the tests documented in this report has been calibrated in accordance with the manufacturer's recommendations, and is traceable to recognize national standards.

4.2. MEASUREMENT UNCERTAINTY

Where relevant, the following measurement uncertainty levels have been estimated for tests performed on the apparatus:

Test Item	Uncertainty
Uncertainty for Conduction emission test	3.62dB
Uncertainty for Radiation Emission test(include Fundamental emission) (9KHz-30MHz)	2.2dB
Uncertainty for Radiation Emission test(include Fundamental emission) (30MHz-1GHz)	4.00dB
Uncertainty for Radiation Emission test (1GHz to 26GHz)(include Fundamental emission)	5.78dB (1GHz-18Gz)
	5.23dB (18GHz-26Gz)
	5.64dB (26GHz-40Gz)
Note: This uncertainty represents an expanded uncertainty expressed at approximately the 95% confidence level using a coverage factor of k=2.	



5. EQUIPMENT UNDER TEST

5.1. DESCRIPTION OF EUT

EUT Name	WIFI+BT Module
Model	WCT54M2001
Radio Technology	IEEE802.11a IEEE802.11n HT20/HT40 IEEE802.11ac VHT20/VHT40/VHT80
Operation frequency	UNII-1/UNII-3
Modulation	OFDM(BPSK,QPSK,16QAM,64QAM,256QAM in ac mode only.)
Rated Input	DC 3.3V



5.2. MAXIMUM EIRP

UNII-1 BAND

IEE Std. 802.11	Frequency (MHz)	Max Power (dBm)	Max EIRP (dBm)
a SISO	5150-5250	15.00	17.13
n HT20 MIMO	5150-5250	17.73	19.86
n HT40 MIMO	5150-5250	16.87	19.00
ac VHT20 MIMO	5150-5250	17.42	19.55
ac VHT40 MIMO	5150-5250	16.34	18.47
ac VHT80 MIMO	5150-5250	13.86	15.99

UNII-3 BAND

IEE Std. 802.11	Frequency (MHz)	Max Power (dBm)
a SISO	5725-5850	13.06
n HT20 MIMO	5725-5850	17.19
n HT40 MIMO	5725-5850	17.16
ac VHT20 MIMO	5725-5850	17.23
ac VHT40 MIMO	5725-5850	17.16
ac VHT80 MIMO	5725-5850	14.65



5.3. CHANNEL LIST

UNII-1 (For Bandwidth=20MHz)		UNII-1 (For Bandwidth=40MHz)		UNII-1 (For Bandwidth=80MHz)	
Channel	Frequency (MHz)	Channel	Frequency (MHz)	Channel	Frequency (MHz)
36	5180	38	5190	42	5210
40	5200	46	5230		
44	5220				
48	5240				

UNII-3		UNII-3		UNII-3	
Channel	Frequency (MHz)	Channel	Frequency (MHz)	Channel	Frequency (MHz)
149	5745	151	5755	155	5775
153	5765	159	5795		
157	5785				
161	5805				
165	5825				



5.4. THE WORSE CASE POWER SETTING PARAMETER

UNII-1

Mode	Rate	Channel	Soft set value Antenna0	Soft set value Antenna1
11a	6M	36	default	default
		40	default	default
		48	default	default
11n HT20	MCS0	36	default	default
		40	default	default
		48	default	default
11n HT20	MCS0	38	default	default
		46	default	default
11ac VHT20	MCS0	36	default	default
		40	default	default
		48	default	default
11ac VHT40	MCS0	38	default	default
		46	default	default
11ac VHT80	MCS0	42	default	default

UNII-3

Mode	Rate	Channel	Soft set value Antenna0	Soft set value Antenna1
11a	6M	149	default	default
		157	default	default
		165	default	default
11n HT20	MCS0	149	default	default
		157	default	default
		165	default	default
11n HT20	MCS0	151	default	default
		159	default	default
11ac VHT20	MCS0	149	default	default
		157	default	default
		165	default	default
11ac VHT40	MCS0	151	default	default
		159	default	default
11ac VHT80	MCS0	155	default	default



5.5. THE WORSE CASE CONFIGURATIONS

For SISO modes, there are two transmission antennas. The antenna used in any given time can be either ANTENNA 0 or ANTENNA 1. All antenna ports have the same power; output power measurement for SISO modes on both antennas are reported.

For 2TX MIMO modes, ANTENNA 0 and ANTENNA 1, used at the same time.

SISO mode and MIMO mode have the same power setting, so only the worst case MIMO mode will be record in the report.

Worst-case data rates as provided by the client were:

802.11a mode: 6 Mbps

802.11n HT20 mode: MCS0

802.11n HT40 mode: MCS0

802.11ac VHT20 mode: MCS0

802.11ac VHT40 mode: MCS0

802.11ac VHT80 mode: MCS0

802.11ac VHT20 and VHT40 mode are different from 802.11nHT20 and HT40 only in control messages and have the same power settings, so for these 4 modes, only 802.11nHT20 and 802.11nHT40 modes data are recorded in the report .

802.11n HT20/HT40 SISO mode and MIMO mode have the same power setting, so only the worst case MIMO mode will be record in the report.

802.11a support SISO mode, two antenna have the same power setting, so only the worst data for antenna 0 are recorded in the report.



5.6. DESCRIPTION OF AVAILABLE ANTENNAS

Antenna No.	Frequency (MHz)	Antenna Type	Max Antenna Gain (dBi)
0	5150-5250,5725-5850	PIFA Antenna	2.13
1	5150-5250,5725-5850		2.13

Note: Directional gain= $G_{ANT} + 10 \log(N_{ANT})$ dBi=5.14dBi

G_{ANT} : Antenna Gain

N_{ANT} : Antenna numbers

IEE Std. 802.11	Transmit and Receive Mode	Description
802.11a	<input checked="" type="checkbox"/> 2TX, 2RX	ANT 0, 1 can be used as transmitting/receiving antenna.
802.11n HT20	<input checked="" type="checkbox"/> 2TX, 2RX	ANT 0, 1 can be used as transmitting/receiving antenna.
802.11n HT40	<input checked="" type="checkbox"/> 2TX, 2RX	ANT 0, 1 can be used as transmitting/receiving antenna.
802.11ac VHT20	<input checked="" type="checkbox"/> 2TX, 2RX	ANT 0, 1 can be used as transmitting/receiving antenna.
802.11ac VHT40	<input checked="" type="checkbox"/> 2TX, 2RX	ANT 0, 1 can be used as transmitting/receiving antenna.
802.11ac VHT80	<input checked="" type="checkbox"/> 2TX, 2RX	ANT 0, 1 can be used as transmitting/receiving antenna.

Note: Only 802.11a support SISO mode

5.7. DESCRIPTION OF TEST SETUP

SUPPORT EQUIPMENT

Item	Equipment	Brand Name	Model Name	P/N
1	Laptop	ThinkPad	T460S	SL10K24796 JS
2	USB TO UART	/	/	/

I/O CABLES

Cable No	Port	Connector Type	Cable Type	Cable Length(m)	Remarks
1	USB	/	/	0.50	/

Note: The USB cable is for debugging only.

ACCESSORIES

Item	Accessory	Brand Name	Model Name	Description
1	/		/	/

TEST SETUP

The EUT can work in engineering mode with a software through a Laptop.

SETUP DIAGRAM FOR TESTS

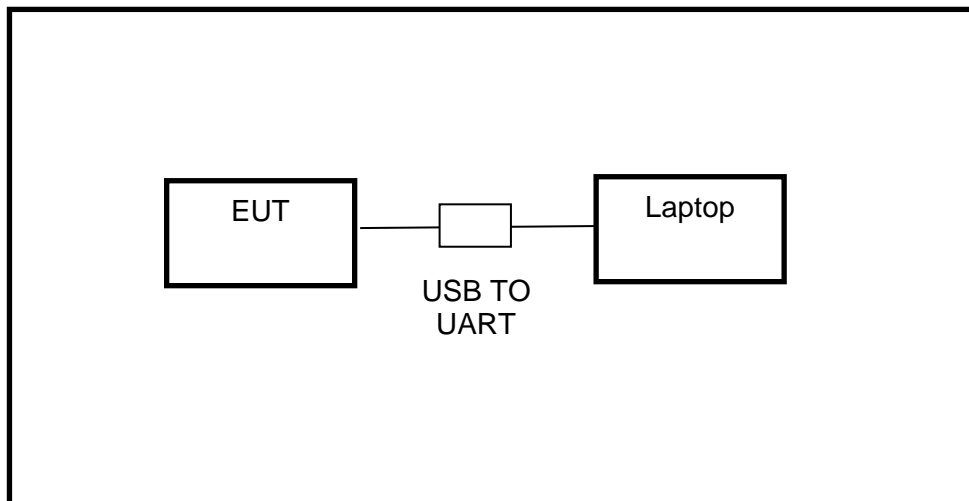



6. MEASURING INSTRUMENT AND SOFTWARE USED

Conducted Emissions						
Instrument						
Used	Equipment	Manufacturer	Model No.	Serial No.	Last Cal.	Next Cal.
<input checked="" type="checkbox"/>	EMI Test Receiver	R&S	ESR3	101961	Dec.10,2018	Dec.10,2019
<input checked="" type="checkbox"/>	Two-Line V-Network	R&S	ENV216	101983	Dec.10,2018	Dec.10,2019
<input checked="" type="checkbox"/>	Artificial Mains Networks	Schwarzbeck	NSLK 8126	8126465	Dec.10,2018	Dec.10,2019
Software						
Used	Description	Manufacturer	Name	Version		
<input checked="" type="checkbox"/>	Test Software for Conducted disturbance	Farad	EZ-EMC	Ver. UL-3A1		
Radiated Emissions						
Instrument						
Used	Equipment	Manufacturer	Model No.	Serial No.	Last Cal.	Next Cal.
<input checked="" type="checkbox"/>	MXE EMI Receiver	KESIGHT	N9038A	MY56400036	Dec.10,2018	Dec.10,2019
<input checked="" type="checkbox"/>	Hybrid Log Periodic Antenna	TDK	HLP-3003C	130960	Sep.17, 2018	Sep.17, 2021
<input checked="" type="checkbox"/>	Preamplifier	HP	8447D	2944A09099	Dec.10,2018	Dec.10,2019
<input checked="" type="checkbox"/>	EMI Measurement Receiver	R&S	ESR26	101377	Dec.10,2018	Dec.10,2019
<input checked="" type="checkbox"/>	Horn Antenna	TDK	HRN-0118	130939	Sep.17, 2018	Sep.17, 2021
<input checked="" type="checkbox"/>	High Gain Horn Antenna	Schwarzbeck	BBHA-9170	691	Aug.11, 2018	Aug.11, 2021
<input checked="" type="checkbox"/>	Preamplifier	TDK	PA-02-0118	TRS-305-00066	Dec.10,2018	Dec.10,2019
<input checked="" type="checkbox"/>	Preamplifier	TDK	PA-02-2	TRS-307-00003	Dec.10,2018	Dec.10,2019
<input checked="" type="checkbox"/>	Loop antenna	Schwarzbeck	1519B	00008	Jan.07, 2019	Jan.07, 2022
<input checked="" type="checkbox"/>	Band Reject Filter	Wainwright	WRCJV8-2350-2400-2483.5-2533.5-40SS	4	Dec.10,2018	Dec.10,2019
<input checked="" type="checkbox"/>	High Pass Filter	Wi	WHKX10-2700-3000-18000-40SS	23	Dec.10,2018	Dec.10,2019
Software						
Used	Description	Manufacturer	Name	Version		
<input checked="" type="checkbox"/>	Test Software for Radiated disturbance	Farad	EZ-EMC	Ver. UL-3A1		



Other instruments						
Used	Equipment	Manufacturer	Model No.	Serial No.	Last Cal.	Next Cal.
<input checked="" type="checkbox"/>	Spectrum Analyzer	Keysight	N9030A	MY55410512	Dec.10,2018	Dec.10,2019
<input checked="" type="checkbox"/>	Power Meter	Keysight	N1911A	MY55416024	Dec.10,2018	Dec.10,2019
<input checked="" type="checkbox"/>	Power Sensor	Keysight	U2021XA	MY5100022	Dec.10,2018	Dec.10,2019
<input checked="" type="checkbox"/>	Power sensor, Power Meter	R&S	OSP- B157W8/X	100921	Dec.10,2018	Dec.10,2019



7. ANTENNA PORT TEST RESULTS

7.1. ON TIME AND DUTY CYCLE

LIMITS

None; for reporting purposes only

TEST SETUP

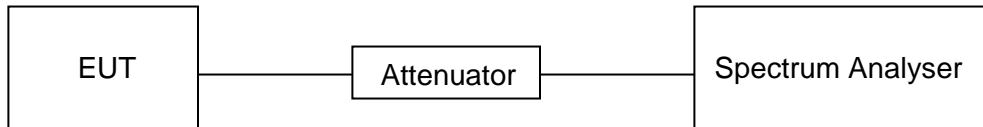

TEST ENVIRONMENT

Temperature	23.5°C	Relative Humidity	59%
Atmosphere Pressure	101kPa	Test Voltage	DC 3.3V

RESULTS

Mode	ON Time (ms)	F (msec)	N (msec)	Period (ms)	Duty Cycle x (Linear)	Duty Cycle (%)	Duty Cycle Correction Factor (dB)	1/T Minimum VBW (KHz)
11a SISO	1.391	0.4613	1.889	1.4277	0.974	97.43%	0.114	0.72
11n HT20 MIMO	1.299	0.09125	1.426	1.33475	0.973	97.32%	0.119	0.77
11n HT40 MIMO	0.647	0.166	0.849	0.683	0.947	94.73%	0.237	1.55
11ac VHT80 MIMO	0.1863	0.08688	0.310	0.22312	0.835	83.50%	0.783	5.37

Note:

Period=N-F

Where: F is starting time of the Period

Where: N is ending time of the Period

Duty Cycle Correction Factor=10log (1/x).

Where: x is Duty Cycle (Linear)

Where: T is On Time

If that calculated VBW is not available on the analyzer then the next higher value should be used.

Antenna 0 and Antenna 1 has the same duty cycle, only ANT 0 data show here.



802.11a

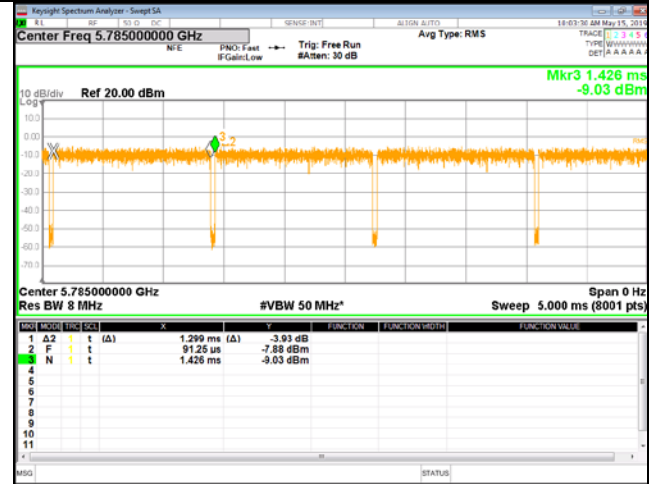

802.11n HT20



802.11n HT40

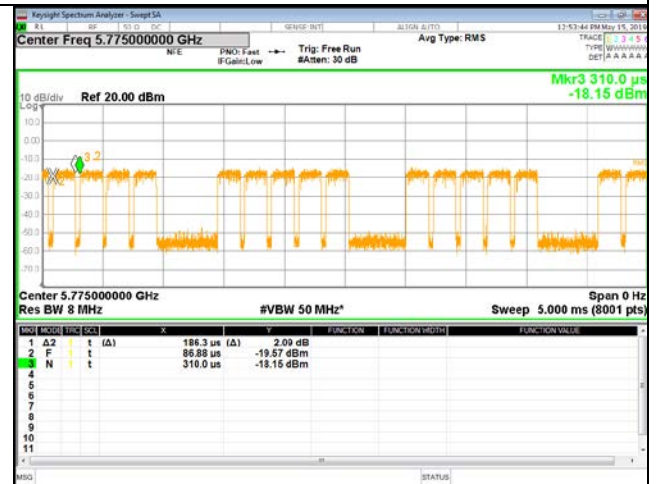

802.11ac HT80

7.2. 6/26/99% dB BANDWIDTH

LIMITS

CFR 47 FCC Part15, Subpart E ISED RSS-247		
Test Item	Limit	Frequency Range (MHz)
Bandwidth	26 dB Bandwidth	5150-5250
	26 dB Bandwidth	5250-5350
	26 dB Bandwidth	For FCC:5470-5725 For IC:5470-5600 5650-5725
	Minimum 500kHz 6dB Bandwidth	5725-5850

ISED RSS-247		
RSS-Gen Clause 6.7	99% Bandwidth	For reporting purposes only.

TEST PROCEDURE

Connect the UUT to the spectrum analyser and use the following settings:

Center Frequency	The center frequency of the channel under test
Detector	Peak
RBW	For 6dB Bandwidth: RBW=100kHz For 26dB Bandwidth: approximately 1% of the emission bandwidth. For 99dB Bandwidth: approximately 1%~5% of the emission bandwidth.
VBW	For 6dB Bandwidth : VBW=300kHz For 26dB Bandwidth : >3RBW For 99%dB Bandwidth : >3RBW
Trace	Max hold
Sweep	Auto couple

Allow the trace to stabilize and measure the maximum width of the emission that is constrained by the frequencies associated with the two outermost amplitude points (upper and lower frequencies) that are attenuated by 6dB/26dB&99% Occupied Bandwidth relative to the maximum level measured in the fundamental emission.

TEST SETUP

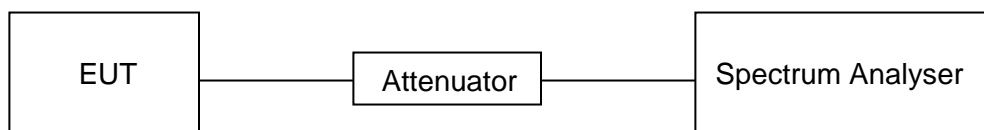



TEST ENVIRONMENT

Temperature	23.5°C	Relative Humidity	59%
Atmosphere Pressure	101kPa	Test Voltage	DC 3.3V

RESULTS



7.2.1. 802.11a SISO MODE

ANT0 WORST CASE

UNII-1 BAND

Channel	Frequency (MHz)	26 dB BW (MHz)	99% BW (MHz)
Low	5180	19.03	16.445
Mid	5200	20.44	16.430
High	5240	19.47	16.407





UNII-3 BAND

Channel	Frequency (MHz)	6 dB BW (MHz)	99% BW (MHz)	Limit For 6dB BW (KHz)	Result
Low	5745	13.54	16.454	500	PASS
Mid	5785	14.75	16.475	500	PASS
High	5825	16.29	16.484	500	PASS

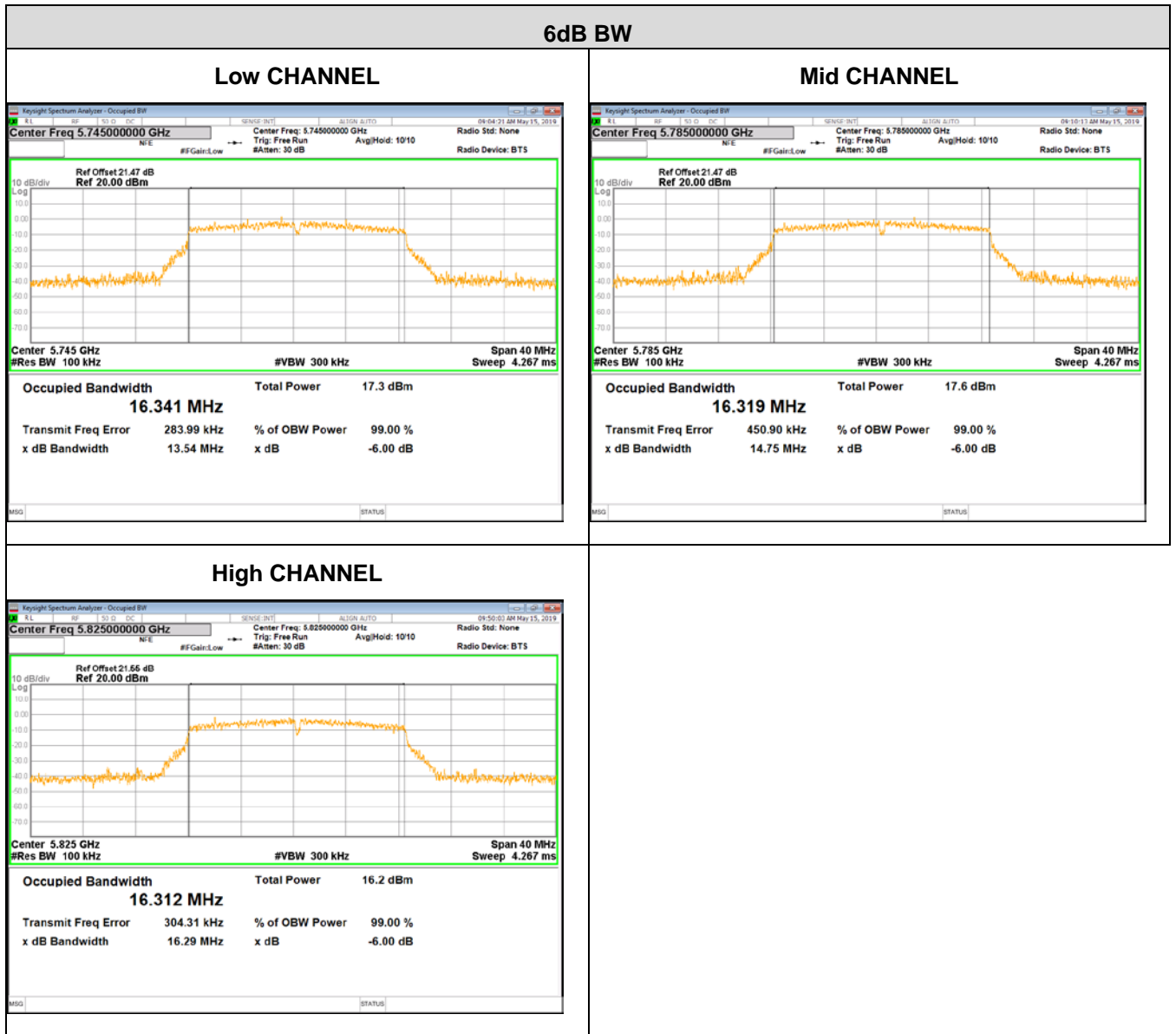



Note: All the modes and antenna ports had been tested, only the worst data recorded in the report.



7.2.2. 802.11n HT20 MIMO MODE

ANT0 WORST CASE

UNII-1 BAND

Channel	Frequency (MHz)	26 dB BW (MHz)	99% BW (MHz)
Low	5180	20.57	17.582
Mid	5200	19.70	17.572
High	5240	19.93	17.571





UNII-3 BAND

Channel	Frequency (MHz)	6 dB BW (MHz)	99% BW (MHz)	Limit For 6dB BW (KHz)	Result
Low	5745	16.91	17.510	500	PASS
Mid	5785	15.77	17.574	500	PASS
High	5825	14.73	17.597	500	PASS





Note: All the modes and antenna ports had been tested, only the worst data recorded in the report.



7.2.3. 802.11n HT40 MIMO MODE

ANT0 WORST CASE

UNII-1 BAND

Channel	Frequency (MHz)	26 dB BW (MHz)	99% BW (MHz)
Low	5190	40.47	36.194
High	5230	44.43	36.163

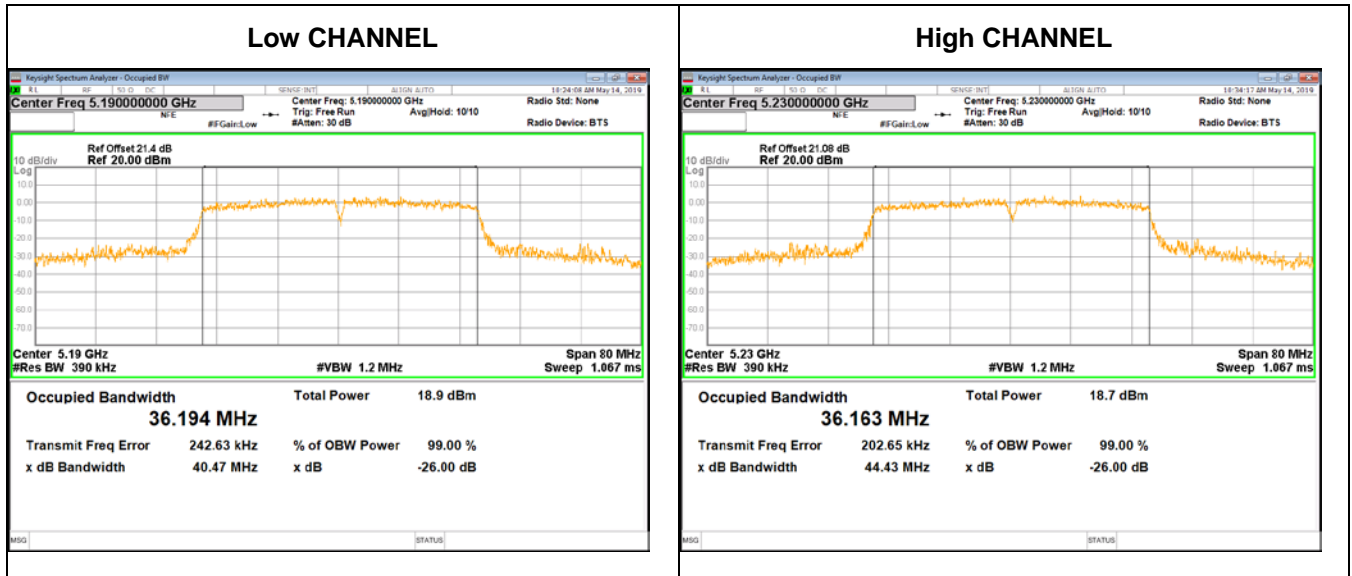



UNII-3 BAND

Channel	Frequency (MHz)	6 dB BW (MHz)	99% BW (MHz)	Limit (KHz)	Result
Low	5755	35.59	36.152	500	PASS
High	5795	35.10	36.129	500	PASS

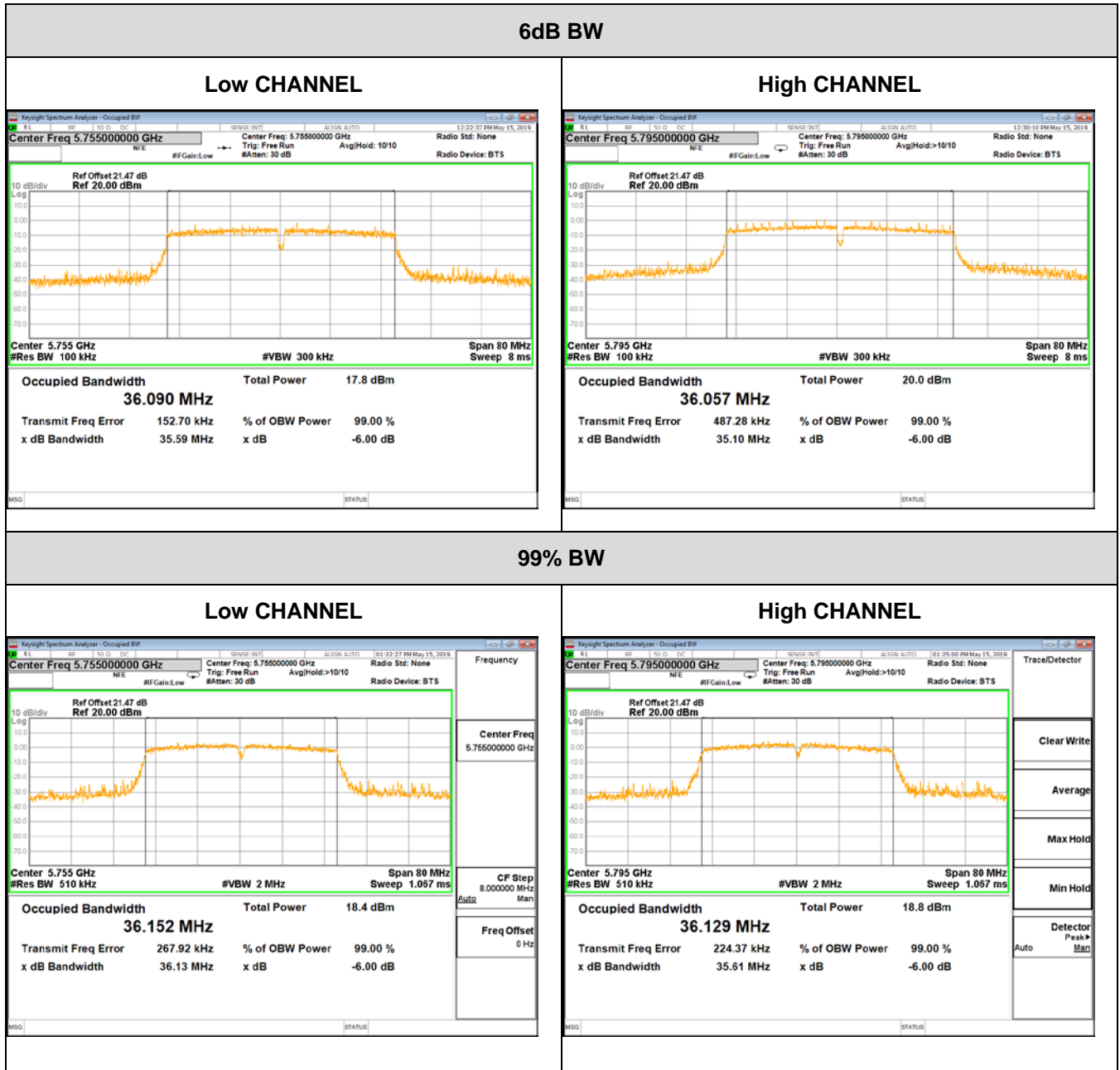

Note: All the modes and antenna ports had been tested, only the worst data recorded in the report.



7.2.4. 802.11ac VHT80 MIMO MODE

ANT0 WORST CASE

UNII-1 BAND

Channel	Frequency (MHz)	26 dB BW (MHz)	99% BW (MHz)
Mid	5210	78.95	75.528

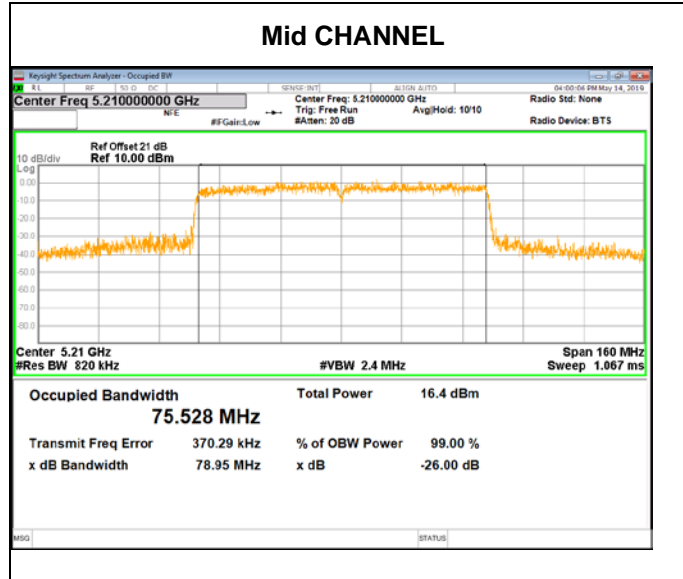



UNII-3 BAND

Channel	Frequency (MHz)	6 dB BW (MHz)	99% BW (MHz)	Limit For 6dB BW (KHz)	Result
Mid	5775	75.16	76.659	500	PASS

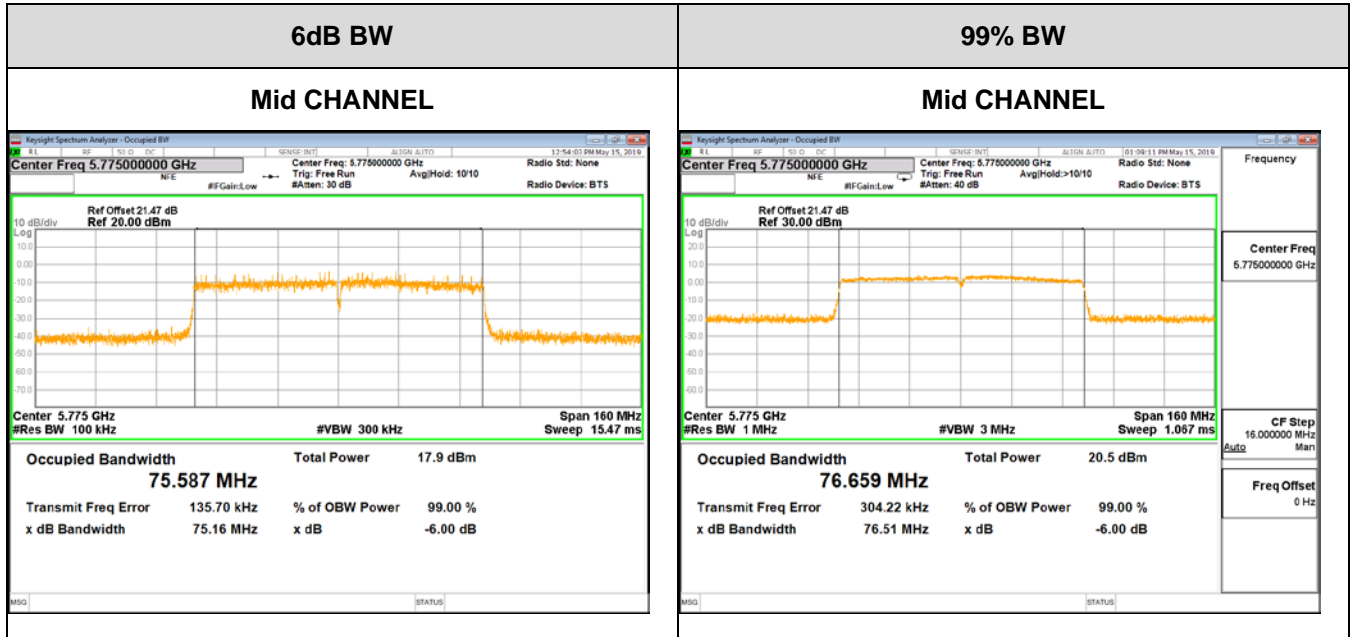

Note: All the modes and antenna ports had been tested, only the worst data recorded in the report.

7.3. MAXIMUM CONDUCTED OUTPUT POWER

LIMITS

FCC Part15, Subpart E/ RSS-247		
Test Item	Limit	Frequency Range (MHz)
Conducted Output Power	For FCC client devices:250mW (24dBm)	5150-5250
	250mW (24dBm) or $10 + 10 \log_{10} B$	5250-5350
	250mW (24dBm) or $10 + 10 \log_{10} B$	5470-5725
	1 Watt (30dBm)	5725-5850
<p>Note:</p> <ol style="list-style-type: none"> 1. If transmitting antennas of directional gain greater than 6 dBi are used, both the maximum conducted output power and the maximum power spectral density shall be reduced by the amount in dB that the directional gain of the antenna exceeds 6dBi. 2. Directional gain= $G_{ANT} + 10 \log(N_{ANT})$ dBi=5.14dBi =4.59<6dBi, where N_{ANT} is the number of outputs, G_{ANT} is the Antenna gain. 3. B is the 26 dB emission bandwidth in megahertz 		

TEST PROCEDURE

Refer to KDB 789033 D02 General UNII Test Procedures New Rules v02r01

Connect the EUT to the a broadband average RF power meter, the power meter shall have a video bandwidth that is greater than or equal to the bandwidth and shall utilize a fast-responding diode detector.

Straddle channel power is measured using PXA spectrum analyzer.

TEST SETUP

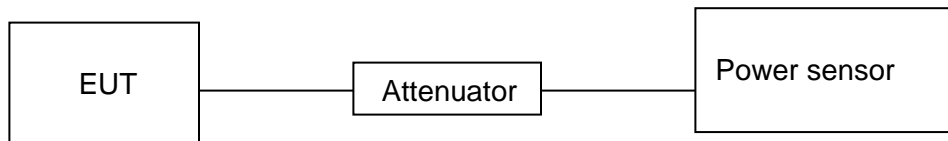

TEST ENVIRONMENT

Temperature	23.5°C	Relative Humidity	59%
Atmosphere Pressure	101kPa	Test Voltage	DC 3.3V



RESULTS

7.3.1. UNII-1 BAND

Mode	Frequency (MHz)	Chain	CONDUCTED POWER (dBm)		Limit (dBm)	EIRP (dBm)	EIRP Limit (dBm)
			Single	Total			
a	5180	0	15.00		23	17.13	24
		1	14.06			16.19	
	5200	0	14.44		23	16.57	24
		1	13.25			15.38	
	5240	0	14.63		23	16.76	24
		1	13.54			15.67	
n HT20	5180	0	14.23	16.93	23	19.06	24
		1	13.59				
	5200	0	14.65	17.52	23	19.65	24
		1	14.37				
	5240	0	14.86	17.73	23	19.86	24
		1	14.57				
ac HT20	5180	0	14.21	16.72	23	18.85	24
		1	13.15				
	5200	0	14.65	17.33	23	19.46	24
		1	13.96				
	5240	0	14.53	17.42	23	19.55	24
		1	14.29				
n HT40	5190	0	14.48	16.87	24	19.00	24
		1	13.13				
	5230	0	14.16	16.69	24	18.82	24
		1	13.14				
ac VHT40	5190	0	13.74	16.34	24	18.47	24
		1	12.88				
	5230	0	13.86	15.87	24	18.00	24
		1	11.57				
ac VHT80	5210	0	11.19	13.86	24	15.99	24
		1	10.47				

Note: 1. Conducted Power=Meas. Level+ Correction Factor
 2. About correction Factor please refer to section 7.1
 3. EIRP=conducted Power + Antenna Gain



7.3.2. UNII-3 BAND

Mode	Frequency (MHz)	Chain	CONDUCTED POWER (dBm)		Limit (dBm)
			Single	Total	
a	5745	1	12.40		30
		2	12.57		
	5785	1	13.06		30
		2	12.98		
	5825	1	11.79		30
		2	11.61		
n HT20	5745	1	13.94	16.75	30
		2	13.54		
	5785	1	14.01	17.19	30
		2	14.35		
	5825	1	13.62	16.55	30
		2	13.46		
ac HT20	5745	1	13.34	16.92	30
		2	14.42		
	5785	1	14.18	17.23	30
		2	14.25		
	5825	1	14.23	16.97	30
		2	13.67		
n HT40	5755	1	13.32	16.73	30
		2	14.09		
	5795	1	14.14	17.16	30
		2	14.15		
ac VHT40	5755	1	13.67	16.95	30
		2	14.19		
	5795	1	14.00	17.16	30
		2	14.29		
ac VHT80	5775	1	11.47	14.65	30
		2	11.80		

Note: 1. Conducted Power=Meas. Level+ Correction Factor
2. About correction Factor please refer to section 7.1



7.4. POWER SPECTRAL DENSITY

LIMITS

CFR 47 FCC Part15, Subpart E ISED RSS-247		
Test Item	Limit	Frequency Range (MHz)
Power Spectral Density	For FCC: Other than Mobile and portable:17dBm/MHz Mobile and portable:11dBm/MHz	5150-5250
	For RSS: e.i.r.p. 10dBm/MHz	
	11dBm/MHz	5250-5350
	11dBm/MHz	For FCC:5470-5725 For IC:5470-5600 5650-5725
	30dBm/500kHz	5725-5850
<p>Note:</p> <ol style="list-style-type: none"> If transmitting antennas of directional gain greater than 6 dBi are used, both the maximum conducted output power and the maximum power spectral density shall be reduced by the amount in dB that the directional gain of the antenna exceeds 6dBi. Directional gain = $10\log[(10^{G1/20} + 10^{G2/20})^2 / N_{ANT}] = 4.59 < 6\text{dBi}$, where N_{ANT} is the number of outputs, $G_{1/2}$ is the Antenna gain. 		

TEST PROCEDURE

Connect the UUT to the spectrum analyser and use the following settings:

For UNII-1, UNII-2A and UNII-2C band:

Center Frequency	The center frequency of the channel under test
Detector	RMS
RBW	1MHz
VBW	$\geq 3 \times \text{RBW}$
Span	Encompass the entire emissions bandwidth (EBW) of the signal
Trace	Max hold
Sweep time	Auto

For U-NII-3:

Center Frequency	The center frequency of the channel under test
Detector	RMS
RBW	500kHz
VBW	$\geq 3 \times \text{RBW}$
Span	Encompass the entire emissions bandwidth (EBW) of the signal
Trace	Max hold
Sweep time	Auto



Allow trace to fully stabilize and use the peak marker function to determine the maximum amplitude level within the RBW.

TEST SETUP

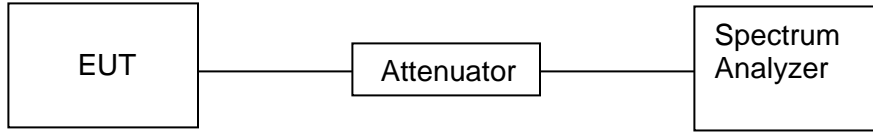

TEST ENVIRONMENT

Temperature	23.5°C	Relative Humidity	59%
Atmosphere Pressure	101kPa	Test Voltage	DC 3.3V

RESULTS



7.4.1. 802.11a SISO MODE

UNII-1 BAND

Test Channel	Frequency (MHz)	ANT	Meas. Level (dBm/MHz)		Limit (dBm/MHz)
			Single	Total	
Low	5180	0	5.050	N/A	11
		1	3.718		
Middle	5200	0	4.282		
		1	3.710		
High	5240	0	4.497		
		1	3.444		

Note: 1.PSD=Meas. Level+ Correction Factor
2. About correction Factor please refer to section 7.1

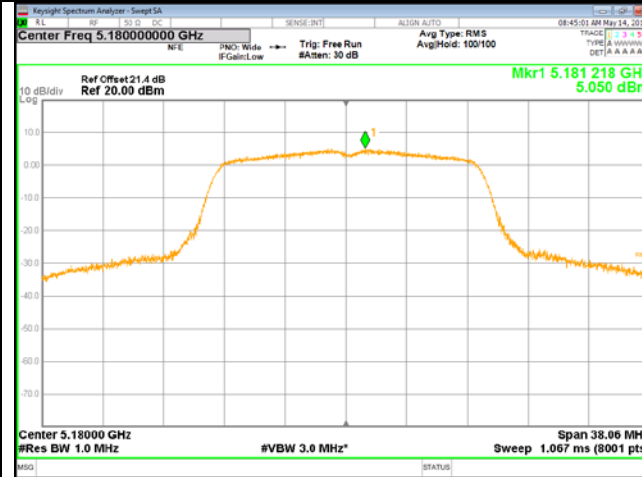

ANT 0, LOW CHANNEL

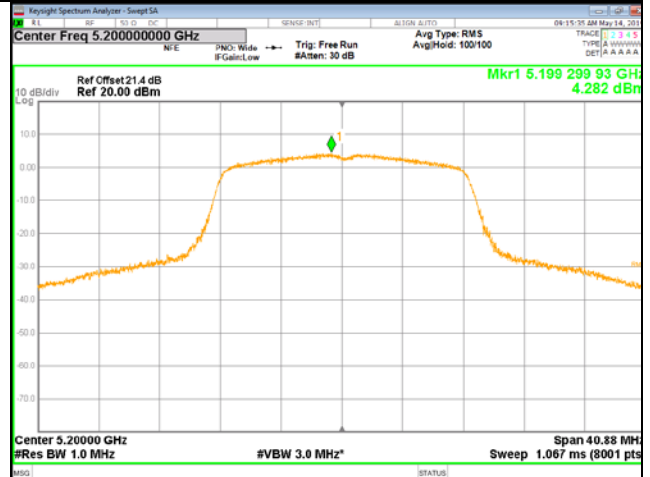

ANT 0, MID CHANNEL

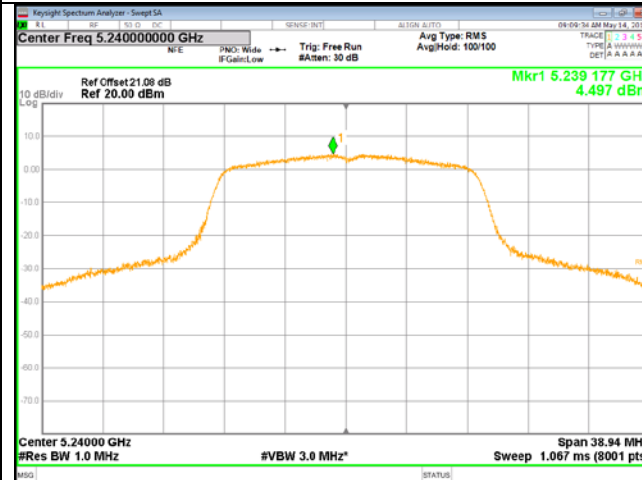

ANT 0, HIGH CHANNEL

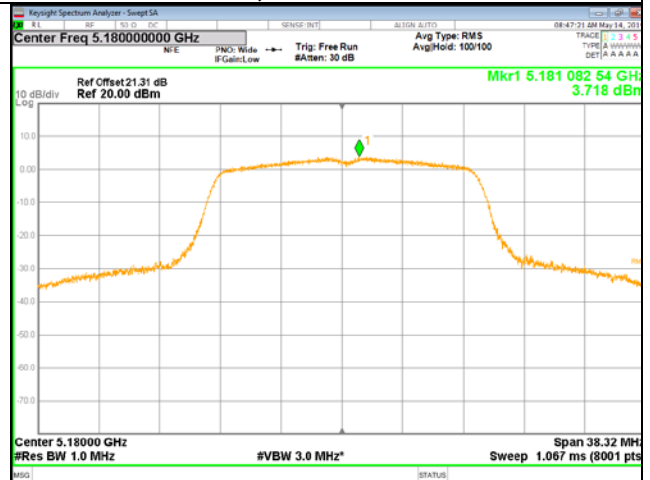

ANT 1, LOW CHANNEL

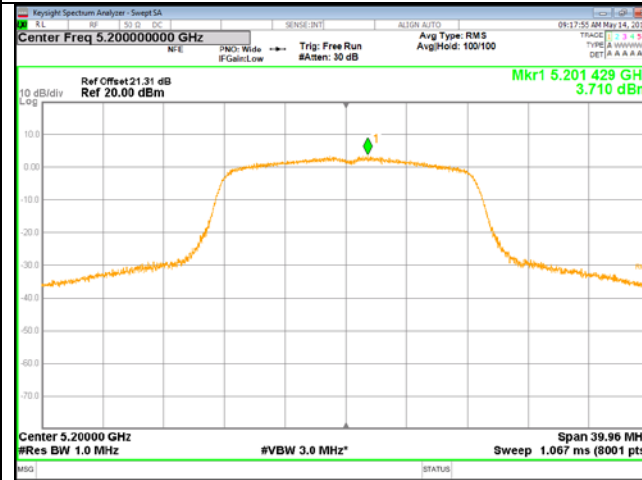

ANT 1, MID CHANNEL

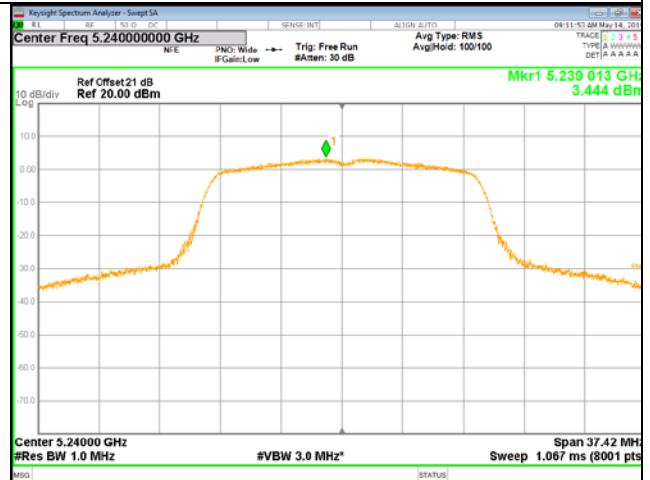

ANT 1, HIGH CHANNEL



UNII-3 BAND

Test Channel	Frequency (MHz)	ANT	Meas. Level (dBm/500KHz)		Limit (dBm/500KHz)
			Single	Total	
Low	5745	0	0.371	N/A	30
		1	0.131		
Middle	5785	0	0.617		
		1	0.146		
High	5825	0	-1.020		
		1	-0.934		

Note: 1.PSD=Meas. Level+ Correction Factor
2. About correction Factor please refer to section 7.1

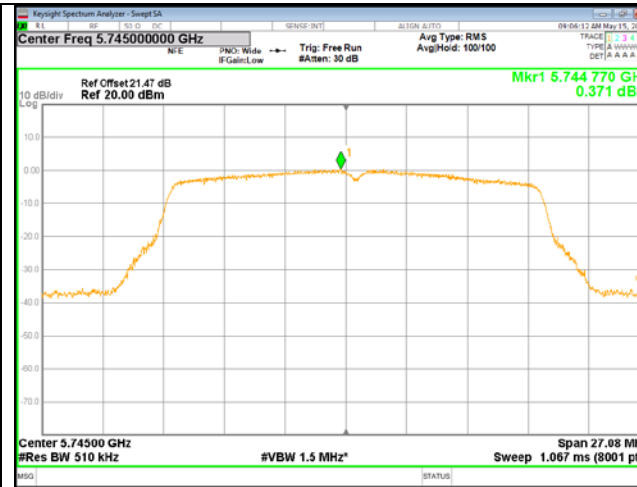

ANT 0, LOW CHANNEL

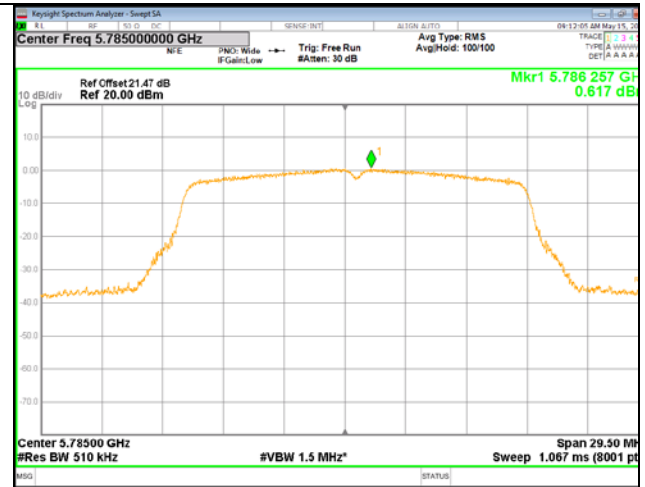

ANT 0, MID CHANNEL

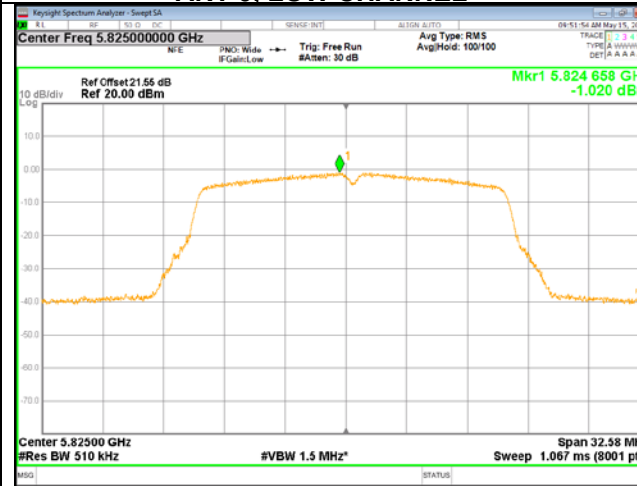

ANT 0, HIGH CHANNEL

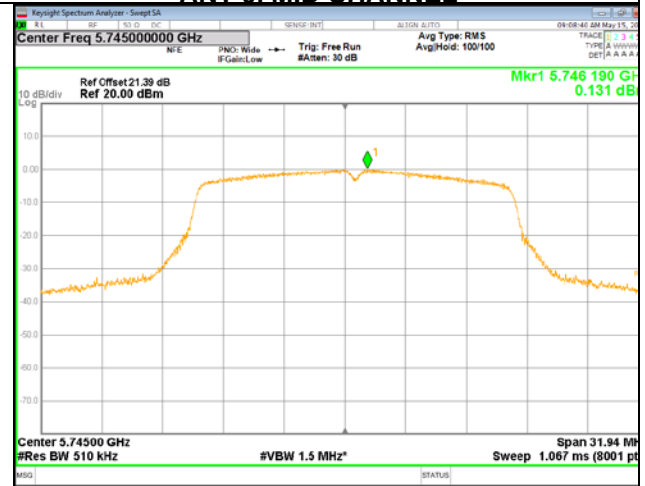

ANT 1, LOW CHANNEL

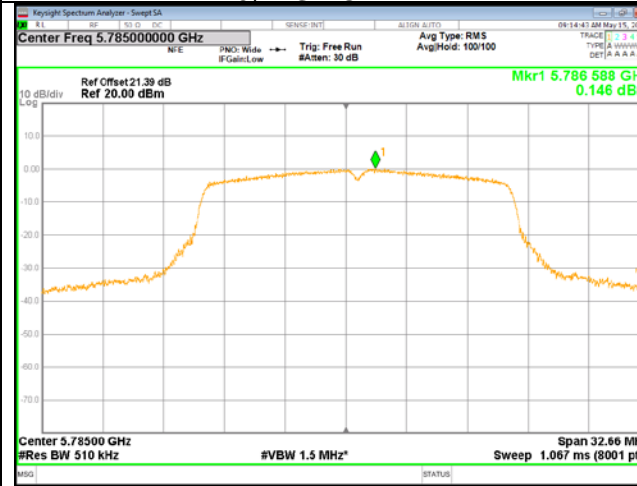

ANT 1, MID CHANNEL

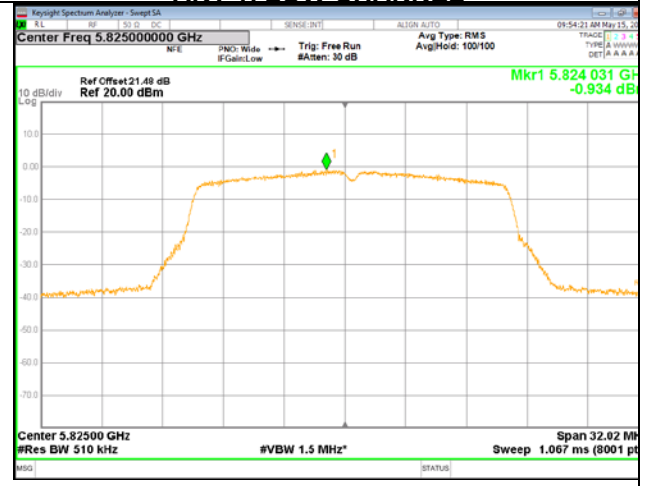

ANT 1, HIGH CHANNEL



7.4.2. 802.11n HT20 MIMO MODE

UNII-1 BAND

Test Channel	Frequency (MHz)	ANT	Meas. Level (dBm/MHz)		Limit (dBm/MHz)
			Single	Total	
Low	5180	0	4.044	6.80	11
		1	3.510		
Middle	5200	0	4.838	7.66	
		1	4.448		
High	5240	0	4.957	7.80	
		1	4.623		

- Note: 1.PSD=Meas. Level+ Correction Factor
2. About correction Factor please refer to section 7.1

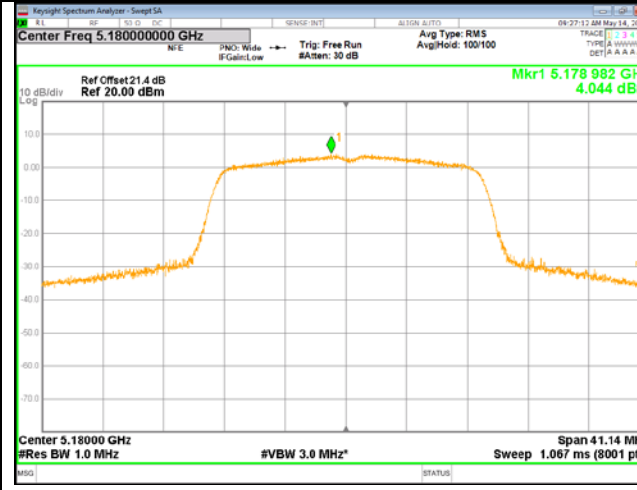

ANT 0, LOW CHANNEL

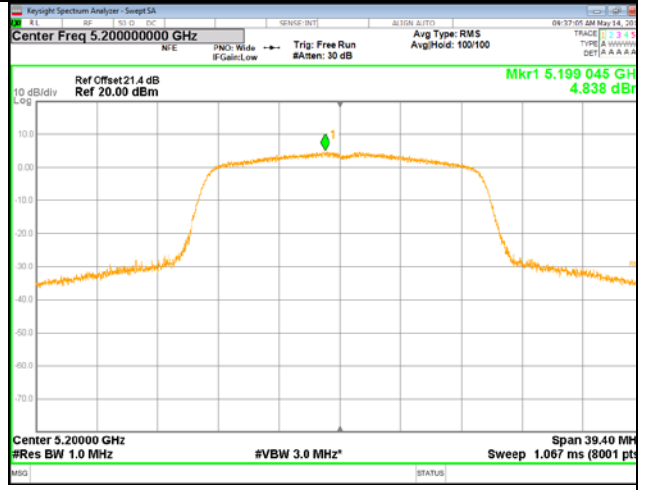

ANT 0, MID CHANNEL

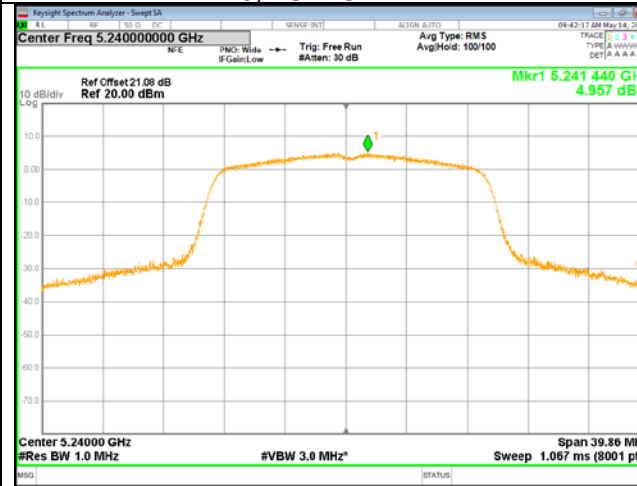

ANT 0, HIGH CHANNEL

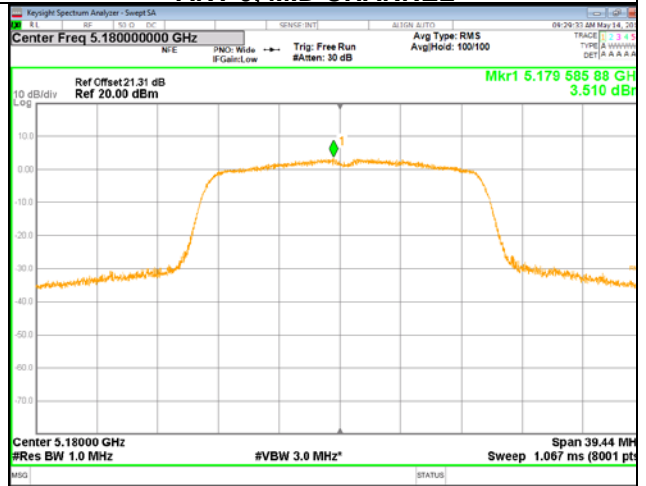

ANT 1, LOW CHANNEL

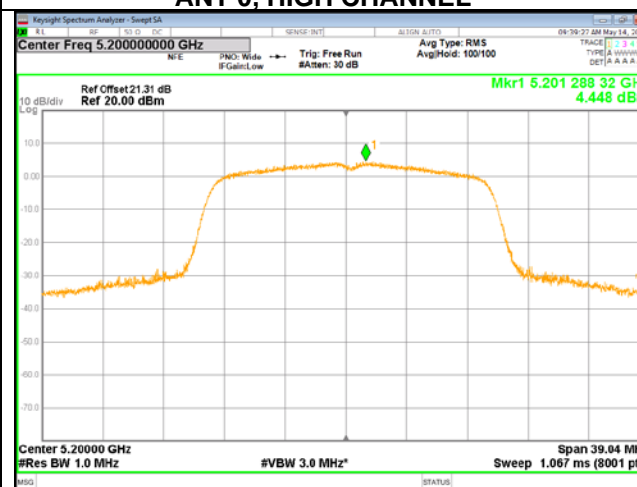

ANT 1, MID CHANNEL

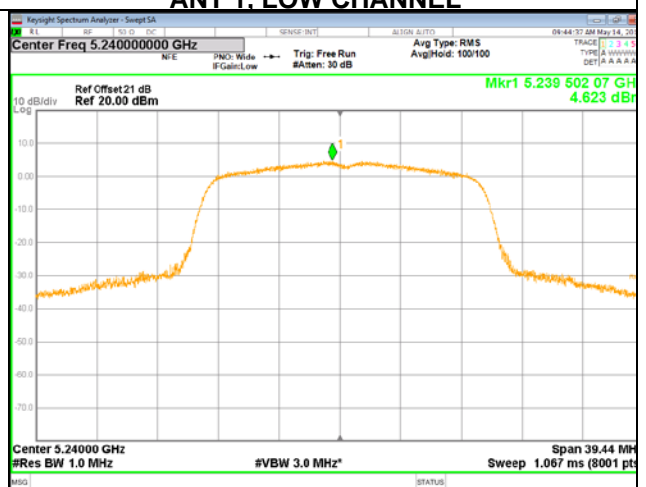

ANT 1, HIGH CHANNEL



UNII-3 BAND

Test Channel	Frequency (MHz)	ANT	Meas. Level (dBm/500KHz)		Limit (dBm/500KHz)
			Single	Total	
Low	5745	0	1.131	4.27	30
		1	1.377		
Middle	5785	0	1.685	4.78	
		1	1.843		
High	5825	0	1.555	4.44	
		1	1.291		

Note: 1.PSD=Meas. Level+ Correction Factor
2. About correction Factor please refer to section 7.1

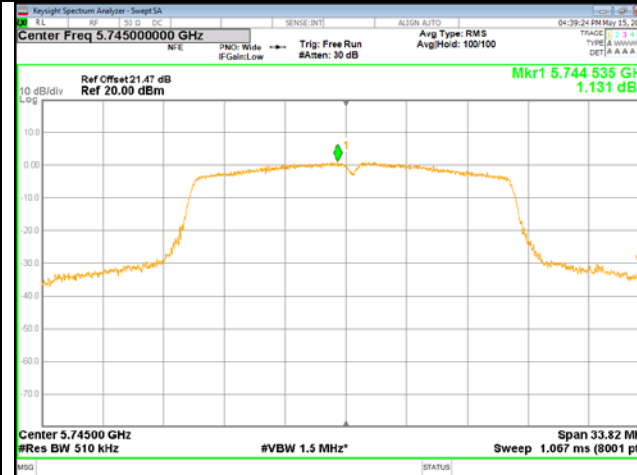

ANT 0, LOW CHANNEL

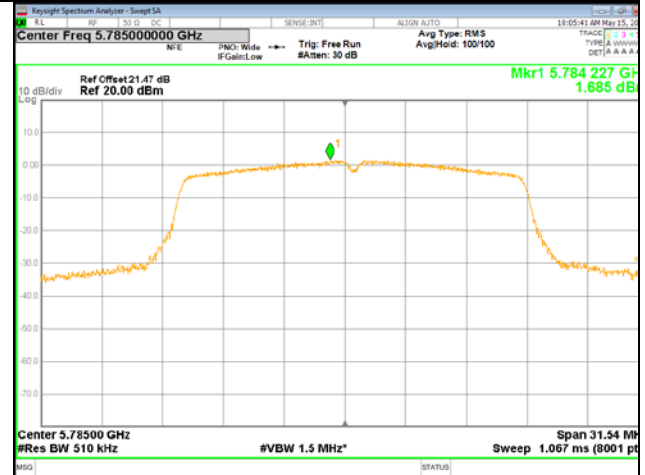

ANT 0, MID CHANNEL

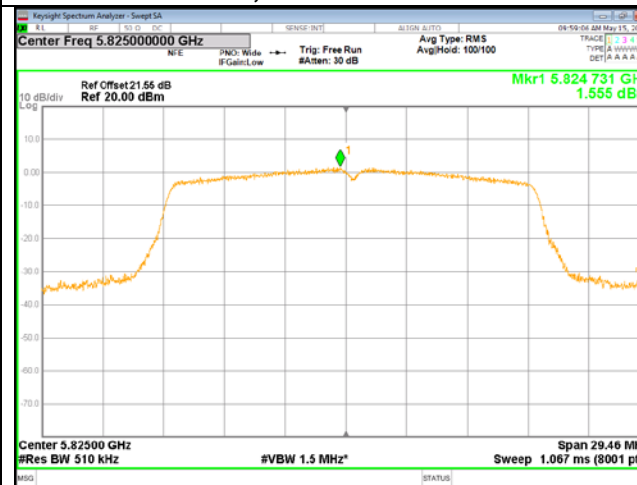

ANT 0, HIGH CHANNEL

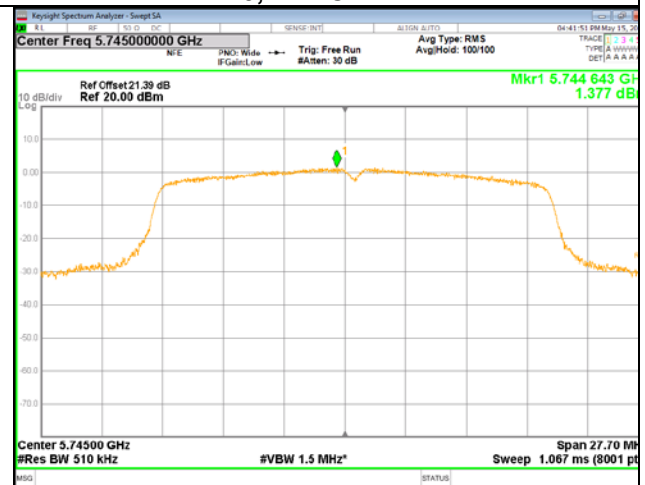

ANT 1, LOW CHANNEL

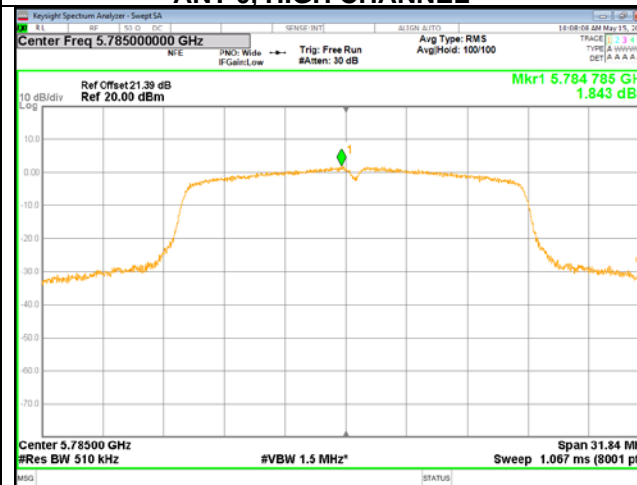

ANT 1, MID CHANNEL

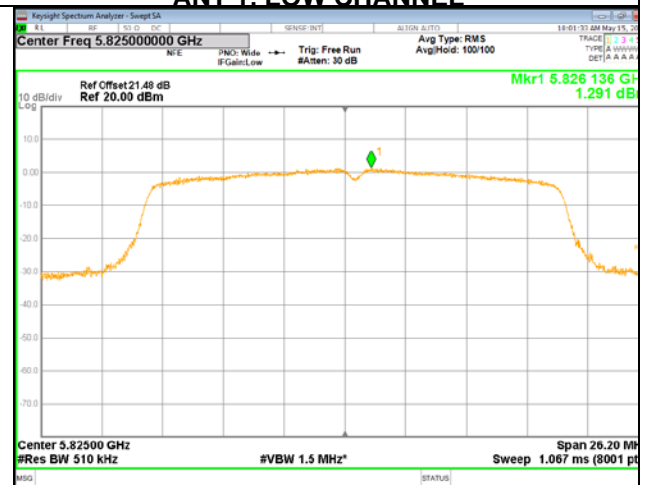

ANT 1, HIGH CHANNEL



7.4.3. 802.11n HT40 MIMO MODE

UNII-1 BAND

Test Channel	Frequency (MHz)	ANT	Meas. Level (dBm/MHz)		Limit (dBm/MHz)
			Single	Total	
Low	5190	0	0.875	3.40	11
		1	-0.166		
High	5230	0	1.005	3.40	
		1	-0.332		

Note: 1. PSD=Meas. Level+ Correction Factor
2. About correction Factor please refer to section 7.1

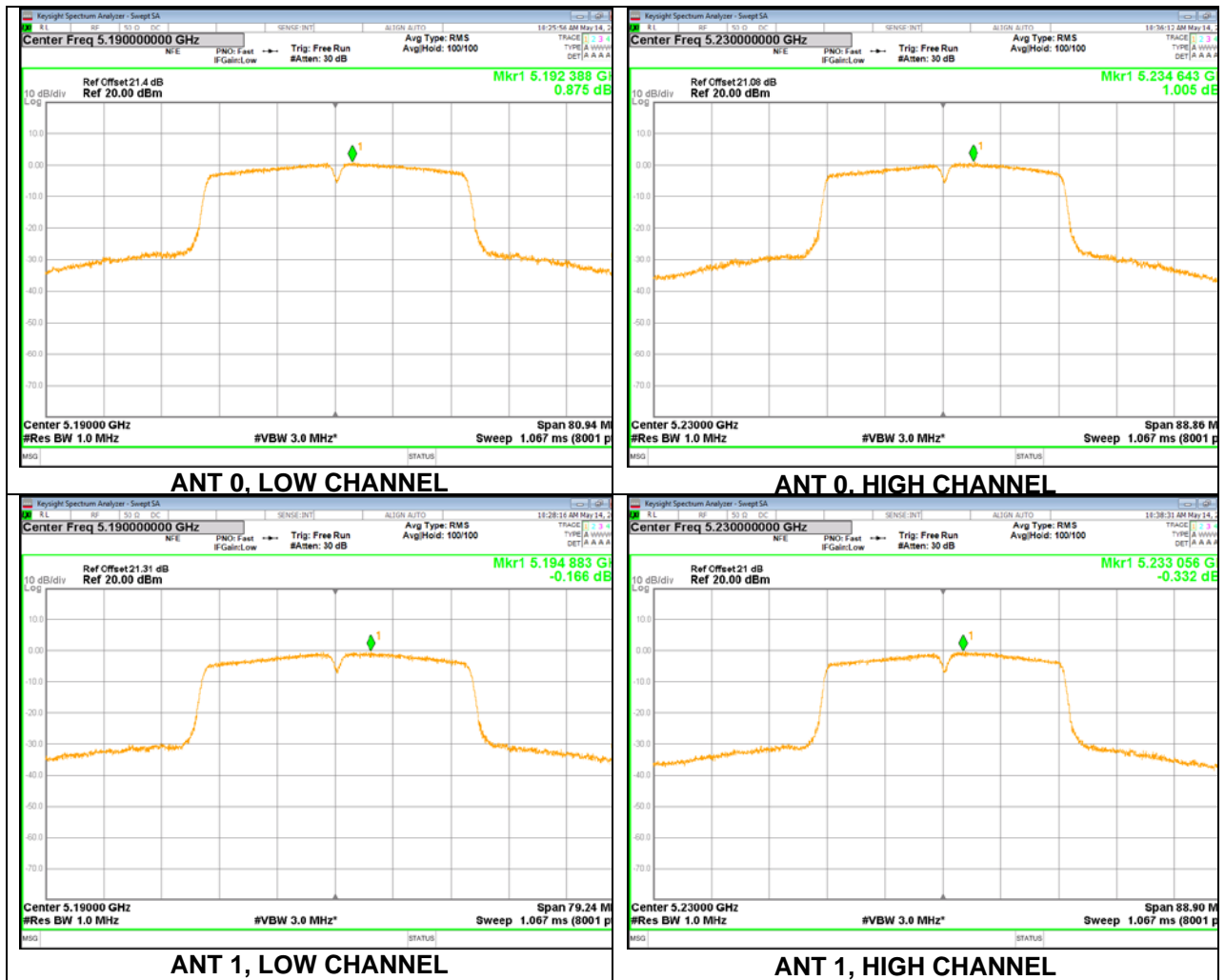



UNII-3 BAND

Test Channel	Frequency (MHz)	ANT	Meas. Level (dBm/500KHz)		Limit (dBm/500KHz)
			Single	Total	
Low	5755	0	-2.873	0.46	11
		1	-2.251		
High	5795	0	-2.182	0.98	
		1	-1.879		

Note: 1. PSD=Meas. Level+ Correction Factor
2. About correction Factor please refer to section 7.1

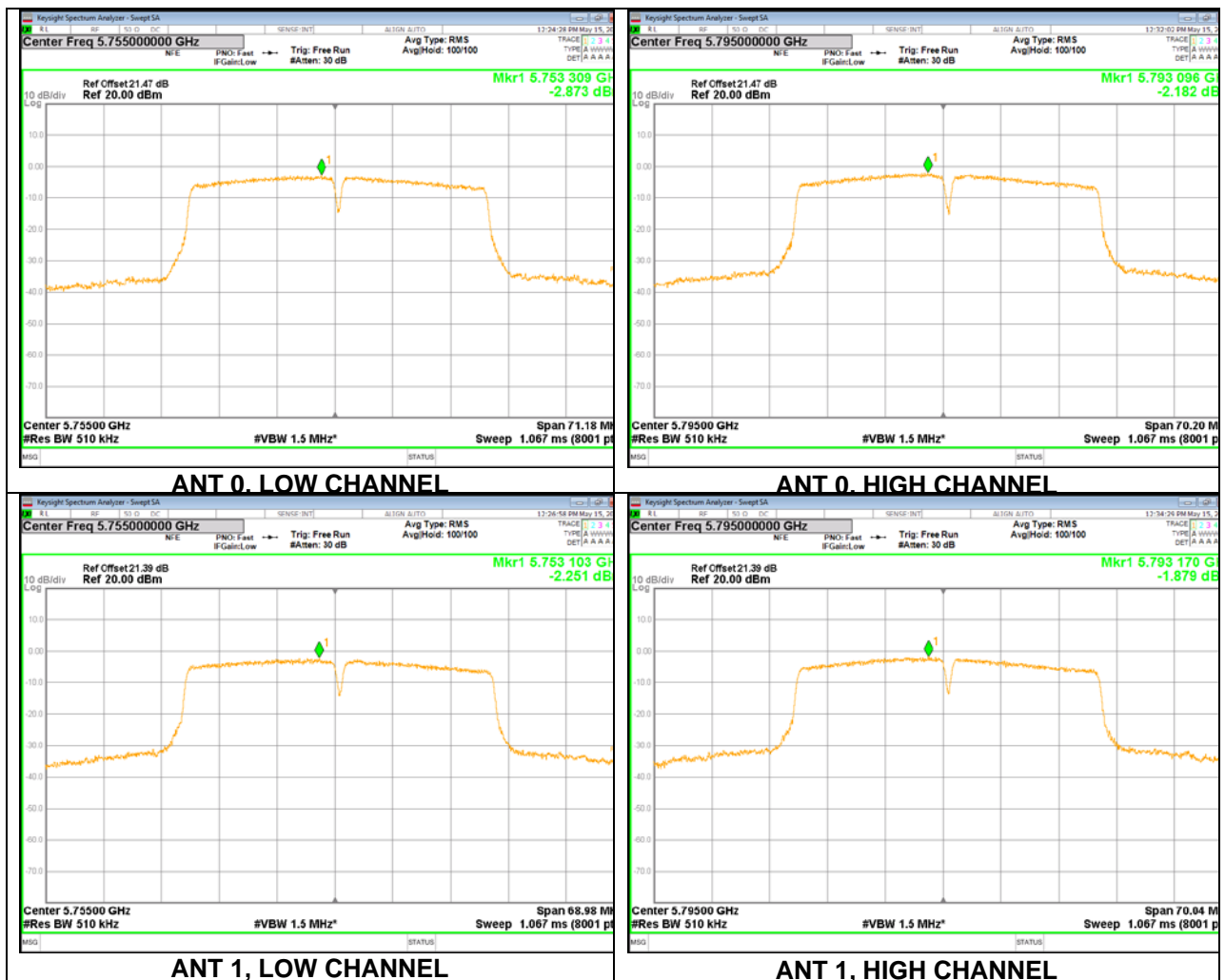



7.4.4. 802.11ac VHT80 MIMO MODE

UNII-1 BAND

Test Channel	Frequency (MHz)	ANT	Meas. Level (dBm/MHz)		Limit (dBm/MHz)
			Single	Total	
Low	5210	0	-5.772	-3.17	11
		1	-6.635		

Note: 1.PSD=Meas. Level+ Correction Factor
2. About correction Factor please refer to section 7.1

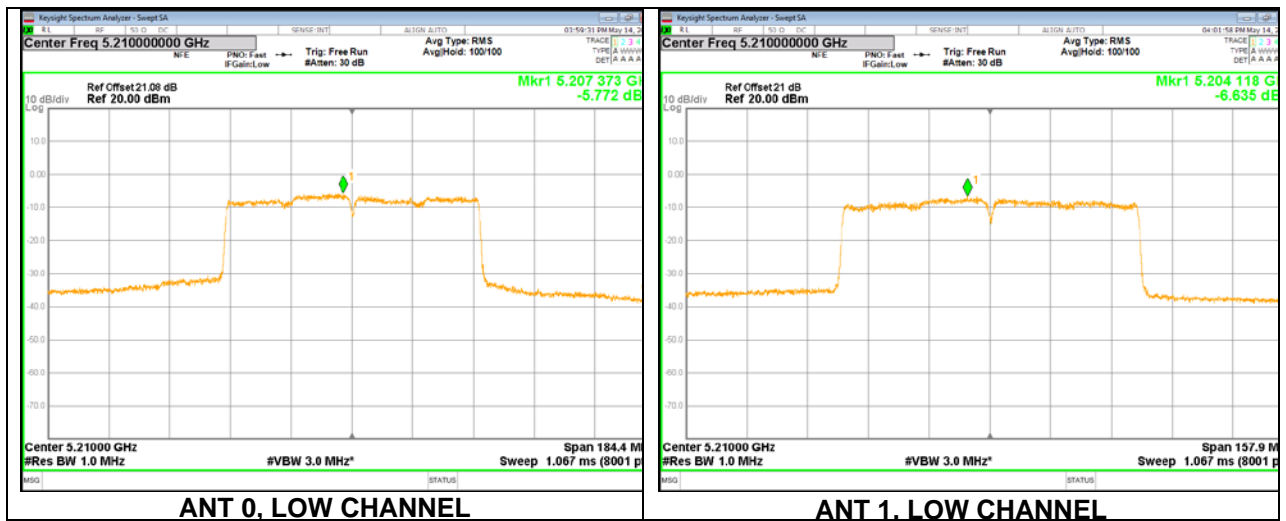



UNII-3 BAND

Test Channel	Frequency (MHz)	ANT	Meas. Level (dBm/500KHz)		Limit (dBm/500KHz)
			Single	Total	
MID	5775	0	-8.387	-5.25	11
		1	-8.138		

- Note: 1.PSD=Meas. Level+ Correction Factor
2. About correction Factor please refer to section 7.1

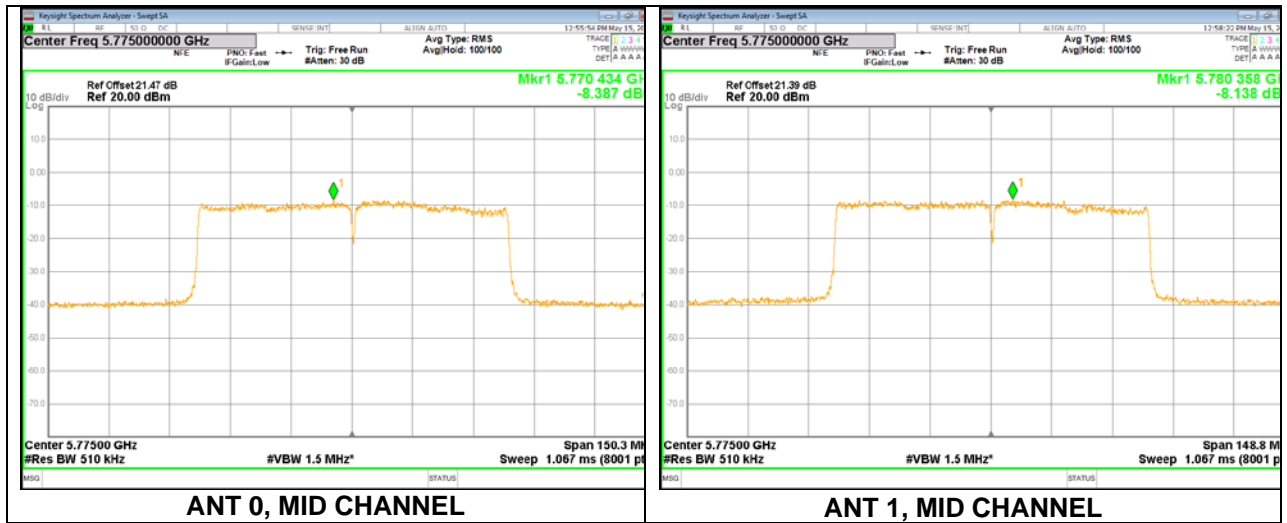

Note: All the modes and antenna ports had been tested, only the worst data recorded in the report.



8. RADIATED TEST RESULTS

LIMITS

Please refer to CFR 47 FCC §15.205, §15.209 and §15.407(b) (4)

Please refer to ISED RSS-GEN Clause 8.9

Radiation Disturbance Test Limit for FCC (Class B)(9kHz-1GHz)

Frequency (MHz)	Field Strength (microvolts/meter)	Measurement Distance (meters)
0.009~0.490	2400/F(kHz)	300
0.490~1.705	24000/F(kHz)	30
1.705~30.0	30	30
30~88	100	3
88~216	150	3
216~960	200	3
960~1000	500	3

Note: 1) At frequencies at or above 30 MHz, measurements may be performed at a distance other than what is specified provided: measurements are not made in the near field except where it can be shown that near field measurements are appropriate due to the characteristics of the device; and it can be demonstrated that the signal levels needed to be measured at the distance employed can be detected by the measurement equipment. Measurements shall not be performed at a distance greater than 30 meters unless it can be further demonstrated that measurements at a distance of 30 meters or less are impractical. When performing measurements at a distance other than that specified, the results shall be extrapolated to the specified distance using an extrapolation factor of 20 dB/decade (inverse linear-distance for field strength measurements; inverse-linear-distance-squared for power density measurements).

(2) At frequencies below 30 MHz, measurements may be performed at a distance closer than that specified in the regulations; however, an attempt should be made to avoid making measurements in the near field. Pending the development of an appropriate measurement procedure for measurements performed below 30 MHz, when performing measurements at a closer distance than specified, the results shall be extrapolated to the specified distance by either making measurements at a minimum of two distances on at least one radial to determine the proper extrapolation factor or by using the square of an inverse linear distance extrapolation factor (40 dB/decade). This paragraph (f) shall not apply to Access BPL devices operating below 30 MHz.



IC Restricted bands please refer to ISED RSS-GEN Clause 8.10.
FCC Restricted bands please refer to CFR 47 FCC 15.209.

Radiated emissions which fall in the restricted bands must comply with the radiated emission limits specified as below table.

LIMITS OF RADIATED EMISSION MEASUREMENT (Below 1GHz)			
Frequency Range (MHz)	Field Strength Limit (uV/m) at 3 m	Field Strength Limit (dBuV/m) at 3 m	
		Quasi-Peak	
30 - 88	100	40	
88 - 216	150	43.5	
216 - 960	200	46	
Above 960	500	54	
Above 1000	500	Peak	Average
		74	54

Limits of unwanted emission out of the restricted bands

LIMITS OF RADIATED EMISSION MEASUREMENT (Above 1GHz)			
Frequency Range (MHz)	EIRP Limit	Field Strength Limit (dBuV/m) at 3 m	
5150~5250 MHz	PK:-27 (dBm/MHz)	PK:68.2(dBμV/m)	
5250~5350 MHz			
5470~5725 MHz			
5725~5850 MHz	PK:-27 (dBm/MHz) *1 PK:10 (dBm/MHz) *2 PK:15.6 (dBm/MHz) *3 PK:27 (dBm/MHz) *4	PK: 68.2(dBμV/m) *1 PK:105.2 (dBμV/m) *2 PK: 110.8(dBμV/m) *3 PK:122.2 (dBμV/m) *4	
<p>Note:</p> <p>*1 beyond 75 MHz or more above of the band edge.</p> <p>*2 below the band edge increasing linearly to 10 dBm/MHz at 25 MHz above.</p> <p>*3 below the band edge increasing linearly to a level of 15.6 dBm/MHz at 5 MHz above.</p> <p>*4 from 5 MHz above or below the band edge increasing linearly to a level of 27 dBm/MHz at the band edge.</p>			

TEST SETUP AND PROCEDURE

Below 30MHz

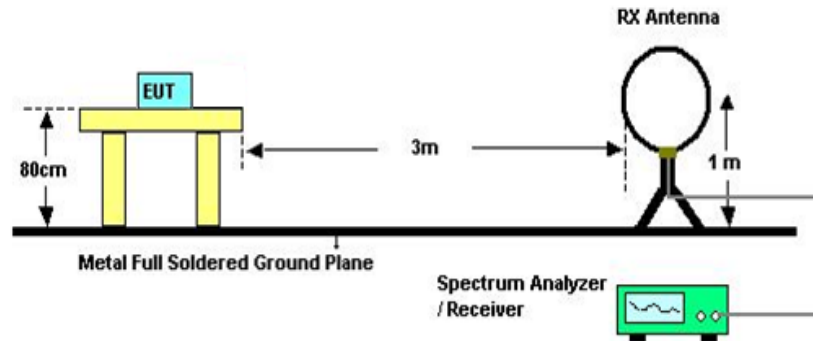

The setting of the spectrum analyser

RBW	200Hz (From 9kHz to 0.15MHz)/ 9kHz (From 0.15MHz to 30MHz)
VBW	200Hz (From 9kHz to 0.15MHz)/ 9kHz (From 0.15MHz to 30MHz)
Sweep	Auto
Detector	Peak/QP/ Average
Trace	Max hold

1. The testing follows the guidelines in ANSI C63.10-2013
2. The EUT was arranged to its worst case and then turntable (from 0 degree to 360 degrees) to find the maximum reading. A pre-amp and a high pass filter are used for the test in order to get better signal level. Both horizontal and vertical polarizations of the antenna are set to make the measurement.
3. The EUT was placed on a turntable with 0.8 meter above ground.
4. The EUT was set 3 meters from the interference receiving antenna, which was mounted on the top of a variable height antenna tower.
5. For measurement below 1GHz, the initial step in collecting conducted emission data is a spectrum analyzer peak detector mode pre-scanning the measurement frequency range. Significant peaks are then marked and then Quasi Peak detector mode re-measured. If the emission level of the EUT measured by the peak detector is 3 dB lower than the applicable limit, the peak emission level will be reported. Otherwise, the emission measurement will be repeated using the quasi-peak detector and reported.
6. Although these tests were performed other than open field site, adequate comparison measurements were confirmed against 30m open field site. Therefore sufficient tests were made to demonstrate that the alternative site produces results that correlate with the ones of tests made in an open field site based on KDB 414788.

Below 1G

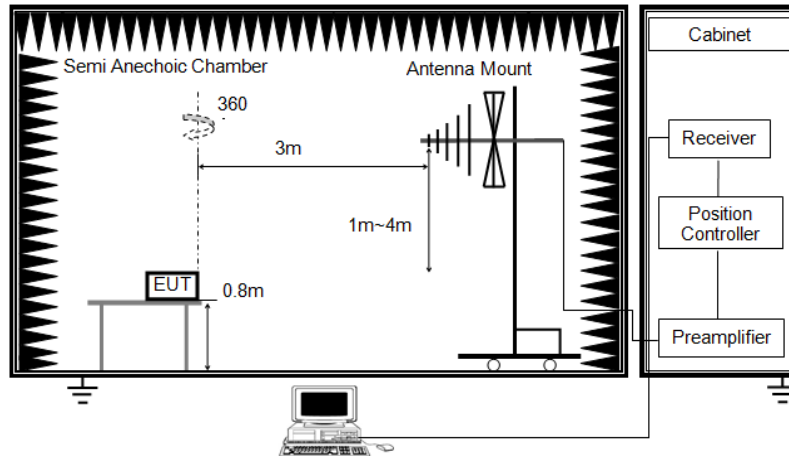

The setting of the spectrum analyser

RBW	120kHz
VBW	300kHz
Sweep	Auto
Detector	Peak/QP
Trace	Max hold

1. The testing follows the guidelines in ANSI C63.10-2013.
2. The EUT was arranged to its worst case and then tune the antenna tower (from 1 m to 4 m) and turntable (from 0 degree to 360 degrees) to find the maximum reading. A pre-amp and a high pass filter are used for the test in order to get better signal level. Both horizontal and vertical polarizations of the antenna are set to make the measurement.
3. The EUT was placed on a turntable with 0.8 meter above ground.
4. The EUT was set 3 meters from the interference receiving antenna, which was mounted on the top of a variable height antenna tower.
5. For measurement below 1GHz, the initial step in collecting conducted emission data is a spectrum analyzer peak detector mode pre-scanning the measurement frequency range. Significant peaks are then marked and then Quasi Peak detector mode re-measured. If the emission level of the EUT measured by the peak detector is 3 dB lower than the applicable limit, the peak emission level will be reported. Otherwise, the emission measurement will be repeated using the quasi-peak detector and reported.

Above 1G

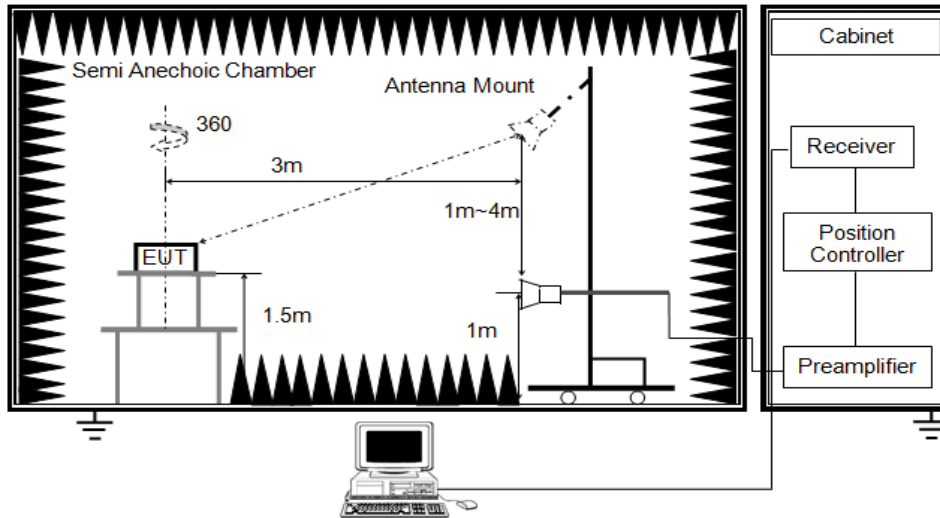

The setting of the spectrum analyser

RBW	1MHz
VBW	PEAK: 3MHz AVG: see note 6
Sweep	Auto
Detector	Peak
Trace	Max hold

1. The testing follows the guidelines in ANSI C63.10-2013.
2. The EUT was arranged to its worst case and then tune the antenna tower (from 1 m to 4 m) and turntable (from 0 degree to 360 degrees) to find the maximum reading. A pre-amp and a high pass filter are used for the test in order to get better signal level. Both horizontal and vertical polarizations of the antenna are set to make the measurement.
3. The EUT was placed on a turntable with 1.5m above ground.
4. The EUT was set 3 meters from the interference receiving antenna, which was mounted on the top of a variable height antenna tower.
5. For measurement above 1GHz, the emission measurement will be measured by the peak detector. This peak level, once corrected, must comply with the limit specified in Section 15.209.
6. For measurements above 1 GHz the resolution bandwidth is set to 1 MHz, then the video bandwidth is set to 3 MHz for peak measurements and 1 MHz resolution bandwidth with 1/T video bandwidth with peak detector for average measurements. For the Duty Cycle please refer to clause 7.1.ON TIME AND DUTY CYCLE.

X axis, Y axis, Z axis positions:

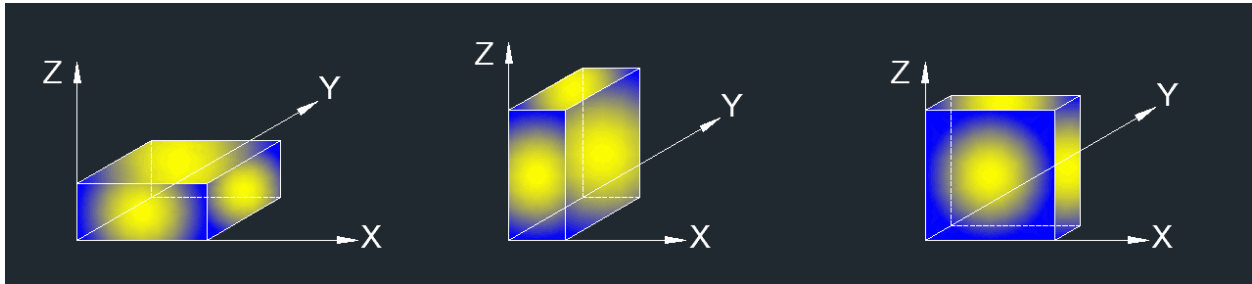

Note 1: For all radiated test, EUT in each of three orthogonal axis emissions had been tested, but only the worst case (Y axis) data recorded in the report.

Note 2: The EUT was fully exercised with external accessories during the test. In the case of multiple accessory external ports, an external accessory shall be connected to one of each type of port.

Note 3: All the EUT's emissions had been evaluated for simultaneous transmission with the other WIFI 2.4GHz, WIFI 5GHz and BT transmitter and there were no any additional or worse emissions found.

TEST ENVIRONMENT

Temperature	22.8°C	Relative Humidity	64%
Atmosphere Pressure	101kPa	Test Voltage	DC 3.3V



8.1. 802.11a SISO MODE

ANTENNA 0 (WORST-CASE CONFIGURATION)

8.1.1. UNII-1 BAND

RESTRICTED BANDEDGE LOW CHANNEL

HORIZONTAL RESULTS
PEAK

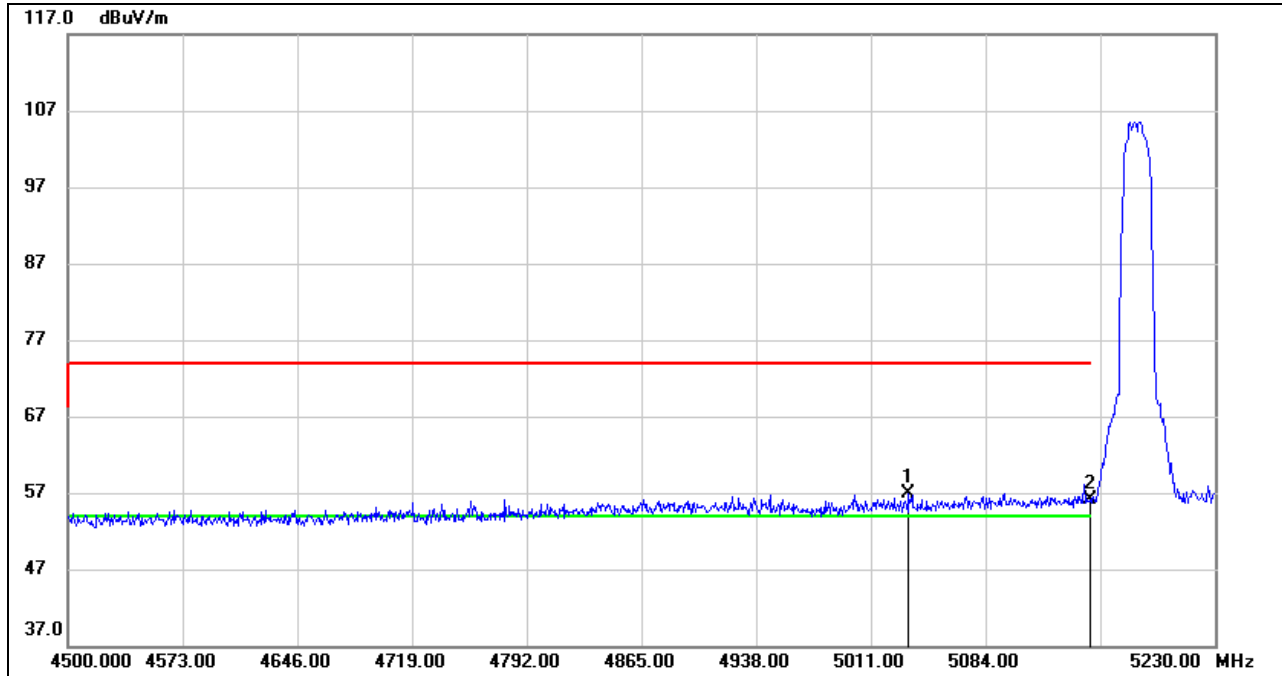

No.	Frequency (MHz)	Reading (dBuV)	Correct (dB/m)	Result (dBuV/m)	Limit (dBuV/m)	Margin (dB)	Remark
1	5035.090	16.71	40.11	56.82	74.00	-17.18	peak
2	5150.000	15.59	40.46	56.05	74.00	-17.95	peak

- Note: 1. Measurement = Reading Level + Correct Factor.
 2. If Peak Result complies with AV limit, AV Result is deemed to comply with AV limit.
 3. Peak: Peak detector.
 4. Only the worst case emission will be recorder, if it complies with the limit, the other emissions deemed to comply with the limit.



AVG

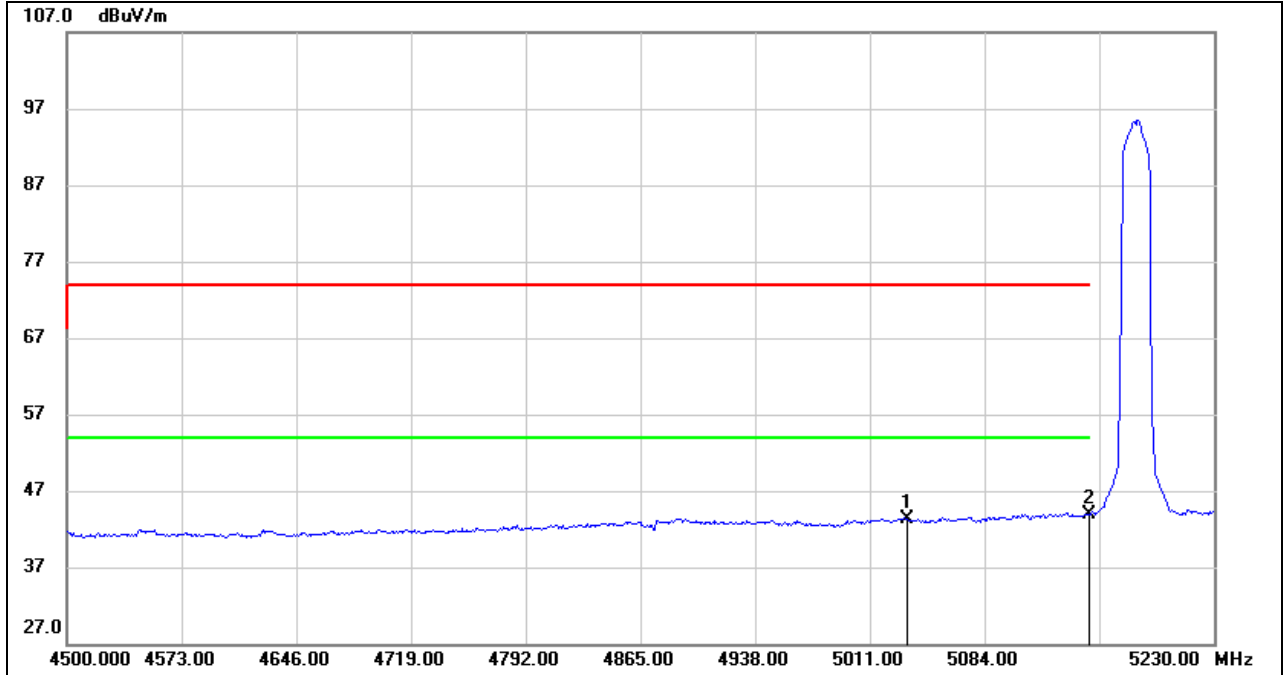

No.	Frequency (MHz)	Reading (dBuV)	Correct (dB/m)	Result (dBuV/m)	Limit (dBuV/m)	Margin (dB)	Remark
1	5035.090	3.22	40.11	43.33	54.00	-10.67	AVG
2	5150.000	3.43	40.46	43.89	54.00	-10.11	AVG

- Note: 1. Measurement = Reading Level + Correct Factor.
 2. AVG: $VBW=1/T_{on}$ where: t_{on} is transmit duration.
 3. For duty cycle, please refer to clause 7.1.
 4. Only the worst case emission will be recorder, if it complies with the limit, the other emissions deemed to comply with the limit.



VERTICAL RESULTS
PEAK

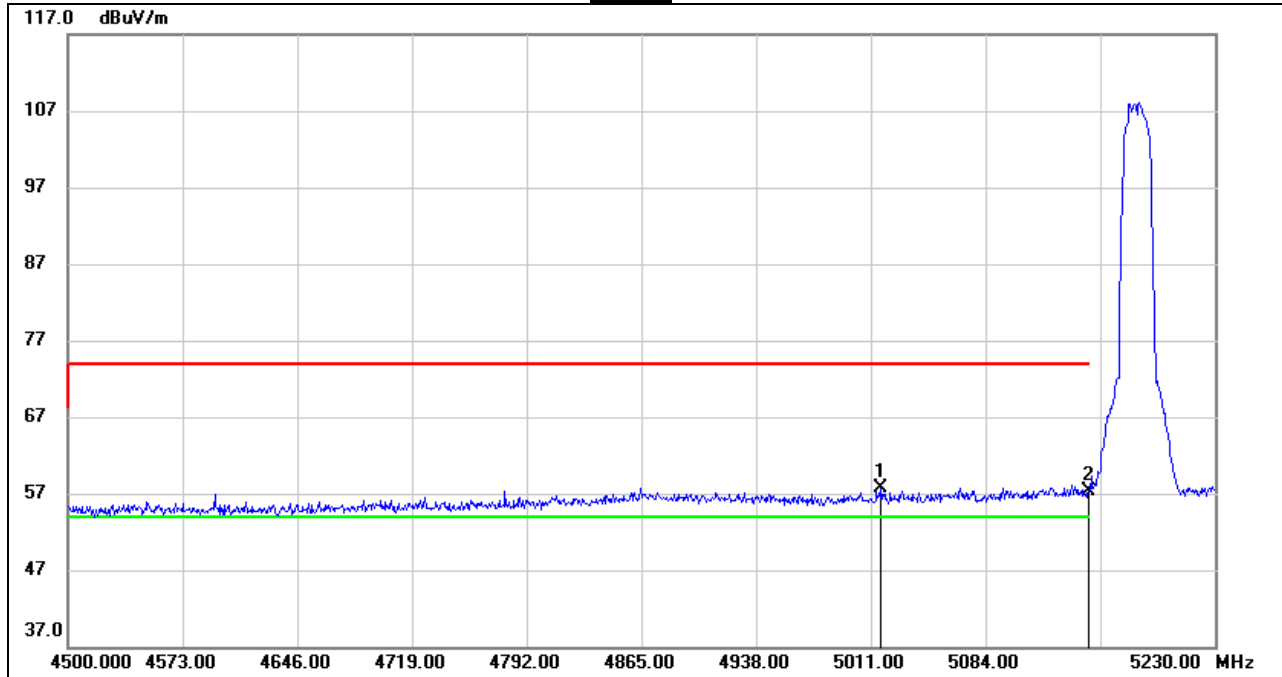

No.	Frequency (MHz)	Reading (dBuV)	Correct (dB/m)	Result (dBuV/m)	Limit (dBuV/m)	Margin (dB)	Remark
1	5017.570	17.71	40.09	57.80	74.00	-16.20	peak
2	5150.000	16.75	40.46	57.21	74.00	-16.79	peak

- Note: 1. Measurement = Reading Level + Correct Factor.
 2. If Peak Result complies with AV limit, AV Result is deemed to comply with AV limit.
 3. Peak: Peak detector.
 4. Only the worst case emission will be recorder, if it complies with the limit, the other emissions deemed to comply with the limit.



AVG

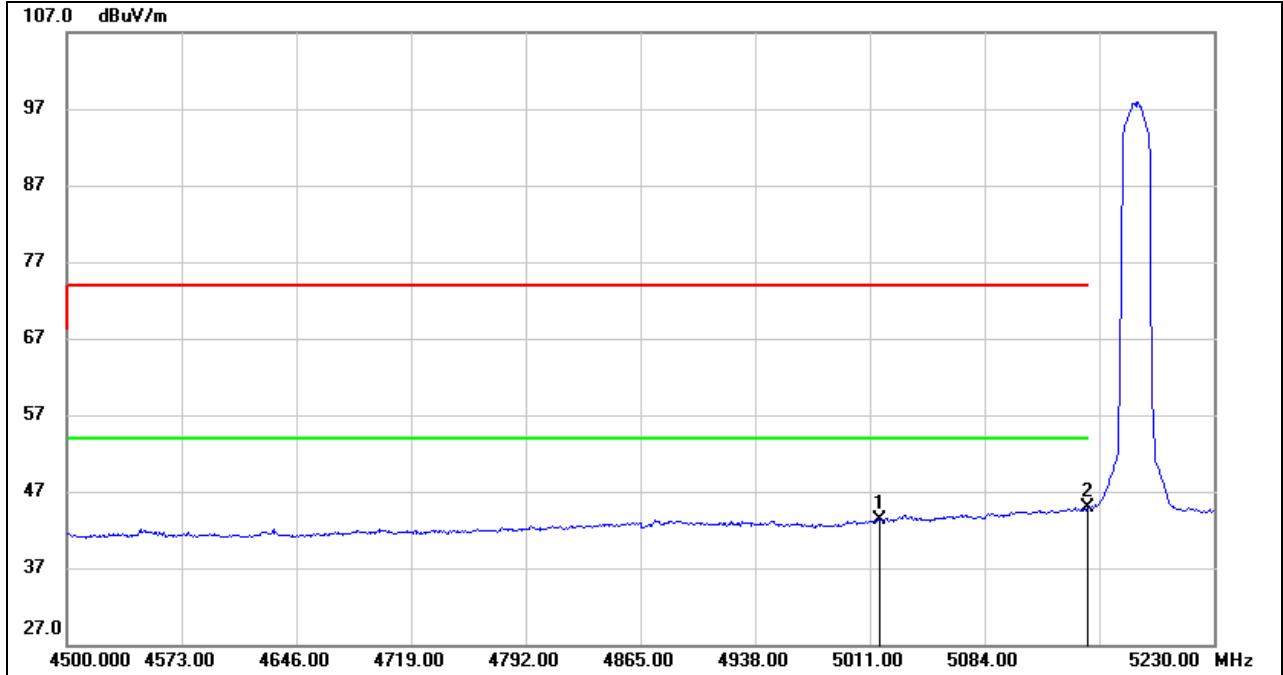

No.	Frequency (MHz)	Reading (dBuV)	Correct (dB/m)	Result (dBuV/m)	Limit (dBuV/m)	Margin (dB)	Remark
1	5017.570	3.24	40.09	43.33	54.00	-10.67	AVG
2	5150.000	4.39	40.46	44.85	54.00	-9.15	AVG

- Note: 1. Measurement = Reading Level + Correct Factor.
 2. AVG: $VBW=1/Ton$ where: ton is transmit duration.
 3. For duty cycle, please refer to clause 7.1.
 4. Only the worst case emission will be recorder, if it complies with the limit, the other emissions deemed to comply with the limit.



HARMONICS AND SPURIOUS EMISSIONS LOW CHANNEL

HORIZONTAL RESULTS
1-7GHz

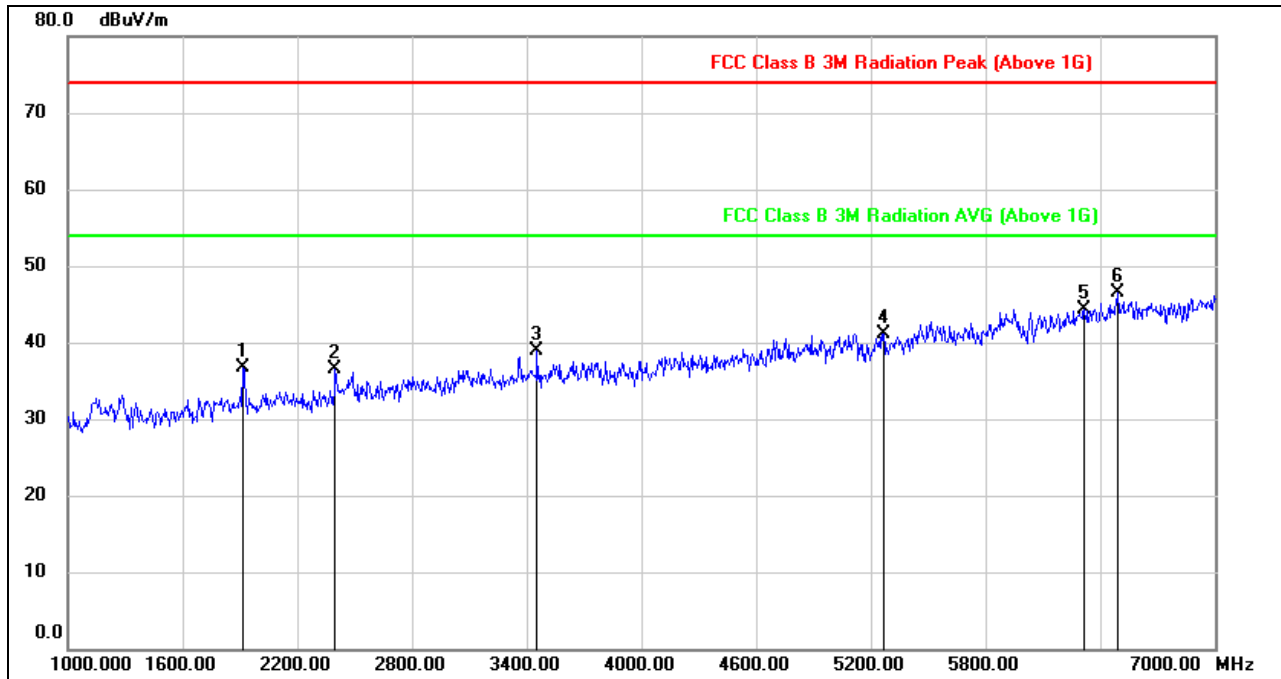

No.	Frequency (MHz)	Reading (dBuV)	Correct (dB/m)	Result (dBuV/m)	Limit (dBuV/m)	Margin (dB)	Remark
1	1918.000	47.53	-10.83	36.70	74.00	-37.30	peak
2	2398.000	45.54	-9.04	36.50	74.00	-37.50	peak
3	3454.000	44.41	-5.56	38.85	74.00	-35.15	peak
4	5266.000	40.20	0.98	41.18	74.00	-32.82	peak
5	6316.000	40.14	4.21	44.35	74.00	-29.65	peak
6	6490.000	40.67	5.75	46.42	74.00	-27.58	peak

Note: 1. Measurement = Reading Level + Correct Factor.
 2. If Peak Result complies with AV limit, AV Result is deemed to comply with AV limit.
 3. Peak: Peak detector.
 4. Filter losses were only considered in then spurious frequency bands and the authorized band was not corrected for BRF losses.
 5. Proper operation of the transmitter prior to adding the filter to the measurement chain.
 6. Owing to the highest peak level complies with the lowest limit of unwanted emission out of the restricted bands (Please refer to page 50), so all the test point were deemed to comply with the limits list in the standard.



HORIZONTAL RESULTS
7-18GHz

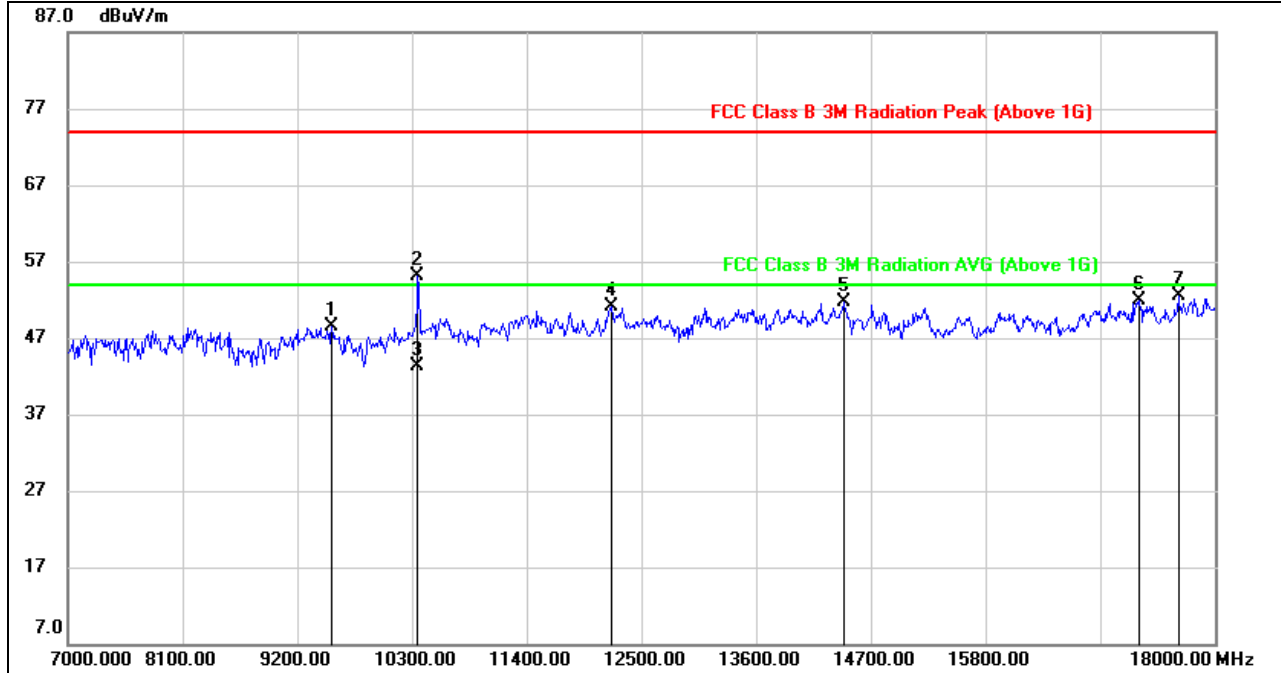

No.	Frequency (MHz)	Reading (dBuV)	Correct (dB/m)	Result (dBuV/m)	Limit (dBuV/m)	Margin (dB)	Remark
1	9530.000	37.88	10.57	48.45	74.00	-25.55	peak
2	10358.137	43.37	11.80	55.17	74.00	-18.83	peak
3	10358.137	31.50	11.80	43.30	54.00	-10.70	AVG
4	12214.000	36.21	14.96	51.17	74.00	-22.83	peak
5	14436.000	35.09	16.58	51.67	74.00	-22.33	peak
6	17274.000	30.13	21.68	51.81	74.00	-22.19	peak
7	17648.000	30.65	21.90	52.55	74.00	-21.45	peak

Note: 1. Measurement = Reading Level + Correct Factor.
 2. If Peak Result complies with AV limit, AV Result is deemed to comply with AV limit.
 3. Peak: Peak detector.
 4. AVG: $VBW=1/Ton$ where: ton is transmit duration.
 5. For duty cycle, please refer to clause 7.1.
 6. The High Pass filter loss factor already add into the correct factor.
 7. Proper operation of the transmitter prior to adding the filter to the measurement chain.
 8. Owing to the highest peak level complies with the lowest limit of unwanted emission out of the restricted bands (Please refer to page 51), so all the test point were deemed to comply with the limits list in the standard.



VERTICAL RESULTS
1-7GHz

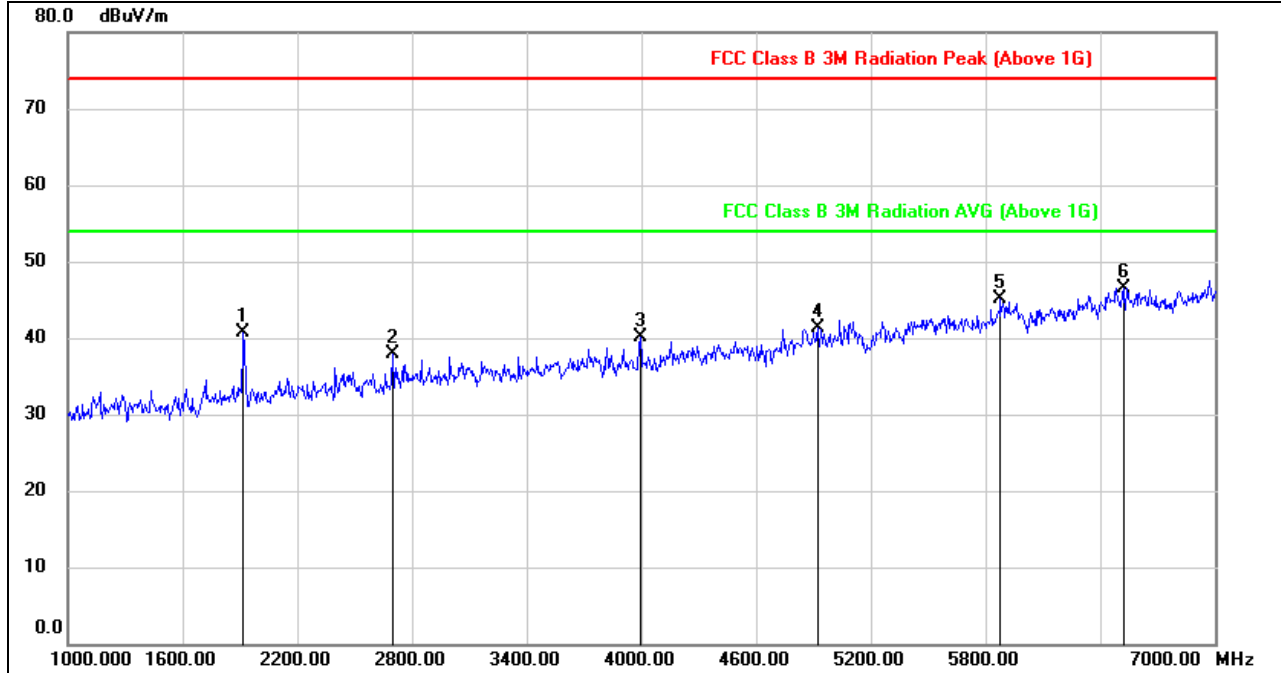

No.	Frequency (MHz)	Reading (dBuV)	Correct (dB/m)	Result (dBuV/m)	Limit (dBuV/m)	Margin (dB)	Remark
1	1918.000	51.59	-10.83	40.76	74.00	-33.24	peak
2	2698.000	45.84	-7.92	37.92	74.00	-36.08	peak
3	3994.000	44.23	-4.08	40.15	74.00	-33.85	peak
4	4924.000	41.85	-0.63	41.22	74.00	-32.78	peak
5	5878.000	40.65	4.43	45.08	74.00	-28.92	peak
6	6520.000	40.69	5.81	46.50	74.00	-27.50	peak

Note: 1. Measurement = Reading Level + Correct Factor.
 2. If Peak Result complies with AV limit, AV Result is deemed to comply with AV limit.
 3. Peak: Peak detector.
 4. Filter losses were only considered in then spurious frequency bands and the authorized band was not corrected for BRF losses.
 5. Proper operation of the transmitter prior to adding the filter to the measurement chain.
 6. Owing to the highest peak level complies with the lowest limit of unwanted emission out of the restricted bands (Please refer to page 50), so all the test point were deemed to comply with the limits list in the standard.



7-18GHz

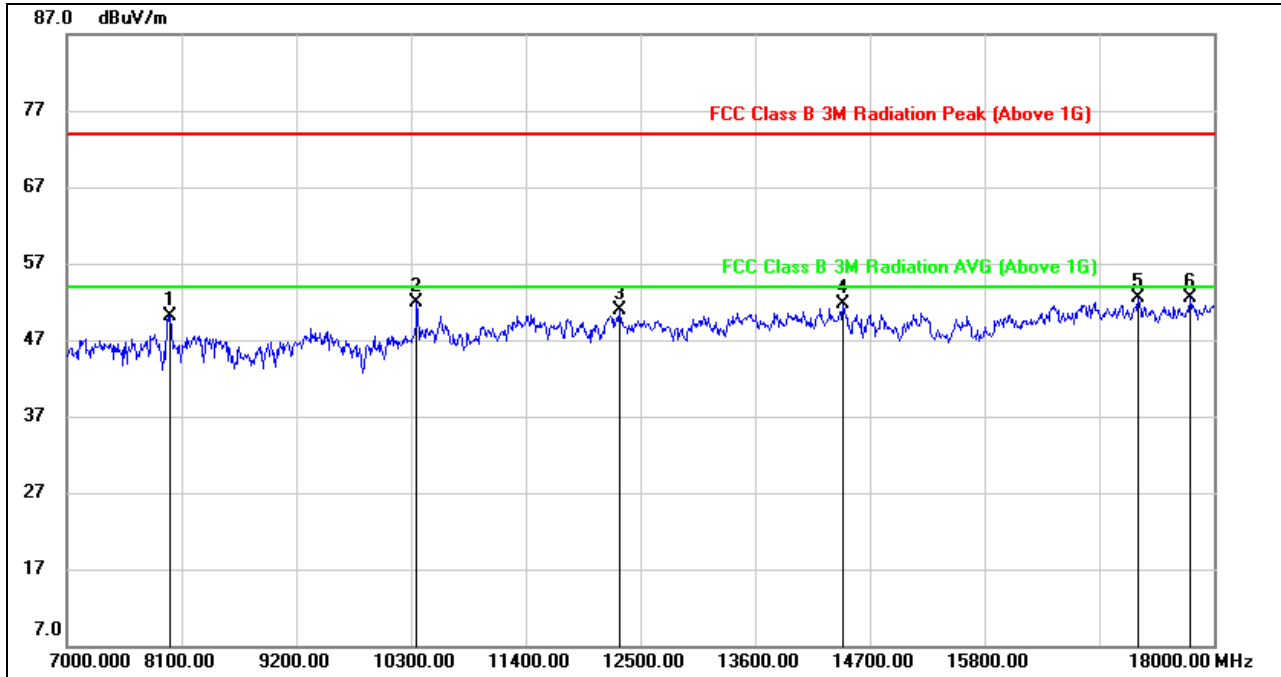

No.	Frequency (MHz)	Reading (dBuV)	Correct (dB/m)	Result (dBuV/m)	Limit (dBuV/m)	Margin (dB)	Remark
1	7990.000	41.49	8.66	50.15	74.00	-23.85	peak
2	10355.000	40.12	11.80	51.92	74.00	-22.08	peak
3	12302.000	35.71	15.16	50.87	74.00	-23.13	peak
4	14436.000	35.11	16.58	51.69	74.00	-22.31	peak
5	17274.000	30.79	21.68	52.47	74.00	-21.53	peak
6	17769.000	29.67	22.91	52.58	74.00	-21.42	peak

Note: 1. Measurement = Reading Level + Correct Factor.
 2. If Peak Result complies with AV limit, AV Result is deemed to comply with AV limit.
 3. Peak: Peak detector.
 4. The High Pass filter loss factor already add into the correct factor.
 5. Proper operation of the transmitter prior to adding the filter to the measurement chain.
 6. Owing to the highest peak level complies with the lowest limit of unwanted emission out of the restricted bands (Please refer to page 50), so all the test point were deemed to comply with the limits list in the standard.



HARMONICS AND SPURIOUS EMISSIONS MID CHANNEL

HORIZONTAL RESULTS
1-7GHz

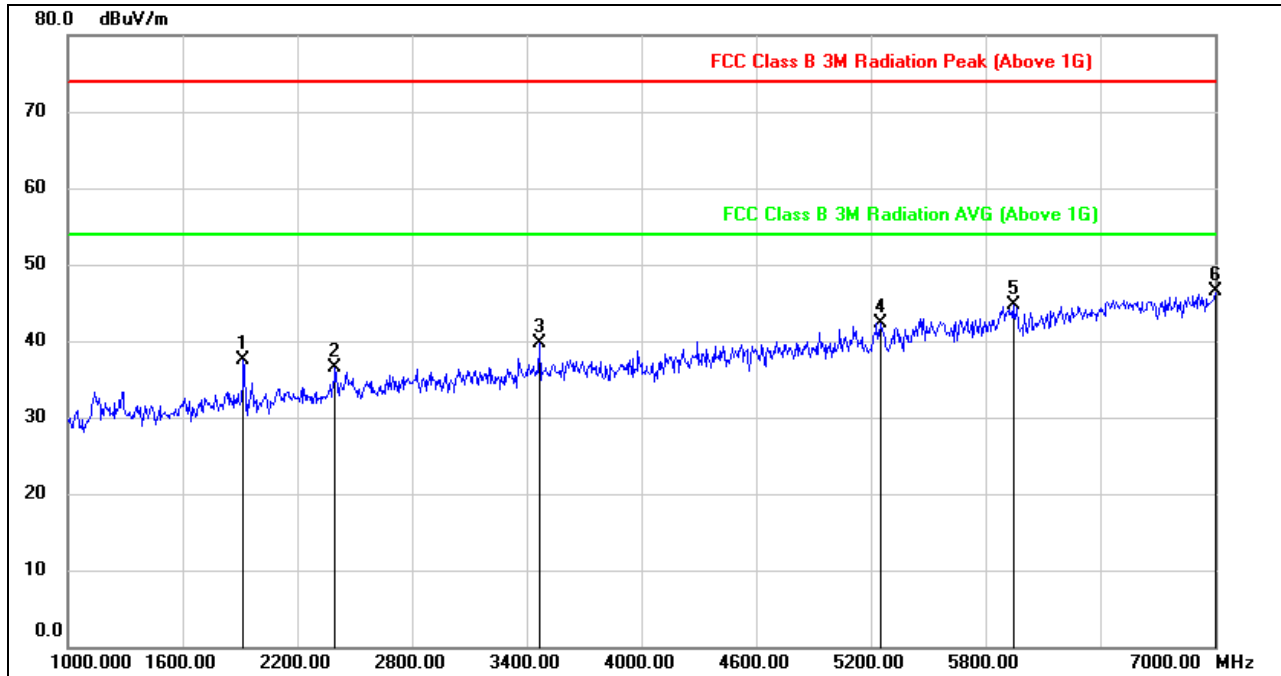

No.	Frequency (MHz)	Reading (dBuV)	Correct (dB/m)	Result (dBuV/m)	Limit (dBuV/m)	Margin (dB)	Remark
1	1918.000	48.38	-10.83	37.55	74.00	-36.45	peak
2	2398.000	45.50	-9.04	36.46	74.00	-37.54	peak
3	3466.000	45.22	-5.52	39.70	74.00	-34.30	peak
4	5254.000	41.43	0.97	42.40	74.00	-31.60	peak
5	5944.000	40.52	4.17	44.69	74.00	-29.31	peak
6	7000.000	40.14	6.42	46.56	74.00	-27.44	peak

Note: 1. Measurement = Reading Level + Correct Factor.
 2. If Peak Result complies with AV limit, AV Result is deemed to comply with AV limit.
 3. Peak: Peak detector.
 4. Filter losses were only considered in then spurious frequency bands and the authorized band was not corrected for BRF losses.
 5. Proper operation of the transmitter prior to adding the filter to the measurement chain.
 6. Owing to the highest peak level complies with the lowest limit of unwanted emission out of the restricted bands (Please refer to page 50), so all the test point were deemed to comply with the limits list in the standard.



HORIZONTAL RESULTS
7-18GHz

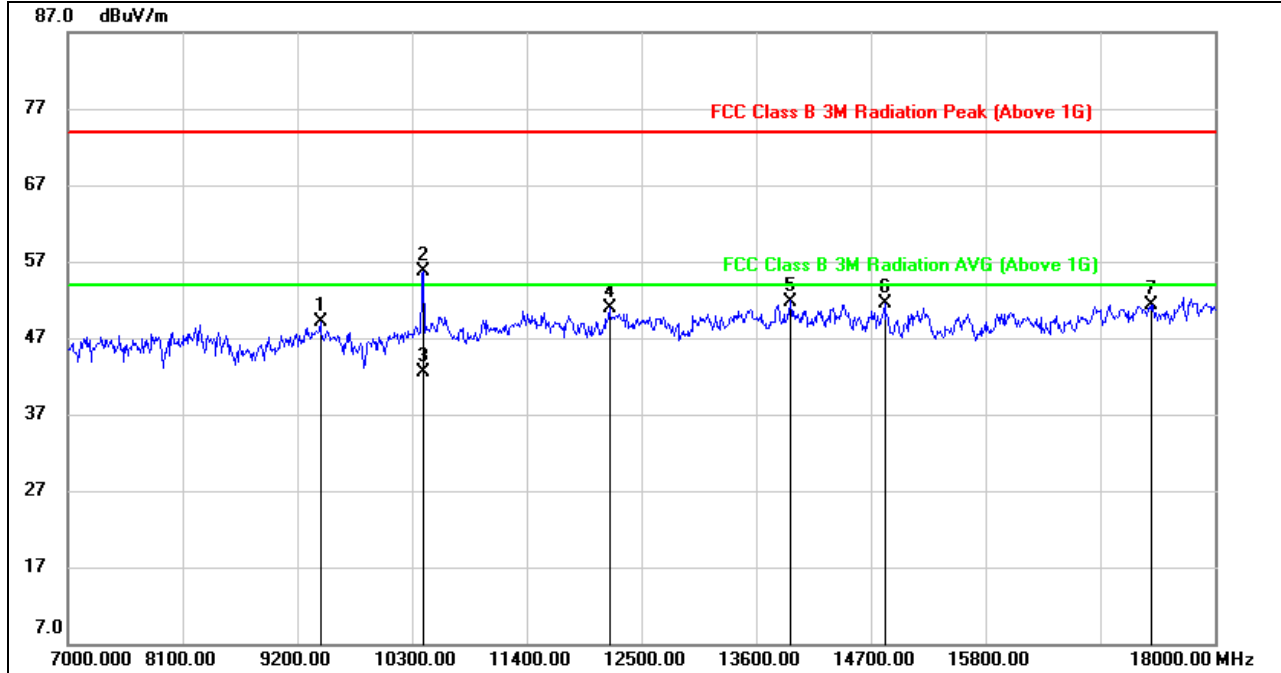

No.	Frequency (MHz)	Reading (dBuV)	Correct (dB/m)	Result (dBuV/m)	Limit (dBuV/m)	Margin (dB)	Remark
1	9420.000	38.30	10.74	49.04	74.00	-24.96	peak
2	10401.359	43.84	11.81	55.65	74.00	-18.35	peak
3	10401.359	30.69	11.81	42.50	54.00	-11.50	AVG
4	12192.000	35.97	14.91	50.88	74.00	-23.12	peak
5	13930.000	35.41	16.39	51.80	74.00	-22.20	peak
6	14832.000	35.68	15.81	51.49	74.00	-22.51	peak
7	17384.000	29.68	21.60	51.28	74.00	-22.72	peak

Note: 1. Measurement = Reading Level + Correct Factor.
 2. If Peak Result complies with AV limit, AV Result is deemed to comply with AV limit.
 3. Peak: Peak detector.
 4. AVG: $VBW=1/Ton$ where: ton is transmit duration.
 5. For duty cycle, please refer to clause 7.1.
 6. The High Pass filter loss factor already add into the correct factor.
 7. Proper operation of the transmitter prior to adding the filter to the measurement chain.
 8. Owing to the highest peak level complies with the lowest limit of unwanted emission out of the restricted bands (Please refer to page 51), so all the test point were deemed to comply with the limits list in the standard.



VERTICAL RESULTS
1-7GHz

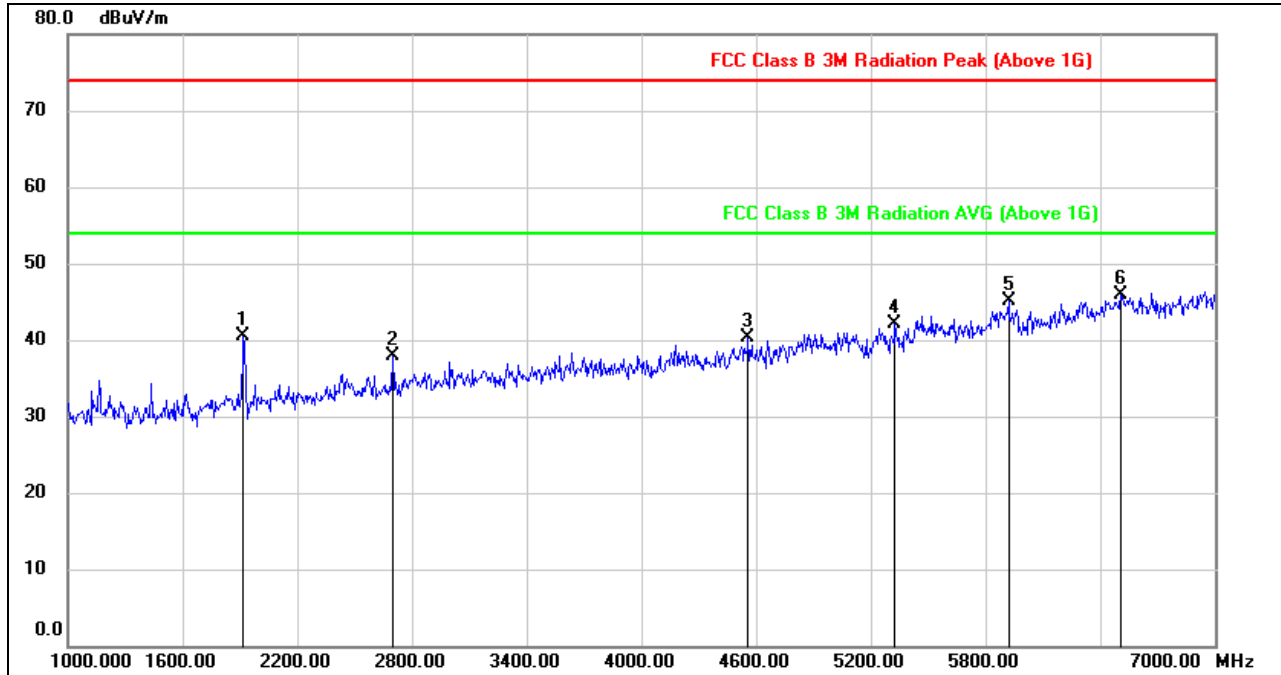

No.	Frequency (MHz)	Reading (dBuV)	Correct (dB/m)	Result (dBuV/m)	Limit (dBuV/m)	Margin (dB)	Remark
1	1918.000	51.38	-10.83	40.55	74.00	-33.45	peak
2	2698.000	45.86	-7.92	37.94	74.00	-36.06	peak
3	4558.000	42.31	-2.06	40.25	74.00	-33.75	peak
4	5326.000	41.21	0.98	42.19	74.00	-31.81	peak
5	5920.000	40.48	4.55	45.03	74.00	-28.97	peak
6	6508.000	40.14	5.85	45.99	74.00	-28.01	peak

Note: 1. Measurement = Reading Level + Correct Factor.
 2. If Peak Result complies with AV limit, AV Result is deemed to comply with AV limit.
 3. Peak: Peak detector.
 4. Filter losses were only considered in then spurious frequency bands and the authorized band was not corrected for BRF losses.
 5. Proper operation of the transmitter prior to adding the filter to the measurement chain.
 6. Owing to the highest peak level complies with the lowest limit of unwanted emission out of the restricted bands (Please refer to page 50), so all the test point were deemed to comply with the limits list in the standard.



7-18GHz

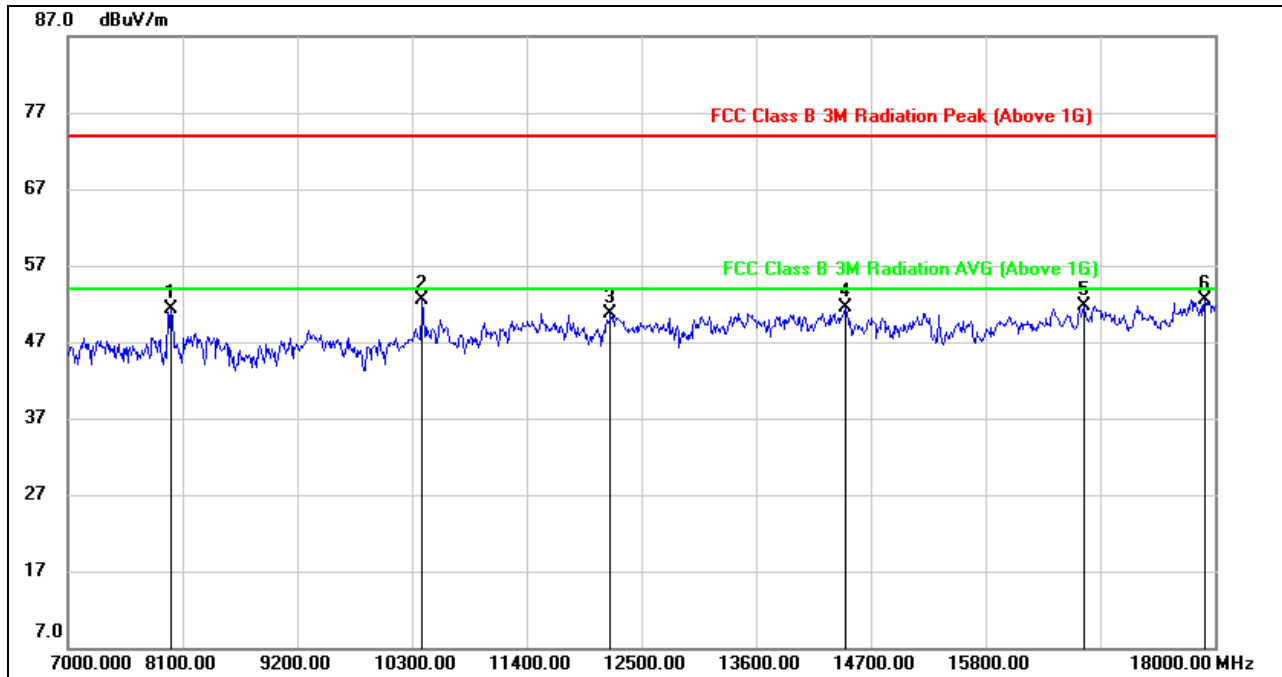

No.	Frequency (MHz)	Reading (dBuV)	Correct (dB/m)	Result (dBuV/m)	Limit (dBuV/m)	Margin (dB)	Remark
1	7990.000	42.67	8.66	51.33	74.00	-22.67	peak
2	10399.000	40.74	11.81	52.55	74.00	-21.45	peak
3	12203.000	35.73	14.94	50.67	74.00	-23.33	peak
4	14458.000	35.00	16.54	51.54	74.00	-22.46	peak
5	16746.000	31.65	20.01	51.66	74.00	-22.34	peak
6	17901.000	29.45	23.14	52.59	74.00	-21.41	peak

Note: 1. Measurement = Reading Level + Correct Factor.
 2. If Peak Result complies with AV limit, AV Result is deemed to comply with AV limit.
 3. Peak: Peak detector.
 4. The High Pass filter loss factor already add into the correct factor.
 5. Proper operation of the transmitter prior to adding the filter to the measurement chain.
 6. Owing to the highest peak level complies with the lowest limit of unwanted emission out of the restricted bands (Please refer to page 50), so all the test point were deemed to comply with the limits list in the standard.



HARMONICS AND SPURIOUS EMISSIONS HIGH CHANNEL

HORIZONTAL RESULTS
1-7GHz

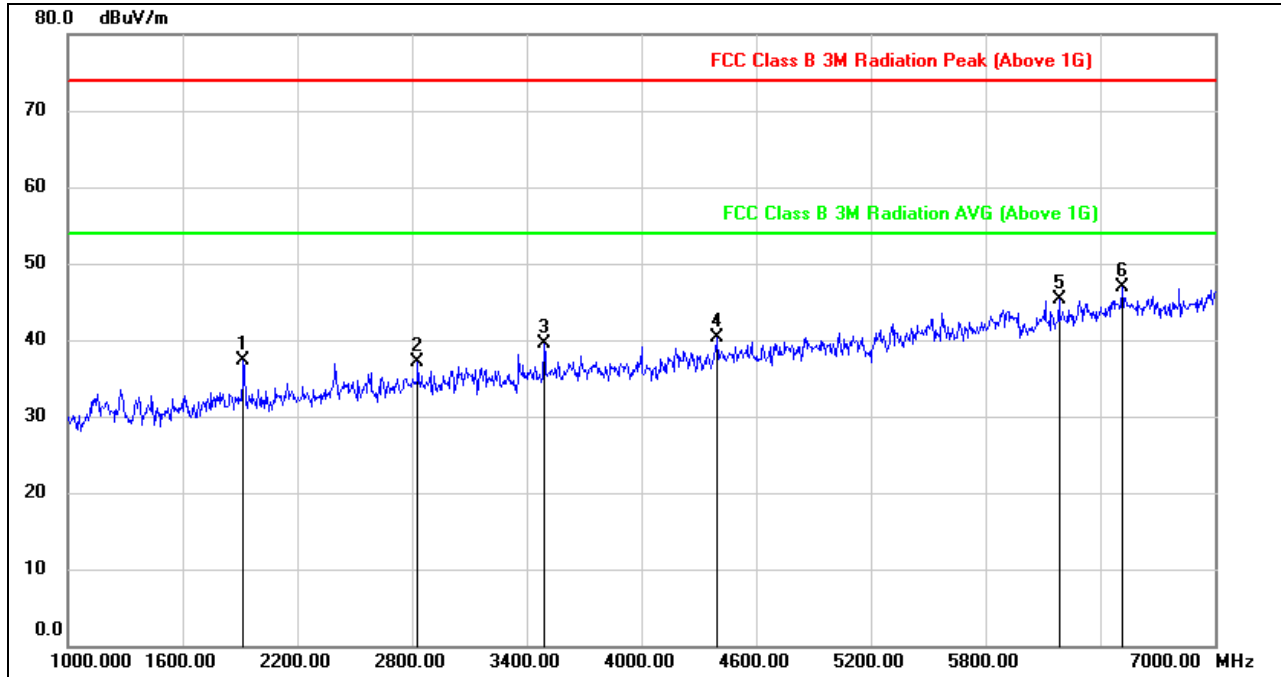

No.	Frequency (MHz)	Reading (dBuV)	Correct (dB/m)	Result (dBuV/m)	Limit (dBuV/m)	Margin (dB)	Remark
1	1918.000	48.04	-10.83	37.21	74.00	-36.79	peak
2	2830.000	44.20	-7.08	37.12	74.00	-36.88	peak
3	3490.000	44.87	-5.44	39.43	74.00	-34.57	peak
4	4396.000	43.26	-3.02	40.24	74.00	-33.76	peak
5	6184.000	41.60	3.69	45.29	74.00	-28.71	peak
6	6514.000	41.01	5.84	46.85	74.00	-27.15	peak

Note: 1. Measurement = Reading Level + Correct Factor.
 2. If Peak Result complies with AV limit, AV Result is deemed to comply with AV limit.
 3. Peak: Peak detector.
 4. Filter losses were only considered in then spurious frequency bands and the authorized band was not corrected for BRF losses.
 5. Proper operation of the transmitter prior to adding the filter to the measurement chain.
 6. Owing to the highest peak level complies with the lowest limit of unwanted emission out of the restricted bands (Please refer to page 50), so all the test point were deemed to comply with the limits list in the standard.



HORIZONTAL RESULTS
7-18GHz

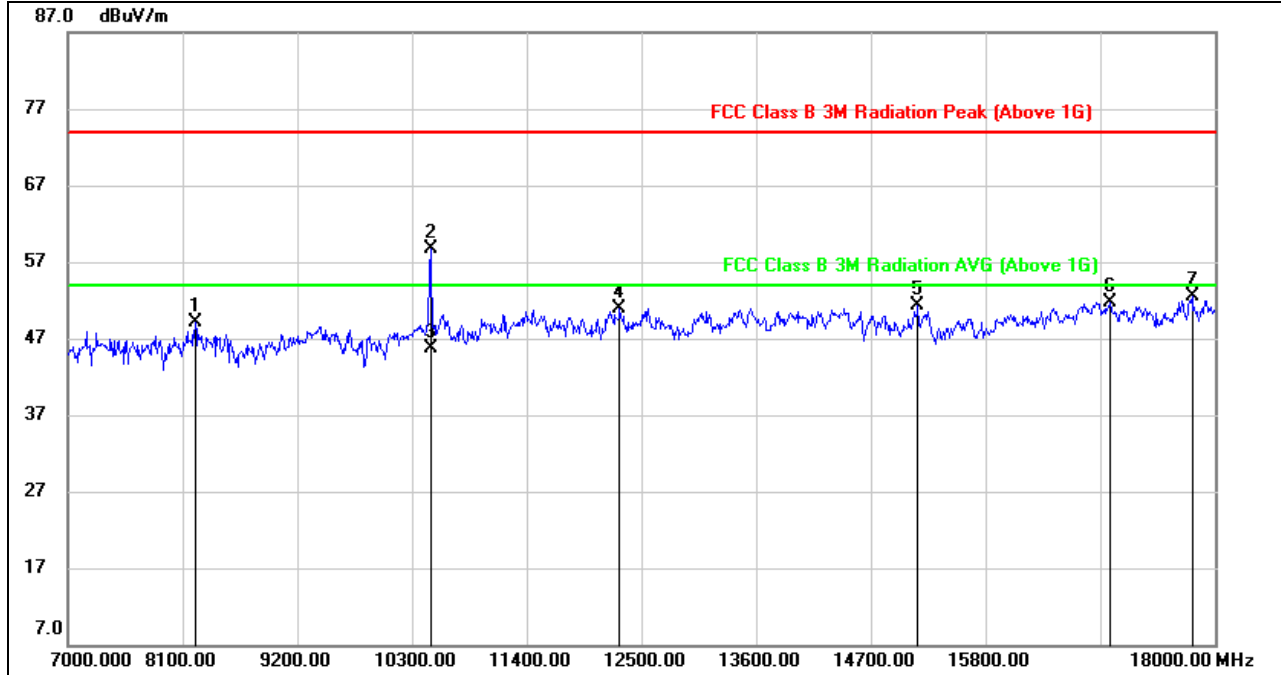

No.	Frequency (MHz)	Reading (dBuV)	Correct (dB/m)	Result (dBuV/m)	Limit (dBuV/m)	Margin (dB)	Remark
1	8221.000	39.17	9.99	49.16	74.00	-24.84	peak
2	10480.056	46.74	12.01	58.75	74.00	-15.25	peak
3	10480.056	33.73	12.01	45.74	54.00	-8.26	AVG
4	12291.000	35.70	15.15	50.85	74.00	-23.15	peak
5	15151.000	35.45	15.77	51.22	74.00	-22.78	peak
6	16999.000	30.93	20.72	51.65	74.00	-22.35	peak
7	17780.000	29.43	23.01	52.44	74.00	-21.56	peak

Note: 1. Measurement = Reading Level + Correct Factor.
 2. If Peak Result complies with AV limit, AV Result is deemed to comply with AV limit.
 3. Peak: Peak detector.
 4. AVG: $VBW=1/Ton$ where: ton is transmit duration.
 5. For duty cycle, please refer to clause 7.1.
 6. The High Pass filter loss factor already add into the correct factor.
 7. Proper operation of the transmitter prior to adding the filter to the measurement chain.
 8. Owing to the highest peak level complies with the lowest limit of unwanted emission out of the restricted bands (Please refer to page 51), so all the test point were deemed to comply with the limits list in the standard.



VERTICAL RESULTS
1-7GHz

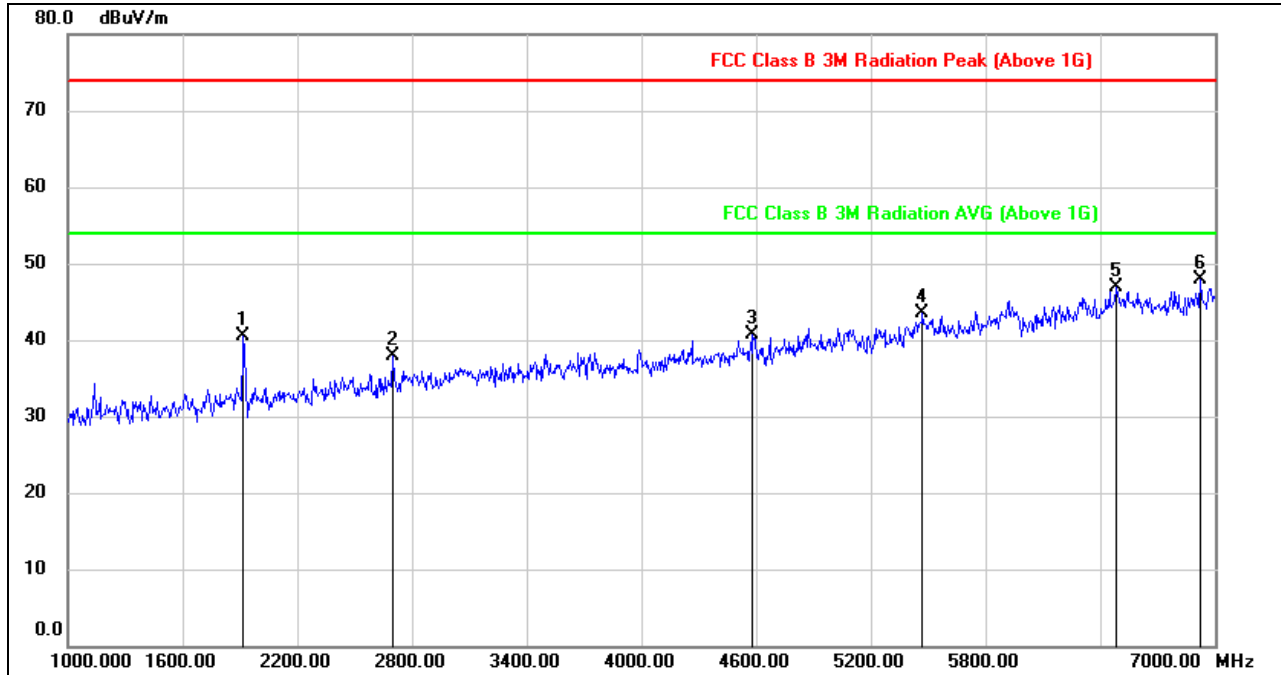

No.	Frequency (MHz)	Reading (dBuV)	Correct (dB/m)	Result (dBuV/m)	Limit (dBuV/m)	Margin (dB)	Remark
1	1918.000	51.31	-10.83	40.48	74.00	-33.52	peak
2	2698.000	45.75	-7.92	37.83	74.00	-36.17	peak
3	4582.000	42.81	-2.03	40.78	74.00	-33.22	peak
4	5470.000	41.60	1.88	43.48	74.00	-30.52	peak
5	6484.000	41.14	5.67	46.81	74.00	-27.19	peak
6	6922.000	41.51	6.32	47.83	74.00	-26.17	peak

Note: 1. Measurement = Reading Level + Correct Factor.
 2. If Peak Result complies with AV limit, AV Result is deemed to comply with AV limit.
 3. Peak: Peak detector.
 4. Filter losses were only considered in then spurious frequency bands and the authorized band was not corrected for BRF losses.
 5. Proper operation of the transmitter prior to adding the filter to the measurement chain.
 6. Owing to the highest peak level complies with the lowest limit of unwanted emission out of the restricted bands (Please refer to page 50), so all the test point were deemed to comply with the limits list in the standard.



7-18GHz

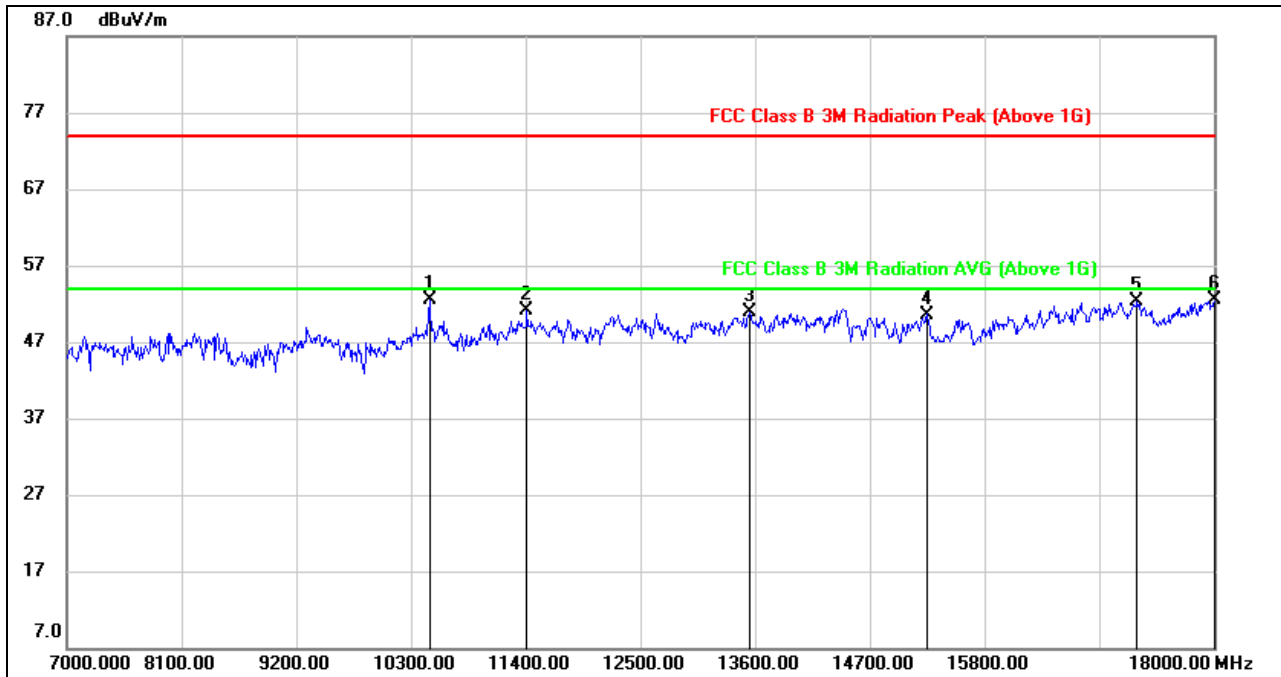

No.	Frequency (MHz)	Reading (dBuV)	Correct (dB/m)	Result (dBuV/m)	Limit (dBuV/m)	Margin (dB)	Remark
1	10476.000	40.59	12.00	52.59	74.00	-21.41	peak
2	11411.000	37.38	13.81	51.19	74.00	-22.81	peak
3	13545.000	34.83	16.06	50.89	74.00	-23.11	peak
4	15250.000	34.85	15.75	50.60	74.00	-23.40	peak
5	17263.000	30.80	21.59	52.39	74.00	-21.61	peak
6	18000.000	29.41	23.15	52.56	74.00	-21.44	peak

Note: 1. Measurement = Reading Level + Correct Factor.
 2. If Peak Result complies with AV limit, AV Result is deemed to comply with AV limit.
 3. Peak: Peak detector.
 4. The High Pass filter loss factor already add into the correct factor.
 5. Proper operation of the transmitter prior to adding the filter to the measurement chain.
 6. Owing to the highest peak level complies with the lowest limit of unwanted emission out of the restricted bands (Please refer to page 50), so all the test point were deemed to comply with the limits list in the standard.



8.1.2. UNII-3 BAND

RESTRICTED BANDEDGE LOW CHANNEL

HORIZONTAL RESULTS
PEAK

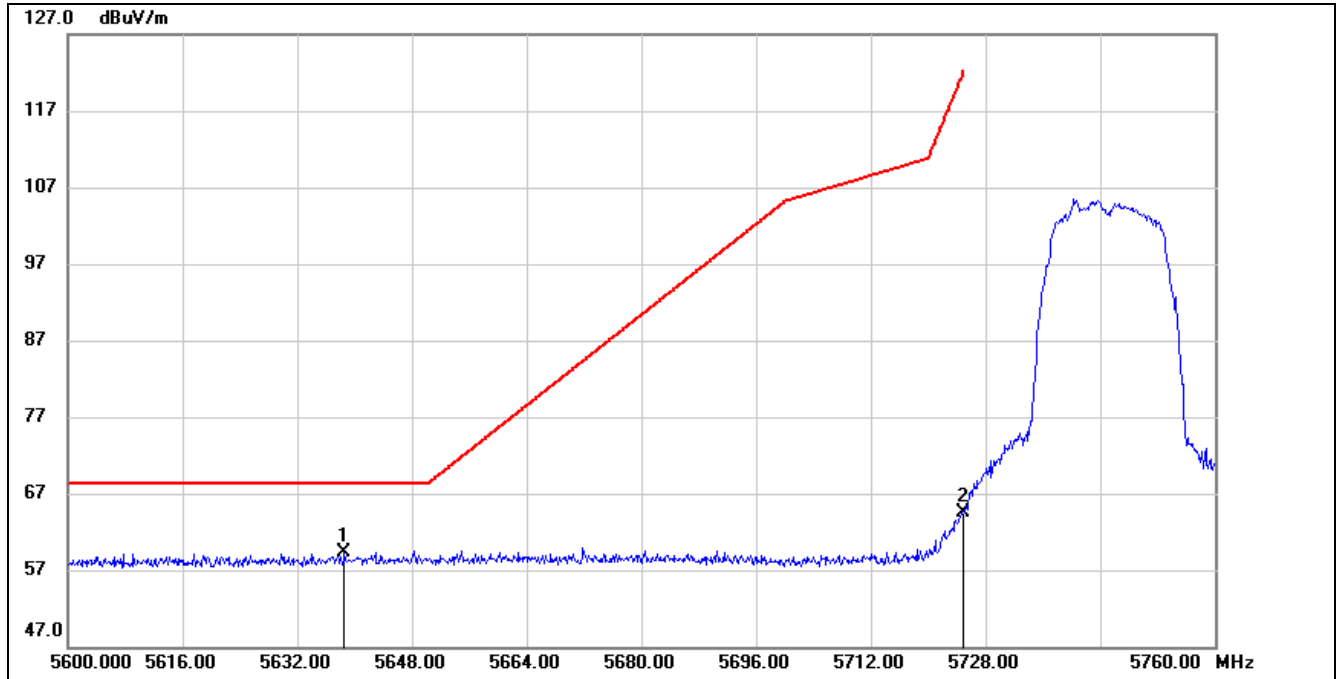

No.	Frequency (MHz)	Reading (dBuV)	Correct (dB/m)	Result (dBuV/m)	Limit (dBuV/m)	Margin (dB)	Remark
1	5638.560	17.84	41.48	59.32	68.20	-8.88	peak
2	5725.000	22.97	41.61	64.58	122.20	-57.62	peak

Note: 1. Measurement = Reading Level + Correct Factor.



VERTICAL RESULTS
PEAK

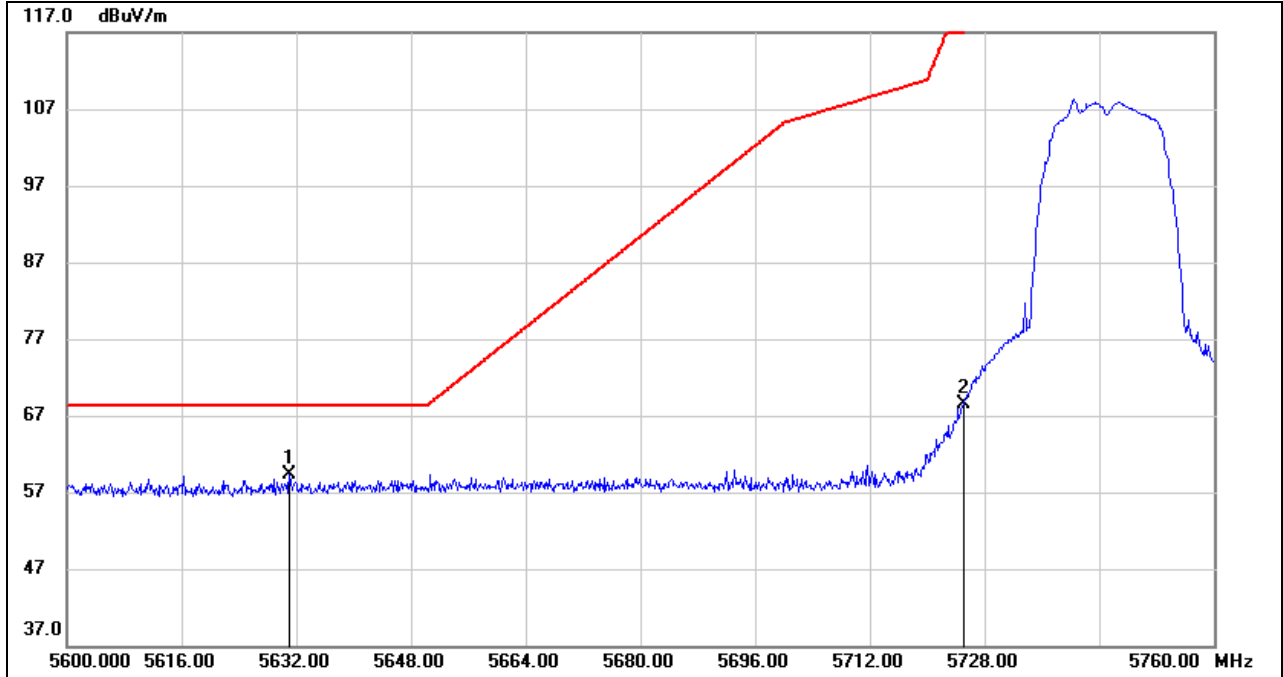

No.	Frequency (MHz)	Reading (dBuV)	Correct (dB/m)	Result (dBuV/m)	Limit (dBuV/m)	Margin (dB)	Remark
1	5631.040	17.75	41.48	59.23	68.20	-8.97	peak
2	5725.000	26.98	41.61	68.59	122.20	-53.61	peak

Note: 1. Measurement = Reading Level + Correct Factor.



RESTRICTED BANDEGE HIGH CHANNEL

HORIZONTAL RESULTS
PEAK

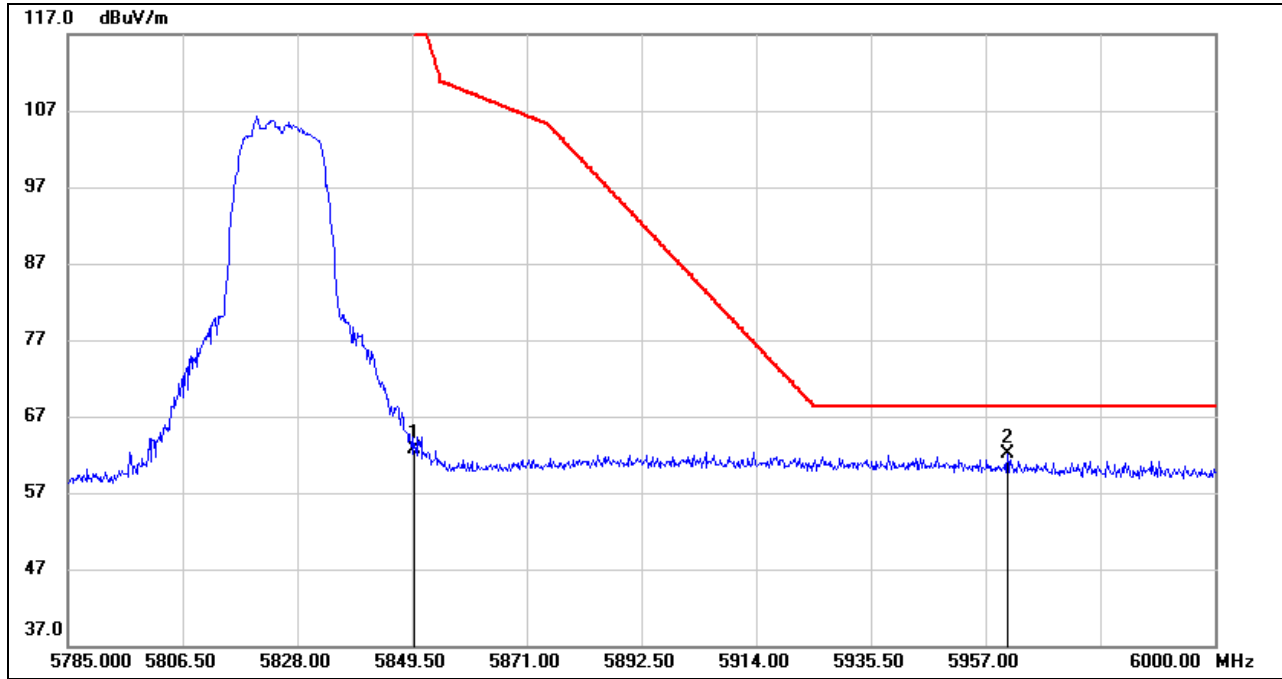

No.	Frequency (MHz)	Reading (dBuV)	Correct (dB/m)	Result (dBuV/m)	Limit (dBuV/m)	Margin (dB)	Remark
1	5850.000	19.74	42.89	62.63	122.20	-59.57	peak
2	5961.085	19.21	42.80	62.01	68.20	-6.19	peak

Note: 1. Measurement = Reading Level + Correct Factor.



VERTICAL RESULTS
PEAK

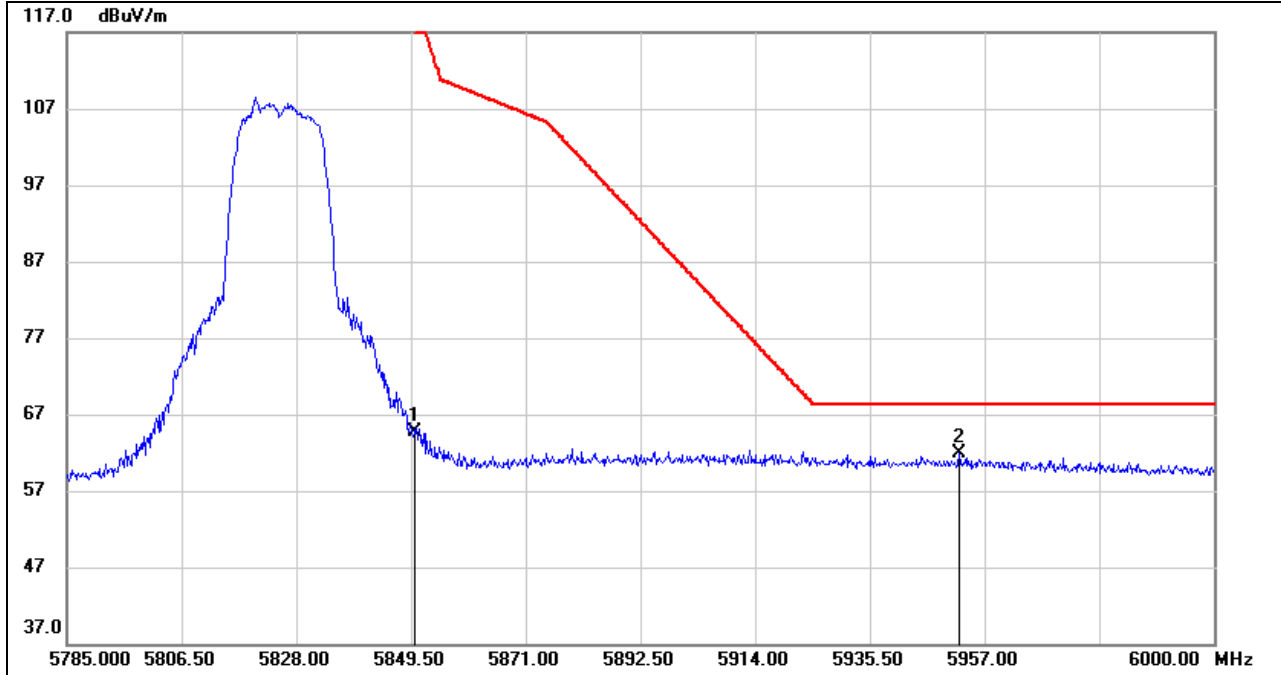

No.	Frequency (MHz)	Reading (dBuV)	Correct (dB/m)	Result (dBuV/m)	Limit (dBuV/m)	Margin (dB)	Remark
1	5850.000	21.77	42.89	64.66	122.20	-57.54	peak
2	5952.270	18.96	42.95	61.91	68.20	-6.29	peak

Note: 1. Measurement = Reading Level + Correct Factor.



HARMONICS AND SPURIOUS EMISSIONS LOW CHANNEL

HORIZONTAL RESULTS
1-7GHz

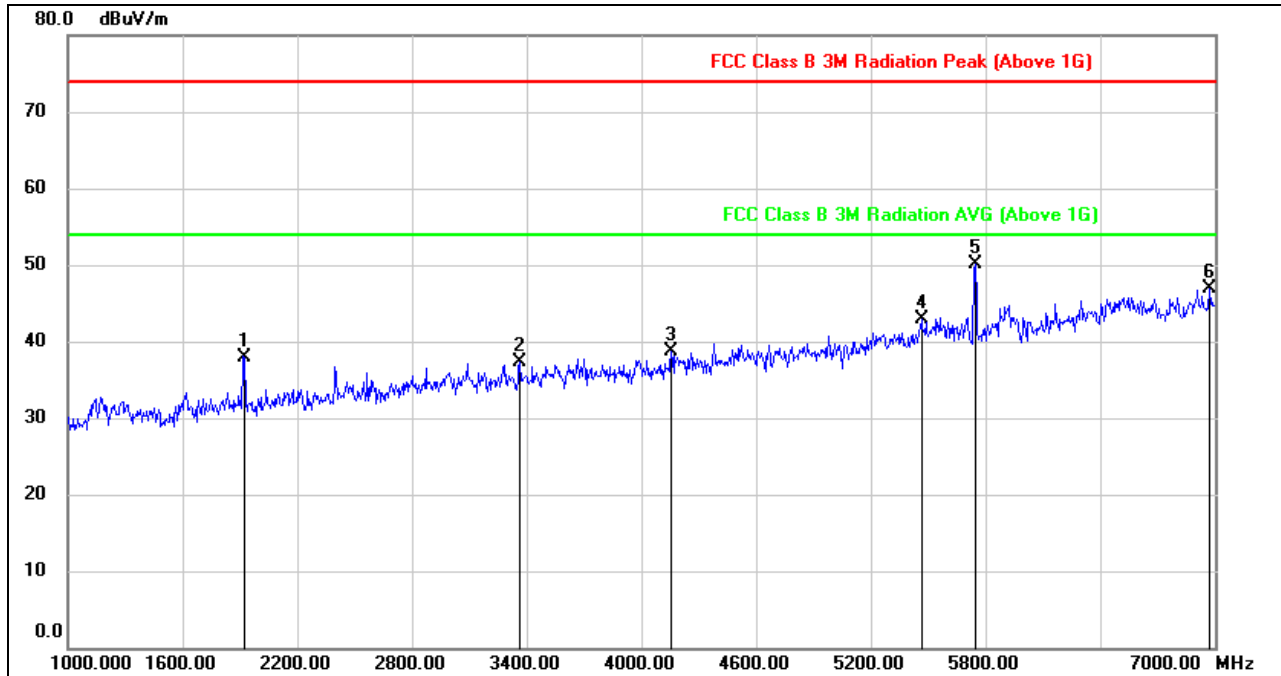

No.	Frequency (MHz)	Reading (dBuV)	Correct (dB/m)	Result (dBuV/m)	Limit (dBuV/m)	Margin (dB)	Remark
1	1924.000	48.74	-10.84	37.90	74.00	-36.10	peak
2	3364.000	42.89	-5.68	37.21	74.00	-36.79	peak
3	4156.000	42.08	-3.29	38.79	74.00	-35.21	peak
4	5464.000	41.16	1.80	42.96	74.00	-31.04	peak
5	5746.000	47.60	2.54	50.14	74.00	-23.86	peak
6	6970.000	40.43	6.39	46.82	74.00	-27.18	peak

Note: 1. Measurement = Reading Level + Correct Factor.
 2. If Peak Result complies with AV limit, AV Result is deemed to comply with AV limit.
 3. Peak: Peak detector.
 4. Filter losses were only considered in then spurious frequency bands and the authorized band was not corrected for BRF losses.
 5. Proper operation of the transmitter prior to adding the filter to the measurement chain.
 6. Owing to the highest peak level complies with the lowest limit of unwanted emission out of the restricted bands (Please refer to page 50), so all the test point were deemed to comply with the limits list in the standard.



HORIZONTAL RESULTS
7-18GHz

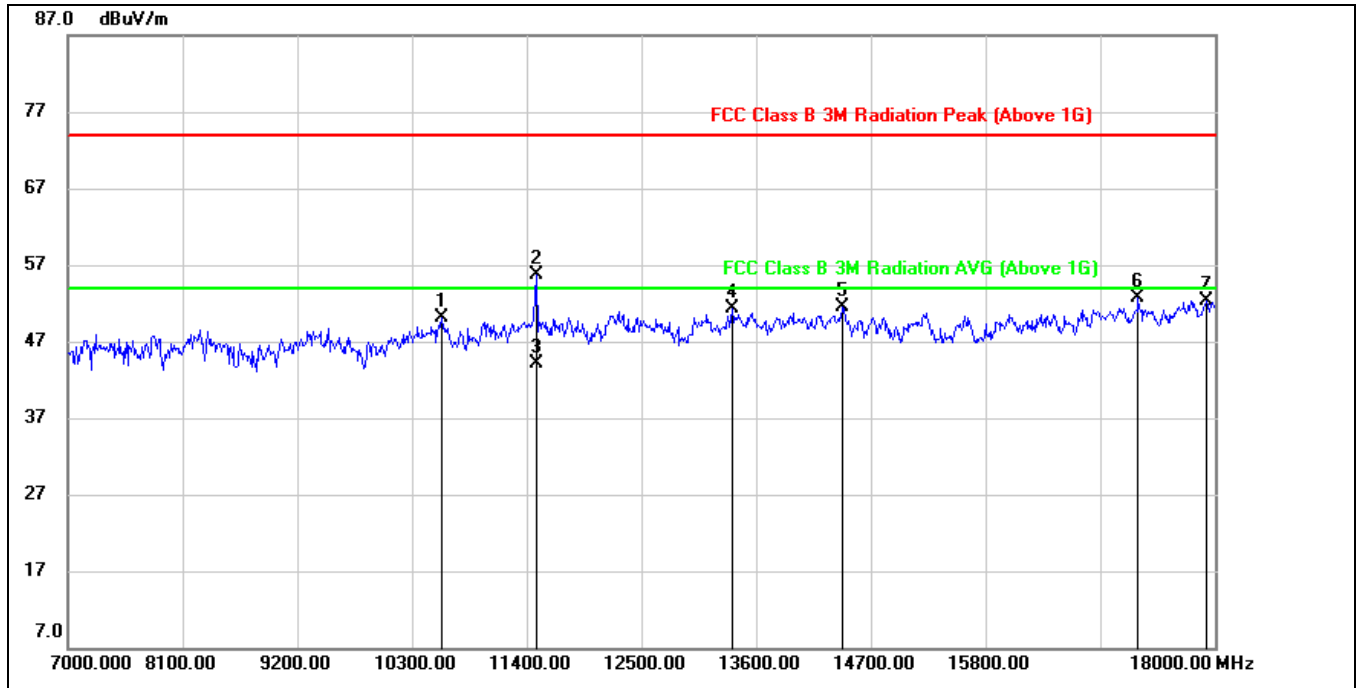

No.	Frequency (MHz)	Reading (dBuV)	Correct (dB/m)	Result (dBuV/m)	Limit (dBuV/m)	Margin (dB)	Remark
1	10586.000	37.14	13.00	50.14	74.00	-23.86	peak
2	11491.756	41.25	14.36	55.61	74.00	-18.39	peak
3	11491.756	29.84	14.36	44.20	54.00	-9.80	AVG
4	13369.000	35.28	16.07	51.35	74.00	-22.65	peak
5	14425.000	34.83	16.59	51.42	74.00	-22.58	peak
6	17263.000	31.07	21.59	52.66	74.00	-21.34	peak
7	17923.000	29.16	23.14	52.30	74.00	-21.70	peak

Note: 1. Measurement = Reading Level + Correct Factor.
 2. If Peak Result complies with AV limit, AV Result is deemed to comply with AV limit.
 3. Peak: Peak detector.
 4. AVG: $VBW=1/Ton$ where: ton is transmit duration.
 5. For duty cycle, please refer to clause 7.1.
 6. The High Pass filter loss factor already add into the correct factor.
 7. Proper operation of the transmitter prior to adding the filter to the measurement chain.
 8. Owing to the highest peak level complies with the lowest limit of unwanted emission out of the restricted bands (Please refer to page 51), so all the test point were deemed to comply with the limits list in the standard.



VERTICAL RESULTS
1-7GHz

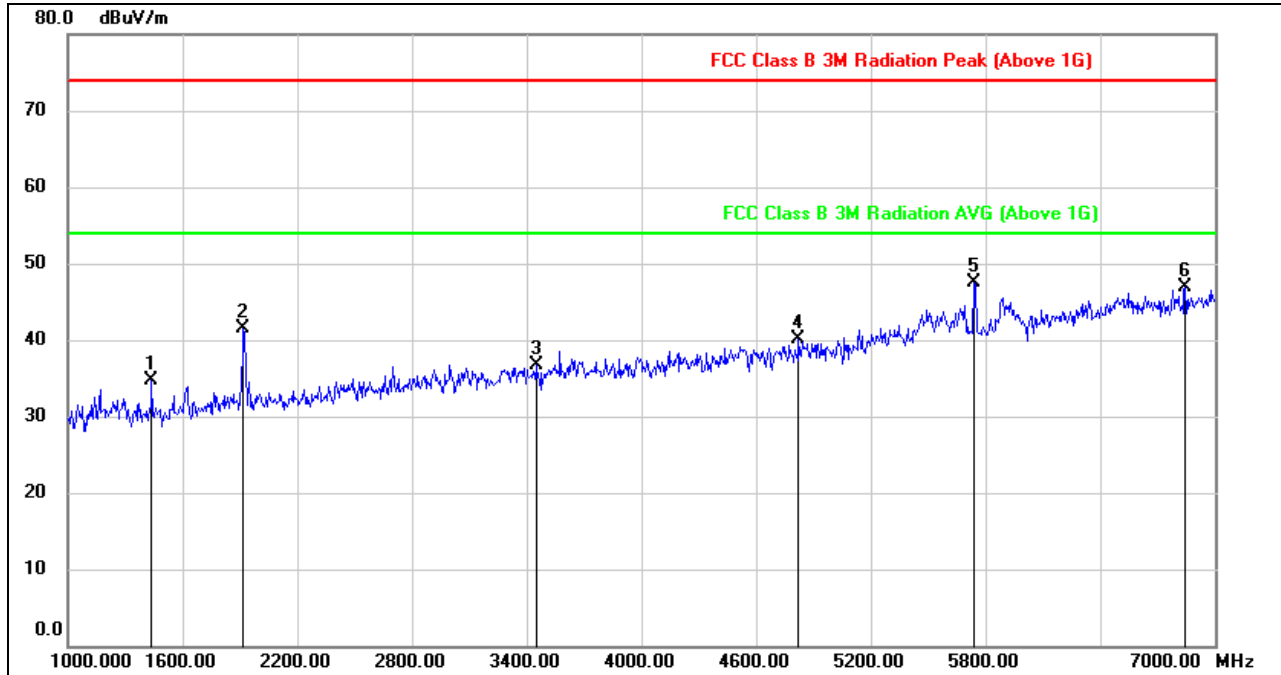

No.	Frequency (MHz)	Reading (dBuV)	Correct (dB/m)	Result (dBuV/m)	Limit (dBuV/m)	Margin (dB)	Remark
1	1438.000	47.85	-13.21	34.64	74.00	-39.36	peak
2	1918.000	52.34	-10.83	41.51	74.00	-32.49	peak
3	3448.000	42.31	-5.57	36.74	74.00	-37.26	peak
4	4822.000	41.04	-0.91	40.13	74.00	-33.87	peak
5	5740.000	44.93	2.50	47.43	74.00	-26.57	peak
6	6844.000	40.97	5.90	46.87	74.00	-27.13	peak

Note: 1. Measurement = Reading Level + Correct Factor.
 2. If Peak Result complies with AV limit, AV Result is deemed to comply with AV limit.
 3. Peak: Peak detector.
 4. Filter losses were only considered in then spurious frequency bands and the authorized band was not corrected for BRF losses.
 5. Proper operation of the transmitter prior to adding the filter to the measurement chain.
 6. Owing to the highest peak level complies with the lowest limit of unwanted emission out of the restricted bands (Please refer to page 50), so all the test point were deemed to comply with the limits list in the standard.



7-18GHz

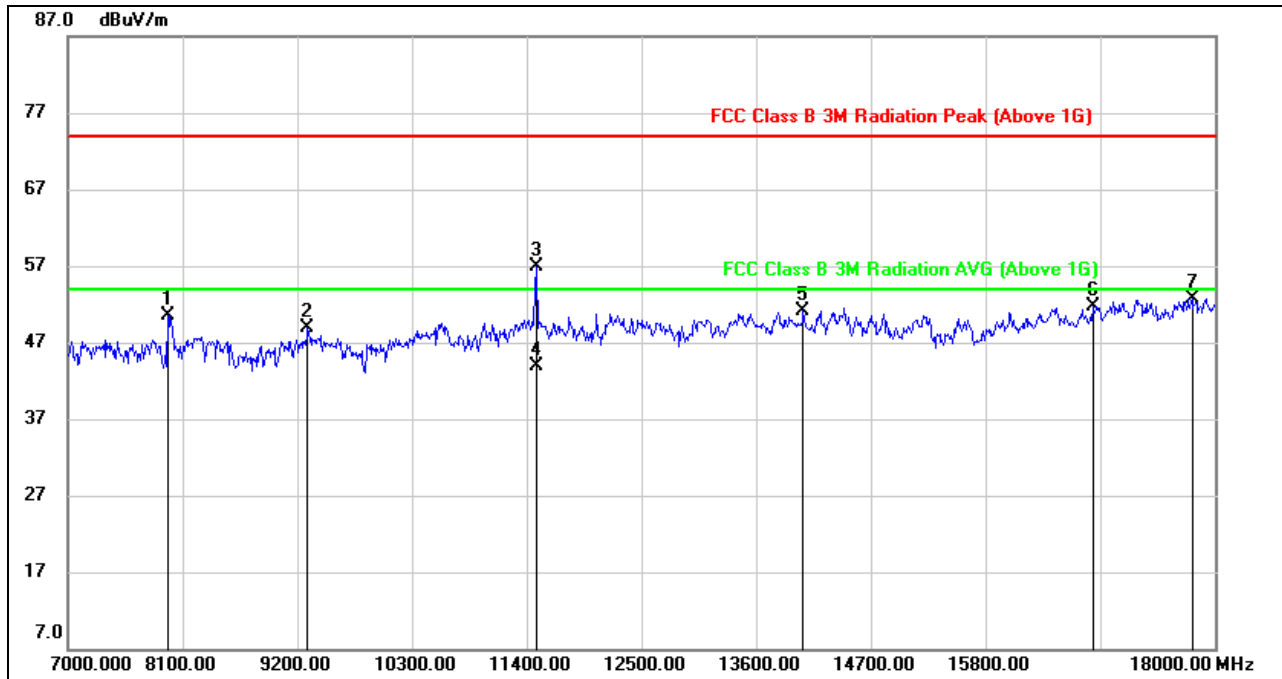

No.	Frequency (MHz)	Reading (dBuV)	Correct (dB/m)	Result (dBuV/m)	Limit (dBuV/m)	Margin (dB)	Remark
1	7957.000	41.72	8.73	50.45	74.00	-23.55	peak
2	9299.000	38.57	10.27	48.84	74.00	-25.16	peak
3	11491.796	42.54	14.36	56.90	74.00	-17.10	peak
4	11491.796	29.55	14.36	43.91	54.00	-10.09	AVG
5	14051.000	34.57	16.50	51.07	74.00	-22.93	peak
6	16834.000	31.49	20.18	51.67	74.00	-22.33	peak
7	17780.000	29.79	23.01	52.80	74.00	-21.20	peak

Note: 1. Measurement = Reading Level + Correct Factor.
 2. If Peak Result complies with AV limit, AV Result is deemed to comply with AV limit.
 3. Peak: Peak detector.
 4. AVG: $VBW=1/Ton$ where: ton is transmit duration.
 5. For duty cycle, please refer to clause 7.1.
 6. The High Pass filter loss factor already add into the correct factor.
 7. Proper operation of the transmitter prior to adding the filter to the measurement chain.
 8. Owing to the highest peak level complies with the lowest limit of unwanted emission out of the restricted bands (Please refer to page 51), so all the test point were deemed to comply with the limits list in the standard.



HARMONICS AND SPURIOUS EMISSIONS MID CHANNEL

HORIZONTAL RESULTS
1-7GHz

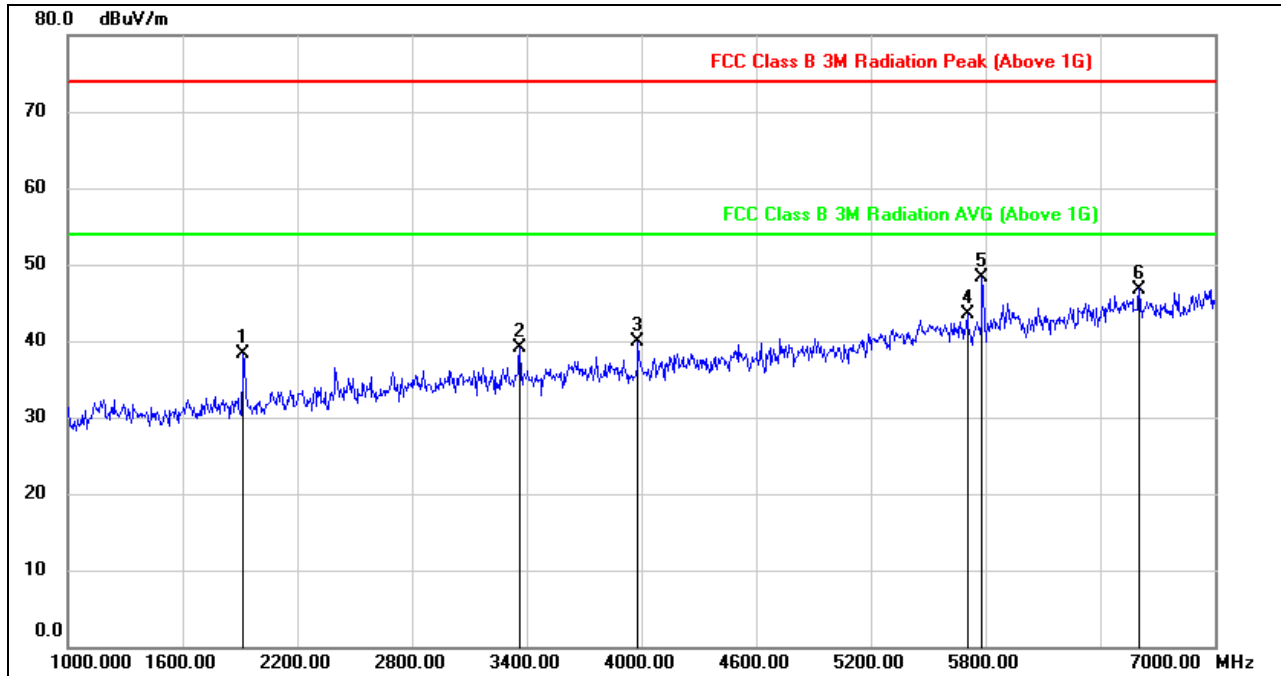

No.	Frequency (MHz)	Reading (dBuV)	Correct (dB/m)	Result (dBuV/m)	Limit (dBuV/m)	Margin (dB)	Remark
1	1918.000	49.10	-10.83	38.27	74.00	-35.73	peak
2	3364.000	44.71	-5.68	39.03	74.00	-34.97	peak
3	3982.000	43.99	-4.10	39.89	74.00	-34.11	peak
4	5704.000	41.19	2.25	43.44	74.00	-30.56	peak
5	5782.000	45.50	2.78	48.28	74.00	-25.72	peak
6	6604.000	41.27	5.53	46.80	74.00	-27.20	peak

Note: 1. Measurement = Reading Level + Correct Factor.
 2. If Peak Result complies with AV limit, AV Result is deemed to comply with AV limit.
 3. Peak: Peak detector.
 4. Filter losses were only considered in then spurious frequency bands and the authorized band was not corrected for BRF losses.
 5. Proper operation of the transmitter prior to adding the filter to the measurement chain.
 6. Owing to the highest peak level complies with the lowest limit of unwanted emission out of the restricted bands (Please refer to page 50), so all the test point were deemed to comply with the limits list in the standard.



HORIZONTAL RESULTS
7-18GHz

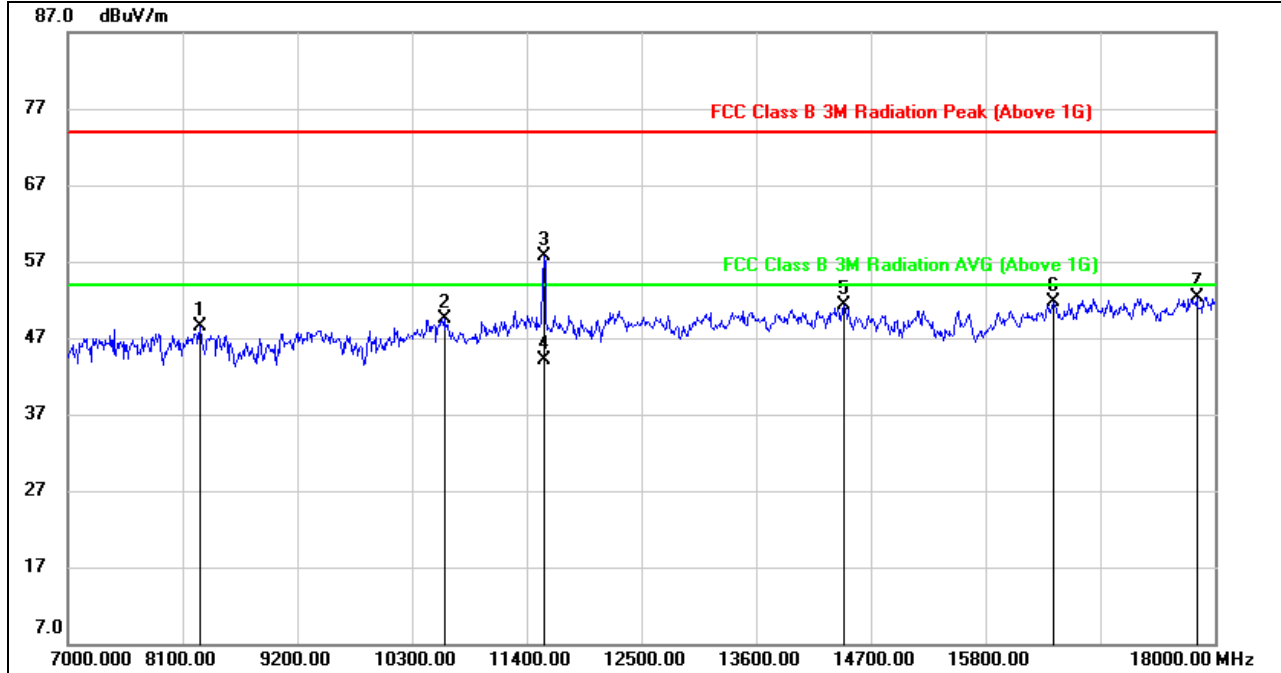

No.	Frequency (MHz)	Reading (dBuV)	Correct (dB/m)	Result (dBuV/m)	Limit (dBuV/m)	Margin (dB)	Remark
1	8265.000	38.91	9.55	48.46	74.00	-25.54	peak
2	10608.000	36.37	13.08	49.45	74.00	-24.55	peak
3	11568.137	43.40	14.35	57.75	74.00	-16.25	peak
4	11568.137	29.81	14.35	44.16	54.00	-9.84	AVG
5	14436.000	34.76	16.58	51.34	74.00	-22.66	peak
6	16449.000	32.72	18.97	51.69	74.00	-22.31	peak
7	17824.000	29.10	23.19	52.29	74.00	-21.71	peak

Note: 1. Measurement = Reading Level + Correct Factor.
 2. If Peak Result complies with AV limit, AV Result is deemed to comply with AV limit.
 3. Peak: Peak detector.
 4. AVG: $VBW=1/Ton$ where: ton is transmit duration.
 5. For duty cycle, please refer to clause 7.1.
 6. The High Pass filter loss factor already add into the correct factor.
 7. Proper operation of the transmitter prior to adding the filter to the measurement chain.
 8. Owing to the highest peak level complies with the lowest limit of unwanted emission out of the restricted bands (Please refer to page 51), so all the test point were deemed to comply with the limits list in the standard.



VERTICAL RESULTS
1-7GHz

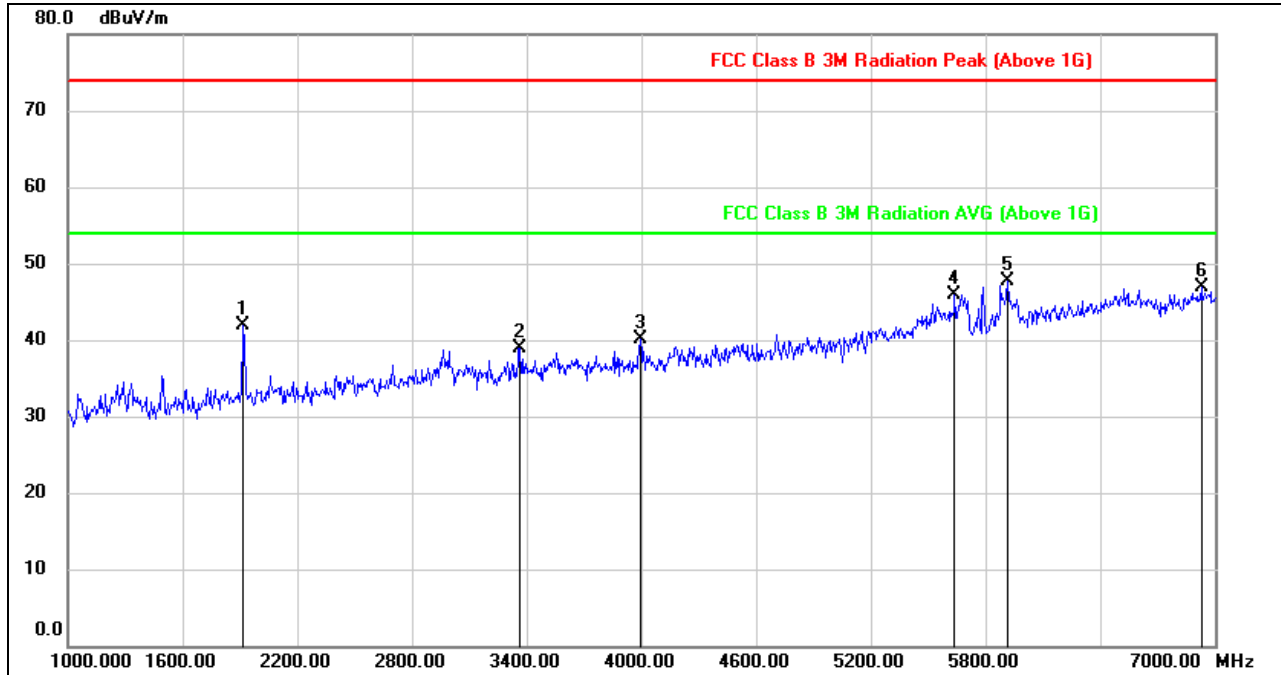

No.	Frequency (MHz)	Reading (dBuV)	Correct (dB/m)	Result (dBuV/m)	Limit (dBuV/m)	Margin (dB)	Remark
1	1918.000	52.68	-10.83	41.85	74.00	-32.15	peak
2	3364.000	44.65	-5.68	38.97	74.00	-35.03	peak
3	3994.000	44.19	-4.08	40.11	74.00	-33.89	peak
4	5638.000	43.67	2.16	45.83	74.00	-28.17	peak
5	5914.000	43.00	4.65	47.65	74.00	-26.35	peak
6	6928.000	40.68	6.32	47.00	74.00	-27.00	peak

Note: 1. Measurement = Reading Level + Correct Factor.
 2. If Peak Result complies with AV limit, AV Result is deemed to comply with AV limit.
 3. Peak: Peak detector.
 4. Filter losses were only considered in then spurious frequency bands and the authorized band was not corrected for BRF losses.
 5. Proper operation of the transmitter prior to adding the filter to the measurement chain.
 6. Owing to the highest peak level complies with the lowest limit of unwanted emission out of the restricted bands (Please refer to page 50), so all the test point were deemed to comply with the limits list in the standard.



7-18GHz

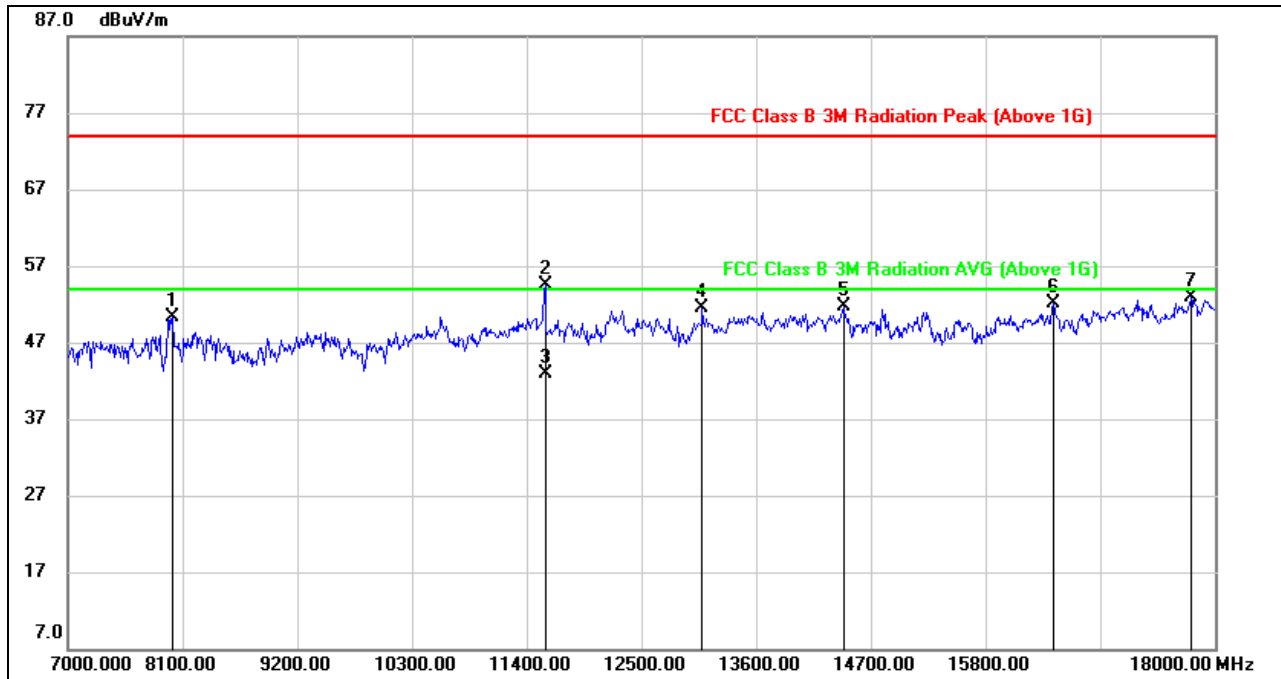

No.	Frequency (MHz)	Reading (dBuV)	Correct (dB/m)	Result (dBuV/m)	Limit (dBuV/m)	Margin (dB)	Remark
1	8001.000	41.66	8.64	50.30	74.00	-23.70	peak
2	11569.227	40.25	14.35	54.60	74.00	-19.40	peak
3	11569.227	28.50	14.35	42.85	54.00	-11.15	AVG
4	13083.000	36.19	15.27	51.46	74.00	-22.54	peak
5	14436.000	35.05	16.58	51.63	74.00	-22.37	peak
6	16449.000	33.08	18.97	52.05	74.00	-21.95	peak
7	17769.000	29.91	22.91	52.82	74.00	-21.18	peak

Note: 1. Measurement = Reading Level + Correct Factor.
 2. If Peak Result complies with AV limit, AV Result is deemed to comply with AV limit.
 3. Peak: Peak detector.
 4. AVG: $VBW=1/Ton$ where: ton is transmit duration.
 5. For duty cycle, please refer to clause 7.1.
 6. The High Pass filter loss factor already add into the correct factor.
 7. Proper operation of the transmitter prior to adding the filter to the measurement chain.
 8. Owing to the highest peak level complies with the lowest limit of unwanted emission out of the restricted bands (Please refer to page 51), so all the test point were deemed to comply with the limits list in the standard.



HARMONICS AND SPURIOUS EMISSIONS HIGH CHANNEL

HORIZONTAL RESULTS
1-7GHz

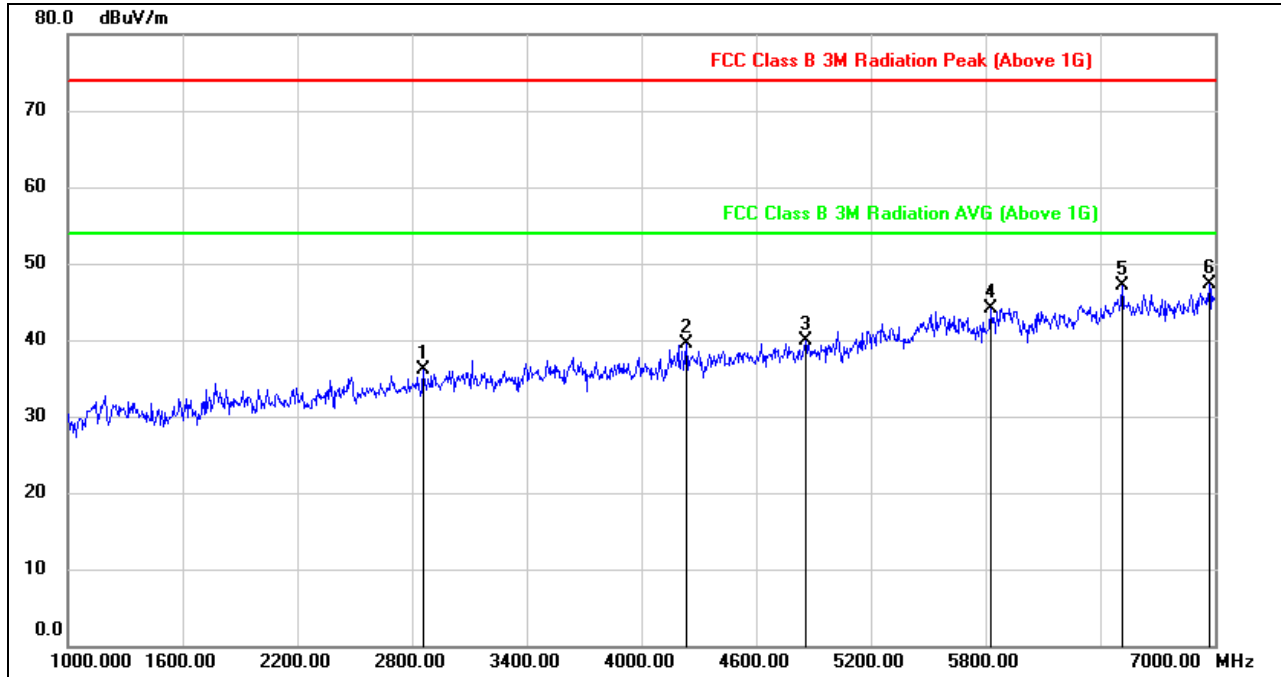

No.	Frequency (MHz)	Reading (dBuV)	Correct (dB/m)	Result (dBuV/m)	Limit (dBuV/m)	Margin (dB)	Remark
1	2860.000	43.11	-6.92	36.19	74.00	-37.81	peak
2	4234.000	42.48	-2.96	39.52	74.00	-34.48	peak
3	4858.000	40.87	-0.87	40.00	74.00	-34.00	peak
4	5824.000	40.82	3.38	44.20	74.00	-29.80	peak
5	6514.000	41.23	5.84	47.07	74.00	-26.93	peak
6	6970.000	40.88	6.39	47.27	74.00	-26.73	peak

Note: 1. Measurement = Reading Level + Correct Factor.
 2. If Peak Result complies with AV limit, AV Result is deemed to comply with AV limit.
 3. Peak: Peak detector.
 4. Filter losses were only considered in then spurious frequency bands and the authorized band was not corrected for BRF losses.
 5. Proper operation of the transmitter prior to adding the filter to the measurement chain.
 6. Owing to the highest peak level complies with the lowest limit of unwanted emission out of the restricted bands (Please refer to page 50), so all the test point were deemed to comply with the limits list in the standard.



HORIZONTAL RESULTS
7-18GHz

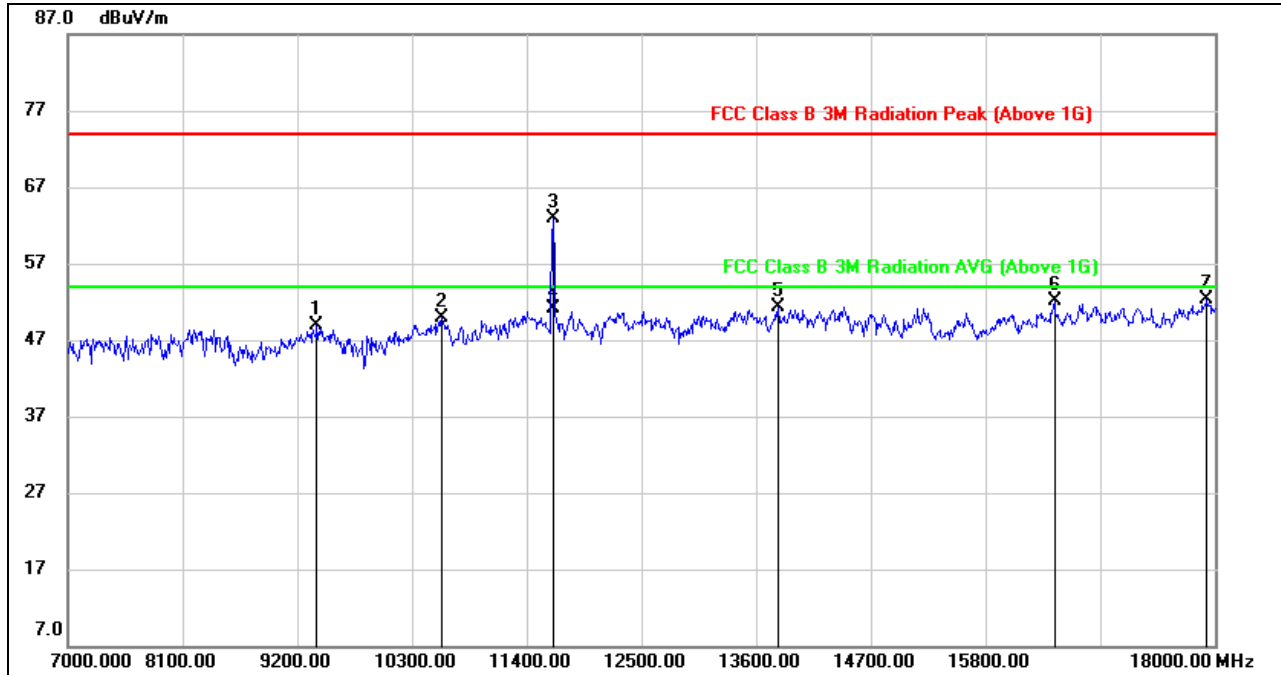

No.	Frequency (MHz)	Reading (dBuV)	Correct (dB/m)	Result (dBuV/m)	Limit (dBuV/m)	Margin (dB)	Remark
1	9387.000	38.22	10.68	48.90	74.00	-25.10	peak
2	10586.000	36.84	13.00	49.84	74.00	-24.16	peak
3	11651.701	48.75	14.22	62.97	74.00	-11.03	peak
4	11651.701	36.95	14.22	51.17	54.00	-2.83	AVG
5	13809.000	34.35	16.96	51.31	74.00	-22.69	peak
6	16460.000	33.17	19.01	52.18	74.00	-21.82	peak
7	17923.000	29.16	23.14	52.30	74.00	-21.70	peak

Note: 1. Measurement = Reading Level + Correct Factor.
 2. If Peak Result complies with AV limit, AV Result is deemed to comply with AV limit.
 3. Peak: Peak detector.
 4. AVG: VBW=1/Ton where: ton is transmit duration.
 5. For duty cycle, please refer to clause 7.1.
 6. The High Pass filter loss factor already add into the correct factor.
 7. Proper operation of the transmitter prior to adding the filter to the measurement chain.
 8. Owing to the highest peak level complies with the lowest limit of unwanted emission out of the restricted bands (Please refer to page 51), so all the test point were deemed to comply with the limits list in the standard.



VERTICAL RESULTS
1-7GHz

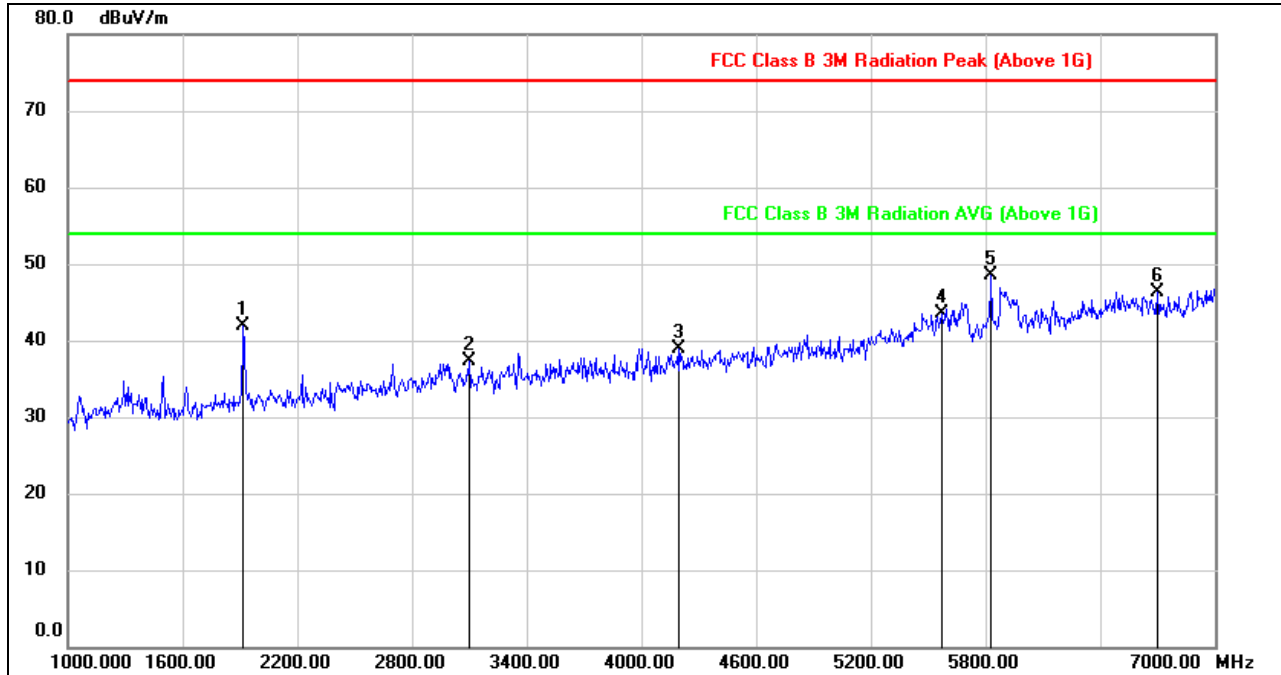

No.	Frequency (MHz)	Reading (dBuV)	Correct (dB/m)	Result (dBuV/m)	Limit (dBuV/m)	Margin (dB)	Remark
1	1918.000	52.67	-10.83	41.84	74.00	-32.16	peak
2	3100.000	42.88	-5.63	37.25	74.00	-36.75	peak
3	4192.000	41.73	-2.88	38.85	74.00	-35.15	peak
4	5572.000	41.26	2.18	43.44	74.00	-30.56	peak
5	5830.000	45.04	3.50	48.54	74.00	-25.46	peak
6	6700.000	40.74	5.60	46.34	74.00	-27.66	peak

Note: 1. Measurement = Reading Level + Correct Factor.
 2. If Peak Result complies with AV limit, AV Result is deemed to comply with AV limit.
 3. Peak: Peak detector.
 4. Filter losses were only considered in then spurious frequency bands and the authorized band was not corrected for BRF losses.
 5. Proper operation of the transmitter prior to adding the filter to the measurement chain.
 6. Owing to the highest peak level complies with the lowest limit of unwanted emission out of the restricted bands (Please refer to page 50), so all the test point were deemed to comply with the limits list in the standard.



7-18GHz

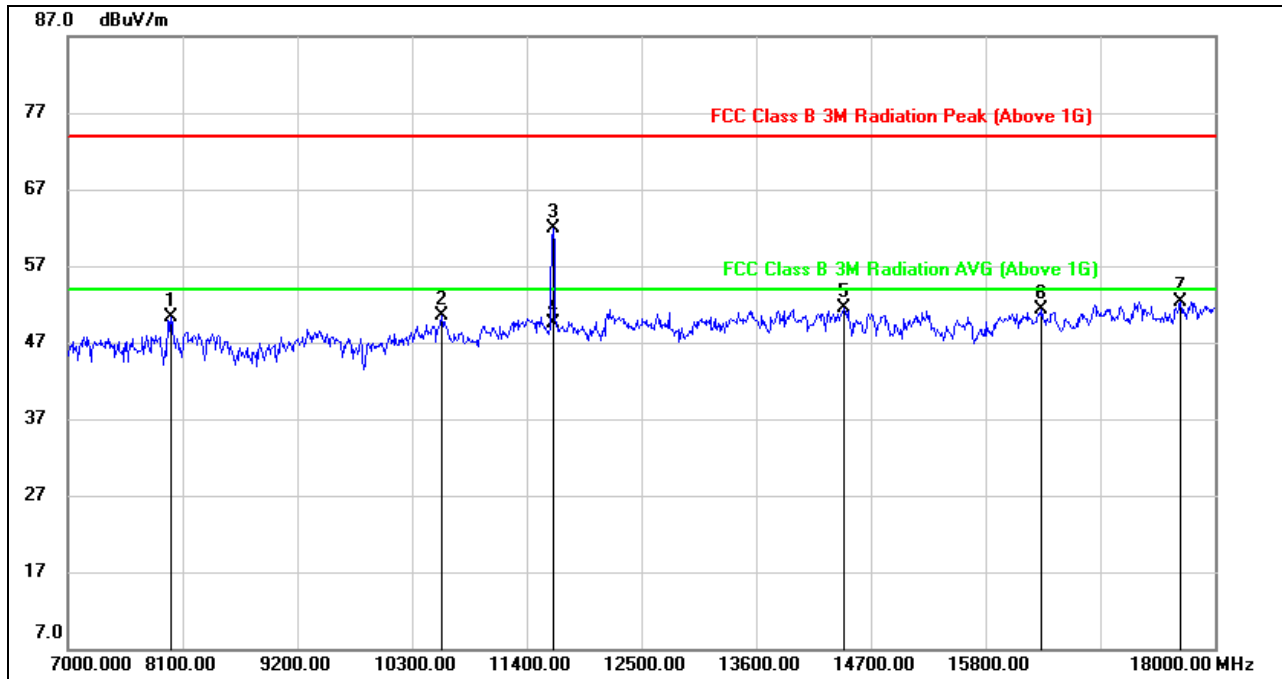

No.	Frequency (MHz)	Reading (dBuV)	Correct (dB/m)	Result (dBuV/m)	Limit (dBuV/m)	Margin (dB)	Remark
1	7990.000	41.60	8.66	50.26	74.00	-23.74	peak
2	10586.000	37.43	13.00	50.43	74.00	-23.57	peak
3	11653.000	47.72	14.22	61.94	74.00	-12.06	peak
4	11653.000	35.37	14.22	49.59	54.00	-4.41	AVG
5	14447.000	34.88	16.56	51.44	74.00	-22.56	peak
6	16339.000	32.96	18.41	51.37	74.00	-22.63	peak
7	17670.000	30.33	22.06	52.39	74.00	-21.61	peak

Note: 1. Measurement = Reading Level + Correct Factor.
 2. If Peak Result complies with AV limit, AV Result is deemed to comply with AV limit.
 3. Peak: Peak detector.
 4. AVG: $VBW=1/T_{on}$ where: t_{on} is transmit duration.
 5. For duty cycle, please refer to clause 7.1.
 6. The High Pass filter loss factor already add into the correct factor.
 7. Proper operation of the transmitter prior to adding the filter to the measurement chain.
 8. Owing to the highest peak level complies with the lowest limit of unwanted emission out of the restricted bands (Please refer to page 51), so all the test point were deemed to comply with the limits list in the standard.



8.2. 802.11n HT20 MIMO MODE

MIMO CDD MODE (WORST-CASE CONFIGURATION)

8.2.1. UNII-1 BAND

RESTRICTED BANDEDGE LOW CHANNEL

HORIZONTAL RESULTS PEAK

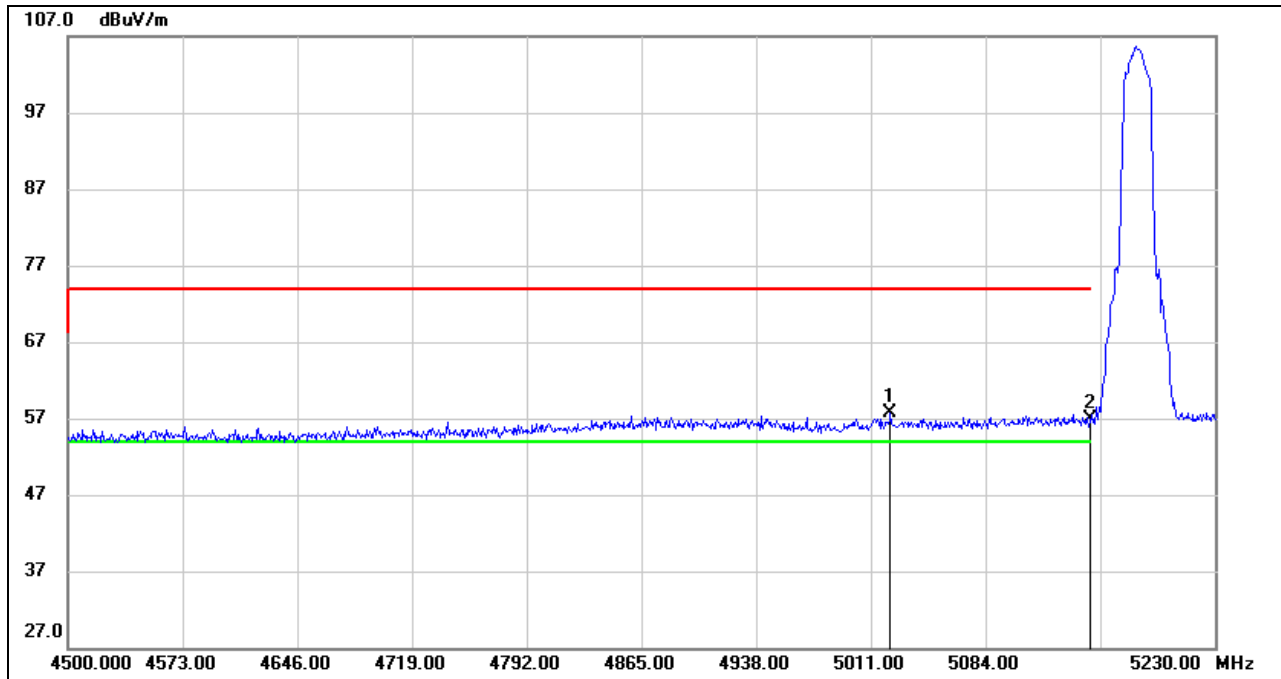

No.	Frequency (MHz)	Reading (dBuV)	Correct (dB/m)	Result (dBuV/m)	Limit (dBuV/m)	Margin (dB)	Remark
1	5023.410	17.52	40.10	57.62	74.00	-16.38	peak
2	5150.000	16.51	40.46	56.97	74.00	-17.03	peak

- Note: 1. Measurement = Reading Level + Correct Factor.
 2. If Peak Result complies with AV limit, AV Result is deemed to comply with AV limit.
 3. Peak: Peak detector.
 4. Only the worst case emission will be recorder, if it complies with the limit, the other emissions deemed to comply with the limit.



AVG

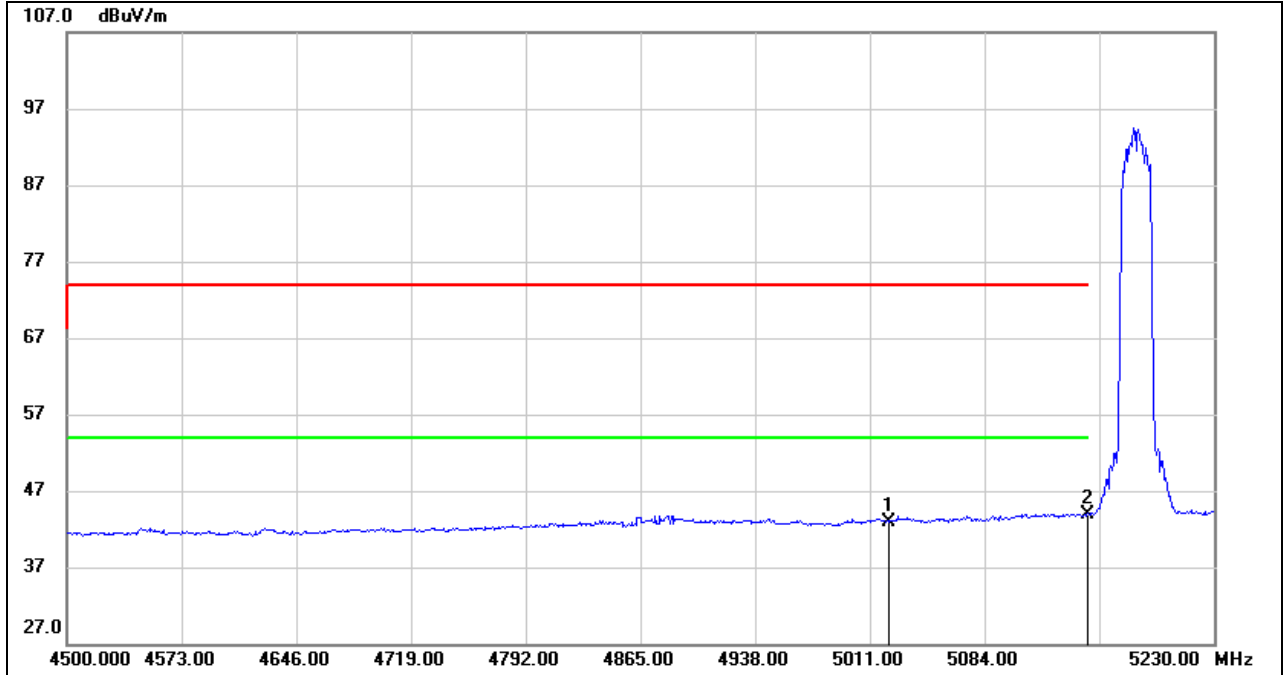

No.	Frequency (MHz)	Reading (dBuV)	Correct (dB/m)	Result (dBuV/m)	Limit (dBuV/m)	Margin (dB)	Remark
1	5023.410	2.90	40.10	43.00	54.00	-11.00	AVG
2	5150.000	3.44	40.46	43.90	54.00	-10.10	AVG

- Note: 1. Measurement = Reading Level + Correct Factor.
 2. AVG: $VBW=1/Ton$ where: ton is transmit duration.
 3. For duty cycle, please refer to clause 7.1.
 4. Only the worst case emission will be recorder, if it complies with the limit, the other emissions deemed to comply with the limit.



VERTICAL RESULTS
PEAK

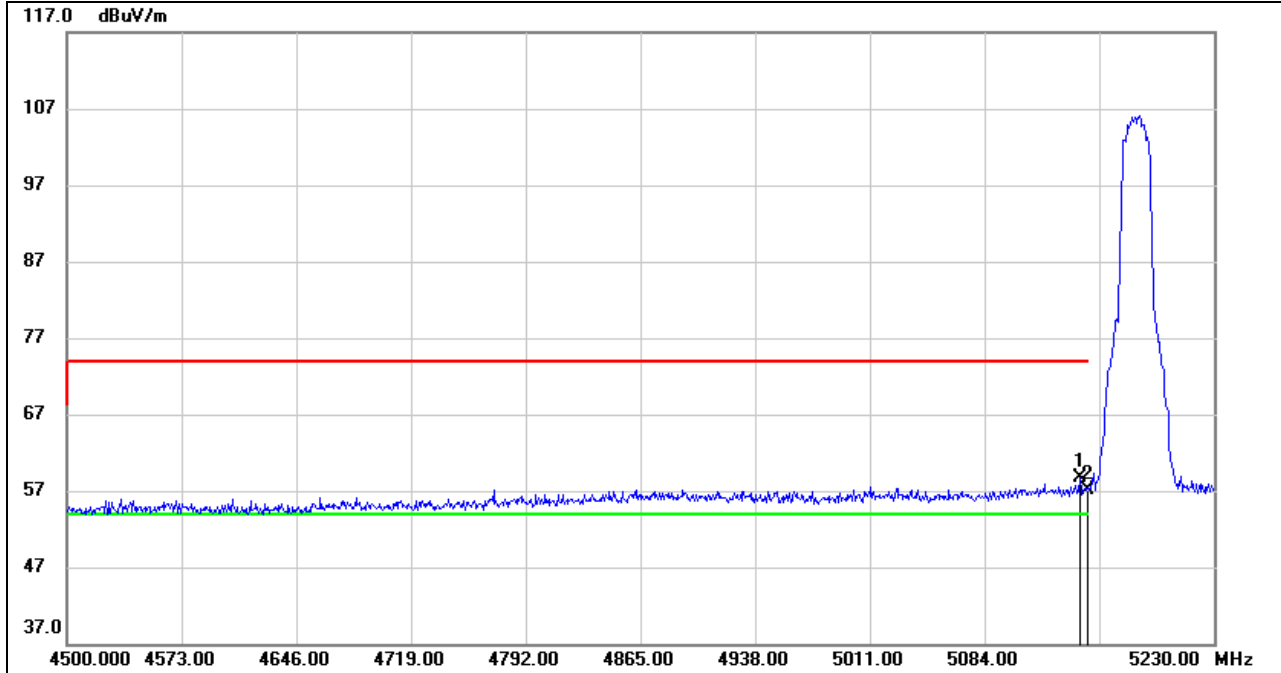

No.	Frequency (MHz)	Reading (dBuV)	Correct (dB/m)	Result (dBuV/m)	Limit (dBuV/m)	Margin (dB)	Remark
1	5144.590	18.27	40.43	58.70	74.00	-15.30	peak
2	5150.000	16.66	40.46	57.12	74.00	-16.88	peak

- Note: 1. Measurement = Reading Level + Correct Factor.
 2. If Peak Result complies with AV limit, AV Result is deemed to comply with AV limit.
 3. Peak: Peak detector.
 4. Only the worst case emission will be recorder, if it complies with the limit, the other emissions deemed to comply with the limit.



AVG

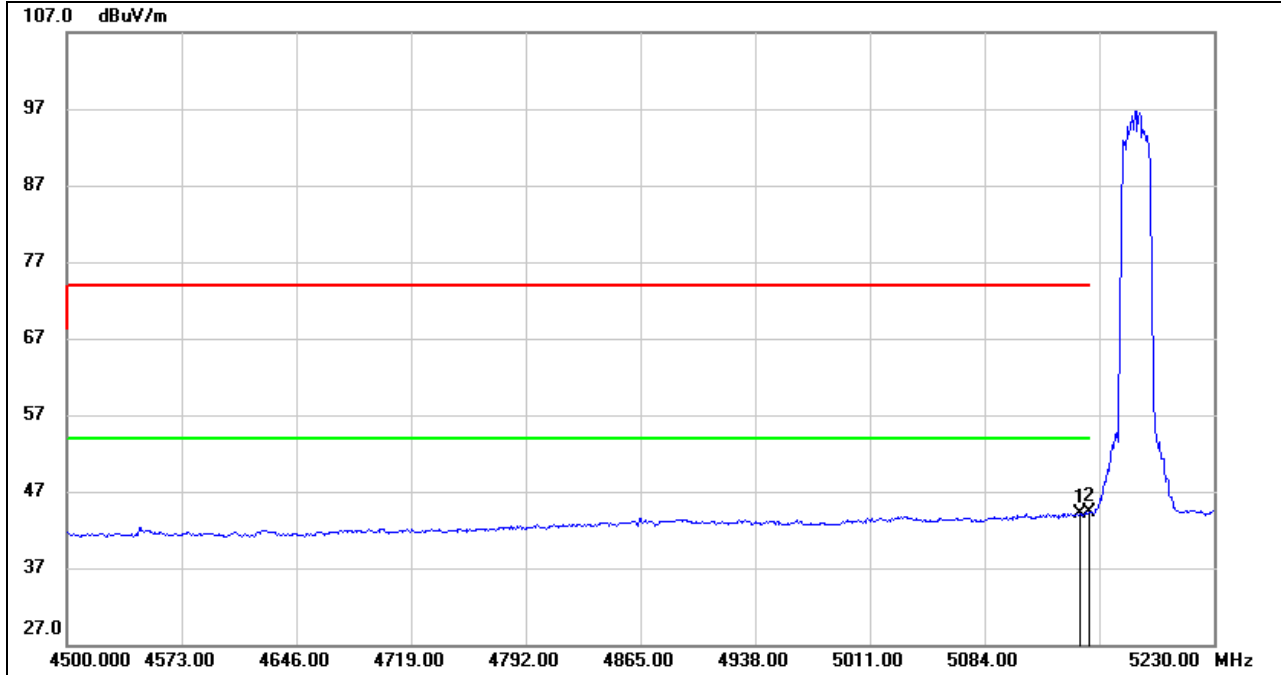

No.	Frequency (MHz)	Reading (dBuV)	Correct (dB/m)	Result (dBuV/m)	Limit (dBuV/m)	Margin (dB)	Remark
1	5144.590	3.67	40.43	44.10	54.00	-9.90	AVG
2	5150.000	3.86	40.46	44.32	54.00	-9.68	AVG

- Note: 1. Measurement = Reading Level + Correct Factor.
 2. AVG: VBW=1/Ton where: ton is transmit duration.
 3. For duty cycle, please refer to clause 7.1.
 4. Only the worst case emission will be recorder, if it complies with the limit, the other emissions deemed to comply with the limit.



HARMONICS AND SPURIOUS EMISSIONS LOW CHANNEL

HORIZONTAL RESULTS
1-7GHz

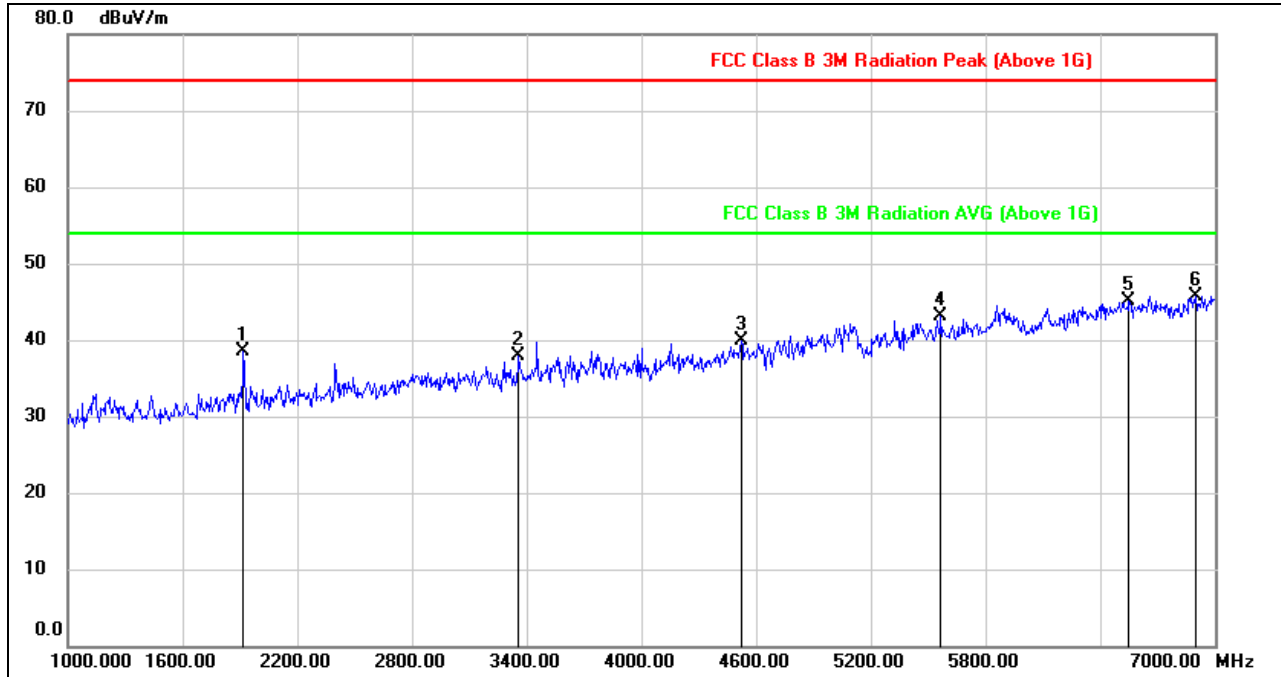

No.	Frequency (MHz)	Reading (dBuV)	Correct (dB/m)	Result (dBuV/m)	Limit (dBuV/m)	Margin (dB)	Remark
1	1918.000	49.27	-10.83	38.44	74.00	-35.56	peak
2	3358.000	43.60	-5.66	37.94	74.00	-36.06	peak
3	4522.000	42.04	-2.08	39.96	74.00	-34.04	peak
4	5566.000	40.84	2.19	43.03	74.00	-30.97	peak
5	6550.000	39.37	5.70	45.07	74.00	-28.93	peak
6	6898.000	39.45	6.28	45.73	74.00	-28.27	peak

Note: 1. Measurement = Reading Level + Correct Factor.
 2. If Peak Result complies with AV limit, AV Result is deemed to comply with AV limit.
 3. Peak: Peak detector.
 4. Filter losses were only considered in then spurious frequency bands and the authorized band was not corrected for BRF losses.
 5. Proper operation of the transmitter prior to adding the filter to the measurement chain.
 6. Owing to the highest peak level complies with the lowest limit of unwanted emission out of the restricted bands (Please refer to page 50), so all the test point were deemed to comply with the limits list in the standard.



HORIZONTAL RESULTS
7-18GHz

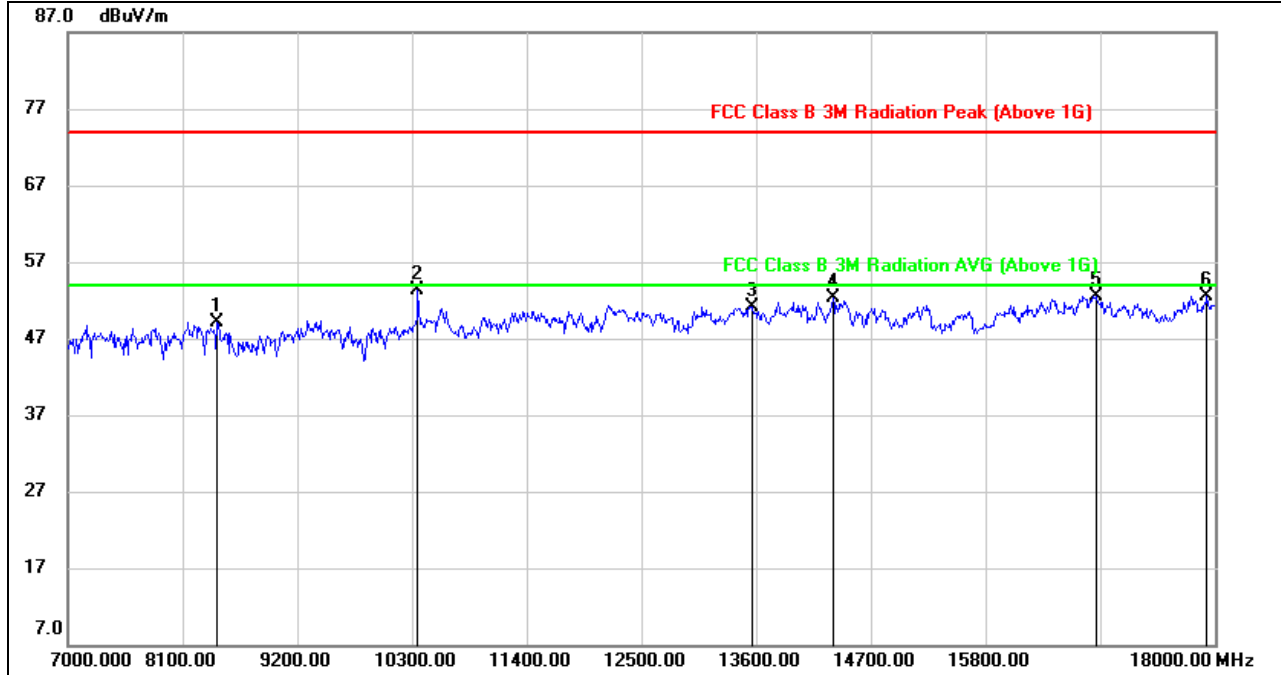

No.	Frequency (MHz)	Reading (dBuV)	Correct (dB/m)	Result (dBuV/m)	Limit (dBuV/m)	Margin (dB)	Remark
1	8430.000	39.92	9.22	49.14	74.00	-24.86	peak
2	10355.000	41.44	11.80	53.24	74.00	-20.76	peak
3	13567.000	35.02	16.14	51.16	74.00	-22.84	peak
4	14337.000	35.68	16.53	52.21	74.00	-21.79	peak
5	16856.000	32.34	20.22	52.56	74.00	-21.44	peak
6	17923.000	29.41	23.14	52.55	74.00	-21.45	peak

Note: 1. Measurement = Reading Level + Correct Factor.
 2. If Peak Result complies with AV limit, AV Result is deemed to comply with AV limit.
 3. Peak: Peak detector.
 4. The High Pass filter loss factor already add into the correct factor.
 5. Proper operation of the transmitter prior to adding the filter to the measurement chain.
 6. Owing to the highest peak level complies with the lowest limit of unwanted emission out of the restricted bands (Please refer to page 50), so all the test point were deemed to comply with the limits list in the standard.



VERTICAL RESULTS
1-7GHz

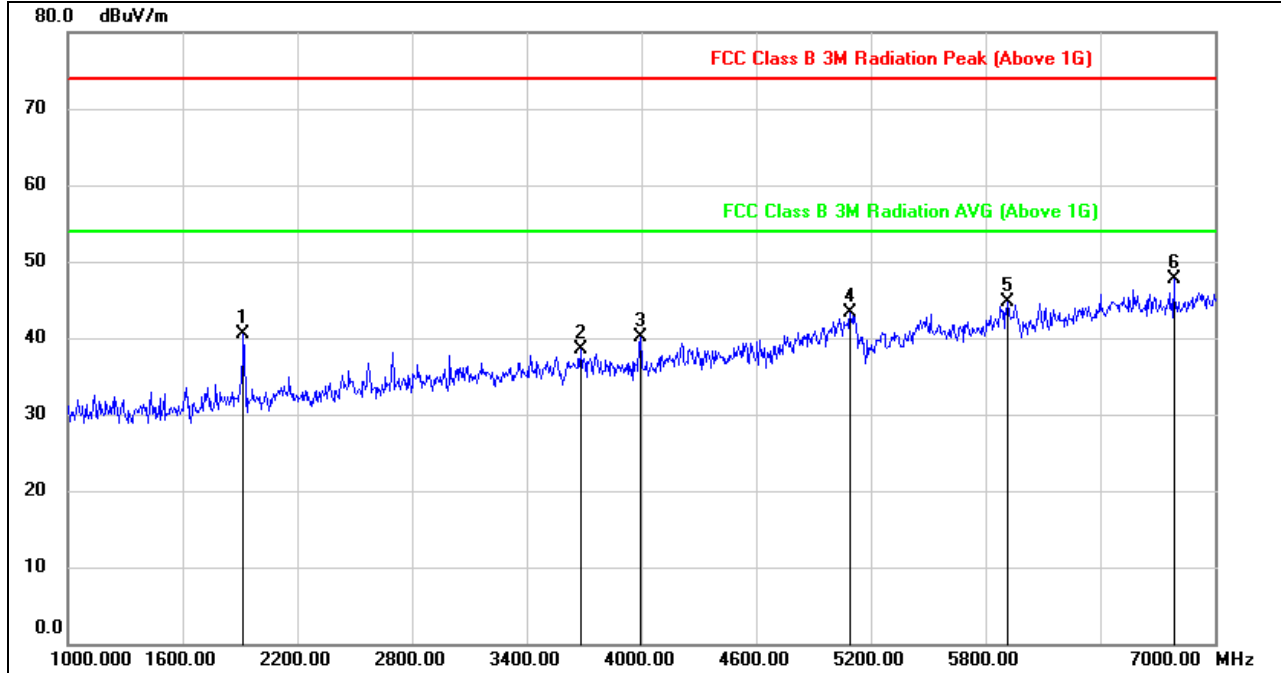

No.	Frequency (MHz)	Reading (dBuV)	Correct (dB/m)	Result (dBuV/m)	Limit (dBuV/m)	Margin (dB)	Remark
1	1918.000	51.27	-10.83	40.44	74.00	-33.56	peak
2	3682.000	42.61	-4.20	38.41	74.00	-35.59	peak
3	3994.000	44.22	-4.08	40.14	74.00	-33.86	peak
4	5092.000	43.25	0.11	43.36	74.00	-30.64	peak
5	5914.000	40.02	4.65	44.67	74.00	-29.33	peak
6	6784.000	42.02	5.60	47.62	74.00	-26.38	peak

Note: 1. Measurement = Reading Level + Correct Factor.
 2. If Peak Result complies with AV limit, AV Result is deemed to comply with AV limit.
 3. Peak: Peak detector.
 4. Filter losses were only considered in then spurious frequency bands and the authorized band was not corrected for BRF losses.
 5. Proper operation of the transmitter prior to adding the filter to the measurement chain.
 6. Owing to the highest peak level complies with the lowest limit of unwanted emission out of the restricted bands (Please refer to page 50), so all the test point were deemed to comply with the limits list in the standard.



7-18GHz

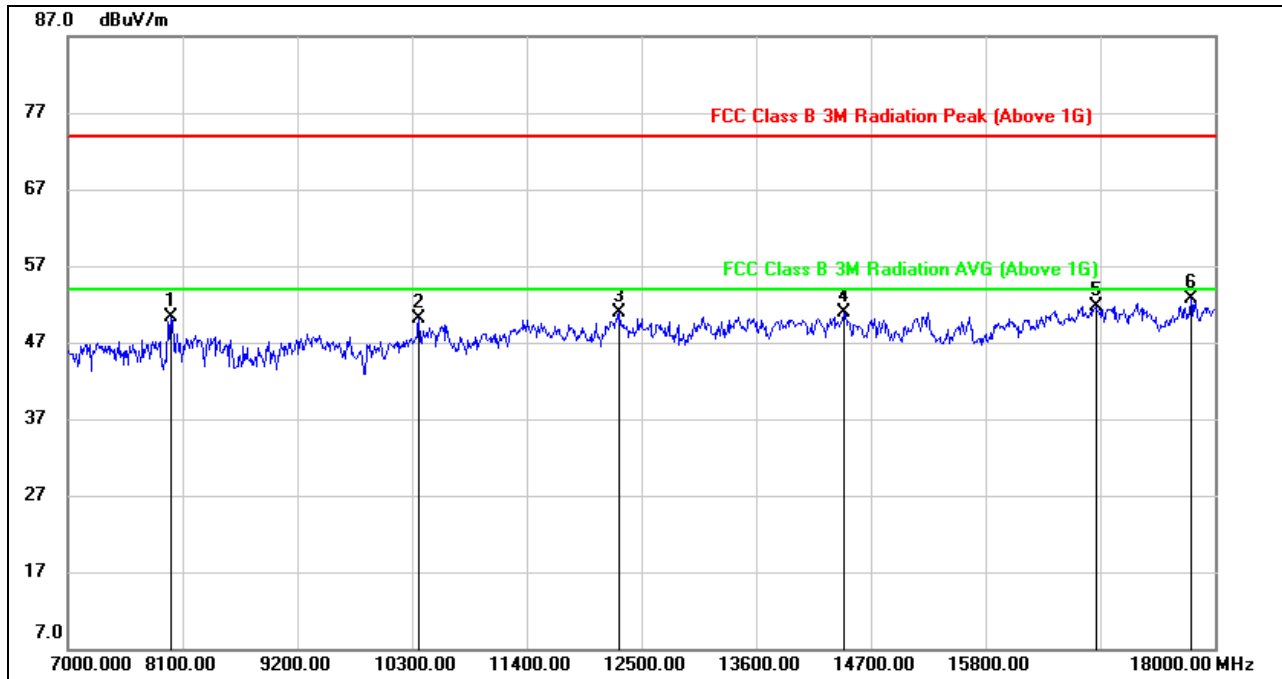

No.	Frequency (MHz)	Reading (dBuV)	Correct (dB/m)	Result (dBuV/m)	Limit (dBuV/m)	Margin (dB)	Remark
1	7990.000	41.68	8.66	50.34	74.00	-23.66	peak
2	10366.000	38.22	11.81	50.03	74.00	-23.97	peak
3	12291.000	35.66	15.15	50.81	74.00	-23.19	peak
4	14447.000	34.44	16.56	51.00	74.00	-23.00	peak
5	16856.000	31.57	20.22	51.79	74.00	-22.21	peak
6	17769.000	29.88	22.91	52.79	74.00	-21.21	peak

Note: 1. Measurement = Reading Level + Correct Factor.
 2. If Peak Result complies with AV limit, AV Result is deemed to comply with AV limit.
 3. Peak: Peak detector.
 4. The High Pass filter loss factor already add into the correct factor.
 5. Proper operation of the transmitter prior to adding the filter to the measurement chain.
 6. Owing to the highest peak level complies with the lowest limit of unwanted emission out of the restricted bands (Please refer to page 50), so all the test point were deemed to comply with the limits list in the standard.



HARMONICS AND SPURIOUS EMISSIONS MID CHANNEL

HORIZONTAL RESULTS
1-7GHz

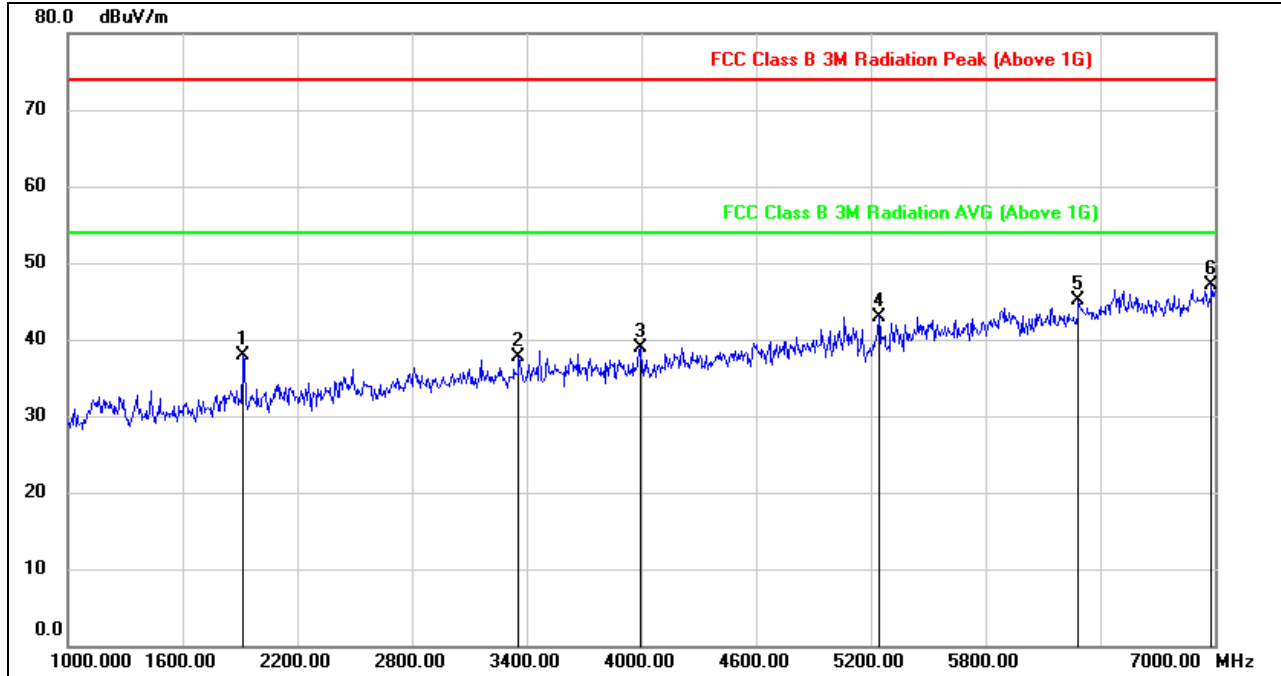

No.	Frequency (MHz)	Reading (dBuV)	Correct (dB/m)	Result (dBuV/m)	Limit (dBuV/m)	Margin (dB)	Remark
1	1918.000	48.66	-10.83	37.83	74.00	-36.17	peak
2	3358.000	43.34	-5.66	37.68	74.00	-36.32	peak
3	3994.000	43.08	-4.08	39.00	74.00	-35.00	peak
4	5242.000	42.05	0.95	43.00	74.00	-31.00	peak
5	6286.000	41.05	4.09	45.14	74.00	-28.86	peak
6	6982.000	40.61	6.40	47.01	74.00	-26.99	peak

Note: 1. Measurement = Reading Level + Correct Factor.
 2. If Peak Result complies with AV limit, AV Result is deemed to comply with AV limit.
 3. Peak: Peak detector.
 4. Filter losses were only considered in then spurious frequency bands and the authorized band was not corrected for BRF losses.
 5. Proper operation of the transmitter prior to adding the filter to the measurement chain.
 6. Owing to the highest peak level complies with the lowest limit of unwanted emission out of the restricted bands (Please refer to page 50), so all the test point were deemed to comply with the limits list in the standard.



HORIZONTAL RESULTS
7-18GHz

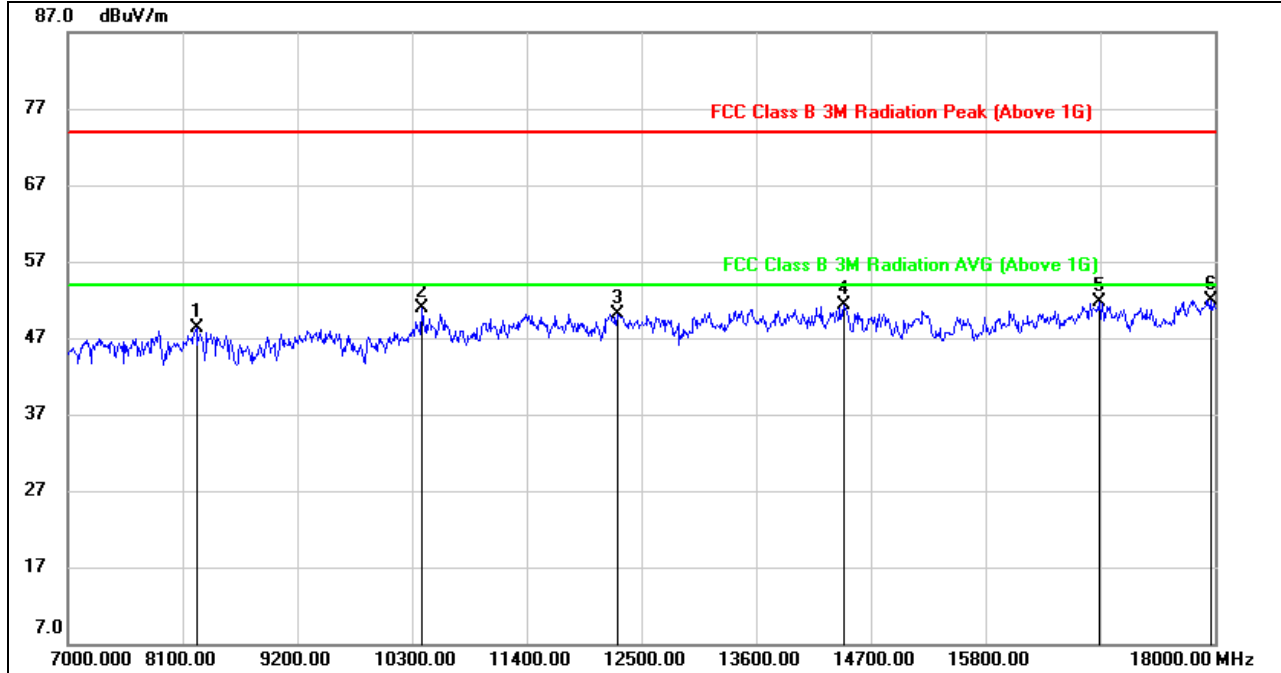

No.	Frequency (MHz)	Reading (dBuV)	Correct (dB/m)	Result (dBuV/m)	Limit (dBuV/m)	Margin (dB)	Remark
1	8232.000	38.38	9.88	48.26	74.00	-25.74	peak
2	10388.000	39.13	11.81	50.94	74.00	-23.06	peak
3	12269.000	35.09	15.09	50.18	74.00	-23.82	peak
4	14436.000	34.64	16.58	51.22	74.00	-22.78	peak
5	16889.000	31.44	20.28	51.72	74.00	-22.28	peak
6	17956.000	28.73	23.15	51.88	74.00	-22.12	peak

Note: 1. Measurement = Reading Level + Correct Factor.
 2. If Peak Result complies with AV limit, AV Result is deemed to comply with AV limit.
 3. Peak: Peak detector.
 4. The High Pass filter loss factor already add into the correct factor.
 5. Proper operation of the transmitter prior to adding the filter to the measurement chain.
 6. Owing to the highest peak level complies with the lowest limit of unwanted emission out of the restricted bands (Please refer to page 50), so all the test point were deemed to comply with the limits list in the standard.



VERTICAL RESULTS
1-7GHz

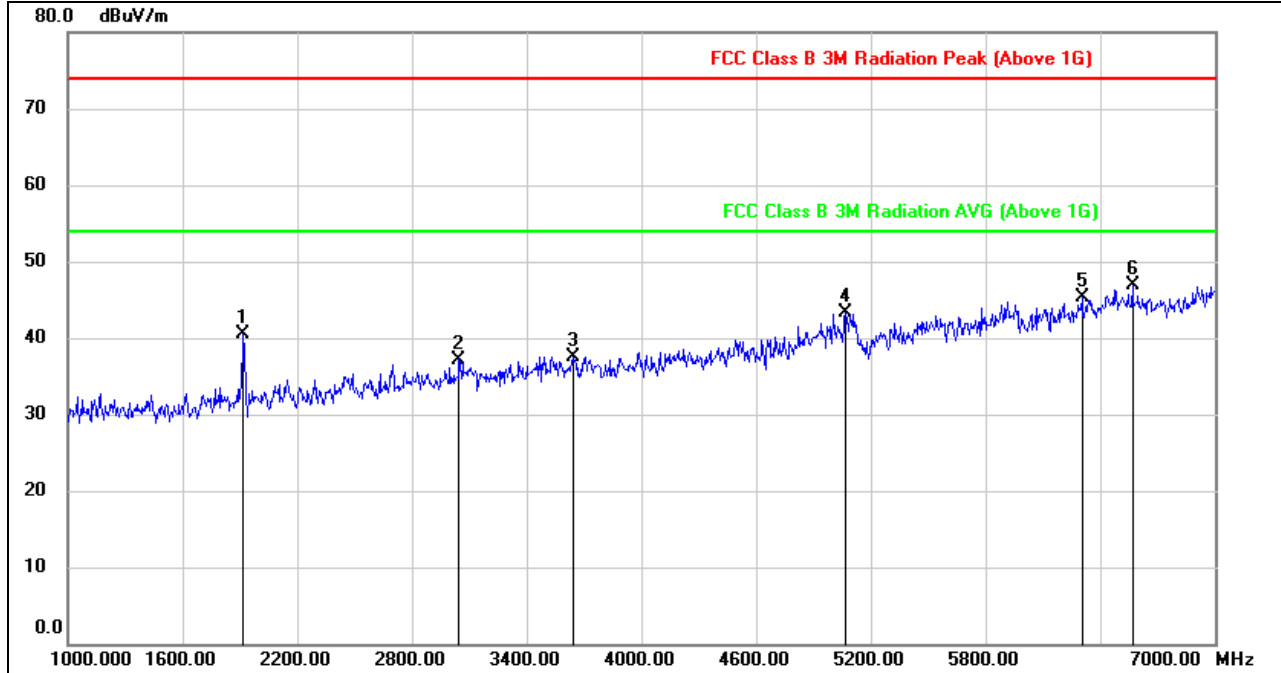

No.	Frequency (MHz)	Reading (dBuV)	Correct (dB/m)	Result (dBuV/m)	Limit (dBuV/m)	Margin (dB)	Remark
1	1918.000	51.34	-10.83	40.51	74.00	-33.49	peak
2	3046.000	43.17	-5.97	37.20	74.00	-36.80	peak
3	3640.000	42.09	-4.54	37.55	74.00	-36.45	peak
4	5068.000	43.19	0.07	43.26	74.00	-30.74	peak
5	6304.000	41.09	4.17	45.26	74.00	-28.74	peak
6	6568.000	41.26	5.64	46.90	74.00	-27.10	peak

Note: 1. Measurement = Reading Level + Correct Factor.
 2. If Peak Result complies with AV limit, AV Result is deemed to comply with AV limit.
 3. Peak: Peak detector.
 4. Filter losses were only considered in then spurious frequency bands and the authorized band was not corrected for BRF losses.
 5. Proper operation of the transmitter prior to adding the filter to the measurement chain.
 6. Owing to the highest peak level complies with the lowest limit of unwanted emission out of the restricted bands (Please refer to page 50), so all the test point were deemed to comply with the limits list in the standard.



7-18GHz

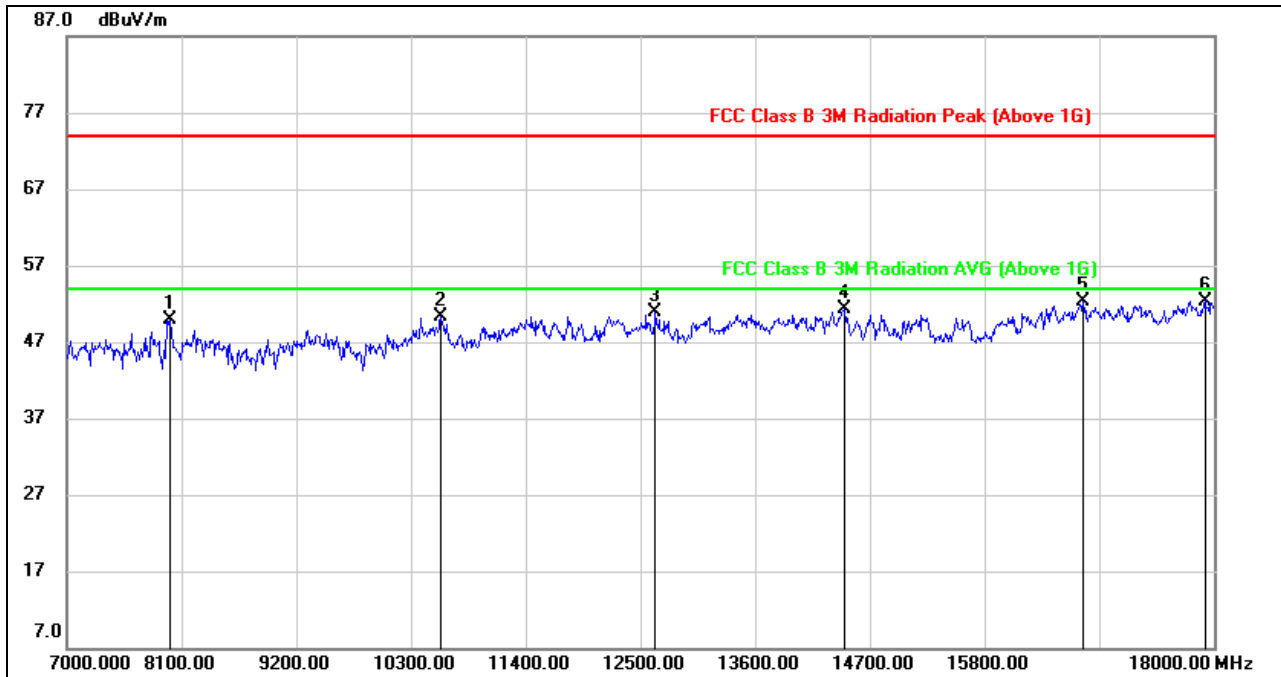

No.	Frequency (MHz)	Reading (dBuV)	Correct (dB/m)	Result (dBuV/m)	Limit (dBuV/m)	Margin (dB)	Remark
1	7990.000	41.21	8.66	49.87	74.00	-24.13	peak
2	10586.000	37.26	13.00	50.26	74.00	-23.74	peak
3	12643.000	36.16	14.76	50.92	74.00	-23.08	peak
4	14458.000	34.82	16.54	51.36	74.00	-22.64	peak
5	16746.000	32.38	20.01	52.39	74.00	-21.61	peak
6	17912.000	29.26	23.14	52.40	74.00	-21.60	peak

Note: 1. Measurement = Reading Level + Correct Factor.
 2. If Peak Result complies with AV limit, AV Result is deemed to comply with AV limit.
 3. Peak: Peak detector.
 4. The High Pass filter loss factor already add into the correct factor.
 5. Proper operation of the transmitter prior to adding the filter to the measurement chain.
 6. Owing to the highest peak level complies with the lowest limit of unwanted emission out of the restricted bands (Please refer to page 50), so all the test point were deemed to comply with the limits list in the standard.



HARMONICS AND SPURIOUS EMISSIONS HIGH CHANNEL

HORIZONTAL RESULTS
1-7GHz

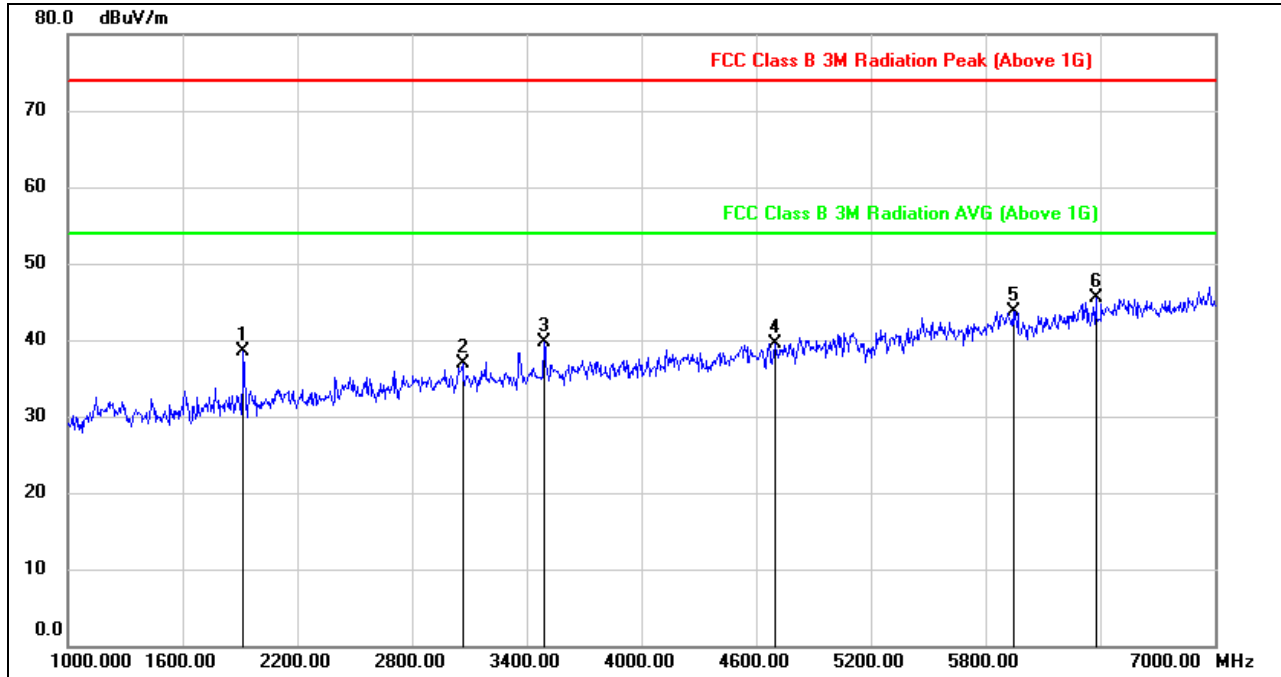

No.	Frequency (MHz)	Reading (dBuV)	Correct (dB/m)	Result (dBuV/m)	Limit (dBuV/m)	Margin (dB)	Remark
1	1918.000	49.39	-10.83	38.56	74.00	-35.44	peak
2	3064.000	42.84	-5.86	36.98	74.00	-37.02	peak
3	3490.000	45.06	-5.44	39.62	74.00	-34.38	peak
4	4696.000	40.87	-1.39	39.48	74.00	-34.52	peak
5	5944.000	39.54	4.17	43.71	74.00	-30.29	peak
6	6376.000	41.12	4.44	45.56	74.00	-28.44	peak

Note: 1. Measurement = Reading Level + Correct Factor.
 2. If Peak Result complies with AV limit, AV Result is deemed to comply with AV limit.
 3. Peak: Peak detector.
 4. Filter losses were only considered in then spurious frequency bands and the authorized band was not corrected for BRF losses.
 5. Proper operation of the transmitter prior to adding the filter to the measurement chain.
 6. Owing to the highest peak level complies with the lowest limit of unwanted emission out of the restricted bands (Please refer to page 50), so all the test point were deemed to comply with the limits list in the standard.



HORIZONTAL RESULTS
7-18GHz

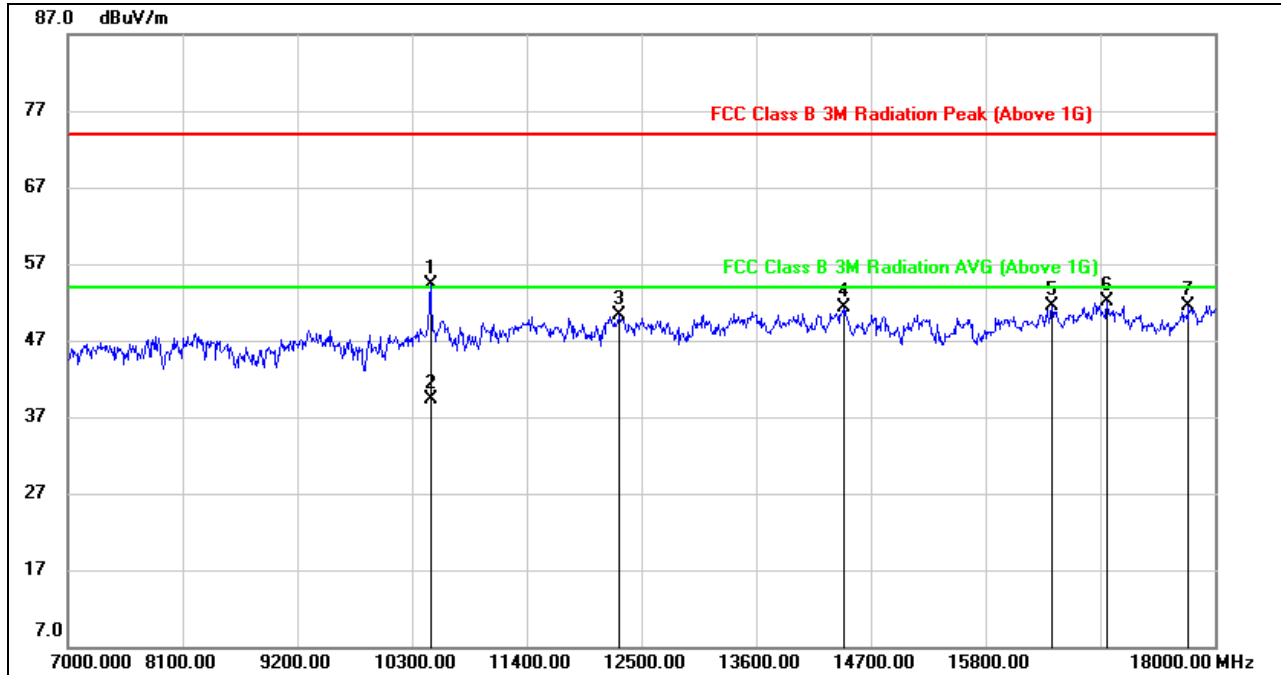

No.	Frequency (MHz)	Reading (dBuV)	Correct (dB/m)	Result (dBuV/m)	Limit (dBuV/m)	Margin (dB)	Remark
1	10477.479	42.33	12.00	54.33	74.00	-19.67	peak
2	10477.479	27.30	12.00	39.30	54.00	-14.70	AVG
3	12291.000	35.14	15.15	50.29	74.00	-23.71	peak
4	14447.000	34.72	16.56	51.28	74.00	-22.72	peak
5	16438.000	32.52	18.91	51.43	74.00	-22.57	peak
6	16966.000	31.42	20.59	52.01	74.00	-21.99	peak
7	17747.000	28.88	22.71	51.59	74.00	-22.41	peak

Note: 1. Measurement = Reading Level + Correct Factor.
 2. If Peak Result complies with AV limit, AV Result is deemed to comply with AV limit.
 3. Peak: Peak detector.
 4. AVG: $VBW=1/Ton$ where: ton is transmit duration.
 5. For duty cycle, please refer to clause 7.1.
 6. The High Pass filter loss factor already add into the correct factor.
 7. Proper operation of the transmitter prior to adding the filter to the measurement chain.
 8. Owing to the highest peak level complies with the lowest limit of unwanted emission out of the restricted bands (Please refer to page 51), so all the test point were deemed to comply with the limits list in the standard.



VERTICAL RESULTS
1-7GHz

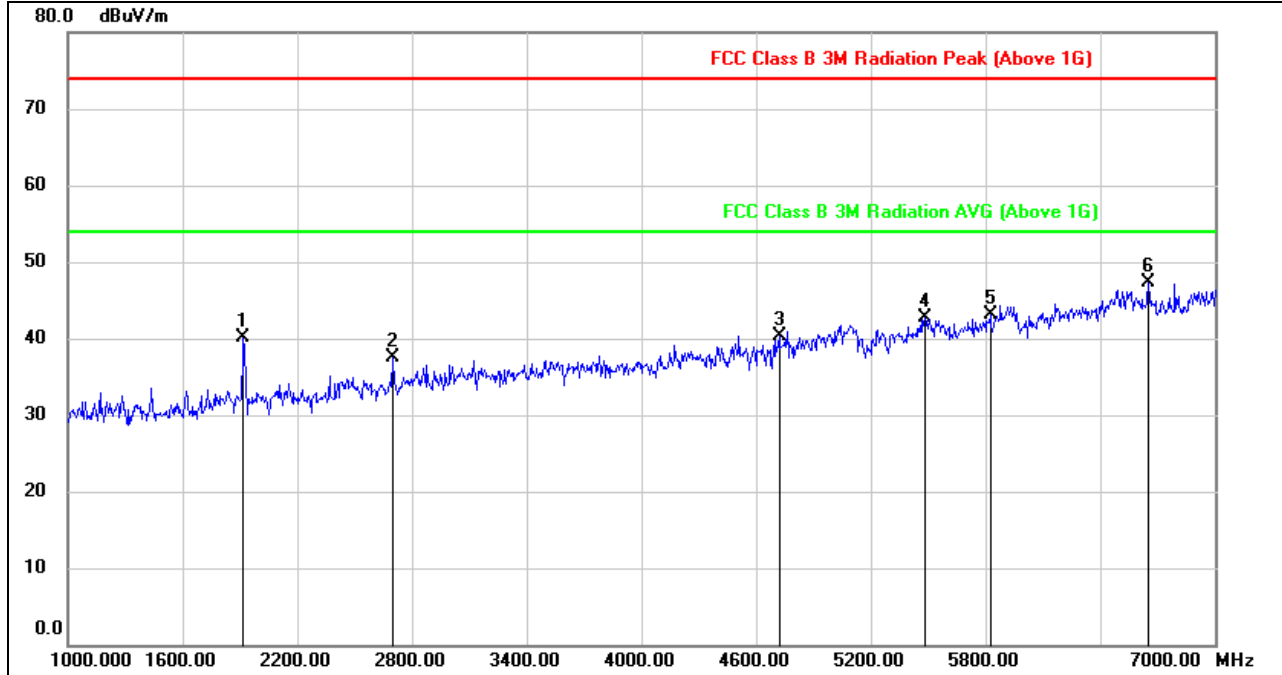

No.	Frequency (MHz)	Reading (dBuV)	Correct (dB/m)	Result (dBuV/m)	Limit (dBuV/m)	Margin (dB)	Remark
1	1918.000	50.96	-10.83	40.13	74.00	-33.87	peak
2	2698.000	45.47	-7.92	37.55	74.00	-36.45	peak
3	4720.000	41.61	-1.27	40.34	74.00	-33.66	peak
4	5482.000	40.65	2.06	42.71	74.00	-31.29	peak
5	5824.000	39.66	3.38	43.04	74.00	-30.96	peak
6	6652.000	41.73	5.56	47.29	74.00	-26.71	peak

Note: 1. Measurement = Reading Level + Correct Factor.
 2. If Peak Result complies with AV limit, AV Result is deemed to comply with AV limit.
 3. Peak: Peak detector.
 4. Filter losses were only considered in then spurious frequency bands and the authorized band was not corrected for BRF losses.
 5. Proper operation of the transmitter prior to adding the filter to the measurement chain.
 6. Owing to the highest peak level complies with the lowest limit of unwanted emission out of the restricted bands (Please refer to page 50), so all the test point were deemed to comply with the limits list in the standard.



7-18GHz

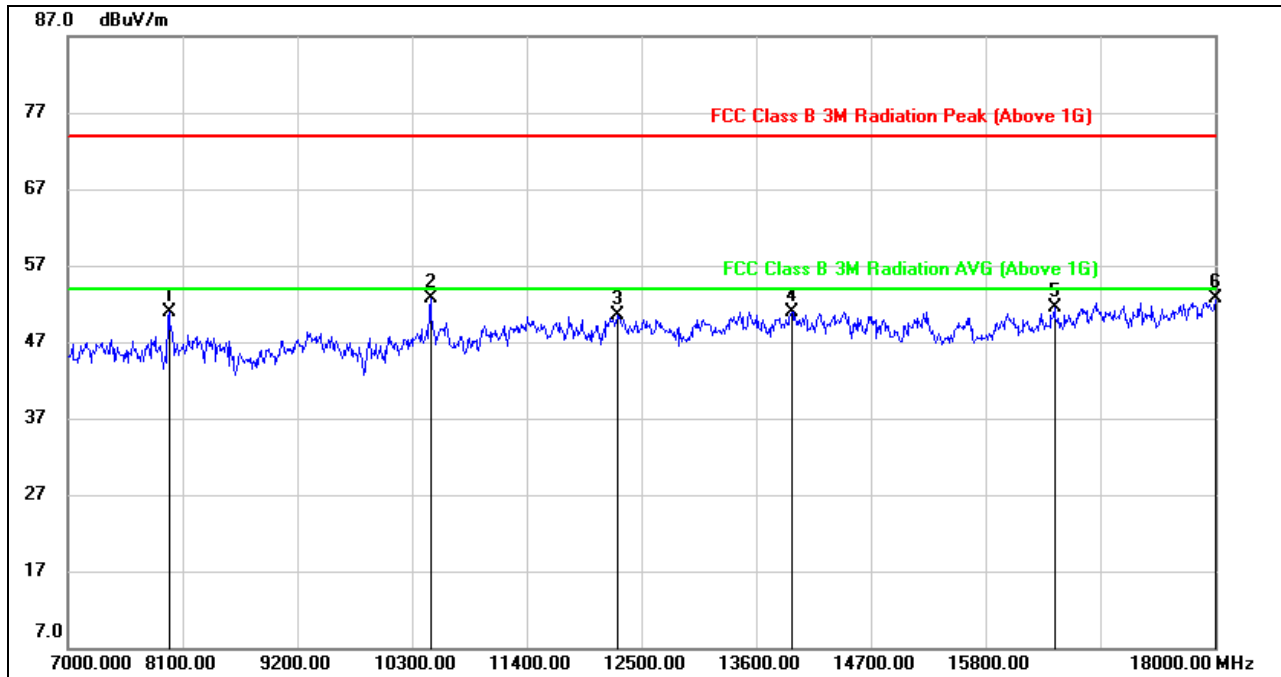

No.	Frequency (MHz)	Reading (dBuV)	Correct (dB/m)	Result (dBuV/m)	Limit (dBuV/m)	Margin (dB)	Remark
1	7968.000	42.13	8.72	50.85	74.00	-23.15	peak
2	10476.000	40.64	12.00	52.64	74.00	-21.36	peak
3	12269.000	35.43	15.09	50.52	74.00	-23.48	peak
4	13941.000	34.55	16.41	50.96	74.00	-23.04	peak
5	16460.000	32.40	19.01	51.41	74.00	-22.59	peak
6	18000.000	29.55	23.15	52.70	74.00	-21.30	peak

Note: 1. Measurement = Reading Level + Correct Factor.
 2. If Peak Result complies with AV limit, AV Result is deemed to comply with AV limit.
 3. Peak: Peak detector.
 4. The High Pass filter loss factor already add into the correct factor.
 5. Proper operation of the transmitter prior to adding the filter to the measurement chain.
 6. Owing to the highest peak level complies with the lowest limit of unwanted emission out of the restricted bands (Please refer to page 50), so all the test point were deemed to comply with the limits list in the standard.



8.2.2. UNII-3 BAND

RESTRICTED BANDEDGE LOW CHANNEL

HORIZONTAL RESULTS

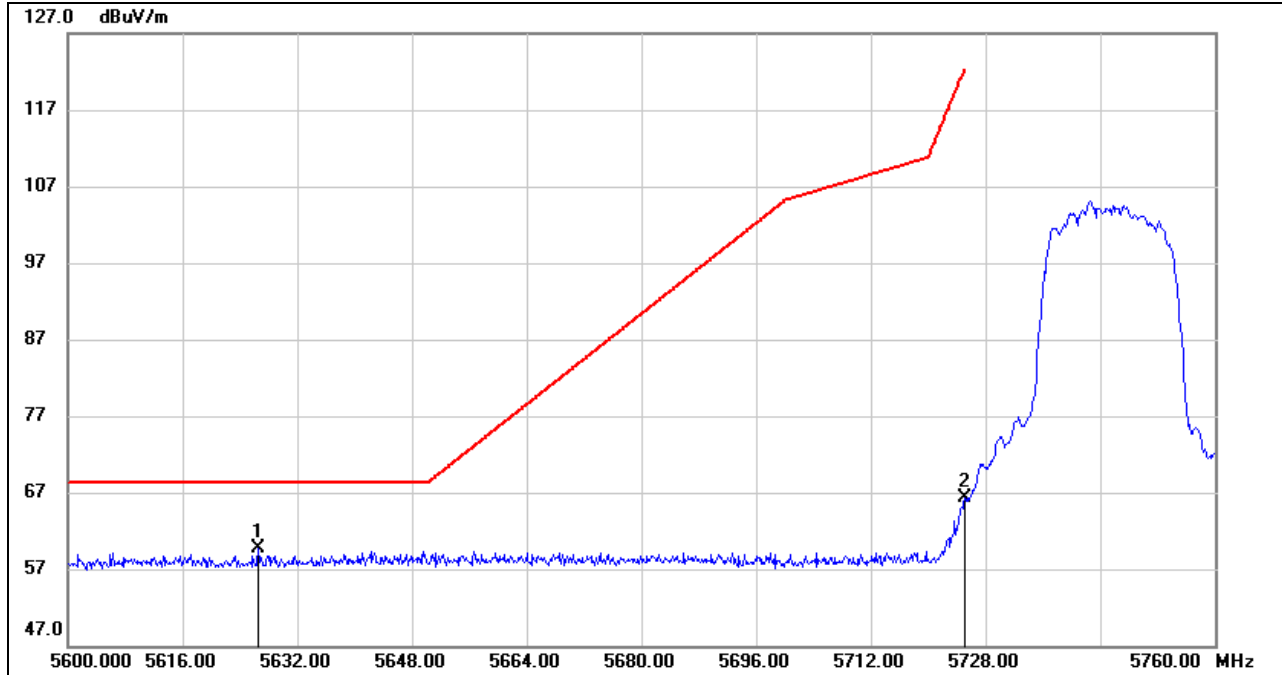

No.	Frequency (MHz)	Reading (dBuV)	Correct (dB/m)	Result (dBuV/m)	Limit (dBuV/m)	Margin (dB)	Remark
1	5626.560	18.15	41.47	59.62	68.20	-8.58	peak
2	5725.000	24.77	41.61	66.38	122.20	-55.82	peak

Note: 1. Measurement = Reading Level + Correct Factor.



VERTICAL RESULTS

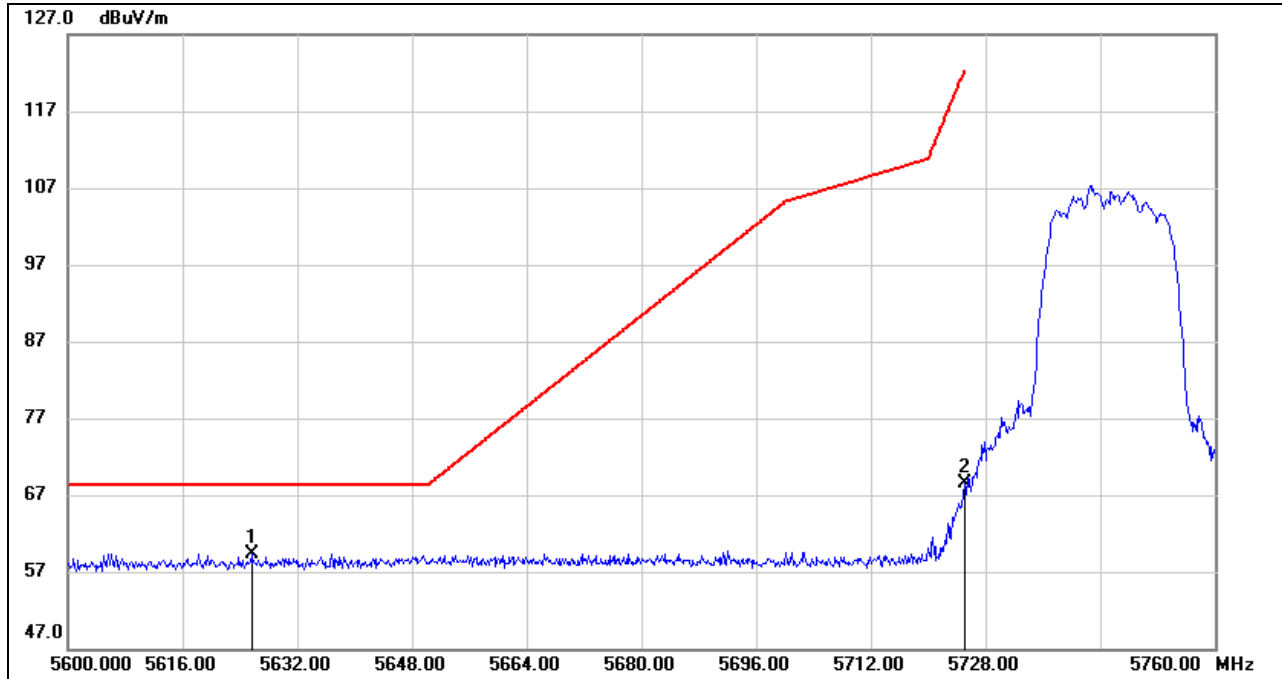

No.	Frequency (MHz)	Reading (dBuV)	Correct (dB/m)	Result (dBuV/m)	Limit (dBuV/m)	Margin (dB)	Remark
1	5625.600	17.90	41.47	59.37	68.20	-8.83	peak
2	5725.000	26.95	41.61	68.56	122.20	-53.64	peak

Note: 1. Measurement = Reading Level + Correct Factor.



RESTRICTED BANDEDGE HIGH CHANNEL

HORIZONTAL RESULTS

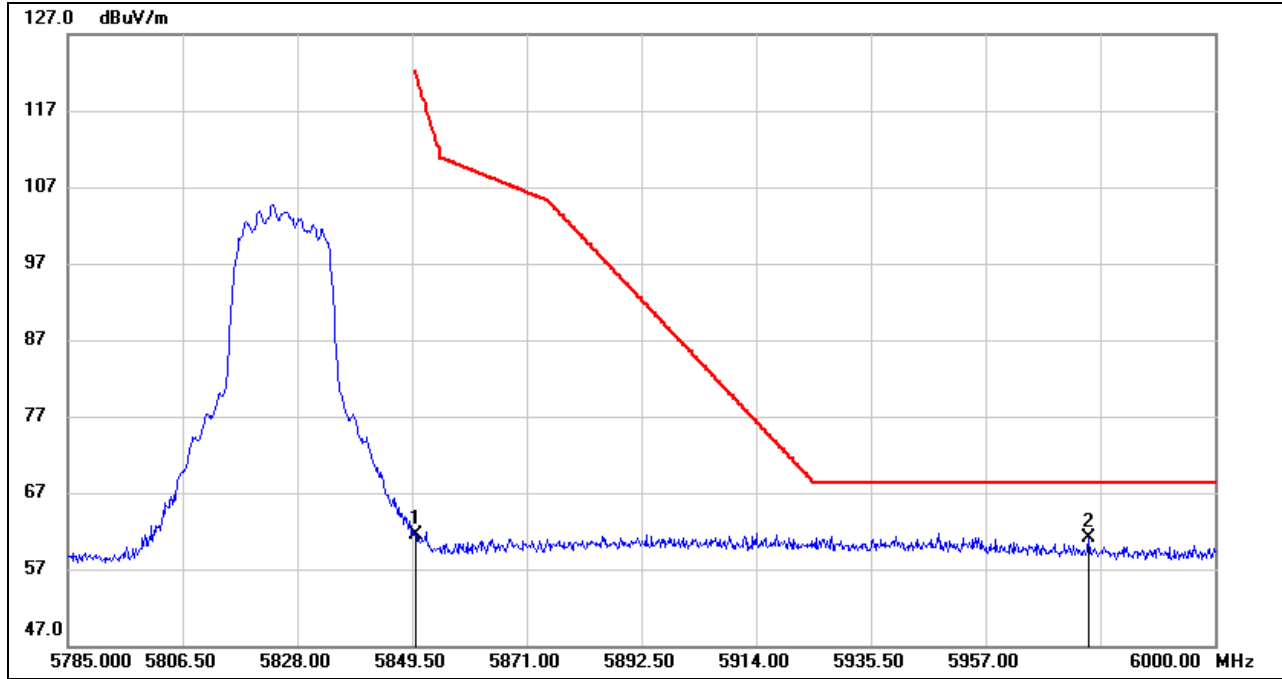

No.	Frequency (MHz)	Reading (dBuV)	Correct (dB/m)	Result (dBuV/m)	Limit (dBuV/m)	Margin (dB)	Remark
1	5850.000	18.64	42.89	61.53	122.20	-60.67	peak
2	5976.350	18.50	42.54	61.04	68.20	-7.16	peak

Note: 1. Measurement = Reading Level + Correct Factor.



VERTICAL RESULTS

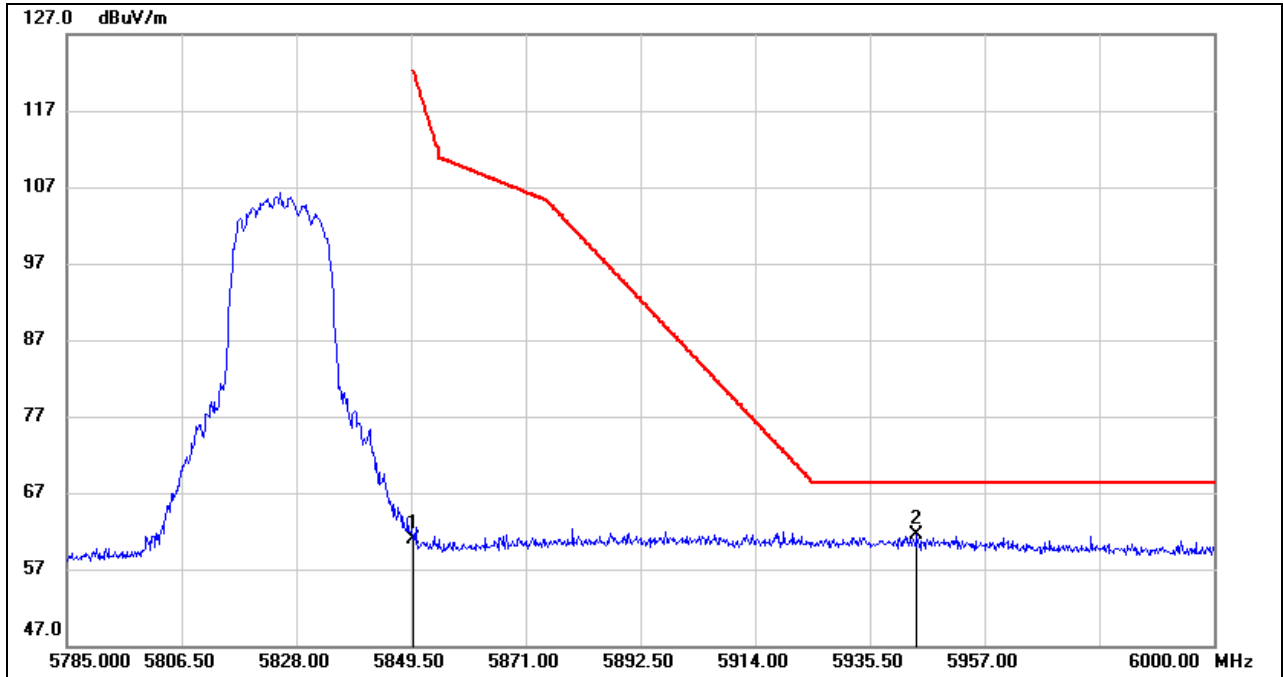

No.	Frequency (MHz)	Reading (dBuV)	Correct (dB/m)	Result (dBuV/m)	Limit (dBuV/m)	Margin (dB)	Remark
1	5850.000	17.94	42.89	60.83	122.20	-61.37	peak
2	5944.315	18.33	43.09	61.42	68.20	-6.78	peak

Note: 1. Measurement = Reading Level + Correct Factor.



HARMONICS AND SPURIOUS EMISSIONS LOW CHANNEL

HORIZONTAL RESULTS
1-7GHz

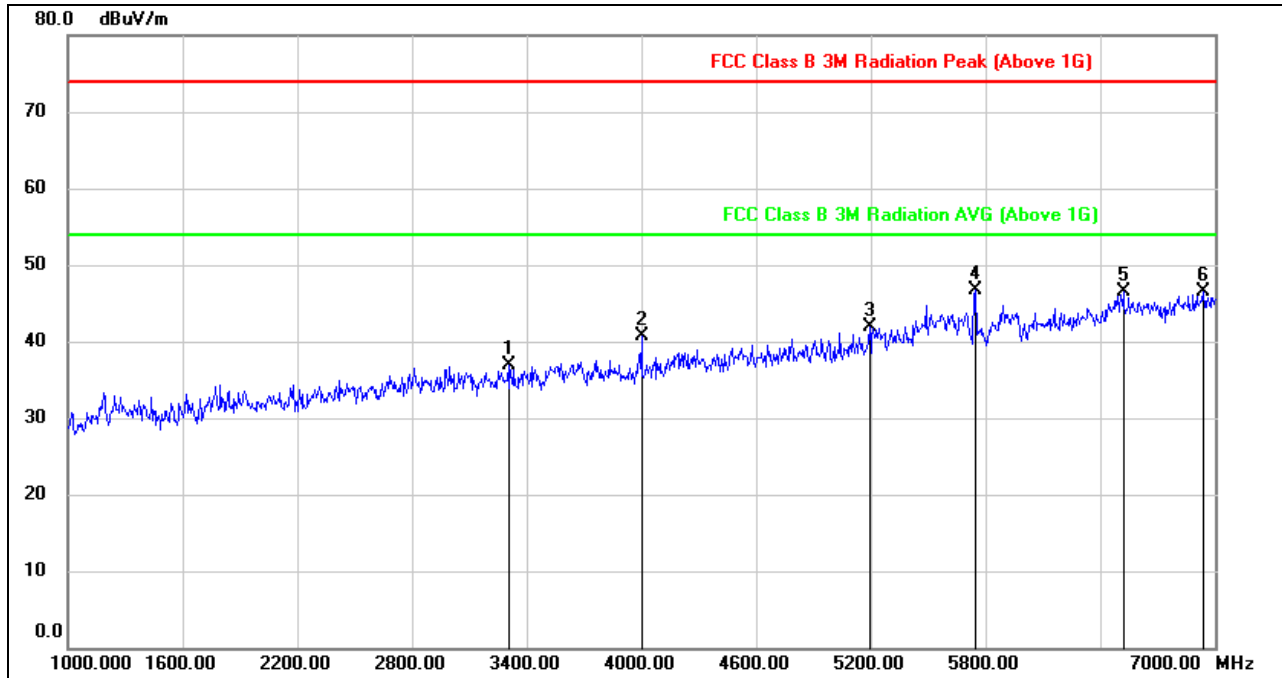

No.	Frequency (MHz)	Reading (dBuV)	Correct (dB/m)	Result (dBuV/m)	Limit (dBuV/m)	Margin (dB)	Remark
1	3304.000	42.48	-5.57	36.91	74.00	-37.09	peak
2	4000.000	44.74	-4.08	40.66	74.00	-33.34	peak
3	5194.000	41.06	0.86	41.92	74.00	-32.08	peak
4	5746.000	44.11	2.54	46.65	74.00	-27.35	peak
5	6520.000	40.60	5.81	46.41	74.00	-27.59	peak
6	6940.000	40.13	6.34	46.47	74.00	-27.53	peak

Note: 1. Measurement = Reading Level + Correct Factor.
 2. If Peak Result complies with AV limit, AV Result is deemed to comply with AV limit.
 3. Peak: Peak detector.
 4. Filter losses were only considered in then spurious frequency bands and the authorized band was not corrected for BRF losses.
 5. Proper operation of the transmitter prior to adding the filter to the measurement chain.
 6. Owing to the highest peak level complies with the lowest limit of unwanted emission out of the restricted bands (Please refer to page 50), so all the test point were deemed to comply with the limits list in the standard.



HORIZONTAL RESULTS
7-18GHz

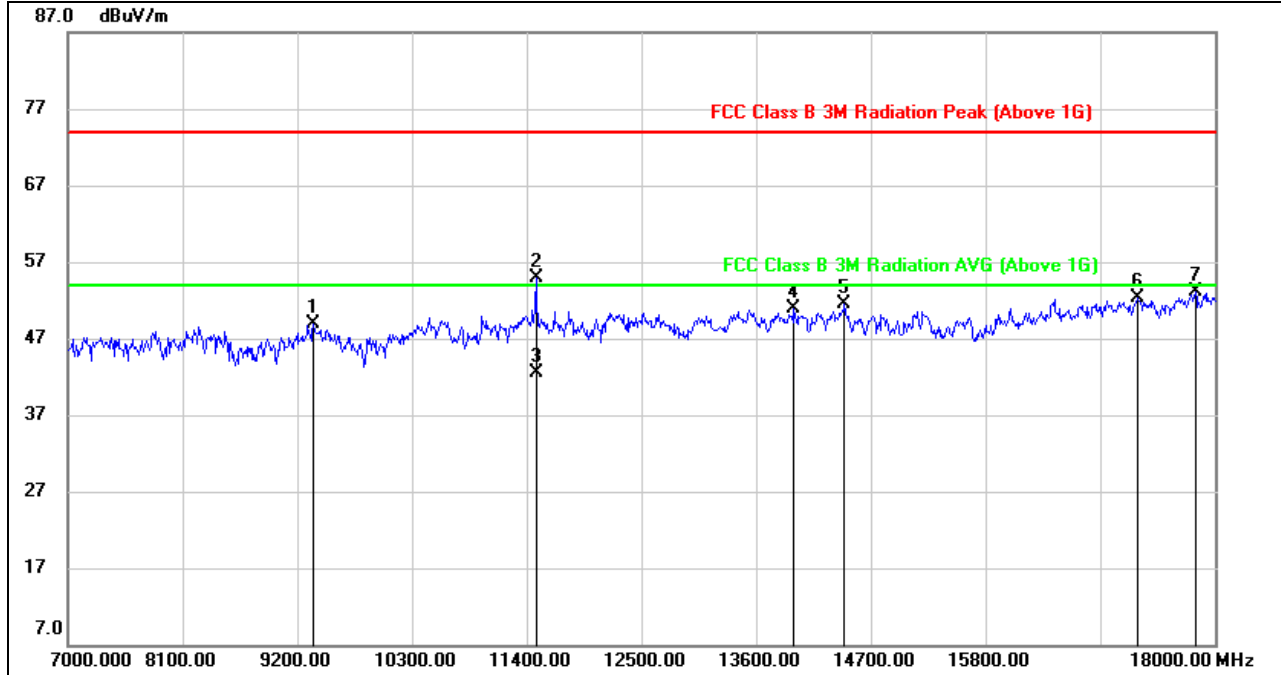

No.	Frequency (MHz)	Reading (dBuV)	Correct (dB/m)	Result (dBuV/m)	Limit (dBuV/m)	Margin (dB)	Remark
1	9354.000	38.42	10.53	48.95	74.00	-25.05	peak
2	11490.458	40.48	14.35	54.83	74.00	-19.17	peak
3	11490.458	28.16	14.35	42.51	54.00	-11.49	AVG
4	13963.000	34.38	16.45	50.83	74.00	-23.17	peak
5	14447.000	34.87	16.56	51.43	74.00	-22.57	peak
6	17252.000	30.84	21.49	52.33	74.00	-21.67	peak
7	17813.000	29.85	23.19	53.04	74.00	-20.96	peak

Note: 1. Measurement = Reading Level + Correct Factor.
 2. If Peak Result complies with AV limit, AV Result is deemed to comply with AV limit.
 3. Peak: Peak detector.
 4. AVG: $VBW=1/T_{on}$ where: t_{on} is transmit duration.
 5. For duty cycle, please refer to clause 7.1.
 6. The High Pass filter loss factor already add into the correct factor.
 7. Proper operation of the transmitter prior to adding the filter to the measurement chain.
 8. Owing to the highest peak level complies with the lowest limit of unwanted emission out of the restricted bands (Please refer to page 51), so all the test point were deemed to comply with the limits list in the standard.



VERTICAL RESULTS
1-7GHz

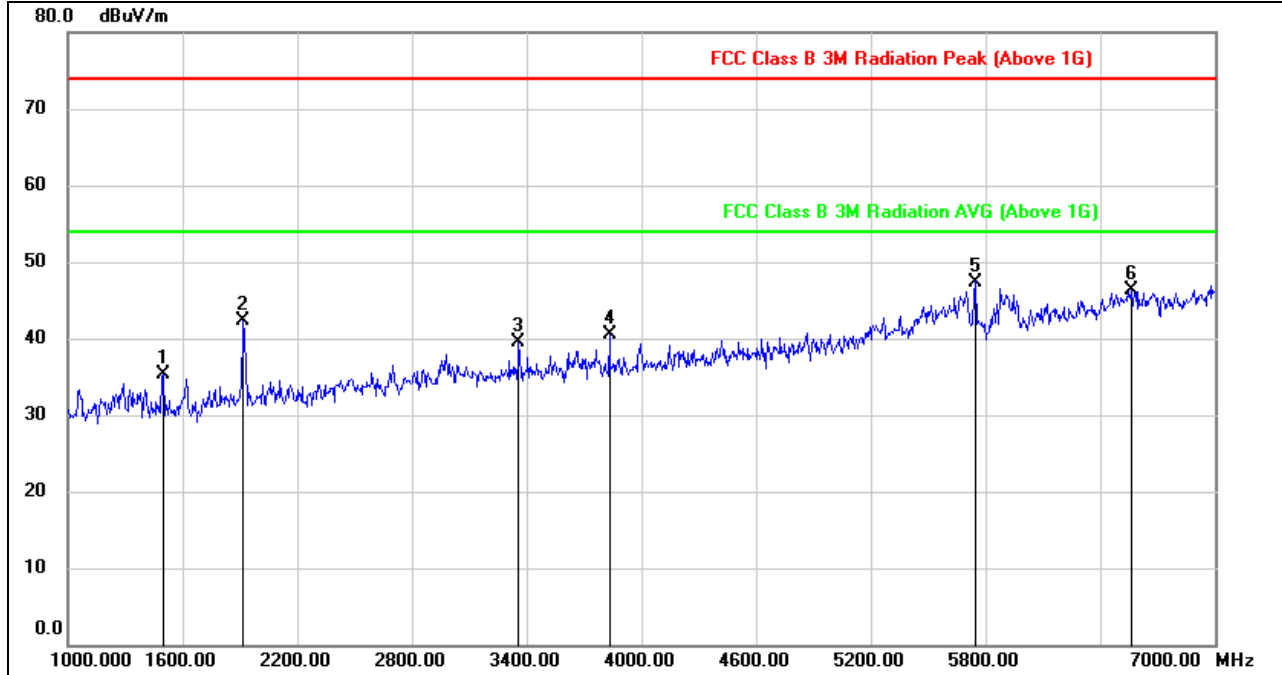

No.	Frequency (MHz)	Reading (dBuV)	Correct (dB/m)	Result (dBuV/m)	Limit (dBuV/m)	Margin (dB)	Remark
1	1498.000	48.30	-13.08	35.22	74.00	-38.78	peak
2	1918.000	53.04	-10.83	42.21	74.00	-31.79	peak
3	3358.000	45.14	-5.66	39.48	74.00	-34.52	peak
4	3832.000	44.72	-4.21	40.51	74.00	-33.49	peak
5	5746.000	44.86	2.54	47.40	74.00	-26.60	peak
6	6562.000	40.60	5.66	46.26	74.00	-27.74	peak

Note: 1. Measurement = Reading Level + Correct Factor.
 2. If Peak Result complies with AV limit, AV Result is deemed to comply with AV limit.
 3. Peak: Peak detector.
 4. Filter losses were only considered in then spurious frequency bands and the authorized band was not corrected for BRF losses.
 5. Proper operation of the transmitter prior to adding the filter to the measurement chain.
 6. Owing to the highest peak level complies with the lowest limit of unwanted emission out of the restricted bands (Please refer to page 50), so all the test point were deemed to comply with the limits list in the standard.



VERTICAL RESULTS
7-18GHz

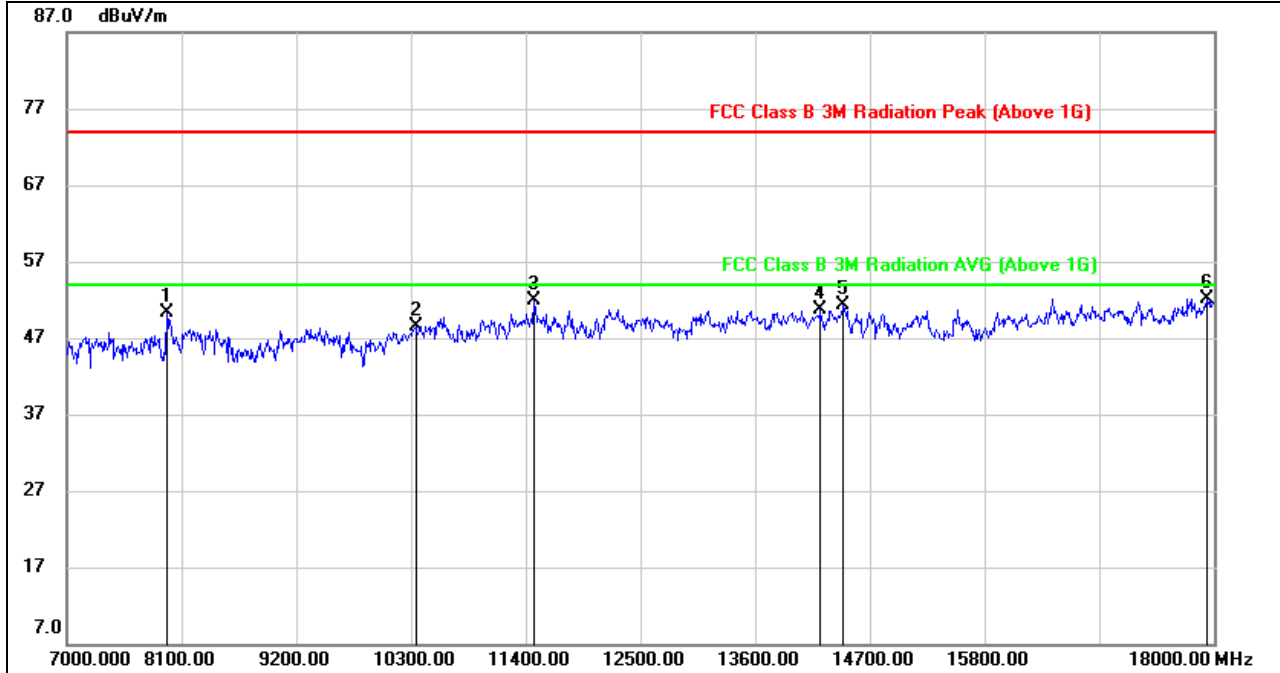

No.	Frequency (MHz)	Reading (dBuV)	Correct (dB/m)	Result (dBuV/m)	Limit (dBuV/m)	Margin (dB)	Remark
1	7957.000	41.60	8.73	50.33	74.00	-23.67	peak
2	10344.000	36.72	11.80	48.52	74.00	-25.48	peak
3	11477.000	37.65	14.27	51.92	74.00	-22.08	peak
4	14227.000	33.96	16.70	50.66	74.00	-23.34	peak
5	14447.000	34.69	16.56	51.25	74.00	-22.75	peak
6	17934.000	29.04	23.14	52.18	74.00	-21.82	peak

Note: 1. Measurement = Reading Level + Correct Factor.
 2. If Peak Result complies with AV limit, AV Result is deemed to comply with AV limit.
 3. Peak: Peak detector.
 4. The High Pass filter loss factor already add into the correct factor.
 5. Proper operation of the transmitter prior to adding the filter to the measurement chain.
 6. Owing to the highest peak level complies with the lowest limit of unwanted emission out of the restricted bands (Please refer to page 50), so all the test point were deemed to comply with the limits list in the standard.



HARMONICS AND SPURIOUS EMISSIONS MID CHANNEL

HORIZONTAL RESULTS
1-7GHz

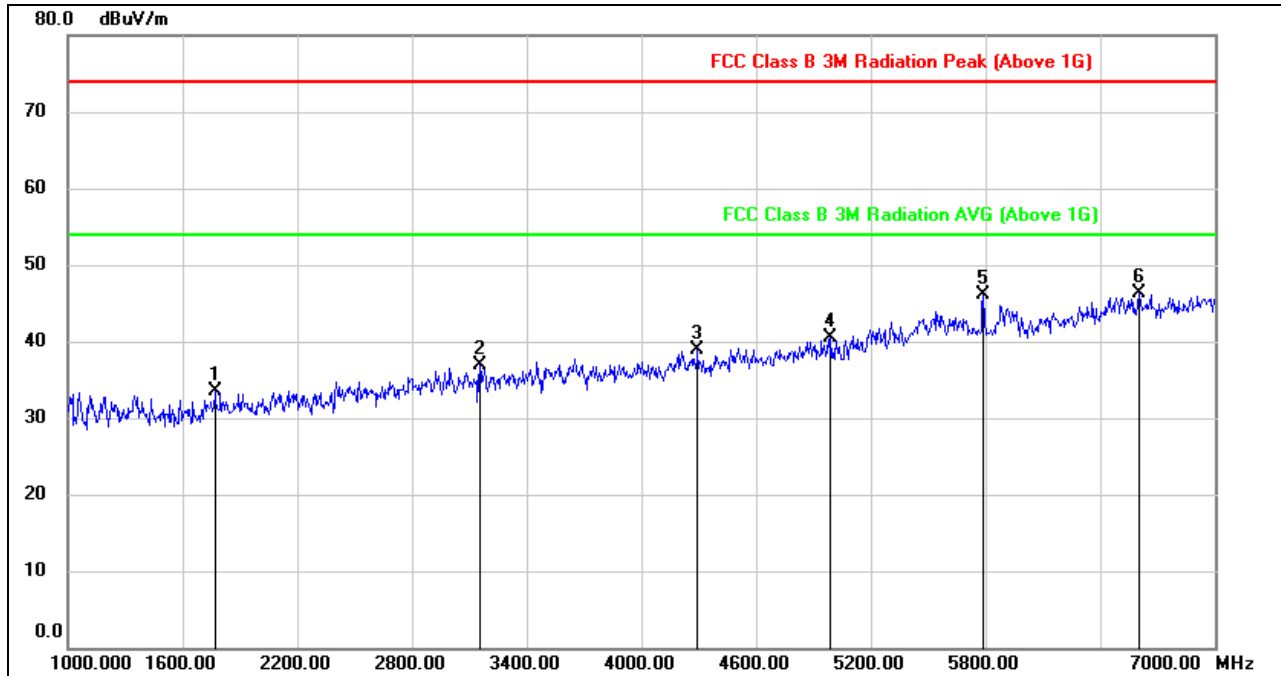

No.	Frequency (MHz)	Reading (dBuV)	Correct (dB/m)	Result (dBuV/m)	Limit (dBuV/m)	Margin (dB)	Remark
1	1768.000	44.67	-11.26	33.41	74.00	-40.59	peak
2	3154.000	42.64	-5.83	36.81	74.00	-37.19	peak
3	4294.000	42.11	-3.26	38.85	74.00	-35.15	peak
4	4990.000	40.58	-0.14	40.44	74.00	-33.56	peak
5	5788.000	43.25	2.83	46.08	74.00	-27.92	peak
6	6604.000	40.82	5.53	46.35	74.00	-27.65	peak

Note: 1. Measurement = Reading Level + Correct Factor.
 2. If Peak Result complies with AV limit, AV Result is deemed to comply with AV limit.
 3. Peak: Peak detector.
 4. Filter losses were only considered in then spurious frequency bands and the authorized band was not corrected for BRF losses.
 5. Proper operation of the transmitter prior to adding the filter to the measurement chain.
 6. Owing to the highest peak level complies with the lowest limit of unwanted emission out of the restricted bands (Please refer to page 50), so all the test point were deemed to comply with the limits list in the standard.



HORIZONTAL RESULTS
7-18GHz

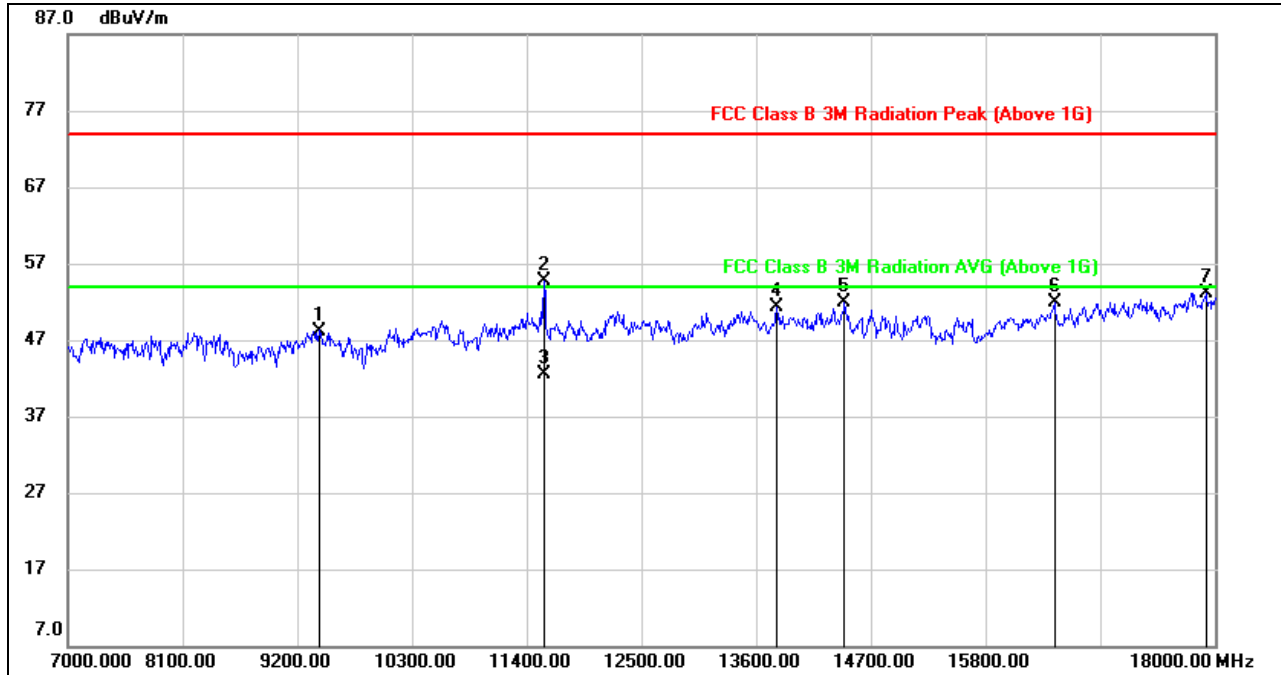

No.	Frequency (MHz)	Reading (dBuV)	Correct (dB/m)	Result (dBuV/m)	Limit (dBuV/m)	Margin (dB)	Remark
1	9409.000	37.46	10.74	48.20	74.00	-25.80	peak
2	11567.897	40.42	14.35	54.77	74.00	-19.23	peak
3	11567.897	28.17	14.35	42.52	54.00	-11.48	AVG
4	13798.000	34.22	17.01	51.23	74.00	-22.77	peak
5	14447.000	35.29	16.55	51.84	74.00	-22.16	peak
6	16460.000	32.86	19.01	51.87	74.00	-22.13	peak
7	17912.000	29.95	23.14	53.09	74.00	-20.91	peak

Note: 1. Measurement = Reading Level + Correct Factor.
 2. If Peak Result complies with AV limit, AV Result is deemed to comply with AV limit.
 3. Peak: Peak detector.
 4. AVG: VBW=1/Ton where: ton is transmit duration.
 5. For duty cycle, please refer to clause 7.1.
 6. The High Pass filter loss factor already add into the correct factor.
 7. Proper operation of the transmitter prior to adding the filter to the measurement chain.
 8. Owing to the highest peak level complies with the lowest limit of unwanted emission out of the restricted bands (Please refer to page 51), so all the test point were deemed to comply with the limits list in the standard.



VERTICAL RESULTS
1-7GHz

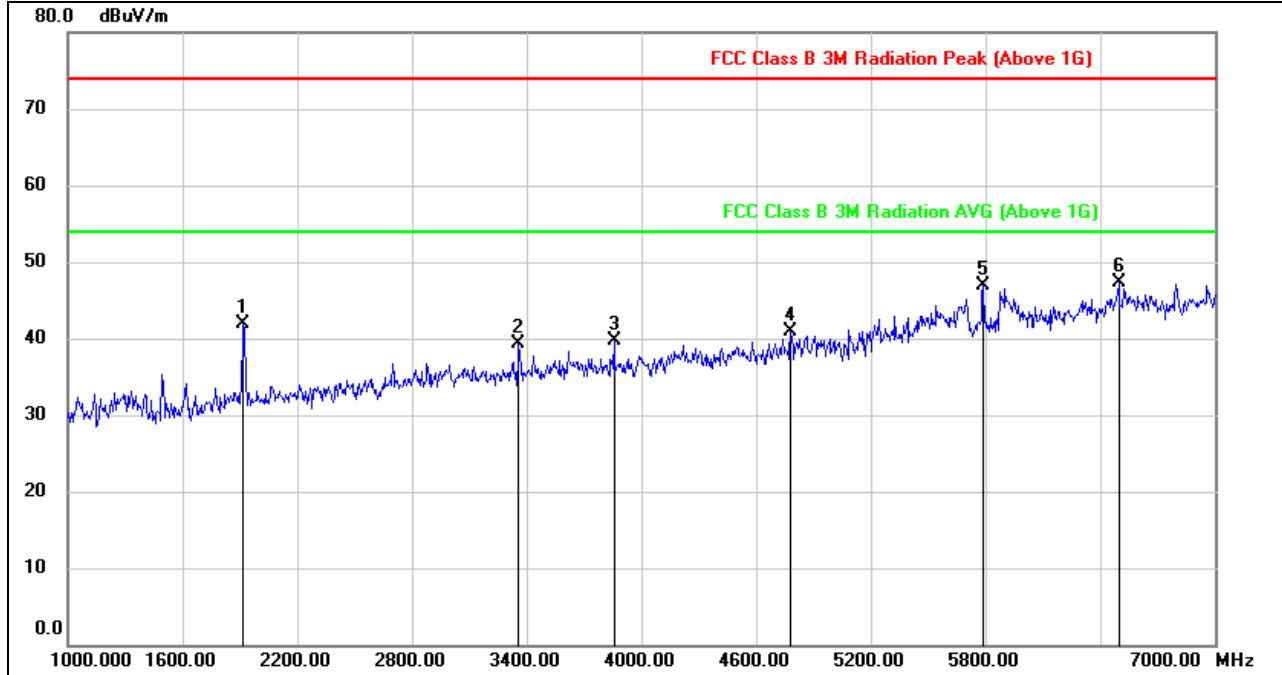

No.	Frequency (MHz)	Reading (dBuV)	Correct (dB/m)	Result (dBuV/m)	Limit (dBuV/m)	Margin (dB)	Remark
1	1918.000	52.67	-10.83	41.84	74.00	-32.16	peak
2	3358.000	44.91	-5.66	39.25	74.00	-34.75	peak
3	3856.000	43.85	-4.20	39.65	74.00	-34.35	peak
4	4780.000	41.95	-1.03	40.92	74.00	-33.08	peak
5	5788.000	44.05	2.83	46.88	74.00	-27.12	peak
6	6496.000	41.49	5.82	47.31	74.00	-26.69	peak

Note: 1. Measurement = Reading Level + Correct Factor.
 2. If Peak Result complies with AV limit, AV Result is deemed to comply with AV limit.
 3. Peak: Peak detector.
 4. Filter losses were only considered in then spurious frequency bands and the authorized band was not corrected for BRF losses.
 5. Proper operation of the transmitter prior to adding the filter to the measurement chain.
 6. Owing to the highest peak level complies with the lowest limit of unwanted emission out of the restricted bands (Please refer to page 50), so all the test point were deemed to comply with the limits list in the standard.



VERTICAL RESULTS
7-18GHz

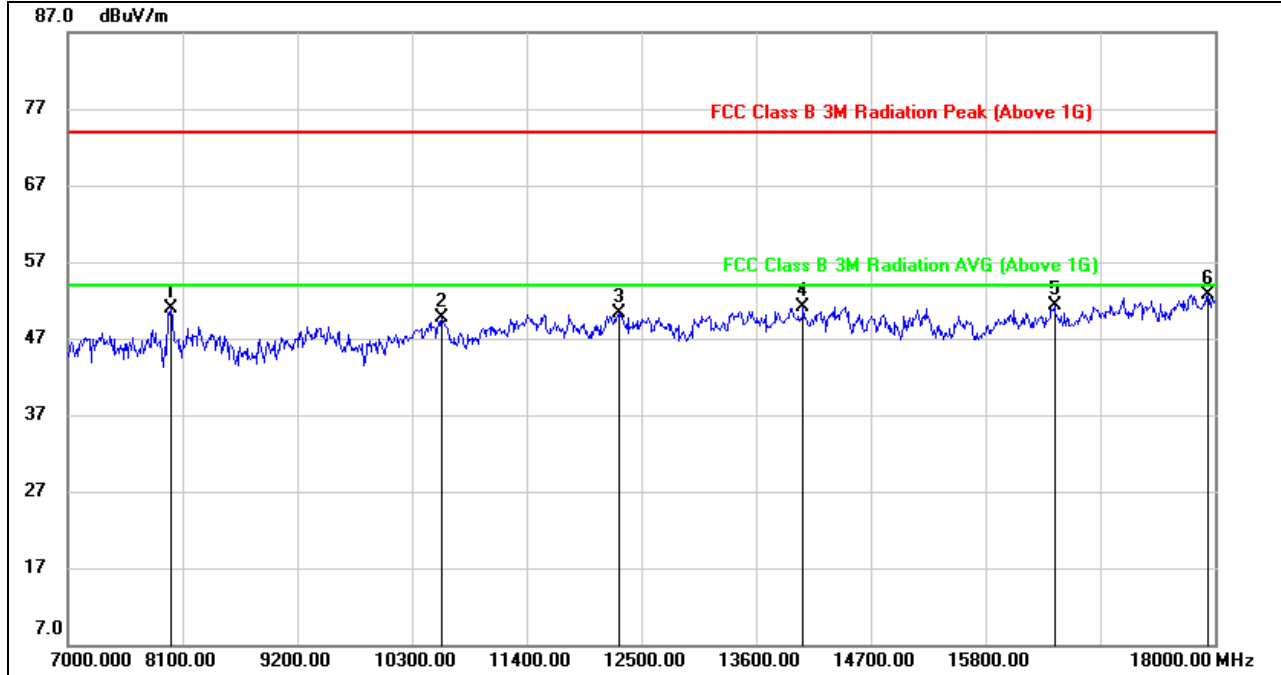

No.	Frequency (MHz)	Reading (dBuV)	Correct (dB/m)	Result (dBuV/m)	Limit (dBuV/m)	Margin (dB)	Remark
1	7990.000	42.26	8.66	50.92	74.00	-23.08	peak
2	10586.000	36.63	13.00	49.63	74.00	-24.37	peak
3	12280.000	35.16	15.12	50.28	74.00	-23.72	peak
4	14051.000	34.65	16.50	51.15	74.00	-22.85	peak
5	16460.000	32.28	19.01	51.29	74.00	-22.71	peak
6	17934.000	29.53	23.14	52.67	74.00	-21.33	peak

Note: 1. Measurement = Reading Level + Correct Factor.
 2. If Peak Result complies with AV limit, AV Result is deemed to comply with AV limit.
 3. Peak: Peak detector.
 4. The High Pass filter loss factor already add into the correct factor.
 5. Proper operation of the transmitter prior to adding the filter to the measurement chain.
 6. Owing to the highest peak level complies with the lowest limit of unwanted emission out of the restricted bands (Please refer to page 50), so all the test point were deemed to comply with the limits list in the standard.



HARMONICS AND SPURIOUS EMISSIONS HIGH CHANNEL

HORIZONTAL RESULTS
1-7GHz

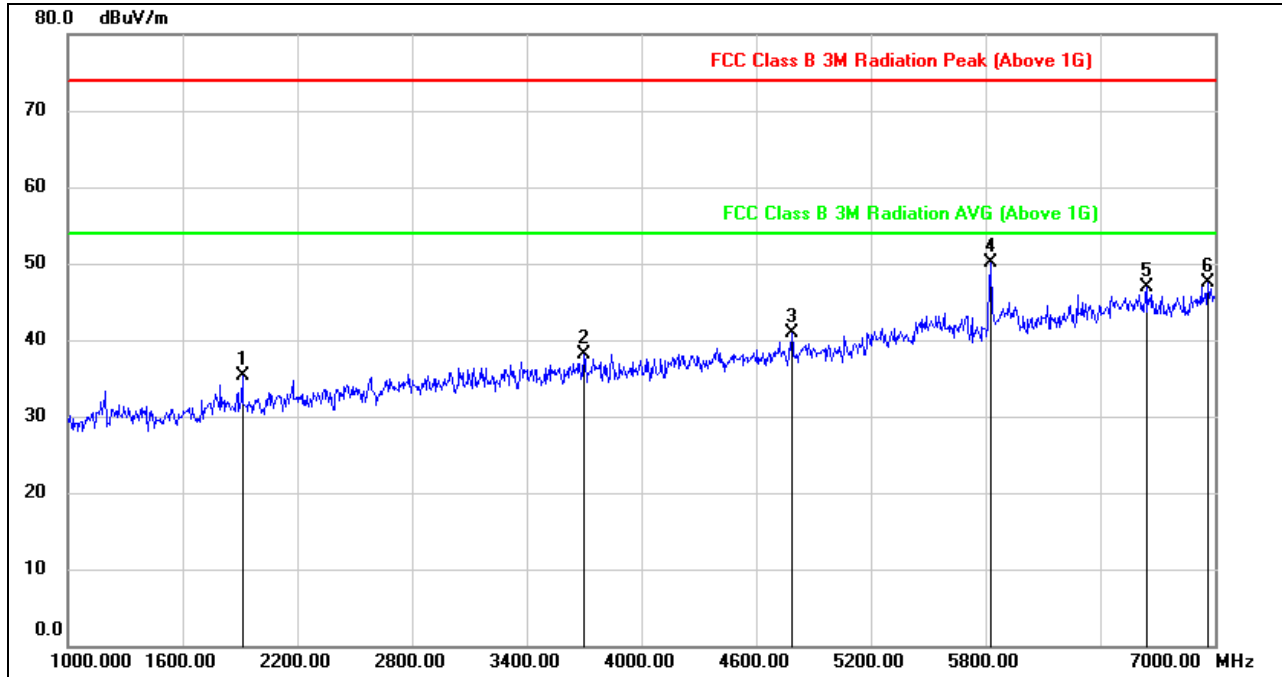

No.	Frequency (MHz)	Reading (dBuV)	Correct (dB/m)	Result (dBuV/m)	Limit (dBuV/m)	Margin (dB)	Remark
1	1912.000	46.05	-10.83	35.22	74.00	-38.78	peak
2	3700.000	42.14	-4.04	38.10	74.00	-35.90	peak
3	4786.000	41.83	-1.00	40.83	74.00	-33.17	peak
4	5830.000	46.65	3.50	50.15	74.00	-23.85	peak
5	6640.000	41.28	5.55	46.83	74.00	-27.17	peak
6	6964.000	41.06	6.38	47.44	74.00	-26.56	peak

- Note: 1. Measurement = Reading Level + Correct Factor.
 2. If Peak Result complies with AV limit, AV Result is deemed to comply with AV limit.
 3. Peak: Peak detector.
 4. Filter losses were only considered in then spurious frequency bands and the authorized band was not corrected for BRF losses.
 5. Proper operation of the transmitter prior to adding the filter to the measurement chain.
 6. Owing to the highest peak level complies with the lowest limit of unwanted emission out of the restricted bands (Please refer to page 50), so all the test point were deemed to comply with the limits list in the standard.



HORIZONTAL RESULTS
7-18GHz

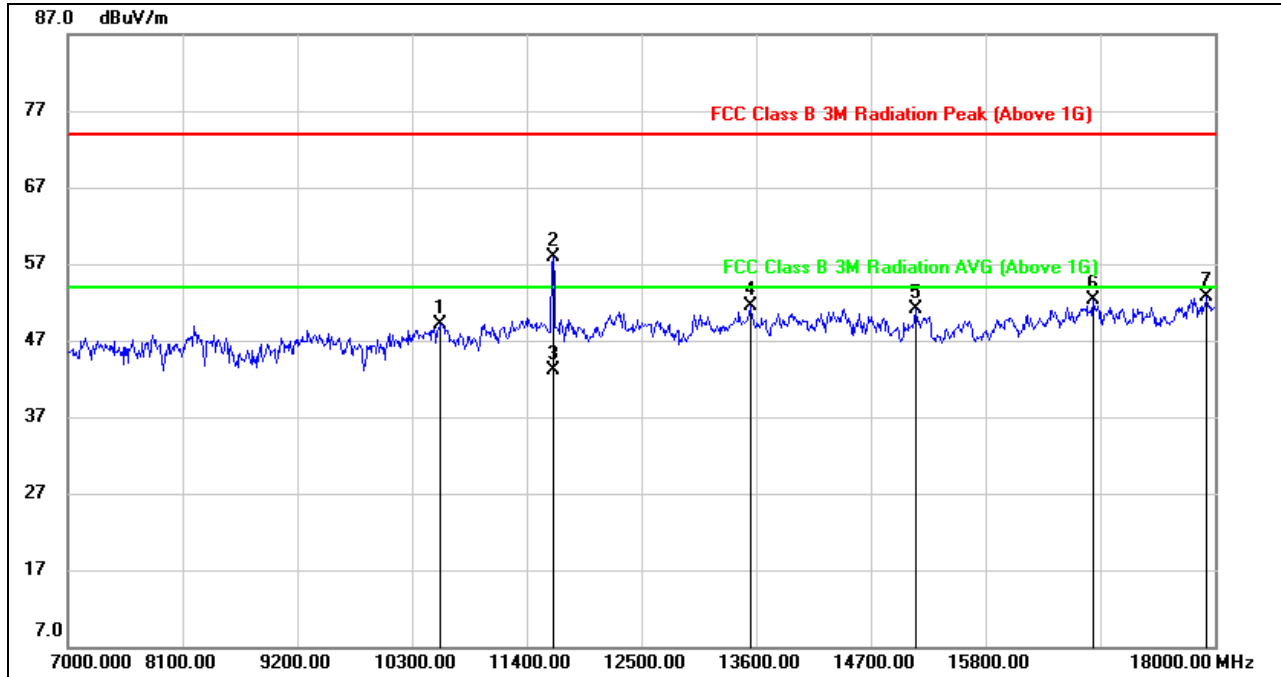

No.	Frequency (MHz)	Reading (dBuV)	Correct (dB/m)	Result (dBuV/m)	Limit (dBuV/m)	Margin (dB)	Remark
1	10575.000	36.32	12.87	49.19	74.00	-24.81	peak
2	11651.821	43.76	14.22	57.98	74.00	-16.02	peak
3	11651.821	28.96	14.22	43.18	54.00	-10.82	AVG
4	13545.000	35.37	16.06	51.43	74.00	-22.57	peak
5	15129.000	35.33	15.77	51.10	74.00	-22.90	peak
6	16834.000	32.11	20.18	52.29	74.00	-21.71	peak
7	17923.000	29.50	23.14	52.64	74.00	-21.36	peak

Note: 1. Measurement = Reading Level + Correct Factor.
 2. If Peak Result complies with AV limit, AV Result is deemed to comply with AV limit.
 3. Peak: Peak detector.
 4. AVG: $VBW=1/Ton$ where: ton is transmit duration.
 5. For duty cycle, please refer to clause 7.1.
 6. The High Pass filter loss factor already add into the correct factor.
 7. Proper operation of the transmitter prior to adding the filter to the measurement chain.
 8. Owing to the highest peak level complies with the lowest limit of unwanted emission out of the restricted bands (Please refer to page 51), so all the test point were deemed to comply with the limits list in the standard.



VERTICAL RESULTS
1-7GHz

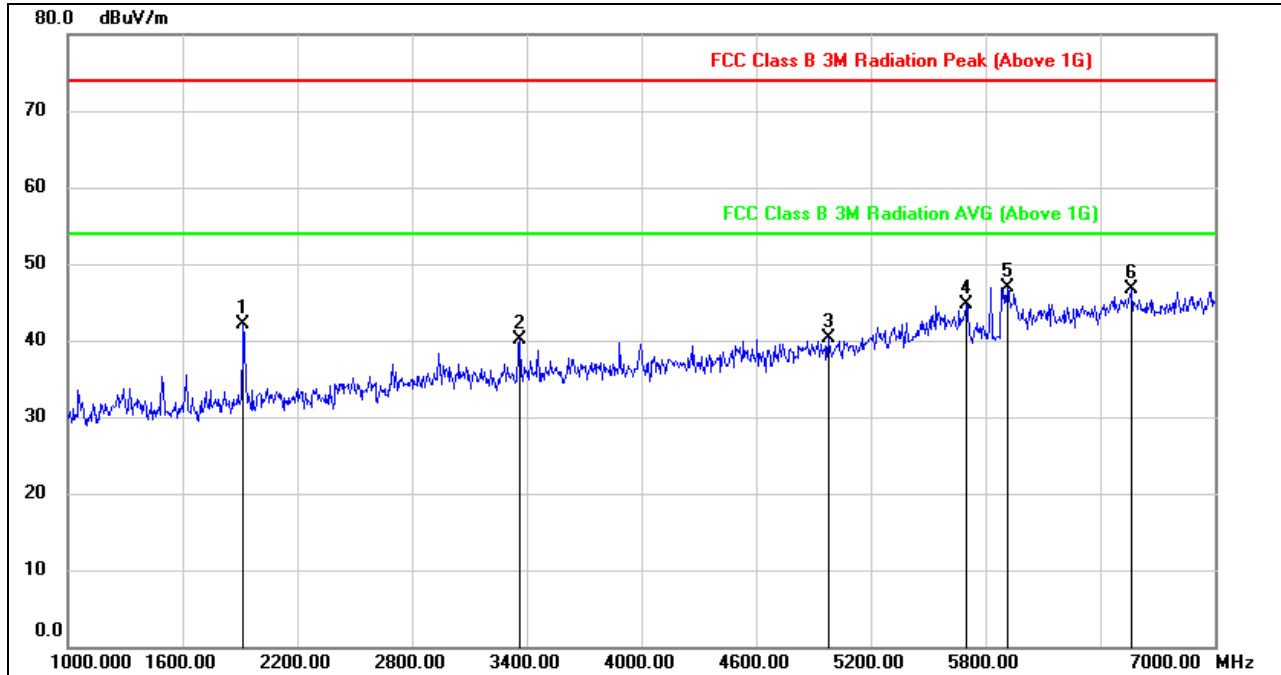

No.	Frequency (MHz)	Reading (dBuV)	Correct (dB/m)	Result (dBuV/m)	Limit (dBuV/m)	Margin (dB)	Remark
1	1918.000	52.92	-10.83	42.09	74.00	-31.91	peak
2	3364.000	45.83	-5.68	40.15	74.00	-33.85	peak
3	4978.000	40.50	-0.23	40.27	74.00	-33.73	peak
4	5698.000	42.47	2.22	44.69	74.00	-29.31	peak
5	5914.000	42.31	4.65	46.96	74.00	-27.04	peak
6	6562.000	41.06	5.66	46.72	74.00	-27.28	peak

Note: 1. Measurement = Reading Level + Correct Factor.
 2. If Peak Result complies with AV limit, AV Result is deemed to comply with AV limit.
 3. Peak: Peak detector.
 4. Filter losses were only considered in then spurious frequency bands and the authorized band was not corrected for BRF losses.
 5. Proper operation of the transmitter prior to adding the filter to the measurement chain.
 6. Owing to the highest peak level complies with the lowest limit of unwanted emission out of the restricted bands (Please refer to page 50), so all the test point were deemed to comply with the limits list in the standard.



VERTICAL RESULTS
7-18GHz

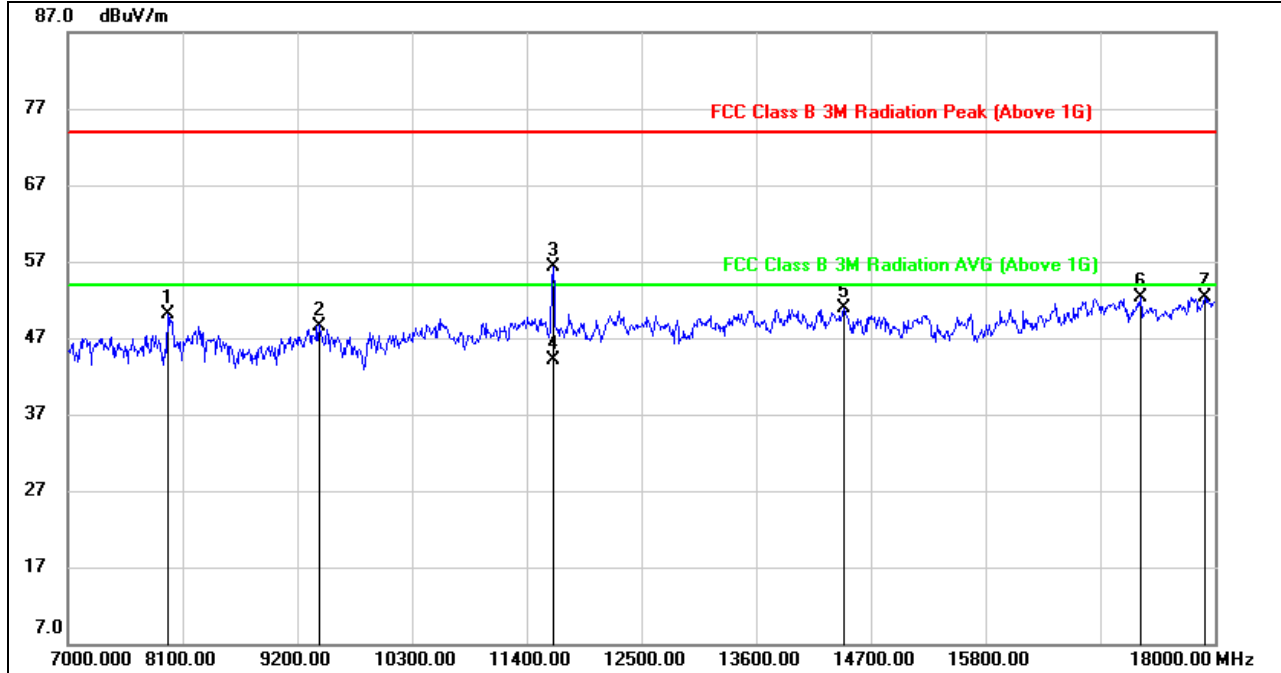

No.	Frequency (MHz)	Reading (dBuV)	Correct (dB/m)	Result (dBuV/m)	Limit (dBuV/m)	Margin (dB)	Remark
1	7957.000	41.32	8.73	50.05	74.00	-23.95	peak
2	9409.000	37.86	10.74	48.60	74.00	-25.40	peak
3	11650.602	42.15	14.23	56.38	74.00	-17.62	peak
4	11650.602	29.80	14.23	44.03	54.00	-9.97	AVG
5	14436.000	34.33	16.58	50.91	74.00	-23.09	peak
6	17285.000	30.59	21.78	52.37	74.00	-21.63	peak
7	17901.000	29.25	23.14	52.39	74.00	-21.61	peak

Note: 1. Measurement = Reading Level + Correct Factor.
 2. If Peak Result complies with AV limit, AV Result is deemed to comply with AV limit.
 3. Peak: Peak detector.
 4. AVG: $VBW=1/Ton$ where: ton is transmit duration.
 5. For duty cycle, please refer to clause 7.1.
 6. The High Pass filter loss factor already add into the correct factor.
 7. Proper operation of the transmitter prior to adding the filter to the measurement chain.
 8. Owing to the highest peak level complies with the lowest limit of unwanted emission out of the restricted bands (Please refer to page 51), so all the test point were deemed to comply with the limits list in the standard.



8.3. 802.11n HT40 MIMO MODE

MIMO CDD MODE (WORST-CASE CONFIGURATION)

8.3.1. UNII-1 BAND

RESTRICTED BANDEDGE LOW CHANNEL

HORIZONTAL RESULTS PEAK

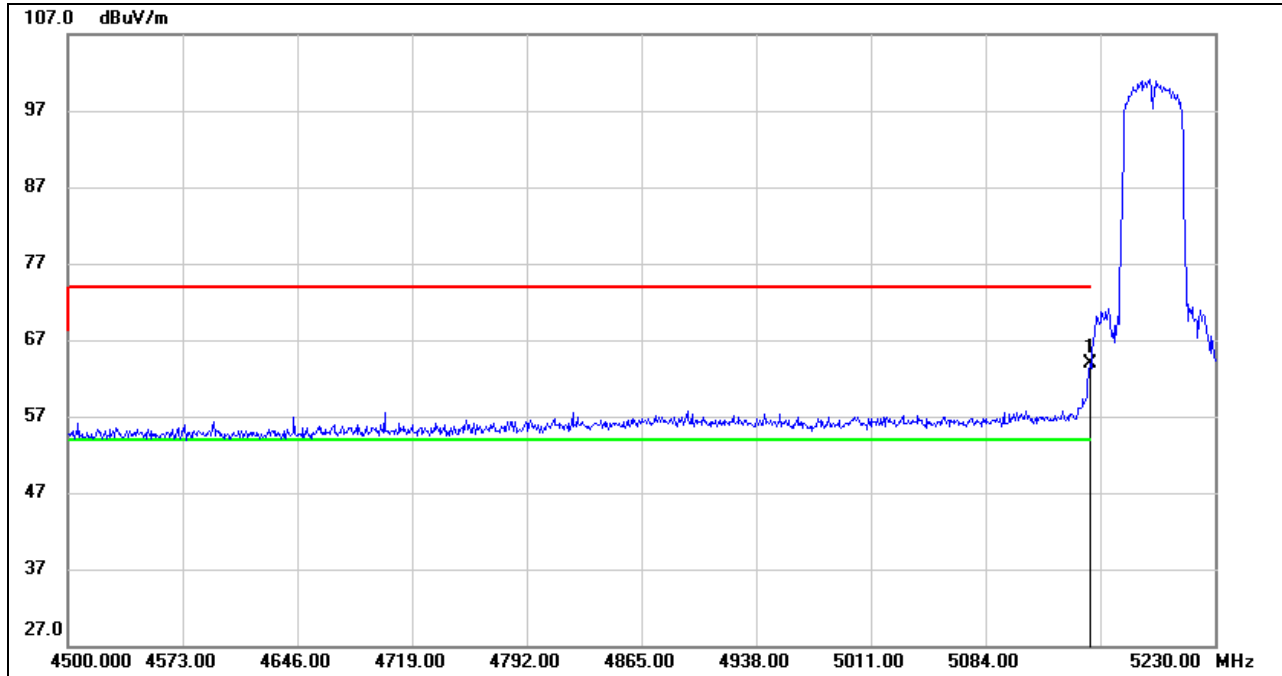

No.	Frequency (MHz)	Reading (dBuV)	Correct (dB/m)	Result (dBuV/m)	Limit (dBuV/m)	Margin (dB)	Remark
1	5150.000	23.39	40.46	63.85	74.00	-10.15	peak

- Note:
1. Measurement = Reading Level + Correct Factor.
 2. If Peak Result complies with AV limit, AV Result is deemed to comply with AV limit.
 3. Peak: Peak detector.
 4. Only the worst case emission will be recorder, if it complies with the limit, the other emissions deemed to comply with the limit.



AVG

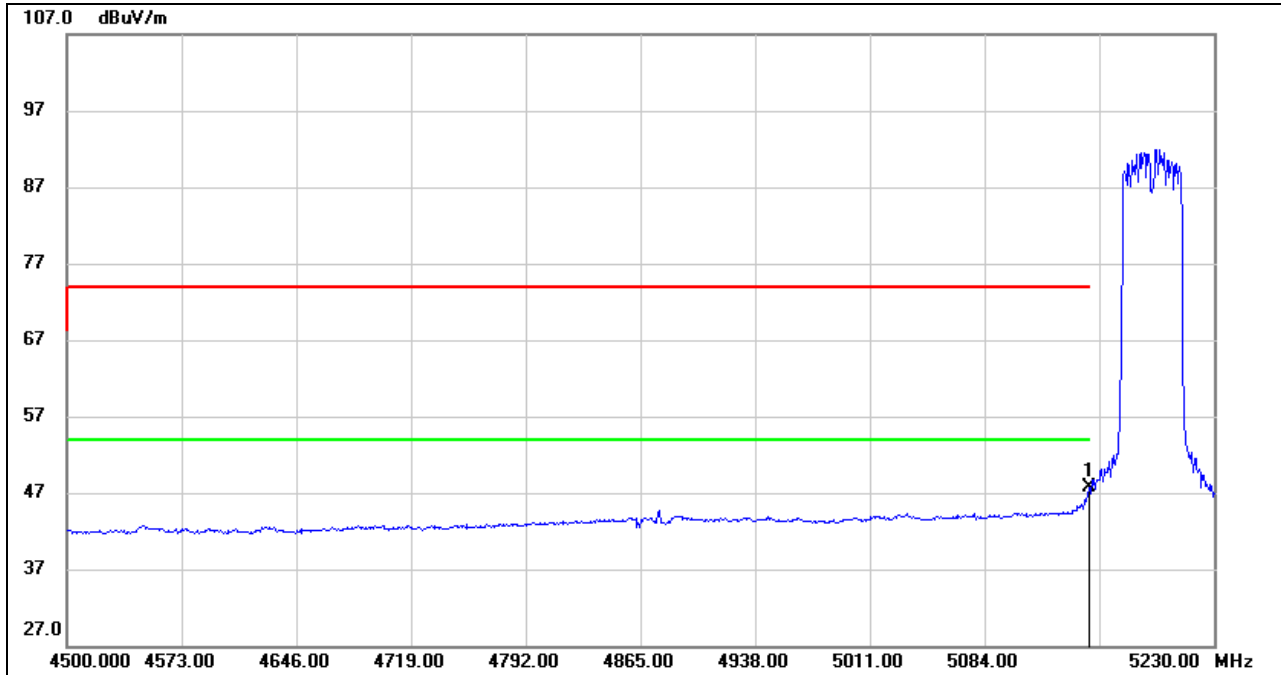

No.	Frequency (MHz)	Reading (dBuV)	Correct (dB/m)	Result (dBuV/m)	Limit (dBuV/m)	Margin (dB)	Remark
1	5150.000	7.15	40.46	47.61	54.00	-6.39	AVG

- Note: 1. Measurement = Reading Level + Correct Factor.
 2. AVG: VBW=1/Ton where: ton is transmit duration.
 3. For duty cycle, please refer to clause 7.1.
 4. Only the worst case emission will be recorder, if it complies with the limit, the other emissions deemed to comply with the limit.



VERTICAL RESULTS
PEAK

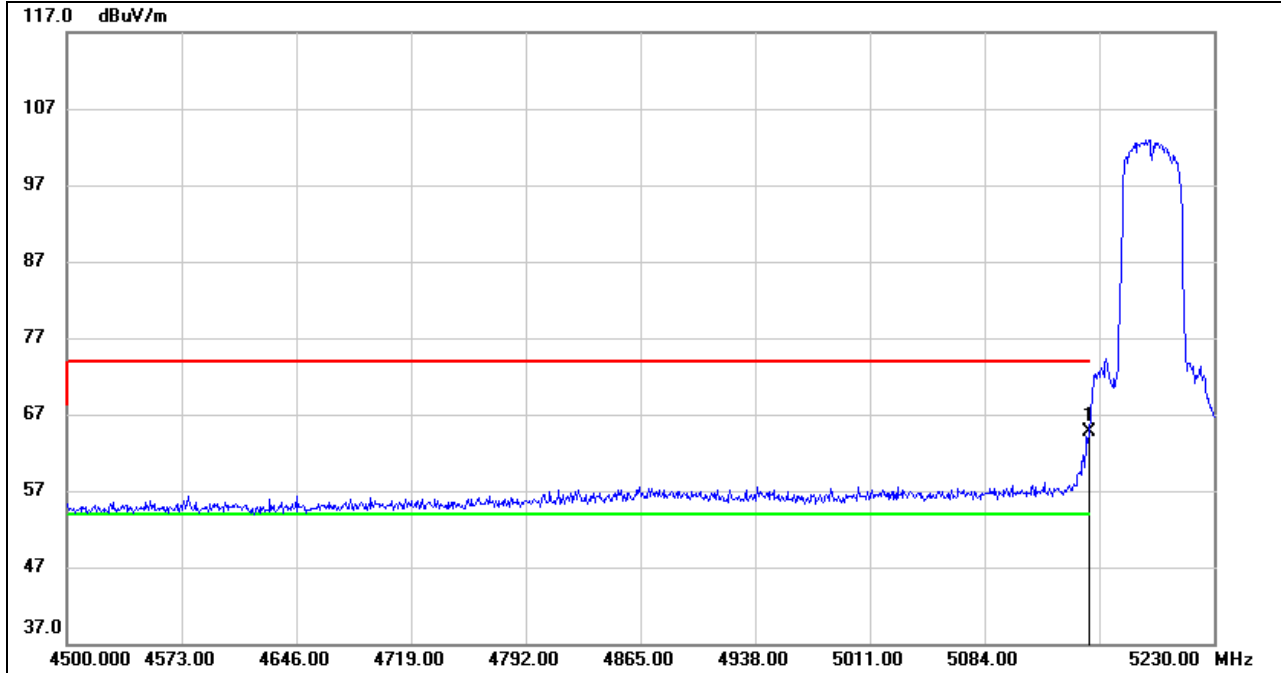

No.	Frequency (MHz)	Reading (dBuV)	Correct (dB/m)	Result (dBuV/m)	Limit (dBuV/m)	Margin (dB)	Remark
1	5150.000	24.15	40.46	64.61	74.00	-9.39	peak

- Note:
1. Measurement = Reading Level + Correct Factor.
 2. If Peak Result complies with AV limit, AV Result is deemed to comply with AV limit.
 3. Peak: Peak detector.
 4. Only the worst case emission will be recorder, if it complies with the limit, the other emissions deemed to comply with the limit.



AVG

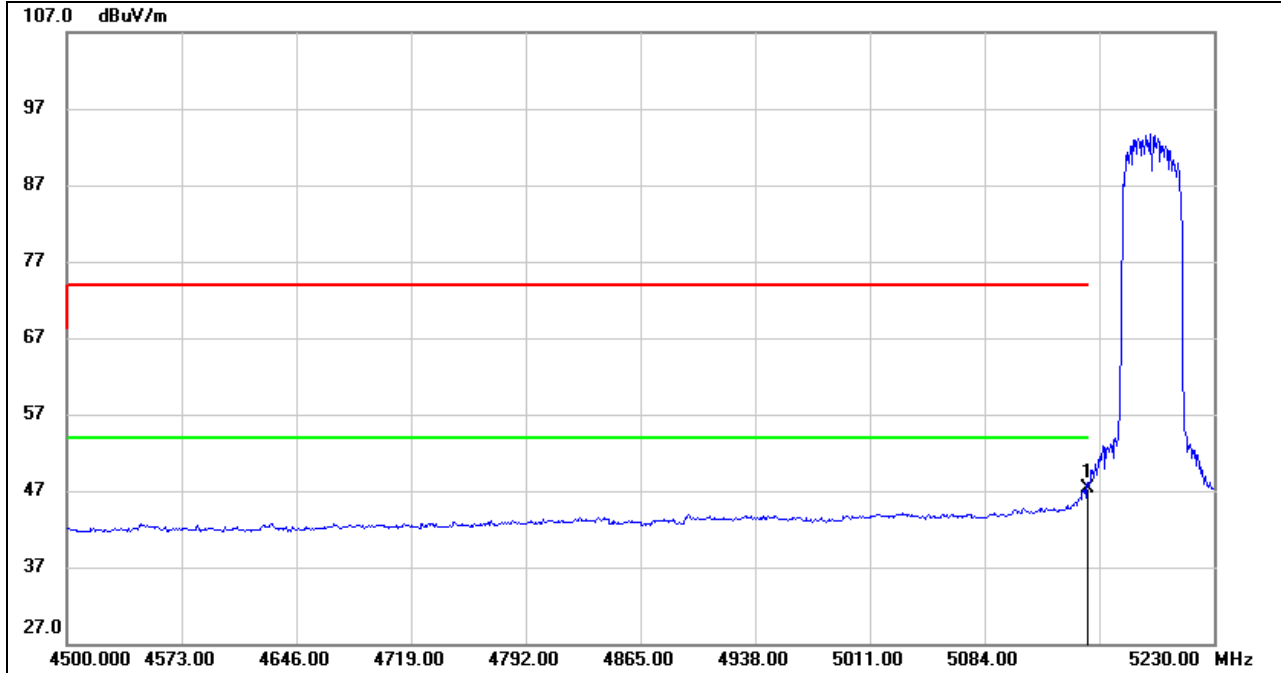

No.	Frequency (MHz)	Reading (dBuV)	Correct (dB/m)	Result (dBuV/m)	Limit (dBuV/m)	Margin (dB)	Remark
1	5150.000	6.94	40.46	47.40	54.00	-6.60	AVG

- Note:
1. Measurement = Reading Level + Correct Factor.
 2. AVG: $VBW=1/Ton$ where: ton is transmit duration.
 3. For duty cycle, please refer to clause 7.1.
 4. Only the worst case emission will be recorder, if it complies with the limit, the other emissions deemed to comply with the limit.



HARMONICS AND SPURIOUS EMISSIONS LOW CHANNEL

HORIZONTAL RESULTS
1-7GHz

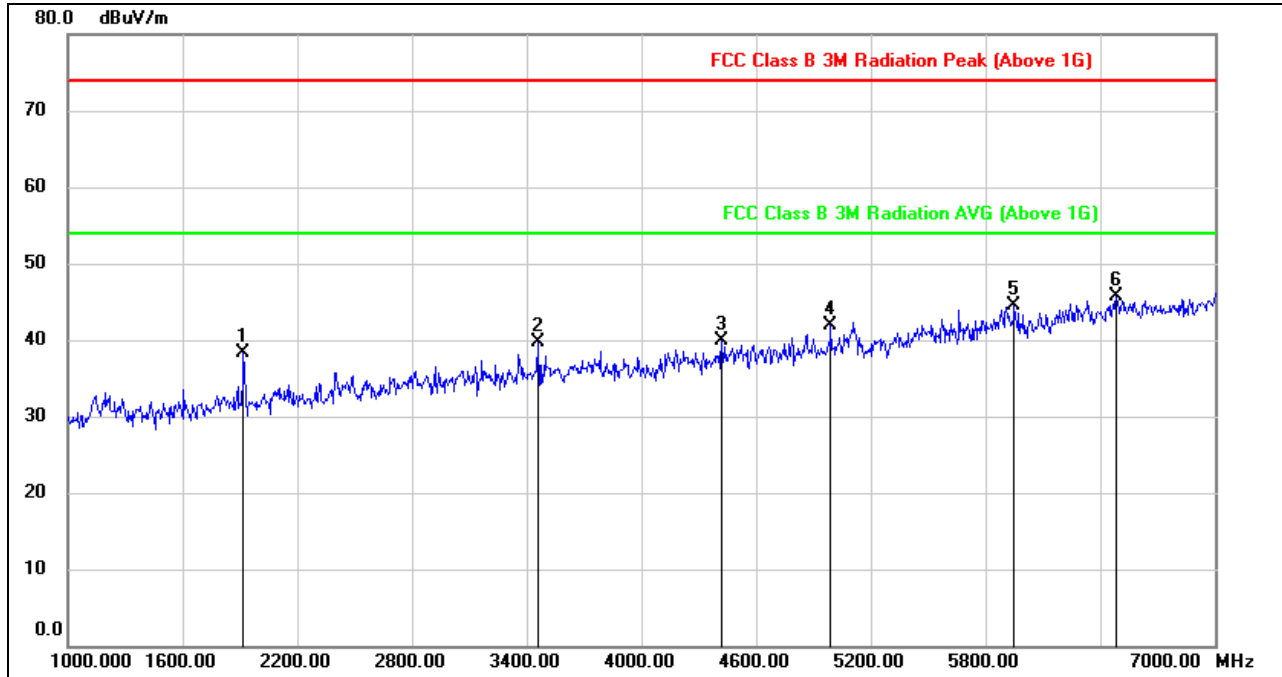

No.	Frequency (MHz)	Reading (dBuV)	Correct (dB/m)	Result (dBuV/m)	Limit (dBuV/m)	Margin (dB)	Remark
1	1918.000	49.15	-10.83	38.32	74.00	-35.68	peak
2	3460.000	45.29	-5.54	39.75	74.00	-34.25	peak
3	4420.000	42.65	-2.83	39.82	74.00	-34.18	peak
4	4990.000	42.04	-0.14	41.90	74.00	-32.10	peak
5	5950.000	40.39	4.08	44.47	74.00	-29.53	peak
6	6484.000	40.11	5.67	45.78	74.00	-28.22	peak

Note: 1. Measurement = Reading Level + Correct Factor.
 2. If Peak Result complies with AV limit, AV Result is deemed to comply with AV limit.
 3. Peak: Peak detector.
 4. Filter losses were only considered in then spurious frequency bands and the authorized band was not corrected for BRF losses.
 5. Proper operation of the transmitter prior to adding the filter to the measurement chain.
 6. Owing to the highest peak level complies with the lowest limit of unwanted emission out of the restricted bands (Please refer to page 50), so all the test point were deemed to comply with the limits list in the standard.



HORIZONTAL RESULTS
7-18GHz

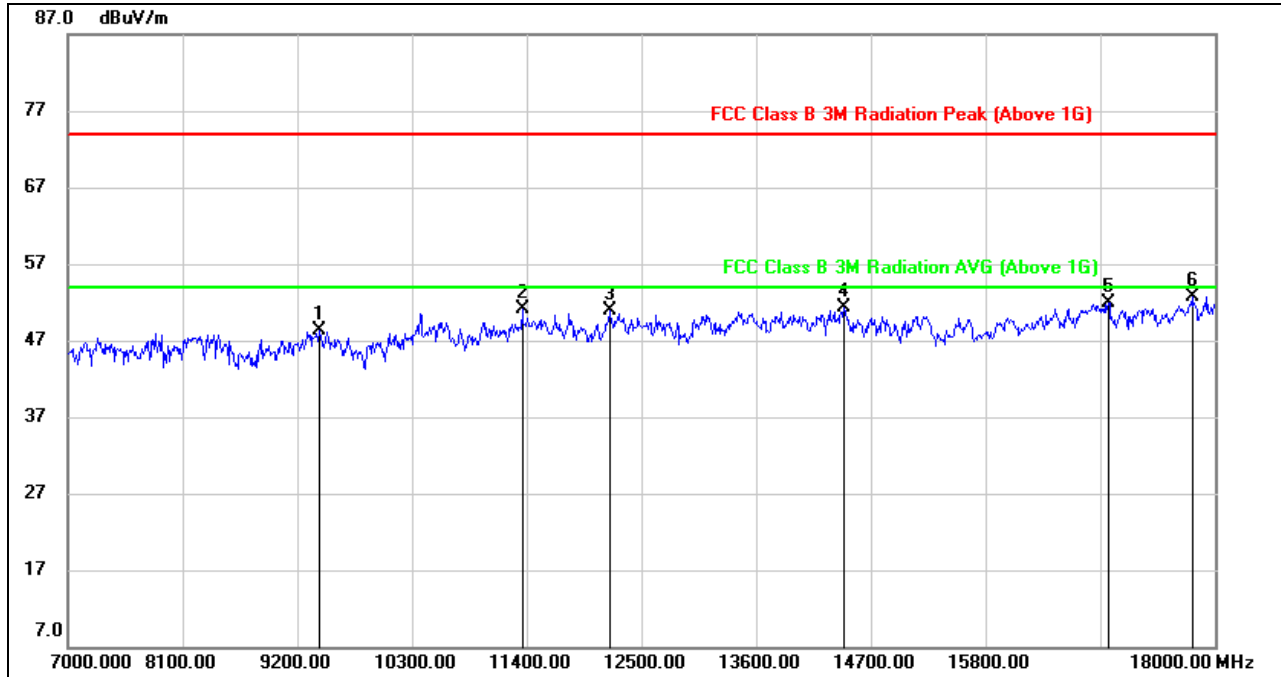

No.	Frequency (MHz)	Reading (dBuV)	Correct (dB/m)	Result (dBuV/m)	Limit (dBuV/m)	Margin (dB)	Remark
1	9409.000	37.66	10.74	48.40	74.00	-25.60	peak
2	11356.000	37.65	13.54	51.19	74.00	-22.81	peak
3	12192.000	35.99	14.91	50.90	74.00	-23.10	peak
4	14436.000	34.75	16.58	51.33	74.00	-22.67	peak
5	16977.000	31.35	20.62	51.97	74.00	-22.03	peak
6	17780.000	29.73	23.01	52.74	74.00	-21.26	peak

Note: 1. Measurement = Reading Level + Correct Factor.
 2. If Peak Result complies with AV limit, AV Result is deemed to comply with AV limit.
 3. Peak: Peak detector.
 4. The High Pass filter loss factor already add into the correct factor.
 5. Proper operation of the transmitter prior to adding the filter to the measurement chain.
 6. Owing to the highest peak level complies with the lowest limit of unwanted emission out of the restricted bands (Please refer to page 50), so all the test point were deemed to comply with the limits list in the standard.



VERTICAL RESULTS
1-7GHz

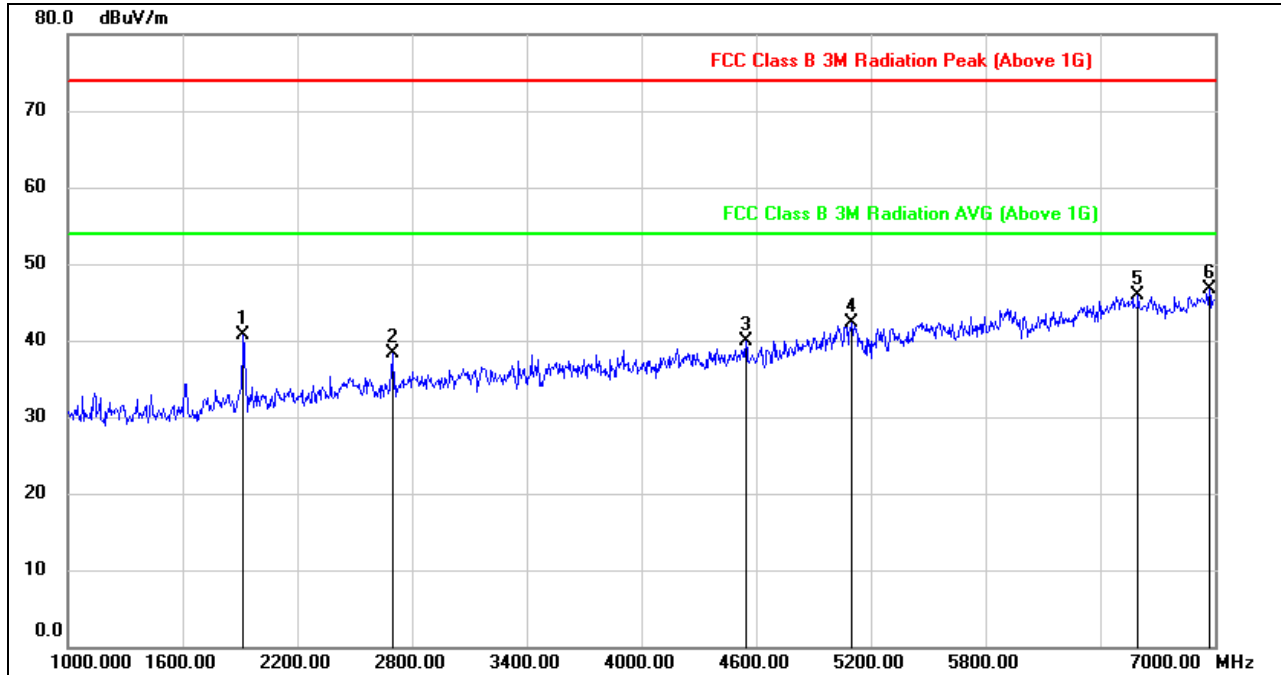

No.	Frequency (MHz)	Reading (dBuV)	Correct (dB/m)	Result (dBuV/m)	Limit (dBuV/m)	Margin (dB)	Remark
1	1918.000	51.60	-10.83	40.77	74.00	-33.23	peak
2	2698.000	46.31	-7.92	38.39	74.00	-35.61	peak
3	4546.000	42.02	-2.06	39.96	74.00	-34.04	peak
4	5098.000	42.09	0.13	42.22	74.00	-31.78	peak
5	6598.000	40.46	5.53	45.99	74.00	-28.01	peak
6	6970.000	40.33	6.39	46.72	74.00	-27.28	peak

Note: 1. Measurement = Reading Level + Correct Factor.
 2. If Peak Result complies with AV limit, AV Result is deemed to comply with AV limit.
 3. Peak: Peak detector.
 4. Filter losses were only considered in then spurious frequency bands and the authorized band was not corrected for BRF losses.
 5. Proper operation of the transmitter prior to adding the filter to the measurement chain.
 6. Owing to the highest peak level complies with the lowest limit of unwanted emission out of the restricted bands (Please refer to page 50), so all the test point were deemed to comply with the limits list in the standard.



7-18GHz

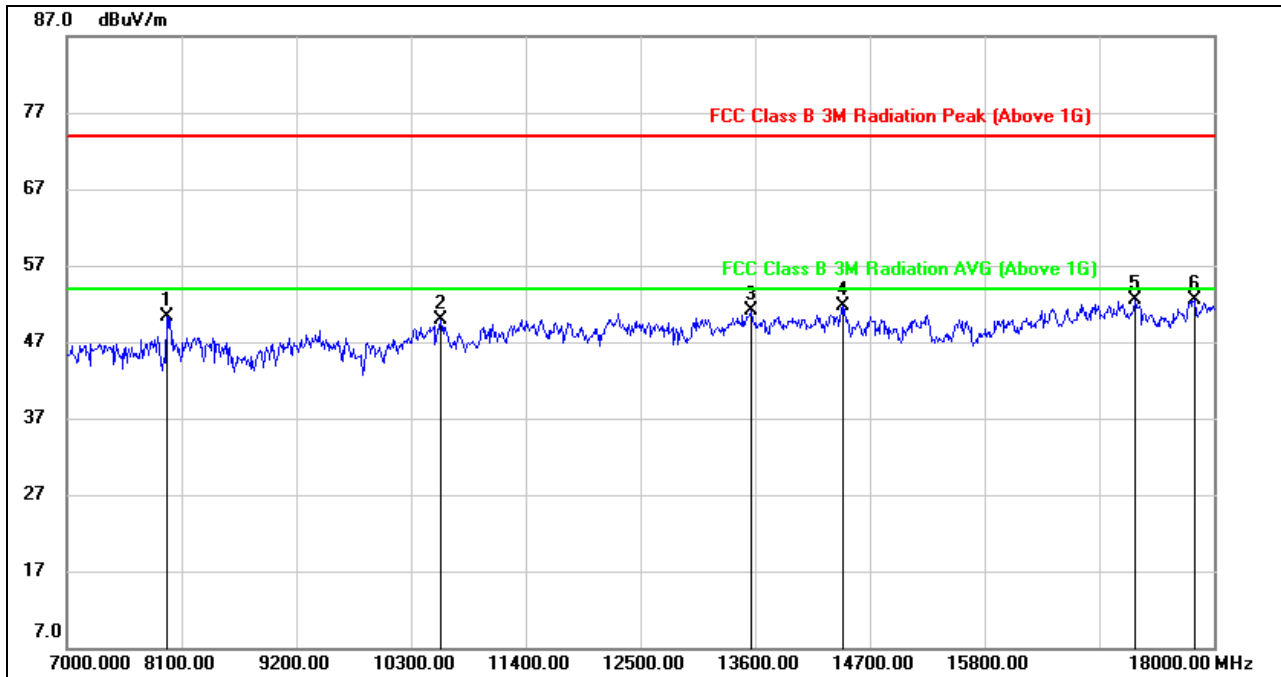

No.	Frequency (MHz)	Reading (dBuV)	Correct (dB/m)	Result (dBuV/m)	Limit (dBuV/m)	Margin (dB)	Remark
1	7957.000	41.55	8.73	50.28	74.00	-23.72	peak
2	10586.000	36.98	13.00	49.98	74.00	-24.02	peak
3	13556.000	34.93	16.10	51.03	74.00	-22.97	peak
4	14436.000	35.07	16.58	51.65	74.00	-22.35	peak
5	17241.000	31.05	21.39	52.44	74.00	-21.56	peak
6	17813.000	29.25	23.19	52.44	74.00	-21.56	peak

Note: 1. Measurement = Reading Level + Correct Factor.
 2. If Peak Result complies with AV limit, AV Result is deemed to comply with AV limit.
 3. Peak: Peak detector.
 4. The High Pass filter loss factor already add into the correct factor.
 5. Proper operation of the transmitter prior to adding the filter to the measurement chain.
 6. Owing to the highest peak level complies with the lowest limit of unwanted emission out of the restricted bands (Please refer to page 50), so all the test point were deemed to comply with the limits list in the standard.



HARMONICS AND SPURIOUS EMISSIONS HIGH CHANNEL

HORIZONTAL RESULTS
1-7GHz

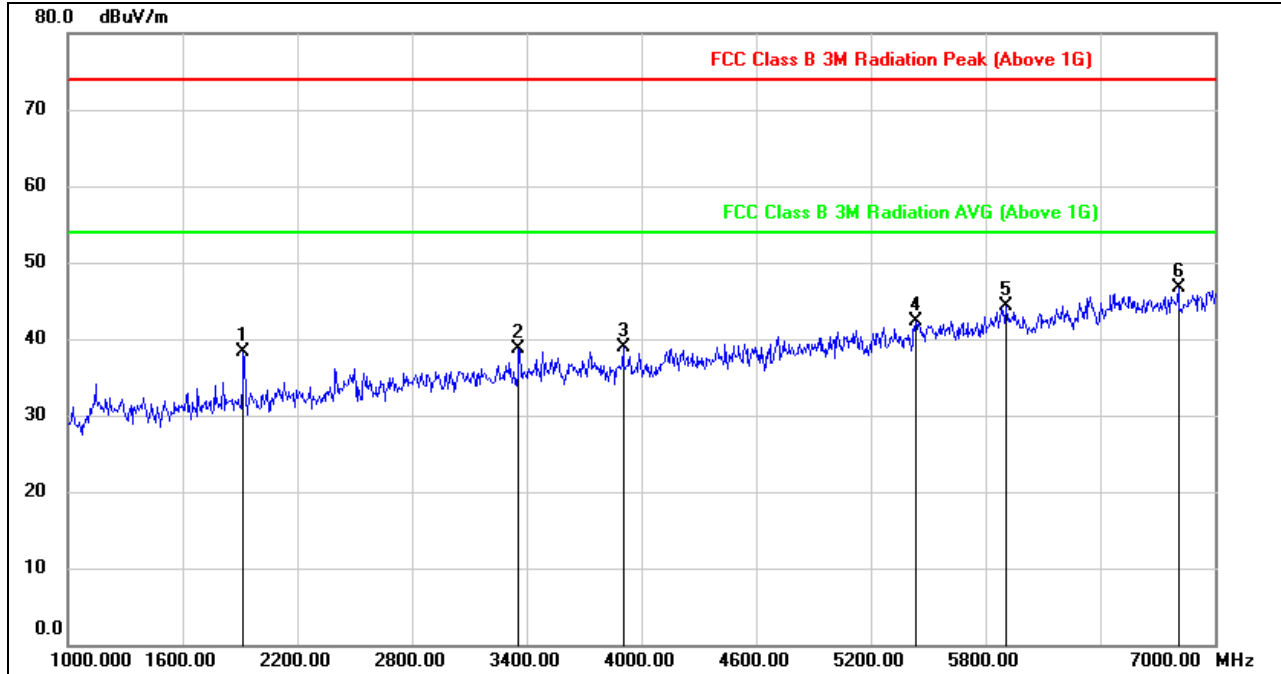

No.	Frequency (MHz)	Reading (dBuV)	Correct (dB/m)	Result (dBuV/m)	Limit (dBuV/m)	Margin (dB)	Remark
1	1918.000	49.17	-10.83	38.34	74.00	-35.66	peak
2	3358.000	44.33	-5.66	38.67	74.00	-35.33	peak
3	3904.000	43.14	-4.17	38.97	74.00	-35.03	peak
4	5434.000	40.92	1.36	42.28	74.00	-31.72	peak
5	5908.000	39.59	4.75	44.34	74.00	-29.66	peak
6	6808.000	41.02	5.66	46.68	74.00	-27.32	peak

Note: 1. Measurement = Reading Level + Correct Factor.
 2. If Peak Result complies with AV limit, AV Result is deemed to comply with AV limit.
 3. Peak: Peak detector.
 4. Filter losses were only considered in then spurious frequency bands and the authorized band was not corrected for BRF losses.
 5. Proper operation of the transmitter prior to adding the filter to the measurement chain.
 6. Owing to the highest peak level complies with the lowest limit of unwanted emission out of the restricted bands (Please refer to page 50), so all the test point were deemed to comply with the limits list in the standard.



HORIZONTAL RESULTS
7-18GHz

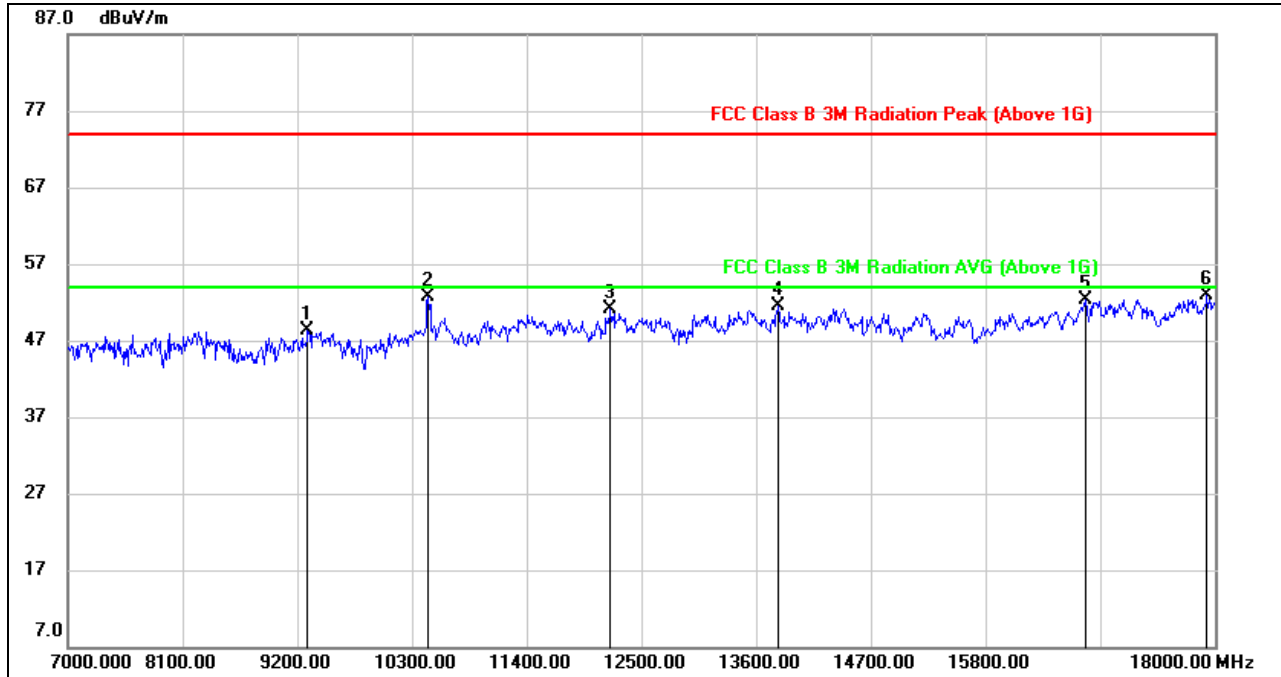

No.	Frequency (MHz)	Reading (dBuV)	Correct (dB/m)	Result (dBuV/m)	Limit (dBuV/m)	Margin (dB)	Remark
1	9299.000	37.95	10.27	48.22	74.00	-25.78	peak
2	10454.000	40.77	11.95	52.72	74.00	-21.28	peak
3	12203.000	36.17	14.94	51.11	74.00	-22.89	peak
4	13809.000	34.49	16.96	51.45	74.00	-22.55	peak
5	16757.000	32.29	20.03	52.32	74.00	-21.68	peak
6	17923.000	29.73	23.14	52.87	74.00	-21.13	peak

Note: 1. Measurement = Reading Level + Correct Factor.
 2. If Peak Result complies with AV limit, AV Result is deemed to comply with AV limit.
 3. Peak: Peak detector.
 4. The High Pass filter loss factor already add into the correct factor.
 5. Proper operation of the transmitter prior to adding the filter to the measurement chain.
 6. Owing to the highest peak level complies with the lowest limit of unwanted emission out of the restricted bands (Please refer to page 50), so all the test point were deemed to comply with the limits list in the standard.



VERTICAL RESULTS
1-7GHz

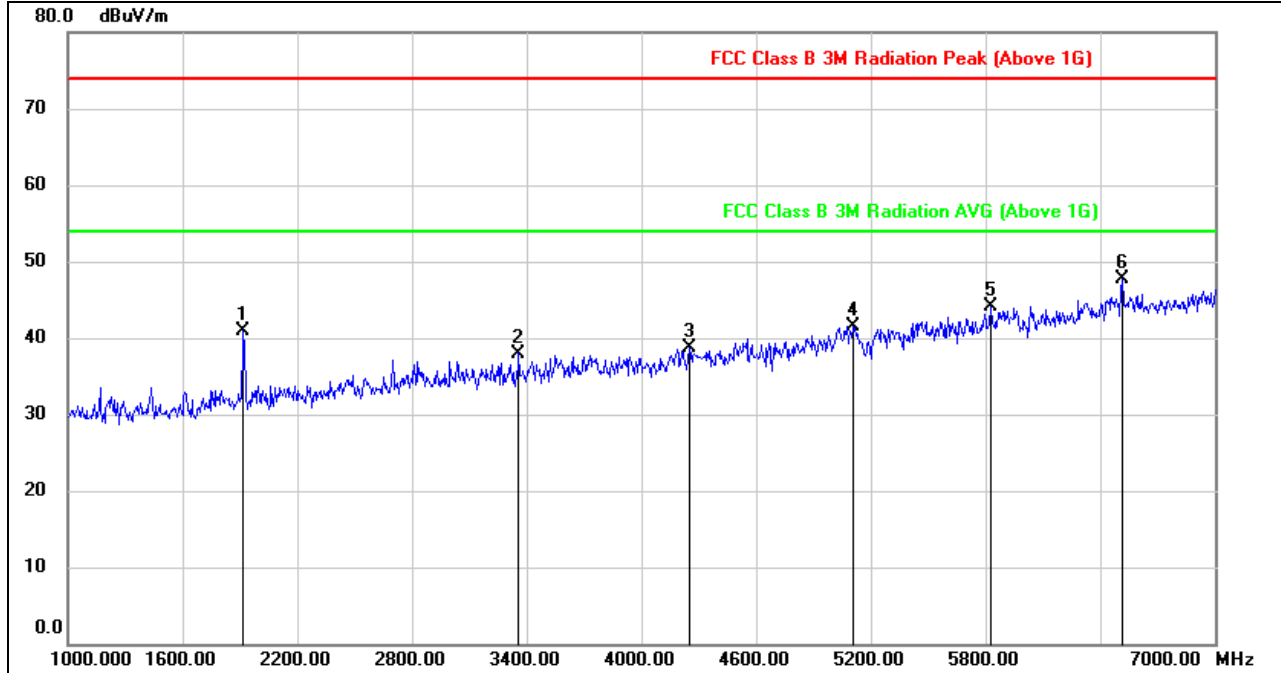

No.	Frequency (MHz)	Reading (dBuV)	Correct (dB/m)	Result (dBuV/m)	Limit (dBuV/m)	Margin (dB)	Remark
1	1918.000	51.69	-10.83	40.86	74.00	-33.14	peak
2	3358.000	43.66	-5.66	38.00	74.00	-36.00	peak
3	4252.000	41.78	-3.05	38.73	74.00	-35.27	peak
4	5104.000	41.44	0.16	41.60	74.00	-32.40	peak
5	5824.000	40.65	3.38	44.03	74.00	-29.97	peak
6	6514.000	41.80	5.84	47.64	74.00	-26.36	peak

Note: 1. Measurement = Reading Level + Correct Factor.
 2. If Peak Result complies with AV limit, AV Result is deemed to comply with AV limit.
 3. Peak: Peak detector.
 4. Filter losses were only considered in then spurious frequency bands and the authorized band was not corrected for BRF losses.
 5. Proper operation of the transmitter prior to adding the filter to the measurement chain.
 6. Owing to the highest peak level complies with the lowest limit of unwanted emission out of the restricted bands (Please refer to page 50), so all the test point were deemed to comply with the limits list in the standard.



7-18GHz

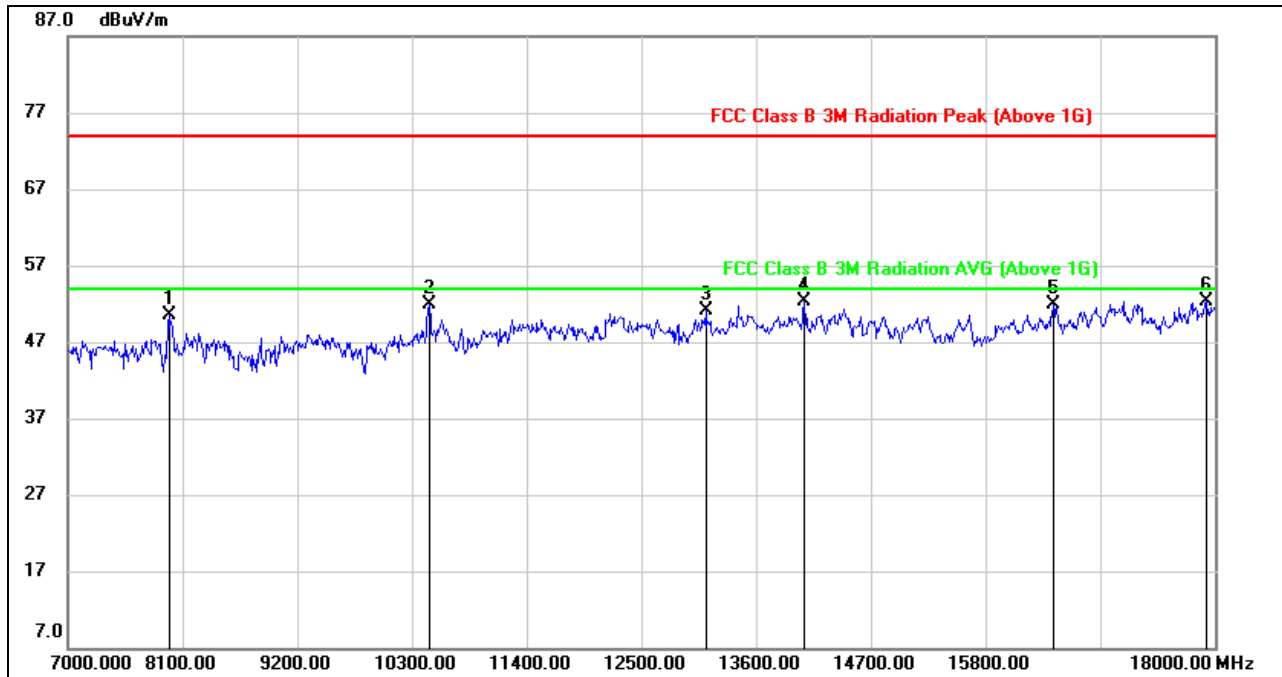

No.	Frequency (MHz)	Reading (dBuV)	Correct (dB/m)	Result (dBuV/m)	Limit (dBuV/m)	Margin (dB)	Remark
1	7968.000	41.88	8.72	50.60	74.00	-23.40	peak
2	10465.000	39.99	11.97	51.96	74.00	-22.04	peak
3	13116.000	35.81	15.32	51.13	74.00	-22.87	peak
4	14062.000	35.72	16.50	52.22	74.00	-21.78	peak
5	16449.000	32.93	18.97	51.90	74.00	-22.10	peak
6	17923.000	29.11	23.14	52.25	74.00	-21.75	peak

Note: 1. Measurement = Reading Level + Correct Factor.
 2. If Peak Result complies with AV limit, AV Result is deemed to comply with AV limit.
 3. Peak: Peak detector.
 4. The High Pass filter loss factor already add into the correct factor.
 5. Proper operation of the transmitter prior to adding the filter to the measurement chain.
 6. Owing to the highest peak level complies with the lowest limit of unwanted emission out of the restricted bands (Please refer to page 50), so all the test point were deemed to comply with the limits list in the standard.



8.3.2. UNII-3 BAND

RESTRICTED BANDEDGE LOW CHANNEL

HORIZONTAL RESULTS

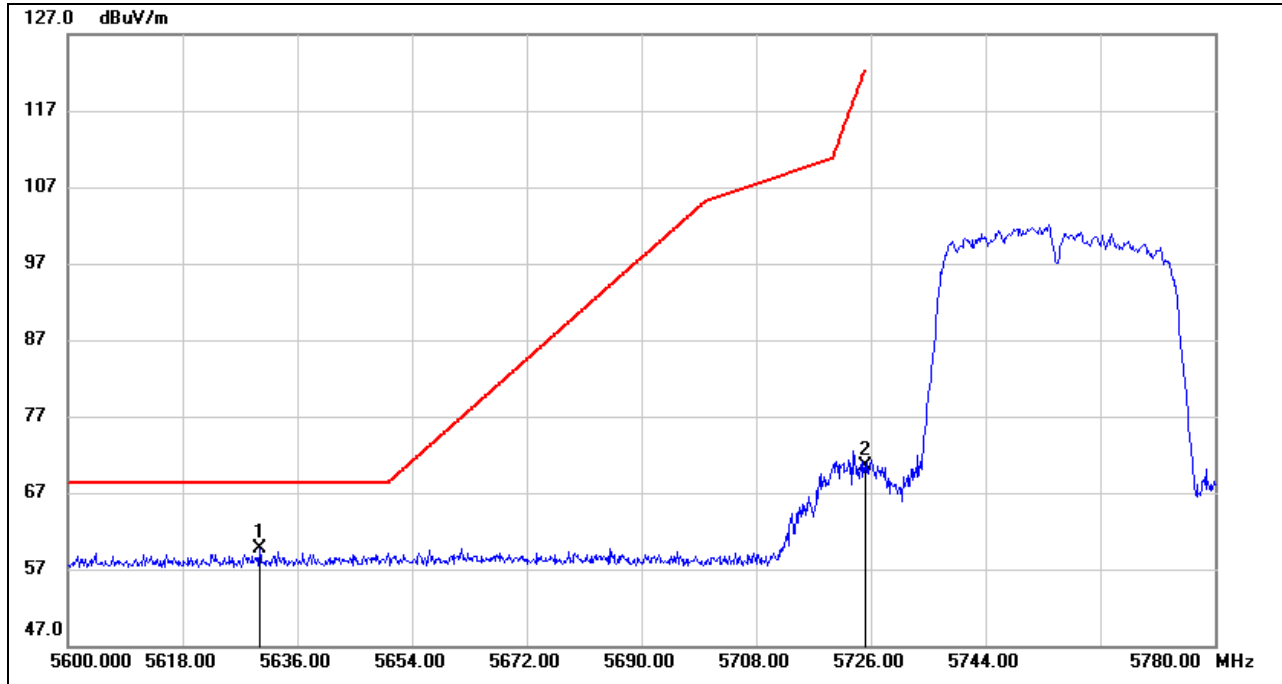

No.	Frequency (MHz)	Reading (dBuV)	Correct (dB/m)	Result (dBuV/m)	Limit (dBuV/m)	Margin (dB)	Remark
1	5630.060	18.15	41.48	59.63	68.20	-8.57	peak
2	5725.000	28.89	41.61	70.50	122.20	-51.70	peak

Note: 1. Measurement = Reading Level + Correct Factor.



VERTICAL RESULTS

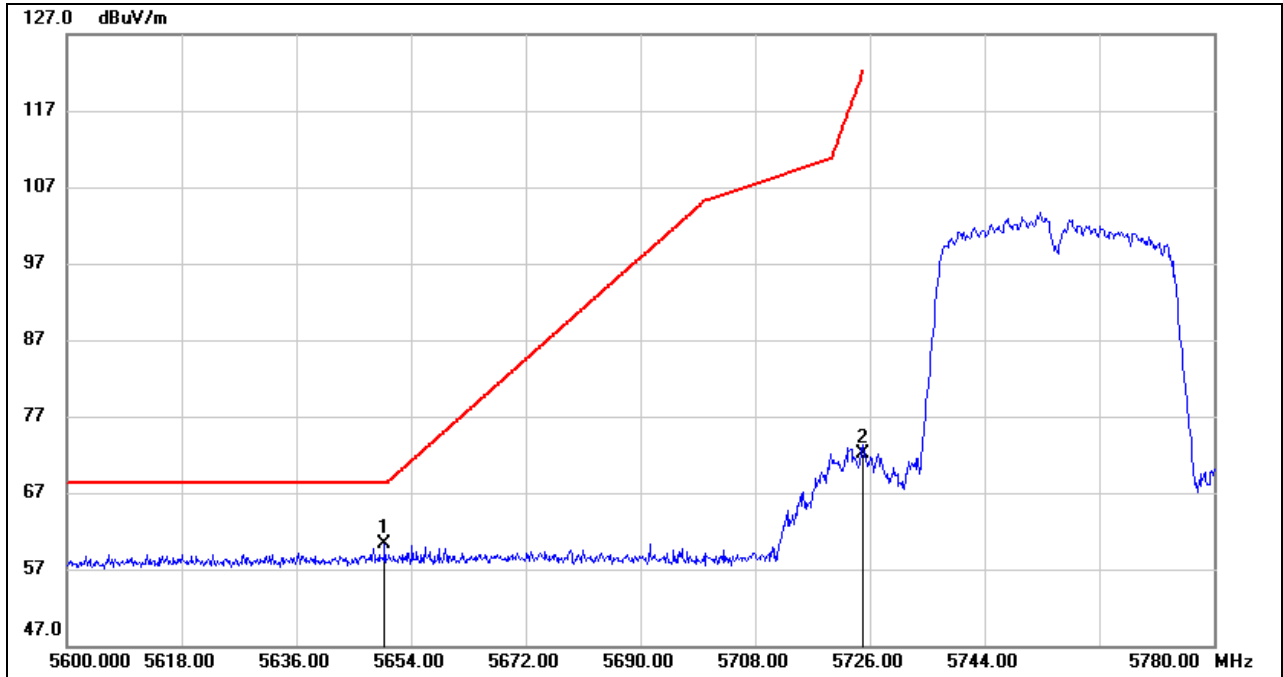

No.	Frequency (MHz)	Reading (dBuV)	Correct (dB/m)	Result (dBuV/m)	Limit (dBuV/m)	Margin (dB)	Remark
1	5649.860	18.88	41.48	60.36	68.20	-7.84	peak
2	5725.000	30.40	41.61	72.01	122.20	-50.19	peak

Note: 1. Measurement = Reading Level + Correct Factor.



RESTRICTED BANDEGE HIGH CHANNEL

HORIZONTAL RESULTS

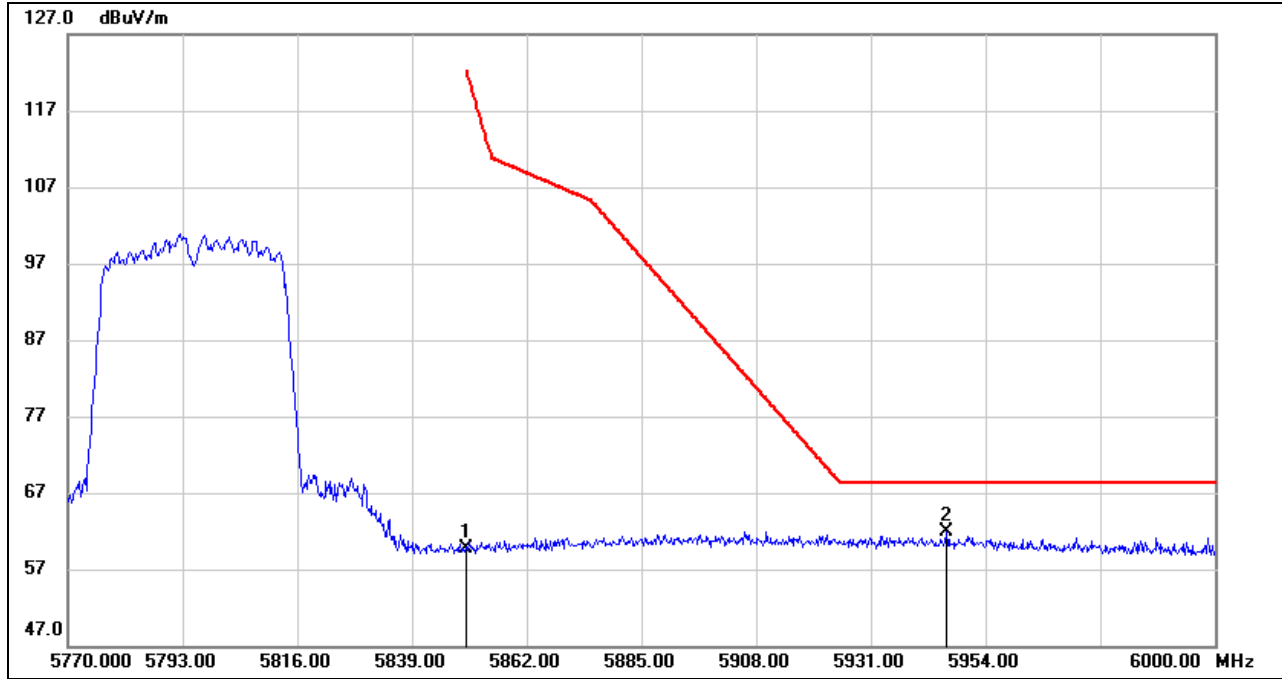

No.	Frequency (MHz)	Reading (dBuV)	Correct (dB/m)	Result (dBuV/m)	Limit (dBuV/m)	Margin (dB)	Remark
1	5850.000	16.85	42.89	59.74	122.20	-62.46	peak
2	5946.180	18.81	43.06	61.87	68.20	-6.33	peak

Note: 1. Measurement = Reading Level + Correct Factor.



VERTICAL RESULTS

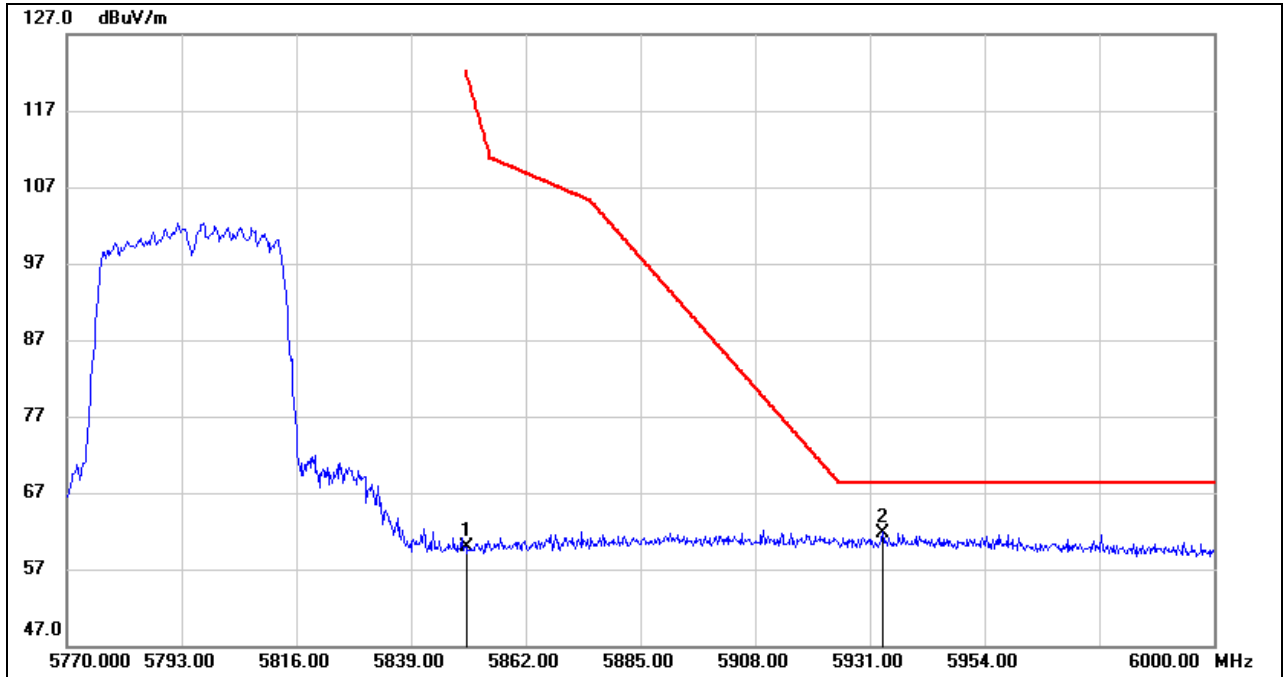

No.	Frequency (MHz)	Reading (dBuV)	Correct (dB/m)	Result (dBuV/m)	Limit (dBuV/m)	Margin (dB)	Remark
1	5850.000	17.10	42.89	59.99	122.20	-62.21	peak
2	5933.530	18.52	43.28	61.80	68.20	-6.40	peak

Note: 1. Measurement = Reading Level + Correct Factor.



HARMONICS AND SPURIOUS EMISSIONS LOW CHANNEL

HORIZONTAL RESULTS
1-7GHz

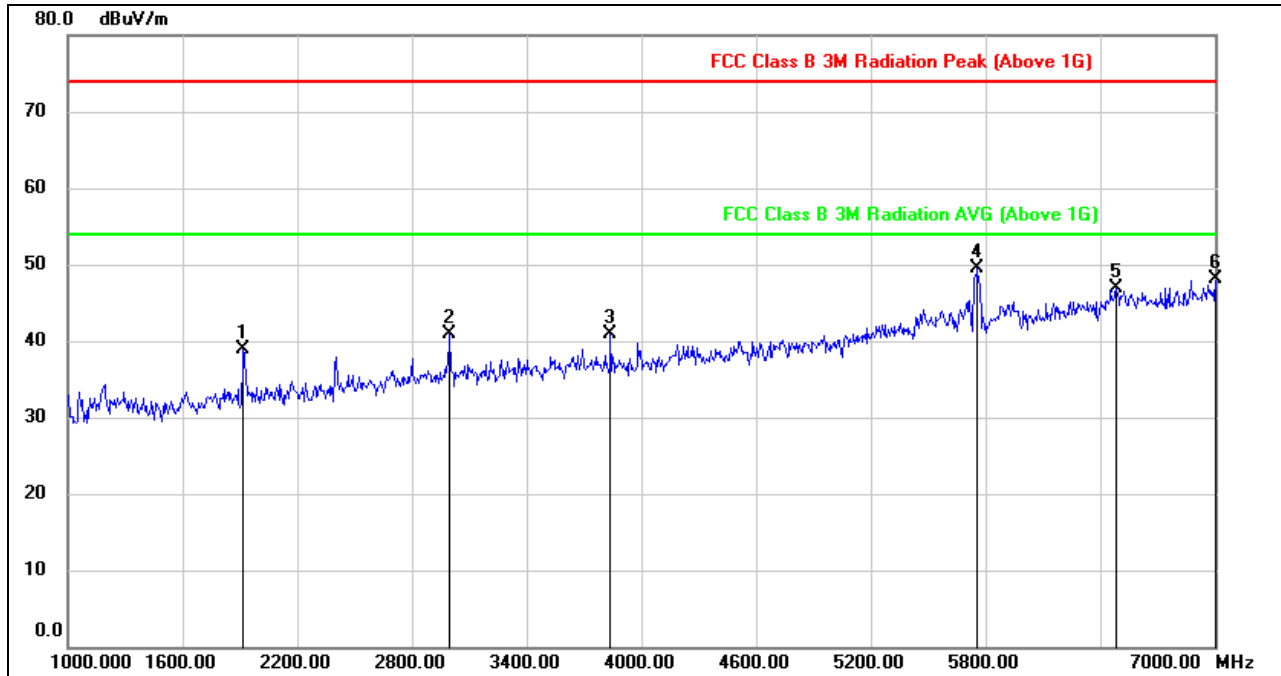

No.	Frequency (MHz)	Reading (dBuV)	Correct (dB/m)	Result (dBuV/m)	Limit (dBuV/m)	Margin (dB)	Remark
1	1918.000	49.76	-10.83	38.93	74.00	-35.07	peak
2	2998.000	47.14	-6.27	40.87	74.00	-33.13	peak
3	3838.000	45.10	-4.20	40.90	74.00	-33.10	peak
4	5758.000	46.91	2.62	49.53	74.00	-24.47	peak
5	6484.000	41.16	5.67	46.83	74.00	-27.17	peak
6	7000.000	41.64	6.42	48.06	74.00	-25.94	peak

Note: 1. Measurement = Reading Level + Correct Factor.
 2. If Peak Result complies with AV limit, AV Result is deemed to comply with AV limit.
 3. Peak: Peak detector.
 4. Filter losses were only considered in then spurious frequency bands and the authorized band was not corrected for BRF losses.
 5. Proper operation of the transmitter prior to adding the filter to the measurement chain.
 6. Owing to the highest peak level complies with the lowest limit of unwanted emission out of the restricted bands (Please refer to page 50), so all the test point were deemed to comply with the limits list in the standard.



HORIZONTAL RESULTS
7-18GHz

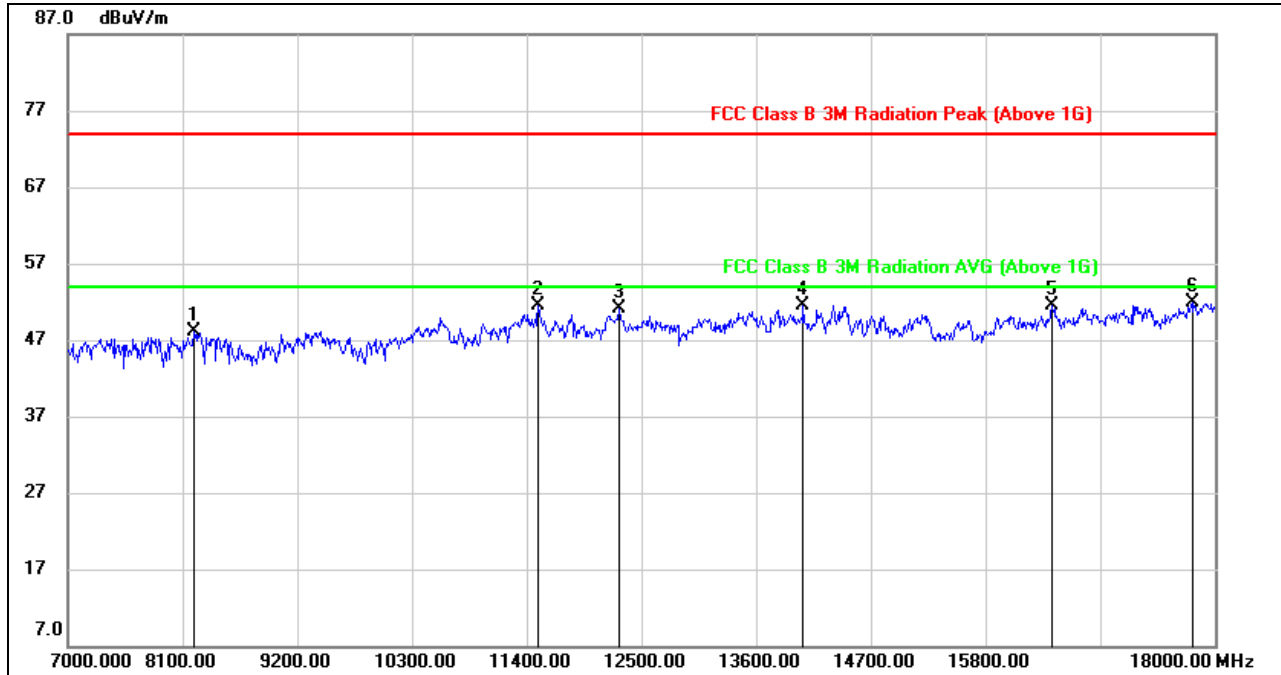

No.	Frequency (MHz)	Reading (dBuV)	Correct (dB/m)	Result (dBuV/m)	Limit (dBuV/m)	Margin (dB)	Remark
1	8210.000	38.02	10.11	48.13	74.00	-25.87	peak
2	11510.000	37.08	14.42	51.50	74.00	-22.50	peak
3	12291.000	35.88	15.15	51.03	74.00	-22.97	peak
4	14051.000	35.03	16.50	51.53	74.00	-22.47	peak
5	16438.000	32.58	18.91	51.49	74.00	-22.51	peak
6	17780.000	28.98	23.01	51.99	74.00	-22.01	peak

Note: 1. Measurement = Reading Level + Correct Factor.
 2. If Peak Result complies with AV limit, AV Result is deemed to comply with AV limit.
 3. Peak: Peak detector.
 4. The High Pass filter loss factor already add into the correct factor.
 5. Proper operation of the transmitter prior to adding the filter to the measurement chain.
 6. Owing to the highest peak level complies with the lowest limit of unwanted emission out of the restricted bands (Please refer to page 50), so all the test point were deemed to comply with the limits list in the standard.



VERTICAL RESULTS
1-7GHz

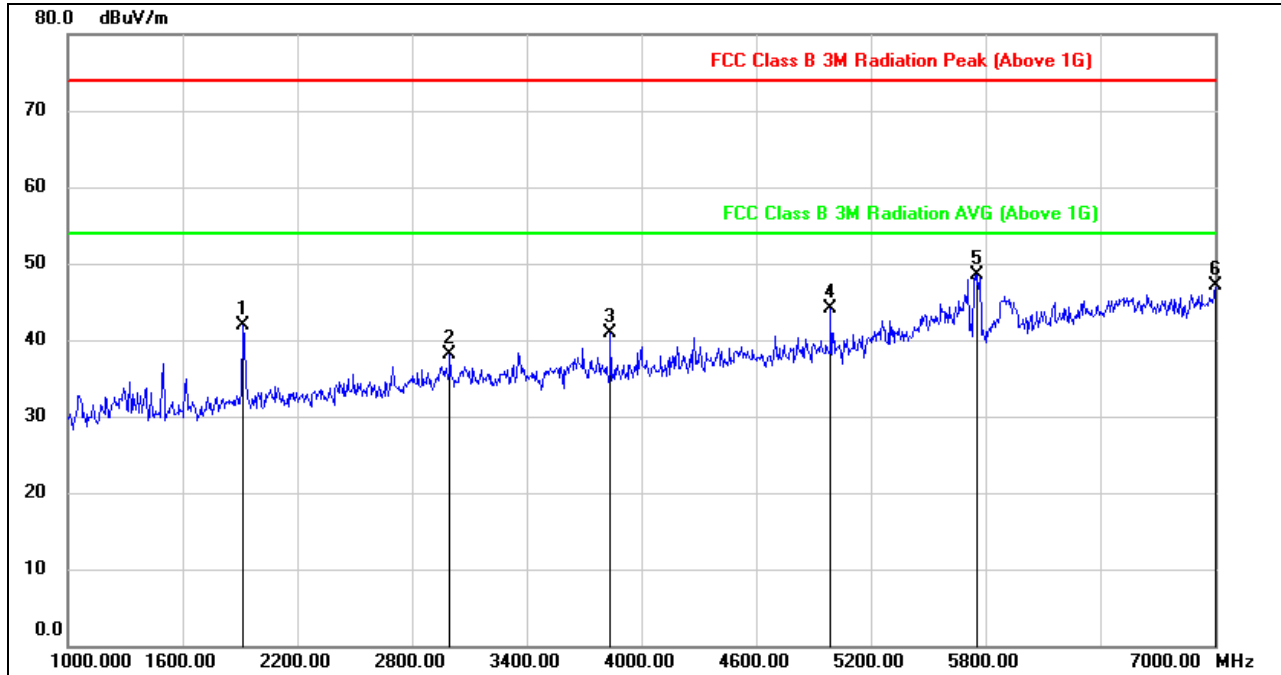

No.	Frequency (MHz)	Reading (dBuV)	Correct (dB/m)	Result (dBuV/m)	Limit (dBuV/m)	Margin (dB)	Remark
1	1918.000	52.65	-10.83	41.82	74.00	-32.18	peak
2	2998.000	44.32	-6.27	38.05	74.00	-35.95	peak
3	3838.000	45.10	-4.20	40.90	74.00	-33.10	peak
4	4990.000	44.19	-0.14	44.05	74.00	-29.95	peak
5	5758.000	45.92	2.62	48.54	74.00	-25.46	peak
6	7000.000	40.64	6.42	47.06	74.00	-26.94	peak

Note: 1. Measurement = Reading Level + Correct Factor.
 2. If Peak Result complies with AV limit, AV Result is deemed to comply with AV limit.
 3. Peak: Peak detector.
 4. Filter losses were only considered in then spurious frequency bands and the authorized band was not corrected for BRF losses.
 5. Proper operation of the transmitter prior to adding the filter to the measurement chain.
 6. Owing to the highest peak level complies with the lowest limit of unwanted emission out of the restricted bands (Please refer to page 50), so all the test point were deemed to comply with the limits list in the standard.



7-18GHz

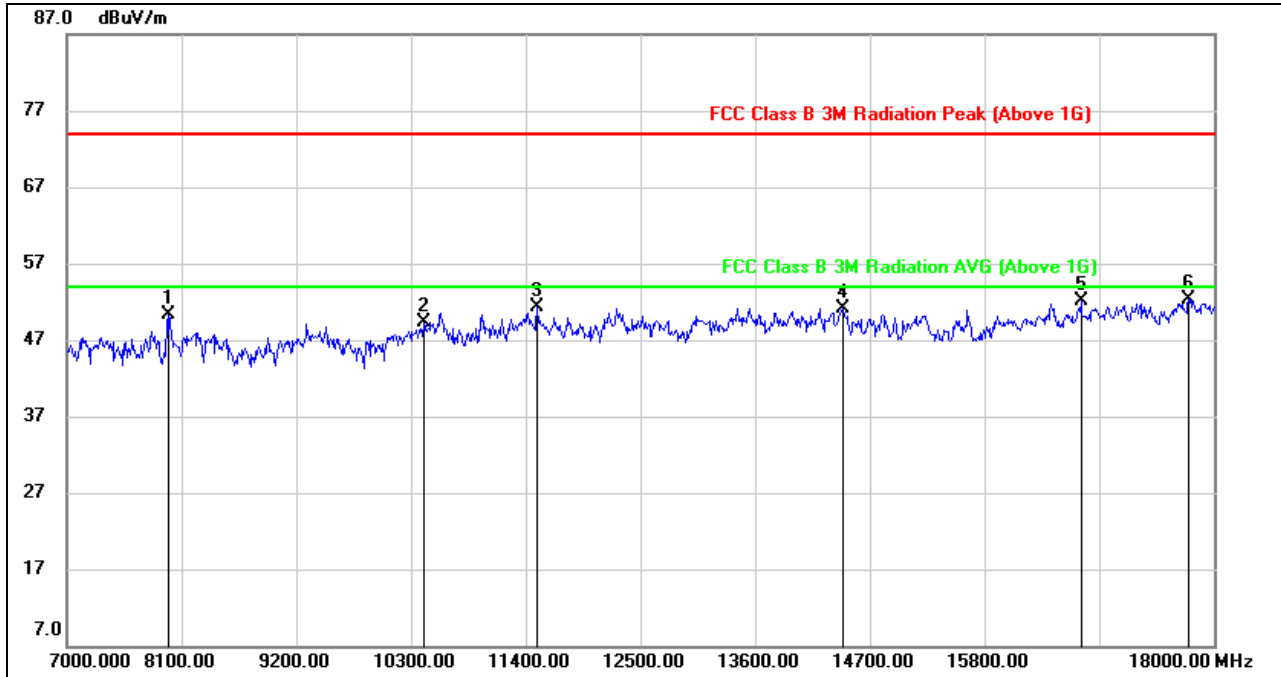

No.	Frequency (MHz)	Reading (dBuV)	Correct (dB/m)	Result (dBuV/m)	Limit (dBuV/m)	Margin (dB)	Remark
1	7968.000	41.55	8.72	50.27	74.00	-23.73	peak
2	10421.000	37.43	11.86	49.29	74.00	-24.71	peak
3	11510.000	36.93	14.42	51.35	74.00	-22.65	peak
4	14436.000	34.56	16.58	51.14	74.00	-22.86	peak
5	16724.000	32.20	19.98	52.18	74.00	-21.82	peak
6	17758.000	29.41	22.82	52.23	74.00	-21.77	peak

Note: 1. Measurement = Reading Level + Correct Factor.
 2. If Peak Result complies with AV limit, AV Result is deemed to comply with AV limit.
 3. Peak: Peak detector.
 4. The High Pass filter loss factor already add into the correct factor.
 5. Proper operation of the transmitter prior to adding the filter to the measurement chain.
 6. Owing to the highest peak level complies with the lowest limit of unwanted emission out of the restricted bands (Please refer to page 50), so all the test point were deemed to comply with the limits list in the standard.



HARMONICS AND SPURIOUS EMISSIONS HIGH CHANNEL

HORIZONTAL RESULTS
1-7GHz

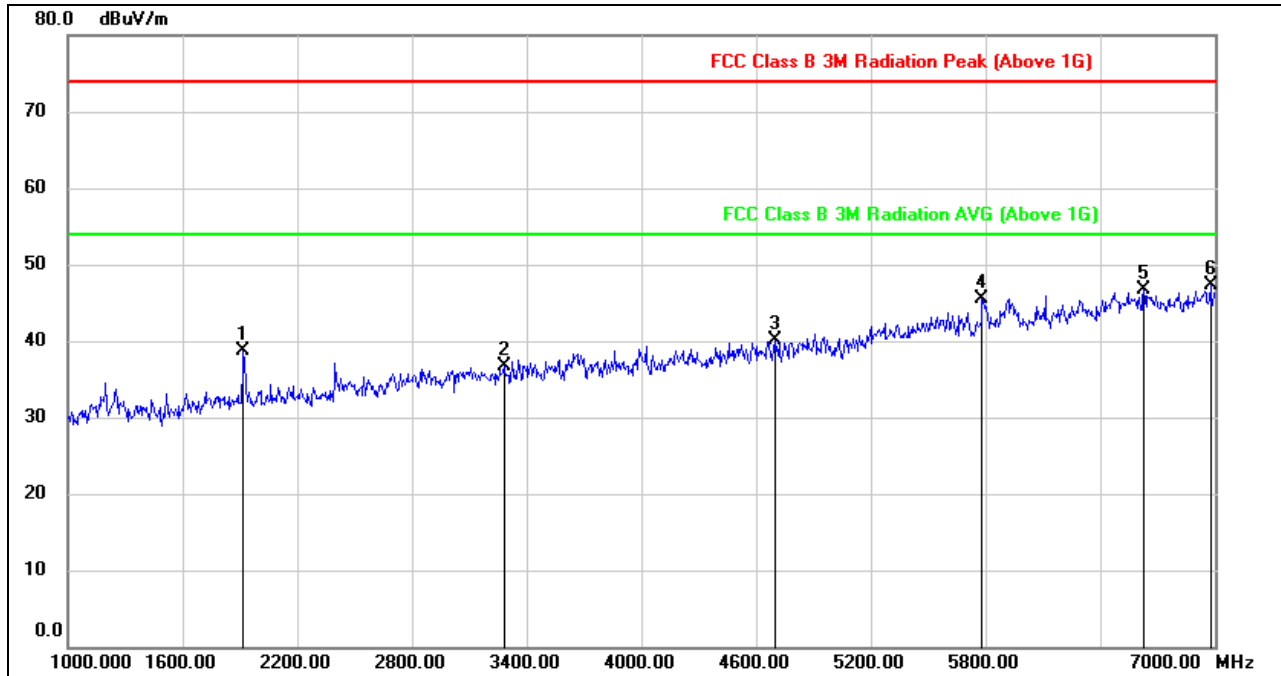

No.	Frequency (MHz)	Reading (dBuV)	Correct (dB/m)	Result (dBuV/m)	Limit (dBuV/m)	Margin (dB)	Remark
1	1918.000	49.45	-10.83	38.62	74.00	-35.38	peak
2	3280.000	42.30	-5.65	36.65	74.00	-37.35	peak
3	4696.000	41.53	-1.39	40.14	74.00	-33.86	peak
4	5782.000	42.75	2.78	45.53	74.00	-28.47	peak
5	6628.000	41.20	5.55	46.75	74.00	-27.25	peak
6	6976.000	40.91	6.39	47.30	74.00	-26.70	peak

Note: 1. Measurement = Reading Level + Correct Factor.
 2. If Peak Result complies with AV limit, AV Result is deemed to comply with AV limit.
 3. Peak: Peak detector.
 4. Filter losses were only considered in then spurious frequency bands and the authorized band was not corrected for BRF losses.
 5. Proper operation of the transmitter prior to adding the filter to the measurement chain.
 6. Owing to the highest peak level complies with the lowest limit of unwanted emission out of the restricted bands (Please refer to page 50), so all the test point were deemed to comply with the limits list in the standard.



HORIZONTAL RESULTS
7-18GHz

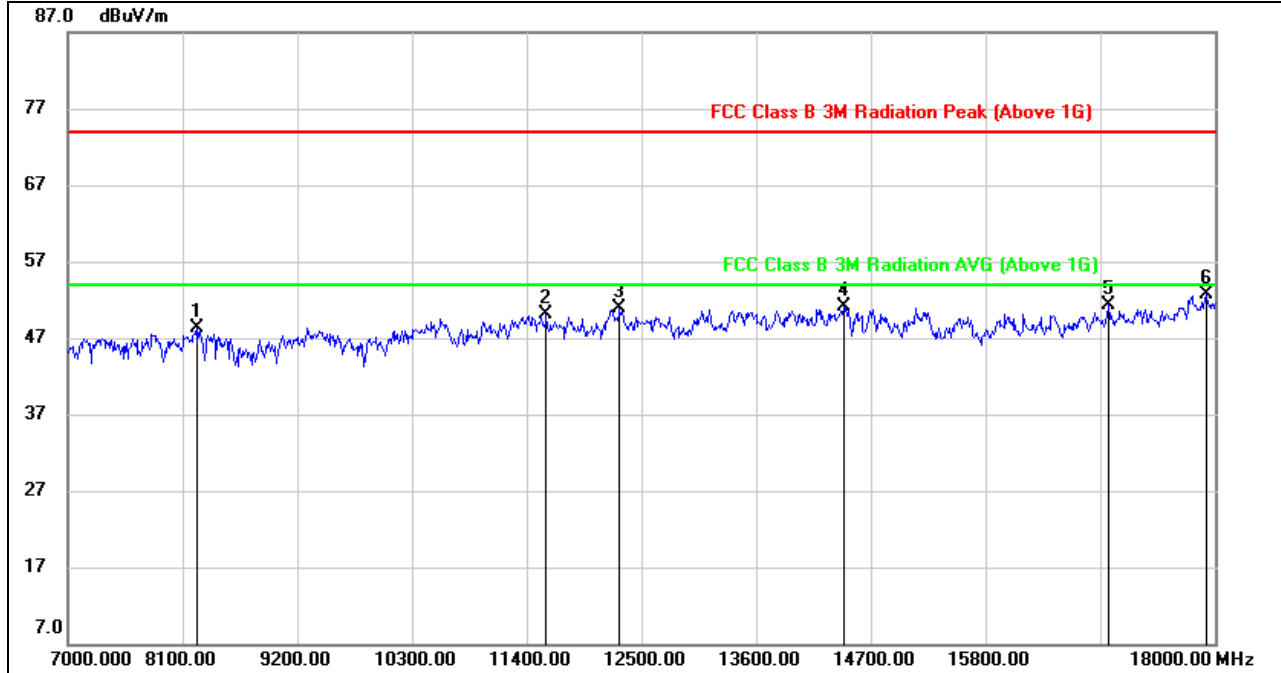

No.	Frequency (MHz)	Reading (dBuV)	Correct (dB/m)	Result (dBuV/m)	Limit (dBuV/m)	Margin (dB)	Remark
1	8232.000	38.47	9.88	48.35	74.00	-25.65	peak
2	11587.000	35.85	14.34	50.19	74.00	-23.81	peak
3	12291.000	35.73	15.15	50.88	74.00	-23.12	peak
4	14447.000	34.55	16.56	51.11	74.00	-22.89	peak
5	16977.000	30.64	20.62	51.26	74.00	-22.74	peak
6	17912.000	29.57	23.14	52.71	74.00	-21.29	peak

Note: 1. Measurement = Reading Level + Correct Factor.
 2. If Peak Result complies with AV limit, AV Result is deemed to comply with AV limit.
 3. Peak: Peak detector.
 4. The High Pass filter loss factor already add into the correct factor.
 5. Proper operation of the transmitter prior to adding the filter to the measurement chain.
 6. Owing to the highest peak level complies with the lowest limit of unwanted emission out of the restricted bands (Please refer to page 50), so all the test point were deemed to comply with the limits list in the standard.



VERTICAL RESULTS
1-7GHz

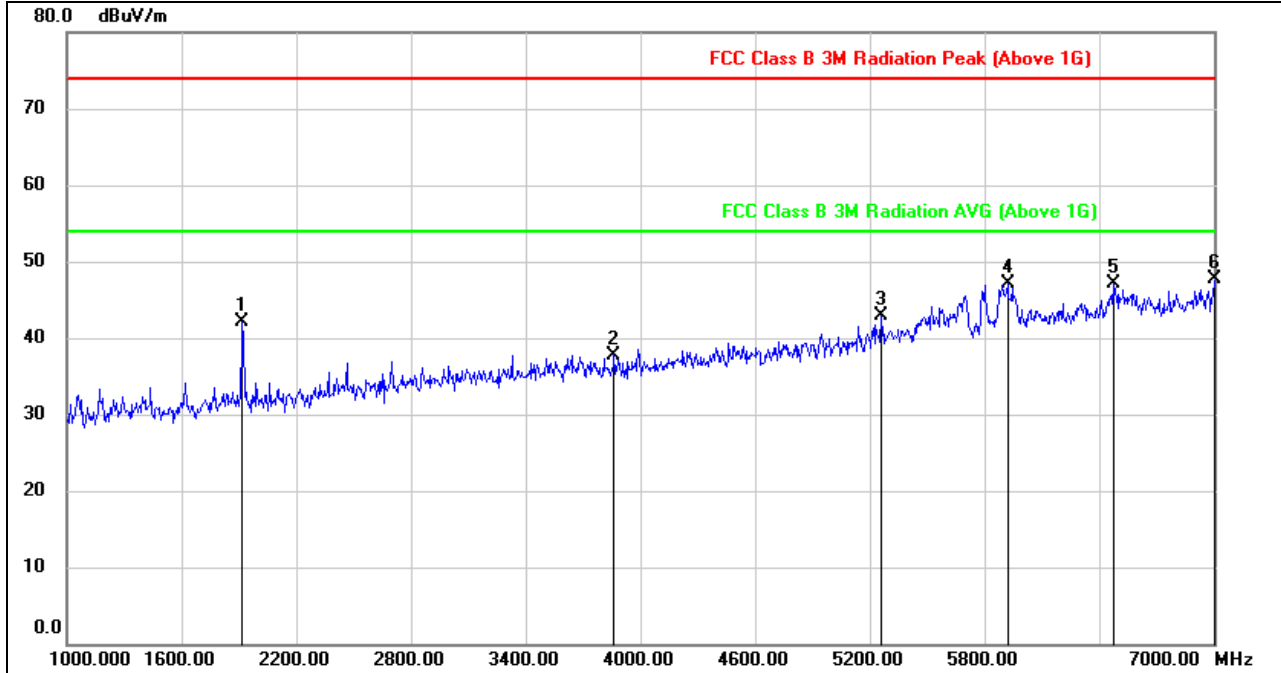

No.	Frequency (MHz)	Reading (dBuV)	Correct (dB/m)	Result (dBuV/m)	Limit (dBuV/m)	Margin (dB)	Remark
1	1918.000	52.94	-10.83	42.11	74.00	-31.89	peak
2	3862.000	42.00	-4.20	37.80	74.00	-36.20	peak
3	5260.000	41.87	0.97	42.84	74.00	-31.16	peak
4	5920.000	42.59	4.55	47.14	74.00	-26.86	peak
5	6472.000	41.63	5.51	47.14	74.00	-26.86	peak
6	7000.000	41.27	6.42	47.69	74.00	-26.31	peak

Note: 1. Measurement = Reading Level + Correct Factor.
 2. If Peak Result complies with AV limit, AV Result is deemed to comply with AV limit.
 3. Peak: Peak detector.
 4. Filter losses were only considered in then spurious frequency bands and the authorized band was not corrected for BRF losses.
 5. Proper operation of the transmitter prior to adding the filter to the measurement chain.
 6. Owing to the highest peak level complies with the lowest limit of unwanted emission out of the restricted bands (Please refer to page 50), so all the test point were deemed to comply with the limits list in the standard.



7-18GHz

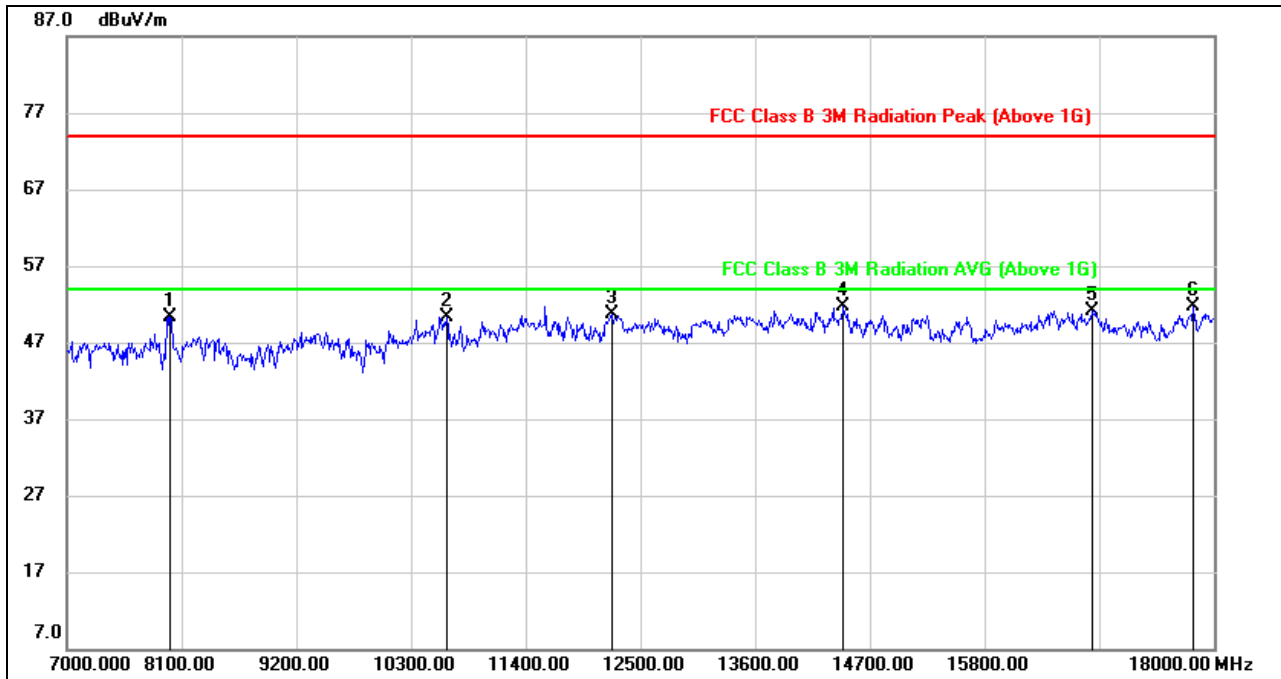

No.	Frequency (MHz)	Reading (dBuV)	Correct (dB/m)	Result (dBuV/m)	Limit (dBuV/m)	Margin (dB)	Remark
1	7990.000	41.71	8.66	50.37	74.00	-23.63	peak
2	10641.000	37.49	12.86	50.35	74.00	-23.65	peak
3	12225.000	35.67	14.99	50.66	74.00	-23.34	peak
4	14447.000	35.11	16.56	51.67	74.00	-22.33	peak
5	16834.000	30.97	20.18	51.15	74.00	-22.85	peak
6	17802.000	28.54	23.19	51.73	74.00	-22.27	peak

Note: 1. Measurement = Reading Level + Correct Factor.
 2. If Peak Result complies with AV limit, AV Result is deemed to comply with AV limit.
 3. Peak: Peak detector.
 4. The High Pass filter loss factor already add into the correct factor.
 5. Proper operation of the transmitter prior to adding the filter to the measurement chain.
 6. Owing to the highest peak level complies with the lowest limit of unwanted emission out of the restricted bands (Please refer to page 50), so all the test point were deemed to comply with the limits list in the standard.



8.4. 802.11ac VHT80 MIMO MODE

MIMO CDD MODE (WORST-CASE CONFIGURATION)

8.4.1. UNII-1 BAND

RESTRICTED BANDEDGE LOW CHANNEL

HORIZONTAL RESULTS
PEAK

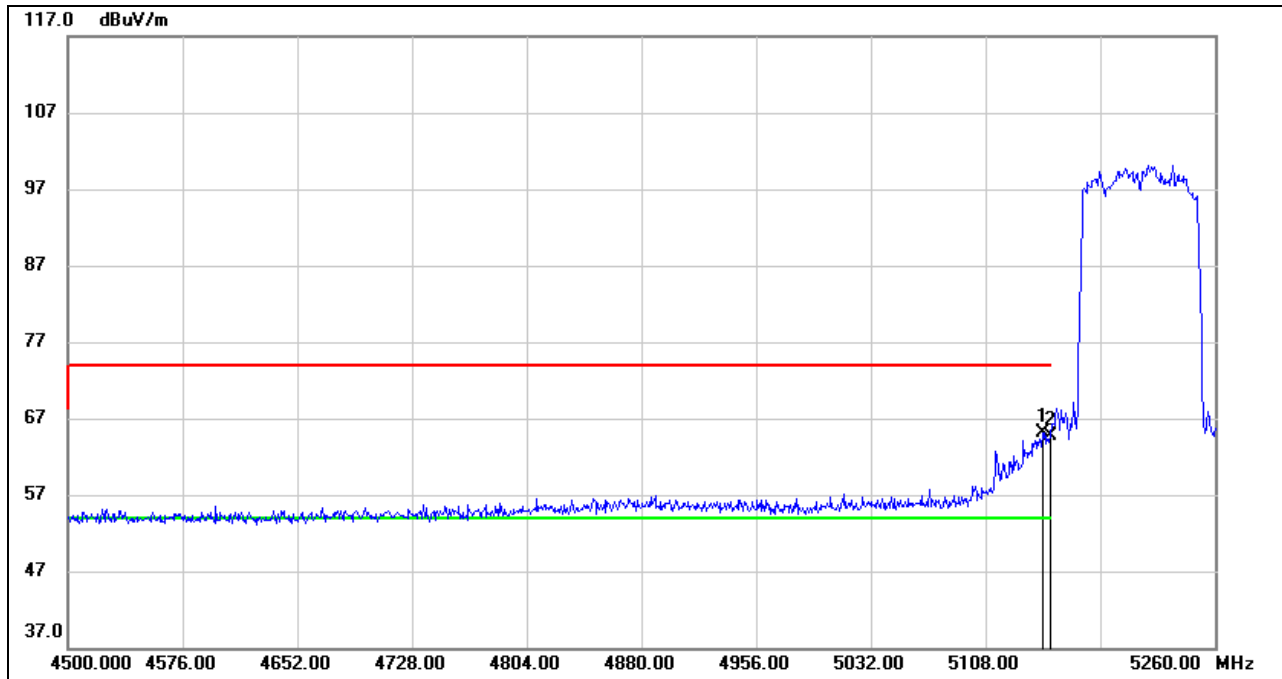

No.	Frequency (MHz)	Reading (dBuV)	Correct (dB/m)	Result (dBuV/m)	Limit (dBuV/m)	Margin (dB)	Remark
1	5146.000	24.64	40.45	65.09	74.00	-8.91	peak
2	5150.000	24.28	40.46	64.74	74.00	-9.26	peak

- Note: 1. Measurement = Reading Level + Correct Factor.
 2. If Peak Result complies with AV limit, AV Result is deemed to comply with AV limit.
 3. Peak: Peak detector.
 4. Only the worst case emission will be recorder, if it complies with the limit, the other emissions deemed to comply with the limit.



AVG

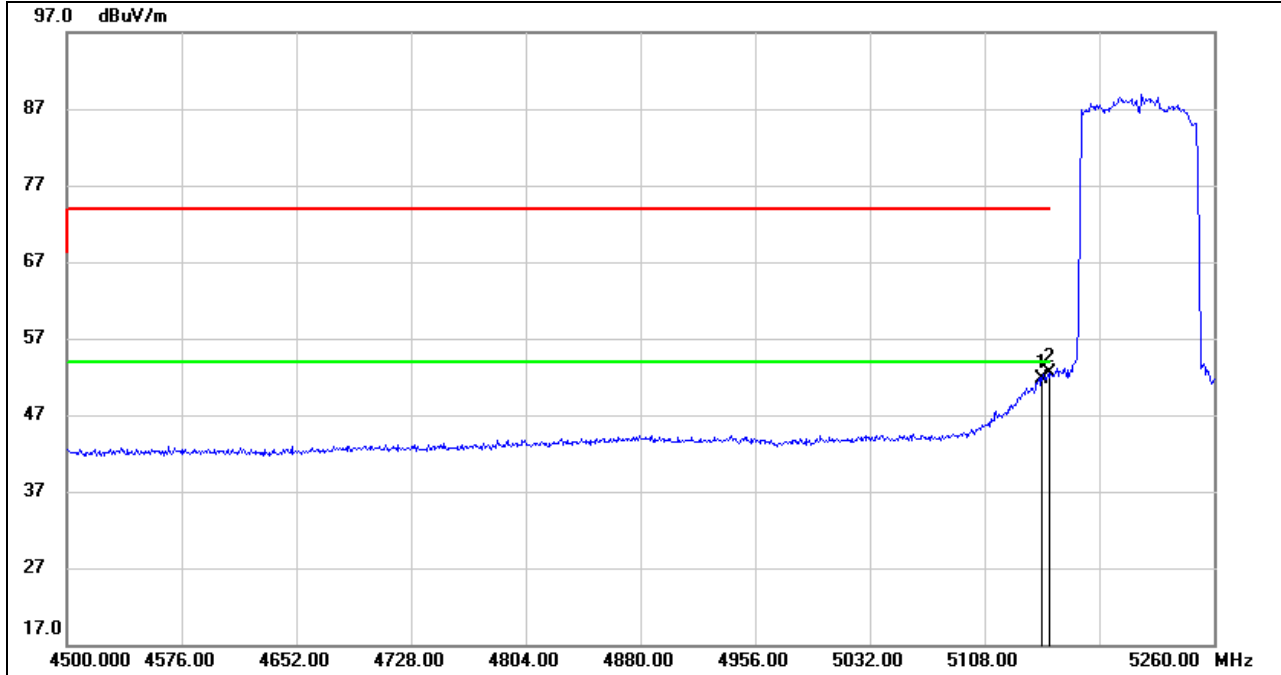

No.	Frequency (MHz)	Reading (dBuV)	Correct (dB/m)	Result (dBuV/m)	Limit (dBuV/m)	Margin (dB)	Remark
1	5146.000	11.22	40.45	51.67	54.00	-2.33	AVG
2	5150.000	12.05	40.46	52.51	54.00	-1.49	AVG

- Note: 1. Measurement = Reading Level + Correct Factor
 2. AVG: VBW=1/Ton where: ton is transmit duration.
 3. For duty cycle, please refer to clause 7.1.
 4. Only the worst case emission will be recorder, if it complies with the limit, the other emissions deemed to comply with the limit.



VERTICAL RESULTS
PEAK

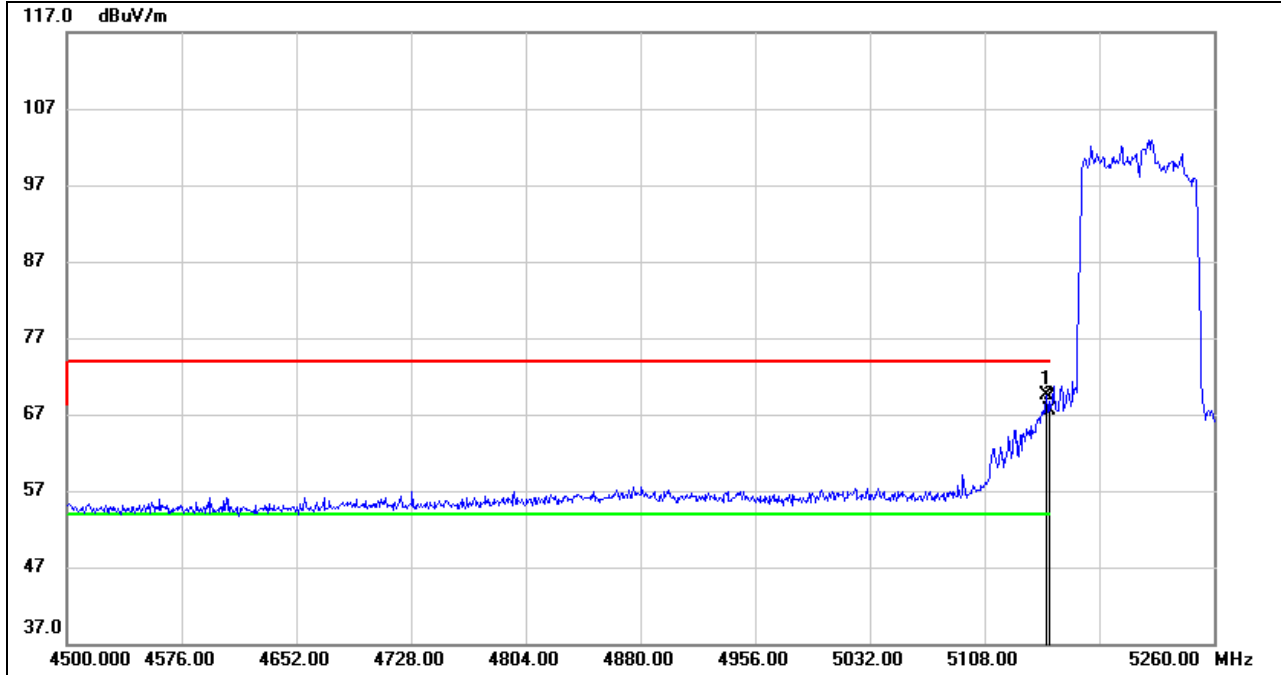

No.	Frequency (MHz)	Reading (dBuV)	Correct (dB/m)	Result (dBuV/m)	Limit (dBuV/m)	Margin (dB)	Remark
1	5149.040	29.08	40.46	69.54	74.00	-4.46	peak
2	5150.000	26.95	40.46	67.41	74.00	-6.59	peak

- Note: 1. Measurement = Reading Level + Correct Factor.
 2. If Peak Result complies with AV limit, AV Result is deemed to comply with AV limit.
 3. Peak: Peak detector.
 4. Only the worst case emission will be recorder, if it complies with the limit, the other emissions deemed to comply with the limit.



AVG

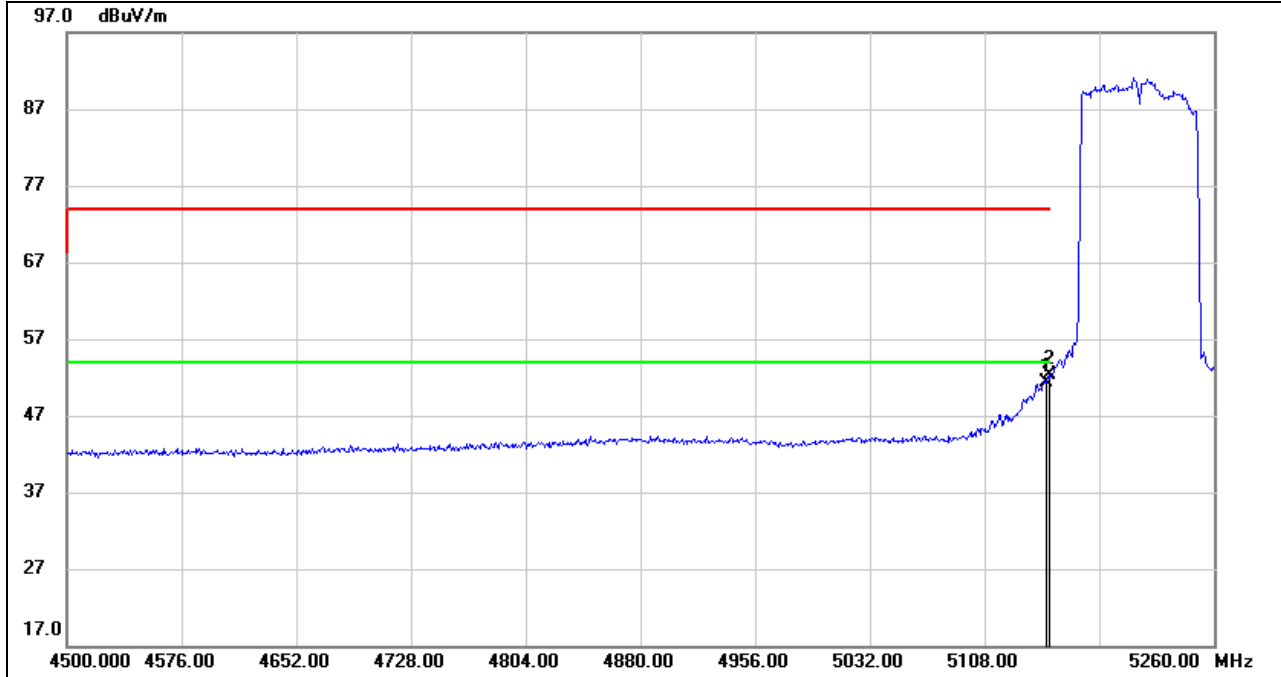

No.	Frequency (MHz)	Reading (dBuV)	Correct (dB/m)	Result (dBuV/m)	Limit (dBuV/m)	Margin (dB)	Remark
1	5149.040	10.82	40.46	51.28	54.00	-2.72	AVG
2	5150.000	11.87	40.46	52.33	54.00	-1.67	AVG

- Note: 1. Measurement = Reading Level + Correct Factor
 2. AVG: VBW=1/Ton where: ton is transmit duration.
 3. For duty cycle, please refer to clause 7.1.
 4. Only the worst case emission will be recorder, if it complies with the limit, the other emissions deemed to comply with the limit.



HARMONICS AND SPURIOUS EMISSIONS LOW CHANNEL

HORIZONTAL RESULTS
1-7GHz

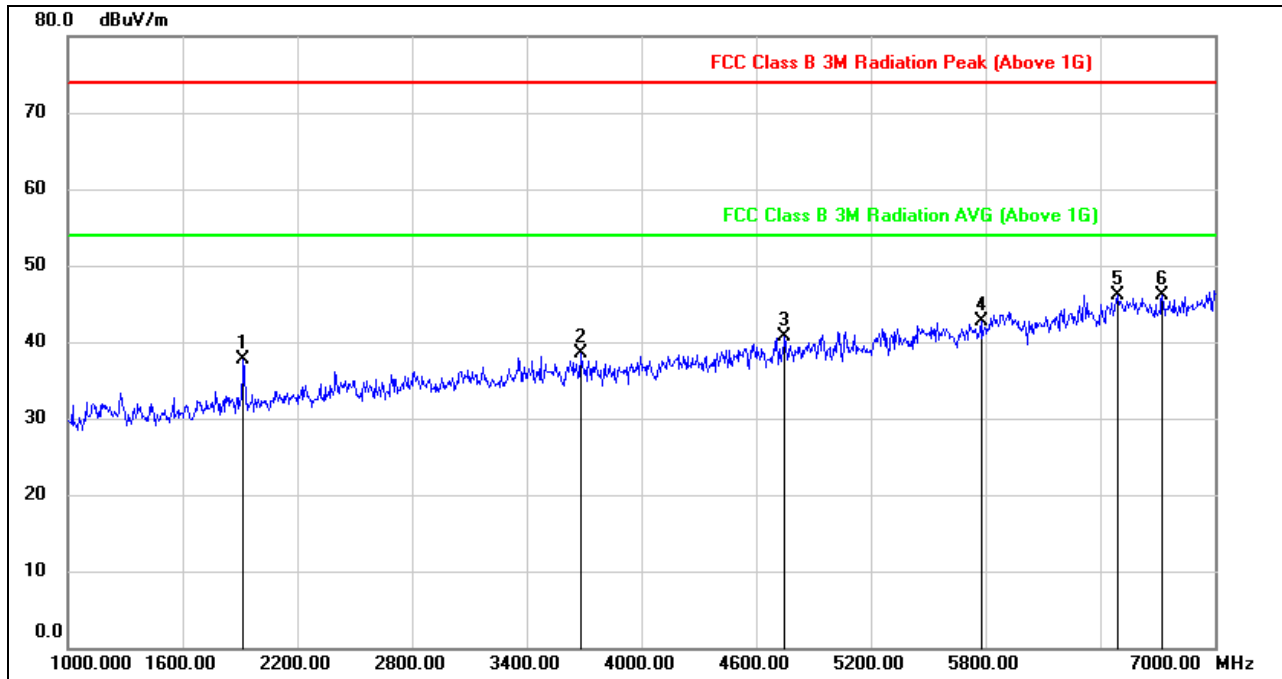

No.	Frequency (MHz)	Reading (dBuV)	Correct (dB/m)	Result (dBuV/m)	Limit (dBuV/m)	Margin (dB)	Remark
1	1918.000	48.44	-10.83	37.61	74.00	-36.39	peak
2	3682.000	42.65	-4.20	38.45	74.00	-35.55	peak
3	4750.000	41.89	-1.15	40.74	74.00	-33.26	peak
4	5776.000	40.02	2.74	42.76	74.00	-31.24	peak
5	6490.000	40.30	5.75	46.05	74.00	-27.95	peak
6	6724.000	40.52	5.59	46.11	74.00	-27.89	peak

- Note: 1. Measurement = Reading Level + Correct Factor.
 2. If Peak Result complies with AV limit, AV Result is deemed to comply with AV limit.
 3. Peak: Peak detector.
 4. Filter losses were only considered in then spurious frequency bands and the authorized band was not corrected for BRF losses.
 5. Proper operation of the transmitter prior to adding the filter to the measurement chain.
 6. Owing to the highest peak level complies with the lowest limit of unwanted emission out of the restricted bands (Please refer to page 50), so all the test point were deemed to comply with the limits list in the standard.



HORIZONTAL RESULTS
7-18GHz

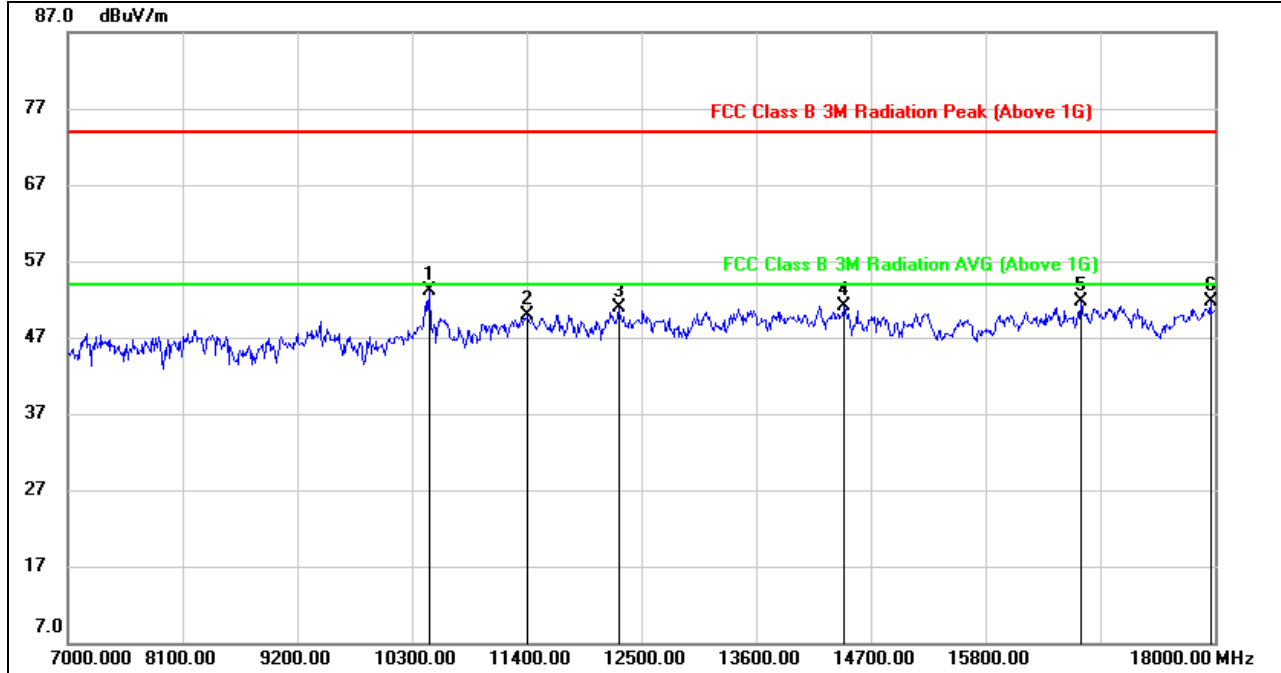

No.	Frequency (MHz)	Reading (dBuV)	Correct (dB/m)	Result (dBuV/m)	Limit (dBuV/m)	Margin (dB)	Remark
1	10465.000	41.09	11.97	53.06	74.00	-20.94	peak
2	11411.000	36.16	13.81	49.97	74.00	-24.03	peak
3	12280.000	35.78	15.12	50.90	74.00	-23.10	peak
4	14447.000	34.61	16.56	51.17	74.00	-22.83	peak
5	16713.000	31.67	19.95	51.62	74.00	-22.38	peak
6	17956.000	28.65	23.15	51.80	74.00	-22.20	peak

Note: 1. Measurement = Reading Level + Correct Factor.
 2. If Peak Result complies with AV limit, AV Result is deemed to comply with AV limit.
 3. Peak: Peak detector.
 4. The High Pass filter loss factor already add into the correct factor.
 5. Proper operation of the transmitter prior to adding the filter to the measurement chain.
 6. Owing to the highest peak level complies with the lowest limit of unwanted emission out of the restricted bands (Please refer to page 50), so all the test point were deemed to comply with the limits list in the standard.



VERTICAL RESULTS
1-7GHz

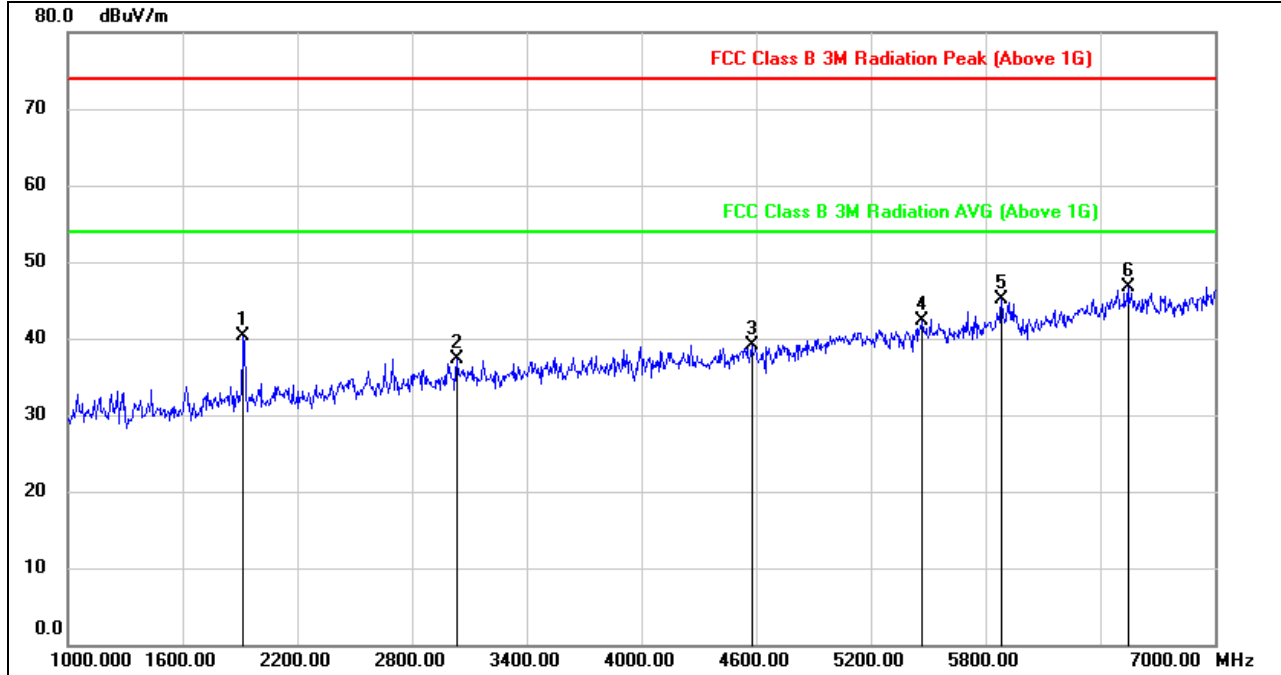

No.	Frequency (MHz)	Reading (dBuV)	Correct (dB/m)	Result (dBuV/m)	Limit (dBuV/m)	Margin (dB)	Remark
1	1918.000	51.15	-10.83	40.32	74.00	-33.68	peak
2	3034.000	43.41	-6.05	37.36	74.00	-36.64	peak
3	4576.000	41.14	-2.04	39.10	74.00	-34.90	peak
4	5470.000	40.46	1.88	42.34	74.00	-31.66	peak
5	5884.000	40.55	4.55	45.10	74.00	-28.90	peak
6	6544.000	41.02	5.73	46.75	74.00	-27.25	peak

Note: 1. Measurement = Reading Level + Correct Factor.
 2. If Peak Result complies with AV limit, AV Result is deemed to comply with AV limit.
 3. Peak: Peak detector.
 4. Filter losses were only considered in then spurious frequency bands and the authorized band was not corrected for BRF losses.
 5. Proper operation of the transmitter prior to adding the filter to the measurement chain.
 6. Owing to the highest peak level complies with the lowest limit of unwanted emission out of the restricted bands (Please refer to page 50), so all the test point were deemed to comply with the limits list in the standard.



7-18GHz

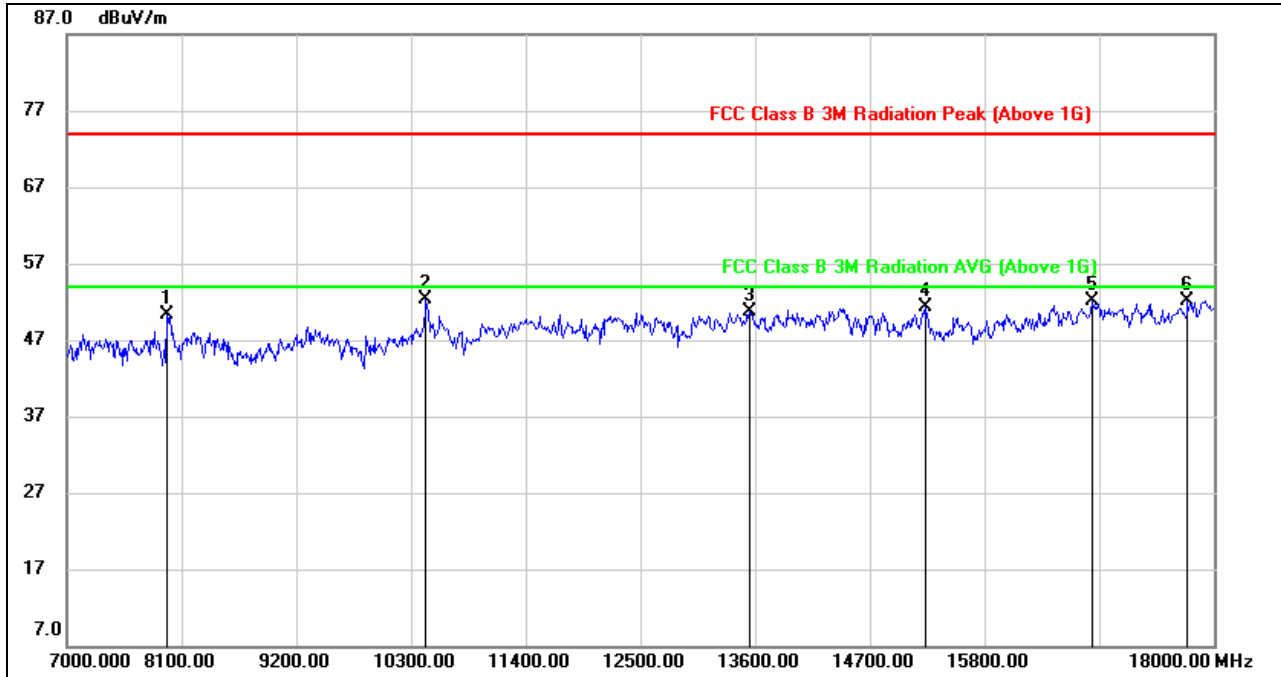

No.	Frequency (MHz)	Reading (dBuV)	Correct (dB/m)	Result (dBuV/m)	Limit (dBuV/m)	Margin (dB)	Remark
1	7957.000	41.51	8.73	50.24	74.00	-23.76	peak
2	10443.000	40.31	11.92	52.23	74.00	-21.77	peak
3	13545.000	34.59	16.06	50.65	74.00	-23.35	peak
4	15239.000	35.60	15.75	51.35	74.00	-22.65	peak
5	16834.000	32.02	20.18	52.20	74.00	-21.80	peak
6	17747.000	29.39	22.71	52.10	74.00	-21.90	peak

Note: 1. Measurement = Reading Level + Correct Factor.
 2. If Peak Result complies with AV limit, AV Result is deemed to comply with AV limit.
 3. Peak: Peak detector.
 4. The High Pass filter loss factor already add into the correct factor.
 5. Proper operation of the transmitter prior to adding the filter to the measurement chain.
 6. Owing to the highest peak level complies with the lowest limit of unwanted emission out of the restricted bands (Please refer to page 50), so all the test point were deemed to comply with the limits list in the standard.



8.4.2. UNII-3 BAND

RESTRICTED BANDEDGE MID CHANNEL

HORIZONTAL RESULTS

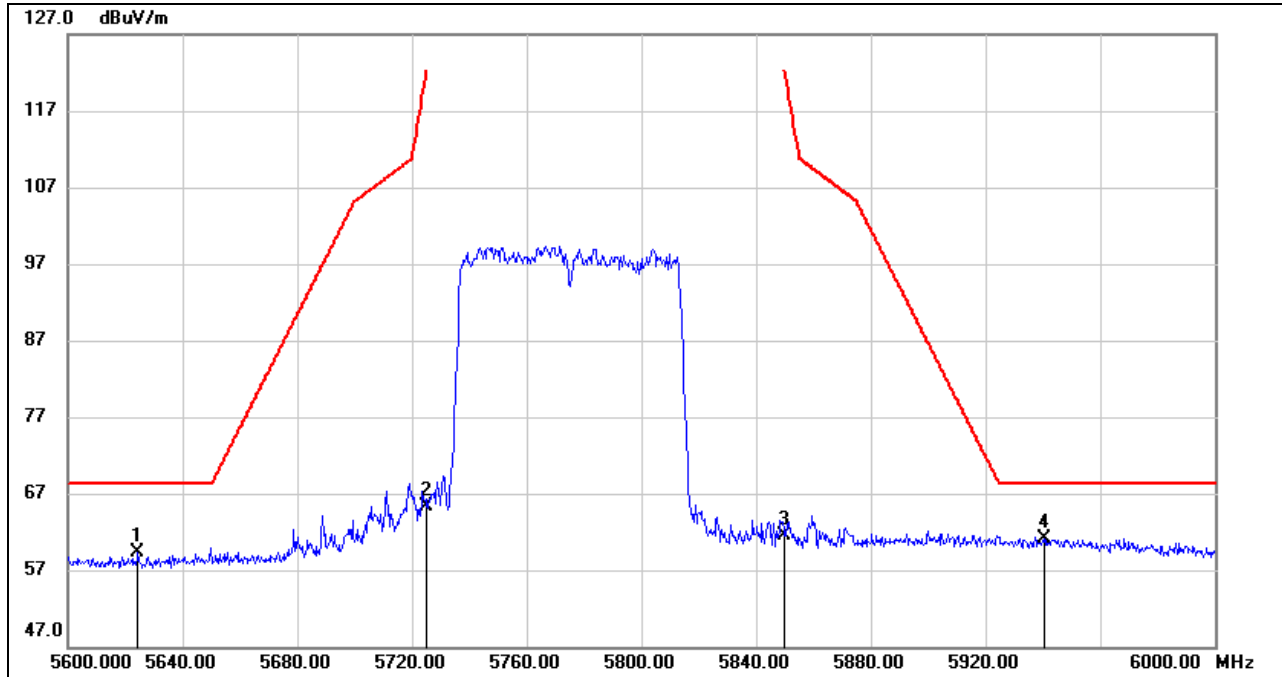

No.	Frequency (MHz)	Reading (dBuV)	Correct (dB/m)	Result (dBuV/m)	Limit (dBuV/m)	Margin (dB)	Remark
1	5624.400	17.73	41.47	59.20	68.20	-9.00	peak
2	5725.000	23.66	41.61	65.27	122.20	-56.93	peak
3	5850.000	18.66	42.89	61.55	122.20	-60.65	peak
4	5940.400	17.88	43.16	61.04	68.20	-7.16	peak

Note: 1. Measurement = Reading Level + Correct Factor.

2. Only the worst case emission will be recorder, if it complies with the limit, the other emissions deemed to comply with the limit.



VERTICAL RESULTS

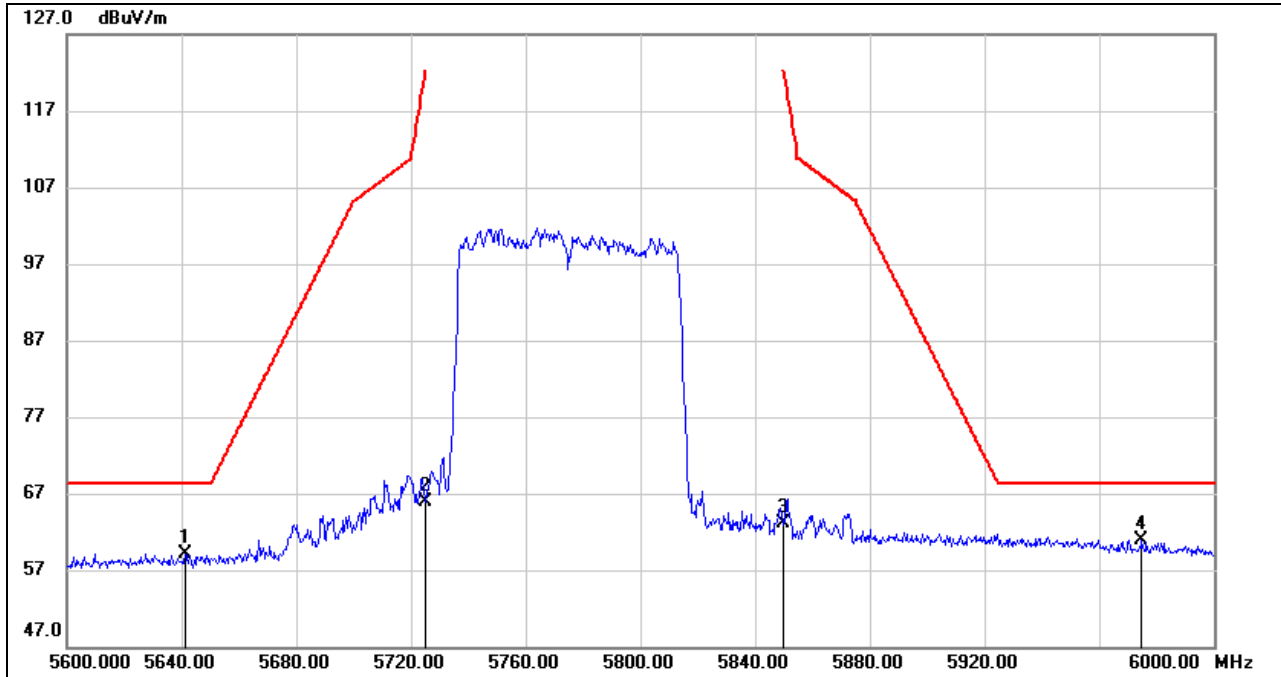

No.	Frequency (MHz)	Reading (dBuV)	Correct (dB/m)	Result (dBuV/m)	Limit (dBuV/m)	Margin (dB)	Remark
1	5641.200	17.60	41.48	59.08	68.20	-9.12	peak
2	5725.000	24.20	41.61	65.81	122.20	-56.39	peak
3	5850.000	20.16	42.89	63.05	122.20	-59.15	peak
4	5974.800	18.38	42.57	60.95	68.20	-7.25	peak

Note: 1. Measurement = Reading Level + Correct Factor.

2. Only the worst case emission will be recorder, if it complies with the limit, the other emissions deemed to comply with the limit.



HARMONICS AND SPURIOUS EMISSIONS MID CHANNEL

HORIZONTAL RESULTS
1-7GHz

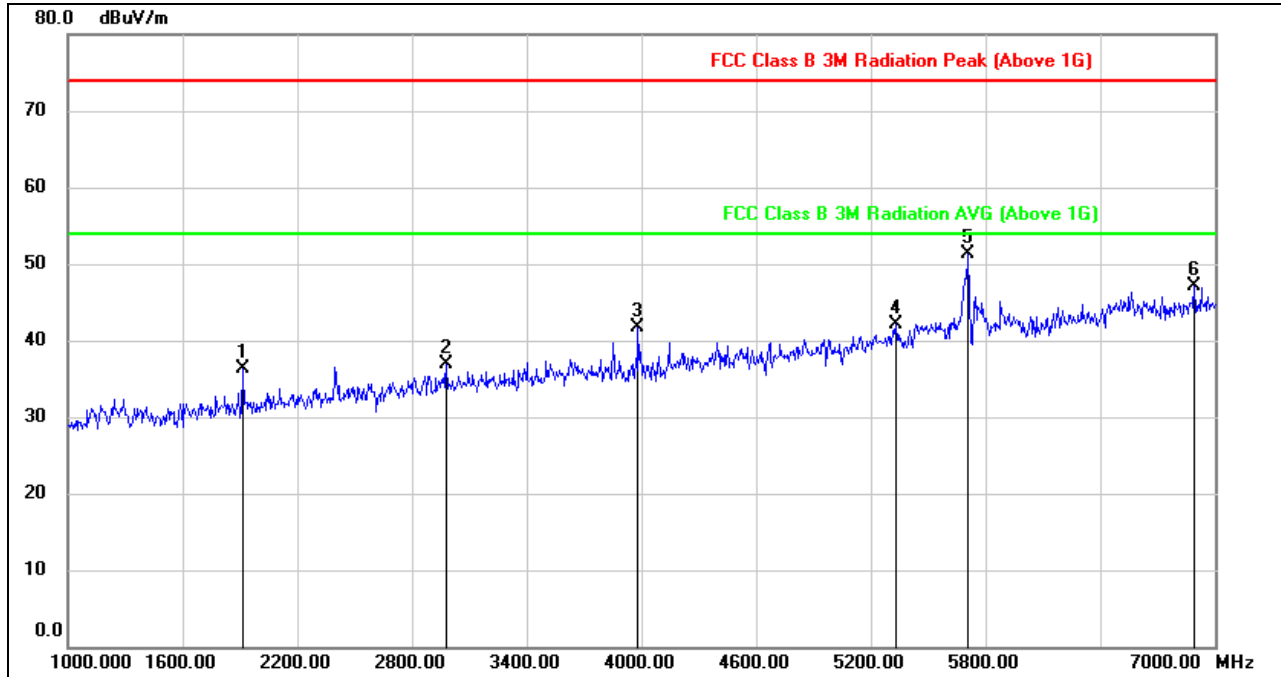

No.	Frequency (MHz)	Reading (dBuV)	Correct (dB/m)	Result (dBuV/m)	Limit (dBuV/m)	Margin (dB)	Remark
1	1912.000	47.12	-10.83	36.29	74.00	-37.71	peak
2	2980.000	43.17	-6.35	36.82	74.00	-37.18	peak
3	3982.000	45.84	-4.10	41.74	74.00	-32.26	peak
4	5332.000	41.10	0.98	42.08	74.00	-31.92	peak
5	5710.000	48.95	2.28	51.23	74.00	-22.77	peak
6	6892.000	40.78	6.24	47.02	74.00	-26.98	peak

Note: 1. Measurement = Reading Level + Correct Factor.
 2. If Peak Result complies with AV limit, AV Result is deemed to comply with AV limit.
 3. Peak: Peak detector.
 4. Filter losses were only considered in then spurious frequency bands and the authorized band was not corrected for BRF losses.
 5. Proper operation of the transmitter prior to adding the filter to the measurement chain.
 6. Owing to the highest peak level complies with the lowest limit of unwanted emission out of the restricted bands (Please refer to page 50), so all the test point were deemed to comply with the limits list in the standard.



HORIZONTAL RESULTS
7-18GHz

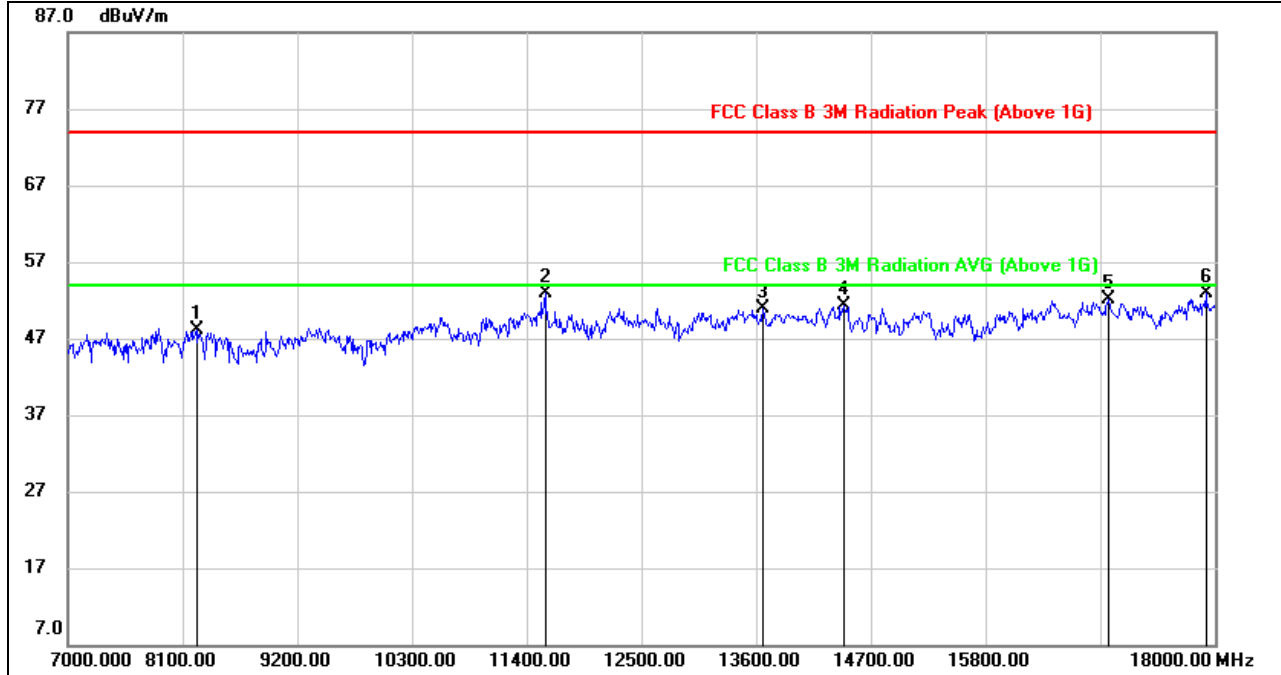

No.	Frequency (MHz)	Reading (dBuV)	Correct (dB/m)	Result (dBuV/m)	Limit (dBuV/m)	Margin (dB)	Remark
1	8232.000	38.25	9.88	48.13	74.00	-25.87	peak
2	11576.000	38.55	14.36	52.91	74.00	-21.09	peak
3	13666.000	34.77	16.16	50.93	74.00	-23.07	peak
4	14436.000	34.81	16.58	51.39	74.00	-22.61	peak
5	16977.000	31.57	20.62	52.19	74.00	-21.81	peak
6	17912.000	29.73	23.14	52.87	74.00	-21.13	peak

Note: 1. Measurement = Reading Level + Correct Factor.
 2. If Peak Result complies with AV limit, AV Result is deemed to comply with AV limit.
 3. Peak: Peak detector.
 4. The High Pass filter loss factor already add into the correct factor.
 5. Proper operation of the transmitter prior to adding the filter to the measurement chain.
 6. Owing to the highest peak level complies with the lowest limit of unwanted emission out of the restricted bands (Please refer to page 50), so all the test point were deemed to comply with the limits list in the standard.



VERTICAL RESULTS
1-7GHz

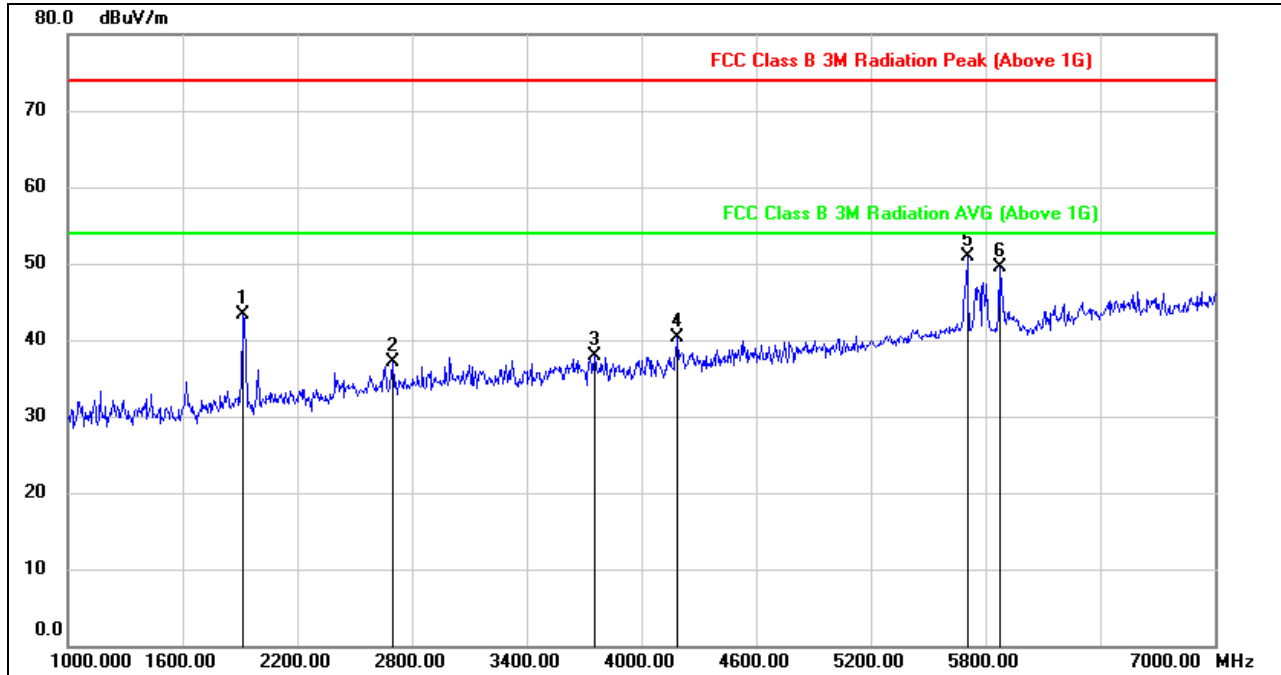

No.	Frequency (MHz)	Reading (dBuV)	Correct (dB/m)	Result (dBuV/m)	Limit (dBuV/m)	Margin (dB)	Remark
1	1918.000	54.08	-10.83	43.25	74.00	-30.75	peak
2	2698.000	45.05	-7.92	37.13	74.00	-36.87	peak
3	3754.000	42.03	-4.14	37.89	74.00	-36.11	peak
4	4186.000	43.24	-2.95	40.29	74.00	-33.71	peak
5	5704.000	48.73	2.25	50.98	74.00	-23.02	peak
6	5872.000	45.16	4.33	49.49	74.00	-24.51	peak

Note: 1. Measurement = Reading Level + Correct Factor.
 2. If Peak Result complies with AV limit, AV Result is deemed to comply with AV limit.
 3. Peak: Peak detector.
 4. Filter losses were only considered in then spurious frequency bands and the authorized band was not corrected for BRF losses.
 5. Proper operation of the transmitter prior to adding the filter to the measurement chain.
 6. Owing to the highest peak level complies with the lowest limit of unwanted emission out of the restricted bands (Please refer to page 50), so all the test point were deemed to comply with the limits list in the standard.



7-18GHz

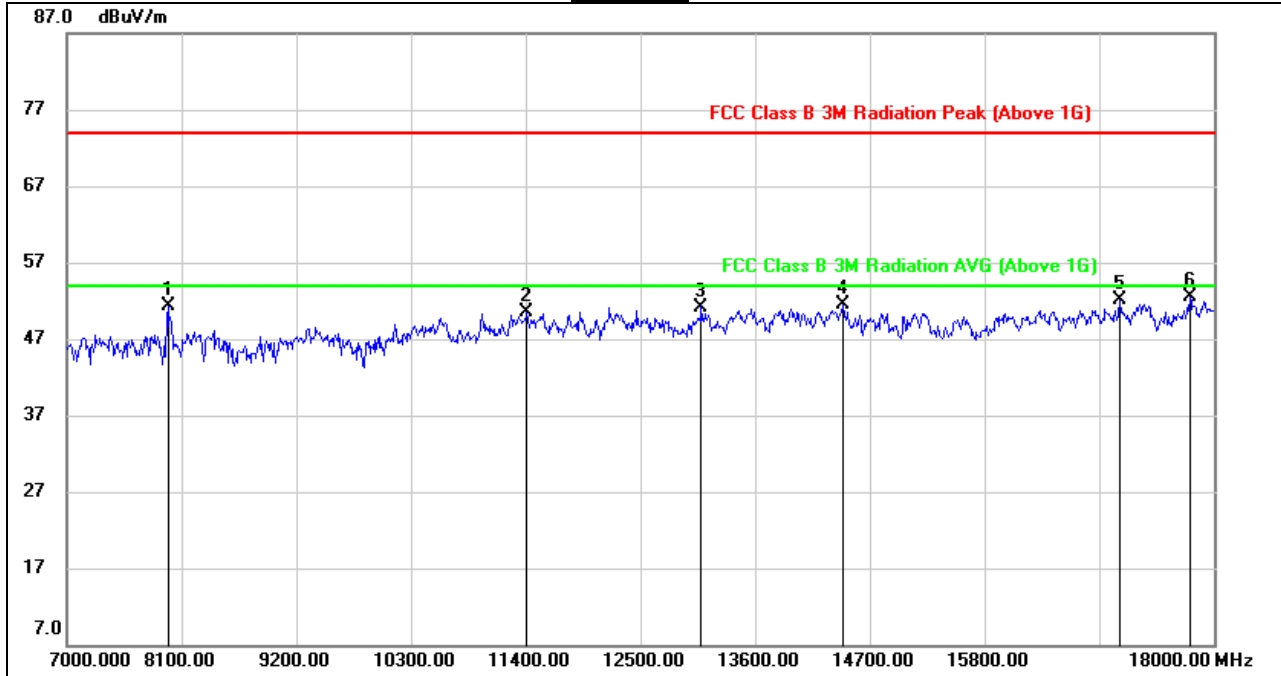

No.	Frequency (MHz)	Reading (dBuV)	Correct (dB/m)	Result (dBuV/m)	Limit (dBuV/m)	Margin (dB)	Remark
1	7968.000	42.55	8.72	51.27	74.00	-22.73	peak
2	11411.000	36.71	13.81	50.52	74.00	-23.48	peak
3	13083.000	35.93	15.27	51.20	74.00	-22.80	peak
4	14436.000	34.86	16.58	51.44	74.00	-22.56	peak
5	17098.000	31.18	20.93	52.11	74.00	-21.89	peak
6	17769.000	29.51	22.91	52.42	74.00	-21.58	peak

Note: 1. Measurement = Reading Level + Correct Factor.
 2. If Peak Result complies with AV limit, AV Result is deemed to comply with AV limit.
 3. Peak: Peak detector.
 4. The High Pass filter loss factor already add into the correct factor.
 5. Proper operation of the transmitter prior to adding the filter to the measurement chain.
 6. Owing to the highest peak level complies with the lowest limit of unwanted emission out of the restricted bands (Please refer to page 50), so all the test point were deemed to comply with the limits list in the standard.



8.1. WORST-CASE CO-LOCATION

8.1.1. BT GFSK AND 802.11n HT20 MIMO MODE

SPURIOUS EMISSIONS (LOW CHANNEL, WORST-CASE CONFIGURATION, HORIZONTAL)

1-7GHz

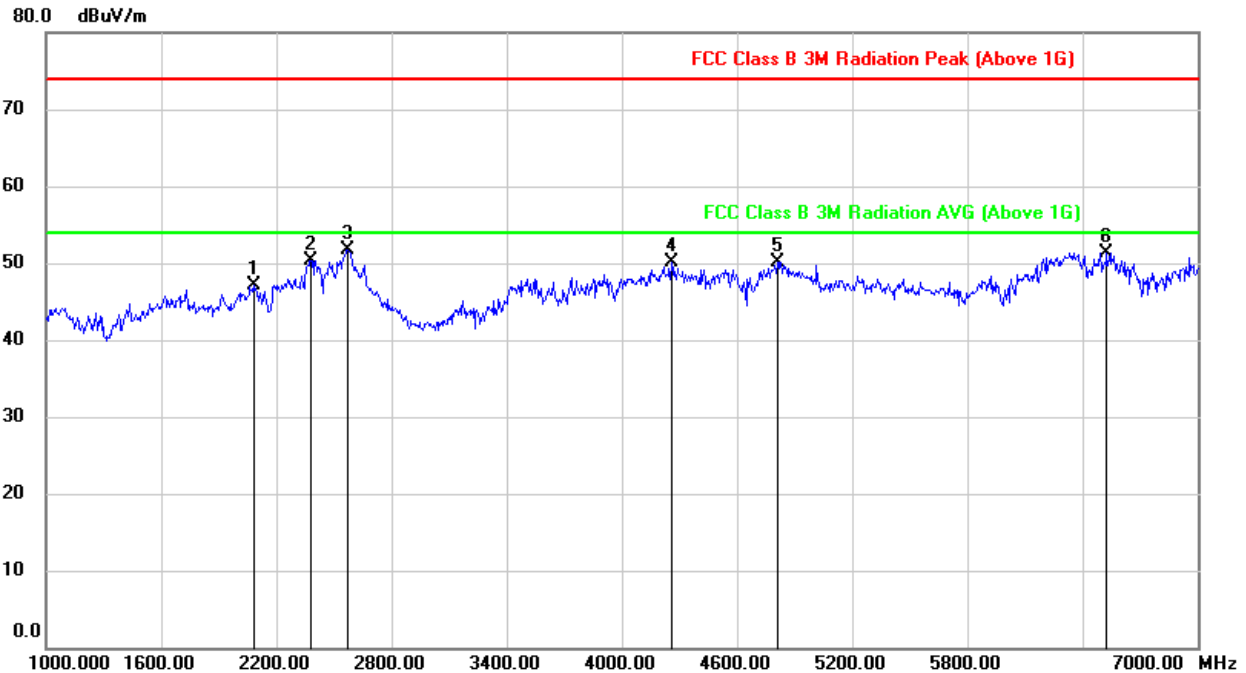

No.	Frequency (MHz)	Reading (dBuV)	Correct (dB/m)	Result (dBuV)	Limit (dBuV)	Margin (dB)	Remark
1	2080.000	57.44	-10.33	47.11	74.00	-26.89	peak
2	2380.000	59.50	-9.13	50.37	74.00	-23.63	peak
3	2572.000	60.24	-8.48	51.76	74.00	-22.24	peak
4	4258.000	53.11	-3.08	50.03	74.00	-23.97	peak
5	4810.000	50.98	-0.94	50.04	74.00	-23.96	peak
6	6526.000	45.52	5.80	51.32	74.00	-22.68	peak

- Note: 1. Peak Result = Reading Level + Correct Factor.
 2. If Peak Result complies with AV limit, AV Result is deemed to comply with AV limit.
 3. Peak: Peak detector.
 4. The Band Reject filter loss factor already add into the correct factor.
 5. Proper operation of the transmitter prior to adding the filter to the measurement chain.



SPURIOUS EMISSIONS (LOW CHANNEL, WORST-CASE CONFIGURATION, VERTICAL)

1-7GHz

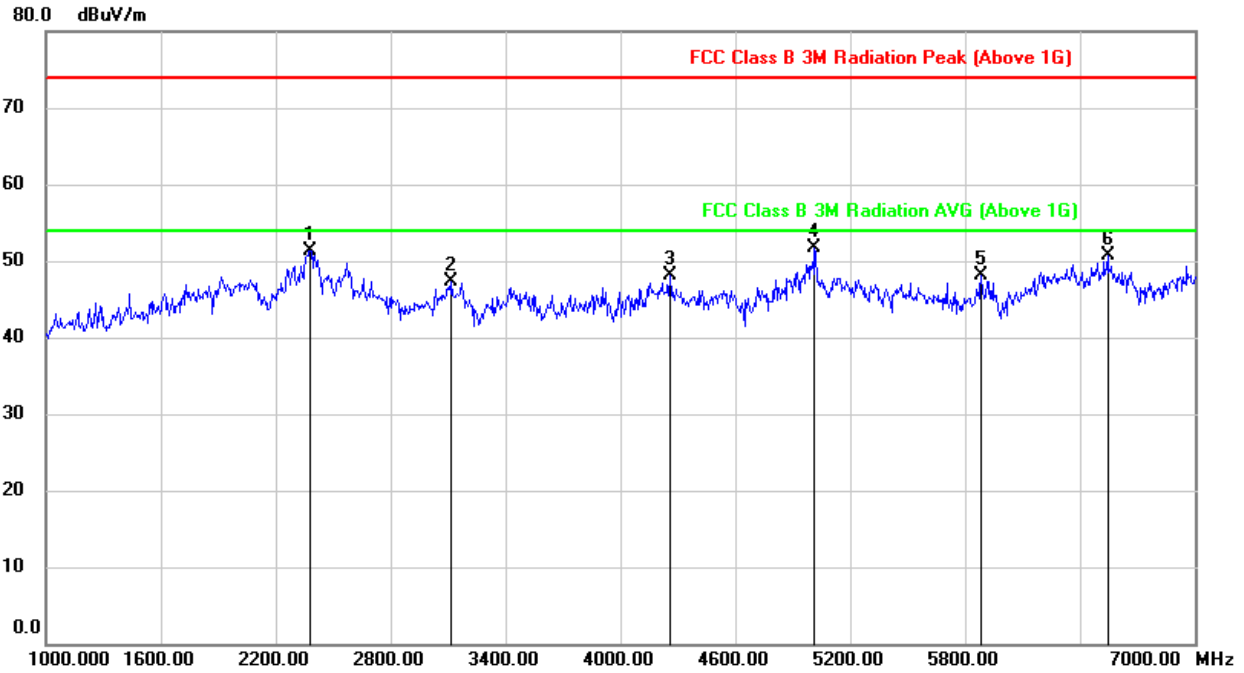

No.	Frequency (MHz)	Reading (dBuV)	Correct (dB/m)	Result (dBuV)	Limit (dBuV)	Margin (dB)	Remark
1	2380.000	60.50	-9.13	51.37	74.00	-22.63	peak
2	3118.000	52.92	-5.70	47.22	74.00	-26.78	peak
3	4258.000	51.11	-3.08	48.03	74.00	-25.97	peak
4	5014.000	51.77	-0.03	51.74	74.00	-22.26	peak
5	5884.000	43.55	4.55	48.10	74.00	-25.90	peak
6	6544.000	45.02	5.73	50.75	74.00	-23.25	peak

- Note: 1. Peak Result = Reading Level + Correct Factor.
 2. If Peak Result complies with AV limit, AV Result is deemed to comply with AV limit.
 3. Peak: Peak detector.
 4. The Band Reject filter loss factor already add into the correct factor.
 5. Proper operation of the transmitter prior to adding the filter to the measurement chain.



SPURIOUS EMISSIONS (LOW CHANNEL, WORST-CASE CONFIGURATION, HORIZONTAL)

7-18GHz

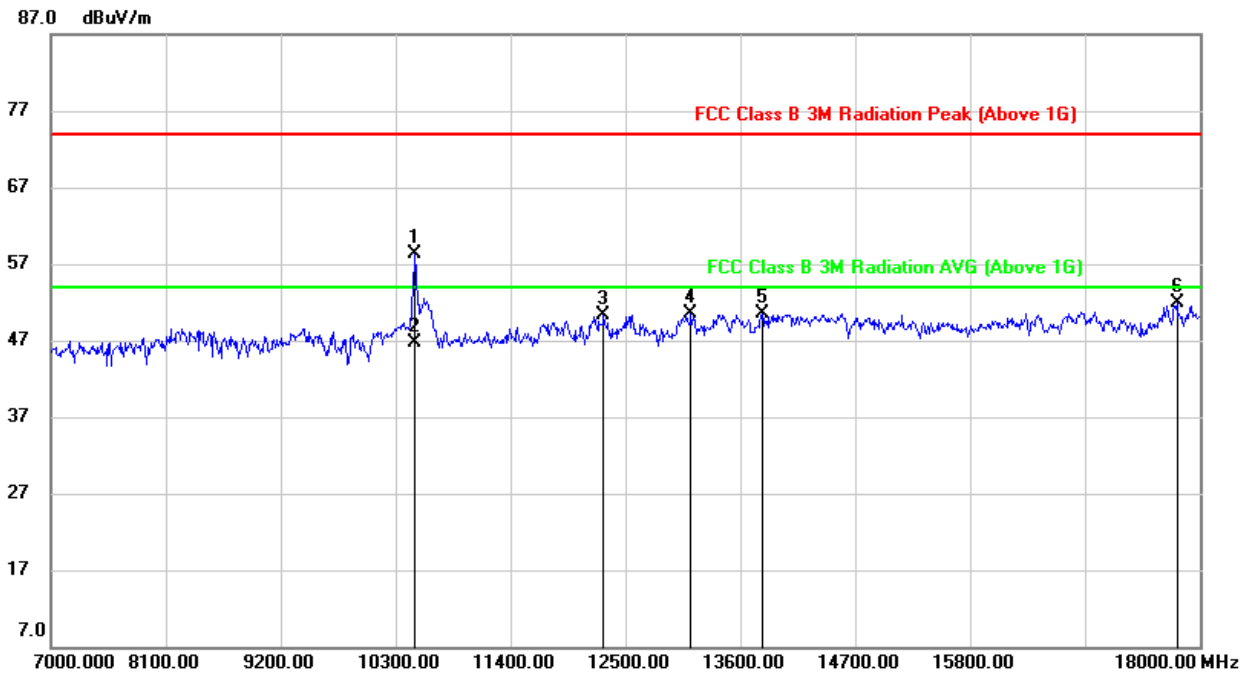

No.	Frequency (MHz)	Reading (dBuV)	Correct (dB/m)	Result (dBuV)	Limit (dBuV)	Margin (dB)	Remark
1	10487.000	46.19	12.03	58.22	74.00	-15.78	peak
2	10487.000	34.59	12.03	46.62	54.00	-7.38	AVG
3	12291.000	35.20	15.15	50.35	74.00	-23.65	peak
4	13127.000	35.14	15.30	50.44	74.00	-23.56	peak
5	13809.000	33.58	16.96	50.54	74.00	-23.46	peak
6	17780.000	28.93	23.01	51.94	74.00	-22.06	peak

- Note: 1. Peak Result = Reading Level + Correct Factor.
 2. If Peak Result complies with AV limit, AV Result is deemed to comply with AV limit.
 3. Peak: Peak detector.
 4. The High Pass filter loss factor already add into the correct factor.
 5. Proper operation of the transmitter prior to adding the filter to the measurement chain.

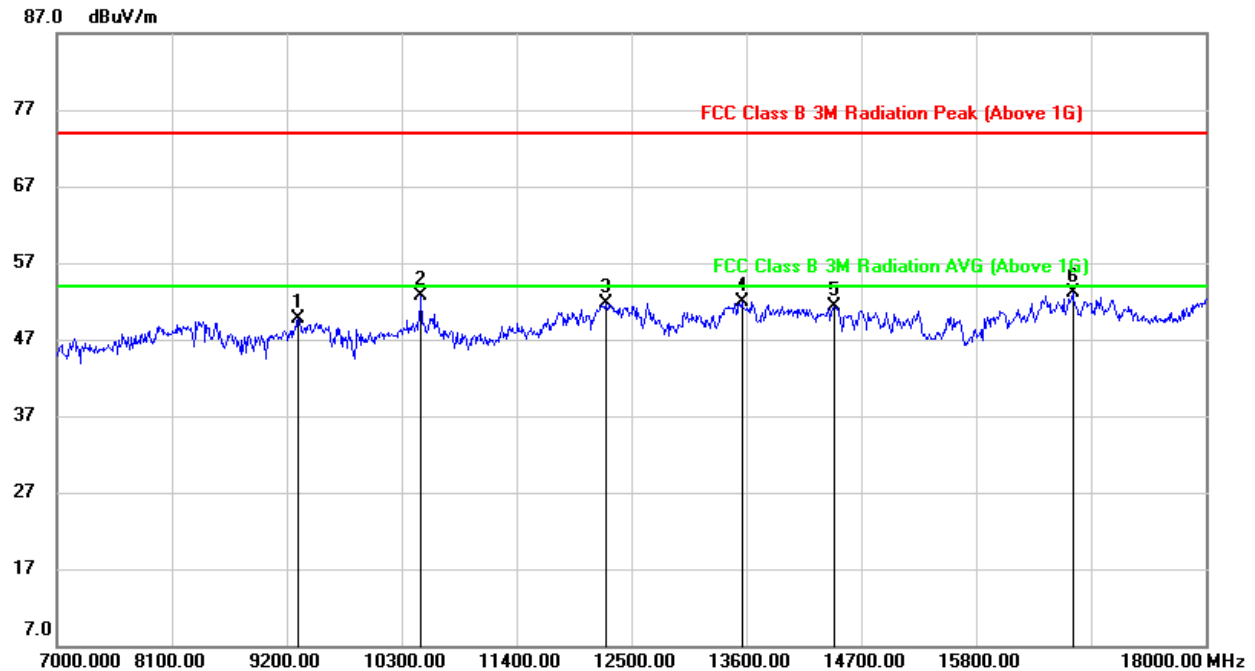
**SPURIOUS EMISSIONS (LOW CHANNEL, WORST-CASE CONFIGURATION, VERTICAL)****3-18GHz**

No.	Frequency (MHz)	Reading (dBuV)	Correct (dB/m)	Result (dBuV)	Limit (dBuV)	Margin (dB)	Remark
1	9310.000	39.39	10.32	49.71	74.00	-24.29	peak
2	10487.000	40.69	12.03	52.72	74.00	-21.28	peak
3	12258.000	36.58	15.07	51.65	74.00	-22.35	peak
4	13556.000	35.75	16.10	51.85	74.00	-22.15	peak
5	14436.000	34.74	16.58	51.32	74.00	-22.68	peak
6	16724.000	33.06	19.98	53.04	74.00	-20.96	peak

- Note: 1. Peak Result = Reading Level + Correct Factor.
 2. If Peak Result complies with AV limit, AV Result is deemed to comply with AV limit.
 3. Peak: Peak detector.
 4. The High Pass filter loss factor already add into the correct factor.
 5. Proper operation of the transmitter prior to adding the filter to the measurement chain.



8.2. SPURIOUS EMISSIONS 18~26GHz

8.2.1. 802.11n HT20 MIMO MODE

UNII-1 MIMO CDD MODE (WORST-CASE CONFIGURATION)

SPURIOUS EMISSIONS (HIGH CHANNEL, HORIZONTAL)

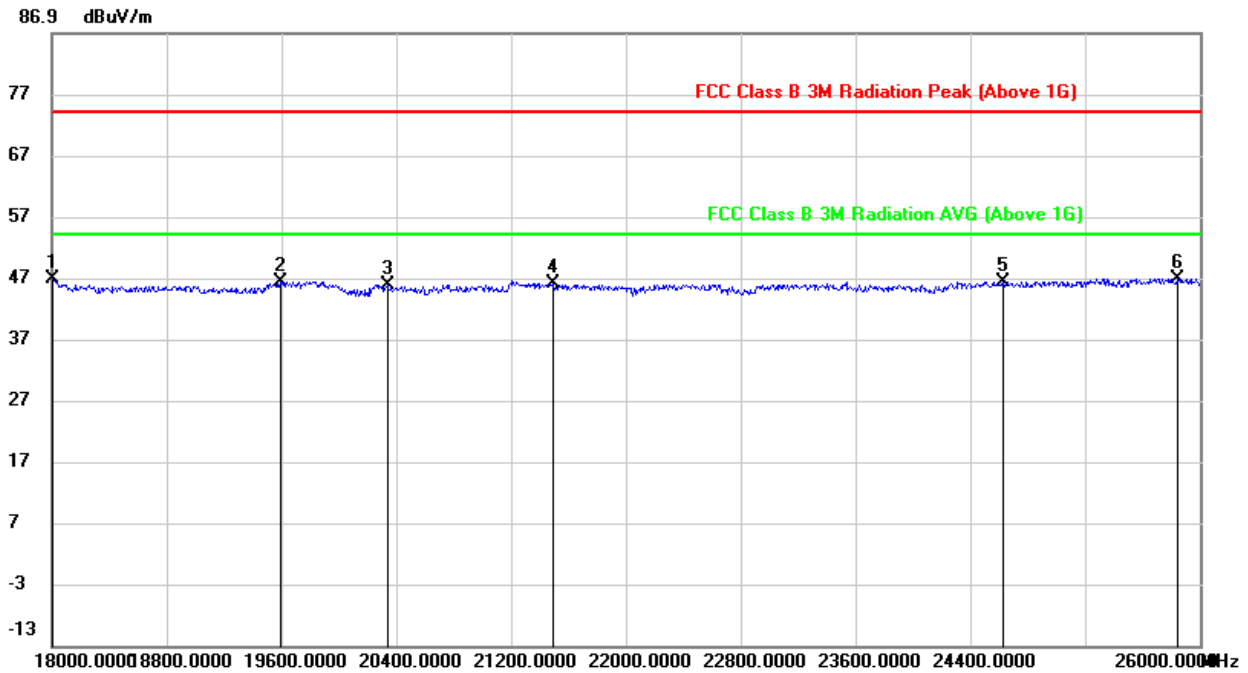

No.	Frequency (MHz)	Reading (dBuV)	Correct (dB/m)	Result (dBuV/m)	Limit (dBuV/m)	Margin (dB)	Remark
1	18008.000	50.64	-3.89	46.75	74.00	-27.25	peak
2	19592.000	51.02	-4.63	46.39	74.00	-27.61	peak
3	20336.000	50.78	-4.91	45.87	74.00	-28.13	peak
4	21488.000	51.85	-5.76	46.09	74.00	-27.91	peak
5	24624.000	48.65	-2.27	46.38	74.00	-27.62	peak
6	25840.000	48.57	-1.73	46.84	74.00	-27.16	peak

- Note: 1. Measurement = Reading Level + Correct Factor.
 2. If Peak Result complies with AV limit, AV Result is deemed to comply with AV limit.
 3. Peak: Peak detector.
 4. Proper operation of the transmitter prior to adding the filter to the measurement chain.



SPURIOUS EMISSIONS (HIGH CHANNEL, VERTICAL)

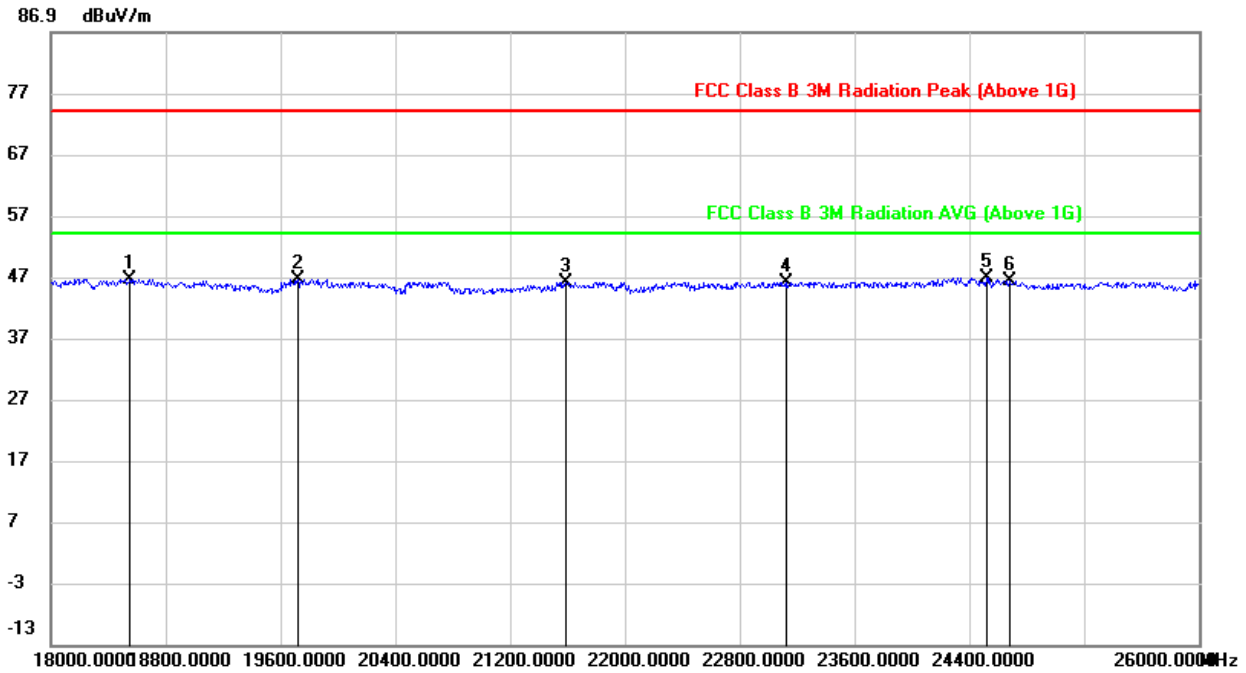

No.	Frequency (MHz)	Reading (dBuV)	Correct (dB/m)	Result (dBuV/m)	Limit (dBuV/m)	Margin (dB)	Remark
1	18552.000	51.11	-4.48	46.63	74.00	-27.37	peak
2	19720.000	51.00	-4.39	46.61	74.00	-27.39	peak
3	21592.000	51.92	-5.77	46.15	74.00	-27.85	peak
4	23128.000	51.58	-5.43	46.15	74.00	-27.85	peak
5	24520.000	49.37	-2.54	46.83	74.00	-27.17	peak
6	24680.000	48.48	-2.12	46.36	74.00	-27.64	peak

- Note: 1. Measurement = Reading Level + Correct Factor.
 2. If Peak Result complies with AV limit, AV Result is deemed to comply with AV limit.
 3. Peak: Peak detector.
 4. Proper operation of the transmitter prior to adding the filter to the measurement chain.

Note: All antennas and test modes have been tested, only the worst data record in the report.



8.3. SPURIOUS EMISSIONS 26~40GHz

8.3.1. 802.11n HT20 MIMO MODE

UNII-1 MIMO CDD MODE (WORST-CASE CONFIGURATION)

SPURIOUS EMISSIONS (HIGH CHANNEL, HORIZONTAL)

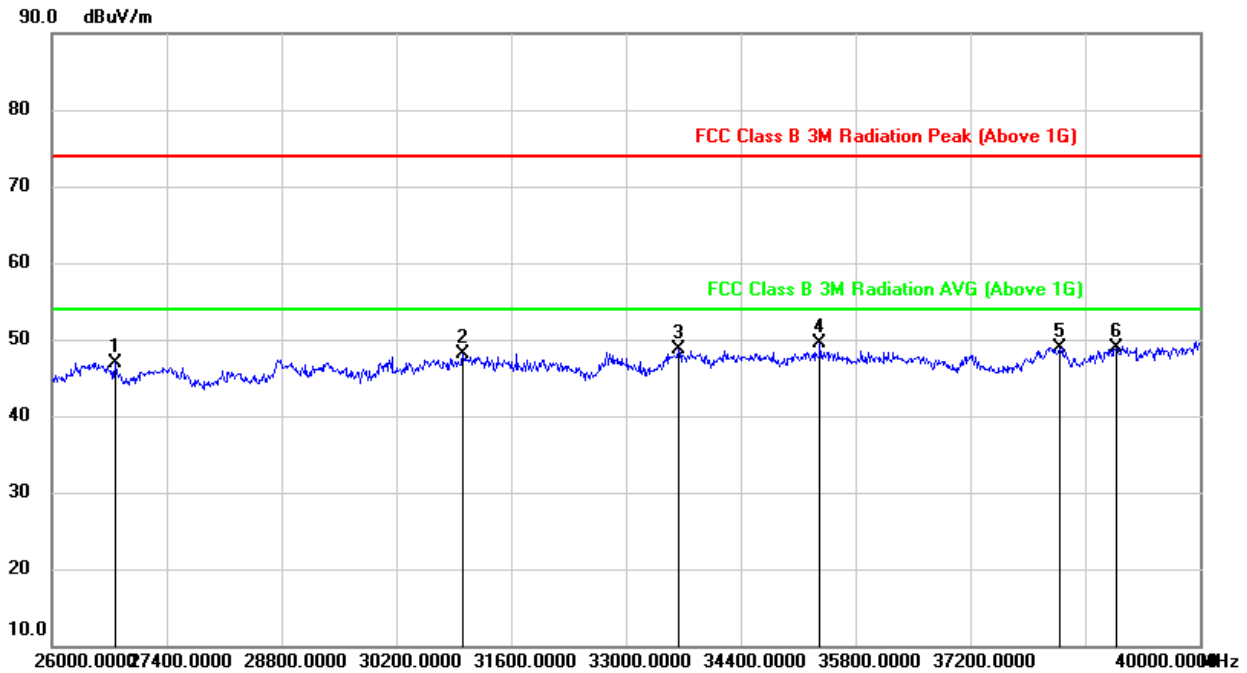

No.	Frequency (MHz)	Reading (dBuV)	Correct (dB/m)	Result (dBuV/m)	Limit (dBuV/m)	Margin (dB)	Remark
1	26770.000	51.70	-4.83	46.87	74.00	-27.13	peak
2	31012.000	48.83	-0.71	48.12	74.00	-25.88	peak
3	33644.000	48.31	0.42	48.73	74.00	-25.27	peak
4	35366.000	46.90	2.59	49.49	74.00	-24.51	peak
5	38292.000	45.12	3.80	48.92	74.00	-25.08	peak
6	38978.000	44.62	4.35	48.97	74.00	-25.03	peak

- Note: 1. Measurement = Reading Level + Correct Factor.
 2. If Peak Result complies with AV limit, AV Result is deemed to comply with AV limit.
 3. Peak: Peak detector.
 4. Proper operation of the transmitter prior to adding the filter to the measurement chain.



SPURIOUS EMISSIONS (HIGH CHANNEL, VERTICAL)

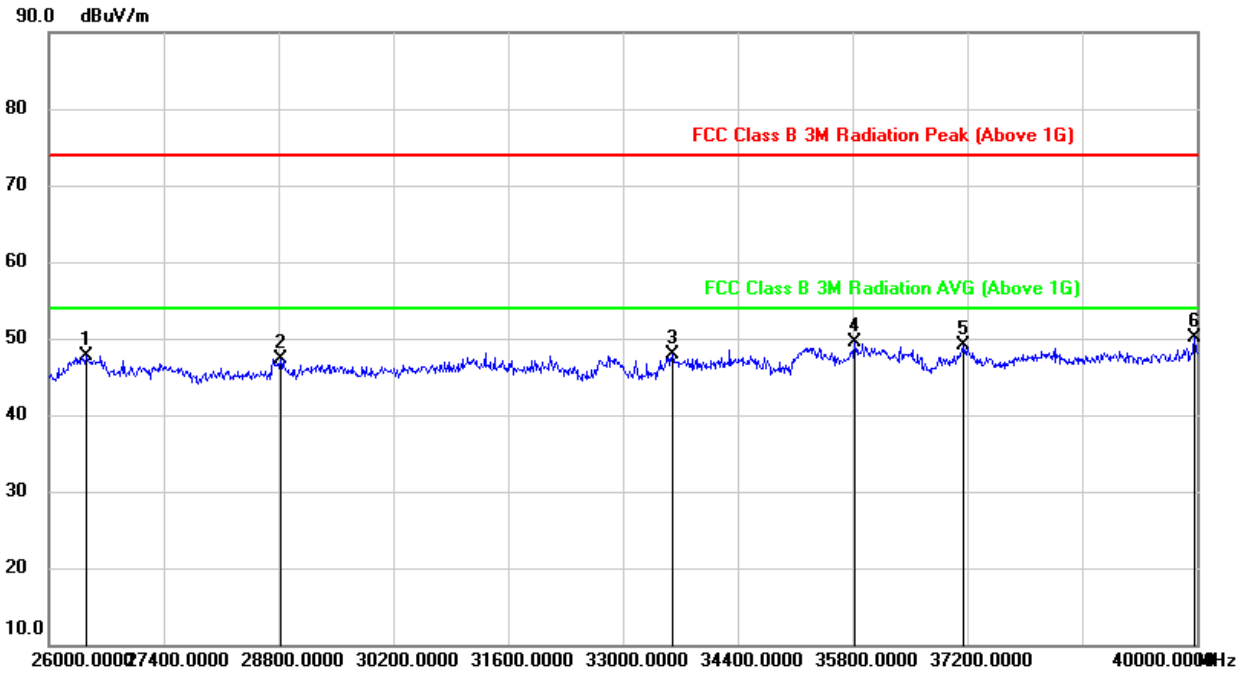

No.	Frequency (MHz)	Reading (dBuV)	Correct (dB/m)	Result (dBuV/m)	Limit (dBuV/m)	Margin (dB)	Remark
1	26448.000	52.55	-4.85	47.70	74.00	-26.30	peak
2	28828.000	48.13	-0.79	47.34	74.00	-26.66	peak
3	33602.000	47.51	0.46	47.97	74.00	-26.03	peak
4	35828.000	45.75	3.67	49.42	74.00	-24.58	peak
5	37158.000	45.84	3.17	49.01	74.00	-24.99	peak
6	39972.000	44.95	5.13	50.08	74.00	-23.92	peak

- Note: 1. Measurement = Reading Level + Correct Factor.
 2. If Peak Result complies with AV limit, AV Result is deemed to comply with AV limit.
 3. Peak: Peak detector.
 4. Proper operation of the transmitter prior to adding the filter to the measurement chain.

Note: All antennas and test modes have been tested, only the worst data record in the report.



8.4. SPURIOUS EMISSIONS 30M ~ 1 GHz

8.4.1. 802.11n HT20 MIMO MODE

UNII-1 MIMO CDD MODE (WORST-CASE CONFIGURATION)

SPURIOUS EMISSIONS (HIGH CHANNEL HORIZONTAL)

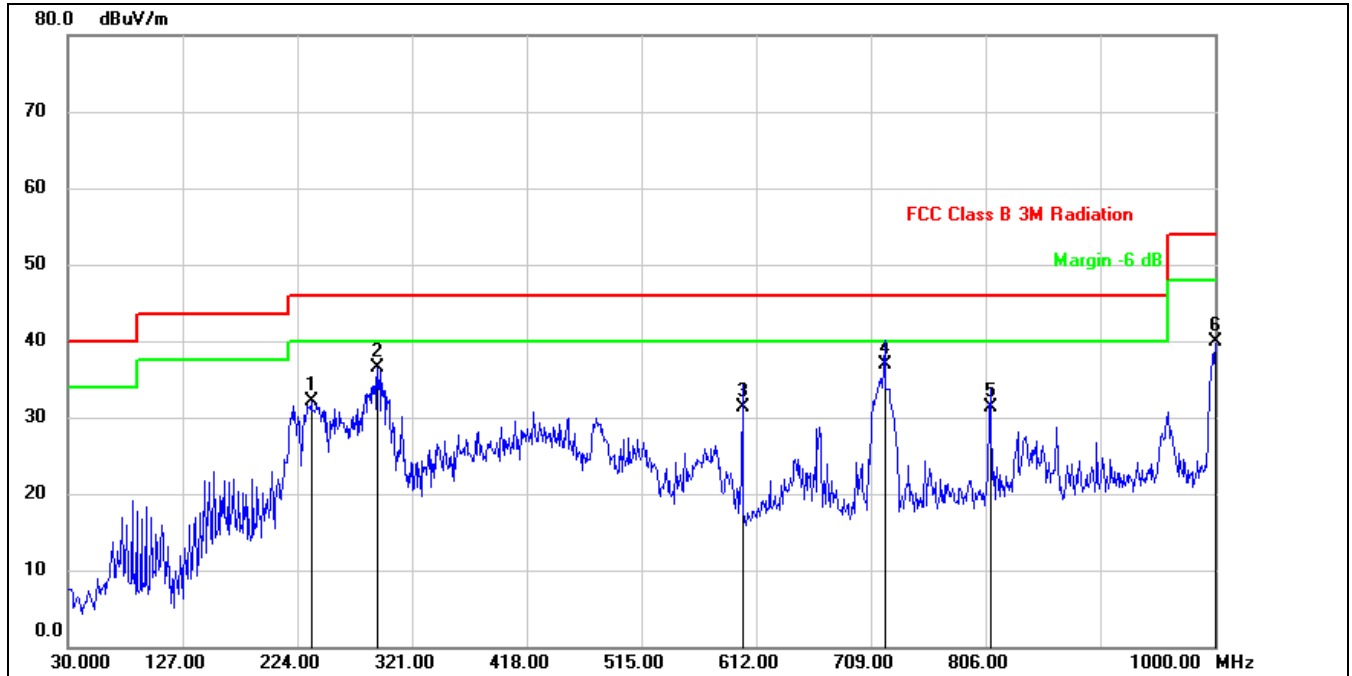

No.	Frequency (MHz)	Reading (dBuV)	Correct (dB/m)	Result (dBuV/m)	Limit (dBuV/m)	Margin (dB)	Remark
1	235.6400	49.73	-17.60	32.13	46.00	-13.87	QP
2	291.9000	50.78	-14.34	36.44	46.00	-9.56	QP
3	600.3600	39.65	-8.42	31.23	46.00	-14.77	QP
4	720.6400	42.96	-6.10	36.86	46.00	-9.14	QP
5	809.8800	36.49	-5.27	31.22	46.00	-14.78	QP
6	1000.0000	42.80	-2.84	39.96	54.00	-14.04	QP

- Note: 1. Result Level = Read Level + Correct Factor.
 2. If Peak Result complies with QP limit, QP Result is deemed to comply with QP limit.
 3. Test setup: RBW: 120 kHz, VBW: 300 kHz, Sweep time: auto.



SPURIOUS EMISSIONS (HIGH CHANNEL, VERTICAL)

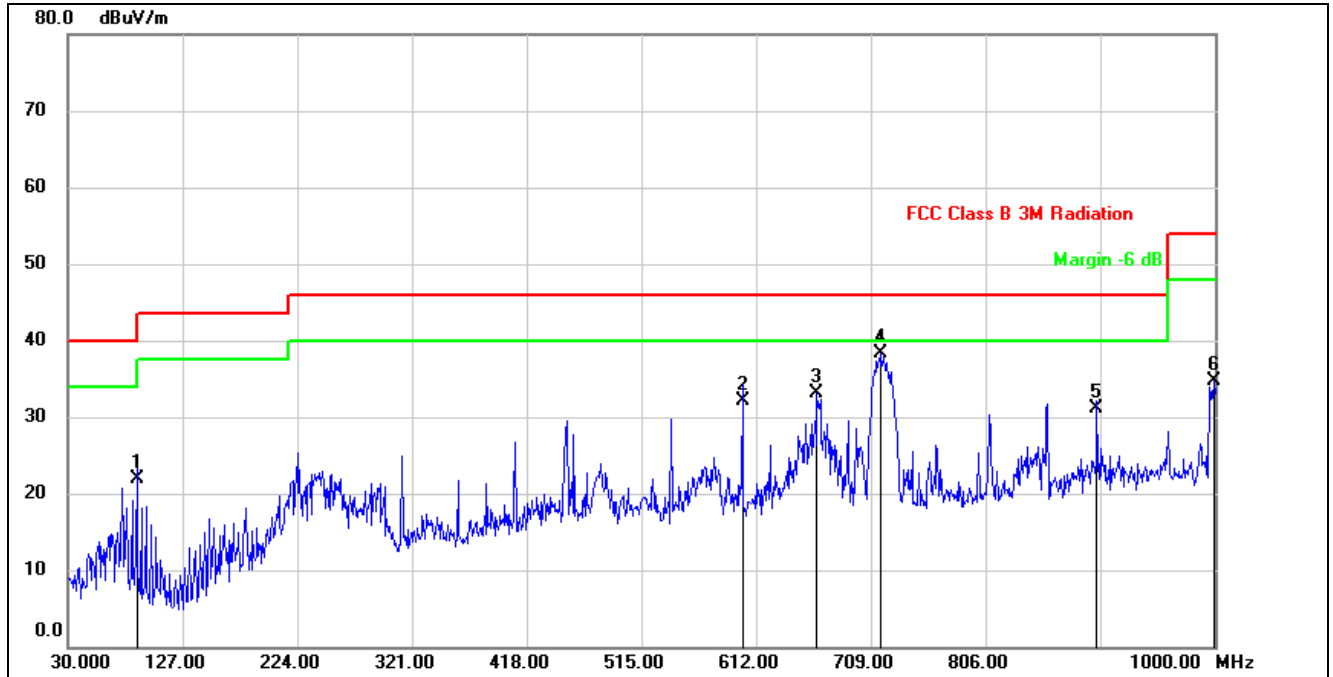

No.	Frequency (MHz)	Reading (dBuV)	Correct (dB/m)	Result (dBuV/m)	Limit (dBuV/m)	Margin (dB)	Remark
1	88.2000	42.95	-21.03	21.92	43.50	-21.58	QP
2	600.3600	40.54	-8.42	32.12	46.00	-13.88	QP
3	663.4099	40.40	-7.27	33.13	46.00	-12.87	QP
4	717.7300	44.43	-6.16	38.27	46.00	-7.73	QP
5	900.0900	35.12	-4.11	31.01	46.00	-14.99	QP
6	999.0300	37.47	-2.86	34.61	54.00	-19.39	QP

- Note: 1. Result Level = Read Level + Correct Factor.
 2. If Peak Result complies with QP limit, QP Result is deemed to comply with QP limit.
 3. Test setup: RBW: 120 kHz, VBW: 300 kHz, Sweep time: auto

Note: All antennas and test modes have been tested, only the worst data record in the report.



8.5. SPURIOUS EMISSIONS BELOW 30M

8.5.1. 802.11n HT20 MIMO MODE

UNII -1 MIMO CDD MODE (WORST-CASE CONFIGURATION)

SPURIOUS EMISSIONS (HIGH CHANNEL, LOOP ANTENNA FACE ON TO THE EUT, WORST-CASE CONFIGURATION)

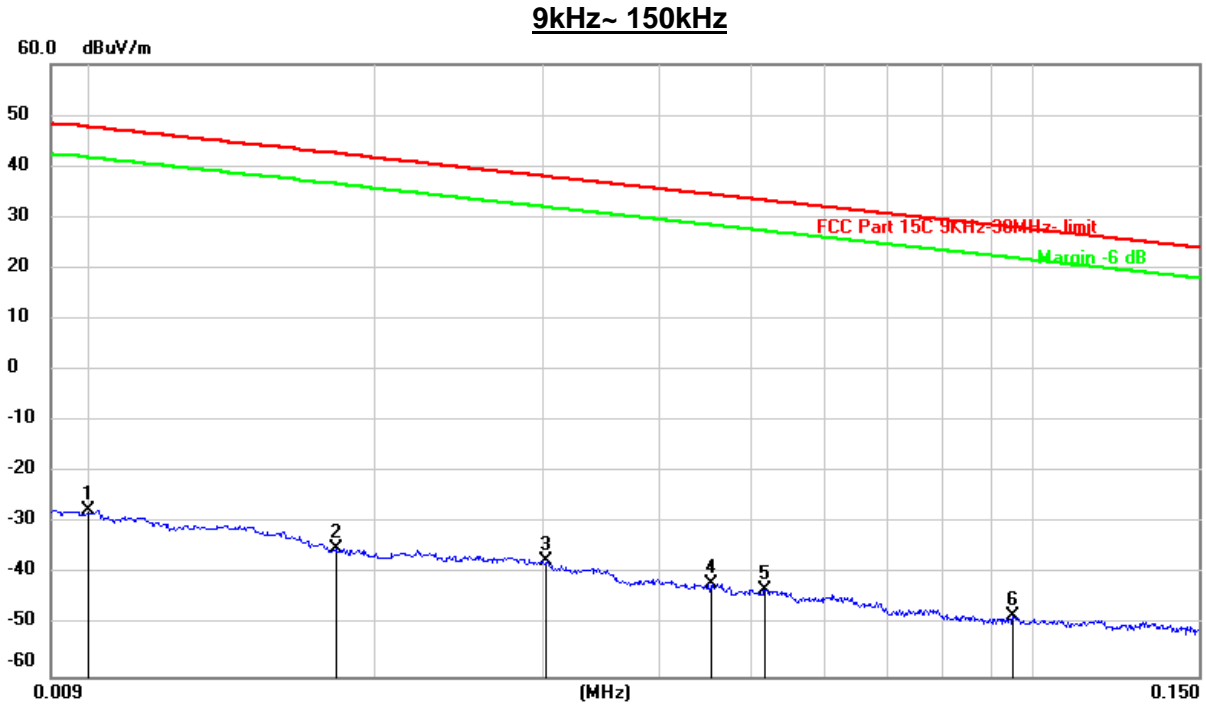

No.	Frequency (MHz)	Reading (dBuV)	Correct (dB/m)	Result (dBuV/m)	Limit (dBuV/m)	Margin (dB)	Remark
1	0.0100	73.85	-101.40	-27.55	47.60	-75.15	peak
2	0.0181	66.35	-101.36	-35.01	42.45	-77.46	peak
3	0.0303	63.93	-101.39	-37.46	37.97	-75.43	peak
4	0.0454	59.73	-101.46	-41.73	34.46	-76.19	peak
5	0.0517	58.37	-101.49	-43.12	33.33	-76.45	peak
6	0.0952	53.71	-101.76	-48.05	28.03	-76.08	peak

Note: 1. Measurement = Reading Level + Correct Factor.

2. If Peak Result complies with AV and QP limit, AV and QP Result are deemed to comply with AV limit.

3. All 3 polarizations(Horizontal, Face-on and Face-off) of the loop antenna had been tested, but only the worst data recorded in the report.



150kHz ~ 490kHz

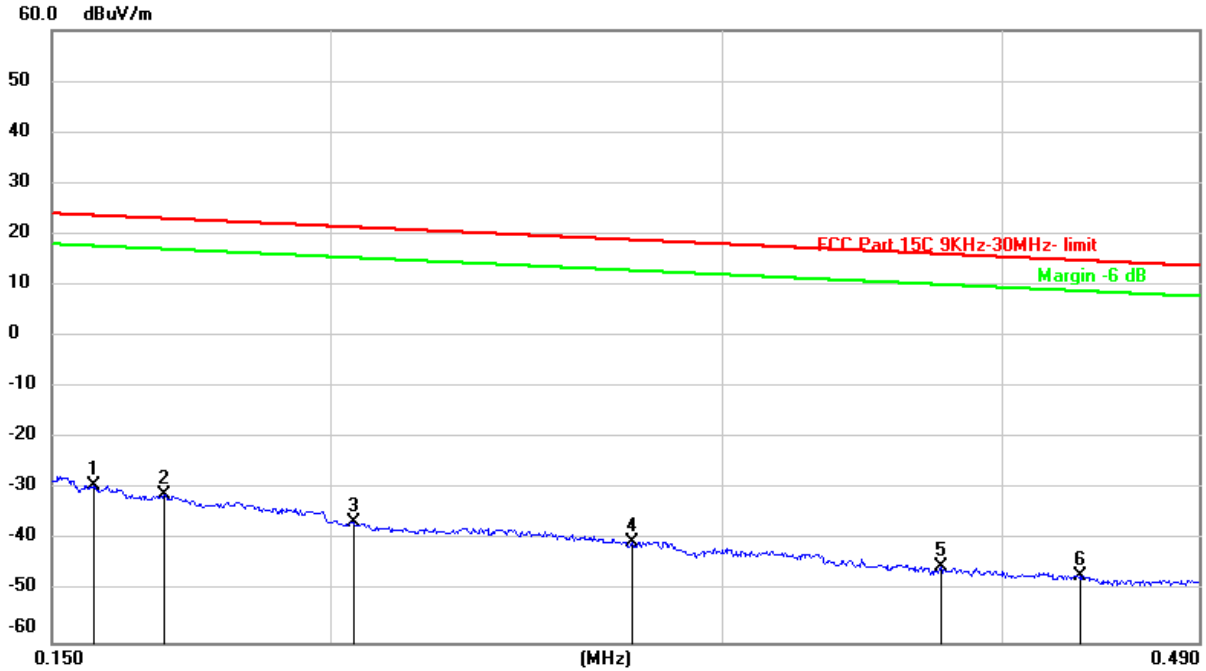

No.	Frequency (MHz)	Reading (dBuV)	Correct (dB/m)	Result (dBuV/m)	Limit (dBuV/m)	Margin (dB)	Remark
1	0.1567	72.45	-101.65	-29.20	23.70	-52.90	peak
2	0.1685	70.61	-101.67	-31.06	23.08	-54.14	peak
3	0.2048	65.30	-101.73	-36.43	21.37	-57.80	peak
4	0.2731	61.50	-101.83	-40.33	18.88	-59.21	peak
5	0.3754	56.87	-101.93	-45.06	16.11	-61.17	peak
6	0.4339	55.12	-101.99	-46.87	14.85	-61.72	peak

Note: 1. Measurement = Reading Level + Correct Factor.

2. If Peak Result complies with AV and QP limit, AV and QP Result are deemed to comply with AV limit.

3. All 3 polarizations(Horizontal, Face-on and Face-off) of the loop antenna had been tested, but only the worst data recorded in the report.



490kHz ~ 30MHz

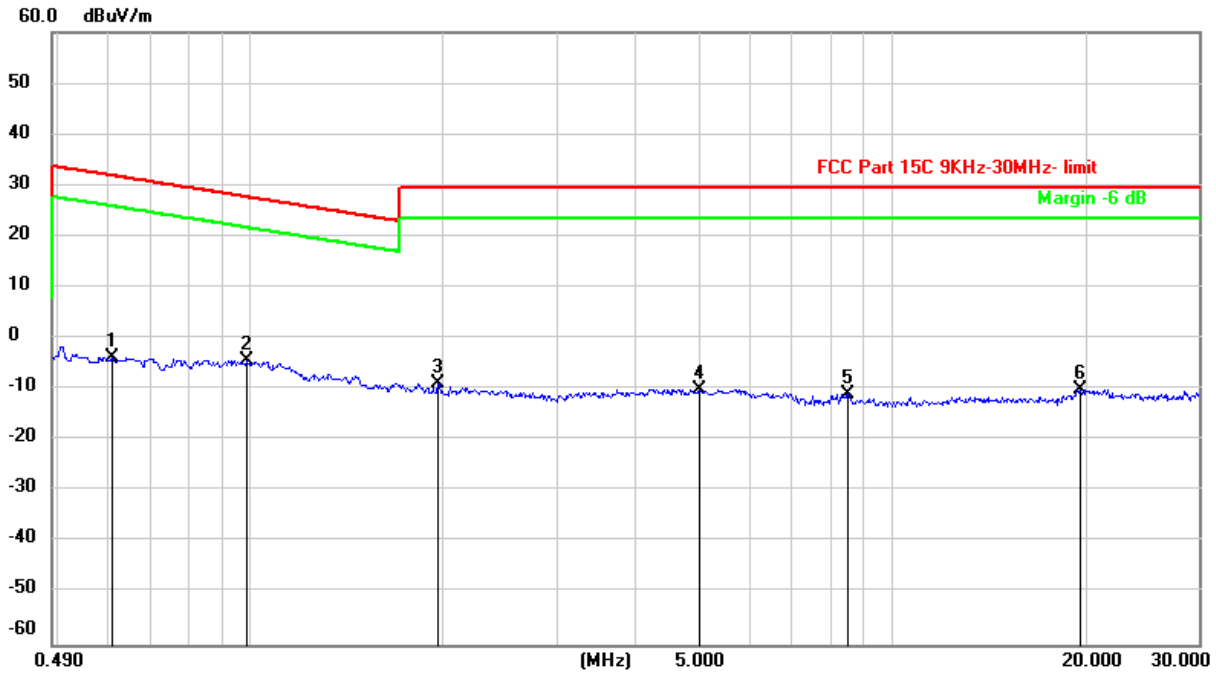

No.	Frequency (MHz)	Reading (dBuV)	Correct (dB/m)	Result (dBuV/m)	Limit (dBuV/m)	Margin (dB)	Remark
1	0.6078	58.48	-62.09	-3.61	31.93	-35.54	peak
2	0.9858	57.93	-62.26	-4.33	27.72	-32.05	peak
3	1.9519	53.11	-61.84	-8.73	29.54	-38.27	peak
4	5.0049	51.46	-61.49	-10.03	29.54	-39.57	peak
5	8.5462	50.19	-61.00	-10.81	29.54	-40.35	peak
6	19.7010	50.74	-60.84	-10.10	29.54	-39.64	peak

Note: 1. Measurement = Reading Level + Correct Factor.

2. If Peak Result complies with AV and QP limit, AV and QP Result are deemed to comply with AV limit.

3. All 3 polarizations(Horizontal, Face-on and Face-off) of the loop antenna had been tested, but only the worst data recorded in the report.

Note: All antennas and test modes have been tested, only the worst data record in the report.

9. AC POWER LINE CONDUCTED EMISSIONS

LIMITS

Please refer to CFR 47 FCC §15.207 (a) and ISED RSS-Gen Clause 8.8

FREQUENCY(MHz)	Quasi-peak	Average
0.15 -0.5	66 - 56 *	56 - 46 *
0.50 -5.0	56.00	46.00
5.0 -30.0	60.00	50.00

TEST SETUP AND PROCEDURE

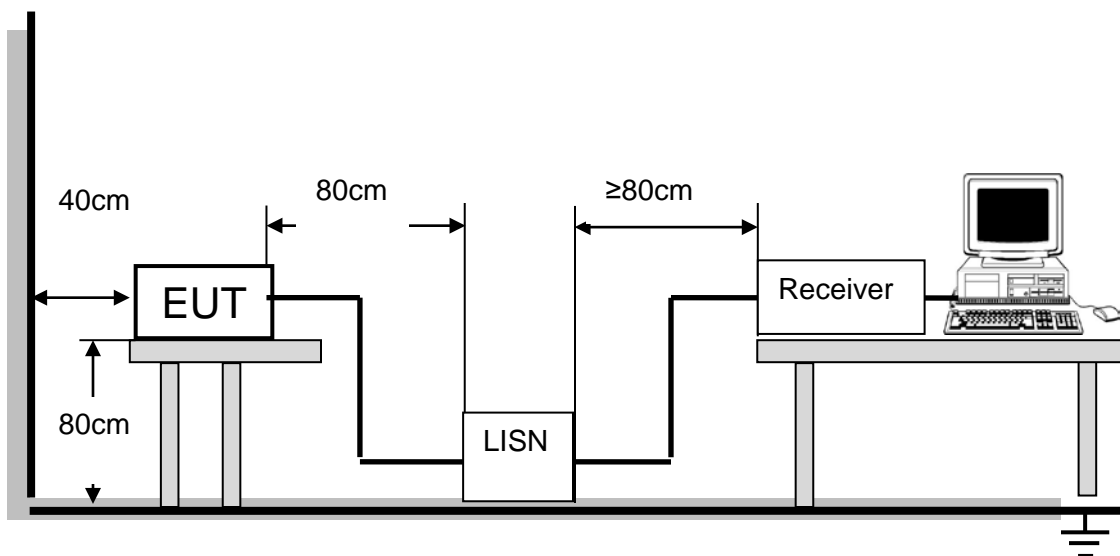

The EUT is put on a table of non-conducting material that is 80cm high. The vertical conducting wall of shielding is located 40cm to the rear of the EUT. The power line of the EUT is connected to the AC mains through an Artificial Mains Network (A.M.N.). A EMI Measurement Receiver (R&S Test Receiver ESR3) is used to test the emissions from both sides of AC line. According to the requirements in Section 6.2 of ANSI C63.10 -2013. Conducted emissions from the EUT measured in the frequency range between 0.15 MHz and 30MHz using CISPR Quasi-Peak and average detector mode. The bandwidth of EMI test receiver is set at 9kHz.

The arrangement of the equipment is installed to meet the standards and operating in a manner, which tends to maximize its emission characteristics in a normal application.

TEST RESULTS



**9.1. 802.11n HT20 MIMO MODE
UNII-1 MIMO CDD MODE (WORST-CASE CONFIGURATION)**

LINE N RESULTS (HIGH CHANNEL)

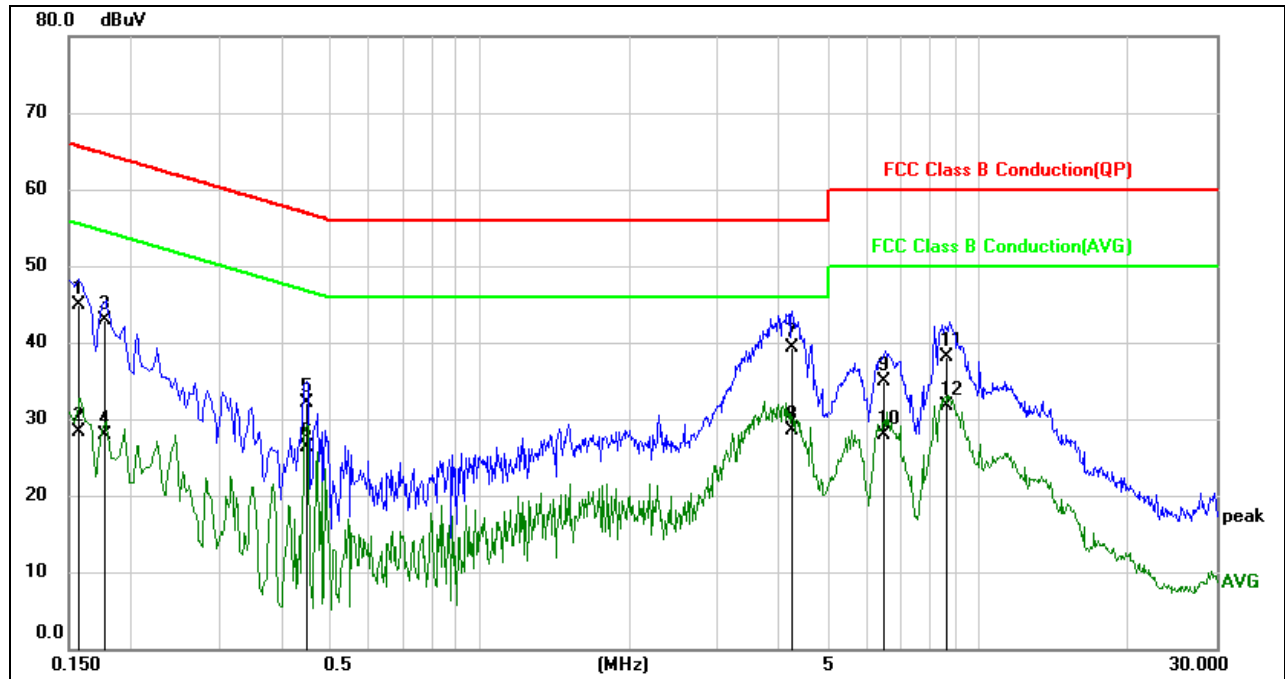

No.	Frequency (MHz)	Reading (dBuV)	Correct (dB)	Result (dBuV)	Limit (dBuV)	Margin (dB)	Remark
1	0.1577	35.26	9.60	44.86	65.58	-20.72	QP
2	0.1577	18.65	9.60	28.25	55.58	-27.33	AVG
3	0.1768	33.29	9.60	42.89	64.63	-21.74	QP
4	0.1768	18.24	9.60	27.84	54.63	-26.79	AVG
5	0.4483	22.43	9.60	32.03	56.91	-24.88	QP
6	0.4483	16.70	9.60	26.30	46.91	-20.61	AVG
7	4.2510	29.63	9.66	39.29	56.00	-16.71	QP
8	4.2510	18.77	9.66	28.43	46.00	-17.57	AVG
9	6.4470	25.13	9.71	34.84	60.00	-25.16	QP
10	6.4470	18.22	9.71	27.93	50.00	-22.07	AVG
11	8.6813	28.28	9.74	38.02	60.00	-21.98	QP
12	8.6813	21.87	9.74	31.61	50.00	-18.39	AVG

- Note: 1. Result = Reading +Correct Factor.
 2. If QP Result complies with AV limit, AV Result is deemed to comply with AV limit.
 3. Test setup: RBW: 200 Hz (9 kHz—150 kHz), 9 kHz (150 kHz—30 MHz).
 4. Step size: 80Hz (0.009MHz-0.15MHz), 4 kHz (0.15MHz-30MHz), Scan time: auto.



LINE L RESULTS (LOW CHANNEL)

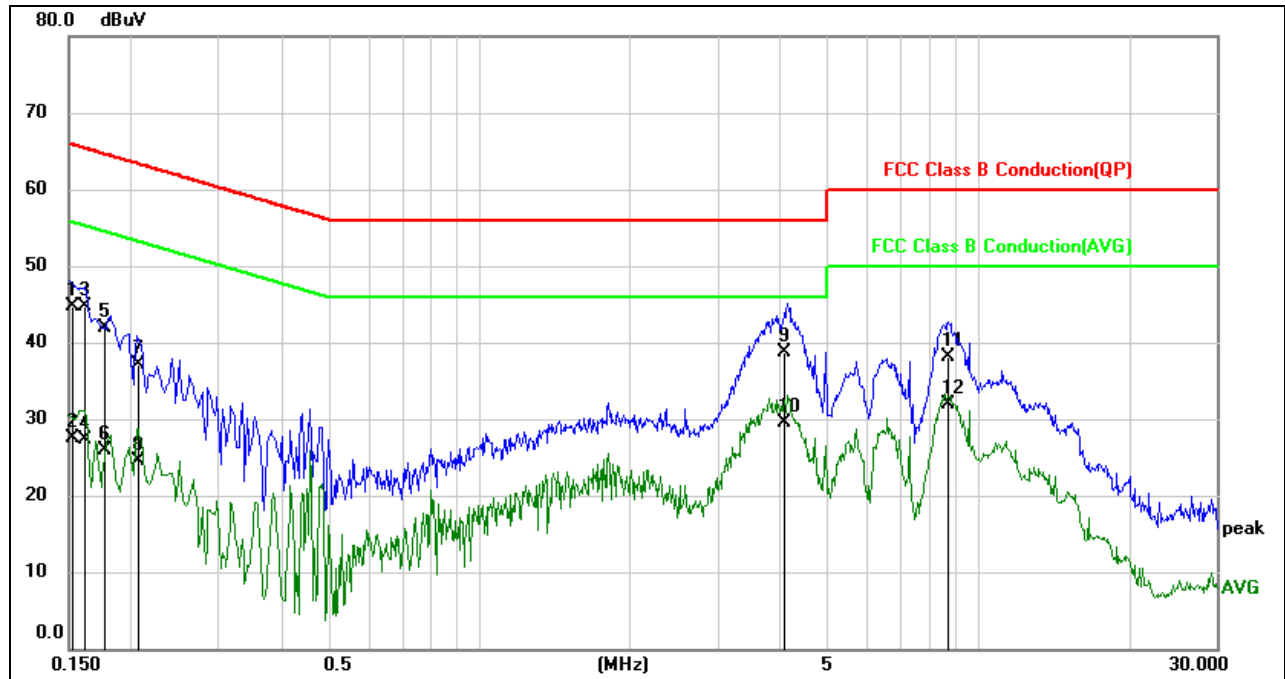

No.	Frequency (MHz)	Reading (dBuV)	Correct (dB)	Result (dBuV)	Limit (dBuV)	Margin (dB)	Remark
1	0.1526	35.15	9.61	44.76	65.86	-21.10	QP
2	0.1526	17.82	9.61	27.43	55.86	-28.43	AVG
3	0.1621	35.07	9.61	44.68	65.36	-20.68	QP
4	0.1621	17.63	9.61	27.24	55.36	-28.12	AVG
5	0.1771	32.38	9.61	41.99	64.62	-22.63	QP
6	0.1771	16.30	9.61	25.91	54.62	-28.71	AVG
7	0.2067	27.42	9.60	37.02	63.34	-26.32	QP
8	0.2067	14.91	9.60	24.51	53.34	-28.83	AVG
9	4.1080	29.08	9.66	38.74	56.00	-17.26	QP
10	4.1080	19.86	9.66	29.52	46.00	-16.48	AVG
11	8.7130	28.46	9.73	38.19	60.00	-21.81	QP
12	8.7130	22.15	9.73	31.88	50.00	-18.12	AVG

- Note: 1. Result = Reading +Correct Factor.
 2. If QP Result complies with AV limit, AV Result is deemed to comply with AV limit.
 3. Test setup: RBW: 200 Hz (9 kHz—150 kHz), 9 kHz (150 kHz—30 MHz).
 4. Step size: 80Hz (0.009MHz-0.15MHz), 4 kHz (0.15MHz-30MHz), Scan time: auto.

Note: All antennas and test modes have been tested, only the worst data record in the report.



10. FREQUENCY STABILITY

LIMITS

The frequency of the carrier signal shall be maintained within band of operation

TEST SETUP AND PROCEDURE

Connect the UUT to the spectrum analyser and use the following settings:

Center Frequency	The center frequency of the channel under test
Detector	PEAK
RBW	10kHz
VBW	$\geq 3 \times \text{RBW}$
Span	Encompass the entire emissions bandwidth (EBW) of the signal
Trace	Max hold
Sweep time	Auto

Allow the trace to stabilize, find the peak value of the power envelope and record the frequency, then calculated the frequency drift.

The test extreme voltage is to change the primary supply voltage from 85 to 115 percent of the nominal value.

User manual temperature is 0°C~40°C.

TEST SETUP

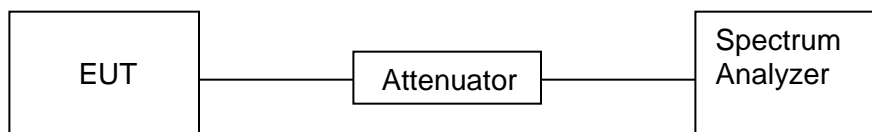

	Normal Test Conditions	Extreme Test Conditions
Temperature	NT(Normal Temperature): 23.5°C	LT(Low Temperature): 0°C
		HT(High Temperature): 40°C
Supply Voltage	NV(Normal Voltage): DC 5V	LT(Low Voltage): DC 4.25V
		HT(High Voltage): DC 5.75V



TEST RESULTS

Frequency Error vs. Voltage									
802.11a:5200MHz									
Temp.	Volt.	0 Minute		2 Minute		5 Minute		10 Minute	
		Freq.Error (MHz)	Tolerance (ppm)	Freq.Error (MHz)	Tolerance (ppm)	Freq.Error (MHz)	Tolerance (ppm)	Freq.Error (MHz)	Tolerance (ppm)
TN	VL	5200.0214	4.11	5200.0332	6.39	5200.0312	6.00	5200.0424	8.15
TN	VN	5200.0311	5.99	5200.0345	6.64	5200.0331	6.37	5200.0434	8.35
TN	VH	5200.0321	6.18	5200.0423	8.14	5200.0342	6.58	5200.0330	6.34

Frequency Error vs. Temperature									
802.11a:5200MHz									
Temp.	Volt.	0 Minute		2 Minute		5 Minute		10 Minute	
		Freq.Error (MHz)	Tolerance (ppm)	Freq.Error (MHz)	Tolerance (ppm)	Freq.Error (MHz)	Tolerance (ppm)	Freq.Error (MHz)	Tolerance (ppm)
40	VN	5200.0312	6.01	5200.0321	6.18	5200.0332	6.38	5200.0331	6.37
30	VN	5200.0323	6.22	5200.0321	6.18	5200.0323	6.22	5200.0423	8.14
20	VN	5200.0357	6.86	5200.0458	8.80	5200.0324	6.24	5200.0339	6.52
10	VN	5200.0221	4.26	5200.0327	6.28	5200.0392	7.54	5200.0321	6.18
0	VN	5200.0331	6.37	5200.0331	6.37	5200.0297	5.71	5200.0371	7.14

Frequency Error vs. Voltage									
802.11a:5825MHz									
Temp.	Volt.	0 Minute		2 Minute		5 Minute		10 Minute	
		Freq.Error (MHz)	Tolerance (ppm)	Freq.Error (MHz)	Tolerance (ppm)	Freq.Error (MHz)	Tolerance (ppm)	Freq.Error (MHz)	Tolerance (ppm)
TN	VL	5825.0367	6.30	5825.0333	5.71	5825.0468	8.03	5825.0355	6.09
TN	VN	5825.0355	6.09	5825.0353	6.07	5825.0398	6.83	5825.0378	6.49
TN	VH	5825.0425	7.29	5825.0472	8.11	5825.0334	5.73	5825.0427	7.32

Frequency Error vs. Temperature									
802.11a:5825MHz									
Temp.	Volt.	0 Minute		2 Minute		5 Minute		10 Minute	
		Freq.Error (MHz)	Tolerance (ppm)	Freq.Error (MHz)	Tolerance (ppm)	Freq.Error (MHz)	Tolerance (ppm)	Freq.Error (MHz)	Tolerance (ppm)
40	VN	5825.0398	6.83	5825.0342	5.86	5825.0468	8.03	5825.0413	7.09
30	VN	5825.0319	5.47	5825.0358	6.14	5825.0352	6.05	5825.0364	6.24
20	VN	5825.0412	7.07	5825.0277	4.75	5825.0365	6.27	5825.0414	7.11
10	VN	5825.0351	6.03	5825.0412	7.08	5825.0335	5.74	5825.0441	7.57
0	VN	5825.0292	5.01	5825.0344	5.90	5825.0391	6.72	5825.0417	7.15

Note: All antennas and test modes have been tested, only the worst data record in the report.



11. ANTENNA REQUIREMENTS

APPLICABLE REQUIREMENTS

Please refer to FCC §15.203

An intentional radiator shall be designed to ensure that no antenna other than that furnished by the responsible party shall be used with the device. The use of a permanently attached antenna or of an antenna that uses a unique coupling to the intentional radiator shall be considered sufficient to comply with the provisions of this section. The manufacturer may design the unit so that a broken antenna can be replaced by the user, but the use of a standard antenna jack or electrical connector is prohibited.

Please refer to FCC §15.247(b)(4)

The conducted output power limit specified in paragraph (b) of this section is based on the use of antennas with directional gains that do not exceed 6 dBi. Except as shown in paragraph (c) of this section, if transmitting antennas of directional gain greater than 6 dBi are used, the conducted output power from the intentional radiator shall be reduced below the stated values in paragraphs (b)(1), (b)(2), and (b)(3) of this section, as appropriate, by the amount in dB that the directional gain of the antenna exceeds 6 dBi.

RESULTS

Complies

END OF REPORT