

# FCC Radio Test Report

**FCC ID: 2AC23-WCT3EM2611**

**FCC 47 CFR Part 15 Subpart C**

**Product :** WIFI Module

**Trade Name :** GSD

**Model Number :** WCT3EM2611

**Firmware Version Identification Number (FVIN):** 1.0

## **Issued for**

Hui Zhou Gaoshengda Technology Co.,LTD

NO.75 Zhongkai Development Area, Huizhou, Guangdong, China

## **Issued by**

Shenzhen ATL Testing Technology Co., Ltd.

F/4, Building 10, Dayuan Industrial Zone, Xili Town, Nanshan District, Shenzhen,  
China

Tel.: +86-0755-26909822 Fax.: +86-0755-61605504

Website: [www.atllab.org](http://www.atllab.org)

*Note: This report shall not be reproduced except in full, without the written approval of Shenzhen ATL Testing Technology Co., Ltd.. This document may be altered or revised by Shenzhen ATL Testing Technology Co., Ltd. personnel only, and shall be noted in the revision section of the document. The test results in the report only apply to the tested sample*



<b>Table of Contents</b>	<b>Page</b>
1 . TEST SUMMARY	5
1.1 TEST FACILITY	6
1.2 MEASUREMENT UNCERTAINTY	6
2 . GENERAL INFORMATION	7
2.1 GENERAL DESCRIPTION OF EUT	7
2.2 DESCRIPTION OF TEST MODES	9
2.3 DESCRIPTION OF TEST SETUP	10
2.4 DESCRIPTION TEST PERIPHERAL AND EUT PERIPHERAL	11
2.5 EUT Exercise Software	11
3 . CONDUCTED EMISSION TEST	12
3.1 CONDUCTED EMISSION MEASUREMENT (Frequency Range 150KHz-30MHz)	12
3.2 TEST PROCEDURE	12
3.3 TEST SETUP	13
3.4 TEST INSTRUMENTS	13
3.5 EUT OPERATING CONDITIONS	13
3.6 TEST RESULTS	14
4 . RADIATED EMISSION MEASUREMENT	16
4.1 RADIATED EMISSION LIMIT (Frequency Range 9KHz-1000MHz)	16
4.2 TEST PROCEDURE	16
4.3 TEST SETUP	17
4.4 TEST INSTRUMENTS	18
4.5 EUT OPERATING CONDITIONS	18
4.6 TEST RESULTS	19
5 . MAXIMUM CONDUCTED OUTPUT POWER MEASUREMENT	33
5.1 LIMITS	33
5.2 TEST PROCEDURE	33
5.3 TEST SETUP	33
5.4 TEST INSTRUMENTS	33
5.5 EUT OPERATING CONDITIONS	33
5.6 TEST RESULTS	33
6 . OCCUPIED BANDWIDTH MEASUREMENT	35
6.1 LIMITS	35
6.2 TEST PROCEDURE	35

<b>Table of Contents</b>	<b>Page</b>
6.3 TEST SETUP	35
6.4 TEST INSTRUMENTS	35
6.5 EUT OPERATING CONDITIONS	35
6.6 TEST RESULTS	35
7 . POWER SPECTRAL DENSITY	44
7.1 LIMITS	44
7.2 TEST PROCEDURE	44
7.3 TEST SETUP	44
7.4 TEST INSTRUMENTS	44
7.5 EUT OPERATING CONDITIONS	44
7.6 TEST RESULTS	44
8 . ANTENNA CONDUCTED SPURIOUS EMISSION	57
8.1 LIMITS	57
8.2 TEST PROCEDURE	57
8.3 TEST SETUP	57
8.4 TEST INSTRUMENTS	57
8.5 EUT OPERATING CONDITIONS	57
8.6 TEST RESULTS	57
9 . ANTENNA REQUIREMENT	74
9.1 REQUIREMENT	74
9.2 ANTENNA CONNECTOR CONSTRUCTION	74

### 1. TEST SUMMARY

Test procedures according to the technical standards:

FCC Part 15 Subpart C (15.247)/RSS 247 Issue 1: 2015				
Standard Section		Test Item	Judgment	Remark
FCC	IC			
15.207	RSS Gen	AC Power Conducted Emission	PASS	
15.247(d)	RSS 247 Section 5.5	Antenna Conducted Spurious Emissions	PASS	
15.247(b)(3)	RSS 247 Section 5.4(4)	Output Power	PASS	
15.247(a)(2)	RSS 247 Section 5.2(1)	6dB RF Bandwidth	PASS	
15.247(e)	RSS 247 Section 5.2(2)	Power Spectral Density	PASS	
15.209/ 15.205	RSS 247 Section 5.5 RSS Gen	Transmitter Radiated Emissions	PASS	
15.203	/	Antenna Requirement	PASS	

**NOTE:**

(1) "N/A" denotes test is not applicable in this Test Report

(2) The test results of this report relate only to the tested sample(s) identified in this report.

## 1.1 TEST FACILITY

Shenzhen ATL Testing Technology Co., Ltd.

Add. : F/4, Building 10, Dayuan Industrial Zone, Xili Town, Nanshan District, Shenzhen, China

## 1.2 MEASUREMENT UNCERTAINTY

The reported uncertainty of measurement  $y \pm U$ , where expanded uncertainty  $U$  is based on a standard uncertainty multiplied by a coverage factor of  $k=2$ , providing a level of confidence of approximately **95** %.

### A. Conducted Emission :

The measurement uncertainty is evaluated as  $\pm 3.2$  dB.

### B. Radiated Measurement :

The measurement uncertainty is evaluated as  $\pm 3.7$  dB.

## 2. GENERAL INFORMATION

### 2.1 GENERAL DESCRIPTION OF EUT

Equipment	WIFI Module
Model Name	WCT3EM2611
Additional Model Number(s)	N/A
Model Difference	N/A
Frequency Range	2412~2462 MHz
Modulation Type	802.11b: DSSS 802.11g: OFDM 802.11n: OFDM
Data Rate	802.11b: 1/2/5.5/11 Mbps 802.11g: 6/9/12/18/24/36/48/54 Mbps 802.11n: 450 Mbps
RF Output Power	802.11b: 20.45 dBm 802.11g: 18.70 dBm 802.11n(HT20): 19.94 dBm 802.11n(HT40): 19.42 dBm
Antenna Type	PIFA Antenna (Max. Gain: 2.0 dBi)
Power Source	DC Powered by host system.
Power Rating	DC 5V from USB interference.
Remark	More details EUT technical specifications, please refer to the User's Manual.

**Note:**

- (1) This Test Report is FCC Part 15 Subpart C, 15.247 for IEEE 802.11b/g/n. And the Test procedure follows the FCC KDB 558074 D01 DTS Meas Guidance v03r05.
- (2) Transmitting mode with antennas

Mode	TX Antenna (s)
802.11b	1
802.11g	1
802.11n(HT20)	2
802.11n(HT40)	2

(3) Channel List.

2.4 GHz Band				
Frequency Band	Channel No.	Frequency	Channel No.	Frequency
2400~2483.5MHz	1	2412 MHz	7	2442 MHz
	2	2417 MHz	8	2447 MHz
	3	2422 MHz	9	2452 MHz
	4	2427 MHz	10	2457 MHz
	5	2432 MHz	11	2462 MHz
	6	2437 MHz		

For 802.11b/g/n(HT20), use channel 1~11  
 For 802.11n(HT40), use channel 3~9



## 2.2 DESCRIPTION OF TEST MODES

To investigate the maximum EMI emission characteristics generates from EUT, the test system was pre-scanning tested base on the consideration of following EUT operation mode or test configuration mode which possible have effect on EMI emission level. Each of these EUT operation mode(s) or test configuration mode(s) mentioned above was evaluated respectively.

Pretest Mode	Description
Mode 1	WiFi TX Mode
Mode 2	WiFi TX 802.11b Mode
Mode 3	WiFi TX 802.11g Mode
Mode 4	WiFi TX 802.11n(HT20)Mode
Mode 5	WiFi TX 802.11n(HT40) Mode

For Conducted Test	
Final Test Mode	Description
Mode 2	WiFi TX Mode

For Radiated Test	
Final Test Mode	Description
Mode 1	WiFi TX Mode
Mode 2	WiFi TX 802.11b Mode
Mode 3	WiFi TX 802.11g Mode
Mode 4	WiFi TX 802.11n(HT20)Mode
Mode 5	WiFi TX 802.11n(HT40) Mode

**Note:**

- (1) Software used to control the EUT for staying in continuous transmitting mode was programmed. After verification, all tests were carried out with the worst case test modes as shown below.
- (2) IEEE 802.11b Mode:  
Channel (2412/2437/2462 MHz) with 1Mbps data rate were chosen for full testing.
- (3) IEEE 802.11g Mode:  
Channel (2412/2437/2462 MHz) with 6 Mbps data rate were chosen for full testing.
- (4) IEEE 802.11n(HT20) Mode:  
Channel (2412/2437/2462 MHz) with MCS 0 data rate were chosen for full testing.
- (5) IEEE 802.11n(HT40) Mode:  
Channel (2422/2437/2452 MHz) with MCS 0 data rate were chosen for full testing.
- (6) By preliminary testing and verifying three axis (X, Y and Z) position of EUT transmitted status, it was found that "X axis" position was the worst, then the final test was executed the worst condition and test data were recorded in this report.

### 2.3 DESCRIPTION OF TEST SETUP

#### Radiated Emission

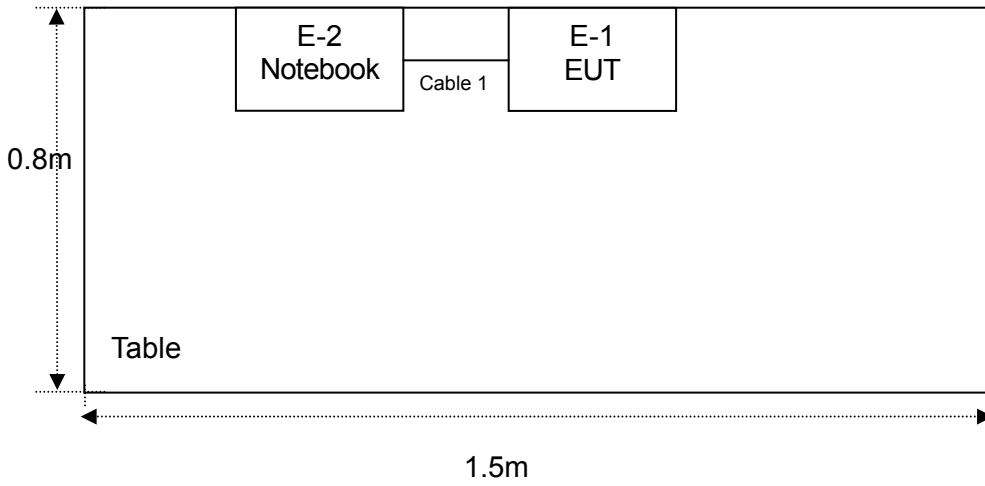

## 2.4 DESCRIPTION TEST PERIPHERAL AND EUT PERIPHERAL

The EUT has been tested as an independent unit together with other necessary accessories or support units. The following support units or accessories were used to form a representative test configuration during the tests.

Item	Equipment	Mfr/Brand	Model/Type No.	Series No.	Note
E-1	WIFI Module	GSD	WCT3EM2611	N/A	EUT
E-2	Notebook	LENOVO	P405	DOC	

Item	Shielded Type	Ferrite Core	Length	Note
1	NO	NO	15cm	

**Note:**

- (1) The support equipment was authorized by Declaration of Confirmation.
- (2) For detachable type I/O cable should be specified the length in cm in 『Length』 column.
- (3) “YES” means “shielded” “with core”; “NO” means “unshielded” “without core”.

## 2.5 EUT Exercise Software

Power Parameters for Testing			
Test Software Version	MT7662UQA.exe		
Mode	Frequency/ Parameters		
802.11b	2412 MHz	2437 MHz	2462 MHz
	DEF	DEF	DEF
802.11g	2412 MHz	2437 MHz	2462 MHz
	DEF	DEF	DEF
802.11n(HT20)	2412 MHz	2437 MHz	2462 MHz
	DEF	DEF	DEF
802.11n(HT40)	2422 MHz	2437 MHz	2452 MHz
	DEF	DEF	DEF

### 3. CONDUCTED EMISSION TEST

#### 3.1 CONDUCTED EMISSION MEASUREMENT (Frequency Range 150KHz-30MHz)

FREQUENCY (MHz)	Quasi-peak	Average
	dBuV	dBuV
0.15 -0.5	66 - 56 *	56 - 46 *
0.50 -5.0	56.00	46.00
5.0 -30.0	60.00	50.00

Note:

- (1) The tighter limit applies at the band edges.
- (2) The limit of " \* " marked band means the limitation decreases linearly with the logarithm of the frequency in the range.

The following table is the setting of the receiver

Receiver Parameters	Setting
Attenuation	10 dB
Start Frequency	0.15 MHz
Stop Frequency	30 MHz
IF Bandwidth	9 kHz

#### 3.2 TEST PROCEDURE

- a. The EUT was placed 0.8 meters from the horizontal ground plane with EUT being connected to the power mains through a line impedance stabilization network (LISN). All other support equipments powered from additional LISN(s). The LISN provide 50 Ohm/ 50uH of coupling impedance for the measuring instrument.
- b. Interconnecting cables that hang closer than 40 cm to the ground plane shall be folded back and forth in the center forming a bundle 30 to 40 cm long.
- c. I/O cables that are not connected to a peripheral shall be bundled in the center. The end of the cable may be terminated, if required, using the correct terminating impedance. The overall length shall not exceed 1 m.
- d. LISN at least 80 cm from nearest part of EUT chassis.
- e. For the actual test configuration, please refer to the related Item –EUT Test Photos.

### 3.3 TEST SETUP

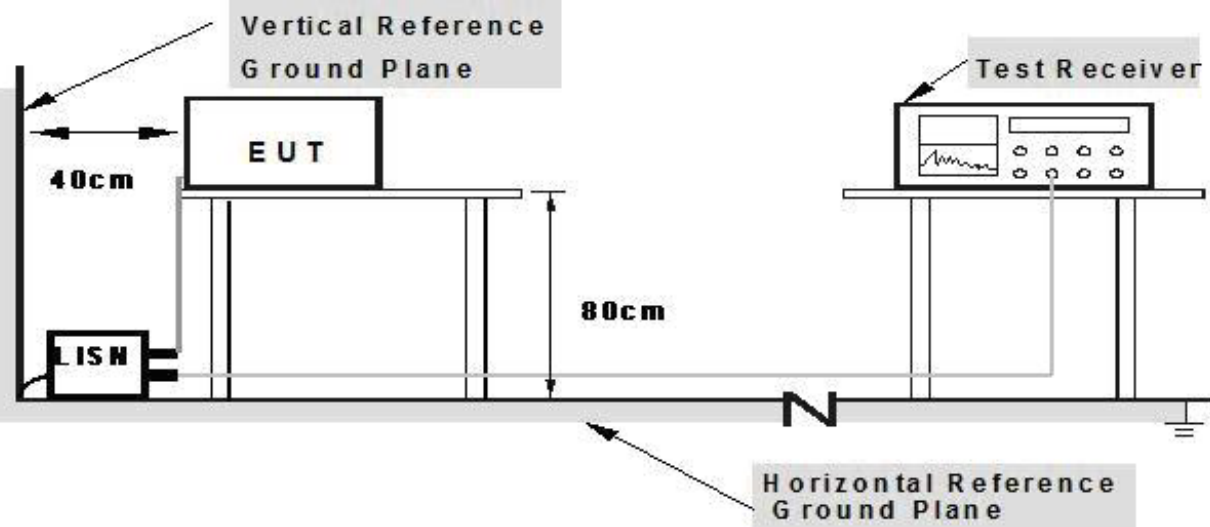

- Note: 1. Support units were connected to second LISN.**  
**2. Both of LISNs (AMN) are 80 cm from EUT and at least 80 from other units and other metal planes**

### 3.4 TEST INSTRUMENTS

Equipment	Manufacturer	Type No.	Serial No.	Last calibration	Calibrated until	Calibration period
LISN	R&S	NSLK81	8126466	Jul. 04. 2016	Jul. 03. 2017	1 year
LISN	R&S	NSLK81	8126487	Dec. 23, 2015	Dec. 22, 2016	1 year
50Ω Switch	ANRITSU CORP	MP59B	6200983704	Jul. 04. 2016	Jul. 03. 2017	1 year
Test Cable	N/A	C01	N/A	Jul. 04. 2016	Jul. 03. 2017	1 year
Test Cable	N/A	C02	N/A	Jul. 04. 2016	Jul. 03. 2017	1 year
Test Cable	N/A	C03	N/A	Jul. 04. 2016	Jul. 03. 2017	1 year
EMI Test Receiver	R&S	ESCI	1166.595	Jul. 04. 2016	Jul. 03. 2017	1 year
Passive Voltage Probe	ESH2-Z3	R&S	100196	Jul. 04. 2016	Jul. 03. 2017	1 year

### 3.5 EUT OPERATING CONDITIONS

The EUT tested system was configured as the statements of 2.3 Unless otherwise a special operating condition is specified in the follows during the testing.

### 3.6 TEST RESULTS

EUT :	WIFI Module	Model Name. :	WCT3EM2611
Temperature :	26 °C	Relative Humidity :	56%
Pressure :	1010hPa	Terminal:	Line
Test Mode :	WIFI TX Mode (B 2412MHz)		
Test Voltage :	120V/ 60Hz		

No.	Mk.	Freq. MHz	Reading Level dBuV	Correct Factor dB	Measure- ment dBuV	Limit dBuV	Over dB	Detector
1		0.1500	31.91	9.92	41.83	66.00	-24.17	peak
2	*	0.4020	28.81	10.02	38.83	57.81	-18.98	peak
3		0.6660	20.88	10.10	30.98	56.00	-25.02	peak
4		1.2660	21.08	10.06	31.14	56.00	-24.86	peak
5		1.6580	21.01	10.06	31.07	56.00	-24.93	peak
6		4.0660	19.72	9.99	29.71	56.00	-26.29	peak

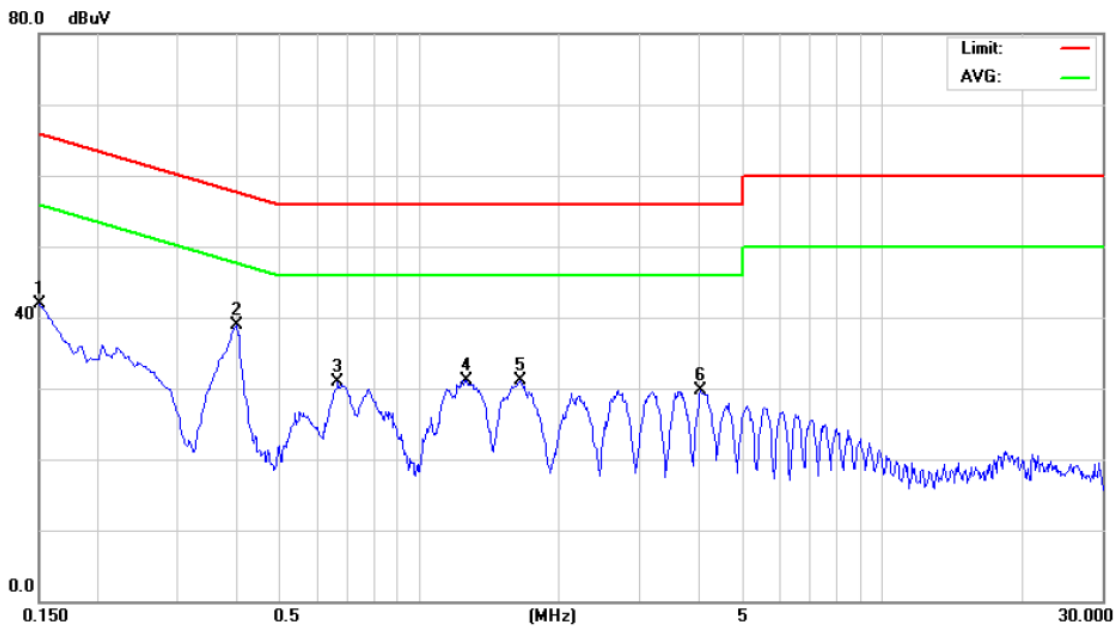

EUT :	WIFI Module	Model Name. :	WCT3EM2611
Temperature :	26 °C	Relative Humidity :	56%
Pressure :	1010hPa	Terminal:	Neutral
Test Mode :	WIFI TX Mode (B 2412MHz)		
Test Voltage :	120V/ 60Hz		

No. Mk.	Freq. MHz	Reading Level dBuV	Correct Factor dB	Measurement dBuV	Limit dBuV	Over dB	Detector
1	0.1500	31.69	10.12	41.81	66.00	-24.19	peak
2 *	0.3980	27.79	10.05	37.84	57.90	-20.06	peak
3	0.6700	21.02	10.02	31.04	56.00	-24.96	peak
4	1.2700	21.32	10.13	31.45	56.00	-24.55	peak
5	1.6060	21.15	10.10	31.25	56.00	-24.75	peak
6	4.0940	20.84	10.06	30.90	56.00	-25.10	peak

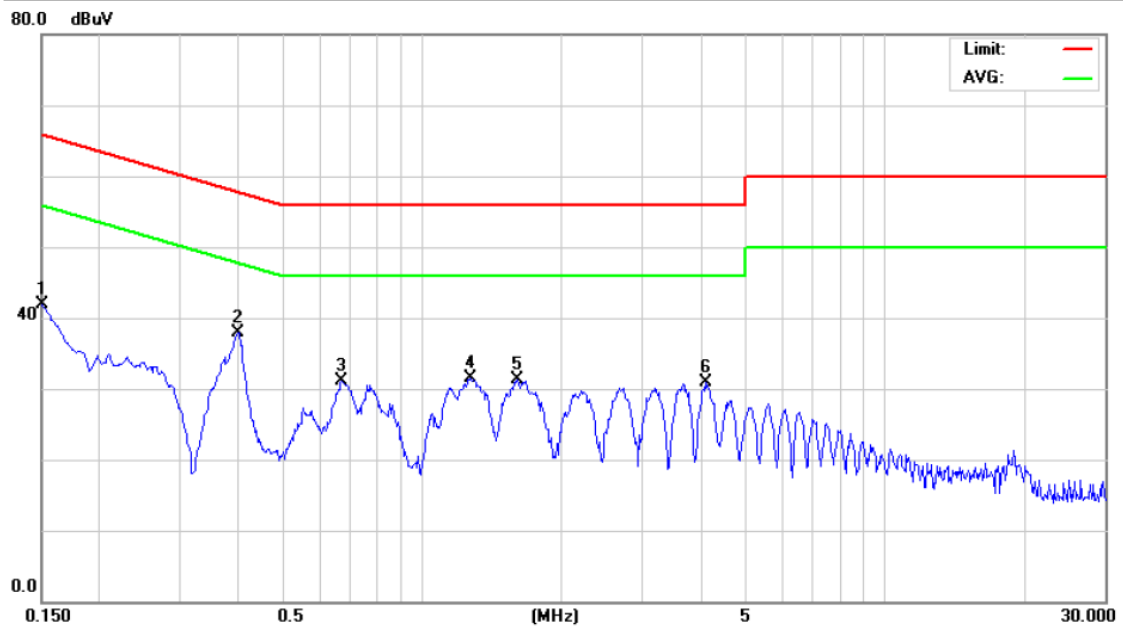

#### 4. RADIATED EMISSION MEASUREMENT

##### 4.1 RADIATED EMISSION LIMIT (Frequency Range 9KHz-1000MHz)

20 dBc in any 100 kHz bandwidth outside the operating frequency band. In case the emission fall within the restricted band specified on 15.205(a) and RSS-210 Section 2.2&A8.5, then the 15.209(a) and RSS-General limit in the table below has to be followed.

FREQUENCY (MHz)	Field Strength (uV/m at meter)	Measurement Distance (meters)
0.009 -0.490	2400/F(KHz)	300
0.490 -1.705	24000/F(KHz)	30
1.705 -30.0	30	30
30 -88	100	3
88 -216	150	3
216~960	200	3
Above 960	500	3

##### RADIATED EMISSION LIMITS (Above 1000MHz)

FREQUENCY (MHz)	Class A (dBuV/m)(at 3 M)		Class B (dBuV/m)(at 3 M)	
	Peak	Average		Peak
Above 1000	80	60	74	54

Note:

- (1) The limit for radiated test was performed according to FCC PART 15C.
- (2) The tighter limit applies at the band edges.
- (2) Emission Level(dBuV/m)=20log Emission Level(uV/m)

The following table is the setting of the receiver

Receiver Parameter	Setting
Attenuation	Auto
Start Frequency~ Stop Frequency	9kHz~150kHz/ RB 200Hz for QP
Start Frequency~ Stop Frequency	150kHz~30MHz/ RB 9kHz for QP
Start Frequency~ Stop Frequency	30MHz~1000MHz/ RB120kHz for QP

The following table is the setting of the spectrum

Spectrum Parameter	Setting
Attenuation	Auto
Start Frequency	1000 MHz
Stop Frequency	10 <sup>th</sup> carrier harmonic
RB/ VB (emission in restricted band)	1MHz/ 3 MHz for Peak, 1MHz/ 10Hz for Average

##### 4.2 TEST PROCEDURE

- a. The measuring distance of at 3 m shall be used for measurements at frequency up to 1GHz. For frequencies above 1GHz, any suitable measuring distance may be used.



- b. The EUT was placed on the top of a rotating table 0.8 meters above the ground at a 3 meter open area test site. The table was rotated 360 degrees to determine the position of the highest radiation.
- c. The height of the equipment or of the substitution antenna shall be 1.5 m; the height of the test antenna shall vary between 1 m to 4 m. Both horizontal and vertical polarizations of the antenna are set to make the measurement.
- d. The initial step in collecting conducted emission data is a spectrum analyzer peak detector mode pre-scanning the measurement frequency range. Significant peaks are then marked and then Quasi Peak detector mode re-measured, above 1G Average detector mode will be instead.
- e. If the Peak Mode measured value compliance with and lower than Quasi Peak Mode Limit, the EUT shall be deemed to meet QP Limits and then no additional QP Mode measurement performed.
- f. For the actual test configuration, please refer to the related Item –EUT Test Photos.

Note:

Both horizontal and vertical antenna polarities were tested.

And performed pretest to three orthogonal axis. The worst case emissions were reported.

### 4.3 TEST SETUP

#### (A) Radiated Emission Test Set-Up Frequency Below 30MHz

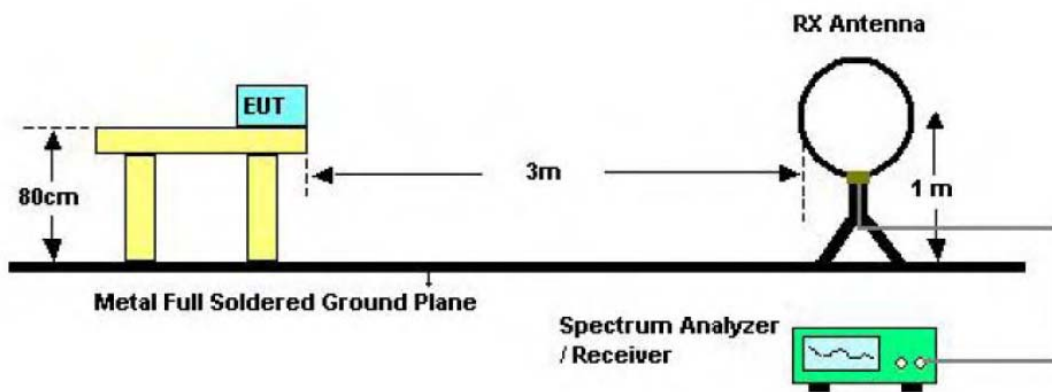

#### (B) Radiated Emission Test Set-Up Frequency Below 1 GHz

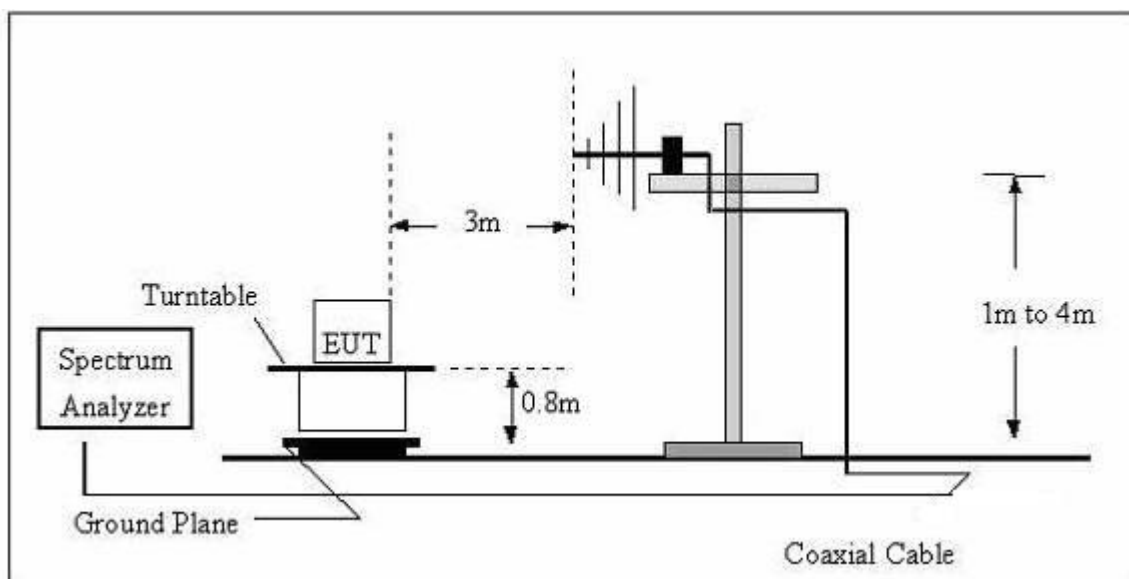

(C) Radiated Emission Test Set-Up Frequency Above 1GHz

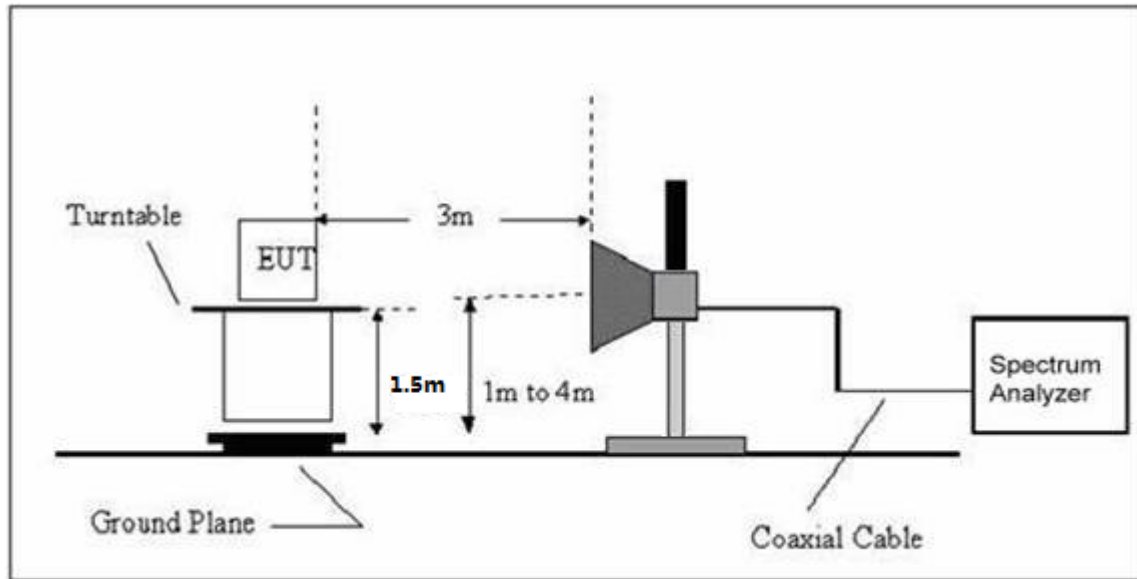

4.4 TEST INSTRUMENTS

Equipment	Manufacturer	Type No.	Serial No.	Last calibration	Calibrated until	Calibration period
Broadband Antenna	R&S	VULB 9168	VULB 9168-456	Jul. 05, 2015	Jul. 04. 2016	1 year
Test Cable	N/A	R-01	N/A	Dec. 23, 2015	Dec. 22, 2016	1 year
Test Cable	N/A	R-02	N/A	Dec. 23, 2015	Dec. 22, 2016	1 year
EMI Test Receiver	R&S	ESCI	101324	Jul. 05, 2015	Jul. 04. 2016	1 year
Antenna Mast	EM	SC100_1	N/A	N/A	N/A	N/A
Turn Table	EM	SC100	060531	N/A	N/A	N/A
50Ω Switch	Anritsu Corp	MP59B	6200983705	Jul. 05, 2015	Jul. 04. 2016	1 year
Spectrum Analyzer	R&S	FSP40	100154	Jul. 05, 2015	Jul. 04. 2016	1 year
Horn Antenna	R&S	HF906	10029	Jul. 05, 2015	Jul. 04. 2016	1 year
Amplifier	EM	EM-30180	060538	Jul. 05, 2015	Jul. 04. 2016	1 year

4.5 EUT OPERATING CONDITIONS

The EUT tested system was configured as the statements of 2.3 Unless otherwise a special operating condition is specified in the follows during the testing.

### 4.6 TEST RESULTS

#### 4.6.1 TEST RESULTS (Bellow 1GHz)

EUT :	WIFI Module	Model Name. :	WCT3EM2611
Temperature :	26 °C	Relative Humidity :	56%
Pressure :	1010hPa	Ant. Pol.:	Horizontal
Test Mode :	WIFI TX Mode (B 2412MHz)		
Test Voltage :	DC 5V		

No.	Mk.	Freq. MHz	Reading Level dBuV	Correct Factor dB	Measure- ment dBuV/m	Limit dBuV/m	Over dB	Detector
1	!	57.9992	56.40	-20.97	35.43	40.00	-4.57	peak
2		125.0066	54.34	-19.20	35.14	43.50	-8.36	peak
3		228.4901	54.63	-18.78	35.85	46.00	-10.15	peak
4	*	250.3010	61.19	-18.40	42.79	46.00	-3.21	peak
5	!	299.3158	58.34	-16.73	41.61	46.00	-4.39	peak
6		860.0352	48.63	-11.19	37.44	46.00	-8.56	peak

Remark:

Factor = Antenna Factor + Cable Loss.

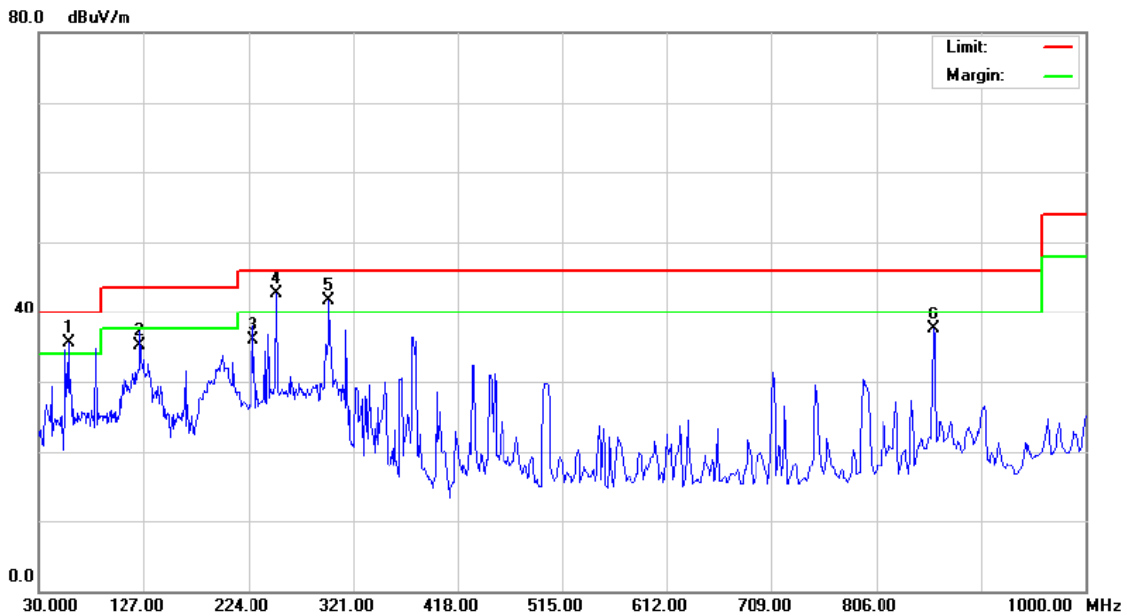

EUT :	WIFI Module	Model Name. :	WCT3EM2611
Temperature :	26 °C	Relative Humidity :	56%
Pressure :	1010hPa	Ant. Pol.:	Vertical
Test Mode :	WIFI TX Mode (B 2412MHz)		
Test Voltage :	DC 5V		

No.	Mk.	Freq. MHz	Reading Level dBuV	Correct Factor dB	Measure- ment dBuV/m	Limit dBuV/m	Over dB	Detector
1		183.8440	54.83	-19.00	35.83	43.50	-7.67	QP
2	!	243.3771	61.72	-18.56	43.16	46.00	-2.84	peak
3	!	299.3158	58.93	-16.73	42.20	46.00	-3.80	QP
4	*	333.6865	59.72	-16.34	43.38	46.00	-2.62	peak
5		377.2590	53.09	-15.92	37.17	46.00	-8.83	peak
6		432.5457	51.28	-15.28	36.00	46.00	-10.00	peak

Remark:

Factor = Antenna Factor + Cable Loss.

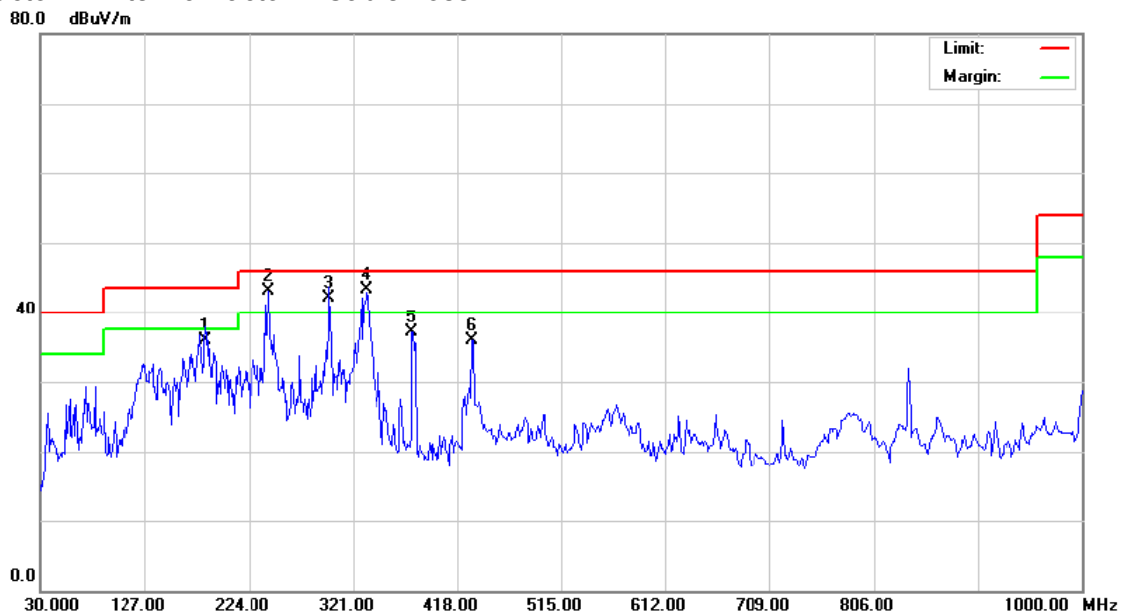

4.6.2 TEST RESULTS (Above 1GHz)

EUT :	WIFI Module	Model Name. :	WCT3EM2611
Temperature :	26 °C	Relative Humidity :	56%
Pressure :	1010hPa	Ant. Pol.:	Horizontal
Test Mode :	WIFI TX Mode (B 2412MHz)		
Test Voltage :	DC 5V		

No. Mk.	Freq.	Reading Level	Correct Factor	Measurement	Limit	Over	Detector	Comment
	MHz	dBuV	dB	dBuV/m	dBuV/m	dB		
1	2390.000	50.67	0.77	51.44	74.00	-22.56	peak	
2	2390.000	41.88	0.77	42.65	54.00	-11.35	AVG	
3 *	2411.100	105.0	0.86	105.86	54.00	51.86	AVG	FUNDAMENTAL FREQUENCY
4 X	2413.100	109.3	0.86	110.17	74.00	36.17	peak	FUNDAMENTAL FREQUENCY

No. Mk.	Freq.	Reading Level	Correct Factor	Measurement	Limit	Over	Detector	Comment
	MHz	dBuV	dB	dBuV/m	dBuV/m	dB		
1	4824.150	42.80	13.56	56.36	74.00	-17.64	peak	
2 *	4824.190	29.22	13.56	42.78	54.00	-11.22	AVG	

Remark:

Factor = Antenna Factor + Cable Loss.

EUT :	WIFI Module	Model Name. :	WCT3EM2611
Temperature :	26 °C	Relative Humidity :	56%
Pressure :	1010hPa	Ant. Pol.:	Vertical
Test Mode :	WIFI TX Mode (B 2412MHz)		
Test Voltage :	DC 5V		

No. Mk.	Freq.	Reading Level	Correct Factor	Measurement	Limit	Over	Detector	Comment
	MHz	dBuV	dB	dBuV/m	dBuV/m	dB		
1	2390.000	46.89	0.77	47.66	74.00	-26.34	peak	
2	2390.000	38.71	0.77	39.48	54.00	-14.52	AVG	
3 X	2411.200	103.7	0.86	104.57	74.00	30.57	peak	FUNDAMENTAL FREQUENCY
4 *	2412.800	97.23	0.86	98.09	54.00	44.09	AVG	FUNDAMENTAL FREQUENCY

No. Mk.	Freq.	Reading Level	Correct Factor	Measurement	Limit	Over	Detector	Comment
	MHz	dBuV	dB	dBuV/m	dBuV/m	dB		
1	4824.240	45.09	13.56	58.65	74.00	-15.35	peak	
2 *	4824.280	31.15	13.56	44.71	54.00	-9.29	AVG	

Remark:

Factor = Antenna Factor + Cable Loss.

EUT :	WIFI Module	Model Name. :	WCT3EM2611
Temperature :	26 °C	Relative Humidity :	56%
Pressure :	1010hPa	Ant. Pol.:	Horizontal
Test Mode :	WIFI TX Mode (B 2437MHz)		
Test Voltage :	DC 5V		

No. Mk.	Freq.	Reading Level	Correct Factor	Measurement	Limit	Over	Detector	Comment
	MHz	dBuV	dB	dBuV/m	dBuV/m	dB		
1 *	4874.149	28.20	13.86	42.06	54.00	-11.94	AVG	
2	4874.168	42.72	13.86	56.58	74.00	-17.42	peak	

Remark:

Factor = Antenna Factor + Cable Loss.

EUT :	WIFI Module	Model Name. :	WCT3EM2611
Temperature :	26 °C	Relative Humidity :	56%
Pressure :	1010hPa	Ant. Pol.:	Vertical
Test Mode :	WIFI TX Mode (B 2437MHz)		
Test Voltage :	DC 5V		

No. Mk.	Freq.	Reading Level	Correct Factor	Measurement	Limit	Over	Detector	Comment
	MHz	dBuV	dB	dBuV/m	dBuV/m	dB		
1	4874.262	44.91	13.86	58.77	74.00	-15.23	peak	
2 *	4874.612	31.04	13.86	44.90	54.00	-9.10	AVG	

Remark:

Factor = Antenna Factor + Cable Loss.

EUT :	WIFI Module	Model Name. :	WCT3EM2611
Temperature :	26 °C	Relative Humidity :	56%
Pressure :	1010hPa	Ant. Pol.:	Horizontal
Test Mode :	WIFI TX Mode (B 2462MHz)		
Test Voltage :	DC 5V		

No. Mk.	Freq.	Reading Level	Correct Factor	Measurement	Limit	Over	Detector	Comment
	MHz	dBuV	dB	dBuV/m	dBuV/m	dB		
1 *	2462.700	106.0	1.08	107.14	54.00	53.14	AVG	FUNDAMENTAL FREQUENCY
2 X	2463.100	111.1	1.08	112.21	74.00	38.21	peak	FUNDAMENTAL FREQUENCY
3	2483.500	54.91	1.17	56.08	74.00	-17.92	peak	
4	2483.500	43.81	1.17	44.98	54.00	-9.02	AVG	

No. Mk.	Freq.	Reading Level	Correct Factor	Measurement	Limit	Over	Detector	Comment
	MHz	dBuV	dB	dBuV/m	dBuV/m	dB		
1	4924.216	43.94	14.15	58.09	74.00	-15.91	peak	
2 *	4924.489	30.62	14.15	44.77	54.00	-9.23	AVG	

Remark:

Factor = Antenna Factor + Cable Loss.

EUT :	WIFI Module	Model Name. :	WCT3EM2611
Temperature :	26 °C	Relative Humidity :	56%
Pressure :	1010hPa	Ant. Pol.:	Vertical
Test Mode :	WIFI TX Mode (B 2462MHz)		
Test Voltage :	DC 5V		

No. Mk.	Freq.	Reading Level	Correct Factor	Measurement	Limit	Over	Detector	Comment
	MHz	dBuV	dB	dBuV/m	dBuV/m	dB		
1 X	2461.000	108.5	1.06	109.58	74.00	35.58	peak	FUNDAMENTAL FREQUENCY
2 *	2462.700	103.7	1.08	104.81	54.00	50.81	AVG	FUNDAMENTAL FREQUENCY
3	2483.500	44.19	1.17	45.36	74.00	-28.64	peak	
4	2483.500	51.51	1.17	52.68	74.00	-21.32	peak	

No. Mk.	Freq.	Reading Level	Correct Factor	Measurement	Limit	Over	Detector	Comment
	MHz	dBuV	dB	dBuV/m	dBuV/m	dB		
1 *	4924.120	29.73	14.15	43.88	54.00	-10.12	AVG	
2	4925.012	43.94	14.16	58.10	74.00	-15.90	peak	

Remark:

Factor = Antenna Factor + Cable Loss.

EUT :	WIFI Module	Model Name. :	WCT3EM2611
Temperature :	26 °C	Relative Humidity :	56%
Pressure :	1010hPa	Ant. Pol.:	Horizontal
Test Mode :	WIFI TX Mode (G 2412MHz)		
Test Voltage :	DC 5V		

No. Mk.	Freq.	Reading Level	Correct Factor	Measurement	Limit	Over	Detector	Comment
	MHz	dBuV	dB	dBuV/m	dBuV/m	dB		
1	2390.000	63.64	0.77	64.41	74.00	-9.59	peak	
2	2390.000	47.25	0.77	48.02	54.00	-5.98	AVG	
3 *	2415.900	97.37	0.88	98.25	54.00	44.25	AVG	FUNDAMENTAL FREQUENCY
4 X	2417.000	108.7	0.88	109.60	74.00	35.60	peak	FUNDAMENTAL FREQUENCY

No. Mk.	Freq.	Reading Level	Correct Factor	Measurement	Limit	Over	Detector	Comment
	MHz	dBuV	dB	dBuV/m	dBuV/m	dB		
1	4824.268	43.78	13.56	57.34	74.00	-16.66	peak	
2 *	4824.735	29.33	13.56	42.89	54.00	-11.11	AVG	

Remark:  
Factor = Antenna Factor + Cable Loss.

EUT :	WIFI Module	Model Name. :	WCT3EM2611
Temperature :	26 °C	Relative Humidity :	56%
Pressure :	1010hPa	Ant. Pol.:	Vertical
Test Mode :	WIFI TX Mode (G 2412MHz)		
Test Voltage :	DC 5V		

No. Mk.	Freq.	Reading Level	Correct Factor	Measurement	Limit	Over	Detector	Comment
	MHz	dBuV	dB	dBuV/m	dBuV/m	dB		
1	2390.000	61.79	0.77	62.56	74.00	-11.44	peak	
2	2390.000	46.38	0.77	47.15	54.00	-6.85	AVG	
3 *	2405.500	91.44	0.84	92.28	54.00	38.28	AVG	FUNDAMENTAL FREQUENCY
4 X	2417.600	102.6	0.89	103.55	74.00	29.55	peak	FUNDAMENTAL FREQUENCY

No. Mk.	Freq.	Reading Level	Correct Factor	Measurement	Limit	Over	Detector	Comment
	MHz	dBuV	dB	dBuV/m	dBuV/m	dB		
1	4824.012	44.03	13.56	57.59	74.00	-16.41	peak	
2 *	4824.365	29.00	13.56	42.56	54.00	-11.44	AVG	

Remark:  
Factor = Antenna Factor + Cable Loss.



EUT :	WIFI Module	Model Name. :	WCT3EM2611
Temperature :	26 °C	Relative Humidity :	56%
Pressure :	1010hPa	Ant. Pol.:	Horizontal
Test Mode :	WIFI TX Mode (G 2437MHz)		
Test Voltage :	DC 5V		

No. Mk.	Freq.	Reading Level	Correct Factor	Measurement	Limit	Over	Detector	Comment
	MHz	dBuV	dB	dBuV/m	dBuV/m	dB		
1 *	4874.270	29.23	13.86	43.09	54.00	-10.91	AVG	
2	4874.691	43.12	13.86	56.98	74.00	-17.02	peak	

Remark:

Factor = Antenna Factor + Cable Loss.

EUT :	WIFI Module	Model Name. :	WCT3EM2611
Temperature :	26 °C	Relative Humidity :	56%
Pressure :	1010hPa	Ant. Pol.:	Vertical
Test Mode :	WIFI TX Mode (G 2437MHz)		
Test Voltage :	DC 5V		

No. Mk.	Freq.	Reading Level	Correct Factor	Measurement	Limit	Over	Detector	Comment
	MHz	dBuV	dB	dBuV/m	dBuV/m	dB		
1 *	4874.290	28.62	13.86	42.48	54.00	-11.52	AVG	
2	4874.784	42.84	13.86	56.70	74.00	-17.30	peak	

Remark:

Factor = Antenna Factor + Cable Loss.

EUT :	WIFI Module	Model Name. :	WCT3EM2611
Temperature :	26 °C	Relative Humidity :	56%
Pressure :	1010hPa	Ant. Pol.:	Horizontal
Test Mode :	WIFI TX Mode (G 2462MHz)		
Test Voltage :	DC 5V		

No. Mk.	Freq.	Reading Level	Correct Factor	Measurement	Limit	Over	Detector	Comment
	MHz	dBuV	dB	dBuV/m	dBuV/m	dB		
1 *	2458.800	98.89	1.06	99.95	54.00	45.95	AVG	FUNDAMENTAL FREQUENCY
2 X	2467.300	109.4	1.10	110.55	74.00	36.55	peak	FUNDAMENTAL FREQUENCY
3	2483.500	61.31	1.17	62.48	74.00	-11.52	peak	
4	2483.500	48.61	1.17	49.78	54.00	-4.22	AVG	

No. Mk.	Freq.	Reading Level	Correct Factor	Measurement	Limit	Over	Detector	Comment
	MHz	dBuV	dB	dBuV/m	dBuV/m	dB		
1 *	4924.160	29.61	14.15	43.76	54.00	-10.24	AVG	
2	4924.863	43.45	14.15	57.60	74.00	-16.40	peak	

Remark:

Factor = Antenna Factor + Cable Loss.

EUT :	WIFI Module	Model Name. :	WCT3EM2611
Temperature :	26 °C	Relative Humidity :	56%
Pressure :	1010hPa	Ant. Pol.:	Vertical
Test Mode :	WIFI TX Mode (G 2462MHz)		
Test Voltage :	DC 5V		

No. Mk.	Freq.	Reading Level	Correct Factor	Measurement	Limit	Over	Detector	Comment
	MHz	dBuV	dB	dBuV/m	dBuV/m	dB		
1 *	2463.900	91.39	1.08	92.47	54.00	38.47	AVG	FUNDAMENTAL FREQUENCY
2 X	2467.700	102.1	1.10	103.26	74.00	29.26	peak	FUNDAMENTAL FREQUENCY
3	2483.500	59.63	1.17	60.80	74.00	-13.20	peak	
4	2483.500	45.56	1.17	46.73	54.00	-7.27	AVG	

No. Mk.	Freq.	Reading Level	Correct Factor	Measurement	Limit	Over	Detector	Comment
	MHz	dBuV	dB	dBuV/m	dBuV/m	dB		
1	4924.270	43.52	14.15	57.67	74.00	-16.33	peak	
2 *	4924.579	29.63	14.15	43.78	54.00	-10.22	AVG	

Remark:

Factor = Antenna Factor + Cable Loss.

EUT :	WIFI Module	Model Name. :	WCT3EM2611
Temperature :	26 °C	Relative Humidity :	56%
Pressure :	1010hPa	Ant. Pol.:	Horizontal
Test Mode :	WIFI TX Mode (N20 2412MHz)		
Test Voltage :	DC 5V		

No. Mk.	Freq.	Reading Level	Correct Factor	Measurement	Limit	Over	Detector	Comment
	MHz	dBuV	dB	dBuV/m	dBuV/m	dB		
1	2390.000	59.31	0.77	60.08	74.00	-13.92	peak	
2	2390.000	45.21	0.77	45.98	54.00	-8.02	AVG	
3 *	2405.600	96.22	0.84	97.06	54.00	43.06	AVG	FUNDAMENTAL FREQUENCY
4 X	2406.200	107.6	0.84	108.44	74.00	34.44	peak	FUNDAMENTAL FREQUENCY

No. Mk.	Freq.	Reading Level	Correct Factor	Measurement	Limit	Over	Detector	Comment
	MHz	dBuV	dB	dBuV/m	dBuV/m	dB		
1 *	4824.165	29.33	13.56	42.89	54.00	-11.11	AVG	
2	4824.685	43.99	13.56	57.55	74.00	-16.45	peak	

Remark:

Factor = Antenna Factor + Cable Loss.

EUT :	WIFI Module	Model Name. :	WCT3EM2611
Temperature :	26 °C	Relative Humidity :	56%
Pressure :	1010hPa	Ant. Pol.:	Vertical
Test Mode :	WIFI TX Mode (N20 2412MHz)		
Test Voltage :	DC 5V		

No. Mk.	Freq.	Reading Level	Correct Factor	Measurement	Limit	Over	Detector	Comment
	MHz	dBuV	dB	dBuV/m	dBuV/m	dB		
1	2390.000	58.07	0.77	58.84	74.00	-15.16	peak	
2	2390.000	43.05	0.77	43.82	74.00	-30.18	peak	
3 X	2407.000	101.9	0.84	102.82	74.00	28.82	peak	FUNDAMENTAL FREQUENCY
4 *	2407.400	90.99	0.85	91.84	54.00	37.84	AVG	FUNDAMENTAL FREQUENCY

No. Mk.	Freq.	Reading Level	Correct Factor	Measurement	Limit	Over	Detector	Comment
	MHz	dBuV	dB	dBuV/m	dBuV/m	dB		
1 *	4824.241	28.76	13.56	42.32	54.00	-11.68	AVG	
2	4824.729	43.30	13.56	56.86	74.00	-17.14	peak	

Remark:

Factor = Antenna Factor + Cable Loss.

EUT :	WIFI Module	Model Name. :	WCT3EM2611
Temperature :	26 °C	Relative Humidity :	56%
Pressure :	1010hPa	Ant. Pol.:	Horizontal
Test Mode :	WIFI TX Mode (N20 2437MHz)		
Test Voltage :	DC 5V		

No.	Mk.	Freq.	Reading Level	Correct Factor	Measurement	Limit	Over	Detector	Comment
		MHz	dBuV	dB	dBuV/m	dBuV/m	dB		
1	*	4874.020	28.80	13.86	42.66	54.00	-11.34	AVG	
2		4874.758	42.96	13.86	56.82	74.00	-17.18	peak	

Remark:

Factor = Antenna Factor + Cable Loss.

EUT :	WIFI Module	Model Name. :	WCT3EM2611
Temperature :	26 °C	Relative Humidity :	56%
Pressure :	1010hPa	Ant. Pol.:	Vertical
Test Mode :	WIFI TX Mode (N20 2437MHz)		
Test Voltage :	DC 5V		

No.	Mk.	Freq.	Reading Level	Correct Factor	Measurement	Limit	Over	Detector	Comment
		MHz	dBuV	dB	dBuV/m	dBuV/m	dB		
1	*	4874.134	29.91	13.86	43.77	54.00	-10.23	AVG	
2		4874.871	42.94	13.86	56.80	74.00	-17.20	peak	

Remark:

Factor = Antenna Factor + Cable Loss.

EUT :	WIFI Module	Model Name. :	WCT3EM2611
Temperature :	26 °C	Relative Humidity :	56%
Pressure :	1010hPa	Ant. Pol.:	Horizontal
Test Mode :	WIFI TX Mode (N20 2462MHz)		
Test Voltage :	DC 5V		

No.	Mk.	Freq.	Reading Level	Correct Factor	Measurement	Limit	Over	Detector	Comment
		MHz	dBuV	dB	dBuV/m	dBuV/m	dB		
1	X	2458.600	107.3	1.06	108.45	74.00	34.45	peak	FUNDAMENTAL FREQUENCY
2	*	2460.300	96.38	1.06	97.44	54.00	43.44	AVG	FUNDAMENTAL FREQUENCY
3		2483.500	58.31	1.17	59.48	74.00	-14.52	peak	
4		2483.500	45.12	1.17	46.29	54.00	-7.71	AVG	

No.	Mk.	Freq.	Reading Level	Correct Factor	Measurement	Limit	Over	Detector	Comment
		MHz	dBuV	dB	dBuV/m	dBuV/m	dB		
1	*	4924.128	28.78	14.15	42.93	54.00	-11.07	AVG	
2		4924.420	42.74	14.15	56.89	74.00	-17.11	peak	

Remark:

Factor = Antenna Factor + Cable Loss.

EUT :	WIFI Module	Model Name. :	WCT3EM2611
Temperature :	26 °C	Relative Humidity :	56%
Pressure :	1010hPa	Ant. Pol.:	Vertical
Test Mode :	WIFI TX Mode (N20 2462MHz)		
Test Voltage :	DC 5V		

No.	Mk.	Freq.	Reading Level	Correct Factor	Measurement	Limit	Over	Detector	Comment
		MHz	dBuV	dB	dBuV/m	dBuV/m	dB		
1	X	2456.600	89.98	1.05	91.03	74.00	17.03	peak	FUNDAMENTAL FREQUENCY
2	*	2458.100	101.8	1.06	102.87	54.00	48.87	AVG	FUNDAMENTAL FREQUENCY
3		2483.500	57.05	1.17	58.22	74.00	-15.78	peak	
4		2483.500	42.26	1.17	43.43	54.00	-10.57	AVG	

No.	Mk.	Freq.	Reading Level	Correct Factor	Measurement	Limit	Over	Detector	Comment
		MHz	dBuV	dB	dBuV/m	dBuV/m	dB		
1	*	4924.160	29.73	14.15	43.88	54.00	-10.12	AVG	
2		4924.582	42.86	14.15	57.01	74.00	-16.99	peak	

Remark:

Factor = Antenna Factor + Cable Loss.

EUT :	WIFI Module	Model Name. :	WCT3EM2611
Temperature :	26 °C	Relative Humidity :	56%
Pressure :	1010hPa	Ant. Pol.:	Horizontal
Test Mode :	WIFI TX Mode (N40 2422MHz)		
Test Voltage :	DC 5V		

No. Mk.	Freq.	Reading Level	Correct Factor	Measurement	Limit	Over	Detector	Comment
	MHz	dBuV	dB	dBuV/m	dBuV/m	dB		
1	2390.000	57.30	0.77	58.07	74.00	-15.93	peak	
2	2390.000	44.78	0.77	45.55	54.00	-8.45	AVG	
3 X	2409.000	102.8	0.85	103.66	74.00	29.66	peak	FUNDAMENTAL FREQUENCY
4 *	2420.200	91.48	0.89	92.37	54.00	38.37	AVG	FUNDAMENTAL FREQUENCY

No. Mk.	Freq.	Reading Level	Correct Factor	Measurement	Limit	Over	Detector	Comment
	MHz	dBuV	dB	dBuV/m	dBuV/m	dB		
1	4843.988	43.08	13.68	56.76	74.00	-17.24	peak	
2 *	4844.621	27.40	13.68	41.08	54.00	-12.92	AVG	

Remark:  
Factor = Antenna Factor + Cable Loss.

EUT :	WIFI Module	Model Name. :	WCT3EM2611
Temperature :	26 °C	Relative Humidity :	56%
Pressure :	1010hPa	Ant. Pol.:	Vertical
Test Mode :	WIFI TX Mode (N40 2422MHz)		
Test Voltage :	DC 5V		

No. Mk.	Freq.	Reading Level	Correct Factor	Measurement	Limit	Over	Detector	Comment
	MHz	dBuV	dB	dBuV/m	dBuV/m	dB		
1	2390.000	57.71	0.77	58.48	74.00	-15.52	peak	
2	2390.000	46.98	0.77	47.75	54.00	-6.25	AVG	
3 *	2419.300	89.88	0.89	90.77	54.00	36.77	AVG	FUNDAMENTAL FREQUENCY
4 X	2420.300	101.0	0.89	101.92	74.00	27.92	peak	FUNDAMENTAL FREQUENCY

No. Mk.	Freq.	Reading Level	Correct Factor	Measurement	Limit	Over	Detector	Comment
	MHz	dBuV	dB	dBuV/m	dBuV/m	dB		
1 *	4843.792	27.09	13.68	40.77	54.00	-13.23	AVG	
2	4844.260	41.62	13.68	55.30	74.00	-18.70	peak	

Remark:  
Factor = Antenna Factor + Cable Loss.

EUT :	WIFI Module	Model Name. :	WCT3EM2611
Temperature :	26 °C	Relative Humidity :	56%
Pressure :	1010hPa	Ant. Pol.:	Horizontal
Test Mode :	WIFI TX Mode (N40 2437MHz)		
Test Voltage :	DC 5V		

No. Mk.	Freq.	Reading Level	Correct Factor	Measurement	Limit	Over	Detector	Comment
	MHz	dBuV	dB	dBuV/m	dBuV/m	dB		
1	4873.990	42.03	13.86	55.89	74.00	-18.11	peak	
2 *	4874.208	27.56	13.86	41.42	54.00	-12.58	AVG	

Remark:

Factor = Antenna Factor + Cable Loss.

EUT :	WIFI Module	Model Name. :	WCT3EM2611
Temperature :	26 °C	Relative Humidity :	56%
Pressure :	1010hPa	Ant. Pol.:	Vertical
Test Mode :	WIFI TX Mode (N40 2437MHz)		
Test Voltage :	DC 5V		

No. Mk.	Freq.	Reading Level	Correct Factor	Measurement	Limit	Over	Detector	Comment
	MHz	dBuV	dB	dBuV/m	dBuV/m	dB		
1 *	4873.909	28.58	13.86	42.44	54.00	-11.56	AVG	
2	4874.265	44.04	13.86	57.90	74.00	-16.10	peak	

Remark:

Factor = Antenna Factor + Cable Loss.

EUT :	WIFI Module	Model Name. :	WCT3EM2611
Temperature :	26 °C	Relative Humidity :	56%
Pressure :	1010hPa	Ant. Pol.:	Horizontal
Test Mode :	WIFI TX Mode (N40 2452MHz)		
Test Voltage :	DC 5V		

No. Mk.	Freq.	Reading Level	Correct Factor	Measurement	Limit	Over	Detector	Comment
	MHz	dBuV	dB	dBuV/m	dBuV/m	dB		
1 X	2445.400	102.0	1.01	103.09	74.00	29.09	peak	FUNDAMENTAL FREQUENCY
2 *	2449.500	92.36	1.02	93.38	54.00	39.38	AVG	FUNDAMENTAL FREQUENCY
3	2483.500	57.52	1.17	58.69	74.00	-15.31	peak	
4	2483.500	44.50	1.17	45.67	54.00	-8.33	AVG	

No. Mk.	Freq.	Reading Level	Correct Factor	Measurement	Limit	Over	Detector	Comment
	MHz	dBuV	dB	dBuV/m	dBuV/m	dB		
1 *	4903.962	27.98	14.03	42.01	54.00	-11.99	AVG	
2	4904.331	42.74	14.03	56.77	74.00	-17.23	peak	

Remark:

Factor = Antenna Factor + Cable Loss.

EUT :	WIFI Module	Model Name. :	WCT3EM2611
Temperature :	26 °C	Relative Humidity :	56%
Pressure :	1010hPa	Ant. Pol.:	Vertical
Test Mode :	WIFI TX Mode (N40 2452MHz)		
Test Voltage :	DC 5V		

No. Mk.	Freq.	Reading Level	Correct Factor	Measurement	Limit	Over	Detector	Comment
	MHz	dBuV	dB	dBuV/m	dBuV/m	dB		
1 *	2449.700	88.59	1.02	89.61	54.00	35.61	AVG	FUNDAMENTAL FREQUENCY
2 X	2450.400	100.5	1.02	101.56	74.00	27.56	peak	FUNDAMENTAL FREQUENCY
3	2483.500	56.92	1.17	58.09	74.00	-15.91	peak	
4	2483.500	43.42	1.17	44.59	54.00	-9.41	AVG	

No. Mk.	Freq.	Reading Level	Correct Factor	Measurement	Limit	Over	Detector	Comment
	MHz	dBuV	dB	dBuV/m	dBuV/m	dB		
1 *	4903.962	28.98	14.03	43.01	54.00	-10.99	AVG	
2	4904.260	43.85	14.03	57.88	74.00	-16.12	peak	

Remark:

Factor = Antenna Factor + Cable Loss.



## 5. MAXIMUM CONDUCTED OUTPUT POWER MEASUREMENT

### 5.1 LIMITS

FCC Part 15.247, subpart C/ RSS 247 Section 5.4(4)	
Frequency Range (MHz)	2400~2483.5
Limits	30

### 5.2 TEST PROCEDURE

The measurement is according to section 9.1.2 of FCC KDB 558074 D01 DTS Meas Guidance v03r02.

The EUT was directly connected to the power meter and antenna output port as show in the block diagram as bellow.

### 5.3 TEST SETUP

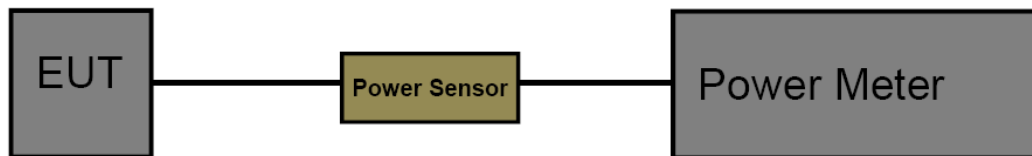

### 5.4 TEST INSTRUMENTS

Equipment	Manufacturer	Type No.	Serial No.	Last calibration	Calibrated until	Calibration period
P-Series Power Meter	Agilent	N1911A	MY45100482	Jul. 04. 2016	Jul. 03. 2017	1 year
Wideband Power Sensor	Agilent	N1921A	MY51200145	Jul. 04. 2016	Jul. 03. 2017	1 year

### 5.5 EUT OPERATING CONDITIONS

The EUT was set to continuously transmitting in the maximum power during the test.

### 5.6 TEST RESULTS

2.4 G Band Conducted Power					
802.11b Power					
Channel	Frequency	Conducted Power (dBm)			Max. Limit (dBm)
		Ant. 0	Ant. 1	Total	
1	2412 MHz	20.45		20.45	30
6	2437 MHz	20.02		20.02	
11	2462 MHz	20.14		20.14	
802.11g Power					
Channel	Frequency	Conducted Power (dBm)			Max. Limit (dBm)
		Ant. 0	Ant. 1	Total	
1	2412 MHz	18.70		18.70	30
6	2437 MHz	18.57		18.57	
11	2462 MHz	18.26		18.26	
802.11n(HT20) Power					
Channel	Frequency	Conducted Power (dBm)			Max. Limit (dBm)
		Ant. 0	Ant. 1	Total	
1	2412 MHz	17.60	16.14	19.94	30
6	2437 MHz	17.32	16.35	19.87	
11	2462 MHz	17.02	16.05	19.57	
802.11n(HT40) Power					
Channel	Frequency	Conducted Power (dBm)			Max. Limit (dBm)
		Ant. 0	Ant. 1	Total	
1	2412 MHz	16.87	15.89	19.42	30
6	2437 MHz	16.22	16.10	19.17	
11	2462 MHz	16.45	16.04	19.26	

## 6. OCCUPIED BANDWIDTH MEASUREMENT

### 6.1 LIMITS

FCC Part 15.247, subpart C/ RSS 247 Section 5.2(1)	
Frequency Range (MHz)	2400~2483.5
Limits	6 dB Bandwidth>500 KHz

### 6.2 TEST PROCEDURE

The EUT was directly connected to the power meter and antenna output port as show in the block diagram as bellow.

Spectrum Parameters	Setting
Attenuation	Auto
Span	>6 dB Bandwidth
RBW	100 kHz
VBW	$\geq 3RBW$
Detector	Peak
Trace	Max Hold
Sweep Time	Auto

### 6.3 TEST SETUP

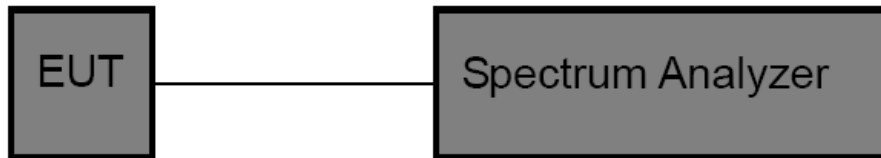

### 6.4 TEST INSTRUMENTS

Equipment	Manufacturer	Type No.	Serial No.	Last calibration	Calibrated until	Calibration period
Spectrum Analyzer	R&S	FSP40	100154	Jul. 04. 2016	Jul. 03. 2017	1 year

### 6.5 EUT OPERATING CONDITIONS

The EUT was set to continuously transmitting in the maximum power during the test.

### 6.6 TEST RESULTS

801.11b Mode			
Frequency (MHz)	6dB Bandwidth (MHz)	99% OBW (MHz)	Limit
2412	8.080	10.08	>=500 kHz
2437	8.080	10.08	
2462	8.080	10.08	

**B Mode 2412 MHz**

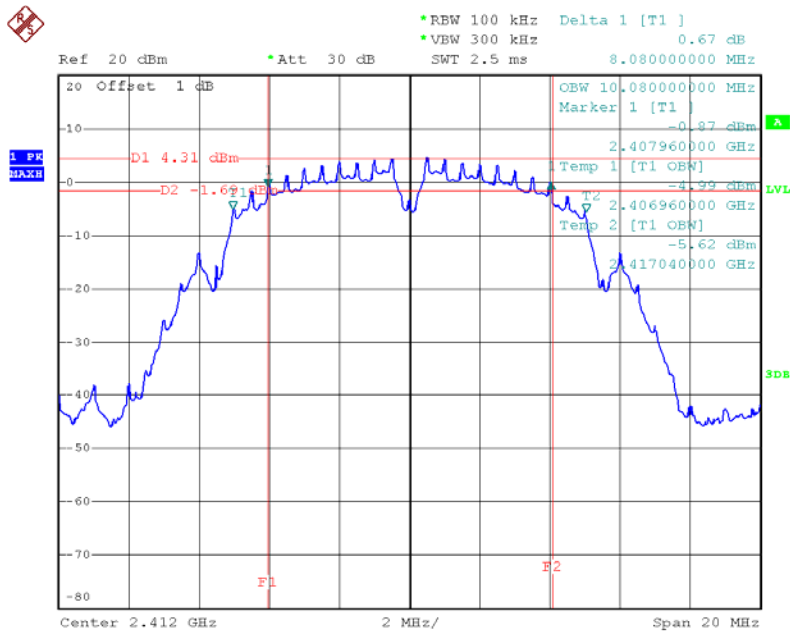

Date: 27.OCT.2016 15:06:35

### B Mode 2437 MHz

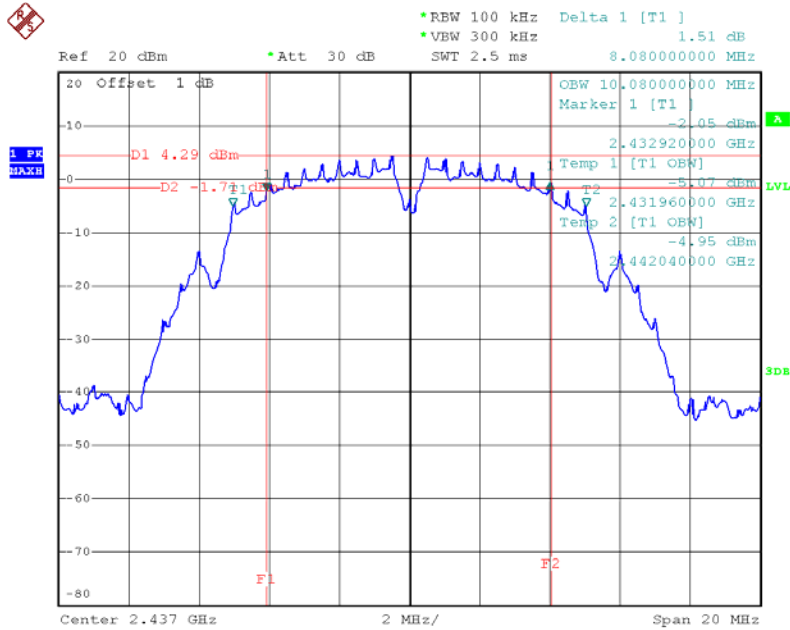

Date: 27.OCT.2016 15:09:49

### B Mode 2462 MHz

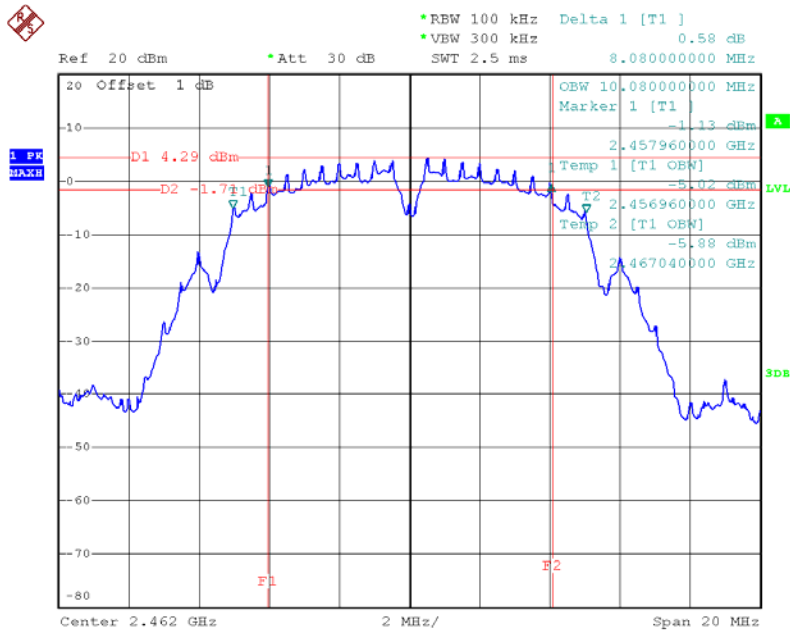

Date: 27.OCT.2016 15:11:46

801.11g Mode			
Frequency (MHz)	6dB Bandwidth (MHz)	99% OBW (MHz)	Limit
2412	15.080	16.32	>=500 kHz
2437	15.080	16.32	
2462	15.120	16.32	

**G Mode 2412 MHz**

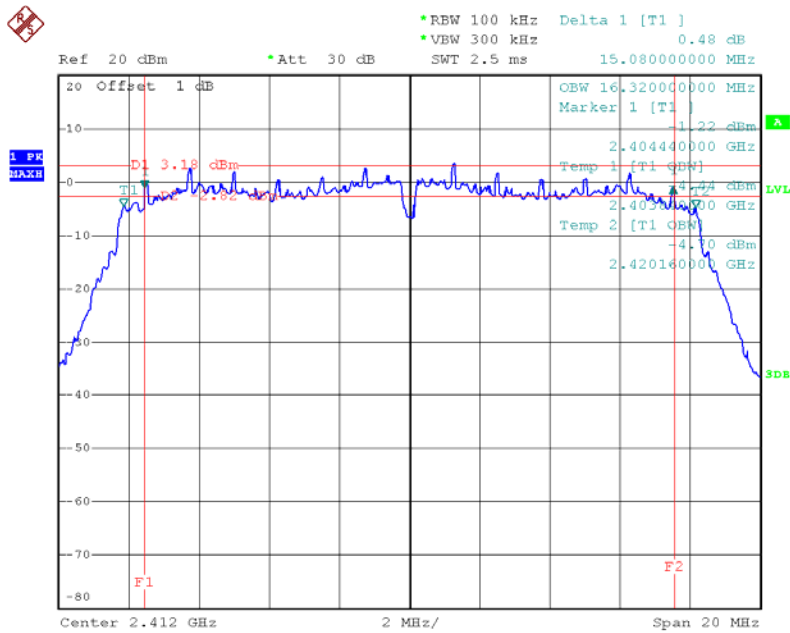

Date: 27.OCT.2016 15:19:22

### G Mode 2437 MHz

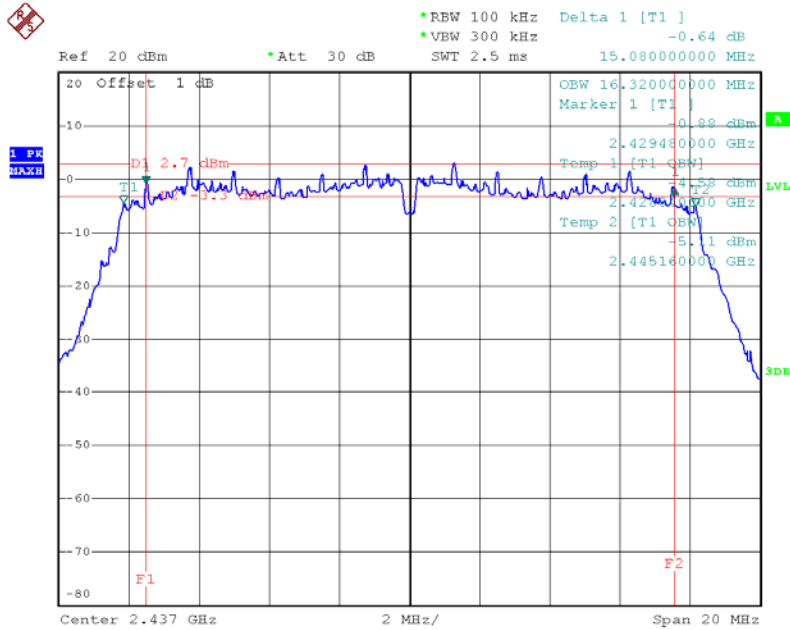

Date: 27.OCT.2016 15:17:24

### G Mode 2462 MHz

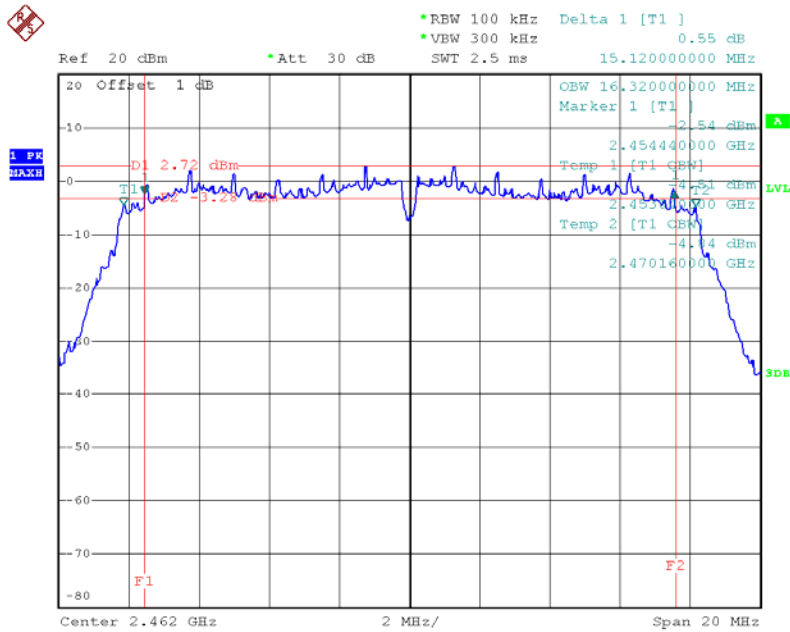

Date: 27.OCT.2016 15:16:01

801.11n(HT20) Mode			
Frequency (MHz)	6dB Bandwidth (MHz)	99% OBW (MHz)	Limit
2412	15.120	17.36	≥500 kHz
2437	15.120	17.36	
2462	15.120	17.40	

N Mode 2412 MHz

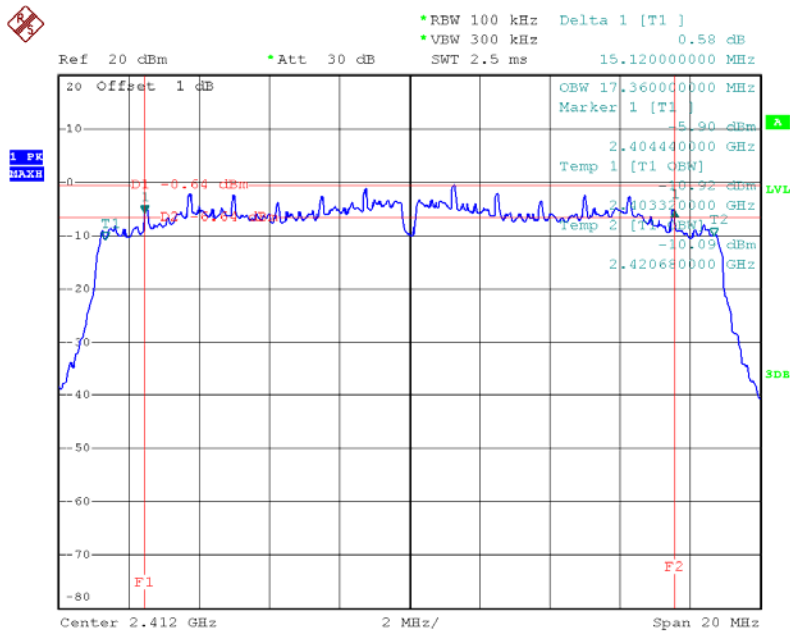

Date: 27.OCT.2016 15:40:36



### N Mode 2437 MHz

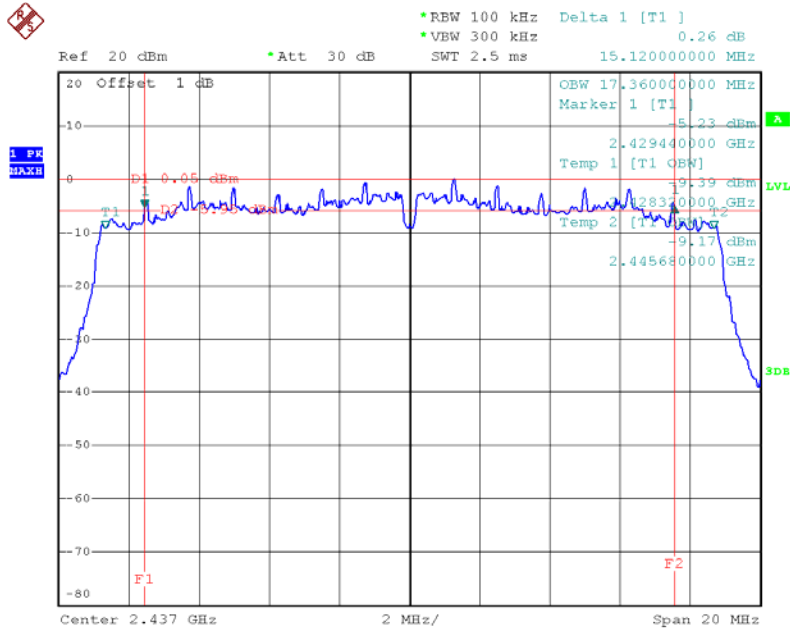

Date: 27.OCT.2016 15:37:25

### N Mode 2462 MHz



Date: 27.OCT.2016 15:36:06

801.11n(HT40) Mode			
Frequency (MHz)	6dB Bandwidth (MHz)	99% OBW (MHz)	Limit
2422	36.000	36.32	>=500 kHz
2437	36.000	36.32	
2452	35.080	36.32	

N Mode 2422 MHz

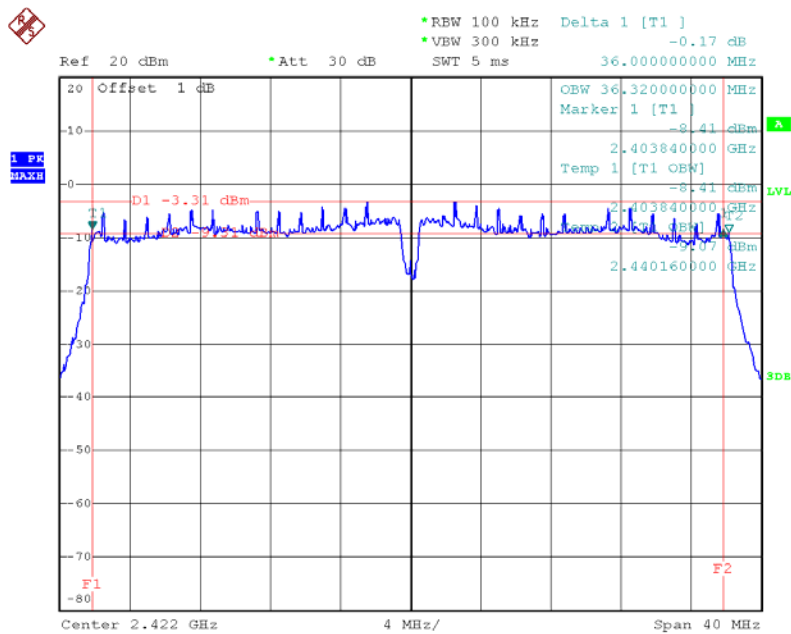

Date: 27.OCT.2016 15:43:03

### N Mode 2437 MHz

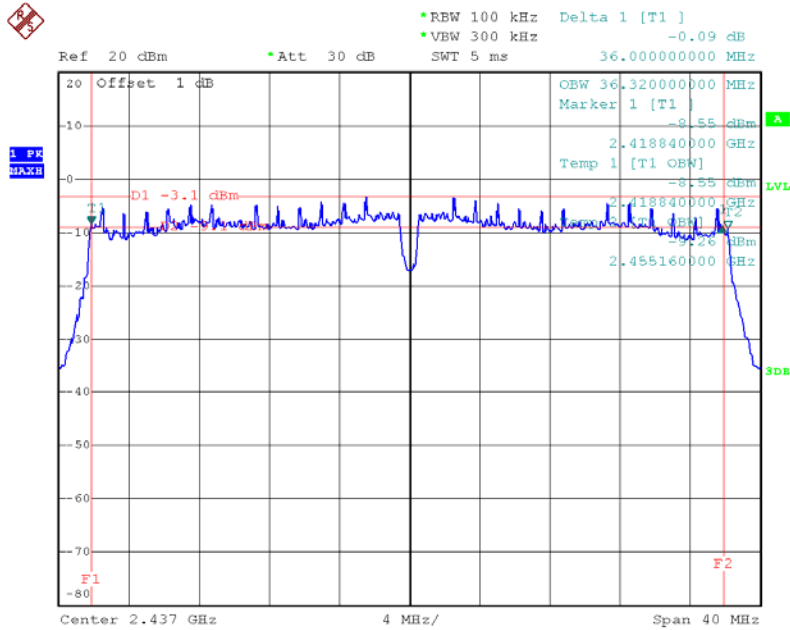

Date: 27.OCT.2016 15:46:22

### N Mode 2452 MHz

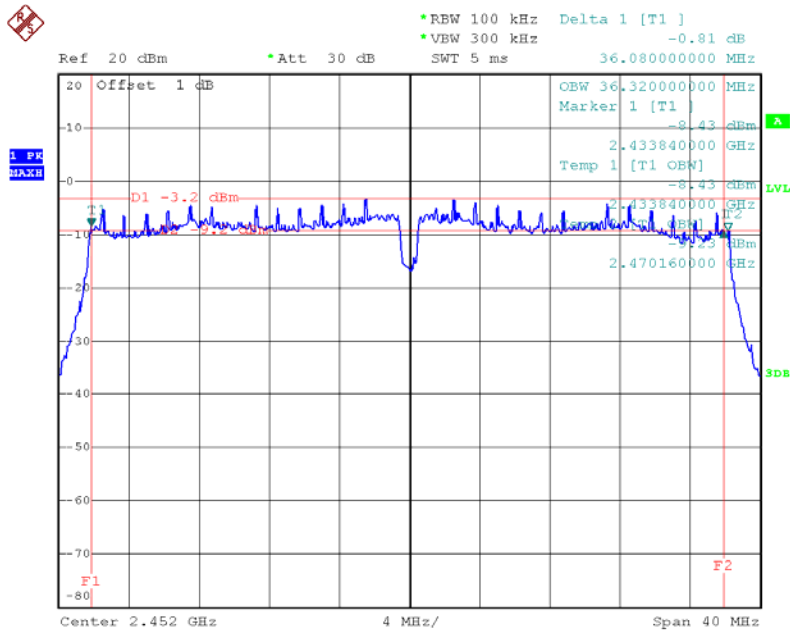

Date: 27.OCT.2016 15:49:28

## 7. POWER SPECTRAL DENSITY

### 7.1 LIMITS

FCC Part 15.247, Subpart C/ RSS 247 Section 5.2(2)	
Frequency Range (MHz)	2400~2483.5
99% Occupied Bandwidth	8 dBm in any 3 kHz

### 7.2 TEST PROCEDURE

The EUT was directly connected to the power meter and antenna output port as show in the block diagram as bellow.

Spectrum Parameters	Setting
Attenuation	Auto
Span	Set the span to 1.5 times the DTS channel bandwidth
RBW	3 kHz
VBW	$\geq 3\text{RBW}$
Detector	Reak
Trace	Max Hold
Sweep Time	Auto

### 7.3 TEST SETUP

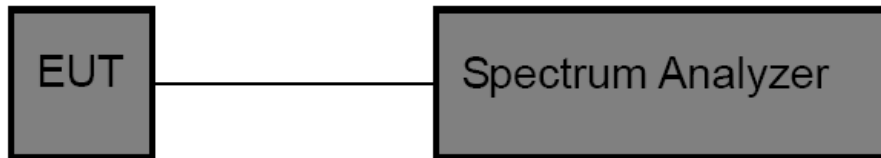

### 7.4 TEST INSTRUMENTS

Equipment	Manufacturer	Type No.	Serial No.	Last calibration	Calibrated until	Calibration period
Spectrum Analyzer	R&S	FSP40	100154	Jul. 04. 2016	Jul. 03. 2017	1 year

### 7.5 EUT OPERATING CONDITIONS

The EUT was set to continuously transmitting in the maximum power during the test.

### 7.6 TEST RESULTS

801.11b Mode					
Frequency (MHz)	Power Density (3 kHz/dBm)			Limit (dBm/3KHz)	Result
	ANT 0	ANT 1	Total		
2412	-9.11		-9.11	8	Pass
2437	-9.52		-9.52		
2462	-9.47		-9.47		

**B Mode 2412 MHz-ANT 0**

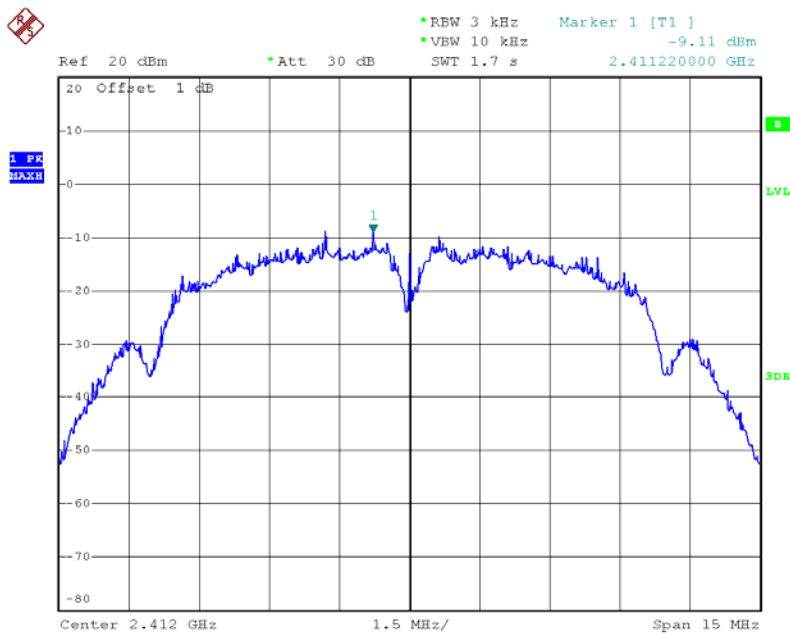

Date: 27.OCT.2016 15:06:55

### B Mode 2437 MHz-ANT 0

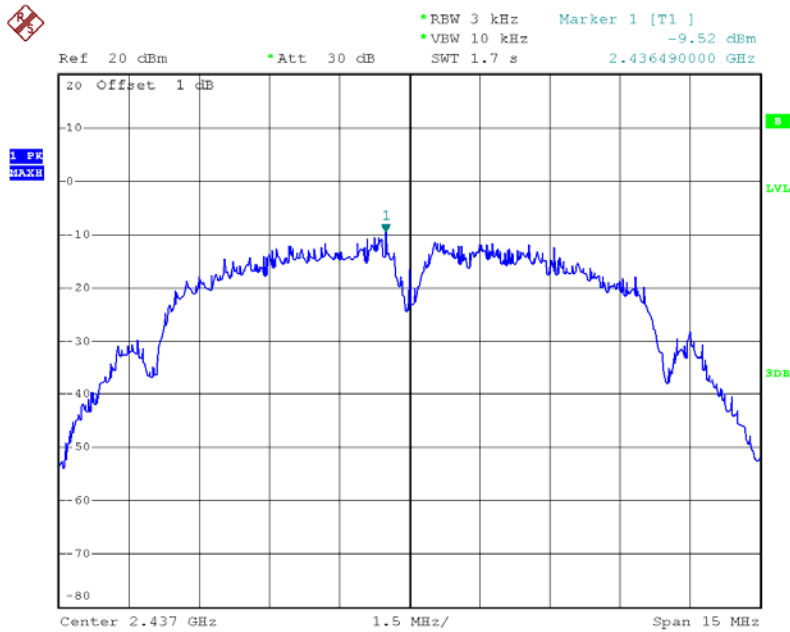

Date: 27.OCT.2016 15:10:05

### B Mode 2462 MHz-ANT 0

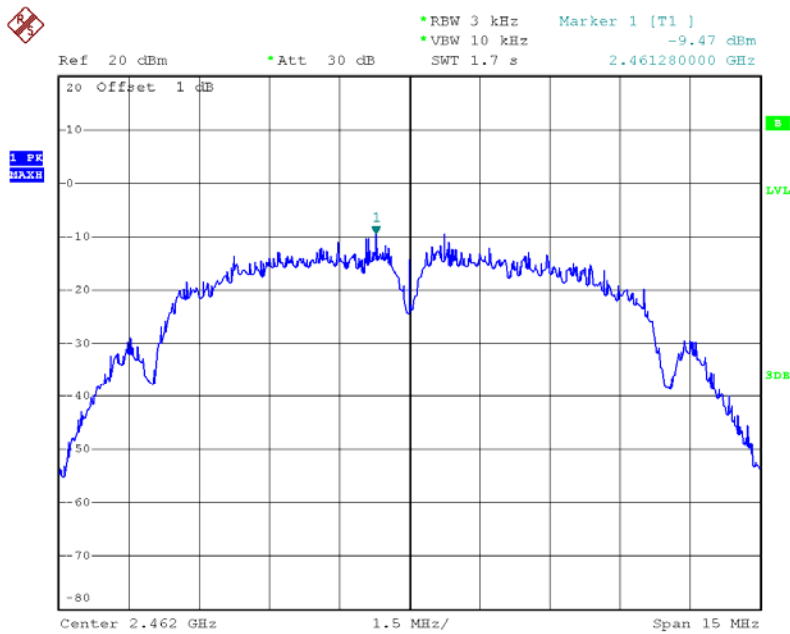

Date: 27.OCT.2016 15:10:24

801.11g Mode					
Frequency (MHz)	Power Density (3 kHz/dBm)			Limit (dBm/3KHz)	Result
	ANT 0	ANT 1	Total		
2412	-11.17		-12.99	8	Pass
2437	-11.34		-10.14		
2462	-11.81		-14.15		

G Mode 2412 MHz-ANT 0

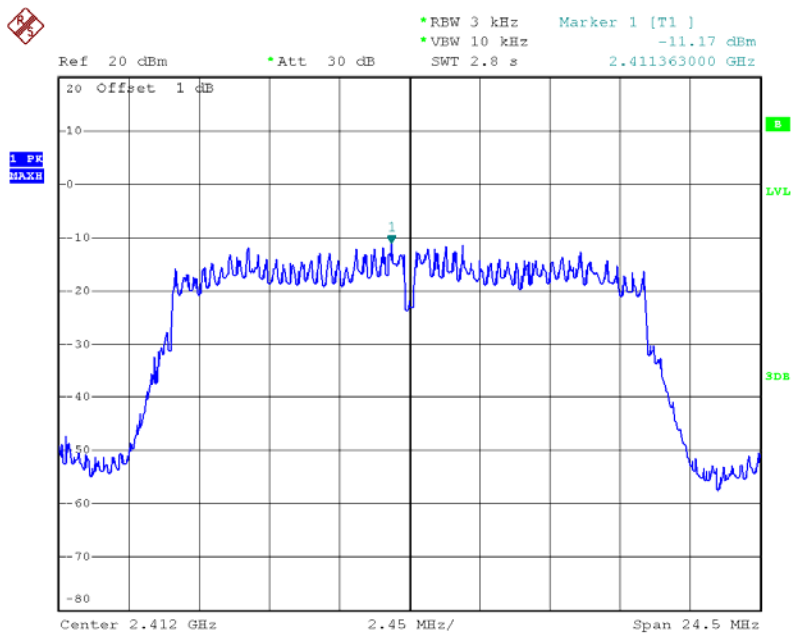

Date: 27.OCT.2016 15:20:54

### G Mode 2437 MHz-ANT 0

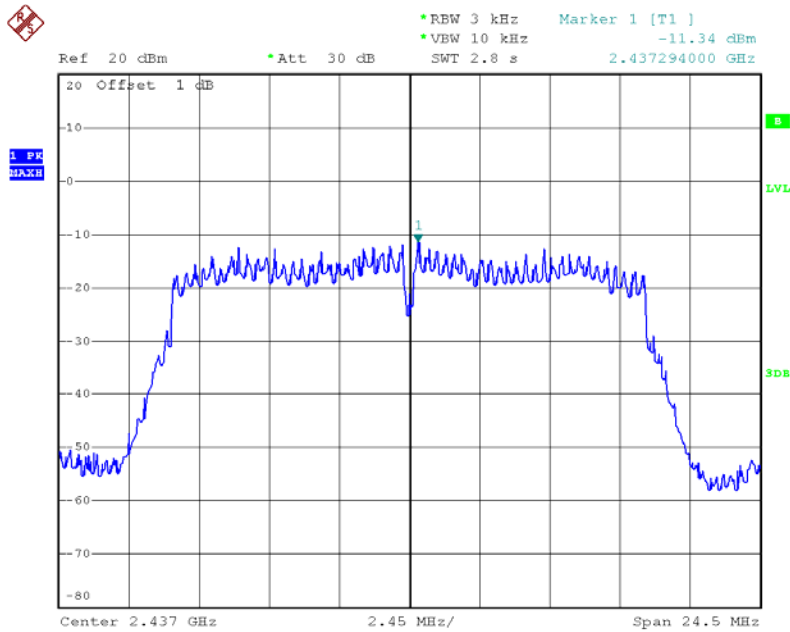

Date: 27.OCT.2016 15:16:43

### G Mode 2462 MHz-ANT 0

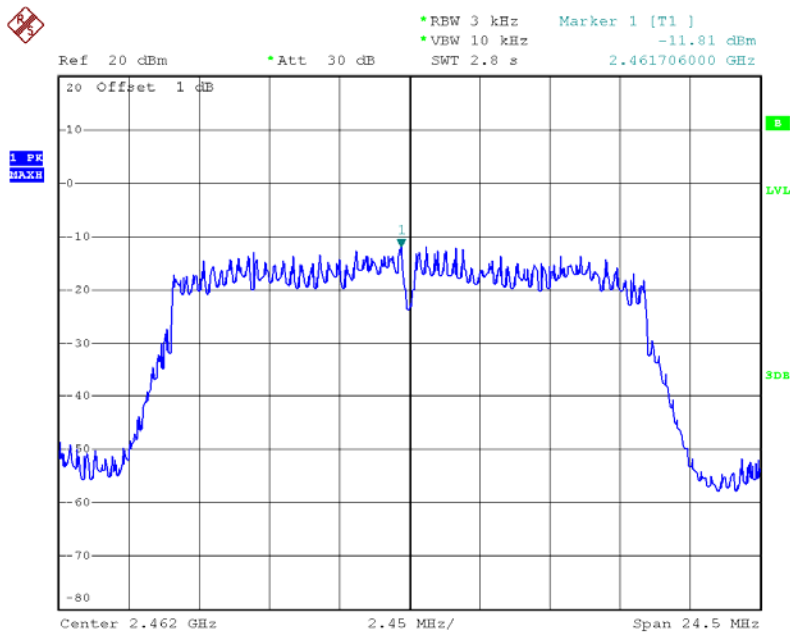

Date: 27.OCT.2016 15:16:20



801.11n(HT20) Mode					
Frequency (MHz)	Power Density (3 kHz/dBm)			Limit (dBm/3KHz)	Result
	ANT 0	ANT 1	Total		
2412	-12.49	-14.75	-10.46	8	Pass
2437	-13.09	-14.47	-10.71		
2462	-14.82	-14.96	-11.88		

**N (HT20) Mode 2412 MHz-ANT 0**

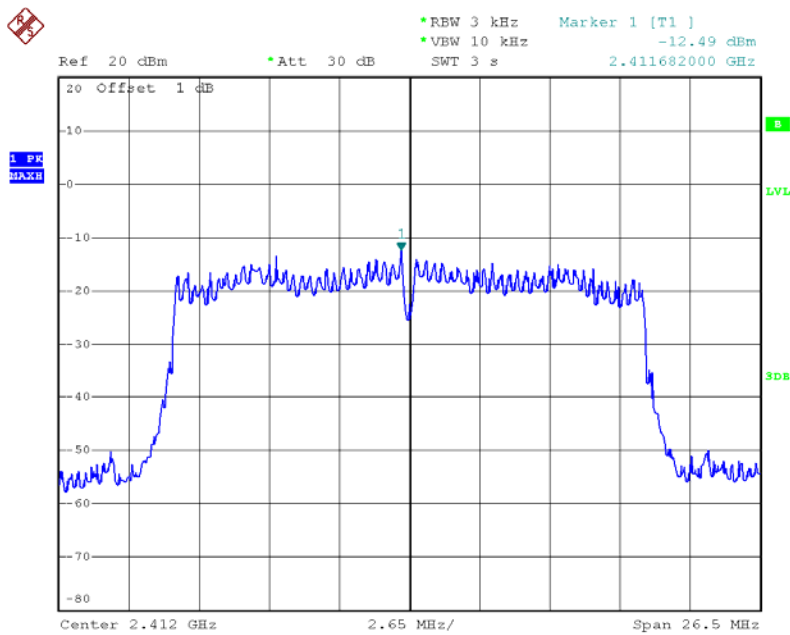

Date: 27.OCT.2016 15:24:23

### N (HT20) 2437 MHz-ANT 0

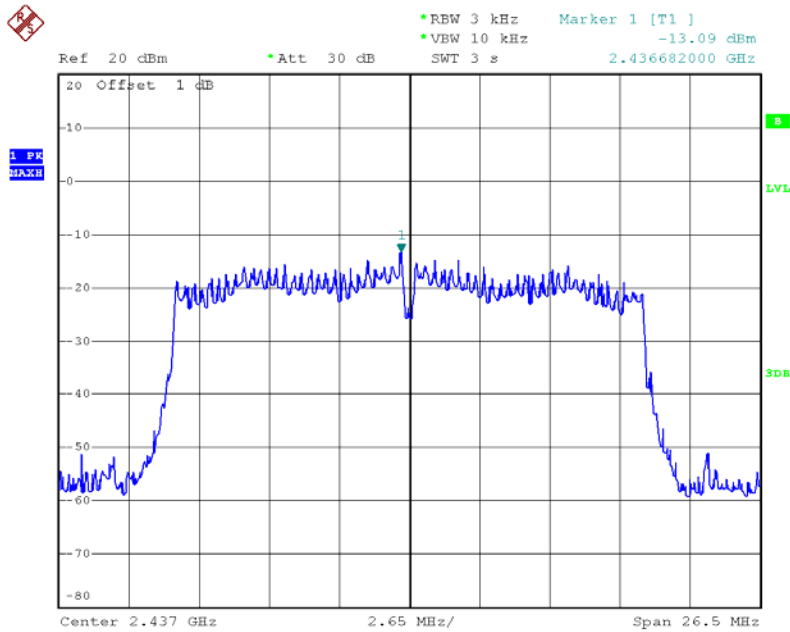

Date: 27.OCT.2016 15:24:44

### N (HT20) 2462 MHz-ANT 0

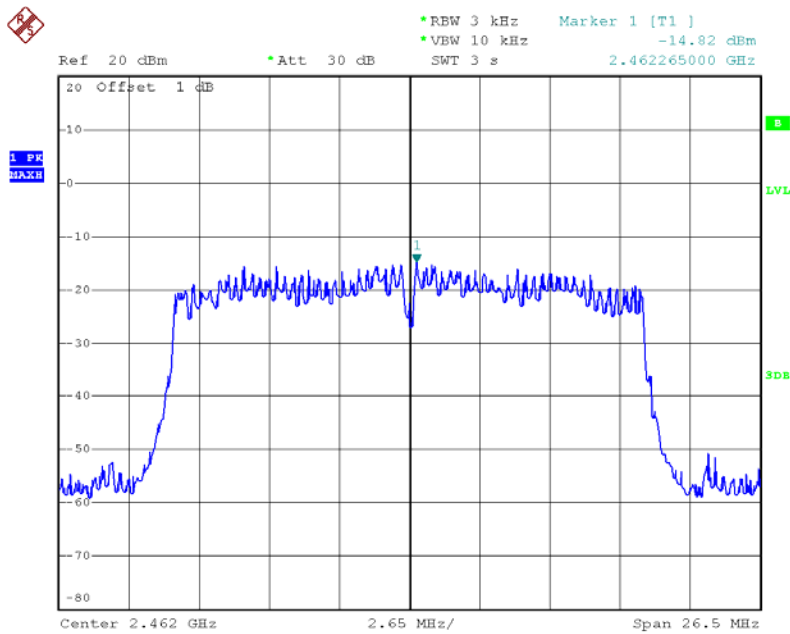

Date: 27.OCT.2016 15:33:24

### N (HT20) 2412 MHz-ANT 1

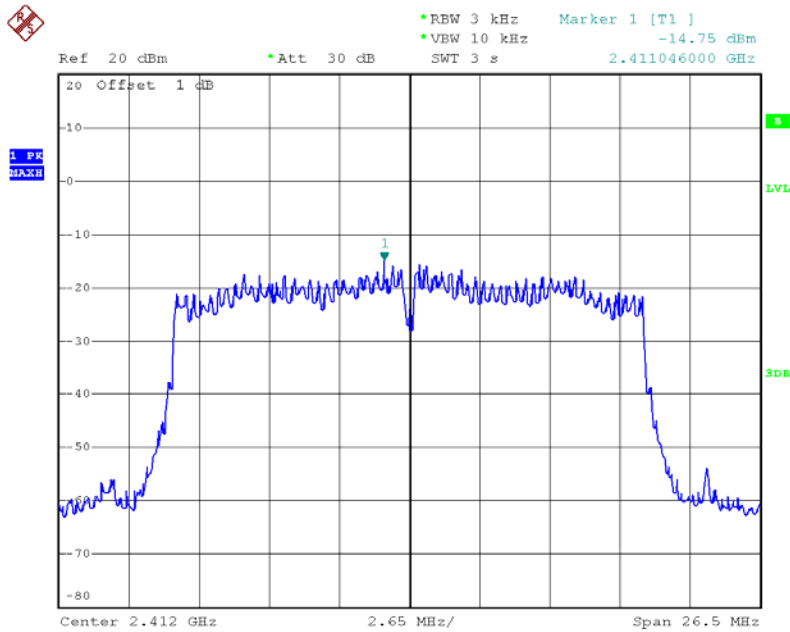

Date: 27.OCT.2016 15:39:26

### N (HT20) 2437 MHz-ANT 1

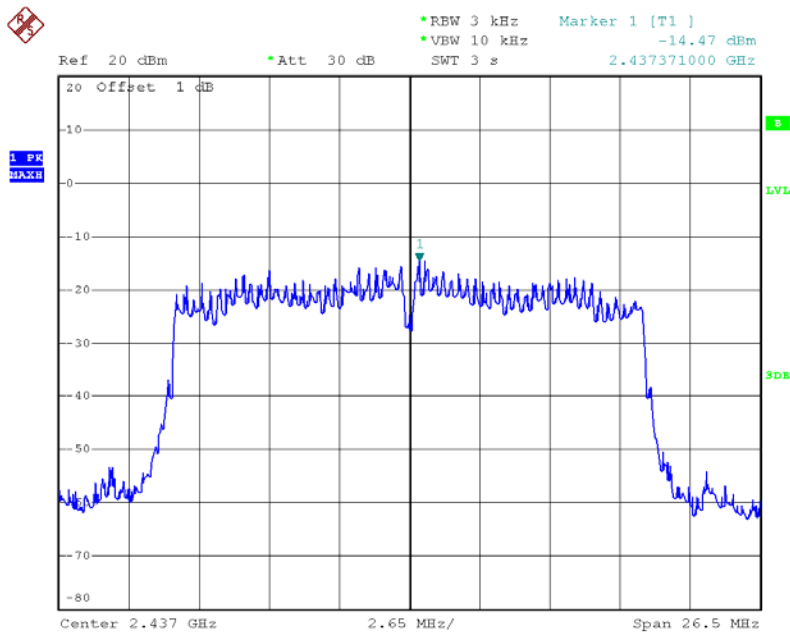

Date: 27.OCT.2016 15:38:50

### N (HT20) 2462 MHz-ANT 1

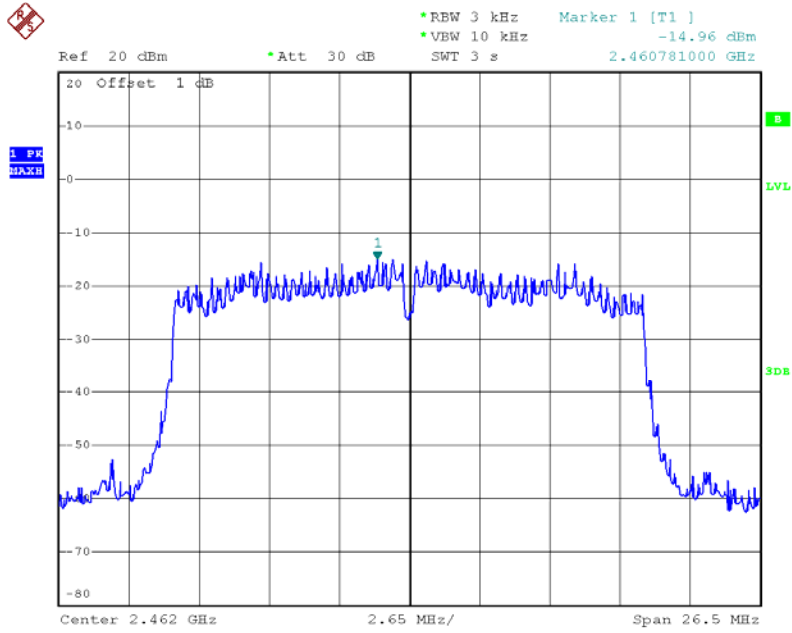

Date: 27.OCT.2016 15:34:11

801.11n(HT40) Mode					
Frequency (MHz)	Power Density (3 kHz/dBm)			Limit (dBm/3KHz)	Result
	ANT 0	ANT 1	Total		
2422	-16.04	-19.12	-14.30	8	Pass
2437	-17.12	-17.48	-14.28		
2452	-16.94	-17.75	-14.31		

**N (HT40) Mode 2422 MHz-ANT 0**

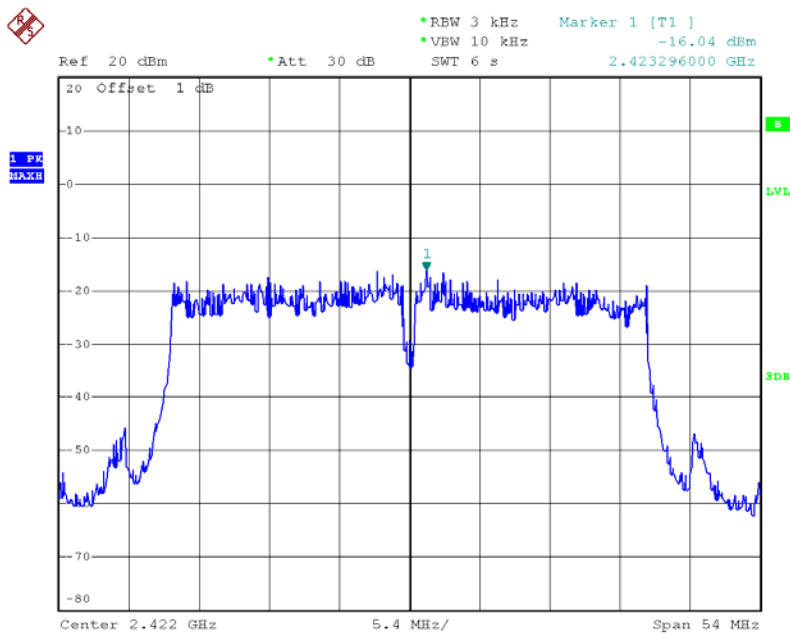

Date: 27.OCT.2016 15:59:11

### N (HT40) 2437 MHz-ANT 0

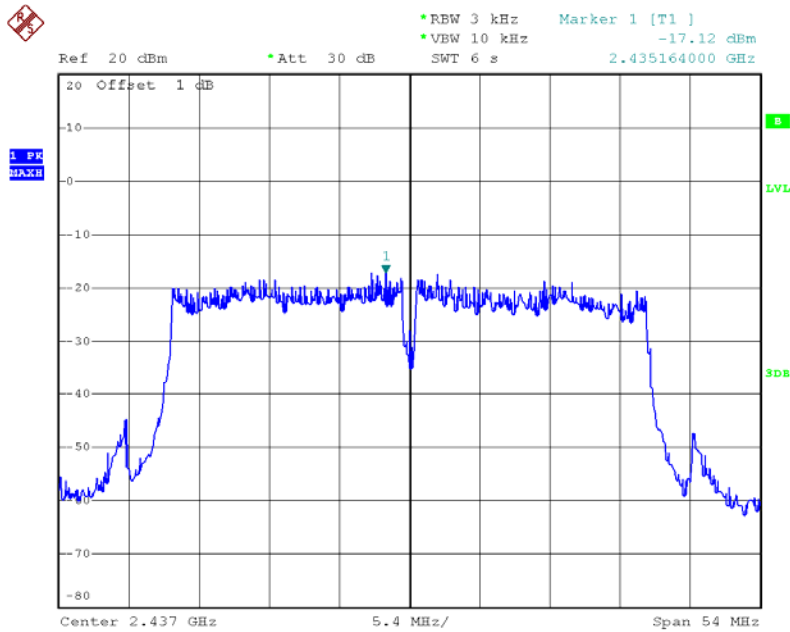

Date: 27.OCT.2016 15:58:46

### N (HT40) 2452 MHz-ANT 0

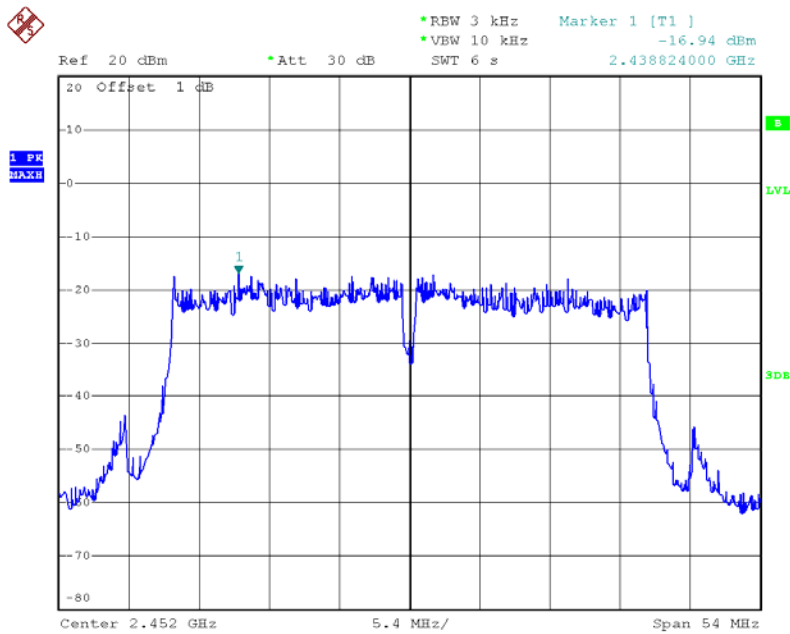

Date: 27.OCT.2016 15:54:06

### N (HT40) Mode 2422 MHz-ANT 1

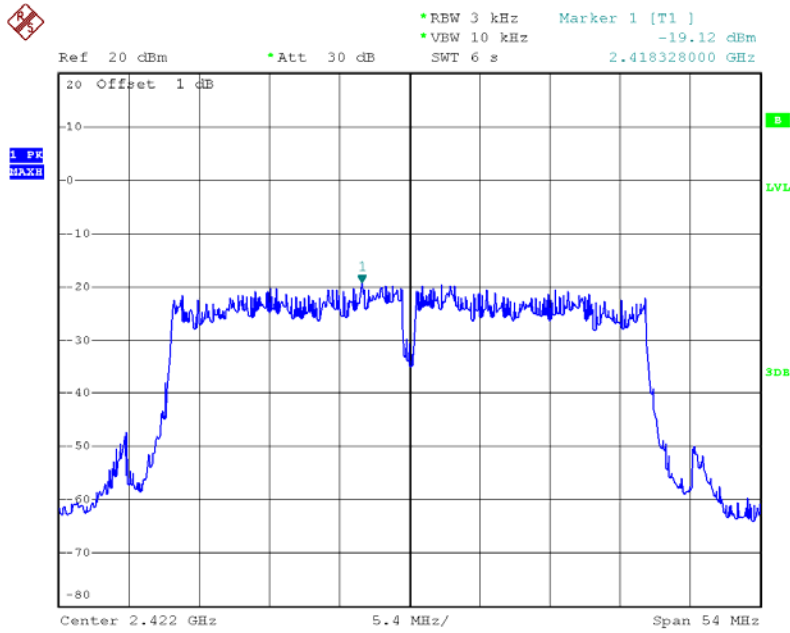

Date: 27.OCT.2016 15:44:49

### N (HT40) 2437 MHz-ANT 1

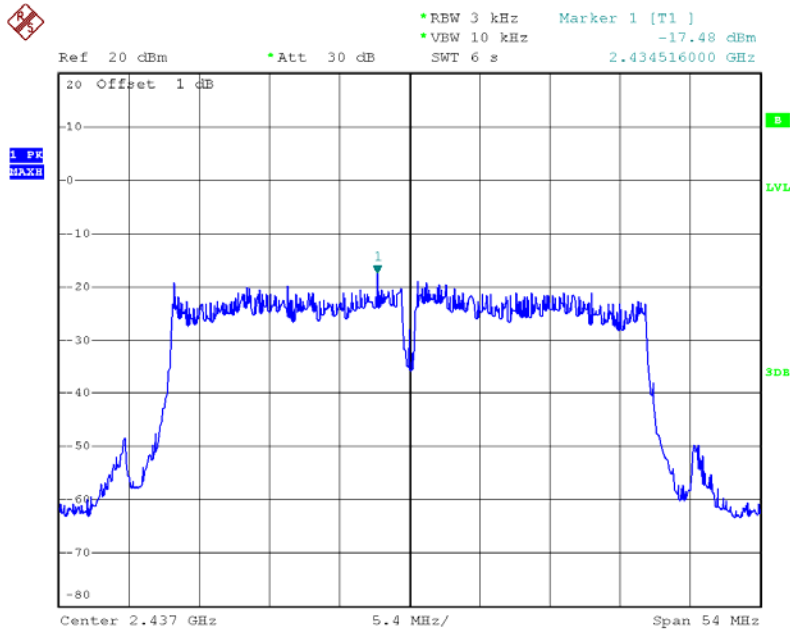

Date: 27.OCT.2016 15:45:38

### N (HT40) 2452 MHz-ANT 1

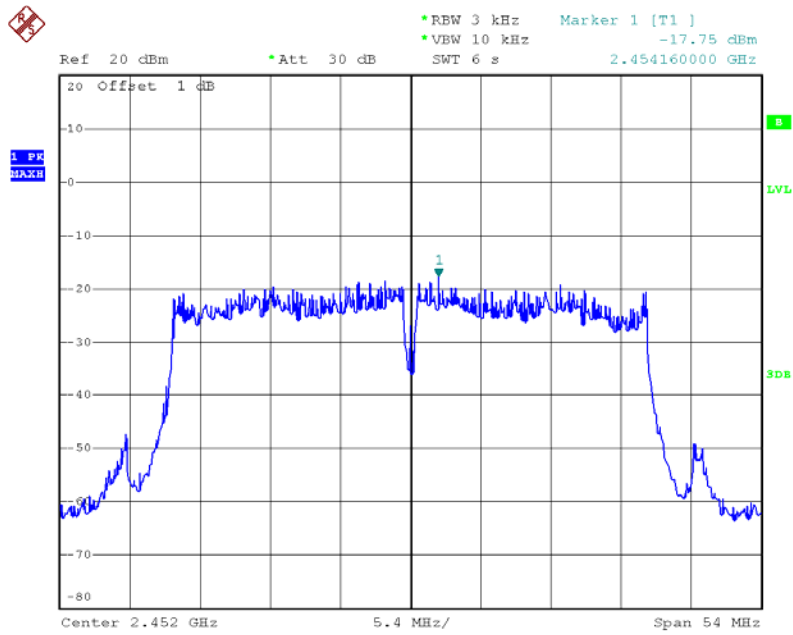

Date: 27.OCT.2016 15:49:50



## 8. ANTENNA CONDUCTED SPURIOUS EMISSION

### 8.1 LIMITS

FCC Part 15.247, Subpart C/ RSS 247 Section 5.5	
Frequency Range (MHz)	2400~2483.5
Limit	In any 100 kHz bandwidth outside the intentional radiation frequency band, the radio frequency power shall be at least 20 dB below the highest level of the desired power, based on either an RF conducted measurement, provide the transmitter demonstrates compliance with the peak conducted power limits.

### 8.2 TEST PROCEDURE

The EUT was directly connected to the power meter and antenna output port as show in the block diagram as bellow.

- Set frequency range to capture low band-edge from 2310 MHz up to 2390 MHz, and for up band-edge from 2483.5 MHz up to 2500 MHz
- For low band-edge set the equipment transmit at the lowest channel, and for up band-edge set the equipment transmit at the highest channel
- Set the VBW  $\geq$  3 RBW (100kHz/ 300kHz) for conducted measurement
- For radiated measurements the RBW set to 1 MHz, and the VBW set to 1 MHz for peak measurements and 10 Hz for average measurement

### 8.3 TEST SETUP

Conducted Emission Test Setup

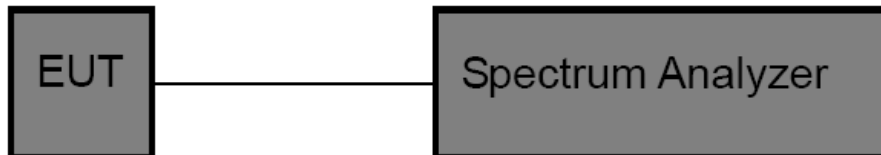

### 8.4 TEST INSTRUMENTS

Equipment	Manufacturer	Type No.	Serial No.	Last calibration	Calibrated until	Calibration period
Spectrum Analyzer	R&S	FSP40	100154	Jul. 04. 2016	Jul. 03. 2017	1 year

### 8.5 EUT OPERATING CONDITIONS

The EUT was set to continuously transmitting in the maximum power during the test.

### 8.6 TEST RESULTS

Only showed the worst mode data of ANT 0 transmitting.

### B Mode Low CH

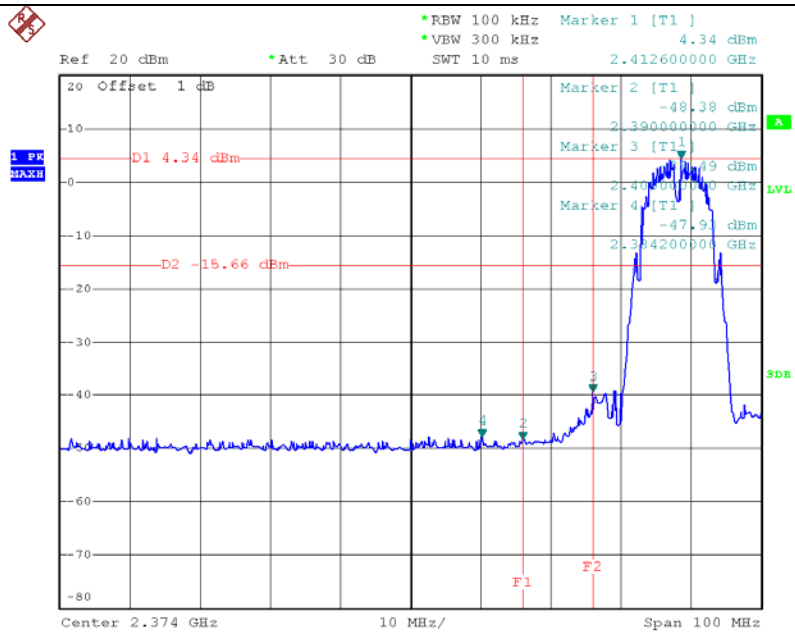

Date: 27.OCT.2016 15:07:33

### B Mode High CH

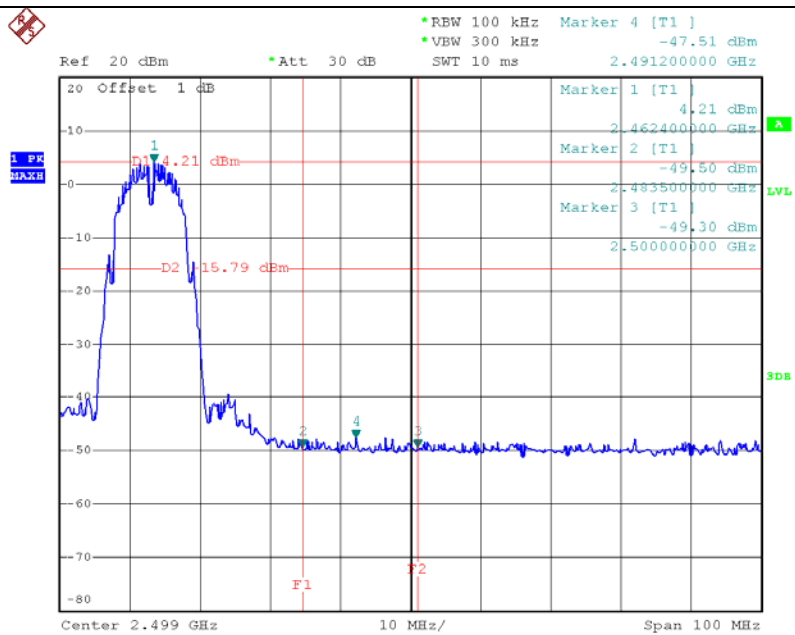

Date: 27.OCT.2016 15:12:36

### G Mode Low CH

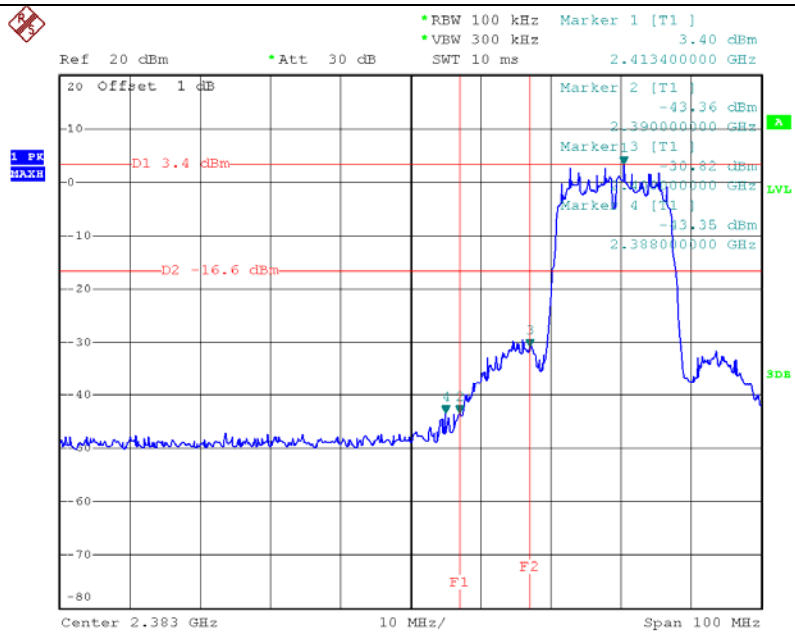

Date: 27.OCT.2016 15:20:07

### G Mode High CH

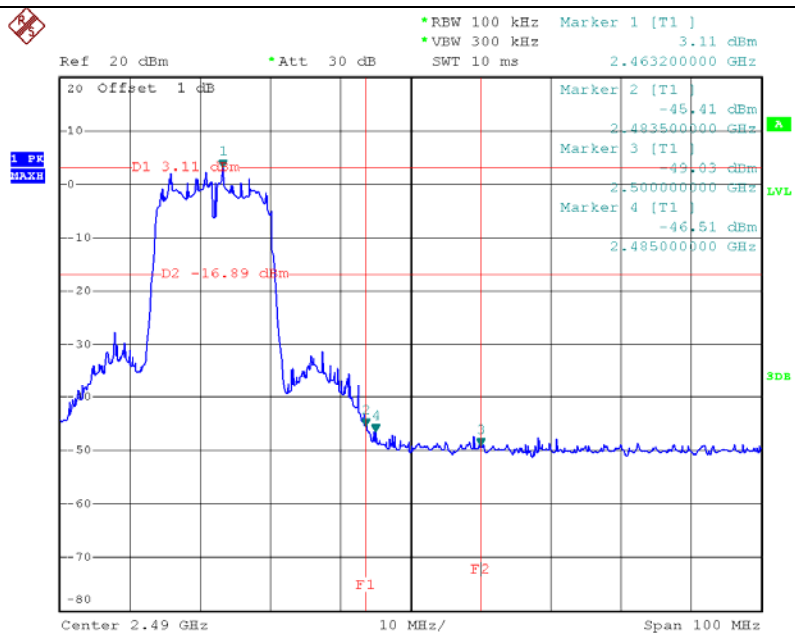

Date: 27.OCT.2016 15:14:18

### N(20) Mode Low CH

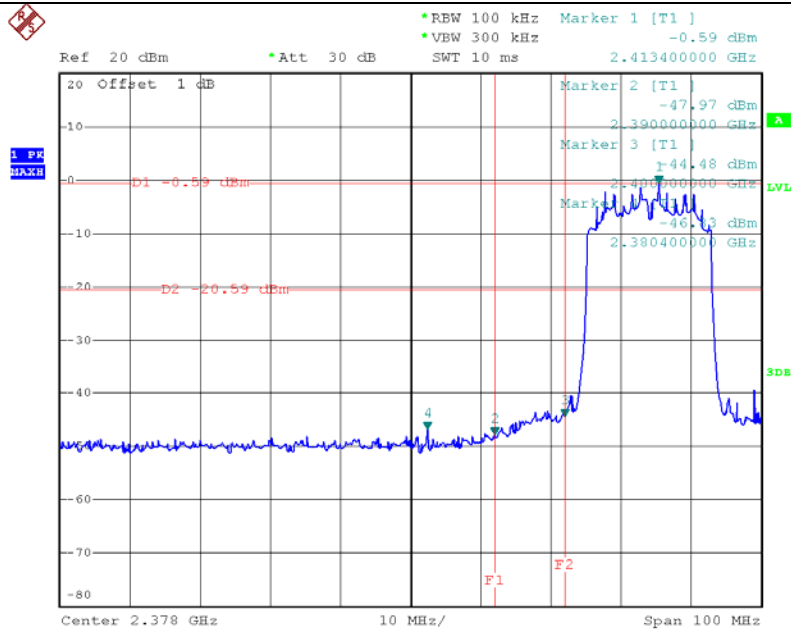

Date: 27.OCT.2016 15:41:17

### N(20) Mode High CH

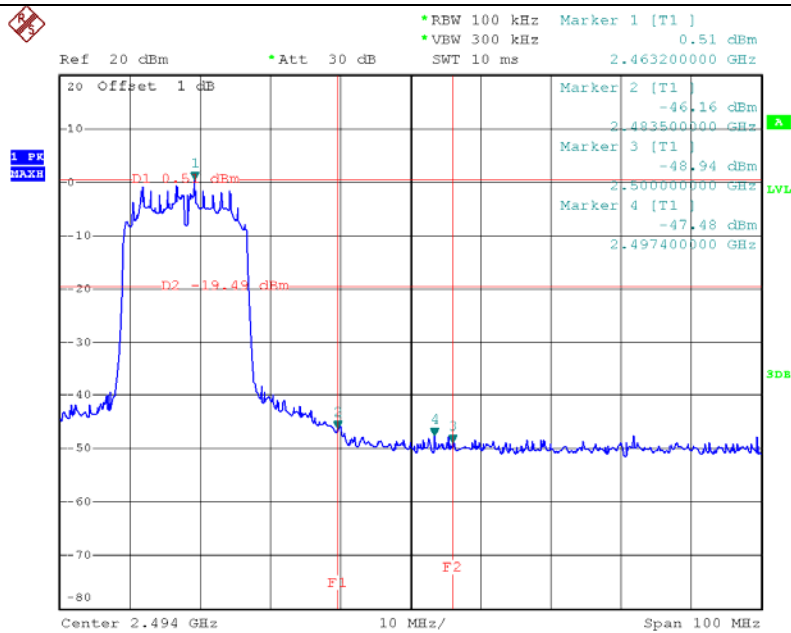

Date: 27.OCT.2016 15:34:47

### N(40) Mode Low CH

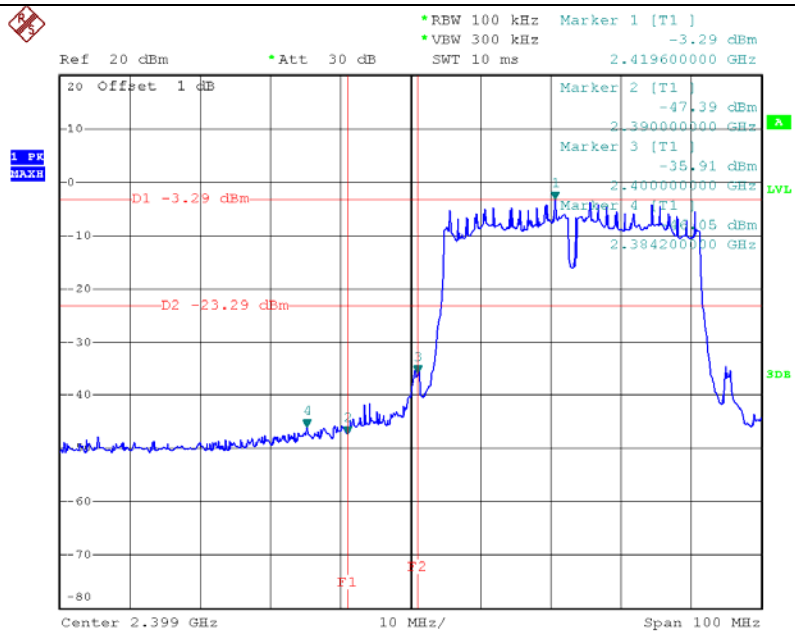

Date: 27.OCT.2016 15:43:55

### N(40) Mode High CH

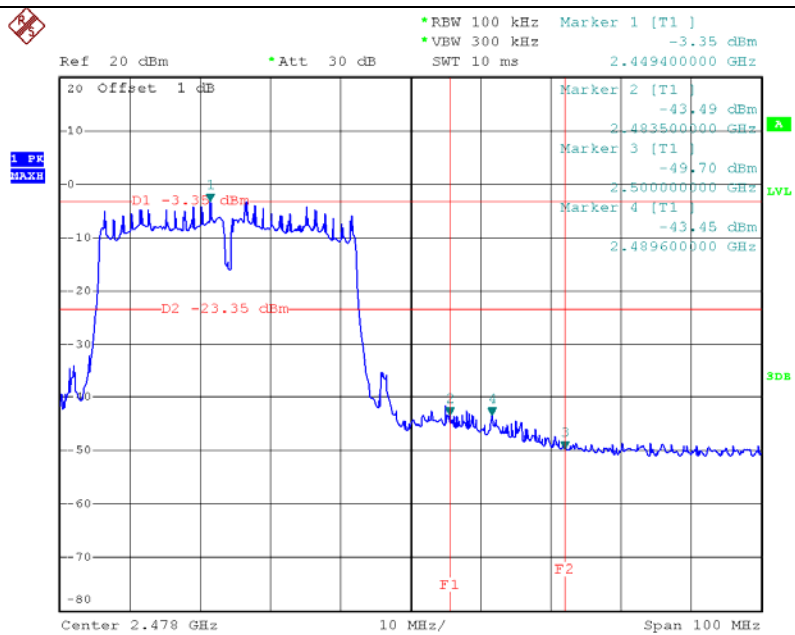

Date: 27.OCT.2016 15:48:13

### B Mode Low CH (30MHz~1GHz)

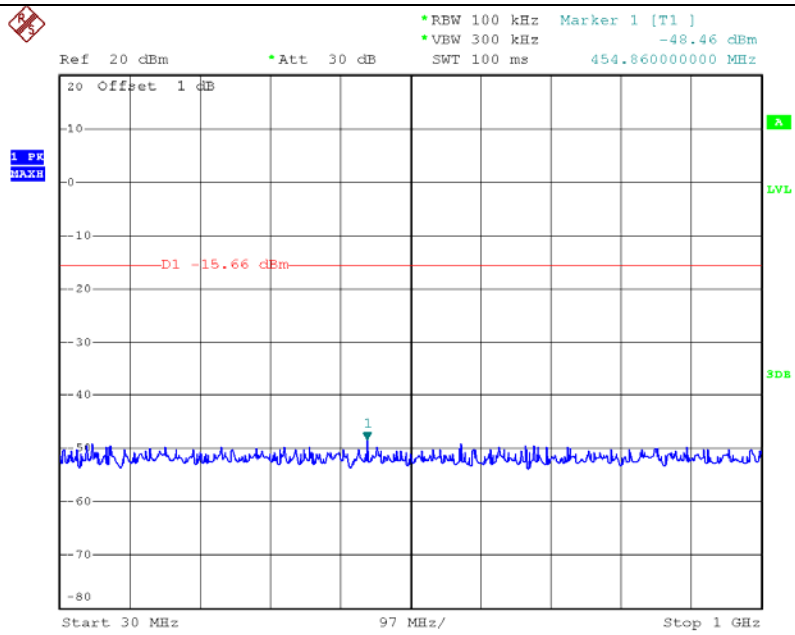

Date: 27.OCT.2016 15:07:42

### B Mode Low CH (1GHz~26.5GHz)

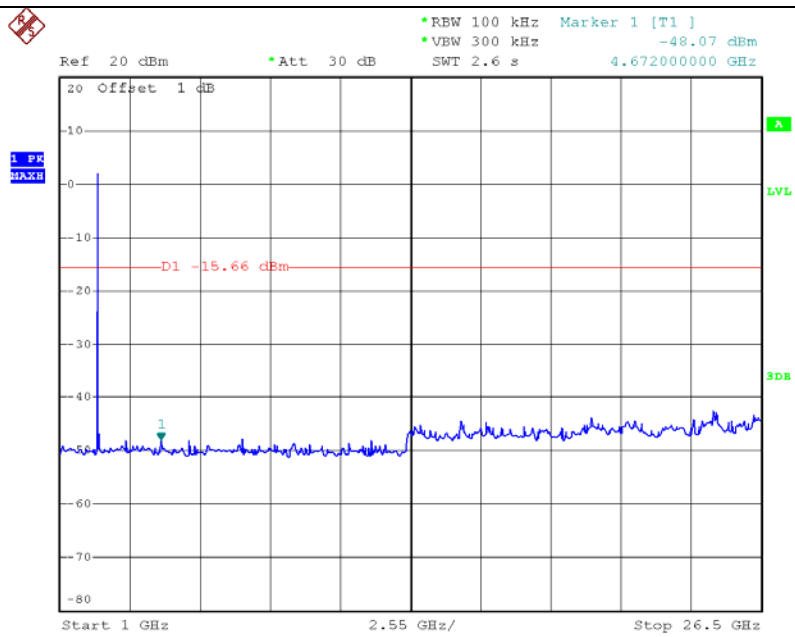

Date: 27.OCT.2016 15:07:57

### B Mode Mid CH (30MHz~1GHz)

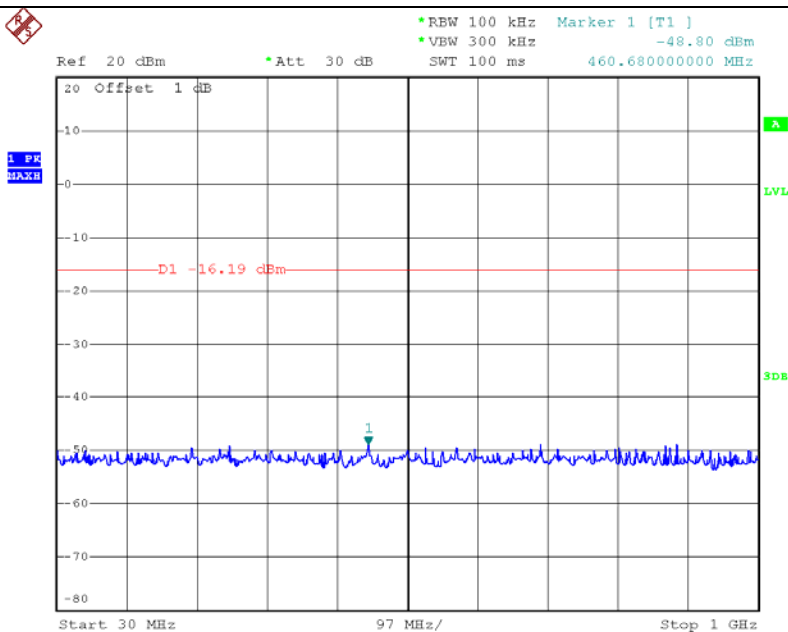

Date: 27.OCT.2016 15:08:46

### B Mode Mid CH (1GHz~26.5GHz)

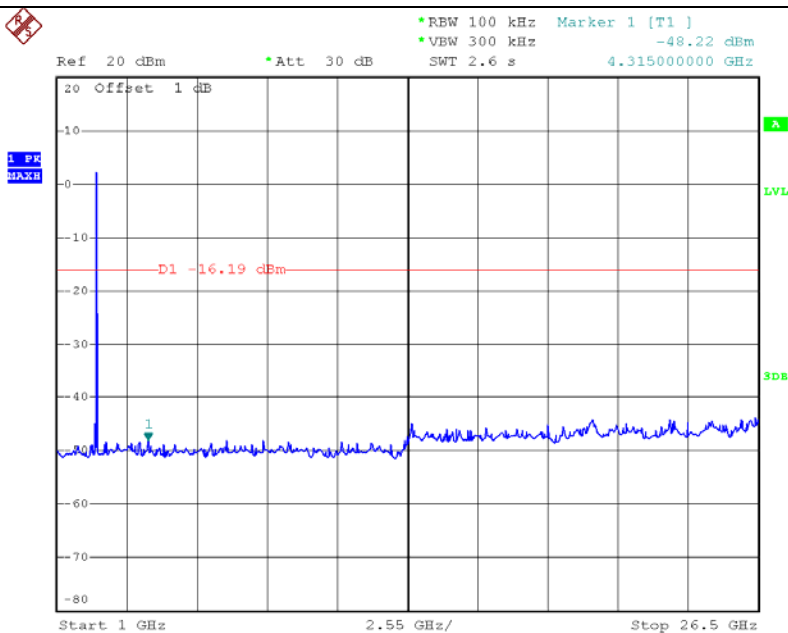

Date: 27.OCT.2016 15:08:59

### B Mode High CH (30MHz~1GHz)

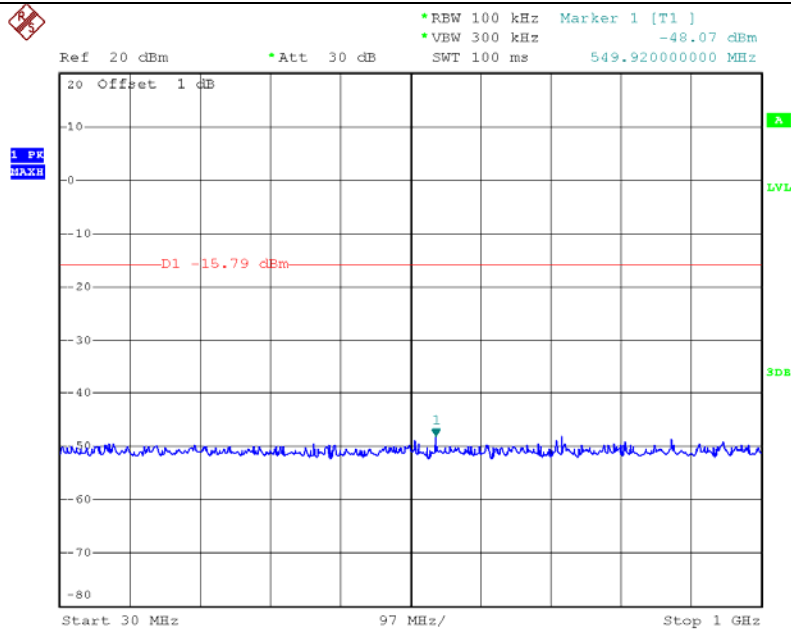

Date: 27.OCT.2016 15:12:53

### B Mode High CH (1GHz~26.5GHz)

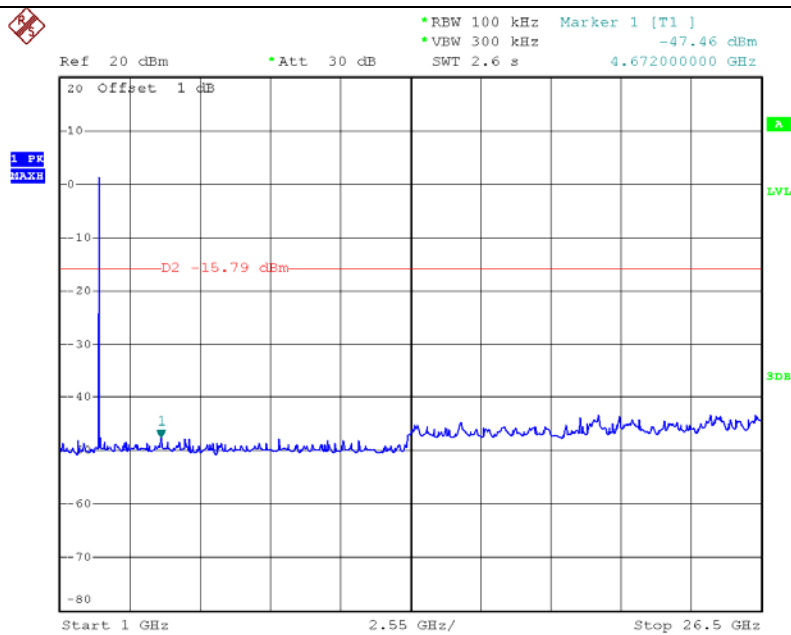

Date: 27.OCT.2016 15:13:16



### G Mode Low CH (30MHz~1GHz)

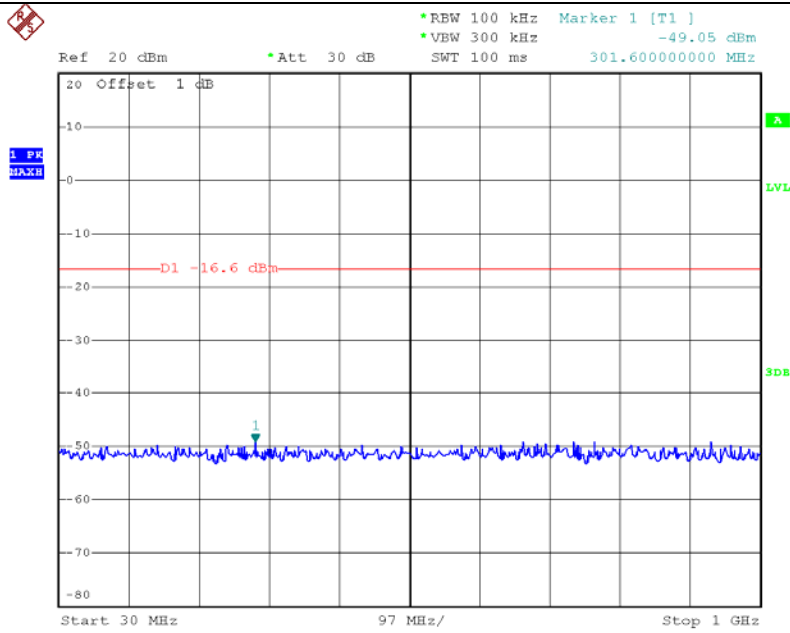

Date: 27.OCT.2016 15:20:16

### G Mode Low CH (1GHz~26.5GHz)

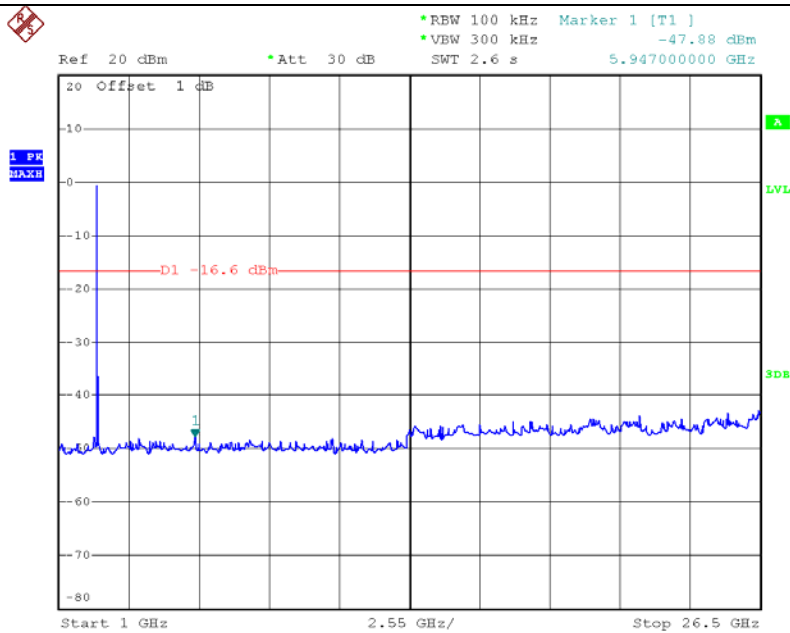

Date: 27.OCT.2016 15:20:33

### G Mode Mid CH (30MHz~1GHz)

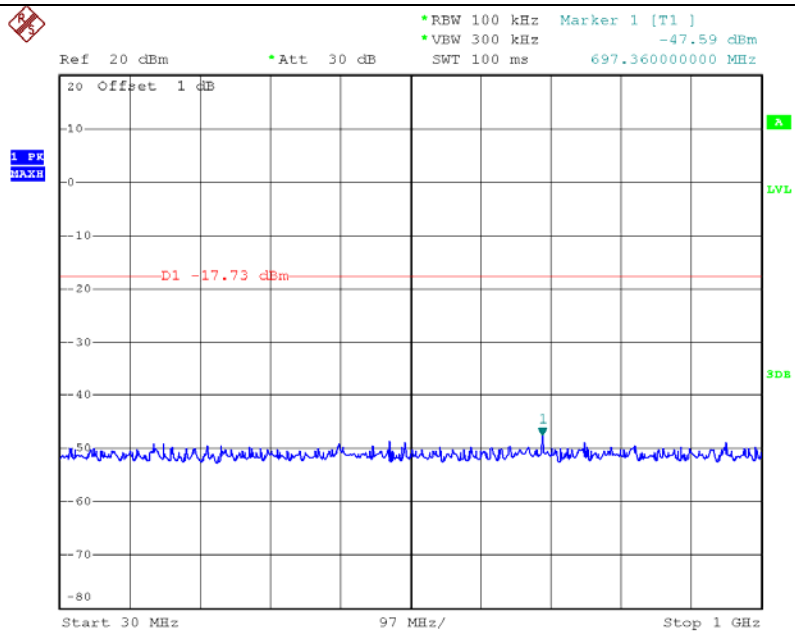

Date: 27.OCT.2016 15:18:03

### G Mode Mid CH (1GHz~26.5GHz)

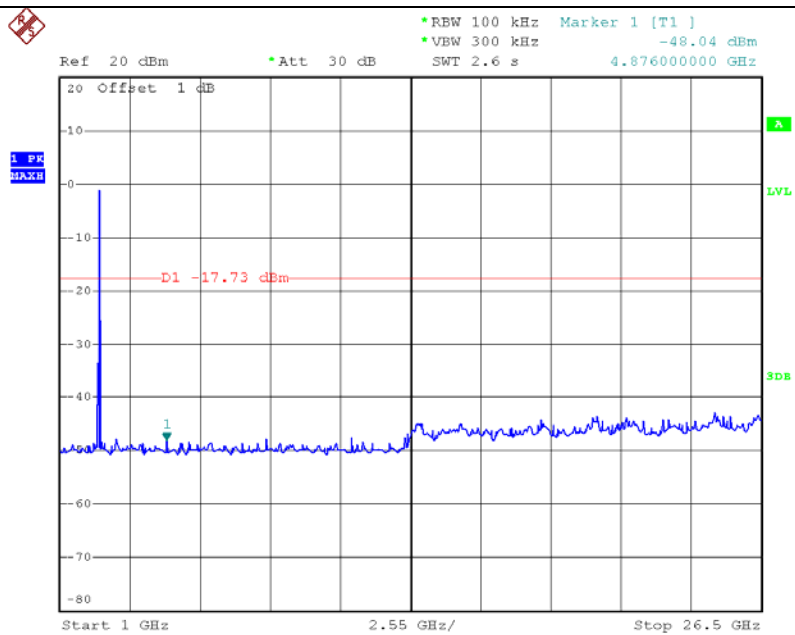

Date: 27.OCT.2016 15:18:26

### G Mode High CH (30MHz~1GHz)

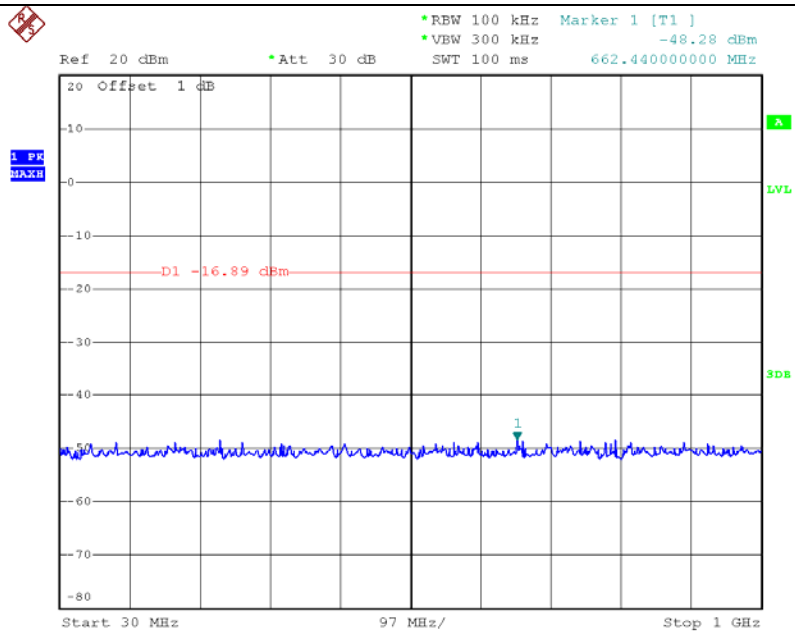

Date: 27.OCT.2016 15:14:45

### G Mode High CH (1GHz~26.5GHz)

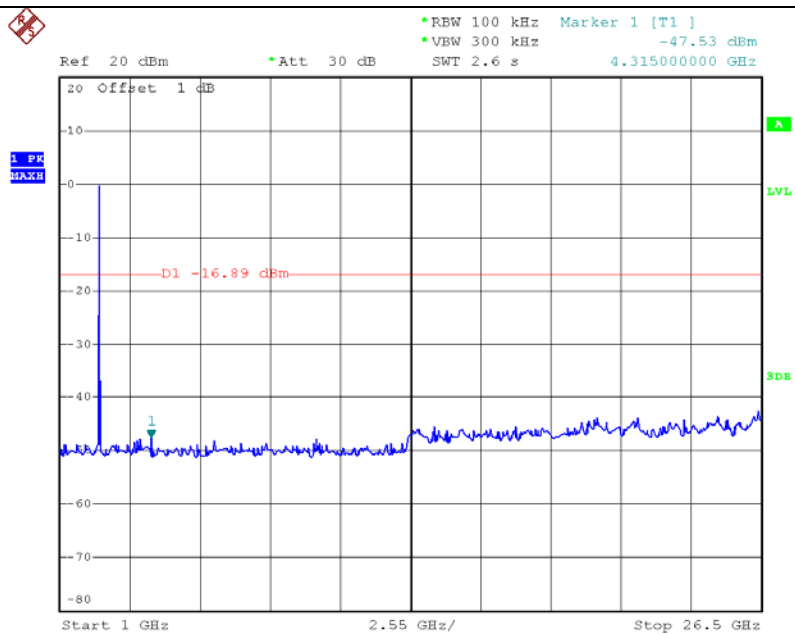

Date: 27.OCT.2016 15:14:59

### N(20) Mode Low CH (30MHz~1GHz)

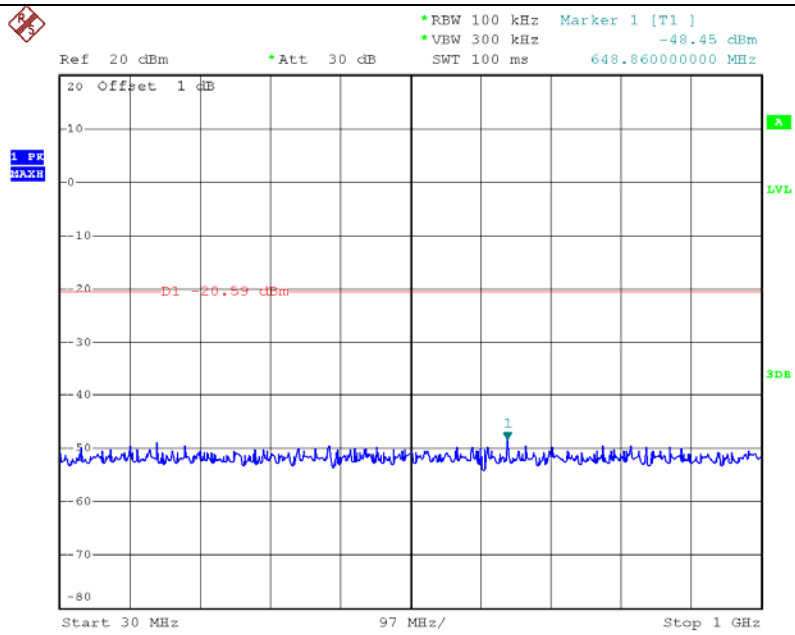

Date: 27.OCT.2016 15:41:26

### N(20) Mode Low CH (1GHz~26.5GHz)

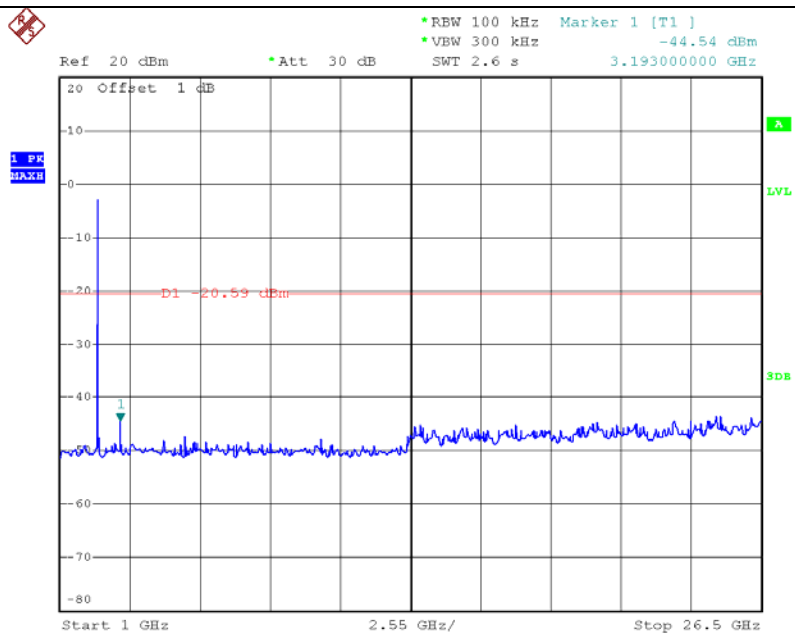

Date: 27.OCT.2016 15:41:38

### N(20) Mode Mid CH (30MHz~1GHz)

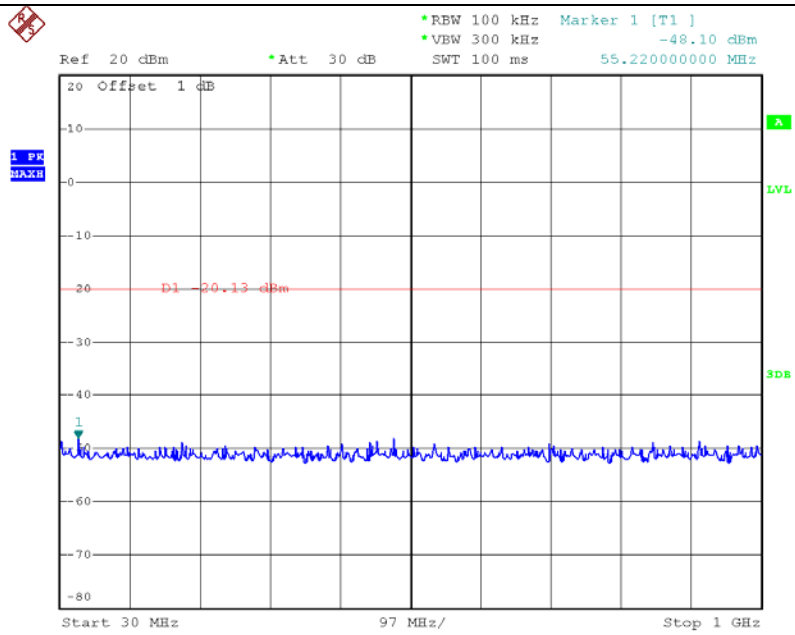

Date: 27.OCT.2016 15:38:15

### N(20) Mode Mid CH (1GHz~26.5GHz)

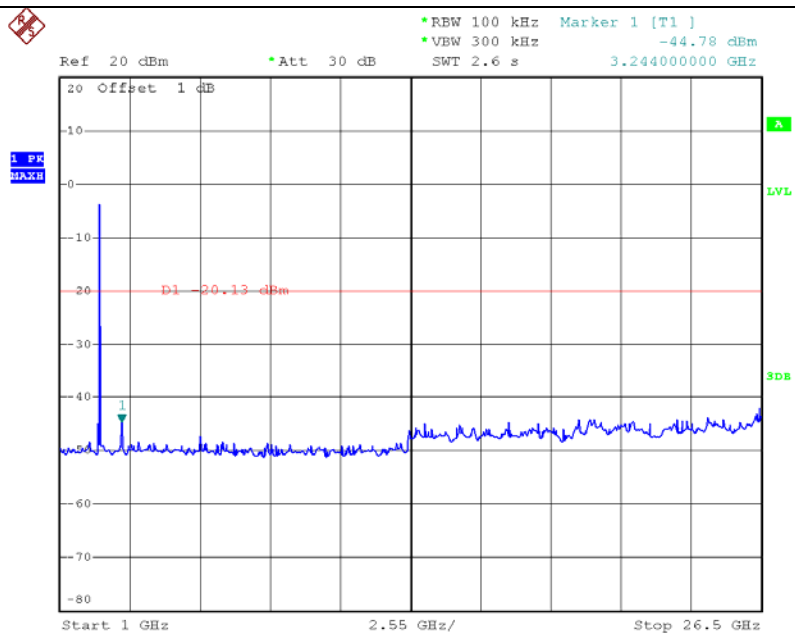

Date: 27.OCT.2016 15:38:30

### N(20) Mode High CH (30MHz~1GHz)

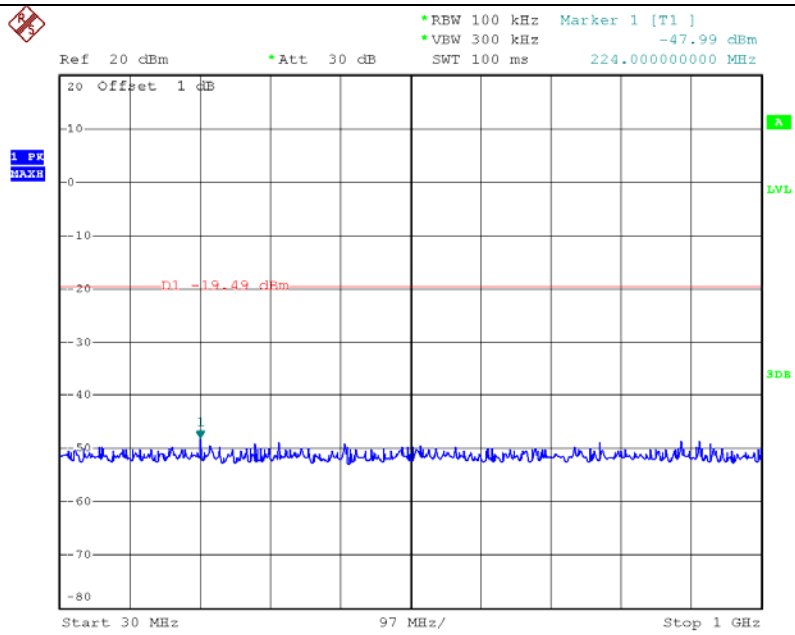

Date: 27.OCT.2016 15:34:57

### N(20) Mode High CH (1GHz~26.5GHz)

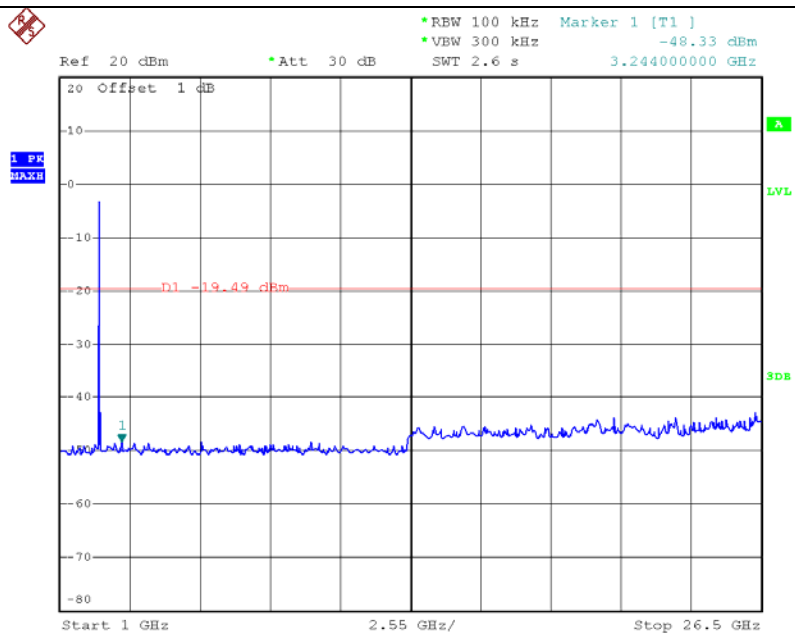

Date: 27.OCT.2016 15:35:15

### N(40) Mode Low CH (30MHz~1GHz)

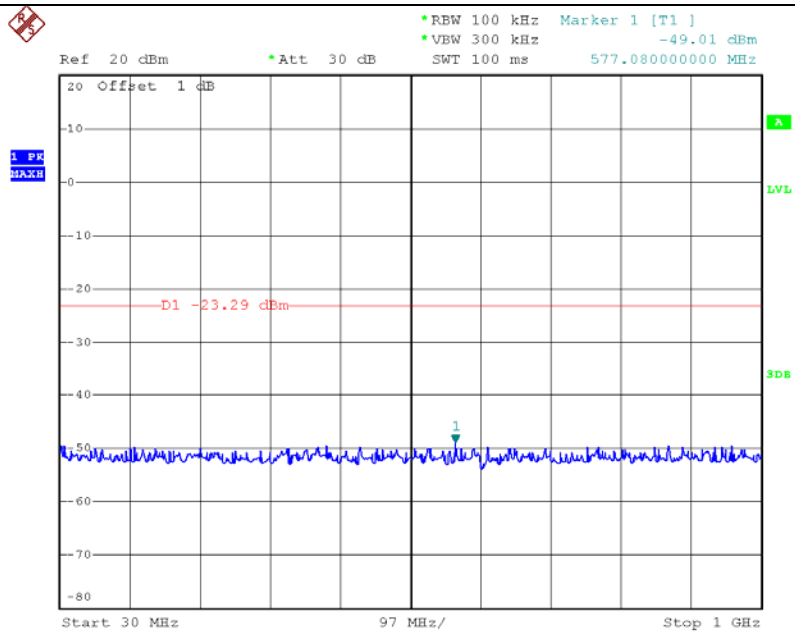

Date: 27.OCT.2016 15:44:05

### N(40) Mode Low CH (1GHz~26.5GHz)

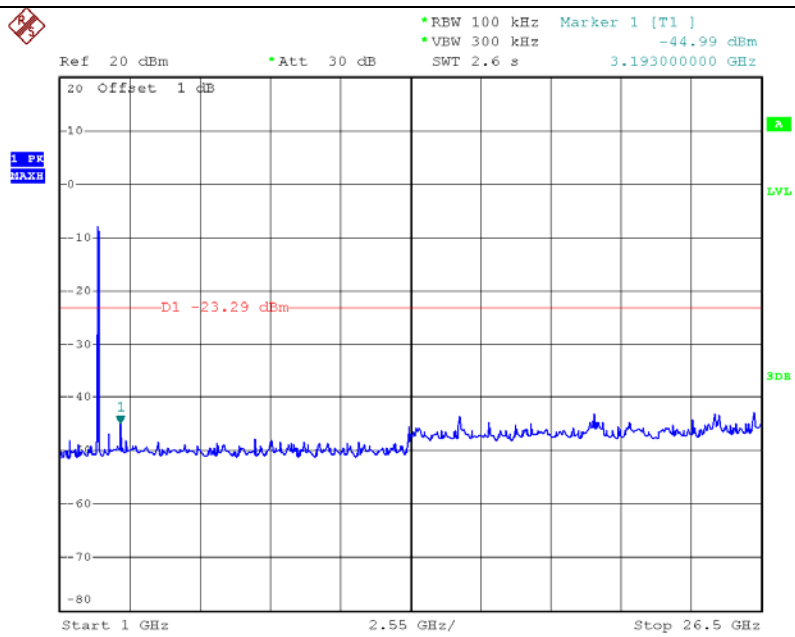

Date: 27.OCT.2016 15:44:17

### N(40) Mode Mid CH (30MHz~1GHz)

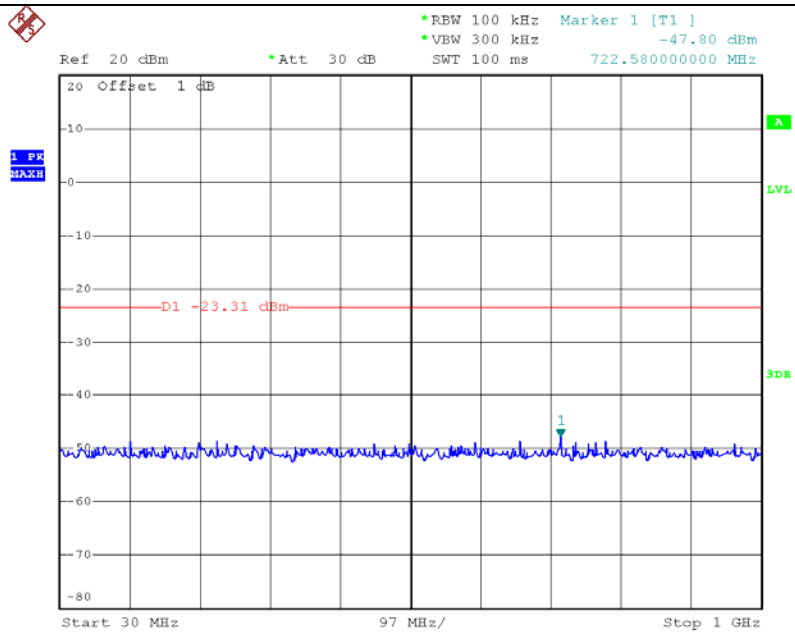

Date: 27.OCT.2016 15:47:11

### N(40) Mode Mid CH (1GHz~26.5GHz)

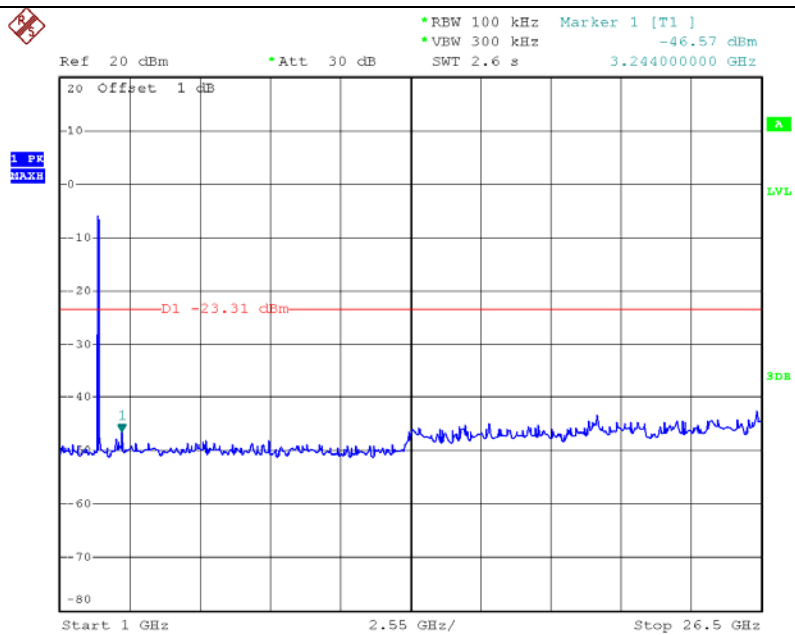

Date: 27.OCT.2016 15:47:29



### N(40) Mode High CH (30MHz~1GHz)

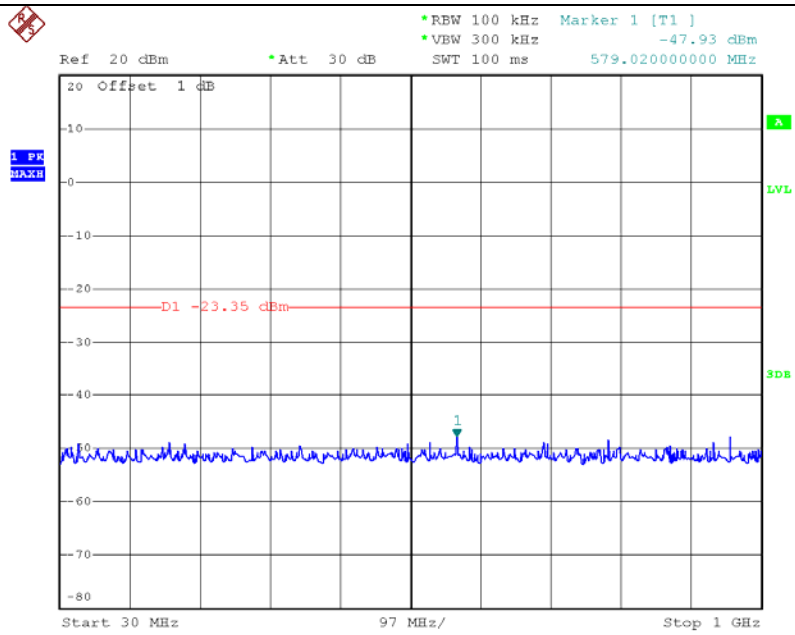

Date: 27.OCT.2016 15:48:22

### N(40) Mode High CH (1GHz~26.5GHz)

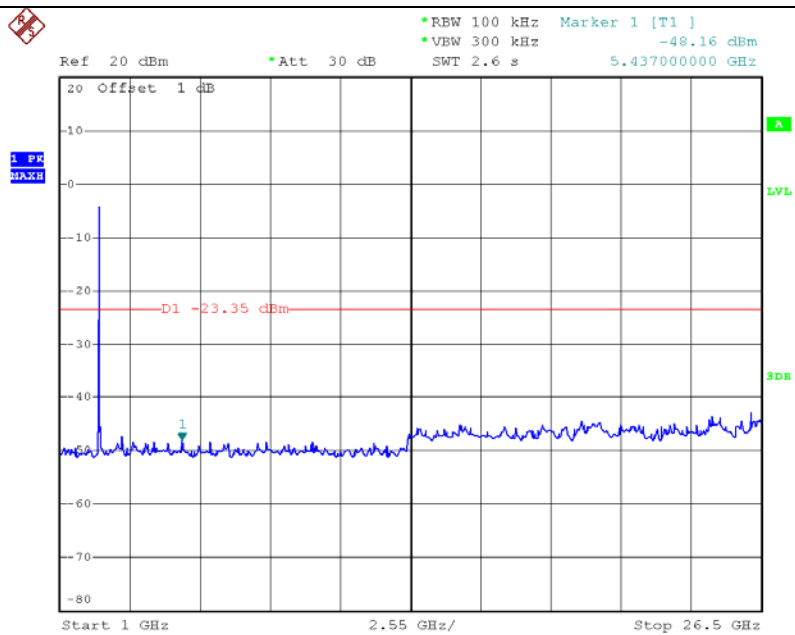

Date: 27.OCT.2016 15:48:35

## 9. ANTENNA REQUIREMENT

### 9.1 REQUIREMENT

Antenna Requirement (15.203)	An intentional radiator shall be designed to ensure that no antenna other than that furnished by the responsible party shall be used with the device. The use of a permanently attached antenna or of an antenna that uses a unique coupling to the intentional radiator shall be considered sufficient to comply with the provisions of this Section. The manufacturer may design the unit so that a broken antenna can be replaced by the user, but the use of a standard antenna jack or electrical connector is prohibited.
Antenna Requirement (15.247)	If transmitting antennas of directional gain greater than 6 dBi are used, the power shall be reduced by the amount in dB that the directional gain of the antenna exceeds 6 dBi.

### 9.2 ANTENNA CONNECTOR CONSTRUCTION

The EUT antenna is a FPC Antenna. And the maximum gain of this antenna is 2.0 dBi. It complies with the standard requirement.