

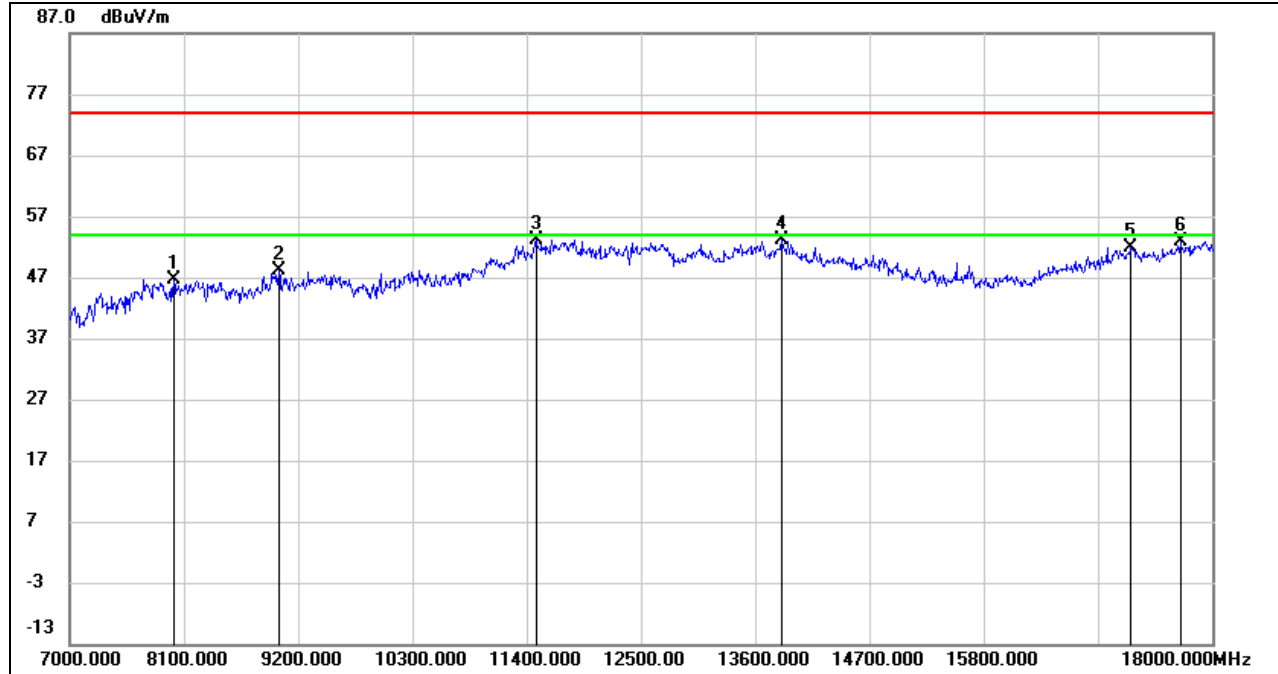

UNII-3 BAND

HARMONICS AND SPURIOUS EMISSIONS (LOW CHANNEL, HORIZONTAL)



No.	Frequency (MHz)	Reading (dBuV)	Correct (dB/m)	Result (dBuV/m)	Limit (dBuV/m)	Margin (dB)	Remark
1	8006.500	38.16	8.41	46.57	74.00	-27.43	peak
2	9013.000	36.92	11.16	48.08	74.00	-25.92	peak
3	11493.500	35.75	17.38	53.13	74.00	-20.87	peak
4	13858.500	33.18	19.83	53.01	74.00	-20.99	peak
5	17224.500	30.75	21.14	51.89	74.00	-22.11	peak
6	17697.500	29.88	23.09	52.97	74.00	-21.03	peak

- Note:
1. Measurement = Reading Level + Correct Factor.
 2. If Peak Result complies with AV limit, AV Result is deemed to comply with AV limit.
 3. Peak: Peak detector.
 4. AVG: $VBW=1/Ton$, where: Ton is the transmitting duration.
 5. For the transmitting duration, please refer to clause 7.1.
 6. Filter losses were only considered in the spurious frequency bands and the authorized band was not corrected for High Pass Filter losses.
 7. Proper operation of the transmitter prior to adding the filter to the measurement chain.
 8. Since non-restricted band peak emissions are less than the average limit, they also comply with the -27dBm/MHz (68.2dBuV/m) limit.

HARMONICS AND SPURIOUS EMISSIONS (LOW CHANNEL, VERTICAL)

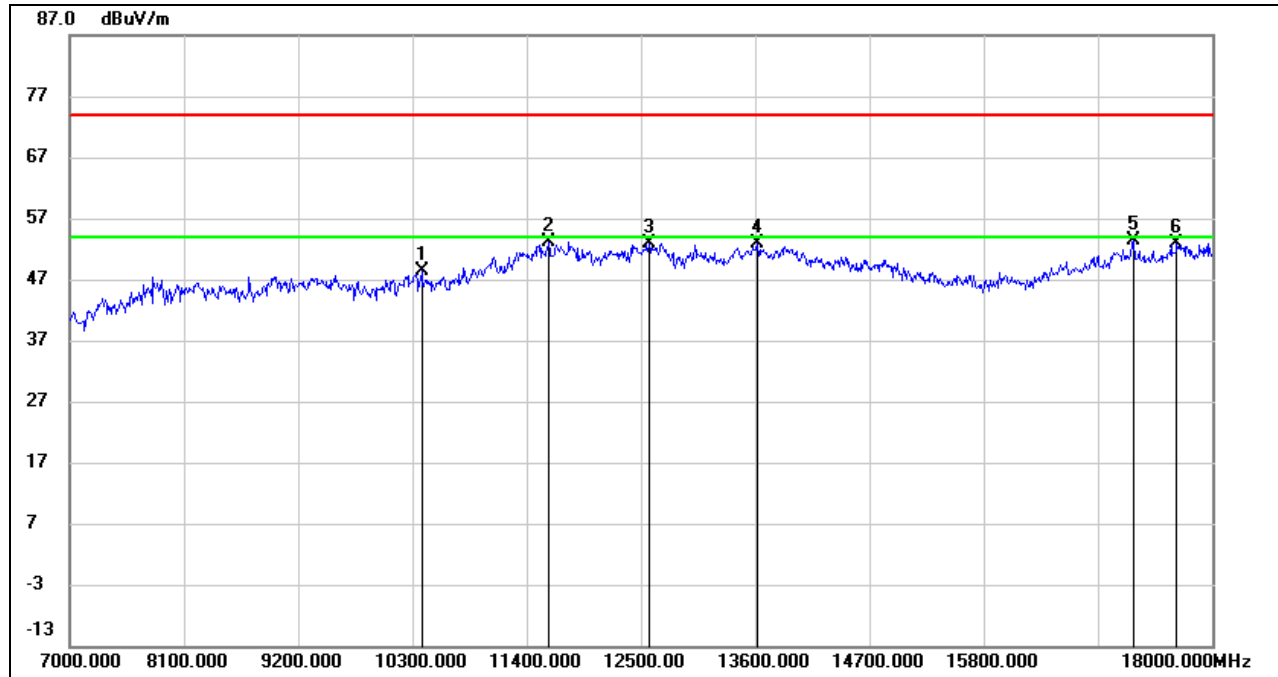

No.	Frequency (MHz)	Reading (dBuV)	Correct (dB/m)	Result (dBuV/m)	Limit (dBuV/m)	Margin (dB)	Remark
1	10393.500	35.22	13.11	48.33	74.00	-25.67	peak
2	11609.000	35.41	17.62	53.03	74.00	-20.97	peak
3	12582.500	34.64	18.15	52.79	74.00	-21.21	peak
4	13627.500	33.50	19.44	52.94	74.00	-21.06	peak
5	17241.000	32.17	21.12	53.29	74.00	-20.71	peak
6	17659.000	30.27	22.71	52.98	74.00	-21.02	peak

- Note:
1. Measurement = Reading Level + Correct Factor.
 2. If Peak Result complies with AV limit, AV Result is deemed to comply with AV limit.
 3. Peak: Peak detector.
 4. AVG: $VBW=1/Ton$, where: Ton is the transmitting duration.
 5. For the transmitting duration, please refer to clause 7.1.
 6. Filter losses were only considered in the spurious frequency bands and the authorized band was not corrected for High Pass Filter losses.
 7. Proper operation of the transmitter prior to adding the filter to the measurement chain.
 8. Since non-restricted band peak emissions are less than the average limit, they also comply with the -27dBm/MHz (68.2dBuV/m) limit.



HARMONICS AND SPURIOUS EMISSIONS (MID CHANNEL, HORIZONTAL)

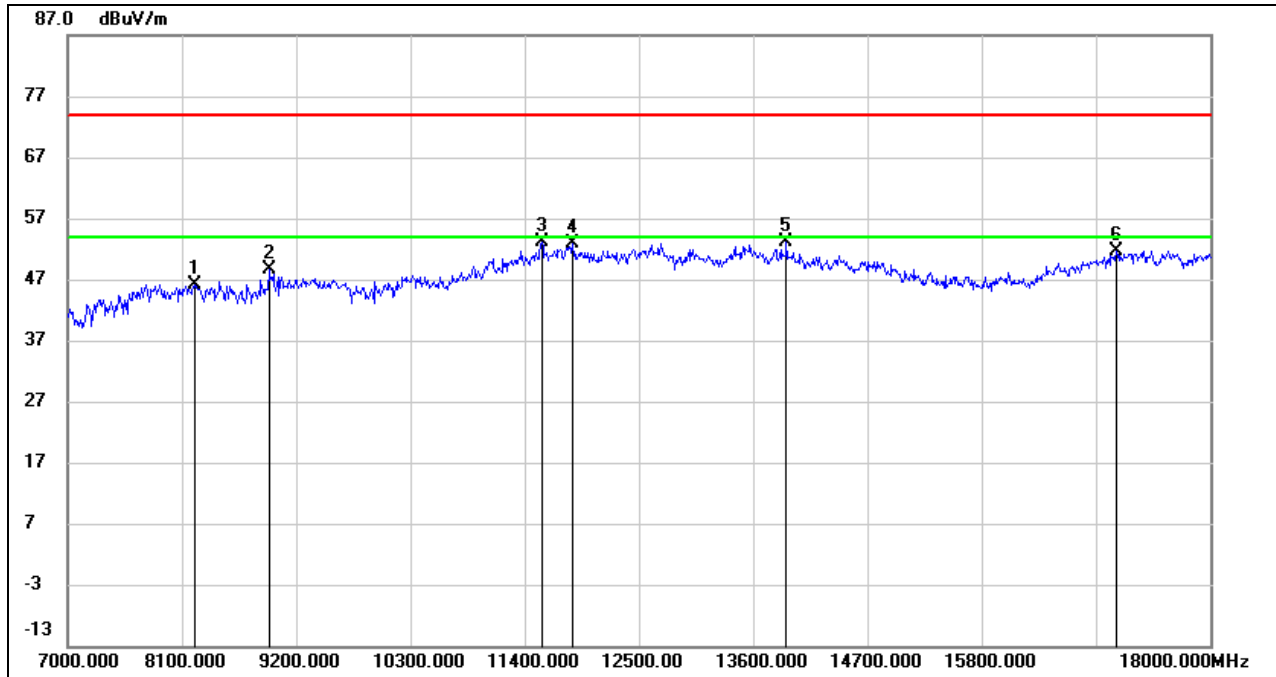

No.	Frequency (MHz)	Reading (dBuV)	Correct (dB/m)	Result (dBuV/m)	Limit (dBuV/m)	Margin (dB)	Remark
1	8226.500	36.43	9.79	46.22	74.00	-27.78	peak
2	8941.500	37.91	10.63	48.54	74.00	-25.46	peak
3	11570.500	35.51	17.53	53.04	74.00	-20.96	peak
4	11867.500	34.61	18.36	52.97	74.00	-21.03	peak
5	13924.500	33.40	19.71	53.11	74.00	-20.89	peak
6	17098.000	31.32	20.40	51.72	74.00	-22.28	peak

- Note: 1. Measurement = Reading Level + Correct Factor.
 2. If Peak Result complies with AV limit, AV Result is deemed to comply with AV limit.
 3. Peak: Peak detector.
 4. AVG: $VBW=1/Ton$, where: Ton is the transmitting duration.
 5. For the transmitting duration, please refer to clause 7.1.
 6. Filter losses were only considered in the spurious frequency bands and the authorized band was not corrected for High Pass Filter losses.
 7. Proper operation of the transmitter prior to adding the filter to the measurement chain.
 8. Since non-restricted band peak emissions are less than the average limit, they also comply with the -27dBm/MHz (68.2dBuV/m) limit.



HARMONICS AND SPURIOUS EMISSIONS (MID CHANNEL, VERTICAL)

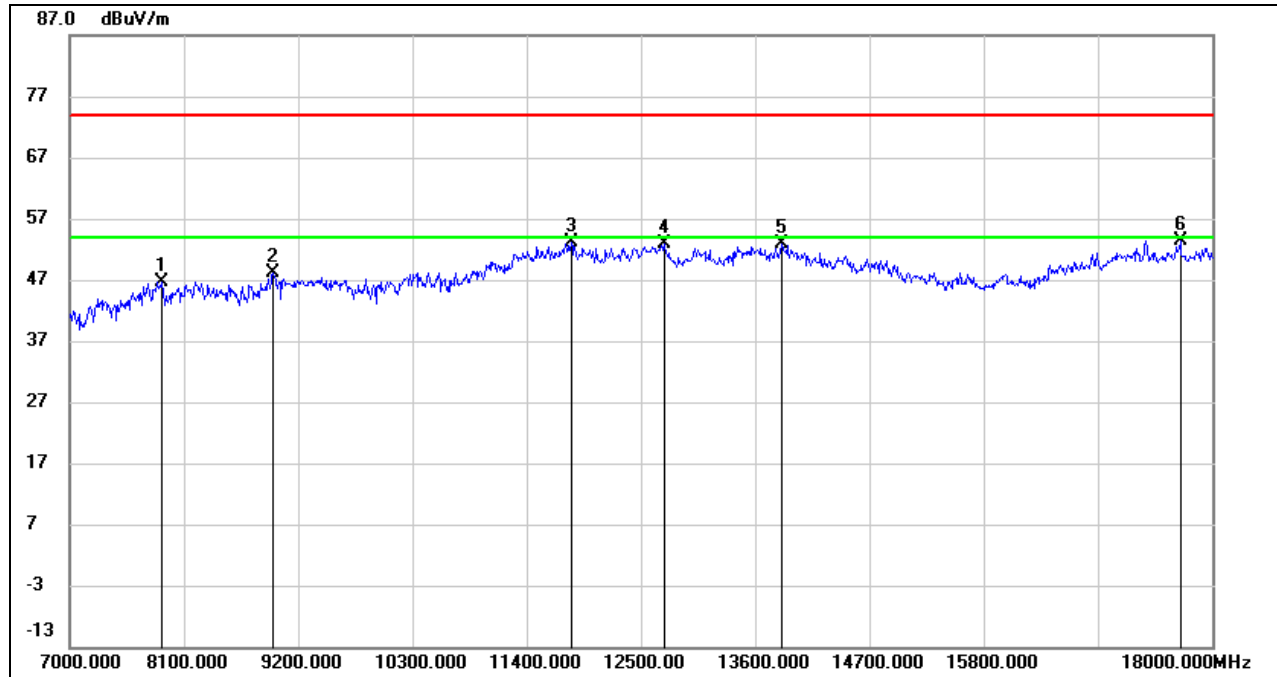

No.	Frequency (MHz)	Reading (dBuV)	Correct (dB/m)	Result (dBuV/m)	Limit (dBuV/m)	Margin (dB)	Remark
1	7891.000	38.10	8.61	46.71	74.00	-27.29	peak
2	8963.500	37.28	10.85	48.13	74.00	-25.87	peak
3	11829.000	34.64	18.40	53.04	74.00	-20.96	peak
4	12725.500	34.56	18.20	52.76	74.00	-21.24	peak
5	13853.000	33.05	19.84	52.89	74.00	-21.11	peak
6	17692.000	30.35	23.03	53.38	74.00	-20.62	peak

- Note:
1. Measurement = Reading Level + Correct Factor.
 2. If Peak Result complies with AV limit, AV Result is deemed to comply with AV limit.
 3. Peak: Peak detector.
 4. AVG: $VBW=1/Ton$, where: Ton is the transmitting duration.
 5. For the transmitting duration, please refer to clause 7.1.
 6. Filter losses were only considered in the spurious frequency bands and the authorized band was not corrected for High Pass Filter losses.
 7. Proper operation of the transmitter prior to adding the filter to the measurement chain.
 8. Since non-restricted band peak emissions are less than the average limit, they also comply with the -27dBm/MHz (68.2dBuV/m) limit.



HARMONICS AND SPURIOUS EMISSIONS (HIGH CHANNEL, HORIZONTAL)

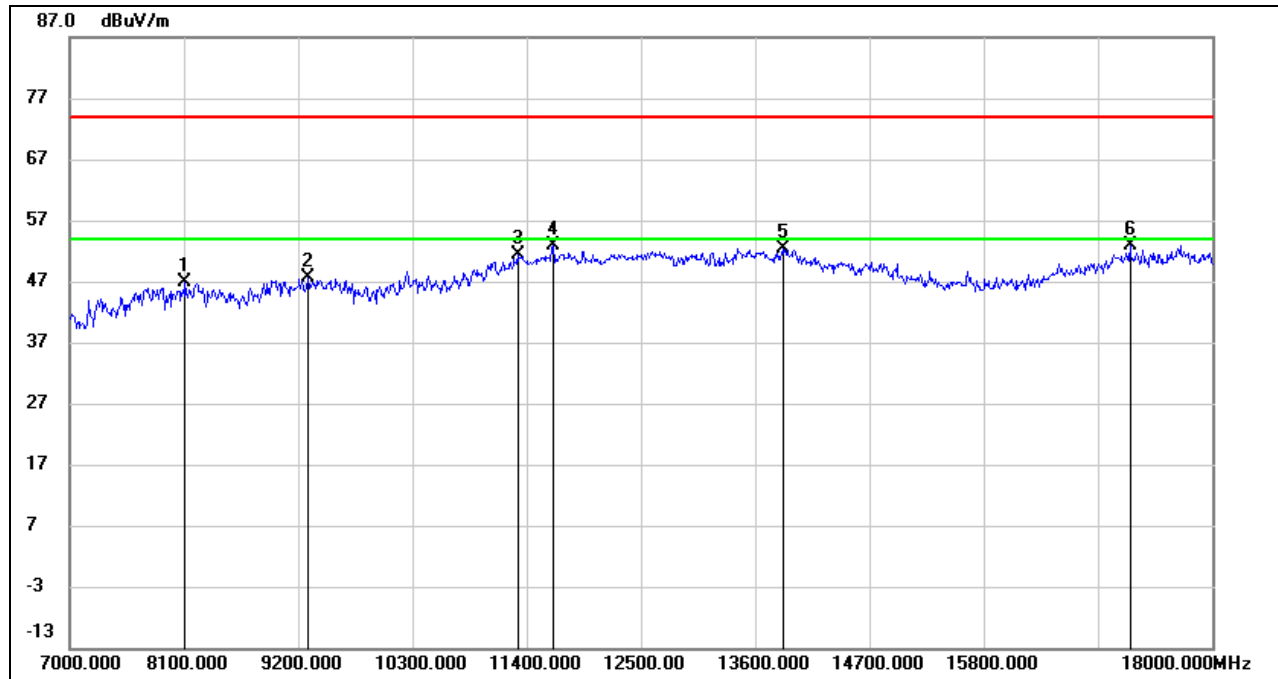

No.	Frequency (MHz)	Reading (dBuV)	Correct (dB/m)	Result (dBuV/m)	Limit (dBuV/m)	Margin (dB)	Remark
1	8116.500	37.58	9.25	46.83	74.00	-27.17	peak
2	9299.000	36.84	10.74	47.58	74.00	-26.42	peak
3	11312.000	34.79	16.66	51.45	74.00	-22.55	peak
4	11653.000	34.98	17.80	52.78	74.00	-21.22	peak
5	13864.000	32.62	19.81	52.43	74.00	-21.57	peak
6	17213.500	31.77	21.16	52.93	74.00	-21.07	peak

- Note: 1. Measurement = Reading Level + Correct Factor.
 2. If Peak Result complies with AV limit, AV Result is deemed to comply with AV limit.
 3. Peak: Peak detector.
 4. AVG: $VBW=1/Ton$, where: Ton is the transmitting duration.
 5. For the transmitting duration, please refer to clause 7.1.
 6. Filter losses were only considered in the spurious frequency bands and the authorized band was not corrected for High Pass Filter losses.
 7. Proper operation of the transmitter prior to adding the filter to the measurement chain.
 8. Since non-restricted band peak emissions are less than the average limit, they also comply with the -27dBm/MHz (68.2dBuV/m) limit.



HARMONICS AND SPURIOUS EMISSIONS (HIGH CHANNEL, VERTICAL)

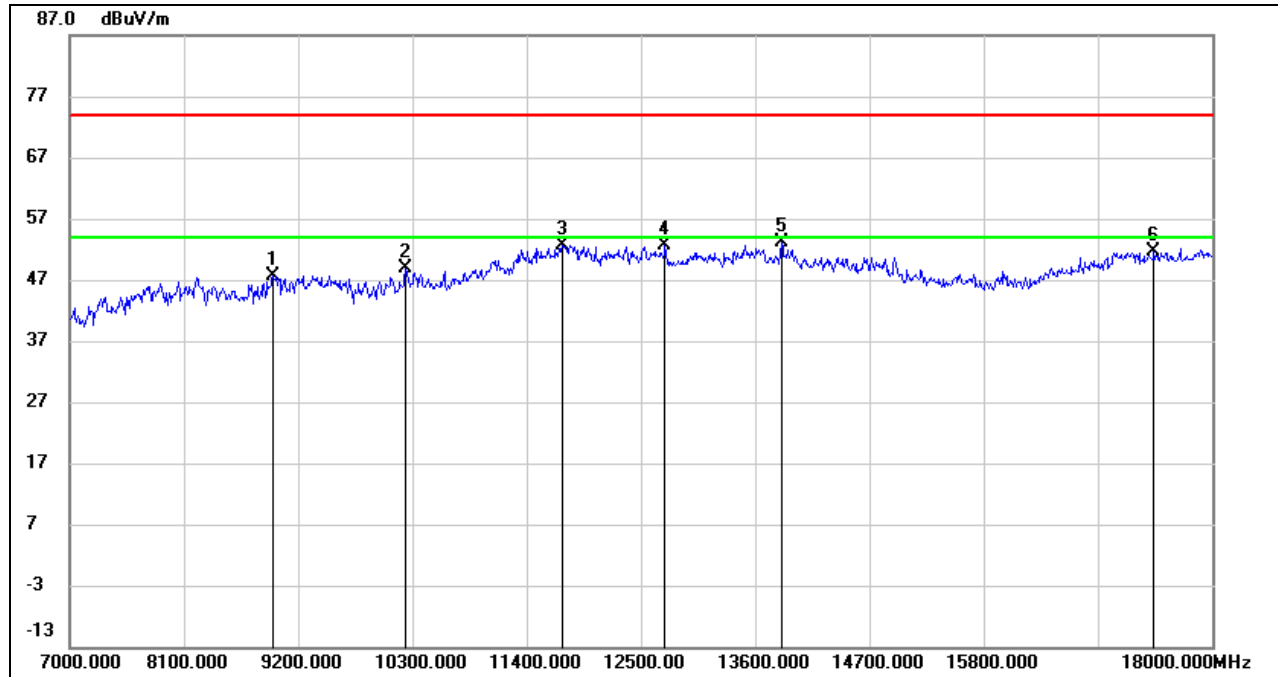

No.	Frequency (MHz)	Reading (dBuV)	Correct (dB/m)	Result (dBuV/m)	Limit (dBuV/m)	Margin (dB)	Remark
1	8963.500	36.88	10.85	47.73	74.00	-26.27	peak
2	10234.000	36.42	12.47	48.89	74.00	-25.11	peak
3	11746.500	34.46	18.21	52.67	74.00	-21.33	peak
4	12731.000	34.51	18.20	52.71	74.00	-21.29	peak
5	13858.500	33.29	19.83	53.12	74.00	-20.88	peak
6	17444.500	30.62	21.13	51.75	74.00	-22.25	peak

- Note:
1. Measurement = Reading Level + Correct Factor.
 2. If Peak Result complies with AV limit, AV Result is deemed to comply with AV limit.
 3. Peak: Peak detector.
 4. AVG: $VBW=1/Ton$, where: Ton is the transmitting duration.
 5. For the transmitting duration, please refer to clause 7.1.
 6. Filter losses were only considered in the spurious frequency bands and the authorized band was not corrected for High Pass Filter losses.
 7. Proper operation of the transmitter prior to adding the filter to the measurement chain.
 8. Since non-restricted band peak emissions are less than the average limit, they also comply with the -27dBm/MHz (68.2dBuV/m) limit.

8.3.3. 802.11n HT40 MIMO MODE

UNII-1 BAND

HARMONICS AND SPURIOUS EMISSIONS (LOW CHANNEL, HORIZONTAL)

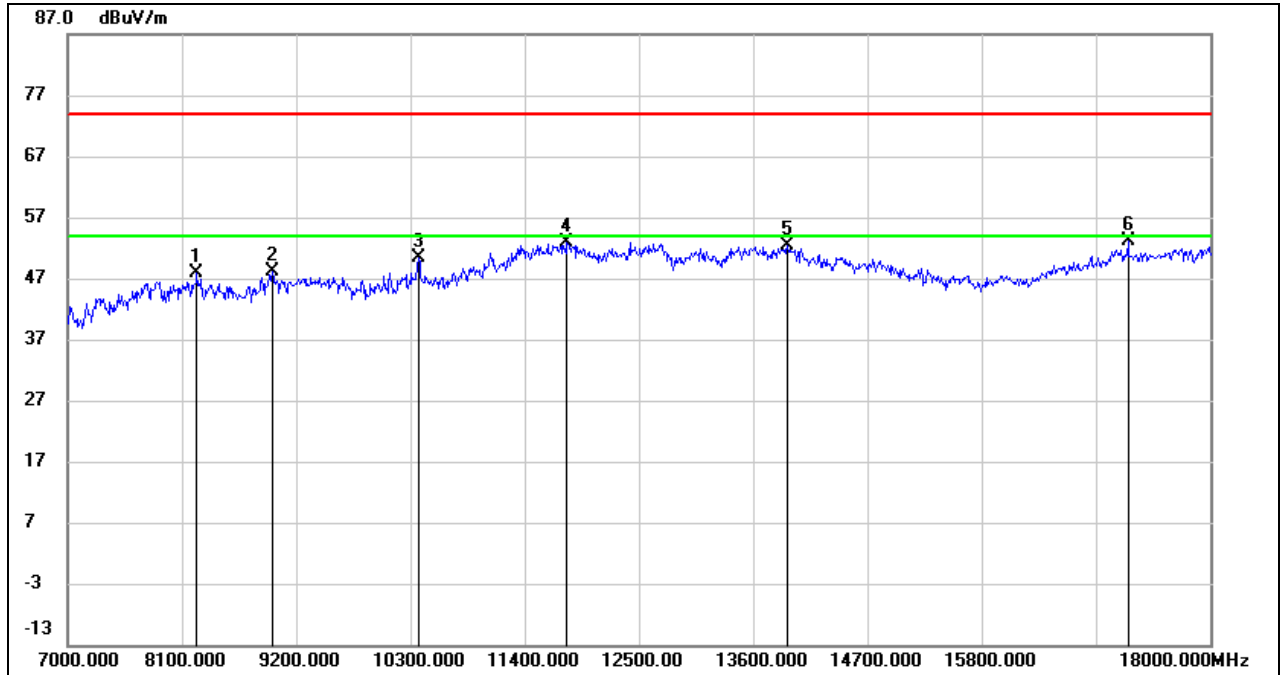

No.	Frequency (MHz)	Reading (dBuV)	Correct (dB/m)	Result (dBuV/m)	Limit (dBuV/m)	Margin (dB)	Remark
1	8243.000	38.13	9.72	47.85	74.00	-26.15	peak
2	8974.500	37.23	10.96	48.19	74.00	-25.81	peak
3	10377.000	37.36	13.05	50.41	74.00	-23.59	peak
4	11807.000	34.36	18.44	52.80	74.00	-21.20	peak
5	13935.500	32.63	19.70	52.33	74.00	-21.67	peak
6	17213.500	31.85	21.16	53.01	74.00	-20.99	peak

- Note: 1. Measurement = Reading Level + Correct Factor.
 2. If Peak Result complies with AV limit, AV Result is deemed to comply with AV limit.
 3. Peak: Peak detector.
 4. AVG: $VBW=1/Ton$, where: Ton is the transmitting duration.
 5. For the transmitting duration, please refer to clause 7.1.
 6. Filter losses were only considered in the spurious frequency bands and the authorized band was not corrected for High Pass Filter losses.
 7. Proper operation of the transmitter prior to adding the filter to the measurement chain.
 8. Since non-restricted band peak emissions are less than the average limit, they also comply with the -27dBm/MHz (68.2dBuV/m) limit.

HARMONICS AND SPURIOUS EMISSIONS (LOW CHANNEL, VERTICAL)

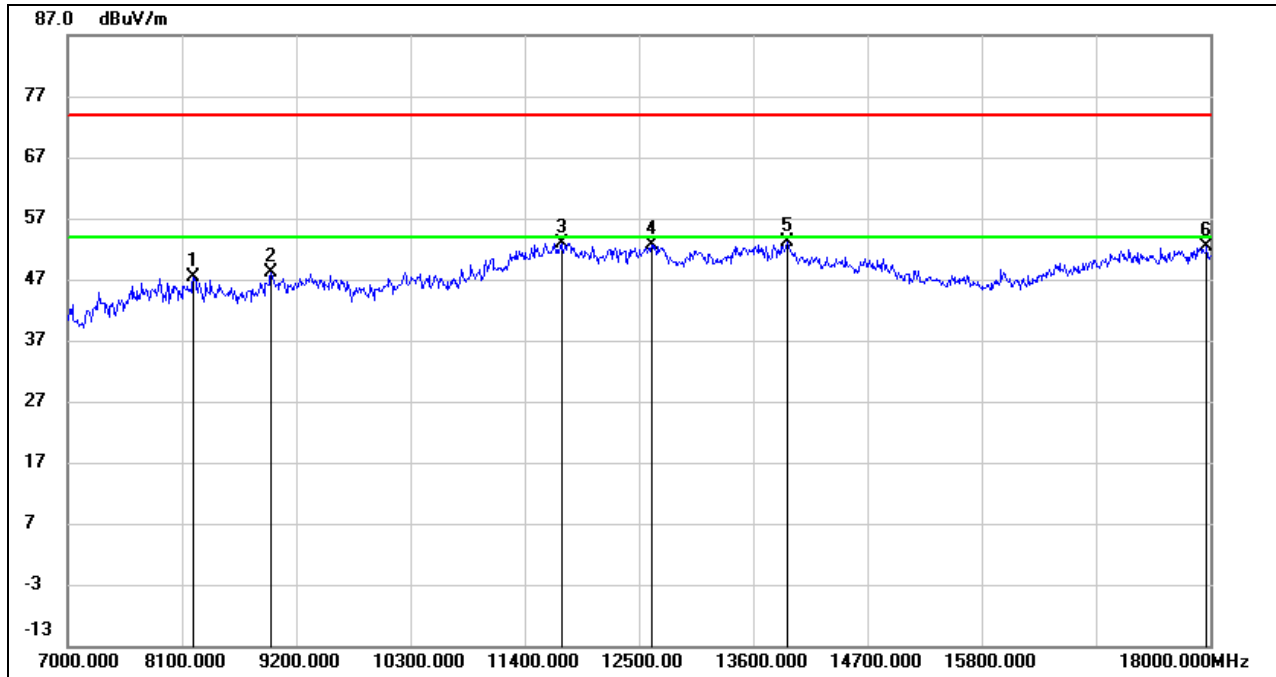

No.	Frequency (MHz)	Reading (dBuV)	Correct (dB/m)	Result (dBuV/m)	Limit (dBuV/m)	Margin (dB)	Remark
1	8215.500	37.43	9.83	47.26	74.00	-26.74	peak
2	8963.500	37.17	10.85	48.02	74.00	-25.98	peak
3	11752.000	34.72	18.23	52.95	74.00	-21.05	peak
4	12621.000	34.48	18.18	52.66	74.00	-21.34	peak
5	13935.500	33.36	19.70	53.06	74.00	-20.94	peak
6	17967.000	27.76	24.61	52.37	74.00	-21.63	peak

- Note:
1. Measurement = Reading Level + Correct Factor.
 2. If Peak Result complies with AV limit, AV Result is deemed to comply with AV limit.
 3. Peak: Peak detector.
 4. AVG: $VBW=1/Ton$, where: Ton is the transmitting duration.
 5. For the transmitting duration, please refer to clause 7.1.
 6. Filter losses were only considered in the spurious frequency bands and the authorized band was not corrected for High Pass Filter losses.
 7. Proper operation of the transmitter prior to adding the filter to the measurement chain.
 8. Since non-restricted band peak emissions are less than the average limit, they also comply with the -27dBm/MHz (68.2dBuV/m) limit.



HARMONICS AND SPURIOUS EMISSIONS (HIGH CHANNEL, HORIZONTAL)

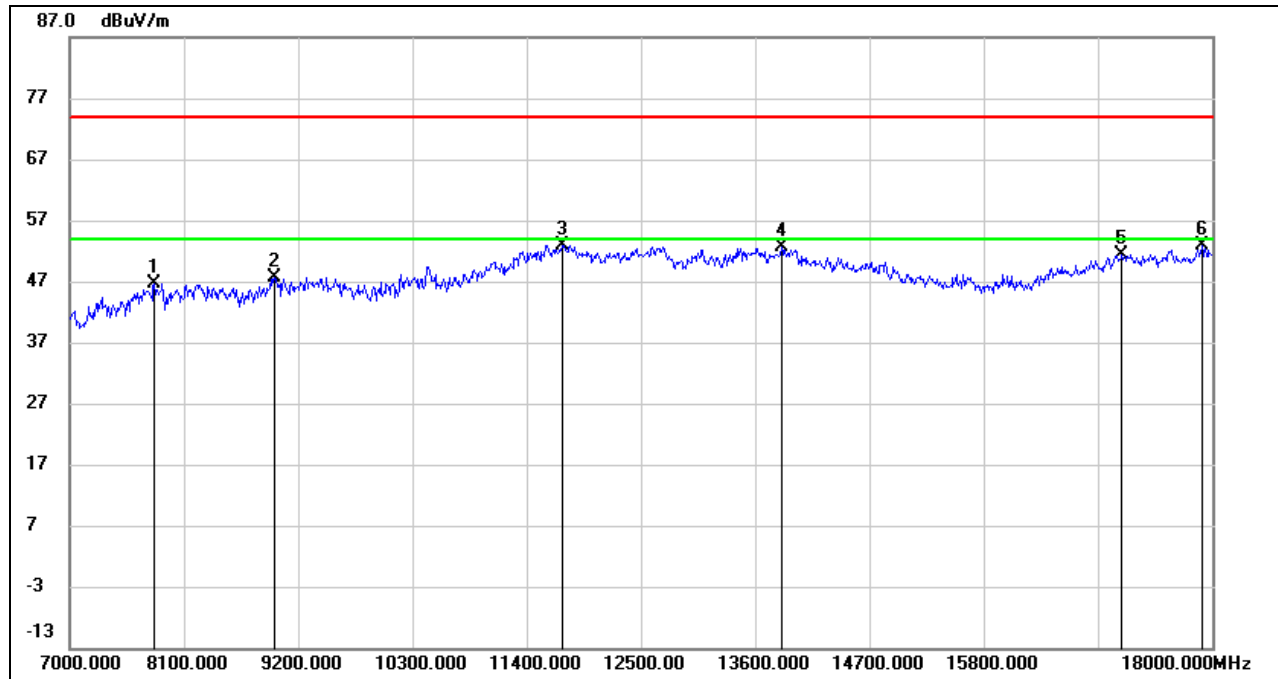

No.	Frequency (MHz)	Reading (dBuV)	Correct (dB/m)	Result (dBuV/m)	Limit (dBuV/m)	Margin (dB)	Remark
1	7819.500	37.94	8.79	46.73	74.00	-27.27	peak
2	8974.500	36.72	10.96	47.68	74.00	-26.32	peak
3	11746.500	34.69	18.21	52.90	74.00	-21.10	peak
4	13853.000	32.75	19.84	52.59	74.00	-21.41	peak
5	17131.000	30.68	20.66	51.34	74.00	-22.66	peak
6	17901.000	28.43	24.41	52.84	74.00	-21.16	peak

- Note: 1. Measurement = Reading Level + Correct Factor.
 2. If Peak Result complies with AV limit, AV Result is deemed to comply with AV limit.
 3. Peak: Peak detector.
 4. AVG: $VBW=1/Ton$, where: Ton is the transmitting duration.
 5. For the transmitting duration, please refer to clause 7.1.
 6. Filter losses were only considered in the spurious frequency bands and the authorized band was not corrected for High Pass Filter losses.
 7. Proper operation of the transmitter prior to adding the filter to the measurement chain.
 8. Since non-restricted band peak emissions are less than the average limit, they also comply with the -27dBm/MHz (68.2dBuV/m) limit.



HARMONICS AND SPURIOUS EMISSIONS (HIGH CHANNEL, VERTICAL)

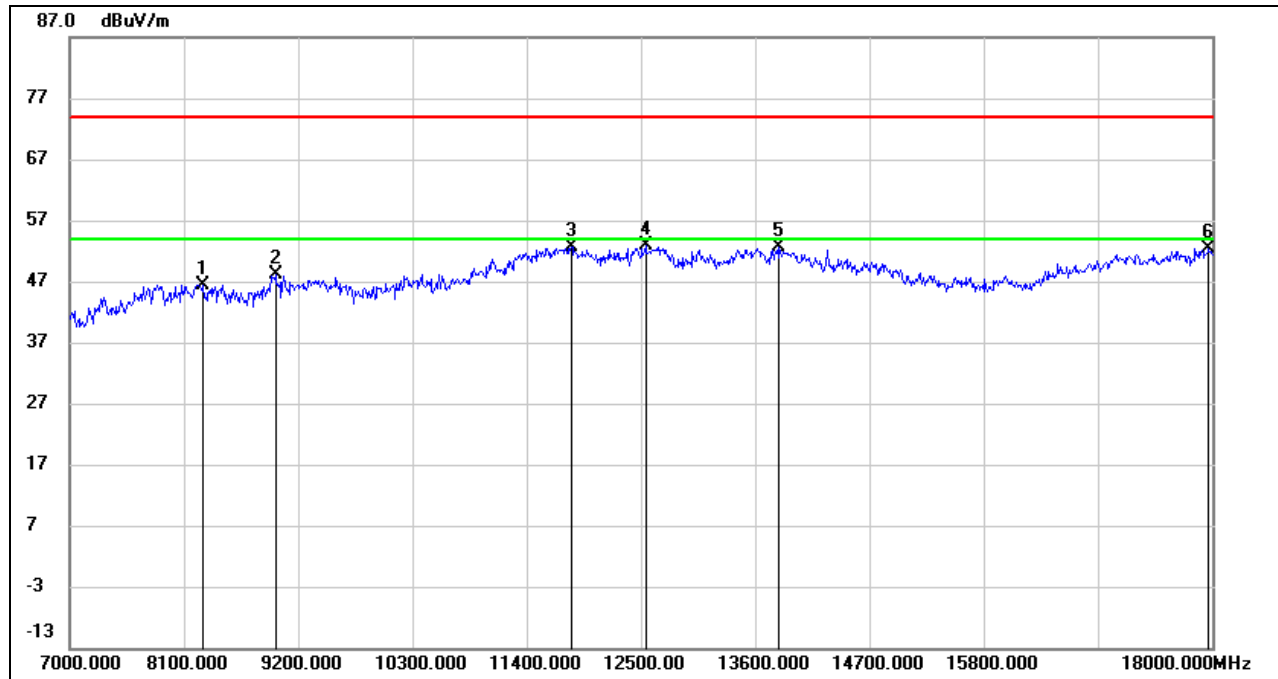

No.	Frequency (MHz)	Reading (dBuV)	Correct (dB/m)	Result (dBuV/m)	Limit (dBuV/m)	Margin (dB)	Remark
1	8292.500	36.95	9.54	46.49	74.00	-27.51	peak
2	8980.000	37.09	11.02	48.11	74.00	-25.89	peak
3	11829.000	34.20	18.40	52.60	74.00	-21.40	peak
4	12544.000	34.87	18.08	52.95	74.00	-21.05	peak
5	13836.500	32.70	19.88	52.58	74.00	-21.42	peak
6	17972.500	27.81	24.64	52.45	74.00	-21.55	peak

- Note:
1. Measurement = Reading Level + Correct Factor.
 2. If Peak Result complies with AV limit, AV Result is deemed to comply with AV limit.
 3. Peak: Peak detector.
 4. AVG: $VBW=1/Ton$, where: Ton is the transmitting duration.
 5. For the transmitting duration, please refer to clause 7.1.
 6. Filter losses were only considered in the spurious frequency bands and the authorized band was not corrected for High Pass Filter losses.
 7. Proper operation of the transmitter prior to adding the filter to the measurement chain.
 8. Since non-restricted band peak emissions are less than the average limit, they also comply with the -27dBm/MHz (68.2dBuV/m) limit.

UNII-2A BAND

HARMONICS AND SPURIOUS EMISSIONS (LOW CHANNEL, HORIZONTAL)

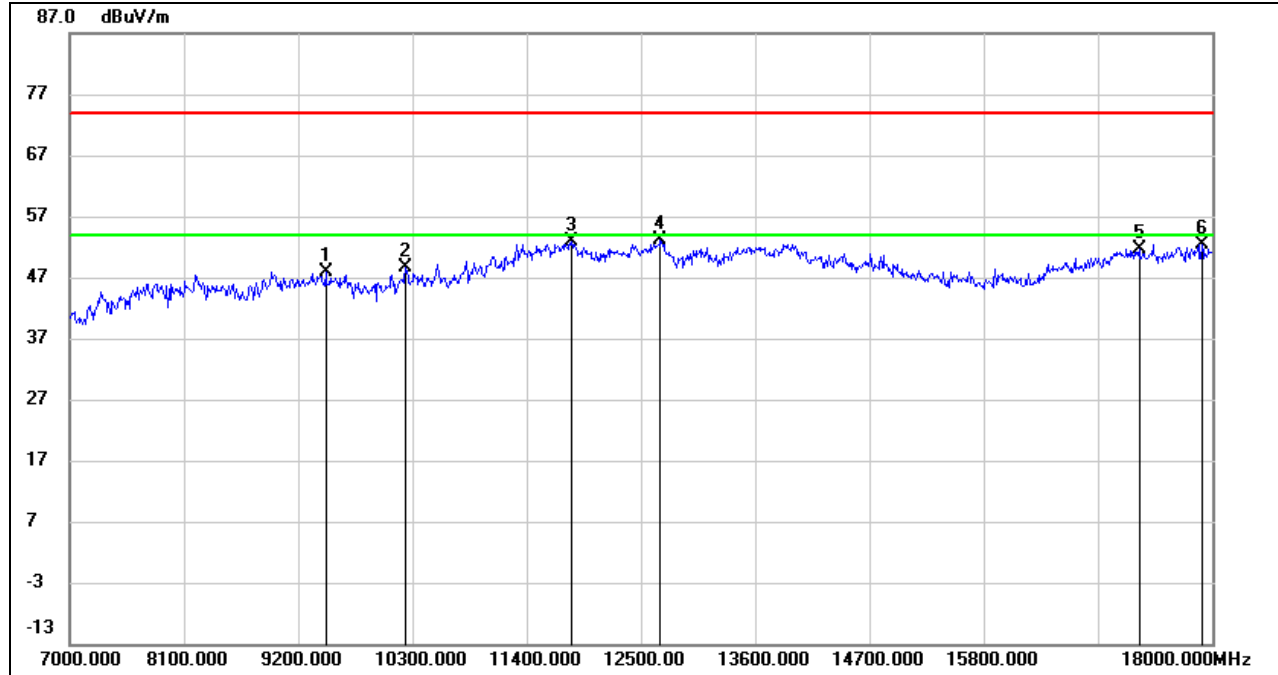

No.	Frequency (MHz)	Reading (dBuV)	Correct (dB/m)	Result (dBuV/m)	Limit (dBuV/m)	Margin (dB)	Remark
1	9464.000	36.37	11.51	47.88	74.00	-26.12	peak
2	10239.500	36.20	12.49	48.69	74.00	-25.31	peak
3	11834.500	34.42	18.40	52.82	74.00	-21.18	peak
4	12687.000	34.92	18.19	53.11	74.00	-20.89	peak
5	17296.000	30.51	21.07	51.58	74.00	-22.42	peak
6	17906.500	28.03	24.42	52.45	74.00	-21.55	peak

- Note: 1. Measurement = Reading Level + Correct Factor.
 2. If Peak Result complies with AV limit, AV Result is deemed to comply with AV limit.
 3. Peak: Peak detector.
 4. AVG: $VBW=1/Ton$, where: Ton is the transmitting duration.
 5. For the transmitting duration, please refer to clause 7.1.
 6. Filter losses were only considered in the spurious frequency bands and the authorized band was not corrected for High Pass Filter losses.
 7. Proper operation of the transmitter prior to adding the filter to the measurement chain.
 8. Since non-restricted band peak emissions are less than the average limit, they also comply with the -27dBm/MHz (68.2dBuV/m) limit.



HARMONICS AND SPURIOUS EMISSIONS (LOW CHANNEL, VERTICAL)

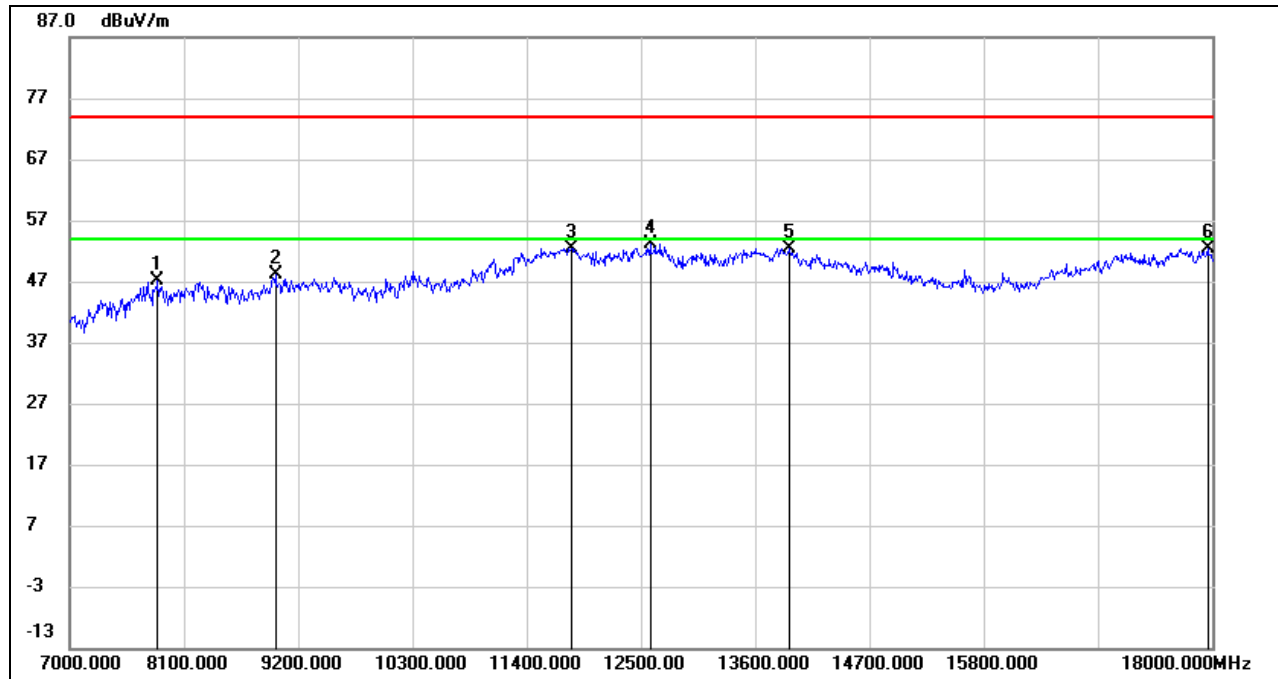

No.	Frequency (MHz)	Reading (dBuV)	Correct (dB/m)	Result (dBuV/m)	Limit (dBuV/m)	Margin (dB)	Remark
1	7847.000	38.52	8.72	47.24	74.00	-26.76	peak
2	8980.000	37.23	11.02	48.25	74.00	-25.75	peak
3	11834.500	34.04	18.40	52.44	74.00	-21.56	peak
4	12593.500	35.06	18.16	53.22	74.00	-20.78	peak
5	13930.000	32.73	19.71	52.44	74.00	-21.56	peak
6	17961.500	27.85	24.60	52.45	74.00	-21.55	peak

- Note: 1. Measurement = Reading Level + Correct Factor.
 2. If Peak Result complies with AV limit, AV Result is deemed to comply with AV limit.
 3. Peak: Peak detector.
 4. AVG: $VBW=1/Ton$, where: Ton is the transmitting duration.
 5. For the transmitting duration, please refer to clause 7.1.
 6. Filter losses were only considered in the spurious frequency bands and the authorized band was not corrected for High Pass Filter losses.
 7. Proper operation of the transmitter prior to adding the filter to the measurement chain.
 8. Since non-restricted band peak emissions are less than the average limit, they also comply with the -27dBm/MHz (68.2dBuV/m) limit.



HARMONICS AND SPURIOUS EMISSIONS (HIGH CHANNEL, HORIZONTAL)

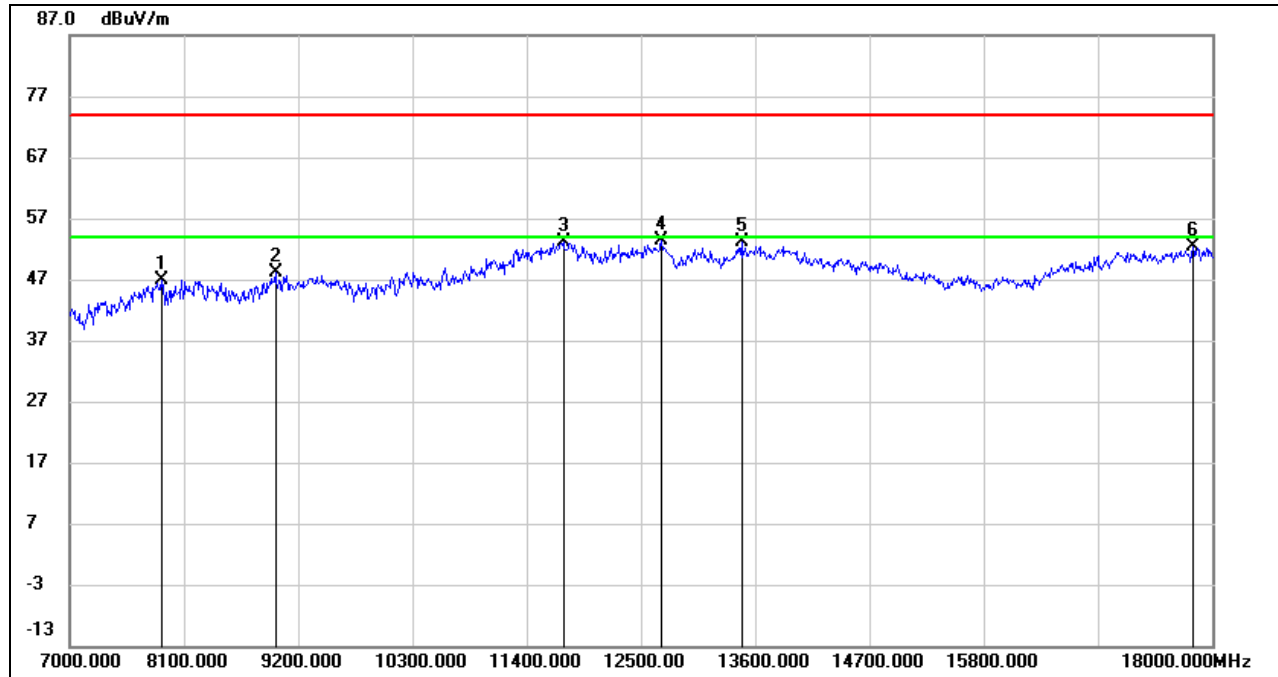

No.	Frequency (MHz)	Reading (dBuV)	Correct (dB/m)	Result (dBuV/m)	Limit (dBuV/m)	Margin (dB)	Remark
1	7885.500	38.18	8.63	46.81	74.00	-27.19	peak
2	8980.000	37.21	11.02	48.23	74.00	-25.77	peak
3	11757.500	34.83	18.26	53.09	74.00	-20.91	peak
4	12703.500	35.17	18.19	53.36	74.00	-20.64	peak
5	13468.000	33.59	19.42	53.01	74.00	-20.99	peak
6	17818.500	28.14	24.14	52.28	74.00	-21.72	peak

- Note:
1. Measurement = Reading Level + Correct Factor.
 2. If Peak Result complies with AV limit, AV Result is deemed to comply with AV limit.
 3. Peak: Peak detector.
 4. AVG: $VBW=1/Ton$, where: Ton is the transmitting duration.
 5. For the transmitting duration, please refer to clause 7.1.
 6. Filter losses were only considered in the spurious frequency bands and the authorized band was not corrected for High Pass Filter losses.
 7. Proper operation of the transmitter prior to adding the filter to the measurement chain.
 8. Since non-restricted band peak emissions are less than the average limit, they also comply with the -27dBm/MHz (68.2dBuV/m) limit.



HARMONICS AND SPURIOUS EMISSIONS (HIGH CHANNEL, VERTICAL)

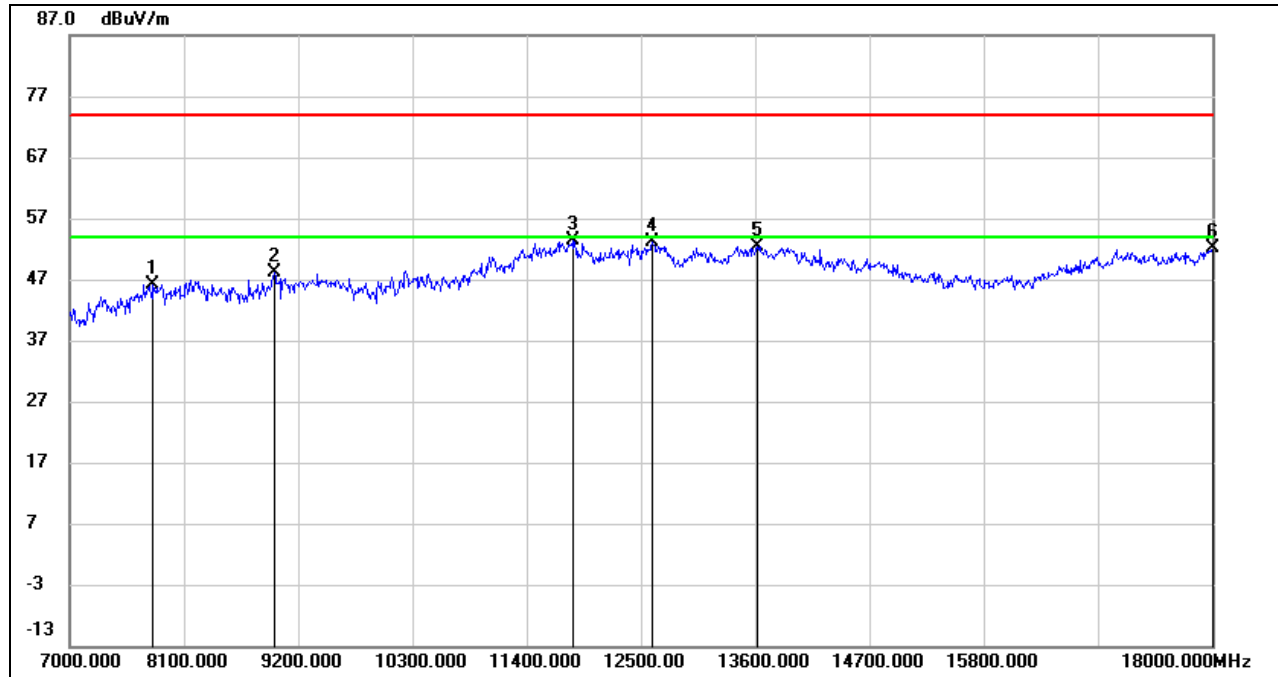

No.	Frequency (MHz)	Reading (dBuV)	Correct (dB/m)	Result (dBuV/m)	Limit (dBuV/m)	Margin (dB)	Remark
1	7808.500	37.35	8.82	46.17	74.00	-27.83	peak
2	8969.000	37.23	10.90	48.13	74.00	-25.87	peak
3	11840.000	34.88	18.39	53.27	74.00	-20.73	peak
4	12615.500	34.87	18.17	53.04	74.00	-20.96	peak
5	13622.000	33.05	19.43	52.48	74.00	-21.52	peak
6	18000.000	27.46	24.72	52.18	74.00	-21.82	peak

- Note:
1. Measurement = Reading Level + Correct Factor.
 2. If Peak Result complies with AV limit, AV Result is deemed to comply with AV limit.
 3. Peak: Peak detector.
 4. AVG: $VBW=1/Ton$, where: Ton is the transmitting duration.
 5. For the transmitting duration, please refer to clause 7.1.
 6. Filter losses were only considered in the spurious frequency bands and the authorized band was not corrected for High Pass Filter losses.
 7. Proper operation of the transmitter prior to adding the filter to the measurement chain.
 8. Since non-restricted band peak emissions are less than the average limit, they also comply with the -27dBm/MHz (68.2dBuV/m) limit.



UNII-2C BAND

HARMONICS AND SPURIOUS EMISSIONS (LOW CHANNEL, HORIZONTAL)

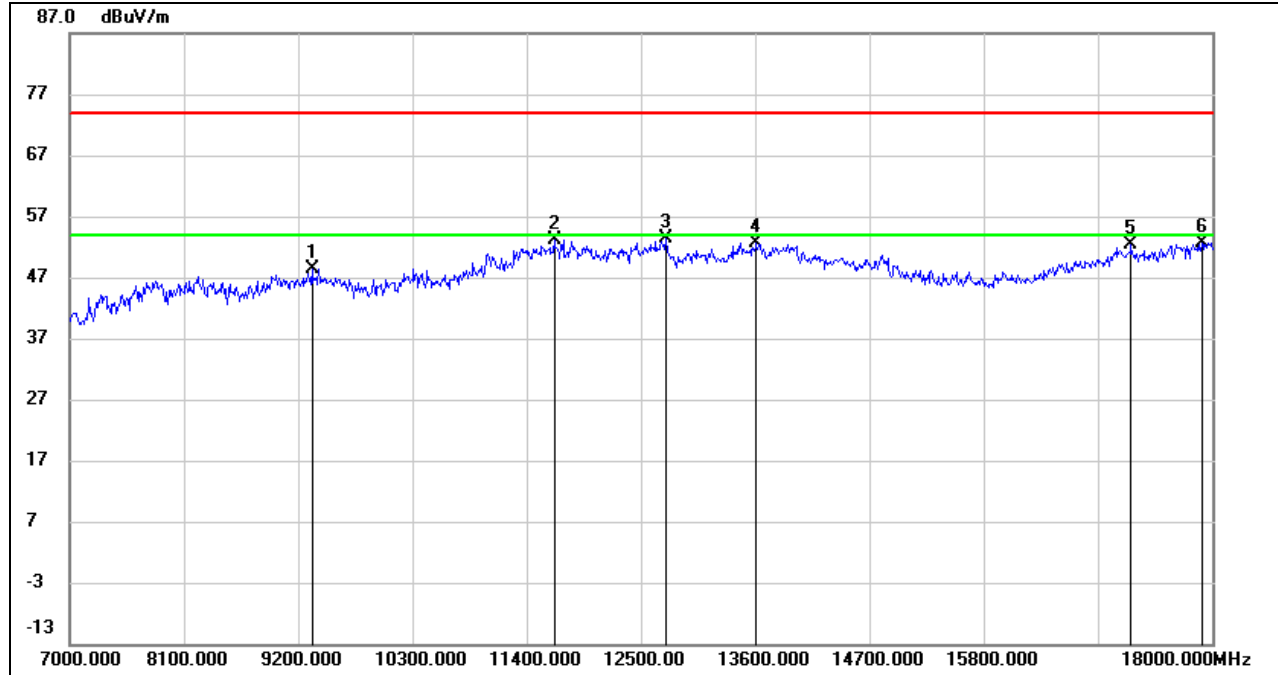

No.	Frequency (MHz)	Reading (dBuV)	Correct (dB/m)	Result (dBuV/m)	Limit (dBuV/m)	Margin (dB)	Remark
1	9337.500	37.51	10.94	48.45	74.00	-25.55	peak
2	11664.000	35.32	17.86	53.18	74.00	-20.82	peak
3	12742.000	35.07	18.20	53.27	74.00	-20.73	peak
4	13611.000	33.15	19.40	52.55	74.00	-21.45	peak
5	17224.500	31.27	21.14	52.41	74.00	-21.59	peak
6	17906.500	28.22	24.42	52.64	74.00	-21.36	peak

- Note:
1. Measurement = Reading Level + Correct Factor.
 2. If Peak Result complies with AV limit, AV Result is deemed to comply with AV limit.
 3. Peak: Peak detector.
 4. AVG: $VBW=1/Ton$, where: Ton is the transmitting duration.
 5. For the transmitting duration, please refer to clause 7.1.
 6. Filter losses were only considered in the spurious frequency bands and the authorized band was not corrected for High Pass Filter losses.
 7. Proper operation of the transmitter prior to adding the filter to the measurement chain.
 8. Since non-restricted band peak emissions are less than the average limit, they also comply with the -27dBm/MHz (68.2dBuV/m) limit.

HARMONICS AND SPURIOUS EMISSIONS (LOW CHANNEL, VERTICAL)

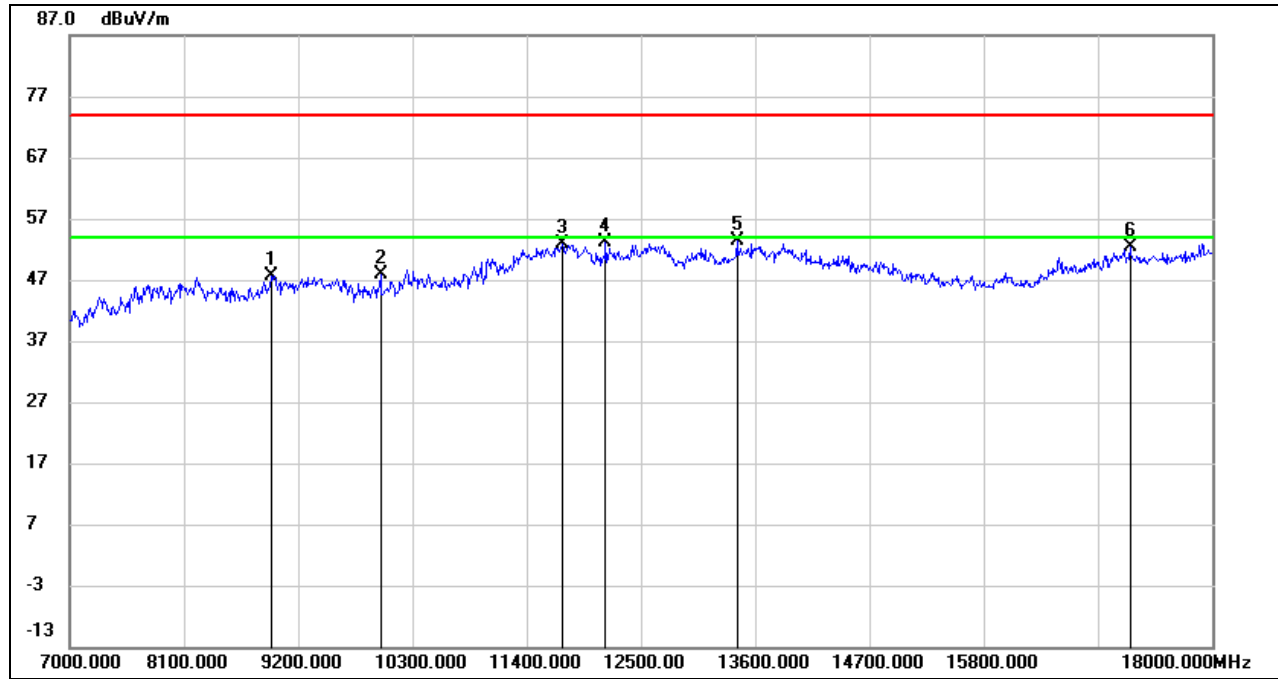

No.	Frequency (MHz)	Reading (dBuV)	Correct (dB/m)	Result (dBuV/m)	Limit (dBuV/m)	Margin (dB)	Remark
1	8941.500	37.00	10.63	47.63	74.00	-26.37	peak
2	9992.000	35.98	11.97	47.95	74.00	-26.05	peak
3	11746.500	34.67	18.21	52.88	74.00	-21.12	peak
4	12159.000	35.20	17.97	53.17	74.00	-20.83	peak
5	13429.500	33.96	19.35	53.31	74.00	-20.69	peak
6	17213.500	31.18	21.16	52.34	74.00	-21.66	peak

- Note:
1. Measurement = Reading Level + Correct Factor.
 2. If Peak Result complies with AV limit, AV Result is deemed to comply with AV limit.
 3. Peak: Peak detector.
 4. AVG: $VBW=1/Ton$, where: Ton is the transmitting duration.
 5. For the transmitting duration, please refer to clause 7.1.
 6. Filter losses were only considered in the spurious frequency bands and the authorized band was not corrected for High Pass Filter losses.
 7. Proper operation of the transmitter prior to adding the filter to the measurement chain.
 8. Since non-restricted band peak emissions are less than the average limit, they also comply with the -27dBm/MHz (68.2dBuV/m) limit.



HARMONICS AND SPURIOUS EMISSIONS (MID CHANNEL, HORIZONTAL)

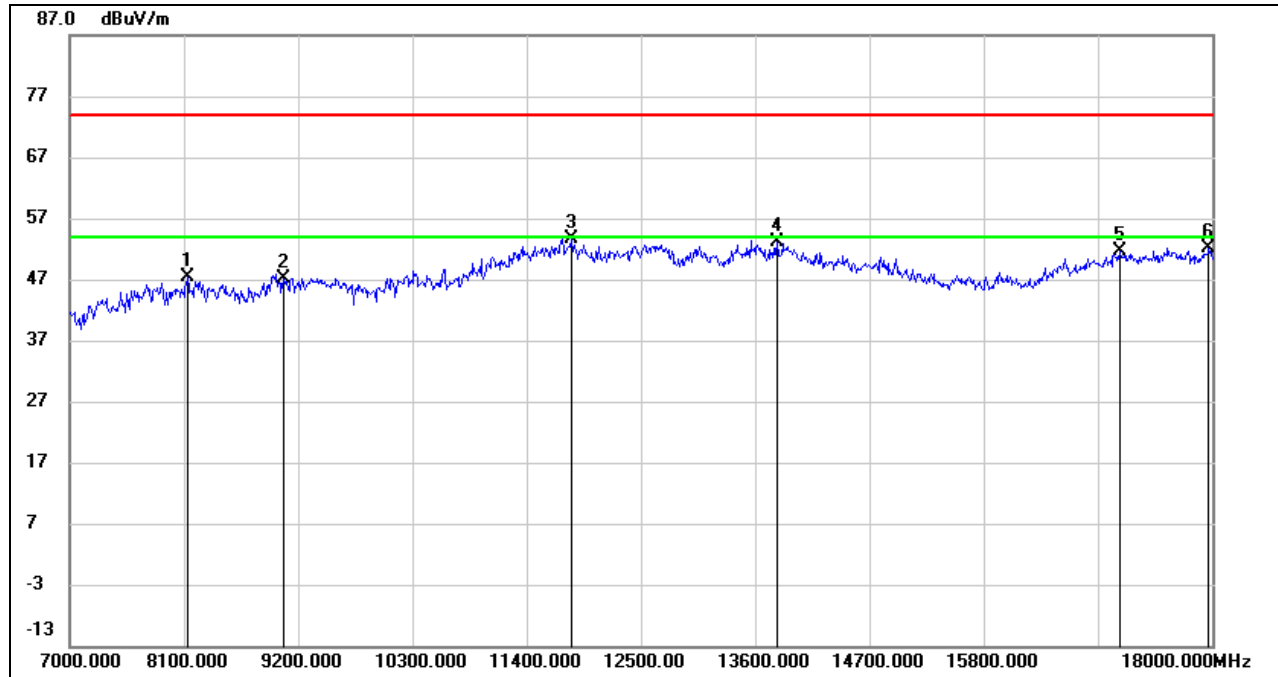

No.	Frequency (MHz)	Reading (dBuV)	Correct (dB/m)	Result (dBuV/m)	Limit (dBuV/m)	Margin (dB)	Remark
1	8138.500	38.07	9.41	47.48	74.00	-26.52	peak
2	9062.500	36.31	10.91	47.22	74.00	-26.78	peak
3	11829.000	35.25	18.40	53.65	74.00	-20.35	peak
4	13809.000	33.09	19.93	53.02	74.00	-20.98	peak
5	17109.000	31.10	20.49	51.59	74.00	-22.41	peak
6	17972.500	27.46	24.64	52.10	74.00	-21.90	peak

- Note:
1. Measurement = Reading Level + Correct Factor.
 2. If Peak Result complies with AV limit, AV Result is deemed to comply with AV limit.
 3. Peak: Peak detector.
 4. AVG: $VBW=1/Ton$, where: Ton is the transmitting duration.
 5. For the transmitting duration, please refer to clause 7.1.
 6. Filter losses were only considered in the spurious frequency bands and the authorized band was not corrected for High Pass Filter losses.
 7. Proper operation of the transmitter prior to adding the filter to the measurement chain.
 8. Since non-restricted band peak emissions are less than the average limit, they also comply with the -27dBm/MHz (68.2dBuV/m) limit.

HARMONICS AND SPURIOUS EMISSIONS (MID CHANNEL, VERTICAL)

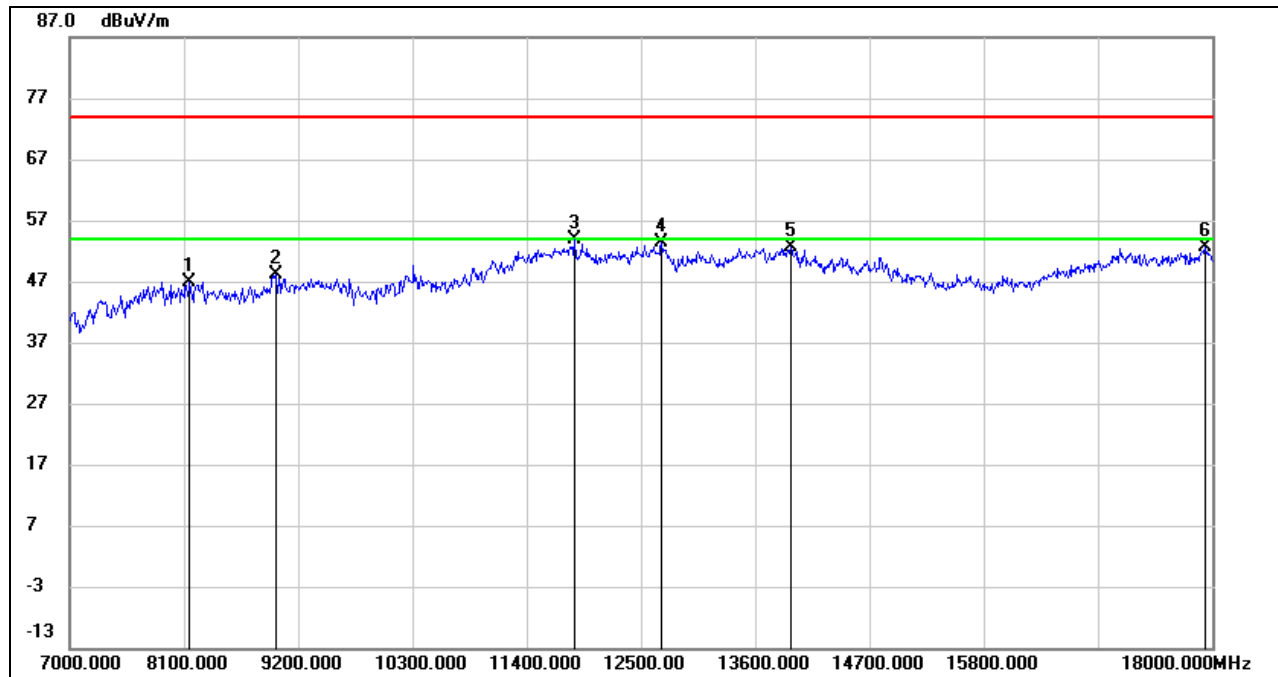

No.	Frequency (MHz)	Reading (dBuV)	Correct (dB/m)	Result (dBuV/m)	Limit (dBuV/m)	Margin (dB)	Remark
1	8160.500	37.24	9.59	46.83	74.00	-27.17	peak
2	8991.000	36.98	11.13	48.11	74.00	-25.89	peak
3	11862.000	35.48	18.37	53.85	74.00	-20.15	peak
4	12703.500	35.10	18.19	53.29	74.00	-20.71	peak
5	13946.500	32.98	19.68	52.66	74.00	-21.34	peak
6	17934.000	28.16	24.50	52.66	74.00	-21.34	peak

- Note: 1. Measurement = Reading Level + Correct Factor.
 2. If Peak Result complies with AV limit, AV Result is deemed to comply with AV limit.
 3. Peak: Peak detector.
 4. AVG: $VBW=1/Ton$, where: Ton is the transmitting duration.
 5. For the transmitting duration, please refer to clause 7.1.
 6. Filter losses were only considered in the spurious frequency bands and the authorized band was not corrected for High Pass Filter losses.
 7. Proper operation of the transmitter prior to adding the filter to the measurement chain.
 8. Since non-restricted band peak emissions are less than the average limit, they also comply with the -27dBm/MHz (68.2dBuV/m) limit.



HARMONICS AND SPURIOUS EMISSIONS (HIGH CHANNEL, HORIZONTAL)

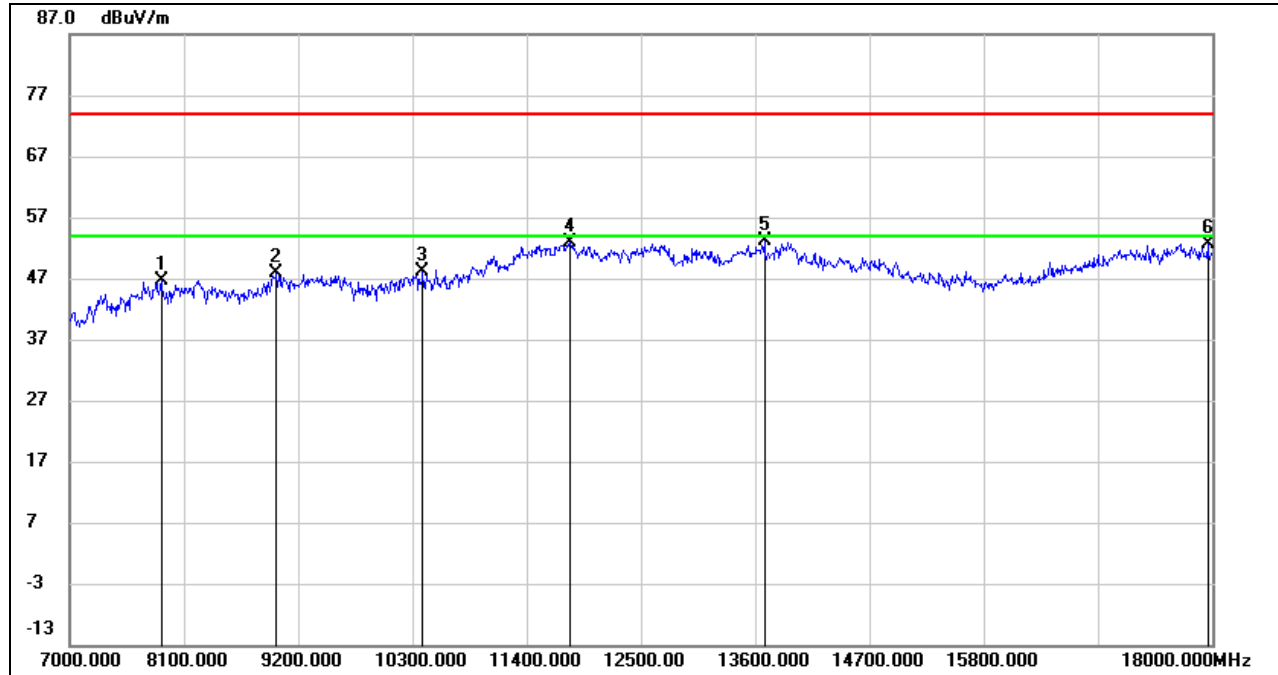

No.	Frequency (MHz)	Reading (dBuV)	Correct (dB/m)	Result (dBuV/m)	Limit (dBuV/m)	Margin (dB)	Remark
1	7885.500	38.00	8.63	46.63	74.00	-27.37	peak
2	8991.000	36.75	11.13	47.88	74.00	-26.12	peak
3	10399.000	34.93	13.14	48.07	74.00	-25.93	peak
4	11823.500	34.47	18.42	52.89	74.00	-21.11	peak
5	13693.500	33.53	19.63	53.16	74.00	-20.84	peak
6	17956.000	27.93	24.58	52.51	74.00	-21.49	peak

- Note:
1. Measurement = Reading Level + Correct Factor.
 2. If Peak Result complies with AV limit, AV Result is deemed to comply with AV limit.
 3. Peak: Peak detector.
 4. AVG: $VBW=1/Ton$, where: Ton is the transmitting duration.
 5. For the transmitting duration, please refer to clause 7.1.
 6. Filter losses were only considered in the spurious frequency bands and the authorized band was not corrected for High Pass Filter losses.
 7. Proper operation of the transmitter prior to adding the filter to the measurement chain.
 8. Since non-restricted band peak emissions are less than the average limit, they also comply with the -27dBm/MHz (68.2dBuV/m) limit.



HARMONICS AND SPURIOUS EMISSIONS (HIGH CHANNEL, VERTICAL)

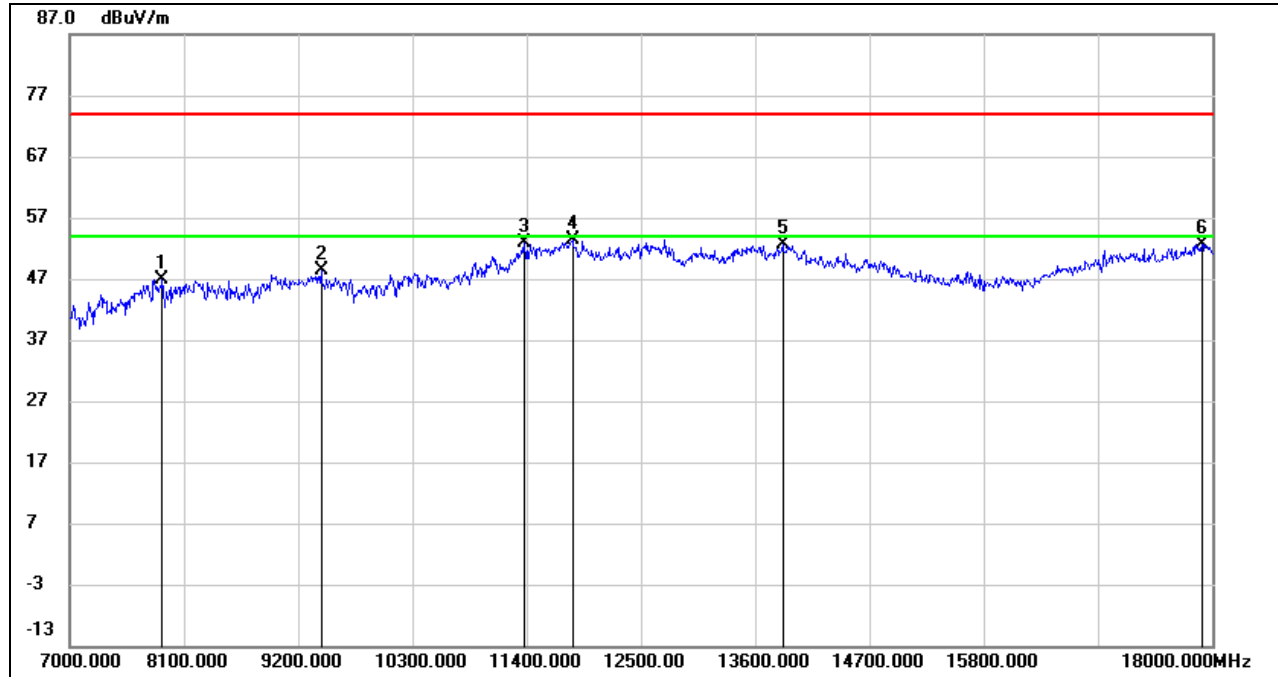

No.	Frequency (MHz)	Reading (dBuV)	Correct (dB/m)	Result (dBuV/m)	Limit (dBuV/m)	Margin (dB)	Remark
1	7891.000	38.27	8.61	46.88	74.00	-27.12	peak
2	9420.000	36.97	11.33	48.30	74.00	-25.70	peak
3	11383.500	35.83	16.98	52.81	74.00	-21.19	peak
4	11840.000	34.94	18.39	53.33	74.00	-20.67	peak
5	13864.000	32.85	19.81	52.66	74.00	-21.34	peak
6	17906.500	28.32	24.42	52.74	74.00	-21.26	peak

- Note:
1. Measurement = Reading Level + Correct Factor.
 2. If Peak Result complies with AV limit, AV Result is deemed to comply with AV limit.
 3. Peak: Peak detector.
 4. AVG: $VBW=1/Ton$, where: Ton is the transmitting duration.
 5. For the transmitting duration, please refer to clause 7.1.
 6. Filter losses were only considered in the spurious frequency bands and the authorized band was not corrected for High Pass Filter losses.
 7. Proper operation of the transmitter prior to adding the filter to the measurement chain.
 8. Since non-restricted band peak emissions are less than the average limit, they also comply with the -27dBm/MHz (68.2dBuV/m) limit.

STRADDLE CHANNEL 142

HARMONICS AND SPURIOUS EMISSIONS (HORIZONTAL)

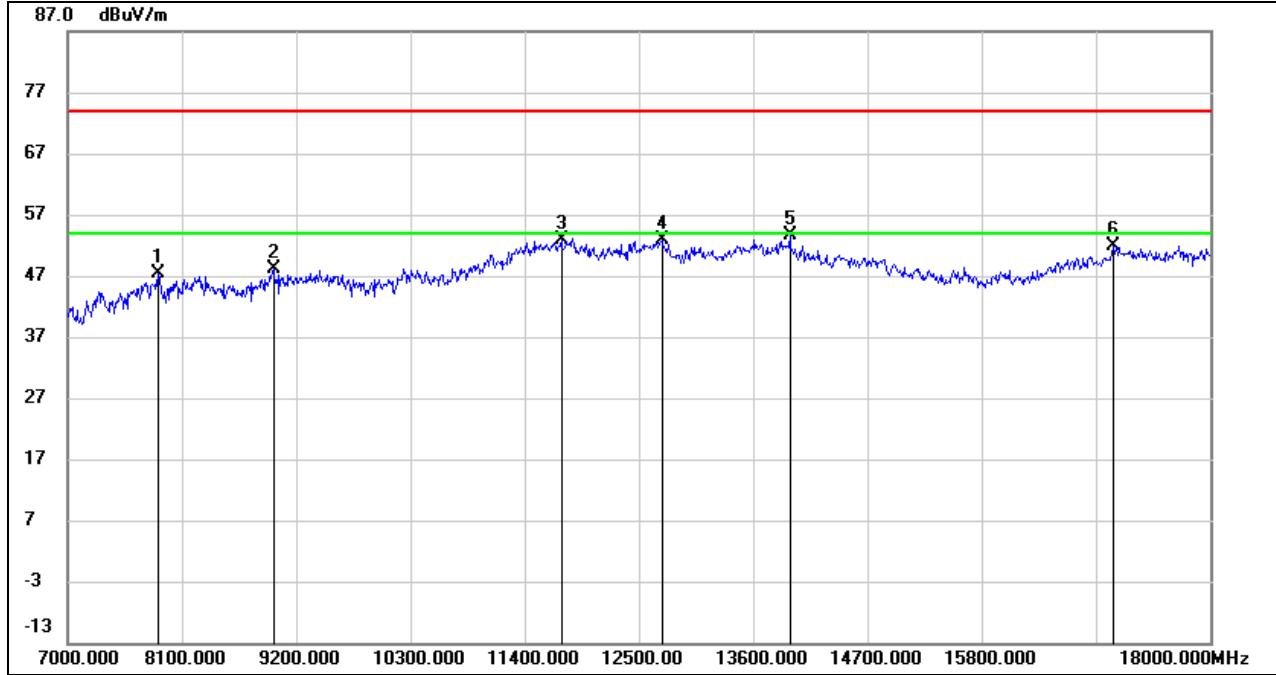

No.	Frequency (MHz)	Reading (dBuV)	Correct (dB/m)	Result (dBuV/m)	Limit (dBuV/m)	Margin (dB)	Remark
1	7874.500	38.74	8.65	47.39	74.00	-26.61	peak
2	8985.500	37.10	11.07	48.17	74.00	-25.83	peak
3	11752.000	34.62	18.23	52.85	74.00	-21.15	peak
4	12725.500	34.56	18.20	52.76	74.00	-21.24	peak
5	13952.000	33.90	19.67	53.57	74.00	-20.43	peak
6	17065.000	31.70	20.16	51.86	74.00	-22.14	peak

- Note:
1. Measurement = Reading Level + Correct Factor.
 2. If Peak Result complies with AV limit, AV Result is deemed to comply with AV limit.
 3. Peak: Peak detector.
 4. AVG: VBW=1/Ton, where: Ton is the transmitting duration.
 5. For the transmitting duration, please refer to clause 7.1.
 6. Filter losses were only considered in the spurious frequency bands and the authorized band was not corrected for High Pass Filter losses.
 7. Proper operation of the transmitter prior to adding the filter to the measurement chain.
 8. Since non-restricted band peak emissions are less than the average limit, they also comply with the -27dBm/MHz (68.2dBuV/m) limit.



HARMONICS AND SPURIOUS EMISSIONS (VERTICAL)

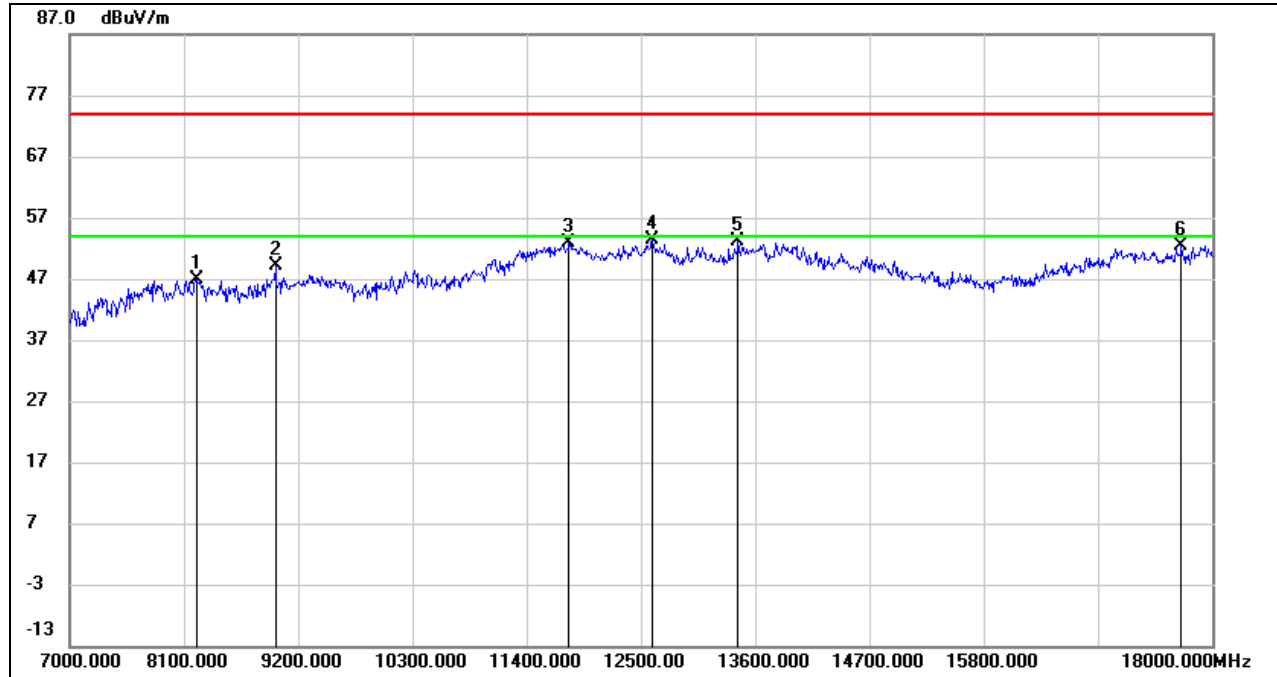

No.	Frequency (MHz)	Reading (dBuV)	Correct (dB/m)	Result (dBuV/m)	Limit (dBuV/m)	Margin (dB)	Remark
1	8226.500	37.09	9.79	46.88	74.00	-27.12	peak
2	8980.000	38.09	11.02	49.11	74.00	-24.89	peak
3	11807.000	34.34	18.44	52.78	74.00	-21.22	peak
4	12615.500	35.20	18.17	53.37	74.00	-20.63	peak
5	13440.500	33.66	19.37	53.03	74.00	-20.97	peak
6	17703.000	29.34	23.14	52.48	74.00	-21.52	peak

- Note:
1. Measurement = Reading Level + Correct Factor.
 2. If Peak Result complies with AV limit, AV Result is deemed to comply with AV limit.
 3. Peak: Peak detector.
 4. AVG: $VBW=1/Ton$, where: Ton is the transmitting duration.
 5. For the transmitting duration, please refer to clause 7.1.
 6. Filter losses were only considered in the spurious frequency bands and the authorized band was not corrected for High Pass Filter losses.
 7. Proper operation of the transmitter prior to adding the filter to the measurement chain.
 8. Since non-restricted band peak emissions are less than the average limit, they also comply with the -27dBm/MHz (68.2dBuV/m) limit.



UNII-3 BAND

HARMONICS AND SPURIOUS EMISSIONS (LOW CHANNEL, HORIZONTAL)

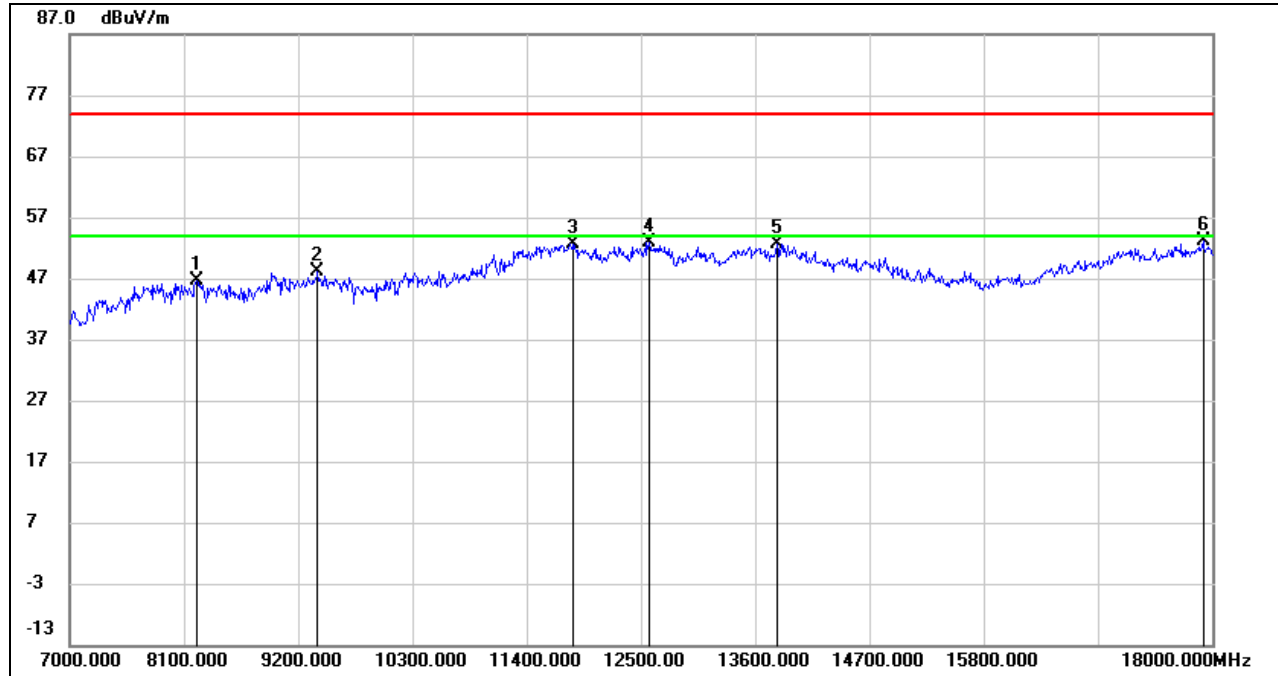

No.	Frequency (MHz)	Reading (dBuV)	Correct (dB/m)	Result (dBuV/m)	Limit (dBuV/m)	Margin (dB)	Remark
1	8226.500	36.77	9.79	46.56	74.00	-27.44	peak
2	9387.000	36.99	11.19	48.18	74.00	-25.82	peak
3	11845.500	34.28	18.39	52.67	74.00	-21.33	peak
4	12582.500	34.63	18.15	52.78	74.00	-21.22	peak
5	13809.000	32.76	19.93	52.69	74.00	-21.31	peak
6	17917.500	28.75	24.46	53.21	74.00	-20.79	peak

- Note: 1. Measurement = Reading Level + Correct Factor.
 2. If Peak Result complies with AV limit, AV Result is deemed to comply with AV limit.
 3. Peak: Peak detector.
 4. AVG: $VBW=1/Ton$, where: Ton is the transmitting duration.
 5. For the transmitting duration, please refer to clause 7.1.
 6. Filter losses were only considered in the spurious frequency bands and the authorized band was not corrected for High Pass Filter losses.
 7. Proper operation of the transmitter prior to adding the filter to the measurement chain.
 8. Since non-restricted band peak emissions are less than the average limit, they also comply with the -27dBm/MHz (68.2dBuV/m) limit.

HARMONICS AND SPURIOUS EMISSIONS (LOW CHANNEL, VERTICAL)

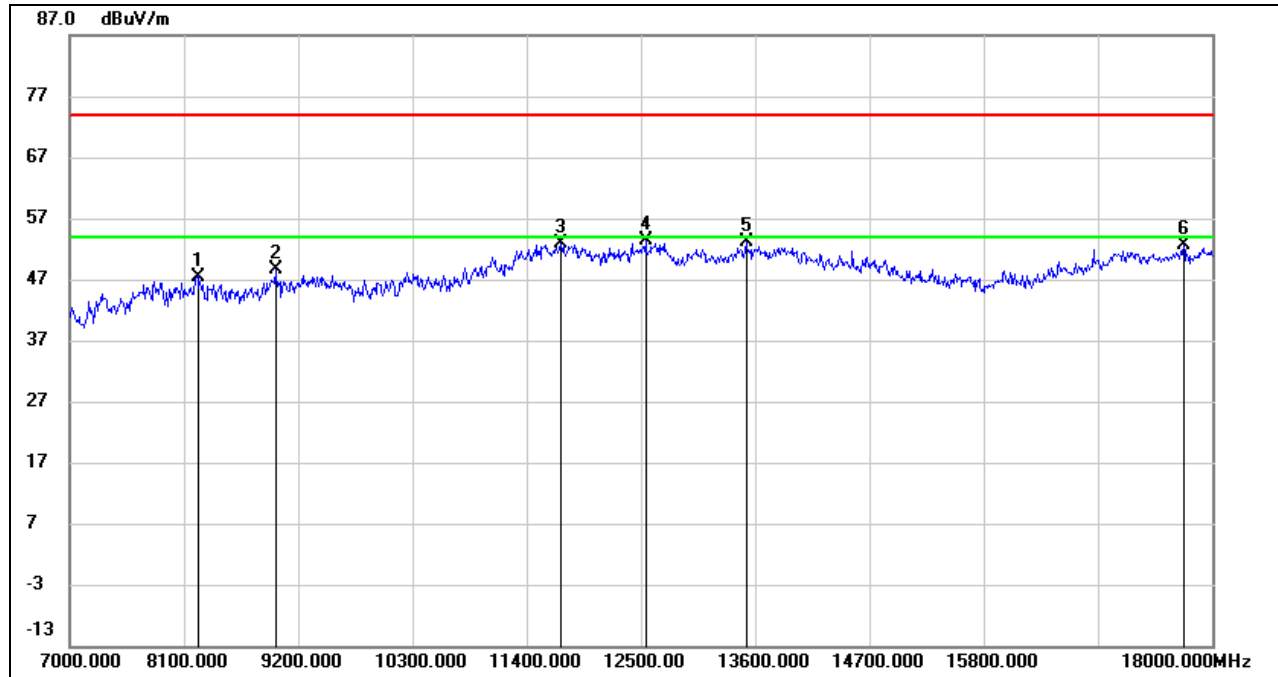

No.	Frequency (MHz)	Reading (dBuV)	Correct (dB/m)	Result (dBuV/m)	Limit (dBuV/m)	Margin (dB)	Remark
1	8237.500	37.76	9.74	47.50	74.00	-26.50	peak
2	8985.500	37.60	11.07	48.67	74.00	-25.33	peak
3	11735.500	34.76	18.16	52.92	74.00	-21.08	peak
4	12549.500	35.27	18.09	53.36	74.00	-20.64	peak
5	13517.500	33.61	19.44	53.05	74.00	-20.95	peak
6	17725.000	29.19	23.35	52.54	74.00	-21.46	peak

- Note: 1. Measurement = Reading Level + Correct Factor.
 2. If Peak Result complies with AV limit, AV Result is deemed to comply with AV limit.
 3. Peak: Peak detector.
 4. AVG: $VBW=1/Ton$, where: Ton is the transmitting duration.
 5. For the transmitting duration, please refer to clause 7.1.
 6. Filter losses were only considered in the spurious frequency bands and the authorized band was not corrected for High Pass Filter losses.
 7. Proper operation of the transmitter prior to adding the filter to the measurement chain.
 8. Since non-restricted band peak emissions are less than the average limit, they also comply with the -27dBm/MHz (68.2dBuV/m) limit.



HARMONICS AND SPURIOUS EMISSIONS (HIGH CHANNEL, HORIZONTAL)

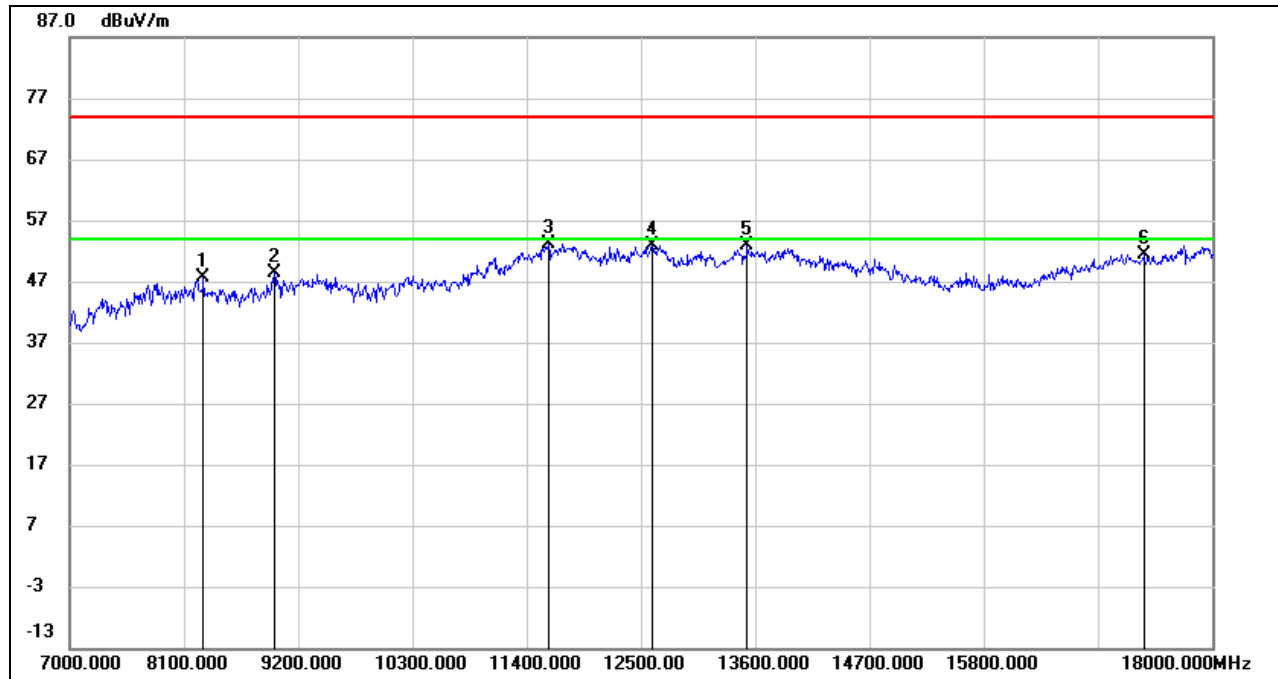

No.	Frequency (MHz)	Reading (dBuV)	Correct (dB/m)	Result (dBuV/m)	Limit (dBuV/m)	Margin (dB)	Remark
1	8292.500	37.98	9.54	47.52	74.00	-26.48	peak
2	8974.500	37.45	10.96	48.41	74.00	-25.59	peak
3	11609.000	35.62	17.62	53.24	74.00	-20.76	peak
4	12615.500	34.72	18.17	52.89	74.00	-21.11	peak
5	13528.500	33.32	19.44	52.76	74.00	-21.24	peak
6	17345.500	30.41	21.01	51.42	74.00	-22.58	peak

Note: 1. Measurement = Reading Level + Correct Factor.
 2. If Peak Result complies with AV limit, AV Result is deemed to comply with AV limit.
 3. Peak: Peak detector.
 4. Filter losses were only considered in the spurious frequency bands and the authorized band was not corrected for High Pass Filter losses.
 5. Proper operation of the transmitter prior to adding the filter to the measurement chain.
 6. Since non-restricted band peak emissions are less than the average limit, they also comply with the -27dBm/MHz (68.2dBuV/m) limit.



HARMONICS AND SPURIOUS EMISSIONS (HIGH CHANNEL, VERTICAL)

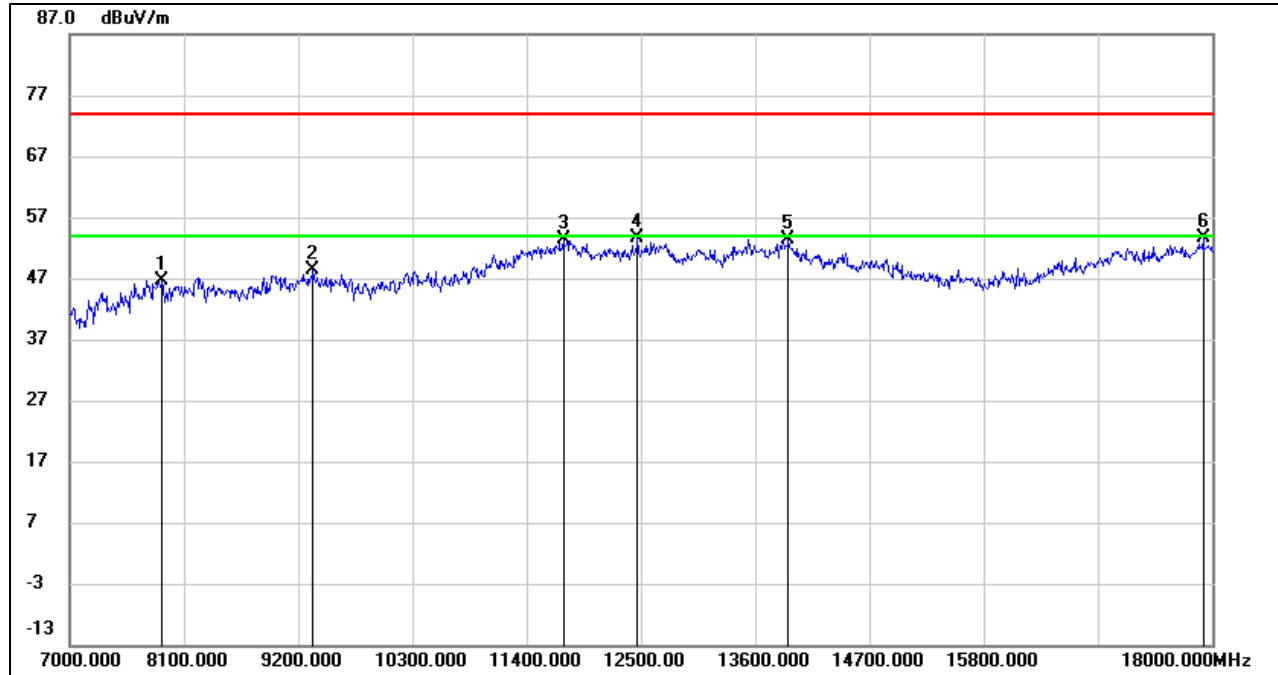

No.	Frequency (MHz)	Reading (dBuV)	Correct (dB/m)	Result (dBuV/m)	Limit (dBuV/m)	Margin (dB)	Remark
1	7891.000	38.09	8.61	46.70	74.00	-27.30	peak
2	9343.000	37.47	10.97	48.44	74.00	-25.56	peak
3	11752.000	35.17	18.23	53.40	74.00	-20.60	peak
4	12467.000	35.69	18.04	53.73	74.00	-20.27	peak
5	13924.500	33.79	19.71	53.50	74.00	-20.50	peak
6	17912.000	29.11	24.44	53.55	74.00	-20.45	peak

- Note: 1. Measurement = Reading Level + Correct Factor.
 2. If Peak Result complies with AV limit, AV Result is deemed to comply with AV limit.
 3. Peak: Peak detector.
 4. AVG: $VBW=1/Ton$, where: Ton is the transmitting duration.
 5. For the transmitting duration, please refer to clause 7.1.
 6. Filter losses were only considered in the spurious frequency bands and the authorized band was not corrected for High Pass Filter losses.
 7. Proper operation of the transmitter prior to adding the filter to the measurement chain.
 8. Since non-restricted band peak emissions are less than the average limit, they also comply with the -27dBm/MHz (68.2dBuV/m) limit.



8.3.4. 802.11ac VHT80 MIMO MODE

UNII-1 BAND

HARMONICS AND SPURIOUS EMISSIONS (LOW CHANNEL, HORIZONTAL)

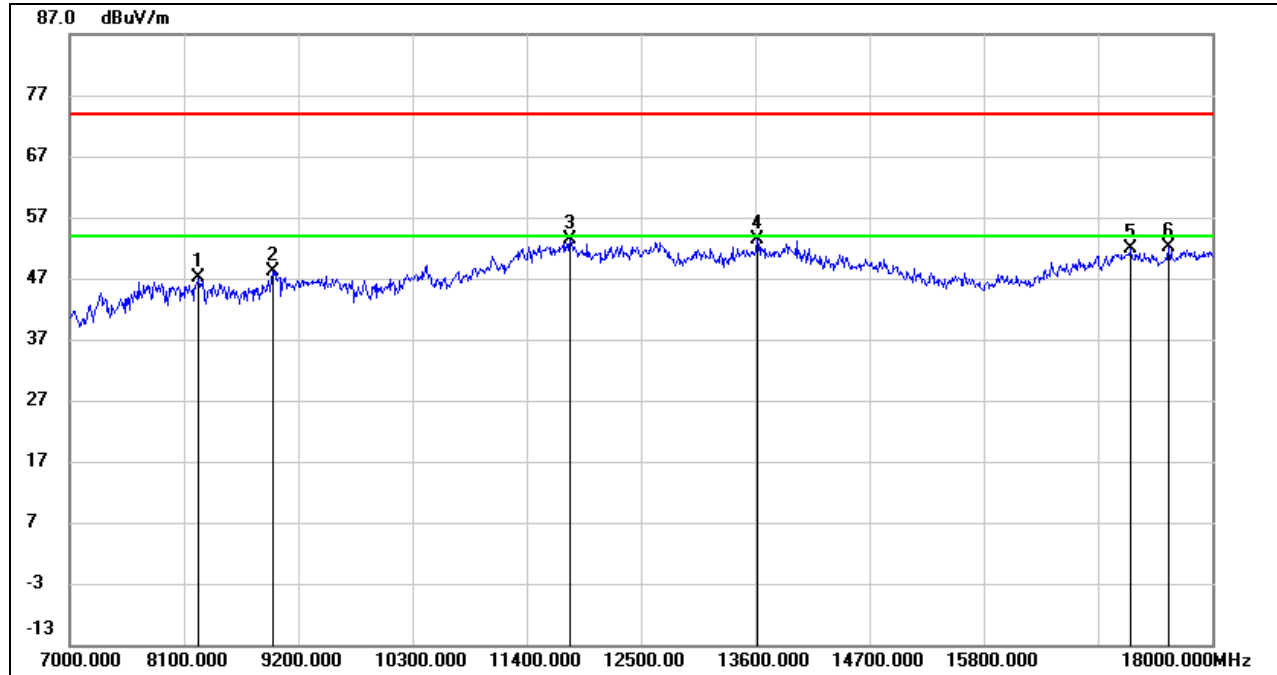

No.	Frequency (MHz)	Reading (dBuV)	Correct (dB/m)	Result (dBuV/m)	Limit (dBuV/m)	Margin (dB)	Remark
1	8243.000	37.30	9.72	47.02	74.00	-26.98	peak
2	8963.500	37.38	10.85	48.23	74.00	-25.77	peak
3	11823.500	34.90	18.42	53.32	74.00	-20.68	peak
4	13627.500	33.96	19.44	53.40	74.00	-20.60	peak
5	17219.000	30.71	21.14	51.85	74.00	-22.15	peak
6	17582.000	30.11	22.01	52.12	74.00	-21.88	peak

- Note: 1. Measurement = Reading Level + Correct Factor.
 2. If Peak Result complies with AV limit, AV Result is deemed to comply with AV limit.
 3. Peak: Peak detector.
 4. AVG: $VBW=1/T_{on}$, where: T_{on} is the transmitting duration.
 5. For the transmitting duration, please refer to clause 7.1.
 6. Filter losses were only considered in the spurious frequency bands and the authorized band was not corrected for High Pass Filter losses.
 7. Proper operation of the transmitter prior to adding the filter to the measurement chain.
 8. Since non-restricted band peak emissions are less than the average limit, they also comply with the -27dBm/MHz (68.2dBuV/m) limit.

HARMONICS AND SPURIOUS EMISSIONS (LOW CHANNEL, VERTICAL)

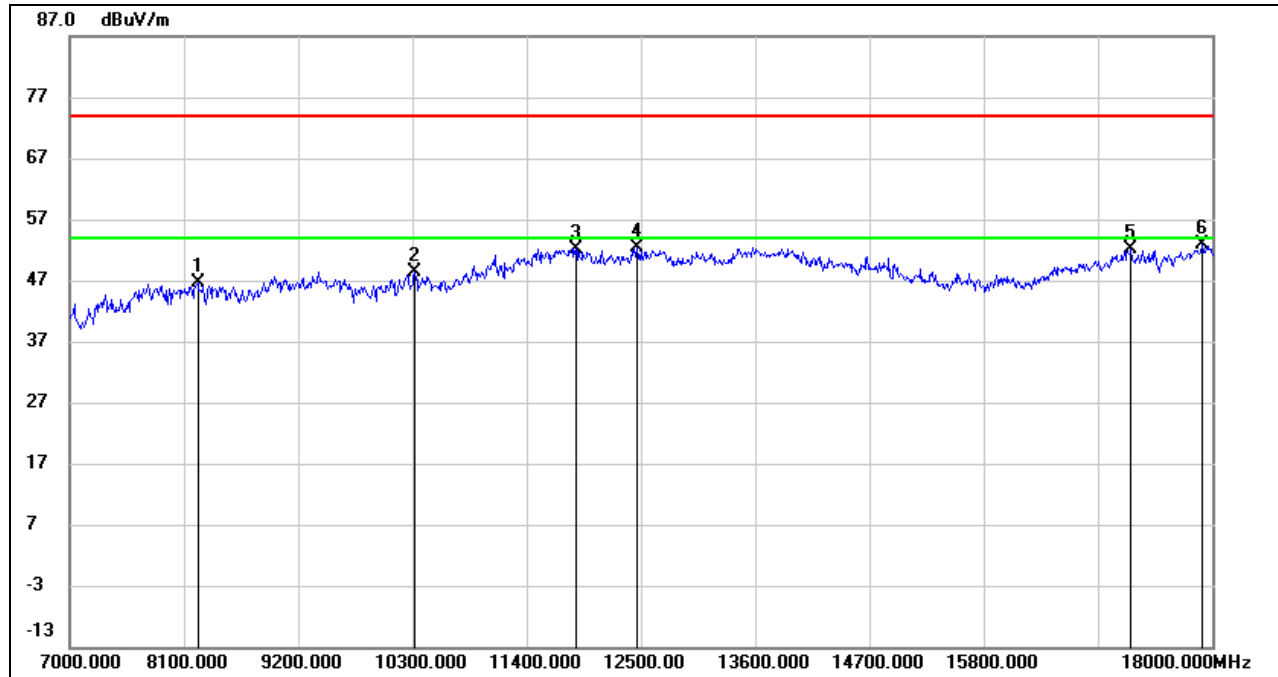

No.	Frequency (MHz)	Reading (dBuV)	Correct (dB/m)	Result (dBuV/m)	Limit (dBuV/m)	Margin (dB)	Remark
1	8237.500	36.84	9.74	46.58	74.00	-27.42	peak
2	10322.000	35.63	12.83	48.46	74.00	-25.54	peak
3	11873.000	33.89	18.36	52.25	74.00	-21.75	peak
4	12456.000	34.41	18.05	52.46	74.00	-21.54	peak
5	17224.500	30.92	21.14	52.06	74.00	-21.94	peak
6	17901.000	28.58	24.41	52.99	74.00	-21.01	peak

- Note:
1. Measurement = Reading Level + Correct Factor.
 2. If Peak Result complies with AV limit, AV Result is deemed to comply with AV limit.
 3. Peak: Peak detector.
 4. AVG: $VBW=1/Ton$, where: Ton is the transmitting duration.
 5. For the transmitting duration, please refer to clause 7.1.
 6. Filter losses were only considered in the spurious frequency bands and the authorized band was not corrected for High Pass Filter losses.
 7. Proper operation of the transmitter prior to adding the filter to the measurement chain.
 8. Since non-restricted band peak emissions are less than the average limit, they also comply with the -27dBm/MHz (68.2dBuV/m) limit.



UNII-2A BAND

HARMONICS AND SPURIOUS EMISSIONS (LOW CHANNEL, HORIZONTAL)

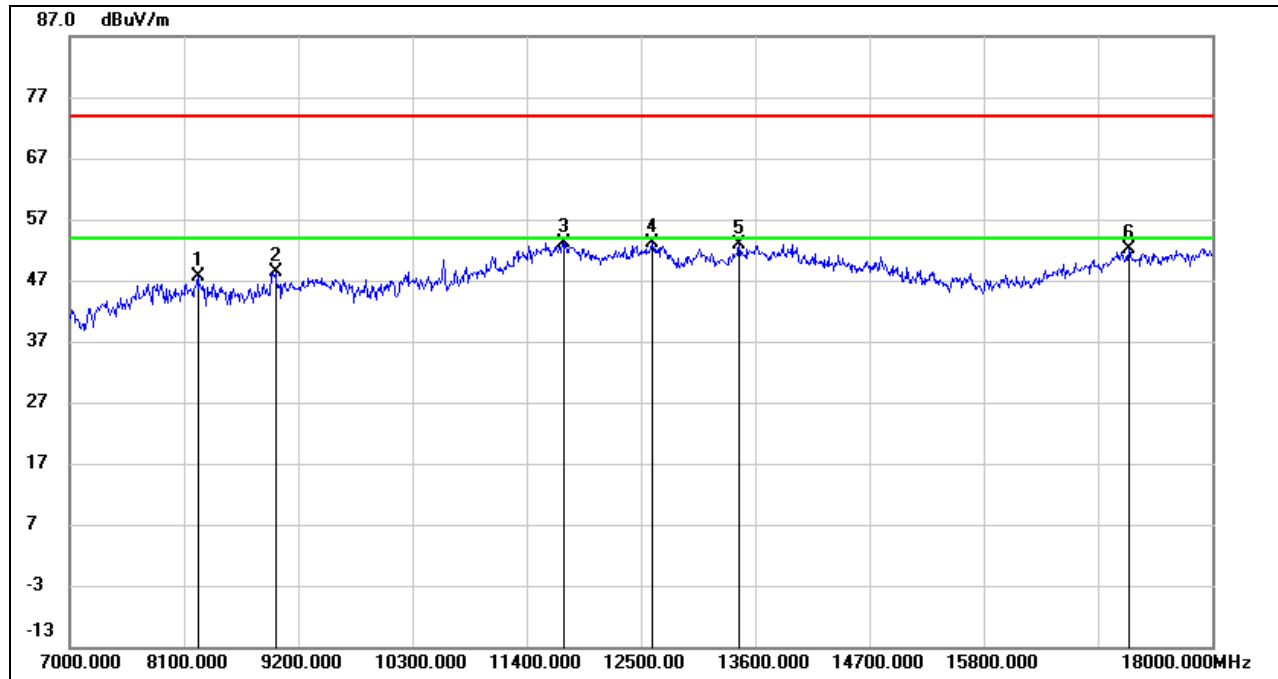

No.	Frequency (MHz)	Reading (dBuV)	Correct (dB/m)	Result (dBuV/m)	Limit (dBuV/m)	Margin (dB)	Remark
1	8232.000	37.81	9.77	47.58	74.00	-26.42	peak
2	8980.000	37.34	11.02	48.36	74.00	-25.64	peak
3	11752.000	35.02	18.23	53.25	74.00	-20.75	peak
4	12610.000	35.03	18.16	53.19	74.00	-20.81	peak
5	13451.500	33.60	19.39	52.99	74.00	-21.01	peak
6	17197.000	31.05	21.15	52.20	74.00	-21.80	peak

- Note: 1. Measurement = Reading Level + Correct Factor.
 2. If Peak Result complies with AV limit, AV Result is deemed to comply with AV limit.
 3. Peak: Peak detector.
 4. Filter losses were only considered in the spurious frequency bands and the authorized band was not corrected for High Pass Filter losses.
 5. Proper operation of the transmitter prior to adding the filter to the measurement chain.
 6. Since non-restricted band peak emissions are less than the average limit, they also comply with the -27dBm/MHz (68.2dBuV/m) limit.

HARMONICS AND SPURIOUS EMISSIONS (LOW CHANNEL, VERTICAL)

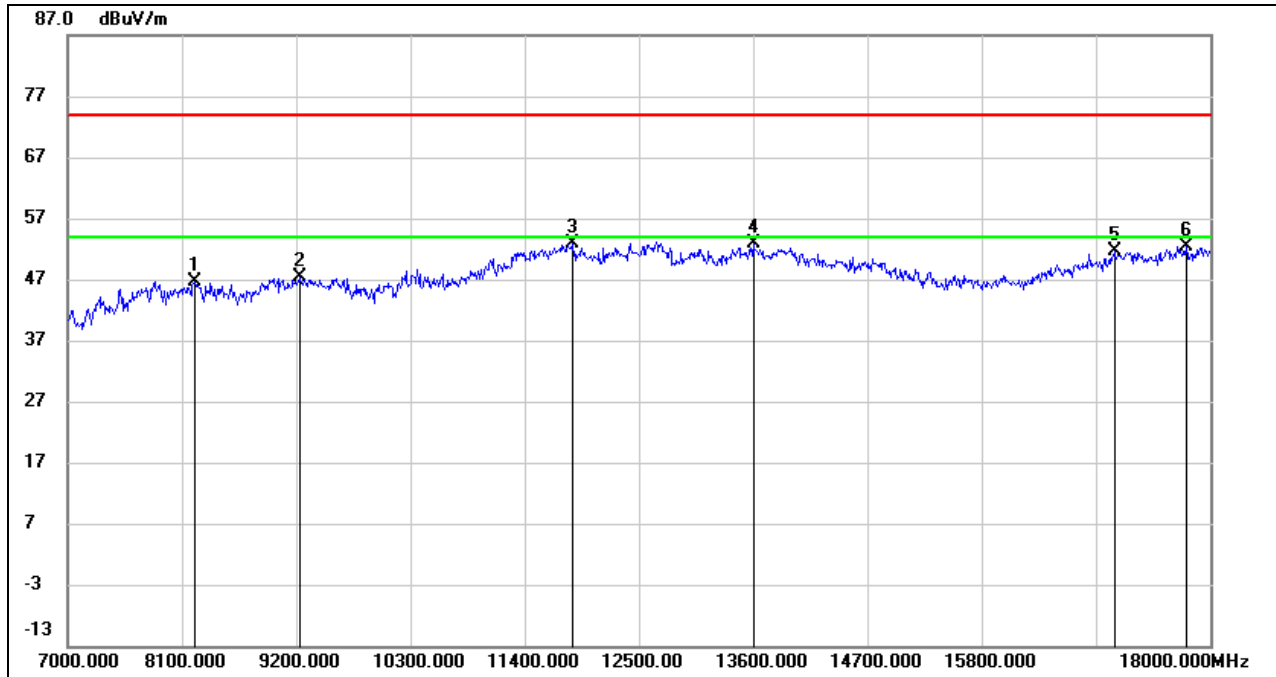

No.	Frequency (MHz)	Reading (dBuV)	Correct (dB/m)	Result (dBuV/m)	Limit (dBuV/m)	Margin (dB)	Remark
1	8226.500	36.90	9.79	46.69	74.00	-27.31	peak
2	9238.500	36.94	10.42	47.36	74.00	-26.64	peak
3	11862.000	34.45	18.37	52.82	74.00	-21.18	peak
4	13600.000	33.39	19.37	52.76	74.00	-21.24	peak
5	17081.500	31.24	20.28	51.52	74.00	-22.48	peak
6	17769.000	28.60	23.78	52.38	74.00	-21.62	peak

- Note:
1. Measurement = Reading Level + Correct Factor.
 2. If Peak Result complies with AV limit, AV Result is deemed to comply with AV limit.
 3. Peak: Peak detector.
 4. AVG: $VBW=1/Ton$, where: Ton is the transmitting duration.
 5. For the transmitting duration, please refer to clause 7.1.
 6. Filter losses were only considered in the spurious frequency bands and the authorized band was not corrected for High Pass Filter losses.
 7. Proper operation of the transmitter prior to adding the filter to the measurement chain.
 8. Since non-restricted band peak emissions are less than the average limit, they also comply with the -27dBm/MHz (68.2dBuV/m) limit.



UNII-2C BAND

HARMONICS AND SPURIOUS EMISSIONS (LOW CHANNEL, HORIZONTAL)

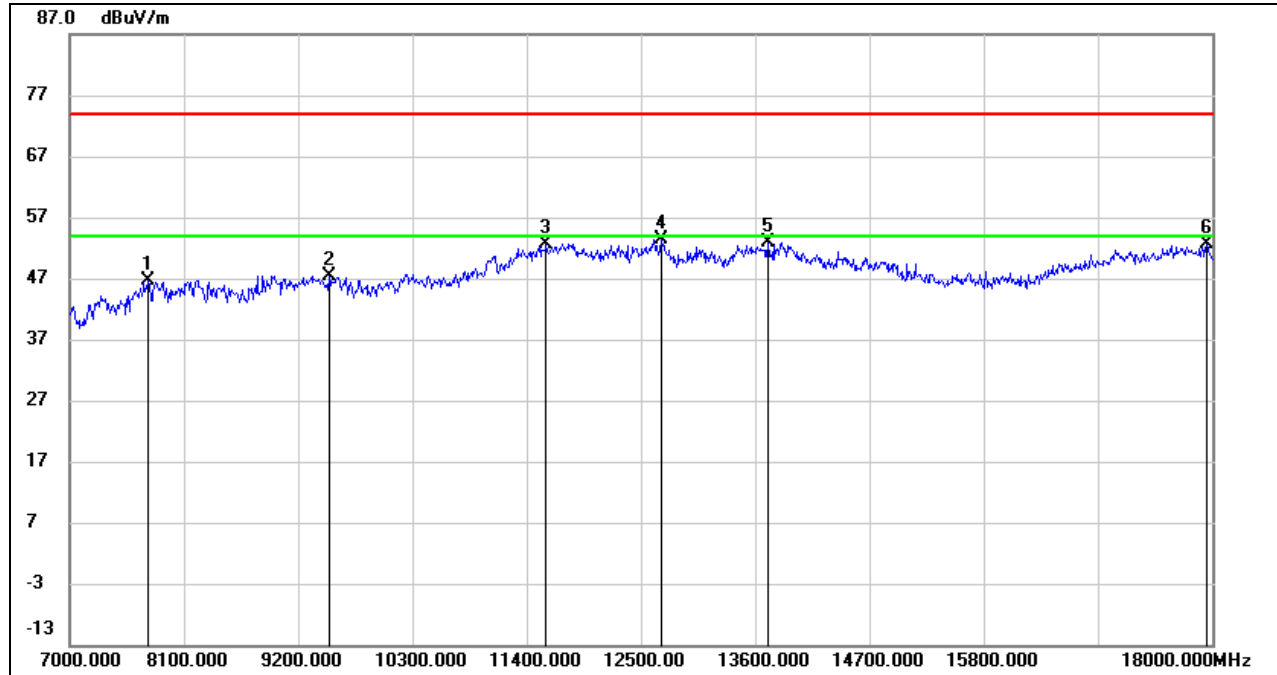

No.	Frequency (MHz)	Reading (dBuV)	Correct (dB/m)	Result (dBuV/m)	Limit (dBuV/m)	Margin (dB)	Remark
1	7753.500	37.99	8.65	46.64	74.00	-27.36	peak
2	9497.000	35.79	11.64	47.43	74.00	-26.57	peak
3	11592.500	35.15	17.56	52.71	74.00	-21.29	peak
4	12698.000	35.29	18.19	53.48	74.00	-20.52	peak
5	13726.500	33.21	19.73	52.94	74.00	-21.06	peak
6	17945.000	28.09	24.54	52.63	74.00	-21.37	peak

- Note: 1. Measurement = Reading Level + Correct Factor.
 2. If Peak Result complies with AV limit, AV Result is deemed to comply with AV limit.
 3. Peak: Peak detector.
 4. AVG: $VBW=1/Ton$, where: Ton is the transmitting duration.
 5. For the transmitting duration, please refer to clause 7.1.
 6. Filter losses were only considered in the spurious frequency bands and the authorized band was not corrected for High Pass Filter losses.
 7. Proper operation of the transmitter prior to adding the filter to the measurement chain.
 8. Since non-restricted band peak emissions are less than the average limit, they also comply with the -27dBm/MHz (68.2dBuV/m) limit.



HARMONICS AND SPURIOUS EMISSIONS (LOW CHANNEL, VERTICAL)

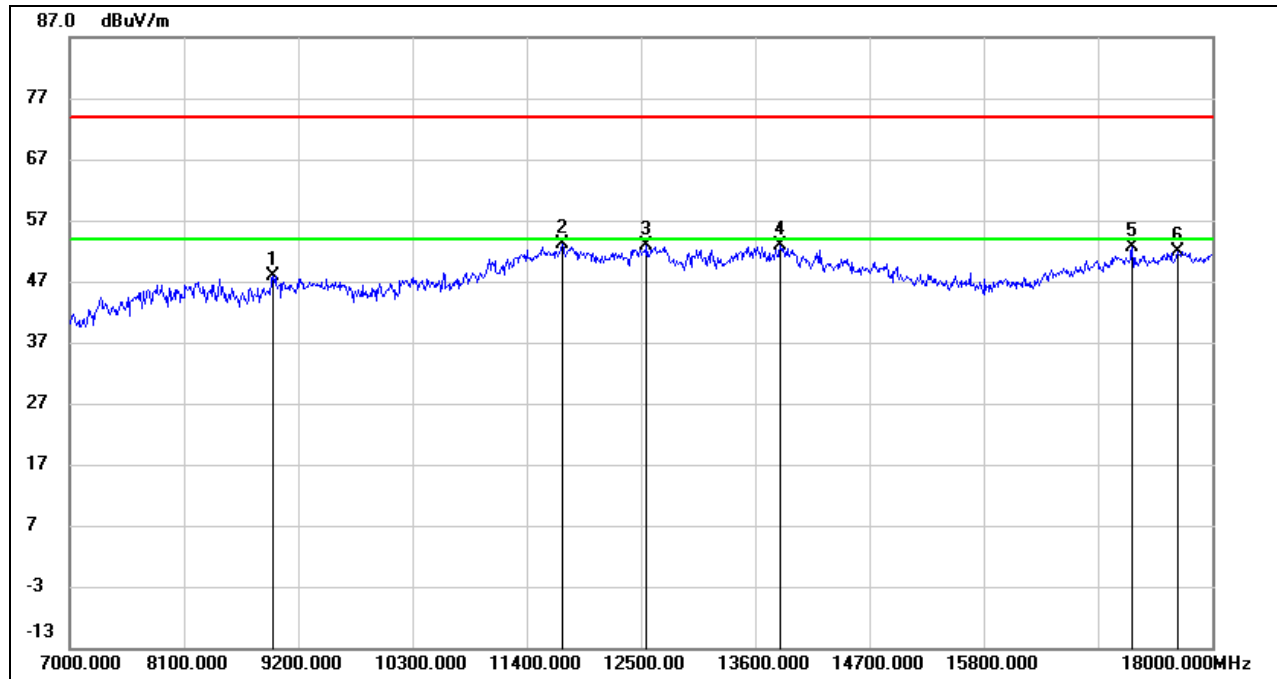

No.	Frequency (MHz)	Reading (dBuV)	Correct (dB/m)	Result (dBuV/m)	Limit (dBuV/m)	Margin (dB)	Remark
1	8963.500	37.10	10.85	47.95	74.00	-26.05	peak
2	11746.500	34.87	18.21	53.08	74.00	-20.92	peak
3	12555.000	34.68	18.11	52.79	74.00	-21.21	peak
4	13847.500	33.07	19.85	52.92	74.00	-21.08	peak
5	17230.000	31.42	21.13	52.55	74.00	-21.45	peak
6	17670.000	29.17	22.82	51.99	74.00	-22.01	peak

- Note:
1. Measurement = Reading Level + Correct Factor.
 2. If Peak Result complies with AV limit, AV Result is deemed to comply with AV limit.
 3. Peak: Peak detector.
 4. AVG: $VBW=1/Ton$, where: Ton is the transmitting duration.
 5. For the transmitting duration, please refer to clause 7.1.
 6. Filter losses were only considered in the spurious frequency bands and the authorized band was not corrected for High Pass Filter losses.
 7. Proper operation of the transmitter prior to adding the filter to the measurement chain.
 8. Since non-restricted band peak emissions are less than the average limit, they also comply with the -27dBm/MHz (68.2dBuV/m) limit.



HARMONICS AND SPURIOUS EMISSIONS (HIGH CHANNEL, HORIZONTAL)

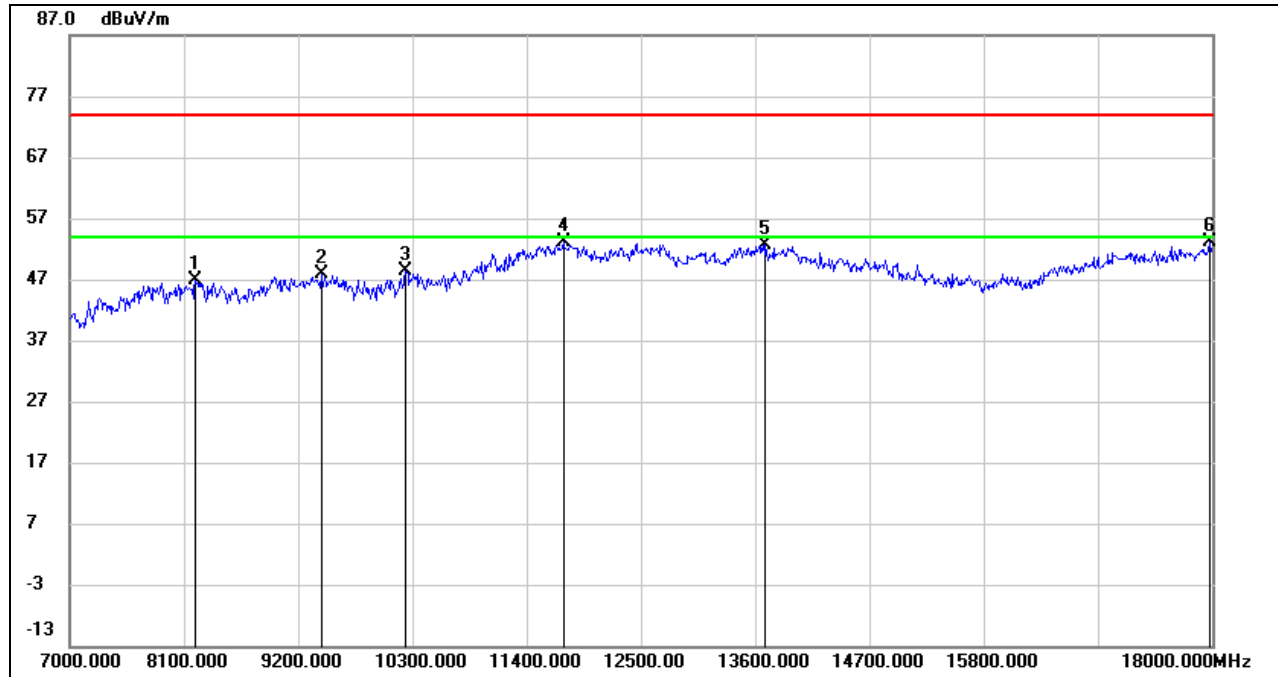

No.	Frequency (MHz)	Reading (dBuV)	Correct (dB/m)	Result (dBuV/m)	Limit (dBuV/m)	Margin (dB)	Remark
1	8215.500	36.98	9.83	46.81	74.00	-27.19	peak
2	9425.500	36.51	11.36	47.87	74.00	-26.13	peak
3	10239.500	35.89	12.49	48.38	74.00	-25.62	peak
4	11752.000	34.91	18.23	53.14	74.00	-20.86	peak
5	13699.000	32.97	19.65	52.62	74.00	-21.38	peak
6	17983.500	28.40	24.67	53.07	74.00	-20.93	peak

- Note: 1. Measurement = Reading Level + Correct Factor.
 2. If Peak Result complies with AV limit, AV Result is deemed to comply with AV limit.
 3. Peak: Peak detector.
 4. AVG: $VBW=1/Ton$, where: Ton is the transmitting duration.
 5. For the transmitting duration, please refer to clause 7.1.
 6. Filter losses were only considered in the spurious frequency bands and the authorized band was not corrected for High Pass Filter losses.
 7. Proper operation of the transmitter prior to adding the filter to the measurement chain.
 8. Since non-restricted band peak emissions are less than the average limit, they also comply with the -27dBm/MHz (68.2dBuV/m) limit.



HARMONICS AND SPURIOUS EMISSIONS (HIGH CHANNEL, VERTICAL)

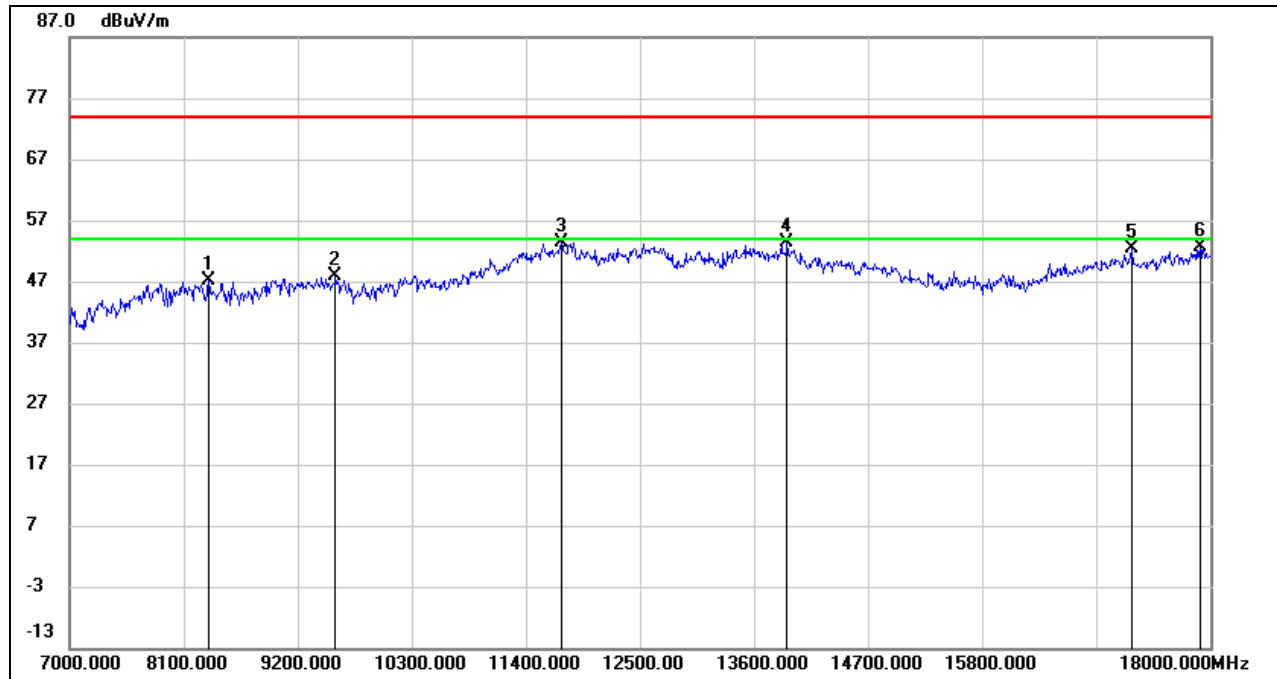

No.	Frequency (MHz)	Reading (dBuV)	Correct (dB/m)	Result (dBuV/m)	Limit (dBuV/m)	Margin (dB)	Remark
1	8347.500	37.80	9.33	47.13	74.00	-26.87	peak
2	9568.500	36.05	11.89	47.94	74.00	-26.06	peak
3	11741.000	35.18	18.18	53.36	74.00	-20.64	peak
4	13924.500	33.57	19.71	53.28	74.00	-20.72	peak
5	17246.500	31.28	21.11	52.39	74.00	-21.61	peak
6	17906.500	28.18	24.42	52.60	74.00	-21.40	peak

- Note: 1. Measurement = Reading Level + Correct Factor.
 2. If Peak Result complies with AV limit, AV Result is deemed to comply with AV limit.
 3. Peak: Peak detector.
 4. AVG: $VBW=1/Ton$, where: Ton is the transmitting duration.
 5. For the transmitting duration, please refer to clause 7.1.
 6. Filter losses were only considered in the spurious frequency bands and the authorized band was not corrected for High Pass Filter losses.
 7. Proper operation of the transmitter prior to adding the filter to the measurement chain.
 8. Since non-restricted band peak emissions are less than the average limit, they also comply with the -27dBm/MHz (68.2dBuV/m) limit.



STRADDLE CHANNEL 138

HARMONICS AND SPURIOUS EMISSIONS (HIGH CHANNEL, HORIZONTAL)

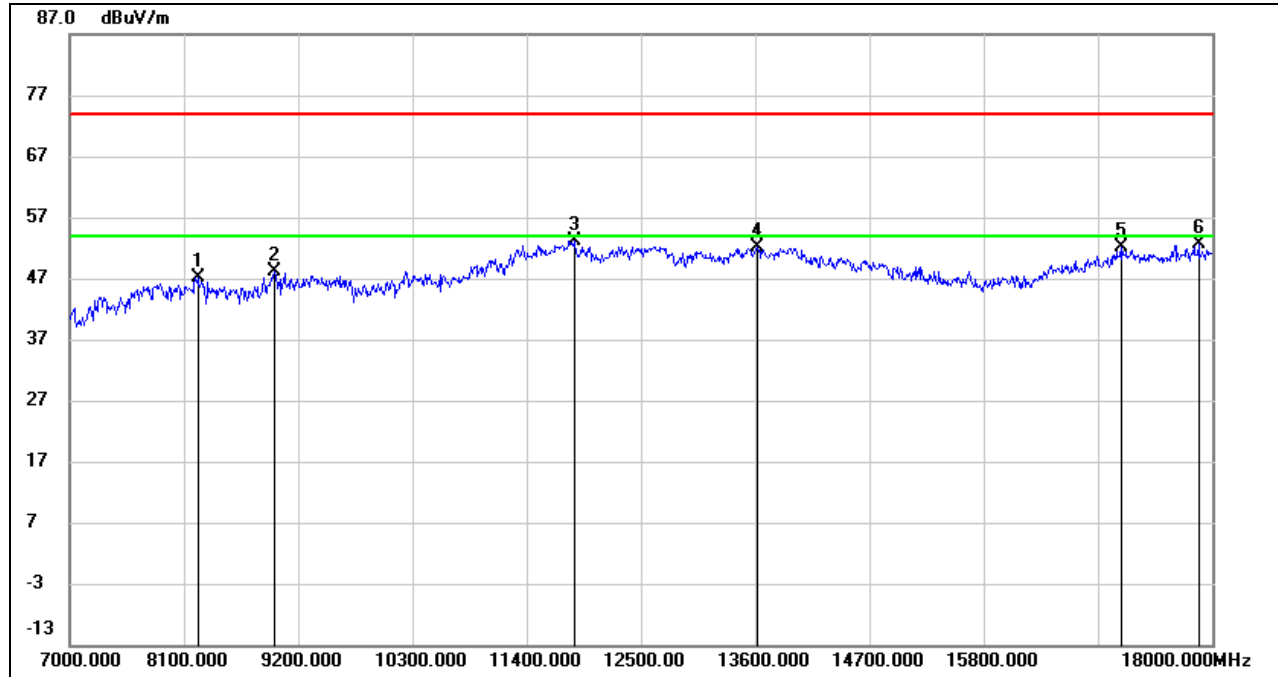

No.	Frequency (MHz)	Reading (dBuV)	Correct (dB/m)	Result (dBuV/m)	Limit (dBuV/m)	Margin (dB)	Remark
1	8237.500	37.42	9.74	47.16	74.00	-26.84	peak
2	8969.000	37.32	10.90	48.22	74.00	-25.78	peak
3	11862.000	34.66	18.37	53.03	74.00	-20.97	peak
4	13627.500	32.63	19.44	52.07	74.00	-21.93	peak
5	17120.000	31.48	20.57	52.05	74.00	-21.95	peak
6	17868.000	28.37	24.30	52.67	74.00	-21.33	peak

- Note:
1. Measurement = Reading Level + Correct Factor.
 2. If Peak Result complies with AV limit, AV Result is deemed to comply with AV limit.
 3. Peak: Peak detector.
 4. AVG: $VBW=1/Ton$, where: Ton is the transmitting duration.
 5. For the transmitting duration, please refer to clause 7.1.
 6. Filter losses were only considered in the spurious frequency bands and the authorized band was not corrected for High Pass Filter losses.
 7. Proper operation of the transmitter prior to adding the filter to the measurement chain.
 8. Since non-restricted band peak emissions are less than the average limit, they also comply with the -27dBm/MHz (68.2dBuV/m) limit.



HARMONICS AND SPURIOUS EMISSIONS (HIGH CHANNEL, VERTICAL)

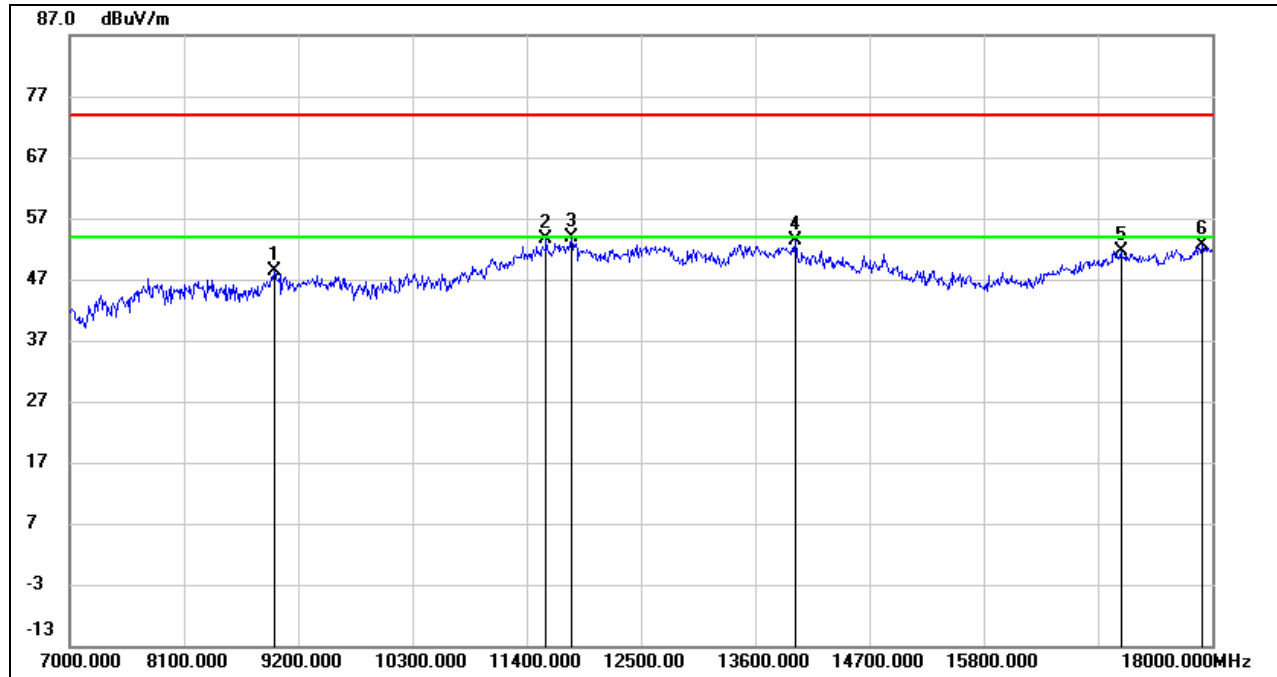

No.	Frequency (MHz)	Reading (dBuV)	Correct (dB/m)	Result (dBuV/m)	Limit (dBuV/m)	Margin (dB)	Remark
1	8974.500	37.36	10.96	48.32	74.00	-25.68	peak
2	11592.500	35.95	17.56	53.51	74.00	-20.49	peak
3	11829.000	35.56	18.40	53.96	74.00	-20.04	peak
4	13985.000	33.72	19.61	53.33	74.00	-20.67	peak
5	17125.500	30.94	20.61	51.55	74.00	-22.45	peak
6	17906.500	28.13	24.42	52.55	74.00	-21.45	peak

- Note:
1. Measurement = Reading Level + Correct Factor.
 2. If Peak Result complies with AV limit, AV Result is deemed to comply with AV limit.
 3. Peak: Peak detector.
 4. AVG: $VBW=1/Ton$, where: Ton is the transmitting duration.
 5. For the transmitting duration, please refer to clause 7.1.
 6. Filter losses were only considered in the spurious frequency bands and the authorized band was not corrected for High Pass Filter losses.
 7. Proper operation of the transmitter prior to adding the filter to the measurement chain.
 8. Since non-restricted band peak emissions are less than the average limit, they also comply with the -27dBm/MHz (68.2dBuV/m) limit.



UNII-3 BAND

HARMONICS AND SPURIOUS EMISSIONS (LOW CHANNEL, HORIZONTAL)

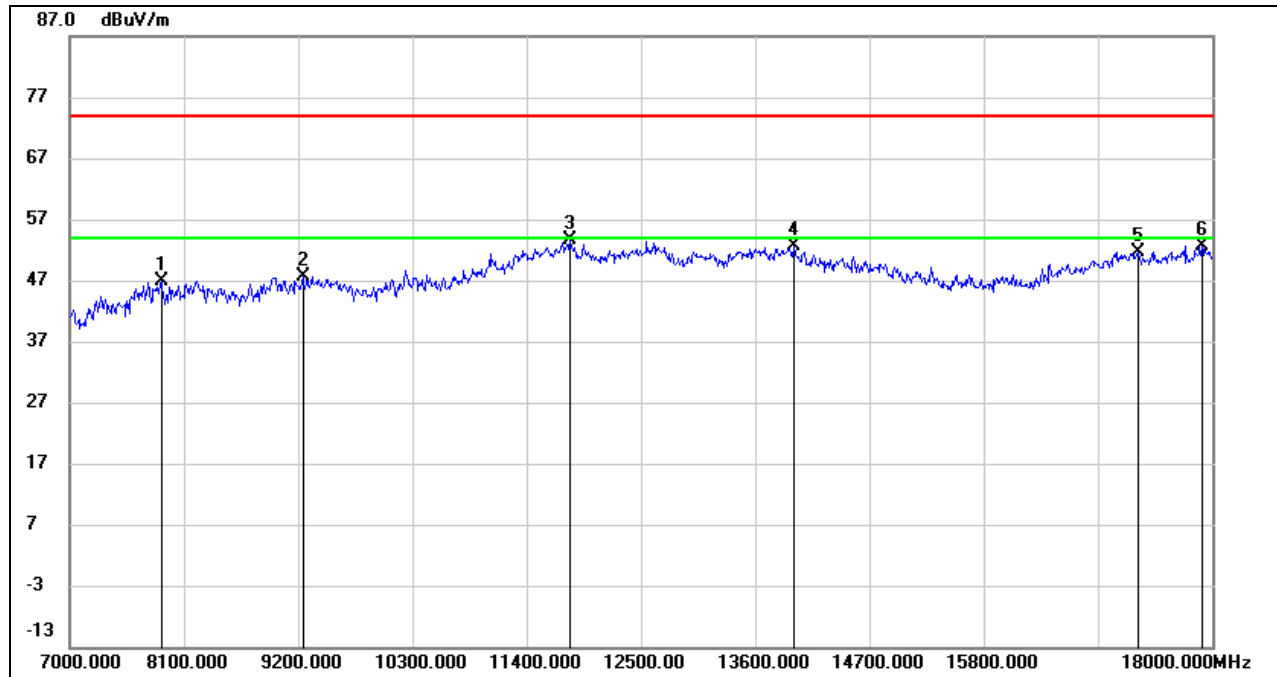

No.	Frequency (MHz)	Reading (dBuV)	Correct (dB/m)	Result (dBuV/m)	Limit (dBuV/m)	Margin (dB)	Remark
1	7880.000	38.18	8.64	46.82	74.00	-27.18	peak
2	9244.000	37.25	10.45	47.70	74.00	-26.30	peak
3	11823.500	35.21	18.42	53.63	74.00	-20.37	peak
4	13974.000	32.99	19.62	52.61	74.00	-21.39	peak
5	17290.500	30.53	21.07	51.60	74.00	-22.40	peak
6	17901.000	28.22	24.41	52.63	74.00	-21.37	peak

Note: 1. Measurement = Reading Level + Correct Factor.
 2. If Peak Result complies with AV limit, AV Result is deemed to comply with AV limit.
 3. Peak: Peak detector.
 4. Filter losses were only considered in the spurious frequency bands and the authorized band was not corrected for High Pass Filter losses.
 5. Proper operation of the transmitter prior to adding the filter to the measurement chain.
 6. Since non-restricted band peak emissions are less than the average limit, they also comply with the -27dBm/MHz (68.2dBuV/m) limit.



HARMONICS AND SPURIOUS EMISSIONS (LOW CHANNEL, VERTICAL)

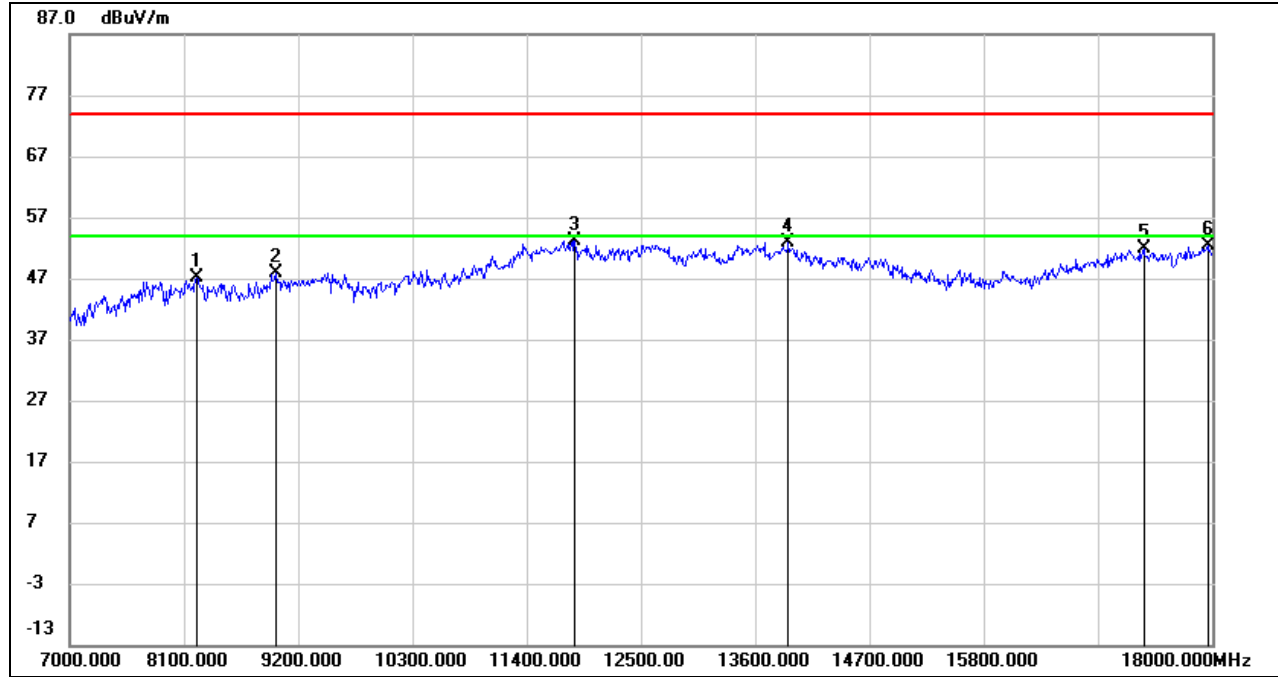

No.	Frequency (MHz)	Reading (dBuV)	Correct (dB/m)	Result (dBuV/m)	Limit (dBuV/m)	Margin (dB)	Remark
1	8221.000	37.37	9.81	47.18	74.00	-26.82	peak
2	8985.500	36.78	11.07	47.85	74.00	-26.15	peak
3	11862.000	34.81	18.37	53.18	74.00	-20.82	peak
4	13924.500	33.13	19.71	52.84	74.00	-21.16	peak
5	17345.500	30.82	21.01	51.83	74.00	-22.17	peak
6	17961.500	27.88	24.60	52.48	74.00	-21.52	peak

- Note: 1. Measurement = Reading Level + Correct Factor.
 2. If Peak Result complies with AV limit, AV Result is deemed to comply with AV limit.
 3. Peak: Peak detector.
 4. AVG: $VBW=1/Ton$, where: Ton is the transmitting duration.
 5. For the transmitting duration, please refer to clause 7.1.
 6. Filter losses were only considered in the spurious frequency bands and the authorized band was not corrected for High Pass Filter losses.
 7. Proper operation of the transmitter prior to adding the filter to the measurement chain.
 8. Since non-restricted band peak emissions are less than the average limit, they also comply with the -27dBm/MHz (68.2dBuV/m) limit.



8.4. SPURIOUS EMISSIONS (18 GHz ~ 26 GHz)

8.4.1. 802.11n HT40 MODE

SPURIOUS EMISSIONS (UNII-2A BAND HIGH CHANNEL, HORIZONTAL, WORST-CASE CONFIGURATION)

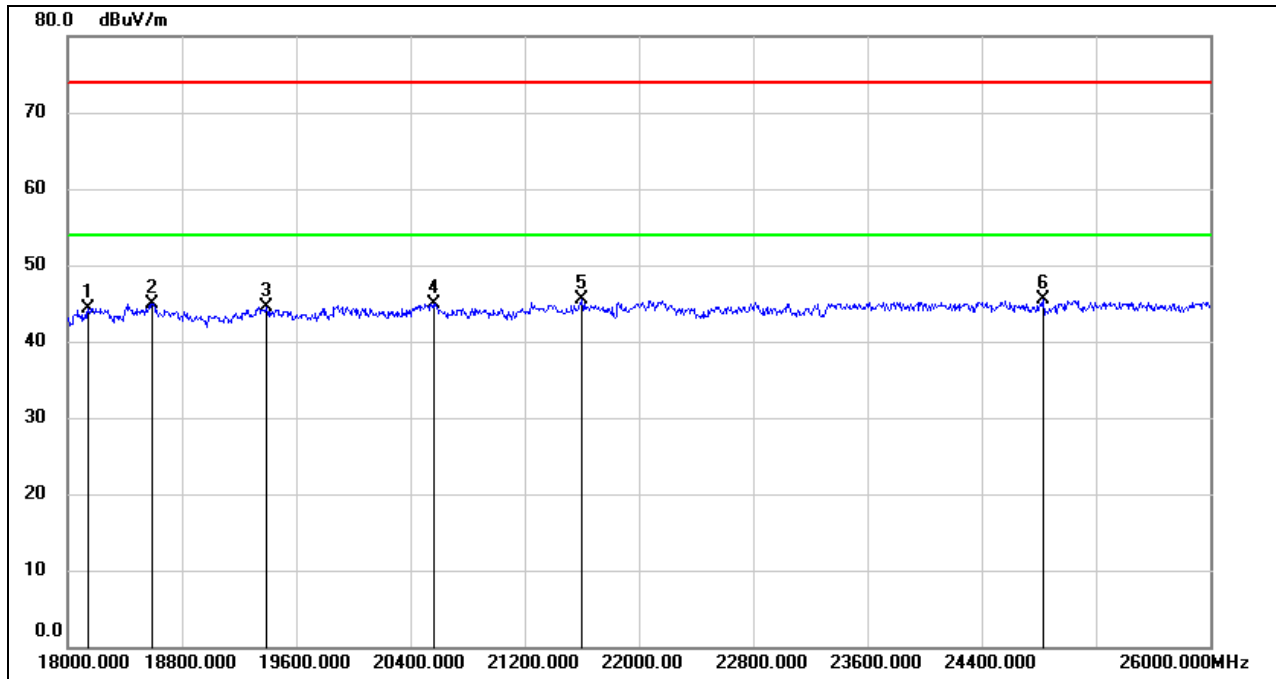

No.	Frequency (MHz)	Reading (dBuV)	Correct (dB/m)	Result (dBuV/m)	Limit (dBuV/m)	Margin (dB)	Remark
1	18144.000	49.77	-5.48	44.29	74.00	-29.71	peak
2	18592.000	50.25	-5.31	44.94	74.00	-29.06	peak
3	19392.000	50.12	-5.57	44.55	74.00	-29.45	peak
4	20560.000	50.23	-5.30	44.93	74.00	-29.07	peak
5	21600.000	50.02	-4.54	45.48	74.00	-28.52	peak
6	24832.000	47.70	-2.24	45.46	74.00	-28.54	peak

- Note: 1. Measurement = Reading Level + Correct Factor.
 2. If Peak Result complies with AV limit, AV Result is deemed to comply with AV limit.
 3. Peak: Peak detector.

SPURIOUS EMISSIONS (UNII-2A BAND HIGH CHANNEL, VERTICAL, WORST-CASE CONFIGURATION)

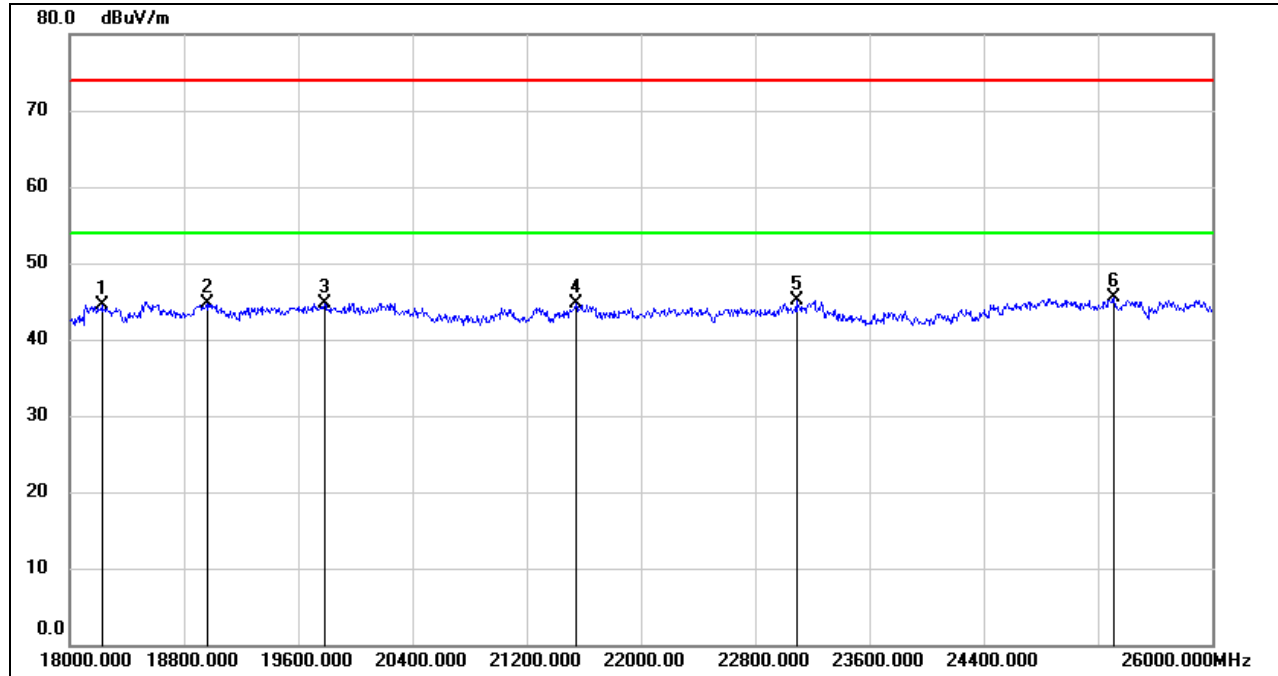

No.	Frequency (MHz)	Reading (dBuV)	Correct (dB/m)	Result (dBuV/m)	Limit (dBuV/m)	Margin (dB)	Remark
1	18224.000	50.08	-5.53	44.55	74.00	-29.45	peak
2	18960.000	50.01	-5.25	44.76	74.00	-29.24	peak
3	19784.000	50.07	-5.28	44.79	74.00	-29.21	peak
4	21544.000	49.26	-4.63	44.63	74.00	-29.37	peak
5	23088.000	48.52	-3.41	45.11	74.00	-28.89	peak
6	25312.000	47.20	-1.70	45.50	74.00	-28.50	peak

- Note: 1. Measurement = Reading Level + Correct Factor.
 2. If Peak Result complies with AV limit, AV Result is deemed to comply with AV limit.
 3. Peak: Peak detector.

Note: All the modes and antennas had been tested, but only the worst data was recorded in the report.



8.5. SPURIOUS EMISSIONS (26 GHz ~ 40 GHz)

8.5.1. 802.11n HT40 MODE

SPURIOUS EMISSIONS (UNII-2A BAND HIGH CHANNEL, HORIZONTAL, WORST-CASE CONFIGURATION)

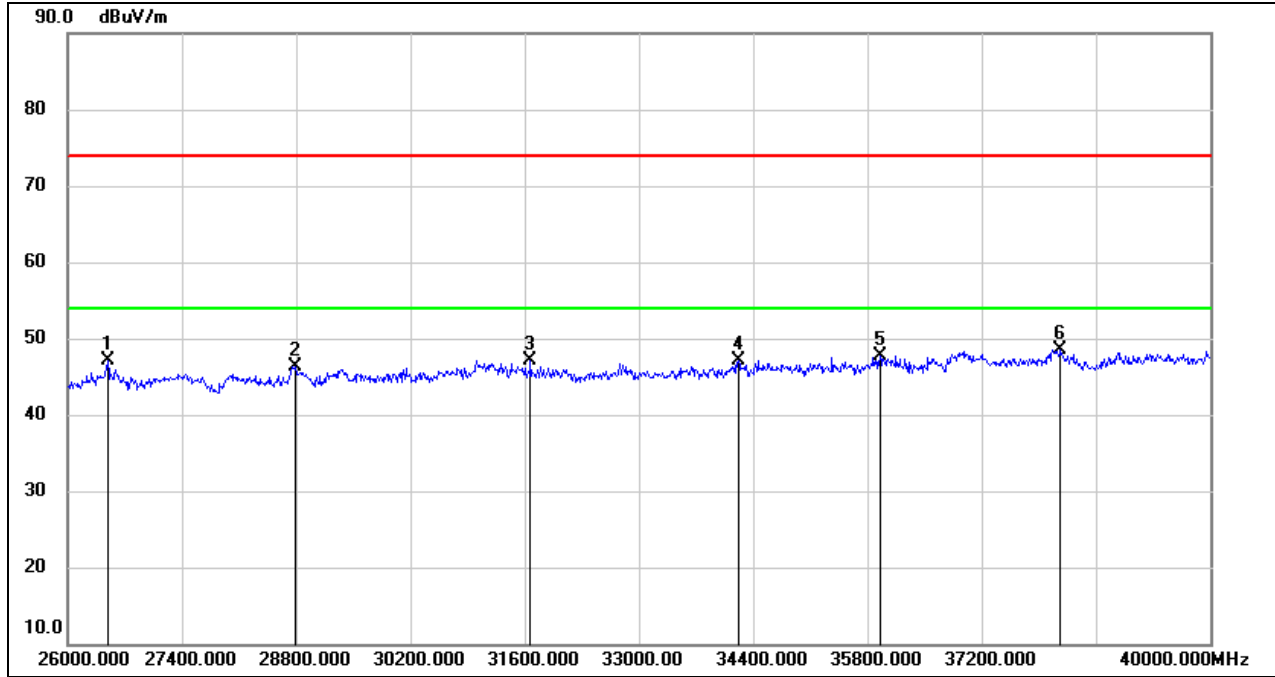

No.	Frequency (MHz)	Reading (dBuV)	Correct (dB/m)	Result (dBuV/m)	Limit (dBuV/m)	Margin (dB)	Remark
1	26490.000	51.79	-4.74	47.05	74.00	-26.95	peak
2	28786.000	46.99	-0.64	46.35	74.00	-27.65	peak
3	31670.000	48.36	-1.21	47.15	74.00	-26.85	peak
4	34218.000	45.96	1.13	47.09	74.00	-26.91	peak
5	35954.000	43.84	3.94	47.78	74.00	-26.22	peak
6	38166.000	44.92	3.66	48.58	74.00	-25.42	peak

- Note: 1. Measurement = Reading Level + Correct Factor.
 2. If Peak Result complies with AV limit, AV Result is deemed to comply with AV limit.
 3. Peak: Peak detector.



SPURIOUS EMISSIONS (UNII-2A BAND HIGH CHANNEL, VERTICAL, WORST-CASE CONFIGURATION)

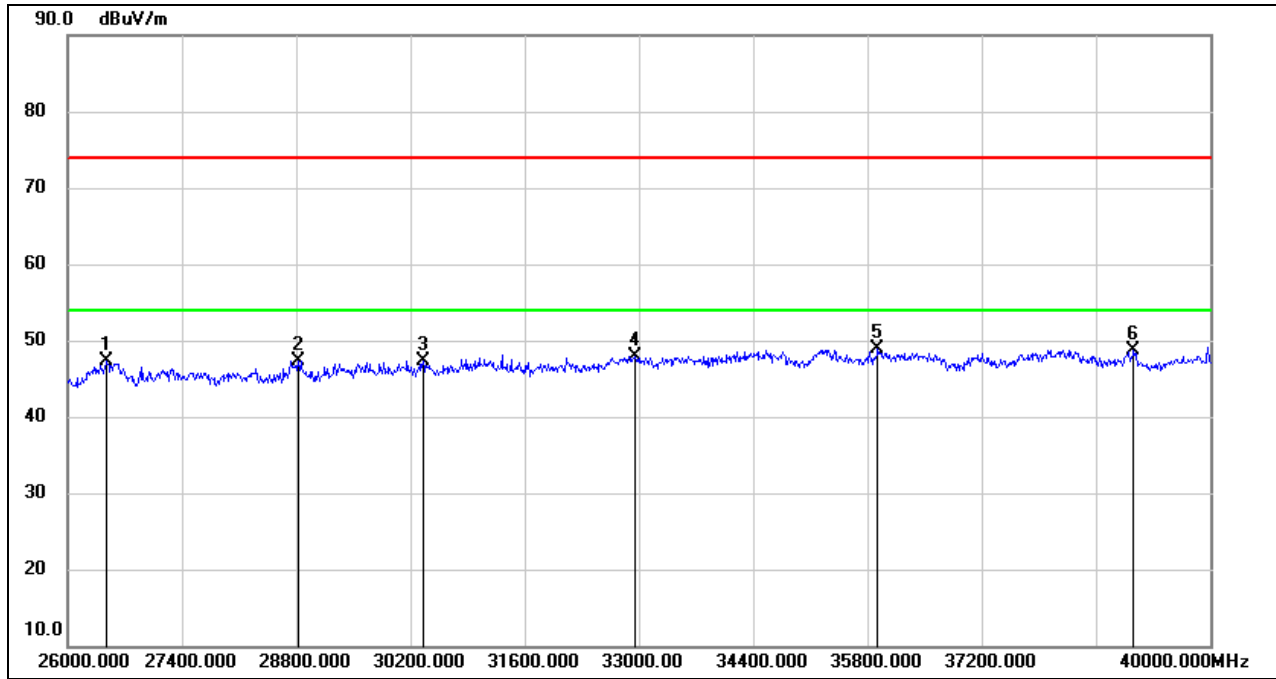

No.	Frequency (MHz)	Reading (dBuV)	Correct (dB/m)	Result (dBuV/m)	Limit (dBuV/m)	Margin (dB)	Remark
1	26476.000	52.03	-4.78	47.25	74.00	-26.75	peak
2	28828.000	48.13	-0.79	47.34	74.00	-26.66	peak
3	30354.000	48.49	-1.14	47.35	74.00	-26.65	peak
4	32958.000	48.64	-0.76	47.88	74.00	-26.12	peak
5	35926.000	44.94	3.88	48.82	74.00	-25.18	peak
6	39062.000	44.48	4.30	48.78	74.00	-25.22	peak

- Note: 1. Measurement = Reading Level + Correct Factor.
 2. If Peak Result complies with AV limit, AV Result is deemed to comply with AV limit.
 3. Peak: Peak detector.

Note: All the modes and antennas had been tested, but only the worst data was recorded in the report.



8.6. SPURIOUS EMISSIONS (30 MHz ~ 1 GHz)

8.6.1. 802.11n HT40 MODE

SPURIOUS EMISSIONS (UNII-2A BAND HIGH CHANNEL, HORIZONTAL, WORST-CASE CONFIGURATION)

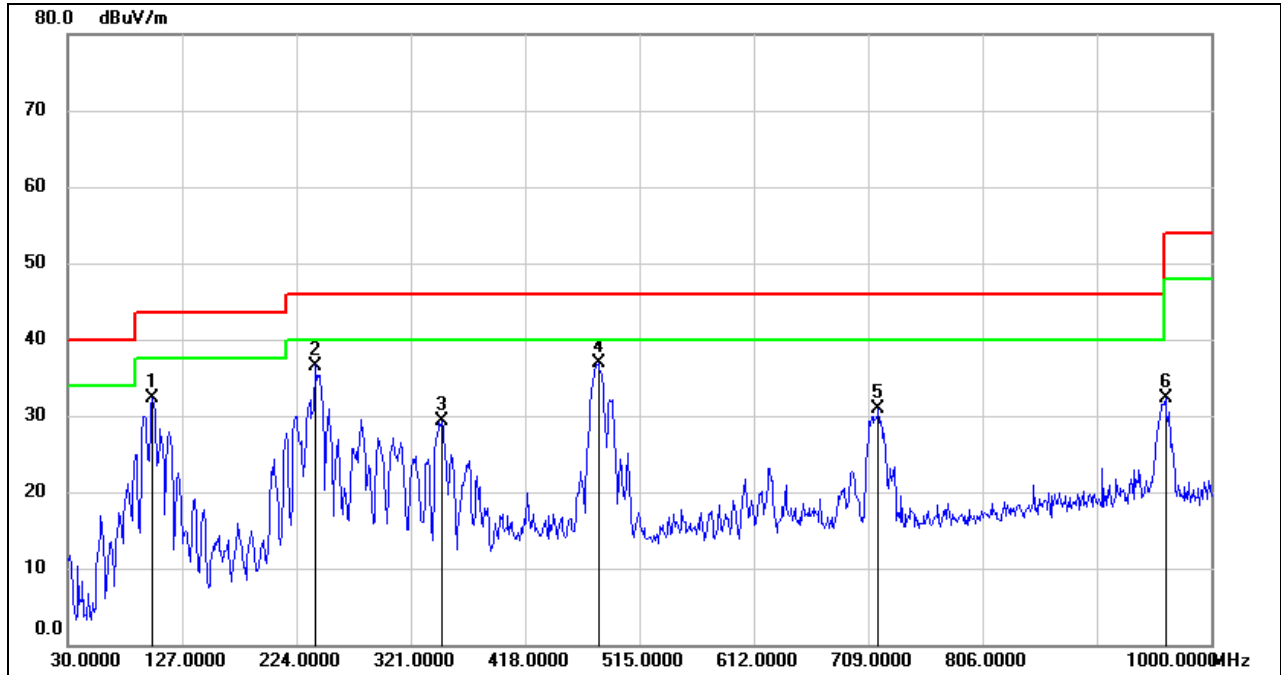

No.	Frequency (MHz)	Reading (dBuV)	Correct (dB/m)	Result (dBuV/m)	Limit (dBuV/m)	Margin (dB)	Remark
1	101.7800	53.35	-21.00	32.35	43.50	-11.15	QP
2	239.5200	55.76	-19.16	36.60	46.00	-9.40	QP
3	347.1900	43.63	-14.35	29.28	46.00	-16.72	QP
4	480.0800	48.66	-11.79	36.87	46.00	-9.13	QP
5	717.7300	39.05	-8.11	30.94	46.00	-15.06	QP
6	961.2000	36.75	-4.52	32.23	54.00	-21.77	QP

- Note: 1. Result Level = Read Level + Correct Factor.
 2. If Peak Result complies with QP limit, QP Result is deemed to comply with QP limit.
 3. Test setup: RBW: 120 kHz, VBW: 300 kHz, Sweep time: auto.



SPURIOUS EMISSIONS (UNII-2A BAND HIGH CHANNEL, VERTICAL, WORST-CASE CONFIGURATION)

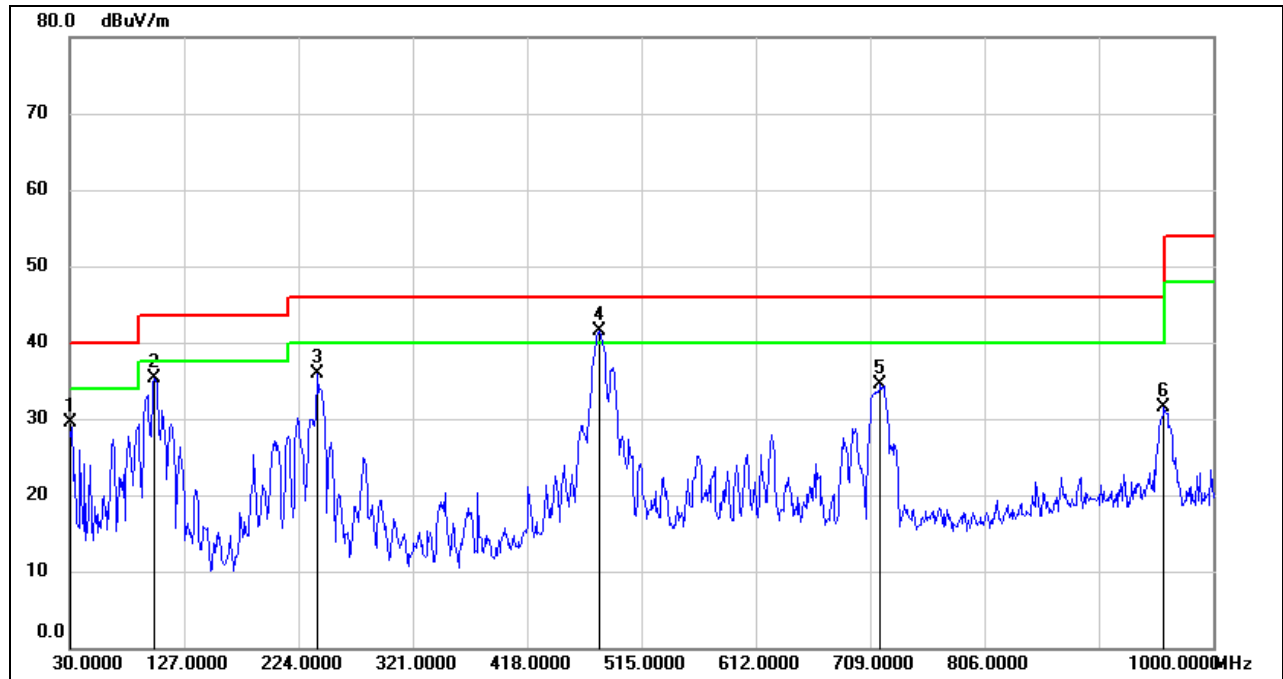

No.	Frequency (MHz)	Reading (dBuV)	Correct (dB/m)	Result (dBuV/m)	Limit (dBuV/m)	Margin (dB)	Remark
1	30.0000	48.51	-18.94	29.57	40.00	-10.43	QP
2	101.7800	56.33	-21.00	35.33	43.50	-8.17	QP
3	239.5200	55.08	-19.16	35.92	46.00	-10.08	QP
4	479.1100	53.31	-11.82	41.49	46.00	-4.51	QP
5	717.7300	42.59	-8.11	34.48	46.00	-11.52	QP
6	958.2900	35.94	-4.52	31.42	46.00	-14.58	QP

- Note: 1. Result Level = Read Level + Correct Factor.
 2. If Peak Result complies with QP limit, QP Result is deemed to comply with QP limit.
 3. Test setup: RBW: 120 kHz, VBW: 300 kHz, Sweep time: auto

Note: All the modes and antennas had been tested, but only the worst data was recorded in the report.

8.7. SPURIOUS EMISSIONS BELOW 30 MHz

8.7.1. 802.11n HT40 MODE

SPURIOUS EMISSIONS (UNII-2A BAND HIGH CHANNEL, LOOP ANTENNA FACE ON TO THE EUT, WORST-CASE CONFIGURATION)

9 kHz~ 150 kHz

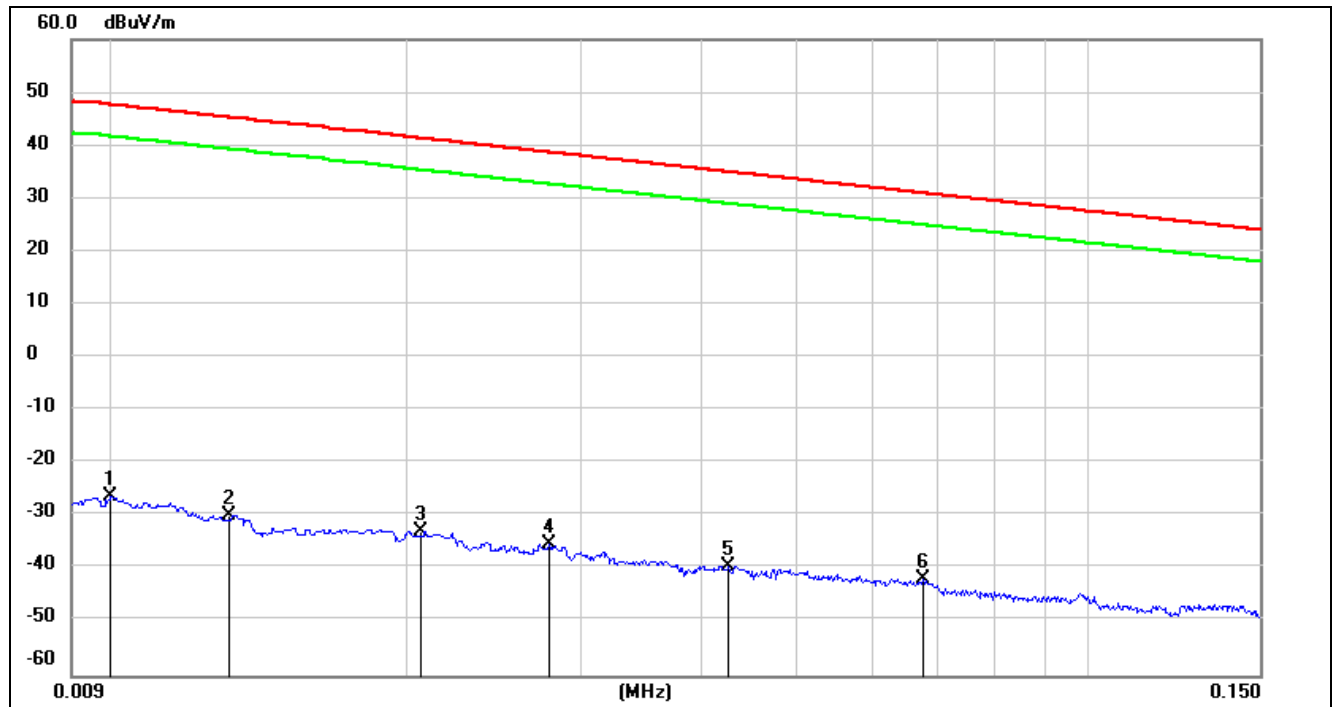

No.	Frequency (MHz)	Reading (dBuV)	Correct (dB/m)	FCC Result (dBuV/m)	FCC Limit (dBuV/m)	ISED Result (dBuA/m)	ISED Limit (dBuA/m)	Margin (dB)	Remark
1	0.0100	75.22	-101.40	-26.18	47.6	-77.68	-3.90	-73.78	peak
2	0.0131	71.47	-101.38	-29.91	45.25	-81.41	-6.25	-75.16	peak
3	0.0206	68.42	-101.35	-32.93	41.32	-84.43	-10.18	-74.25	peak
4	0.0279	66.17	-101.38	-35.21	38.69	-86.71	-12.81	-73.90	peak
5	0.0427	62.14	-101.45	-39.31	34.99	-90.81	-16.51	-74.30	peak
6	0.0675	59.64	-101.56	-41.92	31.02	-93.42	-20.48	-72.94	peak

Note: 1. Measurement = Reading Level + Correct Factor.

2. If Peak Result complies with AV and QP limit, AV and QP Result are deemed to comply with AV limit.

3. All 3 polarizations (Horizontal, Face-on and Face-off) of the loop antenna had been tested, but only the worst data recorded in the report.

4. $\text{dBuA/m} = \text{dBuV/m} - 20\log_{10}(120\pi) = \text{dBuV/m} - 51.5$.



150 kHz ~ 490 kHz

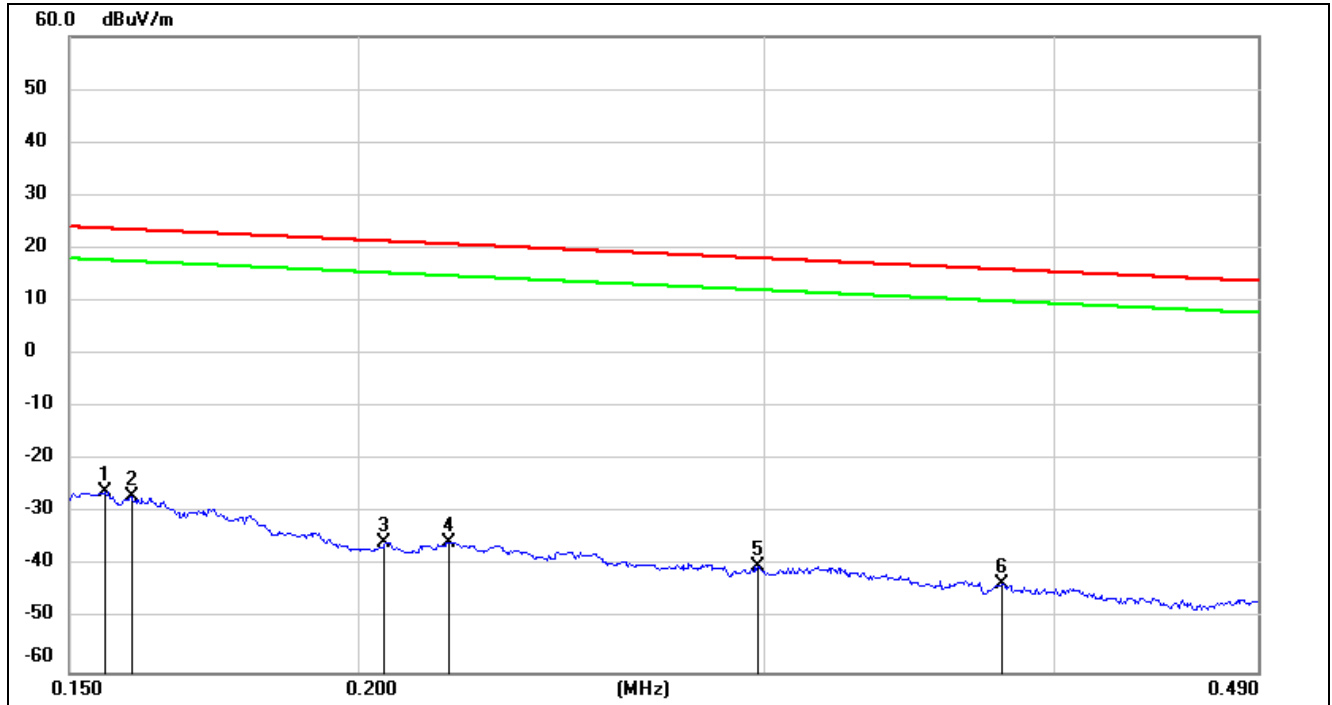

No.	Frequency (MHz)	Reading (dBuV)	Correct (dB/m)	FCC Result (dBuV/m)	FCC Limit (dBuV/m)	ISED Result (dBuA/m)	ISED Limit (dBuA/m)	Margin (dB)	Remark
1	0.1554	75.77	-101.65	-25.88	23.77	-77.38	-27.73	-49.65	peak
2	0.1595	74.86	-101.65	-26.79	23.55	-78.29	-27.95	-50.34	peak
3	0.2053	66.29	-101.73	-35.44	21.35	-86.94	-30.15	-56.79	peak
4	0.2190	66.27	-101.75	-35.48	20.79	-86.98	-30.71	-56.27	peak
5	0.2977	61.91	-101.85	-39.94	18.13	-91.44	-33.37	-58.07	peak
6	0.3800	58.52	-101.94	-43.42	16.01	-94.92	-35.49	-59.43	peak

Note: 1. Measurement = Reading Level + Correct Factor.

2. If Peak Result complies with AV and QP limit, AV and QP Result are deemed to comply with AV limit.

3. All 3 polarizations (Horizontal, Face-on and Face-off) of the loop antenna had been tested, but only the worst data recorded in the report.

4. $\text{dBuA/m} = \text{dBuV/m} - 20\log_{10}(120\pi) = \text{dBuV/m} - 51.5$.

490 kHz ~ 30 MHz

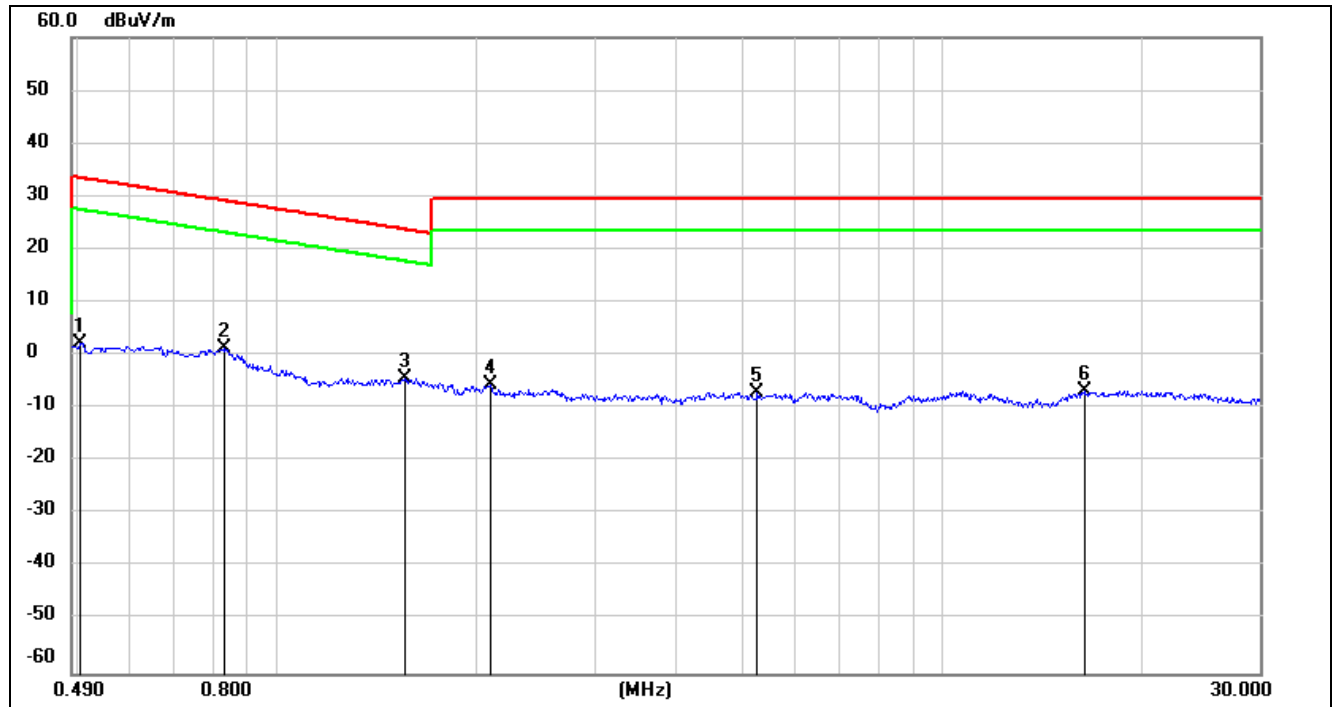

No.	Frequency (MHz)	Reading (dBuV)	Correct (dB/m)	FCC Result (dBuV/m)	FCC Limit (dBuV/m)	ISED Result (dBuA/m)	ISED Limit (dBuA/m)	Margin (dB)	Remark
1	0.5039	64.44	-62.07	2.37	33.56	-49.13	-17.94	-31.19	peak
2	0.8296	63.44	-62.17	1.27	29.23	-50.23	-22.27	-27.96	peak
3	1.5564	57.68	-62.02	-4.34	23.76	-55.84	-27.74	-28.10	peak
4	2.0939	56.39	-61.79	-5.4	29.54	-56.90	-21.96	-34.94	peak
5	5.2705	54.54	-61.45	-6.91	29.54	-58.41	-21.96	-36.45	peak
6	16.3959	54.17	-60.96	-6.79	29.54	-58.29	-21.96	-36.33	peak

- Note: 1. Measurement = Reading Level + Correct Factor.
 2. If Peak Result complies with AV and QP limit, AV and QP Result are deemed to comply with AV limit.
 3. All 3 polarizations (Horizontal, Face-on and Face-off) of the loop antenna had been tested, but only the worst data recorded in the report.
 4. $\text{dBuA/m} = \text{dBuV/m} - 20\log_{10}(120\pi) = \text{dBuV/m} - 51.5$.

Note: All the modes and antennas had been tested, but only the worst data was recorded in the report.

9. AC POWER LINE CONDUCTED EMISSIONS

LIMITS

Please refer to CFR 47 FCC §15.207 (a) and ISED RSS-Gen Clause 8.8

FREQUENCY (MHz)	Quasi-peak	Average
0.15 -0.5	66 - 56 *	56 - 46 *
0.50 -5.0	56.00	46.00
5.0 -30.0	60.00	50.00

TEST SETUP AND PROCEDURE

Refer to ANSI C63.10-2013 clause 6.2.

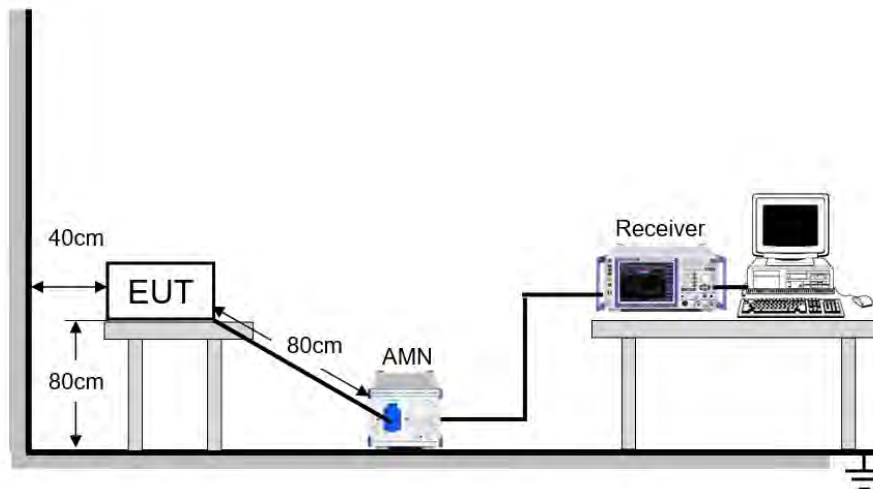

The EUT is put on a table of non-conducting material that is 80 cm high. The vertical conducting wall of shielding is located 40 cm to the rear of the EUT. The power line of the EUT is connected to the AC mains through a Artificial Mains Network (A.M.N.). A EMI Measurement Receiver (R&S Test Receiver ESR3) is used to test the emissions from both sides of AC line. According to the requirements in Section 6.2 of ANSI C63.10-2013. Conducted emissions from the EUT measured in the frequency range between 0.15 MHz and 30 MHz using CISPR Quasi-Peak and average detector mode. The bandwidth of EMI test receiver is set at 9 kHz.

The arrangement of the equipment is installed to meet the standards and operating in a manner, which tends to maximize its emission characteristics in a normal application.

TEST ENVIRONMENT

Temperature	27.6 °C	Relative Humidity	64.8 %
Atmosphere Pressure	101 kPa	Test Voltage	AC 120 V, 60 Hz

RESULTS

9.1.1. 802.11n HT40 MODE

LINE L RESULTS (UNII-2A BAND HIGH CHANNEL, WORST-CASE CONFIGURATION)

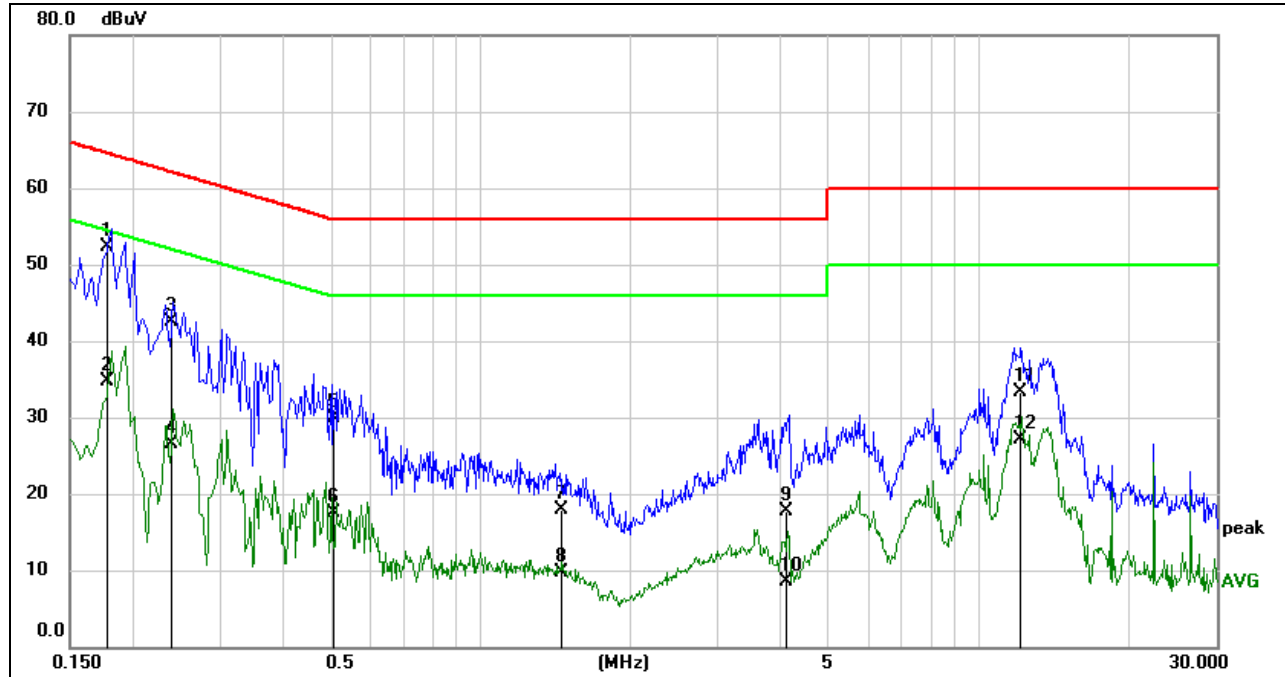

No.	Frequency (MHz)	Reading (dBuV)	Correct (dB)	Result (dBuV)	Limit (dBuV)	Margin (dB)	Remark
1	0.1783	42.63	9.59	52.22	64.56	-12.34	QP
2	0.1783	25.03	9.59	34.62	54.56	-19.94	AVG
3	0.2392	33.00	9.59	42.59	62.12	-19.53	QP
4	0.2392	17.00	9.59	26.59	52.12	-25.53	AVG
5	0.5064	20.25	9.60	29.85	56.00	-26.15	QP
6	0.5064	7.88	9.60	17.48	46.00	-28.52	AVG
7	1.4609	8.30	9.62	17.92	56.00	-38.08	QP
8	1.4609	0.13	9.62	9.75	46.00	-36.25	AVG
9	4.1241	8.04	9.60	17.64	56.00	-38.36	QP
10	4.1241	-1.09	9.60	8.51	46.00	-37.49	AVG
11	12.1130	23.71	9.66	33.37	60.00	-26.63	QP
12	12.1130	17.49	9.66	27.15	50.00	-22.85	AVG

Note: 1. Result = Reading + Correct Factor.
 2. If QP Result complies with AV limit, AV Result is deemed to comply with AV limit.
 3. Test setup: RBW: 200 Hz (9 kHz ~ 150 kHz), 9 kHz (150 kHz ~ 30 MHz).
 4. Step size: 80 Hz (0.009 MHz ~ 0.15 MHz), 4 kHz (0.15 MHz ~ 30 MHz), Scan time: auto.

LINE N RESULTS (UNII-2A BAND HIGH CHANNEL, WORST-CASE CONFIGURATION)

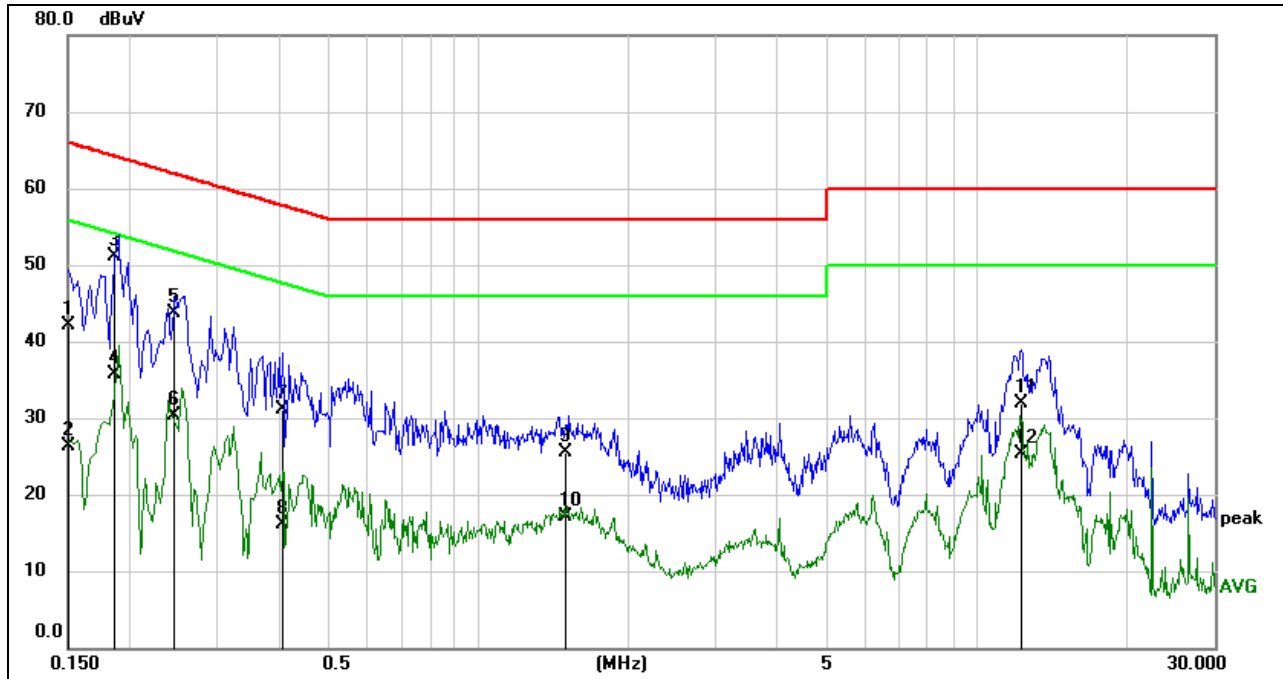

No.	Frequency (MHz)	Reading (dBuV)	Correct (dB)	Result (dBuV)	Limit (dBuV)	Margin (dB)	Remark
1	0.1505	32.42	9.59	42.01	65.97	-23.96	QP
2	0.1505	16.81	9.59	26.40	55.97	-29.57	AVG
3	0.1864	41.50	9.59	51.09	64.20	-13.11	QP
4	0.1864	26.05	9.59	35.64	54.20	-18.56	AVG
5	0.2452	34.05	9.59	43.64	61.92	-18.28	QP
6	0.2452	20.67	9.59	30.26	51.92	-21.66	AVG
7	0.4044	21.57	9.60	31.17	57.76	-26.59	QP
8	0.4044	6.46	9.60	16.06	47.76	-31.70	AVG
9	1.4916	15.90	9.62	25.52	56.00	-30.48	QP
10	1.4916	7.46	9.62	17.08	46.00	-28.92	AVG
11	12.3285	22.30	9.66	31.96	60.00	-28.04	QP
12	12.3285	15.69	9.66	25.35	50.00	-24.65	AVG

- Note: 1. Result = Reading + Correct Factor.
 2. If QP Result complies with AV limit, AV Result is deemed to comply with AV limit.
 3. Test setup: RBW: 200 Hz (9 kHz ~ 150 kHz), 9 kHz (150 kHz ~ 30 MHz).
 4. Step size: 80 Hz (0.009 MHz ~ 0.15 MHz), 4 kHz (0.15 MHz ~ 30 MHz), Scan time: auto.

Note: All the modes had been tested, but only the worst data was recorded in the report.

10. FREQUENCY STABILITY

LIMITS

The frequency of the carrier signal shall be maintained within band of operation.

TEST PROCEDURE

1. The EUT was placed inside an environmental chamber as the temperature in the chamber was varied between 0 °C ~ 70 °C (declared by customer).
2. The temperature was incremented by 10 °C intervals and the unit allowed to stabilize at each temperature before each measurement. The center frequency of the transmitting channel was evaluated at each temperature and the frequency deviation from the channel's center frequency was recorded.
3. The primary supply voltage is varied from 85 % to 115 % of the nominal value for non hand-carried battery and AC powered equipment. For hand-carried, battery-powered equipment, primary supply voltage is reduced to the battery operating end point which shall be specified by the manufacturer.

Connect the EUT to the spectrum analyser and use the following settings:

Center Frequency	The center frequency of the channel under test
Detector	Peak
RBW	10 kHz
VBW	$\geq 3 \times \text{RBW}$
Span	Encompass the entire emissions bandwidth (EBW) of the signal
Trace	Max hold
Sweep time	Auto

4. While maintaining a constant temperature inside the environmental chamber, turn the EUT on and record the operating frequency at startup, and at 2 minutes, 5minutes, and 10 minutes after the EUT is energized.
5. Allow the trace to stabilize, find the peak value of the power envelope and record the frequency, then calculated the frequency drift.

TEST SETUP

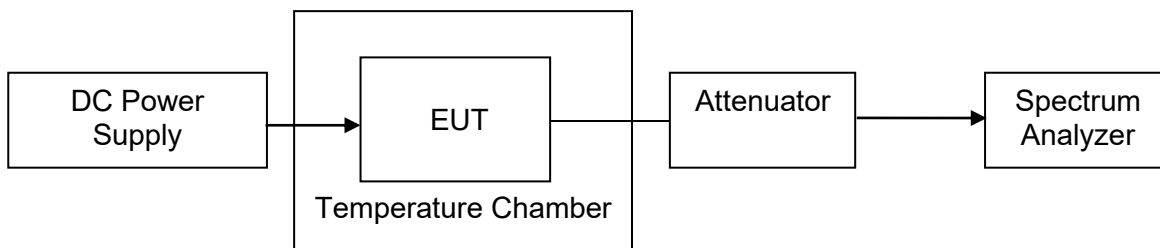



TEST ENVIRONMENT

	Normal Test Conditions	Extreme Test Conditions
Relative Humidity	20 % - 75 %	/
Atmospheric Pressure	100 kPa ~102 kPa	/
Temperature	T _N (Normal Temperature): 25.1 °C	T _L (Low Temperature): 0 °C
		T _H (High Temperature): 70 °C
Supply Voltage	V _N (Normal Voltage): AC 120 V	V _L (Low Voltage): AC 102 V
		V _H (High Voltage): AC 138 V

RESULTS

Please refer to Appendix H.

11. DYNAMIC FREQUENCY SELECTION

APPLICABILITY OF DFS REQUIREMENTS

A U-NII network will employ a DFS function to detect signals from radar systems and to avoid co-channel operation with these systems. This applies to the 5250-5350 MHz and/or 5470-5725 MHz bands.

Within the context of the operation of the DFS function, a U-NII device will operate in either Master Mode or Client Mode. U-NII devices operating in Client Mode can only operate in a network controlled by a U-NII device operating in Master Mode.

Table 1: Applicability of DFS Requirements Prior to Use of a Channel

Requirement	Operational Mode		
	<input type="checkbox"/> Master	<input checked="" type="checkbox"/> Client Without Radar Detection	<input type="checkbox"/> Client With Radar Detection
Non-Occupancy Period	Yes	Not required	Yes
DFS Detection Threshold	Yes	Not required	Yes
Channel Availability Check Time	Yes	Not required	Not required
U-NII Detection Bandwidth	Yes	Not required	Yes

Table 2: Applicability of DFS requirements during normal operation

Requirement	Operational Mode	
	<input type="checkbox"/> Master Device or Client with Radar Detection	<input checked="" type="checkbox"/> Client Without Radar Detection
DFS Detection Threshold	Yes	Not required
Channel Closing Transmission Time	Yes	Yes
Channel Move Time	Yes	Yes
U-NII Detection Bandwidth	Yes	Not required

Additional requirements for devices with multiple bandwidth modes	<input type="checkbox"/> Master Device or Client with Radar Detection	<input checked="" type="checkbox"/> Client Without Radar Detection
U-NII Detection Bandwidth and Statistical Performance Check	All BW modes must be tested	Not required
Channel Move Time and Channel Closing Transmission Time	Test using widest BW mode available	Test using the widest BW mode available for the link
All other tests	Any single BW mode	Not required

Note: Frequencies selected for statistical performance check should include several frequencies within the radar detection bandwidth and frequencies near the edge of the radar detection bandwidth. For 802.11 devices it is suggested to select frequencies in each of the bonded 20 MHz channels and the channel center frequency.

LIMITS

(1) DFS Detection Thresholds

Table 3: DFS Detection Thresholds for Master Devices and Client Devices With Radar Detection

Maximum Transmit Power	Value (See Notes 1, 2, and 3)
EIRP \geq 200 milliwatt	-64 dBm
EIRP < 200 milliwatt and power spectral density < 10 dBm/MHz	-62 dBm
EIRP < 200 milliwatt that do not meet the power spectral density requirement	-64 dBm

Note 1: This is the level at the input of the receiver assuming a 0 dBi receive antenna.
 Note 2: Throughout these test procedures an additional 1 dB has been added to the amplitude of the test transmission waveforms to account for variations in measurement equipment. This will ensure that the test signal is at or above the detection threshold level to trigger a DFS response.
 Note3: EIRP is based on the highest antenna gain. For MIMO devices refer to KDB Publication 662911 D01.

(2) DFS Response Requirements

Table 4: DFS Response Requirement Values

Parameter	Value
Non-occupancy period	Minimum 30 minutes
Channel Availability Check Time	60 seconds
Channel Move Time	10 seconds See Note 1.
Channel Closing Transmission Time	200 milliseconds + an aggregate of 60 milliseconds over remaining 10 second period. See Notes 1 and 2.
U-NII Detection Bandwidth	Minimum 100% of the U-NII 99% transmission power bandwidth. See Note 3.

Note 1: Channel Move Time and the Channel Closing Transmission Time should be performed with Radar Type 0. The measurement timing begins at the end of the Radar Type 0 burst.
 Note 2: The Channel Closing Transmission Time is comprised of 200 milliseconds starting at the beginning of the Channel Move Time plus any additional intermittent control signals required facilitating a Channel move (an aggregate of 60 milliseconds) during the remainder of the 10 second period. The aggregate duration of control signals will not count quiet periods in between transmissions.
 Note 3: During the U-NII Detection Bandwidth detection test, radar type 0 should be used. For each frequency step the minimum percentage of detection is 90 percent. Measurements are performed with no data traffic.

PARAMETERS OF RADAR TEST WAVEFORMS

This section provides the parameters for required test waveforms, minimum percentage of successful detections, and the minimum number of trials that must be used for determining DFS conformance. Step intervals of 0.1 microsecond for Pulse Width, 1 microsecond for PRI, 1 MHz for chirp width and 1 for the number of pulses will be utilized for the random determination of specific test waveforms.

Table 5 Short Pulse Radar Test Waveforms

Radars Type	Pulse Width (µsec)	PRI (µsec)	Number of Pulses	Minimum Percentage of Successful Detection	Minimum Number of Trials
0	1	1428	18	See Note 1	See Note 1
1	1	Test A	Roundup $\left\{ \begin{matrix} \frac{1}{360} \\ \frac{19 \cdot 10^9}{PRI_{\mu sec}} \end{matrix} \right\}$	60%	30
		Test B			
2	1-5	150-230	23-29	60%	30
3	6-10	200-500	16-18	60%	30
4	11-20	200-500	12-16	60%	30
Aggregate (Radars Types 1-4)				80%	120
<p>Note 1: Short Pulse Radar Type 0 should be used for the detection bandwidth test, channel move time, and channel closing time tests.</p> <p>Test A: 15 unique PRI values randomly selected from the list of 23 PRI values in Table 5a.</p> <p>Test B: 15 unique PRI values randomly selected within the range of 518-3066 µsec, with a minimum increment of 1 µsec, excluding PRI values selected in Test A.</p>					

A minimum of 30 unique waveforms are required for each of the Short Pulse Radar Types 2 through 4. If more than 30 waveforms are used for Short Pulse Radar Types 2 through 4, then each additional waveform must also be unique and not repeated from the previous waveforms. If more than 30 waveforms are used for Short Pulse Radar Type 1, then each additional waveform is generated with Test B and must also be unique and not repeated from the previous waveforms in Tests A or B. Test aggregate is average of the percentage of successful detections of short pulse radar types 1-4.

TEST SETUP

Setup for Client with injection at the Master

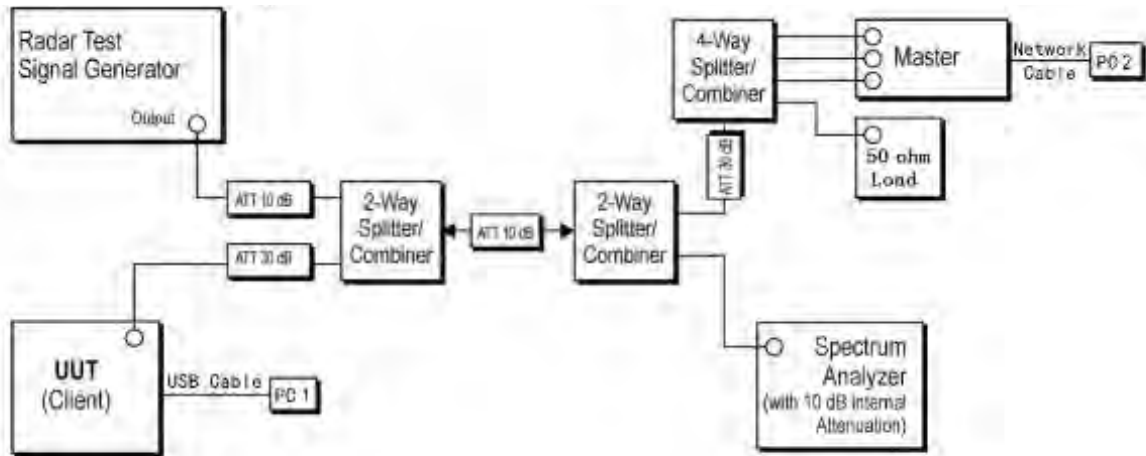

TEST ENVIRONMENT

Temperature	26.2 °C	Relative Humidity	55.8 %
Atmosphere Pressure	101 kPa	Test Voltage	DC 5 V

RESULTS

Please refer to Appendix E & F & G.

12. ANTENNA REQUIREMENTS

APPLICABLE REQUIREMENTS

Please refer to FCC §15.203

An intentional radiator shall be designed to ensure that no antenna other than that furnished by the responsible party shall be used with the device. The use of a permanently attached antenna or of an antenna that uses a unique coupling to the intentional radiator shall be considered sufficient to comply with the provisions of this section. The manufacturer may design the unit so that a broken antenna can be replaced by the user, but the use of a standard antenna jack or electrical connector is prohibited.

Please refer to FCC §15.247(b)(4)

The conducted output power limit specified in paragraph (b) of this section is based on the use of antennas with directional gains that do not exceed 6 dBi. Except as shown in paragraph (c) of this section, if transmitting antennas of directional gain greater than 6 dBi are used, the conducted output power from the intentional radiator shall be reduced below the stated values in paragraphs (b)(1), (b)(2), and (b)(3) of this section, as appropriate, by the amount in dB that the directional gain of the antenna exceeds 6 dBi.

RESULTS

Complies



12.1. Appendix A1: Emission Bandwidth

12.1.1. Test Result

Test Mode	Antenna	Channel	26db EBW [MHz]	FL[MHz]	FH[MHz]	Verdict
11A	Ant1	5180	20.000	5169.880	5189.880	PASS
	Ant2	5180	19.280	5170.440	5189.720	PASS
	Ant1	5200	19.720	5190.000	5209.720	PASS
	Ant2	5200	19.640	5189.960	5209.600	PASS
	Ant1	5240	19.920	5230.120	5250.040	PASS
	Ant2	5240	19.800	5230.080	5249.880	PASS
	Ant1	5260	19.440	5250.280	5269.720	PASS
	Ant2	5260	19.480	5250.200	5269.680	PASS
	Ant1	5280	19.640	5270.360	5290.000	PASS
	Ant2	5280	20.240	5269.920	5290.160	PASS
	Ant1	5320	19.800	5310.120	5329.920	PASS
	Ant2	5320	19.040	5310.640	5329.680	PASS
	Ant1	5500	19.400	5490.280	5509.680	PASS
	Ant2	5500	19.280	5490.320	5509.600	PASS
	Ant1	5580	19.840	5570.120	5589.960	PASS
	Ant2	5580	19.360	5570.240	5589.600	PASS
	Ant1	5700	19.480	5690.240	5709.720	PASS
	Ant2	5700	19.440	5690.200	5709.640	PASS
	Ant1	5720	19.760	5709.920	5729.680	PASS
	Ant2	5720	19.400	5710.200	5729.600	PASS
	Ant1	5720 UNII-2C	15.08	5709.920	5725	PASS
	Ant2	5720 UNII-2C	14.8	5710.200	5725	PASS
	Ant1	5720 UNII-3	4.68	5725	5729.680	PASS
	Ant2	5720 UNII-3	4.6	5725	5729.600	PASS
	Ant1	5745	19.720	5735.040	5754.760	PASS
	Ant2	5745	19.520	5735.160	5754.680	PASS
	Ant1	5785	19.560	5775.200	5794.760	PASS
	Ant2	5785	19.400	5775.280	5794.680	PASS
	Ant1	5825	19.640	5815.000	5834.640	PASS
	Ant2	5825	19.680	5815.200	5834.880	PASS
11N20MIMO	Ant1	5180	20.080	5170.000	5190.080	PASS
	Ant2	5180	19.640	5170.160	5189.800	PASS
	Ant1	5200	20.080	5190.000	5210.080	PASS
	Ant2	5200	19.880	5190.000	5209.880	PASS
	Ant1	5240	20.120	5229.880	5250.000	PASS
	Ant2	5240	19.520	5230.240	5249.760	PASS
	Ant1	5260	20.080	5250.000	5270.080	PASS
	Ant2	5260	19.800	5250.040	5269.840	PASS
	Ant1	5280	20.240	5269.880	5290.120	PASS
	Ant2	5280	19.760	5270.120	5289.880	PASS
	Ant1	5320	20.640	5309.400	5330.040	PASS
	Ant2	5320	19.560	5310.280	5329.840	PASS
	Ant1	5500	20.160	5489.840	5510.000	PASS
	Ant2	5500	19.920	5490.000	5509.920	PASS
	Ant1	5580	19.960	5570.040	5590.000	PASS
	Ant2	5580	20.080	5570.040	5590.120	PASS
	Ant1	5700	19.920	5690.120	5710.040	PASS
	Ant2	5700	19.960	5689.840	5709.800	PASS
	Ant1	5720	19.960	5709.920	5729.880	PASS
	Ant2	5720	19.720	5710.040	5729.760	PASS
	Ant1	5720 UNII-2C	15.08	5709.920	5725	PASS
	Ant2	5720 UNII-2C	14.96	5710.040	5725	PASS
	Ant1	5720 UNII-3	4.88	5725	5729.880	PASS
	Ant2	5720 UNII-3	4.76	5725	5729.760	PASS



	Ant1	5745	19.960	5734.920	5754.880	PASS
	Ant2	5745	19.800	5735.280	5755.080	PASS
	Ant1	5785	20.520	5774.520	5795.040	PASS
	Ant2	5785	19.960	5775.120	5795.080	PASS
	Ant1	5825	20.200	5814.920	5835.120	PASS
	Ant2	5825	19.600	5815.240	5834.840	PASS
11N40MIMO	Ant1	5190	40.160	5169.920	5210.080	PASS
	Ant2	5190	40.000	5170.240	5210.240	PASS
	Ant1	5230	44.480	5210.000	5254.480	PASS
	Ant2	5230	40.480	5209.680	5250.160	PASS
	Ant1	5270	40.320	5249.920	5290.240	PASS
	Ant2	5270	40.000	5250.240	5290.240	PASS
	Ant1	5310	40.480	5289.920	5330.400	PASS
	Ant2	5310	39.440	5290.560	5330.000	PASS
	Ant1	5510	40.640	5489.680	5530.320	PASS
	Ant2	5510	40.080	5490.080	5530.160	PASS
	Ant1	5550	40.960	5529.840	5570.800	PASS
	Ant2	5550	40.080	5529.920	5570.000	PASS
	Ant1	5670	40.960	5649.600	5690.560	PASS
	Ant2	5670	39.680	5650.240	5689.920	PASS
	Ant1	5710	40.240	5689.920	5730.160	PASS
	Ant2	5710	39.840	5690.080	5729.920	PASS
	Ant1	5710 UNII-2C	35.08	5689.920	5725	PASS
	Ant2	5710 UNII-2C	34.92	5690.080	5725	PASS
	Ant1	5710 UNII-3	5.16	5725	5730.160	PASS
	Ant2	5710 UNII-3	4.92	5725	5729.920	PASS
Ant1	5755	40.480	5734.760	5775.240	PASS	
Ant2	5755	39.760	5735.240	5775.000	PASS	
Ant1	5795	40.160	5775.080	5815.240	PASS	
Ant2	5795	39.840	5774.840	5814.680	PASS	
11AC80MIMO	Ant1	5210	80.000	5170.320	5250.320	PASS
	Ant2	5210	80.160	5170.160	5250.320	PASS
	Ant1	5290	81.120	5249.680	5330.800	PASS
	Ant2	5290	80.160	5250.160	5330.320	PASS
	Ant1	5530	80.640	5489.520	5570.160	PASS
	Ant2	5530	80.320	5490.160	5570.480	PASS
	Ant1	5610	80.320	5569.680	5650.000	PASS
	Ant2	5610	80.640	5569.840	5650.480	PASS
	Ant1	5690	80.000	5649.840	5729.840	PASS
	Ant2	5690	80.000	5650.000	5730.000	PASS
	Ant1	5690 UNII-2C	75.16	5649.840	5725	PASS
	Ant2	5690 UNII-2C	75	5650.000	5725	PASS
	Ant1	5690 UNII-3	4.84	5725	5729.840	PASS
	Ant2	5690 UNII-3	5	5725	5730.000	PASS
	Ant1	5775	80.320	5735.000	5815.320	PASS
Ant2	5775	79.200	5735.480	5814.680	PASS	

12.1.2. Test Graphs





11A Ant2 5200



11A Ant1 5240



11A Ant2 5240



11A Ant1 5260



11A Ant2 5260



11A Ant1 5280



11A Ant2 5280



11A Ant1 5320



11A Ant2 5320



11A Ant1 5500



11A Ant2 5500



11A Ant1 5580



11A Ant2 5580



11A Ant1 5700



11A Ant2 5700



11A Ant1 5720

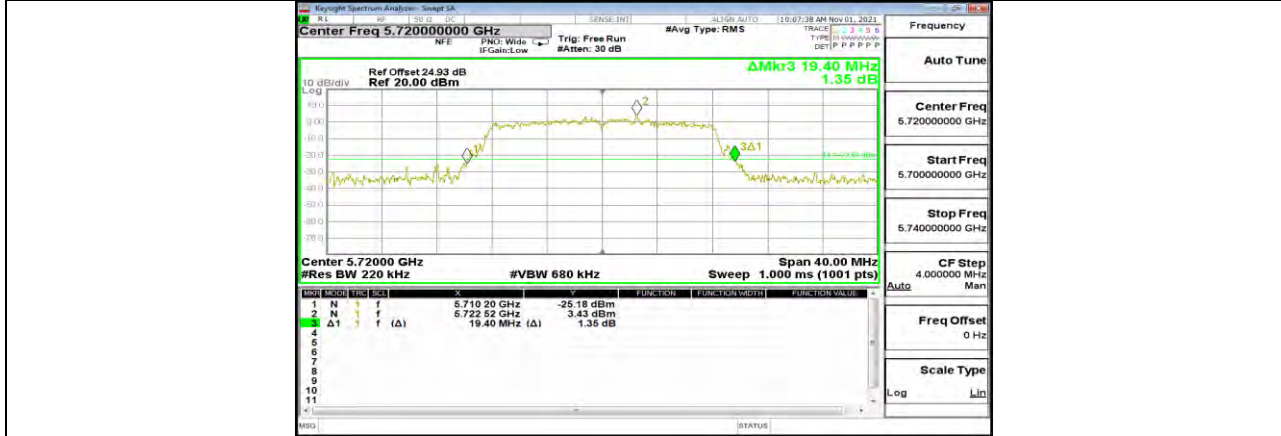

11A Ant2 5720



11A Ant1 5745



11A Ant2 5745

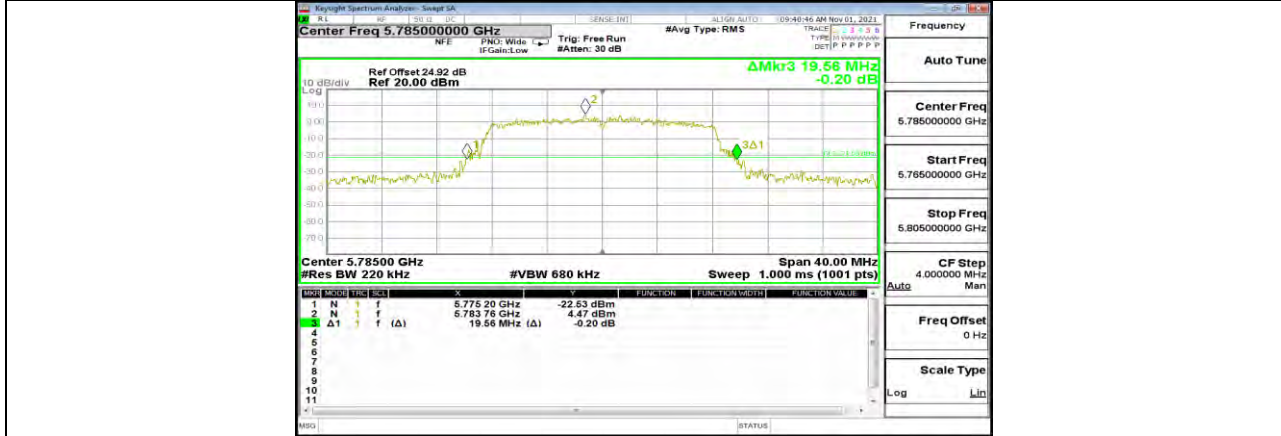

11A Ant1 5785



11A Ant2 5785



11A Ant1 5825



11A Ant2 5825



11N20MIMO Ant1 5180



11N20MIMO Ant2 5180



11N20MIMO Ant1 5200



11N20MIMO Ant2 5200



11N20MIMO Ant1 5240



11N20MIMO Ant2 5240



11N20MIMO Ant1 5260



11N20MIMO Ant2 5260



11N20MIMO Ant1 5280



11N20MIMO Ant2 5280



11N20MIMO Ant1 5320

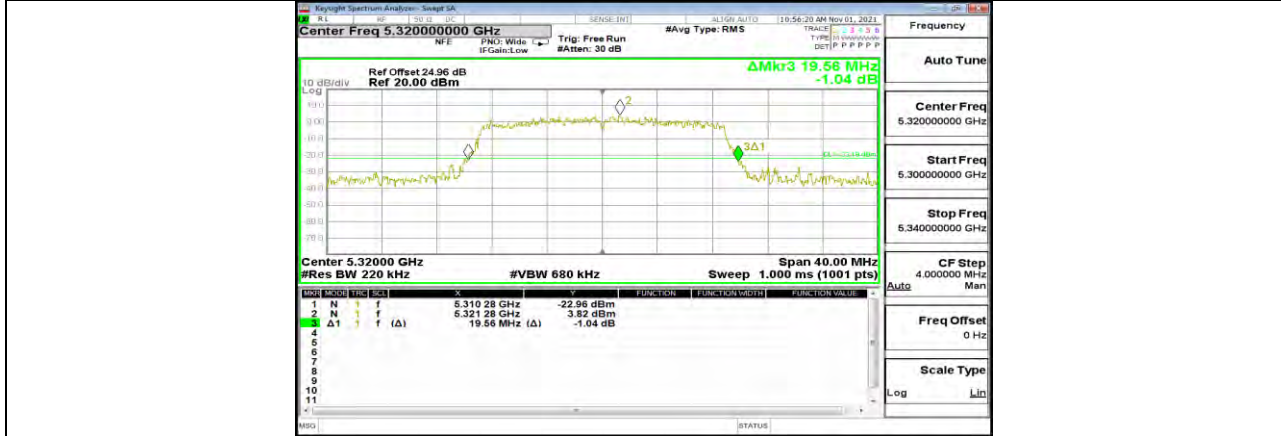

11N20MIMO Ant2 5320



11N20MIMO Ant1 5500



11N20MIMO Ant2 5500



11N20MIMO Ant1 5580



11N20MIMO Ant2 5580



11N20MIMO Ant1 5700



11N20MIMO Ant2 5700



11N20MIMO Ant1 5720



11N20MIMO Ant2 5720



11N20MIMO Ant1 5745



11N20MIMO Ant2 5745



11N20MIMO Ant1 5785



11N20MIMO Ant2 5785



11N20MIMO Ant1 5825



11N20MIMO Ant2 5825



11N40MIMO Ant1 5190



11N40MIMO Ant2 5190

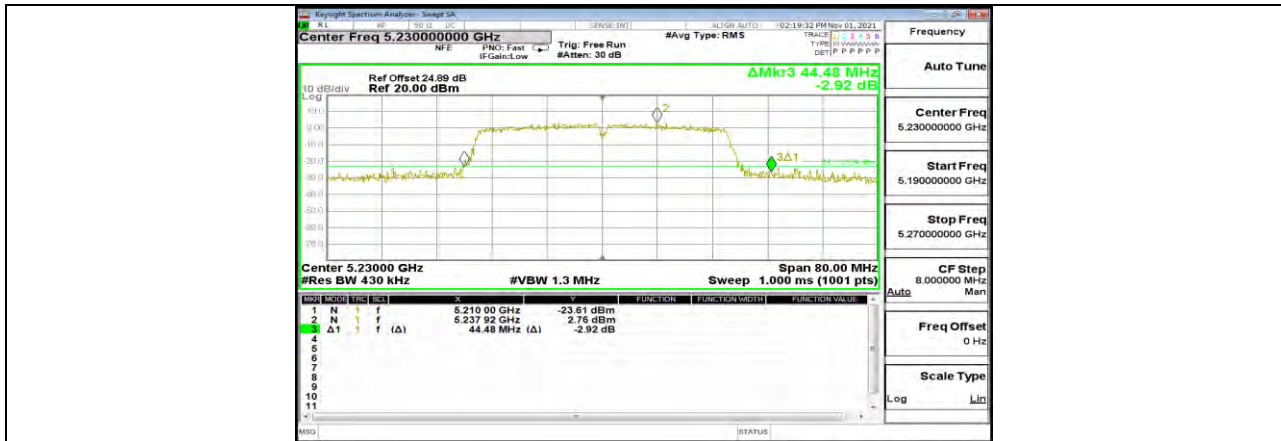

11N40MIMO Ant1 5230

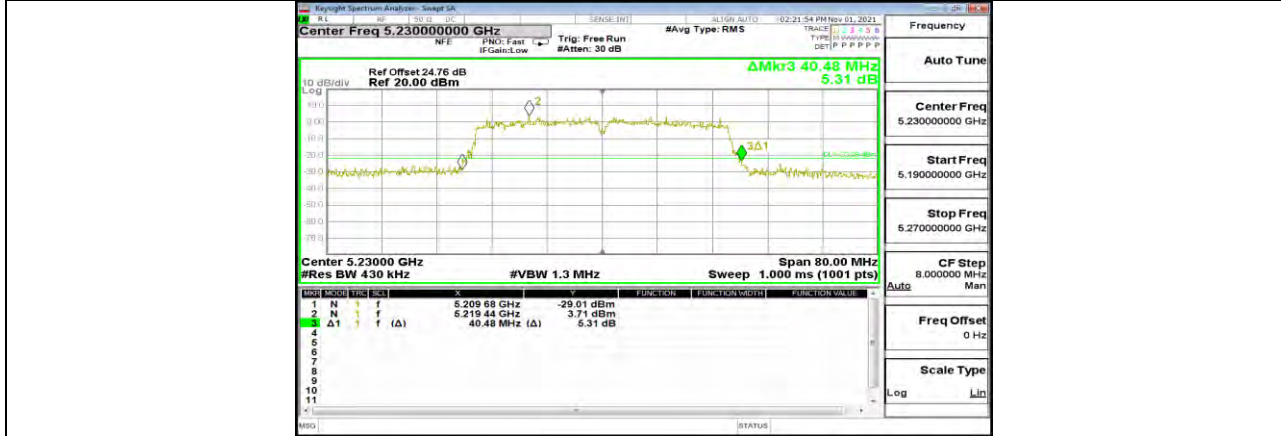

11N40MIMO Ant2 5230



11N40MIMO Ant1 5270



11N40MIMO Ant2 5270



11N40MIMO Ant1 5310



11N40MIMO Ant2 5310



11N40MIMO Ant1 5510

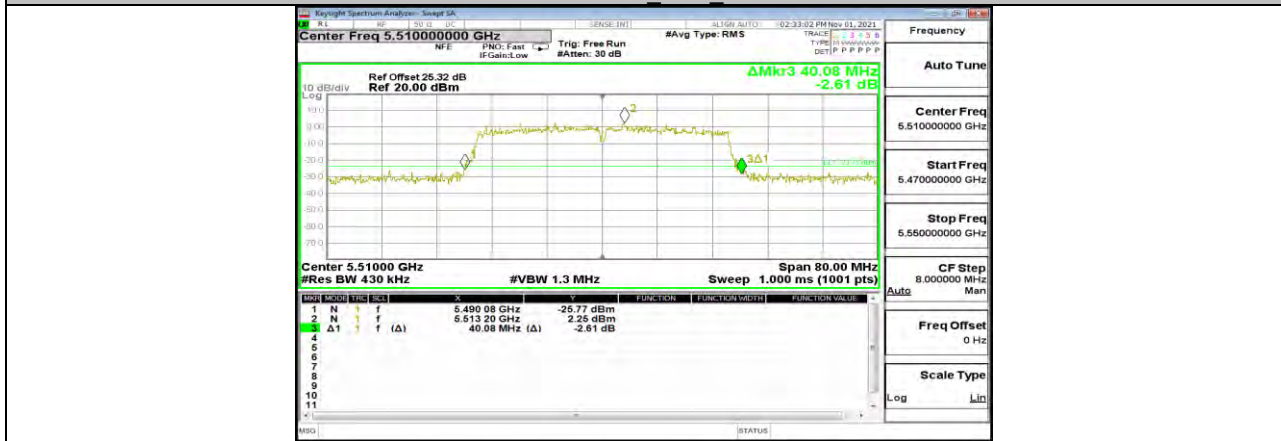

11N40MIMO Ant2 5510



11N40MIMO Ant1 5550



11N40MIMO Ant2 5550

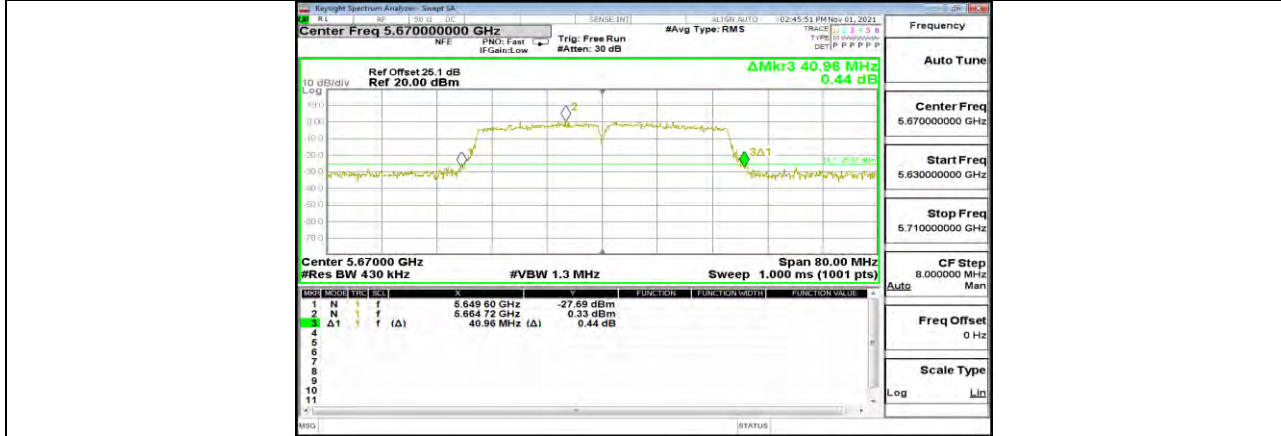

11N40MIMO Ant1 5670



11N40MIMO Ant2 5670



11N40MIMO Ant1 5710



11N40MIMO Ant2 5710



11N40MIMO Ant1 5755



11N40MIMO Ant2 5755



11N40MIMO Ant1 5795



11N40MIMO Ant2 5795



11AC80MIMO Ant1 5210

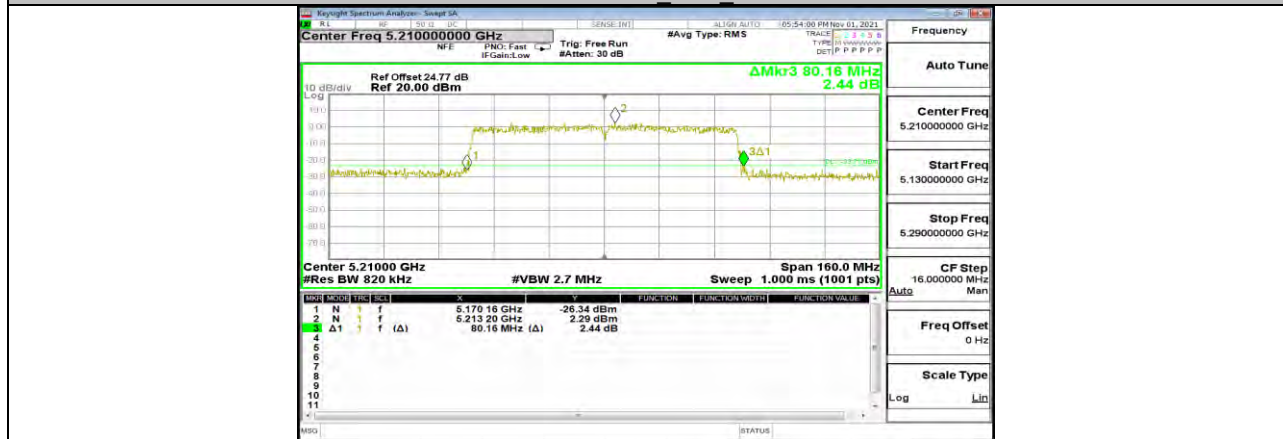

11AC80MIMO Ant2 5210



11AC80MIMO Ant1 5290

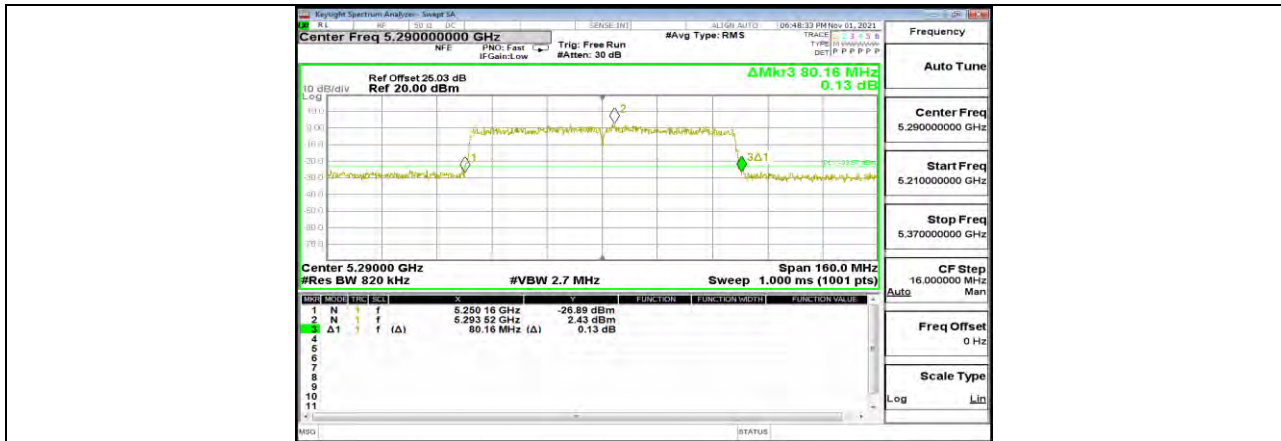

11AC80MIMO_Ant2_5290

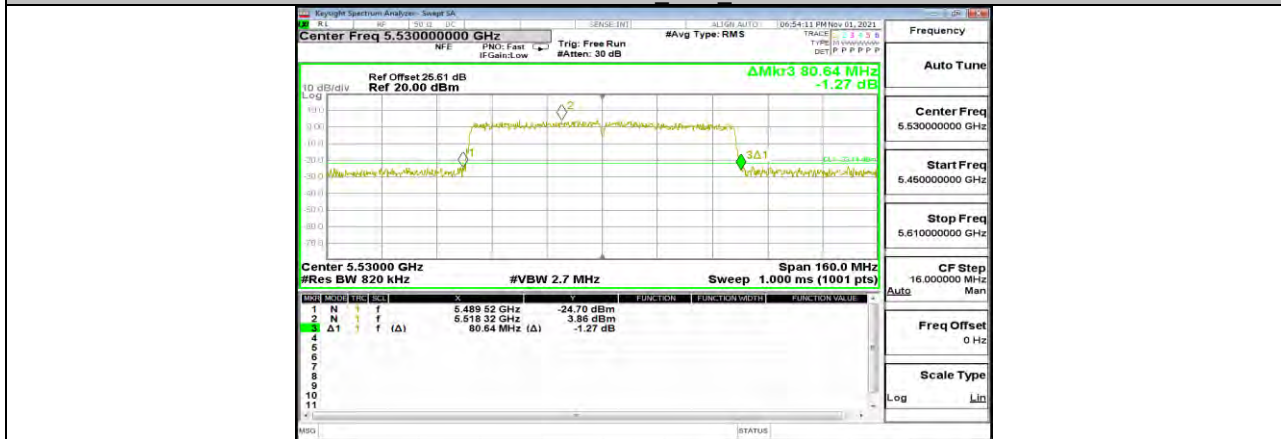

11AC80MIMO_Ant1_5530



11AC80MIMO_Ant2_5530



11AC80MIMO Ant1 5610



11AC80MIMO Ant2 5610



11AC80MIMO Ant1 5690



11AC80MIMO Ant2_5690

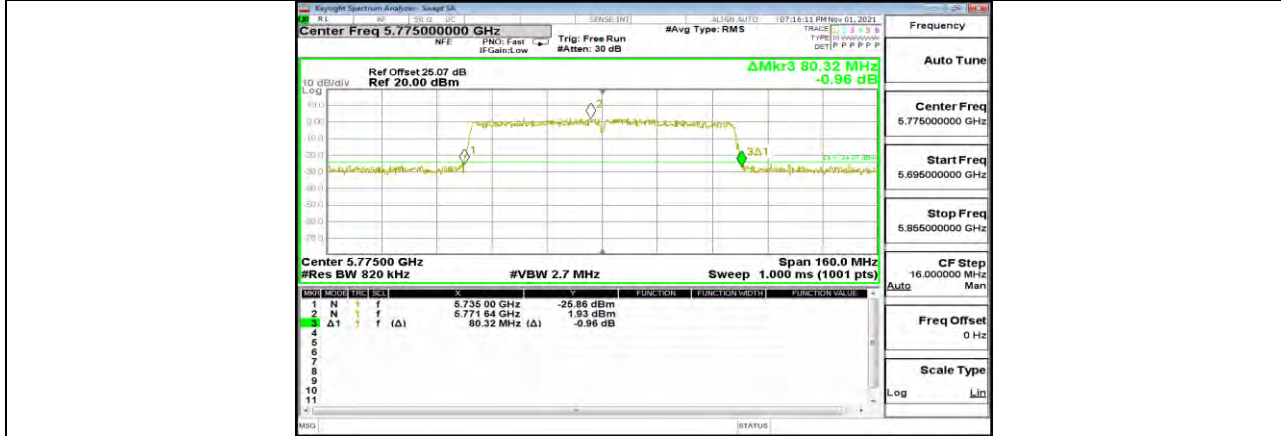

11AC80MIMO Ant1_5775



11AC80MIMO Ant2_5775



12.2. Appendix A2: Occupied channel bandwidth

12.2.1. Test Result

Test Mode	Antenna	Channel	OCB [MHz]	FL[MHz]	FH[MHz]	Verdict
11A	Ant1	5180	16.638	5171.648	5188.286	PASS
	Ant2	5180	16.538	5171.712	5188.250	PASS
	Ant1	5200	16.616	5191.725	5208.341	PASS
	Ant2	5200	16.659	5191.632	5208.291	PASS
	Ant1	5240	16.676	5231.594	5248.270	PASS
	Ant2	5240	16.594	5231.708	5248.302	PASS
	Ant1	5260	16.542	5251.703	5268.245	PASS
	Ant2	5260	16.527	5251.775	5268.302	PASS
	Ant1	5280	16.634	5271.664	5288.298	PASS
	Ant2	5280	16.630	5271.665	5288.295	PASS
	Ant1	5320	16.608	5311.623	5328.231	PASS
	Ant2	5320	16.497	5311.699	5328.196	PASS
	Ant1	5500	16.723	5491.605	5508.328	PASS
	Ant2	5500	16.548	5491.781	5508.329	PASS
	Ant1	5580	16.534	5571.698	5588.232	PASS
	Ant2	5580	16.604	5571.676	5588.280	PASS
	Ant1	5700	16.471	5691.783	5708.254	PASS
	Ant2	5700	16.561	5691.687	5708.248	PASS
	Ant1	5720	16.640	5711.572	5728.212	PASS
	Ant2	5720	16.752	5711.597	5728.349	PASS
	Ant1	5720 UNII-2C	13.428	5711.572	5725	PASS
	Ant2	5720 UNII-2C	13.403	5711.597	5725	PASS
	Ant1	5720 UNII-3	3.212	5725	5728.212	PASS
	Ant2	5720 UNII-3	3.349	5725	5728.349	PASS
	Ant1	5745	16.529	5736.697	5753.226	PASS
	Ant2	5745	16.587	5736.731	5753.318	PASS
	Ant1	5785	16.533	5776.735	5793.268	PASS
	Ant2	5785	16.593	5776.684	5793.277	PASS
Ant1	5825	16.504	5816.753	5833.257	PASS	
Ant2	5825	16.555	5816.681	5833.236	PASS	
11N20MIMO	Ant1	5180	17.729	5171.120	5188.849	PASS
	Ant2	5180	17.550	5171.244	5188.794	PASS
	Ant1	5200	17.753	5191.097	5208.850	PASS
	Ant2	5200	17.667	5191.194	5208.861	PASS
	Ant1	5240	17.693	5231.162	5248.855	PASS
	Ant2	5240	17.553	5231.214	5248.767	PASS
	Ant1	5260	17.735	5251.114	5268.849	PASS
	Ant2	5260	17.543	5251.204	5268.747	PASS
	Ant1	5280	17.638	5271.184	5288.822	PASS
	Ant2	5280	17.572	5271.263	5288.835	PASS
	Ant1	5320	17.646	5311.208	5328.854	PASS
	Ant2	5320	17.572	5311.296	5328.868	PASS
	Ant1	5500	17.655	5491.184	5508.839	PASS
	Ant2	5500	17.559	5491.167	5508.726	PASS
	Ant1	5580	17.745	5571.099	5588.844	PASS
	Ant2	5580	17.621	5571.215	5588.836	PASS
	Ant1	5700	17.659	5691.181	5708.840	PASS
	Ant2	5700	17.650	5691.179	5708.829	PASS
	Ant1	5720	17.635	5711.220	5728.855	PASS
	Ant2	5720	17.693	5711.172	5728.865	PASS
	Ant1	5720 UNII-2C	13.78	5711.220	5725	PASS
	Ant2	5720 UNII-2C	13.828	5711.172	5725	PASS



	Ant1	5720 UNII-3	3.855	5725	5728.855	PASS
	Ant2	5720 UNII-3	3.865	5725	5728.865	PASS
	Ant1	5745	17.604	5736.213	5753.817	PASS
	Ant2	5745	17.678	5736.196	5753.874	PASS
	Ant1	5785	17.633	5776.167	5793.800	PASS
	Ant2	5785	17.616	5776.270	5793.886	PASS
	Ant1	5825	17.770	5816.183	5833.953	PASS
	Ant2	5825	17.630	5816.208	5833.838	PASS
11N40MIMO	Ant1	5190	36.301	5171.918	5208.219	PASS
	Ant2	5190	36.227	5171.962	5208.189	PASS
	Ant1	5230	36.311	5211.908	5248.219	PASS
	Ant2	5230	36.484	5211.790	5248.274	PASS
	Ant1	5270	36.394	5251.805	5288.199	PASS
	Ant2	5270	36.181	5251.939	5288.120	PASS
	Ant1	5310	36.263	5291.960	5328.223	PASS
	Ant2	5310	36.170	5292.044	5328.214	PASS
	Ant1	5510	36.385	5491.873	5528.258	PASS
	Ant2	5510	36.385	5491.827	5528.212	PASS
	Ant1	5550	36.327	5531.888	5568.215	PASS
	Ant2	5550	36.389	5531.836	5568.225	PASS
	Ant1	5670	36.297	5651.931	5688.228	PASS
	Ant2	5670	36.585	5651.723	5688.308	PASS
	Ant1	5710	36.302	5691.893	5728.195	PASS
	Ant2	5710	36.105	5691.963	5728.068	PASS
	Ant1	5710 UNII-2C	33.107	5691.893	5725	PASS
	Ant2	5710 UNII-2C	33.037	5691.963	5725	PASS
	Ant1	5710 UNII-3	3.195	5725	5728.195	PASS
	Ant2	5710 UNII-3	3.068	5725	5728.068	PASS
	Ant1	5755	36.367	5736.883	5773.250	PASS
	Ant2	5755	36.384	5736.903	5773.287	PASS
	Ant1	5795	36.328	5776.872	5813.200	PASS
	Ant2	5795	36.227	5776.958	5813.185	PASS
11AC80MIMO	Ant1	5210	76.201	5171.968	5248.169	PASS
	Ant2	5210	76.307	5171.797	5248.104	PASS
	Ant1	5290	76.070	5252.090	5328.160	PASS
	Ant2	5290	76.216	5252.022	5328.238	PASS
	Ant1	5530	76.334	5491.896	5568.230	PASS
	Ant2	5530	76.356	5491.869	5568.225	PASS
	Ant1	5610	76.270	5571.954	5648.224	PASS
	Ant2	5610	76.383	5571.870	5648.253	PASS
	Ant1	5690	76.082	5652.099	5728.181	PASS
	Ant2	5690	76.529	5651.868	5728.397	PASS
	Ant1	5690 UNII-2C	72.901	5652.099	5725	PASS
	Ant2	5690 UNII-2C	73.132	5651.868	5725	PASS
	Ant1	5690 UNII-3	3.181	5725	5728.181	PASS
	Ant2	5690 UNII-3	3.397	5725	5728.397	PASS
	Ant1	5775	76.223	5737.012	5813.235	PASS
	Ant2	5775	76.074	5737.172	5813.246	PASS