

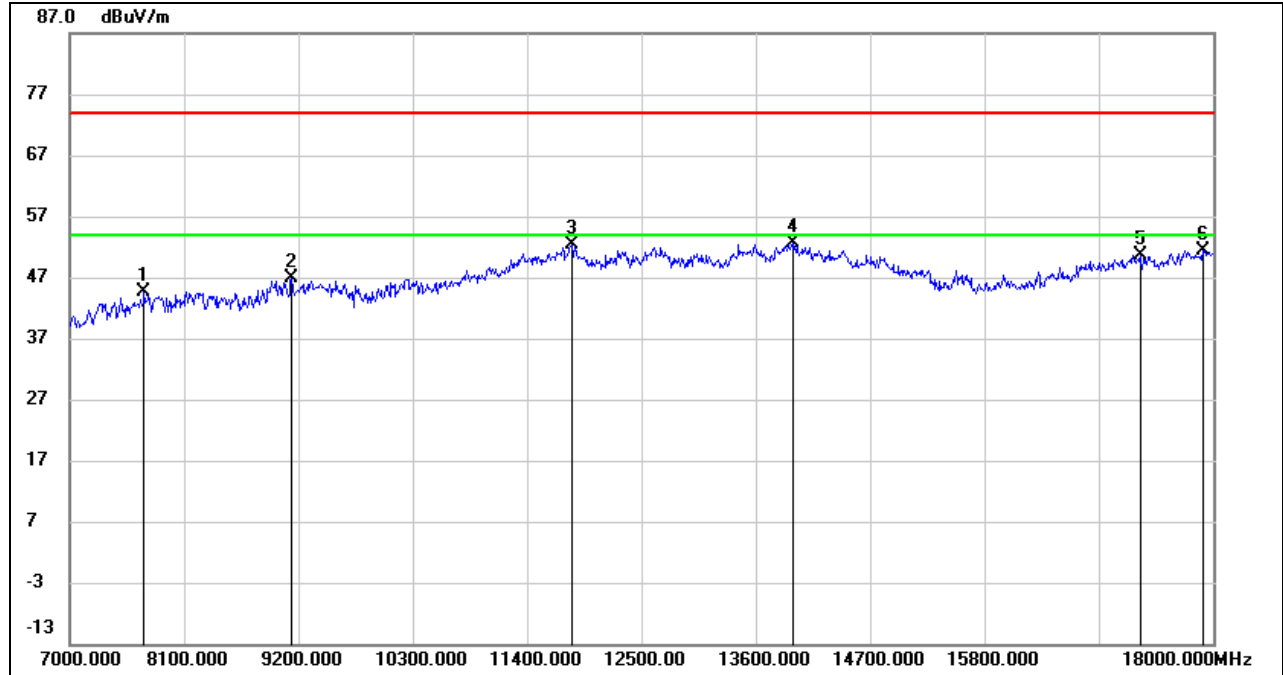

UNII-2C BAND

HARMONICS AND SPURIOUS EMISSIONS (LOW CHANNEL, HORIZONTAL)



No.	Frequency (MHz)	Reading (dBuV)	Correct (dB/m)	Result (dBuV/m)	Limit (dBuV/m)	Margin (dB)	Remark
1	7715.000	38.71	5.81	44.52	74.00	-29.48	peak
2	9134.000	37.98	8.78	46.76	74.00	-27.24	peak
3	11829.000	35.22	17.20	52.42	74.00	-21.58	peak
4	13952.000	32.04	20.61	52.65	74.00	-21.35	peak
5	17296.000	30.51	20.18	50.69	74.00	-23.31	peak
6	17901.000	27.94	23.44	51.38	74.00	-22.62	peak

- Note:
1. Measurement = Reading Level + Correct Factor.
 2. If Peak Result complies with AV limit, AV Result is deemed to comply with AV limit.
 3. Peak: Peak detector.
 4. AVG: $VBW=1/Ton$, where: Ton is the transmitting duration.
 5. For the transmitting duration, please refer to clause 7.1.
 6. Filter losses were only considered in the spurious frequency bands and the authorized band was not corrected for High Pass Filter losses.
 7. Proper operation of the transmitter prior to adding the filter to the measurement chain.
 8. Since non-restricted band peak emissions are less than the average limit, they also comply with the -27dBm/MHz (68.2dBuV/m) limit.



HARMONICS AND SPURIOUS EMISSIONS (LOW CHANNEL, VERTICAL)

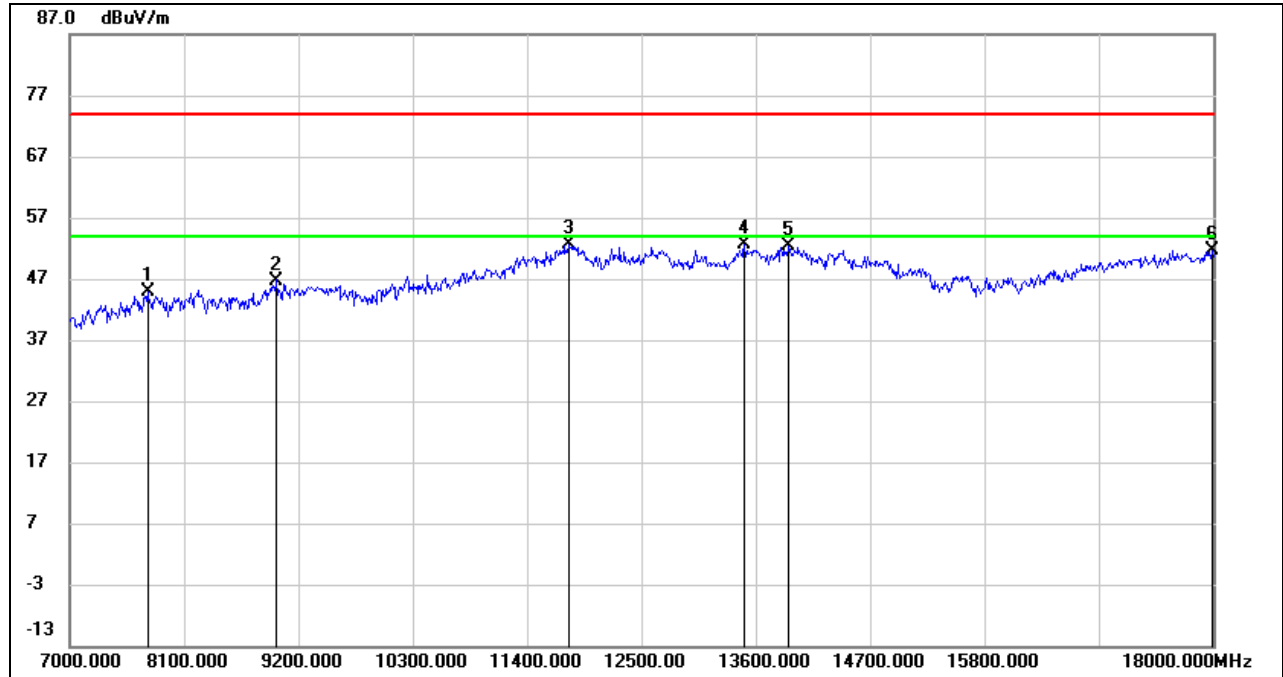

No.	Frequency (MHz)	Reading (dBuV)	Correct (dB/m)	Result (dBuV/m)	Limit (dBuV/m)	Margin (dB)	Remark
1	7748.000	38.98	5.92	44.90	74.00	-29.10	peak
2	8991.000	37.33	9.42	46.75	74.00	-27.25	peak
3	11796.000	35.42	17.19	52.61	74.00	-21.39	peak
4	13490.000	32.98	19.55	52.53	74.00	-21.47	peak
5	13919.000	31.73	20.58	52.31	74.00	-21.69	peak
6	17989.000	27.97	23.65	51.62	74.00	-22.38	peak

- Note:
1. Measurement = Reading Level + Correct Factor.
 2. If Peak Result complies with AV limit, AV Result is deemed to comply with AV limit.
 3. Peak: Peak detector.
 4. AVG: $VBW=1/Ton$, where: Ton is the transmitting duration.
 5. For the transmitting duration, please refer to clause 7.1.
 6. Filter losses were only considered in the spurious frequency bands and the authorized band was not corrected for High Pass Filter losses.
 7. Proper operation of the transmitter prior to adding the filter to the measurement chain.
 8. Since non-restricted band peak emissions are less than the average limit, they also comply with the -27dBm/MHz (68.2dBuV/m) limit.



HARMONICS AND SPURIOUS EMISSIONS (MID CHANNEL, HORIZONTAL)

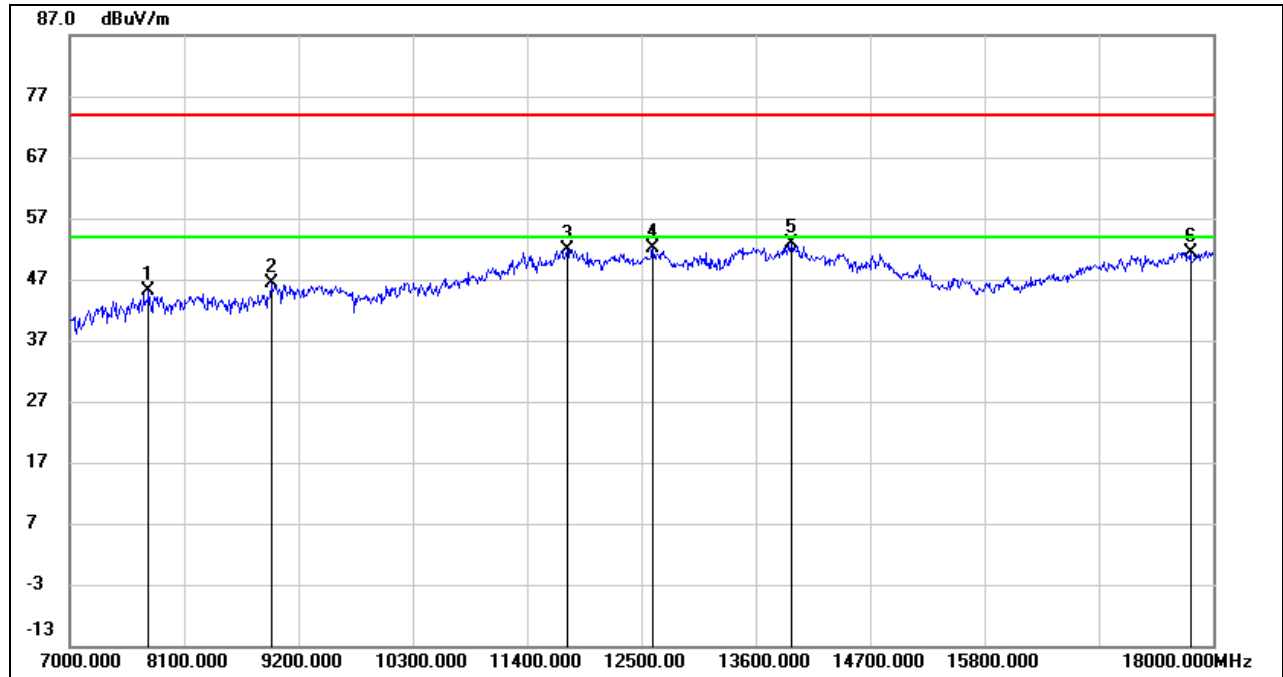

No.	Frequency (MHz)	Reading (dBuV)	Correct (dB/m)	Result (dBuV/m)	Limit (dBuV/m)	Margin (dB)	Remark
1	7759.000	39.25	5.95	45.20	74.00	-28.80	peak
2	8936.000	37.65	8.76	46.41	74.00	-27.59	peak
3	11785.000	34.83	17.12	51.95	74.00	-22.05	peak
4	12610.000	35.20	16.83	52.03	74.00	-21.97	peak
5	13941.000	32.20	20.60	52.80	74.00	-21.20	peak
6	17780.000	28.47	22.98	51.45	74.00	-22.55	peak

- Note:
1. Measurement = Reading Level + Correct Factor.
 2. If Peak Result complies with AV limit, AV Result is deemed to comply with AV limit.
 3. Peak: Peak detector.
 4. AVG: $VBW=1/Ton$, where: Ton is the transmitting duration.
 5. For the transmitting duration, please refer to clause 7.1.
 6. Filter losses were only considered in the spurious frequency bands and the authorized band was not corrected for High Pass Filter losses.
 7. Proper operation of the transmitter prior to adding the filter to the measurement chain.
 8. Since non-restricted band peak emissions are less than the average limit, they also comply with the -27dBm/MHz (68.2dBuV/m) limit.

HARMONICS AND SPURIOUS EMISSIONS (MID CHANNEL, VERTICAL)

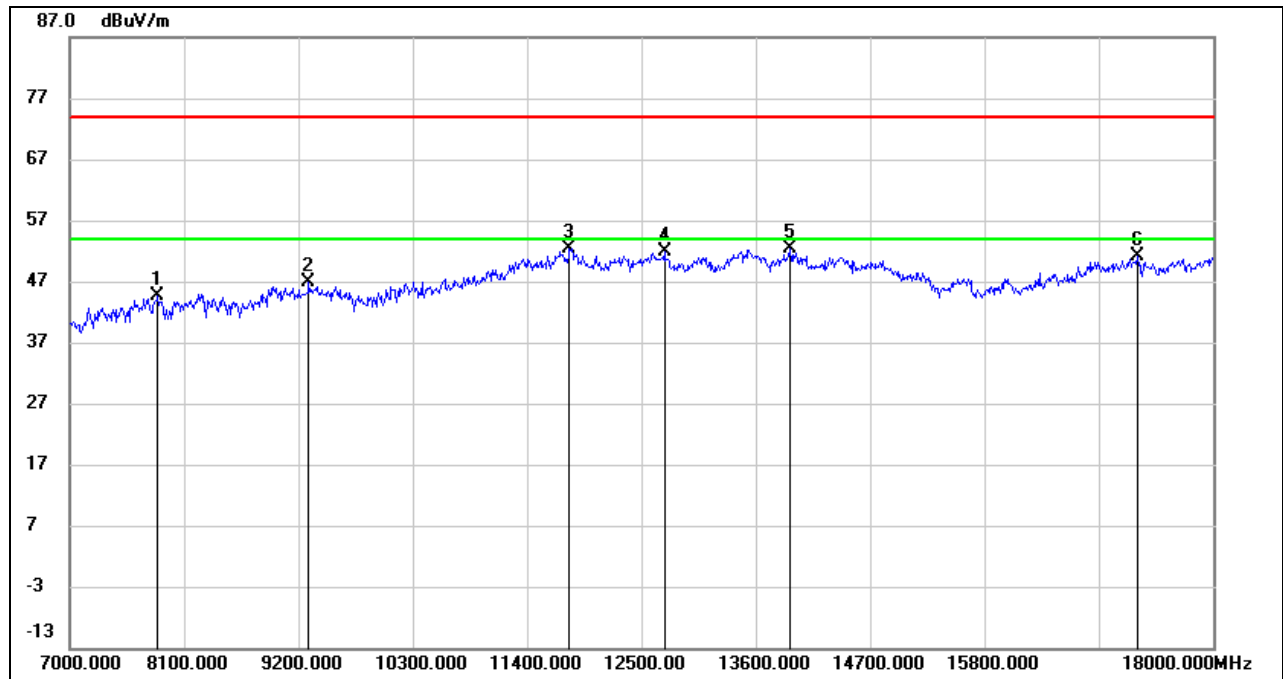

No.	Frequency (MHz)	Reading (dBuV)	Correct (dB/m)	Result (dBuV/m)	Limit (dBuV/m)	Margin (dB)	Remark
1	7847.000	38.63	5.91	44.54	74.00	-29.46	peak
2	9299.000	37.78	9.05	46.83	74.00	-27.17	peak
3	11807.000	35.13	17.22	52.35	74.00	-21.65	peak
4	12720.000	34.74	17.09	51.83	74.00	-22.17	peak
5	13930.000	31.77	20.59	52.36	74.00	-21.64	peak
6	17274.000	31.05	20.17	51.22	74.00	-22.78	peak

- Note:
1. Measurement = Reading Level + Correct Factor.
 2. If Peak Result complies with AV limit, AV Result is deemed to comply with AV limit.
 3. Peak: Peak detector.
 4. AVG: $VBW=1/Ton$, where: Ton is the transmitting duration.
 5. For the transmitting duration, please refer to clause 7.1.
 6. Filter losses were only considered in the spurious frequency bands and the authorized band was not corrected for High Pass Filter losses.
 7. Proper operation of the transmitter prior to adding the filter to the measurement chain.
 8. Since non-restricted band peak emissions are less than the average limit, they also comply with the -27dBm/MHz (68.2dBuV/m) limit.



HARMONICS AND SPURIOUS EMISSIONS (HIGH CHANNEL, HORIZONTAL)

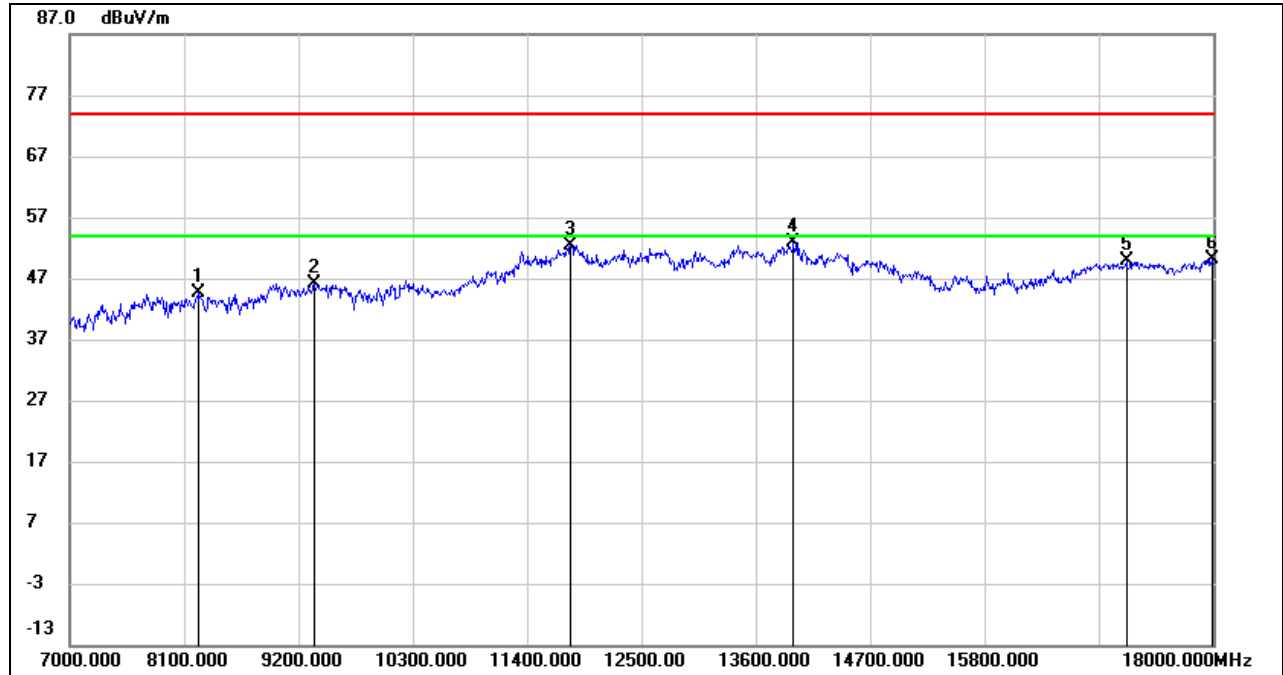

No.	Frequency (MHz)	Reading (dBuV)	Correct (dB/m)	Result (dBuV/m)	Limit (dBuV/m)	Margin (dB)	Remark
1	8243.000	37.41	7.10	44.51	74.00	-29.49	peak
2	9354.000	36.82	9.39	46.21	74.00	-27.79	peak
3	11818.000	35.22	17.20	52.42	74.00	-21.58	peak
4	13963.000	32.19	20.61	52.80	74.00	-21.20	peak
5	17164.000	29.84	19.93	49.77	74.00	-24.23	peak
6	17989.000	26.45	23.65	50.10	74.00	-23.90	peak

Note: 1. Measurement = Reading Level + Correct Factor.
 2. If Peak Result complies with AV limit, AV Result is deemed to comply with AV limit.
 3. Peak: Peak detector.
 4. AVG: VBW=1/Ton, where: Ton is the transmitting duration.
 5. For the transmitting duration, please refer to clause 7.1.
 6. Filter losses were only considered in the spurious frequency bands and the authorized band was not corrected for High Pass Filter losses.
 7. Proper operation of the transmitter prior to adding the filter to the measurement chain.
 8. Since non-restricted band peak emissions are less than the average limit, they also comply with the -27dBm/MHz (68.2dBuV/m) limit.



HARMONICS AND SPURIOUS EMISSIONS (HIGH CHANNEL, VERTICAL)

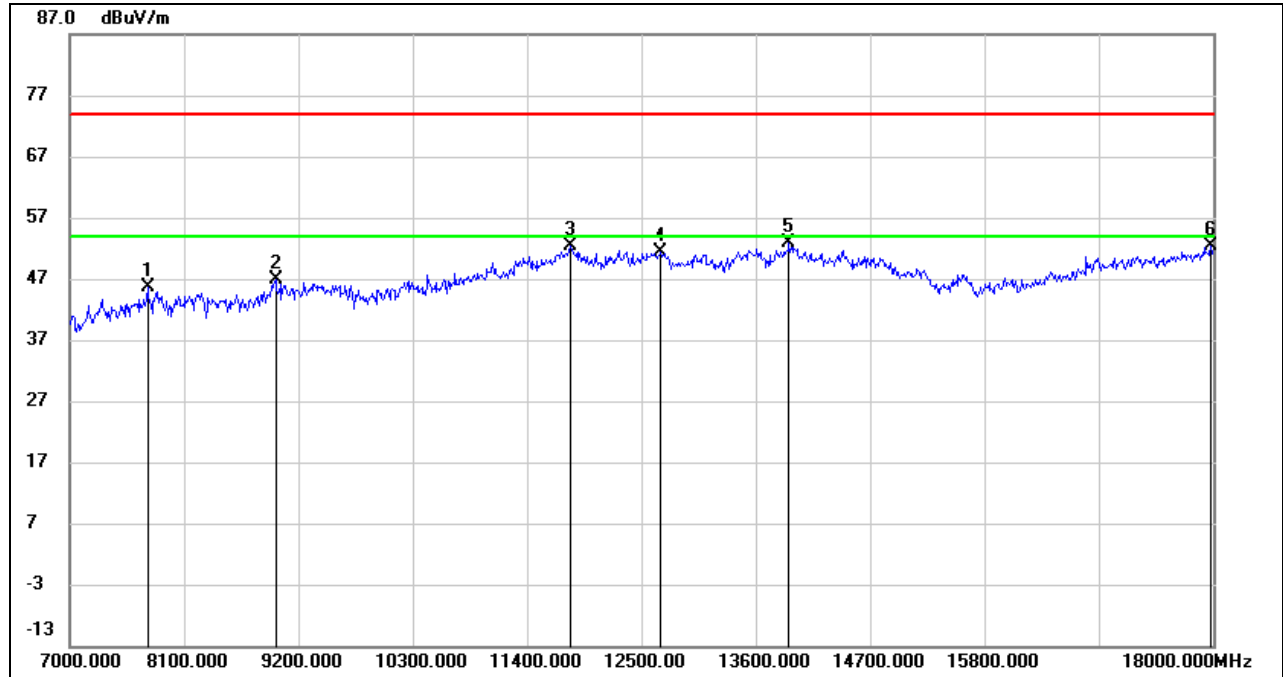

No.	Frequency (MHz)	Reading (dBuV)	Correct (dB/m)	Result (dBuV/m)	Limit (dBuV/m)	Margin (dB)	Remark
1	7748.000	39.77	5.92	45.69	74.00	-28.31	peak
2	8980.000	37.47	9.29	46.76	74.00	-27.24	peak
3	11818.000	35.13	17.20	52.33	74.00	-21.67	peak
4	12687.000	34.35	17.01	51.36	74.00	-22.64	peak
5	13919.000	32.23	20.58	52.81	74.00	-21.19	peak
6	17978.000	28.67	23.63	52.30	74.00	-21.70	peak

- Note:
1. Measurement = Reading Level + Correct Factor.
 2. If Peak Result complies with AV limit, AV Result is deemed to comply with AV limit.
 3. Peak: Peak detector.
 4. AVG: $VBW=1/Ton$, where: Ton is the transmitting duration.
 5. For the transmitting duration, please refer to clause 7.1.
 6. Filter losses were only considered in the spurious frequency bands and the authorized band was not corrected for High Pass Filter losses.
 7. Proper operation of the transmitter prior to adding the filter to the measurement chain.
 8. Since non-restricted band peak emissions are less than the average limit, they also comply with the -27dBm/MHz (68.2dBuV/m) limit.

STRADDLE CHANNEL 142

HARMONICS AND SPURIOUS EMISSIONS (HORIZONTAL)

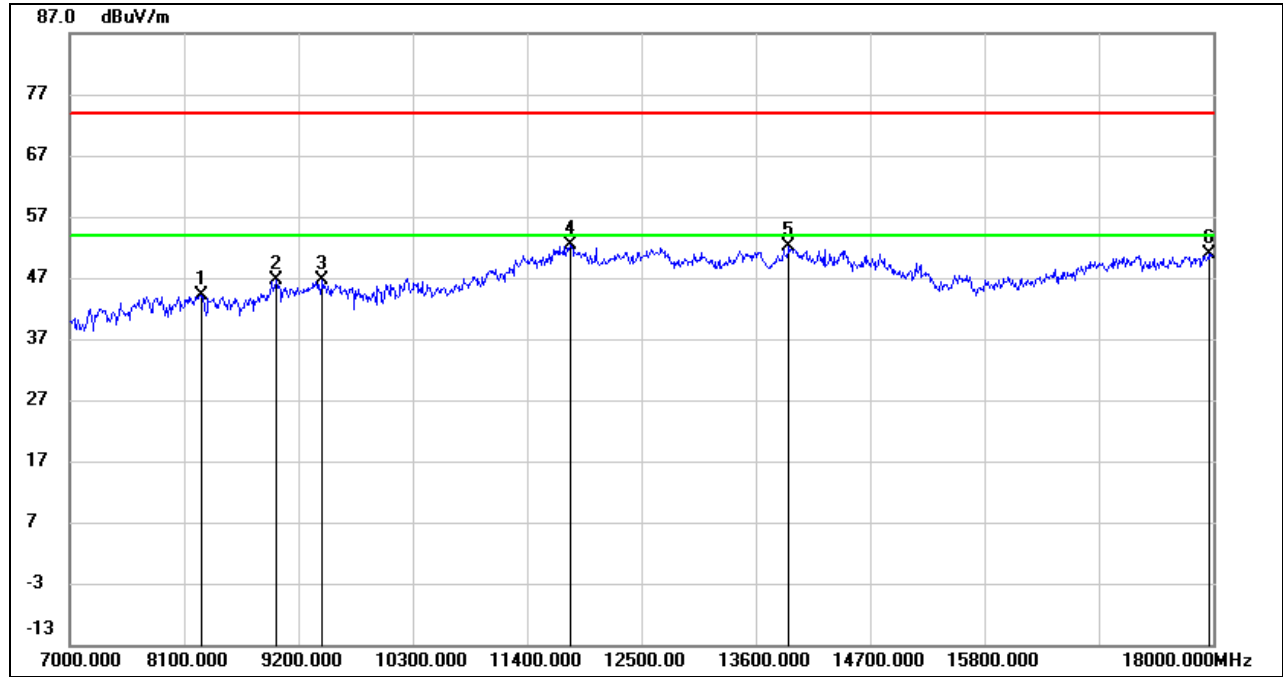

No.	Frequency (MHz)	Reading (dBuV)	Correct (dB/m)	Result (dBuV/m)	Limit (dBuV/m)	Margin (dB)	Remark
1	8265.000	37.03	7.03	44.06	74.00	-29.94	peak
2	8991.000	37.16	9.42	46.58	74.00	-27.42	peak
3	9431.000	36.86	9.76	46.62	74.00	-27.38	peak
4	11818.000	35.22	17.20	52.42	74.00	-21.58	peak
5	13919.000	31.44	20.58	52.02	74.00	-21.98	peak
6	17956.000	27.29	23.57	50.86	74.00	-23.14	peak

Note: 1. Measurement = Reading Level + Correct Factor.
 2. If Peak Result complies with AV limit, AV Result is deemed to comply with AV limit.
 3. Peak: Peak detector.
 4. AVG: VBW=1/Ton, where: Ton is the transmitting duration.
 5. For the transmitting duration, please refer to clause 7.1.
 6. Filter losses were only considered in the spurious frequency bands and the authorized band was not corrected for High Pass Filter losses.
 7. Proper operation of the transmitter prior to adding the filter to the measurement chain.
 8. Since non-restricted band peak emissions are less than the average limit, they also comply with the -27dBm/MHz (68.2dBuV/m) limit.



HARMONICS AND SPURIOUS EMISSIONS (VERTICAL)

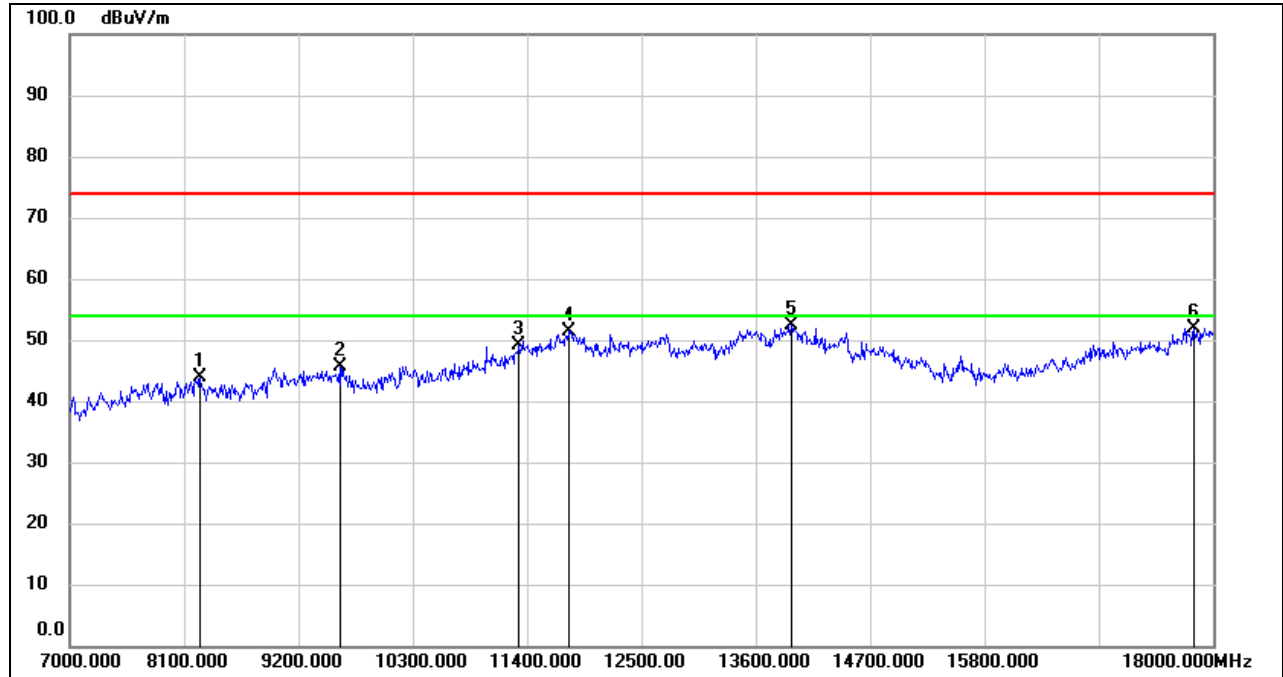

No.	Frequency (MHz)	Reading (dBuV)	Correct (dB/m)	Result (dBuV/m)	Limit (dBuV/m)	Margin (dB)	Remark
1	8254.000	36.83	7.07	43.90	74.00	-30.10	peak
2	9596.000	35.40	10.13	45.53	74.00	-28.47	peak
3	11323.000	34.17	14.84	49.01	74.00	-24.99	peak
4	11796.000	34.29	17.19	51.48	74.00	-22.52	peak
5	13941.000	31.85	20.60	52.45	74.00	-21.55	peak
6	17813.000	28.75	23.23	51.98	74.00	-22.02	peak

- Note:
1. Measurement = Reading Level + Correct Factor.
 2. If Peak Result complies with AV limit, AV Result is deemed to comply with AV limit.
 3. Peak: Peak detector.
 4. AVG: $VBW=1/Ton$, where: Ton is the transmitting duration.
 5. For the transmitting duration, please refer to clause 7.1.
 6. Filter losses were only considered in the spurious frequency bands and the authorized band was not corrected for High Pass Filter losses.
 7. Proper operation of the transmitter prior to adding the filter to the measurement chain.
 8. Since non-restricted band peak emissions are less than the average limit, they also comply with the -27dBm/MHz (68.2dBuV/m) limit.



UNII-3 BAND

HARMONICS AND SPURIOUS EMISSIONS (LOW CHANNEL, HORIZONTAL)

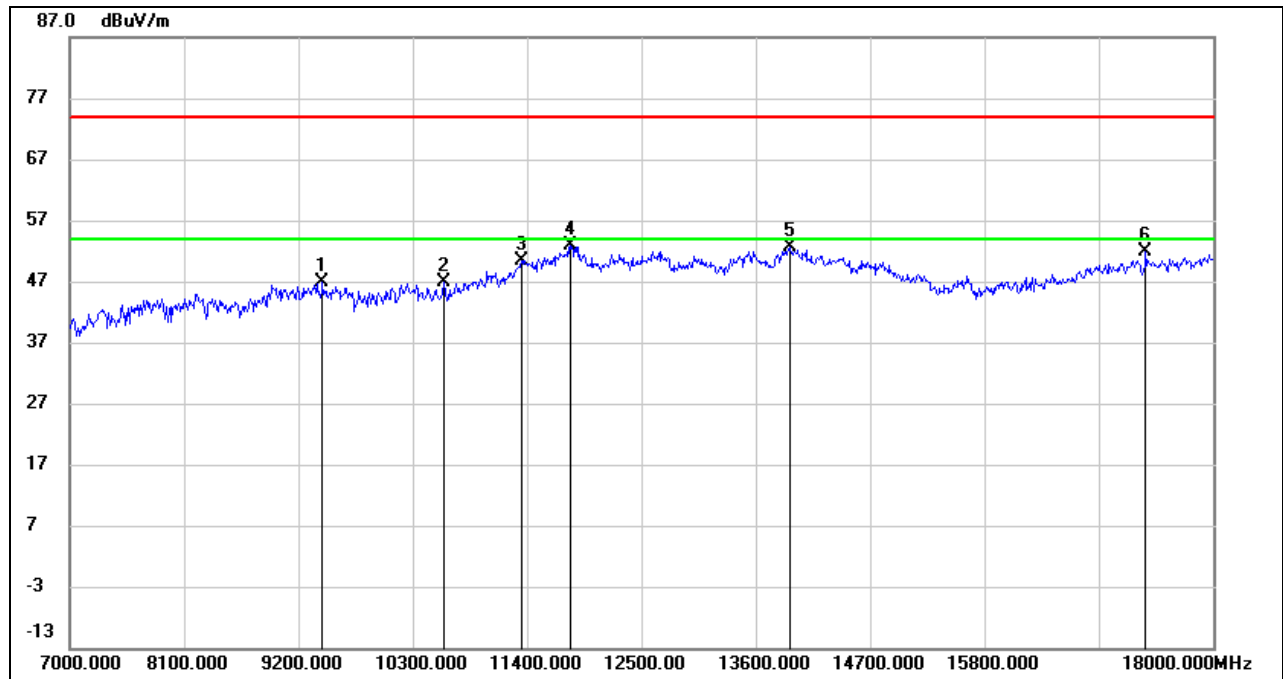

No.	Frequency (MHz)	Reading (dBuV)	Correct (dB/m)	Result (dBuV/m)	Limit (dBuV/m)	Margin (dB)	Remark
1	9431.000	37.10	9.76	46.86	74.00	-27.14	peak
2	10597.000	34.65	12.25	46.90	74.00	-27.10	peak
3	11345.000	35.47	14.97	50.44	74.00	-23.56	peak
4	11818.000	35.78	17.20	52.98	74.00	-21.02	peak
5	13930.000	32.07	20.59	52.66	74.00	-21.34	peak
6	17351.000	31.57	20.19	51.76	74.00	-22.24	peak

- Note:
1. Measurement = Reading Level + Correct Factor.
 2. If Peak Result complies with AV limit, AV Result is deemed to comply with AV limit.
 3. Peak: Peak detector.
 4. AVG: $VBW=1/Ton$, where: Ton is the transmitting duration.
 5. For the transmitting duration, please refer to clause 7.1.
 6. Filter losses were only considered in the spurious frequency bands and the authorized band was not corrected for High Pass Filter losses.
 7. Proper operation of the transmitter prior to adding the filter to the measurement chain.
 8. Since non-restricted band peak emissions are less than the average limit, they also comply with the -27dBm/MHz (68.2dBuV/m) limit.

HARMONICS AND SPURIOUS EMISSIONS (LOW CHANNEL, VERTICAL)

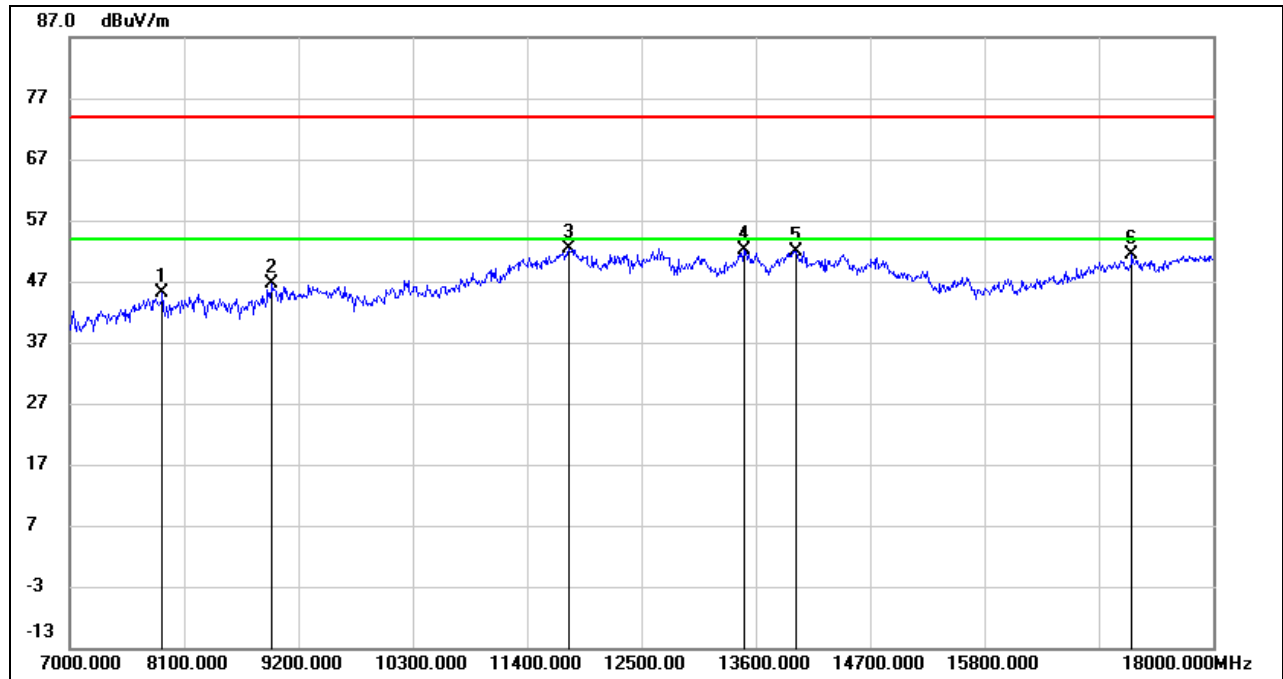

No.	Frequency (MHz)	Reading (dBuV)	Correct (dB/m)	Result (dBuV/m)	Limit (dBuV/m)	Margin (dB)	Remark
1	7891.000	39.29	5.74	45.03	74.00	-28.97	peak
2	8947.000	37.73	8.89	46.62	74.00	-27.38	peak
3	11796.000	35.17	17.19	52.36	74.00	-21.64	peak
4	13490.000	32.60	19.55	52.15	74.00	-21.85	peak
5	13985.000	31.31	20.63	51.94	74.00	-22.06	peak
6	17219.000	31.13	20.15	51.28	74.00	-22.72	peak

- Note: 1. Measurement = Reading Level + Correct Factor.
 2. If Peak Result complies with AV limit, AV Result is deemed to comply with AV limit.
 3. Peak: Peak detector.
 4. AVG: $VBW=1/Ton$, where: Ton is the transmitting duration.
 5. For the transmitting duration, please refer to clause 7.1.
 6. Filter losses were only considered in the spurious frequency bands and the authorized band was not corrected for High Pass Filter losses.
 7. Proper operation of the transmitter prior to adding the filter to the measurement chain.
 8. Since non-restricted band peak emissions are less than the average limit, they also comply with the -27dBm/MHz (68.2dBuV/m) limit.



HARMONICS AND SPURIOUS EMISSIONS (HIGH CHANNEL, HORIZONTAL)

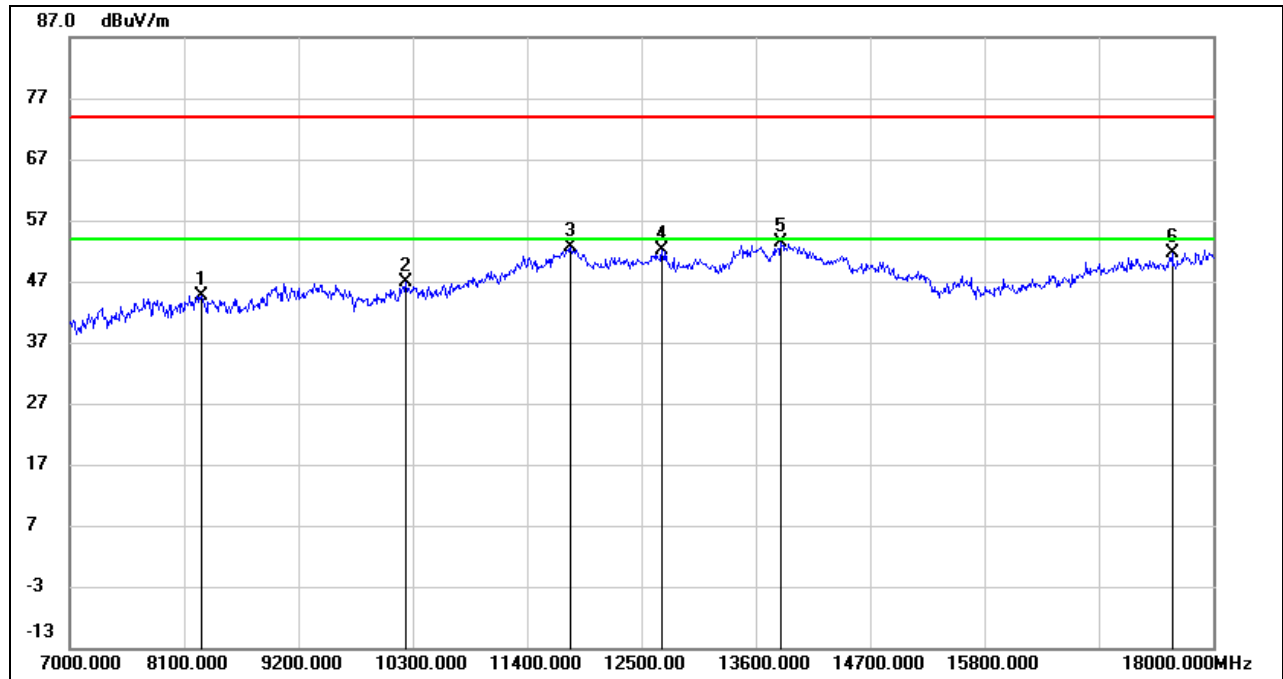

No.	Frequency (MHz)	Reading (dBuV)	Correct (dB/m)	Result (dBuV/m)	Limit (dBuV/m)	Margin (dB)	Remark
1	8265.000	37.70	7.03	44.73	74.00	-29.27	peak
2	10234.000	35.89	11.01	46.90	74.00	-27.10	peak
3	11818.000	35.32	17.20	52.52	74.00	-21.48	peak
4	12698.000	34.96	17.05	52.01	74.00	-21.99	peak
5	13842.000	32.73	20.53	53.26	74.00	-20.74	peak
6	17604.000	30.39	21.15	51.54	74.00	-22.46	peak

Note: 1. Measurement = Reading Level + Correct Factor.
 2. If Peak Result complies with AV limit, AV Result is deemed to comply with AV limit.
 3. Peak: Peak detector.
 4. Filter losses were only considered in the spurious frequency bands and the authorized band was not corrected for High Pass Filter losses.
 5. Proper operation of the transmitter prior to adding the filter to the measurement chain.
 6. Since non-restricted band peak emissions are less than the average limit, they also comply with the -27dBm/MHz (68.2dBuV/m) limit.



HARMONICS AND SPURIOUS EMISSIONS (HIGH CHANNEL, VERTICAL)

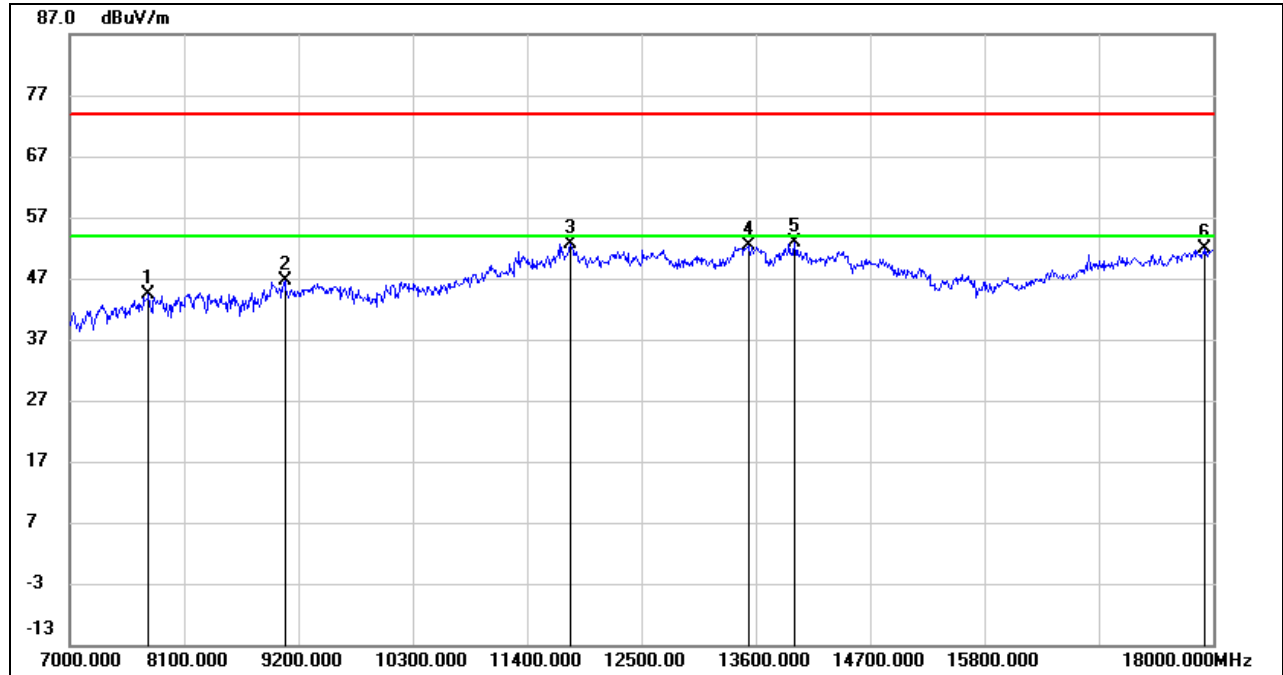

No.	Frequency (MHz)	Reading (dBuV)	Correct (dB/m)	Result (dBuV/m)	Limit (dBuV/m)	Margin (dB)	Remark
1	7759.000	38.42	5.95	44.37	74.00	-29.63	peak
2	9068.000	37.46	9.16	46.62	74.00	-27.38	peak
3	11818.000	35.41	17.20	52.61	74.00	-21.39	peak
4	13534.000	32.64	19.63	52.27	74.00	-21.73	peak
5	13974.000	32.16	20.63	52.79	74.00	-21.21	peak
6	17923.000	28.44	23.50	51.94	74.00	-22.06	peak

- Note: 1. Measurement = Reading Level + Correct Factor.
 2. If Peak Result complies with AV limit, AV Result is deemed to comply with AV limit.
 3. Peak: Peak detector.
 4. AVG: $VBW=1/Ton$, where: Ton is the transmitting duration.
 5. For the transmitting duration, please refer to clause 7.1.
 6. Filter losses were only considered in the spurious frequency bands and the authorized band was not corrected for High Pass Filter losses.
 7. Proper operation of the transmitter prior to adding the filter to the measurement chain.
 8. Since non-restricted band peak emissions are less than the average limit, they also comply with the -27dBm/MHz (68.2dBuV/m) limit.

8.3.4. 802.11ac VHT80 MIMO MODE

UNII-1 BAND

HARMONICS AND SPURIOUS EMISSIONS (LOW CHANNEL, HORIZONTAL)

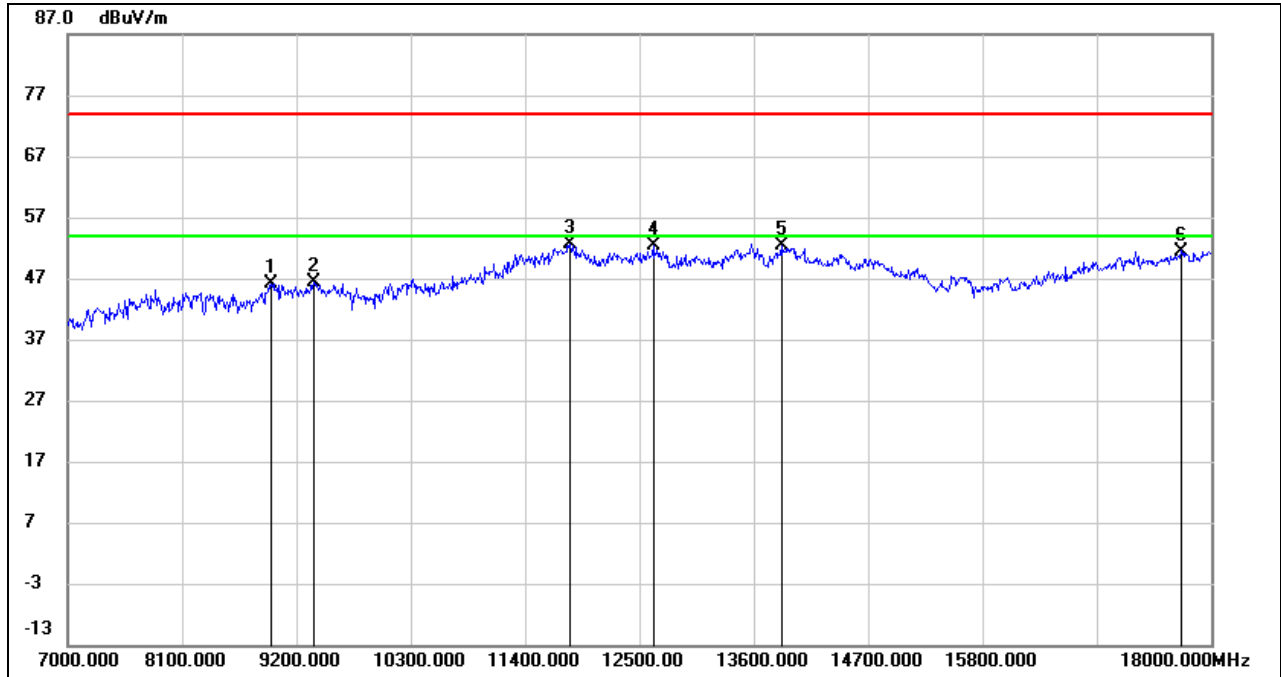

No.	Frequency (MHz)	Reading (dBuV)	Correct (dB/m)	Result (dBuV/m)	Limit (dBuV/m)	Margin (dB)	Remark
1	8958.000	37.07	9.02	46.09	74.00	-27.91	peak
2	9365.000	36.90	9.46	46.36	74.00	-27.64	peak
3	11829.000	35.54	17.20	52.74	74.00	-21.26	peak
4	12632.000	35.48	16.89	52.37	74.00	-21.63	peak
5	13864.000	31.81	20.54	52.35	74.00	-21.65	peak
6	17714.000	29.21	22.29	51.50	74.00	-22.50	peak

- Note: 1. Measurement = Reading Level + Correct Factor.
 2. If Peak Result complies with AV limit, AV Result is deemed to comply with AV limit.
 3. Peak: Peak detector.
 4. AVG: $VBW=1/Ton$, where: Ton is the transmitting duration.
 5. For the transmitting duration, please refer to clause 7.1.
 6. Filter losses were only considered in the spurious frequency bands and the authorized band was not corrected for High Pass Filter losses.
 7. Proper operation of the transmitter prior to adding the filter to the measurement chain.
 8. Since non-restricted band peak emissions are less than the average limit, they also comply with the -27dBm/MHz (68.2dBuV/m) limit.



HARMONICS AND SPURIOUS EMISSIONS (LOW CHANNEL, VERTICAL)

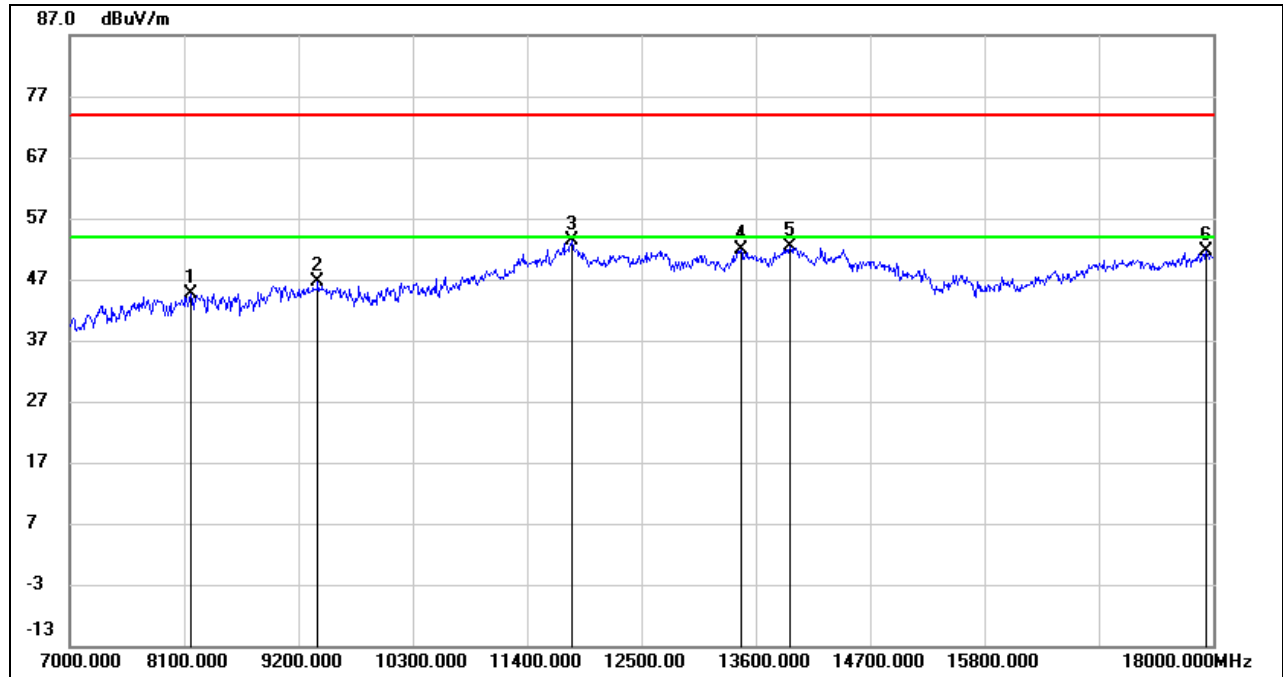

No.	Frequency (MHz)	Reading (dBuV)	Correct (dB/m)	Result (dBuV/m)	Limit (dBuV/m)	Margin (dB)	Remark
1	8166.000	37.80	6.90	44.70	74.00	-29.30	peak
2	9387.000	36.91	9.60	46.51	74.00	-27.49	peak
3	11829.000	36.06	17.20	53.26	74.00	-20.74	peak
4	13457.000	32.34	19.42	51.76	74.00	-22.24	peak
5	13930.000	31.82	20.59	52.41	74.00	-21.59	peak
6	17934.000	28.02	23.52	51.54	74.00	-22.46	peak

- Note: 1. Measurement = Reading Level + Correct Factor.
 2. If Peak Result complies with AV limit, AV Result is deemed to comply with AV limit.
 3. Peak: Peak detector.
 4. AVG: $VBW=1/Ton$, where: Ton is the transmitting duration.
 5. For the transmitting duration, please refer to clause 7.1.
 6. Filter losses were only considered in the spurious frequency bands and the authorized band was not corrected for High Pass Filter losses.
 7. Proper operation of the transmitter prior to adding the filter to the measurement chain.
 8. Since non-restricted band peak emissions are less than the average limit, they also comply with the -27dBm/MHz (68.2dBuV/m) limit.

UNII-2A BAND

HARMONICS AND SPURIOUS EMISSIONS (LOW CHANNEL, HORIZONTAL)

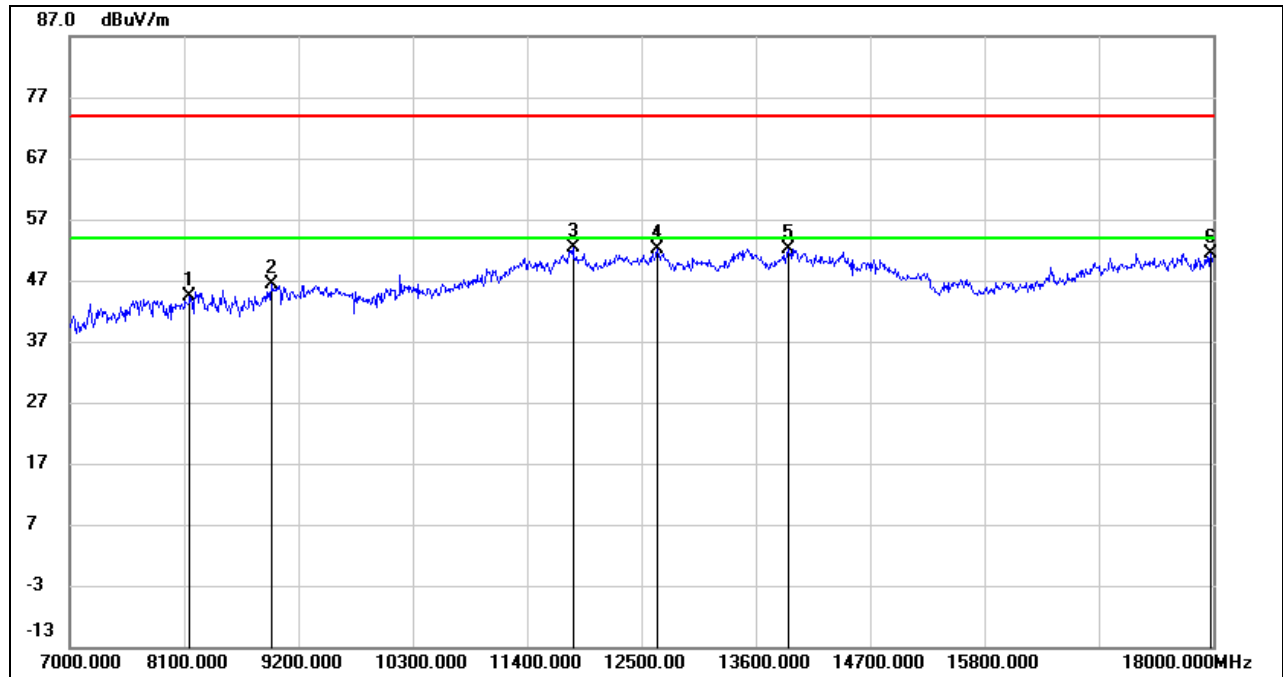

No.	Frequency (MHz)	Reading (dBuV)	Correct (dB/m)	Result (dBuV/m)	Limit (dBuV/m)	Margin (dB)	Remark
1	8155.000	37.57	6.81	44.38	74.00	-29.62	peak
2	8936.000	37.52	8.76	46.28	74.00	-27.72	peak
3	11840.000	35.19	17.20	52.39	74.00	-21.61	peak
4	12654.000	35.17	16.93	52.10	74.00	-21.90	peak
5	13908.000	31.61	20.58	52.19	74.00	-21.81	peak
6	17978.000	27.82	23.63	51.45	74.00	-22.55	peak

- Note: 1. Measurement = Reading Level + Correct Factor.
 2. If Peak Result complies with AV limit, AV Result is deemed to comply with AV limit.
 3. Peak: Peak detector.
 4. Filter losses were only considered in the spurious frequency bands and the authorized band was not corrected for High Pass Filter losses.
 5. Proper operation of the transmitter prior to adding the filter to the measurement chain.
 6. Since non-restricted band peak emissions are less than the average limit, they also comply with the -27dBm/MHz (68.2dBuV/m) limit.



HARMONICS AND SPURIOUS EMISSIONS (LOW CHANNEL, VERTICAL)

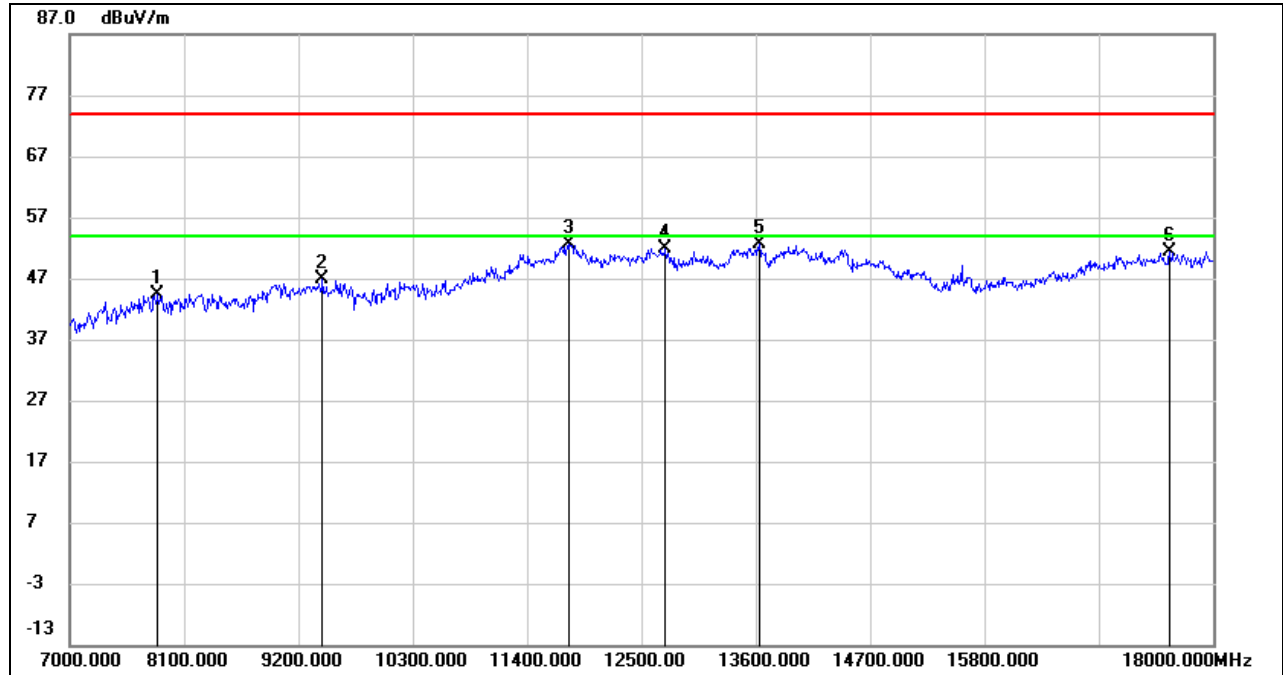

No.	Frequency (MHz)	Reading (dBuV)	Correct (dB/m)	Result (dBuV/m)	Limit (dBuV/m)	Margin (dB)	Remark
1	7847.000	38.39	5.91	44.30	74.00	-29.70	peak
2	9431.000	37.01	9.76	46.77	74.00	-27.23	peak
3	11807.000	35.48	17.22	52.70	74.00	-21.30	peak
4	12731.000	34.78	17.13	51.91	74.00	-22.09	peak
5	13633.000	32.82	19.85	52.67	74.00	-21.33	peak
6	17582.000	30.28	21.00	51.28	74.00	-22.72	peak

- Note:
1. Measurement = Reading Level + Correct Factor.
 2. If Peak Result complies with AV limit, AV Result is deemed to comply with AV limit.
 3. Peak: Peak detector.
 4. AVG: $VBW=1/Ton$, where: Ton is the transmitting duration.
 5. For the transmitting duration, please refer to clause 7.1.
 6. Filter losses were only considered in the spurious frequency bands and the authorized band was not corrected for High Pass Filter losses.
 7. Proper operation of the transmitter prior to adding the filter to the measurement chain.
 8. Since non-restricted band peak emissions are less than the average limit, they also comply with the -27dBm/MHz (68.2dBuV/m) limit.



UNII-2C BAND

HARMONICS AND SPURIOUS EMISSIONS (LOW CHANNEL, HORIZONTAL)

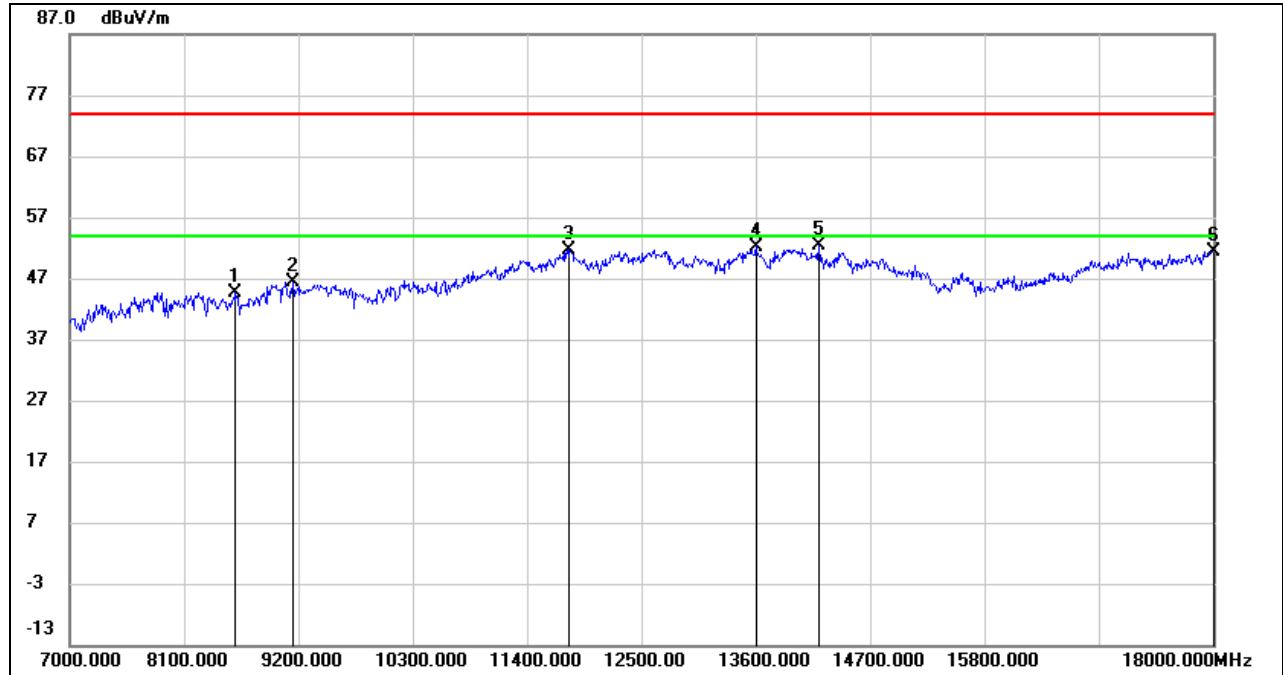

No.	Frequency (MHz)	Reading (dBuV)	Correct (dB/m)	Result (dBuV/m)	Limit (dBuV/m)	Margin (dB)	Remark
1	8595.000	37.91	6.84	44.75	74.00	-29.25	peak
2	9145.000	37.65	8.73	46.38	74.00	-27.62	peak
3	11807.000	34.47	17.22	51.69	74.00	-22.31	peak
4	13600.000	32.53	19.72	52.25	74.00	-21.75	peak
5	14205.000	32.79	19.64	52.43	74.00	-21.57	peak
6	18000.000	27.71	23.68	51.39	74.00	-22.61	peak

- Note: 1. Measurement = Reading Level + Correct Factor.
 2. If Peak Result complies with AV limit, AV Result is deemed to comply with AV limit.
 3. Peak: Peak detector.
 4. AVG: VBW=1/Ton, where: Ton is the transmitting duration.
 5. For the transmitting duration, please refer to clause 7.1.
 6. Filter losses were only considered in the spurious frequency bands and the authorized band was not corrected for High Pass Filter losses.
 7. Proper operation of the transmitter prior to adding the filter to the measurement chain.
 8. Since non-restricted band peak emissions are less than the average limit, they also comply with the -27dBm/MHz (68.2dBuV/m) limit.



HARMONICS AND SPURIOUS EMISSIONS (LOW CHANNEL, VERTICAL)

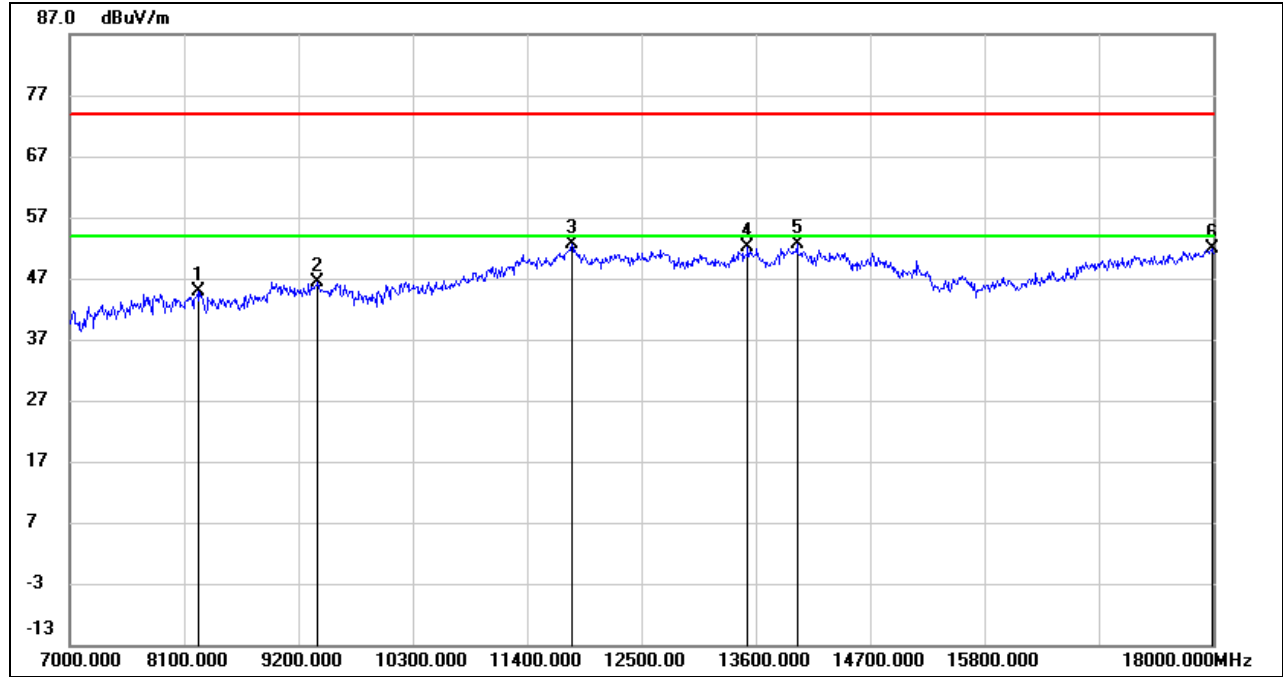

No.	Frequency (MHz)	Reading (dBuV)	Correct (dB/m)	Result (dBuV/m)	Limit (dBuV/m)	Margin (dB)	Remark
1	8232.000	37.75	7.14	44.89	74.00	-29.11	peak
2	9387.000	36.74	9.60	46.34	74.00	-27.66	peak
3	11829.000	35.31	17.20	52.51	74.00	-21.49	peak
4	13523.000	32.50	19.62	52.12	74.00	-21.88	peak
5	13996.000	32.00	20.63	52.63	74.00	-21.37	peak
6	17989.000	28.31	23.65	51.96	74.00	-22.04	peak

Note: 1. Measurement = Reading Level + Correct Factor.
 2. If Peak Result complies with AV limit, AV Result is deemed to comply with AV limit.
 3. Peak: Peak detector.
 4. AVG: $VBW=1/Ton$, where: Ton is the transmitting duration.
 5. For the transmitting duration, please refer to clause 7.1.
 6. Filter losses were only considered in the spurious frequency bands and the authorized band was not corrected for High Pass Filter losses.
 7. Proper operation of the transmitter prior to adding the filter to the measurement chain.
 8. Since non-restricted band peak emissions are less than the average limit, they also comply with the -27dBm/MHz (68.2dBuV/m) limit.

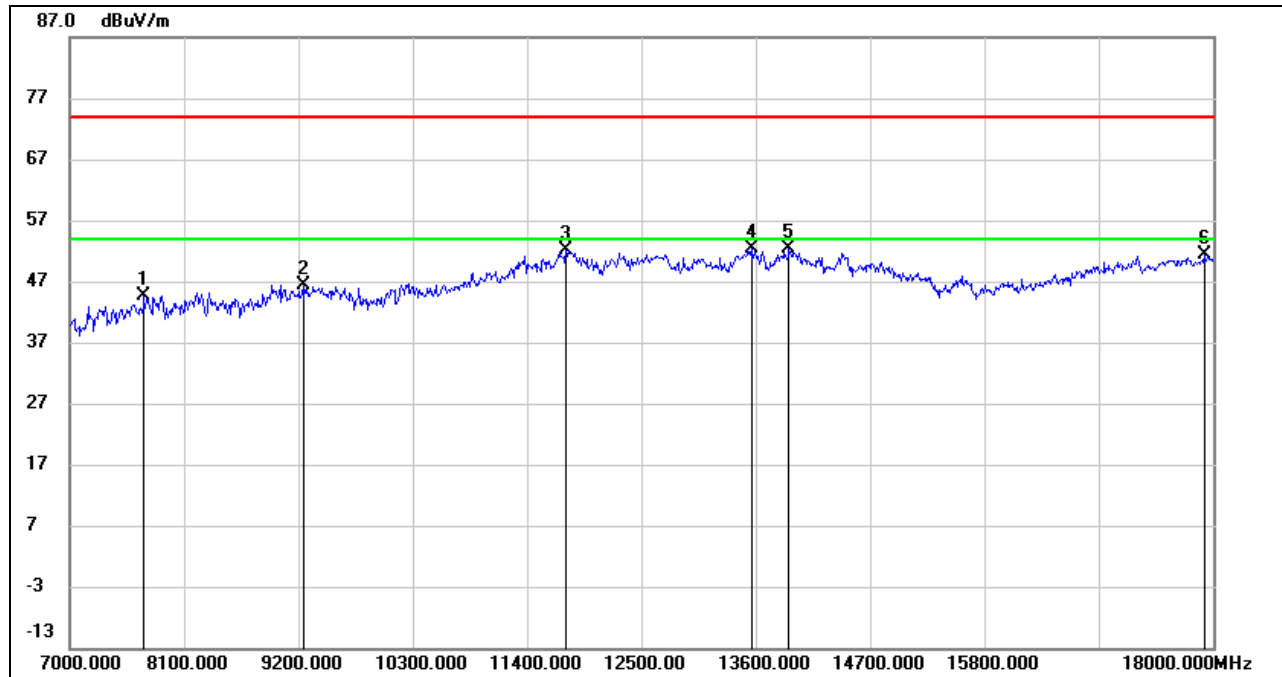
**HARMONICS AND SPURIOUS EMISSIONS (HIGH CHANNEL, HORIZONTAL)**

No.	Frequency (MHz)	Reading (dBuV)	Correct (dB/m)	Result (dBuV/m)	Limit (dBuV/m)	Margin (dB)	Remark
1	7715.000	38.74	5.81	44.55	74.00	-29.45	peak
2	9244.000	37.80	8.69	46.49	74.00	-27.51	peak
3	11774.000	34.97	17.06	52.03	74.00	-21.97	peak
4	13556.000	32.75	19.67	52.42	74.00	-21.58	peak
5	13919.000	31.69	20.58	52.27	74.00	-21.73	peak
6	17912.000	27.95	23.46	51.41	74.00	-22.59	peak

Note: 1. Measurement = Reading Level + Correct Factor.

2. If Peak Result complies with AV limit, AV Result is deemed to comply with AV limit.

3. Peak: Peak detector.

4. AVG: $VBW=1/Ton$, where: Ton is the transmitting duration.

5. For the transmitting duration, please refer to clause 7.1.

6. Filter losses were only considered in the spurious frequency bands and the authorized band was not corrected for High Pass Filter losses.

7. Proper operation of the transmitter prior to adding the filter to the measurement chain.

8. Since non-restricted band peak emissions are less than the average limit, they also comply with the -27dBm/MHz (68.2dBuV/m) limit.

HARMONICS AND SPURIOUS EMISSIONS (HIGH CHANNEL, VERTICAL)

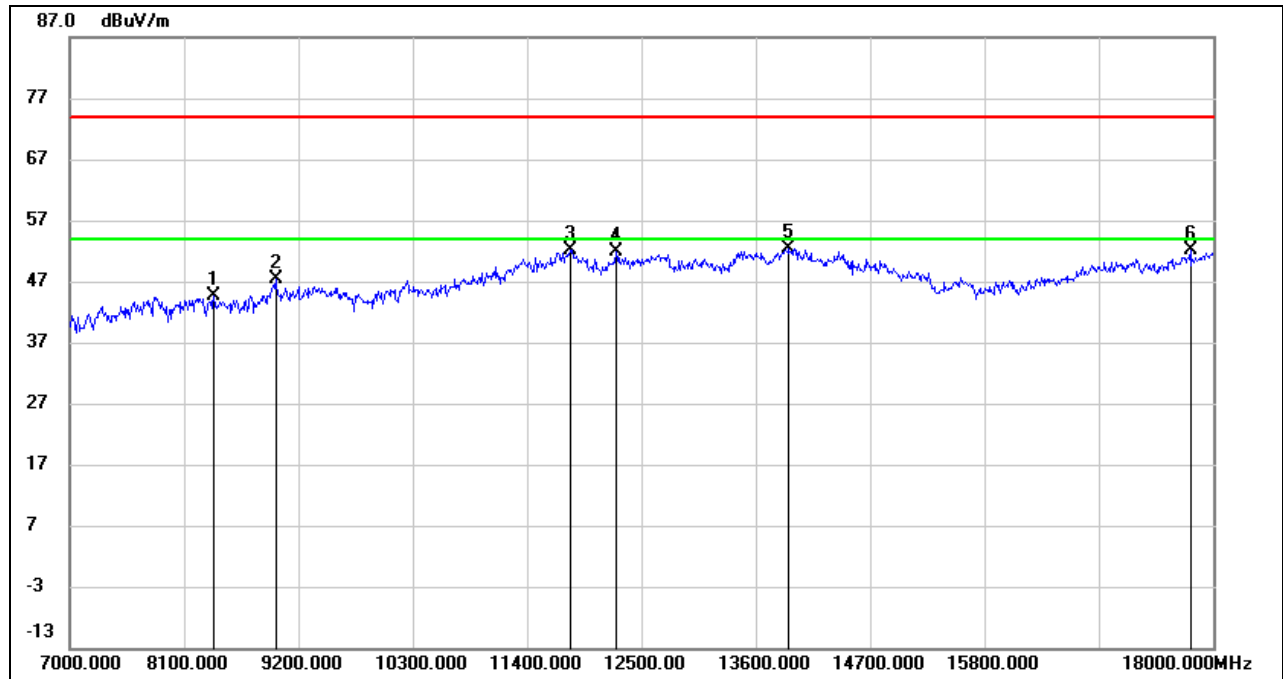

No.	Frequency (MHz)	Reading (dBuV)	Correct (dB/m)	Result (dBuV/m)	Limit (dBuV/m)	Margin (dB)	Remark
1	8386.000	38.04	6.68	44.72	74.00	-29.28	peak
2	8980.000	37.97	9.29	47.26	74.00	-26.74	peak
3	11818.000	34.88	17.20	52.08	74.00	-21.92	peak
4	12258.000	34.92	16.84	51.76	74.00	-22.24	peak
5	13919.000	31.83	20.58	52.41	74.00	-21.59	peak
6	17780.000	29.15	22.98	52.13	74.00	-21.87	peak

- Note:
1. Measurement = Reading Level + Correct Factor.
 2. If Peak Result complies with AV limit, AV Result is deemed to comply with AV limit.
 3. Peak: Peak detector.
 4. AVG: $VBW=1/Ton$, where: Ton is the transmitting duration.
 5. For the transmitting duration, please refer to clause 7.1.
 6. Filter losses were only considered in the spurious frequency bands and the authorized band was not corrected for High Pass Filter losses.
 7. Proper operation of the transmitter prior to adding the filter to the measurement chain.
 8. Since non-restricted band peak emissions are less than the average limit, they also comply with the -27dBm/MHz (68.2dBuV/m) limit.

STRADDLE CHANNEL 138

HARMONICS AND SPURIOUS EMISSIONS (HIGH CHANNEL, HORIZONTAL)

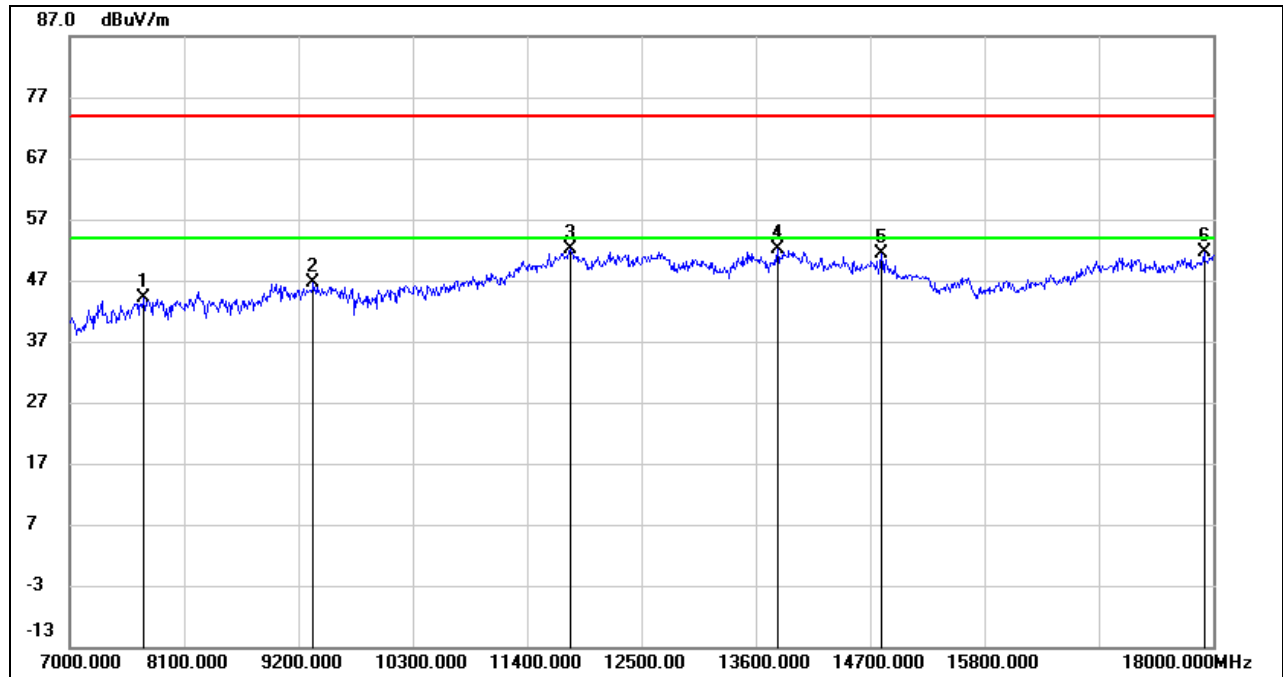

No.	Frequency (MHz)	Reading (dBuV)	Correct (dB/m)	Result (dBuV/m)	Limit (dBuV/m)	Margin (dB)	Remark
1	7715.000	38.34	5.81	44.15	74.00	-29.85	peak
2	9343.000	37.24	9.32	46.56	74.00	-27.44	peak
3	11818.000	34.82	17.20	52.02	74.00	-21.98	peak
4	13809.000	31.61	20.51	52.12	74.00	-21.88	peak
5	14810.000	34.15	17.23	51.38	74.00	-22.62	peak
6	17912.000	28.12	23.46	51.58	74.00	-22.42	peak

- Note: 1. Measurement = Reading Level + Correct Factor.
 2. If Peak Result complies with AV limit, AV Result is deemed to comply with AV limit.
 3. Peak: Peak detector.
 4. AVG: $VBW=1/Ton$, where: Ton is the transmitting duration.
 5. For the transmitting duration, please refer to clause 7.1.
 6. Filter losses were only considered in the spurious frequency bands and the authorized band was not corrected for High Pass Filter losses.
 7. Proper operation of the transmitter prior to adding the filter to the measurement chain.
 8. Since non-restricted band peak emissions are less than the average limit, they also comply with the -27dBm/MHz (68.2dBuV/m) limit.

HARMONICS AND SPURIOUS EMISSIONS (HIGH CHANNEL, VERTICAL)

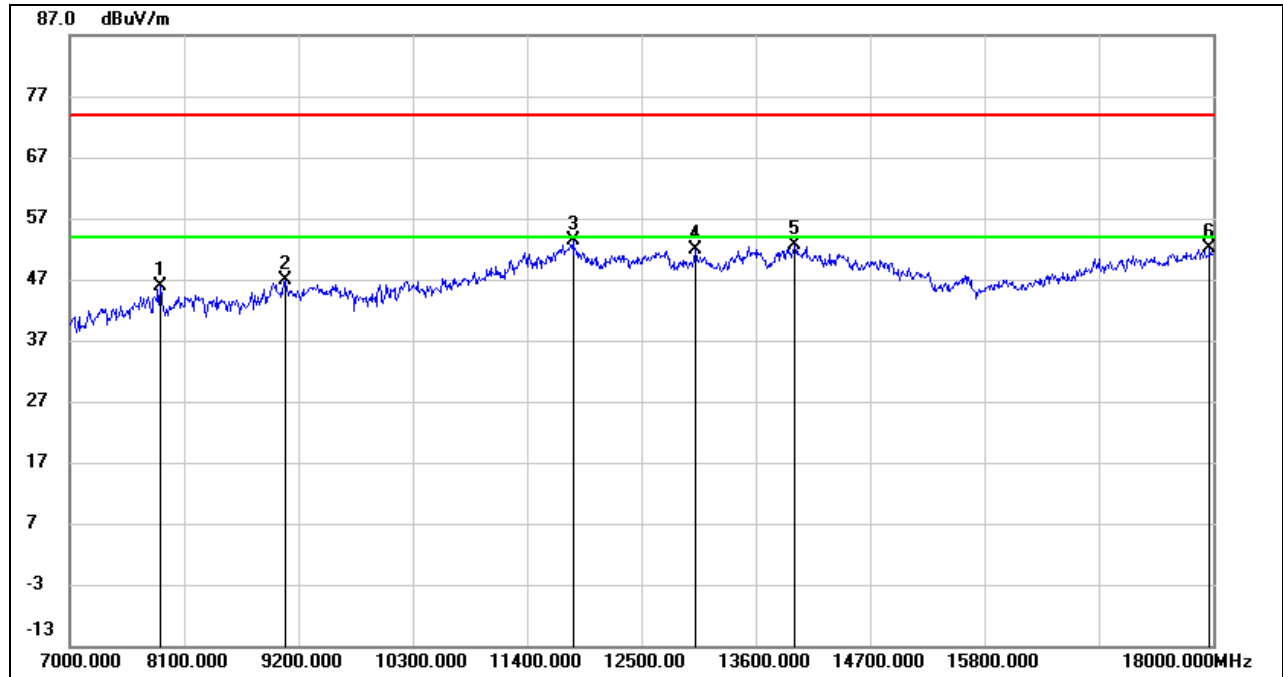

No.	Frequency (MHz)	Reading (dBuV)	Correct (dB/m)	Result (dBuV/m)	Limit (dBuV/m)	Margin (dB)	Remark
1	7869.000	40.12	5.82	45.94	74.00	-28.06	peak
2	9068.000	37.60	9.16	46.76	74.00	-27.24	peak
3	11840.000	36.18	17.20	53.38	74.00	-20.62	peak
4	13017.000	34.75	17.22	51.97	74.00	-22.03	peak
5	13974.000	31.88	20.63	52.51	74.00	-21.49	peak
6	17967.000	28.44	23.59	52.03	74.00	-21.97	peak

- Note:
1. Measurement = Reading Level + Correct Factor.
 2. If Peak Result complies with AV limit, AV Result is deemed to comply with AV limit.
 3. Peak: Peak detector.
 4. AVG: $VBW=1/Ton$, where: Ton is the transmitting duration.
 5. For the transmitting duration, please refer to clause 7.1.
 6. Filter losses were only considered in the spurious frequency bands and the authorized band was not corrected for High Pass Filter losses.
 7. Proper operation of the transmitter prior to adding the filter to the measurement chain.
 8. Since non-restricted band peak emissions are less than the average limit, they also comply with the -27dBm/MHz (68.2dBuV/m) limit.

UNII-3 BAND

HARMONICS AND SPURIOUS EMISSIONS (LOW CHANNEL, HORIZONTAL)

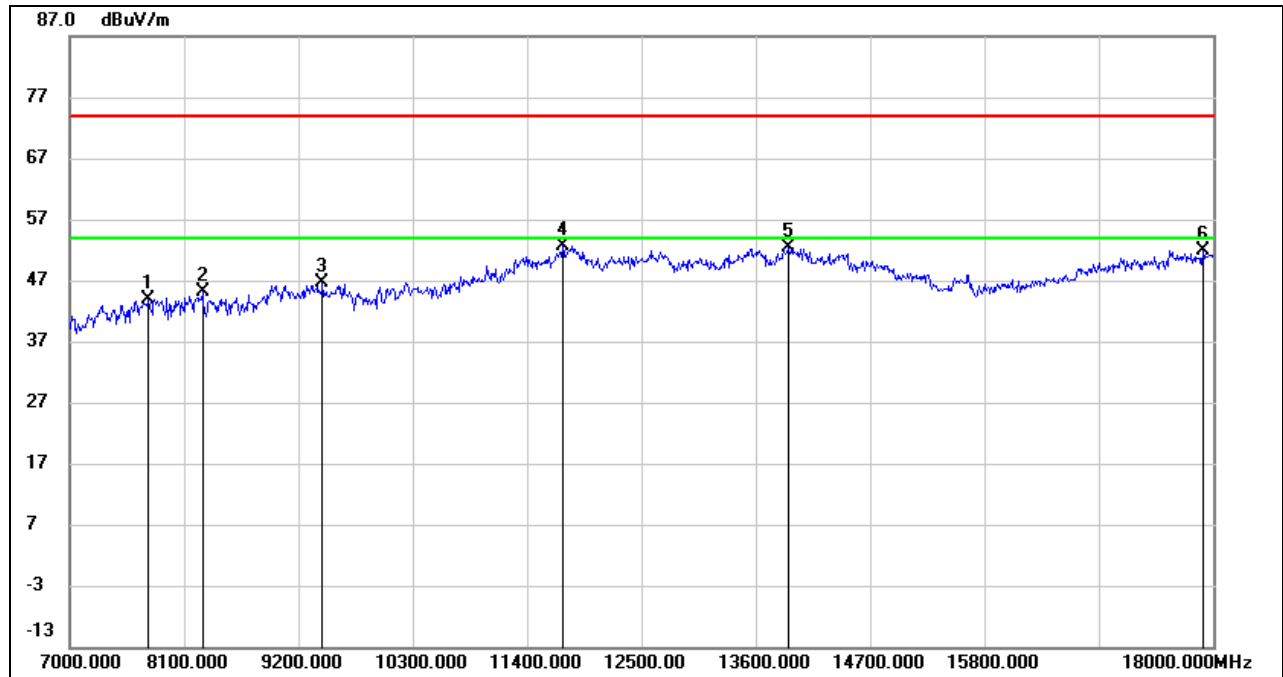

No.	Frequency (MHz)	Reading (dBuV)	Correct (dB/m)	Result (dBuV/m)	Limit (dBuV/m)	Margin (dB)	Remark
1	7759.000	37.94	5.95	43.89	74.00	-30.11	peak
2	8276.000	38.11	7.00	45.11	74.00	-28.89	peak
3	9431.000	36.92	9.76	46.68	74.00	-27.32	peak
4	11741.000	35.69	16.84	52.53	74.00	-21.47	peak
5	13919.000	31.75	20.58	52.33	74.00	-21.67	peak
6	17901.000	28.55	23.44	51.99	74.00	-22.01	peak

Note: 1. Measurement = Reading Level + Correct Factor.
 2. If Peak Result complies with AV limit, AV Result is deemed to comply with AV limit.
 3. Peak: Peak detector.
 4. Filter losses were only considered in the spurious frequency bands and the authorized band was not corrected for High Pass Filter losses.
 5. Proper operation of the transmitter prior to adding the filter to the measurement chain.
 6. Since non-restricted band peak emissions are less than the average limit, they also comply with the -27dBm/MHz (68.2dBuV/m) limit.

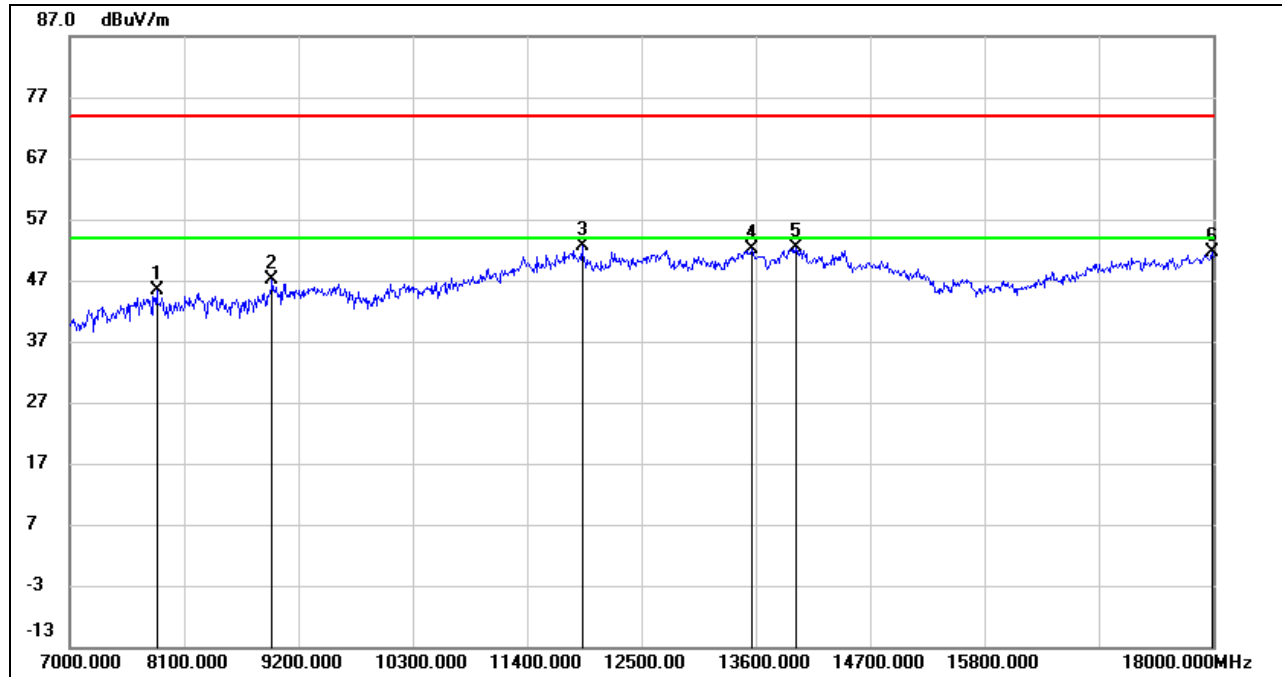
**HARMONICS AND SPURIOUS EMISSIONS (LOW CHANNEL, VERTICAL)**

No.	Frequency (MHz)	Reading (dBuV)	Correct (dB/m)	Result (dBuV/m)	Limit (dBuV/m)	Margin (dB)	Remark
1	7836.000	39.38	5.95	45.33	74.00	-28.67	peak
2	8947.000	38.27	8.89	47.16	74.00	-26.84	peak
3	11928.000	35.61	17.14	52.75	74.00	-21.25	peak
4	13567.000	32.51	19.67	52.18	74.00	-21.82	peak
5	13985.000	31.65	20.63	52.28	74.00	-21.72	peak
6	17989.000	28.01	23.65	51.66	74.00	-22.34	peak

- Note:
1. Measurement = Reading Level + Correct Factor.
 2. If Peak Result complies with AV limit, AV Result is deemed to comply with AV limit.
 3. Peak: Peak detector.
 4. AVG: $VBW=1/Ton$, where: Ton is the transmitting duration.
 5. For the transmitting duration, please refer to clause 7.1.
 6. Filter losses were only considered in the spurious frequency bands and the authorized band was not corrected for High Pass Filter losses.
 7. Proper operation of the transmitter prior to adding the filter to the measurement chain.
 8. Since non-restricted band peak emissions are less than the average limit, they also comply with the -27dBm/MHz (68.2dBuV/m) limit.

8.4. SPURIOUS EMISSIONS (18 GHz ~ 26 GHz)

8.4.1. 802.11n HT20 MODE

SPURIOUS EMISSIONS (UNII-2C BAND HIGH CHANNEL, HORIZONTAL, WORST-CASE CONFIGURATION)

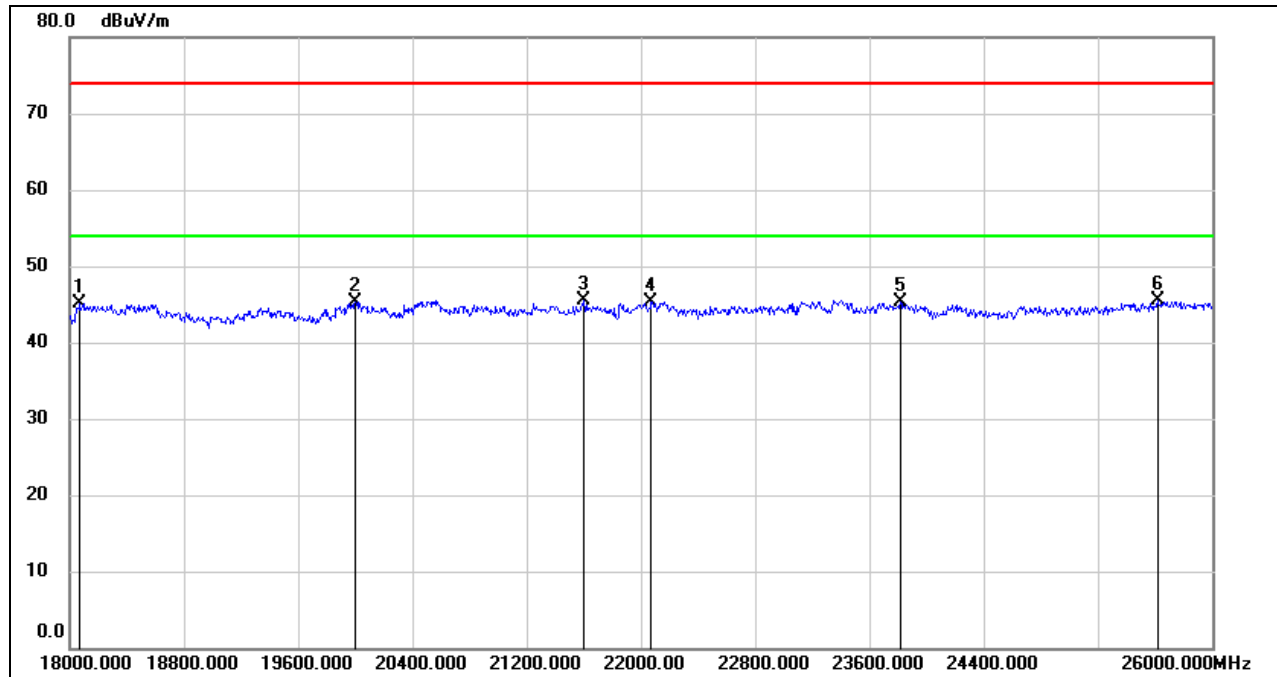

No.	Frequency (MHz)	Reading (dBuV)	Correct (dB/m)	Result (dBuV/m)	Limit (dBuV/m)	Margin (dB)	Remark
1	18072.000	50.45	-5.43	45.02	74.00	-28.98	peak
2	20000.000	50.81	-5.45	45.36	74.00	-28.64	peak
3	21600.000	50.02	-4.54	45.48	74.00	-28.52	peak
4	22072.000	49.77	-4.41	45.36	74.00	-28.64	peak
5	23816.000	48.39	-3.08	45.31	74.00	-28.69	peak
6	25616.000	46.68	-1.24	45.44	74.00	-28.56	peak

- Note: 1. Measurement = Reading Level + Correct Factor.
 2. If Peak Result complies with AV limit, AV Result is deemed to comply with AV limit.
 3. Peak: Peak detector.

SPURIOUS EMISSIONS (UNII-2C BAND HIGH CHANNEL, VERTICAL, WORST-CASE CONFIGURATION)

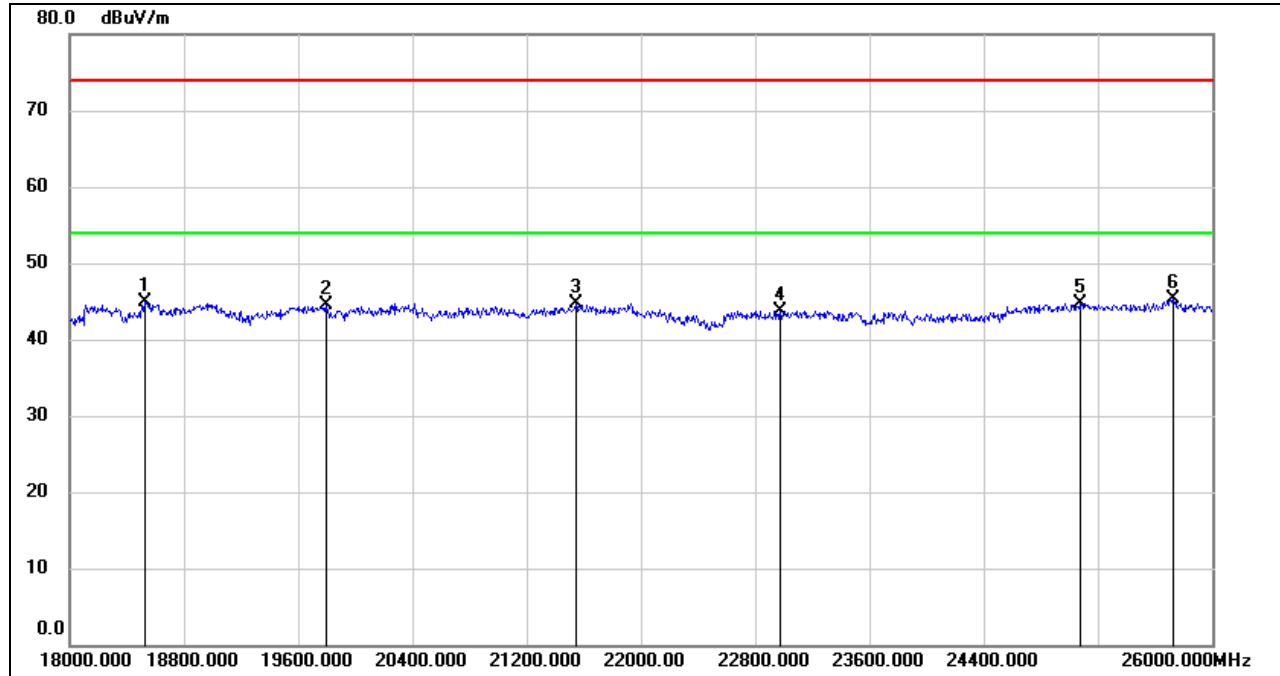

No.	Frequency (MHz)	Reading (dBuV)	Correct (dB/m)	Result (dBuV/m)	Limit (dBuV/m)	Margin (dB)	Remark
1	18528.000	50.11	-5.26	44.85	74.00	-29.15	peak
2	19792.000	49.70	-5.29	44.41	74.00	-29.59	peak
3	21544.000	49.26	-4.63	44.63	74.00	-29.37	peak
4	22976.000	47.26	-3.46	43.80	74.00	-30.20	peak
5	25080.000	46.60	-1.96	44.64	74.00	-29.36	peak
6	25728.000	46.11	-0.72	45.39	74.00	-28.61	peak

Note: 1. Measurement = Reading Level + Correct Factor.
 2. If Peak Result complies with AV limit, AV Result is deemed to comply with AV limit.
 3. Peak: Peak detector.

Note: All the modes and antennas had been tested, but only the worst data was recorded in the report.

8.5. SPURIOUS EMISSIONS (26 GHz ~ 40 GHz)

8.5.1. 802.11n HT20 MODE

SPURIOUS EMISSIONS (UNII-2C BAND HIGH CHANNEL, HORIZONTAL, WORST-CASE CONFIGURATION)

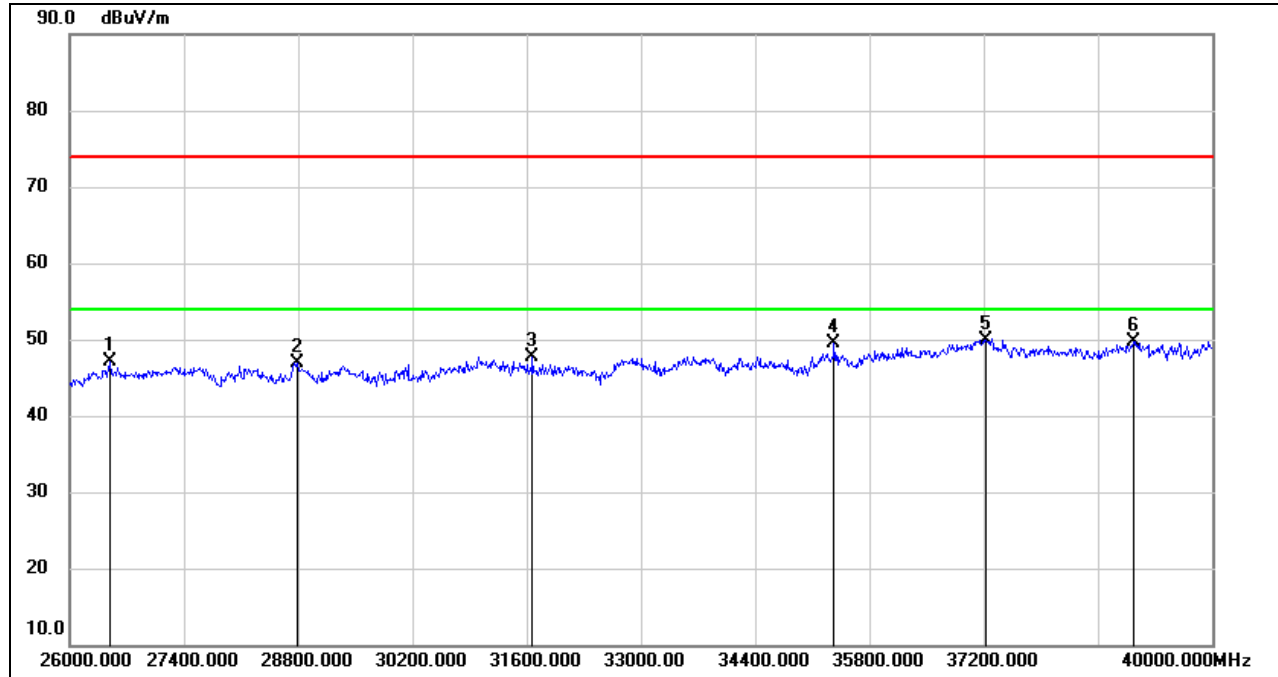

No.	Frequency (MHz)	Reading (dBuV)	Correct (dB/m)	Result (dBuV/m)	Limit (dBuV/m)	Margin (dB)	Remark
1	26490.000	51.79	-4.74	47.05	74.00	-26.95	peak
2	28786.000	47.49	-0.64	46.85	74.00	-27.15	peak
3	31670.000	48.86	-1.21	47.65	74.00	-26.35	peak
4	35366.000	46.90	2.59	49.49	74.00	-24.51	peak
5	37228.000	46.73	3.14	49.87	74.00	-24.13	peak
6	39034.000	45.31	4.33	49.64	74.00	-24.36	peak

- Note: 1. Measurement = Reading Level + Correct Factor.
 2. If Peak Result complies with AV limit, AV Result is deemed to comply with AV limit.
 3. Peak: Peak detector.



SPURIOUS EMISSIONS (UNII-2C BAND HIGH CHANNEL, VERTICAL, WORST-CASE CONFIGURATION)

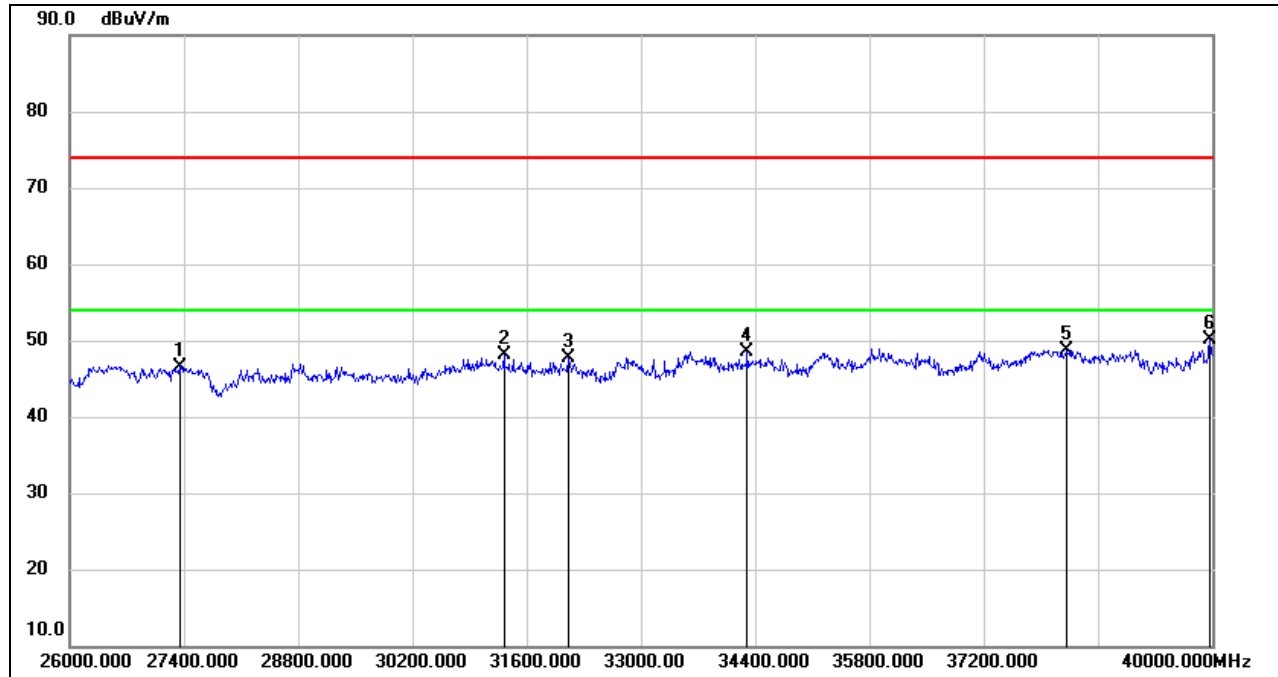

No.	Frequency (MHz)	Reading (dBuV)	Correct (dB/m)	Result (dBuV/m)	Limit (dBuV/m)	Margin (dB)	Remark
1	27344.000	50.60	-4.00	46.60	74.00	-27.40	peak
2	31320.000	49.11	-0.93	48.18	74.00	-25.82	peak
3	32104.000	49.49	-1.75	47.74	74.00	-26.26	peak
4	34302.000	47.45	1.10	48.55	74.00	-25.45	peak
5	38208.000	44.93	3.76	48.69	74.00	-25.31	peak
6	39972.000	44.95	5.13	50.08	74.00	-23.92	peak

- Note: 1. Measurement = Reading Level + Correct Factor.
 2. If Peak Result complies with AV limit, AV Result is deemed to comply with AV limit.
 3. Peak: Peak detector.

Note: All the modes and antennas had been tested, but only the worst data was recorded in the report.

8.6. SPURIOUS EMISSIONS (30 MHz ~ 1 GHz)

8.6.1. 802.11n HT20 MODE

SPURIOUS EMISSIONS (UNII-2C BAND HIGH CHANNEL, HORIZONTAL, WORST-CASE CONFIGURATION)

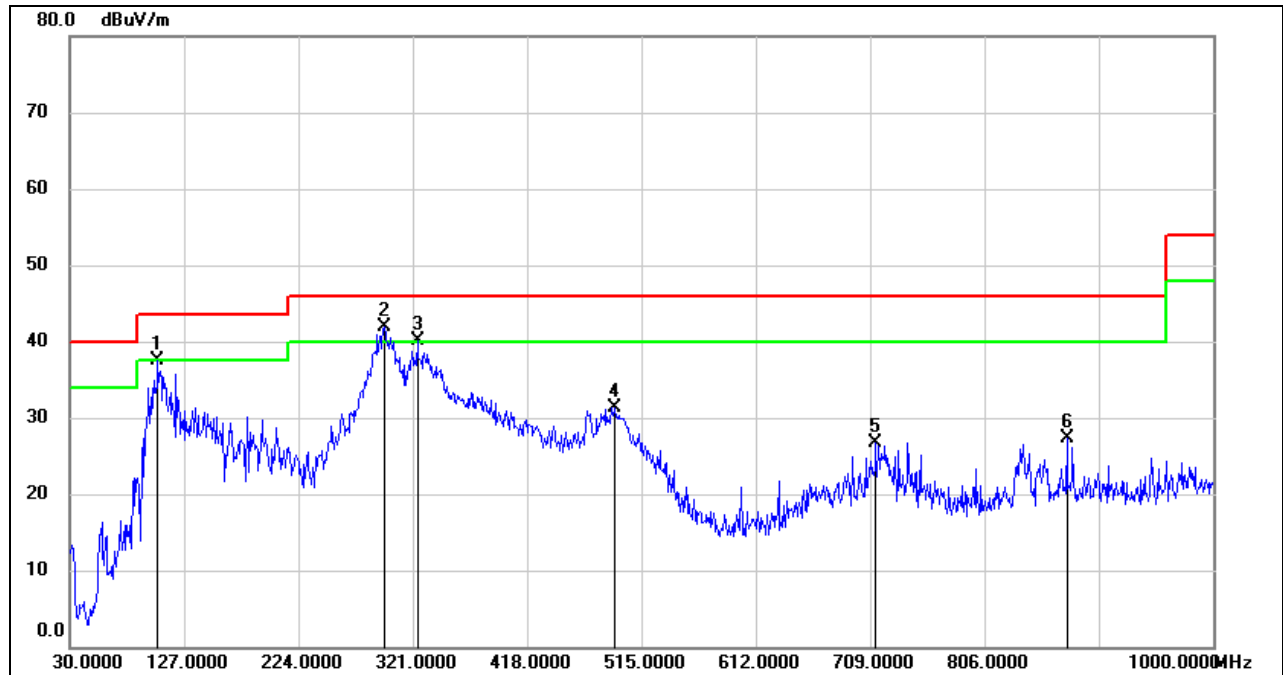

No.	Frequency (MHz)	Reading (dBuV)	Correct (dB/m)	Result (dBuV/m)	Limit (dBuV/m)	Margin (dB)	Remark
1	104.6900	58.23	-20.76	37.47	43.50	-6.03	QP
2	296.7500	57.49	-15.50	41.99	46.00	-4.01	QP
3	324.8800	54.78	-14.73	40.05	46.00	-5.95	QP
4	491.7200	43.03	-11.66	31.37	46.00	-14.63	QP
5	713.8500	34.87	-8.19	26.68	46.00	-19.32	QP
6	875.8400	32.94	-5.62	27.32	46.00	-18.68	QP

Note: 1. Result Level = Read Level + Correct Factor.
 2. If Peak Result complies with QP limit, QP Result is deemed to comply with QP limit.
 3. Test setup: RBW: 120 kHz, VBW: 300 kHz, Sweep time: auto.



SPURIOUS EMISSIONS (UNII-2C BAND HIGH CHANNEL, VERTICAL, WORST-CASE CONFIGURATION)

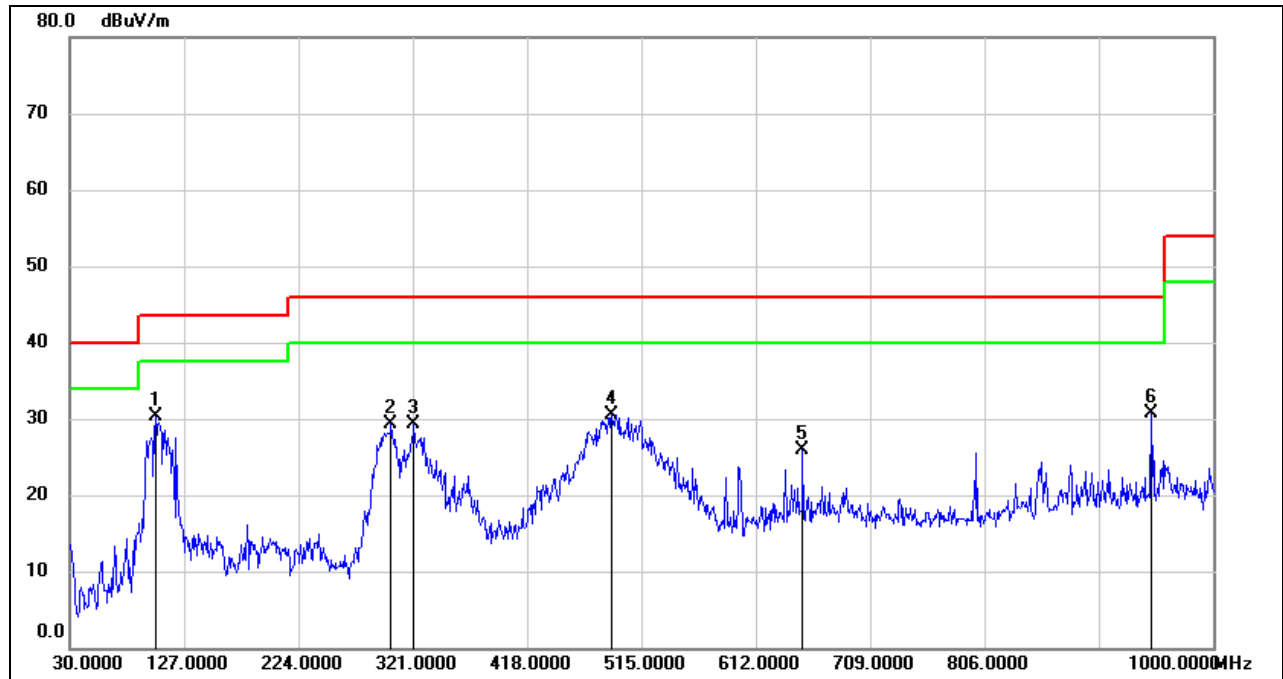

No.	Frequency (MHz)	Reading (dBuV)	Correct (dB/m)	Result (dBuV/m)	Limit (dBuV/m)	Margin (dB)	Remark
1	102.7500	51.18	-20.91	30.27	43.50	-13.23	QP
2	302.5700	44.61	-15.25	29.36	46.00	-16.64	QP
3	321.9700	44.00	-14.75	29.25	46.00	-16.75	QP
4	489.7800	42.22	-11.70	30.52	46.00	-15.48	QP
5	651.7700	34.85	-8.99	25.86	46.00	-20.14	QP
6	947.6200	35.09	-4.43	30.66	46.00	-15.34	QP

- Note: 1. Result Level = Read Level + Correct Factor.
 2. If Peak Result complies with QP limit, QP Result is deemed to comply with QP limit.
 3. Test setup: RBW: 120 kHz, VBW: 300 kHz, Sweep time: auto

Note: All the modes and antennas had been tested, but only the worst data was recorded in the report.

8.7. SPURIOUS EMISSIONS BELOW 30 MHz

8.7.1. 802.11n HT20 MODE

SPURIOUS EMISSIONS (UNII-2C BAND HIGH CHANNEL, LOOP ANTENNA FACE ON TO THE EUT, WORST-CASE CONFIGURATION)

9 kHz~ 150 kHz

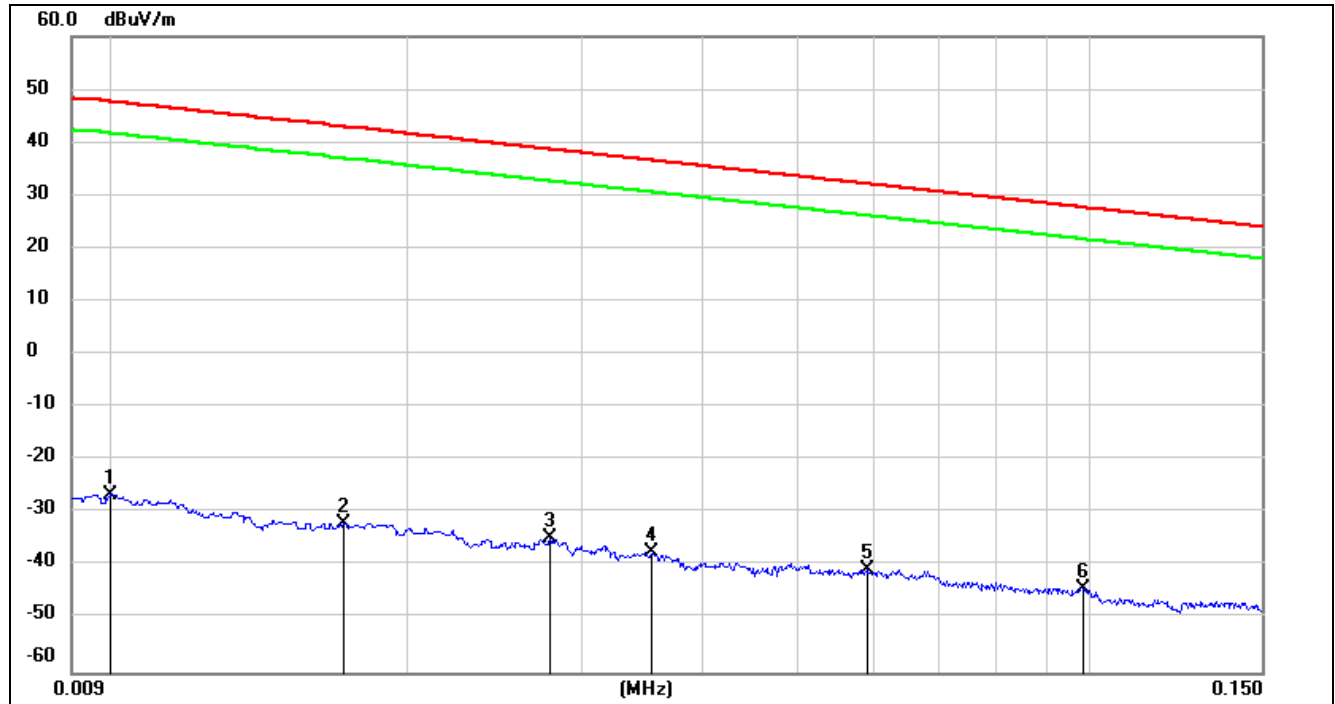

No.	Frequency (MHz)	Reading (dBuV)	Correct (dB/m)	FCC Result (dBuV/m)	FCC Limit (dBuV/m)	ISED Result (dBuA/m)	ISED Limit (dBuA/m)	Margin (dB)	Remark
1	0.0100	74.72	-101.40	-26.68	47.6	-78.18	-3.90	-74.28	peak
2	0.0171	69.38	-101.36	-31.98	42.94	-83.48	-8.56	-74.92	peak
3	0.0279	66.67	-101.38	-34.71	38.69	-86.21	-12.81	-73.40	peak
4	0.0354	63.97	-101.41	-37.44	36.62	-88.94	-14.88	-74.06	peak
5	0.0589	60.81	-101.52	-40.71	32.2	-92.21	-19.30	-72.91	peak
6	0.0985	57.55	-101.78	-44.23	27.73	-95.73	-23.77	-71.96	peak

Note: 1. Measurement = Reading Level + Correct Factor.

2. If Peak Result complies with AV and QP limit, AV and QP Result are deemed to comply with AV limit.

3. All 3 polarizations (Horizontal, Face-on and Face-off) of the loop antenna had been tested, but only the worst data recorded in the report.

4. $\text{dBuA/m} = \text{dBuV/m} - 20\log_{10}(120\pi) = \text{dBuV/m} - 51.5$.

150 kHz ~ 490 kHz

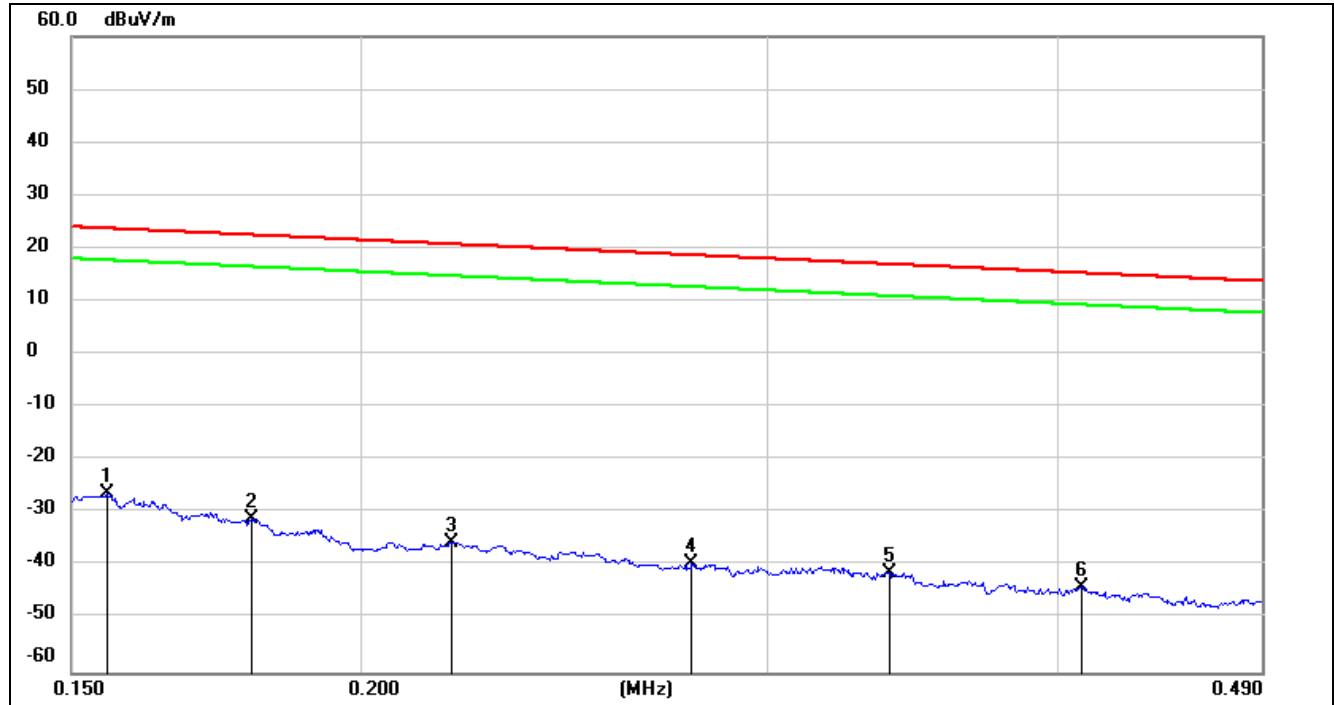

No.	Frequency (MHz)	Reading (dBuV)	Correct (dB/m)	FCC Result (dBuV/m)	FCC Limit (dBuV/m)	ISED Result (dBuA/m)	ISED Limit (dBuA/m)	Margin (dB)	Remark
1	0.1554	75.27	-101.65	-26.38	23.77	-77.88	-27.73	-50.15	peak
2	0.1794	70.77	-101.68	-30.91	22.53	-82.41	-28.97	-53.44	peak
3	0.2190	66.27	-101.75	-35.48	20.79	-86.98	-30.71	-56.27	peak
4	0.2782	62.29	-101.83	-39.54	18.71	-91.04	-32.79	-58.25	peak
5	0.3382	60.73	-101.90	-41.17	17.02	-92.67	-34.48	-58.19	peak
6	0.4097	58.02	-101.97	-43.95	15.35	-95.45	-36.15	-59.30	peak

- Note: 1. Measurement = Reading Level + Correct Factor.
 2. If Peak Result complies with AV and QP limit, AV and QP Result are deemed to comply with AV limit.
 3. All 3 polarizations (Horizontal, Face-on and Face-off) of the loop antenna had been tested, but only the worst data recorded in the report.
 4. $\text{dBuA/m} = \text{dBuV/m} - 20\log_{10}(120\pi) = \text{dBuV/m} - 51.5$.

490 kHz ~ 30 MHz

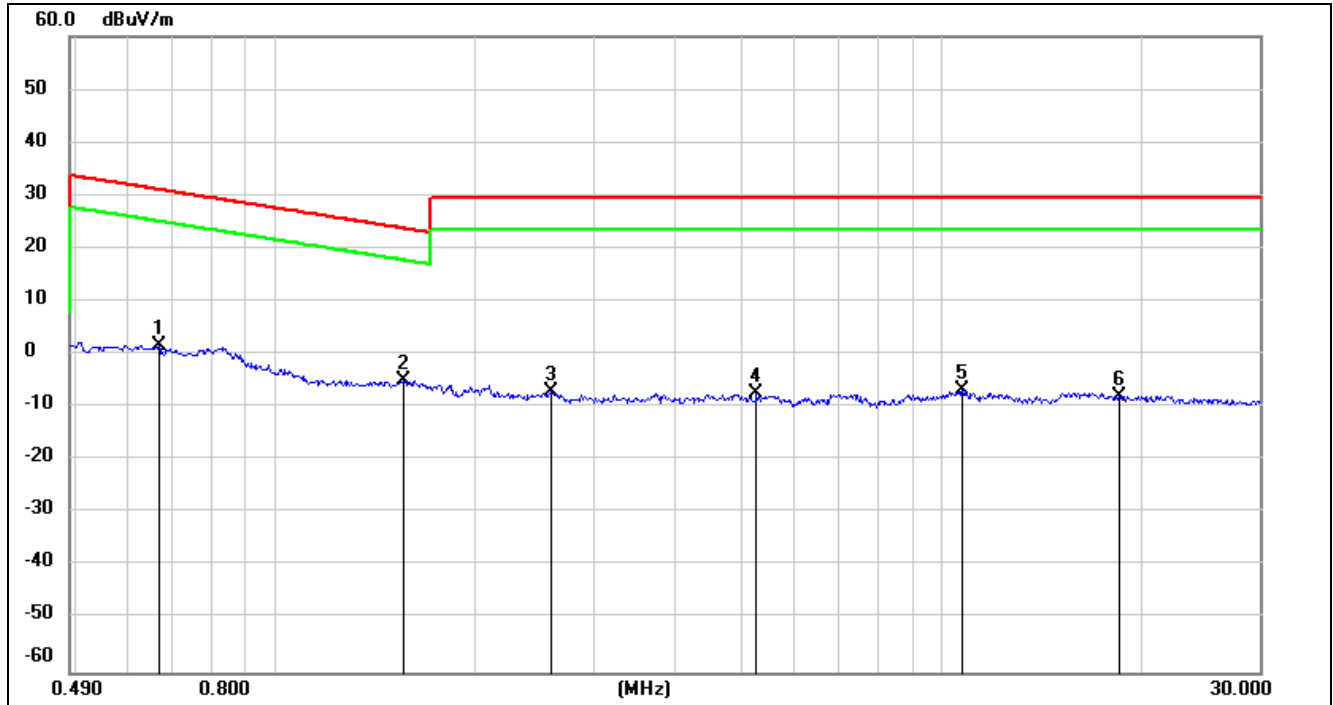

No.	Frequency (MHz)	Reading (dBuV)	Correct (dB/m)	FCC Result (dBuV/m)	FCC Limit (dBuV/m)	ISED Result (dBuA/m)	ISED Limit (dBuA/m)	Margin (dB)	Remark
1	0.6671	63.75	-62.10	1.65	31.12	-49.85	-20.38	-29.47	peak
2	1.5564	57.18	-62.02	-4.84	23.76	-56.34	-27.74	-28.60	peak
3	2.5935	54.61	-61.68	-7.07	29.54	-58.57	-21.96	-36.61	peak
4	5.2705	54.04	-61.45	-7.41	29.54	-58.91	-21.96	-36.95	peak
5	10.7299	53.98	-60.83	-6.85	29.54	-58.35	-21.96	-36.39	peak
6	18.4908	53.06	-60.89	-7.83	29.54	-59.33	-21.96	-37.37	peak

Note: 1. Measurement = Reading Level + Correct Factor.

2. If Peak Result complies with AV and QP limit, AV and QP Result are deemed to comply with AV limit.

3. All 3 polarizations (Horizontal, Face-on and Face-off) of the loop antenna had been tested, but only the worst data recorded in the report.

4. $\text{dBuA/m} = \text{dBuV/m} - 20\log_{10}(120\pi) = \text{dBuV/m} - 51.5$.

Note: All the modes and antennas had been tested, but only the worst data was recorded in the report.

9. AC POWER LINE CONDUCTED EMISSIONS

LIMITS

Please refer to CFR 47 FCC §15.207 (a) and ISED RSS-Gen Clause 8.8

FREQUENCY (MHz)	Quasi-peak	Average
0.15 -0.5	66 - 56 *	56 - 46 *
0.50 -5.0	56.00	46.00
5.0 -30.0	60.00	50.00

TEST SETUP AND PROCEDURE

Refer to ANSI C63.10-2013 clause 6.2.

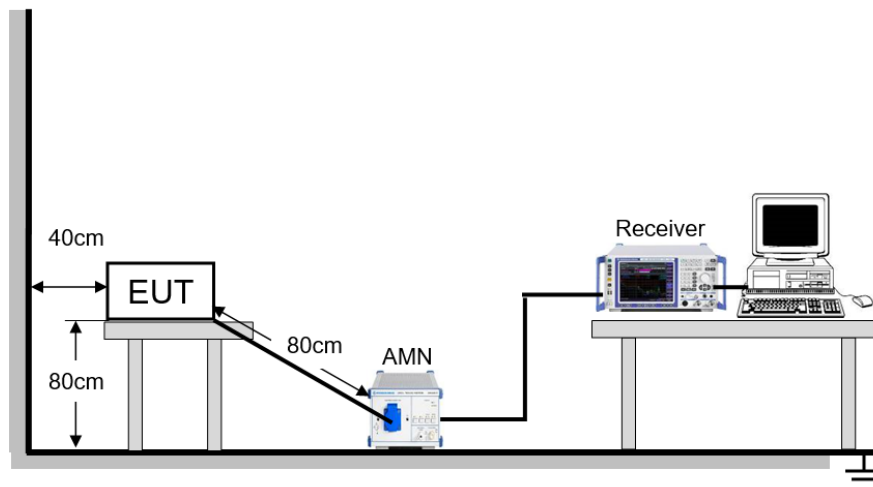

The EUT is put on a table of non-conducting material that is 80 cm high. The vertical conducting wall of shielding is located 40 cm to the rear of the EUT. The power line of the EUT is connected to the AC mains through a Artificial Mains Network (A.M.N.). A EMI Measurement Receiver (R&S Test Receiver ESR3) is used to test the emissions from both sides of AC line. According to the requirements in Section 6.2 of ANSI C63.10-2013. Conducted emissions from the EUT measured in the frequency range between 0.15 MHz and 30 MHz using CISPR Quasi-Peak and average detector mode. The bandwidth of EMI test receiver is set at 9 kHz.

The arrangement of the equipment is installed to meet the standards and operating in a manner, which tends to maximize its emission characteristics in a normal application.

TEST ENVIRONMENT

Temperature	23.5 °C	Relative Humidity	61.2 %
Atmosphere Pressure	101 kPa	Test Voltage	AC 120 V, 60 Hz

RESULTS

9.1.1. 802.11n HT20 MODE

LINE L RESULTS (UNII-2C BAND HIGH CHANNEL, WORST-CASE CONFIGURATION)

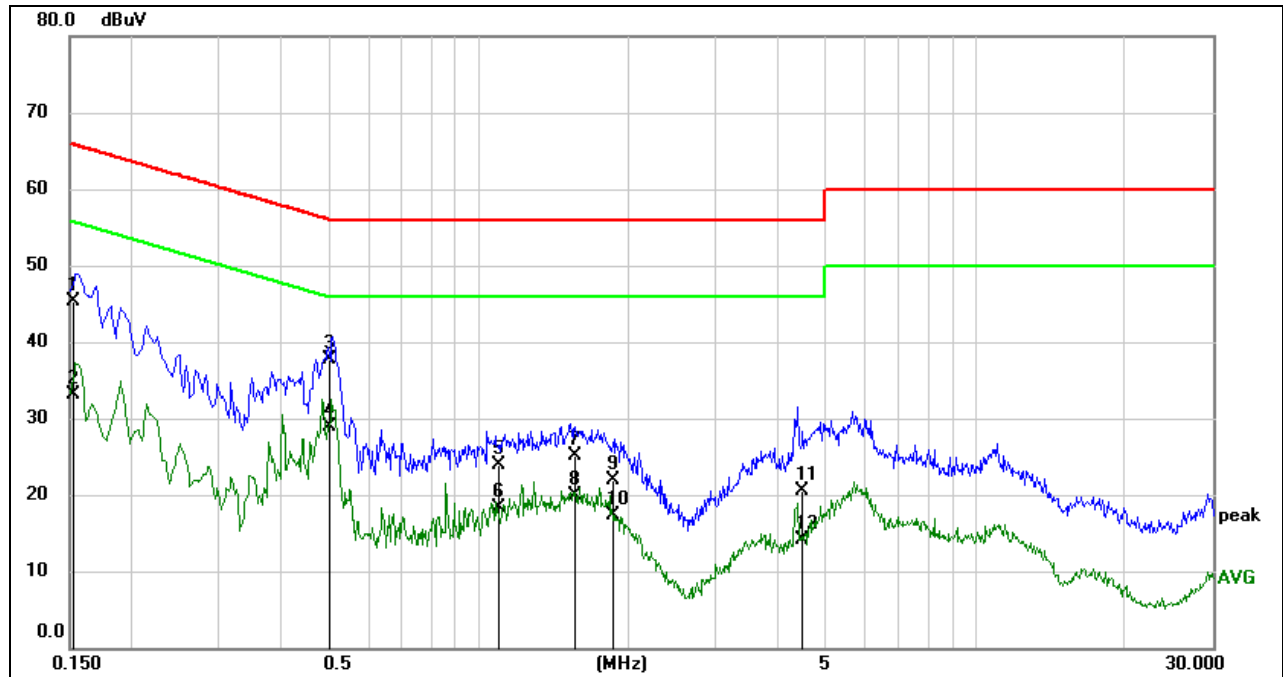

No.	Frequency (MHz)	Reading (dBuV)	Correct (dB)	Result (dBuV)	Limit (dBuV)	Margin (dB)	Remark
1	0.1518	35.78	9.59	45.37	65.90	-20.53	QP
2	0.1518	23.50	9.59	33.09	55.90	-22.81	AVG
3	0.4999	28.32	9.30	37.62	56.00	-18.38	QP
4	0.4999	19.55	9.30	28.85	46.00	-17.15	AVG
5	1.0921	14.38	9.61	23.99	56.00	-32.01	QP
6	1.0921	8.68	9.61	18.29	46.00	-27.71	AVG
7	1.5647	15.50	9.62	25.12	56.00	-30.88	QP
8	1.5647	10.24	9.62	19.86	46.00	-26.14	AVG
9	1.8633	12.38	9.62	22.00	56.00	-34.00	QP
10	1.8633	7.59	9.62	17.21	46.00	-28.79	AVG
11	4.4691	10.81	9.61	20.42	56.00	-35.58	QP
12	4.4691	4.54	9.61	14.15	46.00	-31.85	AVG

- Note: 1. Result = Reading + Correct Factor.
 2. If QP Result complies with AV limit, AV Result is deemed to comply with AV limit.
 3. Test setup: RBW: 200 Hz (9 kHz ~ 150 kHz), 9 kHz (150 kHz ~ 30 MHz).
 4. Step size: 80 Hz (0.009 MHz ~ 0.15 MHz), 4 kHz (0.15 MHz ~ 30 MHz), Scan time: auto.

LINE N RESULTS (UNII-2C BAND HIGH CHANNEL, WORST-CASE CONFIGURATION)

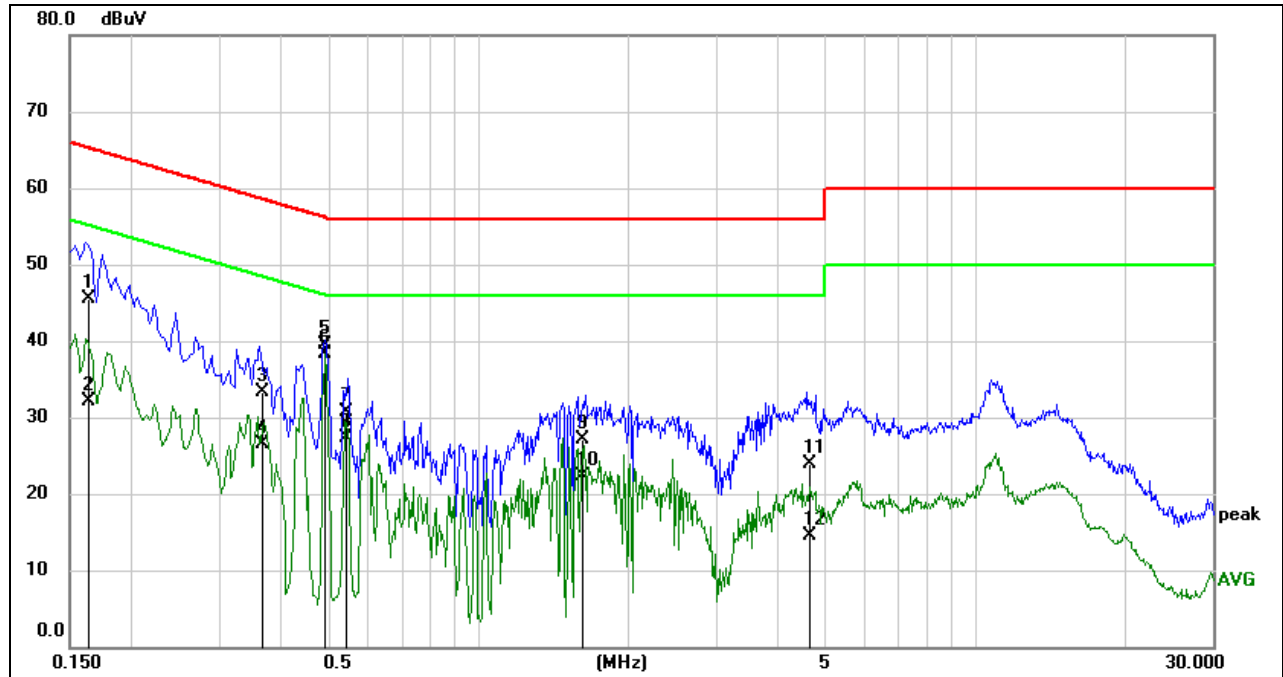

No.	Frequency (MHz)	Reading (dBuV)	Correct (dB)	Result (dBuV)	Limit (dBuV)	Margin (dB)	Remark
1	0.1637	35.86	9.59	45.45	65.27	-19.82	QP
2	0.1637	22.50	9.59	32.09	55.27	-23.18	AVG
3	0.3660	23.92	9.42	33.34	58.59	-25.25	QP
4	0.3660	17.00	9.42	26.42	48.59	-22.17	AVG
5	0.4912	30.12	9.31	39.43	56.15	-16.72	QP
6	0.4912	29.07	9.31	38.38	46.15	-7.77	AVG
7	0.5395	21.43	9.36	30.79	56.00	-25.21	QP
8	0.5395	17.98	9.36	27.34	46.00	-18.66	AVG
9	1.6080	17.39	9.62	27.01	56.00	-28.99	QP
10	1.6080	12.69	9.62	22.31	46.00	-23.69	AVG
11	4.6229	14.26	9.61	23.87	56.00	-32.13	QP
12	4.6229	4.96	9.61	14.57	46.00	-31.43	AVG

- Note: 1. Result = Reading + Correct Factor.
 2. If QP Result complies with AV limit, AV Result is deemed to comply with AV limit.
 3. Test setup: RBW: 200 Hz (9 kHz ~ 150 kHz), 9 kHz (150 kHz ~ 30 MHz).
 4. Step size: 80 Hz (0.009 MHz ~ 0.15 MHz), 4 kHz (0.15 MHz ~ 30 MHz), Scan time: auto.

Note: All the modes had been tested, but only the worst data was recorded in the report.

10. FREQUENCY STABILITY

LIMITS

The frequency of the carrier signal shall be maintained within band of operation.

TEST PROCEDURE

1. The EUT was placed inside an environmental chamber as the temperature in the chamber was varied between 0 °C ~ 70 °C (declared by customer).
2. The temperature was incremented by 10 °C intervals and the unit allowed to stabilize at each temperature before each measurement. The center frequency of the transmitting channel was evaluated at each temperature and the frequency deviation from the channel's center frequency was recorded.
3. The primary supply voltage is varied from 85 % to 115 % of the nominal value for non hand-carried battery and AC powered equipment. For hand-carried, battery-powered equipment, primary supply voltage is reduced to the battery operating end point which shall be specified by the manufacturer.

Connect the EUT to the spectrum analyser and use the following settings:

Center Frequency	The center frequency of the channel under test
Detector	Peak
RBW	10 kHz
VBW	$\geq 3 \times \text{RBW}$
Span	Encompass the entire emissions bandwidth (EBW) of the signal
Trace	Max hold
Sweep time	Auto

4. While maintaining a constant temperature inside the environmental chamber, turn the EUT on and record the operating frequency at startup, and at 2 minutes, 5minutes, and 10 minutes after the EUT is energized.
5. Allow the trace to stabilize, find the peak value of the power envelope and record the frequency, then calculated the frequency drift.

TEST SETUP

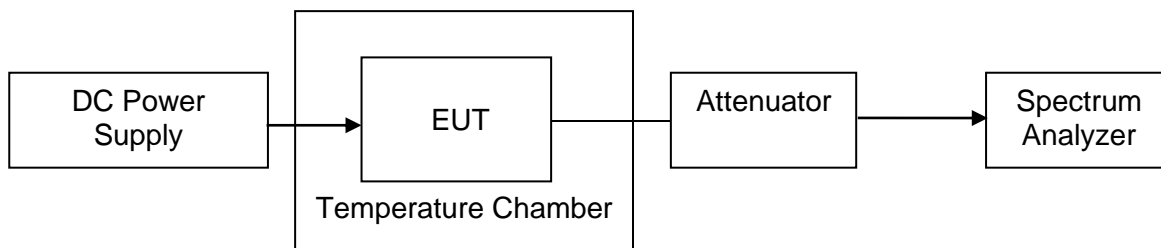



TEST ENVIRONMENT

	Normal Test Conditions	Extreme Test Conditions
Relative Humidity	20 % - 75 %	/
Atmospheric Pressure	100 kPa ~102 kPa	/
Temperature	T _N (Normal Temperature): 25.1 °C	T _L (Low Temperature): 0 °C
		T _H (High Temperature): 70 °C
Supply Voltage	V _N (Normal Voltage): DC 3.3 V	V _L (Low Voltage): DC 2.97 V
		V _H (High Voltage): DC 3.63 V

Note: The manufacturer's declared operating voltage range is 3.3 Vdc ± 10 %.

RESULTS

Please refer to Appendix H.

11. DYNAMIC FREQUENCY SELECTION

APPLICABILITY OF DFS REQUIREMENTS

A U-NII network will employ a DFS function to detect signals from radar systems and to avoid co-channel operation with these systems. This applies to the 5250-5350 MHz and/or 5470-5725 MHz bands.

Within the context of the operation of the DFS function, a U-NII device will operate in either Master Mode or Client Mode. U-NII devices operating in Client Mode can only operate in a network controlled by a U-NII device operating in Master Mode.

Table 1: Applicability of DFS Requirements Prior to Use of a Channel

Requirement	Operational Mode		
	<input type="checkbox"/> Master	<input checked="" type="checkbox"/> Client Without Radar Detection	<input type="checkbox"/> Client With Radar Detection
Non-Occupancy Period	Yes	Not required	Yes
DFS Detection Threshold	Yes	Not required	Yes
Channel Availability Check Time	Yes	Not required	Not required
U-NII Detection Bandwidth	Yes	Not required	Yes

Table 2: Applicability of DFS requirements during normal operation

Requirement	Operational Mode	
	<input type="checkbox"/> Master Device or Client with Radar Detection	<input checked="" type="checkbox"/> Client Without Radar Detection
DFS Detection Threshold	Yes	Not required
Channel Closing Transmission Time	Yes	Yes
Channel Move Time	Yes	Yes
U-NII Detection Bandwidth	Yes	Not required

Additional requirements for devices with multiple bandwidth modes	<input type="checkbox"/> Master Device or Client with Radar Detection	<input checked="" type="checkbox"/> Client Without Radar Detection
U-NII Detection Bandwidth and Statistical Performance Check	All BW modes must be tested	Not required
Channel Move Time and Channel Closing Transmission Time	Test using widest BW mode available	Test using the widest BW mode available for the link
All other tests	Any single BW mode	Not required

Note: Frequencies selected for statistical performance check should include several frequencies within the radar detection bandwidth and frequencies near the edge of the radar detection bandwidth. For 802.11 devices it is suggested to select frequencies in each of the bonded 20 MHz channels and the channel center frequency.

LIMITS

(1) DFS Detection Thresholds

Table 3: DFS Detection Thresholds for Master Devices and Client Devices With Radar Detection

Maximum Transmit Power	Value (See Notes 1, 2, and 3)
EIRP \geq 200 milliwatt	-64 dBm
EIRP < 200 milliwatt and power spectral density < 10 dBm/MHz	-62 dBm
EIRP < 200 milliwatt that do not meet the power spectral density requirement	-64 dBm

Note 1: This is the level at the input of the receiver assuming a 0 dBi receive antenna.
 Note 2: Throughout these test procedures an additional 1 dB has been added to the amplitude of the test transmission waveforms to account for variations in measurement equipment. This will ensure that the test signal is at or above the detection threshold level to trigger a DFS response.
 Note3: EIRP is based on the highest antenna gain. For MIMO devices refer to KDB Publication 662911 D01.

(2) DFS Response Requirements

Table 4: DFS Response Requirement Values

Parameter	Value
Non-occupancy period	Minimum 30 minutes
Channel Availability Check Time	60 seconds
Channel Move Time	10 seconds See Note 1.
Channel Closing Transmission Time	200 milliseconds + an aggregate of 60 milliseconds over remaining 10 second period. See Notes 1 and 2.
U-NII Detection Bandwidth	Minimum 100% of the U-NII 99% transmission power bandwidth. See Note 3.

Note 1: Channel Move Time and the Channel Closing Transmission Time should be performed with Radar Type 0. The measurement timing begins at the end of the Radar Type 0 burst.
 Note 2: The Channel Closing Transmission Time is comprised of 200 milliseconds starting at the beginning of the Channel Move Time plus any additional intermittent control signals required facilitating a Channel move (an aggregate of 60 milliseconds) during the remainder of the 10 second period. The aggregate duration of control signals will not count quiet periods in between transmissions.
 Note 3: During the U-NII Detection Bandwidth detection test, radar type 0 should be used. For each frequency step the minimum percentage of detection is 90 percent. Measurements are performed with no data traffic.

PARAMETERS OF RADAR TEST WAVEFORMS

This section provides the parameters for required test waveforms, minimum percentage of successful detections, and the minimum number of trials that must be used for determining DFS conformance. Step intervals of 0.1 microsecond for Pulse Width, 1 microsecond for PRI, 1 MHz for chirp width and 1 for the number of pulses will be utilized for the random determination of specific test waveforms.

Table 5 Short Pulse Radar Test Waveforms

Radar Type	Pulse Width (μsec)	PRI (μsec)	Number of Pulses	Minimum Percentage of Successful Detection	Minimum Number of Trials
0	1	1428	18	See Note 1	See Note 1
1	1	Test A	Roundup $\left\{ \left(\frac{1}{360} \right) \cdot \left(\frac{19 \cdot 10^6}{\text{PRI}_{\mu\text{sec}}} \right) \right\}$	60%	30
		Test B			
2	1-5	150-230	23-29	60%	30
3	6-10	200-500	16-18	60%	30
4	11-20	200-500	12-16	60%	30
Aggregate (Radar Types 1-4)				80%	120
<p>Note 1: Short Pulse Radar Type 0 should be used for the detection bandwidth test, channel move time, and channel closing time tests.</p> <p>Test A: 15 unique PRI values randomly selected from the list of 23 PRI values in Table 5a</p> <p>Test B: 15 unique PRI values randomly selected within the range of 518-3066 μsec, with a minimum increment of 1 μsec, excluding PRI values selected in Test A</p>					

A minimum of 30 unique waveforms are required for each of the Short Pulse Radar Types 2 through 4. If more than 30 waveforms are used for Short Pulse Radar Types 2 through 4, then each additional waveform must also be unique and not repeated from the previous waveforms. If more than 30 waveforms are used for Short Pulse Radar Type 1, then each additional waveform is generated with Test B and must also be unique and not repeated from the previous waveforms in Tests A or B. Test aggregate is average of the percentage of successful detections of short pulse radar types 1-4.

TEST SETUP

Setup for Client with injection at the Master

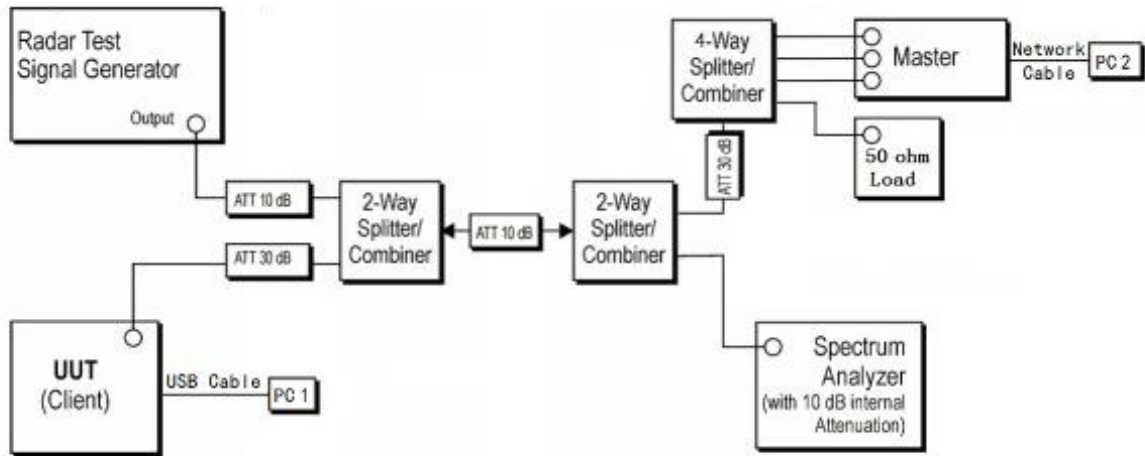

TEST ENVIRONMENT

Temperature	25.5 °C	Relative Humidity	53 %
Atmosphere Pressure	101 kPa	Test Voltage	DC 3.3 V

RESULTS

Please refer to Appendix E & F & G.



12. ANTENNA REQUIREMENTS

APPLICABLE REQUIREMENTS

Please refer to FCC §15.203

An intentional radiator shall be designed to ensure that no antenna other than that furnished by the responsible party shall be used with the device. The use of a permanently attached antenna or of an antenna that uses a unique coupling to the intentional radiator shall be considered sufficient to comply with the provisions of this section. The manufacturer may design the unit so that a broken antenna can be replaced by the user, but the use of a standard antenna jack or electrical connector is prohibited.

Please refer to FCC §15.247(b)(4)

The conducted output power limit specified in paragraph (b) of this section is based on the use of antennas with directional gains that do not exceed 6 dBi. Except as shown in paragraph (c) of this section, if transmitting antennas of directional gain greater than 6 dBi are used, the conducted output power from the intentional radiator shall be reduced below the stated values in paragraphs (b)(1), (b)(2), and (b)(3) of this section, as appropriate, by the amount in dB that the directional gain of the antenna exceeds 6 dBi.

RESULTS

Complies

**12.1. Appendix A1: Emission Bandwidth****12.1.1. Test Result**

Test Mode	Antenna	Channel	26db EBW [MHz]	FL[MHz]	FH[MHz]	Verdict	
11A	Ant1	5180	18.40	5170.80	5189.20	PASS	
	Ant2	5180	18.36	5170.76	5189.12	PASS	
	Ant1	5200	18.40	5190.80	5209.20	PASS	
	Ant2	5200	18.52	5190.72	5209.24	PASS	
	Ant1	5240	18.36	5230.72	5249.08	PASS	
	Ant2	5240	18.56	5230.80	5249.36	PASS	
	Ant1	5260	18.48	5250.80	5269.28	PASS	
	Ant2	5260	18.56	5250.80	5269.36	PASS	
	Ant1	5280	18.44	5270.72	5289.16	PASS	
	Ant2	5280	18.52	5270.80	5289.32	PASS	
	Ant1	5320	18.52	5310.76	5329.28	PASS	
	Ant2	5320	18.40	5310.76	5329.16	PASS	
	Ant1	5500	18.56	5490.84	5509.40	PASS	
	Ant2	5500	18.36	5490.88	5509.24	PASS	
	Ant1	5580	18.48	5570.72	5589.20	PASS	
	Ant2	5580	18.44	5570.76	5589.20	PASS	
	Ant1	5700	18.36	5690.84	5709.20	PASS	
	Ant2	5700	18.36	5690.88	5709.24	PASS	
	Ant1	5720	18.96	5710.80	5729.76	PASS	
	Ant2	5720	18.48	5710.76	5729.24	PASS	
	Ant1	5720_UNII-2C	14.2	5710.80	5725	PASS	
	Ant2	5720_UNII-2C	14.24	5710.76	5725	PASS	
	Ant1	5720_UNII-3	4.76	5725	5729.76	PASS	
	Ant2	5720_UNII-3	4.24	5725	5729.24	PASS	
	Ant1	5745	18.68	5735.76	5754.44	PASS	
	Ant2	5745	18.44	5735.80	5754.24	PASS	
	Ant1	5785	18.56	5775.68	5794.24	PASS	
	Ant2	5785	18.40	5775.80	5794.20	PASS	
	Ant1	5825	18.64	5815.72	5834.36	PASS	
	Ant2	5825	18.36	5815.80	5834.16	PASS	
	11N20MIMO	Ant1	5180	19.28	5170.36	5189.64	PASS
		Ant2	5180	19.32	5170.36	5189.68	PASS
Ant1		5200	19.24	5190.36	5209.60	PASS	
Ant2		5200	19.32	5190.32	5209.64	PASS	
Ant1		5240	19.40	5230.28	5249.68	PASS	
Ant2		5240	19.36	5230.36	5249.72	PASS	
Ant1		5260	19.40	5250.28	5269.68	PASS	
Ant2		5260	19.36	5250.36	5269.72	PASS	
Ant1		5280	19.40	5270.28	5289.68	PASS	
Ant2		5280	19.40	5270.32	5289.72	PASS	
Ant1		5320	19.28	5310.28	5329.56	PASS	
Ant2		5320	19.28	5310.32	5329.60	PASS	
Ant1		5500	19.48	5490.28	5509.76	PASS	
Ant2		5500	19.44	5490.28	5509.72	PASS	
Ant1		5580	19.36	5570.28	5589.64	PASS	
Ant2		5580	19.16	5570.48	5589.64	PASS	
Ant1		5700	19.36	5690.32	5709.68	PASS	
Ant2		5700	19.36	5690.32	5709.68	PASS	
Ant1		5720	19.44	5710.28	5729.72	PASS	
Ant2		5720	19.40	5710.28	5729.68	PASS	
Ant1		5720_UNII-2C	14.72	5710.28	5725	PASS	
Ant2		5720_UNII-2C	14.72	5710.28	5725	PASS	
Ant1		5720_UNII-3	4.72	5725	5729.72	PASS	
Ant2		5720_UNII-3	4.68	5725	5729.68	PASS	
Ant1	5745	19.48	5735.32	5754.80	PASS		



	Ant2	5745	19.48	5735.28	5754.76	PASS
	Ant1	5785	19.36	5775.36	5794.72	PASS
	Ant2	5785	19.36	5775.28	5794.64	PASS
	Ant1	5825	19.40	5815.28	5834.68	PASS
	Ant2	5825	19.48	5815.16	5834.64	PASS
11N40MIMO	Ant1	5190	41.84	5169.12	5210.96	PASS
	Ant2	5190	41.60	5168.96	5210.56	PASS
	Ant1	5230	41.68	5209.12	5250.80	PASS
	Ant2	5230	41.68	5209.12	5250.80	PASS
	Ant1	5270	41.92	5249.04	5290.96	PASS
	Ant2	5270	41.36	5249.28	5290.64	PASS
	Ant1	5310	41.60	5289.12	5330.72	PASS
	Ant2	5310	41.36	5289.12	5330.48	PASS
	Ant1	5510	42.40	5489.20	5531.60	PASS
	Ant2	5510	41.44	5489.44	5530.88	PASS
	Ant1	5590	42.16	5568.88	5611.04	PASS
	Ant2	5590	41.52	5569.28	5610.80	PASS
	Ant1	5670	41.52	5649.20	5690.72	PASS
	Ant2	5670	41.44	5649.36	5690.80	PASS
	Ant1	5710	42.64	5688.24	5730.88	PASS
	Ant2	5710	41.44	5689.20	5730.64	PASS
	Ant1	5710_UNII-2C	36.76	5688.24	5725	PASS
	Ant2	5710_UNII-2C	35.8	5689.20	5725	PASS
	Ant1	5710_UNII-3	5.88	5725	5730.88	PASS
	Ant2	5710_UNII-3	5.64	5725	5730.64	PASS
	Ant1	5755	42.16	5734.28	5776.44	PASS
	Ant2	5755	41.92	5734.04	5775.96	PASS
	Ant1	5795	42.32	5773.48	5815.80	PASS
	Ant2	5795	41.76	5774.20	5815.96	PASS
11AC80MIMO	Ant1	5210	81.28	5169.36	5250.64	PASS
	Ant2	5210	80.96	5169.52	5250.48	PASS
	Ant1	5290	81.60	5249.52	5331.12	PASS
	Ant2	5290	81.28	5249.68	5330.96	PASS
	Ant1	5530	80.64	5490.00	5570.64	PASS
	Ant2	5530	81.28	5489.52	5570.80	PASS
	Ant1	5610	81.92	5569.36	5651.28	PASS
	Ant2	5610	81.12	5569.68	5650.80	PASS
	Ant1	5690	81.44	5649.52	5730.96	PASS
	Ant2	5690	81.44	5649.52	5730.96	PASS
	Ant1	5690_UNII-2C	75.48	5649.52	5725	PASS
	Ant2	5690_UNII-2C	75.48	5649.52	5725	PASS
	Ant1	5690_UNII-3	5.96	5725	5730.96	PASS
	Ant2	5690_UNII-3	5.96	5725	5730.96	PASS
	Ant1	5775	81.28	5734.68	5815.96	PASS
	Ant2	5775	82.08	5734.52	5816.60	PASS

12.1.2. Test Graphs

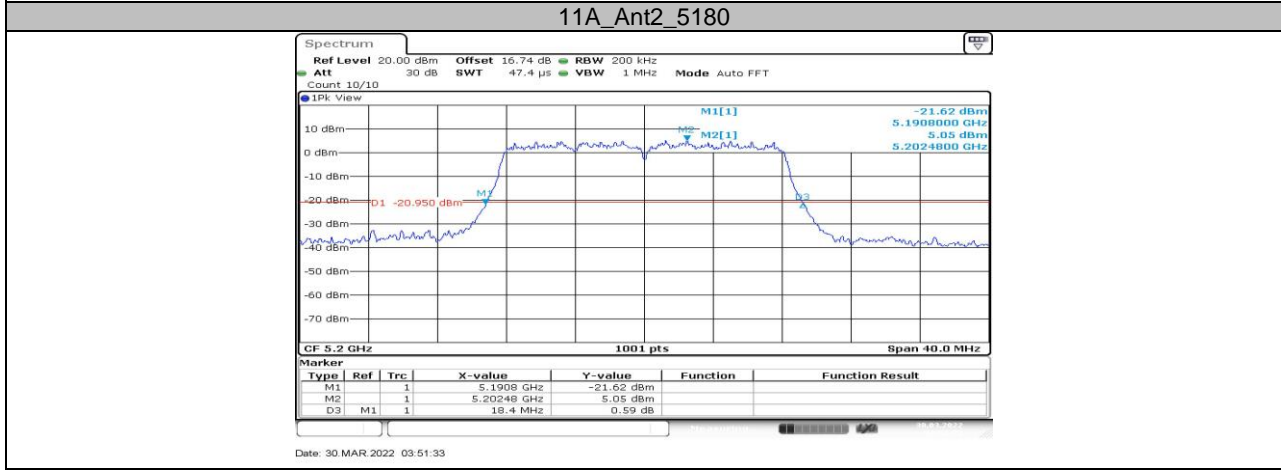
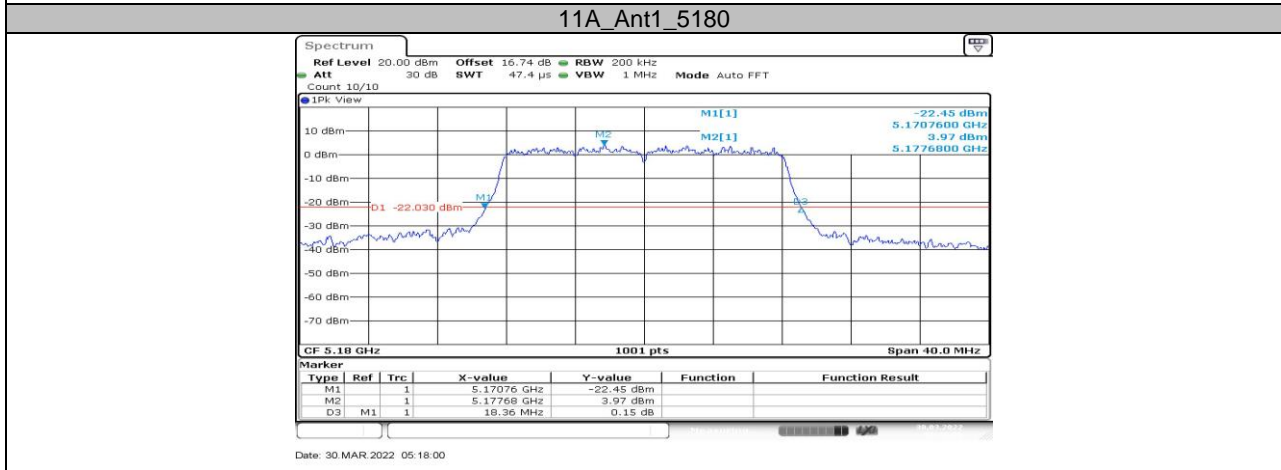
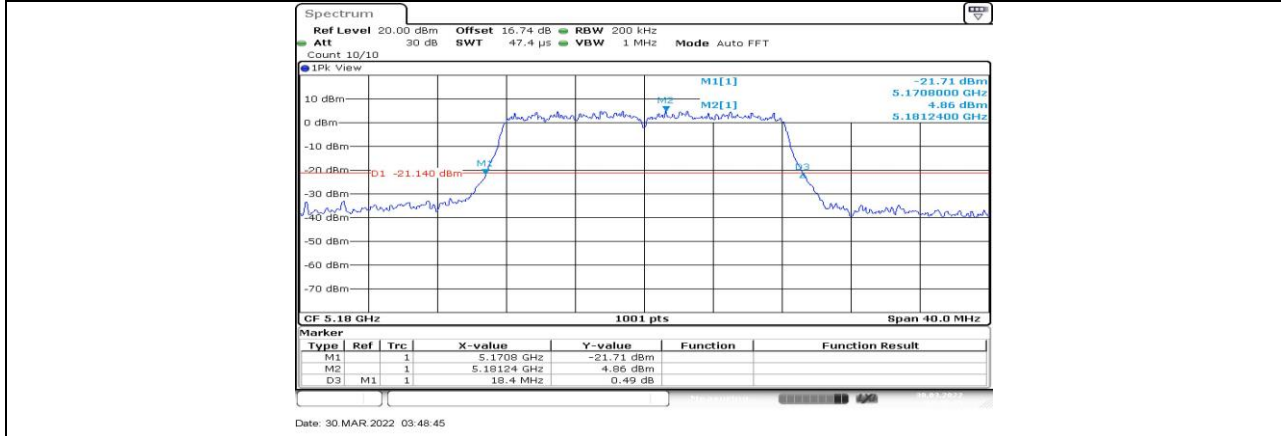

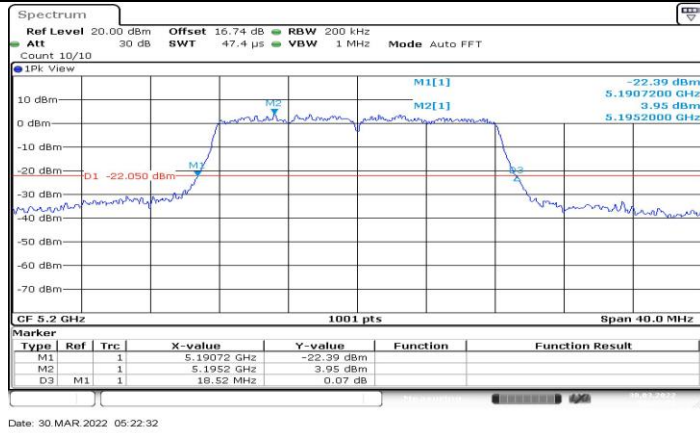

Date: 30 MAR 2022 05:22:32

11A_Ant2_5200

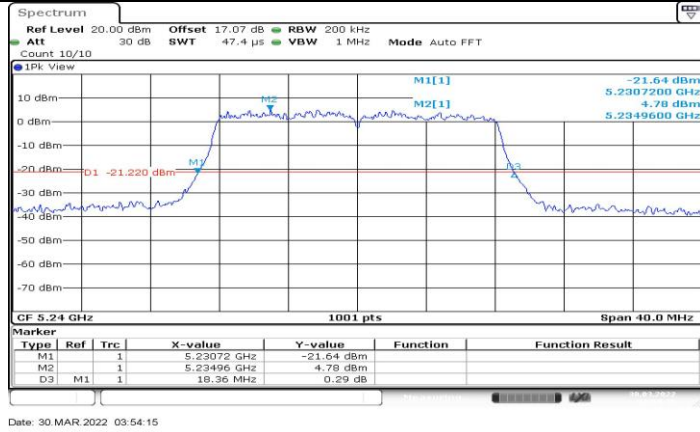

Date: 30 MAR 2022 03:54:15

11A_Ant1_5240

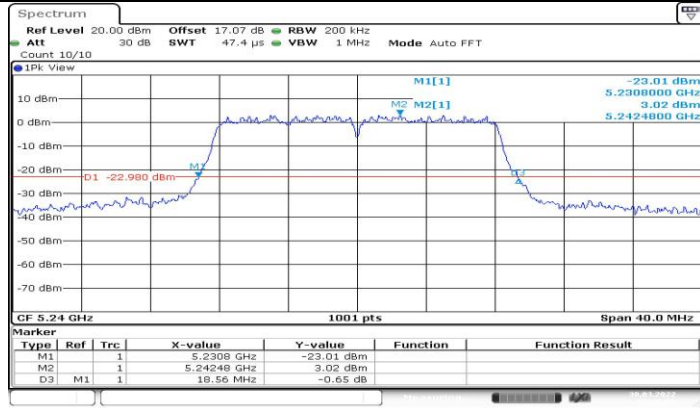

Date: 30 MAR 2022 05:28:09

11A_Ant2_5240

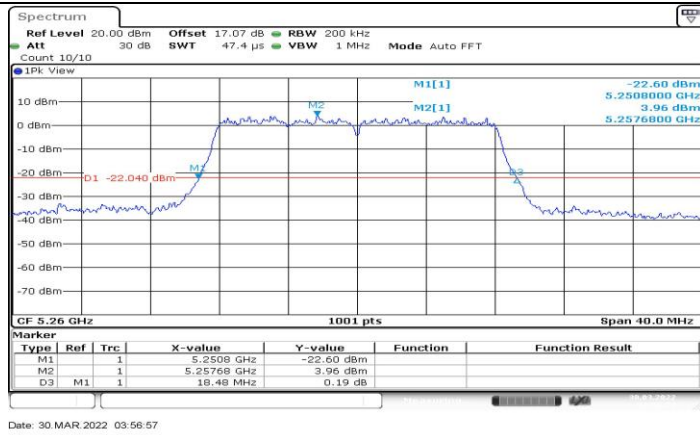

11A_Ant1_5260

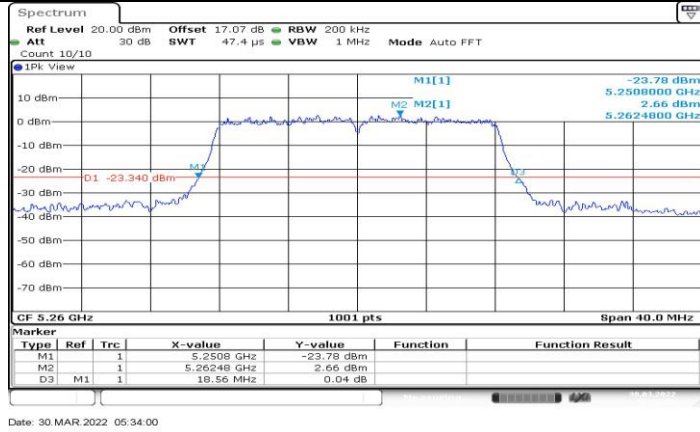

11A_Ant2_5260

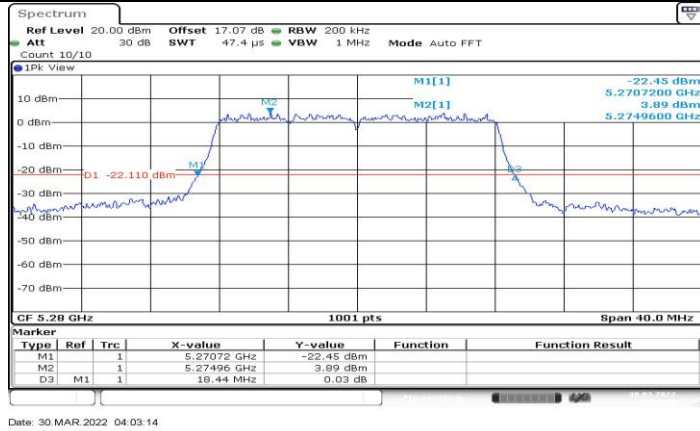

11A_Ant1_5280

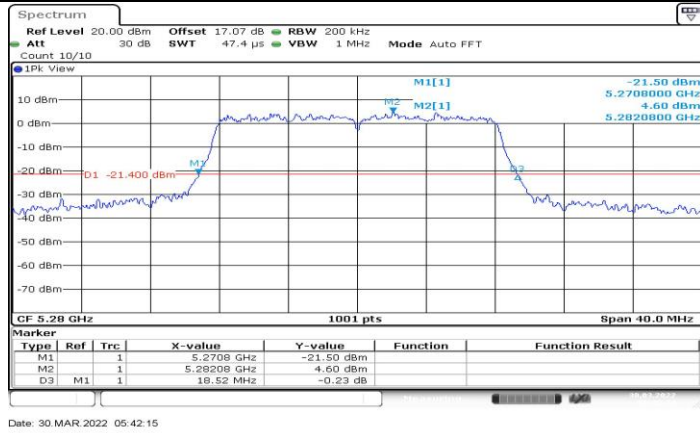

11A_Ant2_5280

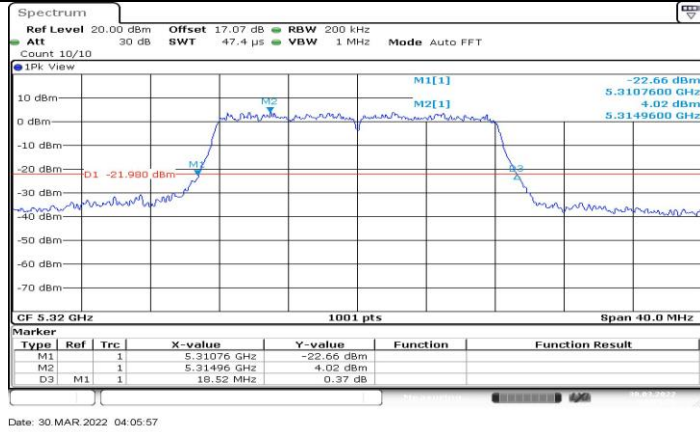

11A_Ant1_5320

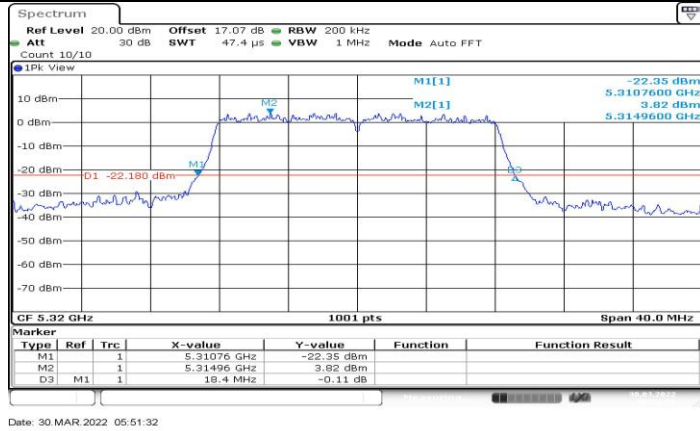

11A_Ant2_5320

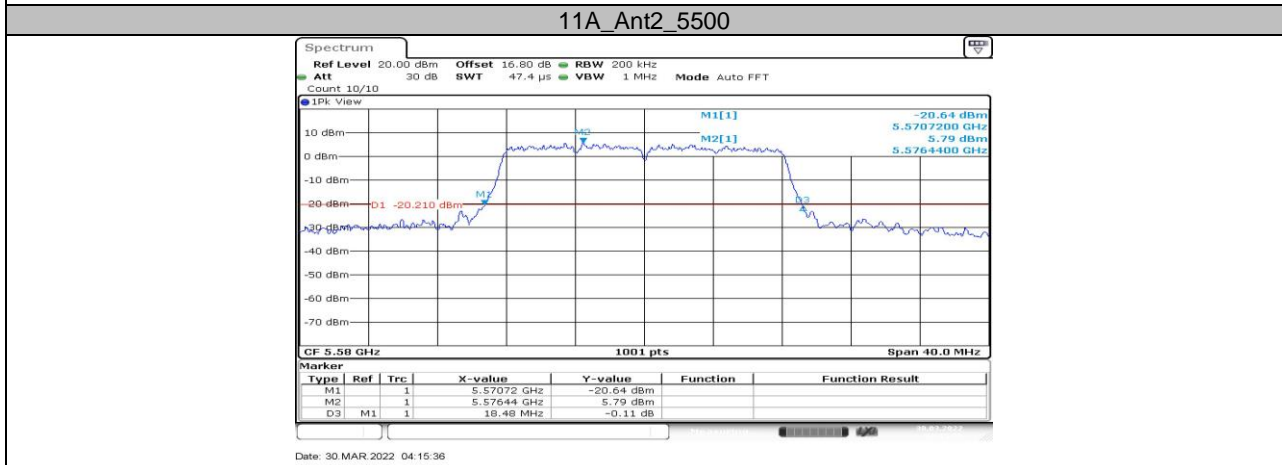
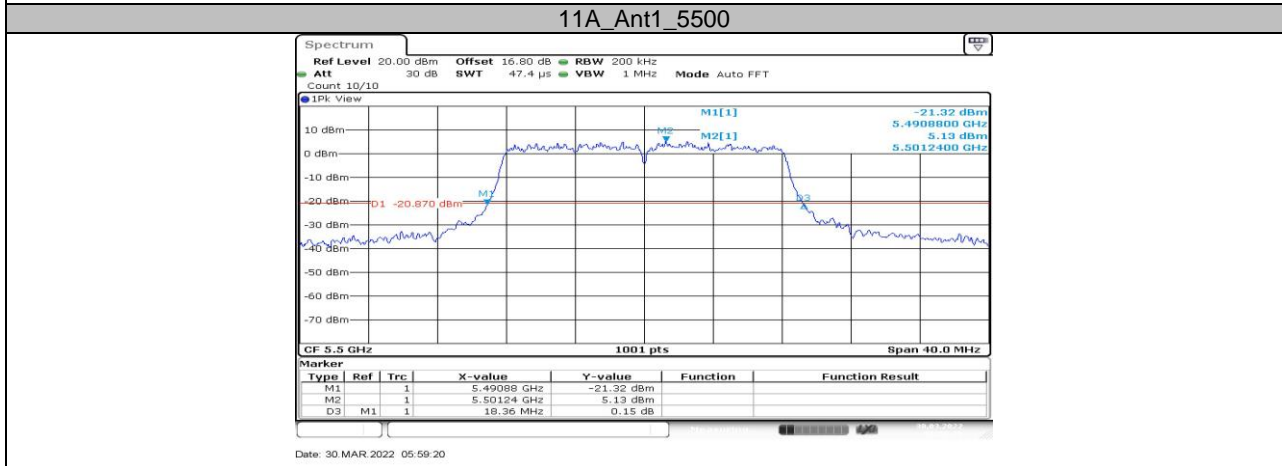
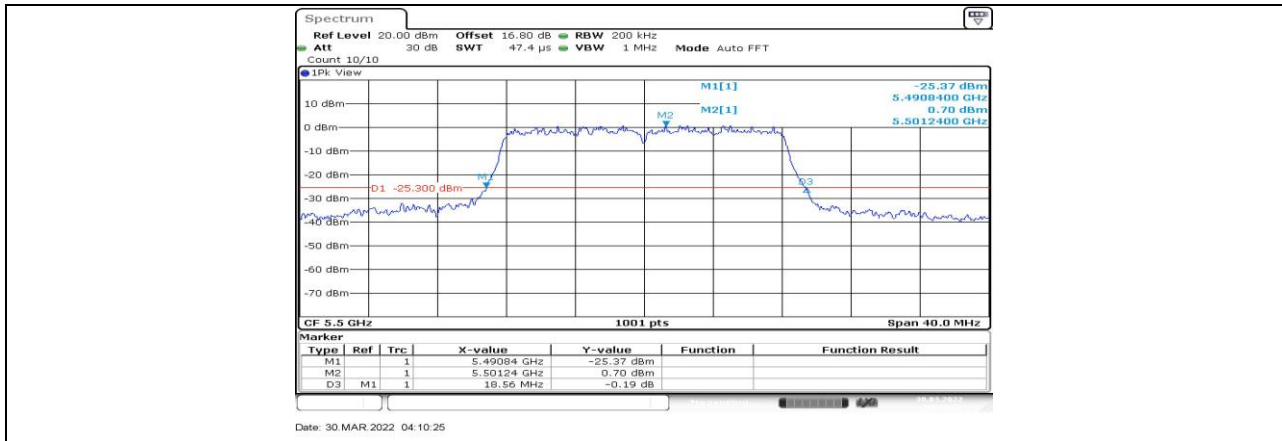

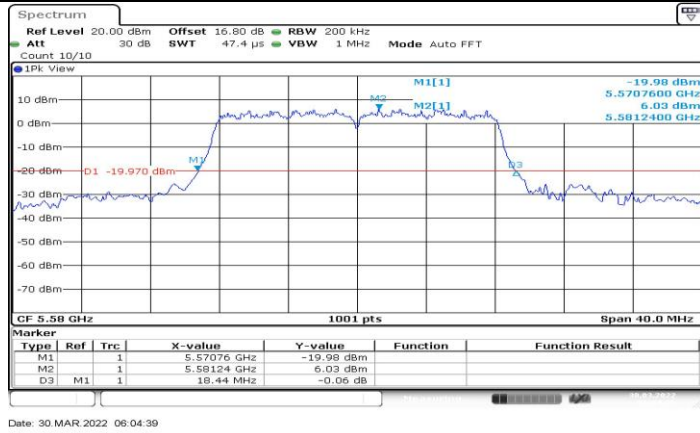

11A_Ant2_5580

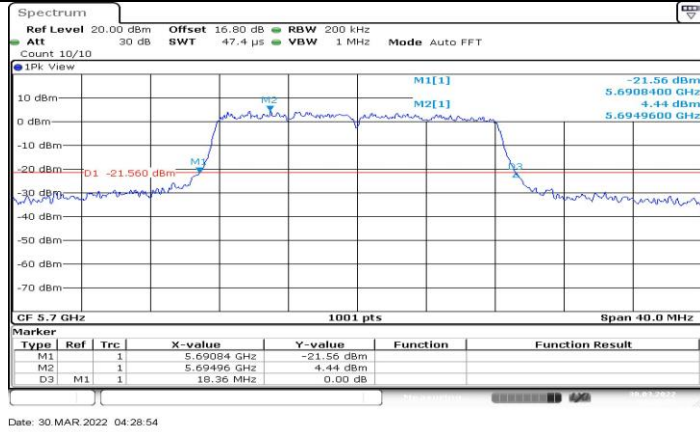

11A_Ant1_5700

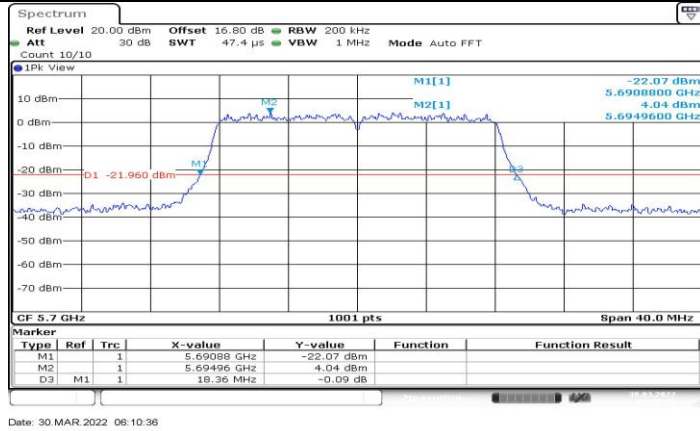

11A_Ant2_5700



11A_Ant1_5720

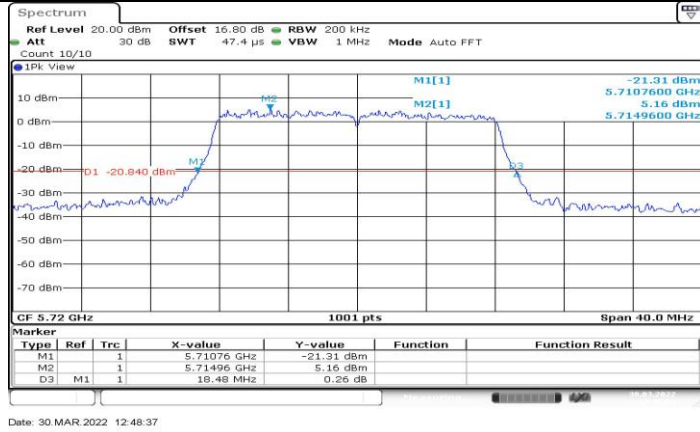

11A_Ant2_5720

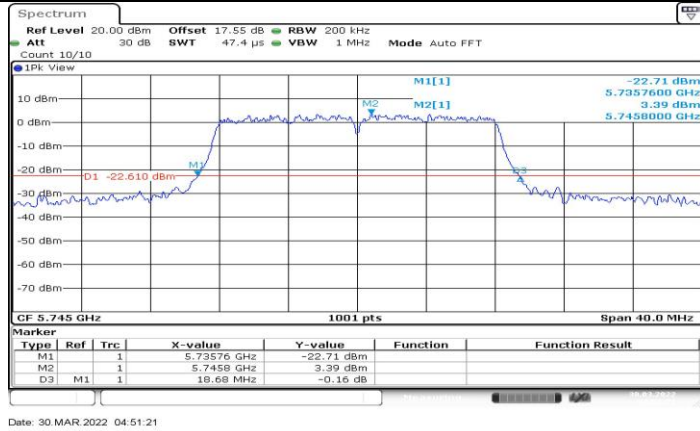

11A_Ant1_5745

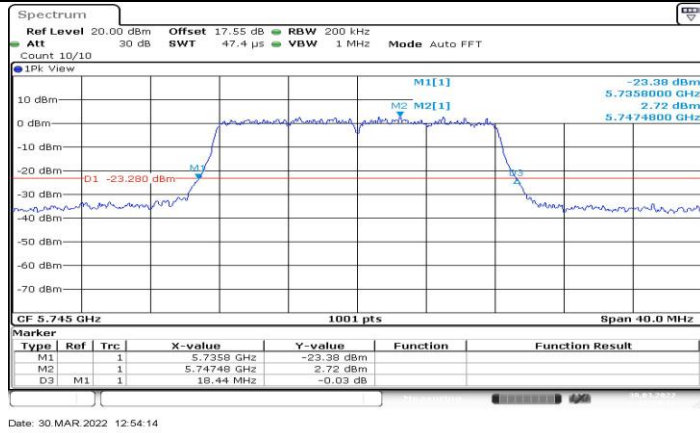

11A_Ant2_5745

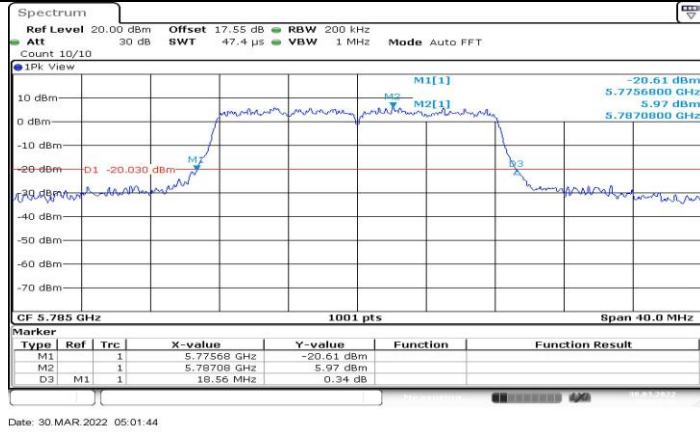

11A_Ant1_5785

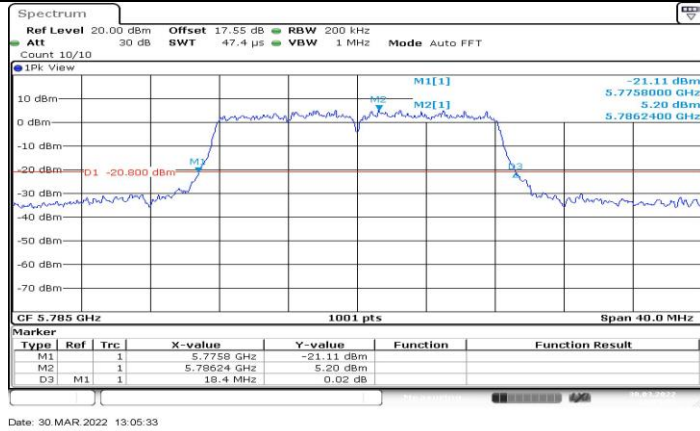

11A_Ant2_5785

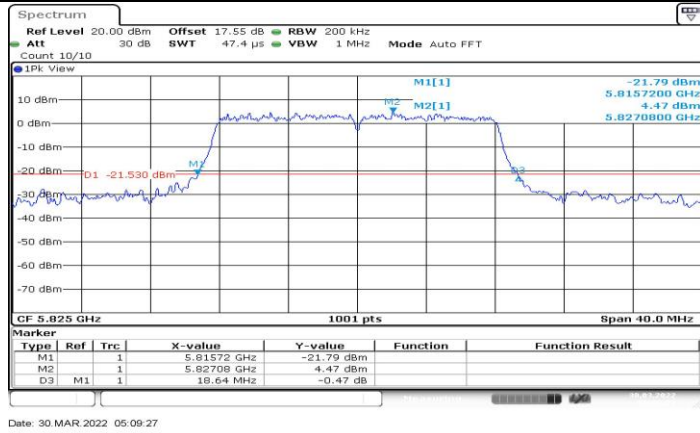

11A_Ant1_5825

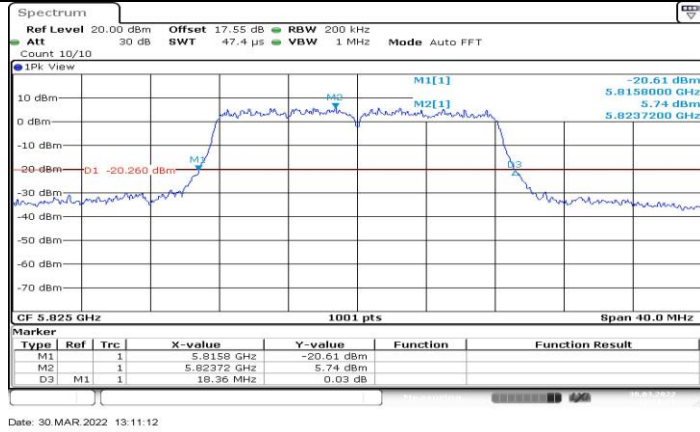

11A_Ant2_5825

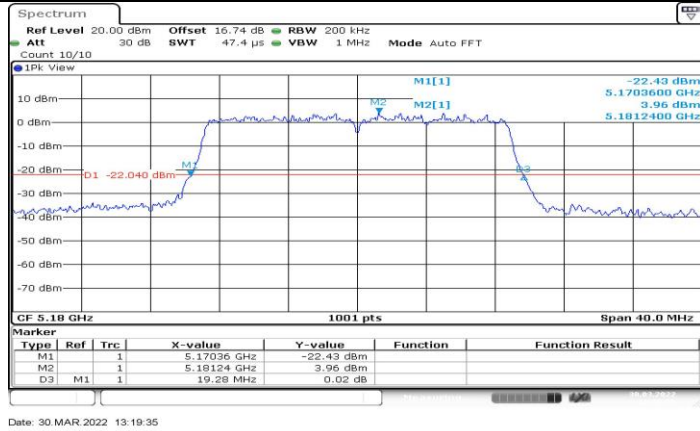

11N20MIMO_Ant1_5180

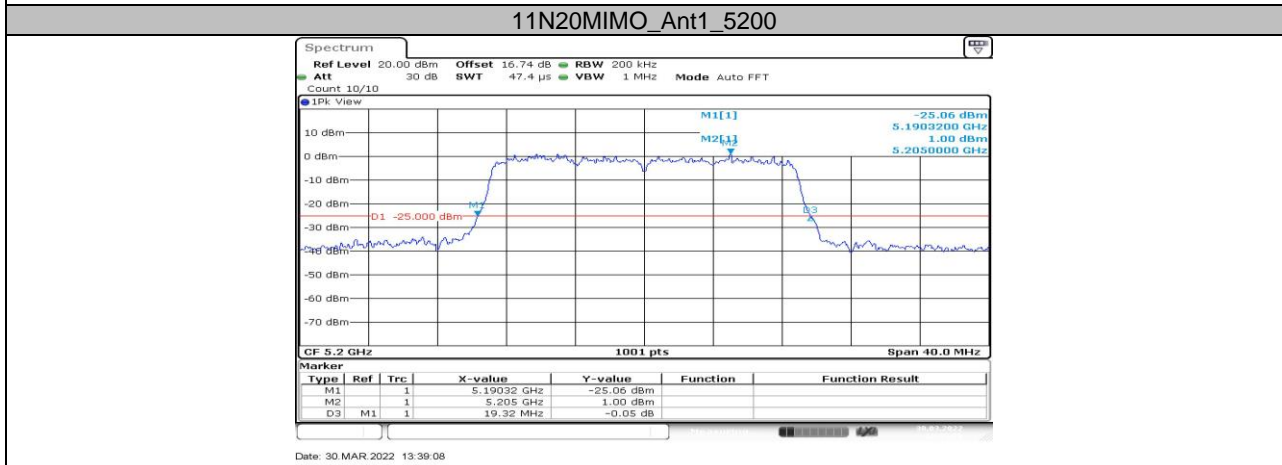
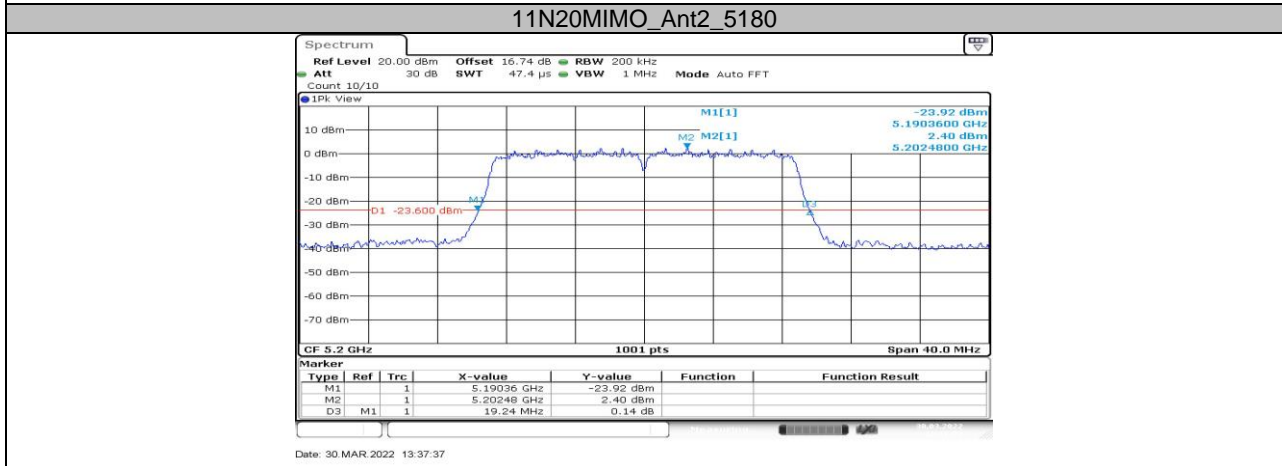
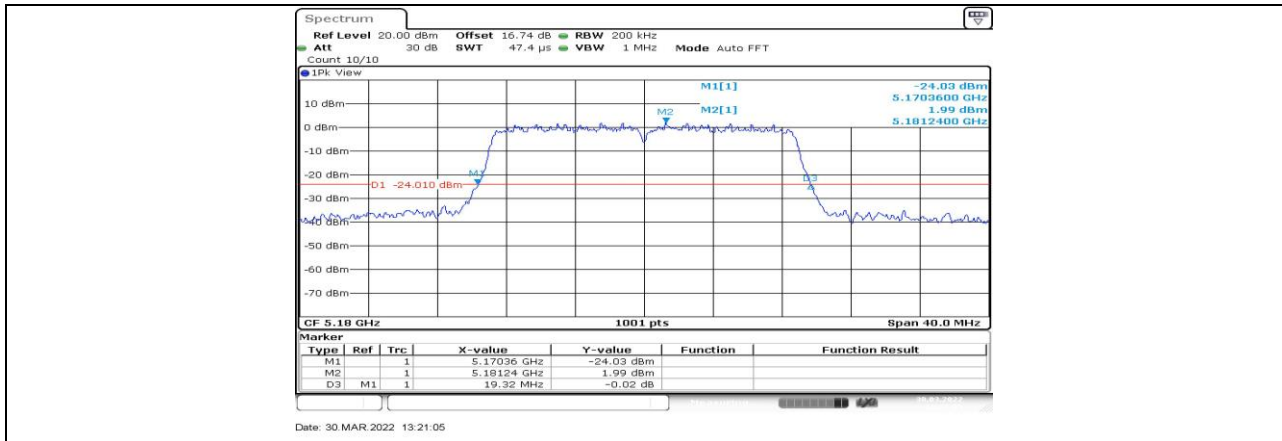

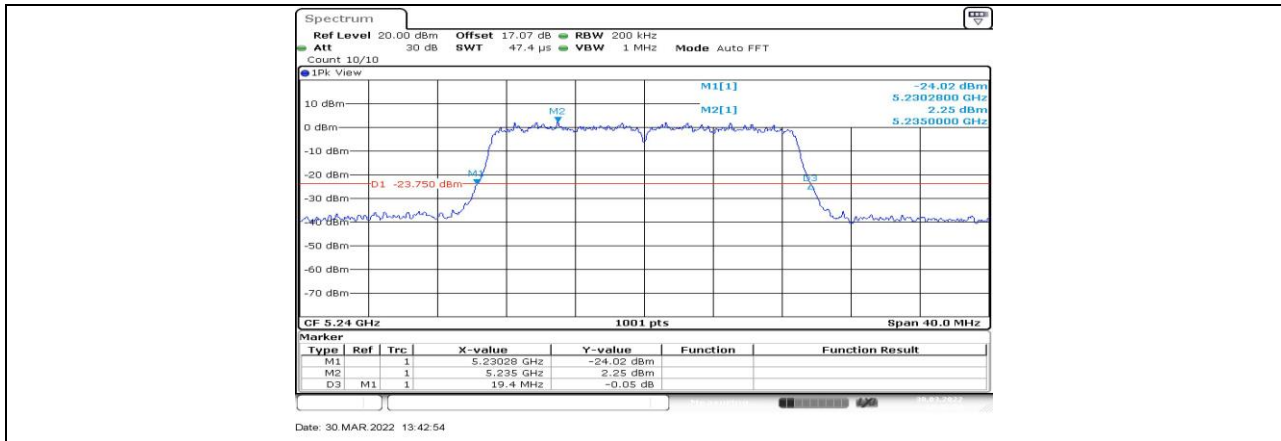

11N20MIMO_Ant1_5240

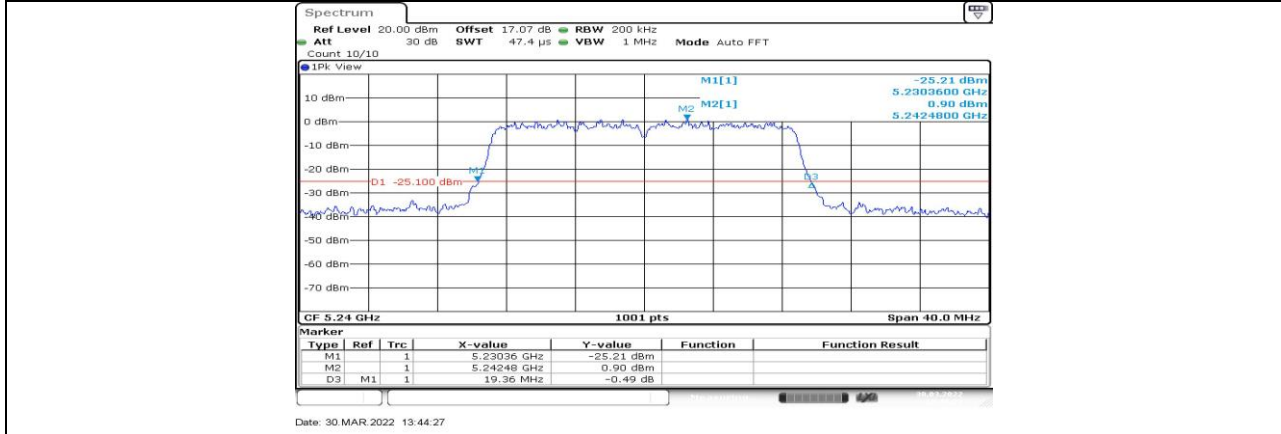

11N20MIMO_Ant2_5240

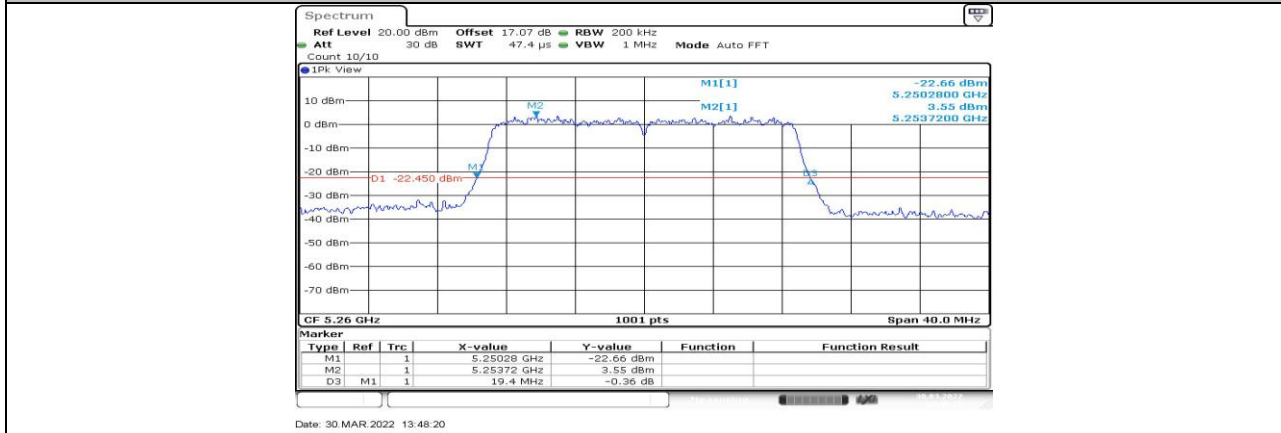

11N20MIMO_Ant1_5260

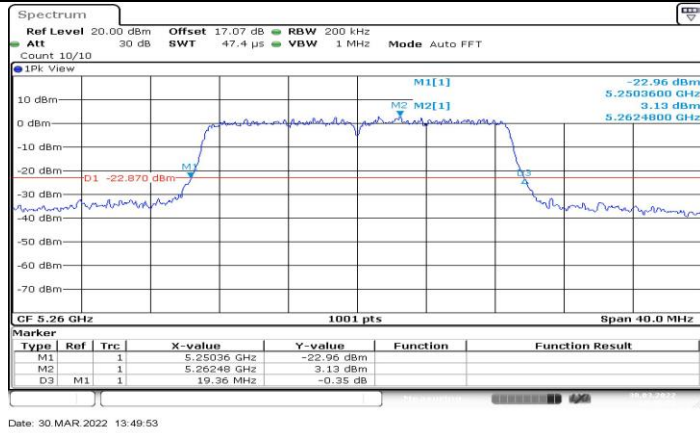

11N20MIMO_Ant2_5260

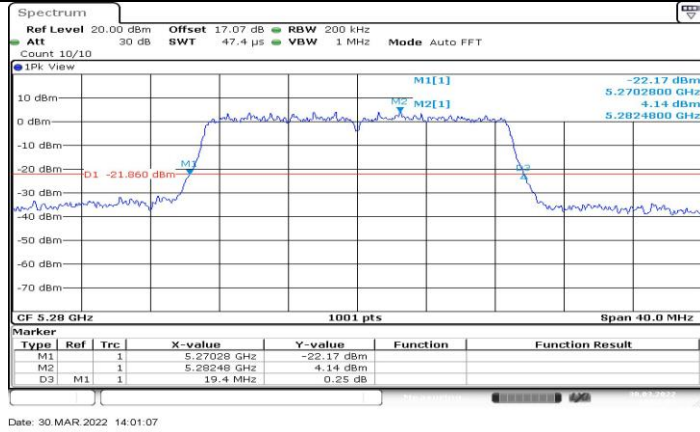

11N20MIMO_Ant1_5280

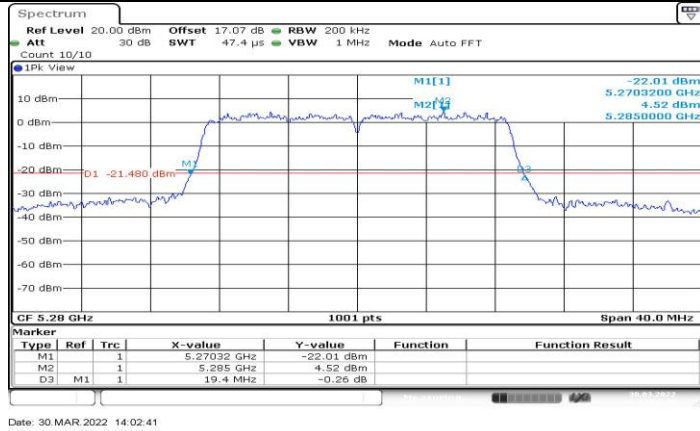

11N20MIMO_Ant2_5280

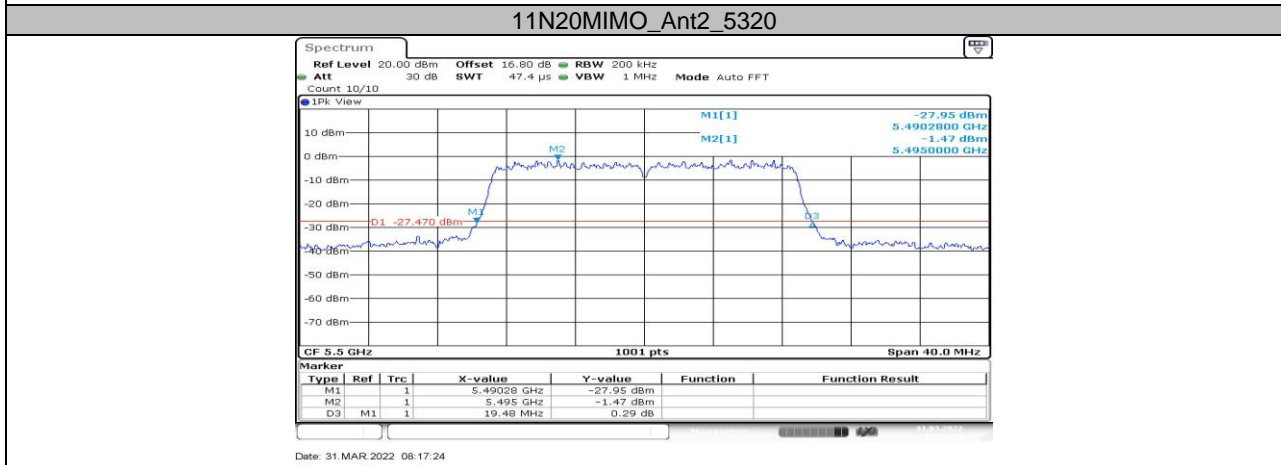
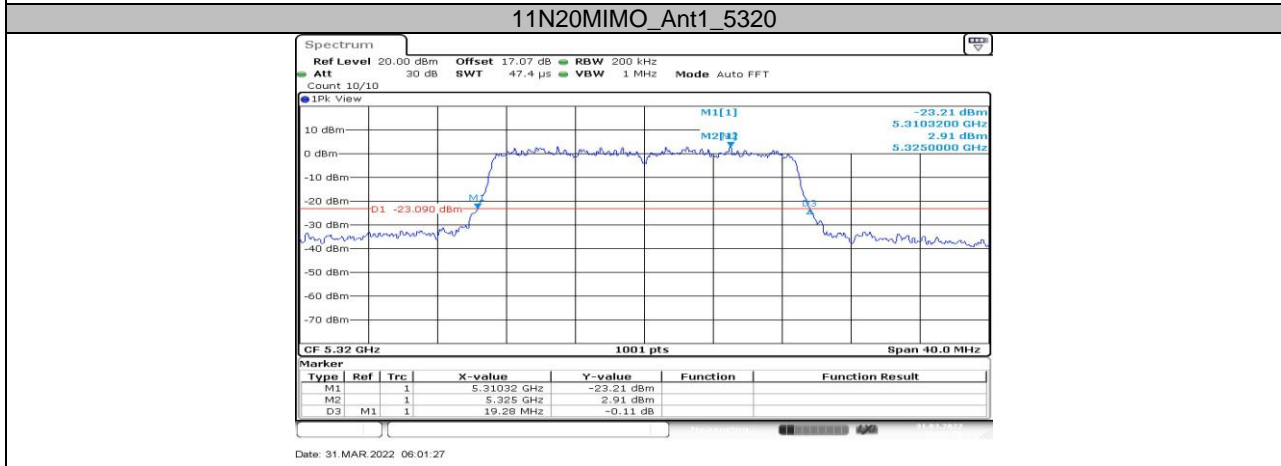
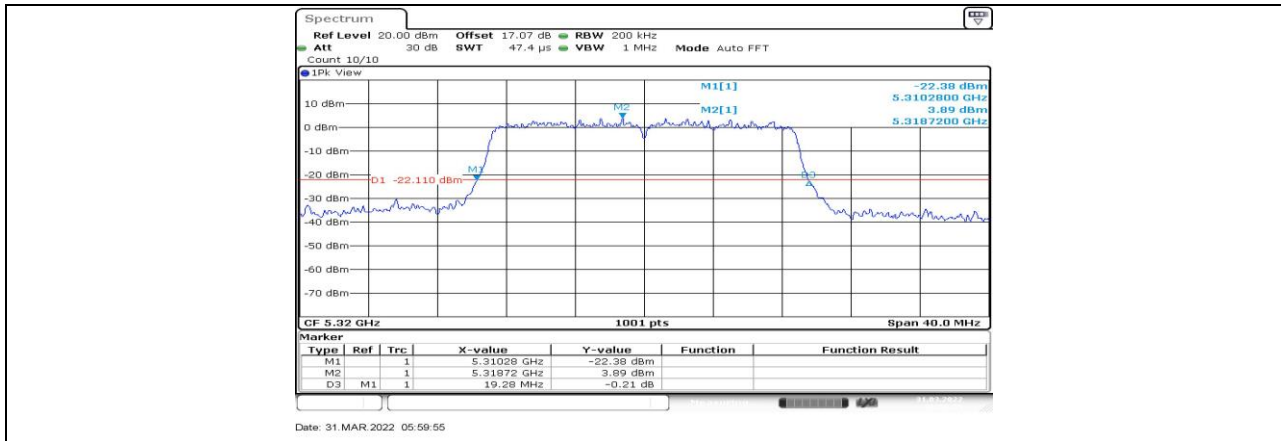

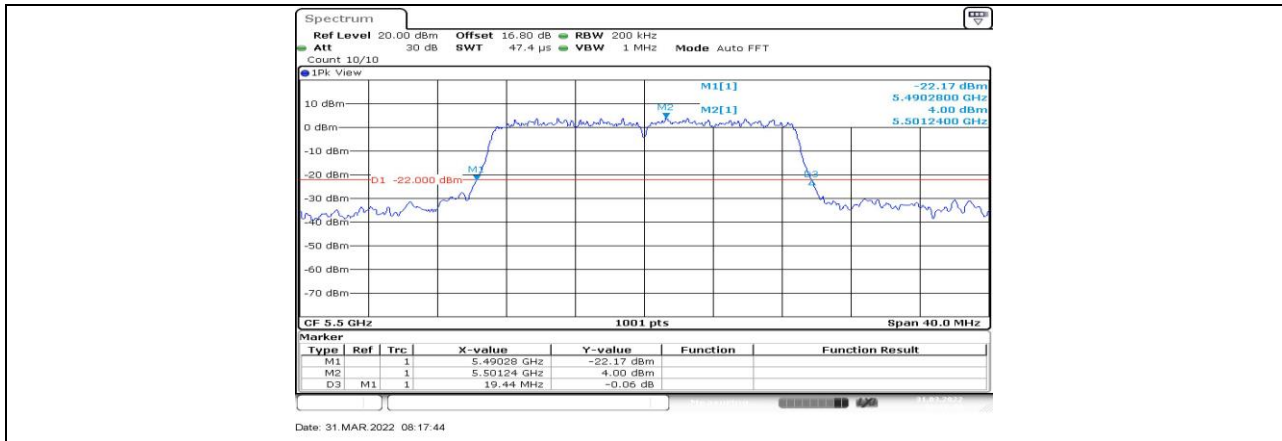

11N20MIMO_Ant2_5500

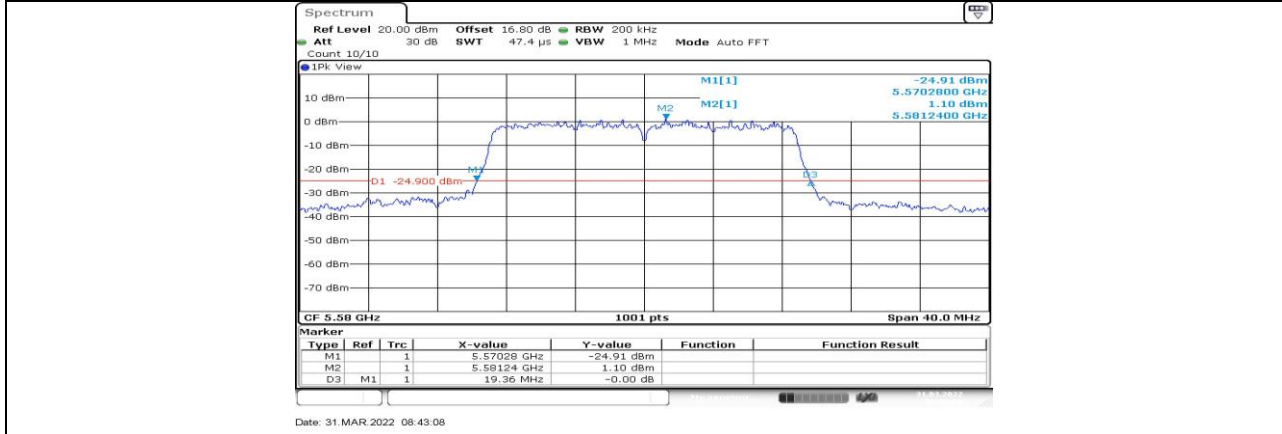

11N20MIMO_Ant1_5580

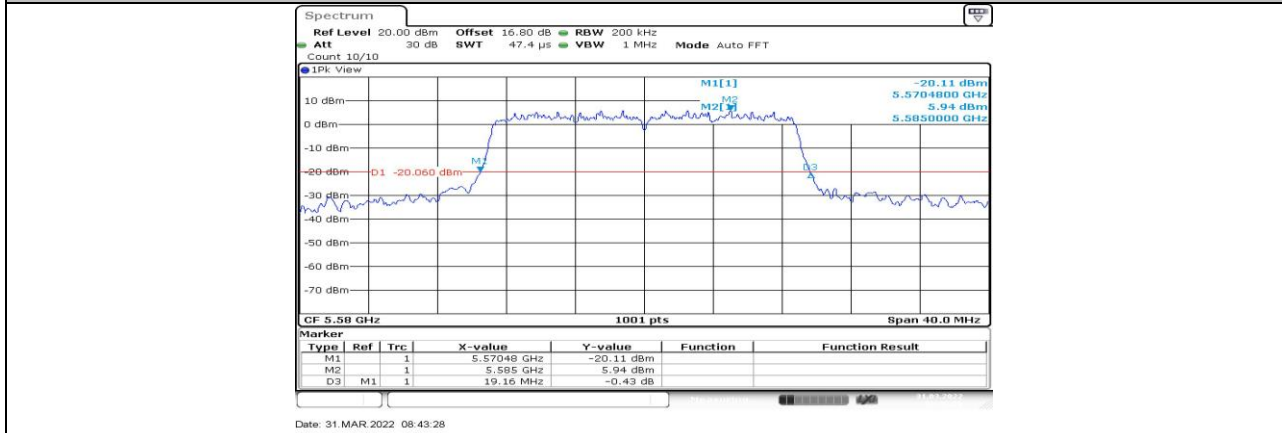

11N20MIMO_Ant2_5580

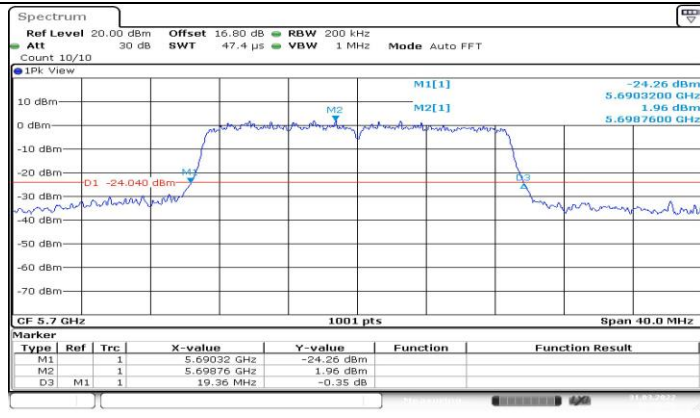

Date: 31.MAR.2022 08:59:56

11N20MIMO_Ant1_5700

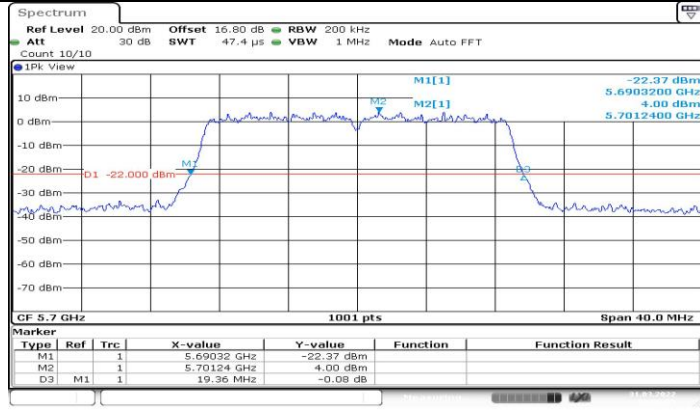

Date: 31.MAR.2022 09:00:05

11N20MIMO_Ant2_5700

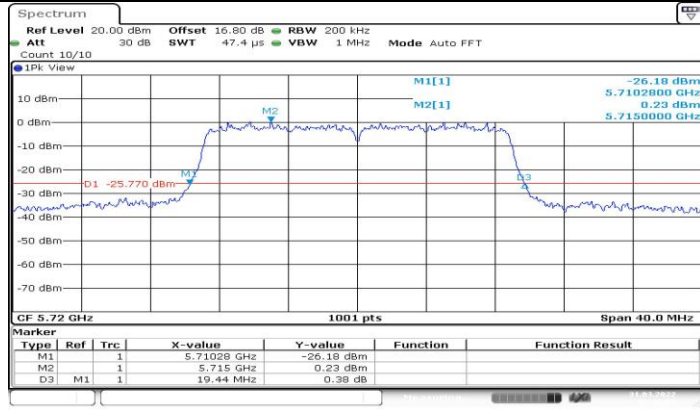

Date: 31.MAR.2022 09:18:04

11N20MIMO_Ant1_5720

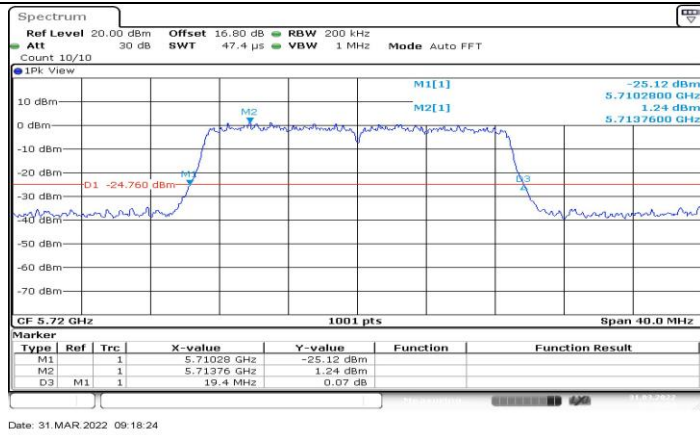

Date: 31.MAR.2022 09:18:24

11N20MIMO_Ant2_5720

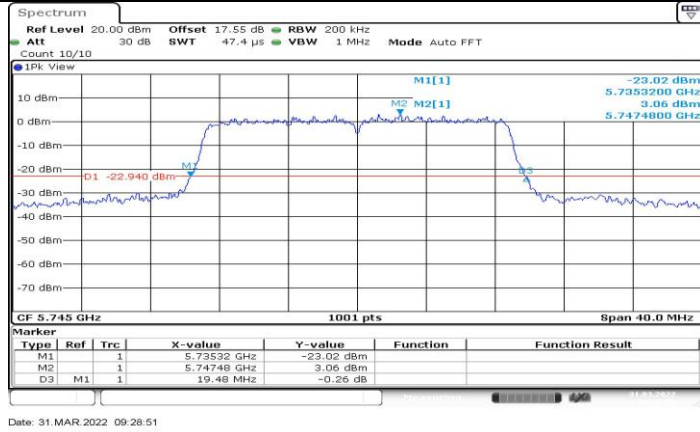

Date: 31.MAR.2022 09:28:51

11N20MIMO_Ant1_5745

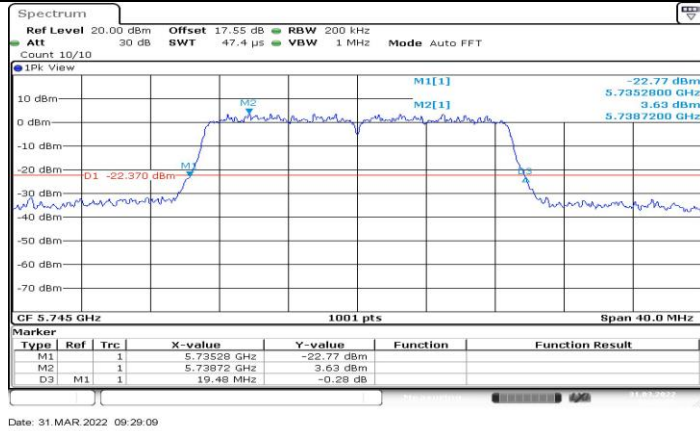

Date: 31.MAR.2022 09:29:09

11N20MIMO_Ant2_5745

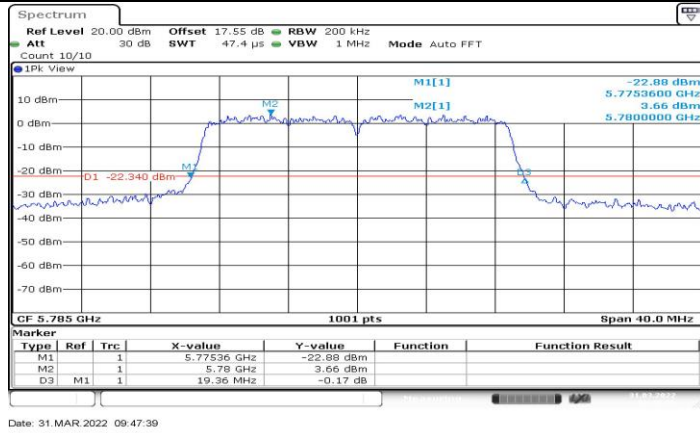

11N20MIMO_Ant1_5785

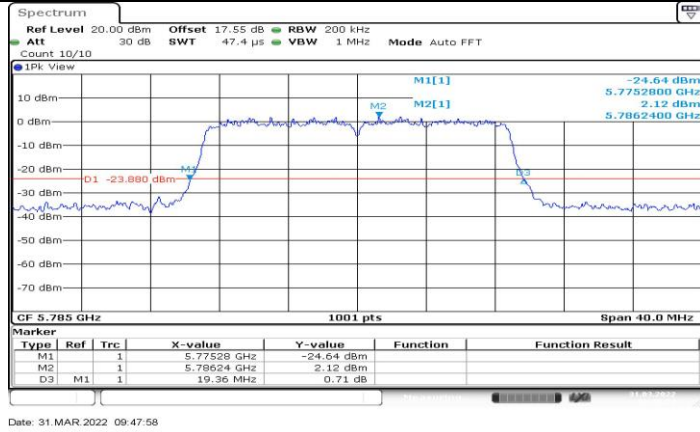

11N20MIMO_Ant2_5785

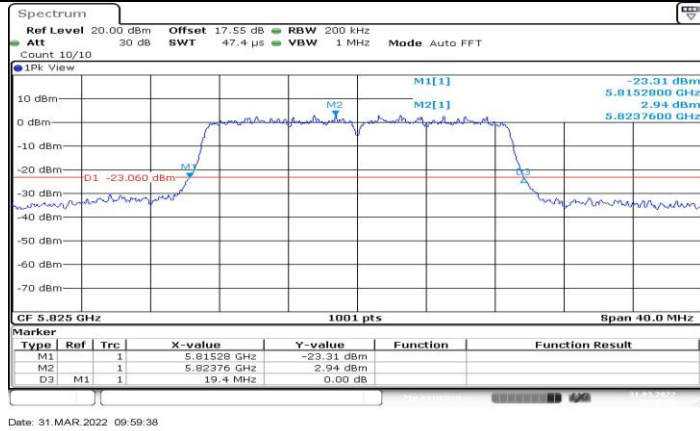

11N20MIMO_Ant1_5825

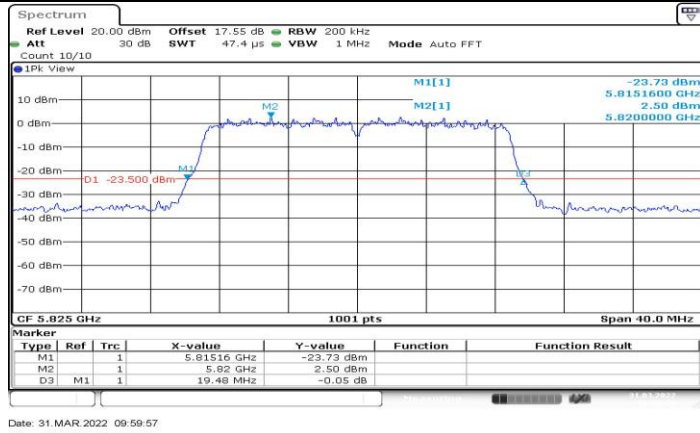

11N20MIMO_Ant2_5825



11N40MIMO_Ant1_5190



11N40MIMO_Ant2_5190

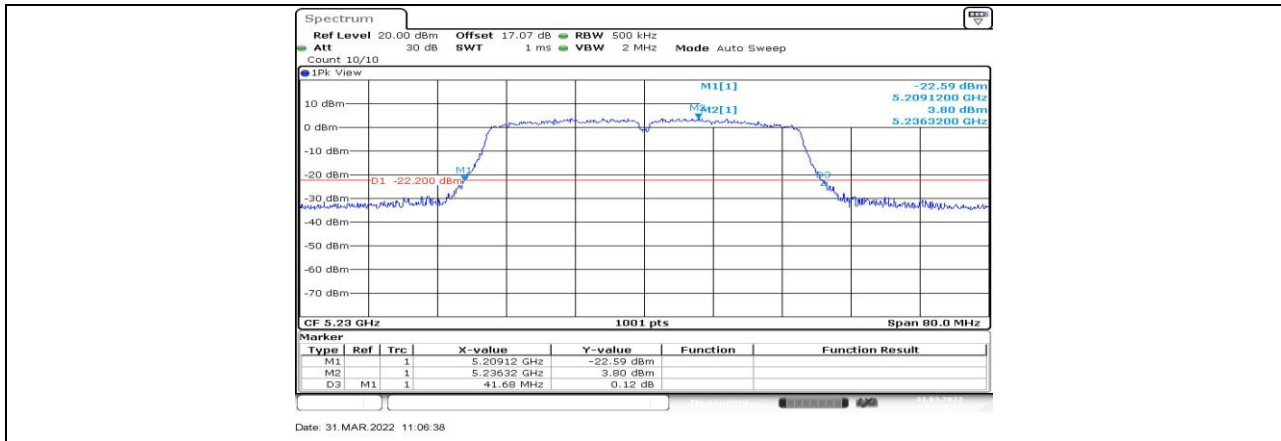

11N40MIMO_Ant1_5230

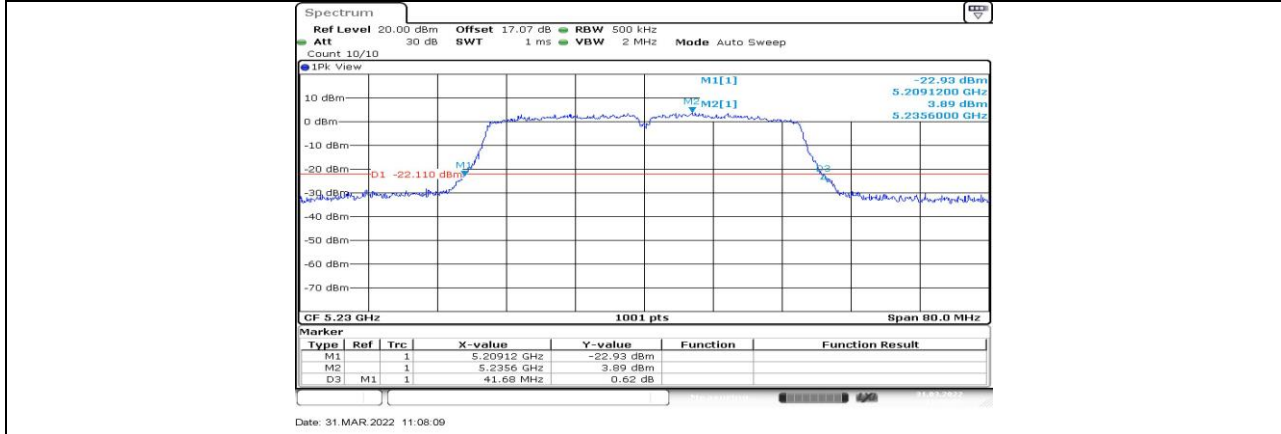

11N40MIMO_Ant2_5230

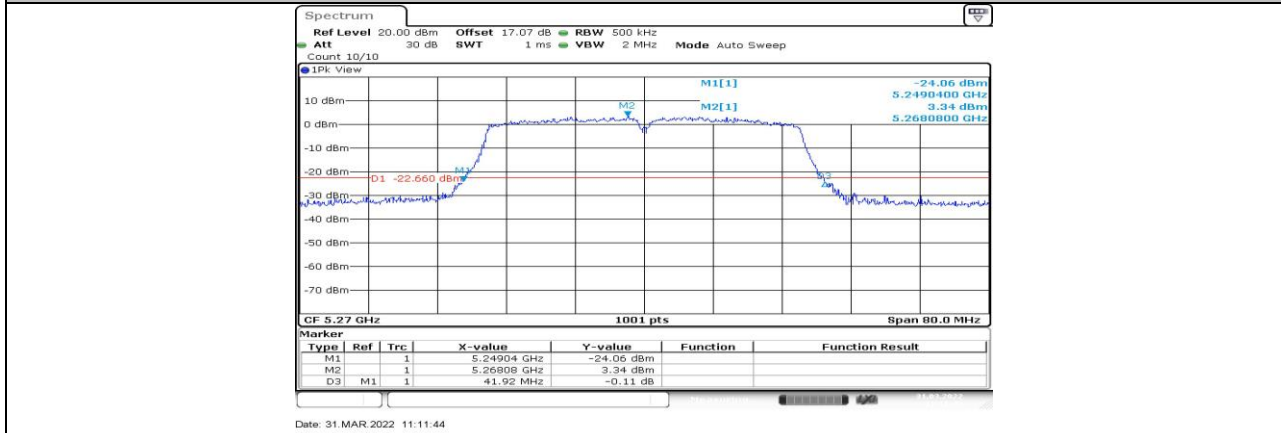

11N40MIMO_Ant1_5270

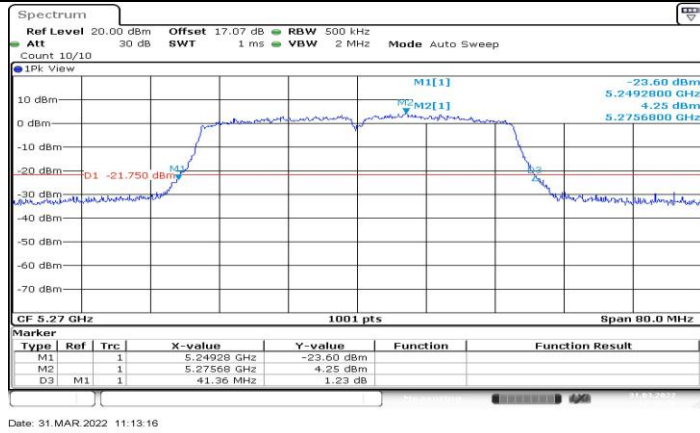

Date: 31.MAR.2022 11:13:16

11N40MIMO_Ant2_5270

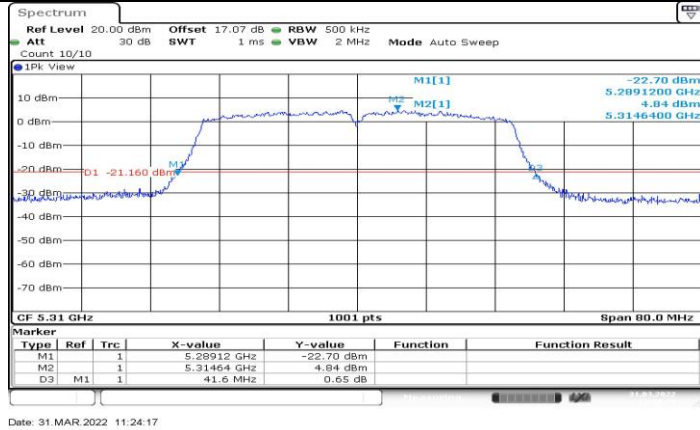

Date: 31.MAR.2022 11:24:17

11N40MIMO_Ant1_5310

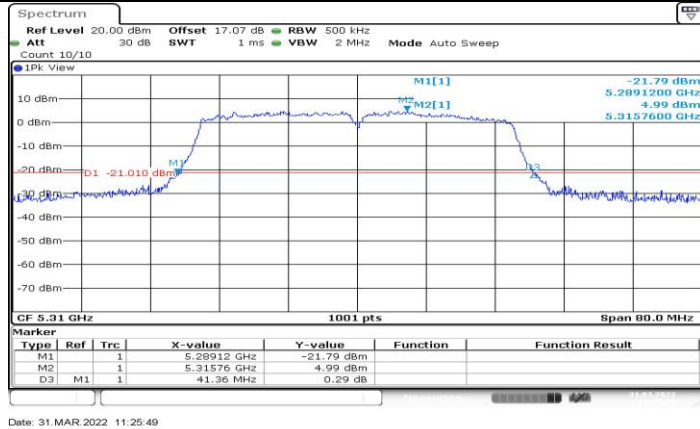

Date: 31.MAR.2022 11:25:49

11N40MIMO_Ant2_5310

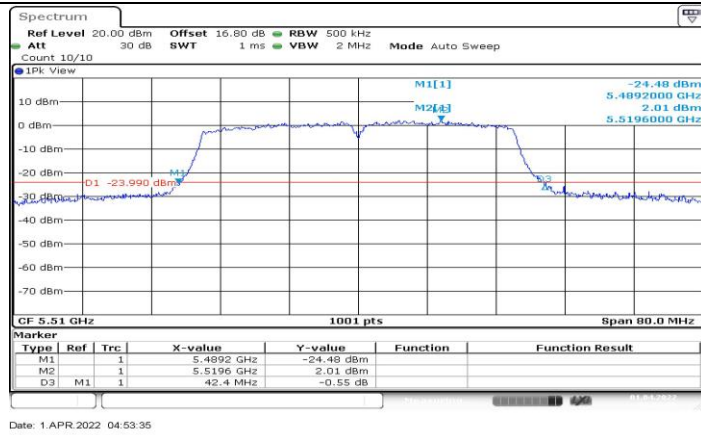

11N40MIMO_Ant1_5510

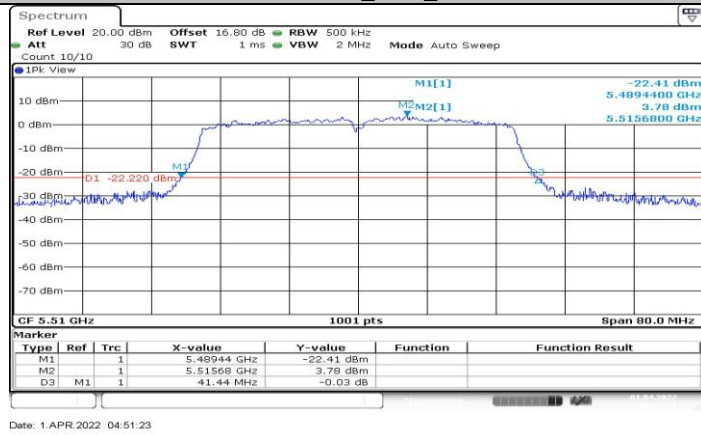

11N40MIMO_Ant2_5510

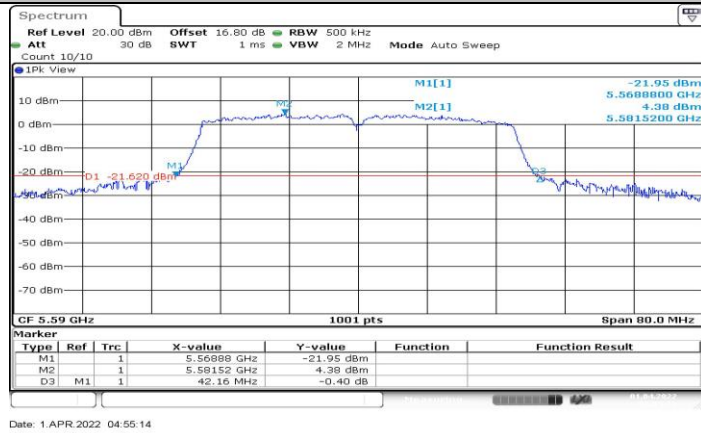

11N40MIMO_Ant1_5590