



**CFR 47 FCC PART 15 SUBPART E
CERTIFICATION TEST REPORT**

For

WIFI Module

MODEL NUMBER: WC5FM2601F

FCC ID: 2AC23-WC5F

REPORT NUMBER: 4790487037-3

ISSUE DATE: August 5, 2022

Prepared for

**Hui Zhou Gaoshengda Technology Co.,LTD
No.2,Jin-da Road,Huinan High-tech Industrial Park,Hui-ao Avenue,Huizhou
City,Guangdong,China**

Prepared by

UL Verification Services (Guangzhou) Co., Ltd, Song Shan Lake Branch

Building 10, Innovation Technology Park, No. 1, Li Bin Road, Song Shan Lake Hi-Tech Development Zone Dongguan, 523808, People's Republic of China

Tel: +86 769 22038881

Fax: +86 769 33244054

Website: www.ul.com



Revision History

Rev.	Issue Date	Revisions	Revised By
V0	08/05/2022	Initial Issue	

Note: This is a report base on 4789971838.2-5 which is issued by UL Verification Services (Guangzhou) Co., Ltd, Song Shan Lake Branch on July 20, 2021. The module WC5FM2601F had already applied for single module approval and the FCC ID is 2AC23-WC5F. Now the customer wants to add two antennas but the module remained unchanged. The antenna type of the new antennas is the same as the original antenna, but the gain is different. Spot check had been done for the conducted output power, the power of module remained unchanged after MU consideration, so we retest all radiated emission and show in this report but others data were refer to the original test report.

The summary of spot-check test data compared to the original test data:

Item	Test Mode	Frequency (MHz)	Antenna	Worst Case Test Result		
				Original Test Result (dBm)	Spot Check Result (dBm)	Difference
Conducted AV Power	802.11a20	5200	0	19.20	19.33	0.13
			1	19.00	19.12	0.12
	802.11n HT20	5180	0	15.69	15.54	-0.15
			1	15.75	15.66	-0.09
	802.11n HT40	5190	0	15.97	15.86	-0.11
			1	16.17	16.25	-0.08



Summary of Test Results			
Clause	Test Items	FCC Rules	Test Results
1	6dB/26dB Bandwidth	FCC 15.407 (a)&©	PASS
2	Conducted Output Power	FCC 15.407 (a)	PASS
3	Power Spectral Density	FCC 15.407 (a)	PASS
4	Radiated Bandedge and Spurious Emission	FCC 15.407 (b) FCC 15.209 FCC 15.205	PASS
5	Conducted Emission Test for AC Power Port	FCC 15.207	PASS
6	Frequency Stability	FCC 15.407 (g)	PASS
7	Dynamic Frequency Selection	FCC 15.407 (h)	PASS
8	Antenna Requirement	FCC 15.203	PASS
Note: 1.This test report is only published to and used by the applicant, and it is not for evidence purpose in China. 2. The measurement result for the sample received is <Pass> according to < CFR 47 FCC PART 15 SUBPART E > when <Accuracy Method> decision rule is applied.			



TABLE OF CONTENTS

1. ATTESTATION OF TEST RESULTS	7
2. TEST METHODOLOGY	8
3. FACILITIES AND ACCREDITATION	8
4. CALIBRATION AND UNCERTAINTY	9
4.1. <i>MEASURING INSTRUMENT CALIBRATION</i>	9
4.2. <i>MEASUREMENT UNCERTAINTY</i>	9
5. EQUIPMENT UNDER TEST	10
5.1. <i>DESCRIPTION OF EUT</i>	10
5.2. <i>MAXIMUM OUTPUT POWER</i>	11
5.3. <i>CHANNEL LIST</i>	12
5.4. <i>DESCRIPTION OF AVAILABLE ANTENNAS</i>	13
5.5. <i>THE WORSE CASE POWER SETTING PARAMETER</i>	16
5.6. <i>THE WORSE CASE CONFIGURATIONS</i>	18
5.7. <i>DESCRIPTION OF TEST SETUP</i>	19
6. MEASURING INSTRUMENT AND SOFTWARE USED	20
7. ANTENNA PORT TEST RESULTS	24
7.1. <i>ON TIME AND DUTY CYCLE</i>	24
7.2. <i>6/26 dB EMISSION BANDWIDTH AND 99 % OCCUPIED BANDWIDTH</i>	25
7.3. <i>CONDUCTED OUTPUT POWER</i>	27
7.4. <i>POWER SPECTRAL DENSITY</i>	30
8. RADIATED TEST RESULTS	32
8.1. <i>RESTRICTED BANDEDGE</i>	39
8.1.1. 802.11a 20 SISO MODE	39
UNII-1 BAND	39
UNII-2A BAND	43
UNII-2C BAND.....	47
UNII-3 BAND	50
8.1.2. 802.11n HT20 MIMO MODE	52
UNII-1 BAND	52
UNII-2A BAND	56
UNII-2C BAND.....	60
UNII-3 BAND	63
8.1.3. 802.11n HT40 MIMO MODE	65
UNII-1 BAND	65
UNII-2A BAND	69
UNII-2C BAND.....	73



UNII-3 BAND	76
8.2. SPURIOUS EMISSIONS (1 GHz ~ 7 GHz).....	78
8.2.1. 802.11n HT20 SISO MODE	78
UNII-1 BAND	78
UNII-2A BAND.....	84
UNII-2C BAND.....	90
STRADDLE CHANNEL 144	96
UNII-3 BAND	98
8.3. SPURIOUS EMISSIONS (7 GHz ~ 18 GHz).....	104
8.3.1. 802.11a 20 SISO MODE	104
UNII-1 BAND	104
UNII-2A BAND.....	110
UNII-2C BAND.....	116
STRADDLE CHANNEL 144	122
UNII-3 BAND	124
8.3.2. 802.11n HT20 MIMO MODE	130
UNII-1 BAND	130
UNII-2A BAND.....	136
UNII-2C BAND.....	142
STRADDLE CHANNEL 144	148
UNII-3 BAND	150
8.3.3. 802.11n HT40 MIMO MODE	156
UNII-1 BAND	156
UNII-2A BAND.....	160
UNII-2C BAND.....	164
STRADDLE CHANNEL 142	170
UNII-3 BAND	172
8.4. SPURIOUS EMISSIONS (18 GHz ~ 26 GHz).....	176
8.4.1. 802.11n HT20 MODE	176
8.5. SPURIOUS EMISSIONS (26 GHz ~ 40 GHz).....	178
8.5.1. 802.11n HT20 MODE	178
8.6. SPURIOUS EMISSIONS (30 MHz ~ 1 GHz).....	180
8.6.1. 802.11n HT20 MODE	180
8.7. SPURIOUS EMISSIONS BELOW 30 MHz	182
8.7.1. 802.11n HT20 MODE	182
9. AC POWER LINE CONDUCTED EMISSIONS.....	185
9.1.1. 802.11n HT20 MODE	186
10. FREQUENCY STABILITY	188
11. DYNAMIC FREQUENCY SELECTION	190
12. ANTENNA REQUIREMENTS.....	194
13. Appendix.....	195
13.1. Appendix A1: Emission Bandwidth	195
13.1.1. Test Result.....	195



13.1.2. Test Graphs 197

13.2. Appendix A2: Occupied Channel Bandwidth221

13.2.1. Test Result.....221

13.2.2. Test Graphs223

13.3. Appendix A3: Min Emission Bandwidth247

13.3.1. Test Result.....247

13.3.2. Test Graphs248

13.4. Appendix B1: Maximum Average Conducted Output Power256

13.4.1. Test Result.....256

13.4.2. Test Graphs258

13.4.3. Spot Check Test Result262

13.5. Appendix C1: Maximum Power Spectral Density263

13.5.1. Test Result.....263

13.5.2. Test Graphs265

13.6. Appendix D: Duty Cycle291

13.6.1. Test Result.....291

13.6.2. Test Graphs292

13.7. Appendix E: Frequency Stability293

Test Result.....293

13.8. Appendix F: Dynamic Frequency Selection295



1. ATTESTATION OF TEST RESULTS

Applicant Information

Company Name: Hui Zhou Gaoshengda Technology Co.,LTD
Address: No.2,Jin-da Road,Huinan High-tech Industrial Park,Hui-ao Avenue,Huizhou City,Guangdong,China

Manufacturer Information

Company Name: Hui Zhou Gaoshengda Technology Co.,LTD
Address: No.2,Jin-da Road,Huinan High-tech Industrial Park,Hui-ao Avenue,Huizhou City,Guangdong,China

EUT Information

EUT Name: WIFI Module
Model: WC5FM2601F
Brand: GSD
Last Time Sample Received Date: June 4, 2021
This Time Sample Received Date: July 12, 2022
Sample Status: Normal
Sample ID: 3964244/5143871
Date of Tested for Last Time: June 4, 2021 ~ June 18, 2021
Date of Tested for This Time: July 12, 2022 ~ July 26, 2022

APPLICABLE STANDARDS	
STANDARD	TEST RESULTS
CFR 47 FCC PART 15 SUBPART E	PASS

Prepared By:

Kebo Zhang
Senior Project Engineer

Checked By:

Denny Huang
Senior Project Engineer

Approved By:

Stephen Guo
Laboratory Manager



2. TEST METHODOLOGY

The tests documented in this report were performed in accordance with ANSI C63.10-2013, CFR 47 FCC Part 2, CFR 47 FCC Part 15, KDB 789033 D02 v02r01, KDB414788 D01 Radiated Test Site v01r01, KDB 662911 D01 Multiple Transmitter Output v02r01, KDB 905462 D02 UNII DFS Compliance Procedures New Rules v02, KDB 905462 D03 UNII clients without radar detection New Rules v01r02, KDB 905462 D04 Operational Modes for DFS Testing New Rules v01 and KDB 905462 D06 802 11 Channel Plans New Rules v02.

3. FACILITIES AND ACCREDITATION

Accreditation Certificate	<p>A2LA (Certificate No.: 4102.01) UL Verification Services (Guangzhou) Co., Ltd. Song Shan Lake Branch. Has been assessed and proved to be in compliance with A2LA.</p> <p>FCC (FCC Designation No.: CN1187) UL Verification Services (Guangzhou) Co., Ltd. Song Shan Lake Branch. Has been recognized to perform compliance testing on equipment subject to the Commission's Declaration of Conformity (DoC) and Certification rules</p> <p>ISED (Company No.: 21320) UL Verification Services (Guangzhou) Co., Ltd. Song Shan Lake Branch. Has been registered and fully described in a report filed with ISED. The Company Number is 21320 and the test lab Conformity Assessment Body Identifier (CABID) is CN0046.</p> <p>VCCI (Registration No.: G-20019, R-20004, C-20012 and T-20011) UL Verification Services (Guangzhou) Co., Ltd. Song Shan Lake Branch. Has been assessed and proved to be in compliance with VCCI, the Membership No. is 3793. Facility Name: Chamber D, the VCCI registration No. is G-20019 and R-20004 Shielding Room B, the VCCI registration No. is C-20012 and T-20011</p>
---------------------------	--

Note 1: All tests measurement facilities use to collect the measurement data are located at Building 10, Innovation Technology Park, Song Shan Lake Hi tech Development Zone, Dongguan, 523808, China

Note 2: The test anechoic chamber in UL Verification Services (Guangzhou) Co., Ltd. Song Shan Lake Branch had been calibrated and compared to the open field sites and the test anechoic chamber is shown to be equivalent to or worst case from the open field site.

Note 3: For below 30 MHz, lab had performed measurements at test anechoic chamber and comparing to measurements obtained on an open field site. And these measurements below 30 MHz had been correlated to measurements performed on an OFS.

4. CALIBRATION AND UNCERTAINTY

4.1. MEASURING INSTRUMENT CALIBRATION

The measuring equipment utilized to perform the tests documented in this report has been calibrated in accordance with the manufacturer's recommendations and is traceable to recognize national standards.

4.2. MEASUREMENT UNCERTAINTY

Where relevant, the following measurement uncertainty levels have been estimated for tests performed on the apparatus:

Test Item	Uncertainty
Conduction emission	3.62 dB
Radiated Emission (Included Fundamental Emission) (9 kHz ~ 30 MHz)	2.2 dB
Radiated Emission (Included Fundamental Emission) (30 MHz ~ 1 GHz)	4.00 dB
Radiated Emission (Included Fundamental Emission) (1 GHz to 40 GHz)	5.78 dB (1 GHz-18 GHz)
	5.23dB (18 GHz-26 GHz)
	5.64 dB (26 GHz-40 GHz)
Note: This uncertainty represents an expanded uncertainty expressed at approximately the 95 % confidence level using a coverage factor of k=2.	



5. EQUIPMENT UNDER TEST

5.1. DESCRIPTION OF EUT

EUT Name:	WIFI Module
Model Name:	WC5FM2601F
Radio Technology	WLAN (IEEE 802.11a 20/n HT20/n HT40)
Operation Frequency	UNII-1: 5150 ~ 5250 MHz UNII-2A: 5250 ~ 5350 MHz UNII-2C: 5470 ~ 5725 MHz UNII-3: 5725 ~ 5850 MHz
Modulation	IEEE 802.11a 20: OFDM (64QAM, 16QAM, QPSK, BPSK) IEEE 802.11n HT20: OFDM (64QAM, 16QAM, QPSK, BPSK) IEEE 802.11n HT40: OFDM (64QAM, 16QAM, QPSK, BPSK)
Rated Input	DC 3.3 V



5.2. MAXIMUM OUTPUT POWER

UNII-1 BAND

IEEE Std. 802.11	Frequency (MHz)	Maximum Average Conducted Power (dBm)
a 20	5150 ~ 5250	19.20
n HT20		18.73
n HT40		19.08

UNII-2A BAND

IEEE Std. 802.11	Frequency (MHz)	Maximum Average Conducted Power (dBm)
a 20	5250 ~ 5350	19.09
n HT20		18.53
n HT40		18.65

UNII-2C BAND

IEEE Std. 802.11	Frequency (MHz)	Maximum Average Conducted Power (dBm)
a 20	5470 ~ 5725	16.16
n HT20		15.98
n HT40		15.83

UNII-3 BAND

IEEE Std. 802.11	Frequency (MHz)	Maximum Average Conducted Power (dBm)
a 20	5725 ~ 5850	19.46
n HT20		19.79
n HT40		19.63

**5.3. CHANNEL LIST**

UNII-1 (For Bandwidth=20MHz)		UNII-1 (For Bandwidth=40MHz)	
Channel	Frequency (MHz)	Channel	Frequency (MHz)
36	5180	38	5190
40	5200	46	5230
44	5220		
48	5240		

UNII-2A (For Bandwidth=20MHz)		UNII-2A (For Bandwidth=40MHz)	
Channel	Frequency (MHz)	Channel	Frequency (MHz)
52	5260	54	5270
56	5280	62	5310
60	5300		
64	5320		

UNII-2C (For Bandwidth=20MHz)		UNII-2C (For Bandwidth=40MHz)	
Channel	Frequency (MHz)	Channel	Frequency (MHz)
100	5500	102	5510
104	5520	110	5550
108	5540	118	5590
112	5560	126	5630
116	5580	134	5670
120	5600	142	5710
124	5620		
128	5640		
132	5660		
136	5680		
140	5700		
144	5720		

UNII-3 (For Bandwidth=20MHz)		UNII-3 (For Bandwidth=40MHz)	
Channel	Frequency (MHz)	Channel	Frequency (MHz)
149	5745	151	5755
153	5765	159	5795
157	5785		
161	5805		
165	5825		

5.4. DESCRIPTION OF AVAILABLE ANTENNAS

Antenna Group 1				
Antenna No.	Frequency (MHz)	Antenna Type	Maximum Antenna Gain (dBi)	Manufacturer
0	5180 ~ 5825	PIFA	4.13	Zhongshan B&T Communication Technology Co., Ltd
1	5180 ~ 5825	PIFA	3	/

The EUT support Cyclic Shift Diversity (CDD), Space Time Coding (STBC), Spatial Division Multiplexing (SDM) modes.

According to KDB 662911 D01:

The Directional Gain was calculated as the following method:

For CDD mode:

For output power measurements:

Directional gain = $G_{ANT} + \text{Array Gain} = 4.13 \text{ dBi}$

G_{ANT} : equal to the gain of the antenna having the highest gain

Array Gain = 0 dB (i.e., no array gain) for $N_{ANT} \leq 4$

For power spectral density (PSD) measurements:

Directional gain = $G_{ANT} + \text{Array Gain} = 7.14 \text{ dBi}$

Array Gain = $10 \log(N_{ANT}/N_{SS}) \text{ dB}$.

N_{ANT} : number of transmit antennas

N_{SS} : number of spatial streams, the worst case directional gain will occur when $N_{SS} = 1$

For STBC and SDM mode:

For output power measurements and power spectral density (PSD) measurements

Directional gain = $G_{ANT} = 4.13 \text{ dBi}$

IEE Std. 802.11	Transmit and Receive Mode	Description
802.11a 20	☒2TX, 2RX	ANT 0 and ANT 1 can be used as transmitting/receiving antenna.
802.11n HT20	☒2TX, 2RX	ANT 0 and ANT 1 can be used as transmitting/receiving antenna.
802.11n HT40	☒2TX, 2RX	ANT 0 and ANT 1 can be used as transmitting/receiving antenna.
802.11ac VHT20	☒2TX, 2RX	ANT 0 and ANT 1 can be used as transmitting/receiving antenna.
802.11ac VHT40	☒2TX, 2RX	ANT 0 and ANT 1 can be used as transmitting/receiving antenna.
802.11ac VHT80	☒2TX, 2RX	ANT 0 and ANT 1 can be used as transmitting/receiving antenna.

Note:

1. WLAN 2.4G & WLAN 5G can't transmit simultaneously. (Declared by client)

Antenna Group 2				
Antenna No.	Frequency (MHz)	Antenna Type	Maximum Antenna Gain (dBi)	Manufacturer
0	5180 ~ 5825	PIFA	2.57	Shenzhen Yishengbang Technology Company Limited
1	5180 ~ 5825	PIFA	3	/

The EUT support Cyclic Shift Diversity (CDD), Space Time Coding (STBC), Spatial Division Multiplexing (SDM) modes.

According to KDB 662911 D01:

The Directional Gain was calculated as the following method:

For CDD mode:

For output power measurements:

Directional gain = $G_{ANT} + \text{Array Gain} = 3 \text{ dBi}$

G_{ANT} : equal to the gain of the antenna having the highest gain

Array Gain = 0 dB (i.e., no array gain) for $N_{ANT} \leq 4$

For power spectral density (PSD) measurements:

Directional gain = $G_{ANT} + \text{Array Gain} = 6.01 \text{ dBi}$

Array Gain = $10 \log (N_{ANT}/N_{SS}) \text{ dB}$.

N_{ANT} : number of transmit antennas

N_{SS} : number of spatial streams, the worst case directional gain will occur when $N_{SS} = 1$

For STBC and SDM mode:

For output power measurements and power spectral density (PSD) measurements

Directional gain = $G_{ANT} = 2.57 \text{ dBi}$

IEE Std. 802.11	Transmit and Receive Mode	Description
802.11a 20	<input checked="" type="checkbox"/> 2TX, 2RX	ANT 0 and ANT 1 can be used as transmitting/receiving antenna.
802.11n HT20	<input checked="" type="checkbox"/> 2TX, 2RX	ANT 0 and ANT 1 can be used as transmitting/receiving antenna.
802.11n HT40	<input checked="" type="checkbox"/> 2TX, 2RX	ANT 0 and ANT 1 can be used as transmitting/receiving antenna.
802.11ac VHT20	<input checked="" type="checkbox"/> 2TX, 2RX	ANT 0 and ANT 1 can be used as transmitting/receiving antenna.
802.11ac VHT40	<input checked="" type="checkbox"/> 2TX, 2RX	ANT 0 and ANT 1 can be used as transmitting/receiving antenna.
802.11ac VHT80	<input checked="" type="checkbox"/> 2TX, 2RX	ANT 0 and ANT 1 can be used as transmitting/receiving antenna.
Note: 1. WLAN 2.4G & WLAN 5G can't transmit simultaneously. (Declared by client)		



Note:

1. The value of the antenna gain was declared by customer.
2. Antenna No. 1 for each group is the same as the original antenna.
3. Antenna No. 0 is new antenna and it has 2 kinds which is made by difference manufacturer (B&T and Yishengbang).
4. For Antenna No. 0, pre-scan had been done for all the antennas and cables, but only the worst data (B&T Antenna) was recorded in the report.

**5.5. THE WORSE CASE POWER SETTING PARAMETER**

The Worse Case Power Setting Parameter	
Test Software	QA tool

UNII-1

Mode	Rate	Channel	Soft set value
			2 TX
11a 20	6M	36	23
		40	25
		48	25
11n HT20	MCS0	36	1E
		40	1E
		48	1E
11n HT40	MCS0	38	1E
		46	1E

UNII-2A

Mode	Rate	Channel	Soft set value
			2 TX
11a 20	6M	52	25
		60	25
		64	24
11n HT20	MCS0	52	1E
		60	1E
		64	1E
11n HT40	MCS0	54	1E
		62	18



UNII-2C

Mode	Rate	Channel	Soft set value
			2 TX
11a 20	6M	100	1F
		120	1D
		140	19
11n HT20	MCS0	100	18
		120	18
		140	18
11n HT40	MCS0	102	18
		118	18
		134	18
		142	18

UNII-3

Mode	Rate	Channel	Soft set value
			2 TX
11a 20	6M	149	25
		157	25
		165	25
11n HT20	MCS0	149	22
		157	22
		165	22
11n HT40	MCS0	151	20
		159	20

5.6. THE WORSE CASE CONFIGURATIONS

The EUT was tested in the following configuration(s):

Controlled in test mode using a software application on the EUT supplied by customer. The application was used to enable a continuous transmission and to select the mode, test channels, bandwidth, data rates as required.

Test channels referring to section 5.4.

Maximum power setting referring to section 5.6.

Worst-case data rates as provided by the client were:

802.11a 20 mode: 6 Mbps

802.11n HT20 mode: MCS0

802.11n HT40 mode: MCS0

802.11a only support SISO mode.

802.11 n HT20/HT40 support SISO and MIMO mode.

802.11a SISO mode, Antenna 0 and Antenna 1 has the same power setting, so only Antenna 0 worst case test data were recorded in the report.

802.11n SISO mode and MIMO mode have the same power setting, so only the worst case power mode(MIMO) will be record in the report.

Antenna 0 and Antenna 1 have the same power setting, but the power test data are different. (Declared by customer.)

The measured additional path loss was included in any path loss calculations for all RF cable used during tested.

Conducted output power, power spectral density tests separately on each port with all supported SISO & MIMO port combinations.

The EUT support Cyclic Shift Diversity(CDD), Space Time Coding(STBC), Spartial Division Multiplexing(SDM) modes. They use the same conducted power per chain in any given mode, CDD mode have the maximum power setting, so we only chose the worst case mode CDD for final testing.

5.7. DESCRIPTION OF TEST SETUP

SUPPORT EQUIPMENT

Item	Equipment	Brand Name	Model Name	Remarks
1	Laptop	Lenovo	XIAOXIN 5000	/
2	UART	/	/	/
3	AC Adapter	Lenovo	ADLX65YCC3D	Input: 100-240 Vac, 50/60 Hz Output: 20 Vdc, 3.25A

I/O CABLES

Cable No	Port	Connector Type	Cable Type	Cable Length(m)	Remarks
1	USB	N/A	N/A	1	N/A

ACCESSORIES

Item	Accessory	Brand Name	Model Name	Description
/	/	/	/	/

TEST SETUP

The EUT can work in engineering mode with a software through a Laptop.

SETUP DIAGRAM FOR TESTS

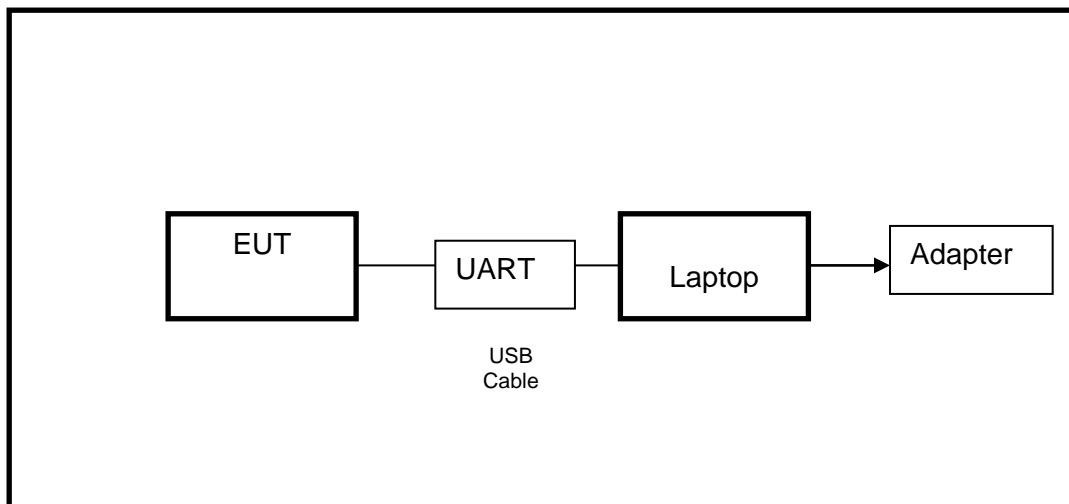

Note: AC adapter only use for AC POWER LINE CONDUCTED EMISSIONS testing.



6. MEASURING INSTRUMENT AND SOFTWARE USED

Last time calibration information:

Conducted Emissions					
Equipment	Manufacturer	Model No.	Serial No.	Last Cal.	Due Date
EMI Test Receiver	R&S	ESR3	101961	Nov. 12, 2020	Nov. 11, 2021
Two-Line V-Network	R&S	ENV216	101983	Nov. 12, 2020	Nov. 11, 2021
Software					
Description		Manufacturer	Name	Version	
Test Software for Conducted Emissions		Farad	EZ-EMC	Ver. UL-3A1	

Radiated Emissions					
Equipment	Manufacturer	Model No.	Serial No.	Last Cal.	Due Date
MXE EMI Receiver	KESIGHT	N9038A	MY56400036	Nov. 12, 2020	Nov. 11, 2021
Hybrid Log Periodic Antenna	TDK	HLP-3003C	130960	Aug. 11, 2018	Aug. 10, 2021
Preamplifier	HP	8447D	2944A09099	Nov. 12, 2020	Nov. 11, 2021
EMI Measurement Receiver	R&S	ESR26	101377	Nov. 12, 2020	Nov. 11, 2021
Horn Antenna	TDK	HRN-0118	130939	Sept. 17, 2018	Sept. 17, 2021
Preamplifier	TDK	PA-02-0118	TRS-305-00067	Nov. 20, 2020	Nov. 19, 2021
Horn Antenna	Schwarzbeck	BBHA9170	#691	Aug. 11, 2018	Aug. 11, 2021
Preamplifier	TDK	PA-02-2	TRS-307-00003	Nov. 12, 2020	Nov. 11, 2021
Preamplifier	TDK	PA-02-3	TRS-308-00002	Nov. 12, 2020	Nov. 11, 2021
Loop antenna	Schwarzbeck	1519B	00008	Jan.17, 2019	Jan.17,2022
Preamplifier	TDK	PA-02-001-3000	TRS-302-00050	Nov. 12, 2020	Nov. 11, 2021
Preamplifier	Mini-Circuits	ZX60-83LN-S+	SUP01201941	Nov. 20, 2020	Nov. 19, 2021
Highpass Filter	Wainwright	WHKX10-5850-6500-1800-40SS	4	Nov. 12, 2020	Nov. 11, 2021
Band Reject Filter	Wainwright	WRCJV12-5695-5725-5850-5880-40SS	4	Nov. 12, 2020	Nov. 11, 2021
Band Reject Filter	Wainwright	WRCJV20-5120-5150-5350-5380-	2	Nov. 12, 2020	Nov. 11, 2021



		60SS			
Band Reject Filter	Wainwright	WRCJV20-5440-5470-5725-5755-60SS	1	Nov. 12, 2020	Nov. 11, 2021
Software					
Description		Manufacturer	Name	Version	
Test Software for Radiated Emissions		Farad	EZ-EMC	Ver. UL-3A1	

Tonsend RF Test System					
Equipment	Manufacturer	Model No.	Serial No.	Last Cal.	Due. Date
Wideband Radio Communication Tester	R&S	CMW500	155523	Nov.20,2020	Nov.19,2021
PXA Signal Analyzer	Keysight	N9030A	MY55410512	Nov.20,2020	Nov.19,2021
MXG Vector Signal Generator	Keysight	N5182B	MY56200284	Nov.20,2020	Nov.19,2021
MXG Vector Signal Generator	Keysight	N5172B	MY56200301	Nov.20,2020	Nov.19,2021
DC power supply	Keysight	E3642A	MY55159130	Nov.24,2020	Nov.23,2021
Temperature & Humidity Chamber	SANMOOD	SG-80-CC-2	2088	Nov.20,2020	Nov.19,2021
Software					
Description		Manufacturer	Name		Version
Tonsend SRD Test System		Tonsend	JS1120-3 RF Test System		2.6.77.0518

Other Instruments					
Equipment	Manufacturer	Model No.	Serial No.	Last Cal.	Next Cal.
Power sensor, Power Meter	R&S	OSP120	100921	Mar.13,2020	Mar.13,2021



This time calibration information:

Radiated Emissions					
Equipment	Manufacturer	Model No.	Serial No.	Last Cal.	Due Date
MXE EMI Receiver	KESIGHT	N9038A	MY56400036	Oct.30, 2021	Oct.29, 2022
Hybrid Log Periodic Antenna	TDK	HLP-3003C	130959	Aug.02, 2021	Aug.01, 2024
Preamplifier	HP	8447D	2944A09099	Oct.30, 2021	Oct.29, 2022
EMI Measurement Receiver	R&S	ESR26	101377	Oct.30, 2021	Oct.29, 2022
Horn Antenna	TDK	HRN-0118	130940	July 20, 2021	July 19, 2024
Preamplifier	TDK	PA-02-0118	TRS-305-00067	Oct.30, 2021	Oct.29, 2022
Horn Antenna	Schwarzbeck	BBHA9170	697	July 20, 2021	July 19, 2024
Preamplifier	TDK	PA-02-2	TRS-307-00003	Oct.31, 2021	Oct.30, 2022
Preamplifier	TDK	PA-02-3	TRS-308-00002	Oct.31, 2021	Oct.30, 2022
Loop antenna	Schwarzbeck	1519B	00008	Dec.14, 2021	Dec.13, 2024
Preamplifier	TDK	PA-02-001-3000	TRS-302-00050	Oct.31, 2021	Oct.30, 2022
Highpass Filter	Wainwright	WHKX10-5850-6500-1800-40SS	4	Oct.31, 2021	Oct.30, 2022
Band Reject Filter	Wainwright	WRCJV12-5695-5725-5850-5880-40SS	4	Oct.31, 2021	Oct.30, 2022
Band Reject Filter	Wainwright	WRCJV20-5120-5150-5350-5380-60SS	2	Oct.31, 2021	Oct.30, 2022
Band Reject Filter	Wainwright	WRCJV20-5440-5470-5725-5755-60SS	1	Oct.31, 2021	Oct.30, 2022
Software					
Description			Manufacturer	Name	Version
Test Software for Radiated Emissions			Farad	EZ-EMC	Ver. UL-3A1



Tonsend RF Test System					
Equipment	Manufacturer	Model No.	Serial No.	Last Cal.	Due. Date
PXA Signal Analyzer	Keysight	N9030A	MY55410512	Oct.30, 2021	Oct.29, 2022
MXG Vector Signal Generator	Keysight	N5182B	MY56200284	Oct.30, 2021	Oct.29, 2022
MXG Vector Signal Generator	Keysight	N5172B	MY56200301	Oct.30, 2021	Oct.29, 2022
DC power supply	Keysight	E3642A	MY55159130	Oct.30, 2021	Oct.29, 2022
Temperature & Humidity Chamber	SANMOOD	SG-80-CC-2	2088	Nov.20,2020	Nov.19,2022
Software					
Description	Manufacturer	Name		Version	
Tonsend SRD Test System	Tonsend	JS1120-3 RF Test System		2.6.77.0518	

Other Instruments					
Equipment	Manufacturer	Model No.	Serial No.	Last Cal.	Next Cal.
Power sensor, Power Meter	R&S	OSP120	100921	Mar.2, 2022	Mar.1, 2023

7. ANTENNA PORT TEST RESULTS

7.1. ON TIME AND DUTY CYCLE

LIMITS

None; for reporting purposes only.

PROCEDURE

Refer to KDB 789033 D02 General U-NII Test Procedures New Rules v02r01 section II.B.

The zero-span mode on a spectrum analyzer or EMI receiver, if the response time and spacing between bins on the sweep are sufficient to permit accurate measurements of the on and off times of the transmitted signal. Set the center frequency of the instrument to the center frequency of the transmission. Set $RBW \geq EBW$ if possible; otherwise, set RBW to the largest available value. Set $VBW \geq RBW$. Set detector = peak or average. The zero-span measurement method shall not be used unless both RBW and VBW are $> 50/T$, where T is defined in II.B.1.a), and the number of sweep points across duration T exceeds 100. (For example, if VBW and/or RBW are limited to 3 MHz, then the zero-span method of measuring duty cycle shall not be used if $T \leq 16.7$ microseconds.)

TEST SETUP

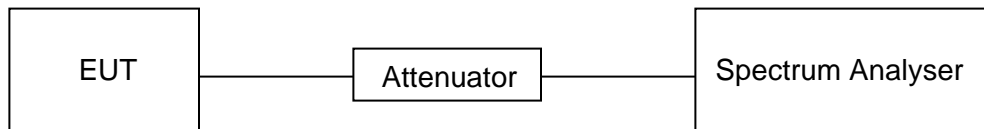

TEST ENVIRONMENT

Temperature	24.1 °C	Relative Humidity	60.5 %
Atmosphere Pressure	101 kPa	Test Voltage	DC 3.3 V

RESULTS

Please refer to appendix D.



7.2. 6/26 dB EMISSION BANDWIDTH AND 99 % OCCUPIED BANDWIDTH

LIMITS

CFR 47 FCC Part15, Subpart E ISED RSS-247 ISSUE 2		
Test Item	Limit	Frequency Range (MHz)
26 dB Emission Bandwidth	For reporting purposes only.	5150 ~ 5250
26 dB Emission Bandwidth	For reporting purposes only.	5250 ~ 5350
26 dB Emission Bandwidth	For reporting purposes only.	5470 ~ 5725 (For FCC) 5470 ~ 5600 (For ISED) 5650 ~ 5725 (For ISED)
6 dB Emission Bandwidth	The minimum 6 dB emission bandwidth shall be 500 kHz.	5725 ~ 5850
99 % Occupied Bandwidth	For reporting purposes only.	5150 ~ 5825 (For ISED)

TEST PROCEDURE

Refer to KDB 789033 D02 General U-NII Test Procedures New Rules v02r01 section II.C1. for 26 dB Emission Bandwidth; section II.C2. for 6 dB Emission Bandwidth; section II.D. for 99 % Occupied Bandwidth.

Connect the EUT to the spectrum analyser and use the following settings:

Center Frequency	The center frequency of the channel under test
Detector	Peak
RBW	For 6 dB Emission Bandwidth: RBW=100 kHz For 26 dB Emission bandwidth: approximately 1 % of the EBW. For 99 % Occupied Bandwidth: approximately 1 % ~ 5 % of the OBW.
VBW	For 6 dB Bandwidth: $\geq 3 \cdot \text{RBW}$ For 26 dB Bandwidth: $> 3 \cdot \text{RBW}$ For 99 % Bandwidth: $> 3 \cdot \text{RBW}$
Trace	Max hold
Sweep	Auto couple

- a) Use the 99 % power bandwidth function of the instrument, allow the trace to stabilize and report the measured bandwidth.
- b) Allow the trace to stabilize and measure the maximum width of the emission that is constrained by the frequencies associated with the two outermost amplitude points (upper and lower frequencies) that are attenuated by 6/26 dB relative to the maximum level measured in the fundamental emission.

Calculation for 99 % Bandwidth of UNII-2C and UNII-3 Straddle Channel:

For Example: Fundamental Frequency: 5720 MHz

99 % OBW: 21.00 MHz

Turning Frequency: 5725 MHz

99 % Bandwidth of UNII-2C Band Portion = $(5725-(5720-(21.00/2))) = 15.50$ MHz

99 % Bandwidth of UNII-3 Band Portion = $(5720+(21.00/2)-5725) = 5.50$ MHz

Calculation for 26 dB Bandwidth of UNII-2C Straddle Channel:

For Example: Fundamental frequency: 5720 MHz

26 dB BW: 20.00 MHz

FL: 5710.16 MHz

FH: 5730.16 MHz

Turning Frequency: 5725 MHz

26 dB Bandwidth of UNII-2C Band Portion = $5725-5710.16=14.84$ MHz

Calculation for 6dB Bandwidth of UNII-3 Straddle Channel:

For Example: Fundamental frequency: 5720 MHz

6 dB BW: 16.44 MHz

FL: 5711.76 MHz

FH: 5728.2 MHz

Turning Frequency: 5725 MHz

6 dB Bandwidth of UNII-3 band Portion = $5728.2-5725=3.2$ MHz

TEST SETUP

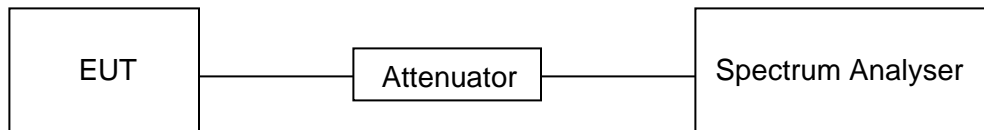

TEST ENVIRONMENT

Temperature	24.1 °C	Relative Humidity	60.5 %
Atmosphere Pressure	101 kPa	Test Voltage	DC 3.3 V

RESULTS

Please refer to Appendix A1&A2&A3.



7.3. CONDUCTED OUTPUT POWER

LIMITS

CFR 47 FCC Part15, Subpart E		
Test Item	Limit	Frequency Range (MHz)
Conducted Output Power	<input type="checkbox"/> Outdoor Access Point: 1 W (30 dBm) <input type="checkbox"/> Indoor Access Point: 1 W (30 dBm) <input type="checkbox"/> Fixed Point-To-Point Access Points: 1 W (30 dBm) <input checked="" type="checkbox"/> Client Devices: 250 mW (24 dBm)	5150 ~ 5250
	Shall not exceed the lesser of 250 mW (24dBm) or 11 dBm + 10 log B, where B is the 26 dB emission bandwidth in megahertz.	5250 ~ 5350 5470 ~ 5725
	Shall not exceed 1 Watt (30 dBm).	5725 ~ 5850

Note:

The above limits are based upon the maximum antenna gain does not exceed 6 dBi. If transmitting antennas of directional gain greater than 6 dBi are used, the maximum conducted output power shall be reduced by the amount in dB that the directional gain of the antenna exceeds 6 dBi.

TEST PROCEDURE

Refer to KDB 789033 D02 General U-NII Test Procedures New Rules v02r01 section II.E.

Method SA-1 (trace averaging with the EUT transmitting at full power throughout each sweep):

- (2) Set span to encompass the entire emission bandwidth (EBW) (or, alternatively, the entire 99% occupied bandwidth) of the signal.
- (ii) Set RBW = 1 MHz.
- (iii) Set VBW \geq 3 MHz.
- (iv) Number of points in sweep $\geq 2 \times$ span / RBW. (This ensures that bin-to-bin spacing is \leq RBW/2, so that narrowband signals are not lost between frequency bins.)
- (v) Sweep time = auto.
- (vi) Detector = power averaging (rms), if available. Otherwise, use sample detector mode.
- (vii) If transmit duty cycle $<$ 98 %, use a video trigger with the trigger level set to enable triggering only on full power pulses. Transmitter must operate at maximum power control level for the entire duration of every sweep. If the EUT transmits continuously (i.e., with no off intervals) or at duty cycle \geq 98 %, and if each transmission is entirely at the maximum power control level, then the trigger shall be set to “free run.”
- (viii) Trace average at least 100 traces in power averaging (rms) mode.
- (ix) Compute power by integrating the spectrum across the EBW (or, alternatively, the entire 99% occupied bandwidth) of the signal using the instrument’s band power measurement function with band limits set equal to the EBW (or occupied bandwidth) band edges. If the instrument does not have a band power function, sum the spectrum levels (in power units) at 1 MHz intervals extending across the EBW (or, alternatively, the entire 99% occupied bandwidth) of the spectrum.

Method PM (Measurement using an RF average power meter):

- (i) Measurements may be performed using a wideband RF power meter with a thermocouple detector or equivalent if all of the following conditions are satisfied:
 - a. The EUT is configured to transmit continuously or to transmit with a constant duty cycle.
 - b. At all times when the EUT is transmitting, it must be transmitting at its maximum power control level.
 - c. The integration period of the power meter exceeds the repetition period of the transmitted signal by at least a factor of five.
- (ii) If the transmitter does not transmit continuously, measure the duty cycle, x , of the transmitter output signal as described in II.B.
- (iii) Measure the average power of the transmitter. This measurement is an average over both the on and off periods of the transmitter.
- (iv) Adjust the measurement in dBm by adding $10 \log (1/x)$ where x is the duty cycle (e.g., $10 \log (1/0.25)$ if the duty cycle is 25 %).

Method PM-G (Measurement using a gated RF average power meter):

Measurements may be performed using a wideband gated RF power meter provided that the gate parameters are adjusted such that the power is measured only when the EUT is transmitting at its maximum power control level. Since the measurement is made only during the ON time of the transmitter, no duty cycle correction factor is required.

Straddle channel power was measured using spectrum analyzer.

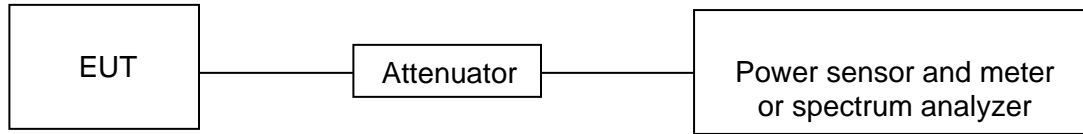
TEST SETUP**TEST ENVIRONMENT**

Temperature	24.1 °C	Relative Humidity	60.5 %
Atmosphere Pressure	101 kPa	Test Voltage	DC 3.3 V

RESULTS

Please refer to Appendix B.

7.4. POWER SPECTRAL DENSITY

LIMITS

CFR 47 FCC Part15, Subpart E		
Test Item	Limit	Frequency Range (MHz)
Power Spectral Density	<input type="checkbox"/> Outdoor Access Point: 17 dBm/MHz <input type="checkbox"/> Indoor Access Point: 17 dBm/MHz <input type="checkbox"/> Fixed Point-To-Point Access Points: 17 dBm/MHz <input checked="" type="checkbox"/> Client Devices: 11 dBm/MHz	5150 ~ 5250
	11 dBm/MHz	5250 ~ 5350 5470 ~ 5725
	30 dBm/500kHz	5725 ~ 5850

Note:

The above limits are based upon the maximum antenna gain does not exceed 6 dBi.
If transmitting antennas of directional gain greater than 6 dBi are used, maximum power spectral density shall be reduced by the amount in dB that the directional gain of the antenna exceeds 6 dBi.

TEST PROCEDURE

Refer to KDB 789033 D02 General U-NII Test Procedures New Rules v02r01 section II.F.

Connect the EUT to the spectrum analyser and use the following settings:

For U-NII-1, U-NII-2A and U-NII-2C band:

Center Frequency	The center frequency of the channel under test
Detector	RMS
RBW	1 MHz
VBW	$\geq 3 \times \text{RBW}$
Span	Encompass the entire emissions bandwidth (EBW) of the signal
Trace	Max hold
Sweep time	Auto

For U-NII-3:

Center Frequency	The center frequency of the channel under test
Detector	RMS
RBW	500 kHz
VBW	$\geq 3 \times \text{RBW}$
Span	Encompass the entire emissions bandwidth (EBW) of the signal
Trace	Max hold
Sweep time	Auto

Allow trace to fully stabilize and Use the peak search function on the instrument to find the peak of the spectrum and record its value.

Add $10 \log(1/x)$, where x is the duty cycle, to the peak of the spectrum, the result is the Maximum PSD over 1 MHz / 500 kHz reference bandwidth.

TEST SETUP

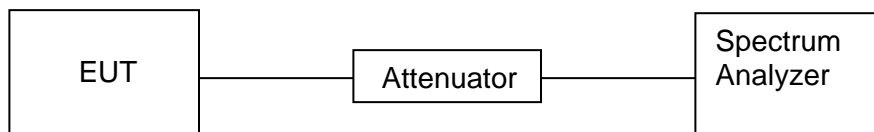

TEST ENVIRONMENT

Temperature	24.1 °C	Relative Humidity	60.5 %
Atmosphere Pressure	101 kPa	Test Voltage	DC 3.3 V

RESULTS

Please refer to Appendix C.



8. RADIATED TEST RESULTS

LIMITS

Refer to CFR 47 FCC §15.205, §15.209 and §15.407 (b).

Radiation Disturbance Test Limit for FCC (Class B) (9 kHz ~ 1 GHz)

Emissions radiated outside of the specified frequency bands above 30 MHz			
Frequency Range (MHz)	Field Strength Limit (uV/m) at 3 m	Field Strength Limit (dBuV/m) at 3 m	
		Quasi-Peak	
30 – 88	100	40	
88 – 216	150	43.5	
216 – 960	200	46	
Above 960	500	54	
Above 1000	500	Peak	Average
		74	54

FCC Emissions radiated outside of the specified frequency bands below 30 MHz		
Frequency (MHz)	Field strength (microvolts/meter)	Measurement distance (meters)
0.009-0.490	2400/F(kHz)	300
0.490-1.705	24000/F(kHz)	30
1.705-30.0	30	30



FCC Restricted bands of operation refer to FCC §15.205 (a):

MHz	MHz	MHz	GHz
0.090-0.110	16.42-16.423	399.9-410	4.5-5.15
¹ 0.495-0.505	16.69475-16.69525	608-614	5.35-5.46
2.1735-2.1905	16.80425-16.80475	960-1240	7.25-7.75
4.125-4.128	25.5-25.67	1300-1427	8.025-8.5
4.17725-4.17775	37.5-38.25	1435-1626.5	9.0-9.2
4.20725-4.20775	73-74.6	1645.5-1646.5	9.3-9.5
6.215-6.218	74.8-75.2	1660-1710	10.6-12.7
6.26775-6.26825	108-121.94	1718.8-1722.2	13.25-13.4
6.31175-6.31225	123-138	2200-2300	14.47-14.5
8.291-8.294	149.9-150.05	2310-2390	15.35-16.2
8.362-8.366	156.52475-156.52525	2483.5-2500	17.7-21.4
8.37625-8.38675	156.7-156.9	2690-2900	22.01-23.12
8.41425-8.41475	162.0125-167.17	3260-3267	23.6-24.0
12.29-12.293	167.72-173.2	3332-3339	31.2-31.8
12.51975-12.52025	240-285	3345.8-3358	36.43-36.5
12.57675-12.57725	322-335.4	3600-4400	(²)
13.36-13.41			

Note: ¹Until February 1, 1999, this restricted band shall be 0.490-0.510 MHz.

²Above 38.6c

Limits of unwanted/undesirable emission out of the restricted bands refer to CFR 47 FCC §15.407 (b) and ISSED RSS-247 6.2.

LIMITS OF RADIATED EMISSION MEASUREMENT (Above 1GHz)		
Frequency Range (MHz)	EIRP Limit	Field Strength Limit (dBuV/m) at 3 m
5150~5250 MHz	PK: -27 (dBm/MHz)	PK: 68.2(dBμV/m)
5250~5350 MHz		
5470~5725 MHz		
5725~5850 MHz	PK: -27 (dBm/MHz) *1 PK: 10 (dBm/MHz) *2 PK: 15.6 (dBm/MHz) *3 PK: 27 (dBm/MHz) *4	PK: 68.2(dBμV/m) *1 PK: 105.2 (dBμV/m) *2 PK: 110.8(dBμV/m) *3 PK: 122.2 (dBμV/m) *4

Note:

*1 beyond 75 MHz or more above of the band edge.

*2 below the band edge increasing linearly to 10 dBm/MHz at 25 MHz above.

*3 below the band edge increasing linearly to a level of 15.6 dBm/MHz at 5 MHz above.

*4 from 5 MHz above or below the band edge increasing linearly to a level of 27 dBm/MHz at the band edge.

TEST SETUP AND PROCEDURE

Below 30 MHz

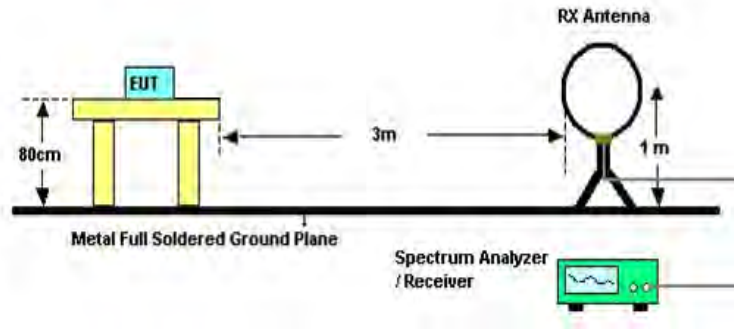

The setting of the spectrum analyser

RBW	200 Hz (From 9 kHz to 0.15 MHz)/ 9 kHz (From 0.15 MHz to 30 MHz)
VBW	200 Hz (From 9 kHz to 0.15 MHz)/ 9 kHz (From 0.15 MHz to 30 MHz)
Sweep	Auto
Trace	Max hold

1. The testing follows the guidelines in ANSI C63.10-2013 clause 6.4.
2. The EUT was arranged to its worst case and then turntable (from 0 degree to 360 degrees) to find the maximum reading. A pre-amp and a high pass filter are used for the test in order to get better signal level. Both Horizontal, Face-on and Face-off polarizations of the antenna are set to make the measurement.
3. The EUT was placed on a turntable with 80 cm above ground.
4. The EUT was set 3 meters from the interference receiving antenna, which was mounted on the top of a 1 m height antenna tower.
5. The radiated emission limits are based on measurements employing a CISPR quasi-peak detector except for the frequency bands 9-90 kHz, 110-490 kHz and above 1000 MHz. Radiated emission limits in these three bands are based on measurements employing an average detector.
6. For measurement below 1 GHz, the initial step in collecting conducted emission data is a spectrum analyzer peak detector mode pre-scanning the measurement frequency range. Significant peaks are then marked and then Quasi Peak and average detector mode re-measured. If the emission level of the EUT measured by the peak detector is 3 dB lower than the applicable limit, the peak emission level will be reported. Otherwise, the emission measurement will be repeated using the quasi-peak and average detector and reported.
7. Although these tests were performed other than open field site, adequate comparison measurements were confirmed against 30m open field site. Therefore sufficient tests were made to demonstrate that the alternative site produces results that correlate with the ones of tests made in an open field site based on KDB 414788.
 2. The limits in CFR 47, Part 15, Subpart C, paragraph 15.209 (a), are identical to those in RSS-GEN Section 8.9, Table 6, since the measurements are performed in terms of magnetic field strength and converted to electric field strength levels (as reported in the table) using the free space impedance of 377Ω. For example, the measurement frequency X KHz resulted in a level of Y dBuV/m, which is equivalent to $Y-51.5 = Z$



dBuA/m, which has the same margin, W dB, to the corresponding RSS-GEN Table 6 limit as it has to be 15.209(a) limit.

Below 1 GHz and above 30 MHz

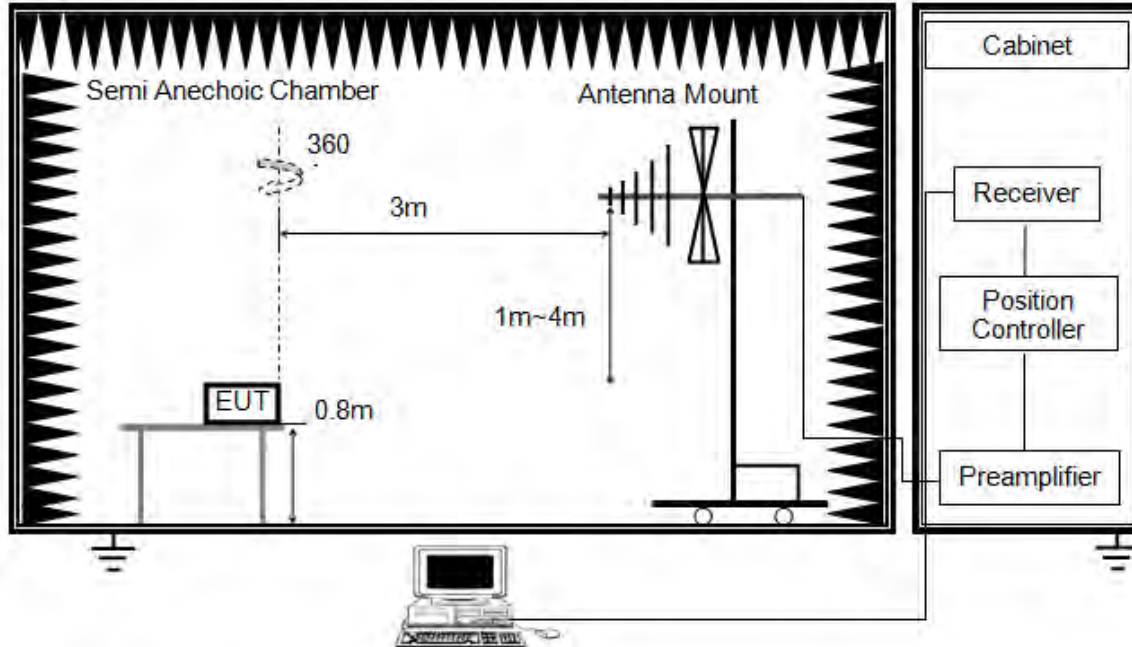

The setting of the spectrum analyser

RBW	120 kHz
VBW	300 kHz
Sweep	Auto
Detector	Peak/QP
Trace	Max hold

1. The testing follows the guidelines in ANSI C63.10-2013 clause 6.5.
2. The EUT was arranged to its worst case and then tune the antenna tower (from 1 m to 4 m) and turntable (from 0 degree to 360 degrees) to find the maximum reading. A pre-amp and a high pass filter are used for the test in order to get better signal level. Both horizontal and vertical polarizations of the antenna are set to make the measurement.
3. The EUT was placed on a turntable with 80 cm above ground.
4. The EUT was set 3 meters from the interference receiving antenna, which was mounted on the top of a variable height antenna tower.
5. For measurement below 1 GHz, the initial step in collecting conducted emission data is a spectrum analyzer peak detector mode pre-scanning the measurement frequency range. Significant peaks are then marked and then Quasi Peak detector mode re-measured. If the emission level of the EUT measured by the peak detector is 3 dB lower than the applicable limit, the peak emission level will be reported. Otherwise, the emission measurement will be repeated using the quasi-peak detector and reported.

Above 1 GHz

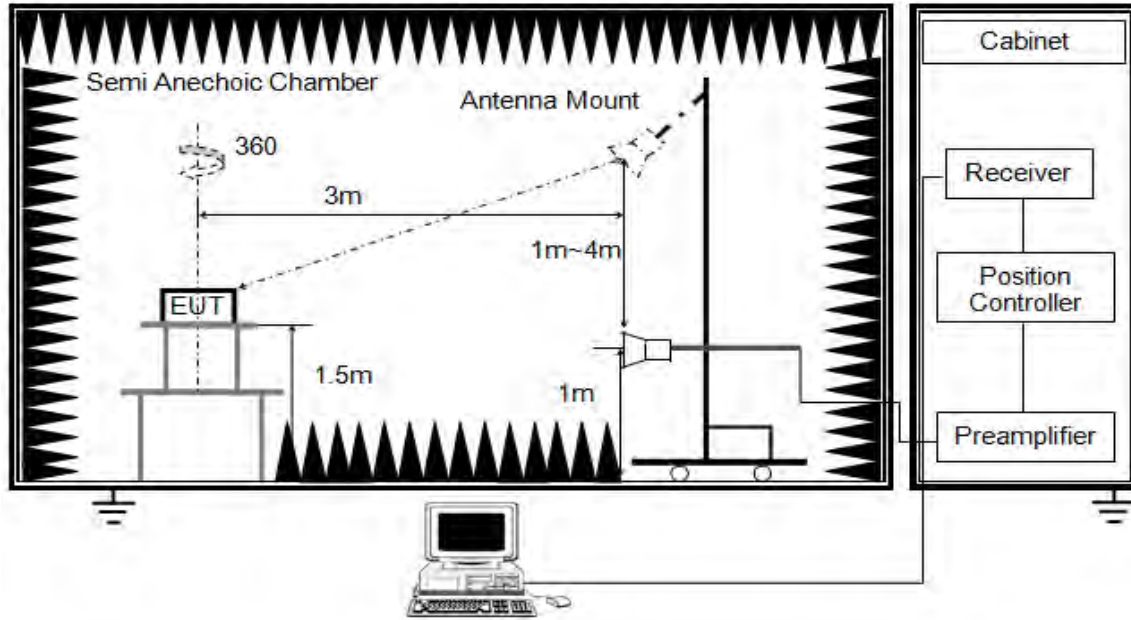

The setting of the spectrum analyser

RBW	1 MHz
VBW	PEAK: 3 MHz AVG: see note 6
Sweep	Auto
Detector	Peak
Trace	Max hold

1. The testing follows the guidelines in KDB 789033 D02 General U-NII Test Procedures New Rules v02r01 section II.G.3 ~ II.G.6.
2. The EUT was arranged to its worst case and then tune the antenna tower (from 1 m to 4 m) and turntable (from 0 degree to 360 degrees) to find the maximum reading. A pre-amp and a high pass filter are used for the test in order to get better signal level. Both horizontal and vertical polarizations of the antenna are set to make the measurement.
3. The EUT was placed on a turntable with 1.5 m above ground.
4. The EUT was set 3 meters from the interference receiving antenna, which was mounted on the top of a variable height antenna tower.
5. For measurement above 1 GHz, the emission measurement will be measured by the peak detector. This peak level, once corrected, must comply with the limit specified in Section 15.209.
6. For measurements above 1 GHz the resolution bandwidth is set to 1 MHz, then the video bandwidth is set to 3 MHz for peak measurements and 1 MHz resolution bandwidth with 1/T video bandwidth with peak detector for average measurements. For the Duty Cycle please refer to clause 7.1.ON TIME AND DUTY CYCLE.

X axis, Y axis, Z axis positions :

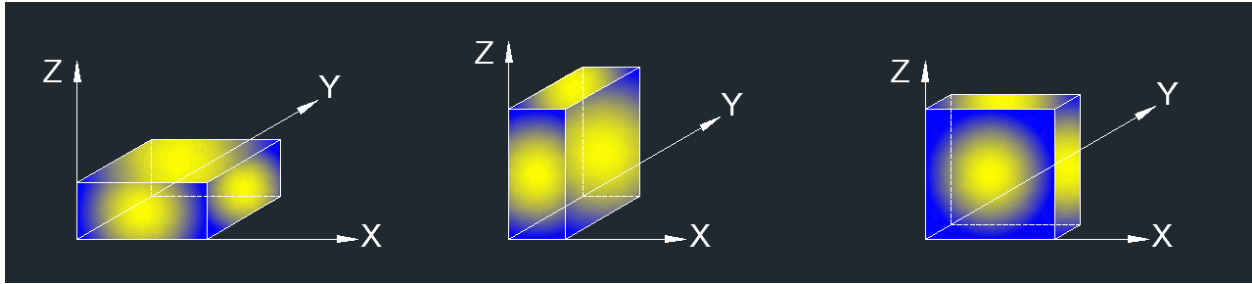

Note 1: For all radiated test, EUT in each of three orthogonal axis emissions had been tested, but only the worst case (X axis) data recorded in the report.

TEST ENVIRONMENT

Temperature	24.3 °C	Relative Humidity	61 %
Atmosphere Pressure	101 kPa	Test Voltage	DC 3.3 V

RESULTS

8.1. RESTRICTED BANDEGE

8.1.1. 802.11a 20 SISO MODE

UNII-1 BAND

ANTENNA 0 TEST RESULTS (WORST CASE)

RESTRICTED BANDEGE (LOW CHANNEL, HORIZONTAL)

PEAK

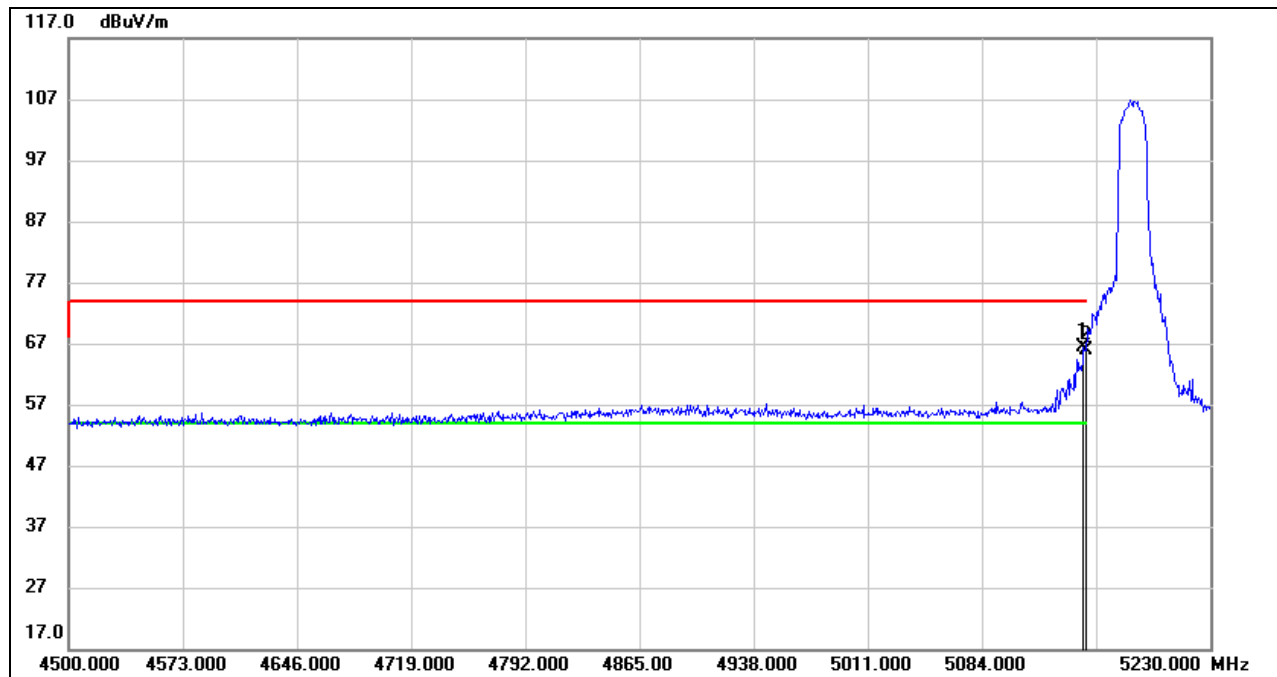

No.	Frequency (MHz)	Reading (dBuV)	Correct (dB/m)	Result (dBuV/m)	Limit (dBuV/m)	Margin (dB)	Remark
1	5148.970	26.02	40.28	66.30	74.00	-7.70	peak
2	5150.000	25.72	40.27	65.99	74.00	-8.01	peak

- Note: 1. Measurement = Reading Level + Correct Factor.
 2. If Peak Result complies with AV limit, AV Result is deemed to comply with AV limit.
 3. Peak: Peak detector.
 4. Only the worst data was recorded, if it complies with the limit, the other emissions deemed to comply with the limit.



AVG

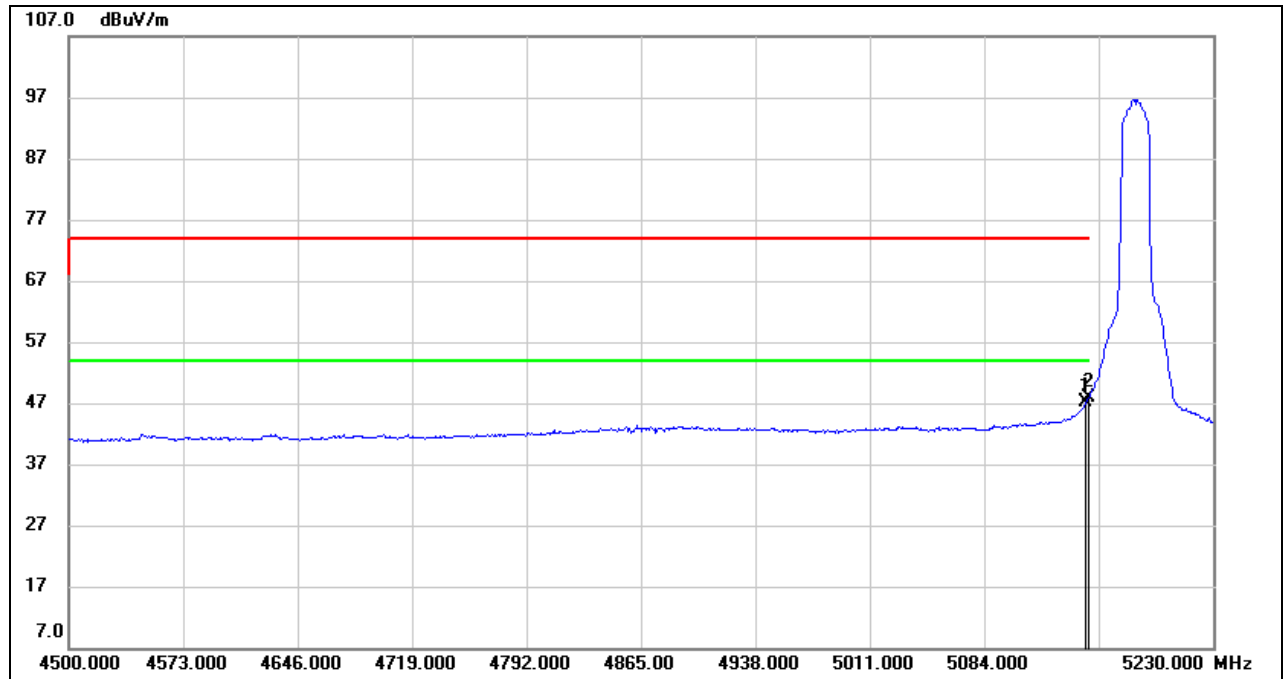

No.	Frequency (MHz)	Reading (dBuV)	Correct (dB/m)	Result (dBuV/m)	Limit (dBuV/m)	Margin (dB)	Remark
1	5148.970	6.84	40.28	47.12	74.00	-26.88	AVG
2	5150.000	7.59	40.27	47.86	54.00	-6.14	AVG

- Note:
1. Measurement = Reading Level + Correct Factor.
 2. If Peak Result complies with AV limit, AV Result is deemed to comply with AV limit.
 3. AVG: $VBW=1/T_{on}$, where: T_{on} is the transmitting duration.
 4. For the transmitting duration, please refer to clause 7.1.
 5. Only the worst data was recorded, if it complies with the limit, the other emissions deemed to comply with the limit.

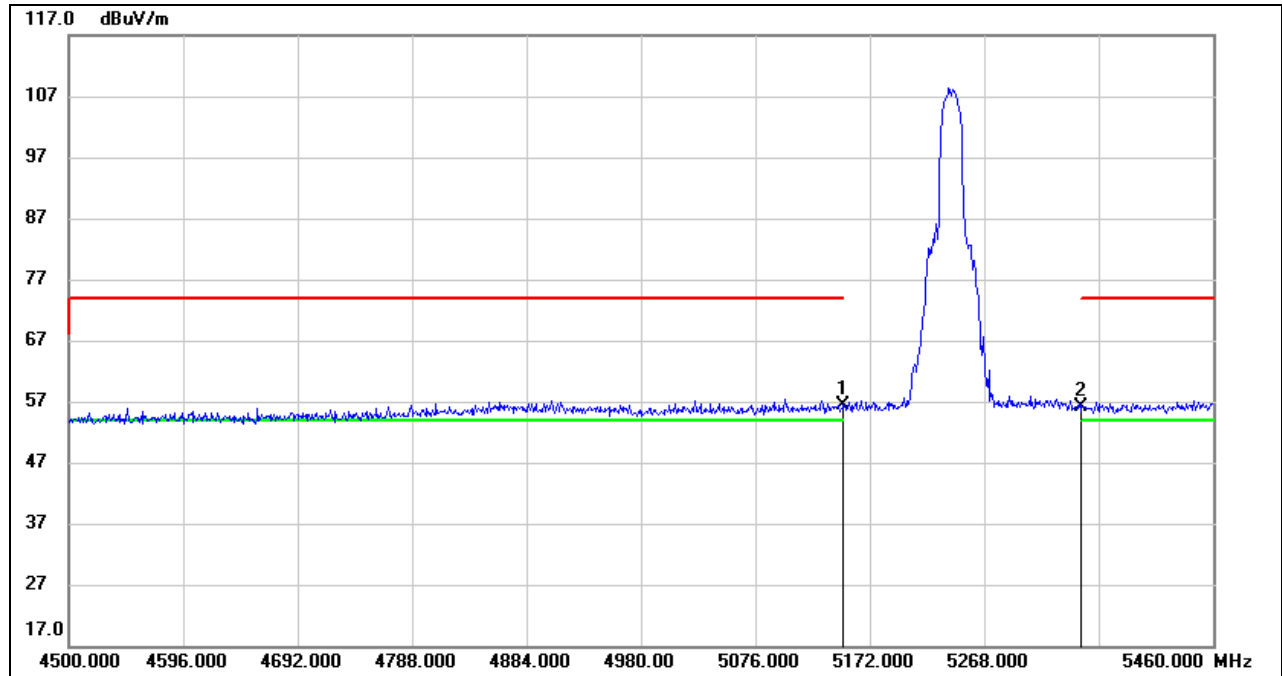
**RESTRICTED BANDEDGE (HIGH CHANNEL, HORIZONTAL)****PEAK**

No.	Frequency (MHz)	Reading (dBuV)	Correct (dB/m)	Result (dBuV/m)	Limit (dBuV/m)	Margin (dB)	Remark
1	5150.000	16.05	40.27	56.32	74.00	-17.68	peak
2	5350.000	15.54	40.49	56.03	74.00	-17.97	peak

Note: 1. Measurement = Reading Level + Correct Factor.

2. If Peak Result complies with AV limit, AV Result is deemed to comply with AV limit.

3. Peak: Peak detector.

4. Only the worst data was recorded, if it complies with the limit, the other emissions deemed to comply with the limit.

AVG

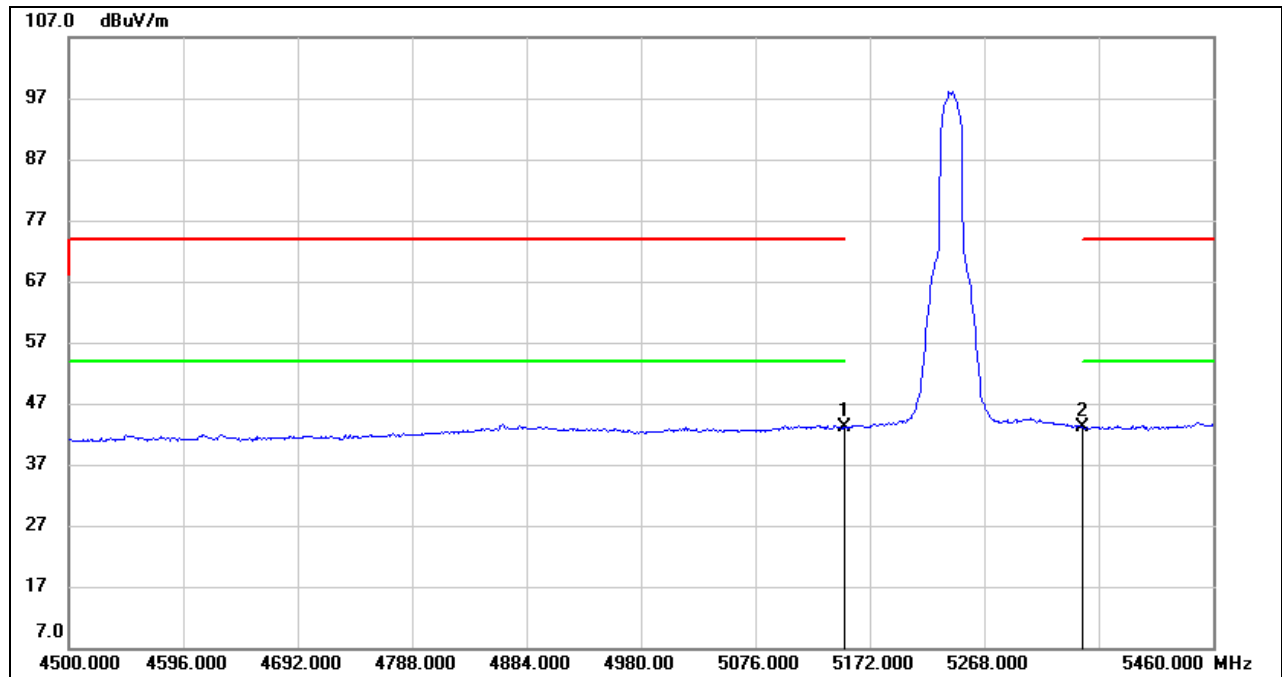

No.	Frequency (MHz)	Reading (dBuV)	Correct (dB/m)	Result (dBuV/m)	Limit (dBuV/m)	Margin (dB)	Remark
1	5150.000	2.92	40.27	43.19	54.00	-10.81	AVG
2	5350.000	2.58	40.49	43.07	54.00	-10.93	AVG

- Note: 1. Measurement = Reading Level + Correct Factor.
 2. If Peak Result complies with AV limit, AV Result is deemed to comply with AV limit.
 3. AVG: $VBW=1/Ton$, where: Ton is the transmitting duration.
 4. For the transmitting duration, please refer to clause 7.1.
 5. Only the worst data was recorded, if it complies with the limit, the other emissions deemed to comply with the limit.



UNII-2A BAND

ANTENNA 1 TEST RESULTS (WORST CASE)

RESTRICTED BANDEDGE (LOW CHANNEL, HORIZONTAL)

PEAK

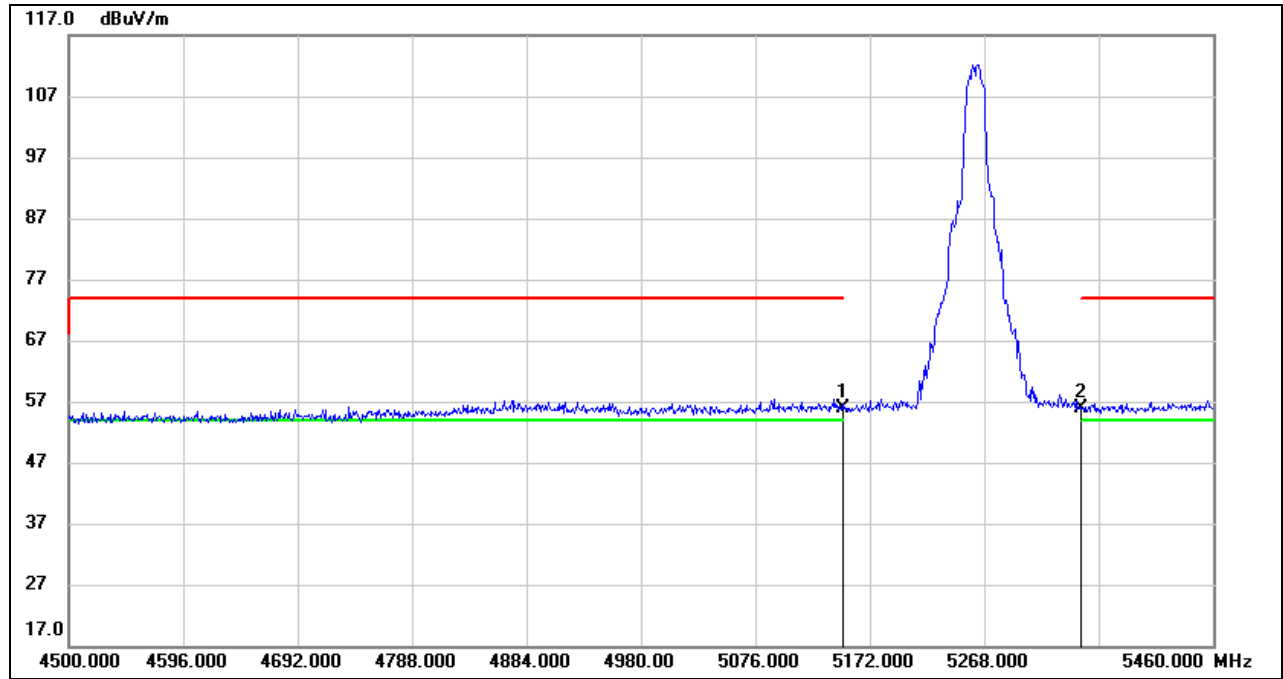

No.	Frequency (MHz)	Reading (dBuV)	Correct (dB/m)	Result (dBuV/m)	Limit (dBuV/m)	Margin (dB)	Remark
1	5150.000	15.65	40.27	55.92	74.00	-18.08	peak
2	5350.000	15.27	40.49	55.76	74.00	-18.24	peak

Note: 1. Measurement = Reading Level + Correct Factor.
 2. If Peak Result complies with AV limit, AV Result is deemed to comply with AV limit.
 3. Peak: Peak detector.
 4. Only the worst data was recorded, if it complies with the limit, the other emissions deemed to comply with the limit.



AVG

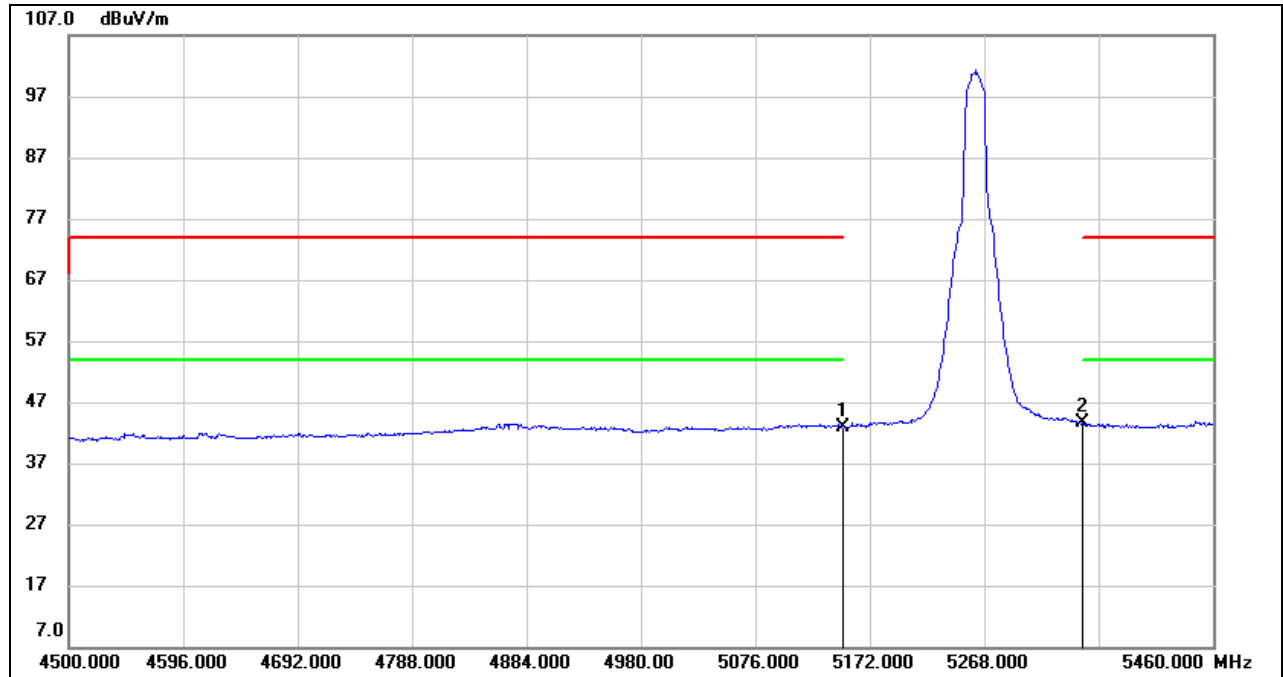

No.	Frequency (MHz)	Reading (dBuV)	Correct (dB/m)	Result (dBuV/m)	Limit (dBuV/m)	Margin (dB)	Remark
1	5150.000	2.72	40.27	42.99	54.00	-11.01	AVG
2	5350.000	3.10	40.49	43.59	54.00	-10.41	AVG

- Note: 1. Measurement = Reading Level + Correct Factor.
 2. If Peak Result complies with AV limit, AV Result is deemed to comply with AV limit.
 3. AVG: VBW=1/Ton, where: Ton is the transmitting duration.
 4. For the transmitting duration, please refer to clause 7.1.
 5. Only the worst data was recorded, if it complies with the limit, the other emissions deemed to comply with the limit.

RESTRICTED BANDEDGE (HIGH CHANNEL, HORIZONTAL)

PEAK

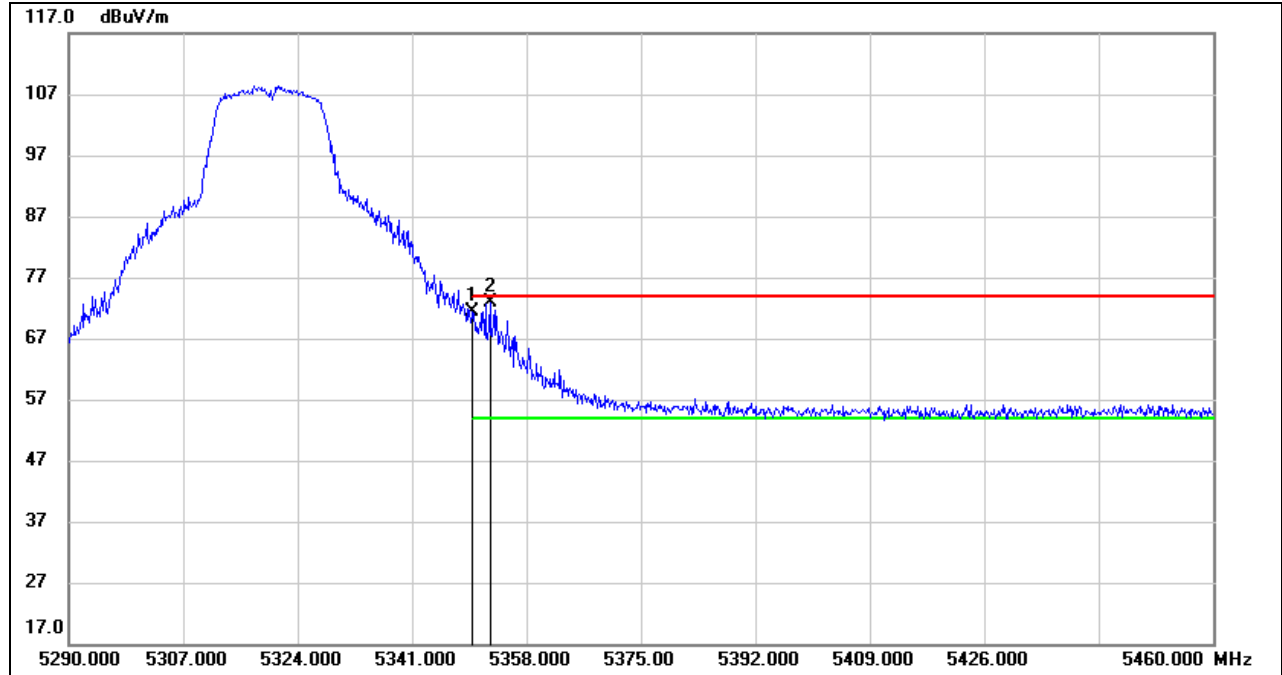

No.	Frequency (MHz)	Reading (dBuV)	Correct (dB/m)	Result (dBuV/m)	Limit (dBuV/m)	Margin (dB)	Remark
1	5350.000	30.86	40.49	71.35	74.00	-2.65	peak
2	5352.560	32.41	40.50	72.91	74.00	-1.09	peak

- Note: 1. Measurement = Reading Level + Correct Factor.
 2. If Peak Result complies with AV limit, AV Result is deemed to comply with AV limit.
 3. Peak: Peak detector.
 4. Only the worst data was recorded, if it complies with the limit, the other emissions deemed to comply with the limit.



AVG

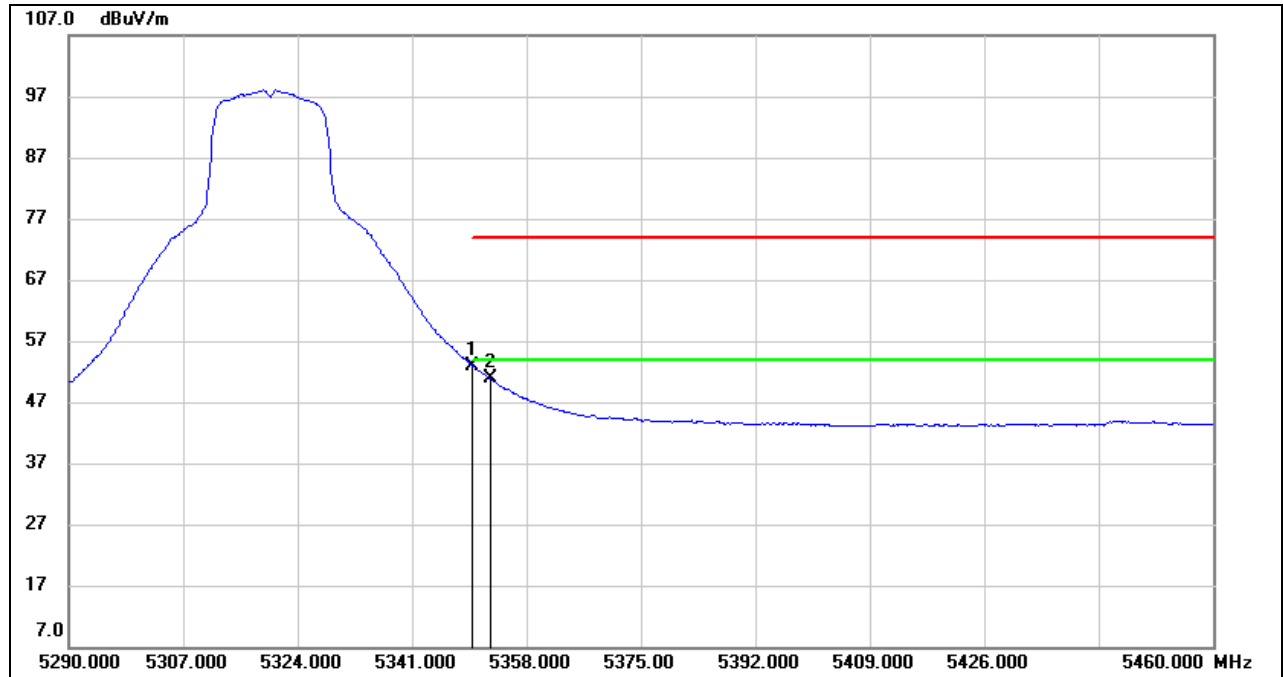

No.	Frequency (MHz)	Reading (dBuV)	Correct (dB/m)	Result (dBuV/m)	Limit (dBuV/m)	Margin (dB)	Remark
1	5350.000	12.44	40.49	52.93	54.00	-1.07	AVG
2	5352.560	10.45	40.50	50.95	54.00	-3.05	AVG

- Note: 1. Measurement = Reading Level + Correct Factor.
 2. If Peak Result complies with AV limit, AV Result is deemed to comply with AV limit.
 3. AVG: $VBW=1/Ton$, where: Ton is the transmitting duration.
 4. For the transmitting duration, please refer to clause 7.1.
 5. Only the worst data was recorded, if it complies with the limit, the other emissions deemed to comply with the limit.

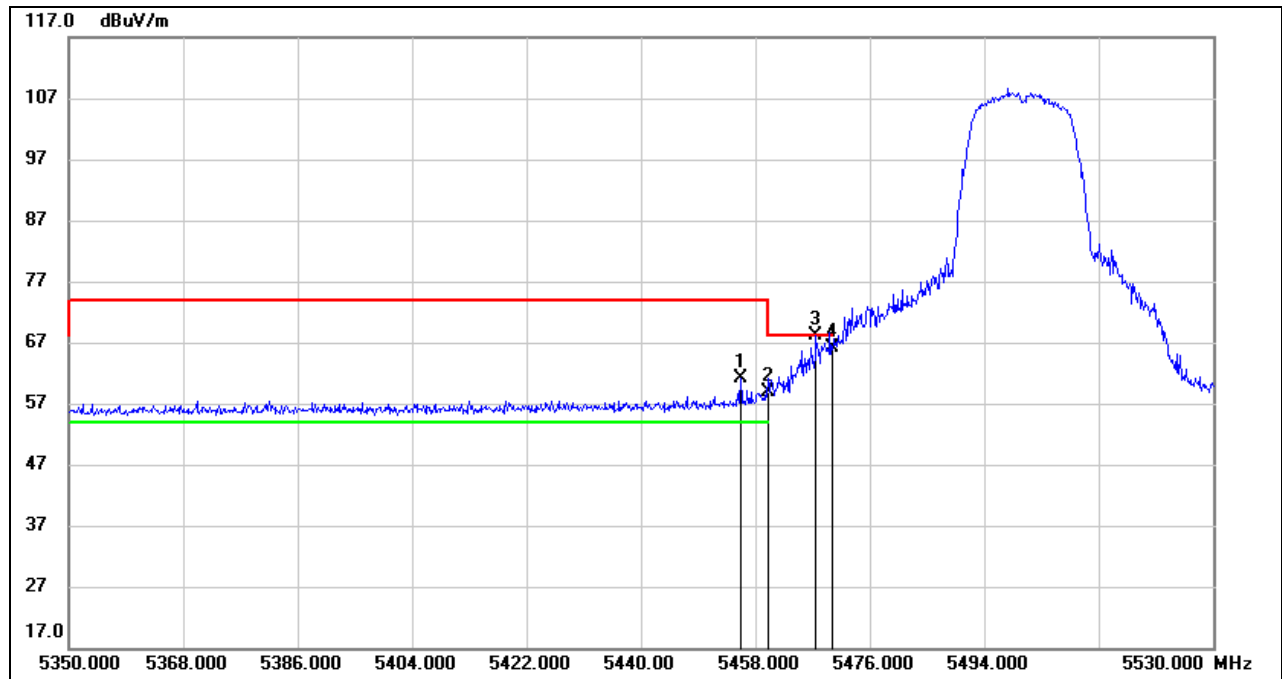
**UNII-2C BAND****ANTENNA 1 TEST RESULTS (WORST CASE)****RESTRICTED BANDEDGE (LOW CHANNEL, HORIZONTAL)****PEAK**

No.	Frequency (MHz)	Reading (dBuV)	Correct (dB/m)	Result (dBuV/m)	Limit (dBuV/m)	Margin (dB)	Remark
1	5455.660	20.47	40.61	61.08	74.00	-12.92	peak
2	5460.000	18.27	40.62	58.89	74.00	-15.11	peak
3	5467.540	27.38	40.63	68.01	68.20	-0.19	peak
4	5470.000	25.44	40.63	66.07	68.20	-2.13	peak

Note: 1. Measurement = Reading Level + Correct Factor.
 2. If Peak Result complies with AV limit, AV Result is deemed to comply with AV limit.
 3. Peak: Peak detector.
 4. Only the worst data was recorded, if it complies with the limit, the other emissions deemed to comply with the limit.

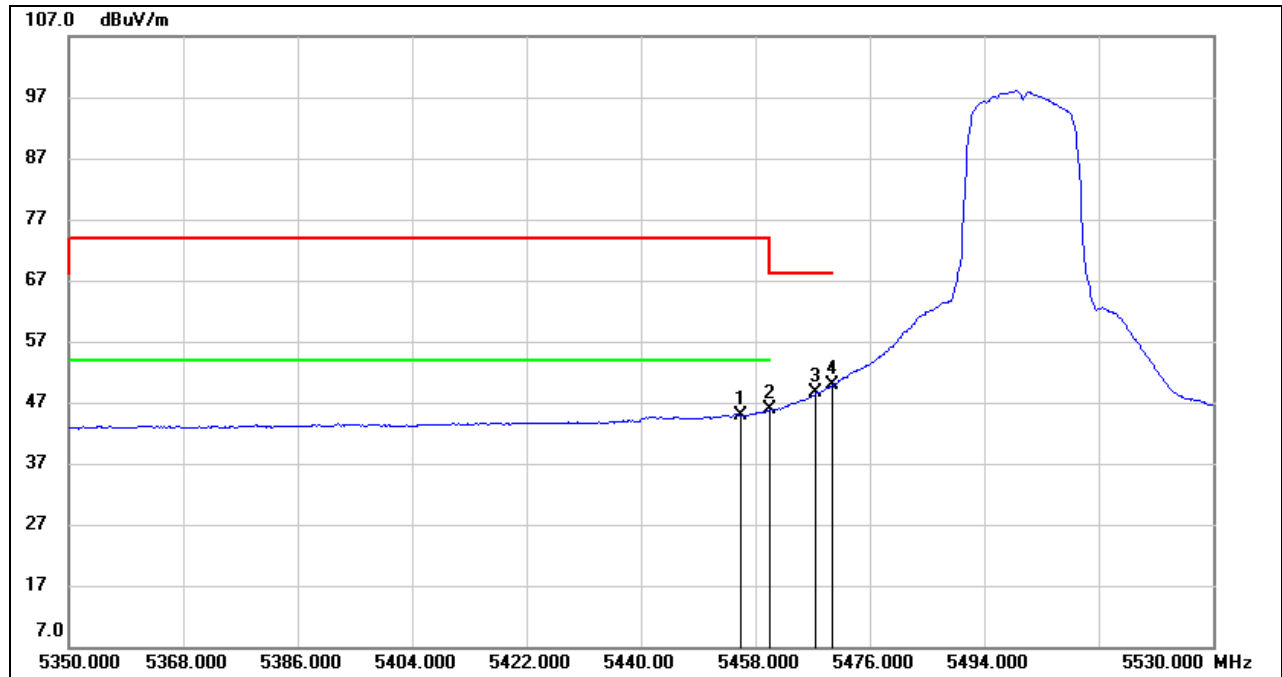
**AVG**

No.	Frequency (MHz)	Reading (dBuV)	Correct (dB/m)	Result (dBuV/m)	Limit (dBuV/m)	Margin (dB)	Remark
1	5455.660	4.27	40.61	44.88	54.00	-9.12	AVG
2	5460.000	5.17	40.62	45.79	54.00	-8.21	AVG
3	5467.540	7.91	40.63	48.54	/	/	AVG
4	5470.000	9.13	40.63	49.76	/	/	AVG

- Note: 1. Measurement = Reading Level + Correct Factor.
 2. If Peak Result complies with AV limit, AV Result is deemed to comply with AV limit.
 3. AVG: $VBW=1/Ton$, where: Ton is the transmitting duration.
 4. For the transmitting duration, please refer to clause 7.1.
 5. Only the worst data was recorded, if it complies with the limit, the other emissions deemed to comply with the limit.



RESTRICTED BANDEDGE (HIGH CHANNEL, HORIZONTAL)

PEAK

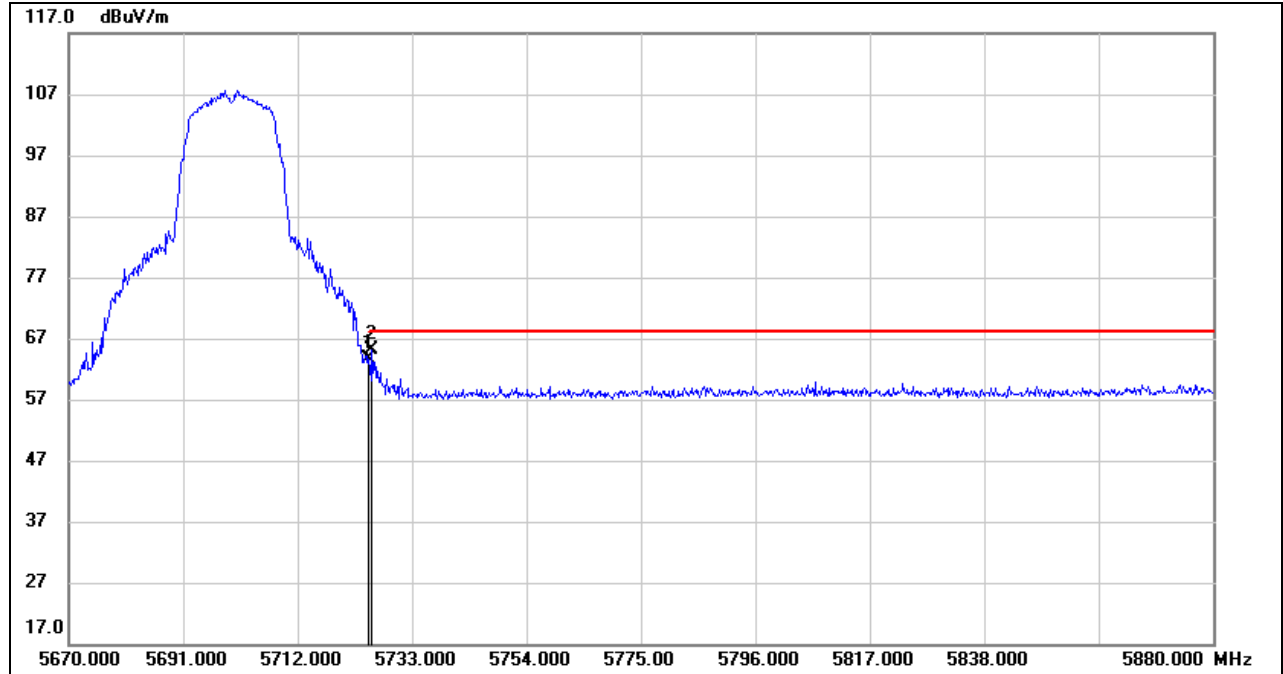

No.	Frequency (MHz)	Reading (dBuV)	Correct (dB/m)	Result (dBuV/m)	Limit (dBuV/m)	Margin (dB)	Remark
1	5725.000	22.27	41.27	63.54	68.20	-4.66	peak
2	5725.650	23.74	41.27	65.01	68.20	-3.19	peak

Note: 1. Measurement = Reading Level + Correct Factor.
 2. If Peak Result complies with AV limit, AV Result is deemed to comply with AV limit.
 3. Peak: Peak detector.
 4. Only the worst data was recorded, if it complies with the limit, the other emissions deemed to comply with the limit.

UNII-3 BAND

ANTENNA 1 TEST RESULTS (WORST CASE)

RESTRICTED BANDEDGE (LOW CHANNEL, HORIZONTAL)

PEAK

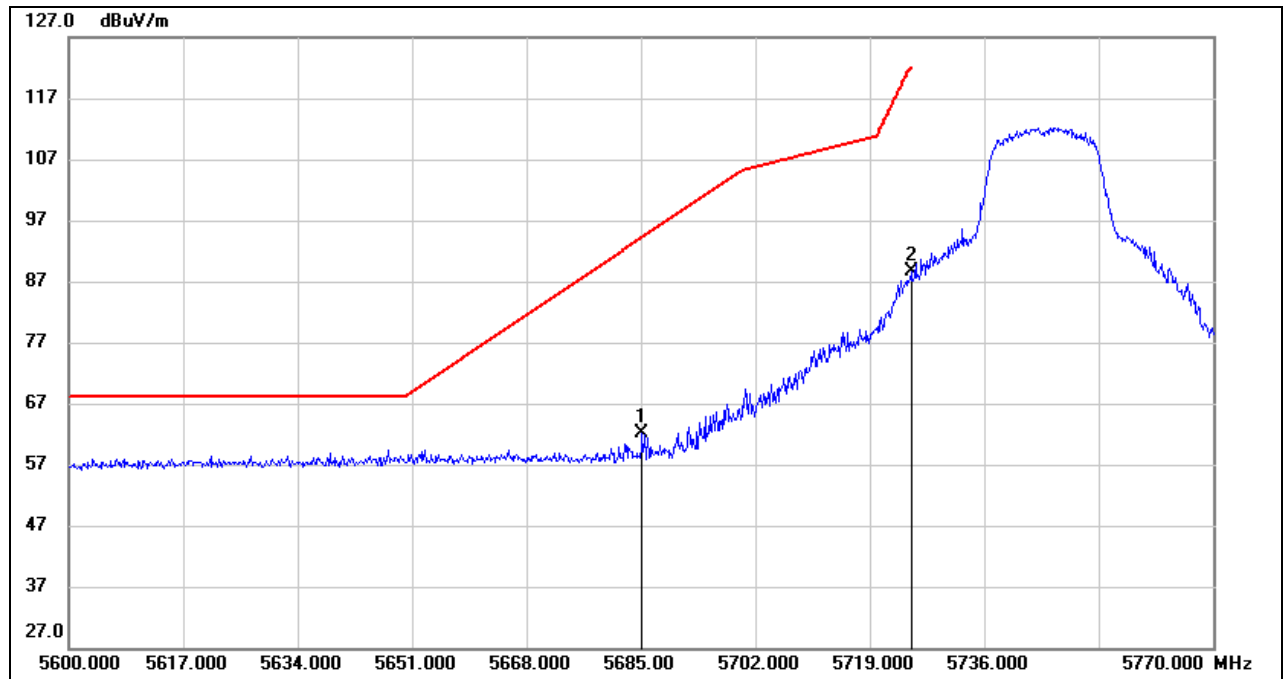

No.	Frequency (MHz)	Reading (dBuV)	Correct (dB/m)	Result (dBuV/m)	Limit (dBuV/m)	Margin (dB)	Remark
1	5685.170	21.04	41.16	62.20	94.26	-32.06	peak
2	5725.000	47.48	41.27	88.75	122.20	-33.45	peak

Note: 1. Measurement = Reading Level + Correct Factor.
 2. If Peak Result complies with AV limit, AV Result is deemed to comply with AV limit.
 3. Peak: Peak detector.
 4. Only the worst data was recorded, if it complies with the limit, the other emissions deemed to comply with the limit.

RESTRICTED BANDEDGE (HIGH CHANNEL, HORIZONTAL)

PEAK

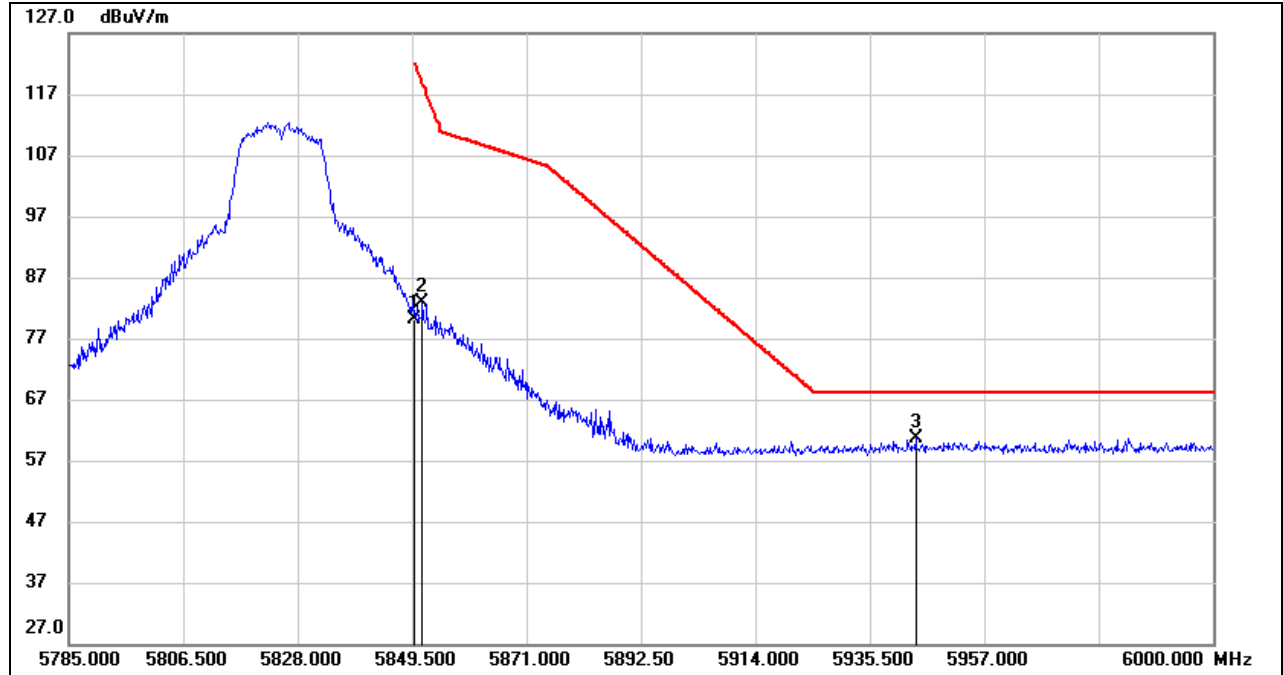

No.	Frequency (MHz)	Reading (dBuV)	Correct (dB/m)	Result (dBuV/m)	Limit (dBuV/m)	Margin (dB)	Remark
1	5850.000	38.45	41.60	80.05	122.20	-42.15	peak
2	5851.435	41.22	41.60	82.82	118.93	-36.11	peak
3	5944.100	18.88	41.85	60.73	68.20	-7.47	peak

- Note: 1. Measurement = Reading Level + Correct Factor.
 2. If Peak Result complies with AV limit, AV Result is deemed to comply with AV limit.
 3. Peak: Peak detector.
 4. Only the worst data was recorded, if it complies with the limit, the other emissions deemed to comply with the limit.

Note: All the polarities (Vertical & Horizontal) and Antennas had been tested, only the worst data was recorded in the report.

8.1.2. 802.11n HT20 MIMO MODE

UNII-1 BAND

RESTRICTED BANDEDGE (LOW CHANNEL, HORIZONTAL)

PEAK

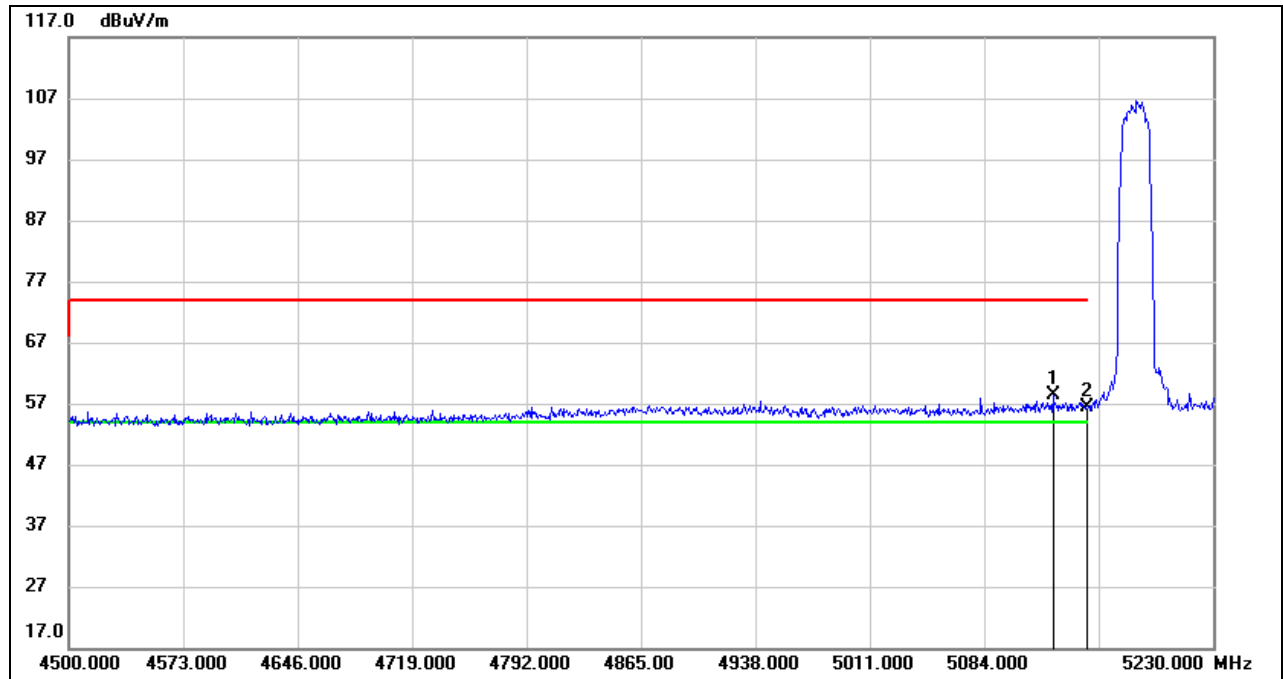

No.	Frequency (MHz)	Reading (dBuV)	Correct (dB/m)	Result (dBuV/m)	Limit (dBuV/m)	Margin (dB)	Remark
1	5127.800	18.01	40.25	58.26	74.00	-15.74	peak
2	5150.000	16.10	40.27	56.37	74.00	-17.63	peak

Note: 1. Measurement = Reading Level + Correct Factor.
 2. If Peak Result complies with AV limit, AV Result is deemed to comply with AV limit.
 3. Peak: Peak detector.
 4. Only the worst data was recorded, if it complies with the limit, the other emissions deemed to comply with the limit.

AVG

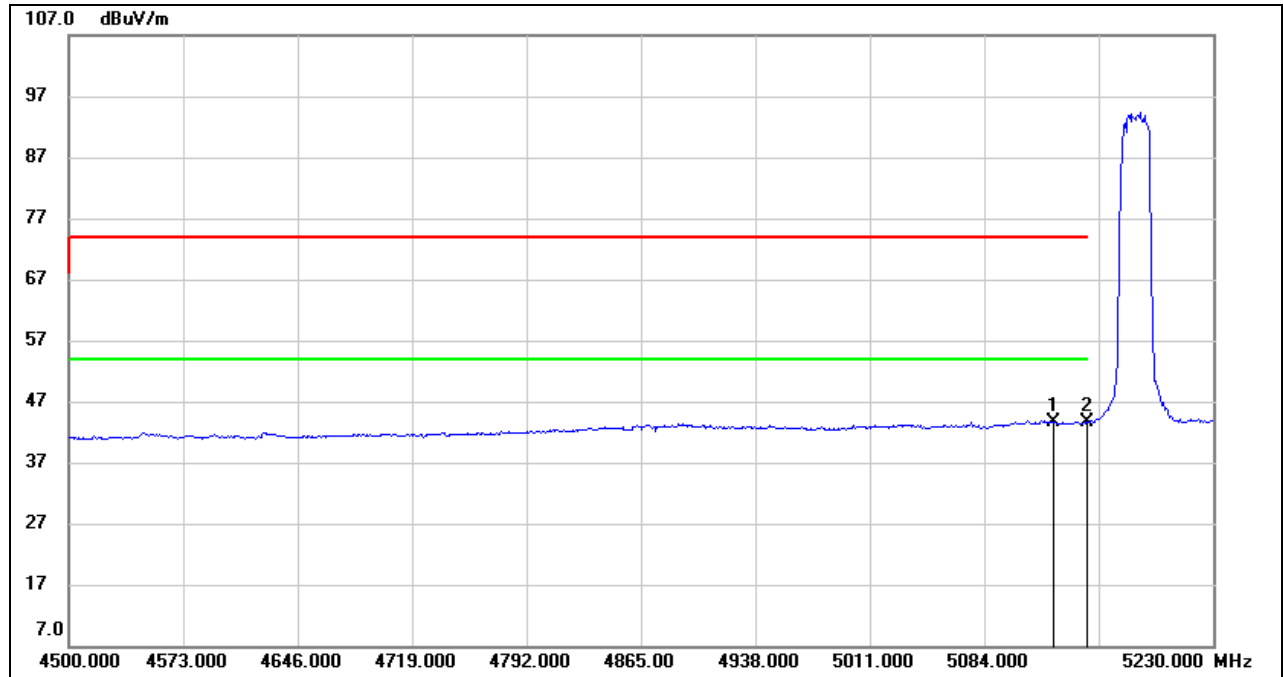

No.	Frequency (MHz)	Reading (dBuV)	Correct (dB/m)	Result (dBuV/m)	Limit (dBuV/m)	Margin (dB)	Remark
1	5127.800	3.38	40.25	43.63	54.00	-10.37	AVG
2	5150.000	3.40	40.27	43.67	54.00	-10.33	AVG

- Note:
1. Measurement = Reading Level + Correct Factor.
 2. If Peak Result complies with AV limit, AV Result is deemed to comply with AV limit.
 3. AVG: $VBW=1/Ton$, where: Ton is the transmitting duration.
 4. For the transmitting duration, please refer to clause 7.1.
 5. Only the worst data was recorded, if it complies with the limit, the other emissions deemed to comply with the limit.

RESTRICTED BANDEDGE (HIGH CHANNEL, HORIZONTAL)

PEAK

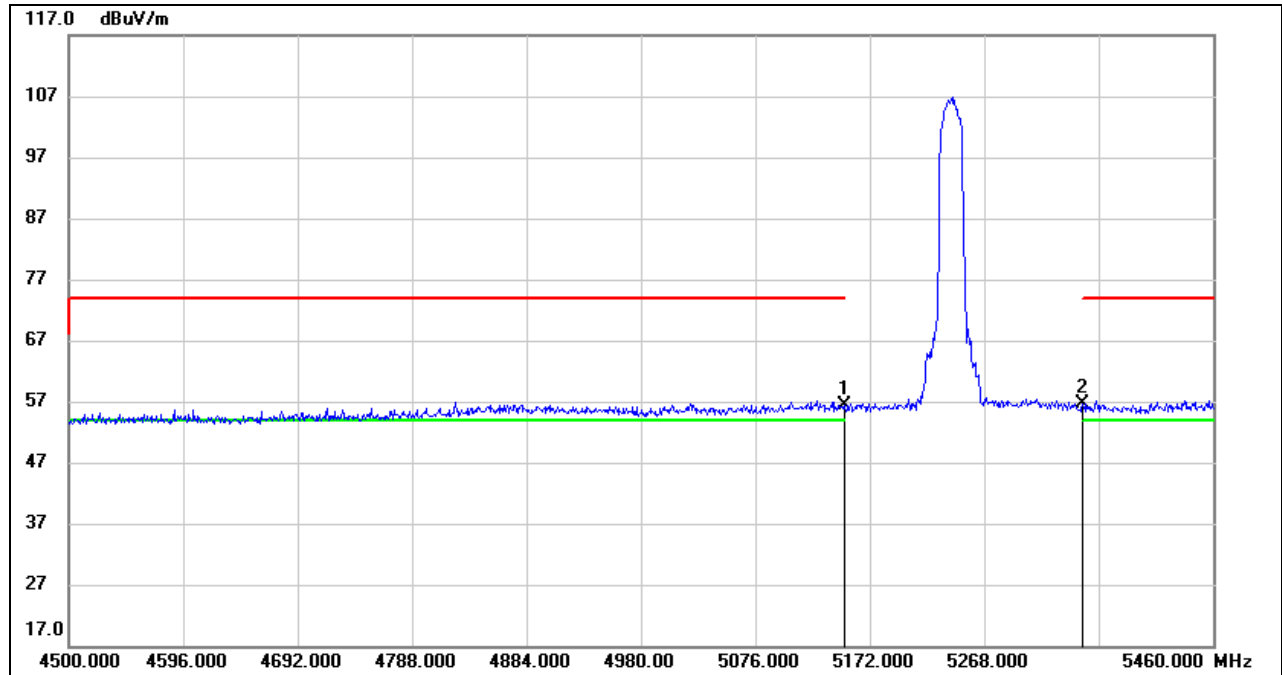

No.	Frequency (MHz)	Reading (dBuV)	Correct (dB/m)	Result (dBuV/m)	Limit (dBuV/m)	Margin (dB)	Remark
1	5150.000	16.02	40.27	56.29	74.00	-17.71	peak
2	5350.000	16.02	40.49	56.51	74.00	-17.49	peak

- Note:
1. Measurement = Reading Level + Correct Factor.
 2. If Peak Result complies with AV limit, AV Result is deemed to comply with AV limit.
 3. Peak: Peak detector.
 4. Only the worst data was recorded, if it complies with the limit, the other emissions deemed to comply with the limit.

AVG

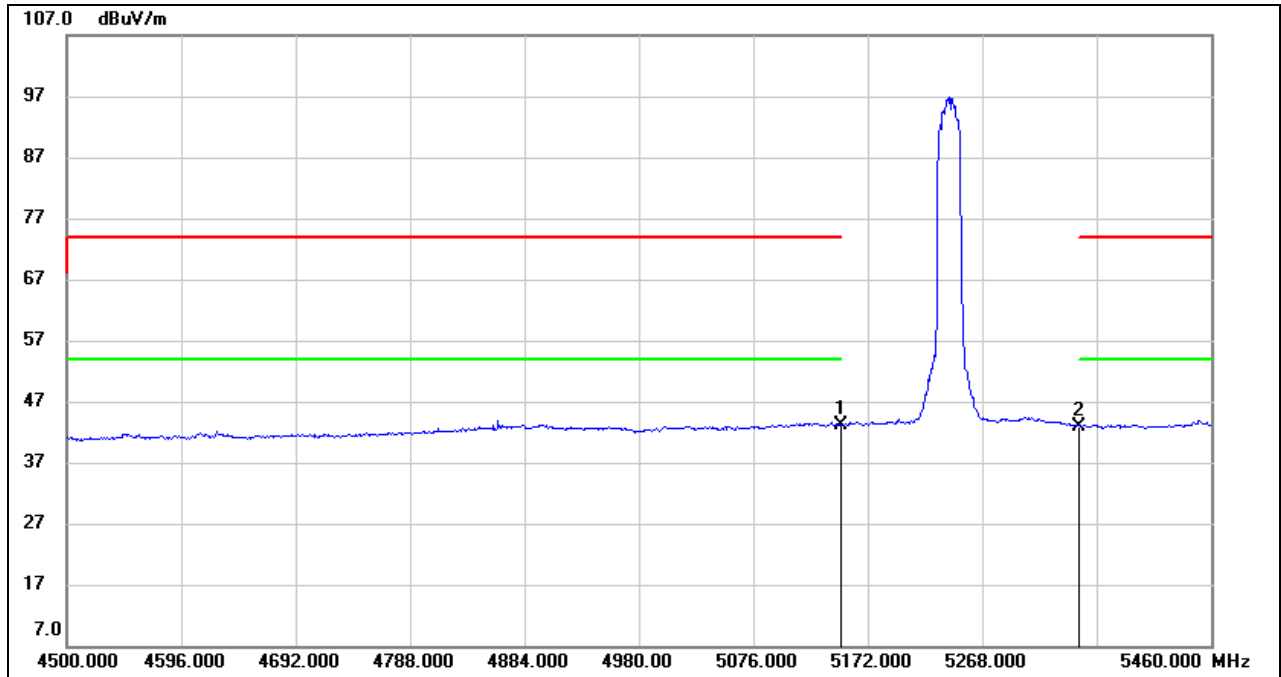

No.	Frequency (MHz)	Reading (dBuV)	Correct (dB/m)	Result (dBuV/m)	Limit (dBuV/m)	Margin (dB)	Remark
1	5150.000	2.85	40.27	43.12	54.00	-10.88	AVG
2	5350.000	2.49	40.49	42.98	54.00	-11.02	AVG

- Note:
1. Measurement = Reading Level + Correct Factor.
 2. If Peak Result complies with AV limit, AV Result is deemed to comply with AV limit.
 3. AVG: $VBW=1/T_{on}$, where: T_{on} is the transmitting duration.
 4. For the transmitting duration, please refer to clause 7.1.
 5. Only the worst data was recorded, if it complies with the limit, the other emissions deemed to comply with the limit.

UNII-2A BAND

RESTRICTED BANDEDGE (LOW CHANNEL, HORIZONTAL)

PEAK

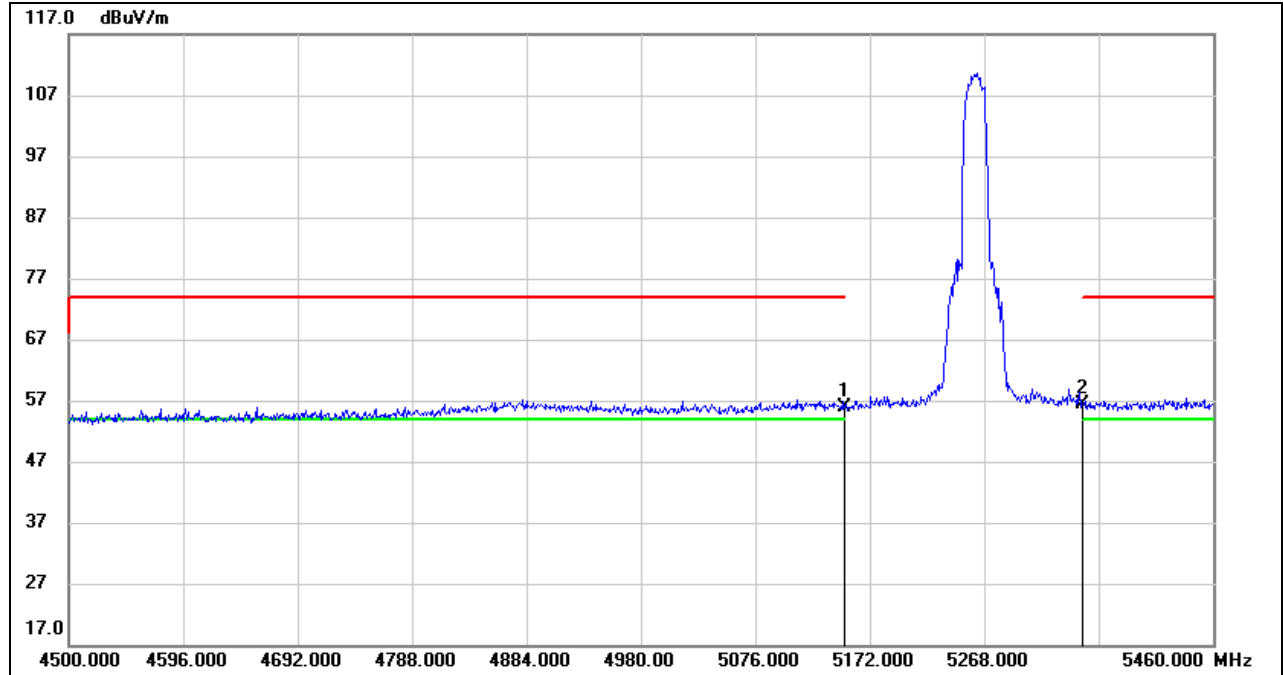

No.	Frequency (MHz)	Reading (dBuV)	Correct (dB/m)	Result (dBuV/m)	Limit (dBuV/m)	Margin (dB)	Remark
1	5150.000	15.62	40.27	55.89	74.00	-18.11	peak
2	5350.000	15.97	40.49	56.46	74.00	-17.54	peak

- Note: 1. Measurement = Reading Level + Correct Factor.
 2. If Peak Result complies with AV limit, AV Result is deemed to comply with AV limit.
 3. Peak: Peak detector.
 4. Only the worst data was recorded, if it complies with the limit, the other emissions deemed to comply with the limit.

AVG

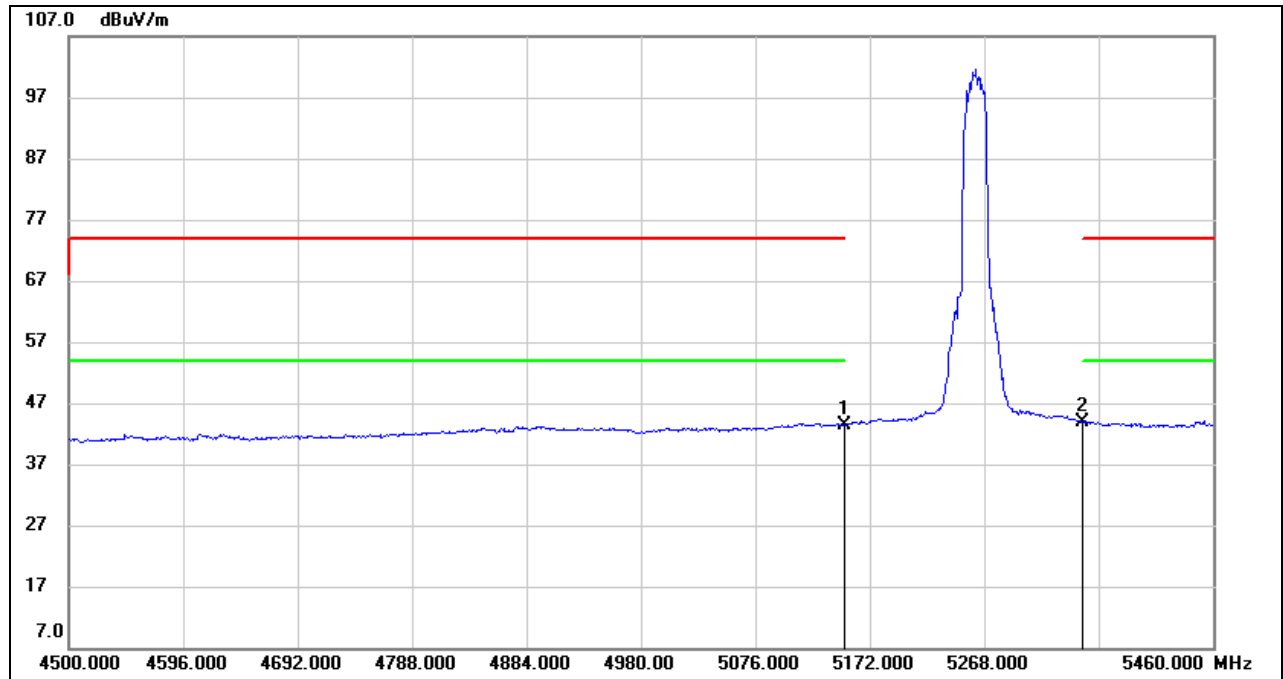

No.	Frequency (MHz)	Reading (dBuV)	Correct (dB/m)	Result (dBuV/m)	Limit (dBuV/m)	Margin (dB)	Remark
1	5150.000	3.16	40.27	43.43	54.00	-10.57	AVG
2	5350.000	3.46	40.49	43.95	54.00	-10.05	AVG

- Note:
1. Measurement = Reading Level + Correct Factor.
 2. If Peak Result complies with AV limit, AV Result is deemed to comply with AV limit.
 3. AVG: $VBW=1/Ton$, where: Ton is the transmitting duration.
 4. For the transmitting duration, please refer to clause 7.1.
 5. Only the worst data was recorded, if it complies with the limit, the other emissions deemed to comply with the limit.

RESTRICTED BANDEDGE (HIGH CHANNEL, HORIZONTAL)

PEAK

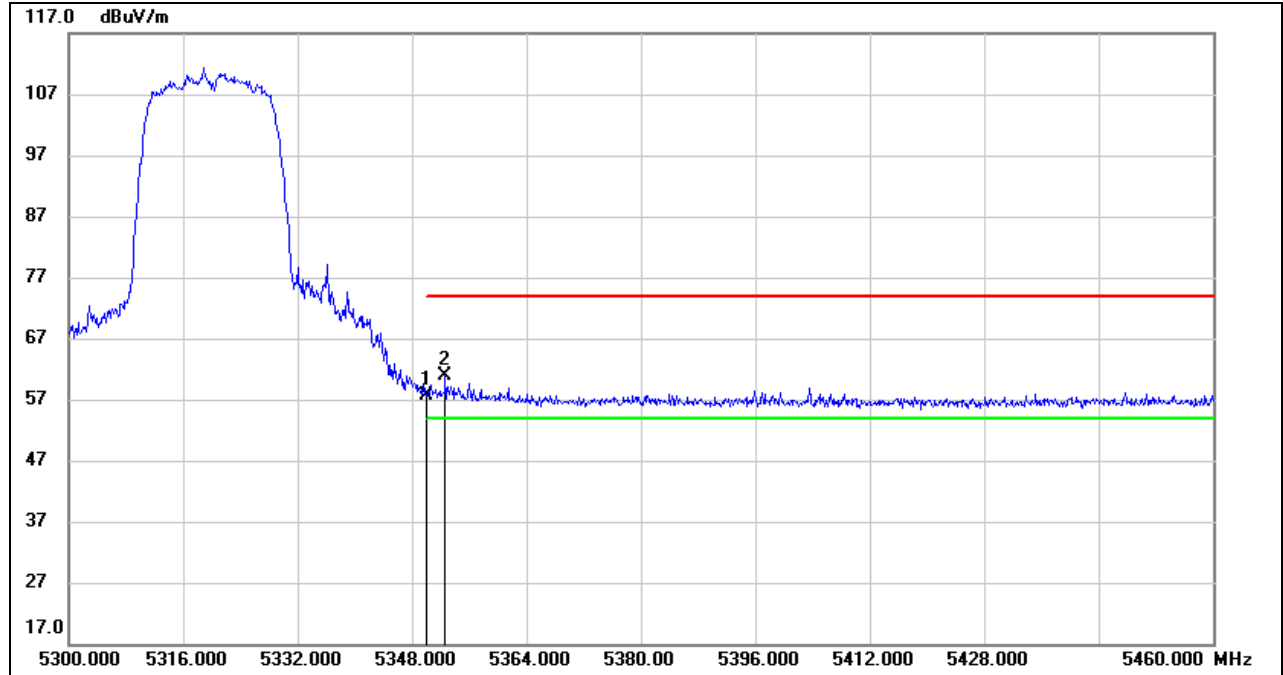

No.	Frequency (MHz)	Reading (dBuV)	Correct (dB/m)	Result (dBuV/m)	Limit (dBuV/m)	Margin (dB)	Remark
1	5350.000	17.21	40.49	57.70	74.00	-16.30	peak
2	5352.640	20.41	40.50	60.91	74.00	-13.09	peak

Note: 1. Measurement = Reading Level + Correct Factor.
 2. If Peak Result complies with AV limit, AV Result is deemed to comply with AV limit.
 3. Peak: Peak detector.
 4. Only the worst data was recorded, if it complies with the limit, the other emissions deemed to comply with the limit.

AVG

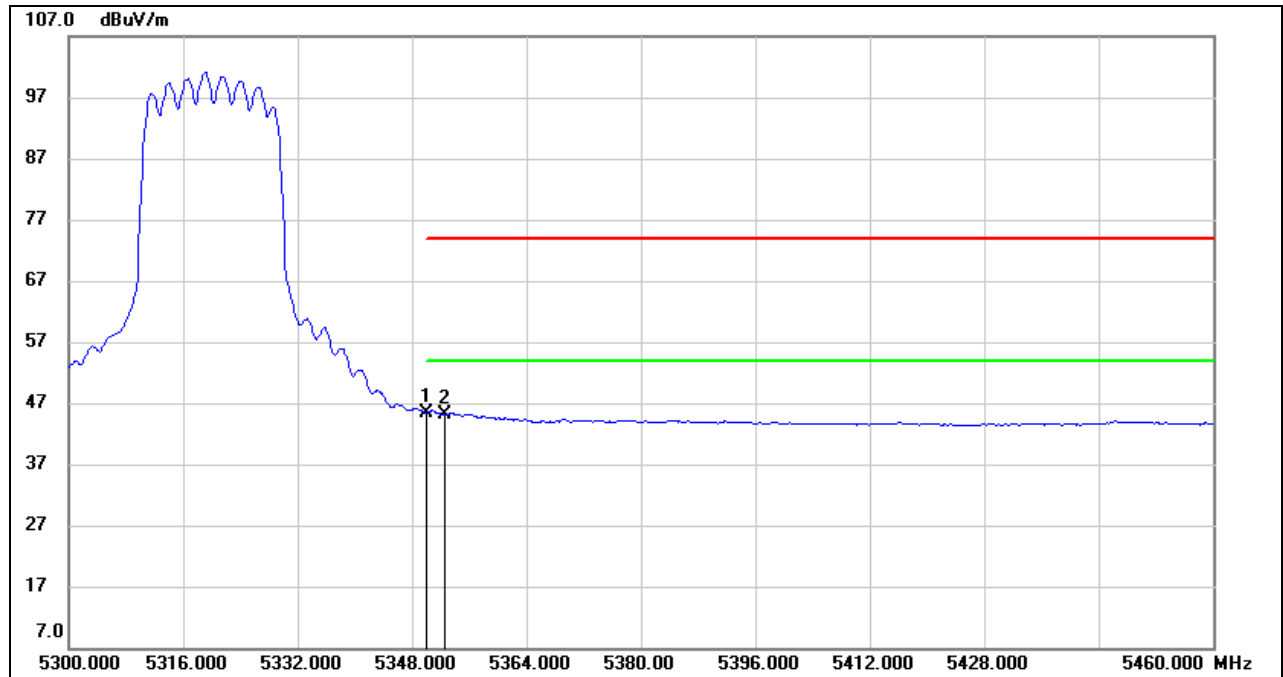

No.	Frequency (MHz)	Reading (dBuV)	Correct (dB/m)	Result (dBuV/m)	Limit (dBuV/m)	Margin (dB)	Remark
1	5350.000	4.92	40.49	45.41	54.00	-8.59	AVG
2	5352.640	4.73	40.50	45.23	54.00	-8.77	AVG

- Note:
1. Measurement = Reading Level + Correct Factor.
 2. If Peak Result complies with AV limit, AV Result is deemed to comply with AV limit.
 3. AVG: $VBW=1/Ton$, where: Ton is the transmitting duration.
 4. For the transmitting duration, please refer to clause 7.1.
 5. Only the worst data was recorded, if it complies with the limit, the other emissions deemed to comply with the limit.

UNII-2C BAND

RESTRICTED BANDEDGE (LOW CHANNEL, HORIZONTAL)

PEAK

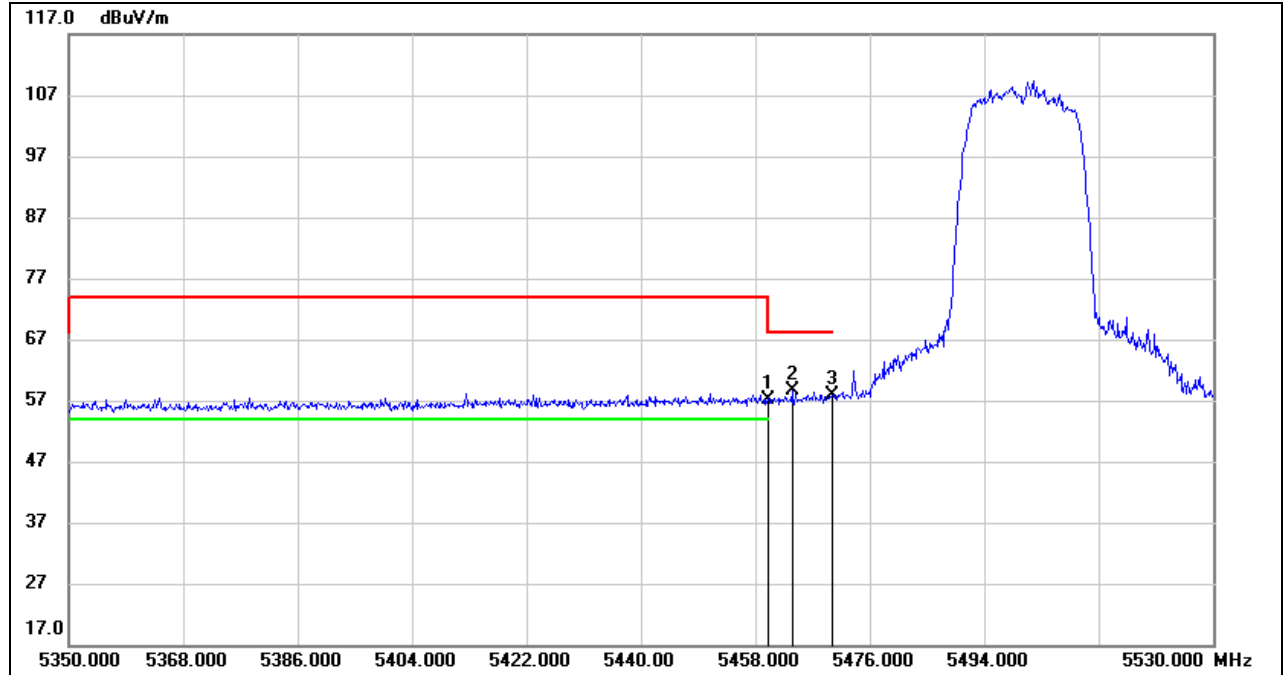

No.	Frequency (MHz)	Reading (dBuV)	Correct (dB/m)	Result (dBuV/m)	Limit (dBuV/m)	Margin (dB)	Remark
1	5460.000	16.48	40.62	57.10	74.00	-16.9	peak
2	5463.760	18.13	40.62	58.75	68.20	-9.45	peak
3	5470.000	17.27	40.63	57.90	68.20	-10.30	peak

Note: 1. Measurement = Reading Level + Correct Factor.
 2. If Peak Result complies with AV limit, AV Result is deemed to comply with AV limit.
 3. Peak: Peak detector.
 4. Only the worst data was recorded, if it complies with the limit, the other emissions deemed to comply with the limit.

AVG

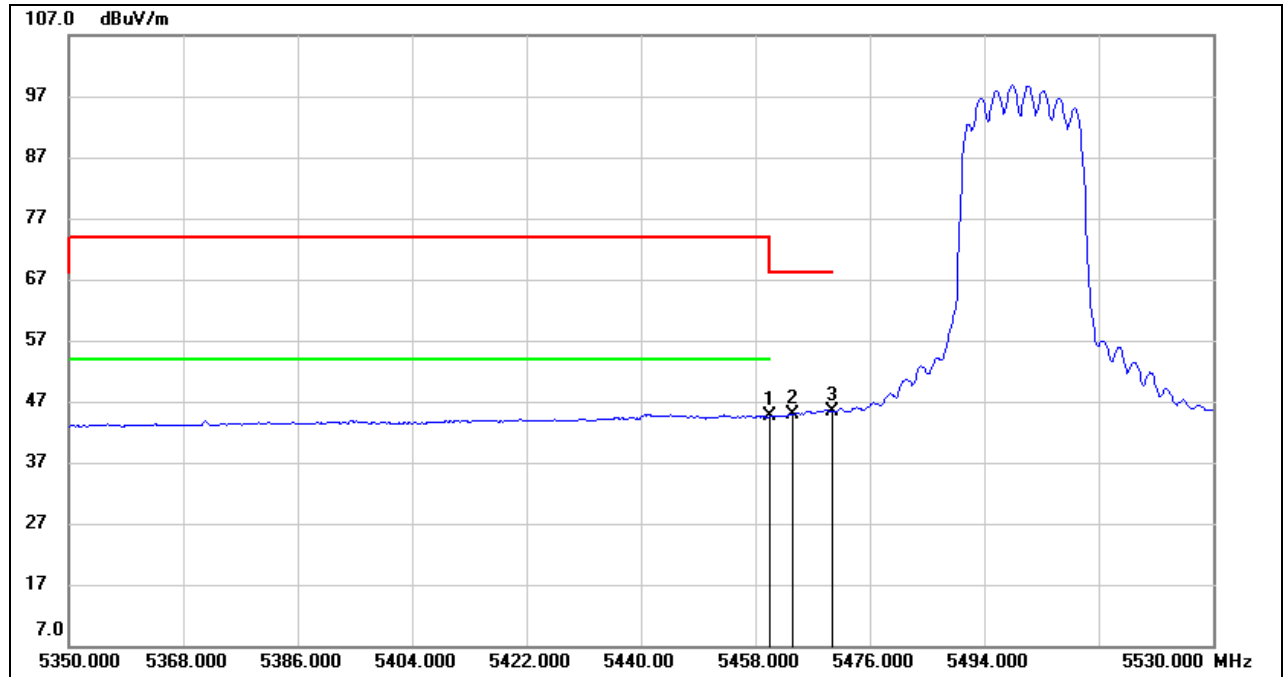

No.	Frequency (MHz)	Reading (dBuV)	Correct (dB/m)	Result (dBuV/m)	Limit (dBuV/m)	Margin (dB)	Remark
1	5460.000	3.99	40.62	44.61	54.00	-9.39	AVG
2	5463.760	4.22	40.62	44.84	/	/	AVG
3	5470.000	4.87	40.63	45.50	/	/	AVG

- Note:
1. Measurement = Reading Level + Correct Factor.
 2. If Peak Result complies with AV limit, AV Result is deemed to comply with AV limit.
 3. AVG: $VBW=1/Ton$, where: Ton is the transmitting duration.
 4. For the transmitting duration, please refer to clause 7.1.
 5. Only the worst data was recorded, if it complies with the limit, the other emissions deemed to comply with the limit.

RESTRICTED BANDEDGE (HIGH CHANNEL, HORIZONTAL)

PEAK

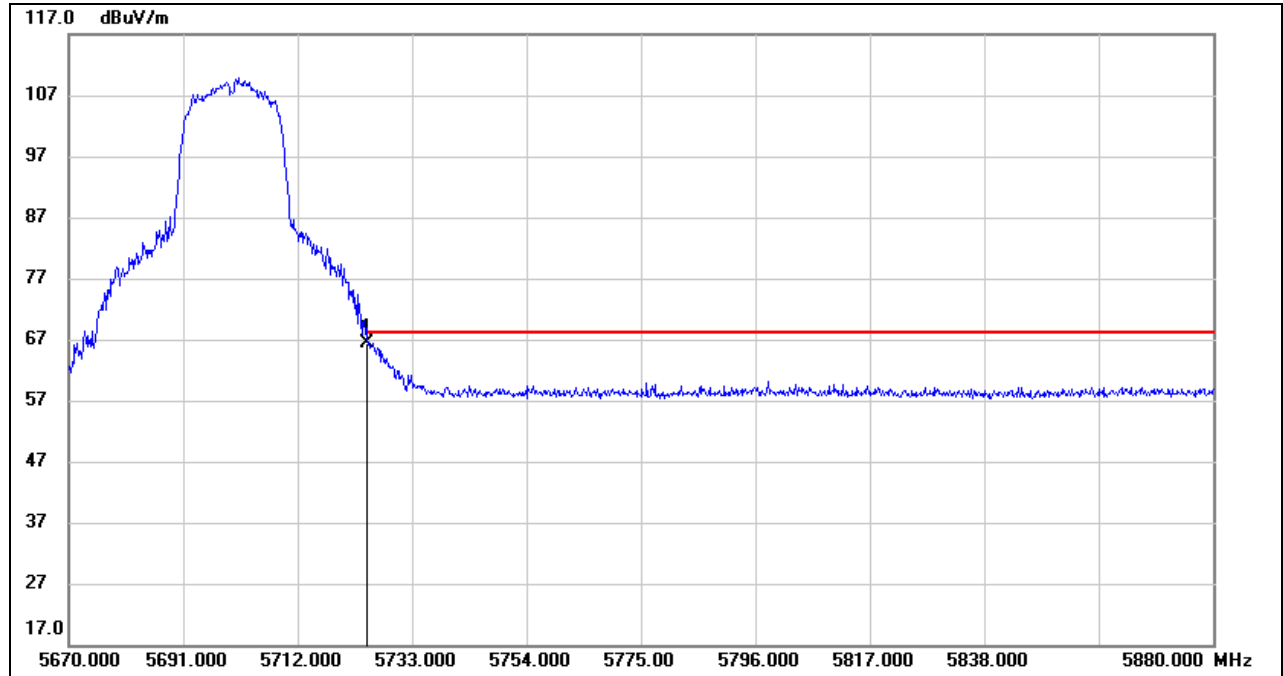

No.	Frequency (MHz)	Reading (dBuV)	Correct (dB/m)	Result (dBuV/m)	Limit (dBuV/m)	Margin (dB)	Remark
1	5725.000	25.16	41.27	66.43	68.20	-1.77	peak

- Note:
1. Measurement = Reading Level + Correct Factor.
 2. If Peak Result complies with AV limit, AV Result is deemed to comply with AV limit.
 3. Peak: Peak detector.
 4. Only the worst data was recorded, if it complies with the limit, the other emissions deemed to comply with the limit.

UNII-3 BAND

RESTRICTED BANDEDGE (LOW CHANNEL, HORIZONTAL)

PEAK

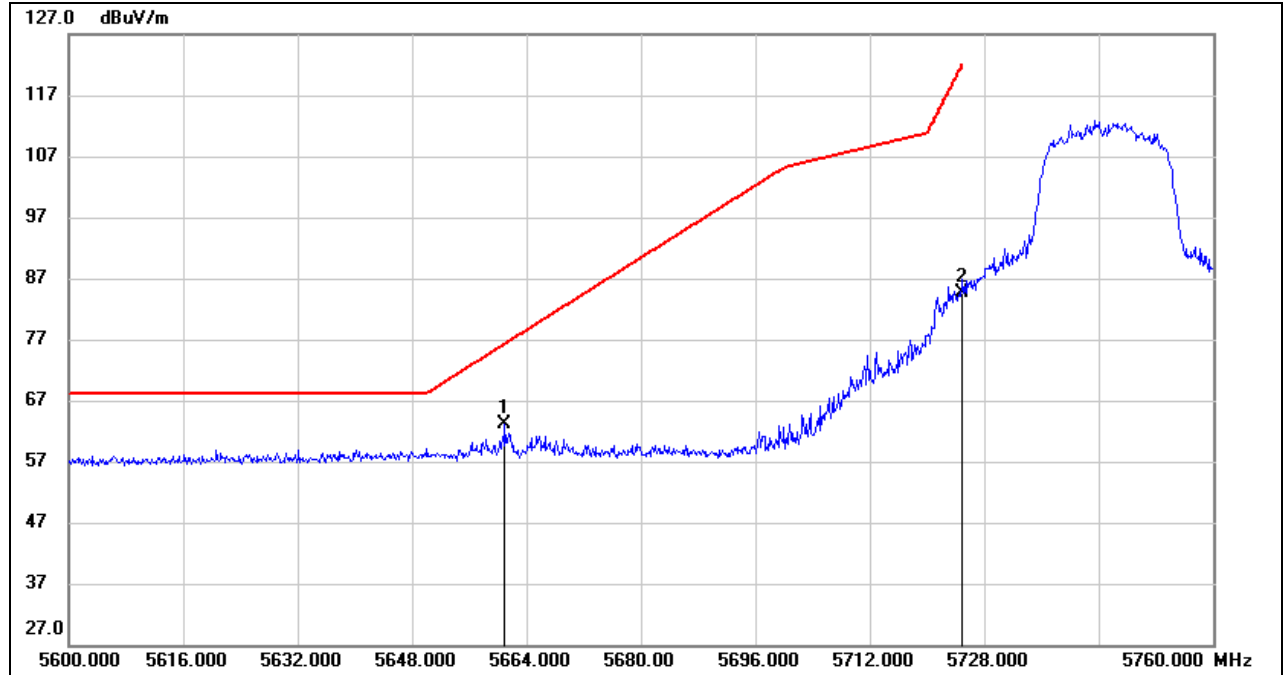

No.	Frequency (MHz)	Reading (dBuV)	Correct (dB/m)	Result (dBuV/m)	Limit (dBuV/m)	Margin (dB)	Remark
1	5660.960	22.01	41.09	63.10	76.34	-13.24	peak
2	5725.000	43.44	41.27	84.71	122.20	-37.49	peak

Note: 1. Measurement = Reading Level + Correct Factor.
 2. If Peak Result complies with AV limit, AV Result is deemed to comply with AV limit.
 3. Peak: Peak detector.
 4. Only the worst data was recorded, if it complies with the limit, the other emissions deemed to comply with the limit.

RESTRICTED BANDEDGE (HIGH CHANNEL, HORIZONTAL)

PEAK

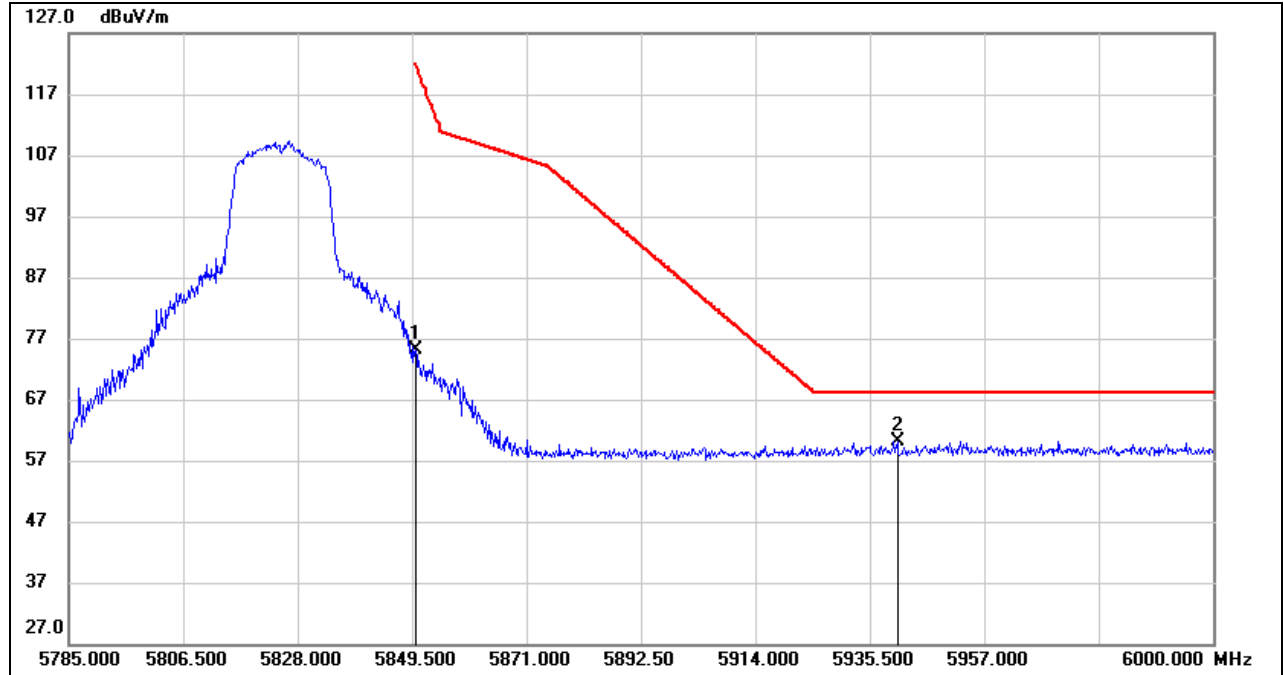

No.	Frequency (MHz)	Reading (dBuV)	Correct (dB/m)	Result (dBuV/m)	Limit (dBuV/m)	Margin (dB)	Remark
1	5850.000	33.49	41.60	75.09	122.20	-47.11	peak
2	5940.660	18.22	41.84	60.06	68.20	-8.14	peak

- Note: 1. Measurement = Reading Level + Correct Factor.
 2. If Peak Result complies with AV limit, AV Result is deemed to comply with AV limit.
 3. Peak: Peak detector.
 4. Only the worst data was recorded, if it complies with the limit, the other emissions deemed to comply with the limit.

Note: All the polarities (Vertical & Horizontal) had been tested, only the worst data was recorded in the report.

8.1.3. 802.11n HT40 MIMO MODE

UNII-1 BAND

RESTRICTED BANDEDGE (LOW CHANNEL, HORIZONTAL)

PEAK

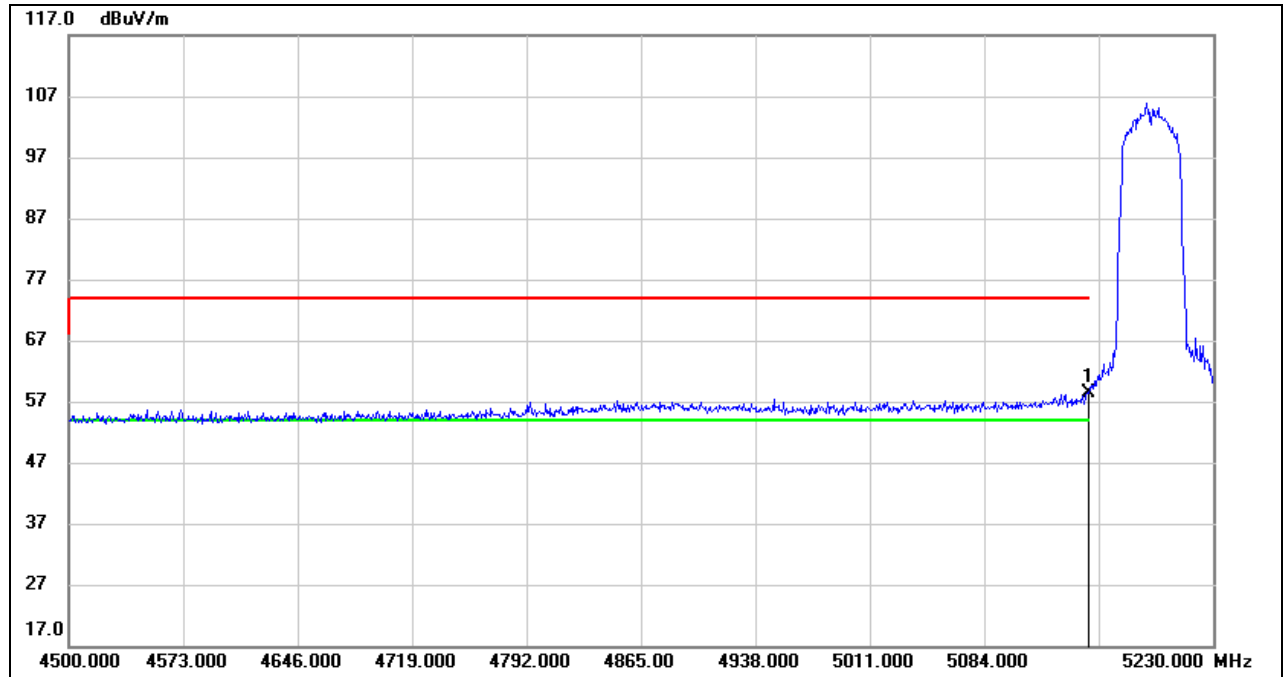

No.	Frequency (MHz)	Reading (dBuV)	Correct (dB/m)	Result (dBuV/m)	Limit (dBuV/m)	Margin (dB)	Remark
1	5150.000	18.15	40.27	58.42	74.00	-15.58	peak

- Note:
1. Measurement = Reading Level + Correct Factor.
 2. If Peak Result complies with AV limit, AV Result is deemed to comply with AV limit.
 3. Peak: Peak detector.
 4. Only the worst data was recorded, if it complies with the limit, the other emissions deemed to comply with the limit.



AVG

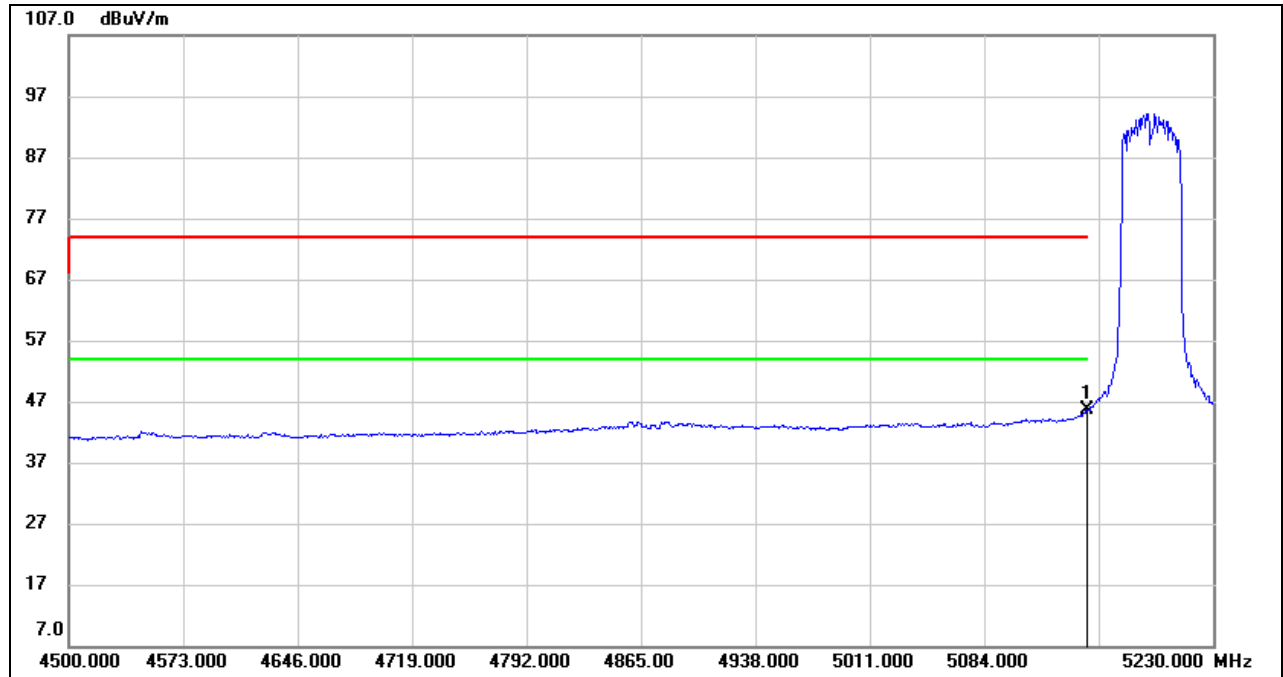

No.	Frequency (MHz)	Reading (dBuV)	Correct (dB/m)	Result (dBuV/m)	Limit (dBuV/m)	Margin (dB)	Remark
1	5150.000	5.34	40.27	45.61	54.00	-8.39	AVG

- Note:
1. Measurement = Reading Level + Correct Factor.
 2. If Peak Result complies with AV limit, AV Result is deemed to comply with AV limit.
 3. AVG: $VBW=1/T_{on}$, where: T_{on} is the transmitting duration.
 4. For the transmitting duration, please refer to clause 7.1.
 5. Only the worst data was recorded, if it complies with the limit, the other emissions deemed to comply with the limit.

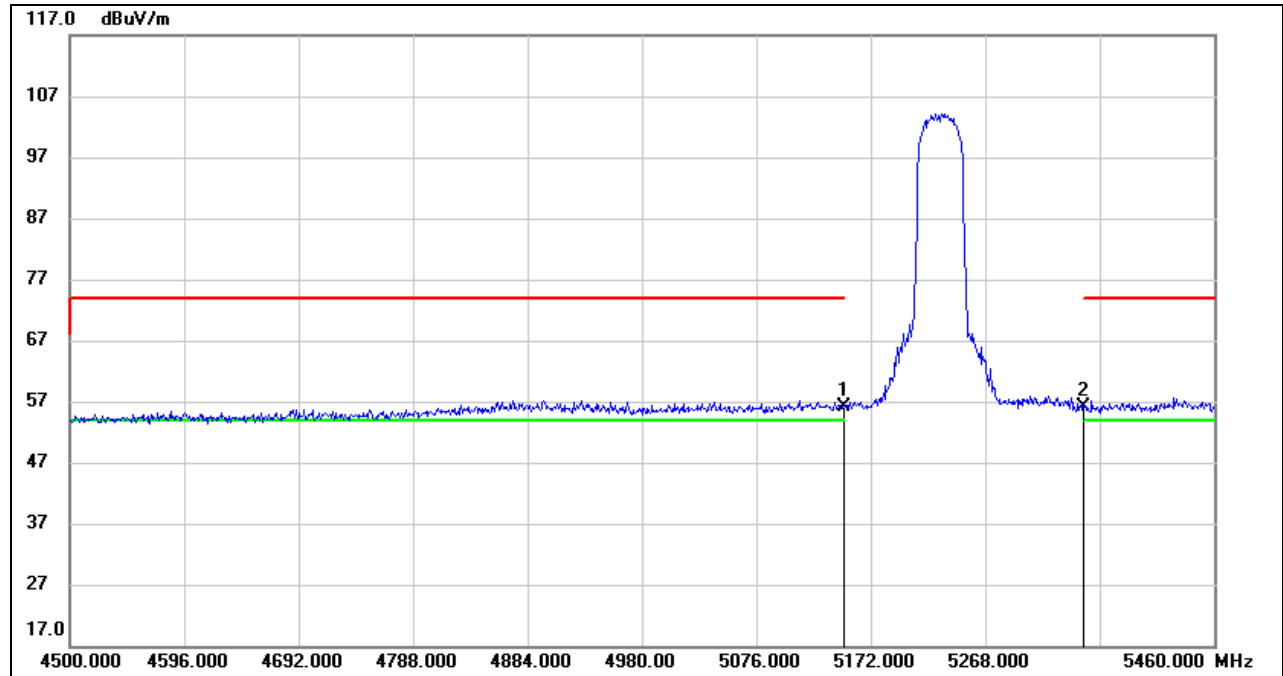
**RESTRICTED BANDEDGE (HIGH CHANNEL, HORIZONTAL)****PEAK**

No.	Frequency (MHz)	Reading (dBuV)	Correct (dB/m)	Result (dBuV/m)	Limit (dBuV/m)	Margin (dB)	Remark
1	5150.000	15.97	40.27	56.24	74.00	-17.76	peak
2	5350.000	15.52	40.49	56.01	74.00	-17.99	peak

- Note: 1. Measurement = Reading Level + Correct Factor.
 2. If Peak Result complies with AV limit, AV Result is deemed to comply with AV limit.
 3. Peak: Peak detector.
 4. Only the worst data was recorded, if it complies with the limit, the other emissions deemed to comply with the limit.

AVG

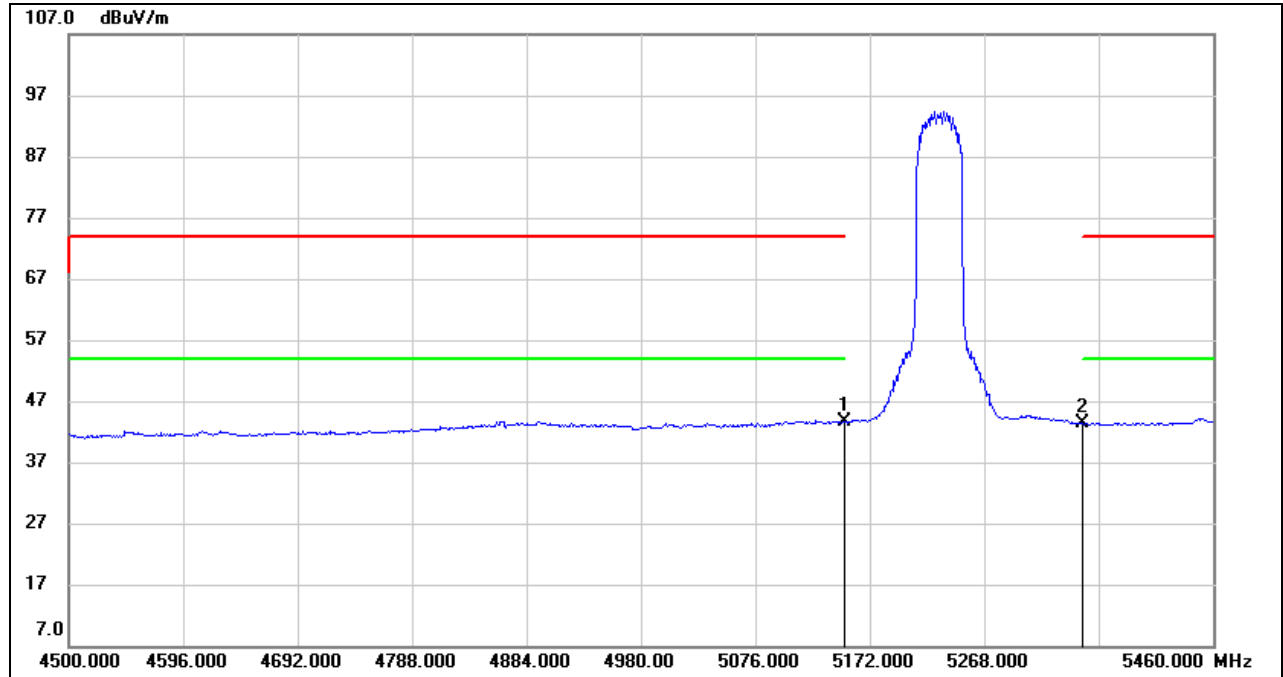

No.	Frequency (MHz)	Reading (dBuV)	Correct (dB/m)	Result (dBuV/m)	Limit (dBuV/m)	Margin (dB)	Remark
1	5150.000	3.33	40.27	43.60	54.00	-10.40	AVG
2	5350.000	2.85	40.49	43.34	54.00	-10.66	AVG

- Note:
1. Measurement = Reading Level + Correct Factor.
 2. If Peak Result complies with AV limit, AV Result is deemed to comply with AV limit.
 3. AVG: $VBW=1/T_{on}$, where: T_{on} is the transmitting duration.
 4. For the transmitting duration, please refer to clause 7.1.
 5. Only the worst data was recorded, if it complies with the limit, the other emissions deemed to comply with the limit.

UNII-2A BAND

RESTRICTED BANDEDGE (LOW CHANNEL, HORIZONTAL)

PEAK

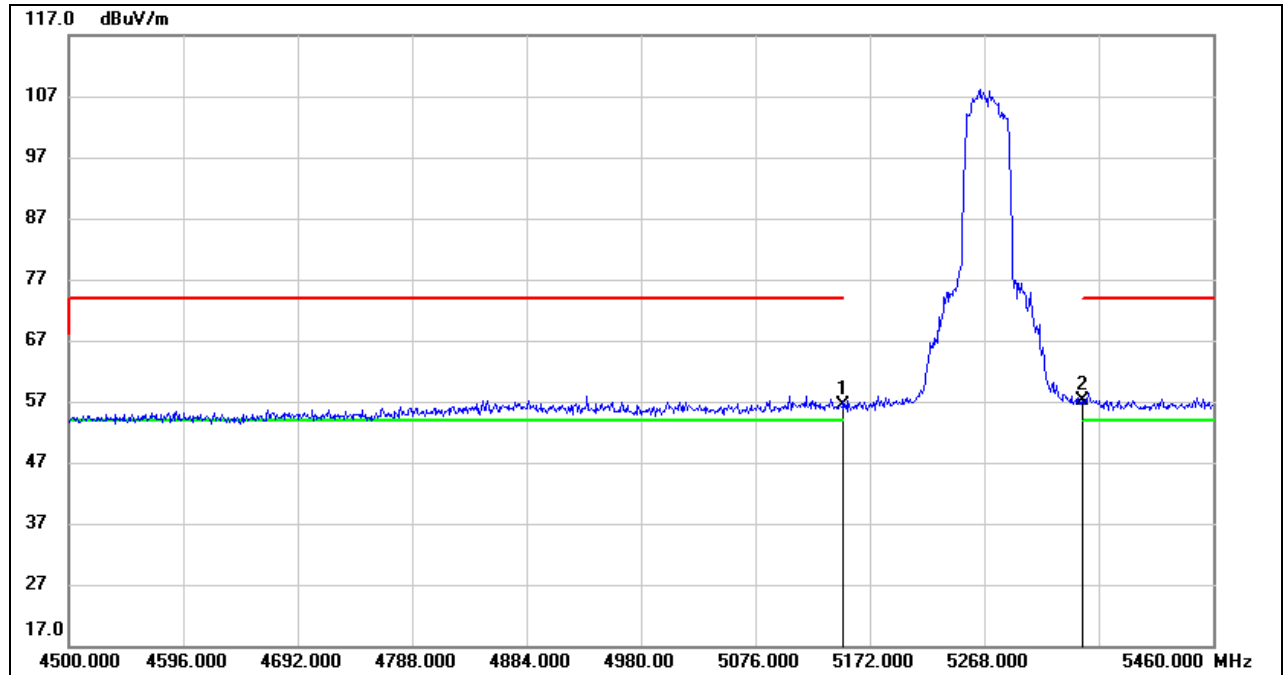

No.	Frequency (MHz)	Reading (dBuV)	Correct (dB/m)	Result (dBuV/m)	Limit (dBuV/m)	Margin (dB)	Remark
1	5150.000	16.00	40.27	56.27	74.00	-17.73	peak
2	5350.000	16.52	40.49	57.01	74.00	-16.99	peak

- Note: 1. Measurement = Reading Level + Correct Factor.
 2. If Peak Result complies with AV limit, AV Result is deemed to comply with AV limit.
 3. Peak: Peak detector.
 4. Only the worst data was recorded, if it complies with the limit, the other emissions deemed to comply with the limit.



AVG

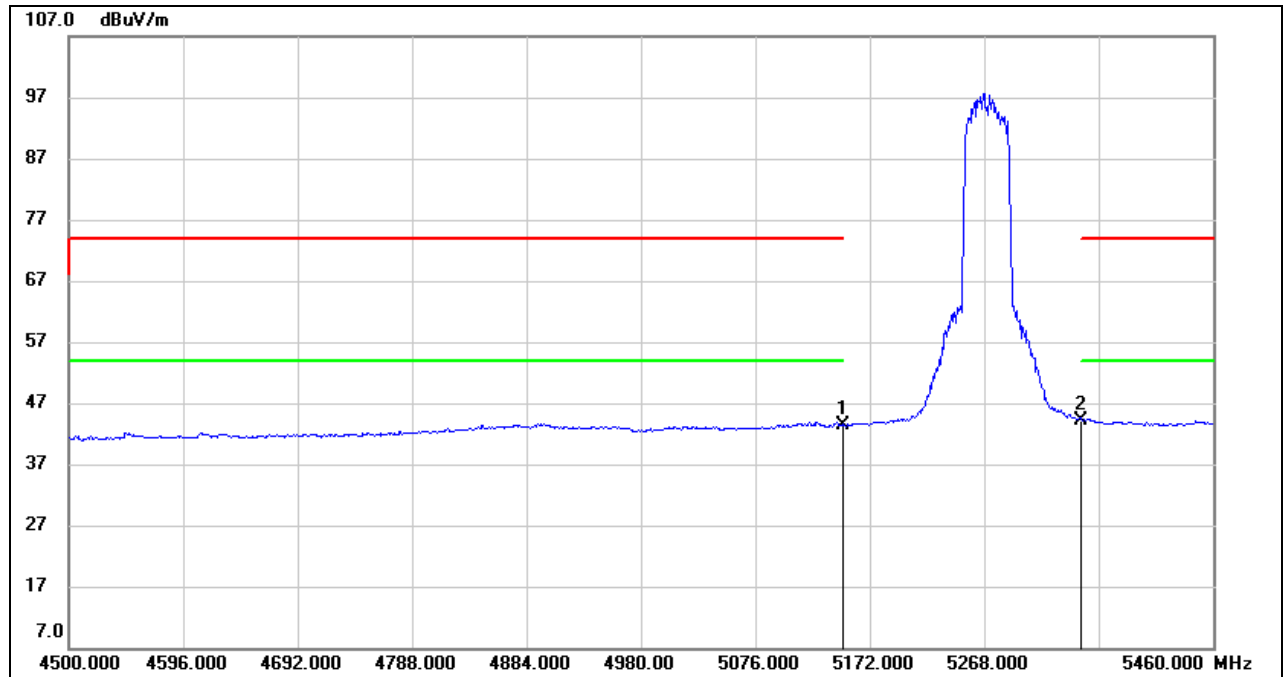

No.	Frequency (MHz)	Reading (dBuV)	Correct (dB/m)	Result (dBuV/m)	Limit (dBuV/m)	Margin (dB)	Remark
1	5150.000	3.22	40.27	43.49	54.00	-10.51	AVG
2	5350.000	3.74	40.49	44.23	54.00	-9.77	AVG

- Note:
1. Measurement = Reading Level + Correct Factor.
 2. If Peak Result complies with AV limit, AV Result is deemed to comply with AV limit.
 3. AVG: $VBW=1/Ton$, where: Ton is the transmitting duration.
 4. For the transmitting duration, please refer to clause 7.1.
 5. Only the worst data was recorded, if it complies with the limit, the other emissions deemed to comply with the limit.

RESTRICTED BANDEDGE (HIGH CHANNEL, HORIZONTAL)

PEAK

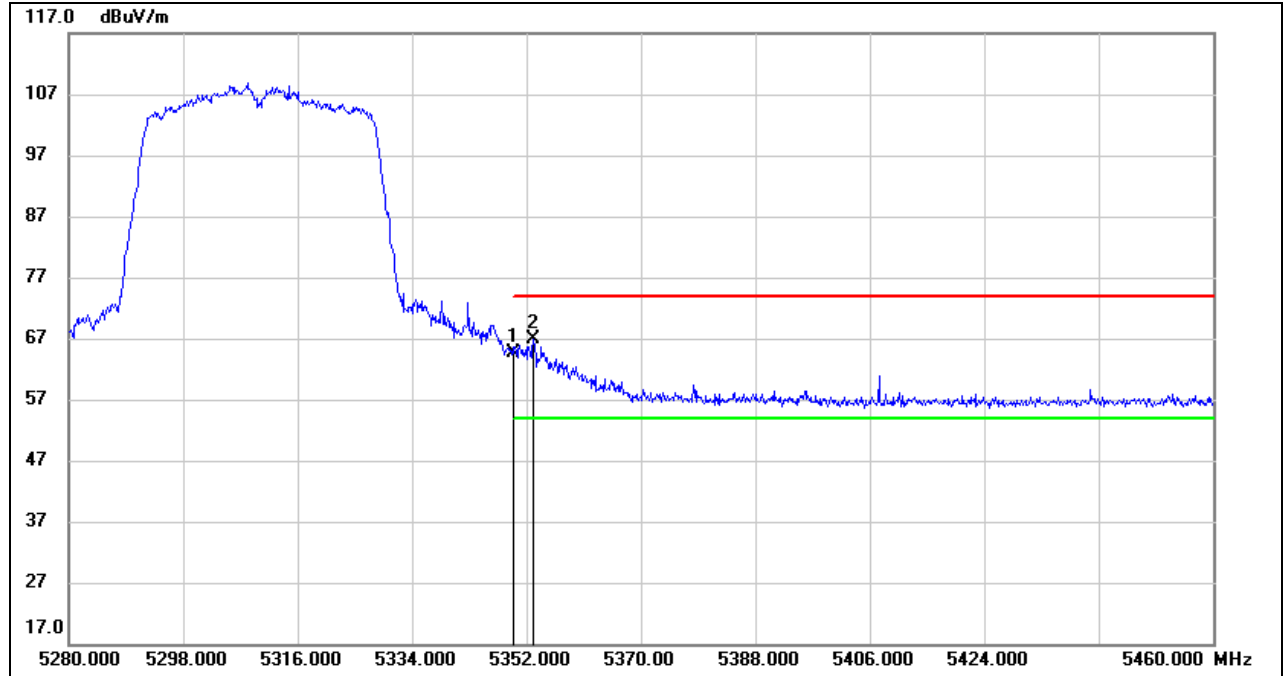

No.	Frequency (MHz)	Reading (dBuV)	Correct (dB/m)	Result (dBuV/m)	Limit (dBuV/m)	Margin (dB)	Remark
1	5350.000	24.17	40.49	64.66	74.00	-9.34	peak
2	5353.080	26.40	40.50	66.90	74.00	-7.10	peak

- Note: 1. Measurement = Reading Level + Correct Factor.
 2. If Peak Result complies with AV limit, AV Result is deemed to comply with AV limit.
 3. Peak: Peak detector.
 4. Only the worst data was recorded, if it complies with the limit, the other emissions deemed to comply with the limit.

AVG

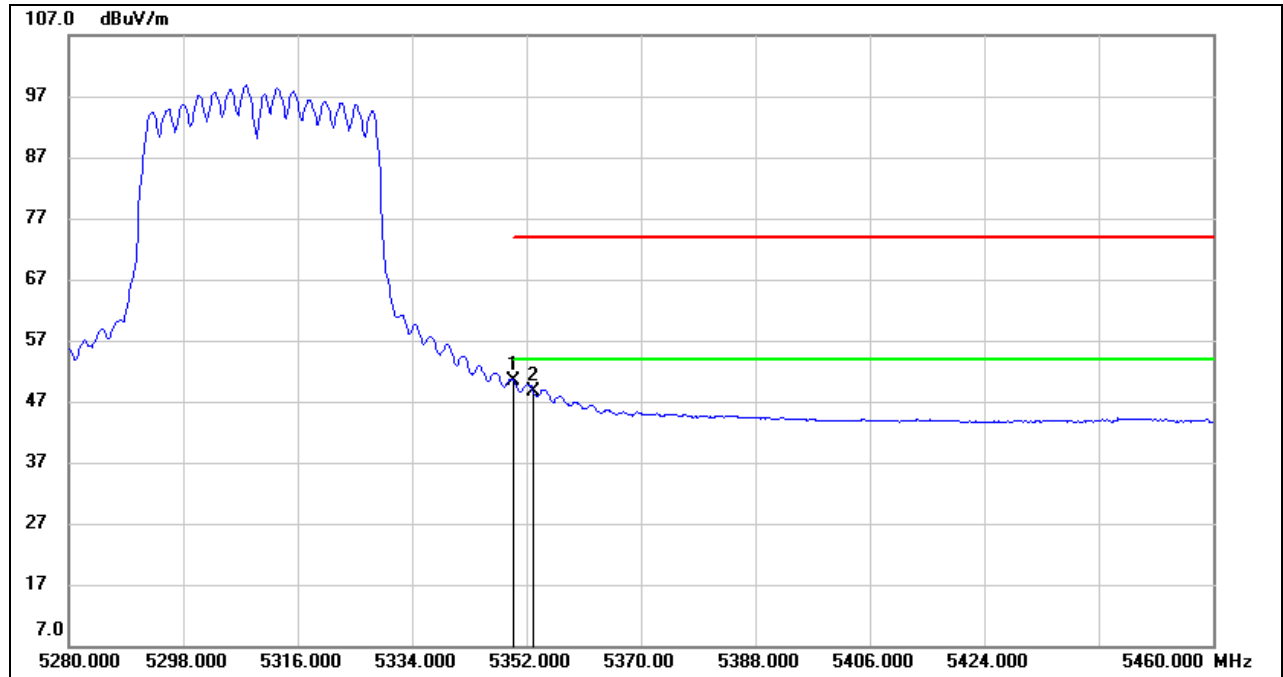

No.	Frequency (MHz)	Reading (dBuV)	Correct (dB/m)	Result (dBuV/m)	Limit (dBuV/m)	Margin (dB)	Remark
1	5350.000	9.91	40.49	50.40	54.00	-3.60	AVG
2	5353.080	8.25	40.50	48.75	54.00	-5.25	AVG

Note: 1. Measurement = Reading Level + Correct Factor.
 2. If Peak Result complies with AV limit, AV Result is deemed to comply with AV limit.
 3. AVG: $VBW=1/Ton$, where: Ton is the transmitting duration.
 4. For the transmitting duration, please refer to clause 7.1.
 5. Only the worst data was recorded, if it complies with the limit, the other emissions deemed to comply with the limit.



UNII-2C BAND

RESTRICTED BANDEDGE (LOW CHANNEL, HORIZONTAL)

PEAK

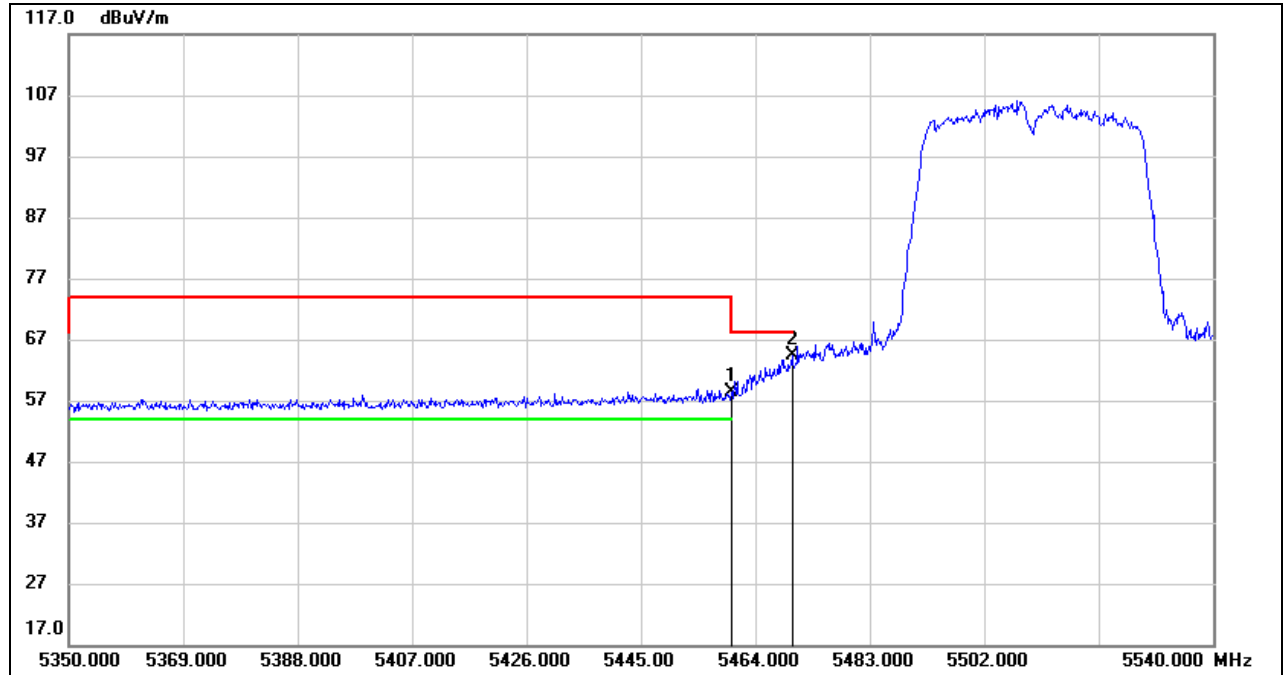

No.	Frequency (MHz)	Reading (dBuV)	Correct (dB/m)	Result (dBuV/m)	Limit (dBuV/m)	Margin (dB)	Remark
1	5460.000	17.81	40.62	58.43	74.00	-15.57	peak
2	5470.000	23.69	40.63	64.32	68.20	-3.88	peak

- Note: 1. Measurement = Reading Level + Correct Factor.
 2. If Peak Result complies with AV limit, AV Result is deemed to comply with AV limit.
 3. Peak: Peak detector.
 4. Only the worst data was recorded, if it complies with the limit, the other emissions deemed to comply with the limit.



AVG

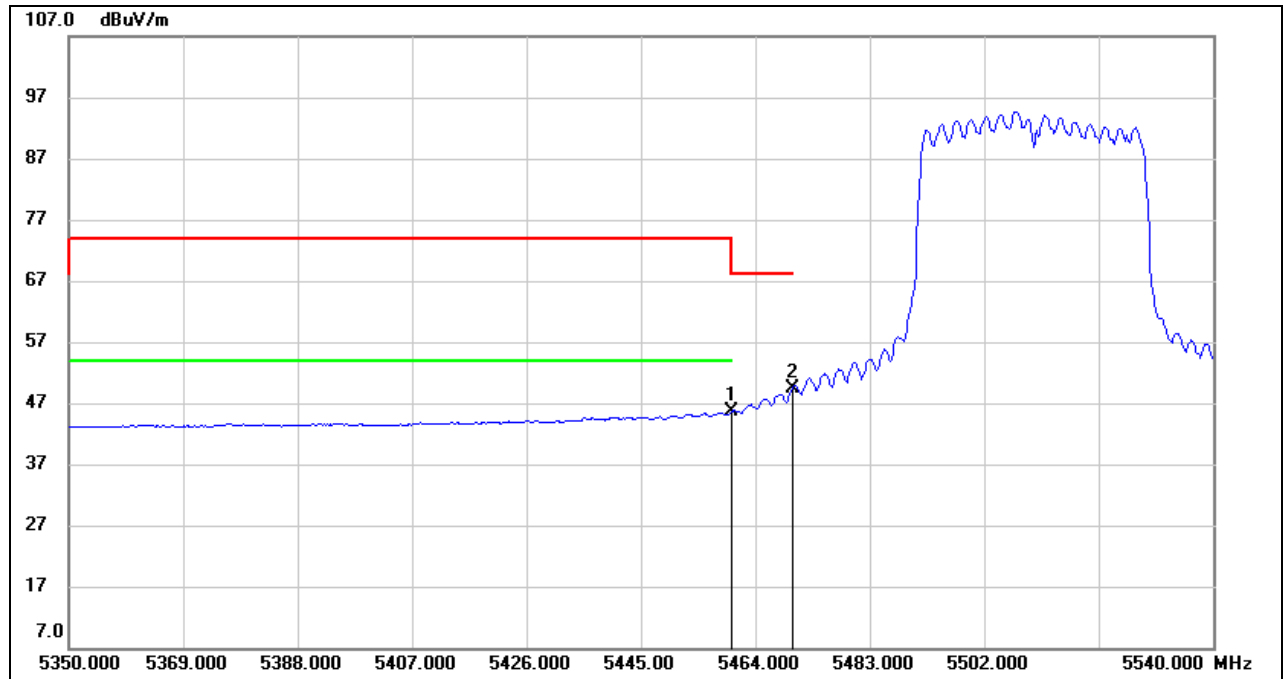

No.	Frequency (MHz)	Reading (dBuV)	Correct (dB/m)	Result (dBuV/m)	Limit (dBuV/m)	Margin (dB)	Remark
1	5460.000	4.90	40.62	45.52	54.00	-8.48	AVG
2	5470.000	8.66	40.63	49.29	/	/	AVG

- Note:
1. Measurement = Reading Level + Correct Factor.
 2. If Peak Result complies with AV limit, AV Result is deemed to comply with AV limit.
 3. AVG: $VBW=1/T_{on}$, where: T_{on} is the transmitting duration.
 4. For the transmitting duration, please refer to clause 7.1.
 5. Only the worst data was recorded, if it complies with the limit, the other emissions deemed to comply with the limit.



RESTRICTED BANDEDGE (HIGH CHANNEL, HORIZONTAL)

PEAK

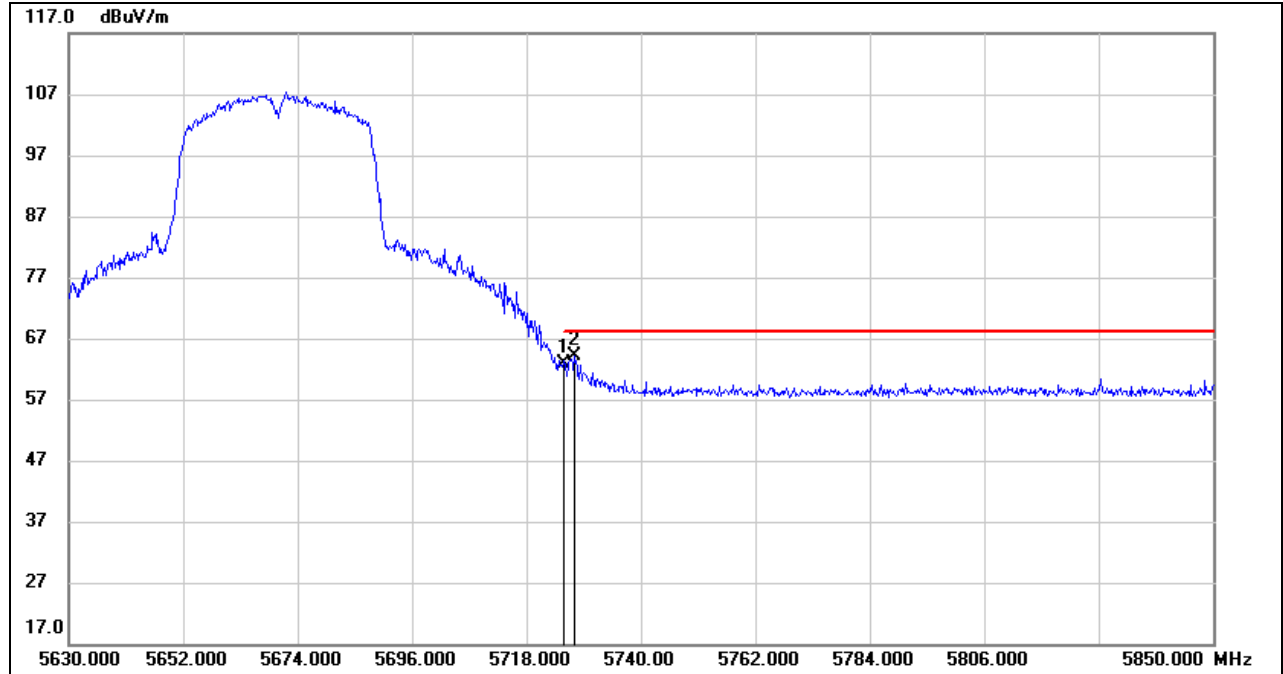

No.	Frequency (MHz)	Reading (dBuV)	Correct (dB/m)	Result (dBuV/m)	Limit (dBuV/m)	Margin (dB)	Remark
1	5725.000	21.62	41.27	62.89	68.20	-5.31	peak
2	5727.240	22.98	41.27	64.25	68.20	-3.95	peak

- Note: 1. Measurement = Reading Level + Correct Factor.
 2. If Peak Result complies with AV limit, AV Result is deemed to comply with AV limit.
 3. Peak: Peak detector.
 4. Only the worst data was recorded, if it complies with the limit, the other emissions deemed to comply with the limit.

UNII-3 BAND

RESTRICTED BANDEDGE (LOW CHANNEL, HORIZONTAL)

PEAK

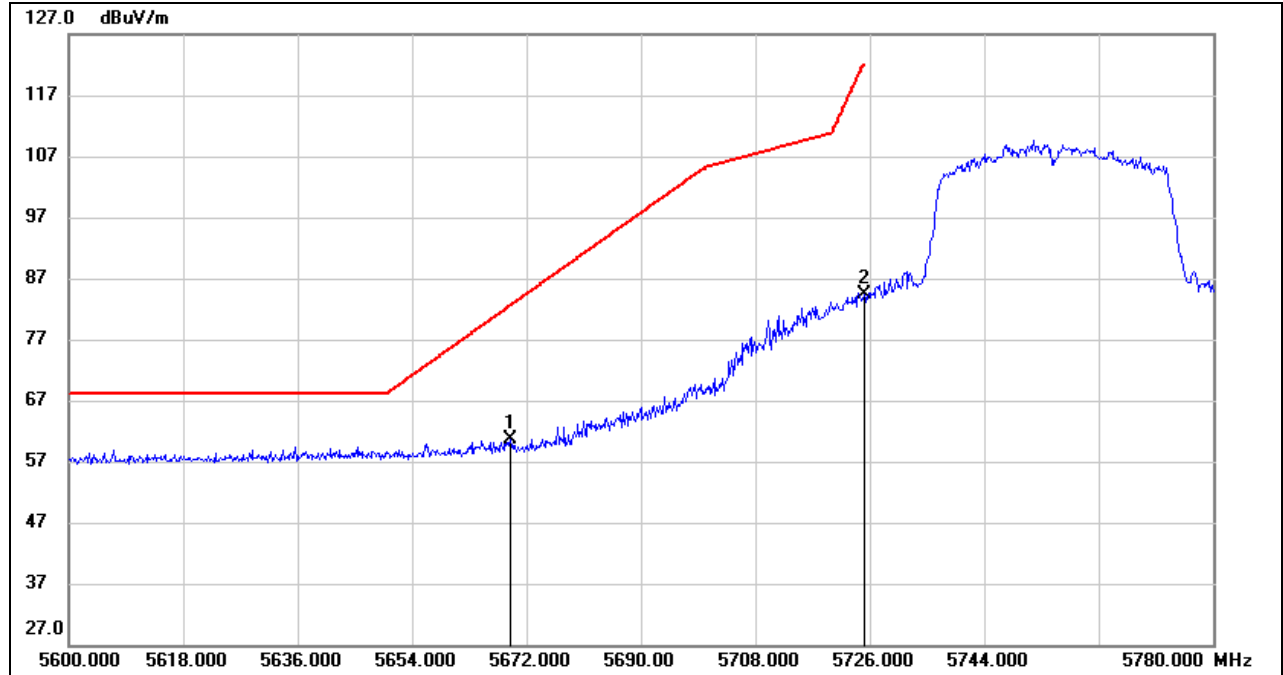

No.	Frequency (MHz)	Reading (dBuV)	Correct (dB/m)	Result (dBuV/m)	Limit (dBuV/m)	Margin (dB)	Remark
1	5669.480	19.41	41.11	60.52	82.65	-22.13	peak
2	5725.000	43.11	41.27	84.38	122.20	-37.82	peak

Note: 1. Measurement = Reading Level + Correct Factor.
 2. If Peak Result complies with AV limit, AV Result is deemed to comply with AV limit.
 3. Peak: Peak detector.
 4. Only the worst data was recorded, if it complies with the limit, the other emissions deemed to comply with the limit.

RESTRICTED BANDEDGE (HIGH CHANNEL, HORIZONTAL)

PEAK

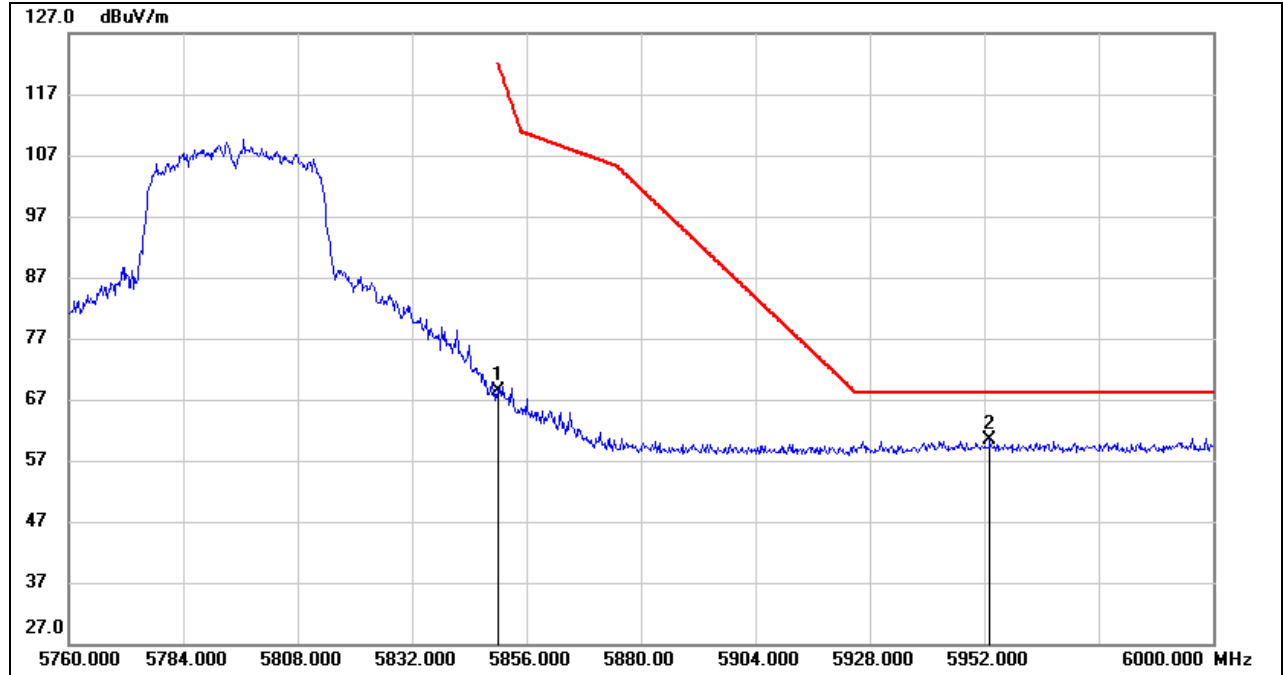

No.	Frequency (MHz)	Reading (dBuV)	Correct (dB/m)	Result (dBuV/m)	Limit (dBuV/m)	Margin (dB)	Remark
1	5850.000	26.90	41.60	68.50	122.20	-53.70	peak
2	5953.200	18.51	41.87	60.38	68.20	-7.82	peak

- Note: 1. Measurement = Reading Level + Correct Factor.
 2. If Peak Result complies with AV limit, AV Result is deemed to comply with AV limit.
 3. Peak: Peak detector.
 4. Only the worst data was recorded, if it complies with the limit, the other emissions deemed to comply with the limit.

Note: All the polarities (Vertical & Horizontal) had been tested, only the worst data was recorded in the report.



8.2. SPURIOUS EMISSIONS (1 GHz ~ 7 GHz)

8.2.1. 802.11n HT20 SISO MODE

UNII-1 BAND

ANTENNA 0 TEST RESULTS (WORST CASE)

HARMONICS AND SPURIOUS EMISSIONS (LOW CHANNEL, HORIZONTAL)

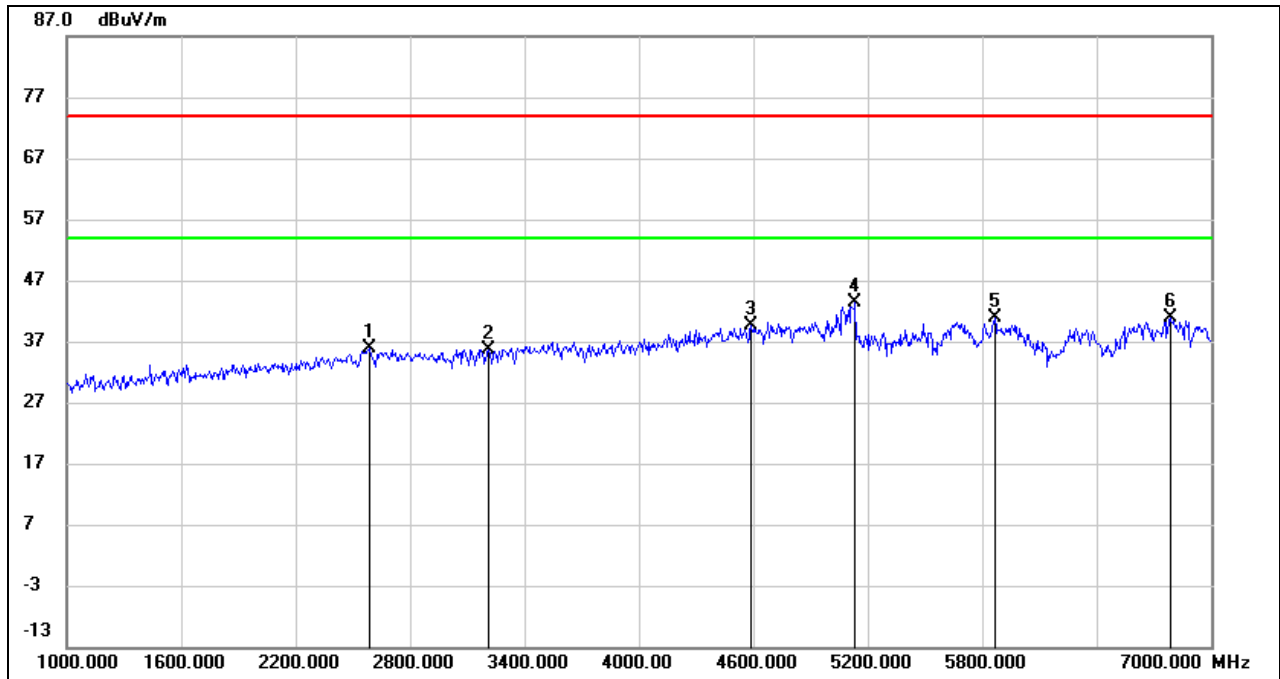

No.	Frequency (MHz)	Reading (dBuV)	Correct (dB/m)	Result (dBuV/m)	Limit (dBuV/m)	Margin (dB)	Remark
1	2590.000	44.22	-8.22	36.00	74.00	-38.00	peak
2	3208.000	42.21	-6.51	35.70	74.00	-38.30	peak
3	4588.000	41.33	-1.79	39.54	74.00	-34.46	peak
4	5134.000	43.31	0.00	43.31	74.00	-30.69	peak
5	5866.000	39.51	1.47	40.98	74.00	-33.02	peak
6	6784.000	35.74	5.13	40.87	74.00	-33.13	peak

Note: 1. Measurement = Reading Level + Correct Factor.

2. If Peak Result complies with AV limit, AV Result is deemed to comply with AV limit.

3. Peak: Peak detector.

4. Filter losses were only considered in the spurious frequency bands and the authorized band was not corrected for Band reject filter losses.

5. Proper operation of the transmitter prior to adding the filter to the measurement chain.

6. Since non-restricted band peak emissions are less than the average limit, they also comply with the -27dBm/MHz (68.2dBuV/m) limit.

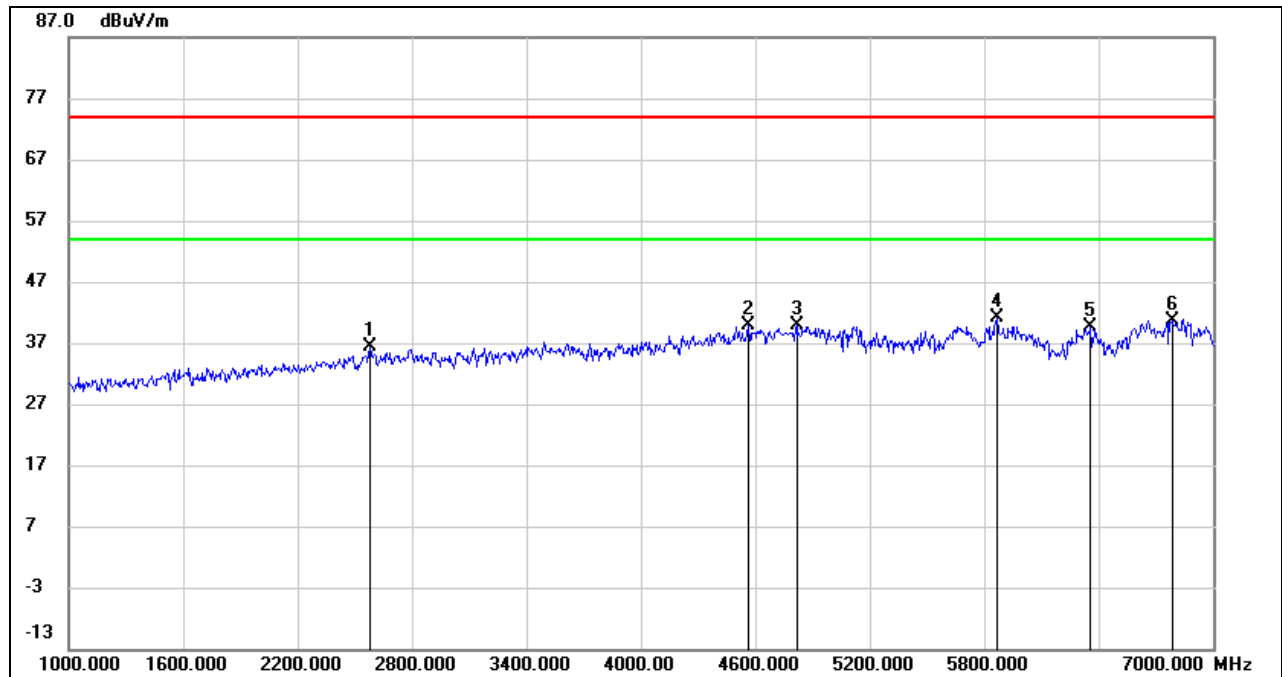
**HARMONICS AND SPURIOUS EMISSIONS (LOW CHANNEL, VERTICAL)**

No.	Frequency (MHz)	Reading (dBuV)	Correct (dB/m)	Result (dBuV/m)	Limit (dBuV/m)	Margin (dB)	Remark
1	2578.000	44.64	-8.26	36.38	74.00	-37.62	peak
2	4564.000	41.71	-1.89	39.82	74.00	-34.18	peak
3	4816.000	40.72	-0.89	39.83	74.00	-34.17	peak
4	5866.000	39.61	1.47	41.08	74.00	-32.92	peak
5	6358.000	36.45	3.18	39.63	74.00	-34.37	peak
6	6784.000	35.57	5.13	40.70	74.00	-33.30	peak

Note: 1. Measurement = Reading Level + Correct Factor.

2. If Peak Result complies with AV limit, AV Result is deemed to comply with AV limit.

3. Peak: Peak detector.

4. Filter losses were only considered in the spurious frequency bands and the authorized band was not corrected for Band reject filter losses.

5. Proper operation of the transmitter prior to adding the filter to the measurement chain.

6. Since non-restricted band peak emissions are less than the average limit, they also comply with the -27dBm/MHz (68.2dBuV/m) limit.

HARMONICS AND SPURIOUS EMISSIONS (MID CHANNEL, HORIZONTAL)

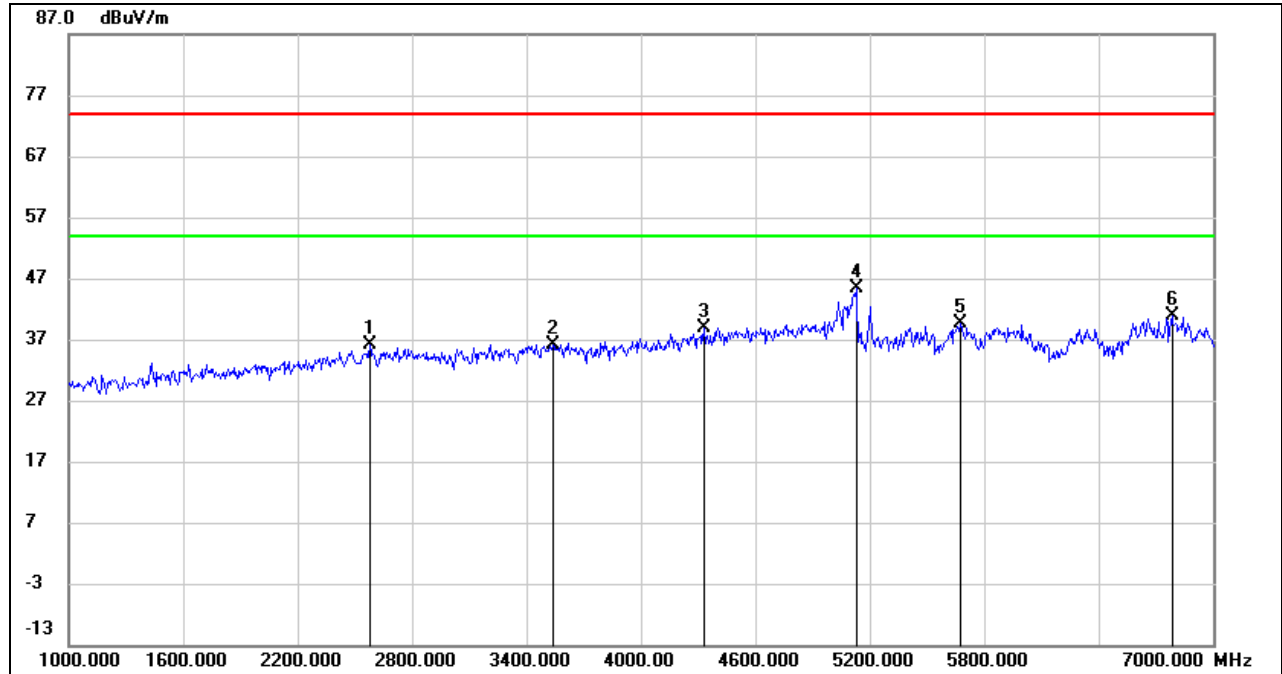

No.	Frequency (MHz)	Reading (dBuV)	Correct (dB/m)	Result (dBuV/m)	Limit (dBuV/m)	Margin (dB)	Remark
1	2578.000	44.28	-8.26	36.02	74.00	-37.98	peak
2	3538.000	41.89	-5.74	36.15	74.00	-37.85	peak
3	4330.000	41.76	-2.94	38.82	74.00	-35.18	peak
4	5128.000	45.50	0.00	45.50	74.00	-28.50	peak
5	5674.000	38.77	0.92	39.69	74.00	-34.31	peak
6	6784.000	35.71	5.13	40.84	74.00	-33.16	peak

Note: 1. Measurement = Reading Level + Correct Factor.

2. If Peak Result complies with AV limit, AV Result is deemed to comply with AV limit.

3. Peak: Peak detector.

4. Filter losses were only considered in the spurious frequency bands and the authorized band was not corrected for Band reject filter losses.

5. Proper operation of the transmitter prior to adding the filter to the measurement chain.

6. Since non-restricted band peak emissions are less than the average limit, they also comply with the -27dBm/MHz (68.2dBuV/m) limit.

HARMONICS AND SPURIOUS EMISSIONS (MID CHANNEL, VERTICAL)

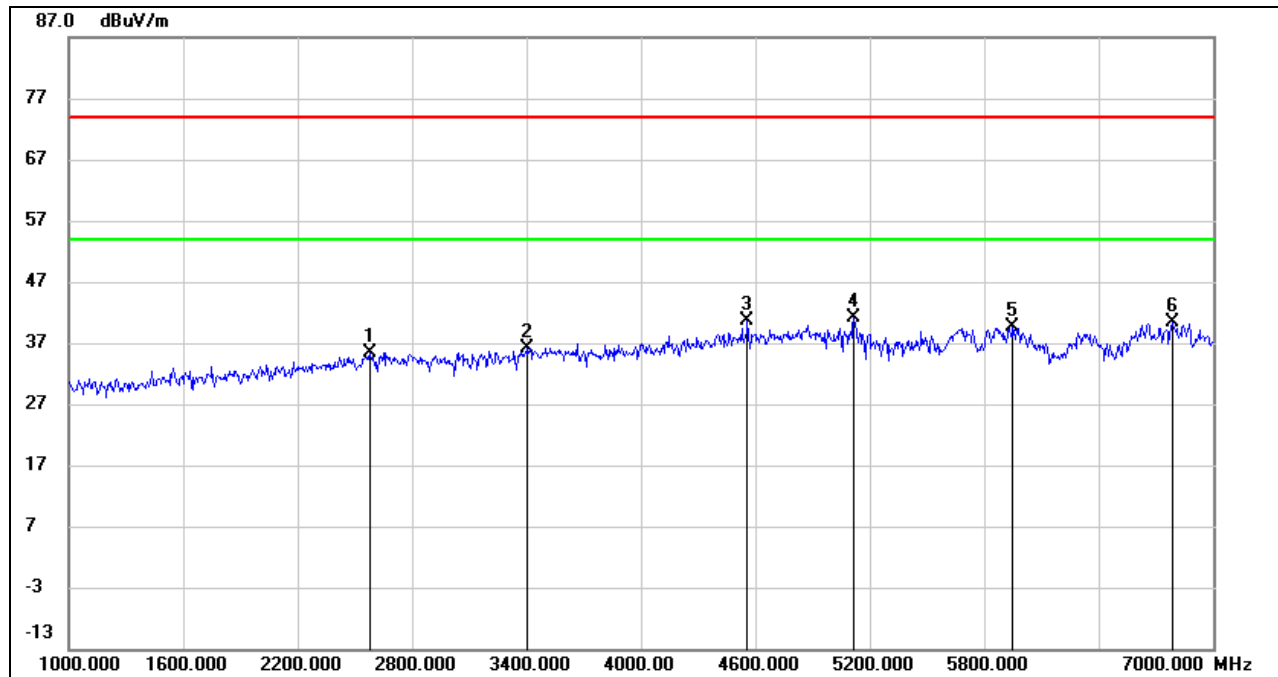

No.	Frequency (MHz)	Reading (dBuV)	Correct (dB/m)	Result (dBuV/m)	Limit (dBuV/m)	Margin (dB)	Remark
1	2578.000	43.74	-8.26	35.48	74.00	-38.52	peak
2	3400.000	42.23	-6.08	36.15	74.00	-37.85	peak
3	4558.000	42.50	-1.91	40.59	74.00	-33.41	peak
4	5116.000	41.12	-0.02	41.10	74.00	-32.90	peak
5	5950.000	37.85	1.70	39.55	74.00	-34.45	peak
6	6784.000	35.26	5.13	40.39	74.00	-33.61	peak

Note: 1. Measurement = Reading Level + Correct Factor.

2. If Peak Result complies with AV limit, AV Result is deemed to comply with AV limit.

3. Peak: Peak detector.

4. Filter losses were only considered in the spurious frequency bands and the authorized band was not corrected for Band reject filter losses.

5. Proper operation of the transmitter prior to adding the filter to the measurement chain.

6. Since non-restricted band peak emissions are less than the average limit, they also comply with the -27dBm/MHz (68.2dBuV/m) limit.

HARMONICS AND SPURIOUS EMISSIONS (HIGH CHANNEL, HORIZONTAL)

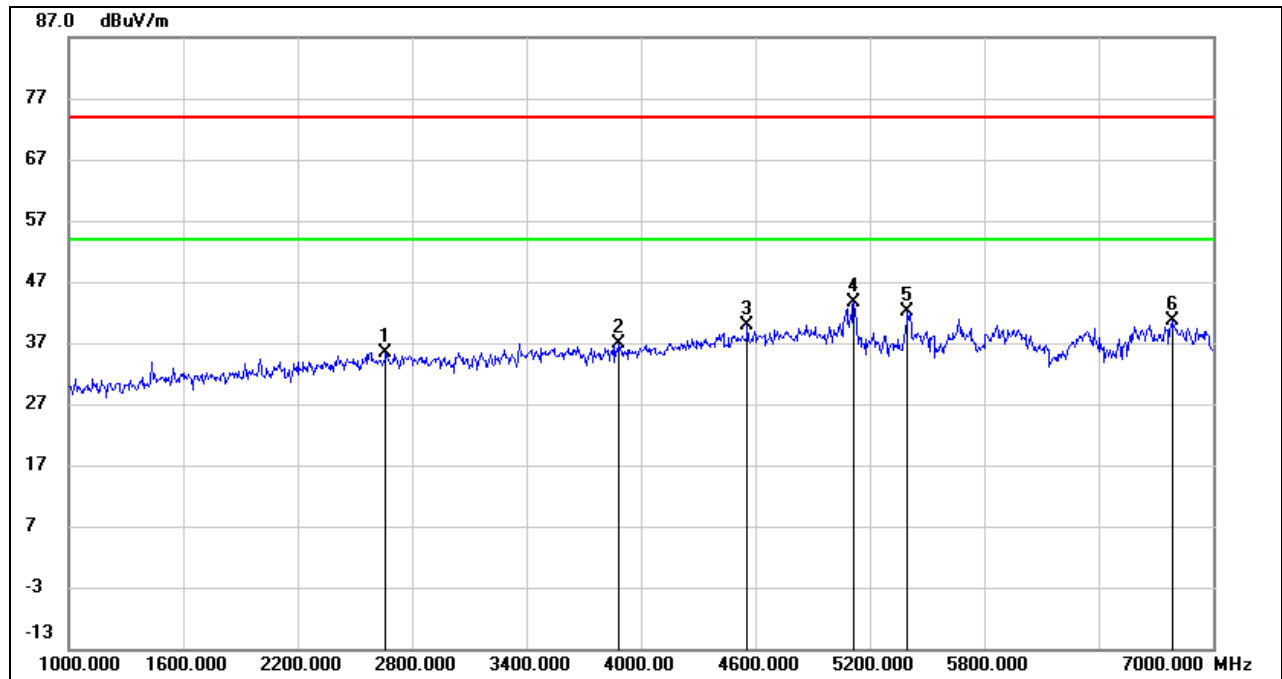

No.	Frequency (MHz)	Reading (dBuV)	Correct (dB/m)	Result (dBuV/m)	Limit (dBuV/m)	Margin (dB)	Remark
1	2662.000	43.50	-8.01	35.49	74.00	-38.51	peak
2	3880.000	41.81	-4.81	37.00	74.00	-37.00	peak
3	4558.000	41.89	-1.91	39.98	74.00	-34.02	peak
4	5116.000	43.62	-0.02	43.60	74.00	-30.40	peak
5	5398.000	41.88	0.31	42.19	74.00	-31.81	peak
6	6784.000	35.53	5.13	40.66	74.00	-33.34	peak

Note: 1. Measurement = Reading Level + Correct Factor.

2. If Peak Result complies with AV limit, AV Result is deemed to comply with AV limit.

3. Peak: Peak detector.

4. Filter losses were only considered in the spurious frequency bands and the authorized band was not corrected for Band reject filter losses.

5. Proper operation of the transmitter prior to adding the filter to the measurement chain.

6. Since non-restricted band peak emissions are less than the average limit, they also comply with the -27dBm/MHz (68.2dBuV/m) limit.

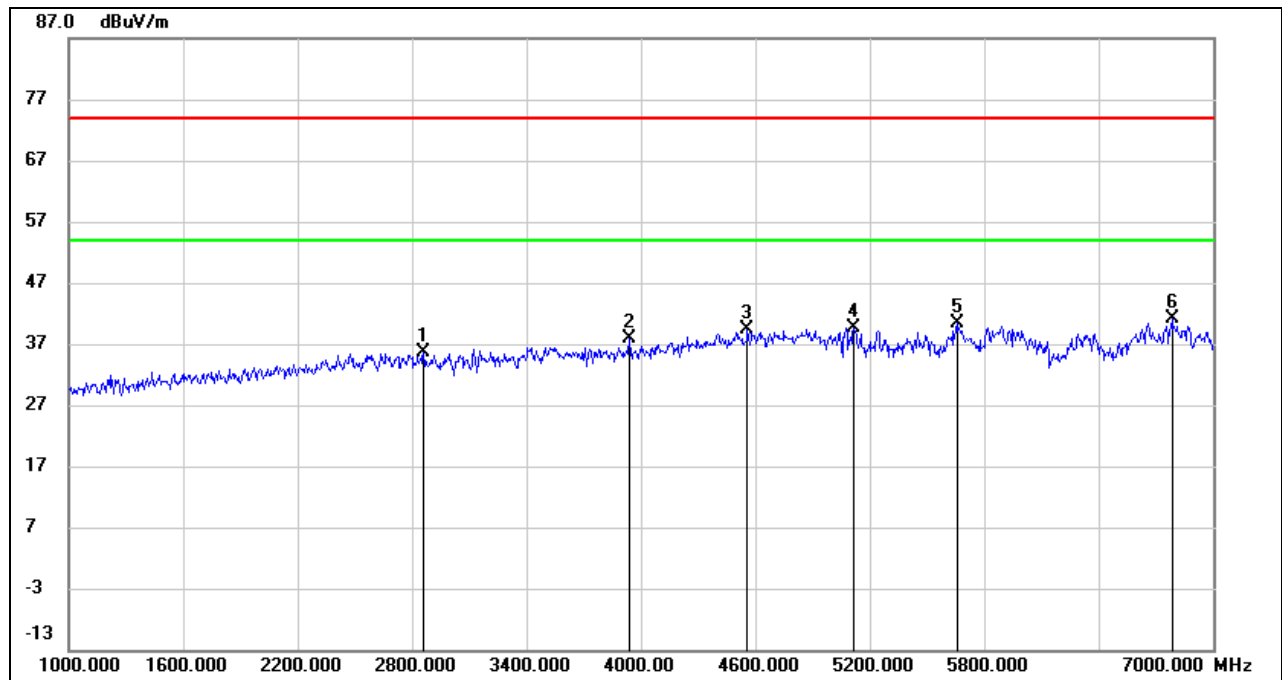
**HARMONICS AND SPURIOUS EMISSIONS (HIGH CHANNEL, VERTICAL)**

No.	Frequency (MHz)	Reading (dBuV)	Correct (dB/m)	Result (dBuV/m)	Limit (dBuV/m)	Margin (dB)	Remark
1	2860.000	43.00	-7.40	35.60	74.00	-38.40	peak
2	3940.000	42.52	-4.64	37.88	74.00	-36.12	peak
3	4558.000	41.24	-1.91	39.33	74.00	-34.67	peak
4	5116.000	39.71	-0.02	39.69	74.00	-34.31	peak
5	5656.000	39.45	0.87	40.32	74.00	-33.68	peak
6	6784.000	35.94	5.13	41.07	74.00	-32.93	peak

Note: 1. Measurement = Reading Level + Correct Factor.

2. If Peak Result complies with AV limit, AV Result is deemed to comply with AV limit.

3. Peak: Peak detector.

4. Filter losses were only considered in the spurious frequency bands and the authorized band was not corrected for Band reject filter losses.

5. Proper operation of the transmitter prior to adding the filter to the measurement chain.

6. Since non-restricted band peak emissions are less than the average limit, they also comply with the -27dBm/MHz (68.2dBuV/m) limit.

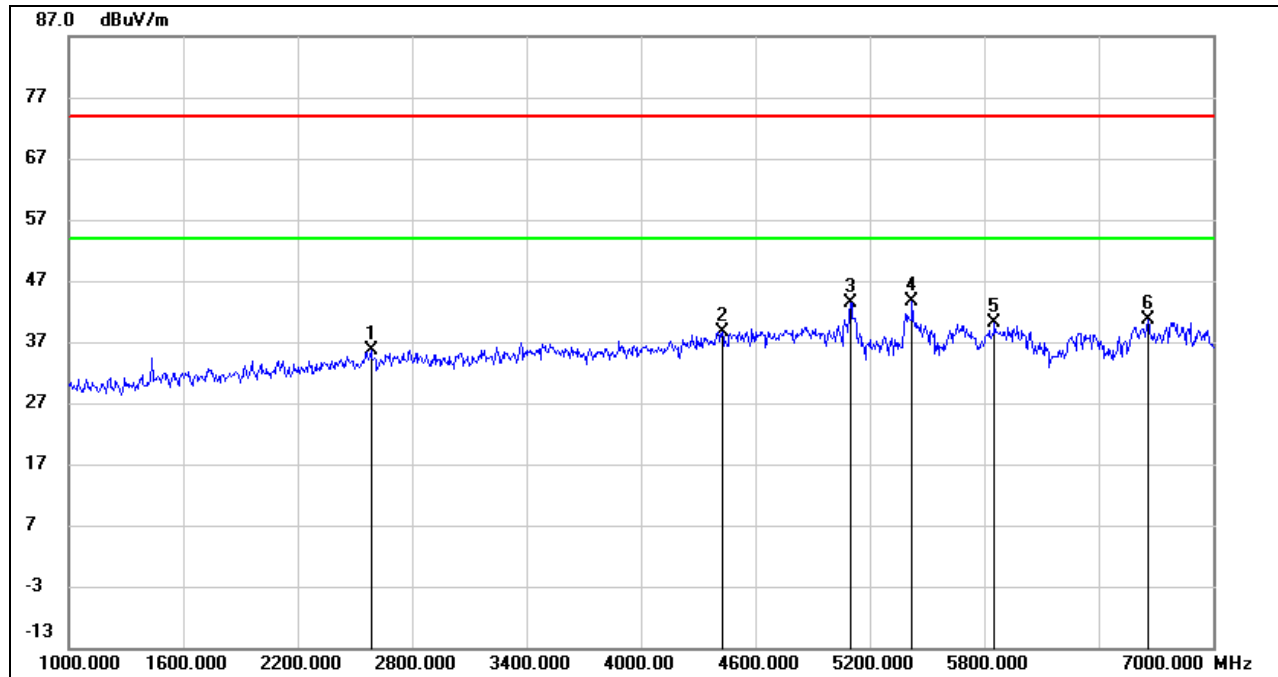
UNII-2A BAND
ANTENNA 1 TEST RESULTS (WORST CASE)
HARMONICS AND SPURIOUS EMISSIONS (LOW CHANNEL, HORIZONTAL)

No.	Frequency (MHz)	Reading (dBuV)	Correct (dB/m)	Result (dBuV/m)	Limit (dBuV/m)	Margin (dB)	Remark
1	2584.000	43.94	-8.24	35.70	74.00	-38.30	peak
2	4426.000	41.07	-2.49	38.58	74.00	-35.42	peak
3	5098.000	43.41	-0.03	43.38	74.00	-30.62	peak
4	5422.000	43.38	0.32	43.70	74.00	-30.30	peak
5	5854.000	38.60	1.43	40.03	74.00	-33.97	peak
6	6658.000	36.24	4.49	40.73	74.00	-33.27	peak

Note: 1. Measurement = Reading Level + Correct Factor.

2. If Peak Result complies with AV limit, AV Result is deemed to comply with AV limit.

3. Peak: Peak detector.

4. Filter losses were only considered in the spurious frequency bands and the authorized band was not corrected for Band reject filter losses.

5. Proper operation of the transmitter prior to adding the filter to the measurement chain.

6. Since non-restricted band peak emissions are less than the average limit, they also comply with the -27dBm/MHz (68.2dBuV/m) limit.

HARMONICS AND SPURIOUS EMISSIONS (LOW CHANNEL, VERTICAL)

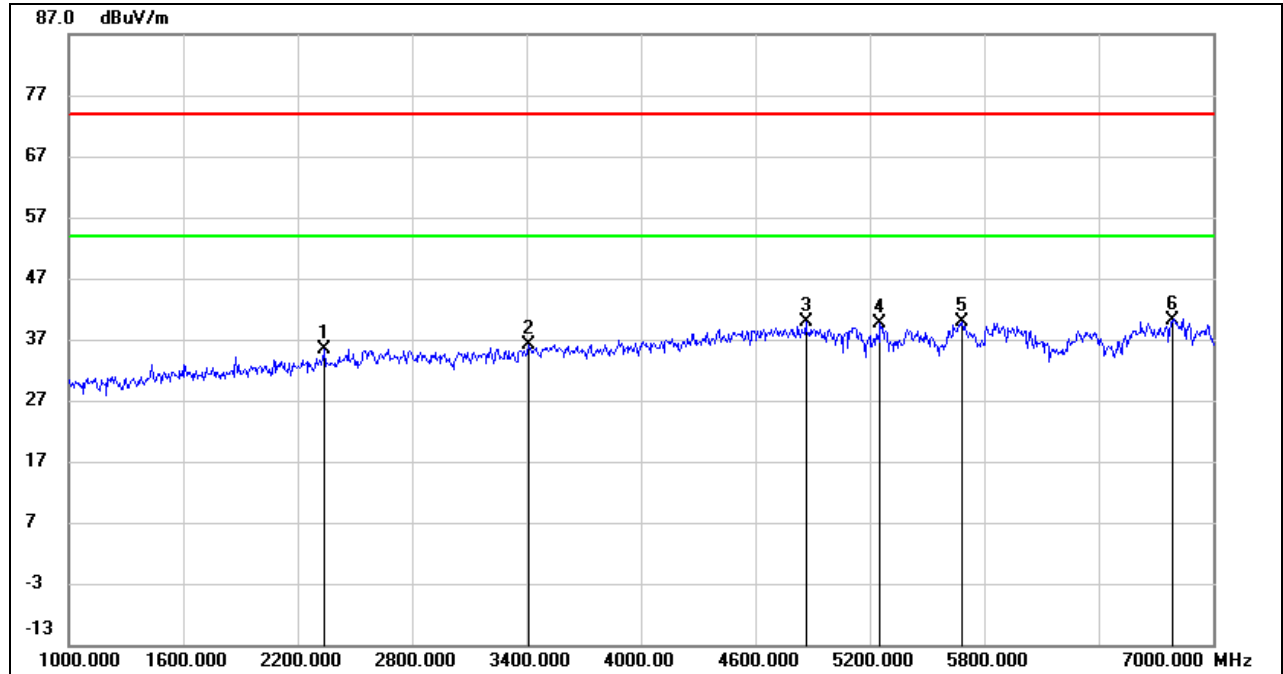

No.	Frequency (MHz)	Reading (dBuV)	Correct (dB/m)	Result (dBuV/m)	Limit (dBuV/m)	Margin (dB)	Remark
1	2338.000	44.78	-9.32	35.46	74.00	-38.54	peak
2	3412.000	42.21	-6.05	36.16	74.00	-37.84	peak
3	4864.000	40.50	-0.70	39.80	74.00	-34.20	peak
4	5254.000	39.58	0.15	39.73	74.00	-34.27	peak
5	5680.000	38.99	0.94	39.93	74.00	-34.07	peak
6	6790.000	35.05	5.15	40.20	74.00	-33.80	peak

Note: 1. Measurement = Reading Level + Correct Factor.
 2. If Peak Result complies with AV limit, AV Result is deemed to comply with AV limit.
 3. Peak: Peak detector.
 4. Filter losses were only considered in the spurious frequency bands and the authorized band was not corrected for Band reject filter losses.
 5. Proper operation of the transmitter prior to adding the filter to the measurement chain.
 6. Since non-restricted band peak emissions are less than the average limit, they also comply with the -27dBm/MHz (68.2dBuV/m) limit.

HARMONICS AND SPURIOUS EMISSIONS (MID CHANNEL, HORIZONTAL)

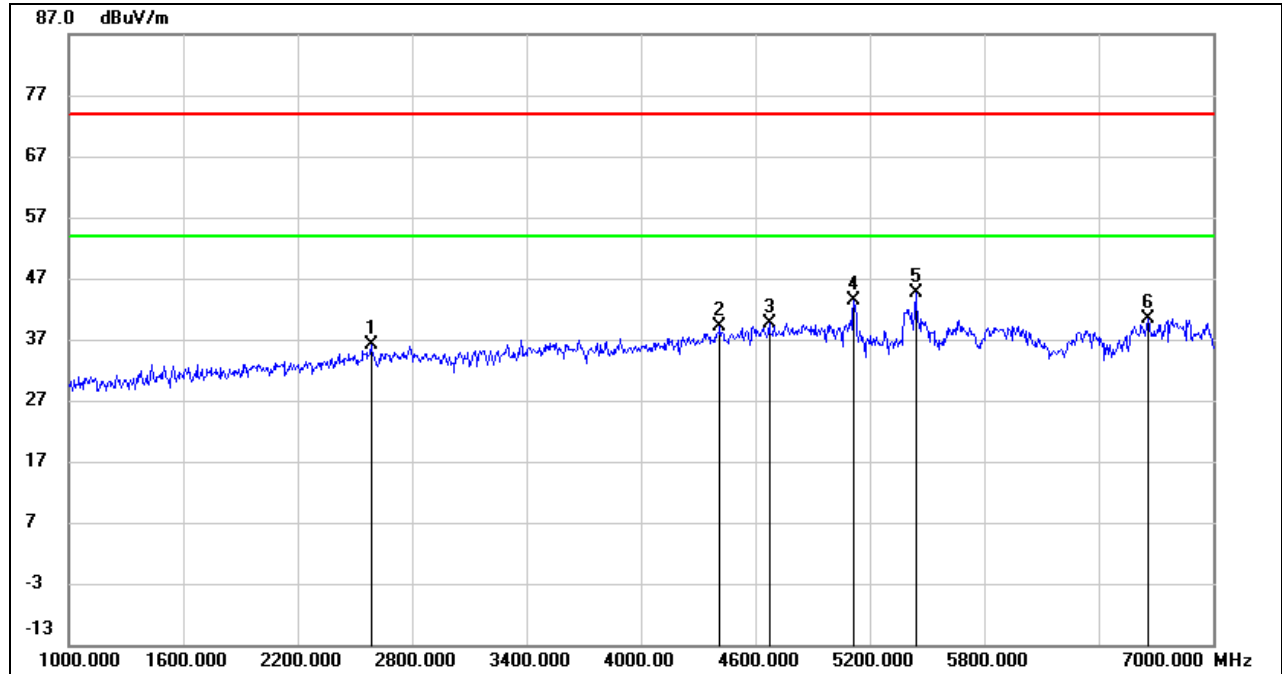

No.	Frequency (MHz)	Reading (dBuV)	Correct (dB/m)	Result (dBuV/m)	Limit (dBuV/m)	Margin (dB)	Remark
1	2584.000	44.49	-8.24	36.25	74.00	-37.75	peak
2	4414.000	41.55	-2.54	39.01	74.00	-34.99	peak
3	4672.000	41.18	-1.46	39.72	74.00	-34.28	peak
4	5116.000	43.49	-0.02	43.47	74.00	-30.53	peak
5	5440.000	44.38	0.35	44.73	74.00	-29.27	peak
6	6658.000	35.88	4.49	40.37	74.00	-33.63	peak

Note: 1. Measurement = Reading Level + Correct Factor.

2. If Peak Result complies with AV limit, AV Result is deemed to comply with AV limit.

3. Peak: Peak detector.

4. Filter losses were only considered in the spurious frequency bands and the authorized band was not corrected for Band reject filter losses.

5. Proper operation of the transmitter prior to adding the filter to the measurement chain.

6. Since non-restricted band peak emissions are less than the average limit, they also comply with the -27dBm/MHz (68.2dBuV/m) limit.

HARMONICS AND SPURIOUS EMISSIONS (MID CHANNEL, VERTICAL)

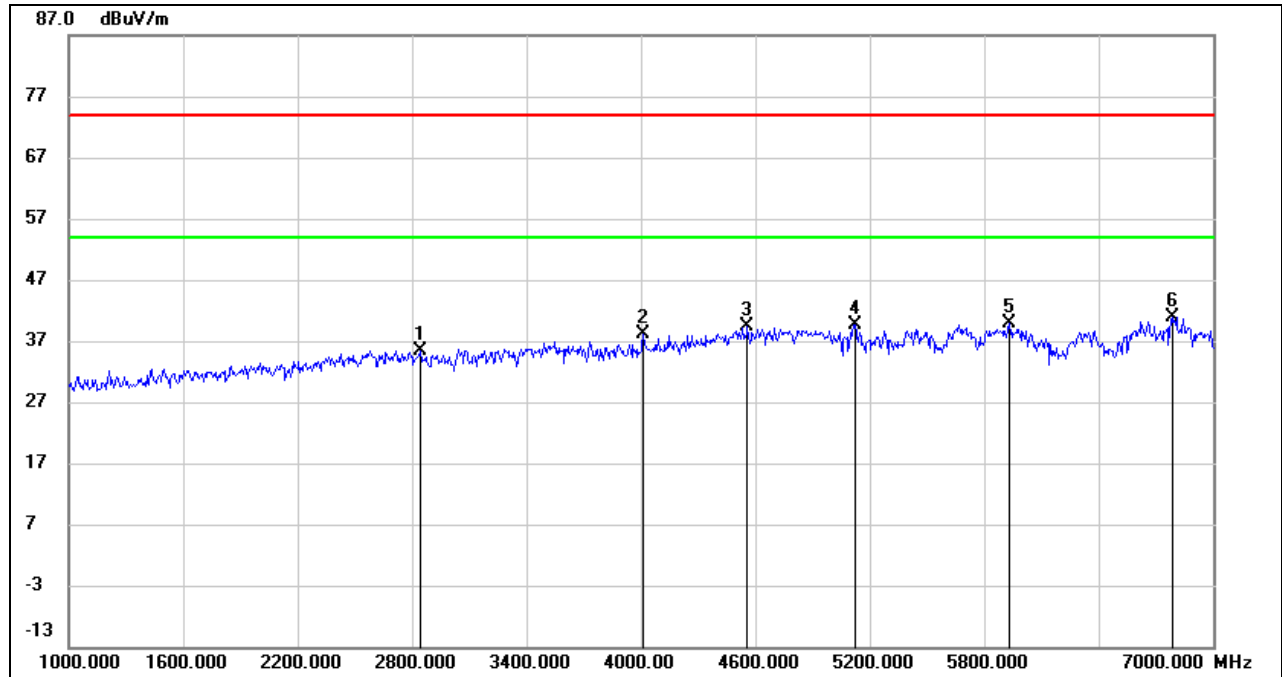

No.	Frequency (MHz)	Reading (dBuV)	Correct (dB/m)	Result (dBuV/m)	Limit (dBuV/m)	Margin (dB)	Remark
1	2842.000	42.80	-7.45	35.35	74.00	-38.65	peak
2	4012.000	42.45	-4.43	38.02	74.00	-35.98	peak
3	4558.000	41.21	-1.91	39.30	74.00	-34.70	peak
4	5122.000	39.74	-0.02	39.72	74.00	-34.28	peak
5	5932.000	38.23	1.65	39.88	74.00	-34.12	peak
6	6784.000	35.78	5.13	40.91	74.00	-33.09	peak

Note: 1. Measurement = Reading Level + Correct Factor.

2. If Peak Result complies with AV limit, AV Result is deemed to comply with AV limit.

3. Peak: Peak detector.

4. Filter losses were only considered in the spurious frequency bands and the authorized band was not corrected for Band reject filter losses.

5. Proper operation of the transmitter prior to adding the filter to the measurement chain.

6. Since non-restricted band peak emissions are less than the average limit, they also comply with the -27dBm/MHz (68.2dBuV/m) limit.

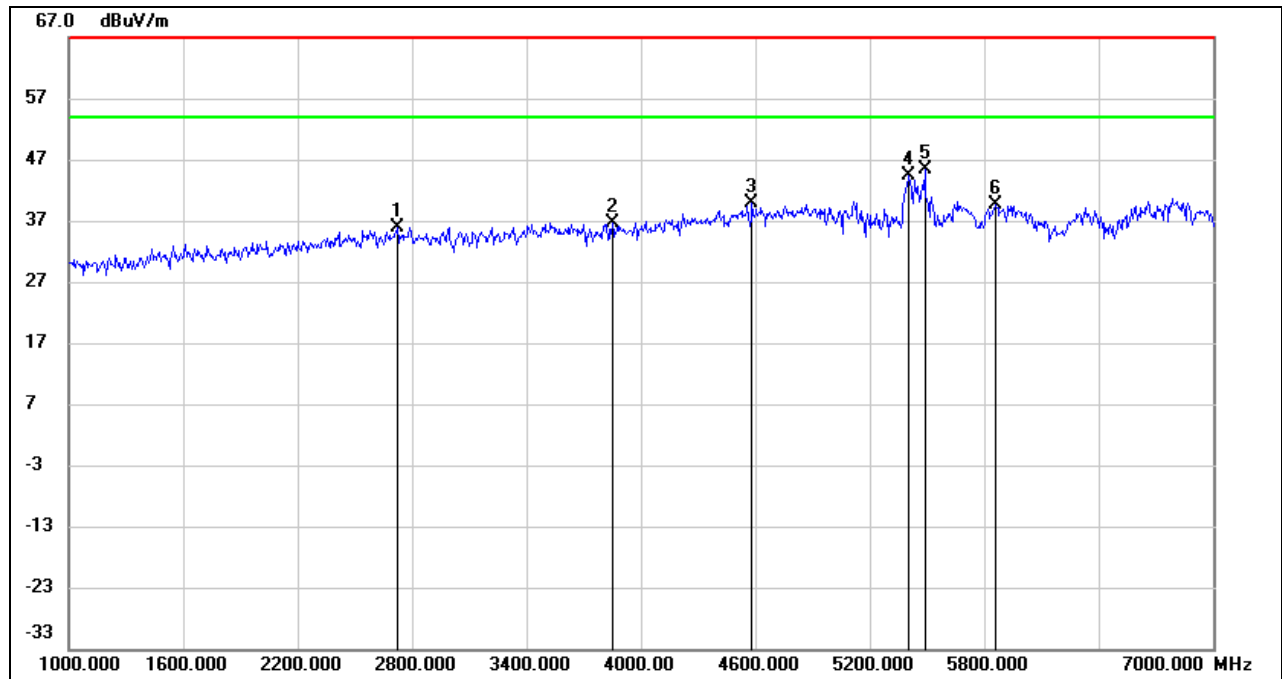
**HARMONICS AND SPURIOUS EMISSIONS (HIGH CHANNEL, HORIZONTAL)**

No.	Frequency (MHz)	Reading (dBuV)	Correct (dB/m)	Result (dBuV/m)	Limit (dBuV/m)	Margin (dB)	Remark
1	2722.000	43.79	-7.81	35.98	74.00	-38.02	peak
2	3850.000	41.57	-4.89	36.68	74.00	-37.32	peak
3	4582.000	41.68	-1.82	39.86	74.00	-34.14	peak
4	5404.000	43.98	0.31	44.29	74.00	-29.71	peak
5	5488.000	45.08	0.41	45.49	74.00	-28.51	peak
6	5860.000	38.08	1.45	39.53	74.00	-34.47	peak

Note: 1. Measurement = Reading Level + Correct Factor.

2. If Peak Result complies with AV limit, AV Result is deemed to comply with AV limit.

3. Peak: Peak detector.

4. Filter losses were only considered in the spurious frequency bands and the authorized band was not corrected for Band reject filter losses.

5. Proper operation of the transmitter prior to adding the filter to the measurement chain.

6. Since non-restricted band peak emissions are less than the average limit, they also comply with the -27dBm/MHz (68.2dBuV/m) limit.

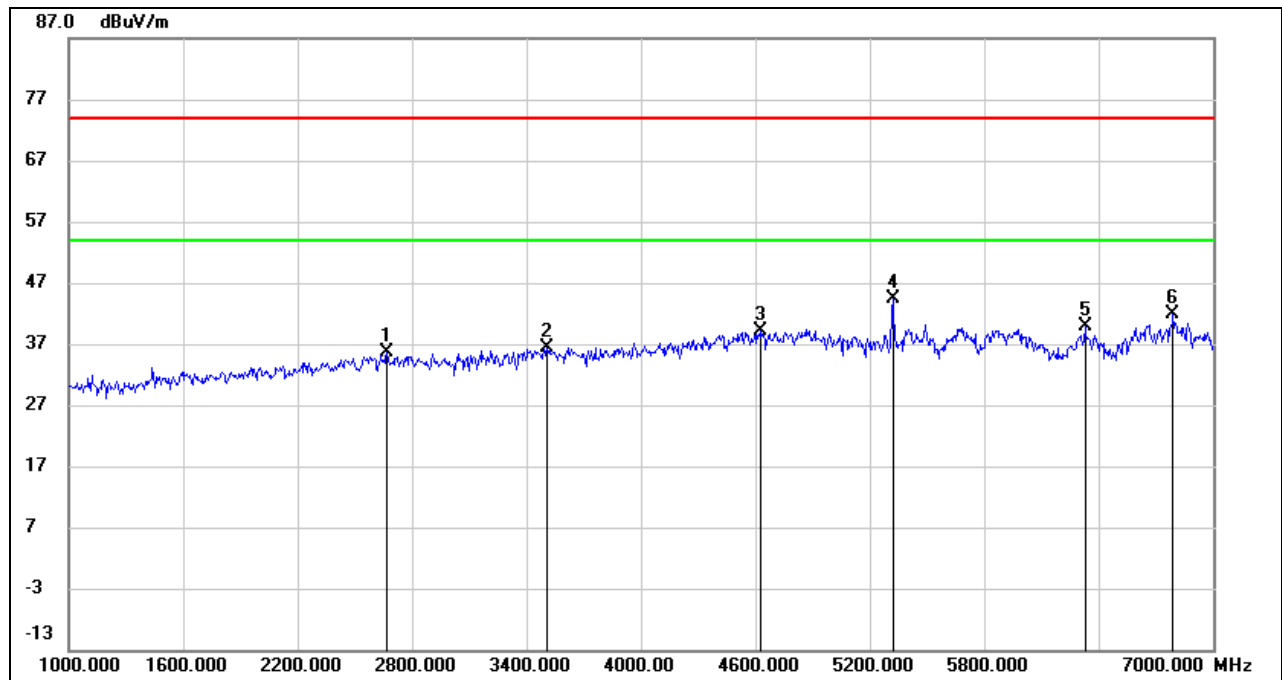
**HARMONICS AND SPURIOUS EMISSIONS (HIGH CHANNEL, VERTICAL)**

No.	Frequency (MHz)	Reading (dBuV)	Correct (dB/m)	Result (dBuV/m)	Limit (dBuV/m)	Margin (dB)	Remark
1	2668.000	43.57	-7.98	35.59	74.00	-38.41	peak
2	3508.000	42.21	-5.82	36.39	74.00	-37.61	peak
3	4630.000	40.72	-1.63	39.09	74.00	-34.91	peak
4	5320.000	44.05	0.21	44.26	74.00	-29.74	peak
5	6328.000	36.70	3.08	39.78	74.00	-34.22	peak
6	6790.000	36.61	5.15	41.76	74.00	-32.24	peak

Note: 1. Measurement = Reading Level + Correct Factor.

2. If Peak Result complies with AV limit, AV Result is deemed to comply with AV limit.

3. Peak: Peak detector.

4. Filter losses were only considered in the spurious frequency bands and the authorized band was not corrected for Band reject filter losses.

5. Proper operation of the transmitter prior to adding the filter to the measurement chain.

6. Since non-restricted band peak emissions are less than the average limit, they also comply with the -27dBm/MHz (68.2dBuV/m) limit.



UNII-2C BAND

ANTENNA 1 TEST RESULTS (WORST CASE)

HARMONICS AND SPURIOUS EMISSIONS (LOW CHANNEL, HORIZONTAL)

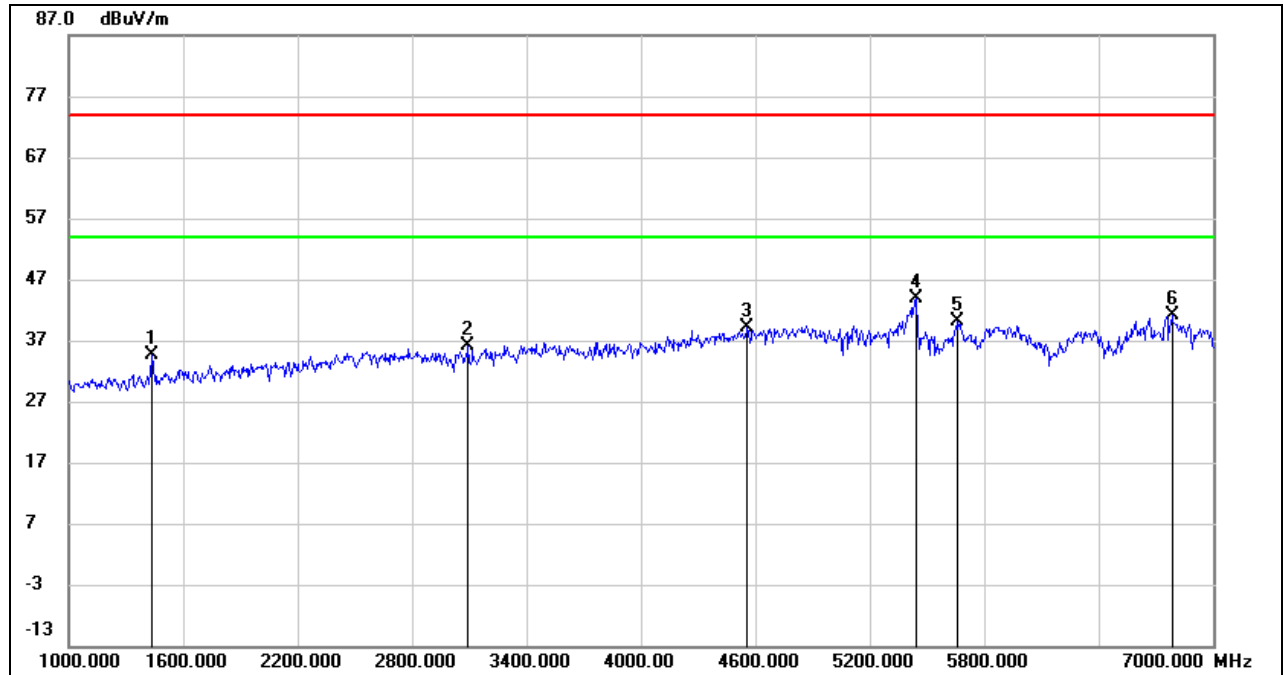

No.	Frequency (MHz)	Reading (dBuV)	Correct (dB/m)	Result (dBuV/m)	Limit (dBuV/m)	Margin (dB)	Remark
1	1438.000	47.67	-13.00	34.67	74.00	-39.33	peak
2	3094.000	42.85	-6.77	36.08	74.00	-37.92	peak
3	4558.000	41.13	-1.91	39.22	74.00	-34.78	peak
4	5440.000	43.58	0.35	43.93	74.00	-30.07	peak
5	5662.000	39.12	0.89	40.01	74.00	-33.99	peak
6	6784.000	36.01	5.13	41.14	74.00	-32.86	peak

- Note: 1. Measurement = Reading Level + Correct Factor.
 2. If Peak Result complies with AV limit, AV Result is deemed to comply with AV limit.
 3. Peak: Peak detector.
 4. Filter losses were only considered in the spurious frequency bands and the authorized band was not corrected for Band reject filter losses.
 5. Proper operation of the transmitter prior to adding the filter to the measurement chain.
 6. Since non-restricted band peak emissions are less than the average limit, they also comply with the -27dBm/MHz (68.2dBuV/m) limit.

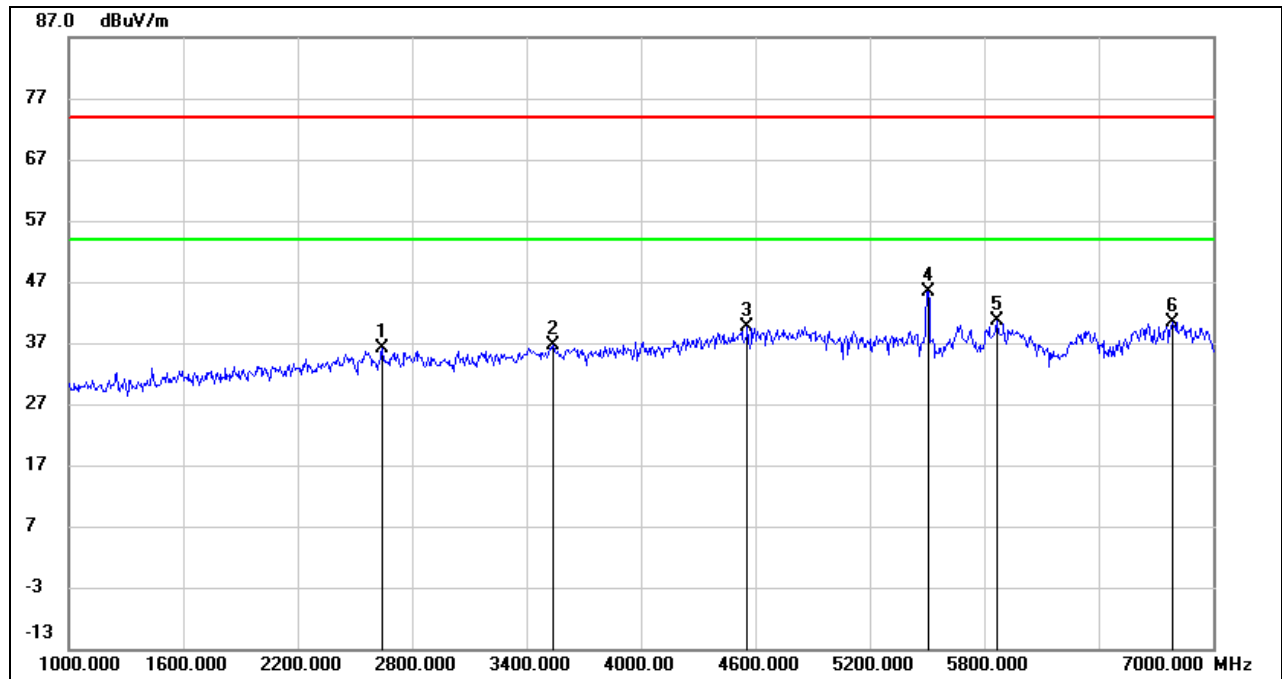
**HARMONICS AND SPURIOUS EMISSIONS (LOW CHANNEL, VERTICAL)**

No.	Frequency (MHz)	Reading (dBuV)	Correct (dB/m)	Result (dBuV/m)	Limit (dBuV/m)	Margin (dB)	Remark
1	2644.000	44.15	-8.06	36.09	74.00	-37.91	peak
2	3538.000	42.31	-5.74	36.57	74.00	-37.43	peak
3	4558.000	41.46	-1.91	39.55	74.00	-34.45	peak
4	5506.000	44.99	0.44	45.43	74.00	-28.57	peak
5	5866.000	39.18	1.47	40.65	74.00	-33.35	peak
6	6790.000	35.27	5.15	40.42	74.00	-33.58	peak

Note: 1. Measurement = Reading Level + Correct Factor.

2. If Peak Result complies with AV limit, AV Result is deemed to comply with AV limit.

3. Peak: Peak detector.

4. Filter losses were only considered in the spurious frequency bands and the authorized band was not corrected for Band reject filter losses.

5. Proper operation of the transmitter prior to adding the filter to the measurement chain.

6. Since non-restricted band peak emissions are less than the average limit, they also comply with the -27dBm/MHz (68.2dBuV/m) limit.

HARMONICS AND SPURIOUS EMISSIONS (MID CHANNEL, HORIZONTAL)

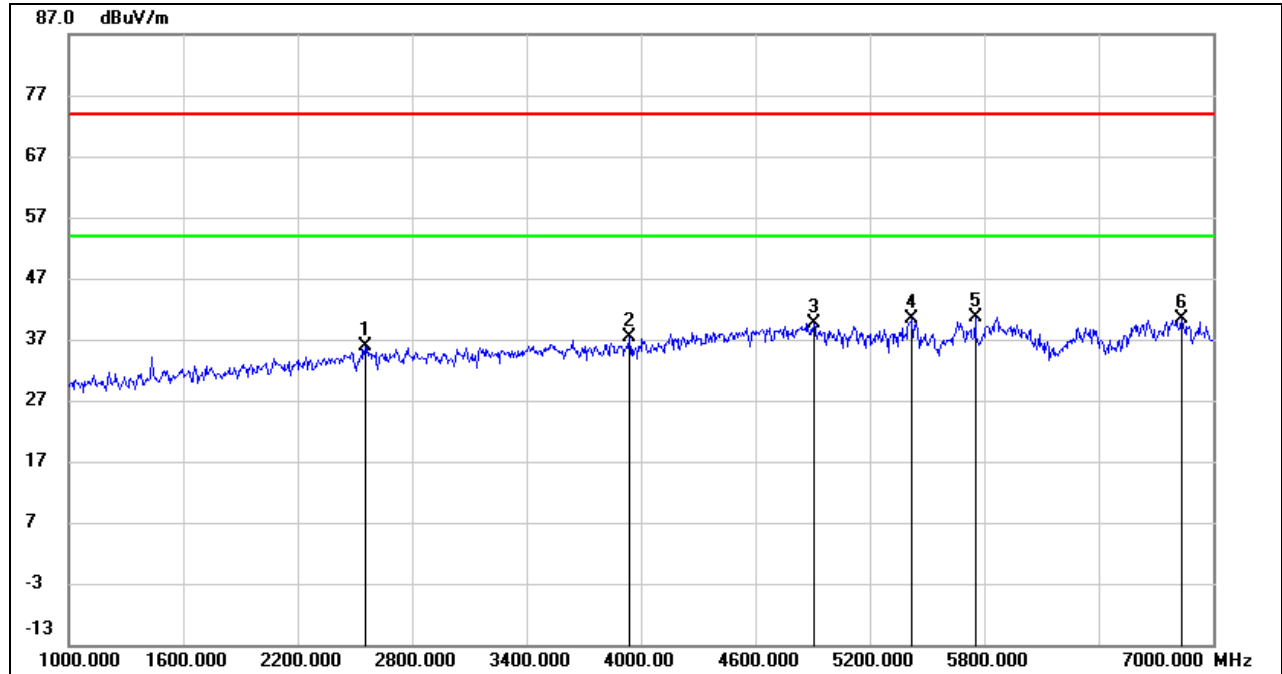

No.	Frequency (MHz)	Reading (dBuV)	Correct (dB/m)	Result (dBuV/m)	Limit (dBuV/m)	Margin (dB)	Remark
1	2554.000	44.31	-8.32	35.99	74.00	-38.01	peak
2	3940.000	41.94	-4.64	37.30	74.00	-36.70	peak
3	4906.000	40.22	-0.53	39.69	74.00	-34.31	peak
4	5422.000	40.13	0.32	40.45	74.00	-33.55	peak
5	5752.000	39.45	1.14	40.59	74.00	-33.41	peak
6	6832.000	35.13	5.37	40.50	74.00	-33.50	peak

Note: 1. Measurement = Reading Level + Correct Factor.

2. If Peak Result complies with AV limit, AV Result is deemed to comply with AV limit.

3. Peak: Peak detector.

4. Filter losses were only considered in the spurious frequency bands and the authorized band was not corrected for Band reject filter losses.

5. Proper operation of the transmitter prior to adding the filter to the measurement chain.

6. Since non-restricted band peak emissions are less than the average limit, they also comply with the -27dBm/MHz (68.2dBuV/m) limit.



HARMONICS AND SPURIOUS EMISSIONS (MID CHANNEL, VERTICAL)

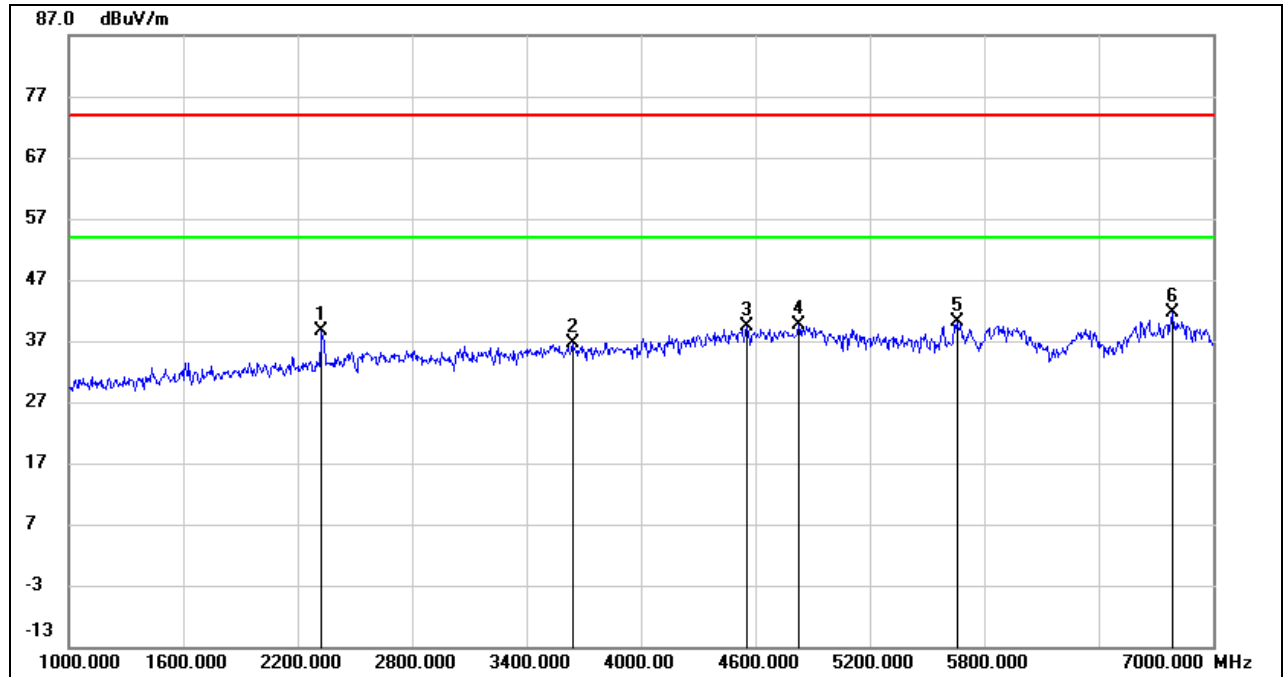

No.	Frequency (MHz)	Reading (dBuV)	Correct (dB/m)	Result (dBuV/m)	Limit (dBuV/m)	Margin (dB)	Remark
1	2326.000	48.09	-9.38	38.71	74.00	-35.29	peak
2	3640.000	42.17	-5.47	36.70	74.00	-37.30	peak
3	4552.000	41.30	-1.93	39.37	74.00	-34.63	peak
4	4828.000	40.39	-0.83	39.56	74.00	-34.44	peak
5	5656.000	39.25	0.87	40.12	74.00	-33.88	peak
6	6790.000	36.60	5.15	41.75	74.00	-32.25	peak

Note: 1. Measurement = Reading Level + Correct Factor.
 2. If Peak Result complies with AV limit, AV Result is deemed to comply with AV limit.
 3. Peak: Peak detector.
 4. Filter losses were only considered in the spurious frequency bands and the authorized band was not corrected for Band reject filter losses.
 5. Proper operation of the transmitter prior to adding the filter to the measurement chain.
 6. Since non-restricted band peak emissions are less than the average limit, they also comply with the -27dBm/MHz (68.2dBuV/m) limit.

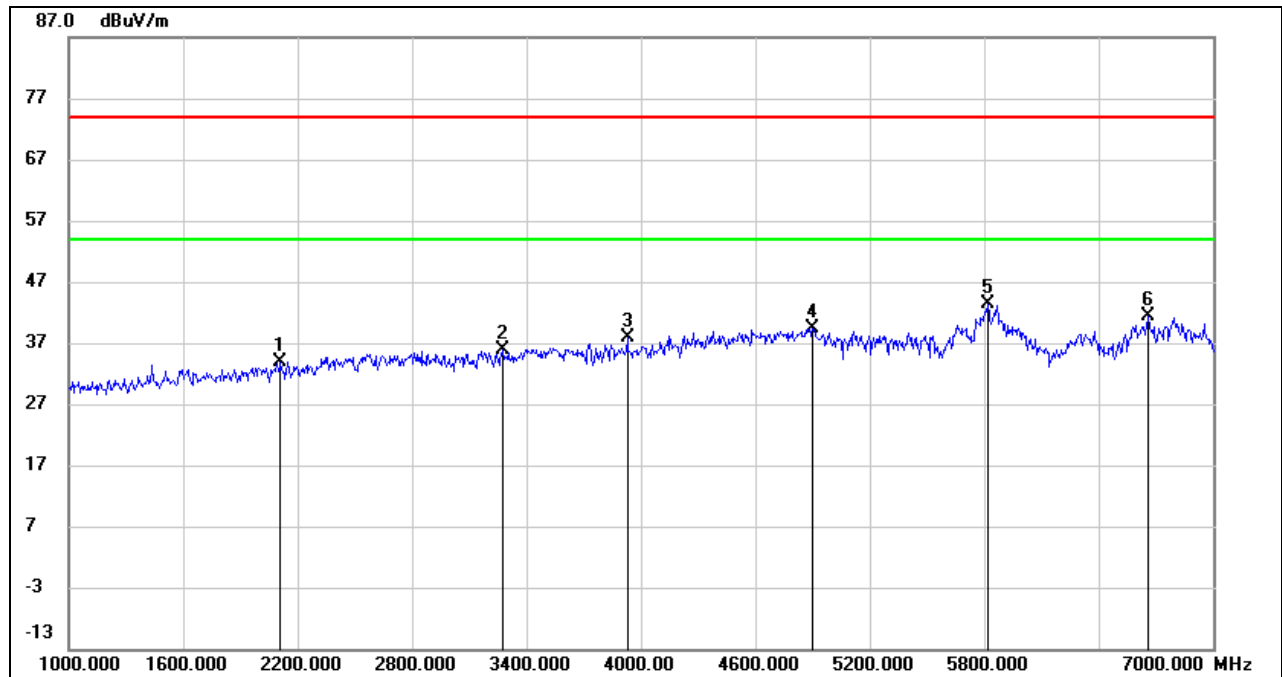
**HARMONICS AND SPURIOUS EMISSIONS (HIGH CHANNEL, HORIZONTAL)**

No.	Frequency (MHz)	Reading (dBuV)	Correct (dB/m)	Result (dBuV/m)	Limit (dBuV/m)	Margin (dB)	Remark
1	2110.000	44.34	-10.49	33.85	74.00	-40.15	peak
2	3274.000	42.13	-6.36	35.77	74.00	-38.23	peak
3	3928.000	42.46	-4.67	37.79	74.00	-36.21	peak
4	4900.000	40.01	-0.55	39.46	74.00	-34.54	peak
5	5818.000	41.94	1.33	43.27	74.00	-30.73	peak
6	6658.000	36.82	4.49	41.31	74.00	-32.69	peak

Note: 1. Measurement = Reading Level + Correct Factor.

2. If Peak Result complies with AV limit, AV Result is deemed to comply with AV limit.

3. Peak: Peak detector.

4. Filter losses were only considered in the spurious frequency bands and the authorized band was not corrected for Band reject filter losses.

5. Proper operation of the transmitter prior to adding the filter to the measurement chain.

6. Since non-restricted band peak emissions are less than the average limit, they also comply with the -27dBm/MHz (68.2dBuV/m) limit.

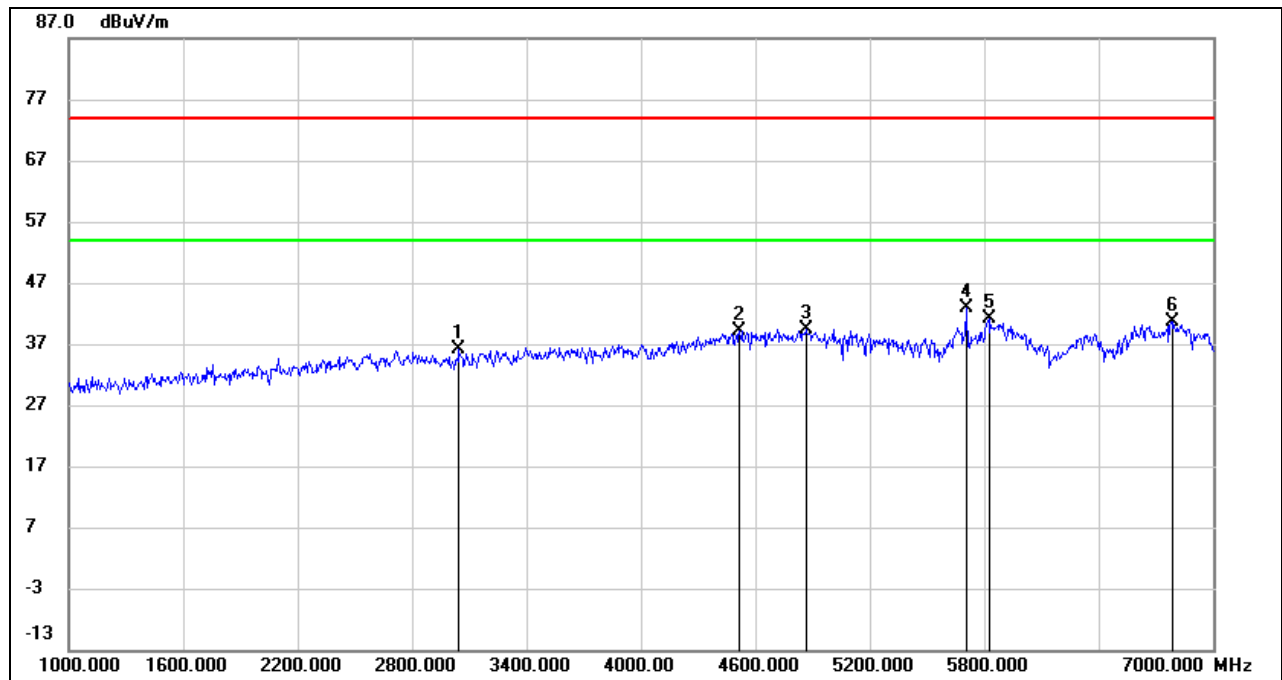
**HARMONICS AND SPURIOUS EMISSIONS (HIGH CHANNEL, VERTICAL)**

No.	Frequency (MHz)	Reading (dBuV)	Correct (dB/m)	Result (dBuV/m)	Limit (dBuV/m)	Margin (dB)	Remark
1	3046.000	42.91	-6.88	36.03	74.00	-37.97	peak
2	4516.000	41.22	-2.08	39.14	74.00	-34.86	peak
3	4864.000	40.12	-0.70	39.42	74.00	-34.58	peak
4	5704.000	41.76	1.00	42.76	74.00	-31.24	peak
5	5824.000	39.82	1.34	41.16	74.00	-32.84	peak
6	6784.000	35.56	5.13	40.69	74.00	-33.31	peak

Note: 1. Measurement = Reading Level + Correct Factor.

2. If Peak Result complies with AV limit, AV Result is deemed to comply with AV limit.

3. Peak: Peak detector.

4. Filter losses were only considered in the spurious frequency bands and the authorized band was not corrected for Band reject filter losses.

5. Proper operation of the transmitter prior to adding the filter to the measurement chain.

6. Since non-restricted band peak emissions are less than the average limit, they also comply with the -27dBm/MHz (68.2dBuV/m) limit.



STRADDLE CHANNEL 144

ANTENNA 1 TEST RESULTS (WORST CASE)

HARMONICS AND SPURIOUS EMISSIONS (HORIZONTAL)

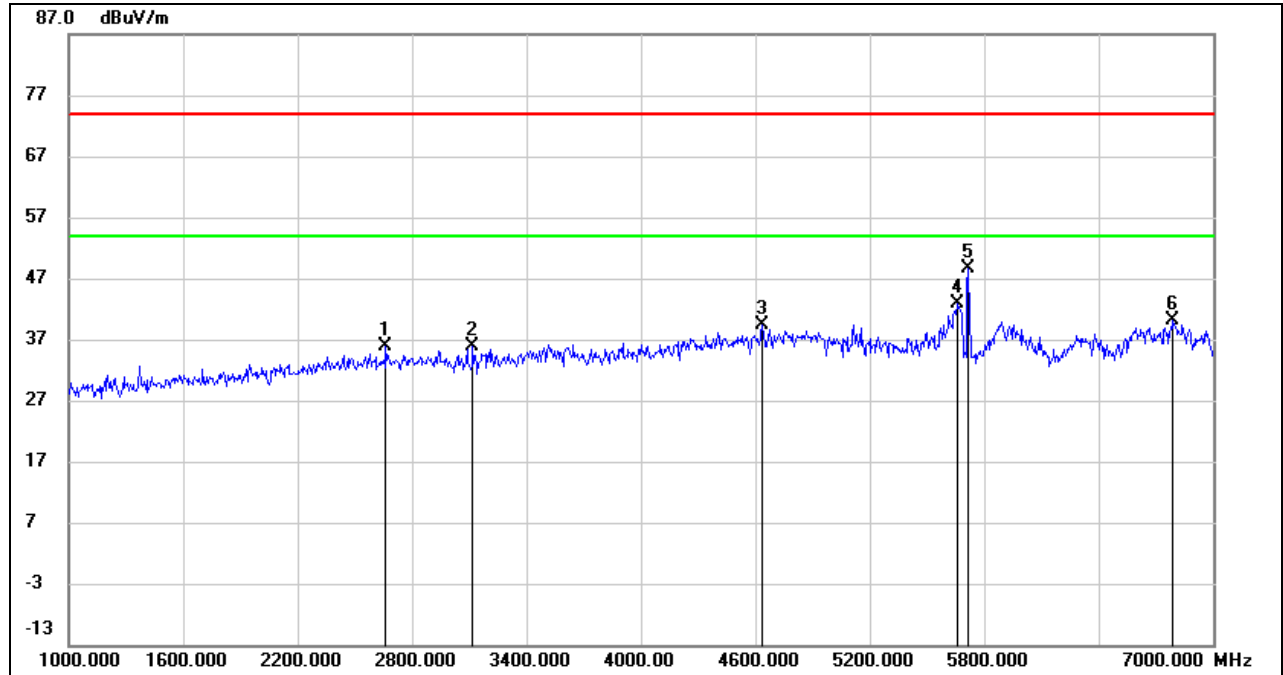

No.	Frequency (MHz)	Reading (dBuV)	Correct (dB/m)	Result (dBuV/m)	Limit (dBuV/m)	Margin (dB)	Remark
1	2662.000	43.84	-8.01	35.83	74.00	-38.17	peak
2	3118.000	42.64	-6.71	35.93	74.00	-38.07	peak
3	4636.000	40.96	-1.59	39.37	74.00	-34.63	peak
4	5656.000	42.00	0.87	42.87	74.00	-31.13	peak
5	5716.000	47.55	1.04	48.59	74.00	-25.41	peak
6	6790.000	35.06	5.15	40.21	74.00	-33.79	peak

Note: 1. Measurement = Reading Level + Correct Factor.
 2. If Peak Result complies with AV limit, AV Result is deemed to comply with AV limit.
 3. Peak: Peak detector.
 4. AVG: $VBW=1/Ton$, where: Ton is the transmitting duration.
 5. For the transmitting duration, please refer to clause 7.1.
 6. Filter losses were only considered in the spurious frequency bands and the authorized band was not corrected for Band reject filter losses.
 7. Proper operation of the transmitter prior to adding the filter to the measurement chain.
 8. Since non-restricted band peak emissions are less than the average limit, they also comply with the -27dBm/MHz (68.2dBuV/m) limit.



HARMONICS AND SPURIOUS EMISSIONS (VERTICAL)

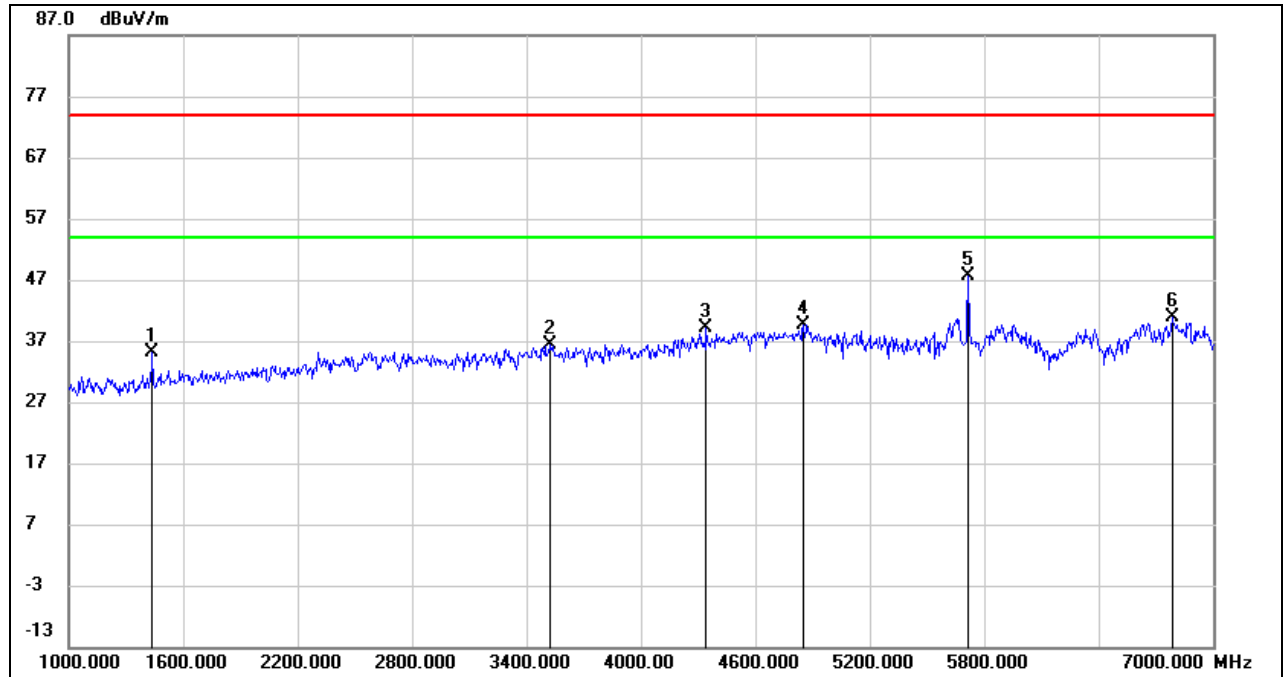

No.	Frequency (MHz)	Reading (dBuV)	Correct (dB/m)	Result (dBuV/m)	Limit (dBuV/m)	Margin (dB)	Remark
1	1438.000	48.09	-13.00	35.09	74.00	-38.91	peak
2	3520.000	42.09	-5.80	36.29	74.00	-37.71	peak
3	4342.000	42.05	-2.88	39.17	74.00	-34.83	peak
4	4852.000	40.45	-0.74	39.71	74.00	-34.29	peak
5	5716.000	46.62	1.04	47.66	74.00	-26.34	peak
6	6784.000	35.74	5.13	40.87	74.00	-33.13	peak

- Note:
1. Measurement = Reading Level + Correct Factor.
 2. If Peak Result complies with AV limit, AV Result is deemed to comply with AV limit.
 3. Peak: Peak detector.
 4. AVG: VBW=1/Ton, where: Ton is the transmitting duration.
 5. For the transmitting duration, please refer to clause 7.1.
 6. Filter losses were only considered in the spurious frequency bands and the authorized band was not corrected for Band reject filter losses.
 7. Proper operation of the transmitter prior to adding the filter to the measurement chain.
 8. Since non-restricted band peak emissions are less than the average limit, they also comply with the -27dBm/MHz (68.2dBuV/m) limit.

UNII-3 BAND

ANTENNA 1 TEST RESULTS (WORST CASE)

HARMONICS AND SPURIOUS EMISSIONS (LOW CHANNEL, HORIZONTAL)

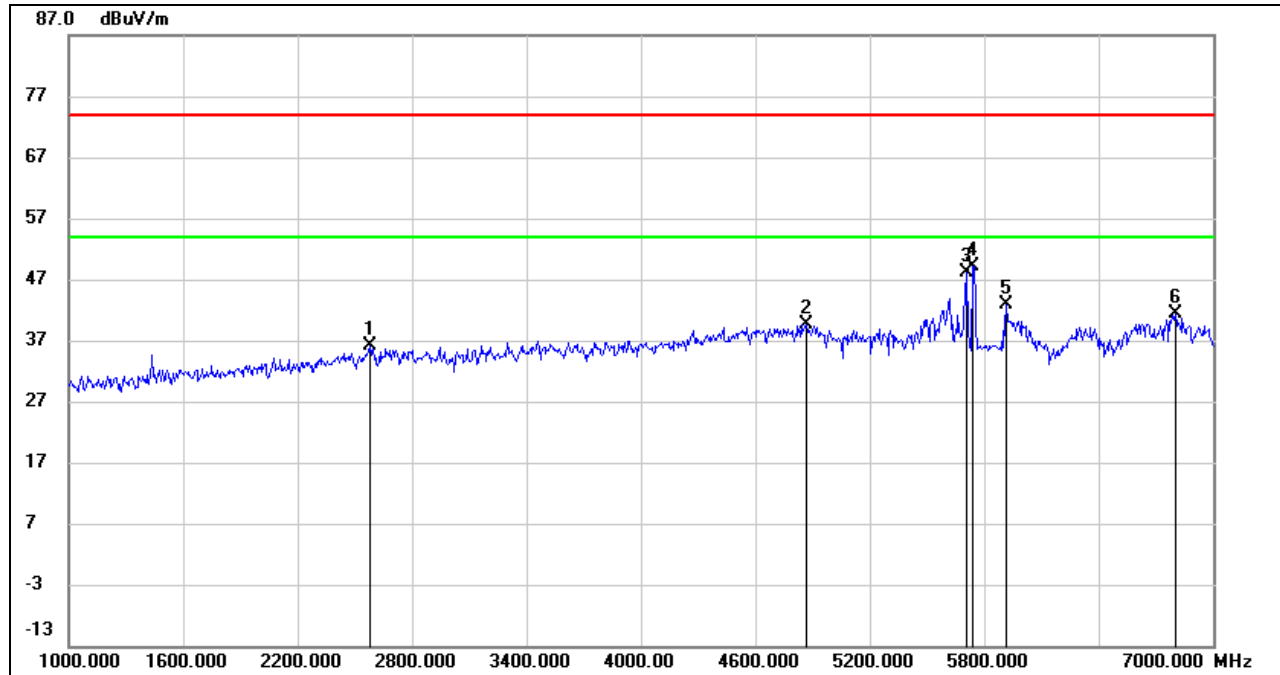

No.	Frequency (MHz)	Reading (dBuV)	Correct (dB/m)	Result (dBuV/m)	Limit (dBuV/m)	Margin (dB)	Remark
1	2578.000	44.41	-8.26	36.15	74.00	-37.85	peak
2	4870.000	40.20	-0.66	39.54	74.00	-34.46	peak
3	5710.000	47.23	1.02	48.25	74.00	-25.75	peak
4	5740.000	48.07	1.10	49.17	74.00	-24.83	peak
5	5914.000	41.26	1.60	42.86	74.00	-31.14	peak
6	6802.000	36.25	5.21	41.46	74.00	-32.54	peak

Note: 1. Measurement = Reading Level + Correct Factor.
 2. If Peak Result complies with AV limit, AV Result is deemed to comply with AV limit.
 3. Peak: Peak detector.
 4. Filter losses were only considered in the spurious frequency bands and the authorized band was not corrected for Band reject filter losses.
 5. Proper operation of the transmitter prior to adding the filter to the measurement chain.
 6. Since non-restricted band peak emissions are less than the average limit, they also comply with the -27dBm/MHz (68.2dBuV/m) limit.

HARMONICS AND SPURIOUS EMISSIONS (LOW CHANNEL, VERTICAL)

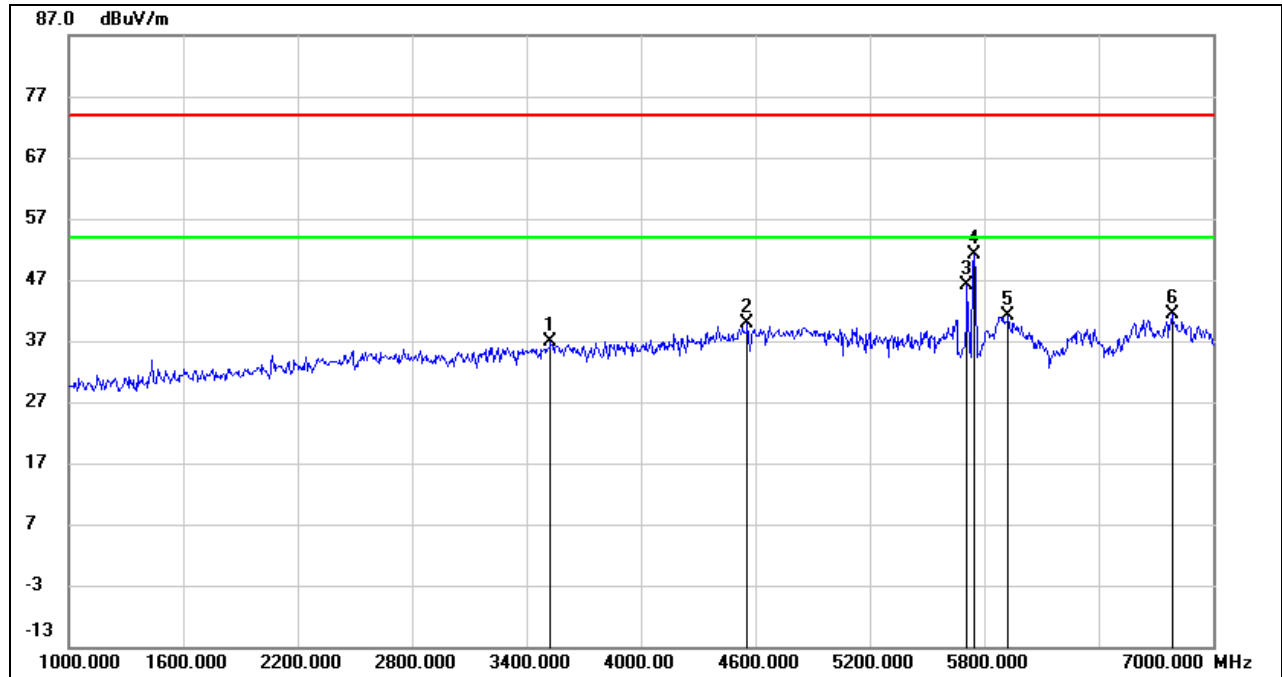

No.	Frequency (MHz)	Reading (dBuV)	Correct (dB/m)	Result (dBuV/m)	Limit (dBuV/m)	Margin (dB)	Remark
1	3526.000	42.78	-5.78	37.00	74.00	-37.00	peak
2	4558.000	41.68	-1.91	39.77	74.00	-34.23	peak
3	5710.000	45.22	1.02	46.24	74.00	-27.76	peak
4	5746.000	50.08	1.12	51.20	74.00	-22.80	peak
5	5926.000	39.55	1.64	41.19	74.00	-32.81	peak
6	6784.000	36.35	5.13	41.48	74.00	-32.52	peak

Note: 1. Measurement = Reading Level + Correct Factor.

2. If Peak Result complies with AV limit, AV Result is deemed to comply with AV limit.

3. Peak: Peak detector.

4. Filter losses were only considered in the spurious frequency bands and the authorized band was not corrected for Band reject filter losses.

5. Proper operation of the transmitter prior to adding the filter to the measurement chain.

6. Since non-restricted band peak emissions are less than the average limit, they also comply with the -27dBm/MHz (68.2dBuV/m) limit.

HARMONICS AND SPURIOUS EMISSIONS (MID CHANNEL, HORIZONTAL)

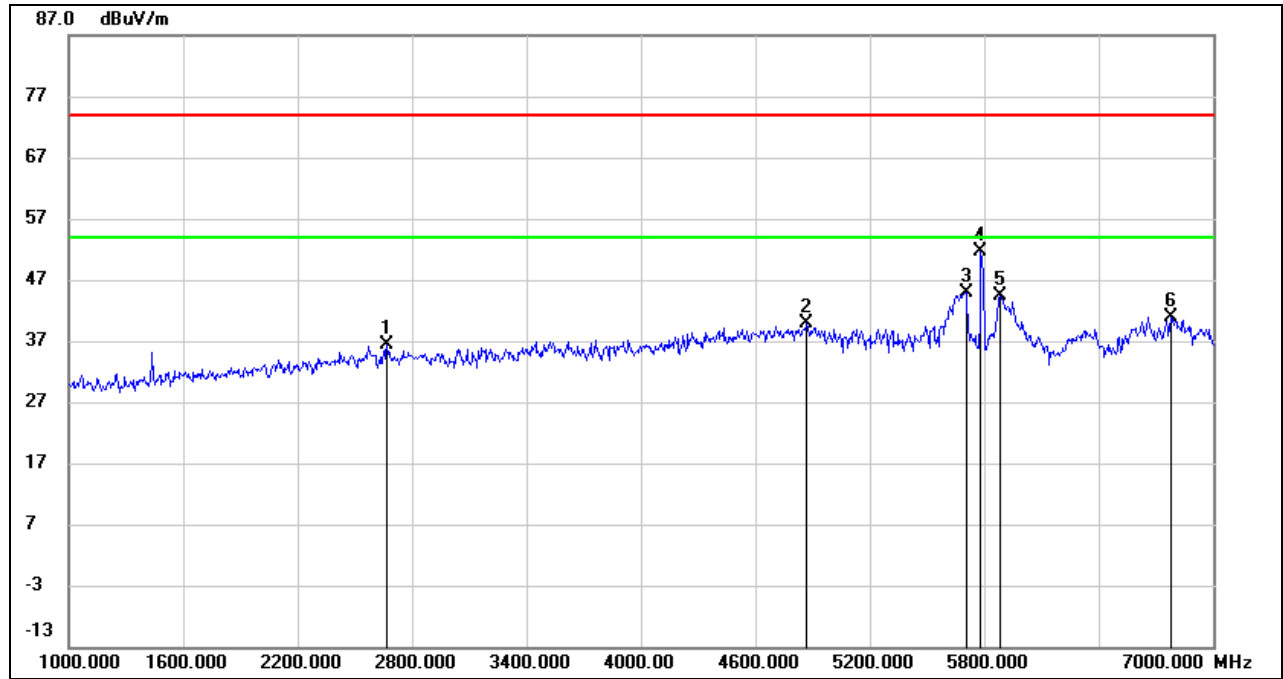

No.	Frequency (MHz)	Reading (dBuV)	Correct (dB/m)	Result (dBuV/m)	Limit (dBuV/m)	Margin (dB)	Remark
1	2668.000	44.31	-7.98	36.33	74.00	-37.67	peak
2	4870.000	40.48	-0.66	39.82	74.00	-34.18	peak
3	5704.000	43.95	1.00	44.95	74.00	-29.05	peak
4	5782.000	50.48	1.23	51.71	74.00	-22.29	peak
5	5884.000	42.92	1.52	44.44	74.00	-29.56	peak
6	6778.000	35.85	5.10	40.95	74.00	-33.05	peak

Note: 1. Measurement = Reading Level + Correct Factor.
 2. If Peak Result complies with AV limit, AV Result is deemed to comply with AV limit.
 3. Peak: Peak detector.
 4. Filter losses were only considered in the spurious frequency bands and the authorized band was not corrected for Band reject filter losses.
 5. Proper operation of the transmitter prior to adding the filter to the measurement chain.
 6. Since non-restricted band peak emissions are less than the average limit, they also comply with the -27dBm/MHz (68.2dBuV/m) limit.

HARMONICS AND SPURIOUS EMISSIONS (MID CHANNEL, VERTICAL)

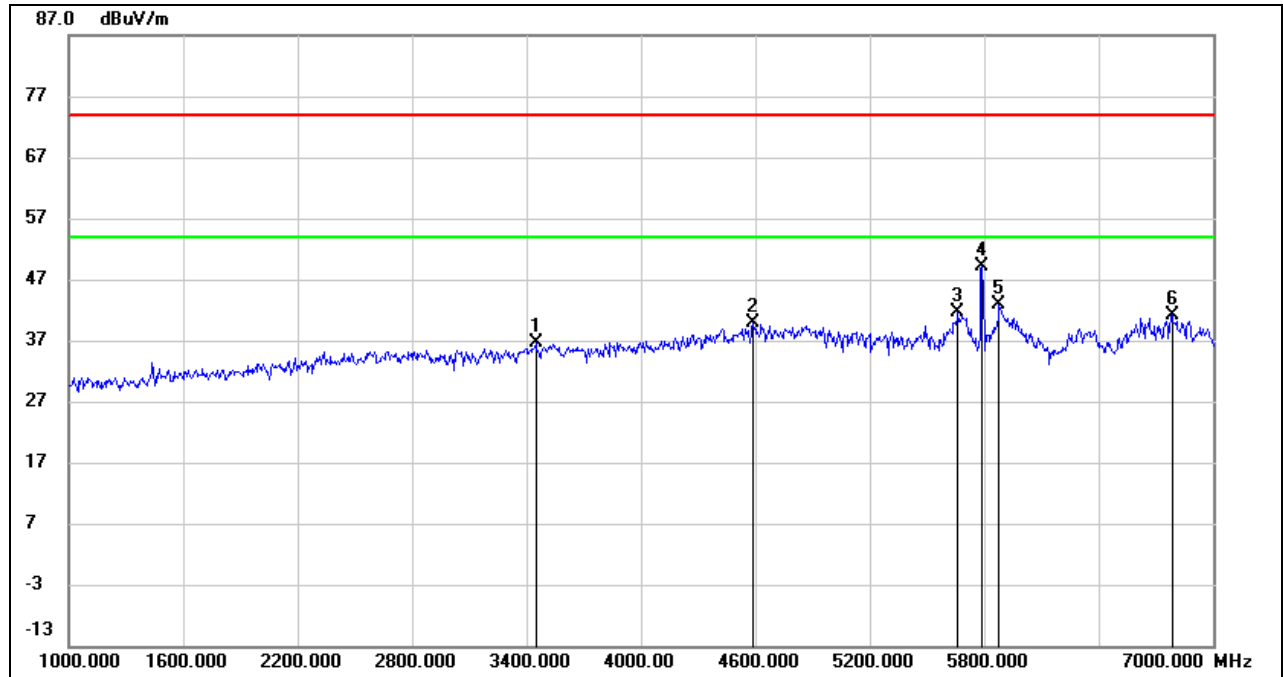

No.	Frequency (MHz)	Reading (dBuV)	Correct (dB/m)	Result (dBuV/m)	Limit (dBuV/m)	Margin (dB)	Remark
1	3448.000	42.49	-5.96	36.53	74.00	-37.47	peak
2	4588.000	41.56	-1.79	39.77	74.00	-34.23	peak
3	5662.000	40.74	0.89	41.63	74.00	-32.37	peak
4	5788.000	47.96	1.25	49.21	74.00	-24.79	peak
5	5878.000	41.32	1.51	42.83	74.00	-31.17	peak
6	6784.000	36.01	5.13	41.14	74.00	-32.86	peak

Note: 1. Measurement = Reading Level + Correct Factor.
 2. If Peak Result complies with AV limit, AV Result is deemed to comply with AV limit.
 3. Peak: Peak detector.
 4. Filter losses were only considered in the spurious frequency bands and the authorized band was not corrected for Band reject filter losses.
 5. Proper operation of the transmitter prior to adding the filter to the measurement chain.
 6. Since non-restricted band peak emissions are less than the average limit, they also comply with the -27dBm/MHz (68.2dBuV/m) limit.

HARMONICS AND SPURIOUS EMISSIONS (HIGH CHANNEL, HORIZONTAL)

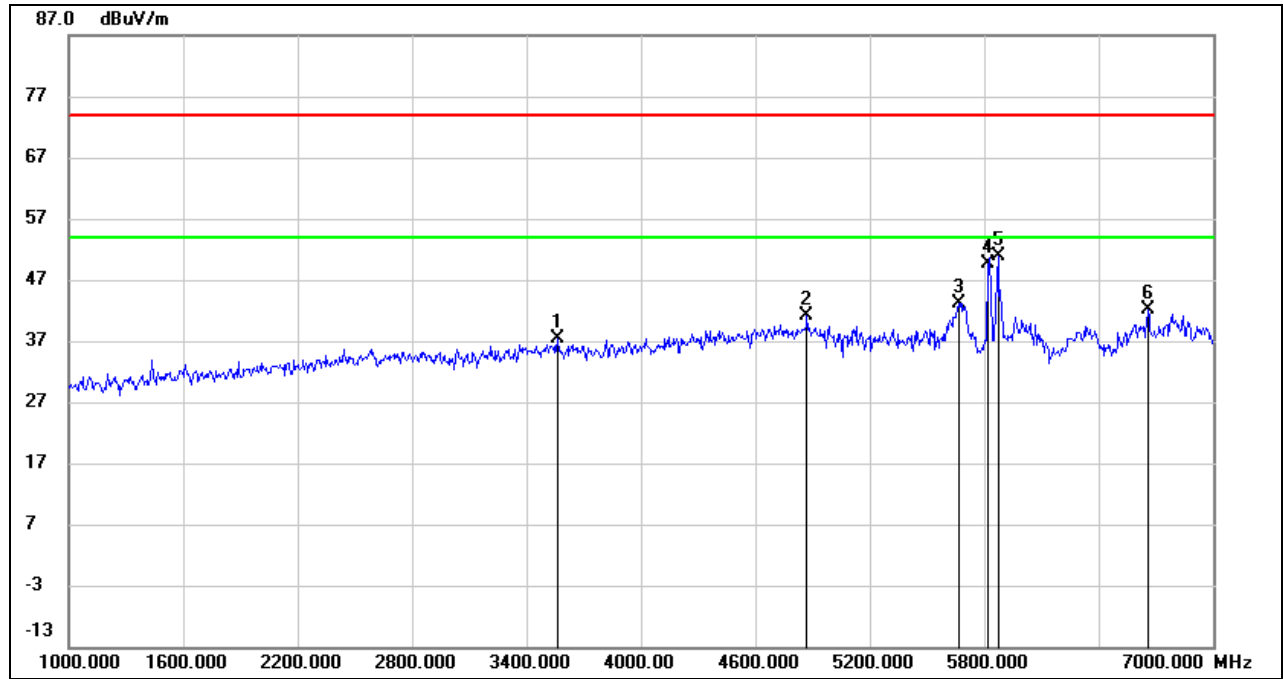

No.	Frequency (MHz)	Reading (dBuV)	Correct (dB/m)	Result (dBuV/m)	Limit (dBuV/m)	Margin (dB)	Remark
1	3562.000	42.95	-5.68	37.27	74.00	-36.73	peak
2	4870.000	41.70	-0.66	41.04	74.00	-32.96	peak
3	5668.000	42.33	0.91	43.24	74.00	-30.76	peak
4	5818.000	48.21	1.33	49.54	74.00	-24.46	peak
5	5872.000	49.29	1.48	50.77	74.00	-23.23	peak
6	6658.000	37.74	4.49	42.23	74.00	-31.77	peak

Note: 1. Measurement = Reading Level + Correct Factor.
 2. If Peak Result complies with AV limit, AV Result is deemed to comply with AV limit.
 3. Peak: Peak detector.
 4. Filter losses were only considered in the spurious frequency bands and the authorized band was not corrected for Band reject filter losses.
 5. Proper operation of the transmitter prior to adding the filter to the measurement chain.
 6. Since non-restricted band peak emissions are less than the average limit, they also comply with the -27dBm/MHz (68.2dBuV/m) limit.



HARMONICS AND SPURIOUS EMISSIONS (HIGH CHANNEL, VERTICAL)

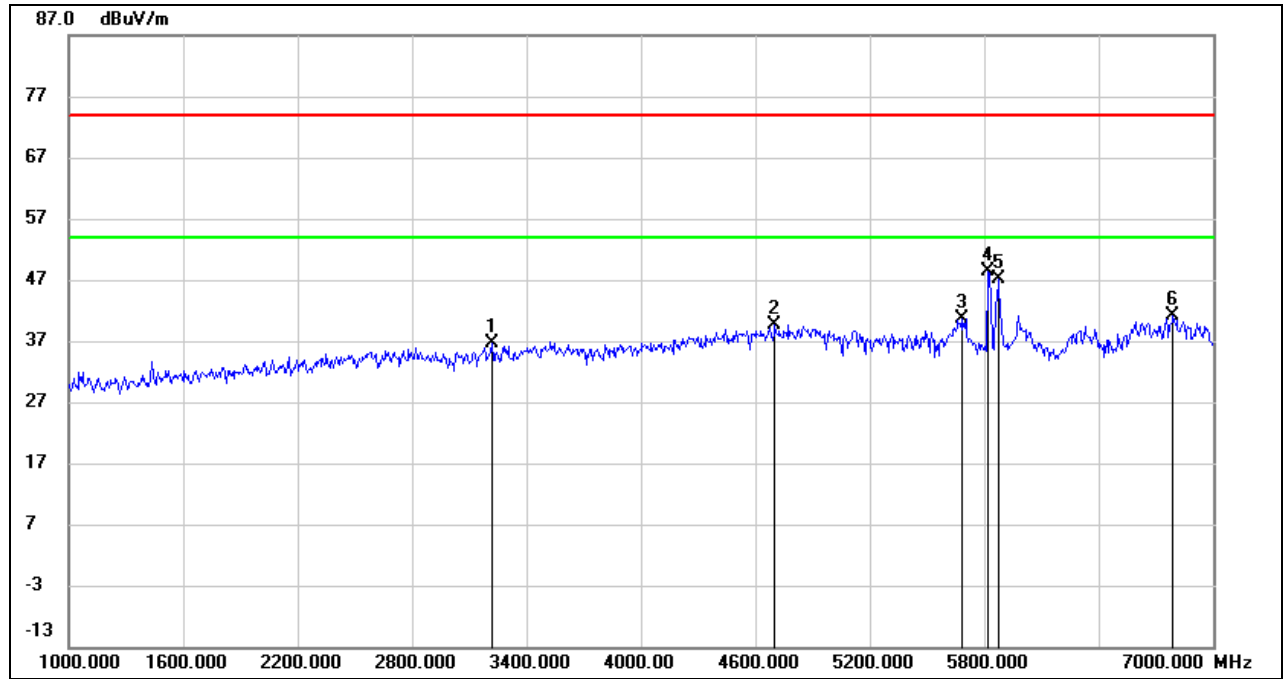

No.	Frequency (MHz)	Reading (dBuV)	Correct (dB/m)	Result (dBuV/m)	Limit (dBuV/m)	Margin (dB)	Remark
1	3220.000	43.06	-6.48	36.58	74.00	-37.42	peak
2	4702.000	41.04	-1.34	39.70	74.00	-34.30	peak
3	5686.000	39.79	0.96	40.75	74.00	-33.25	peak
4	5818.000	47.04	1.33	48.37	74.00	-25.63	peak
5	5872.000	45.73	1.48	47.21	74.00	-26.79	peak
6	6790.000	35.86	5.15	41.01	74.00	-32.99	peak

- Note: 1. Measurement = Reading Level + Correct Factor.
 2. If Peak Result complies with AV limit, AV Result is deemed to comply with AV limit.
 3. Peak: Peak detector.
 4. Filter losses were only considered in the spurious frequency bands and the authorized band was not corrected for Band reject filter losses.
 5. Proper operation of the transmitter prior to adding the filter to the measurement chain.
 6. Since non-restricted band peak emissions are less than the average limit, they also comply with the -27dBm/MHz (68.2dBuV/m) limit.

Note: All the modes, bands and antennas had been tested, but only the worst data was recorded in the report.

8.3. SPURIOUS EMISSIONS (7 GHz ~ 18 GHz)

8.3.1. 802.11a 20 SISO MODE

UNII-1 BAND

ANTENNA 0 TEST RESULTS (WORST CASE)

HARMONICS AND SPURIOUS EMISSIONS (LOW CHANNEL, HORIZONTAL)

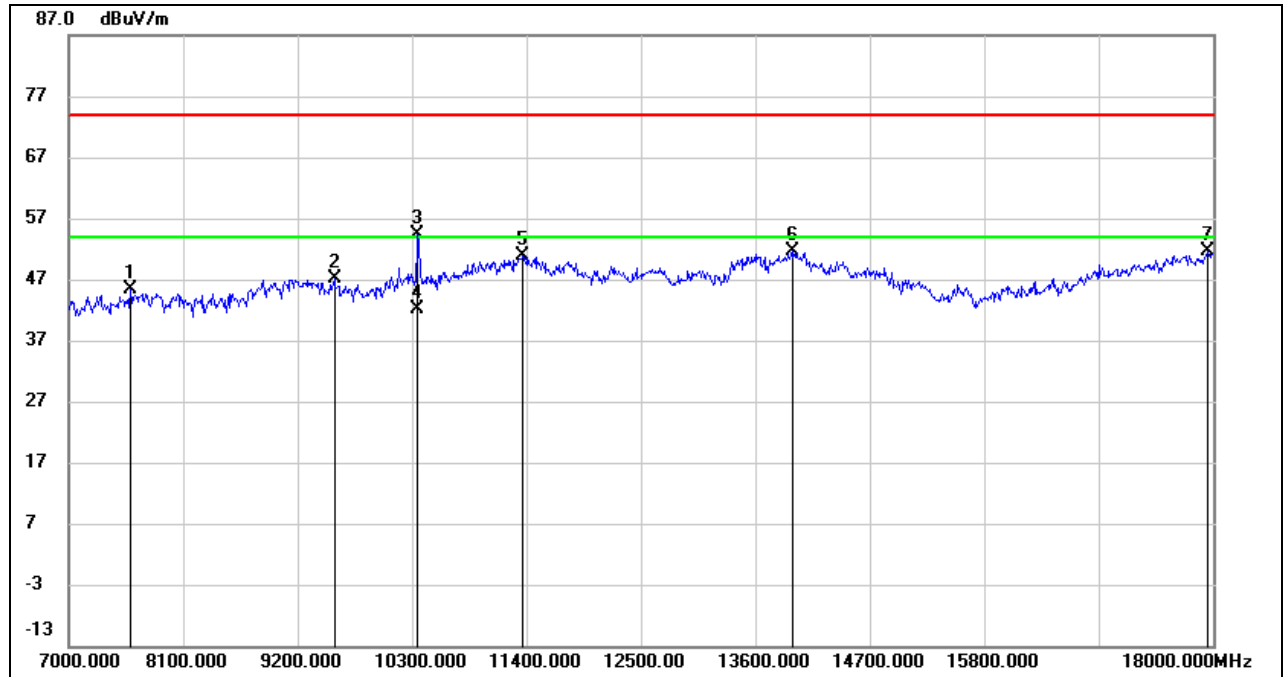

No.	Frequency (MHz)	Reading (dBuV)	Correct (dB/m)	Result (dBuV/m)	Limit (dBuV/m)	Margin (dB)	Remark
1	7594.000	38.51	6.79	45.30	74.00	-28.70	peak
2	9552.000	36.49	10.76	47.25	74.00	-26.75	peak
3	10355.000	41.85	12.52	54.37	74.00	-19.63	peak
4	10355.000	29.54	12.52	42.06	54.00	-11.94	AVG
5	11367.000	34.66	16.22	50.88	74.00	-23.12	peak
6	13952.000	29.76	21.76	51.52	74.00	-22.48	peak
7	17945.000	25.92	25.75	51.67	74.00	-22.33	peak

- Note: 1. Measurement = Reading Level + Correct Factor.
 2. If Peak Result complies with AV limit, AV Result is deemed to comply with AV limit.
 3. Peak: Peak detector.
 4. Filter losses were only considered in the spurious frequency bands and the authorized band was not corrected for High Pass Filter losses.
 5. Proper operation of the transmitter prior to adding the filter to the measurement chain.
 6. Since non-restricted band peak emissions are less than the average limit, they also comply with the -27dBm/MHz (68.2dBuV/m) limit.

HARMONICS AND SPURIOUS EMISSIONS (LOW CHANNEL, VERTICAL)

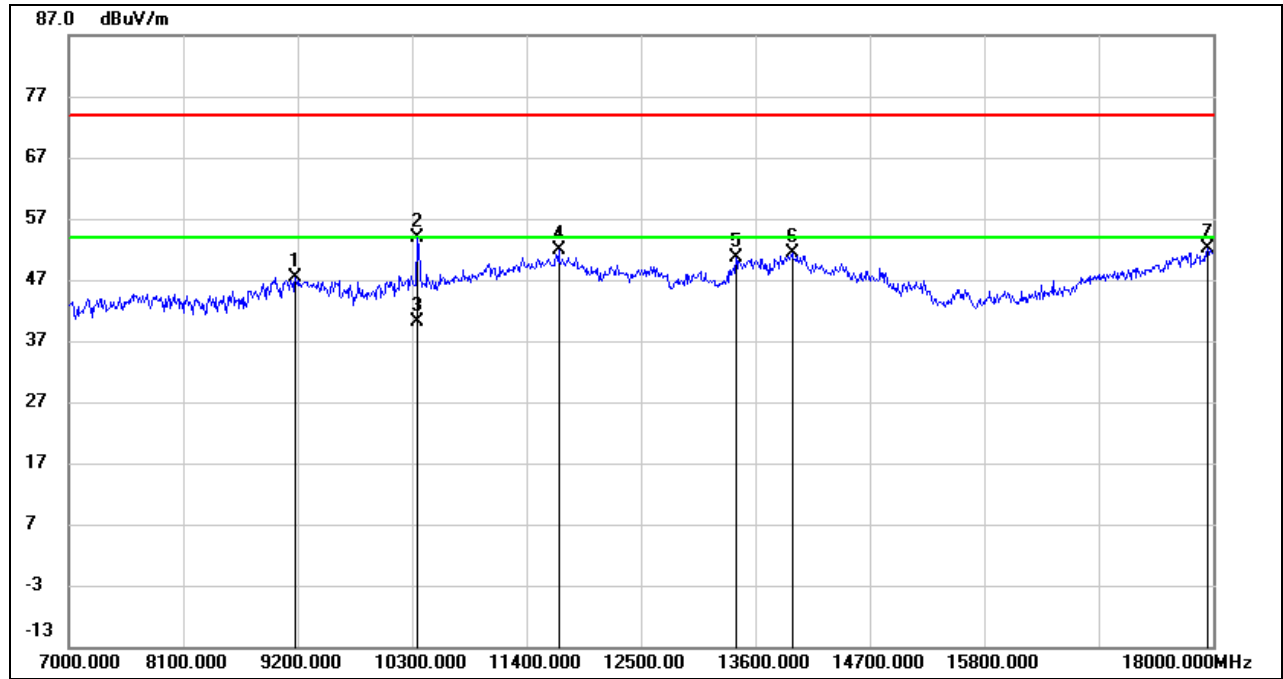

No.	Frequency (MHz)	Reading (dBuV)	Correct (dB/m)	Result (dBuV/m)	Limit (dBuV/m)	Margin (dB)	Remark
1	9178.000	36.86	10.45	47.31	74.00	-26.69	peak
2	10344.000	41.46	12.49	53.95	74.00	-20.05	peak
3	10344.000	27.63	12.49	40.12	54.00	-13.88	AVG
4	11708.000	34.70	17.16	51.86	74.00	-22.14	peak
5	13413.000	30.27	20.26	50.53	74.00	-23.47	peak
6	13952.000	29.51	21.76	51.27	74.00	-22.73	peak
7	17945.000	26.29	25.75	52.04	74.00	-21.96	peak

Note: 1. Measurement = Reading Level + Correct Factor.
 2. If Peak Result complies with AV limit, AV Result is deemed to comply with AV limit.
 3. Peak: Peak detector.
 4. Filter losses were only considered in the spurious frequency bands and the authorized band was not corrected for High Pass Filter losses.
 5. Proper operation of the transmitter prior to adding the filter to the measurement chain.
 6. Since non-restricted band peak emissions are less than the average limit, they also comply with the -27dBm/MHz (68.2dBuV/m) limit.



HARMONICS AND SPURIOUS EMISSIONS (MID CHANNEL, HORIZONTAL)

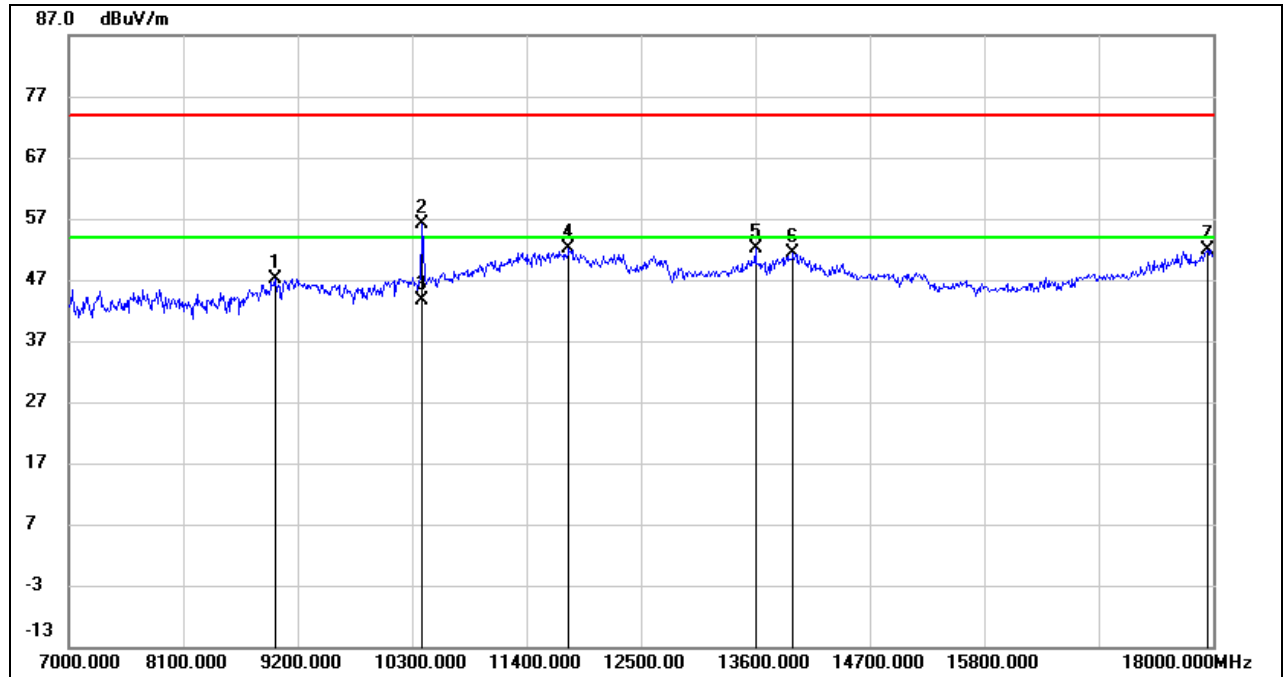

No.	Frequency (MHz)	Reading (dBuV)	Correct (dB/m)	Result (dBuV/m)	Limit (dBuV/m)	Margin (dB)	Remark
1	8980.000	36.88	10.21	47.09	74.00	-26.91	peak
2	10399.000	43.62	12.61	56.23	74.00	-17.77	peak
3	10399.000	31.14	12.61	43.75	54.00	-10.25	AVG
4	11807.000	34.67	17.34	52.01	74.00	-21.99	peak
5	13600.000	31.16	20.89	52.05	74.00	-21.95	peak
6	13963.000	29.53	21.78	51.31	74.00	-22.69	peak
7	17945.000	26.04	25.75	51.79	74.00	-22.21	peak

Note: 1. Measurement = Reading Level + Correct Factor.
 2. If Peak Result complies with AV limit, AV Result is deemed to comply with AV limit.
 3. Peak: Peak detector.
 4. Filter losses were only considered in the spurious frequency bands and the authorized band was not corrected for High Pass Filter losses.
 5. Proper operation of the transmitter prior to adding the filter to the measurement chain.
 6. Since non-restricted band peak emissions are less than the average limit, they also comply with the -27dBm/MHz (68.2dBuV/m) limit.

HARMONICS AND SPURIOUS EMISSIONS (MID CHANNEL, VERTICAL)

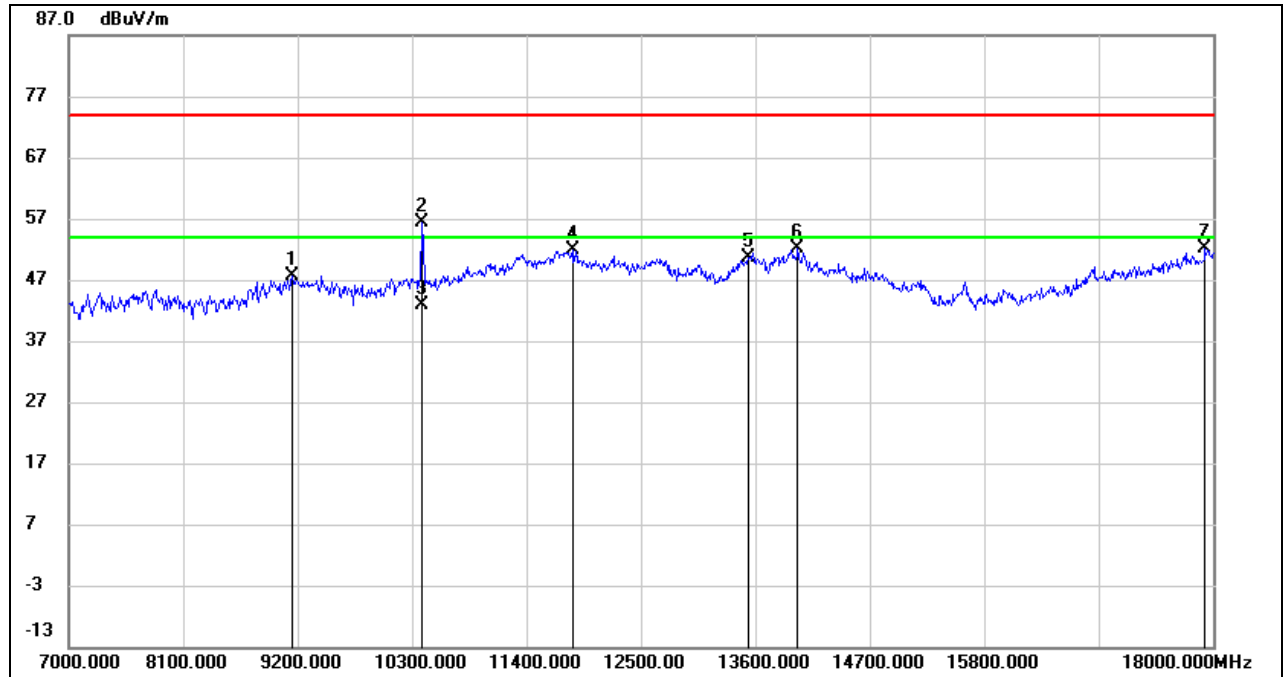

No.	Frequency (MHz)	Reading (dBuV)	Correct (dB/m)	Result (dBuV/m)	Limit (dBuV/m)	Margin (dB)	Remark
1	9145.000	37.22	10.43	47.65	74.00	-26.35	peak
2	10399.000	43.68	12.61	56.29	74.00	-17.71	peak
3	10399.000	30.35	12.61	42.96	54.00	-11.04	AVG
4	11840.000	34.39	17.40	51.79	74.00	-22.21	peak
5	13534.000	29.97	20.73	50.70	74.00	-23.30	peak
6	14007.000	30.32	21.85	52.17	74.00	-21.83	peak
7	17923.000	26.55	25.60	52.15	74.00	-21.85	peak

Note: 1. Measurement = Reading Level + Correct Factor.
 2. If Peak Result complies with AV limit, AV Result is deemed to comply with AV limit.
 3. Peak: Peak detector.
 4. Filter losses were only considered in the spurious frequency bands and the authorized band was not corrected for High Pass Filter losses.
 5. Proper operation of the transmitter prior to adding the filter to the measurement chain.
 6. Since non-restricted band peak emissions are less than the average limit, they also comply with the -27dBm/MHz (68.2dBuV/m) limit.



HARMONICS AND SPURIOUS EMISSIONS (HIGH CHANNEL, HORIZONTAL)

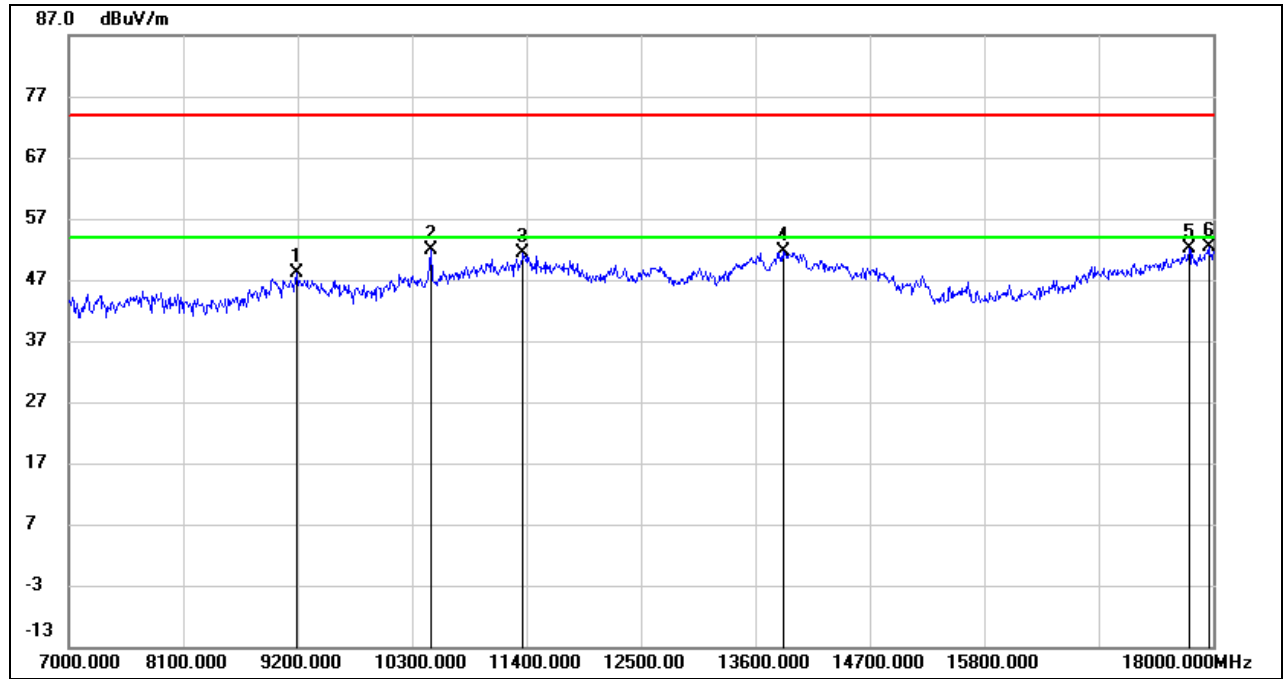

No.	Frequency (MHz)	Reading (dBuV)	Correct (dB/m)	Result (dBuV/m)	Limit (dBuV/m)	Margin (dB)	Remark
1	9189.000	37.75	10.46	48.21	74.00	-25.79	peak
2	10487.000	38.98	12.79	51.77	74.00	-22.23	peak
3	11367.000	35.13	16.22	51.35	74.00	-22.65	peak
4	13864.000	30.07	21.53	51.60	74.00	-22.40	peak
5	17769.000	27.59	24.53	52.12	74.00	-21.88	peak
6	17956.000	26.61	25.82	52.43	74.00	-21.57	peak

- Note: 1. Measurement = Reading Level + Correct Factor.
 2. If Peak Result complies with AV limit, AV Result is deemed to comply with AV limit.
 3. Peak: Peak detector.
 4. Filter losses were only considered in the spurious frequency bands and the authorized band was not corrected for High Pass Filter losses.
 5. Proper operation of the transmitter prior to adding the filter to the measurement chain.
 6. Since non-restricted band peak emissions are less than the average limit, they also comply with the -27dBm/MHz (68.2dBuV/m) limit.



HARMONICS AND SPURIOUS EMISSIONS (HIGH CHANNEL, VERTICAL)

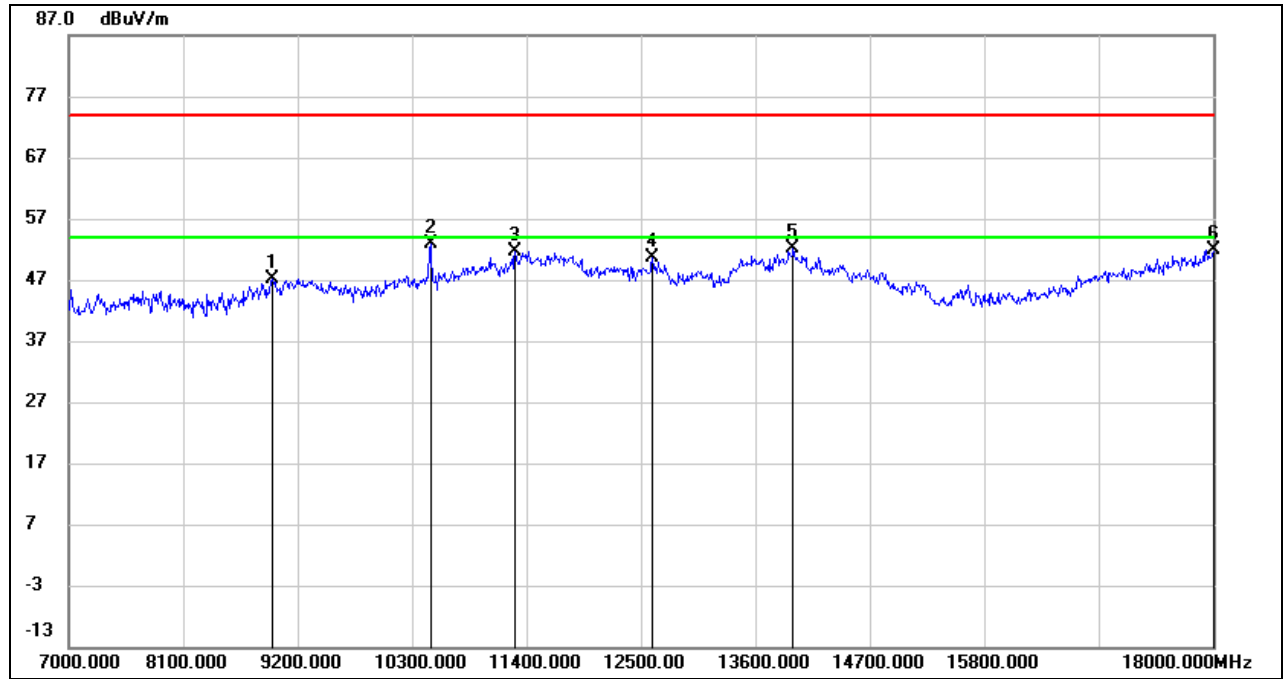

No.	Frequency (MHz)	Reading (dBuV)	Correct (dB/m)	Result (dBuV/m)	Limit (dBuV/m)	Margin (dB)	Remark
1	8958.000	37.00	10.05	47.05	74.00	-26.95	peak
2	10476.000	40.05	12.77	52.82	74.00	-21.18	peak
3	11290.000	35.82	15.90	51.72	74.00	-22.28	peak
4	12610.000	32.60	17.97	50.57	74.00	-23.43	peak
5	13963.000	30.27	21.78	52.05	74.00	-21.95	peak
6	18000.000	25.88	26.12	52.00	74.00	-22.00	peak

Note: 1. Measurement = Reading Level + Correct Factor.
 2. If Peak Result complies with AV limit, AV Result is deemed to comply with AV limit.
 3. Peak: Peak detector.
 4. Filter losses were only considered in the spurious frequency bands and the authorized band was not corrected for High Pass Filter losses.
 5. Proper operation of the transmitter prior to adding the filter to the measurement chain.
 6. Since non-restricted band peak emissions are less than the average limit, they also comply with the -27dBm/MHz (68.2dBuV/m) limit.

UNII-2A BAND

ANTENNA 1 TEST RESULTS (WORST CASE)

HARMONICS AND SPURIOUS EMISSIONS (LOW CHANNEL, HORIZONTAL)

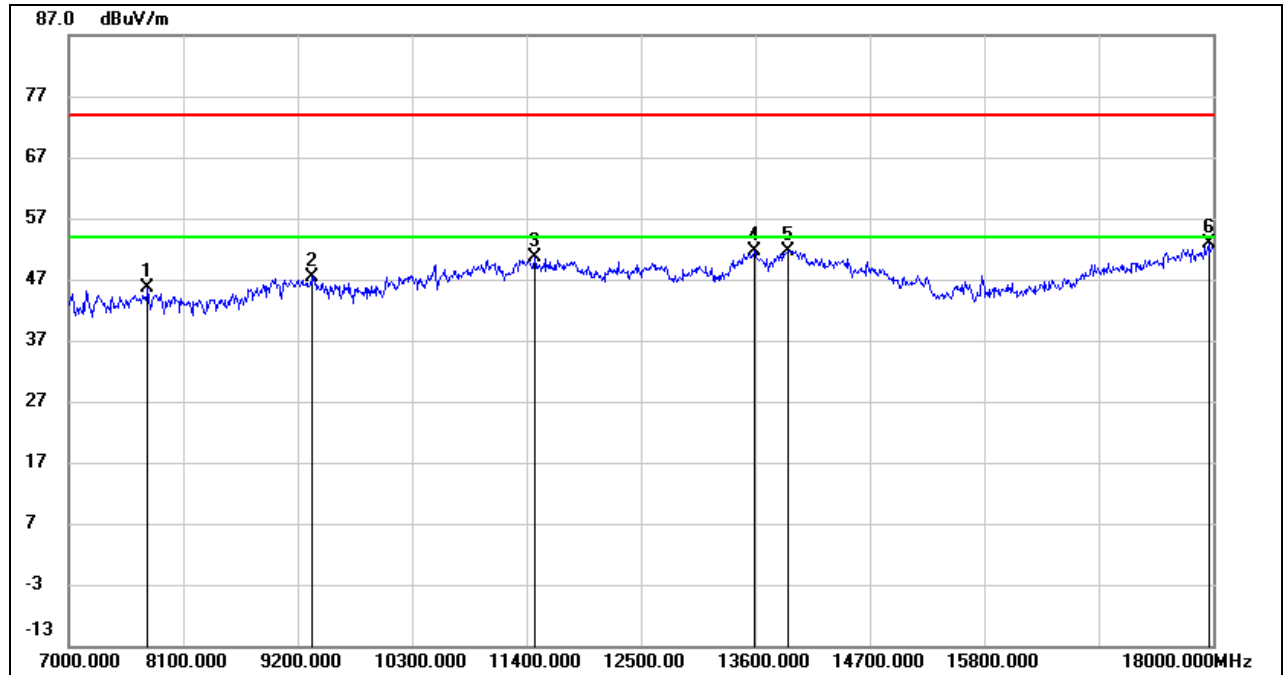

No.	Frequency (MHz)	Reading (dBuV)	Correct (dB/m)	Result (dBuV/m)	Limit (dBuV/m)	Margin (dB)	Remark
1	7759.000	38.92	6.64	45.56	74.00	-28.44	peak
2	9332.000	36.84	10.54	47.38	74.00	-26.62	peak
3	11477.000	33.90	16.67	50.57	74.00	-23.43	peak
4	13589.000	30.74	20.86	51.60	74.00	-22.40	peak
5	13919.000	30.02	21.68	51.70	74.00	-22.30	peak
6	17956.000	26.97	25.82	52.79	74.00	-21.21	peak

Note: 1. Measurement = Reading Level + Correct Factor.
 2. If Peak Result complies with AV limit, AV Result is deemed to comply with AV limit.
 3. Peak: Peak detector.
 4. Filter losses were only considered in the spurious frequency bands and the authorized band was not corrected for High Pass Filter losses.
 5. Proper operation of the transmitter prior to adding the filter to the measurement chain.
 6. Since non-restricted band peak emissions are less than the average limit, they also comply with the -27dBm/MHz (68.2dBuV/m) limit.

HARMONICS AND SPURIOUS EMISSIONS (LOW CHANNEL, VERTICAL)

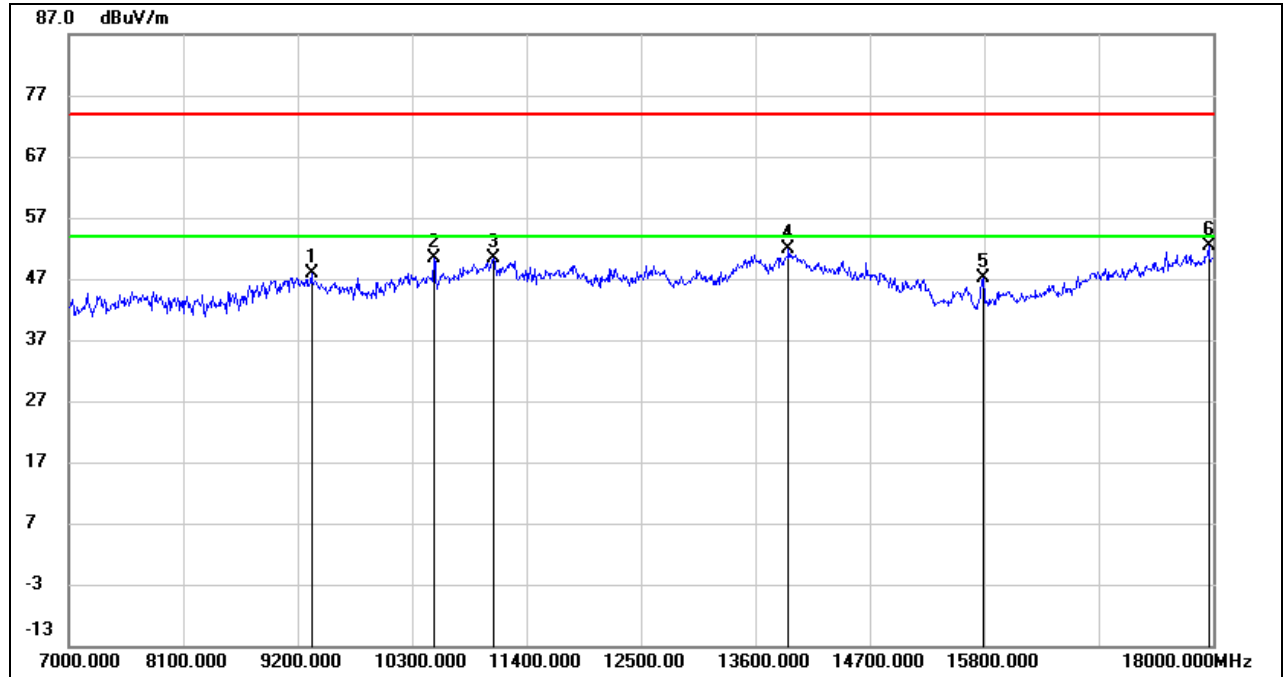

No.	Frequency (MHz)	Reading (dBuV)	Correct (dB/m)	Result (dBuV/m)	Limit (dBuV/m)	Margin (dB)	Remark
1	9332.000	37.23	10.54	47.77	74.00	-26.23	peak
2	10509.000	37.53	12.85	50.38	74.00	-23.62	peak
3	11081.000	35.41	15.05	50.46	74.00	-23.54	peak
4	13919.000	30.25	21.68	51.93	74.00	-22.07	peak
5	15789.000	30.21	16.84	47.05	74.00	-26.95	peak
6	17956.000	26.61	25.82	52.43	74.00	-21.57	peak

- Note: 1. Measurement = Reading Level + Correct Factor.
 2. If Peak Result complies with AV limit, AV Result is deemed to comply with AV limit.
 3. Peak: Peak detector.
 4. Filter losses were only considered in the spurious frequency bands and the authorized band was not corrected for High Pass Filter losses.
 5. Proper operation of the transmitter prior to adding the filter to the measurement chain.
 6. Since non-restricted band peak emissions are less than the average limit, they also comply with the -27dBm/MHz (68.2dBuV/m) limit.

HARMONICS AND SPURIOUS EMISSIONS (MID CHANNEL, HORIZONTAL)

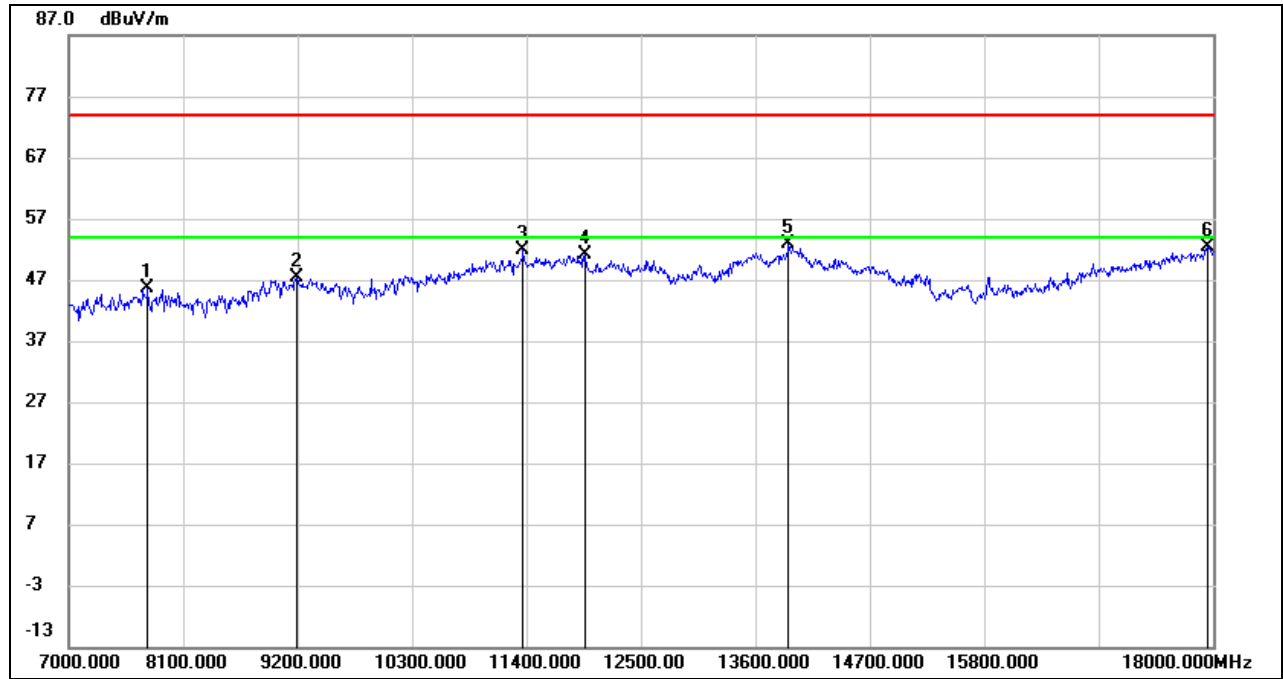

No.	Frequency (MHz)	Reading (dBuV)	Correct (dB/m)	Result (dBuV/m)	Limit (dBuV/m)	Margin (dB)	Remark
1	7759.000	38.92	6.64	45.56	74.00	-28.44	peak
2	9189.000	37.02	10.46	47.48	74.00	-26.52	peak
3	11367.000	35.71	16.22	51.93	74.00	-22.07	peak
4	11961.000	33.56	17.62	51.18	74.00	-22.82	peak
5	13919.000	31.16	21.68	52.84	74.00	-21.16	peak
6	17945.000	26.73	25.75	52.48	74.00	-21.52	peak

- Note: 1. Measurement = Reading Level + Correct Factor.
 2. If Peak Result complies with AV limit, AV Result is deemed to comply with AV limit.
 3. Peak: Peak detector.
 4. Filter losses were only considered in the spurious frequency bands and the authorized band was not corrected for High Pass Filter losses.
 5. Proper operation of the transmitter prior to adding the filter to the measurement chain.
 6. Since non-restricted band peak emissions are less than the average limit, they also comply with the -27dBm/MHz (68.2dBuV/m) limit.



HARMONICS AND SPURIOUS EMISSIONS (MID CHANNEL, VERTICAL)

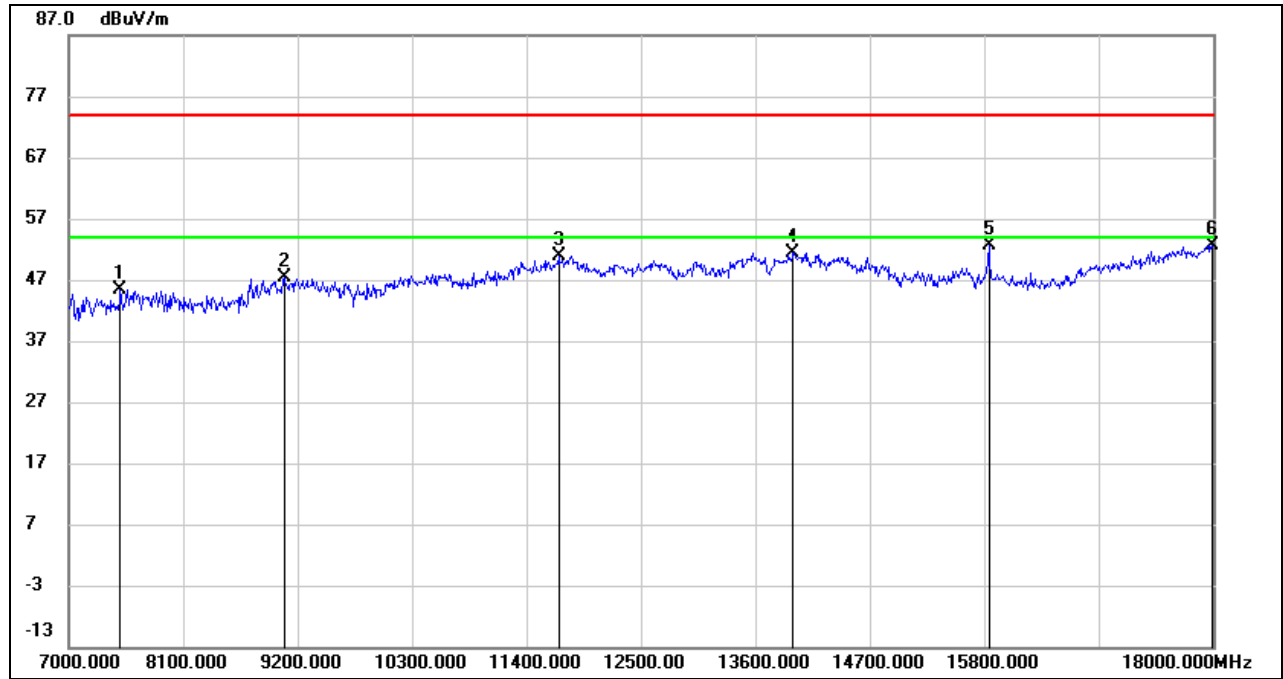

No.	Frequency (MHz)	Reading (dBuV)	Correct (dB/m)	Result (dBuV/m)	Limit (dBuV/m)	Margin (dB)	Remark
1	7495.000	38.60	6.87	45.47	74.00	-28.53	peak
2	9068.000	37.00	10.39	47.39	74.00	-26.61	peak
3	11708.000	33.78	17.16	50.94	74.00	-23.06	peak
4	13963.000	29.66	21.78	51.44	74.00	-22.56	peak
5	15844.000	35.85	16.86	52.71	74.00	-21.29	peak
6	17989.000	26.69	26.04	52.73	74.00	-21.27	peak

Note: 1. Measurement = Reading Level + Correct Factor.
 2. If Peak Result complies with AV limit, AV Result is deemed to comply with AV limit.
 3. Peak: Peak detector.
 4. Filter losses were only considered in the spurious frequency bands and the authorized band was not corrected for High Pass Filter losses.
 5. Proper operation of the transmitter prior to adding the filter to the measurement chain.
 6. Since non-restricted band peak emissions are less than the average limit, they also comply with the -27dBm/MHz (68.2dBuV/m) limit.

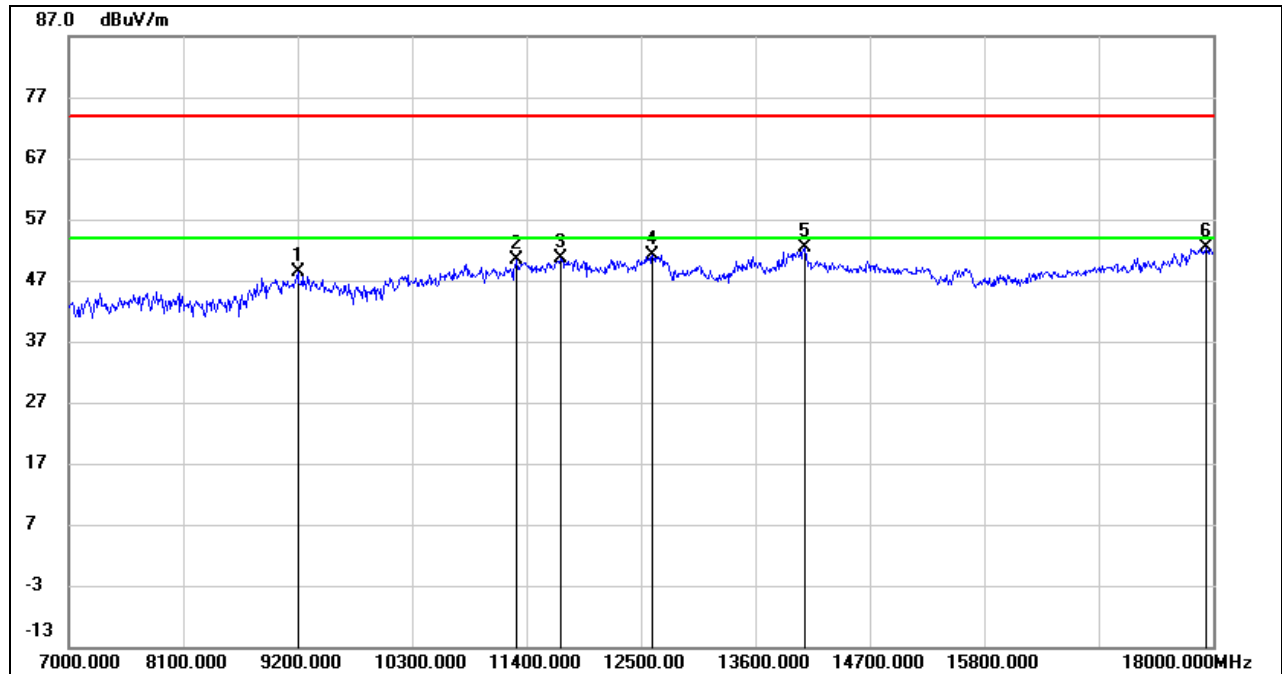
**HARMONICS AND SPURIOUS EMISSIONS (HIGH CHANNEL, HORIZONTAL)**

No.	Frequency (MHz)	Reading (dBuV)	Correct (dB/m)	Result (dBuV/m)	Limit (dBuV/m)	Margin (dB)	Remark
1	9200.000	37.97	10.46	48.43	74.00	-25.57	peak
2	11301.000	34.31	15.95	50.26	74.00	-23.74	peak
3	11730.000	33.33	17.19	50.52	74.00	-23.48	peak
4	12610.000	33.21	17.97	51.18	74.00	-22.82	peak
5	14073.000	30.80	21.57	52.37	74.00	-21.63	peak
6	17934.000	26.66	25.67	52.33	74.00	-21.67	peak

Note: 1. Measurement = Reading Level + Correct Factor.

2. If Peak Result complies with AV limit, AV Result is deemed to comply with AV limit.

3. Peak: Peak detector.

4. Filter losses were only considered in the spurious frequency bands and the authorized band was not corrected for High Pass Filter losses.

5. Proper operation of the transmitter prior to adding the filter to the measurement chain.

6. Since non-restricted band peak emissions are less than the average limit, they also comply with the -27dBm/MHz (68.2dBuV/m) limit.



HARMONICS AND SPURIOUS EMISSIONS (HIGH CHANNEL, VERTICAL)

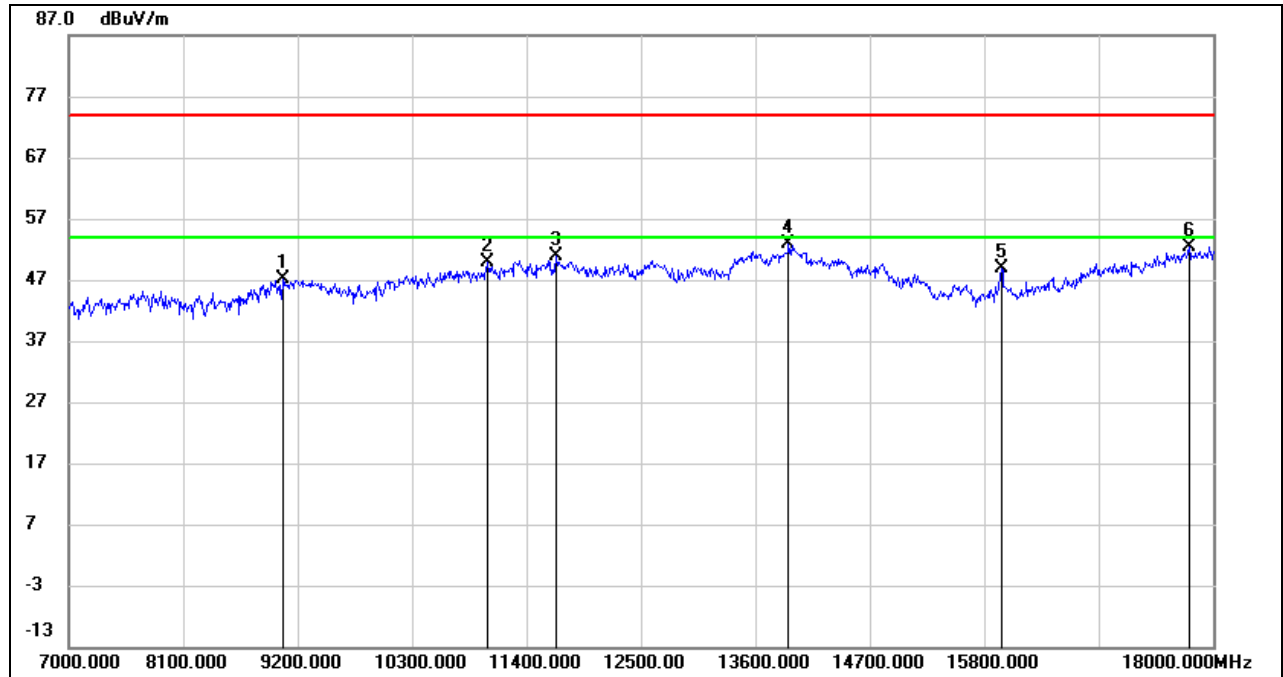

No.	Frequency (MHz)	Reading (dBuV)	Correct (dB/m)	Result (dBuV/m)	Limit (dBuV/m)	Margin (dB)	Remark
1	9057.000	36.82	10.38	47.20	74.00	-26.80	peak
2	11026.000	35.01	14.82	49.83	74.00	-24.17	peak
3	11686.000	33.73	17.12	50.85	74.00	-23.15	peak
4	13919.000	31.30	21.68	52.98	74.00	-21.02	peak
5	15965.000	32.06	16.91	48.97	74.00	-25.03	peak
6	17769.000	27.85	24.53	52.38	74.00	-21.62	peak

Note: 1. Measurement = Reading Level + Correct Factor.
 2. If Peak Result complies with AV limit, AV Result is deemed to comply with AV limit.
 3. Peak: Peak detector.
 4. Filter losses were only considered in the spurious frequency bands and the authorized band was not corrected for High Pass Filter losses.
 5. Proper operation of the transmitter prior to adding the filter to the measurement chain.
 6. Since non-restricted band peak emissions are less than the average limit, they also comply with the -27dBm/MHz (68.2dBuV/m) limit.

UNII-2C BAND

ANTENNA 1 TEST RESULTS (WORST CASE)

HARMONICS AND SPURIOUS EMISSIONS (LOW CHANNEL, HORIZONTAL)

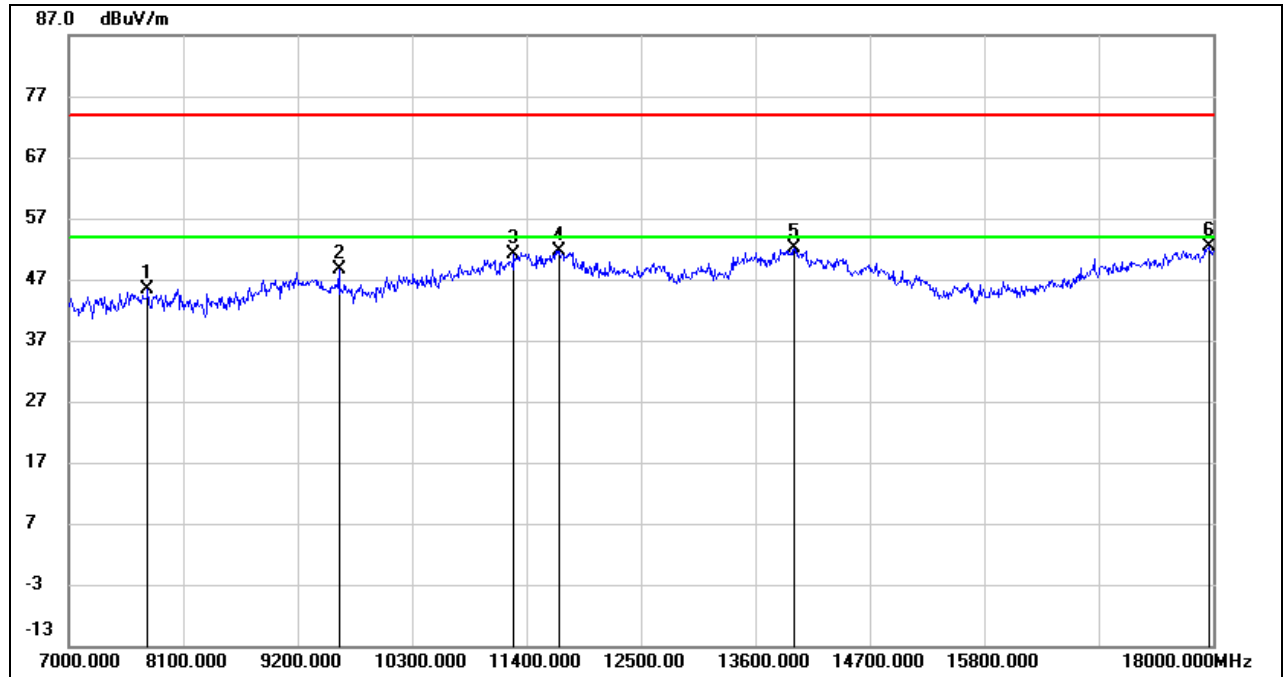

No.	Frequency (MHz)	Reading (dBuV)	Correct (dB/m)	Result (dBuV/m)	Limit (dBuV/m)	Margin (dB)	Remark
1	7759.000	38.74	6.64	45.38	74.00	-28.62	peak
2	9596.000	37.76	10.87	48.63	74.00	-25.37	peak
3	11279.000	35.23	15.86	51.09	74.00	-22.91	peak
4	11719.000	34.57	17.18	51.75	74.00	-22.25	peak
5	13974.000	30.19	21.82	52.01	74.00	-21.99	peak
6	17956.000	26.60	25.82	52.42	74.00	-21.58	peak

Note: 1. Measurement = Reading Level + Correct Factor.
 2. If Peak Result complies with AV limit, AV Result is deemed to comply with AV limit.
 3. Peak: Peak detector.
 4. Filter losses were only considered in the spurious frequency bands and the authorized band was not corrected for High Pass Filter losses.
 5. Proper operation of the transmitter prior to adding the filter to the measurement chain.
 6. Since non-restricted band peak emissions are less than the average limit, they also comply with the -27dBm/MHz (68.2dBuV/m) limit.



HARMONICS AND SPURIOUS EMISSIONS (LOW CHANNEL, VERTICAL)

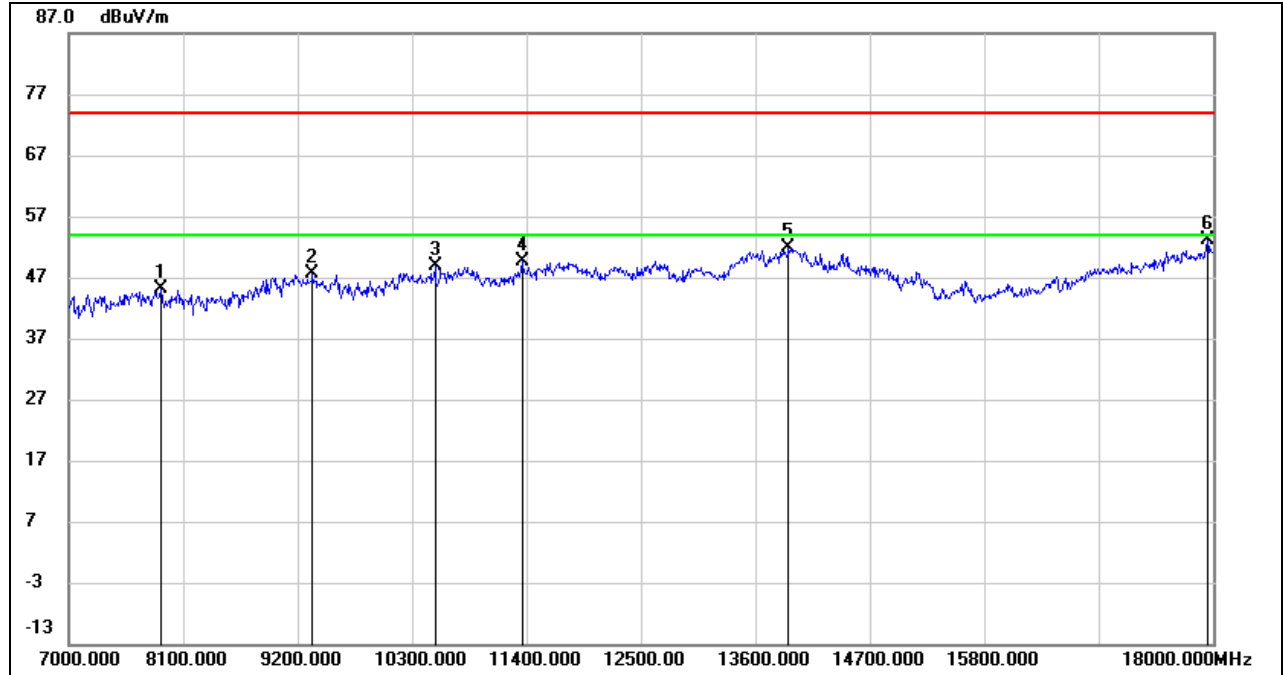

No.	Frequency (MHz)	Reading (dBuV)	Correct (dB/m)	Result (dBuV/m)	Limit (dBuV/m)	Margin (dB)	Remark
1	7891.000	38.71	6.52	45.23	74.00	-28.77	peak
2	9343.000	37.00	10.55	47.55	74.00	-26.45	peak
3	10520.000	36.04	12.90	48.94	74.00	-25.06	peak
4	11356.000	33.52	16.19	49.71	74.00	-24.29	peak
5	13919.000	30.15	21.68	51.83	74.00	-22.17	peak
6	17945.000	27.36	25.75	53.11	74.00	-20.89	peak

- Note: 1. Measurement = Reading Level + Correct Factor.
 2. If Peak Result complies with AV limit, AV Result is deemed to comply with AV limit.
 3. Peak: Peak detector.
 4. Filter losses were only considered in the spurious frequency bands and the authorized band was not corrected for High Pass Filter losses.
 5. Proper operation of the transmitter prior to adding the filter to the measurement chain.
 6. Since non-restricted band peak emissions are less than the average limit, they also comply with the -27dBm/MHz (68.2dBuV/m) limit.



HARMONICS AND SPURIOUS EMISSIONS (MID CHANNEL, HORIZONTAL)

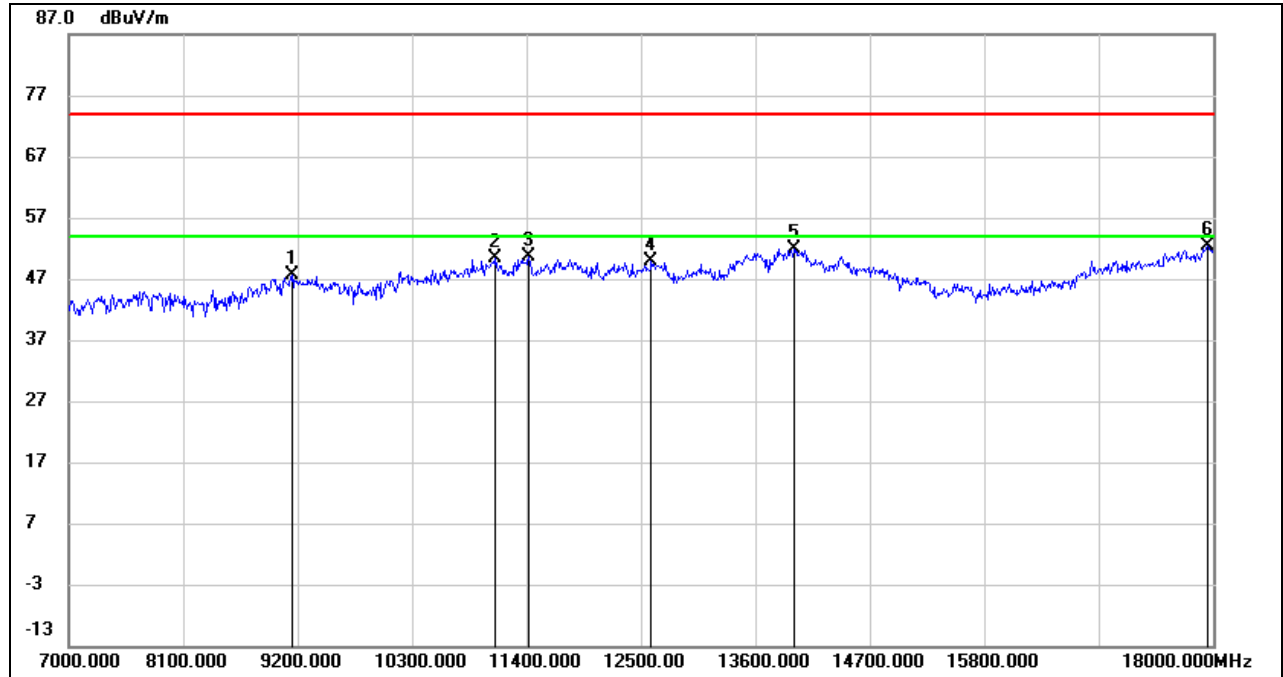

No.	Frequency (MHz)	Reading (dBuV)	Correct (dB/m)	Result (dBuV/m)	Limit (dBuV/m)	Margin (dB)	Remark
1	9145.000	37.20	10.43	47.63	74.00	-26.37	peak
2	11103.000	35.18	15.15	50.33	74.00	-23.67	peak
3	11422.000	34.12	16.46	50.58	74.00	-23.42	peak
4	12599.000	31.95	17.95	49.90	74.00	-24.10	peak
5	13974.000	30.09	21.82	51.91	74.00	-22.09	peak
6	17945.000	26.68	25.75	52.43	74.00	-21.57	peak

Note: 1. Measurement = Reading Level + Correct Factor.
 2. If Peak Result complies with AV limit, AV Result is deemed to comply with AV limit.
 3. Peak: Peak detector.
 4. Filter losses were only considered in the spurious frequency bands and the authorized band was not corrected for High Pass Filter losses.
 5. Proper operation of the transmitter prior to adding the filter to the measurement chain.
 6. Since non-restricted band peak emissions are less than the average limit, they also comply with the -27dBm/MHz (68.2dBuV/m) limit.

HARMONICS AND SPURIOUS EMISSIONS (MID CHANNEL, VERTICAL)

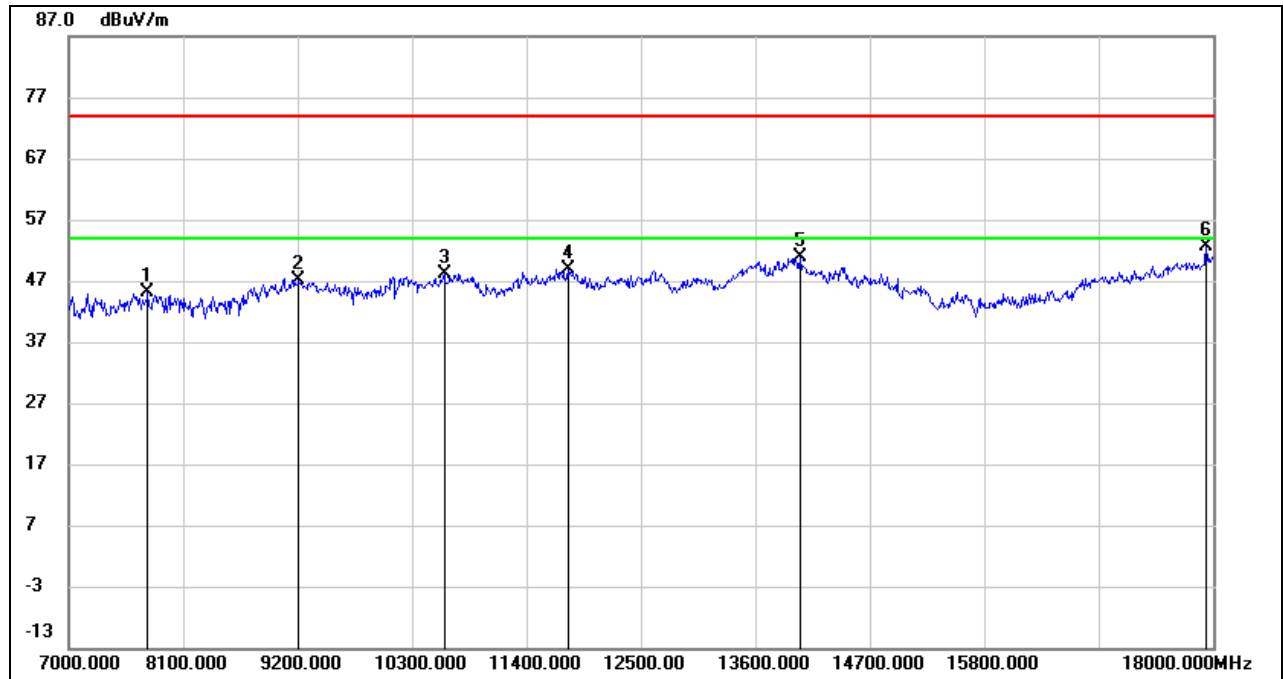

No.	Frequency (MHz)	Reading (dBuV)	Correct (dB/m)	Result (dBuV/m)	Limit (dBuV/m)	Margin (dB)	Remark
1	7759.000	38.55	6.64	45.19	74.00	-28.81	peak
2	9211.000	36.59	10.47	47.06	74.00	-26.94	peak
3	10608.000	34.93	13.23	48.16	74.00	-25.84	peak
4	11796.000	31.51	17.32	48.83	74.00	-25.17	peak
5	14029.000	29.15	21.76	50.91	74.00	-23.09	peak
6	17934.000	26.85	25.67	52.52	74.00	-21.48	peak

Note: 1. Measurement = Reading Level + Correct Factor.
 2. If Peak Result complies with AV limit, AV Result is deemed to comply with AV limit.
 3. Peak: Peak detector.
 4. Filter losses were only considered in the spurious frequency bands and the authorized band was not corrected for High Pass Filter losses.
 5. Proper operation of the transmitter prior to adding the filter to the measurement chain.
 6. Since non-restricted band peak emissions are less than the average limit, they also comply with the -27dBm/MHz (68.2dBuV/m) limit.



HARMONICS AND SPURIOUS EMISSIONS (HIGH CHANNEL, HORIZONTAL)

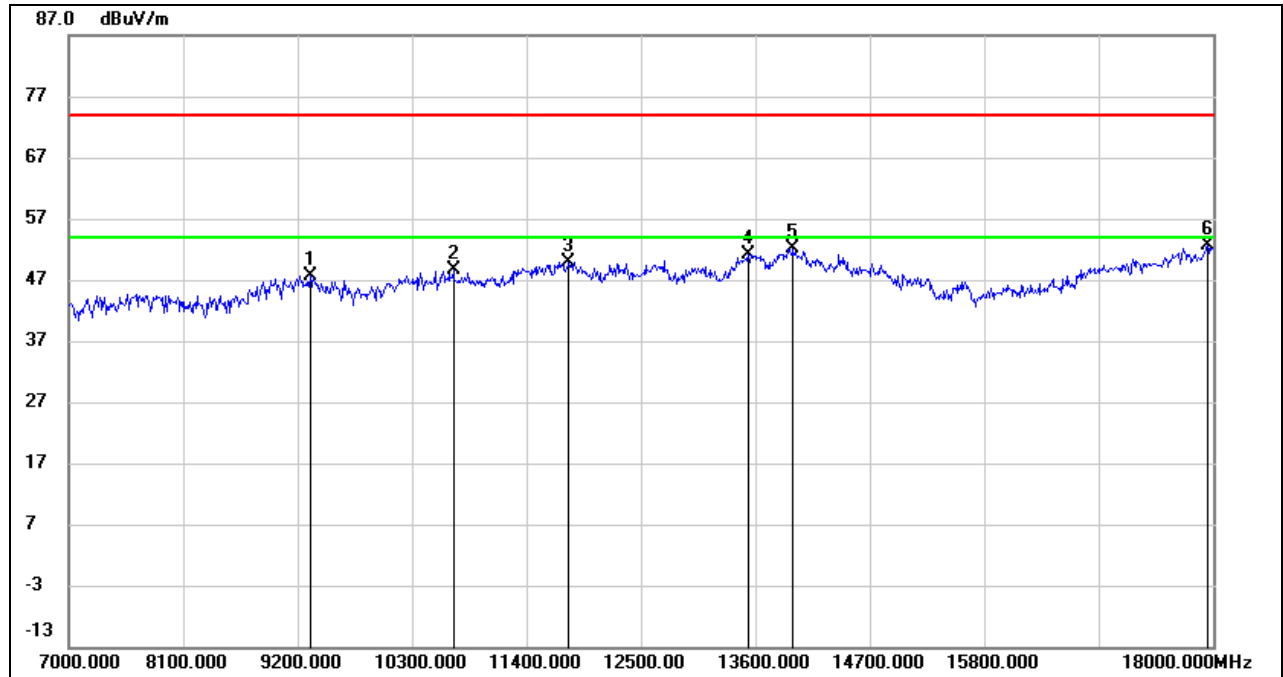

No.	Frequency (MHz)	Reading (dBuV)	Correct (dB/m)	Result (dBuV/m)	Limit (dBuV/m)	Margin (dB)	Remark
1	9321.000	37.21	10.53	47.74	74.00	-26.26	peak
2	10696.000	35.00	13.56	48.56	74.00	-25.44	peak
3	11807.000	32.66	17.34	50.00	74.00	-24.00	peak
4	13534.000	30.48	20.73	51.21	74.00	-22.79	peak
5	13963.000	30.45	21.78	52.23	74.00	-21.77	peak
6	17945.000	26.88	25.75	52.63	74.00	-21.37	peak

Note: 1. Measurement = Reading Level + Correct Factor.
 2. If Peak Result complies with AV limit, AV Result is deemed to comply with AV limit.
 3. Peak: Peak detector.
 4. Filter losses were only considered in the spurious frequency bands and the authorized band was not corrected for High Pass Filter losses.
 5. Proper operation of the transmitter prior to adding the filter to the measurement chain.
 6. Since non-restricted band peak emissions are less than the average limit, they also comply with the -27dBm/MHz (68.2dBuV/m) limit.



HARMONICS AND SPURIOUS EMISSIONS (HIGH CHANNEL, VERTICAL)

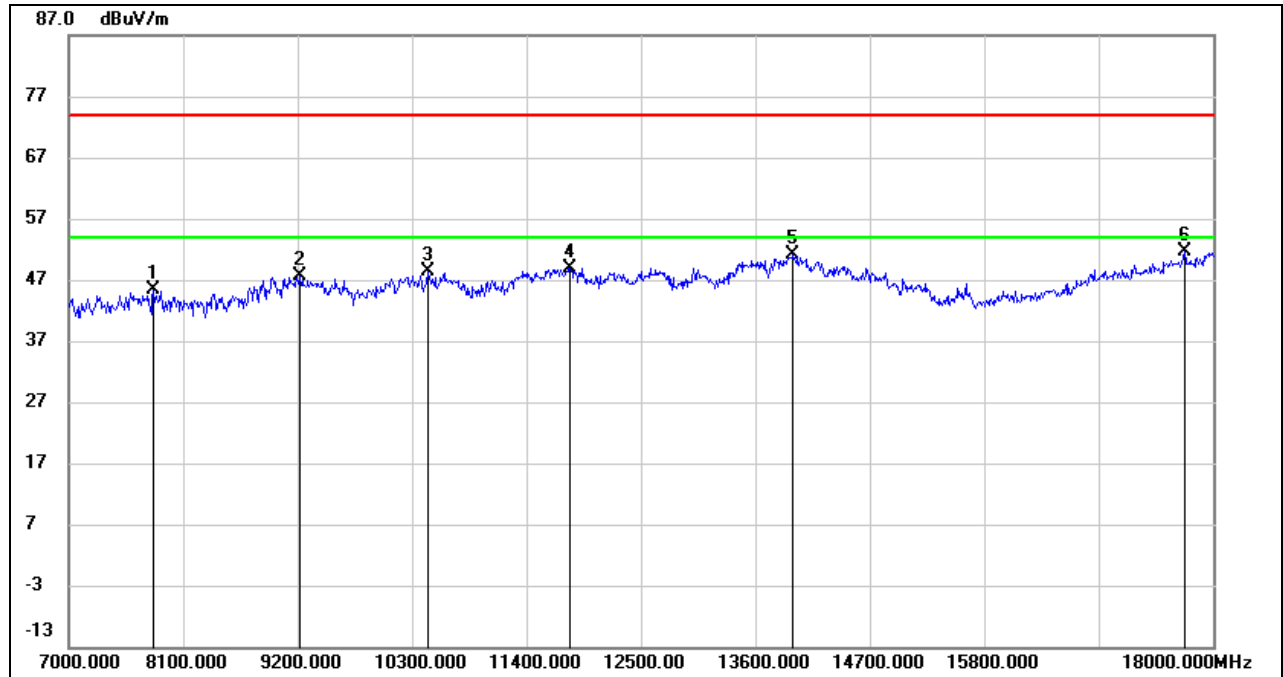

No.	Frequency (MHz)	Reading (dBuV)	Correct (dB/m)	Result (dBuV/m)	Limit (dBuV/m)	Margin (dB)	Remark
1	7814.000	38.74	6.60	45.34	74.00	-28.66	peak
2	9222.000	37.11	10.48	47.59	74.00	-26.41	peak
3	10454.000	35.54	12.73	48.27	74.00	-25.73	peak
4	11818.000	31.62	17.36	48.98	74.00	-25.02	peak
5	13963.000	29.27	21.78	51.05	74.00	-22.95	peak
6	17725.000	27.29	24.24	51.53	74.00	-22.47	peak

Note: 1. Measurement = Reading Level + Correct Factor.
 2. If Peak Result complies with AV limit, AV Result is deemed to comply with AV limit.
 3. Peak: Peak detector.
 4. Filter losses were only considered in the spurious frequency bands and the authorized band was not corrected for High Pass Filter losses.
 5. Proper operation of the transmitter prior to adding the filter to the measurement chain.
 6. Since non-restricted band peak emissions are less than the average limit, they also comply with the -27dBm/MHz (68.2dBuV/m) limit.

STRADDLE CHANNEL 144

ANTENNA 1 TEST RESULTS (WORST CASE)

HARMONICS AND SPURIOUS EMISSIONS (HORIZONTAL)

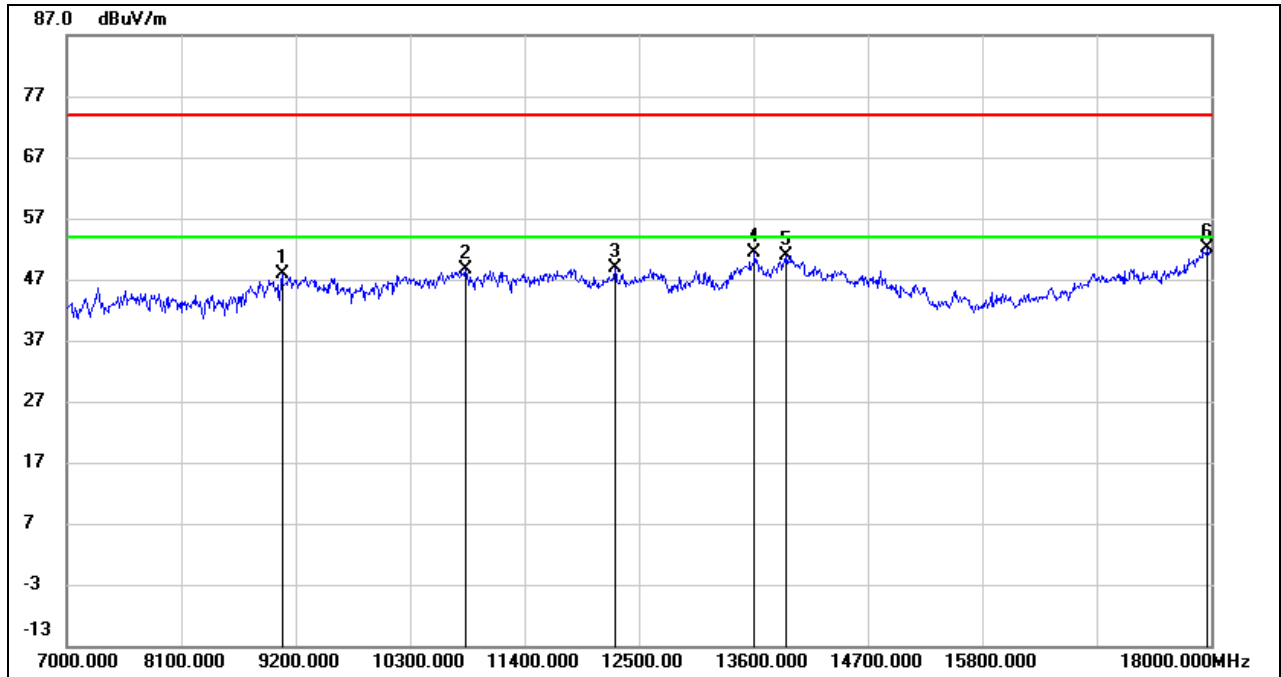

No.	Frequency (MHz)	Reading (dBuV)	Correct (dB/m)	Result (dBuV/m)	Limit (dBuV/m)	Margin (dB)	Remark
1	9068.000	37.37	10.39	47.76	74.00	-26.24	peak
2	10828.000	34.54	14.07	48.61	74.00	-25.39	peak
3	12269.000	31.13	17.77	48.90	74.00	-25.10	peak
4	13611.000	30.44	20.92	51.36	74.00	-22.64	peak
5	13919.000	29.26	21.68	50.94	74.00	-23.06	peak
6	17967.000	26.30	25.89	52.19	74.00	-21.81	peak

Note: 1. Measurement = Reading Level + Correct Factor.
 2. If Peak Result complies with AV limit, AV Result is deemed to comply with AV limit.
 3. Peak: Peak detector.
 4. Filter losses were only considered in the spurious frequency bands and the authorized band was not corrected for High Pass Filter losses.
 5. Proper operation of the transmitter prior to adding the filter to the measurement chain.
 6. Since non-restricted band peak emissions are less than the average limit, they also comply with the -27dBm/MHz (68.2dBuV/m) limit.

HARMONICS AND SPURIOUS EMISSIONS (VERTICAL)

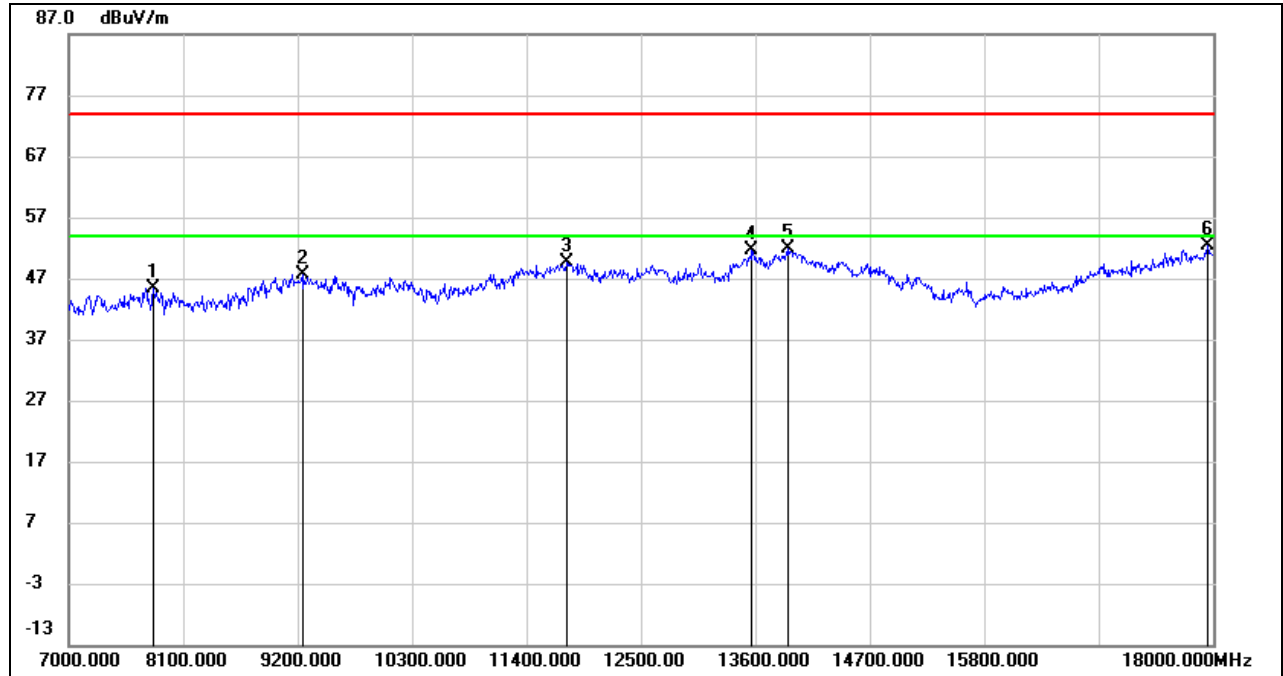

No.	Frequency (MHz)	Reading (dBuV)	Correct (dB/m)	Result (dBuV/m)	Limit (dBuV/m)	Margin (dB)	Remark
1	7814.000	38.88	6.60	45.48	74.00	-28.52	peak
2	9244.000	37.21	10.49	47.70	74.00	-26.30	peak
3	11785.000	32.27	17.30	49.57	74.00	-24.43	peak
4	13567.000	30.72	20.80	51.52	74.00	-22.48	peak
5	13919.000	30.10	21.68	51.78	74.00	-22.22	peak
6	17945.000	26.75	25.75	52.50	74.00	-21.50	peak

Note: 1. Measurement = Reading Level + Correct Factor.
 2. If Peak Result complies with AV limit, AV Result is deemed to comply with AV limit.
 3. Peak: Peak detector.
 4. Filter losses were only considered in the spurious frequency bands and the authorized band was not corrected for High Pass Filter losses.
 5. Proper operation of the transmitter prior to adding the filter to the measurement chain.
 6. Since non-restricted band peak emissions are less than the average limit, they also comply with the -27dBm/MHz (68.2dBuV/m) limit.



UNII-3 BAND

ANTENNA 1 TEST RESULTS (WORST CASE)

HARMONICS AND SPURIOUS EMISSIONS (LOW CHANNEL, HORIZONTAL)

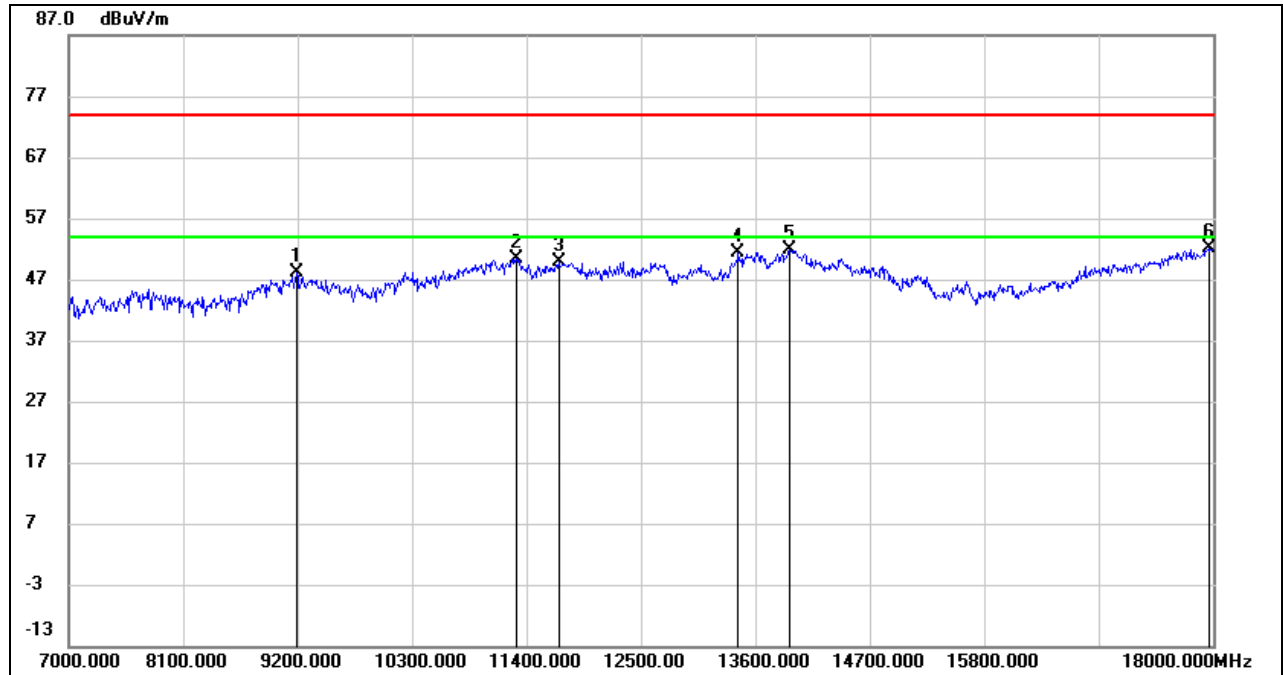

No.	Frequency (MHz)	Reading (dBuV)	Correct (dB/m)	Result (dBuV/m)	Limit (dBuV/m)	Margin (dB)	Remark
1	9189.000	37.64	10.46	48.10	74.00	-25.90	peak
2	11301.000	34.46	15.95	50.41	74.00	-23.59	peak
3	11708.000	32.70	17.16	49.86	74.00	-24.14	peak
4	13435.000	30.94	20.35	51.29	74.00	-22.71	peak
5	13930.000	30.25	21.71	51.96	74.00	-22.04	peak
6	17956.000	26.28	25.82	52.10	74.00	-21.90	peak

Note: 1. Measurement = Reading Level + Correct Factor.
 2. If Peak Result complies with AV limit, AV Result is deemed to comply with AV limit.
 3. Peak: Peak detector.
 4. Filter losses were only considered in the spurious frequency bands and the authorized band was not corrected for High Pass Filter losses.
 5. Proper operation of the transmitter prior to adding the filter to the measurement chain.
 6. Since non-restricted band peak emissions are less than the average limit, they also comply with the -27dBm/MHz (68.2dBuV/m) limit.

HARMONICS AND SPURIOUS EMISSIONS (LOW CHANNEL, VERTICAL)

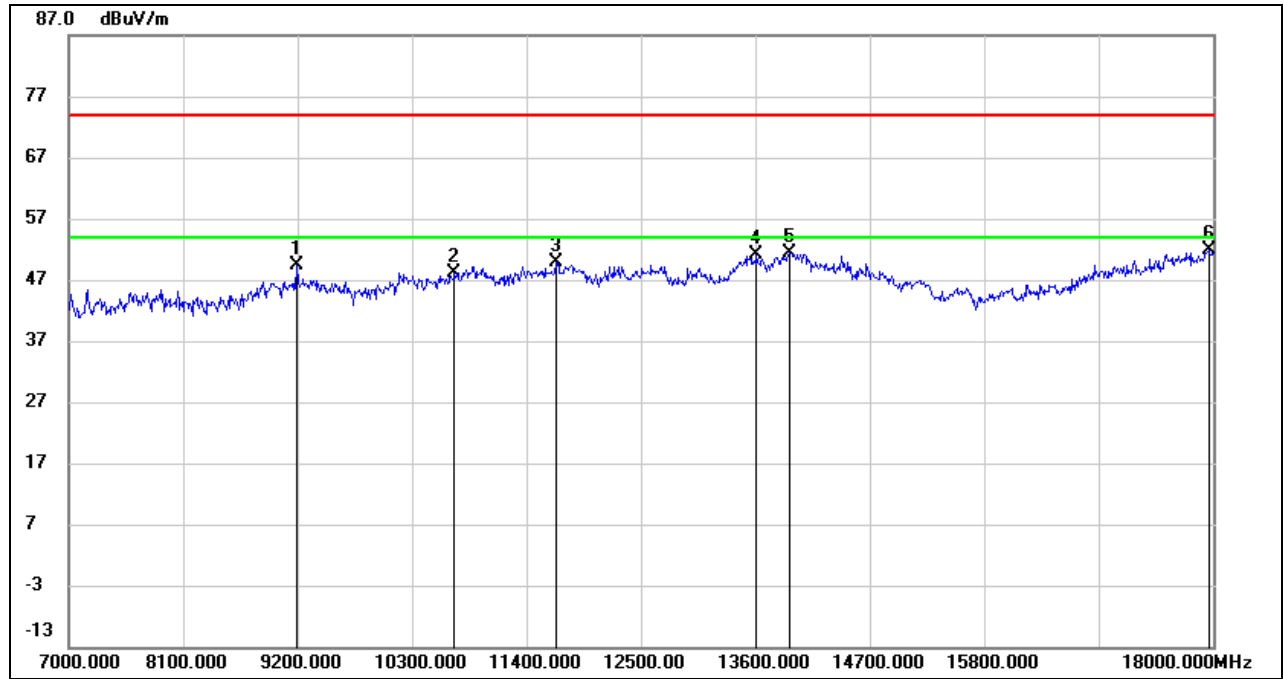

No.	Frequency (MHz)	Reading (dBuV)	Correct (dB/m)	Result (dBuV/m)	Limit (dBuV/m)	Margin (dB)	Remark
1	9189.000	38.99	10.46	49.45	74.00	-24.55	peak
2	10707.000	34.52	13.60	48.12	74.00	-25.88	peak
3	11686.000	32.73	17.12	49.85	74.00	-24.15	peak
4	13611.000	30.33	20.92	51.25	74.00	-22.75	peak
5	13930.000	29.70	21.71	51.41	74.00	-22.59	peak
6	17956.000	25.97	25.82	51.79	74.00	-22.21	peak

Note: 1. Measurement = Reading Level + Correct Factor.
 2. If Peak Result complies with AV limit, AV Result is deemed to comply with AV limit.
 3. Peak: Peak detector.
 4. Filter losses were only considered in the spurious frequency bands and the authorized band was not corrected for High Pass Filter losses.
 5. Proper operation of the transmitter prior to adding the filter to the measurement chain.
 6. Since non-restricted band peak emissions are less than the average limit, they also comply with the -27dBm/MHz (68.2dBuV/m) limit.

HARMONICS AND SPURIOUS EMISSIONS (MID CHANNEL, HORIZONTAL)

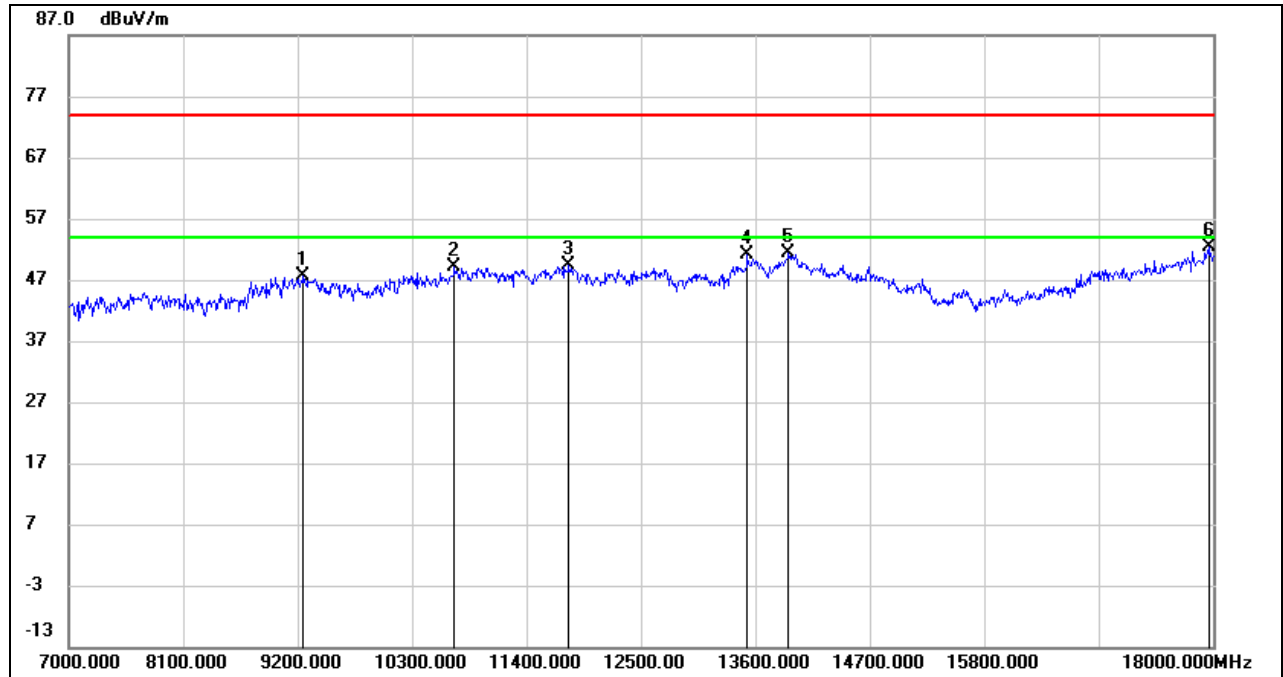

No.	Frequency (MHz)	Reading (dBuV)	Correct (dB/m)	Result (dBuV/m)	Limit (dBuV/m)	Margin (dB)	Remark
1	9255.000	37.08	10.51	47.59	74.00	-26.41	peak
2	10707.000	35.54	13.60	49.14	74.00	-24.86	peak
3	11807.000	31.94	17.34	49.28	74.00	-24.72	peak
4	13523.000	30.31	20.70	51.01	74.00	-22.99	peak
5	13919.000	29.68	21.68	51.36	74.00	-22.64	peak
6	17956.000	26.66	25.82	52.48	74.00	-21.52	peak

Note: 1. Measurement = Reading Level + Correct Factor.
 2. If Peak Result complies with AV limit, AV Result is deemed to comply with AV limit.
 3. Peak: Peak detector.
 4. Filter losses were only considered in the spurious frequency bands and the authorized band was not corrected for High Pass Filter losses.
 5. Proper operation of the transmitter prior to adding the filter to the measurement chain.
 6. Since non-restricted band peak emissions are less than the average limit, they also comply with the -27dBm/MHz (68.2dBuV/m) limit.

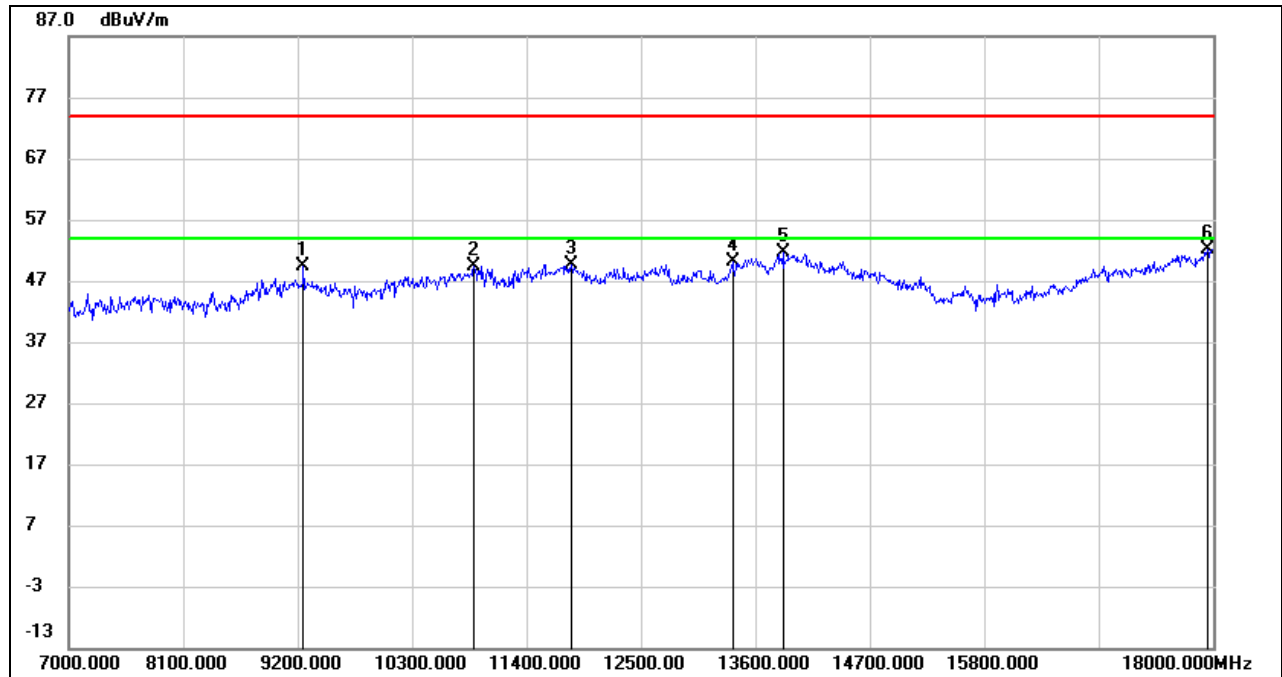
**HARMONICS AND SPURIOUS EMISSIONS (MID CHANNEL, VERTICAL)**

No.	Frequency (MHz)	Reading (dBuV)	Correct (dB/m)	Result (dBuV/m)	Limit (dBuV/m)	Margin (dB)	Remark
1	9255.000	38.98	10.51	49.49	74.00	-24.51	peak
2	10894.000	35.08	14.32	49.40	74.00	-24.60	peak
3	11829.000	32.22	17.38	49.60	74.00	-24.40	peak
4	13380.000	30.09	20.12	50.21	74.00	-23.79	peak
5	13864.000	30.20	21.53	51.73	74.00	-22.27	peak
6	17945.000	26.39	25.75	52.14	74.00	-21.86	peak

Note: 1. Measurement = Reading Level + Correct Factor.

2. If Peak Result complies with AV limit, AV Result is deemed to comply with AV limit.

3. Peak: Peak detector.

4. Filter losses were only considered in the spurious frequency bands and the authorized band was not corrected for High Pass Filter losses.

5. Proper operation of the transmitter prior to adding the filter to the measurement chain.

6. Since non-restricted band peak emissions are less than the average limit, they also comply with the -27dBm/MHz (68.2dBuV/m) limit.



HARMONICS AND SPURIOUS EMISSIONS (HIGH CHANNEL, HORIZONTAL)

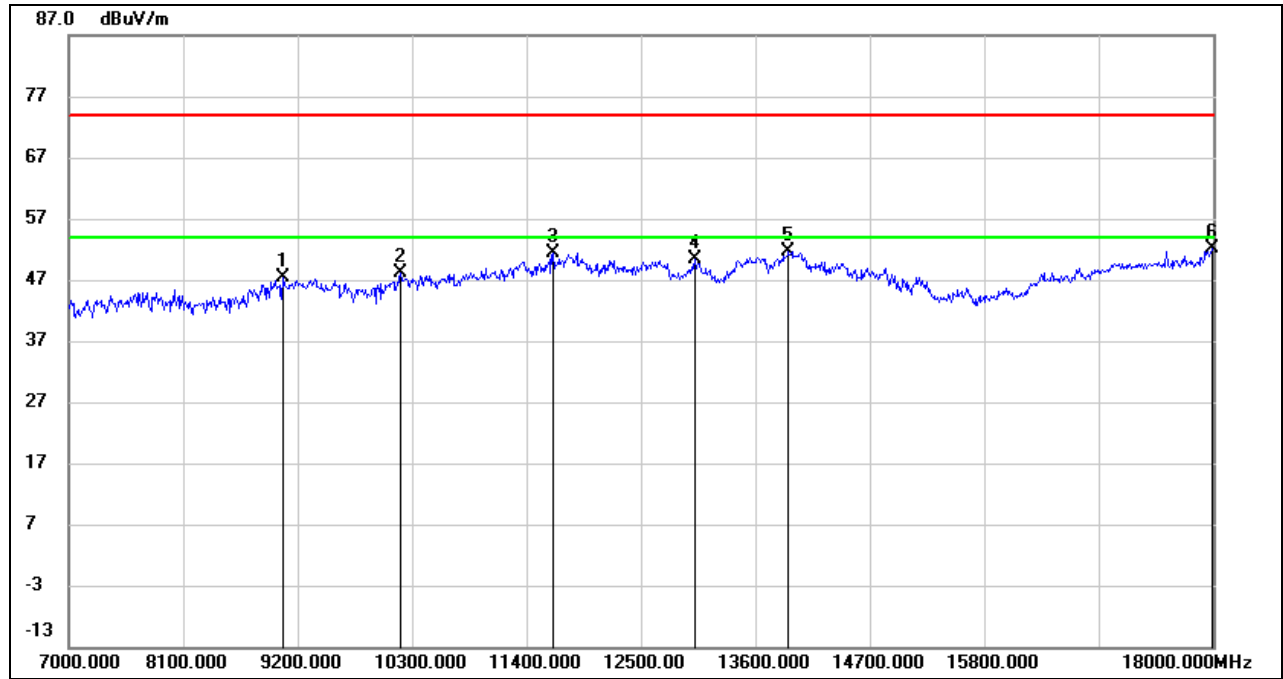

No.	Frequency (MHz)	Reading (dBuV)	Correct (dB/m)	Result (dBuV/m)	Limit (dBuV/m)	Margin (dB)	Remark
1	9057.000	37.00	10.38	47.38	74.00	-26.62	peak
2	10190.000	35.96	12.18	48.14	74.00	-25.86	peak
3	11653.000	34.37	17.05	51.42	74.00	-22.58	peak
4	13017.000	31.92	18.53	50.45	74.00	-23.55	peak
5	13919.000	30.01	21.68	51.69	74.00	-22.31	peak
6	17989.000	25.97	26.04	52.01	74.00	-21.99	peak

Note: 1. Measurement = Reading Level + Correct Factor.
 2. If Peak Result complies with AV limit, AV Result is deemed to comply with AV limit.
 3. Peak: Peak detector.
 4. Filter losses were only considered in the spurious frequency bands and the authorized band was not corrected for High Pass Filter losses.
 5. Proper operation of the transmitter prior to adding the filter to the measurement chain.
 6. Since non-restricted band peak emissions are less than the average limit, they also comply with the -27dBm/MHz (68.2dBuV/m) limit.

HARMONICS AND SPURIOUS EMISSIONS (HIGH CHANNEL, VERTICAL)

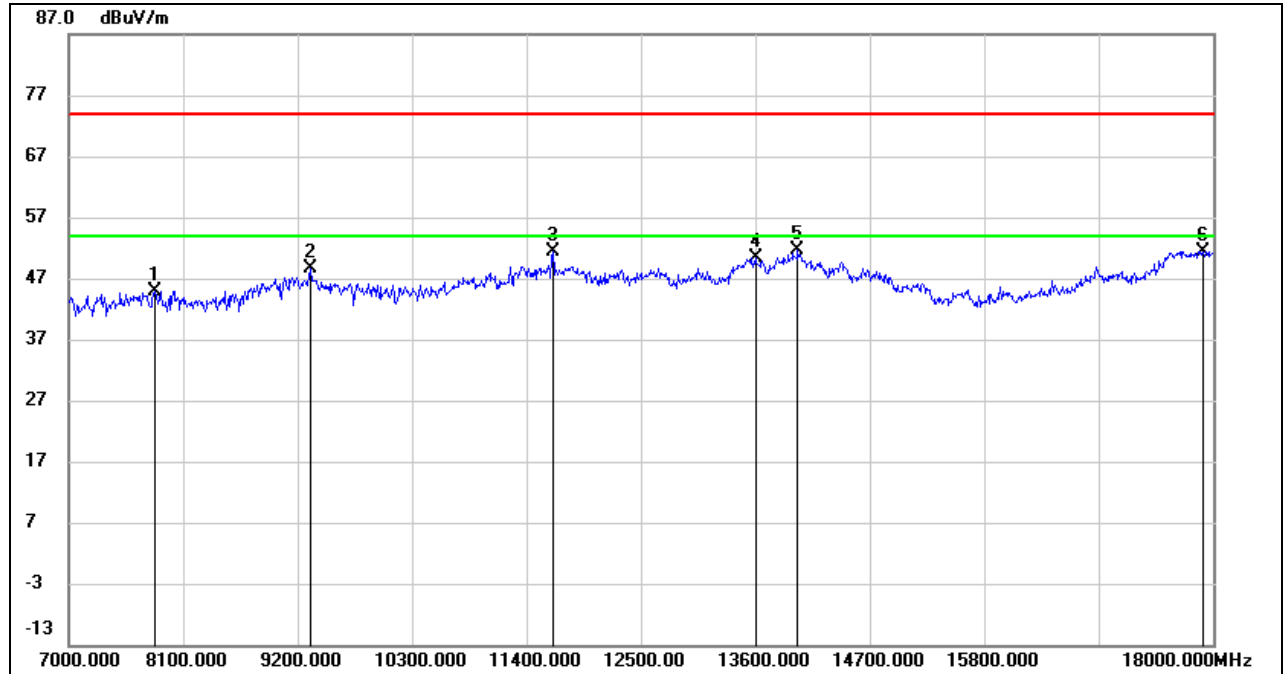

No.	Frequency (MHz)	Reading (dBuV)	Correct (dB/m)	Result (dBuV/m)	Limit (dBuV/m)	Margin (dB)	Remark
1	7825.000	38.33	6.58	44.91	74.00	-29.09	peak
2	9321.000	38.13	10.53	48.66	74.00	-25.34	peak
3	11653.000	34.28	17.05	51.33	74.00	-22.67	peak
4	13600.000	29.47	20.89	50.36	74.00	-23.64	peak
5	14007.000	29.74	21.85	51.59	74.00	-22.41	peak
6	17901.000	26.00	25.45	51.45	74.00	-22.55	peak

- Note: 1. Measurement = Reading Level + Correct Factor.
 2. If Peak Result complies with AV limit, AV Result is deemed to comply with AV limit.
 3. Peak: Peak detector.
 4. Filter losses were only considered in the spurious frequency bands and the authorized band was not corrected for High Pass Filter losses.
 5. Proper operation of the transmitter prior to adding the filter to the measurement chain.
 6. Since non-restricted band peak emissions are less than the average limit, they also comply with the -27dBm/MHz (68.2dBuV/m) limit.

8.3.2. 802.11n HT20 MIMO MODE

UNII-1 BAND

HARMONICS AND SPURIOUS EMISSIONS (LOW CHANNEL, HORIZONTAL)

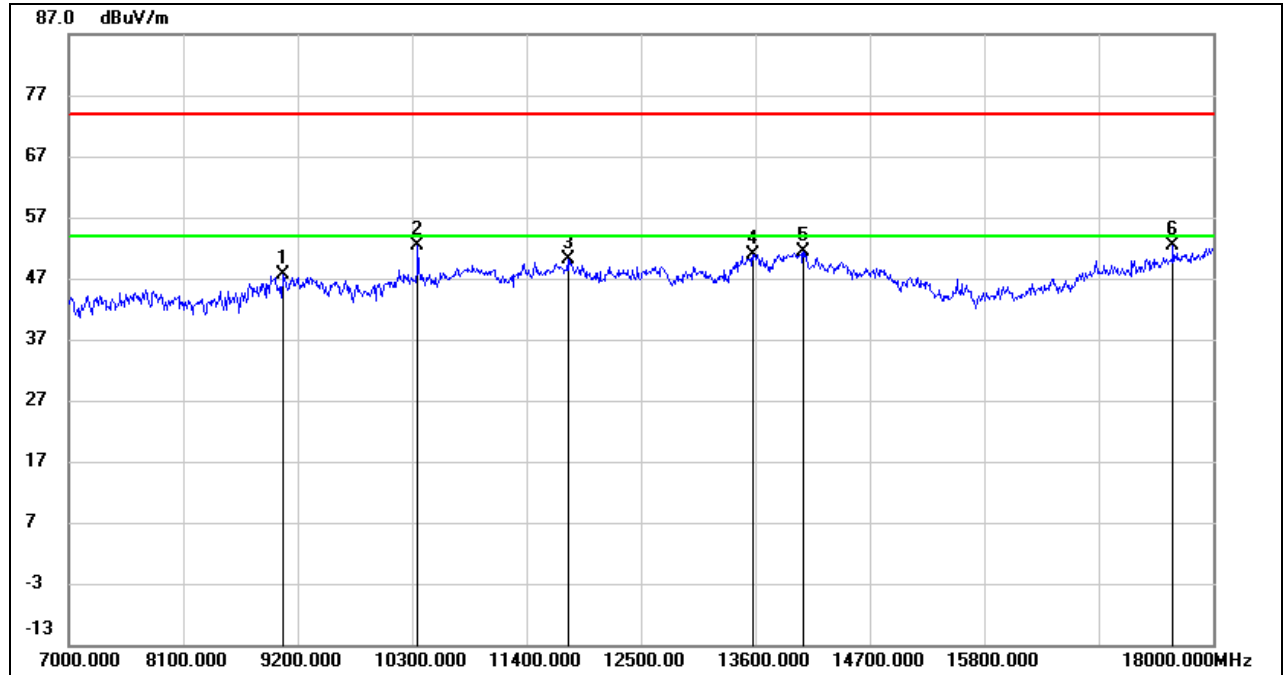

No.	Frequency (MHz)	Reading (dBuV)	Correct (dB/m)	Result (dBuV/m)	Limit (dBuV/m)	Margin (dB)	Remark
1	9057.000	37.20	10.38	47.58	74.00	-26.42	peak
2	10355.000	39.89	12.52	52.41	74.00	-21.59	peak
3	11796.000	32.80	17.32	50.12	74.00	-23.88	peak
4	13578.000	30.06	20.83	50.89	74.00	-23.11	peak
5	14062.000	29.74	21.62	51.36	74.00	-22.64	peak
6	17615.000	28.82	23.49	52.31	74.00	-21.69	peak

Note: 1. Measurement = Reading Level + Correct Factor.
 2. If Peak Result complies with AV limit, AV Result is deemed to comply with AV limit.
 3. Peak: Peak detector.
 4. Filter losses were only considered in the spurious frequency bands and the authorized band was not corrected for High Pass Filter losses.
 5. Proper operation of the transmitter prior to adding the filter to the measurement chain.
 6. Since non-restricted band peak emissions are less than the average limit, they also comply with the -27dBm/MHz (68.2dBuV/m) limit.



HARMONICS AND SPURIOUS EMISSIONS (LOW CHANNEL, VERTICAL)

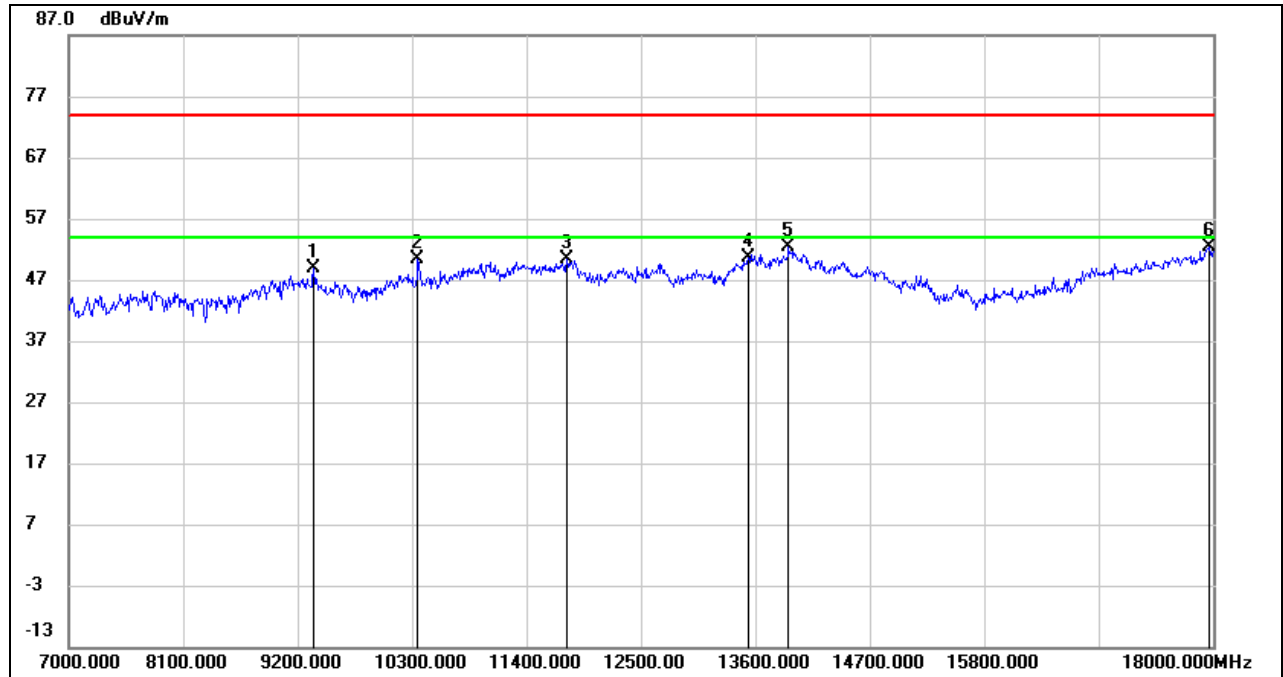

No.	Frequency (MHz)	Reading (dBuV)	Correct (dB/m)	Result (dBuV/m)	Limit (dBuV/m)	Margin (dB)	Remark
1	9354.000	38.38	10.56	48.94	74.00	-25.06	peak
2	10355.000	37.93	12.52	50.45	74.00	-23.55	peak
3	11785.000	33.04	17.30	50.34	74.00	-23.66	peak
4	13534.000	29.86	20.73	50.59	74.00	-23.41	peak
5	13919.000	30.64	21.68	52.32	74.00	-21.68	peak
6	17967.000	26.42	25.89	52.31	74.00	-21.69	peak

Note: 1. Measurement = Reading Level + Correct Factor.
 2. If Peak Result complies with AV limit, AV Result is deemed to comply with AV limit.
 3. Peak: Peak detector.
 4. Filter losses were only considered in the spurious frequency bands and the authorized band was not corrected for High Pass Filter losses.
 5. Proper operation of the transmitter prior to adding the filter to the measurement chain.
 6. Since non-restricted band peak emissions are less than the average limit, they also comply with the -27dBm/MHz (68.2dBuV/m) limit.



HARMONICS AND SPURIOUS EMISSIONS (MID CHANNEL, HORIZONTAL)

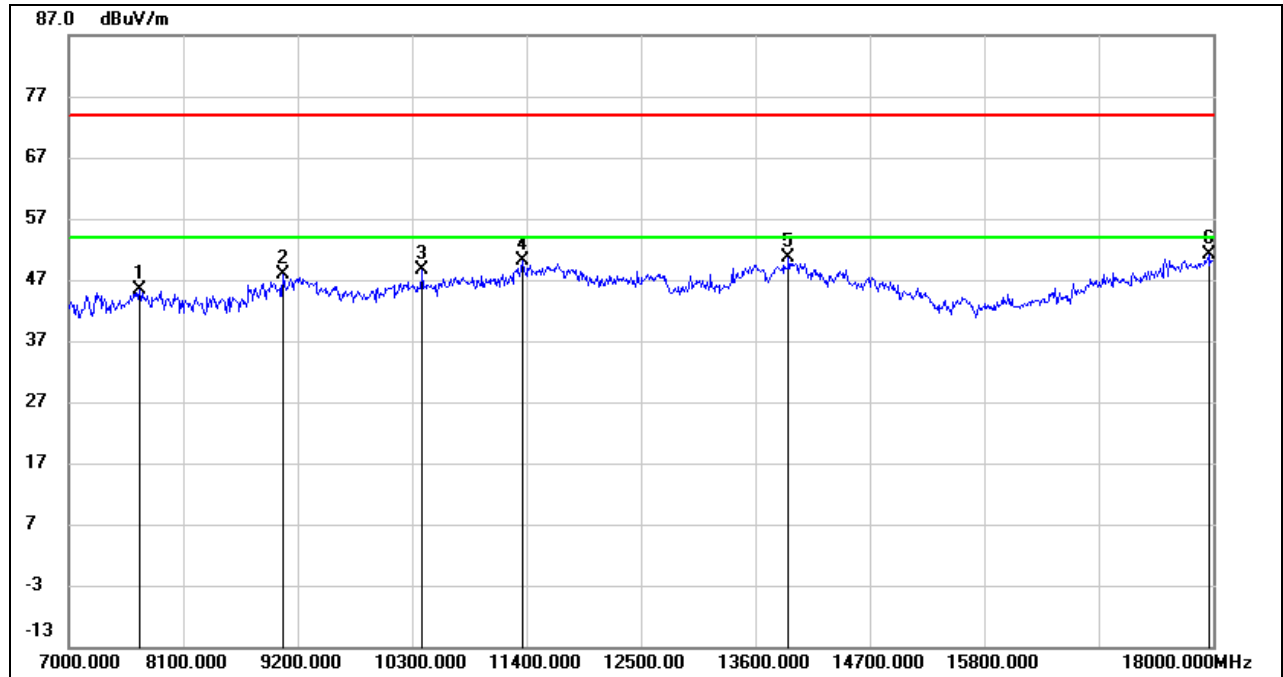

No.	Frequency (MHz)	Reading (dBuV)	Correct (dB/m)	Result (dBuV/m)	Limit (dBuV/m)	Margin (dB)	Remark
1	7682.000	38.59	6.71	45.30	74.00	-28.70	peak
2	9057.000	37.42	10.38	47.80	74.00	-26.20	peak
3	10399.000	36.01	12.61	48.62	74.00	-25.38	peak
4	11356.000	33.93	16.19	50.12	74.00	-23.88	peak
5	13919.000	28.92	21.68	50.60	74.00	-23.40	peak
6	17956.000	25.35	25.82	51.17	74.00	-22.83	peak

- Note: 1. Measurement = Reading Level + Correct Factor.
 2. If Peak Result complies with AV limit, AV Result is deemed to comply with AV limit.
 3. Peak: Peak detector.
 4. Filter losses were only considered in the spurious frequency bands and the authorized band was not corrected for High Pass Filter losses.
 5. Proper operation of the transmitter prior to adding the filter to the measurement chain.
 6. Since non-restricted band peak emissions are less than the average limit, they also comply with the -27dBm/MHz (68.2dBuV/m) limit.

HARMONICS AND SPURIOUS EMISSIONS (MID CHANNEL, VERTICAL)

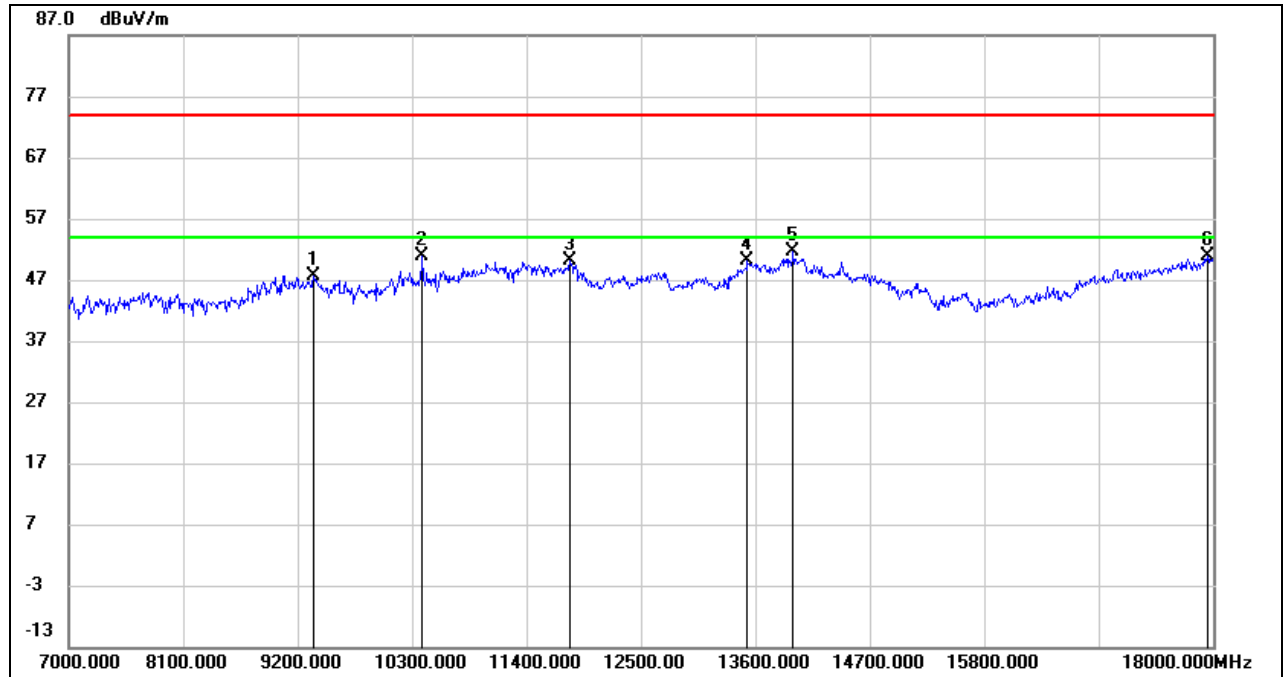

No.	Frequency (MHz)	Reading (dBuV)	Correct (dB/m)	Result (dBuV/m)	Limit (dBuV/m)	Margin (dB)	Remark
1	9354.000	37.17	10.56	47.73	74.00	-26.27	peak
2	10399.000	38.22	12.61	50.83	74.00	-23.17	peak
3	11818.000	32.82	17.36	50.18	74.00	-23.82	peak
4	13523.000	29.35	20.70	50.05	74.00	-23.95	peak
5	13963.000	29.89	21.78	51.67	74.00	-22.33	peak
6	17945.000	25.02	25.75	50.77	74.00	-23.23	peak

Note: 1. Measurement = Reading Level + Correct Factor.
 2. If Peak Result complies with AV limit, AV Result is deemed to comply with AV limit.
 3. Peak: Peak detector.
 4. Filter losses were only considered in the spurious frequency bands and the authorized band was not corrected for High Pass Filter losses.
 5. Proper operation of the transmitter prior to adding the filter to the measurement chain.
 6. Since non-restricted band peak emissions are less than the average limit, they also comply with the -27dBm/MHz (68.2dBuV/m) limit.



HARMONICS AND SPURIOUS EMISSIONS (HIGH CHANNEL, HORIZONTAL)

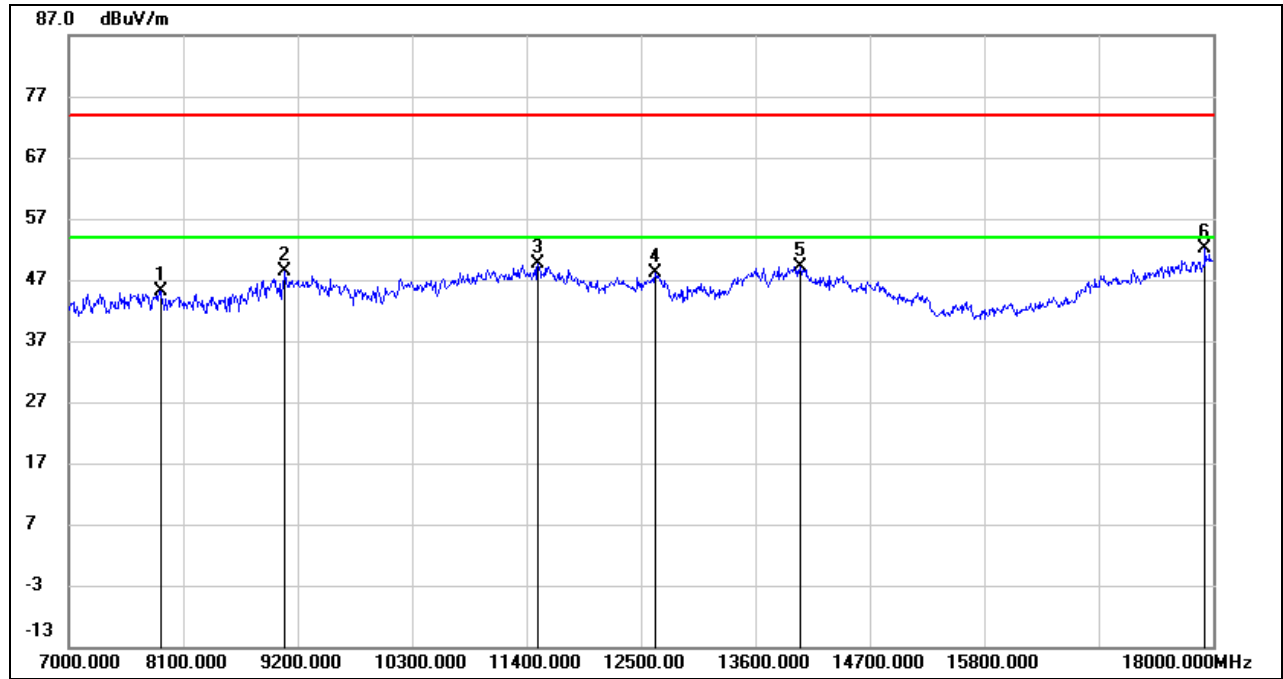

No.	Frequency (MHz)	Reading (dBuV)	Correct (dB/m)	Result (dBuV/m)	Limit (dBuV/m)	Margin (dB)	Remark
1	7880.000	38.66	6.54	45.20	74.00	-28.80	peak
2	9079.000	37.90	10.39	48.29	74.00	-25.71	peak
3	11510.000	32.80	16.79	49.59	74.00	-24.41	peak
4	12643.000	30.18	18.01	48.19	74.00	-25.81	peak
5	14029.000	27.39	21.76	49.15	74.00	-24.85	peak
6	17923.000	26.44	25.60	52.04	74.00	-21.96	peak

Note: 1. Measurement = Reading Level + Correct Factor.
 2. If Peak Result complies with AV limit, AV Result is deemed to comply with AV limit.
 3. Peak: Peak detector.
 4. Filter losses were only considered in the spurious frequency bands and the authorized band was not corrected for High Pass Filter losses.
 5. Proper operation of the transmitter prior to adding the filter to the measurement chain.
 6. Since non-restricted band peak emissions are less than the average limit, they also comply with the -27dBm/MHz (68.2dBuV/m) limit.

HARMONICS AND SPURIOUS EMISSIONS (HIGH CHANNEL, VERTICAL)

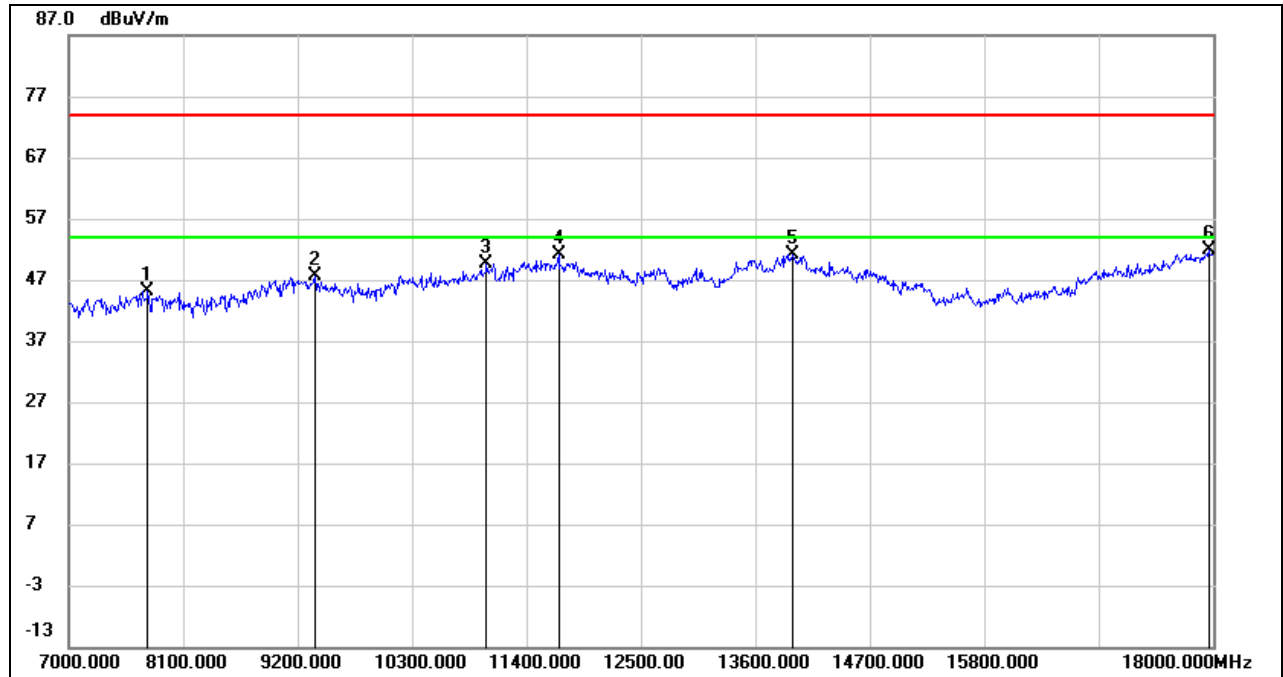

No.	Frequency (MHz)	Reading (dBuV)	Correct (dB/m)	Result (dBuV/m)	Limit (dBuV/m)	Margin (dB)	Remark
1	7759.000	38.44	6.64	45.08	74.00	-28.92	peak
2	9365.000	36.96	10.57	47.53	74.00	-26.47	peak
3	11015.000	34.91	14.79	49.70	74.00	-24.30	peak
4	11708.000	33.96	17.16	51.12	74.00	-22.88	peak
5	13952.000	29.32	21.76	51.08	74.00	-22.92	peak
6	17956.000	26.16	25.82	51.98	74.00	-22.02	peak

Note: 1. Measurement = Reading Level + Correct Factor.
 2. If Peak Result complies with AV limit, AV Result is deemed to comply with AV limit.
 3. Peak: Peak detector.
 4. Filter losses were only considered in the spurious frequency bands and the authorized band was not corrected for High Pass Filter losses.
 5. Proper operation of the transmitter prior to adding the filter to the measurement chain.
 6. Since non-restricted band peak emissions are less than the average limit, they also comply with the -27dBm/MHz (68.2dBuV/m) limit.



UNII-2A BAND

HARMONICS AND SPURIOUS EMISSIONS (LOW CHANNEL, HORIZONTAL)

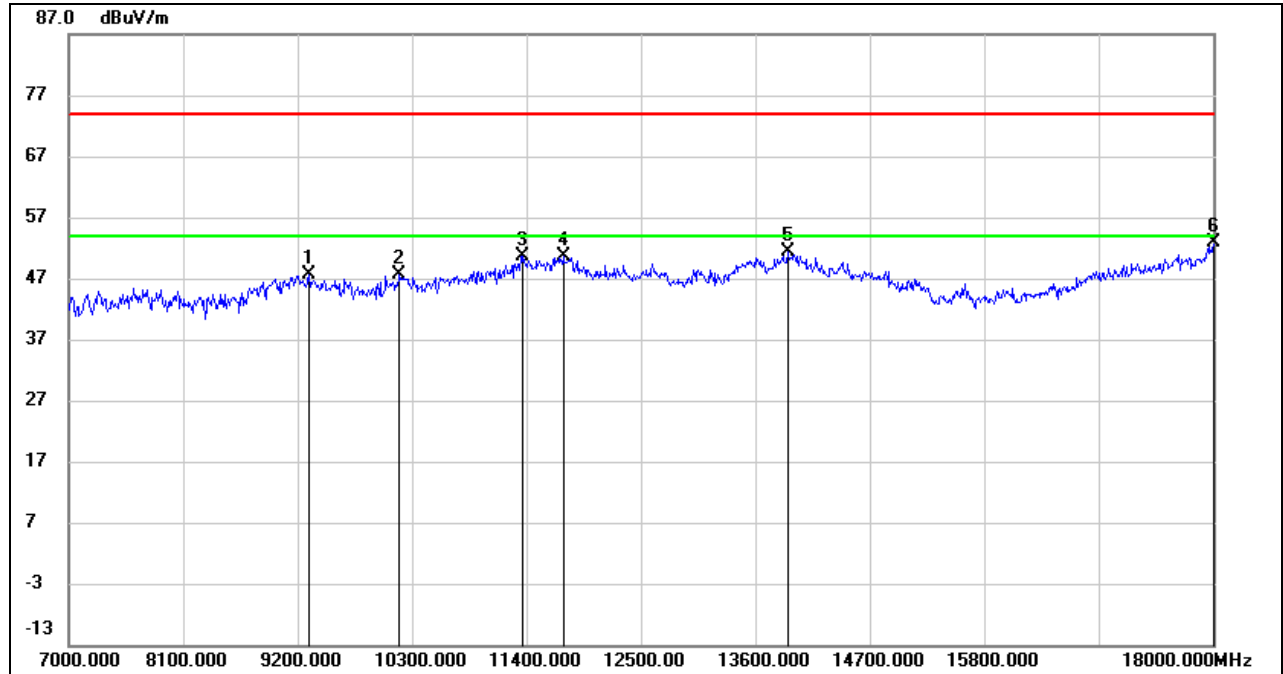

No.	Frequency (MHz)	Reading (dBuV)	Correct (dB/m)	Result (dBuV/m)	Limit (dBuV/m)	Margin (dB)	Remark
1	9310.000	37.15	10.54	47.69	74.00	-26.31	peak
2	10179.000	35.46	12.14	47.60	74.00	-26.40	peak
3	11367.000	34.40	16.22	50.62	74.00	-23.38	peak
4	11752.000	33.28	17.24	50.52	74.00	-23.48	peak
5	13908.000	29.64	21.66	51.30	74.00	-22.70	peak
6	18000.000	26.65	26.12	52.77	74.00	-21.23	peak

Note: 1. Measurement = Reading Level + Correct Factor.
 2. If Peak Result complies with AV limit, AV Result is deemed to comply with AV limit.
 3. Peak: Peak detector.
 4. Filter losses were only considered in the spurious frequency bands and the authorized band was not corrected for High Pass Filter losses.
 5. Proper operation of the transmitter prior to adding the filter to the measurement chain.
 6. Since non-restricted band peak emissions are less than the average limit, they also comply with the -27dBm/MHz (68.2dBuV/m) limit.

HARMONICS AND SPURIOUS EMISSIONS (LOW CHANNEL, VERTICAL)

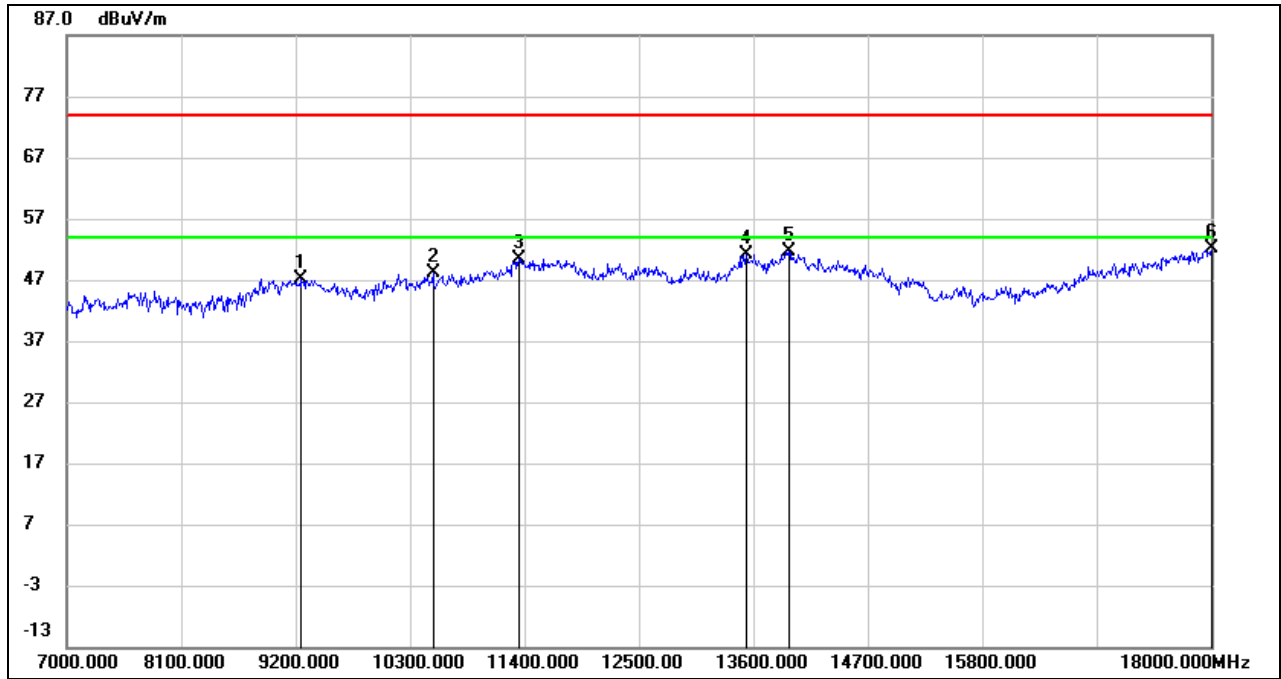

No.	Frequency (MHz)	Reading (dBuV)	Correct (dB/m)	Result (dBuV/m)	Limit (dBuV/m)	Margin (dB)	Remark
1	9255.000	36.70	10.51	47.21	74.00	-26.79	peak
2	10520.000	35.33	12.90	48.23	74.00	-25.77	peak
3	11345.000	34.33	16.14	50.47	74.00	-23.53	peak
4	13534.000	30.49	20.73	51.22	74.00	-22.78	peak
5	13941.000	29.89	21.73	51.62	74.00	-22.38	peak
6	18000.000	26.10	26.12	52.22	74.00	-21.78	peak

Note: 1. Measurement = Reading Level + Correct Factor.
 2. If Peak Result complies with AV limit, AV Result is deemed to comply with AV limit.
 3. Peak: Peak detector.
 4. Filter losses were only considered in the spurious frequency bands and the authorized band was not corrected for High Pass Filter losses.
 5. Proper operation of the transmitter prior to adding the filter to the measurement chain.
 6. Since non-restricted band peak emissions are less than the average limit, they also comply with the -27dBm/MHz (68.2dBuV/m) limit.



HARMONICS AND SPURIOUS EMISSIONS (MID CHANNEL, HORIZONTAL)

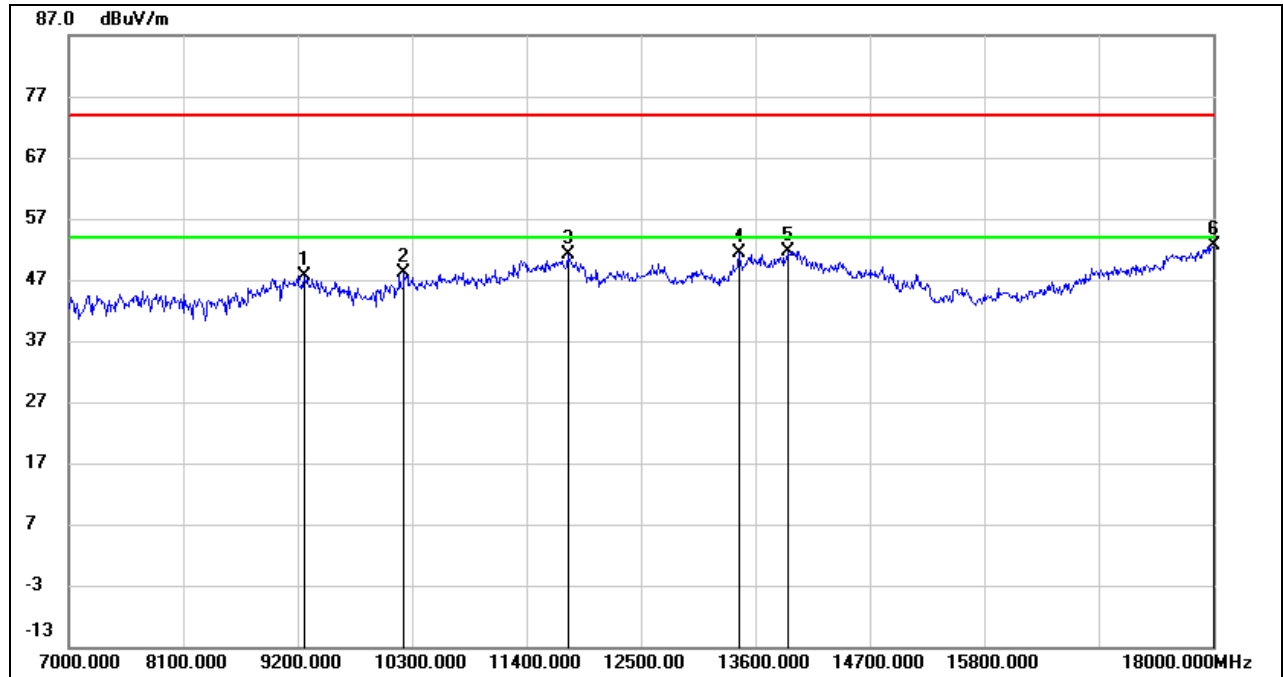

No.	Frequency (MHz)	Reading (dBuV)	Correct (dB/m)	Result (dBuV/m)	Limit (dBuV/m)	Margin (dB)	Remark
1	9266.000	37.07	10.51	47.58	74.00	-26.42	peak
2	10223.000	35.79	12.24	48.03	74.00	-25.97	peak
3	11796.000	33.91	17.32	51.23	74.00	-22.77	peak
4	13446.000	30.90	20.41	51.31	74.00	-22.69	peak
5	13908.000	30.07	21.66	51.73	74.00	-22.27	peak
6	18000.000	26.53	26.12	52.65	74.00	-21.35	peak

Note: 1. Measurement = Reading Level + Correct Factor.
 2. If Peak Result complies with AV limit, AV Result is deemed to comply with AV limit.
 3. Peak: Peak detector.
 4. Filter losses were only considered in the spurious frequency bands and the authorized band was not corrected for High Pass Filter losses.
 5. Proper operation of the transmitter prior to adding the filter to the measurement chain.
 6. Since non-restricted band peak emissions are less than the average limit, they also comply with the -27dBm/MHz (68.2dBuV/m) limit.



HARMONICS AND SPURIOUS EMISSIONS (MID CHANNEL, VERTICAL)

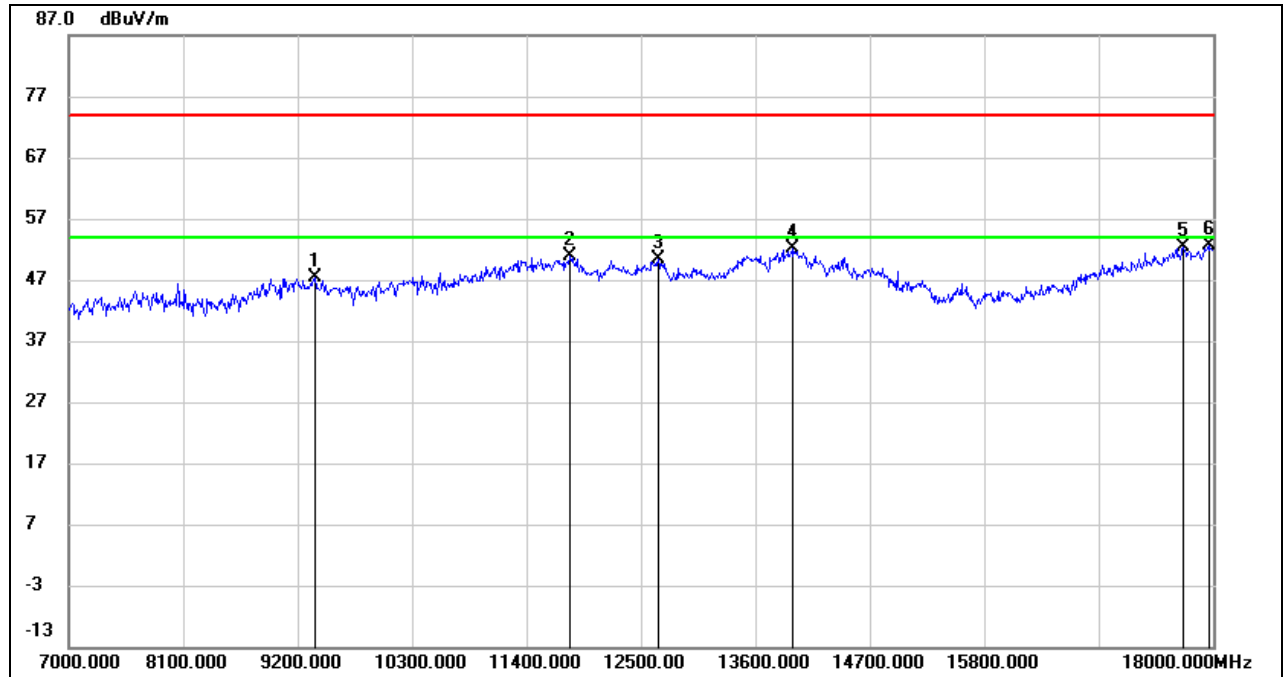

No.	Frequency (MHz)	Reading (dBuV)	Correct (dB/m)	Result (dBuV/m)	Limit (dBuV/m)	Margin (dB)	Remark
1	9365.000	36.73	10.57	47.30	74.00	-26.70	peak
2	11818.000	33.58	17.36	50.94	74.00	-23.06	peak
3	12665.000	32.26	18.04	50.30	74.00	-23.70	peak
4	13952.000	30.41	21.76	52.17	74.00	-21.83	peak
5	17714.000	28.25	24.16	52.41	74.00	-21.59	peak
6	17956.000	26.80	25.82	52.62	74.00	-21.38	peak

Note: 1. Measurement = Reading Level + Correct Factor.
 2. If Peak Result complies with AV limit, AV Result is deemed to comply with AV limit.
 3. Peak: Peak detector.
 4. Filter losses were only considered in the spurious frequency bands and the authorized band was not corrected for High Pass Filter losses.
 5. Proper operation of the transmitter prior to adding the filter to the measurement chain.
 6. Since non-restricted band peak emissions are less than the average limit, they also comply with the -27dBm/MHz (68.2dBuV/m) limit.

HARMONICS AND SPURIOUS EMISSIONS (HIGH CHANNEL, HORIZONTAL)

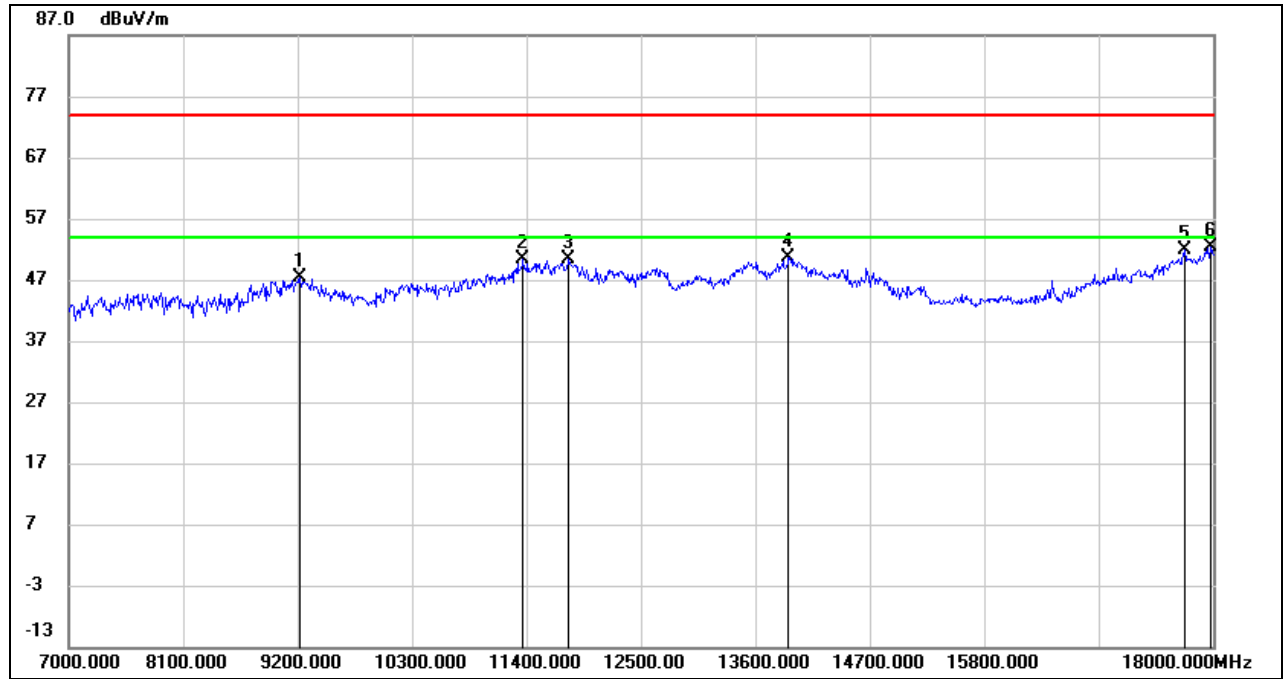

No.	Frequency (MHz)	Reading (dBuV)	Correct (dB/m)	Result (dBuV/m)	Limit (dBuV/m)	Margin (dB)	Remark
1	9222.000	36.84	10.48	47.32	74.00	-26.68	peak
2	11367.000	34.07	16.22	50.29	74.00	-23.71	peak
3	11807.000	33.07	17.34	50.41	74.00	-23.59	peak
4	13919.000	29.07	21.68	50.75	74.00	-23.25	peak
5	17725.000	27.67	24.24	51.91	74.00	-22.09	peak
6	17978.000	26.38	25.97	52.35	74.00	-21.65	peak

Note: 1. Measurement = Reading Level + Correct Factor.
 2. If Peak Result complies with AV limit, AV Result is deemed to comply with AV limit.
 3. Peak: Peak detector.
 4. Filter losses were only considered in the spurious frequency bands and the authorized band was not corrected for High Pass Filter losses.
 5. Proper operation of the transmitter prior to adding the filter to the measurement chain.
 6. Since non-restricted band peak emissions are less than the average limit, they also comply with the -27dBm/MHz (68.2dBuV/m) limit.



HARMONICS AND SPURIOUS EMISSIONS (HIGH CHANNEL, VERTICAL)

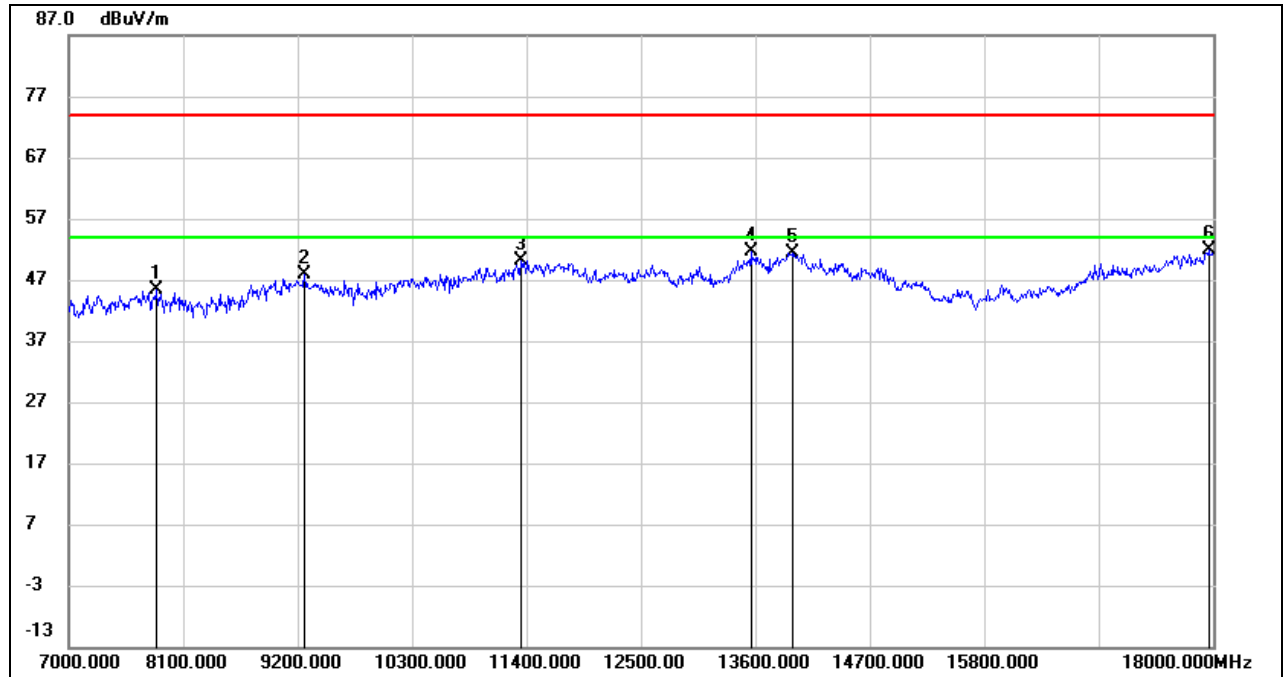

No.	Frequency (MHz)	Reading (dBuV)	Correct (dB/m)	Result (dBuV/m)	Limit (dBuV/m)	Margin (dB)	Remark
1	7847.000	38.84	6.57	45.41	74.00	-28.59	peak
2	9266.000	37.37	10.51	47.88	74.00	-26.12	peak
3	11345.000	33.91	16.14	50.05	74.00	-23.95	peak
4	13556.000	30.74	20.78	51.52	74.00	-22.48	peak
5	13963.000	29.72	21.78	51.50	74.00	-22.50	peak
6	17956.000	26.05	25.82	51.87	74.00	-22.13	peak

Note: 1. Measurement = Reading Level + Correct Factor.
 2. If Peak Result complies with AV limit, AV Result is deemed to comply with AV limit.
 3. Peak: Peak detector.
 4. Filter losses were only considered in the spurious frequency bands and the authorized band was not corrected for High Pass Filter losses.
 5. Proper operation of the transmitter prior to adding the filter to the measurement chain.
 6. Since non-restricted band peak emissions are less than the average limit, they also comply with the -27dBm/MHz (68.2dBuV/m) limit.

UNII-2C BAND

HARMONICS AND SPURIOUS EMISSIONS (LOW CHANNEL, HORIZONTAL)

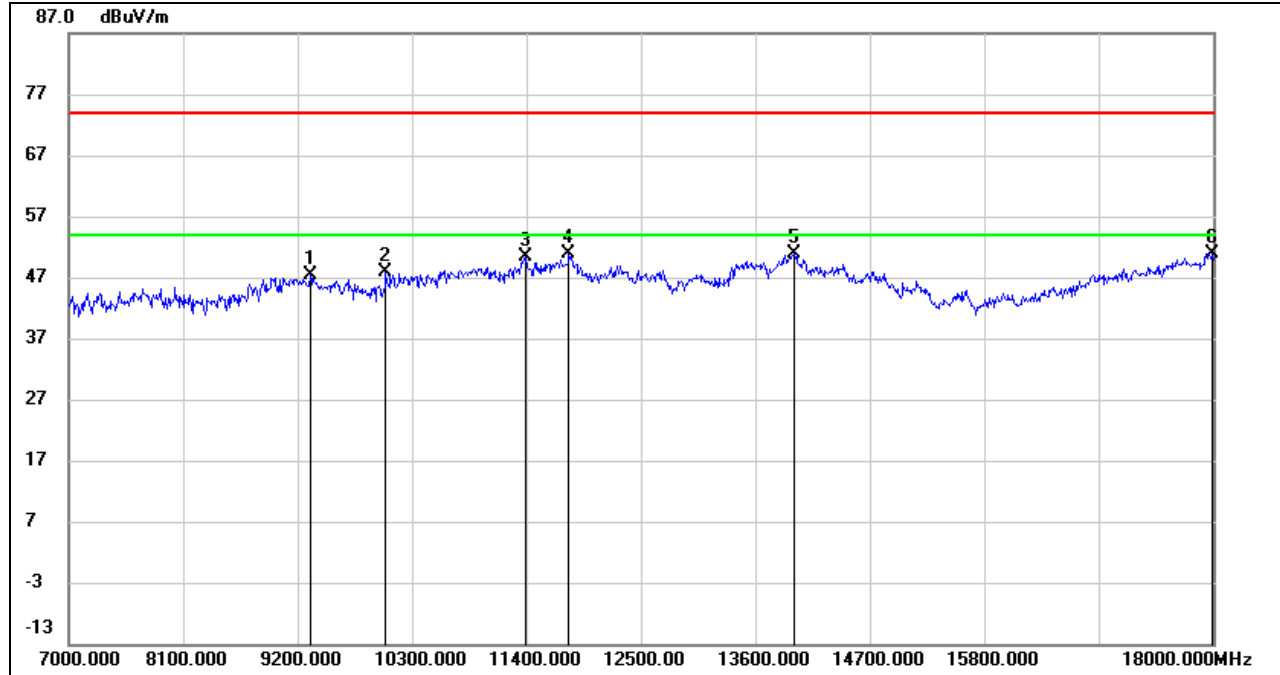

No.	Frequency (MHz)	Reading (dBuV)	Correct (dB/m)	Result (dBuV/m)	Limit (dBuV/m)	Margin (dB)	Remark
1	9321.000	36.80	10.53	47.33	74.00	-26.67	peak
2	10047.000	36.06	11.87	47.93	74.00	-26.07	peak
3	11389.000	34.04	16.31	50.35	74.00	-23.65	peak
4	11807.000	33.57	17.34	50.91	74.00	-23.09	peak
5	13974.000	29.03	21.82	50.85	74.00	-23.15	peak
6	17989.000	24.77	26.04	50.81	74.00	-23.19	peak

Note: 1. Measurement = Reading Level + Correct Factor.
 2. If Peak Result complies with AV limit, AV Result is deemed to comply with AV limit.
 3. Peak: Peak detector.
 4. Filter losses were only considered in the spurious frequency bands and the authorized band was not corrected for High Pass Filter losses.
 5. Proper operation of the transmitter prior to adding the filter to the measurement chain.
 6. Since non-restricted band peak emissions are less than the average limit, they also comply with the -27dBm/MHz (68.2dBuV/m) limit.

HARMONICS AND SPURIOUS EMISSIONS (LOW CHANNEL, VERTICAL)

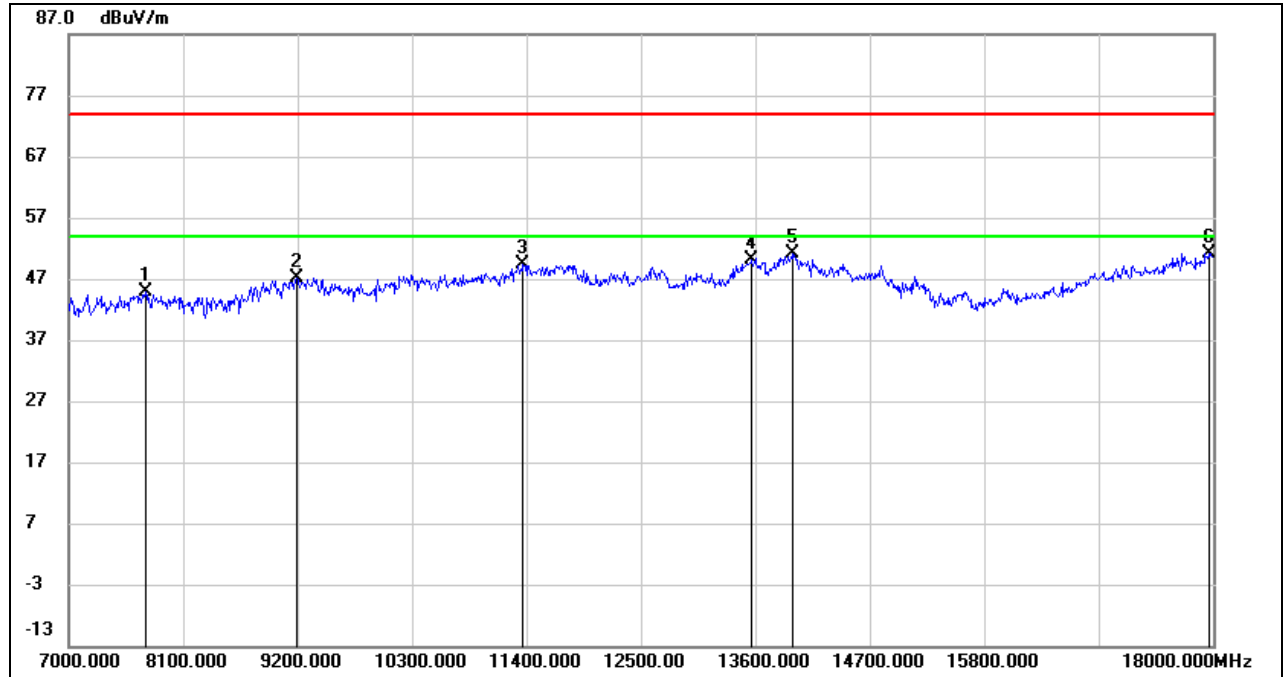

No.	Frequency (MHz)	Reading (dBuV)	Correct (dB/m)	Result (dBuV/m)	Limit (dBuV/m)	Margin (dB)	Remark
1	7737.000	38.30	6.66	44.96	74.00	-29.04	peak
2	9189.000	36.77	10.46	47.23	74.00	-26.77	peak
3	11367.000	33.19	16.22	49.41	74.00	-24.59	peak
4	13567.000	29.23	20.80	50.03	74.00	-23.97	peak
5	13952.000	29.42	21.76	51.18	74.00	-22.82	peak
6	17956.000	25.40	25.82	51.22	74.00	-22.78	peak

Note: 1. Measurement = Reading Level + Correct Factor.
 2. If Peak Result complies with AV limit, AV Result is deemed to comply with AV limit.
 3. Peak: Peak detector.
 4. Filter losses were only considered in the spurious frequency bands and the authorized band was not corrected for High Pass Filter losses.
 5. Proper operation of the transmitter prior to adding the filter to the measurement chain.
 6. Since non-restricted band peak emissions are less than the average limit, they also comply with the -27dBm/MHz (68.2dBuV/m) limit.

HARMONICS AND SPURIOUS EMISSIONS (MID CHANNEL, HORIZONTAL)

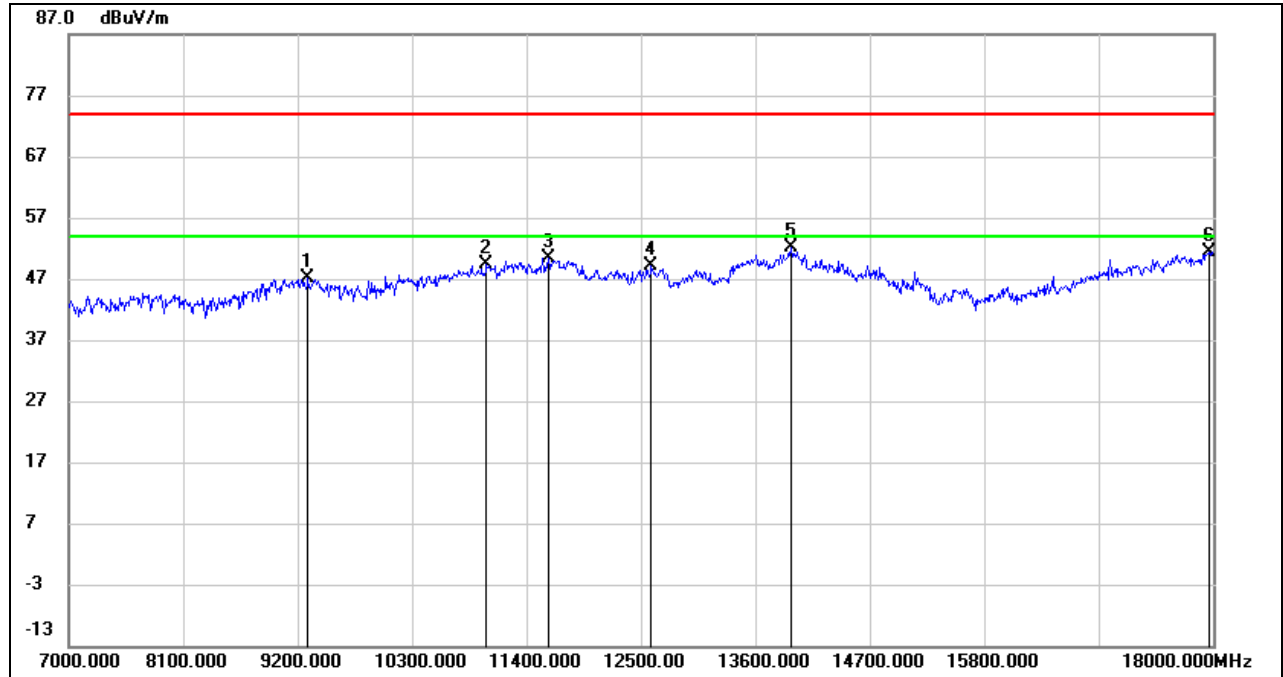

No.	Frequency (MHz)	Reading (dBuV)	Correct (dB/m)	Result (dBuV/m)	Limit (dBuV/m)	Margin (dB)	Remark
1	9299.000	36.68	10.53	47.21	74.00	-26.79	peak
2	11015.000	34.47	14.79	49.26	74.00	-24.74	peak
3	11609.000	33.51	16.98	50.49	74.00	-23.51	peak
4	12599.000	31.23	17.95	49.18	74.00	-24.82	peak
5	13941.000	30.35	21.73	52.08	74.00	-21.92	peak
6	17967.000	25.56	25.89	51.45	74.00	-22.55	peak

Note: 1. Measurement = Reading Level + Correct Factor.
 2. If Peak Result complies with AV limit, AV Result is deemed to comply with AV limit.
 3. Peak: Peak detector.
 4. Filter losses were only considered in the spurious frequency bands and the authorized band was not corrected for High Pass Filter losses.
 5. Proper operation of the transmitter prior to adding the filter to the measurement chain.
 6. Since non-restricted band peak emissions are less than the average limit, they also comply with the -27dBm/MHz (68.2dBuV/m) limit.



HARMONICS AND SPURIOUS EMISSIONS (MID CHANNEL, VERTICAL)

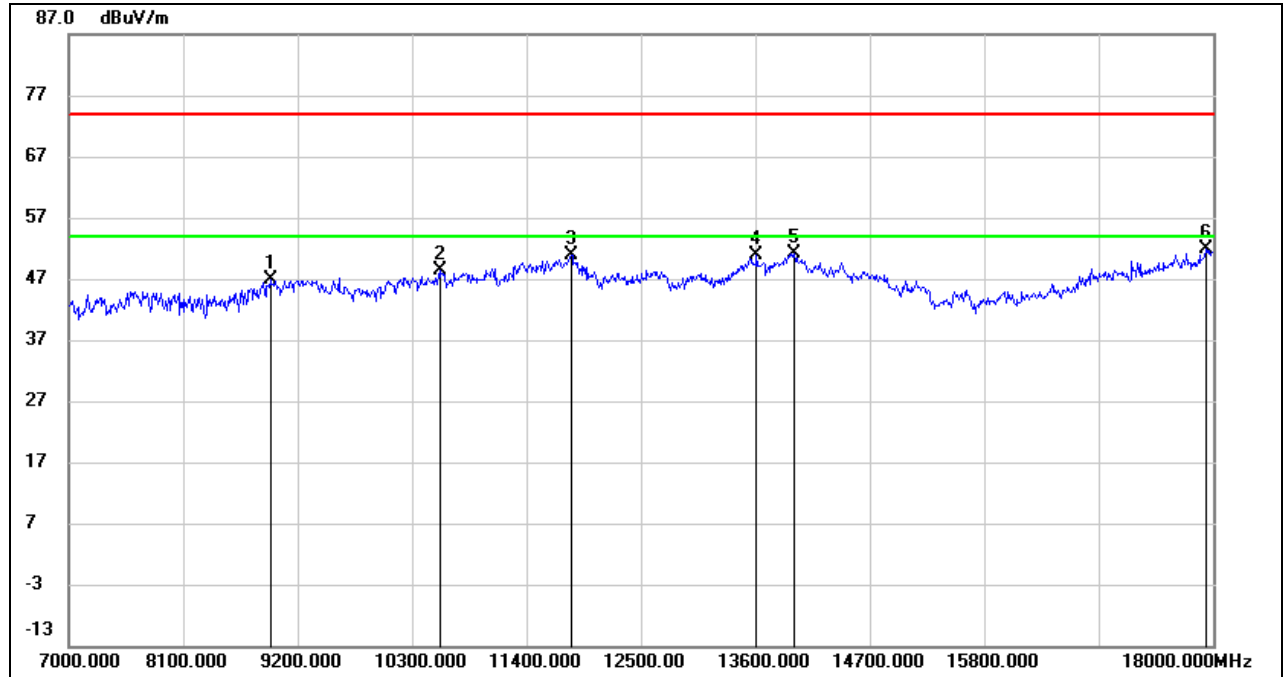

No.	Frequency (MHz)	Reading (dBuV)	Correct (dB/m)	Result (dBuV/m)	Limit (dBuV/m)	Margin (dB)	Remark
1	8936.000	36.86	9.90	46.76	74.00	-27.24	peak
2	10564.000	35.21	13.06	48.27	74.00	-25.73	peak
3	11829.000	33.40	17.38	50.78	74.00	-23.22	peak
4	13611.000	29.86	20.92	50.78	74.00	-23.22	peak
5	13974.000	29.20	21.82	51.02	74.00	-22.98	peak
6	17934.000	26.14	25.67	51.81	74.00	-22.19	peak

Note: 1. Measurement = Reading Level + Correct Factor.
 2. If Peak Result complies with AV limit, AV Result is deemed to comply with AV limit.
 3. Peak: Peak detector.
 4. Filter losses were only considered in the spurious frequency bands and the authorized band was not corrected for High Pass Filter losses.
 5. Proper operation of the transmitter prior to adding the filter to the measurement chain.
 6. Since non-restricted band peak emissions are less than the average limit, they also comply with the -27dBm/MHz (68.2dBuV/m) limit.

HARMONICS AND SPURIOUS EMISSIONS (HIGH CHANNEL, HORIZONTAL)

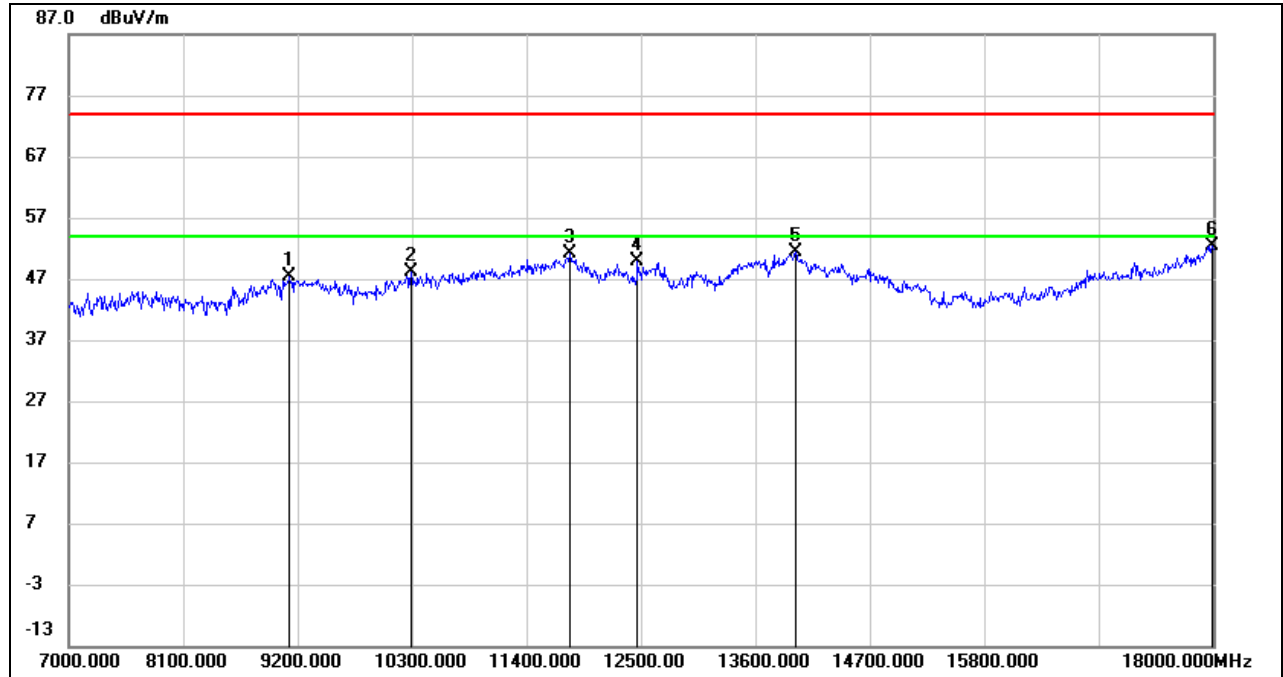

No.	Frequency (MHz)	Reading (dBuV)	Correct (dB/m)	Result (dBuV/m)	Limit (dBuV/m)	Margin (dB)	Remark
1	9123.000	37.01	10.42	47.43	74.00	-26.57	peak
2	10289.000	35.68	12.38	48.06	74.00	-25.94	peak
3	11818.000	33.84	17.36	51.20	74.00	-22.80	peak
4	12467.000	32.15	17.82	49.97	74.00	-24.03	peak
5	13985.000	29.59	21.85	51.44	74.00	-22.56	peak
6	17989.000	26.29	26.04	52.33	74.00	-21.67	peak

Note: 1. Measurement = Reading Level + Correct Factor.
 2. If Peak Result complies with AV limit, AV Result is deemed to comply with AV limit.
 3. Peak: Peak detector.
 4. Filter losses were only considered in the spurious frequency bands and the authorized band was not corrected for High Pass Filter losses.
 5. Proper operation of the transmitter prior to adding the filter to the measurement chain.
 6. Since non-restricted band peak emissions are less than the average limit, they also comply with the -27dBm/MHz (68.2dBuV/m) limit.

HARMONICS AND SPURIOUS EMISSIONS (HIGH CHANNEL, VERTICAL)

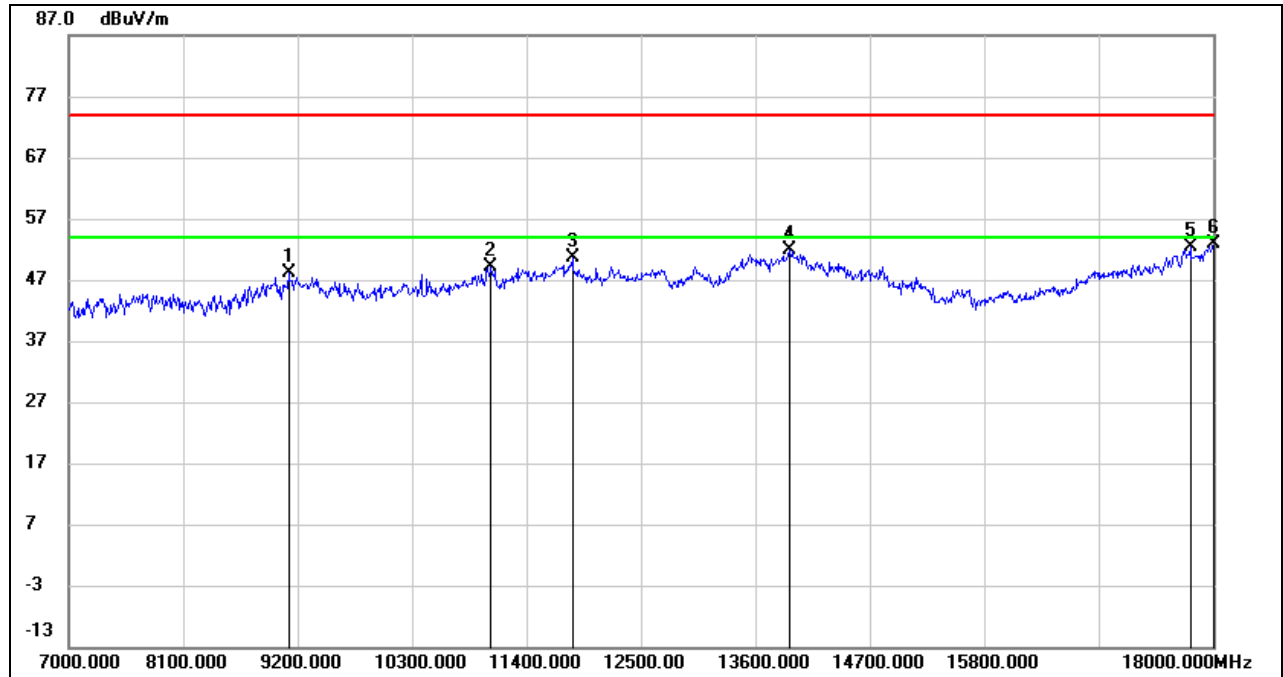

No.	Frequency (MHz)	Reading (dBuV)	Correct (dB/m)	Result (dBuV/m)	Limit (dBuV/m)	Margin (dB)	Remark
1	9112.000	37.68	10.41	48.09	74.00	-25.91	peak
2	11059.000	34.14	14.96	49.10	74.00	-24.90	peak
3	11840.000	33.25	17.40	50.65	74.00	-23.35	peak
4	13930.000	30.18	21.71	51.89	74.00	-22.11	peak
5	17780.000	27.67	24.61	52.28	74.00	-21.72	peak
6	18000.000	26.80	26.12	52.92	74.00	-21.08	peak

Note: 1. Measurement = Reading Level + Correct Factor.
 2. If Peak Result complies with AV limit, AV Result is deemed to comply with AV limit.
 3. Peak: Peak detector.
 4. Filter losses were only considered in the spurious frequency bands and the authorized band was not corrected for High Pass Filter losses.
 5. Proper operation of the transmitter prior to adding the filter to the measurement chain.
 6. Since non-restricted band peak emissions are less than the average limit, they also comply with the -27dBm/MHz (68.2dBuV/m) limit.



STRADDLE CHANNEL 144

HARMONICS AND SPURIOUS EMISSIONS (HORIZONTAL)

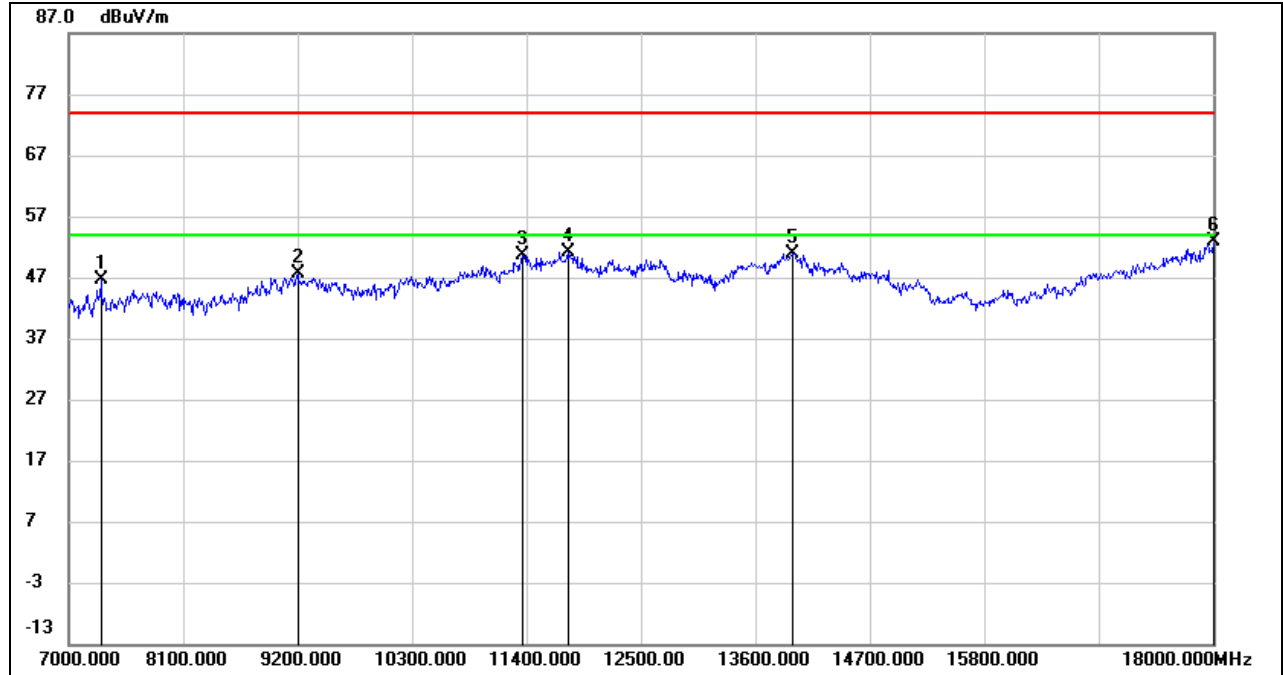

No.	Frequency (MHz)	Reading (dBuV)	Correct (dB/m)	Result (dBuV/m)	Limit (dBuV/m)	Margin (dB)	Remark
1	7308.000	39.77	6.94	46.71	74.00	-27.29	peak
2	9200.000	37.17	10.46	47.63	74.00	-26.37	peak
3	11367.000	34.41	16.22	50.63	74.00	-23.37	peak
4	11796.000	33.93	17.32	51.25	74.00	-22.75	peak
5	13963.000	29.17	21.78	50.95	74.00	-23.05	peak
6	18000.000	26.72	26.12	52.84	74.00	-21.16	peak

- Note: 1. Measurement = Reading Level + Correct Factor.
 2. If Peak Result complies with AV limit, AV Result is deemed to comply with AV limit.
 3. Peak: Peak detector.
 4. Filter losses were only considered in the spurious frequency bands and the authorized band was not corrected for High Pass Filter losses.
 5. Proper operation of the transmitter prior to adding the filter to the measurement chain.
 6. Since non-restricted band peak emissions are less than the average limit, they also comply with the -27dBm/MHz (68.2dBuV/m) limit.



HARMONICS AND SPURIOUS EMISSIONS (VERTICAL)

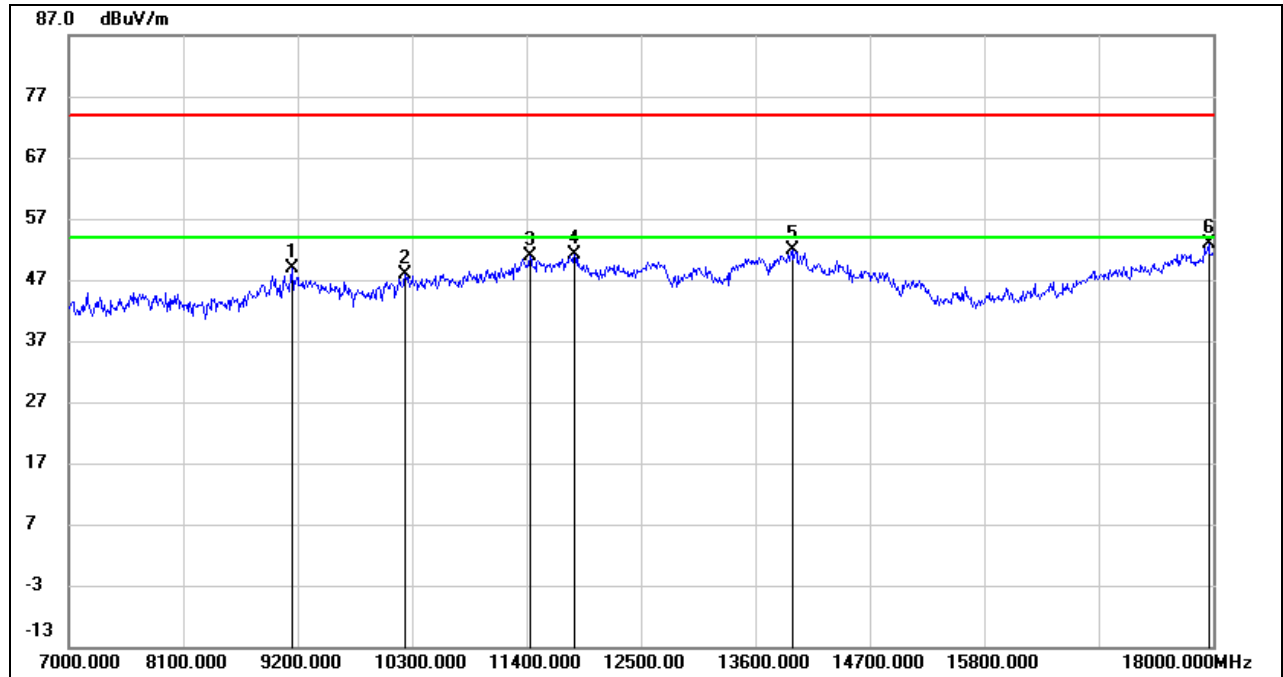

No.	Frequency (MHz)	Reading (dBuV)	Correct (dB/m)	Result (dBuV/m)	Limit (dBuV/m)	Margin (dB)	Remark
1	9145.000	38.45	10.43	48.88	74.00	-25.12	peak
2	10234.000	35.60	12.26	47.86	74.00	-26.14	peak
3	11433.000	34.45	16.50	50.95	74.00	-23.05	peak
4	11862.000	33.56	17.45	51.01	74.00	-22.99	peak
5	13952.000	30.03	21.76	51.79	74.00	-22.21	peak
6	17956.000	26.99	25.82	52.81	74.00	-21.19	peak

Note: 1. Measurement = Reading Level + Correct Factor.
 2. If Peak Result complies with AV limit, AV Result is deemed to comply with AV limit.
 3. Peak: Peak detector.
 4. Filter losses were only considered in the spurious frequency bands and the authorized band was not corrected for High Pass Filter losses.
 5. Proper operation of the transmitter prior to adding the filter to the measurement chain.
 6. Since non-restricted band peak emissions are less than the average limit, they also comply with the -27dBm/MHz (68.2dBuV/m) limit.

UNII-3 BAND

HARMONICS AND SPURIOUS EMISSIONS (LOW CHANNEL, HORIZONTAL)

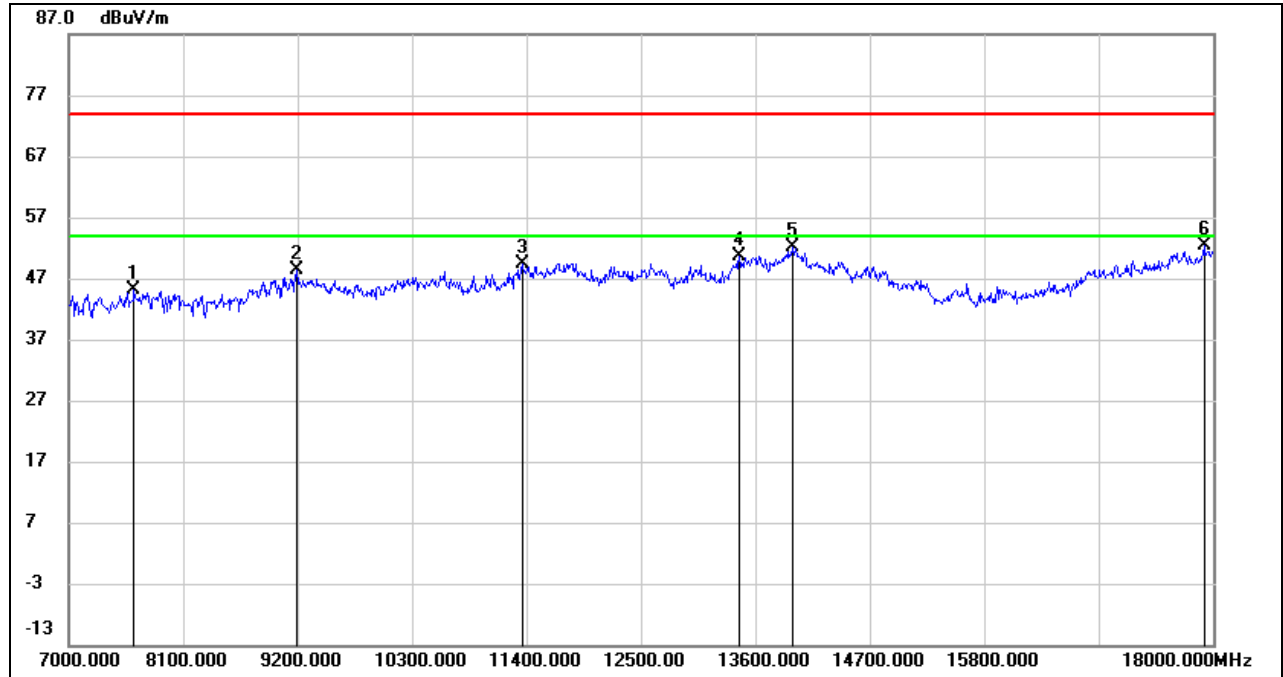

No.	Frequency (MHz)	Reading (dBuV)	Correct (dB/m)	Result (dBuV/m)	Limit (dBuV/m)	Margin (dB)	Remark
1	7627.000	38.39	6.76	45.15	74.00	-28.85	peak
2	9189.000	38.02	10.46	48.48	74.00	-25.52	peak
3	11356.000	33.30	16.19	49.49	74.00	-24.51	peak
4	13446.000	30.23	20.41	50.64	74.00	-23.36	peak
5	13952.000	30.38	21.76	52.14	74.00	-21.86	peak
6	17912.000	26.80	25.52	52.32	74.00	-21.68	peak

- Note: 1. Measurement = Reading Level + Correct Factor.
 2. If Peak Result complies with AV limit, AV Result is deemed to comply with AV limit.
 3. Peak: Peak detector.
 4. Filter losses were only considered in the spurious frequency bands and the authorized band was not corrected for High Pass Filter losses.
 5. Proper operation of the transmitter prior to adding the filter to the measurement chain.
 6. Since non-restricted band peak emissions are less than the average limit, they also comply with the -27dBm/MHz (68.2dBuV/m) limit.

HARMONICS AND SPURIOUS EMISSIONS (LOW CHANNEL, VERTICAL)

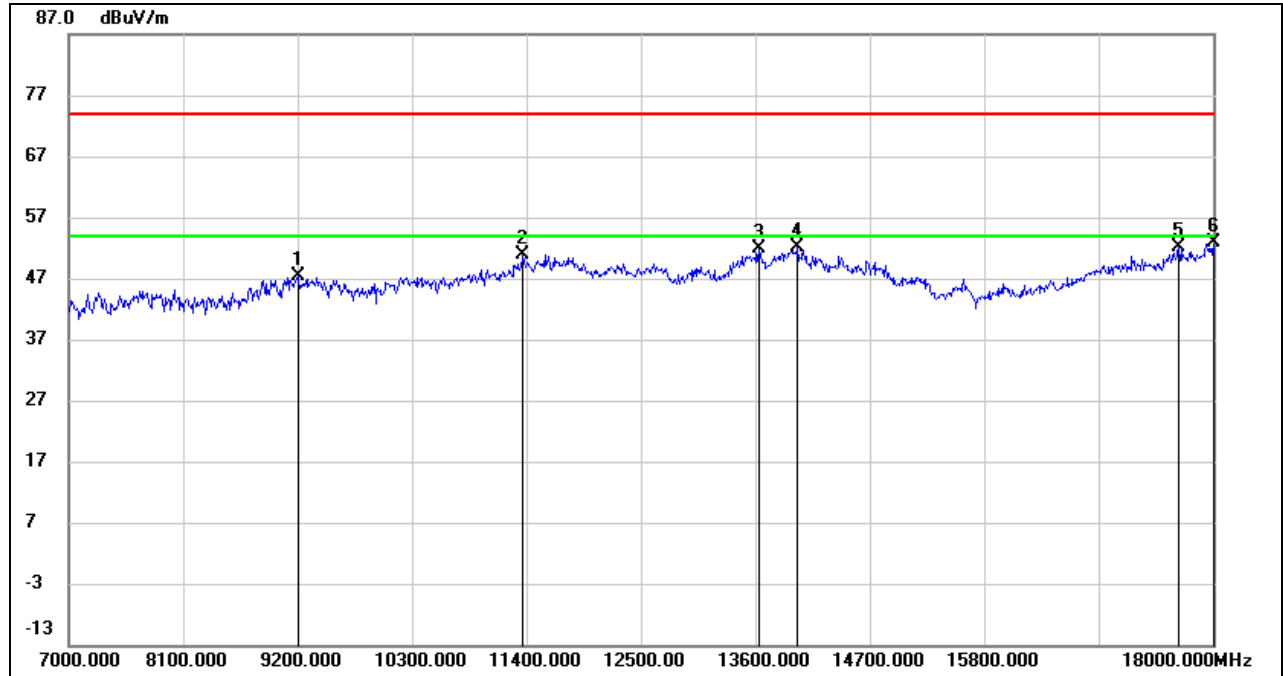

No.	Frequency (MHz)	Reading (dBuV)	Correct (dB/m)	Result (dBuV/m)	Limit (dBuV/m)	Margin (dB)	Remark
1	9200.000	36.93	10.46	47.39	74.00	-26.61	peak
2	11367.000	34.67	16.22	50.89	74.00	-23.11	peak
3	13633.000	30.79	20.97	51.76	74.00	-22.24	peak
4	14007.000	30.33	21.85	52.18	74.00	-21.82	peak
5	17670.000	28.33	23.86	52.19	74.00	-21.81	peak
6	18000.000	26.72	26.12	52.84	74.00	-21.16	peak

Note: 1. Measurement = Reading Level + Correct Factor.
 2. If Peak Result complies with AV limit, AV Result is deemed to comply with AV limit.
 3. Peak: Peak detector.
 4. Filter losses were only considered in the spurious frequency bands and the authorized band was not corrected for High Pass Filter losses.
 5. Proper operation of the transmitter prior to adding the filter to the measurement chain.
 6. Since non-restricted band peak emissions are less than the average limit, they also comply with the -27dBm/MHz (68.2dBuV/m) limit.

HARMONICS AND SPURIOUS EMISSIONS (MID CHANNEL, HORIZONTAL)

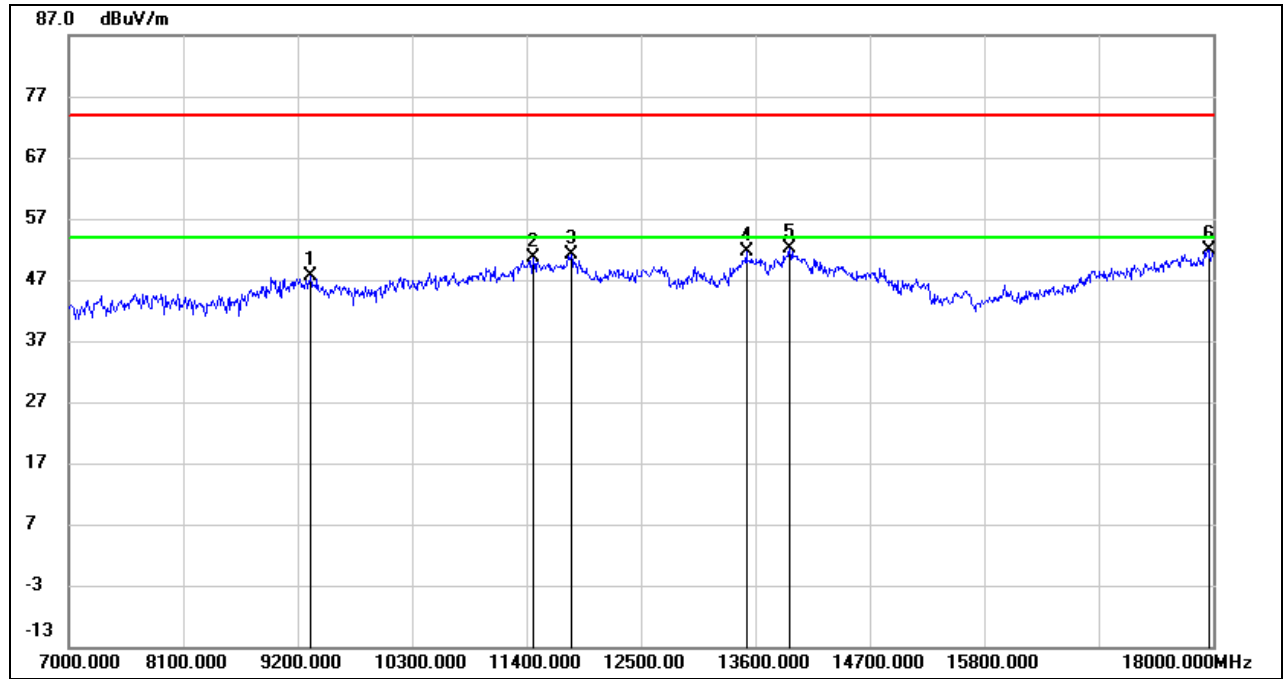

No.	Frequency (MHz)	Reading (dBuV)	Correct (dB/m)	Result (dBuV/m)	Limit (dBuV/m)	Margin (dB)	Remark
1	9321.000	37.13	10.53	47.66	74.00	-26.34	peak
2	11466.000	33.88	16.63	50.51	74.00	-23.49	peak
3	11829.000	33.63	17.38	51.01	74.00	-22.99	peak
4	13512.000	30.95	20.68	51.63	74.00	-22.37	peak
5	13930.000	30.34	21.71	52.05	74.00	-21.95	peak
6	17956.000	26.15	25.82	51.97	74.00	-22.03	peak

Note: 1. Measurement = Reading Level + Correct Factor.
 2. If Peak Result complies with AV limit, AV Result is deemed to comply with AV limit.
 3. Peak: Peak detector.
 4. Filter losses were only considered in the spurious frequency bands and the authorized band was not corrected for High Pass Filter losses.
 5. Proper operation of the transmitter prior to adding the filter to the measurement chain.
 6. Since non-restricted band peak emissions are less than the average limit, they also comply with the -27dBm/MHz (68.2dBuV/m) limit.

HARMONICS AND SPURIOUS EMISSIONS (MID CHANNEL, VERTICAL)

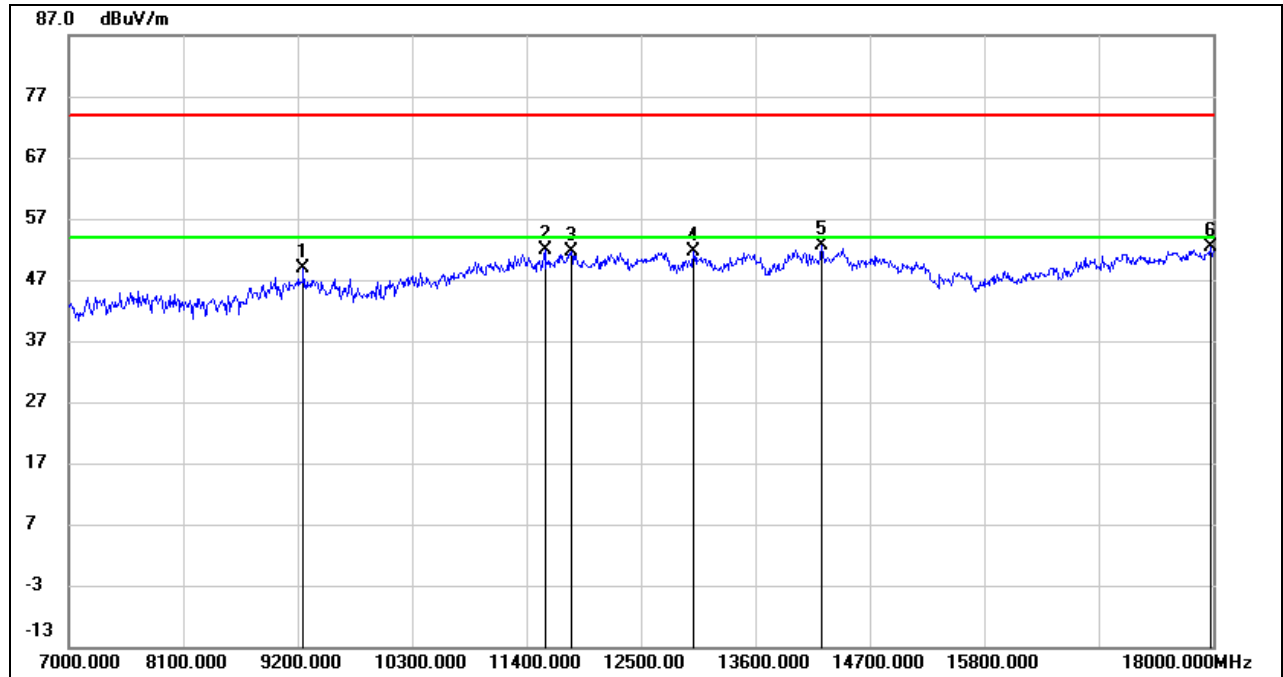

No.	Frequency (MHz)	Reading (dBuV)	Correct (dB/m)	Result (dBuV/m)	Limit (dBuV/m)	Margin (dB)	Remark
1	9255.000	38.26	10.51	48.77	74.00	-25.23	peak
2	11576.000	35.06	16.91	51.97	74.00	-22.03	peak
3	11829.000	34.22	17.38	51.60	74.00	-22.40	peak
4	13006.000	33.07	18.47	51.54	74.00	-22.46	peak
5	14238.000	31.72	20.88	52.60	74.00	-21.40	peak
6	17978.000	26.41	25.97	52.38	74.00	-21.62	peak

- Note: 1. Measurement = Reading Level + Correct Factor.
 2. If Peak Result complies with AV limit, AV Result is deemed to comply with AV limit.
 3. Peak: Peak detector.
 4. Filter losses were only considered in the spurious frequency bands and the authorized band was not corrected for High Pass Filter losses.
 5. Proper operation of the transmitter prior to adding the filter to the measurement chain.
 6. Since non-restricted band peak emissions are less than the average limit, they also comply with the -27dBm/MHz (68.2dBuV/m) limit.

HARMONICS AND SPURIOUS EMISSIONS (HIGH CHANNEL, HORIZONTAL)

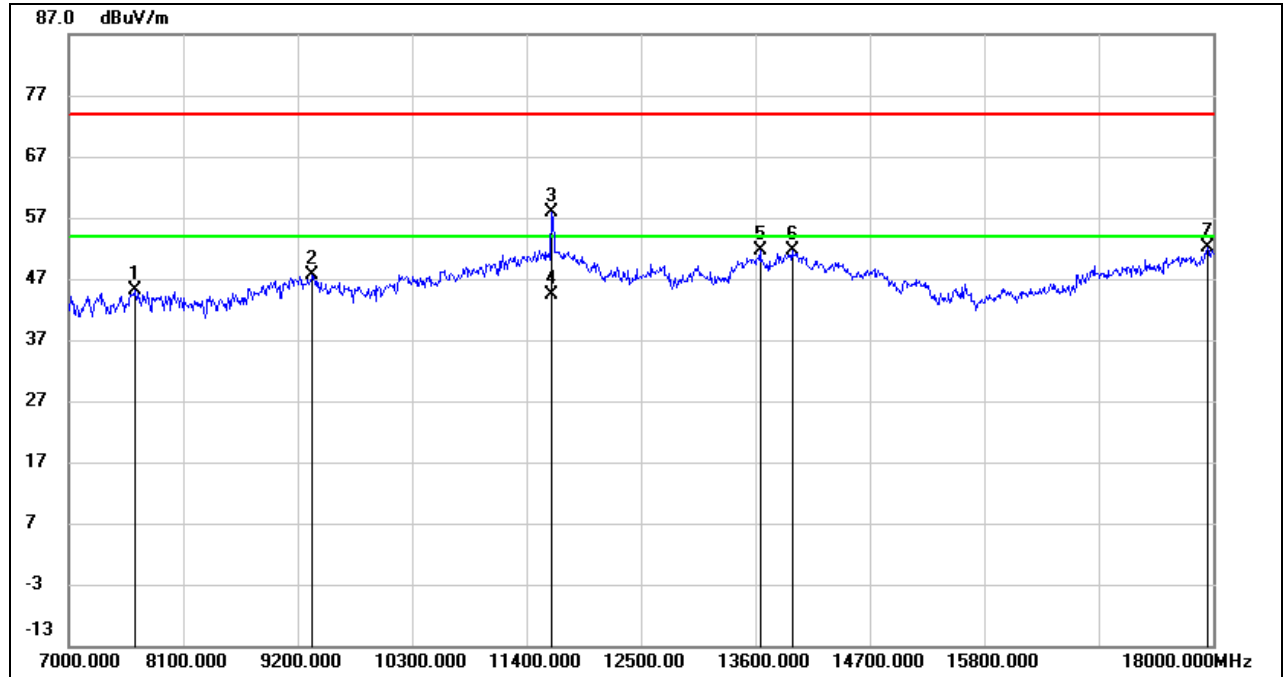

No.	Frequency (MHz)	Reading (dBuV)	Correct (dB/m)	Result (dBuV/m)	Limit (dBuV/m)	Margin (dB)	Remark
1	7638.000	38.30	6.75	45.05	74.00	-28.95	peak
2	9343.000	36.99	10.55	47.54	74.00	-26.46	peak
3	11642.000	40.79	17.03	57.82	74.00	-16.18	peak
4	11642.000	27.33	17.03	44.36	54.00	-9.64	AVG
5	13644.000	30.71	20.99	51.70	74.00	-22.30	peak
6	13952.000	29.76	21.76	51.52	74.00	-22.48	peak
7	17945.000	26.45	25.75	52.20	74.00	-21.80	peak

- Note: 1. Measurement = Reading Level + Correct Factor.
 2. If Peak Result complies with AV limit, AV Result is deemed to comply with AV limit.
 3. Peak: Peak detector.
 4. Filter losses were only considered in the spurious frequency bands and the authorized band was not corrected for High Pass Filter losses.
 5. Proper operation of the transmitter prior to adding the filter to the measurement chain.
 6. Since non-restricted band peak emissions are less than the average limit, they also comply with the -27dBm/MHz (68.2dBuV/m) limit.

HARMONICS AND SPURIOUS EMISSIONS (HIGH CHANNEL, VERTICAL)

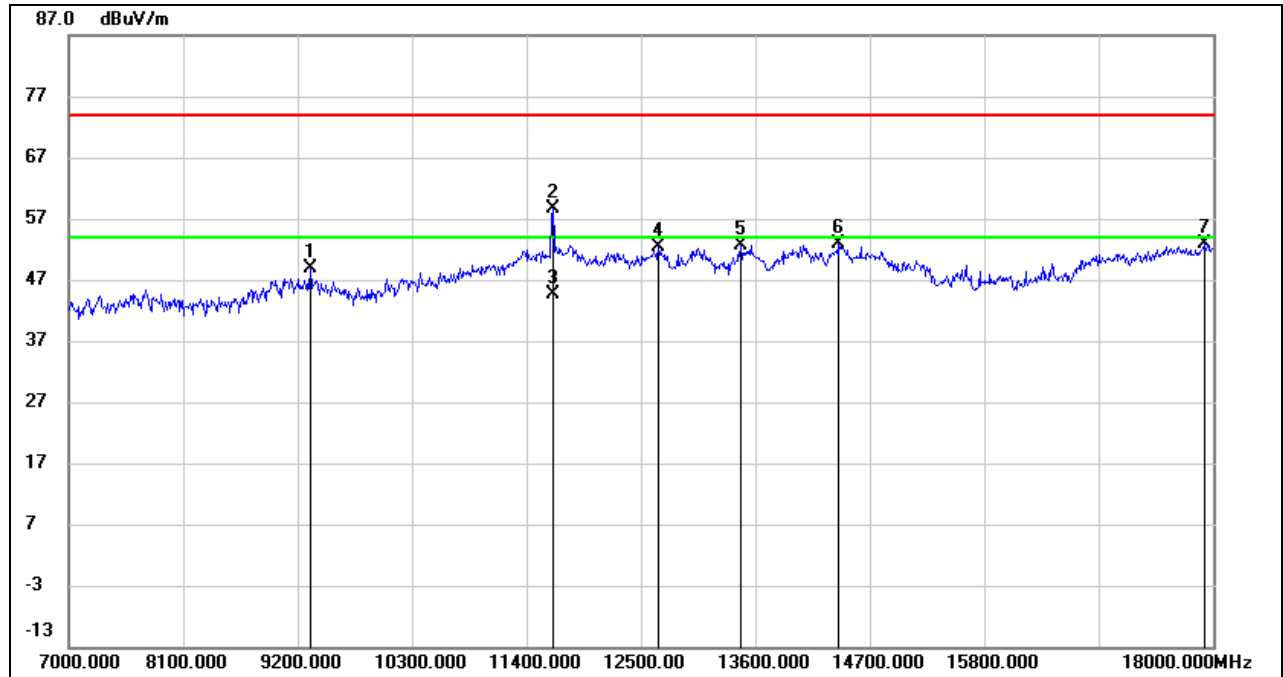

No.	Frequency (MHz)	Reading (dBuV)	Correct (dB/m)	Result (dBuV/m)	Limit (dBuV/m)	Margin (dB)	Remark
1	9321.000	38.43	10.53	48.96	74.00	-25.04	peak
2	11653.000	41.58	17.05	58.63	74.00	-15.37	peak
3	11653.000	27.57	17.05	44.62	54.00	-9.38	AVG
4	12665.000	34.46	18.04	52.50	74.00	-21.50	peak
5	13457.000	32.21	20.46	52.67	74.00	-21.33	peak
6	14403.000	32.71	20.19	52.90	74.00	-21.10	peak
7	17912.000	27.27	25.52	52.79	74.00	-21.21	peak

Note: 1. Measurement = Reading Level + Correct Factor.
 2. If Peak Result complies with AV limit, AV Result is deemed to comply with AV limit.
 3. Peak: Peak detector.
 4. Filter losses were only considered in the spurious frequency bands and the authorized band was not corrected for High Pass Filter losses.
 5. Proper operation of the transmitter prior to adding the filter to the measurement chain.
 6. Since non-restricted band peak emissions are less than the average limit, they also comply with the -27dBm/MHz (68.2dBuV/m) limit.



8.3.3. 802.11n HT40 MIMO MODE

UNII-1 BAND

HARMONICS AND SPURIOUS EMISSIONS (LOW CHANNEL, HORIZONTAL)

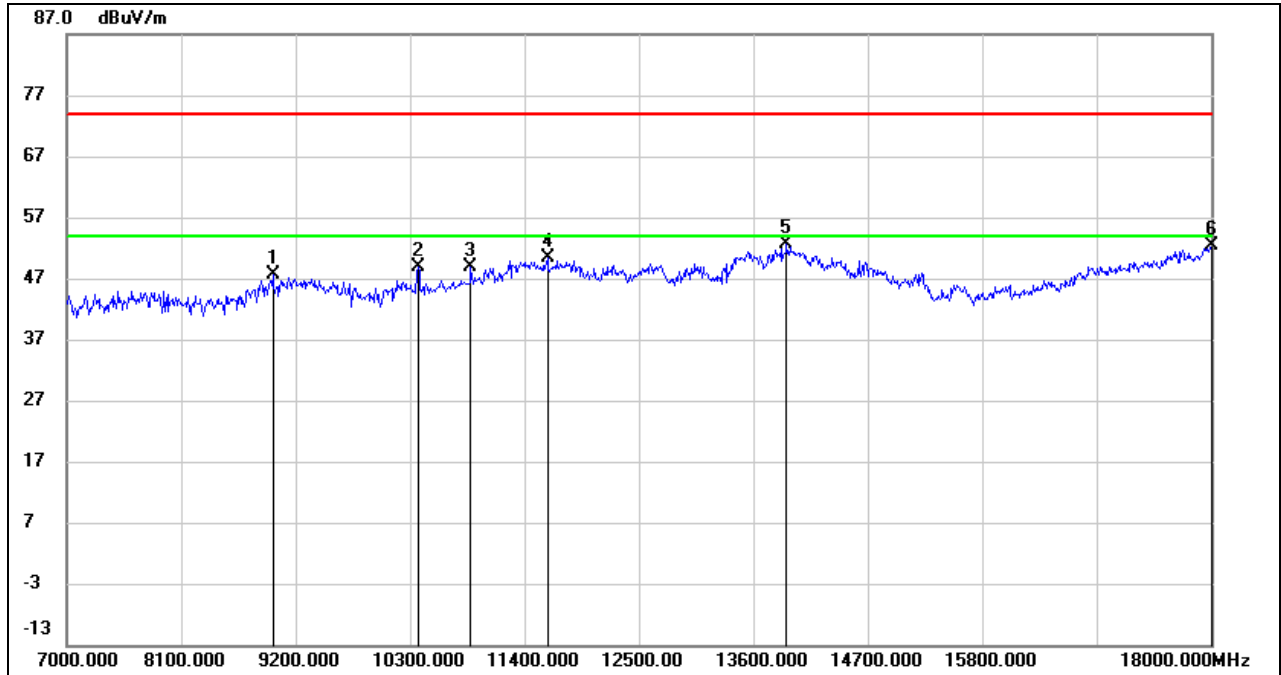

No.	Frequency (MHz)	Reading (dBuV)	Correct (dB/m)	Result (dBuV/m)	Limit (dBuV/m)	Margin (dB)	Remark
1	8980.000	37.35	10.21	47.56	74.00	-26.44	peak
2	10377.000	36.21	12.56	48.77	74.00	-25.23	peak
3	10883.000	34.52	14.27	48.79	74.00	-25.21	peak
4	11620.000	33.27	16.99	50.26	74.00	-23.74	peak
5	13919.000	30.99	21.68	52.67	74.00	-21.33	peak
6	18000.000	26.26	26.12	52.38	74.00	-21.62	peak

Note: 1. Measurement = Reading Level + Correct Factor.
 2. If Peak Result complies with AV limit, AV Result is deemed to comply with AV limit.
 3. Peak: Peak detector.
 4. Filter losses were only considered in the spurious frequency bands and the authorized band was not corrected for High Pass Filter losses.
 5. Proper operation of the transmitter prior to adding the filter to the measurement chain.
 6. Since non-restricted band peak emissions are less than the average limit, they also comply with the -27dBm/MHz (68.2dBuV/m) limit.

HARMONICS AND SPURIOUS EMISSIONS (LOW CHANNEL, VERTICAL)

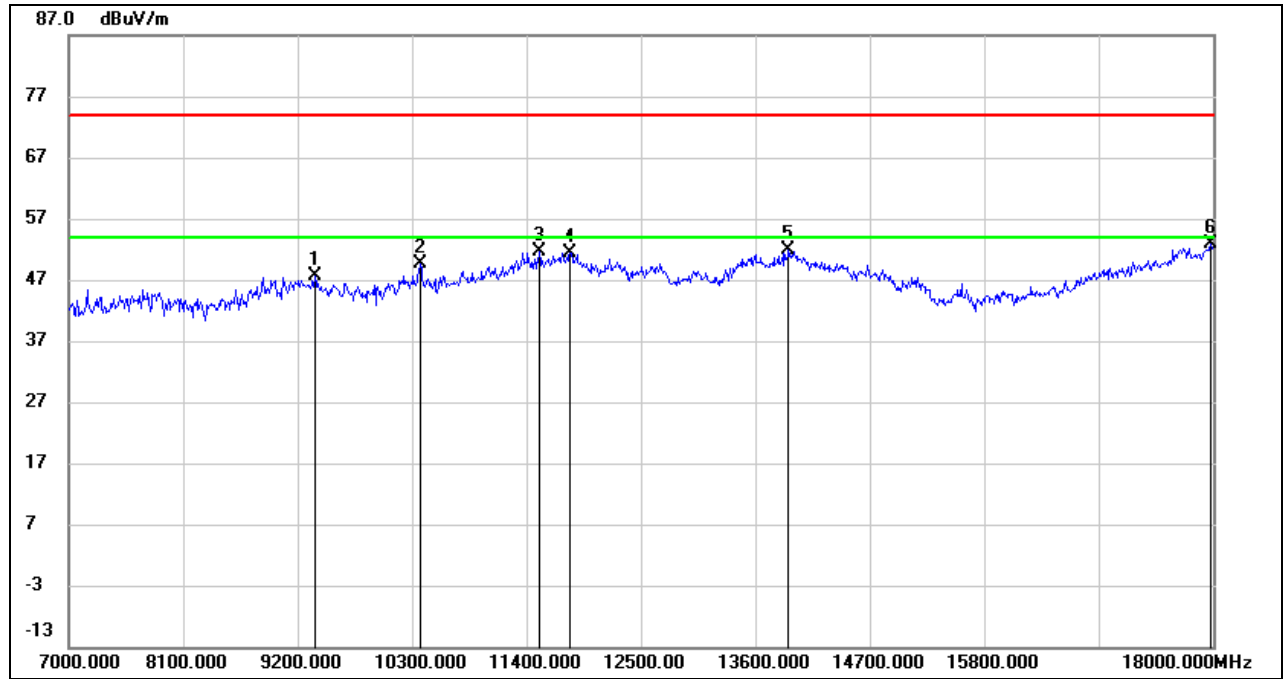

No.	Frequency (MHz)	Reading (dBuV)	Correct (dB/m)	Result (dBuV/m)	Limit (dBuV/m)	Margin (dB)	Remark
1	9365.000	37.08	10.57	47.65	74.00	-26.35	peak
2	10377.000	37.03	12.56	49.59	74.00	-24.41	peak
3	11521.000	34.79	16.82	51.61	74.00	-22.39	peak
4	11818.000	33.98	17.36	51.34	74.00	-22.66	peak
5	13919.000	30.18	21.68	51.86	74.00	-22.14	peak
6	17978.000	26.83	25.97	52.80	74.00	-21.20	peak

- Note: 1. Measurement = Reading Level + Correct Factor.
 2. If Peak Result complies with AV limit, AV Result is deemed to comply with AV limit.
 3. Peak: Peak detector.
 4. Filter losses were only considered in the spurious frequency bands and the authorized band was not corrected for High Pass Filter losses.
 5. Proper operation of the transmitter prior to adding the filter to the measurement chain.
 6. Since non-restricted band peak emissions are less than the average limit, they also comply with the -27dBm/MHz (68.2dBuV/m) limit.

HARMONICS AND SPURIOUS EMISSIONS (HIGH CHANNEL, HORIZONTAL)

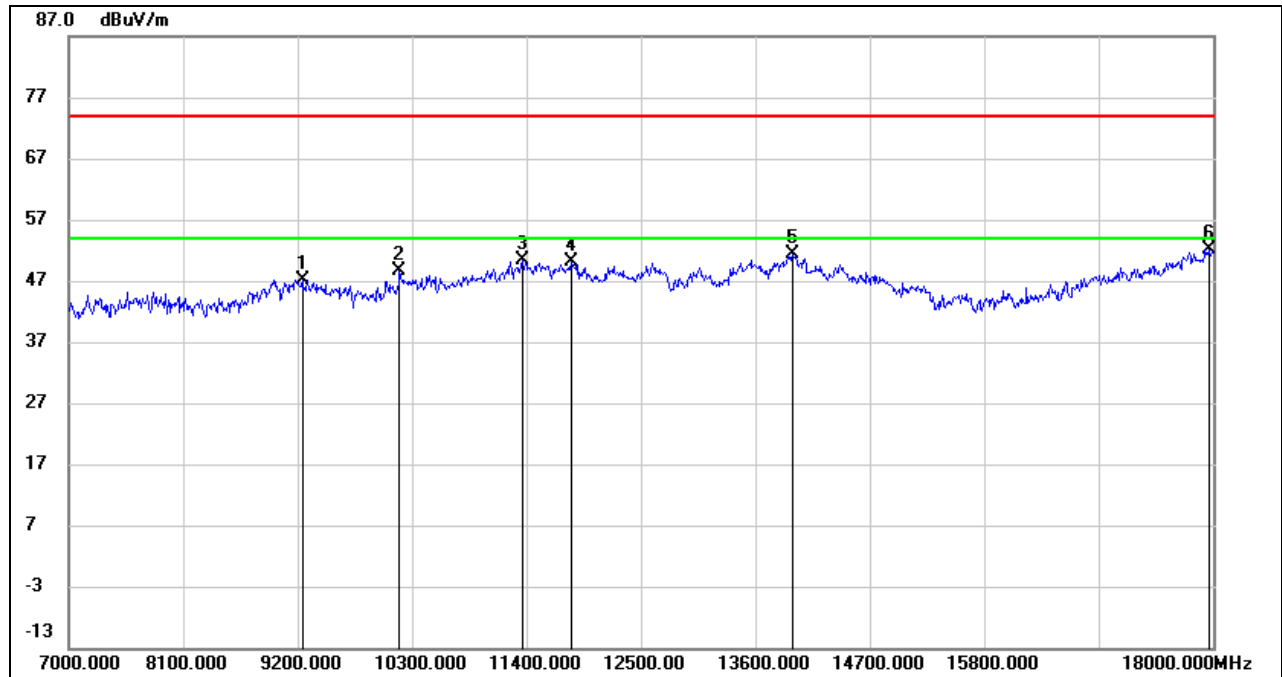

No.	Frequency (MHz)	Reading (dBuV)	Correct (dB/m)	Result (dBuV/m)	Limit (dBuV/m)	Margin (dB)	Remark
1	9244.000	36.70	10.49	47.19	74.00	-26.81	peak
2	10179.000	36.43	12.14	48.57	74.00	-25.43	peak
3	11356.000	34.23	16.19	50.42	74.00	-23.58	peak
4	11829.000	32.72	17.38	50.10	74.00	-23.90	peak
5	13952.000	29.54	21.76	51.30	74.00	-22.70	peak
6	17967.000	26.22	25.89	52.11	74.00	-21.89	peak

Note: 1. Measurement = Reading Level + Correct Factor.

2. If Peak Result complies with AV limit, AV Result is deemed to comply with AV limit.

3. Peak: Peak detector.

4. Filter losses were only considered in the spurious frequency bands and the authorized band was not corrected for High Pass Filter losses.

5. Proper operation of the transmitter prior to adding the filter to the measurement chain.

6. Since non-restricted band peak emissions are less than the average limit, they also comply with the -27dBm/MHz (68.2dBuV/m) limit.



HARMONICS AND SPURIOUS EMISSIONS (HIGH CHANNEL, VERTICAL)

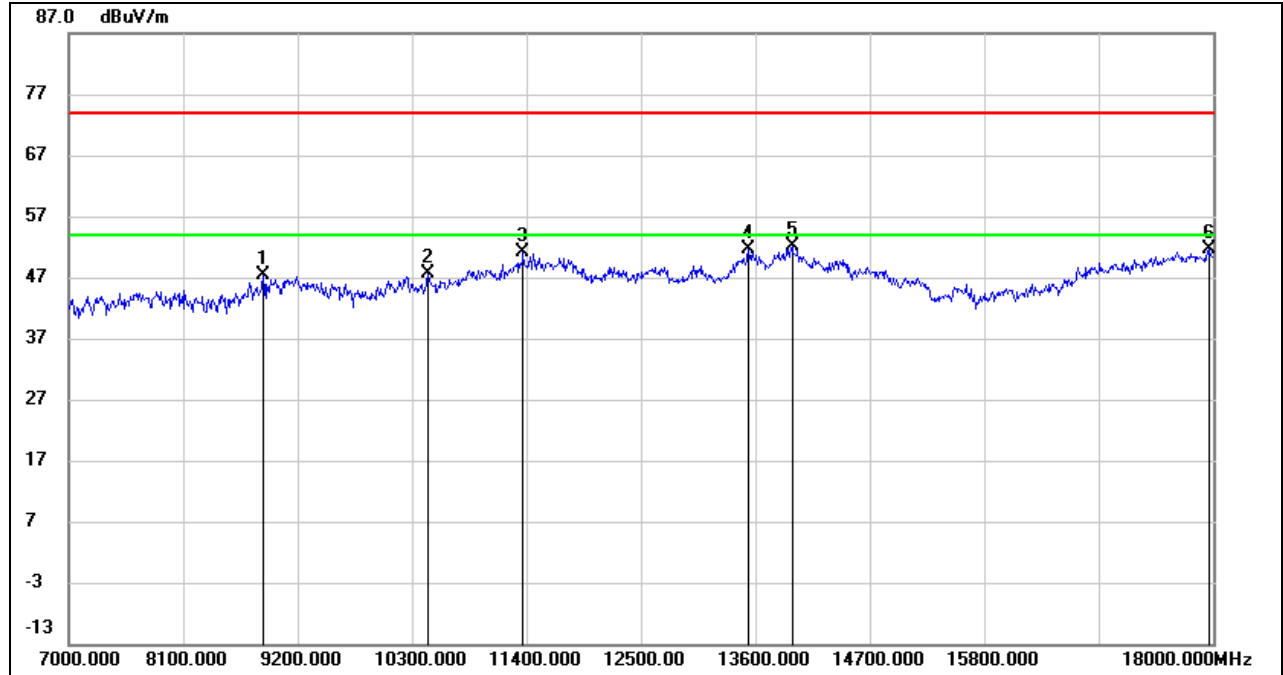

No.	Frequency (MHz)	Reading (dBuV)	Correct (dB/m)	Result (dBuV/m)	Limit (dBuV/m)	Margin (dB)	Remark
1	8870.000	37.82	9.44	47.26	74.00	-26.74	peak
2	10454.000	34.78	12.73	47.51	74.00	-26.49	peak
3	11367.000	34.96	16.22	51.18	74.00	-22.82	peak
4	13534.000	30.80	20.73	51.53	74.00	-22.47	peak
5	13952.000	30.37	21.76	52.13	74.00	-21.87	peak
6	17956.000	25.71	25.82	51.53	74.00	-22.47	peak

- Note: 1. Measurement = Reading Level + Correct Factor.
 2. If Peak Result complies with AV limit, AV Result is deemed to comply with AV limit.
 3. Peak: Peak detector.
 4. Filter losses were only considered in the spurious frequency bands and the authorized band was not corrected for High Pass Filter losses.
 5. Proper operation of the transmitter prior to adding the filter to the measurement chain.
 6. Since non-restricted band peak emissions are less than the average limit, they also comply with the -27dBm/MHz (68.2dBuV/m) limit.



UNII-2A BAND

HARMONICS AND SPURIOUS EMISSIONS (LOW CHANNEL, HORIZONTAL)

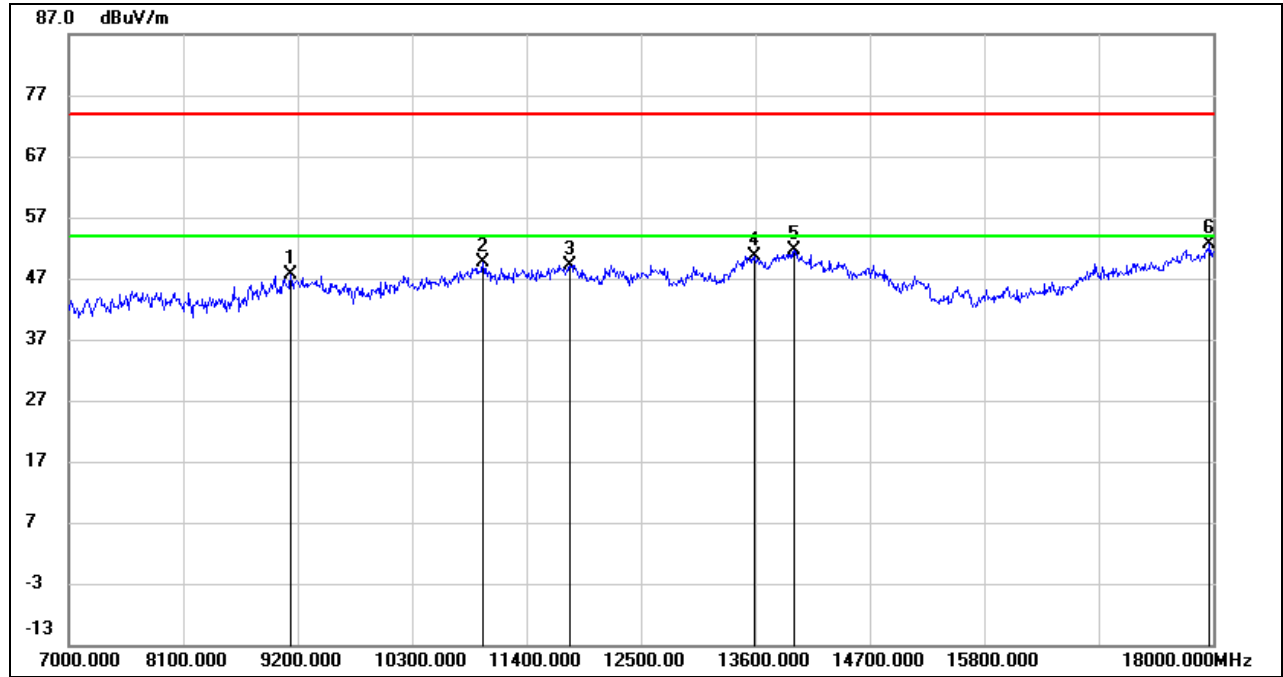

No.	Frequency (MHz)	Reading (dBuV)	Correct (dB/m)	Result (dBuV/m)	Limit (dBuV/m)	Margin (dB)	Remark
1	9134.000	37.20	10.41	47.61	74.00	-26.39	peak
2	10982.000	34.93	14.64	49.57	74.00	-24.43	peak
3	11818.000	31.74	17.36	49.10	74.00	-24.90	peak
4	13589.000	29.76	20.86	50.62	74.00	-23.38	peak
5	13974.000	29.71	21.82	51.53	74.00	-22.47	peak
6	17967.000	26.65	25.89	52.54	74.00	-21.46	peak

- Note: 1. Measurement = Reading Level + Correct Factor.
 2. If Peak Result complies with AV limit, AV Result is deemed to comply with AV limit.
 3. Peak: Peak detector.
 4. Filter losses were only considered in the spurious frequency bands and the authorized band was not corrected for High Pass Filter losses.
 5. Proper operation of the transmitter prior to adding the filter to the measurement chain.
 6. Since non-restricted band peak emissions are less than the average limit, they also comply with the -27dBm/MHz (68.2dBuV/m) limit.

HARMONICS AND SPURIOUS EMISSIONS (LOW CHANNEL, VERTICAL)

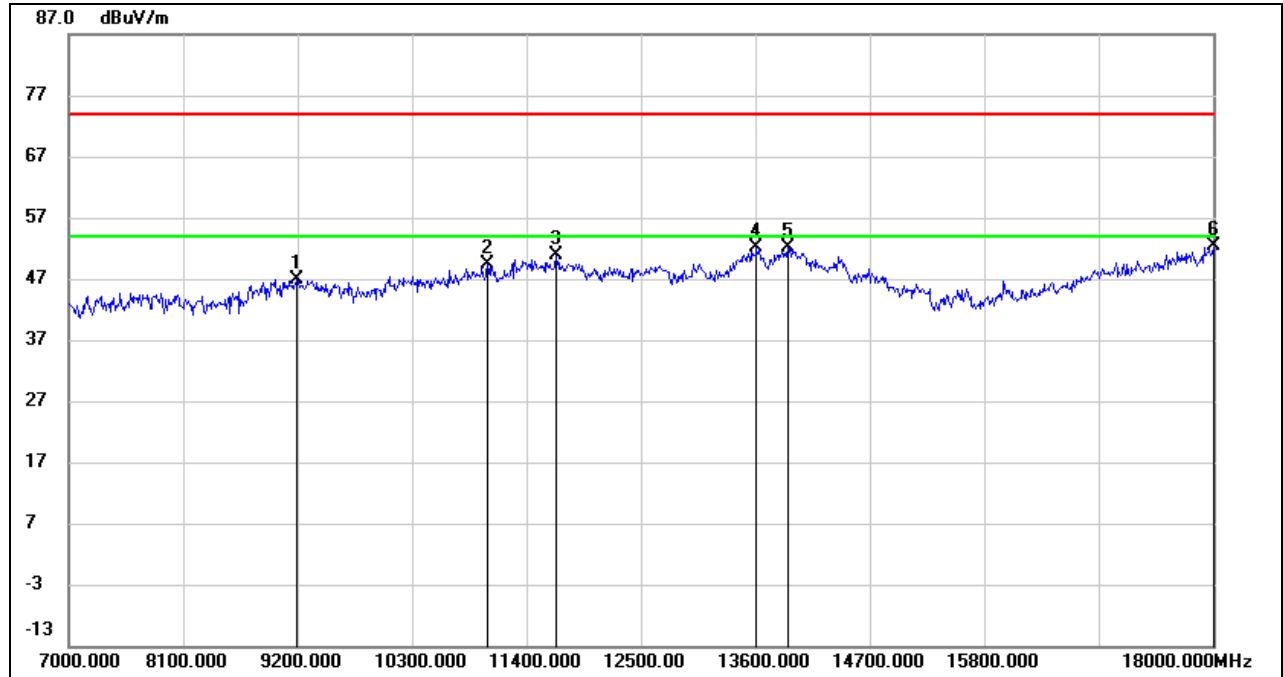

No.	Frequency (MHz)	Reading (dBuV)	Correct (dB/m)	Result (dBuV/m)	Limit (dBuV/m)	Margin (dB)	Remark
1	9189.000	36.36	10.46	46.82	74.00	-27.18	peak
2	11026.000	34.47	14.82	49.29	74.00	-24.71	peak
3	11686.000	33.77	17.12	50.89	74.00	-23.11	peak
4	13611.000	31.13	20.92	52.05	74.00	-21.95	peak
5	13908.000	30.52	21.66	52.18	74.00	-21.82	peak
6	18000.000	26.14	26.12	52.26	74.00	-21.74	peak

- Note: 1. Measurement = Reading Level + Correct Factor.
 2. If Peak Result complies with AV limit, AV Result is deemed to comply with AV limit.
 3. Peak: Peak detector.
 4. Filter losses were only considered in the spurious frequency bands and the authorized band was not corrected for High Pass Filter losses.
 5. Proper operation of the transmitter prior to adding the filter to the measurement chain.
 6. Since non-restricted band peak emissions are less than the average limit, they also comply with the -27dBm/MHz (68.2dBuV/m) limit.

HARMONICS AND SPURIOUS EMISSIONS (HIGH CHANNEL, HORIZONTAL)

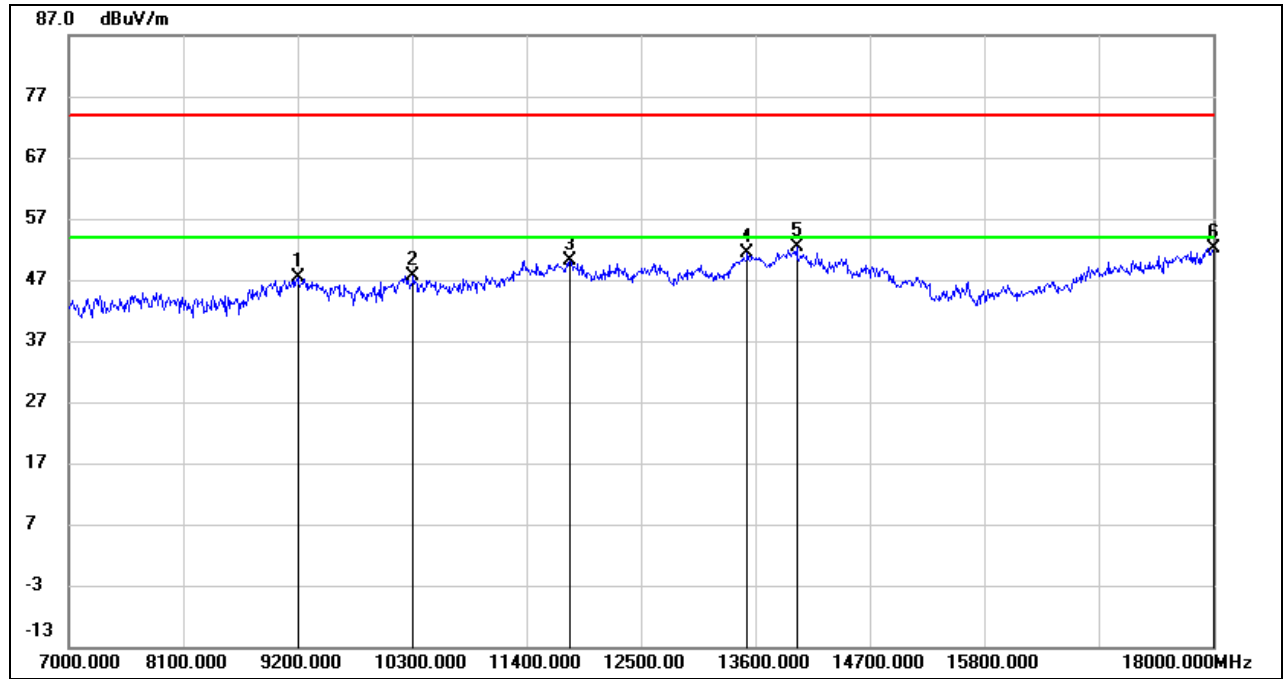

No.	Frequency (MHz)	Reading (dBuV)	Correct (dB/m)	Result (dBuV/m)	Limit (dBuV/m)	Margin (dB)	Remark
1	9200.000	37.00	10.46	47.46	74.00	-26.54	peak
2	10311.000	35.28	12.42	47.70	74.00	-26.30	peak
3	11818.000	32.78	17.36	50.14	74.00	-23.86	peak
4	13523.000	30.60	20.70	51.30	74.00	-22.70	peak
5	13996.000	30.55	21.87	52.42	74.00	-21.58	peak
6	18000.000	26.11	26.12	52.23	74.00	-21.77	peak

Note: 1. Measurement = Reading Level + Correct Factor.
 2. If Peak Result complies with AV limit, AV Result is deemed to comply with AV limit.
 3. Peak: Peak detector.
 4. Filter losses were only considered in the spurious frequency bands and the authorized band was not corrected for High Pass Filter losses.
 5. Proper operation of the transmitter prior to adding the filter to the measurement chain.
 6. Since non-restricted band peak emissions are less than the average limit, they also comply with the -27dBm/MHz (68.2dBuV/m) limit.



HARMONICS AND SPURIOUS EMISSIONS (HIGH CHANNEL, VERTICAL)

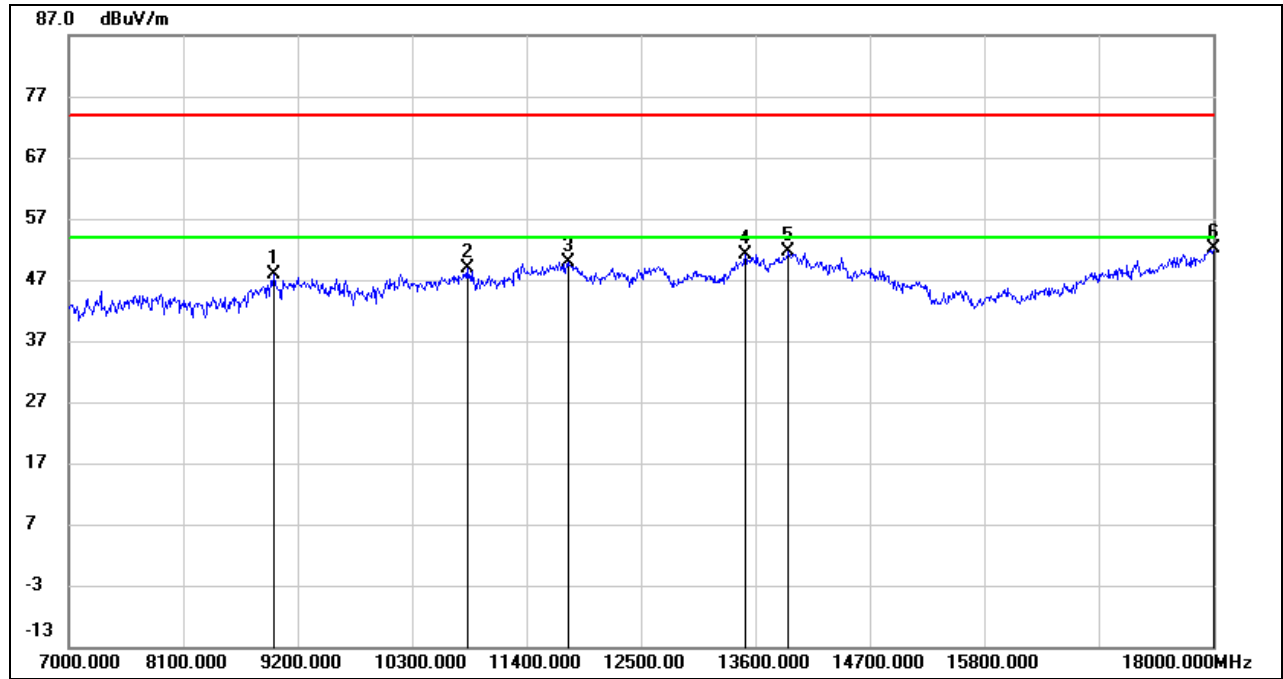

No.	Frequency (MHz)	Reading (dBuV)	Correct (dB/m)	Result (dBuV/m)	Limit (dBuV/m)	Margin (dB)	Remark
1	8969.000	37.72	10.13	47.85	74.00	-26.15	peak
2	10828.000	34.76	14.07	48.83	74.00	-25.17	peak
3	11796.000	32.64	17.32	49.96	74.00	-24.04	peak
4	13501.000	30.50	20.64	51.14	74.00	-22.86	peak
5	13919.000	30.06	21.68	51.74	74.00	-22.26	peak
6	18000.000	26.13	26.12	52.25	74.00	-21.75	peak

Note: 1. Measurement = Reading Level + Correct Factor.
 2. If Peak Result complies with AV limit, AV Result is deemed to comply with AV limit.
 3. Peak: Peak detector.
 4. Filter losses were only considered in the spurious frequency bands and the authorized band was not corrected for High Pass Filter losses.
 5. Proper operation of the transmitter prior to adding the filter to the measurement chain.
 6. Since non-restricted band peak emissions are less than the average limit, they also comply with the -27dBm/MHz (68.2dBuV/m) limit.

UNII-2C BAND

HARMONICS AND SPURIOUS EMISSIONS (LOW CHANNEL, HORIZONTAL)

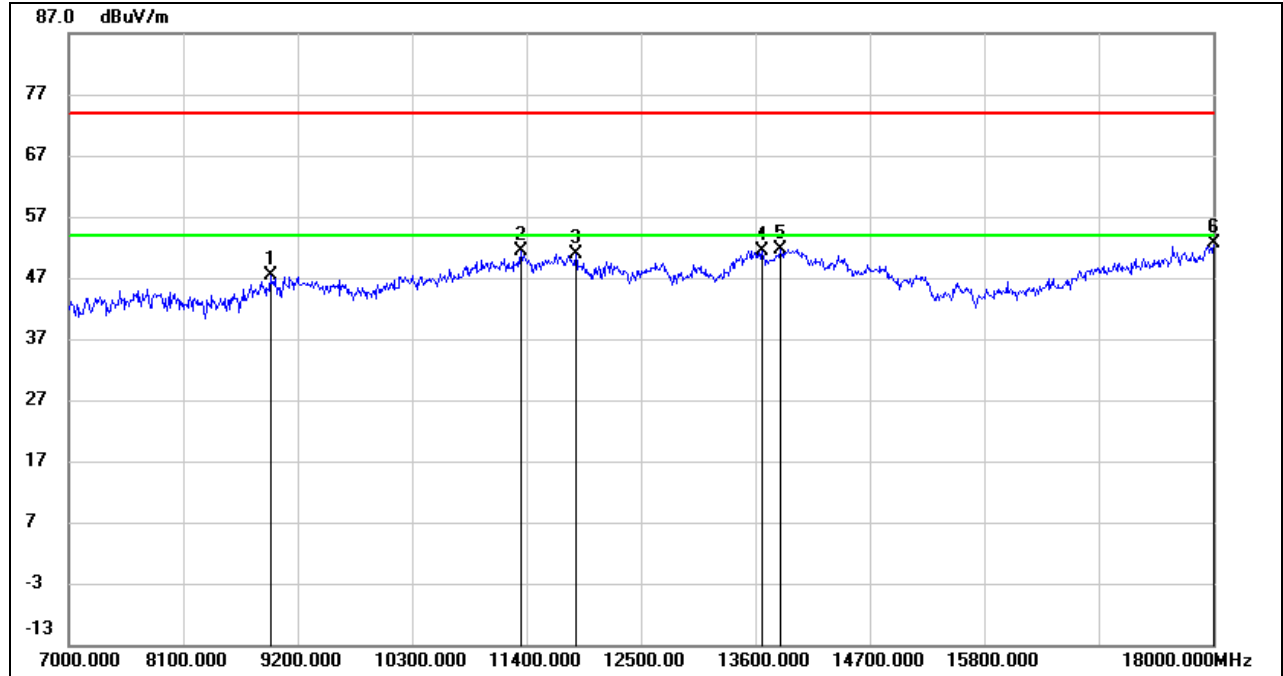

No.	Frequency (MHz)	Reading (dBuV)	Correct (dB/m)	Result (dBuV/m)	Limit (dBuV/m)	Margin (dB)	Remark
1	8936.000	37.46	9.90	47.36	74.00	-26.64	peak
2	11345.000	35.12	16.14	51.26	74.00	-22.74	peak
3	11873.000	33.52	17.46	50.98	74.00	-23.02	peak
4	13666.000	30.34	21.05	51.39	74.00	-22.61	peak
5	13842.000	30.25	21.49	51.74	74.00	-22.26	peak
6	18000.000	26.42	26.12	52.54	74.00	-21.46	peak

Note: 1. Measurement = Reading Level + Correct Factor.
 2. If Peak Result complies with AV limit, AV Result is deemed to comply with AV limit.
 3. Peak: Peak detector.
 4. Filter losses were only considered in the spurious frequency bands and the authorized band was not corrected for High Pass Filter losses.
 5. Proper operation of the transmitter prior to adding the filter to the measurement chain.
 6. Since non-restricted band peak emissions are less than the average limit, they also comply with the -27dBm/MHz (68.2dBuV/m) limit.



HARMONICS AND SPURIOUS EMISSIONS (LOW CHANNEL, VERTICAL)

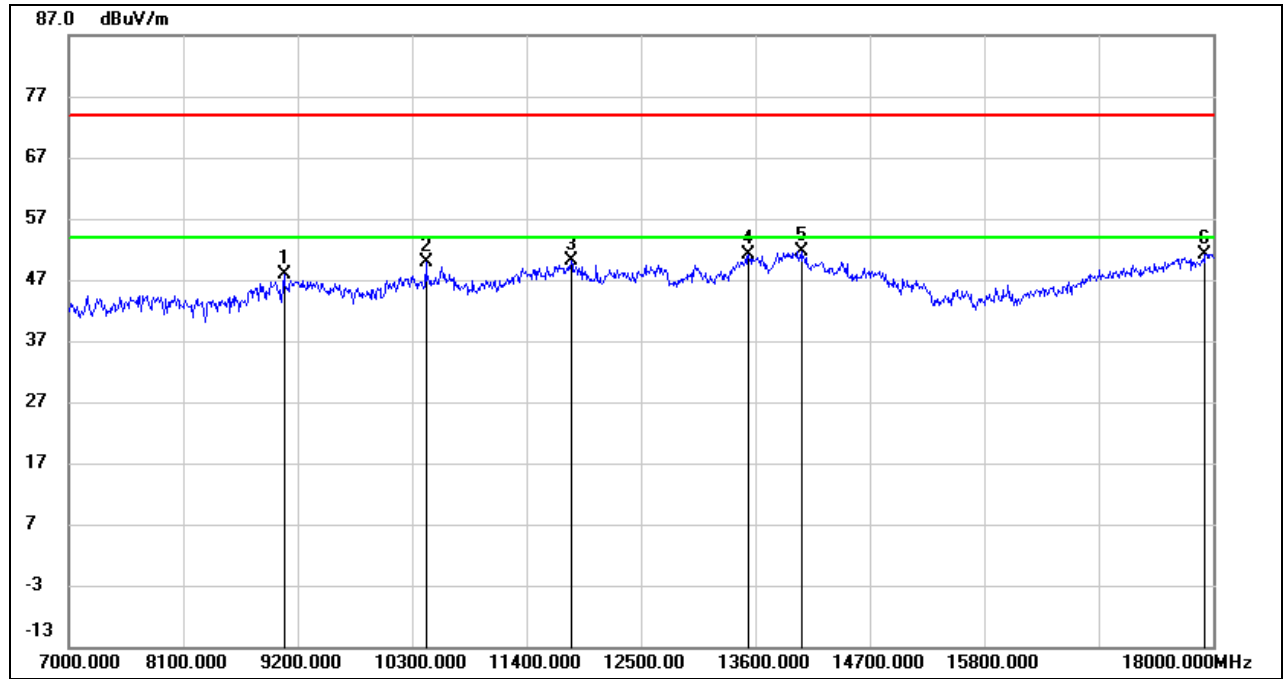

No.	Frequency (MHz)	Reading (dBuV)	Correct (dB/m)	Result (dBuV/m)	Limit (dBuV/m)	Margin (dB)	Remark
1	9068.000	37.50	10.39	47.89	74.00	-26.11	peak
2	10432.000	37.14	12.67	49.81	74.00	-24.19	peak
3	11829.000	32.68	17.38	50.06	74.00	-23.94	peak
4	13534.000	30.41	20.73	51.14	74.00	-22.86	peak
5	14040.000	29.96	21.70	51.66	74.00	-22.34	peak
6	17923.000	25.62	25.60	51.22	74.00	-22.78	peak

- Note: 1. Measurement = Reading Level + Correct Factor.
 2. If Peak Result complies with AV limit, AV Result is deemed to comply with AV limit.
 3. Peak: Peak detector.
 4. Filter losses were only considered in the spurious frequency bands and the authorized band was not corrected for High Pass Filter losses.
 5. Proper operation of the transmitter prior to adding the filter to the measurement chain.
 6. Since non-restricted band peak emissions are less than the average limit, they also comply with the -27dBm/MHz (68.2dBuV/m) limit.

HARMONICS AND SPURIOUS EMISSIONS (MID CHANNEL, HORIZONTAL)

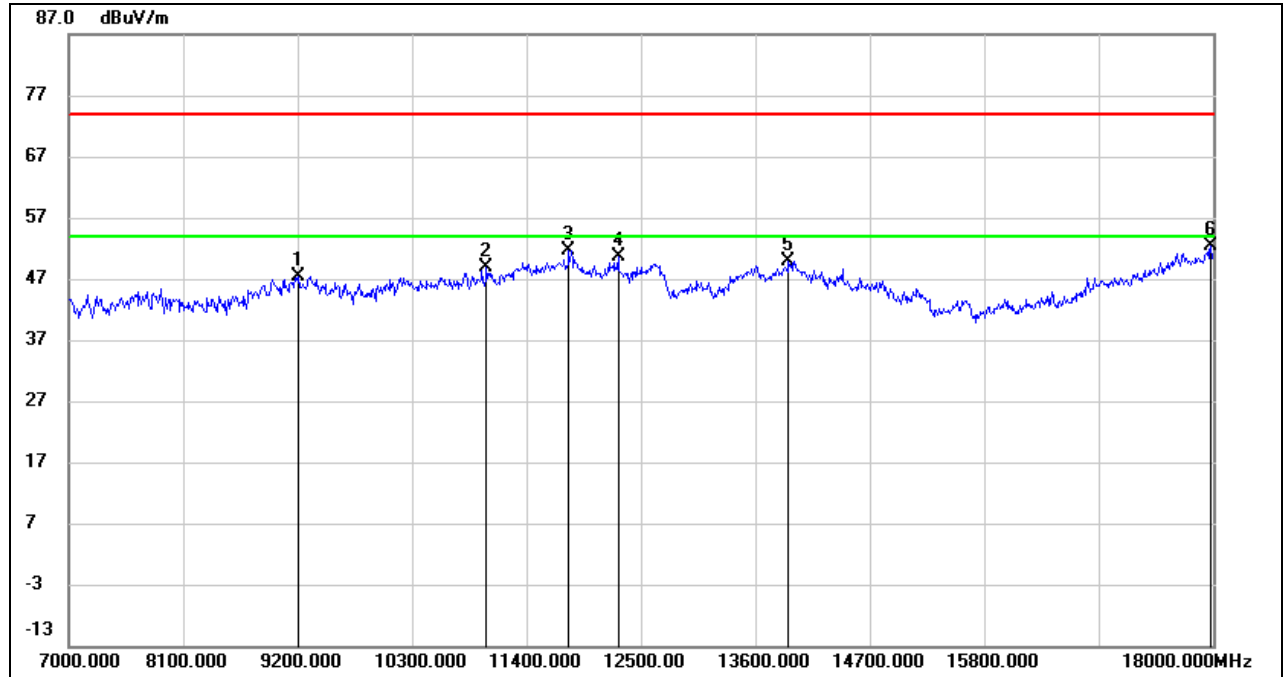

No.	Frequency (MHz)	Reading (dBuV)	Correct (dB/m)	Result (dBuV/m)	Limit (dBuV/m)	Margin (dB)	Remark
1	9211.000	37.03	10.47	47.50	74.00	-26.50	peak
2	11015.000	34.12	14.79	48.91	74.00	-25.09	peak
3	11807.000	34.28	17.34	51.62	74.00	-22.38	peak
4	12280.000	32.92	17.77	50.69	74.00	-23.31	peak
5	13919.000	28.24	21.68	49.92	74.00	-24.08	peak
6	17978.000	26.35	25.97	52.32	74.00	-21.68	peak

Note: 1. Measurement = Reading Level + Correct Factor.
 2. If Peak Result complies with AV limit, AV Result is deemed to comply with AV limit.
 3. Peak: Peak detector.
 4. Filter losses were only considered in the spurious frequency bands and the authorized band was not corrected for High Pass Filter losses.
 5. Proper operation of the transmitter prior to adding the filter to the measurement chain.
 6. Since non-restricted band peak emissions are less than the average limit, they also comply with the -27dBm/MHz (68.2dBuV/m) limit.



HARMONICS AND SPURIOUS EMISSIONS (MID CHANNEL, VERTICAL)

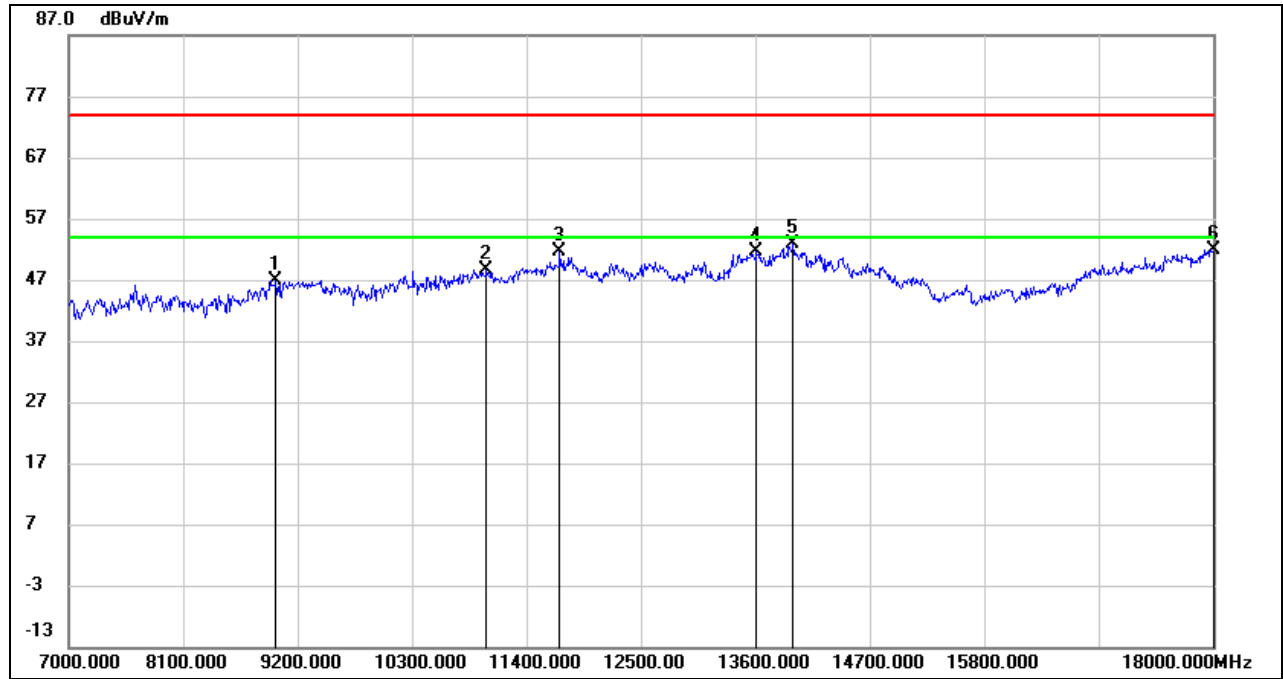

No.	Frequency (MHz)	Reading (dBuV)	Correct (dB/m)	Result (dBuV/m)	Limit (dBuV/m)	Margin (dB)	Remark
1	8991.000	36.67	10.28	46.95	74.00	-27.05	peak
2	11015.000	33.77	14.79	48.56	74.00	-25.44	peak
3	11719.000	34.49	17.18	51.67	74.00	-22.33	peak
4	13611.000	30.63	20.92	51.55	74.00	-22.45	peak
5	13963.000	31.20	21.78	52.98	74.00	-21.02	peak
6	18000.000	25.88	26.12	52.00	74.00	-22.00	peak

Note: 1. Measurement = Reading Level + Correct Factor.
 2. If Peak Result complies with AV limit, AV Result is deemed to comply with AV limit.
 3. Peak: Peak detector.
 4. Filter losses were only considered in the spurious frequency bands and the authorized band was not corrected for High Pass Filter losses.
 5. Proper operation of the transmitter prior to adding the filter to the measurement chain.
 6. Since non-restricted band peak emissions are less than the average limit, they also comply with the -27dBm/MHz (68.2dBuV/m) limit.

HARMONICS AND SPURIOUS EMISSIONS (HIGH CHANNEL, HORIZONTAL)

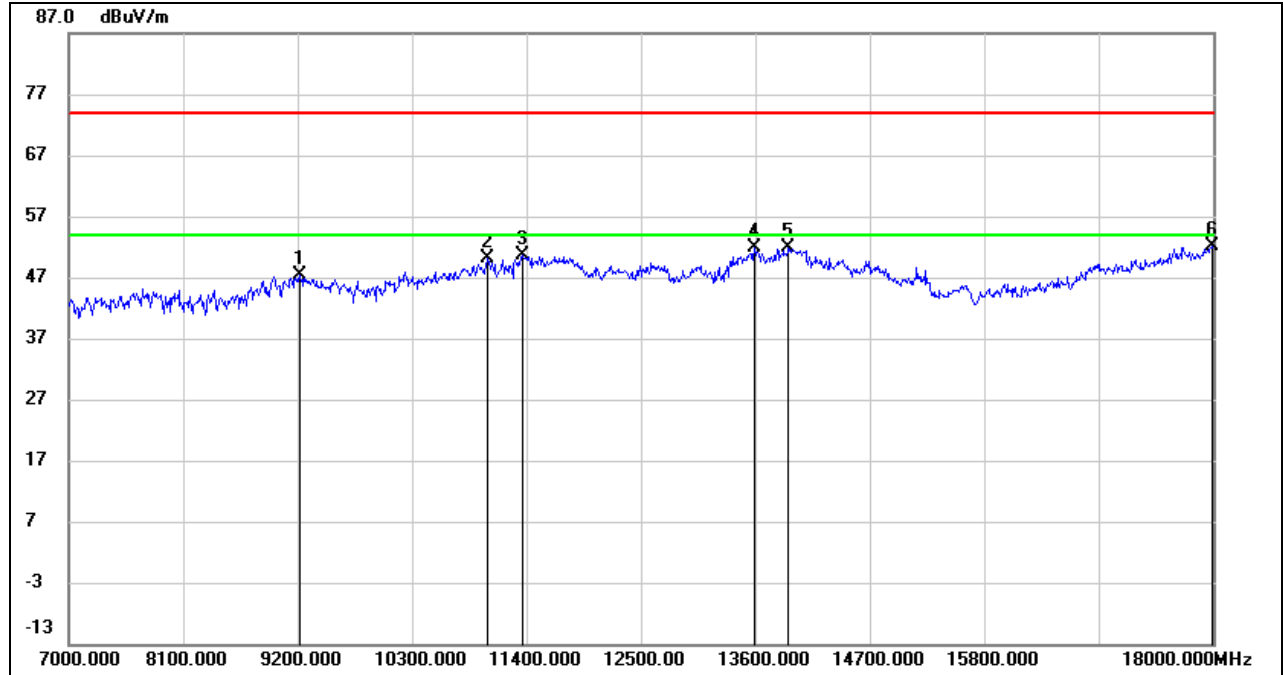

No.	Frequency (MHz)	Reading (dBuV)	Correct (dB/m)	Result (dBuV/m)	Limit (dBuV/m)	Margin (dB)	Remark
1	9222.000	36.81	10.48	47.29	74.00	-26.71	peak
2	11026.000	35.37	14.82	50.19	74.00	-23.81	peak
3	11367.000	34.38	16.22	50.60	74.00	-23.40	peak
4	13589.000	31.03	20.86	51.89	74.00	-22.11	peak
5	13919.000	30.26	21.68	51.94	74.00	-22.06	peak
6	17989.000	26.04	26.04	52.08	74.00	-21.92	peak

- Note: 1. Measurement = Reading Level + Correct Factor.
 2. If Peak Result complies with AV limit, AV Result is deemed to comply with AV limit.
 3. Peak: Peak detector.
 4. Filter losses were only considered in the spurious frequency bands and the authorized band was not corrected for High Pass Filter losses.
 5. Proper operation of the transmitter prior to adding the filter to the measurement chain.
 6. Since non-restricted band peak emissions are less than the average limit, they also comply with the -27dBm/MHz (68.2dBuV/m) limit.



HARMONICS AND SPURIOUS EMISSIONS (HIGH CHANNEL, VERTICAL)

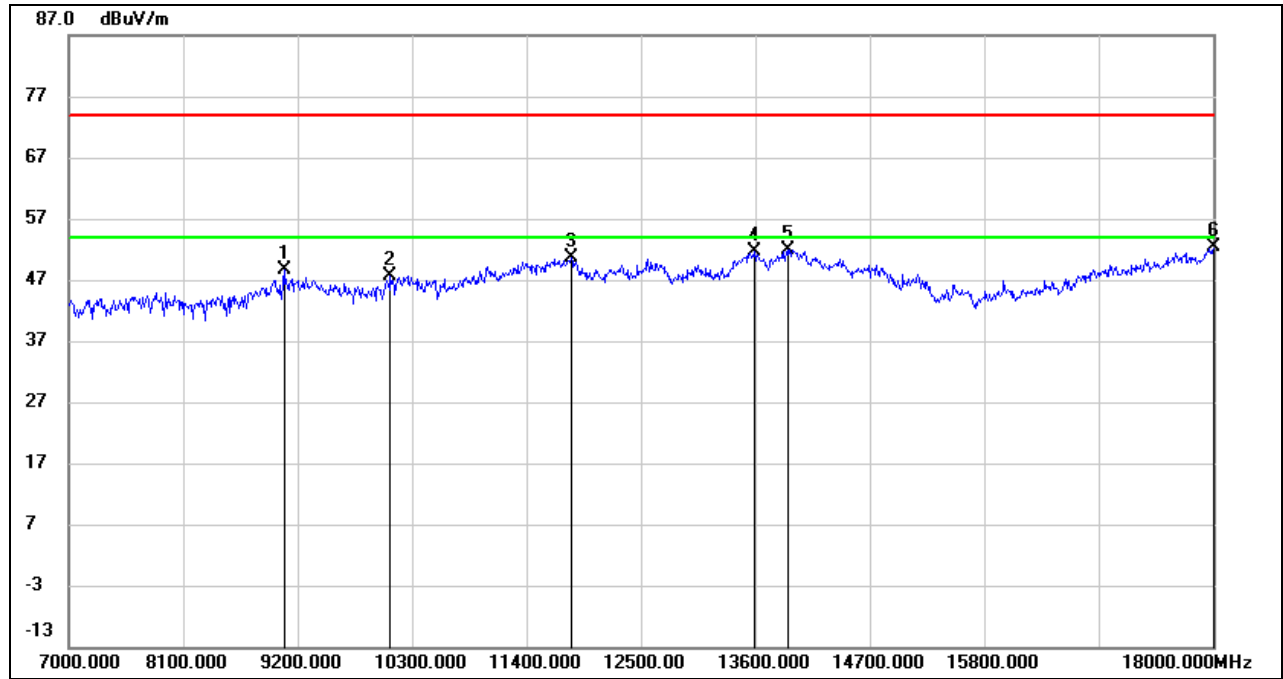

No.	Frequency (MHz)	Reading (dBuV)	Correct (dB/m)	Result (dBuV/m)	Limit (dBuV/m)	Margin (dB)	Remark
1	9068.000	38.32	10.39	48.71	74.00	-25.29	peak
2	10091.000	35.59	11.97	47.56	74.00	-26.44	peak
3	11829.000	33.15	17.38	50.53	74.00	-23.47	peak
4	13589.000	30.69	20.86	51.55	74.00	-22.45	peak
5	13908.000	30.23	21.66	51.89	74.00	-22.11	peak
6	18000.000	26.19	26.12	52.31	74.00	-21.69	peak

Note: 1. Measurement = Reading Level + Correct Factor.
 2. If Peak Result complies with AV limit, AV Result is deemed to comply with AV limit.
 3. Peak: Peak detector.
 4. Filter losses were only considered in the spurious frequency bands and the authorized band was not corrected for High Pass Filter losses.
 5. Proper operation of the transmitter prior to adding the filter to the measurement chain.
 6. Since non-restricted band peak emissions are less than the average limit, they also comply with the -27dBm/MHz (68.2dBuV/m) limit.



STRADDLE CHANNEL 142

HARMONICS AND SPURIOUS EMISSIONS (HORIZONTAL)

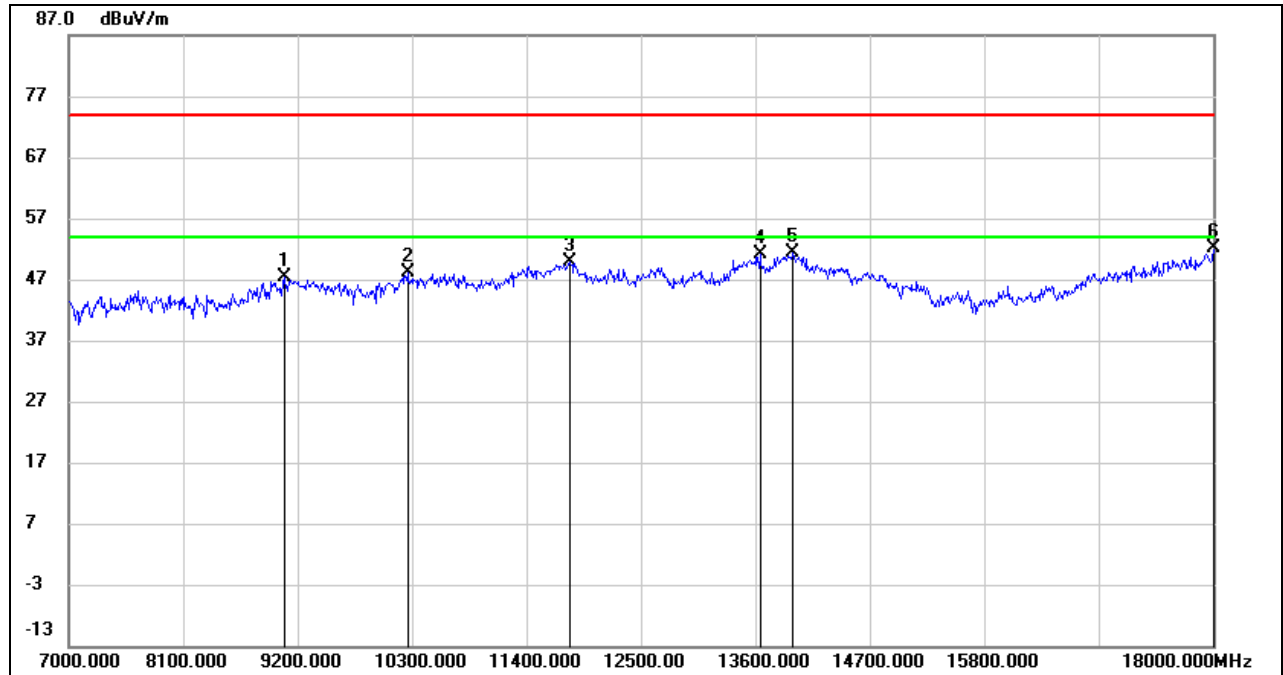

No.	Frequency (MHz)	Reading (dBuV)	Correct (dB/m)	Result (dBuV/m)	Limit (dBuV/m)	Margin (dB)	Remark
1	9068.000	36.92	10.39	47.31	74.00	-26.69	peak
2	10256.000	35.73	12.31	48.04	74.00	-25.96	peak
3	11818.000	32.48	17.36	49.84	74.00	-24.16	peak
4	13644.000	30.21	20.99	51.20	74.00	-22.80	peak
5	13963.000	29.62	21.78	51.40	74.00	-22.60	peak
6	18000.000	25.90	26.12	52.02	74.00	-21.98	peak

Note: 1. Measurement = Reading Level + Correct Factor.
 2. If Peak Result complies with AV limit, AV Result is deemed to comply with AV limit.
 3. Peak: Peak detector.
 4. Filter losses were only considered in the spurious frequency bands and the authorized band was not corrected for High Pass Filter losses.
 5. Proper operation of the transmitter prior to adding the filter to the measurement chain.
 6. Since non-restricted band peak emissions are less than the average limit, they also comply with the -27dBm/MHz (68.2dBuV/m) limit.



HARMONICS AND SPURIOUS EMISSIONS (VERTICAL)

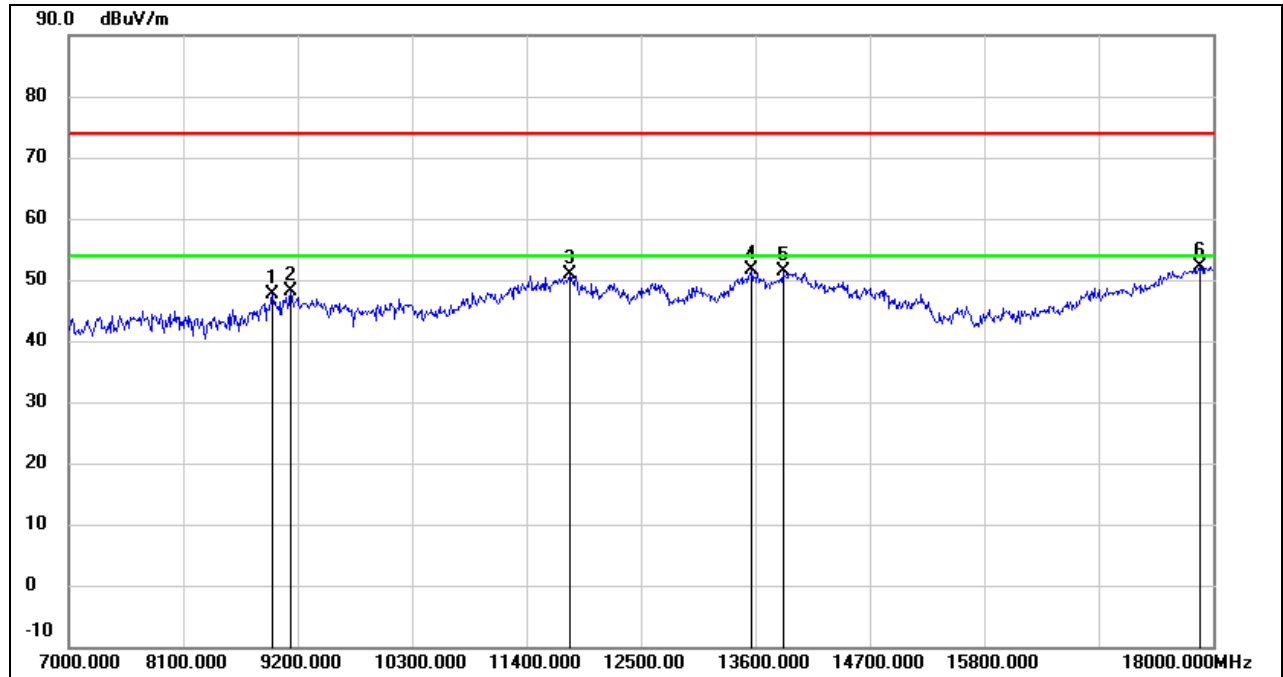

No.	Frequency (MHz)	Reading (dBuV)	Correct (dB/m)	Result (dBuV/m)	Limit (dBuV/m)	Margin (dB)	Remark
1	8958.000	37.70	10.05	47.75	74.00	-26.25	peak
2	9134.000	37.83	10.41	48.24	74.00	-25.76	peak
3	11818.000	33.48	17.36	50.84	74.00	-23.16	peak
4	13567.000	30.79	20.80	51.59	74.00	-22.41	peak
5	13864.000	29.86	21.53	51.39	74.00	-22.61	peak
6	17868.000	26.91	25.22	52.13	74.00	-21.87	peak

Note: 1. Measurement = Reading Level + Correct Factor.
 2. If Peak Result complies with AV limit, AV Result is deemed to comply with AV limit.
 3. Peak: Peak detector.
 4. Filter losses were only considered in the spurious frequency bands and the authorized band was not corrected for High Pass Filter losses.
 5. Proper operation of the transmitter prior to adding the filter to the measurement chain.
 6. Since non-restricted band peak emissions are less than the average limit, they also comply with the -27dBm/MHz (68.2dBuV/m) limit.



UNII-3 BAND

HARMONICS AND SPURIOUS EMISSIONS (LOW CHANNEL, HORIZONTAL)

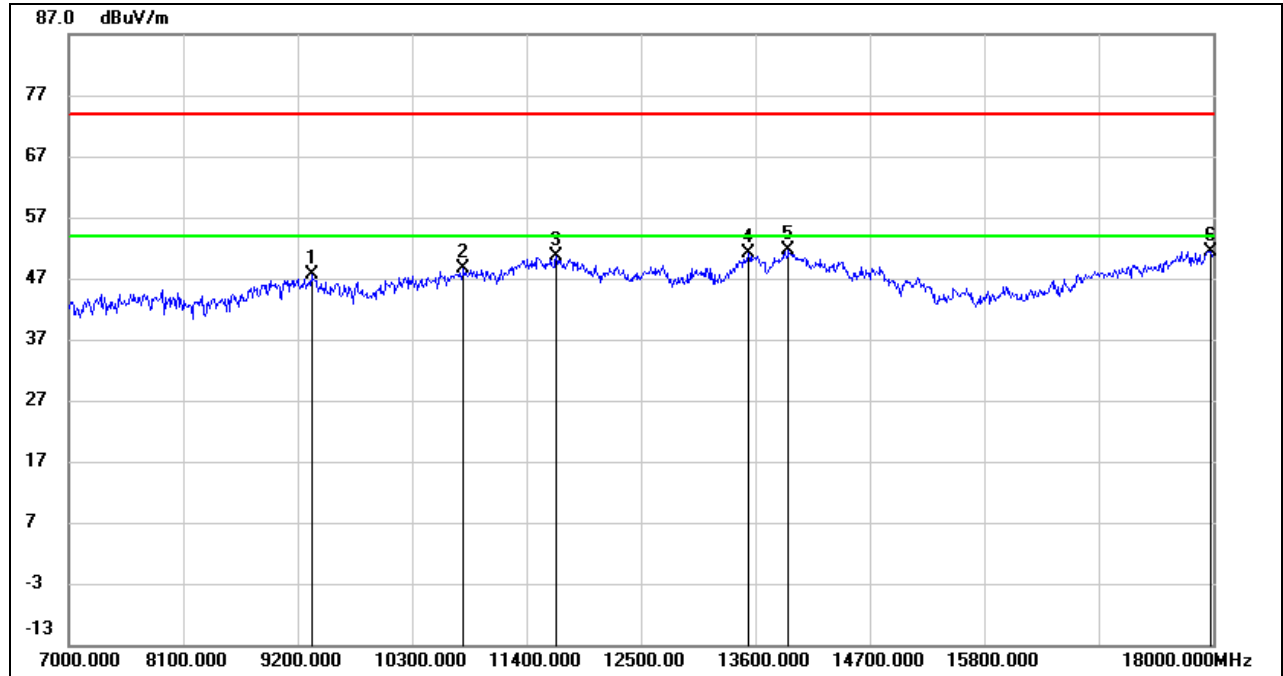

No.	Frequency (MHz)	Reading (dBuV)	Correct (dB/m)	Result (dBuV/m)	Limit (dBuV/m)	Margin (dB)	Remark
1	9332.000	37.17	10.54	47.71	74.00	-26.29	peak
2	10795.000	34.81	13.94	48.75	74.00	-25.25	peak
3	11686.000	33.40	17.12	50.52	74.00	-23.48	peak
4	13534.000	30.37	20.73	51.10	74.00	-22.90	peak
5	13919.000	29.88	21.68	51.56	74.00	-22.44	peak
6	17978.000	25.53	25.97	51.50	74.00	-22.50	peak

Note: 1. Measurement = Reading Level + Correct Factor.
 2. If Peak Result complies with AV limit, AV Result is deemed to comply with AV limit.
 3. Peak: Peak detector.
 4. Filter losses were only considered in the spurious frequency bands and the authorized band was not corrected for High Pass Filter losses.
 5. Proper operation of the transmitter prior to adding the filter to the measurement chain.
 6. Since non-restricted band peak emissions are less than the average limit, they also comply with the -27dBm/MHz (68.2dBuV/m) limit.



HARMONICS AND SPURIOUS EMISSIONS (LOW CHANNEL, VERTICAL)

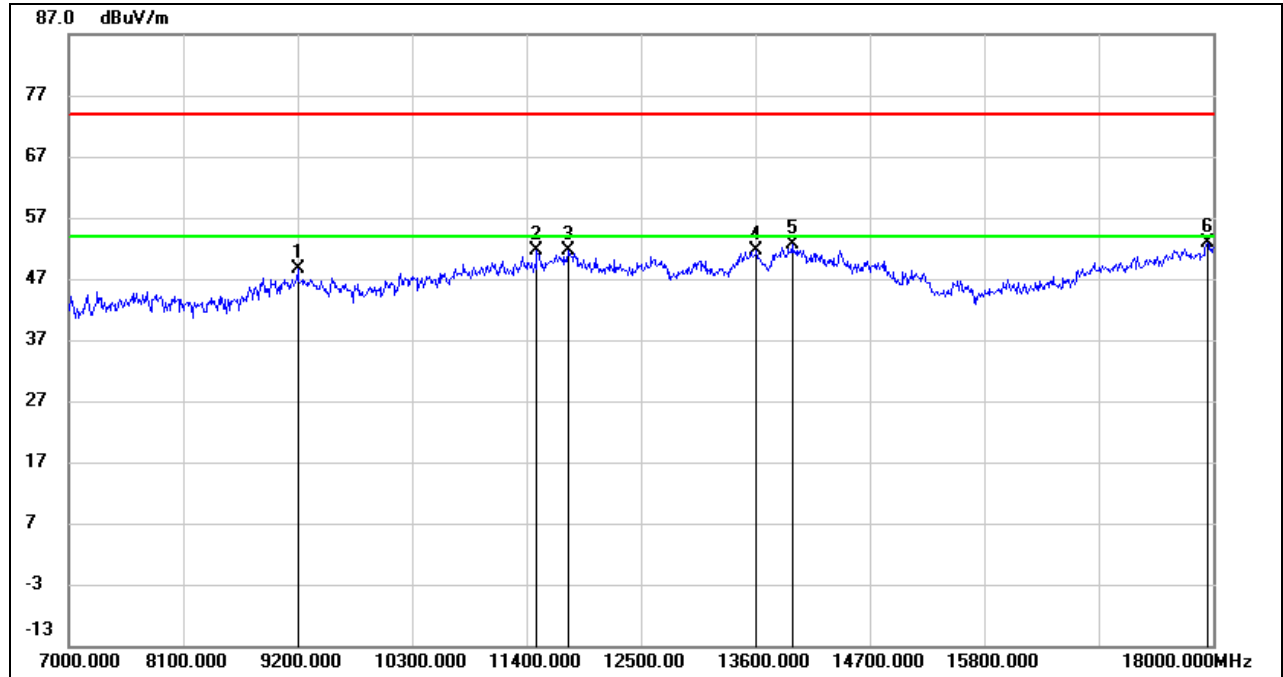

No.	Frequency (MHz)	Reading (dBuV)	Correct (dB/m)	Result (dBuV/m)	Limit (dBuV/m)	Margin (dB)	Remark
1	9200.000	38.13	10.46	48.59	74.00	-25.41	peak
2	11499.000	34.96	16.77	51.73	74.00	-22.27	peak
3	11796.000	34.40	17.32	51.72	74.00	-22.28	peak
4	13611.000	30.71	20.92	51.63	74.00	-22.37	peak
5	13952.000	30.85	21.76	52.61	74.00	-21.39	peak
6	17945.000	27.13	25.75	52.88	74.00	-21.12	peak

Note: 1. Measurement = Reading Level + Correct Factor.
 2. If Peak Result complies with AV limit, AV Result is deemed to comply with AV limit.
 3. Peak: Peak detector.
 4. Filter losses were only considered in the spurious frequency bands and the authorized band was not corrected for High Pass Filter losses.
 5. Proper operation of the transmitter prior to adding the filter to the measurement chain.
 6. Since non-restricted band peak emissions are less than the average limit, they also comply with the -27dBm/MHz (68.2dBuV/m) limit.



HARMONICS AND SPURIOUS EMISSIONS (HIGH CHANNEL, HORIZONTAL)

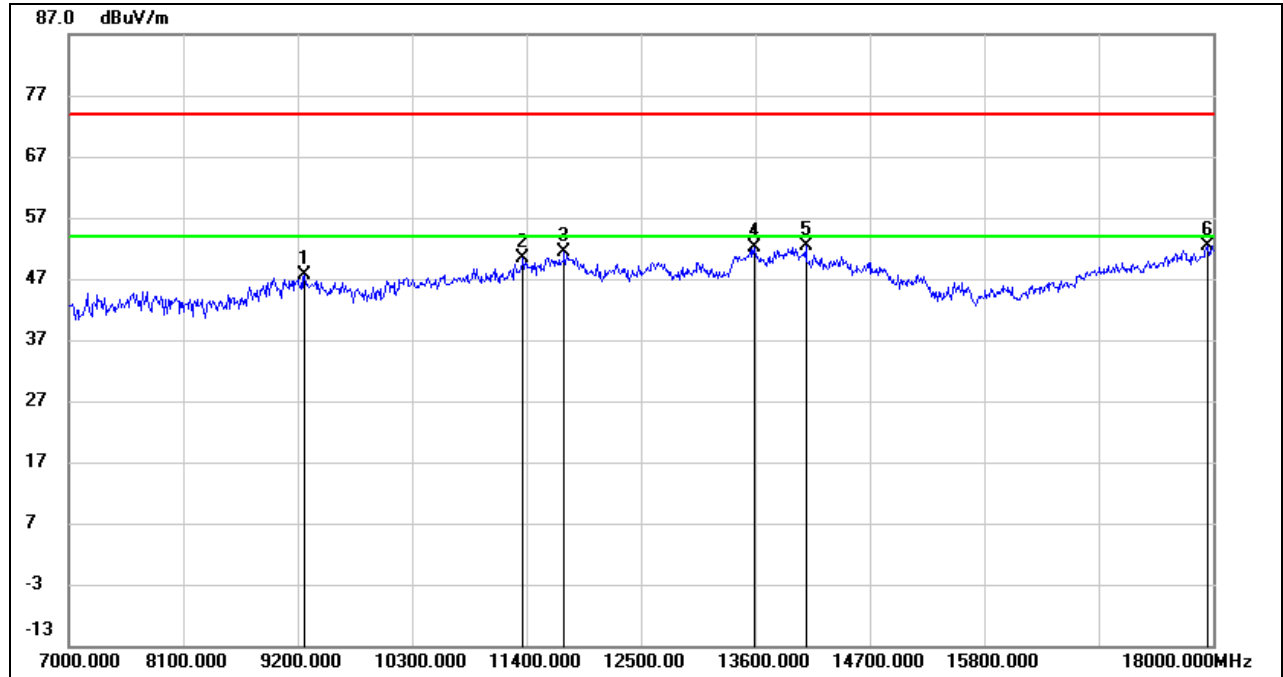

No.	Frequency (MHz)	Reading (dBuV)	Correct (dB/m)	Result (dBuV/m)	Limit (dBuV/m)	Margin (dB)	Remark
1	9266.000	37.08	10.51	47.59	74.00	-26.41	peak
2	11367.000	34.11	16.22	50.33	74.00	-23.67	peak
3	11763.000	34.09	17.26	51.35	74.00	-22.65	peak
4	13589.000	31.19	20.86	52.05	74.00	-21.95	peak
5	14084.000	30.82	21.52	52.34	74.00	-21.66	peak
6	17945.000	26.60	25.75	52.35	74.00	-21.65	peak

- Note: 1. Measurement = Reading Level + Correct Factor.
 2. If Peak Result complies with AV limit, AV Result is deemed to comply with AV limit.
 3. Peak: Peak detector.
 4. Filter losses were only considered in the spurious frequency bands and the authorized band was not corrected for High Pass Filter losses.
 5. Proper operation of the transmitter prior to adding the filter to the measurement chain.
 6. Since non-restricted band peak emissions are less than the average limit, they also comply with the -27dBm/MHz (68.2dBuV/m) limit.

HARMONICS AND SPURIOUS EMISSIONS (HIGH CHANNEL, VERTICAL)

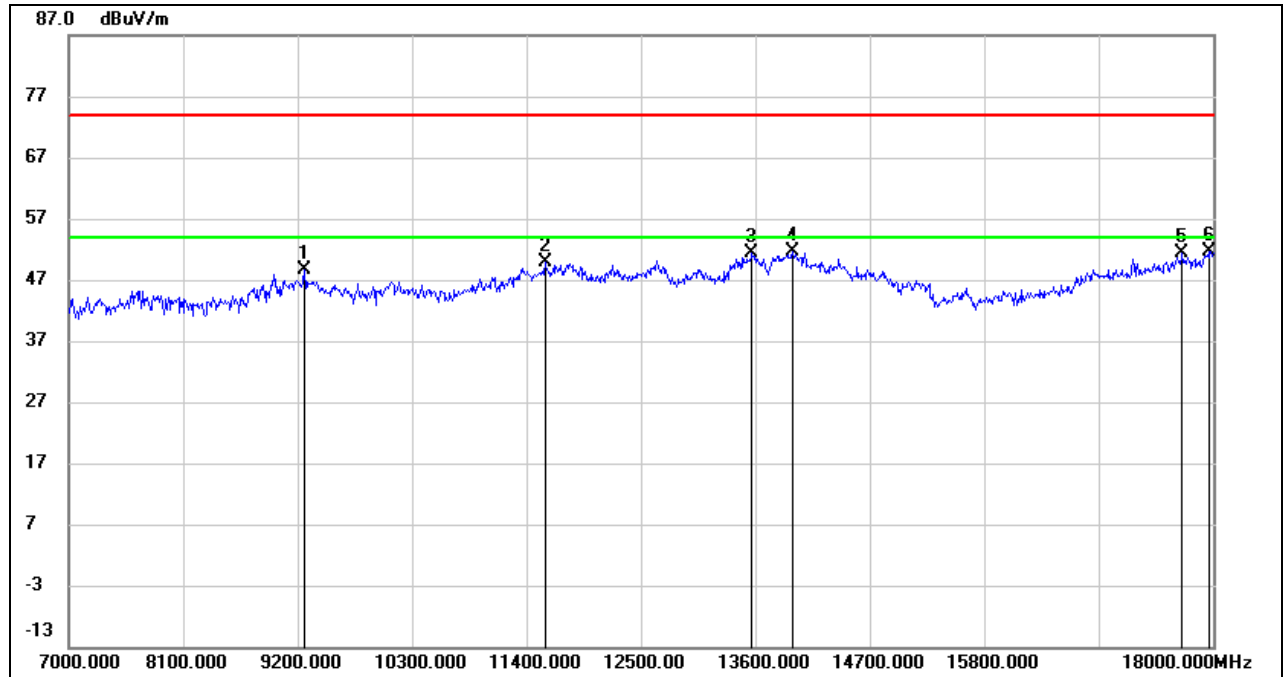

No.	Frequency (MHz)	Reading (dBuV)	Correct (dB/m)	Result (dBuV/m)	Limit (dBuV/m)	Margin (dB)	Remark
1	9266.000	38.07	10.51	48.58	74.00	-25.42	peak
2	11576.000	33.06	16.91	49.97	74.00	-24.03	peak
3	13567.000	30.47	20.80	51.27	74.00	-22.73	peak
4	13952.000	29.82	21.76	51.58	74.00	-22.42	peak
5	17703.000	27.22	24.09	51.31	74.00	-22.69	peak
6	17956.000	25.91	25.82	51.73	74.00	-22.27	peak

Note: 1. Measurement = Reading Level + Correct Factor.
 2. If Peak Result complies with AV limit, AV Result is deemed to comply with AV limit.
 3. Peak: Peak detector.
 4. Filter losses were only considered in the spurious frequency bands and the authorized band was not corrected for High Pass Filter losses.
 5. Proper operation of the transmitter prior to adding the filter to the measurement chain.
 6. Since non-restricted band peak emissions are less than the average limit, they also comply with the -27dBm/MHz (68.2dBuV/m) limit.

8.4. SPURIOUS EMISSIONS (18 GHz ~ 26 GHz)

8.4.1. 802.11n HT20 MODE

SPURIOUS EMISSIONS (UNII-3 BAND MID CHANNEL, HORIZONTAL, WORST-CASE CONFIGURATION)

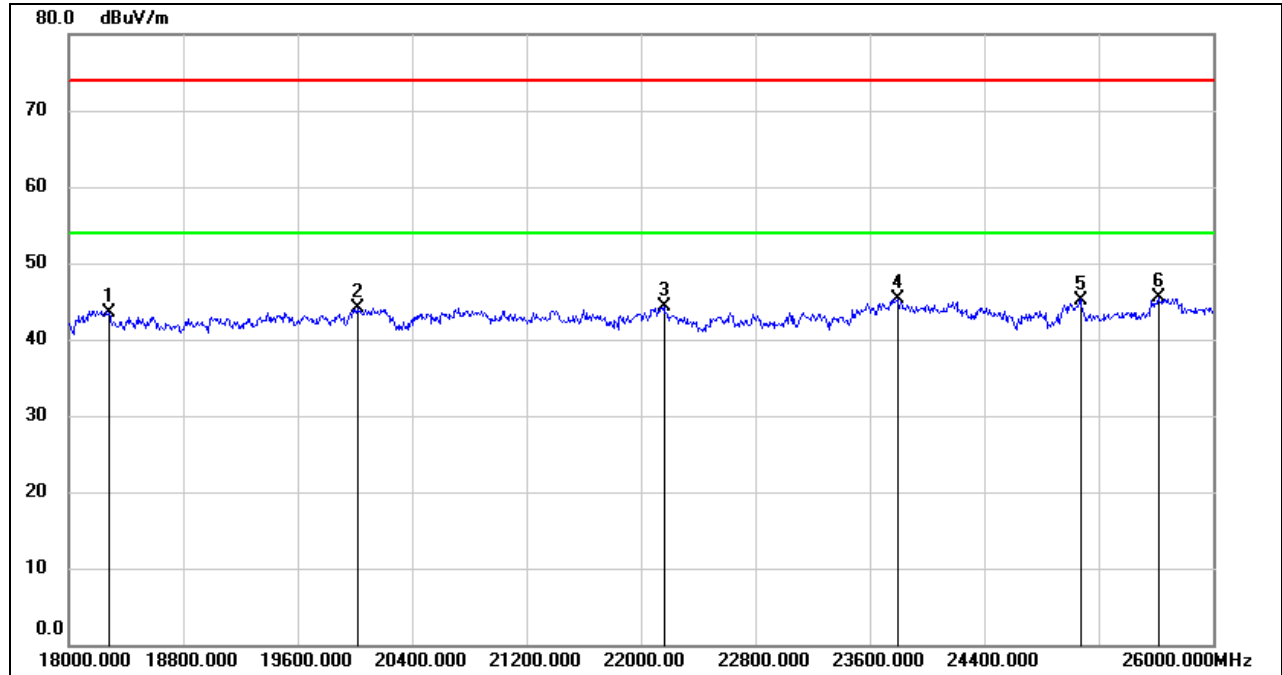

No.	Frequency (MHz)	Reading (dBuV)	Correct (dB/m)	Result (dBuV/m)	Limit (dBuV/m)	Margin (dB)	Remark
1	18280.000	49.11	-5.52	43.59	74.00	-30.41	peak
2	20016.000	49.56	-5.47	44.09	74.00	-29.91	peak
3	22160.000	48.58	-4.31	44.27	74.00	-29.73	peak
4	23800.000	48.41	-3.11	45.30	74.00	-28.70	peak
5	25072.000	47.17	-1.97	45.20	74.00	-28.80	peak
6	25616.000	46.68	-1.24	45.44	74.00	-28.56	peak

- Note: 1. Measurement = Reading Level + Correct Factor.
 2. If Peak Result complies with AV limit, AV Result is deemed to comply with AV limit.
 3. Peak: Peak detector.
 4. The preamplifier only effect to the above 18GHz signal and no filter added to the measurement chain.

SPURIOUS EMISSIONS (UNII-3 BAND MID CHANNEL, VERTICAL, WORST-CASE CONFIGURATION)

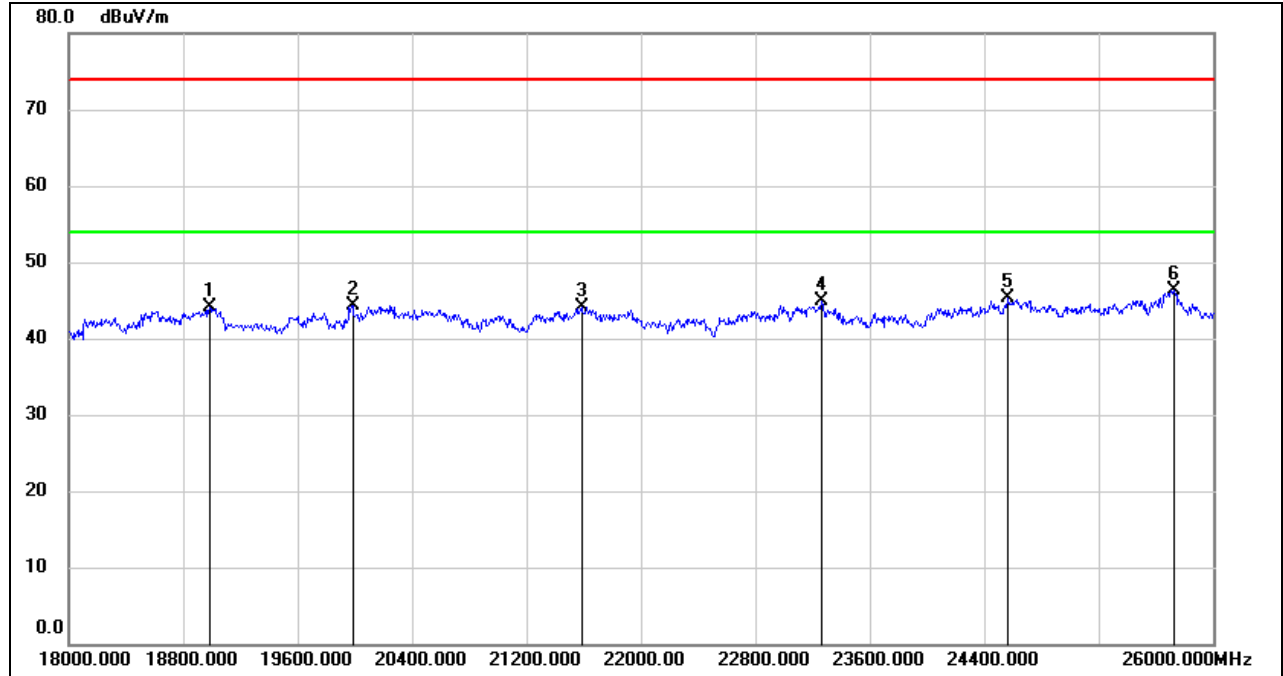

No.	Frequency (MHz)	Reading (dBuV)	Correct (dB/m)	Result (dBuV/m)	Limit (dBuV/m)	Margin (dB)	Remark
1	18984.000	49.29	-5.23	44.06	74.00	-29.94	peak
2	19984.000	49.71	-5.44	44.27	74.00	-29.73	peak
3	21584.000	48.60	-4.56	44.04	74.00	-29.96	peak
4	23264.000	48.26	-3.36	44.90	74.00	-29.10	peak
5	24568.000	47.60	-2.33	45.27	74.00	-28.73	peak
6	25728.000	47.11	-0.72	46.39	74.00	-27.61	peak

Note: 1. Measurement = Reading Level + Correct Factor.
 2. If Peak Result complies with AV limit, AV Result is deemed to comply with AV limit.
 3. Peak: Peak detector.
 4. The preamplifier only effect to the above 18GHz signal and no filter added to the measurement chain.

Note: All the modes and antennas had been tested, but only the worst data was recorded in the report.

8.5. SPURIOUS EMISSIONS (26 GHz ~ 40 GHz)

8.5.1. 802.11n HT20 MODE

SPURIOUS EMISSIONS (UNII-3 BAND MID CHANNEL, HORIZONTAL, WORST-CASE CONFIGURATION)

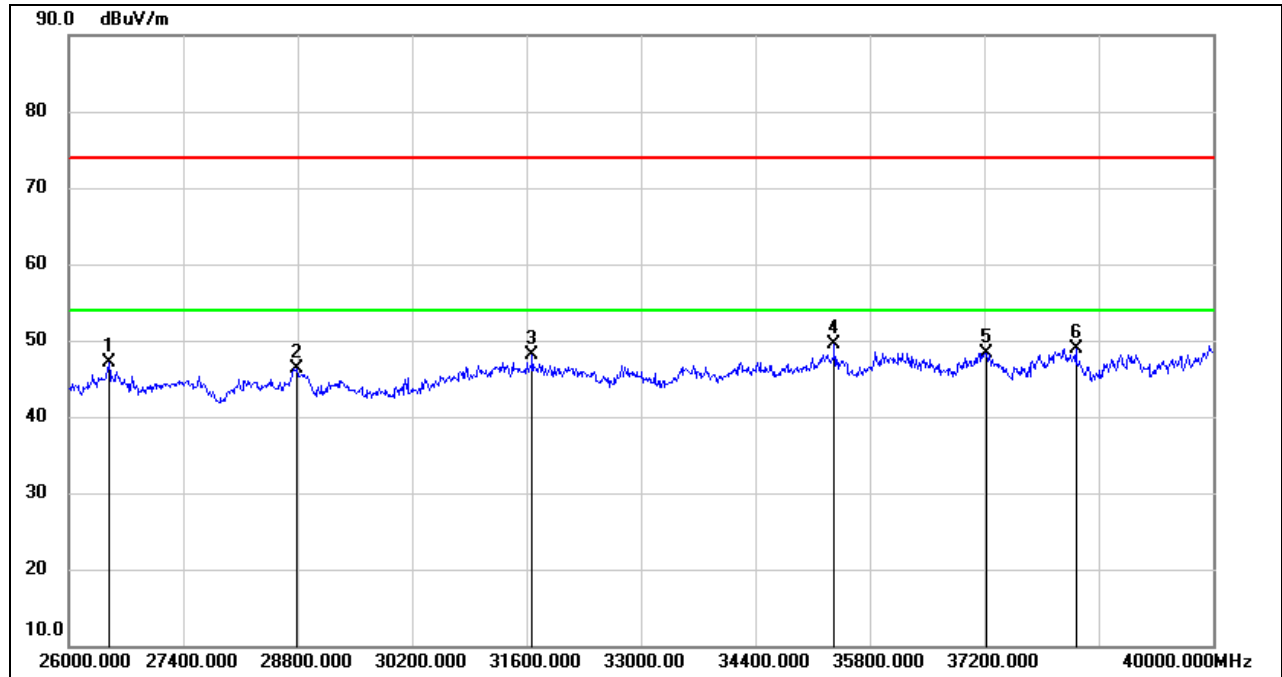

No.	Frequency (MHz)	Reading (dBuV)	Correct (dB/m)	Result (dBuV/m)	Limit (dBuV/m)	Margin (dB)	Remark
1	26490.000	51.79	-4.74	47.05	74.00	-26.95	peak
2	28786.000	46.99	-0.64	46.35	74.00	-27.65	peak
3	31670.000	49.36	-1.21	48.15	74.00	-25.85	peak
4	35366.000	46.90	2.59	49.49	74.00	-24.51	peak
5	37228.000	45.23	3.14	48.37	74.00	-25.63	peak
6	38320.000	45.06	3.77	48.83	74.00	-25.17	peak

Note: 1. Measurement = Reading Level + Correct Factor.
 2. If Peak Result complies with AV limit, AV Result is deemed to comply with AV limit.
 3. Peak: Peak detector.
 4. The preamplifier only effect to the above 18GHz signal and no filter added to the measurement chain.

SPURIOUS EMISSIONS (UNII-3 BAND MID CHANNEL, VERTICAL, WORST-CASE CONFIGURATION)

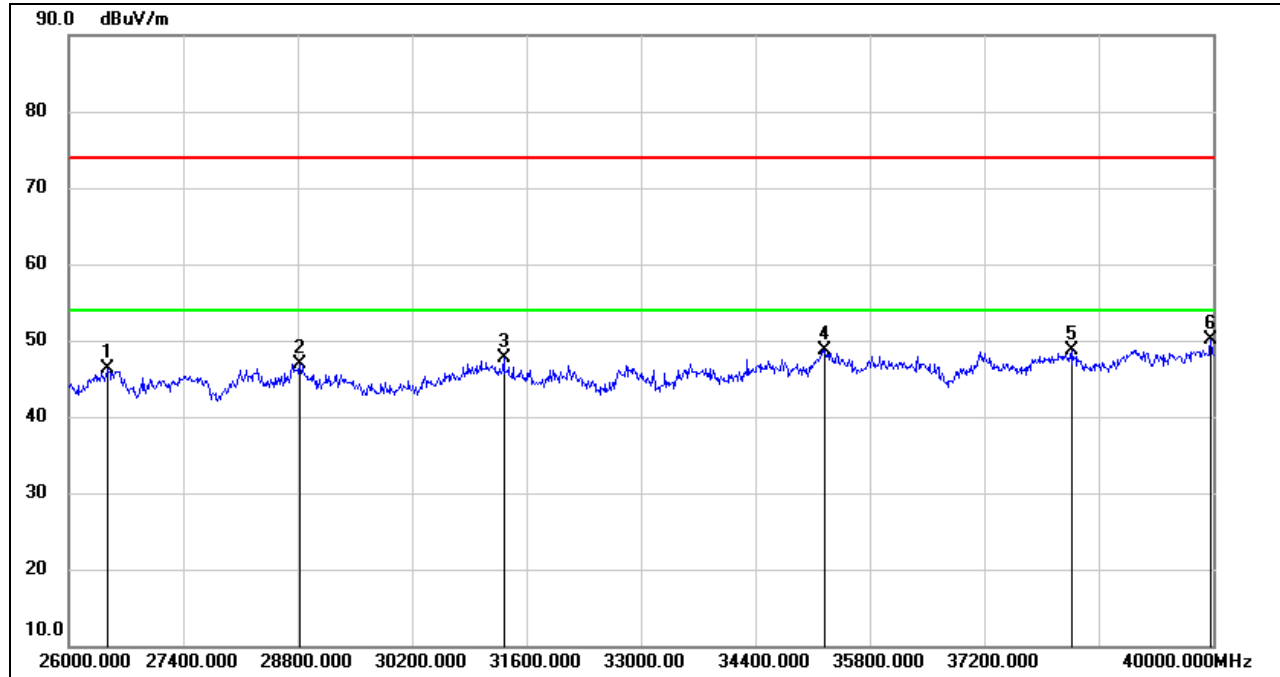

No.	Frequency (MHz)	Reading (dBuV)	Correct (dB/m)	Result (dBuV/m)	Limit (dBuV/m)	Margin (dB)	Remark
1	26476.000	51.03	-4.78	46.25	74.00	-27.75	peak
2	28828.000	47.63	-0.79	46.84	74.00	-27.16	peak
3	31320.000	48.61	-0.93	47.68	74.00	-26.32	peak
4	35254.000	46.12	2.65	48.77	74.00	-25.23	peak
5	38278.000	44.82	3.82	48.64	74.00	-25.36	peak
6	39972.000	44.95	5.13	50.08	74.00	-23.92	peak

Note: 1. Measurement = Reading Level + Correct Factor.
 2. If Peak Result complies with AV limit, AV Result is deemed to comply with AV limit.
 3. Peak: Peak detector.
 4. The preamplifier only effect to the above 18GHz signal and no filter added to the measurement chain.

Note: All the modes and antennas had been tested, but only the worst data was recorded in the report.

8.6. SPURIOUS EMISSIONS (30 MHz ~ 1 GHz)

8.6.1. 802.11n HT20 MODE

SPURIOUS EMISSIONS (UNII-3 BAND MID CHANNEL, HORIZONTAL, WORST-CASE CONFIGURATION)

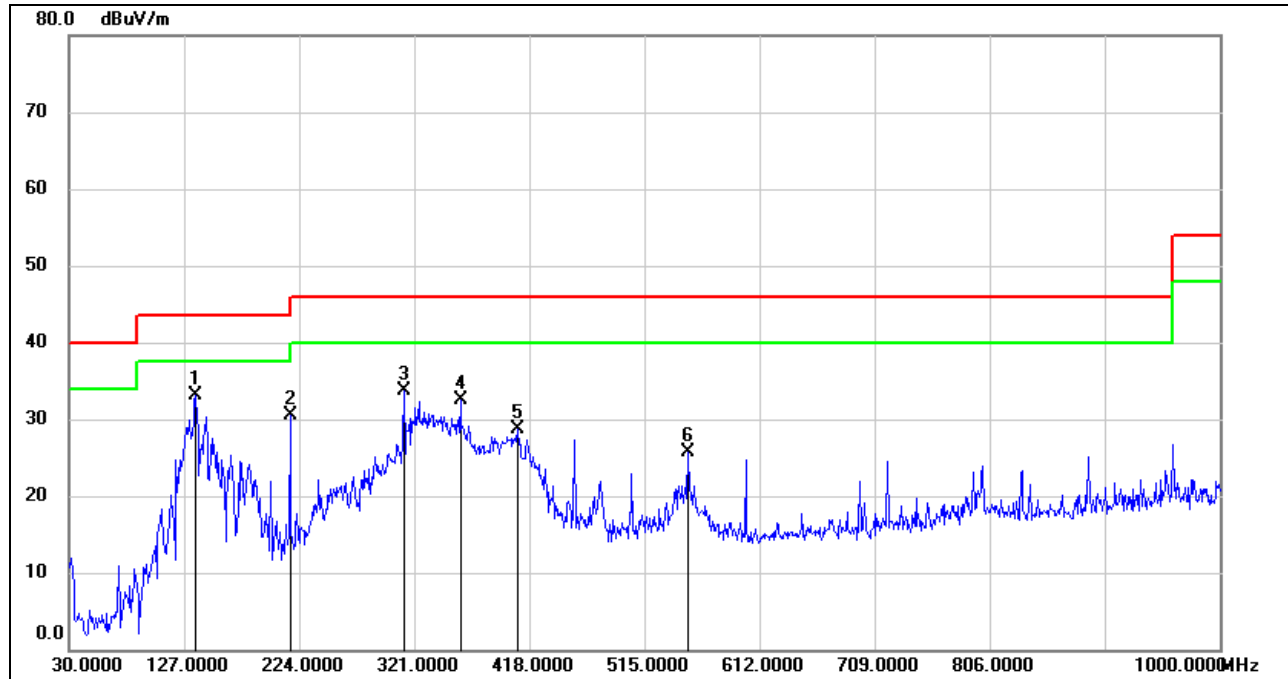

No.	Frequency (MHz)	Reading (dBuV)	Correct (dB/m)	Result (dBuV/m)	Limit (dBuV/m)	Margin (dB)	Remark
1	136.7000	52.20	-19.02	33.18	43.50	-10.32	QP
2	216.2400	48.29	-17.84	30.45	46.00	-15.55	QP
3	312.2700	48.71	-15.01	33.70	46.00	-12.30	QP
4	359.8000	46.65	-14.10	32.55	46.00	-13.45	QP
5	408.3000	41.91	-13.17	28.74	46.00	-17.26	QP
6	551.8600	36.21	-10.46	25.75	46.00	-20.25	QP

- Note: 1. Result Level = Read Level + Correct Factor.
 2. If Peak Result complies with QP limit, QP Result is deemed to comply with QP limit.
 3. Test setup: RBW: 120 kHz, VBW: 300 kHz, Sweep time: auto.

SPURIOUS EMISSIONS (UNII-3 BAND MID CHANNEL, VERTICAL, WORST-CASE CONFIGURATION)

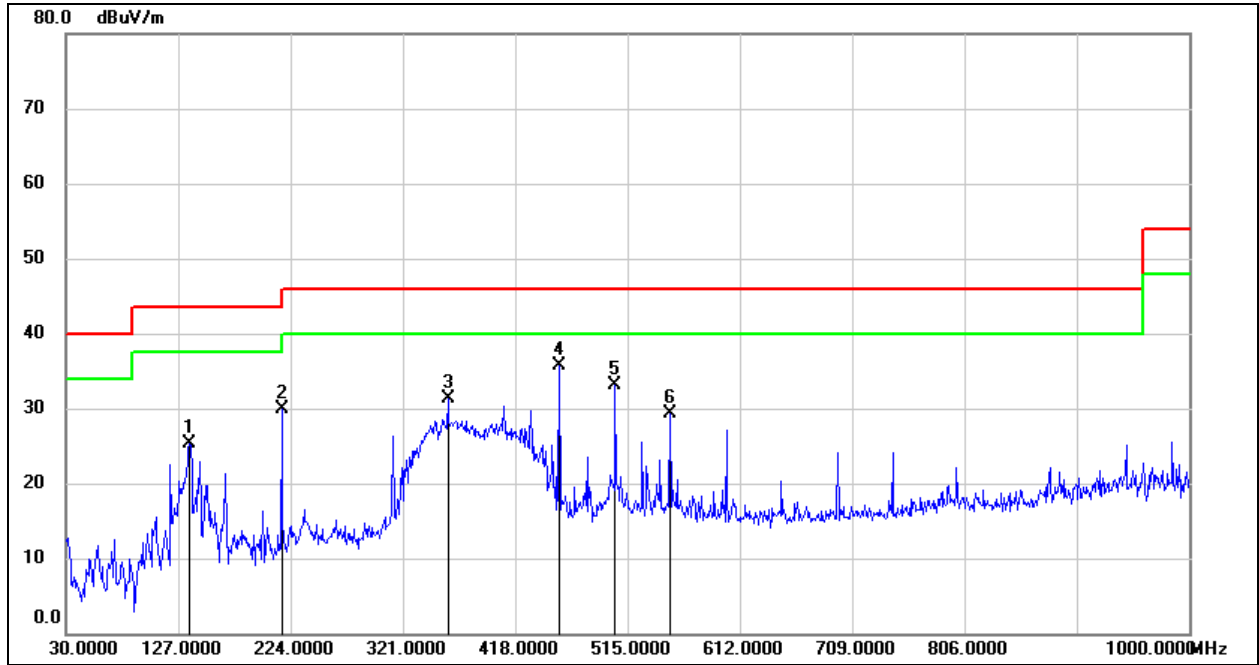

No.	Frequency (MHz)	Reading (dBuV)	Correct (dB/m)	Result (dBuV/m)	Limit (dBuV/m)	Margin (dB)	Remark
1	136.7000	44.31	-19.02	25.29	43.50	-18.21	QP
2	216.2400	47.80	-17.84	29.96	46.00	-16.04	QP
3	359.8000	45.39	-14.10	31.29	46.00	-14.71	QP
4	455.8300	47.97	-12.27	35.70	46.00	-10.30	QP
5	504.3300	44.55	-11.37	33.18	46.00	-12.82	QP
6	551.8600	39.82	-10.46	29.36	46.00	-16.64	QP

- Note: 1. Result Level = Read Level + Correct Factor.
 2. If Peak Result complies with QP limit, QP Result is deemed to comply with QP limit.
 3. Test setup: RBW: 120 kHz, VBW: 300 kHz, Sweep time: auto

Note: All the modes and antennas had been tested, but only the worst data was recorded in the report.

8.7. SPURIOUS EMISSIONS BELOW 30 MHz

8.7.1. 802.11n HT20 MODE

SPURIOUS EMISSIONS (UNII-3 BAND MID CHANNEL, LOOP ANTENNA FACE ON TO THE EUT, WORST-CASE CONFIGURATION)

9 kHz ~ 150 kHz

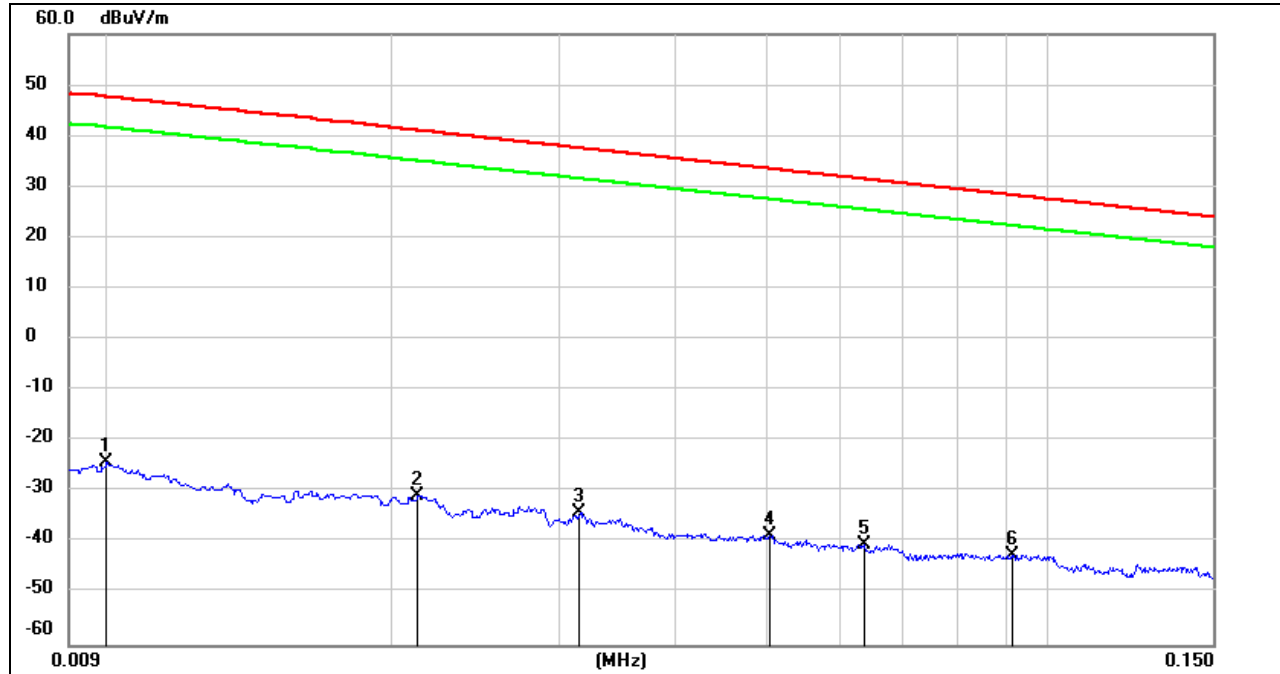

No.	Frequency (MHz)	Reading (dBuV)	Correct (dB/m)	Result (dBuV/m)	Limit (dBuV/m)	Margin (dB)	Remark
1	0.0100	77.22	-101.40	-24.18	47.60	-71.78	peak
2	0.0212	70.54	-101.35	-30.81	41.07	-71.88	peak
3	0.0316	67.24	-101.40	-34.16	37.61	-71.77	peak
4	0.0504	62.88	-101.48	-38.60	33.55	-72.15	peak
5	0.0636	61.31	-101.54	-40.23	31.53	-71.76	peak
6	0.0918	59.41	-101.73	-42.32	28.35	-70.67	peak

Note: 1. Measurement = Reading Level + Correct Factor.

2. If Peak Result complies with AV and QP limit, AV and QP Result are deemed to comply with AV limit.

3. All 3 polarizations (Horizontal, Face-on and Face-off) of the loop antenna had been tested, but only the worst data recorded in the report.

4. $\text{dBuA/m} = \text{dBuV/m} - 20\log_{10}(120\pi) = \text{dBuV/m} - 51.5$.



150 kHz ~ 490 kHz

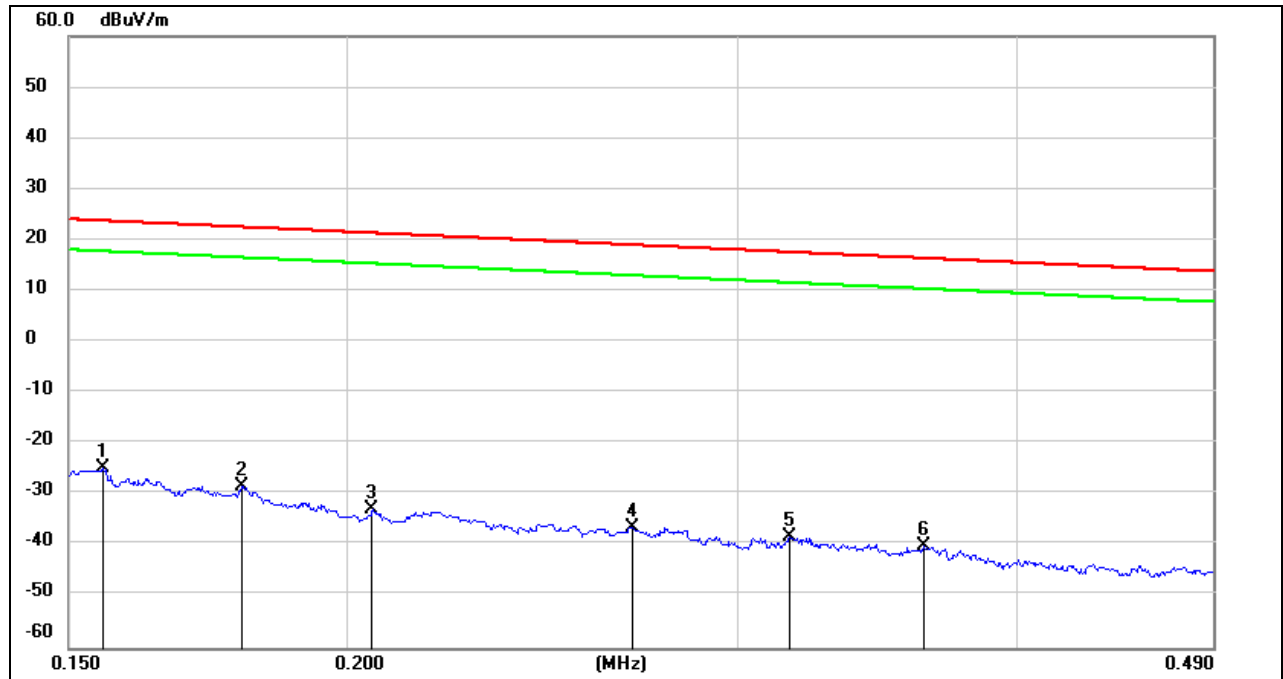

No.	Frequency (MHz)	Reading (dBuV)	Correct (dB/m)	Result (dBuV/m)	Limit (dBuV/m)	Margin (dB)	Remark
1	0.1554	76.77	-101.65	-24.88	23.77	-48.65	peak
2	0.1794	73.27	-101.68	-28.41	22.53	-50.94	peak
3	0.2053	68.79	-101.73	-32.94	21.35	-54.29	peak
4	0.2690	65.48	-101.82	-36.34	19.01	-55.35	peak
5	0.3163	63.70	-101.87	-38.17	17.60	-55.77	peak
6	0.3634	61.82	-101.93	-40.11	16.39	-56.50	peak

Note: 1. Measurement = Reading Level + Correct Factor.

2. If Peak Result complies with AV and QP limit, AV and QP Result are deemed to comply with AV limit.

3. All 3 polarizations (Horizontal, Face-on and Face-off) of the loop antenna had been tested, but only the worst data recorded in the report.

4. $\text{dBuA/m} = \text{dBuV/m} - 20\log_{10}(120\pi) = \text{dBuV/m} - 51.5$.

490 kHz ~ 30 MHz

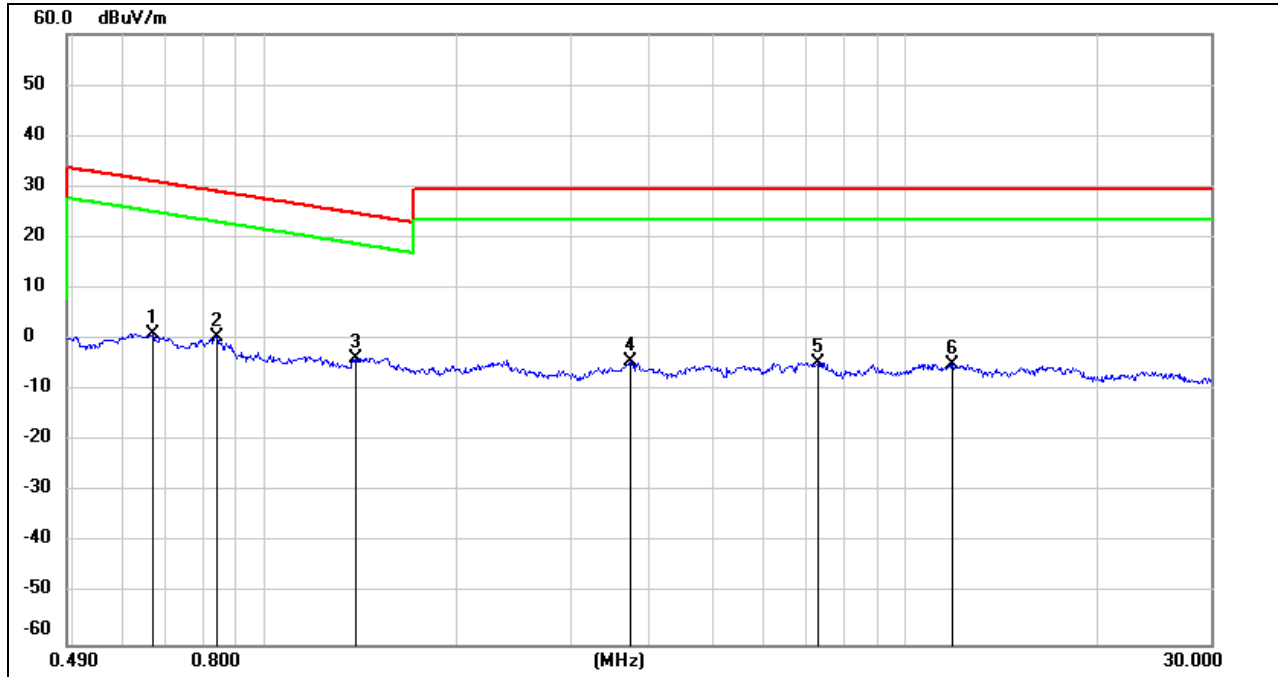

No.	Frequency (MHz)	Reading (dBuV)	Correct (dB/m)	Result (dBuV/m)	Limit (dBuV/m)	Margin (dB)	Remark
1	0.6671	63.25	-62.10	1.15	31.12	-29.97	peak
2	0.8400	62.71	-62.17	0.54	29.12	-28.58	peak
3	1.3810	58.47	-62.10	-3.63	24.80	-28.43	peak
4	3.7100	57.20	-61.41	-4.21	29.54	-33.75	peak
5	7.3361	56.58	-61.17	-4.59	29.54	-34.13	peak
6	11.8513	56.06	-60.88	-4.82	29.54	-34.36	peak

Note: 1. Measurement = Reading Level + Correct Factor.

2. If Peak Result complies with AV and QP limit, AV and QP Result are deemed to comply with AV limit.

3. All 3 polarizations (Horizontal, Face-on and Face-off) of the loop antenna had been tested, but only the worst data recorded in the report.

4. $\text{dBuA/m} = \text{dBuV/m} - 20\log_{10}(120\pi) = \text{dBuV/m} - 51.5$.

Note: All the modes and antennas had been tested, but only the worst data was recorded in the report.

9. AC POWER LINE CONDUCTED EMISSIONS

LIMITS

Please refer to CFR 47 FCC §15.207 (a).

FREQUENCY (MHz)	Quasi-peak	Average
0.15 -0.5	66 – 56 *	56 – 46 *
0.50 -5.0	56.00	46.00
5.0 -30.0	60.00	50.00

TEST SETUP AND PROCEDURE

Refer to ANSI C63.10-2013 clause 6.2.

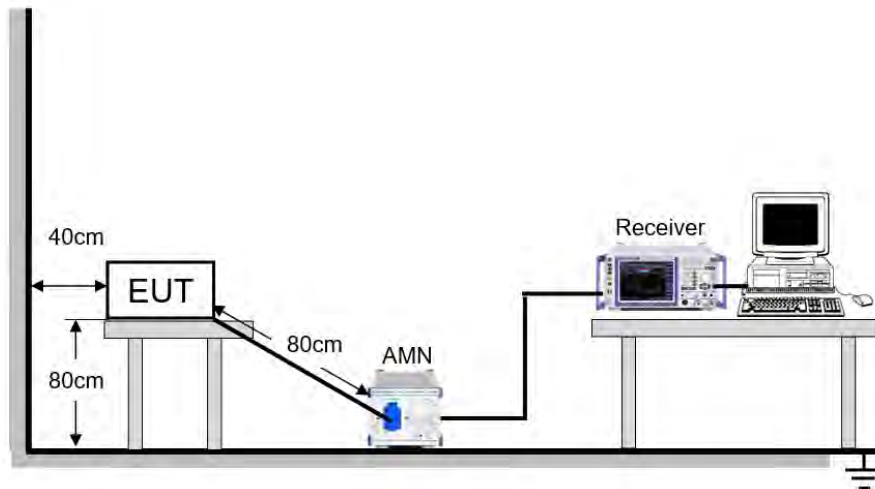

The EUT is put on a table of non-conducting material that is 80 cm high. The vertical conducting wall of shielding is located 40 cm to the rear of the EUT. The power line of the EUT is connected to the AC mains through a Artificial Mains Network (A.M.N.). A EMI Measurement Receiver (R&S Test Receiver ESR3) is used to test the emissions from both sides of AC line. According to the requirements in Section 6.2 of ANSI C63.10-2013. Conducted emissions from the EUT measured in the frequency range between 0.15 MHz and 30 MHz using CISPR Quasi-Peak and average detector mode. The bandwidth of EMI test receiver is set at 9 kHz.

The arrangement of the equipment is installed to meet the standards and operating in a manner, which tends to maximize its emission characteristics in a normal application.

TEST ENVIRONMENT

Temperature	23.8 °C	Relative Humidity	72.3 %
Atmosphere Pressure	101 kPa	Test Voltage	DC 3.3 V



RESULTS

9.1.1. 802.11n HT20 MODE

LINE N RESULTS (UNII-3 BAND MID CHANNEL, WORST-CASE CONFIGURATION)

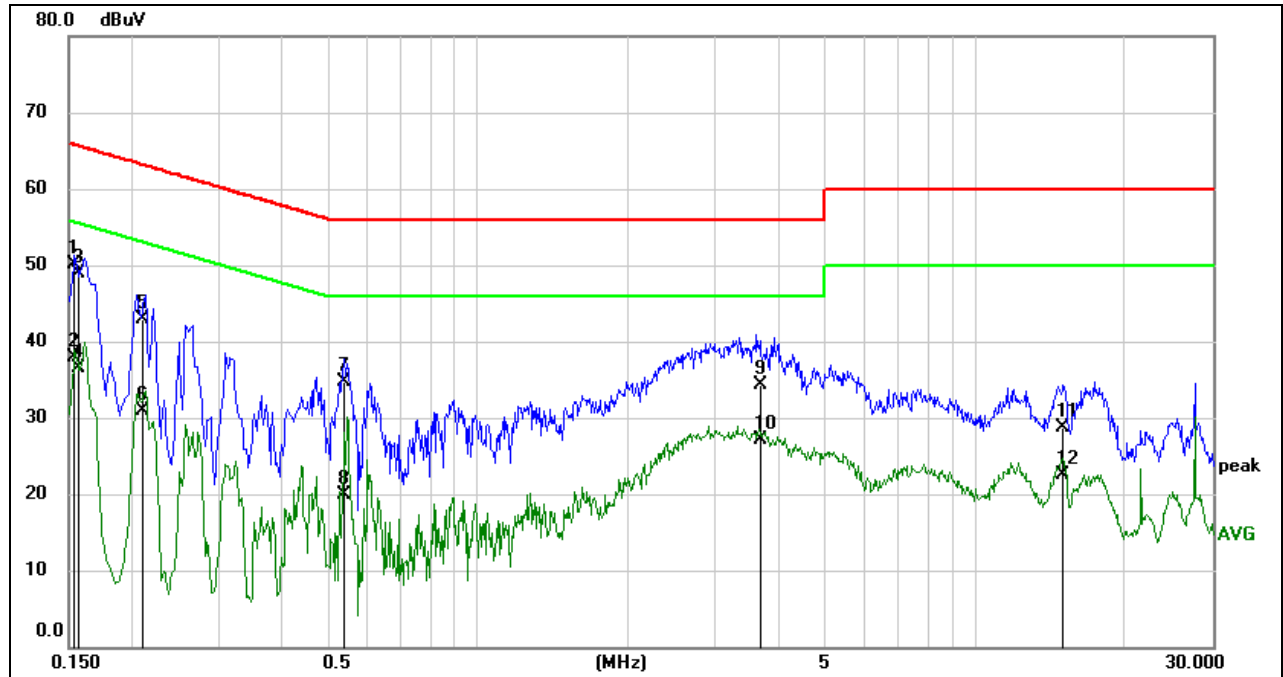

No.	Frequency (MHz)	Reading (dBuV)	Correct (dB)	Result (dBuV)	Limit (dBuV)	Margin (dB)	Remark
1	0.1544	40.45	9.59	50.04	65.76	-15.72	QP
2	0.1544	28.34	9.59	37.93	55.76	-17.83	AVG
3	0.1578	39.22	9.59	48.81	65.58	-16.77	QP
4	0.1578	26.93	9.59	36.52	55.58	-19.06	AVG
5	0.2104	33.40	9.59	42.99	63.19	-20.20	QP
6	0.2104	21.34	9.59	30.93	53.19	-22.26	AVG
7	0.5406	25.18	9.60	34.78	56.00	-21.22	QP
8	0.5406	10.27	9.60	19.87	46.00	-26.13	AVG
9	3.7071	24.63	9.61	34.24	56.00	-21.76	QP
10	3.7071	17.50	9.61	27.11	46.00	-18.89	AVG
11	14.9790	19.12	9.66	28.78	60.00	-31.22	QP
12	14.9790	12.94	9.66	22.60	50.00	-27.40	AVG

Note: 1. Result = Reading + Correct Factor.

2. If QP Result complies with AV limit, AV Result is deemed to comply with AV limit.

3. Test setup: RBW: 200 Hz (9 kHz ~ 150 kHz), 9 kHz (150 kHz ~ 30 MHz).

4. Step size: 80 Hz (0.009 MHz ~ 0.15 MHz), 4 kHz (0.15 MHz ~ 30 MHz), Scan time: auto.

LINE L RESULTS (UNII-2C BAND MID CHANNEL, WORST-CASE CONFIGURATION)

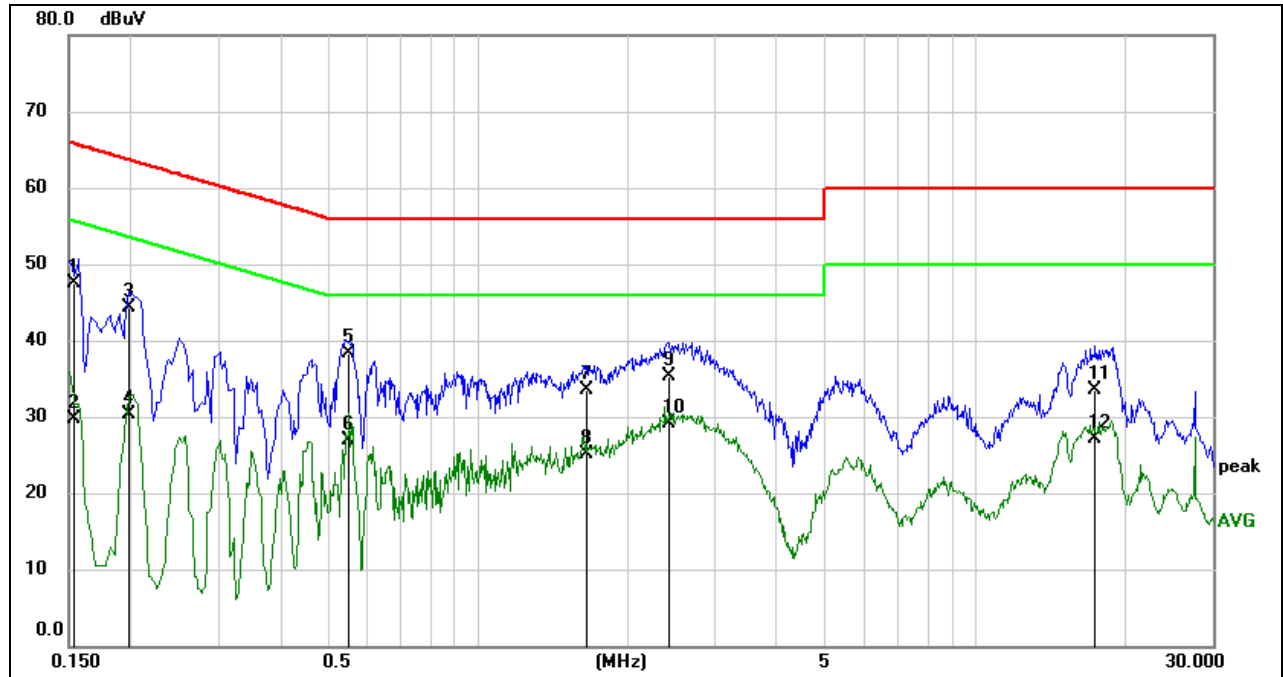

No.	Frequency (MHz)	Reading (dBuV)	Correct (dB)	Result (dBuV)	Limit (dBuV)	Margin (dB)	Remark
1	0.1535	37.90	9.59	47.49	65.81	-18.32	QP
2	0.1535	20.17	9.59	29.76	55.81	-26.05	AVG
3	0.1980	34.66	9.59	44.25	63.69	-19.44	QP
4	0.1980	20.65	9.59	30.24	53.69	-23.45	AVG
5	0.5464	28.78	9.60	38.38	56.00	-17.62	QP
6	0.5464	17.36	9.60	26.96	46.00	-19.04	AVG
7	1.6422	23.81	9.62	33.43	56.00	-22.57	QP
8	1.6422	15.41	9.62	25.03	46.00	-20.97	AVG
9	2.4388	25.68	9.63	35.31	56.00	-20.69	QP
10	2.4388	19.39	9.63	29.02	46.00	-16.98	AVG
11	17.3865	23.82	9.69	33.51	60.00	-26.49	QP
12	17.3865	17.49	9.69	27.18	50.00	-22.82	AVG

- Note: 1. Result = Reading + Correct Factor.
 2. If QP Result complies with AV limit, AV Result is deemed to comply with AV limit.
 3. Test setup: RBW: 200 Hz (9 kHz ~ 150 kHz), 9 kHz (150 kHz ~ 30 MHz).
 4. Step size: 80 Hz (0.009 MHz ~ 0.15 MHz), 4 kHz (0.15 MHz ~ 30 MHz), Scan time: auto.

Note: All the modes had been tested, but only the worst data was recorded in the report.

10. FREQUENCY STABILITY

LIMITS

The frequency of the carrier signal shall be maintained within band of operation.

TEST PROCEDURE

2. The EUT was placed inside an environmental chamber as the temperature in the chamber was varied between 0 °C ~ 70 °C (declared by customer).
2. The temperature was incremented by 10 °C intervals and the unit allowed to stabilize at each temperature before each measurement. The center frequency of the transmitting channel was evaluated at each temperature and the frequency deviation from the channel's center frequency was recorded.
3. The primary supply voltage is varied from 85 % to 115 % of the nominal value for non hand-carried battery and AC powered equipment. For hand-carried, battery-powered equipment, primary supply voltage is reduced to the battery operating end point which shall be specified by the manufacturer.

Connect the EUT to the spectrum analyser and use the following settings:

Center Frequency	The center frequency of the channel under test
Detector	Peak
RBW	10 kHz
VBW	$\geq 3 \times \text{RBW}$
Span	Encompass the entire emissions bandwidth (EBW) of the signal
Trace	Max hold
Sweep time	Auto

4. While maintaining a constant temperature inside the environmental chamber, turn the EUT on and record the operating frequency at startup, and at 2 minutes, 5 minutes, and 10 minutes after the EUT is energized.
5. Allow the trace to stabilize, find the peak value of the power envelope and record the frequency, then calculated the frequency drift.

TEST SETUP

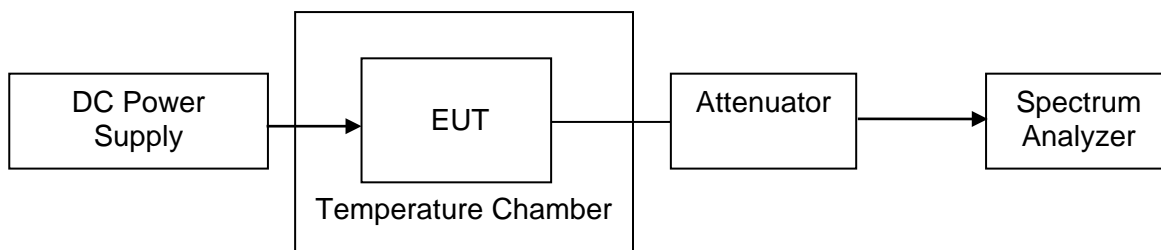



TEST ENVIRONMENT

	Normal Test Conditions	Extreme Test Conditions
Relative Humidity	20 % - 75 %	/
Atmospheric Pressure	100 kPa ~102 kPa	/
Temperature	T _N (Normal Temperature): 25.1 °C	T _L (Low Temperature): 0 °C
		T _H (High Temperature): 70 °C
Supply Voltage	V _N (Normal Voltage): DC 3.3 V	V _L (Low Voltage): DC 2.97 V
		V _H (High Voltage): DC 3.63 V

RESULTS

Please refer to Appendix E.

11. DYNAMIC FREQUENCY SELECTION

APPLICABILITY OF DFS REQUIREMENTS

A U-NII network will employ a DFS function to detect signals from radar systems and to avoid co-channel operation with these systems. This applies to the 5250-5350 MHz and/or 5470-5725 MHz bands.

Within the context of the operation of the DFS function, a U-NII device will operate in either Master Mode or Client Mode. U-NII devices operating in Client Mode can only operate in a network controlled by a U-NII device operating in Master Mode.

Table 1: Applicability of DFS Requirements Prior to Use of a Channel

Requirement	Operational Mode		
	<input type="checkbox"/> Master	<input checked="" type="checkbox"/> Client Without Radar Detection	<input type="checkbox"/> Client With Radar Detection
Non-Occupancy Period	Yes	Not required	Yes
DFS Detection Threshold	Yes	Not required	Yes
Channel Availability Check Time	Yes	Not required	Not required
U-NII Detection Bandwidth	Yes	Not required	Yes

Table 2: Applicability of DFS requirements during normal operation

Requirement	Operational Mode	
	<input type="checkbox"/> Master Device or Client with Radar Detection	<input checked="" type="checkbox"/> Client Without Radar Detection
DFS Detection Threshold	Yes	Not required
Channel Closing Transmission Time	Yes	Yes
Channel Move Time	Yes	Yes
U-NII Detection Bandwidth	Yes	Not required

Additional requirements for devices with multiple bandwidth modes	<input type="checkbox"/> Master Device or Client with Radar Detection	<input checked="" type="checkbox"/> Client Without Radar Detection
U-NII Detection Bandwidth and Statistical Performance Check	All BW modes must be tested	Not required
Channel Move Time and Channel Closing Transmission Time	Test using widest BW mode available	Test using the widest BW mode available for the link
All other tests	Any single BW mode	Not required

Note: Frequencies selected for statistical performance check should include several frequencies within the radar detection bandwidth and frequencies near the edge of the radar detection bandwidth. For 802.11 devices it is suggested to select frequencies in each of the bonded 20 MHz channels and the channel center frequency.

LIMITS

(1) DFS Detection Thresholds

Table 3: DFS Detection Thresholds for Master Devices and Client Devices With Radar Detection

Maximum Transmit Power	Value (See Notes 1, 2, and 3)
EIRP \geq 200 milliwatt	-64 dBm
EIRP < 200 milliwatt and power spectral density < 10 dBm/MHz	-62 dBm
EIRP < 200 milliwatt that do not meet the power spectral density requirement	-64 dBm

Note 1: This is the level at the input of the receiver assuming a 0 dBi receive antenna.
 Note 2: Throughout these test procedures an additional 1 dB has been added to the amplitude of the test transmission waveforms to account for variations in measurement equipment. This will ensure that the test signal is at or above the detection threshold level to trigger a DFS response.
 Note3: EIRP is based on the highest antenna gain. For MIMO devices refer to KDB Publication 662911 D01.

(2) DFS Response Requirements

Table 4: DFS Response Requirement Values

Parameter	Value
Non-occupancy period	Minimum 30 minutes
Channel Availability Check Time	60 seconds
Channel Move Time	10 seconds See Note 1.
Channel Closing Transmission Time	200 milliseconds + an aggregate of 60 milliseconds over remaining 10 second period. See Notes 1 and 2.
U-NII Detection Bandwidth	Minimum 100% of the U-NII 99% transmission power bandwidth. See Note 3.

Note 1: Channel Move Time and the Channel Closing Transmission Time should be performed with Radar Type 0. The measurement timing begins at the end of the Radar Type 0 burst.
 Note 2: The Channel Closing Transmission Time is comprised of 200 milliseconds starting at the beginning of the Channel Move Time plus any additional intermittent control signals required facilitating a Channel move (an aggregate of 60 milliseconds) during the remainder of the 10 second period. The aggregate duration of control signals will not count quiet periods in between transmissions.
 Note 3: During the U-NII Detection Bandwidth detection test, radar type 0 should be used. For each frequency step the minimum percentage of detection is 90 percent. Measurements are performed with no data traffic.

PARAMETERS OF RADAR TEST WAVEFORMS

This section provides the parameters for required test waveforms, minimum percentage of successful detections, and the minimum number of trials that must be used for determining DFS conformance. Step intervals of 0.1 microsecond for Pulse Width, 1 microsecond for PRI, 1 MHz for chirp width and 1 for the number of pulses will be utilized for the random determination of specific test waveforms.

Table 5 Short Pulse Radar Test Waveforms

Radar Type	Pulse Width (µsec)	PRI (µsec)	Number of Pulses	Minimum Percentage of Successful Detection	Minimum Number of Trials
0	1	1428	18	See Note 1	See Note 1
1	1	Test A	Roundup $\left\{ \frac{1}{360} \right\}$	60%	30
		Test B			
2	1-5	150-230	23-29	60%	30
3	6-10	200-500	16-18	60%	30
4	11-20	200-500	12-16	60%	30
Aggregate (Radar Types 1-4)				80%	120
Note 1: Short Pulse Radar Type 0 should be used for the detection bandwidth test, channel move time, and channel closing time tests. Test A: 15 unique PRI values randomly selected from the list of 23 PRI values in Table 5a Test B: 15 unique PRI values randomly selected within the range of 518-3066 µsec, with a minimum increment of 1 µsec, excluding PRI values selected in Test A					

A minimum of 30 unique waveforms are required for each of the Short Pulse Radar Types 2 through 4. If more than 30 waveforms are used for Short Pulse Radar Types 2 through 4, then each additional waveform must also be unique and not repeated from the previous waveforms. If more than 30 waveforms are used for Short Pulse Radar Type 1, then each additional waveform is generated with Test B and must also be unique and not repeated from the previous waveforms in Tests A or B. Test aggregate is average of the percentage of successful detections of short pulse radar types 1-4.

TEST SETUP

Setup for Client with injection at the Master

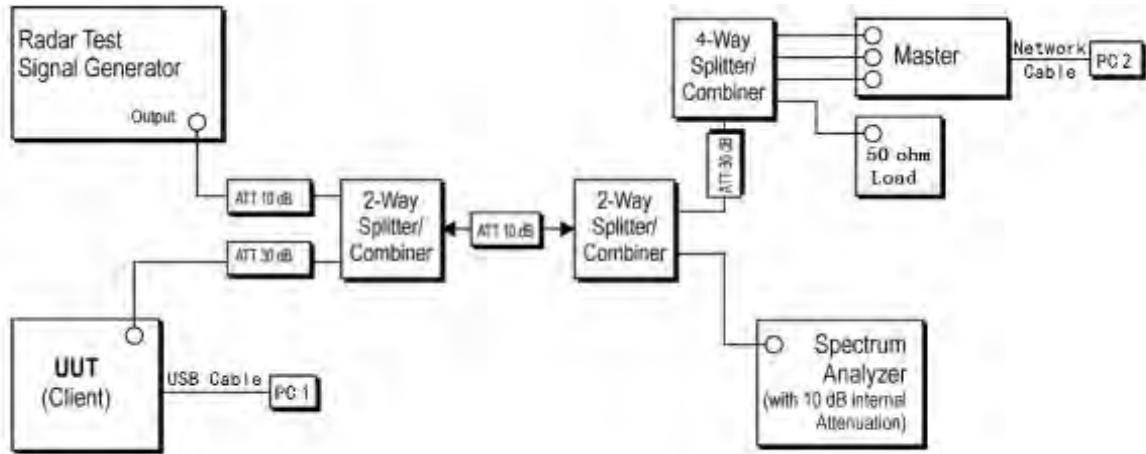

TEST ENVIRONMENT

Temperature	24.1 °C	Relative Humidity	60.5 %
Atmosphere Pressure	101 kPa	Test Voltage	DC 3.3 V

RESULTS

Please refer to Appendix F.

12. ANTENNA REQUIREMENTS

APPLICABLE REQUIREMENTS

Please refer to FCC §15.203

An intentional radiator shall be designed to ensure that no antenna other than that furnished by the responsible party shall be used with the device. The use of a permanently attached antenna or of an antenna that uses a unique coupling to the intentional radiator shall be considered sufficient to comply with the provisions of this section. The manufacturer may design the unit so that a broken antenna can be replaced by the user, but the use of a standard antenna jack or electrical connector is prohibited.

Please refer to FCC §15.247(b)(4)

The conducted output power limit specified in paragraph (b) of this section is based on the use of antennas with directional gains that do not exceed 6 dBi. Except as shown in paragraph (c) of this section, if transmitting antennas of directional gain greater than 6 dBi are used, the conducted output power from the intentional radiator shall be reduced below the stated values in paragraphs (b)(1), (b)(2), and (b)(3) of this section, as appropriate, by the amount in dB that the directional gain of the antenna exceeds 6 dBi.

RESULTS

Complies



13. Appendix

13.1. Appendix A1: Emission Bandwidth

13.1.1. Test Result

Test Mode	Antenna	Channel	26db EBW [MHz]	FL[MHz]	FH[MHz]	Verdict
11A20	Ant0	5180	19.880	5170.000	5189.880	PASS
	Ant1	5180	19.680	5169.960	5189.640	PASS
	Ant0	5200	20.000	5190.000	5210.000	PASS
	Ant1	5200	19.760	5189.840	5209.600	PASS
	Ant0	5240	20.320	5229.920	5250.240	PASS
	Ant1	5240	19.920	5230.200	5250.120	PASS
	Ant0	5260	19.640	5250.160	5269.800	PASS
	Ant1	5260	19.680	5250.200	5269.880	PASS
	Ant0	5280	19.840	5270.160	5290.000	PASS
	Ant1	5280	19.560	5270.160	5289.720	PASS
	Ant0	5320	19.760	5310.160	5329.920	PASS
	Ant1	5320	19.560	5310.160	5329.720	PASS
	Ant0	5500	19.800	5490.160	5509.960	PASS
	Ant1	5500	19.800	5490.080	5509.880	PASS
	Ant0	5580	20.080	5570.120	5590.200	PASS
	Ant1	5580	19.840	5570.160	5590.000	PASS
	Ant0	5700	20.160	5690.080	5710.240	PASS
	Ant1	5700	20.160	5690.120	5710.280	PASS
	Ant0	5720	19.880	5710.040	5729.920	PASS
	Ant1	5720	19.960	5710.160	5730.120	PASS
	Ant0	5720_UNII-2C	14.96	5710.040	5725	PASS
	Ant1	5720_UNII-2C	14.84	5710.160	5725	PASS
	Ant0	5720_UNII-3	4.92	5725	5729.920	PASS
	Ant1	5720_UNII-3	5.12	5725	5730.120	PASS
	Ant0	5745	20.160	5735.040	5755.200	PASS
	Ant1	5745	20.280	5734.920	5755.200	PASS
	Ant0	5785	19.600	5775.200	5794.800	PASS
	Ant1	5785	20.000	5775.000	5795.000	PASS
	Ant0	5825	19.880	5814.960	5834.840	PASS
	Ant1	5825	20.080	5814.920	5835.000	PASS
11N20MIMO	Ant0	5180	19.720	5170.360	5190.080	PASS
	Ant1	5180	20.240	5169.800	5190.040	PASS
	Ant0	5200	20.520	5190.000	5210.520	PASS
	Ant1	5200	19.680	5190.120	5209.800	PASS
	Ant0	5240	20.320	5229.800	5250.120	PASS
	Ant1	5240	20.040	5230.120	5250.160	PASS
	Ant0	5260	20.240	5249.920	5270.160	PASS
	Ant1	5260	19.600	5250.080	5269.680	PASS
	Ant0	5280	19.840	5270.200	5290.040	PASS
	Ant1	5280	19.840	5270.120	5289.960	PASS
	Ant0	5320	20.040	5310.000	5330.040	PASS
	Ant1	5320	19.840	5309.960	5329.800	PASS
	Ant0	5500	19.880	5490.240	5510.120	PASS
	Ant1	5500	19.960	5490.000	5509.960	PASS
	Ant0	5580	19.960	5570.080	5590.040	PASS
	Ant1	5580	20.320	5569.960	5590.280	PASS
	Ant0	5700	19.880	5690.040	5709.920	PASS
	Ant1	5700	19.840	5690.040	5709.880	PASS
	Ant0	5720	19.840	5710.280	5730.120	PASS
	Ant1	5720	19.840	5710.040	5729.880	PASS
	Ant0	5720_UNII-2C	14.72	5710.280	5725	PASS
	Ant1	5720_UNII-2C	14.96	5710.040	5725	PASS



	Ant0	5720_UNII-3	5.12	5725	5730.120	PASS
	Ant1	5720_UNII-3	4.88	5725	5729.880	PASS
	Ant0	5745	20.040	5735.160	5755.200	PASS
	Ant1	5745	19.480	5735.320	5754.800	PASS
	Ant0	5785	20.240	5775.040	5795.280	PASS
	Ant1	5785	20.160	5774.920	5795.080	PASS
	Ant0	5825	19.880	5815.320	5835.200	PASS
	Ant1	5825	20.040	5815.040	5835.080	PASS
11N40MIMO	Ant0	5190	40.160	5169.840	5210.000	PASS
	Ant1	5190	39.760	5169.920	5209.680	PASS
	Ant0	5230	40.640	5209.760	5250.400	PASS
	Ant1	5230	39.040	5210.240	5249.280	PASS
	Ant0	5270	40.240	5249.760	5290.000	PASS
	Ant1	5270	40.320	5250.320	5290.640	PASS
	Ant0	5310	40.240	5290.080	5330.320	PASS
	Ant1	5310	39.200	5290.160	5329.360	PASS
	Ant0	5510	40.560	5490.000	5530.560	PASS
	Ant1	5510	40.320	5489.920	5530.240	PASS
	Ant0	5550	39.520	5530.480	5570.000	PASS
	Ant1	5550	39.840	5530.400	5570.240	PASS
	Ant0	5670	40.000	5650.240	5690.240	PASS
	Ant1	5670	39.920	5650.320	5690.240	PASS
	Ant0	5710	39.840	5690.320	5730.160	PASS
	Ant1	5710	41.600	5689.360	5730.960	PASS
	Ant0	5710_UNII-2C	34.68	5690.320	5725	PASS
	Ant1	5710_UNII-2C	35.64	5689.360	5725	PASS
	Ant0	5710_UNII-3	5.16	5725	5730.160	PASS
	Ant1	5710_UNII-3	5.96	5725	5730.960	PASS
	Ant0	5755	39.920	5735.320	5775.240	PASS
	Ant1	5755	40.160	5734.520	5774.680	PASS
	Ant0	5795	40.240	5775.000	5815.240	PASS
	Ant1	5795	40.720	5774.600	5815.320	PASS

13.1.2. Test Graphs



11A_Ant1_5180



11A_Ant2_5180

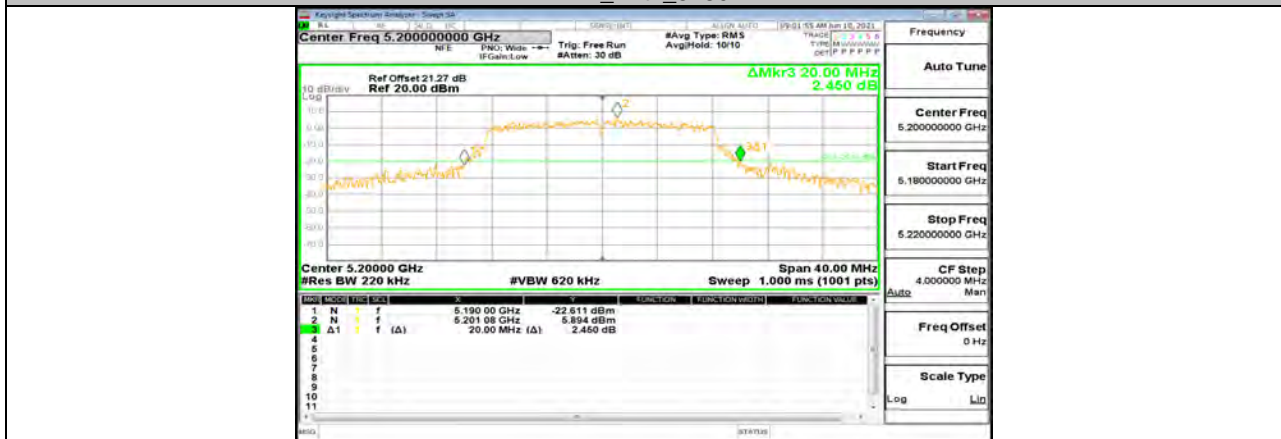

11A_Ant1_5200



11A_Ant2_5200



11A_Ant1_5240

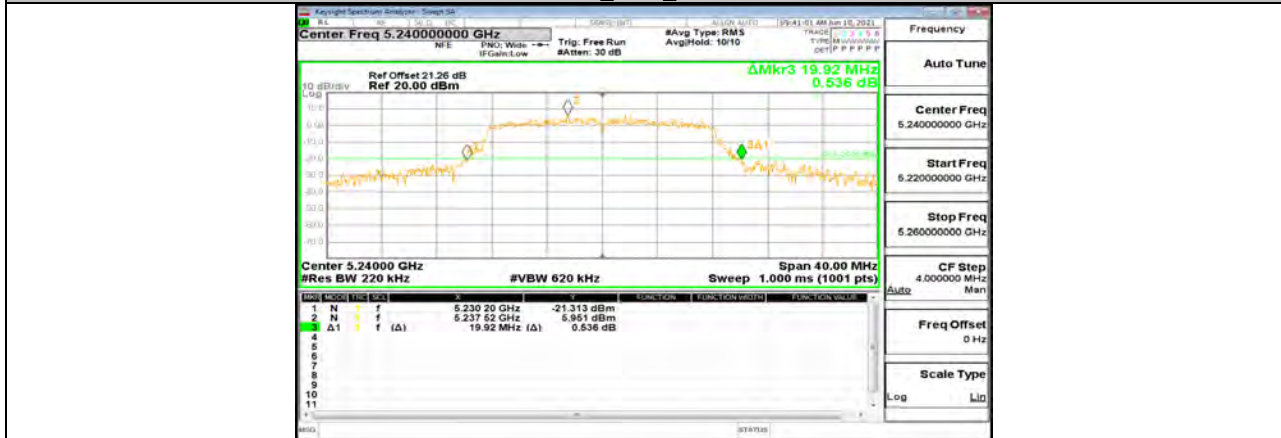

11A_Ant2_5240



11A_Ant1_5260



11A_Ant2_5260



11A_Ant1_5280

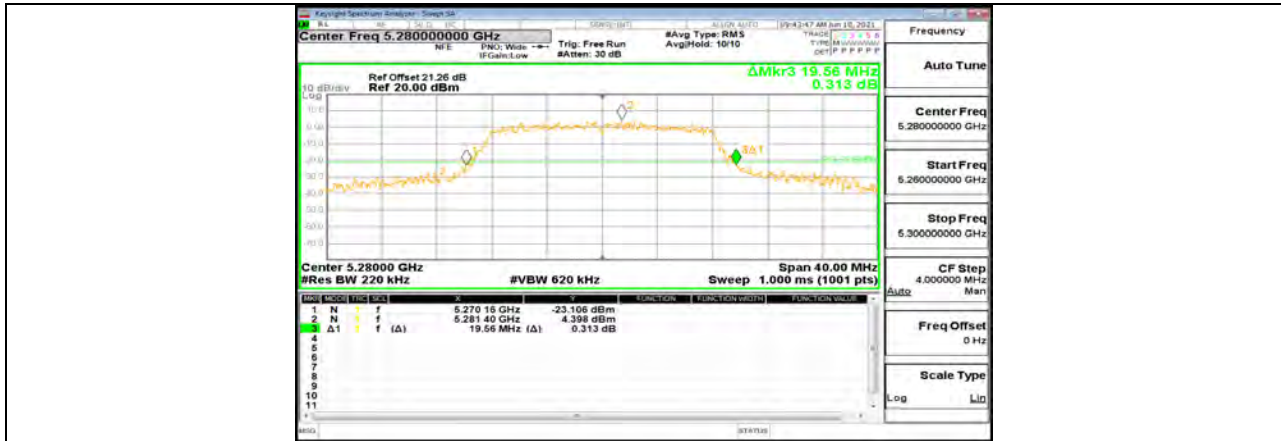

11A_Ant2_5280



11A_Ant1_5320

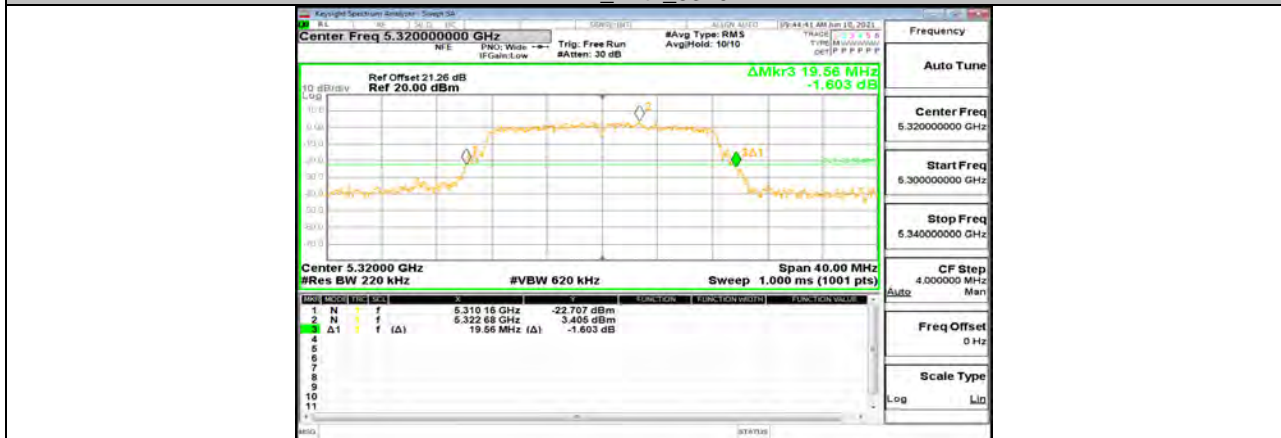

11A_Ant2_5320