



**CFR 47 FCC PART 15 SUBPART C
ISED RSS-247 ISSUE 2**

CERTIFICATION TEST REPORT

For

WIFI Module

MODEL NUMBER: WC5EM2601F

FCC ID: 2AC23-WC5E

IC: 12290A-WC5E

REPORT NUMBER: 4790487035-1

ISSUE DATE: July 28, 2022

Prepared for

**Hui Zhou Gaoshengda Technology Co.,LTD
No.2,Jin-da Road,Huinan High-tech Industrial Park,Hui-ao Avenue,Huizhou
City,Guangdong,China**

Prepared by

UL Verification Services (Guangzhou) Co., Ltd, Song Shan Lake Branch

Building 10, Innovation Technology Park, No. 1, Li Bin Road, Song Shan Lake Hi-Tech Development Zone Dongguan, 523808, People's Republic of China

Tel: +86 769 22038881

Fax: +86 769 33244054

Website: www.ul.com



Revision History

Rev.	Issue Date	Revisions	Revised By
V0	07/28/2022	Initial Issue	

Note: This is a report base on 4790105656.2-1 which is issued by UL Verification Services (Guangzhou) Co., Ltd, Song Shan Lake Branch on October 29, 2021. The module WC5EM2601F had already applied for single module approval and the FCC ID is 2AC23-WC5E, IC is 12290A-WC5E. Now the customer wants to add two antennas but the module remained unchanged. The antenna type of the new antennas is the same as the original antenna, but the gain is different. Spot check had been done for the conducted output power, the power of module remained unchanged, so we retest all radiated emission and show in this report but others data were refer to the original test report.

The summary of spot-check test data compared to the original test data:

Item	Test Mode	Frequency (MHz)	Antenna	Worst Case Test Result		
				Original Test Result (dBm)	Spot Check Result (dBm)	Difference
Conducted AV Power	802.11b	2437	1	19.25	19.56	0.31
			2	19.26	19.43	0.17
	802.11g	2437	1	18.51	18.72	0.21
			2	18.57	18.69	0.12
	802.11n HT20	2437	1	16.29	16.44	0.15
			2	16.22	16.38	0.16
	802.11n HT40	2437	1	16.58	16.84	0.26
			2	16.52	16.73	0.21



Summary of Test Results			
Clause	Test Items	FCC/ISED Rules	Test Results
1	6dB Bandwidth and 99% Occupied Bandwidth	FCC Part 15.247 (a) (2) RSS-247 Clause 5.2 (a) ISED RSS-Gen Clause 6.7	Pass
2	Conducted Output Power	FCC Part 15.247 (b) (3) RSS-247 Clause 5.4 (d)	Pass
3	Power Spectral Density	FCC Part 15.247 (e) RSS-247 Clause 5.2 (b)	Pass
4	Conducted Bandedge and Spurious Emission	FCC Part 15.247 (d) RSS-247 Clause 5.5	Pass
5	Radiated Bandedge and Spurious Emission	FCC Part 15.247 (d) FCC Part 15.209 FCC Part 15.205 RSS-247 Clause 5.5 RSS-GEN Clause 8.9	Pass
6	Conducted Emission Test for AC Power Port	FCC Part 15.207 RSS-GEN Clause 8.8	Pass
7	Antenna Requirement	FCC Part 15.203 RSS-GEN Clause 6.8	Pass
Note: 1. This test report is only published to and used by the applicant, and it is not for evidence purpose in China. 2. The measurement result for the sample received is <Pass> according to < CFR 47 FCC PART 15 SUBPART C > when <Accuracy Method> decision rule is applied.			

TABLE OF CONTENTS

1. ATTESTATION OF TEST RESULTS	6
2. TEST METHODOLOGY	7
3. FACILITIES AND ACCREDITATION	7
4. CALIBRATION AND UNCERTAINTY	8
4.1. <i>MEASURING INSTRUMENT CALIBRATION</i>	8
4.2. <i>MEASUREMENT UNCERTAINTY</i>	8
5. EQUIPMENT UNDER TEST	9
5.1. <i>DESCRIPTION OF EUT</i>	9
5.2. <i>CHANNEL LIST</i>	9
5.3. <i>MAXIMUM OUTPUT POWER</i>	9
5.4. <i>TEST CHANNEL CONFIGURATION</i>	10
5.5. <i>THE WORSE CASE POWER SETTING PARAMETER</i>	10
5.6. <i>THE WORSE CASE CONFIGURATIONS</i>	11
5.7. <i>DESCRIPTION OF AVAILABLE ANTENNAS</i>	12
5.8. <i>DESCRIPTION OF TEST SETUP</i>	15
6. MEASURING INSTRUMENT AND SOFTWARE USED	16
7. ANTENNA PORT TEST RESULTS	19
7.1. <i>ON TIME AND DUTY CYCLE</i>	19
7.2. <i>6 dB DTS BANDWIDTH AND 99 % OCCUPIED BANDWIDTH</i>	20
7.3. <i>CONDUCTED OUTPUT POWER</i>	22
7.4. <i>POWER SPECTRAL DENSITY</i>	23
7.5. <i>CONDUCTED BANDEDGE AND SPURIOUS EMISSIONS</i>	25
8. RADIATED TEST RESULTS	27
8.1. <i>RESTRICTED BANDEDGE</i>	33
8.1.1. 802.11b SISO MODE	33
8.1.2. 802.11g SISO MODE	37
8.1.3. 802.11n HT20 MIMO MODE	41
8.1.4. 802.11n HT40 MIMO MODE	45
8.2. <i>SPURIOUS EMISSIONS (1 GHz ~ 3 GHz)</i>	49
8.2.1. 802.11n HT20 MIMO MODE	49
8.3. <i>SPURIOUS EMISSIONS (3 GHz ~ 18 GHz)</i>	55
8.3.1. 802.11b SISO MODE	55
8.3.2. 802.11g SISO MODE	61
8.3.3. 802.11n HT20 MIMO MODE	67
8.3.4. 802.11n HT40 MIMO MODE	73



8.5.	SPURIOUS EMISSIONS (18 GHz ~ 26 GHz)	79
8.5.1.	802.11n HT20 MIMO MODE	79
8.6.	SPURIOUS EMISSIONS (30 MHz ~ 1 GHz)	81
8.6.1.	802.11n HT20 MIMO MODE	81
8.7.	SPURIOUS EMISSIONS BELOW 30 MHz	83
8.7.1.	802.11n HT20 MIMO MODE	83
9.	AC POWER LINE CONDUCTED EMISSIONS	86
9.1.	802.11n HT20 MIMO MODE	87
10.	ANTENNA REQUIREMENTS	89
11.	Appendix	90
11.1.	Appendix A: DTS Bandwidth	90
11.1.1.	Test Result	90
11.1.2.	Test Graphs	91
11.2.	Appendix B: Occupied Channel Bandwidth	99
11.2.1.	Test Result	99
11.2.2.	Test Graphs	100
11.3.	Appendix C: Maximum Average Conducted Output Power	108
11.3.1.	Test Result	108
11.3.2.	Spot check Test Result	109
11.4.	Appendix D: Maximum Power Spectral Density	110
11.4.1.	Test Result	110
11.4.2.	Test Graphs	111
11.5.	Appendix E: Band Edge Measurements	117
11.5.1.	Test Result	117
11.5.2.	Test Graphs	118
11.6.	Appendix F: Conducted Spurious Emission	122
11.6.1.	Test Result	122
11.6.2.	Test Graphs	124
11.7.	Appendix G: Duty Cycle	142
11.7.1.	Test Result	142
11.7.2.	Test Graphs	143



1. ATTESTATION OF TEST RESULTS

Applicant Information

Company Name: Hui Zhou Gaoshengda Technology Co.,LTD
Address: No.2,Jin-da Road,Huinan High-tech Industrial Park,Hui-ao Avenue,Huizhou City,Guangdong,China

Manufacturer Information

Company Name: Hui Zhou Gaoshengda Technology Co.,LTD
Address: No.2,Jin-da Road,Huinan High-tech Industrial Park,Hui-ao Avenue,Huizhou City,Guangdong,China

EUT Information

EUT Name: WIFI Module
Model: WC5EM2601F
Brand: GSD
Last Time Sample Received Date: September 22, 2021
This Time Sample Received Date: July 12, 2022
Sample Status: Normal
Sample ID: 4245286/5143870
Date of Tested for Last Time: September 24, 2021 ~ October 25, 2021
Date of Tested for This Time: July 12, 2022 ~ July 29, 2022

APPLICABLE STANDARDS	
STANDARD	TEST RESULTS
CFR 47 FCC PART 15 SUBPART C	PASS
ISED RSS-247 Issue 2	PASS
ISED RSS-GEN Issue 5	PASS

Prepared By:

Kebo Zhang
Senior Project Engineer

Checked By:

Denny Huang
Senior Project Engineer

Approved By:

Stephen Guo
Laboratory Manager



2. TEST METHODOLOGY

The tests documented in this report were performed in accordance with KDB 558074 D01 15.247 Meas Guidance v05r02, KDB 662911 D01 Multiple Transmitter Output v02r01, KDB 414788 D01 Radiated Test Site v01r01, CFR 47 FCC Part 2, CFR 47 FCC Part 15, ANSI C63.10-2013, ISED RSS-247 Issue 2 and ISED RSS-GEN Issue 5.

3. FACILITIES AND ACCREDITATION

Accreditation Certificate	<p>A2LA (Certificate No.: 4102.01) UL Verification Services (Guangzhou) Co., Ltd. Song Shan Lake Branch. has been assessed and proved to be in compliance with A2LA.</p> <p>FCC (FCC Designation No.: CN1187) UL Verification Services (Guangzhou) Co., Ltd. Song Shan Lake Branch. Has been recognized to perform compliance testing on equipment subject to the Commission's Declaration of Conformity (DoC) and Certification rules</p> <p>ISED (Company No.: 21320) UL Verification Services (Guangzhou) Co., Ltd. Song Shan Lake Branch. has been registered and fully described in a report filed with ISED. The Company Number is 21320 and the test lab Conformity Assessment Body Identifier (CABID) is CN0046.</p> <p>VCCI (Registration No.: G-20019, R-20004, C-20012 and T-20011) UL Verification Services (Guangzhou) Co., Ltd. Song Shan Lake Branch. has been assessed and proved to be in compliance with VCCI, the Membership No. is 3793. Facility Name: Chamber D, the VCCI registration No. is G-20019 and R-20004 Shielding Room B , the VCCI registration No. is C-20012 and T-20011</p>
---------------------------	---

Note 1: All tests measurement facilities use to collect the measurement data are located at Building 10, Innovation Technology Park, Song Shan Lake Hi tech Development Zone, Dongguan, 523808, China

Note 2: The test anechoic chamber in UL Verification Services (Guangzhou) Co., Ltd. Song Shan Lake Branch had been calibrated and compared to the open field sites and the test anechoic chamber is shown to be equivalent to or worst case from the open field site.

Note 3: For below 30 MHz, lab had performed measurements at test anechoic chamber and comparing to measurements obtained on an open field site. And these measurements below 30 MHz had been correlated to measurements performed on an OFS.



4. CALIBRATION AND UNCERTAINTY

4.1. MEASURING INSTRUMENT CALIBRATION

The measuring equipment utilized to perform the tests documented in this report has been calibrated in accordance with the manufacturer's recommendations and is traceable to recognize national standards.

4.2. MEASUREMENT UNCERTAINTY

Where relevant, the following measurement uncertainty levels have been estimated for tests performed on the apparatus:

Test Item	Uncertainty
Conduction emission	3.62 dB
Radiated Emission (Included Fundamental Emission) (9 kHz ~ 30 MHz)	2.2 dB
Radiated Emission (Included Fundamental Emission) (30 MHz ~ 1 GHz)	4.00 dB
Radiated Emission (Included Fundamental Emission) (1 GHz to 26 GHz)	5.78 dB (1 GHz ~ 18 GHz)
	5.23 dB (18 GHz ~ 26 GHz)
Duty Cycle	±0.028%
DTS and 99% Occupied Bandwidth	±0.0196%
Maximum Conducted Output Power	±0.686 dB
Maximum Power Spectral Density Level	±0.743 dB
Conducted Band-edge Compliance	±1.328 dB
Conducted Unwanted Emissions In Non-restricted Frequency Bands	±0.746 dB (9 kHz ~ 1 GHz)
	±1.328dB (1 GHz ~ 26 GHz)
Note: This uncertainty represents an expanded uncertainty expressed at approximately the 95% confidence level using a coverage factor of k=2.	



5. EQUIPMENT UNDER TEST

5.1. DESCRIPTION OF EUT

EUT Name	WIFI Module
Model Name	WC5EM2601F
Radio Technology	IEEE802.11b/g/n HT20/HT40
Operation frequency	IEEE 802.11b: 2412MHz ~ 2462MHz IEEE 802.11g: 2412MHz ~ 2462MHz IEEE 802.11n HT20: 2412MHz ~ 2462MHz IEEE 802.11n HT40: 2422MHz ~ 2452MHz
Modulation	IEEE 802.11b: DSSS (CCK) IEEE 802.11g: OFDM (64QAM, 16QAM, QPSK, BPSK) IEEE 802.11n HT20: OFDM (64QAM, 16QAM, QPSK, BPSK) IEEE 802.11n HT40: OFDM (64QAM, 16QAM, QPSK, BPSK)
Rated Input	DC 3.3 V

5.2. CHANNEL LIST

Channel List for 802.11b/g/n (20 MHz)							
Channel	Frequency (MHz)	Channel	Frequency (MHz)	Channel	Frequency (MHz)	Channel	Frequency (MHz)
1	2412	4	2427	7	2442	10	2457
2	2417	5	2432	8	2447	11	2462
3	2422	6	2437	9	2452	/	/

Channel List for 802.11n (40 MHz)							
Channel	Frequency (MHz)	Channel	Frequency (MHz)	Channel	Frequency (MHz)	Channel	Frequency (MHz)
3	2422	5	2432	7	2442	9	2452
4	2427	6	2437	8	2447	/	/

5.3. MAXIMUM OUTPUT POWER

IEEE Std. 802.11	Frequency (MHz)	Channel Number	Maximum Average Conducted Output Power (dBm)
b	2412 ~ 2462	1-11[11]	19.25
g	2412 ~ 2462	1-11[11]	18.99
n HT20	2412 ~ 2462	1-11[11]	19.56
n HT40	2422 ~ 2452	3-9[7]	19.56

**5.4. TEST CHANNEL CONFIGURATION**

IEEE Std. 802.11	Test Channel Number	Frequency
b	CH 1(Low Channel), CH 6(MID Channel), CH 11(High Channel)	2412 MHz, 2437 MHz, 2462 MHz
g	CH 1(Low Channel), CH 6(MID Channel), CH 11(High Channel)	2412 MHz, 2437 MHz, 2462 MHz
n HT20	CH 1(Low Channel), CH 6(MID Channel), CH 11(High Channel)	2412 MHz, 2437 MHz, 2462 MHz
n HT40	CH 3(Low Channel), CH 6(MID Channel), CH 9(High Channel)	2422 MHz, 2437 MHz, 2452 MHz

5.5. THE WORSE CASE POWER SETTING PARAMETER

The Worst Case Power Setting Parameter under 2400 ~ 2483.5MHz Band							
Test Software		QA Tool					
Modulation Mode	Transmit Antenna Number	Test Channel					
		NCB: 20MHz			NCB: 40MHz		
		CH 1	CH 6	CH 11	CH 3	CH 6	CH 9
802.11b	1	25	25	23	/		
	2	25	25	23			
802.11g	1	24	23	20			
	2	24	23	20			
802.11n HT20	1	20	20	20			
	2	20	20	20			
802.11n HT40	1	/			1F	20	1D
	2	/			1F	20	1D

5.6. THE WORSE CASE CONFIGURATIONS

The EUT was tested in the following configuration(s):

Controlled in test mode using a software application on the EUT supplied by customer. The application was used to enable a continuous transmission and to select the mode, test channels, bandwidth, data rates as required.

Test channels referring to section 5.4.

Maximum power setting referring to section 5.5.

Worst-case data rates as provided by the client were:

802.11b mode: 1 Mbps

802.11g mode: 6 Mbps

802.11n HT20 mode: MCS0

802.11n HT40 mode: MCS0

802.11b/g only support SISO mode.

802.11 n HT20/HT40 support SISO and MIMO mode.

802.11a SISO mode, Antenna 1 and Antenna 2 has the same power setting, so only worst case test data (Antenna 2) was recorded in the report.

802.11n SISO mode and MIMO mode have the same power setting, so only the worst case power mode(MIMO) will be record in the report.

The EUT has 2 separate antennas which correspond to 2 separate antenna ports. Core 1 and Core 2 correspond to antenna 1 and antenna 2 respectively.

The measured additional path loss was included in any path loss calculations for all RF cable used during tested.

Conducted output power, power spectral density tests separately on each port with all supported SISO & MIMO port combinations.

The EUT support Cyclic Shift Diversity (CDD), Space Time Coding (STBC), Spartial Division Multiplexing (SDM) modes. They use the same conducted power per chain in any given mode, CDD mode have the maximum power setting, so we only chose the worst case mode CDD for final testing.

5.7. DESCRIPTION OF AVAILABLE ANTENNAS

Antenna Group 1				
Antenna No.	Frequency (MHz)	Antenna Type	Maximum Antenna Gain (dBi)	Manufacturer
1	2412 ~ 2462	PIFA	2.32	Zhongshan B&T Communication Technology Co., Ltd
2	2412 ~ 2462	PIFA	2	/

The EUT support Cyclic Shift Diversity (CDD), Space Time Coding (STBC), Spatial Division Multiplexing (SDM) modes.

According to KDB 662911 D01:

The Directional Gain was calculated as the following method:

The EUT support Cyclic Shift Diversity (CDD) mode.

MIMO output power port and MIMO PSD port summing was performed in accordance with KDB 662911 D01. For the CDD results the Directional Gain was calculated in accordance with the following method.

For output power measurements:

Directional gain = $G_{ANT} + \text{Array Gain} = 2.32 \text{ dBi}$

G_{ANT} : equal to the gain of the antenna having the highest gain

Array Gain = 0 dB (i.e., no array gain) for $N_{ANT} \leq 4$

For power spectral density (PSD) measurements:

Directional gain = $G_{ANT} + \text{Array Gain} = 5.32 \text{ dBi}$

Array Gain = $10 \log(N_{ANT}/N_{SS}) \text{ dB}$.

N_{ANT} : number of transmit antennas

N_{SS} : number of spatial streams, The worst case directional gain will occur when $N_{SS} = 1$

For STBC and SDM mode:

For output power measurements and power spectral density (PSD) measurements

Directional gain = $G_{ANT} = 2.32 \text{ dBi}$

Test Mode	Transmit and Receive Mode	Description
IEEE 802.11b	<input checked="" type="checkbox"/> 2TX, 2RX	ANT 1 and ANT 2 can be used as transmitting/receiving antenna.
IEEE 802.11g	<input checked="" type="checkbox"/> 2TX, 2RX	ANT 1 and ANT 2 can be used as transmitting/receiving antenna.
IEEE 802.11n HT20	<input checked="" type="checkbox"/> 2TX, 2RX	ANT 1 and ANT 2 can be used as transmitting/receiving antenna.
IEEE 802.11n HT40	<input checked="" type="checkbox"/> 2TX, 2RX	ANT 1 and ANT 2 can be used as transmitting/receiving antenna.

Note:

1. WLAN 2.4G & WLAN 5G can't transmit simultaneously. (Declared by client)

Antenna Group 2				
Antenna No.	Frequency (MHz)	Antenna Type	Maximum Antenna Gain (dBi)	Manufacturer
1	2412 ~ 2462	PIFA	1.72	Shenzhen Yishengbang Technology Company Limited
2	2412 ~ 2462	PIFA	2	/

The EUT support Cyclic Shift Diversity (CDD), Space Time Coding (STBC), Spatial Division Multiplexing (SDM) modes.

According to KDB 662911 D01:

The Directional Gain was calculated as the following method:

The EUT support Cyclic Shift Diversity (CDD) mode.

MIMO output power port and MIMO PSD port summing was performed in accordance with KDB 662911 D01. For the CDD results the Directional Gain was calculated in accordance with the following method.

For output power measurements:

Directional gain= $G_{ANT} + \text{Array Gain} = 2 \text{ dBi}$

G_{ANT} : equal to the gain of the antenna having the highest gain

Array Gain = 0 dB (i.e., no array gain) for $N_{ANT} \leq 4$

For power spectral density (PSD) measurements:

Directional gain= $G_{ANT} + \text{Array Gain} = 5 \text{ dBi}$

Array Gain = $10 \log (N_{ANT}/N_{SS}) \text{ dB}$.

N_{ANT} : number of transmit antennas

N_{SS} : number of spatial streams, The worst case directional gain will occur when $N_{SS} = 1$

For STBC and SDM mode:

For output power measurements and power spectral density (PSD) measurements

Directional gain = $G_{ANT} = 1.72 \text{ dBi}$

Test Mode	Transmit and Receive Mode	Description
IEEE 802.11b	<input checked="" type="checkbox"/> 2TX, 2RX	ANT 1 and ANT 2 can be used as transmitting/receiving antenna.
IEEE 802.11g	<input checked="" type="checkbox"/> 2TX, 2RX	ANT 1 and ANT 2 can be used as transmitting/receiving antenna.
IEEE 802.11n HT20	<input checked="" type="checkbox"/> 2TX, 2RX	ANT 1 and ANT 2 can be used as transmitting/receiving antenna.
IEEE 802.11n HT40	<input checked="" type="checkbox"/> 2TX, 2RX	ANT 1 and ANT 2 can be used as transmitting/receiving antenna.

Note:

1. WLAN 2.4G & WLAN 5G can't transmit simultaneously. (Declared by client)



Note:

1. The value of the antenna gain was declared by customer.
2. Antenna No. 2 for each group is the same as the original antenna.
3. Antenna No. 1 is new antenna and it has 2 kinds which is made by difference manufacturer (B&T and Yishengbang).
4. For Antenna No. 1, pre-scan had been done for all the antennas and cables, but only the worst data (B&T Antenna) was recorded in the report.

5.8. DESCRIPTION OF TEST SETUP

SUPPORT EQUIPMENT

Item	Equipment	Brand Name	Model Name	Remarks
1	Laptop	Lenovo	XIAOXIN 5000	/
2	AC Adapter	Lenovo	42T4434	Input: AC 100 ~ 240 V, 1.5 A, 50-60 Hz Output: DC 20 V, 4.5 A

I/O CABLES

Cable No	Port	Connector Type	Cable Type	Cable Length(m)	Remarks
1	USB	/	/	0.3	/

ACCESSORIES

Item	Accessory	Brand Name	Model Name	Description
1	/	/	/	/

Note: The cable is provided by customer.

TEST SETUP

The EUT can work in engineering mode with a software through a Laptop.

SETUP DIAGRAM FOR TESTS

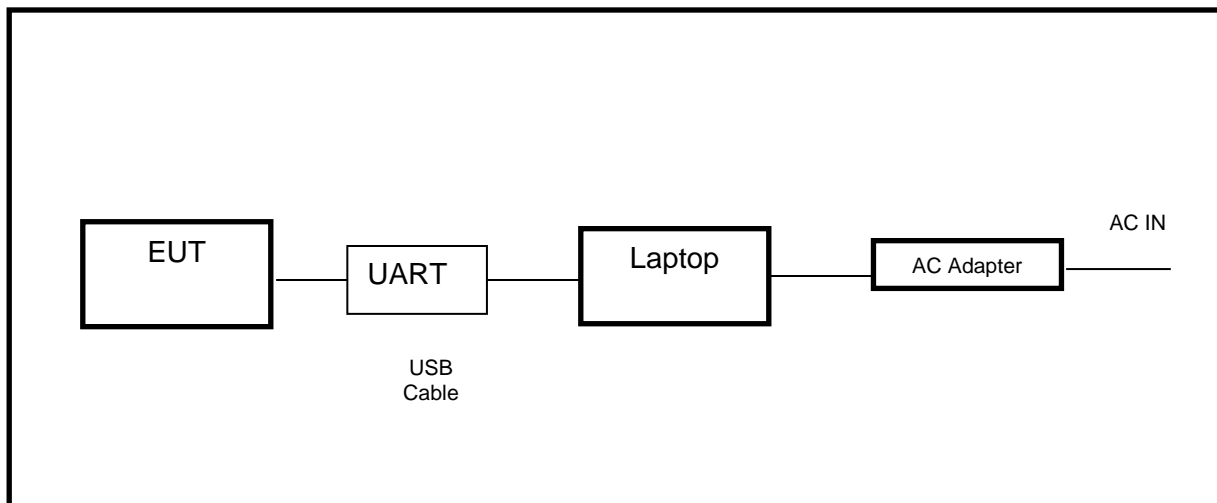



6. MEASURING INSTRUMENT AND SOFTWARE USED

Last time calibration information:

Conducted Emissions					
Equipment	Manufacturer	Model No.	Serial No.	Last Cal.	Due Date
EMI Test Receiver	R&S	ESR3	101961	Nov. 12, 2020	Nov. 11, 2021
Two-Line V-Network	R&S	ENV216	101983	Nov. 12, 2020	Nov. 11, 2021
Software					
Description			Manufacturer	Name	Version
Test Software for Conducted Emissions			Farad	EZ-EMC	Ver. UL-3A1

Radiated Emissions					
Equipment	Manufacturer	Model No.	Serial No.	Last Cal.	Due Date
MXE EMI Receiver	KESIGHT	N9038A	MY56400036	Nov. 12, 2020	Nov. 11, 2021
Hybrid Log Periodic Antenna	TDK	HLP-3003C	130960	Aug. 02, 2021	Aug. 01, 2024
Preamplifier	HP	8447D	2944A09099	Nov. 12, 2020	Nov. 11, 2021
EMI Measurement Receiver	R&S	ESR26	101377	Nov. 12, 2020	Nov. 11, 2021
Horn Antenna	TDK	HRN-0118	130940	July 20, 2021	July 19, 2024
Preamplifier	TDK	PA-02-0118	TRS-305-00067	Nov. 20, 2020	Nov. 19, 2021
Horn Antenna	Schwarzbeck	BBHA9170	#697	July 20, 2021	July 19, 2024
Preamplifier	TDK	PA-02-2	TRS-307-00003	Nov. 12, 2020	Nov. 11, 2021
Preamplifier	TDK	PA-02-3	TRS-308-00002	Nov. 12, 2020	Nov. 11, 2021
Loop antenna	Schwarzbeck	1519B	00008	Jan.17, 2019	Jan.17,2022
Preamplifier	TDK	PA-02-001-3000	TRS-302-00050	Nov. 12, 2020	Nov. 11, 2021
Preamplifier	Mini-Circuits	ZX60-83LN-S+	SUP01201941	Nov. 20, 2020	Nov. 19, 2021
High Pass Filter	Wi	WHKX10-2700-3000-18000-40SS	23	Nov. 12, 2020	Nov. 11, 2021
Band Reject Filter	Wainwright	WRCJV8-2350-2400-2483.5-2533.5-40SS	4	Nov. 12, 2020	Nov. 11, 2021
Software					
Description			Manufacturer	Name	Version



Test Software for Radiated Emissions	Farad	EZ-EMC	Ver. UL-3A1
--------------------------------------	-------	--------	-------------

Tonsend RF Test System					
Equipment	Manufacturer	Model No.	Serial No.	Last Cal.	Due. Date
Wideband Radio Communication Tester	R&S	CMW500	155523	Nov.20,2020	Nov.19,2021
PXA Signal Analyzer	Keysight	N9030A	MY55410512	Nov.20,2020	Nov.19,2021
MXG Vector Signal Generator	Keysight	N5182B	MY56200284	Nov.20,2020	Nov.19,2021
MXG Vector Signal Generator	Keysight	N5172B	MY56200301	Nov.20,2020	Nov.19,2021
DC power supply	Keysight	E3642A	MY55159130	Nov.24,2020	Nov.23,2021
Software					
Description	Manufacturer	Name		Version	
Tonsend SRD Test System	Tonsend	JS1120-3 RF Test System		2.6.77.0518	

Other Instruments					
Equipment	Manufacturer	Model No.	Serial No.	Last Cal.	Next Cal.
Dual Channel Power Meter	Keysight	N1912A	MY55416024	Nov. 20, 2020	Nov. 19, 2021
Power Sensor	Keysight	USB Wideband Power Sensor	MY5100022	Nov. 20, 2020	Nov. 19, 2021

This time calibration information:

Radiated Emissions					
Equipment	Manufacturer	Model No.	Serial No.	Last Cal.	Due Date
MXE EMI Receiver	KESIGHT	N9038A	MY56400036	Oct.30, 2021	Oct.29, 2022
Hybrid Log Periodic Antenna	TDK	HLP-3003C	130959	Aug.02, 2021	Aug.01, 2024
Preamplifier	HP	8447D	2944A09099	Oct.30, 2021	Oct.29, 2022
EMI Measurement Receiver	R&S	ESR26	101377	Oct.30, 2021	Oct.29, 2022
Horn Antenna	TDK	HRN-0118	130940	July 20, 2021	July 19, 2024
Preamplifier	TDK	PA-02-0118	TRS-305-00067	Oct.30, 2021	Oct.29, 2022
Horn Antenna	Schwarzbeck	BBHA9170	697	July 20, 2021	July 19, 2024
Preamplifier	TDK	PA-02-2	TRS-307-00003	Oct.31, 2021	Oct.30, 2022



Preamplifier	TDK	PA-02-3	TRS-308-00002	Oct.31, 2021	Oct.30, 2022
Loop antenna	Schwarzbeck	1519B	00008	Dec.14, 2021	Dec.13, 2024
Preamplifier	TDK	PA-02-001-3000	TRS-302-00050	Oct.31, 2021	Oct.30, 2022
High Pass Filter	Wi	WHKX10-2700-3000-18000-40SS	23	Oct.31, 2021	Oct.30, 2022
Band Reject Filter	Wainwright	WRCJV8-2350-2400-2483.5-2533.5-40SS	4	Oct.31, 2021	Oct.30, 2022
Software					
Description		Manufacturer		Name	Version
Test Software for Radiated Emissions		Farad		EZ-EMC	Ver. UL-3A1

Tonsend RF Test System					
Equipment	Manufacturer	Model No.	Serial No.	Last Cal.	Due. Date
PXA Signal Analyzer	Keysight	N9030A	MY55410512	Oct.30, 2021	Oct.29, 2022
MXG Vector Signal Generator	Keysight	N5182B	MY56200284	Oct.30, 2021	Oct.29, 2022
MXG Vector Signal Generator	Keysight	N5172B	MY56200301	Oct.30, 2021	Oct.29, 2022
DC power supply	Keysight	E3642A	MY55159130	Oct.30, 2021	Oct.29, 2022
Temperature & Humidity Chamber	SANMOOD	SG-80-CC-2	2088	Nov.20,2020	Nov.19,2022
Software					
Description		Manufacturer		Name	Version
Tonsend SRD Test System		Tonsend		JS1120-3 RF Test System	2.6.77.0518

Other Instruments					
Equipment	Manufacturer	Model No.	Serial No.	Last Cal.	Next Cal.
Dual Channel Power Meter	Keysight	N1912A	MY55416024	Oct.30, 2021	Oct.29, 2022
Power Sensor	Keysight	USB Wideband Power Sensor	MY5100022	Oct.30, 2021	Oct.29, 2022

7. ANTENNA PORT TEST RESULTS

7.1. ON TIME AND DUTY CYCLE

LIMITS

None; for reporting purposes only

PROCEDURE

Refer to ANSI C63.10-2013 clause 11.6 Zero – Span Spectrum Analyzer method.

TEST SETUP

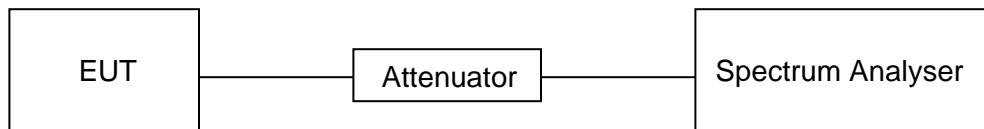

TEST ENVIRONMENT

Temperature	26.2 °C	Relative Humidity	56.1 %
Atmosphere Pressure	101 kPa	Test Voltage	DC 3.3 V

RESULTS

Please refer to appendix G.

7.2. 6 dB DTS BANDWIDTH AND 99 % OCCUPIED BANDWIDTH

LIMITS

CFR 47 FCC Part15 (15.247) Subpart C			
Section	Test Item	Limit	Frequency Range (MHz)
CFR 47 FCC 15.247(a)(2)	6 dB Bandwidth	≥ 500 kHz	2400-2483.5
ISED RSS-Gen Clause 6.7	99 % Occupied Bandwidth	For reporting purposes only.	2400-2483.5

TEST PROCEDURE

Connect the EUT to the spectrum analyser and use the following settings:

Center Frequency	The center frequency of the channel under test
Frequency Span	Between 1.5 times and 5.0 times the OBW
Detector	Peak
RBW	For 6 dB Bandwidth: 100 kHz For 99 % Occupied Bandwidth: 1 % to 5 % of the occupied bandwidth
VBW	For 6 dB Bandwidth: ≥3 × RBW For 99 % Occupied Bandwidth: ≥3 × RBW
Trace	Max hold
Sweep	Auto couple

- a) Use the 99 % power bandwidth function of the instrument, allow the trace to stabilize and report the measured bandwidth.
- b) Allow the trace to stabilize and measure the maximum width of the emission that is constrained by the frequencies associated with the two outermost amplitude points (upper and lower frequencies) that are attenuated by 6 dB relative to the maximum level measured in the fundamental emission.

TEST SETUP

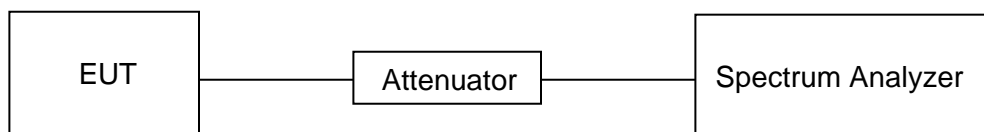



TEST ENVIRONMENT

Temperature	26.2 °C	Relative Humidity	56.1 %
Atmosphere Pressure	101 kPa	Test Voltage	DC 3.3 V

RESULTS

Please refer to appendix A & B.

7.3. CONDUCTED OUTPUT POWER

LIMITS

CFR 47 FCC Part15 (15.247) Subpart C ISED RSS-247 ISSUE 2			
Section	Test Item	Limit	Frequency Range (MHz)
CFR 47 FCC 15.247(b)(3) ISED RSS-247 5.4 (d)	AVG Output Power	1 watt or 30 dBm	2400-2483.5

TEST PROCEDURE

Connect the EUT to a low loss RF cable from the antenna port to the power sensor (video bandwidth is greater than the occupied bandwidth).
Measure peak emission level, the indicated level is the average output power, after any corrections for external attenuators and cables.

TEST SETUP

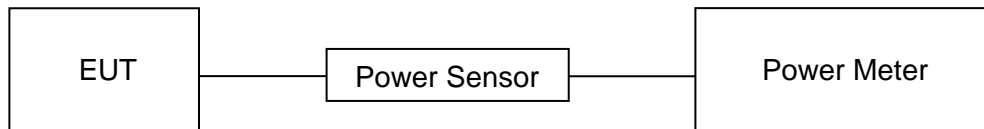

TEST ENVIRONMENT

Temperature	26.2 °C	Relative Humidity	56.1 %
Atmosphere Pressure	101 kPa	Test Voltage	DC 3.3 V

RESULTS

Please refer to appendix C.

7.4. POWER SPECTRAL DENSITY

LIMITS

CFR 47 FCC Part15 (15.247) Subpart C ISED RSS-247 ISSUE 2			
Section	Test Item	Limit	Frequency Range (MHz)
CFR 47 FCC §15.247 (e) ISED RSS-247 5.2 (b)	Power Spectral Density	8 dBm/3 kHz	2400-2483.5

TEST PROCEDURE

Refer to ANSI C63.10-2013 clause 11.10.

Connect the EUT to the spectrum analyser and use the following settings:

Center Frequency	The center frequency of the channel under test
Detector	PEAK
RBW	$3 \text{ kHz} \leq \text{RBW} \leq 100 \text{ kHz}$
VBW	$\geq 3 \times \text{RBW}$
Span	1.5 x DTS bandwidth
Trace	Max hold
Sweep time	Auto couple

Allow trace to fully stabilize and use the peak marker function to determine the maximum amplitude level within the RBW.

If measured value exceeds limit, reduce RBW (no less than 3 kHz) and repeat.

TEST SETUP

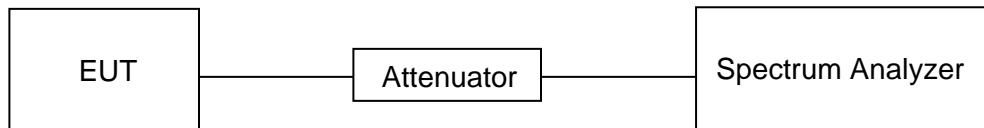

TEST ENVIRONMENT

Temperature	26.2 °C	Relative Humidity	56.1 %
Atmosphere Pressure	101 kPa	Test Voltage	DC 3.3 V



RESULTS

Please refer to appendix D.

7.5. CONDUCTED BANDEGE AND SPURIOUS EMISSIONS

LIMITS

CFR 47 FCC Part15 (15.247) Subpart C ISED RSS-247 ISSUE 2		
Section	Test Item	Limit
CFR 47 FCC §15.247 (d) ISED RSS-247 5.5	Conducted Bandedge and Spurious Emissions	at least 30 dB below that in the 100 kHz bandwidth within the band that contains the highest level of the desired power

TEST PROCEDURE

Refer to ANSI C63.10-2013 clause 11.11 and 11.13.

Connect the EUT to the spectrum analyser and use the following settings for reference level measurement:

Center Frequency	The center frequency of the channel under test
Detector	Peak
RBW	100 kHz
VBW	$\geq 3 \times \text{RBW}$
Span	1.5 x DTS bandwidth
Trace	Max hold
Sweep time	Auto couple.

Allow trace to fully stabilize and use the peak marker function to determine the maximum PSD level.

Change the settings for emission level measurement:

Span	Set the center frequency and span to encompass frequency range to be measured
Detector	Peak
RBW	100 kHz
VBW	$\geq 3 \times \text{RBW}$
measurement points	$\geq \text{span}/\text{RBW}$
Trace	Max hold
Sweep time	Auto couple.

Allow trace to fully stabilize and use the peak marker function to determine the maximum PSD level. Ensure that the amplitude of all unwanted emissions outside of the authorized frequency band (excluding restricted frequency bands) is attenuated by at least the minimum requirements specified in 11.11.



TEST SETUP

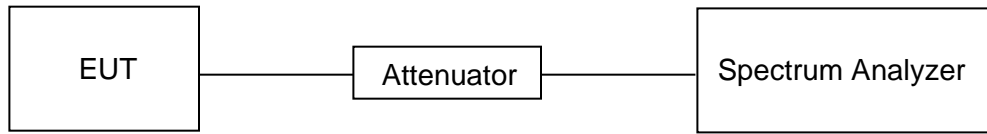

TEST ENVIRONMENT

Temperature	26.2 °C	Relative Humidity	56.1 %
Atmosphere Pressure	101 kPa	Test Voltage	DC 3.3 V

RESULTS

Please refer to appendix E & F.



8. RADIATED TEST RESULTS

LIMITS

Please refer to CFR 47 FCC §15.205 and §15.209.

Please refer to ISED RSS-GEN Clause 8.9 and Clause 8.10.

Radiation Disturbance Test Limit for FCC (Class B) (9 kHz ~ 1 GHz)

Emissions radiated outside of the specified frequency bands above 30 MHz			
Frequency Range (MHz)	Field Strength Limit (uV/m) at 3 m	Field Strength Limit (dBuV/m) at 3 m	
		Quasi-Peak	
30 - 88	100	40	
88 - 216	150	43.5	
216 - 960	200	46	
Above 960	500	54	
Above 1000	500	Peak	Average
		74	54

FCC Emissions radiated outside of the specified frequency bands below 30 MHz		
Frequency (MHz)	Field strength (microvolts/meter)	Measurement distance (meters)
0.009-0.490	2400/F(kHz)	300
0.490-1.705	24000/F(kHz)	30
1.705-30.0	30	30

ISED General field strength limits at frequencies below 30 MHz

Table 6 – General field strength limits at frequencies below 30 MHz		
Frequency	Magnetic field strength (H-Field) (µA/m)	Measurement distance (m)
9 - 490 kHz ^{Note 1}	6.37/F (F in kHz)	300
490 - 1705 kHz	63.7/F (F in kHz)	30
1.705 - 30 MHz	0.08	30

Note 1: The emission limits for the ranges 9-90 kHz and 110-490 kHz are based on measurements employing a linear average detector.

ISED Restricted bands please refer to ISED RSS-GEN Clause 8.10

Table 7 – Restricted frequency bands^{Note 1}

MHz	MHz	GHz
0.090 - 0.110	149.9 - 150.05	9.0 - 9.2
0.495 - 0.505	156.52475 - 156.52525	9.3 - 9.5
2.1735 - 2.1905	156.7 - 156.9	10.0 - 12.7
3.020 - 3.026	162.0125 - 167.17	13.25 - 13.4
4.125 - 4.128	167.72 - 173.2	14.47 - 14.5
4.17725 - 4.17775	240 - 285	15.35 - 16.2
4.20725 - 4.20775	322 - 335.4	17.7 - 21.4
5.677 - 5.683	399.9 - 410	22.01 - 23.12
6.215 - 6.218	608 - 614	23.6 - 24.0
6.26775 - 6.26825	960 - 1427	31.2 - 31.8
6.31175 - 6.31225	1435 - 1626.5	36.43 - 36.5
8.291 - 8.294	1645.5 - 1646.5	Above 38.6
8.362 - 8.366	1660 - 1710	
8.37625 - 8.38675	1718.8 - 1722.2	
8.41425 - 8.41475	2200 - 2300	
12.29 - 12.293	2310 - 2390	
12.51975 - 12.52025	2483.5 - 2500	
12.57675 - 12.57725	2655 - 2900	
13.36 - 13.41	3260 - 3267	
16.42 - 16.423	3332 - 3339	
16.69475 - 16.69525	3345.8 - 3358	
16.80425 - 16.80475	3500 - 4400	
25.5 - 25.67	4500 - 5150	
37.5 - 38.25	5350 - 5460	
73 - 74.6	7250 - 7750	
74.8 - 75.2	8025 - 8500	
108 - 138		

Note 1: Certain frequency bands listed in table 7 and in bands above 38.6 GHz are designated for licence-exempt applications. These frequency bands and the requirements that apply to related devices are set out in the 200 and 300 series of RSSs.

FCC Restricted bands of operation refer to FCC §15.205 (a):

MHz	MHz	MHz	GHz
0.090-0.110	16.42-16.423	399.9-410	4.5-5.15
¹ 0.495-0.505	16.69475-16.69525	608-614	5.35-5.46
2.1735-2.1905	16.80425-16.80475	960-1240	7.25-7.75
4.125-4.128	25.5-25.67	1300-1427	8.025-8.5
4.17725-4.17775	37.5-38.25	1435-1626.5	9.0-9.2
4.20725-4.20775	73-74.6	1645.5-1646.5	9.3-9.5
6.215-6.218	74.8-75.2	1660-1710	10.6-12.7
6.26775-6.26825	108-121.94	1718.8-1722.2	13.25-13.4
6.31175-6.31225	123-138	2200-2300	14.47-14.5
8.291-8.294	149.9-150.05	2310-2390	15.35-16.2
8.362-8.366	156.52475-156.52525	2483.5-2500	17.7-21.4
8.37625-8.38675	156.7-156.9	2690-2900	22.01-23.12
8.41425-8.41475	162.0125-167.17	3260-3267	23.6-24.0
12.29-12.293	167.72-173.2	3332-3339	31.2-31.8
12.51975-12.52025	240-285	3345.8-3358	36.43-36.5
12.57675-12.57725	322-335.4	3600-4400	(²)
13.36-13.41			

Note: ¹Until February 1, 1999, this restricted band shall be 0.490-0.510 MHz.

²Above 38.6c

TEST SETUP AND PROCEDURE

Below 30 MHz

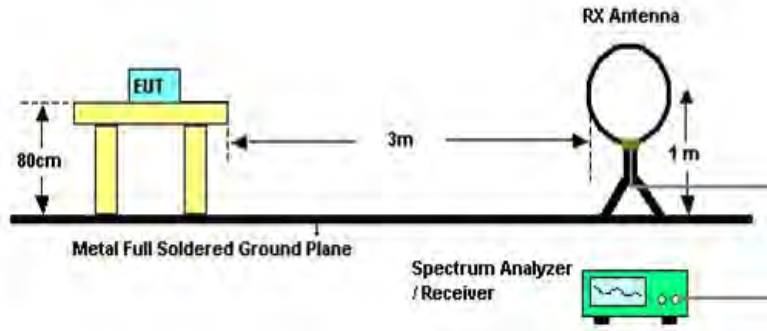

The setting of the spectrum analyser

RBW	200 Hz (From 9 kHz to 0.15 MHz)/ 9 kHz (From 0.15 MHz to 30 MHz)
VBW	200 Hz (From 9 kHz to 0.15 MHz)/ 9 kHz (From 0.15 MHz to 30 MHz)
Sweep	Auto
Trace	Max hold

1. The testing follows the guidelines in ANSI C63.10-2013 clause 11.11 and 11.12.
2. The EUT was arranged to its worst case and then turntable (from 0 degree to 360 degrees) to find the maximum reading. A pre-amp and a high pass filter are used for the test in order to get better signal level. Both Horizontal, Face-on and Face-off polarizations of the antenna are set to make the measurement.
3. The EUT was placed on a turntable with 80 cm above ground.
4. The EUT was set 3 meters from the interference receiving antenna, which was mounted on the top of a 1 m height antenna tower.
5. The radiated emission limits are based on measurements employing a CISPR quasi-peak detector except for the frequency bands 9-90 kHz, 110-490 kHz and above 1000 MHz. Radiated emission limits in these three bands are based on measurements employing an average detector.
6. For measurement below 1 GHz, the initial step in collecting conducted emission data is a spectrum analyzer peak detector mode pre-scanning the measurement frequency range. Significant peaks are then marked and then Quasi Peak and average detector mode re-measured. If the emission level of the EUT measured by the peak detector is 3 dB lower than the applicable limit, the peak emission level will be reported. Otherwise, the emission measurement will be repeated using the quasi-peak and average detector and reported.
7. Although these tests were performed other than open field site, adequate comparison measurements were confirmed against 30m open field site. Therefore sufficient tests were made to demonstrate that the alternative site produces results that correlate with the ones of tests made in an open field site based on KDB 414788.
8. The limits in CFR 47, Part 15, Subpart C, paragraph 15.209 (a), are identical to those in RSS-GEN Section 8.9, Table 6, since the measurements are performed in terms of magnetic field strength and converted to electric field strength levels (as reported in the table) using the free space impedance of 377Ω; For example, the measurement frequency X kHz resulted in a level of Y dBuV/m, which is equivalent to $Y - 51.5 = Z$ dBuA/m, which has the same margin, W dB, to the corresponding RSS-GEN Table 6 limit as it has to be 15.209(a) limit.

Below 1 GHz and above 30 MHz

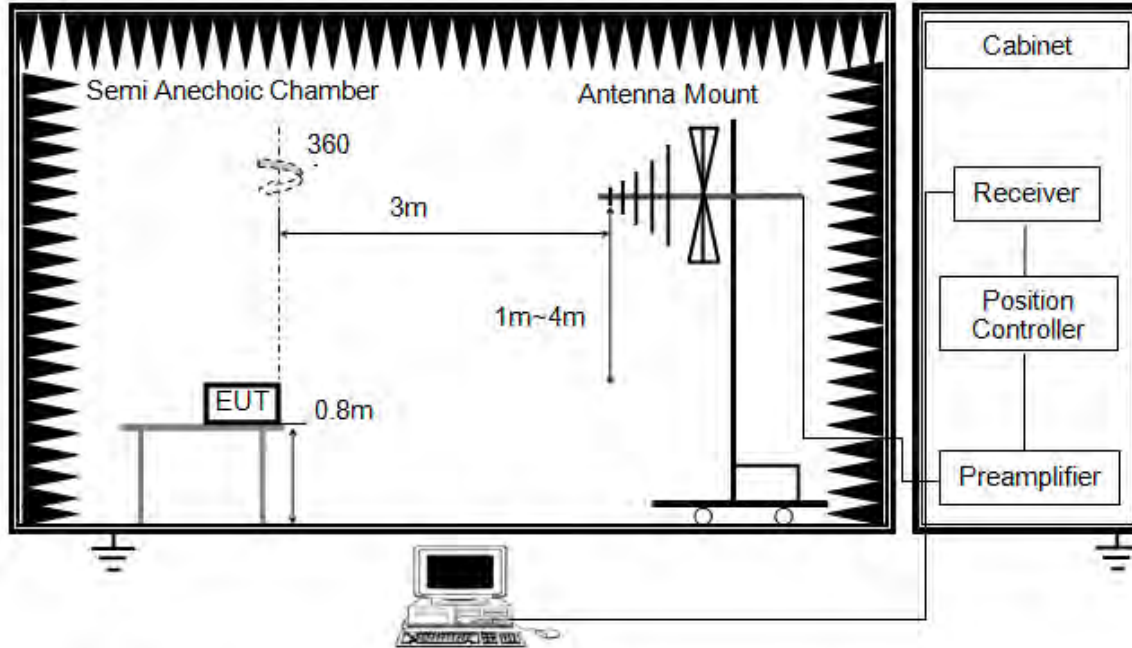

The setting of the spectrum analyser

RBW	120 kHz
VBW	300 kHz
Sweep	Auto
Detector	Peak/QP
Trace	Max hold

1. The testing follows the guidelines in ANSI C63.10-2013 clause 6.5.
2. The EUT was arranged to its worst case and then tune the antenna tower (from 1 m to 4 m) and turntable (from 0 degree to 360 degrees) to find the maximum reading. A pre-amp and a high pass filter are used for the test in order to get better signal level. Both horizontal and vertical polarizations of the antenna are set to make the measurement.
3. The EUT was placed on a turntable with 80 cm above ground.
4. The EUT was set 3 meters from the interference receiving antenna, which was mounted on the top of a variable height antenna tower.
5. For measurement below 1 GHz, the initial step in collecting conducted emission data is a spectrum analyzer peak detector mode pre-scanning the measurement frequency range. Significant peaks are then marked and then Quasi Peak detector mode re-measured. If the emission level of the EUT measured by the peak detector is 3 dB lower than the applicable limit, the peak emission level will be reported. Otherwise, the emission measurement will be repeated using the quasi-peak detector and reported.

Above 1 GHz

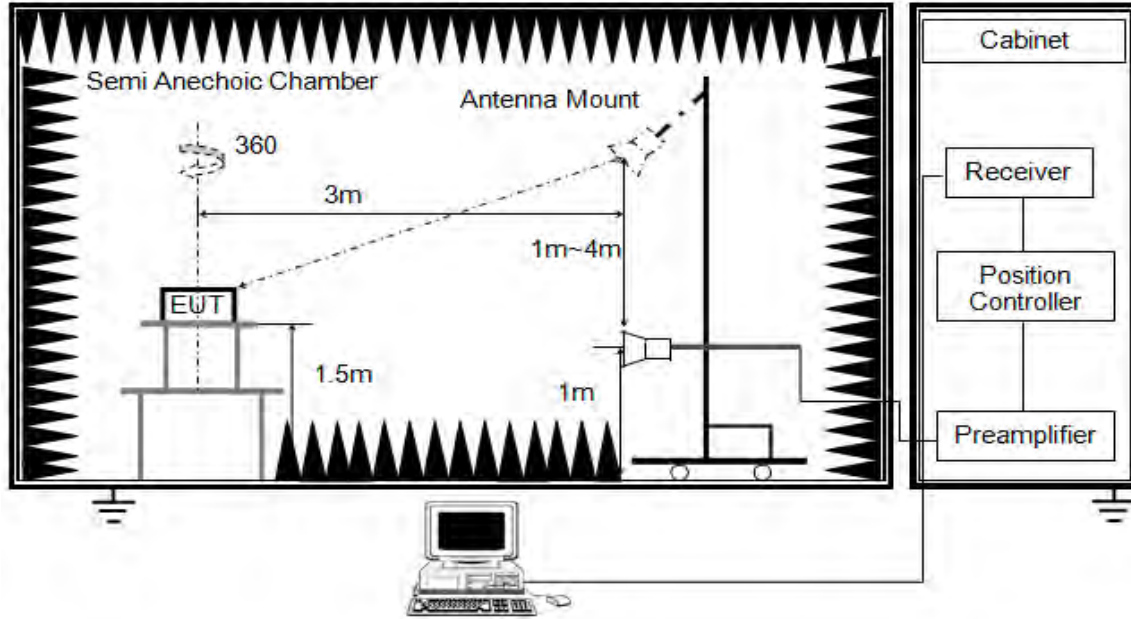

The setting of the spectrum analyser

RBW	1 MHz
VBW	PEAK: 3 MHz AVG: see note 6
Sweep	Auto
Detector	Peak
Trace	Max hold

1. The testing follows the guidelines in ANSI C63.10-2013 clause 6.6.
2. The EUT was arranged to its worst case and then tune the antenna tower (from 1 m to 4 m) and turntable (from 0 degree to 360 degrees) to find the maximum reading. A pre-amp and a high pass filter are used for the test in order to get better signal level. Both horizontal and vertical polarizations of the antenna are set to make the measurement.
3. The EUT was placed on a turntable with 1.5 m above ground.
4. The EUT was set 3 meters from the interference receiving antenna, which was mounted on the top of a variable height antenna tower.
5. For measurement above 1 GHz, the emission measurement will be measured by the peak detector. This peak level, once corrected, must comply with the limit specified in Section 15.209.
6. For measurements above 1 GHz the resolution bandwidth is set to 1 MHz, then the video bandwidth is set to 3 MHz for peak measurements and 1 MHz resolution bandwidth with 1/T video bandwidth with peak detector for average measurements. For the Duty Cycle please refer to clause 7.1.ON TIME AND DUTY CYCLE.

X axis, Y axis, Z axis positions:

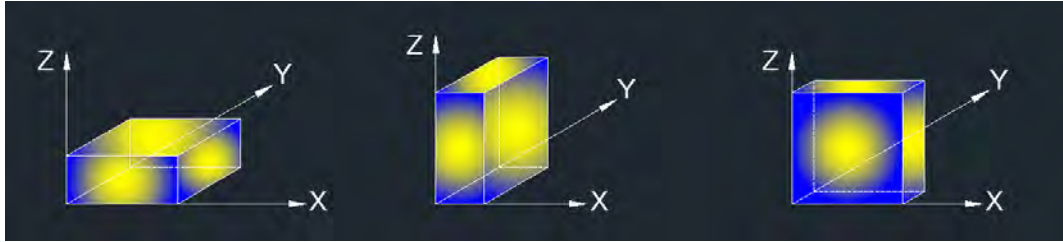

Note 1: For all radiated test, EUT in each of three orthogonal axis emissions had been tested, but only the worst case (X axis) data recorded in the report.

Note 2: The EUT was fully exercised with external accessories during the test. In the case of multiple accessory external ports, an external accessory shall be connected to one of each type of port.

TEST ENVIRONMENT

Temperature	24.3 °C	Relative Humidity	61 %
Atmosphere Pressure	101 kPa	Test Voltage	DC 3.3 V

RESULTS

8.1. RESTRICTED BANDEDGE

8.1.1. 802.11b SISO MODE

ANTENNA 2 TEST RESULTS (WORST CASE)

RESTRICTED BANDEDGE (LOW CHANNEL, VERTICAL)

PEAK

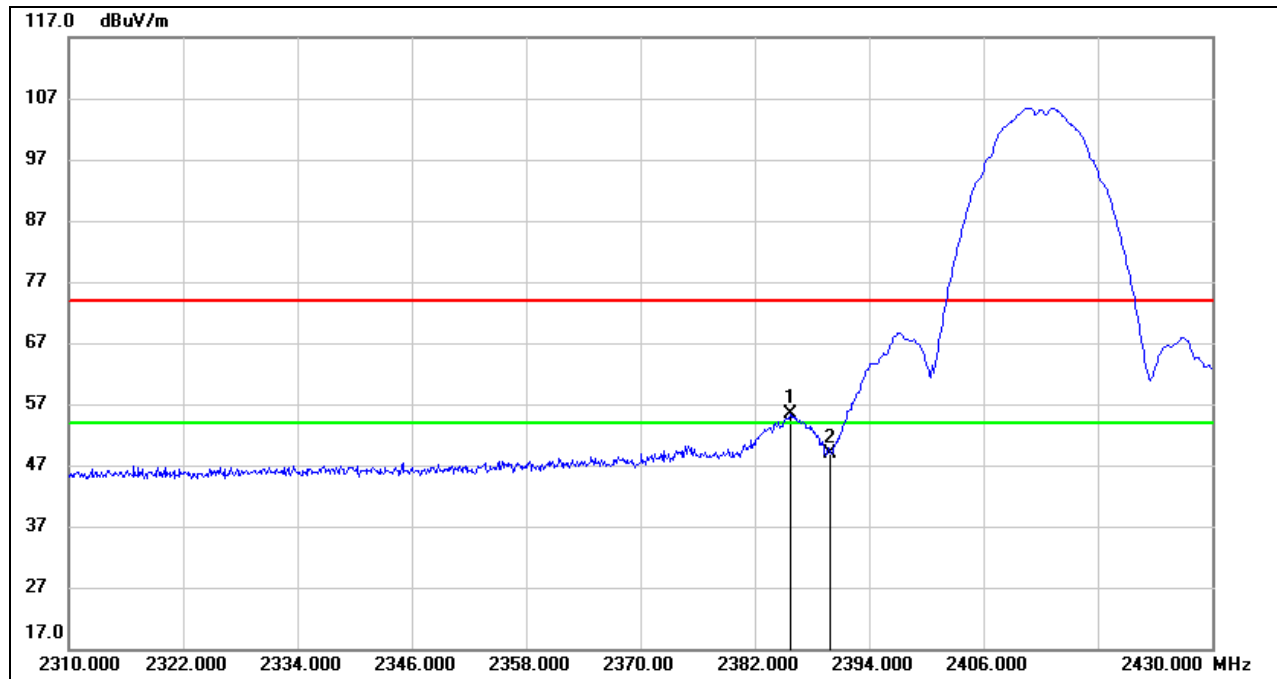

No.	Frequency (MHz)	Reading (dBuV)	Correct (dB/m)	Result (dBuV/m)	Limit (dBuV/m)	Margin (dB)	Remark
1	2385.720	23.26	32.14	55.40	74.00	-18.60	peak
2	2390.000	16.83	32.16	48.99	74.00	-25.01	peak

Note: 1. Measurement = Reading Level + Correct Factor.

2. Peak: Peak detector.

3. Only the worst data was recorded, if it complies with the limit, the other emissions deemed to comply with the limit.



AVG

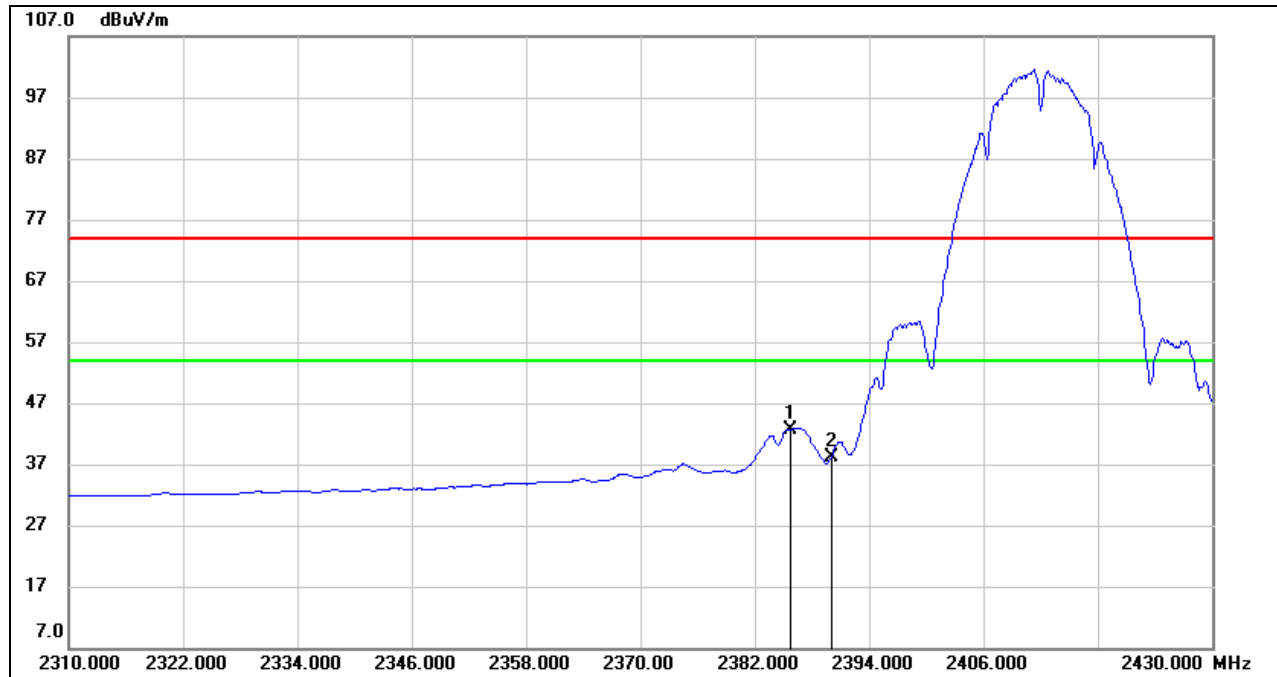

No.	Frequency (MHz)	Reading (dBuV)	Correct (dB/m)	Result (dBuV/m)	Limit (dBuV/m)	Margin (dB)	Remark
1	2385.720	10.60	32.14	42.74	54.00	-11.26	AVG
2	2390.000	6.00	32.16	38.16	54.00	-15.84	AVG

Note: 1. Measurement = Reading Level + Correct Factor.
 2. Peak: Peak detector.
 3. Only the worst data was recorded, if it complies with the limit, the other emissions deemed to comply with the limit.



RESTRICTED BANDEDGE (HIGH CHANNEL, VERTICAL)

PEAK

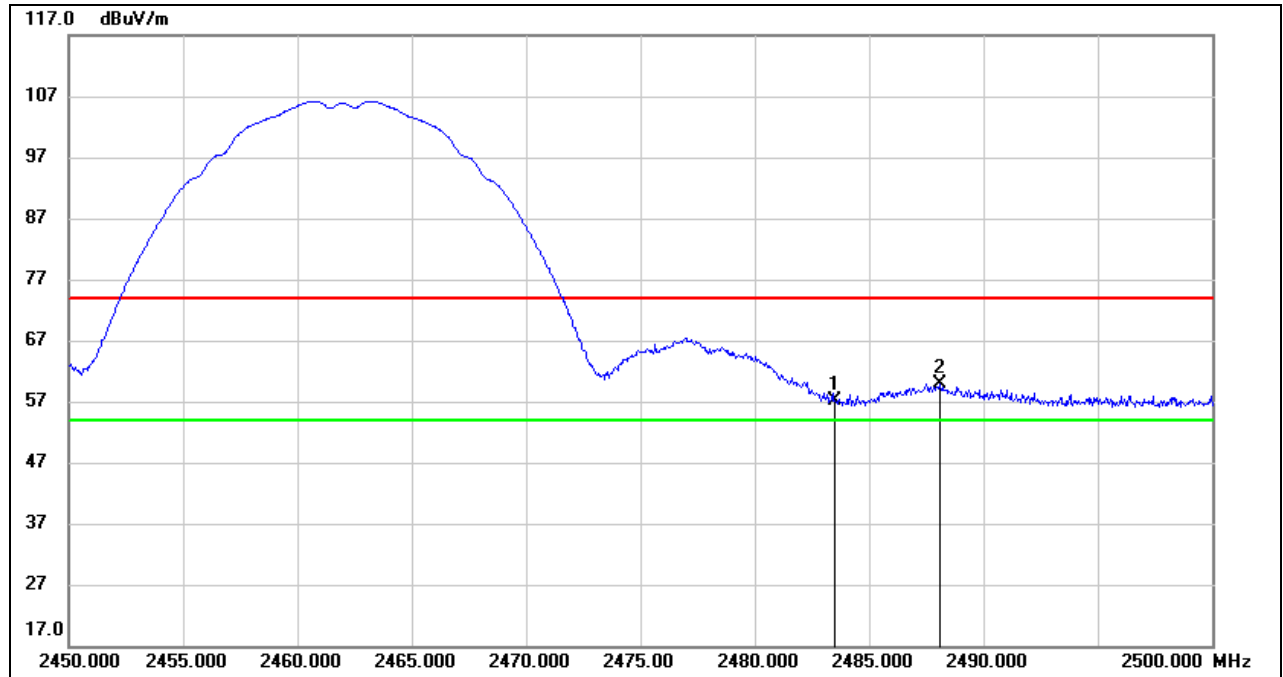

No.	Frequency (MHz)	Reading (dBuV)	Correct (dB/m)	Result (dBuV/m)	Limit (dBuV/m)	Margin (dB)	Remark
1	2483.500	24.69	32.44	57.13	74.00	-16.87	peak
2	2488.100	27.33	32.46	59.79	74.00	-14.21	peak

Note: 1. Measurement = Reading Level + Correct Factor.
 2. Peak: Peak detector.
 3. Only the worst data was recorded, if it complies with the limit, the other emissions deemed to comply with the limit.

AVG

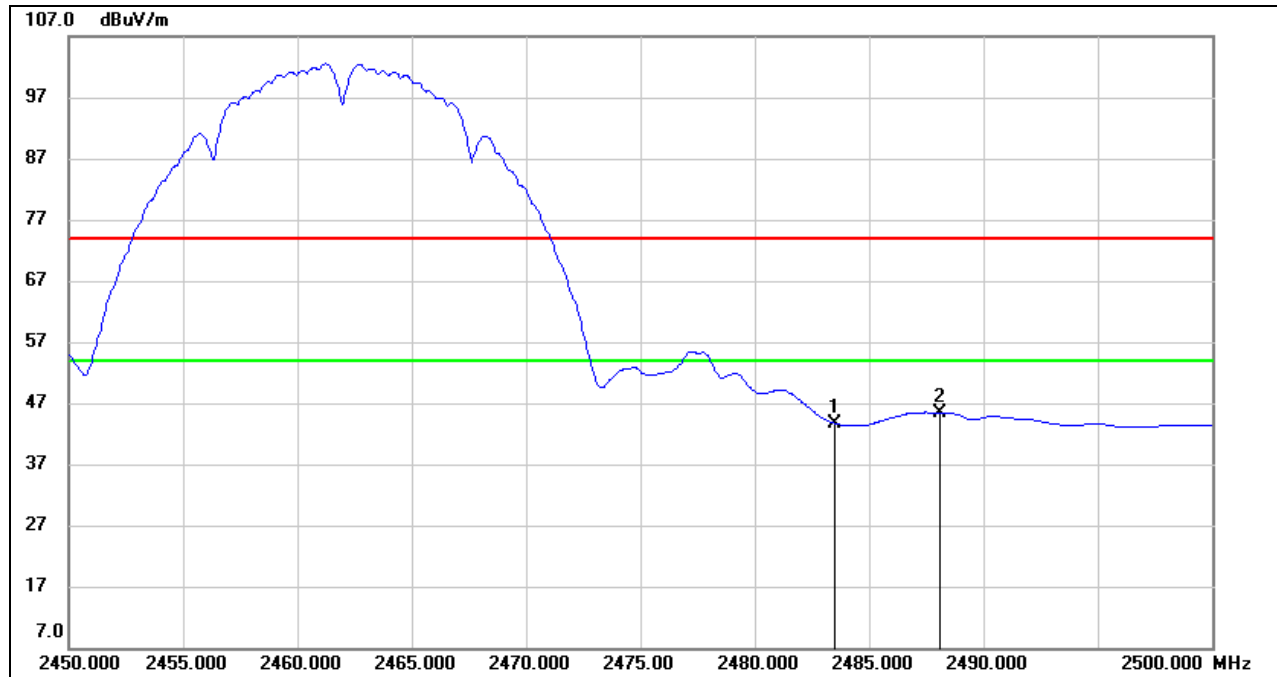

No.	Frequency (MHz)	Reading (dBuV)	Correct (dB/m)	Result (dBuV/m)	Limit (dBuV/m)	Margin (dB)	Remark
1	2483.500	11.22	32.44	43.66	54.00	-10.34	AVG
2	2488.100	12.96	32.46	45.42	54.00	-8.58	AVG

Note: 1. Measurement = Reading Level + Correct Factor.
 2. Peak: Peak detector.
 3. Only the worst data was recorded, if it complies with the limit, the other emissions deemed to comply with the limit.

Note: Horizontal and Vertical have been tested, only the worst data was recorded in the report.
 Note: Both antennas have been tested, only the worst data was recorded in the report.

8.1.2. 802.11g SISO MODE
ANTENNA 2 TEST RESULTS (WORST CASE)
RESTRICTED BANDEDGE (LOW CHANNEL, VERTICAL)
PEAK

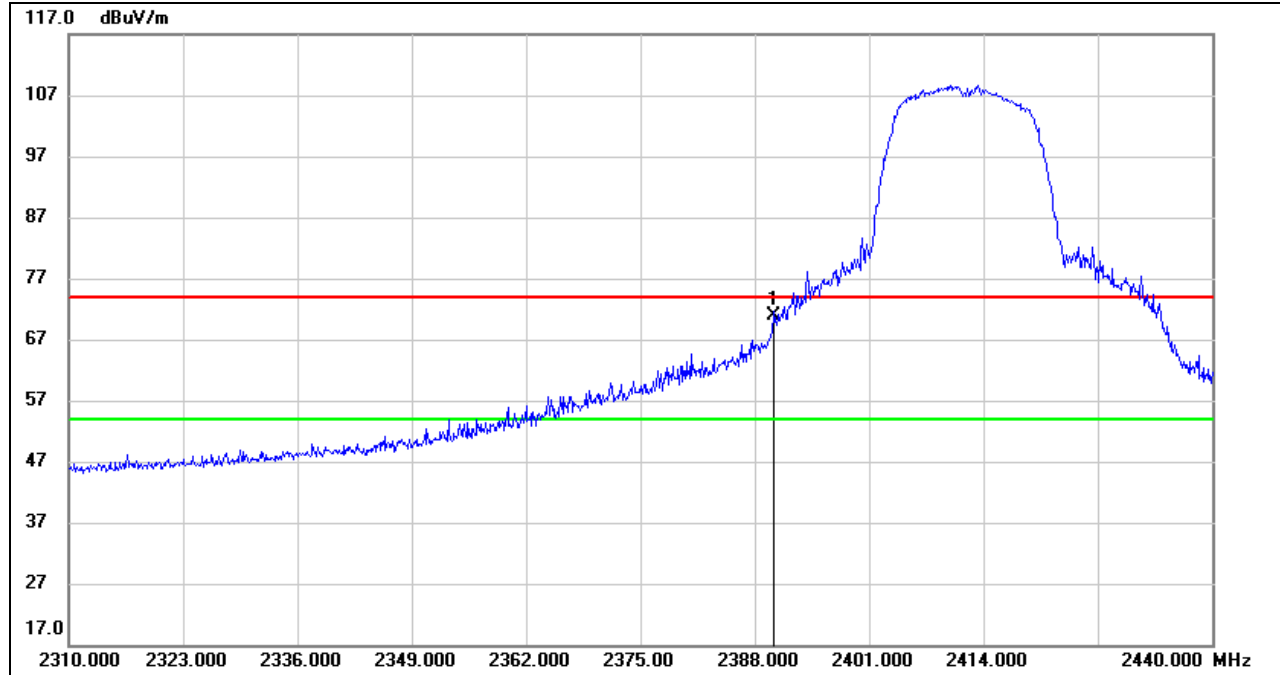

No.	Frequency (MHz)	Reading (dBuV)	Correct (dB/m)	Result (dBuV/m)	Limit (dBuV/m)	Margin (dB)	Remark
1	2390.000	38.68	32.16	70.84	74.00	-3.16	peak

Note: 1. Measurement = Reading Level + Correct Factor.
 2. Peak: Peak detector.
 3. Only the worst data was recorded, if it complies with the limit, the other emissions deemed to comply with the limit.

AVG

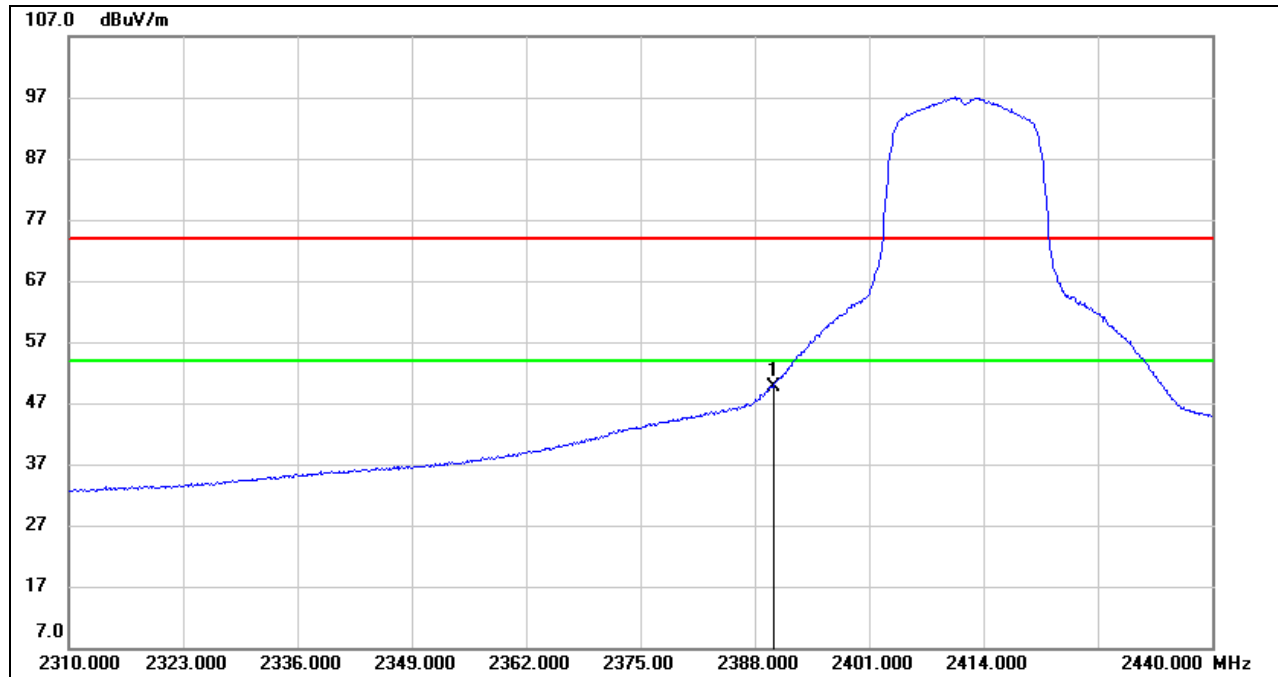

No.	Frequency (MHz)	Reading (dBuV)	Correct (dB/m)	Result (dBuV/m)	Limit (dBuV/m)	Margin (dB)	Remark
1	2390.000	17.47	32.16	49.63	54.00	-4.37	AVG

- Note: 1. Measurement = Reading Level + Correct Factor.
 2. AVG: $VBW=1/Ton$, where: Ton is the transmitting duration.
 3. For the transmitting duration, please refer to clause 7.1.
 4. Only the worst data was recorded, if it complies with the limit, the other emissions deemed to comply with the limit.

RESTRICTED BANDEDGE (HIGH CHANNEL, VERTICAL)

PEAK

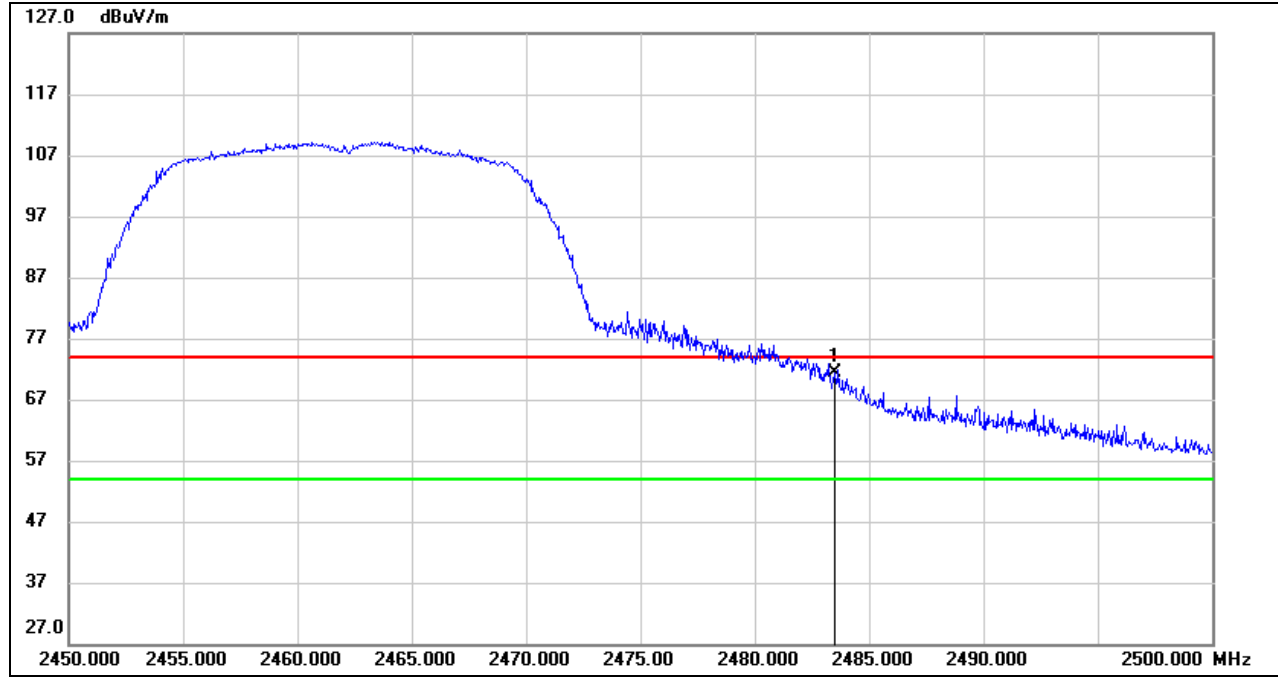

No.	Frequency (MHz)	Reading (dBuV)	Correct (dB/m)	Result (dBuV/m)	Limit (dBuV/m)	Margin (dB)	Remark
1	2483.500	38.89	32.44	71.33	74.00	-2.67	peak

Note: 1. Measurement = Reading Level + Correct Factor.
 2. Peak: Peak detector.
 3. Only the worst data was recorded, if it complies with the limit, the other emissions deemed to comply with the limit.

AVG

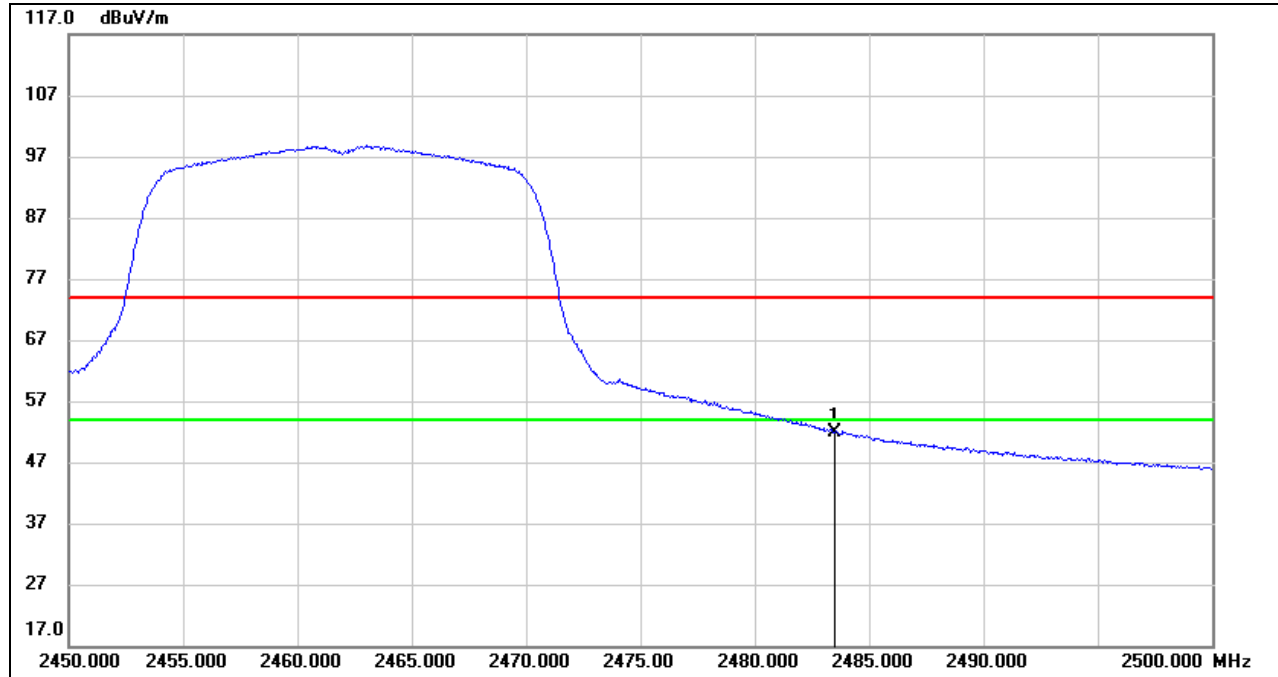

No.	Frequency (MHz)	Reading (dBuV)	Correct (dB/m)	Result (dBuV/m)	Limit (dBuV/m)	Margin (dB)	Remark
1	2483.500	19.49	32.44	51.93	54.00	-2.07	AVG

- Note: 1. Measurement = Reading Level + Correct Factor.
 2. AVG: $VBW=1/Ton$, where: Ton is the transmitting duration.
 3. For the transmitting duration, please refer to clause 7.1.
 4. Only the worst data was recorded, if it complies with the limit, the other emissions deemed to comply with the limit.

Note: Horizontal and Vertical have been tested, only the worst data was recorded in the report.
 Note: Both antennas have been tested, only the worst data was recorded in the report.

8.1.3. 802.11n HT20 MIMO MODE

RESTRICTED BANDEDGE (LOW CHANNEL, VERTICAL)

PEAK

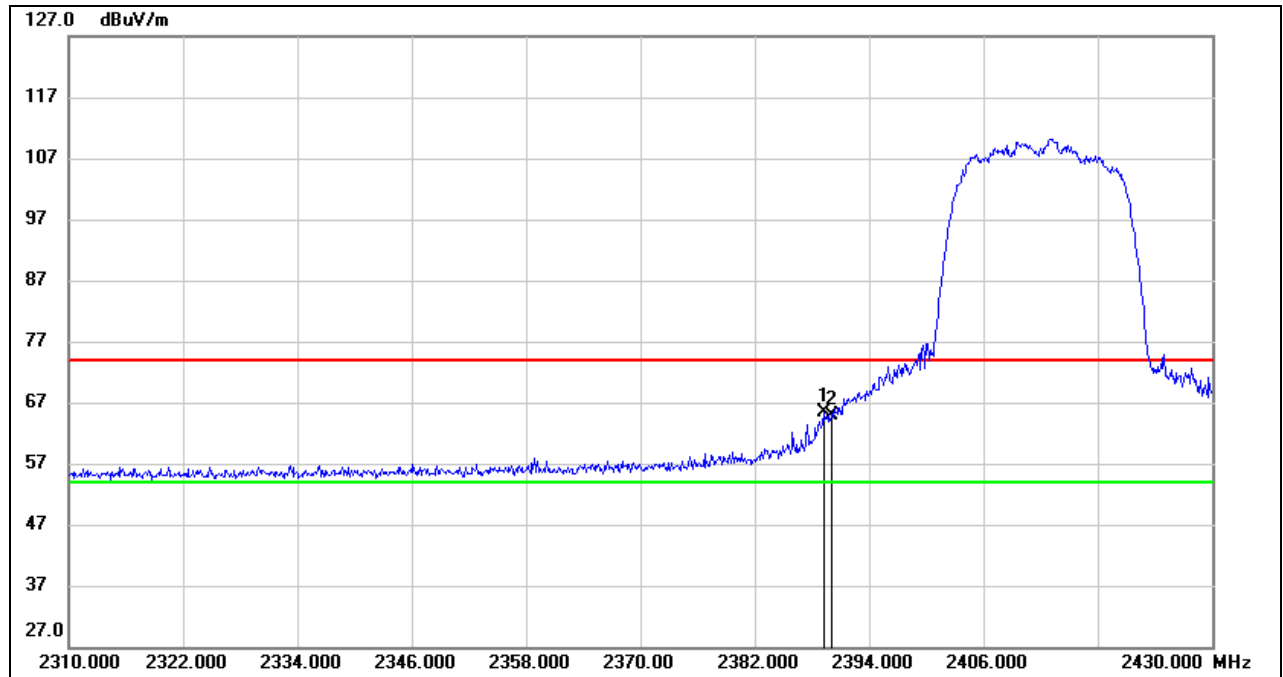

No.	Frequency (MHz)	Reading (dBuV)	Correct (dB/m)	Result (dBuV/m)	Limit (dBuV/m)	Margin (dB)	Remark
1	2389.200	33.23	32.16	65.39	74.00	-8.61	peak
2	2390.000	32.78	32.16	64.94	74.00	-9.06	peak

Note: 1. Measurement = Reading Level + Correct Factor.
 2. Peak: Peak detector.
 3. Only the worst data was recorded, if it complies with the limit, the other emissions deemed to comply with the limit.

AVG

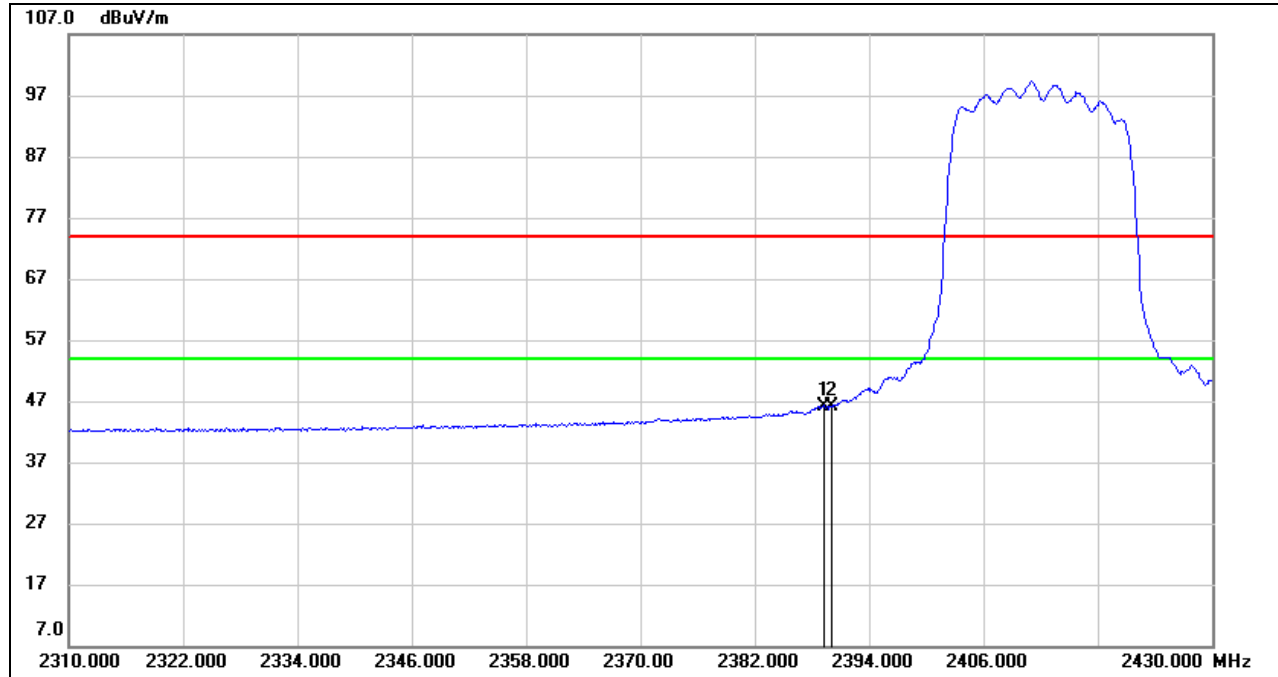

No.	Frequency (MHz)	Reading (dBuV)	Correct (dB/m)	Result (dBuV/m)	Limit (dBuV/m)	Margin (dB)	Remark
1	2389.200	13.96	32.16	46.12	54.00	-7.88	AVG
2	2390.000	14.04	32.16	46.20	54.00	-7.80	AVG

- Note: 1. Measurement = Reading Level + Correct Factor.
 2. AVG: $VBW=1/T_{on}$, where: T_{on} is the transmitting duration.
 3. For the transmitting duration, please refer to clause 7.1.
 4. Only the worst data was recorded, if it complies with the limit, the other emissions deemed to comply with the limit.



RESTRICTED BANDEDGE (HIGH CHANNEL, VERTICAL)

PEAK

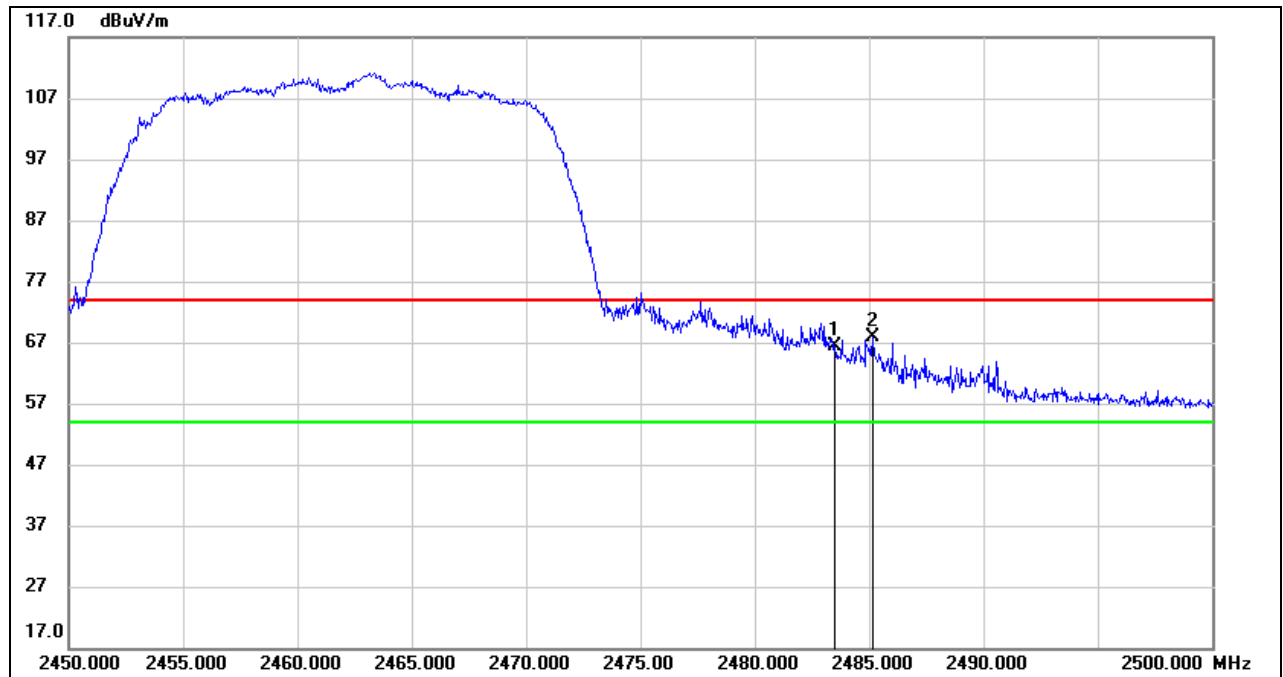

No.	Frequency (MHz)	Reading (dBuV)	Correct (dB/m)	Result (dBuV/m)	Limit (dBuV/m)	Margin (dB)	Remark
1	2483.500	33.96	32.44	66.40	74.00	-7.60	peak
2	2485.150	35.51	32.44	67.95	74.00	-6.05	peak

Note: 1. Measurement = Reading Level + Correct Factor.
 2. Peak: Peak detector.
 3. Only the worst data was recorded, if it complies with the limit, the other emissions deemed to comply with the limit.

AVG

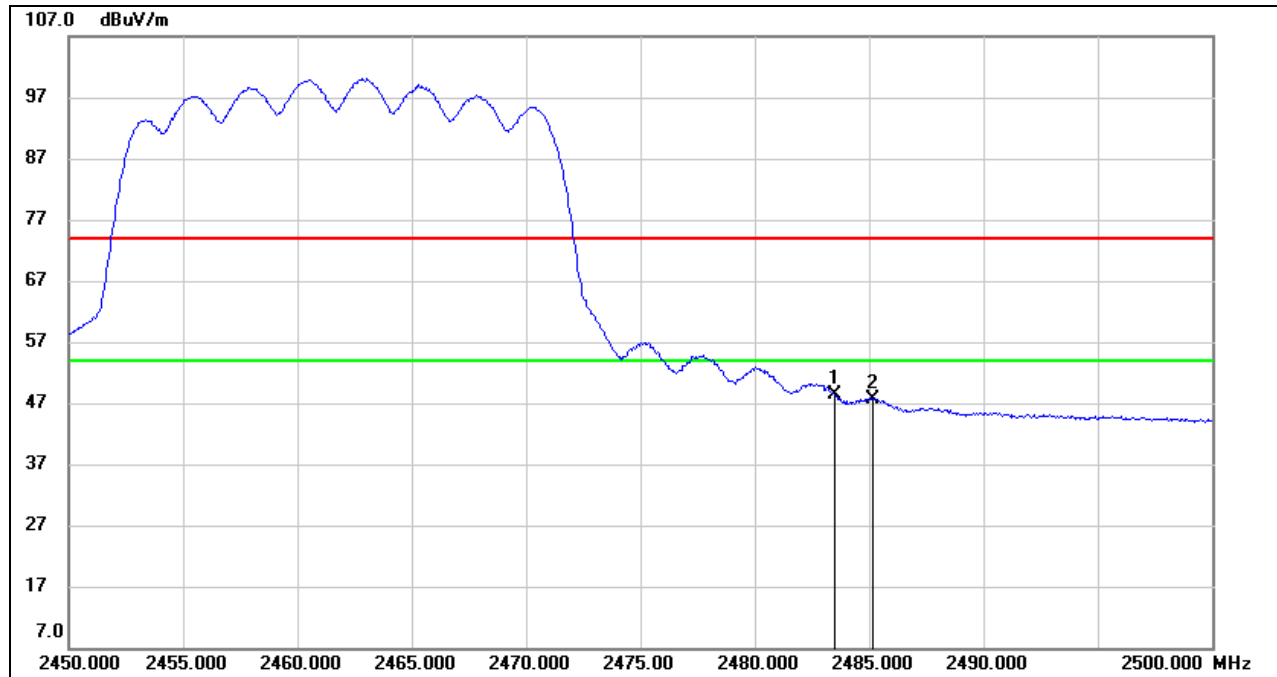

No.	Frequency (MHz)	Reading (dBuV)	Correct (dB/m)	Result (dBuV/m)	Limit (dBuV/m)	Margin (dB)	Remark
1	2483.500	15.93	32.44	48.37	54.00	-5.63	AVG
2	2485.150	15.17	32.44	47.61	54.00	-6.39	AVG

- Note: 1. Measurement = Reading Level + Correct Factor.
 2. AVG: $VBW=1/Ton$, where: Ton is the transmitting duration.
 3. For the transmitting duration, please refer to clause 7.1.
 4. Only the worst data was recorded, if it complies with the limit, the other emissions deemed to comply with the limit.

Note: Horizontal and Vertical have been tested, only the worst data was recorded in the report.
 Note: All modes have been tested, only the worst data was recorded in the report.

8.1.4. 802.11n HT40 MIMO MODE

RESTRICTED BANDEDGE (LOW CHANNEL, VERTICAL)

PEAK

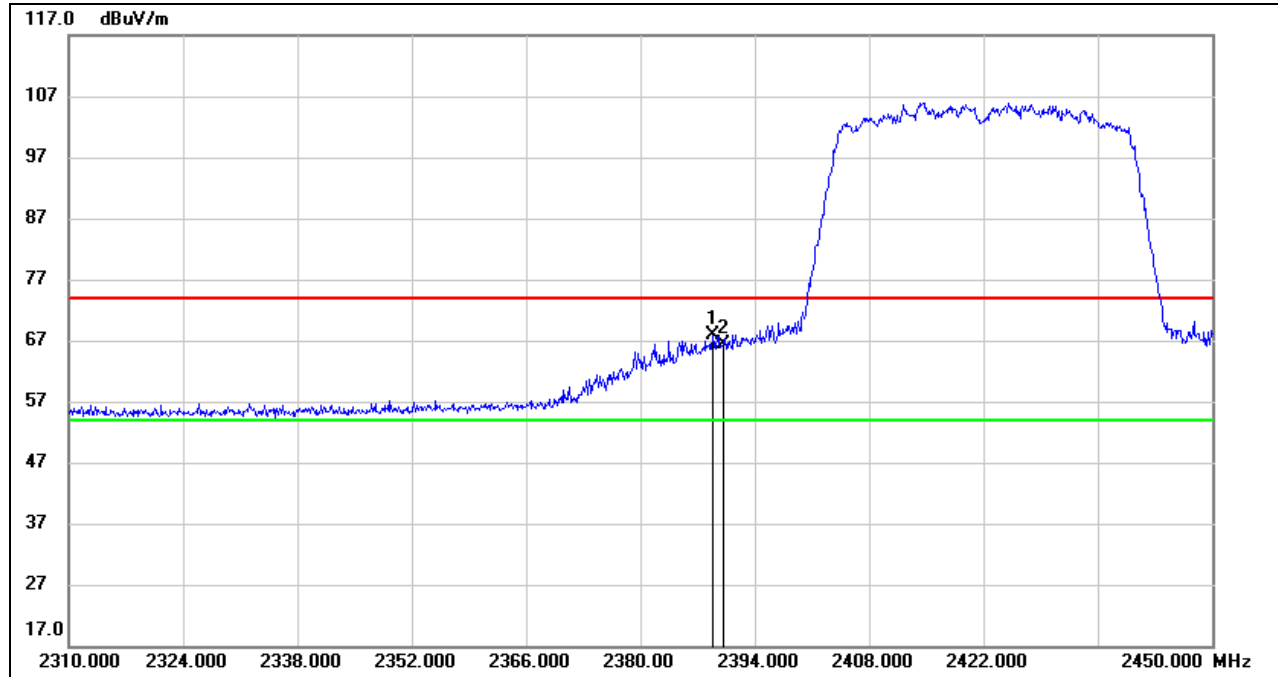

No.	Frequency (MHz)	Reading (dBuV)	Correct (dB/m)	Result (dBuV/m)	Limit (dBuV/m)	Margin (dB)	Remark
1	2388.820	35.63	32.16	67.79	74.00	-6.21	peak
2	2390.000	34.28	32.16	66.44	74.00	-7.56	peak

Note: 1. Measurement = Reading Level + Correct Factor.

2. Peak: Peak detector.

3. Only the worst data was recorded, if it complies with the limit, the other emissions deemed to comply with the limit.

AVG

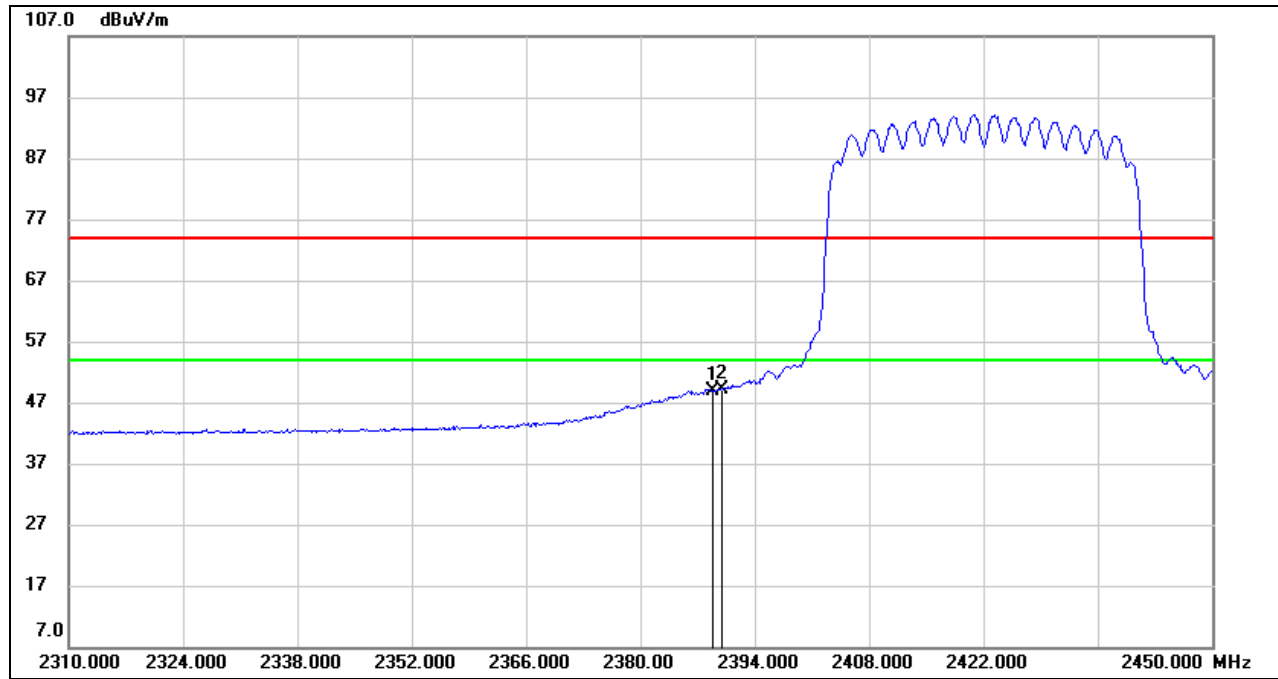

No.	Frequency (MHz)	Reading (dBuV)	Correct (dB/m)	Result (dBuV/m)	Limit (dBuV/m)	Margin (dB)	Remark
1	2388.820	16.77	32.16	48.93	54.00	-5.07	AVG
2	2390.000	17.04	32.16	49.20	54.00	-4.80	AVG

- Note: 1. Measurement = Reading Level + Correct Factor.
 2. AVG: $VBW=1/T_{on}$, where: T_{on} is the transmitting duration.
 3. For the transmitting duration, please refer to clause 7.1.
 4. Only the worst data was recorded, if it complies with the limit, the other emissions deemed to comply with the limit.

RESTRICTED BANDEDGE (HIGH CHANNEL, VERTICAL)

PEAK

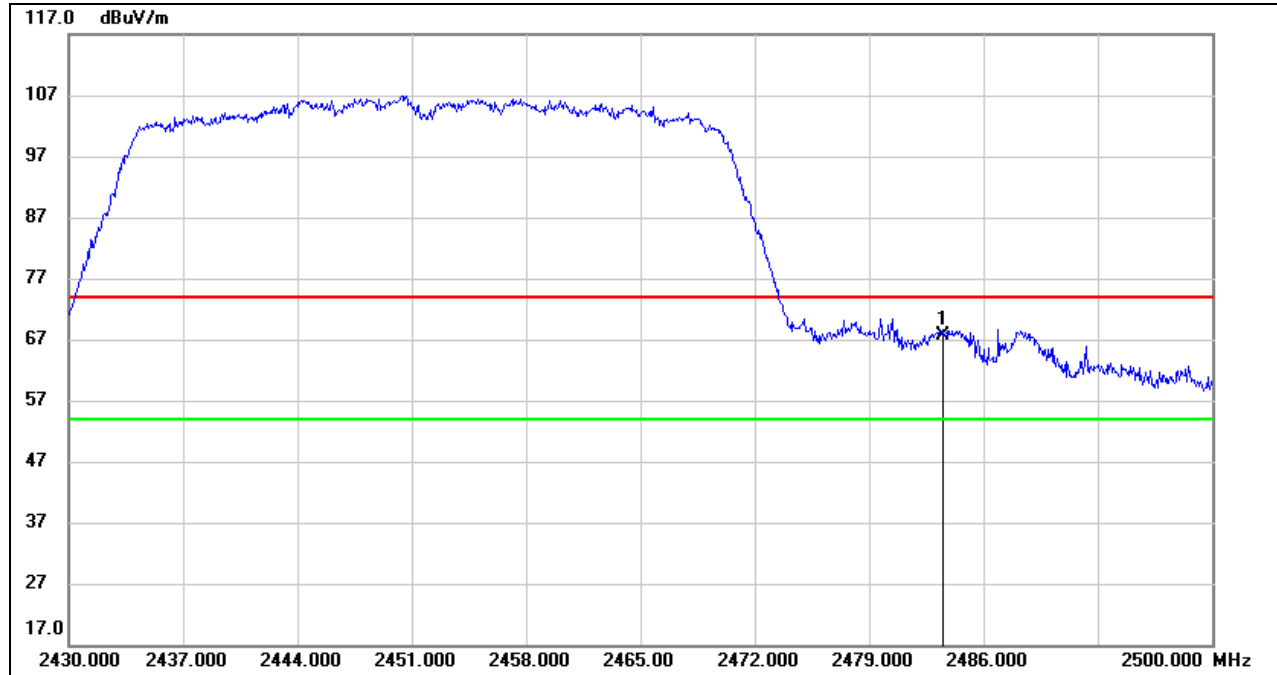

No.	Frequency (MHz)	Reading (dBuV)	Correct (dB/m)	Result (dBuV/m)	Limit (dBuV/m)	Margin (dB)	Remark
1	2483.500	35.09	32.44	67.53	74.00	-6.47	peak

- Note: 1. Measurement = Reading Level + Correct Factor.
 2. Peak: Peak detector.
 3. Only the worst data was recorded, if it complies with the limit, the other emissions deemed to comply with the limit.

AVG

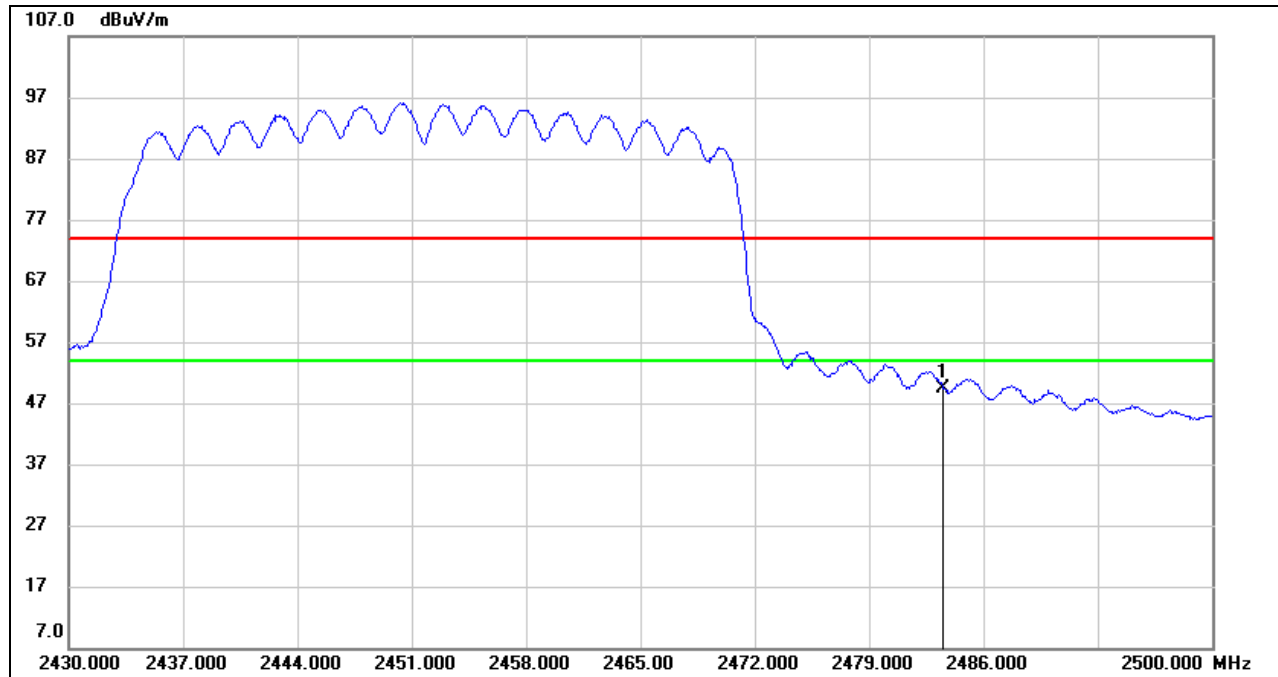

No.	Frequency (MHz)	Reading (dBuV)	Correct (dB/m)	Result (dBuV/m)	Limit (dBuV/m)	Margin (dB)	Remark
1	2483.500	17.01	32.44	49.45	54.00	-4.55	AVG

- Note: 1. Measurement = Reading Level + Correct Factor.
 2. AVG: $VBW=1/T_{on}$, where: T_{on} is the transmitting duration.
 3. For the transmitting duration, please refer to clause 7.1.
 4. Only the worst data was recorded, if it complies with the limit, the other emissions deemed to comply with the limit.

Note: Horizontal and Vertical have been tested, only the worst data was recorded in the report.
 Note: All modes have been tested, only the worst data was recorded in the report.

8.2. SPURIOUS EMISSIONS (1 GHz ~ 3 GHz)

8.2.1. 802.11n HT20 MIMO MODE

HARMONICS AND SPURIOUS EMISSIONS (LOW CHANNEL, HORIZONTAL)

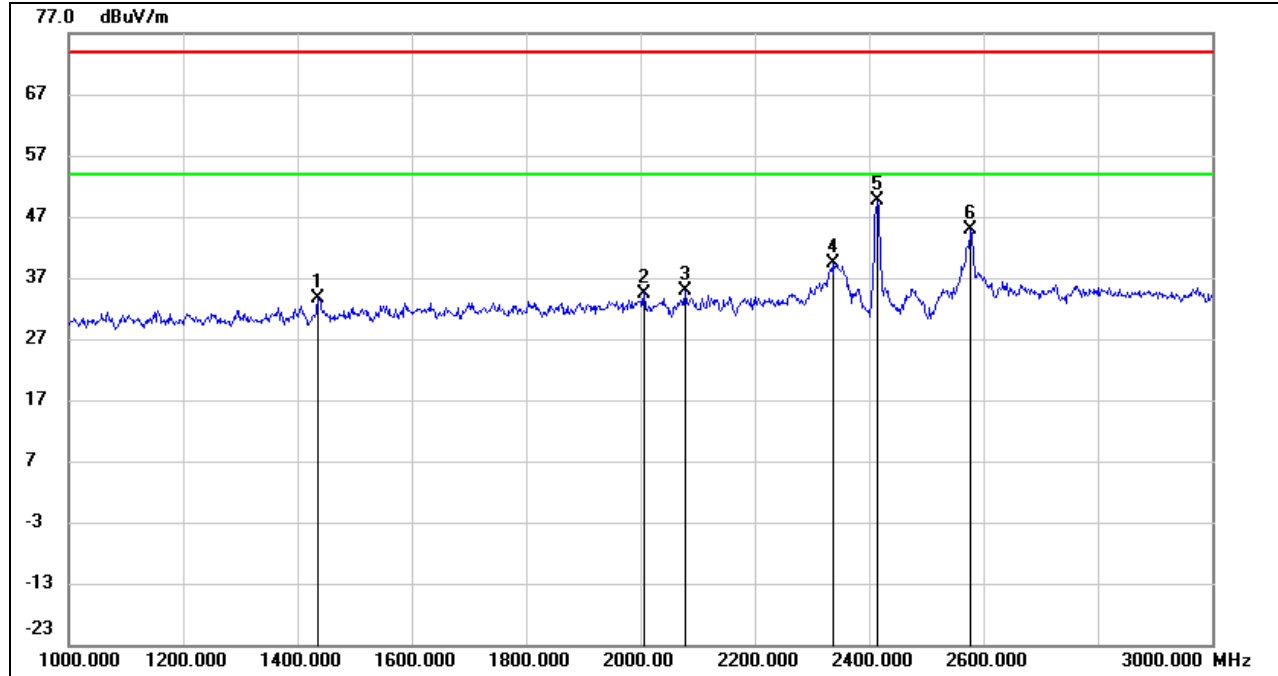

No.	Frequency (MHz)	Reading (dBuV)	Correct (dB/m)	Result (dBuV/m)	Limit (dBuV/m)	Margin (dB)	Remark
1	1436.000	46.60	-13.01	33.59	74.00	-40.41	peak
2	2006.000	45.53	-11.03	34.50	74.00	-39.50	peak
3	2078.000	45.59	-10.67	34.92	74.00	-39.08	peak
4	2338.000	48.58	-9.32	39.26	74.00	-34.74	peak
5	2412.000	58.52	-8.93	49.59	/	/	Fundamental
6	2578.000	53.17	-8.26	44.91	74.00	-29.09	peak

Note: 1. Measurement = Reading Level + Correct Factor.

2. If Peak Result complies with AV limit, AV Result is deemed to comply with AV limit.

3. Peak: Peak detector.

4. Filter losses were only considered in the spurious frequency bands and the authorized band was not corrected for Band reject filter losses.

5. Proper operation of the transmitter prior to adding the filter to the measurement chain.

HARMONICS AND SPURIOUS EMISSIONS (LOW CHANNEL, VERTICAL)

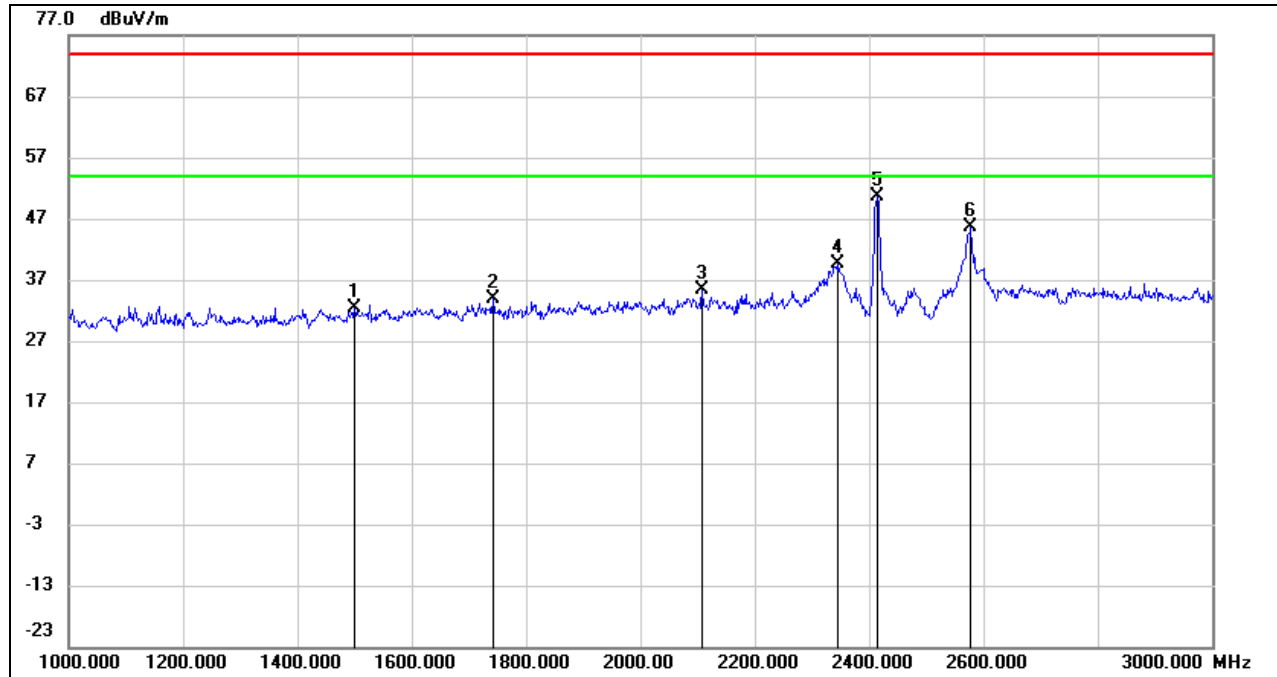

No.	Frequency (MHz)	Reading (dBuV)	Correct (dB/m)	Result (dBuV/m)	Limit (dBuV/m)	Margin (dB)	Remark
1	1500.000	45.10	-12.71	32.39	74.00	-41.61	peak
2	1742.000	45.68	-11.91	33.77	74.00	-40.23	peak
3	2108.000	45.90	-10.50	35.40	74.00	-38.60	peak
4	2346.000	49.01	-9.28	39.73	74.00	-34.27	peak
5	2412.000	59.65	-8.93	50.72	/	/	Fundamental
6	2578.000	53.77	-8.26	45.51	74.00	-28.49	peak

- Note: 1. Measurement = Reading Level + Correct Factor.
 2. If Peak Result complies with AV limit, AV Result is deemed to comply with AV limit.
 3. Peak: Peak detector.
 4. Filter losses were only considered in the spurious frequency bands and the authorized band was not corrected for Band reject filter losses.
 5. Proper operation of the transmitter prior to adding the filter to the measurement chain.

HARMONICS AND SPURIOUS EMISSIONS (MID CHANNEL, HORIZONTAL)

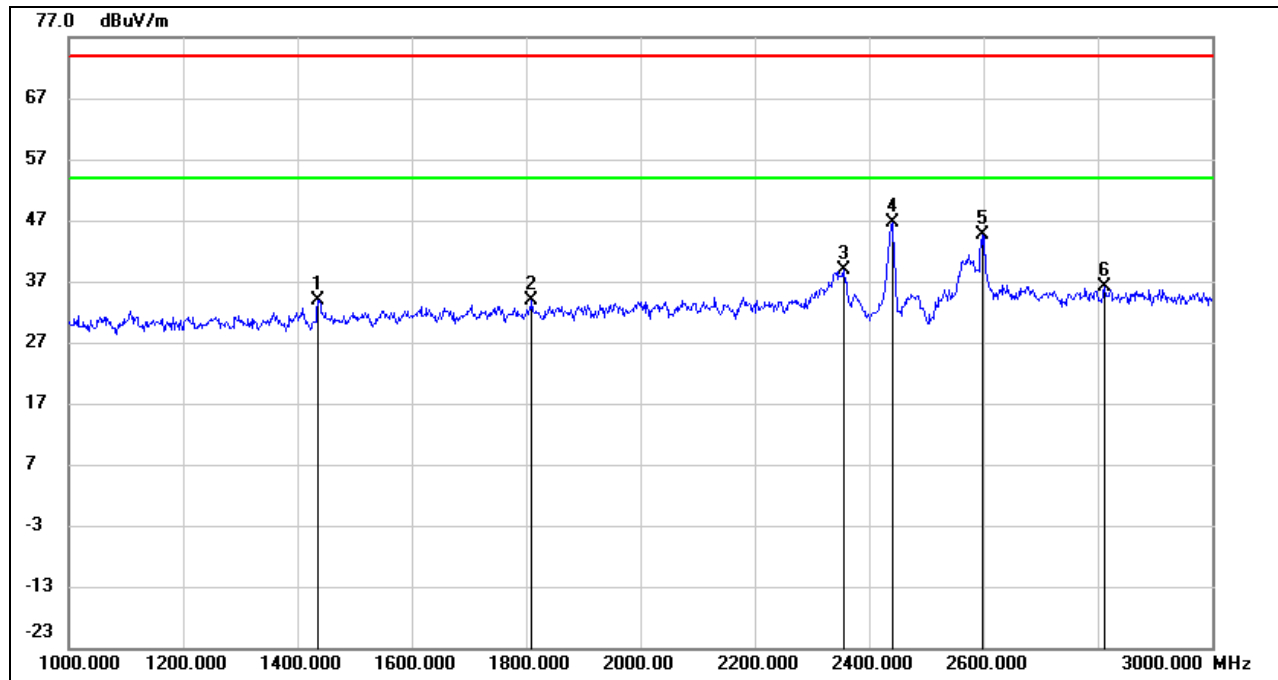

No.	Frequency (MHz)	Reading (dBuV)	Correct (dB/m)	Result (dBuV/m)	Limit (dBuV/m)	Margin (dB)	Remark
1	1436.000	46.88	-13.01	33.87	74.00	-40.13	peak
2	1810.000	45.66	-11.69	33.97	74.00	-40.03	peak
3	2356.000	48.18	-9.22	38.96	74.00	-35.04	peak
4	2437.000	55.33	-8.80	46.53	/	/	Fundamental
5	2598.000	52.77	-8.19	44.58	74.00	-29.42	peak
6	2812.000	43.71	-7.55	36.16	74.00	-37.84	peak

- Note: 1. Measurement = Reading Level + Correct Factor.
 2. If Peak Result complies with AV limit, AV Result is deemed to comply with AV limit.
 3. Peak: Peak detector.
 4. Filter losses were only considered in the spurious frequency bands and the authorized band was not corrected for Band reject filter losses.
 5. Proper operation of the transmitter prior to adding the filter to the measurement chain.

HARMONICS AND SPURIOUS EMISSIONS (MID CHANNEL, VERTICAL)

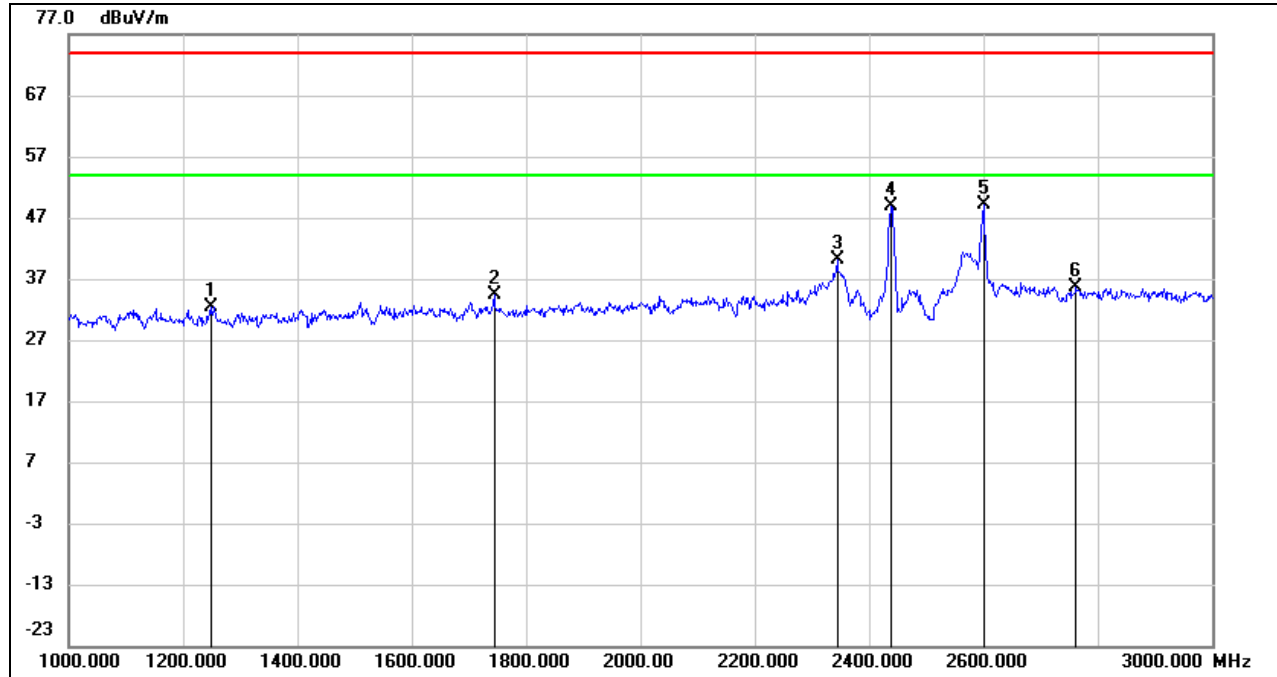

No.	Frequency (MHz)	Reading (dBuV)	Correct (dB/m)	Result (dBuV/m)	Limit (dBuV/m)	Margin (dB)	Remark
1	1248.000	46.23	-13.88	32.35	74.00	-41.65	peak
2	1744.000	46.37	-11.90	34.47	74.00	-39.53	peak
3	2344.000	49.31	-9.30	40.01	74.00	-33.99	peak
4	2437.000	57.64	-8.80	48.84	/	/	Fundamental
5	2600.000	57.25	-8.19	49.06	74.00	-24.94	peak
6	2762.000	43.25	-7.70	35.55	74.00	-38.45	peak

- Note: 1. Measurement = Reading Level + Correct Factor.
 2. If Peak Result complies with AV limit, AV Result is deemed to comply with AV limit.
 3. Peak: Peak detector.
 4. Filter losses were only considered in the spurious frequency bands and the authorized band was not corrected for Band reject filter losses.
 5. Proper operation of the transmitter prior to adding the filter to the measurement chain.

HARMONICS AND SPURIOUS EMISSIONS (HIGH CHANNEL, HORIZONTAL)

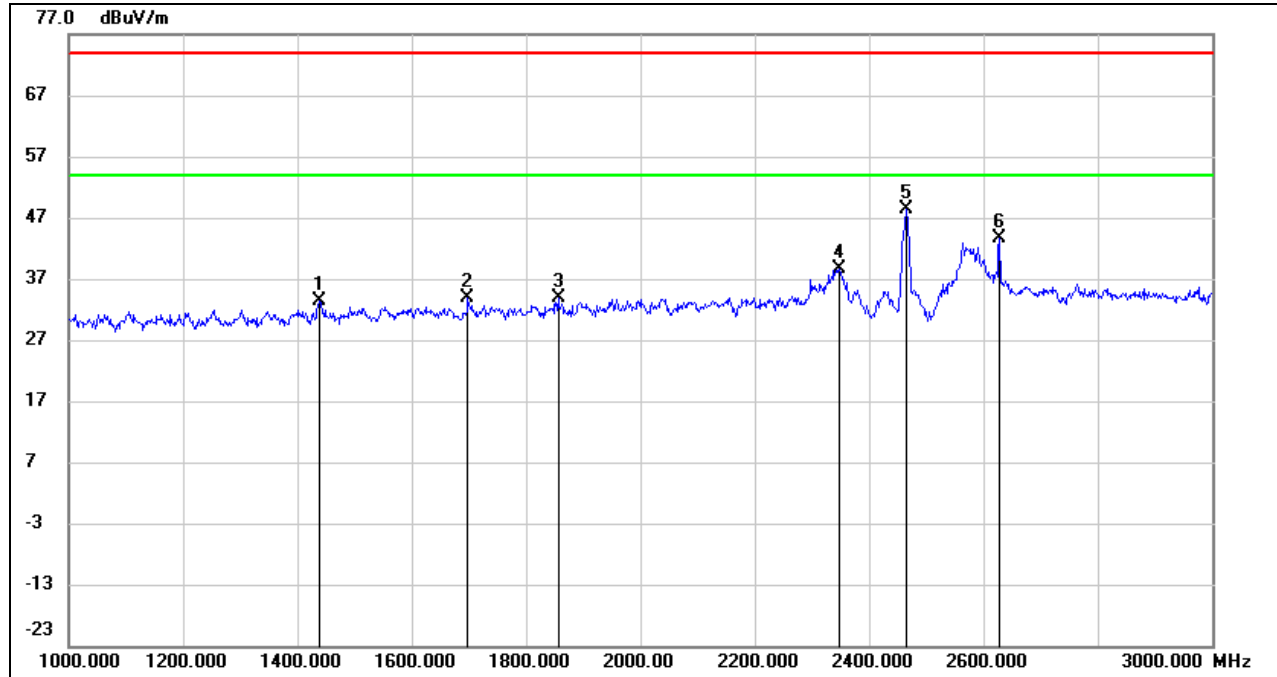

No.	Frequency (MHz)	Reading (dBuV)	Correct (dB/m)	Result (dBuV/m)	Limit (dBuV/m)	Margin (dB)	Remark
1	1438.000	46.49	-13.00	33.49	74.00	-40.51	peak
2	1698.000	45.85	-12.05	33.80	74.00	-40.20	peak
3	1856.000	45.38	-11.54	33.84	74.00	-40.16	peak
4	2348.000	47.82	-9.28	38.54	74.00	-35.46	peak
5	2462.000	57.12	-8.68	48.44	/	/	Fundamental
6	2628.000	51.66	-8.10	43.56	74.00	-30.44	peak

- Note: 1. Measurement = Reading Level + Correct Factor.
 2. If Peak Result complies with AV limit, AV Result is deemed to comply with AV limit.
 3. Peak: Peak detector.
 4. Filter losses were only considered in the spurious frequency bands and the authorized band was not corrected for Band reject filter losses.
 5. Proper operation of the transmitter prior to adding the filter to the measurement chain.

HARMONICS AND SPURIOUS EMISSIONS (HIGH CHANNEL, VERTICAL)

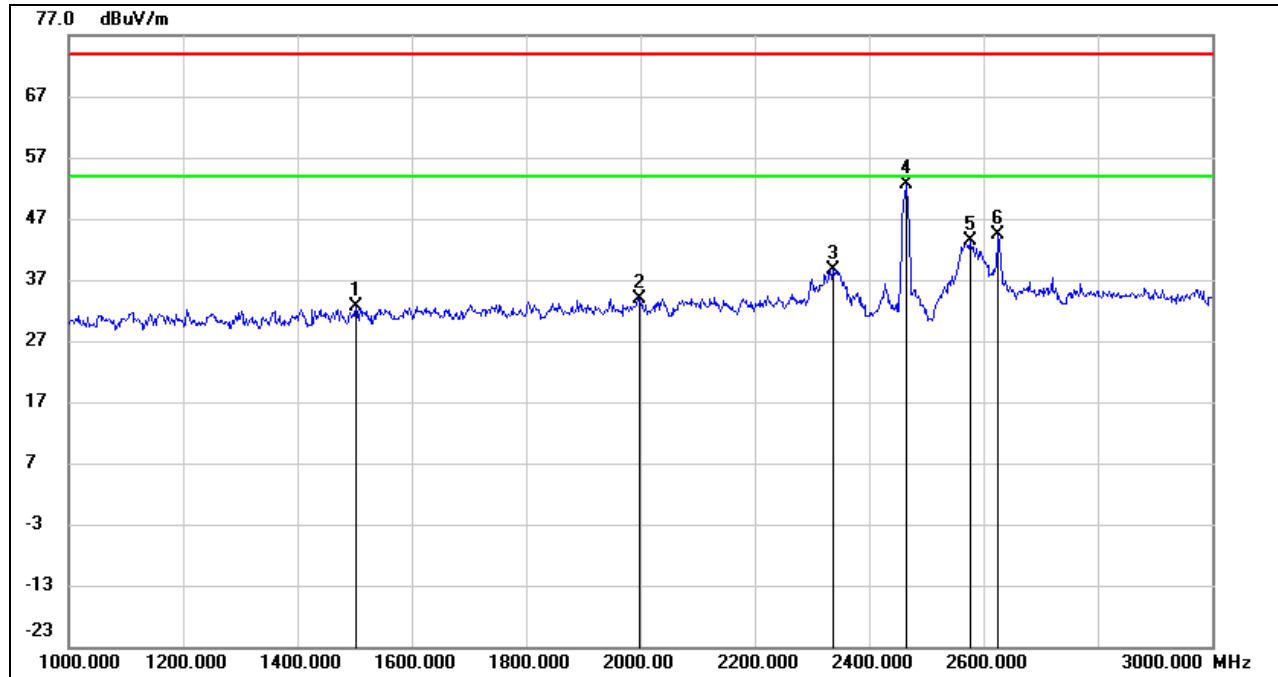

No.	Frequency (MHz)	Reading (dBuV)	Correct (dB/m)	Result (dBuV/m)	Limit (dBuV/m)	Margin (dB)	Remark
1	1502.000	45.26	-12.71	32.55	74.00	-41.45	peak
2	1998.000	44.97	-11.06	33.91	74.00	-40.09	peak
3	2338.000	48.06	-9.32	38.74	74.00	-35.26	peak
4	2462.000	61.24	-8.68	52.56	/	/	Fundamental
5	2576.000	51.54	-8.26	43.28	74.00	-30.72	peak
6	2626.000	52.59	-8.10	44.49	74.00	-29.51	peak

- Note: 1. Measurement = Reading Level + Correct Factor.
 2. If Peak Result complies with AV limit, AV Result is deemed to comply with AV limit.
 3. Peak: Peak detector.
 4. Filter losses were only considered in the spurious frequency bands and the authorized band was not corrected for Band reject filter losses.
 5. Proper operation of the transmitter prior to adding the filter to the measurement chain.

Note: The two antennas had been tested, but only the worst data was recorded in the report.

Note: All modes and channels have been tested, only the worst data was recorded in the report.

8.3. SPURIOUS EMISSIONS (3 GHz ~ 18 GHz)

8.3.1. 802.11b SISO MODE

ANTENNA 2 TEST RESULTS (WORST CASE)

HARMONICS AND SPURIOUS EMISSIONS (LOW CHANNEL, HORIZONTAL)

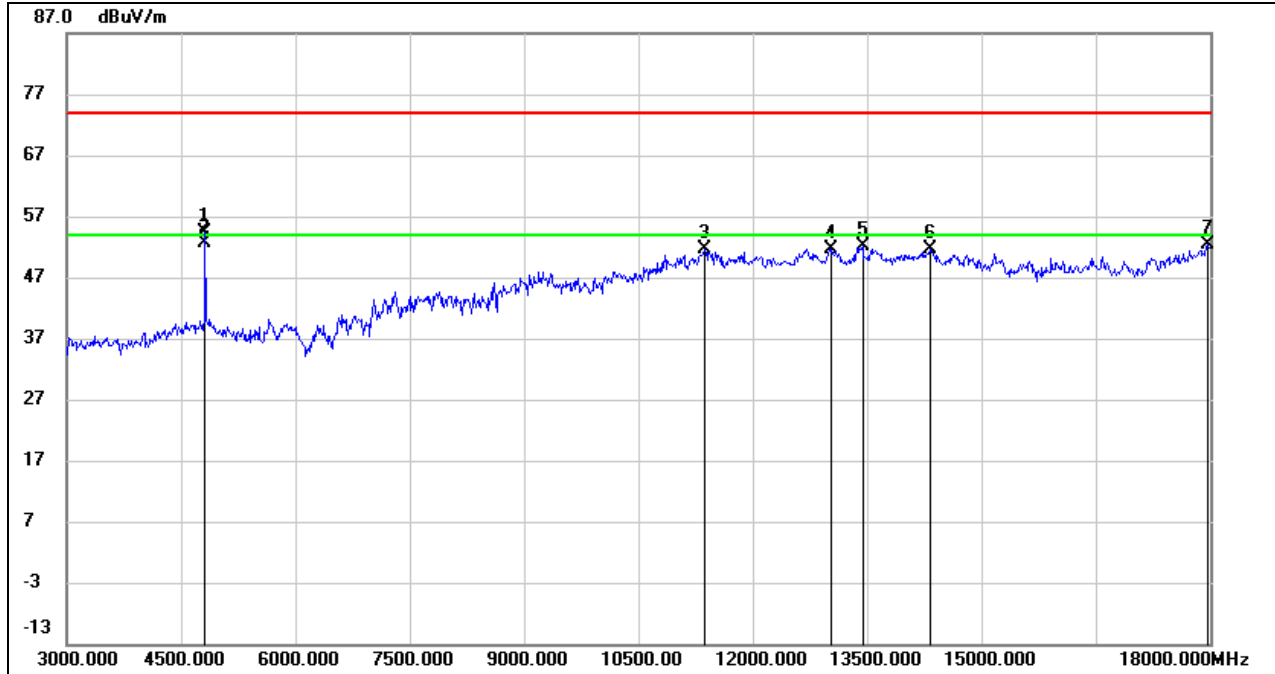

No.	Frequency (MHz)	Reading (dBuV)	Correct (dB/m)	Result (dBuV/m)	Limit (dBuV/m)	Margin (dB)	Remark
1	4815.000	54.62	-0.26	54.36	74.00	-19.64	peak
2	4815.000	52.82	-0.26	52.56	54.00	-1.44	AVG
3	11370.000	35.49	16.12	51.61	74.00	-22.39	peak
4	13035.000	32.82	18.87	51.69	74.00	-22.31	peak
5	13440.000	31.47	20.64	52.11	74.00	-21.89	peak
6	14325.000	30.98	20.63	51.61	74.00	-22.39	peak
7	17970.000	26.78	25.51	52.29	74.00	-21.71	peak

- Note: 1. Peak Result = Reading Level + Correct Factor.
 2. Peak: Peak detector.
 3. AVG: $VBW=1/Ton$, where: Ton is the transmitting duration.
 4. For the transmitting duration, please refer to clause 7.1.
 5. Filter losses were only considered in the spurious frequency bands and the authorized band was not corrected for High Pass Filter losses.
 6. Proper operation of the transmitter prior to adding the filter to the measurement chain.

HARMONICS AND SPURIOUS EMISSIONS (LOW CHANNEL, VERTICAL)

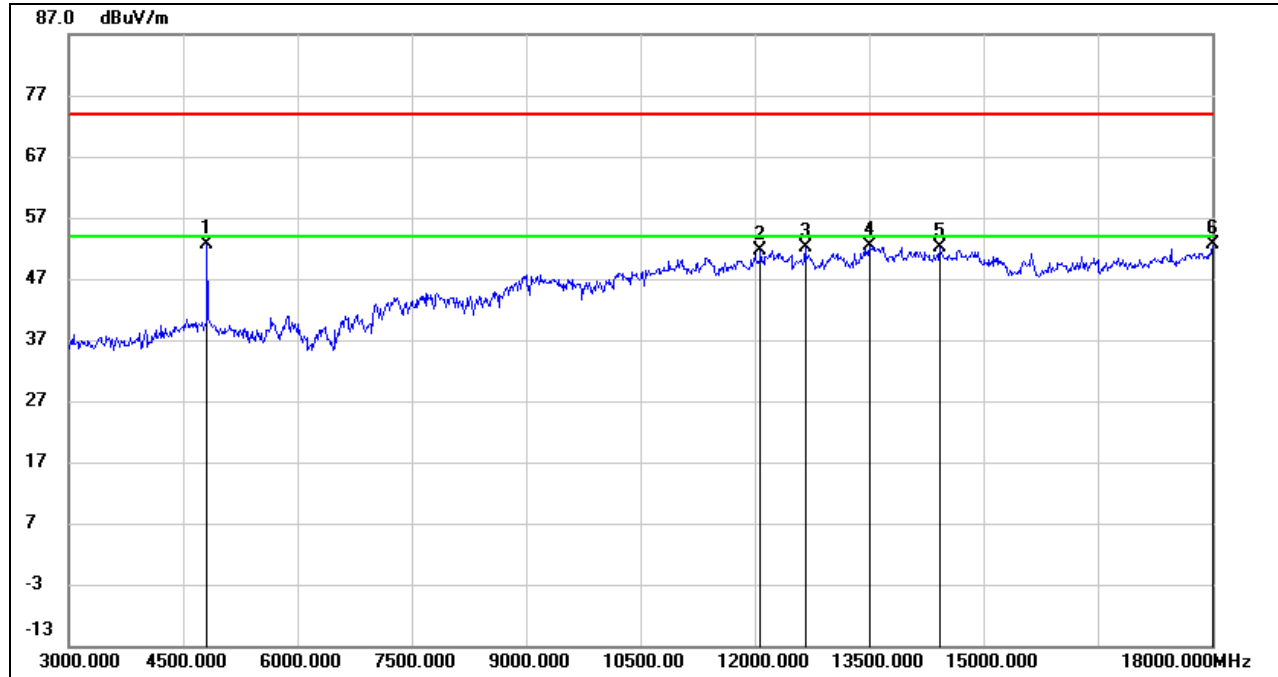

No.	Frequency (MHz)	Reading (dBuV)	Correct (dB/m)	Result (dBuV/m)	Limit (dBuV/m)	Margin (dB)	Remark
1	4815.000	52.93	-0.26	52.67	74.00	-21.33	peak
2	12075.000	33.76	17.90	51.66	74.00	-22.34	peak
3	12660.000	34.09	17.95	52.04	74.00	-21.96	peak
4	13500.000	31.51	20.90	52.41	74.00	-21.59	peak
5	14430.000	31.93	20.20	52.13	74.00	-21.87	peak
6	18000.000	26.91	25.69	52.60	74.00	-21.40	peak

- Note: 1. Peak Result = Reading Level + Correct Factor.
 2. Peak: Peak detector.
 3. AVG: $VBW=1/T_{on}$, where: T_{on} is the transmitting duration.
 4. For the transmitting duration, please refer to clause 7.1.
 5. Filter losses were only considered in the spurious frequency bands and the authorized band was not corrected for High Pass Filter losses.
 6. Proper operation of the transmitter prior to adding the filter to the measurement chain.



HARMONICS AND SPURIOUS EMISSIONS (MID CHANNEL, HORIZONTAL)

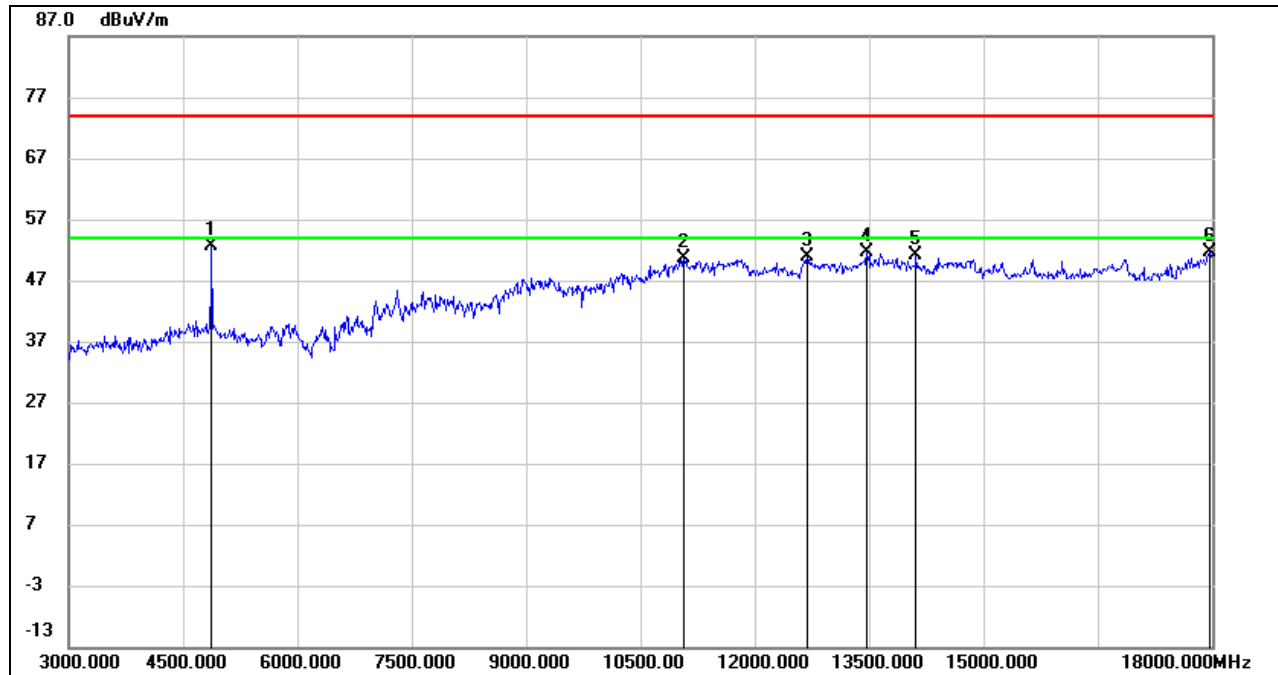

No.	Frequency (MHz)	Reading (dBuV)	Correct (dB/m)	Result (dBuV/m)	Limit (dBuV/m)	Margin (dB)	Remark
1	4875.000	52.62	-0.03	52.59	74.00	-21.41	peak
2	11070.000	35.61	15.03	50.64	74.00	-23.36	peak
3	12690.000	32.74	18.02	50.76	74.00	-23.24	peak
4	13470.000	30.83	20.77	51.60	74.00	-22.40	peak
5	14115.000	29.62	21.49	51.11	74.00	-22.89	peak
6	17970.000	26.18	25.51	51.69	74.00	-22.31	peak

- Note: 1. Peak Result = Reading Level + Correct Factor.
 2. If Peak Result complies with AV limit, AV Result is deemed to comply with AV limit.
 3. Peak: Peak detector.
 4. Filter losses were only considered in the spurious frequency bands and the authorized band was not corrected for High Pass Filter losses.
 5. Proper operation of the transmitter prior to adding the filter to the measurement chain.



HARMONICS AND SPURIOUS EMISSIONS (MID CHANNEL, VERTICAL)

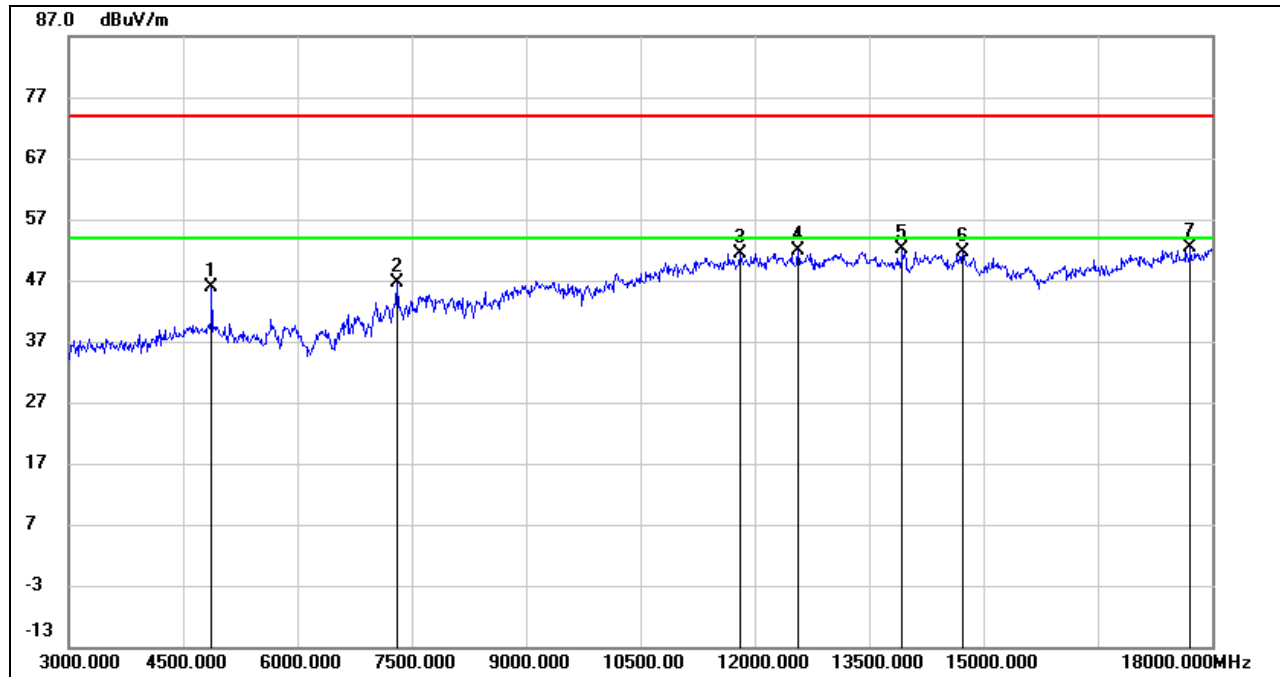

No.	Frequency (MHz)	Reading (dBuV)	Correct (dB/m)	Result (dBuV/m)	Limit (dBuV/m)	Margin (dB)	Remark
1	4875.000	45.86	-0.03	45.83	74.00	-28.17	peak
2	7305.000	40.26	6.47	46.73	74.00	-27.27	peak
3	11805.000	34.04	17.43	51.47	74.00	-22.53	peak
4	12570.000	34.23	17.75	51.98	74.00	-22.02	peak
5	13935.000	30.20	21.82	52.02	74.00	-21.98	peak
6	14730.000	32.69	18.98	51.67	74.00	-22.33	peak
7	17715.000	28.49	24.00	52.49	74.00	-21.51	peak

- Note: 1. Peak Result = Reading Level + Correct Factor.
 2. Peak: Peak detector.
 3. AVG: VBW=1/Ton, where: Ton is the transmitting duration.
 4. For the transmitting duration, please refer to clause 7.1.
 5. Filter losses were only considered in the spurious frequency bands and the authorized band was not corrected for High Pass Filter losses.
 6. Proper operation of the transmitter prior to adding the filter to the measurement chain.

HARMONICS AND SPURIOUS EMISSIONS (HIGH CHANNEL, HORIZONTAL)

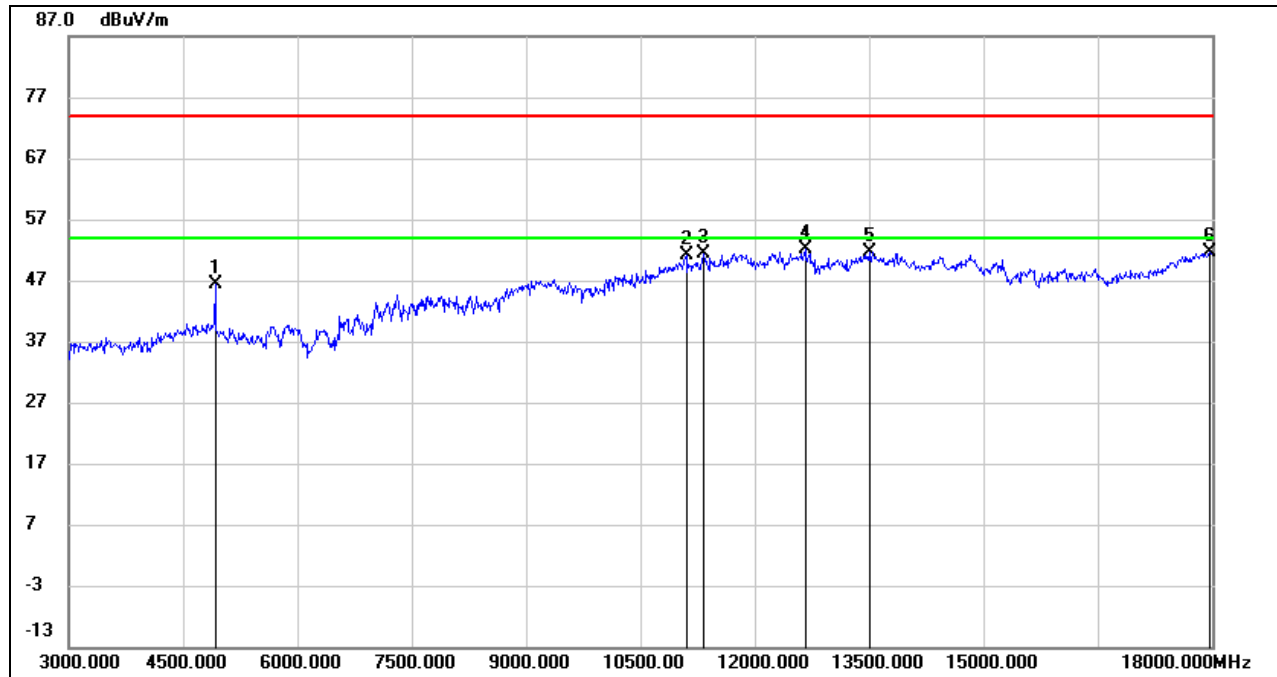

No.	Frequency (MHz)	Reading (dBuV)	Correct (dB/m)	Result (dBuV/m)	Limit (dBuV/m)	Margin (dB)	Remark
1	4920.000	46.33	0.14	46.47	74.00	-27.53	peak
2	11100.000	36.04	15.14	51.18	74.00	-22.82	peak
3	11325.000	35.39	15.95	51.34	74.00	-22.66	peak
4	12660.000	34.07	17.95	52.02	74.00	-21.98	peak
5	13500.000	30.75	20.90	51.65	74.00	-22.35	peak
6	17970.000	26.00	25.51	51.51	74.00	-22.49	peak

Note: 1. Peak Result = Reading Level + Correct Factor.

2. If Peak Result complies with AV limit, AV Result is deemed to comply with AV limit.

3. Peak: Peak detector.

4. Filter losses were only considered in the spurious frequency bands and the authorized band was not corrected for High Pass Filter losses.

5. Proper operation of the transmitter prior to adding the filter to the measurement chain.

HARMONICS AND SPURIOUS EMISSIONS (HIGH CHANNEL, VERTICAL)

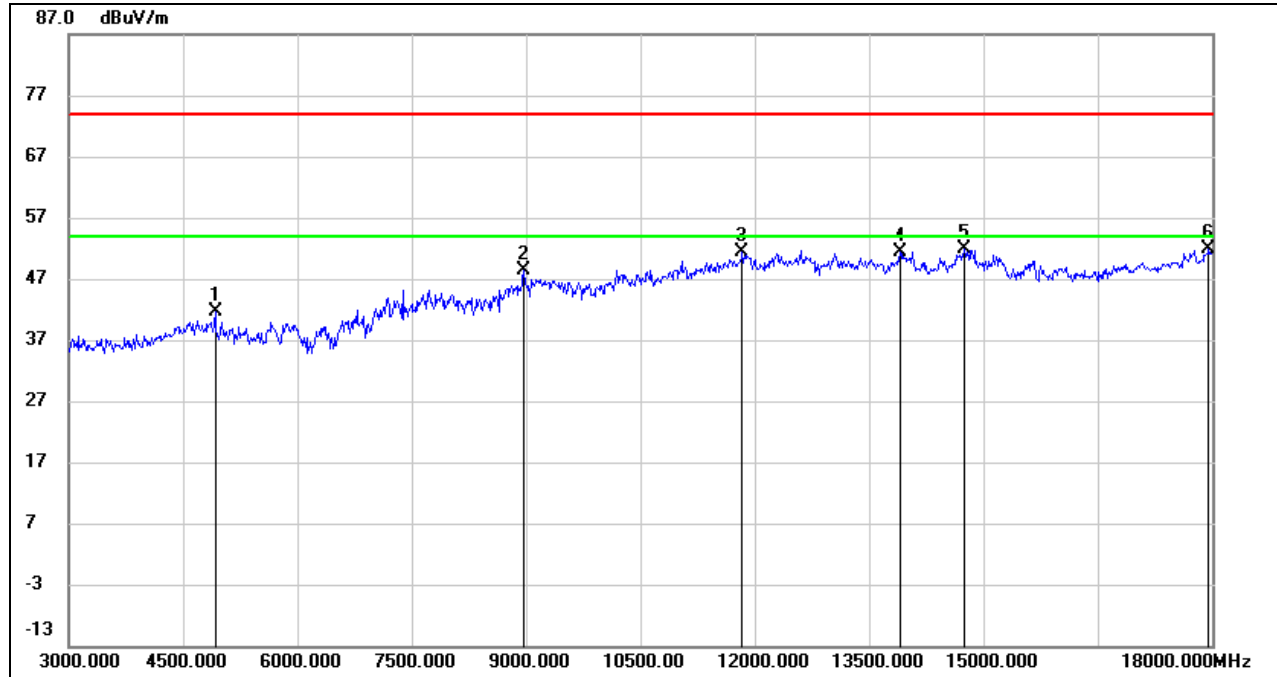

No.	Frequency (MHz)	Reading (dBuV)	Correct (dB/m)	Result (dBuV/m)	Limit (dBuV/m)	Margin (dB)	Remark
1	4920.000	41.59	0.14	41.73	74.00	-32.27	peak
2	8970.000	38.08	10.26	48.34	74.00	-25.66	peak
3	11835.000	33.80	17.51	51.31	74.00	-22.69	peak
4	13905.000	29.72	21.76	51.48	74.00	-22.52	peak
5	14745.000	32.95	18.93	51.88	74.00	-22.12	peak
6	17955.000	26.43	25.42	51.85	74.00	-22.15	peak

- Note: 1. Peak Result = Reading Level + Correct Factor.
 2. Peak: Peak detector.
 3. AVG: $VBW=1/Ton$, where: Ton is the transmitting duration.
 4. For the transmitting duration, please refer to clause 7.1.
 5. Filter losses were only considered in the spurious frequency bands and the authorized band was not corrected for High Pass Filter losses.
 6. Proper operation of the transmitter prior to adding the filter to the measurement chain.

Note: Both the two antennas had been tested, but only the worst data was recorded in the report.

8.3.2. 802.11g SISO MODE

ANTENNA 2 TEST RESULTS (WORST CASE)

HARMONICS AND SPURIOUS EMISSIONS (LOW CHANNEL, HORIZONTAL)

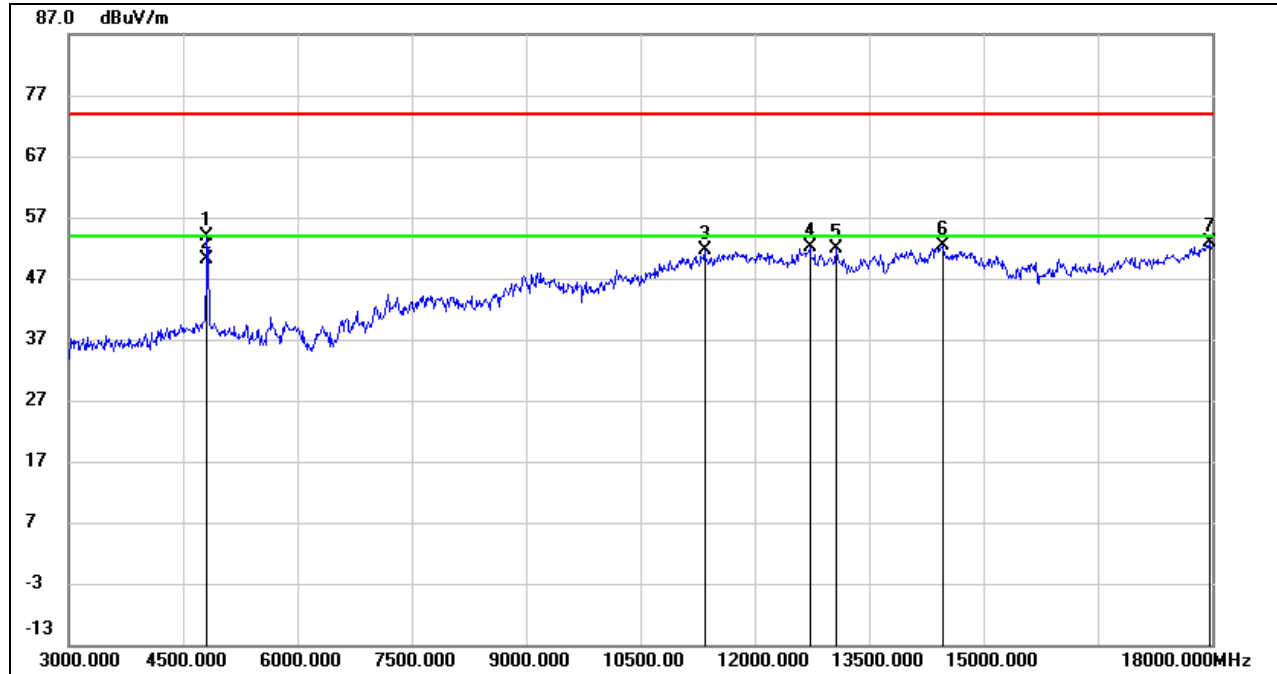

No.	Frequency (MHz)	Reading (dBuV)	Correct (dB/m)	Result (dBuV/m)	Limit (dBuV/m)	Margin (dB)	Remark
1	4815.000	54.17	-0.26	53.91	74.00	-20.09	peak
2	4815.000	50.47	-0.26	50.21	54.00	-3.79	AVG
3	11340.000	35.65	16.01	51.66	74.00	-22.34	peak
4	12720.000	34.11	18.08	52.19	74.00	-21.81	peak
5	13065.000	32.84	19.00	51.84	74.00	-22.16	peak
6	14460.000	32.24	20.08	52.32	74.00	-21.68	peak
7	17970.000	27.35	25.51	52.86	74.00	-21.14	peak

Note: 1. Peak Result = Reading Level + Correct Factor.

2. Peak: Peak detector.

3. AVG: $VBW=1/Ton$, where: Ton is the transmitting duration.

4. For the transmitting duration, please refer to clause 7.1.

5. Filter losses were only considered in the spurious frequency bands and the authorized band was not corrected for High Pass Filter losses.

6. Proper operation of the transmitter prior to adding the filter to the measurement chain.

HARMONICS AND SPURIOUS EMISSIONS (LOW CHANNEL, VERTICAL)

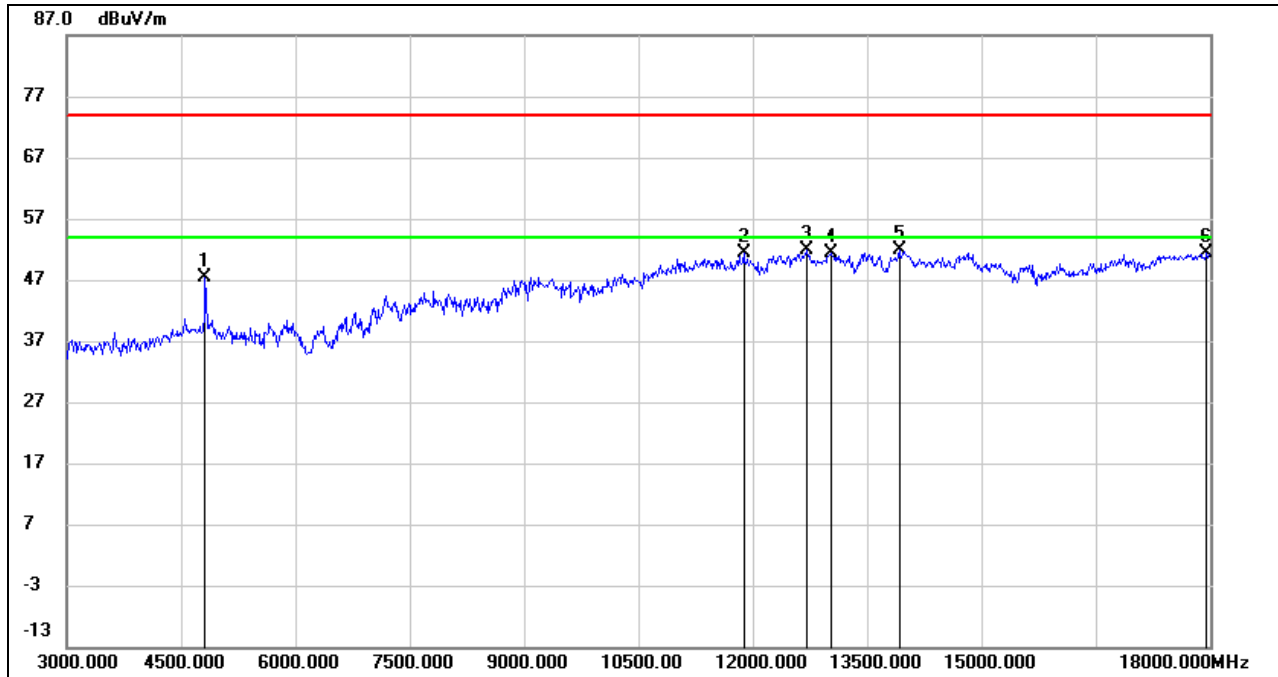

No.	Frequency (MHz)	Reading (dBuV)	Correct (dB/m)	Result (dBuV/m)	Limit (dBuV/m)	Margin (dB)	Remark
1	4815.000	47.73	-0.26	47.47	74.00	-26.53	peak
2	11880.000	33.85	17.63	51.48	74.00	-22.52	peak
3	12705.000	33.71	18.06	51.77	74.00	-22.23	peak
4	13035.000	32.61	18.87	51.48	74.00	-22.52	peak
5	13920.000	30.18	21.79	51.97	74.00	-22.03	peak
6	17955.000	25.97	25.42	51.39	74.00	-22.61	peak

- Note:
1. Peak Result = Reading Level + Correct Factor.
 2. Peak: Peak detector.
 3. AVG: $VBW=1/Ton$, where: Ton is the transmitting duration.
 4. For the transmitting duration, please refer to clause 7.1.
 5. Filter losses were only considered in the spurious frequency bands and the authorized band was not corrected for High Pass Filter losses.
 6. Proper operation of the transmitter prior to adding the filter to the measurement chain.

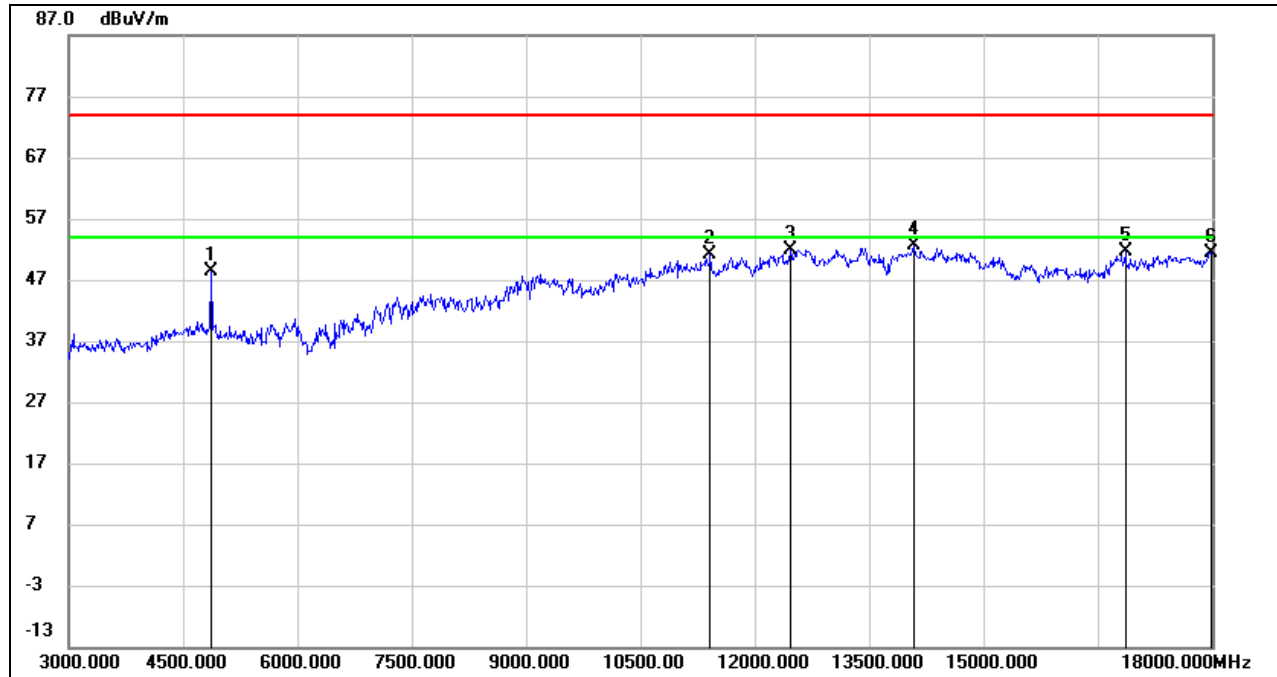
HARMONICS AND SPURIOUS EMISSIONS (MID CHANNEL, HORIZONTAL)

No.	Frequency (MHz)	Reading (dBuV)	Correct (dB/m)	Result (dBuV/m)	Limit (dBuV/m)	Margin (dB)	Remark
1	4875.000	48.39	-0.03	48.36	74.00	-25.64	peak
2	11415.000	34.75	16.29	51.04	74.00	-22.96	peak
3	12465.000	34.36	17.62	51.98	74.00	-22.02	peak
4	14085.000	31.10	21.61	52.71	74.00	-21.29	peak
5	16860.000	31.33	20.28	51.61	74.00	-22.39	peak
6	17985.000	25.70	25.60	51.30	74.00	-22.70	peak

Note: 1. Peak Result = Reading Level + Correct Factor.

2. Peak: Peak detector.

3. AVG: $VBW=1/Ton$, where: Ton is the transmitting duration.

4. For the transmitting duration, please refer to clause 7.1.

5. Filter losses were only considered in the spurious frequency bands and the authorized band was not corrected for High Pass Filter losses.

6. Proper operation of the transmitter prior to adding the filter to the measurement chain.

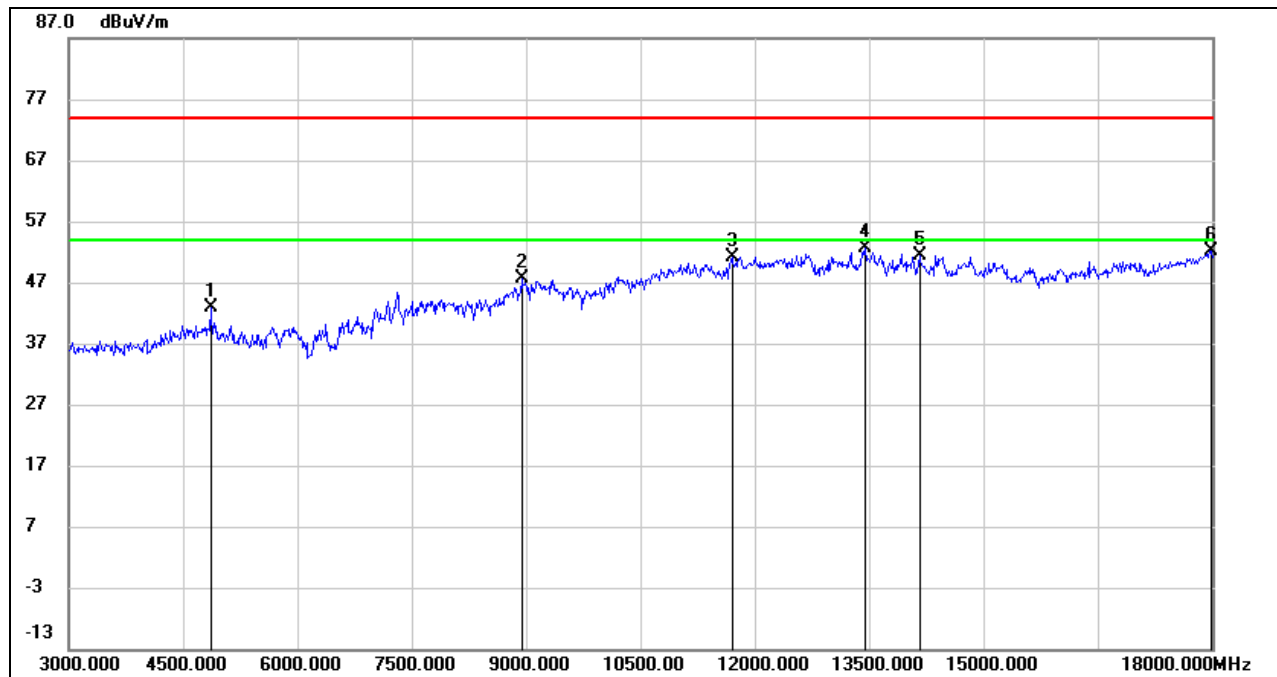
HARMONICS AND SPURIOUS EMISSIONS (MID CHANNEL, VERTICAL)

No.	Frequency (MHz)	Reading (dBuV)	Correct (dB/m)	Result (dBuV/m)	Limit (dBuV/m)	Margin (dB)	Remark
1	4860.000	43.02	-0.09	42.93	74.00	-31.07	peak
2	8940.000	37.55	10.04	47.59	74.00	-26.41	peak
3	11700.000	34.09	17.14	51.23	74.00	-22.77	peak
4	13440.000	32.04	20.64	52.68	74.00	-21.32	peak
5	14160.000	29.99	21.31	51.30	74.00	-22.70	peak
6	17985.000	26.59	25.60	52.19	74.00	-21.81	peak

Note: 1. Peak Result = Reading Level + Correct Factor.

2. Peak: Peak detector.

3. AVG: $VBW=1/Ton$, where: Ton is the transmitting duration.

4. For the transmitting duration, please refer to clause 7.1.

5. Filter losses were only considered in the spurious frequency bands and the authorized band was not corrected for High Pass Filter losses.

6. Proper operation of the transmitter prior to adding the filter to the measurement chain.

HARMONICS AND SPURIOUS EMISSIONS (HIGH CHANNEL, HORIZONTAL)

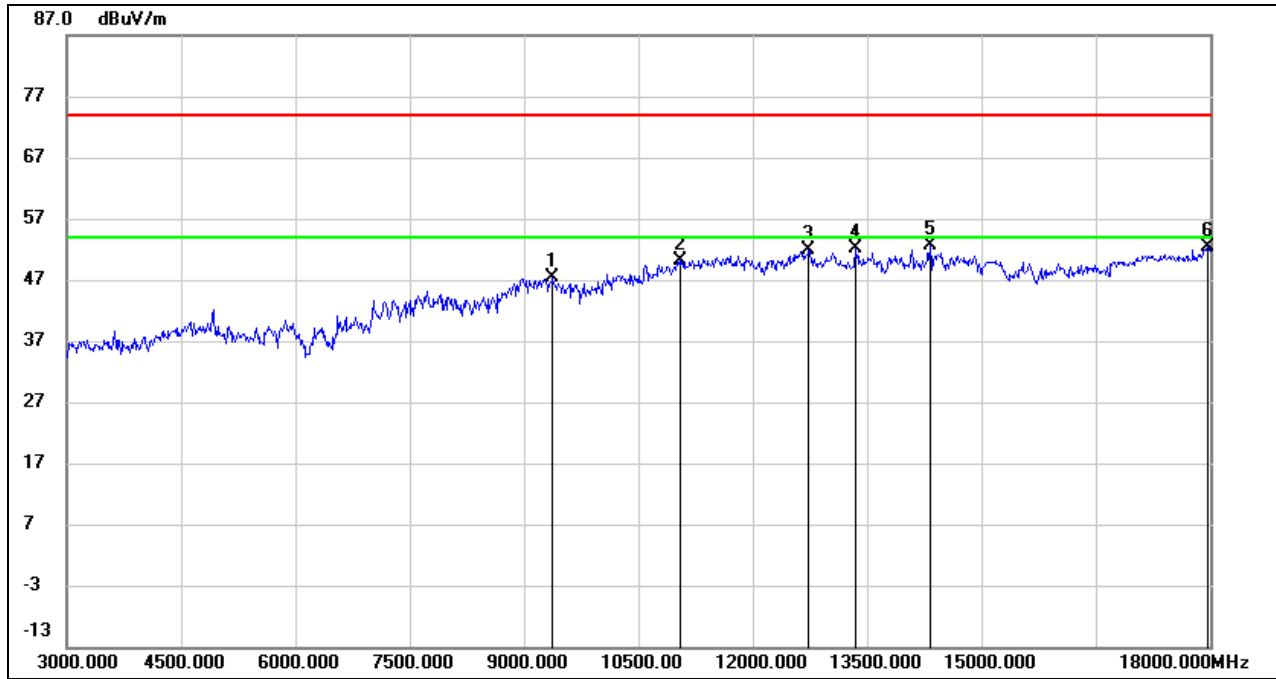

No.	Frequency (MHz)	Reading (dBuV)	Correct (dB/m)	Result (dBuV/m)	Limit (dBuV/m)	Margin (dB)	Remark
1	9375.000	36.77	10.64	47.41	74.00	-26.59	peak
2	11040.000	35.34	14.91	50.25	74.00	-23.75	peak
3	12735.000	33.87	18.12	51.99	74.00	-22.01	peak
4	13350.000	31.97	20.24	52.21	74.00	-21.79	peak
5	14325.000	31.95	20.63	52.58	74.00	-21.42	peak
6	17970.000	26.98	25.51	52.49	74.00	-21.51	peak

- Note: 1. Peak Result = Reading Level + Correct Factor.
 2. If Peak Result complies with AV limit, AV Result is deemed to comply with AV limit.
 3. Peak: Peak detector.
 4. Filter losses were only considered in the spurious frequency bands and the authorized band was not corrected for High Pass Filter losses.
 5. Proper operation of the transmitter prior to adding the filter to the measurement chain.



HARMONICS AND SPURIOUS EMISSIONS (HIGH CHANNEL, VERTICAL)

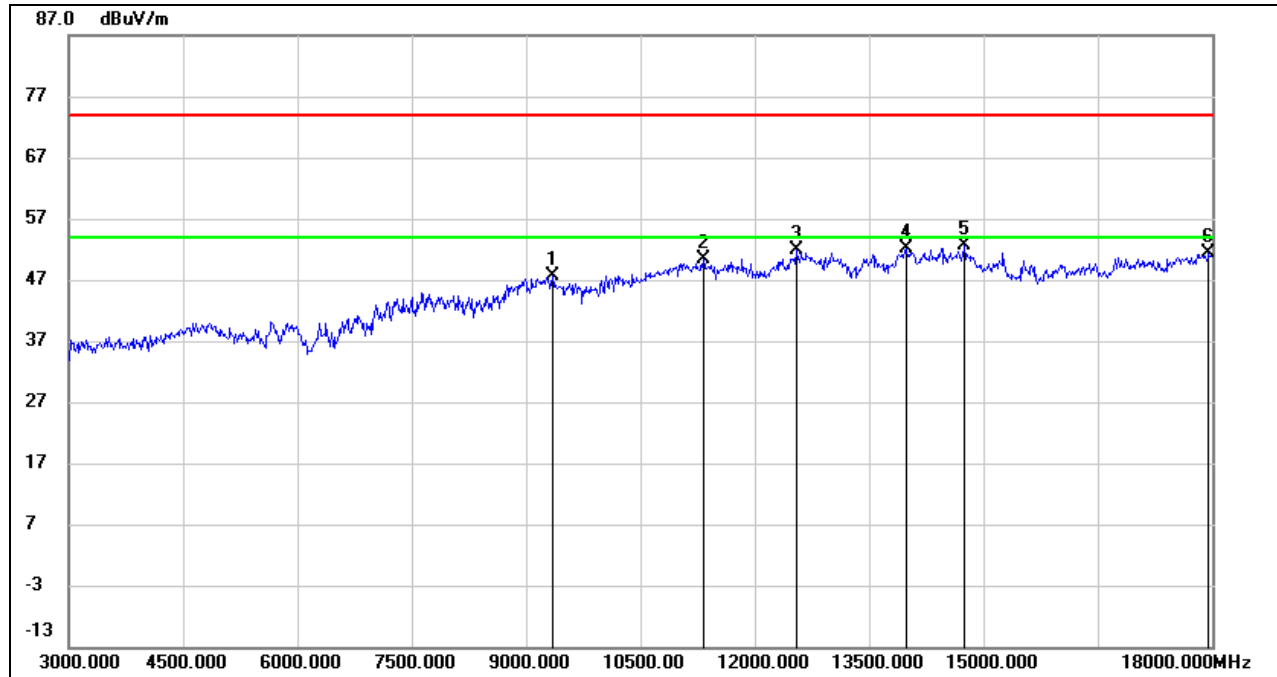

No.	Frequency (MHz)	Reading (dBuV)	Correct (dB/m)	Result (dBuV/m)	Limit (dBuV/m)	Margin (dB)	Remark
1	9345.000	36.91	10.63	47.54	74.00	-26.46	peak
2	11325.000	34.49	15.95	50.44	74.00	-23.56	peak
3	12540.000	34.14	17.69	51.83	74.00	-22.17	peak
4	13980.000	30.28	21.92	52.20	74.00	-21.80	peak
5	14745.000	33.63	18.93	52.56	74.00	-21.44	peak
6	17955.000	25.92	25.42	51.34	74.00	-22.66	peak

- Note: 1. Peak Result = Reading Level + Correct Factor.
 2. Peak: Peak detector.
 3. AVG: $VBW=1/Ton$, where: Ton is the transmitting duration.
 4. For the transmitting duration, please refer to clause 7.1.
 5. Filter losses were only considered in the spurious frequency bands and the authorized band was not corrected for High Pass Filter losses.
 6. Proper operation of the transmitter prior to adding the filter to the measurement chain.

Note: Both the two antennas had been tested, but only the worst data was recorded in the report.

8.3.3. 802.11n HT20 MIMO MODE

HARMONICS AND SPURIOUS EMISSIONS (LOW CHANNEL, HORIZONTAL)

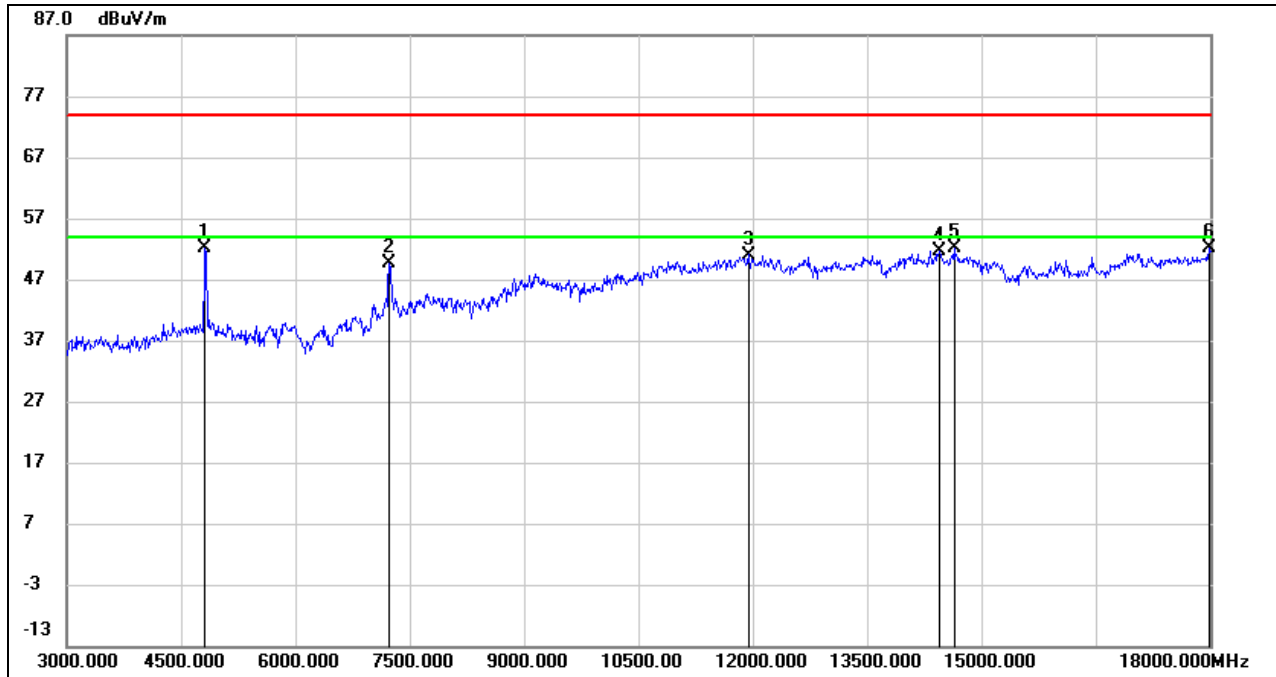

No.	Frequency (MHz)	Reading (dBuV)	Correct (dB/m)	Result (dBuV/m)	Limit (dBuV/m)	Margin (dB)	Remark
1	4815.000	52.32	-0.26	52.06	74.00	-21.94	peak
2	7230.000	43.03	6.53	49.56	74.00	-24.44	peak
3	11940.000	33.20	17.80	51.00	74.00	-23.00	peak
4	14445.000	31.59	20.14	51.73	74.00	-22.27	peak
5	14640.000	32.86	19.34	52.20	74.00	-21.80	peak
6	17985.000	26.46	25.60	52.06	74.00	-21.94	peak

Note: 1. Peak Result = Reading Level + Correct Factor.

2. Peak: Peak detector.

3. AVG: $VBW=1/T_{on}$, where: T_{on} is the transmitting duration.

4. For the transmitting duration, please refer to clause 7.1.

5. Filter losses were only considered in the spurious frequency bands and the authorized band was not corrected for High Pass Filter losses.

6. Proper operation of the transmitter prior to adding the filter to the measurement chain.



HARMONICS AND SPURIOUS EMISSIONS (LOW CHANNEL, VERTICAL)

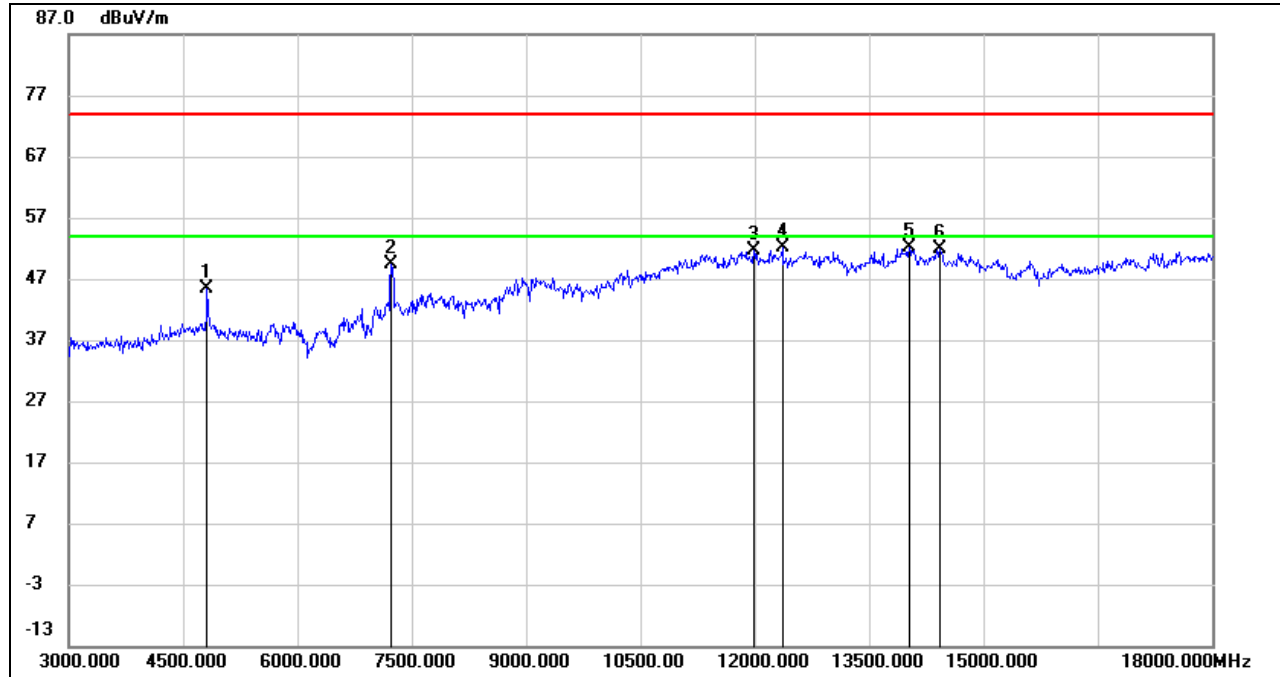

No.	Frequency (MHz)	Reading (dBuV)	Correct (dB/m)	Result (dBuV/m)	Limit (dBuV/m)	Margin (dB)	Remark
1	4815.000	45.60	-0.26	45.34	74.00	-28.66	peak
2	7230.000	42.78	6.53	49.31	74.00	-24.69	peak
3	11985.000	33.75	17.92	51.67	74.00	-22.33	peak
4	12360.000	34.45	17.69	52.14	74.00	-21.86	peak
5	14025.000	30.19	21.86	52.05	74.00	-21.95	peak
6	14430.000	31.75	20.20	51.95	74.00	-22.05	peak

- Note: 1. Peak Result = Reading Level + Correct Factor.
 2. Peak: Peak detector.
 3. AVG: VBW=1/Ton, where: Ton is the transmitting duration.
 4. For the transmitting duration, please refer to clause 7.1.
 5. Filter losses were only considered in the spurious frequency bands and the authorized band was not corrected for High Pass Filter losses.
 6. Proper operation of the transmitter prior to adding the filter to the measurement chain.



HARMONICS AND SPURIOUS EMISSIONS (MID CHANNEL, HORIZONTAL)

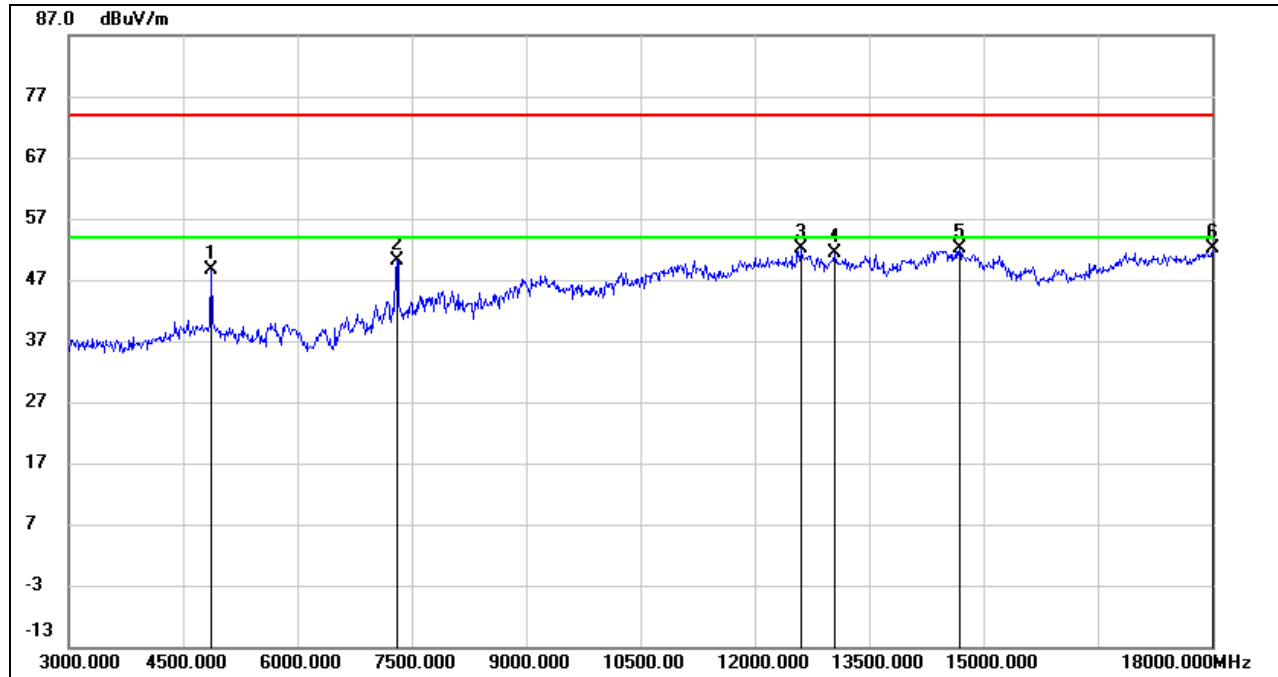

No.	Frequency (MHz)	Reading (dBuV)	Correct (dB/m)	Result (dBuV/m)	Limit (dBuV/m)	Margin (dB)	Remark
1	4860.000	48.63	-0.09	48.54	74.00	-25.46	peak
2	7305.000	43.54	6.47	50.01	74.00	-23.99	peak
3	12615.000	34.17	17.86	52.03	74.00	-21.97	peak
4	13050.000	32.46	18.93	51.39	74.00	-22.61	peak
5	14685.000	32.89	19.16	52.05	74.00	-21.95	peak
6	18000.000	26.44	25.69	52.13	74.00	-21.87	peak

- Note: 1. Peak Result = Reading Level + Correct Factor.
 2. Peak: Peak detector.
 3. AVG: $VBW=1/Ton$, where: Ton is the transmitting duration.
 4. For the transmitting duration, please refer to clause 7.1.
 5. Filter losses were only considered in the spurious frequency bands and the authorized band was not corrected for High Pass Filter losses.
 6. Proper operation of the transmitter prior to adding the filter to the measurement chain.



HARMONICS AND SPURIOUS EMISSIONS (MID CHANNEL, VERTICAL)

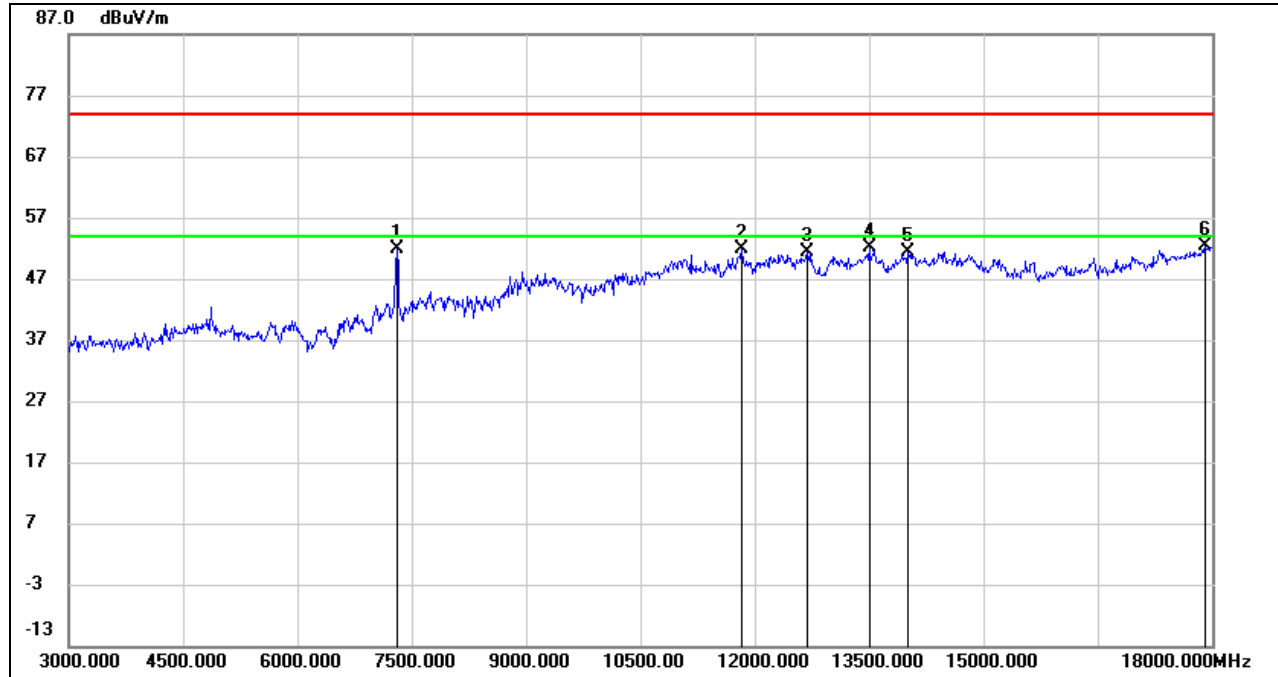

No.	Frequency (MHz)	Reading (dBuV)	Correct (dB/m)	Result (dBuV/m)	Limit (dBuV/m)	Margin (dB)	Remark
1	7305.000	45.38	6.47	51.85	74.00	-22.15	peak
2	11820.000	34.42	17.47	51.89	74.00	-22.11	peak
3	12690.000	33.31	18.02	51.33	74.00	-22.67	peak
4	13500.000	31.22	20.90	52.12	74.00	-21.88	peak
5	14010.000	29.49	21.93	51.42	74.00	-22.58	peak
6	17910.000	27.18	25.16	52.34	74.00	-21.66	peak

- Note: 1. Peak Result = Reading Level + Correct Factor.
 2. Peak: Peak detector.
 3. AVG: VBW=1/Ton, where: Ton is the transmitting duration.
 4. For the transmitting duration, please refer to clause 7.1.
 5. Filter losses were only considered in the spurious frequency bands and the authorized band was not corrected for High Pass Filter losses.
 6. Proper operation of the transmitter prior to adding the filter to the measurement chain.

HARMONICS AND SPURIOUS EMISSIONS (HIGH CHANNEL, HORIZONTAL)

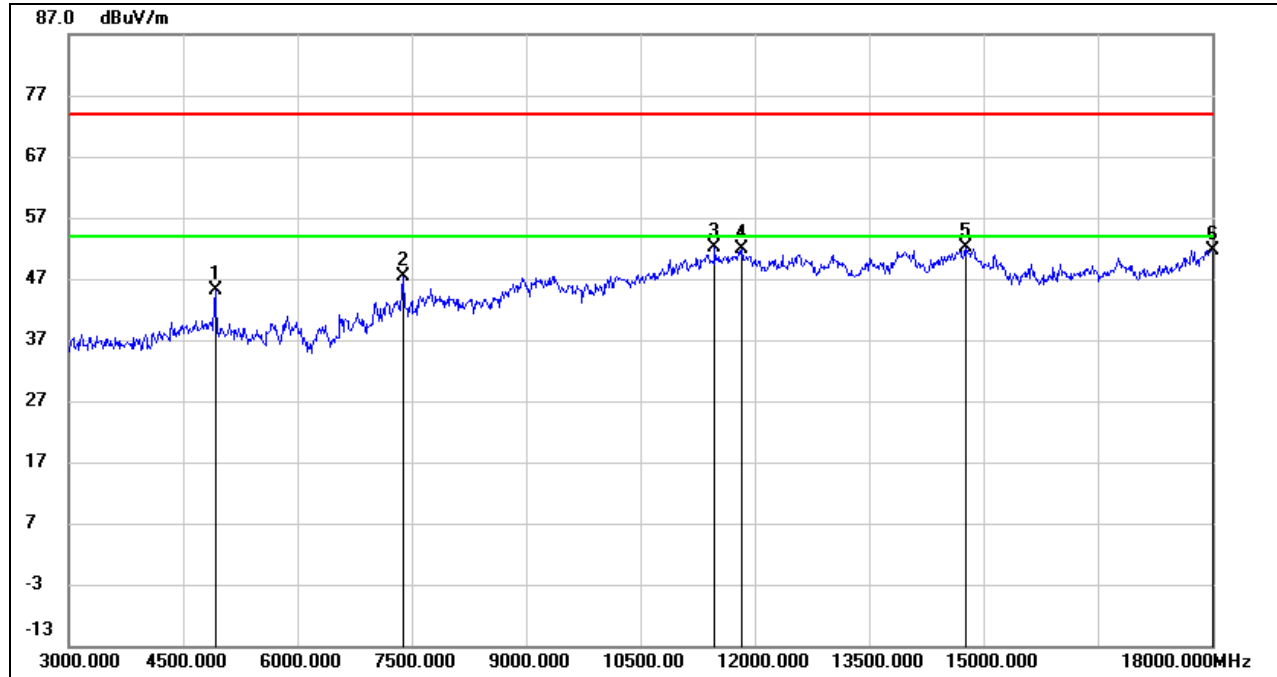

No.	Frequency (MHz)	Reading (dBuV)	Correct (dB/m)	Result (dBuV/m)	Limit (dBuV/m)	Margin (dB)	Remark
1	4920.000	44.97	0.14	45.11	74.00	-28.89	peak
2	7380.000	41.05	6.42	47.47	74.00	-26.53	peak
3	11475.000	35.69	16.51	52.20	74.00	-21.80	peak
4	11835.000	34.31	17.51	51.82	74.00	-22.18	peak
5	14760.000	33.22	18.86	52.08	74.00	-21.92	peak
6	18000.000	26.05	25.69	51.74	74.00	-22.26	peak

- Note: 1. Peak Result = Reading Level + Correct Factor.
 2. Peak: Peak detector.
 3. AVG: $VBW=1/T_{on}$, where: T_{on} is the transmitting duration.
 4. For the transmitting duration, please refer to clause 7.1.
 5. Filter losses were only considered in the spurious frequency bands and the authorized band was not corrected for High Pass Filter losses.
 6. Proper operation of the transmitter prior to adding the filter to the measurement chain.

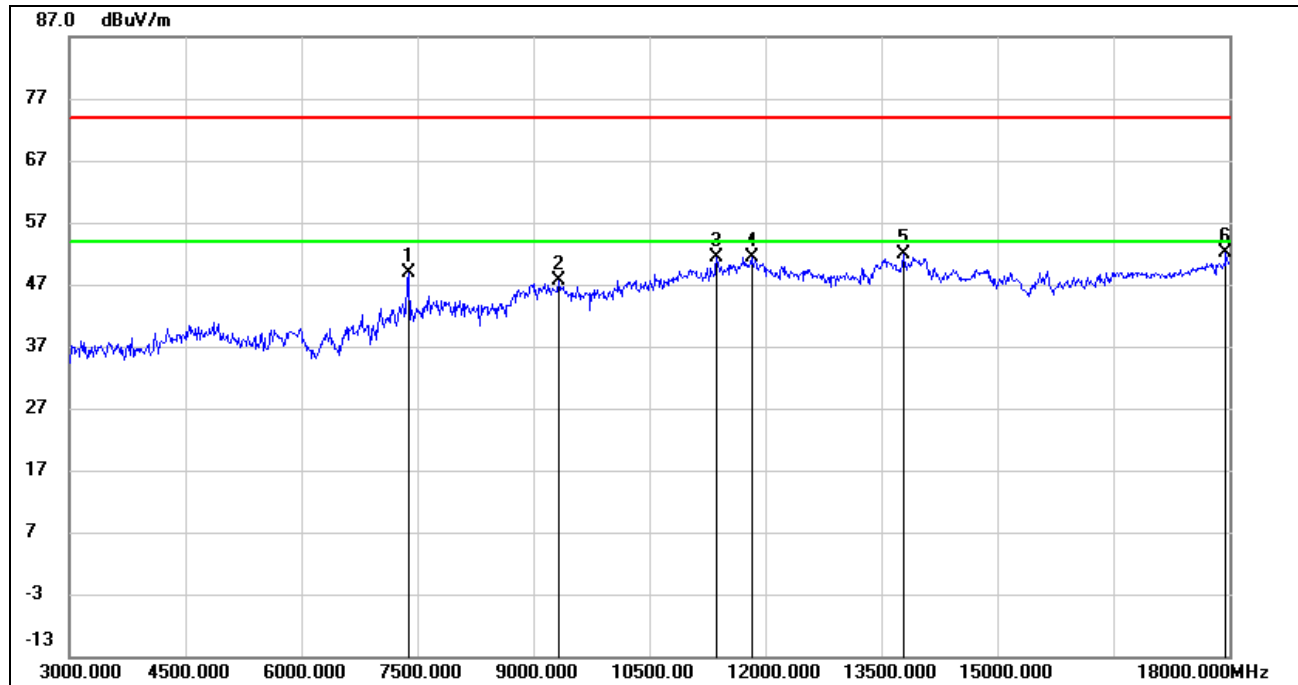
HARMONICS AND SPURIOUS EMISSIONS (HIGH CHANNEL, VERTICAL)

No.	Frequency (MHz)	Reading (dBuV)	Correct (dB/m)	Result (dBuV/m)	Limit (dBuV/m)	Margin (dB)	Remark
1	7380.000	42.47	6.42	48.89	74.00	-25.11	peak
2	9330.000	37.12	10.62	47.74	74.00	-26.26	peak
3	11370.000	35.19	16.12	51.31	74.00	-22.69	peak
4	11820.000	33.99	17.47	51.46	74.00	-22.54	peak
5	13785.000	30.29	21.51	51.80	74.00	-22.20	peak
6	17955.000	26.72	25.42	52.14	74.00	-21.86	peak

Note: 1. Peak Result = Reading Level + Correct Factor.

2. Peak: Peak detector.

3. AVG: $VBW=1/Ton$, where: Ton is the transmitting duration.

4. For the transmitting duration, please refer to clause 7.1.

5. Filter losses were only considered in the spurious frequency bands and the authorized band was not corrected for High Pass Filter losses.

6. Proper operation of the transmitter prior to adding the filter to the measurement chain.

Note: All modes and channels have been tested, only the worst data was recorded in the report.

8.3.4. 802.11n HT40 MIMO MODE

HARMONICS AND SPURIOUS EMISSIONS (LOW CHANNEL, HORIZONTAL)

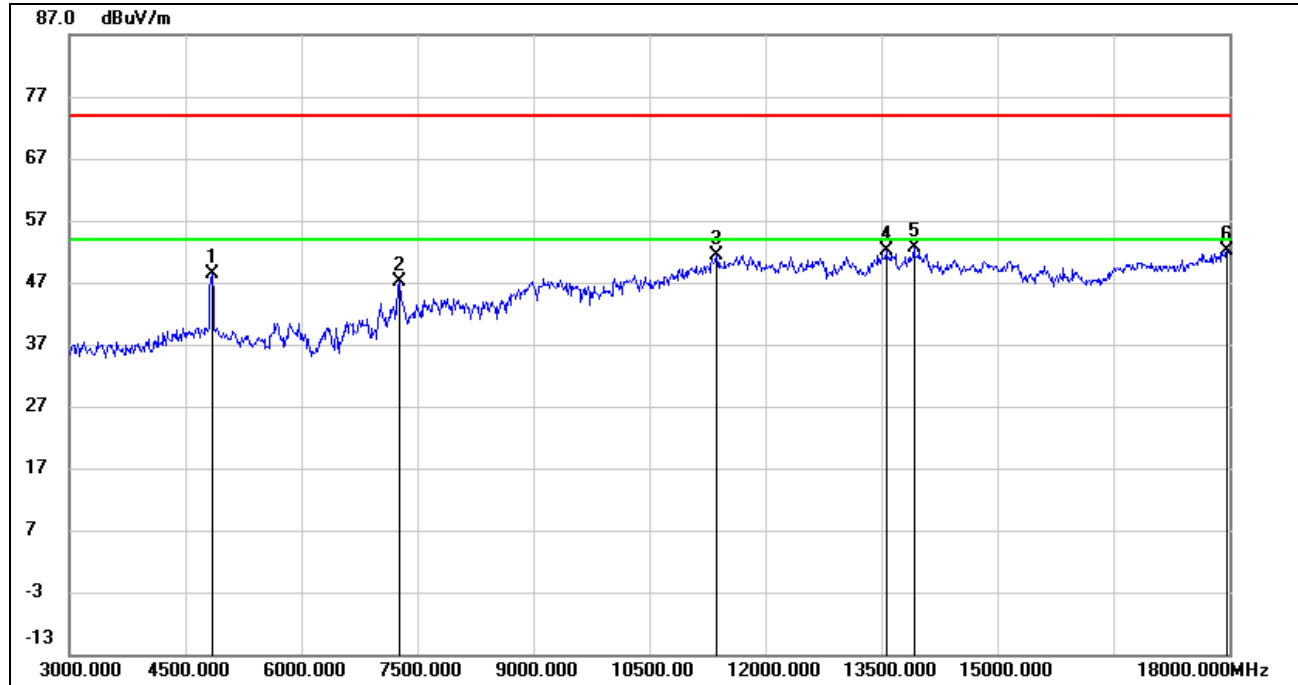

No.	Frequency (MHz)	Reading (dBuV)	Correct (dB/m)	Result (dBuV/m)	Limit (dBuV/m)	Margin (dB)	Remark
1	4845.000	48.56	-0.15	48.41	74.00	-25.59	peak
2	7275.000	40.72	6.49	47.21	74.00	-26.79	peak
3	11370.000	35.19	16.12	51.31	74.00	-22.69	peak
4	13560.000	31.06	21.04	52.10	74.00	-21.90	peak
5	13920.000	30.80	21.79	52.59	74.00	-21.41	peak
6	17970.000	26.64	25.51	52.15	74.00	-21.85	peak

Note: 1. Peak Result = Reading Level + Correct Factor.

2. If Peak Result complies with AV limit, AV Result is deemed to comply with AV limit.

3. Peak: Peak detector.

4. Filter losses were only considered in the spurious frequency bands and the authorized band was not corrected for High Pass Filter losses.

5. Proper operation of the transmitter prior to adding the filter to the measurement chain.



HARMONICS AND SPURIOUS EMISSIONS (LOW CHANNEL, VERTICAL)

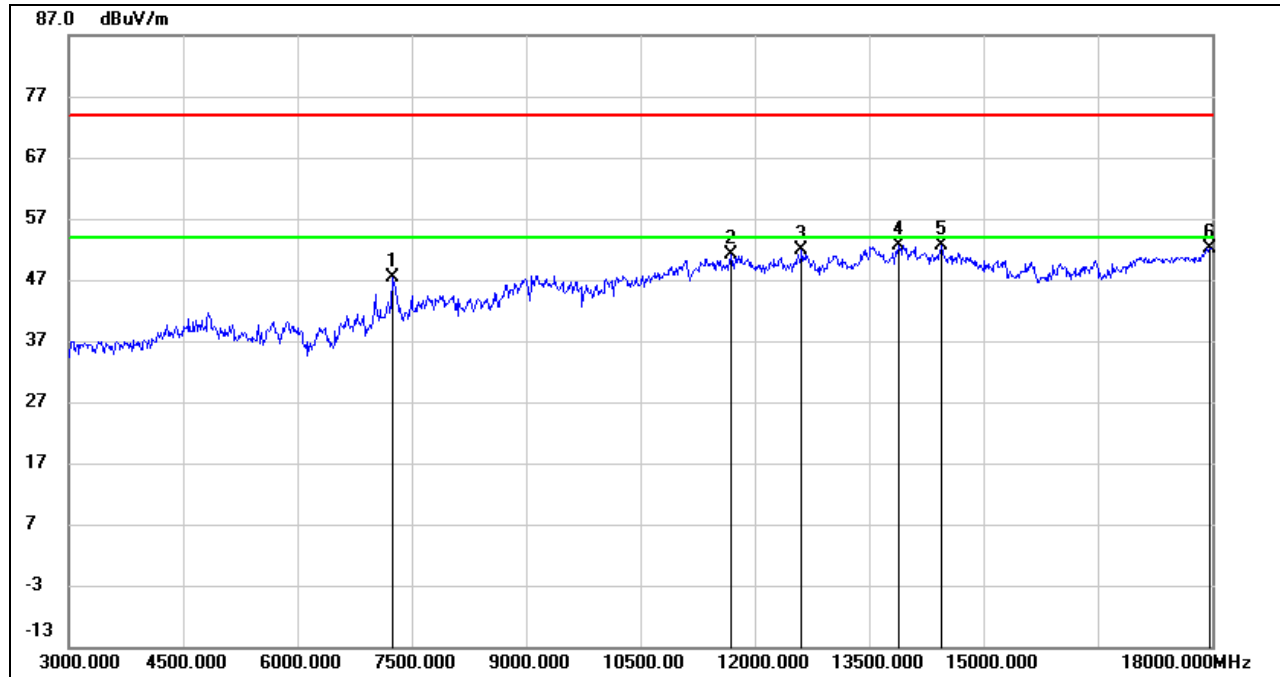

No.	Frequency (MHz)	Reading (dBuV)	Correct (dB/m)	Result (dBuV/m)	Limit (dBuV/m)	Margin (dB)	Remark
1	7245.000	40.97	6.51	47.48	74.00	-26.52	peak
2	11685.000	34.03	17.10	51.13	74.00	-22.87	peak
3	12615.000	34.05	17.86	51.91	74.00	-22.09	peak
4	13890.000	30.98	21.72	52.70	74.00	-21.30	peak
5	14445.000	32.41	20.14	52.55	74.00	-21.45	peak
6	17970.000	26.73	25.51	52.24	74.00	-21.76	peak

- Note: 1. Peak Result = Reading Level + Correct Factor.
 2. If Peak Result complies with AV limit, AV Result is deemed to comply with AV limit.
 3. Peak: Peak detector.
 4. Filter losses were only considered in the spurious frequency bands and the authorized band was not corrected for High Pass Filter losses.
 5. Proper operation of the transmitter prior to adding the filter to the measurement chain.

HARMONICS AND SPURIOUS EMISSIONS (MID CHANNEL, HORIZONTAL)

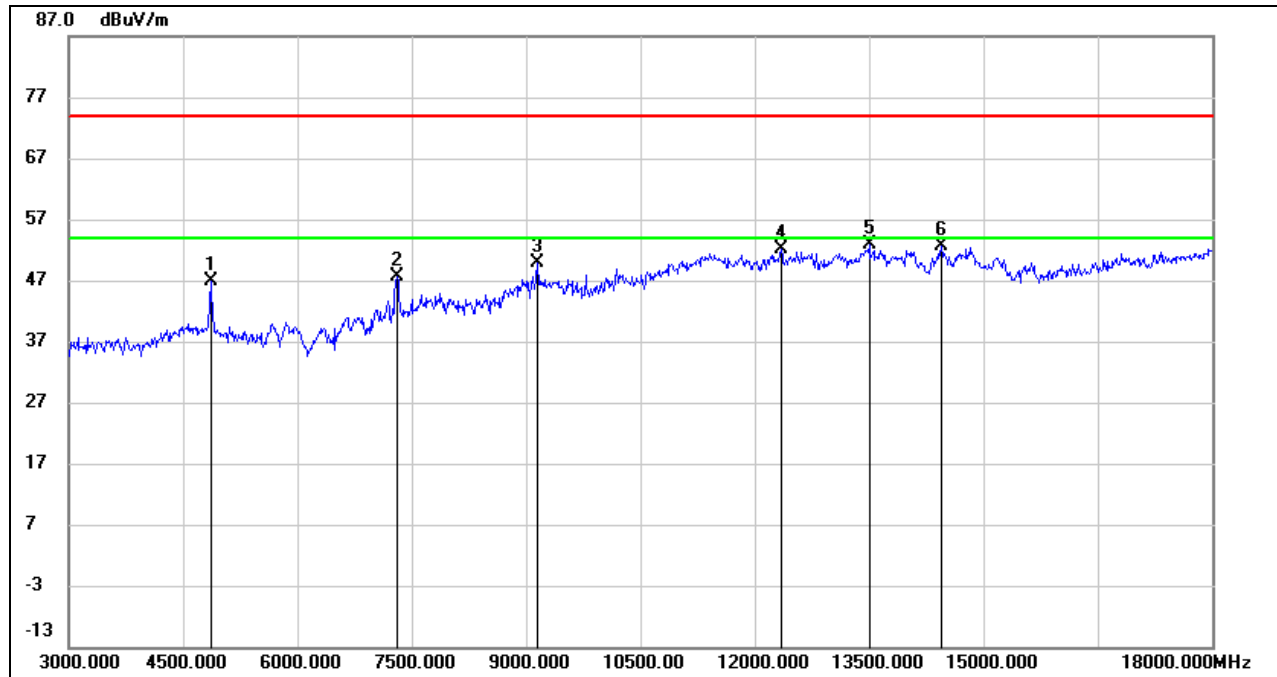

No.	Frequency (MHz)	Reading (dBuV)	Correct (dB/m)	Result (dBuV/m)	Limit (dBuV/m)	Margin (dB)	Remark
1	4860.000	47.05	-0.09	46.96	74.00	-27.04	peak
2	7305.000	41.20	6.47	47.67	74.00	-26.33	peak
3	9150.000	39.46	10.54	50.00	74.00	-24.00	peak
4	12345.000	34.48	17.71	52.19	74.00	-21.81	peak
5	13500.000	31.98	20.90	52.88	74.00	-21.12	peak
6	14445.000	32.59	20.14	52.73	74.00	-21.27	peak

- Note: 1. Peak Result = Reading Level + Correct Factor.
 2. If Peak Result complies with AV limit, AV Result is deemed to comply with AV limit.
 3. Peak: Peak detector.
 4. Filter losses were only considered in the spurious frequency bands and the authorized band was not corrected for High Pass Filter losses.
 5. Proper operation of the transmitter prior to adding the filter to the measurement chain.



HARMONICS AND SPURIOUS EMISSIONS (MID CHANNEL, VERTICAL)

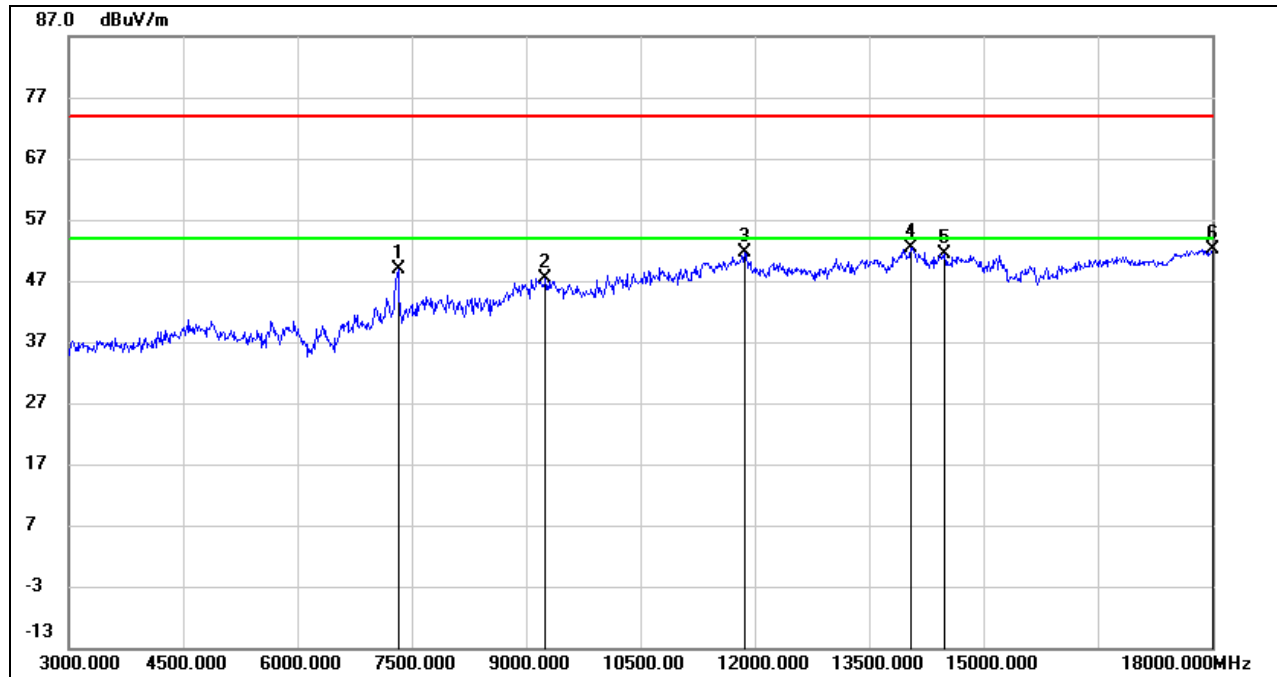

No.	Frequency (MHz)	Reading (dBuV)	Correct (dB/m)	Result (dBuV/m)	Limit (dBuV/m)	Margin (dB)	Remark
1	7320.000	42.54	6.46	49.00	74.00	-25.00	peak
2	9255.000	36.72	10.59	47.31	74.00	-26.69	peak
3	11865.000	34.02	17.59	51.61	74.00	-22.39	peak
4	14040.000	30.67	21.79	52.46	74.00	-21.54	peak
5	14490.000	31.50	19.94	51.44	74.00	-22.56	peak
6	18000.000	26.52	25.69	52.21	74.00	-21.79	peak

- Note: 1. Peak Result = Reading Level + Correct Factor.
 2. If Peak Result complies with AV limit, AV Result is deemed to comply with AV limit.
 3. Peak: Peak detector.
 4. Filter losses were only considered in the spurious frequency bands and the authorized band was not corrected for High Pass Filter losses.
 5. Proper operation of the transmitter prior to adding the filter to the measurement chain.

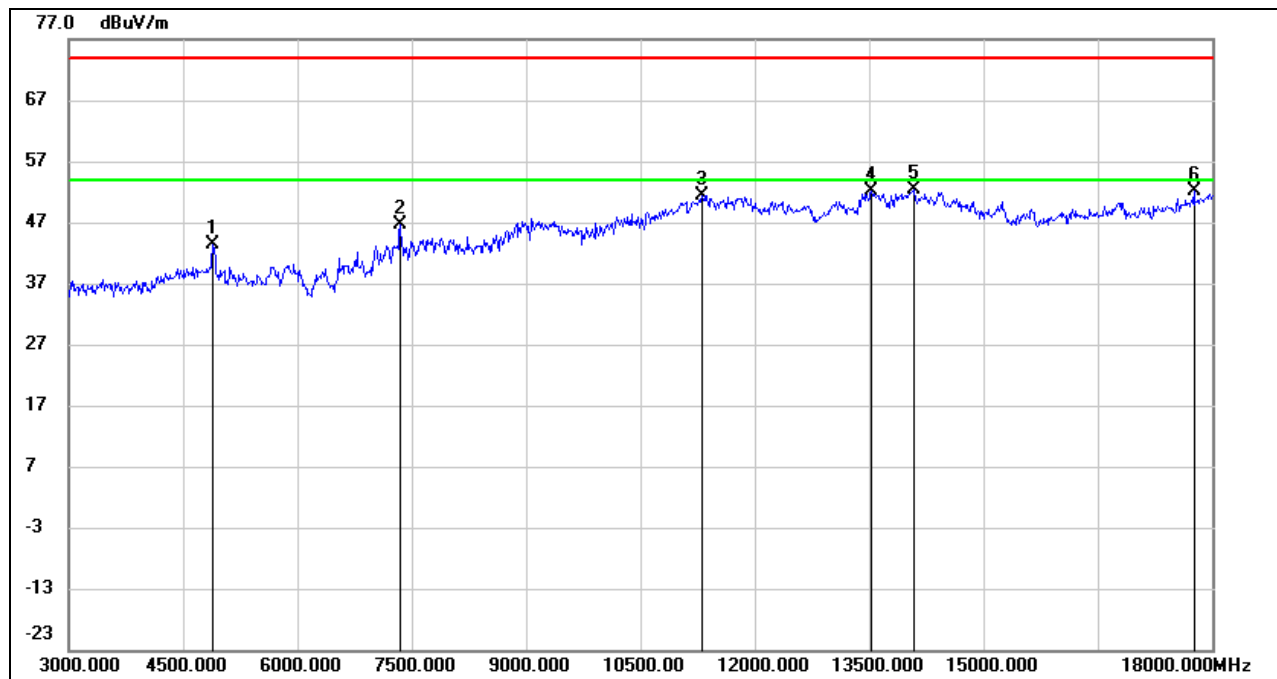
**HARMONICS AND SPURIOUS EMISSIONS (HIGH CHANNEL, HORIZONTAL)**

No.	Frequency (MHz)	Reading (dBuV)	Correct (dB/m)	Result (dBuV/m)	Limit (dBuV/m)	Margin (dB)	Remark
1	4890.000	43.40	0.03	43.43	74.00	-30.57	peak
2	7350.000	40.16	6.44	46.60	74.00	-27.40	peak
3	11310.000	35.50	15.91	51.41	74.00	-22.59	peak
4	13530.000	31.18	20.96	52.14	74.00	-21.86	peak
5	14085.000	30.79	21.61	52.40	74.00	-21.60	peak
6	17760.000	27.79	24.27	52.06	74.00	-21.94	peak

Note: 1. Peak Result = Reading Level + Correct Factor.

2. If Peak Result complies with AV limit, AV Result is deemed to comply with AV limit.

3. Peak: Peak detector.

4. Filter losses were only considered in the spurious frequency bands and the authorized band was not corrected for High Pass Filter losses.

5. Proper operation of the transmitter prior to adding the filter to the measurement chain.



HARMONICS AND SPURIOUS EMISSIONS (HIGH CHANNEL, VERTICAL)

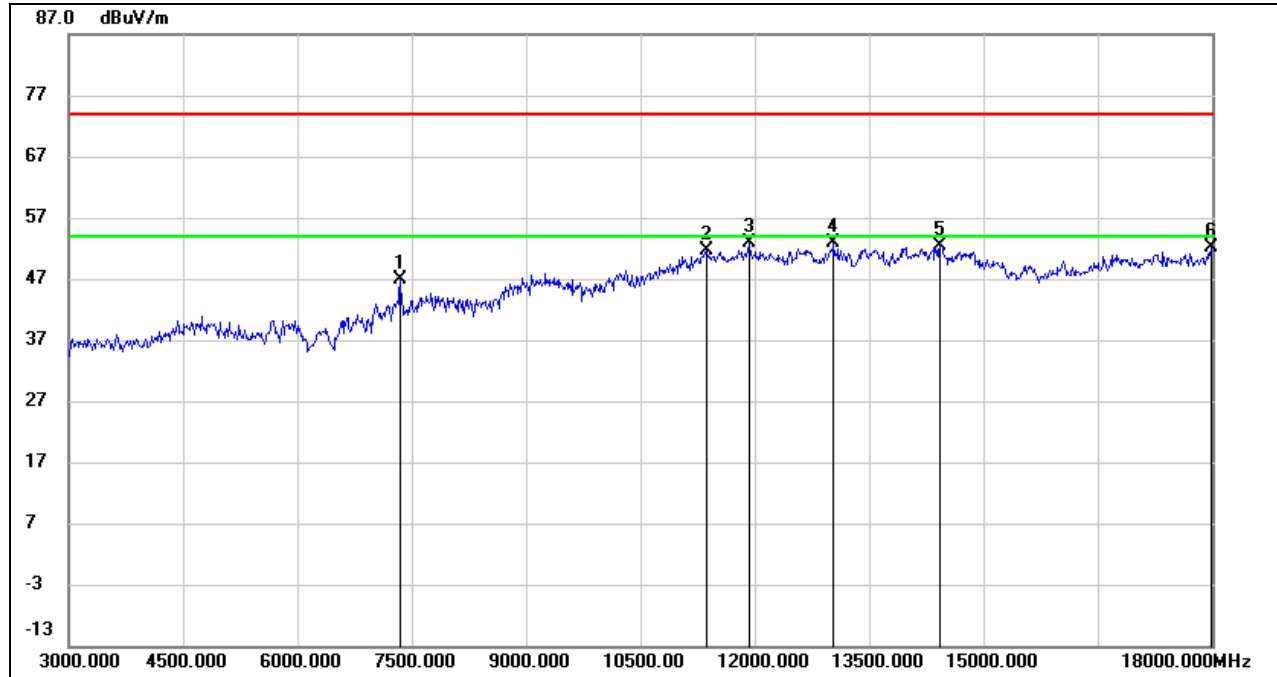

No.	Frequency (MHz)	Reading (dBuV)	Correct (dB/m)	Result (dBuV/m)	Limit (dBuV/m)	Margin (dB)	Remark
1	7350.000	40.46	6.44	46.90	74.00	-27.10	peak
2	11370.000	35.60	16.12	51.72	74.00	-22.28	peak
3	11925.000	35.02	17.75	52.77	74.00	-21.23	peak
4	13035.000	33.98	18.87	52.85	74.00	-21.15	peak
5	14430.000	32.23	20.20	52.43	74.00	-21.57	peak
6	17985.000	26.63	25.60	52.23	74.00	-21.77	peak

- Note: 1. Peak Result = Reading Level + Correct Factor.
 2. If Peak Result complies with AV limit, AV Result is deemed to comply with AV limit.
 3. Peak: Peak detector.
 4. Filter losses were only considered in the spurious frequency bands and the authorized band was not corrected for High Pass Filter losses.
 5. Proper operation of the transmitter prior to adding the filter to the measurement chain.

Note: All modes have been tested, only the worst data was recorded in the report.

8.5. SPURIOUS EMISSIONS (18 GHz ~ 26 GHz)

8.5.1. 802.11n HT20 MIMO MODE

SPURIOUS EMISSIONS (HIGH CHANNEL, WORST-CASE CONFIGURATION, HORIZONTAL)

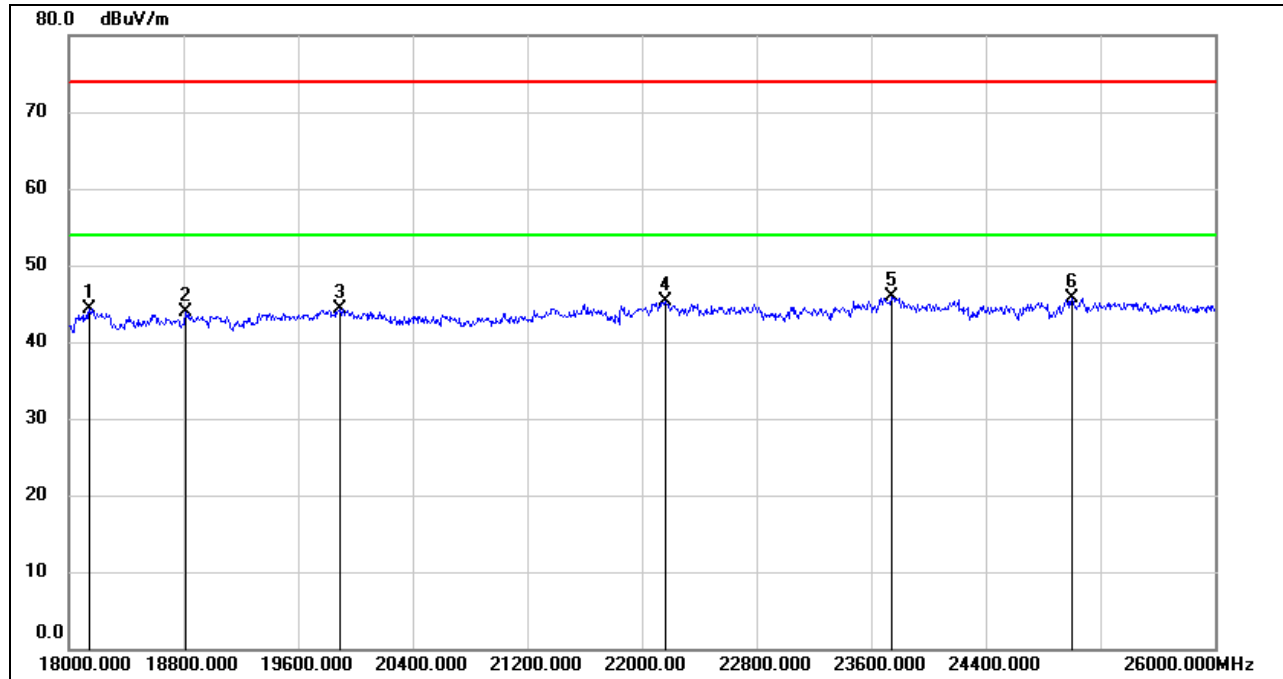

No.	Frequency (MHz)	Reading (dBuV)	Correct (dB/m)	Result (dBuV/m)	Limit (dBuV/m)	Margin (dB)	Remark
1	18144.000	49.77	-5.48	44.29	74.00	-29.71	peak
2	18816.000	49.21	-5.38	43.83	74.00	-30.17	peak
3	19888.000	49.57	-5.36	44.21	74.00	-29.79	peak
4	22160.000	49.58	-4.31	45.27	74.00	-28.73	peak
5	23744.000	49.15	-3.20	45.95	74.00	-28.05	peak
6	25000.000	47.86	-2.10	45.76	74.00	-28.24	peak

- Note: 1. Measurement = Reading Level + Correct Factor.
 2. If Peak Result complies with AV limit, AV Result is deemed to comply with AV limit.
 3. Peak: Peak detector.

SPURIOUS EMISSIONS (HIGH CHANNEL, WORST-CASE CONFIGURATION, VERTICAL)

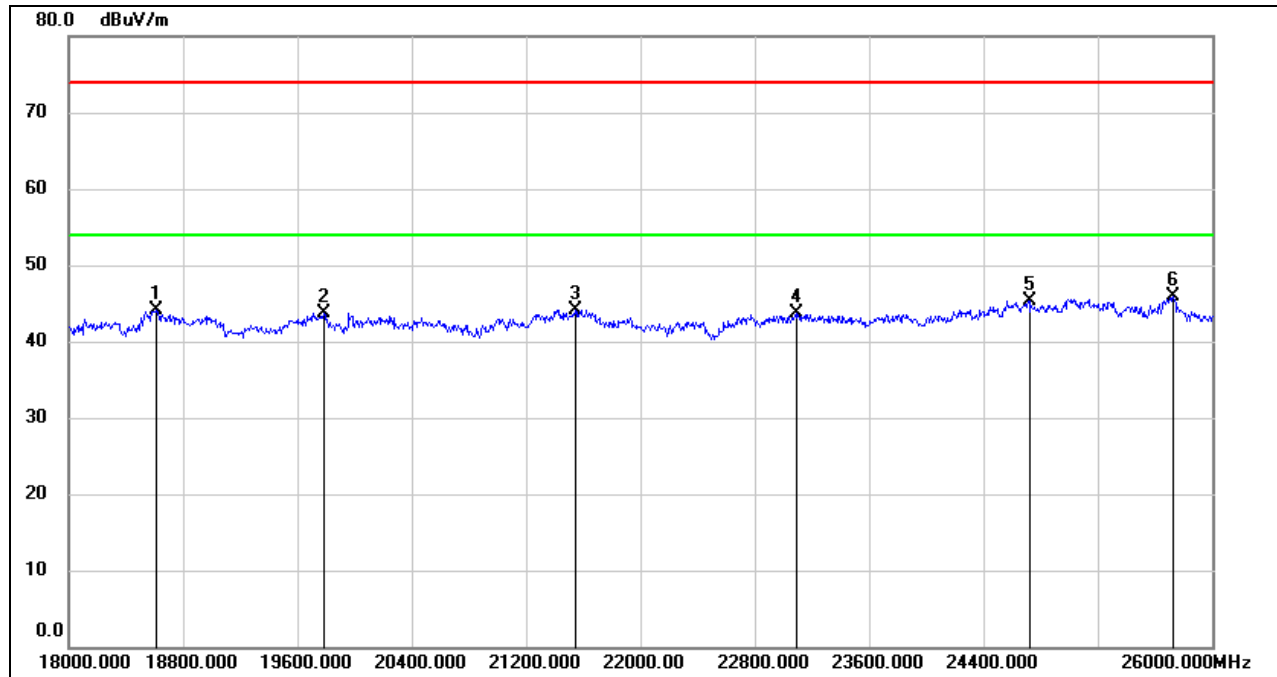

No.	Frequency (MHz)	Reading (dBuV)	Correct (dB/m)	Result (dBuV/m)	Limit (dBuV/m)	Margin (dB)	Remark
1	18616.000	49.39	-5.34	44.05	74.00	-29.95	peak
2	19784.000	49.07	-5.28	43.79	74.00	-30.21	peak
3	21544.000	48.76	-4.63	44.13	74.00	-29.87	peak
4	23088.000	47.02	-3.41	43.61	74.00	-30.39	peak
5	24720.000	47.72	-2.33	45.39	74.00	-28.61	peak
6	25728.000	46.61	-0.72	45.89	74.00	-28.11	peak

- Note: 1. Measurement = Reading Level + Correct Factor.
 2. If Peak Result complies with AV limit, AV Result is deemed to comply with AV limit.
 3. Peak: Peak detector.

Note: All the modes had been tested, but only the worst data was recorded in the report.

8.6. SPURIOUS EMISSIONS (30 MHz ~ 1 GHz)

8.6.1. 802.11n HT20 MIMO MODE

SPURIOUS EMISSIONS (HIGH CHANNEL, WORST-CASE CONFIGURATION, HORIZONTAL)

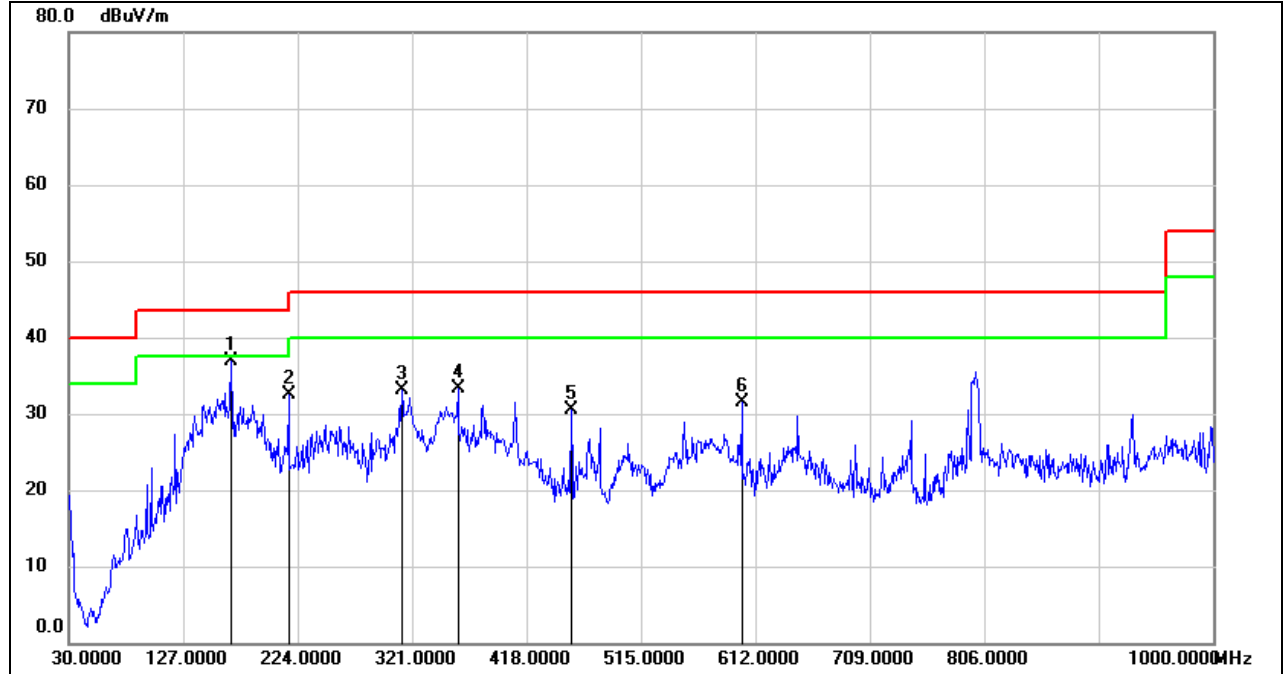

No.	Frequency (MHz)	Reading (dBuV)	Correct (dB/m)	Result (dBuV/m)	Limit (dBuV/m)	Margin (dB)	Remark
1	167.7400	54.41	-17.41	37.00	43.50	-6.50	peak
2	216.2400	50.37	-17.84	32.53	46.00	-13.47	peak
3	312.2700	48.07	-15.01	33.06	46.00	-12.94	peak
4	359.8000	47.37	-14.10	33.27	46.00	-12.73	peak
5	455.8300	42.72	-12.27	30.45	46.00	-15.55	peak
6	600.3600	40.96	-9.54	31.42	46.00	-14.58	peak

- Note: 1. Result Level = Read Level + Correct Factor.
 2. If Peak Result complies with QP limit, QP Result is deemed to comply with QP limit.
 3. Test setup: RBW: 120 kHz, VBW: 300 kHz, Sweep time: auto.

SPURIOUS EMISSIONS (HIGH CHANNEL, WORST-CASE CONFIGURATION, VERTICAL)

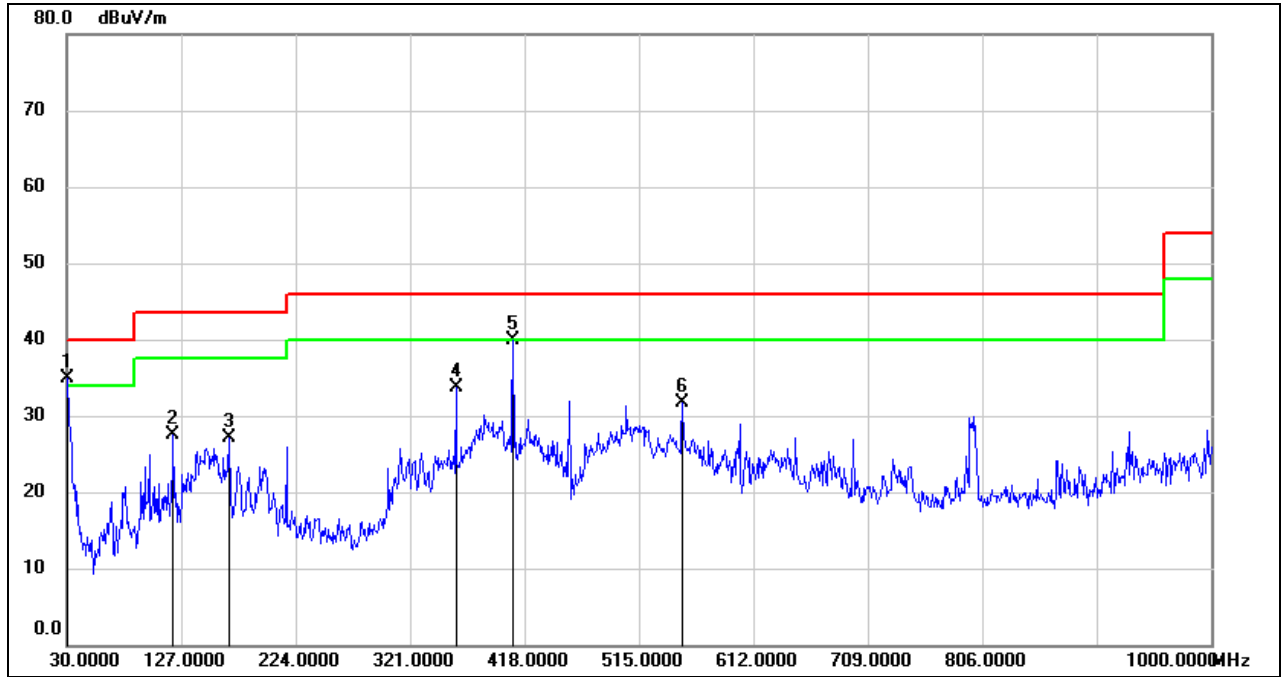

No.	Frequency (MHz)	Reading (dBuV)	Correct (dB/m)	Result (dBuV/m)	Limit (dBuV/m)	Margin (dB)	Remark
1	30.9700	53.87	-19.04	34.83	40.00	-5.17	peak
2	120.2100	47.36	-19.85	27.51	43.50	-15.99	peak
3	167.7400	44.47	-17.41	27.06	43.50	-16.44	peak
4	359.8000	47.78	-14.10	33.68	46.00	-12.32	peak
5	408.3000	53.09	-13.17	39.92	46.00	-6.08	peak
6	551.8600	42.22	-10.46	31.76	46.00	-14.24	peak

- Note: 1. Result Level = Read Level + Correct Factor.
 2. If Peak Result complies with QP limit, QP Result is deemed to comply with QP limit.
 3. Test setup: RBW: 120 kHz, VBW: 300 kHz, Sweep time: auto

Note: All the modes and channels had been tested, but only the worst data was recorded in the report.

8.7. SPURIOUS EMISSIONS BELOW 30 MHz

8.7.1. 802.11n HT20 MIMO MODE

SPURIOUS EMISSIONS (HIGH CHANNEL, LOOP ANTENNA FACE ON TO THE EUT, WORST-CASE CONFIGURATION)

9 kHz ~ 150 kHz

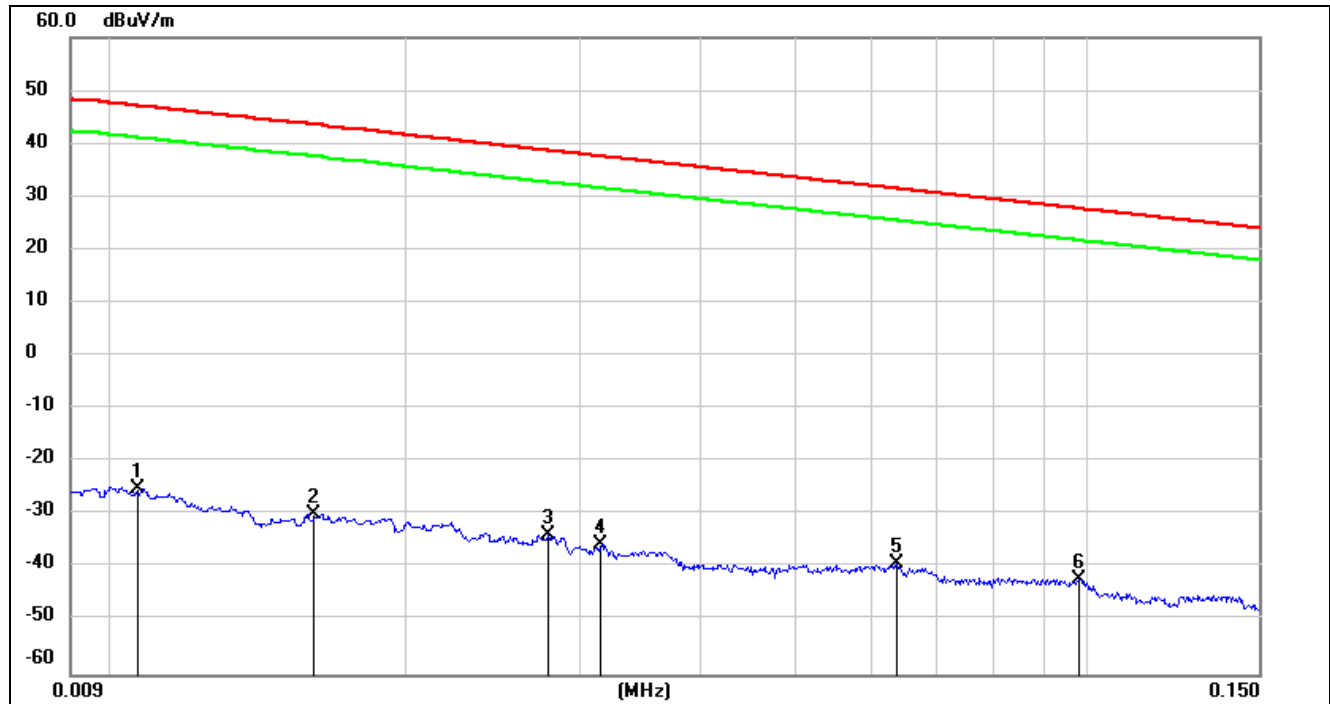

No.	Frequency (MHz)	Reading (dBuV)	Correct (dB/m)	FCC Result (dBuV/m)	FCC Limit (dBuV/m)	ISED Result (dBuA/m)	ISED Limit (dBuA/m)	Margin (dB)	Remark
1	0.0106	76.38	-101.39	-25.01	47.09	-76.51	-4.41	-72.10	peak
2	0.0160	71.47	-101.37	-29.9	43.52	-81.40	-7.98	-73.42	peak
3	0.0279	67.67	-101.38	-33.71	38.69	-85.21	-12.81	-72.40	peak
4	0.0316	65.74	-101.40	-35.66	37.61	-87.16	-13.89	-73.27	peak
5	0.0636	62.31	-101.54	-39.23	31.53	-90.73	-19.97	-70.76	peak
6	0.0981	59.77	-101.78	-42.01	27.77	-93.51	-23.73	-69.78	peak

Note: 1. Measurement = Reading Level + Correct Factor (dBuA/m= dBuV/m- 20Log₁₀[120π] = dBuV/m- 51.5).

2. If Peak Result complies with AV and QP limit, AV and QP Result are deemed to comply with AV limit.

3. All 3 polarizations (Horizontal, Face-on and Face-off) of the loop antenna had been tested, but only the worst data recorded in the report.

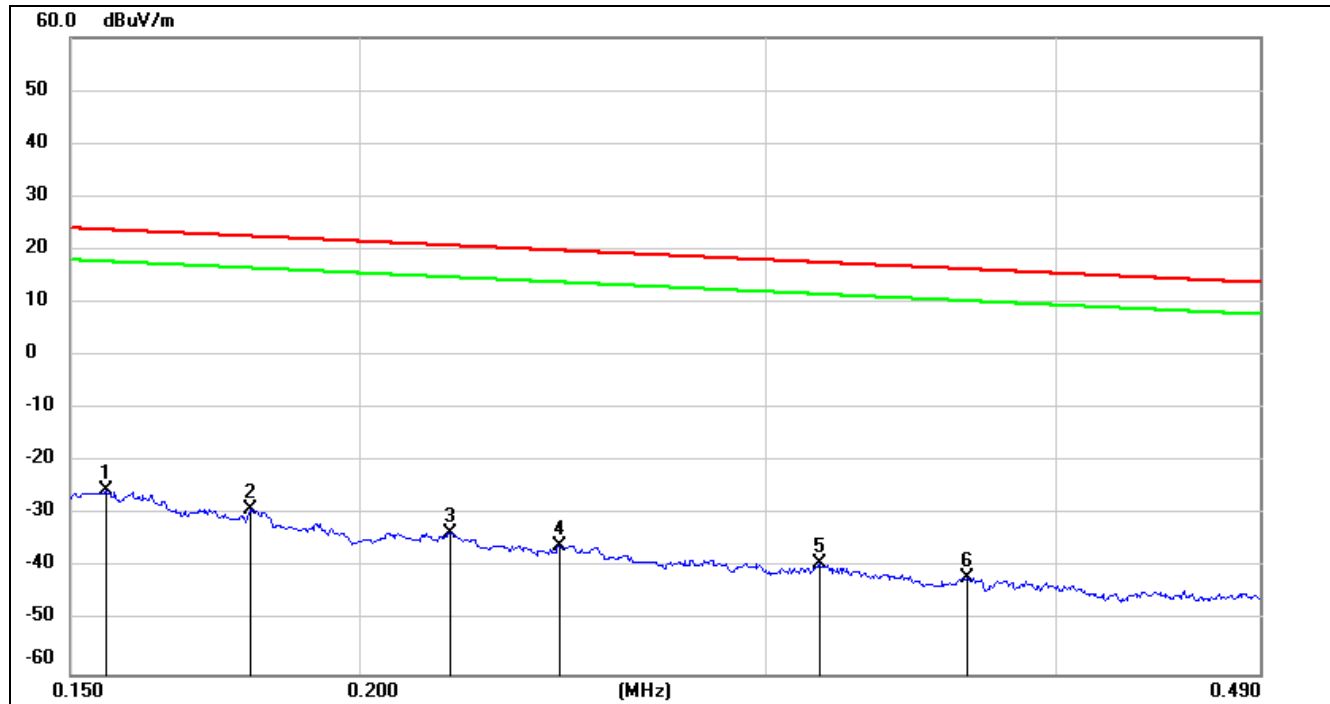
150 kHz ~ 490 kHz

No.	Frequency (MHz)	Reading (dBuV)	Correct (dB/m)	FCC Result (dBuV/m)	FCC Limit (dBuV/m)	ISED Result (dBuA/m)	ISED Limit (dBuA/m)	Margin (dB)	Remark
1	0.1554	76.27	-101.65	-25.38	23.77	-76.88	-27.73	-49.15	peak
2	0.1794	72.77	-101.68	-28.91	22.53	-80.41	-28.97	-51.44	peak
3	0.2190	68.27	-101.75	-33.48	20.79	-84.98	-30.71	-54.27	peak
4	0.2442	66.03	-101.79	-35.76	19.85	-87.26	-31.65	-55.61	peak
5	0.3163	62.70	-101.87	-39.17	17.6	-90.67	-33.90	-56.77	peak
6	0.3662	60.08	-101.93	-41.85	16.33	-93.35	-35.17	-58.18	peak

Note: 1. Measurement = Reading Level + Correct Factor (dBuA/m= dBuV/m- 20Log10[120π] = dBuV/m- 51.5).

2. If Peak Result complies with AV and QP limit, AV and QP Result are deemed to comply with AV limit.

3. All 3 polarizations (Horizontal, Face-on and Face-off) of the loop antenna had been tested, but only the worst data recorded in the report.

490 kHz ~ 30 MHz

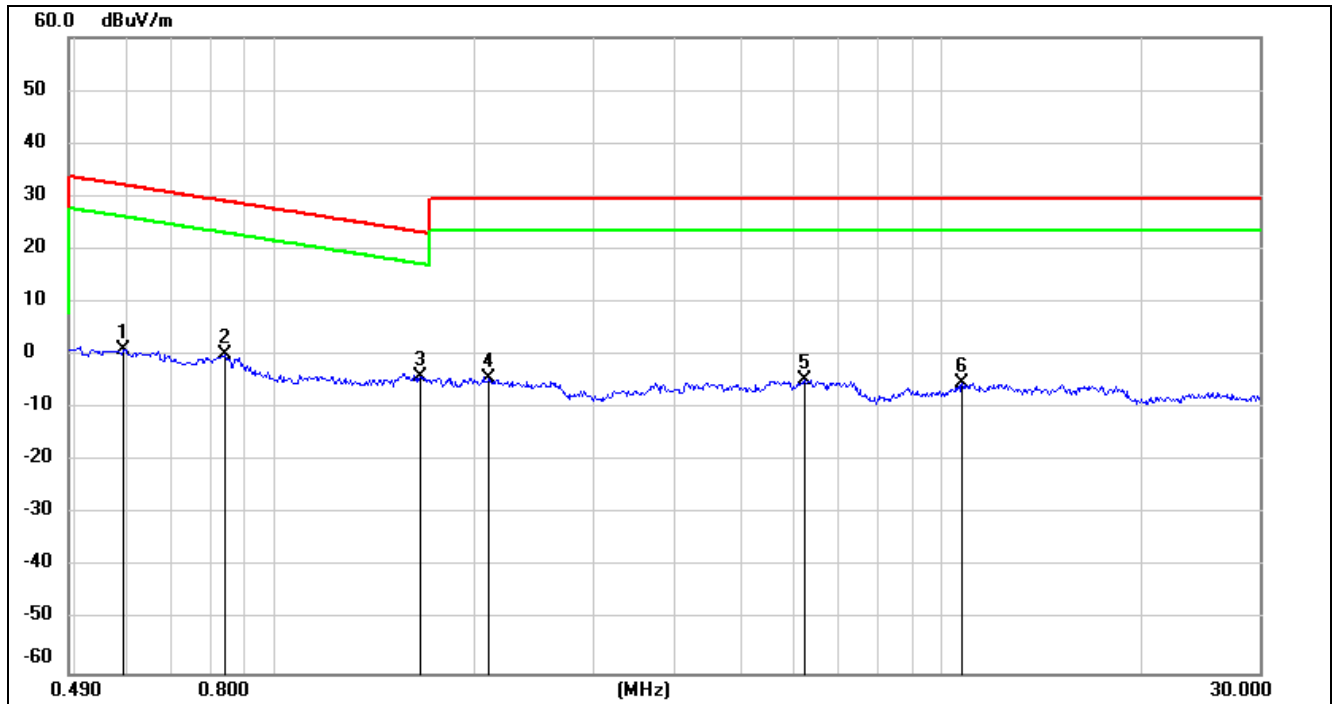

No.	Frequency (MHz)	Reading (dBuV)	Correct (dB/m)	FCC Result (dBuV/m)	FCC Limit (dBuV/m)	ISED Result (dBuA/m)	ISED Limit (dBuA/m)	Margin (dB)	Remark
1	0.5917	63.24	-62.08	1.16	32.16	-50.34	-19.34	-31.00	peak
2	0.8400	62.21	-62.17	0.04	29.12	-51.46	-22.38	-29.08	peak
3	1.6491	58.05	-61.98	-3.93	23.26	-55.43	-28.24	-27.19	peak
4	2.0939	57.39	-61.79	-4.4	29.54	-55.90	-21.96	-33.94	peak
5	6.2445	56.63	-61.32	-4.69	29.54	-56.19	-21.96	-34.23	peak
6	10.7299	55.48	-60.83	-5.35	29.54	-56.85	-21.96	-34.89	peak

Note: 1. Measurement = Reading Level + Correct Factor (dBuA/m= dBuV/m- 20Log10[120π] = dBuV/m- 51.5).

2. If Peak Result complies with AV and QP limit, AV and QP Result are deemed to comply with AV limit.

3. All 3 polarizations (Horizontal, Face-on and Face-off) of the loop antenna had been tested, but only the worst data recorded in the report.

Note: All the modes and channels had been tested, but only the worst data was recorded in the report.

9. AC POWER LINE CONDUCTED EMISSIONS

LIMITS

Please refer to CFR 47 FCC §15.207 (a) and ISED RSS-Gen Clause 8.8

FREQUENCY (MHz)	Quasi-peak	Average
0.15 -0.5	66 - 56 *	56 - 46 *
0.50 -5.0	56.00	46.00
5.0 -30.0	60.00	50.00

TEST SETUP AND PROCEDURE

Refer to ANSI C63.10-2013 clause 6.2.

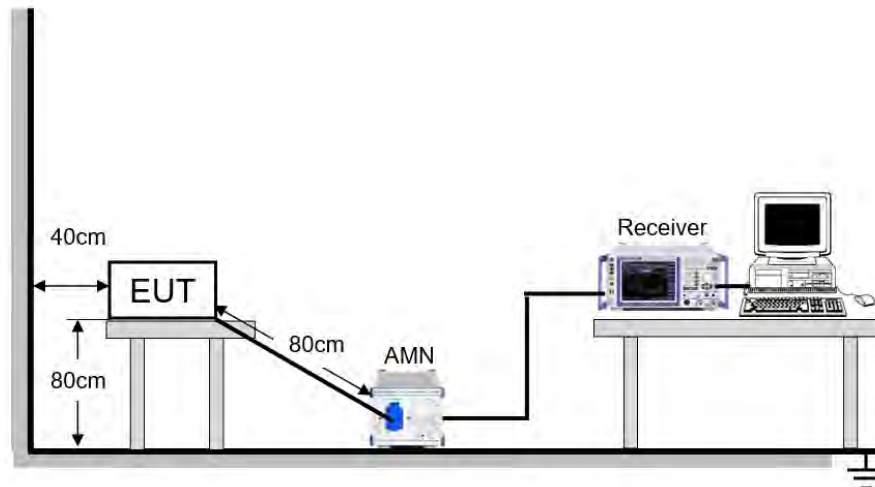

The EUT is put on a table of non-conducting material that is 80 cm high. The vertical conducting wall of shielding is located 40 cm to the rear of the EUT. The power line of the EUT is connected to the AC mains through a Artificial Mains Network (A.M.N.). A EMI Measurement Receiver (R&S Test Receiver ESR3) is used to test the emissions from both sides of AC line. According to the requirements in Section 6.2 of ANSI C63.10-2013. Conducted emissions from the EUT measured in the frequency range between 0.15 MHz and 30 MHz using CISPR Quasi-Peak and average detector mode. The bandwidth of EMI test receiver is set at 9 kHz.

The arrangement of the equipment is installed to meet the standards and operating in a manner, which tends to maximize its emission characteristics in a normal application.

TEST ENVIRONMENT

Temperature	23.8 °C	Relative Humidity	72.3 %
Atmosphere Pressure	101 kPa	Test Voltage	AC 120 V/60 Hz

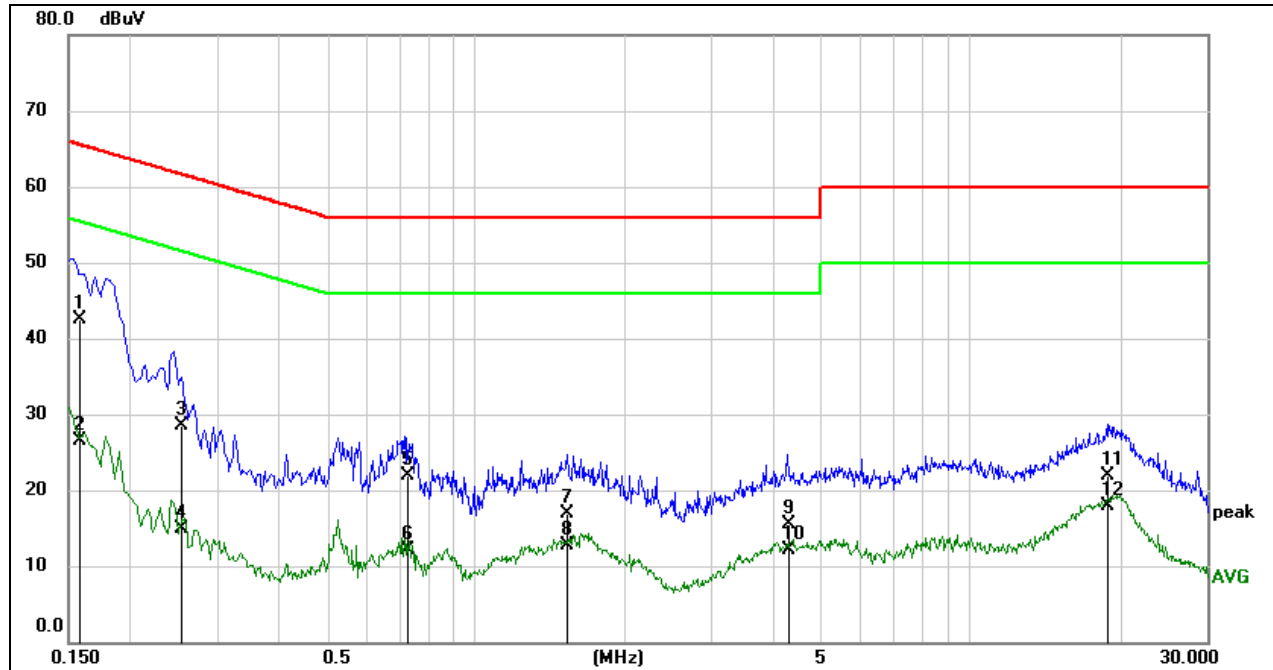
RESULTS
9.1. 802.11n HT20 MIMO MODE
LINE L RESULTS (HIGH CHANNEL, WORST-CASE CONFIGURATION)

No.	Frequency (MHz)	Reading (dBuV)	Correct (dB)	Result (dBuV)	Limit (dBuV)	Margin (dB)	Remark
1	0.1584	32.88	9.59	42.47	65.55	-23.08	QP
2	0.1584	16.82	9.59	26.41	55.55	-29.14	AVG
3	0.2537	18.86	9.59	28.45	61.64	-33.19	QP
4	0.2537	5.26	9.59	14.85	51.64	-36.79	AVG
5	0.7300	12.21	9.60	21.81	56.00	-34.19	QP
6	0.7300	2.47	9.60	12.07	46.00	-33.93	AVG
7	1.5300	7.34	9.62	16.96	56.00	-39.04	QP
8	1.5300	3.13	9.62	12.75	46.00	-33.25	AVG
9	4.3077	5.88	9.60	15.48	56.00	-40.52	QP
10	4.3077	2.52	9.60	12.12	46.00	-33.88	AVG
11	18.9660	12.17	9.80	21.97	60.00	-38.03	QP
12	18.9660	8.10	9.80	17.90	50.00	-32.10	AVG

Note: 1. Result = Reading +Correct Factor.

2. If QP Result complies with AV limit, AV Result is deemed to comply with AV limit.

3. Test setup: RBW: 200 Hz (9 kHz ~ 150 kHz), 9 kHz (150 kHz ~ 30 MHz).

4. Step size: 80 Hz (0.009 MHz ~ 0.15 MHz), 4 kHz (0.15 MHz ~ 30 MHz), Scan time: auto.

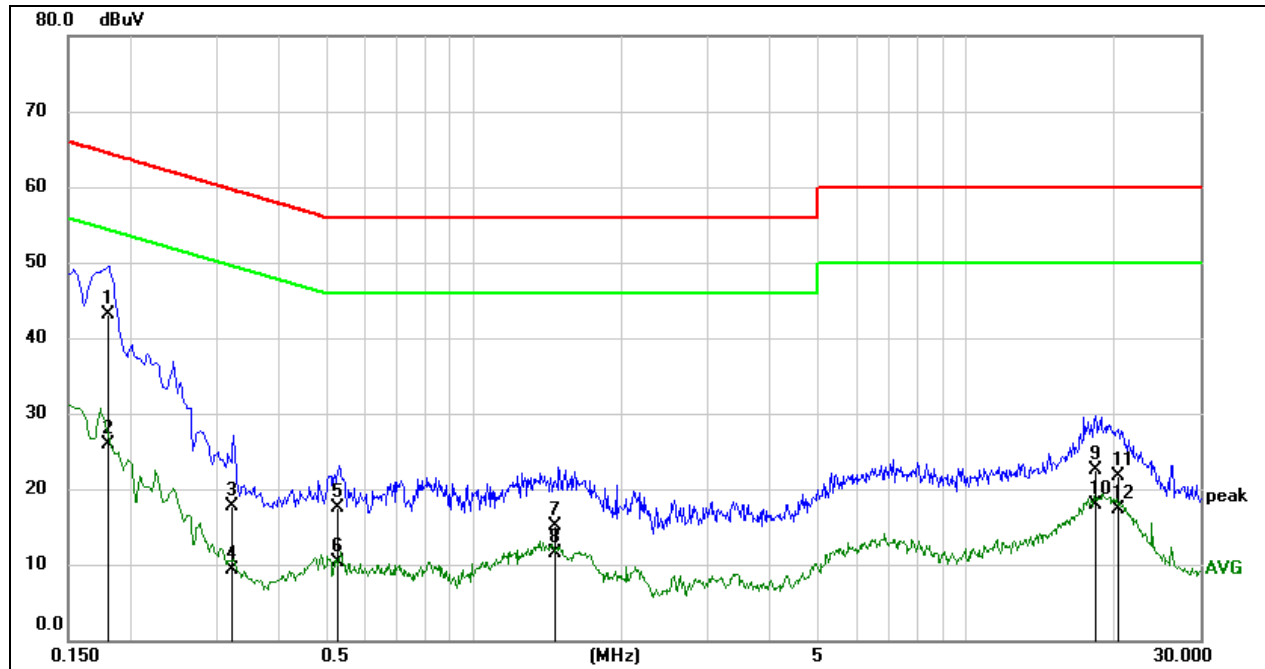
**LINE N RESULTS (HIGH CHANNEL, WORST-CASE CONFIGURATION)**

No.	Frequency (MHz)	Reading (dBuV)	Correct (dB)	Result (dBuV)	Limit (dBuV)	Margin (dB)	Remark
1	0.1844	32.11	9.59	41.70	64.29	-22.59	QP
2	0.1844	15.14	9.59	24.73	54.29	-29.56	AVG
3	0.2835	12.98	9.59	22.57	60.71	-38.14	QP
4	0.2835	3.36	9.59	12.95	50.71	-37.76	AVG
5	0.5184	6.50	9.60	16.10	56.00	-39.90	QP
6	0.5184	-0.32	9.60	9.28	46.00	-36.72	AVG
7	0.8231	5.92	9.60	15.52	56.00	-40.48	QP
8	0.8231	-0.31	9.60	9.29	46.00	-36.71	AVG
9	1.3766	6.37	9.61	15.98	56.00	-40.02	QP
10	1.3766	2.34	9.61	11.95	46.00	-34.05	AVG
11	19.2298	12.67	9.81	22.48	60.00	-37.52	QP
12	19.2298	7.94	9.81	17.75	50.00	-32.25	AVG

Note: 1. Result = Reading +Correct Factor.

2. If QP Result complies with AV limit, AV Result is deemed to comply with AV limit.

3. Test setup: RBW: 200 Hz (9 kHz ~ 150 kHz), 9 kHz (150 kHz ~ 30 MHz).

4. Step size: 80 Hz (0.009 MHz ~ 0.15 MHz), 4 kHz (0.15 MHz ~ 30 MHz), Scan time: auto.

Note: All the modes and channels had been tested, but only the worst data was recorded in the report.



10. ANTENNA REQUIREMENTS

APPLICABLE REQUIREMENTS

Please refer to FCC §15.203

An intentional radiator shall be designed to ensure that no antenna other than that furnished by the responsible party shall be used with the device. The use of a permanently attached antenna or of an antenna that uses a unique coupling to the intentional radiator shall be considered sufficient to comply with the provisions of this section. The manufacturer may design the unit so that a broken antenna can be replaced by the user, but the use of a standard antenna jack or electrical connector is prohibited.

Please refer to FCC §15.247(b)(4)

The conducted output power limit specified in paragraph (b) of this section is based on the use of antennas with directional gains that do not exceed 6 dBi. Except as shown in paragraph (c) of this section, if transmitting antennas of directional gain greater than 6 dBi are used, the conducted output power from the intentional radiator shall be reduced below the stated values in paragraphs (b)(1), (b)(2), and (b)(3) of this section, as appropriate, by the amount in dB that the directional gain of the antenna exceeds 6 dBi.

RESULTS

Complies



11. Appendix

11.1. Appendix A: DTS Bandwidth

11.1.1. Test Result

Test Mode	Antenna	Channel	DTS BW [MHz]	FL[MHz]	FH[MHz]	Limit[MHz]	Verdict
11B	Ant1	2412	8.200	2407.880	2416.080	0.5	PASS
	Ant2	2412	8.640	2407.920	2416.560	0.5	PASS
	Ant1	2437	8.120	2432.920	2441.040	0.5	PASS
	Ant2	2437	7.160	2433.400	2440.560	0.5	PASS
	Ant1	2462	9.160	2457.400	2466.560	0.5	PASS
	Ant2	2462	8.600	2457.440	2466.040	0.5	PASS
11G	Ant1	2412	16.000	2404.160	2420.160	0.5	PASS
	Ant2	2412	16.120	2404.040	2420.160	0.5	PASS
	Ant1	2437	16.320	2428.840	2445.160	0.5	PASS
	Ant2	2437	16.000	2428.800	2444.800	0.5	PASS
	Ant1	2462	15.880	2454.040	2469.920	0.5	PASS
	Ant2	2462	16.400	2453.800	2470.200	0.5	PASS
11N20MIMO	Ant1	2412	17.400	2403.240	2420.640	0.5	PASS
	Ant2	2412	17.000	2403.840	2420.840	0.5	PASS
	Ant1	2437	17.160	2428.440	2445.600	0.5	PASS
	Ant2	2437	17.000	2428.240	2445.240	0.5	PASS
	Ant1	2462	16.960	2453.880	2470.840	0.5	PASS
	Ant2	2462	17.000	2453.840	2470.840	0.5	PASS
11N40MIMO	Ant1	2422	35.280	2404.400	2439.680	0.5	PASS
	Ant2	2422	35.280	2404.400	2439.680	0.5	PASS
	Ant1	2437	35.280	2419.400	2454.680	0.5	PASS
	Ant2	2437	35.200	2419.480	2454.680	0.5	PASS
	Ant1	2452	35.280	2434.400	2469.680	0.5	PASS
	Ant2	2452	35.280	2434.400	2469.680	0.5	PASS

11.1.2. Test Graphs



11B_Ant1_2412



11B_Ant2_2412



11B_Ant1_2437



11B_Ant2_2437



11B_Ant1_2462



11B_Ant2_2462



11G_Ant1_2412



11G_Ant2_2412



11G_Ant1_2437

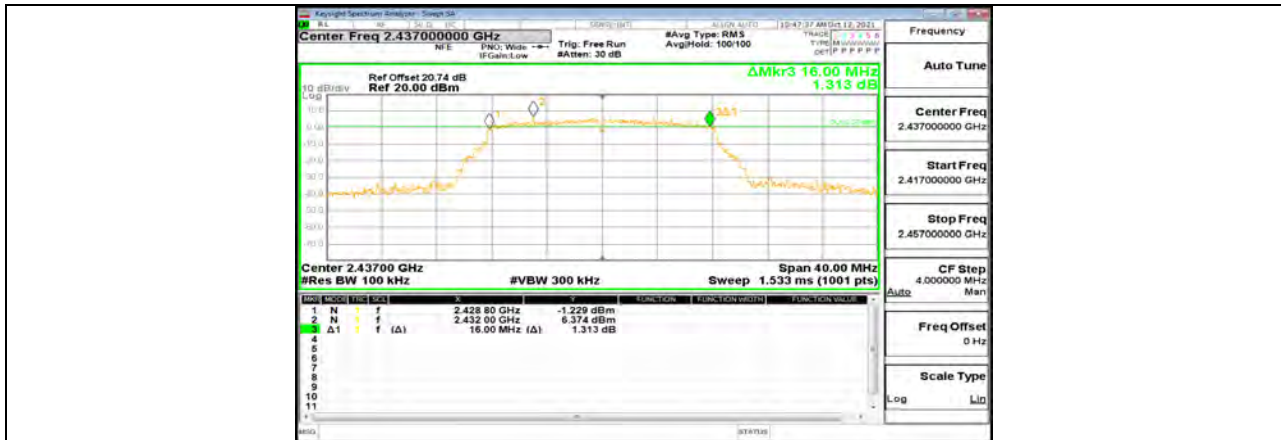

11G_Ant2_2437



11G_Ant1_2462

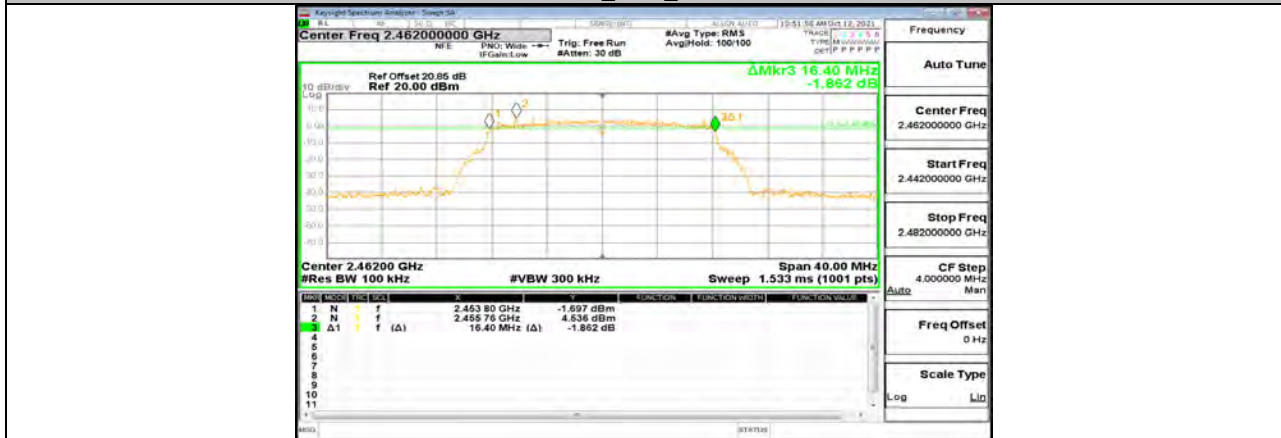

11G_Ant2_2462



11N20MIMO_Ant1_2412



11N20MIMO_Ant2_2412

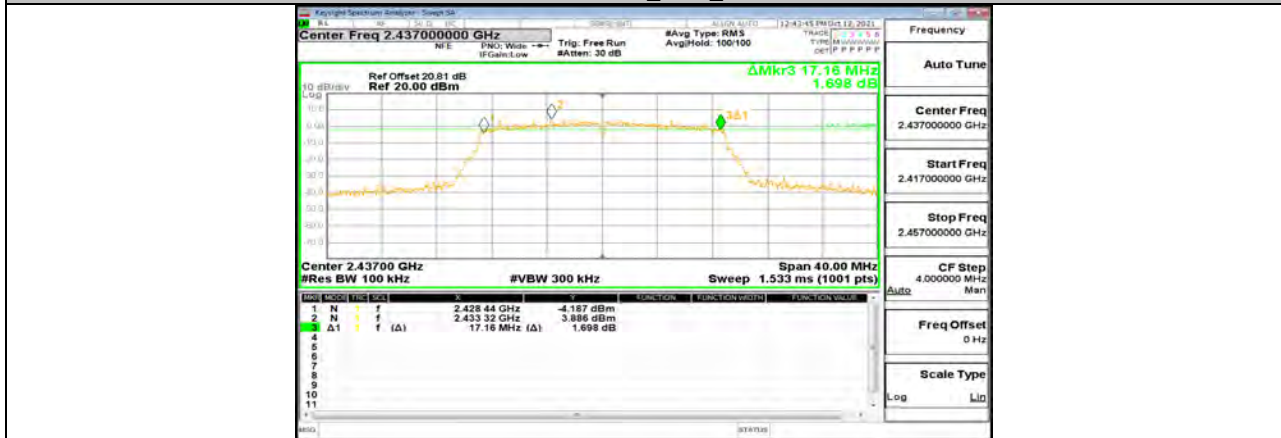

11N20MIMO_Ant1_2437



11N20MIMO_Ant2_2437



11N20MIMO_Ant1_2462

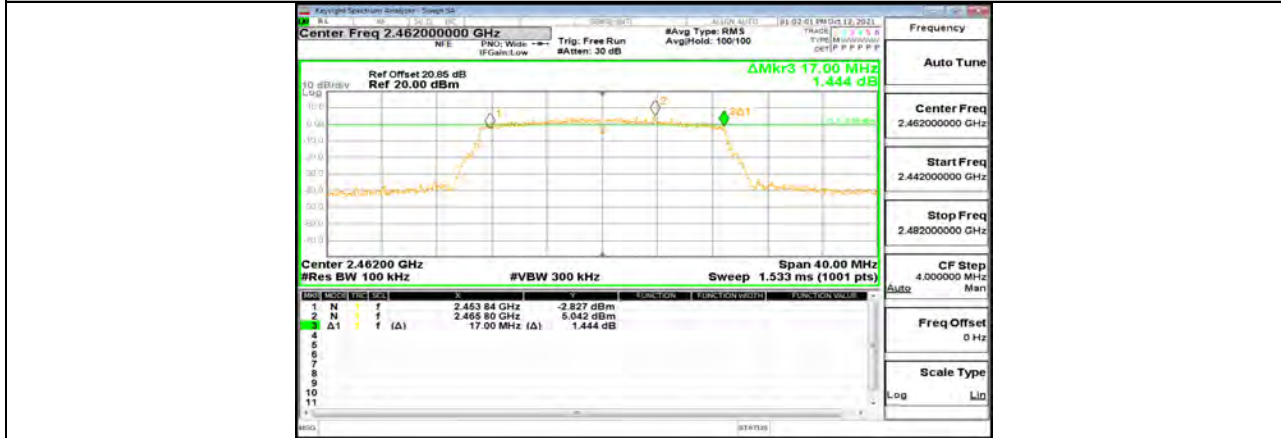

11N20MIMO_Ant2_2462

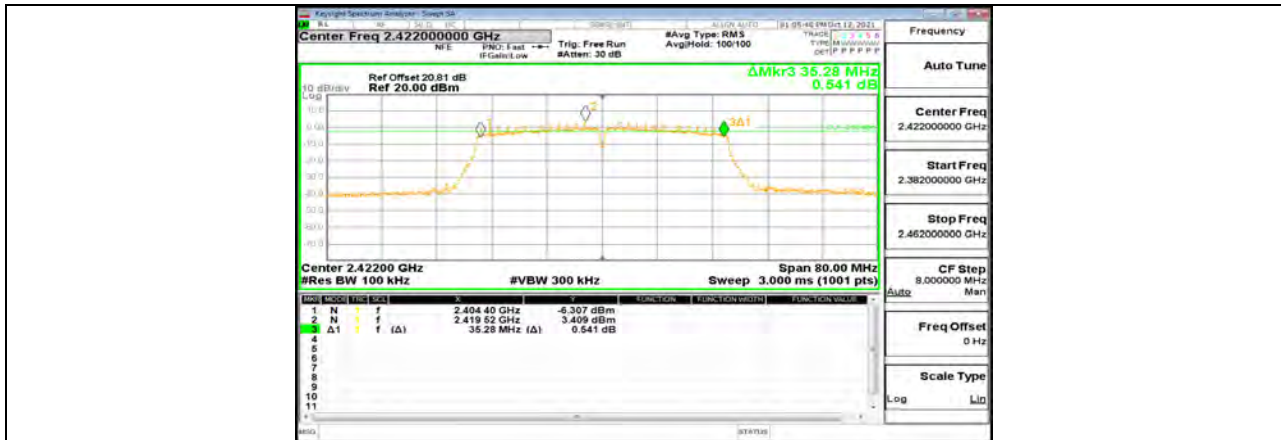

11N40MIMO_Ant1_2422



11N40MIMO_Ant2_2422

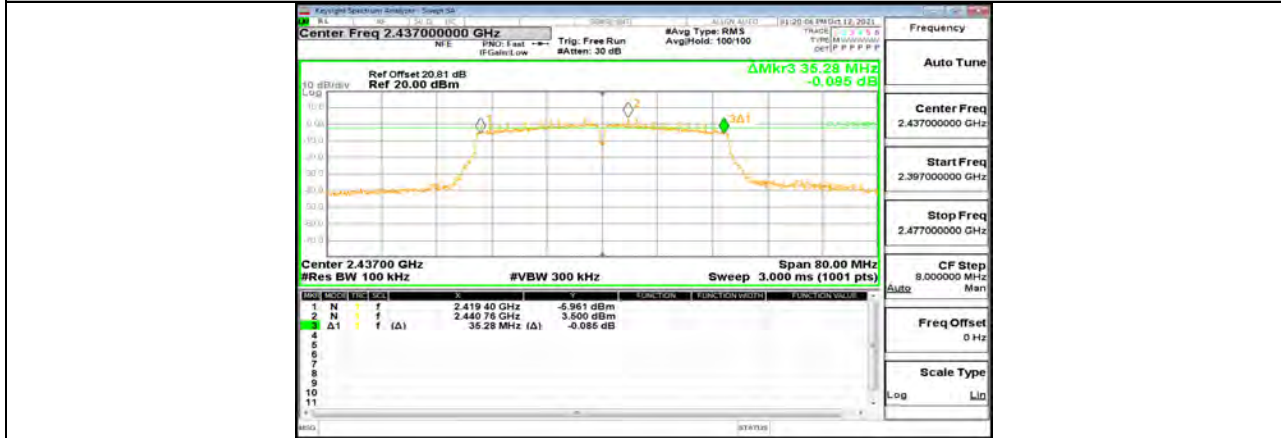

11N40MIMO_Ant1_2437



11N40MIMO_Ant2_2437



11N40MIMO_Ant1_2452



11N40MIMO_Ant2_2452

**11.2. Appendix B: Occupied Channel Bandwidth****11.2.1. Test Result**

Test Mode	Antenna	Channel	OCB [MHz]	FL[MHz]	FH[MHz]	Verdict
11B	Ant1	2412	13.694	2405.152	2418.846	PASS
	Ant2	2412	13.546	2405.245	2418.791	PASS
	Ant1	2437	13.813	2430.076	2443.889	PASS
	Ant2	2437	13.576	2430.188	2443.764	PASS
	Ant1	2462	13.686	2455.144	2468.830	PASS
	Ant2	2462	13.482	2455.249	2468.731	PASS
11G	Ant1	2412	16.785	2403.613	2420.398	PASS
	Ant2	2412	16.881	2403.526	2420.407	PASS
	Ant1	2437	16.751	2428.616	2445.367	PASS
	Ant2	2437	16.859	2428.527	2445.386	PASS
	Ant1	2462	16.864	2453.562	2470.426	PASS
	Ant2	2462	16.865	2453.574	2470.439	PASS
11N20MIMO	Ant1	2412	17.792	2403.157	2420.949	PASS
	Ant2	2412	17.729	2403.205	2420.934	PASS
	Ant1	2437	17.785	2428.164	2445.949	PASS
	Ant2	2437	17.742	2428.203	2445.945	PASS
	Ant1	2462	17.785	2453.162	2470.947	PASS
	Ant2	2462	17.698	2453.215	2470.913	PASS
11N40MIMO	Ant1	2422	36.019	2404.093	2440.112	PASS
	Ant2	2422	36.046	2404.060	2440.106	PASS
	Ant1	2437	36.052	2419.069	2455.121	PASS
	Ant2	2437	35.961	2419.100	2455.061	PASS
	Ant1	2452	36.082	2434.108	2470.190	PASS
	Ant2	2452	36.117	2434.039	2470.156	PASS



11.2.2. Test Graphs



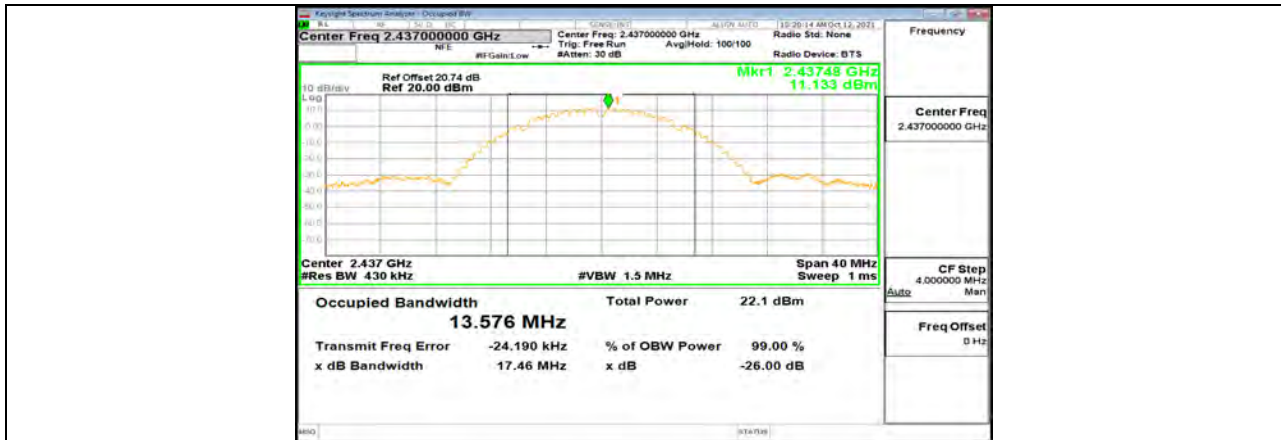

11B_Ant2_2437

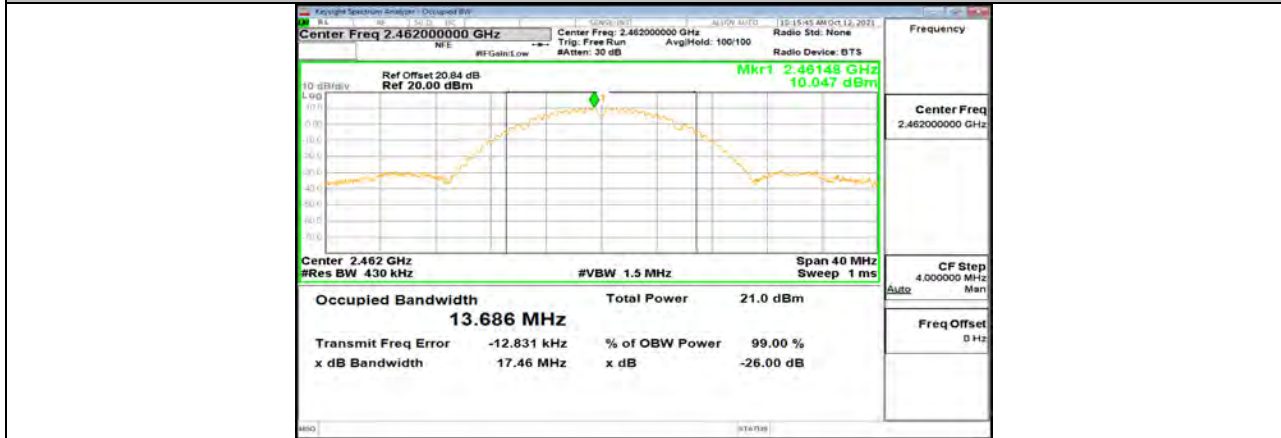

11B_Ant1_2462

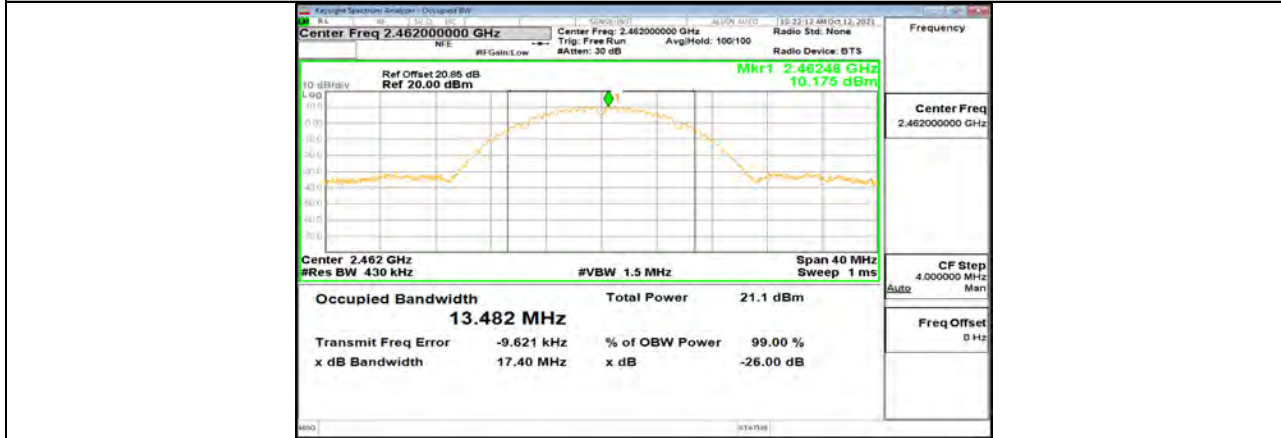

11B_Ant2_2462

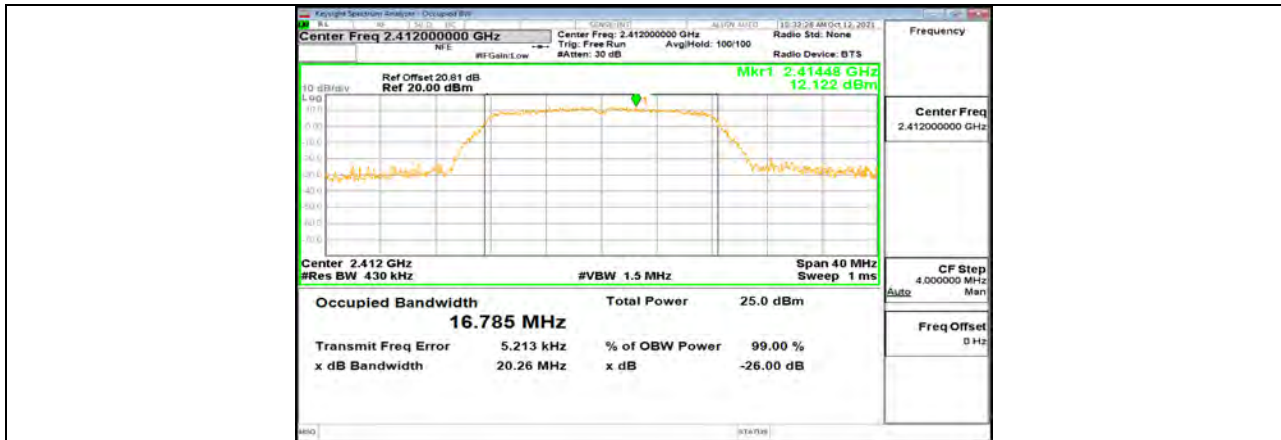

11G_Ant1_2412

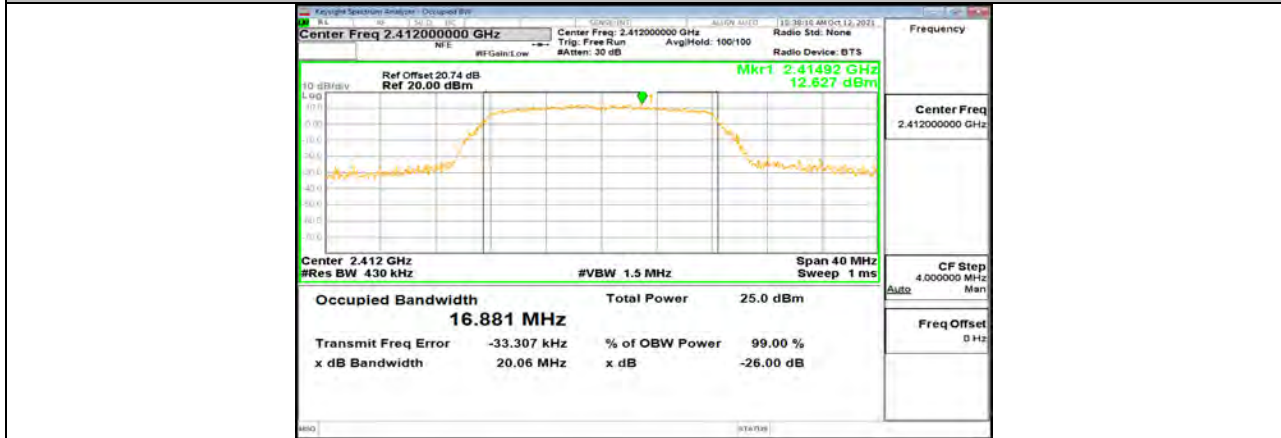

11G_Ant2_2412

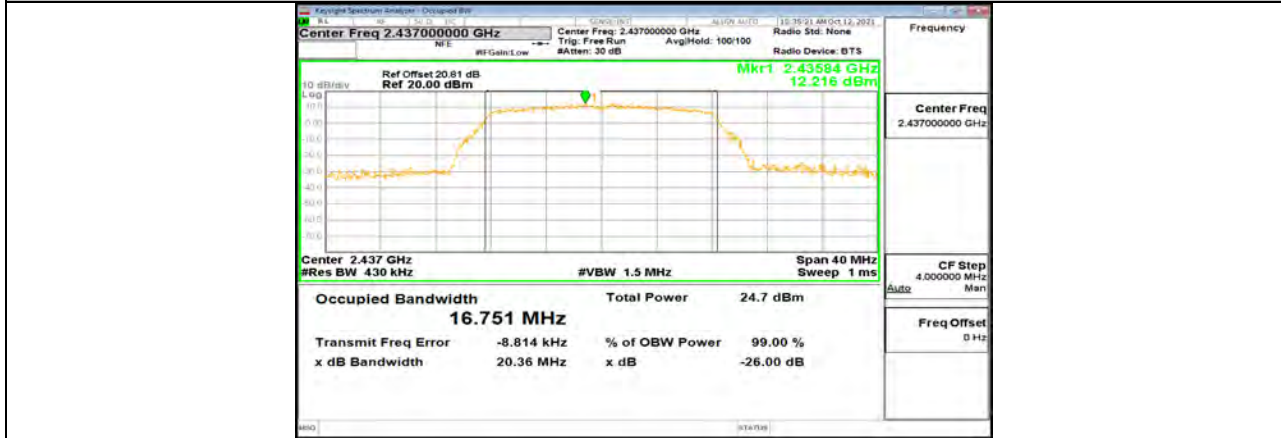

11G_Ant1_2437

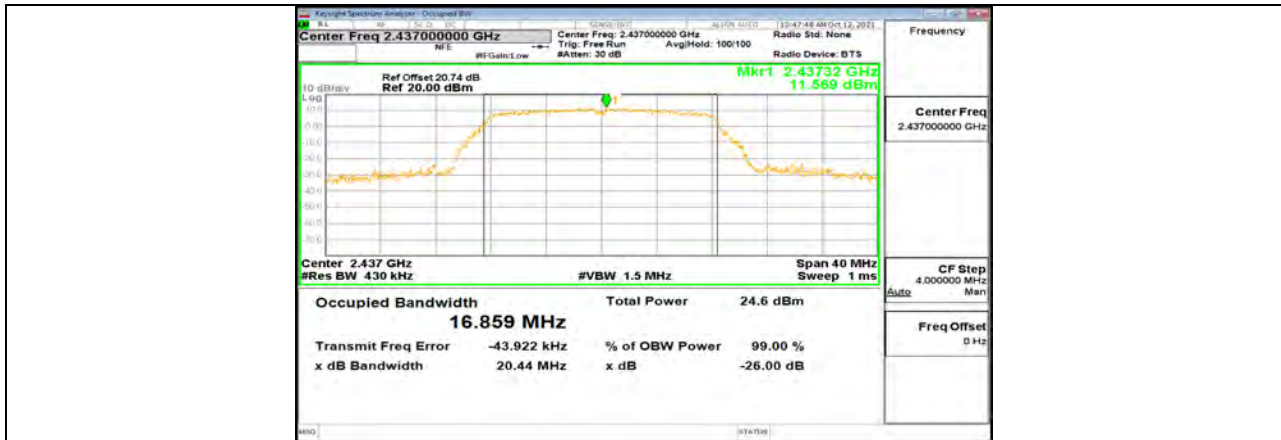

11G_Ant2_2437

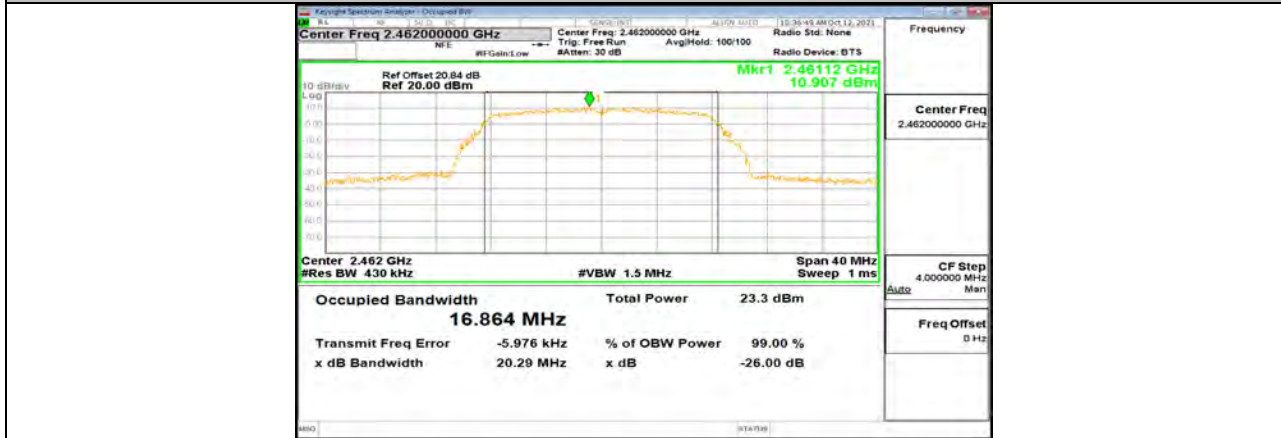

11G_Ant1_2462

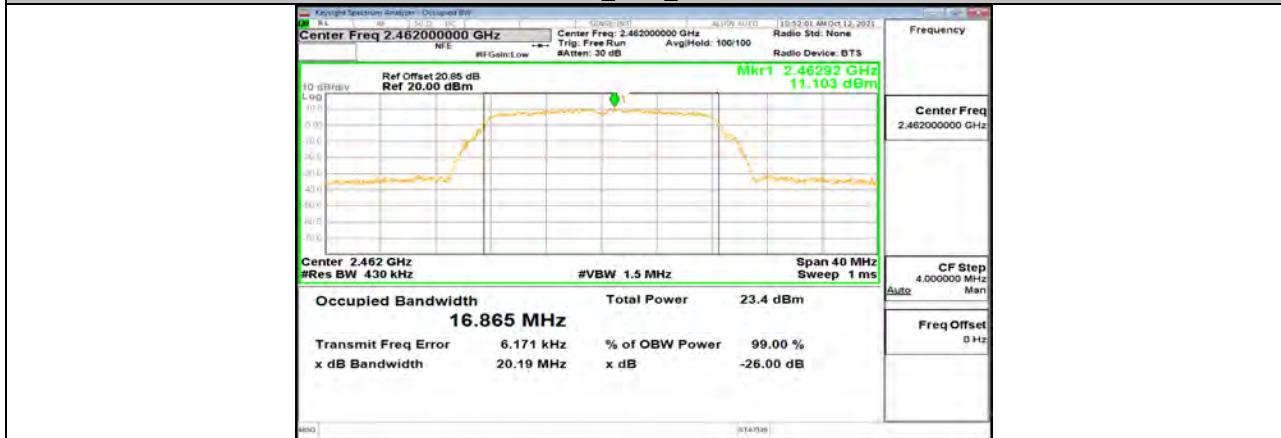

11G_Ant2_2462

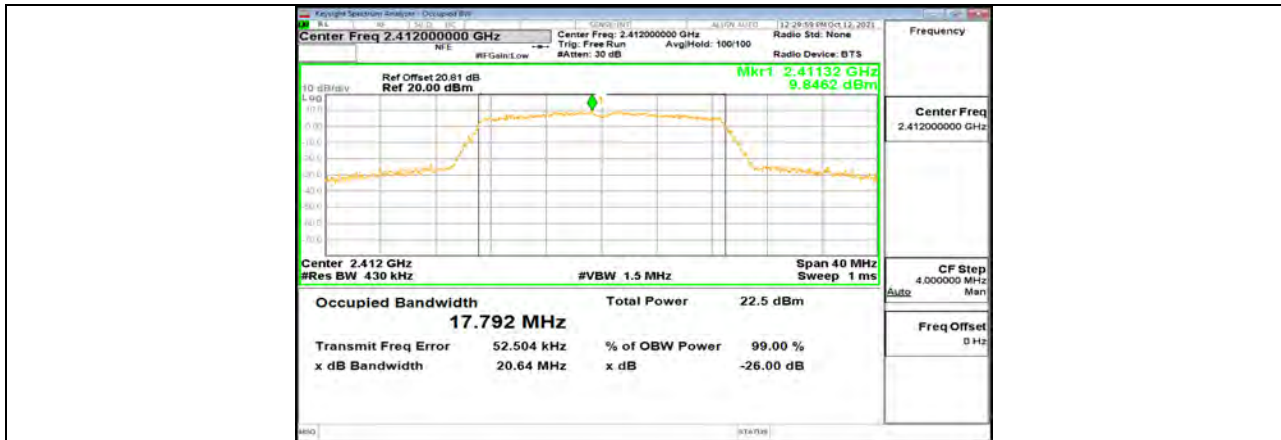

11N20MIMO_Ant1_2412

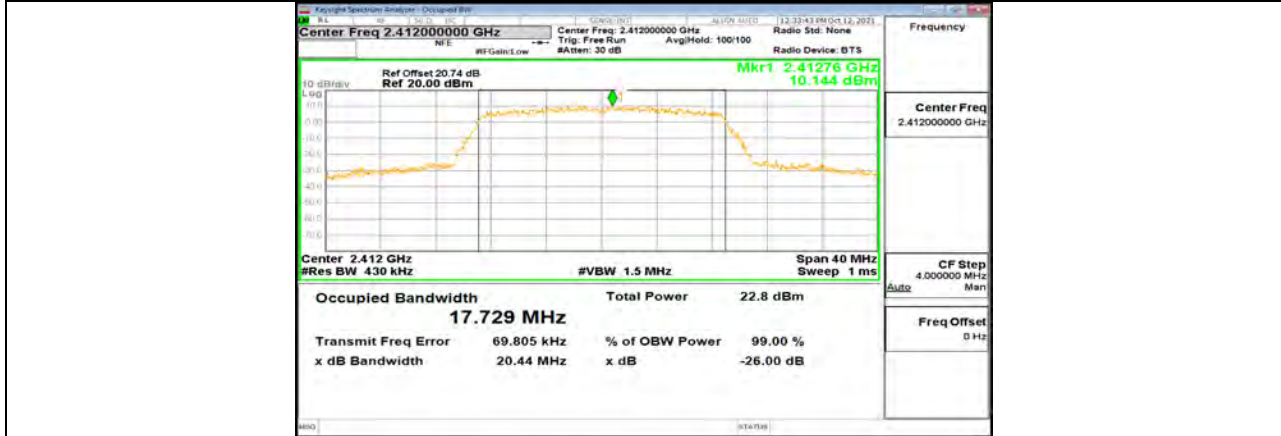

11N20MIMO_Ant2_2412

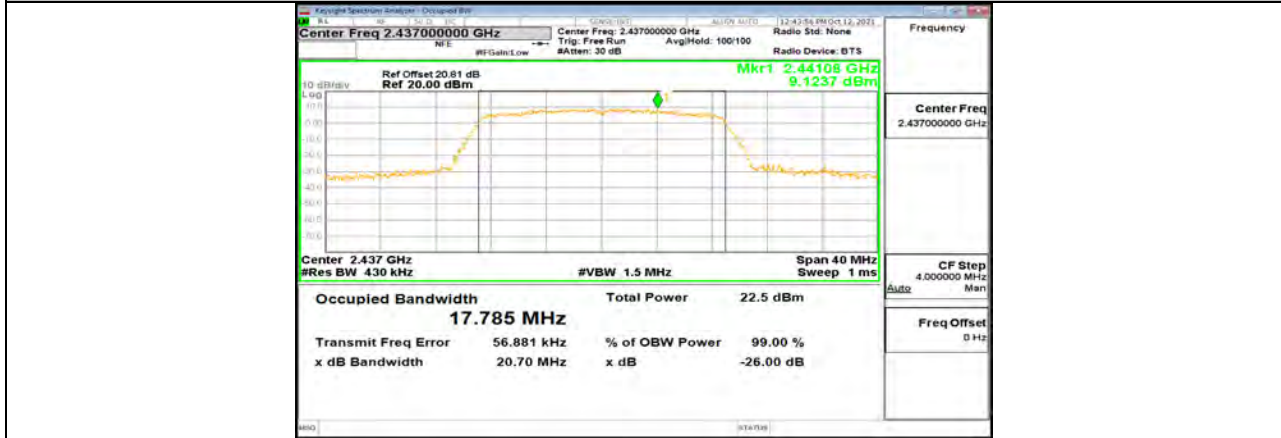

11N20MIMO_Ant1_2437

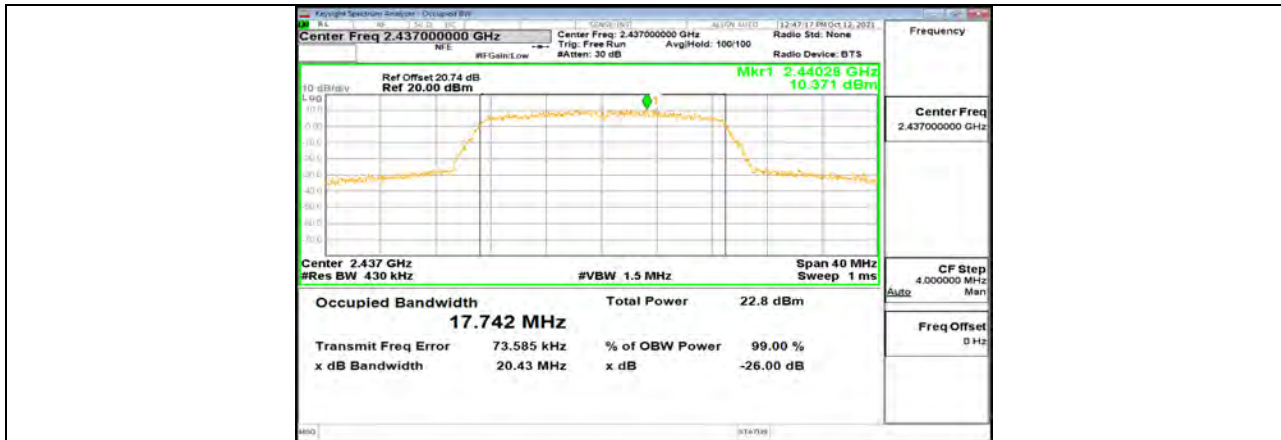

11N20MIMO_Ant2_2437

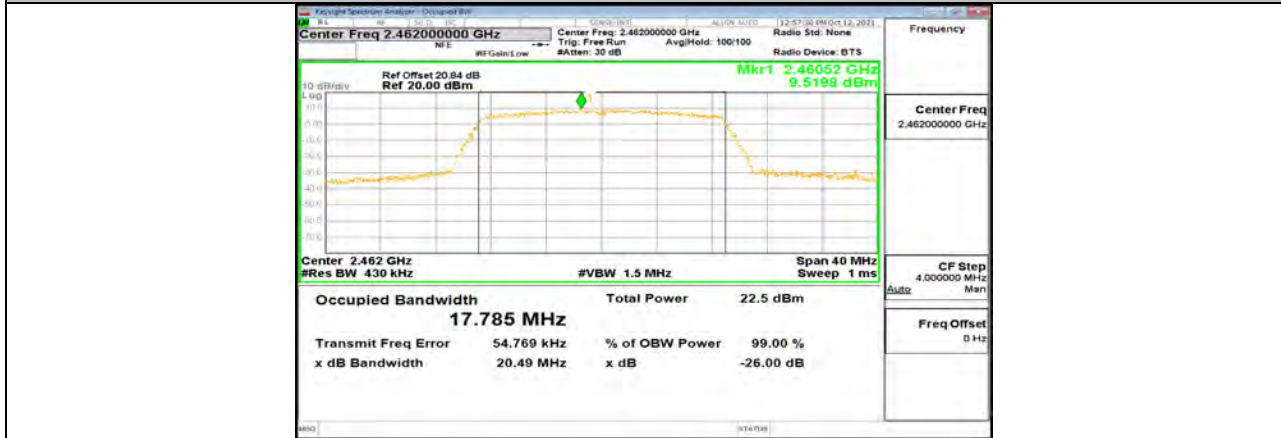

11N20MIMO_Ant1_2462

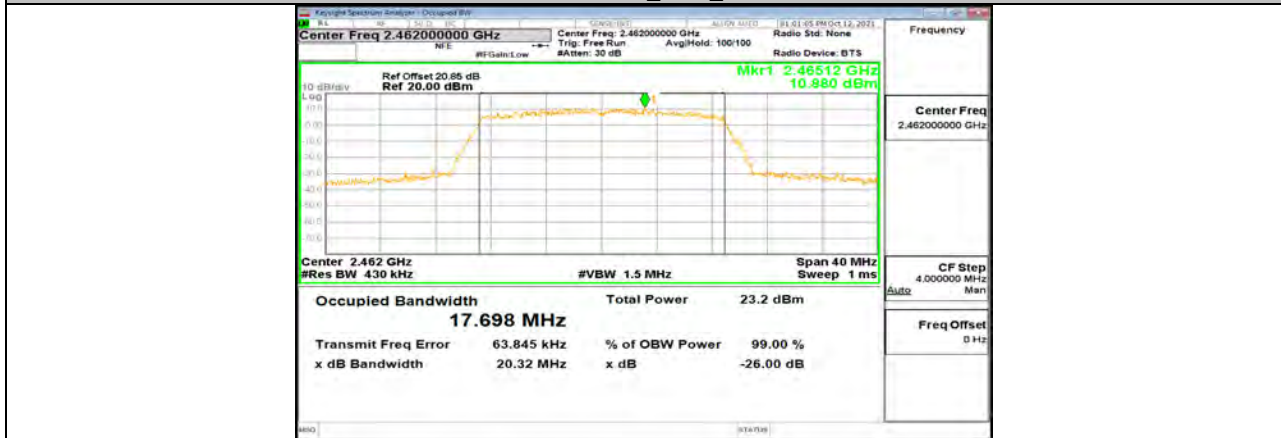

11N20MIMO_Ant2_2462

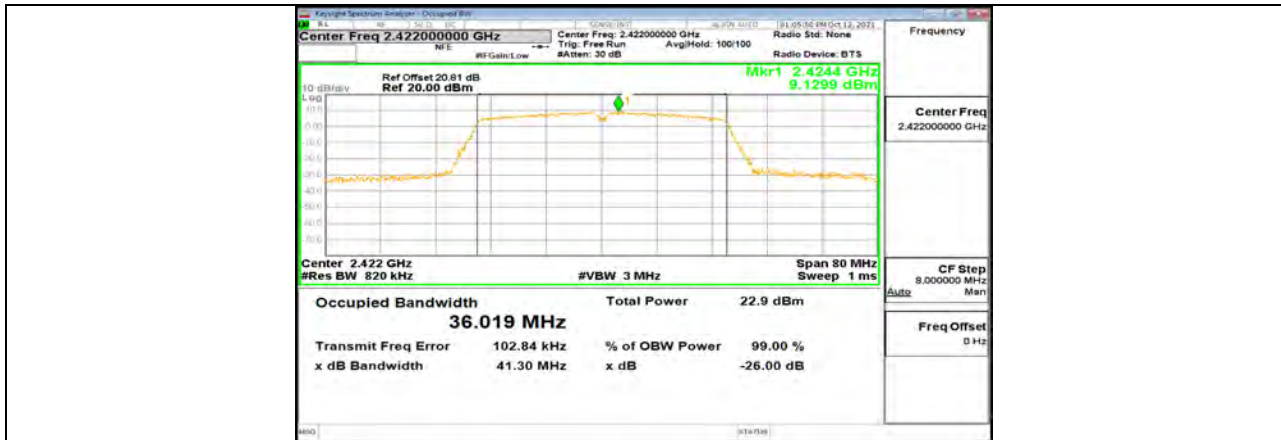

11N40MIMO_Ant1_2422

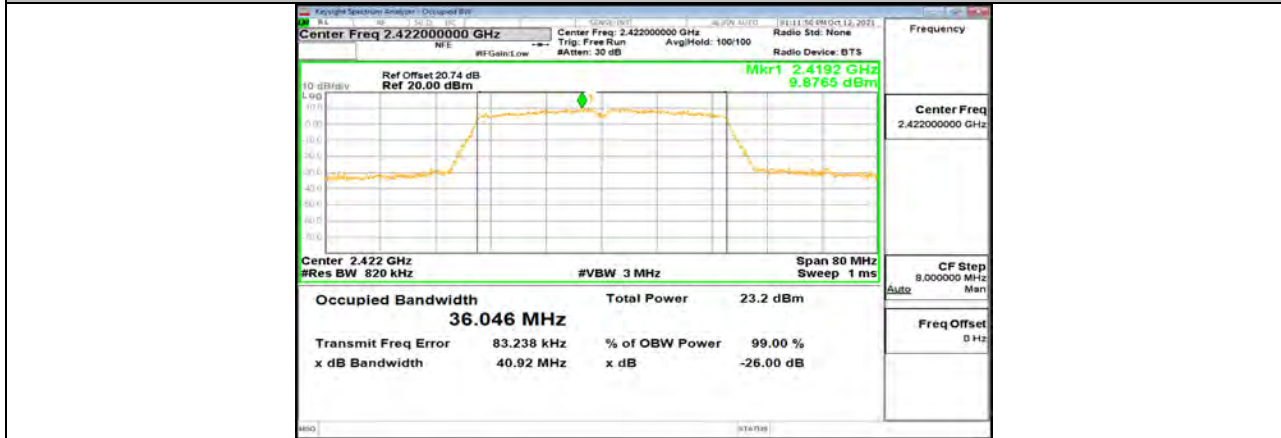

11N40MIMO_Ant2_2422

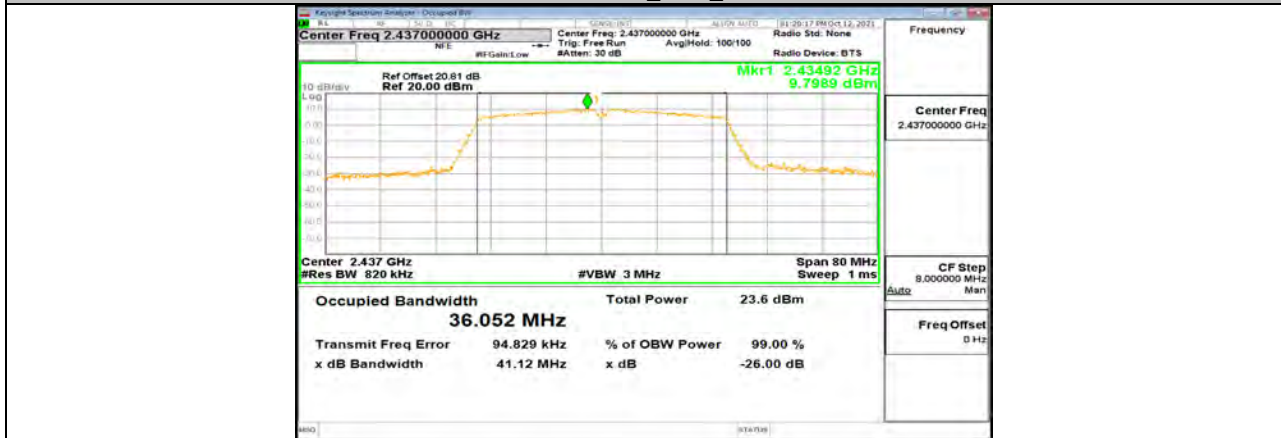

11N40MIMO_Ant1_2437

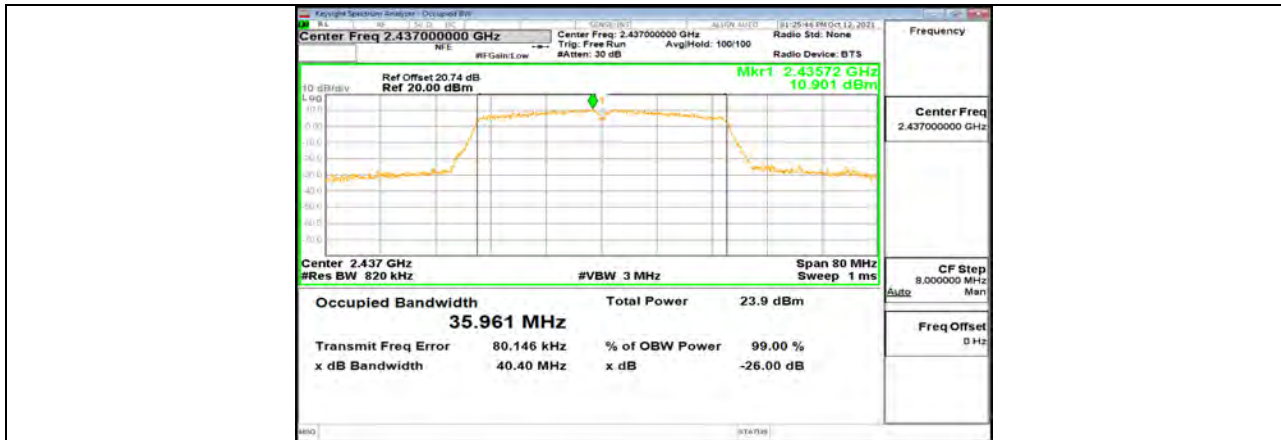

11N40MIMO_Ant2_2437

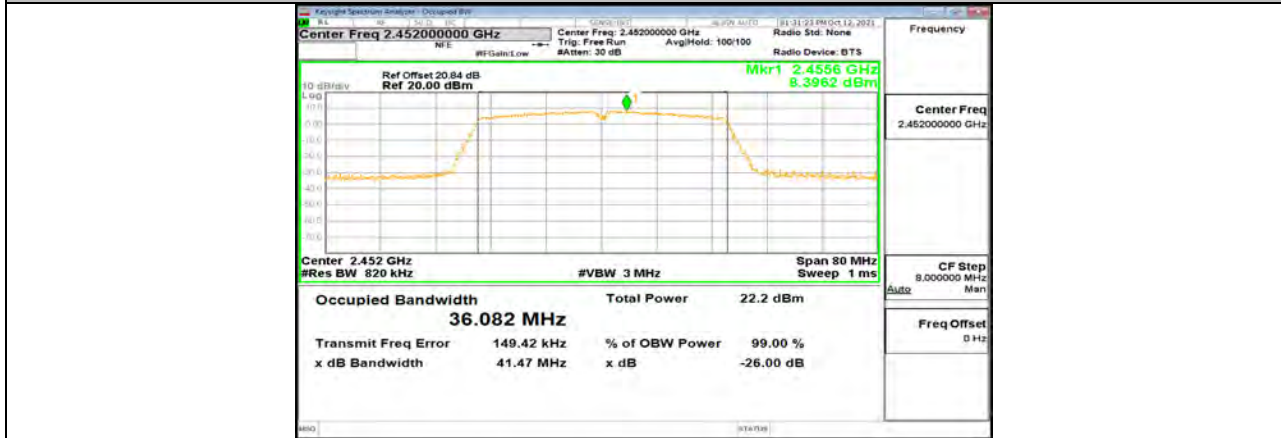

11N40MIMO_Ant1_2452

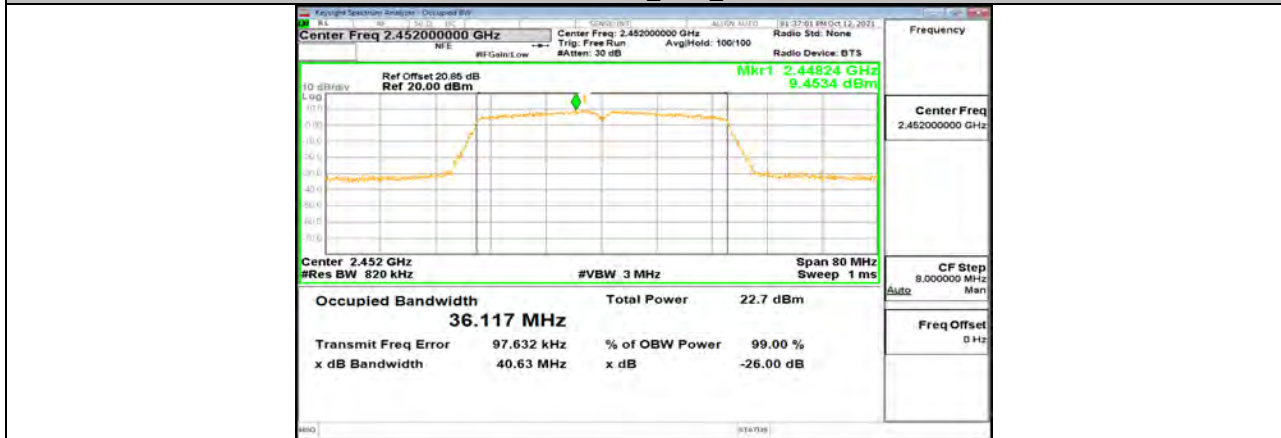

11N40MIMO_Ant2_2452



11.3. Appendix C: Maximum Average Conducted Output Power
11.3.1. Test Result

Test Mode	Antenna	Channel	Result[dBm]	Limit[dBm]	Verdict
11B	Ant1	2412	18.78	<=30	PASS
	Ant2	2412	18.91	<=30	PASS
	Ant1	2437	19.25	<=30	PASS
	Ant2	2437	19.26	<=30	PASS
	Ant1	2462	18.14	<=30	PASS
	Ant2	2462	18.24	<=30	PASS
11G	Ant1	2412	18.95	<=30	PASS
	Ant2	2412	18.99	<=30	PASS
	Ant1	2437	18.51	<=30	PASS
	Ant2	2437	18.57	<=30	PASS
	Ant1	2462	17.11	<=30	PASS
	Ant2	2462	17.26	<=30	PASS
11N20MIMO	Ant1	2412	16.35	<=30	PASS
	Ant2	2412	16.24	<=30	PASS
	total	2412	19.31	<=30	PASS
	Ant1	2437	16.29	<=30	PASS
	Ant2	2437	16.22	<=30	PASS
	total	2437	19.27	<=30	PASS
	Ant1	2462	16.47	<=30	PASS
	Ant2	2462	16.63	<=30	PASS
	total	2462	19.56	<=30	PASS
11N40MIMO	Ant1	2422	16.01	<=30	PASS
	Ant2	2422	15.87	<=30	PASS
	total	2422	18.95	<=30	PASS
	Ant1	2437	16.58	<=30	PASS
	Ant2	2437	16.52	<=30	PASS
	total	2437	19.56	<=30	PASS
	Ant1	2452	15.22	<=30	PASS
	Ant2	2452	15.13	<=30	PASS
	total	2452	18.19	<=30	PASS

Note: 1. Conducted Power=Meas. Level+ Correction Factor
2. The Duty Cycle Factor (refer to section 7.1) had already compensated to the test data.



11.3.2. Spot check Test Result

Test Mode	Antenna	Channel	Result[dBm]	Limit[dBm]	Verdict
11B	Ant1	2437	19.56	<=30	PASS
	Ant2	2437	19.43	<=30	PASS
11G	Ant1	2437	18.72	<=30	PASS
	Ant2	2437	18.69	<=30	PASS
11N20MIMO	Ant1	2437	16.44	<=30	PASS
	Ant2	2437	16.38	<=30	PASS
	total	2437	19.42	<=30	PASS
11N40MIMO	Ant1	2437	16.84	<=30	PASS
	Ant2	2437	16.73	<=30	PASS
	total	2437	19.80	<=30	PASS



11.4. Appendix D: Maximum Power Spectral Density

11.4.1. Test Result

Test Mode	Antenna	Channel	Result[dBm/3kHz]	Limit[dBm/3kHz]	Verdict
11B	Ant2	2412	-2.52	<=8	PASS
		2437	-2.59	<=8	PASS
		2462	-4.11	<=8	PASS
11G	Ant2	2412	-5.01	<=8	PASS
		2437	-4.76	<=8	PASS
		2462	-5.54	<=8	PASS
11N20MIMO	Ant1	2412	-6.68	<=8	PASS
	Ant2	2412	-7.61	<=8	PASS
	total	2412	-4.11	<=8	PASS
	Ant1	2437	-6.78	<=8	PASS
	Ant2	2437	-7.53	<=8	PASS
	total	2437	-4.13	<=8	PASS
	Ant1	2462	-7.41	<=8	PASS
	Ant2	2462	-7.09	<=8	PASS
	total	2462	-4.24	<=8	PASS
11N40MIMO	Ant1	2422	-10.94	<=8	PASS
	Ant2	2422	-11.35	<=8	PASS
	total	2422	-8.13	<=8	PASS
	Ant1	2437	-9.8	<=8	PASS
	Ant2	2437	-10.02	<=8	PASS
	total	2437	-6.90	<=8	PASS
	Ant1	2452	-11.37	<=8	PASS
	Ant2	2452	-12.13	<=8	PASS
	total	2452	-8.72	<=8	PASS

Note: For 802.11b and 802.11g modes, both the two channel had been test, but only the worst data was recorded in the report.



11.4.2. Test Graphs

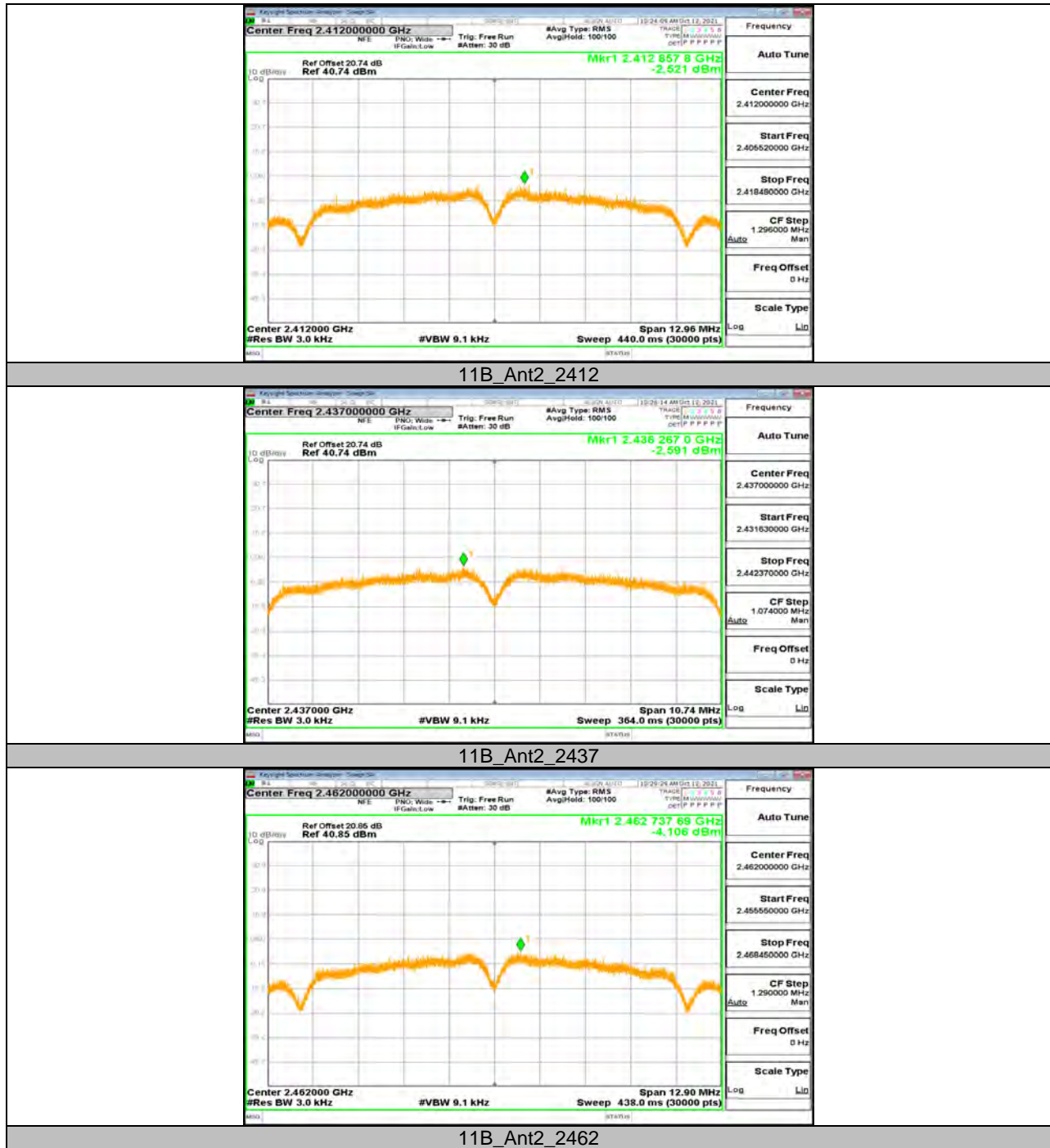

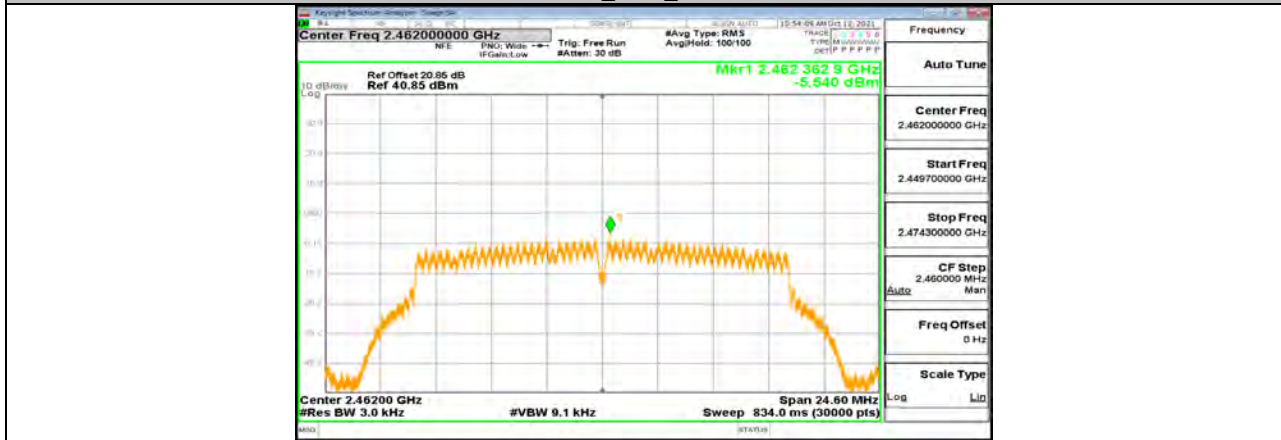
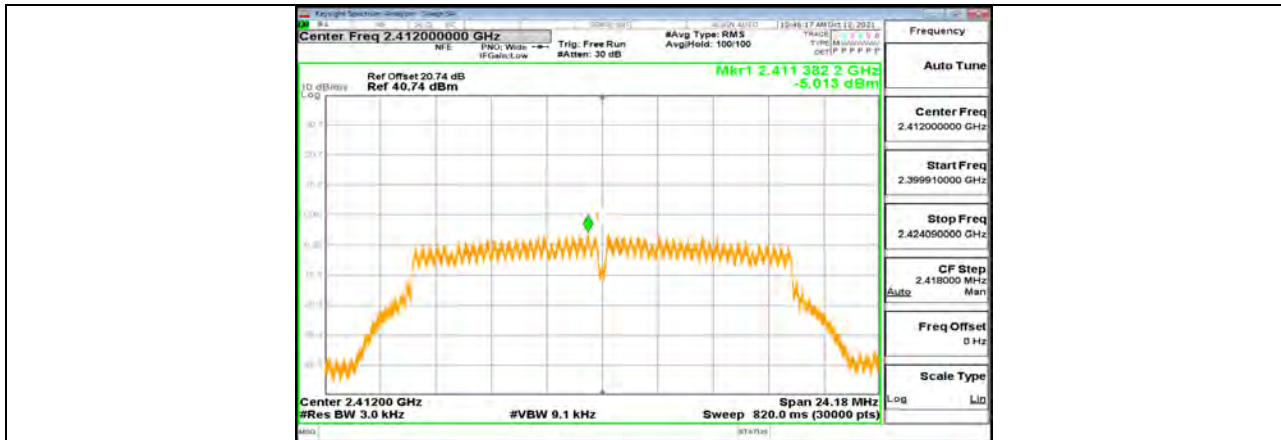

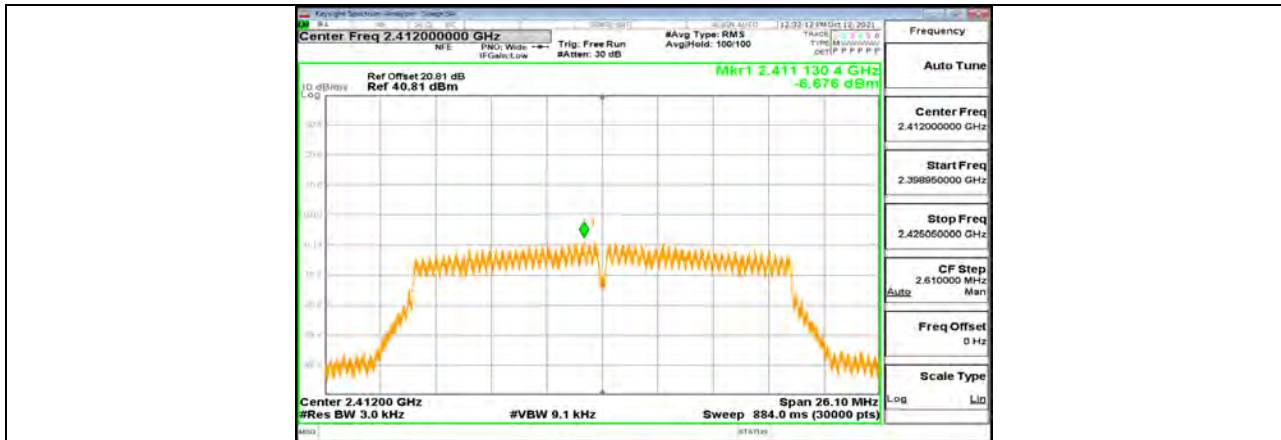

11N20MIMO_Ant1_2412



11N20MIMO_Ant2_2412



11N20MIMO_Ant1_2437

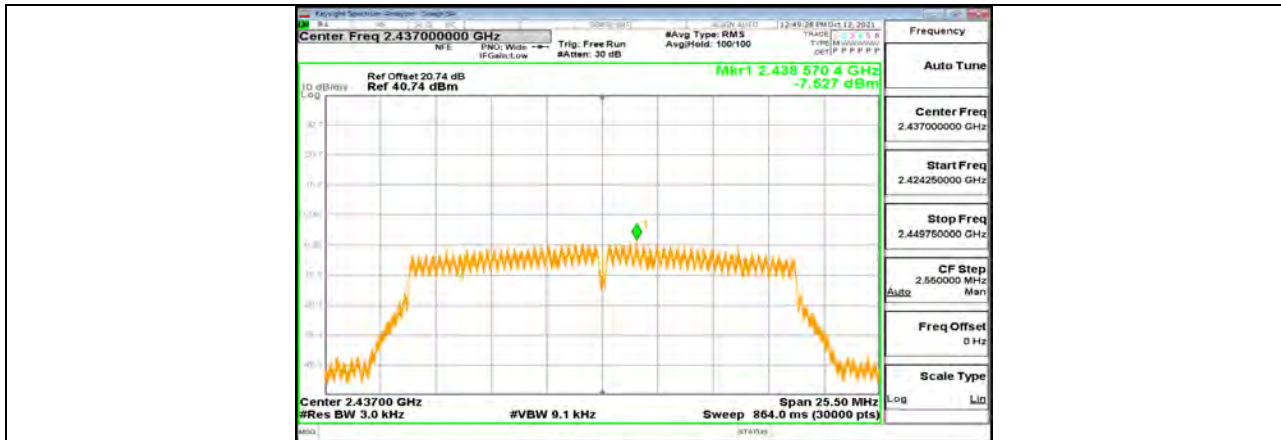

11N20MIMO_Ant2_2437

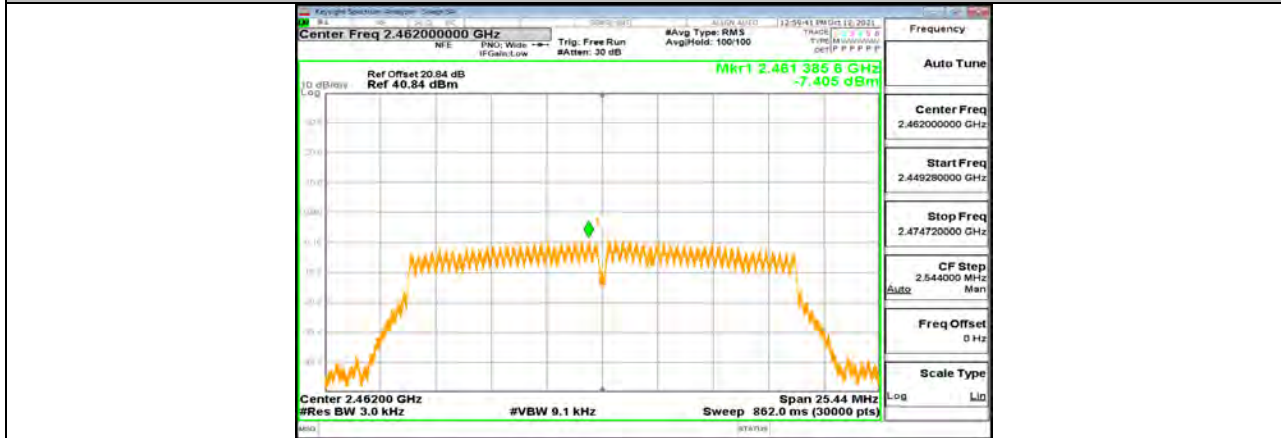

11N20MIMO_Ant1_2462



11N20MIMO_Ant2_2462

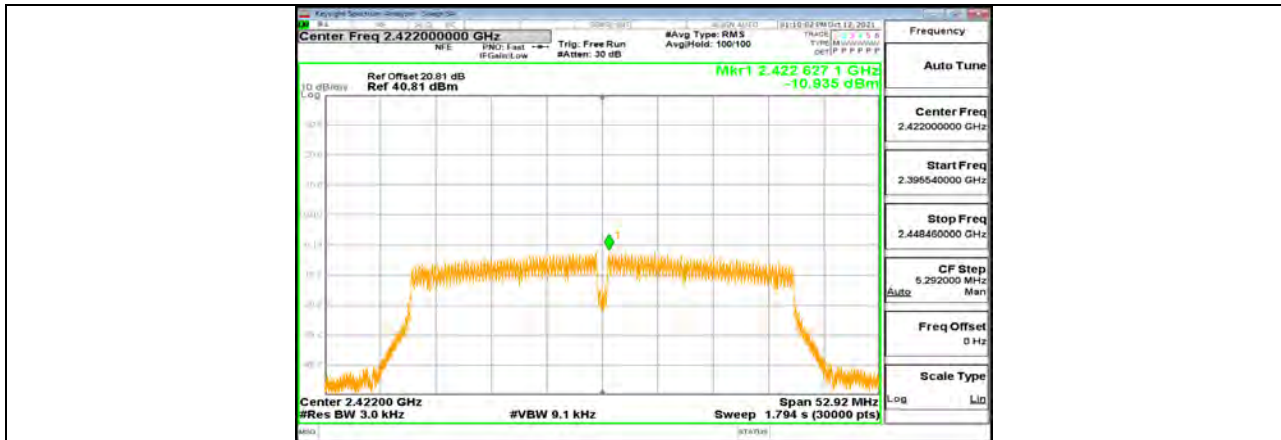

11N40MIMO_Ant1_2422



11N40MIMO_Ant2_2422



11N40MIMO_Ant1_2437

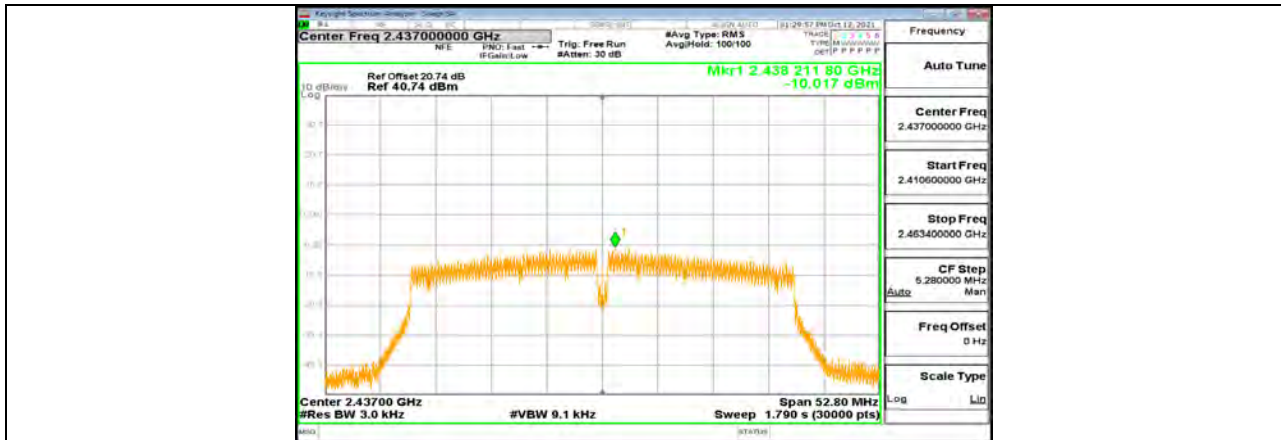

11N40MIMO_Ant2_2437



11N40MIMO_Ant1_2452



11N40MIMO_Ant2_2452



11.5. Appendix E: Band Edge Measurements

11.5.1. Test Result

Test Mode	Antenna	ChName	Channel	Ref Level[dBm]	Result[dBm]	Limit[dBm]	Verdict
11B	Ant2	Low	2412	10.42	-34.95	<=-19.59	PASS
		High	2462	9.68	-39.62	<=-20.32	PASS
11G	Ant2	Low	2412	8.41	-31.43	<=-21.59	PASS
		High	2462	6.51	-39.11	<=-23.49	PASS
11N20MIMO	Ant1	Low	2412	5.97	-30.47	<=-24.03	PASS
	Ant2	Low	2412	6.00	-32.14	<=-24	PASS
	Ant1	High	2462	5.66	-39.34	<=-24.34	PASS
	Ant2	High	2462	6.17	-38.71	<=-23.83	PASS
11N40MIMO	Ant1	Low	2422	3.20	-37.14	<=-26.8	PASS
	Ant2	Low	2422	3.17	-35.19	<=-26.83	PASS
	Ant1	High	2452	1.97	-38.55	<=-28.03	PASS
	Ant2	High	2452	2.10	-39.23	<=-27.9	PASS

Note: For 802.11b and 802.11g modes, both the two channel had been test, but only the worst data was recorded in the report

11.5.2. Test Graphs



11B_Ant2_Low_2412



11B_Ant2_High_2462



11G_Ant2_Low_2412



11G_Ant2_High_2462

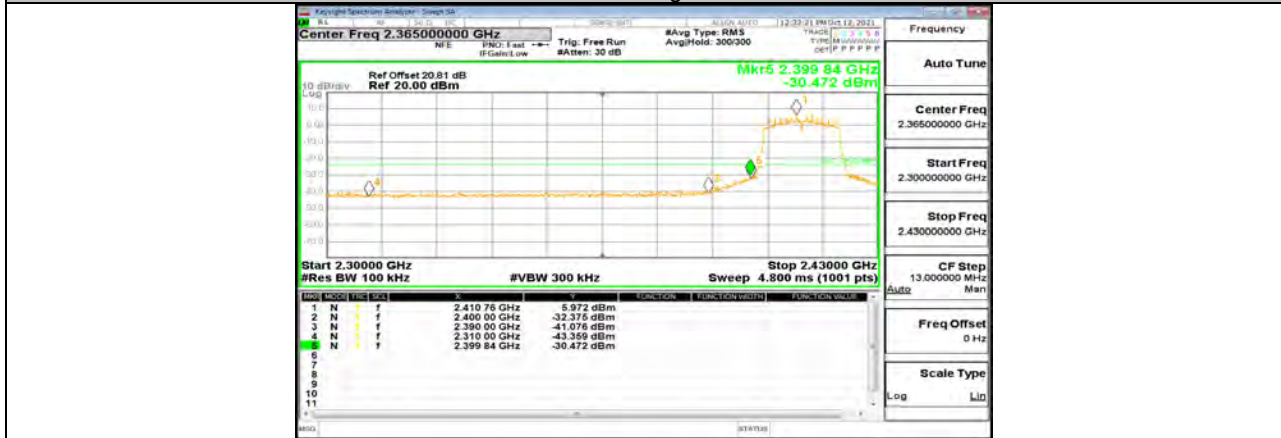

11N20MIMO_Ant1_Low_2412



11N20MIMO_Ant2_Low_2412



11N20MIMO_Ant1_High_2462



11N20MIMO_Ant2_High_2462



11N40MIMO_Ant1_Low_2422



11N40MIMO_Ant2_Low_2422



11N40MIMO_Ant1_High_2452



11N40MIMO_Ant2_High_2452

**11.6. Appendix F: Conducted Spurious Emission****11.6.1. Test Result**

Test Mode	Antenna	Channel	Freq Range [Mhz]	Result [dBm]	Limit [dBm]	Verdict
11B	Ant2	2412	Reference	10.27	---	PASS
			30~1000	-51.5	<=-19.73	PASS
			1000~26500	-42.53	<=-19.73	PASS
		2437	Reference	10.52	---	PASS
			30~1000	-52.49	<=-19.49	PASS
			1000~26500	-43.13	<=-19.49	PASS
		2462	Reference	9.16	---	PASS
			30~1000	-51.62	<=-20.84	PASS
			1000~26500	-42.8	<=-20.84	PASS
11G	Ant2	2412	Reference	8.10	---	PASS
			30~1000	-51.21	<=-21.9	PASS
			1000~26500	-42.88	<=-21.9	PASS
		2437	Reference	8.11	---	PASS
			30~1000	-51.6	<=-21.89	PASS
			1000~26500	-43.02	<=-21.89	PASS
		2462	Reference	6.86	---	PASS
			30~1000	-52.24	<=-23.14	PASS
			1000~26500	-43.42	<=-23.14	PASS
11N20MIMO	Ant1	2412	Reference	5.70	---	PASS
			30~1000	-51.58	<=-24.3	PASS
			1000~26500	-43.43	<=-24.3	PASS
	Ant2	2412	Reference	5.04	---	PASS
			30~1000	-51.68	<=-24.96	PASS
			1000~26500	-43.25	<=-24.96	PASS
	Ant1	2437	Reference	5.81	---	PASS
			30~1000	-51.93	<=-24.19	PASS
			1000~26500	-43.28	<=-24.19	PASS
	Ant2	2437	Reference	5.53	---	PASS
			30~1000	-52.16	<=-24.47	PASS
			1000~26500	-42.86	<=-24.47	PASS
	Ant1	2462	Reference	4.68	---	PASS
			30~1000	-51.27	<=-25.33	PASS
			1000~26500	-42.72	<=-25.33	PASS
	Ant2	2462	Reference	4.84	---	PASS
			30~1000	-50.8	<=-25.16	PASS
			1000~26500	-43.41	<=-25.16	PASS
11N40MIMO	Ant1	2422	Reference	2.10	---	PASS
			30~1000	-51.18	<=-27.9	PASS
			1000~26500	-43.09	<=-27.9	PASS
	Ant2	2422	Reference	3.14	---	PASS
			30~1000	-52.39	<=-26.86	PASS
			1000~26500	-43.21	<=-26.86	PASS
	Ant1	2437	Reference	3.86	---	PASS
			30~1000	-50.26	<=-26.14	PASS
			1000~26500	-43.03	<=-26.14	PASS
	Ant2	2437	Reference	4.01	---	PASS
			30~1000	-51.51	<=-25.99	PASS
			1000~26500	-42.97	<=-25.99	PASS
	Ant1	2452	Reference	1.89	---	PASS
			30~1000	-52.14	<=-28.12	PASS
			1000~26500	-42.35	<=-28.12	PASS
	Ant2	2452	Reference	2.07	---	PASS
			30~1000	-51.84	<=-27.93	PASS
			1000~26500	-42.64	<=-27.93	PASS



Note: For 802.11b and 802.11g modes, both the two channel had been test, but only the worst data was recorded in the report

11.6.2. Test Graphs

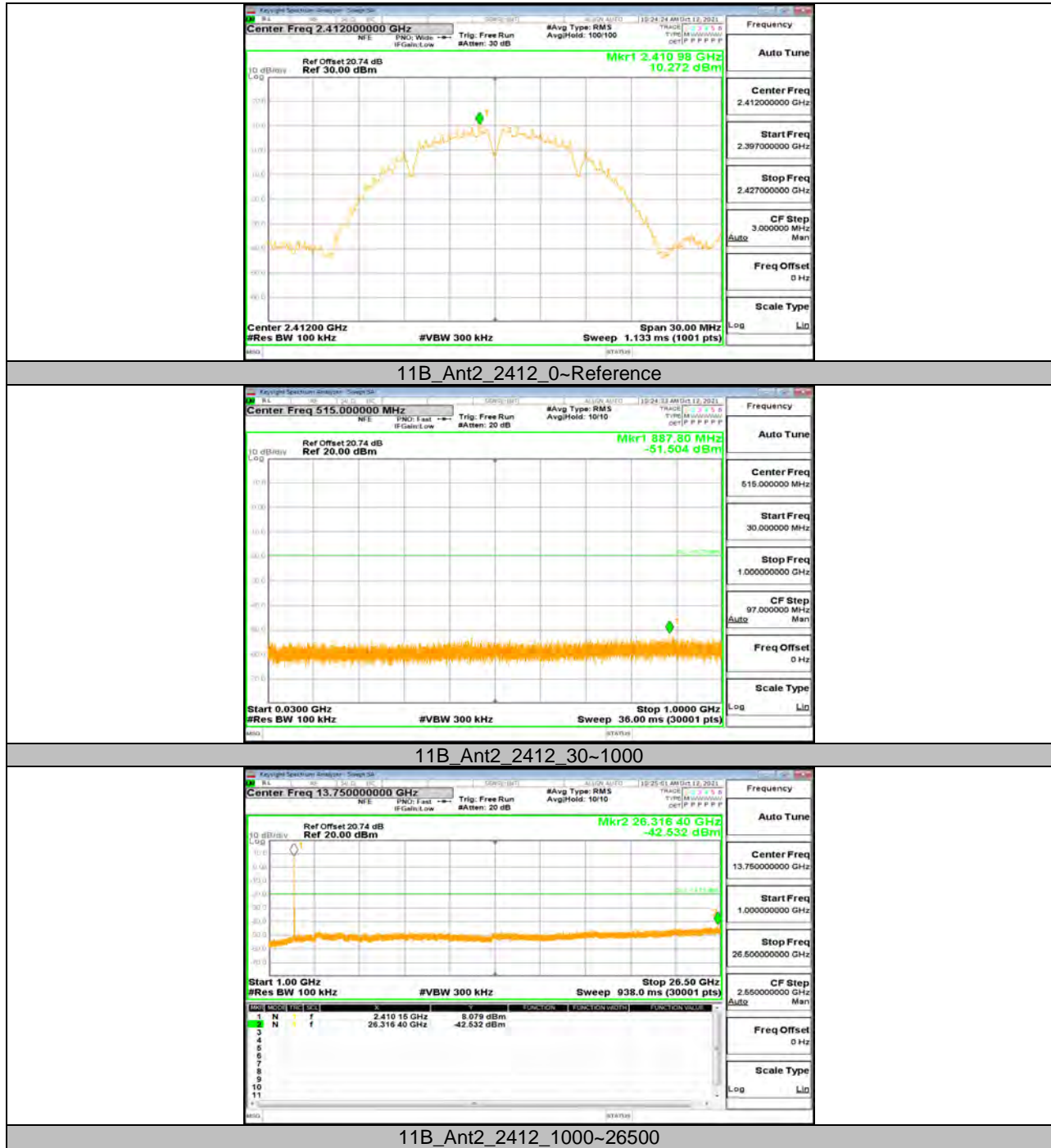



11B_Ant2_2437_0-Reference

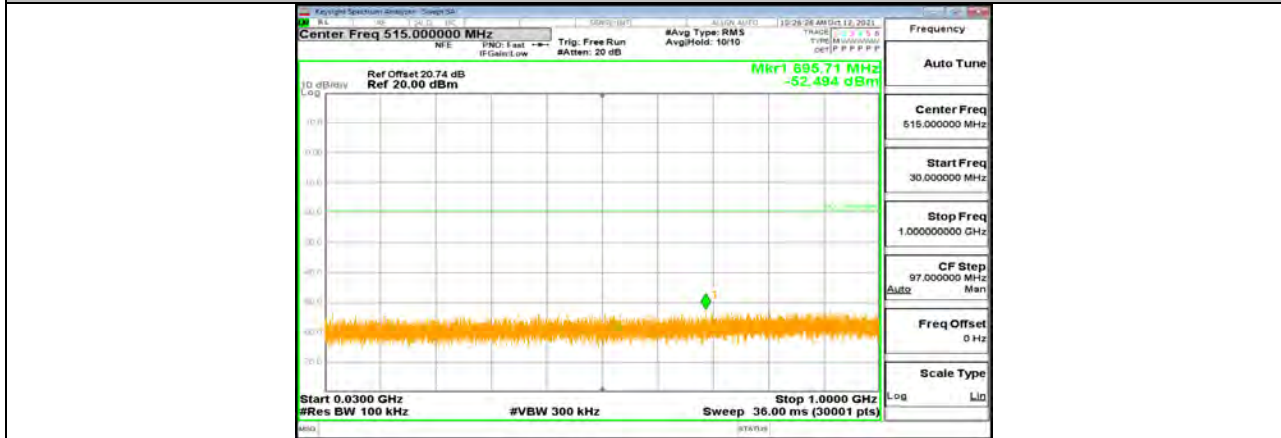

11B_Ant2_2437_30-1000



11B_Ant2_2437_1000-26500



11B_Ant2_2462_0-Reference

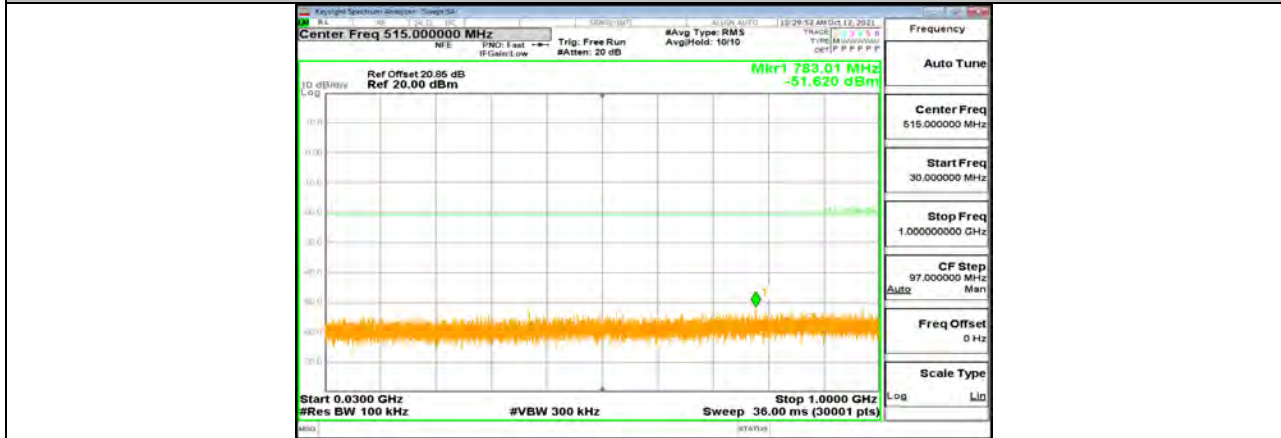

11B_Ant2_2462_30-1000

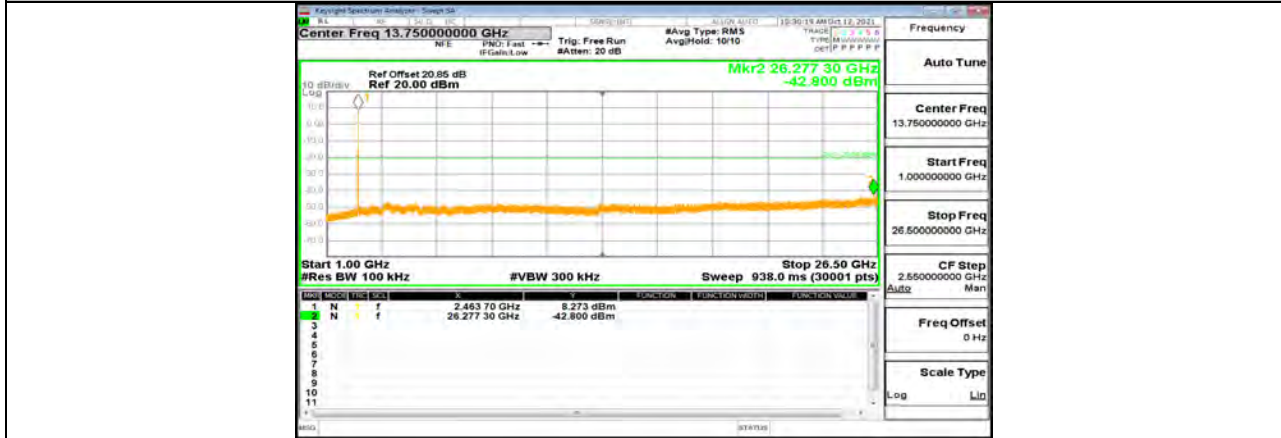

11B_Ant2_2462_1000-26500



11G_Ant2_2412_0-Reference

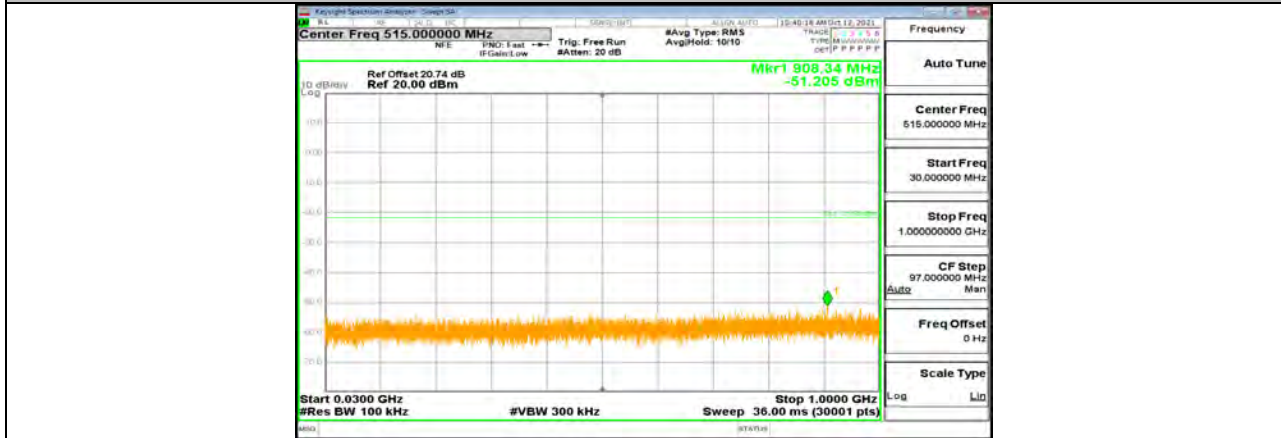

11G_Ant2_2412_30-1000



11G_Ant2_2412_1000-26500

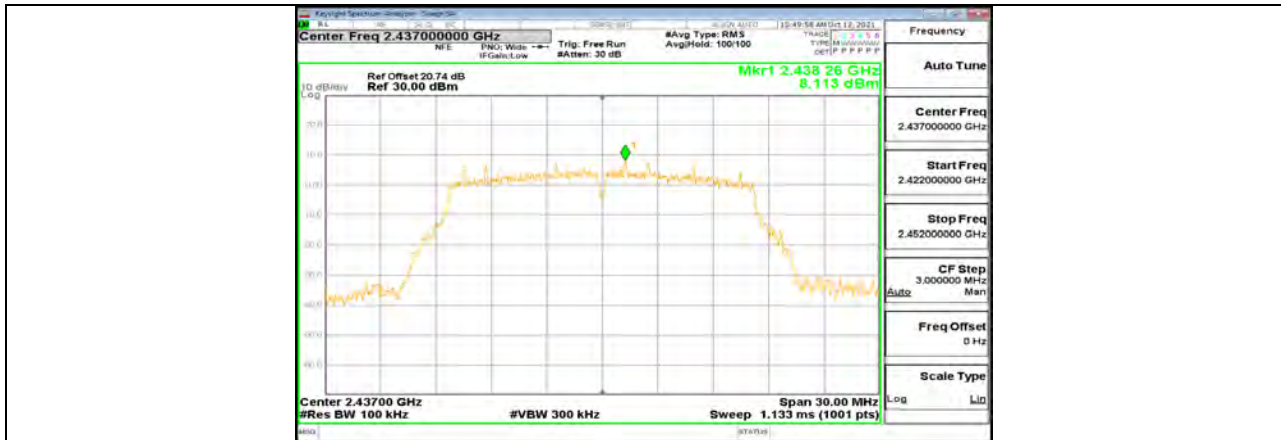

11G_Ant2_2437_0-Reference

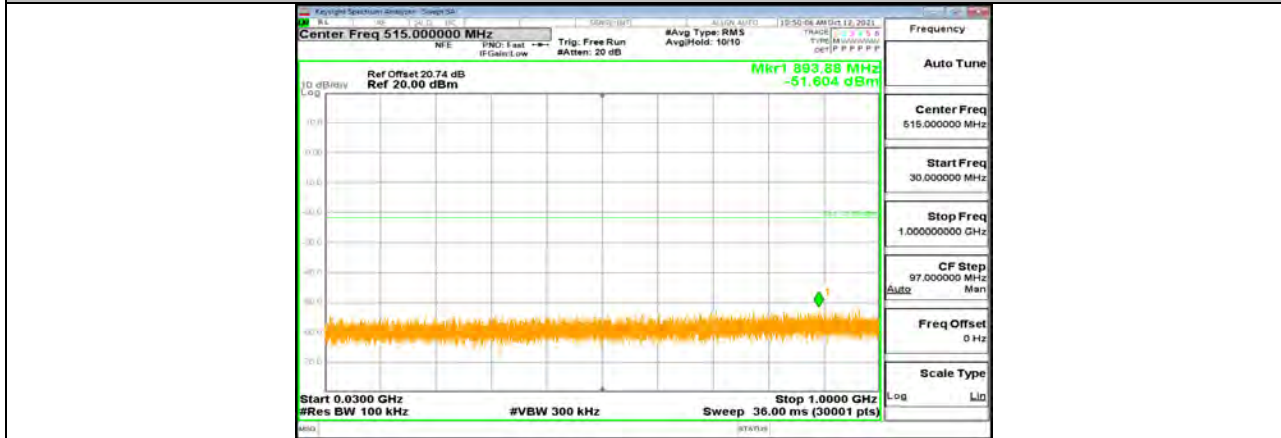

11G_Ant2_2437_30-1000

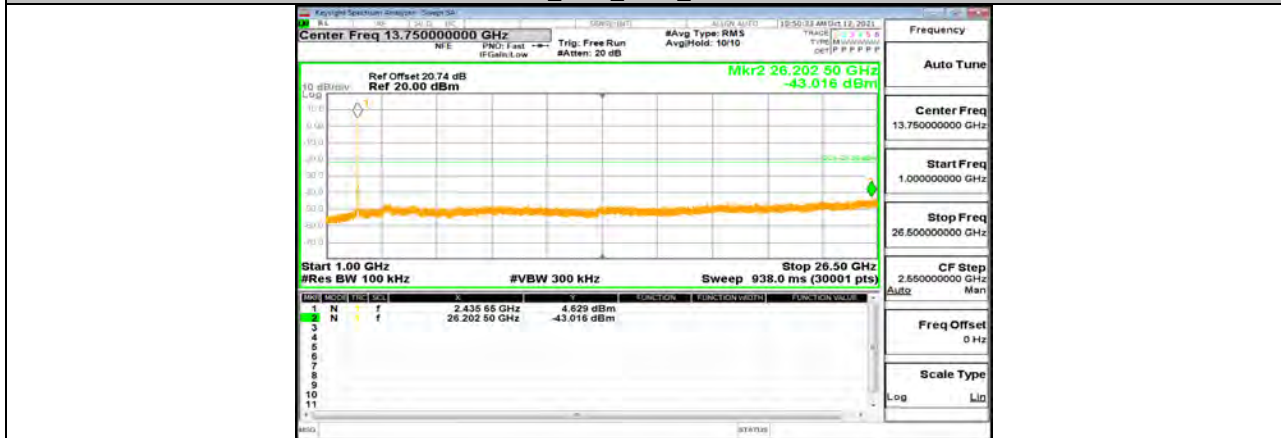

11G_Ant2_2437_1000-26500



11G_Ant2_2462_0-Reference

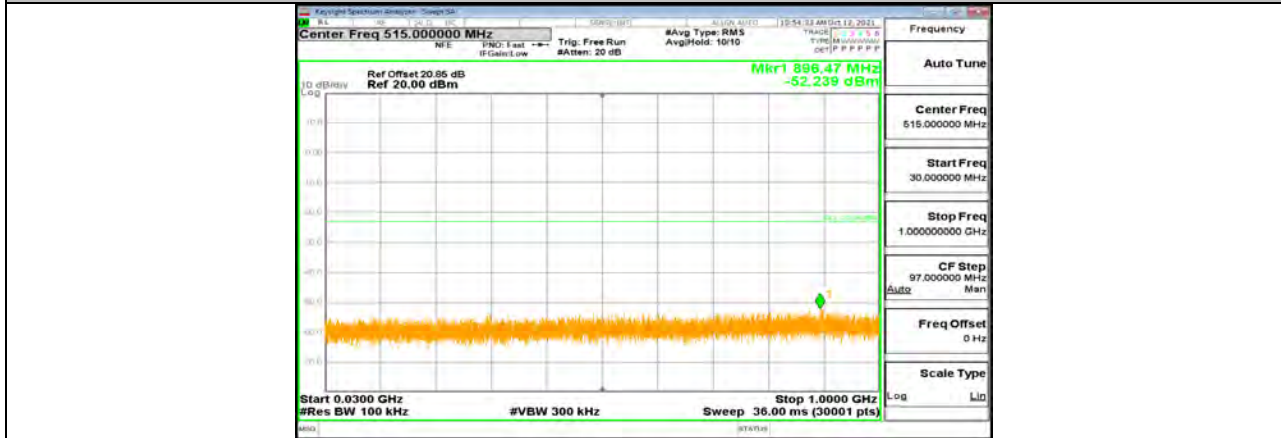

11G_Ant2_2462_30-1000

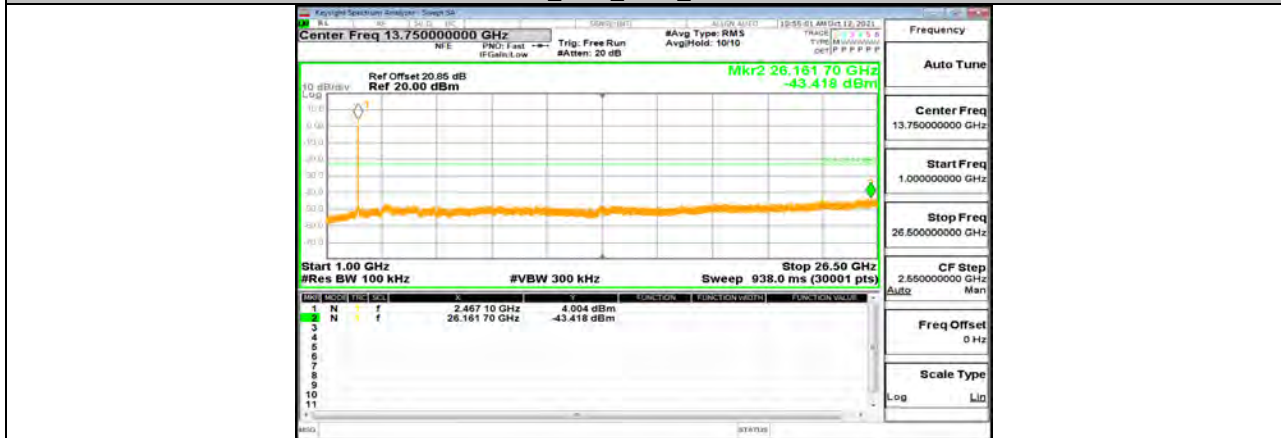

11G_Ant2_2462_1000-26500



11N20MIMO_Ant1_2412_0~Reference

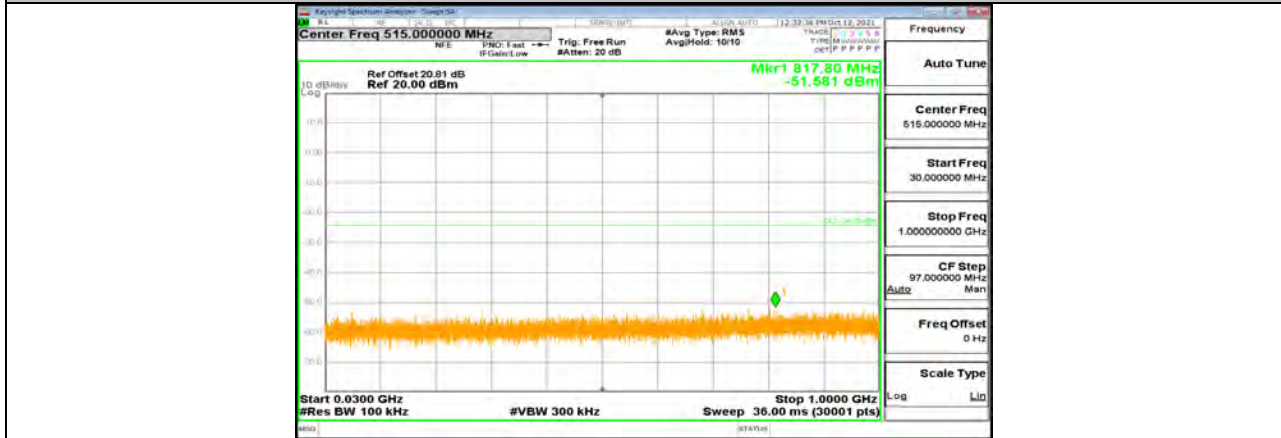

11N20MIMO_Ant1_2412_30~1000



11N20MIMO_Ant1_2412_1000~26500



11N20MIMO_Ant2_2412_0~Reference

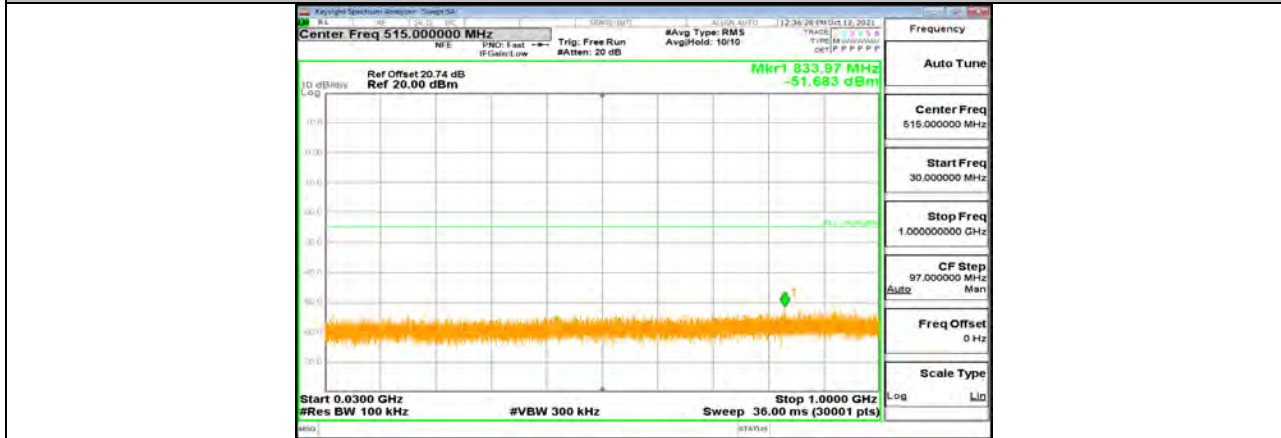

11N20MIMO_Ant2_2412_30~1000



11N20MIMO_Ant2_2412_1000~26500



11N20MIMO_Ant1_2437_0~Reference

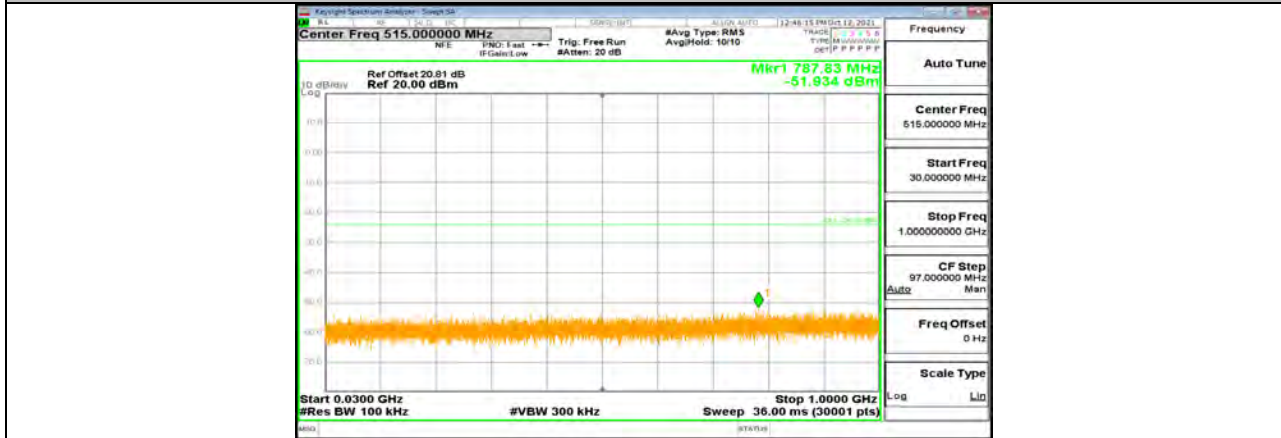

11N20MIMO_Ant1_2437_30~1000

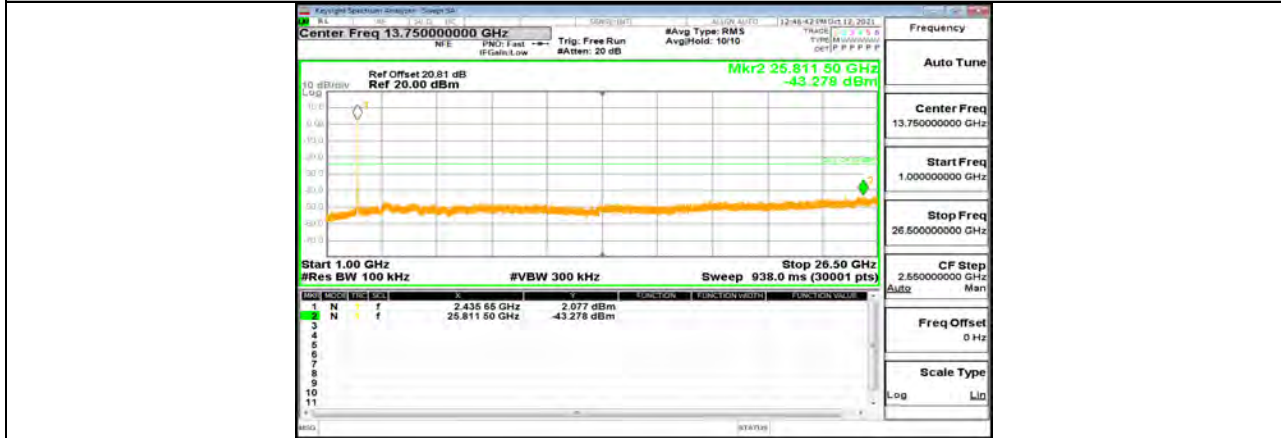

11N20MIMO_Ant1_2437_1000~26500



11N20MIMO_Ant2_2437_0~Reference

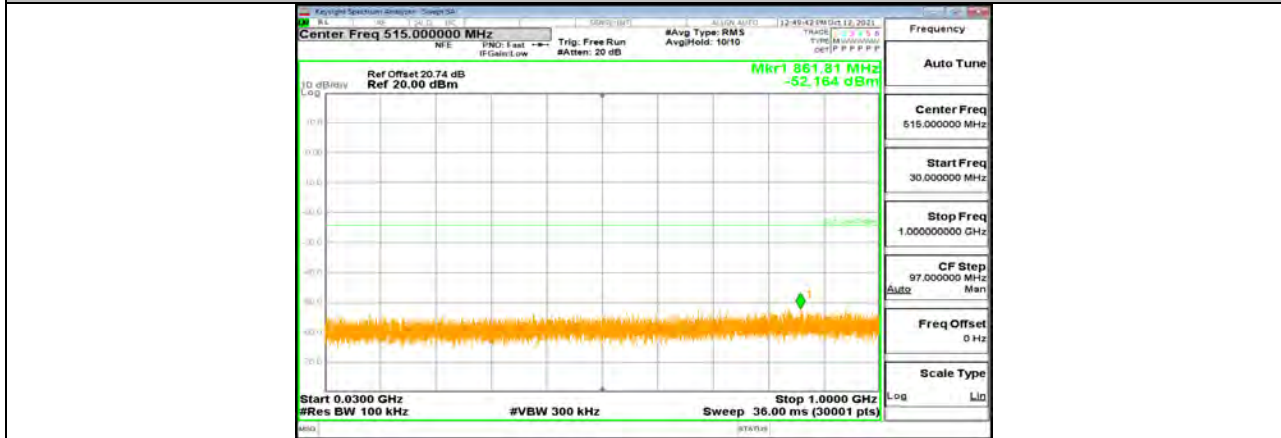

11N20MIMO_Ant2_2437_30~1000

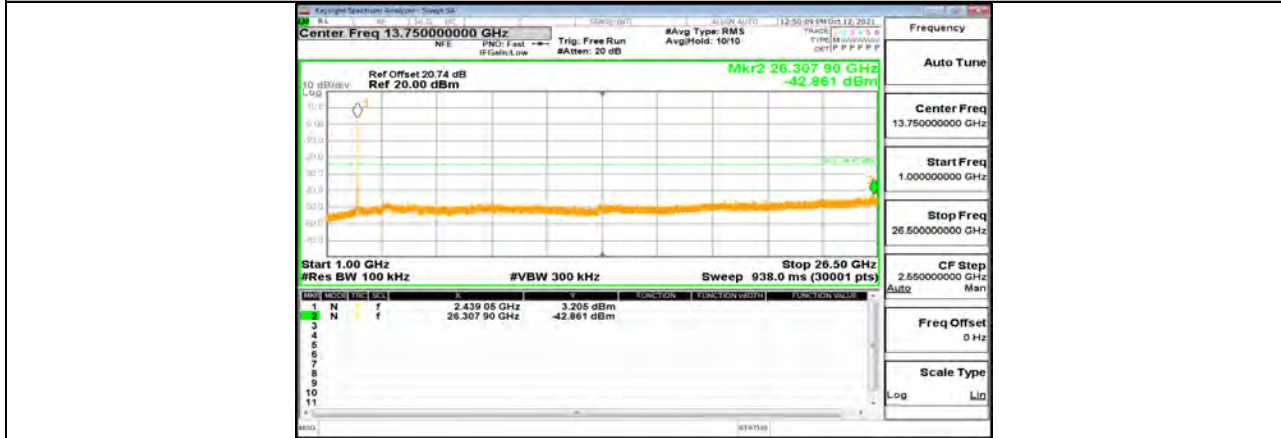

11N20MIMO_Ant2_2437_1000~26500



11N20MIMO_Ant1_2462_0~Reference

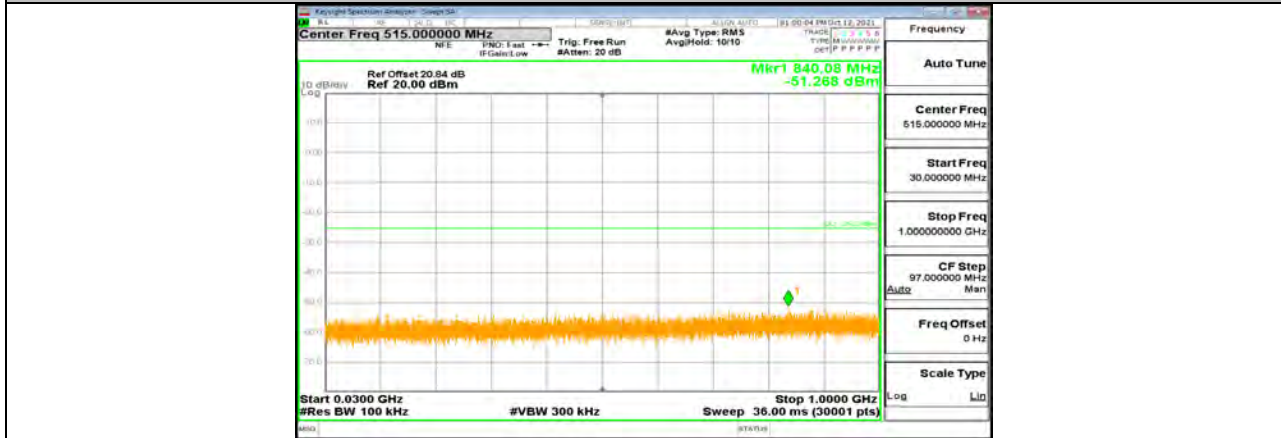

11N20MIMO_Ant1_2462_30~1000

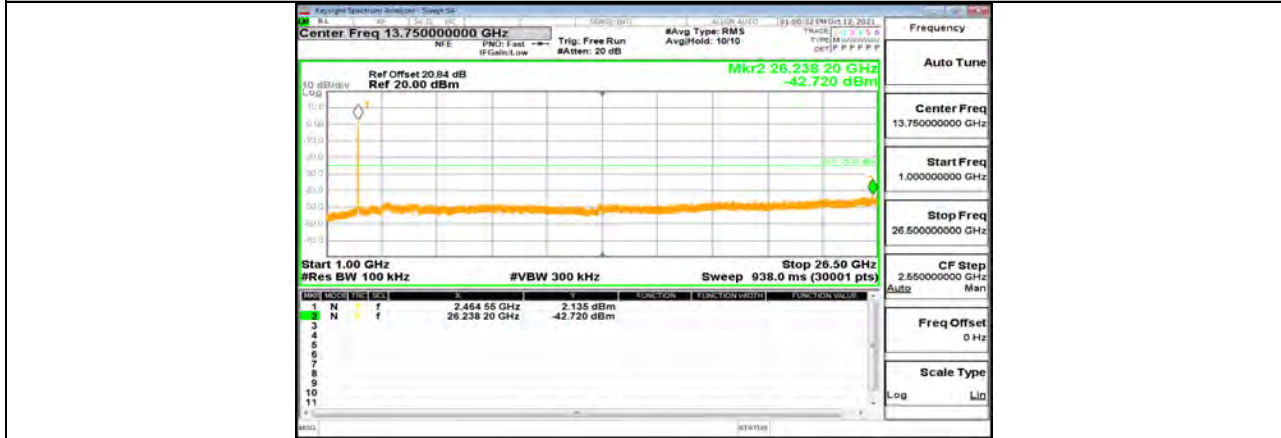

11N20MIMO_Ant1_2462_1000~26500



11N20MIMO_Ant2_2462_0~Reference

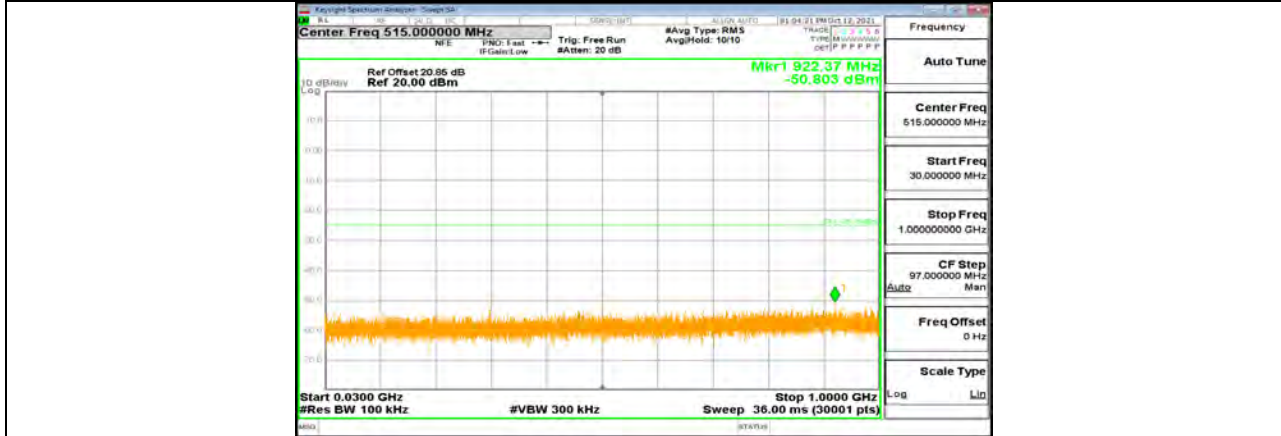

11N20MIMO_Ant2_2462_30~1000

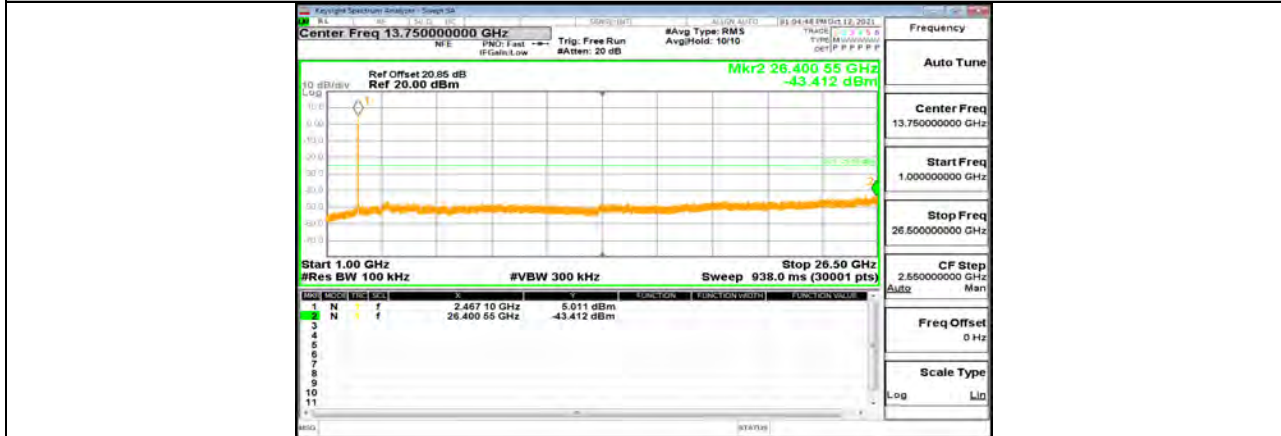

11N20MIMO_Ant2_2462_1000~26500



11N40MIMO_Ant1_2422_0~Reference

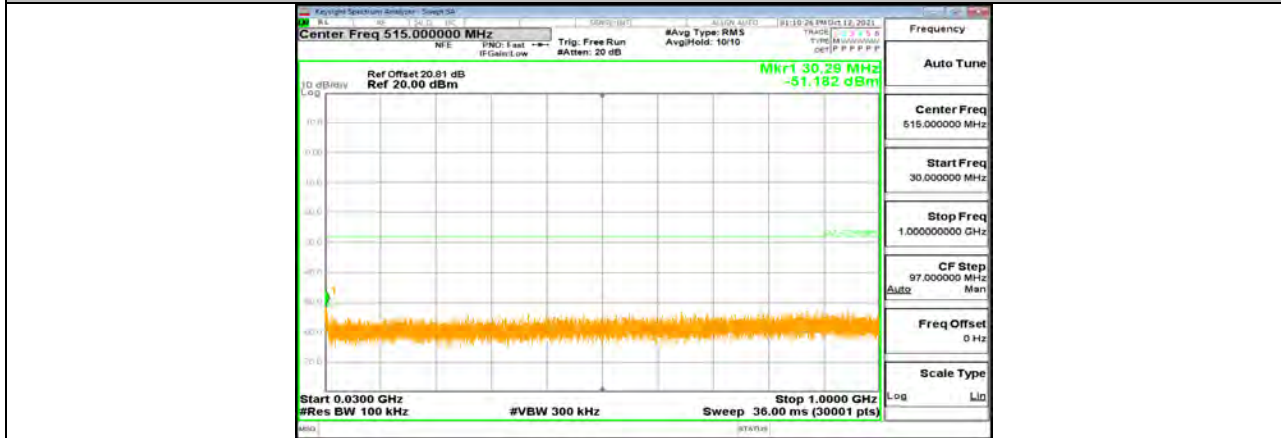

11N40MIMO_Ant1_2422_30~1000



11N40MIMO_Ant1_2422_1000~26500



11N40MIMO_Ant2_2422_0~Reference

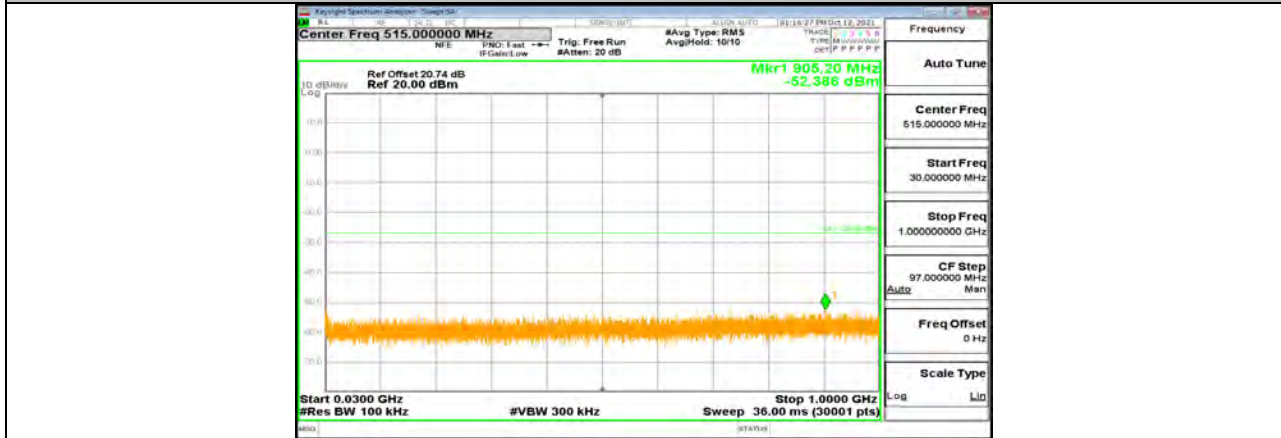

11N40MIMO_Ant2_2422_30~1000

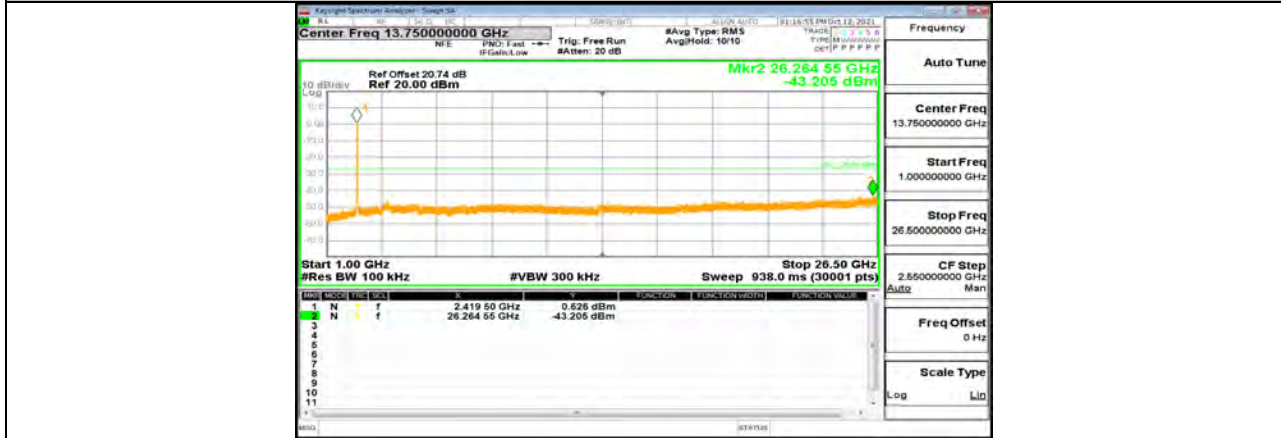

11N40MIMO_Ant2_2422_1000~26500



11N40MIMO_Ant1_2437_0~Reference

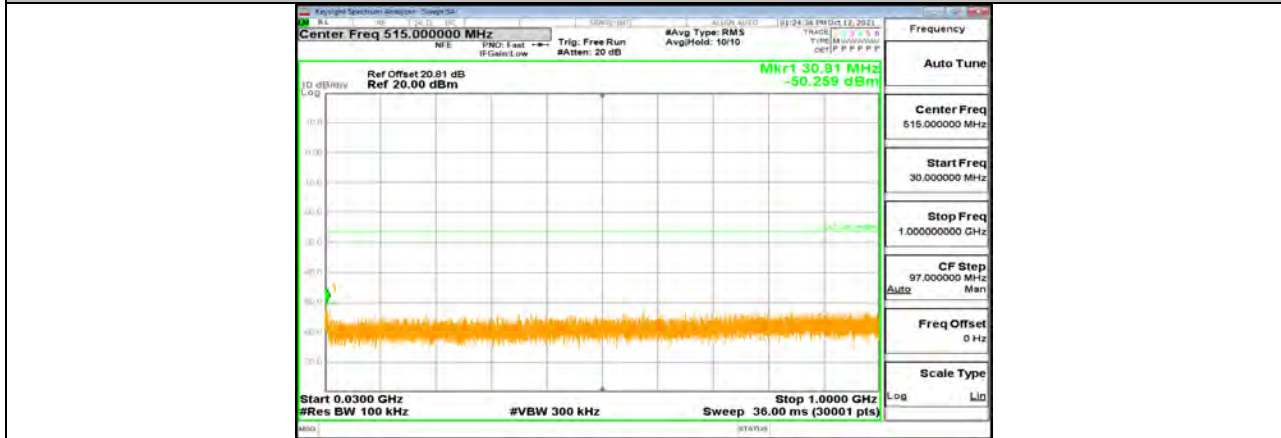

11N40MIMO_Ant1_2437_30~1000



11N40MIMO_Ant1_2437_1000~26500



11N40MIMO_Ant2_2437_0~Reference

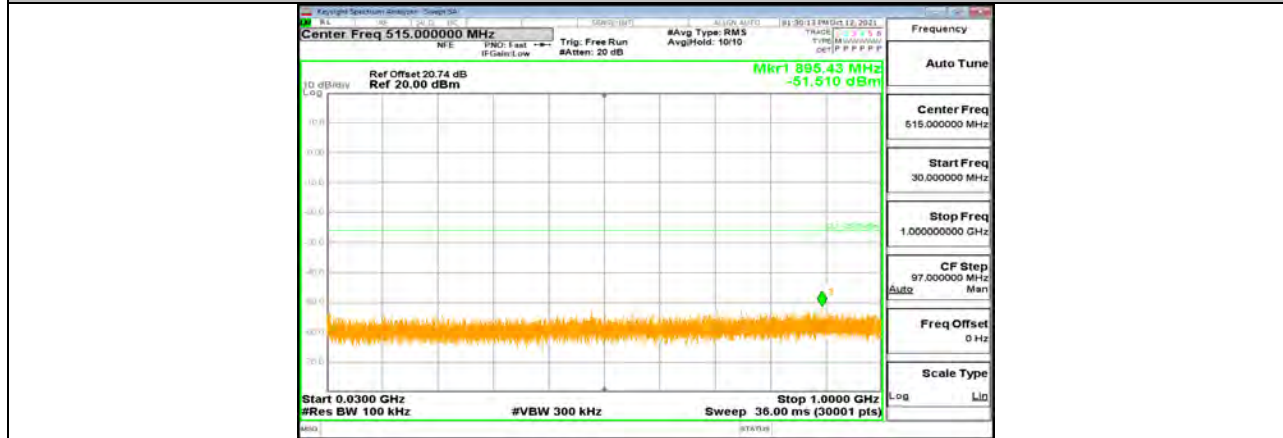

11N40MIMO_Ant2_2437_30~1000

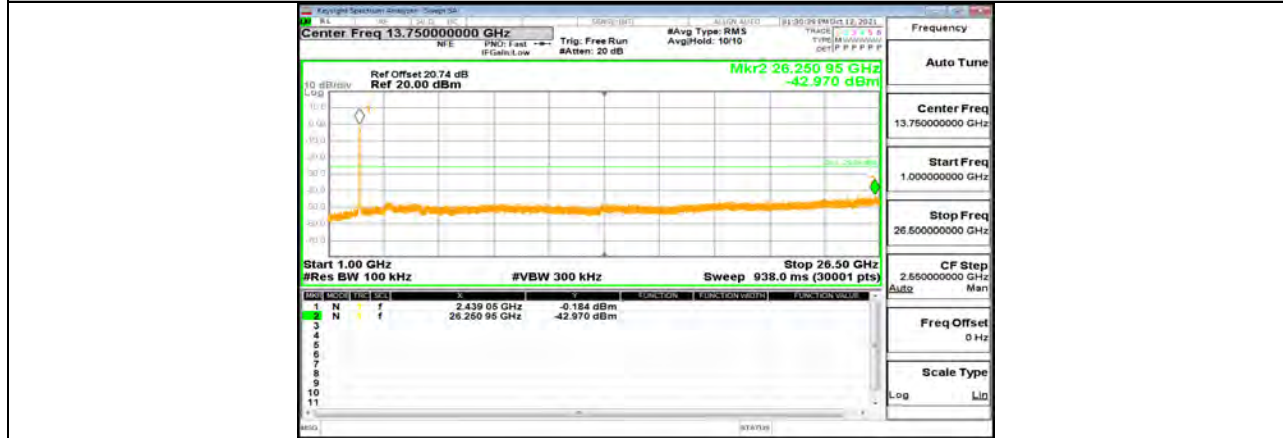

11N40MIMO_Ant2_2437_1000~26500



11N40MIMO_Ant1_2452_0~Reference

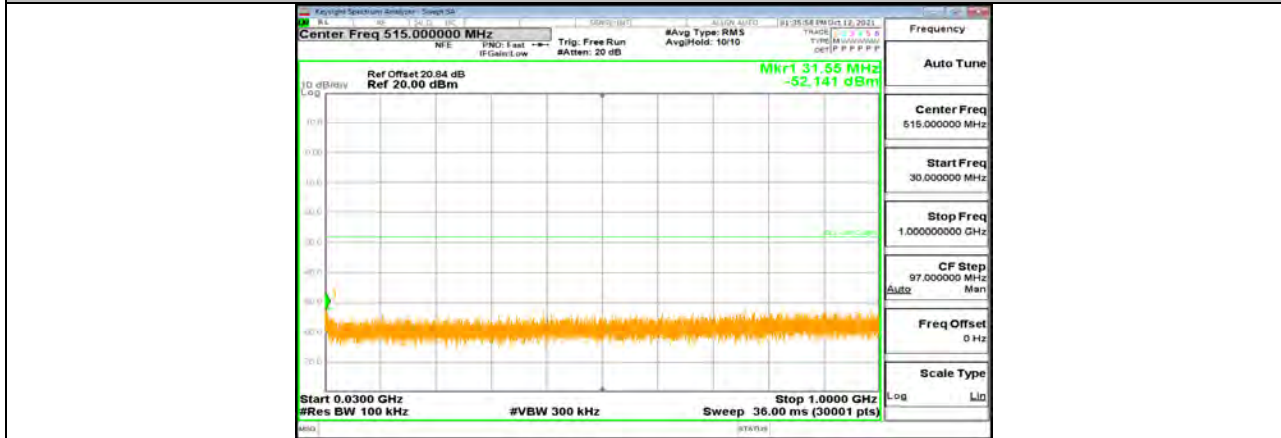

11N40MIMO_Ant1_2452_30~1000

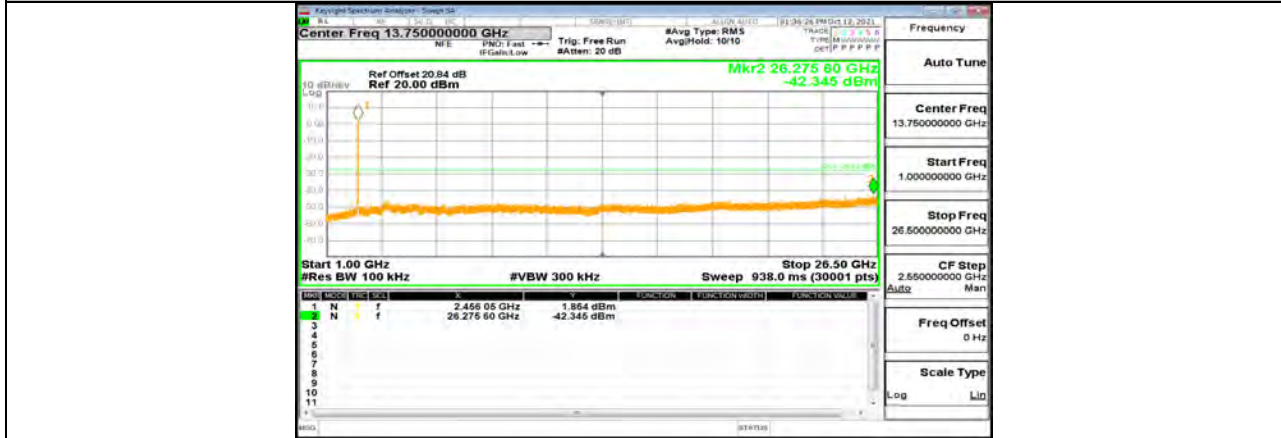

11N40MIMO_Ant1_2452_1000~26500

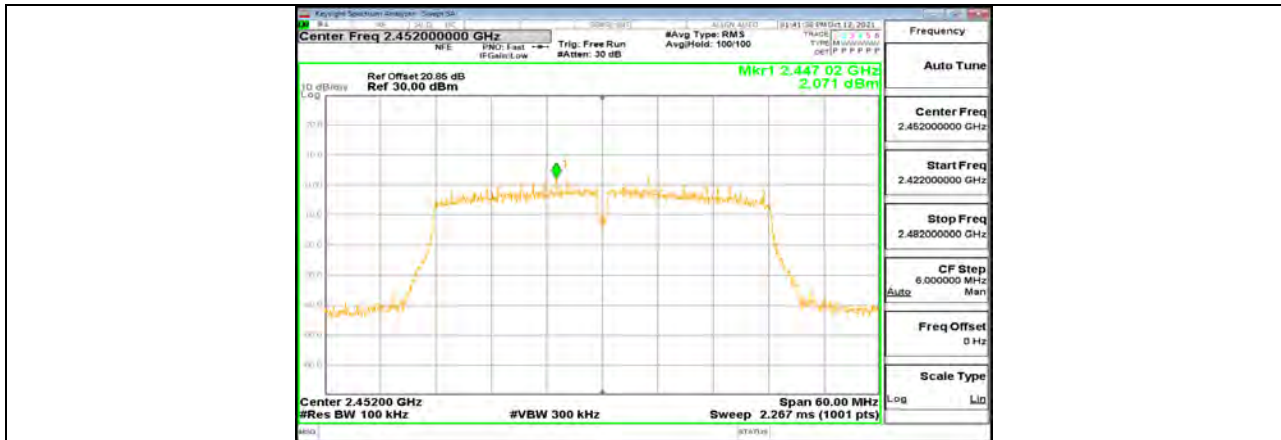

11N40MIMO_Ant2_2452_0~Reference

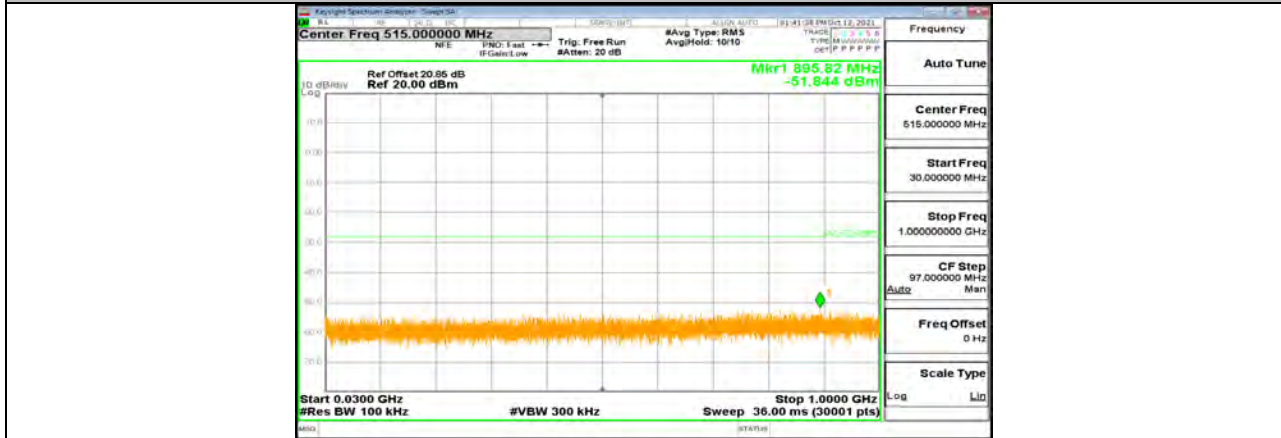

11N40MIMO_Ant2_2452_30~1000

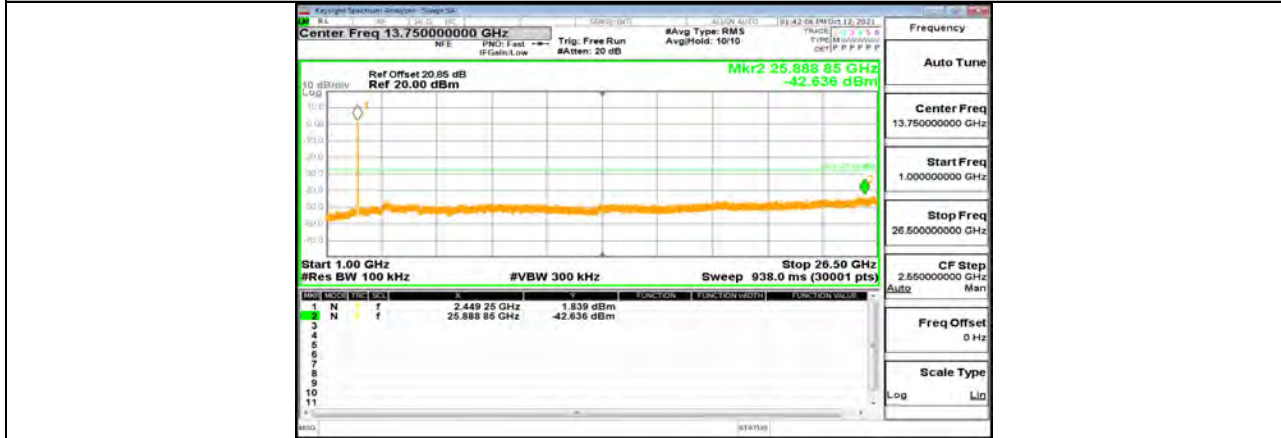

11N40MIMO_Ant2_2452_1000~26500



11.7. Appendix G: Duty Cycle
11.7.1. Test Result

Test Mode	On Time (msec)	Period (msec)	Duty Cycle x (Linear)	Duty Cycle (%)	Duty Cycle Correction Factor (dB)	1/T Minimum VBW (kHz)	Final setting For VBW (kHz)
11B	8.38	8.42	0.9952	99.52	0.02	0.12	0.01
11G	1.39	1.43	0.9720	97.20	0.12	0.72	1
11N20MIMO	1.30	1.34	0.9701	97.01	0.13	0.77	1
11N40MIMO	0.65	0.69	0.9420	94.20	0.26	1.54	2

Note:

Duty Cycle Correction Factor=10log (1/x).

Where: x is Duty Cycle (Linear)

Where: T is On Time

If that calculated VBW is not available on the analyzer then the next higher value should be used.

11.7.2. Test Graphs



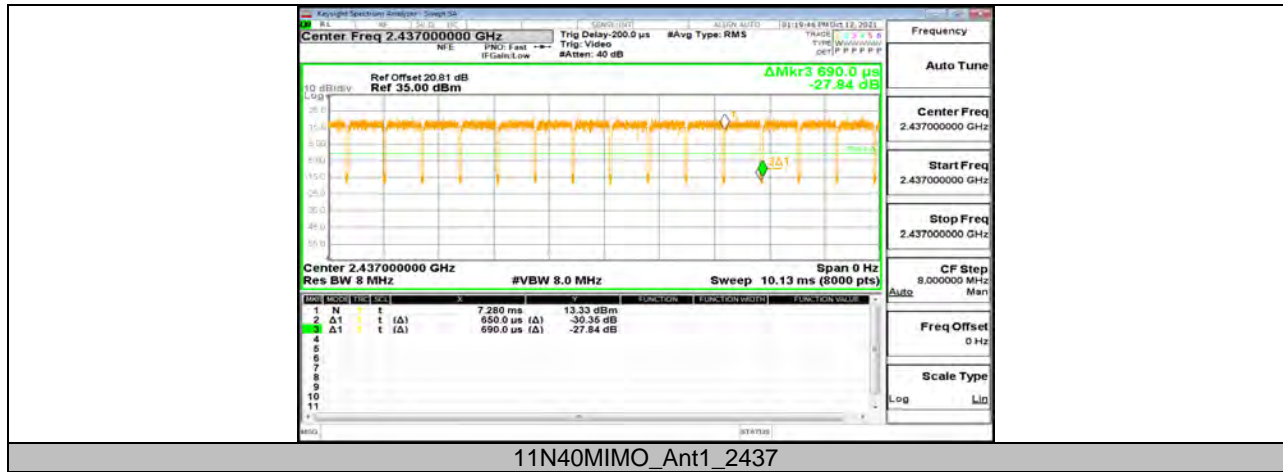

11N40MIMO_Ant1_2437

END OF REPORT