



**CFR 47 FCC PART 15 SUBPART C
ISED RSS-247 ISSUE 2**

CERTIFICATION TEST REPORT

For

WIFI Module

MODEL NUMBER: W8ER2500

FCC ID: 2AC23-W8E

ISED: 12290A-W8E

REPORT NUMBER: 4790076847.2-1

ISSUE DATE: September 18, 2021

Prepared for

**Hui Zhou Gaoshengda Technology Co.,LTD
NO.75 Zhongkai Development Area, Huizhou, Guangdong, China**

Prepared by

UL Verification Services (Guangzhou) Co., Ltd, Song Shan Lake Branch

Building 10, Innovation Technology Park, No. 1, Li Bin Road, Song Shan Lake Hi-Tech Development Zone Dongguan, 523808, People's Republic of China

Tel: +86 769 22038881

Fax: +86 769 33244054

Website: www.ul.com



Revision History

<u>Rev.</u>	<u>Issue Date</u>	<u>Revisions</u>	<u>Revised By</u>
V0	09/18/2021	Initial Issue	



Summary of Test Results			
Clause	Test Items	FCC/ISED Rules	Test Results
1	6dB Bandwidth and 99% Occupied Bandwidth	FCC Part 15.247 (a) (2) RSS-247 Clause 5.2 (a) ISED RSS-Gen Clause 6.7	Pass
2	Conducted Output Power	FCC Part 15.247 (b) (3) RSS-247 Clause 5.4 (d)	Pass
3	Power Spectral Density	FCC Part 15.247 (e) RSS-247 Clause 5.2 (b)	Pass
4	Conducted Bandedge and Spurious Emission	FCC Part 15.247 (d) RSS-247 Clause 5.5	Pass
5	Radiated Bandedge and Spurious Emission	FCC Part 15.247 (d) FCC Part 15.209 FCC Part 15.205 RSS-247 Clause 5.5 RSS-GEN Clause 8.9	Pass
6	Conducted Emission Test for AC Power Port	FCC Part 15.207 RSS-GEN Clause 8.8	Pass
7	Antenna Requirement	FCC Part 15.203 RSS-GEN Clause 6.8	Pass
Note: 1.This test report is only published to and used by the applicant, and it is not for evidence purpose in China. 2. The measurement result for the sample received is <Pass> according to < CFR 47 FCC PART 15 SUBPART C >< ISED RSS-247 > when <Accuracy Method> decision rule is applied.			



TABLE OF CONTENTS

1. ATTESTATION OF TEST RESULTS	6
2. TEST METHODOLOGY	7
3. FACILITIES AND ACCREDITATION	7
4. CALIBRATION AND UNCERTAINTY	8
4.1. <i>MEASURING INSTRUMENT CALIBRATION</i>	8
4.2. <i>MEASUREMENT UNCERTAINTY</i>	8
5. EQUIPMENT UNDER TEST	9
5.1. <i>DESCRIPTION OF EUT</i>	9
5.2. <i>CHANNEL LIST</i>	9
5.3. <i>MAXIMUM OUTPUT POWER</i>	9
5.4. <i>TEST CHANNEL CONFIGURATION</i>	9
5.5. <i>THE WORSE CASE POWER SETTING PARAMETER</i>	10
5.6. <i>THE WORSE CASE CONFIGURATIONS</i>	10
5.7. <i>DESCRIPTION OF AVAILABLE ANTENNAS</i>	12
5.8. <i>DESCRIPTION OF TEST SETUP</i>	13
6. MEASURING INSTRUMENT AND SOFTWARE USED	14
7. ANTENNA PORT TEST RESULTS	16
7.1. <i>ON TIME AND DUTY CYCLE</i>	16
7.2. <i>6 dB DTS BANDWIDTH AND 99 % OCCUPIED BANDWIDTH</i>	17
7.3. <i>CONDUCTED OUTPUT POWER</i>	19
7.4. <i>POWER SPECTRAL DENSITY</i>	20
7.5. <i>CONDUCTED BANDEDGE AND SPURIOUS EMISSIONS</i>	22
8. RADIATED TEST RESULTS	24
8.1. <i>RESTRICTED BANDEDGE</i>	30
8.1.1. <i>802.11b SISO MODE</i>	30
8.1.2. <i>802.11g SISO MODE</i>	35
8.1.3. <i>802.11n HT20 MIMO MODE</i>	39
8.1.4. <i>802.11n HT40 MIMO MODE</i>	43
8.2. <i>SPURIOUS EMISSIONS (1 GHz ~ 3 GHz)</i>	47
8.2.1. <i>802.11b SISO MODE</i>	47
8.3. <i>SPURIOUS EMISSIONS (3 GHz ~ 18 GHz)</i>	53
8.3.1. <i>802.11b SISO MODE</i>	53
8.3.2. <i>802.11g SISO MODE</i>	59
8.3.3. <i>802.11n HT20 MIMO MODE</i>	65
8.3.4. <i>802.11n HT40 MIMO MODE</i>	71



8.5.	SPURIOUS EMISSIONS (18 GHz ~ 26 GHz)	77
8.5.1.	802.11n HT40 MIMO MODE	77
8.6.	SPURIOUS EMISSIONS (30 MHz ~ 1 GHz).....	79
8.6.1.	802.11n HT40 MIMO MODE	79
8.7.	SPURIOUS EMISSIONS BELOW 30 MHz	81
8.7.1.	802.11n HT40 MIMO MODE	81
9.	AC POWER LINE CONDUCTED EMISSIONS	84
9.1.1.	802.11n HT40 MIMO MODE	85
10.	ANTENNA REQUIREMENTS	87
11.	Appendix	88
11.1.	Appendix A: DTS Bandwidth.....	88
11.1.1.	Test Result.....	88
11.1.2.	Test Graphs	89
11.2.	Appendix B: Occupied Channel Bandwidth	97
11.2.1.	Test Result.....	97
11.2.2.	Test Graphs	98
11.3.	Appendix C: Maximum conducted output power	106
11.3.1.	Test Result.....	106
11.4.	Appendix D: Maximum power spectral density	107
11.4.1.	Test Result.....	107
11.4.2.	Test Graphs	108
11.5.	Appendix E: Band edge measurements	114
11.5.1.	Test Result.....	114
11.5.2.	Test Graphs	115
11.6.	Appendix F: Conducted Spurious Emission.....	119
11.6.1.	Test Result.....	119
11.6.2.	Test Graphs	120
11.7.	Appendix G: Duty Cycle.....	138
11.7.1.	Test Result.....	138
11.7.2.	Test Graphs	139



1. ATTESTATION OF TEST RESULTS

Applicant Information

Company Name: Hui Zhou Gaoshengda Technology Co.,LTD
Address: NO.75 Zhongkai Development Area, Huizhou, Guangdong, China

Manufacturer Information

Company Name: Hui Zhou Gaoshengda Technology Co.,LTD
Address: NO.75 Zhongkai Development Area, Huizhou, Guangdong, China

EUT Information

EUT Name: WIFI Module
Model: W8ER2500
Brand: GSD
Sample Received Date: August 24, 2021
Sample Status: Normal
Sample ID: 4167750
Date of Tested: August 24, 2021 ~ September 17, 2021

APPLICABLE STANDARDS	
STANDARD	TEST RESULTS
CFR 47 FCC PART 15 SUBPART C	PASS
ISED RSS-247 Issue 2	PASS
ISED RSS-GEN Issue 5	PASS

Prepared By:

Kebo Zhang
Project Engineer

Checked By:

Shawn Wen
Laboratory Leader

Approved By:

Stephen Guo
Laboratory Manager



2. TEST METHODOLOGY

The tests documented in this report were performed in accordance with KDB 558074 D01 15.247 Meas Guidance v05r02, KDB 414788 D01 Radiated Test Site v01r01, CFR 47 FCC Part 2, CFR 47 FCC Part 15, ANSI C63.10-2013, ISED RSS-247 Issue 2 and ISED RSS-GEN Issue 5.

3. FACILITIES AND ACCREDITATION

Accreditation Certificate	<p>A2LA (Certificate No.: 4102.01) UL Verification Services (Guangzhou) Co., Ltd. Song Shan Lake Branch. has been assessed and proved to be in compliance with A2LA.</p> <p>FCC (FCC Designation No.: CN1187) UL Verification Services (Guangzhou) Co., Ltd. Song Shan Lake Branch. Has been recognized to perform compliance testing on equipment subject to the Commission's Delcaration of Conformity (DoC) and Certification rules</p> <p>ISED (Company No.: 21320) UL Verification Services (Guangzhou) Co., Ltd. Song Shan Lake Branch. has been registered and fully described in a report filed with ISED. The Company Number is 21320 and the test lab Conformity Assessment Body Identifier (CABID) is CN0046.</p> <p>VCCI (Registration No.: G-20019, R-20004, C-20012 and T-20011) UL Verification Services (Guangzhou) Co., Ltd. Song Shan Lake Branch. has been assessed and proved to be in compliance with VCCI, the Membership No. is 3793. Facility Name: Chamber D, the VCCI registration No. is G-20019 and R-20004 Shielding Room B , the VCCI registration No. is C-20012 and T-20011</p>
---------------------------	---

Note 1: All tests measurement facilities use to collect the measurement data are located at Building 10, Innovation Technology Park, Song Shan Lake Hi tech Development Zone, Dongguan, 523808, China

Note 2: The test anechoic chamber in UL Verification Services (Guangzhou) Co., Ltd. Song Shan Lake Branch had been calibrated and compared to the open field sites and the test anechoic chamber is shown to be equivalent to or worst case from the open field site.

Note 3: For below 30 MHz, lab had performed measurements at test anechoic chamber and comparing to measurements obtained on an open field site. And these measurements below 30 MHz had been correlated to measurements performed on an OFS.



4. CALIBRATION AND UNCERTAINTY

4.1. MEASURING INSTRUMENT CALIBRATION

The measuring equipment utilized to perform the tests documented in this report has been calibrated in accordance with the manufacturer's recommendations and is traceable to recognize national standards.

4.2. MEASUREMENT UNCERTAINTY

Where relevant, the following measurement uncertainty levels have been estimated for tests performed on the apparatus:

Test Item	Uncertainty
Conduction emission	3.62 dB
Radiated Emission (Included Fundamental Emission) (9 kHz ~ 30 MHz)	2.2 dB
Radiated Emission (Included Fundamental Emission) (30 MHz ~ 1 GHz)	4.00 dB
Radiated Emission (Included Fundamental Emission) (1 GHz to 26 GHz)	5.78 dB (1 GHz ~ 18 GHz)
	5.23 dB (18 GHz ~ 26 GHz)
Duty Cycle	±0.028%
DTS and 99% Occupied Bandwidth	±0.0196%
Maximum Conducted Output Power	±0.686 dB
Maximum Power Spectral Density Level	±0.743 dB
Conducted Band-edge Compliance	±1.328 dB
Conducted Unwanted Emissions In Non-restricted Frequency Bands	±0.746 dB (9 kHz ~ 1 GHz)
	±1.328dB (1 GHz ~ 26 GHz)
Note: This uncertainty represents an expanded uncertainty expressed at approximately the 95% confidence level using a coverage factor of k=2.	



5. EQUIPMENT UNDER TEST

5.1. DESCRIPTION OF EUT

EUT Name	WIFI Module
Model	W8ER2500
Radio Technology	WLAN (IEEE 802.11b/g/n HT20/n HT40)
Operation frequency	IEEE 802.11b: 2412MHz ~ 2462MHz IEEE 802.11g: 2412MHz ~ 2462MHz IEEE 802.11n HT20: 2412MHz ~ 2462MHz IEEE 802.11n HT40: 2422MHz ~ 2452MHz
Modulation	IEEE 802.11b: DSSS (CCK, DQPSK, DBPSK) IEEE 802.11g: OFDM (64QAM, 16QAM, QPSK, BPSK) IEEE 802.11n HT20: OFDM (64QAM, 16QAM, QPSK, BPSK) IEEE 802.11n HT40: OFDM (64QAM, 16QAM, QPSK, BPSK)
Power Supply	DC 3.3 V

5.2. CHANNEL LIST

Channel List for 802.11b/g/n (20 MHz)							
Channel	Frequency (MHz)	Channel	Frequency (MHz)	Channel	Frequency (MHz)	Channel	Frequency (MHz)
1	2412	4	2427	7	2442	10	2457
2	2417	5	2432	8	2447	11	2462
3	2422	6	2437	9	2452	/	/

Channel List for 802.11n (40 MHz)							
Channel	Frequency (MHz)	Channel	Frequency (MHz)	Channel	Frequency (MHz)	Channel	Frequency (MHz)
3	2422	5	2432	7	2442	9	2452
4	2427	6	2437	8	2447	/	/

5.3. MAXIMUM OUTPUT POWER

IEEE Std. 802.11	Frequency (MHz)	Channel Number	Maximum Conducted AVG Output Power (dBm)	Maximum AVG EIRP (dBm)
b	2412 ~ 2462	1-11[11]	17.82	20.92
g	2412 ~ 2462	1-11[11]	17.58	20.68
n HT20	2412 ~ 2462	1-11[11]	18.49	21.59
n HT40	2422 ~ 2452	3-9[7]	18.76	21.86

5.4. TEST CHANNEL CONFIGURATION

IEEE Std. 802.11	Test Channel Number	Frequency
------------------	---------------------	-----------



b	CH 1(Low Channel), CH 6(MID Channel), CH 11(High Channel)	2412 MHz, 2437 MHz, 2462 MHz
g	CH 1(Low Channel), CH 6(MID Channel), CH 11(High Channel)	2412 MHz, 2437 MHz, 2462 MHz
n HT20	CH 1(Low Channel), CH 6(MID Channel), CH 11(High Channel)	2412 MHz, 2437 MHz, 2462 MHz
n HT40	CH 3(Low Channel), CH 6(MID Channel), CH 9(High Channel)	2422 MHz, 2437 MHz, 2452 MHz

5.5. THE WORSE CASE POWER SETTING PARAMETER

The Worst Case Power Setting Parameter under 2400 ~ 2483.5MHz Band										
Test Software		MP Tool								
Modulation Mode	Transmit Antenna Number	Test Channel								
		NCB: 20MHz			NCB: 40MHz					
		CH 1	CH 6	CH 11	CH 3	CH 6	CH 9			
802.11b	0	39	39	39						
	1	39	39	39						
802.11g	0	47	47	47						
	1	47	47	47						
802.11n HT20	0	46	46	46						
	1	46	46	46						
802.11n HT40	0	/						45	45	45
	1	/						45	45	45

5.6. THE WORSE CASE CONFIGURATIONS

The EUT was tested in the following configuration(s):



Controlled in test mode using a software application on the EUT supplied by customer. The application was used to enable a continuous transmission and to select the mode, test channels, bandwidth, data rates as required.

Test channels referring to section 5.4.

Maximum power setting referring to section 5.5.

Worst-case data rates as provided by the client were:

802.11b mode: 1 Mbps

802.11g mode: 6 Mbps

802.11n HT20 mode: MCS0

802.11n HT40 mode: MCS0

802.11b/g only support SISO mode.

802.11 n HT20/HT40 support SISO and MIMO mode.

802.11b/g SISO mode, Antenna 0 and Antenna 1 has the same power setting, so only Antenna0 worst case test data were recorded in the report.

802.11n SISO mode and MIMO mode have the same power setting, so only the worst case power mode(MIMO) will be record in the report.

The EUT has 2 separate antennas which correspond to 2 separate antenna ports. Core 0 and Core 1 correspond to antenna 0 and antenna 1 respectively.

The measured additional path loss was included in any path loss calculations for all RF cable used during tested.

Conducted output power, power spectral density tests separately on each port with all supported SISO & MIMO port combinations.

The EUT support Cyclic Shift Diversity(CDD), Space Time Coding(STBC), Spatial Division Multiplexing(SDM) modes. They use the same conducted power per chain in any given mode, CDD mode have the maximum power setting, so we only chose the worst case mode CDD for final testing.

**5.7. DESCRIPTION OF AVAILABLE ANTENNAS**

Antenna	Frequency (MHz)	Antenna Type	MAX Antenna Gain (dBi)
0	2412-2462	PCB Antenna	3.1
1	2412-2462	PCB Antenna	3.1

The EUT support Cyclic Shift Diversity(CDD) mode.

MIMO output power port and MIMO PSD port summing was performed in accordance with KDB 662911 D01. For the CDD results the Directional Gain was calculated in accordance with the following method.

For output power measurements:

Directional gain= $G_{ANT} + \text{Array Gain} = 3.1 \text{ dBi}$

G_{ANT} : equal to the gain of the antenna having the highest gain

Array Gain = 0 dB (i.e., no array gain) for $N_{ANT} \leq 4$

For power spectral density (PSD) measurements:

Directional gain= $G_{ANT} + \text{Array Gain} = 6.1 \text{ dBi}$

Array Gain = $10 \log(N_{ANT}/N_{SS}) \text{ dB}$.

N_{ANT} : number of transmit antennas

N_{SS} : number of spatial streams, The worst case directional gain will occur when $N_{SS} = 1$

Test Mode	Transmit and Receive Mode	Description
IEEE 802.11b	<input checked="" type="checkbox"/> 2TX, 2RX	ANT 0 and ANT 1 can be used as transmitting/receiving antenna.
IEEE 802.11g	<input checked="" type="checkbox"/> 2TX, 2RX	ANT 0 and ANT 1 can be used as transmitting/receiving antenna.
IEEE 802.11n HT20	<input checked="" type="checkbox"/> 2TX, 2RX	ANT 0 and ANT 1 can be used as transmitting/receiving antenna.
IEEE 802.11n HT40	<input checked="" type="checkbox"/> 2TX, 2RX	ANT 0 and ANT 1 can be used as transmitting/receiving antenna.

Note: The value of the antenna gain was declared by customer.

5.8. DESCRIPTION OF TEST SETUP

SUPPORT EQUIPMENT

Item	Equipment	Brand Name	Model Name	Remarks
1	Laptop	Lenovo	XIAOXIN 5000	/
2	UART	/	/	/
3	AC Adapter	Lenovo	ADLX65YCC3D	Input: 100-240 Vac, 50/60 Hz Output: 20 Vdc, 3.25A

I/O CABLES

Cable No	Port	Connector Type	Cable Type	Cable Length(m)	Remarks
1	USB	N/A	N/A	1	N/A

ACCESSORIES

Item	Accessory	Brand Name	Model Name	Description
/	/	/	/	/

TEST SETUP

The EUT can work in engineering mode with a software through a Laptop.

SETUP DIAGRAM FOR TESTS

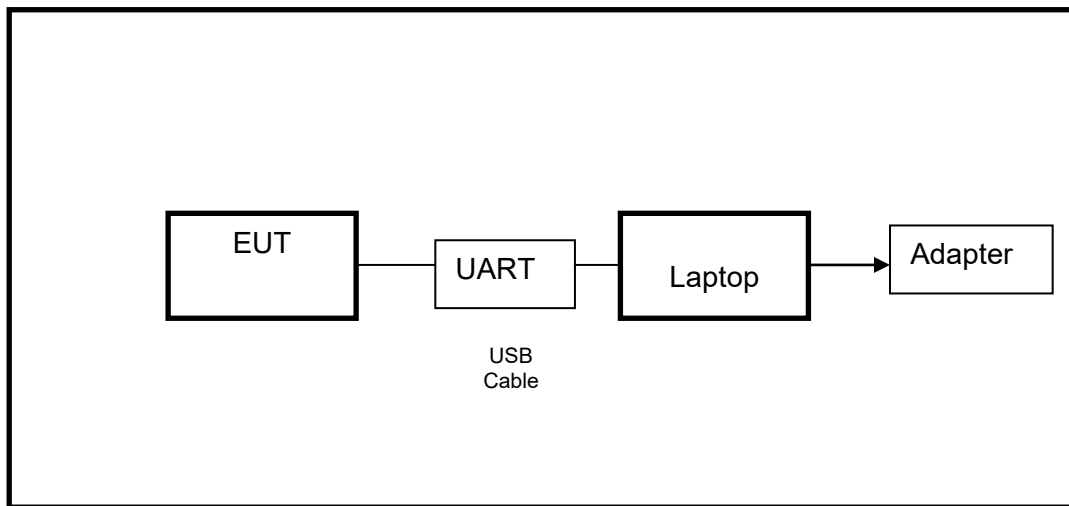

Note: AC adapter only use for AC POWER LINE CONDUCTED EMISSIONS testing.

**6. MEASURING INSTRUMENT AND SOFTWARE USED**

Conducted Emissions					
Equipment	Manufacturer	Model No.	Serial No.	Last Cal.	Due Date
EMI Test Receiver	R&S	ESR3	101961	Nov. 12, 2020	Nov. 11, 2021
Two-Line V-Network	R&S	ENV216	101983	Nov. 12, 2020	Nov. 11, 2021
Software					
Description			Manufacturer	Name	Version
Test Software for Conducted Emissions			Farad	EZ-EMC	Ver. UL-3A1

Radiated Emissions					
Equipment	Manufacturer	Model No.	Serial No.	Last Cal.	Due Date
MXE EMI Receiver	KESIGHT	N9038A	MY56400036	Nov. 12, 2020	Nov. 11, 2021
Hybrid Log Periodic Antenna	TDK	HLP-3003C	130960	Aug. 2, 2021	Aug. 1, 2023
Preamplifier	HP	8447D	2944A09099	Nov. 12, 2020	Nov. 11, 2021
EMI Measurement Receiver	R&S	ESR26	101377	Nov. 12, 2020	Nov. 11, 2021
Horn Antenna	TDK	HRN-0118	130939	Jul. 20, 2021	Jul. 20, 2023
Preamplifier	TDK	PA-02-0118	TRS-305-00067	Nov. 20, 2020	Nov. 19, 2021
Horn Antenna	Schwarzbeck	BBHA9170	#691	Jul. 20, 2021	Jul. 20, 2023
Preamplifier	TDK	PA-02-2	TRS-307-00003	Nov. 12, 2020	Nov. 11, 2021
Preamplifier	TDK	PA-02-3	TRS-308-00002	Nov. 12, 2020	Nov. 11, 2021
Loop antenna	Schwarzbeck	1519B	00008	Jan.17, 2019	Jan.17,2022
Preamplifier	TDK	PA-02-001-3000	TRS-302-00050	Nov. 12, 2020	Nov. 11, 2021
High Pass Filter	Wi	WHKX10-2700-3000-18000-40SS	23	Nov. 12, 2020	Nov. 11, 2021
Band Reject Filter	Wainwright	WRCJV8-2350-2400-2483.5-2533.5-40SS	4	Nov. 12, 2020	Nov. 11, 2021
Software					
Description			Manufacturer	Name	Version
Test Software for Radiated Emissions			Farad	EZ-EMC	Ver. UL-3A1



Tonsend RF Test System					
Equipment	Manufacturer	Model No.	Serial No.	Last Cal.	Due. Date
Wideband Radio Communication Tester	R&S	CMW500	155523	Nov.20,2020	Nov.19,2021
PXA Signal Analyzer	Keysight	N9030A	MY55410512	Nov.20,2020	Nov.19,2021
MXG Vector Signal Generator	Keysight	N5182B	MY56200284	Nov.20,2020	Nov.19,2021
MXG Vector Signal Generator	Keysight	N5172B	MY56200301	Nov.20,2020	Nov.19,2021
DC power supply	Keysight	E3642A	MY55159130	Nov.24,2020	Nov.23,2021
Software					
Description	Manufacturer	Name		Version	
Tonsend SRD Test System	Tonsend	JS1120-3 RF Test System		2.6.77.0518	

Other Instruments					
Equipment	Manufacturer	Model No.	Serial No.	Last Cal.	Next Cal.
Dual Channel Power Meter	Keysight	N1912A	MY55416024	Nov. 20, 2020	Nov. 19, 2021
Power Sensor	Keysight	USB Wideband Power Sensor	MY5100022	Nov. 20, 2020	Nov. 19, 2021

7. ANTENNA PORT TEST RESULTS

7.1. ON TIME AND DUTY CYCLE

LIMITS

None; for reporting purposes only

PROCEDURE

Refer to ANSI C63.10-2013 clause 11.6 Zero – Span Spectrum Analyzer method.

TEST SETUP

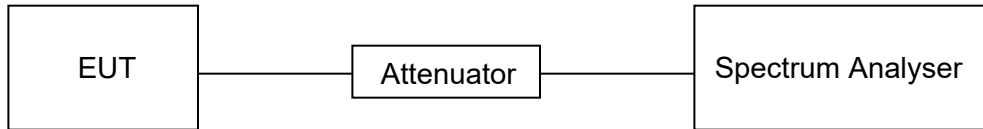

TEST ENVIRONMENT

Temperature	26 °C	Relative Humidity	60.1 %
Atmosphere Pressure	101 kPa	Test Voltage	DC 3.3 V

RESULTS

Please refer to appendix G.

7.2. 6 dB DTS BANDWIDTH AND 99 % OCCUPIED BANDWIDTH

LIMITS

CFR 47 FCC Part15 (15.247) Subpart C ISED RSS-247 ISSUE 2			
Section	Test Item	Limit	Frequency Range (MHz)
CFR 47 FCC 15.247(a)(2) ISED RSS-247 5.2 (a)	6 dB Bandwidth	≥ 500 kHz	2400-2483.5
ISED RSS-Gen Clause 6.7	99 % Occupied Bandwidth	For reporting purposes only.	2400-2483.5

TEST PROCEDURE

Connect the EUT to the spectrum analyser and use the following settings:

Center Frequency	The center frequency of the channel under test
Frequency Span	Between 1.5 times and 5.0 times the OBW
Detector	Peak
RBW	For 6 dB Bandwidth: 100 kHz For 99 % Occupied Bandwidth: 1 % to 5 % of the occupied bandwidth
VBW	For 6 dB Bandwidth: $\geq 3 \times$ RBW For 99 % Occupied Bandwidth: $\geq 3 \times$ RBW
Trace	Max hold
Sweep	Auto couple

a) Use the 99 % power bandwidth function of the instrument, allow the trace to stabilize and report the measured bandwidth.

b) Allow the trace to stabilize and measure the maximum width of the emission that is constrained by the frequencies associated with the two outermost amplitude points (upper and lower frequencies) that are attenuated by 6 dB relative to the maximum level measured in the fundamental emission.

TEST SETUP

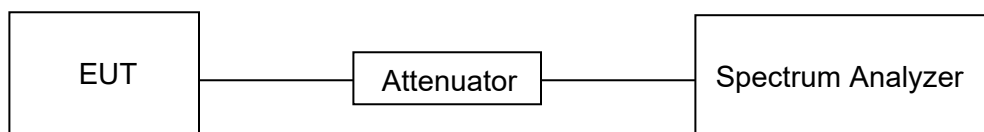



TEST ENVIRONMENT

Temperature	26 °C	Relative Humidity	60.1 %
Atmosphere Pressure	101 kPa	Test Voltage	DC 3.3 V

RESULTS

Please refer to appendix A & B.



7.3. CONDUCTED OUTPUT POWER

LIMITS

CFR 47 FCC Part15 (15.247) Subpart C ISED RSS-247 ISSUE 2			
Section	Test Item	Limit	Frequency Range (MHz)
CFR 47 FCC 15.247(b)(3) ISED RSS-247 5.4 (d)	AVG Output Power	1 watt or 30 dBm	2400-2483.5

TEST PROCEDURE

Connect the EUT to a low loss RF cable from the antenna port to the power sensor (video bandwidth is greater than the occupied bandwidth).
Measure peak emission level, the indicated level is the average output power, after any corrections for external attenuators and cables.

TEST SETUP

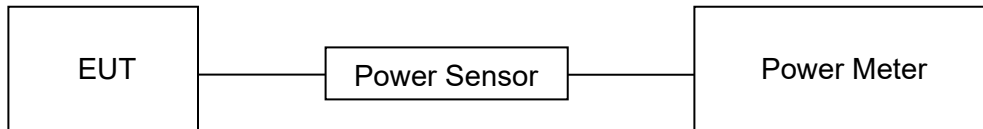

TEST ENVIRONMENT

Temperature	26 °C	Relative Humidity	60.1 %
Atmosphere Pressure	101 kPa	Test Voltage	DC 3.3 V

RESULTS

Please refer to appendix C.

7.4. POWER SPECTRAL DENSITY

LIMITS

CFR 47 FCC Part15 (15.247) Subpart C ISED RSS-247 ISSUE 2			
Section	Test Item	Limit	Frequency Range (MHz)
CFR 47 FCC §15.247 (e) ISED RSS-247 5.2 (b)	Power Spectral Density	8 dBm/3 kHz	2400-2483.5

TEST PROCEDURE

Refer to ANSI C63.10-2013 clause 11.10.

Connect the EUT to the spectrum analyser and use the following settings:

Center Frequency	The center frequency of the channel under test
Detector	PEAK
RBW	$3 \text{ kHz} \leq \text{RBW} \leq 100 \text{ kHz}$
VBW	$\geq 3 \times \text{RBW}$
Span	1.5 x DTS bandwidth
Trace	Max hold
Sweep time	Auto couple

Allow trace to fully stabilize and use the peak marker function to determine the maximum amplitude level within the RBW.

If measured value exceeds limit, reduce RBW (no less than 3 kHz) and repeat.

TEST SETUP

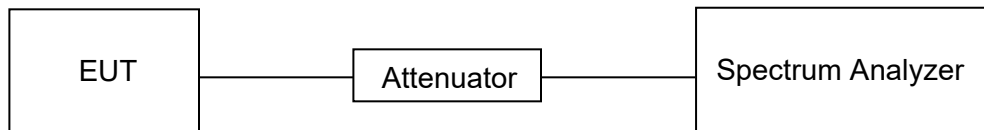

TEST ENVIRONMENT

Temperature	26 °C	Relative Humidity	60.1 %
Atmosphere Pressure	101 kPa	Test Voltage	DC 3.3 V



RESULTS

Please refer to appendix D.



7.5. CONDUCTED BANDEGE AND SPURIOUS EMISSIONS

LIMITS

CFR 47 FCC Part15 (15.247) Subpart C ISED RSS-247 ISSUE 2		
Section	Test Item	Limit
CFR 47 FCC §15.247 (d) ISED RSS-247 5.5	Conducted Bandedge and Spurious Emissions	at least 30 dB below that in the 100 kHz bandwidth within the band that contains the highest level of the desired power

TEST PROCEDURE

Refer to ANSI C63.10-2013 clause 11.11 and 11.13.

Connect the EUT to the spectrum analyser and use the following settings for reference level measurement:

Center Frequency	The center frequency of the channel under test
Detector	Peak
RBW	100 kHz
VBW	$\geq 3 \times \text{RBW}$
Span	1.5 x DTS bandwidth
Trace	Max hold
Sweep time	Auto couple.

Allow trace to fully stabilize and use the peak marker function to determine the maximum PSD level.

Change the settings for emission level measurement:

Span	Set the center frequency and span to encompass frequency range to be measured
Detector	Peak
RBW	100 kHz
VBW	$\geq 3 \times \text{RBW}$
measurement points	$\geq \text{span}/\text{RBW}$
Trace	Max hold
Sweep time	Auto couple.

Allow trace to fully stabilize and use the peak marker function to determine the maximum PSD level. Ensure that the amplitude of all unwanted emissions outside of the authorized frequency band (excluding restricted frequency bands) is attenuated by at least the minimum requirements specified in 11.11.

TEST SETUP

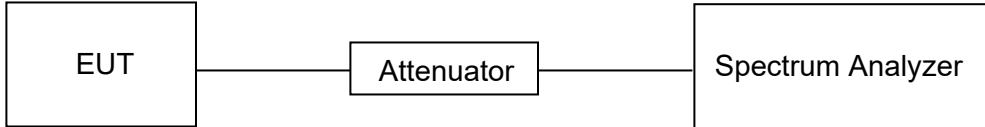

TEST ENVIRONMENT

Temperature	26 °C	Relative Humidity	60.1 %
Atmosphere Pressure	101 kPa	Test Voltage	DC 3.3 V

RESULTS

Please refer to appendix E & F.



8. RADIATED TEST RESULTS

LIMITS

Please refer to CFR 47 FCC §15.205 and §15.209.

Please refer to ISED RSS-GEN Clause 8.9 and Clause 8.10.

Radiation Disturbance Test Limit for FCC (Class B) (9 kHz ~ 1 GHz)

Emissions radiated outside of the specified frequency bands above 30 MHz			
Frequency Range (MHz)	Field Strength Limit (uV/m) at 3 m	Field Strength Limit (dBuV/m) at 3 m	
		Quasi-Peak	
30 - 88	100	40	
88 - 216	150	43.5	
216 - 960	200	46	
Above 960	500	54	
Above 1000	500	Peak	Average
		74	54

FCC Emissions radiated outside of the specified frequency bands below 30 MHz		
Frequency (MHz)	Field strength (microvolts/meter)	Measurement distance (meters)
0.009-0.490	2400/F(kHz)	300
0.490-1.705	24000/F(kHz)	30
1.705-30.0	30	30

ISED General field strength limits at frequencies below 30 MHz

Table 6 – General field strength limits at frequencies below 30 MHz		
Frequency	Magnetic field strength (H-Field) (µA/m)	Measurement distance (m)
9 - 490 kHz ^{Note 1}	6.37/F (F in kHz)	300
490 - 1705 kHz	63.7/F (F in kHz)	30
1.705 - 30 MHz	0.08	30

Note 1: The emission limits for the ranges 9-90 kHz and 110-490 kHz are based on measurements employing a linear average detector.



ISED Restricted bands please refer to ISED RSS-GEN Clause 8.10

Table 7 – Restricted frequency bands ^{Note 1}		
MHz	MHz	GHz
0.090 - 0.110	149.9 - 150.05	9.0 - 9.2
0.495 - 0.505	156.52475 - 156.52525	9.3 - 9.5
2.1735 - 2.1905	156.7 - 156.9	10.6 - 12.7
3.020 - 3.026	162.0125 - 167.17	13.25 - 13.4
4.125 - 4.128	167.72 - 173.2	14.47 - 14.5
4.17725 - 4.17775	240 - 285	15.35 - 16.2
4.20725 - 4.20775	322 - 335.4	17.7 - 21.4
5.677 - 5.683	399.9 - 410	22.01 - 23.12
6.215 - 6.218	608 - 614	23.6 - 24.0
6.26775 - 6.26825	960 - 1427	31.2 - 31.8
6.31175 - 6.31225	1435 - 1626.5	36.43 - 36.5
8.291 - 8.294	1645.5 - 1646.5	Above 38.6
8.362 - 8.366	1660 - 1710	
8.37625 - 8.38675	1718.8 - 1722.2	
8.41425 - 8.41475	2200 - 2300	
12.29 - 12.293	2310 - 2390	
12.51975 - 12.52025	2483.5 - 2500	
12.57675 - 12.57725	2655 - 2900	
13.36 - 13.41	3260 - 3267	
16.42 - 16.423	3332 - 3339	
16.80475 - 16.80525	3345.8 - 3358	
16.80425 - 16.80475	3500 - 4400	
25.5 - 25.67	4500 - 5150	
37.5 - 38.25	5350 - 5460	
73 - 74.6	7250 - 7750	
74.8 - 75.2	8025 - 8500	
108 - 138		

Note 1: Certain frequency bands listed in table 7 and in bands above 38.6 GHz are designated for licence-exempt applications. These frequency bands and the requirements that apply to related devices are set out in the 200 and 300 series of RSSs.

FCC Restricted bands of operation refer to FCC §15.205 (a):

MHz	MHz	MHz	GHz
0.090-0.110	16.42-16.423	399.9-410	4.5-5.15
¹ 0.495-0.505	16.69475-16.69525	608-614	5.35-5.46
2.1735-2.1905	16.80425-16.80475	960-1240	7.25-7.75
4.125-4.128	25.5-25.67	1300-1427	8.025-8.5
4.17725-4.17775	37.5-38.25	1435-1626.5	9.0-9.2
4.20725-4.20775	73-74.6	1645.5-1646.5	9.3-9.5
6.215-6.218	74.8-75.2	1660-1710	10.6-12.7
6.26775-6.26825	108-121.94	1718.8-1722.2	13.25-13.4
6.31175-6.31225	123-138	2200-2300	14.47-14.5
8.291-8.294	149.9-150.05	2310-2390	15.35-16.2
8.362-8.366	156.52475-156.52525	2483.5-2500	17.7-21.4
8.37625-8.38675	156.7-156.9	2690-2900	22.01-23.12
8.41425-8.41475	162.0125-167.17	3260-3267	23.6-24.0
12.29-12.293	167.72-173.2	3332-3339	31.2-31.8
12.51975-12.52025	240-285	3345.8-3358	36.43-36.5
12.57675-12.57725	322-335.4	3600-4400	(²)
13.36-13.41			

Note: ¹Until February 1, 1999, this restricted band shall be 0.490-0.510 MHz.

²Above 38.6c

TEST SETUP AND PROCEDURE

Below 30 MHz

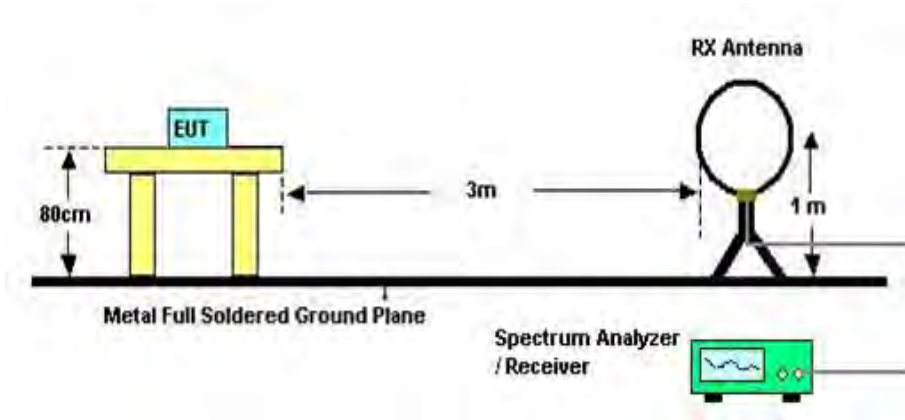

The setting of the spectrum analyser

RBW	200 Hz (From 9 kHz to 0.15 MHz) / 9 kHz (From 0.15 MHz to 30 MHz)
VBW	200 Hz (From 9 kHz to 0.15 MHz) / 9 kHz (From 0.15 MHz to 30 MHz)
Sweep	Auto
Trace	Max hold

1. The testing follows the guidelines in ANSI C63.10-2013 clause 6.4.
2. The EUT was arranged to its worst case and then turntable (from 0 degree to 360 degrees) to find the maximum reading. A pre-amp and a high pass filter are used for the test in order to get better signal level. Both Horizontal, Face-on and Face-off polarizations of the antenna are set to make the measurement.
3. The EUT was placed on a turntable with 80cm above ground.
4. The EUT was set 3 meters from the interference receiving antenna, which was mounted on the top of a 1 m height antenna tower.
5. The radiated emission limits are based on measurements employing a CISPR quasi-peak detector except for the frequency bands 9-90 kHz, 110-490 kHz and above 1000 MHz. Radiated emission limits in these three bands are based on measurements employing an average detector.
6. For measurement below 1 GHz, the initial step in collecting conducted emission data is a spectrum analyzer peak detector mode pre-scanning the measurement frequency range. Significant peaks are then marked and then Quasi Peak and average detector mode re-measured. If the emission level of the EUT measured by the peak detector is 3 dB lower than the applicable limit, the peak emission level will be reported. Otherwise, the emission measurement will be repeated using the quasi-peak and average detector and reported.
7. Although these tests were performed other than open field site, adequate comparison measurements were confirmed against 30 m open field site. Therefore sufficient tests were made to demonstrate that the alternative site produces results that correlate with the ones of tests made in an open field site based on KDB 414788.

Below 1 GHz and above 30 MHz

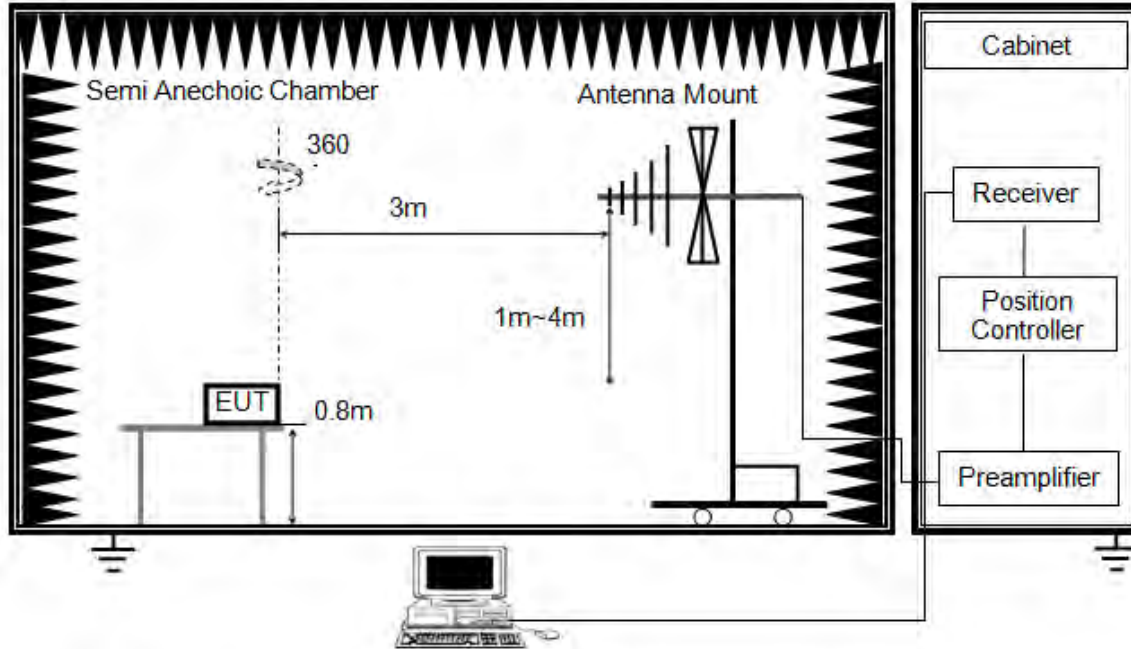

The setting of the spectrum analyser

RBW	120 kHz
VBW	300 kHz
Sweep	Auto
Detector	Peak/QP
Trace	Max hold

1. The testing follows the guidelines in ANSI C63.10-2013 clause 6.5.
2. The EUT was arranged to its worst case and then tune the antenna tower (from 1 m to 4 m) and turntable (from 0 degree to 360 degrees) to find the maximum reading. A pre-amp and a high pass filter are used for the test in order to get better signal level. Both horizontal and vertical polarizations of the antenna are set to make the measurement.
3. The EUT was placed on a turntable with 80 cm above ground.
4. The EUT was set 3 meters from the interference receiving antenna, which was mounted on the top of a variable height antenna tower.
5. For measurement below 1 GHz, the initial step in collecting conducted emission data is a spectrum analyzer peak detector mode pre-scanning the measurement frequency range. Significant peaks are then marked and then Quasi Peak detector mode re-measured. If the emission level of the EUT measured by the peak detector is 3 dB lower than the applicable limit, the peak emission level will be reported. Otherwise, the emission measurement will be repeated using the quasi-peak detector and reported.

Above 1 GHz

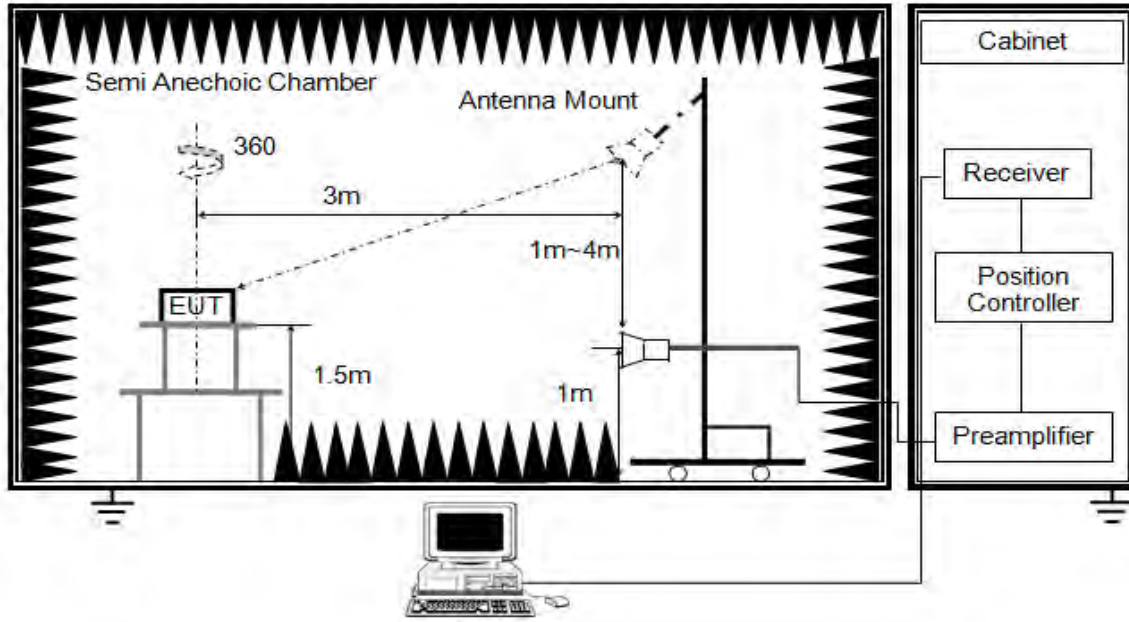

The setting of the spectrum analyser

RBW	1 MHz
VBW	PEAK: 3 MHz AVG: see note 6
Sweep	Auto
Detector	Peak
Trace	Max hold

1. The testing follows the guidelines in ANSI C63.10-2013 clause 6.6.
2. The EUT was arranged to its worst case and then tune the antenna tower (from 1 m to 4 m) and turntable (from 0 degree to 360 degrees) to find the maximum reading. A pre-amp and a high pass filter are used for the test in order to get better signal level. Both horizontal and vertical polarizations of the antenna are set to make the measurement.
3. The EUT was placed on a turntable with 1.5 m above ground.
4. The EUT was set 3 meters from the interference receiving antenna, which was mounted on the top of a variable height antenna tower.
5. For measurement above 1 GHz, the emission measurement will be measured by the peak detector. This peak level, once corrected, must comply with the limit specified in Section 15.209.
6. For measurements above 1 GHz the resolution bandwidth is set to 1 MHz, then the video bandwidth is set to 3 MHz for peak measurements and 1 MHz resolution bandwidth with 1/T video bandwidth with peak detector for average measurements. For the Duty Cycle please refer to clause 7.1.ON TIME AND DUTY CYCLE.

X axis, Y axis, Z axis positions:

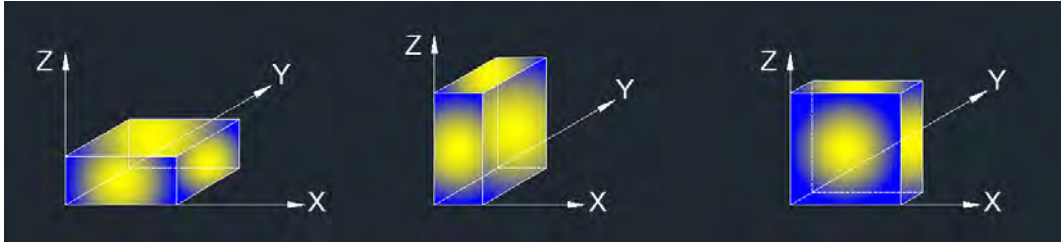

Note 1: For all radiated test, EUT in each of three orthogonal axis emissions had been tested, but only the worst case (X axis) data recorded in the report.

TEST ENVIRONMENT

Temperature	25.2 °C	Relative Humidity	45.5 %
Atmosphere Pressure	101 kPa	Test Voltage	DC 3.3 V

RESULTS

8.1. RESTRICTED BANDEDGE

8.1.1. 802.11b SISO MODE

ANTENNA 0 TEST RESULTS (WORST CASE)

RESTRICTED BANDEDGE (LOW CHANNEL, HORIZONTAL)

PEAK

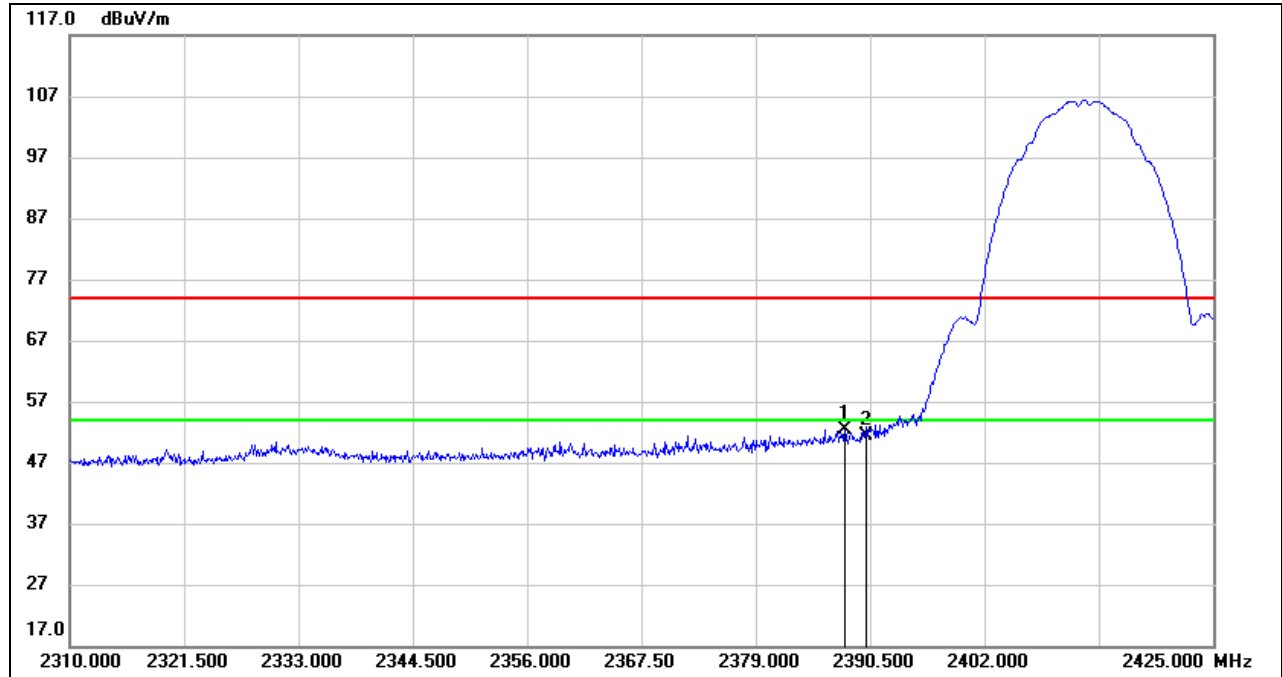

No.	Frequency (MHz)	Reading (dBuV)	Correct (dB/m)	Result (dBuV/m)	Limit (dBuV/m)	Margin (dB)	Remark
1	2387.970	19.13	33.34	52.47	74.00	-21.53	peak
2	2390.000	17.98	33.35	51.33	74.00	-22.67	peak

Note: 1. Measurement = Reading Level + Correct Factor.

2. Peak: Peak detector.

3. Only the worst data was recorded, if it complies with the limit, the other emissions deemed to comply with the limit.





RESTRICTED BANDEDGE (LOW CHANNEL, VERTICAL)

PEAK

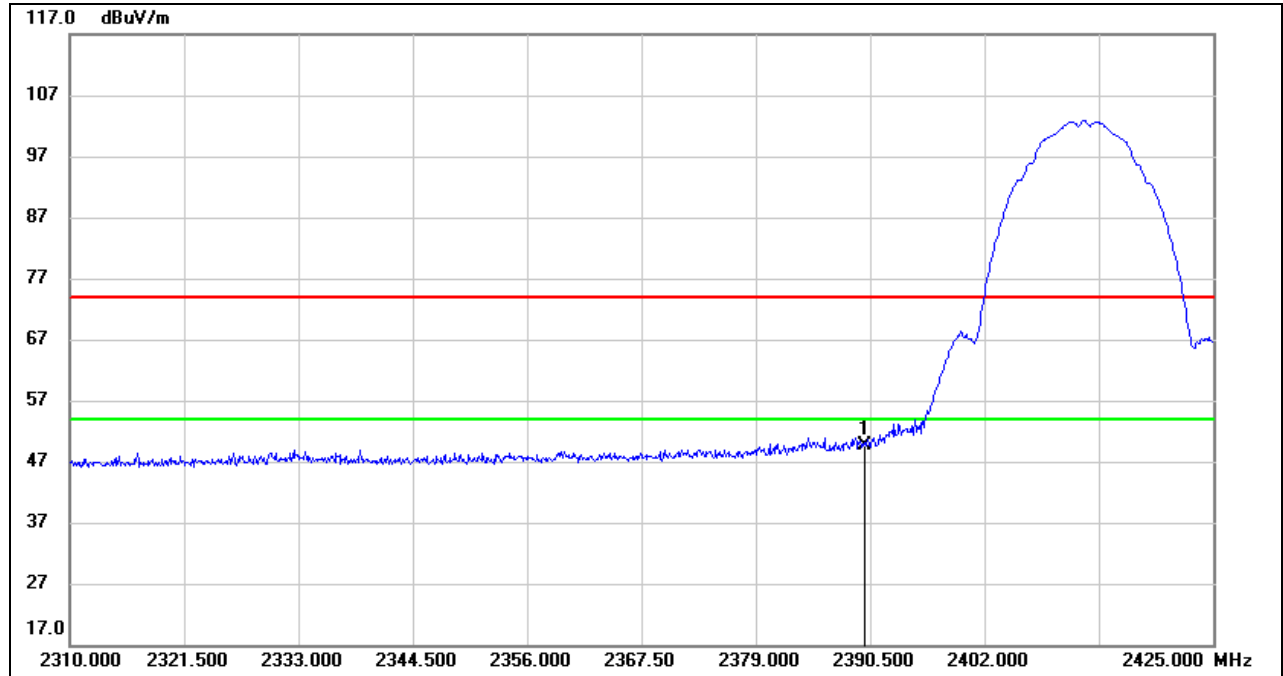

No.	Frequency (MHz)	Reading (dBuV)	Correct (dB/m)	Result (dBuV/m)	Limit (dBuV/m)	Margin (dB)	Remark
1	2390.000	16.26	33.35	49.61	74.00	-24.39	peak

Note: 1. Measurement = Reading Level + Correct Factor.
 2. Peak: Peak detector.
 3. Only the worst data was recorded, if it complies with the limit, the other emissions deemed to comply with the limit.



RESTRICTED BANDEDGE (HIGH CHANNEL, HORIZONTAL)

PEAK

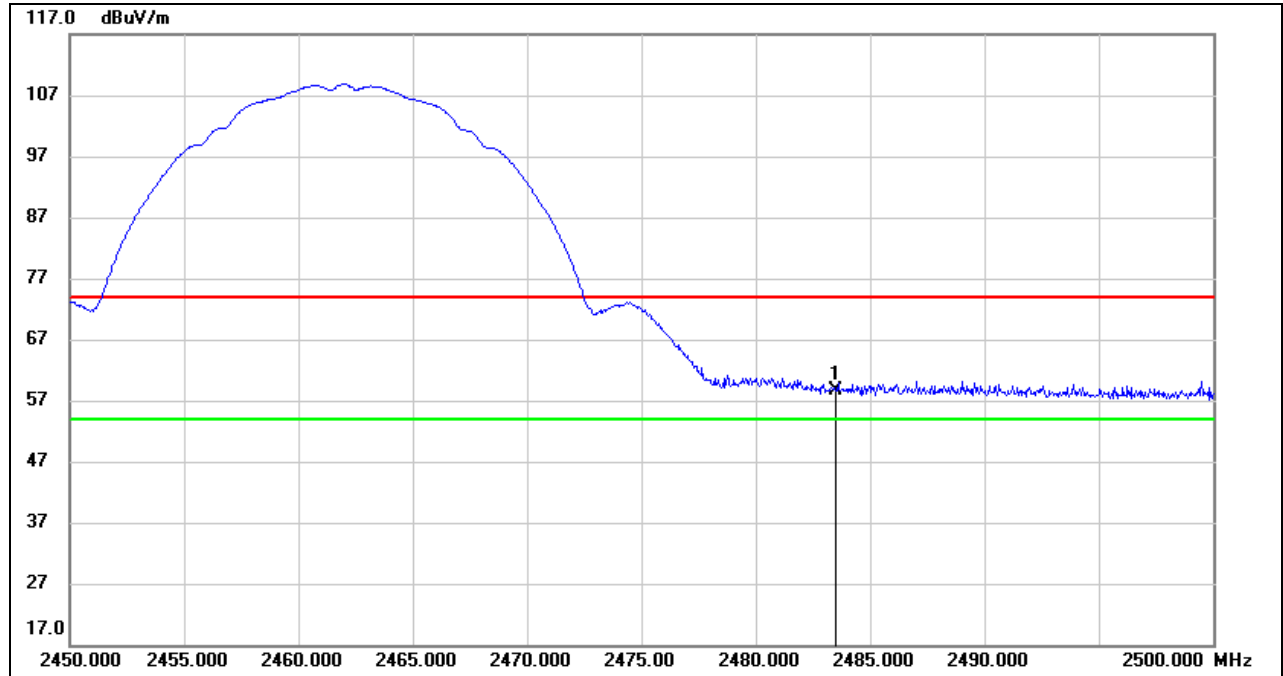

No.	Frequency (MHz)	Reading (dBuV)	Correct (dB/m)	Result (dBuV/m)	Limit (dBuV/m)	Margin (dB)	Remark
1	2483.500	24.86	33.71	58.57	74.00	-15.43	peak

Note: 1. Measurement = Reading Level + Correct Factor.
 2. Peak: Peak detector.
 3. Only the worst data was recorded, if it complies with the limit, the other emissions deemed to comply with the limit.



AVG

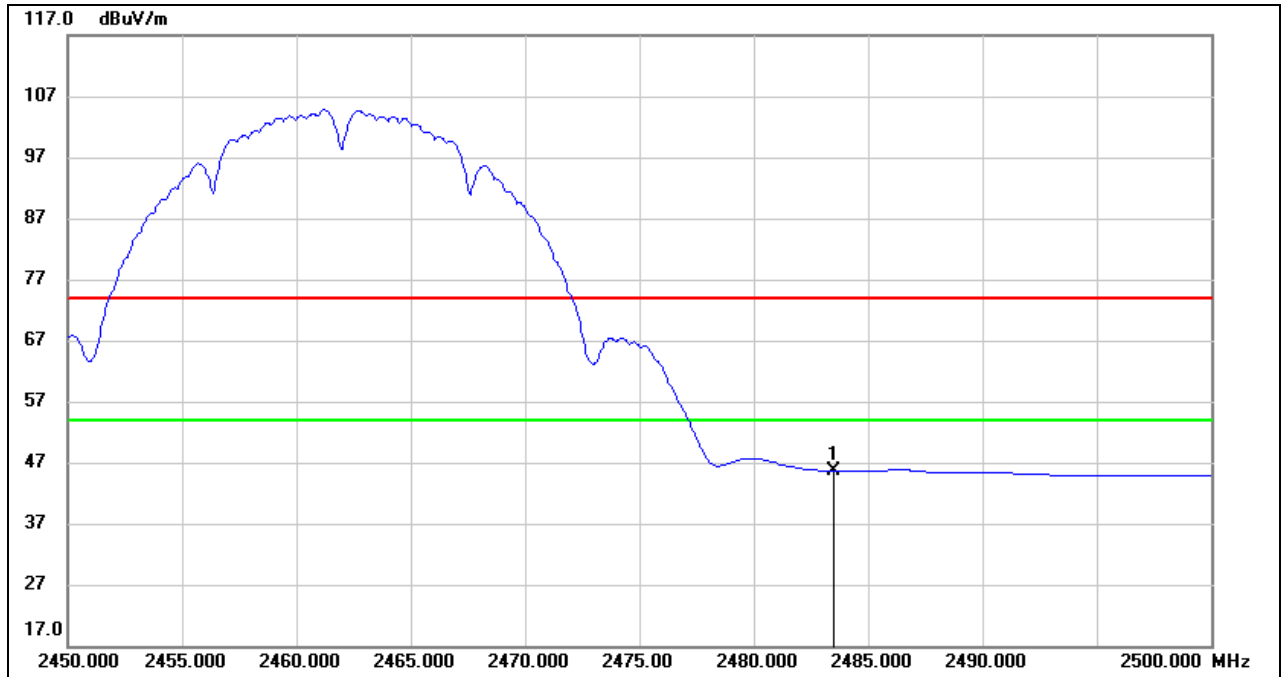

No.	Frequency (MHz)	Reading (dBuV)	Correct (dB/m)	Result (dBuV/m)	Limit (dBuV/m)	Margin (dB)	Remark
1	2483.500	11.99	33.71	45.70	54.00	-8.30	AVG

- Note: 1. Measurement = Reading Level + Correct Factor.
 2. Peak: Peak detector.
 3. Only the worst data was recorded, if it complies with the limit, the other emissions deemed to comply with the limit.

Note: Horizontal and Vertical have been tested, only the worst data was recorded in the report.

8.1.2. 802.11g SISO MODE
ANTENNA 0 TEST RESULTS (WORST CASE)
RESTRICTED BANDEDGE (LOW CHANNEL, HORIZONTAL)
PEAK

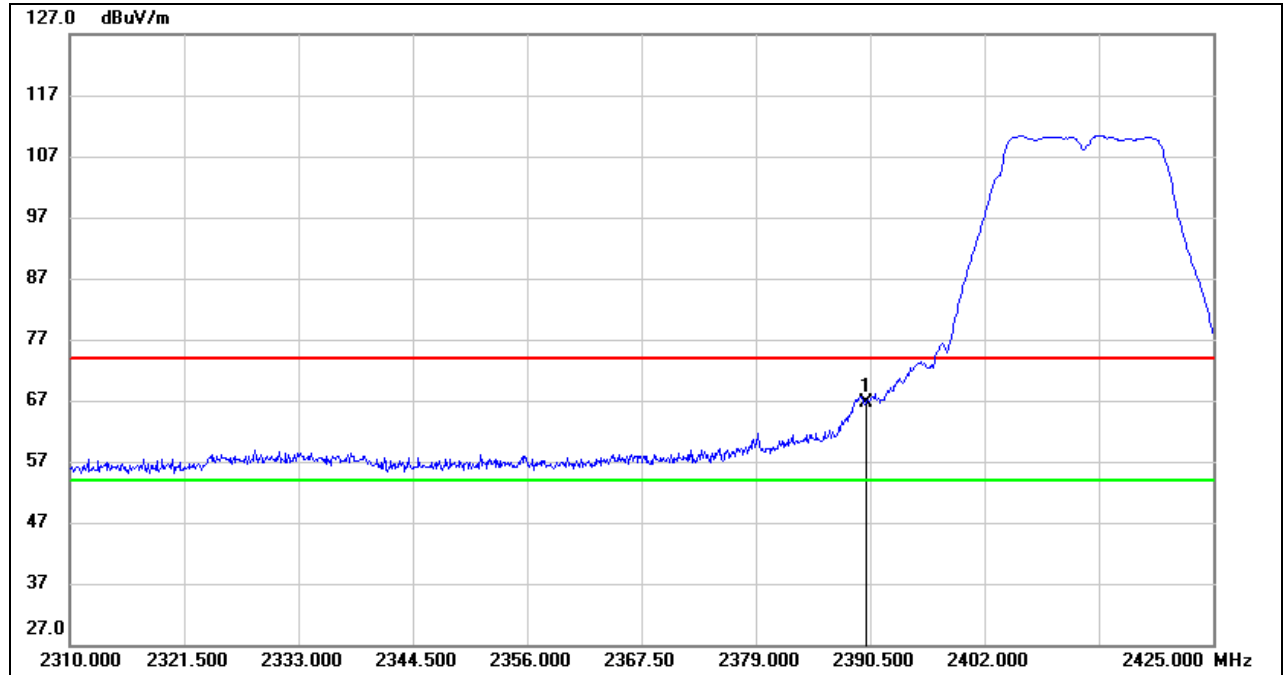

No.	Frequency (MHz)	Reading (dBuV)	Correct (dB/m)	Result (dBuV/m)	Limit (dBuV/m)	Margin (dB)	Remark
1	2390.000	33.23	33.35	66.58	74.00	-7.42	peak

Note: 1. Measurement = Reading Level + Correct Factor.
 2. Peak: Peak detector.
 3. Only the worst data was recorded, if it complies with the limit, the other emissions deemed to comply with the limit.



AVG

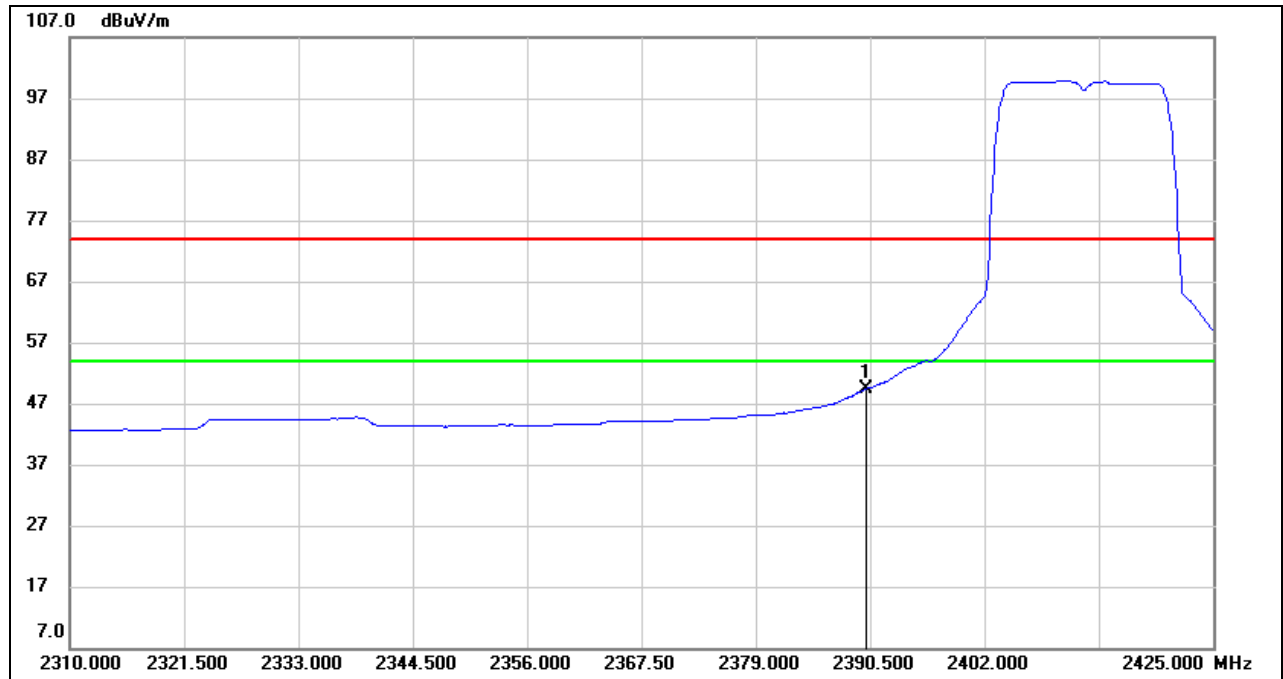

No.	Frequency (MHz)	Reading (dBuV)	Correct (dB/m)	Result (dBuV/m)	Limit (dBuV/m)	Margin (dB)	Remark
1	2390.000	16.06	33.35	49.41	54.00	-4.59	AVG

- Note:
1. Measurement = Reading Level + Correct Factor.
 2. AVG: $VBW=1/T_{on}$, where: T_{on} is the transmitting duration.
 3. For the transmitting duration, please refer to clause 7.1.
 4. Only the worst data was recorded, if it complies with the limit, the other emissions deemed to comply with the limit.



RESTRICTED BANDEDGE (HIGH CHANNEL, HORIZONTAL)

PEAK

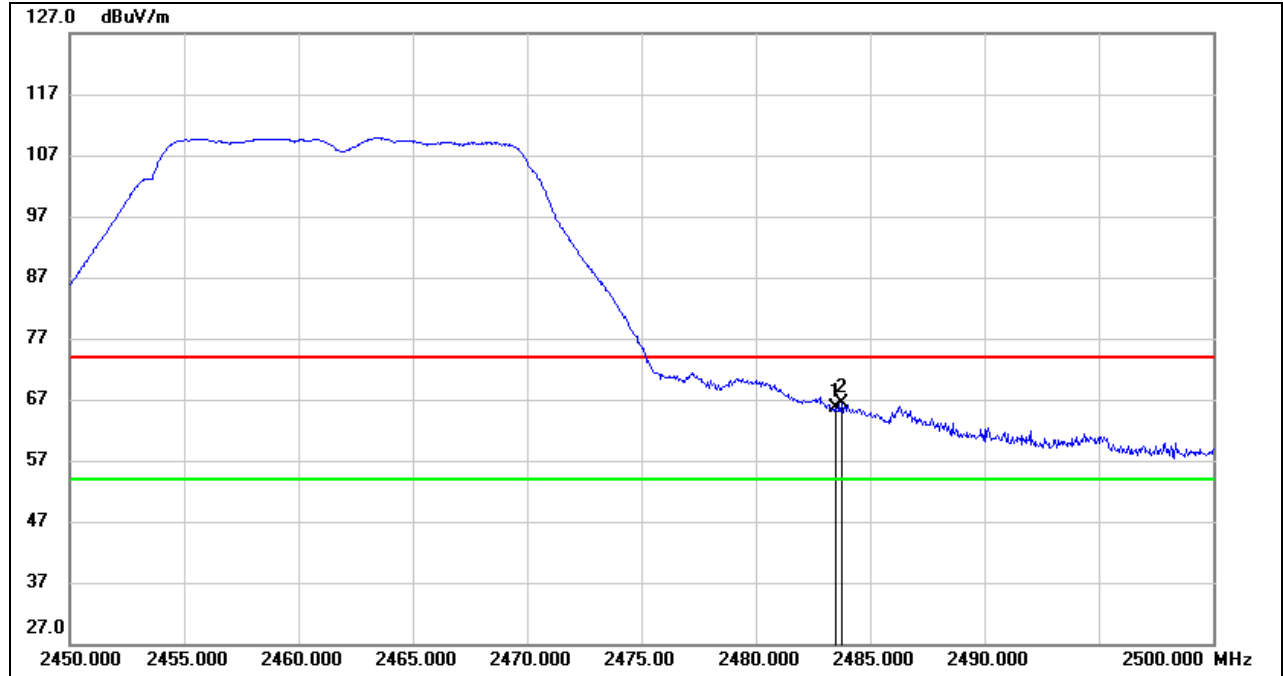

No.	Frequency (MHz)	Reading (dBuV)	Correct (dB/m)	Result (dBuV/m)	Limit (dBuV/m)	Margin (dB)	Remark
1	2483.500	32.01	33.71	65.72	74.00	-8.28	peak
2	2483.750	32.66	33.71	66.37	74.00	-7.63	peak

Note: 1. Measurement = Reading Level + Correct Factor.
 2. Peak: Peak detector.
 3. Only the worst data was recorded, if it complies with the limit, the other emissions deemed to comply with the limit.

AVG

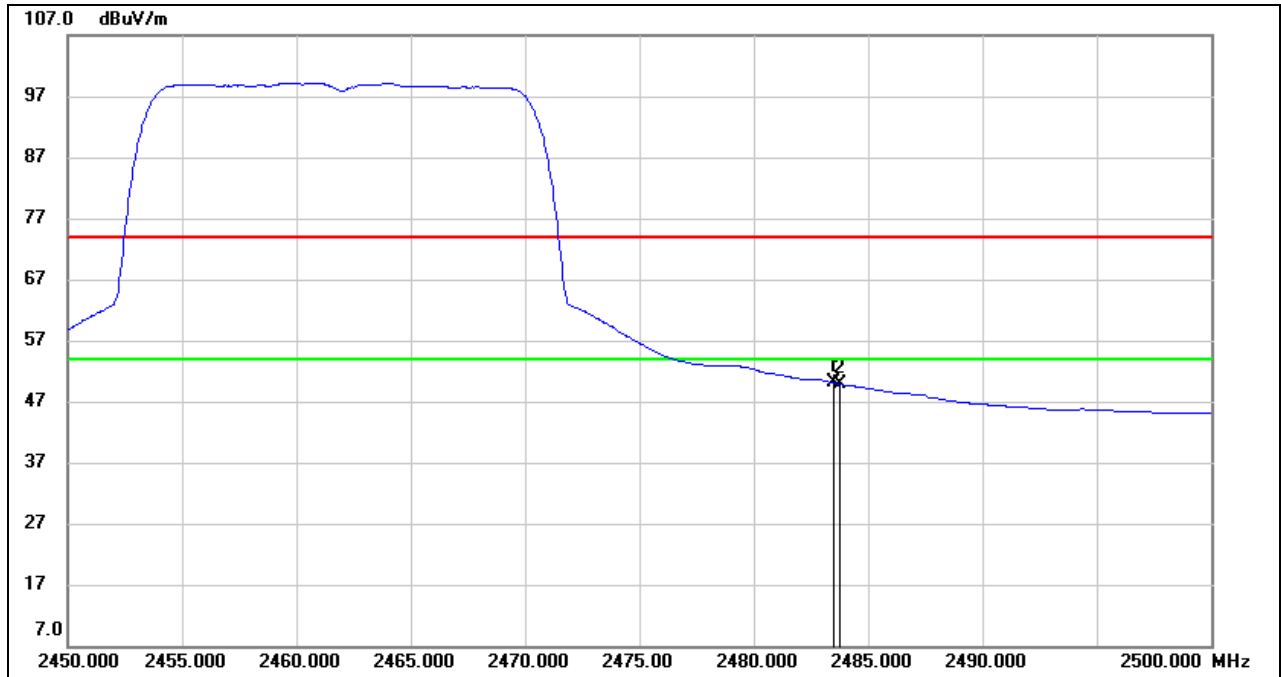

No.	Frequency (MHz)	Reading (dBuV)	Correct (dB/m)	Result (dBuV/m)	Limit (dBuV/m)	Margin (dB)	Remark
1	2483.500	16.43	33.71	50.14	54.00	-3.86	AVG
2	2483.750	16.18	33.71	49.89	54.00	-4.11	AVG

- Note: 1. Measurement = Reading Level + Correct Factor.
 2. AVG: $VBW=1/Ton$, where: Ton is the transmitting duration.
 3. For the transmitting duration, please refer to clause 7.1.
 4. Only the worst data was recorded, if it complies with the limit, the other emissions deemed to comply with the limit.

Note: Horizontal and Vertical have been tested, only the worst data was recorded in the report.



8.1.3. 802.11n HT20 MIMO MODE

RESTRICTED BANDEDGE (LOW CHANNEL, HORIZONTAL)

PEAK

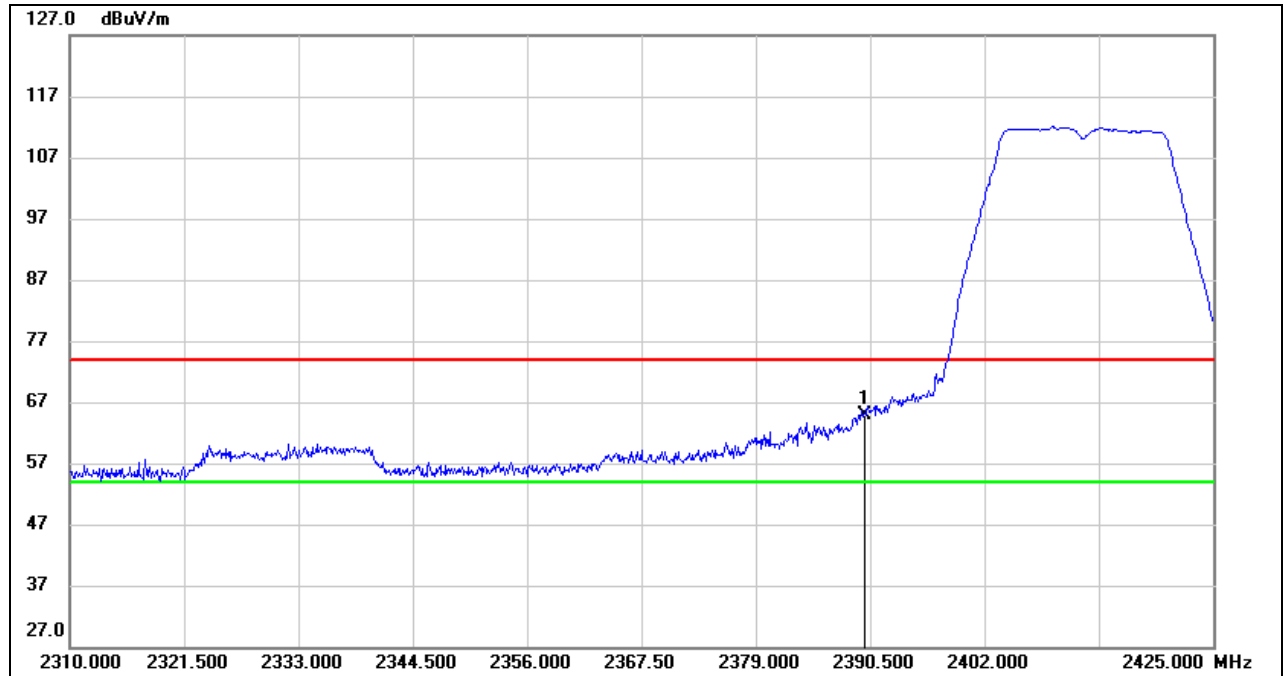

No.	Frequency (MHz)	Reading (dBuV)	Correct (dB/m)	Result (dBuV/m)	Limit (dBuV/m)	Margin (dB)	Remark
1	2390.000	31.49	33.35	64.84	74.00	-9.16	peak

Note: 1. Measurement = Reading Level + Correct Factor.

2. Peak: Peak detector.

3. Only the worst data was recorded, if it complies with the limit, the other emissions deemed to comply with the limit.



AVG

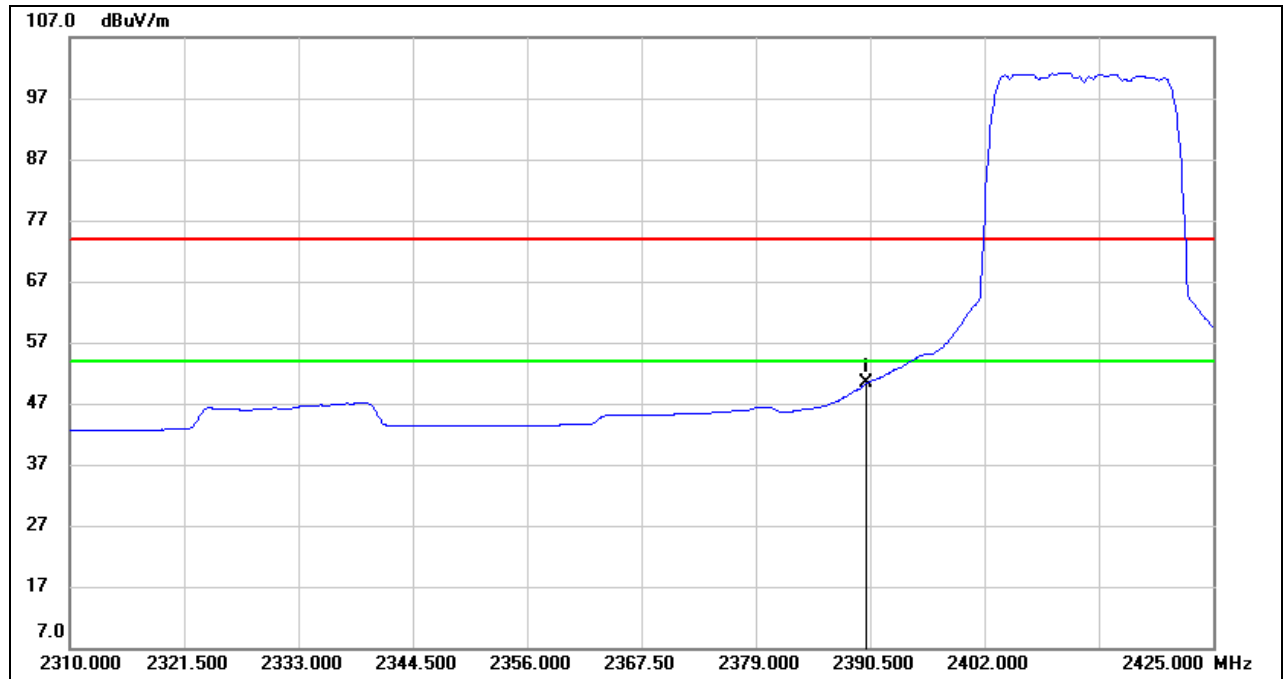

No.	Frequency (MHz)	Reading (dBuV)	Correct (dB/m)	Result (dBuV/m)	Limit (dBuV/m)	Margin (dB)	Remark
1	2390.000	16.91	33.35	50.26	54.00	-3.74	AVG

- Note:
1. Measurement = Reading Level + Correct Factor.
 2. AVG: $VBW=1/T_{on}$, where: T_{on} is the transmitting duration.
 3. For the transmitting duration, please refer to clause 7.1.
 4. Only the worst data was recorded, if it complies with the limit, the other emissions deemed to comply with the limit.



RESTRICTED BANDEDGE (HIGH CHANNEL, HORIZONTAL)

PEAK

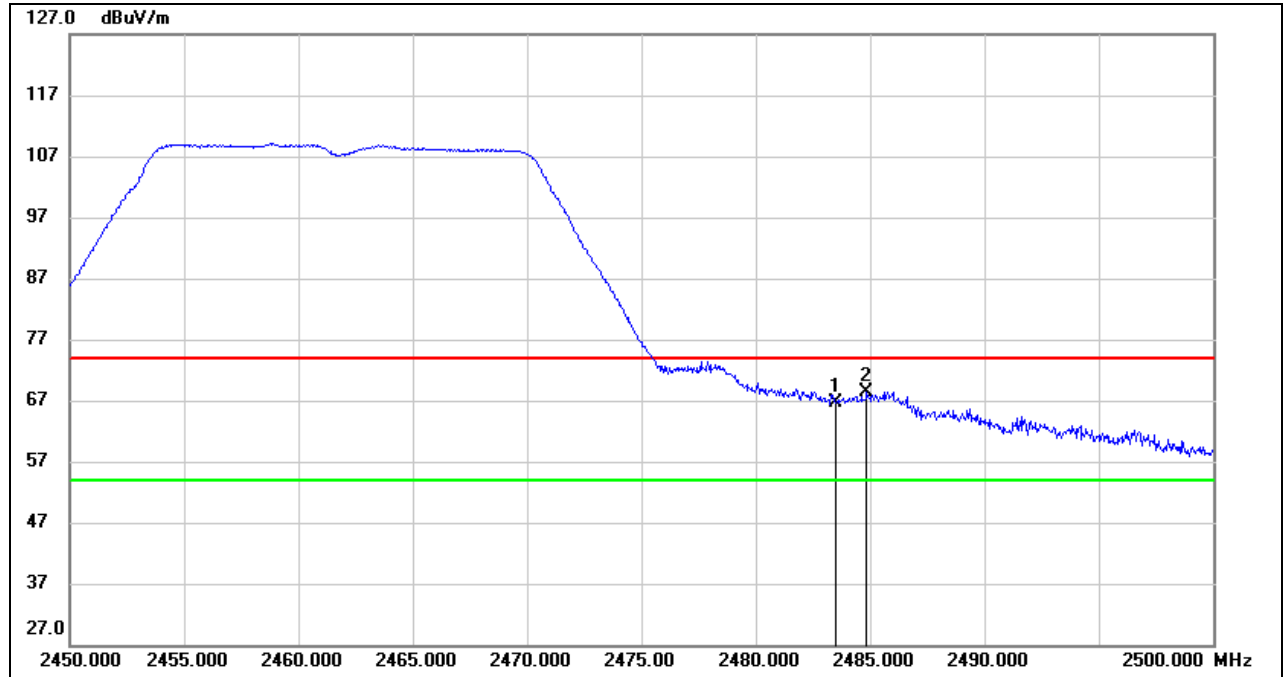

No.	Frequency (MHz)	Reading (dBuV)	Correct (dB/m)	Result (dBuV/m)	Limit (dBuV/m)	Margin (dB)	Remark
1	2483.500	32.86	33.71	66.57	74.00	-7.43	peak
2	2484.850	34.77	33.71	68.48	74.00	-5.52	peak

Note: 1. Measurement = Reading Level + Correct Factor.
 2. Peak: Peak detector.
 3. Only the worst data was recorded, if it complies with the limit, the other emissions deemed to comply with the limit.

AVG

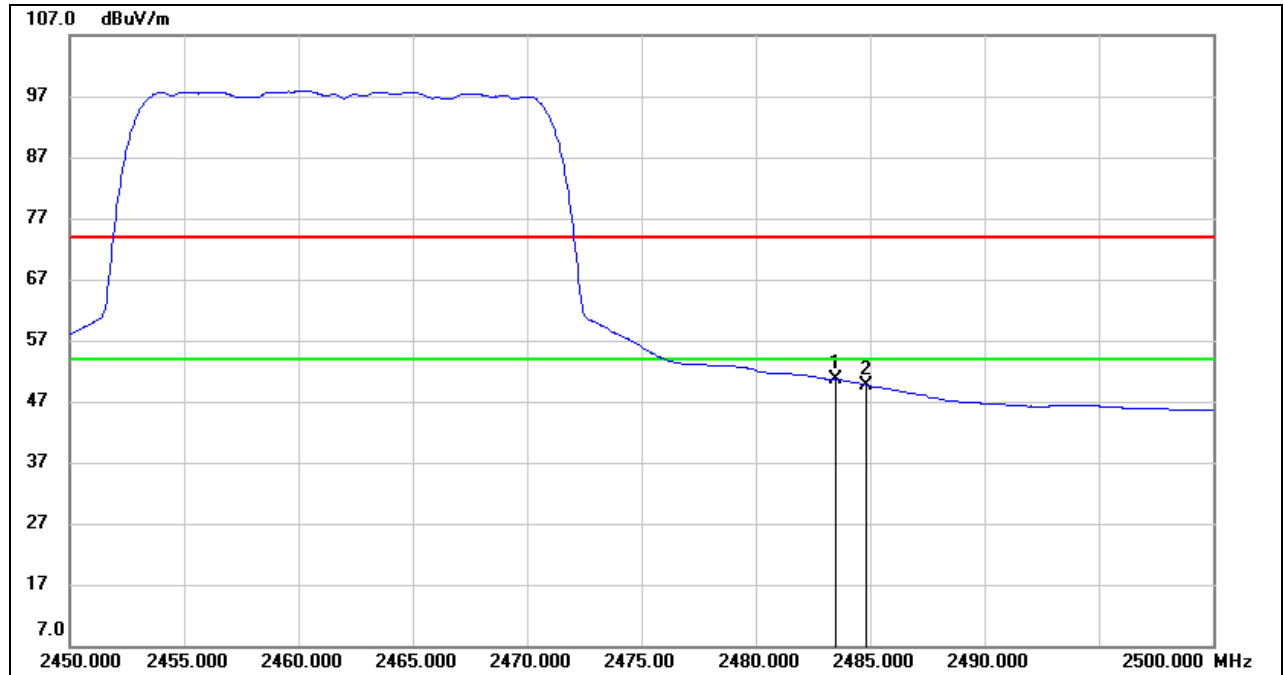

No.	Frequency (MHz)	Reading (dBuV)	Correct (dB/m)	Result (dBuV/m)	Limit (dBuV/m)	Margin (dB)	Remark
1	2483.500	17.00	33.71	50.71	54.00	-3.29	AVG
2	2484.850	15.96	33.71	49.67	54.00	-4.33	AVG

- Note:
1. Measurement = Reading Level + Correct Factor.
 2. AVG: $VBW=1/Ton$, where: Ton is the transmitting duration.
 3. For the transmitting duration, please refer to clause 7.1.
 4. Only the worst data was recorded, if it complies with the limit, the other emissions deemed to comply with the limit.

Note: Horizontal and Vertical have been tested, only the worst data was recorded in the report.



8.1.4. 802.11n HT40 MIMO MODE

RESTRICTED BANDEDGE (LOW CHANNEL, HORIZONTAL)

PEAK

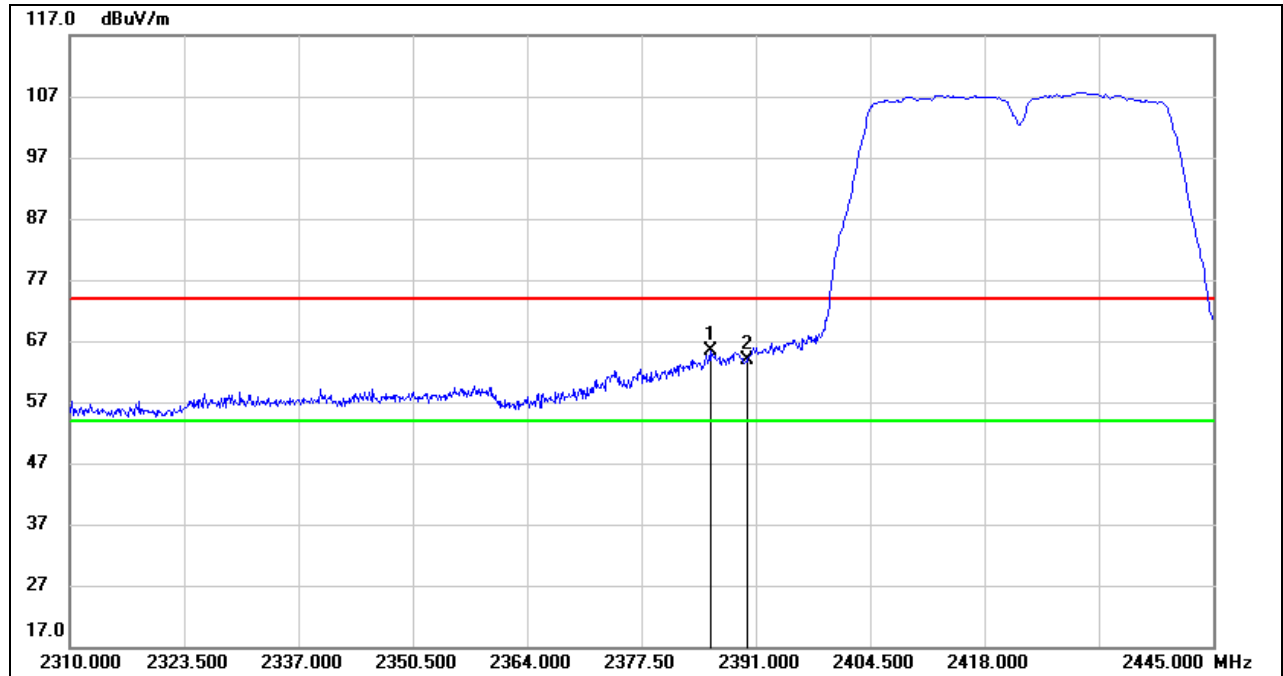

No.	Frequency (MHz)	Reading (dBuV)	Correct (dB/m)	Result (dBuV/m)	Limit (dBuV/m)	Margin (dB)	Remark
1	2385.600	31.95	33.31	65.26	74.00	-8.74	peak
2	2390.000	30.60	33.35	63.95	74.00	-10.05	peak

Note: 1. Measurement = Reading Level + Correct Factor.
 2. Peak: Peak detector.
 3. Only the worst data was recorded, if it complies with the limit, the other emissions deemed to comply with the limit.



AVG

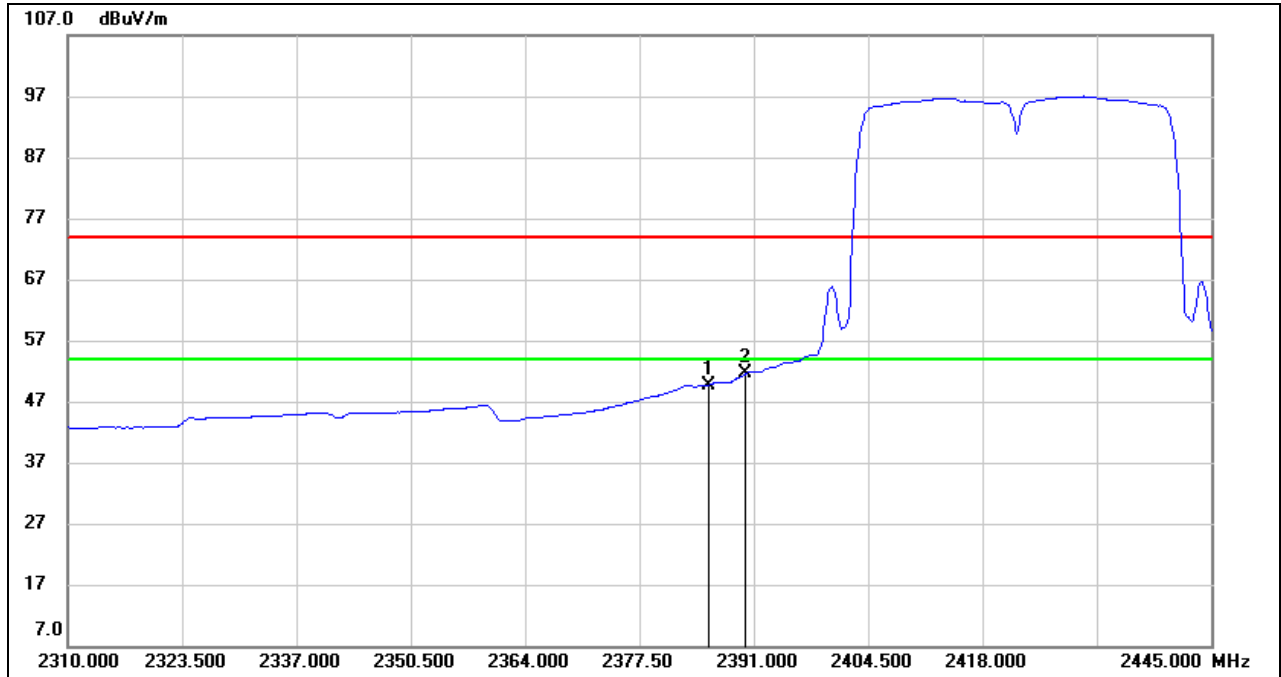

No.	Frequency (MHz)	Reading (dBuV)	Correct (dB/m)	Result (dBuV/m)	Limit (dBuV/m)	Margin (dB)	Remark
1	2385.600	16.34	33.31	49.65	54.00	-4.35	AVG
2	2390.000	18.24	33.35	51.59	54.00	-2.41	AVG

- Note:
1. Measurement = Reading Level + Correct Factor.
 2. AVG: $VBW=1/T_{on}$, where: T_{on} is the transmitting duration.
 3. For the transmitting duration, please refer to clause 7.1.
 4. Only the worst data was recorded, if it complies with the limit, the other emissions deemed to comply with the limit.



RESTRICTED BANDEDGE (HIGH CHANNEL, HORIZONTAL)

PEAK

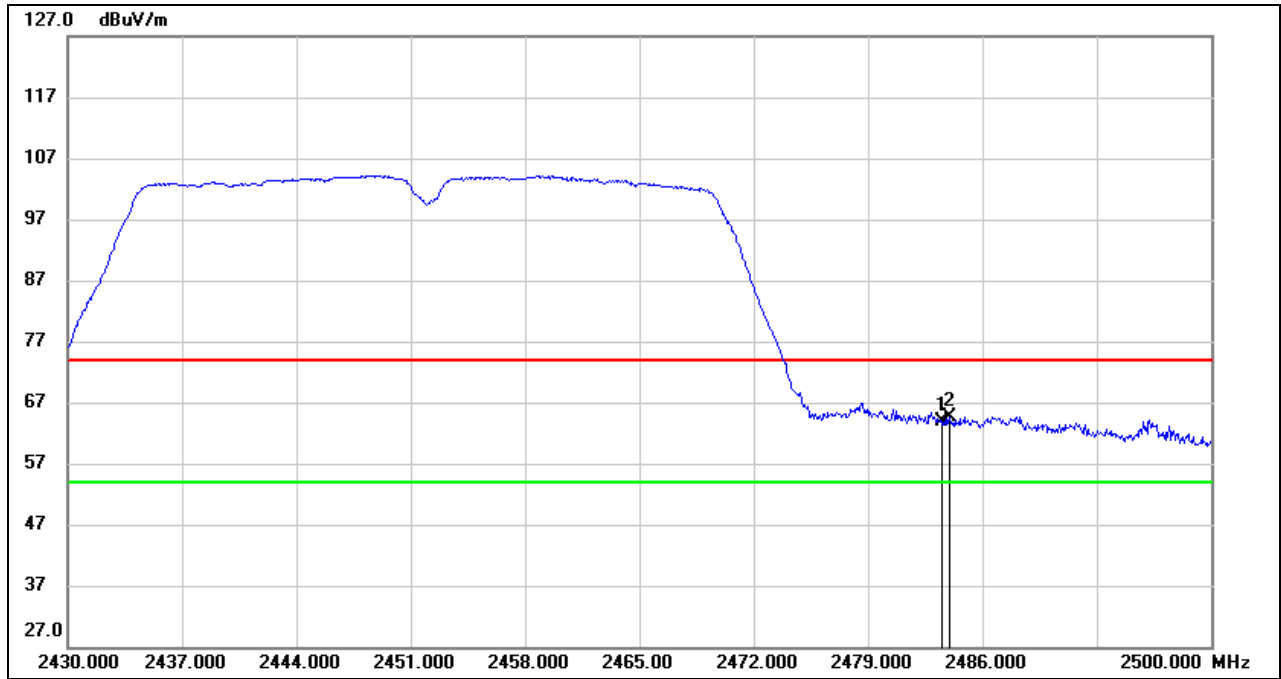

No.	Frequency (MHz)	Reading (dBuV)	Correct (dB/m)	Result (dBuV/m)	Limit (dBuV/m)	Margin (dB)	Remark
1	2483.500	30.29	33.71	64.00	74.00	-10.00	peak
2	2483.970	31.00	33.71	64.71	74.00	-9.29	peak

Note: 1. Measurement = Reading Level + Correct Factor.

2. Peak: Peak detector.

3. Only the worst data was recorded, if it complies with the limit, the other emissions deemed to comply with the limit.

AVG

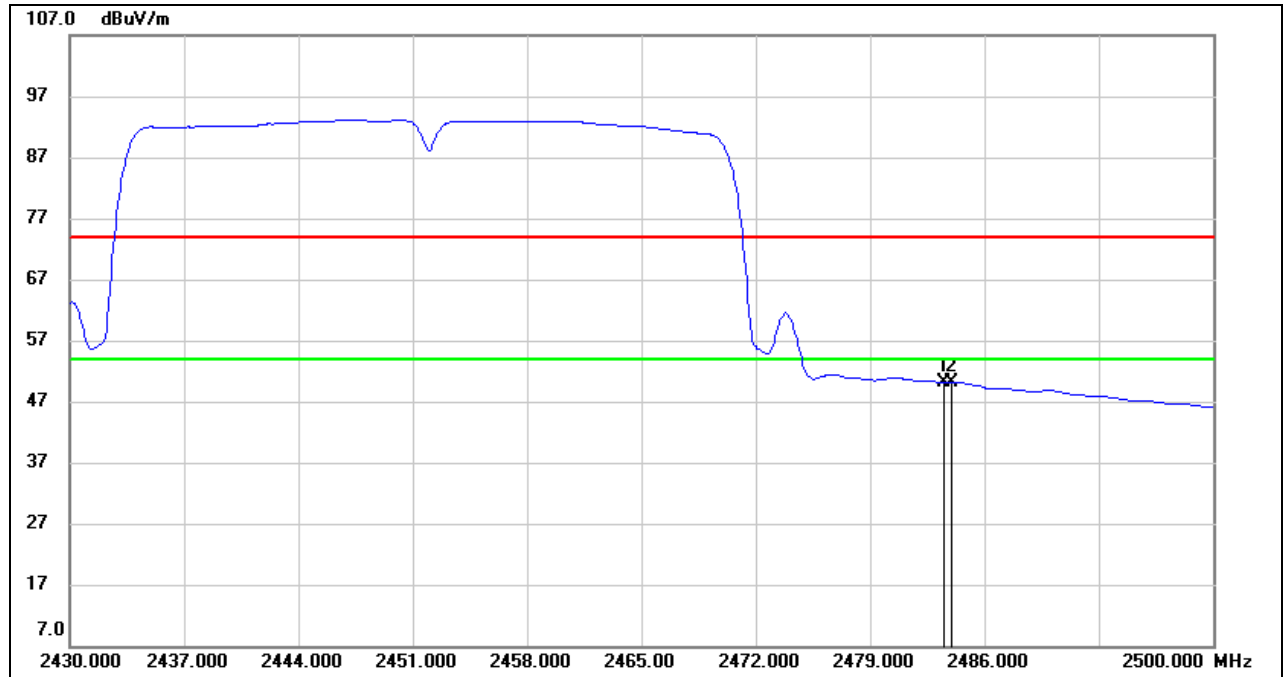

No.	Frequency (MHz)	Reading (dBuV)	Correct (dB/m)	Result (dBuV/m)	Limit (dBuV/m)	Margin (dB)	Remark
1	2483.500	16.45	33.71	50.16	54.00	-3.84	AVG
2	2483.970	16.46	33.71	50.17	54.00	-3.83	AVG

- Note:
1. Measurement = Reading Level + Correct Factor.
 2. AVG: $VBW=1/Ton$, where: Ton is the transmitting duration.
 3. For the transmitting duration, please refer to clause 7.1.
 4. Only the worst data was recorded, if it complies with the limit, the other emissions deemed to comply with the limit.

Note: Horizontal and Vertical have been tested, only the worst data was recorded in the report.

8.2. SPURIOUS EMISSIONS (1 GHz ~ 3 GHz)

8.2.1. 802.11b SISO MODE

ANTENNA 0 TEST RESULTS (WORST CASE)

HARMONICS AND SPURIOUS EMISSIONS (LOW CHANNEL, HORIZONTAL)

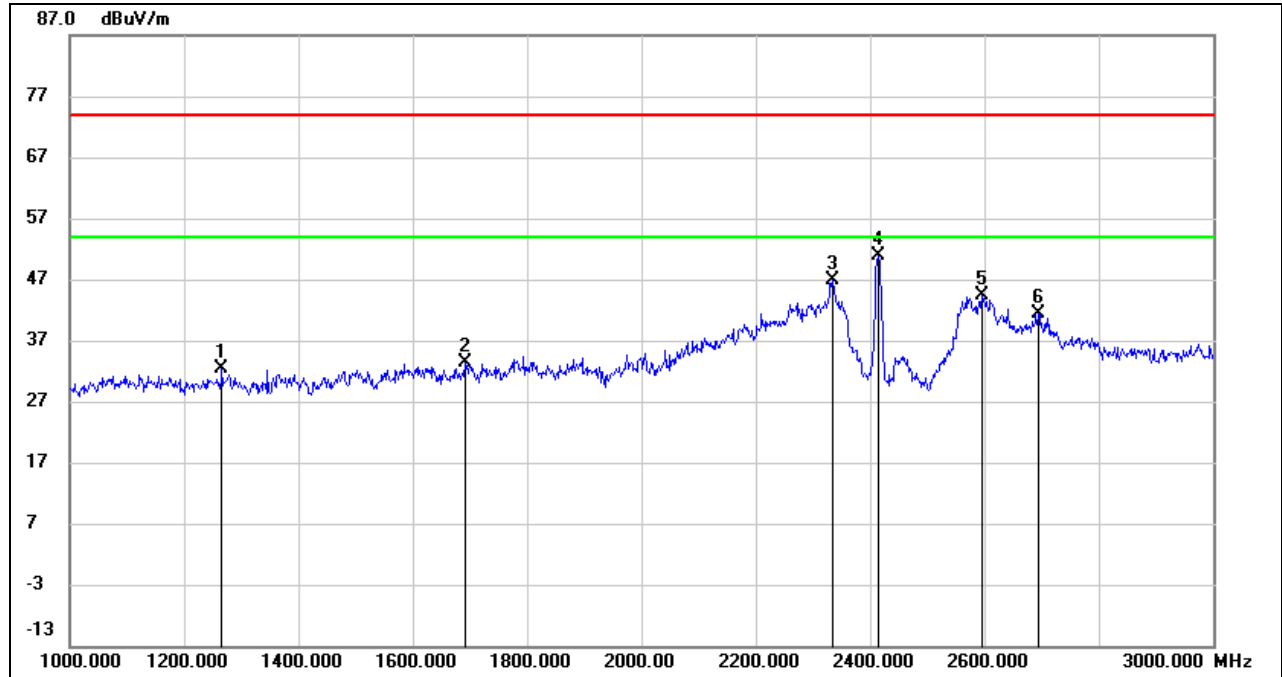

No.	Frequency (MHz)	Reading (dBuV)	Correct (dB/m)	Result (dBuV/m)	Limit (dBuV/m)	Margin (dB)	Remark
1	1266.000	45.22	-12.90	32.32	74.00	-41.68	peak
2	1692.000	44.25	-10.87	33.38	74.00	-40.62	peak
3	2334.000	55.38	-8.61	46.77	74.00	-27.23	peak
4	2412.000	59.26	-8.36	50.90	/	/	Fundamental
5	2596.000	52.24	-7.88	44.36	74.00	-29.64	peak
6	2694.000	48.67	-7.24	41.43	74.00	-32.57	peak

- Note: 1. Measurement = Reading Level + Correct Factor.
 2. If Peak Result complies with AV limit, AV Result is deemed to comply with AV limit.
 3. Peak: Peak detector.
 4. Filter losses were only considered in the spurious frequency bands and the authorized band was not corrected for Band reject filter losses.
 5. Proper operation of the transmitter prior to adding the filter to the measurement chain.

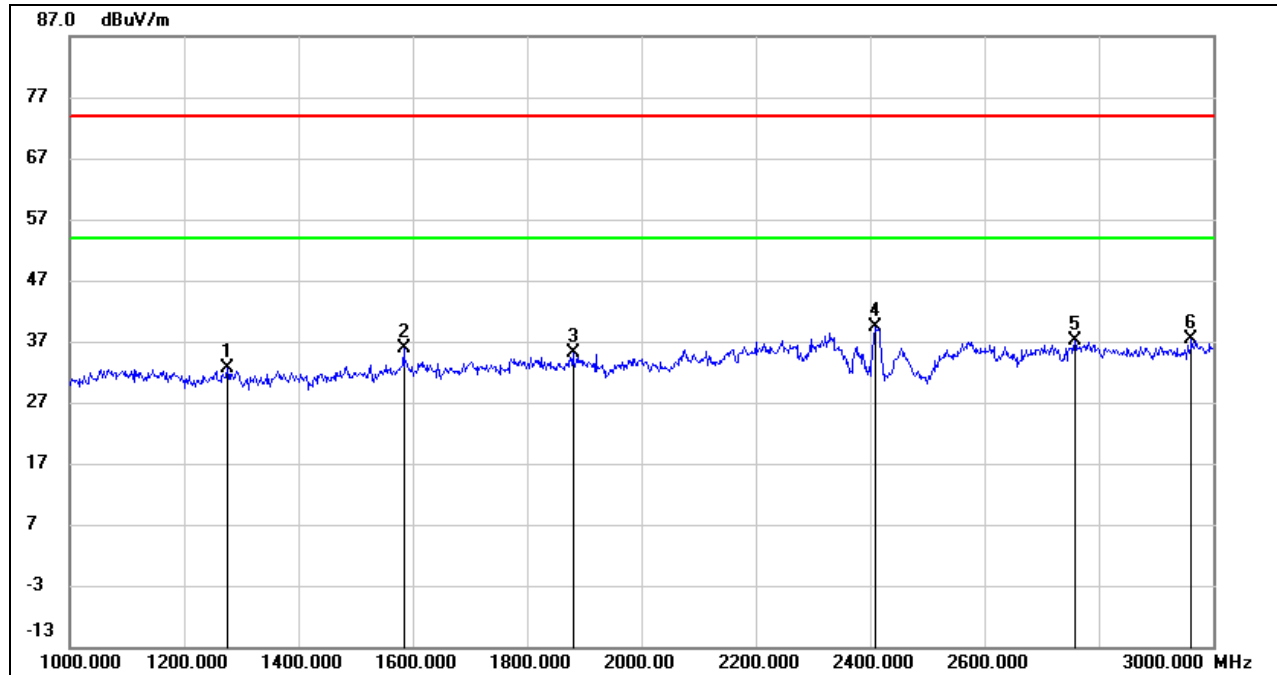
HARMONICS AND SPURIOUS EMISSIONS (LOW CHANNEL, VERTICAL)

No.	Frequency (MHz)	Reading (dBuV)	Correct (dB/m)	Result (dBuV/m)	Limit (dBuV/m)	Margin (dB)	Remark
1	1276.000	45.43	-12.88	32.55	74.00	-41.45	peak
2	1584.000	47.47	-11.66	35.81	74.00	-38.19	peak
3	1880.000	45.25	-10.10	35.15	74.00	-38.85	peak
4	2412.000	47.71	-8.39	39.32	/	/	Fundamental
5	2758.000	43.88	-6.82	37.06	74.00	-36.94	peak
6	2962.000	43.18	-5.78	37.40	74.00	-36.60	peak

Note: 1. Measurement = Reading Level + Correct Factor.

2. If Peak Result complies with AV limit, AV Result is deemed to comply with AV limit.

3. Peak: Peak detector.

4. Filter losses were only considered in the spurious frequency bands and the authorized band was not corrected for Band reject filter losses.

5. Proper operation of the transmitter prior to adding the filter to the measurement chain.



HARMONICS AND SPURIOUS EMISSIONS (MID CHANNEL, HORIZONTAL)

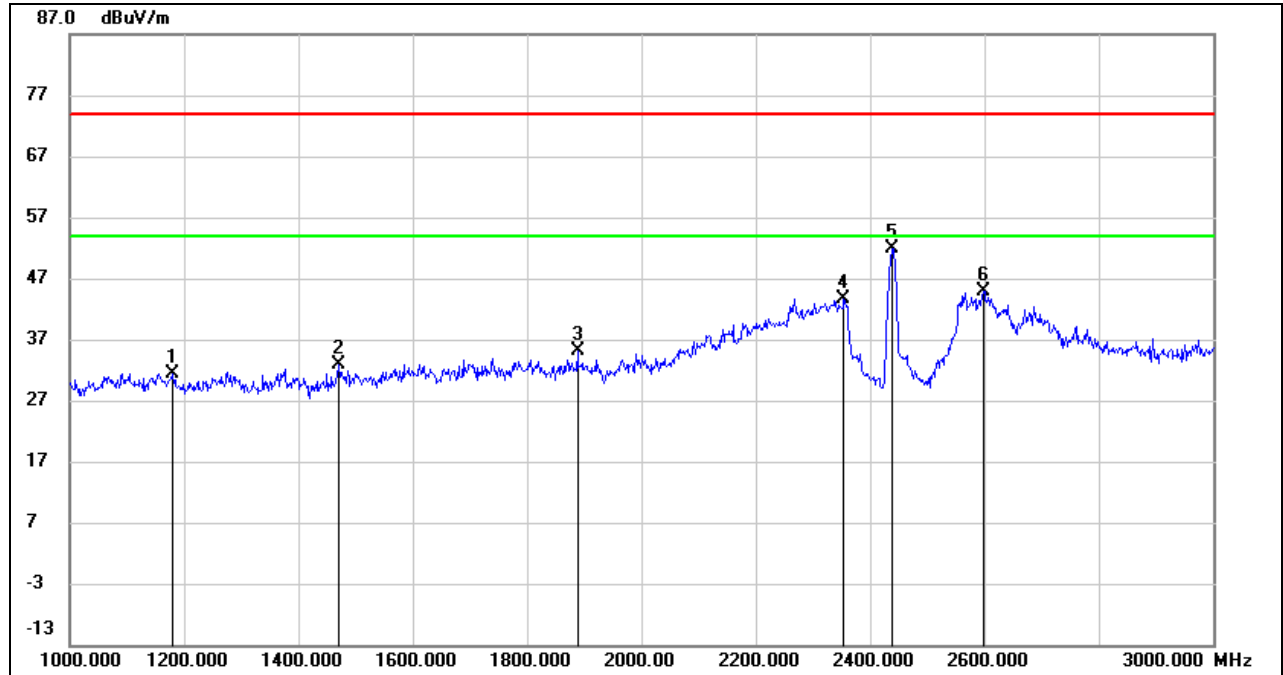

No.	Frequency (MHz)	Reading (dBuV)	Correct (dB/m)	Result (dBuV/m)	Limit (dBuV/m)	Margin (dB)	Remark
1	1180.000	44.57	-13.10	31.47	74.00	-42.53	peak
2	1470.000	45.34	-12.37	32.97	74.00	-41.03	peak
3	1888.000	45.14	-10.12	35.02	74.00	-38.98	peak
4	2354.000	52.22	-8.54	43.68	74.00	-30.32	peak
5	2437.000	60.20	-8.33	51.87	/	/	Fundamental
6	2598.000	52.87	-7.88	44.99	74.00	-29.01	peak

- Note: 1. Measurement = Reading Level + Correct Factor.
 2. If Peak Result complies with AV limit, AV Result is deemed to comply with AV limit.
 3. Peak: Peak detector.
 4. Filter losses were only considered in the spurious frequency bands and the authorized band was not corrected for Band reject filter losses.
 5. Proper operation of the transmitter prior to adding the filter to the measurement chain.

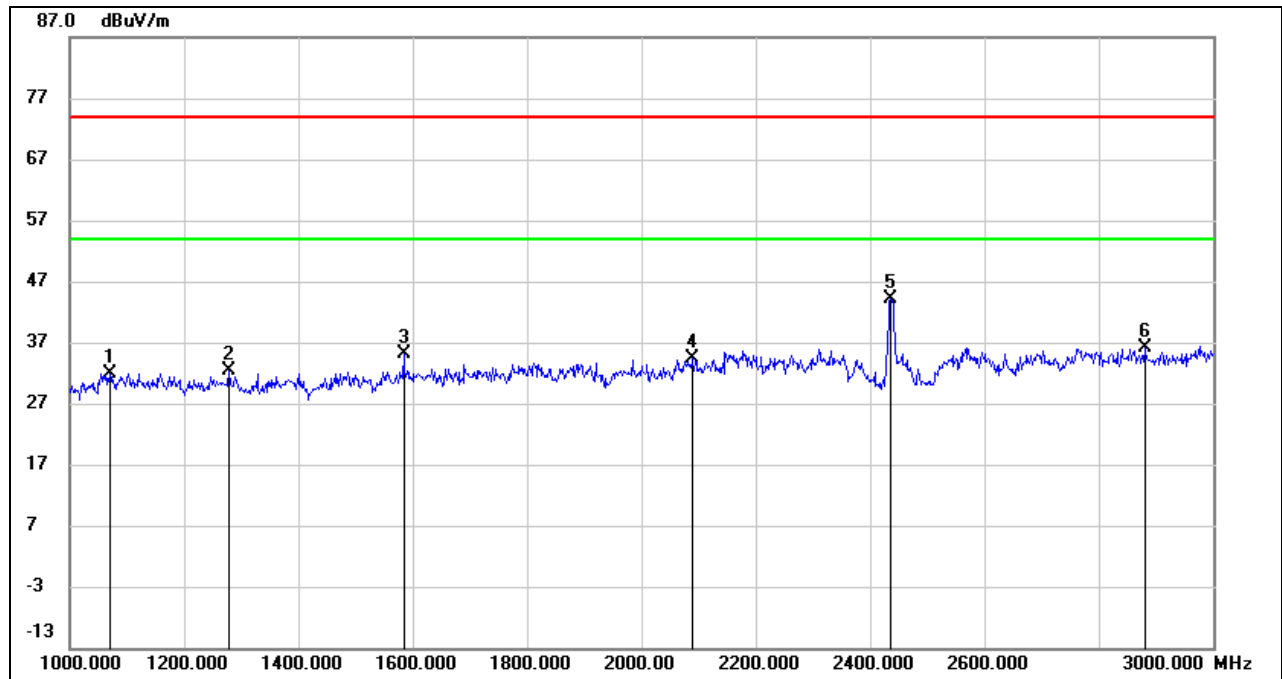
**HARMONICS AND SPURIOUS EMISSIONS (MID CHANNEL, VERTICAL)**

No.	Frequency (MHz)	Reading (dBuV)	Correct (dB/m)	Result (dBuV/m)	Limit (dBuV/m)	Margin (dB)	Remark
1	1070.000	45.62	-13.63	31.99	74.00	-42.01	peak
2	1278.000	45.15	-12.88	32.27	74.00	-41.73	peak
3	1584.000	46.79	-11.66	35.13	74.00	-38.87	peak
4	2090.000	44.03	-9.67	34.36	74.00	-39.64	peak
5	2437.000	52.49	-8.34	44.15	/	/	Fundamental
6	2880.000	42.30	-6.17	36.13	74.00	-37.87	peak

Note: 1. Measurement = Reading Level + Correct Factor.

2. If Peak Result complies with AV limit, AV Result is deemed to comply with AV limit.

3. Peak: Peak detector.

4. Filter losses were only considered in the spurious frequency bands and the authorized band was not corrected for Band reject filter losses.

5. Proper operation of the transmitter prior to adding the filter to the measurement chain.



HARMONICS AND SPURIOUS EMISSIONS (HIGH CHANNEL, HORIZONTAL)

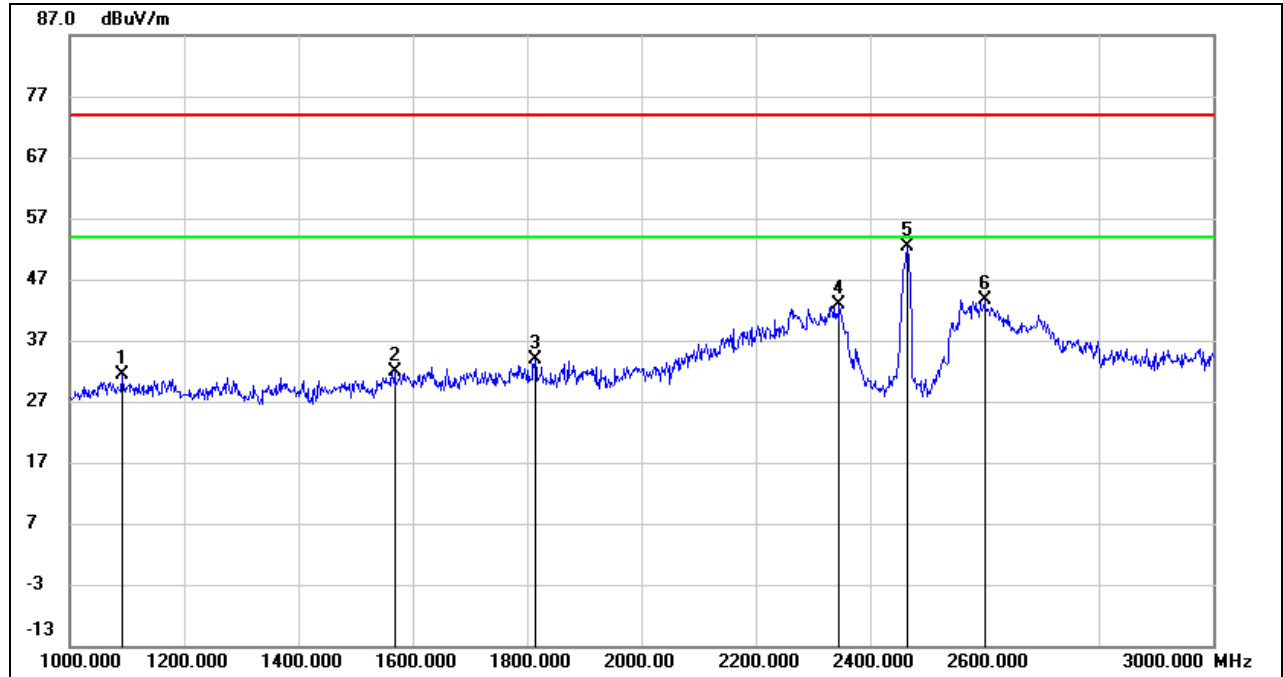

No.	Frequency (MHz)	Reading (dBuV)	Correct (dB/m)	Result (dBuV/m)	Limit (dBuV/m)	Margin (dB)	Remark
1	1092.000	45.02	-13.52	31.50	74.00	-42.50	peak
2	1568.000	43.57	-11.77	31.80	74.00	-42.20	peak
3	1814.000	43.94	-10.06	33.88	74.00	-40.12	peak
4	2346.000	51.42	-8.58	42.84	74.00	-31.16	peak
5	2462.000	60.63	-8.27	52.36	/	/	Fundamental
6	2600.000	51.47	-7.86	43.61	74.00	-30.39	peak

- Note: 1. Measurement = Reading Level + Correct Factor.
 2. If Peak Result complies with AV limit, AV Result is deemed to comply with AV limit.
 3. Peak: Peak detector.
 4. Filter losses were only considered in the spurious frequency bands and the authorized band was not corrected for Band reject filter losses.
 5. Proper operation of the transmitter prior to adding the filter to the measurement chain.

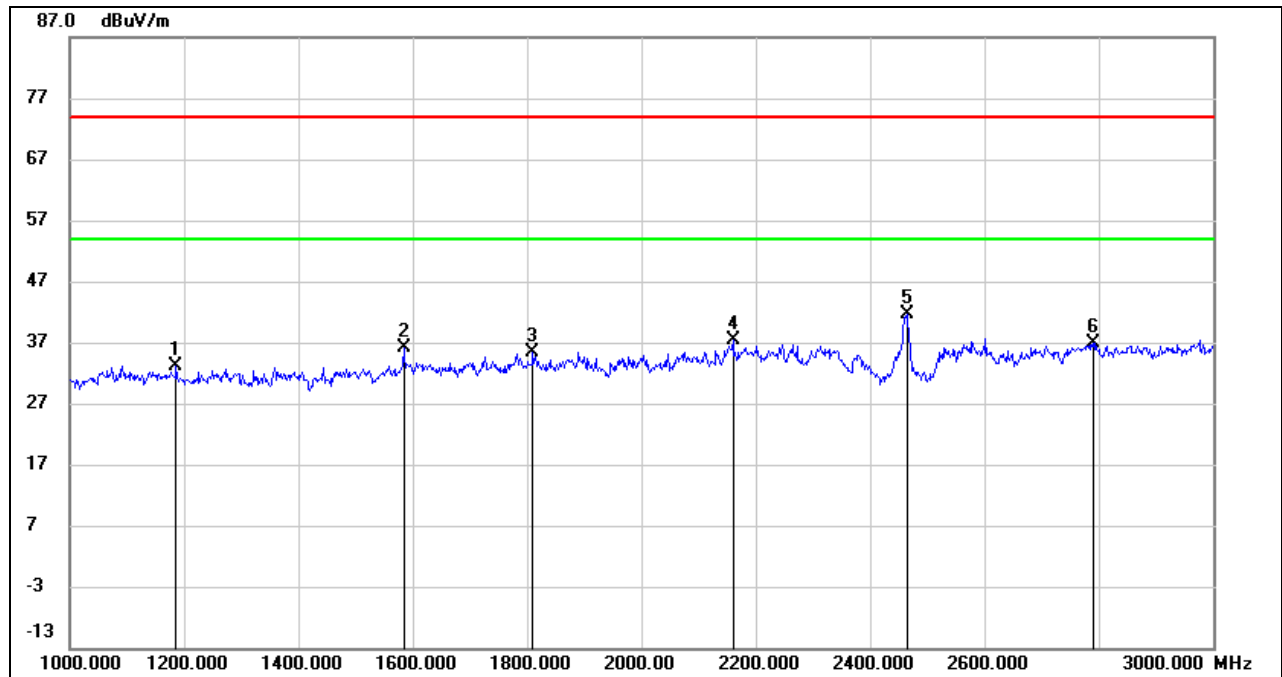
**HARMONICS AND SPURIOUS EMISSIONS (HIGH CHANNEL, VERTICAL)**

No.	Frequency (MHz)	Reading (dBuV)	Correct (dB/m)	Result (dBuV/m)	Limit (dBuV/m)	Margin (dB)	Remark
1	1186.000	46.16	-13.07	33.09	74.00	-40.91	peak
2	1584.000	47.75	-11.66	36.09	74.00	-37.91	peak
3	1810.000	45.49	-10.05	35.44	74.00	-38.56	peak
4	2160.000	46.72	-9.28	37.44	74.00	-36.56	peak
5	2462.000	49.98	-8.27	41.71	/	/	Fundamental
6	2790.000	43.59	-6.62	36.97	74.00	-37.03	peak

Note: 1. Measurement = Reading Level + Correct Factor.

2. If Peak Result complies with AV limit, AV Result is deemed to comply with AV limit.

3. Peak: Peak detector.

4. Filter losses were only considered in the spurious frequency bands and the authorized band was not corrected for Band reject filter losses.

5. Proper operation of the transmitter prior to adding the filter to the measurement chain.

Note: All modes and channels have been tested, only the worst data was recorded in the report.

8.3. SPURIOUS EMISSIONS (3 GHz ~ 18 GHz)

8.3.1. 802.11b SISO MODE

ANTENNA 0 TEST RESULTS (WORST CASE)

HARMONICS AND SPURIOUS EMISSIONS (LOW CHANNEL, HORIZONTAL)

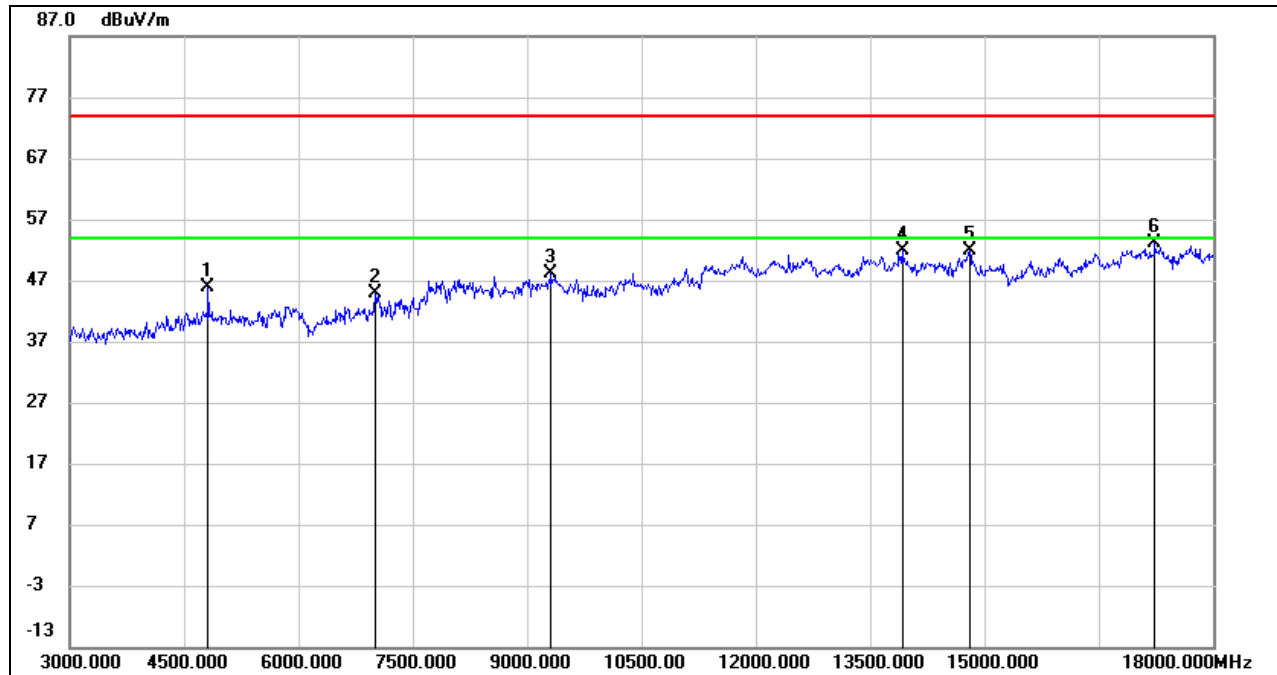

No.	Frequency (MHz)	Reading (dBuV)	Correct (dB/m)	Result (dBuV/m)	Limit (dBuV/m)	Margin (dB)	Remark
1	4815.000	44.46	1.38	45.84	74.00	-28.16	peak
2	7005.000	37.27	7.60	44.87	74.00	-29.13	peak
3	9315.000	37.65	10.48	48.13	74.00	-25.87	peak
4	13920.000	34.29	17.55	51.84	74.00	-22.16	peak
5	14805.000	33.82	18.00	51.82	74.00	-22.18	peak
6	17235.000	30.89	22.21	53.10	74.00	-20.90	peak

Note: 1. Peak Result = Reading Level + Correct Factor.

2. If Peak Result complies with AV limit, AV Result is deemed to comply with AV limit.

3. Peak: Peak detector.

4. Filter losses were only considered in the spurious frequency bands and the authorized band was not corrected for High Pass Filter losses.

5. Proper operation of the transmitter prior to adding the filter to the measurement chain.



HARMONICS AND SPURIOUS EMISSIONS (LOW CHANNEL, VERTICAL)

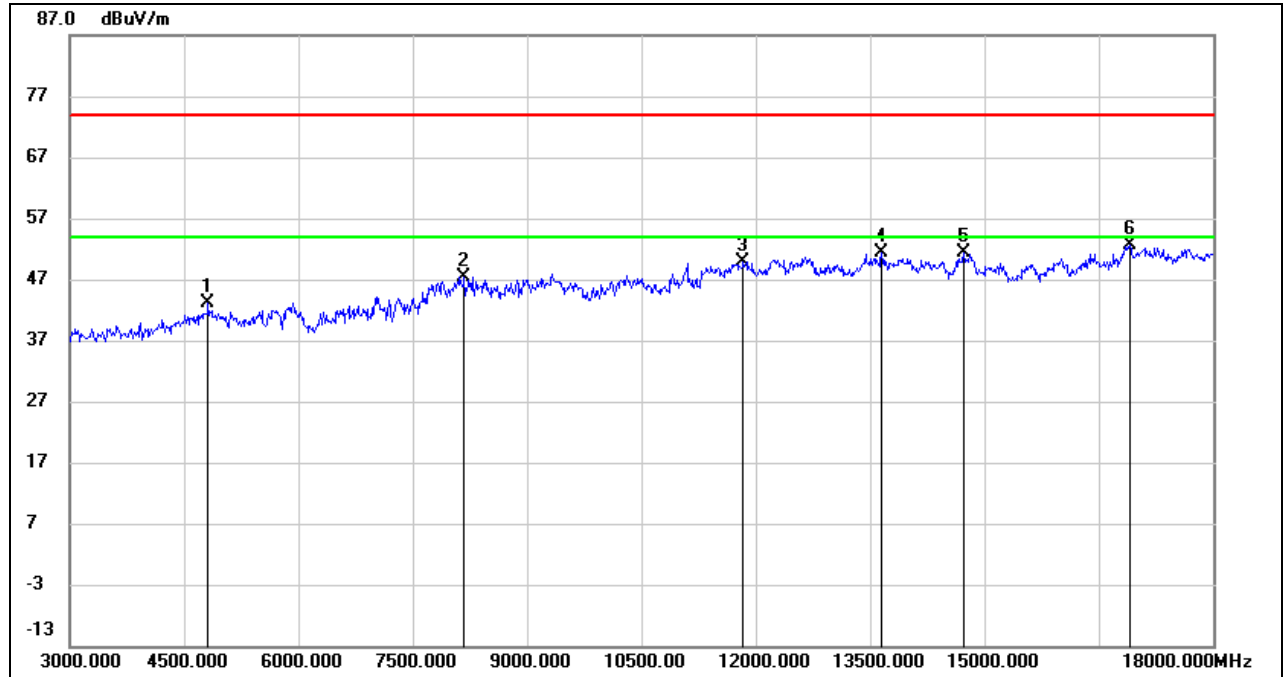

No.	Frequency (MHz)	Reading (dBuV)	Correct (dB/m)	Result (dBuV/m)	Limit (dBuV/m)	Margin (dB)	Remark
1	4815.000	41.78	1.38	43.16	74.00	-30.84	peak
2	8175.000	37.55	9.90	47.45	74.00	-26.55	peak
3	11835.000	34.54	15.34	49.88	74.00	-24.12	peak
4	13650.000	33.96	17.35	51.31	74.00	-22.69	peak
5	14730.000	33.67	17.79	51.46	74.00	-22.54	peak
6	16905.000	31.06	21.55	52.61	74.00	-21.39	peak

- Note: 1. Peak Result = Reading Level + Correct Factor.
 2. If Peak Result complies with AV limit, AV Result is deemed to comply with AV limit.
 3. Peak: Peak detector.
 4. Filter losses were only considered in the spurious frequency bands and the authorized band was not corrected for High Pass Filter losses.
 5. Proper operation of the transmitter prior to adding the filter to the measurement chain.



HARMONICS AND SPURIOUS EMISSIONS (MID CHANNEL, HORIZONTAL)

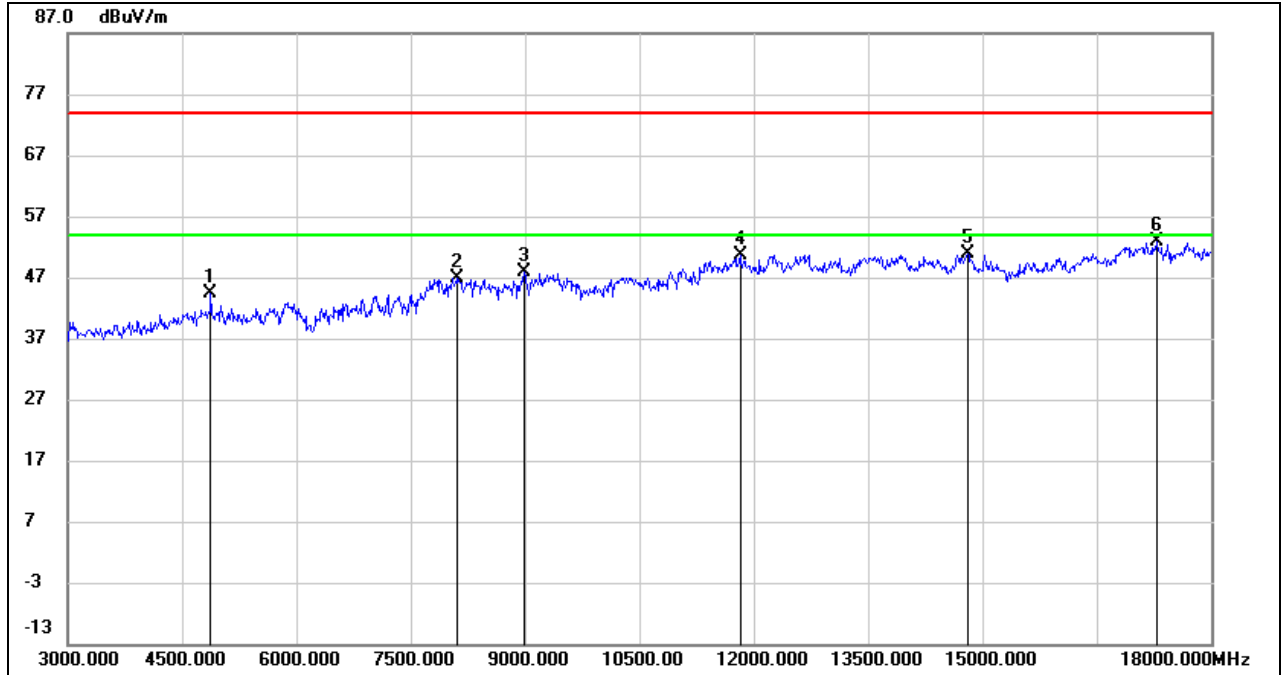

No.	Frequency (MHz)	Reading (dBuV)	Correct (dB/m)	Result (dBuV/m)	Limit (dBuV/m)	Margin (dB)	Remark
1	4875.000	43.13	1.32	44.45	74.00	-29.55	peak
2	8115.000	36.70	10.13	46.83	74.00	-27.17	peak
3	8985.000	36.86	10.99	47.85	74.00	-26.15	peak
4	11820.000	35.22	15.29	50.51	74.00	-23.49	peak
5	14805.000	32.91	18.00	50.91	74.00	-23.09	peak
6	17280.000	30.37	22.48	52.85	74.00	-21.15	peak

- Note: 1. Peak Result = Reading Level + Correct Factor.
 2. If Peak Result complies with AV limit, AV Result is deemed to comply with AV limit.
 3. Peak: Peak detector.
 4. Filter losses were only considered in the spurious frequency bands and the authorized band was not corrected for High Pass Filter losses.
 5. Proper operation of the transmitter prior to adding the filter to the measurement chain.

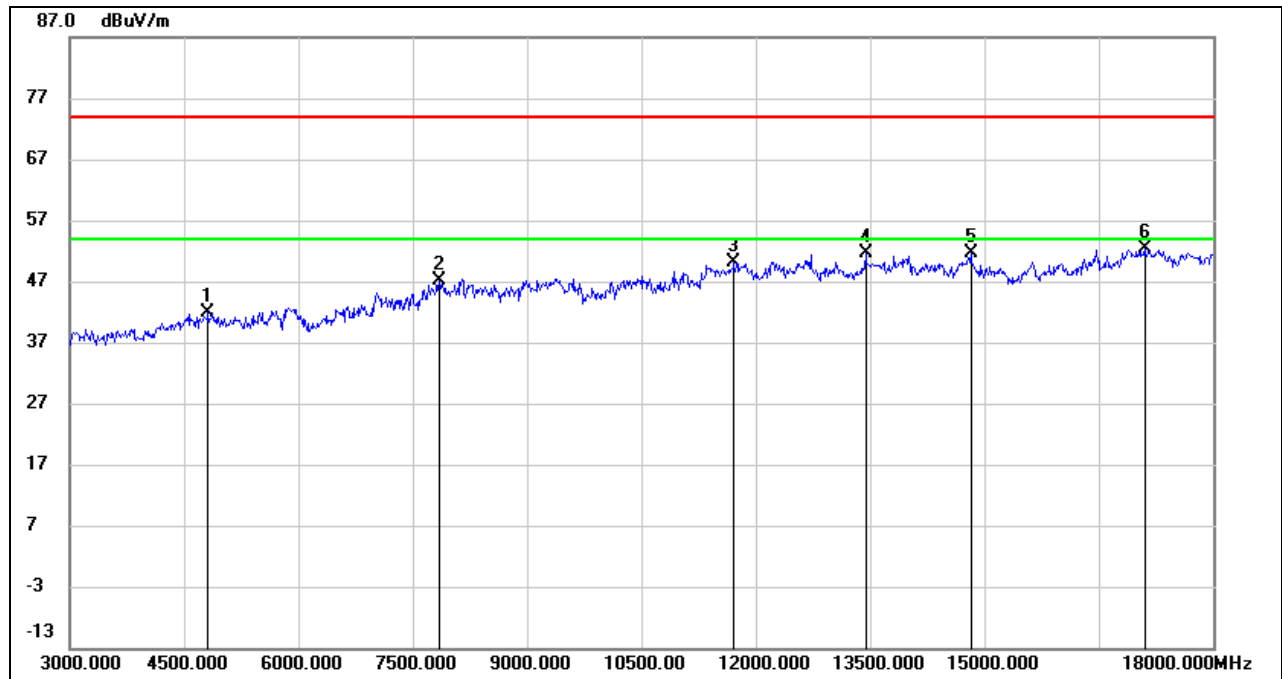
**HARMONICS AND SPURIOUS EMISSIONS (MID CHANNEL, VERTICAL)**

No.	Frequency (MHz)	Reading (dBuV)	Correct (dB/m)	Result (dBuV/m)	Limit (dBuV/m)	Margin (dB)	Remark
1	4815.000	40.52	1.38	41.90	74.00	-32.10	peak
2	7845.000	38.02	9.14	47.16	74.00	-26.84	peak
3	11715.000	34.77	15.34	50.11	74.00	-23.89	peak
4	13440.000	34.50	17.10	51.60	74.00	-22.40	peak
5	14820.000	33.73	17.91	51.64	74.00	-22.36	peak
6	17100.000	30.49	21.90	52.39	74.00	-21.61	peak

Note: 1. Peak Result = Reading Level + Correct Factor.

2. If Peak Result complies with AV limit, AV Result is deemed to comply with AV limit.

3. Peak: Peak detector.

4. Filter losses were only considered in the spurious frequency bands and the authorized band was not corrected for High Pass Filter losses.

5. Proper operation of the transmitter prior to adding the filter to the measurement chain.



HARMONICS AND SPURIOUS EMISSIONS (HIGH CHANNEL, HORIZONTAL)

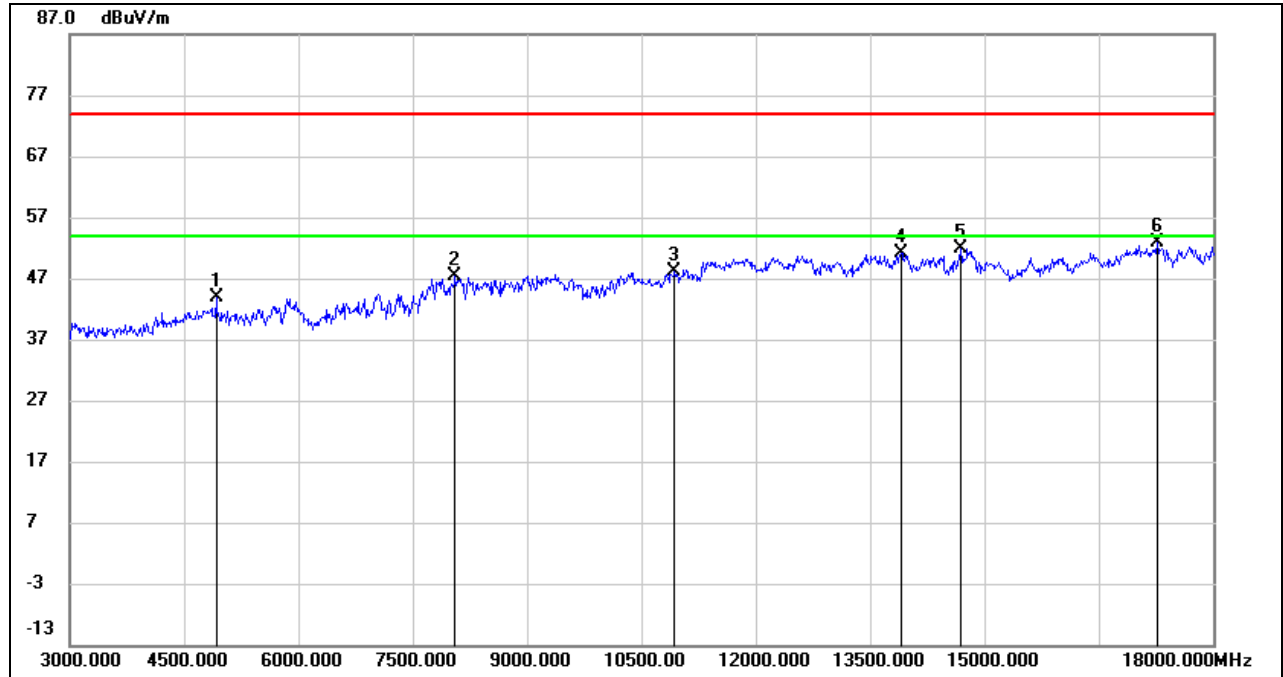

No.	Frequency (MHz)	Reading (dBuV)	Correct (dB/m)	Result (dBuV/m)	Limit (dBuV/m)	Margin (dB)	Remark
1	4920.000	42.46	1.45	43.91	74.00	-30.09	peak
2	8055.000	37.82	9.48	47.30	74.00	-26.70	peak
3	10935.000	34.88	13.34	48.22	74.00	-25.78	peak
4	13905.000	33.51	17.54	51.05	74.00	-22.95	peak
5	14685.000	34.24	17.64	51.88	74.00	-22.12	peak
6	17265.000	30.44	22.39	52.83	74.00	-21.17	peak

- Note: 1. Peak Result = Reading Level + Correct Factor.
 2. If Peak Result complies with AV limit, AV Result is deemed to comply with AV limit.
 3. Peak: Peak detector.
 4. Filter losses were only considered in the spurious frequency bands and the authorized band was not corrected for High Pass Filter losses.
 5. Proper operation of the transmitter prior to adding the filter to the measurement chain.

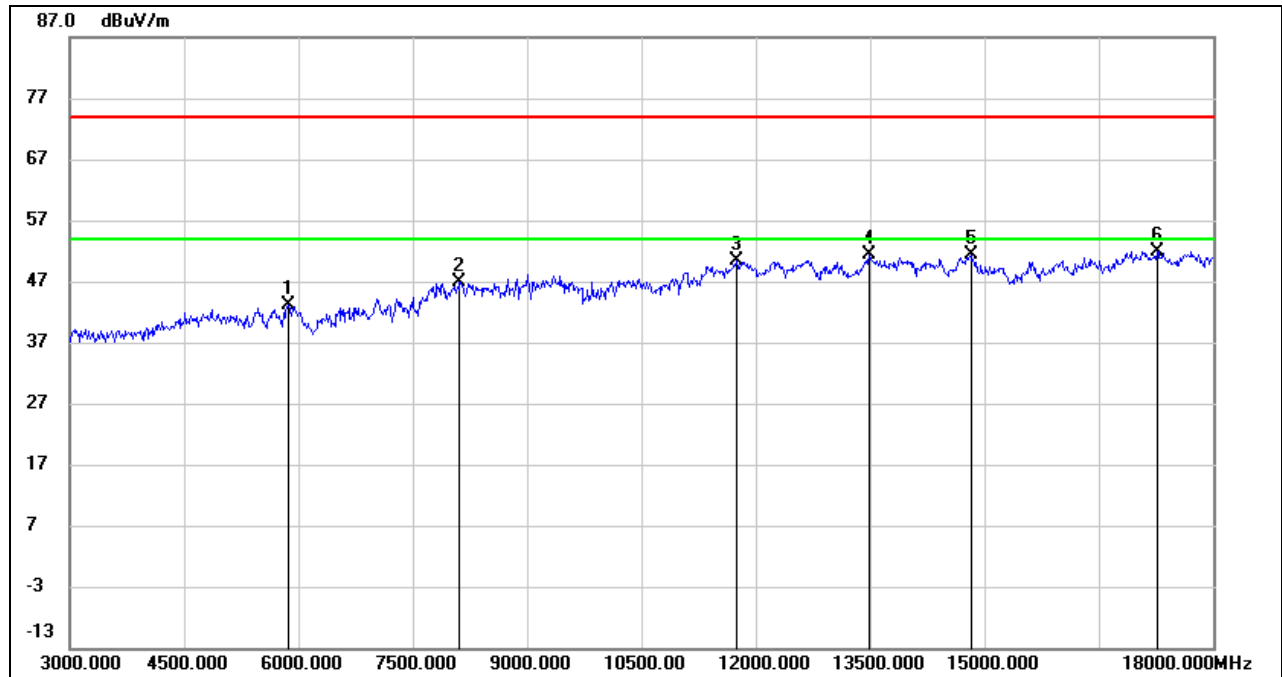
**HARMONICS AND SPURIOUS EMISSIONS (HIGH CHANNEL, VERTICAL)**

No.	Frequency (MHz)	Reading (dBuV)	Correct (dB/m)	Result (dBuV/m)	Limit (dBuV/m)	Margin (dB)	Remark
1	5865.000	39.09	4.16	43.25	74.00	-30.75	peak
2	8115.000	36.85	10.13	46.98	74.00	-27.02	peak
3	11745.000	35.02	15.30	50.32	74.00	-23.68	peak
4	13485.000	34.13	17.19	51.32	74.00	-22.68	peak
5	14820.000	33.46	17.91	51.37	74.00	-22.63	peak
6	17265.000	29.59	22.39	51.98	74.00	-22.02	peak

- Note: 1. Peak Result = Reading Level + Correct Factor.
 2. If Peak Result complies with AV limit, AV Result is deemed to comply with AV limit.
 3. Peak: Peak detector.
 4. Filter losses were only considered in the spurious frequency bands and the authorized band was not corrected for High Pass Filter losses.
 5. Proper operation of the transmitter prior to adding the filter to the measurement chain.

8.3.2. 802.11g SISO MODE

ANTENNA 0 TEST RESULTS (WORST CASE)

HARMONICS AND SPURIOUS EMISSIONS (LOW CHANNEL, HORIZONTAL)

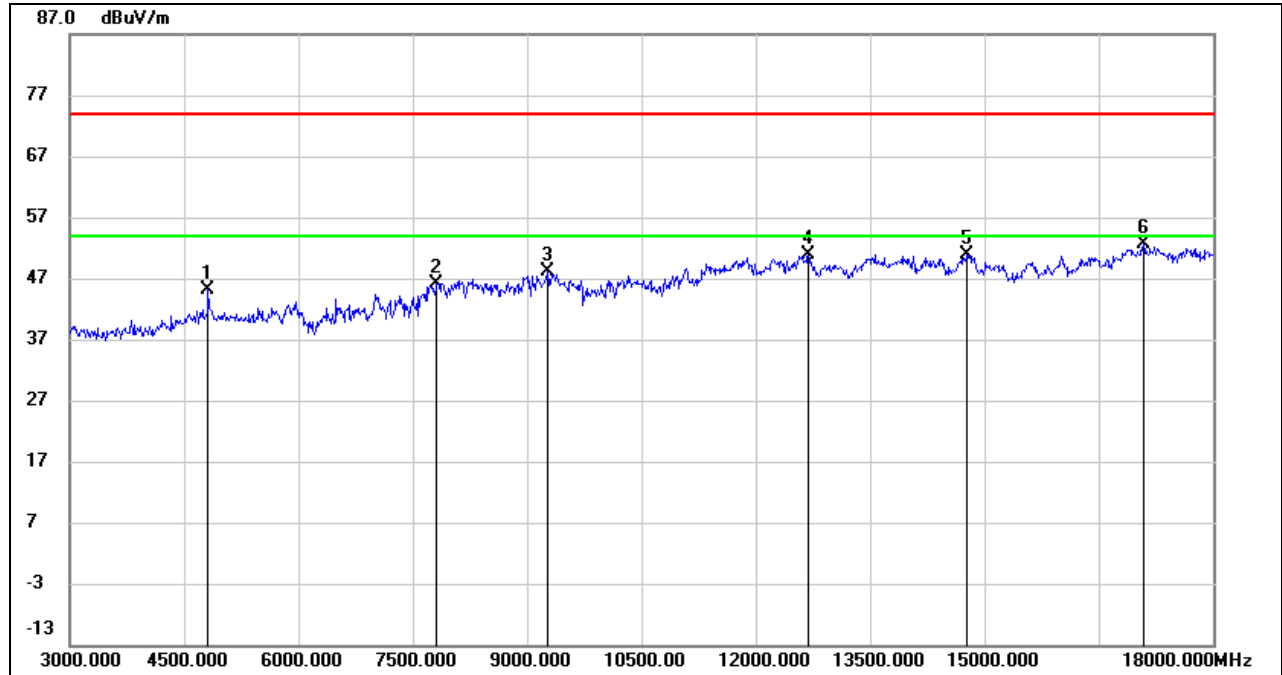

No.	Frequency (MHz)	Reading (dBuV)	Correct (dB/m)	Result (dBuV/m)	Limit (dBuV/m)	Margin (dB)	Remark
1	4815.000	43.69	1.38	45.07	74.00	-28.93	peak
2	7815.000	36.96	9.28	46.24	74.00	-27.76	peak
3	9270.000	37.76	10.25	48.01	74.00	-25.99	peak
4	12690.000	35.30	15.64	50.94	74.00	-23.06	peak
5	14775.000	32.89	17.95	50.84	74.00	-23.16	peak
6	17085.000	30.81	21.80	52.61	74.00	-21.39	peak

Note: 1. Peak Result = Reading Level + Correct Factor.

2. If Peak Result complies with AV limit, AV Result is deemed to comply with AV limit.

3. Peak: Peak detector.

4. Filter losses were only considered in the spurious frequency bands and the authorized band was not corrected for High Pass Filter losses.

5. Proper operation of the transmitter prior to adding the filter to the measurement chain.

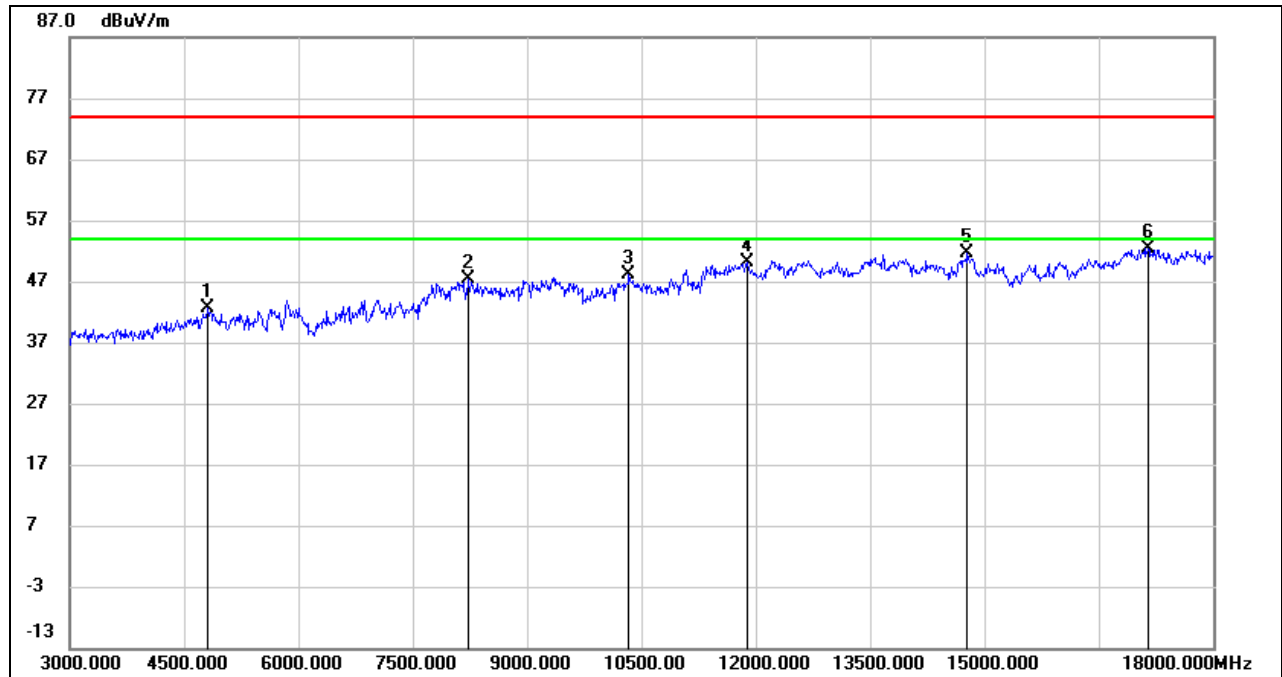
**HARMONICS AND SPURIOUS EMISSIONS (LOW CHANNEL, VERTICAL)**

No.	Frequency (MHz)	Reading (dBuV)	Correct (dB/m)	Result (dBuV/m)	Limit (dBuV/m)	Margin (dB)	Remark
1	4815.000	41.18	1.38	42.56	74.00	-31.44	peak
2	8235.000	37.60	9.76	47.36	74.00	-26.64	peak
3	10335.000	36.16	11.96	48.12	74.00	-25.88	peak
4	11880.000	34.61	15.46	50.07	74.00	-23.93	peak
5	14775.000	33.65	17.95	51.60	74.00	-22.40	peak
6	17145.000	30.53	21.94	52.47	74.00	-21.53	peak

Note: 1. Peak Result = Reading Level + Correct Factor.

2. If Peak Result complies with AV limit, AV Result is deemed to comply with AV limit.

3. Peak: Peak detector.

4. Filter losses were only considered in the spurious frequency bands and the authorized band was not corrected for High Pass Filter losses.

5. Proper operation of the transmitter prior to adding the filter to the measurement chain.

HARMONICS AND SPURIOUS EMISSIONS (MID CHANNEL, HORIZONTAL)

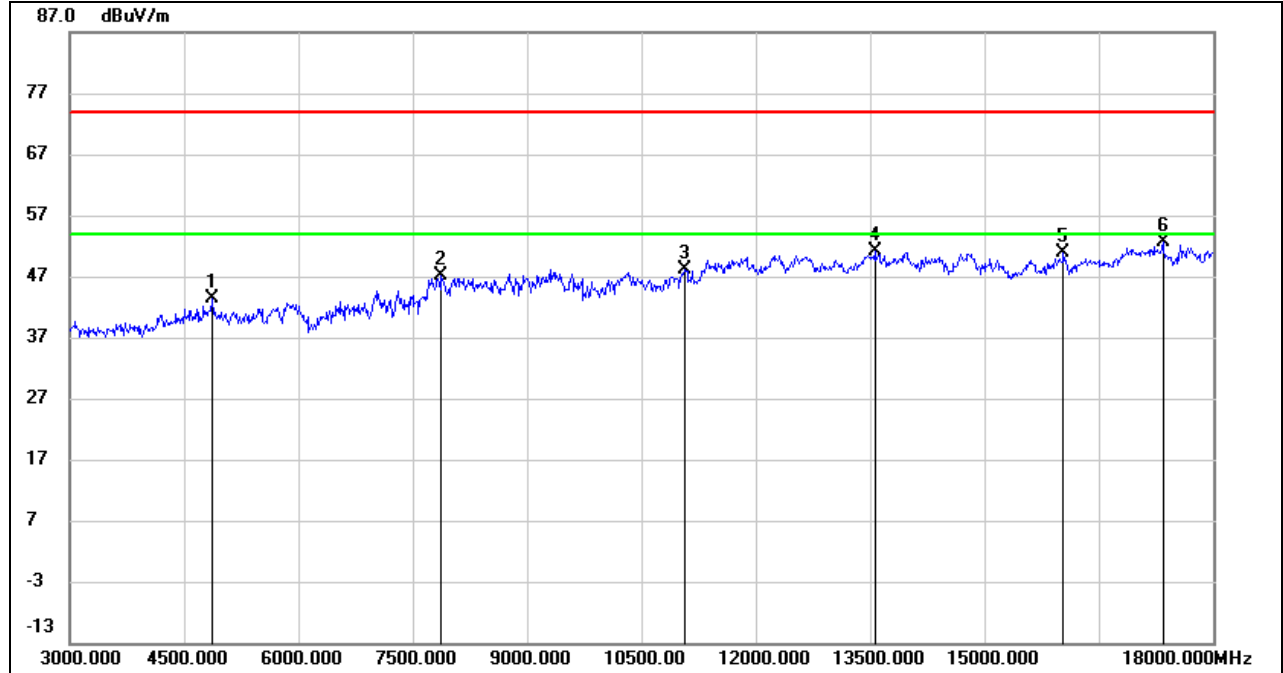

No.	Frequency (MHz)	Reading (dBuV)	Correct (dB/m)	Result (dBuV/m)	Limit (dBuV/m)	Margin (dB)	Remark
1	4875.000	42.18	1.32	43.50	74.00	-30.50	peak
2	7875.000	38.17	8.98	47.15	74.00	-26.85	peak
3	11070.000	34.42	13.65	48.07	74.00	-25.93	peak
4	13560.000	33.98	17.15	51.13	74.00	-22.87	peak
5	16035.000	32.37	18.41	50.78	74.00	-23.22	peak
6	17340.000	30.23	22.31	52.54	74.00	-21.46	peak

- Note: 1. Peak Result = Reading Level + Correct Factor.
 2. If Peak Result complies with AV limit, AV Result is deemed to comply with AV limit.
 3. Peak: Peak detector.
 4. Filter losses were only considered in the spurious frequency bands and the authorized band was not corrected for High Pass Filter losses.
 5. Proper operation of the transmitter prior to adding the filter to the measurement chain.

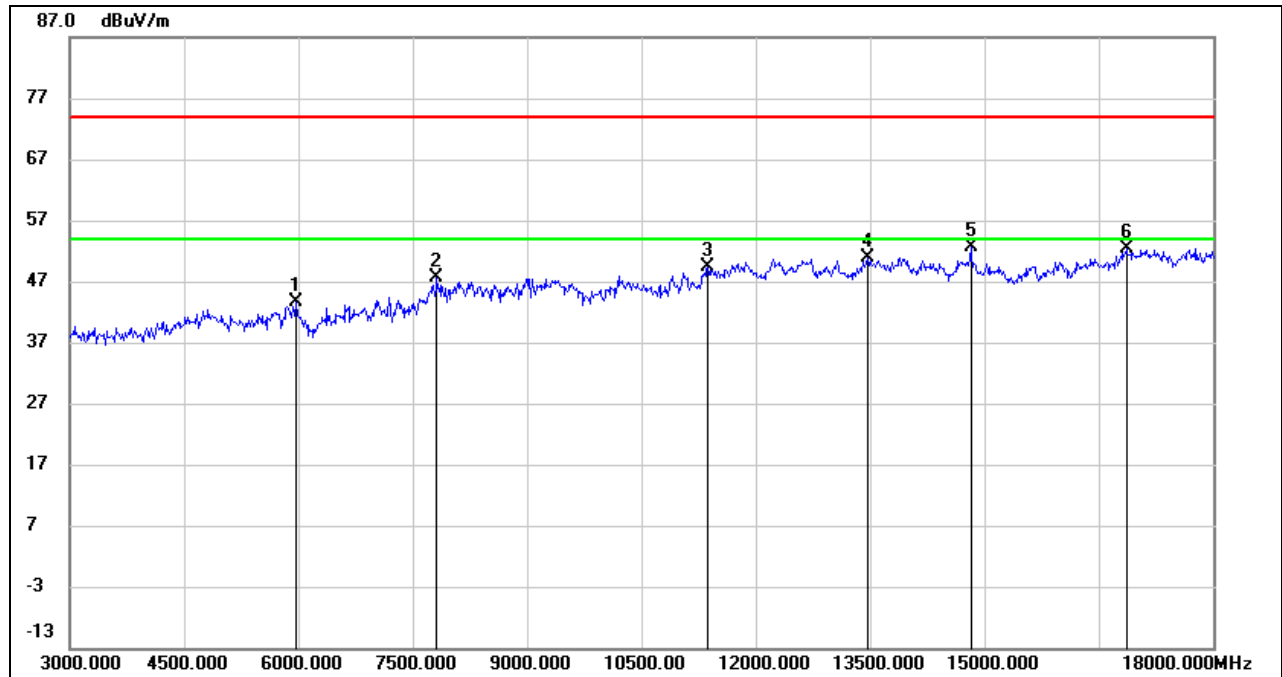
**HARMONICS AND SPURIOUS EMISSIONS (MID CHANNEL, VERTICAL)**

No.	Frequency (MHz)	Reading (dBuV)	Correct (dB/m)	Result (dBuV/m)	Limit (dBuV/m)	Margin (dB)	Remark
1	5970.000	39.49	4.15	43.64	74.00	-30.36	peak
2	7815.000	38.27	9.28	47.55	74.00	-26.45	peak
3	11370.000	34.97	14.49	49.46	74.00	-24.54	peak
4	13470.000	33.61	17.15	50.76	74.00	-23.24	peak
5	14820.000	34.77	17.91	52.68	74.00	-21.32	peak
6	16860.000	31.11	21.22	52.33	74.00	-21.67	peak

- Note: 1. Peak Result = Reading Level + Correct Factor.
 2. If Peak Result complies with AV limit, AV Result is deemed to comply with AV limit.
 3. Peak: Peak detector.
 4. Filter losses were only considered in the spurious frequency bands and the authorized band was not corrected for High Pass Filter losses.
 5. Proper operation of the transmitter prior to adding the filter to the measurement chain.

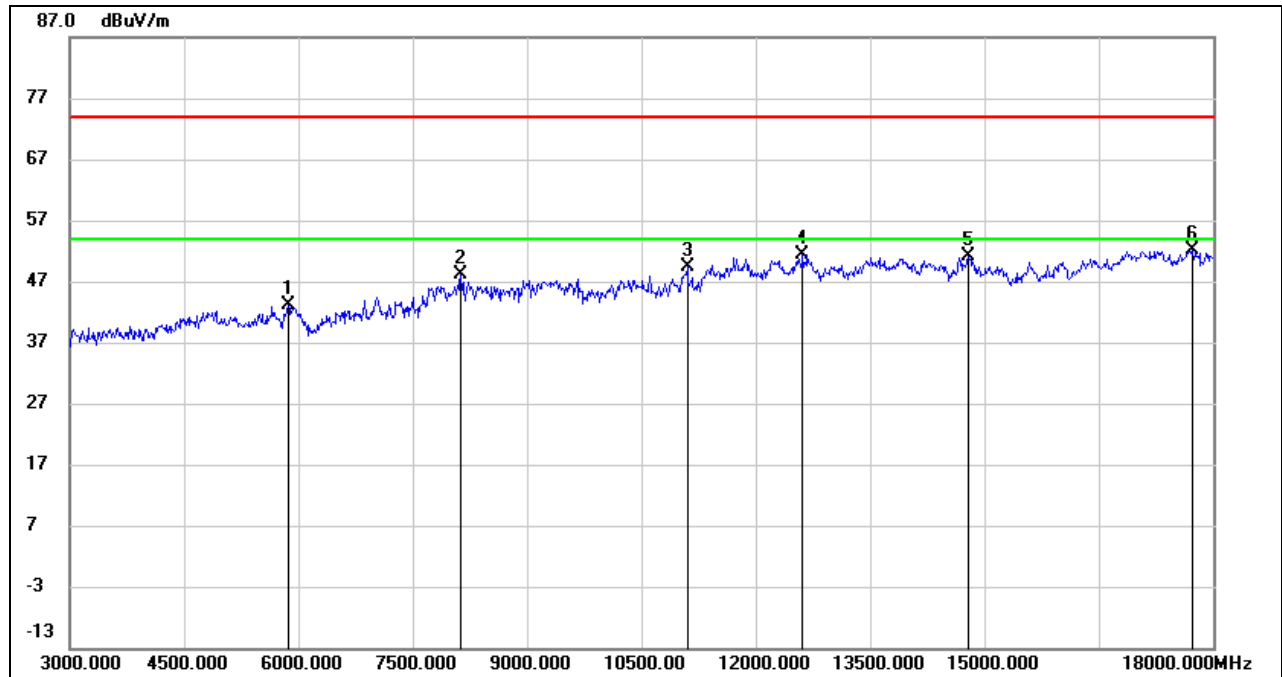
**HARMONICS AND SPURIOUS EMISSIONS (HIGH CHANNEL, HORIZONTAL)**

No.	Frequency (MHz)	Reading (dBuV)	Correct (dB/m)	Result (dBuV/m)	Limit (dBuV/m)	Margin (dB)	Remark
1	5865.000	38.91	4.16	43.07	74.00	-30.93	peak
2	8130.000	38.08	10.06	48.14	74.00	-25.86	peak
3	11100.000	35.55	13.79	49.34	74.00	-24.66	peak
4	12615.000	35.73	15.75	51.48	74.00	-22.52	peak
5	14790.000	33.10	18.01	51.11	74.00	-22.89	peak
6	17730.000	28.39	23.64	52.03	74.00	-21.97	peak

Note: 1. Peak Result = Reading Level + Correct Factor.

2. If Peak Result complies with AV limit, AV Result is deemed to comply with AV limit.

3. Peak: Peak detector.

4. Filter losses were only considered in the spurious frequency bands and the authorized band was not corrected for High Pass Filter losses.

5. Proper operation of the transmitter prior to adding the filter to the measurement chain.



HARMONICS AND SPURIOUS EMISSIONS (HIGH CHANNEL, VERTICAL)

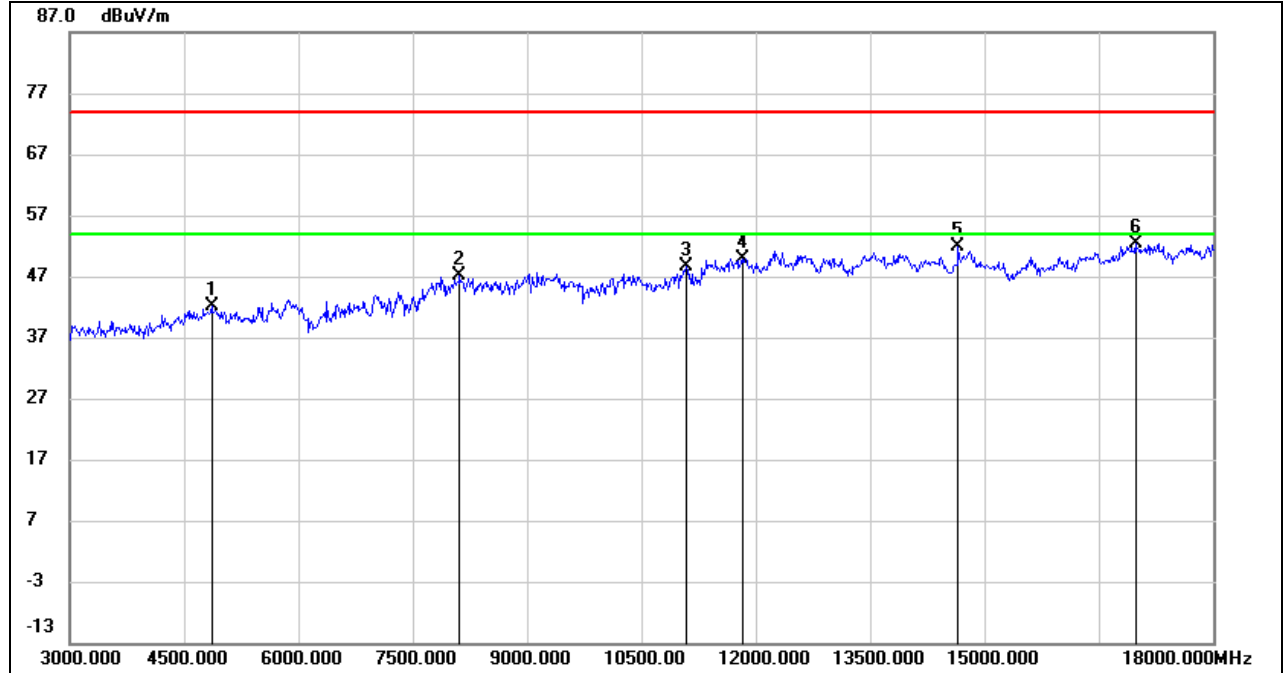

No.	Frequency (MHz)	Reading (dBuV)	Correct (dB/m)	Result (dBuV/m)	Limit (dBuV/m)	Margin (dB)	Remark
1	4860.000	40.72	1.33	42.05	74.00	-31.95	peak
2	8115.000	37.01	10.13	47.14	74.00	-26.86	peak
3	11085.000	34.93	13.72	48.65	74.00	-25.35	peak
4	11820.000	34.54	15.29	49.83	74.00	-24.17	peak
5	14655.000	34.37	17.54	51.91	74.00	-22.09	peak
6	16980.000	31.04	21.30	52.34	74.00	-21.66	peak

- Note: 1. Peak Result = Reading Level + Correct Factor.
 2. If Peak Result complies with AV limit, AV Result is deemed to comply with AV limit.
 3. Peak: Peak detector.
 4. Filter losses were only considered in the spurious frequency bands and the authorized band was not corrected for High Pass Filter losses.
 5. Proper operation of the transmitter prior to adding the filter to the measurement chain.



8.3.3. 802.11n HT20 MIMO MODE

HARMONICS AND SPURIOUS EMISSIONS (LOW CHANNEL, HORIZONTAL)

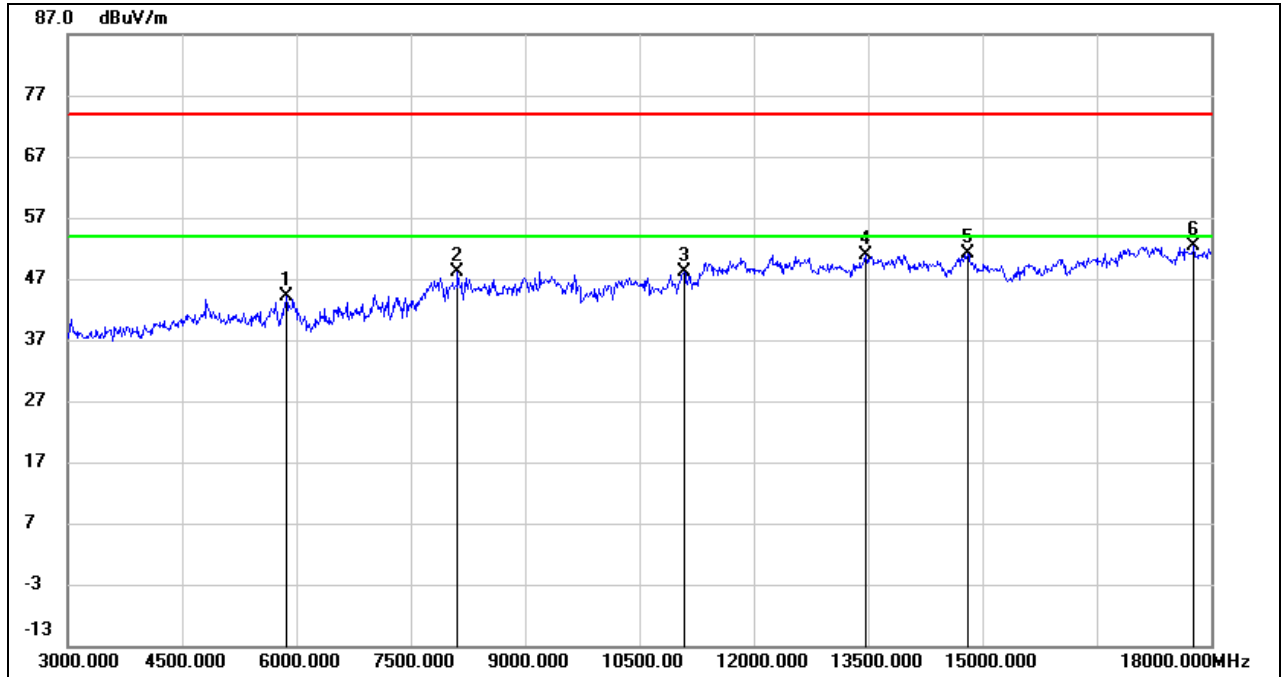

No.	Frequency (MHz)	Reading (dBuV)	Correct (dB/m)	Result (dBuV/m)	Limit (dBuV/m)	Margin (dB)	Remark
1	5865.000	40.03	4.16	44.19	74.00	-29.81	peak
2	8115.000	37.96	10.13	48.09	74.00	-25.91	peak
3	11085.000	34.35	13.72	48.07	74.00	-25.93	peak
4	13470.000	33.67	17.15	50.82	74.00	-23.18	peak
5	14805.000	33.20	18.00	51.20	74.00	-22.80	peak
6	17775.000	28.53	23.91	52.44	74.00	-21.56	peak

- Note: 1. Peak Result = Reading Level + Correct Factor.
 2. If Peak Result complies with AV limit, AV Result is deemed to comply with AV limit.
 3. Peak: Peak detector.
 4. Filter losses were only considered in the spurious frequency bands and the authorized band was not corrected for High Pass Filter losses.
 5. Proper operation of the transmitter prior to adding the filter to the measurement chain.

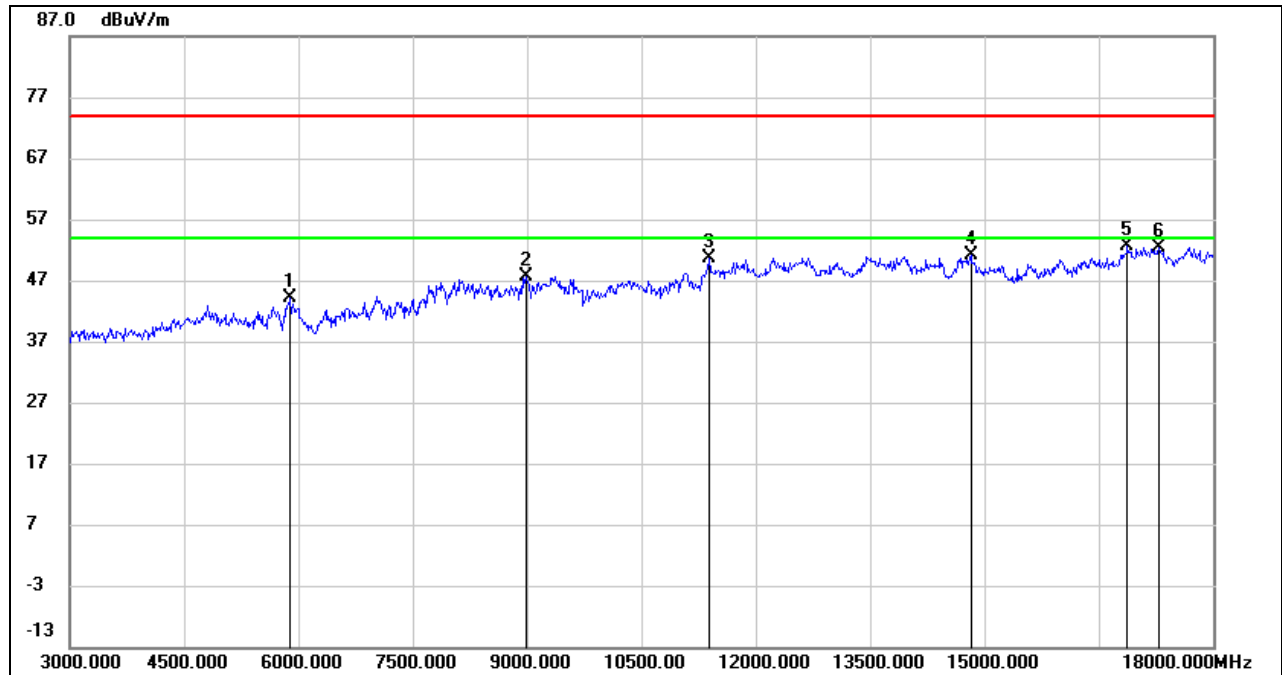
**HARMONICS AND SPURIOUS EMISSIONS (LOW CHANNEL, VERTICAL)**

No.	Frequency (MHz)	Reading (dBuV)	Correct (dB/m)	Result (dBuV/m)	Limit (dBuV/m)	Margin (dB)	Remark
1	5895.000	39.64	4.46	44.10	74.00	-29.90	peak
2	8985.000	36.56	10.99	47.55	74.00	-26.45	peak
3	11385.000	36.04	14.62	50.66	74.00	-23.34	peak
4	14820.000	33.21	17.91	51.12	74.00	-22.88	peak
5	16875.000	31.35	21.35	52.70	74.00	-21.30	peak
6	17280.000	29.99	22.48	52.47	74.00	-21.53	peak

Note: 1. Peak Result = Reading Level + Correct Factor.

2. If Peak Result complies with AV limit, AV Result is deemed to comply with AV limit.

3. Peak: Peak detector.

4. Filter losses were only considered in the spurious frequency bands and the authorized band was not corrected for High Pass Filter losses.

5. Proper operation of the transmitter prior to adding the filter to the measurement chain.

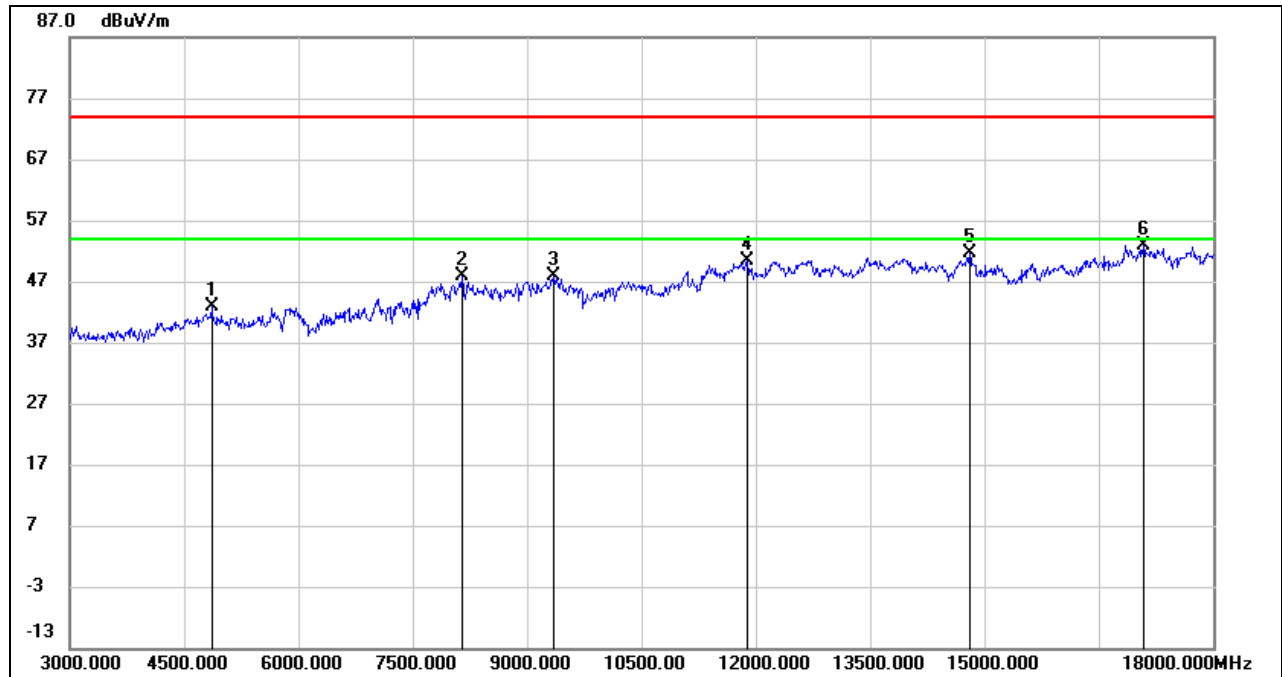
**HARMONICS AND SPURIOUS EMISSIONS (MID CHANNEL, HORIZONTAL)**

No.	Frequency (MHz)	Reading (dBuV)	Correct (dB/m)	Result (dBuV/m)	Limit (dBuV/m)	Margin (dB)	Remark
1	4860.000	41.56	1.33	42.89	74.00	-31.11	peak
2	8145.000	37.83	10.01	47.84	74.00	-26.16	peak
3	9345.000	37.31	10.66	47.97	74.00	-26.03	peak
4	11895.000	34.76	15.50	50.26	74.00	-23.74	peak
5	14805.000	33.56	18.00	51.56	74.00	-22.44	peak
6	17085.000	31.20	21.80	53.00	74.00	-21.00	peak

Note: 1. Peak Result = Reading Level + Correct Factor.

2. If Peak Result complies with AV limit, AV Result is deemed to comply with AV limit.

3. Peak: Peak detector.

4. Filter losses were only considered in the spurious frequency bands and the authorized band was not corrected for High Pass Filter losses.

5. Proper operation of the transmitter prior to adding the filter to the measurement chain.

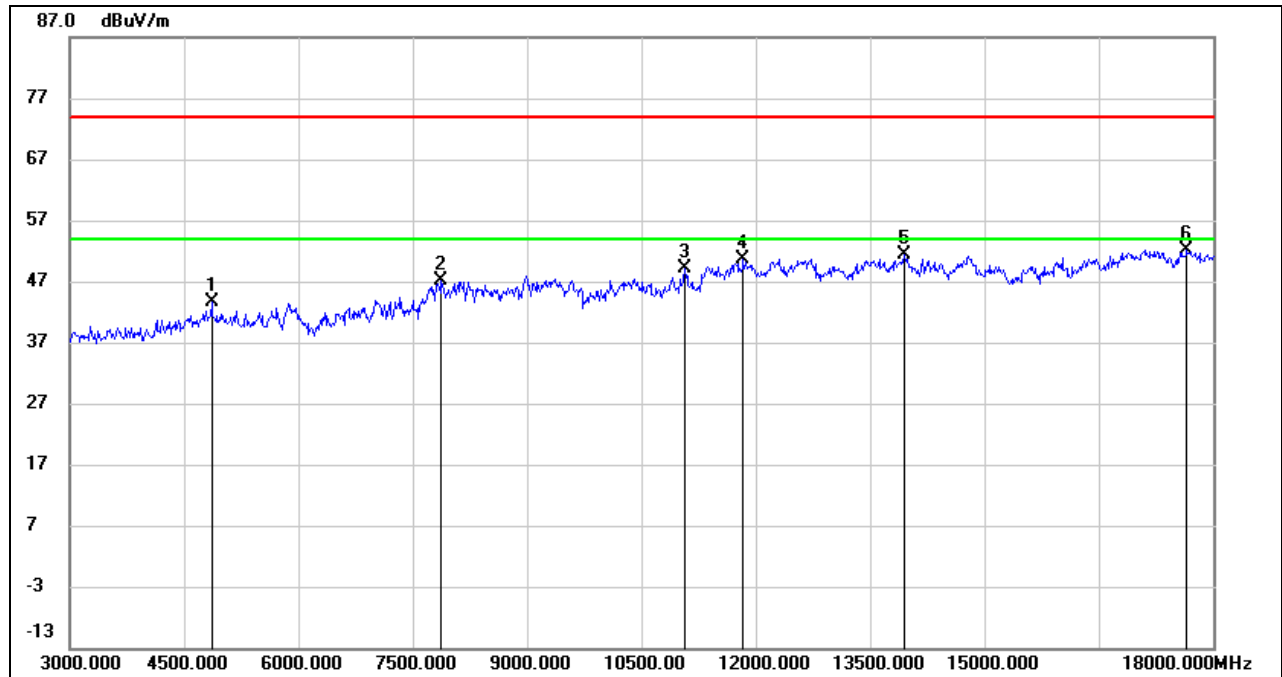
**HARMONICS AND SPURIOUS EMISSIONS (MID CHANNEL, VERTICAL)**

No.	Frequency (MHz)	Reading (dBuV)	Correct (dB/m)	Result (dBuV/m)	Limit (dBuV/m)	Margin (dB)	Remark
1	4860.000	42.38	1.33	43.71	74.00	-30.29	peak
2	7875.000	38.16	8.98	47.14	74.00	-26.86	peak
3	11070.000	35.60	13.65	49.25	74.00	-24.75	peak
4	11835.000	35.30	15.34	50.64	74.00	-23.36	peak
5	13950.000	33.77	17.60	51.37	74.00	-22.63	peak
6	17655.000	29.10	23.14	52.24	74.00	-21.76	peak

Note: 1. Peak Result = Reading Level + Correct Factor.

2. If Peak Result complies with AV limit, AV Result is deemed to comply with AV limit.

3. Peak: Peak detector.

4. Filter losses were only considered in the spurious frequency bands and the authorized band was not corrected for High Pass Filter losses.

5. Proper operation of the transmitter prior to adding the filter to the measurement chain.

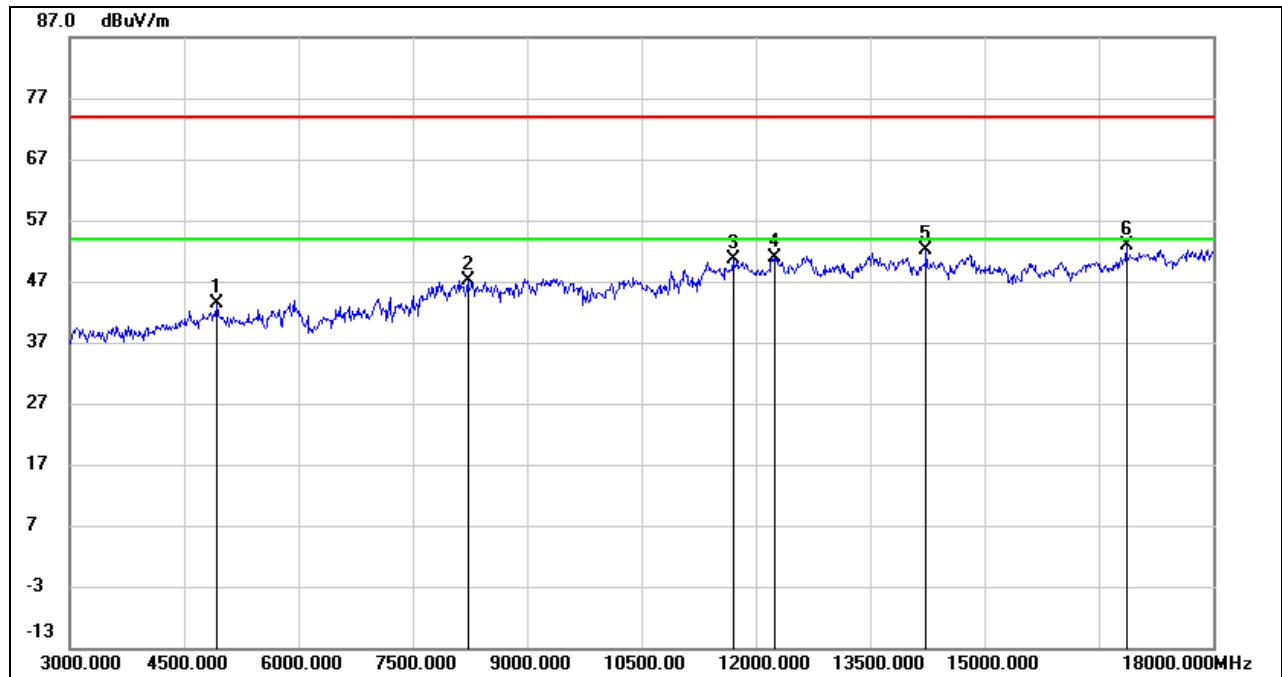
**HARMONICS AND SPURIOUS EMISSIONS (HIGH CHANNEL, HORIZONTAL)**

No.	Frequency (MHz)	Reading (dBuV)	Correct (dB/m)	Result (dBuV/m)	Limit (dBuV/m)	Margin (dB)	Remark
1	4935.000	41.72	1.59	43.31	74.00	-30.69	peak
2	8220.000	37.42	9.79	47.21	74.00	-26.79	peak
3	11700.000	35.32	15.35	50.67	74.00	-23.33	peak
4	12240.000	34.91	16.01	50.92	74.00	-23.08	peak
5	14235.000	34.17	17.91	52.08	74.00	-21.92	peak
6	16860.000	31.60	21.22	52.82	74.00	-21.18	peak

Note: 1. Peak Result = Reading Level + Correct Factor.

2. If Peak Result complies with AV limit, AV Result is deemed to comply with AV limit.

3. Peak: Peak detector.

4. Filter losses were only considered in the spurious frequency bands and the authorized band was not corrected for High Pass Filter losses.

5. Proper operation of the transmitter prior to adding the filter to the measurement chain.

HARMONICS AND SPURIOUS EMISSIONS (HIGH CHANNEL, VERTICAL)

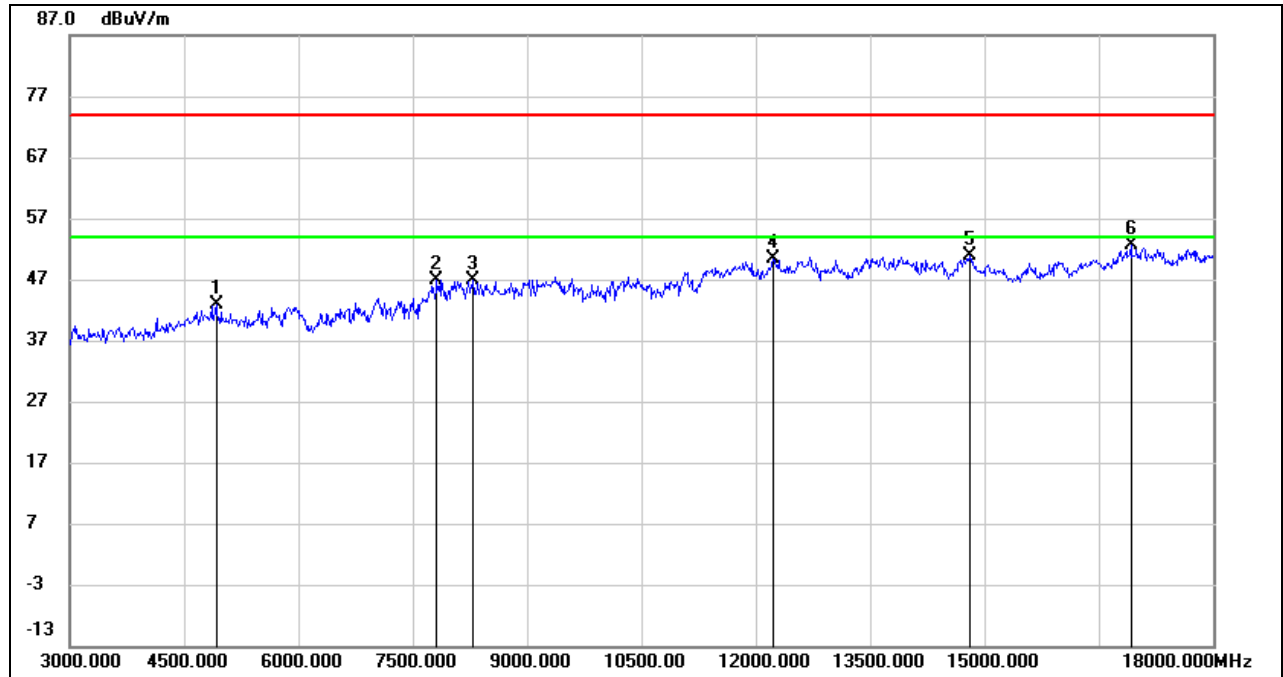

No.	Frequency (MHz)	Reading (dBuV)	Correct (dB/m)	Result (dBuV/m)	Limit (dBuV/m)	Margin (dB)	Remark
1	4920.000	41.35	1.45	42.80	74.00	-31.20	peak
2	7815.000	37.62	9.28	46.90	74.00	-27.10	peak
3	8295.000	37.30	9.69	46.99	74.00	-27.01	peak
4	12225.000	34.30	15.99	50.29	74.00	-23.71	peak
5	14805.000	32.83	18.00	50.83	74.00	-23.17	peak
6	16920.000	31.20	21.51	52.71	74.00	-21.29	peak

- Note: 1. Peak Result = Reading Level + Correct Factor.
 2. If Peak Result complies with AV limit, AV Result is deemed to comply with AV limit.
 3. Peak: Peak detector.
 4. Filter losses were only considered in the spurious frequency bands and the authorized band was not corrected for High Pass Filter losses.
 5. Proper operation of the transmitter prior to adding the filter to the measurement chain.



8.3.4. 802.11n HT40 MIMO MODE

HARMONICS AND SPURIOUS EMISSIONS (LOW CHANNEL, HORIZONTAL)

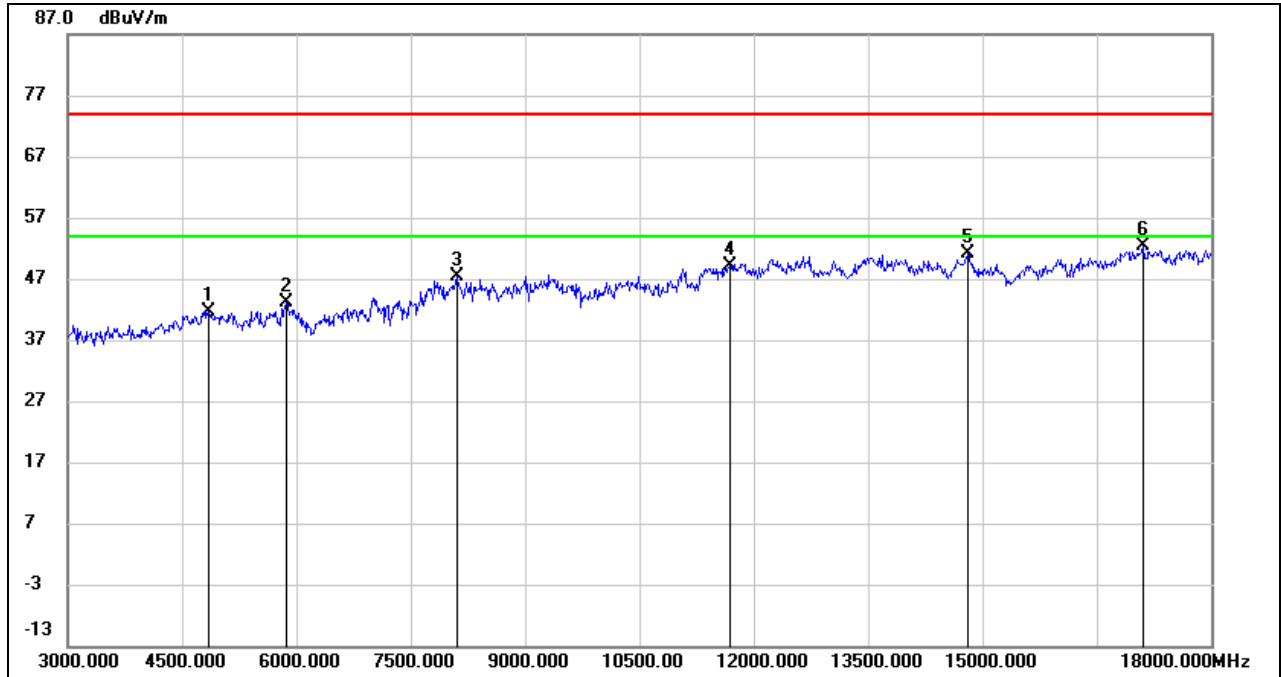

No.	Frequency (MHz)	Reading (dBuV)	Correct (dB/m)	Result (dBuV/m)	Limit (dBuV/m)	Margin (dB)	Remark
1	4845.000	40.40	1.35	41.75	74.00	-32.25	peak
2	5865.000	38.95	4.16	43.11	74.00	-30.89	peak
3	8100.000	37.13	10.18	47.31	74.00	-26.69	peak
4	11685.000	33.98	15.26	49.24	74.00	-24.76	peak
5	14805.000	33.11	18.00	51.11	74.00	-22.89	peak
6	17115.000	30.49	21.91	52.40	74.00	-21.60	peak

- Note: 1. Peak Result = Reading Level + Correct Factor.
 2. If Peak Result complies with AV limit, AV Result is deemed to comply with AV limit.
 3. Peak: Peak detector.
 4. Filter losses were only considered in the spurious frequency bands and the authorized band was not corrected for High Pass Filter losses.
 5. Proper operation of the transmitter prior to adding the filter to the measurement chain.

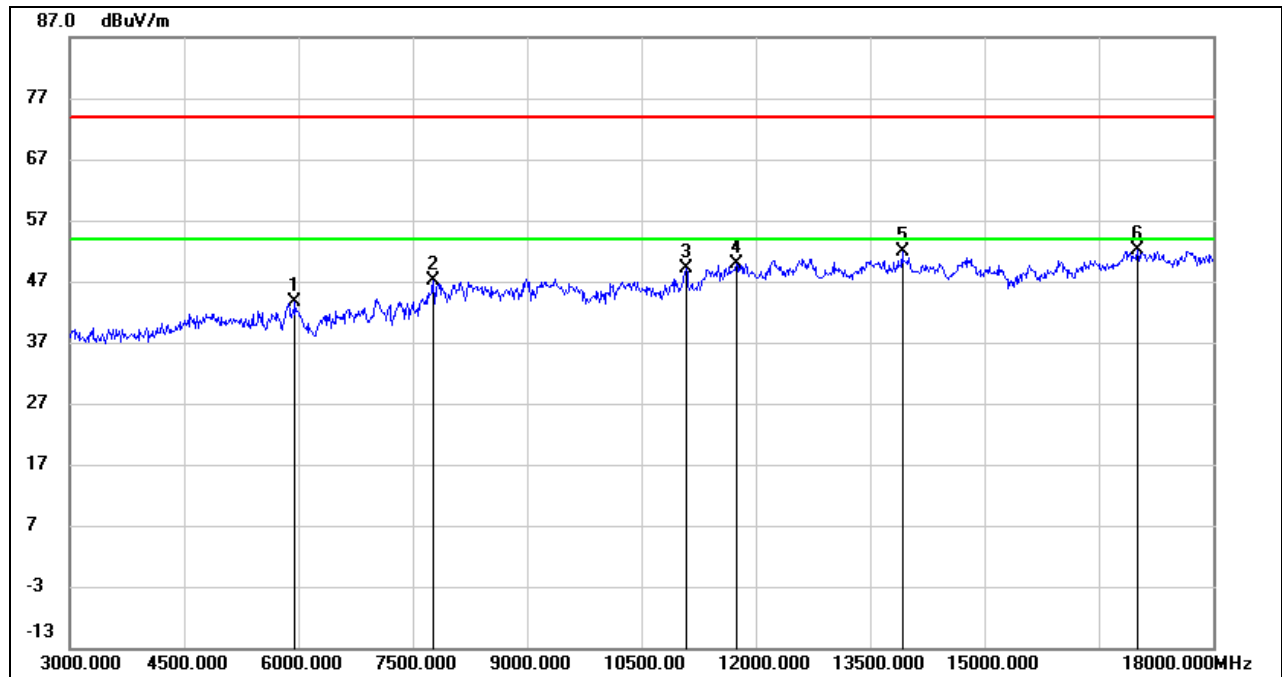
**HARMONICS AND SPURIOUS EMISSIONS (LOW CHANNEL, VERTICAL)**

No.	Frequency (MHz)	Reading (dBuV)	Correct (dB/m)	Result (dBuV/m)	Limit (dBuV/m)	Margin (dB)	Remark
1	5955.000	39.27	4.24	43.51	74.00	-30.49	peak
2	7770.000	38.00	9.09	47.09	74.00	-26.91	peak
3	11085.000	35.30	13.72	49.02	74.00	-24.98	peak
4	11745.000	34.54	15.30	49.84	74.00	-24.16	peak
5	13920.000	34.44	17.55	51.99	74.00	-22.01	peak
6	17010.000	30.82	21.31	52.13	74.00	-21.87	peak

Note: 1. Peak Result = Reading Level + Correct Factor.

2. If Peak Result complies with AV limit, AV Result is deemed to comply with AV limit.

3. Peak: Peak detector.

4. Filter losses were only considered in the spurious frequency bands and the authorized band was not corrected for High Pass Filter losses.

5. Proper operation of the transmitter prior to adding the filter to the measurement chain.

HARMONICS AND SPURIOUS EMISSIONS (MID CHANNEL, HORIZONTAL)

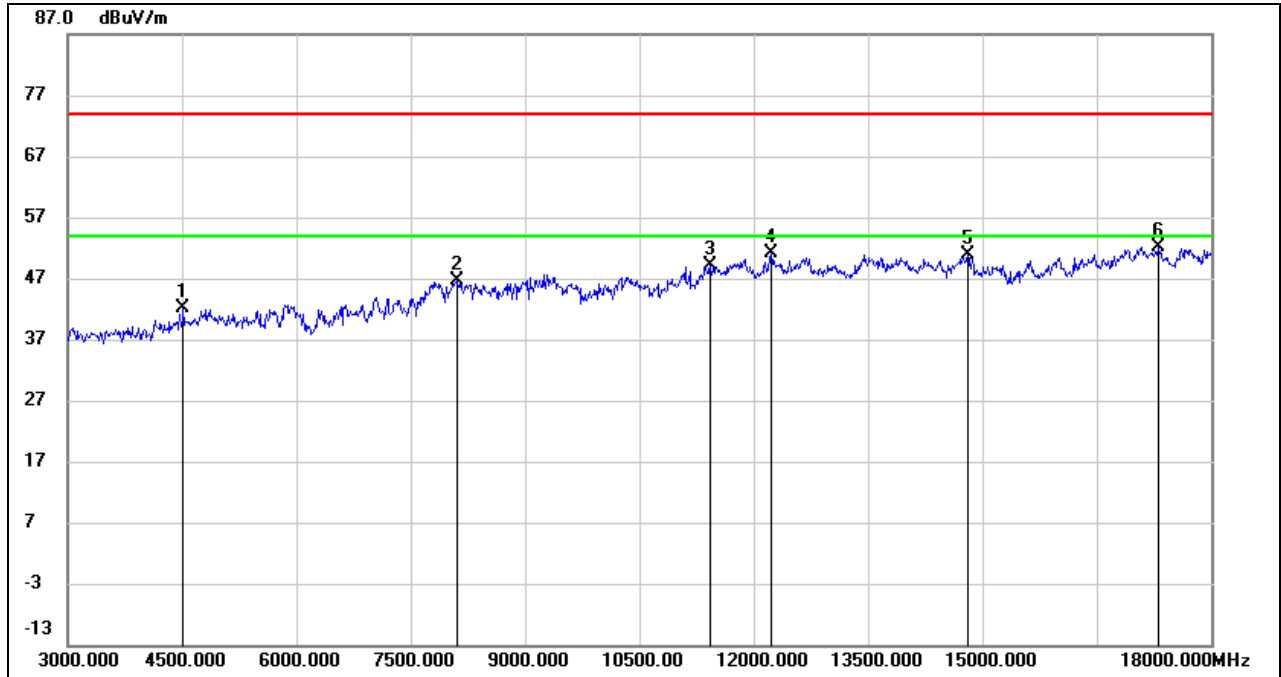

No.	Frequency (MHz)	Reading (dBuV)	Correct (dB/m)	Result (dBuV/m)	Limit (dBuV/m)	Margin (dB)	Remark
1	4515.000	42.52	-0.27	42.25	74.00	-31.75	peak
2	8100.000	36.42	10.18	46.60	74.00	-27.40	peak
3	11430.000	34.33	14.72	49.05	74.00	-24.95	peak
4	12225.000	35.17	15.99	51.16	74.00	-22.84	peak
5	14805.000	32.79	18.00	50.79	74.00	-23.21	peak
6	17310.000	29.66	22.54	52.20	74.00	-21.80	peak

- Note:
1. Peak Result = Reading Level + Correct Factor.
 2. If Peak Result complies with AV limit, AV Result is deemed to comply with AV limit.
 3. Peak: Peak detector.
 4. Filter losses were only considered in the spurious frequency bands and the authorized band was not corrected for High Pass Filter losses.
 5. Proper operation of the transmitter prior to adding the filter to the measurement chain.

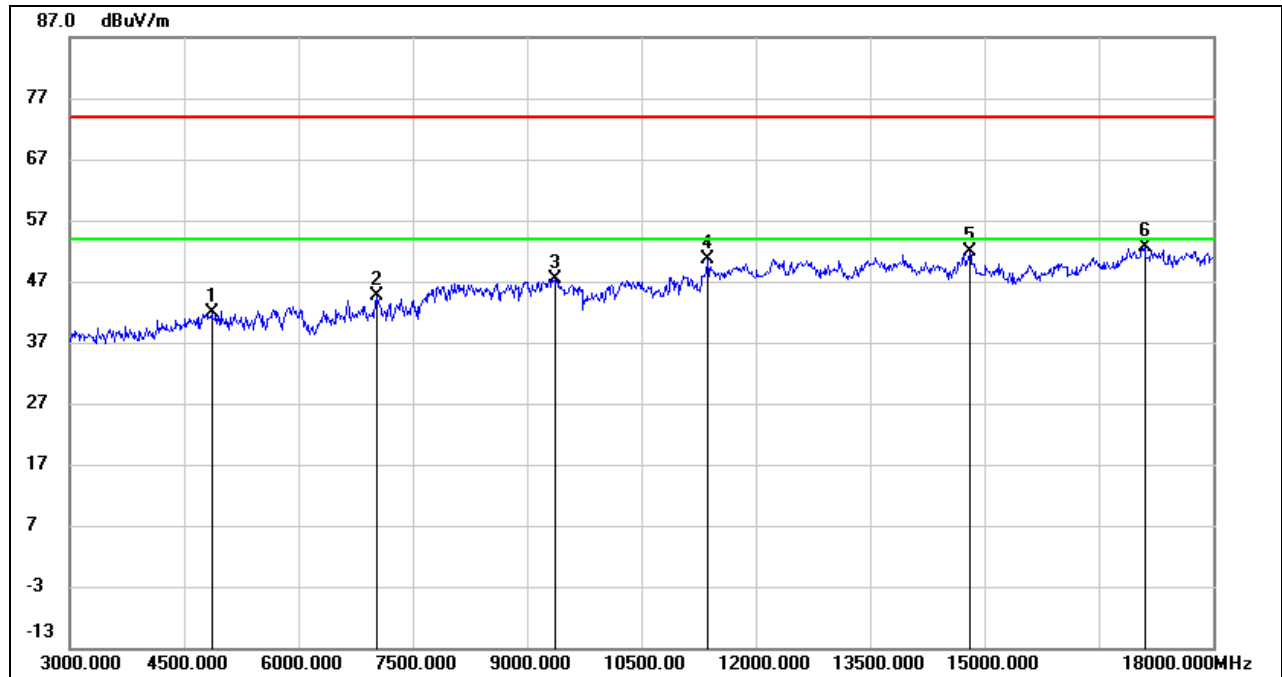
**HARMONICS AND SPURIOUS EMISSIONS (MID CHANNEL, VERTICAL)**

No.	Frequency (MHz)	Reading (dBuV)	Correct (dB/m)	Result (dBuV/m)	Limit (dBuV/m)	Margin (dB)	Remark
1	4860.000	40.47	1.33	41.80	74.00	-32.20	peak
2	7035.000	36.95	7.62	44.57	74.00	-29.43	peak
3	9360.000	36.69	10.75	47.44	74.00	-26.56	peak
4	11370.000	36.12	14.49	50.61	74.00	-23.39	peak
5	14805.000	33.83	18.00	51.83	74.00	-22.17	peak
6	17100.000	30.66	21.90	52.56	74.00	-21.44	peak

Note: 1. Peak Result = Reading Level + Correct Factor.

2. If Peak Result complies with AV limit, AV Result is deemed to comply with AV limit.

3. Peak: Peak detector.

4. Filter losses were only considered in the spurious frequency bands and the authorized band was not corrected for High Pass Filter losses.

5. Proper operation of the transmitter prior to adding the filter to the measurement chain.



HARMONICS AND SPURIOUS EMISSIONS (HIGH CHANNEL, HORIZONTAL)

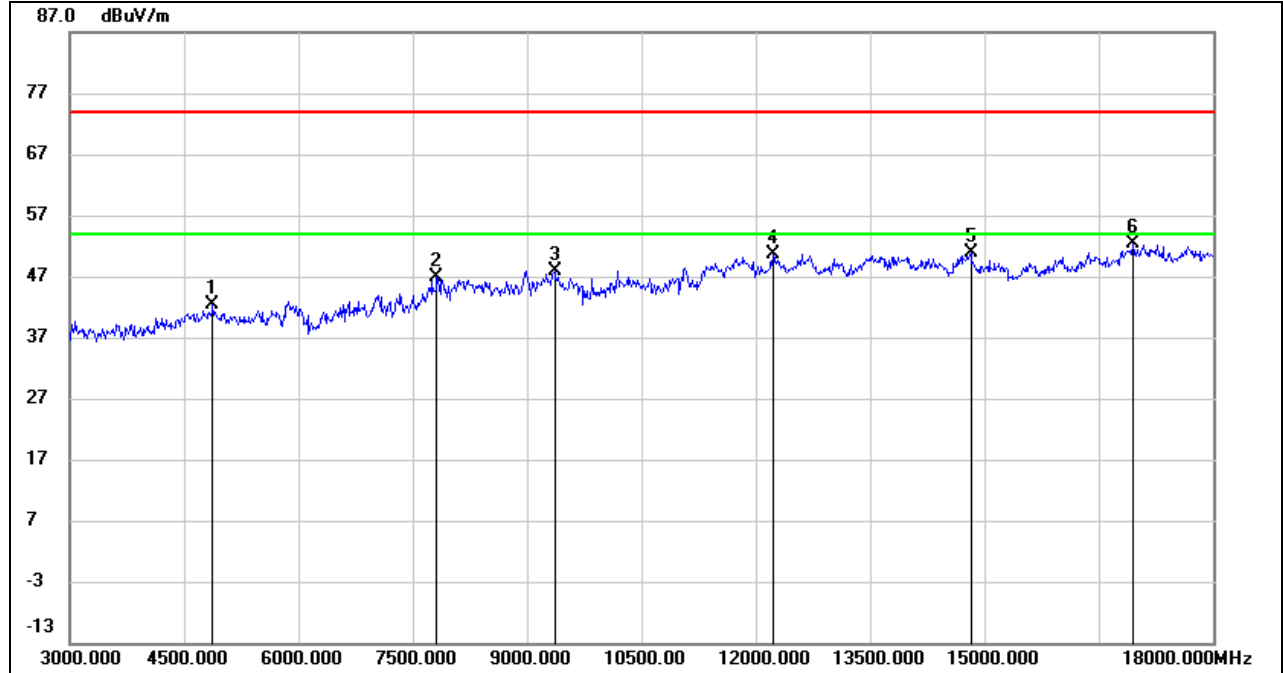

No.	Frequency (MHz)	Reading (dBuV)	Correct (dB/m)	Result (dBuV/m)	Limit (dBuV/m)	Margin (dB)	Remark
1	4875.000	40.97	1.32	42.29	74.00	-31.71	peak
2	7815.000	37.52	9.28	46.80	74.00	-27.20	peak
3	9360.000	37.20	10.75	47.95	74.00	-26.05	peak
4	12225.000	34.57	15.99	50.56	74.00	-23.44	peak
5	14820.000	32.91	17.91	50.82	74.00	-23.18	peak
6	16950.000	31.00	21.41	52.41	74.00	-21.59	peak

- Note: 1. Peak Result = Reading Level + Correct Factor.
 2. If Peak Result complies with AV limit, AV Result is deemed to comply with AV limit.
 3. Peak: Peak detector.
 4. Filter losses were only considered in the spurious frequency bands and the authorized band was not corrected for High Pass Filter losses.
 5. Proper operation of the transmitter prior to adding the filter to the measurement chain.



HARMONICS AND SPURIOUS EMISSIONS (HIGH CHANNEL, VERTICAL)

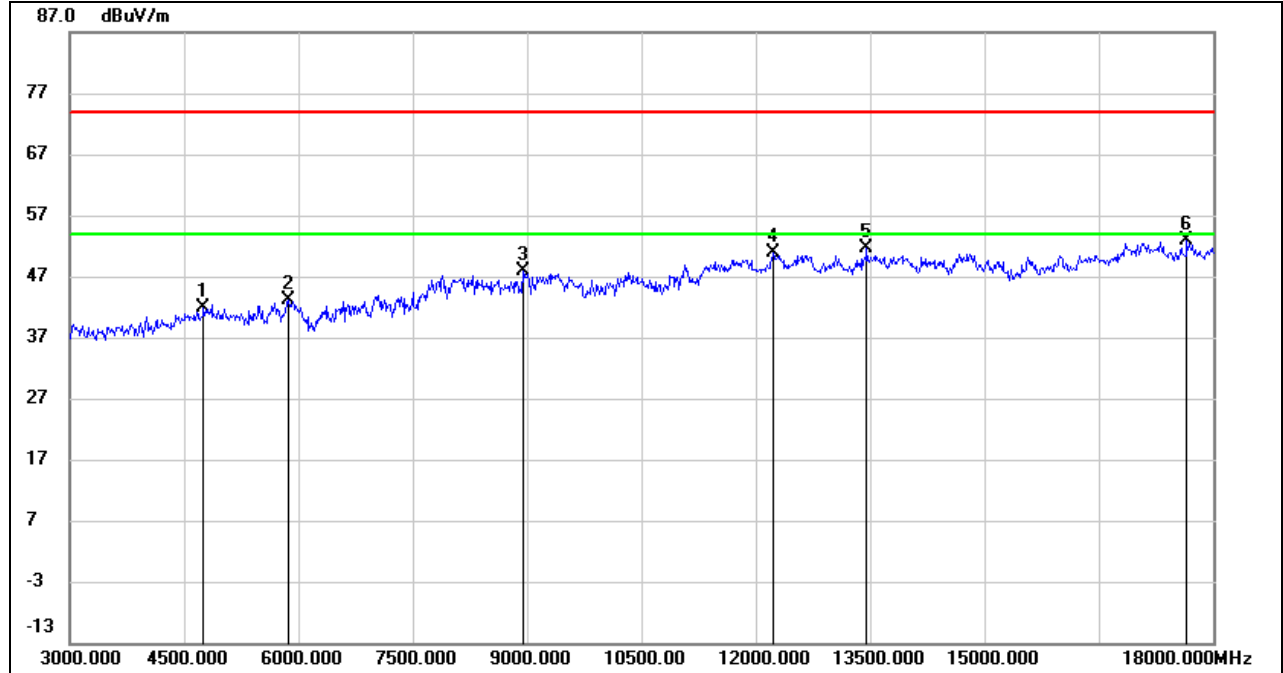

No.	Frequency (MHz)	Reading (dBuV)	Correct (dB/m)	Result (dBuV/m)	Limit (dBuV/m)	Margin (dB)	Remark
1	4755.000	40.91	0.89	41.80	74.00	-32.20	peak
2	5865.000	39.03	4.16	43.19	74.00	-30.81	peak
3	8940.000	37.67	10.13	47.80	74.00	-26.20	peak
4	12225.000	34.89	15.99	50.88	74.00	-23.12	peak
5	13455.000	34.42	17.14	51.56	74.00	-22.44	peak
6	17655.000	29.75	23.14	52.89	74.00	-21.11	peak

- Note: 1. Peak Result = Reading Level + Correct Factor.
 2. If Peak Result complies with AV limit, AV Result is deemed to comply with AV limit.
 3. Peak: Peak detector.
 4. Filter losses were only considered in the spurious frequency bands and the authorized band was not corrected for High Pass Filter losses.
 5. Proper operation of the transmitter prior to adding the filter to the measurement chain.

8.5. SPURIOUS EMISSIONS (18 GHz ~ 26 GHz)

8.5.1. 802.11n HT40 MIMO MODE

SPURIOUS EMISSIONS (MID CHANNEL, WORST-CASE CONFIGURATION, HORIZONTAL)

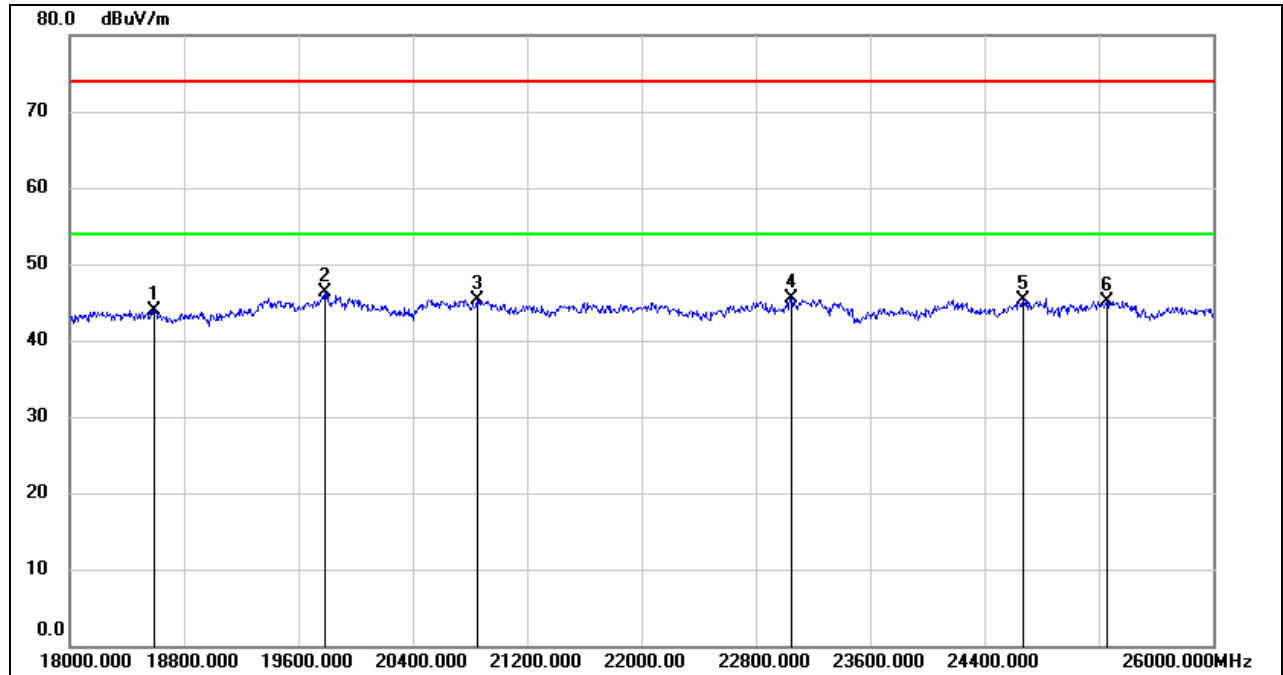

No.	Frequency (MHz)	Reading (dBuV)	Correct (dB/m)	Result (dBuV/m)	Limit (dBuV/m)	Margin (dB)	Remark
1	18592.000	49.25	-5.31	43.94	74.00	-30.06	peak
2	19784.000	51.58	-5.28	46.30	74.00	-27.70	peak
3	20848.000	50.32	-5.03	45.29	74.00	-28.71	peak
4	23048.000	48.93	-3.43	45.50	74.00	-28.50	peak
5	24672.000	47.72	-2.33	45.39	74.00	-28.61	peak
6	25256.000	46.79	-1.67	45.12	74.00	-28.88	peak

- Note: 1. Measurement = Reading Level + Correct Factor.
 2. If Peak Result complies with AV limit, AV Result is deemed to comply with AV limit.
 3. Peak: Peak detector.



SPURIOUS EMISSIONS (MID CHANNEL, WORST-CASE CONFIGURATION, VERTICAL)

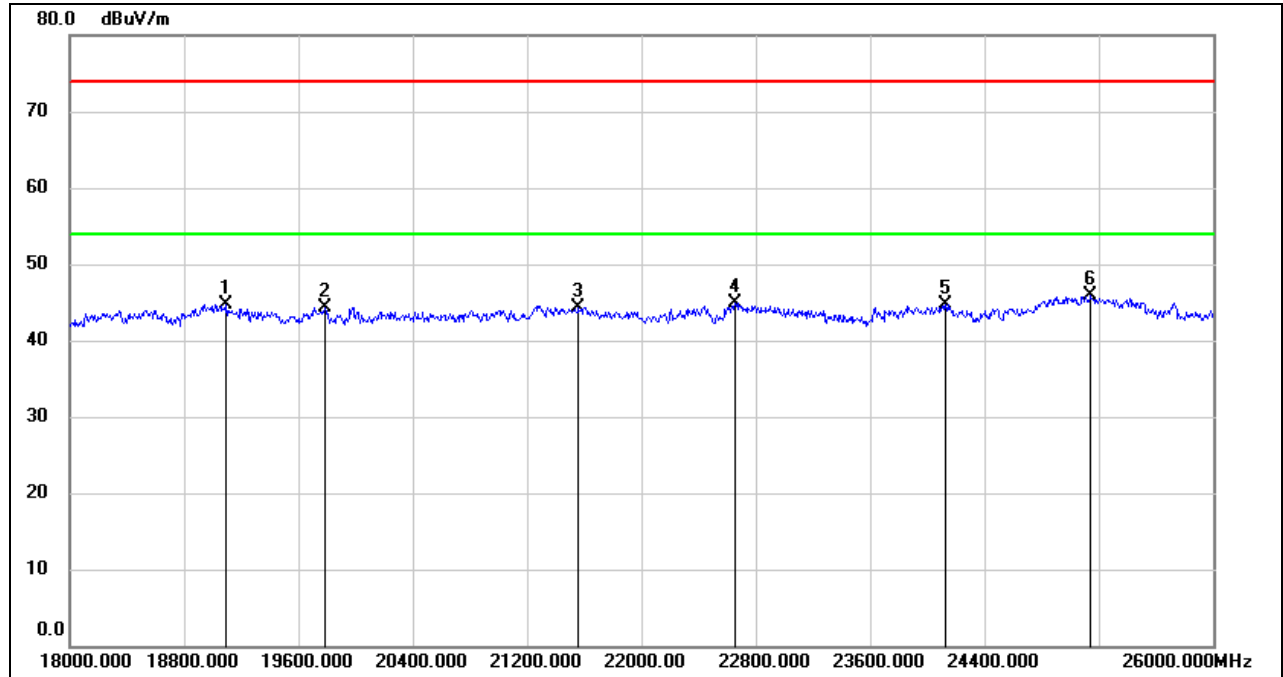

No.	Frequency (MHz)	Reading (dBuV)	Correct (dB/m)	Result (dBuV/m)	Limit (dBuV/m)	Margin (dB)	Remark
1	19096.000	50.03	-5.36	44.67	74.00	-29.33	peak
2	19784.000	49.57	-5.28	44.29	74.00	-29.71	peak
3	21560.000	48.99	-4.60	44.39	74.00	-29.61	peak
4	22656.000	48.71	-3.77	44.94	74.00	-29.06	peak
5	24128.000	47.48	-2.79	44.69	74.00	-29.31	peak
6	25144.000	47.70	-1.86	45.84	74.00	-28.16	peak

- Note: 1. Measurement = Reading Level + Correct Factor.
 2. If Peak Result complies with AV limit, AV Result is deemed to comply with AV limit.
 3. Peak: Peak detector.

Note: All the modes had been tested, but only the worst data was recorded in the report.

8.6. SPURIOUS EMISSIONS (30 MHz ~ 1 GHz)

8.6.1. 802.11n HT40 MIMO MODE

SPURIOUS EMISSIONS (MID CHANNEL, WORST-CASE CONFIGURATION, HORIZONTAL)

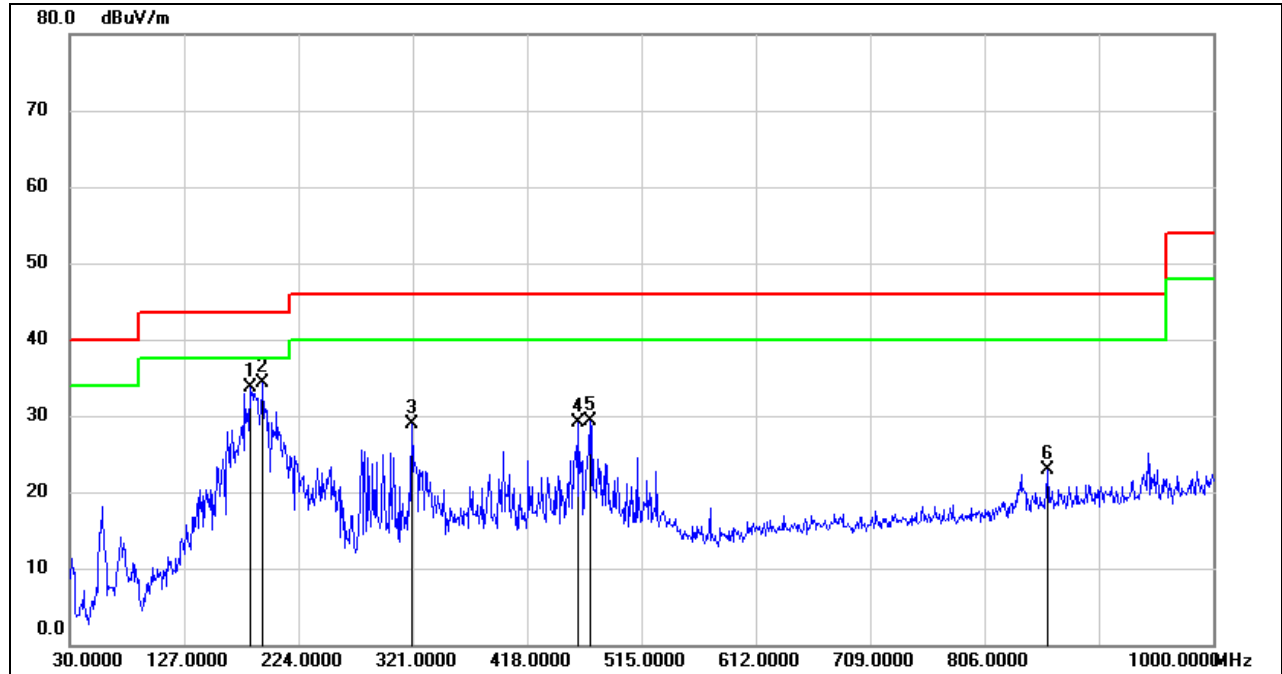

No.	Frequency (MHz)	Reading (dBuV)	Correct (dB/m)	Result (dBuV/m)	Limit (dBuV/m)	Margin (dB)	Remark
1	183.2600	50.38	-16.77	33.61	43.50	-9.89	QP
2	193.9299	50.78	-16.51	34.27	43.50	-9.23	QP
3	320.0300	43.62	-14.78	28.84	46.00	-17.16	QP
4	460.6800	41.29	-12.11	29.18	46.00	-16.82	QP
5	471.3500	41.22	-12.00	29.22	46.00	-16.78	QP
6	859.3500	28.91	-6.01	22.90	46.00	-23.10	QP

- Note: 1. Result Level = Read Level + Correct Factor.
 2. If Peak Result complies with QP limit, QP Result is deemed to comply with QP limit.
 3. Test setup: RBW: 120 kHz, VBW: 300 kHz, Sweep time: auto.

SPURIOUS EMISSIONS (MID CHANNEL, WORST-CASE CONFIGURATION, VERTICAL)

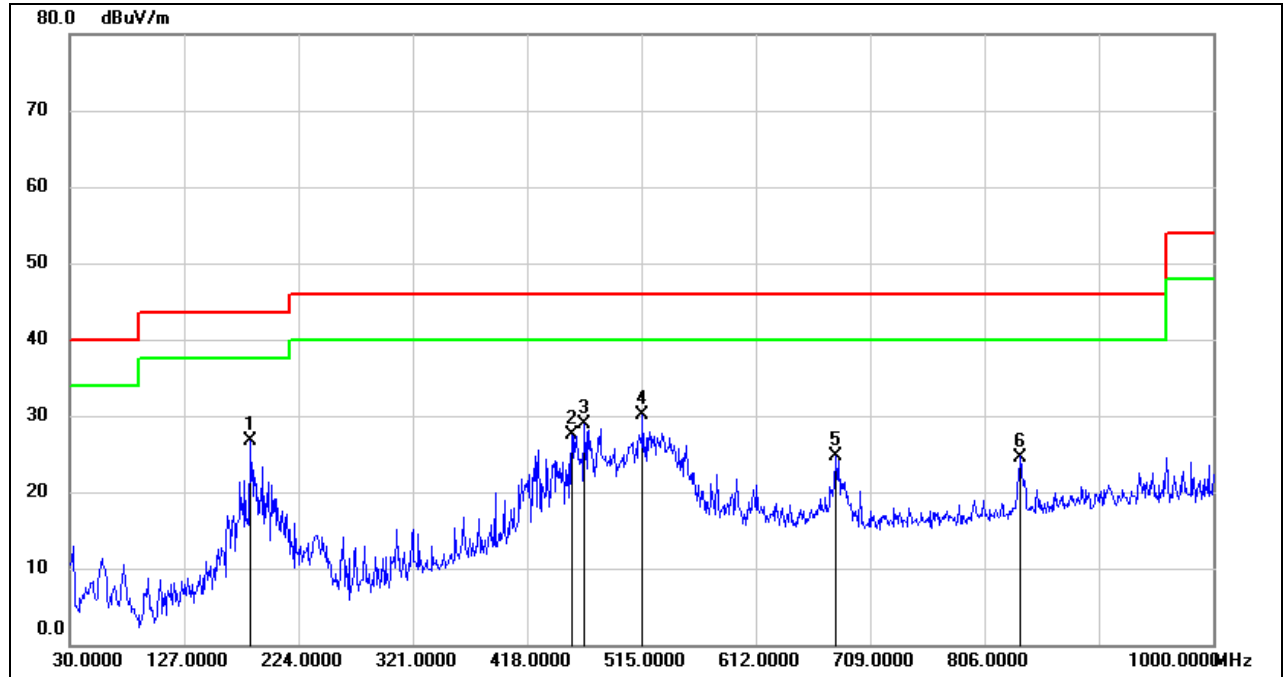

No.	Frequency (MHz)	Reading (dBuV)	Correct (dB/m)	Result (dBuV/m)	Limit (dBuV/m)	Margin (dB)	Remark
1	183.2600	43.43	-16.77	26.66	43.50	-16.84	QP
2	455.8300	39.84	-12.27	27.57	46.00	-18.43	QP
3	466.5000	40.98	-12.06	28.92	46.00	-17.08	QP
4	515.9699	41.21	-11.15	30.06	46.00	-15.94	QP
5	679.9000	33.35	-8.60	24.75	46.00	-21.25	QP
6	836.0700	31.16	-6.56	24.60	46.00	-21.40	QP

- Note: 1. Result Level = Read Level + Correct Factor.
 2. If Peak Result complies with QP limit, QP Result is deemed to comply with QP limit.
 3. Test setup: RBW: 120 kHz, VBW: 300 kHz, Sweep time: auto

Note: All the modes and channels had been tested, but only the worst data was recorded in the report.

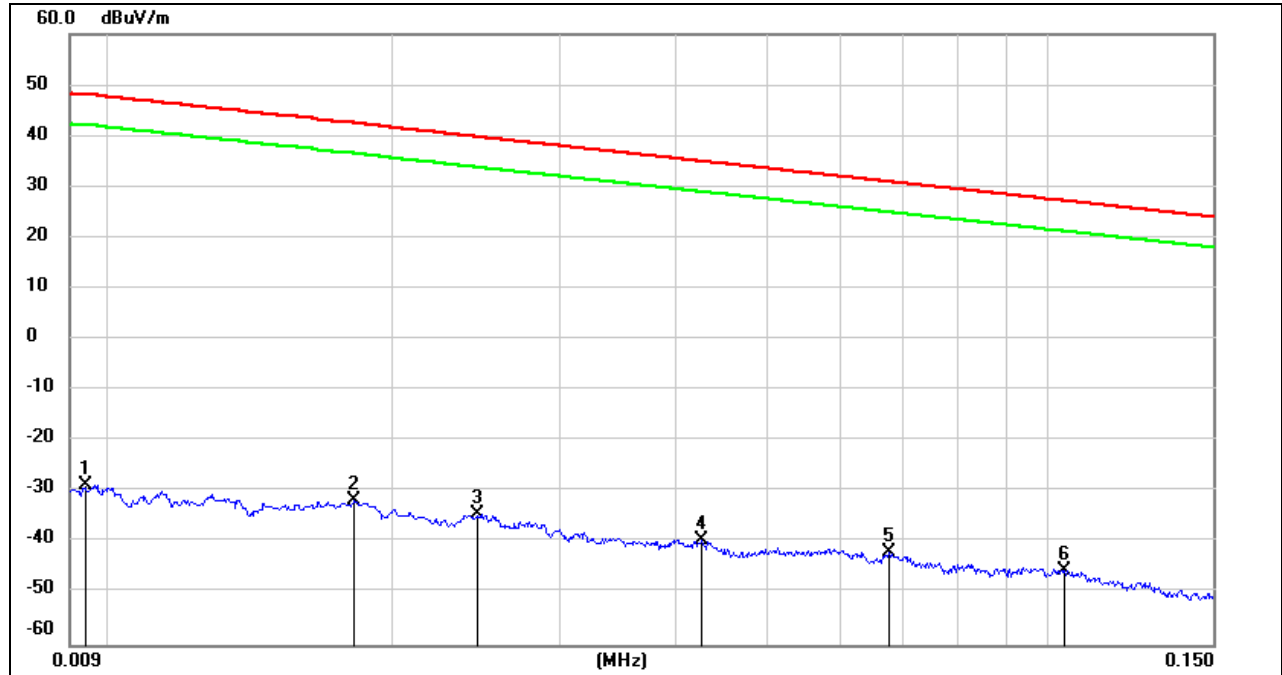
**8.7. SPURIOUS EMISSIONS BELOW 30 MHz****8.7.1. 802.11n HT40 MIMO MODE****SPURIOUS EMISSIONS (MID CHANNEL, LOOP ANTENNA FACE ON TO THE EUT, WORST-CASE CONFIGURATION)****9 kHz ~ 150 kHz**

No.	Frequency (MHz)	Reading (dBuV)	Correct (dB/m)	FCC Result (dBuV/m)	FCC Limit (dBuV/m)	ISED Result (dBuA/m)	ISED Limit (dBuA/m)	Margin (dB)	Remark
1	0.0094	72.66	-101.35	-28.69	48.05	-80.19	-3.45	-76.74	peak
2	0.0181	69.85	-101.36	-31.51	42.45	-83.01	-9.05	-73.96	peak
3	0.0246	66.90	-101.36	-34.46	39.78	-85.96	-11.72	-74.24	peak
4	0.0427	62.14	-101.45	-39.31	34.99	-90.81	-16.51	-74.30	peak
5	0.0675	59.64	-101.56	-41.92	31.02	-93.42	-20.48	-72.94	peak
6	0.1042	56.42	-101.78	-45.36	27.25	-96.86	-24.25	-72.61	peak

Note: 1. Measurement = Reading Level + Correct Factor (dBuA/m= dBuV/m- 20Log10[120π] = dBuV/m- 51.5).

2. If Peak Result complies with AV and QP limit, AV and QP Result are deemed to comply with AV limit.

3. All 3 polarizations (Horizontal, Face-on and Face-off) of the loop antenna had been tested, but only the worst data recorded in the report.



150 kHz ~ 490 kHz

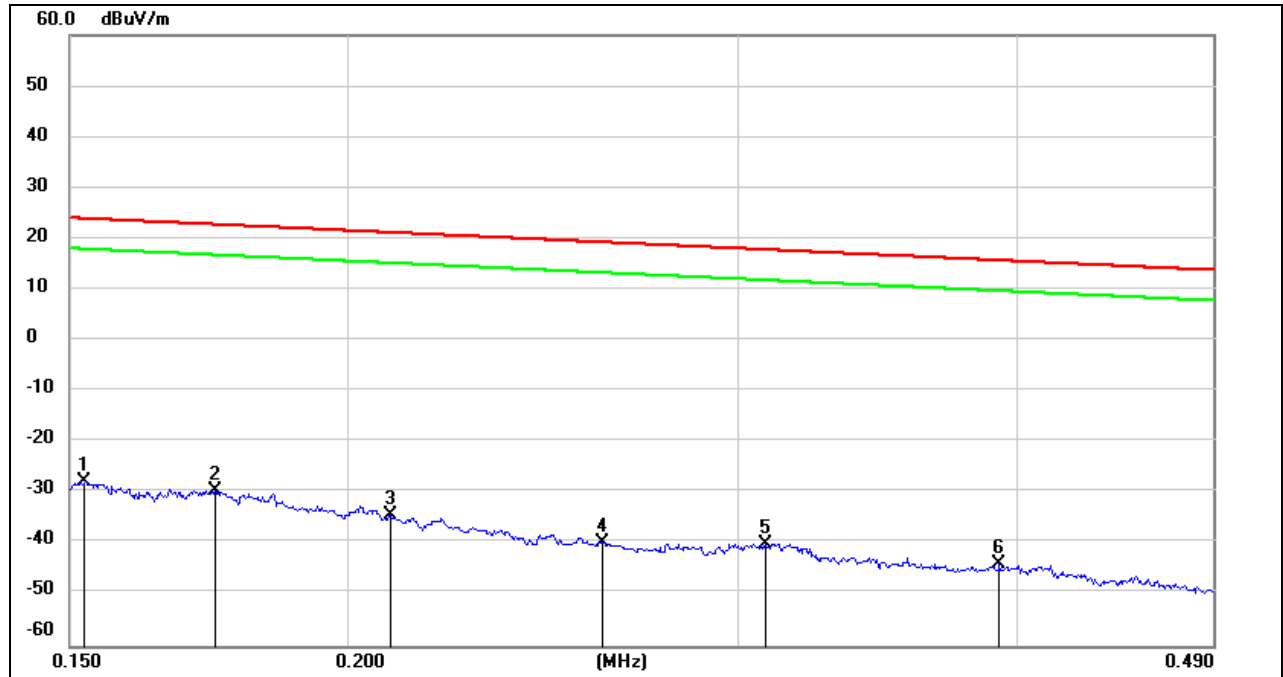

No.	Frequency (MHz)	Reading (dBuV)	Correct (dB/m)	FCC Result (dBuV/m)	FCC Limit (dBuV/m)	ISED Result (dBuA/m)	ISED Limit (dBuA/m)	Margin (dB)	Remark
1	0.1524	73.80	-101.63	-27.83	23.94	-79.33	-27.56	-51.77	peak
2	0.1743	72.16	-101.67	-29.51	22.78	-81.01	-28.72	-52.29	peak
3	0.2091	67.32	-101.73	-34.41	21.19	-85.91	-30.31	-55.60	peak
4	0.2605	62.14	-101.81	-39.67	19.28	-91.17	-32.22	-58.95	peak
5	0.3084	61.95	-101.86	-39.91	17.82	-91.41	-33.68	-57.73	peak
6	0.3930	58.05	-101.96	-43.91	15.71	-95.41	-35.79	-59.62	peak

Note: 1. Measurement = Reading Level + Correct Factor (dBuA/m= dBuV/m- 20Log10[120π] = dBuV/m- 51.5).

2. If Peak Result complies with AV and QP limit, AV and QP Result are deemed to comply with AV limit.

3. All 3 polarizations (Horizontal, Face-on and Face-off) of the loop antenna had been tested, but only the worst data recorded in the report.

490 kHz ~ 30 MHz

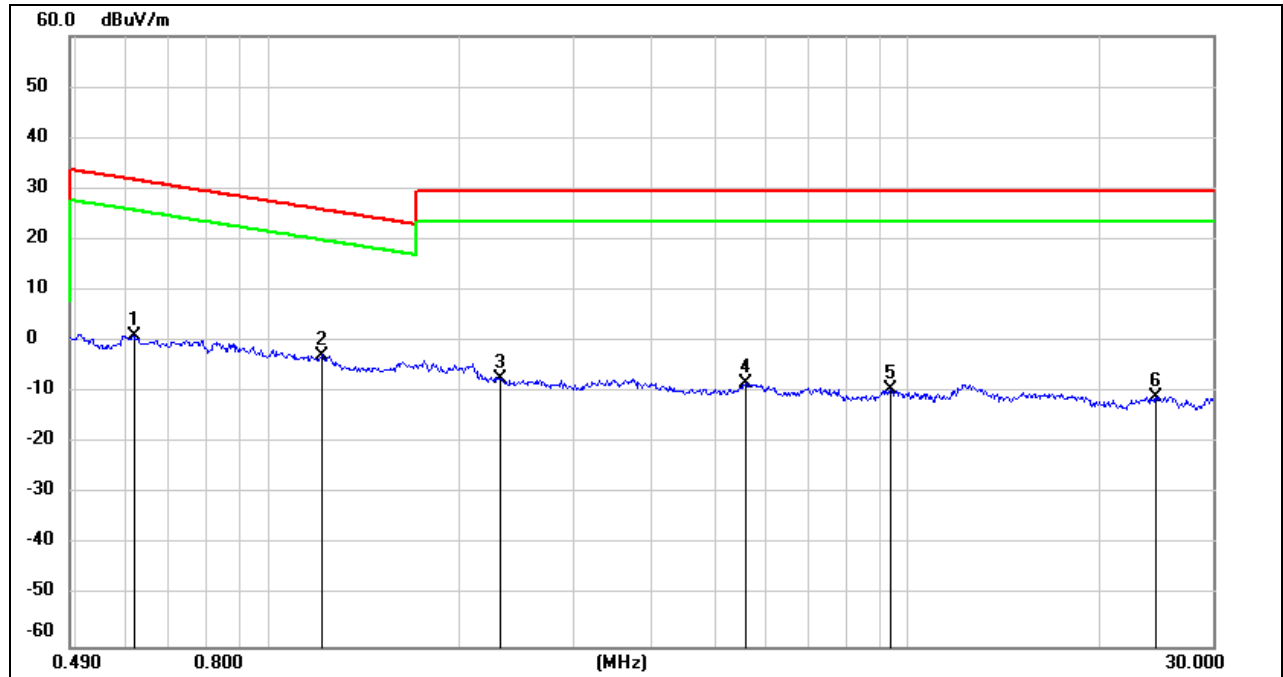

No.	Frequency (MHz)	Reading (dBuV)	Correct (dB/m)	FCC Result (dBuV/m)	FCC Limit (dBuV/m)	ISED Result (dBuA/m)	ISED Limit (dBuA/m)	Margin (dB)	Remark
1	0.6169	63.05	-62.08	0.97	31.8	-50.53	-19.70	-30.83	peak
2	1.2157	59.47	-62.17	-2.7	25.91	-54.20	-25.59	-28.61	peak
3	2.3195	54.54	-61.75	-7.21	29.54	-58.71	-21.96	-36.75	peak
4	5.5952	53.05	-61.41	-8.36	29.54	-59.86	-21.96	-37.90	peak
5	9.4016	51.39	-60.88	-9.49	29.54	-60.99	-21.96	-39.03	peak
6	24.5106	49.58	-60.49	-10.91	29.54	-62.41	-21.96	-40.45	peak

Note: 1. Measurement = Reading Level + Correct Factor (dBuA/m= dBuV/m- 20Log10[120π] = dBuV/m- 51.5).

2. If Peak Result complies with AV and QP limit, AV and QP Result are deemed to comply with AV limit.

3. All 3 polarizations (Horizontal, Face-on and Face-off) of the loop antenna had been tested, but only the worst data recorded in the report.

Note: All the modes and channels had been tested, but only the worst data was recorded in the report.

9. AC POWER LINE CONDUCTED EMISSIONS

LIMITS

Please refer to CFR 47 FCC §15.207 (a) and ISED RSS-Gen Clause 8.8

FREQUENCY (MHz)	Quasi-peak	Average
0.15 -0.5	66 - 56 *	56 - 46 *
0.50 -5.0	56.00	46.00
5.0 -30.0	60.00	50.00

TEST SETUP AND PROCEDURE

Refer to ANSI C63.10-2013 clause 6.2.

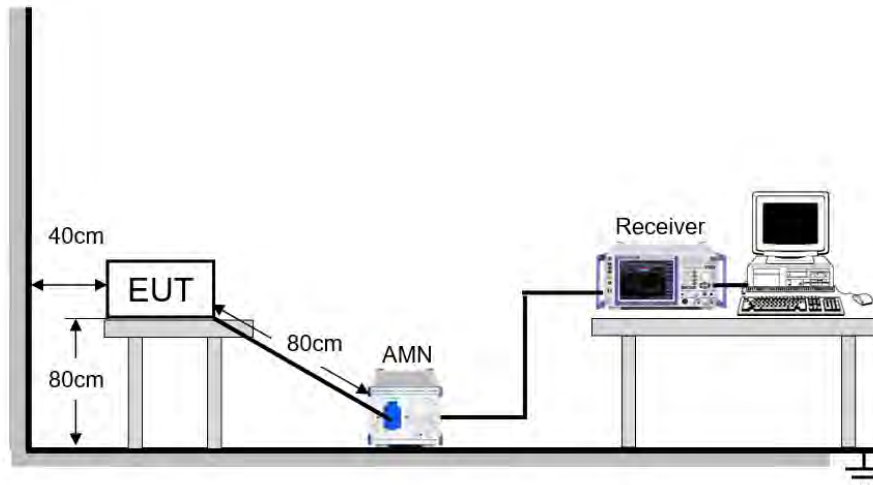

The EUT is put on a table of non-conducting material that is 80 cm high. The vertical conducting wall of shielding is located 40 cm to the rear of the EUT. The power line of the EUT is connected to the AC mains through a Artificial Mains Network (A.M.N.). A EMI Measurement Receiver (R&S Test Receiver ESR3) is used to test the emissions from both sides of AC line. According to the requirements in Section 6.2 of ANSI C63.10-2013. Conducted emissions from the EUT measured in the frequency range between 0.15 MHz and 30 MHz using CISPR Quasi-Peak and average detector mode. The bandwidth of EMI test receiver is set at 9 kHz.

The arrangement of the equipment is installed to meet the standards and operating in a manner, which tends to maximize its emission characteristics in a normal application.

TEST ENVIRONMENT

Temperature	26.3 °C	Relative Humidity	64.4 %
Atmosphere Pressure	101 kPa	Test Voltage	AC 120 V, 60Hz

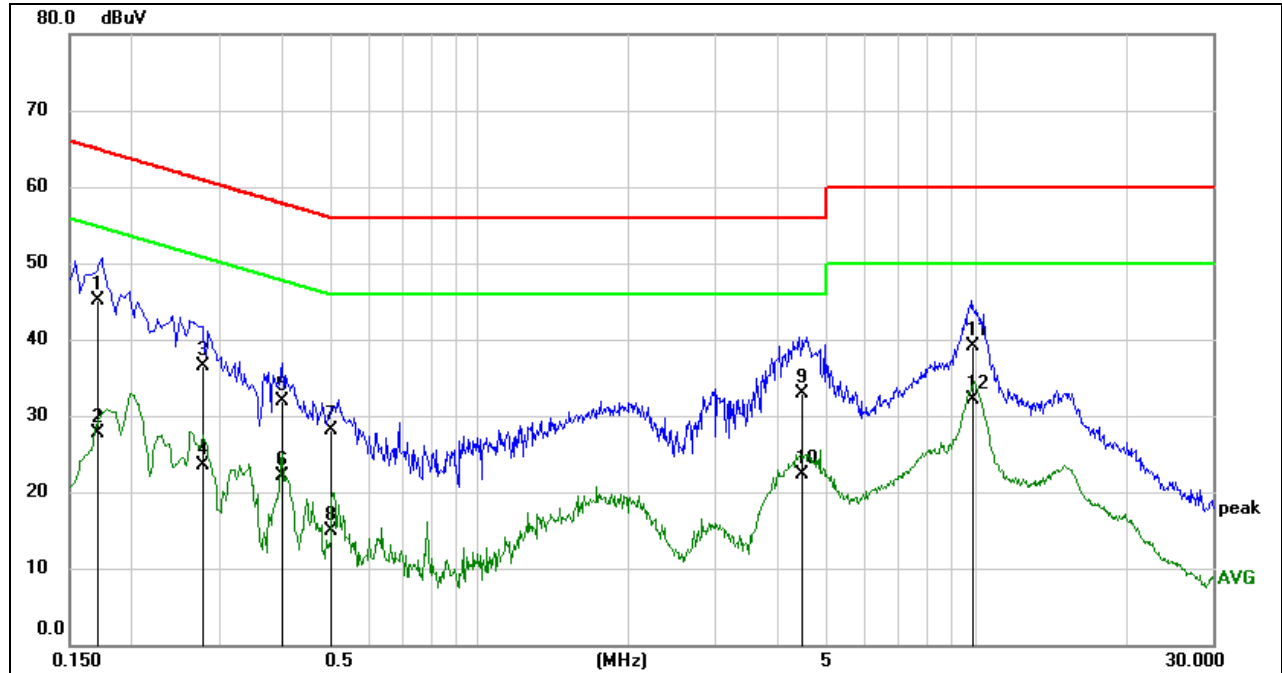
**RESULTS****9.1.1. 802.11n HT40 MIMO MODE****LINE L RESULTS (MID CHANNEL, WORST-CASE CONFIGURATION)**

No.	Frequency (MHz)	Reading (dBuV)	Correct (dB)	Result (dBuV)	Limit (dBuV)	Margin (dB)	Remark
1	0.1703	35.60	9.59	45.19	64.95	-19.76	QP
2	0.1703	18.18	9.59	27.77	54.95	-27.18	AVG
3	0.2760	26.83	9.59	36.42	60.94	-24.52	QP
4	0.2760	13.98	9.59	23.57	50.94	-27.37	AVG
5	0.4029	22.24	9.60	31.84	57.79	-25.95	QP
6	0.4029	12.54	9.60	22.14	47.79	-25.65	AVG
7	0.5099	18.48	9.60	28.08	56.00	-27.92	QP
8	0.5099	5.38	9.60	14.98	46.00	-31.02	AVG
9	4.4570	23.24	9.61	32.85	56.00	-23.15	QP
10	4.4570	12.62	9.61	22.23	46.00	-23.77	AVG
11	9.9140	29.55	9.62	39.17	60.00	-20.83	QP
12	9.9140	22.51	9.62	32.13	50.00	-17.87	AVG

Note: 1. Result = Reading + Correct Factor.

2. If QP Result complies with AV limit, AV Result is deemed to comply with AV limit.

3. Test setup: RBW: 200 Hz (9 kHz ~ 150 kHz), 9 kHz (150 kHz ~ 30 MHz).

4. Step size: 80 Hz (0.009 MHz ~ 0.15 MHz), 4 kHz (0.15 MHz ~ 30 MHz), Scan time: auto.

LINE N RESULTS (MID CHANNEL, WORST-CASE CONFIGURATION)

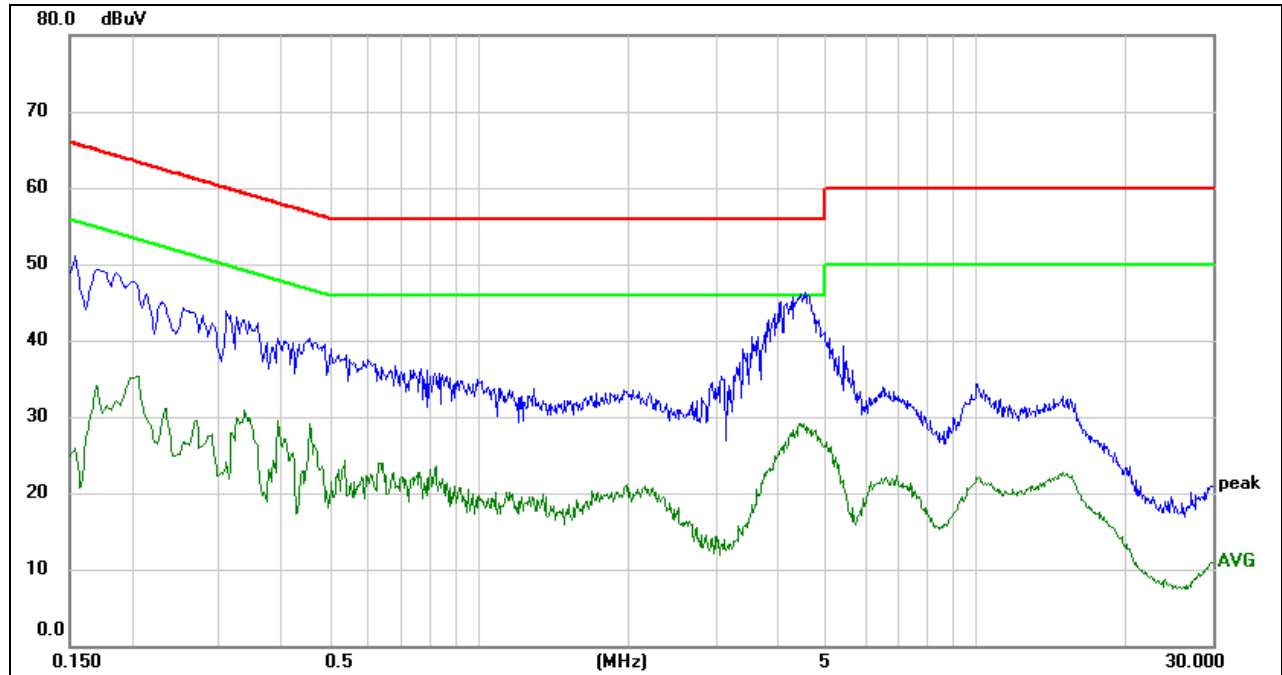

No.	Frequency (MHz)	Reading (dBuV)	Correct (dB)	Result (dBuV)	Limit (dBuV)	Margin (dB)	Remark
1	0.1497	6.01	9.59	15.60	66.02	-50.42	QP
2	0.1497	1.20	9.59	10.79	56.02	-45.23	AVG
3	0.3115	27.40	9.59	36.99	59.93	-22.94	QP
4	0.3115	11.29	9.59	20.88	49.93	-29.05	AVG
5	0.4555	26.31	9.60	35.91	56.77	-20.86	QP
6	0.4555	14.07	9.60	23.67	46.77	-23.10	AVG
7	0.5979	23.96	9.60	33.56	56.00	-22.44	QP
8	0.5979	10.44	9.60	20.04	46.00	-25.96	AVG
9	0.9824	19.94	9.61	29.55	56.00	-26.45	QP
10	0.9824	7.97	9.61	17.58	46.00	-28.42	AVG
11	4.5044	29.18	9.61	38.79	56.00	-17.21	QP
12	4.5044	16.18	9.61	25.79	46.00	-20.21	AVG

Note: 1. Result = Reading +Correct Factor.

2. If QP Result complies with AV limit, AV Result is deemed to comply with AV limit.

3. Test setup: RBW: 200 Hz (9 kHz ~ 150 kHz), 9 kHz (150 kHz ~ 30 MHz).

4. Step size: 80 Hz (0.009 MHz ~ 0.15 MHz), 4 kHz (0.15 MHz ~ 30 MHz), Scan time: auto.

Note: All the modes and channels had been tested, but only the worst data was recorded in the report.



10. ANTENNA REQUIREMENTS

APPLICABLE REQUIREMENTS

Please refer to FCC §15.203

An intentional radiator shall be designed to ensure that no antenna other than that furnished by the responsible party shall be used with the device. The use of a permanently attached antenna or of an antenna that uses a unique coupling to the intentional radiator shall be considered sufficient to comply with the provisions of this section. The manufacturer may design the unit so that a broken antenna can be replaced by the user, but the use of a standard antenna jack or electrical connector is prohibited.

Please refer to FCC §15.247(b)(4)

The conducted output power limit specified in paragraph (b) of this section is based on the use of antennas with directional gains that do not exceed 6 dBi. Except as shown in paragraph (c) of this section, if transmitting antennas of directional gain greater than 6 dBi are used, the conducted output power from the intentional radiator shall be reduced below the stated values in paragraphs (b)(1), (b)(2), and (b)(3) of this section, as appropriate, by the amount in dB that the directional gain of the antenna exceeds 6 dBi.

RESULTS

Complies



11. Appendix

11.1. Appendix A: DTS Bandwidth

11.1.1. Test Result

Test Mode	Antenna	Channel	DTS BW [MHz]	FL[MHz]	FH[MHz]	Limit[MHz]	Verdict
11B	Ant0	2412	9.570	2407.470	2417.040	0.5	PASS
	Ant1	2412	9.600	2407.410	2417.010	0.5	PASS
	Ant0	2437	8.610	2432.950	2441.560	0.5	PASS
	Ant1	2437	9.600	2432.440	2442.040	0.5	PASS
	Ant0	2462	9.630	2456.930	2466.560	0.5	PASS
	Ant1	2462	10.080	2456.960	2467.040	0.5	PASS
11G	Ant0	2412	16.380	2403.810	2420.190	0.5	PASS
	Ant1	2412	16.380	2403.810	2420.190	0.5	PASS
	Ant0	2437	16.380	2428.810	2445.190	0.5	PASS
	Ant1	2437	16.410	2428.780	2445.190	0.5	PASS
	Ant0	2462	16.380	2453.810	2470.190	0.5	PASS
	Ant1	2462	16.380	2453.810	2470.190	0.5	PASS
11N20MIMO	Ant0	2412	17.640	2403.180	2420.820	0.5	PASS
	Ant1	2412	17.640	2403.180	2420.820	0.5	PASS
	Ant0	2437	17.640	2428.180	2445.820	0.5	PASS
	Ant1	2437	17.640	2428.180	2445.820	0.5	PASS
	Ant0	2462	17.610	2453.180	2470.790	0.5	PASS
	Ant1	2462	17.640	2453.180	2470.820	0.5	PASS
11N40MIMO	Ant0	2422	35.880	2404.060	2439.940	0.5	PASS
	Ant1	2422	35.460	2404.720	2440.180	0.5	PASS
	Ant0	2437	35.700	2419.120	2454.820	0.5	PASS
	Ant1	2437	36.120	2419.060	2455.180	0.5	PASS
	Ant0	2452	33.720	2434.660	2468.380	0.5	PASS
	Ant1	2452	35.460	2434.120	2469.580	0.5	PASS

11.1.2. Test Graphs





11B Ant2 2437



11B Ant1 2462

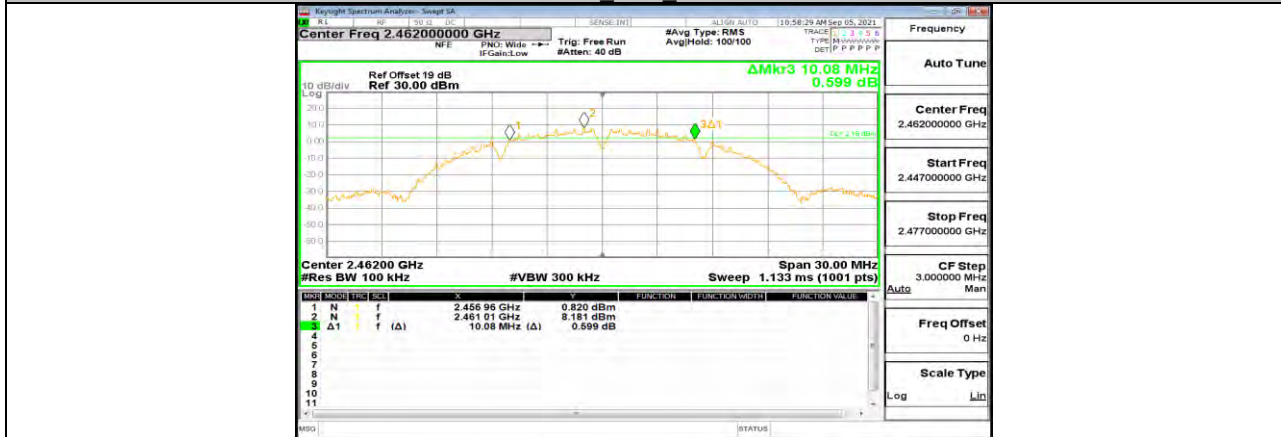

11B Ant2 2462



11G Ant1 2412



11G Ant2 2412



11G Ant1 2437



11G Ant2 2437



11G Ant1 2462



11G Ant2 2462



11N20MIMO Ant1 2412



11N20MIMO Ant2 2412



11N20MIMO Ant1 2437

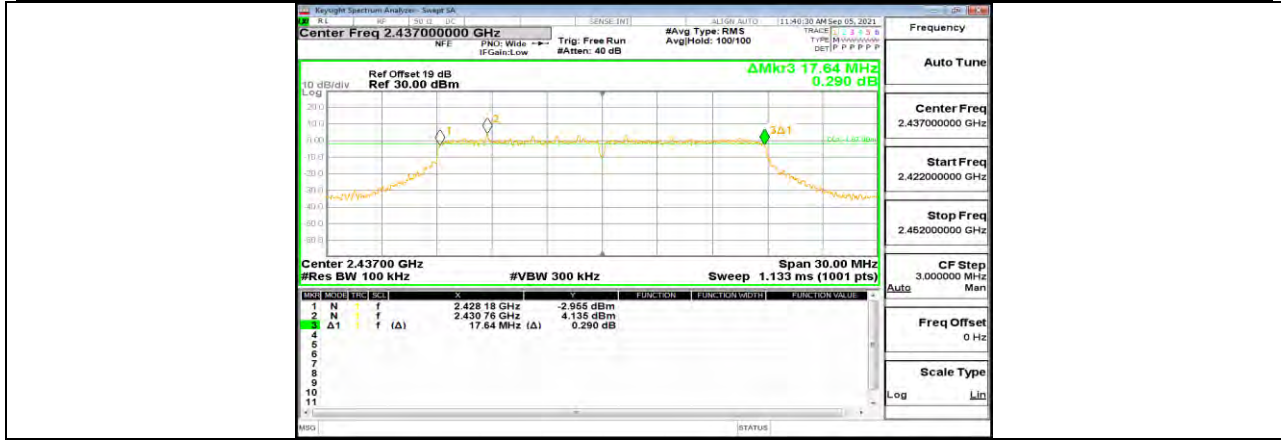



11N40MIMO Ant1 2422



11N40MIMO Ant2 2422



11N40MIMO Ant1 2437



11N40MIMO Ant2 2437



11N40MIMO Ant1 2452



11N40MIMO Ant2 2452

**11.2. Appendix B: Occupied Channel Bandwidth****11.2.1. Test Result**

Test Mode	Antenna	Channel	OCB [MHz]	FL[MHz]	FH[MHz]	Verdict
11B	Ant0	2412	15.266	2404.358	2419.624	PASS
	Ant1	2412	15.231	2404.412	2419.643	PASS
	Ant0	2437	15.299	2429.336	2444.635	PASS
	Ant1	2437	15.267	2429.385	2444.652	PASS
	Ant0	2462	15.314	2454.307	2469.621	PASS
	Ant1	2462	15.272	2454.358	2469.630	PASS
11G	Ant0	2412	17.342	2403.291	2420.633	PASS
	Ant1	2412	17.360	2403.348	2420.708	PASS
	Ant0	2437	17.465	2428.201	2445.666	PASS
	Ant1	2437	17.365	2428.349	2445.714	PASS
	Ant0	2462	17.304	2453.283	2470.587	PASS
	Ant1	2462	17.373	2453.294	2470.667	PASS
11N20MIMO	Ant0	2412	18.351	2402.863	2421.214	PASS
	Ant1	2412	18.353	2402.835	2421.188	PASS
	Ant0	2437	18.411	2427.774	2446.185	PASS
	Ant1	2437	18.312	2427.828	2446.140	PASS
	Ant0	2462	18.386	2452.801	2471.187	PASS
	Ant1	2462	18.293	2452.852	2471.145	PASS
11N40MIMO	Ant0	2422	36.382	2403.793	2440.175	PASS
	Ant1	2422	36.415	2403.812	2440.227	PASS
	Ant0	2437	36.337	2418.781	2455.118	PASS
	Ant1	2437	36.392	2418.805	2455.197	PASS
	Ant0	2452	36.351	2433.840	2470.191	PASS
	Ant1	2452	36.509	2433.728	2470.237	PASS



11.2.2. Test Graphs



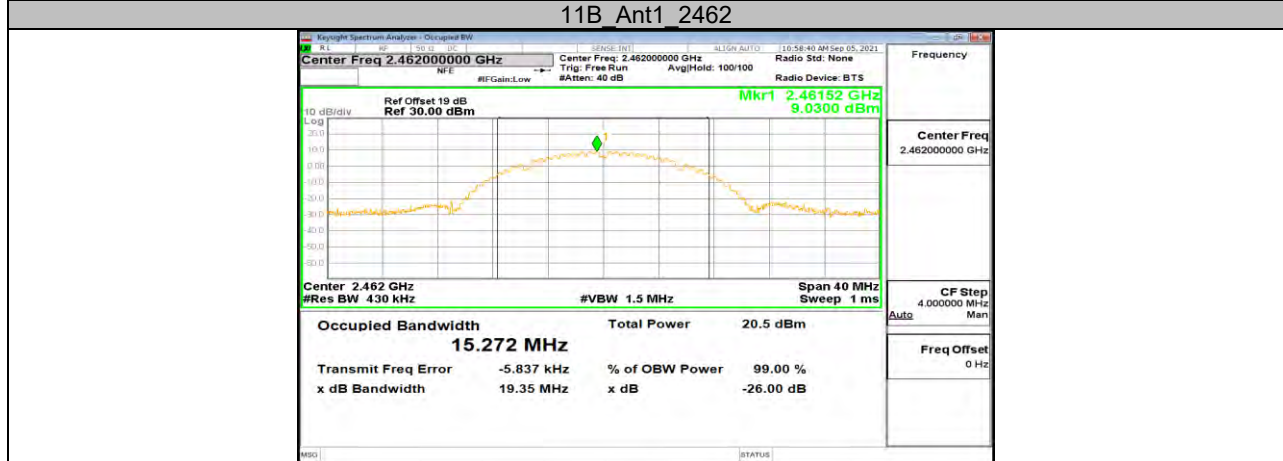
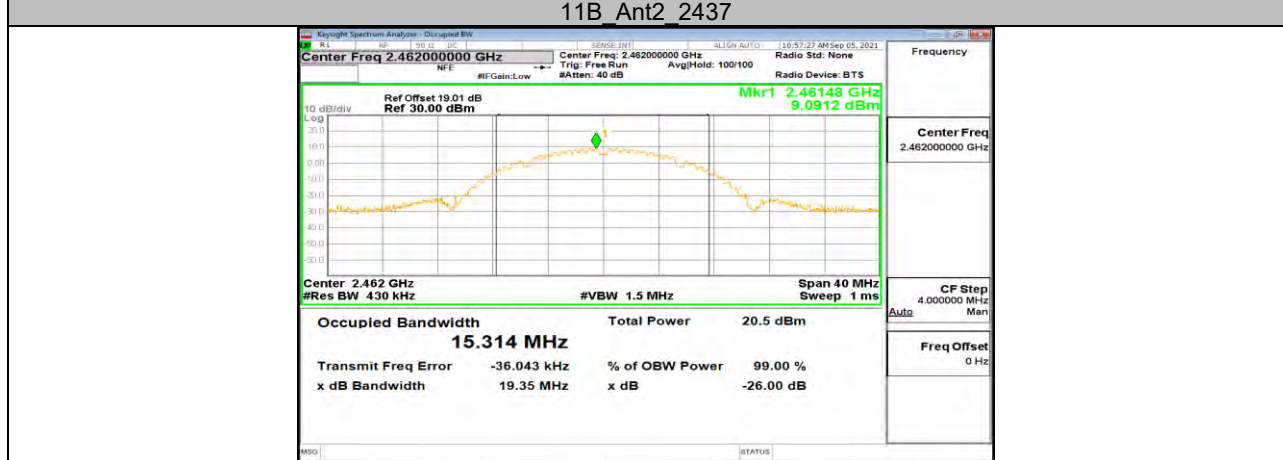
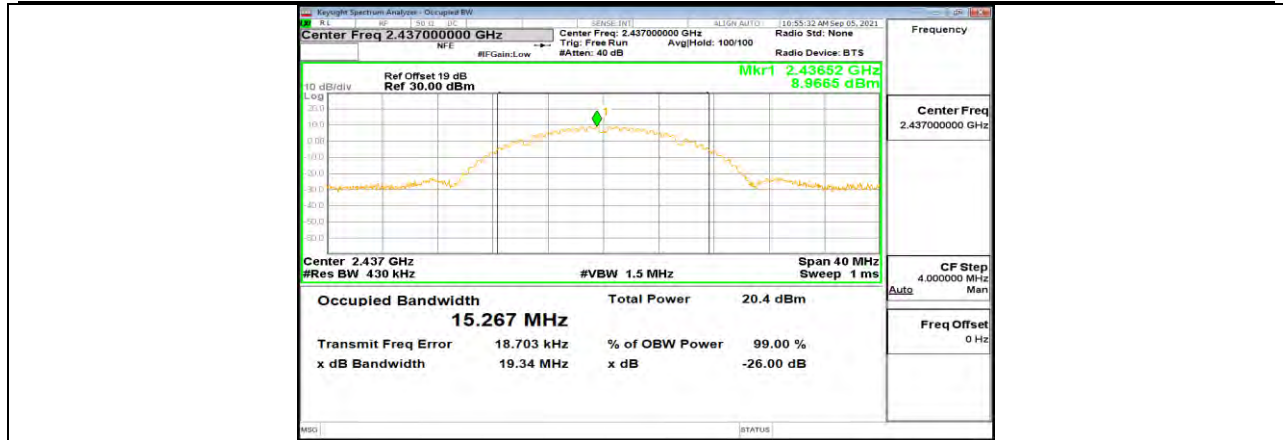

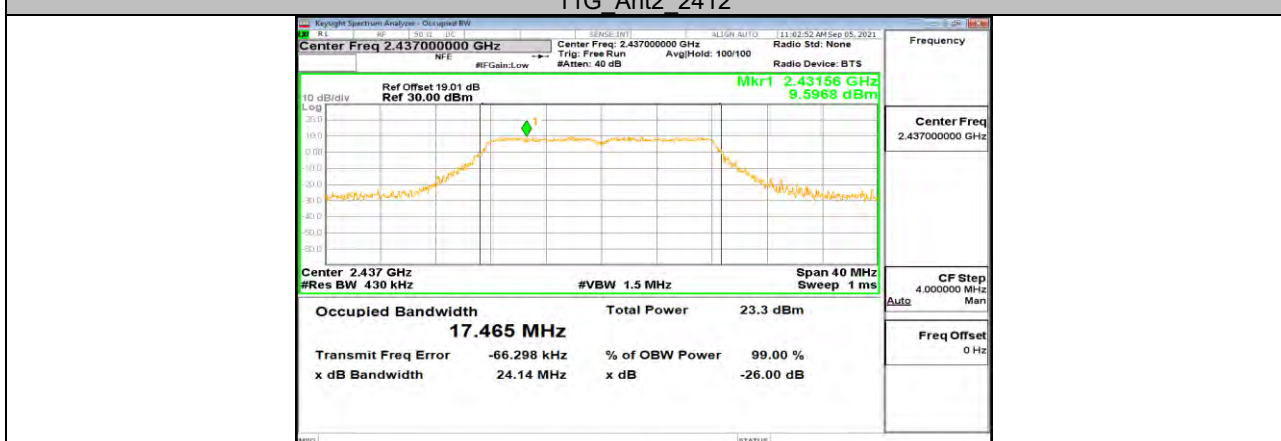
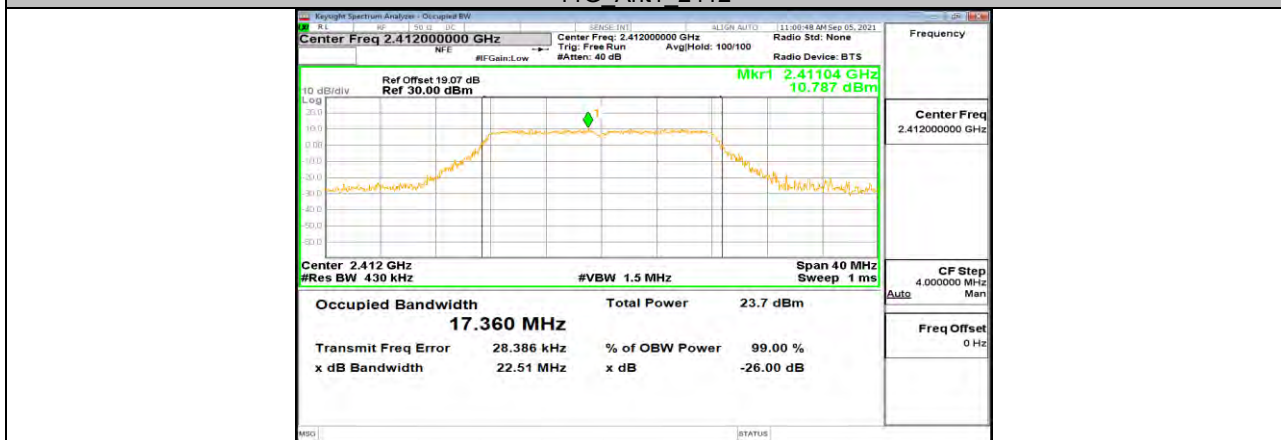
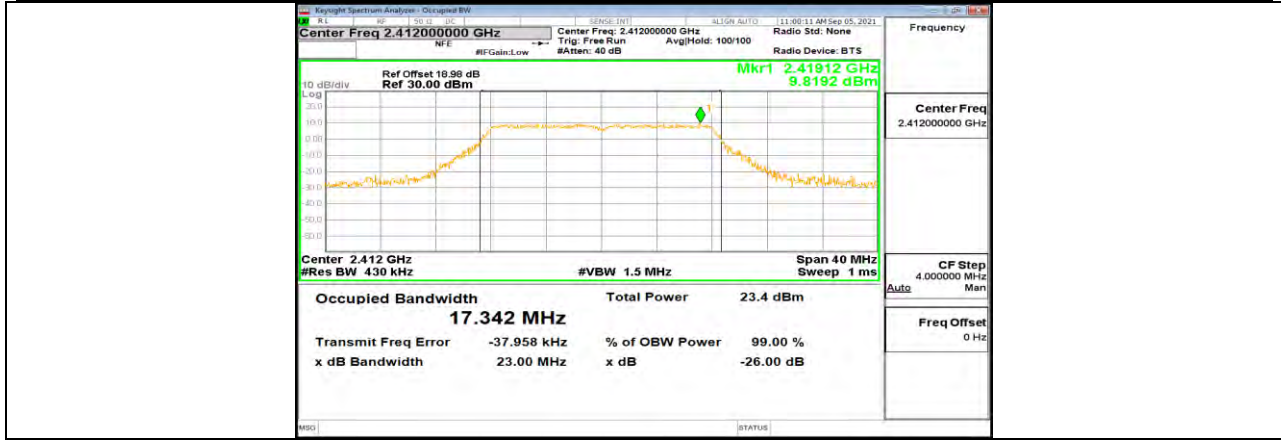

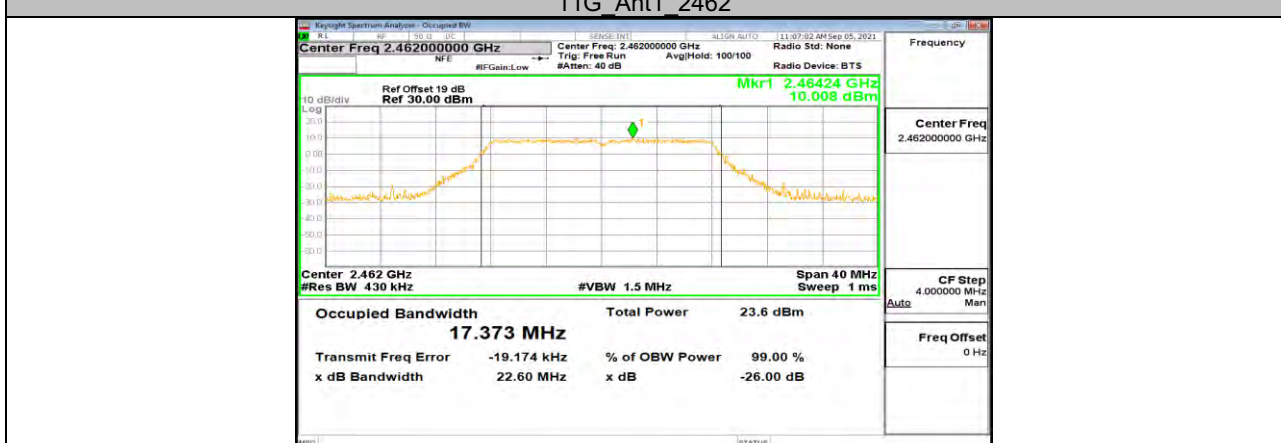
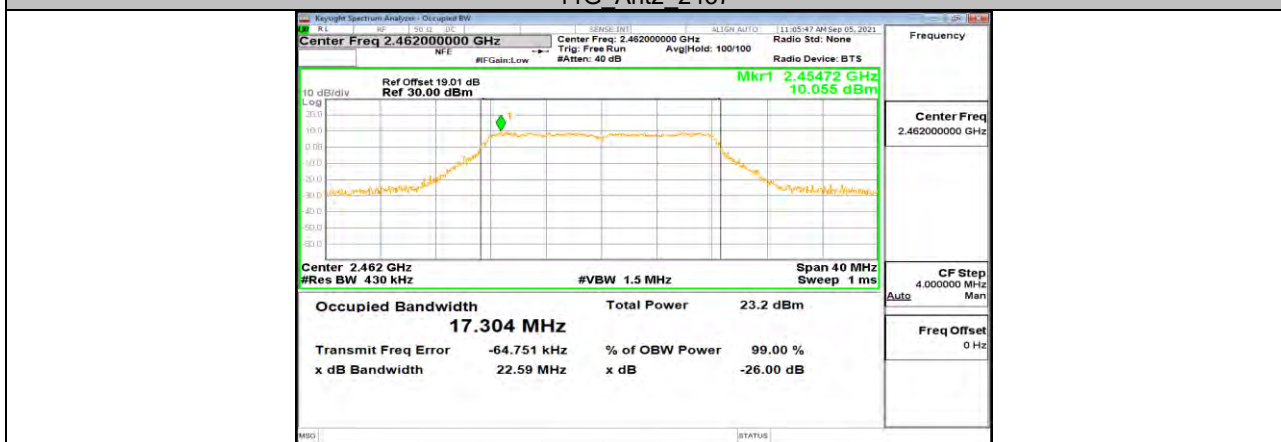
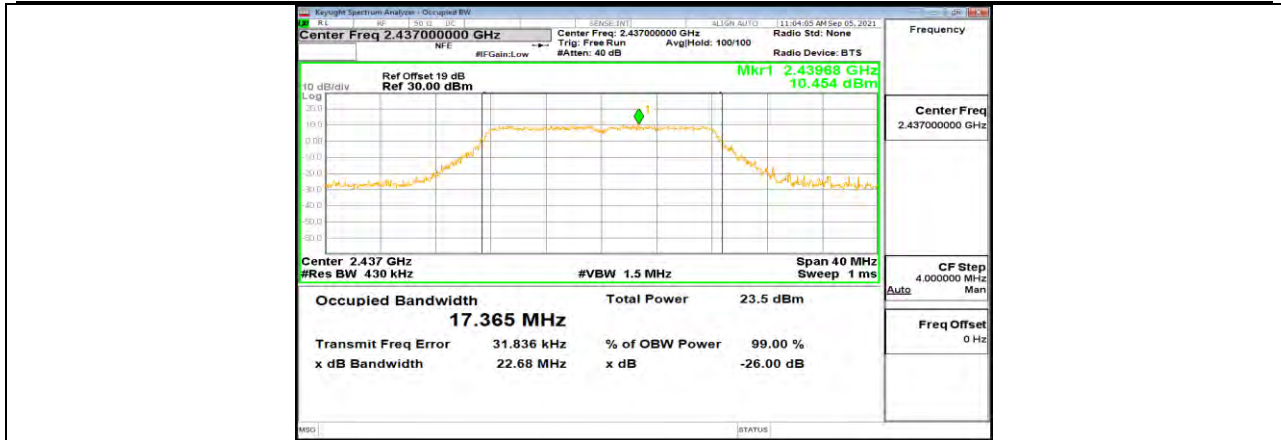

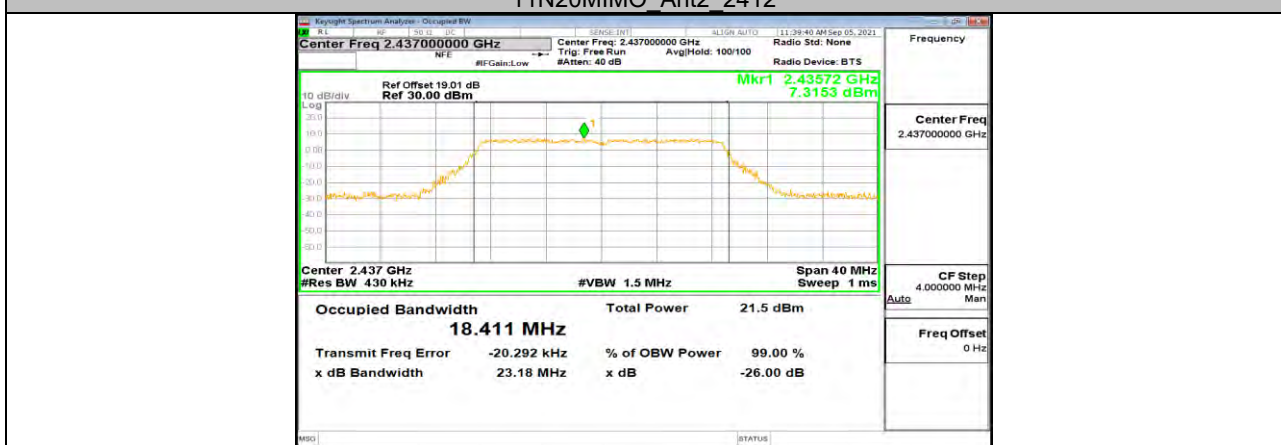
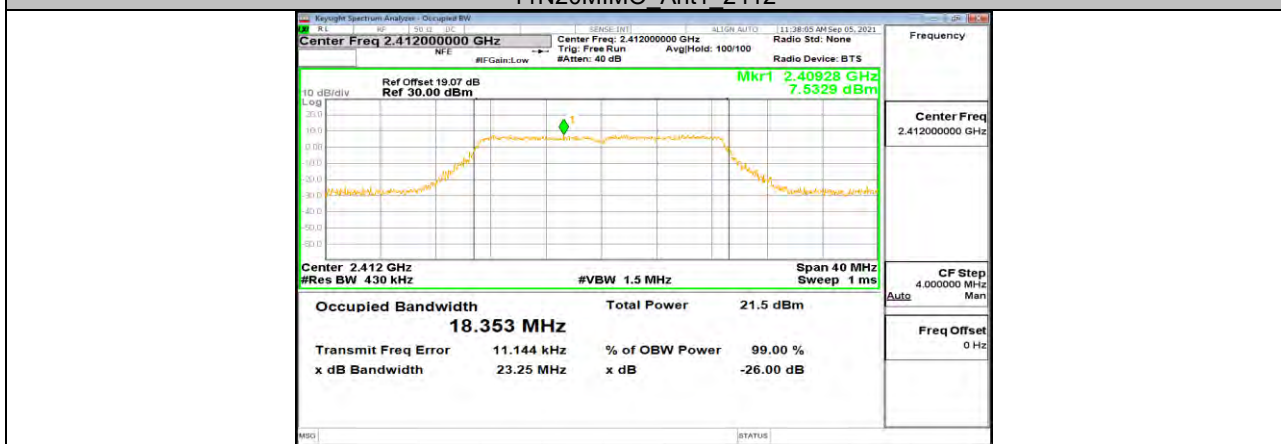
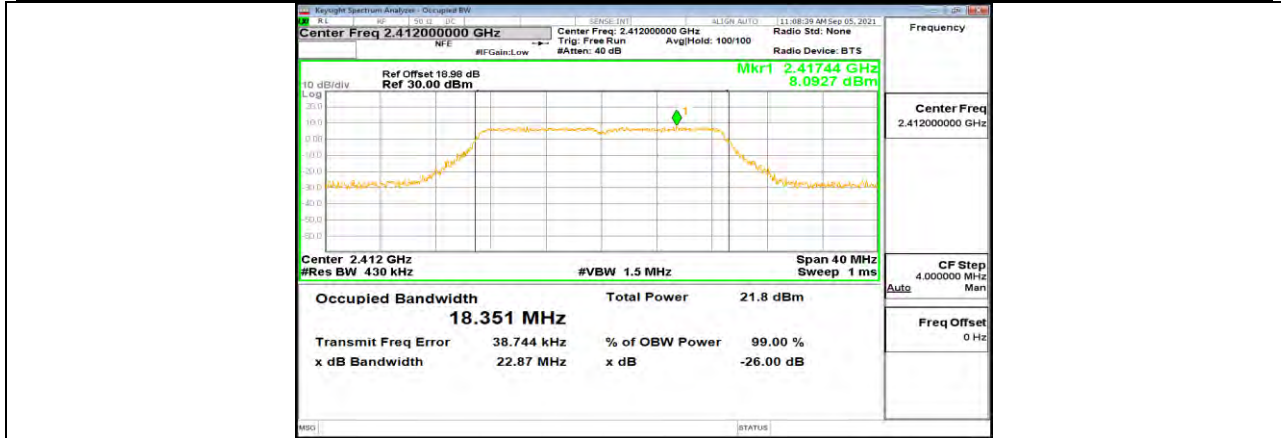

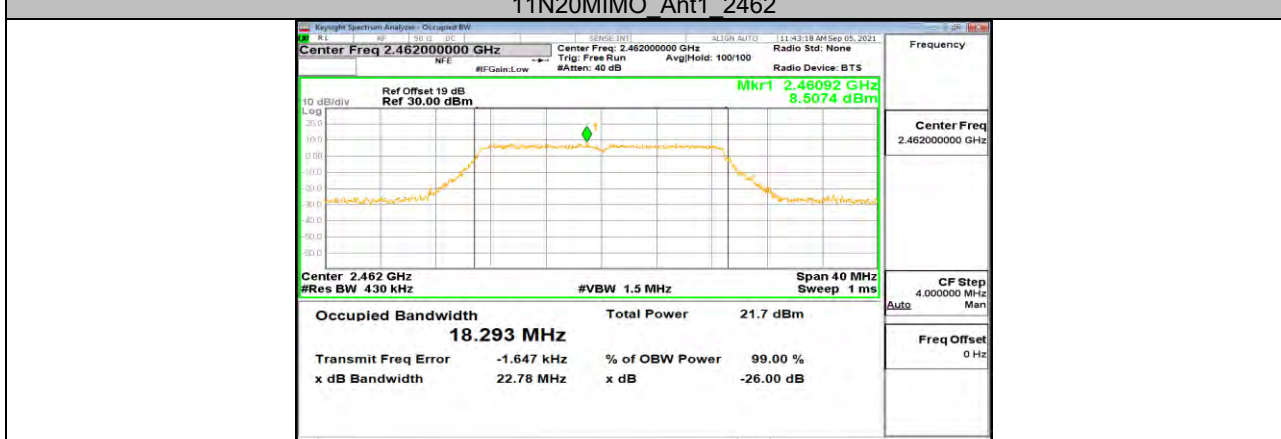
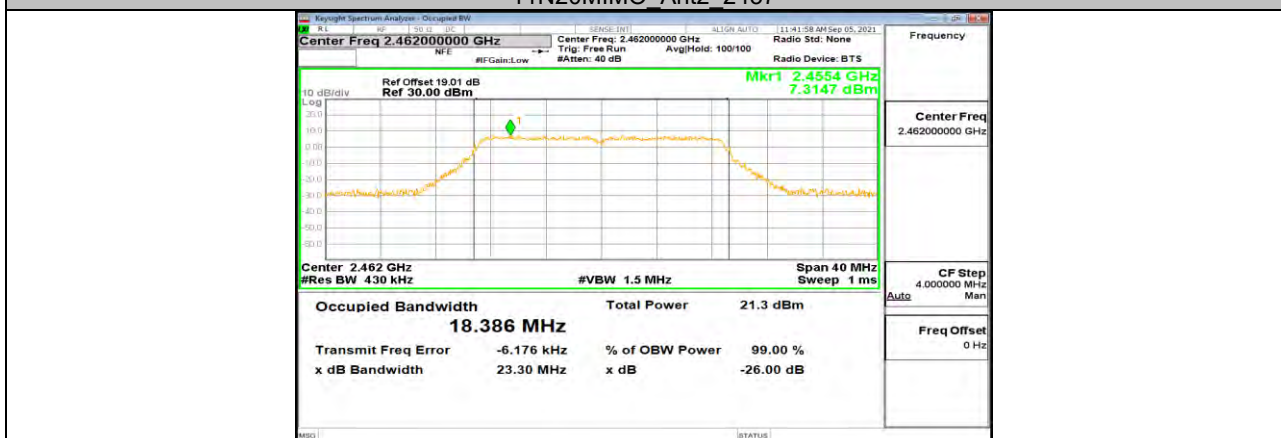
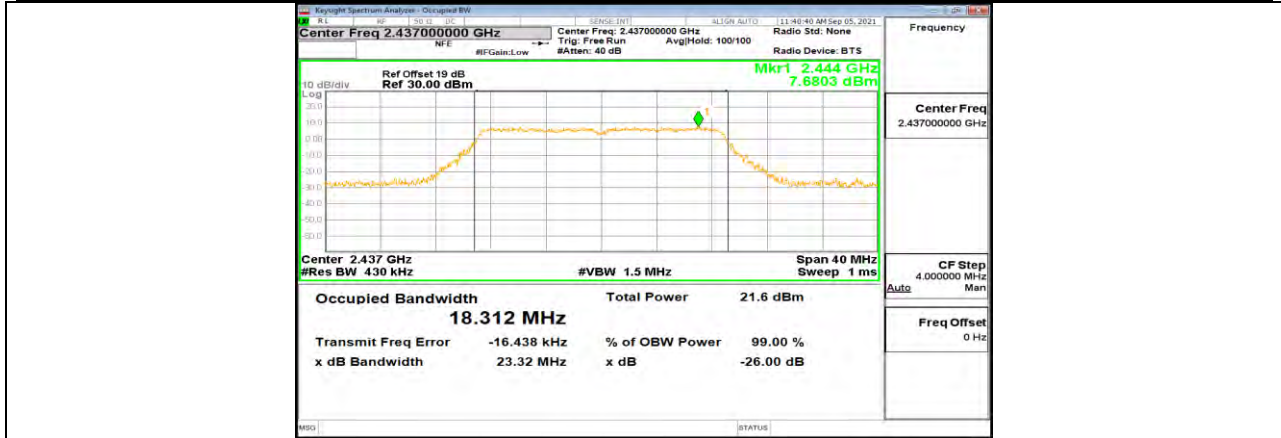

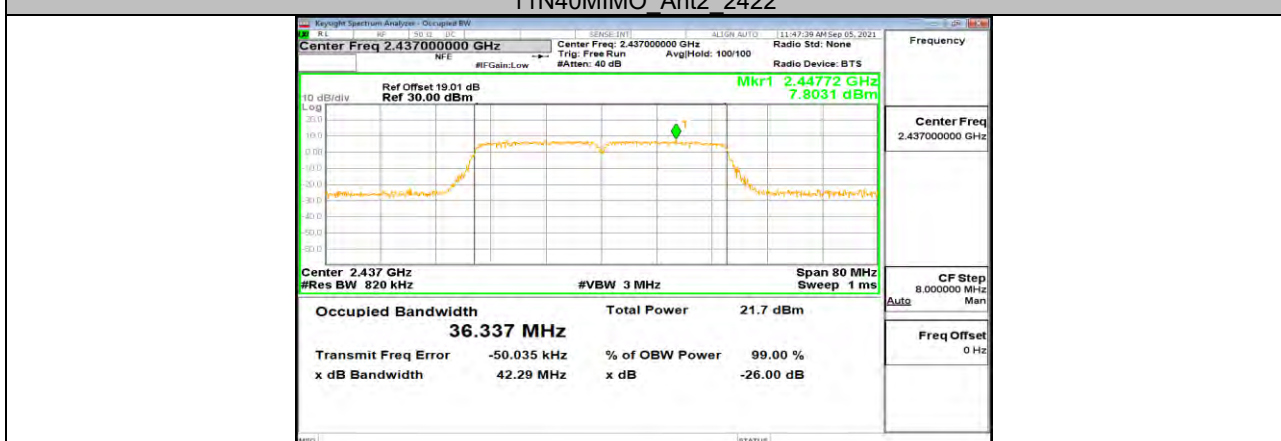
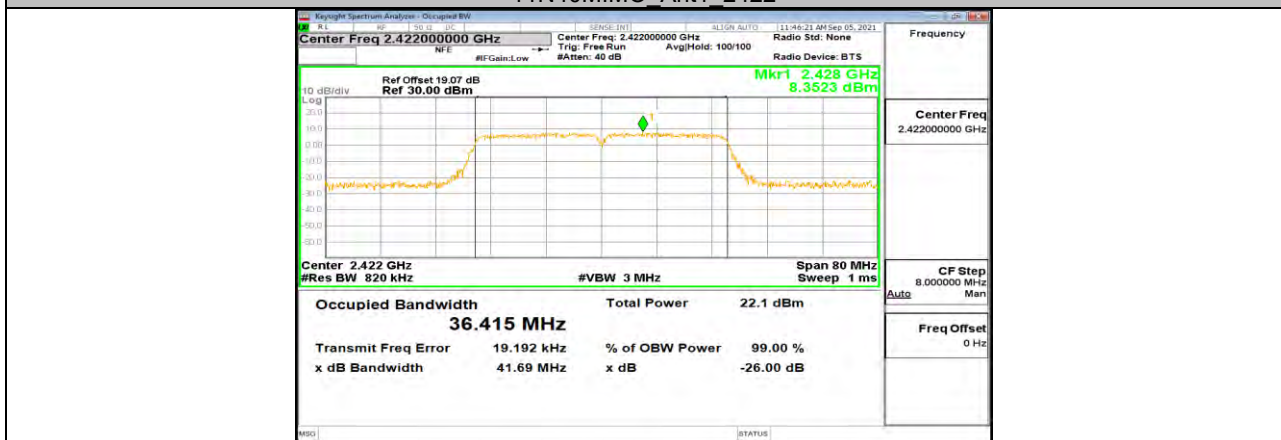
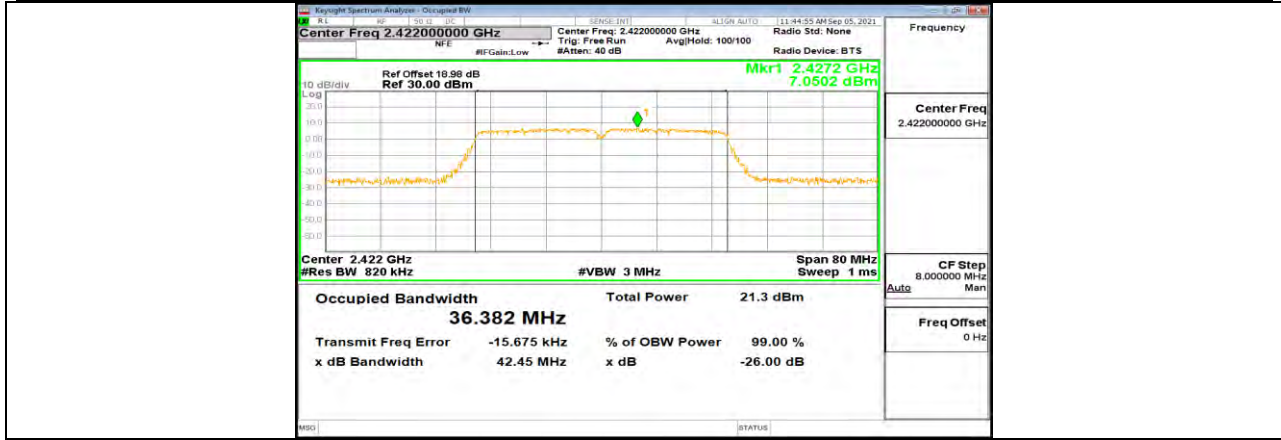

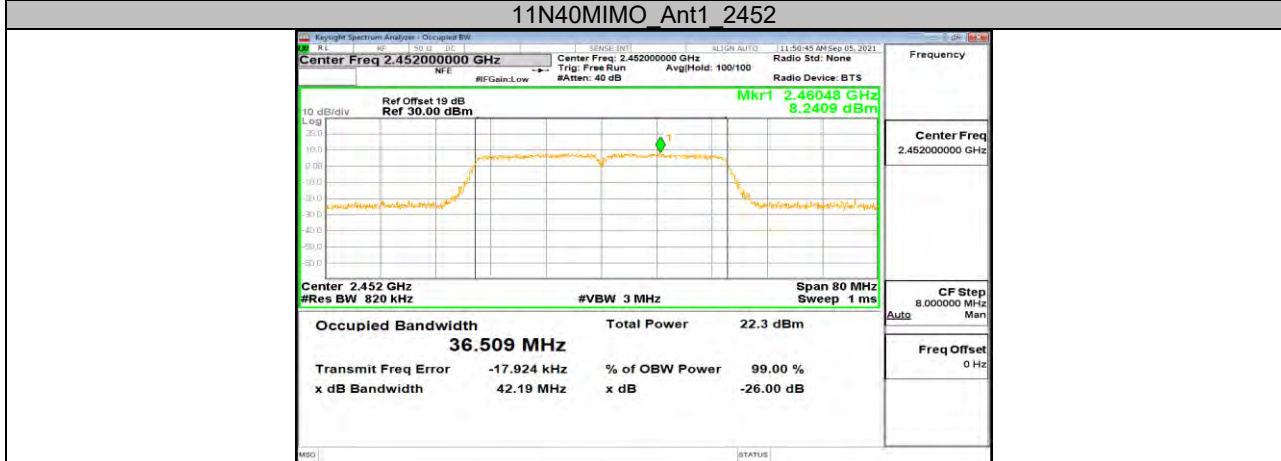
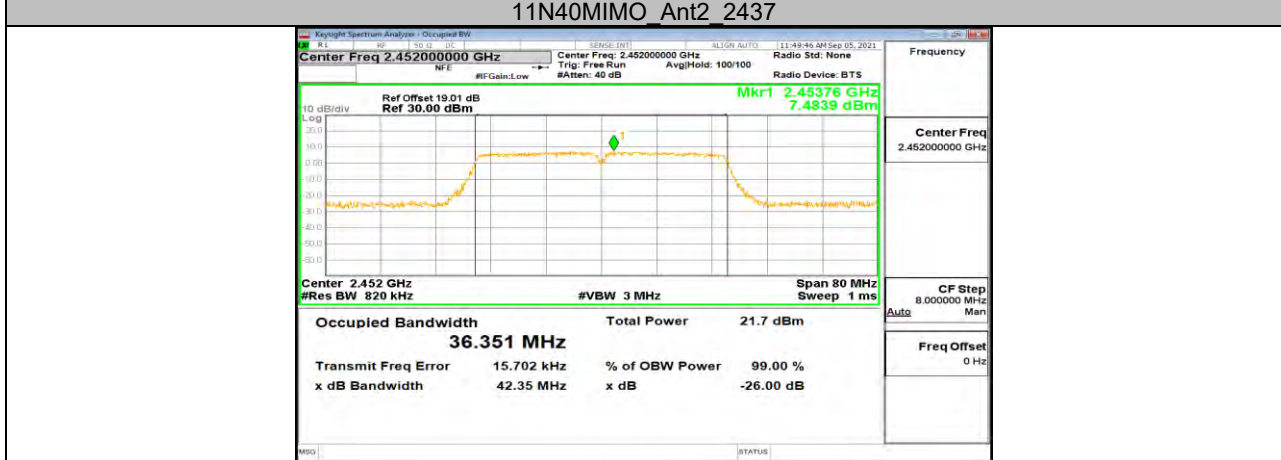
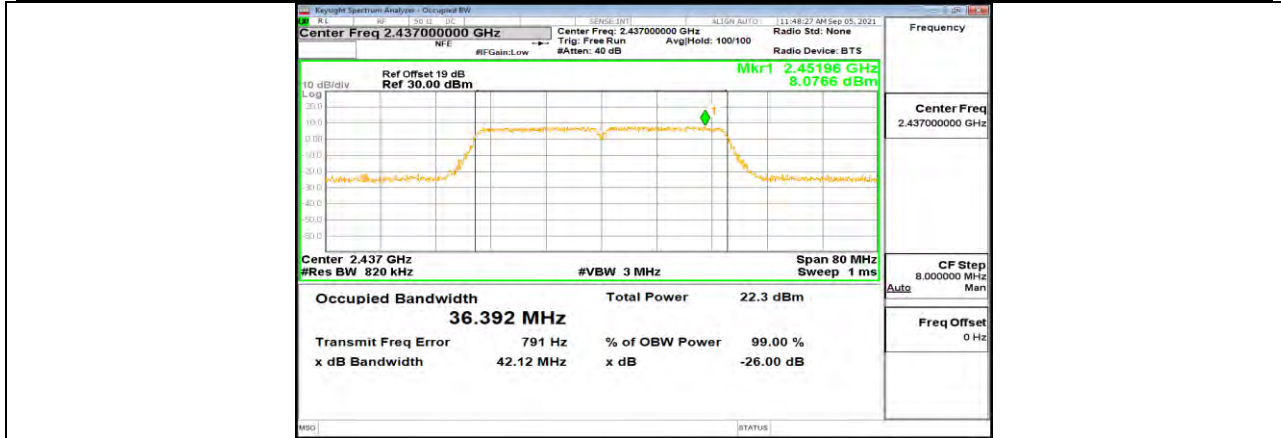



11.3. Appendix C: Maximum conducted output power
11.3.1. Test Result

Test Mode	Antenna	Channel	Result[dBm]	Limit[dBm]	Verdict
11B	Ant0	2412	17.82	<=30	PASS
	Ant1	2412	17.43	<=30	PASS
	Ant0	2437	17.77	<=30	PASS
	Ant1	2437	17.37	<=30	PASS
	Ant0	2462	17.57	<=30	PASS
	Ant1	2462	17.47	<=30	PASS
11G	Ant0	2412	17.58	<=30	PASS
	Ant1	2412	17.32	<=30	PASS
	Ant0	2437	17.23	<=30	PASS
	Ant1	2437	17.25	<=30	PASS
	Ant0	2462	17.20	<=30	PASS
	Ant1	2462	17.42	<=30	PASS
11N20MIMO	Ant0	2412	15.33	<=30	PASS
	Ant1	2412	15.25	<=30	PASS
	total	2412	18.30	<=30	PASS
	Ant0	2437	15.37	<=30	PASS
	Ant1	2437	15.58	<=30	PASS
	total	2437	18.49	<=30	PASS
	Ant0	2462	15.44	<=30	PASS
	Ant1	2462	15.40	<=30	PASS
total	2462	18.43	<=30	PASS	
11N40MIMO	Ant0	2422	14.70	<=30	PASS
	Ant1	2422	16.27	<=30	PASS
	total	2422	18.57	<=30	PASS
	Ant0	2437	16.13	<=30	PASS
	Ant1	2437	15.34	<=30	PASS
	total	2437	18.76	<=30	PASS
	Ant0	2452	15.35	<=30	PASS
	Ant1	2452	15.86	<=30	PASS
total	2452	18.62	<=30	PASS	

Note: 1. Conducted Power=Meas. Level+ Correction Factor
2. The Duty Cycle Factor (refer to section 7.1) had already compensated to the test data.



11.4. Appendix D: Maximum power spectral density
11.4.1. Test Result

Test Mode	Antenna	Channel	Result[dBm/3kHz]	Limit[dBm/3kHz]	Verdict
11B	Ant0	2412	-3.89	<=8	PASS
		2437	-4.19	<=8	PASS
		2462	-5.08	<=8	PASS
11G	Ant0	2412	-7.48	<=8	PASS
		2437	-7.03	<=8	PASS
		2462	-7.53	<=8	PASS
11N20MIMO	Ant0	2412	-8.98	<=8	PASS
	Ant1	2412	-10.13	<=8	PASS
	total	2412	-6.51	<=8	PASS
	Ant0	2437	-9.92	<=8	PASS
	Ant1	2437	-9.02	<=8	PASS
	total	2437	-6.44	<=8	PASS
	Ant0	2462	-9	<=8	PASS
	Ant1	2462	-9.28	<=8	PASS
	total	2462	-6.13	<=8	PASS
11N40MIMO	Ant0	2422	-12.47	<=8	PASS
	Ant1	2422	-12.26	<=8	PASS
	total	2422	-9.35	<=8	PASS
	Ant0	2437	-11.76	<=8	PASS
	Ant1	2437	-13.11	<=8	PASS
	total	2437	-9.37	<=8	PASS
	Ant0	2452	-12.02	<=8	PASS
	Ant1	2452	-12.25	<=8	PASS
total	2452	-9.12	<=8	PASS	

Note: All the Antenna had been tested, but only the worst data was recorded in the report.

11.4.2. Test Graphs

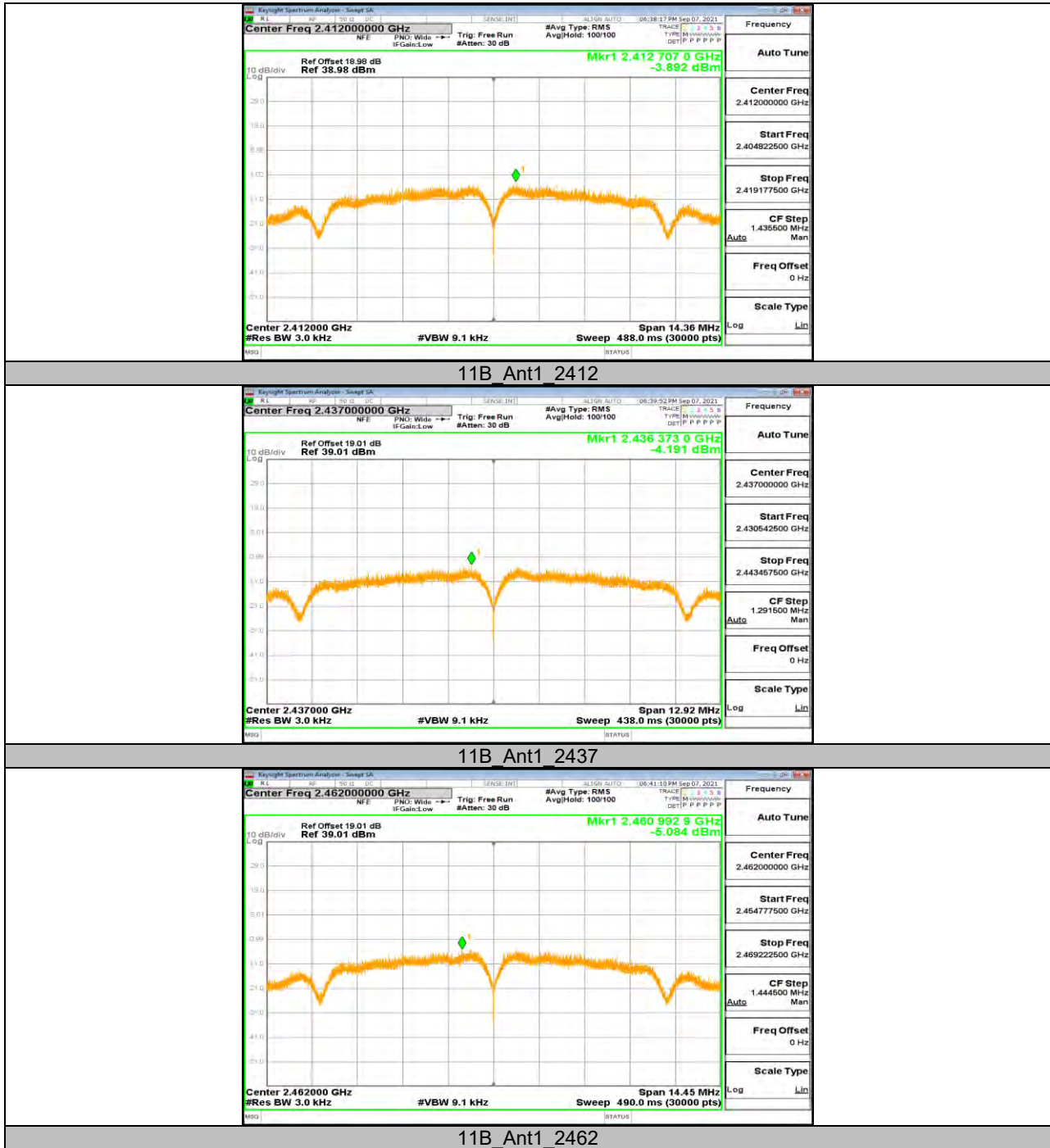

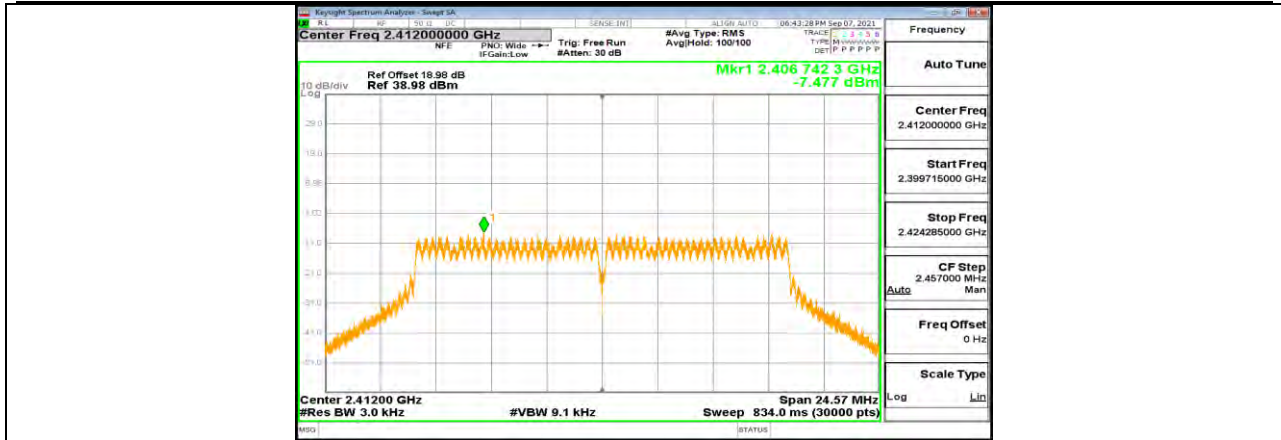

11G Ant1 2412

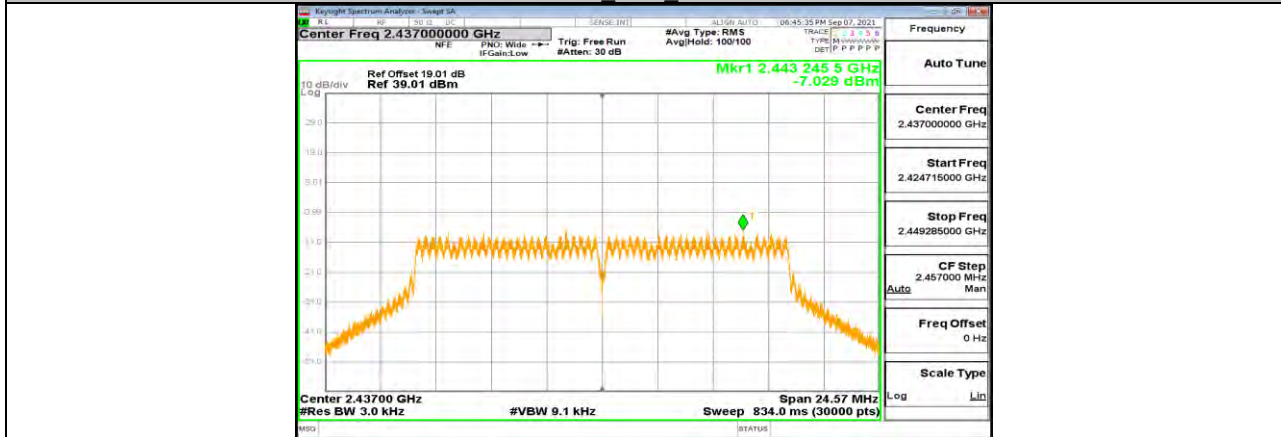

11G Ant1 2437



11G Ant1 2462

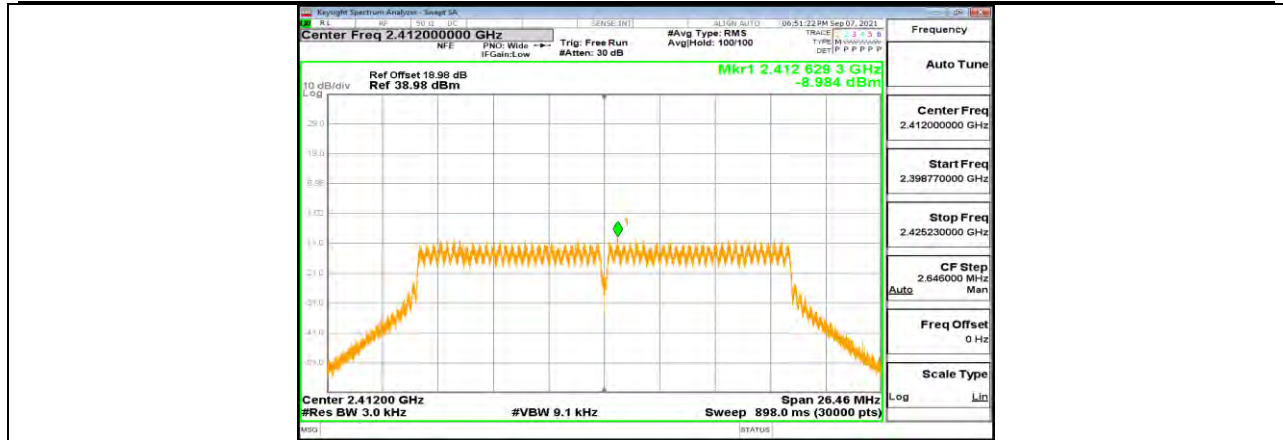

11N20MIMO Ant1 2412

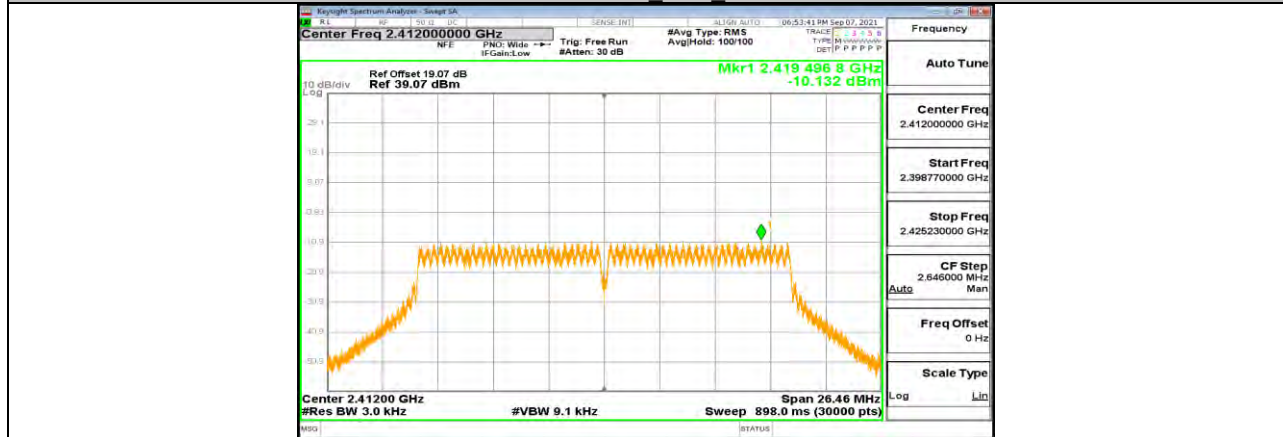

11N20MIMO Ant2 2412

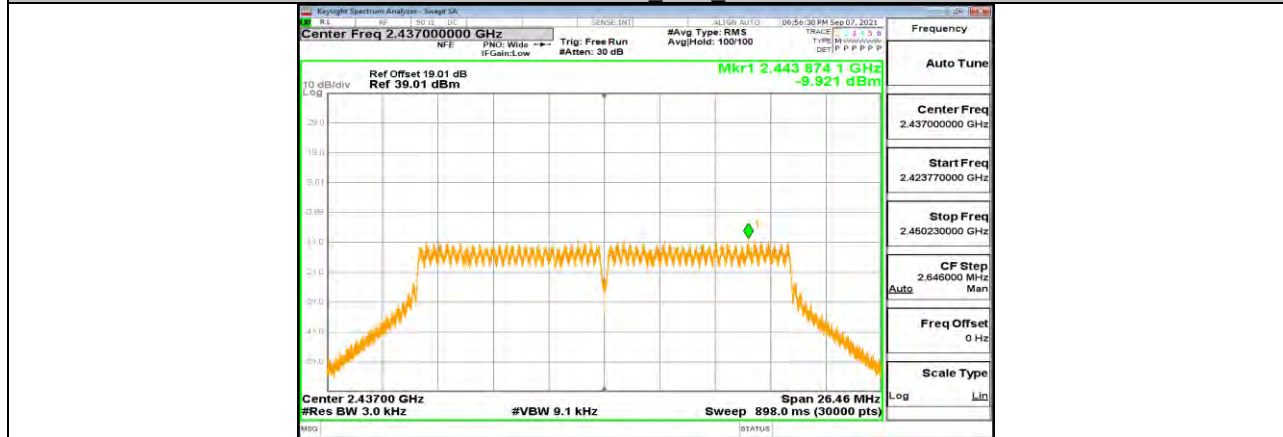

11N20MIMO Ant1 2437

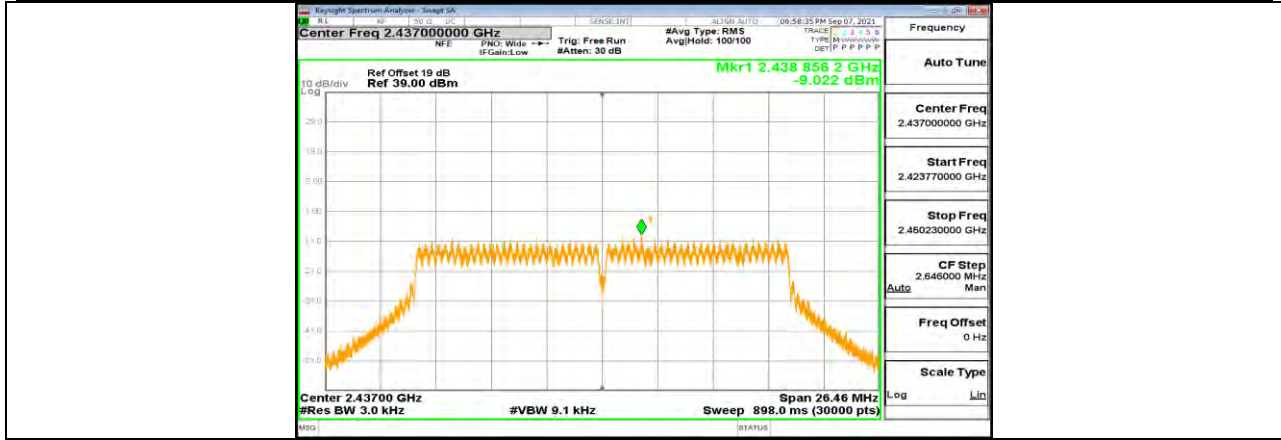

11N20MIMO Ant2 2437



11N20MIMO Ant1 2462



11N20MIMO Ant2 2462

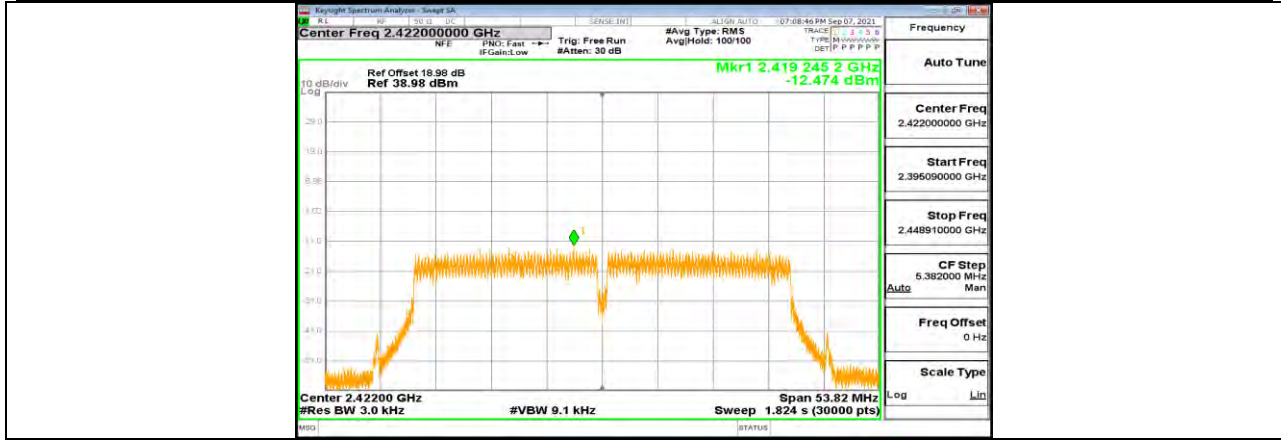

11N40MIMO Ant1 2422



11N40MIMO Ant2 2422

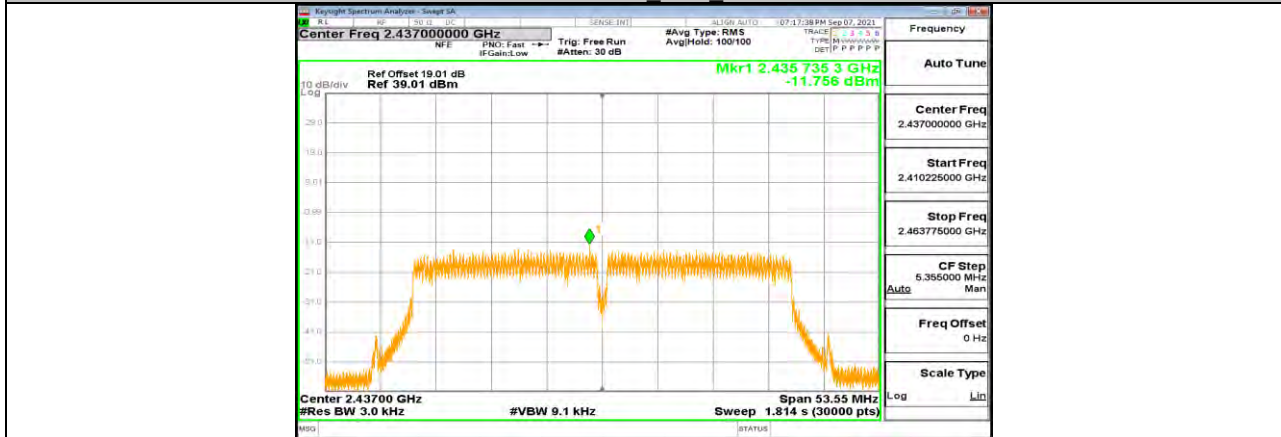

11N40MIMO Ant1 2437



11N40MIMO Ant2 2437



11N40MIMO Ant1 2452

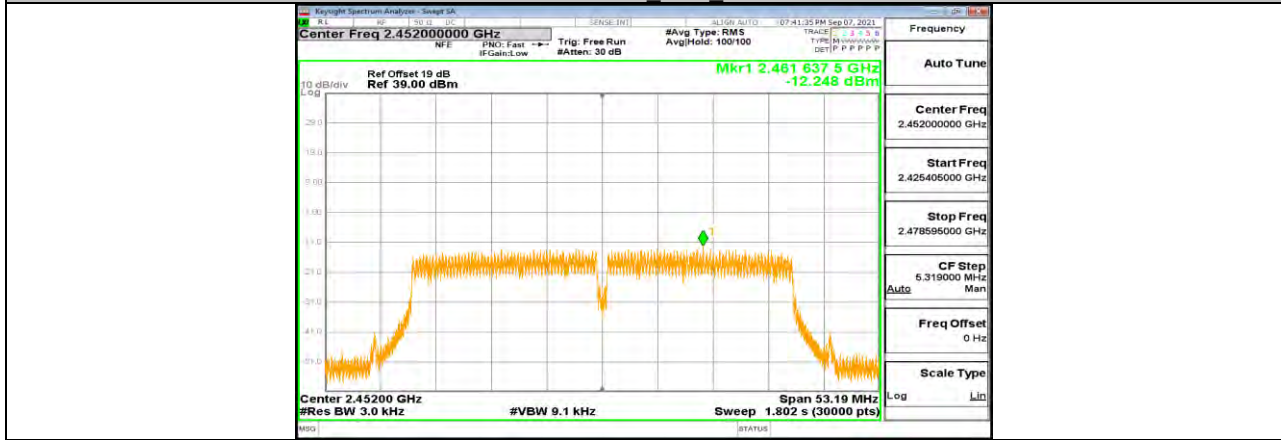

11N40MIMO Ant2 2452



11.5. Appendix E: Band edge measurements 11.5.1. Test Result

Test Mode	Antenna	ChName	Channel	RefLevel[dBm]	Result[dBm]	Limit[dBm]	Verdict
11B	Ant0	Low	2412	9.05	-26.57	<=-20.95	PASS
		High	2462	8.67	-40.81	<=-21.33	PASS
11G	Ant0	Low	2412	5.93	-28.83	<=-24.07	PASS
		High	2462	5.80	-37.21	<=-24.21	PASS
11N20MIMO	Ant0	Low	2412	3.99	-30.63	<=-26.01	PASS
	Ant1	Low	2412	3.92	-30.25	<=-26.08	PASS
	Ant0	High	2462	3.84	-38.99	<=-26.16	PASS
	Ant1	High	2462	4.08	-37.89	<=-25.92	PASS
11N40MIMO	Ant0	Low	2422	0.99	-32.8	<=-29.01	PASS
	Ant1	Low	2422	2.13	-31.83	<=-27.87	PASS
	Ant0	High	2452	1.11	-36.7	<=-28.89	PASS
	Ant1	High	2452	2.16	-32.47	<=-27.84	PASS

Note: All the Antenna had been tested, but only the worst data was recorded in the report.

11.5.2. Test Graphs



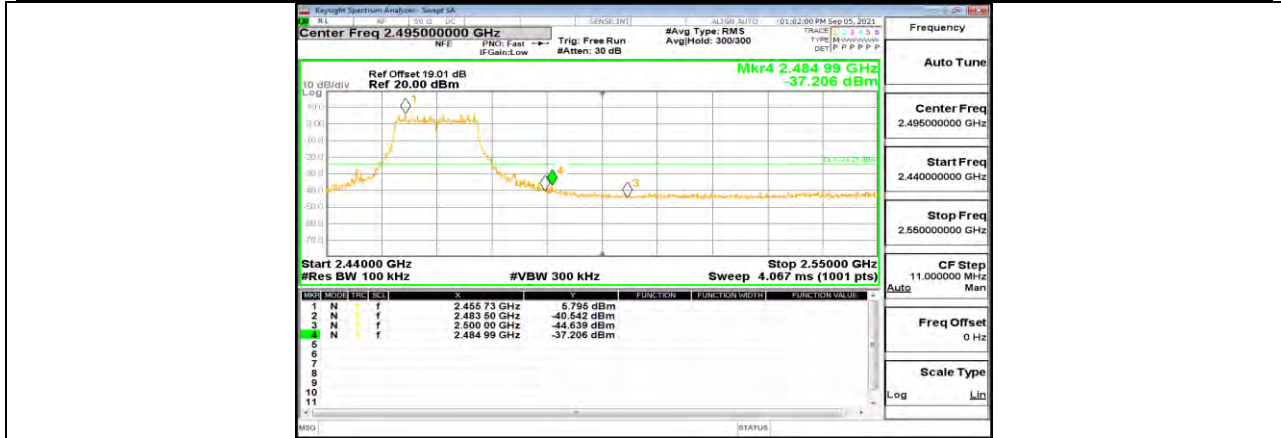

11G Ant1 High 2462

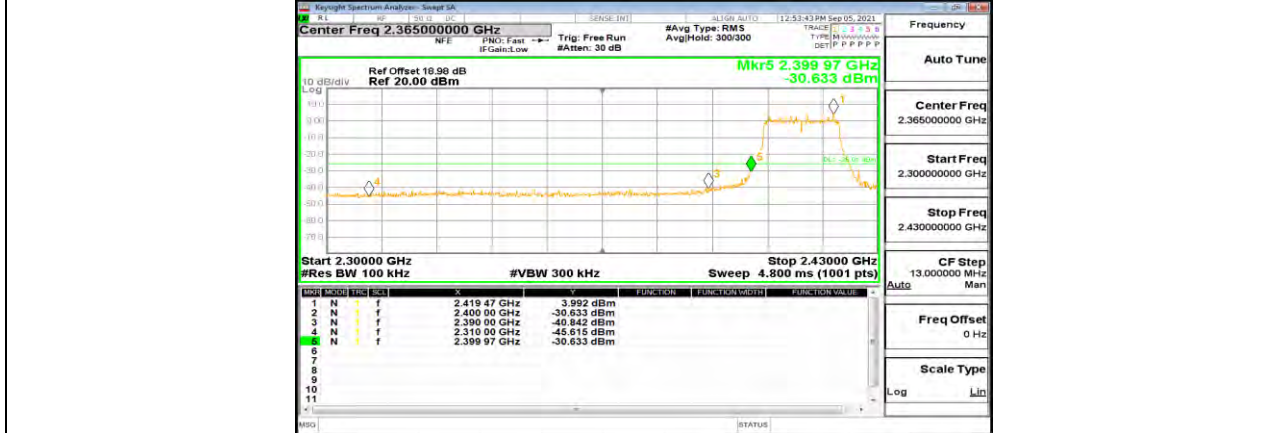

11N20MIMO Ant1 Low 2412

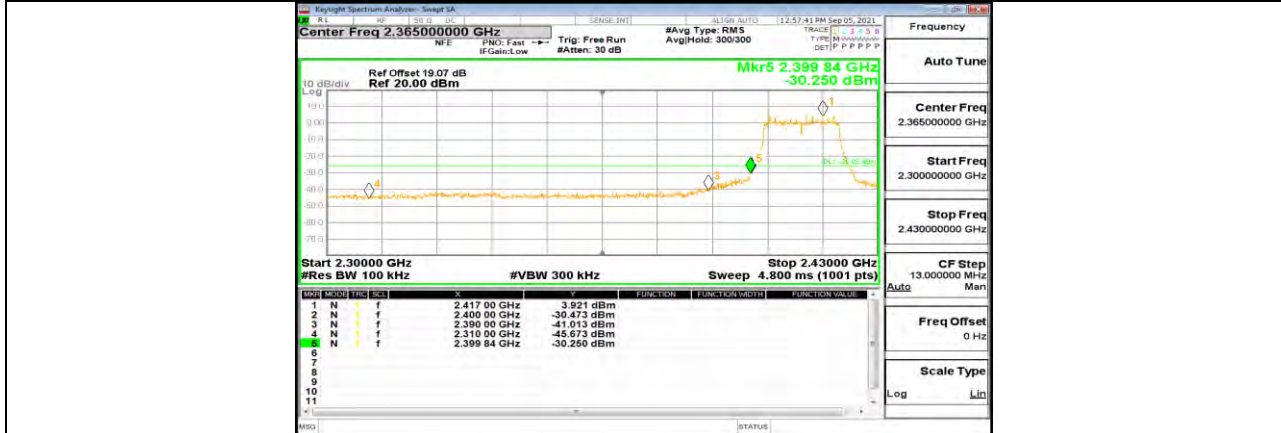

11N20MIMO Ant2 Low 2412



11N20MIMO Ant1 High 2462

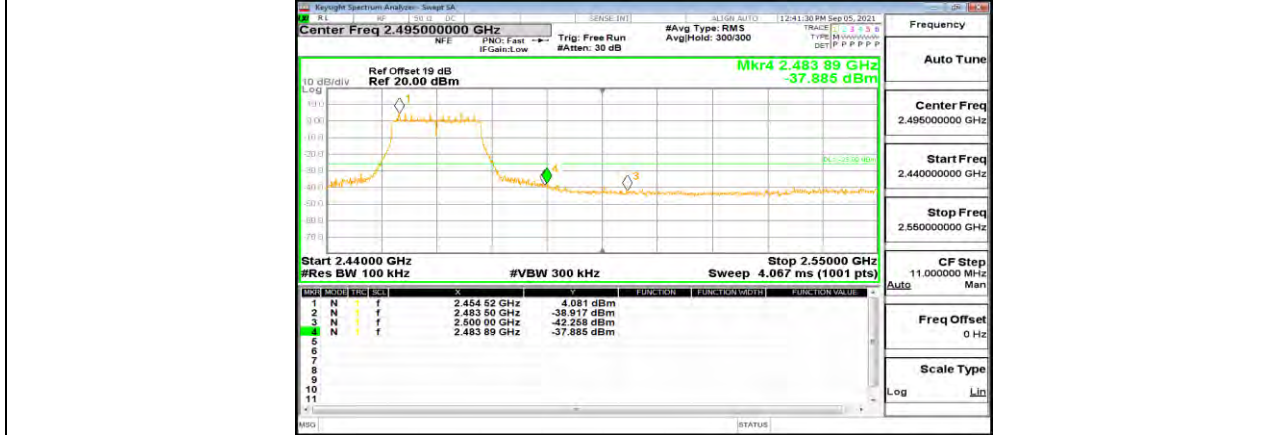

11N20MIMO Ant2 High 2462

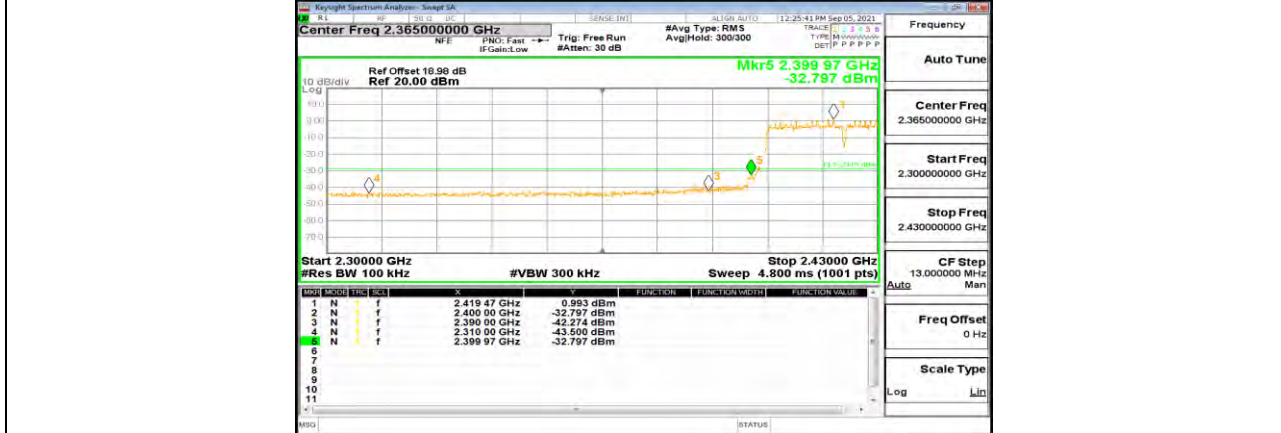

11N40MIMO Ant1 Low 2422

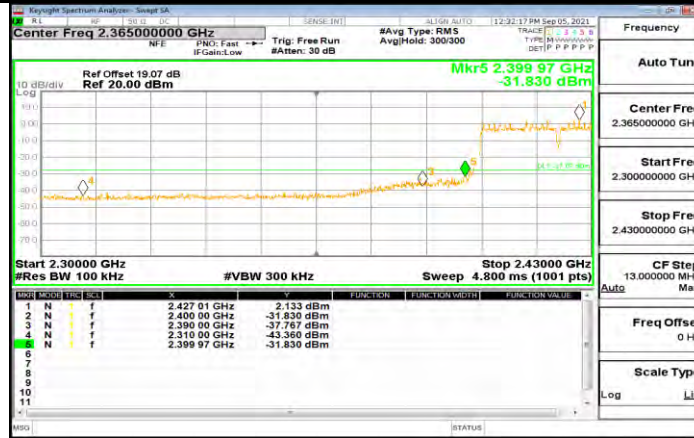

11N40MIMO Ant2 Low 2422

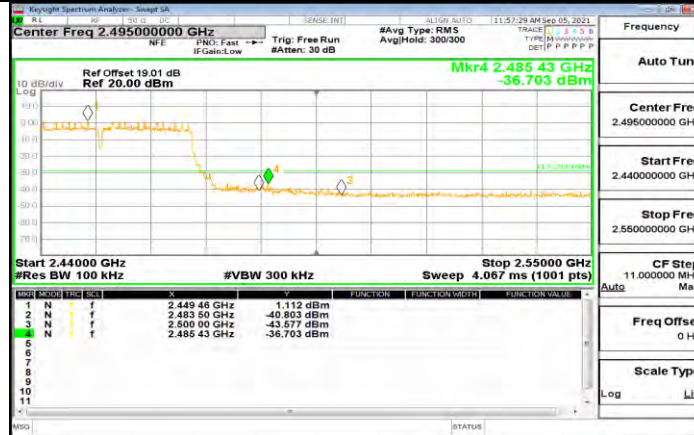

11N40MIMO Ant1 High 2452



11N40MIMO Ant2 High 2452

**11.6. Appendix F: Conducted Spurious Emission****11.6.1. Test Result**

Test Mode	Antenna	Channel	FreqRange [Mhz]	Result [dBm]	Limit [dBm]	Verdict
11B	Ant0	2412	Reference	8.09	---	PASS
			30~1000	-53.04	<=-21.91	PASS
			1000~26500	-39.14	<=-21.91	PASS
		2437	Reference	8.73	---	PASS
			30~1000	-53.41	<=-21.27	PASS
			1000~26500	-41.18	<=-21.27	PASS
		2462	Reference	8.69	---	PASS
			30~1000	-53.8	<=-21.31	PASS
			1000~26500	-42.43	<=-21.31	PASS
11G	Ant0	2412	Reference	5.98	---	PASS
			30~1000	-53.58	<=-24.02	PASS
			1000~26500	-45.04	<=-24.02	PASS
		2437	Reference	5.86	---	PASS
			30~1000	-53.79	<=-24.14	PASS
			1000~26500	-44.42	<=-24.14	PASS
		2462	Reference	5.70	---	PASS
			30~1000	-53.26	<=-24.3	PASS
			1000~26500	-44.38	<=-24.3	PASS
11N20MIMO	Ant0	2412	Reference	3.11	---	PASS
			30~1000	-53.31	<=-26.89	PASS
			1000~26500	-44.27	<=-26.89	PASS
	Ant1	2412	Reference	3.83	---	PASS
			30~1000	-50.98	<=-26.17	PASS
			1000~26500	-45.3	<=-26.17	PASS
	Ant0	2437	Reference	3.64	---	PASS
			30~1000	-53.4	<=-26.36	PASS
			1000~26500	-44.94	<=-26.36	PASS
	Ant1	2437	Reference	3.91	---	PASS
			30~1000	-51.7	<=-26.09	PASS
			1000~26500	-44.84	<=-26.09	PASS
	Ant0	2462	Reference	3.64	---	PASS
			30~1000	-54.34	<=-26.36	PASS
			1000~26500	-45.3	<=-26.36	PASS
	Ant1	2462	Reference	4.26	---	PASS
			30~1000	-51.6	<=-25.74	PASS
			1000~26500	-45.43	<=-25.74	PASS
11N40MIMO	Ant0	2422	Reference	1.10	---	PASS
			30~1000	-53.6	<=-28.9	PASS
			1000~26500	-45.58	<=-28.9	PASS
	Ant1	2422	Reference	1.17	---	PASS
			30~1000	-50	<=-28.83	PASS
			1000~26500	-44.98	<=-28.83	PASS
	Ant0	2437	Reference	0.84	---	PASS
			30~1000	-53.94	<=-29.16	PASS
			1000~26500	-44.8	<=-29.16	PASS
	Ant1	2437	Reference	1.53	---	PASS
			30~1000	-52.21	<=-28.47	PASS
			1000~26500	-44.53	<=-28.47	PASS
	Ant0	2452	Reference	0.97	---	PASS
			30~1000	-53.95	<=-29.03	PASS
			1000~26500	-45.13	<=-29.03	PASS
	Ant1	2452	Reference	1.54	---	PASS
			30~1000	-51.69	<=-28.46	PASS
			1000~26500	-45.02	<=-28.46	PASS

Note: All the Antenna had been tested, but only the worst data was recorded in the report.

11.6.2. Test Graphs

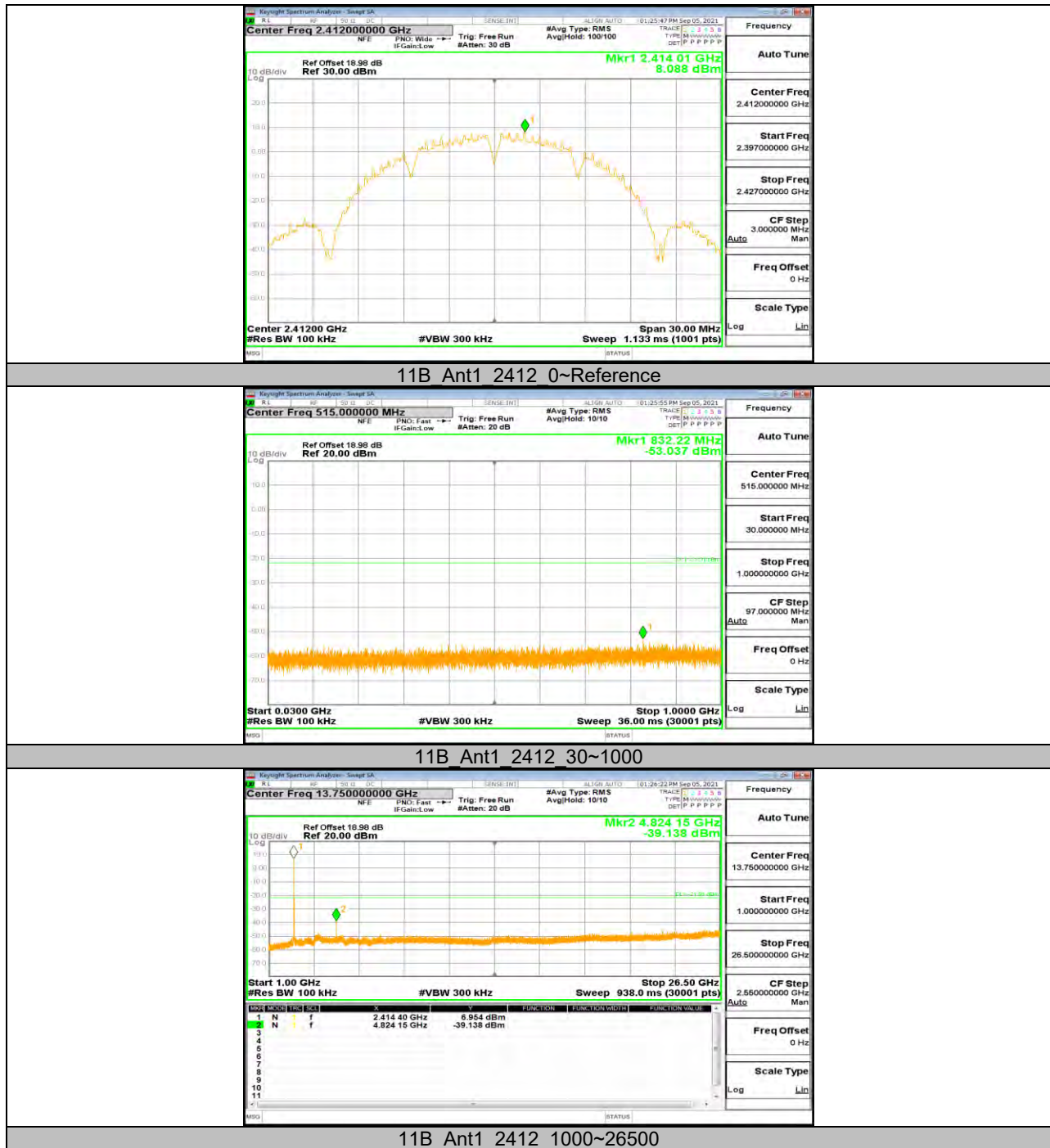



11B Ant1 2437 0~Reference

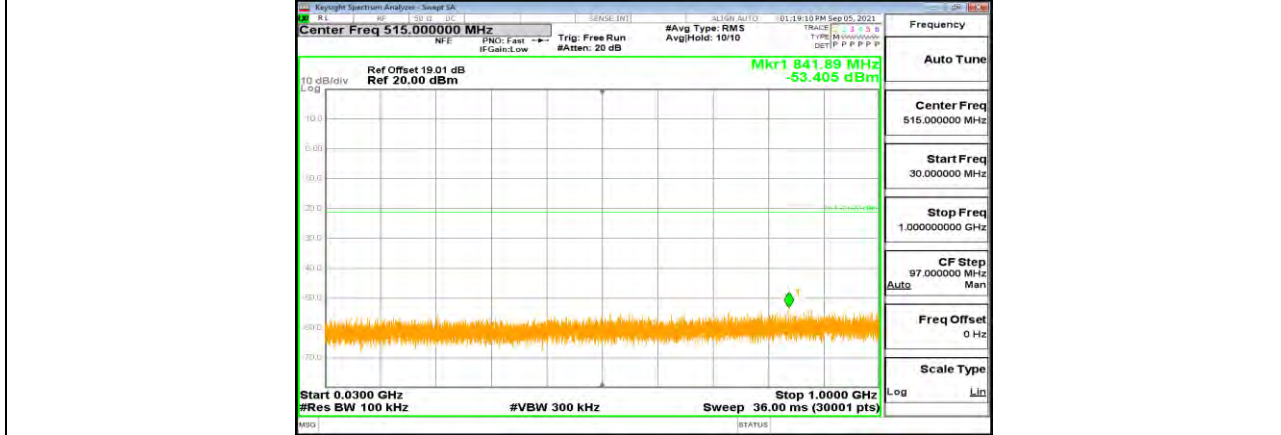

11B Ant1 2437 30~1000

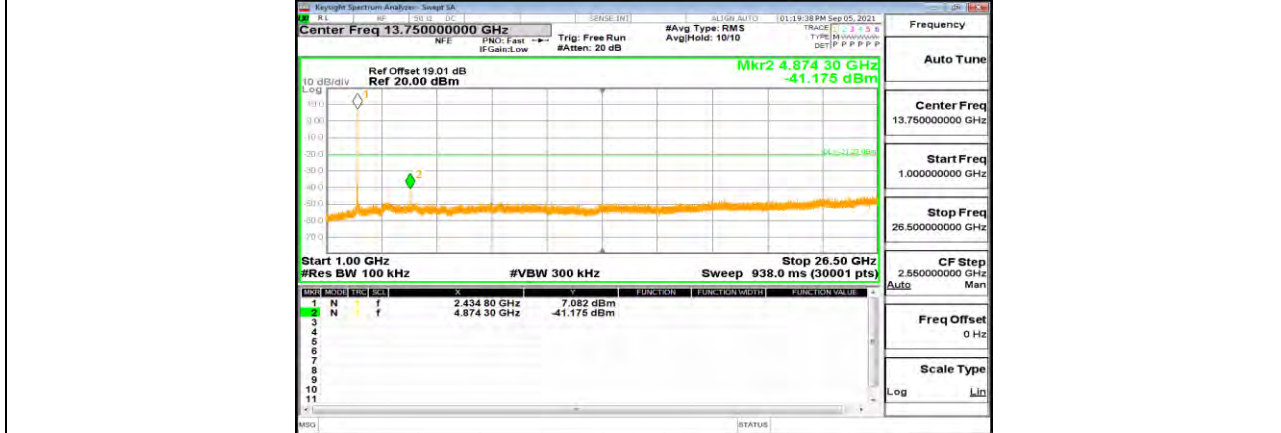

11B Ant1 2437 1000~26500



11B Ant1 2462 0~Reference

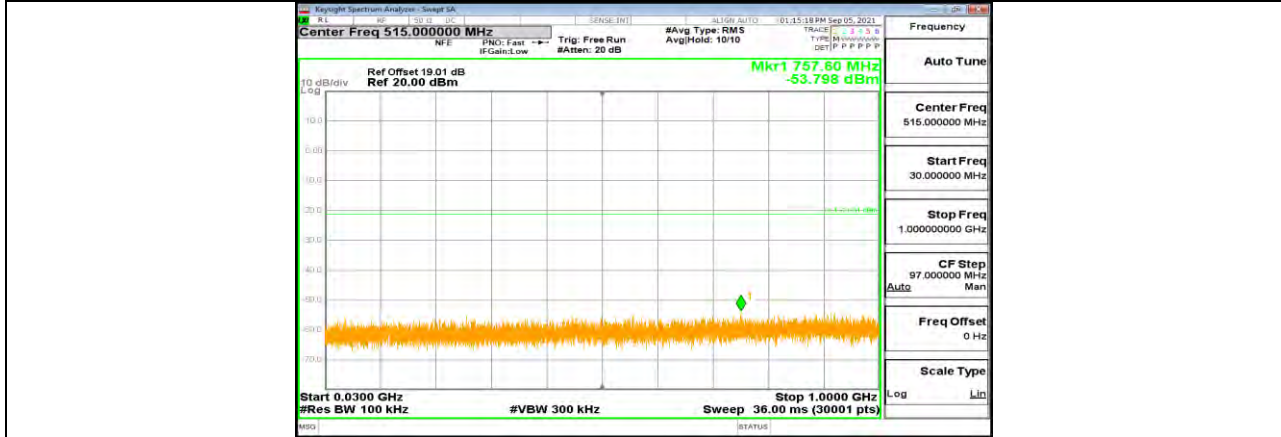

11B Ant1 2462 30~1000

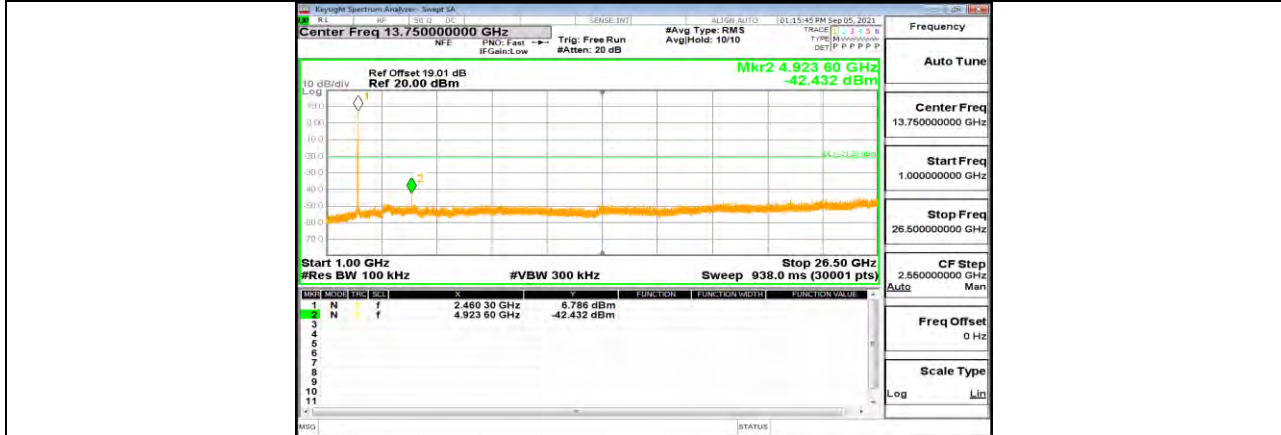

11B Ant1 2462 1000~26500



11G Ant1 2412 0~Reference

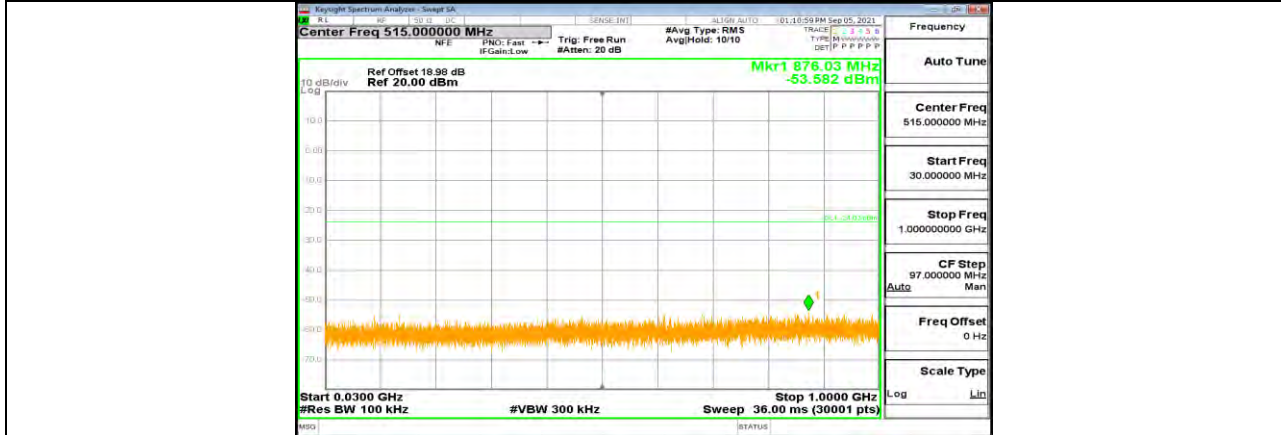

11G Ant1 2412 30~1000

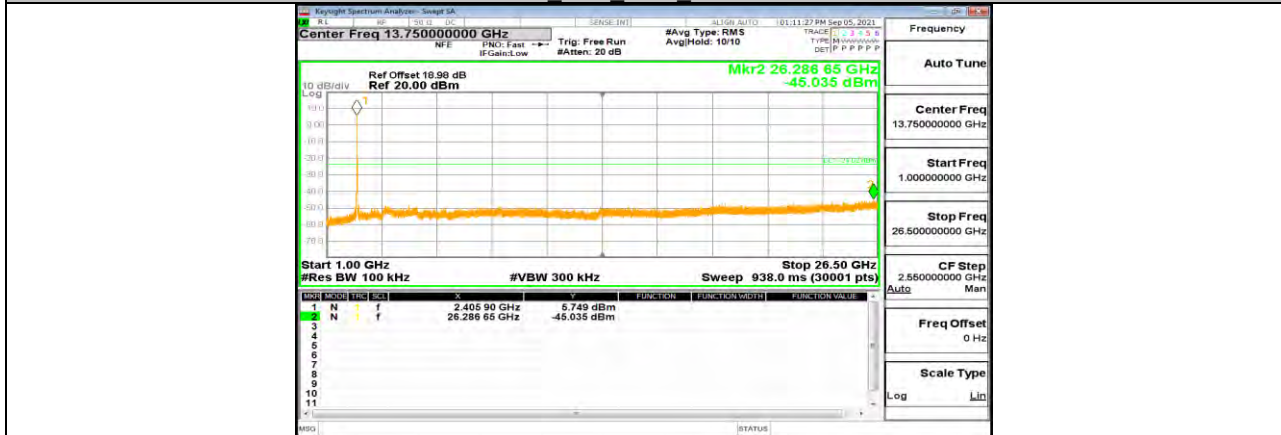

11G Ant1 2412 1000~26500

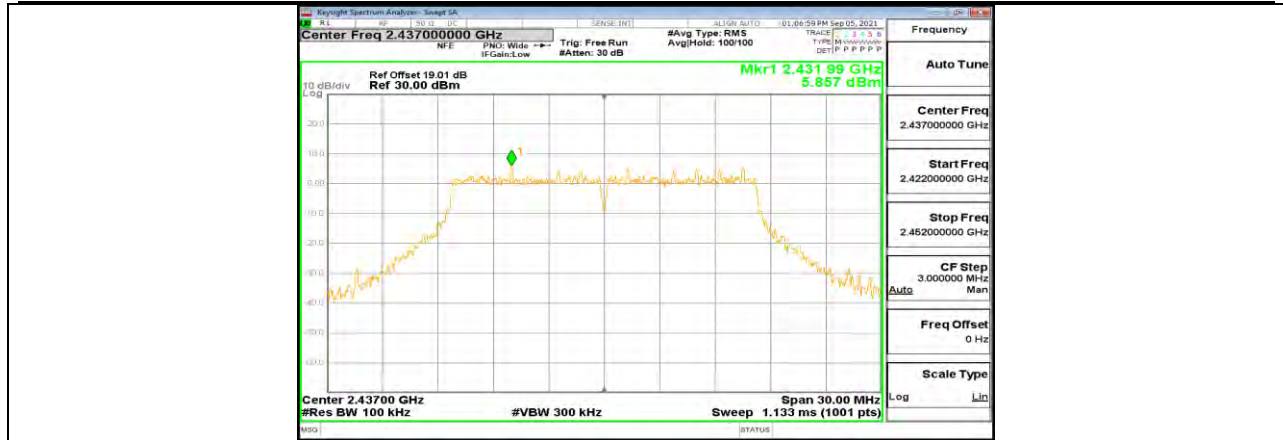

11G Ant1 2437 0~Reference

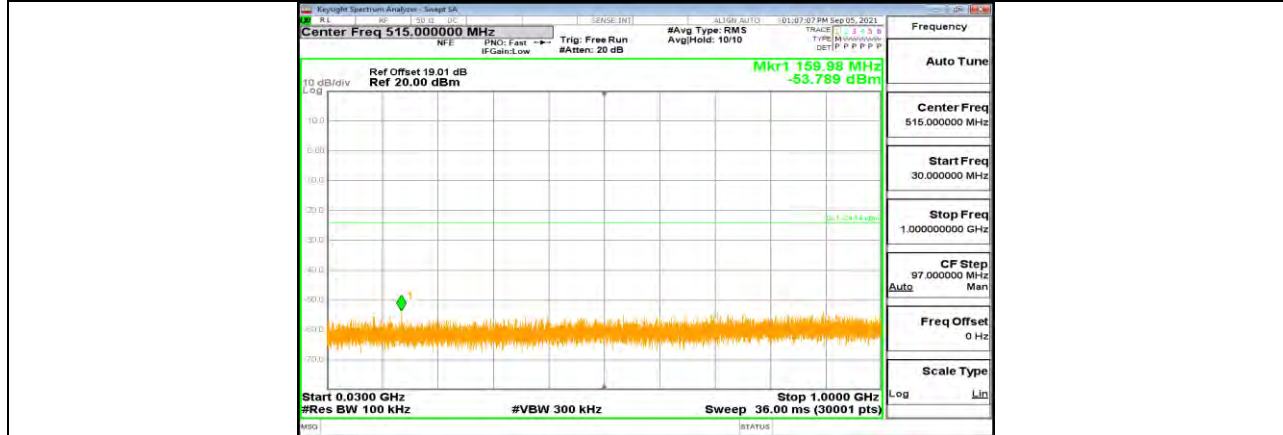

11G Ant1 2437 30~1000

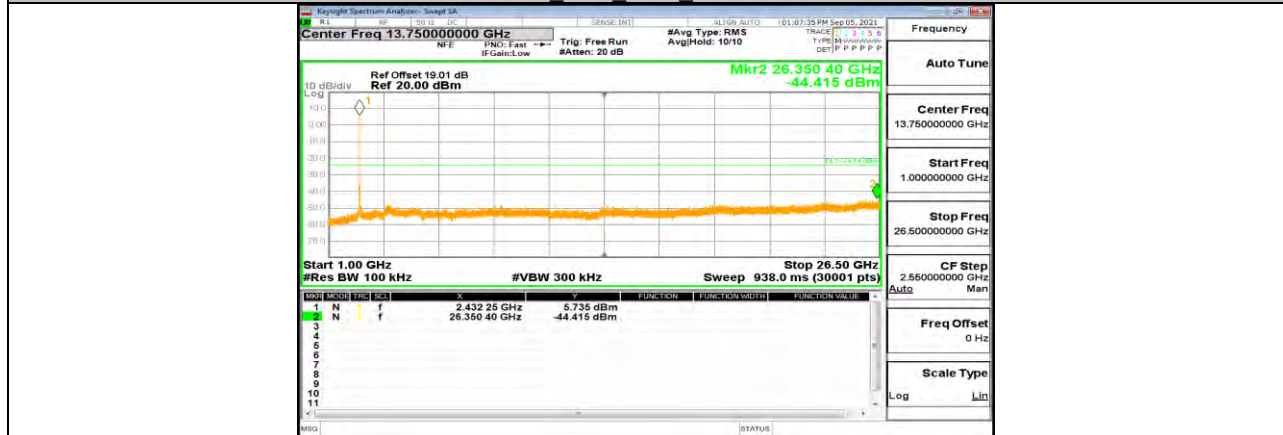

11G Ant1 2437 1000~26500



11G Ant1 2462 0~Reference

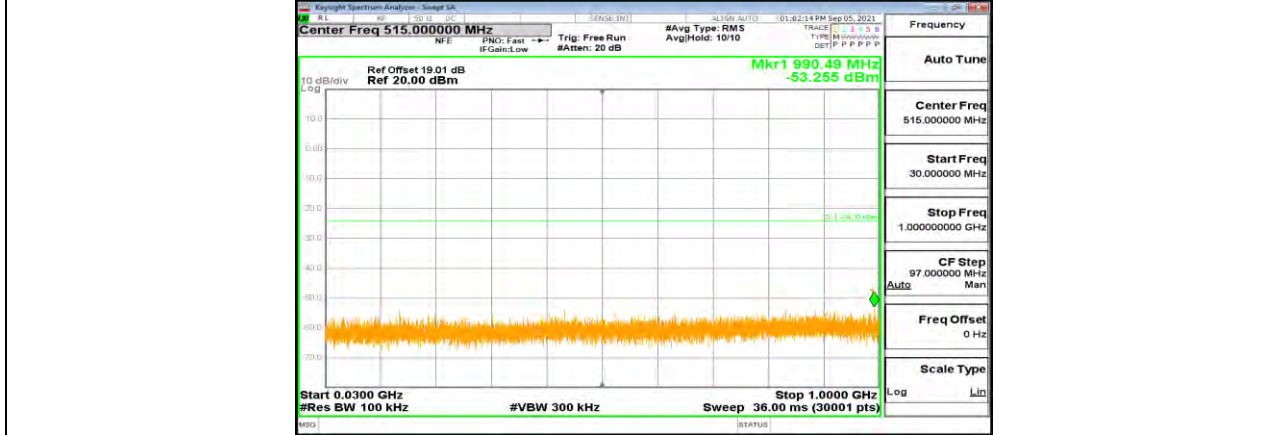

11G Ant1 2462 30~1000

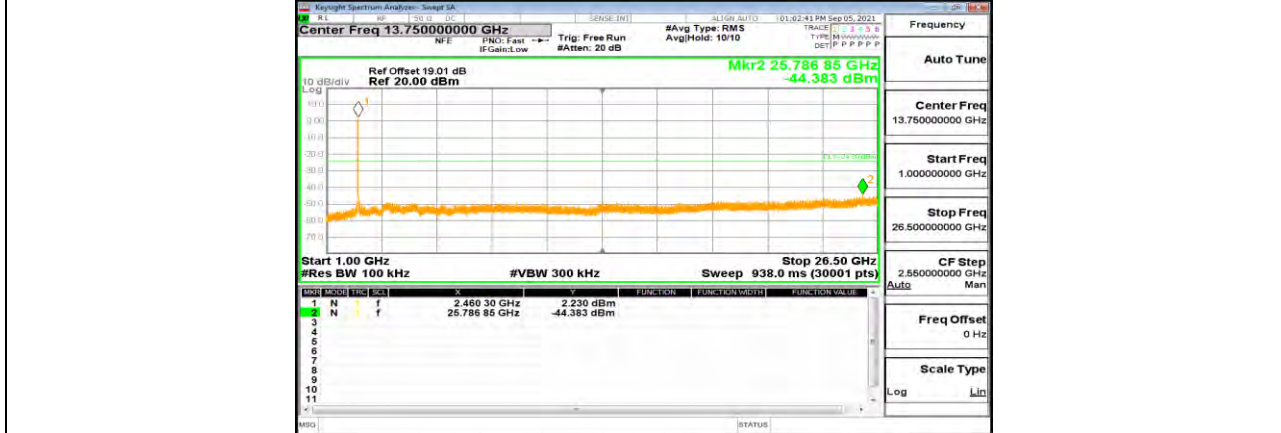

11G Ant1 2462 1000~26500

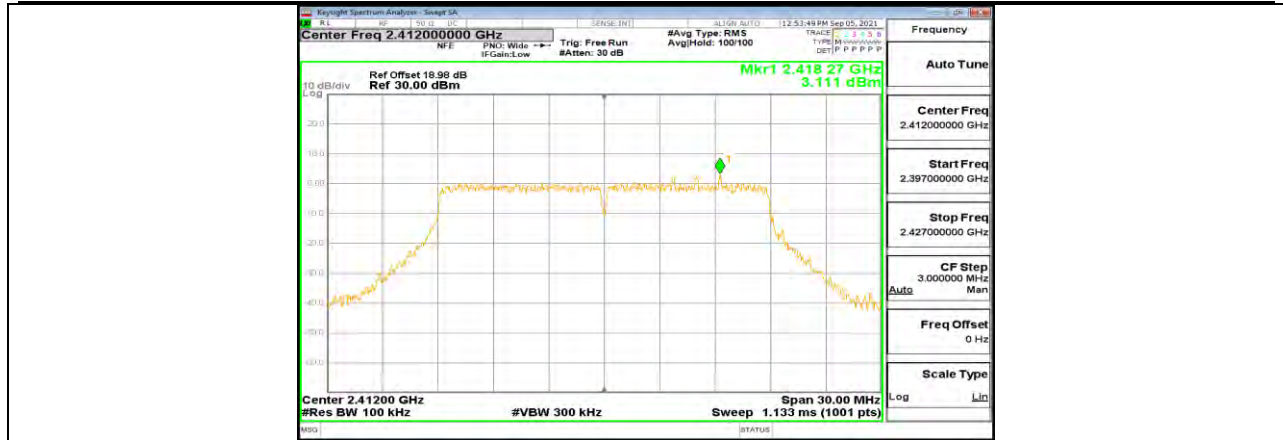

11N20MIMO Ant1 2412 0~Reference

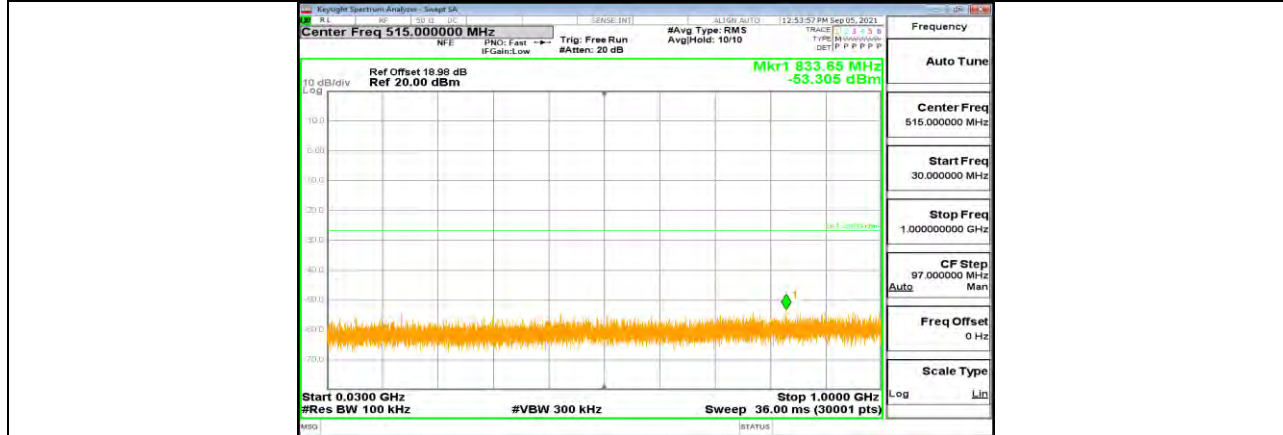

11N20MIMO Ant1 2412 30~1000

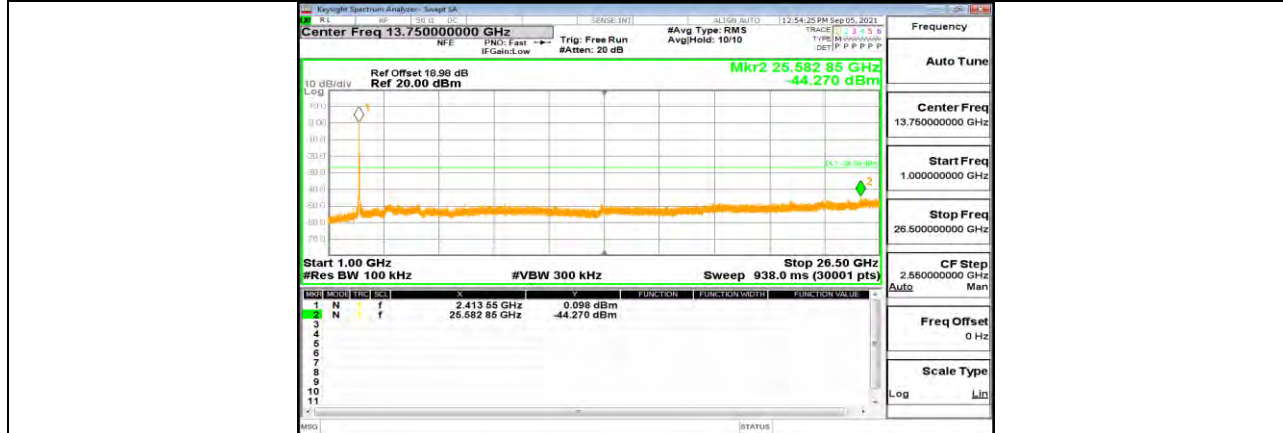

11N20MIMO Ant1 2412 1000~26500



11N20MIMO Ant2 2412 0~Reference

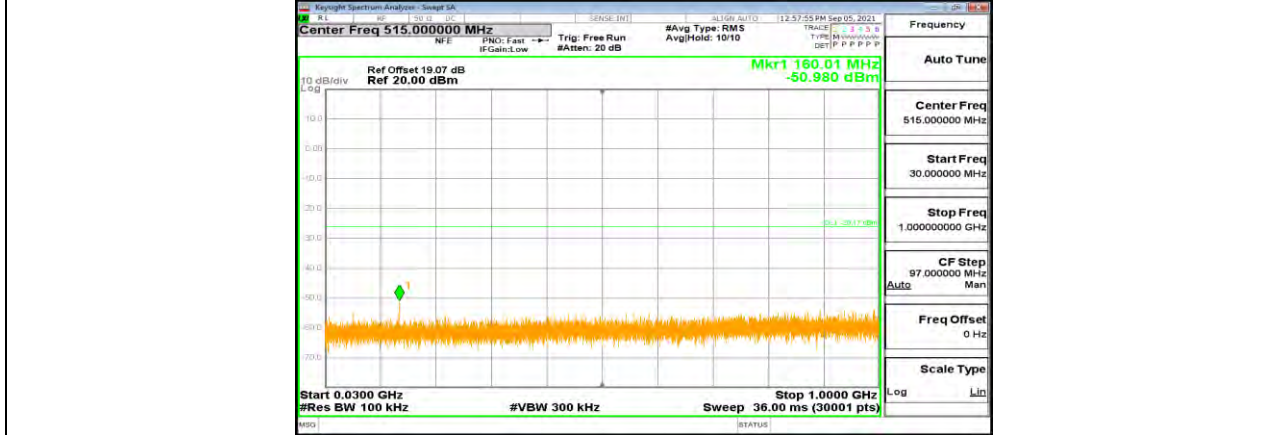

11N20MIMO Ant2 2412 30~1000

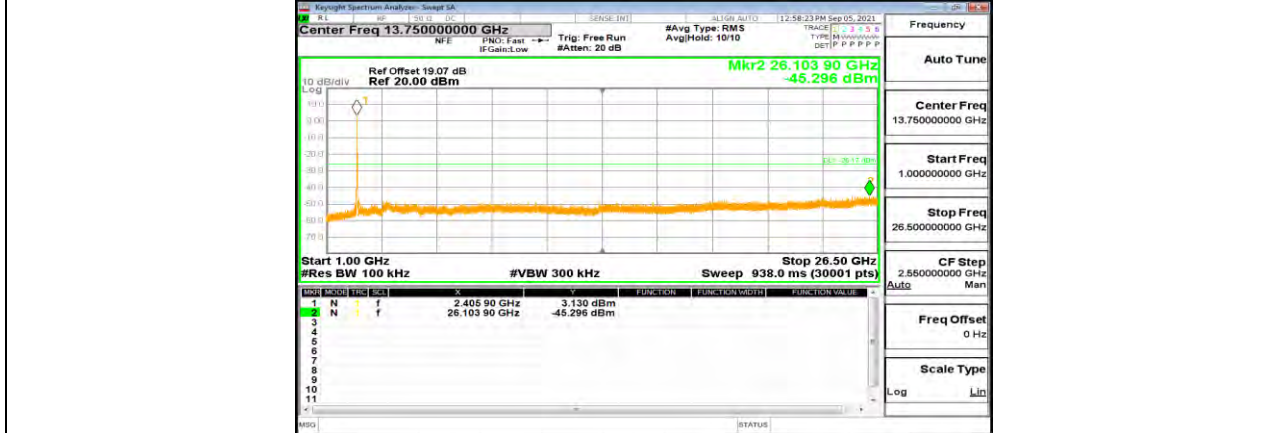

11N20MIMO Ant2 2412 1000~26500

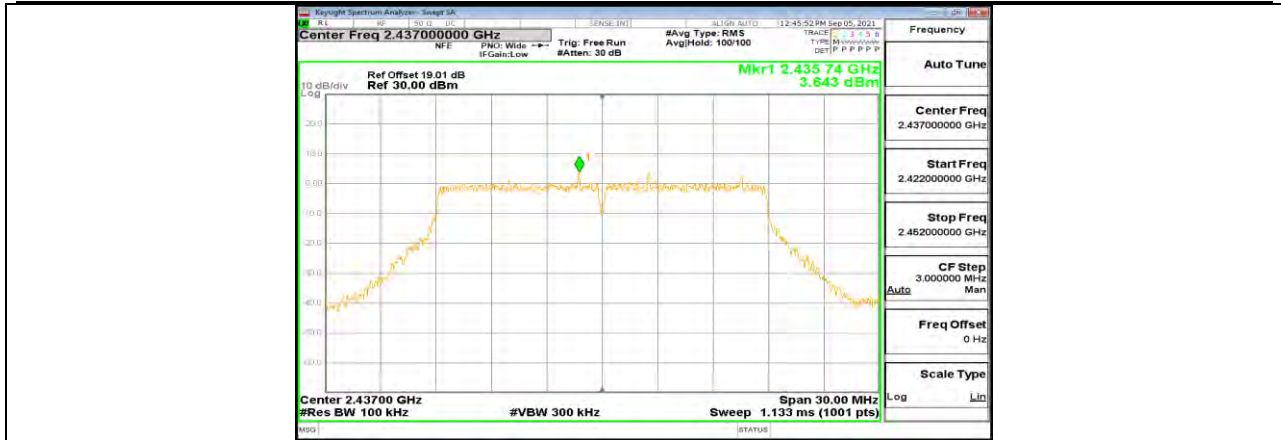

11N20MIMO Ant1 2437 0~Reference

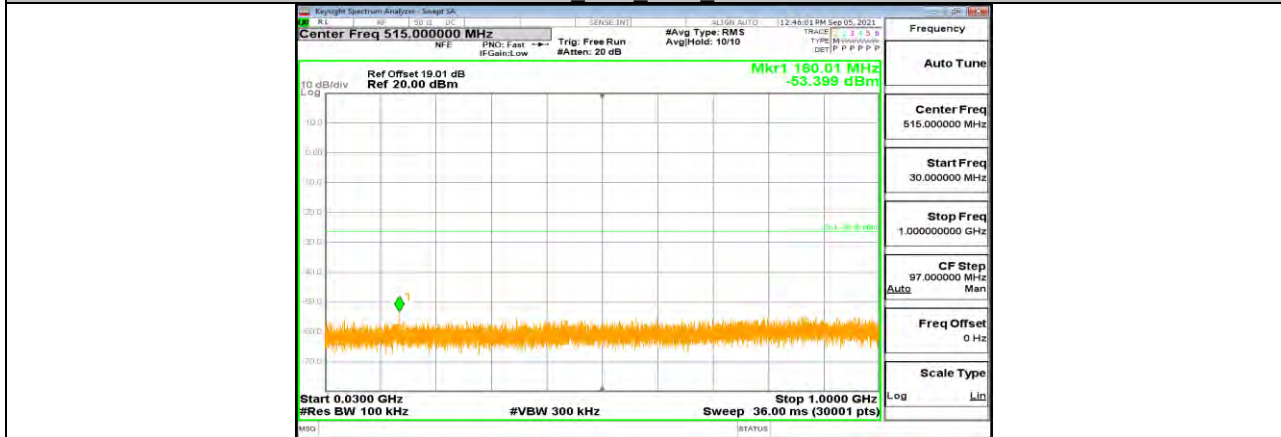

11N20MIMO Ant1 2437 30~1000

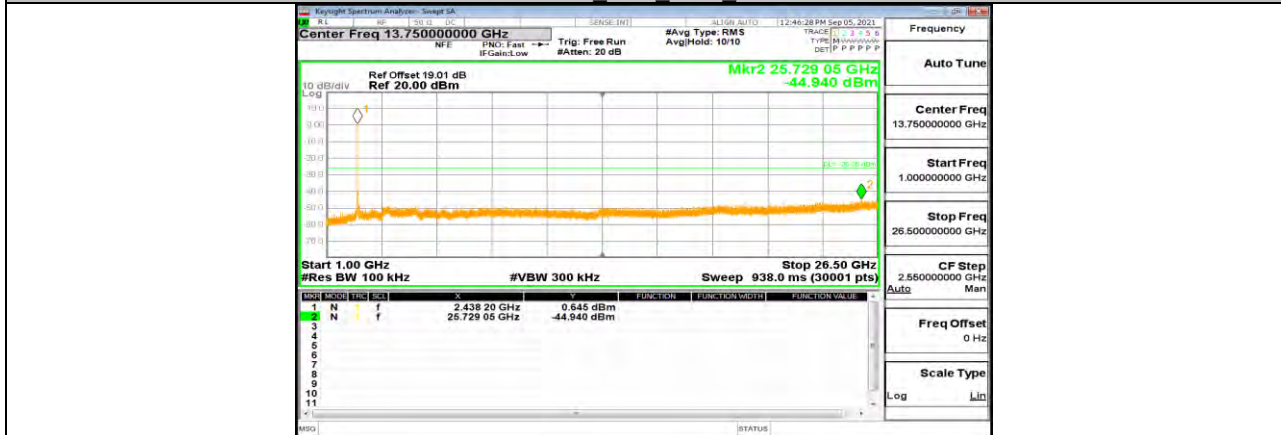

11N20MIMO Ant1 2437 1000~26500



11N20MIMO Ant2 2437 0~Reference

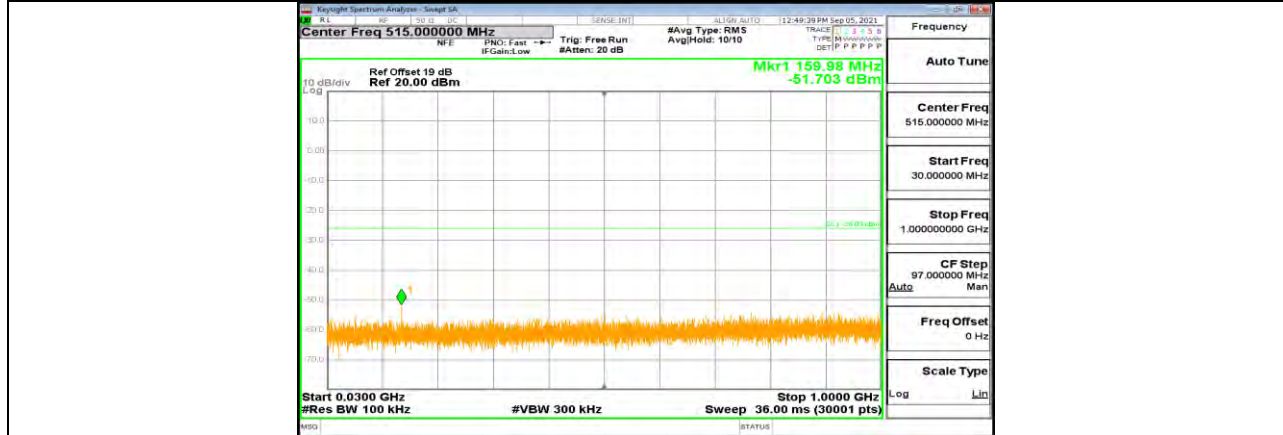

11N20MIMO Ant2 2437 30~1000

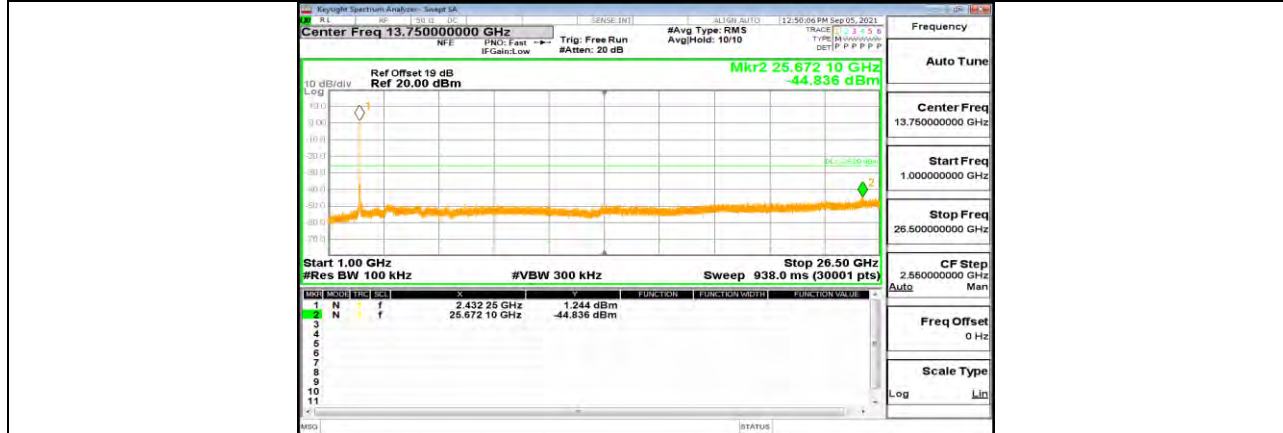

11N20MIMO Ant2 2437 1000~26500



11N20MIMO Ant1 2462 0~Reference

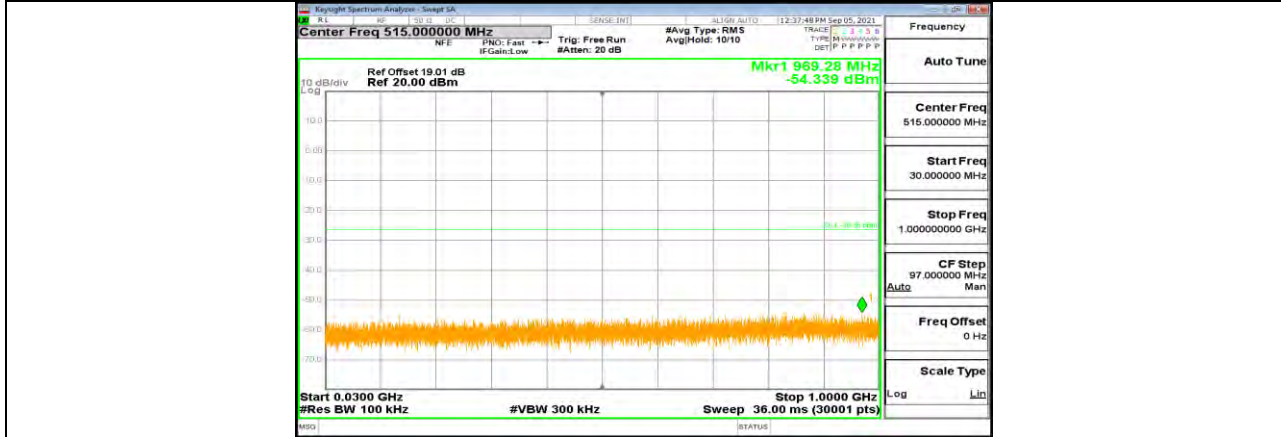

11N20MIMO Ant1 2462 30~1000

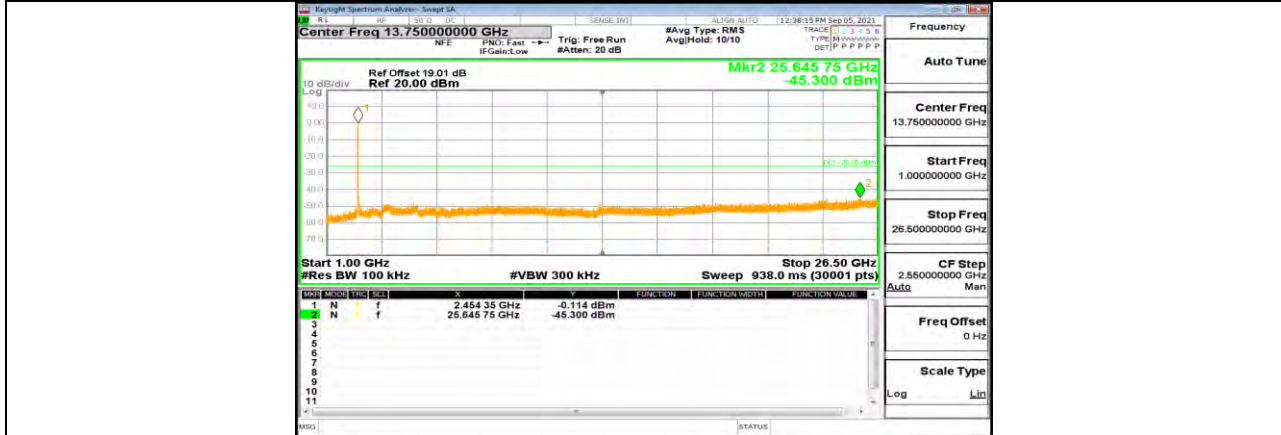

11N20MIMO Ant1 2462 1000~26500



11N20MIMO Ant2 2462 0~Reference

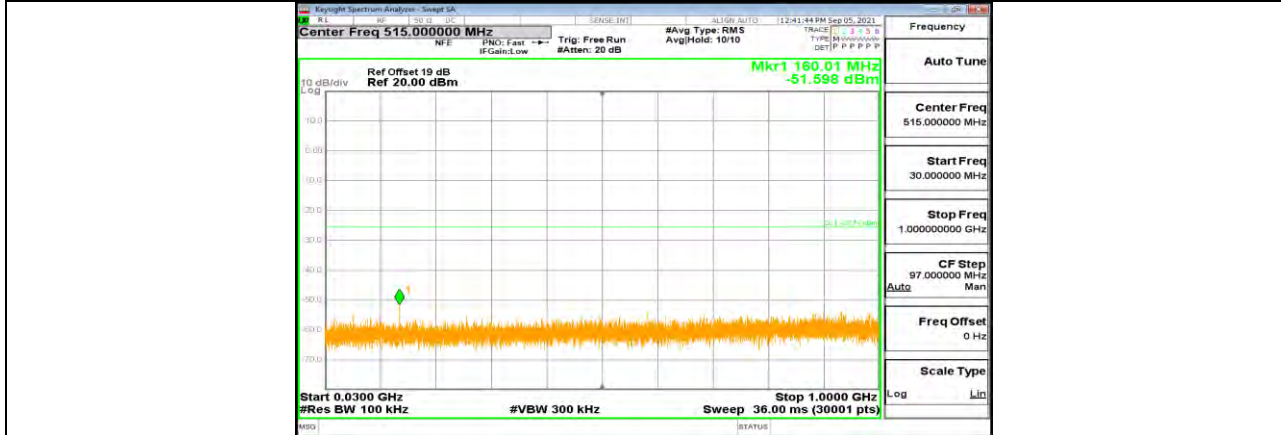

11N20MIMO Ant2 2462 30~1000

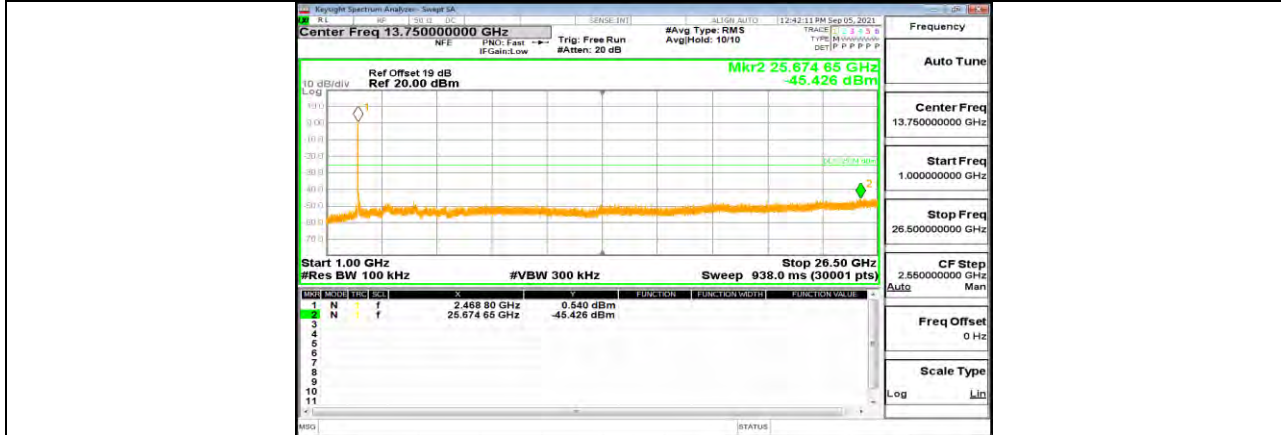

11N20MIMO Ant2 2462 1000~26500



11N40MIMO Ant1 2422 0~Reference

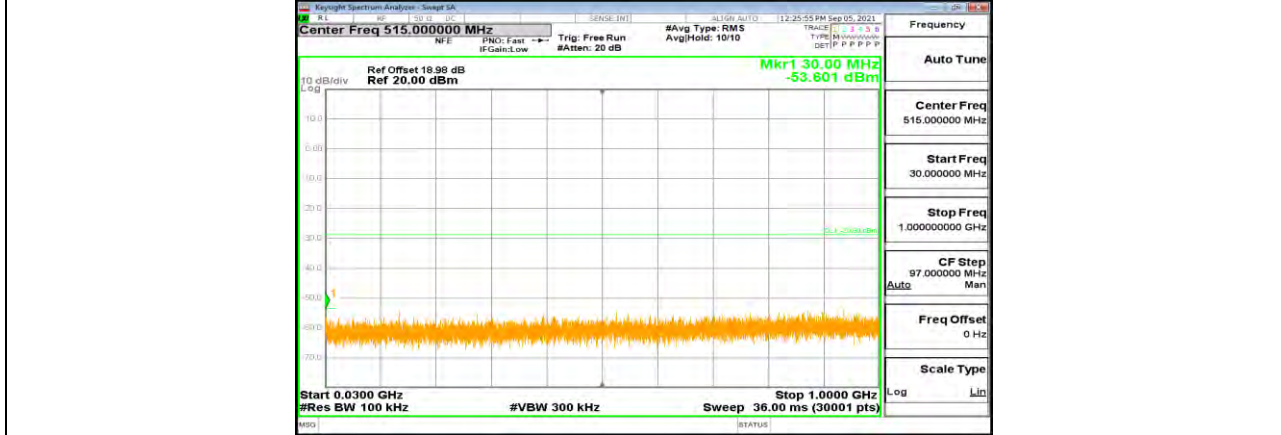

11N40MIMO Ant1 2422 30~1000

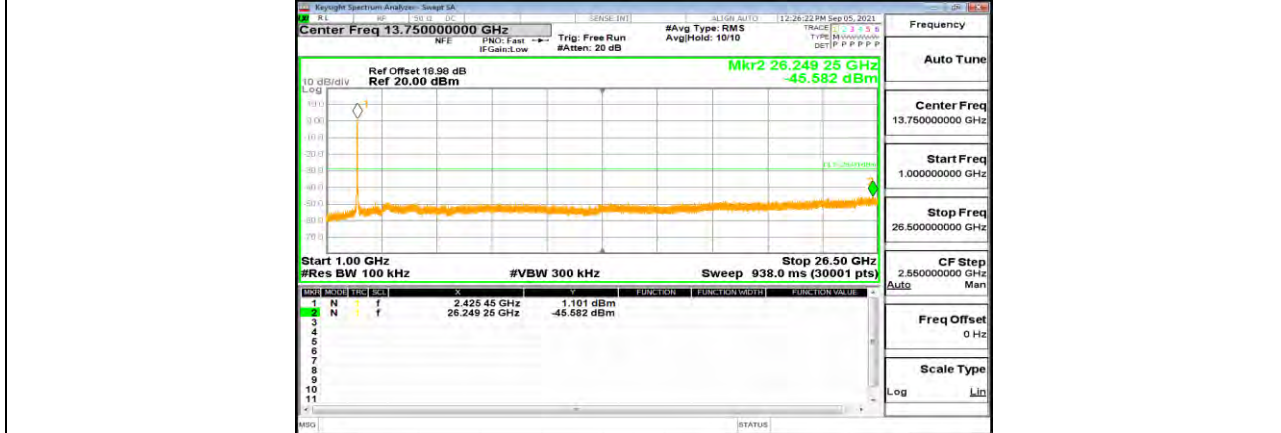

11N40MIMO Ant1 2422 1000~26500

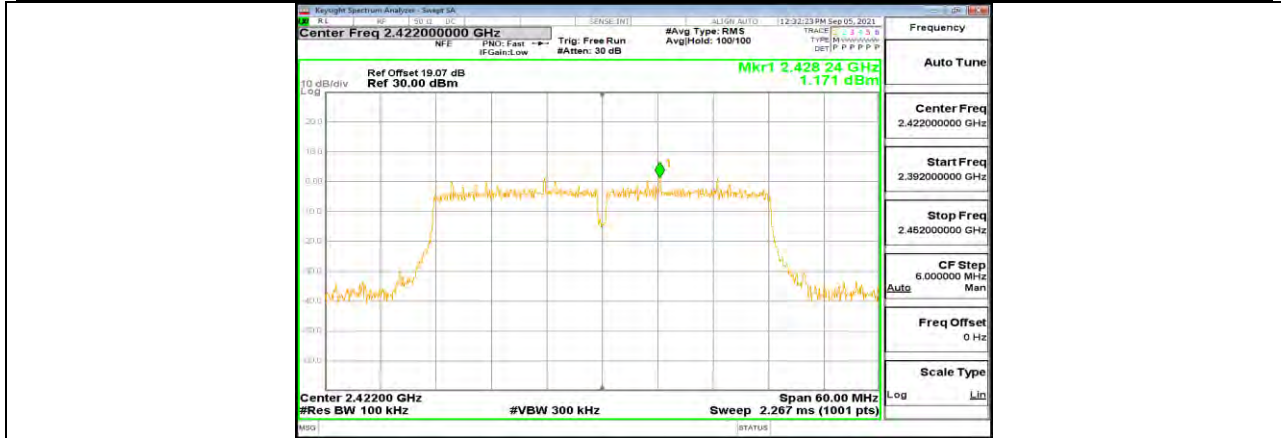

11N40MIMO Ant2 2422 0~Reference

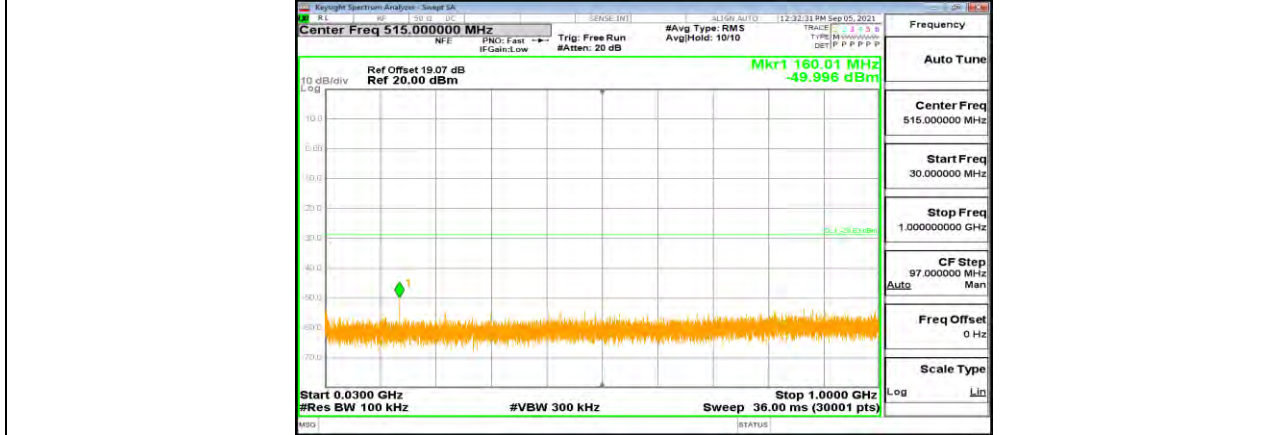

11N40MIMO Ant2 2422 30~1000

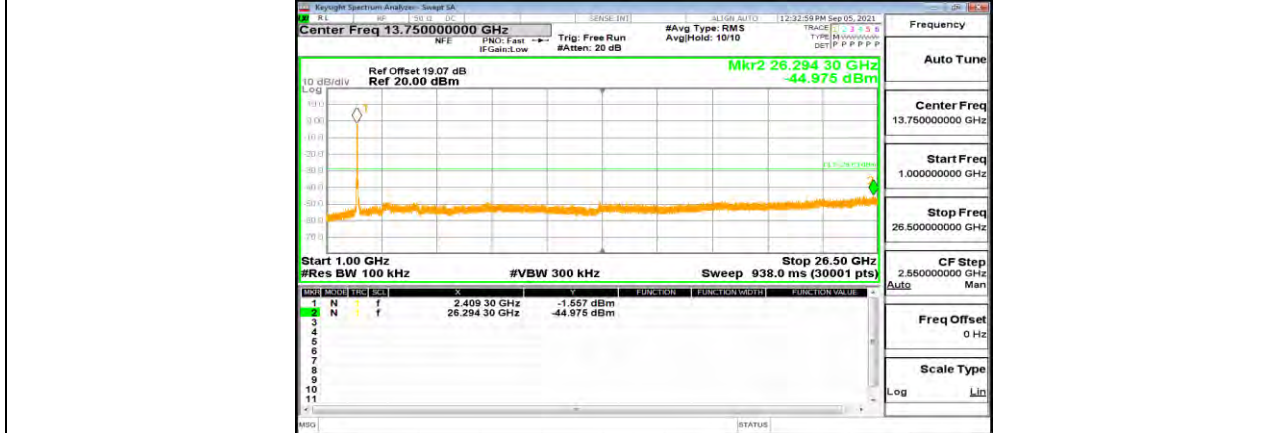

11N40MIMO Ant2 2422 1000~26500



11N40MIMO Ant1 2437 0~Reference

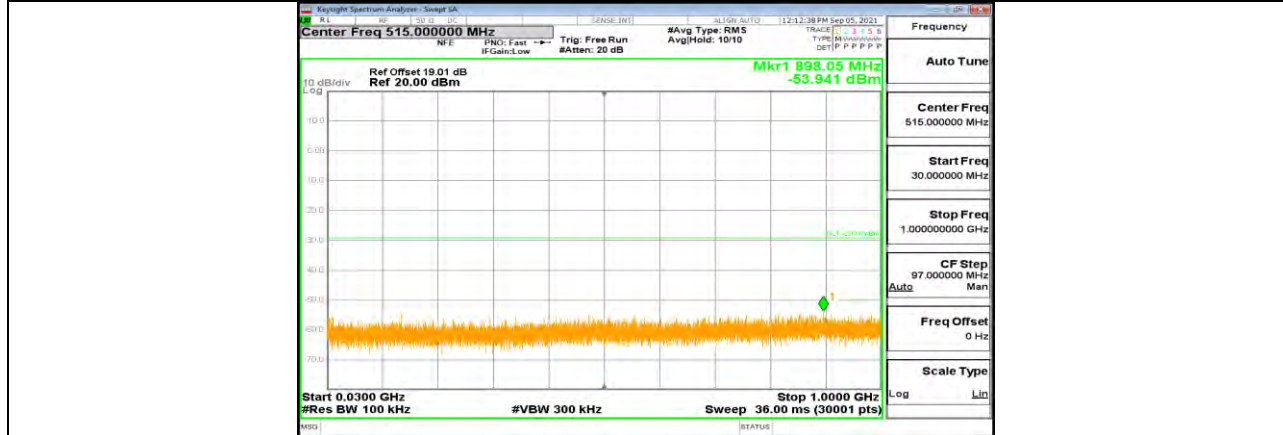

11N40MIMO Ant1 2437 30~1000

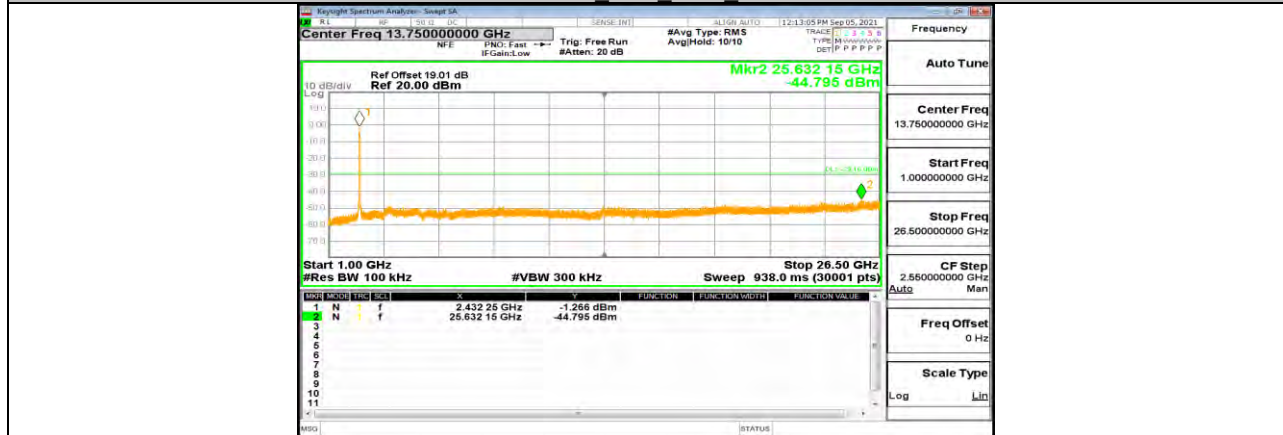

11N40MIMO Ant1 2437 1000~26500



11N40MIMO Ant2 2437 0~Reference

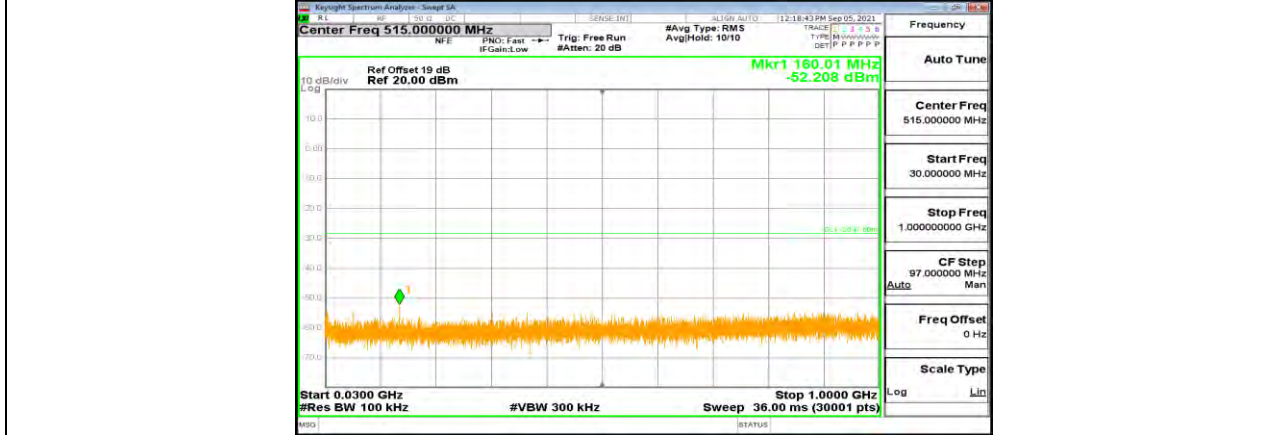

11N40MIMO Ant2 2437 30~1000

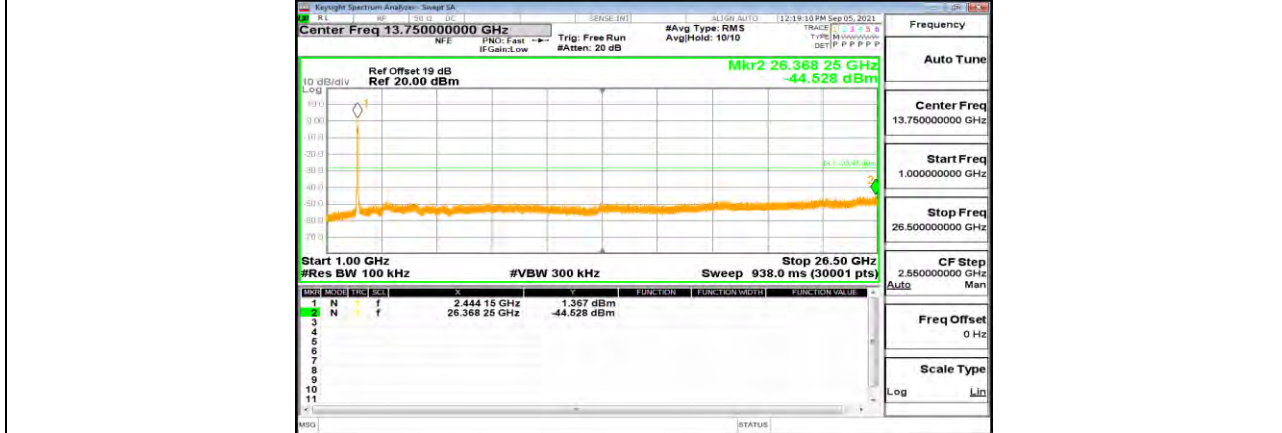

11N40MIMO Ant2 2437 1000~26500



11N40MIMO Ant1 2452 0~Reference

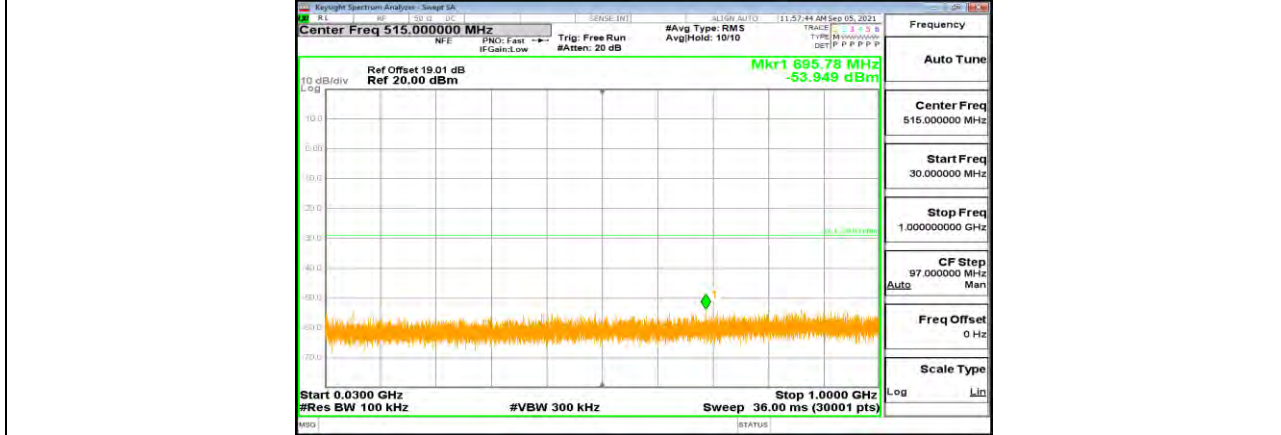

11N40MIMO Ant1 2452 30~1000

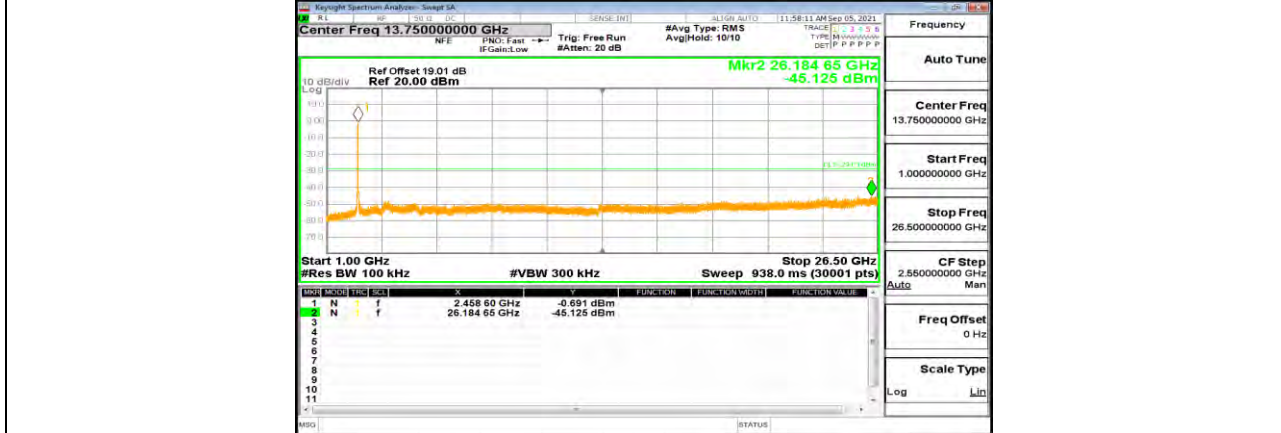

11N40MIMO Ant1 2452 1000~26500



11N40MIMO Ant2 2452 0~Reference

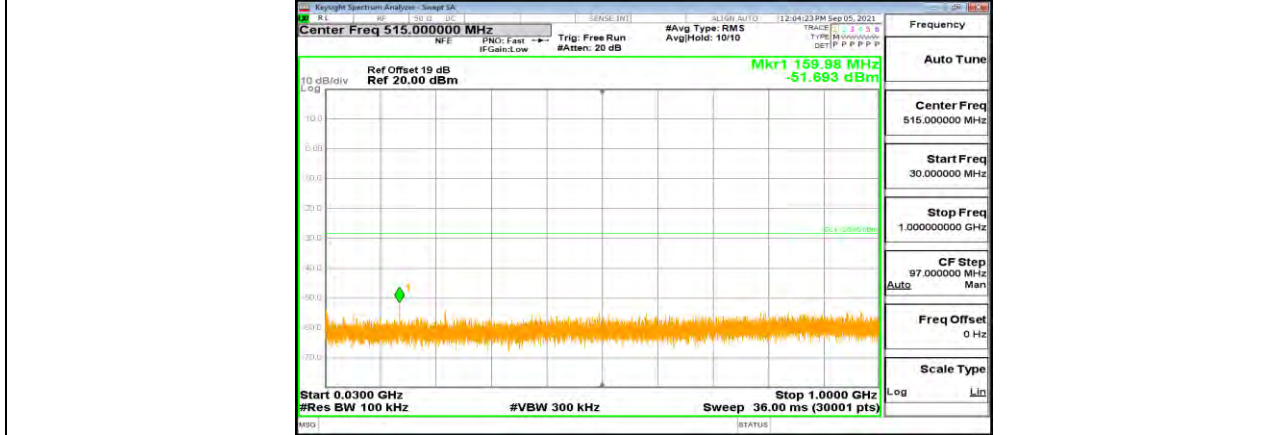

11N40MIMO Ant2 2452 30~1000

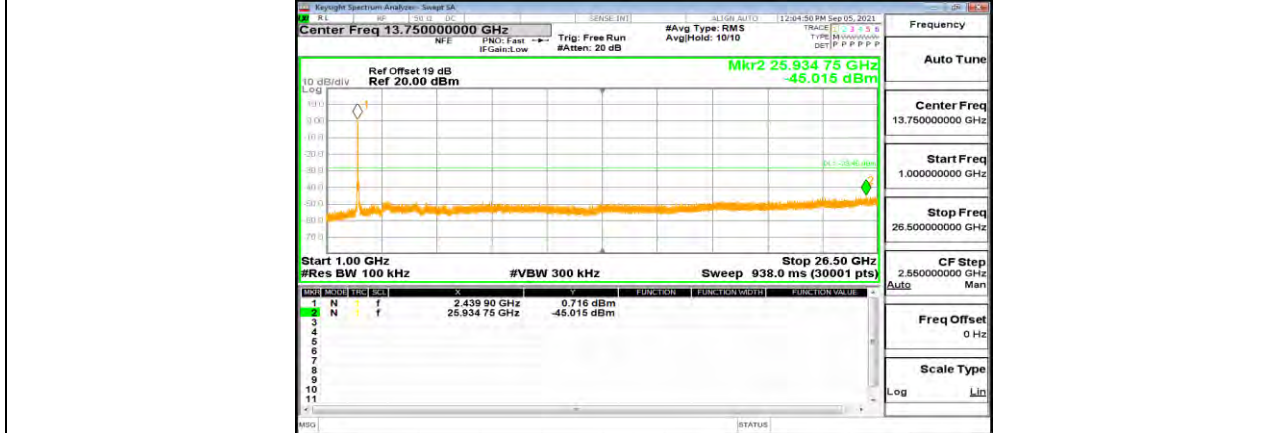

11N40MIMO Ant2 2452 1000~26500



11.7. Appendix G: Duty Cycle
11.7.1. Test Result

Mode	On Time (msec)	Period (msec)	Duty Cycle x (Linear)	Duty Cycle (%)	Duty Cycle Correction Factor (dB)	1/T Minimum VBW (kHz)	Final setting For VBW (kHz)
11B	8.48	8.58	0.9883	98.83	0.05	0.12	0.01
11G	1.41	1.58	0.8924	89.24	0.49	0.71	1
11N20MIMO	1.31	1.48	0.8851	88.51	0.53	0.76	1
11N40MIMO	0.65	1.89	0.3439	34.39	4.64	1.54	2

Note:

Duty Cycle Correction Factor=10log (1/x).

Where: x is Duty Cycle (Linear)

Where: T is On Time

If that calculated VBW is not available on the analyzer then the next higher value should be used.

11.7.2. Test Graphs



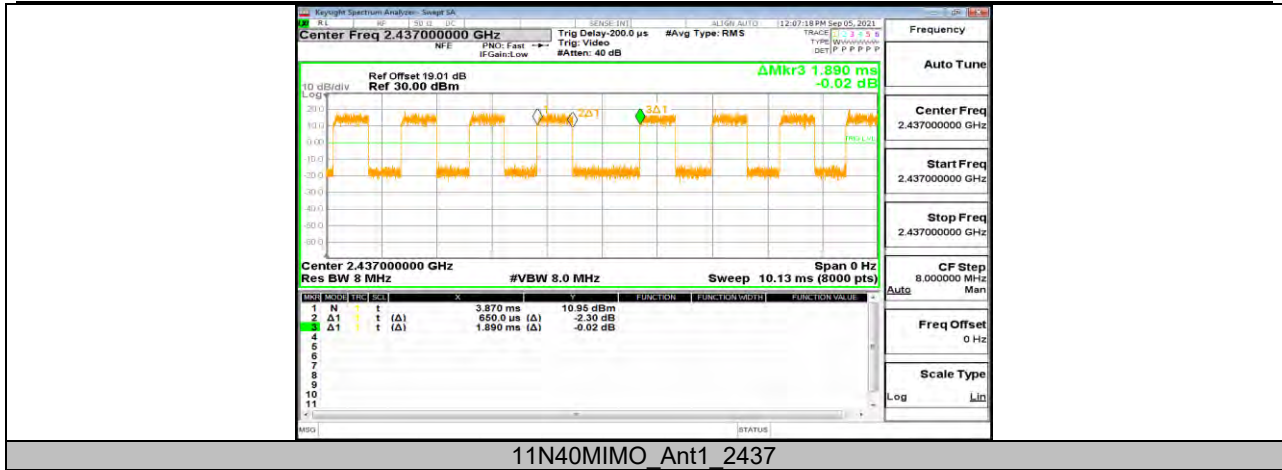

11N40MIMO Ant1 2437

END OF REPORT