

SPECIFICATION

SHEET FOR APPROVAL

(Revision: R: A0)

CUSTOMER(客户名称)	群创光电	
CS P/N(客户机种)	D40F-J09	T40F
PART NAME(品名)	WIFI-1 天线	外露线长 L=190mm
FREQUENCY(频率)	2.4G~2.5G	
ZTX NO.(物料编号)	2.00005686	
DATE(日期)	2022-07-14	

CUSTOMER			
QA CHECKED	ME CHECKED	RF CHECKED	MANAGER CHECKED

Remark(备注):

Sign(客户确认签字盖章): _____

ZHONG TIAN XUN TECHNOLOGY CO., LTD				
MANAGER CHECKED	MANAGER CHECKED	ME CHECKED	RF CHECKED	LISTER
		韦英俊	韦进	



深圳市中天迅通信技术有限公司

SHENZHEN ZHONGTIAN XUN Communication Technology Co., Ltd.

地址: 深圳市宝安区石岩镇石龙大道 34 号(腾达工业园) 邮编: 518000

电话: 0755-27588320 传真: 0755-27588045 <http://www.chinaztx.com>

ANTENNA SPECIFICATION

CUS P/N :D40F-J09 WIFI-1 天线
ZTX P/N :D40F-J09 WIFI-1 天线

ApplicationDate:JUL,14,2022
Editor:

Rev: R:A0
Page 1 of 6

Revision history

版本	日期	状态
A0	2022-07-14	初版



ANTENNA SPECIFICATION

CUS P/N :D40F-J09 WIFI-1 天线
ZTX P/N :D40F-J09 WIFI-1 天线

ApplicationDate:JUL,14,2022
Editor:

Rev: R:A0
Page 2 of 6

1. Mechanical Specification

1-1 Mechanical Configuration (WIFI-1 天线)

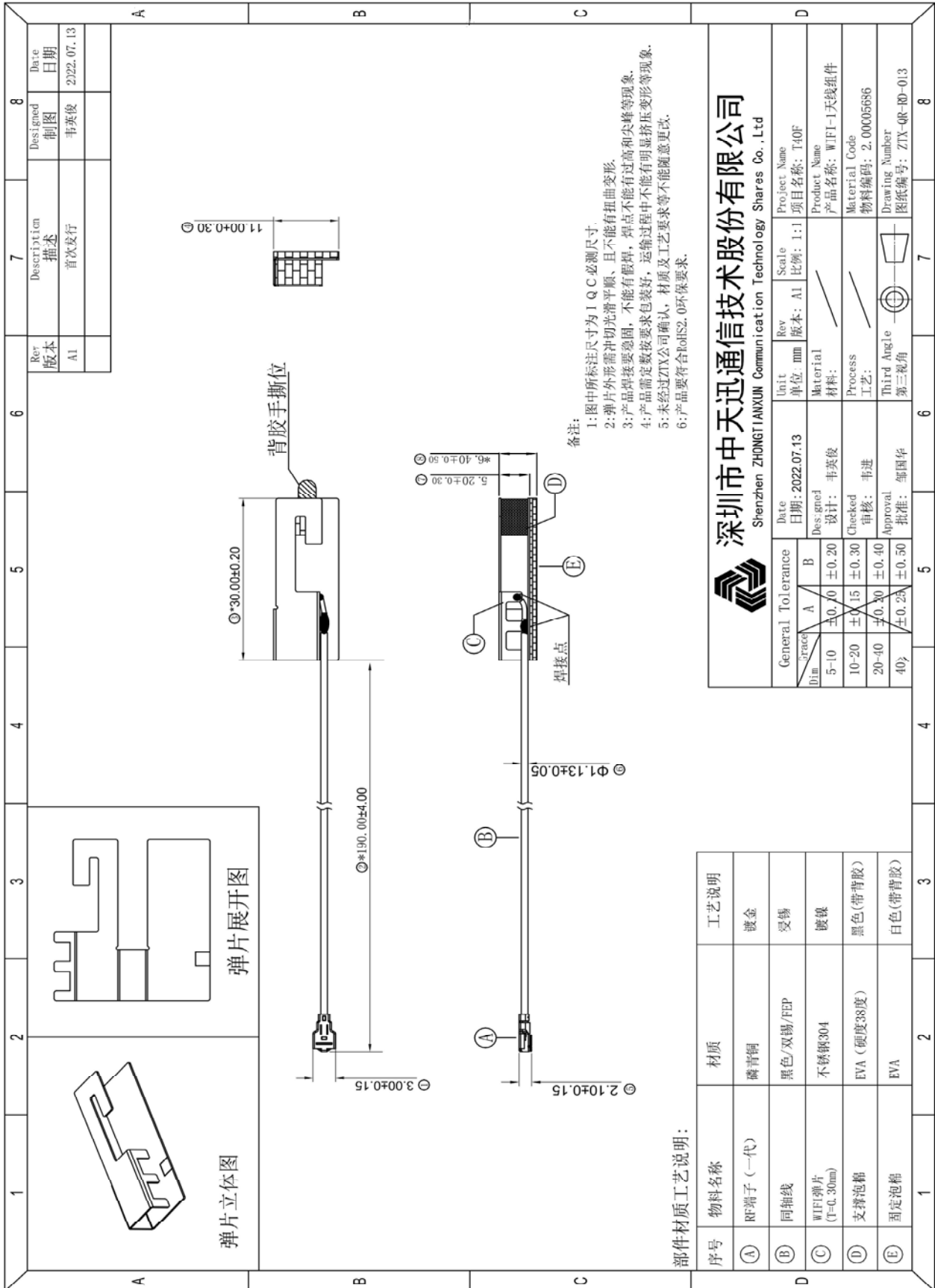

ANTENNA SPECIFICATION

CUS P/N :D40F-J09 WIFI-1 天线
ZTX P/N :D40F-J09 WIFI-1 天线

ApplicationDate:JUL,14,2022
Editor:

Rev: R:A0
Page 3 of 6

2. Test equipment

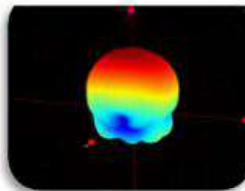
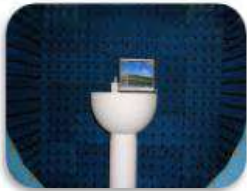
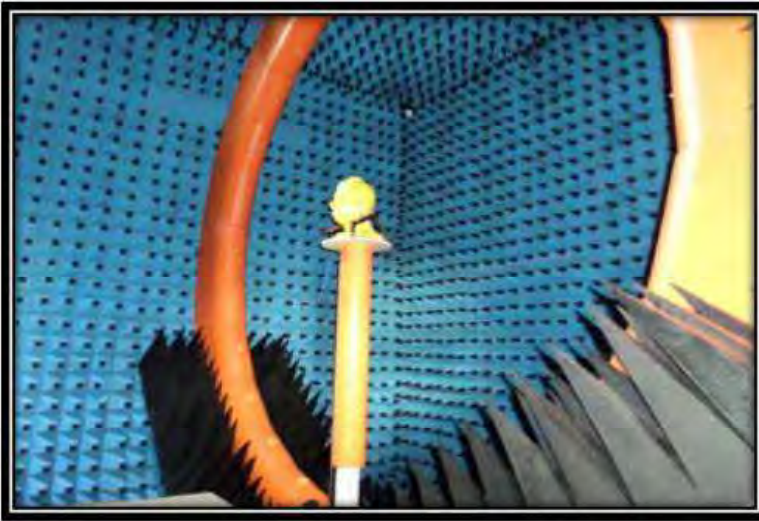

Owned 6 microwave dark room, equipped 2 sets world leading France Satimo SG24 OTA certification test systems (one in SHENZHEN, another one in Shanghai), ETS OTA Standard test system, Blue test reverberation test system which is High repeatability, high accuracy and high resolution. It can quickly provide accurate test reports, fully meet the CITA standards.

Testing range:

Support active, passive testing of GSM/CDMA/WCDMA/TD-SCDMA/LTE/WIFI/WLAN/WiMax/BT/GPS/MIMO/UWB within 0.4-6G.

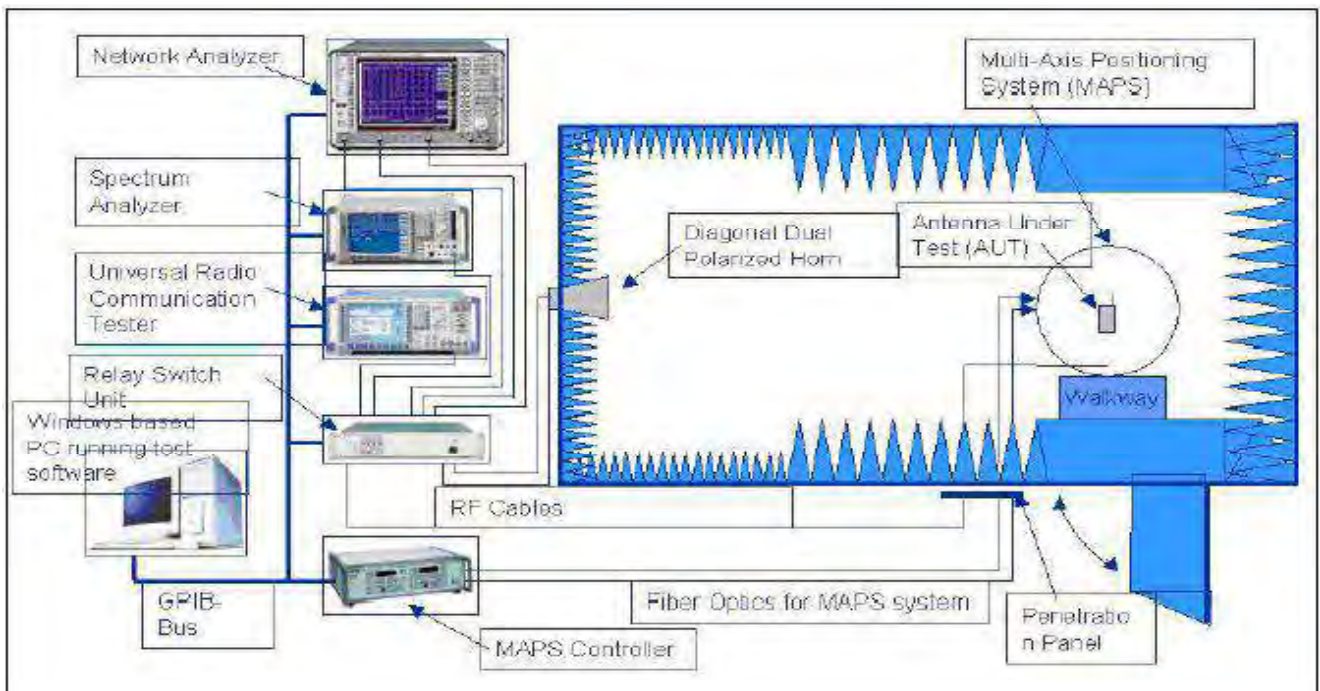

ANTENNA SPECIFICATION

CUS P/N :D40F-J09 WIFI-1 天线
ZTX P/N :D40F-J09 WIFI-1 天线

ApplicationDate:JUL,14,2022
Editor:

Rev: R:A0
Page 4 of 6

3.Antenna test data 3-1 VSWR

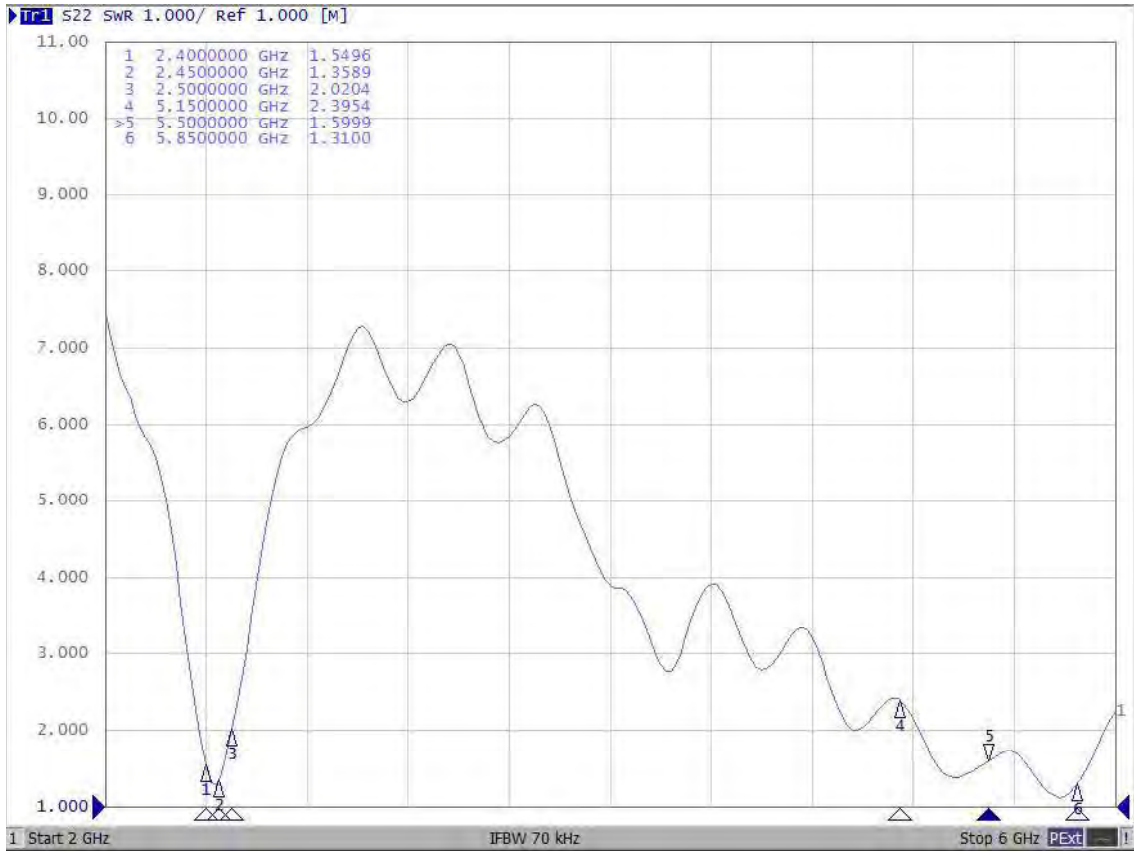

3-2 Return loss plot

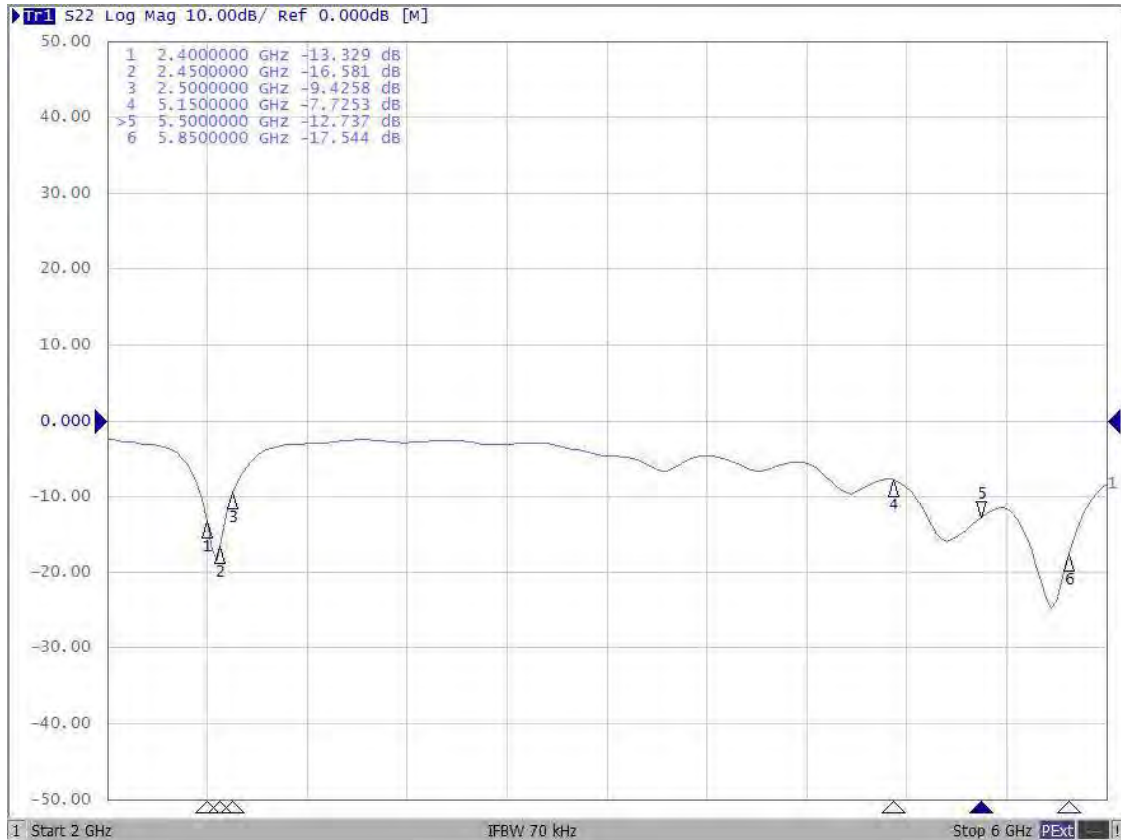

ANTENNA SPECIFICATION

CUS P/N :D40F-J09 WIFI-1 天线
ZTX P/N :D40F-J09 WIFI-1 天线

ApplicationDate:JUL,14,2022
Editor:

Rev: R:A0
Page 5 of 6

3-3 Smith Chart

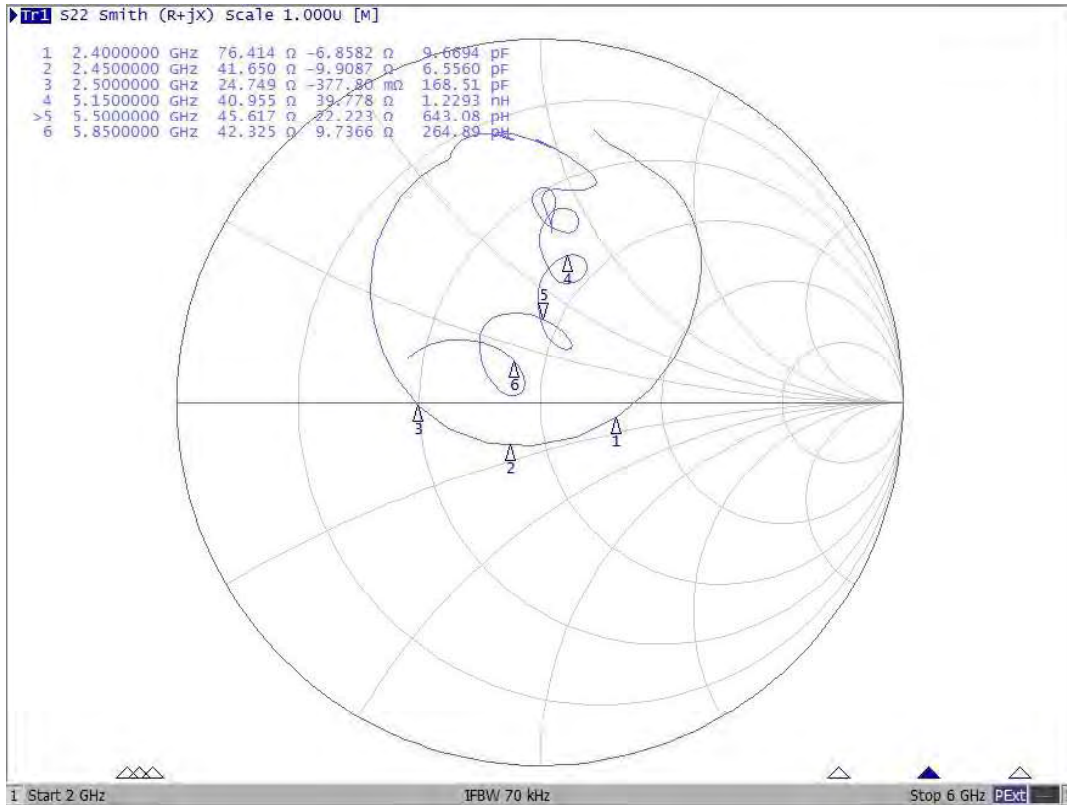

3-4 No-source test data

Frequency	Peak Gain
MHz	dBi
2400	4.21
2410	4.56
2420	4.77
2430	4.88
2440	4.92
2450	4.93
2460	4.57
2470	4.35
2480	4.17
2490	4.23
2500	3.94

ANTENNA SPECIFICATION

CUS P/N :D40F-J09 WIFI-1 天线
ZTX P/N :D40F-J09 WIFI-1 天线

ApplicationDate:JUL,14,2022
Editor:

Rev: R:A0
Page 6 of 6

3-5 Directional drawing of horizontal plane of&3D radiation drawing

