



**CFR 47 FCC PART 15 SUBPART C**

**TEST REPORT**

*For*

**WIFI module**

**MODEL NUMBER: W2FM2510**

**FCC ID: 2AC23-W2FM2510**

**REPORT NUMBER: 4788686591-1**

**ISSUE DATE: December 18 , 2018**

*Prepared for*

**Hui Zhou Gaoshengda Technology Co.,LTD  
NO.75 Zhongkai Development Area,Huizhou,Guangdong, China**

*Prepared by*

**UL Verification Services (Guangzhou) Co., Ltd, Song Shan Lake Branch  
Building 10, Innovation Technology Park, No. 1, Li Bin Road, Song Shan Lake  
Hi-Tech Development Zone Dongguan, People's Republic of China**

**Tel: +86 769 22038881**

**Fax: +86 769 33244054**

**Website: [www.ul.com](http://www.ul.com)**



Revision History

<u>Rev.</u>	<u>Issue Date</u>	<u>Revisions</u>	<u>Revised By</u>
V0	12/18/2018	Initial Issue	



Summary of Test Results			
Clause	Test Items	FCC/IC Rules	Test Results
1	6dB Bandwidth	FCC Part 15.247 (a) (2)	Pass
2	Peak Conducted Output Power	FCC Part 15.247 (b) (3)	Pass
3	Power Spectral Density	FCC Part 15.247 (e)	Pass
4	Conducted Bandedge and Spurious Emission	FCC Part 15.247 (d)	Pass
5	Radiated Bandedge and Spurious Emission	FCC Part 15.247 (d) FCC Part 15.209 FCC Part 15.205	Pass
6	Conducted Emission Test For AC Power Port	FCC Part 15.207	Pass
7	Antenna Requirement	FCC Part 15.203	Pass



## TABLE OF CONTENTS

<b>1. ATTESTATION OF TEST RESULTS .....</b>	<b>6</b>
<b>2. TEST METHODOLOGY .....</b>	<b>7</b>
<b>3. FACILITIES AND ACCREDITATION .....</b>	<b>7</b>
<b>4. CALIBRATION AND UNCERTAINTY .....</b>	<b>8</b>
4.1. <i>MEASURING INSTRUMENT CALIBRATION .....</i>	<i>8</i>
4.2. <i>MEASUREMENT UNCERTAINTY.....</i>	<i>8</i>
<b>5. EQUIPMENT UNDER TEST .....</b>	<b>9</b>
5.1. <i>DESCRIPTION OF EUT.....</i>	<i>9</i>
5.2. <i>MAXIMUM OUTPUT POWER.....</i>	<i>9</i>
5.3. <i>CHANNEL LIST.....</i>	<i>10</i>
5.4. <i>TEST CHANNEL CONFIGURATION.....</i>	<i>10</i>
5.5. <i>THE WORSE CASE CONFIGURATIONS.....</i>	<i>11</i>
5.6. <i>DESCRIPTION OF AVAILABLE ANTENNAS.....</i>	<i>12</i>
5.7. <i>DESCRIPTION OF TEST SETUP .....</i>	<i>13</i>
<b>6. MEASURING INSTRUMENT AND SOFTWARE USED .....</b>	<b>14</b>
<b>7. MEASUREMENT METHODS .....</b>	<b>15</b>
<b>8. ANTENNA PORT TEST RESULTS .....</b>	<b>16</b>
8.1. <i>ON TIME AND DUTY CYCLE.....</i>	<i>16</i>
8.2. <i>6 dB DTS BANDWIDTH .....</i>	<i>19</i>
8.2.1. <i>802.11b MODE.....</i>	<i>20</i>
8.2.2. <i>802.11g MODE.....</i>	<i>22</i>
8.2.3. <i>802.11n HT20 MODE .....</i>	<i>24</i>
8.2.4. <i>802.11n HT40 MODE .....</i>	<i>26</i>
8.3. <i>PEAK CONDUCTED OUTPUT POWER.....</i>	<i>28</i>
8.3.1. <i>802.11b MODE.....</i>	<i>29</i>
8.3.2. <i>802.11g MODE.....</i>	<i>30</i>
8.3.3. <i>802.11n HT20 MODE .....</i>	<i>31</i>
8.3.4. <i>802.11n HT40 MODE .....</i>	<i>32</i>
8.4. <i>POWER SPECTRAL DENSITY.....</i>	<i>33</i>
8.4.1. <i>802.11b MODE.....</i>	<i>34</i>
8.4.1. <i>802.11g MODE.....</i>	<i>37</i>
8.4.2. <i>802.11n HT20 MODE .....</i>	<i>40</i>
8.4.3. <i>802.11n HT40 MODE .....</i>	<i>44</i>
8.5. <i>CONDUCTED BANDEDGE AND SPURIOUS EMISSIONS .....</i>	<i>48</i>
8.5.1. <i>802.11b MODE.....</i>	<i>50</i>
8.5.2. <i>802.11g MODE.....</i>	<i>56</i>



---

8.5.3.	802.11n HT20 MODE .....	62
8.5.4.	802.11n HT40 MODE .....	74
<b>9.</b>	<b>RADIATED TEST RESULTS.....</b>	<b>85</b>
9.1.	<i>RESTRICTED BANDEDGE.....</i>	<i>91</i>
9.1.1.	802.11b MODE .....	91
9.1.2.	802.11g MODE .....	99
9.1.3.	802.11n HT20 MODE .....	107
9.1.4.	802.11n HT40 MODE .....	115
9.2.	<i>SPURIOUS EMISSIONS (1~3GHz).....</i>	<i>123</i>
9.2.1.	802.11b MODE .....	123
9.2.2.	802.11g MODE .....	129
9.2.3.	802.11n HT20 MODE .....	135
9.2.4.	802.11n HT40 MODE .....	141
9.3.	<i>SPURIOUS EMISSIONS (3~18GHz).....</i>	<i>147</i>
9.3.1.	802.11b MODE .....	147
9.3.2.	802.11g MODE .....	153
9.3.3.	802.11n HT20 MODE .....	159
9.3.4.	802.11n HT40 MODE .....	165
9.4.	<i>SPURIOUS EMISSIONS (18~26GHz).....</i>	<i>171</i>
9.4.1.	802.11g MODE .....	171
9.5.	<i>SPURIOUS EMISSIONS (0.03 ~ 1 GHz).....</i>	<i>173</i>
9.5.1.	802.11G MODE .....	173
9.6.	<i>SPURIOUS EMISSIONS BELOW 30M .....</i>	<i>175</i>
9.6.1.	802.11g MODE .....	175
<b>10.</b>	<b>AC POWER LINE CONDUCTED EMISSIONS.....</b>	<b>179</b>
10.1.	802.11g MODE .....	180
<b>11.</b>	<b>ANTENNA REQUIREMENTS.....</b>	<b>182</b>



# 1. ATTESTATION OF TEST RESULTS

## Applicant Information

Company Name: Hui Zhou Gaoshengda Technology Co.,LTD  
Address: NO.75 Zhongkai Development Area,Huizhou,Guangdong, China

## Manufacturer Information

Company Name: Hui Zhou Gaoshengda Technology Co.,LTD  
Address: NO.75 Zhongkai Development Area,Huizhou,Guangdong, China

## EUT Description

EUT Name: WIFI module  
Model: W2FM2510  
Brand Name: GSD  
Sample Status: Normal  
Sample Received Date: October 12, 2018  
Date of Tested: October 12~ December 11, 2018

APPLICABLE STANDARDS	
STANDARD	TEST RESULTS
CFR 47 FCC PART 15 SUBPART C	PASS

Prepared By:

Checked By:

Kebo Zhang  
Engineer Project Associate

Shawn Wen  
Laboratory Leader

Approved By:

Stephen Guo  
Laboratory Manager



## 2. TEST METHODOLOGY

The tests documented in this report were performed in accordance with KDB 558074 D01 DTS Meas Guidance v05, KDB 414788 D01 Radiated Test Site v01r01, KDB 662911 D01 Multiple Transmitter Output v02r01 , CFR 47 FCC Part 2, CFR 47 FCC Part 15 and ANSI C63.10-2013.

## 3. FACILITIES AND ACCREDITATION

Accreditation Certificate	<p><b>A2LA (Certificate No.: 4102.01)</b> UL Verification Services (Guangzhou) Co., Ltd. Song Shan Lake Branch. has been assessed and proved to be in compliance with A2LA.</p> <p><b>FCC (FCC Designation No.: CN1187)</b> UL Verification Services (Guangzhou) Co., Ltd. Song Shan Lake Branch. Has been recognized to perform compliance testing on equipment subject to the Commission's Declaration of Conformity (DoC) and Certification rules</p> <p><b>IC(Company No.: 21320)</b> UL Verification Services (Guangzhou) Co., Ltd. Song Shan Lake Branch. has been registered and fully described in a report filed with ISED. The Company Number is 21320.</p> <p><b>VCCI (Registration No.: G-20019, R-20004, C-20012 and T-20011)</b> UL Verification Services (Guangzhou) Co., Ltd. Song Shan Lake Branch. has been assessed and proved to be in compliance with VCCI, the Membership No. is 3793. Facility Name: Chamber D, the VCCI registration No. is G-20019 and R-20004 Shielding Room B , the VCCI registration No. is C-20012 and T-20011</p>
---------------------------	---

Note 1: All tests measurement facilities use to collect the measurement data are located at Building 10, Innovation Technology Park, Song Shan Lake Hi tech Development Zone, Dongguan, 523808, China

Note 2 : For below 30MHz, lab had performed measurements at test anechoic chamber and comparing to measurements obtained on an open field site. These measurements below 30MHz had been correlated to measurements performed on an OATS.



## 4. CALIBRATION AND UNCERTAINTY

### 4.1. MEASURING INSTRUMENT CALIBRATION

The measuring equipment utilized to perform the tests documented in this report has been calibrated in accordance with the manufacturer's recommendations, and is traceable to recognize national standards.

### 4.2. MEASUREMENT UNCERTAINTY

Where relevant, the following measurement uncertainty levels have been estimated for tests performed on the apparatus:

Test Item	Uncertainty
Conduction emission	3.62dB
Radiation Emission test(include Fundamental emission) (9KHz-30MHz)	2.2dB
Radiation Emission test(include Fundamental emission) (30MHz-1GHz)	4.00dB
Radiation Emission test (1GHz to 26GHz)( include Fundamental emission)	5.78dB (1GHz-18Gz)
	5.23dB (18GHz-26Gz)
Note: This uncertainty represents an expanded uncertainty expressed at approximately the 95% confidence level using a coverage factor of k=2.	





## 5. EQUIPMENT UNDER TEST

### 5.1. DESCRIPTION OF EUT

EUT Name	WIFI module		
Model	W2FM2510		
Radio Technology	IEEE802.11b/g/n HT20/n HT40		
Operation frequency	IEEE 802.11b: 2412MHz—2462MHz IEEE 802.11g: 2412MHz—2462MHz IEEE 802.11n HT20: 2412MHz—2462MHz IEEE 802.11n HT40: 2422MHz—2452MHz		
Modulation	IEEE 802.11b: DSSS(CCK) IEEE 802.11g: OFDM(64QAM, 16QAM, QPSK, BPSK) IEEE 802.11n HT20: OFDM (64QAM, 16QAM, QPSK,BPSK) IEEE 802.11n HT40: OFDM (64QAM, 16QAM, QPSK,BPSK)		
Rated Input	DC 5V		
Power Supply	Power Adapter	Input	/
		Output	/
	Battery	/	

### 5.2. MAXIMUM OUTPUT POWER

Number of Transmit Chains (NTX)	IEE Std. 802.11	Frequency (MHz)	Channel Number	Max PK Conducted Power (dBm)
2	IEEE 802.11b	2412-2462	1-11[11]	20.98
2	IEEE 802.11g	2412-2462	1-11[11]	21.65
2	IEEE 802.11nHT20	2412-2462	1-11[11]	20.88
2	IEEE 802.11nHT40	2422-2452	3-9[7]	19.63



### 5.3. CHANNEL LIST

Channel List for 802.11b/g/n (20 MHz)							
Channel	Frequency (MHz)	Channel	Frequency (MHz)	Channel	Frequency (MHz)	Channel	Frequency (MHz)
1	2412	4	2427	7	2442	10	2457
2	2417	5	2432	8	2447	11	2462
3	2422	6	2437	9	2452	/	/

Channel List for 802.11n (40 MHz)							
Channel	Frequency (MHz)	Channel	Frequency (MHz)	Channel	Frequency (MHz)	Channel	Frequency (MHz)
3	2422	5	2432	7	2442	9	2452
4	2427	6	2437	8	2447	/	/

### 5.4. TEST CHANNEL CONFIGURATION

Test Mode	Test Channel	Frequency
WiFi TX(802.11b)	CH 1, CH 6, CH 11	2412MHz, 2437MHz, 2462MHz
WiFi TX(802.11g)	CH 1, CH 6, CH 11	2412MHz, 2437MHz, 2462MHz
WiFi TX(802.11n HT20)	CH 1, CH 6, CH 11	2412MHz, 2437MHz, 2462MHz
WiFi TX(802.11n HT40)	CH 3, CH 6, CH 9	2422MHz, 2437MHz, 2452MHz



### 5.5. THE WORSE CASE CONFIGURATIONS

The Worst Case Power Setting Parameter under 2400 ~ 2483.5MHz Band													
Test Software		QATest											
Modulation Mode	Transmit Antenna Number	Test Channel											
		NCB: 20MHz			NCB: 40MHz								
		CH 1	CH 6	CH 11	CH 3	CH 6	CH 9						
802.11b	0	1D	1E	1E	/								
	1	1D	1E	1E									
802.11g	0	1A	1A	1A				/					
	1	1A	1A	1A									
802.11n HT20	0	0D	0D	0D							/		
	1	0D	0D	0D									
802.11n HT40	0	/	/	/	0A	0A	0A						
	1	/	/	/	0A	0A	0A						

Note: Only 802.11n HT20 and 802.11n HT40 support MIMO mode, for 802.11b and 802.11g , all antennas had been test ,but only the worst data for Antenna 0 was recorded; for 802.11n HT20 and 802.11n HT40, all antennas had the same power in MIMO mode and SISO mode, so only the worst data for MIMO mode was recorded.



### 5.6. DESCRIPTION OF AVAILABLE ANTENNAS

Antenna	Frequency (MHz)	Antenna Type	Antenna Gain (dBi)
0	2412-2462	PIFA antenna	1.53
1	2412-2462	PIFA antenna	1.53

Note: Directional gain= GANT + 10 log(NANT) dBi=4.54dBi  
GANT : Average of the Antenna Gain  
NANT : Antenna numbers

Test Mode	Transmit and Receive Mode	Description
IEEE 802.11b	<input checked="" type="checkbox"/> 1TX, 1RX	Antenna 0 and Antenna 1 can be used as transmitting/receiving antenna.
IEEE 802.11g	<input checked="" type="checkbox"/> 1TX, 1RX	Antenna 0 and Antenna 1 can be used as transmitting/receiving antenna
IEEE 802.11n HT20	<input checked="" type="checkbox"/> 2TX, 2RX	Antenna 0 and Antenna 1 can be used as transmitting/receiving antenna
IEEE 802.11n HT40	<input checked="" type="checkbox"/> 2TX, 2RX	Antenna 0 and Antenna 1 can be used as transmitting/receiving antenna

## 5.7. DESCRIPTION OF TEST SETUP

### SUPPORT EQUIPMENT

Item	Equipment	Brand Name	Model Name	P/N
1	Laptop	ThinkPad	T460S	SL10K24796 JS
2	Highpass Filter	Wi	WHKX10-2700-3000-18000-40SS	23
3	Band Reject Filter	Wainwright	WRCJV8-2350-2400-2483.5-2533.5-40SS	4
4	USB TO UART	/	/	/

### I/O CABLES

Item	Port	Connector Type	Cable Type	Cable Length(m)	Remarks
1	USB	/	shielded	0.3	/

### ACCESSORIES

Item	Accessory	Brand Name	Model Name	Description
1	/	/	/	/

### TEST SETUP

The EUT can work in engineering mode with a software through a Laptop.

### SETUP DIAGRAM FOR TESTS

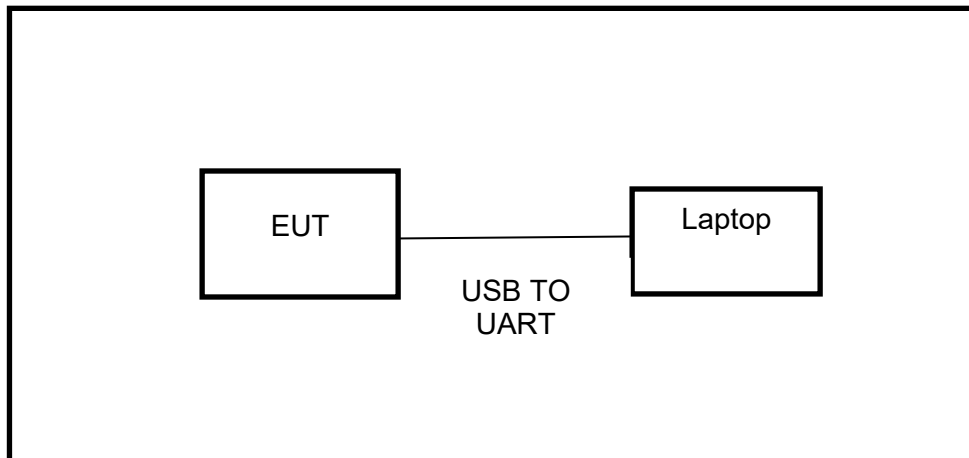

**6. MEASURING INSTRUMENT AND SOFTWARE USED**

Conducted Emissions							
Instrument							
Used	Equipment	Manufacturer	Model No.	Serial No.	Upper Last Cal.	Last Cal.	Next Cal.
<input checked="" type="checkbox"/>	EMI Test Receiver	R&S	ESR3	101961	Dec.12,2017	Dec.10,2018	Dec.10,2019
<input checked="" type="checkbox"/>	Two-Line V-Network	R&S	ENV216	101983	Dec.12,2017	Dec.10,2018	Dec.10,2019
<input checked="" type="checkbox"/>	Artificial Mains Networks	Schwarzbeck	NSLK 8126	8126465	Dec.12,2017	Dec.10,2018	Dec.10,2019
Software							
Used	Description			Manufacturer	Name	Version	
<input checked="" type="checkbox"/>	Test Software for Conducted disturbance			Farad	EZ-EMC	Ver. UL-3A1	
Radiated Emissions							
Instrument							
Used	Equipment	Manufacturer	Model No.	Serial No.	Upper Last Cal.	Last Cal.	Next Cal.
<input checked="" type="checkbox"/>	MXE EMI Receiver	KESIGHT	N9038A	MY56400036	Dec.12,2017	Dec.10,2018	Dec.10,2019
<input checked="" type="checkbox"/>	Hybrid Log Periodic Antenna	TDK	HLP-3003C	130960	Jan.09, 2016	Jan.09, 2016	Jan.09, 2019
<input checked="" type="checkbox"/>	Preamplifier	HP	8447D	2944A09099	Dec.12,2017	Dec.10,2018	Dec.10,2019
<input checked="" type="checkbox"/>	EMI Measurement Receiver	R&S	ESR26	101377	Dec.12,2017	Dec.10,2018	Dec.10,2019
<input checked="" type="checkbox"/>	Horn Antenna	TDK	HRN-0118	130939	Jan. 09, 2016	Jan. 09, 2016	Jan. 09, 2019
<input checked="" type="checkbox"/>	High Gain Horn Antenna	Schwarzbeck	BBHA-9170	691	Jan.06, 2016	Jan.06, 2016	Jan.06, 2019
<input checked="" type="checkbox"/>	Preamplifier	TDK	PA-02-0118	TRS-305-00066	Dec.12,2017	Dec.10,2018	Dec.10,2019
<input checked="" type="checkbox"/>	Preamplifier	TDK	PA-02-2	TRS-307-00003	Dec.12,2017	Dec.10,2018	Dec.10,2019
<input checked="" type="checkbox"/>	Loop antenna	Schwarzbeck	1519B	00008	Mar. 26, 2016	Mar. 26,2016	Mar.26, 2019
Software							
Used	Description			Manufacturer	Name	Version	
<input checked="" type="checkbox"/>	Test Software for Radiated disturbance			Farad	EZ-EMC	Ver. UL-3A1	
Other instruments							
Used	Equipment	Manufacturer	Model No.	Serial No.	Upper Last Cal.	Last Cal.	Next Cal.
<input checked="" type="checkbox"/>	Spectrum Analyzer	Keysight	N9030A	MY55410512	Dec.12,2017	Dec.10,2018	Dec.10,2019
<input checked="" type="checkbox"/>	Power Meter	Keysight	N1911A	MY55416024	Dec.12,2017	Dec.10,2018	Dec.10,2019
<input checked="" type="checkbox"/>	Power Sensor	Keysight	U2021XA	MY5100022	Dec.12,2017	Dec.10,2018	Dec.10,2019



## 7. MEASUREMENT METHODS

No.	Test Item	KDB Name	Section
1	6dB Bandwidth	KDB 558074 D01 DTS Meas Guidance v05	8.2
2	Peak Output Power	KDB 558074 D01 DTS Meas Guidance v05	8.3.1.3/8.3.2.3
3	Power Spectral Density	KDB 558074 D01 DTS Meas Guidance v05	8.4
4	Out-of-band emissions in non-restricted bands	KDB 558074 D01 DTS Meas Guidance v05	8.5
5	Out-of-band emissions in restricted bands	KDB 558074 D01 DTS Meas Guidance v05	8.6
6	Band-edge	KDB 558074 D01 DTS Meas Guidance v05	8.7
7	Conducted Emission Test For AC Power Port	ANSI C63.10-2013	6.2



## 8. ANTENNA PORT TEST RESULTS

### 8.1. ON TIME AND DUTY CYCLE

#### LIMITS

None; for reporting purposes only

#### PROCEDURE

KDB 558074 Zero-Span Spectrum Analyzer Method

#### TEST SETUP

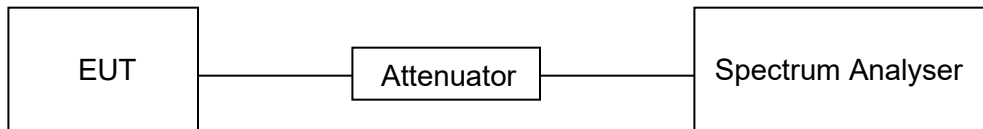

#### TEST ENVIRONMENT

Temperature	24.3°C	Relative Humidity	56%
Atmosphere Pressure	101kPa	Test Voltage	DC 5V

#### RESULTS

##### ANTENNA 0

Mode	On Time (msec)	Period (msec)	Duty Cycle x (Linear)	Duty Cycle (%)	Duty Cycle Correction Factor (dB)	1/T Minimum VBW (KHz)	Final setting For VBW (KHz)
11b	8.340	8.550	0.9754	97.54	0.11	0.12	0.2
11g	1.380	1.545	0.8932	89.32	0.49	0.72	1
11n20	1.290	1.470	0.8776	87.76	0.57	0.78	1
11n40	0.640	0.810	0.7901	79.01	1.02	1.56	2

Note:

Duty Cycle Correction Factor=10log (1/x).

Where: x is Duty Cycle (Linear)

Where: T is On Time

If that calculated VBW is not available on the analyzer then the next higher value should be used.

Antenna 0 and Antenna 1 has the same duty cycle, only Antenna 0 data show here.



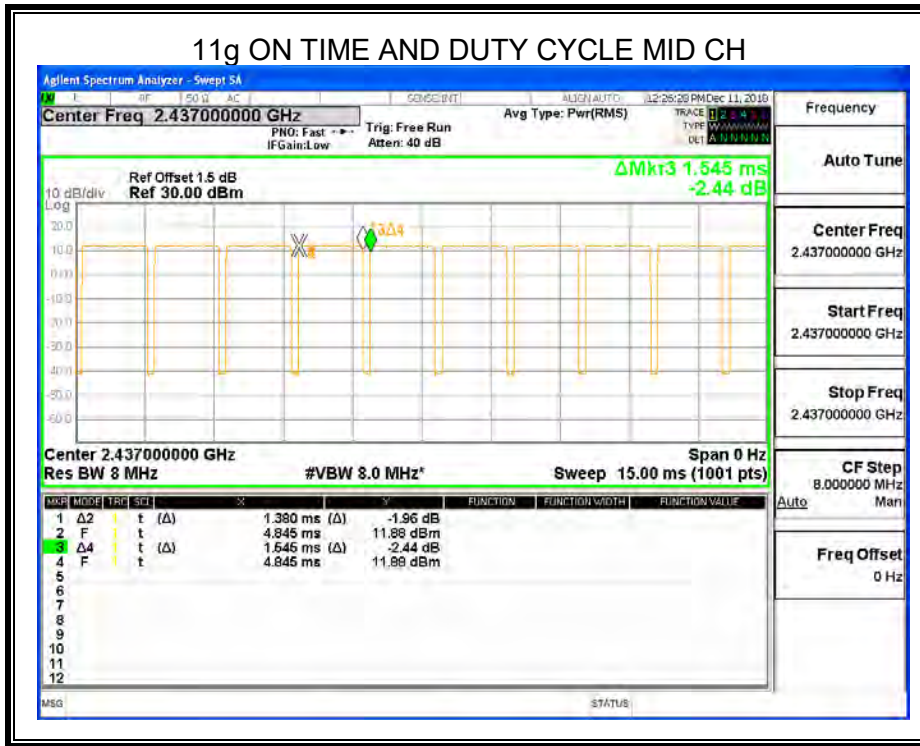
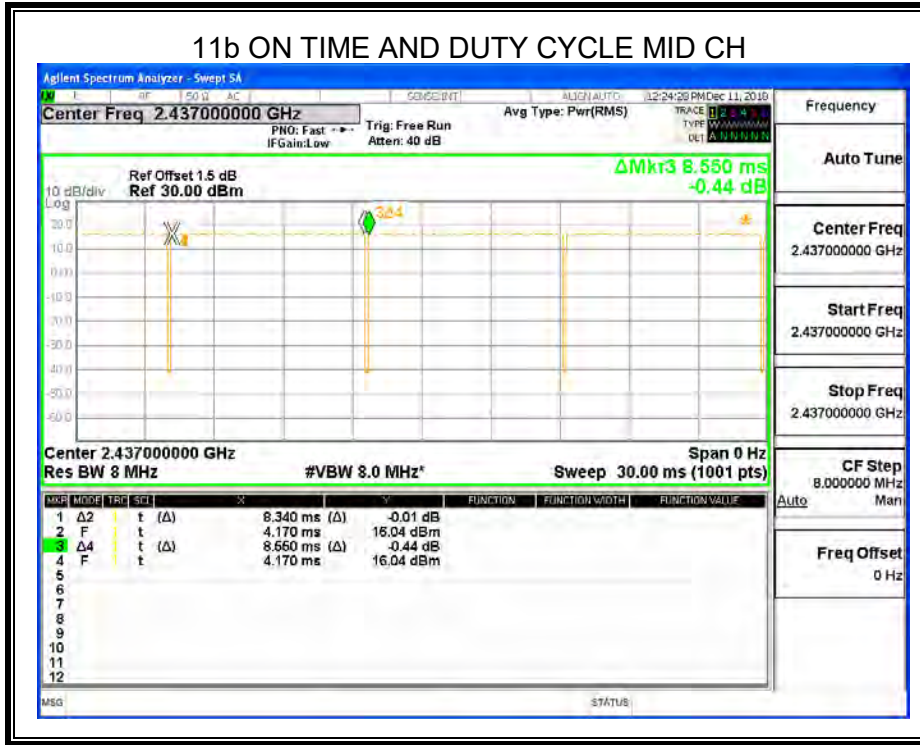

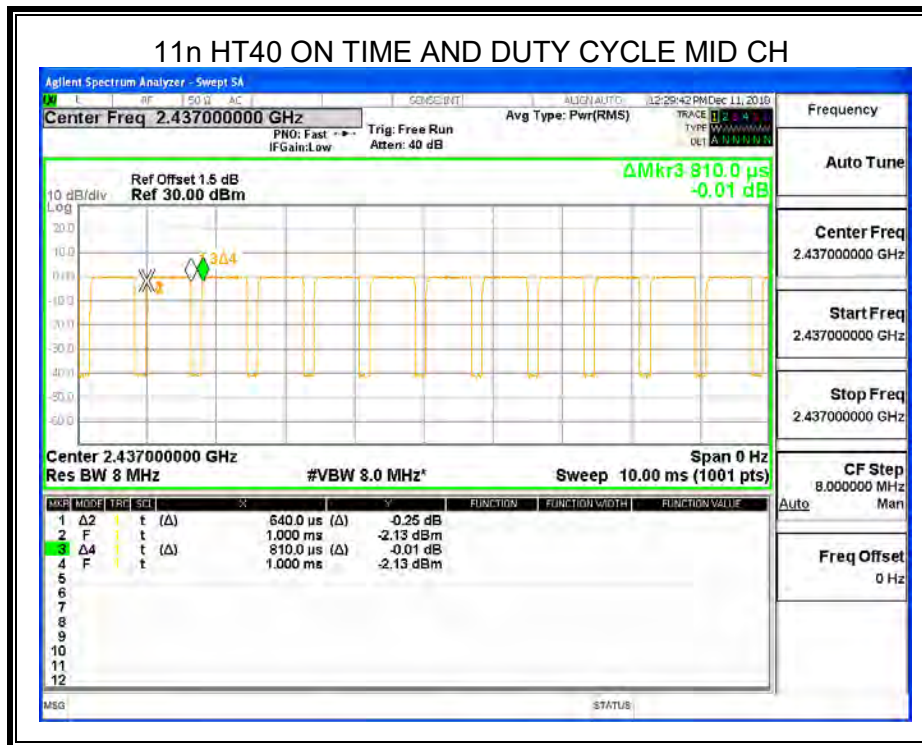
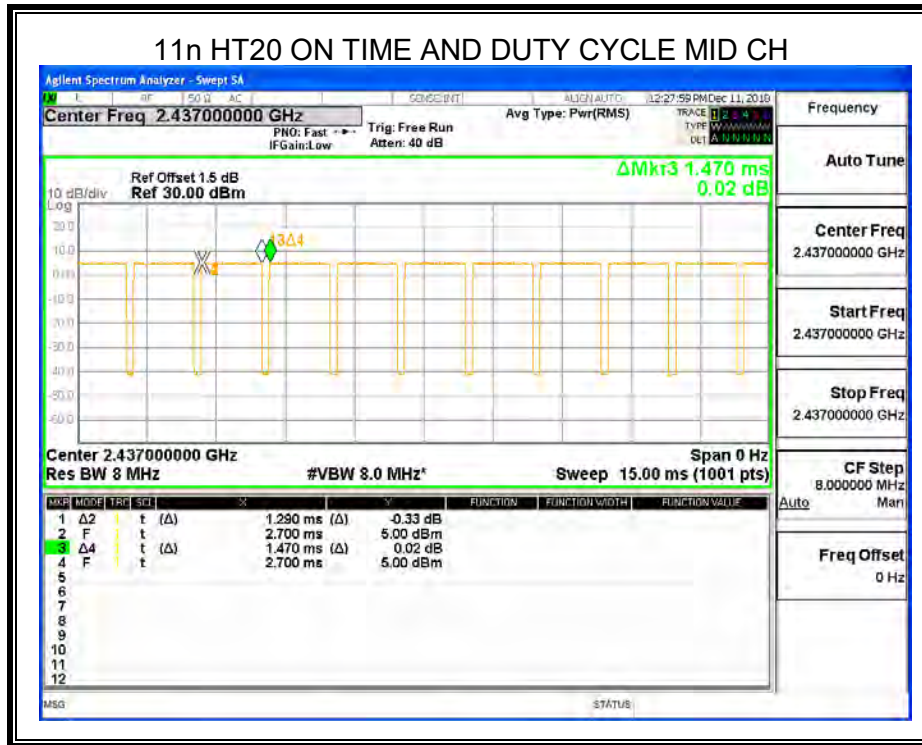



## 8.2. 6 dB DTS BANDWIDTH

### LIMITS

CFR 47 FCC Part15 (15.247) Subpart C			
Section	Test Item	Limit	Frequency Range (MHz)
CFR 47 FCC 15.247(a)(2)	6 dB Bandwidth	≥ 500KHz	2400-2483.5

### TEST PROCEDURE

Connect the UUT to the spectrum analyser and use the following settings:

Center Frequency	The centre frequency of the channel under test
Detector	Peak
RBW	100K
VBW	≥3 × RBW
Trace	Max hold
Sweep	Auto couple

Allow the trace to stabilize and measure the maximum width of the emission that is constrained by the frequencies associated with the two outermost amplitude points (upper and lower frequencies) that are attenuated by 6 dB relative to the maximum level measured in the fundamental emission.

### TEST SETUP

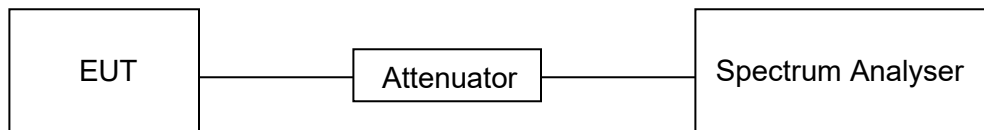



**TEST ENVIRONMENT**

Temperature	24.3°C	Relative Humidity	56%
Atmosphere Pressure	101kPa	Test Voltage	DC 5V

**RESULTS**

**8.2.1. 802.11b MODE**

**ANTENNA 0**

Channel	6dB bandwidth (MHz)	Limit (kHz)	Result
Low	9.565	≥500	Pass
Middle	8.597	≥500	Pass
High	9.554	≥500	Pass

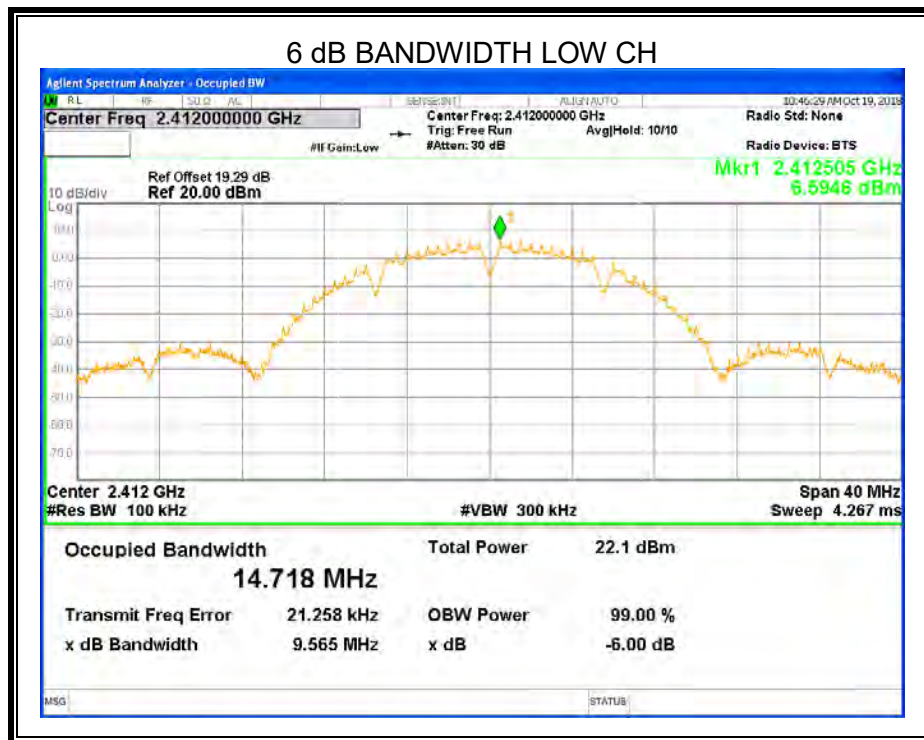



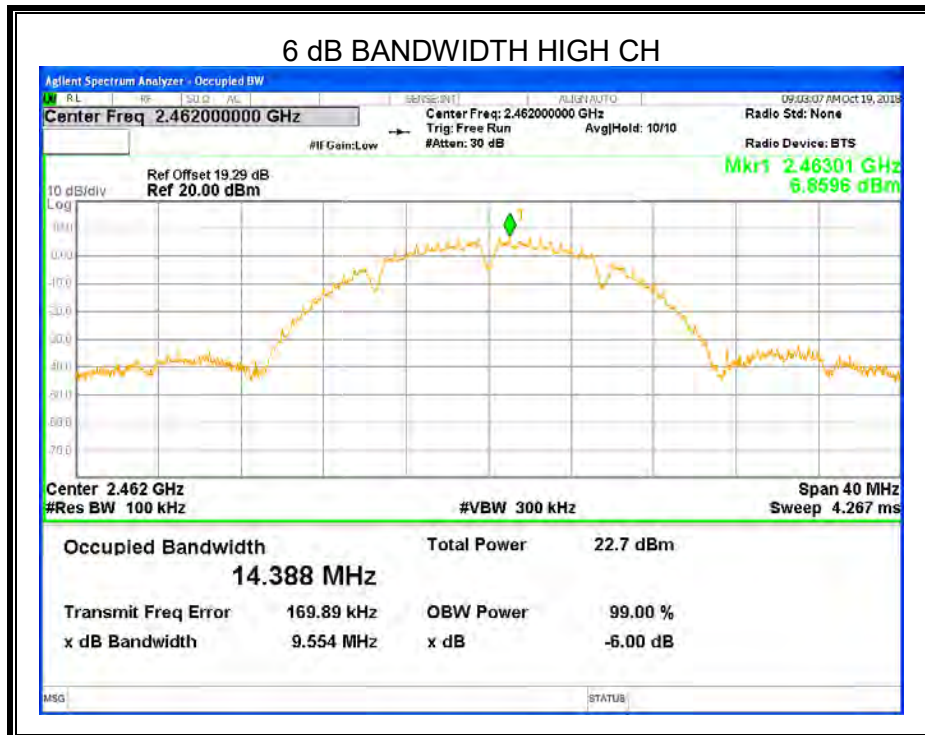
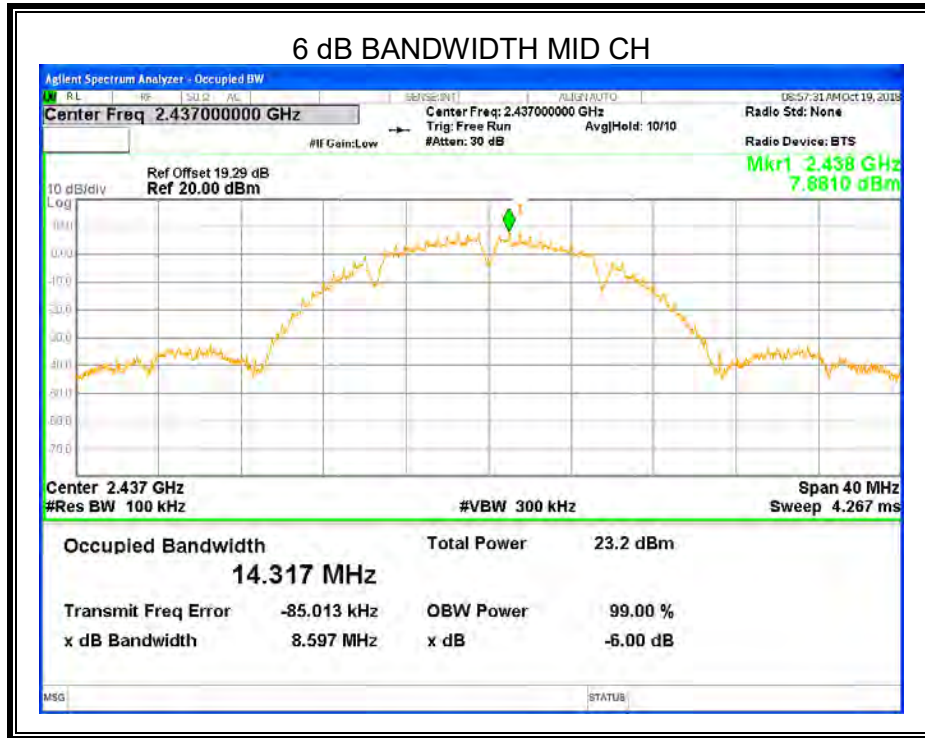



8.2.2. 802.11g MODE

ANTENNA 0

Channel	6dB bandwidth (MHz)	Limit (kHz)	Result
Low	15.32	≥500	Pass
Middle	15.05	≥500	Pass
High	15.07	≥500	Pass

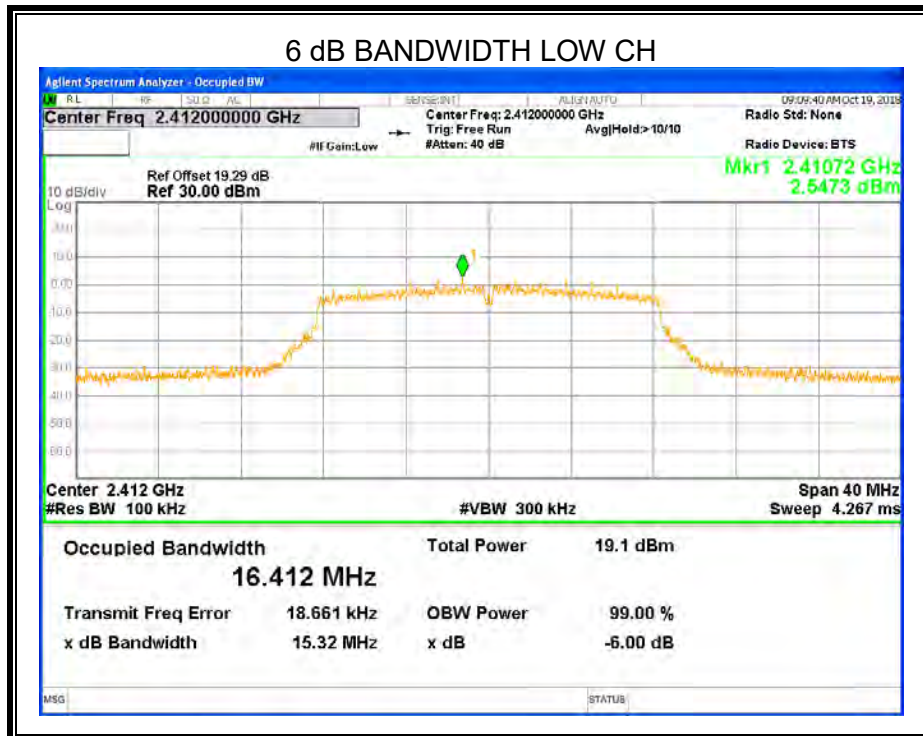

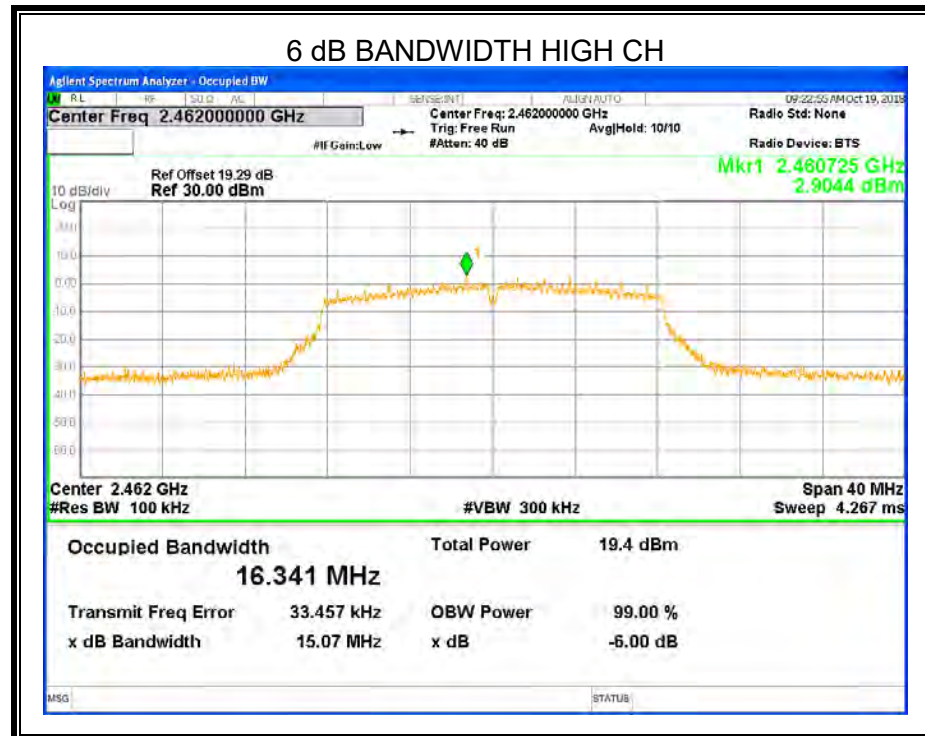
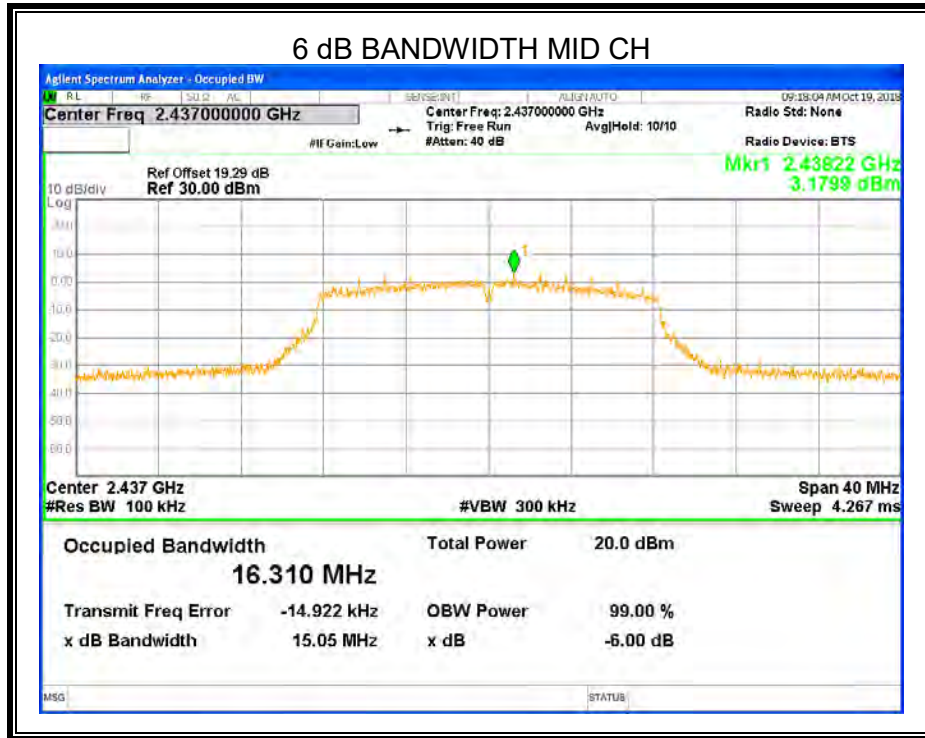



### 8.2.3. 802.11n HT20 MODE

#### ANTENNA 0

Channel	6dB bandwidth (MHz)	Limit (kHz)	Result
Low	15.33	≥500	Pass
Middle	15.14	≥500	Pass
High	16.06	≥500	Pass

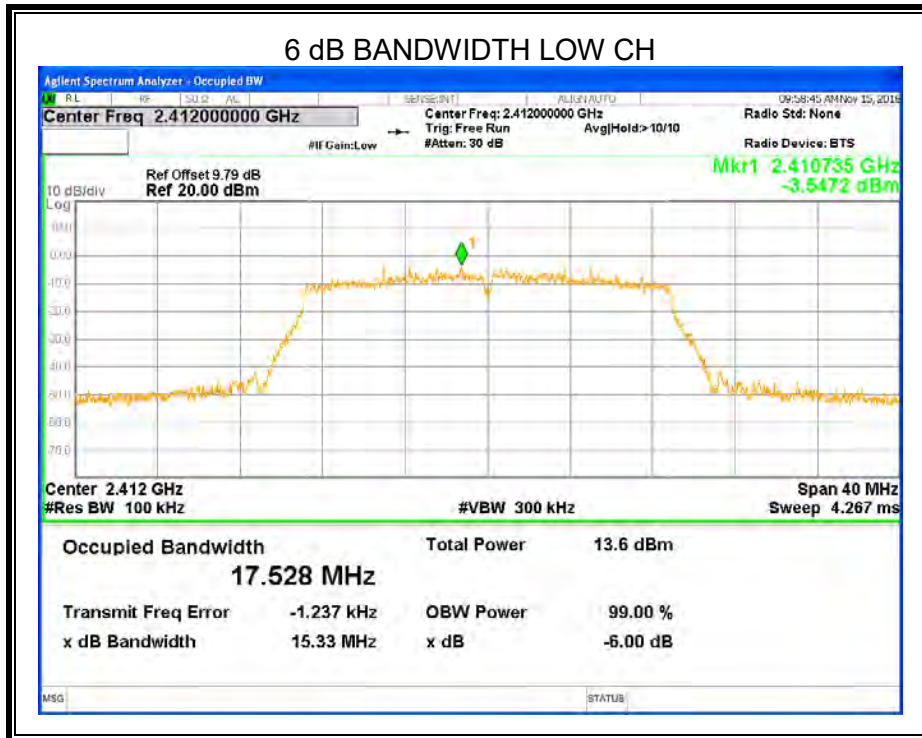



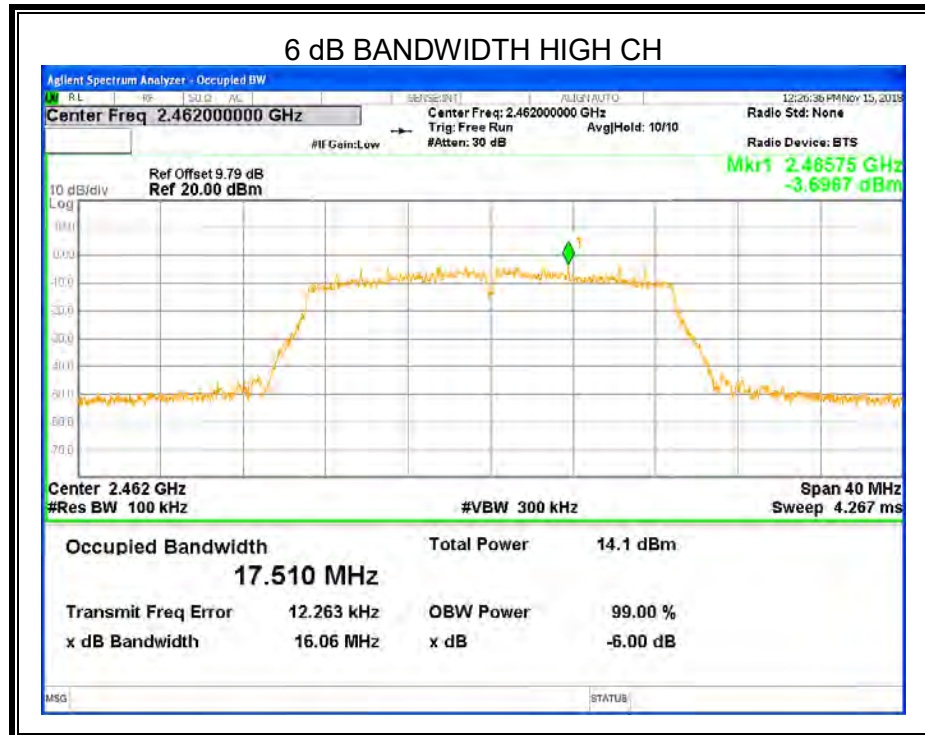
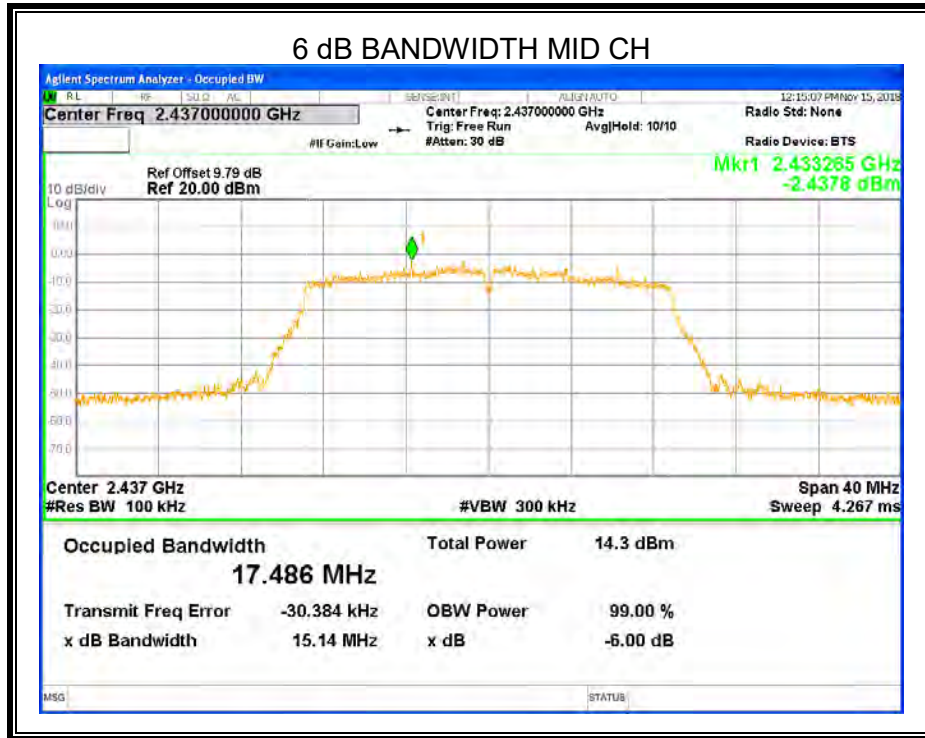



8.2.4. 802.11n HT40 MODE

ANTENNA 0

Channel	6dB bandwidth (MHz)	Limit (kHz)	Result
Low	35.08	≥500	Pass
Middle	34.99	≥500	Pass
High	35.06	≥500	Pass

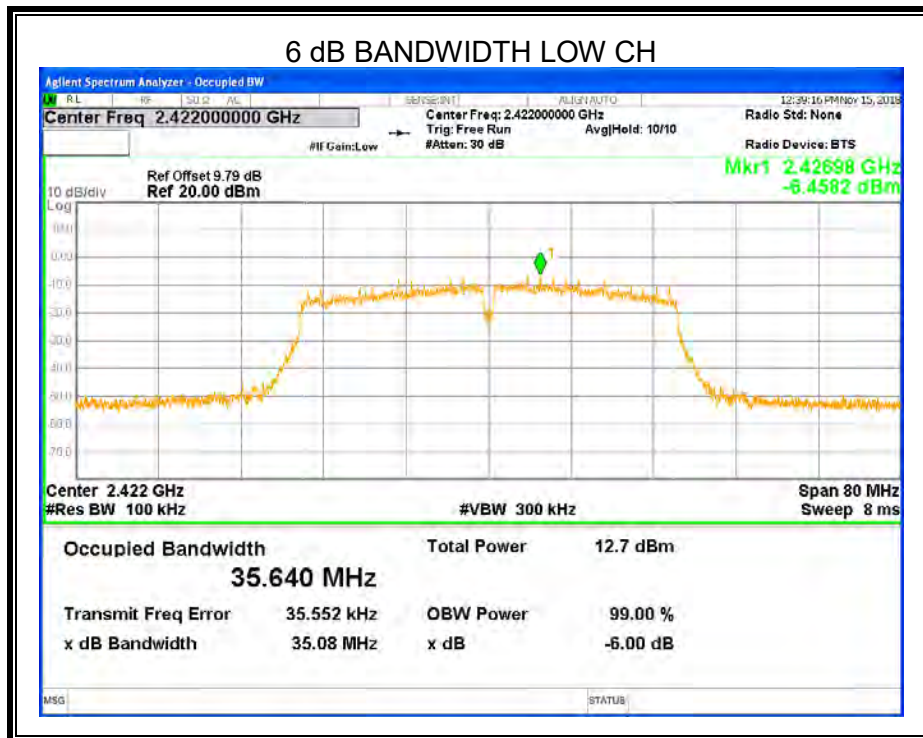

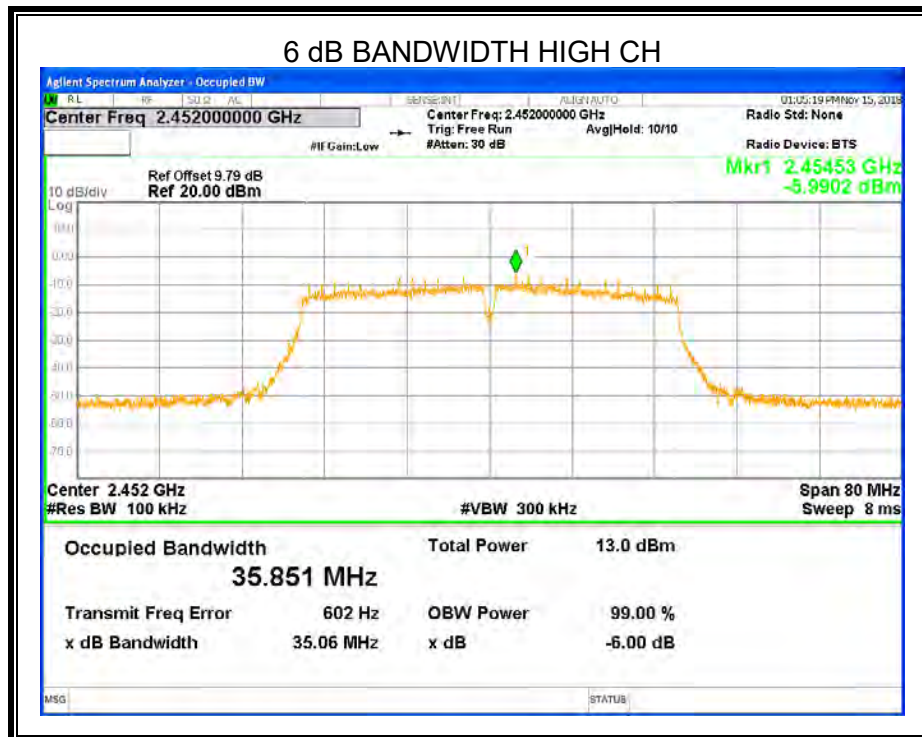
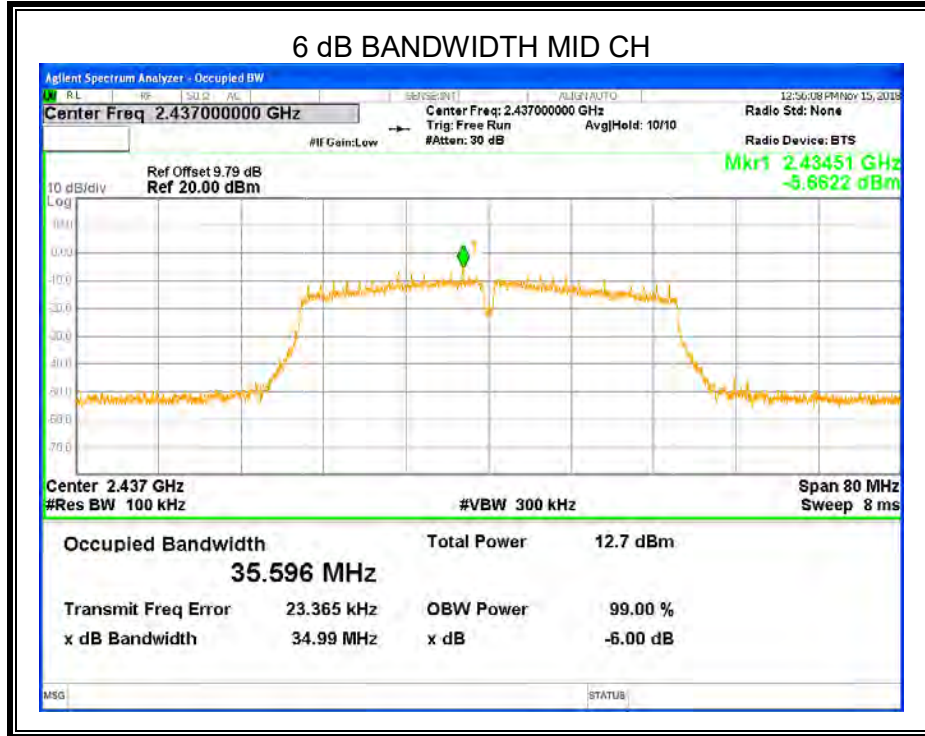

Note: All modes and antennas had been tested, but only the worst data recorded in the report.



### 8.3. PEAK CONDUCTED OUTPUT POWER

#### LIMITS

CFR 47 FCC Part15 (15.247) Subpart C			
Section	Test Item	Limit	Frequency Range (MHz)
CFR 47 FCC 15.247(b)(3)	Peak Output Power	1 watt or 30dBm	2400-2483.5

#### TEST PROCEDURE

Place the EUT on the table and set it in the transmitting mode.  
Remove the antenna from the EUT and then connect a low loss RF cable from the antenna port to the Power sensor.  
Measure peak power each channel.  
Peak Detector use for Peak result.  
AVG Detector use for AVG result.

#### TEST SETUP

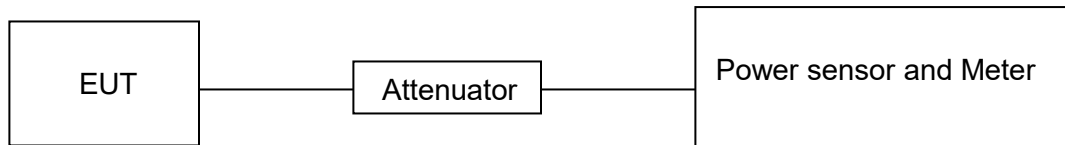

#### TEST ENVIRONMENT

Temperature	24.3°C	Relative Humidity	56%
Atmosphere Pressure	101kPa	Test Voltage	DC 5V



**RESULTS**

**8.3.1. 802.11b MODE**

Frequency (MHz)	ANT	Maximum PK Conducted Output Power (dBm)		Limit	Result
		Single	Total		
Low	0	20.88	/	30	PASS
	1	19.03			
Middle	0	20.98			
	1	19.22			
High	0	20.98			
	1	19.36			

Frequency (MHz)	ANT	Maximum AV Conducted Output Power (dBm)		Limit	Result
		Single	Total		
Low	0	16.58	/	30	PASS
	1	15.21			
Middle	0	16.65			
	1	15.07			
High	0	16.62			
	1	15.00			



### 8.3.2. 802.11g MODE

Frequency (MHz)	ANT	Maximum PK Conducted Output Power (dBm)		Limit	Result
		Single	Total		
Low	0	21.65	/	30	PASS
	1	20.47			
Middle	0	21.54			
	1	20.53			
High	0	21.43			
	1	20.61			

Frequency (MHz)	ANT	Maximum AV Conducted Output Power (dBm)		Limit	Result
		Single	Total		
Low	0	13.93	/	30	PASS
	1	12.73			
Middle	0	13.78			
	1	12.73			
High	0	13.69			
	1	12.90			



**8.3.3. 802.11n HT20 MODE**

Frequency (MHz)	ANT	Maximum PK Conducted Output Power (dBm)		Limit	Result
		Single	Total		
Low	0	18.23	20.79	30	PASS
	1	17.28			
Middle	0	18.38	20.88		
	1	17.30			
High	0	18.25	20.78		
	1	17.23			

Frequency (MHz)	ANT	Maximum AV Conducted Output Power (dBm)		Limit	Result
		Single	Total		
Low	0	7.67	10.31	30	PASS
	1	6.89			
Middle	0	7.85	10.42		
	1	6.91			
High	0	7.83	10.36		
	1	6.81			



**8.3.4. 802.11n HT40 MODE**

Frequency (MHz)	ANT	Maximum PK Conducted Output Power (dBm)		Limit	Result
		Single	Total		
Low	0	16.73	19.41	30	PASS
	1	16.04			
Middle	0	16.68	19.30		
	1	15.87			
High	0	17.17	19.63		
	1	15.98			

Frequency (MHz)	ANT	Maximum AV Conducted Output Power (dBm)		Limit	Result
		Single	Total		
Low	0	6.08	8.85	30	PASS
	1	5.58			
Middle	0	5.91	8.49		
	1	5.01			
High	0	6.49	9.05		
	1	5.54			



## 8.4. POWER SPECTRAL DENSITY

### LIMITS

CFR 47 FCC Part15 (15.247) Subpart C			
Section	Test Item	Limit	Frequency Range (MHz)
CFR 47 FCC §15.247 (e)	Power Spectral Density	8 dBm/3 kHz	2400-2483.5

### TEST PROCEDURE

Connect the UUT to the spectrum analyser and use the following settings:

Center Frequency	The centre frequency of the channel under test
Detector	Peak
RBW	$3 \text{ kHz} \leq \text{RBW} \leq 100 \text{ kHz}$
VBW	$\geq 3 \times \text{RBW}$
Span	1.5 x DTS bandwidth
Trace	Max hold
Sweep time	Auto couple.

Allow trace to fully stabilize and use the peak marker function to determine the maximum amplitude level within the RBW.

If measured value exceeds limit, reduce RBW (no less than 3 kHz) and repeat.

### TEST SETUP

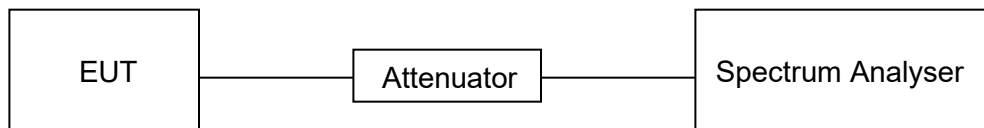

### TEST ENVIRONMENT

Temperature	24.3°C	Relative Humidity	56%
Atmosphere Pressure	101kPa	Test Voltage	DC 5V



**RESULTS**

**8.4.1. 802.11b MODE**

Frequency (MHz)	ANT	Power Spectral Density (dBm/3kHz)		Limit (dBm/3kHz)
		Single	Total	
Low	0	-7.367	NA	8
Middle	0	-5.715		
High	0	-6.931		



**ANTENNA 0**

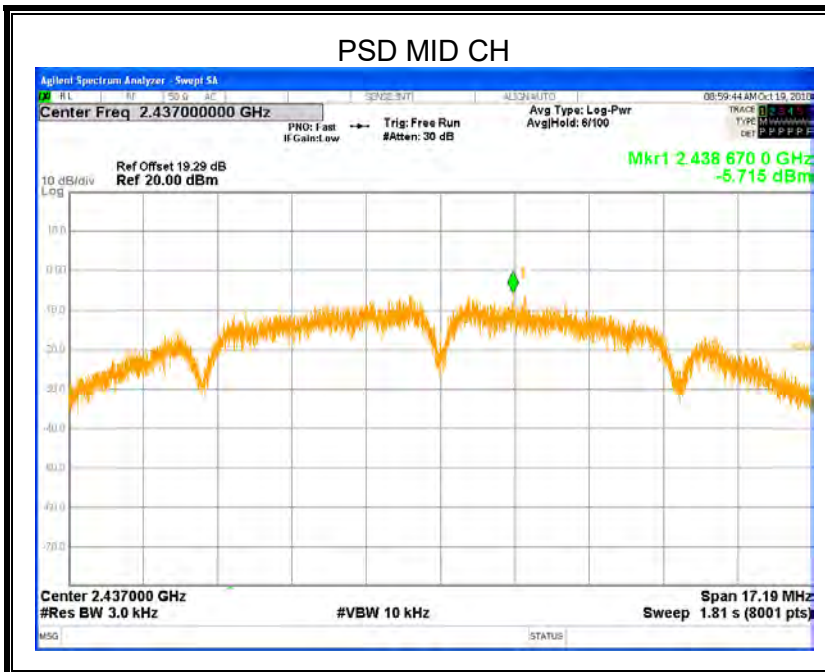
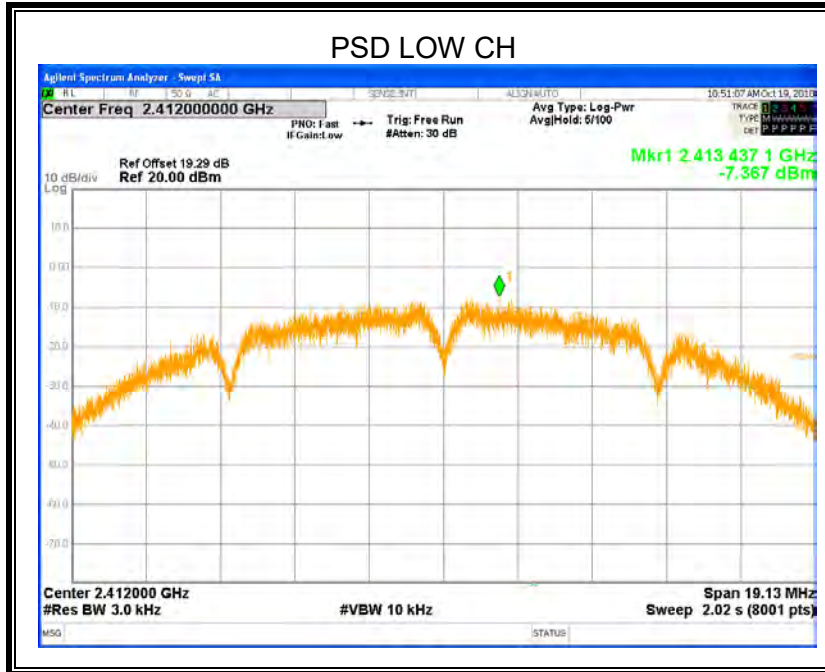

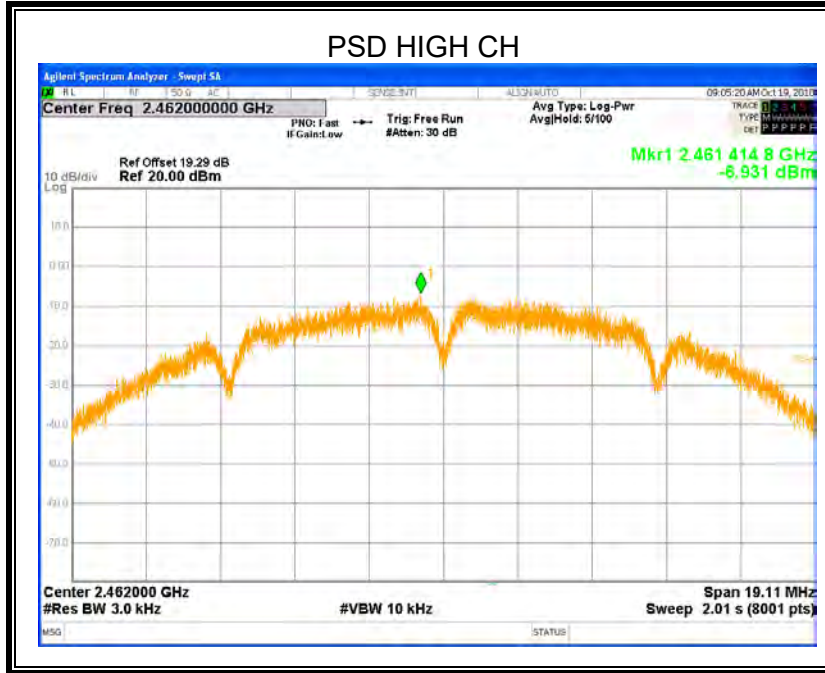

Note: All antennas had been test ,but only the worst data for Antenna 0 was recorded.



### 8.4.1. 802.11g MODE

Frequency (MHz)	ANT	Power Spectral Density (dBm/3kHz)		Limit (dBm/3kHz)
		Single	Total	
Low	0	-8.596	NA	8
Middle	0	-7.243		
High	0	-9.725		



**ANTENNA 0**

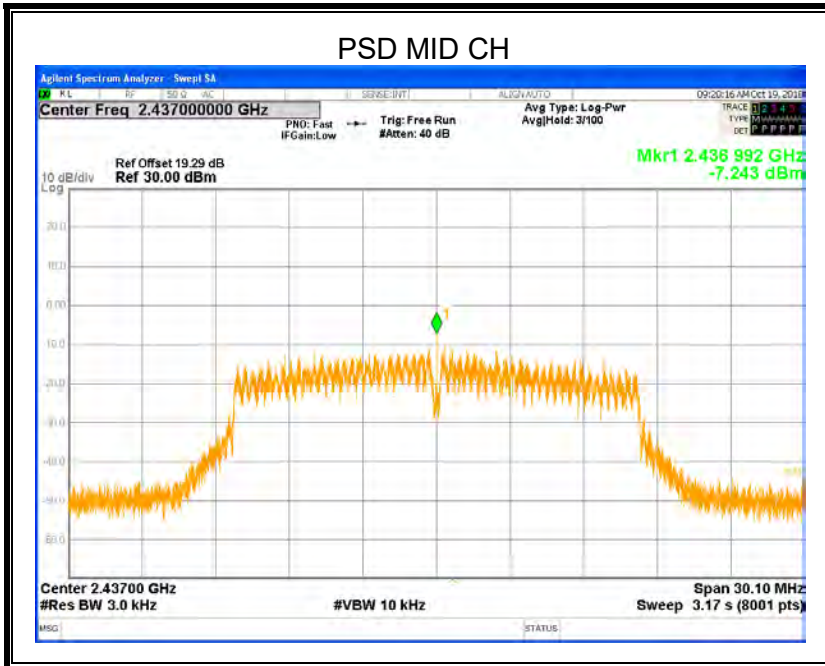
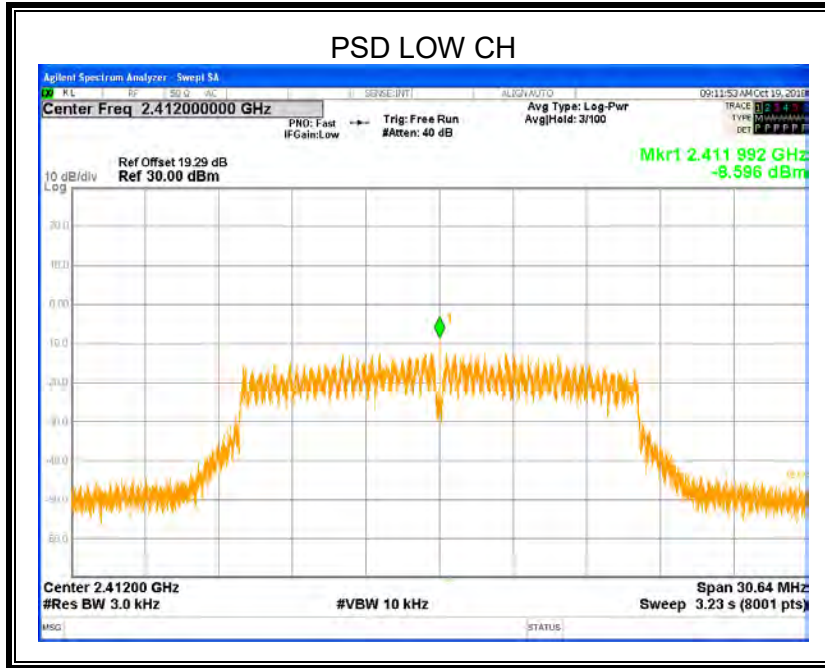

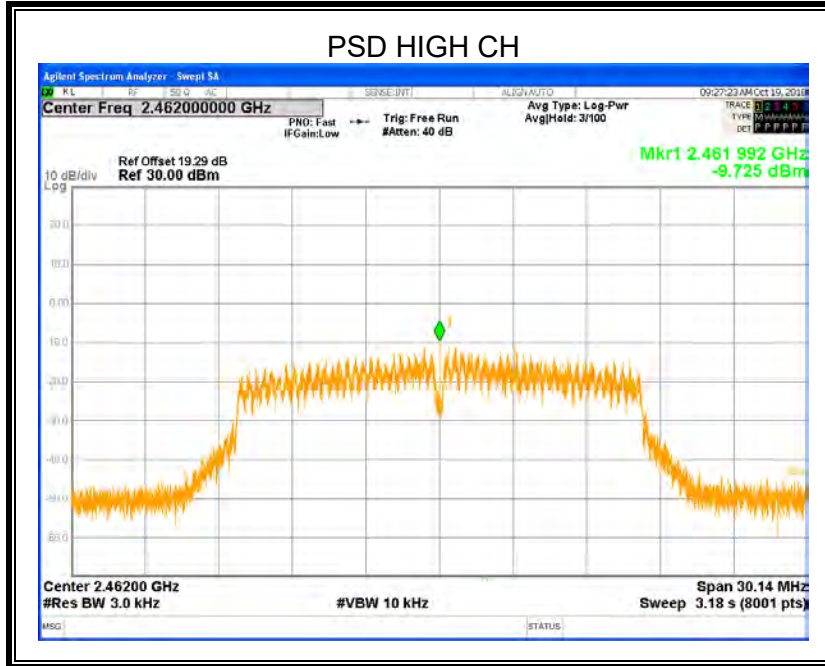

Note: All antennas had been test ,but only the worst data for Antenna 0 was recorded.



**8.4.2. 802.11n HT20 MODE**

Frequency (MHz)	ANT	Power Spectral Density (dBm/3kHz)		Limit (dBm/3kHz)
		Single	Total	
Low	0	-16.976	-14.516	8
	1	-18.158		
Middle	0	-15.832	-13.278	
	1	-16.799		
High	0	-17.089	-14.471	
	1	-17.912		





**ANTENNA 0**

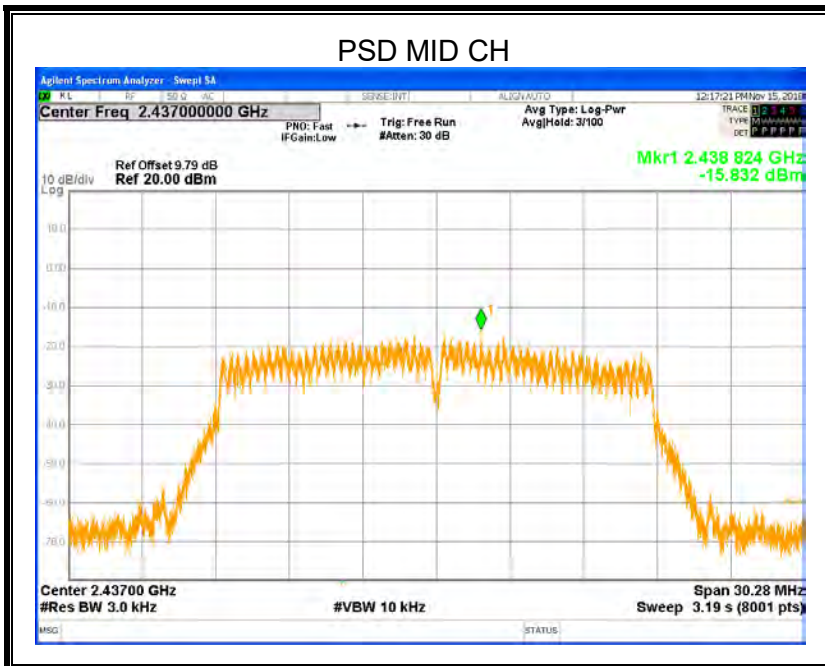
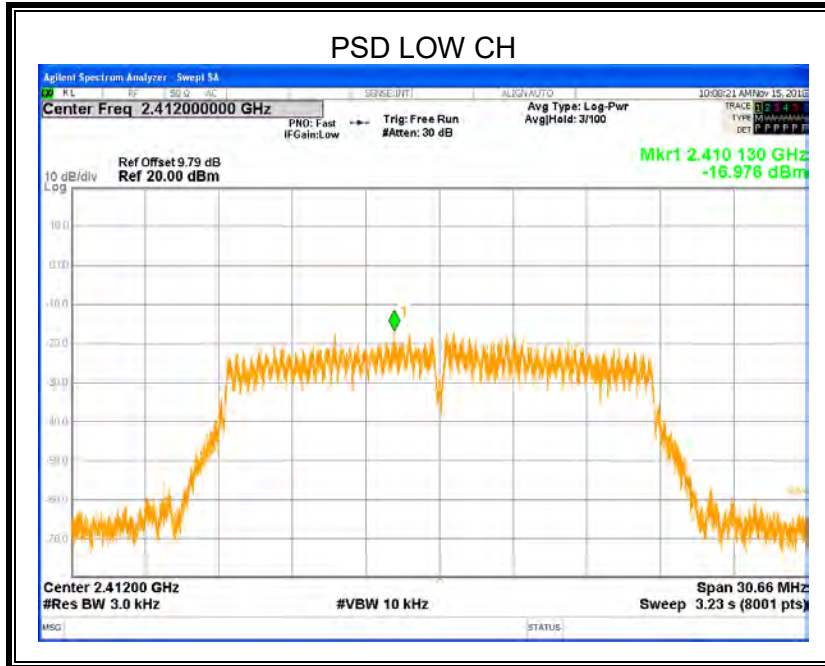

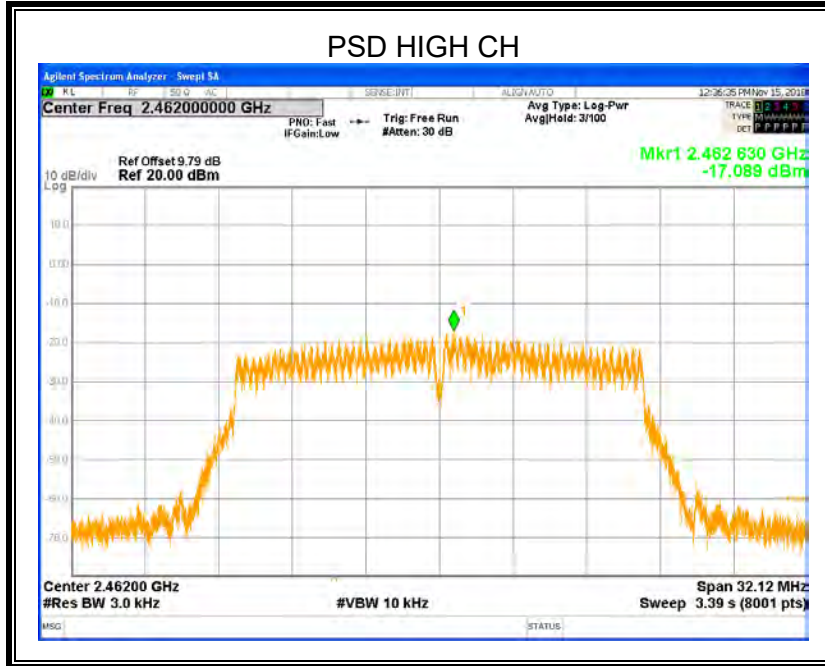

**ANTENNA 1**

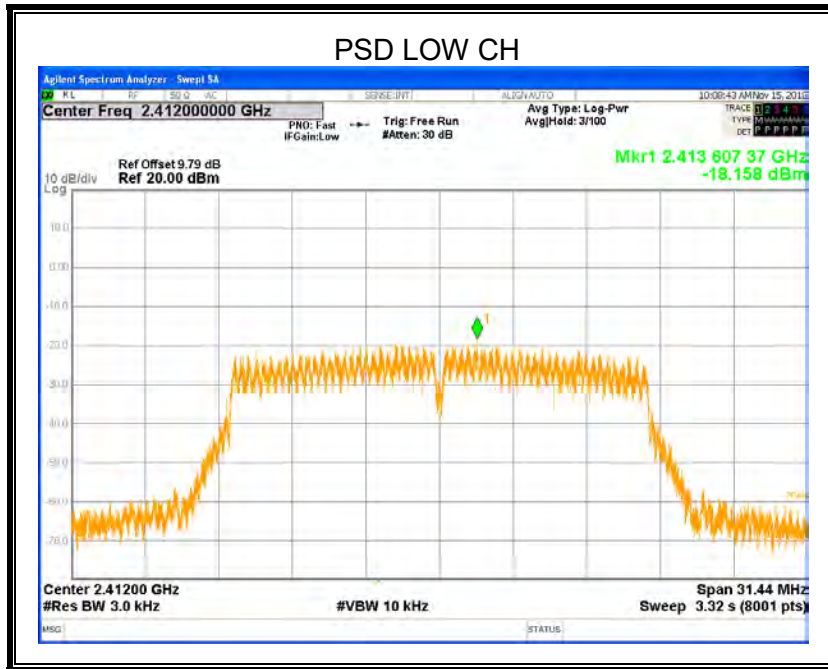

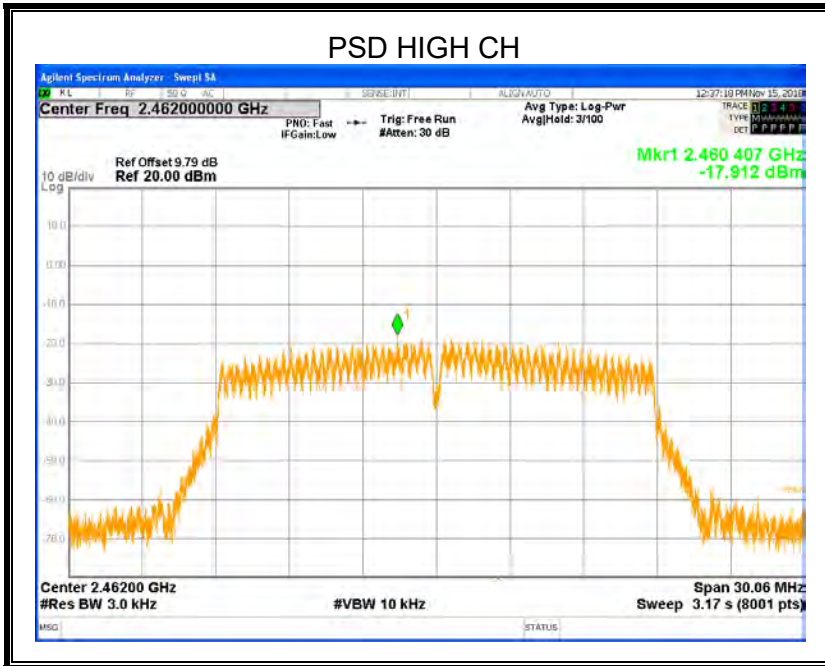
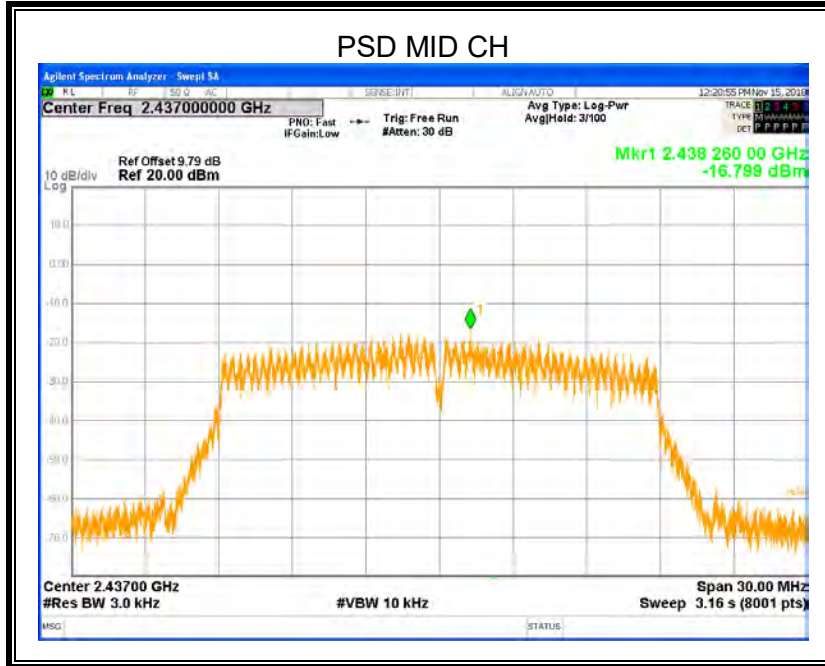



**8.4.3. 802.11n HT40 MODE**

Frequency (MHz)	ANT	Power Spectral Density (dBm/3kHz)		Limit (dBm/3kHz)
		Single	Total	
Low	0	-21.608	-19.442	8
	1	-23.501		
Middle	0	-20.291	-17.368	
	1	-20.468		
High	0	-22.138	-18.622	
	1	-21.180		



**ANTENNA 0**

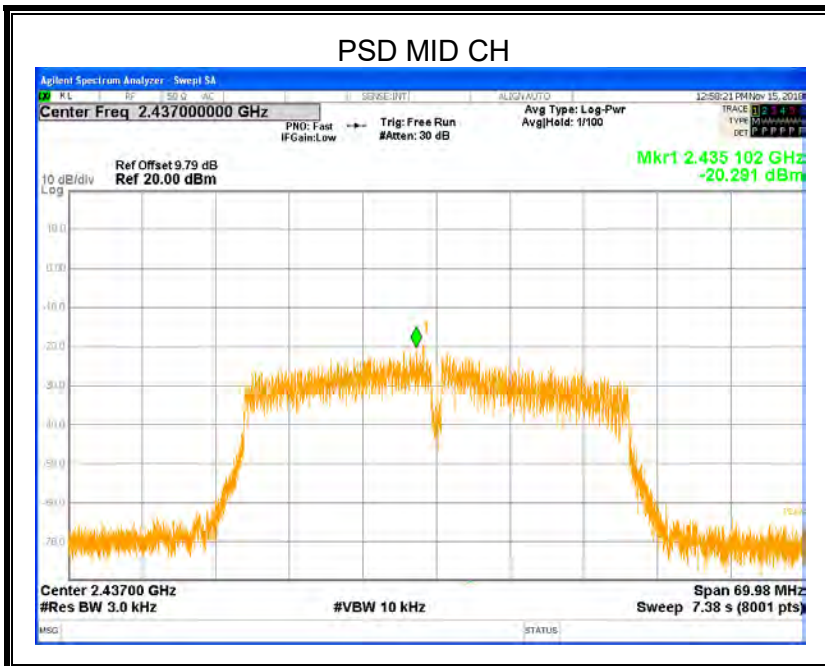
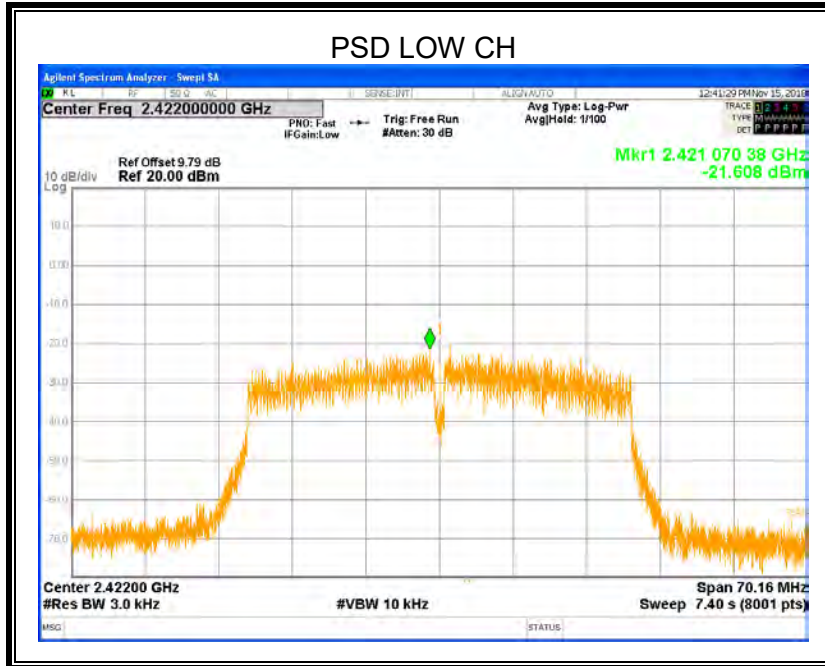



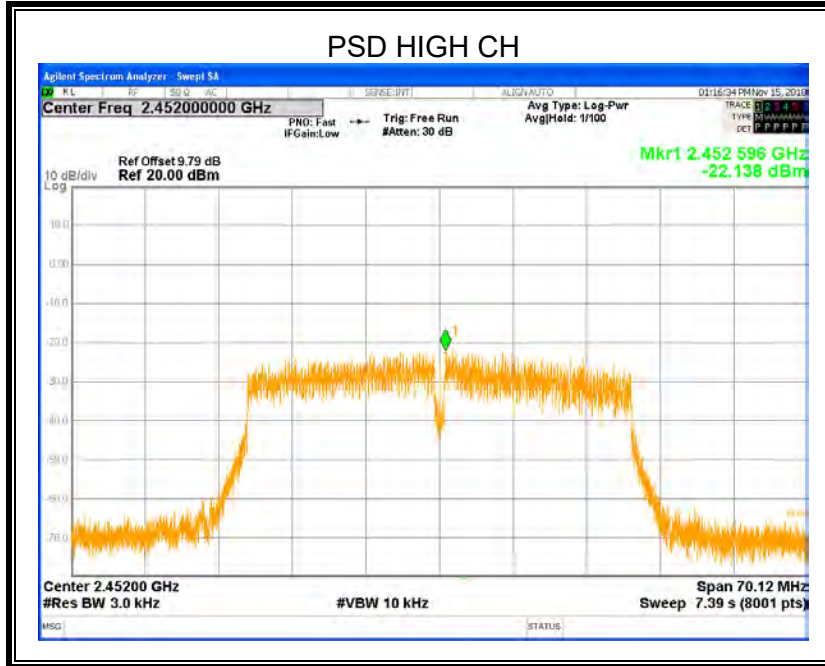

**ANTENNA 1**

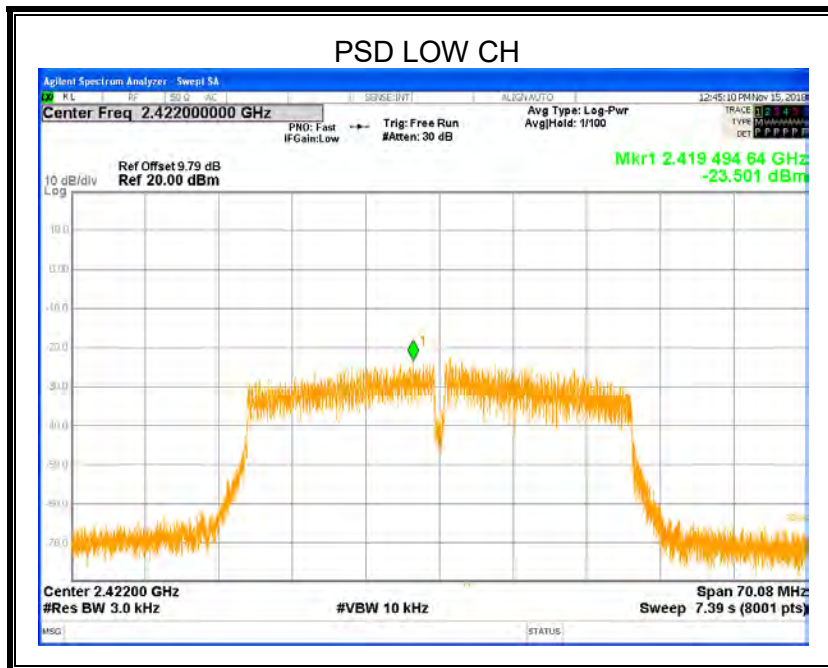

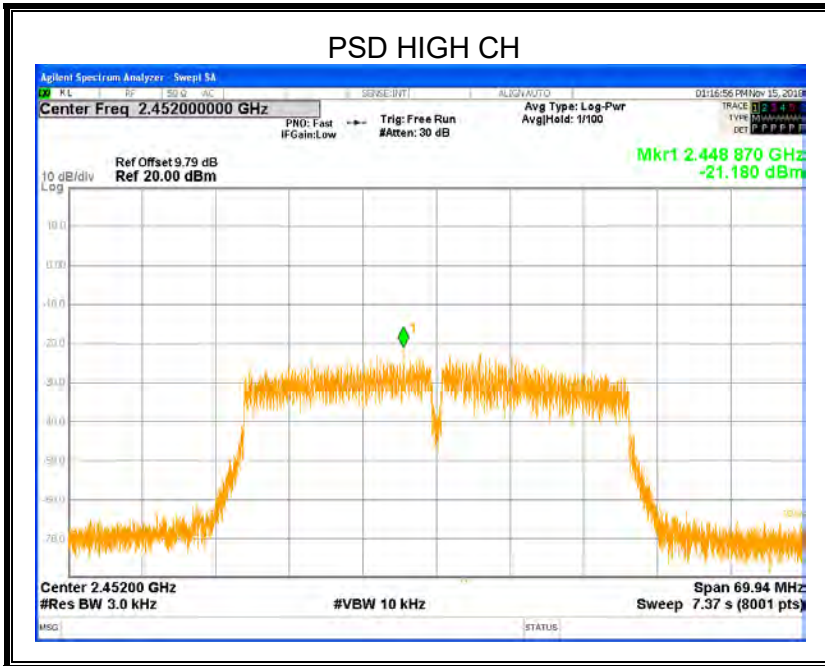
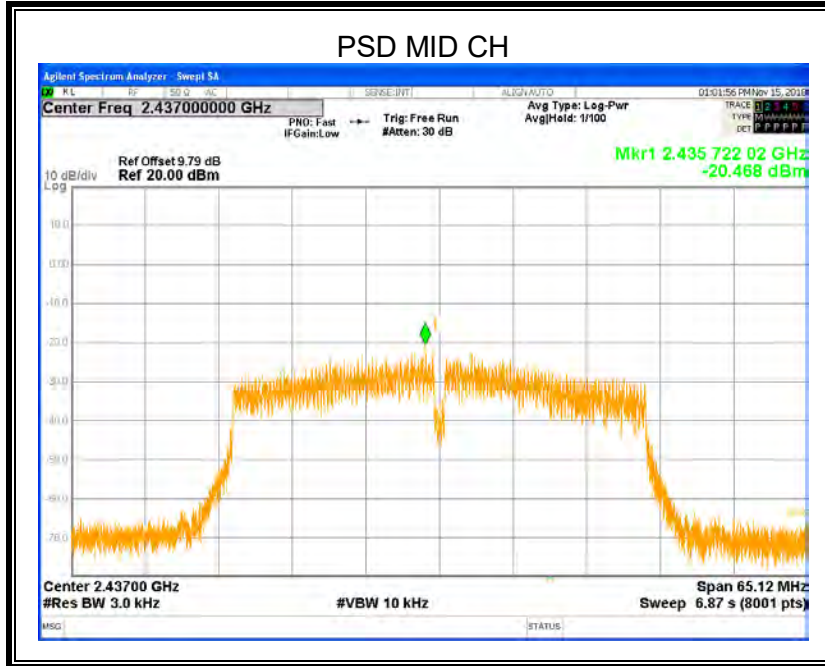



## 8.5. CONDUCTED BANDEGE AND SPURIOUS EMISSIONS

### LIMITS

CFR 47 FCC Part15 (15.247) Subpart C		
Section	Test Item	Limit
CFR 47 FCC §15.247 (d)	Conducted Bandedge and Spurious Emissions	at least 20 dB below that in the 100 kHz bandwidth within the band that contains the highest level of the desired power

### TEST PROCEDURE

Connect the UUT to the spectrum analyser and use the following settings:

Center Frequency	The centre frequency of the channel under test
Detector	Peak
RBW	100K
VBW	$\geq 3 \times \text{RBW}$
Span	1.5 x DTS bandwidth
Trace	Max hold
Sweep time	Auto couple.

Use the peak marker function to determine the maximum PSD level.

Span	Set the center frequency and span to encompass frequency range to be measured
Detector	Peak
RBW	100K
VBW	$\geq 3 \times \text{RBW}$
measurement points	$\geq \text{span}/\text{RBW}$
Trace	Max hold
Sweep time	Auto couple.

Use the peak marker function to determine the maximum amplitude level.





**TEST SETUP**

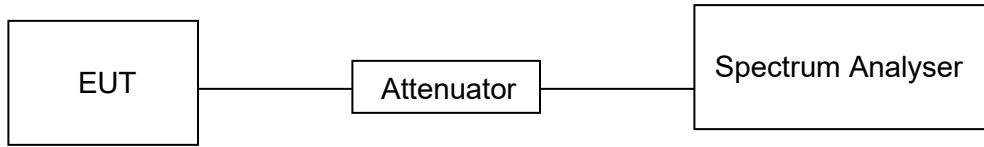

**TEST ENVIRONMENT**

Temperature	24.3°C	Relative Humidity	56%
Atmosphere Pressure	101kPa	Test Voltage	DC 5V

**RESULTS**



### 8.5.1. 802.11b MODE

#### ANTENNA 0

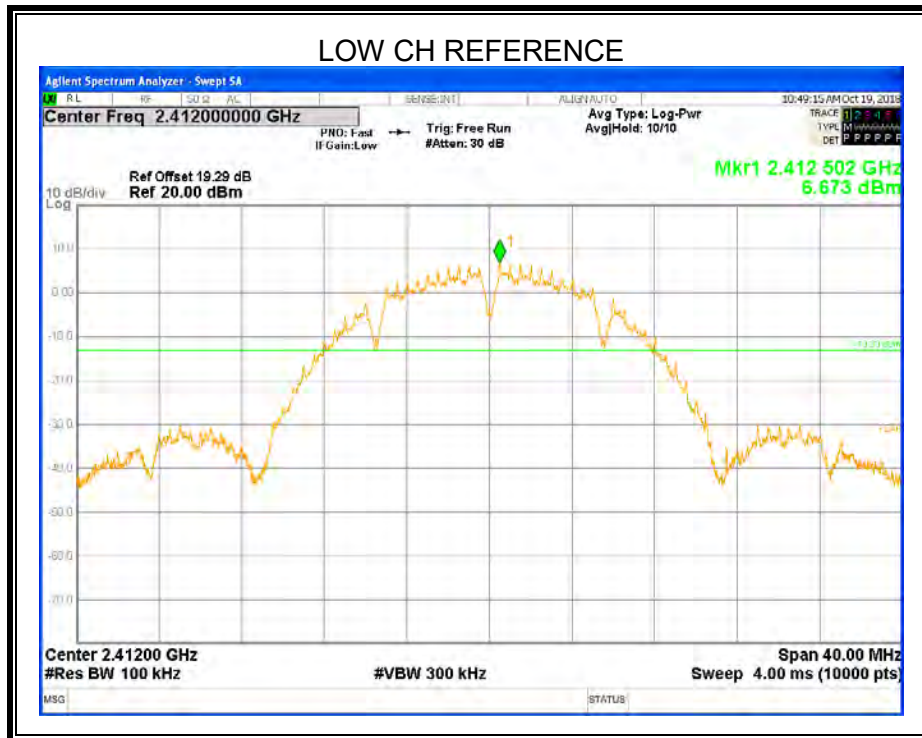
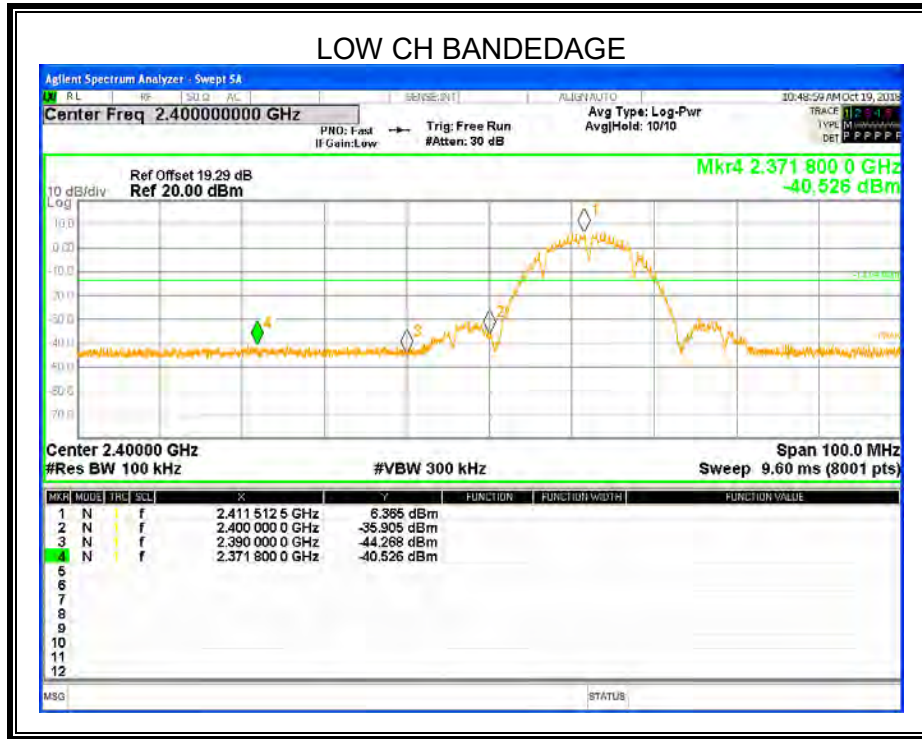

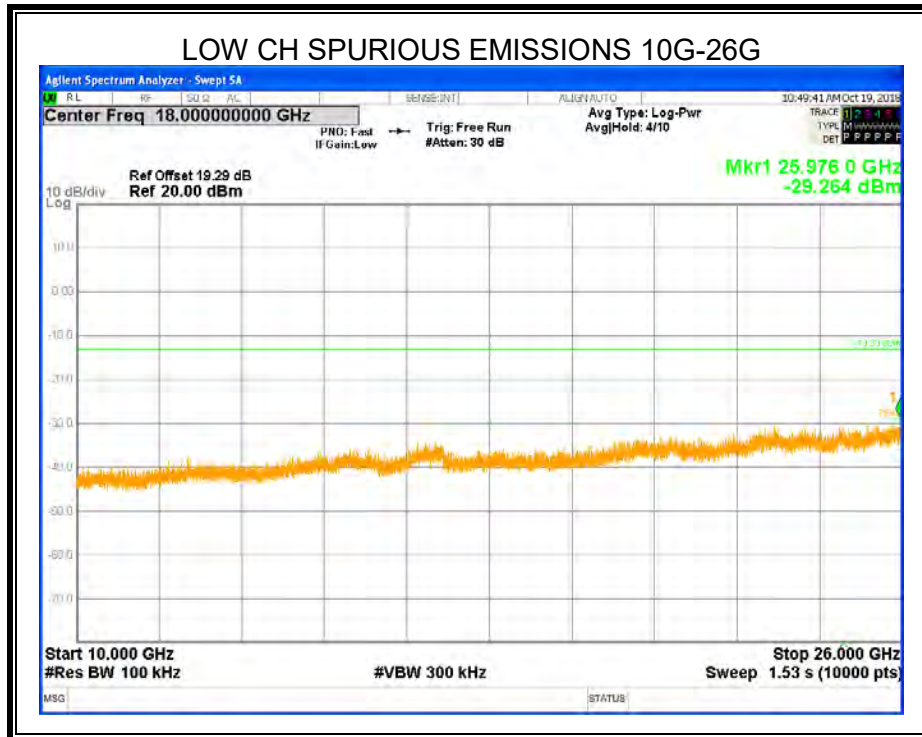
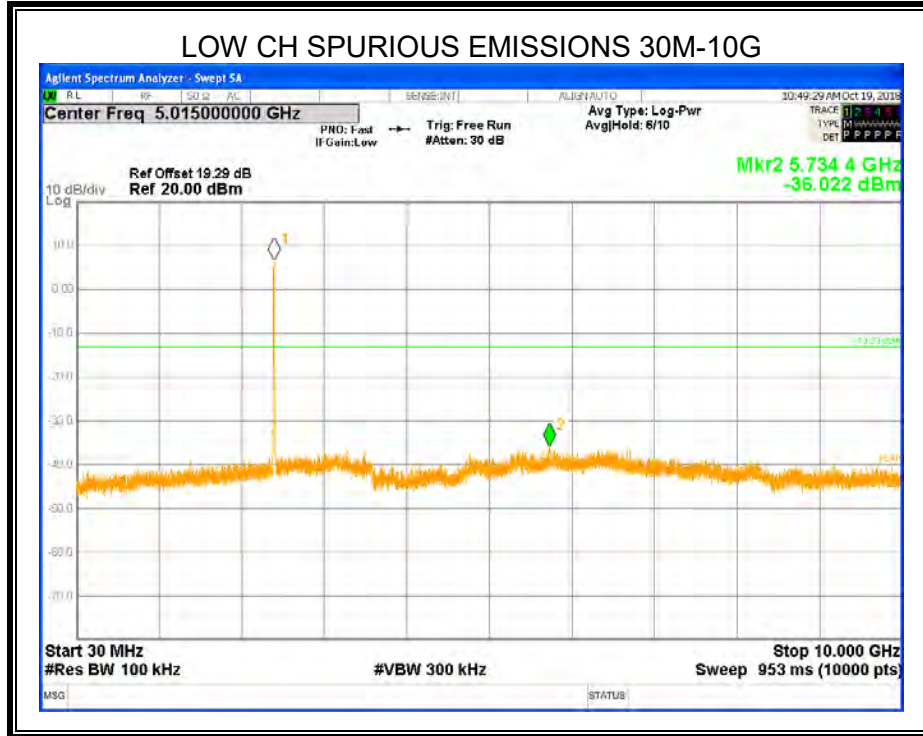

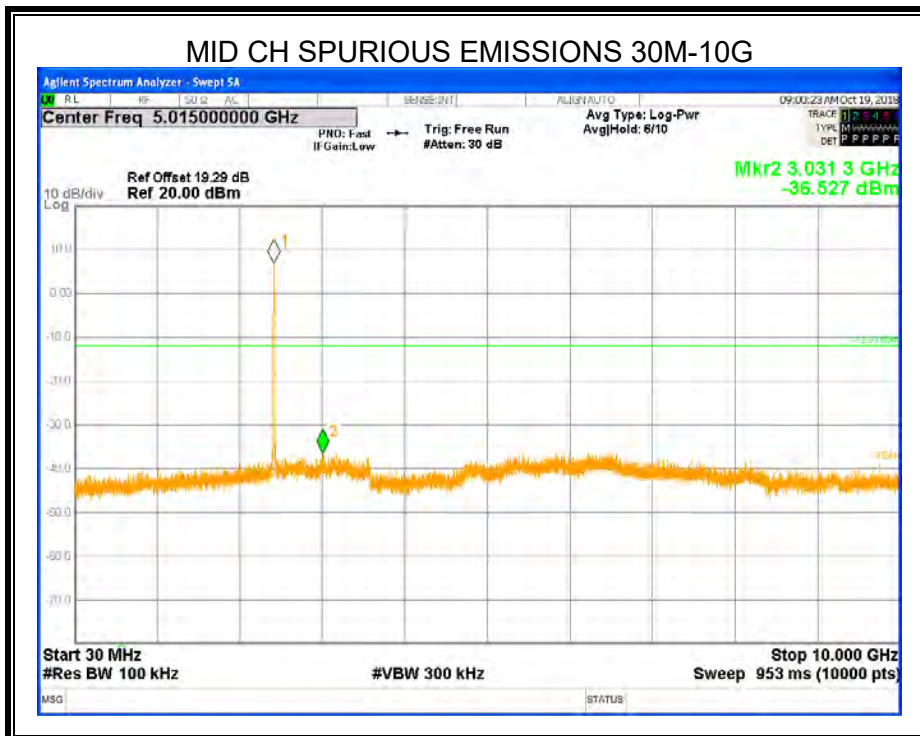
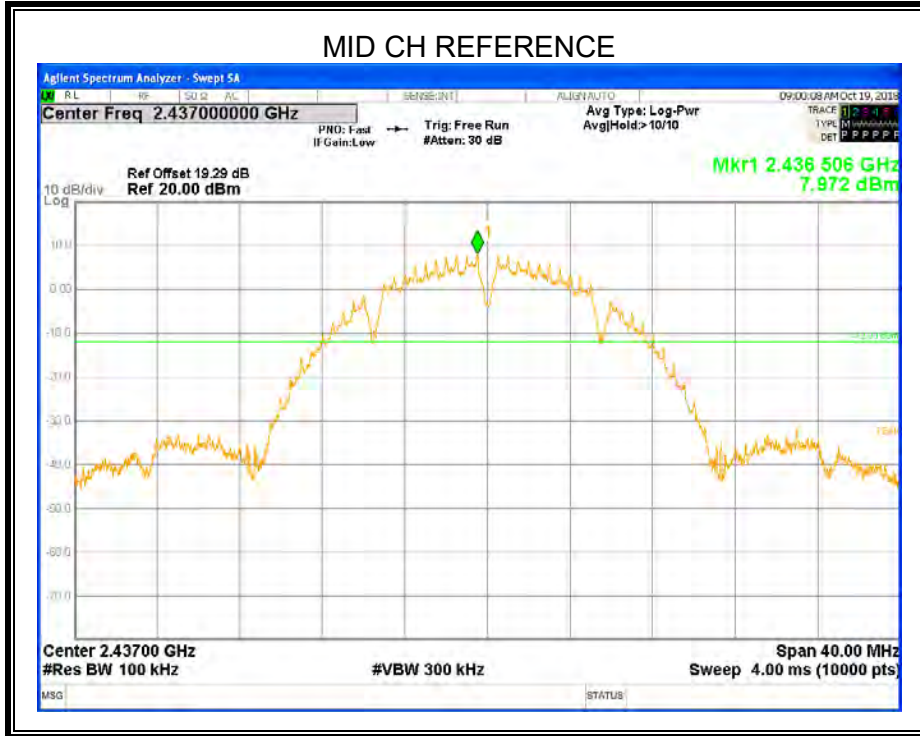

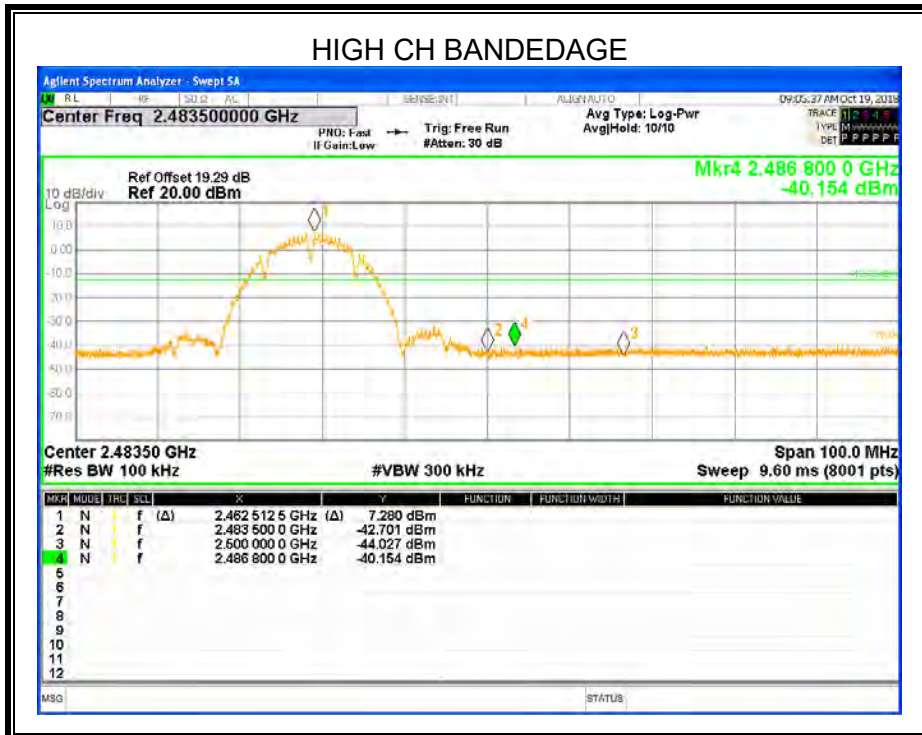
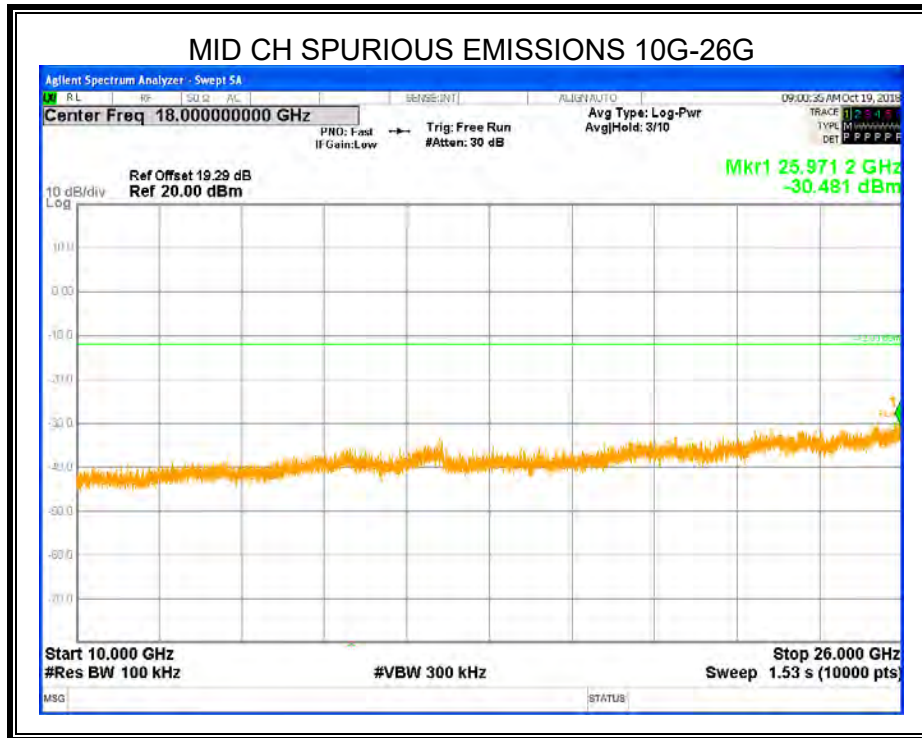



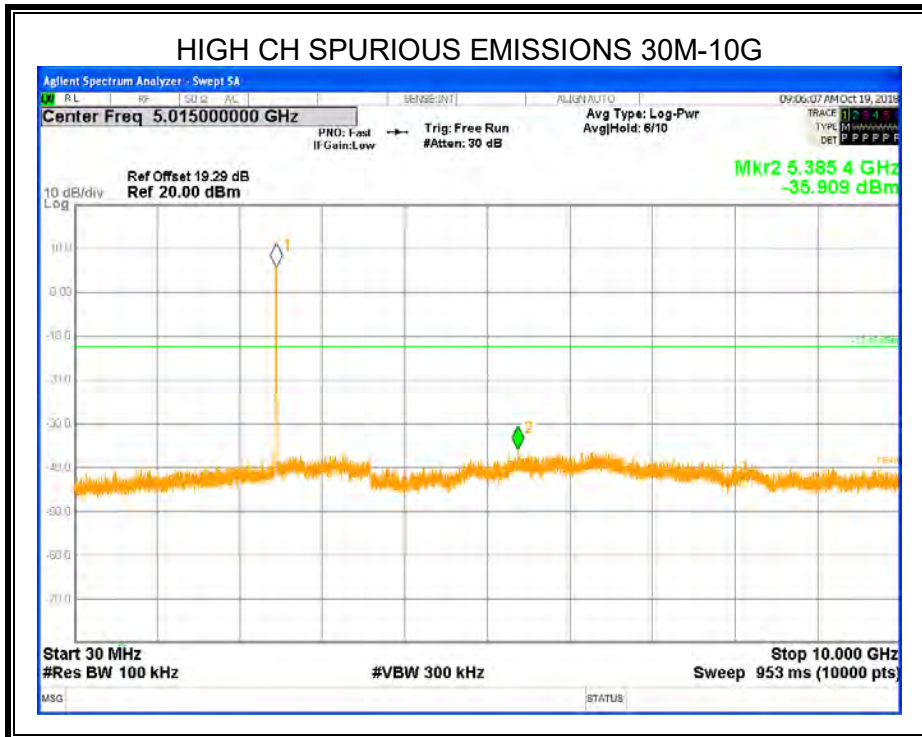
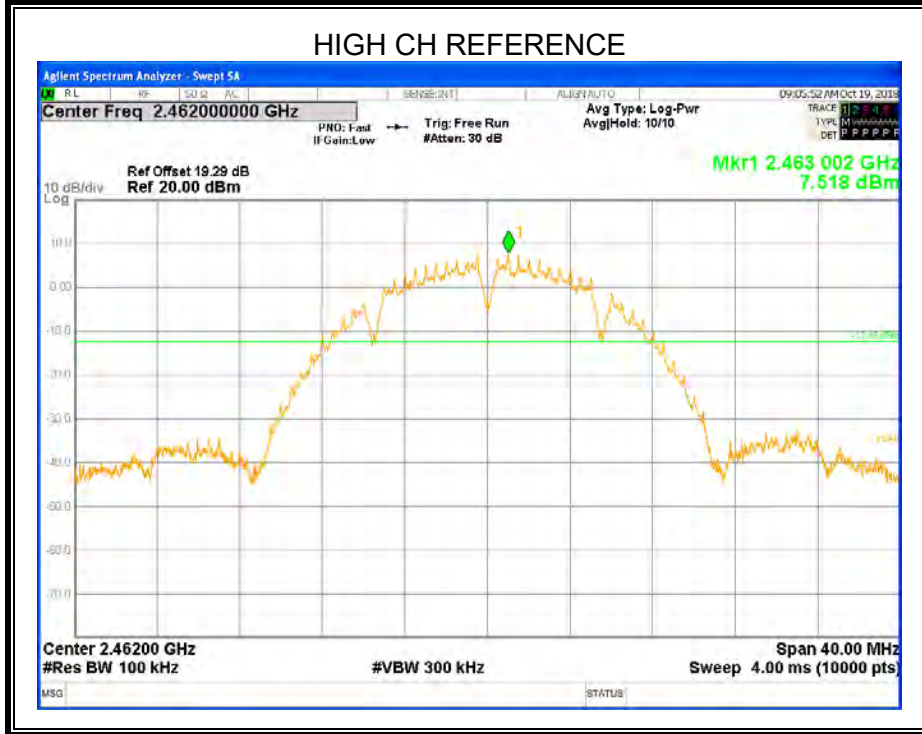

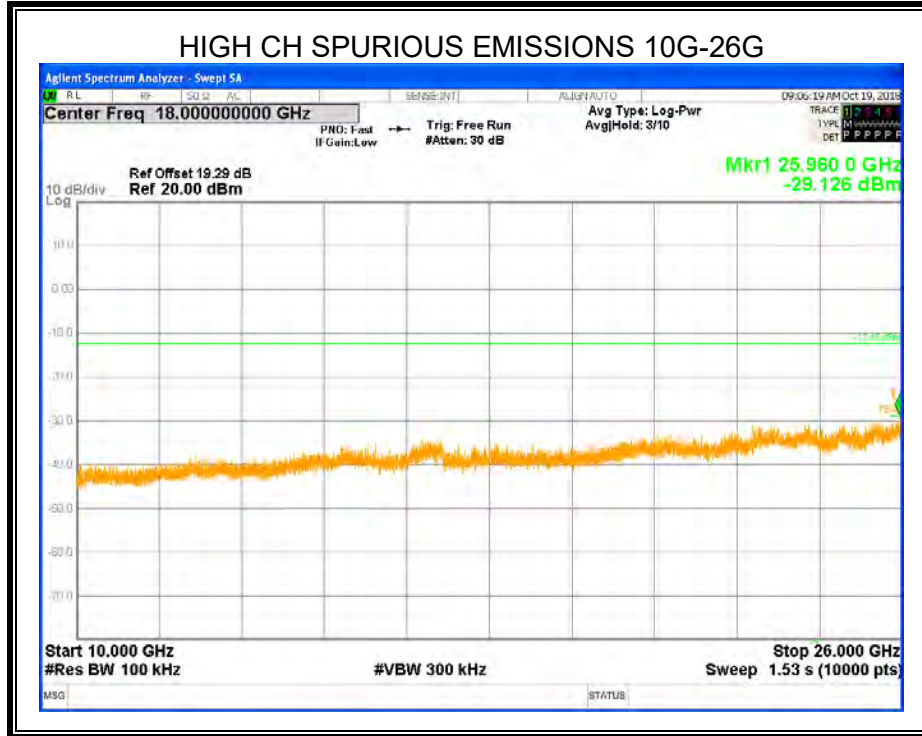

Note: All antennas had been test ,but only the worst data for Antenna 0 was recorded.



### 8.5.2. 802.11g MODE

#### ANTENNA 0

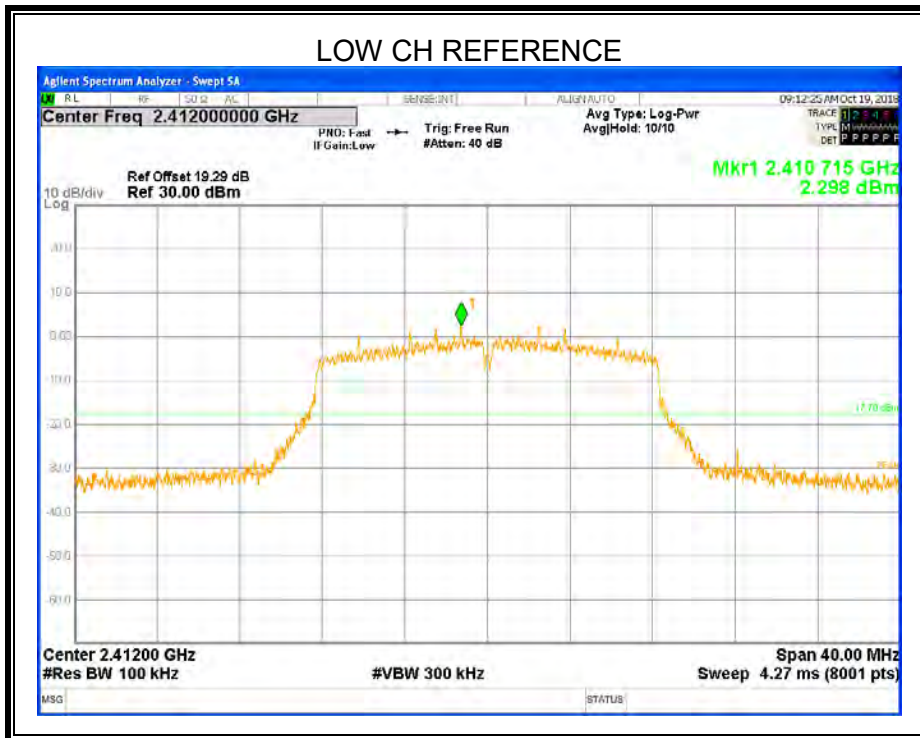
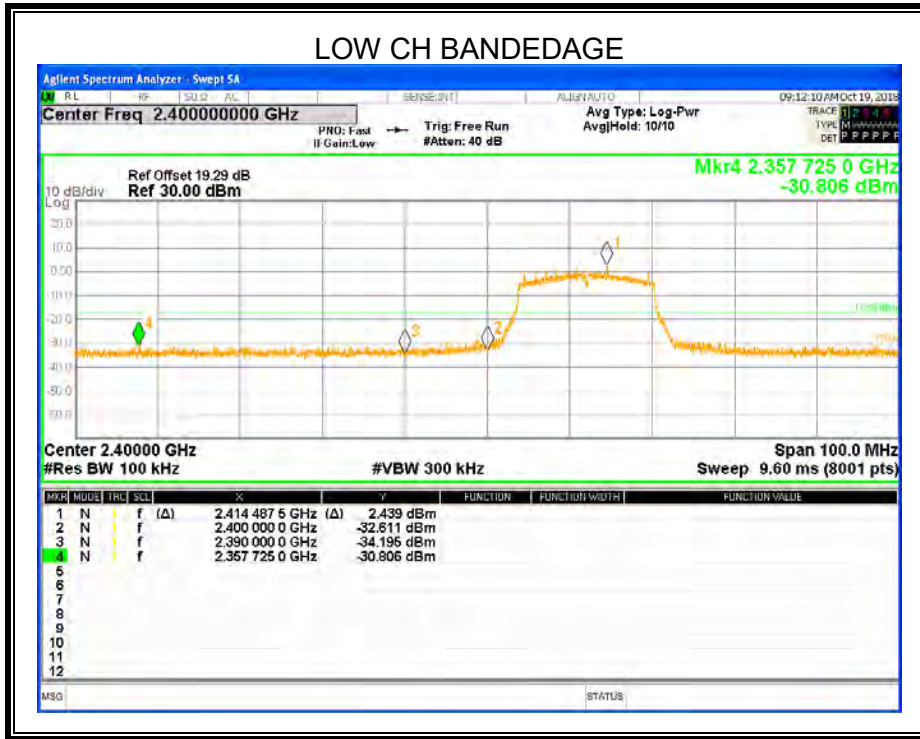



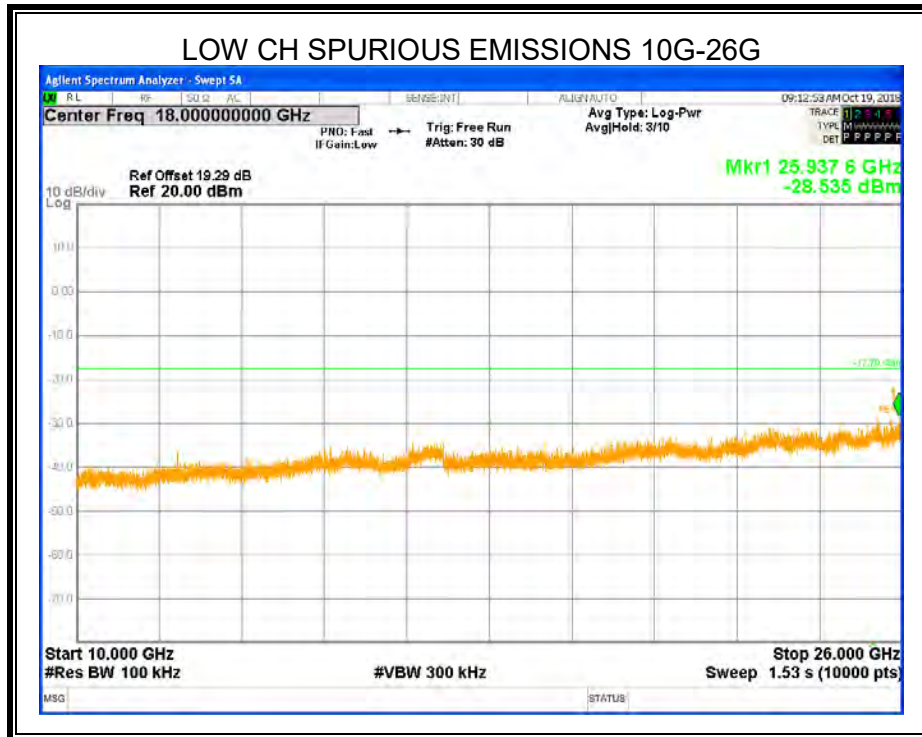
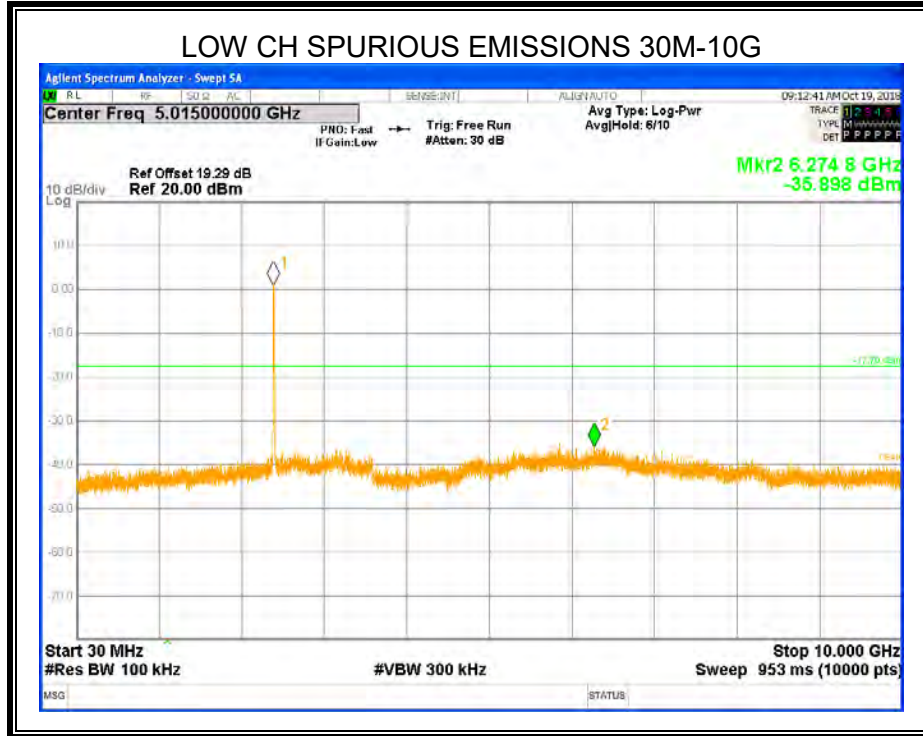

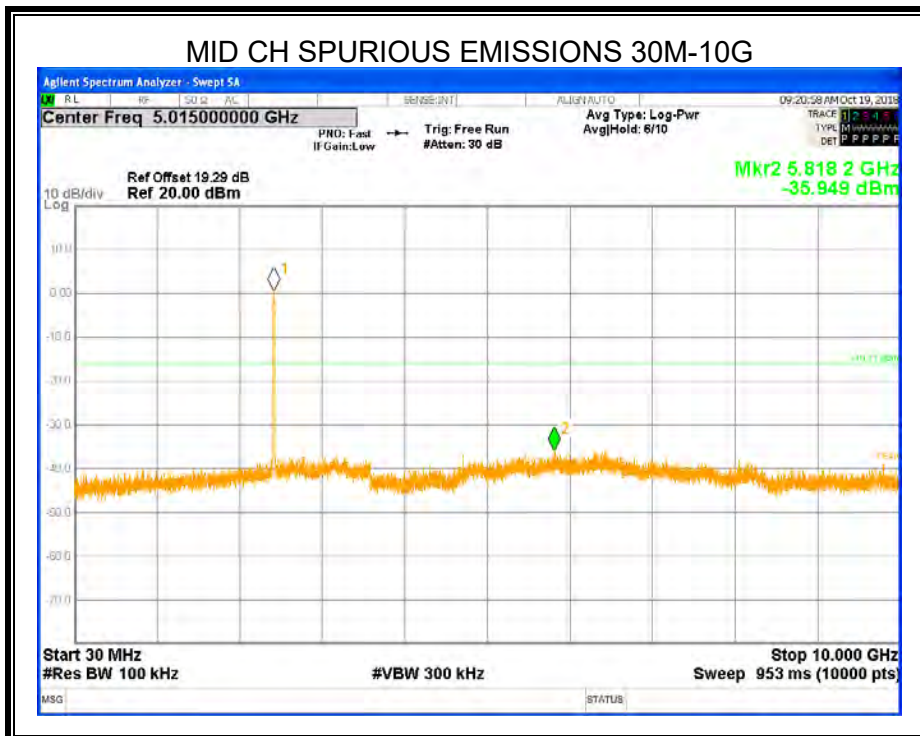
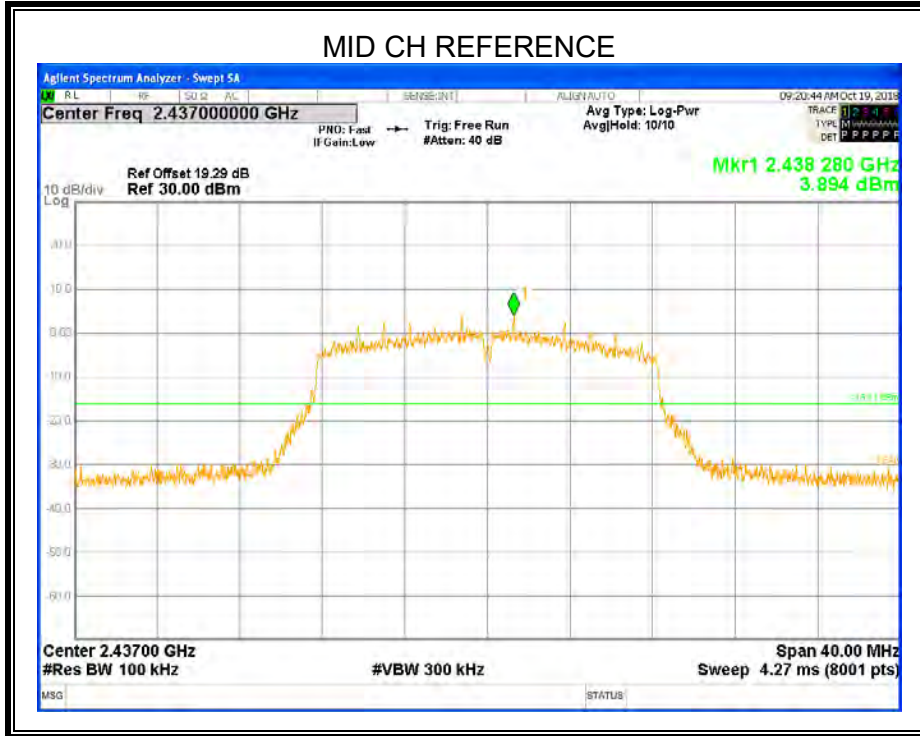

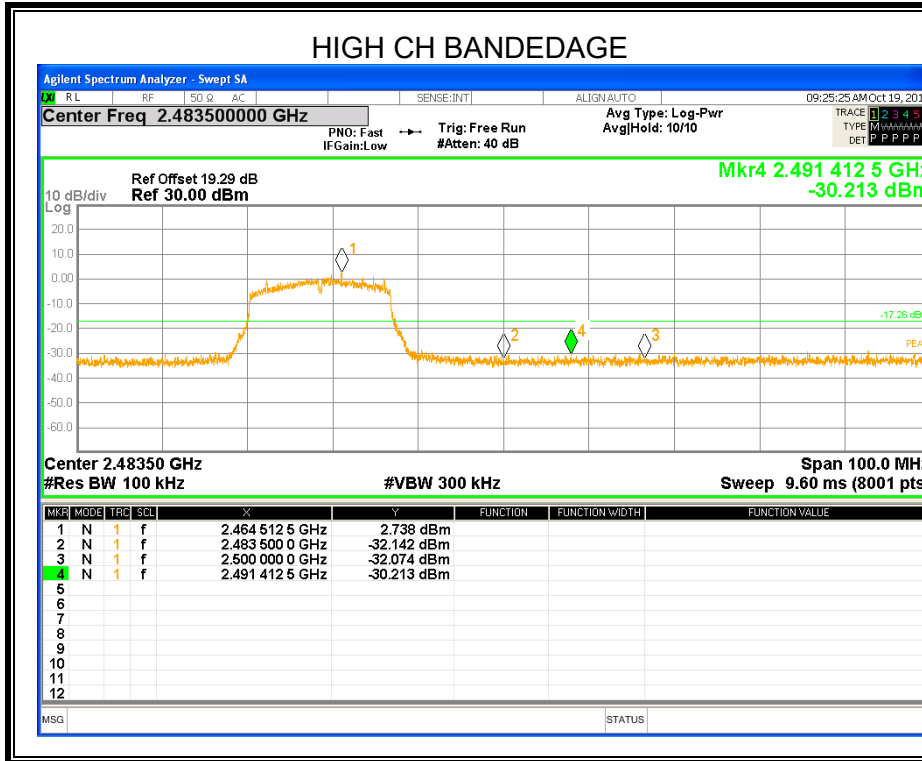
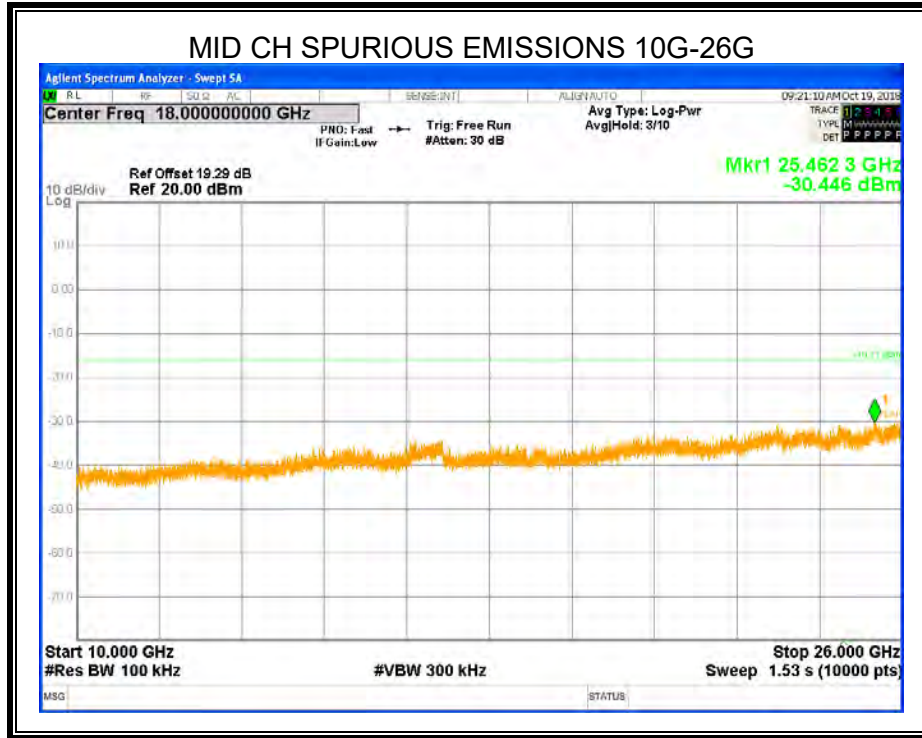

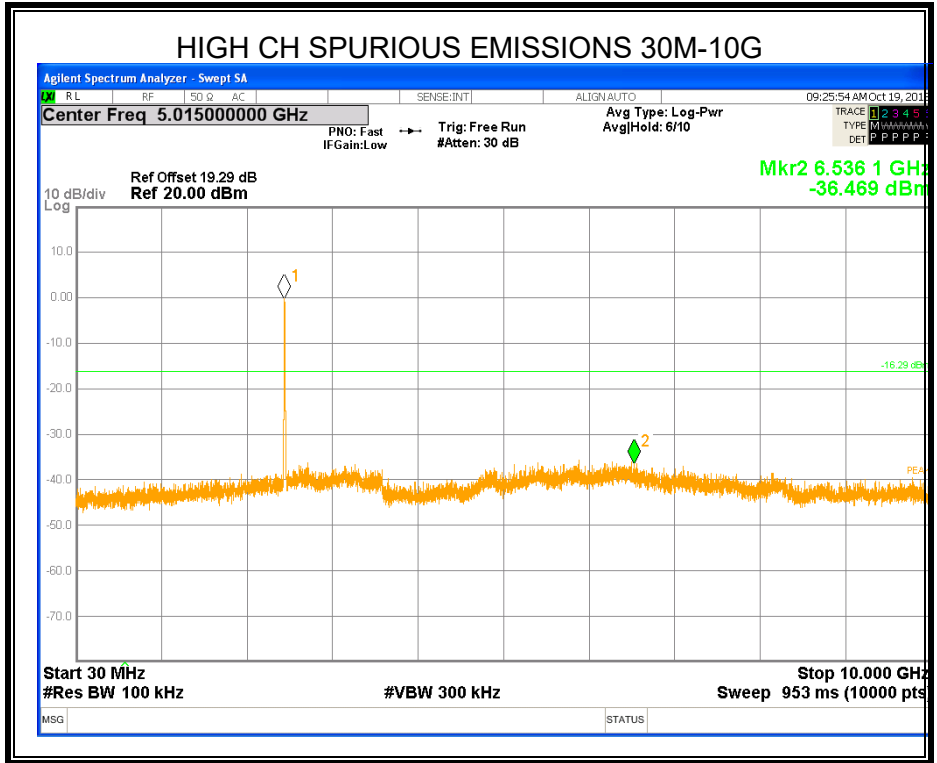
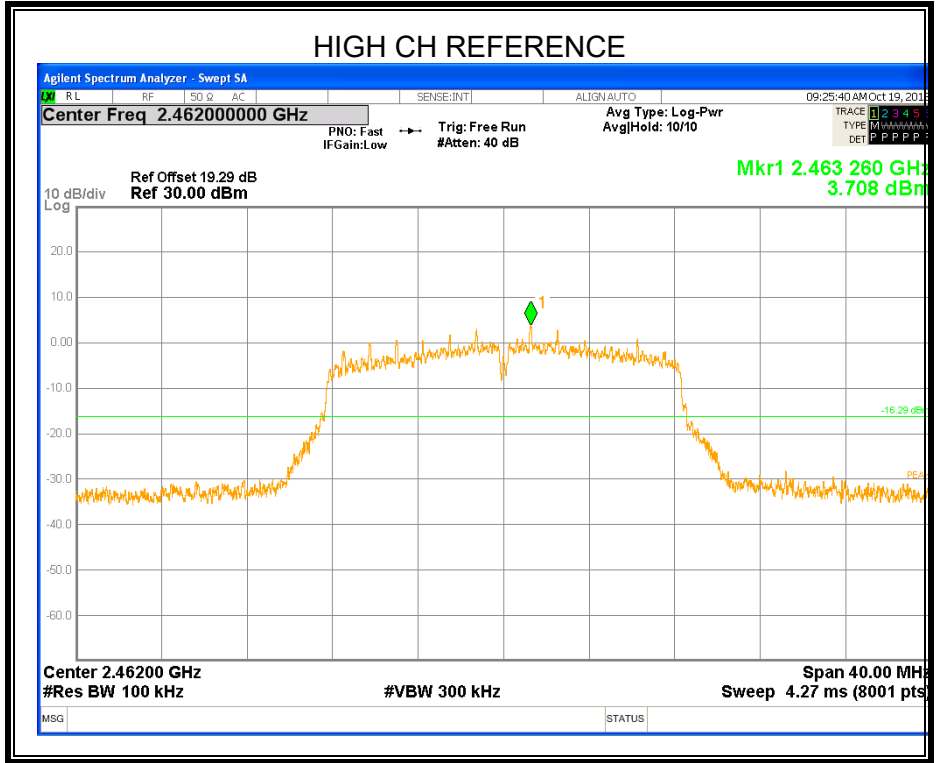

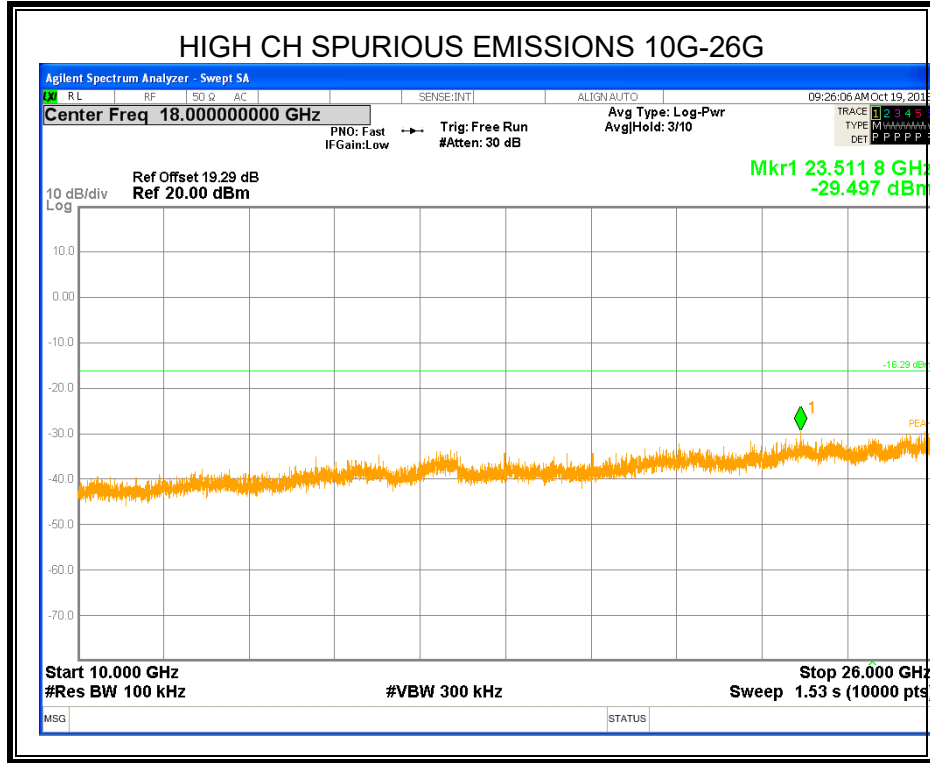

Note: All antennas had been test ,but only the worst data for Antenna 0 was recorded.



### 8.5.3. 802.11n HT20 MODE

#### MIMO MODE-2TX

#### ANTENNA 0

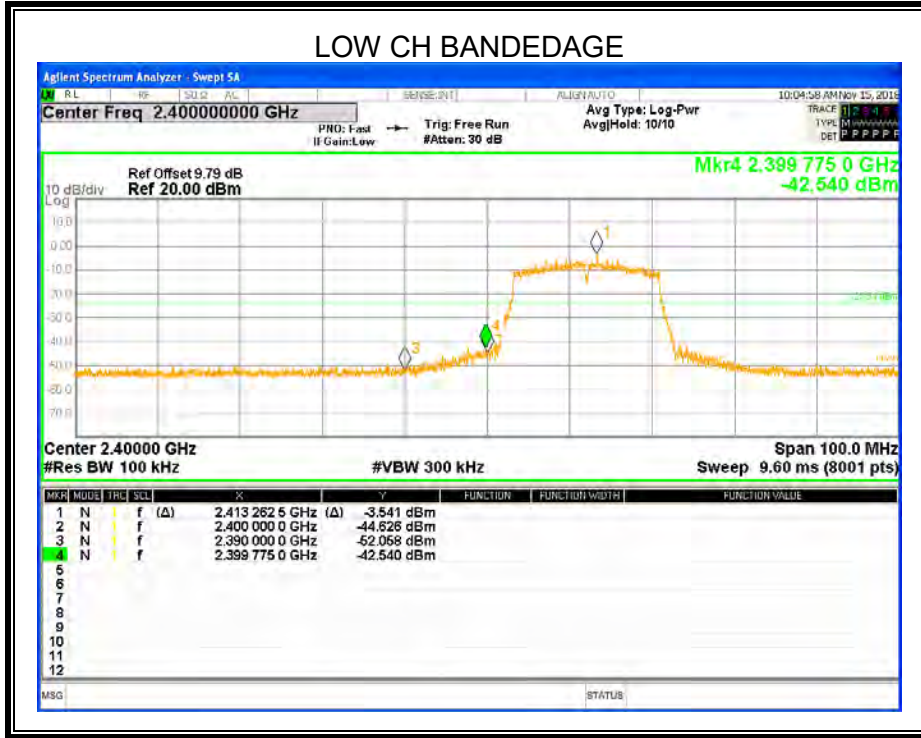



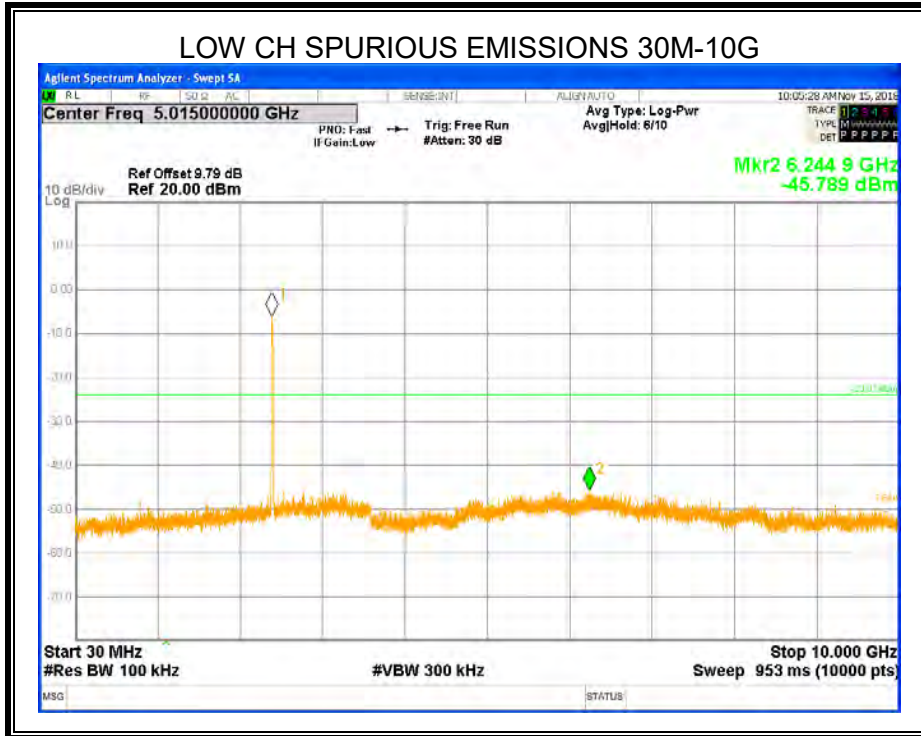
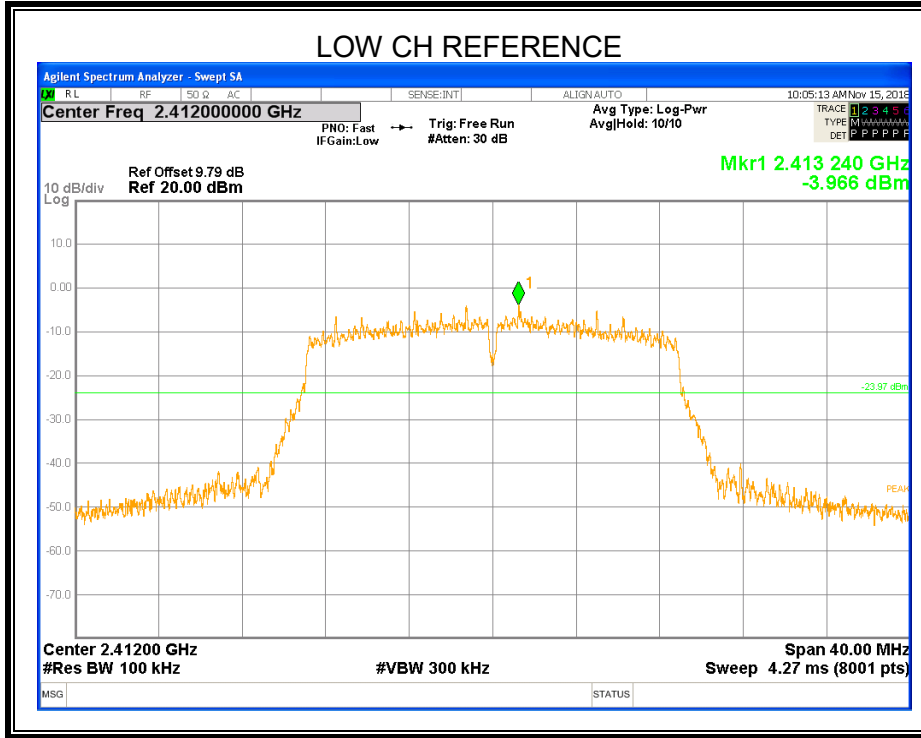

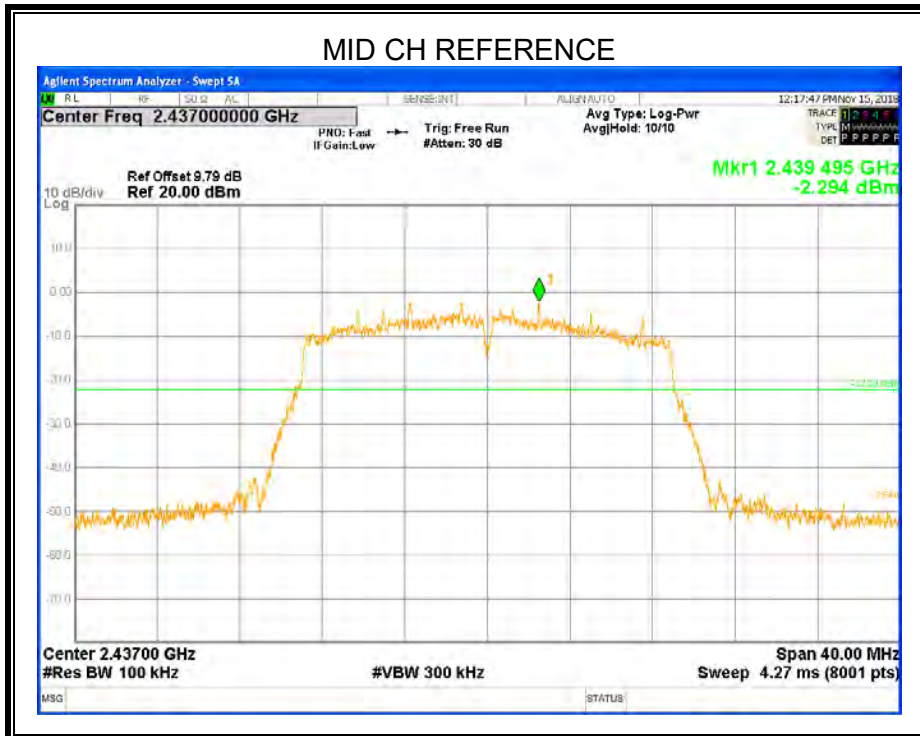
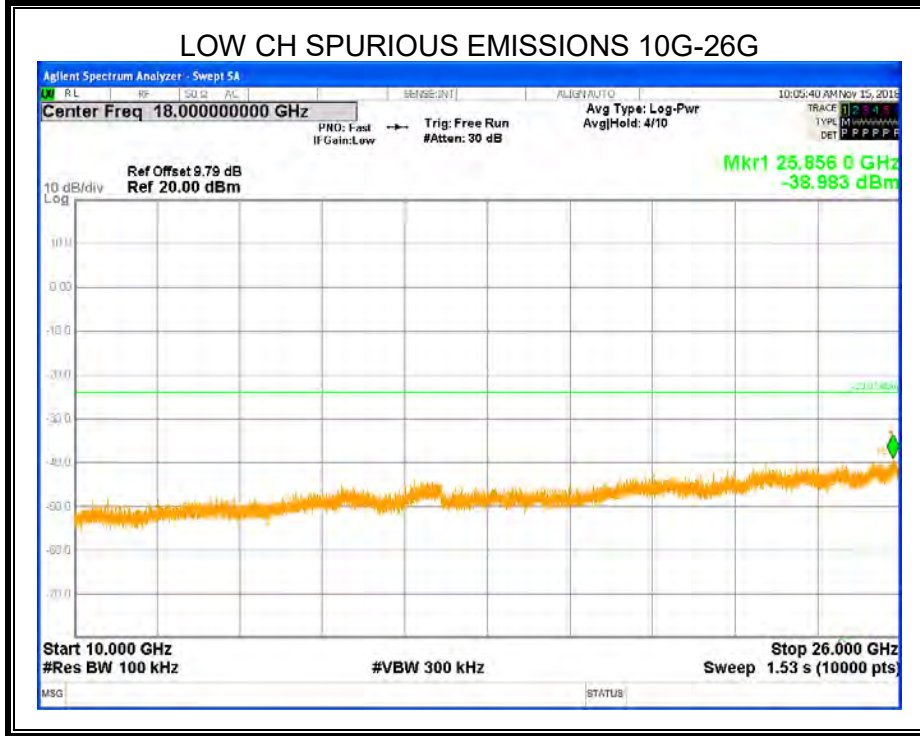



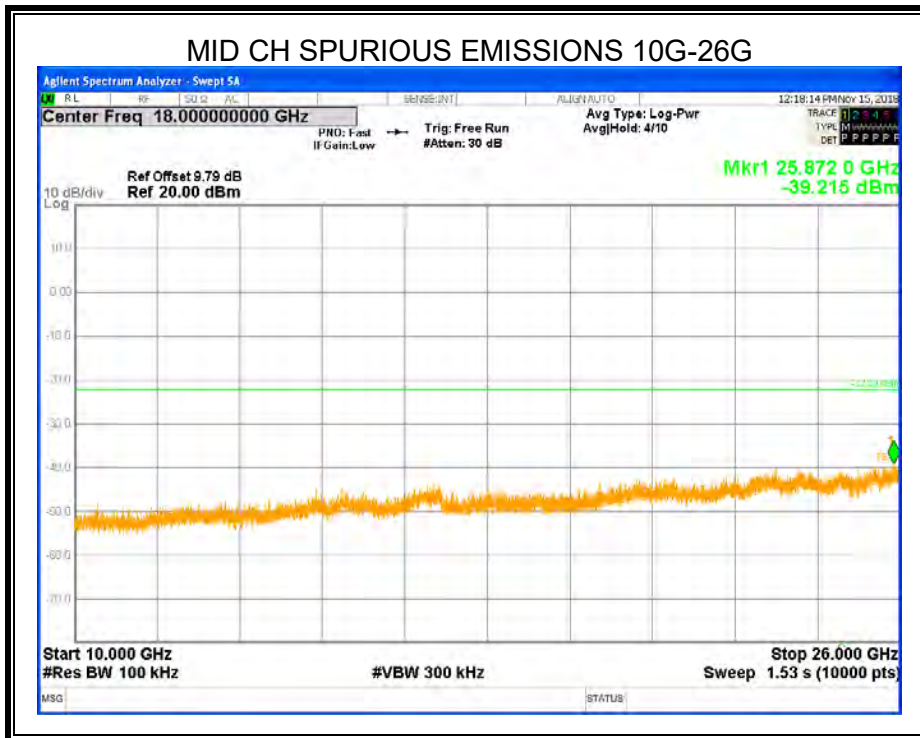
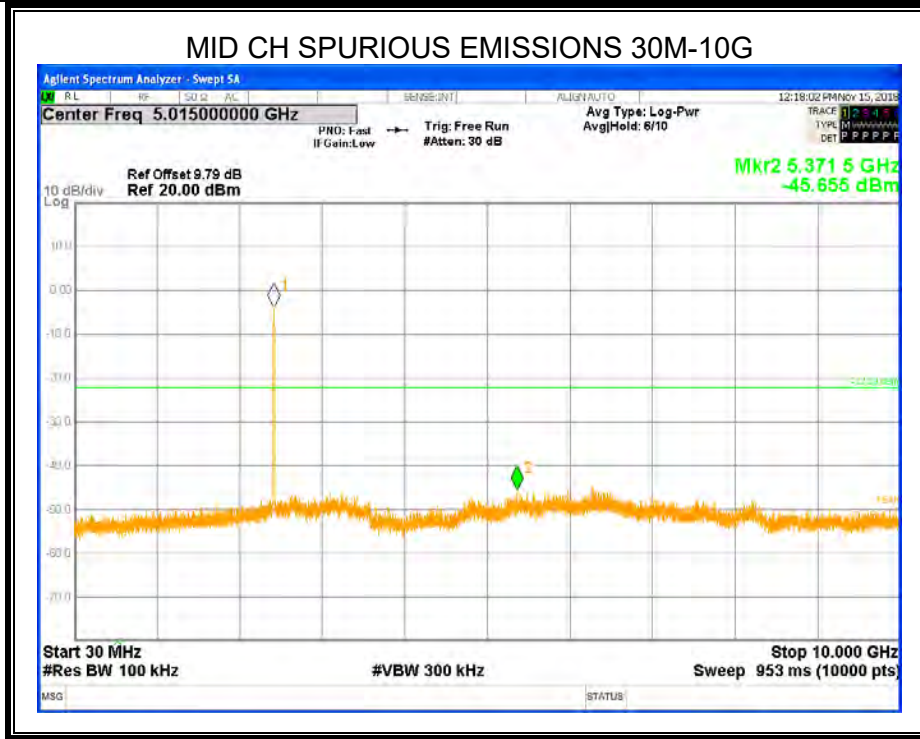

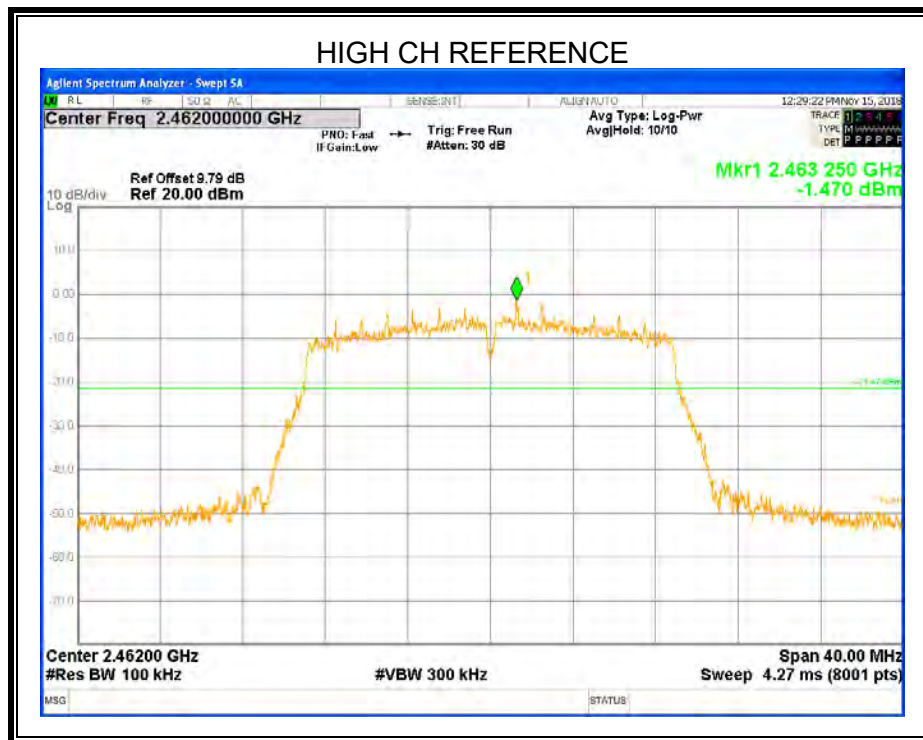
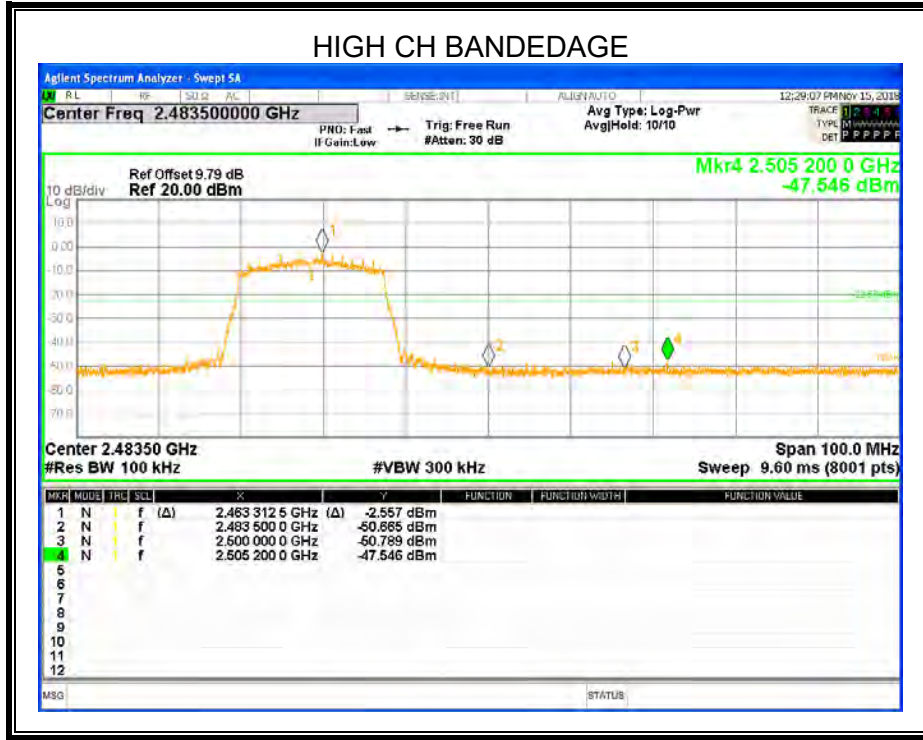

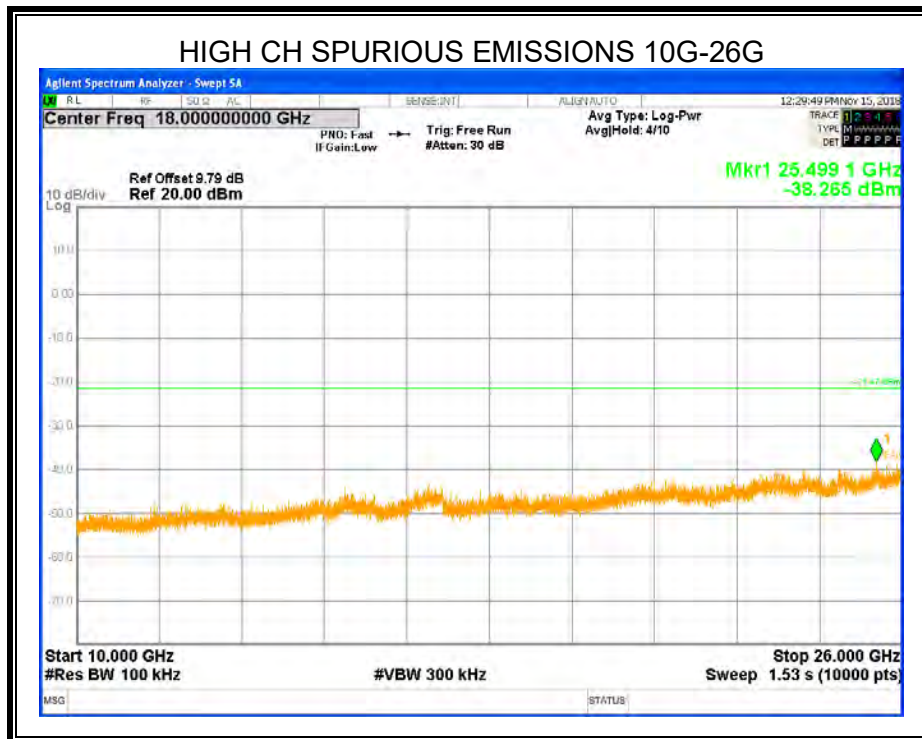
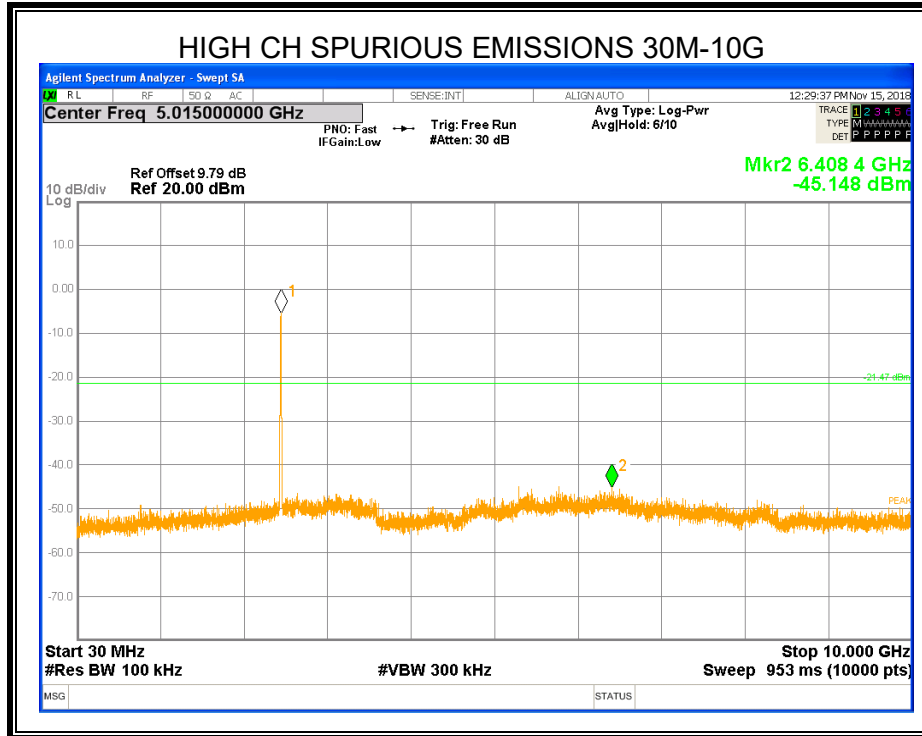



ANTENNA 1

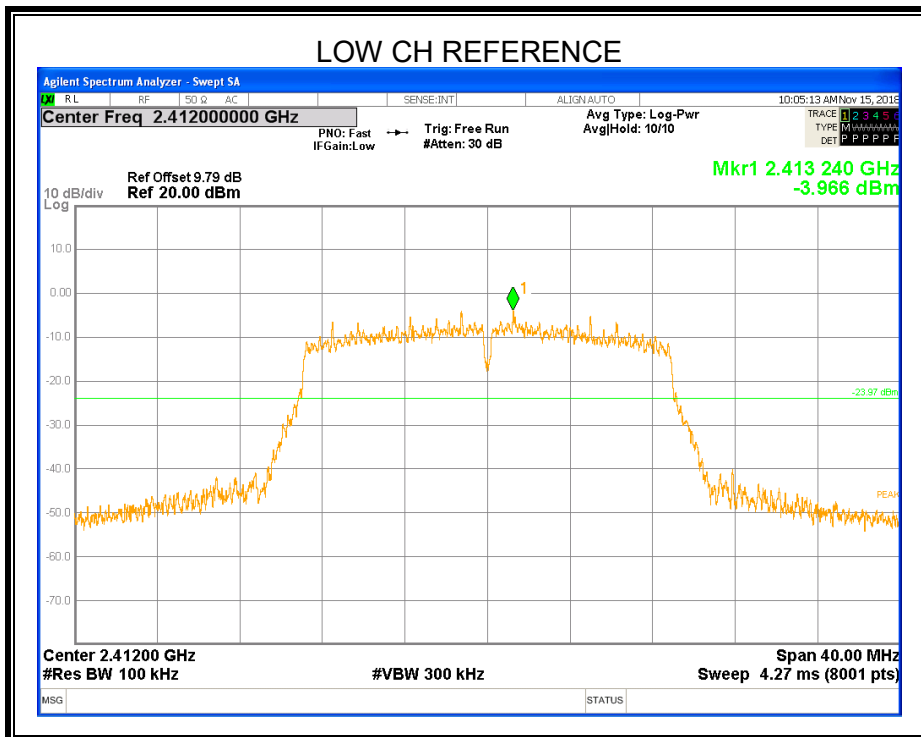
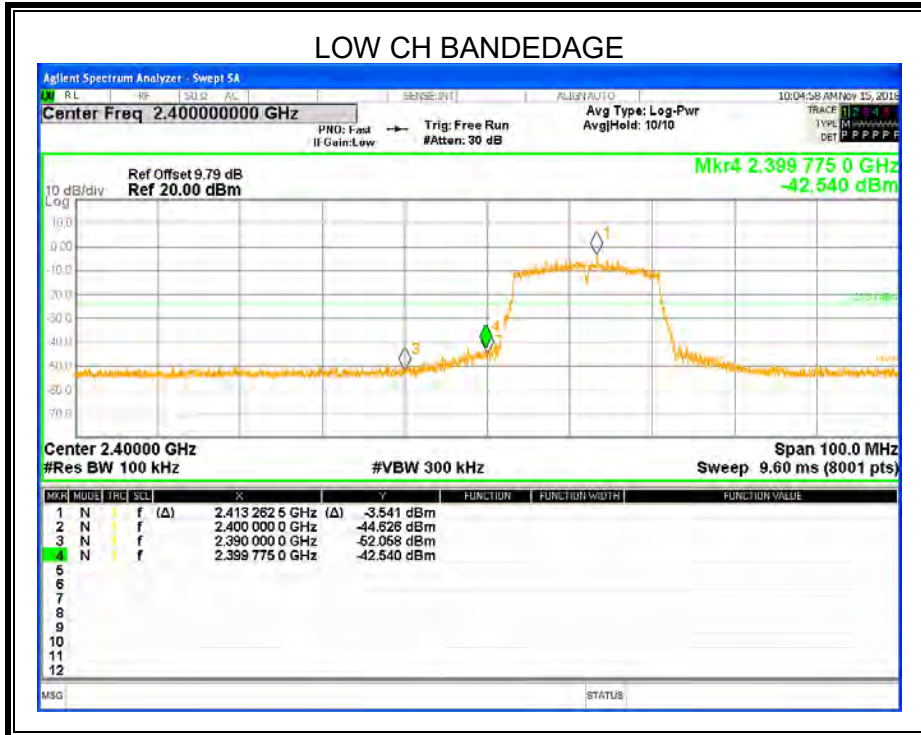



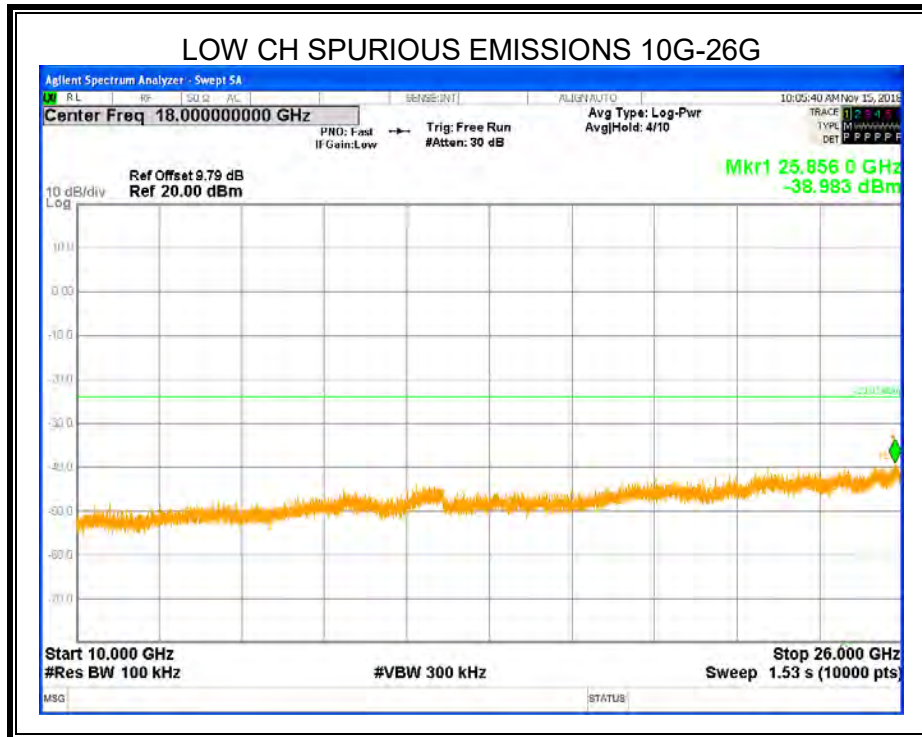
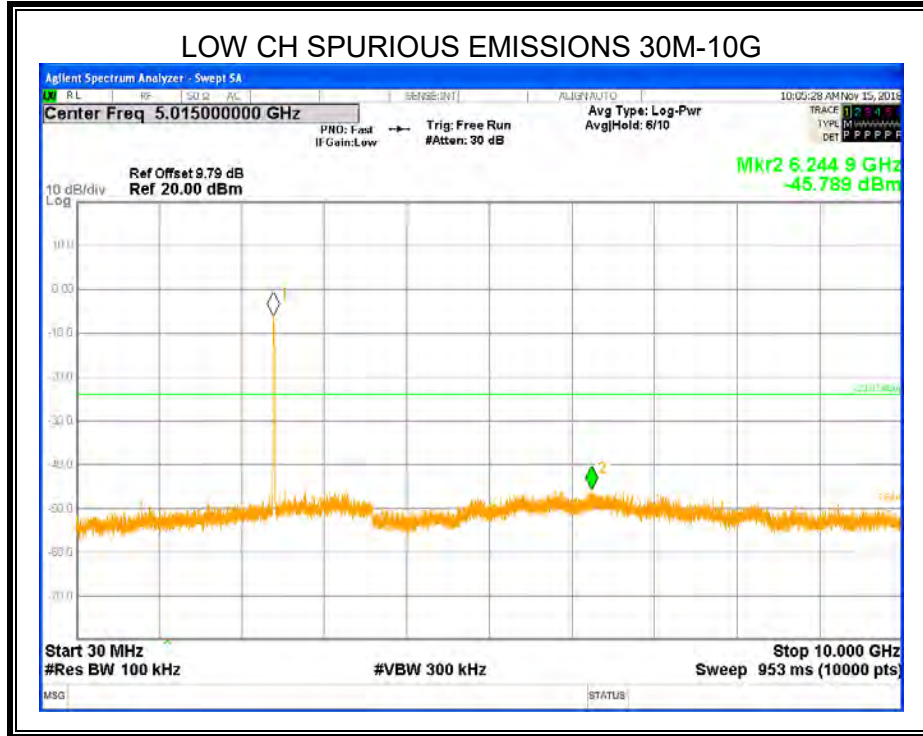

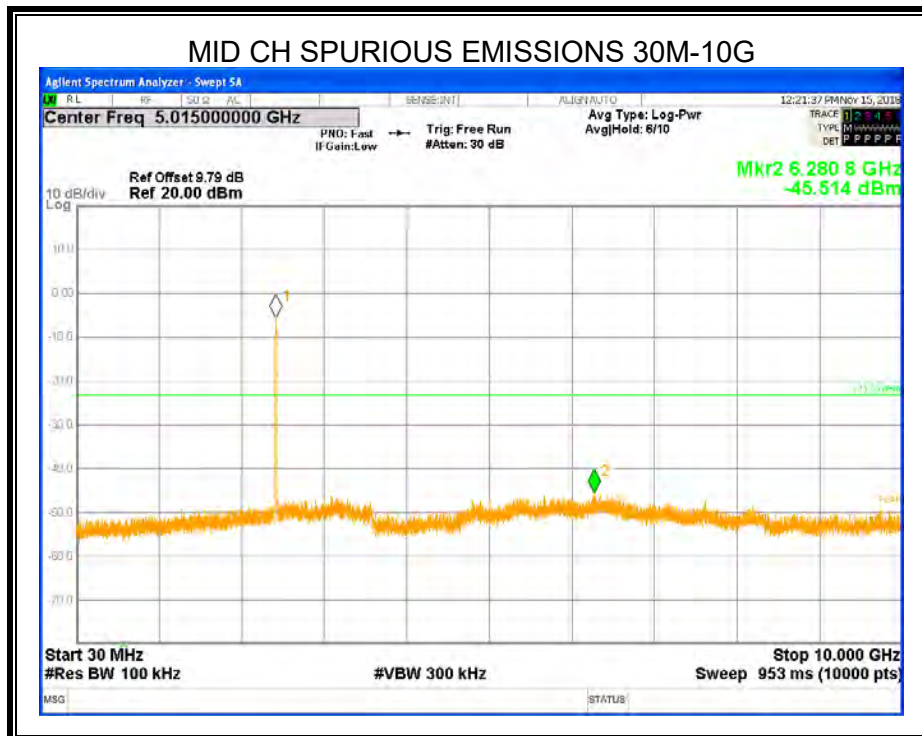
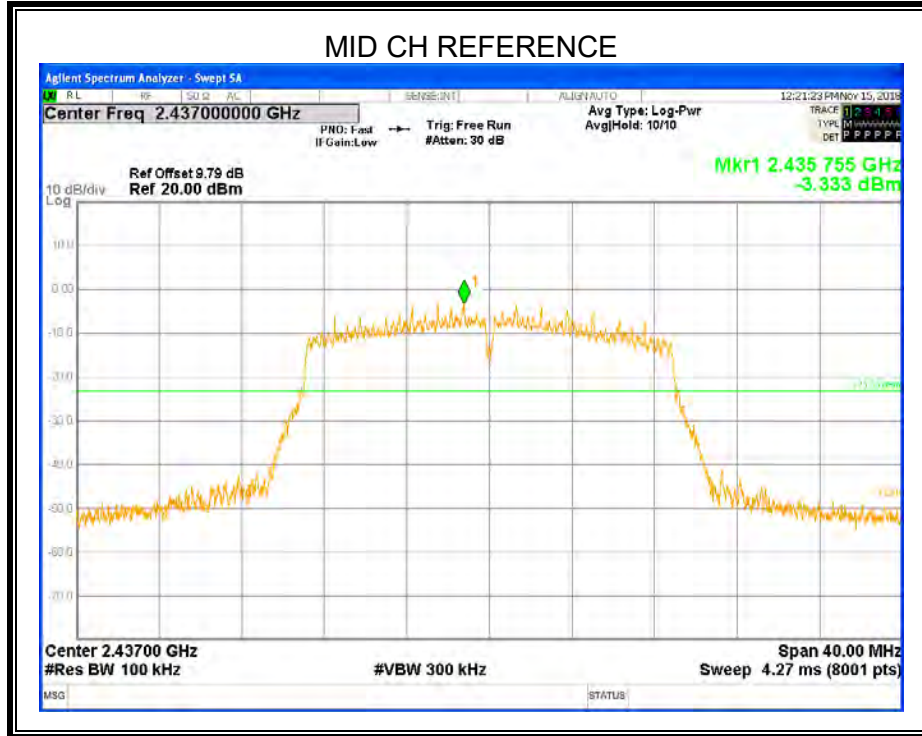

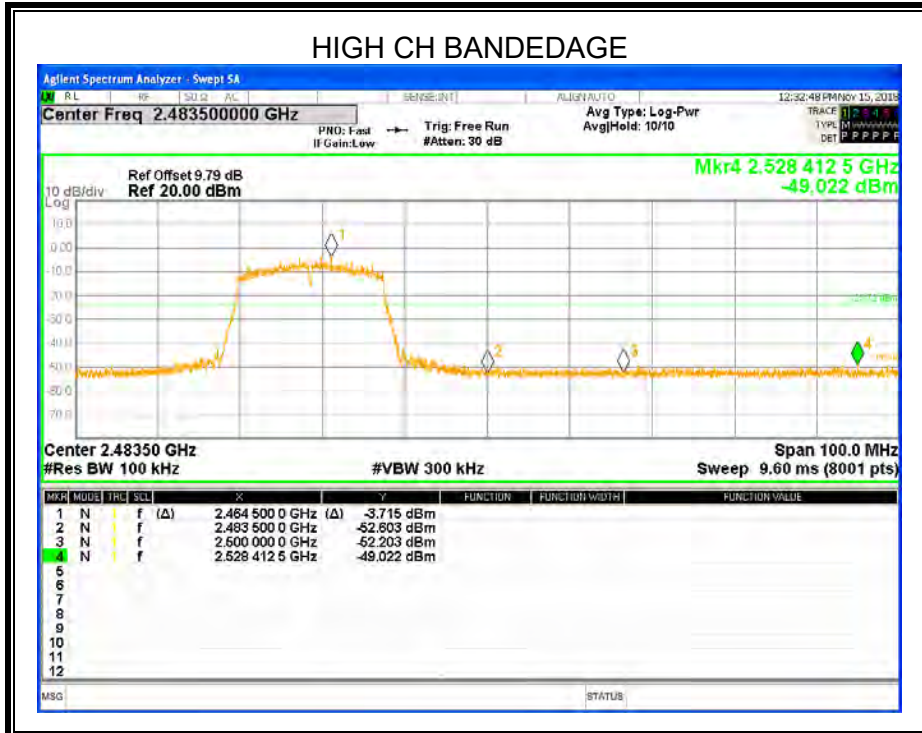
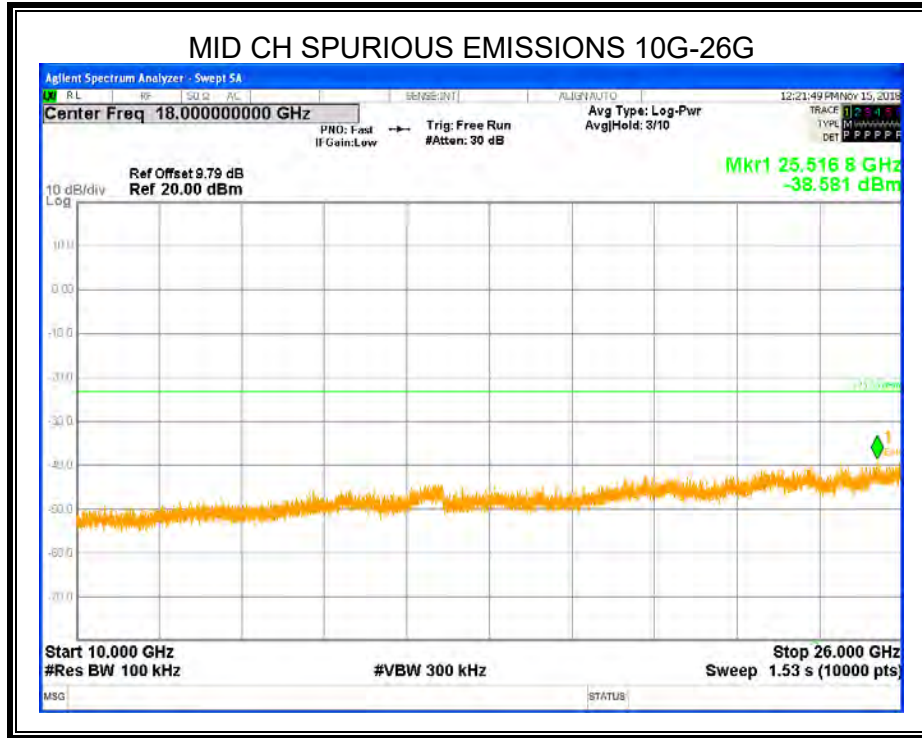

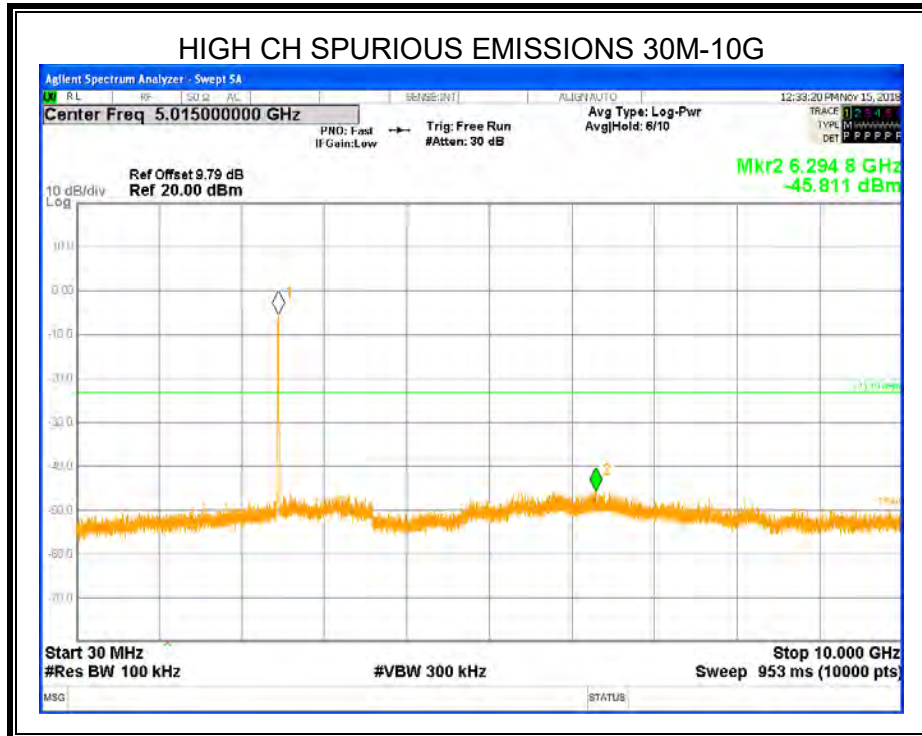
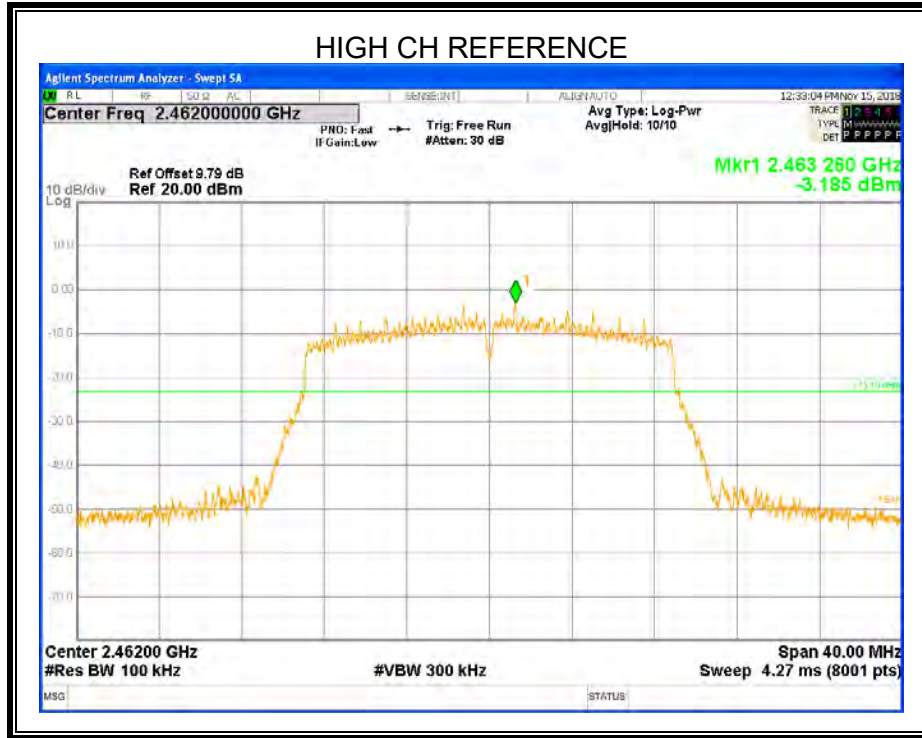



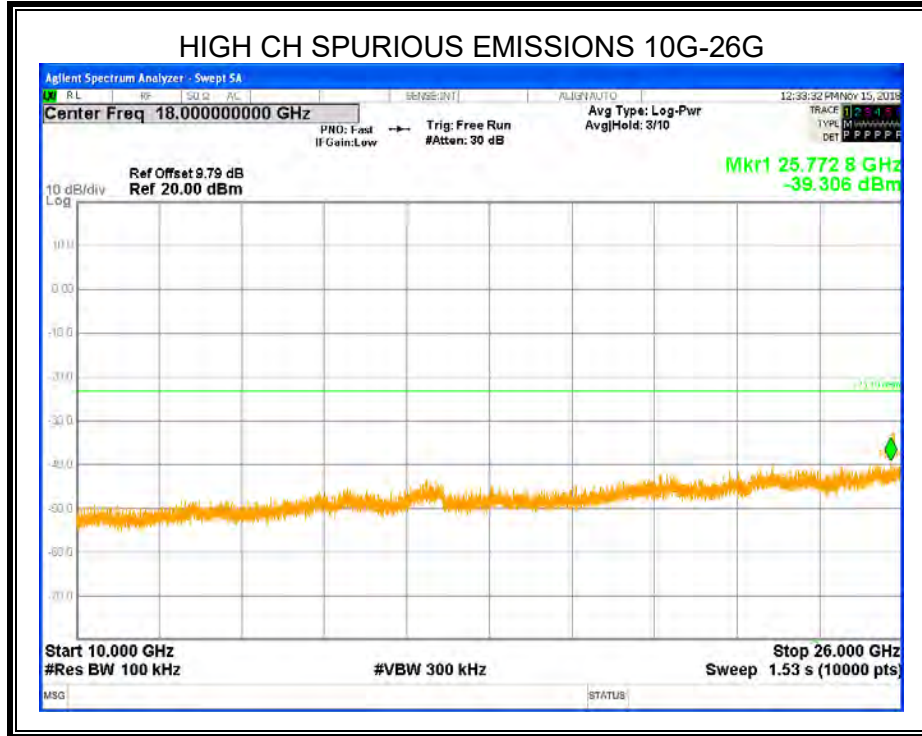

Note: For 802.11n HT20, all antennas had the same power in MIMO mode and SISO mode, so only the worst data for MIMO mode was recorded in the report.



### 8.5.4. 802.11n HT40 MODE

#### MIMO MODE-2TX

#### ANTENNA 0

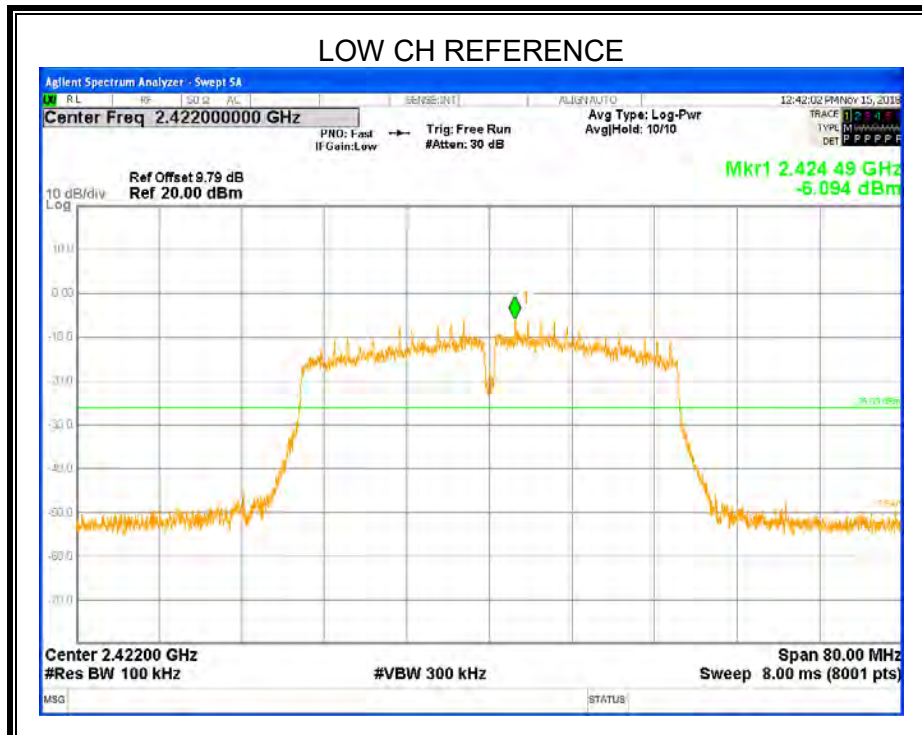
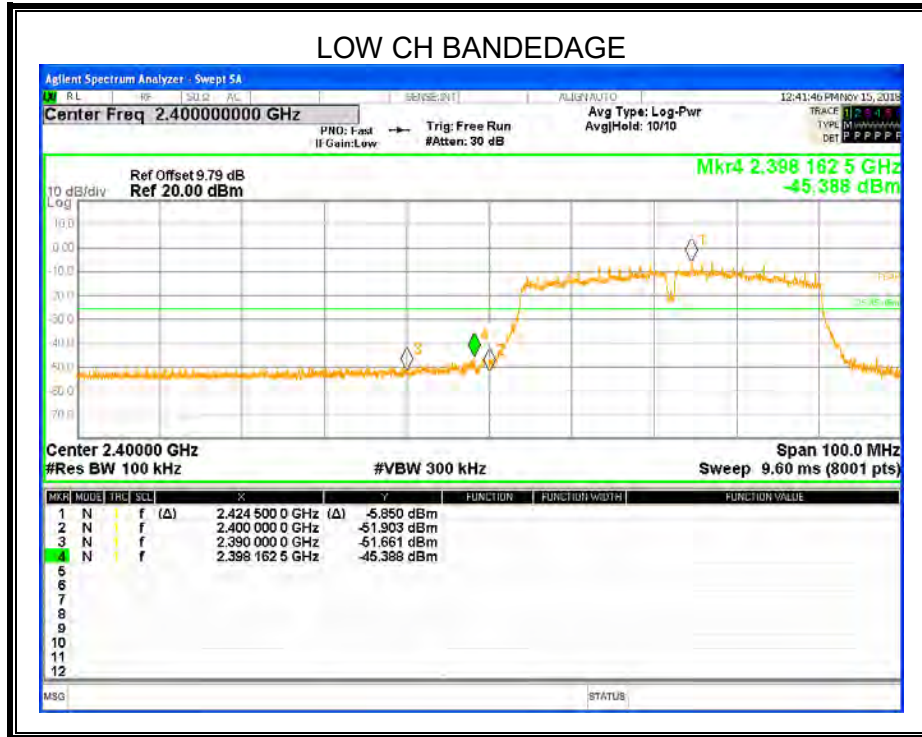

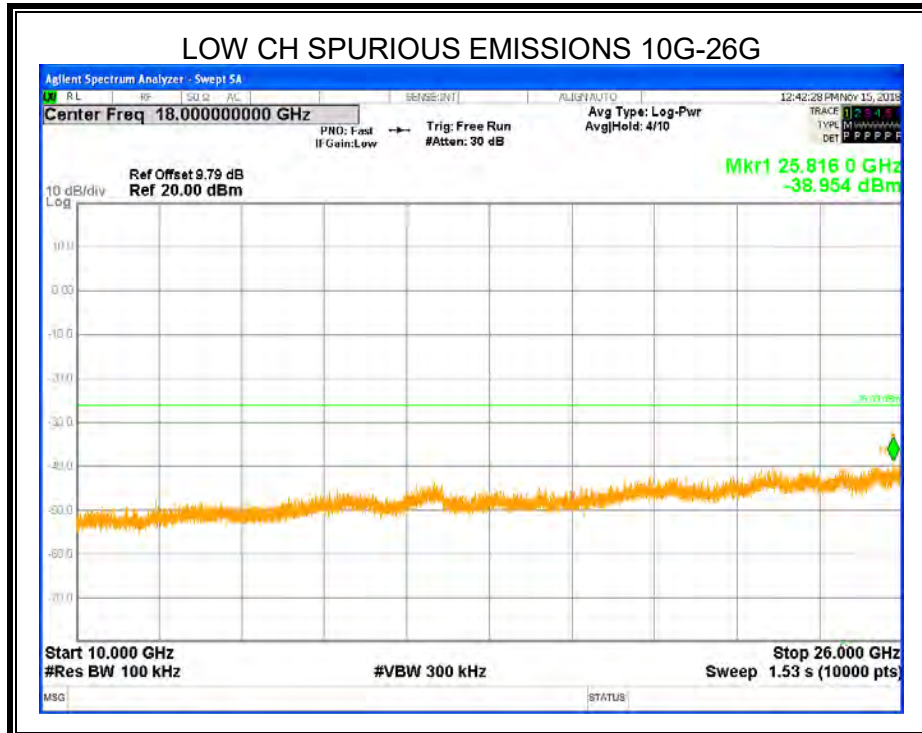
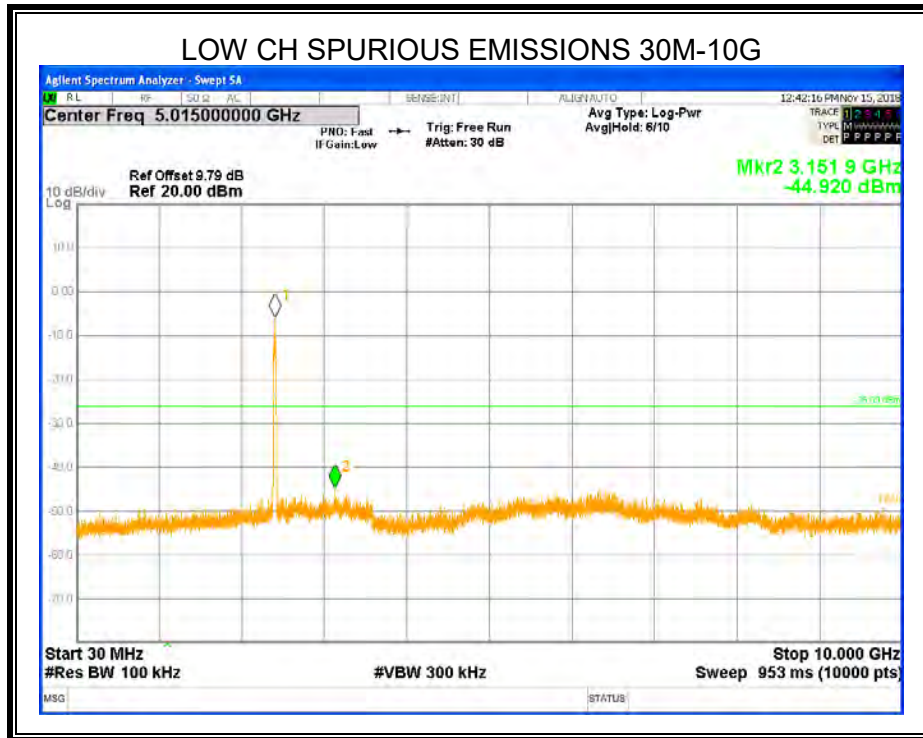

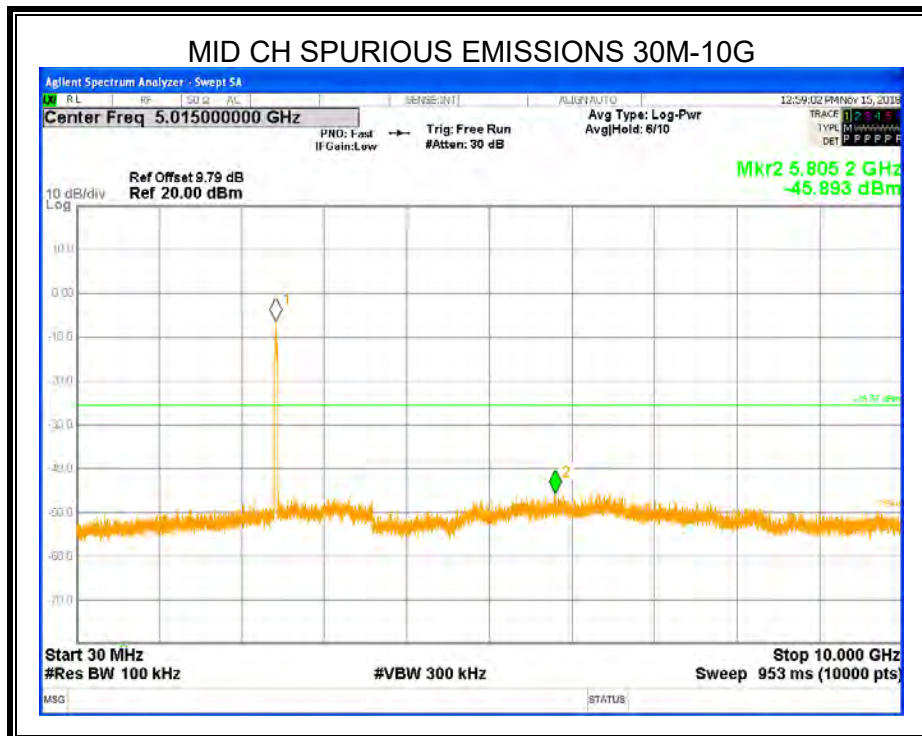
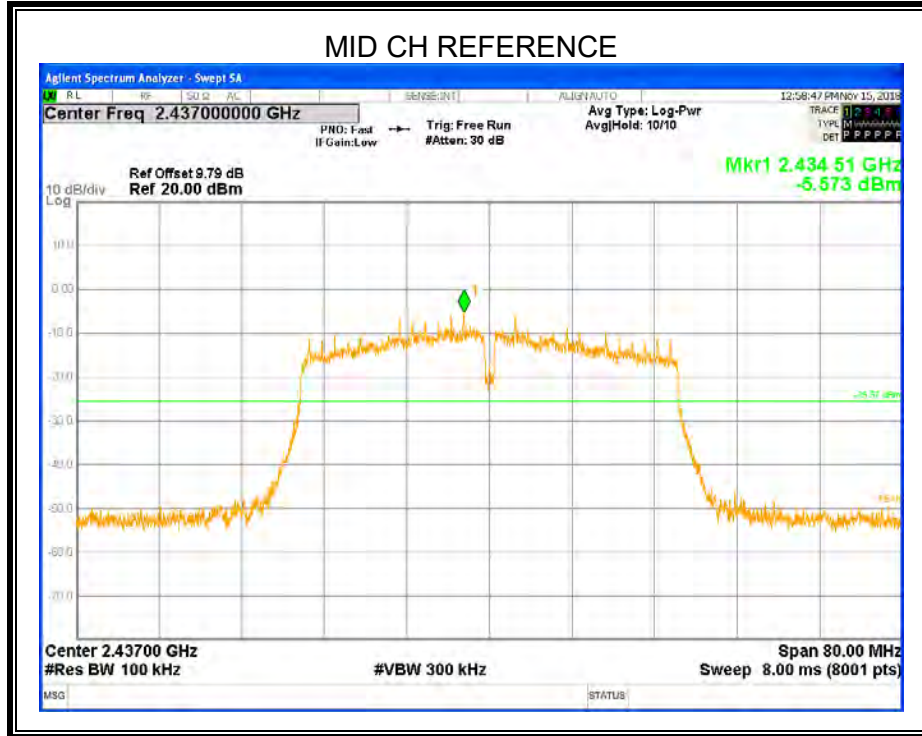



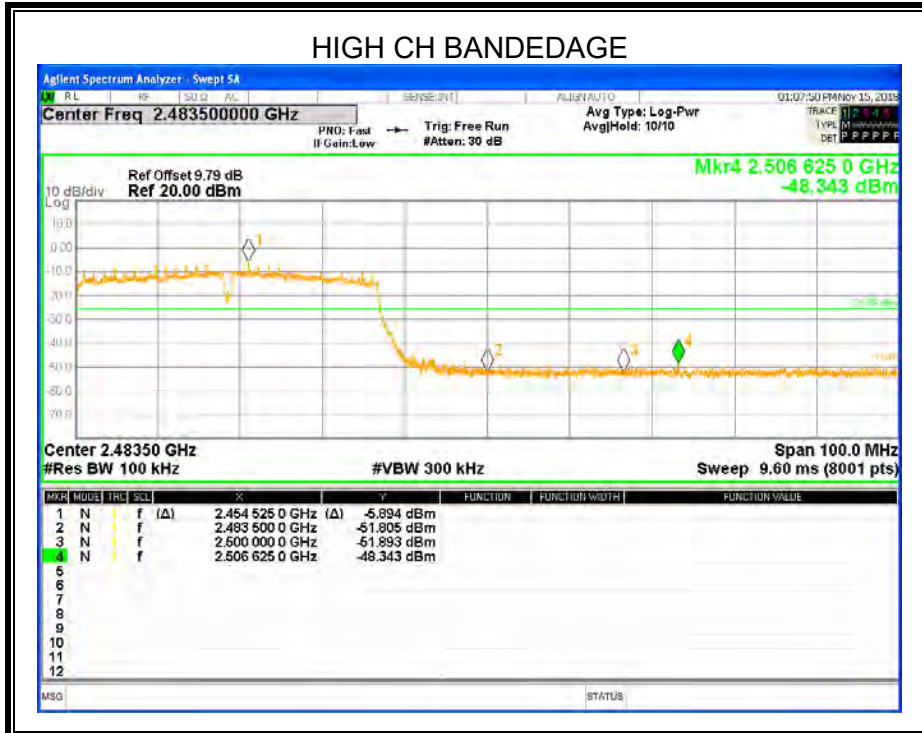
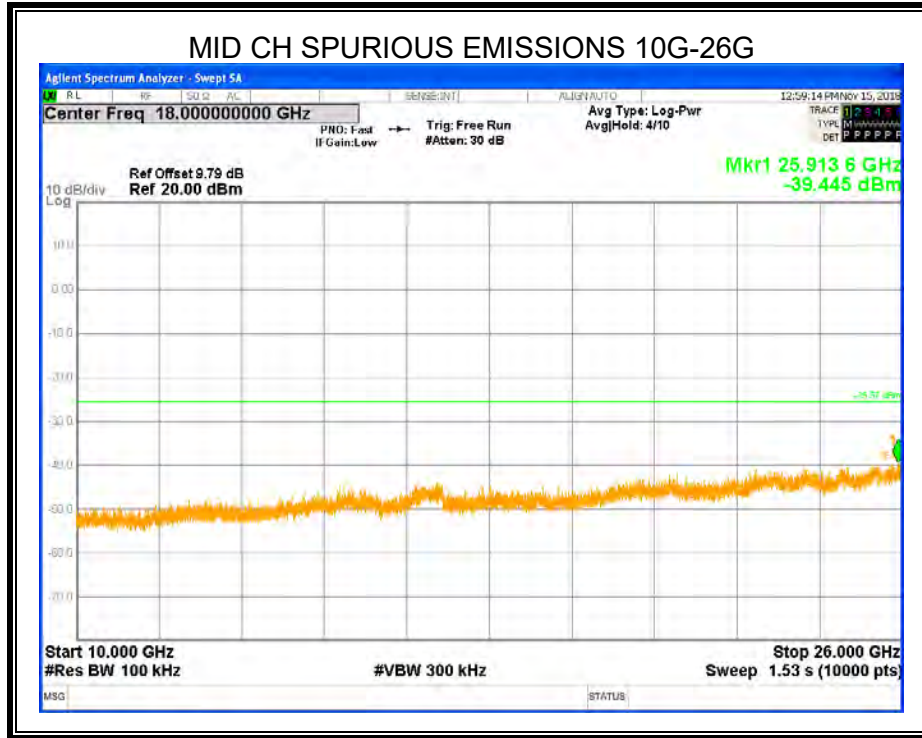

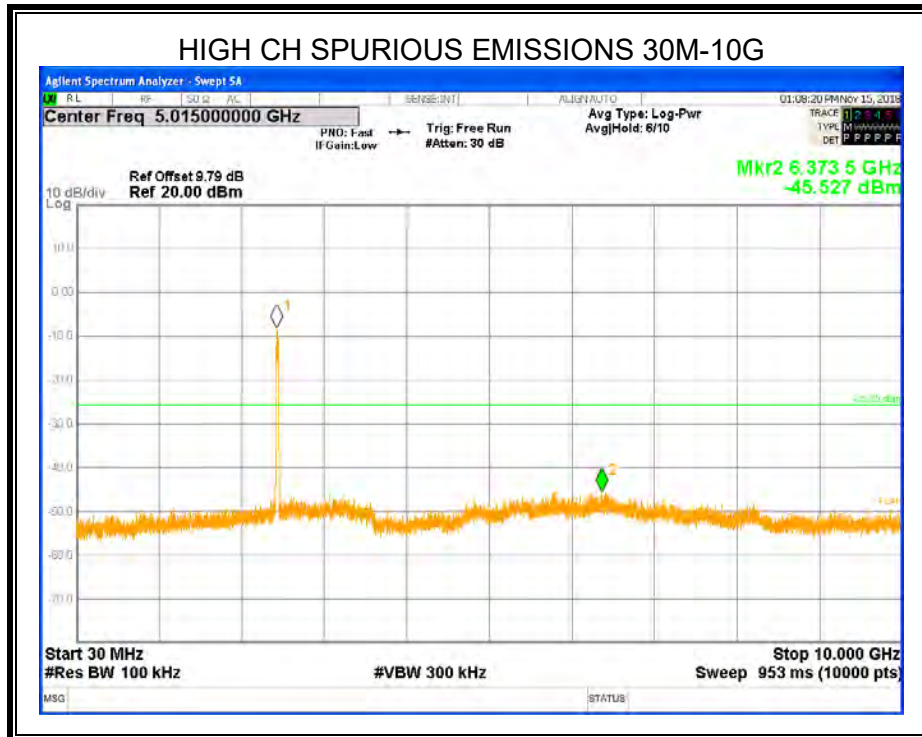
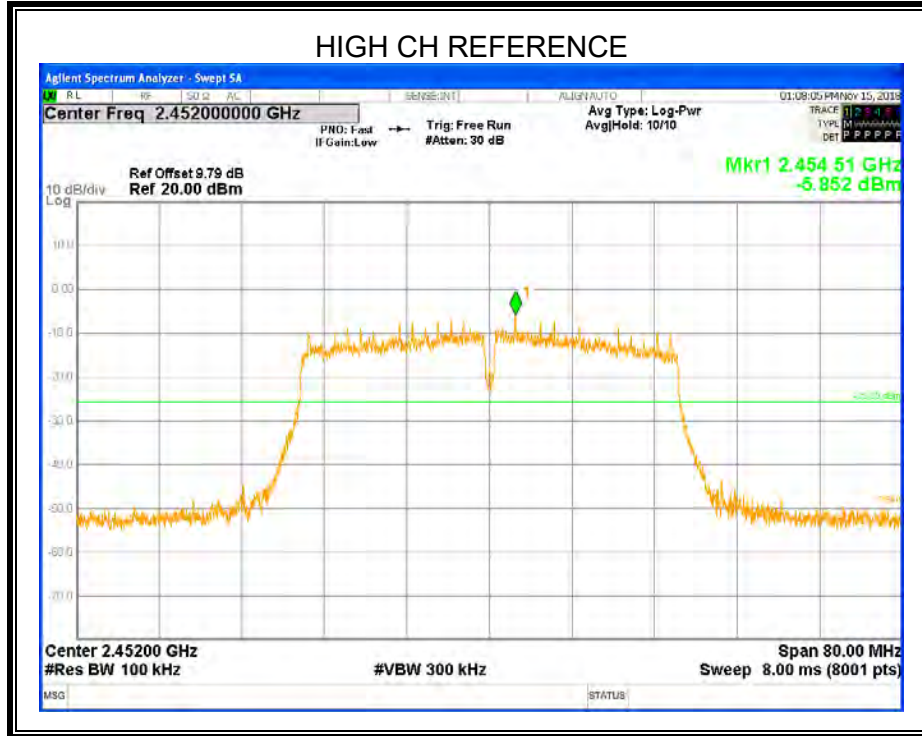

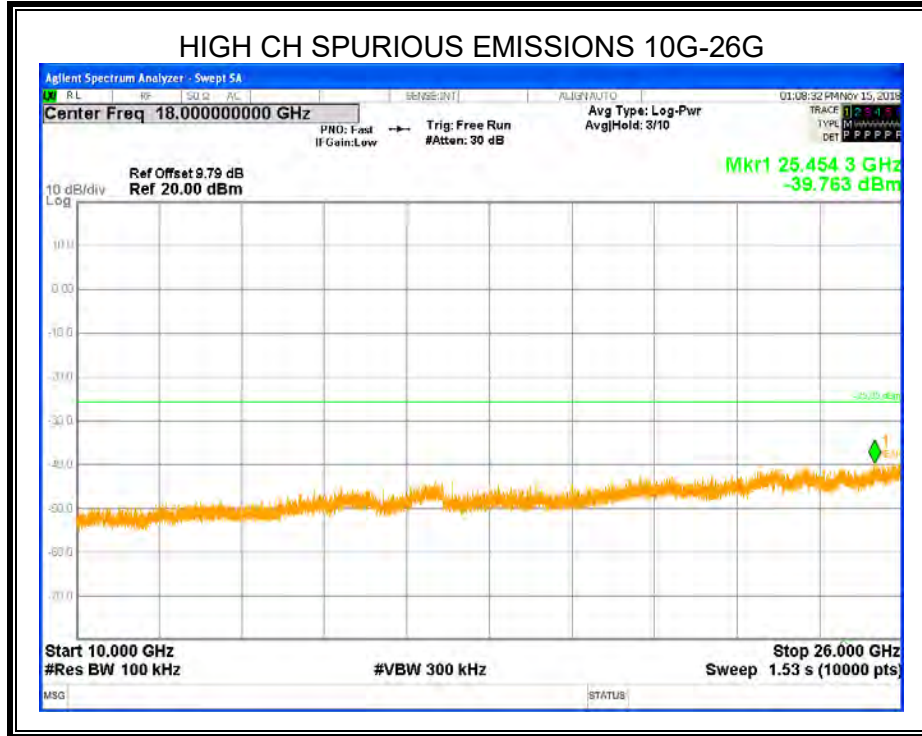

ANTENNA 1

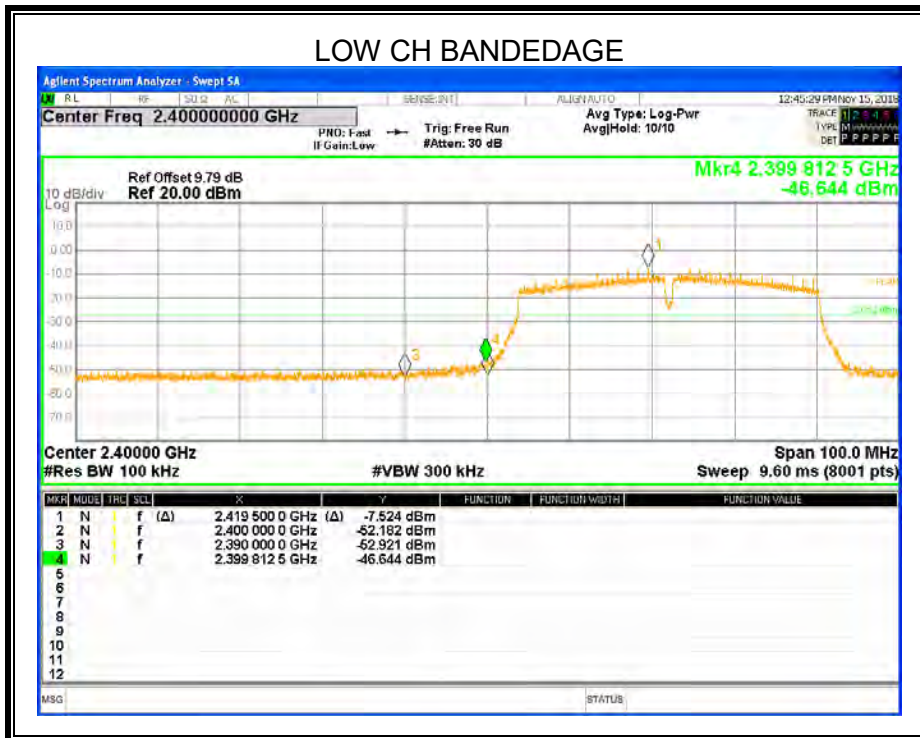



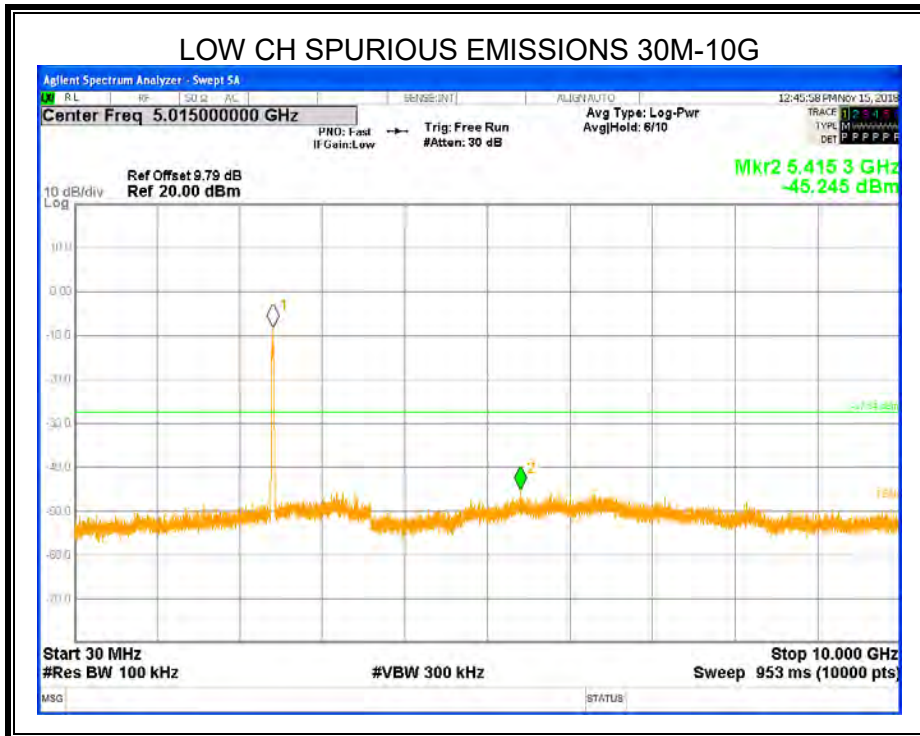
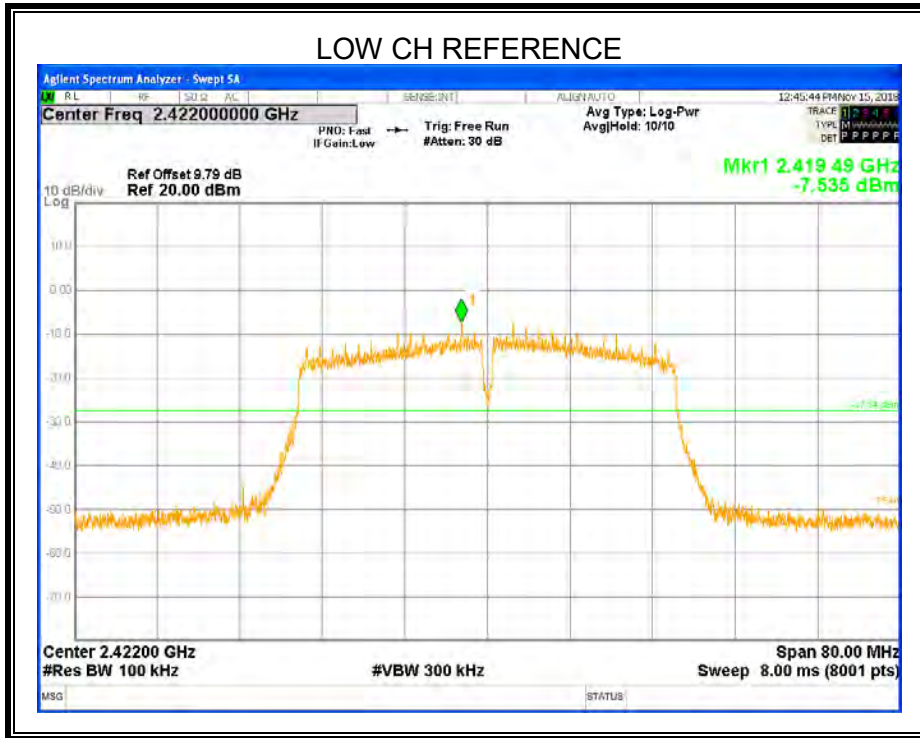

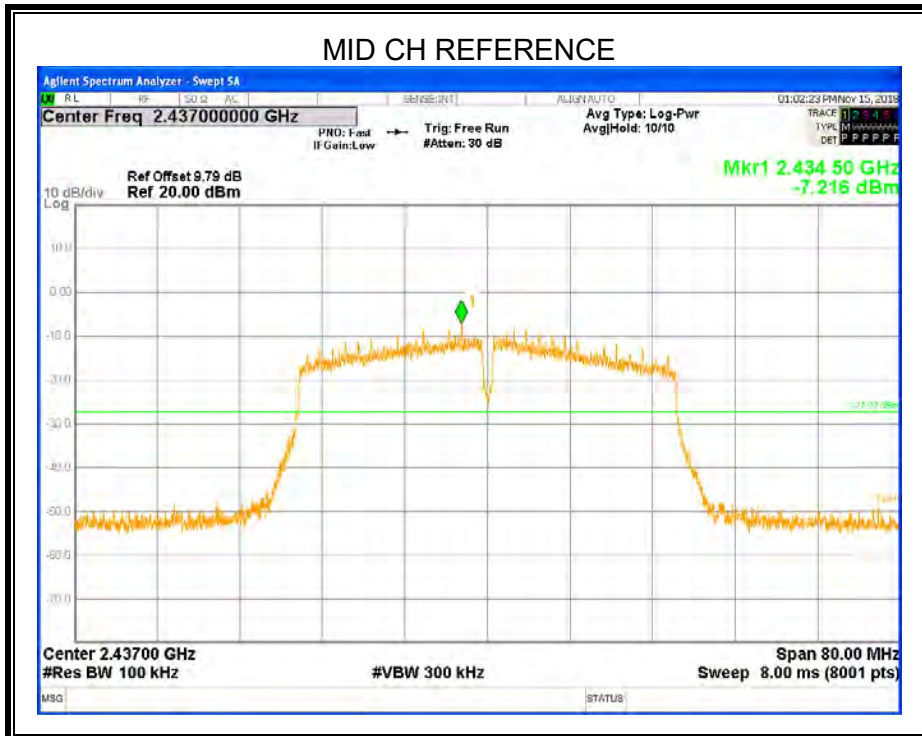
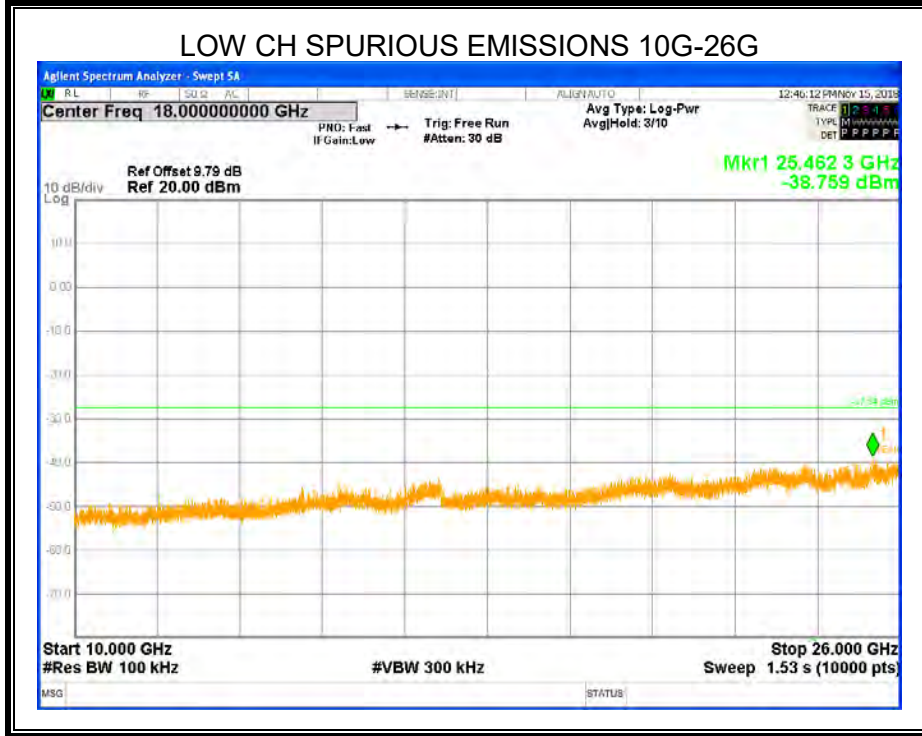

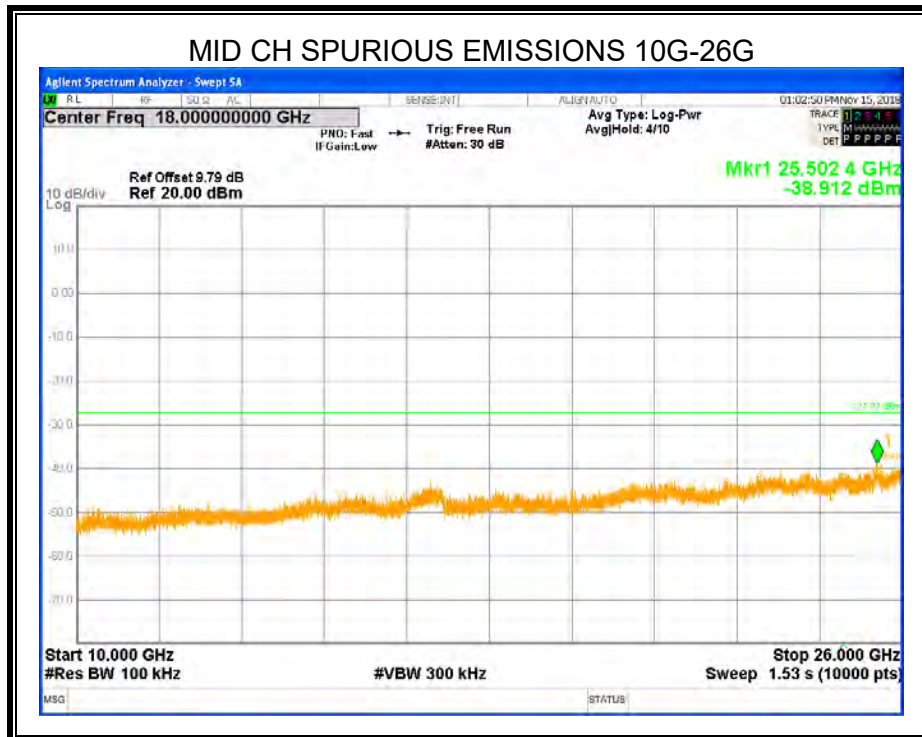
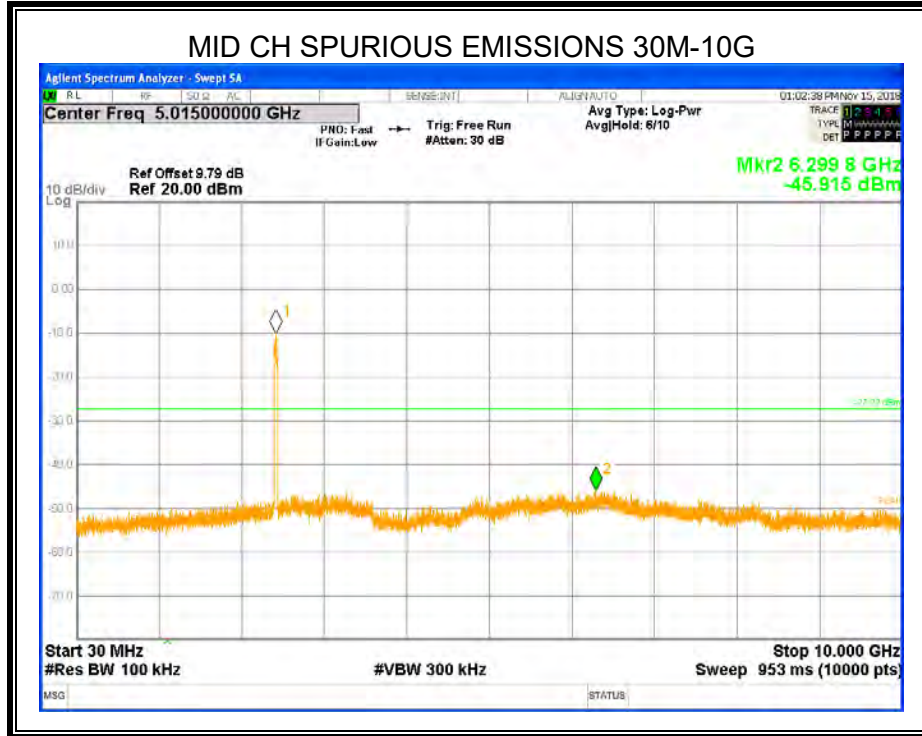

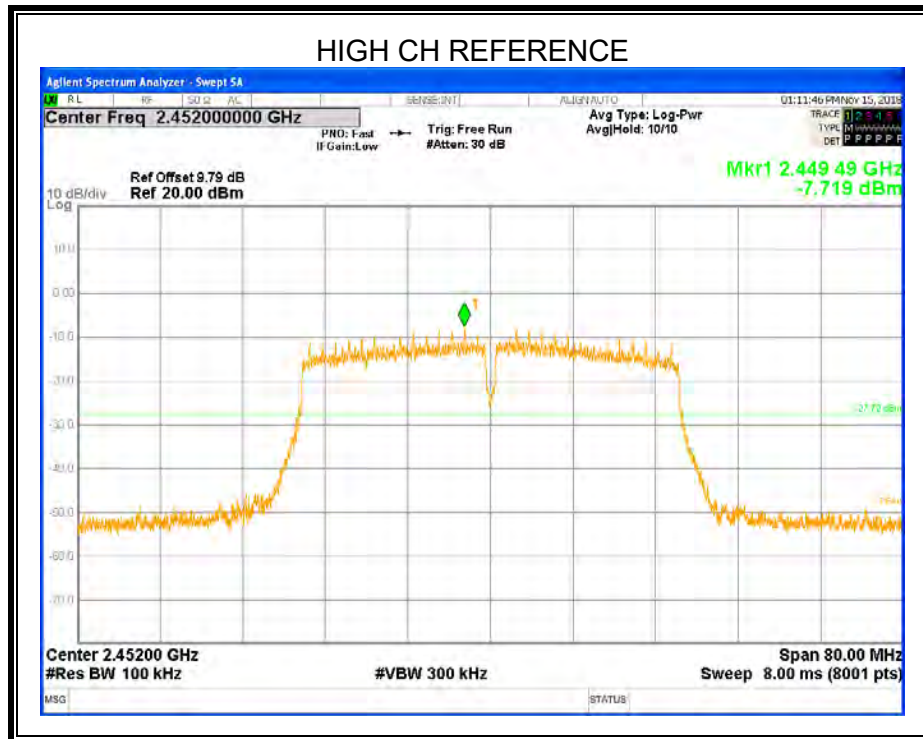
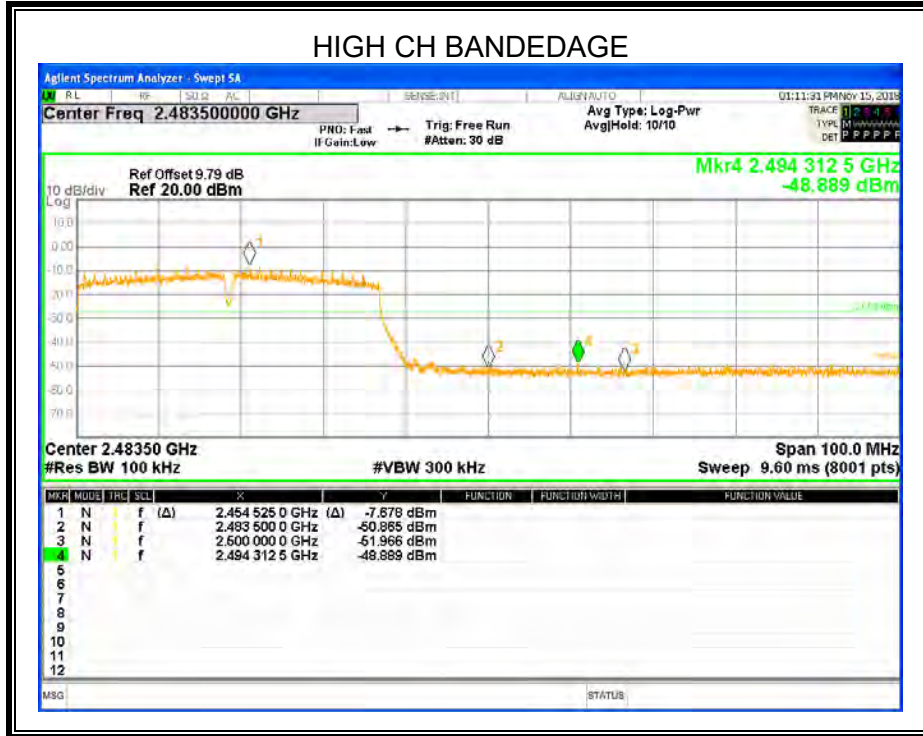



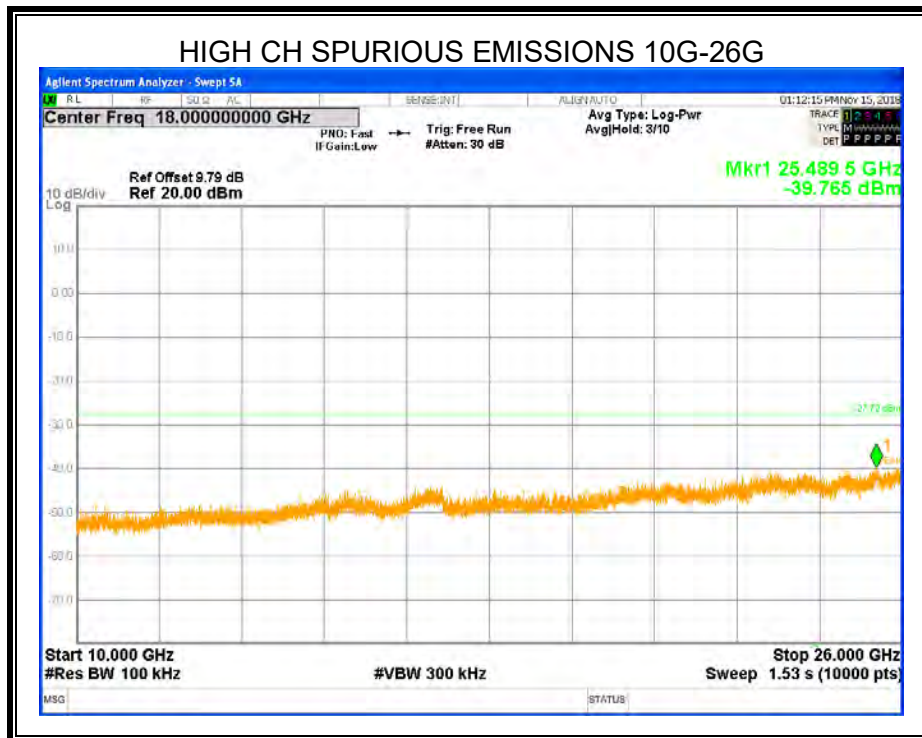
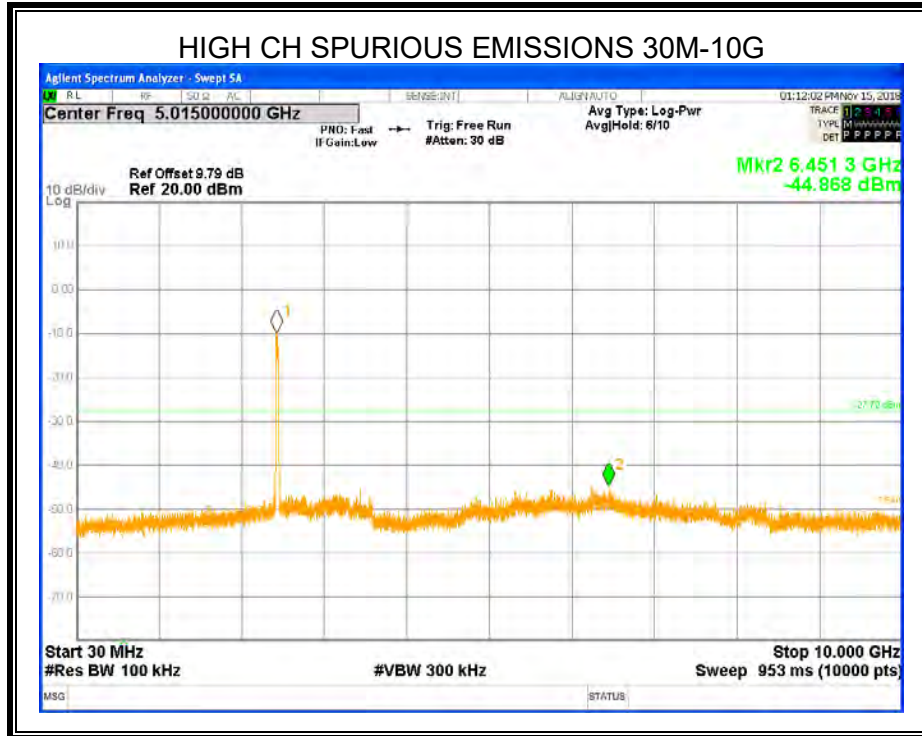

Note: For 802.11n HT40, all antennas had the same power in MIMO mode and SISO mode, so only the worst data for MIMO mode was recorded in the report.



## 9. RADIATED TEST RESULTS

### LIMITS

Please refer to CFR 47 FCC §15.205 and §15.209

Radiation Disturbance Test Limit for FCC (Class B)(9KHz-1GHz)

Frequency (MHz)	Field Strength (microvolts/meter)	Measurement Distance (meters)
0.009~0.490	2400/F(KHz)	300
0.490~1.705	24000/F(KHz)	30
1.705~30.0	30	30
30~88	100	3
88~216	150	3
216~960	200	3
960~1000	500	3

Note: 1) At frequencies at or above 30 MHz, measurements may be performed at a distance other than what is specified provided: measurements are not made in the near field except where it can be shown that near field measurements are appropriate due to the characteristics of the device; and it can be demonstrated that the signal levels needed to be measured at the distance employed can be detected by the measurement equipment. Measurements shall not be performed at a distance greater than 30 meters unless it can be further demonstrated that measurements at a distance of 30 meters or less are impractical. When performing measurements at a distance other than that specified, the results shall be extrapolated to the specified distance using an extrapolation factor of 20 dB/decade (inverse linear-distance for field strength measurements; inverse-linear-distance-squared for power density measurements).

(2) At frequencies below 30 MHz, measurements may be performed at a distance closer than that specified in the regulations; however, an attempt should be made to avoid making measurements in the near field. Pending the development of an appropriate measurement procedure for measurements performed below 30 MHz, when performing measurements at a closer distance than specified, the results shall be extrapolated to the specified distance by either making measurements at a minimum of two distances on at least one radial to determine the proper extrapolation factor or by using the square of an inverse linear distance extrapolation factor (40 dB/decade). This paragraph (f) shall not apply to Access BPL devices operating below 30 MHz.





Radiation Disturbance Test Limit for FCC (Above 1G)

Frequency (MHz)	dB(uV/m) (at 3 meters)	
	Peak	Average
Above 1000	74	54

FCC Restricted bands of operation:

MHz	MHz	MHz	GHz
0.090-0.110	16.42-16.423	399.9-410	4.5-5.15
<sup>1</sup> 0.495-0.505	16.69475-16.69525	608-614	5.35-5.46
2.1735-2.1905	16.80425-16.80475	960-1240	7.25-7.75
4.125-4.128	25.5-25.67	1300-1427	8.025-8.5
4.17725-4.17775	37.5-38.25	1435-1626.5	9.0-9.2
4.20725-4.20775	73-74.6	1645.5-1646.5	9.3-9.5
6.215-6.218	74.8-75.2	1660-1710	10.6-12.7
6.26775-6.26825	108-121.94	1718.8-1722.2	13.25-13.4
6.31175-6.31225	123-138	2200-2300	14.47-14.5
8.291-8.294	149.9-150.05	2310-2390	15.35-16.2
8.362-8.366	156.52475-156.52525	2483.5-2500	17.7-21.4
8.37625-8.38675	156.7-156.9	2690-2900	22.01-23.12
8.41425-8.41475	162.0125-167.17	3260-3267	23.6-24.0
12.29-12.293	167.72-173.2	3332-3339	31.2-31.8
12.51975-12.52025	240-285	3345.8-3358	36.43-36.5
12.57675-12.57725	322-335.4	3600-4400	( <sup>2</sup> )
13.36-13.41			

Note: <sup>1</sup>Until February 1, 1999, this restricted band shall be 0.490-0.510 MHz.  
<sup>2</sup>Above 38.6c

**TEST SETUP AND PROCEDURE**

Below 30MHz

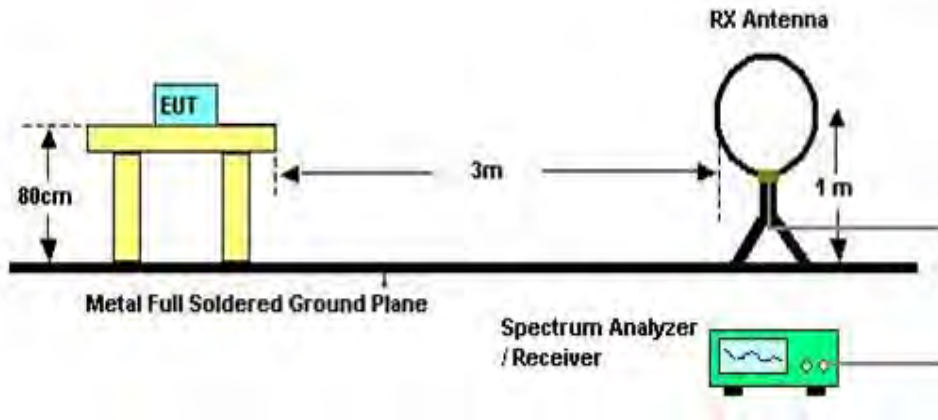

The setting of the spectrum analyser

RBW	200Hz (From 9kHz to 0.15MHz)/ 9KHz (From 0.15MHz to 30MHz)
VBW	200Hz (From 9kHz to 0.15MHz)/ 9KHz (From 0.15MHz to 30MHz)
Sweep	Auto
Detector	Peak/QP/ Average
Trace	Max hold

1. The testing follows the guidelines in ANSI C63.10-2013
2. The EUT was arranged to its worst case and then turntable (from 0 degree to 360 degrees) to find the maximum reading. A pre-amp and a high pass filter are used for the test in order to get better signal level. Both horizontal and vertical polarizations of the antenna are set to make the measurement.
3. The EUT was placed on a turntable with 0.8 meter above ground.
4. The EUT was set 3 meters from the interference receiving antenna, which was mounted on the top of a variable height antenna tower.
5. For measurement below 1GHz, the initial step in collecting conducted emission data is a spectrum analyzer peak detector mode pre-scanning the measurement frequency range. Significant peaks are then marked and then Quasi Peak detector mode re-measured. If the emission level of the EUT measured by the peak detector is 3 dB lower than the applicable limit, the peak emission level will be reported. Otherwise, the emission measurement will be repeated using the quasi-peak detector and reported.
6. For the actual test configuration, please refer to the related item in this test report (Photographs of the Test Configuration)
7. Although these tests were performed other than open area test site, adequate comparison measurements were confirmed against 30m open are test site. Therefore sufficient tests were made to demonstrate that the alternative site produces results that correlate with the ones of tests made in an open field based on KDB 414788.

Below 1G

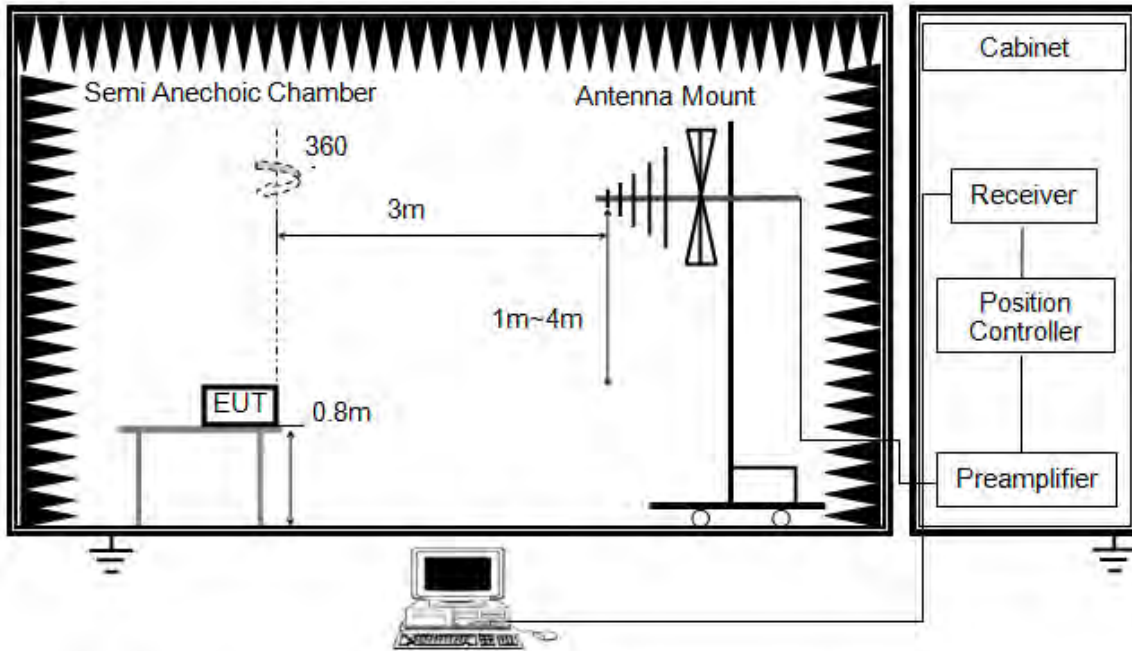

The setting of the spectrum analyser

RBW	120K
VBW	300K
Sweep	Auto
Detector	Peak/QP
Trace	Max hold

1. The testing follows the guidelines in ANSI C63.10-2013.
2. The EUT was arranged to its worst case and then tune the antenna tower (from 1 m to 4 m) and turntable (from 0 degree to 360 degrees) to find the maximum reading. A pre-amp and a high pass filter are used for the test in order to get better signal level. Both horizontal and vertical polarizations of the antenna are set to make the measurement.
3. The EUT was placed on a turntable with 0.8 meter above ground.
4. The EUT was set 3 meters from the interference receiving antenna, which was mounted on the top of a variable height antenna tower.
5. For measurement below 1GHz, the initial step in collecting conducted emission data is a spectrum analyzer peak detector mode pre-scanning the measurement frequency range. Significant peaks are then marked and then Quasi Peak detector mode re-measured. If the emission level of the EUT measured by the peak detector is 3 dB lower than the applicable limit, the peak emission level will be reported. Otherwise, the emission measurement will be repeated using the quasi-peak detector and reported.

ABOVE 1G

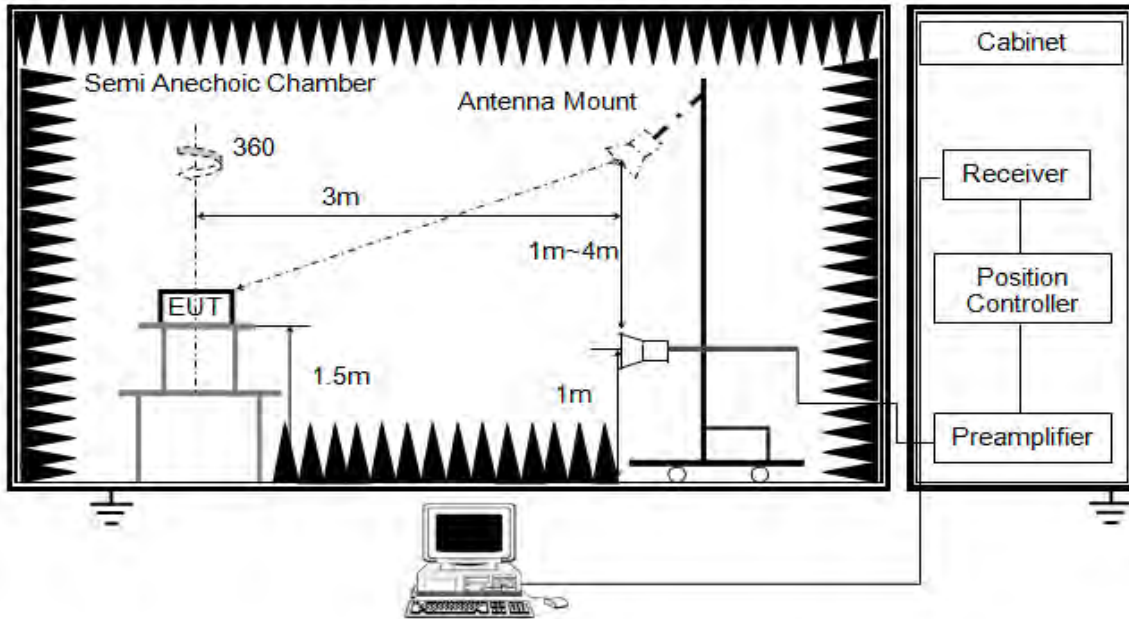

The setting of the spectrum analyser

RBW	1M
VBW	PEAK: 3M AVG: see note 6
Sweep	Auto
Detector	Peak
Trace	Max hold

1. The testing follows the guidelines in ANSI C63.10-2013.
2. The EUT was arranged to its worst case and then tune the antenna tower (from 1 m to 4 m) and turntable (from 0 degree to 360 degrees) to find the maximum reading. A pre-amp and a high pass filter are used for the test in order to get better signal level. Both horizontal and vertical polarizations of the antenna are set to make the measurement.
3. The EUT was placed on a turntable with 1.5m above ground.
4. The EUT was set 3 meters from the interference receiving antenna, which was mounted on the top of a variable height antenna tower.
5. For measurement above 1GHz, the emission measurement will be measured by the peak detector. This peak level, once corrected, must comply with the limit specified in Section 15.209.
6. For measurements above 1 GHz the resolution bandwidth is set to 1 MHz, then the video bandwidth is set to 3 MHz for peak measurements and 1 MHz resolution bandwidth with 1/T video bandwidth with peak detector for average measurements. For the Duty Cycle please refer to clause 8.1.ON TIME AND DUTY CYCLE.

X axis, Y axis, Z axis positions:

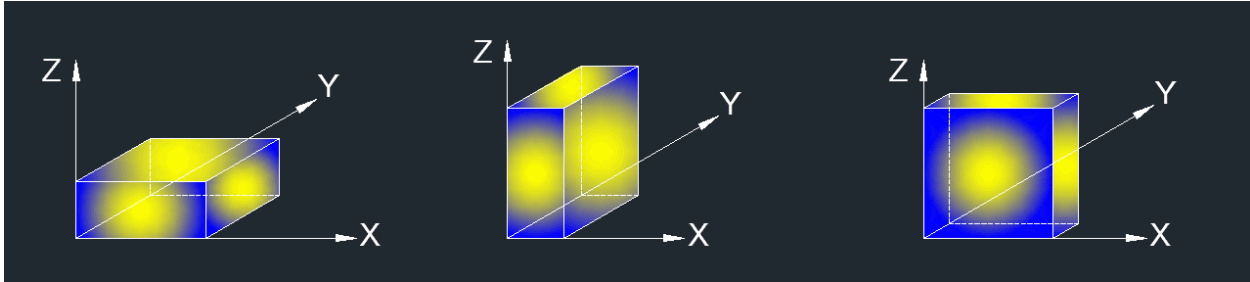

Note 1: For all radiated test, EUT in each of three orthogonal axis emissions had been tested, but only the worst case (X axis) data recorded in the report.

Note 2: The EUT was fully exercised with external accessories during the test. In the case of multiple accessory external ports, an external accessory shall be connected to one of each type of port.

Note3: For 802.11n HT20 and 802.11n HT40, all antennas had the same power in MIMO mode and SISO mode, so only the worst data for MIMO mode was recorded in the report.

**TEST ENVIRONMENT**

Temperature	24.6°C	Relative Humidity	58%
Atmosphere Pressure	101kPa	Test Voltage	DC 5V



## 9.1. RESTRICTED BANDEDGE

### 9.1.1. 802.11b MODE

#### 1TX MODE FOR ANT0 (WORST-CASE CONFIGURATION)

#### RESTRICTED BANDEDGE (LOW CHANNEL, HORIZONTAL)

#### PEAK

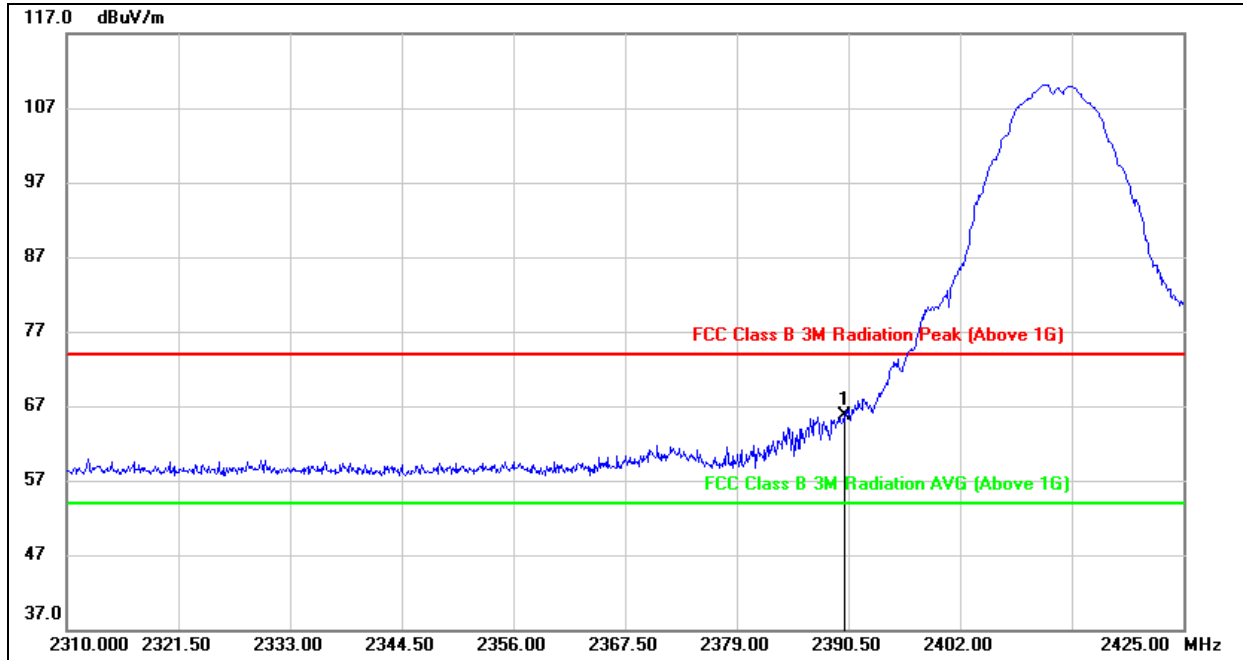

No.	Frequency (MHz)	Reading (dBuV)	Correct (dB/m)	Result (dBuV/m)	Limit (dBuV/m)	Margin (dB)	Remark
1	2390.000	32.62	33.14	65.76	74.00	-8.24	peak

- Note:
1. Measurement = Reading Level + Correct Factor.
  2. If Peak Result complies with AV limit, AV Result is deemed to comply with AV limit.
  3. Peak: Peak detector.
  4. Only the worst case emission was recorded, if it complies with the limit, the other emissions deemed to comply with the limit.





**AVG**

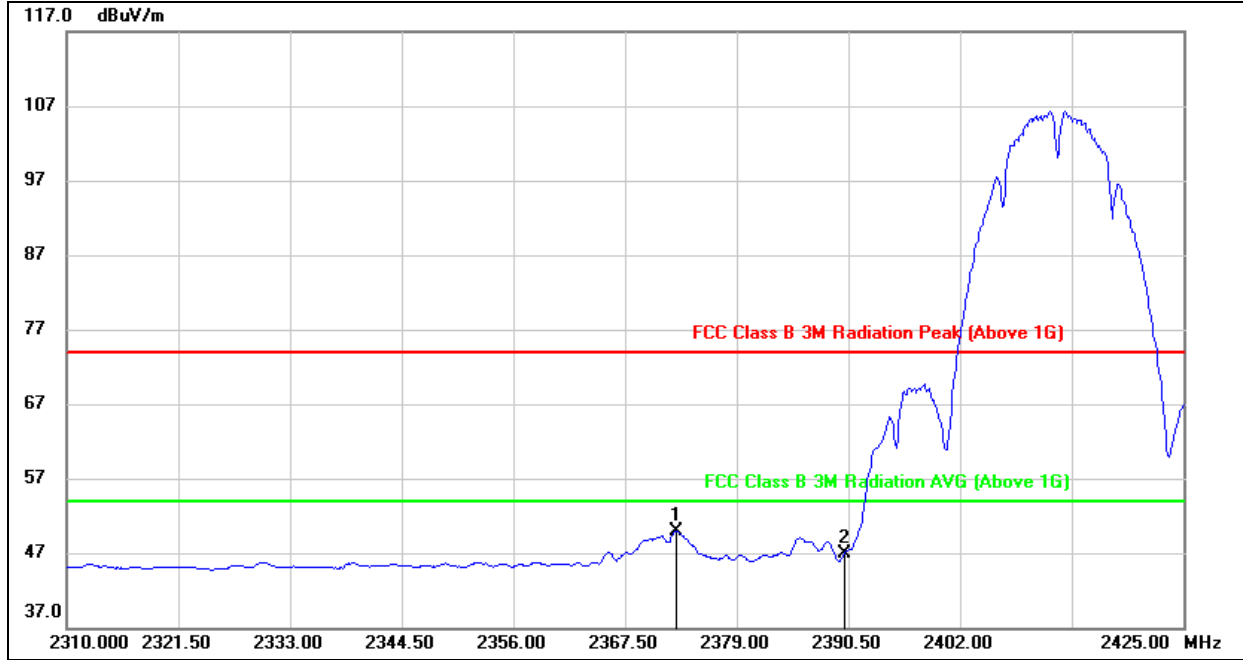

No.	Frequency (MHz)	Reading (dBuV)	Correct (dB/m)	Result (dBuV/m)	Limit (dBuV/m)	Margin (dB)	Remark
1	2372.790	16.71	33.27	49.98	54.00	-4.02	AVG
2	2390.000	13.69	33.14	46.83	54.00	-7.17	AVG

- Note:
1. Measurement = Reading Level + Correct Factor.
  2. If Peak Result complies with AV limit, AV Result is deemed to comply with AV limit.
  3. AVG:  $VBW=1/Ton$  where: ton is transmit duration.
  4. For transmit duration, please refer to clause 8.1.
  5. Only the worst case emission was recorded, if it complies with the limit, the other emissions deemed to comply with the limit.



**RESTRICTED BANDEDGE (LOW CHANNEL, VERTICAL)**

**PEAK**

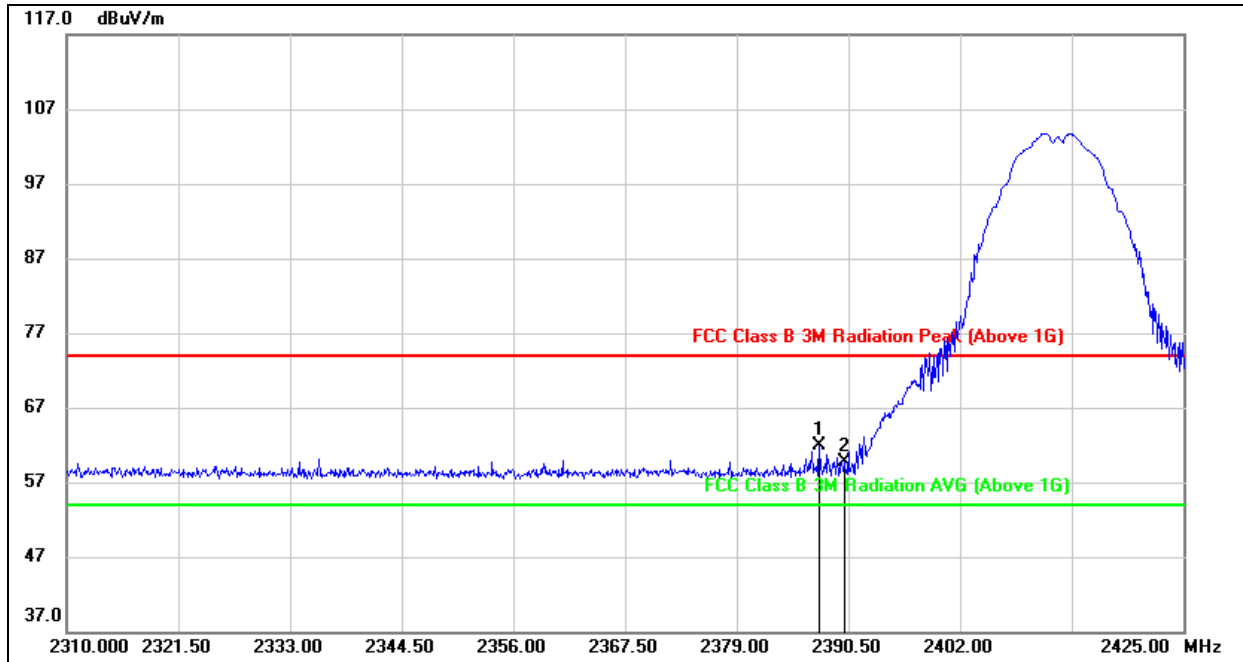

No.	Frequency (MHz)	Reading (dBuV)	Correct (dB/m)	Result (dBuV/m)	Limit (dBuV/m)	Margin (dB)	Remark
1	2387.510	28.70	33.26	61.96	74.00	-12.04	peak
2	2390.000	26.42	33.24	59.66	74.00	-14.34	peak

- Note: 1. Measurement = Reading Level + Correct Factor.  
 2. If Peak Result complies with AV limit, AV Result is deemed to comply with AV limit.  
 3. Peak: Peak detector.  
 4. Only the worst case emission was recorded, if it complies with the limit, the other emissions deemed to comply with the limit.



**AVG**

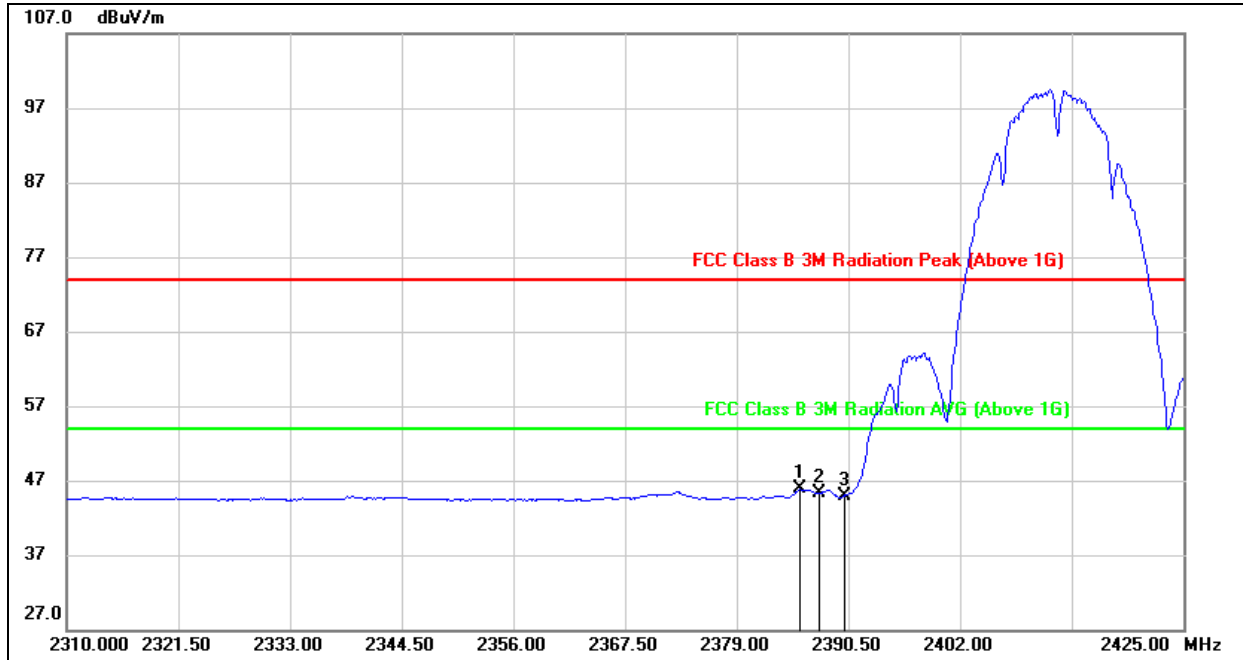

No.	Frequency (MHz)	Reading (dBuV)	Correct (dB/m)	Result (dBuV/m)	Limit (dBuV/m)	Margin (dB)	Remark
1	2385.555	12.54	33.28	45.82	54.00	-8.18	AVG
2	2387.510	12.05	33.26	45.31	54.00	-8.69	AVG
3	2390.000	11.74	33.24	44.98	54.00	-9.02	AVG

- Note:
1. Measurement = Reading Level + Correct Factor.
  2. If Peak Result complies with AV limit, AV Result is deemed to comply with AV limit.
  3. AVG:  $VBW=1/Ton$  where: ton is transmit duration.
  4. For transmit duration, please refer to clause 8.1.
  5. Only the worst case emission was recorded, if it complies with the limit, the other emissions deemed to comply with the limit.



**RESTRICTED BANDEDGE (HIGH CHANNEL, HORIZONTAL)**

**PEAK**

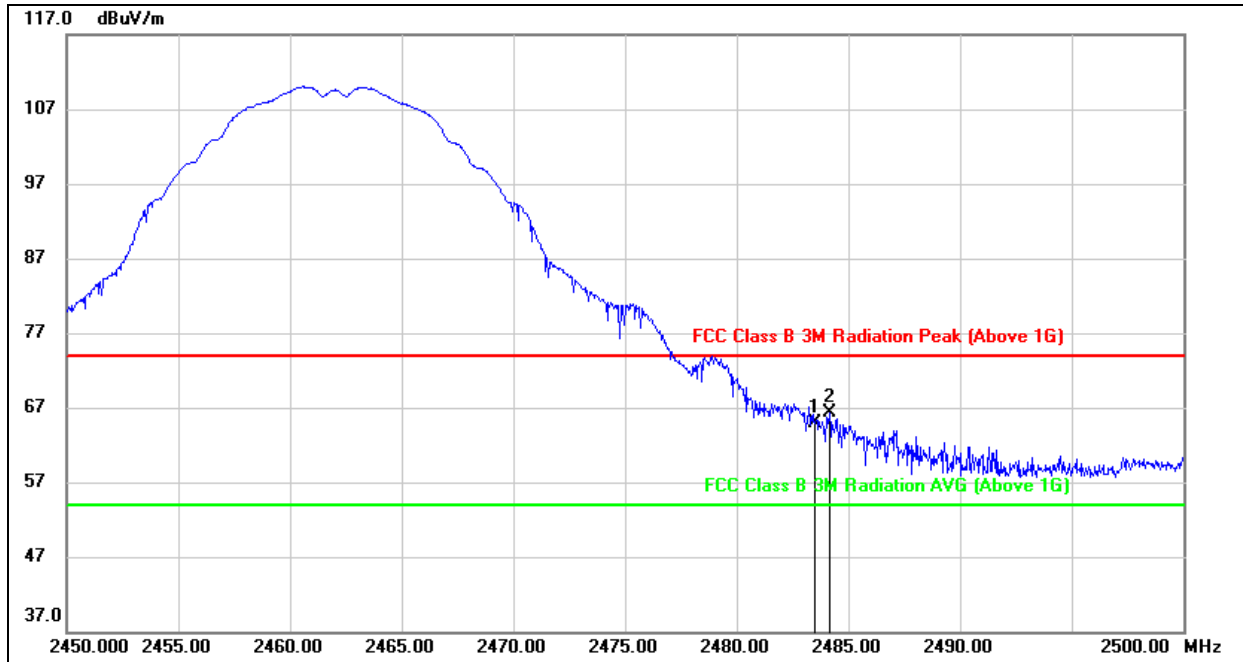

No.	Frequency (MHz)	Reading (dBuV)	Correct (dB/m)	Result (dBuV/m)	Limit (dBuV/m)	Margin (dB)	Remark
1	2483.500	32.11	32.78	64.89	74.00	-9.11	peak
2	2484.150	33.46	32.78	66.24	74.00	-7.76	peak

- Note: 1. Measurement = Reading Level + Correct Factor.  
 2. If Peak Result complies with AV limit, AV Result is deemed to comply with AV limit.  
 3. Peak: Peak detector.  
 4. Only the worst case emission was recorded, if it complies with the limit, the other emissions deemed to comply with the limit.



**AVG**

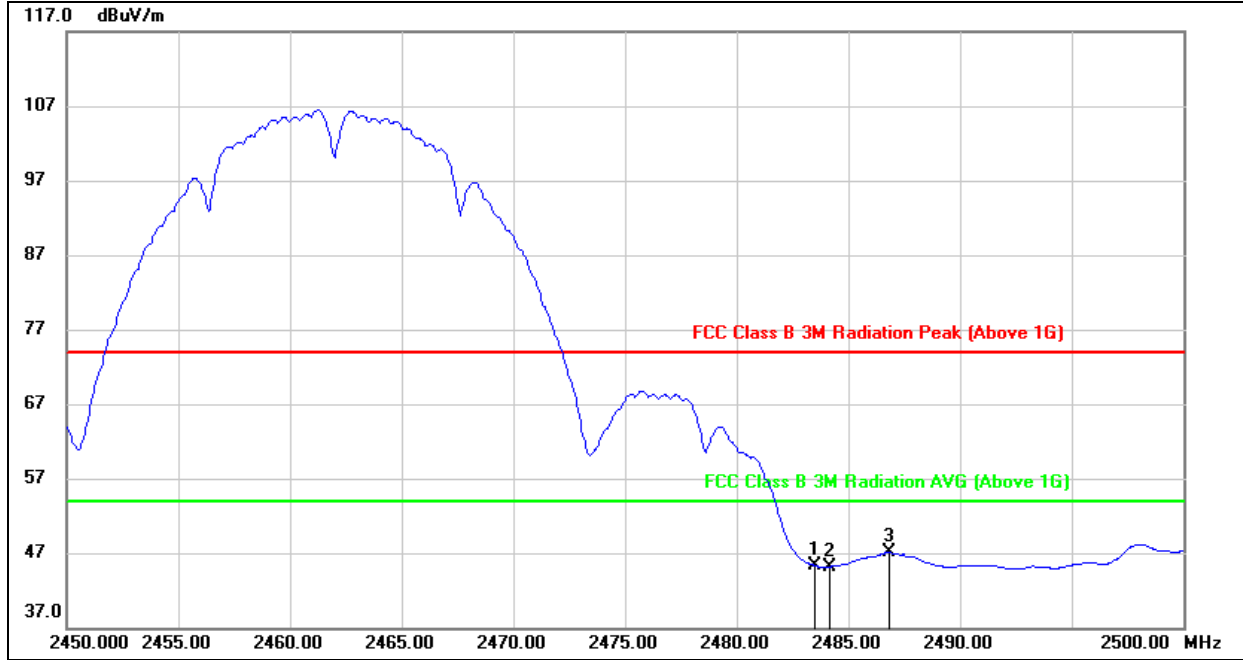

No.	Frequency (MHz)	Reading (dBuV)	Correct (dB/m)	Result (dBuV/m)	Limit (dBuV/m)	Margin (dB)	Remark
1	2483.500	12.54	32.78	45.32	54.00	-8.68	AVG
2	2484.150	12.39	32.78	45.17	54.00	-8.83	AVG
3	2486.850	14.25	32.79	47.04	54.00	-6.96	AVG

- Note:
1. Measurement = Reading Level + Correct Factor.
  2. If Peak Result complies with AV limit, AV Result is deemed to comply with AV limit.
  3. AVG:  $VBW=1/Ton$  where: ton is transmit duration.
  4. For transmit duration, please refer to clause 8.1.
  5. Only the worst case emission was recorded, if it complies with the limit, the other emissions deemed to comply with the limit.



**RESTRICTED BANDEDGE (HIGH CHANNEL, VERTICAL)**

**PEAK**

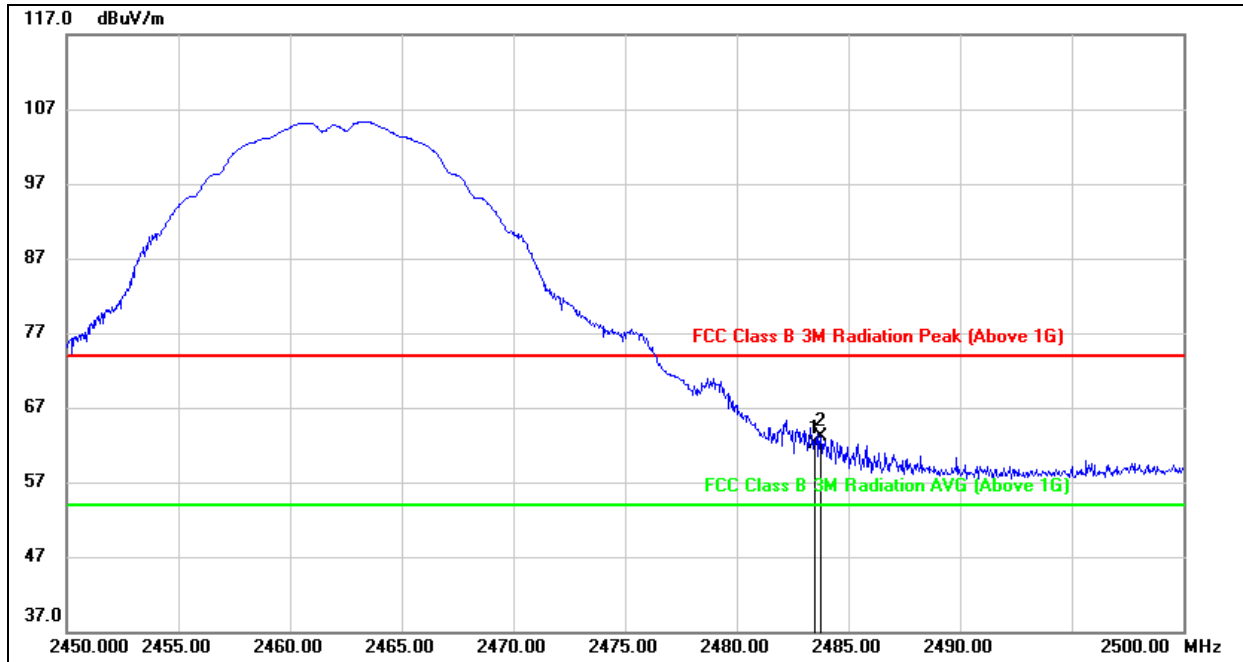

No.	Frequency (MHz)	Reading (dBuV)	Correct (dB/m)	Result (dBuV/m)	Limit (dBuV/m)	Margin (dB)	Remark
1	2483.500	29.25	32.88	62.13	74.00	-11.87	peak
2	2483.750	30.32	32.88	63.20	74.00	-10.80	peak

- Note: 1. Measurement = Reading Level + Correct Factor.  
 2. If Peak Result complies with AV limit, AV Result is deemed to comply with AV limit.  
 3. Peak: Peak detector.  
 4. Only the worst case emission was recorded, if it complies with the limit, the other emissions deemed to comply with the limit.





**AVG**

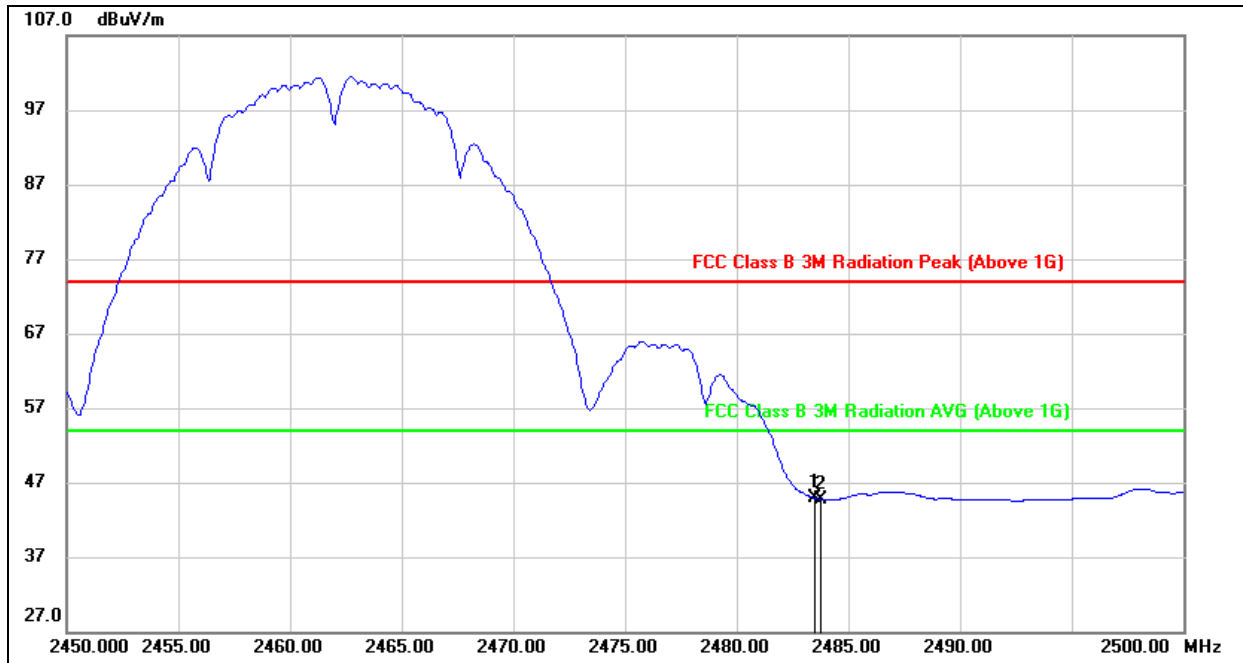

No.	Frequency (MHz)	Reading (dBuV)	Correct (dB/m)	Result (dBuV/m)	Limit (dBuV/m)	Margin (dB)	Remark
1	2483.500	12.04	32.88	44.92	54.00	-9.08	AVG
2	2483.750	11.88	32.88	44.76	54.00	-9.24	AVG

- Note:
1. Measurement = Reading Level + Correct Factor.
  2. If Peak Result complies with AV limit, AV Result is deemed to comply with AV limit.
  3. AVG:  $VBW=1/Ton$  where: ton is transmit duration.
  4. For transmit duration, please refer to clause 8.1.
  5. Only the worst case emission was recorded, if it complies with the limit, the other emissions deemed to comply with the limit.



### 9.1.2. 802.11g MODE

#### 1TX MODE FOR ANT0 (WORST-CASE CONFIGURATION)

#### RESTRICTED BANDEDGE (LOW CHANNEL, HORIZONTAL)

#### PEAK

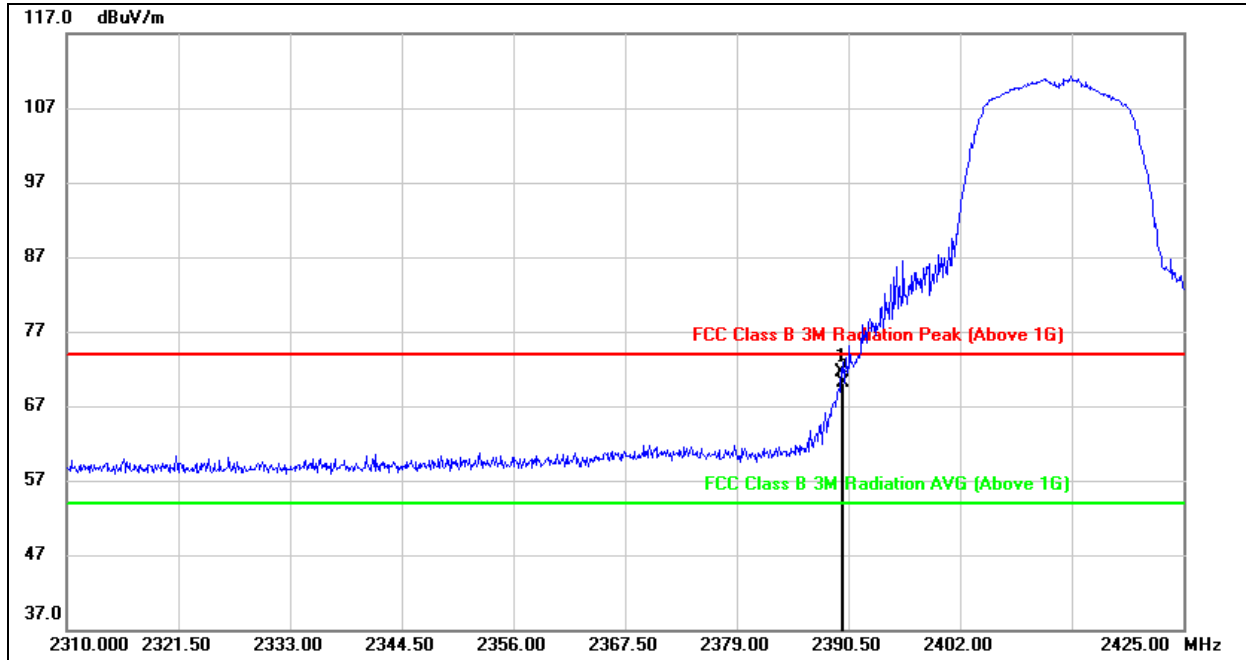

No.	Frequency (MHz)	Reading (dBuV)	Correct (dB/m)	Result (dBuV/m)	Limit (dBuV/m)	Margin (dB)	Remark
1	2389.810	38.41	33.14	71.55	74.00	-2.45	peak
2	2390.000	37.03	33.14	70.17	74.00	-3.83	peak

- Note: 1. Measurement = Reading Level + Correct Factor.  
2. If Peak Result complies with AV limit, AV Result is deemed to comply with AV limit.  
3. Peak: Peak detector.  
4. Only the worst case emission was recorded, if it complies with the limit, the other emissions deemed to comply with the limit.



**AVG**

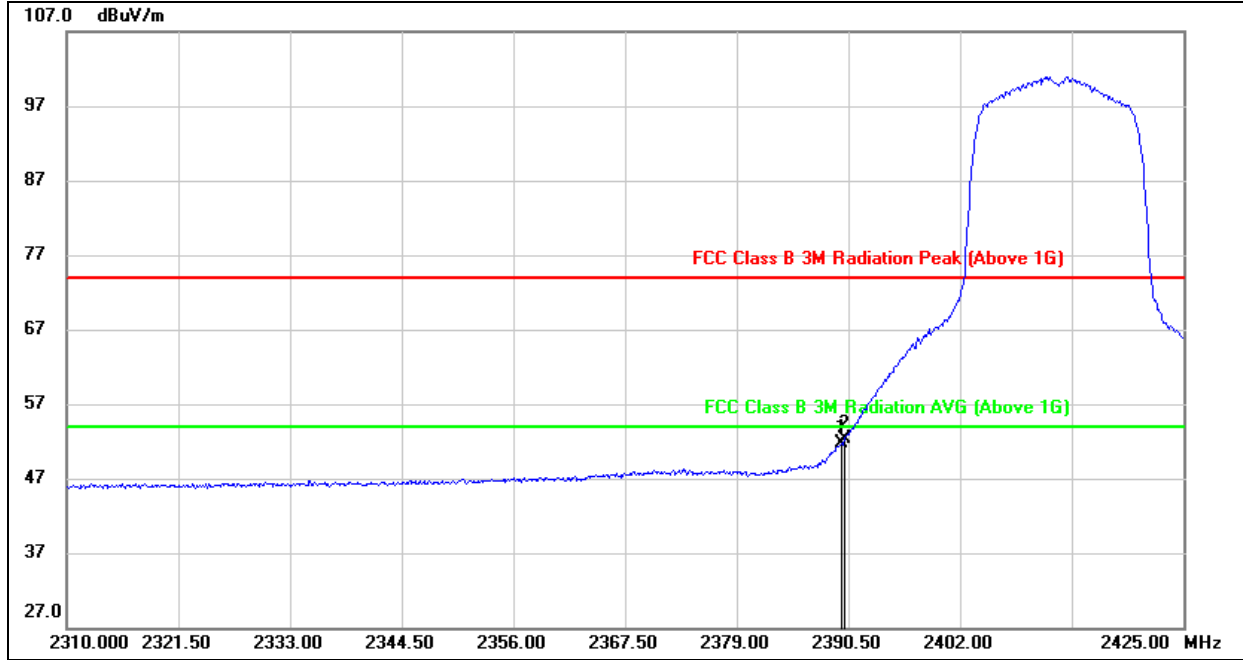

No.	Frequency (MHz)	Reading (dBuV)	Correct (dB/m)	Result (dBuV/m)	Limit (dBuV/m)	Margin (dB)	Remark
1	2389.810	18.59	33.14	51.73	54.00	-2.27	AVG
2	2390.000	19.19	33.14	52.33	54.00	-1.67	AVG

- Note:
1. Measurement = Reading Level + Correct Factor.
  2. If Peak Result complies with AV limit, AV Result is deemed to comply with AV limit.
  3. AVG:  $VBW=1/Ton$  where: ton is transmit duration.
  4. For transmit duration, please refer to clause 8.1.
  5. Only the worst case emission was recorded, if it complies with the limit, the other emissions deemed to comply with the limit.



**RESTRICTED BANDEDGE (LOW CHANNEL, VERTICAL)**

**PEAK**

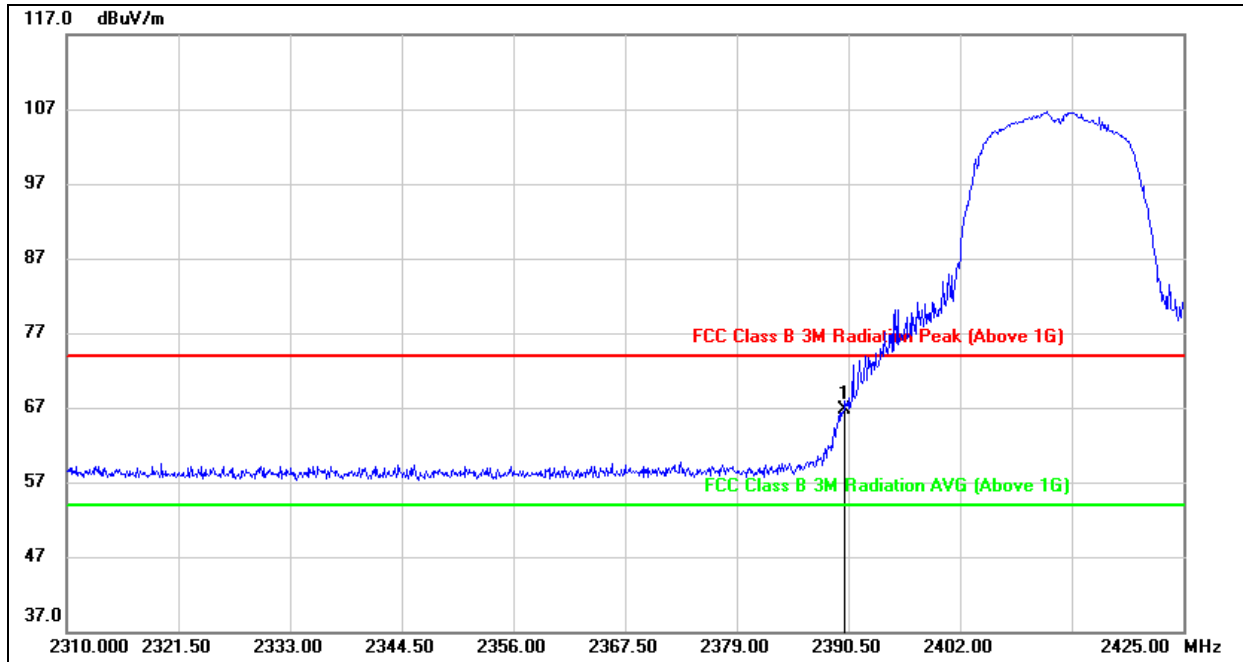

No.	Frequency (MHz)	Reading (dBuV)	Correct (dB/m)	Result (dBuV/m)	Limit (dBuV/m)	Margin (dB)	Remark
1	2390.000	33.44	33.24	66.68	74.00	-7.32	peak

- Note: 1. Measurement = Reading Level + Correct Factor.  
 2. If Peak Result complies with AV limit, AV Result is deemed to comply with AV limit.  
 3. Peak: Peak detector.  
 4. Only the worst case emission was recorded, if it complies with the limit, the other emissions deemed to comply with the limit.



**AVG**

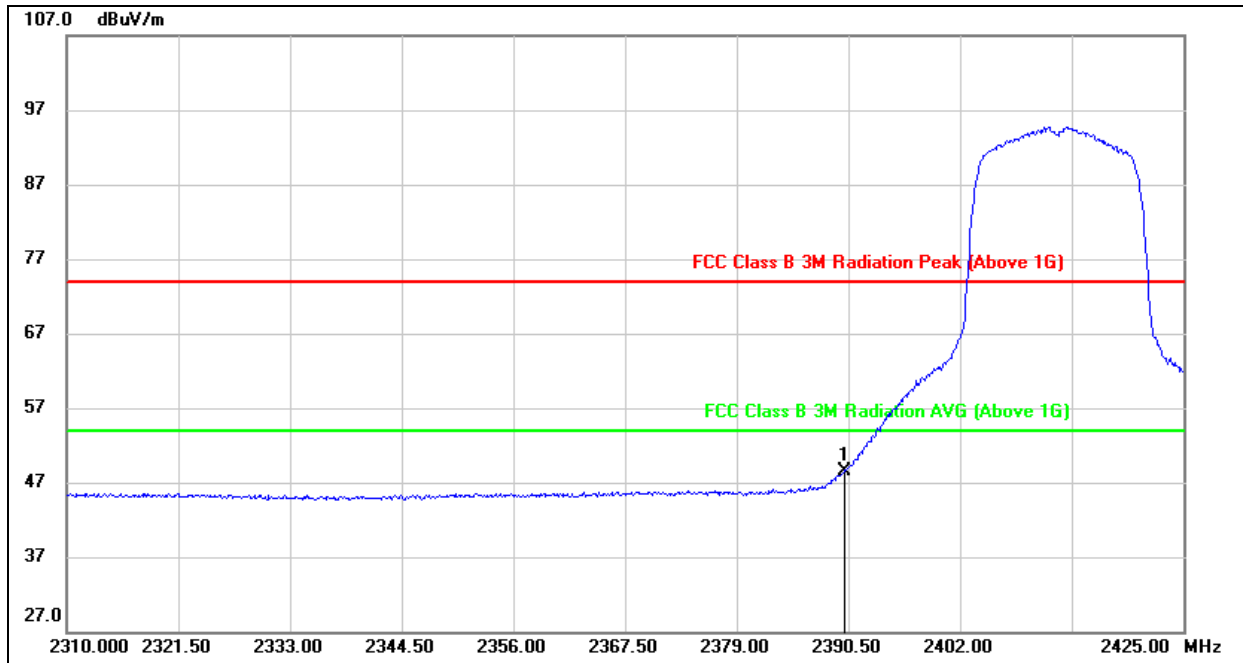

No.	Frequency (MHz)	Reading (dBuV)	Correct (dB/m)	Result (dBuV/m)	Limit (dBuV/m)	Margin (dB)	Remark
1	2390.000	15.27	33.24	48.51	54.00	-5.49	AVG

- Note:
1. Measurement = Reading Level + Correct Factor.
  2. If Peak Result complies with AV limit, AV Result is deemed to comply with AV limit.
  3. AVG:  $VBW=1/Ton$  where: ton is transmit duration.
  4. For transmit duration, please refer to clause 8.1.
  5. Only the worst case emission was recorded, if it complies with the limit, the other emissions deemed to comply with the limit.



**RESTRICTED BANDEDGE (HIGH CHANNEL, HORIZONTAL)**

**PEAK**

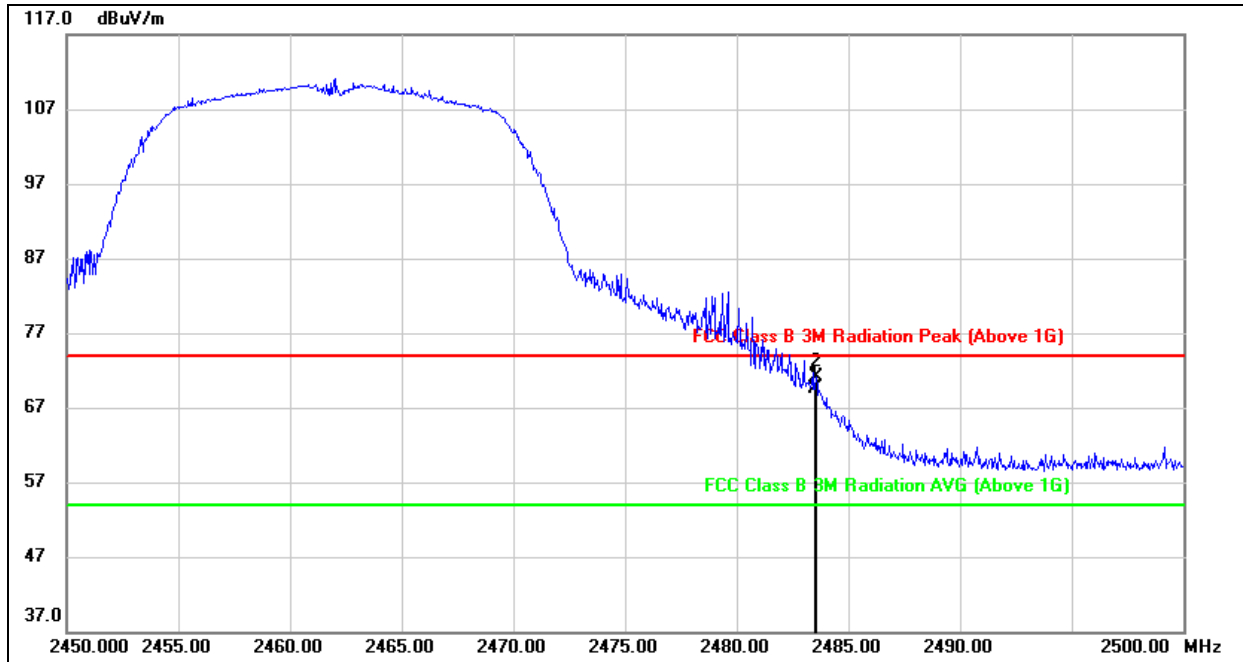

No.	Frequency (MHz)	Reading (dBuV)	Correct (dB/m)	Result (dBuV/m)	Limit (dBuV/m)	Margin (dB)	Remark
1	2483.500	36.74	32.78	69.52	74.00	-4.48	peak
2	2483.550	38.26	32.78	71.04	74.00	-2.96	peak

- Note: 1. Measurement = Reading Level + Correct Factor.  
 2. If Peak Result complies with AV limit, AV Result is deemed to comply with AV limit.  
 3. Peak: Peak detector.  
 4. Only the worst case emission was recorded, if it complies with the limit, the other emissions deemed to comply with the limit.





**AVG**

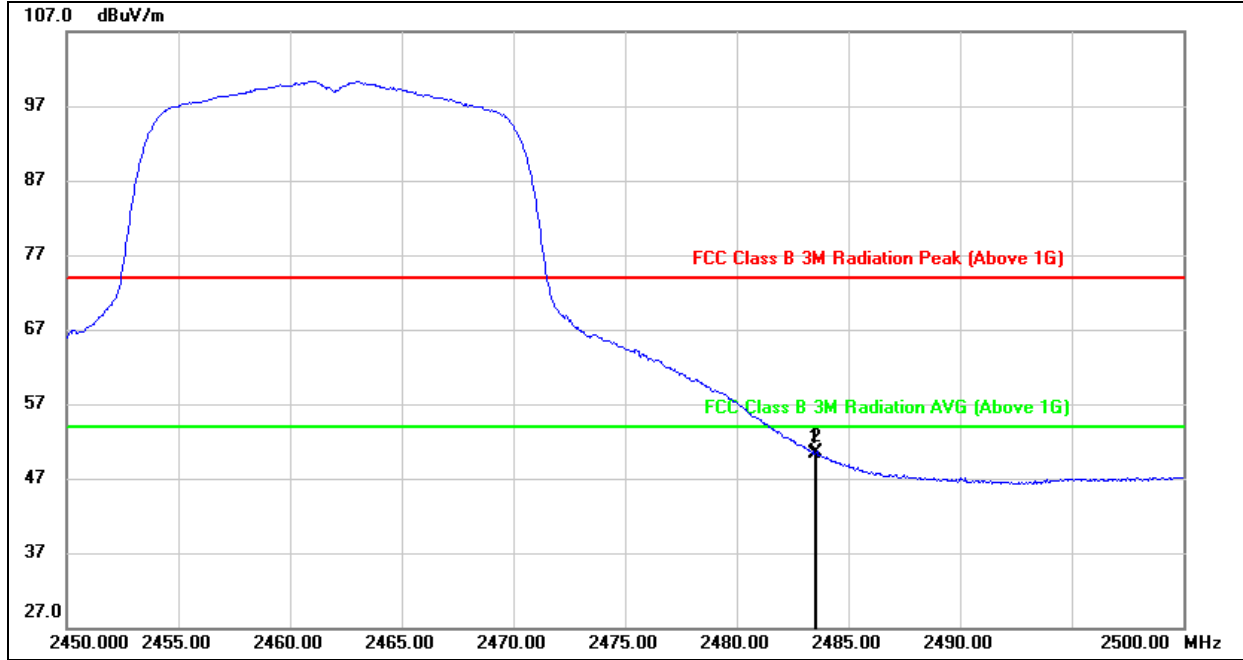

No.	Frequency (MHz)	Reading (dBuV)	Correct (dB/m)	Result (dBuV/m)	Limit (dBuV/m)	Margin (dB)	Remark
1	2483.500	17.49	32.78	50.27	54.00	-3.73	AVG
2	2483.550	17.76	32.78	50.54	54.00	-3.46	AVG

- Note:
1. Measurement = Reading Level + Correct Factor.
  2. If Peak Result complies with AV limit, AV Result is deemed to comply with AV limit.
  3. AVG:  $VBW=1/Ton$  where: ton is transmit duration.
  4. For transmit duration, please refer to clause 8.1.
  5. Only the worst case emission was recorded, if it complies with the limit, the other emissions deemed to comply with the limit.



**RESTRICTED BANDEDGE (HIGH CHANNEL, VERTICAL)**

**PEAK**

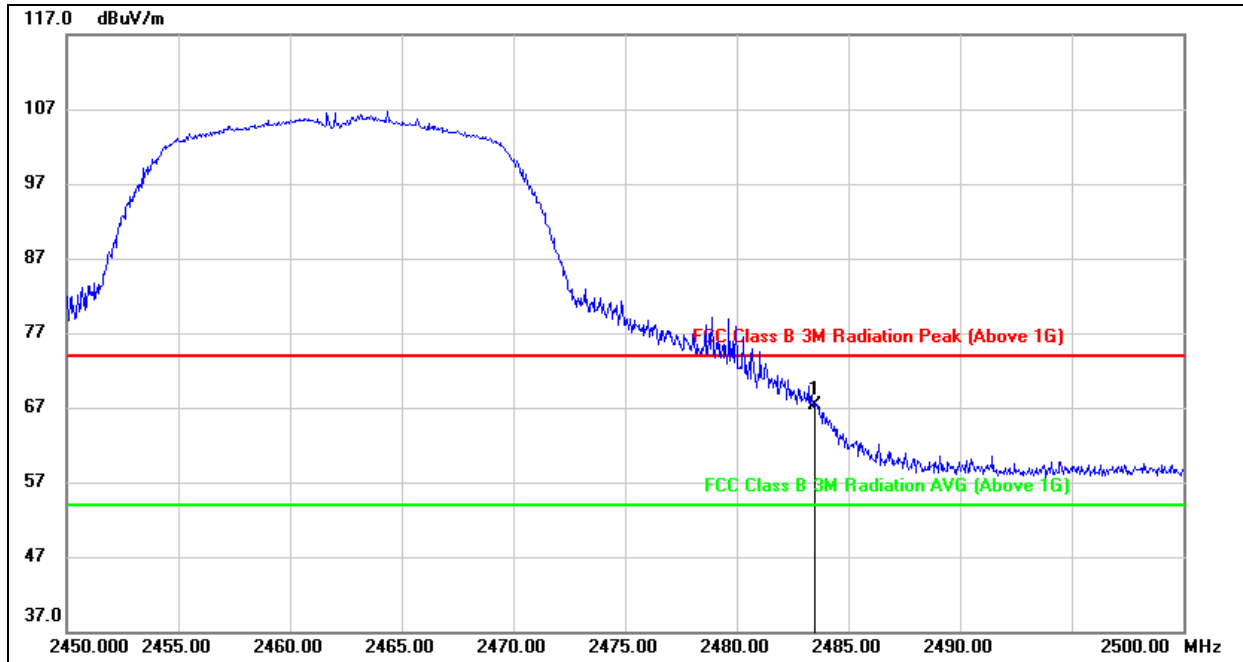

No.	Frequency (MHz)	Reading (dBuV)	Correct (dB/m)	Result (dBuV/m)	Limit (dBuV/m)	Margin (dB)	Remark
1	2483.500	34.38	32.88	67.26	74.00	-6.74	peak

- Note: 1. Measurement = Reading Level + Correct Factor.  
 2. If Peak Result complies with AV limit, AV Result is deemed to comply with AV limit.  
 3. Peak: Peak detector.  
 4. Only the worst case emission was recorded, if it complies with the limit, the other emissions deemed to comply with the limit.



**AVG**

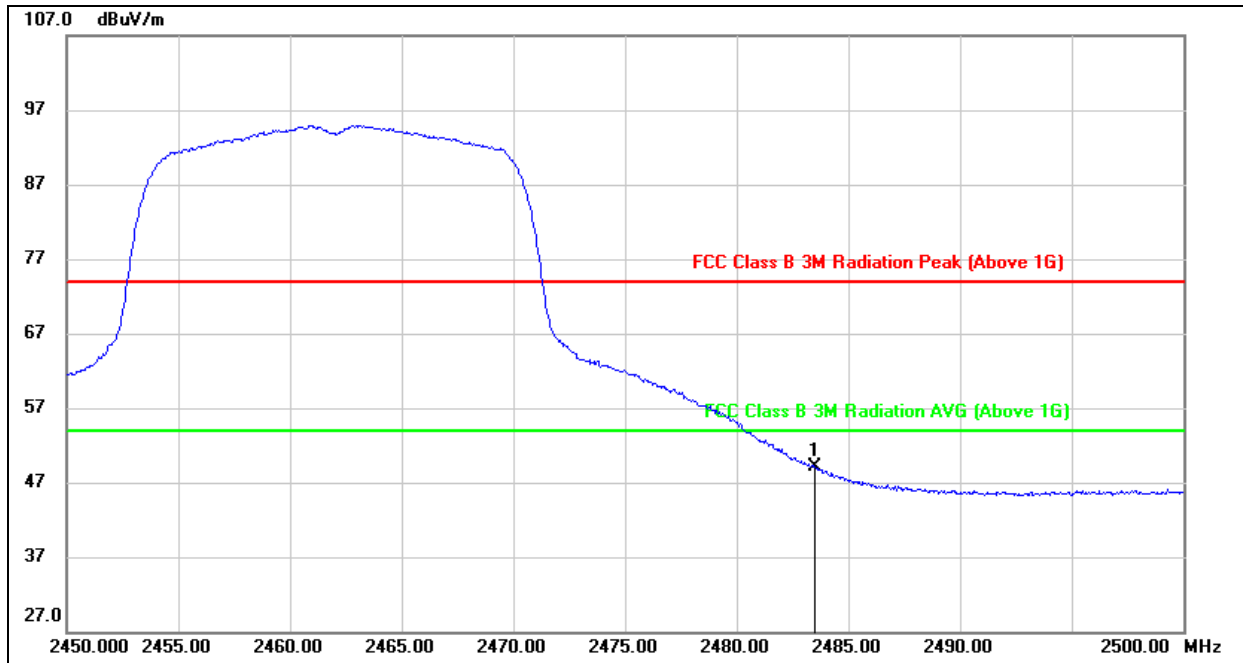

No.	Frequency (MHz)	Reading (dBuV)	Correct (dB/m)	Result (dBuV/m)	Limit (dBuV/m)	Margin (dB)	Remark
1	2483.500	16.18	32.88	49.06	54.00	-4.94	AVG

- Note:
1. Measurement = Reading Level + Correct Factor.
  2. If Peak Result complies with AV limit, AV Result is deemed to comply with AV limit.
  3. AVG:  $VBW=1/Ton$  where: ton is transmit duration.
  4. For transmit duration, please refer to clause 8.1.
  5. Only the worst case emission was recorded, if it complies with the limit, the other emissions deemed to comply with the limit.



**9.1.3. 802.11n HT20 MODE**

**2TX MODE (WORST-CASE CONFIGURATION)**

**RESTRICTED BANDEDGE (LOW CHANNEL, HORIZONTAL)**

**PEAK**

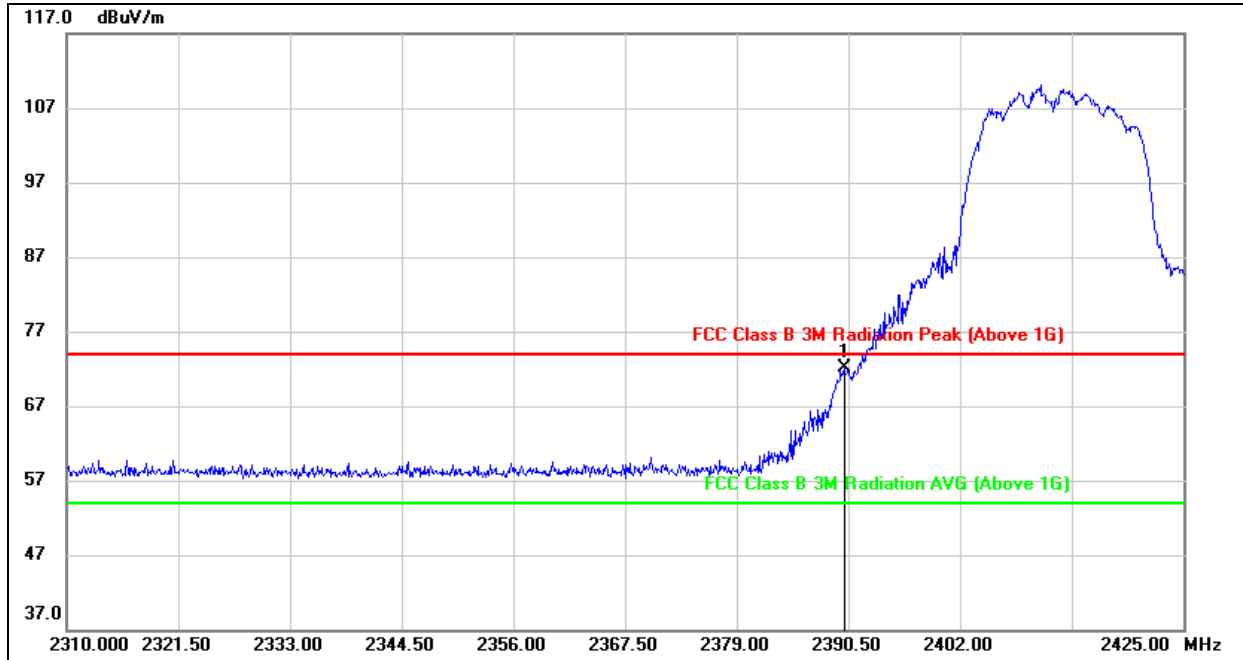

No.	Frequency (MHz)	Reading (dBuV)	Correct (dB/m)	Result (dBuV/m)	Limit (dBuV/m)	Margin (dB)	Remark
1	2390.000	38.92	33.14	72.06	74.00	-1.94	peak

- Note: 1. Measurement = Reading Level + Correct Factor.  
 2. If Peak Result complies with AV limit, AV Result is deemed to comply with AV limit.  
 3. Peak: Peak detector.  
 4. Only the worst case emission was recorded, if it complies with the limit, the other emissions deemed to comply with the limit.



**AVG**

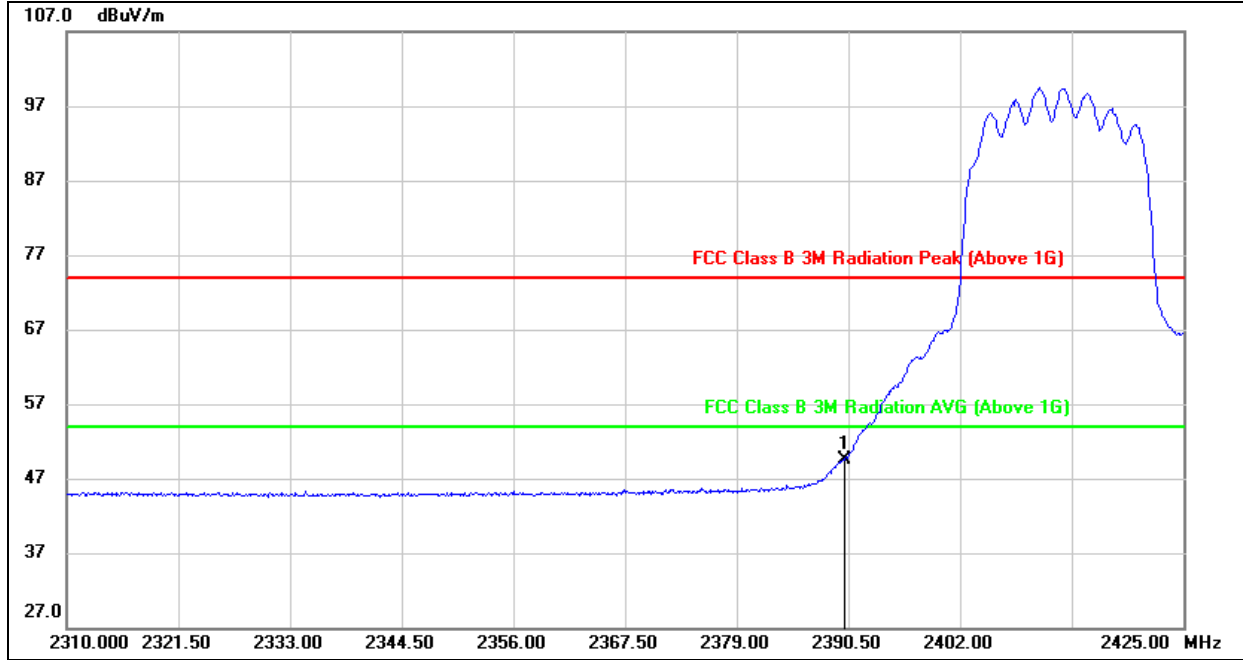

No.	Frequency (MHz)	Reading (dBuV)	Correct (dB/m)	Result (dBuV/m)	Limit (dBuV/m)	Margin (dB)	Remark
1	2390.000	16.37	33.14	49.51	54.00	-4.49	AVG

- Note:
1. Measurement = Reading Level + Correct Factor.
  2. If Peak Result complies with AV limit, AV Result is deemed to comply with AV limit.
  3. AVG:  $VBW=1/Ton$  where: ton is transmit duration.
  4. For transmit duration, please refer to clause 8.1.
  5. Only the worst case emission was recorded, if it complies with the limit, the other emissions deemed to comply with the limit.



**RESTRICTED BANDEDGE (LOW CHANNEL, VERTICAL)**

**PEAK**

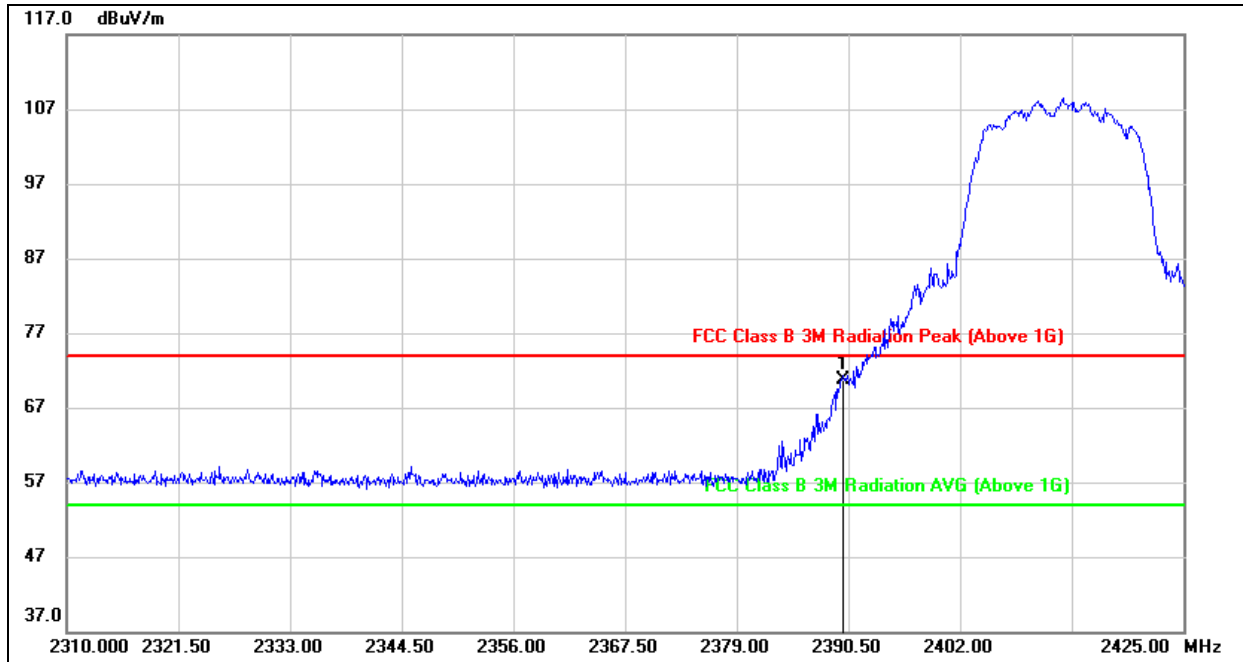

No.	Frequency (MHz)	Reading (dBuV)	Correct (dB/m)	Result (dBuV/m)	Limit (dBuV/m)	Margin (dB)	Remark
1	2390.000	37.56	33.24	70.80	74.00	-3.20	peak

- Note: 1. Measurement = Reading Level + Correct Factor.  
 2. If Peak Result complies with AV limit, AV Result is deemed to comply with AV limit.  
 3. Peak: Peak detector.  
 4. Only the worst case emission was recorded, if it complies with the limit, the other emissions deemed to comply with the limit.





**AVG**

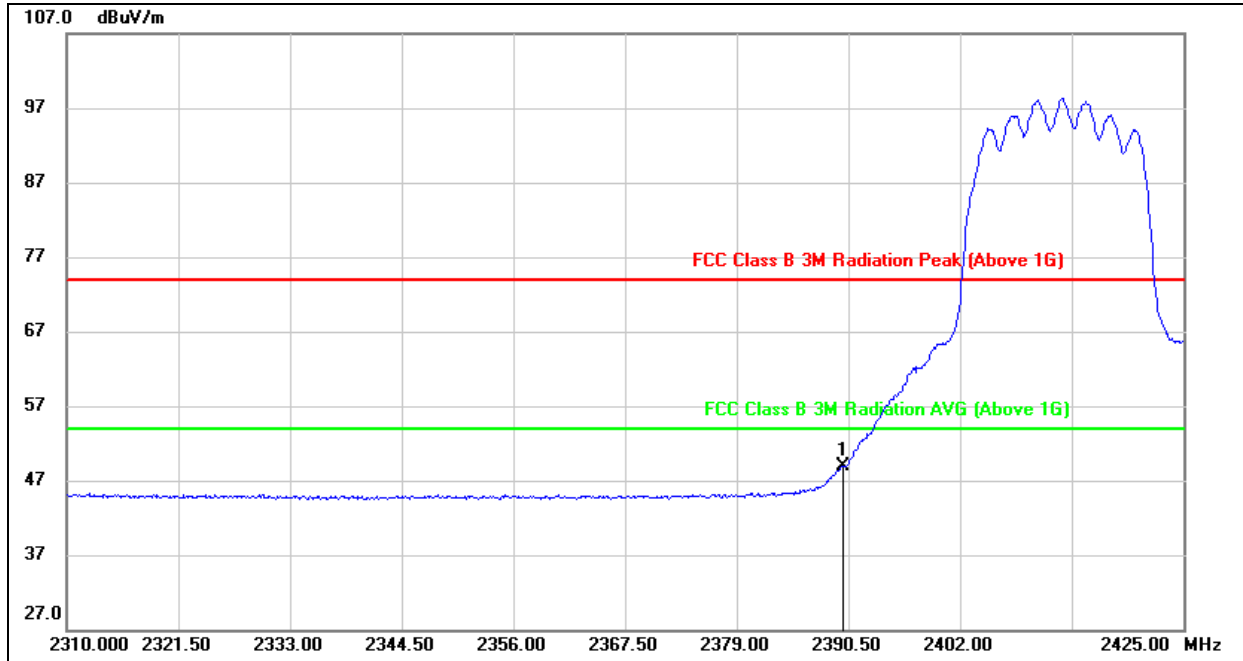

No.	Frequency (MHz)	Reading (dBuV)	Correct (dB/m)	Result (dBuV/m)	Limit (dBuV/m)	Margin (dB)	Remark
1	2390.000	15.69	33.24	48.93	54.00	-5.07	AVG

- Note:
1. Measurement = Reading Level + Correct Factor.
  2. If Peak Result complies with AV limit, AV Result is deemed to comply with AV limit.
  3. AVG:  $VBW=1/Ton$  where: ton is transmit duration.
  4. For transmit duration, please refer to clause 8.1.
  5. Only the worst case emission was recorded, if it complies with the limit, the other emissions deemed to comply with the limit.



**RESTRICTED BANDEDGE (HIGH CHANNEL, HORIZONTAL)**

**PEAK**

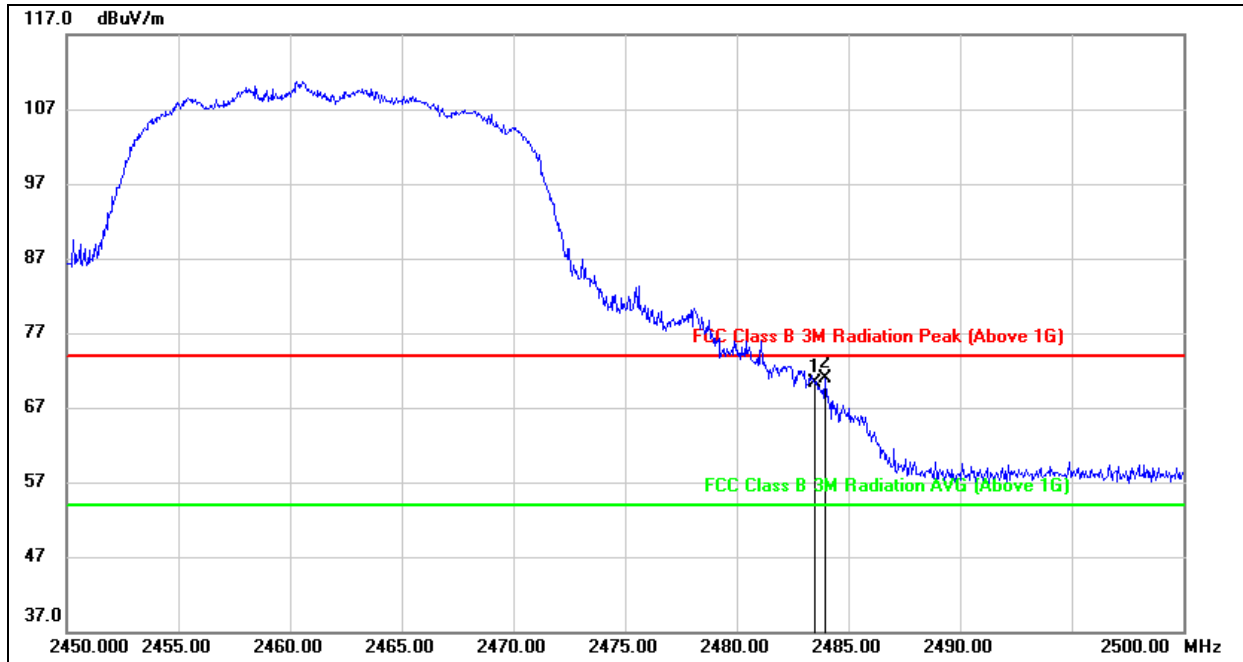

No.	Frequency (MHz)	Reading (dBuV)	Correct (dB/m)	Result (dBuV/m)	Limit (dBuV/m)	Margin (dB)	Remark
1	2483.500	37.47	32.78	70.25	74.00	-3.75	peak
2	2483.950	38.06	32.78	70.84	74.00	-3.16	peak

- Note: 1. Measurement = Reading Level + Correct Factor.  
 2. If Peak Result complies with AV limit, AV Result is deemed to comply with AV limit.  
 3. Peak: Peak detector.  
 4. Only the worst case emission was recorded, if it complies with the limit, the other emissions deemed to comply with the limit.



**AVG**

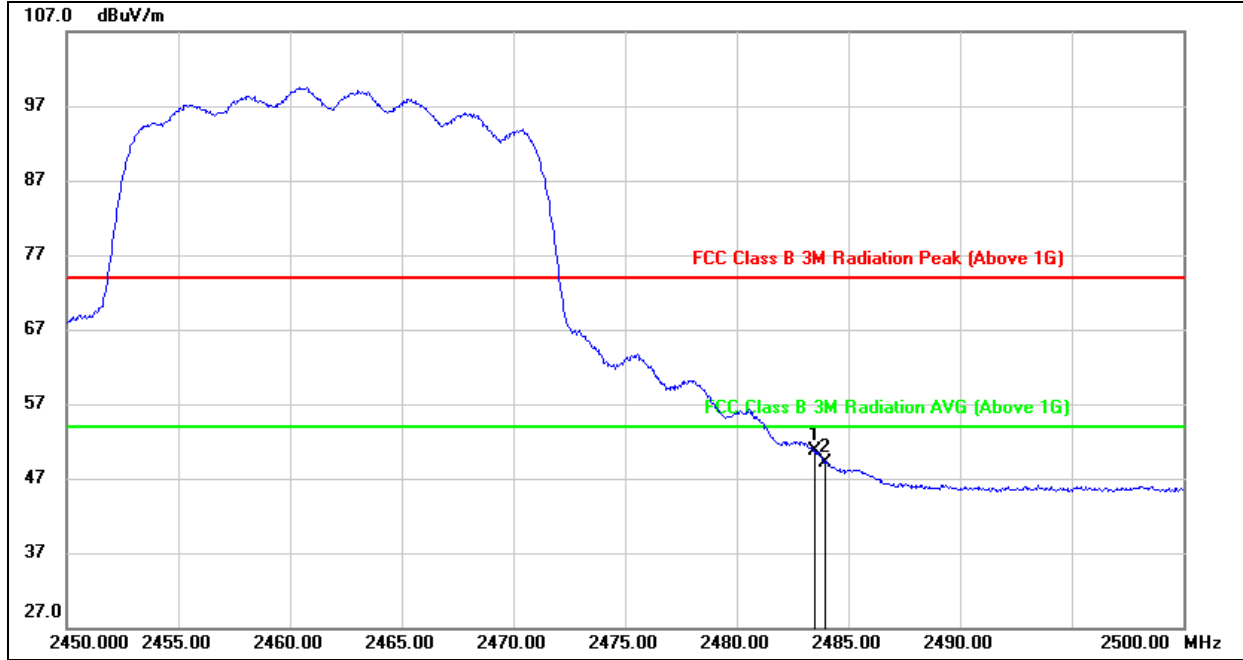

No.	Frequency (MHz)	Reading (dBuV)	Correct (dB/m)	Result (dBuV/m)	Limit (dBuV/m)	Margin (dB)	Remark
1	2483.500	17.84	32.78	50.62	54.00	-3.38	AVG
2	2483.950	16.30	32.78	49.08	54.00	-4.92	AVG

- Note:
1. Measurement = Reading Level + Correct Factor.
  2. If Peak Result complies with AV limit, AV Result is deemed to comply with AV limit.
  3. AVG:  $VBW=1/Ton$  where: ton is transmit duration.
  4. For transmit duration, please refer to clause 8.1.
  5. Only the worst case emission was recorded, if it complies with the limit, the other emissions deemed to comply with the limit.



**RESTRICTED BANDEDGE (HIGH CHANNEL, VERTICAL)**

**PEAK**

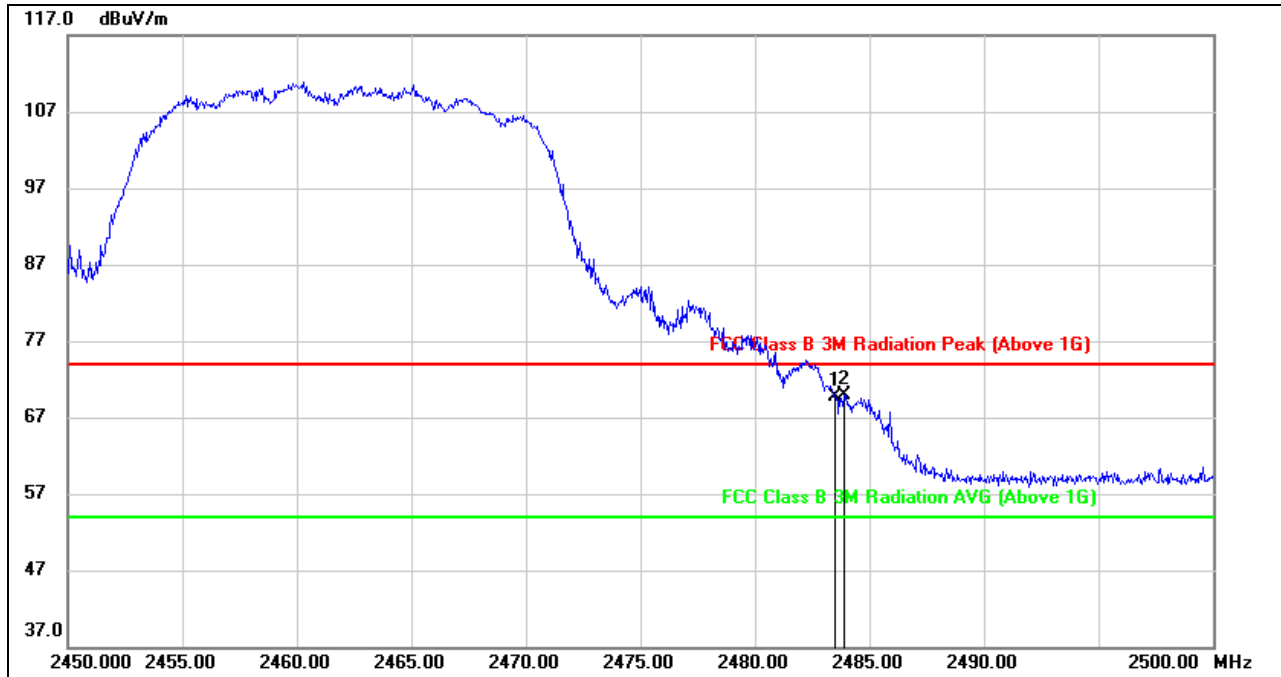

No.	Frequency (MHz)	Reading (dBuV)	Correct (dB/m)	Result (dBuV/m)	Limit (dBuV/m)	Margin (dB)	Remark
1	2483.500	36.89	32.88	69.77	74.00	-4.23	peak
2	2483.900	37.12	32.88	70.00	74.00	-4.00	peak

- Note: 1. Measurement = Reading Level + Correct Factor.  
 2. If Peak Result complies with AV limit, AV Result is deemed to comply with AV limit.  
 3. Peak: Peak detector.  
 4. Only the worst case emission was recorded, if it complies with the limit, the other emissions deemed to comply with the limit.



**AVG**

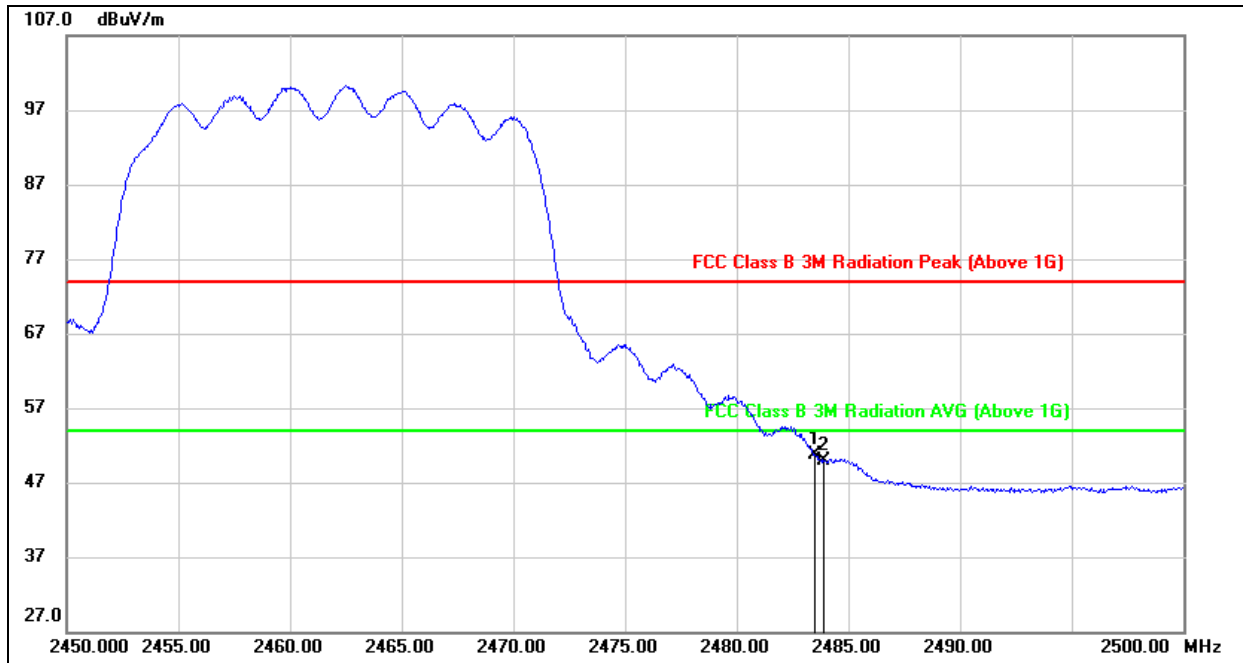

No.	Frequency (MHz)	Reading (dBuV)	Correct (dB/m)	Result (dBuV/m)	Limit (dBuV/m)	Margin (dB)	Remark
1	2483.500	17.76	32.88	50.64	54.00	-3.36	AVG
2	2483.900	16.98	32.88	49.86	54.00	-4.14	AVG

- Note:
1. Measurement = Reading Level + Correct Factor.
  2. If Peak Result complies with AV limit, AV Result is deemed to comply with AV limit.
  3. AVG:  $VBW=1/Ton$  where: ton is transmit duration.
  4. For transmit duration, please refer to clause 8.1.
  5. Only the worst case emission was recorded, if it complies with the limit, the other emissions deemed to comply with the limit.

Note: All the antennas had been tested, but only the worst data record in the report.



**9.1.4. 802.11n HT40 MODE**

**2TX MODE (WORST-CASE CONFIGURATION)**

**RESTRICTED BANDEDGE (LOW CHANNEL, HORIZONTAL)**

**PEAK**

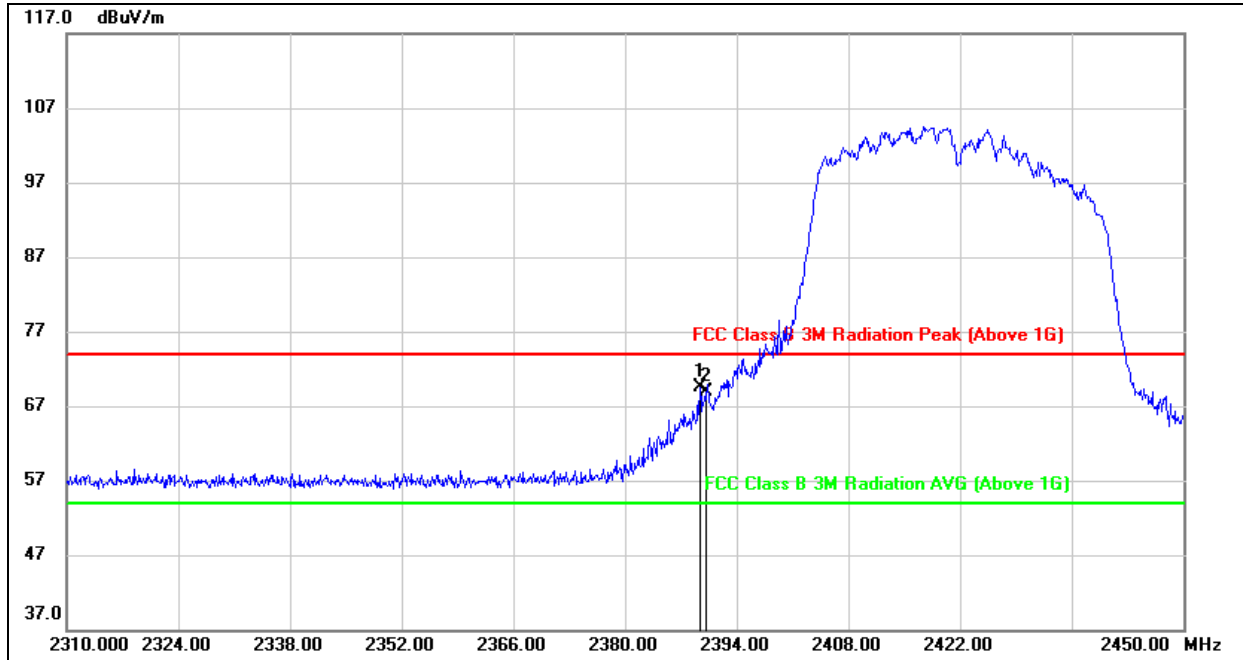

No.	Frequency (MHz)	Reading (dBuV)	Correct (dB/m)	Result (dBuV/m)	Limit (dBuV/m)	Margin (dB)	Remark
1	2389.380	36.46	33.14	69.60	74.00	-4.40	peak
2	2390.000	35.80	33.14	68.94	74.00	-5.06	peak

- Note: 1. Measurement = Reading Level + Correct Factor.  
 2. If Peak Result complies with AV limit, AV Result is deemed to comply with AV limit.  
 3. Peak: Peak detector.  
 4. Only the worst case emission was recorded, if it complies with the limit, the other emissions deemed to comply with the limit.





**AVG**

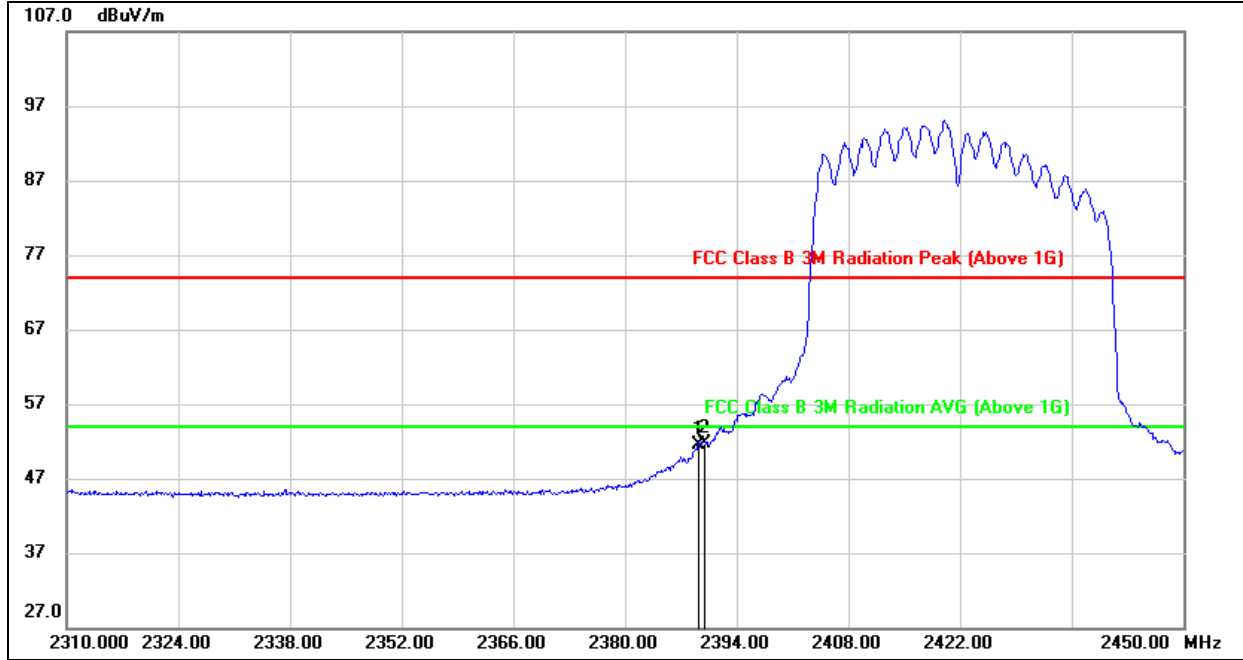

No.	Frequency (MHz)	Reading (dBuV)	Correct (dB/m)	Result (dBuV/m)	Limit (dBuV/m)	Margin (dB)	Remark
1	2389.380	18.35	33.14	51.49	54.00	-2.51	AVG
2	2390.000	18.56	33.14	51.70	54.00	-2.30	AVG

- Note:
1. Measurement = Reading Level + Correct Factor.
  2. If Peak Result complies with AV limit, AV Result is deemed to comply with AV limit.
  3. AVG:  $VBW=1/Ton$  where: ton is transmit duration.
  4. For transmit duration, please refer to clause 8.1.
  5. Only the worst case emission was recorded, if it complies with the limit, the other emissions deemed to comply with the limit.



**RESTRICTED BANDEDGE (LOW CHANNEL, VERTICAL)**

**PEAK**

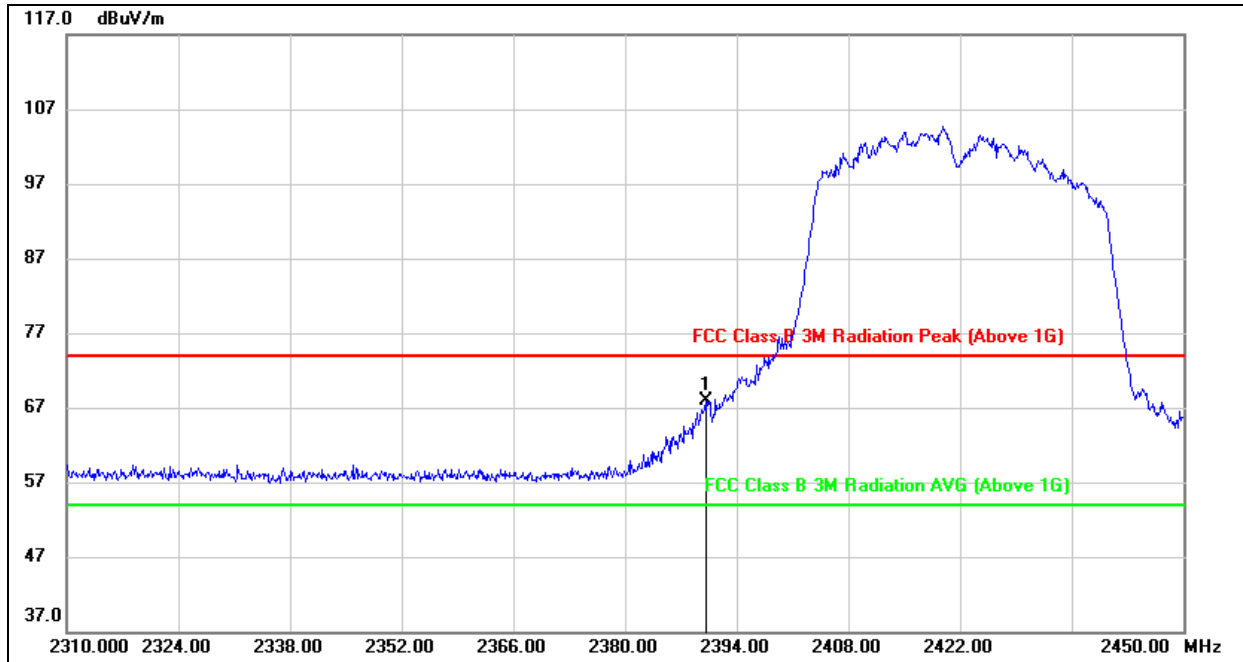

No.	Frequency (MHz)	Reading (dBuV)	Correct (dB/m)	Result (dBuV/m)	Limit (dBuV/m)	Margin (dB)	Remark
1	2390.000	34.76	33.24	68.00	74.00	-6.00	peak

- Note: 1. Measurement = Reading Level + Correct Factor.  
 2. If Peak Result complies with AV limit, AV Result is deemed to comply with AV limit.  
 3. Peak: Peak detector.  
 4. Only the worst case emission was recorded, if it complies with the limit, the other emissions deemed to comply with the limit.



**AVG**

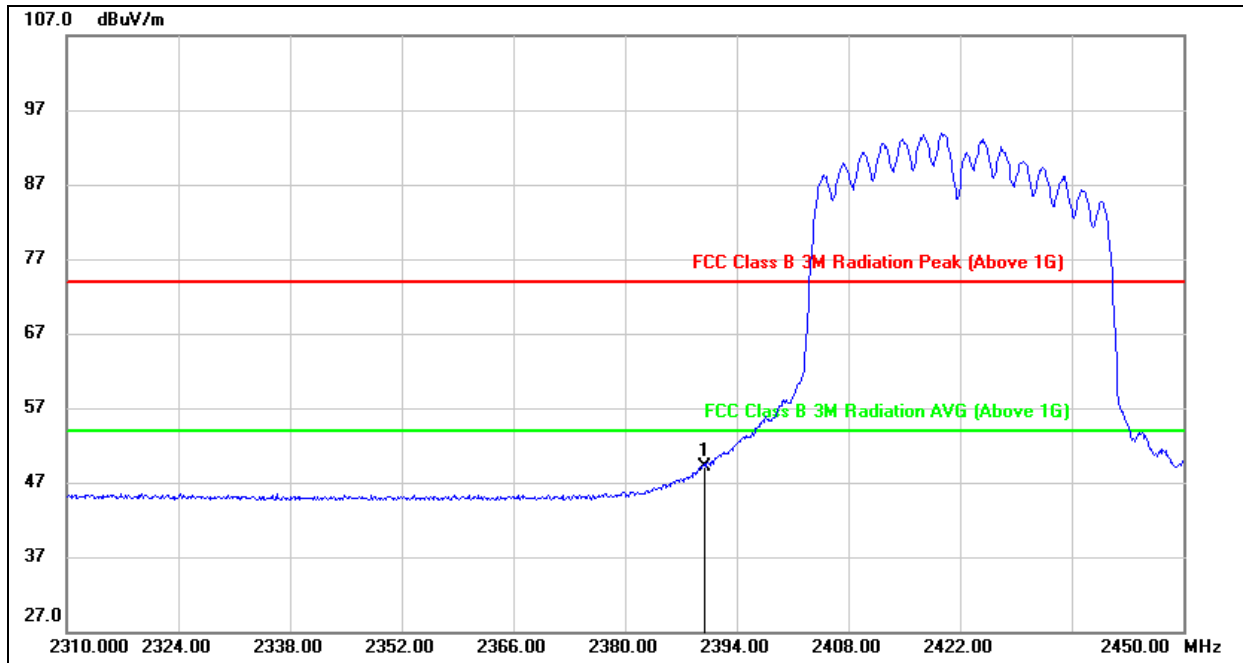

No.	Frequency (MHz)	Reading (dBuV)	Correct (dB/m)	Result (dBuV/m)	Limit (dBuV/m)	Margin (dB)	Remark
1	2390.000	15.80	33.24	49.04	54.00	-4.96	AVG

- Note:
1. Measurement = Reading Level + Correct Factor.
  2. If Peak Result complies with AV limit, AV Result is deemed to comply with AV limit.
  3. AVG:  $VBW=1/Ton$  where: ton is transmit duration.
  4. For transmit duration, please refer to clause 8.1.
  5. Only the worst case emission was recorded, if it complies with the limit, the other emissions deemed to comply with the limit.



**RESTRICTED BANDEDGE (HIGH CHANNEL, HORIZONTAL)**

**PEAK**

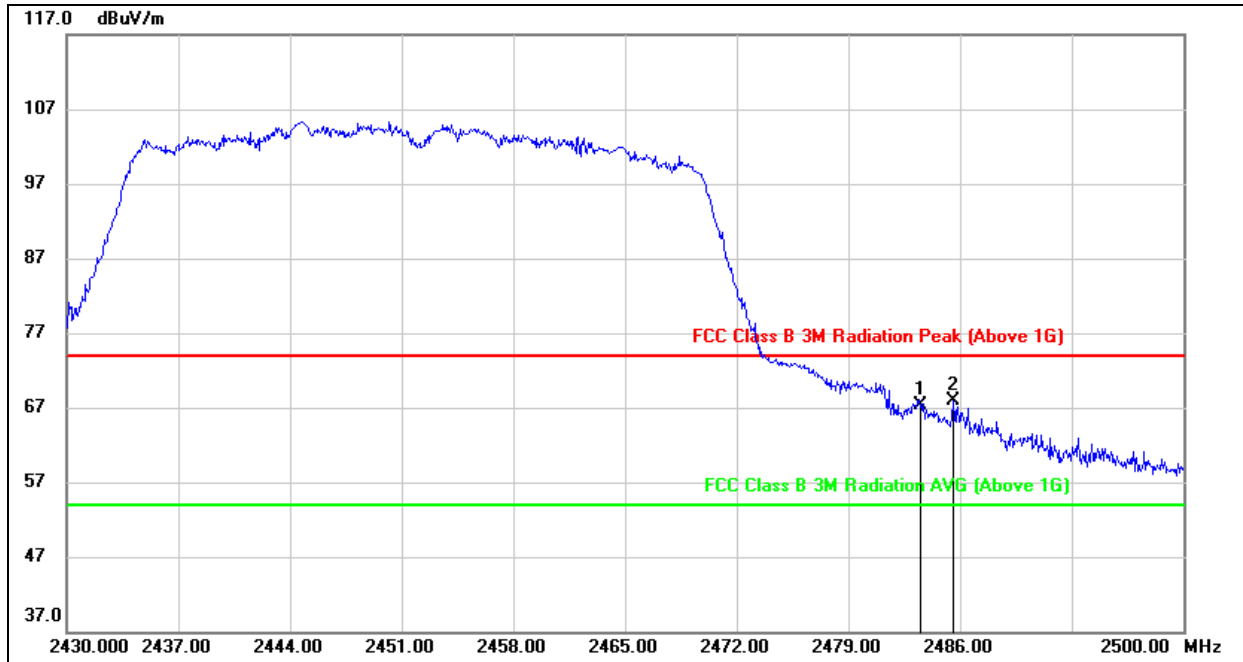

No.	Frequency (MHz)	Reading (dBuV)	Correct (dB/m)	Result (dBuV/m)	Limit (dBuV/m)	Margin (dB)	Remark
1	2483.500	34.61	32.78	67.39	74.00	-6.61	peak
2	2485.580	35.11	32.79	67.90	74.00	-6.10	peak

Note: 1. Measurement = Reading Level + Correct Factor.  
 2. If Peak Result complies with AV limit, AV Result is deemed to comply with AV limit.  
 3. Peak: Peak detector.  
 4. Only the worst case emission was recorded, if it complies with the limit, the other emissions deemed to comply with the limit.



**AVG**

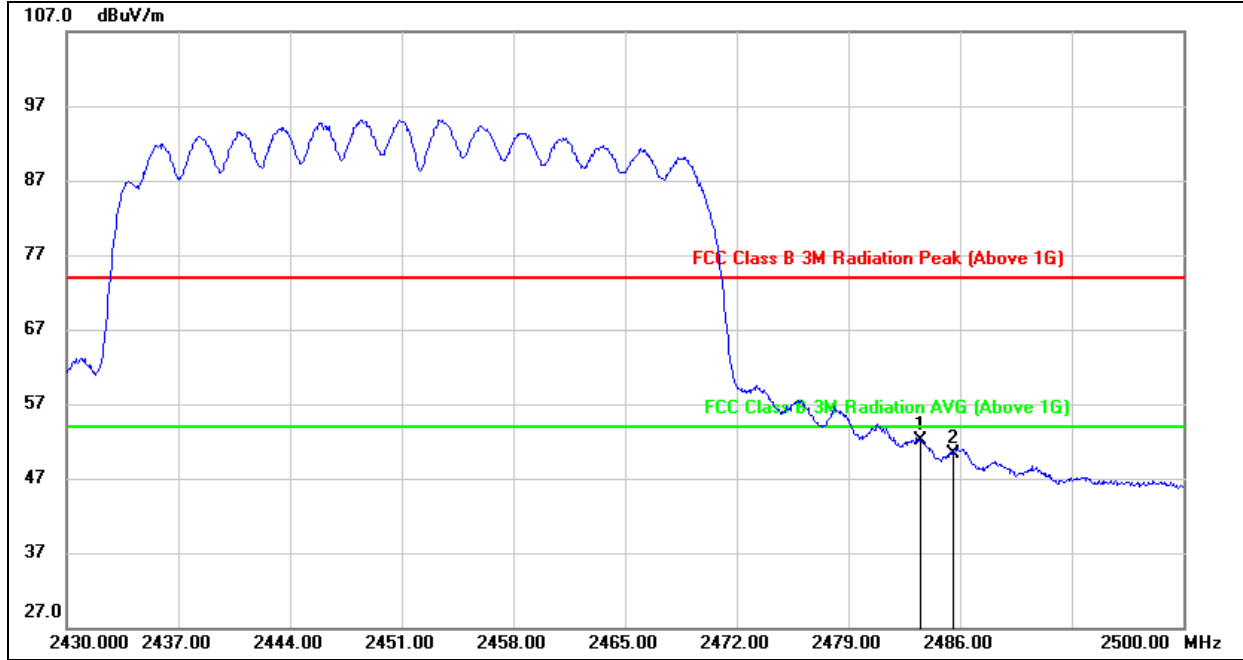

No.	Frequency (MHz)	Reading (dBuV)	Correct (dB/m)	Result (dBuV/m)	Limit (dBuV/m)	Margin (dB)	Remark
1	2483.500	19.28	32.78	52.06	54.00	-1.94	AVG
2	2485.580	17.41	32.79	50.20	54.00	-3.80	AVG

Note: 1. Measurement = Reading Level + Correct Factor.  
 2. If Peak Result complies with AV limit, AV Result is deemed to comply with AV limit.  
 3. AVG: VBW=1/Ton where: ton is transmit duration.  
 4. For transmit duration, please refer to clause 8.1.  
 5. Only the worst case emission was recorded, if it complies with the limit, the other emissions deemed to comply with the limit.



**RESTRICTED BANDEDGE (HIGH CHANNEL, VERTICAL)**

**PEAK**

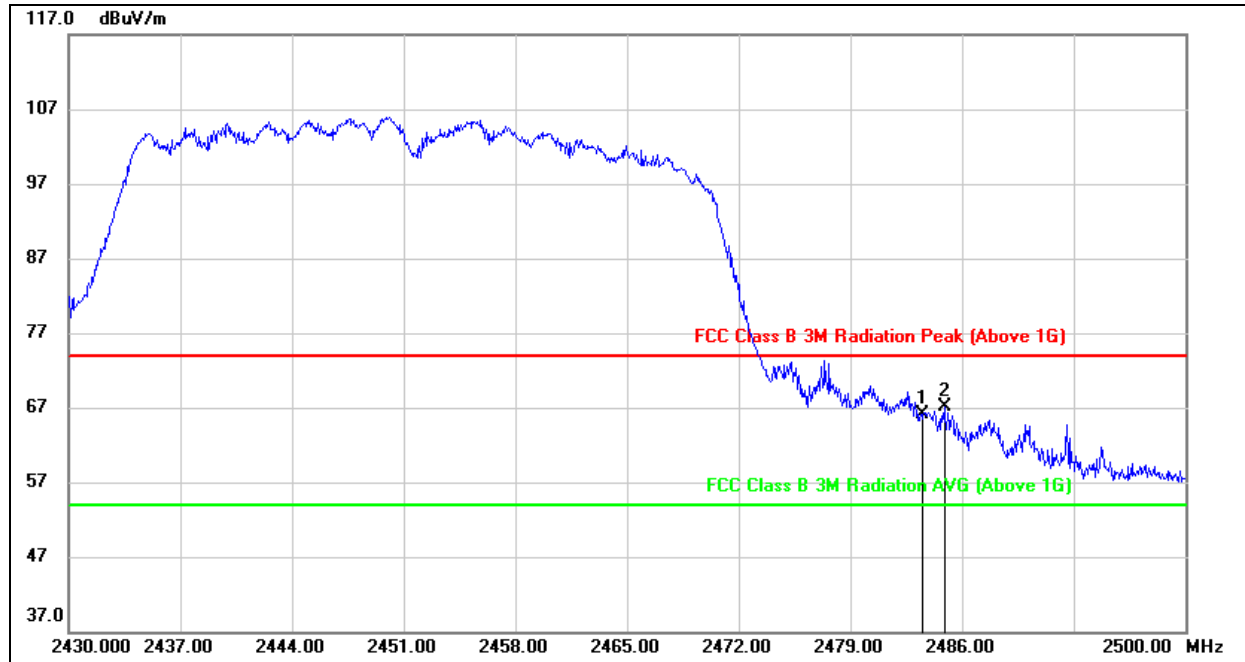

No.	Frequency (MHz)	Reading (dBuV)	Correct (dB/m)	Result (dBuV/m)	Limit (dBuV/m)	Margin (dB)	Remark
1	2483.500	33.19	32.88	66.07	74.00	-7.93	peak
2	2484.880	34.19	32.88	67.07	74.00	-6.93	peak

- Note: 1. Measurement = Reading Level + Correct Factor.  
 2. If Peak Result complies with AV limit, AV Result is deemed to comply with AV limit.  
 3. Peak: Peak detector.  
 4. Only the worst case emission was recorded, if it complies with the limit, the other emissions deemed to comply with the limit.



**AVG**

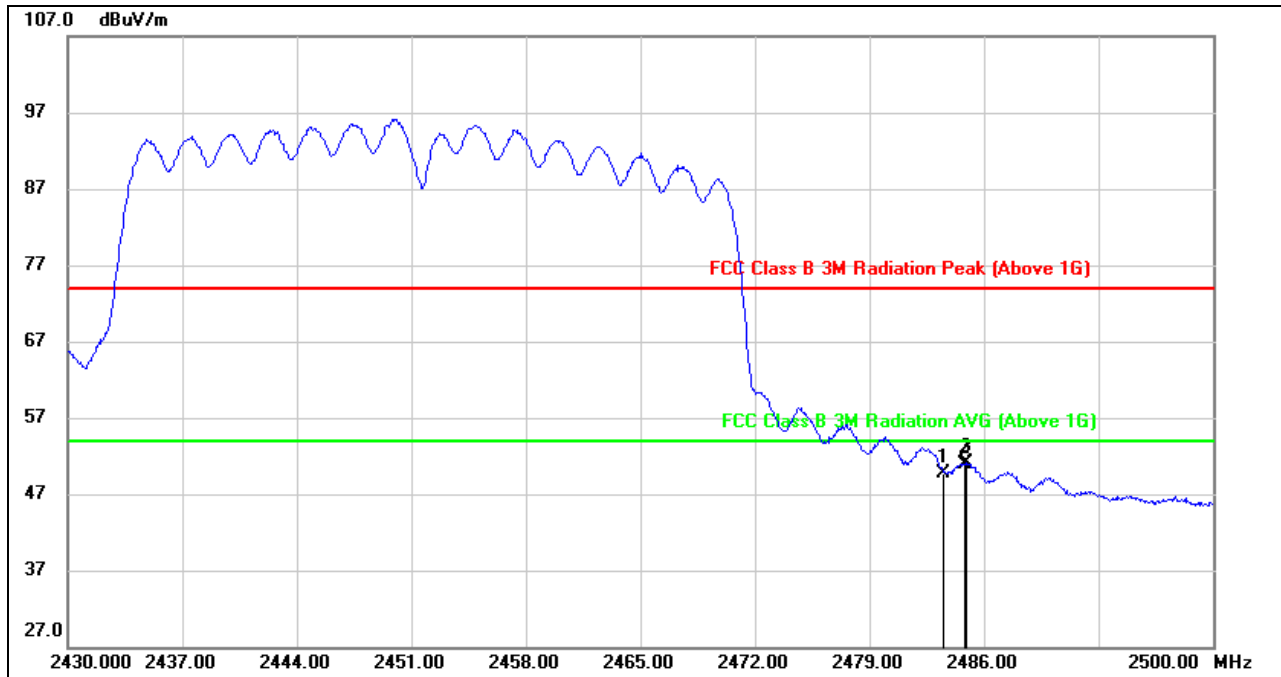

No.	Frequency (MHz)	Reading (dBuV)	Correct (dB/m)	Result (dBuV/m)	Limit (dBuV/m)	Margin (dB)	Remark
1	2483.500	16.92	32.88	49.80	54.00	-4.20	AVG
2	2484.880	18.06	32.88	50.94	54.00	-3.06	AVG
3	2484.950	18.20	32.88	51.08	54.00	-2.92	AVG

- Note:
1. Measurement = Reading Level + Correct Factor.
  2. If Peak Result complies with AV limit, AV Result is deemed to comply with AV limit.
  3. AVG:  $VBW=1/T_{on}$  where:  $t_{on}$  is transmit duration.
  4. For transmit duration, please refer to clause 8.1.
  5. Only the worst case emission was recorded, if it complies with the limit, the other emissions deemed to comply with the limit.

Note: All the antennas had been tested, but only the worst data record in the report.





## 9.2. SPURIOUS EMISSIONS (1~3GHz)

### 9.2.1. 802.11b MODE

#### 1TX MODE (WORST-CASE CONFIGURATION)

#### HARMONICS AND SPURIOUS EMISSIONS (LOW CHANNEL, HORIZONTAL)

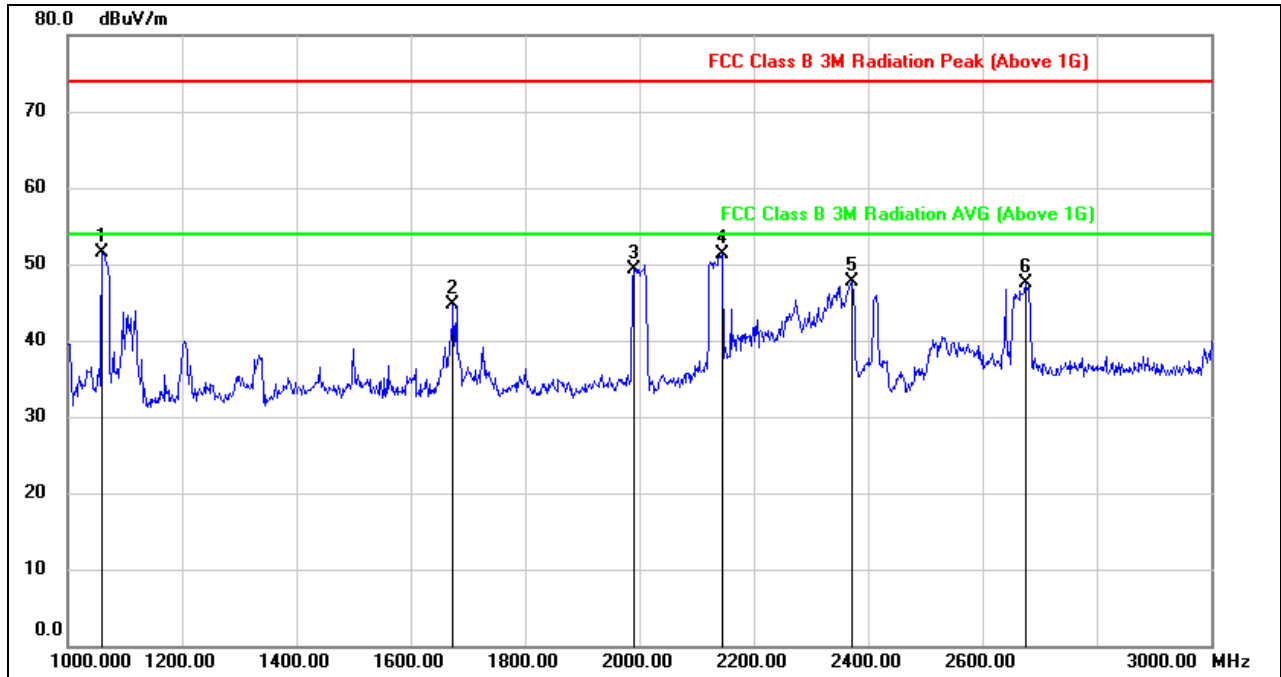

No.	Frequency (MHz)	Reading (dBuV)	Correct (dB/m)	Result (dBuV/m)	Limit (dBuV/m)	Margin (dB)	Remark
1	1060.000	65.08	-13.62	51.46	74.00	-22.54	peak
2	1674.000	56.33	-11.64	44.69	74.00	-29.31	peak
3	1990.000	60.03	-10.64	49.39	74.00	-24.61	peak
4	2144.000	60.41	-9.01	51.40	74.00	-22.60	peak
5	2372.000	55.57	-7.90	47.67	74.00	-26.33	peak
6	2676.000	55.26	-7.72	47.54	74.00	-26.46	peak

- Note: 1. Measurement = Reading Level + Correct Factor.  
 2. If Peak Result complies with AV limit, AV Result is deemed to comply with AV limit.  
 3. Peak: Peak detector.



**HARMONICS AND SPURIOUS EMISSIONS (LOW CHANNEL, VERTICAL)**

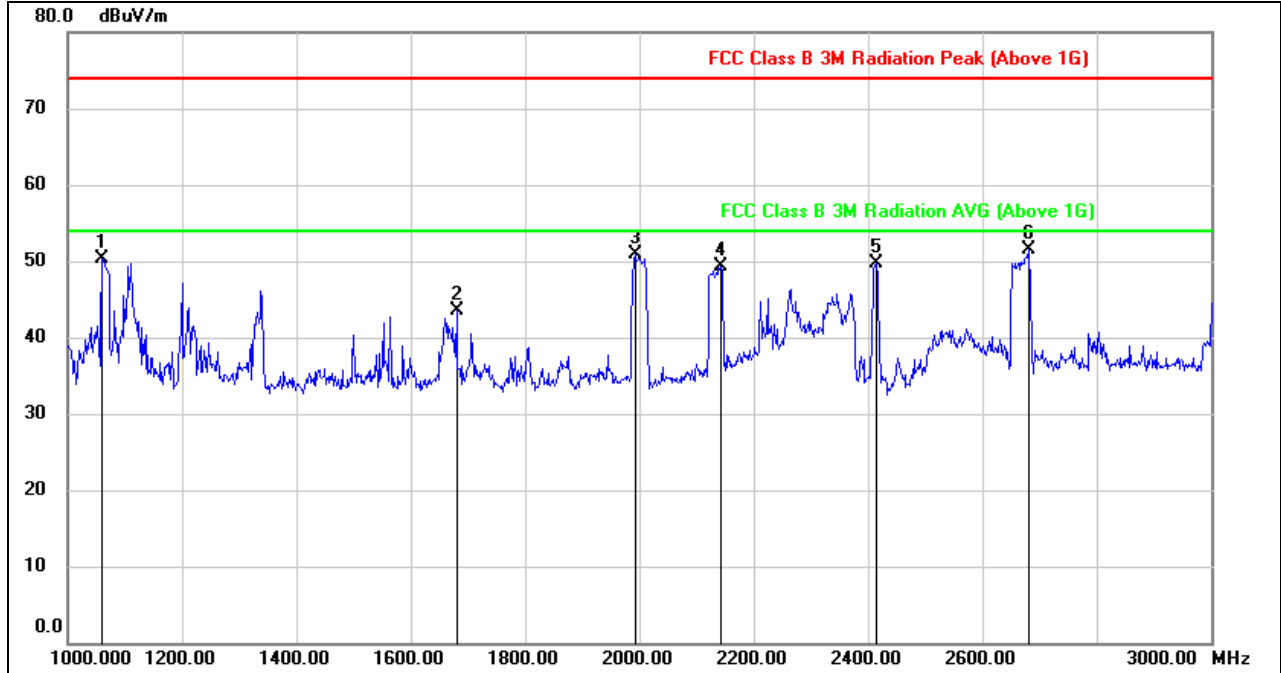

No.	Frequency (MHz)	Reading (dBuV)	Correct (dB/m)	Result (dBuV/m)	Limit (dBuV/m)	Margin (dB)	Remark
1	1060.000	64.30	-13.92	50.38	74.00	-23.62	peak
2	1680.000	55.17	-11.61	43.56	74.00	-30.44	peak
3	1992.000	61.50	-10.65	50.85	74.00	-23.15	peak
4	2142.000	58.49	-9.14	49.35	74.00	-24.65	peak
5	2414.000	57.82	-8.06	49.76	74.00	-24.24	peak
6	2680.000	59.27	-7.74	51.53	74.00	-22.47	peak

- Note: 1. Measurement = Reading Level + Correct Factor.  
 2. If Peak Result complies with AV limit, AV Result is deemed to comply with AV limit.  
 3. Peak: Peak detector.



**HARMONICS AND SPURIOUS EMISSIONS (MID CHANNEL, HORIZONTAL)**

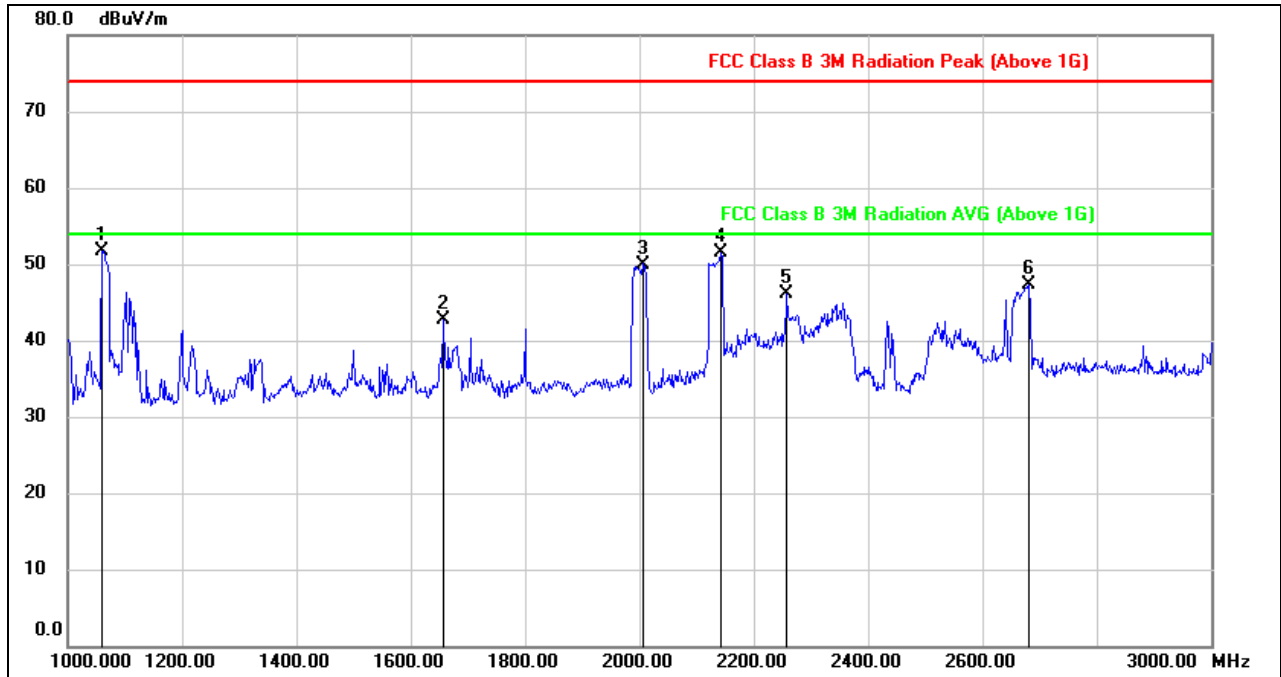

No.	Frequency (MHz)	Reading (dBuV)	Correct (dB/m)	Result (dBuV/m)	Limit (dBuV/m)	Margin (dB)	Remark
1	1060.000	65.25	-13.62	51.63	74.00	-22.37	peak
2	1656.000	54.49	-11.72	42.77	74.00	-31.23	peak
3	2006.000	60.58	-10.58	50.00	74.00	-24.00	peak
4	2142.000	60.47	-9.04	51.43	74.00	-22.57	peak
5	2258.000	53.60	-7.57	46.03	74.00	-27.97	peak
6	2680.000	54.94	-7.70	47.24	74.00	-26.76	peak

- Note: 1. Measurement = Reading Level + Correct Factor.  
 2. If Peak Result complies with AV limit, AV Result is deemed to comply with AV limit.  
 3. Peak: Peak detector.



**HARMONICS AND SPURIOUS EMISSIONS (MID CHANNEL, VERTICAL)**

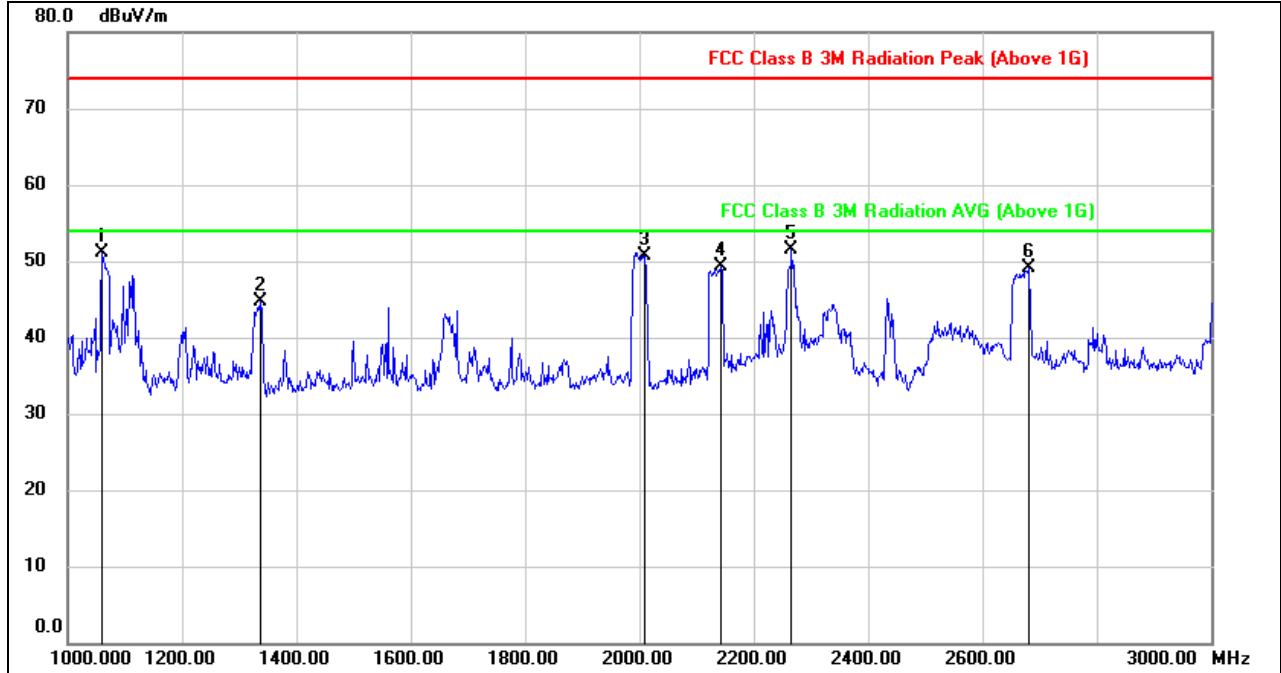

No.	Frequency (MHz)	Reading (dBuV)	Correct (dB/m)	Result (dBuV/m)	Limit (dBuV/m)	Margin (dB)	Remark
1	1060.000	64.93	-13.92	51.01	74.00	-22.99	peak
2	1336.000	57.22	-12.46	44.76	74.00	-29.24	peak
3	2010.000	61.27	-10.56	50.71	74.00	-23.29	peak
4	2142.000	58.38	-9.14	49.24	74.00	-24.76	peak
5	2266.000	58.95	-7.47	51.48	74.00	-22.52	peak
6	2680.000	56.88	-7.74	49.14	74.00	-24.86	peak

- Note: 1. Measurement = Reading Level + Correct Factor.  
 2. If Peak Result complies with AV limit, AV Result is deemed to comply with AV limit.  
 3. Peak: Peak detector.



**HARMONICS AND SPURIOUS EMISSIONS (HIGH CHANNEL, HORIZONTAL)**

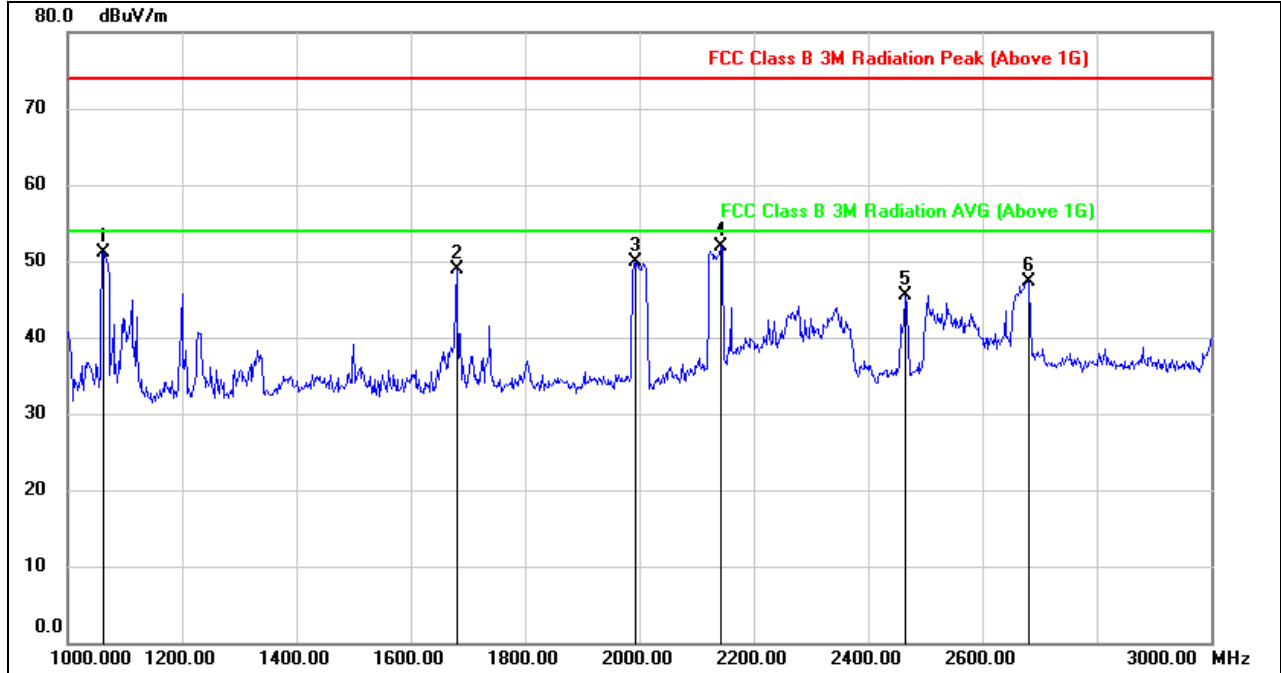

No.	Frequency (MHz)	Reading (dBuV)	Correct (dB/m)	Result (dBuV/m)	Limit (dBuV/m)	Margin (dB)	Remark
1	1062.000	64.77	-13.62	51.15	74.00	-22.85	peak
2	1680.000	60.51	-11.61	48.90	74.00	-25.10	peak
3	1992.000	60.57	-10.64	49.93	74.00	-24.07	peak
4	2142.000	61.02	-9.04	51.98	74.00	-22.02	peak
5	2466.000	53.96	-8.37	45.59	74.00	-28.41	peak
6	2680.000	54.94	-7.70	47.24	74.00	-26.76	peak

- Note: 1. Measurement = Reading Level + Correct Factor.  
 2. If Peak Result complies with AV limit, AV Result is deemed to comply with AV limit.  
 3. Peak: Peak detector.



**HARMONICS AND SPURIOUS EMISSIONS (HIGH CHANNEL, VERTICAL)**

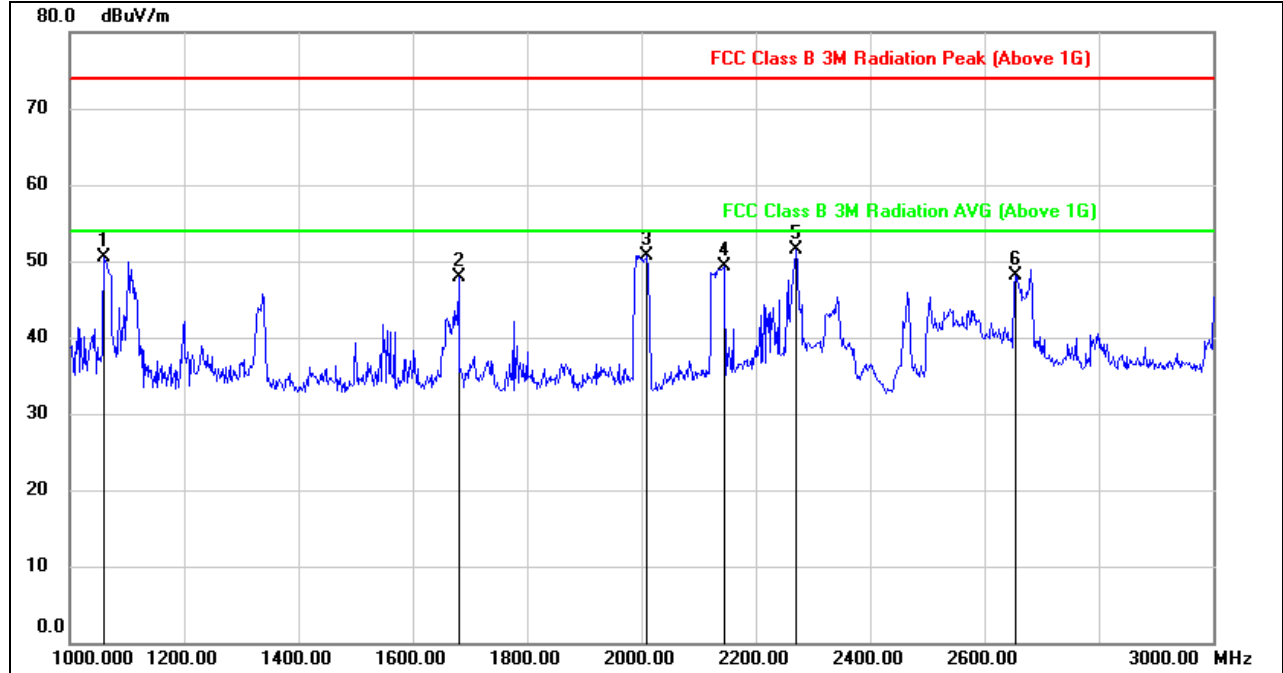

No.	Frequency (MHz)	Reading (dBuV)	Correct (dB/m)	Result (dBuV/m)	Limit (dBuV/m)	Margin (dB)	Remark
1	1060.000	64.33	-13.92	50.41	74.00	-23.59	peak
2	1680.000	59.50	-11.61	47.89	74.00	-26.11	peak
3	2010.000	61.33	-10.56	50.77	74.00	-23.23	peak
4	2144.000	58.45	-9.11	49.34	74.00	-24.66	peak
5	2270.000	58.98	-7.43	51.55	74.00	-22.45	peak
6	2654.000	56.11	-7.93	48.18	74.00	-25.82	peak

- Note: 1. Measurement = Reading Level + Correct Factor.  
 2. If Peak Result complies with AV limit, AV Result is deemed to comply with AV limit.  
 3. Peak: Peak detector.

Note: All the antennas had been tested, but only the worst data record in the report.



### 9.2.2. 802.11g MODE

#### 1TX MODE (WORST-CASE CONFIGURATION)

#### HARMONICS AND SPURIOUS EMISSIONS (LOW CHANNEL, HORIZONTAL)

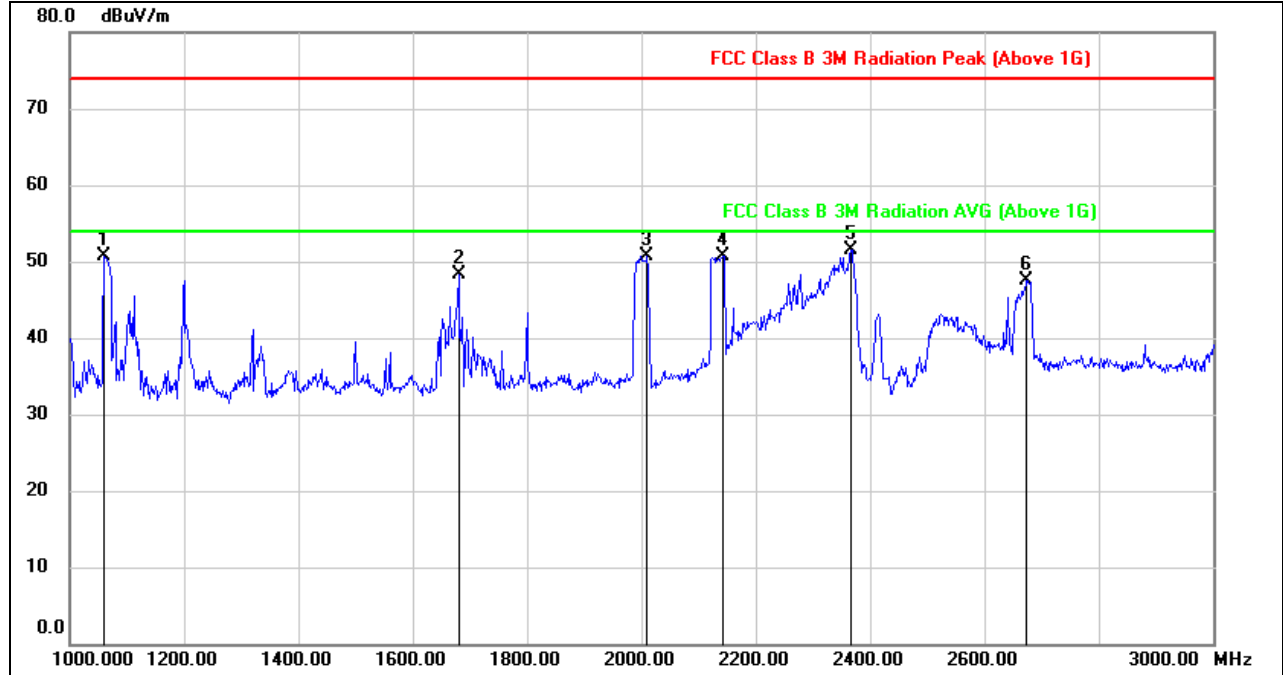

No.	Frequency (MHz)	Reading (dBuV)	Correct (dB/m)	Result (dBuV/m)	Limit (dBuV/m)	Margin (dB)	Remark
1	1060.000	64.33	-13.62	50.71	74.00	-23.29	peak
2	1680.000	59.85	-11.61	48.24	74.00	-25.76	peak
3	2010.000	61.25	-10.54	50.71	74.00	-23.29	peak
4	2142.000	59.76	-9.04	50.72	74.00	-23.28	peak
5	2366.000	59.42	-7.87	51.55	74.00	-22.45	peak
6	2674.000	55.18	-7.73	47.45	74.00	-26.55	peak

- Note: 1. Measurement = Reading Level + Correct Factor.  
 2. If Peak Result complies with AV limit, AV Result is deemed to comply with AV limit.  
 3. Peak: Peak detector.





**HARMONICS AND SPURIOUS EMISSIONS (LOW CHANNEL, VERTICAL)**

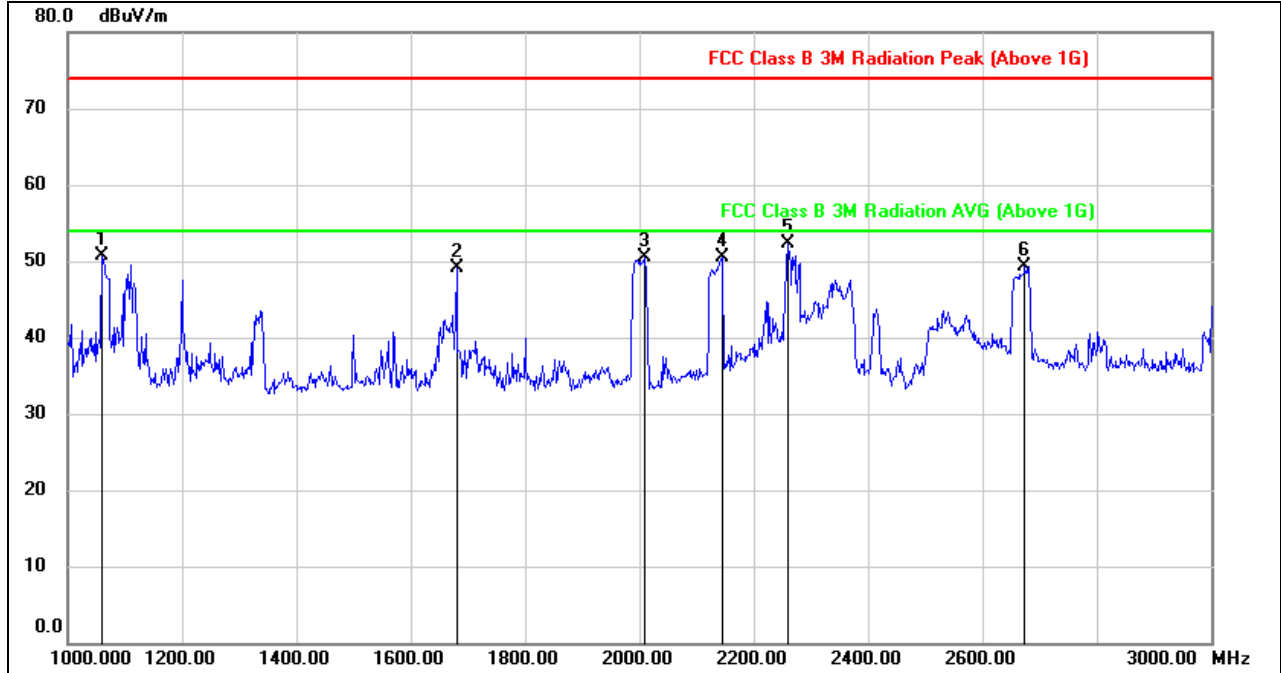

No.	Frequency (MHz)	Reading (dBuV)	Correct (dB/m)	Result (dBuV/m)	Limit (dBuV/m)	Margin (dB)	Remark
1	1060.000	64.56	-13.92	50.64	74.00	-23.36	peak
2	1680.000	60.68	-11.61	49.07	74.00	-24.93	peak
3	2008.000	61.12	-10.58	50.54	74.00	-23.46	peak
4	2144.000	59.54	-9.11	50.43	74.00	-23.57	peak
5	2260.000	59.90	-7.52	52.38	74.00	-21.62	peak
6	2674.000	57.09	-7.79	49.30	74.00	-24.70	peak

- Note: 1. Measurement = Reading Level + Correct Factor.  
 2. If Peak Result complies with AV limit, AV Result is deemed to comply with AV limit.  
 3. Peak: Peak detector.



**HARMONICS AND SPURIOUS EMISSIONS (MID CHANNEL, HORIZONTAL)**

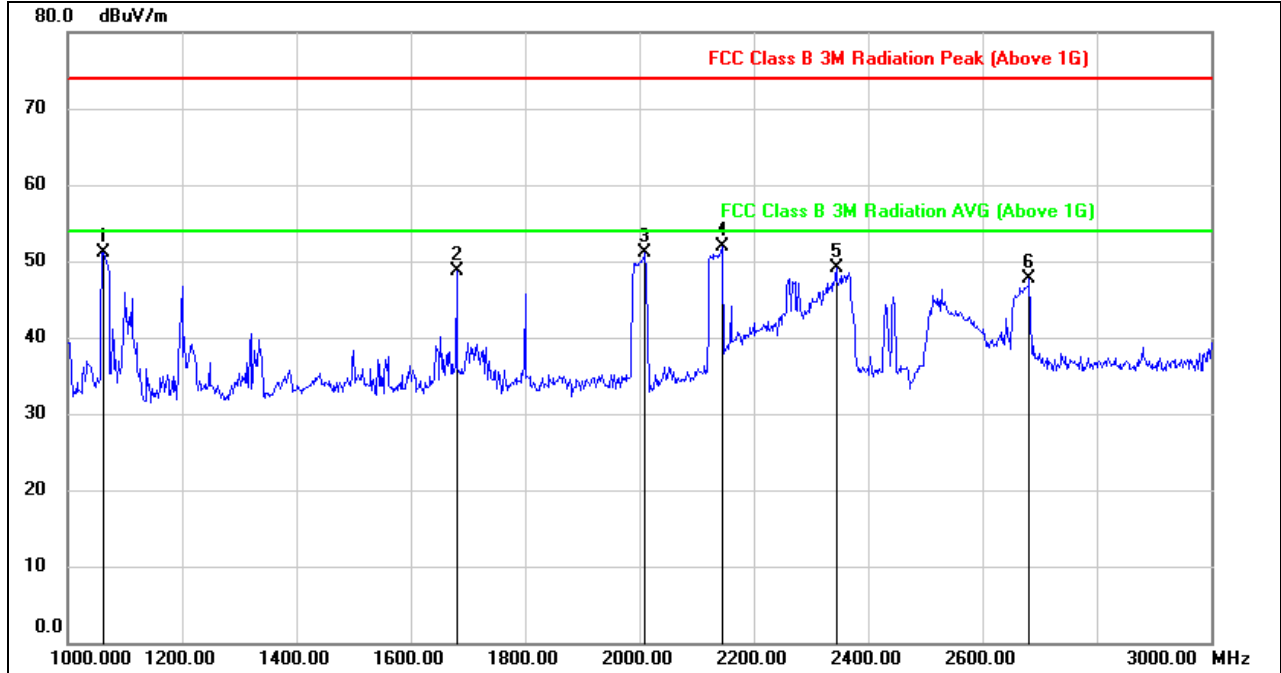

No.	Frequency (MHz)	Reading (dBuV)	Correct (dB/m)	Result (dBuV/m)	Limit (dBuV/m)	Margin (dB)	Remark
1	1062.000	64.79	-13.62	51.17	74.00	-22.83	peak
2	1680.000	60.26	-11.61	48.65	74.00	-25.35	peak
3	2010.000	61.62	-10.54	51.08	74.00	-22.92	peak
4	2144.000	60.84	-9.01	51.83	74.00	-22.17	peak
5	2344.000	56.73	-7.71	49.02	74.00	-24.98	peak
6	2682.000	55.33	-7.69	47.64	74.00	-26.36	peak

- Note: 1. Measurement = Reading Level + Correct Factor.  
 2. If Peak Result complies with AV limit, AV Result is deemed to comply with AV limit.  
 3. Peak: Peak detector.



**HARMONICS AND SPURIOUS EMISSIONS (MID CHANNEL, VERTICAL)**

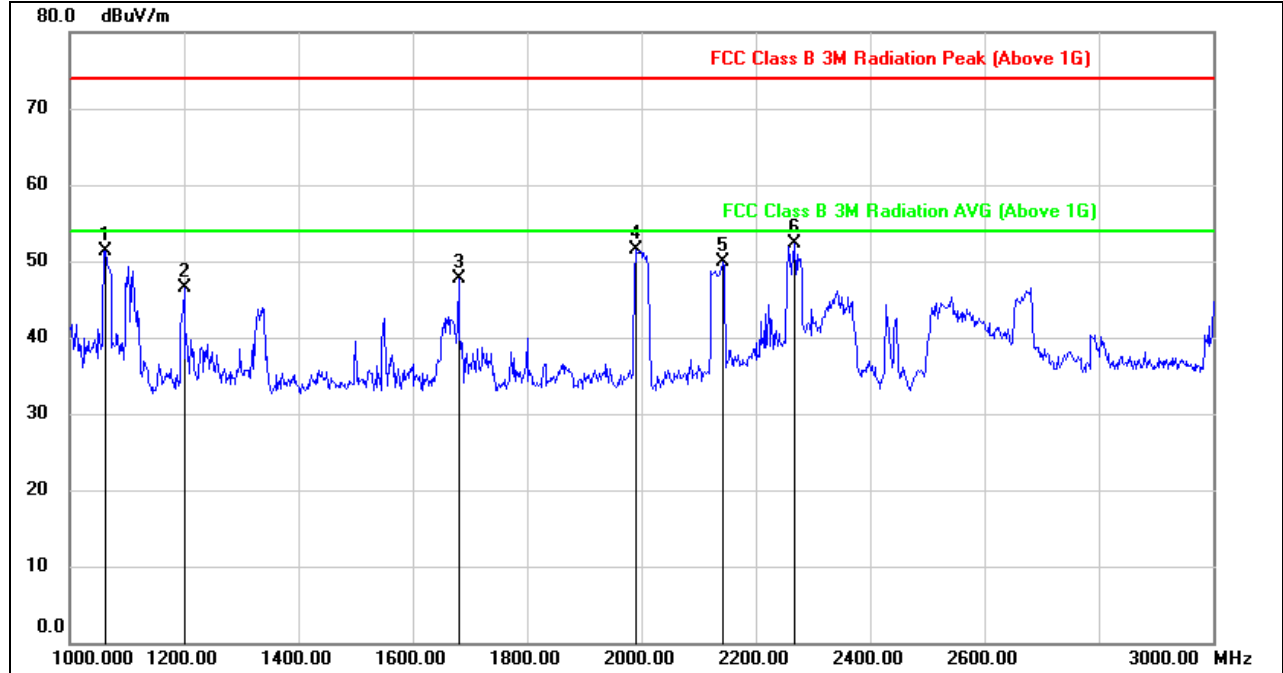

No.	Frequency (MHz)	Reading (dBuV)	Correct (dB/m)	Result (dBuV/m)	Limit (dBuV/m)	Margin (dB)	Remark
1	1062.000	65.24	-13.92	51.32	74.00	-22.68	peak
2	1200.000	59.59	-13.17	46.42	74.00	-27.58	peak
3	1680.000	59.37	-11.61	47.76	74.00	-26.24	peak
4	1990.000	62.18	-10.66	51.52	74.00	-22.48	peak
5	2142.000	58.95	-9.14	49.81	74.00	-24.19	peak
6	2268.000	59.77	-7.45	52.32	74.00	-21.68	peak

- Note: 1. Measurement = Reading Level + Correct Factor.  
 2. If Peak Result complies with AV limit, AV Result is deemed to comply with AV limit.  
 3. Peak: Peak detector.



**HARMONICS AND SPURIOUS EMISSIONS (HIGH CHANNEL, HORIZONTAL)**

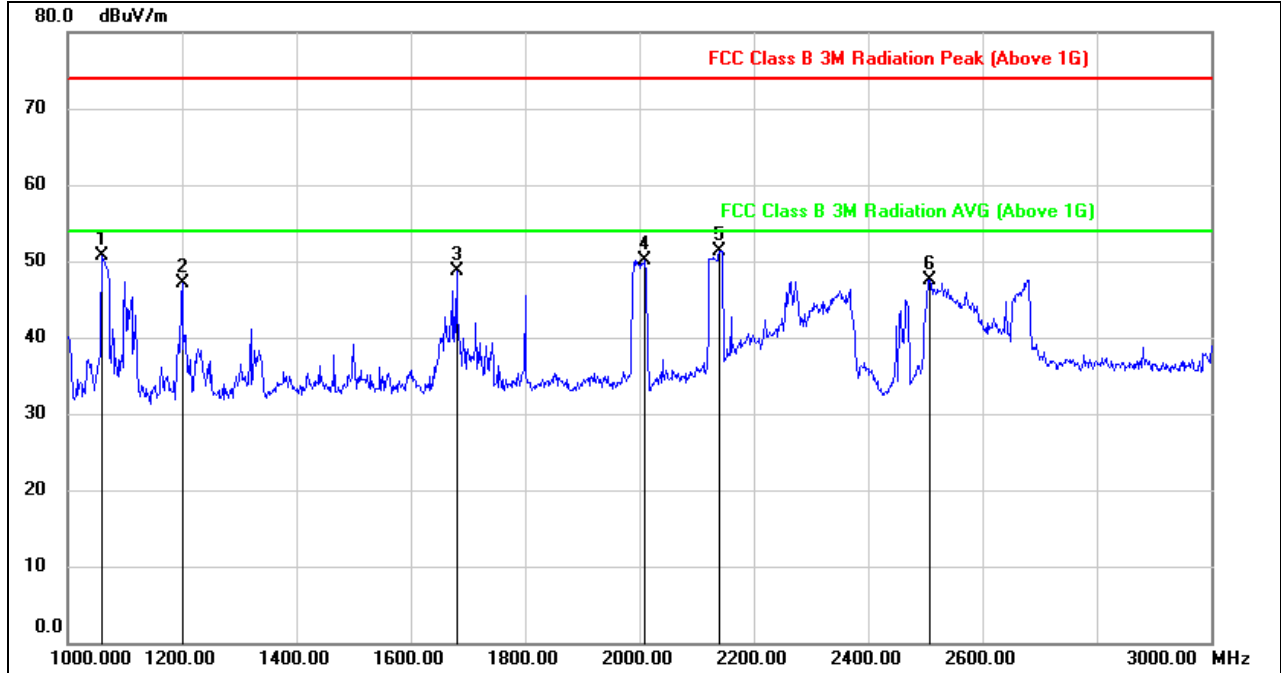

No.	Frequency (MHz)	Reading (dBuV)	Correct (dB/m)	Result (dBuV/m)	Limit (dBuV/m)	Margin (dB)	Remark
1	1060.000	64.29	-13.62	50.67	74.00	-23.33	peak
2	1200.000	60.19	-13.07	47.12	74.00	-26.88	peak
3	1680.000	60.34	-11.61	48.73	74.00	-25.27	peak
4	2010.000	60.72	-10.54	50.18	74.00	-23.82	peak
5	2140.000	60.42	-9.06	51.36	74.00	-22.64	peak
6	2508.000	55.92	-8.40	47.52	74.00	-26.48	peak

- Note: 1. Measurement = Reading Level + Correct Factor.  
 2. If Peak Result complies with AV limit, AV Result is deemed to comply with AV limit.  
 3. Peak: Peak detector.



**HARMONICS AND SPURIOUS EMISSIONS (HIGH CHANNEL, VERTICAL)**

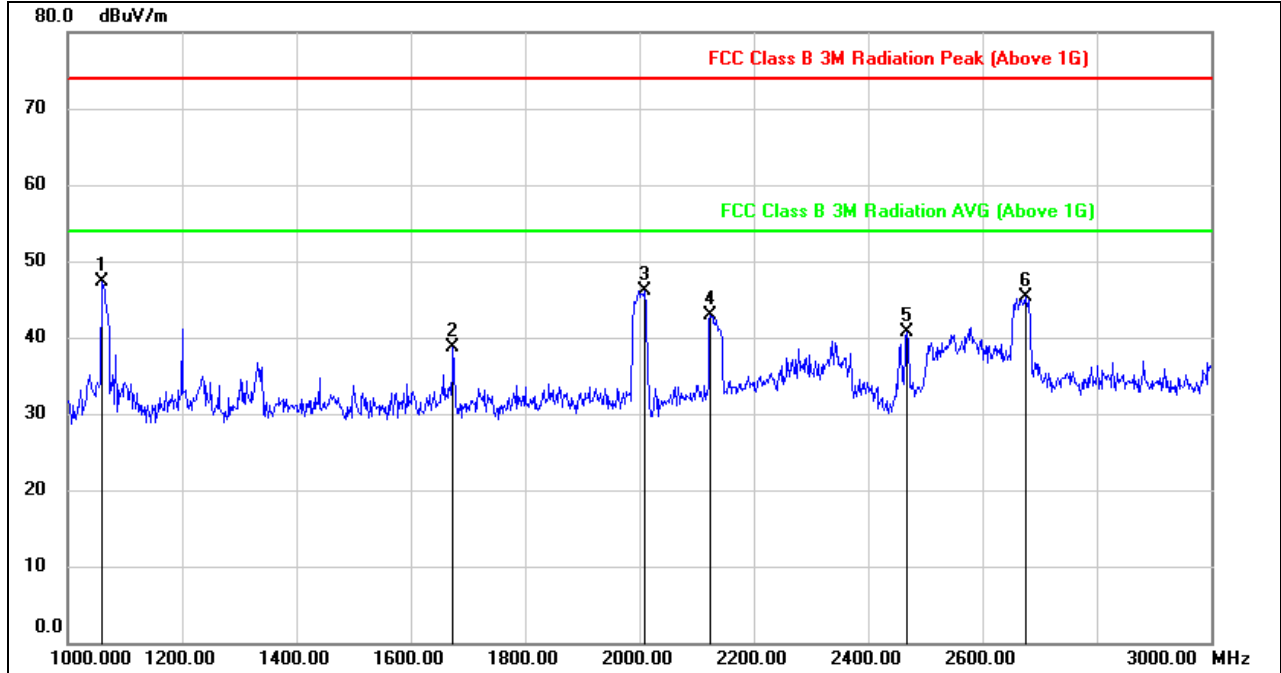

No.	Frequency (MHz)	Reading (dBuV)	Correct (dB/m)	Result (dBuV/m)	Limit (dBuV/m)	Margin (dB)	Remark
1	1060.000	61.18	-13.92	47.26	74.00	-26.74	peak
2	1674.000	50.37	-11.64	38.73	74.00	-35.27	peak
3	2010.000	56.70	-10.56	46.14	74.00	-27.86	peak
4	2124.000	52.34	-9.36	42.98	74.00	-31.02	peak
5	2468.000	49.06	-8.28	40.78	74.00	-33.22	peak
6	2676.000	53.02	-7.76	45.26	74.00	-28.74	peak

- Note: 1. Measurement = Reading Level + Correct Factor.  
 2. If Peak Result complies with AV limit, AV Result is deemed to comply with AV limit.  
 3. Peak: Peak detector.

Note: All the antennas had been tested, but only the worst data record in the report.



### 9.2.3. 802.11n HT20 MODE

#### 2TX MODE (WORST-CASE CONFIGURATION)

#### HARMONICS AND SPURIOUS EMISSIONS (LOW CHANNEL, HORIZONTAL)

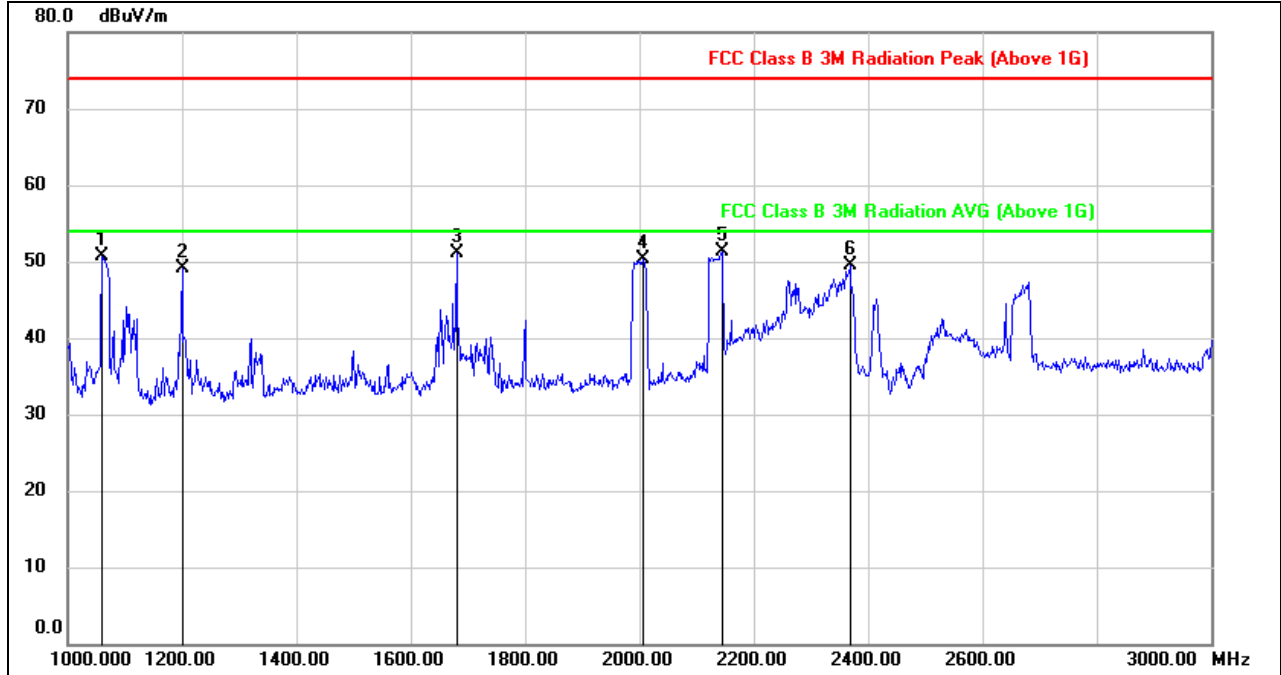

No.	Frequency (MHz)	Reading (dBuV)	Correct (dB/m)	Result (dBuV/m)	Limit (dBuV/m)	Margin (dB)	Remark
1	1060.000	64.29	-13.62	50.67	74.00	-23.33	peak
2	1200.000	62.17	-13.07	49.10	74.00	-24.90	peak
3	1680.000	62.77	-11.61	51.16	74.00	-22.84	peak
4	2006.000	60.89	-10.58	50.31	74.00	-23.69	peak
5	2144.000	60.27	-9.01	51.26	74.00	-22.74	peak
6	2368.000	57.34	-7.88	49.46	74.00	-24.54	peak

- Note: 1. Measurement = Reading Level + Correct Factor.  
 2. If Peak Result complies with AV limit, AV Result is deemed to comply with AV limit.  
 3. Peak: Peak detector.



**HARMONICS AND SPURIOUS EMISSIONS (LOW CHANNEL, VERTICAL)**

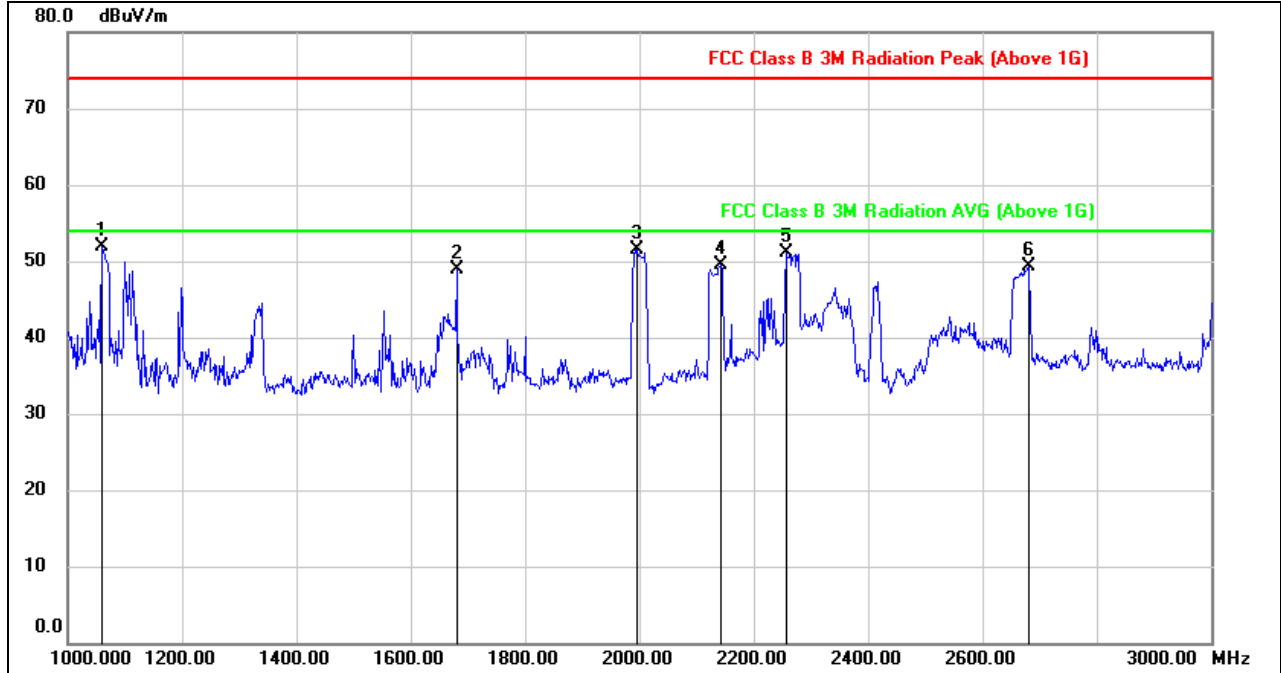

No.	Frequency (MHz)	Reading (dBuV)	Correct (dB/m)	Result (dBuV/m)	Limit (dBuV/m)	Margin (dB)	Remark
1	1060.000	65.77	-13.92	51.85	74.00	-22.15	peak
2	1680.000	60.53	-11.61	48.92	74.00	-25.08	peak
3	1996.000	62.24	-10.65	51.59	74.00	-22.41	peak
4	2142.000	58.72	-9.14	49.58	74.00	-24.42	peak
5	2256.000	58.71	-7.55	51.16	74.00	-22.84	peak
6	2680.000	56.97	-7.74	49.23	74.00	-24.77	peak

- Note: 1. Measurement = Reading Level + Correct Factor.  
 2. If Peak Result complies with AV limit, AV Result is deemed to comply with AV limit.  
 3. Peak: Peak detector.





**HARMONICS AND SPURIOUS EMISSIONS (MID CHANNEL, HORIZONTAL)**

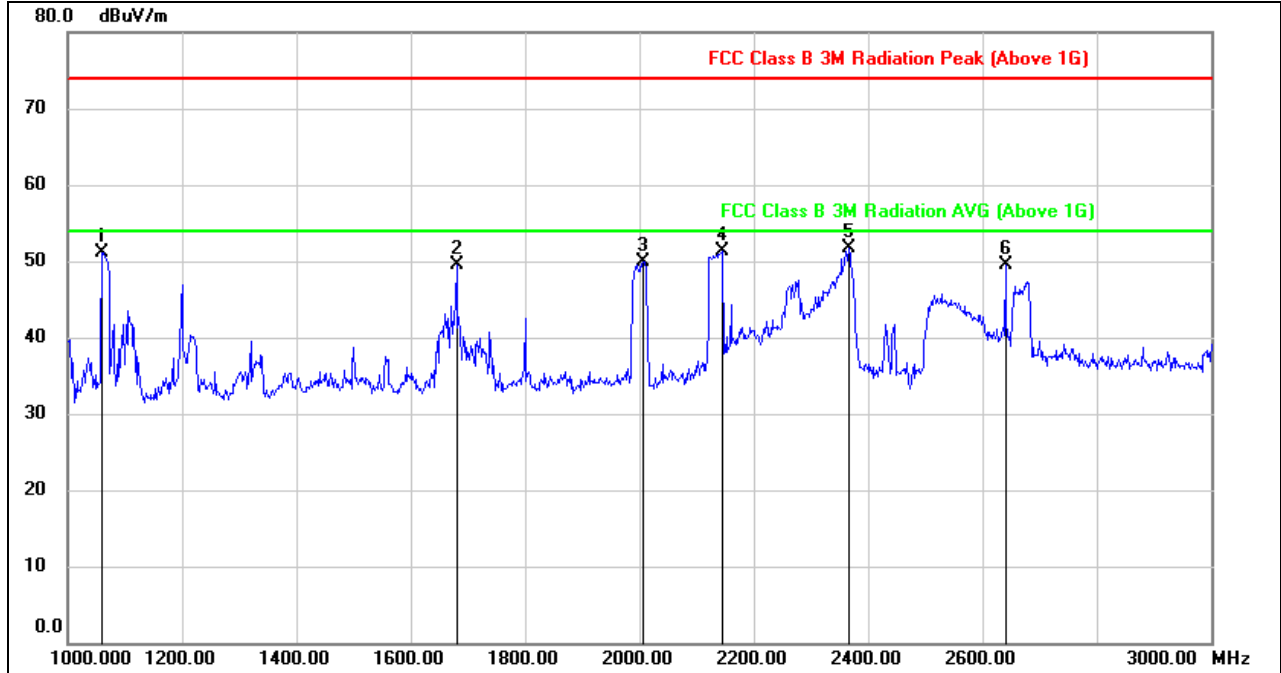

No.	Frequency (MHz)	Reading (dBuV)	Correct (dB/m)	Result (dBuV/m)	Limit (dBuV/m)	Margin (dB)	Remark
1	1060.000	64.77	-13.62	51.15	74.00	-22.85	peak
2	1680.000	61.20	-11.61	49.59	74.00	-24.41	peak
3	2006.000	60.47	-10.58	49.89	74.00	-24.11	peak
4	2144.000	60.38	-9.01	51.37	74.00	-22.63	peak
5	2366.000	59.51	-7.87	51.64	74.00	-22.36	peak
6	2640.000	57.43	-7.91	49.52	74.00	-24.48	peak

- Note: 1. Measurement = Reading Level + Correct Factor.  
 2. If Peak Result complies with AV limit, AV Result is deemed to comply with AV limit.  
 3. Peak: Peak detector.



**HARMONICS AND SPURIOUS EMISSIONS (MID CHANNEL, VERTICAL)**

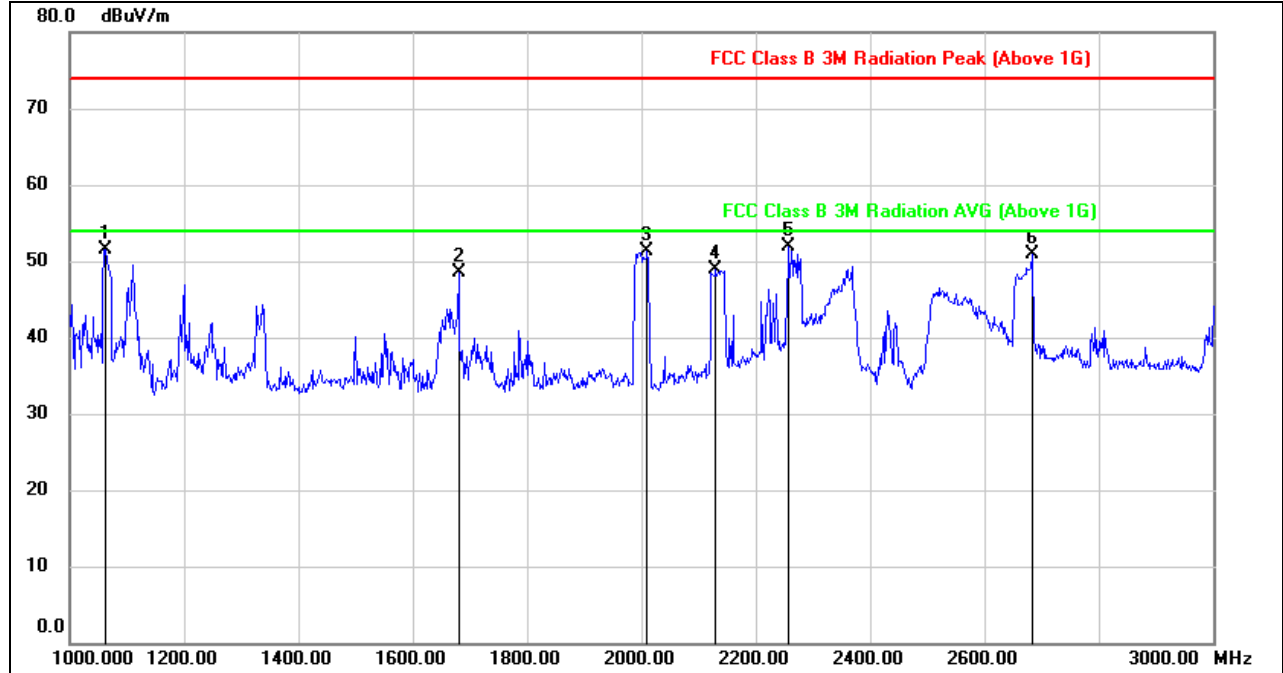

No.	Frequency (MHz)	Reading (dBuV)	Correct (dB/m)	Result (dBuV/m)	Limit (dBuV/m)	Margin (dB)	Remark
1	1062.000	65.46	-13.92	51.54	74.00	-22.46	peak
2	1680.000	60.04	-11.61	48.43	74.00	-25.57	peak
3	2010.000	61.84	-10.56	51.28	74.00	-22.72	peak
4	2130.000	58.15	-9.28	48.87	74.00	-25.13	peak
5	2258.000	59.34	-7.53	51.81	74.00	-22.19	peak
6	2684.000	58.66	-7.72	50.94	74.00	-23.06	peak

- Note: 1. Measurement = Reading Level + Correct Factor.  
 2. If Peak Result complies with AV limit, AV Result is deemed to comply with AV limit.  
 3. Peak: Peak detector.



**HARMONICS AND SPURIOUS EMISSIONS (HIGH CHANNEL, HORIZONTAL)**

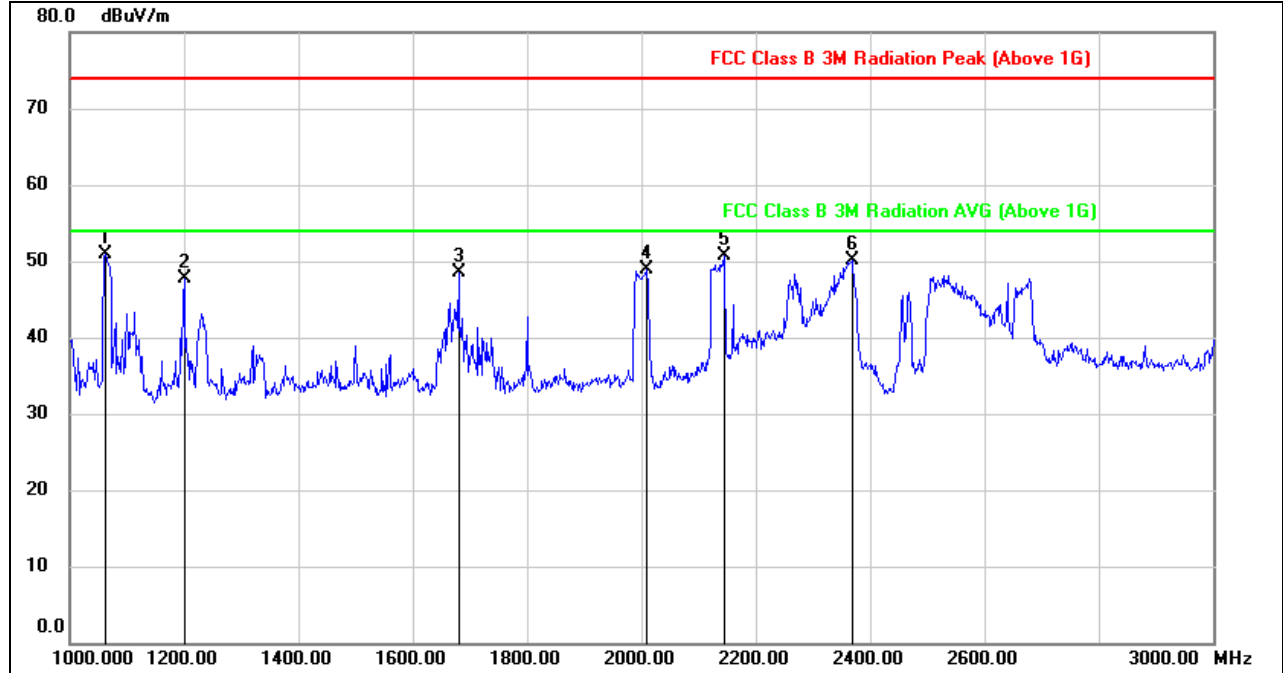

No.	Frequency (MHz)	Reading (dBuV)	Correct (dB/m)	Result (dBuV/m)	Limit (dBuV/m)	Margin (dB)	Remark
1	1062.000	64.47	-13.62	50.85	74.00	-23.15	peak
2	1200.000	60.82	-13.07	47.75	74.00	-26.25	peak
3	1680.000	60.13	-11.61	48.52	74.00	-25.48	peak
4	2010.000	59.50	-10.54	48.96	74.00	-25.04	peak
5	2144.000	59.69	-9.01	50.68	74.00	-23.32	peak
6	2368.000	57.90	-7.88	50.02	74.00	-23.98	peak

- Note: 1. Measurement = Reading Level + Correct Factor.  
 2. If Peak Result complies with AV limit, AV Result is deemed to comply with AV limit.  
 3. Peak: Peak detector.



**HARMONICS AND SPURIOUS EMISSIONS (HIGH CHANNEL, VERTICAL)**

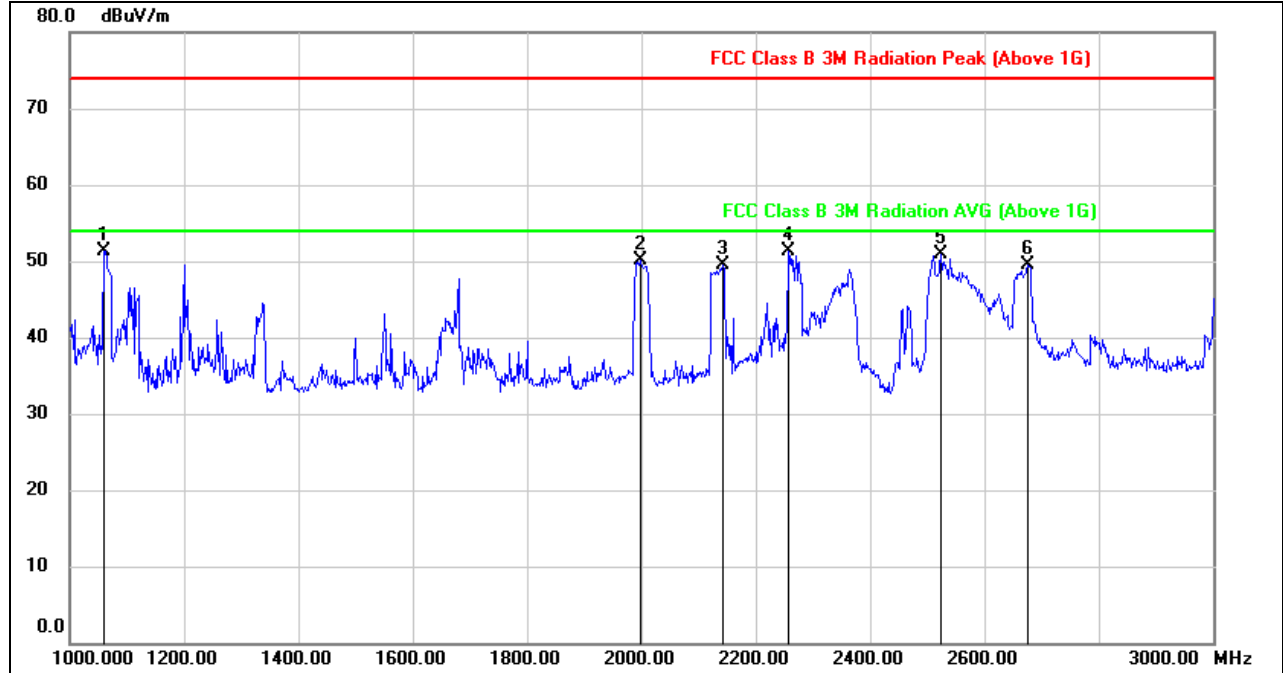

No.	Frequency (MHz)	Reading (dBuV)	Correct (dB/m)	Result (dBuV/m)	Limit (dBuV/m)	Margin (dB)	Remark
1	1060.000	65.32	-13.92	51.40	74.00	-22.60	peak
2	1998.000	60.66	-10.64	50.02	74.00	-23.98	peak
3	2142.000	58.68	-9.14	49.54	74.00	-24.46	peak
4	2256.000	58.85	-7.55	51.30	74.00	-22.70	peak
5	2524.000	59.26	-8.28	50.98	74.00	-23.02	peak
6	2676.000	57.17	-7.76	49.41	74.00	-24.59	peak

- Note: 1. Measurement = Reading Level + Correct Factor.  
 2. If Peak Result complies with AV limit, AV Result is deemed to comply with AV limit.  
 3. Peak: Peak detector.

Note: All the antennas had been tested, but only the worst data record in the report.



### 9.2.4. 802.11n HT40 MODE

#### 2TX MODE (WORST-CASE CONFIGURATION)

#### HARMONICS AND SPURIOUS EMISSIONS (LOW CHANNEL, HORIZONTAL)

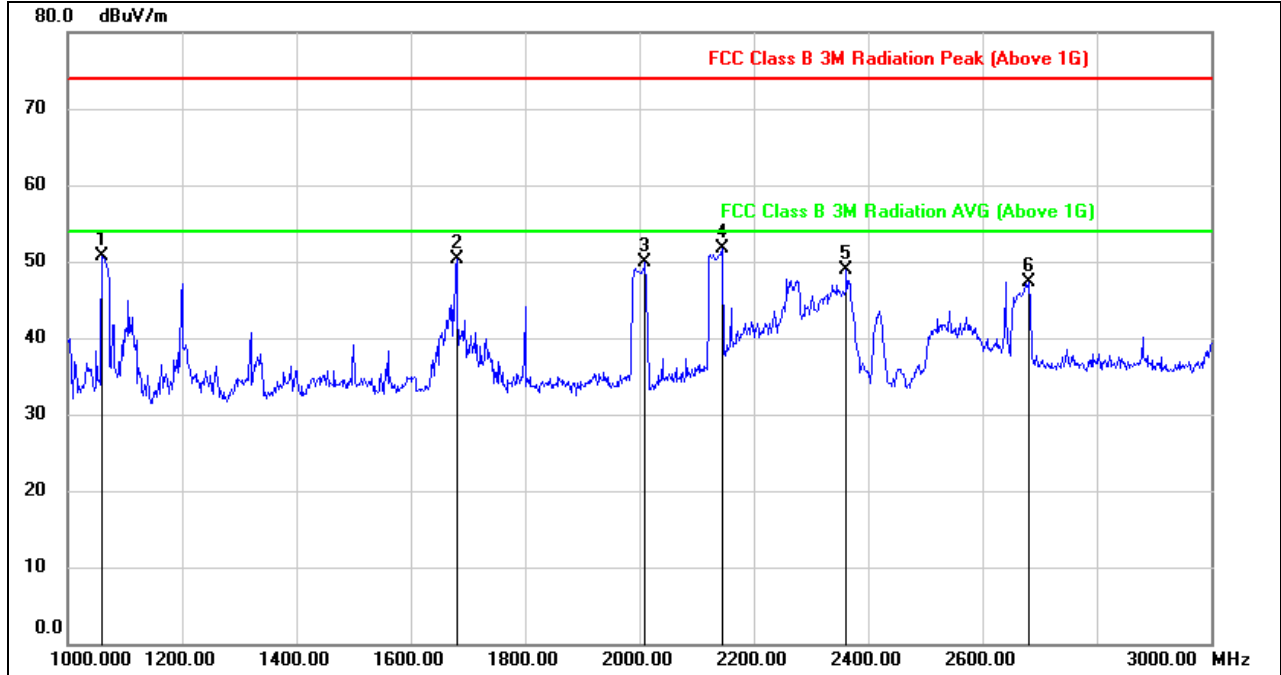

No.	Frequency (MHz)	Reading (dBuV)	Correct (dB/m)	Result (dBuV/m)	Limit (dBuV/m)	Margin (dB)	Remark
1	1060.000	64.35	-13.62	50.73	74.00	-23.27	peak
2	1680.000	61.87	-11.61	50.26	74.00	-23.74	peak
3	2010.000	60.41	-10.54	49.87	74.00	-24.13	peak
4	2144.000	60.73	-9.01	51.72	74.00	-22.28	peak
5	2362.000	56.74	-7.84	48.90	74.00	-25.10	peak
6	2680.000	55.04	-7.70	47.34	74.00	-26.66	peak

- Note: 1. Measurement = Reading Level + Correct Factor.  
 2. If Peak Result complies with AV limit, AV Result is deemed to comply with AV limit.  
 3. Peak: Peak detector.



**HARMONICS AND SPURIOUS EMISSIONS (LOW CHANNEL, VERTICAL)**

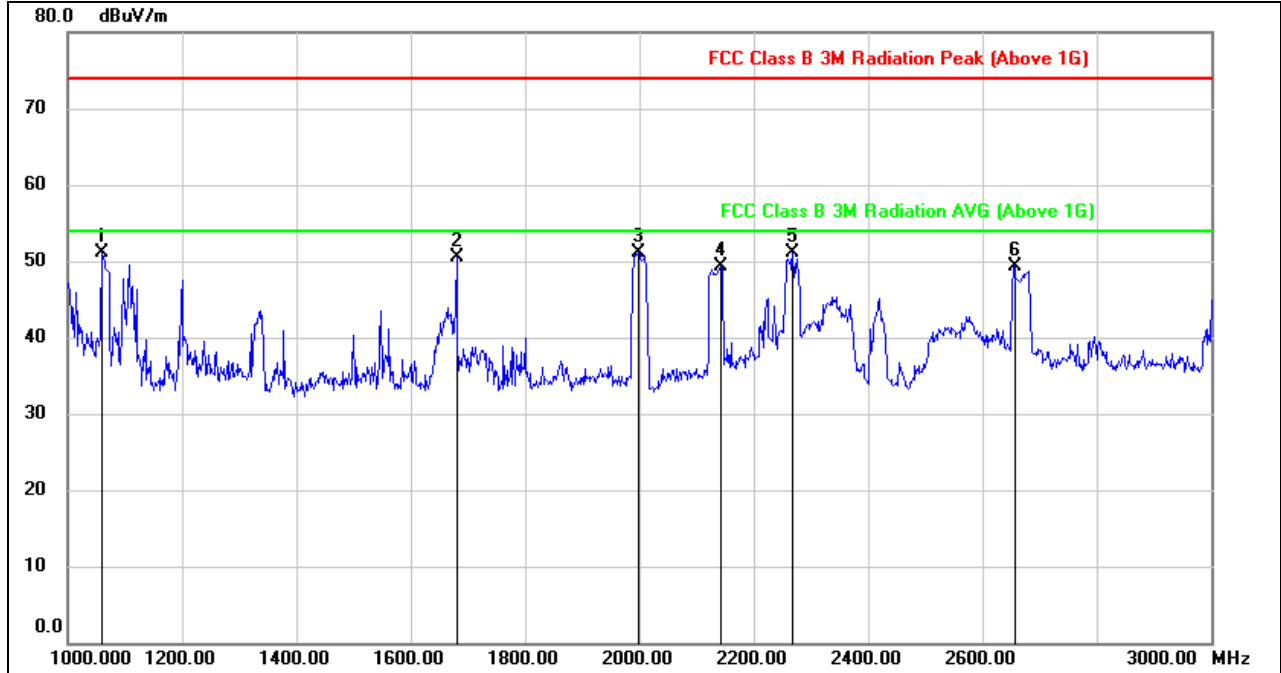

No.	Frequency (MHz)	Reading (dBuV)	Correct (dB/m)	Result (dBuV/m)	Limit (dBuV/m)	Margin (dB)	Remark
1	1060.000	65.08	-13.92	51.16	74.00	-22.84	peak
2	1680.000	62.16	-11.61	50.55	74.00	-23.45	peak
3	1998.000	61.69	-10.64	51.05	74.00	-22.95	peak
4	2142.000	58.47	-9.14	49.33	74.00	-24.67	peak
5	2268.000	58.58	-7.45	51.13	74.00	-22.87	peak
6	2656.000	57.28	-7.91	49.37	74.00	-24.63	peak

- Note: 1. Measurement = Reading Level + Correct Factor.  
 2. If Peak Result complies with AV limit, AV Result is deemed to comply with AV limit.  
 3. Peak: Peak detector.



**HARMONICS AND SPURIOUS EMISSIONS (MID CHANNEL, HORIZONTAL)**

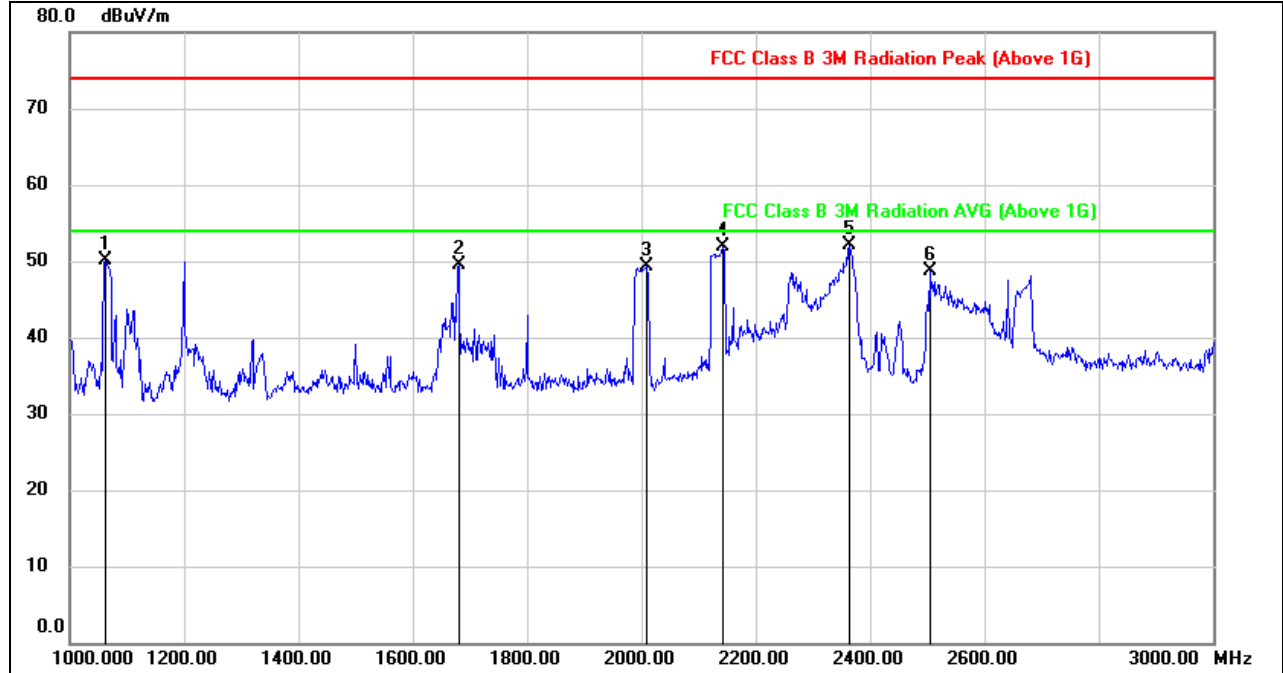

No.	Frequency (MHz)	Reading (dBuV)	Correct (dB/m)	Result (dBuV/m)	Limit (dBuV/m)	Margin (dB)	Remark
1	1062.000	63.69	-13.62	50.07	74.00	-23.93	peak
2	1680.000	61.02	-11.61	49.41	74.00	-24.59	peak
3	2010.000	59.94	-10.54	49.40	74.00	-24.60	peak
4	2142.000	60.99	-9.04	51.95	74.00	-22.05	peak
5	2364.000	59.91	-7.85	52.06	74.00	-21.94	peak
6	2504.000	57.03	-8.40	48.63	74.00	-25.37	peak

- Note: 1. Measurement = Reading Level + Correct Factor.  
 2. If Peak Result complies with AV limit, AV Result is deemed to comply with AV limit.  
 3. Peak: Peak detector.





**HARMONICS AND SPURIOUS EMISSIONS (MID CHANNEL, VERTICAL)**

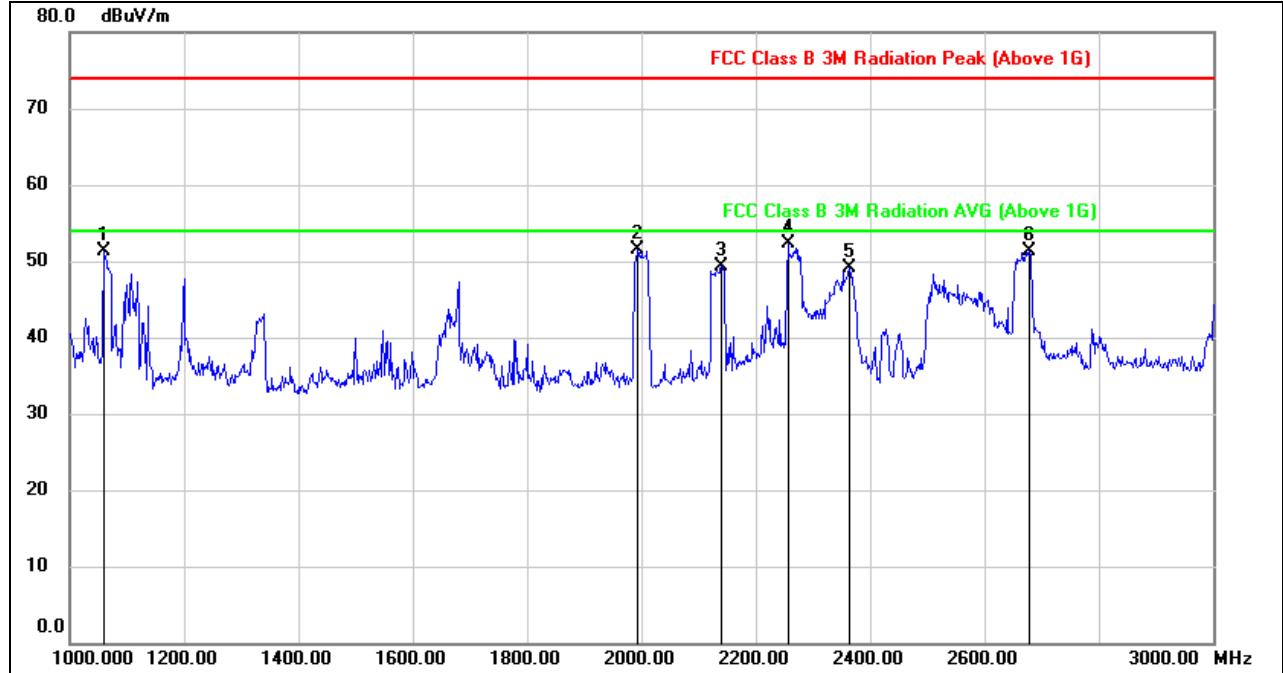

No.	Frequency (MHz)	Reading (dBuV)	Correct (dB/m)	Result (dBuV/m)	Limit (dBuV/m)	Margin (dB)	Remark
1	1060.000	65.18	-13.92	51.26	74.00	-22.74	peak
2	1994.000	62.22	-10.65	51.57	74.00	-22.43	peak
3	2140.000	58.55	-9.16	49.39	74.00	-24.61	peak
4	2256.000	59.85	-7.55	52.30	74.00	-21.70	peak
5	2364.000	56.86	-7.75	49.11	74.00	-24.89	peak
6	2678.000	59.00	-7.75	51.25	74.00	-22.75	peak

- Note: 1. Measurement = Reading Level + Correct Factor.  
 2. If Peak Result complies with AV limit, AV Result is deemed to comply with AV limit.  
 3. Peak: Peak detector.



**HARMONICS AND SPURIOUS EMISSIONS (HIGH CHANNEL, HORIZONTAL)**

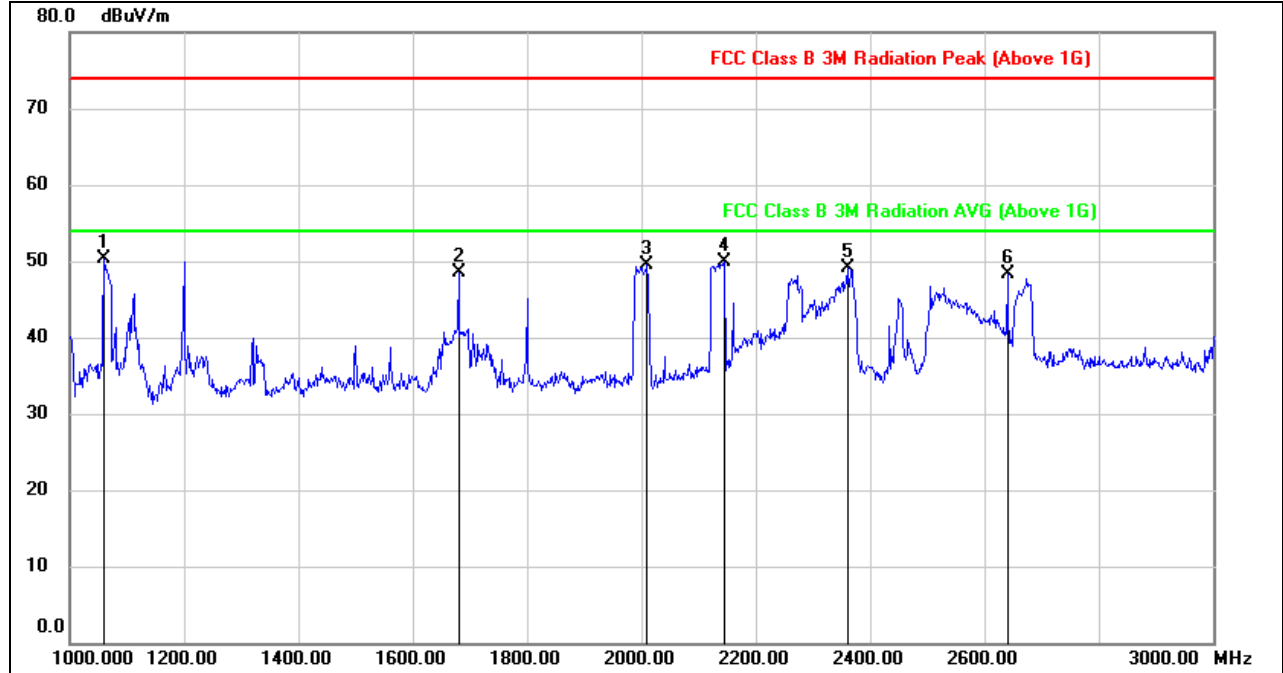

No.	Frequency (MHz)	Reading (dBuV)	Correct (dB/m)	Result (dBuV/m)	Limit (dBuV/m)	Margin (dB)	Remark
1	1060.000	63.91	-13.62	50.29	74.00	-23.71	peak
2	1680.000	60.17	-11.61	48.56	74.00	-25.44	peak
3	2010.000	60.10	-10.54	49.56	74.00	-24.44	peak
4	2144.000	58.92	-9.01	49.91	74.00	-24.09	peak
5	2360.000	56.88	-7.82	49.06	74.00	-24.94	peak
6	2640.000	56.25	-7.91	48.34	74.00	-25.66	peak

- Note: 1. Measurement = Reading Level + Correct Factor.  
 2. If Peak Result complies with AV limit, AV Result is deemed to comply with AV limit.  
 3. Peak: Peak detector.



**HARMONICS AND SPURIOUS EMISSIONS (HIGH CHANNEL, VERTICAL)**

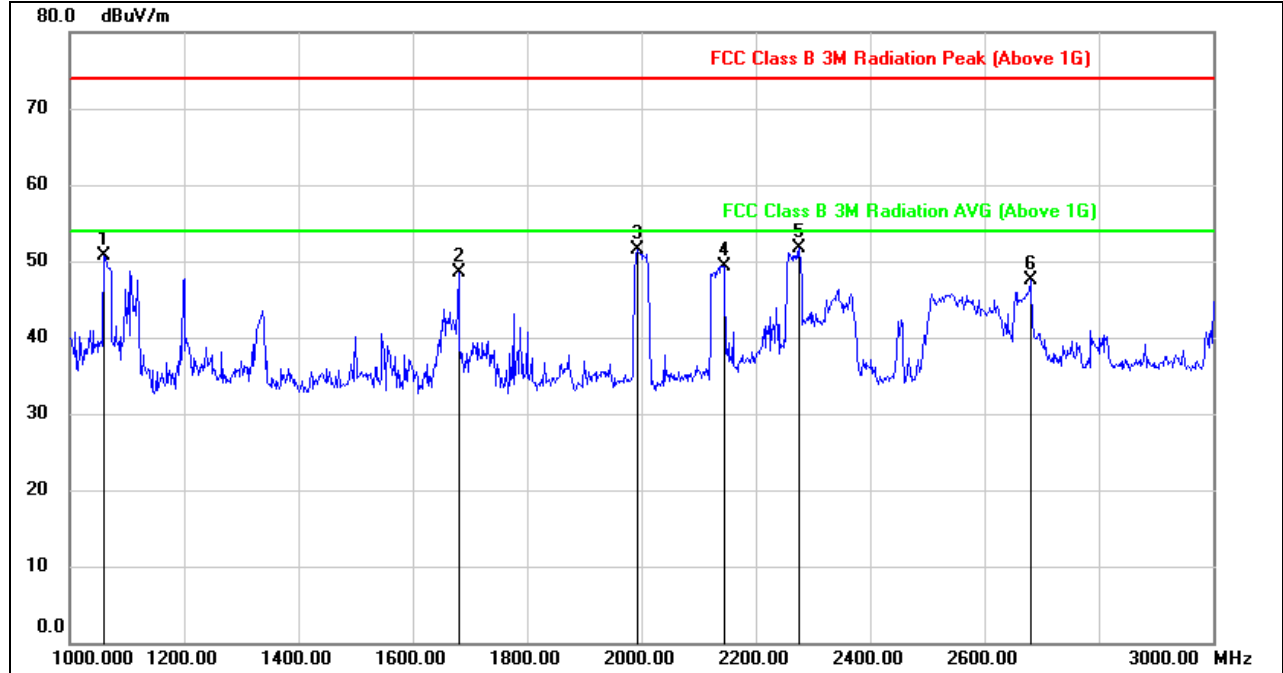

No.	Frequency (MHz)	Reading (dBuV)	Correct (dB/m)	Result (dBuV/m)	Limit (dBuV/m)	Margin (dB)	Remark
1	1060.000	64.62	-13.92	50.70	74.00	-23.30	peak
2	1680.000	60.11	-11.61	48.50	74.00	-25.50	peak
3	1994.000	62.10	-10.65	51.45	74.00	-22.55	peak
4	2144.000	58.48	-9.11	49.37	74.00	-24.63	peak
5	2276.000	59.14	-7.39	51.75	74.00	-22.25	peak
6	2680.000	55.28	-7.74	47.54	74.00	-26.46	peak

- Note: 1. Measurement = Reading Level + Correct Factor.  
 2. If Peak Result complies with AV limit, AV Result is deemed to comply with AV limit.  
 3. Peak: Peak detector.

Note: All the antennas had been tested, but only the worst data record in the report.



### 9.3. SPURIOUS EMISSIONS (3~18GHz)

#### 9.3.1. 802.11b MODE

##### 1TX MODE (WORST-CASE CONFIGURATION)

##### HARMONICS AND SPURIOUS EMISSIONS (LOW CHANNEL, HORIZONTAL)

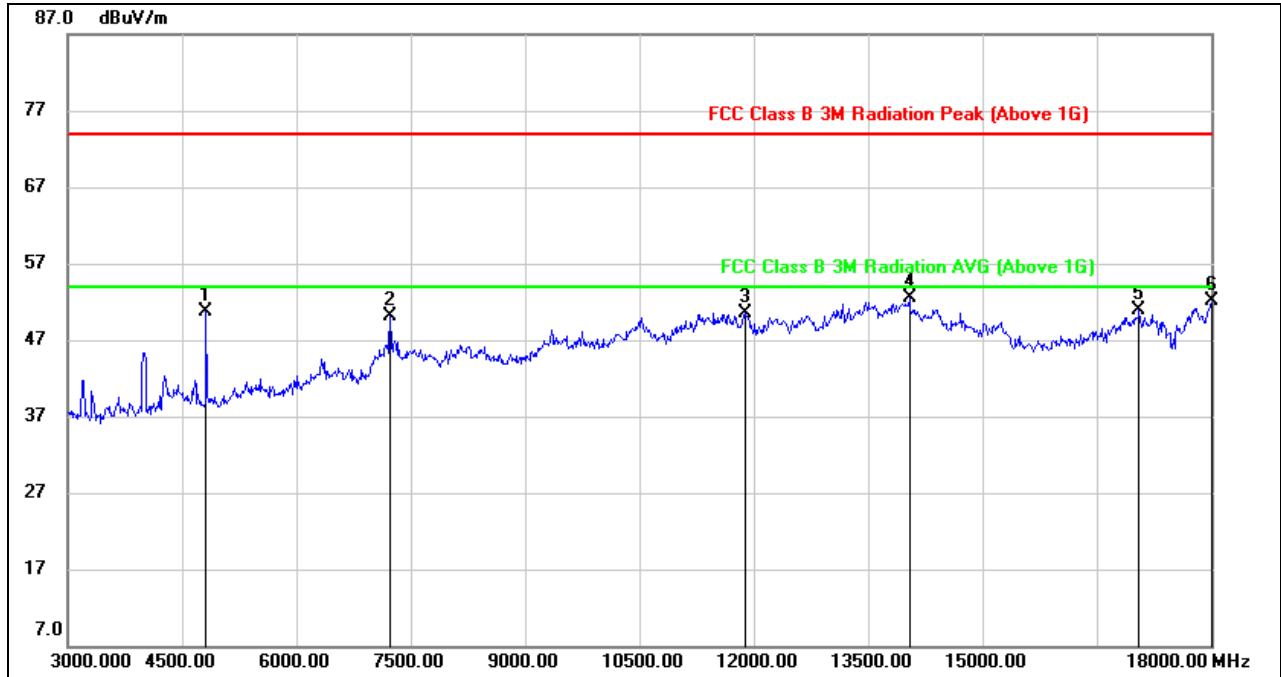

No.	Frequency (MHz)	Reading (dBuV)	Correct (dB/m)	Result (dBuV/m)	Limit (dBuV/m)	Margin (dB)	Remark
1	4815.000	51.10	-0.38	50.72	74.00	-23.28	peak
2	7230.000	42.32	7.81	50.13	74.00	-23.87	peak
3	11895.000	33.42	17.04	50.46	74.00	-23.54	peak
4	14040.000	31.82	20.64	52.46	74.00	-21.54	peak
5	17055.000	28.64	22.17	50.81	74.00	-23.19	peak
6	18000.000	25.09	27.06	52.15	74.00	-21.85	peak

Note: 1. Measurement = Reading Level + Correct Factor.  
2. If Peak Result complies with AV limit, AV Result is deemed to comply with AV limit.  
3. Peak: Peak detector.



**HARMONICS AND SPURIOUS EMISSIONS (LOW CHANNEL, VERTICAL)**

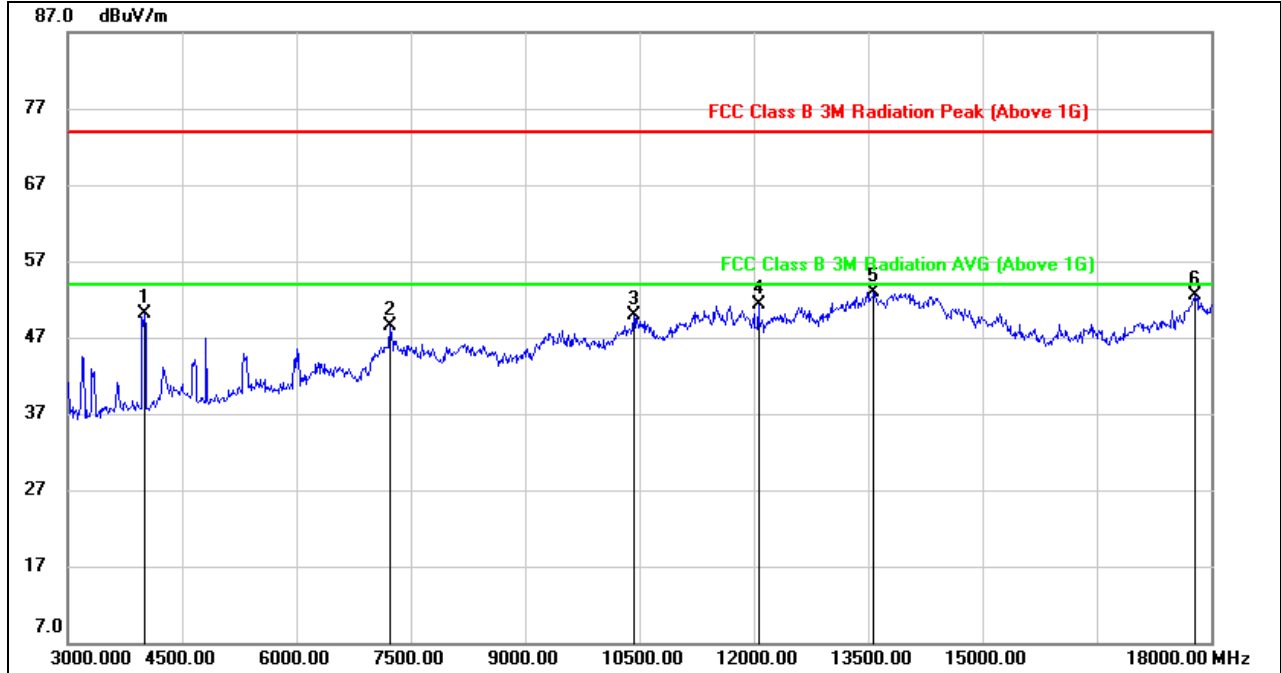

No.	Frequency (MHz)	Reading (dBuV)	Correct (dB/m)	Result (dBuV/m)	Limit (dBuV/m)	Margin (dB)	Remark
1	4005.000	53.04	-2.97	50.07	74.00	-23.93	peak
2	7230.000	40.67	7.79	48.46	74.00	-25.54	peak
3	10425.000	36.54	13.35	49.89	74.00	-24.11	peak
4	12060.000	35.24	16.02	51.26	74.00	-22.74	peak
5	13575.000	32.27	20.63	52.90	74.00	-21.10	peak
6	17790.000	25.67	26.76	52.43	74.00	-21.57	peak

- Note: 1. Measurement = Reading Level + Correct Factor.  
 2. If Peak Result complies with AV limit, AV Result is deemed to comply with AV limit.  
 3. Peak: Peak detector.



**HARMONICS AND SPURIOUS EMISSIONS (MID CHANNEL, HORIZONTAL)**

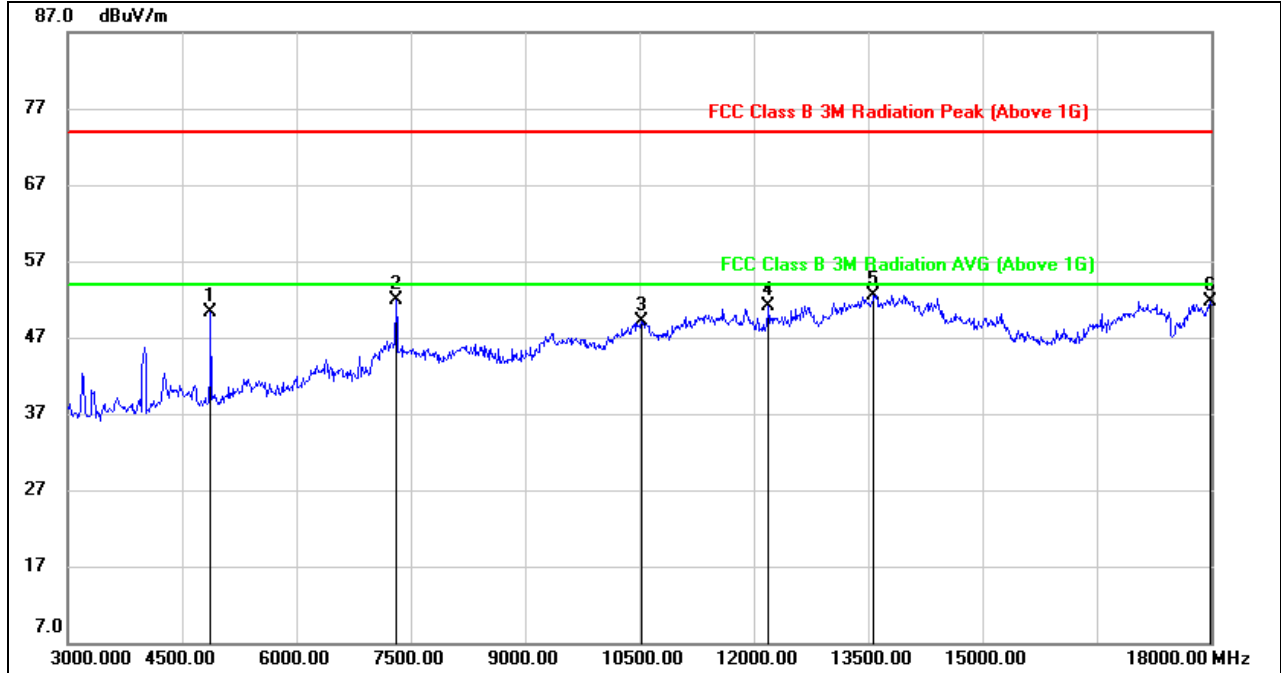

No.	Frequency (MHz)	Reading (dBuV)	Correct (dB/m)	Result (dBuV/m)	Limit (dBuV/m)	Margin (dB)	Remark
1	4875.000	49.90	0.38	50.28	74.00	-23.72	peak
2	7305.000	44.17	7.80	51.97	74.00	-22.03	peak
3	10530.000	35.33	13.76	49.09	74.00	-24.91	peak
4	12195.000	34.96	16.13	51.09	74.00	-22.91	peak
5	13575.000	32.12	20.43	52.55	74.00	-21.45	peak
6	17985.000	24.72	27.05	51.77	74.00	-22.23	peak

- Note: 1. Measurement = Reading Level + Correct Factor.  
 2. If Peak Result complies with AV limit, AV Result is deemed to comply with AV limit.  
 3. Peak: Peak detector.



**HARMONICS AND SPURIOUS EMISSIONS (MID CHANNEL, VERTICAL)**

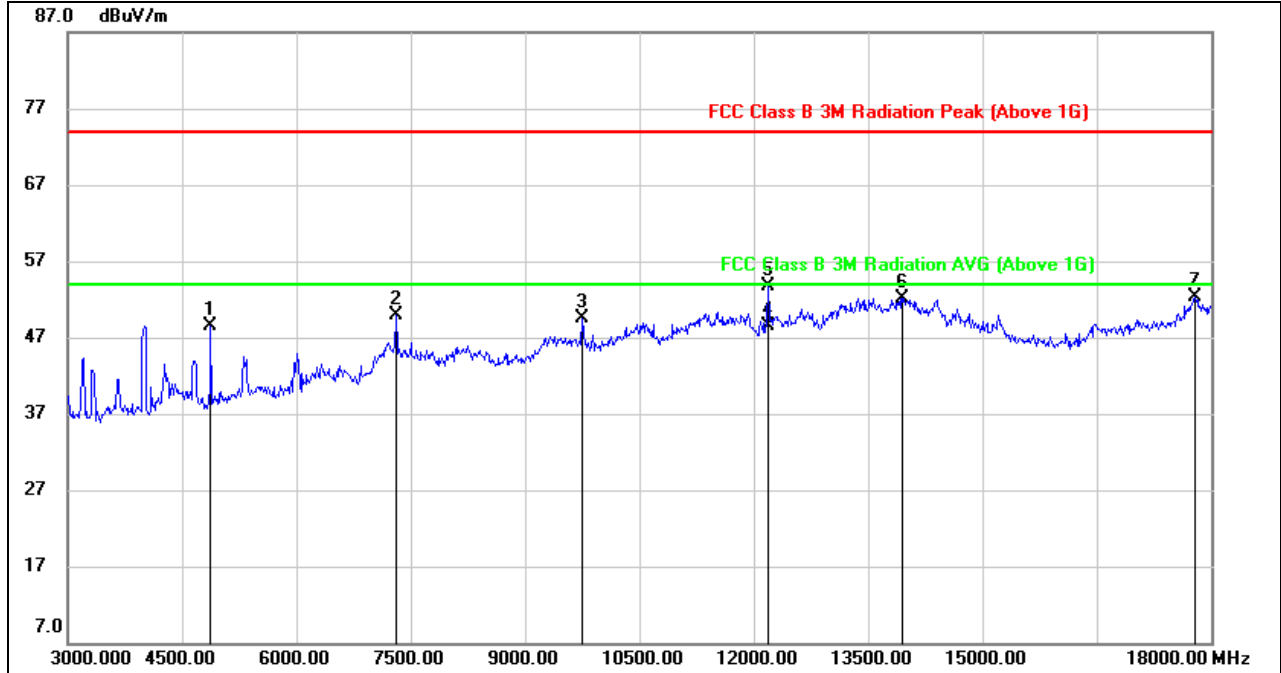

No.	Frequency (MHz)	Reading (dBuV)	Correct (dB/m)	Result (dBuV/m)	Limit (dBuV/m)	Margin (dB)	Remark
1	4875.000	48.25	0.33	48.58	74.00	-25.42	peak
2	7305.000	42.16	7.81	49.97	74.00	-24.03	peak
3	9750.000	37.91	11.67	49.58	74.00	-24.42	peak
4	12185.670	32.20	16.22	48.42	54.00	-5.58	AVG
5	12195.000	37.56	16.17	53.73	74.00	-20.27	peak
6	13950.000	31.36	20.78	52.14	74.00	-21.86	peak
7	17790.000	25.61	26.76	52.37	74.00	-21.63	peak

- Note: 1. Measurement = Reading Level + Correct Factor.  
 2. If Peak Result complies with AV limit, AV Result is deemed to comply with AV limit.  
 3. Peak: Peak detector.  
 4. AVG: VBW=1/Ton where: ton is transmit duration.  
 5. For transmit duration, please refer to clause 8.1.



**HARMONICS AND SPURIOUS EMISSIONS (HIGH CHANNEL, HORIZONTAL)**

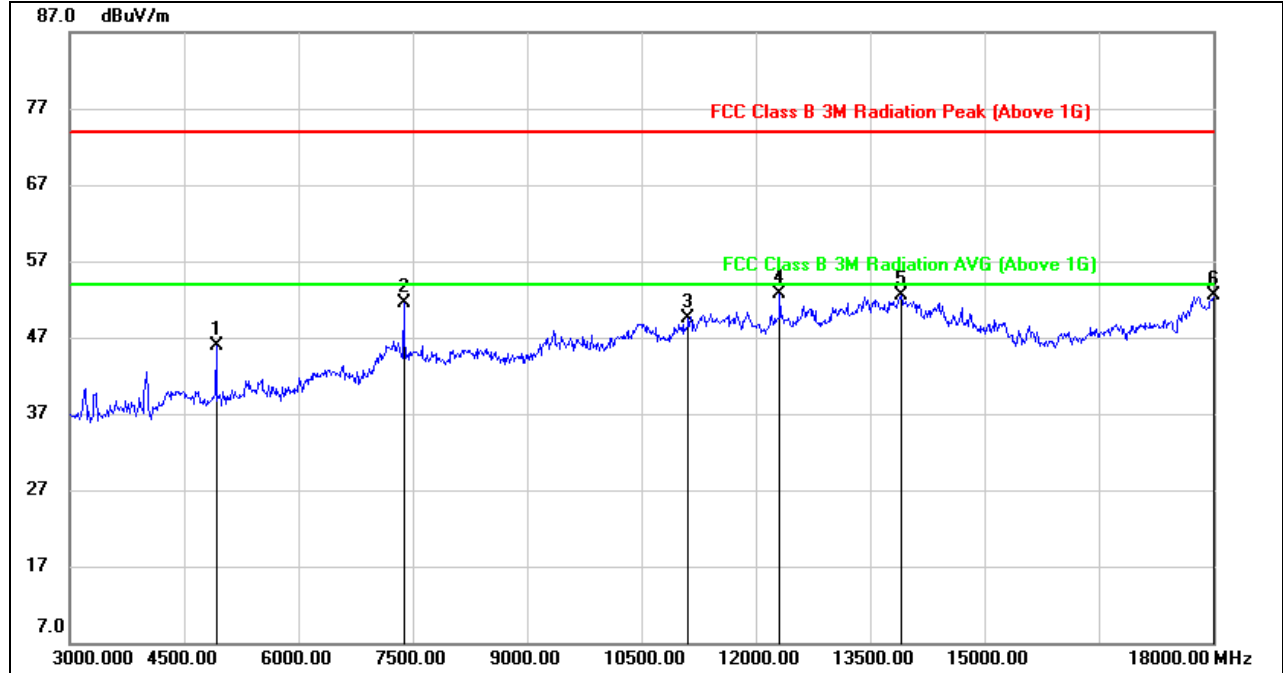

No.	Frequency (MHz)	Reading (dBuV)	Correct (dB/m)	Result (dBuV/m)	Limit (dBuV/m)	Margin (dB)	Remark
1	4920.000	45.32	0.65	45.97	74.00	-28.03	peak
2	7380.000	44.43	7.10	51.53	74.00	-22.47	peak
3	11115.000	34.34	15.07	49.41	74.00	-24.59	peak
4	12315.000	36.56	16.19	52.75	74.00	-21.25	peak
5	13905.000	31.77	20.65	52.42	74.00	-21.58	peak
6	18000.000	25.49	27.06	52.55	74.00	-21.45	peak

- Note: 1. Measurement = Reading Level + Correct Factor.  
 2. If Peak Result complies with AV limit, AV Result is deemed to comply with AV limit.  
 3. Peak: Peak detector.





**HARMONICS AND SPURIOUS EMISSIONS (HIGH CHANNEL, VERTICAL)**

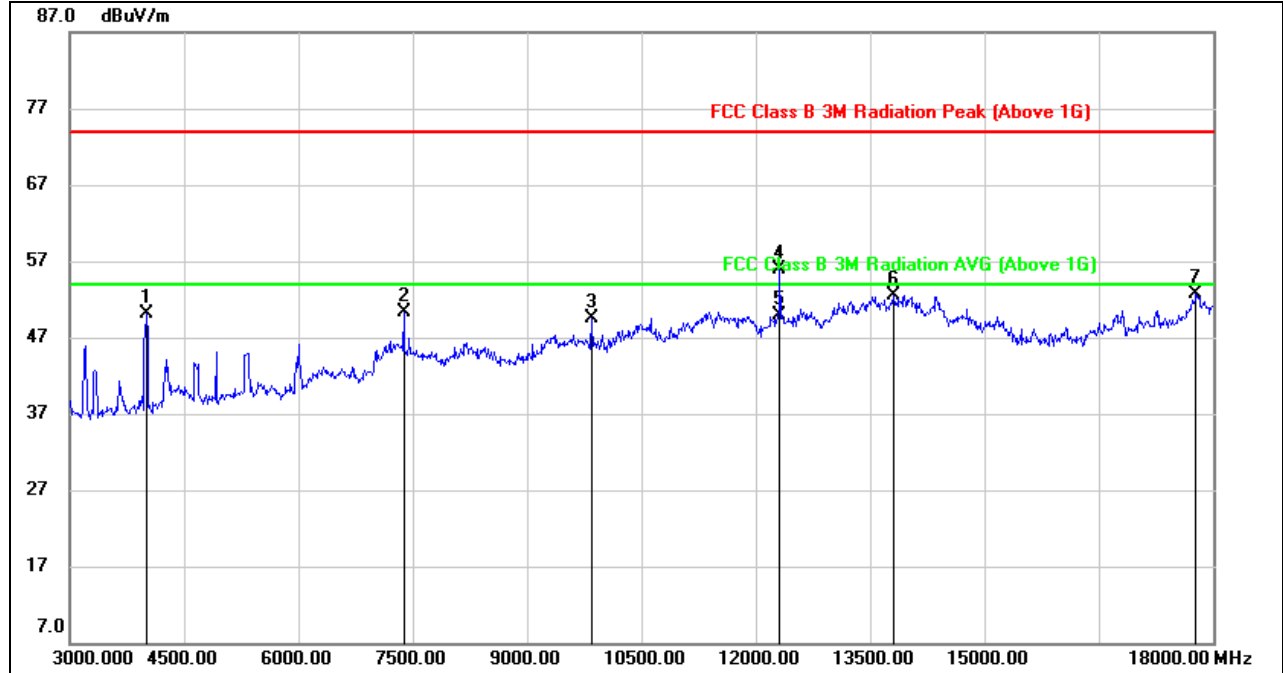

No.	Frequency (MHz)	Reading (dBuV)	Correct (dB/m)	Result (dBuV/m)	Limit (dBuV/m)	Margin (dB)	Remark
1	4005.000	53.01	-2.97	50.04	74.00	-23.96	peak
2	7380.000	43.24	7.14	50.38	74.00	-23.62	peak
3	9840.000	37.52	11.95	49.47	74.00	-24.53	peak
4	12310.604	39.56	16.41	55.97	74.00	-18.03	peak
5	12310.604	33.45	16.41	49.86	54.00	-4.14	AVG
6	13800.000	31.25	21.21	52.46	74.00	-21.54	peak
7	17775.000	26.08	26.57	52.65	74.00	-21.35	peak

- Note: 1. Measurement = Reading Level + Correct Factor.  
 2. If Peak Result complies with AV limit, AV Result is deemed to comply with AV limit.  
 3. Peak: Peak detector.  
 4. AVG:  $VBW=1/Ton$  where: ton is transmit duration.  
 5. For transmit duration, please refer to clause 8.1.

Note: All the antennas had been tested, but only the worst data record in the report.



### 9.3.2. 802.11g MODE

#### 1TX MODE (WORST-CASE CONFIGURATION)

#### HARMONICS AND SPURIOUS EMISSIONS (LOW CHANNEL, HORIZONTAL)

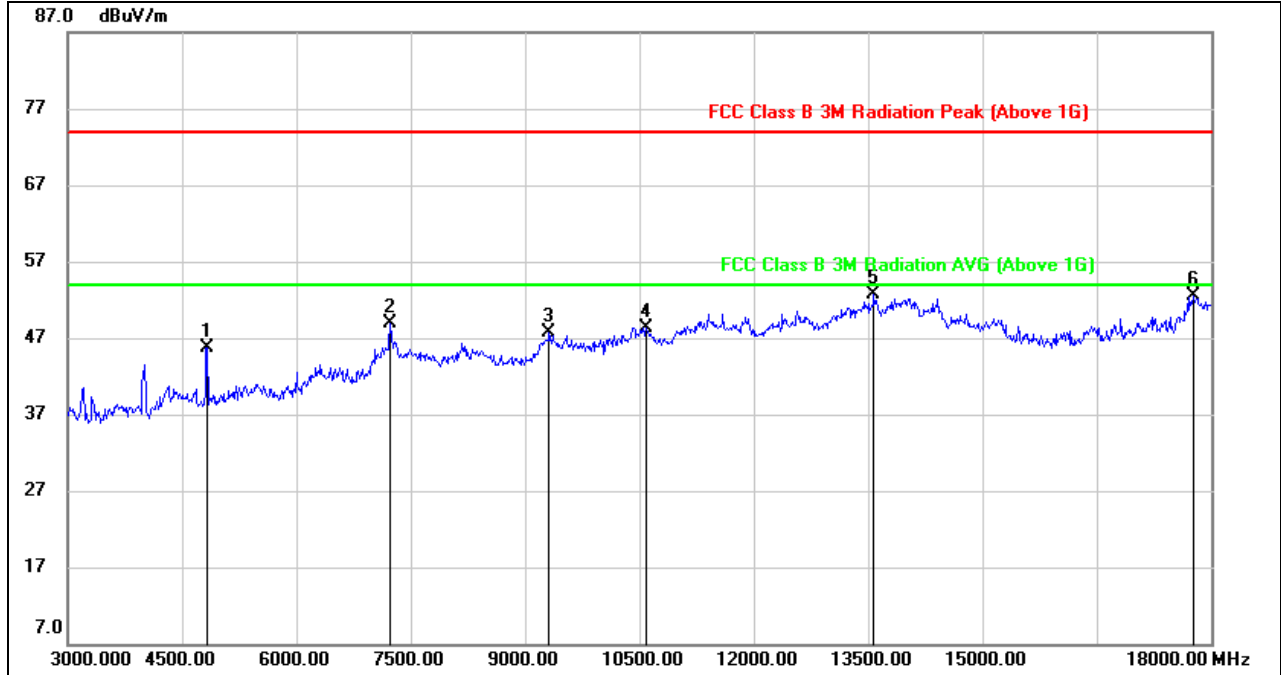

No.	Frequency (MHz)	Reading (dBuV)	Correct (dB/m)	Result (dBuV/m)	Limit (dBuV/m)	Margin (dB)	Remark
1	4830.000	45.95	-0.18	45.77	74.00	-28.23	peak
2	7230.000	41.07	7.81	48.88	74.00	-25.12	peak
3	9315.000	37.09	10.71	47.80	74.00	-26.20	peak
4	10590.000	34.72	13.63	48.35	74.00	-25.65	peak
5	13575.000	32.33	20.43	52.76	74.00	-21.24	peak
6	17760.000	26.61	25.99	52.60	74.00	-21.40	peak

- Note: 1. Measurement = Reading Level + Correct Factor.  
 2. If Peak Result complies with AV limit, AV Result is deemed to comply with AV limit.  
 3. Peak: Peak detector.



**HARMONICS AND SPURIOUS EMISSIONS (LOW CHANNEL, VERTICAL)**

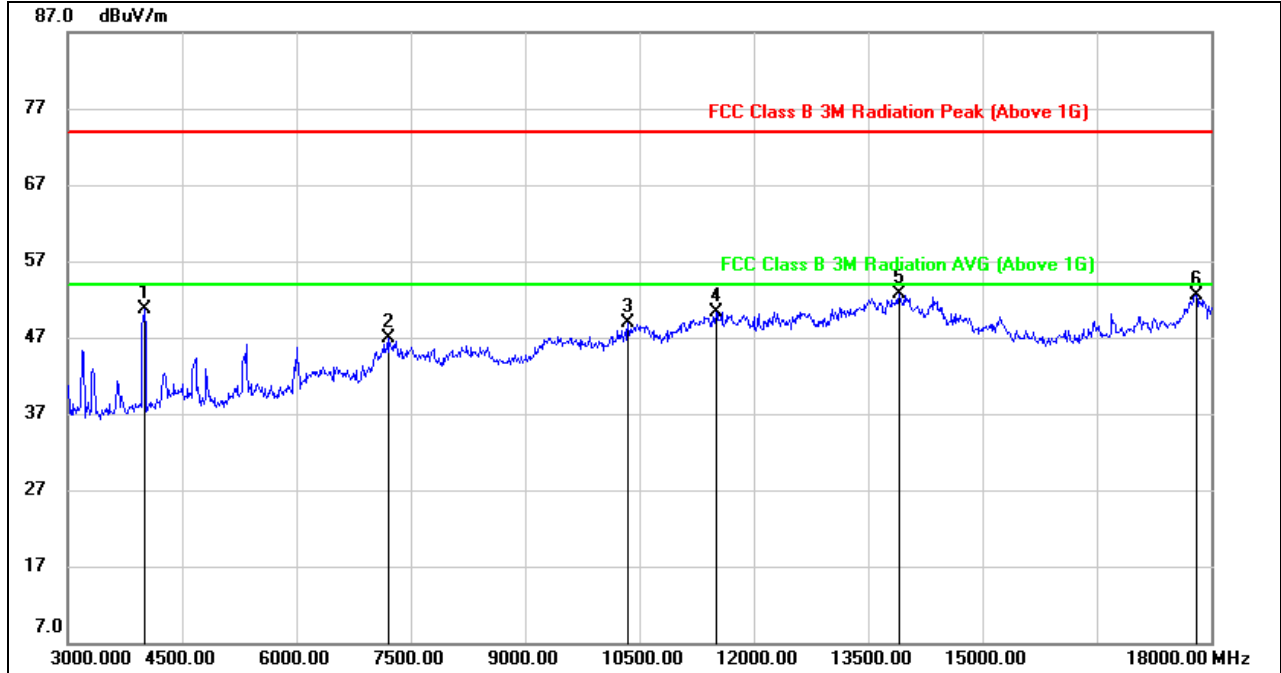

No.	Frequency (MHz)	Reading (dBuV)	Correct (dB/m)	Result (dBuV/m)	Limit (dBuV/m)	Margin (dB)	Remark
1	4005.000	53.65	-2.97	50.68	74.00	-23.32	peak
2	7200.000	38.96	7.85	46.81	74.00	-27.19	peak
3	10350.000	36.07	12.83	48.90	74.00	-25.10	peak
4	11505.000	34.05	16.26	50.31	74.00	-23.69	peak
5	13905.000	31.78	20.84	52.62	74.00	-21.38	peak
6	17805.000	25.75	26.80	52.55	74.00	-21.45	peak

Note: 1. Measurement = Reading Level + Correct Factor.  
 2. If Peak Result complies with AV limit, AV Result is deemed to comply with AV limit.  
 3. Peak: Peak detector.



**HARMONICS AND SPURIOUS EMISSIONS (MID CHANNEL, HORIZONTAL)**

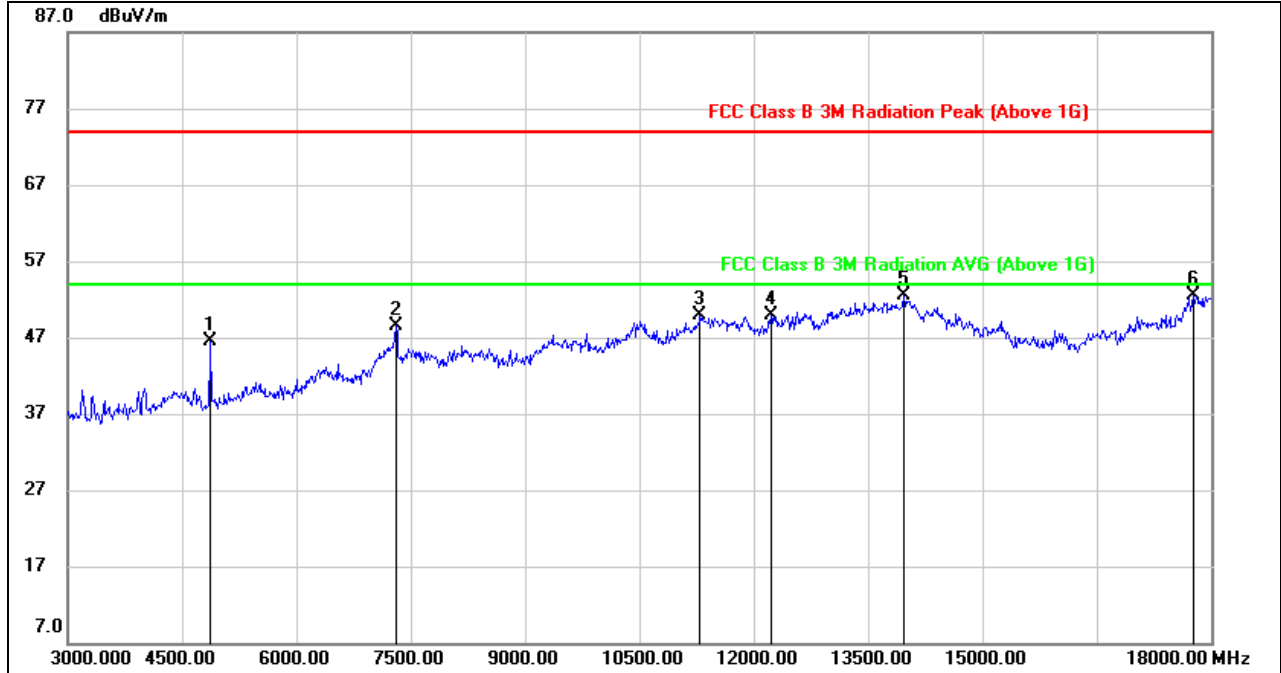

No.	Frequency (MHz)	Reading (dBuV)	Correct (dB/m)	Result (dBuV/m)	Limit (dBuV/m)	Margin (dB)	Remark
1	4875.000	46.06	0.38	46.44	74.00	-27.56	peak
2	7305.000	40.65	7.80	48.45	74.00	-25.55	peak
3	11295.000	34.36	15.53	49.89	74.00	-24.11	peak
4	12225.000	33.72	16.19	49.91	74.00	-24.09	peak
5	13965.000	31.75	20.66	52.41	74.00	-21.59	peak
6	17775.000	26.32	26.17	52.49	74.00	-21.51	peak

- Note: 1. Measurement = Reading Level + Correct Factor.  
 2. If Peak Result complies with AV limit, AV Result is deemed to comply with AV limit.  
 3. Peak: Peak detector.



**HARMONICS AND SPURIOUS EMISSIONS (MID CHANNEL, VERTICAL)**

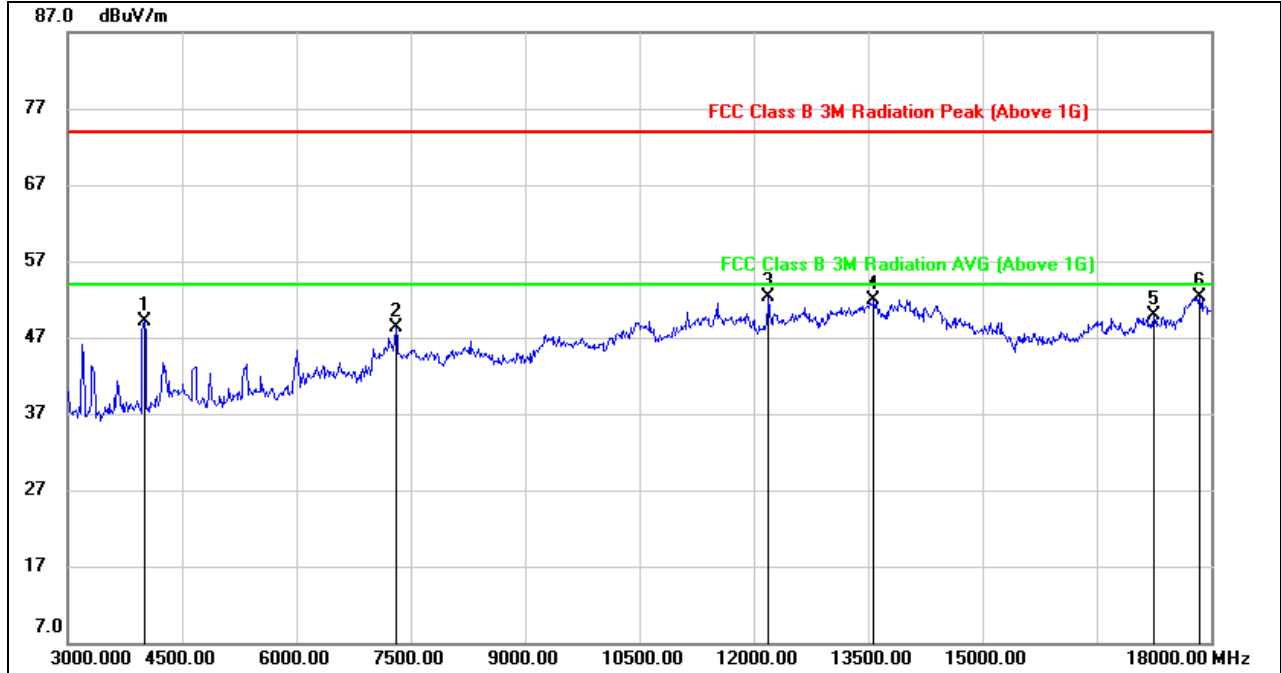

No.	Frequency (MHz)	Reading (dBuV)	Correct (dB/m)	Result (dBuV/m)	Limit (dBuV/m)	Margin (dB)	Remark
1	4005.000	52.14	-2.97	49.17	74.00	-24.83	peak
2	7305.000	40.58	7.81	48.39	74.00	-25.61	peak
3	12195.000	36.21	16.17	52.38	74.00	-21.62	peak
4	13575.000	31.35	20.63	51.98	74.00	-22.02	peak
5	17250.000	26.73	23.19	49.92	74.00	-24.08	peak
6	17850.000	26.18	26.09	52.27	74.00	-21.73	peak

- Note: 1. Measurement = Reading Level + Correct Factor.  
 2. If Peak Result complies with AV limit, AV Result is deemed to comply with AV limit.  
 3. Peak: Peak detector.



**HARMONICS AND SPURIOUS EMISSIONS (HIGH CHANNEL, HORIZONTAL)**

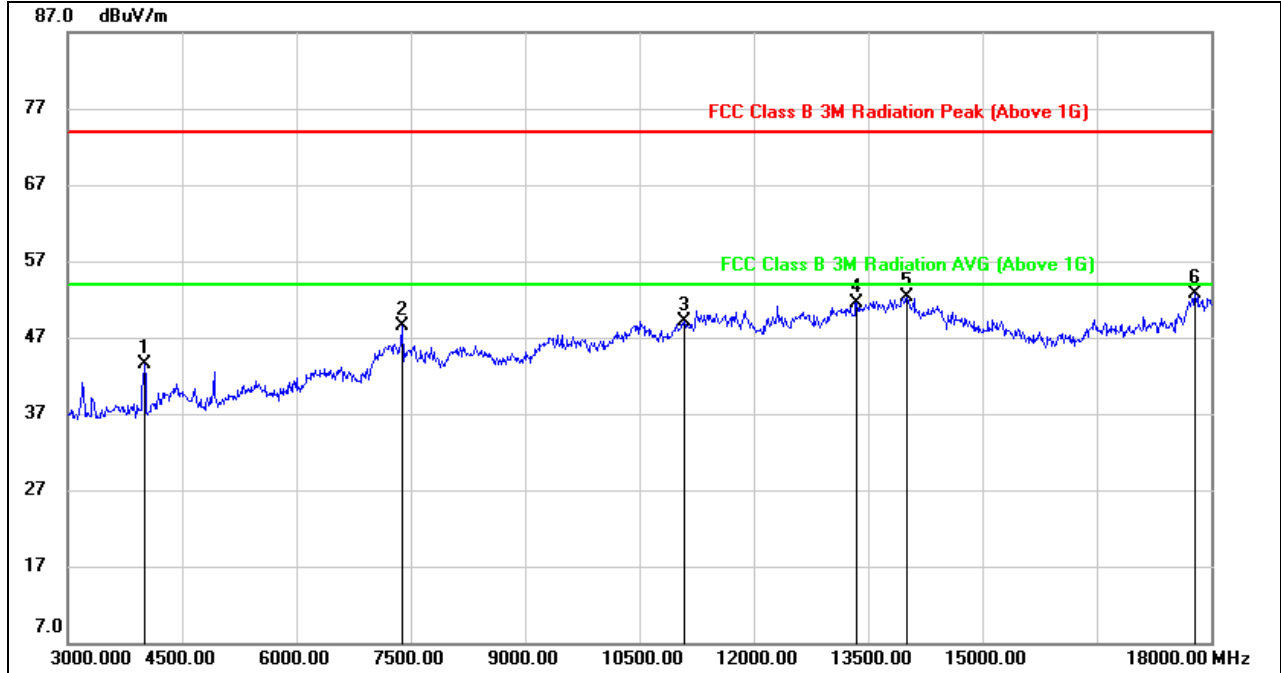

No.	Frequency (MHz)	Reading (dBuV)	Correct (dB/m)	Result (dBuV/m)	Limit (dBuV/m)	Margin (dB)	Remark
1	4005.000	46.49	-2.97	43.52	74.00	-30.48	peak
2	7380.000	41.46	7.10	48.56	74.00	-25.44	peak
3	11085.000	34.23	14.89	49.12	74.00	-24.88	peak
4	13350.000	32.07	19.46	51.53	74.00	-22.47	peak
5	14010.000	31.67	20.61	52.28	74.00	-21.72	peak
6	17790.000	26.30	26.36	52.66	74.00	-21.34	peak

- Note: 1. Measurement = Reading Level + Correct Factor.  
 2. If Peak Result complies with AV limit, AV Result is deemed to comply with AV limit.  
 3. Peak: Peak detector.



**HARMONICS AND SPURIOUS EMISSIONS (HIGH CHANNEL, VERTICAL)**

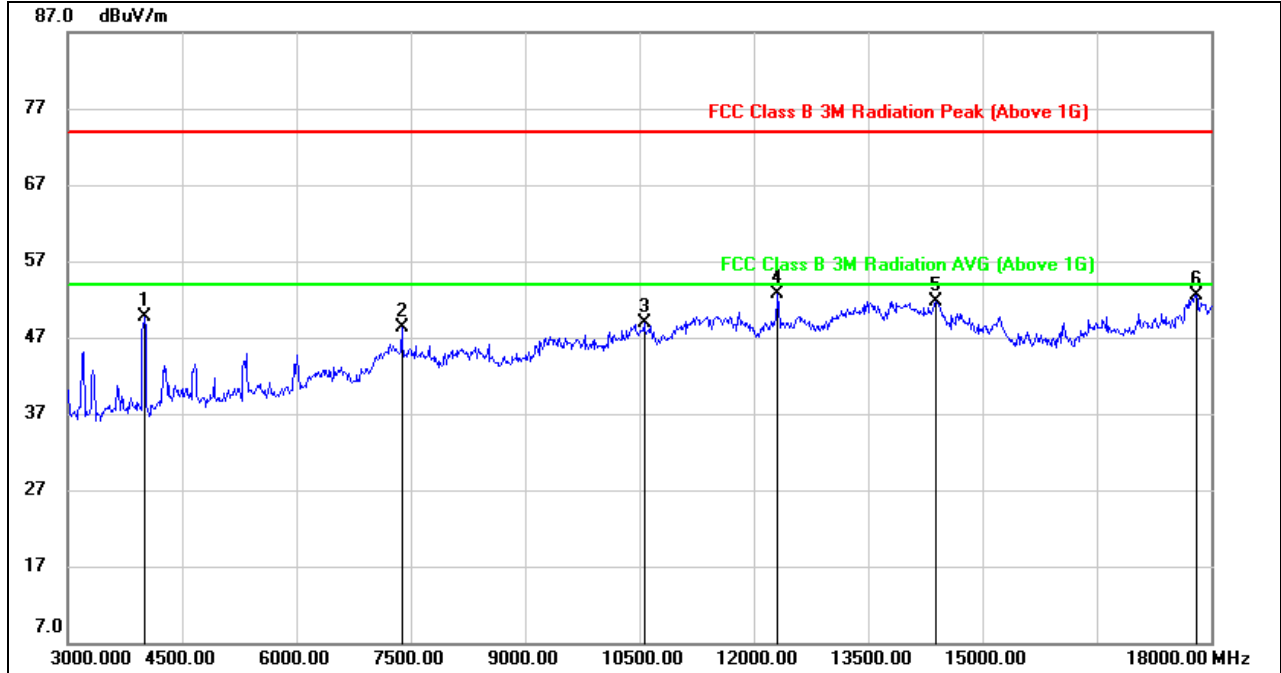

No.	Frequency (MHz)	Reading (dBuV)	Correct (dB/m)	Result (dBuV/m)	Limit (dBuV/m)	Margin (dB)	Remark
1	4005.000	52.74	-2.97	49.77	74.00	-24.23	peak
2	7380.000	41.14	7.14	48.28	74.00	-25.72	peak
3	10560.000	35.18	13.72	48.90	74.00	-25.10	peak
4	12315.000	36.30	16.40	52.70	74.00	-21.30	peak
5	14385.000	31.36	20.37	51.73	74.00	-22.27	peak
6	17805.000	25.78	26.80	52.58	74.00	-21.42	peak

- Note: 1. Measurement = Reading Level + Correct Factor.  
 2. If Peak Result complies with AV limit, AV Result is deemed to comply with AV limit.  
 3. Peak: Peak detector.

Note: All the antennas had been tested, but only the worst data record in the report.



### 9.3.3. 802.11n HT20 MODE

#### 2TX MODE (WORST-CASE CONFIGURATION)

#### HARMONICS AND SPURIOUS EMISSIONS (LOW CHANNEL, HORIZONTAL)

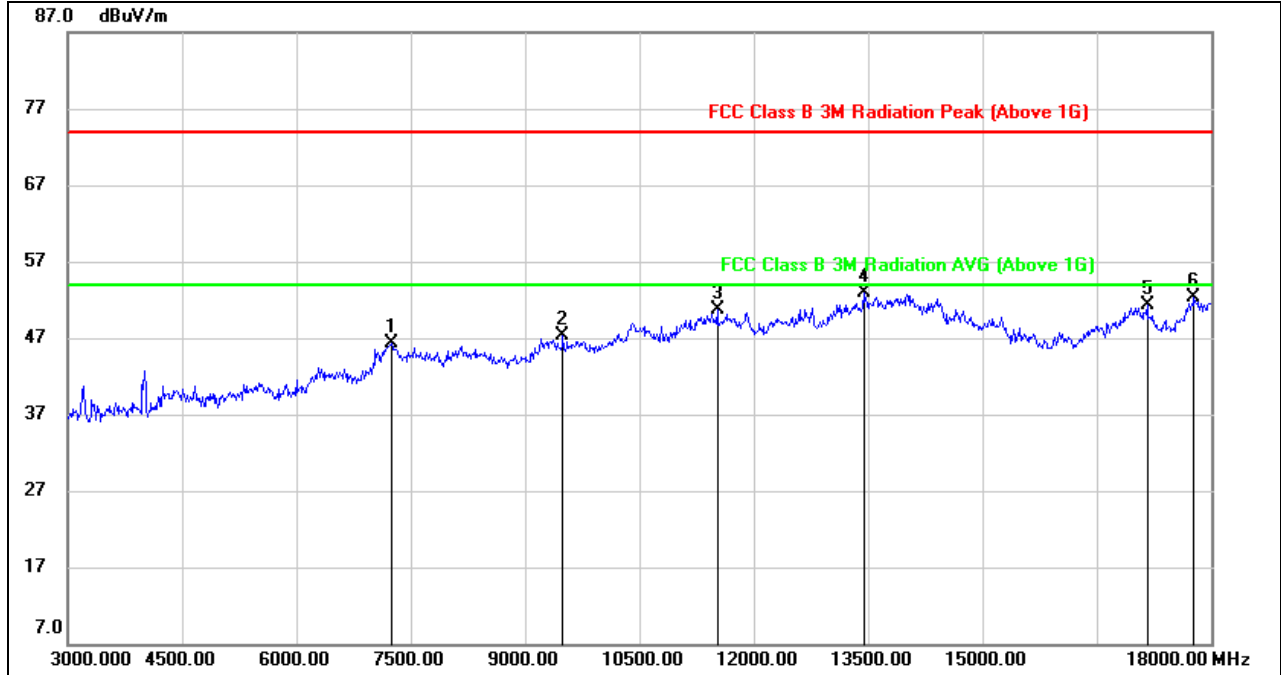

No.	Frequency (MHz)	Reading (dBuV)	Correct (dB/m)	Result (dBuV/m)	Limit (dBuV/m)	Margin (dB)	Remark
1	7245.000	38.51	7.84	46.35	74.00	-27.65	peak
2	9495.000	36.12	11.25	47.37	74.00	-26.63	peak
3	11520.000	34.95	15.73	50.68	74.00	-23.32	peak
4	13440.000	33.00	19.95	52.95	74.00	-21.05	peak
5	17160.000	28.53	22.69	51.22	74.00	-22.78	peak
6	17775.000	26.09	26.17	52.26	74.00	-21.74	peak

- Note:
1. Measurement = Reading Level + Correct Factor.
  2. If Peak Result complies with AV limit, AV Result is deemed to comply with AV limit.
  3. Peak: Peak detector.





**HARMONICS AND SPURIOUS EMISSIONS (LOW CHANNEL, VERTICAL)**

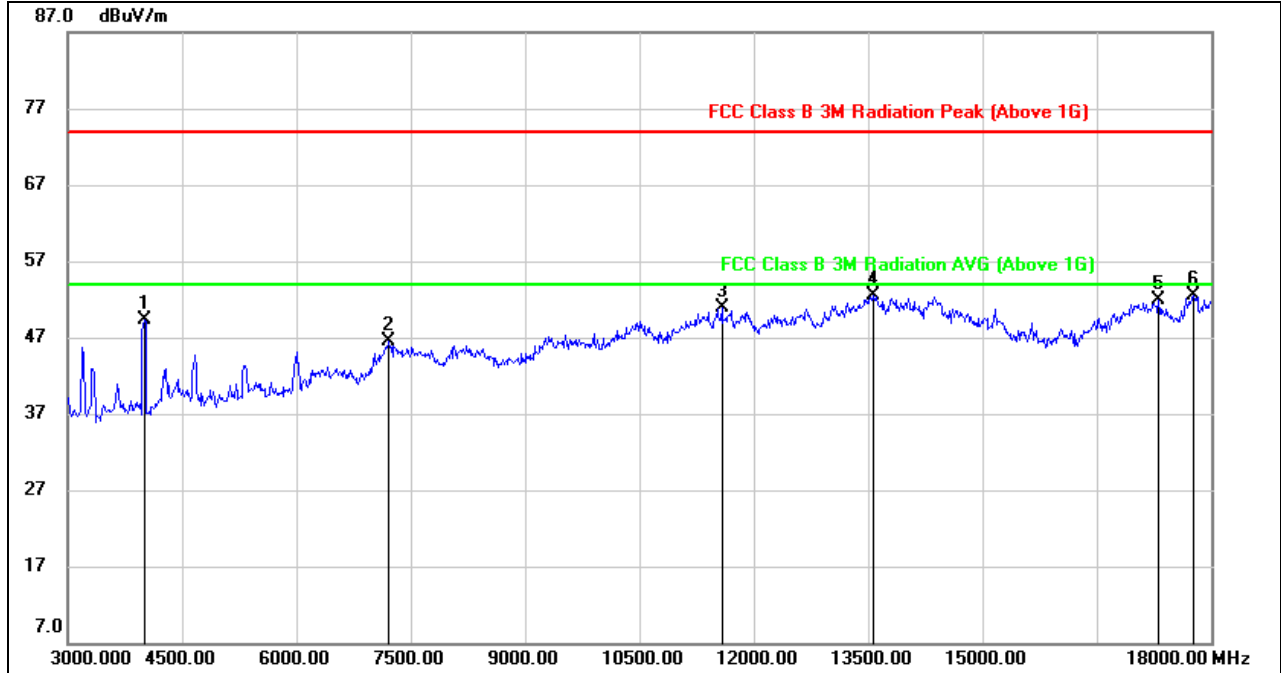

No.	Frequency (MHz)	Reading (dBuV)	Correct (dB/m)	Result (dBuV/m)	Limit (dBuV/m)	Margin (dB)	Remark
1	4005.000	52.19	-2.97	49.22	74.00	-24.78	peak
2	7215.000	38.70	7.82	46.52	74.00	-27.48	peak
3	11580.000	34.90	15.95	50.85	74.00	-23.15	peak
4	13560.000	31.74	20.81	52.55	74.00	-21.45	peak
5	17310.000	28.68	23.14	51.82	74.00	-22.18	peak
6	17775.000	26.00	26.57	52.57	74.00	-21.43	peak

Note: 1. Measurement = Reading Level + Correct Factor.  
 2. If Peak Result complies with AV limit, AV Result is deemed to comply with AV limit.  
 3. Peak: Peak detector.



**HARMONICS AND SPURIOUS EMISSIONS (MID CHANNEL, HORIZONTAL)**

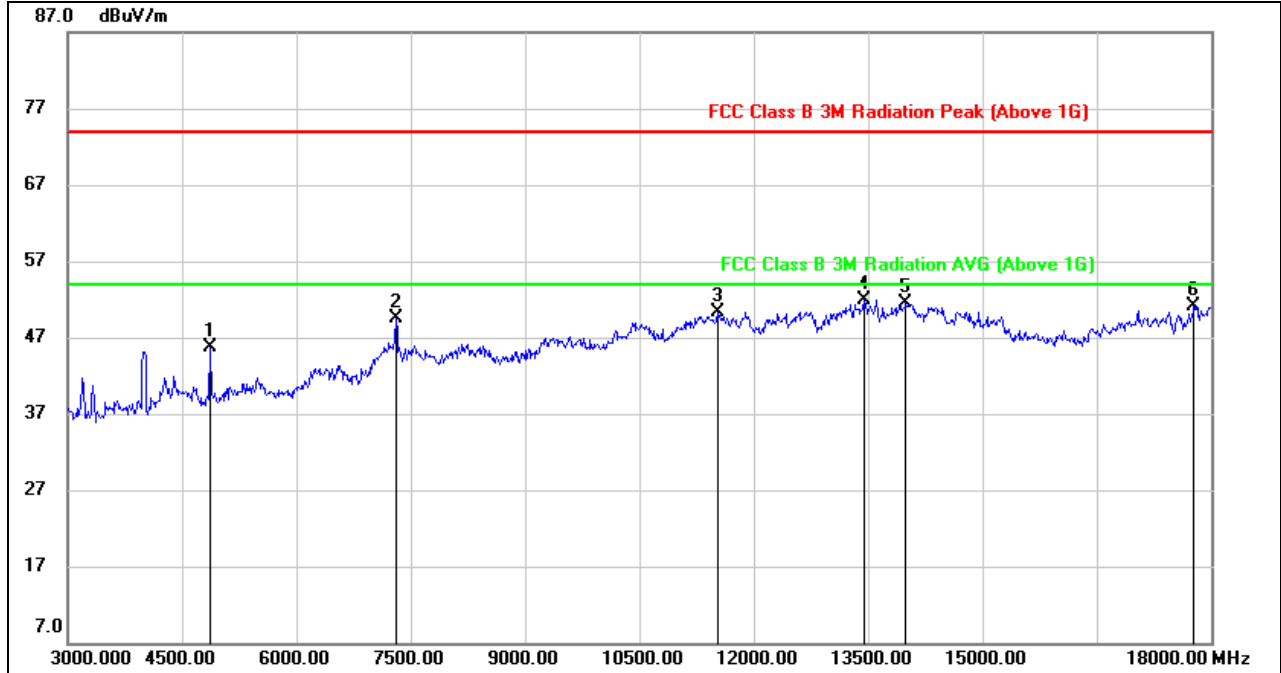

No.	Frequency (MHz)	Reading (dBuV)	Correct (dB/m)	Result (dBuV/m)	Limit (dBuV/m)	Margin (dB)	Remark
1	4860.000	45.42	0.20	45.62	74.00	-28.38	peak
2	7305.000	41.76	7.80	49.56	74.00	-24.44	peak
3	11520.000	34.58	15.73	50.31	74.00	-23.69	peak
4	13440.000	31.97	19.95	51.92	74.00	-22.08	peak
5	13995.000	30.80	20.62	51.42	74.00	-22.58	peak
6	17775.000	25.01	26.17	51.18	74.00	-22.82	peak

- Note: 1. Measurement = Reading Level + Correct Factor.  
 2. If Peak Result complies with AV limit, AV Result is deemed to comply with AV limit.  
 3. Peak: Peak detector.



**HARMONICS AND SPURIOUS EMISSIONS (MID CHANNEL, VERTICAL)**

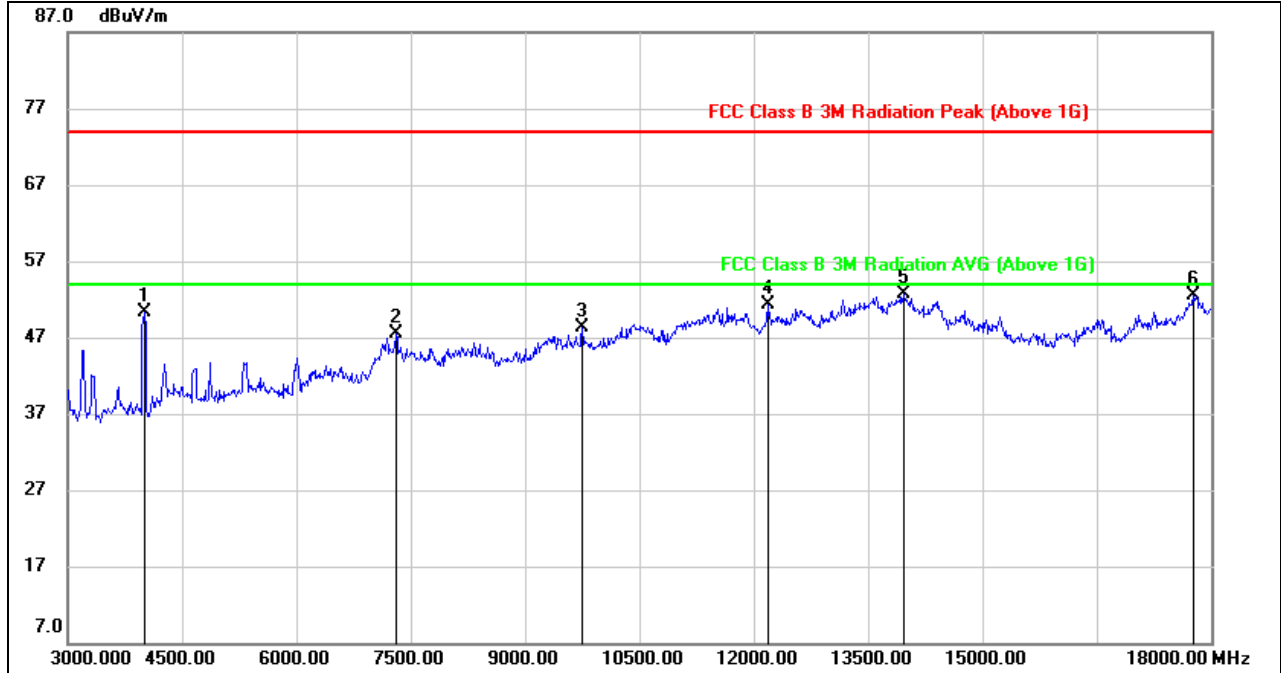

No.	Frequency (MHz)	Reading (dBuV)	Correct (dB/m)	Result (dBuV/m)	Limit (dBuV/m)	Margin (dB)	Remark
1	4005.000	53.27	-2.97	50.30	74.00	-23.70	peak
2	7305.000	39.73	7.81	47.54	74.00	-26.46	peak
3	9750.000	36.70	11.67	48.37	74.00	-25.63	peak
4	12180.000	35.07	16.23	51.30	74.00	-22.70	peak
5	13965.000	31.85	20.76	52.61	74.00	-21.39	peak
6	17760.000	26.14	26.39	52.53	74.00	-21.47	peak

- Note: 1. Measurement = Reading Level + Correct Factor.  
 2. If Peak Result complies with AV limit, AV Result is deemed to comply with AV limit.  
 3. Peak: Peak detector.



**HARMONICS AND SPURIOUS EMISSIONS (HIGH CHANNEL, HORIZONTAL)**

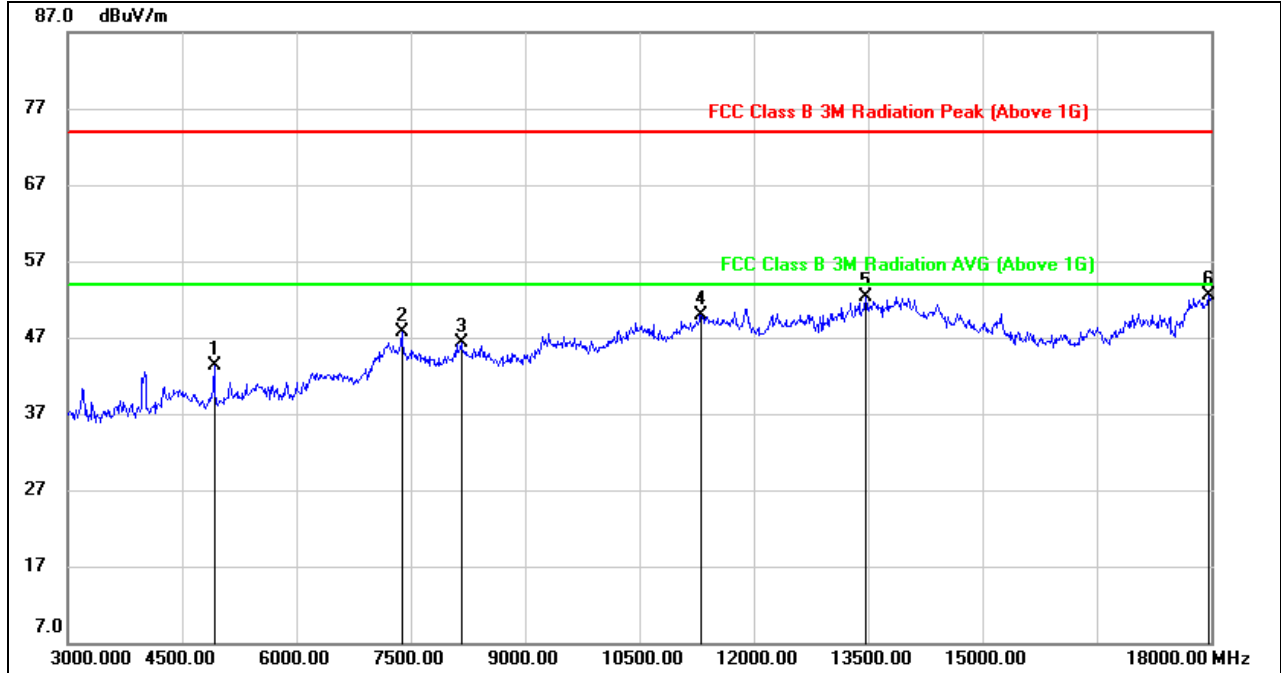

No.	Frequency (MHz)	Reading (dBuV)	Correct (dB/m)	Result (dBuV/m)	Limit (dBuV/m)	Margin (dB)	Remark
1	4920.000	42.72	0.65	43.37	74.00	-30.63	peak
2	7380.000	40.64	7.10	47.74	74.00	-26.26	peak
3	8160.000	37.57	8.70	46.27	74.00	-27.73	peak
4	11310.000	34.48	15.44	49.92	74.00	-24.08	peak
5	13470.000	32.20	20.09	52.29	74.00	-21.71	peak
6	17970.000	25.43	27.04	52.47	74.00	-21.53	peak

Note: 1. Measurement = Reading Level + Correct Factor.  
2. If Peak Result complies with AV limit, AV Result is deemed to comply with AV limit.  
3. Peak: Peak detector.



**HARMONICS AND SPURIOUS EMISSIONS (HIGH CHANNEL, VERTICAL)**

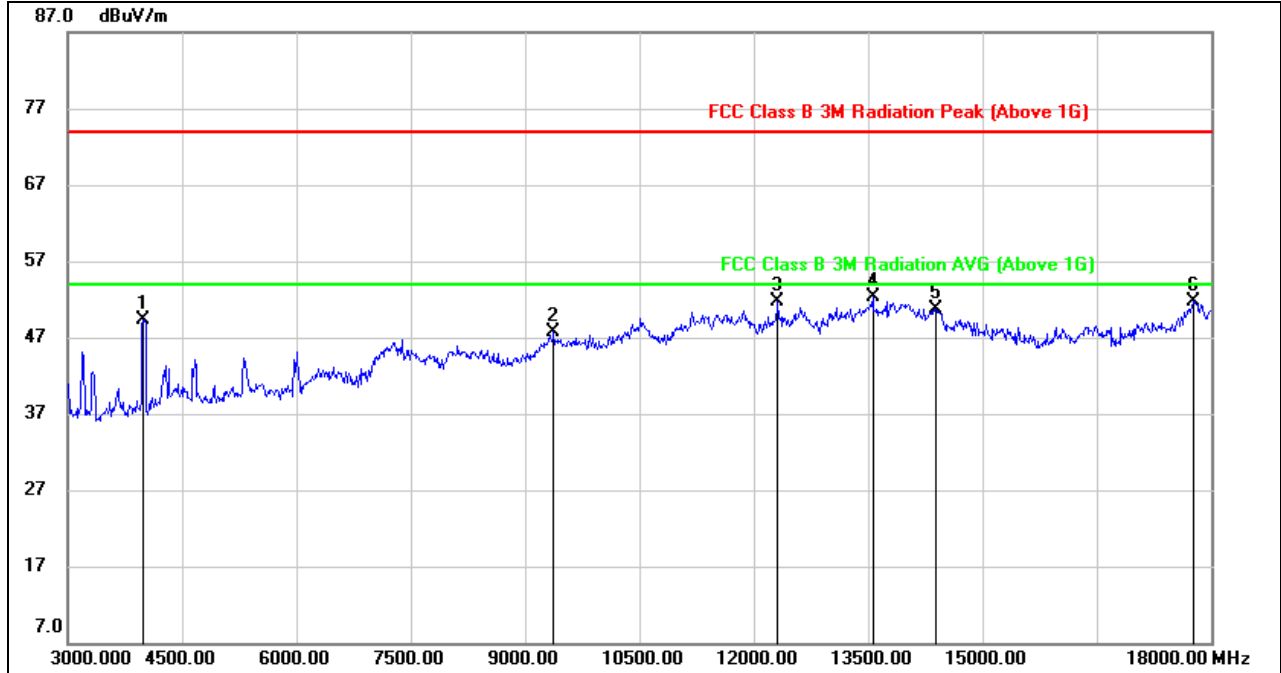

No.	Frequency (MHz)	Reading (dBuV)	Correct (dB/m)	Result (dBuV/m)	Limit (dBuV/m)	Margin (dB)	Remark
1	3990.000	52.39	-3.00	49.39	74.00	-24.61	peak
2	9375.000	36.83	10.88	47.71	74.00	-26.29	peak
3	12315.000	35.27	16.40	51.67	74.00	-22.33	peak
4	13560.000	31.41	20.81	52.22	74.00	-21.78	peak
5	14385.000	30.35	20.37	50.72	74.00	-23.28	peak
6	17760.000	25.26	26.39	51.65	74.00	-22.35	peak

- Note: 1. Measurement = Reading Level + Correct Factor.  
 2. If Peak Result complies with AV limit, AV Result is deemed to comply with AV limit.  
 3. Peak: Peak detector.

Note: All the antennas had been tested, but only the worst data record in the report.



### 9.3.4. 802.11n HT40 MODE

#### 2TX MODE (WORST-CASE CONFIGURATION)

#### HARMONICS AND SPURIOUS EMISSIONS (LOW CHANNEL, HORIZONTAL)

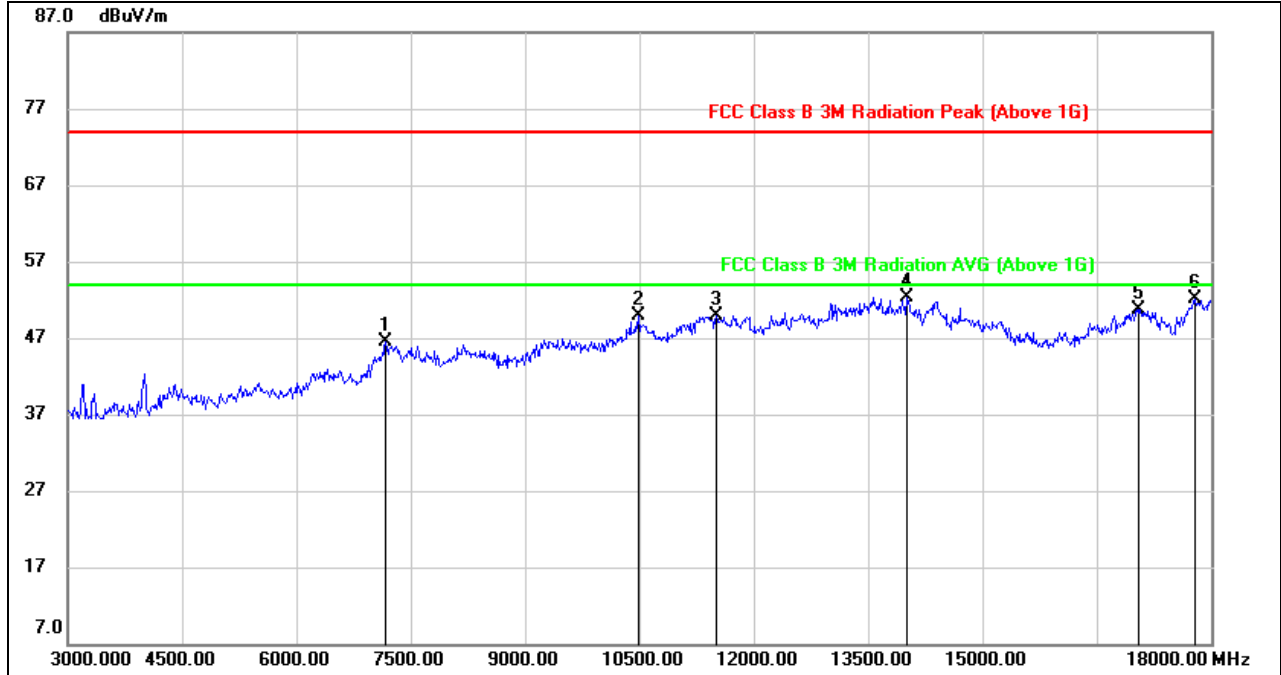

No.	Frequency (MHz)	Reading (dBuV)	Correct (dB/m)	Result (dBuV/m)	Limit (dBuV/m)	Margin (dB)	Remark
1	7170.000	38.79	7.72	46.51	74.00	-27.49	peak
2	10485.000	36.36	13.62	49.98	74.00	-24.02	peak
3	11505.000	34.29	15.68	49.97	74.00	-24.03	peak
4	14010.000	31.77	20.61	52.38	74.00	-21.62	peak
5	17055.000	28.51	22.17	50.68	74.00	-23.32	peak
6	17790.000	25.70	26.36	52.06	74.00	-21.94	peak

- Note: 1. Measurement = Reading Level + Correct Factor.  
 2. If Peak Result complies with AV limit, AV Result is deemed to comply with AV limit.  
 3. Peak: Peak detector.



**HARMONICS AND SPURIOUS EMISSIONS (LOW CHANNEL, VERTICAL)**

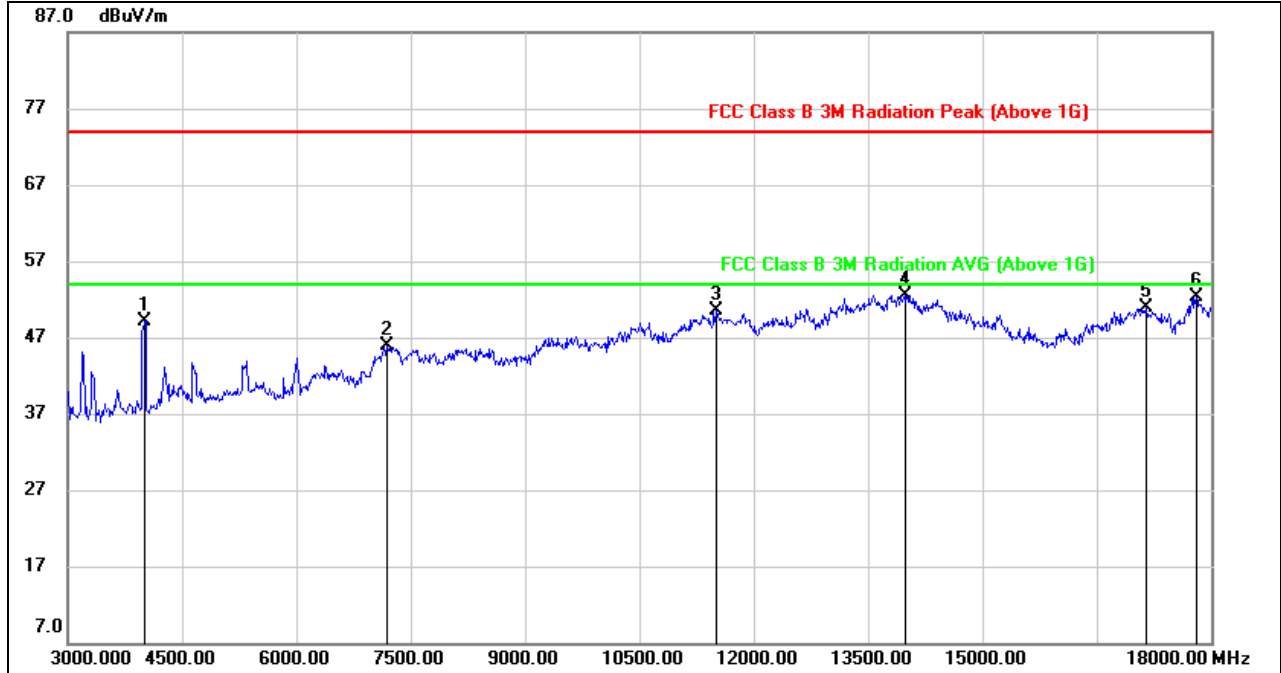

No.	Frequency (MHz)	Reading (dBuV)	Correct (dB/m)	Result (dBuV/m)	Limit (dBuV/m)	Margin (dB)	Remark
1	4005.000	52.09	-2.97	49.12	74.00	-24.88	peak
2	7185.000	38.04	7.83	45.87	74.00	-28.13	peak
3	11505.000	34.17	16.26	50.43	74.00	-23.57	peak
4	13980.000	31.84	20.73	52.57	74.00	-21.43	peak
5	17145.000	28.13	22.86	50.99	74.00	-23.01	peak
6	17805.000	25.55	26.80	52.35	74.00	-21.65	peak

- Note: 1. Measurement = Reading Level + Correct Factor.  
 2. If Peak Result complies with AV limit, AV Result is deemed to comply with AV limit.  
 3. Peak: Peak detector.



**HARMONICS AND SPURIOUS EMISSIONS (MID CHANNEL, HORIZONTAL)**

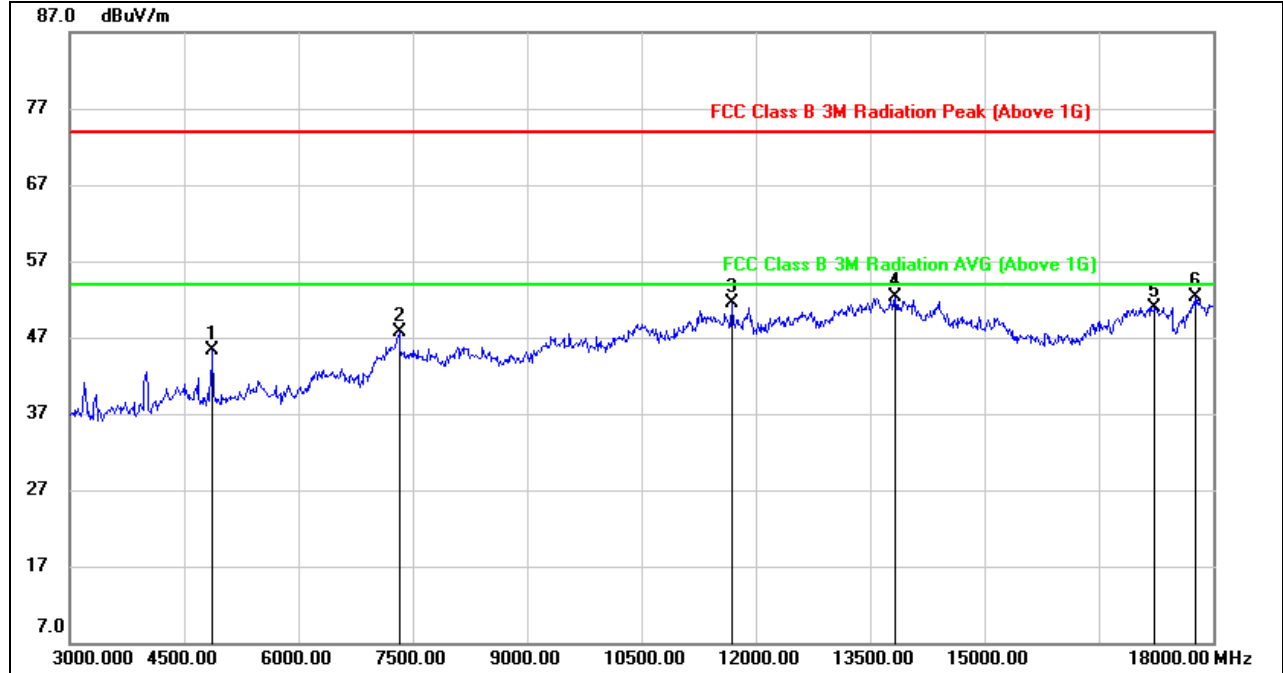

No.	Frequency (MHz)	Reading (dBuV)	Correct (dB/m)	Result (dBuV/m)	Limit (dBuV/m)	Margin (dB)	Remark
1	4875.000	44.95	0.38	45.33	74.00	-28.67	peak
2	7320.000	40.09	7.63	47.72	74.00	-26.28	peak
3	11685.000	35.71	15.84	51.55	74.00	-22.45	peak
4	13830.000	31.60	20.72	52.32	74.00	-21.68	peak
5	17235.000	28.28	22.72	51.00	74.00	-23.00	peak
6	17775.000	26.15	26.17	52.32	74.00	-21.68	peak

- Note: 1. Measurement = Reading Level + Correct Factor.  
 2. If Peak Result complies with AV limit, AV Result is deemed to comply with AV limit.  
 3. Peak: Peak detector.





**HARMONICS AND SPURIOUS EMISSIONS (MID CHANNEL, VERTICAL)**

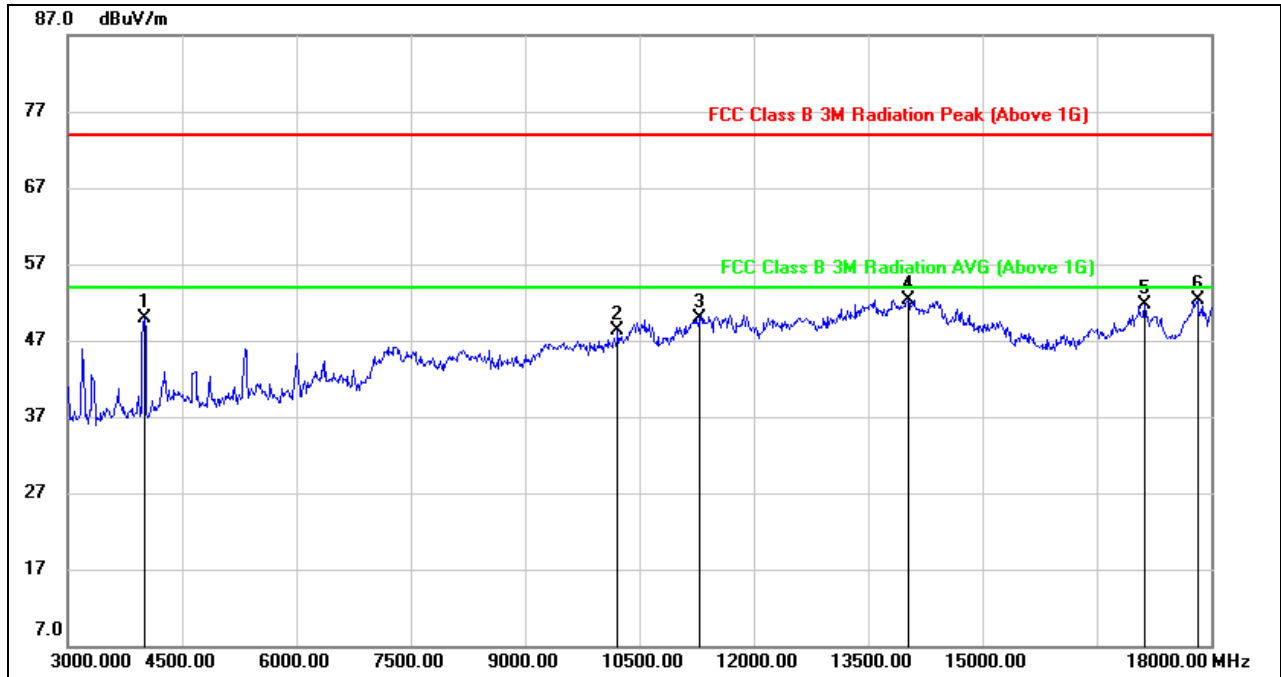

No.	Frequency (MHz)	Reading (dBuV)	Correct (dB/m)	Result (dBuV/m)	Limit (dBuV/m)	Margin (dB)	Remark
1	4005.000	52.92	-2.97	49.95	74.00	-24.05	peak
2	10215.000	35.66	12.72	48.38	74.00	-25.62	peak
3	11280.000	34.79	15.18	49.97	74.00	-24.03	peak
4	14025.000	31.74	20.62	52.36	74.00	-21.64	peak
5	17130.000	28.90	22.86	51.76	74.00	-22.24	peak
6	17820.000	25.68	26.56	52.24	74.00	-21.76	peak

- Note: 1. Measurement = Reading Level + Correct Factor.  
 2. If Peak Result complies with AV limit, AV Result is deemed to comply with AV limit.  
 3. Peak: Peak detector.



**HARMONICS AND SPURIOUS EMISSIONS (HIGH CHANNEL, HORIZONTAL)**

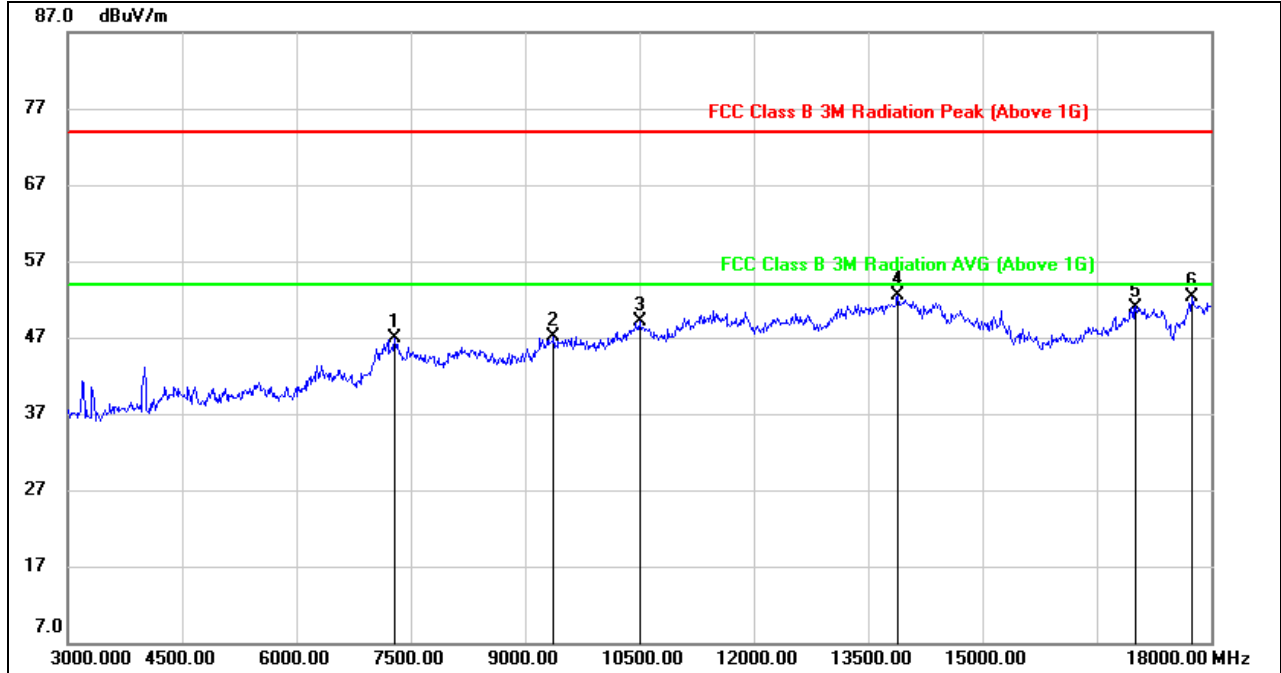

No.	Frequency (MHz)	Reading (dBuV)	Correct (dB/m)	Result (dBuV/m)	Limit (dBuV/m)	Margin (dB)	Remark
1	7290.000	38.95	7.86	46.81	74.00	-27.19	peak
2	9375.000	36.22	10.83	47.05	74.00	-26.95	peak
3	10500.000	35.44	13.71	49.15	74.00	-24.85	peak
4	13890.000	31.89	20.67	52.56	74.00	-21.44	peak
5	17010.000	29.06	21.94	51.00	74.00	-23.00	peak
6	17745.000	26.35	25.86	52.21	74.00	-21.79	peak

- Note: 1. Measurement = Reading Level + Correct Factor.  
 2. If Peak Result complies with AV limit, AV Result is deemed to comply with AV limit.  
 3. Peak: Peak detector.



**HARMONICS AND SPURIOUS EMISSIONS (HIGH CHANNEL, VERTICAL)**

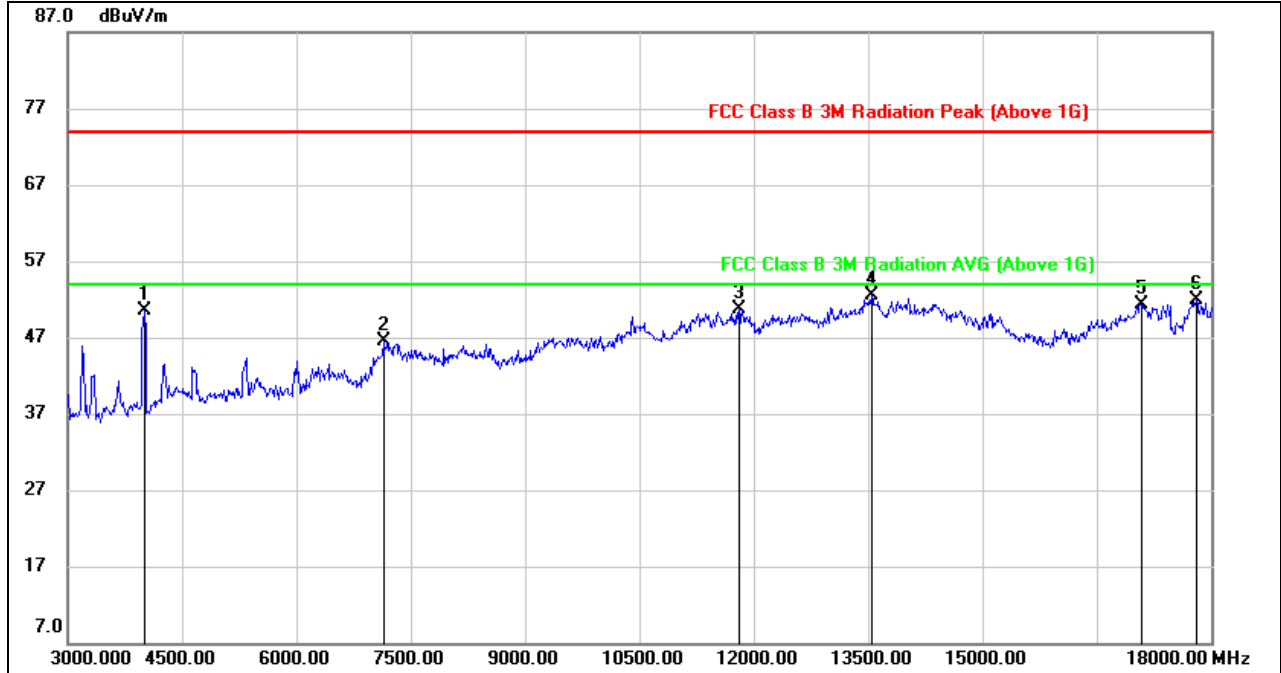

No.	Frequency (MHz)	Reading (dBuV)	Correct (dB/m)	Result (dBuV/m)	Limit (dBuV/m)	Margin (dB)	Remark
1	4005.000	53.55	-2.97	50.58	74.00	-23.42	peak
2	7140.000	38.77	7.72	46.49	74.00	-27.51	peak
3	11805.000	34.25	16.55	50.80	74.00	-23.20	peak
4	13545.000	31.70	20.88	52.58	74.00	-21.42	peak
5	17085.000	28.60	22.79	51.39	74.00	-22.61	peak
6	17805.000	25.12	26.80	51.92	74.00	-22.08	peak

- Note: 1. Measurement = Reading Level + Correct Factor.  
 2. If Peak Result complies with AV limit, AV Result is deemed to comply with AV limit.  
 3. Peak: Peak detector.

Note: All the antennas had been tested, but only the worst data record in the report.



### 9.4. SPURIOUS EMISSIONS (18~26GHz)

#### 9.4.1. 802.11g MODE

#### 1TX MODE FOR ANT0 (WORST-CASE CONFIGURATION)

#### SPURIOUS EMISSIONS (MID CHANNEL, HORIZONTAL)

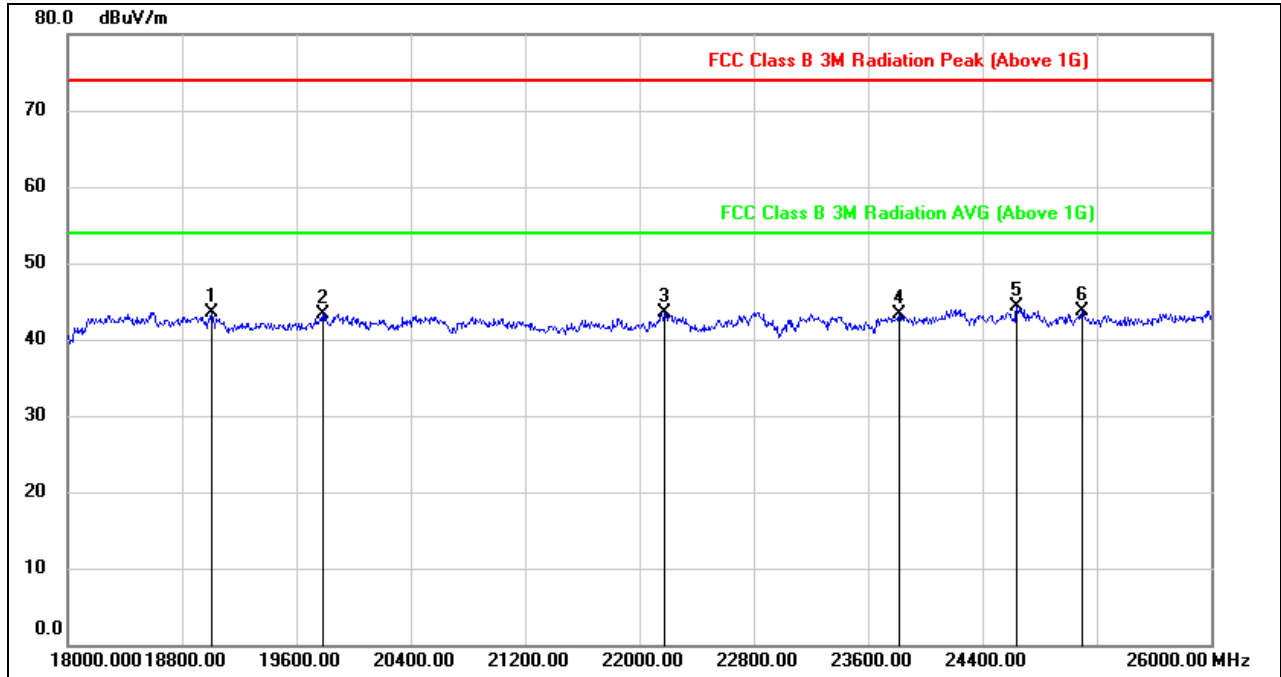

No.	Frequency (MHz)	Reading (dBuV)	Correct (dB/m)	Result (dBuV/m)	Limit (dBuV/m)	Margin (dB)	Remark
1	19008.000	48.77	-5.23	43.54	74.00	-30.46	peak
2	19784.000	48.58	-5.28	43.30	74.00	-30.70	peak
3	22176.000	47.76	-4.29	43.47	74.00	-30.53	peak
4	23816.000	46.39	-3.08	43.31	74.00	-30.69	peak
5	24640.000	46.53	-2.32	44.21	74.00	-29.79	peak
6	25096.000	45.65	-1.93	43.72	74.00	-30.28	peak

- Note: 1. Measurement = Reading Level + Correct Factor.  
 2. If Peak Result complies with AV limit, AV Result is deemed to comply with AV limit.  
 3. Peak: Peak detector.



**SPURIOUS EMISSIONS (MID CHANNEL, VERTICAL)**

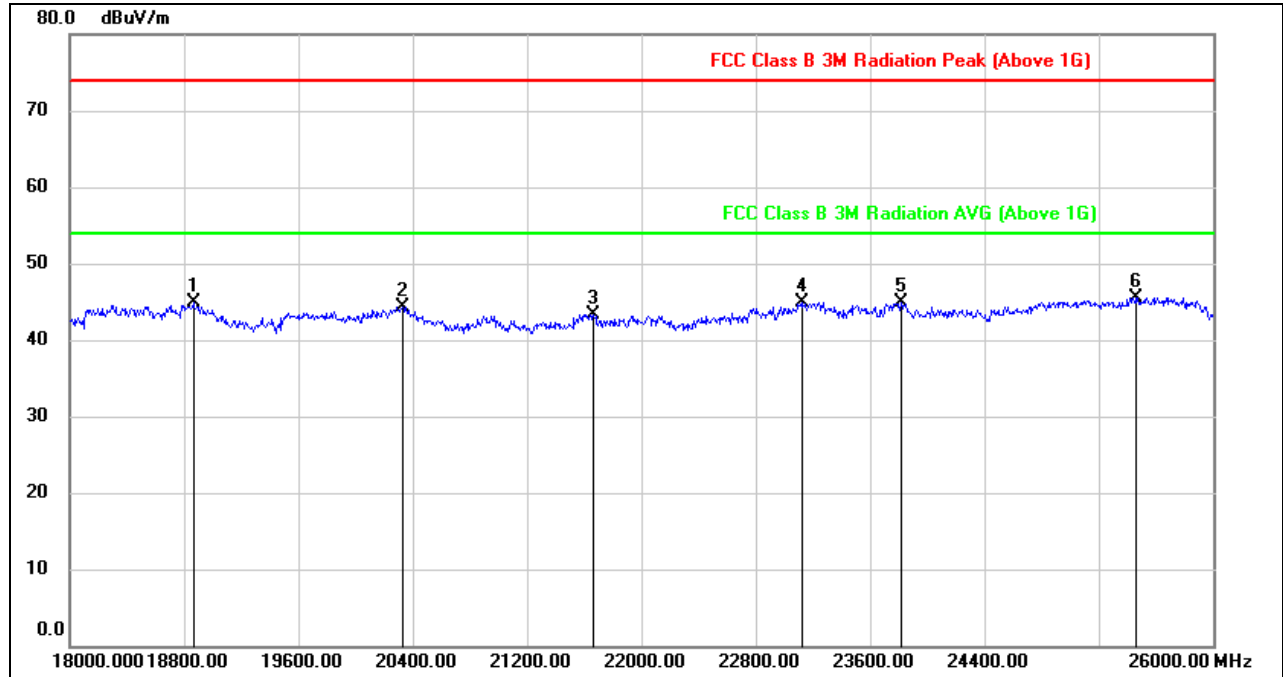

No.	Frequency (MHz)	Reading (dBuV)	Correct (dB/m)	Result (dBuV/m)	Limit (dBuV/m)	Margin (dB)	Remark
1	18864.000	50.18	-5.33	44.85	74.00	-29.15	peak
2	20328.000	49.82	-5.53	44.29	74.00	-29.71	peak
3	21664.000	47.73	-4.45	43.28	74.00	-30.72	peak
4	23120.000	48.24	-3.40	44.84	74.00	-29.16	peak
5	23816.000	47.95	-3.08	44.87	74.00	-29.13	peak
6	25456.000	47.22	-1.75	45.47	74.00	-28.53	peak

Note: 1. Measurement = Reading Level + Correct Factor.  
 2. If Peak Result complies with AV limit, AV Result is deemed to comply with AV limit.  
 3. Peak: Peak detector.

Note: All modes and antennas had been tested, but only the worst data record in the report.



## 9.5. SPURIOUS EMISSIONS (0.03 ~ 1 GHz)

### 9.5.1. 802.11g MODE

#### 1TX MODE FOR ANT0 (WORST-CASE CONFIGURATION)

#### SPURIOUS EMISSIONS (LOW CHANNEL, HORIZONTAL)

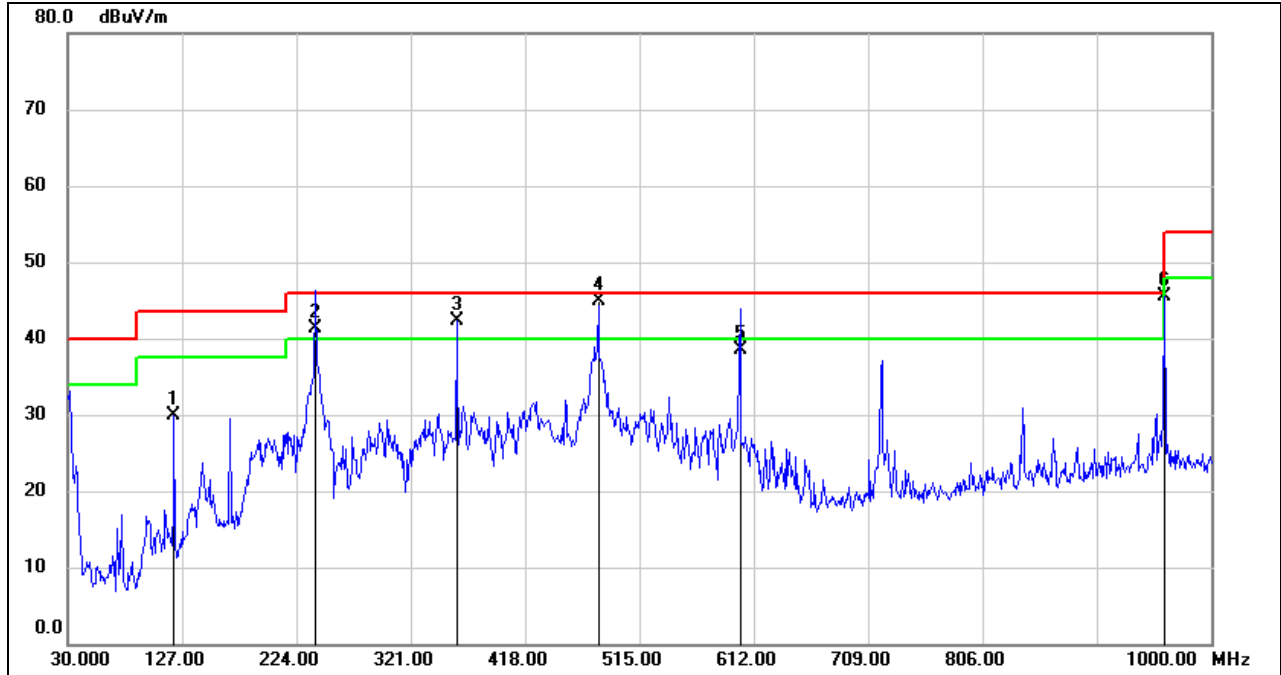

No.	Frequency (MHz)	Reading (dBuV)	Correct (dB/m)	Result (dBuV/m)	Limit (dBuV/m)	Margin (dB)	Remark
1	120.2100	50.86	-20.88	29.98	43.50	-13.52	QP
2	239.5200	58.40	-17.02	41.38	46.00	-4.62	QP
3	359.8000	55.64	-13.35	42.29	46.00	-3.71	QP
4	480.0800	56.11	-11.20	44.91	46.00	-1.09	QP
5	600.3600	47.24	-8.74	38.50	46.00	-7.50	QP
6	960.2300	48.97	-3.49	45.48	54.00	-8.52	QP

- Note: 1. Result Level = Read Level + Correct Factor.  
 2. If Peak Result complies with QP limit, QP Result is deemed to comply with QP limit.  
 3. Test setup: RBW: 120 kHz, VBW: 300 kHz, Sweep time: auto.



**SPURIOUS EMISSIONS (MID CHANNEL, VERTICAL)**

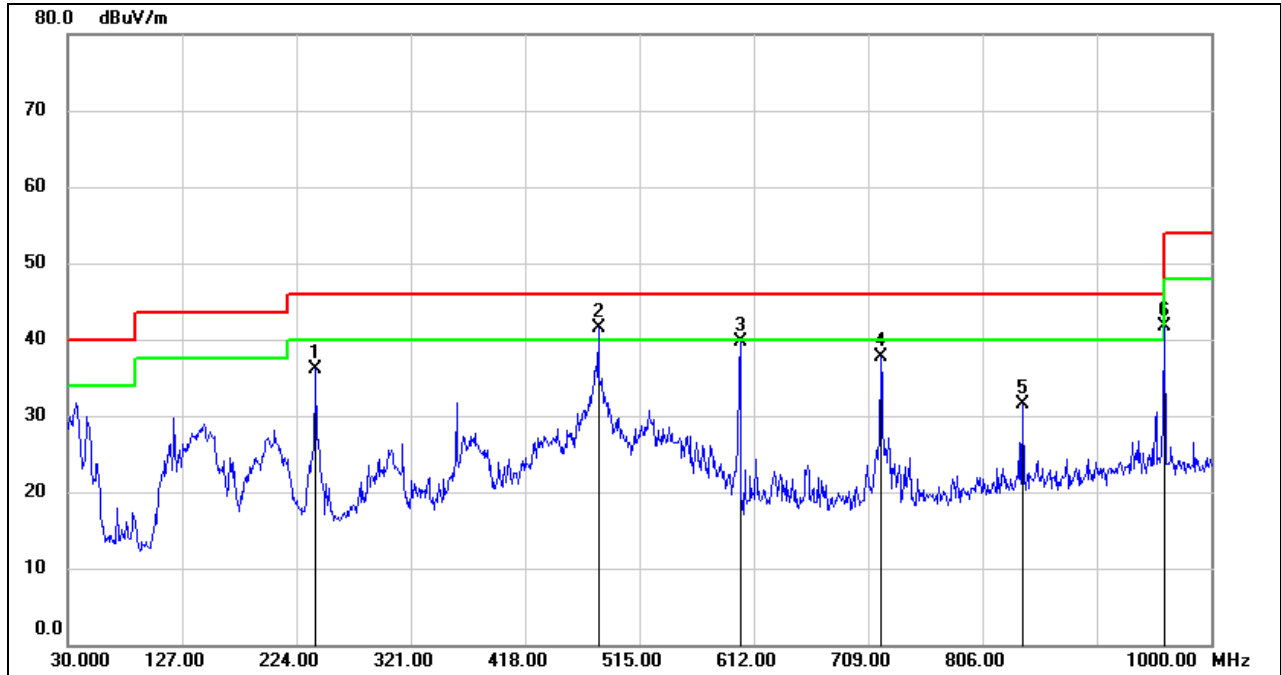

No.	Frequency (MHz)	Reading (dBuV)	Correct (dB/m)	Result (dBuV/m)	Limit (dBuV/m)	Margin (dB)	Remark
1	240.4900	53.00	-16.95	36.05	46.00	-9.95	QP
2	480.0800	52.63	-11.20	41.43	46.00	-4.57	QP
3	600.3600	48.51	-8.74	39.77	46.00	-6.23	QP
4	719.6700	44.11	-6.41	37.70	46.00	-8.30	QP
5	839.9500	36.29	-4.83	31.46	46.00	-14.54	QP
6	960.2300	45.22	-3.49	41.73	54.00	-12.27	QP

- Note: 1. Result Level = Read Level + Correct Factor.  
 2. If Peak Result complies with QP limit, QP Result is deemed to comply with QP limit.  
 3. Test setup: RBW: 120 kHz, VBW: 300 kHz, Sweep time: auto

Note: All modes and antennas had been tested, but only the worst data record in the report.



## 9.6. SPURIOUS EMISSIONS BELOW 30M

### 9.6.1. 802.11g MODE

#### 1TX MODE FOR ANT0 (WORST-CASE CONFIGURATION)

#### SPURIOUS EMISSIONS (LOW CHANNEL, VERTICAL)

0.09kHz~ 150kHz

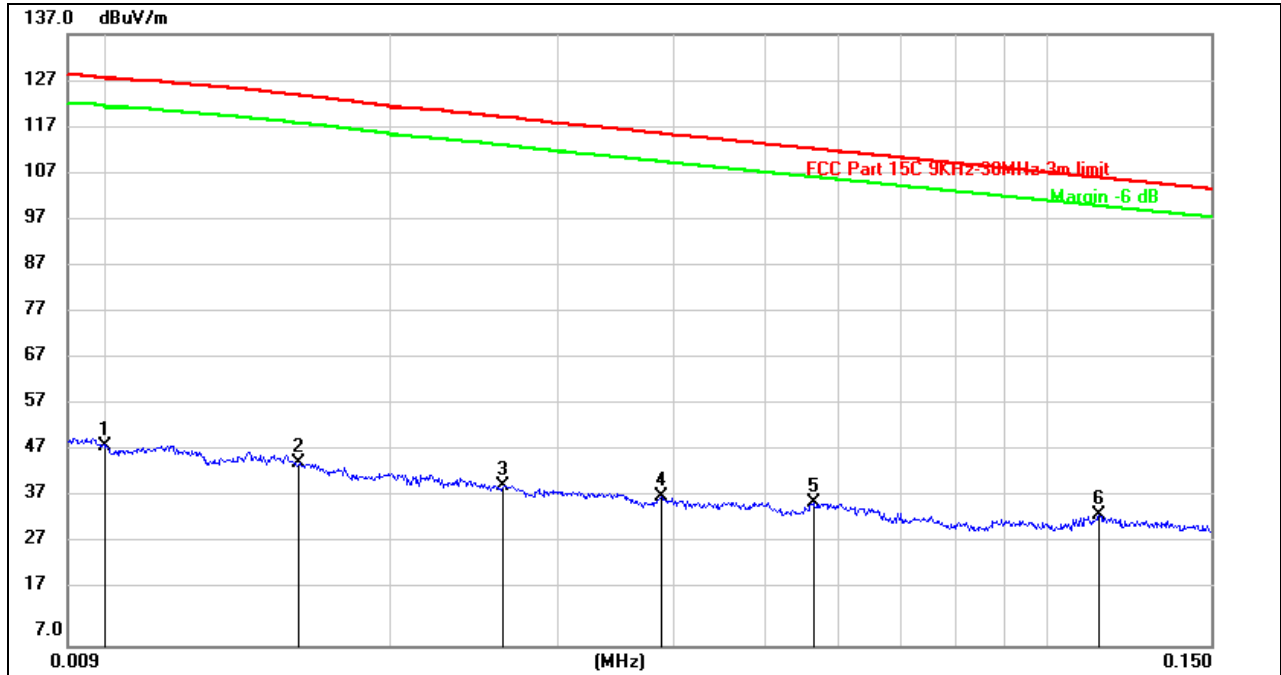

No.	Frequency (MHz)	Reading (dBuV)	Correct (dB/m)	Result (dBuV/m)	Limit (dBuV/m)	Margin (dB)	Remark
1	0.0100	29.35	20.21	49.56	127.60	-78.04	peak
2	0.0159	25.49	20.27	45.76	124.05	-78.29	peak
3	0.0263	20.69	20.31	41.00	119.36	-78.36	peak
4	0.0388	18.25	20.31	38.56	115.86	-77.30	peak
5	0.0563	17.22	20.31	37.53	112.62	-75.09	peak
6	0.1139	14.52	20.28	34.80	106.48	-71.68	peak

Note: 1. Measurement = Reading Level + Correct Factor.

2. If Peak Result complies with AV and QP limit, AV and QP Result are deemed to comply with AV limit.





**150kHz ~ 30MHz**

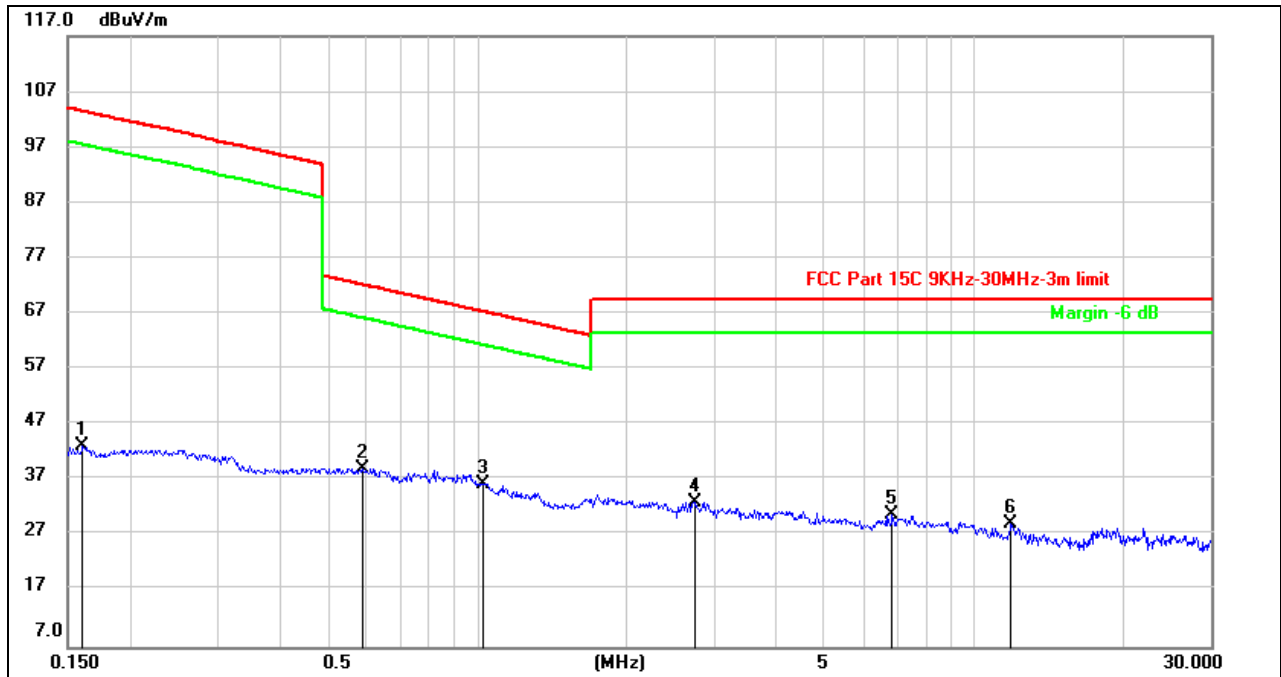

No.	Frequency (MHz)	Reading (dBuV)	Correct (dB/m)	Result (dBuV/m)	Limit (dBuV/m)	Margin (dB)	Remark
1	0.1607	22.63	20.41	43.04	103.48	-60.44	peak
2	0.5885	18.83	20.29	39.12	72.22	-33.10	peak
3	1.0262	15.98	20.38	36.36	67.39	-31.03	peak
4	2.7355	12.19	20.85	33.04	69.54	-36.50	peak
5	6.8410	9.79	20.91	30.70	69.54	-38.84	peak
6	11.8696	8.04	21.01	29.05	69.54	-40.49	peak

Note: 1. Measurement = Reading Level + Correct Factor.  
2. If Peak Result complies with AV and QP limit, AV and QP Result are deemed to comply with AV limit.



**SPURIOUS EMISSIONS (MID CHANNEL, HORIZONTAL)**

**0.09~ 150kHz**

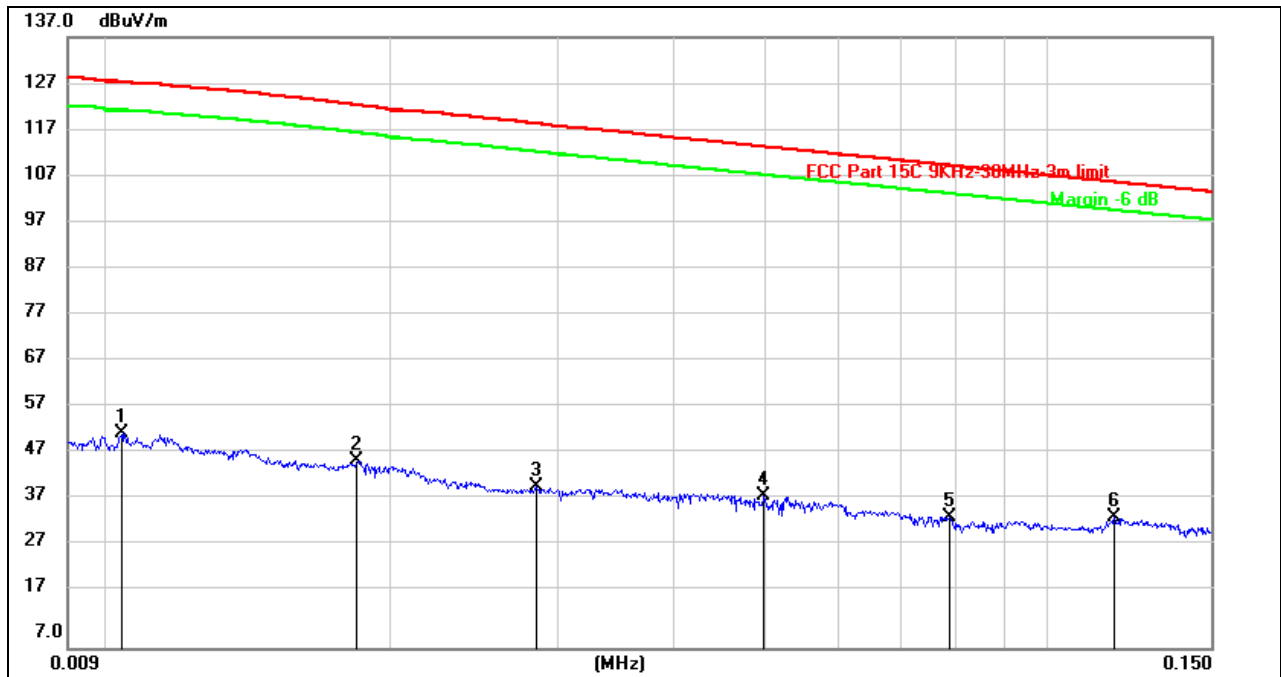

No.	Frequency (MHz)	Reading (dBuV)	Correct (dB/m)	Result (dBuV/m)	Limit (dBuV/m)	Margin (dB)	Remark
1	0.0103	32.32	20.21	52.53	127.42	-74.89	peak
2	0.0183	26.57	20.29	46.86	122.60	-75.74	peak
3	0.0285	21.06	20.31	41.37	118.59	-77.22	peak
4	0.0497	19.01	20.31	39.32	113.68	-74.36	peak
5	0.0786	14.63	20.29	34.92	109.70	-74.78	peak
6	0.1179	14.56	20.29	34.85	106.18	-71.33	peak

Note: 1. Measurement = Reading Level + Correct Factor.

2. If Peak Result complies with AV and QP limit, AV and QP Result are deemed to comply with AV limit.



**150kHz ~ 30M**

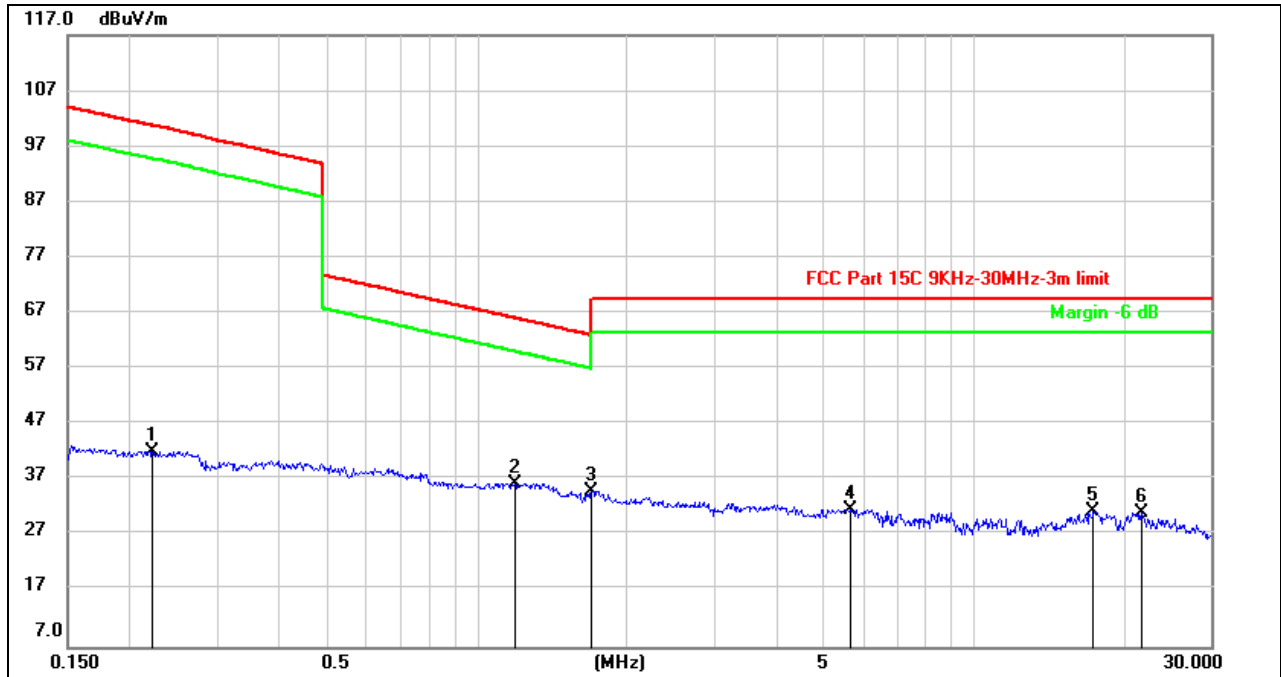

No.	Frequency (MHz)	Reading (dBuV)	Correct (dB/m)	Result (dBuV/m)	Limit (dBuV/m)	Margin (dB)	Remark
1	0.2220	21.83	20.35	42.18	100.81	-58.63	peak
2	1.1907	15.93	20.44	36.37	66.09	-29.72	peak
3	1.6975	14.42	20.62	35.04	63.01	-27.97	peak
4	5.6531	10.85	20.85	31.70	69.54	-37.84	peak
5	17.3826	10.25	20.98	31.23	69.54	-38.31	peak
6	21.7149	9.87	21.22	31.09	69.54	-38.45	peak

Note: 1. Measurement = Reading Level + Correct Factor.

2. If Peak Result complies with AV and QP limit, AV and QP Result are deemed to comply with AV limit.

Note: All modes and antennas had been tested, but only the worst data record in the report.

## 10. AC POWER LINE CONDUCTED EMISSIONS

### LIMITS

Please refer to CFR 47 FCC §15.207 (a) .

FREQUENCY (MHz)	Quasi-peak (dBuV)	Average (dBuV)
0.15 -0.5	66 - 56 *	56 - 46 *
0.50 -5.0	56.00	46.00
5.0 -30.0	60.00	50.00

### TEST SETUP AND PROCEDURE

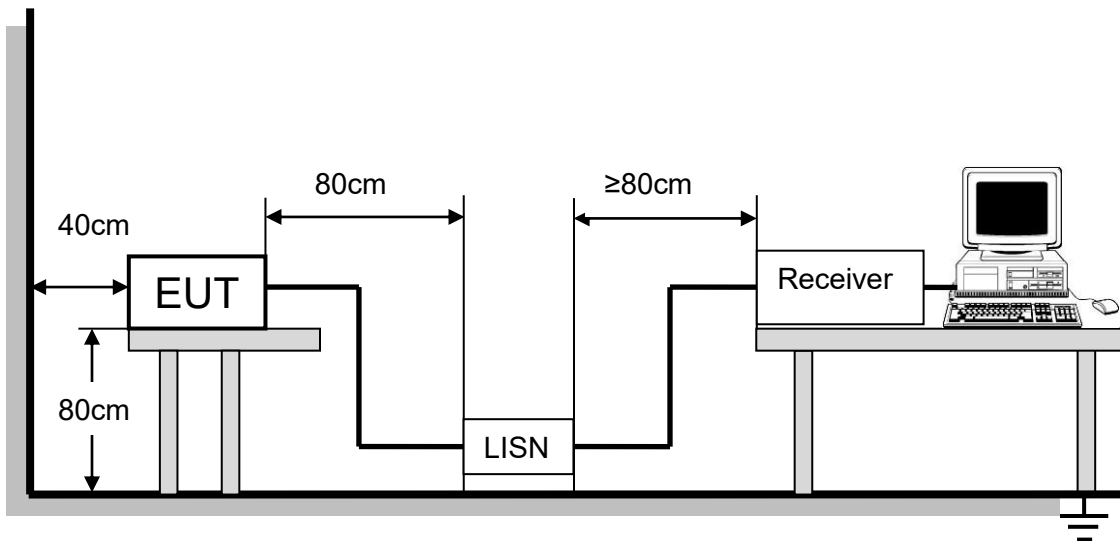

The EUT is put on a table of non-conducting material that is 80cm high. The vertical conducting wall of shielding is located 40cm to the rear of the EUT. The power line of the EUT is connected to the AC mains through a Artificial Mains Network (A.M.N.). A EMI Measurement Receiver (R&S Test Receiver ESR3) is used to test the emissions from both sides of AC line. According to the requirements in Section 7 and 13 of ANSI C63.10-2013. Conducted emissions from the EUT measured in the frequency range between 0.15 MHz and 30MHz using CISPR Quasi-Peak and average detector mode. The bandwidth of EMI test receiver is set at 9kHz.

The arrangement of the equipment is installed to meet the standards and operating in a manner, which tends to maximize its emission characteristics in a normal application.

### TEST ENVIRONMENT

Temperature	24.5°C	Relative Humidity	57%
Atmosphere Pressure	101kPa	Test Voltage	DC 5V



**TEST RESULTS**

**10.1. 802.11g MODE**

**1TX MODE FOR ANT0 (WORST-CASE CONFIGURATION)**

**LINE N RESULTS (LOW CHANNEL)**

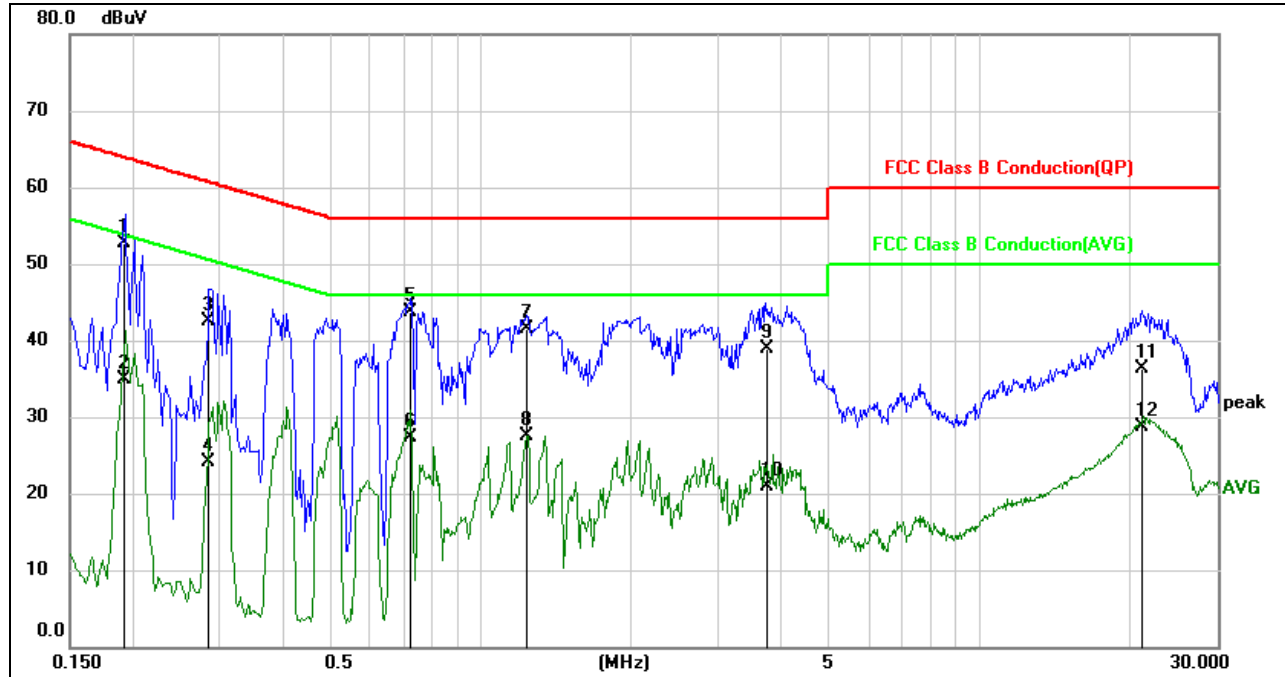

No.	Frequency (MHz)	Reading (dBuV)	Correct (dB)	Result (dBuV)	Limit (dBuV)	Margin (dB)	Remark
1	0.1920	43.14	9.62	52.76	63.95	-11.19	QP
2	0.1920	25.26	9.62	34.88	53.95	-19.07	AVG
3	0.2828	32.89	9.62	42.51	60.73	-18.22	QP
4	0.2828	14.48	9.62	24.10	50.73	-26.63	AVG
5	0.7288	34.11	9.63	43.74	56.00	-12.26	QP
6	0.7288	17.59	9.63	27.22	46.00	-18.78	AVG
7	1.2447	31.91	9.64	41.55	56.00	-14.45	QP
8	1.2447	17.82	9.64	27.46	46.00	-18.54	AVG
9	3.7456	29.12	9.69	38.81	56.00	-17.19	QP
10	3.7456	11.24	9.69	20.93	46.00	-25.07	AVG
11	21.2433	26.40	9.91	36.31	60.00	-23.69	QP
12	21.2433	18.80	9.91	28.71	50.00	-21.29	AVG

- Note: 1. Result = Reading +Correct Factor.  
 2. If QP Result complies with AV limit, AV Result is deemed to comply with AV limit.  
 3. Test setup: RBW: 200 Hz (9 kHz—150 kHz), 9 kHz (150 kHz—30 MHz).  
 4. Step size: 80Hz (0.009MHz-0.15MHz), 4 kHz (0.15MHz-30MHz), Scan time: auto.



**LINE L RESULTS (LOW CHANNEL)**

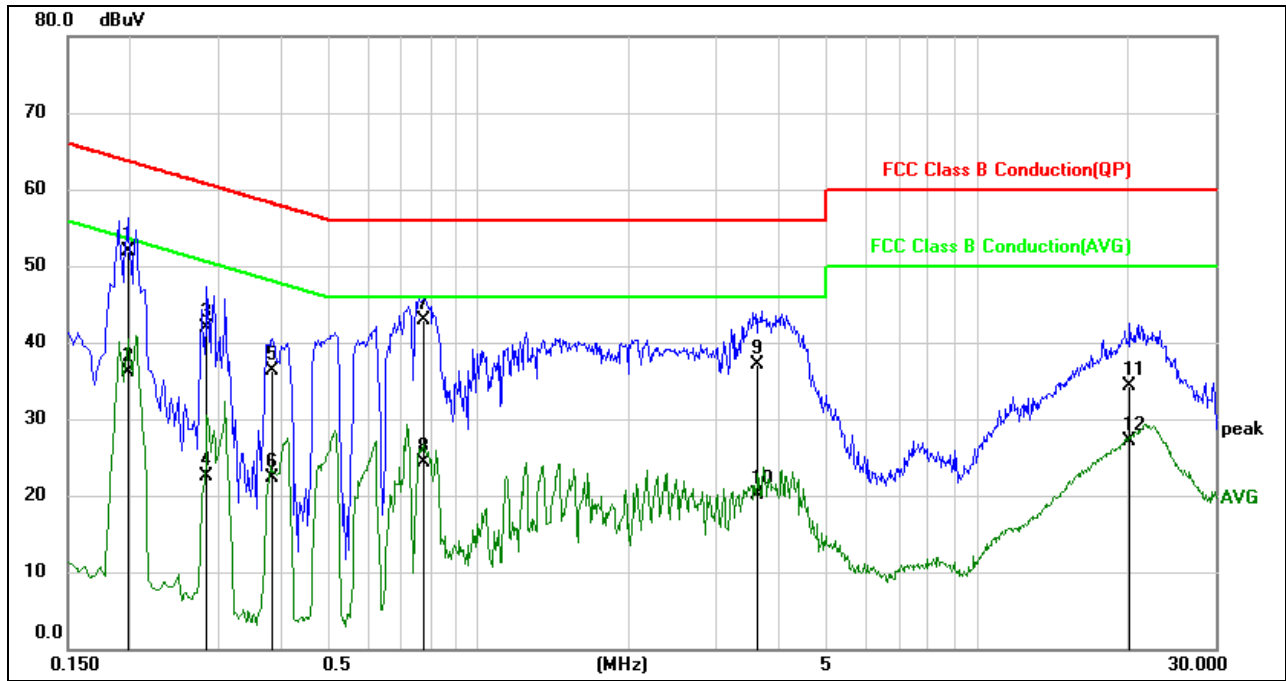

No.	Frequency (MHz)	Reading (dBuV)	Correct (dB)	Result (dBuV)	Limit (dBuV)	Margin (dB)	Remark
1	0.1985	42.37	9.63	52.00	63.67	-11.67	QP
2	0.1985	26.40	9.63	36.03	53.67	-17.64	AVG
3	0.2826	32.31	9.63	41.94	60.74	-18.80	QP
4	0.2826	12.85	9.63	22.48	50.74	-28.26	AVG
5	0.3862	26.67	9.63	36.30	58.15	-21.85	QP
6	0.3862	12.62	9.63	22.25	48.15	-25.90	AVG
7	0.7742	33.17	9.64	42.81	56.00	-13.19	QP
8	0.7742	14.74	9.64	24.38	46.00	-21.62	AVG
9	3.6410	27.33	9.69	37.02	56.00	-18.98	QP
10	3.6410	10.40	9.69	20.09	46.00	-25.91	AVG
11	20.2038	24.53	9.86	34.39	60.00	-25.61	QP
12	20.2038	17.15	9.86	27.01	50.00	-22.99	AVG

- Note: 1. Result = Reading +Correct Factor.  
 2. If QP Result complies with AV limit, AV Result is deemed to comply with AV limit.  
 3. Test setup: RBW: 200 Hz (9 kHz—150 kHz), 9 kHz (150 kHz—30 MHz).  
 4. Step size: 80Hz (0.009MHz-0.15MHz), 4 kHz (0.15MHz-30MHz), Scan time: auto.



## 11. ANTENNA REQUIREMENTS

### APPLICABLE REQUIREMENTS

Please refer to FCC §15.203

An intentional radiator shall be designed to ensure that no antenna other than that furnished by the responsible party shall be used with the device. The use of a permanently attached antenna or of an antenna that uses a unique coupling to the intentional radiator shall be considered sufficient to comply with the provisions of this section. The manufacturer may design the unit so that a broken antenna can be replaced by the user, but the use of a standard antenna jack or electrical connector is prohibited.

Please refer to FCC §15.247(b)(4)

The conducted output power limit specified in paragraph (b) of this section is based on the use of antennas with directional gains that do not exceed 6 dBi. Except as shown in paragraph (c) of this section, if transmitting antennas of directional gain greater than 6 dBi are used, the conducted output power from the intentional radiator shall be reduced below the stated values in paragraphs (b)(1), (b)(2), and (b)(3) of this section, as appropriate, by the amount in dB that the directional gain of the antenna exceeds 6 dBi.

### RESULTS

Complies

**END OF REPORT**