

**CFR 47 FCC PART 15 SUBPART E
ISED RSS-247 ISSUE 3**

TEST REPORT

For

WIFI+BT Module

MODEL NUMBER: DT3AR1501

REPORT NUMBER: 4790836237-1-RF-4

ISSUE DATE: August 28, 2023

**FCC ID:2AC23-DT3A
IC:12290A-DT3A**

Prepared for

**Hui Zhou Gaoshengda Technology Co.,LTD
No.2, Jin-da Road, Huinan High-tech Industrial Park, Huizhou, Guangdong, China**

Prepared by

UL Verification Services (Guangzhou) Co., Ltd, Song Shan Lake Branch

Building 10, Innovation Technology Park, No. 1, Li Bin Road, Song Shan Lake Hi-Tech Development Zone Dongguan, 523808, People's Republic of China

Tel: +86 769 22038881

Fax: +86 769 33244054

Website: www.ul.com

Revision History

| <u>Rev.</u> | <u>Issue Date</u> | <u>Revisions</u> | <u>Revised By</u> |
|-------------|------------------------|----------------------|-------------------|
| <u>V0</u> | <u>August 28, 2023</u> | <u>Initial Issue</u> | <u></u> |

Summary of Test Results

| Test Item | Clause | Limit/Requirement | Result |
|--|---|--|--------|
| ON TIME AND DUTY CYCLE | ANSI C63.10-2013, Clause 12.2 | None; for reporting purposes only. | Pass |
| 6dB AND 26dB EMISSION BANDWIDTH AND 99% OCCUPIED BANDWIDTH | KDB 789033 D02 v02r01 Section C.1 | FCC Part 15.407 (a)/(e), RSS-247 Issue 3, Clause 6.2.1.2 RSS-Gen Clause 6.7 | Pass |
| CONDUCTED OUTPUT POWER | KDB 789033 D02 v02r01 Section E.3.a (Method PM) | FCC 15.407 (a) RSS-247 Clause 6.2 | Pass |
| POWER SPECTRAL DENSITY | KDB 789033 D02 v02r01 Section F | FCC 15.407 (a) RSS-247 Clause 6.2 | Pass |
| AC Power Line Conducted Emission | ANSI C63.10-2013, Clause 6.2. | FCC 15.207 RSS-GEN Clause 8.8 | Pass |
| Radiated Emissions and Band Edge Measurement | KDB 789033 D02 v02r01 Section G.3, G.4, G.5, and G.6 | FCC 15.407 (b) FCC 15.209 FCC 15.205 RSS-247 Clause 6.2 RSS-GEN Clause 8.9 | Pass |
| FREQUENCY STABILITY | ANSI C63.10-2013, Clause 6.8. | FCC 15.407 (g) | Pass |
| Dynamic Frequency Selection (Slave) | KDB 905462 D03 Client Without DFS New Rules v01r02 | FCC Part 15.407 (h), RSS-247 Issue 3 Clause 6.3 | Pass |
| Dynamic Frequency Selection (Master) | KDB 905462 D02 UNII DFS Compliance Procedures New Rules v02 | FCC Part 15.407 (h), RSS-247 Issue 3 Clause 6.3 | N/A |
| Antenna Requirement | N/A | FCC 47 CFR Part 15.203/ 15.407(a)(1) (2), RSS-Gen Issue 5, Clause 6.8 | Pass |

Note:

1. N/A: In this whole report not applicable.

*This test report is only published to and used by the applicant, and it is not for evidence purpose in China.

*The measurement result for the sample received is <Pass> according to <CFR 47 FCC PART 15 SUBPART E><ISED RSS-247 ISSUE 3> when <Accuracy Method> decision rule is applied.

CONTENTS

| | |
|--|------------|
| 1. ATTESTATION OF TEST RESULTS..... | 6 |
| 2. TEST METHODOLOGY..... | 7 |
| 3. FACILITIES AND ACCREDITATION..... | 7 |
| 4. CALIBRATION AND UNCERTAINTY | 8 |
| 4.1. <i>MEASURING INSTRUMENT CALIBRATION</i> | <i>8</i> |
| 4.2. <i>MEASUREMENT UNCERTAINTY.....</i> | <i>8</i> |
| 5. EQUIPMENT UNDER TEST | 9 |
| 5.1. <i>DESCRIPTION OF EUT</i> | <i>9</i> |
| 5.2. <i>CHANNEL LIST</i> | <i>10</i> |
| 5.3. <i>MAXIMUM POWER.....</i> | <i>11</i> |
| 5.4. <i>TEST CHANNEL CONFIGURATION.....</i> | <i>12</i> |
| 5.5. <i>THE WORSE CASE POWER SETTING PARAMETER.....</i> | <i>13</i> |
| 5.6. <i>DESCRIPTION OF AVAILABLE ANTENNAS</i> | <i>16</i> |
| 5.7. <i>SUPPORT UNITS FOR SYSTEM TEST.....</i> | <i>17</i> |
| 6. MEASURING EQUIPMENT AND SOFTWARE USED..... | 18 |
| 7. ANTENNA PORT TEST RESULTS | 21 |
| 7.1. <i>ON TIME AND DUTY CYCLE.....</i> | <i>21</i> |
| 7.2. <i>6DB AND 26DB EMISSION BANDWIDTH AND 99% OCCUPIED BANDWIDTH ...</i> | <i>22</i> |
| 7.3. <i>CONDUCTED OUTPUT POWER.....</i> | <i>24</i> |
| 7.4. <i>POWER SPECTRAL DENSITY</i> | <i>27</i> |
| 7.5. <i>FREQUENCY STABILITY.....</i> | <i>29</i> |
| 7.6. <i>DYNAMIC FREQUENCY SELECTION (SLAVE)</i> | <i>31</i> |
| 8. RADIATED TEST RESULTS..... | 35 |
| 8.1. <i>RESTRICTED BANDEDGE</i> | <i>45</i> |
| 8.2. <i>SPURIOUS EMISSIONS(1 GHZ~7 GHZ)</i> | <i>84</i> |
| 8.3. <i>SPURIOUS EMISSIONS(7 GHZ~18 GHZ)</i> | <i>110</i> |
| 8.4. <i>SPURIOUS EMISSIONS(9 KHZ~30 MHZ)</i> | <i>182</i> |
| 8.5. <i>SPURIOUS EMISSIONS(18 GHZ~26 GHZ)</i> | <i>185</i> |
| 8.6. <i>SPURIOUS EMISSIONS(26 GHZ~40 GHZ)</i> | <i>187</i> |
| 8.7. <i>SPURIOUS EMISSIONS(30 MHZ~1 GHZ).....</i> | <i>189</i> |
| 9. AC POWER LINE CONDUCTED EMISSION | 191 |
| 10. ANTENNA REQUIREMENT | 195 |

| | | |
|------------|--|------------|
| 11. | TEST DATA..... | 196 |
| 11.1. | APPENDIX A: EMISSION BANDWIDTH..... | 196 |
| 11.1.1. | Test Result..... | 196 |
| 11.1.2. | Test Graphs..... | 197 |
| 11.2. | APPENDIX B: OCCUPIED CHANNEL BANDWIDTH..... | 209 |
| 11.2.1. | Test Result..... | 209 |
| 11.2.2. | Test Graphs..... | 210 |
| 11.3. | APPENDIX C: MIN EMISSION BANDWIDTH..... | 222 |
| 11.3.1. | Test Result..... | 222 |
| 11.3.2. | Test Graphs..... | 223 |
| 11.4. | APPENDIX D: MAXIMUM CONDUCTED OUTPUT POWER..... | 227 |
| 11.4.1. | Test Result for ANT1..... | 227 |
| 11.4.2. | Test Graphs for ANT1..... | 228 |
| 11.4.3. | Test Result for ANT2..... | 230 |
| 11.4.4. | Test Graphs for ANT2..... | 231 |
| 11.5. | APPENDIX E: MAXIMUM POWER SPECTRAL DENSITY..... | 233 |
| 11.5.1. | Test Result..... | 233 |
| 11.5.2. | Test Graphs..... | 234 |
| 11.6. | APPENDIX F: FREQUENCY STABILITY..... | 247 |
| 11.6.1. | Test Result..... | 247 |
| 11.7. | APPENDIX G: DUTY CYCLE..... | 248 |
| 11.7.1. | Test Result..... | 248 |
| 11.7.2. | Test Graphs..... | 249 |
| 11.8. | APPENDIX H: DFS DETECTION THRESHOLDS..... | 250 |
| 11.8.1. | Test Result..... | 250 |
| 11.8.2. | Test Graphs..... | 250 |
| 11.9. | APPENDIX I: CHANNEL MOVE TIME AND CHANNEL CLOSING TRANSMISSION TIME | 251 |
| 11.9.1. | Test Result..... | 251 |
| 11.9.2. | Test Graphs..... | 251 |
| 11.10. | APPENDIX J: NON-OCCUPANCY PERIOD..... | 252 |
| 11.10.1. | Test Graphs..... | 252 |

1. ATTESTATION OF TEST RESULTS

Applicant Information

Company Name: Hui Zhou Gaoshengda Technology Co.,LTD
Address: No.2, Jin-da Road, Huinan High-tech Industrial Park, Huizhou, Guangdong, China

Manufacturer Information

Company Name: Hui Zhou Gaoshengda Technology Co.,LTD
Address: No.2, Jin-da Road, Huinan High-tech Industrial Park, Huizhou, Guangdong, China

EUT Information

EUT Name: WIFI+BT Module
Model: DT3AR1501
Brand: GSD
Sample Received Date: May 5, 2023
Sample Status: Normal
Sample ID: 6269427
Date of Tested: July 14, 2023 to August 28, 2023

| APPLICABLE STANDARDS | |
|--|--------------|
| STANDARD | TEST RESULTS |
| CFR 47 FCC PART 15 SUBPART E ISED RSS-247 ISSUE 3 | Pass |

Prepared By:

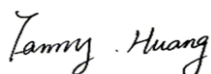

Fanny Huang
Engineer Project Associate

Checked By:



Denny Huang
Senior Project Engineer

Approved By:



Stephen Guo
Operations Manager

2. TEST METHODOLOGY

All tests were performed in accordance with the standard CFR 47 FCC PART 15 SUBPART E ISED RSS-247 ISSUE 3, ANSI C63.10-2013, CFR 47 FCC Part 2, KDB 789033 D02 v02r01, RSS-GEN Issue 5, KDB414788 D01 Radiated Test Site v01, KDB 662911 D01 Multiple Transmitter Output v02r01, KDB 905462 D02 UNII DFS Compliance Procedures New Rules v02, KDB 905462 D03 UNII clients without radar detection New Rules v01r02, KDB 905462 D04 Operational Modes for DFS Testing New Rules v01, KDB 905462 D06 802 11 Channel Plans New Rules v02 and KDB 905462 D02 UNII DFS Compliance Procedures New Rules v02.

3. FACILITIES AND ACCREDITATION

| | |
|---------------------------|---|
| Accreditation Certificate | <p>A2LA (Certificate No.: 4102.01) UL Verification Services (Guangzhou) Co., Ltd. Song Shan Lake Branch. has been assessed and proved to be in compliance with A2LA.</p> <p>FCC (FCC Designation No.: CN1187) UL Verification Services (Guangzhou) Co., Ltd. Song Shan Lake Branch. Has been recognized to perform compliance testing on equipment subject to the Commission's Declaration of Conformity (DoC) and Certification rules</p> <p>ISED (Company No.: 21320) UL Verification Services (Guangzhou) Co., Ltd. Song Shan Lake Branch. has been registered and fully described in a report filed with ISED. The Company Number is 21320 and the test lab Conformity Assessment Body Identifier (CABID) is CN0046.</p> <p>VCCI (Registration No.: G-20019, R-20004, C-20012 and T-20011) UL Verification Services (Guangzhou) Co., Ltd. Song Shan Lake Branch. has been assessed and proved to be in compliance with VCCI, the Membership No. is 3793. Facility Name: Chamber D, the VCCI registration No. is G-20019 and R-20004 Shielding Room B , the VCCI registration No. is C-20012 and T-20011</p> |
|---------------------------|---|

Note1:

All tests measurement facilities use to collect the measurement data are located at Building 10, Innovation Technology Park, No. 1, Li Bin Road, Song Shan Lake Hi-Tech Development Zone Dongguan, 523808, People's Republic of China.

Note2:

The test anechoic chamber in UL Verification Services (Guangzhou) Co., Ltd. Song Shan Lake Branch had been calibrated and compared to the open field sites and the test anechoic chamber is shown to be equivalent to or worst case from the open field site.

Note3:

For below 30 MHz, lab had performed measurements at test anechoic chamber and comparing to measurements obtained on an open field site. And these measurements below 30 MHz had been correlated to measurements performed on an OFS.

4. CALIBRATION AND UNCERTAINTY

4.1. MEASURING INSTRUMENT CALIBRATION

The measuring equipment utilized to perform the tests documented in this report has been calibrated in accordance with the manufacturer's recommendations and is traceable to recognized national standards.

4.2. MEASUREMENT UNCERTAINTY

Where relevant, the following measurement uncertainty levels have been estimated for tests performed on the apparatus:

| Test Item | Uncertainty |
|---|---------------------------|
| Conduction emission | 3.62 dB |
| Radiated Emission (Included Fundamental Emission) (9 kHz ~ 30 MHz) | 2.2 dB |
| Radiated Emission (Included Fundamental Emission) (30 MHz ~ 1 GHz) | 4.00 dB |
| Radiated Emission (Included Fundamental Emission) (1 GHz to 40 GHz) | 5.78 dB (1 GHz ~ 18 GHz) |
| | 5.23 dB (18 GHz ~ 26 GHz) |
| | 5.37 dB (26 GHz ~ 40 GHz) |
| Duty Cycle | ±0.028% |
| Emission Bandwidth and 99% Occupied Bandwidth | ±0.0196% |
| Maximum Conducted Output Power | ±0.766 dB |
| Maximum Power Spectral Density Level | ±1.22 dB |
| Frequency Stability | ±2.76% |
| Conducted Band-edge Compliance | ±1.328 dB |
| Conducted Unwanted Emissions In Non-restricted Frequency Bands | ±0.746 dB (9 kHz ~ 1 GHz) |
| | ±1.328dB (1 GHz ~ 26 GHz) |
| Note: This uncertainty represents an expanded uncertainty expressed at approximately the 95% confidence level using a coverage factor of k=2. | |

5. EQUIPMENT UNDER TEST

5.1. DESCRIPTION OF EUT

| | |
|-----------------------|--|
| EUT Name | WIFI+BT Module |
| Model | DT3AR1501 |
| Frequency Range: | 5180 MHz to 5240 MHz 5260 MHz to 5320 MHz 5500 MHz to 5720 MHz 5745 MHz to 5825 MHz |
| TPC Function: | Not Support |
| DFS Operational mode: | Slave without radar detection |
| Type of Modulation: | IEEE 802.11a: OFDM(64QAM, 16QAM, QPSK, BPSK) IEEE 802.11n: OFDM(64QAM, 16QAM, QPSK, BPSK) |
| Radio Technology: | IEEE 802.11a/n HT20/11n HT40 |
| Normal Test Voltage: | DC 3.3 V |

5.2. CHANNEL LIST

| UNII-1 (For Bandwidth=20MHz) | | UNII-1 (For Bandwidth=40MHz) | | UNII-1 (For Bandwidth=80MHz) | |
|---------------------------------|--------------------|---------------------------------|--------------------|---------------------------------|--------------------|
| Channel | Frequency (MHz) | Channel | Frequency (MHz) | Channel | Frequency (MHz) |
| 36 | 5180 | 38 | 5190 | 42 | 5210 |
| 40 | 5200 | 46 | 5230 | | |
| 44 | 5220 | | | | |
| 48 | 5240 | | | | |

| UNII-2A (For Bandwidth=20MHz) | | UNII-2A (For Bandwidth=40MHz) | | UNII-2A (For Bandwidth=80MHz) | |
|----------------------------------|--------------------|----------------------------------|--------------------|----------------------------------|--------------------|
| Channel | Frequency (MHz) | Channel | Frequency (MHz) | Channel | Frequency (MHz) |
| 52 | 5260 | 54 | 5270 | 58 | 5290 |
| 56 | 5280 | 62 | 5310 | | |
| 60 | 5300 | | | | |
| 64 | 5320 | | | | |

| UNII-2C (For Bandwidth=20MHz) | | UNII-2C (For Bandwidth=40MHz) | | UNII-2C (For Bandwidth=80MHz) | |
|----------------------------------|--------------------|----------------------------------|--------------------|----------------------------------|--------------------|
| Channel | Frequency (MHz) | Channel | Frequency (MHz) | Channel | Frequency (MHz) |
| 100 | 5500 | 102 | 5510 | 106 | 5530 |
| 104 | 5520 | 110 | 5550 | 122 | 5610 |
| 108 | 5540 | 118 | 5590 | 138 | 5690 |
| 112 | 5560 | 126 | 5630 | | |
| 116 | 5580 | 134 | 5670 | | |
| 120 | 5600 | 142 | 5710 | | |
| 124 | 5620 | | | | |
| 128 | 5640 | | | | |
| 132 | 5660 | | | | |
| 136 | 5680 | | | | |
| 140 | 5700 | | | | |
| 144 | 5720 | | | | |

| UNII-3 (For Bandwidth=20MHz) | | UNII-3 (For Bandwidth=40MHz) | | UNII-3 (For Bandwidth=80MHz) | |
|---------------------------------|--------------------|---------------------------------|--------------------|---------------------------------|--------------------|
| Channel | Frequency (MHz) | Channel | Frequency (MHz) | Channel | Frequency (MHz) |
| 149 | 5745 | 151 | 5755 | 155 | 5775 |
| 153 | 5765 | 159 | 5795 | | |
| 157 | 5785 | | | | |
| 161 | 5805 | | | | |
| 165 | 5825 | | | | |

5.3. MAXIMUM POWER

| IEEE Std. 802.11 | Frequency (MHz) | Maximum Average Conducted Power (dBm) | Max Average EIRP (dBm) |
|------------------|-----------------|---------------------------------------|------------------------|
| a | 5180 ~ 5825 | 15.41 | 18.70 |
| n HT20 | | 14.92 | 18.21 |
| n HT40 | | 14.99 | 18.28 |

5.4. TEST CHANNEL CONFIGURATION

| UNII-1 Test Channel Configuration | | |
|-----------------------------------|--|------------------------------|
| IEEE Std. | Test Channel Number | Frequency |
| 802.11a | CH 36(Low Channel), CH 40(MID Channel), CH 48(High Channel) | 5180 MHz, 5200 MHz, 5240 MHz |
| 802.11n HT20 | CH 36(Low Channel), CH 40(MID Channel), CH 48(High Channel) | 5180 MHz, 5200 MHz, 5240 MHz |
| 802.11n HT40 | CH 38(Low Channel), CH 46(High Channel) | 5190 MHz, 5230 MHz |

| UNII-2A Test Channel Configuration | | |
|------------------------------------|--|------------------------------|
| IEEE Std. | Test Channel Number | Frequency |
| 802.11a | CH 52(Low Channel), CH 56(MID Channel), CH 64(High Channel) | 5260 MHz, 5280 MHz, 5320 MHz |
| 802.11n HT20 | CH 52(Low Channel), CH 56(MID Channel), CH 64(High Channel) | 5260 MHz, 5280 MHz, 5320 MHz |
| 802.11n HT40 | CH 54(Low Channel), CH 62(High Channel) | 5270 MHz, 5310 MHz |

| UNII-2C Test Channel Configuration | | |
|------------------------------------|---|---------------------------------|
| IEEE Std. | Test Channel Number | Frequency |
| 802.11a | CH 100(Low Channel), CH 116(MID Channel), CH 140(High Channel) | 5500 MHz, 5580 MHz, 5700 MHz |
| 802.11n HT20 | CH 100(Low Channel), CH 116(MID Channel), CH 140(High Channel) | 5500 MHz, 5580 MHz, 5700 MHz |
| 802.11n HT40 | CH 102(Low Channel), CH 110(MID Channel), CH 134(High Channel) | 5510 MHz, 5550 MHz, 5670 MHz |

| UNII-3 Test Channel Configuration | | |
|-----------------------------------|---|---------------------------------|
| IEEE Std. | Test Channel Number | Frequency |
| 802.11a | CH 149(Low Channel), CH 157(MID Channel), CH 165(High Channel) | 5745 MHz, 5785 MHz, 5825 MHz |
| 802.11n HT20 | CH 149(Low Channel), CH 157(MID Channel), CH 165(High Channel) | 5745 MHz, 5785 MHz, 5825 MHz |
| 802.11n HT40 | CH 151(Low Channel), CH 159(High Channel) | 5755MHz, 5795MHz |

| Straddle Test Channel Configuration | | |
|-------------------------------------|---------------------|-----------|
| IEEE Std. | Test Channel Number | Frequency |
| 802.11a | CH 144 | 5720 MHz |
| 802.11n HT20 | CH 144 | 5720 MHz |
| 802.11n HT40 | CH 142 | 5710 MHz |

5.5. THE WORSE CASE POWER SETTING PARAMETER

| The Worse Case Power Setting Parameter | |
|--|-----------|
| Test Software | RTL8733BU |

UNII-1

| Mode | Rate | Channel | Soft set value | |
|----------|------|---------|----------------|-------|
| | | | ANT 1 | ANT 2 |
| 11a | 6M | 36 | 14 | 13.5 |
| | | 40 | 14 | 13.5 |
| | | 48 | 14 | 13.5 |
| 11n HT20 | MCS0 | 36 | 14 | 13.5 |
| | | 40 | 14 | 13.5 |
| | | 48 | 14 | 13.5 |
| 11n HT40 | MCS0 | 38 | 14 | 13.5 |
| | | 46 | 14 | 13.5 |

UNII-2A

| Mode | Rate | Channel | Soft set value | |
|----------|------|---------|----------------|-------|
| | | | ANT 1 | ANT 2 |
| 11a | 6M | 52 | 14 | 13.5 |
| | | 56 | 14 | 13.5 |
| | | 64 | 14 | 13.5 |
| 11n HT20 | MCS0 | 52 | 14 | 13.5 |
| | | 56 | 14 | 13.5 |
| | | 64 | 14 | 13.5 |
| 11n HT40 | MCS0 | 54 | 14 | 13.5 |
| | | 62 | 14 | 13.5 |

UNII-2C

| Mode | Rate | Channel | Soft set value | |
|----------|------|---------|----------------|-------|
| | | | ANT 1 | ANT 2 |
| 11a | 6M | 100 | 13 | 12.5 |
| | | 116 | 13 | 12.5 |
| | | 140 | 13.5 | 13 |
| | | 144 | 13.5 | 13 |
| 11n HT20 | MCS0 | 100 | 14 | 13.5 |
| | | 116 | 14 | 13.5 |
| | | 140 | 14 | 13.5 |
| | | 144 | 14 | 13.5 |
| 11n HT40 | MCS0 | 102 | 13.5 | 13 |
| | | 118 | 13.5 | 13 |
| | | 134 | 13.5 | 13 |
| | | 142 | 13.5 | 13 |

UNII-3

| Mode | Rate | Channel | Soft set value | |
|----------|------|---------|----------------|-------|
| | | | ANT1 | ANT 2 |
| 11a | 6M | 149 | 13.5 | 13 |
| | | 157 | 13.5 | 13 |
| | | 165 | 13.5 | 13 |
| 11n HT20 | MCS0 | 149 | 14 | 13.5 |
| | | 157 | 14 | 13.5 |
| | | 165 | 14 | 13.5 |
| 11n HT40 | MCS0 | 151 | 14 | 13.5 |
| | | 159 | 14 | 13.5 |

WORSE CASE CONFIGURATIONS

The EUT was tested in the following configuration(s):

Controlled in test mode using a software application on the EUT supplied by customer. The application was used to enable a continuous transmission and to select the mode, test channels, bandwidth, data rates as required.

Test channels referring to section 5.4.

Maximum power setting referring to section 5.5.

Worst case Data Rates declared by the customer:

802.11a 20 mode: 6 Mbps

802.11n HT20 mode: MCS0

802.11n HT40 mode: MCS0

All modes only support SISO mode.

Antenna 1 and Antenna 2 has the same power, so only Antenna 1 worst case test data were recorded in the report.

The EUT has 2 separate antennas which correspond to 2 separate antenna ports. Core 1 and Core 2 correspond to antenna 1 and antenna 2 respectively.

The measured additional path loss was included in any path loss calculations for all RF cable used during tested.

5.6. DESCRIPTION OF AVAILABLE ANTENNAS

| Antenna No. | Frequency Band | Antenna Type | Max Antenna Gain (dBi) |
|-------------|----------------|--------------|------------------------|
| 1 | 5150-5850 | PCB Antenna | 2.42 |
| 2 | 5150-5850 | PCB Antenna | 3.29 |

| IEE Std. 802.11 | Transmit and Receive Mode | Description |
|---|--|---|
| 802.11a | <input checked="" type="checkbox"/> 1TX, 1RX | ANT 1 or ANT 2 can be used as transmitting/receiving antenna. |
| 802.11n HT20 | <input checked="" type="checkbox"/> 1TX, 1RX | ANT 1 or ANT 2 can be used as transmitting/receiving antenna. |
| 802.11n HT40 | <input checked="" type="checkbox"/> 1TX, 1RX | ANT 1 or ANT 2 can be used as transmitting/receiving antenna. |
| Note: 1. BT&WLAN 2.4G, BT & WLAN 5G, WLAN 2.4G & WLAN 5G can't transmit simultaneously (Declared by client) | | |

5.7. SUPPORT UNITS FOR SYSTEM TEST

SUPPORT EQUIPMENT

| Item | Equipment | Brand Name | Model Name | Remark |
|------|------------|------------|-------------|--|
| 1 | PC | Lenovo | E42-80 | / |
| 2 | AC Adaptor | Lenovo | ADLX65YCC3D | Input: AC 100-240V, 1.8A, 50-60Hz Output: DC 20V, 3.25A,65.0W Max |

I/O CABLES

| Cable No | Port | Connector Type | Cable Type | Cable Length(m) | Remarks |
|----------|------|----------------|------------|-----------------|---------|
| 1 | USB | / | / | 1.0 | / |

ACCESSORIES

| Item | Accessory | Brand Name | Model Name | Description |
|------|-----------|------------|------------|-------------|
| / | / | / | / | / |

TEST SETUP

The EUT can work in engineering mode with a software through a Laptop.

SETUP DIAGRAM FOR TESTS

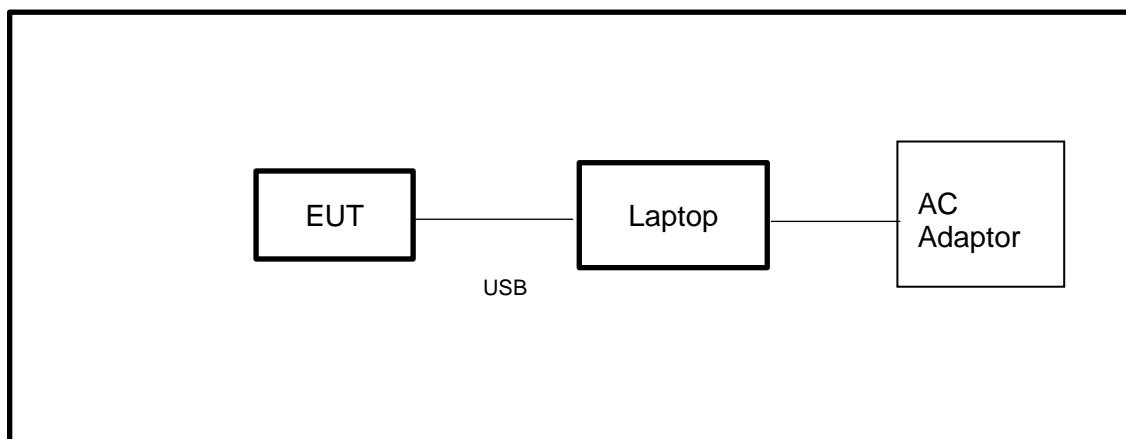

Note: AC Adaptor only use for AC POWER LINE CONDUCTED EMISSION test.

6. MEASURING EQUIPMENT AND SOFTWARE USED

| R&S TS 8997 Test System | | | | | |
|-------------------------------------|-----------------|-------------------------|------------------|---------------|---------------|
| Equipment | Manufacturer | Model No. | Serial No. | Last Cal. | Due. Date |
| Power sensor, Power Meter | R&S | OSP120 | 100921 | Mar.31,2023 | Mar.30,2024 |
| Vector Signal Generator | R&S | SMBV100A | 261637 | Oct.17, 2022 | Oct.16, 2023 |
| Signal Generator | R&S | SMB100A | 178553 | Oct.17, 2022 | Oct.16, 2023 |
| Signal Analyzer | R&S | FSV40 | 101118 | Oct.17, 2022 | Oct.16, 2023 |
| Software | | | | | |
| Description | Manufacturer | Name | | Version | |
| For R&S TS 8997 Test System | Rohde & Schwarz | EMC 32 | | 10.60.10 | |
| Tonsend RF Test System | | | | | |
| Equipment | Manufacturer | Model No. | Serial No. | Last Cal. | Due. Date |
| Wideband Radio Communication Tester | R&S | CMW500 | 155523 | Oct.17, 2022 | Oct.16, 2023 |
| Wireless Connectivity Tester | R&S | CMW270 | 1201.0002N75-102 | Sep.28, 2022 | Sep.27, 2023 |
| PXA Signal Analyzer | Keysight | N9030A | MY55410512 | Oct.17, 2022 | Oct.16, 2023 |
| MXG Vector Signal Generator | Keysight | N5182B | MY56200284 | Oct.17, 2022 | Oct.16, 2023 |
| MXG Vector Signal Generator | Keysight | N5172B | MY56200301 | Oct.17, 2022 | Oct.16, 2023 |
| DC power supply | Keysight | E3642A | MY55159130 | Oct.17, 2022 | Oct.16, 2023 |
| Temperature & Humidity Chamber | SANMOOD | SG-80-CC-2 | 2088 | Oct.17, 2022 | Oct.16, 2023 |
| Attenuator | Aglient | 8495B | 2814a12853 | Oct.18, 2022 | Oct.17, 2023 |
| RF Control Unit | Tonscend | JS0806-2 | 23B80620666 | April 18,2023 | April 17,2024 |
| Software | | | | | |
| Description | Manufacturer | Name | | Version | |
| Tonsend SRD Test System | Tonsend | JS1120-3 RF Test System | | V3.2.22 | |

| Conducted Emissions | | | | | |
|---------------------------------------|--------------|-----------|--------------|--------------|--------------|
| Equipment | Manufacturer | Model No. | Serial No. | Last Cal. | Due Date |
| EMI Test Receiver | R&S | ESR3 | 101961 | Oct.17, 2022 | Oct.16, 2023 |
| Two-Line V-Network | R&S | ENV216 | 101983 | Oct.17, 2022 | Oct.16, 2023 |
| Artificial Mains Networks | Schwarzbeck | NSLK 8126 | 8126465 | Oct.17, 2022 | Oct.16, 2023 |
| Software | | | | | |
| Description | | | Manufacturer | Name | Version |
| Test Software for Conducted Emissions | | | Farad | EZ-EMC | Ver. UL-3A1 |

| Radiated Emissions | | | | | |
|-----------------------------|---------------|----------------------------------|---------------|---------------|---------------|
| Equipment | Manufacturer | Model No. | Serial No. | Last Cal. | Due Date |
| MXE EMI Receiver | KESIGHT | N9038A | MY56400036 | Oct.17, 2022 | Oct.16, 2023 |
| Hybrid Log Periodic Antenna | TDK | HLP-3003C | 130959 | Aug.02, 2021 | Aug.01, 2024 |
| Preamplifier | HP | 8447D | 2944A09099 | Oct.17, 2022 | Oct.16, 2023 |
| EMI Measurement Receiver | R&S | ESR26 | 101377 | Oct.17, 2022 | Oct.16, 2023 |
| Horn Antenna | TDK | HRN-0118 | 130940 | July 20, 2021 | July 19, 2024 |
| Preamplifier | TDK | PA-02-0118 | TRS-305-00067 | Oct.17, 2022 | Oct.16, 2023 |
| Horn Antenna | Schwarzbeck | BBHA9170 | 697 | July 20, 2021 | July 19, 2024 |
| Preamplifier | TDK | PA-02-2 | TRS-307-00003 | Oct.17, 2022 | Oct.16, 2023 |
| Preamplifier | TDK | PA-02-3 | TRS-308-00002 | Oct.17, 2022 | Oct.16, 2023 |
| Loop antenna | Schwarzbeck | 1519B | 00008 | Dec.14, 2021 | Dec.13, 2024 |
| Preamplifier | TDK | PA-02-001-3000 | TRS-302-00050 | Oct.17, 2022 | Oct.16, 2023 |
| Preamplifier | Mini-Circuits | ZX60-83LN-S+ | SUP01202035 | Oct.17, 2022 | Oct.16, 2023 |
| High Pass Filter | Wi | WHKX10-2700-3000-18000-40SS | 23 | Dec.01,2022 | Nov.30,2023 |
| Highpass Filter | Wainwright | WHKX10-5850-6500-1800-40SS | 4 | Dec.01,2022 | Nov.30,2023 |
| Band Reject Filter | Wainwright | WRCJV12-5695-5725-5850-5880-40SS | 4 | Dec.01,2022 | Nov.30,2023 |
| Band Reject Filter | Wainwright | WRCJV20-5120-5150- | 2 | Dec.01,2022 | Nov.30,2023 |

| | | | | | |
|--------------------------------------|------------|--------------------------------------|--------------|-------------|-------------|
| | | 5350-5380-60SS | | | |
| Band Reject Filter | Wainwright | WRCJV20-5440-5470-5725-5755-60SS | 1 | Dec.01,2022 | Nov.30,2023 |
| Band Reject Filter | Wainwright | WRCJV8-2350-2400-2483.5-2533.5-40SS | 4 | Dec.01,2022 | Nov.30,2023 |
| Band Reject Filter | Wainwright | WRCD5-1879-1879.85-1880.15-1881-40SS | 1 | Dec.01,2022 | Nov.30,2023 |
| Notch Filter | Wainwright | WHJ10-882-980-7000-40SS | 1 | Dec.01,2022 | Nov.30,2023 |
| Software | | | | | |
| Description | | | Manufacturer | Name | Version |
| Test Software for Radiated Emissions | | | Farad | EZ-EMC | Ver. UL-3A1 |

| Other Instrument | | | | | |
|----------------------------|--------------|-----------|------------|--------------|--------------|
| Equipment | Manufacturer | Model No. | Serial No. | Last Cal. | Due Date |
| Temperature humidity probe | OMEGA | ITHX-SD-5 | 18470007 | Oct.22, 2022 | Oct.21, 2023 |
| Barometer | Yiyi | Baro | N/A | Oct.24, 2022 | Oct.23, 2023 |
| Attenuator | Agilent | 8495B | 2814a12853 | Oct.18, 2022 | Oct.17, 2023 |

7. ANTENNA PORT TEST RESULTS

7.1. ON TIME AND DUTY CYCLE

LIMITS

None; for reporting purposes only.

TEST PROCEDURE

Refer to KDB 789033 D02 General U-NII Test Procedures New Rules v02r01 section II.B.

The zero-span mode on a spectrum analyzer or EMI receiver, if the response time and spacing between bins on the sweep are sufficient to permit accurate measurements of the on and off times of the transmitted signal. Set the center frequency of the instrument to the center frequency of the transmission. Set $RBW \geq EBW$ if possible; otherwise, set RBW to the largest available value. Set $VBW \geq RBW$. Set detector = peak or average. The zero-span measurement method shall not be used unless both RBW and VBW are $> 50/T$, where T is defined in II.B.1.a), and the number of sweep points across duration T exceeds 100. (For example, if VBW and/or RBW are limited to 3 MHz, then the zero-span method of measuring duty cycle shall not be used if $T \leq 16.7$ microseconds.)

TEST SETUP

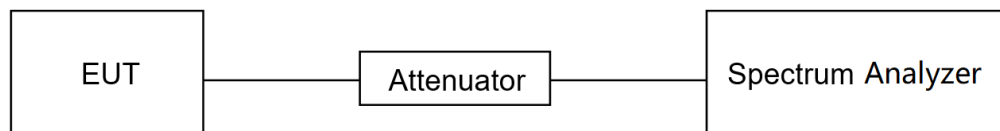

TEST ENVIRONMENT

| | | | |
|---------------------|--------|-------------------|----------|
| Temperature | 23.5°C | Relative Humidity | 55% |
| Atmosphere Pressure | 101kPa | Test Voltage | DC 3.3 V |

TEST DATE / ENGINEER

| | | | |
|-----------|---------------|---------|-------------|
| Test Date | July 15, 2023 | Test By | Denny Huang |
|-----------|---------------|---------|-------------|

TEST RESULTS

Please refer to section "Test Data" - Appendix G

7.2. 6DB AND 26DB EMISSION BANDWIDTH AND 99% OCCUPIED BANDWIDTH

LIMITS

| CFR 47 FCC Part15, Subpart E ISED RSS-247 ISSUE 3 | | |
|--|---|---|
| Test Item | Limit | Frequency Range (MHz) |
| 26 dB Emission Bandwidth | For reporting purposes only. | 5150 ~ 5250 |
| 26 dB Emission Bandwidth | For reporting purposes only. | 5250 ~ 5350 |
| 26 dB Emission Bandwidth | For reporting purposes only. | 5470 ~ 5725 (For FCC) 5470 ~ 5600 (For ISED) 5650 ~ 5725 (For ISED) |
| 6 dB Emission Bandwidth | The minimum 6 dB emission bandwidth shall be 500 kHz. | 5725 ~ 5850 |
| 99 % Occupied Bandwidth | For reporting purposes only. | 5150 ~ 5825 (For ISED) |

TEST PROCEDURE

Refer to KDB 789033 D02 General U-NII Test Procedures New Rules v02r01 section II.C1. for 26 dB Emission Bandwidth; section II.C2. for 6 dB Emission Bandwidth; section II.D. for 99 % Occupied Bandwidth.

Connect the EUT to the spectrum analyser and use the following settings:

| | |
|------------------|---|
| Center Frequency | The center frequency of the channel under test |
| Detector | Peak |
| RBW | For 6 dB Emission Bandwidth: RBW=100 kHz For 26 dB Emission bandwidth: approximately 1 % of the EBW. For 99 % Occupied Bandwidth: approximately 1 % ~ 5 % of the OBW. |
| VBW | For 6 dB Bandwidth: $\geq 3 \times \text{RBW}$ For 26 dB Bandwidth: $> 3 \times \text{RBW}$ For 99 % Bandwidth: $> 3 \times \text{RBW}$ |
| Trace | Max hold |
| Sweep | Auto couple |

- Use the 99 % power bandwidth function of the instrument, allow the trace to stabilize and report the measured bandwidth.
- Allow the trace to stabilize and measure the maximum width of the emission that is constrained by the frequencies associated with the two outermost amplitude points (upper and lower frequencies) that are attenuated by 6/26 dB relative to the maximum level measured in the fundamental emission.

Calculation for 99 % Bandwidth of UNII-2C and UNII-3 Straddle Channel:

For Example: Fundamental Frequency: 5720 MHz

99 % OBW: 21.00 MHz

Turning Frequency: 5725 MHz

99 % Bandwidth of UNII-2C Band Portion = $(5725 - (5720 - (21.00/2))) = 15.50$ MHz

99 % Bandwidth of UNII-3 Band Portion = $(5720 + (21.00/2) - 5725) = 5.50$ MHz

Calculation for 26 dB Bandwidth of UNII-2C Straddle Channel:

For Example: Fundamental frequency: 5720 MHz

26 dB BW: 20.00 MHz

FL: 5710.16 MHz

FH: 5730.16 MHz

Turning Frequency: 5725 MHz

26 dB Bandwidth of UNII-2C Band Portion = 5725-5710.16=14.84 MHz

Calculation for 6dB Bandwidth of UNII-3 Straddle Channel:

For Example: Fundamental frequency: 5720 MHz

6 dB BW: 16.44 MHz

FL: 5711.76 MHz

FH: 5728.2 MHz

Turning Frequency: 5725 MHz

6 dB Bandwidth of UNII-3 band Portion = 5728.2-5725=3.2 MHz

TEST SETUP

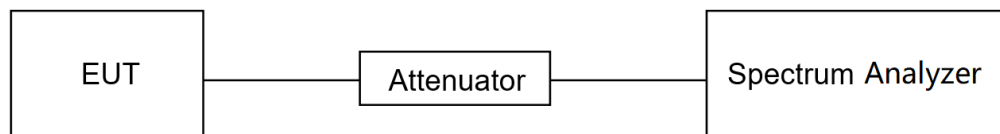

TEST ENVIRONMENT

| | | | |
|---------------------|--------|-------------------|----------|
| Temperature | 23.5°C | Relative Humidity | 55% |
| Atmosphere Pressure | 101kPa | Test Voltage | DC 3.3 V |

TEST DATE / ENGINEER

| | | | |
|-----------|---------------|---------|-------------|
| Test Date | July 15, 2023 | Test By | Denny Huang |
|-----------|---------------|---------|-------------|

TEST RESULTS

Please refer to section "Test Data" - Appendix A & B & C

7.3. CONDUCTED OUTPUT POWER

LIMITS

| CFR 47 FCC Part15, Subpart E | | |
|------------------------------|---|----------------------------|
| Test Item | Limit | Frequency Range (MHz) |
| Conducted Output Power | <input type="checkbox"/> Outdoor Access Point: 1 W (30 dBm) <input type="checkbox"/> Indoor Access Point: 1 W (30 dBm) <input type="checkbox"/> Fixed Point-To-Point Access Points: 1 W (30 dBm) <input checked="" type="checkbox"/> Client Devices: 250 mW (24 dBm) | 5150 ~ 5250 |
| | Shall not exceed the lesser of 250 mW (24dBm) or 11 dBm + 10 log B, where B is the 26 dB emission bandwidth in megahertz. | 5250 ~ 5350 5470 ~ 5725 |
| | Shall not exceed 1 Watt (30 dBm). | 5725 ~ 5850 |

| ISED RSS-247 ISSUE 3 | | |
|------------------------------------|--|---|
| Test Item | Limit | Frequency Range (MHz) |
| Conducted Output Power or e.i.r.p. | The maximum e.i.r.p. shall not exceed 200 mW (23 dBm) or 10 + 10 log ₁₀ B, dBm, whichever power is less. B is the 99 % emission bandwidth in megahertz. | 5150 ~ 5250 |
| | a. The maximum conducted output power shall not exceed 250 mW (24 dBm) or 11 + 10 log ₁₀ B dBm, whichever is less. b. The maximum e.i.r.p. shall not exceed 1.0 W (30 dBm) or 17 + 10 log ₁₀ B dBm, whichever is less. B is the 99 % emission bandwidth in megahertz. Note that devices with a maximum e.i.r.p. greater than 500 mW shall implement TPC in order to have the capability to operate at least 6 dB below the maximum permitted e.i.r.p. of 1 W. | 5250 ~ 5350 5470 ~ 5600 5650 ~ 5725 |
| | Shall not exceed 1 Watt (30 dBm). The e.i.r.p. shall not exceed 4 W | 5725 ~ 5850 |

Note:

The above limits are based upon the maximum antenna gain does not exceed 6 dBi. If transmitting antennas of directional gain greater than 6 dBi are used, the maximum conducted output power shall be reduced by the amount in dB that the directional gain of the antenna exceeds 6 dBi.

TEST PROCEDURE

Refer to KDB 789033 D02 General U-NII Test Procedures New Rules v02r01 section II.E.

Method SA-2 (trace averaging across ON and OFF times of the EUT transmissions, followed by duty cycle correction.):

- (a) Measure the duty cycle D of the transmitter output signal.
- (b) Set span to encompass the entire 26 dB EBW or 99% OBW of the signal.
- (c) Set RBW = 1 MHz.
- (d) Set VBW ≥ 3 MHz.

- (e) Number of points in sweep $\geq [2 \times \text{span} / \text{RBW}]$. (This gives bin-to-bin spacing $\leq \text{RBW} / 2$, so that narrowband signals are not lost between frequency bins.)
- (f) Sweep time = auto.
- (g) Detector = RMS (i.e., power averaging), if available. Otherwise, use sample detector mode.
- (h) Do not use sweep triggering. Allow the sweep to “free run.”
- (i) Trace average at least 100 traces in power averaging (rms) mode; however, the number of traces to be averaged shall be increased above 100 as needed such that the average accurately represents the true average over the ON and OFF periods of the transmitter.
- j) Compute power by integrating the spectrum across the 26 dB EBW or 99% OBW of the signal using the instrument’s band power measurement function with band limits set equal to the EBW or OBW band edges. If the instrument does not have a band power function, then sum the spectrum levels (in power units) at 1 MHz intervals extending across the 26 dB EBW or 99% OBW of the spectrum.
- k) Add $[10 \log (1 / D)]$, where D is the duty cycle, to the measured power to compute the average power during the actual transmission times (because the measurement represents an average over both the ON and OFF times of the transmission). For example, add $[10 \log (1 / 0.25)] = 6 \text{ dB}$ if the duty cycle is 25%.

Method PM (Measurement using an RF average power meter):

- (i) Measurements may be performed using a wideband RF power meter with a thermocouple detector or equivalent if all of the following conditions are satisfied:
 - a. The EUT is configured to transmit continuously or to transmit with a constant duty cycle.
 - b. At all times when the EUT is transmitting, it must be transmitting at its maximum power control level.
 - c. The integration period of the power meter exceeds the repetition period of the transmitted signal by at least a factor of five.
- (ii) If the transmitter does not transmit continuously, measure the duty cycle, x, of the transmitter output signal as described in II.B.
- (iii) Measure the average power of the transmitter. This measurement is an average over both the on and off periods of the transmitter.
- (iv) Adjust the measurement in dBm by adding $10 \log (1/x)$ where x is the duty cycle (e.g., $10 \log (1/0.25)$ if the duty cycle is 25 %).

Note: Method SA-2 was used for straddle channel output power test, and Method PM was used for testing rest channels

TEST SETUP

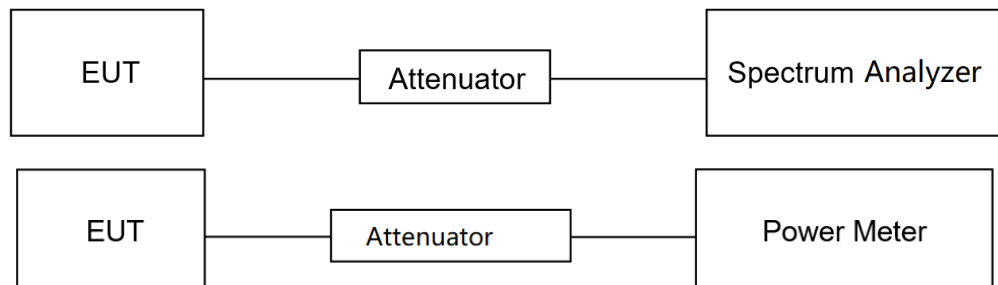

TEST ENVIRONMENT

| | | | |
|---------------------|--------|-------------------|----------|
| Temperature | 23.5°C | Relative Humidity | 55% |
| Atmosphere Pressure | 101kPa | Test Voltage | DC 3.3 V |

TEST DATE / ENGINEER

| | | | |
|-----------|---------------|---------|-------------|
| Test Date | July 15, 2023 | Test By | Denny Huang |
|-----------|---------------|---------|-------------|

TEST RESULTS

Please refer to section "Test Data" - Appendix D

7.4. POWER SPECTRAL DENSITY

LIMITS

| CFR 47 FCC Part15, Subpart E | | |
|------------------------------|--|----------------------------|
| Test Item | Limit | Frequency Range (MHz) |
| Power Spectral Density | <input type="checkbox"/> Outdoor Access Point: 17 dBm/MHz <input type="checkbox"/> Indoor Access Point: 17 dBm/MHz <input type="checkbox"/> Fixed Point-To-Point Access Points: 17 dBm/MHz <input checked="" type="checkbox"/> Client Devices: 11 dBm/MHz | 5150 ~ 5250 |
| | 11 dBm/MHz | 5250 ~ 5350 5470 ~ 5725 |
| | 30 dBm/500kHz | 5725 ~ 5850 |

| ISED RSS-247 ISSUE 3 | | |
|------------------------|--|---|
| Test Item | Limit | Frequency Range (MHz) |
| Power Spectral Density | The e.i.r.p. spectral density shall not exceed 10 dBm in any 1.0 MHz band. | 5150 ~ 5250 |
| | The power spectral density shall not exceed 11 dBm in any 1.0 MHz band. | 5250 ~ 5350 5470 ~ 5600 5650 ~ 5725 |
| | 30 dBm / 500 kHz | 5725 ~ 5850 |

Note:

The above limits are based upon the maximum antenna gain does not exceed 6 dBi. If transmitting antennas of directional gain greater than 6 dBi are used, maximum power spectral density shall be reduced by the amount in dB that the directional gain of the antenna exceeds 6 dBi.

TEST PROCEDURE

Refer to KDB 789033 D02 General U-NII Test Procedures New Rules v02r01 section II.F.

Connect the EUT to the spectrum analyser and use the following settings:

For U-NII-1, U-NII-2A and U-NII-2C band:

| | |
|------------------|--|
| Center Frequency | The center frequency of the channel under test |
| Detector | RMS |
| RBW | 1 MHz |
| VBW | $\geq 3 \times \text{RBW}$ |
| Span | Encompass the entire emissions bandwidth (EBW) of the signal |
| Trace | Max hold |
| Sweep time | Auto |

For U-NII-3:

| | |
|------------------|--|
| Center Frequency | The center frequency of the channel under test |
| Detector | RMS |
| RBW | 500 kHz |
| VBW | $\geq 3 \times \text{RBW}$ |
| Span | Encompass the entire emissions bandwidth (EBW) of the signal |
| Trace | Max hold |
| Sweep time | Auto |

Allow trace to fully stabilize and Use the peak search function on the instrument to find the peak of the spectrum and record its value.

Add $10 \log(1/x)$, where x is the duty cycle, to the peak of the spectrum, the result is the Maximum PSD over 1 MHz / 500 kHz reference bandwidth.

TEST SETUP

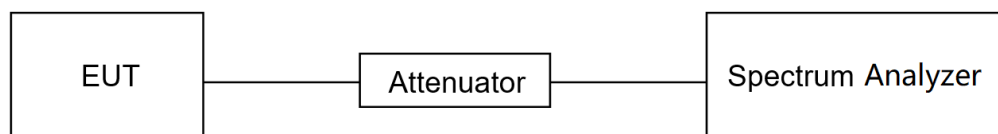

TEST ENVIRONMENT

| | | | |
|---------------------|--------|-------------------|----------|
| Temperature | 23.5°C | Relative Humidity | 55% |
| Atmosphere Pressure | 101kPa | Test Voltage | DC 3.3 V |

TEST DATE / ENGINEER

| | | | |
|-----------|---------------|---------|-------------|
| Test Date | July 15, 2023 | Test By | Denny Huang |
|-----------|---------------|---------|-------------|

TEST RESULTS

Please refer to section "Test Data" - Appendix E

7.5. FREQUENCY STABILITY

LIMITS

The frequency of the carrier signal shall be maintained within band of operation.

TEST PROCEDURE

1. The EUT was placed inside an environmental chamber as the temperature in the chamber was varied between 0 °C ~ 70 °C (declared by customer).
2. The temperature was incremented by 10 °C intervals and the unit allowed to stabilize at each temperature before each measurement. The center frequency of the transmitting channel was evaluated at each temperature and the frequency deviation from the channel's center frequency was recorded.
3. The primary supply voltage is varied from 85 % to 115 % of the nominal value for non hand-carried battery and AC powered equipment. For hand-carried, battery-powered equipment, primary supply voltage is reduced to the battery operating end point which shall be specified by the manufacturer.

Connect the EUT to the spectrum analyser and use the following settings:

| | |
|------------------|--|
| Center Frequency | The center frequency of the channel under test |
| Detector | Peak |
| RBW | 10 kHz |
| VBW | $\geq 3 \times \text{RBW}$ |
| Span | Encompass the entire emissions bandwidth (EBW) of the signal |
| Trace | Max hold |
| Sweep time | Auto |

4. While maintaining a constant temperature inside the environmental chamber, turn the EUT on and record the operating frequency at startup, and at 2 minutes, 5minutes, and 10 minutes after the EUT is energized.
5. Allow the trace to stabilize, find the peak value of the power envelope and record the frequency, then calculated the frequency drift.

TEST ENVIRONMENT

| | Normal Test Conditions | Extreme Test Conditions |
|----------------------|---|---|
| Relative Humidity | 20 % - 75 % | / |
| Atmospheric Pressure | 100 kPa ~102 kPa | / |
| Temperature | T _N (Normal Temperature): 25.1 °C | T _L (Low Temperature): 0 °C |
| | | T _H (High Temperature): 70 °C |
| Supply Voltage | V _N (Normal Voltage): DC 3.3 V | V _L (Low Voltage): DC 2.805 V |
| | | V _H (High Voltage): DC 3.795 V |

TEST SETUP

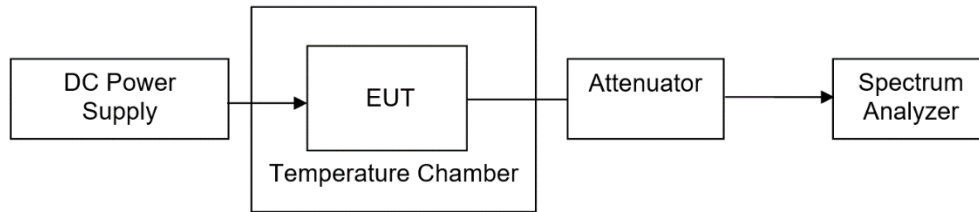

TEST ENVIRONMENT

| | | | |
|---------------------|--------|-------------------|----------|
| Temperature | 23.5°C | Relative Humidity | 55% |
| Atmosphere Pressure | 101kPa | Test Voltage | DC 3.3 V |

TEST DATE / ENGINEER

| | | | |
|-----------|---------------|---------|-------------|
| Test Date | July 15, 2023 | Test By | Denny Huang |
|-----------|---------------|---------|-------------|

TEST RESULTS

Please refer to section "Test Data" - Appendix F

7.6. DYNAMIC FREQUENCY SELECTION (SLAVE)

LIMITS

(1) DFS Detection Thresholds

Table 3: DFS Detection Thresholds for Master Devices and Client Devices With Radar Detection

| Maximum Transmit Power | Value (See Notes 1, 2, and 3) |
|--|-------------------------------|
| EIRP \geq 200 milliwatt | -64 dBm |
| EIRP < 200 milliwatt and power spectral density < 10 dBm/MHz | -62 dBm |
| EIRP < 200 milliwatt that do not meet the power spectral density requirement | -64 dBm |

Note 1: This is the level at the input of the receiver assuming a 0 dBi receive antenna.
 Note 2: Throughout these test procedures an additional 1 dB has been added to the amplitude of the test transmission waveforms to account for variations in measurement equipment. This will ensure that the test signal is at or above the detection threshold level to trigger a DFS response.
 Note3: EIRP is based on the highest antenna gain. For MIMO devices refer to KDB Publication 662911 D01.

(2) DFS Response Requirements

Table 4: DFS Response Requirement Values

| Parameter | Value |
|-----------------------------------|---|
| Non-occupancy period | Minimum 30 minutes |
| Channel Availability Check Time | 60 seconds |
| Channel Move Time | 10 seconds See Note 1. |
| Channel Closing Transmission Time | 200 milliseconds + an aggregate of 60 milliseconds over remaining 10 second period. See Notes 1 and 2. |
| U-NII Detection Bandwidth | Minimum 100% of the U-NII 99% transmission power bandwidth. See Note 3. |

Note 1: Channel Move Time and the Channel Closing Transmission Time should be performed with Radar Type 0. The measurement timing begins at the end of the Radar Type 0 burst.
 Note 2: The Channel Closing Transmission Time is comprised of 200 milliseconds starting at the beginning of the Channel Move Time plus any additional intermittent control signals required facilitating a Channel move (an aggregate of 60 milliseconds) during the remainder of the 10 second period. The aggregate duration of control signals will not count quiet periods in between transmissions.
 Note 3: During the U-NII Detection Bandwidth detection test, radar type 0 should be used. For each frequency step the minimum percentage of detection is 90 percent. Measurements are performed with no data traffic.

APPLICABILITY OF DFS REQUIREMENTS

A U-NII network will employ a DFS function to detect signals from radar systems and to avoid co-channel operation with these systems. This applies to the 5250-5350 MHz and/or 5470-5725 MHz bands.

Within the context of the operation of the DFS function, a U-NII device will operate in either Master Mode or Client Mode. U-NII devices operating in Client Mode can only operate in a network controlled by a U-NII device operating in Master Mode.

Table 1: Applicability of DFS Requirements Prior to Use of a Channel

| Requirement | Operational Mode | | |
|---------------------------------|---------------------------------|--|--|
| | <input type="checkbox"/> Master | <input checked="" type="checkbox"/> Client Without Radar Detection | <input type="checkbox"/> Client With Radar Detection |
| Non-Occupancy Period | Yes | Not required | Yes |
| DFS Detection Threshold | Yes | Not required | Yes |
| Channel Availability Check Time | Yes | Not required | Not required |
| U-NII Detection Bandwidth | Yes | Not required | Yes |

Table 2: Applicability of DFS requirements during normal operation

| Requirement | Operational Mode | |
|-----------------------------------|---|--|
| | <input type="checkbox"/> Master Device or Client with Radar Detection | <input checked="" type="checkbox"/> Client Without Radar Detection |
| DFS Detection Threshold | Yes | Not required |
| Channel Closing Transmission Time | Yes | Yes |
| Channel Move Time | Yes | Yes |
| U-NII Detection Bandwidth | Yes | Not required |

| Additional requirements for devices with multiple bandwidth modes | <input type="checkbox"/> Master Device or Client with Radar Detection | <input checked="" type="checkbox"/> Client Without Radar Detection |
|---|---|--|
| U-NII Detection Bandwidth and Statistical Performance Check | All BW modes must be tested | Not required |
| Channel Move Time and Channel Closing Transmission Time | Test using widest BW mode available | Test using the widest BW mode available for the link |
| All other tests | Any single BW mode | Not required |

Note: Frequencies selected for statistical performance check should include several frequencies within the radar detection bandwidth and frequencies near the edge of the radar detection bandwidth. For 802.11 devices it is suggested to select frequencies in each of the bonded 20 MHz channels and the channel center frequency.

PARAMETERS OF RADAR TEST WAVEFORMS

This section provides the parameters for required test waveforms, minimum percentage of successful detections, and the minimum number of trials that must be used for determining DFS conformance. Step intervals of 0.1 microsecond for Pulse Width, 1 microsecond for PRI, 1 MHz for chirp width and 1 for the number of pulses will be utilized for the random determination of specific test waveforms.

Table 5 Short Pulse Radar Test Waveforms

| Radar Type | Pulse Width (μsec) | PRI (μsec) | Number of Pulses | Minimum Percentage of Successful Detection | Minimum Number of Trials |
|---|--------------------|------------|---|--|--------------------------|
| 0 | 1 | 1428 | 18 | See Note 1 | See Note 1 |
| 1 | 1 | Test A | Roundup $\left\{ \begin{matrix} \frac{1}{360} \\ \frac{19 \cdot 10^6}{PRI_{\mu sec}} \end{matrix} \right\}$ | 60% | 30 |
| | | Test B | | | |
| 2 | 1-5 | 150-230 | 23-29 | 60% | 30 |
| 3 | 6-10 | 200-500 | 16-18 | 60% | 30 |
| 4 | 11-20 | 200-500 | 12-16 | 60% | 30 |
| Aggregate (Radar Types 1-4) | | | | 80% | 120 |
| <p>Note 1: Short Pulse Radar Type 0 should be used for the detection bandwidth test, channel move time, and channel closing time tests.</p> <p>Test A: 15 unique PRI values randomly selected from the list of 23 PRI values in Table 5a</p> <p>Test B: 15 unique PRI values randomly selected within the range of 518-3066 μsec, with a minimum increment of 1 μsec, excluding PRI values selected in Test A</p> | | | | | |

A minimum of 30 unique waveforms are required for each of the Short Pulse Radar Types 2 through 4. If more than 30 waveforms are used for Short Pulse Radar Types 2 through 4, then each additional waveform must also be unique and not repeated from the previous waveforms. If more than 30 waveforms are used for Short Pulse Radar Type 1, then each additional waveform is generated with Test B and must also be unique and not repeated from the previous waveforms in Tests A or B. Test aggregate is average of the percentage of successful detections of short pulse radar types 1-4.

TEST SETUP

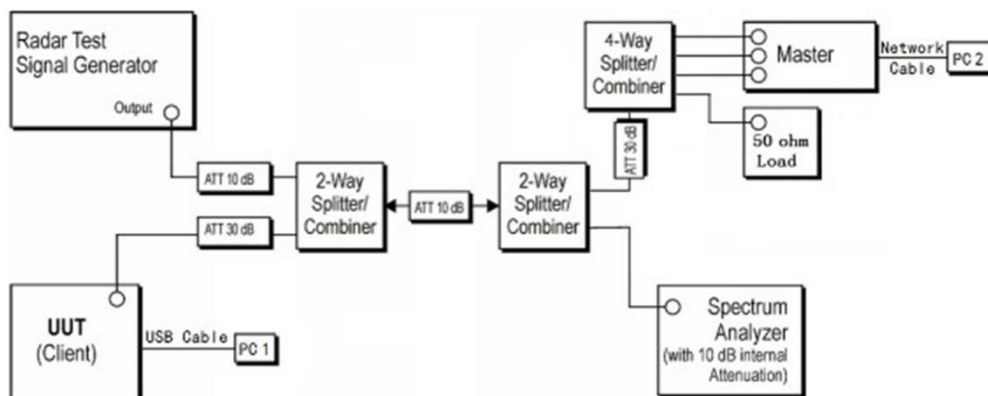

TEST ENVIRONMENT

| | | | |
|---------------------|--------|-------------------|----------|
| Temperature | 25.2°C | Relative Humidity | 66% |
| Atmosphere Pressure | 101kPa | Test Voltage | DC 3.3 V |

TEST DATE / ENGINEER

| | | | |
|-----------|-----------------|---------|-------------|
| Test Date | August 15, 2023 | Test By | Denny Huang |
|-----------|-----------------|---------|-------------|

TEST RESULTS

Please refer to section "Test Data" - Appendix H&I&J

8. RADIATED TEST RESULTS

LIMITS

Refer to CFR 47 FCC §15.205, §15.209 and §15.407 (b).

Refer to ISED RSS-GEN Clause 8.9, Clause 8.10 and ISED RSS-247 6.2.

Radiation Disturbance Test Limit for FCC (Class B) (9 kHz ~ 1 GHz)

| Emissions radiated outside of the specified frequency bands above 30 MHz | | | |
|--|------------------------------------|--------------------------------------|---------|
| Frequency Range (MHz) | Field Strength Limit (uV/m) at 3 m | Field Strength Limit (dBuV/m) at 3 m | |
| | | Quasi-Peak | |
| 30 - 88 | 100 | 40 | |
| 88 - 216 | 150 | 43.5 | |
| 216 - 960 | 200 | 46 | |
| Above 960 | 500 | 54 | |
| Above 1000 | 500 | Peak | Average |
| | | 74 | 54 |

| FCC Emissions radiated outside of the specified frequency bands below 30 MHz | | |
|--|-----------------------------------|-------------------------------|
| Frequency (MHz) | Field strength (microvolts/meter) | Measurement distance (meters) |
| 0.009-0.490 | 2400/F(kHz) | 300 |
| 0.490-1.705 | 24000/F(kHz) | 30 |
| 1.705-30.0 | 30 | 30 |

ISED General field strength limits at frequencies below 30 MHz

| Table 6 – General field strength limits at frequencies below 30 MHz | | |
|---|--|--------------------------|
| Frequency | Magnetic field strength (H-Field) (µA/m) | Measurement distance (m) |
| 9 - 490 kHz ^{Note 1} | 6.37/F (F in kHz) | 300 |
| 490 - 1705 kHz | 63.7/F (F in kHz) | 30 |
| 1.705 - 30 MHz | 0.08 | 30 |

Note 1: The emission limits for the ranges 9-90 kHz and 110-490 kHz are based on measurements employing a linear average detector.

ISED Restricted bands refer to ISED RSS-GEN Clause 8.10

| Table 7 – Restricted frequency bands ^{Note 1} | | |
|--|-----------------------|---------------|
| MHz | MHz | GHz |
| 0.090 - 0.110 | 149.9 - 150.05 | 9.0 - 9.2 |
| 0.495 - 0.505 | 156.52475 - 156.52525 | 9.3 - 9.5 |
| 2.1735 - 2.1905 | 156.7 - 156.9 | 10.6 - 12.7 |
| 3.020 - 3.026 | 162.0125 - 167.17 | 13.25 - 13.4 |
| 4.125 - 4.128 | 167.72 - 173.2 | 14.47 - 14.5 |
| 4.17725 - 4.17775 | 240 - 285 | 15.35 - 16.2 |
| 4.20725 - 4.20775 | 322 - 335.4 | 17.7 - 21.4 |
| 5.677 - 5.683 | 399.9 - 410 | 22.01 - 23.12 |
| 6.215 - 6.218 | 608 - 614 | 23.6 - 24.0 |
| 6.26775 - 6.26825 | 960 - 1427 | 31.2 - 31.8 |
| 6.31175 - 6.31225 | 1435 - 1626.5 | 36.43 - 36.5 |
| 8.291 - 8.294 | 1645.5 - 1646.5 | Above 38.6 |
| 8.362 - 8.366 | 1660 - 1710 | |
| 8.37625 - 8.38675 | 1718.8 - 1722.2 | |
| 8.41425 - 8.41475 | 2200 - 2300 | |
| 12.29 - 12.293 | 2310 - 2390 | |
| 12.51975 - 12.52025 | 2483.5 - 2500 | |
| 12.57675 - 12.57725 | 2655 - 2900 | |
| 13.36 - 13.41 | 3260 - 3267 | |
| 16.42 - 16.423 | 3332 - 3339 | |
| 16.69475 - 16.69525 | 3345.8 - 3358 | |
| 16.80425 - 16.80475 | 3500 - 4400 | |
| 25.5 - 25.67 | 4500 - 5150 | |
| 37.5 - 38.25 | 5350 - 5480 | |
| 73 - 74.6 | 7250 - 7750 | |
| 74.8 - 75.2 | 8025 - 8500 | |
| 108 - 138 | | |

Note 1: Certain frequency bands listed in table 7 and in bands above 38.6 GHz are designated for licence-exempt applications. These frequency bands and the requirements that apply to related devices are set out in the 200 and 300 series of RSSs.

FCC Restricted bands of operation refer to FCC §15.205 (a):

| MHz | MHz | MHz | GHz |
|--------------------------|---------------------|---------------|------------------|
| 0.090-0.110 | 16.42-16.423 | 399.9-410 | 4.5-5.15 |
| ¹ 0.495-0.505 | 16.69475-16.69525 | 608-614 | 5.35-5.46 |
| 2.1735-2.1905 | 16.80425-16.80475 | 960-1240 | 7.25-7.75 |
| 4.125-4.128 | 25.5-25.67 | 1300-1427 | 8.025-8.5 |
| 4.17725-4.17775 | 37.5-38.25 | 1435-1626.5 | 9.0-9.2 |
| 4.20725-4.20775 | 73-74.6 | 1645.5-1646.5 | 9.3-9.5 |
| 6.215-6.218 | 74.8-75.2 | 1660-1710 | 10.6-12.7 |
| 6.26775-6.26825 | 108-121.94 | 1718.8-1722.2 | 13.25-13.4 |
| 6.31175-6.31225 | 123-138 | 2200-2300 | 14.47-14.5 |
| 8.291-8.294 | 149.9-150.05 | 2310-2390 | 15.35-16.2 |
| 8.362-8.366 | 156.52475-156.52525 | 2483.5-2500 | 17.7-21.4 |
| 8.37625-8.38675 | 156.7-156.9 | 2690-2900 | 22.01-23.12 |
| 8.41425-8.41475 | 162.0125-167.17 | 3260-3267 | 23.6-24.0 |
| 12.29-12.293 | 167.72-173.2 | 3332-3339 | 31.2-31.8 |
| 12.51975-12.52025 | 240-285 | 3345.8-3358 | 36.43-36.5 |
| 12.57675-12.57725 | 322-335.4 | 3600-4400 | (²) |
| 13.36-13.41 | | | |

Note: ¹Until February 1, 1999, this restricted band shall be 0.490-0.510 MHz.

²Above 38.6c

Limits of unwanted/undesirable emission out of the restricted bands refer to CFR 47 FCC §15.407 (b) and ISED RSS-247 6.2.

LIMITS OF RADIATED EMISSION MEASUREMENT (Above 1GHz)

| Frequency Range (MHz) | EIRP Limit | Field Strength Limit (dBuV/m) at 3 m |
|--|---|---|
| 5150~5250 MHz | PK: -27 (dBm/MHz) | PK:68.2(dBμV/m) |
| 5250~5350 MHz | | |
| 5470~5725 MHz | | |
| 5725~5850 MHz | PK: -27 (dBm/MHz) *1 PK: 10 (dBm/MHz) *2 PK: 15.6 (dBm/MHz) *3 PK: 27 (dBm/MHz) *4 | PK: 68.2(dBμV/m) *1 PK: 105.2 (dBμV/m) *2 PK: 110.8(dBμV/m) *3 PK: 122.2 (dBμV/m) *4 |
| Note: *1 beyond 75 MHz or more above of the band edge. *2 below the band edge increasing linearly to 10 dBm/MHz at 25 MHz above. *3 below the band edge increasing linearly to a level of 15.6 dBm/MHz at 5 MHz above. *4 from 5 MHz above or below the band edge increasing linearly to a level of 27 dBm/MHz at the band edge. | | |

TEST PROCEDURE

Below 30 MHz

The setting of the spectrum analyser

| | |
|-------|--|
| RBW | 200 Hz (From 9 kHz to 0.15 MHz)/ 9 kHz (From 0.15 MHz to 30 MHz) |
| VBW | 200 Hz (From 9 kHz to 0.15 MHz)/ 9 kHz (From 0.15 MHz to 30 MHz) |
| Sweep | Auto |

1. The testing follows the guidelines in ANSI C63.10-2013 clause 6.4.
2. The EUT was arranged to its worst case and then turntable (from 0 degree to 360 degrees) to find the maximum reading. A pre-amp and a high pass filter are used for the test in order to get better signal level. Both Horizontal, Face-on and Face-off polarizations of the antenna are set to make the measurement.
3. The EUT was placed on a turntable with 80 cm above ground.
4. The EUT was set 3 meters from the interference receiving antenna, which was mounted on the top of a 1 m height antenna tower.
5. The radiated emission limits are based on measurements employing a CISPR quasi-peak detector except for the frequency bands 9-90 kHz, 110-490 kHz and above 1000 MHz Radiated emission limits in these three bands are based on measurements employing an average detector.
6. For measurement below 1 GHz, the initial step in collecting conducted emission data is a spectrum analyzer peak detector mode pre-scanning the measurement frequency range. Significant peaks are then marked and then Quasi Peak and average detector mode re-measured. If the emission level of the EUT measured by the peak detector is 3 dB lower than the applicable limit, the peak emission level will be reported. Otherwise, the emission measurement will be repeated using the quasi-peak and average detector and reported.
7. Although these tests were performed other than open field site, adequate comparison measurements were confirmed against 30m open field site. Therefore sufficient tests were made to demonstrate that the alternative site produces results that correlate with the ones of tests made in an open field site based on KDB 414788.

8. The limits in CFR 47, Part 15, Subpart C, paragraph 15.209 (a), are identical to those in RSS-GEN Section 8.9, Table 6, since the measurements are performed in terms of magnetic field strength and converted to electric field strength levels (as reported in the table) using the free space impedance of 377Ω . For example, the measurement frequency X KHz resulted in a level of Y dBuV/m, which is equivalent to $Y-51.5 = Z$ dBuA/m, which has the same margin, W dB, to the corresponding RSS-GEN Table 6 limit as it has to be 15.209(a) limit.

Below 1 GHz and above 30 MHz

The setting of the spectrum analyser

| | |
|----------|----------|
| RBW | 120 kHz |
| VBW | 300 kHz |
| Sweep | Auto |
| Detector | Peak/QP |
| Trace | Max hold |

1. The testing follows the guidelines in ANSI C63.10-2013 clause 6.5.
2. The EUT was arranged to its worst case and then tune the antenna tower (from 1 m to 4 m) and turntable (from 0 degree to 360 degrees) to find the maximum reading. A pre-amp and a high pass filter are used for the test in order to get better signal level. Both horizontal and vertical polarizations of the antenna are set to make the measurement.
3. The EUT was placed on a turntable with 80 cm above ground.
4. The EUT was set 3 meters from the interference receiving antenna, which was mounted on the top of a variable height antenna tower.
5. For measurement below 1 GHz, the initial step in collecting conducted emission data is a spectrum analyzer peak detector mode pre-scanning the measurement frequency range. Significant peaks are then marked and then Quasi Peak detector mode re-measured. If the emission level of the EUT measured by the peak detector is 3 dB lower than the applicable limit, the peak emission level will be reported. Otherwise, the emission measurement will be repeated using the quasi-peak detector and reported.

Above 1 GHz

The setting of the spectrum analyser

| | |
|----------|--------------------------------|
| RBW | 1 MHz |
| VBW | PEAK: 3 MHz AVG: see note 6 |
| Sweep | Auto |
| Detector | Peak |
| Trace | Max hold |

1. The testing follows the guidelines in KDB 789033 D02 General U-NII Test Procedures New Rules v02r01 section II.G.3 ~ II.G.6.
2. The EUT was arranged to its worst case and then tune the antenna tower (from 1 m to 4 m) and turntable (from 0 degree to 360 degrees) to find the maximum reading. A pre-amp and a high pass filter are used for the test in order to get better signal level. Both horizontal and vertical polarizations of the antenna are set to make the measurement.
3. The EUT was placed on a turntable with 1.5 m above ground.
4. The EUT was set 3 meters from the interference receiving antenna, which was mounted on the top of a variable height antenna tower.
5. For measurement above 1 GHz, the emission measurement will be measured by the peak detector. This peak level, once corrected, must comply with the limit specified in Section 15.209.
6. For measurements above 1 GHz the resolution bandwidth is set to 1 MHz, then the video bandwidth is set to 3 MHz for peak measurements and 1 MHz resolution bandwidth with 1/T video bandwidth with peak detector for average measurements. For the Duty Cycle please refer to clause 7.1.ON TIME AND DUTY CYCLE.

X axis, Y axis, Z axis positions:

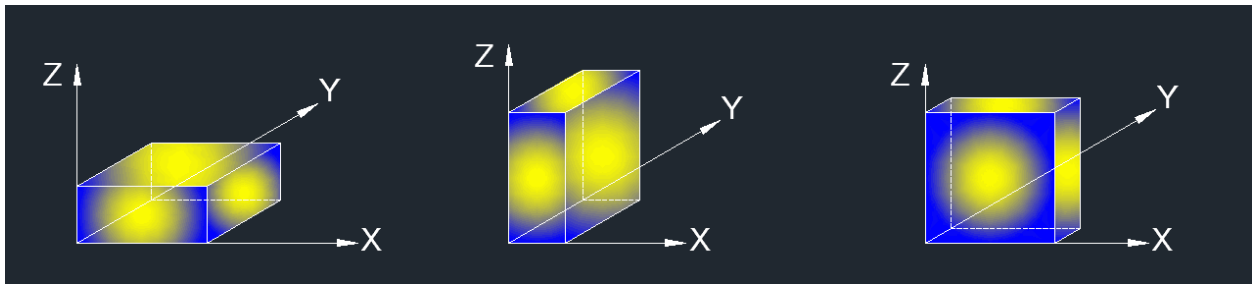

Note 1: For all radiated test, EUT in each of three orthogonal axis emissions had been tested, but only the worst case (X axis) data recorded in the report.

For Band edge:

Note:

1. Measurement = Reading Level + Correct Factor.
2. If the Peak values are less than the Average limit of 54 dBuV/m, the Average result is deemed to comply with Average limit.
3. Peak: Peak detector.
4. AVG: $VBW=1/Ton$, where: Ton is the transmitting duration.
5. For the transmitting duration, please refer to clause 7.1.
6. Only the worst data was recorded, if it complies with the limit, the other emissions deemed to comply with the limit.
7. Horizontal and Vertical have been tested, only the worst data was recorded in the report.
8. All modes, channels and antennas have been tested, only the worst data was recorded in the report.

For Radiate Spurious emission 1GHz-7GHz:

Note:

1. Measurement = Reading Level + Correct Factor.
2. If the Peak values are less than the Average limit of 54 dBuV/m, the Average result is deemed to comply with Average limit.
3. Peak: Peak detector.
4. AVG: $VBW=1/Ton$, where: Ton is the transmitting duration.
5. For the transmitting duration, please refer to clause 7.1.
6. Filter losses were only considered in the spurious frequency bands and the authorized band was not corrected for Band reject filter losses.
7. Proper operation of the transmitter prior to adding the filter to the measurement chain.
8. Since non-restricted band peak emissions are less than the average limit, they also comply with the -27dBm/MHz (68.2dBuV/m) limit.
9. All modes, channels and antennas have been tested, only the worst data was recorded in the report.

For Radiate Spurious emission 7GHz-18GHz:

Note:

1. Measurement = Reading Level + Correct Factor.
2. If the Peak values are less than the Average limit of 54 dBuV/m, the Average result is deemed to comply with Average limit.
3. Peak: Peak detector.
4. AVG: $VBW=1/Ton$, where: Ton is the transmitting duration.
5. For the transmitting duration, please refer to clause 7.1.
6. Filter losses were only considered in the spurious frequency bands and the authorized band was not corrected for High Pass Filter losses.
7. Proper operation of the transmitter prior to adding the filter to the measurement chain.
8. Since non-restricted band peak emissions are less than the average limit, they also comply with the -27dBm/MHz (68.2dBuV/m) limit.
9. All modes, channels and antennas have been tested, only the worst data was recorded in the report.

For Radiate Spurious emission 9kHz-30MHz:

Note:

1. Measurement = Reading Level + Correct Factor
(dBuA/m= dBuV/m- 20Log10[120π] = dBuV/m- 51.5).
2. If the Peak values are less than the QP limit, the QP result is deemed to comply with QP limit.
3. All 3 polarizations (Horizontal, Face-on and Face-off) of the loop antenna had been tested, but only the worst data recorded in the report.
4. All modes, channels and antennas have been tested, only the worst data was recorded in the report.

For Radiate Spurious emission 18GHz-26GHz:

Note:

1. Measurement = Reading Level + Correct Factor.
2. If the Peak values are less than the Average limit of 54 dBuV/m, the Average result is deemed to comply with Average limit.
3. Peak: Peak detector.
4. All modes, channels and antennas have been tested, only the worst data was recorded in the report.

For Radiate Spurious emission 26GHz-40GHz:

Note:

1. Measurement = Reading Level + Correct Factor.
2. If the Peak values are less than the Average limit of 54 dBuV/m, the Average result is deemed to comply with Average limit.
3. Peak: Peak detector.
4. All modes, channels and antennas have been tested, only the worst data was recorded in the report.

For Radiate Spurious emission 30MHz-1GHz:

Note:

1. Result Level = Read Level + Correct Factor.
2. If the Peak values are less than the QP limit, the QP result is deemed to comply with QP limit.
3. Test setup: RBW: 120 kHz, VBW: 300 kHz, Sweep time: auto.
4. All modes, channels and antennas have been tested, only the worst data was recorded in the report.

TEST SETUP

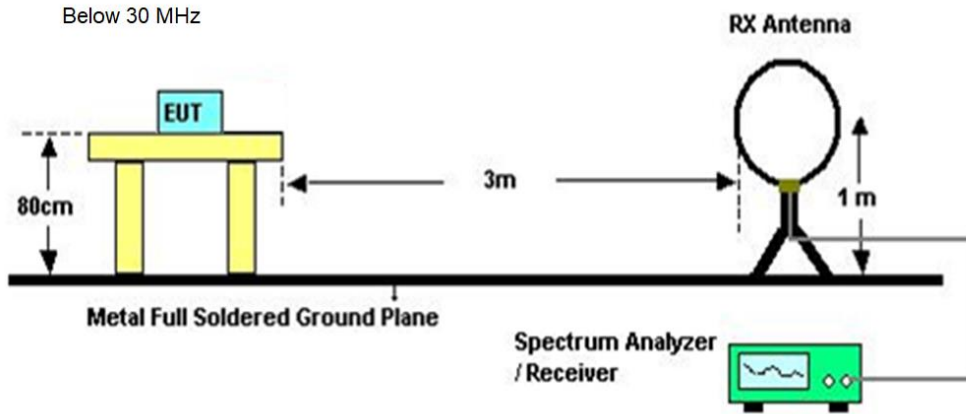

Below 1 GHz and above 30 MHz

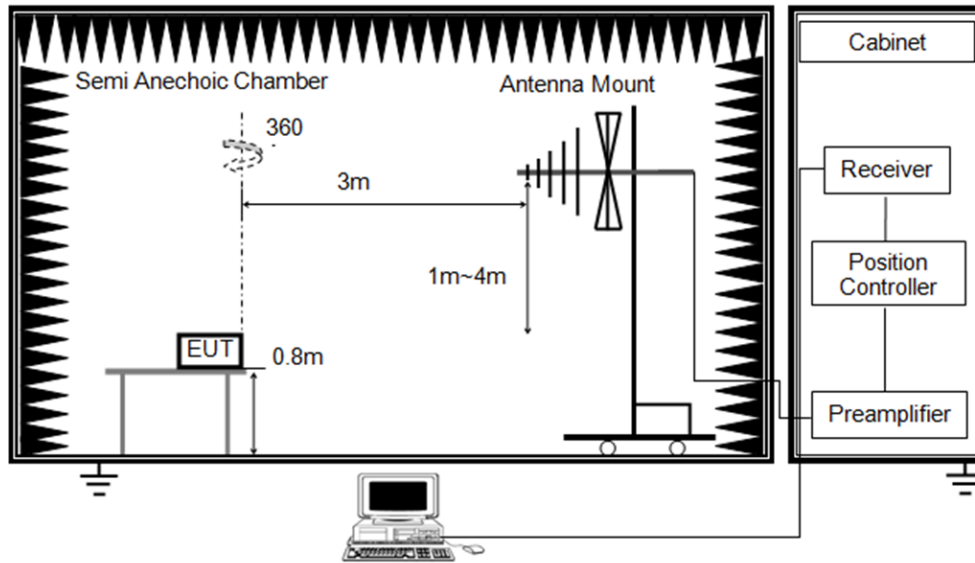

Above 1 GHz

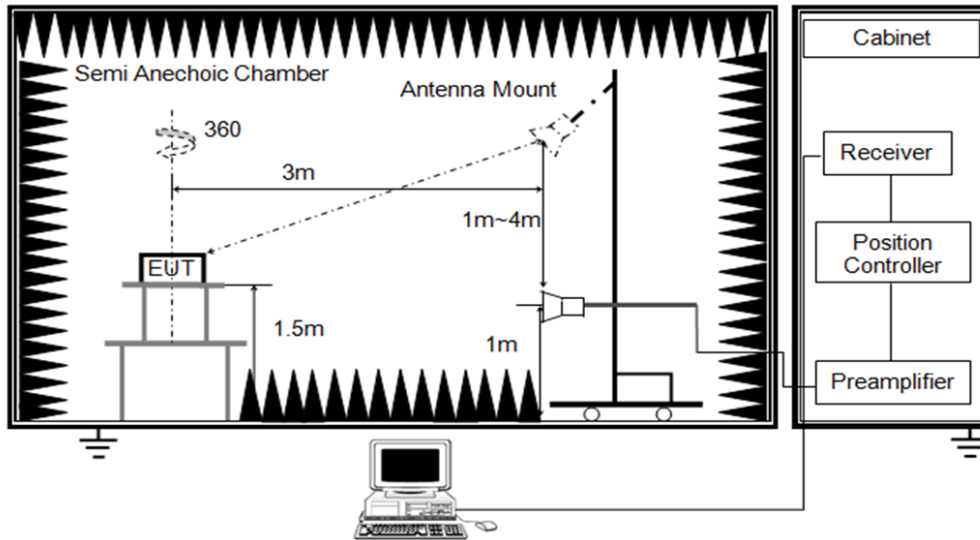

TEST ENVIRONMENT

| | | | |
|---------------------|--------|-------------------|----------|
| Temperature | 25.3°C | Relative Humidity | 65% |
| Atmosphere Pressure | 101kPa | Test Voltage | DC 3.3 V |

TEST DATE / ENGINEER

| | | | |
|-----------|----------------|---------|-----------|
| Test Date | August 2, 2023 | Test By | Rex Huang |
|-----------|----------------|---------|-----------|

TEST RESULTS

8.1. RESTRICTED BANDEDGE

| | | | |
|------------|---------------|-----------------|----------|
| Test Mode: | 802.11a 20 PK | Frequency(MHz): | 5180 |
| Polarity: | Horizontal | Test Voltage: | DC 3.3 V |

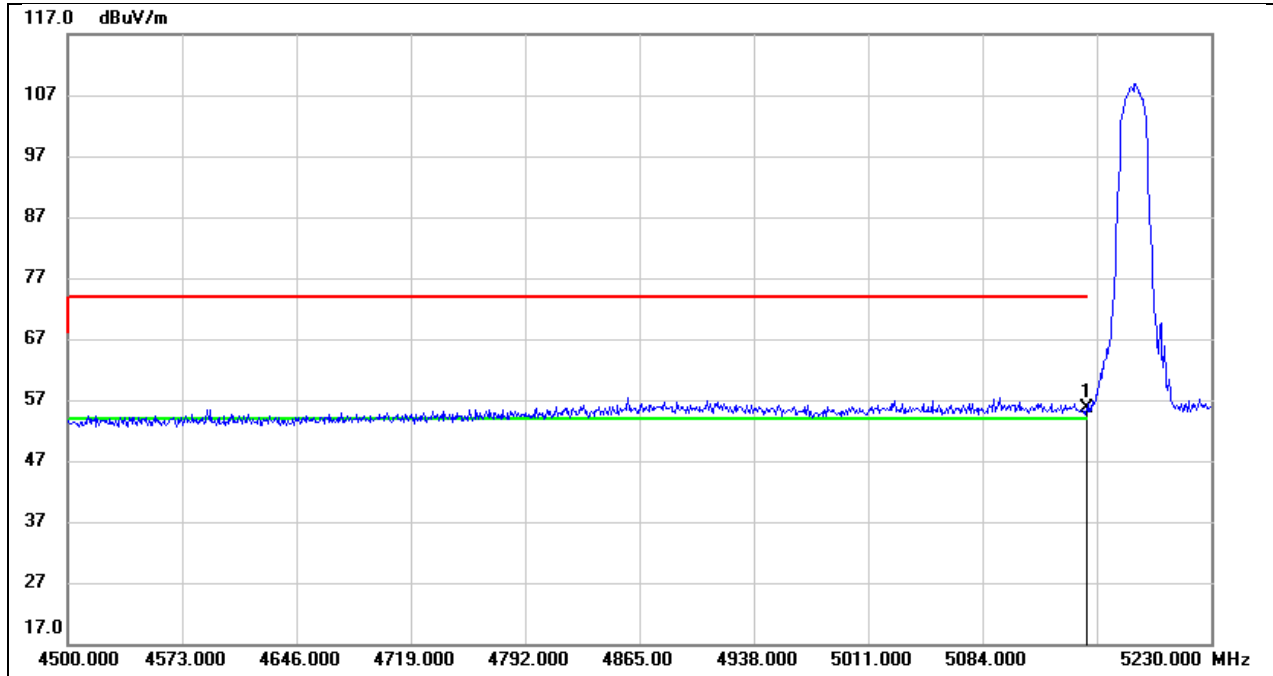

| No. | Frequency (MHz) | Reading (dBuV) | Correct (dB/m) | Result (dBuV/m) | Limit (dBuV/m) | Margin (dB) | Remark |
|-----|-----------------|----------------|----------------|-----------------|----------------|-------------|--------|
| 1 | 5150.000 | 15.34 | 40.27 | 55.61 | 74.00 | -18.39 | peak |

| | | | |
|------------|---------------|-----------------|----------|
| Test Mode: | 802.11a 20 AV | Frequency(MHz): | 5180 |
| Polarity: | Horizontal | Test Voltage: | DC 3.3 V |

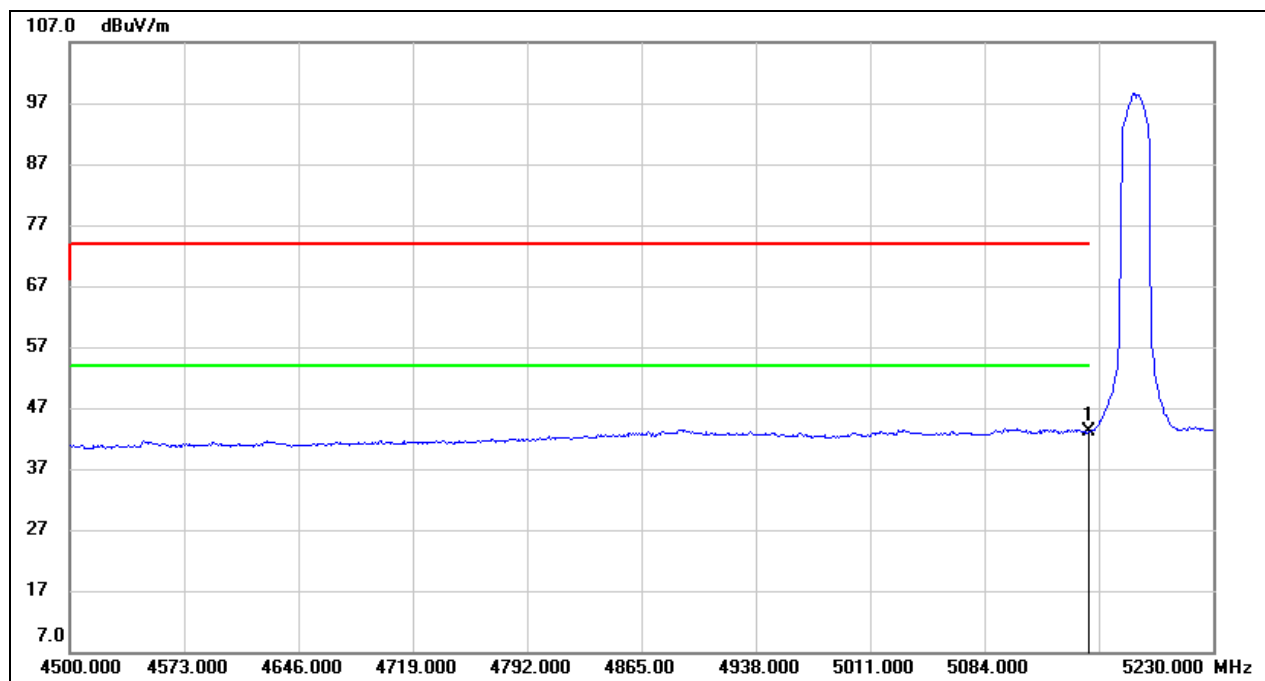

| No. | Frequency (MHz) | Reading (dBuV) | Correct (dB/m) | Result (dBuV/m) | Limit (dBuV/m) | Margin (dB) | Remark |
|-----|-----------------|----------------|----------------|-----------------|----------------|-------------|--------|
| 1 | 5150.000 | 2.85 | 40.27 | 43.12 | 54.00 | -10.88 | AVG |

| | | | |
|------------|---------------|-----------------|----------|
| Test Mode: | 802.11a 20 PK | Frequency(MHz): | 5240 |
| Polarity: | Horizontal | Test Voltage: | DC 3.3 V |

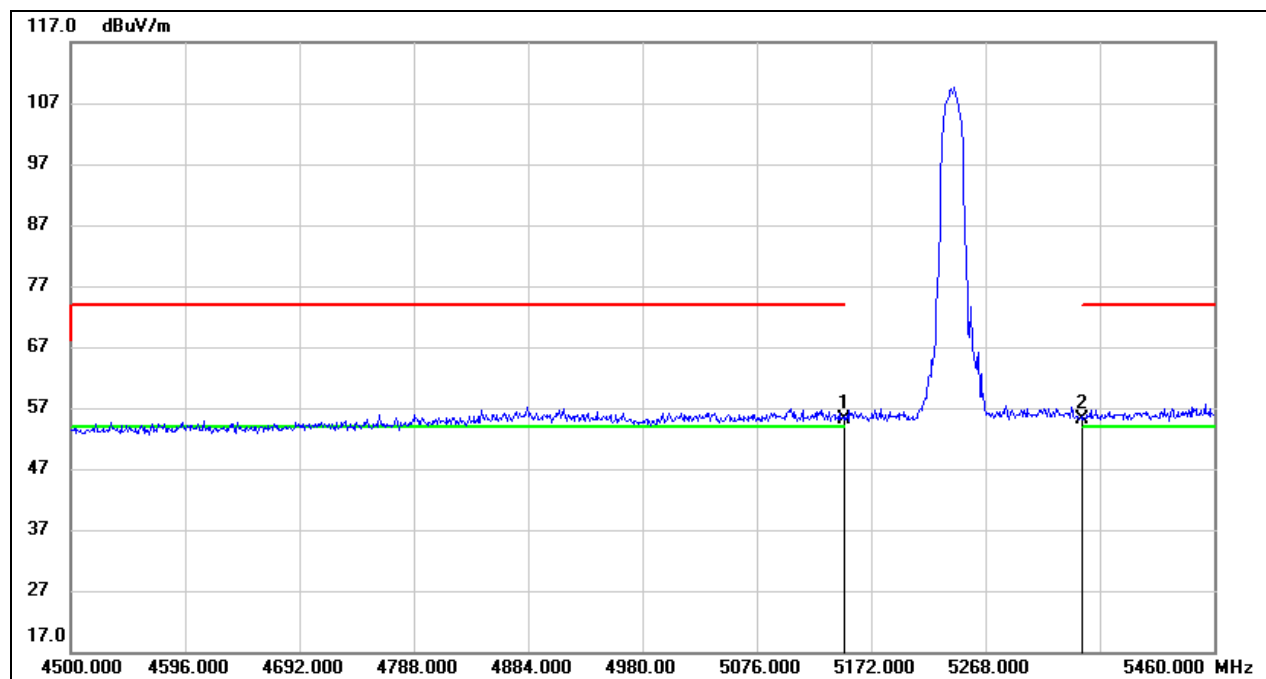

| No. | Frequency (MHz) | Reading (dBuV) | Correct (dB/m) | Result (dBuV/m) | Limit (dBuV/m) | Margin (dB) | Remark |
|-----|-----------------|----------------|----------------|-----------------|----------------|-------------|--------|
| 1 | 5150.000 | 14.84 | 40.27 | 55.11 | 74.00 | -18.89 | peak |
| 2 | 5350.000 | 14.69 | 40.49 | 55.18 | 74.00 | -18.82 | peak |

| | | | |
|------------|---------------|-----------------|----------|
| Test Mode: | 802.11a 20 AV | Frequency(MHz): | 5240 |
| Polarity: | Horizontal | Test Voltage: | DC 3.3 V |

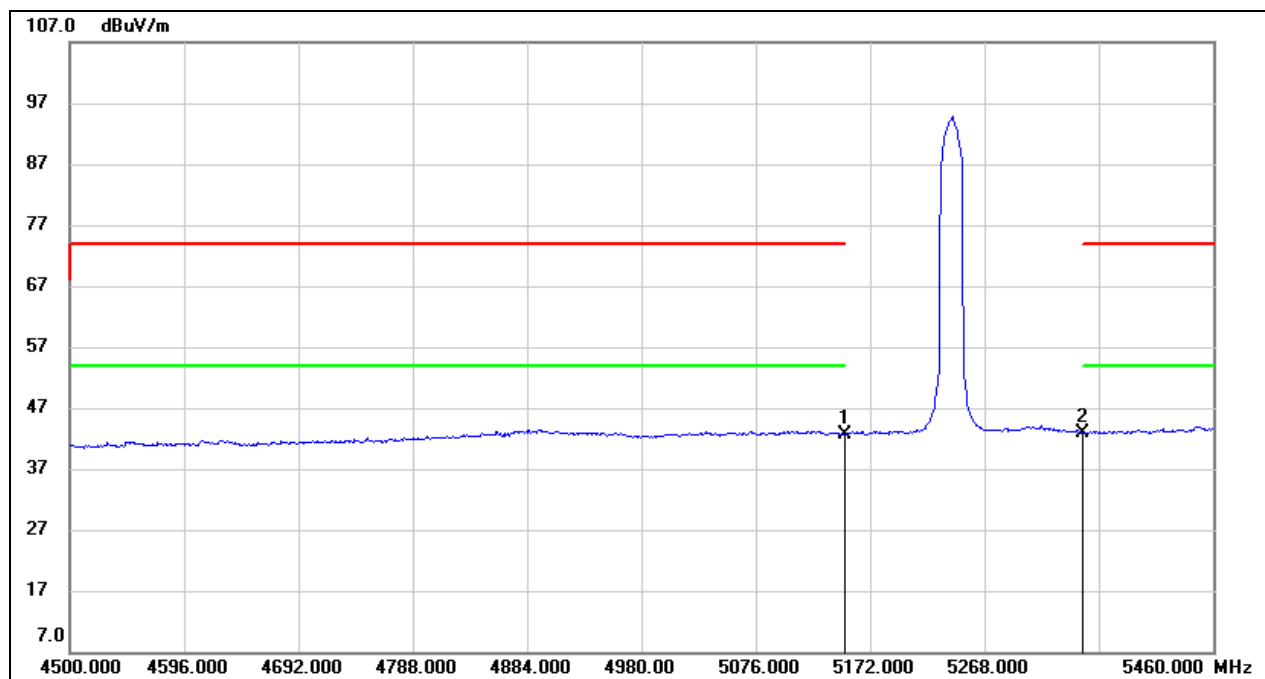

| No. | Frequency (MHz) | Reading (dBuV) | Correct (dB/m) | Result (dBuV/m) | Limit (dBuV/m) | Margin (dB) | Remark |
|-----|-----------------|----------------|----------------|-----------------|----------------|-------------|--------|
| 1 | 5150.000 | 2.44 | 40.27 | 42.71 | 54.00 | -11.29 | AVG |
| 2 | 5350.000 | 2.46 | 40.49 | 42.95 | 54.00 | -11.05 | AVG |

| | | | |
|------------|---------------|-----------------|----------|
| Test Mode: | 802.11a 20 PK | Frequency(MHz): | 5260 |
| Polarity: | Horizontal | Test Voltage: | DC 3.3 V |

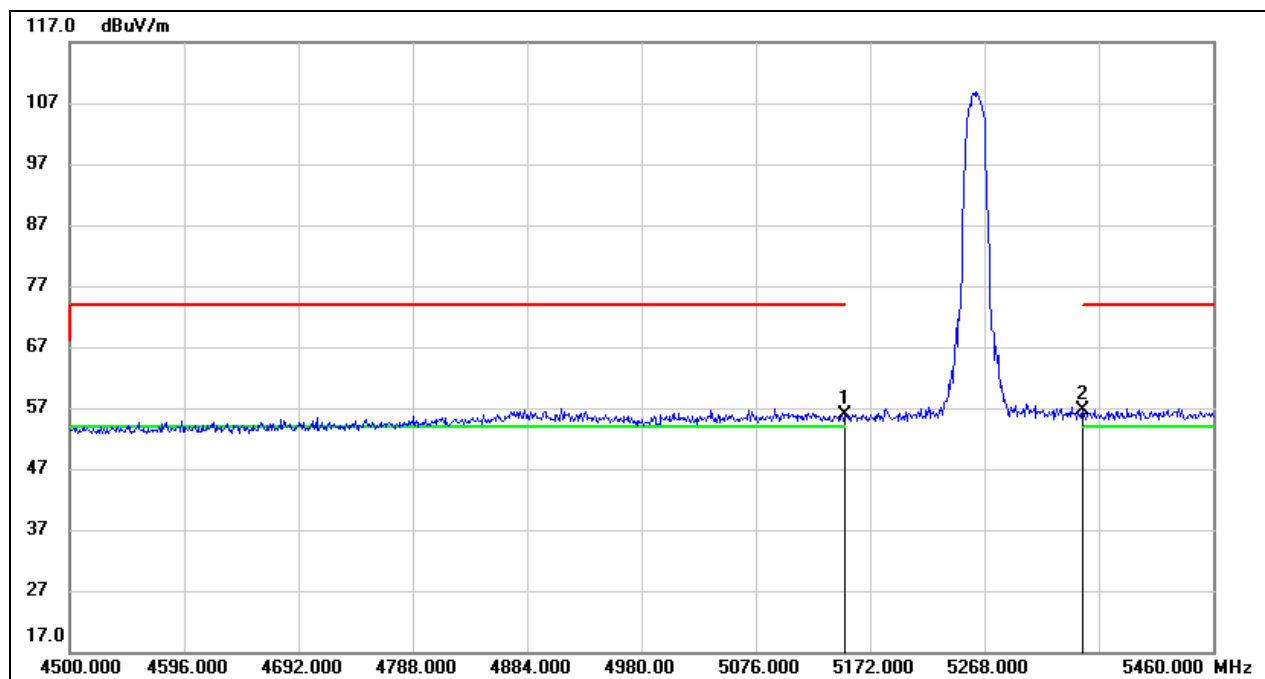

| No. | Frequency (MHz) | Reading (dBuV) | Correct (dB/m) | Result (dBuV/m) | Limit (dBuV/m) | Margin (dB) | Remark |
|-----|-----------------|----------------|----------------|-----------------|----------------|-------------|--------|
| 1 | 5150.000 | 15.51 | 40.27 | 55.78 | 74.00 | -18.22 | peak |
| 2 | 5350.000 | 16.13 | 40.49 | 56.62 | 74.00 | -17.38 | peak |

| | | | |
|------------|---------------|-----------------|----------|
| Test Mode: | 802.11a 20 AV | Frequency(MHz): | 5260 |
| Polarity: | Horizontal | Test Voltage: | DC 3.3 V |

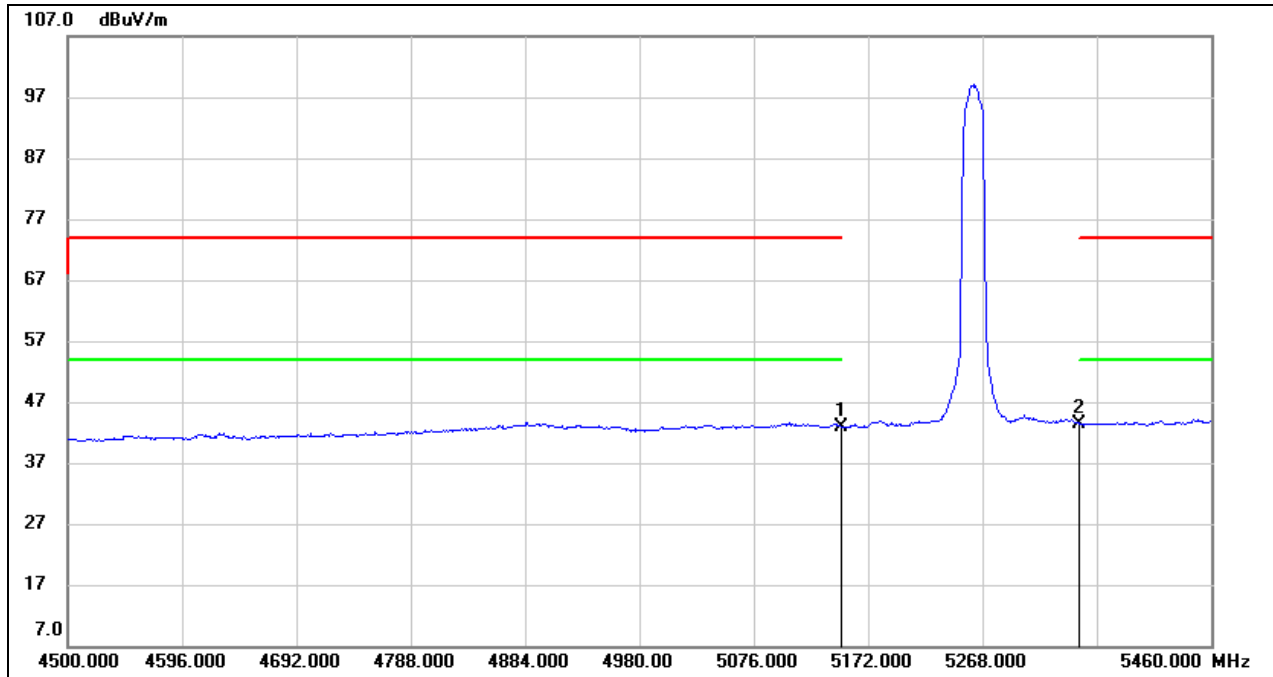

| No. | Frequency (MHz) | Reading (dBuV) | Correct (dB/m) | Result (dBuV/m) | Limit (dBuV/m) | Margin (dB) | Remark |
|-----|-----------------|----------------|----------------|-----------------|----------------|-------------|--------|
| 1 | 5150.000 | 2.61 | 40.27 | 42.88 | 54.00 | -11.12 | AVG |
| 2 | 5350.000 | 2.92 | 40.49 | 43.41 | 54.00 | -10.59 | AVG |

| | | | |
|------------|---------------|-----------------|----------|
| Test Mode: | 802.11a 20 PK | Frequency(MHz): | 5320 |
| Polarity: | Horizontal | Test Voltage: | DC 3.3 V |

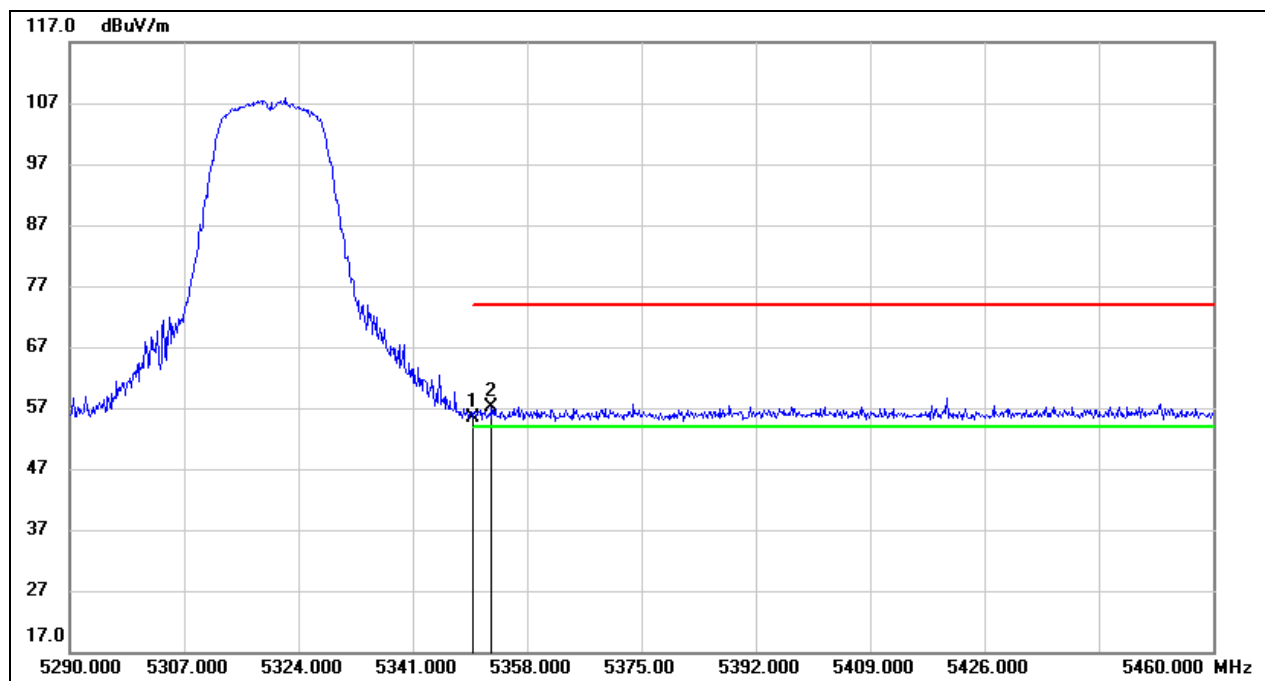

| No. | Frequency (MHz) | Reading (dBuV) | Correct (dB/m) | Result (dBuV/m) | Limit (dBuV/m) | Margin (dB) | Remark |
|-----|-----------------|----------------|----------------|-----------------|----------------|-------------|--------|
| 1 | 5350.000 | 14.97 | 40.49 | 55.46 | 74.00 | -18.54 | peak |
| 2 | 5352.730 | 16.70 | 40.50 | 57.20 | 74.00 | -16.80 | peak |

| | | | |
|------------|---------------|-----------------|----------|
| Test Mode: | 802.11a 20 AV | Frequency(MHz): | 5320 |
| Polarity: | Horizontal | Test Voltage: | DC 3.3 V |

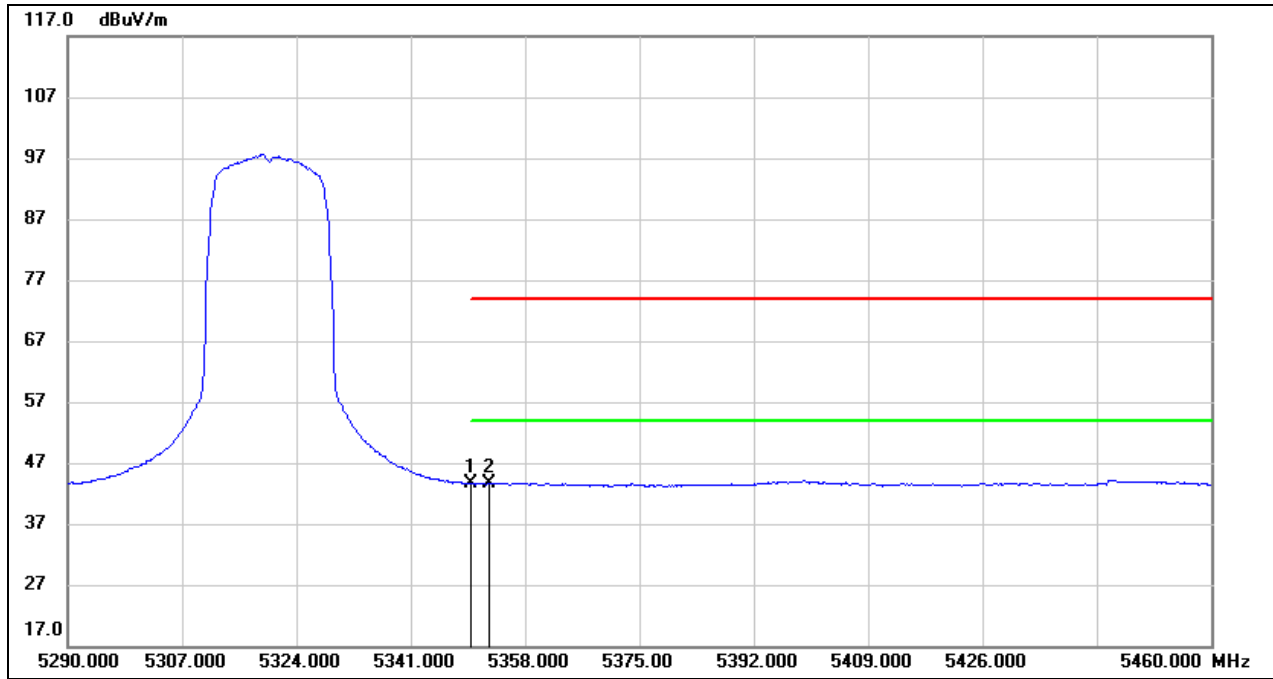

| No. | Frequency (MHz) | Reading (dBuV) | Correct (dB/m) | Result (dBuV/m) | Limit (dBuV/m) | Margin (dB) | Remark |
|-----|-----------------|----------------|----------------|-----------------|----------------|-------------|--------|
| 1 | 5350.000 | 3.13 | 40.49 | 43.62 | 54.00 | -10.38 | AVG |
| 2 | 5352.730 | 3.07 | 40.50 | 43.57 | 54.00 | -10.43 | AVG |

| | | | |
|------------|---------------|-----------------|----------|
| Test Mode: | 802.11a 20 PK | Frequency(MHz): | 5500 |
| Polarity: | Horizontal | Test Voltage: | DC 3.3 V |

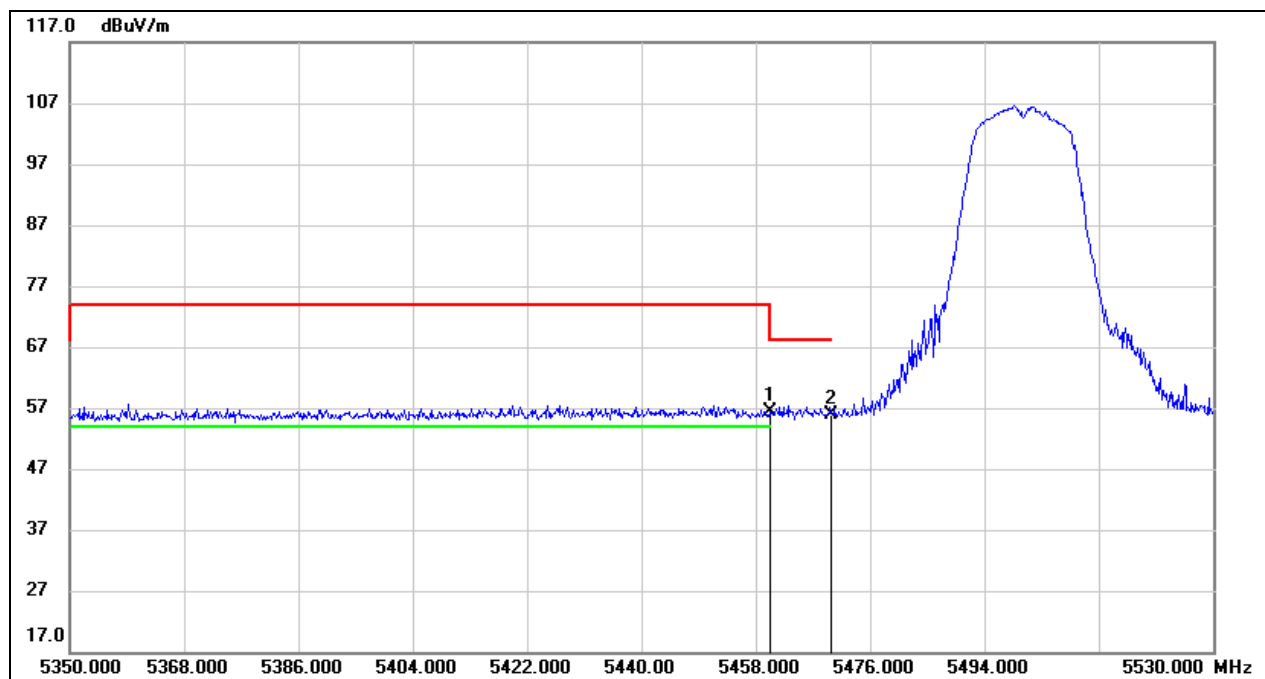

| No. | Frequency (MHz) | Reading (dBuV) | Correct (dB/m) | Result (dBuV/m) | Limit (dBuV/m) | Margin (dB) | Remark |
|-----|-----------------|----------------|----------------|-----------------|----------------|-------------|--------|
| 1 | 5460.000 | 15.66 | 40.62 | 56.28 | 74.00 | -17.72 | peak |
| 2 | 5470.000 | 15.17 | 40.63 | 55.80 | 68.20 | -12.40 | peak |

| | | | |
|------------|---------------|-----------------|----------|
| Test Mode: | 802.11a 20 AV | Frequency(MHz): | 5500 |
| Polarity: | Horizontal | Test Voltage: | DC 3.3 V |

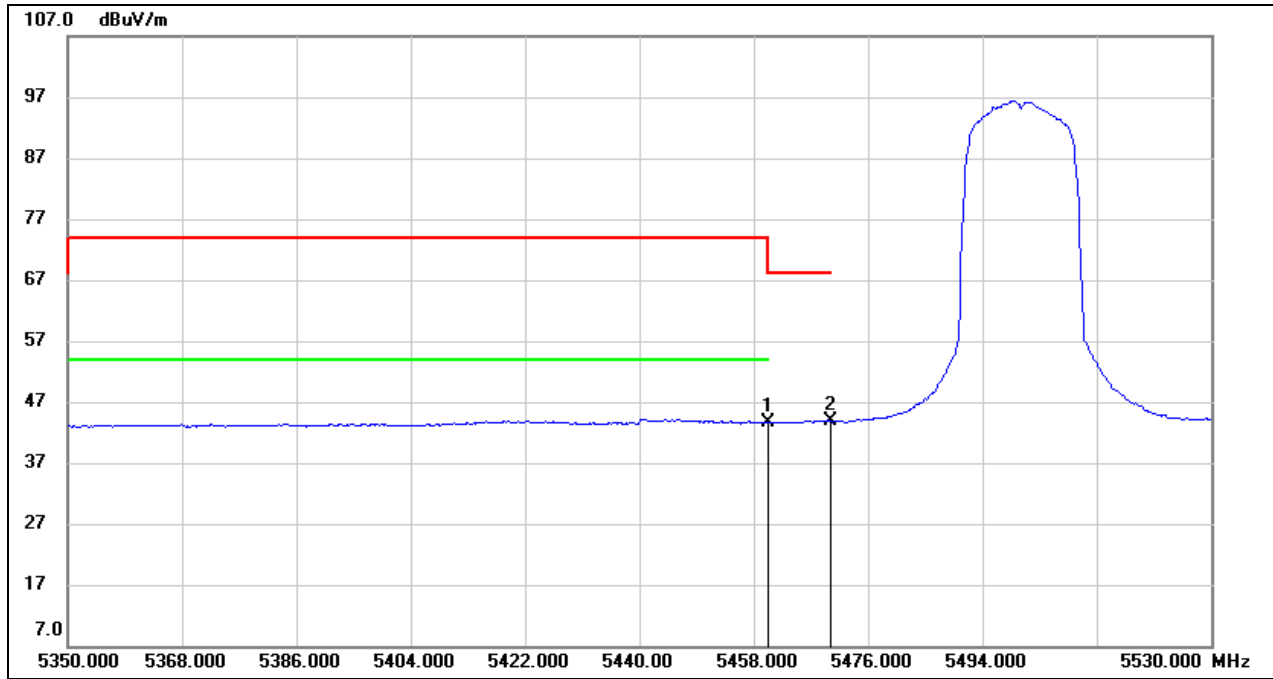

| No. | Frequency (MHz) | Reading (dBuV) | Correct (dB/m) | Result (dBuV/m) | Limit (dBuV/m) | Margin (dB) | Remark |
|-----|-----------------|----------------|----------------|-----------------|----------------|-------------|--------|
| 1 | 5460.000 | 3.06 | 40.62 | 43.68 | 54.00 | -10.32 | AVG |
| 2 | 5470.000 | 3.29 | 40.63 | 43.92 | / | / | AVG |

| | | | |
|------------|---------------|-----------------|----------|
| Test Mode: | 802.11a 20 PK | Frequency(MHz): | 5700 |
| Polarity: | Horizontal | Test Voltage: | DC 3.3 V |

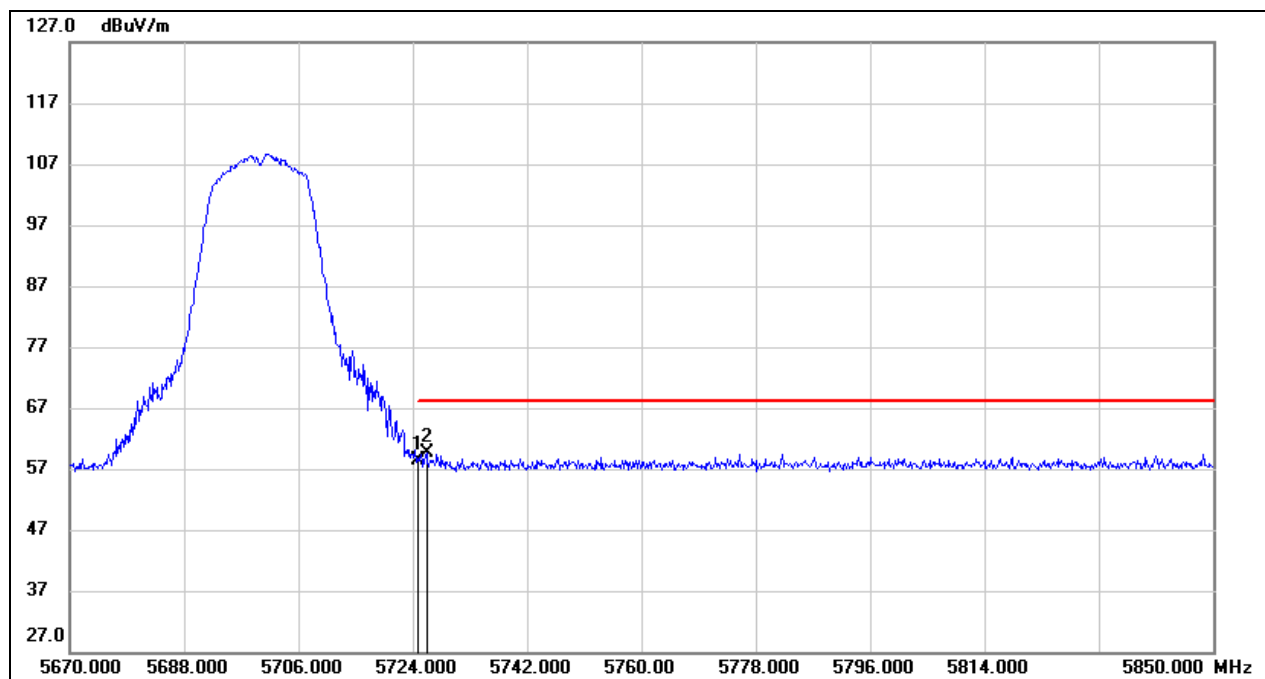

| No. | Frequency (MHz) | Reading (dBuV) | Correct (dB/m) | Result (dBuV/m) | Limit (dBuV/m) | Margin (dB) | Remark |
|-----|-----------------|----------------|----------------|-----------------|----------------|-------------|--------|
| 1 | 5725.000 | 16.99 | 41.27 | 58.26 | 68.20 | -9.94 | peak |
| 2 | 5726.160 | 18.38 | 41.27 | 59.65 | 68.20 | -8.55 | peak |

| | | | |
|------------|---------------|-----------------|----------|
| Test Mode: | 802.11a 20 PK | Frequency(MHz): | 5745 |
| Polarity: | Horizontal | Test Voltage: | DC 3.3 V |

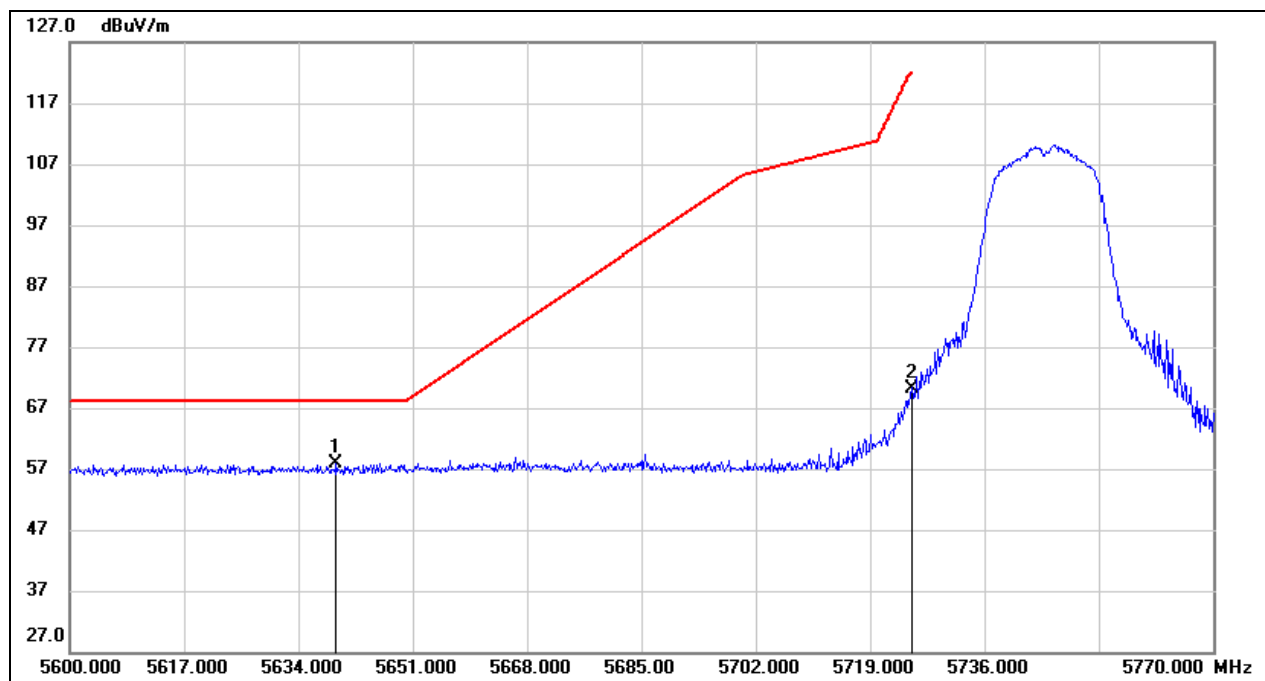

| No. | Frequency (MHz) | Reading (dBuV) | Correct (dB/m) | Result (dBuV/m) | Limit (dBuV/m) | Margin (dB) | Remark |
|-----|-----------------|----------------|----------------|-----------------|----------------|-------------|--------|
| 1 | 5639.610 | 16.80 | 41.03 | 57.83 | 68.20 | -10.37 | peak |
| 2 | 5725.000 | 28.98 | 41.27 | 70.25 | 122.20 | -51.95 | peak |

| | | | |
|------------|---------------|-----------------|----------|
| Test Mode: | 802.11a 20 PK | Frequency(MHz): | 5825 |
| Polarity: | Horizontal | Test Voltage: | DC 3.3 V |

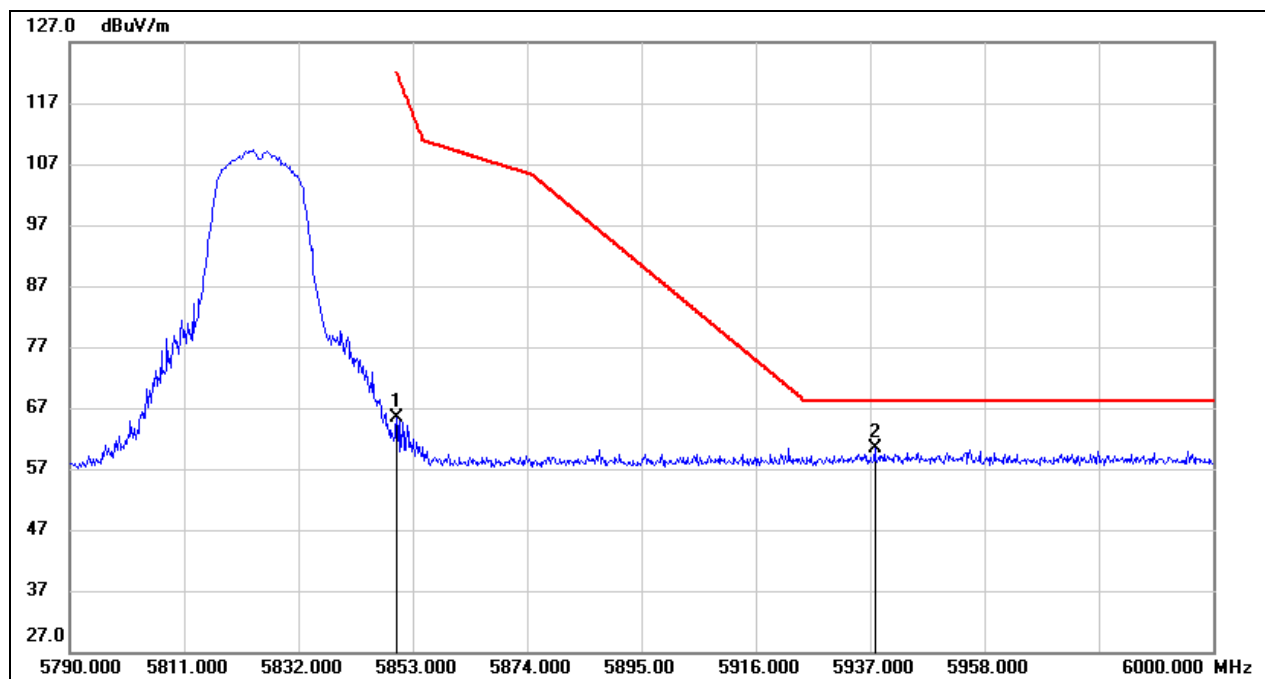

| No. | Frequency (MHz) | Reading (dBuV) | Correct (dB/m) | Result (dBuV/m) | Limit (dBuV/m) | Margin (dB) | Remark |
|-----|-----------------|----------------|----------------|-----------------|----------------|-------------|--------|
| 1 | 5850.000 | 23.75 | 41.60 | 65.35 | 122.20 | -56.85 | peak |
| 2 | 5937.840 | 18.51 | 41.84 | 60.35 | 68.20 | -7.85 | peak |

| | | | |
|------------|-----------------|-----------------|----------|
| Test Mode: | 802.11n HT20 PK | Frequency(MHz): | 5180 |
| Polarity: | Horizontal | Test Voltage: | DC 3.3 V |

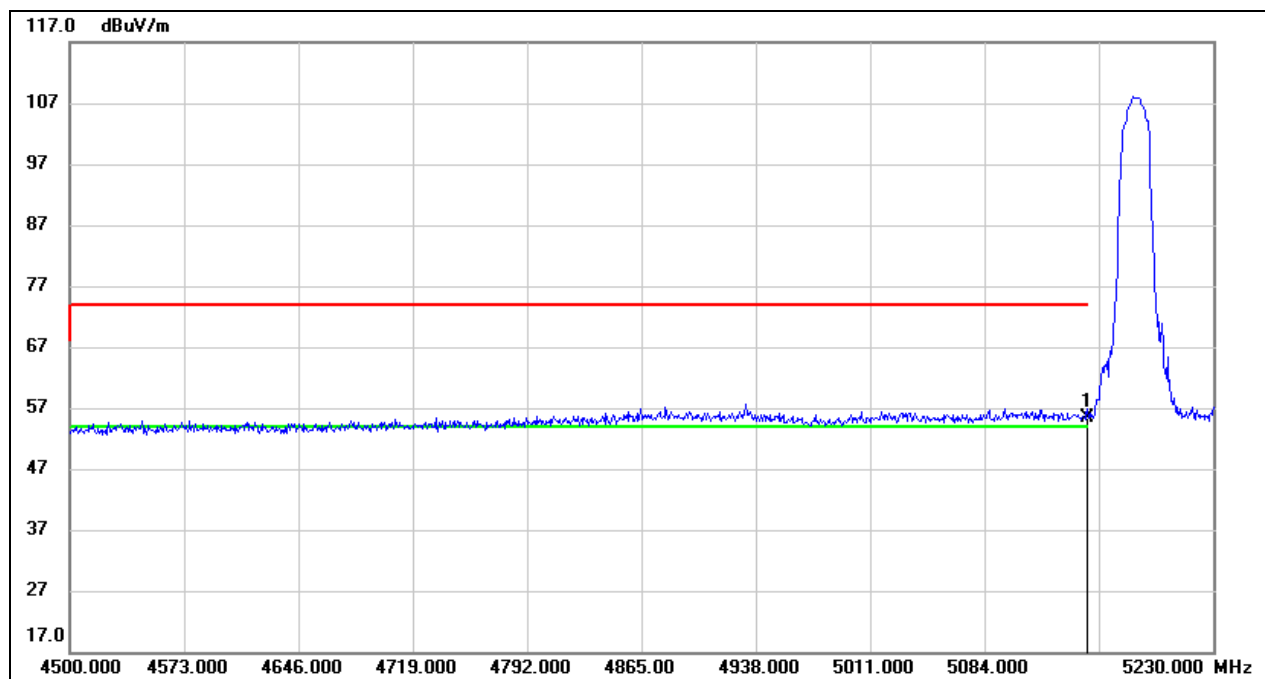

| No. | Frequency (MHz) | Reading (dBuV) | Correct (dB/m) | Result (dBuV/m) | Limit (dBuV/m) | Margin (dB) | Remark |
|-----|-----------------|----------------|----------------|-----------------|----------------|-------------|--------|
| 1 | 5150.000 | 15.00 | 40.27 | 55.27 | 74.00 | -18.73 | peak |

| | | | |
|------------|-----------------|-----------------|----------|
| Test Mode: | 802.11n HT20 AV | Frequency(MHz): | 5180 |
| Polarity: | Horizontal | Test Voltage: | DC 3.3 V |

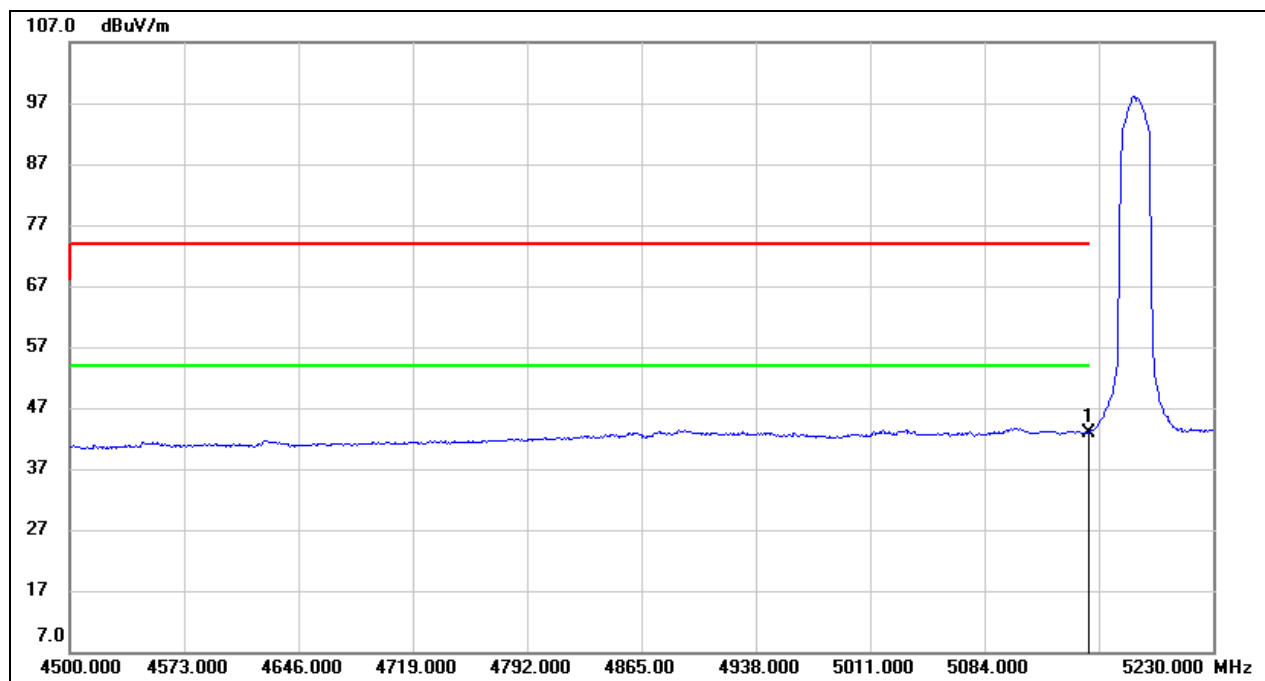

| No. | Frequency (MHz) | Reading (dBuV) | Correct (dB/m) | Result (dBuV/m) | Limit (dBuV/m) | Margin (dB) | Remark |
|-----|-----------------|----------------|----------------|-----------------|----------------|-------------|--------|
| 1 | 5150.000 | 2.73 | 40.27 | 43.00 | 54.00 | -11.00 | AVG |

| | | | |
|------------|-----------------|-----------------|----------|
| Test Mode: | 802.11n HT20 PK | Frequency(MHz): | 5240 |
| Polarity: | Horizontal | Test Voltage: | DC 3.3 V |

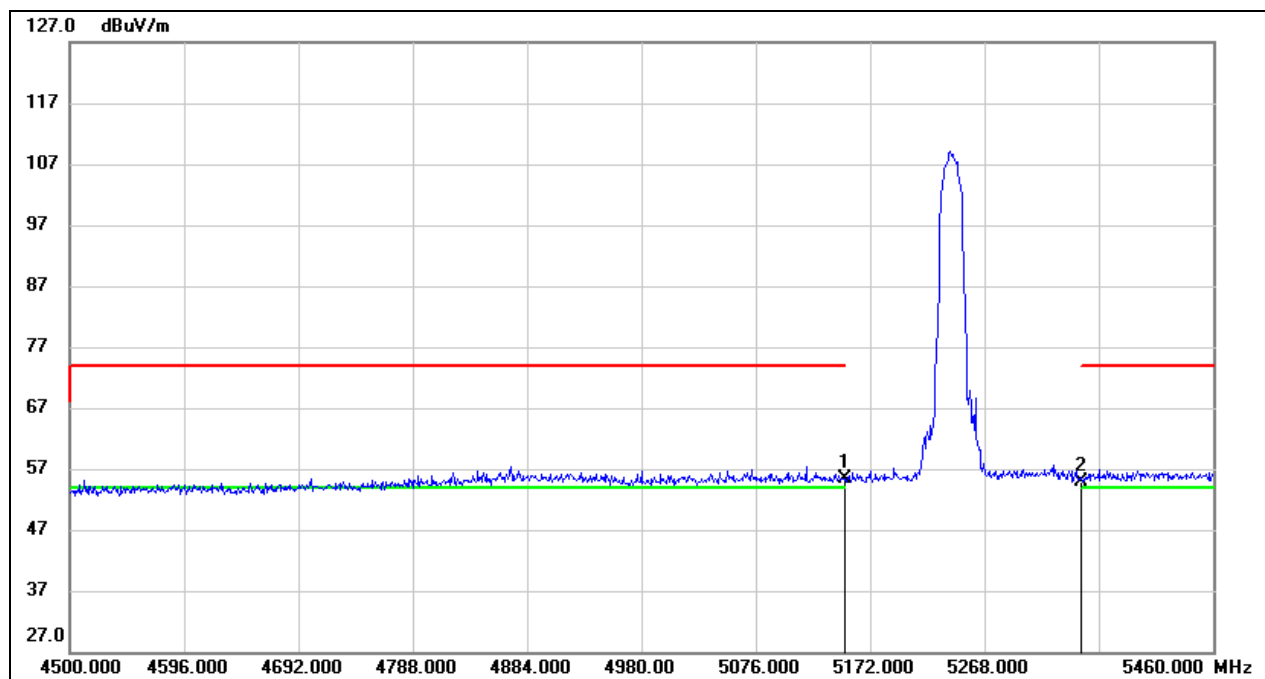

| No. | Frequency (MHz) | Reading (dBuV) | Correct (dB/m) | Result (dBuV/m) | Limit (dBuV/m) | Margin (dB) | Remark |
|-----|-----------------|----------------|----------------|-----------------|----------------|-------------|--------|
| 1 | 5150.000 | 15.11 | 40.27 | 55.38 | 74.00 | -18.62 | peak |
| 2 | 5350.000 | 14.35 | 40.49 | 54.84 | 74.00 | -19.16 | peak |

| | | | |
|------------|-----------------|-----------------|----------|
| Test Mode: | 802.11n HT20 AV | Frequency(MHz): | 5240 |
| Polarity: | Horizontal | Test Voltage: | DC 3.3 V |

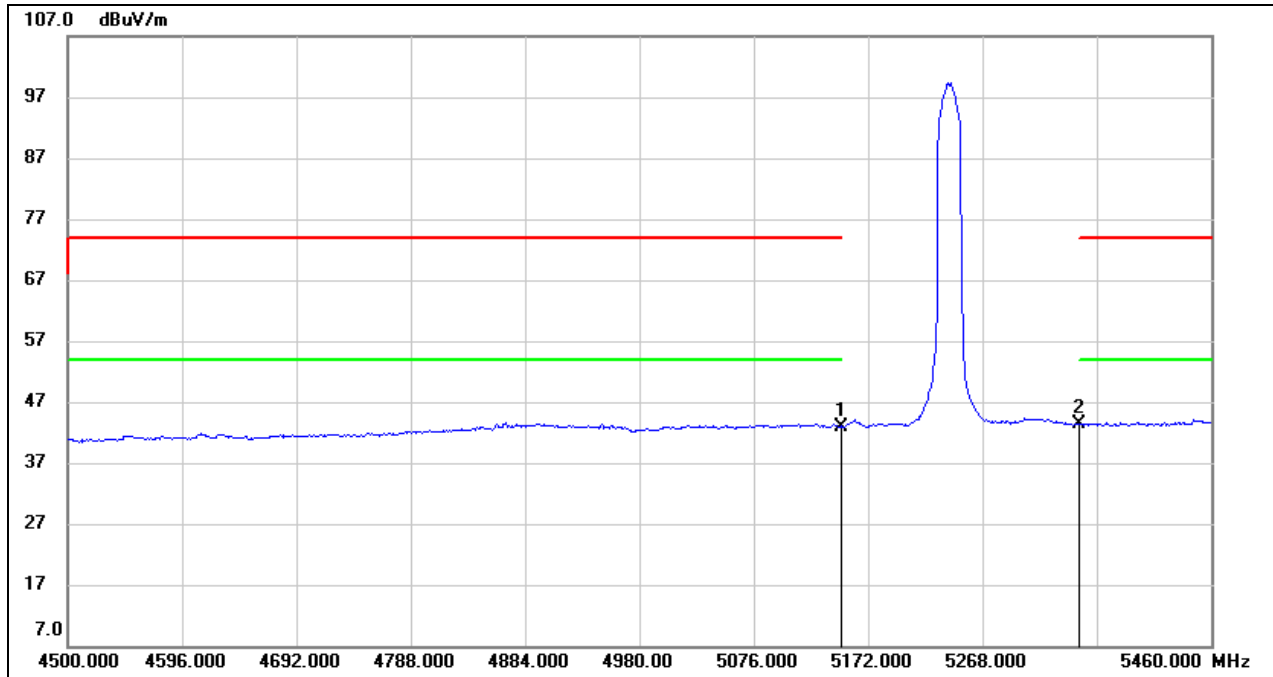

| No. | Frequency (MHz) | Reading (dBuV) | Correct (dB/m) | Result (dBuV/m) | Limit (dBuV/m) | Margin (dB) | Remark |
|-----|-----------------|----------------|----------------|-----------------|----------------|-------------|--------|
| 1 | 5150.000 | 2.49 | 40.27 | 42.76 | 54.00 | -11.24 | AVG |
| 2 | 5350.000 | 2.85 | 40.49 | 43.34 | 54.00 | -10.66 | AVG |

| | | | |
|------------|-----------------|-----------------|----------|
| Test Mode: | 802.11n HT20 PK | Frequency(MHz): | 5260 |
| Polarity: | Horizontal | Test Voltage: | DC 3.3 V |

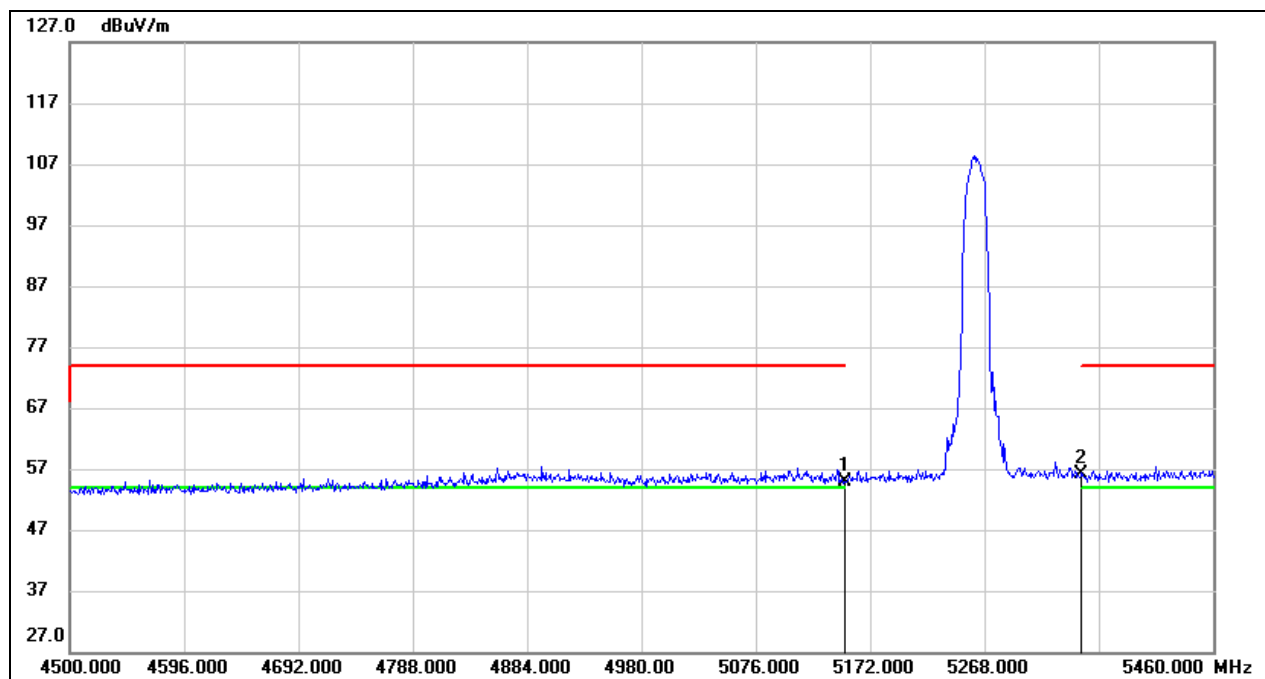

| No. | Frequency (MHz) | Reading (dBuV) | Correct (dB/m) | Result (dBuV/m) | Limit (dBuV/m) | Margin (dB) | Remark |
|-----|-----------------|----------------|----------------|-----------------|----------------|-------------|--------|
| 1 | 5150.000 | 14.71 | 40.27 | 54.98 | 74.00 | -19.02 | peak |
| 2 | 5350.000 | 15.59 | 40.49 | 56.08 | 74.00 | -17.92 | peak |

| | | | |
|------------|-----------------|-----------------|----------|
| Test Mode: | 802.11n HT20 AV | Frequency(MHz): | 5260 |
| Polarity: | Horizontal | Test Voltage: | DC 3.3 V |

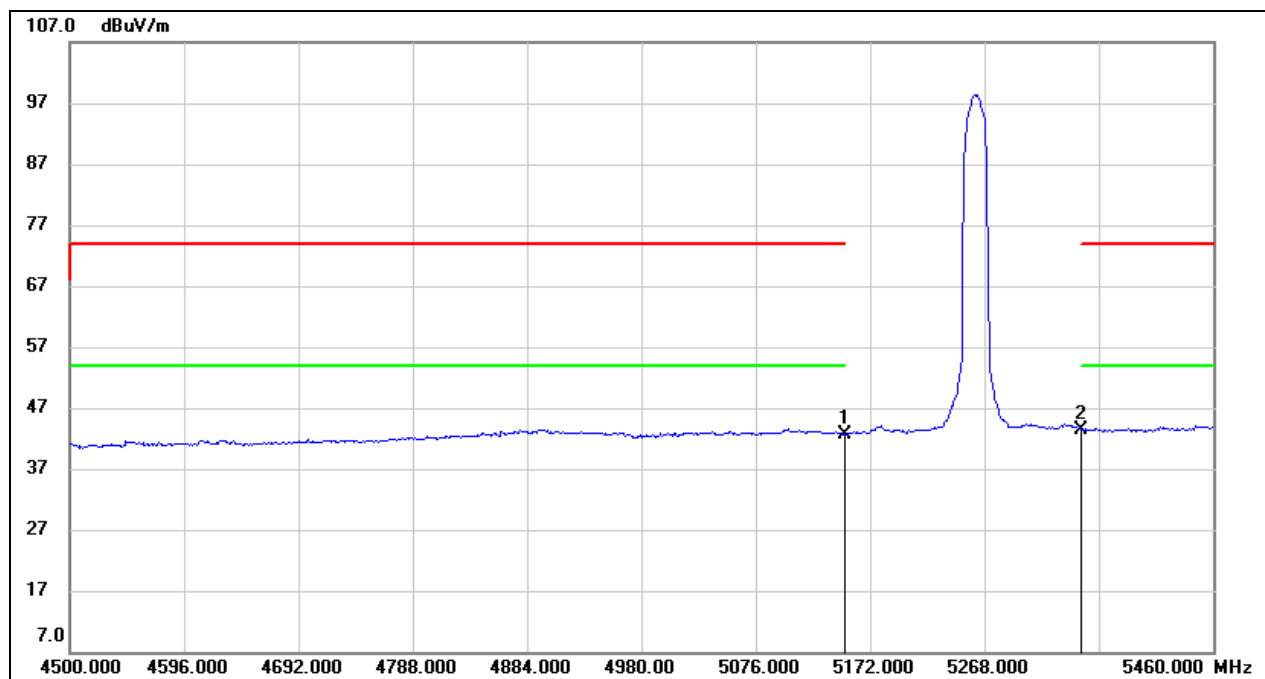

| No. | Frequency (MHz) | Reading (dBuV) | Correct (dB/m) | Result (dBuV/m) | Limit (dBuV/m) | Margin (dB) | Remark |
|-----|-----------------|----------------|----------------|-----------------|----------------|-------------|--------|
| 1 | 5150.000 | 2.45 | 40.27 | 42.72 | 54.00 | -11.28 | AVG |
| 2 | 5350.000 | 2.90 | 40.49 | 43.39 | 54.00 | -10.61 | AVG |

| | | | |
|------------|-----------------|-----------------|----------|
| Test Mode: | 802.11n HT20 PK | Frequency(MHz): | 5320 |
| Polarity: | Horizontal | Test Voltage: | DC 3.3 V |

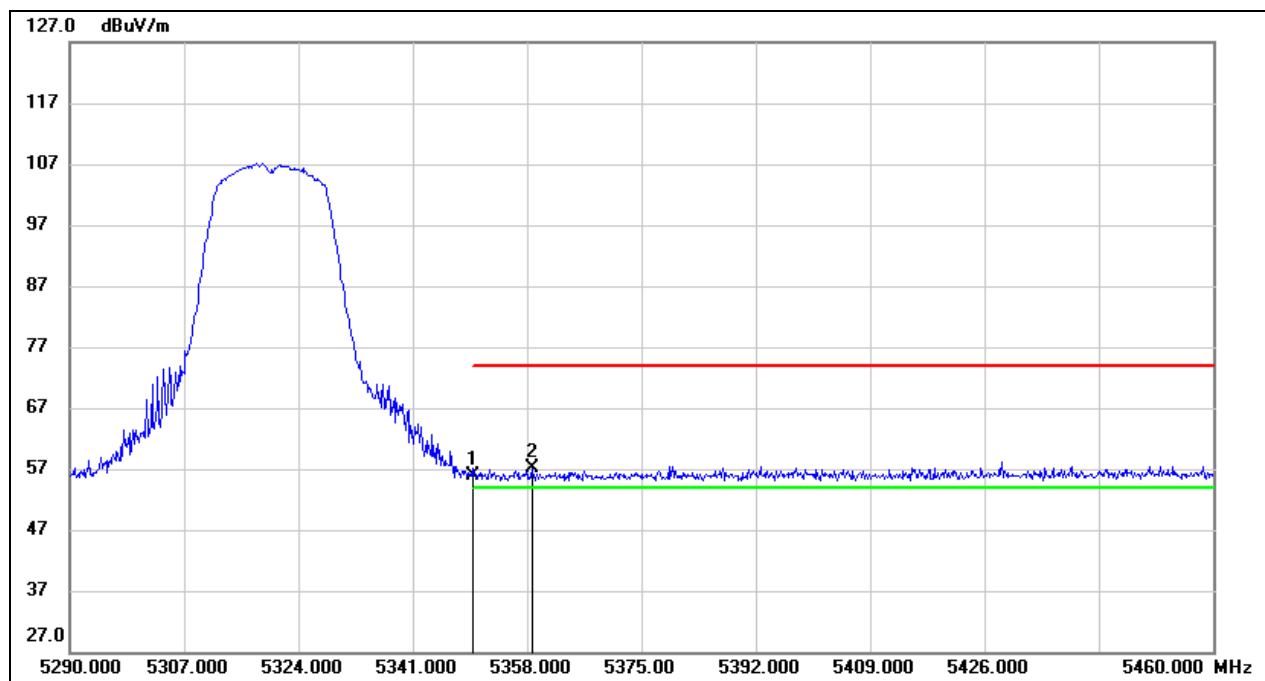

| No. | Frequency (MHz) | Reading (dBuV) | Correct (dB/m) | Result (dBuV/m) | Limit (dBuV/m) | Margin (dB) | Remark |
|-----|-----------------|----------------|----------------|-----------------|----------------|-------------|--------|
| 1 | 5350.000 | 15.39 | 40.49 | 55.88 | 74.00 | -18.12 | peak |
| 2 | 5358.680 | 16.70 | 40.51 | 57.21 | 74.00 | -16.79 | peak |

| | | | |
|------------|-----------------|-----------------|----------|
| Test Mode: | 802.11n HT20 AV | Frequency(MHz): | 5320 |
| Polarity: | Horizontal | Test Voltage: | DC 3.3 V |

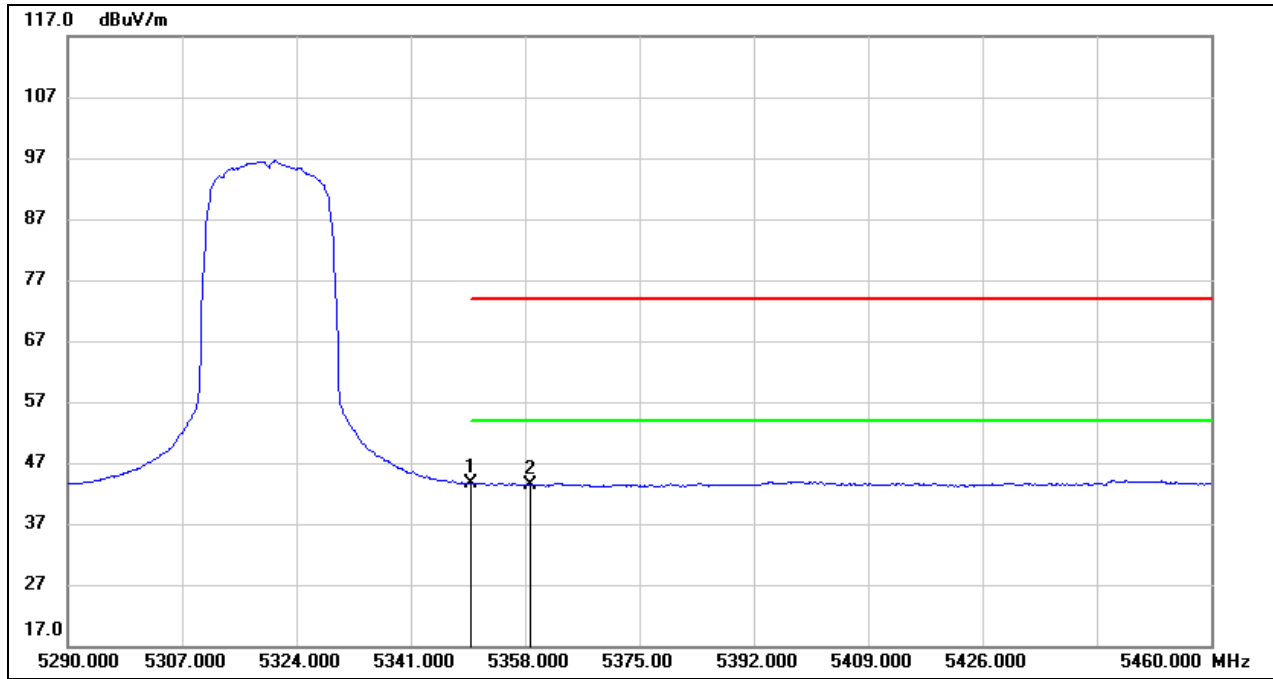

| No. | Frequency (MHz) | Reading (dBuV) | Correct (dB/m) | Result (dBuV/m) | Limit (dBuV/m) | Margin (dB) | Remark |
|-----|-----------------|----------------|----------------|-----------------|----------------|-------------|--------|
| 1 | 5350.000 | 3.17 | 40.49 | 43.66 | 54.00 | -10.34 | AVG |
| 2 | 5358.680 | 2.88 | 40.51 | 43.39 | 54.00 | -10.61 | AVG |

| | | | |
|------------|-----------------|-----------------|----------|
| Test Mode: | 802.11n HT20 PK | Frequency(MHz): | 5500 |
| Polarity: | Horizontal | Test Voltage: | DC 3.3 V |

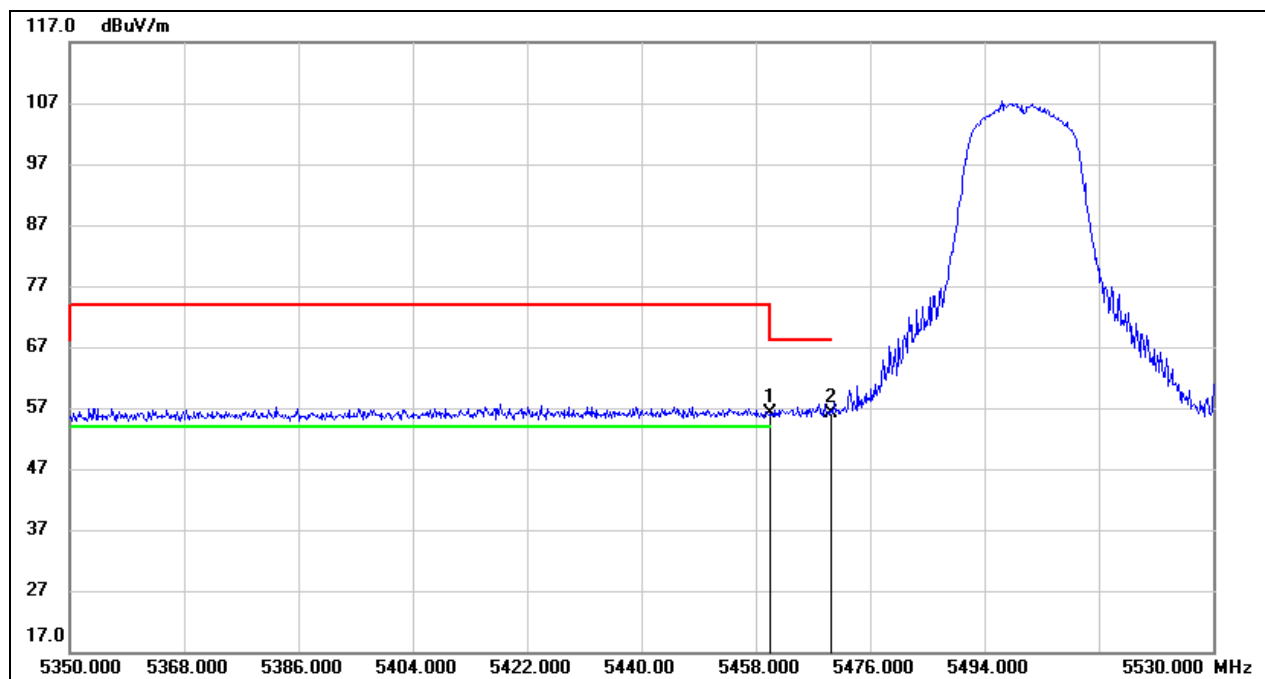

| No. | Frequency (MHz) | Reading (dBuV) | Correct (dB/m) | Result (dBuV/m) | Limit (dBuV/m) | Margin (dB) | Remark |
|-----|-----------------|----------------|----------------|-----------------|----------------|-------------|--------|
| 1 | 5460.000 | 15.55 | 40.62 | 56.17 | 74.00 | -17.83 | peak |
| 2 | 5470.000 | 15.48 | 40.63 | 56.11 | 68.20 | -12.09 | peak |

| | | | |
|------------|-----------------|-----------------|----------|
| Test Mode: | 802.11n HT20 AV | Frequency(MHz): | 5500 |
| Polarity: | Horizontal | Test Voltage: | DC 3.3 V |

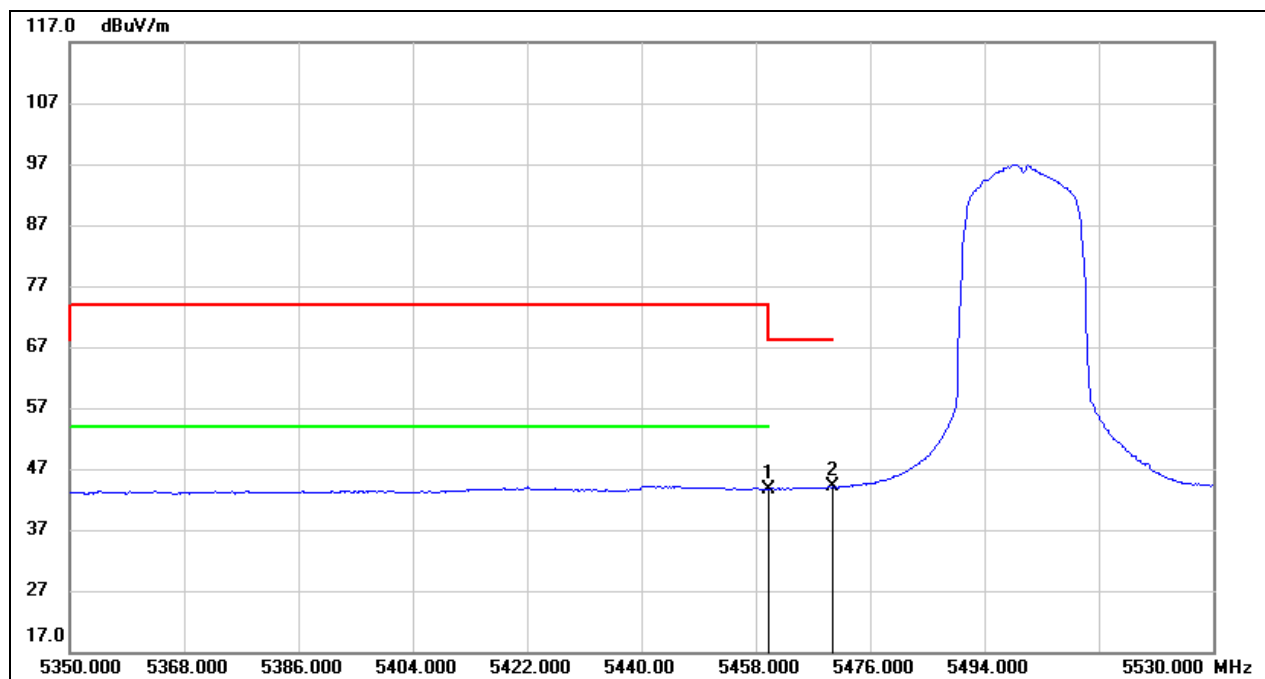

| No. | Frequency (MHz) | Reading (dBuV) | Correct (dB/m) | Result (dBuV/m) | Limit (dBuV/m) | Margin (dB) | Remark |
|-----|-----------------|----------------|----------------|-----------------|----------------|-------------|--------|
| 1 | 5460.000 | 3.07 | 40.62 | 43.69 | 54.00 | -10.31 | AVG |
| 2 | 5470.000 | 3.38 | 40.63 | 44.01 | / | / | AVG |

| | | | |
|------------|-----------------|-----------------|----------|
| Test Mode: | 802.11n HT20 PK | Frequency(MHz): | 5700 |
| Polarity: | Horizontal | Test Voltage: | DC 3.3 V |

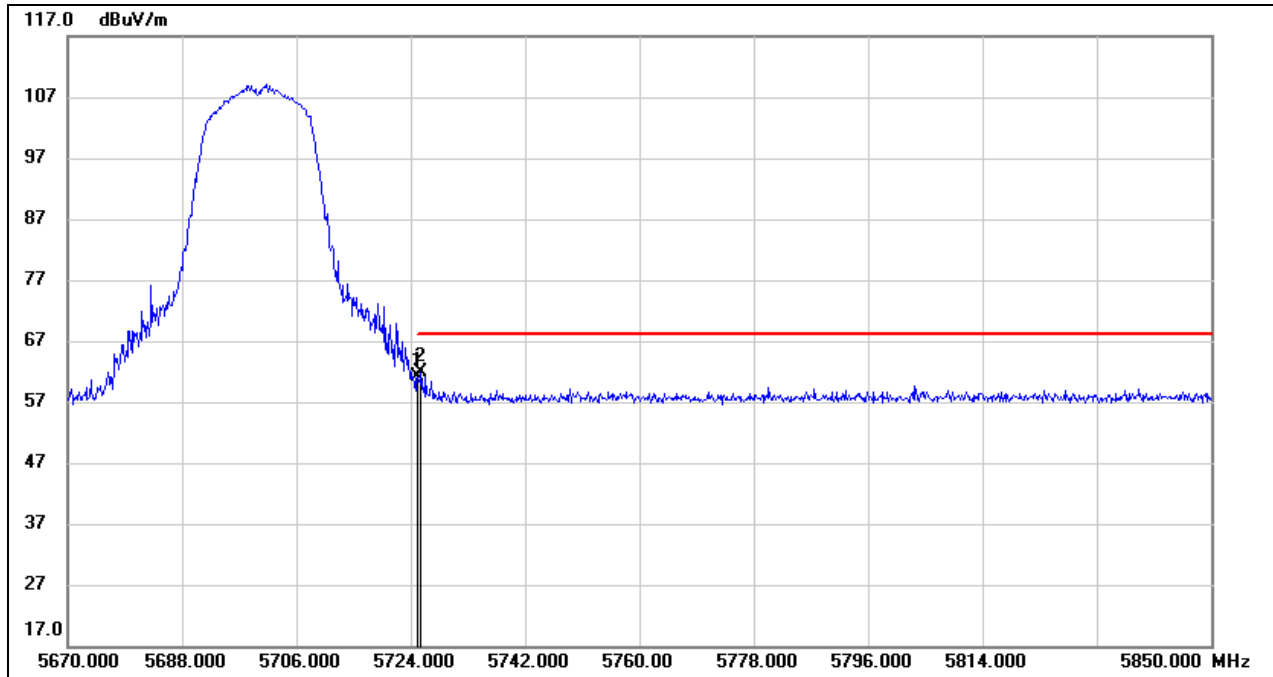

| No. | Frequency (MHz) | Reading (dBuV) | Correct (dB/m) | Result (dBuV/m) | Limit (dBuV/m) | Margin (dB) | Remark |
|-----|-----------------|----------------|----------------|-----------------|----------------|-------------|--------|
| 1 | 5725.000 | 19.89 | 41.27 | 61.16 | 68.20 | -7.04 | peak |
| 2 | 5725.620 | 20.60 | 41.27 | 61.87 | 68.20 | -6.33 | peak |

| | | | |
|------------|-----------------|-----------------|----------|
| Test Mode: | 802.11n HT20 PK | Frequency(MHz): | 5745 |
| Polarity: | Horizontal | Test Voltage: | DC 3.3 V |

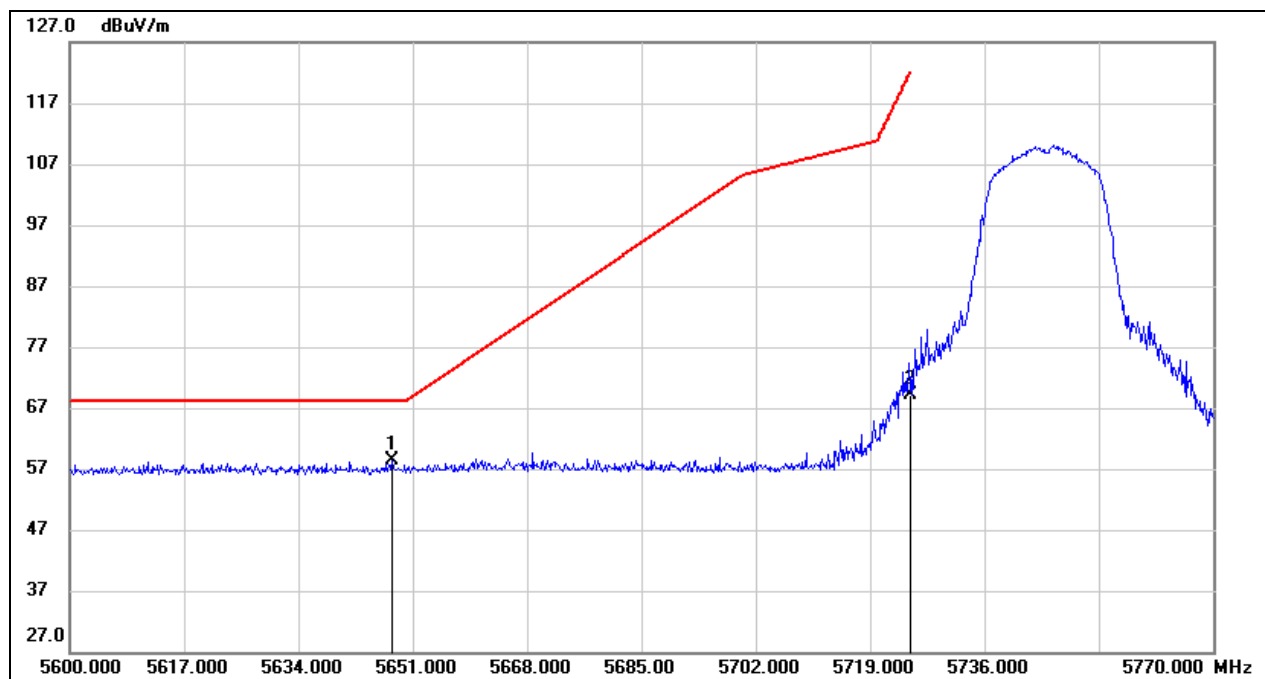

| No. | Frequency (MHz) | Reading (dBuV) | Correct (dB/m) | Result (dBuV/m) | Limit (dBuV/m) | Margin (dB) | Remark |
|-----|-----------------|----------------|----------------|-----------------|----------------|-------------|--------|
| 1 | 5647.940 | 17.28 | 41.06 | 58.34 | 68.20 | -9.86 | peak |
| 2 | 5725.000 | 27.90 | 41.27 | 69.17 | 122.20 | -53.03 | peak |

| | | | |
|------------|-----------------|-----------------|----------|
| Test Mode: | 802.11n HT20 PK | Frequency(MHz): | 5825 |
| Polarity: | Horizontal | Test Voltage: | DC 3.3 V |

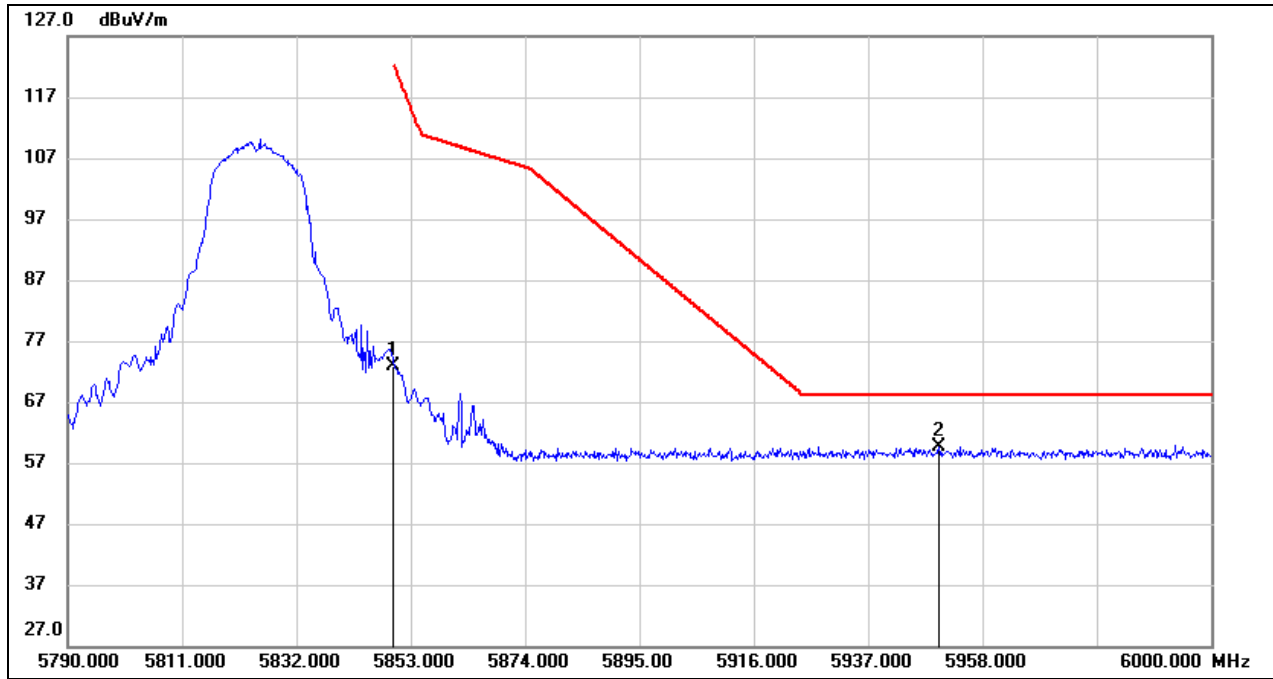

| No. | Frequency (MHz) | Reading (dBuV) | Correct (dB/m) | Result (dBuV/m) | Limit (dBuV/m) | Margin (dB) | Remark |
|-----|-----------------|----------------|----------------|-----------------|----------------|-------------|--------|
| 1 | 5850.000 | 31.33 | 41.60 | 72.93 | 122.20 | -49.27 | peak |
| 2 | 5950.020 | 17.77 | 41.87 | 59.64 | 68.20 | -8.56 | peak |

| | | | |
|------------|-----------------|-----------------|----------|
| Test Mode: | 802.11n HT40 PK | Frequency(MHz): | 5190 |
| Polarity: | Horizontal | Test Voltage: | DC 3.3 V |

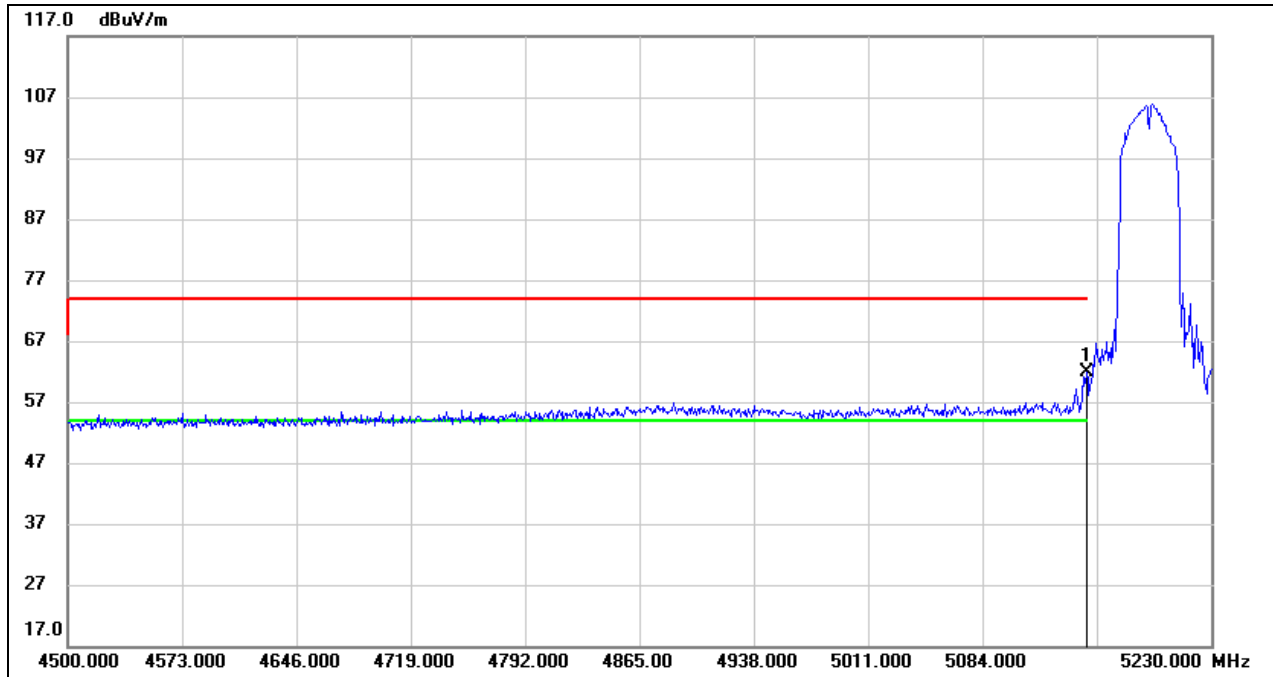

| No. | Frequency (MHz) | Reading (dBuV) | Correct (dB/m) | Result (dBuV/m) | Limit (dBuV/m) | Margin (dB) | Remark |
|-----|-----------------|----------------|----------------|-----------------|----------------|-------------|--------|
| 1 | 5150.000 | 21.73 | 40.27 | 62.00 | 74.00 | -12.00 | peak |

| | | | |
|------------|-----------------|-----------------|----------|
| Test Mode: | 802.11n HT40 AV | Frequency(MHz): | 5190 |
| Polarity: | Horizontal | Test Voltage: | DC 3.3 V |

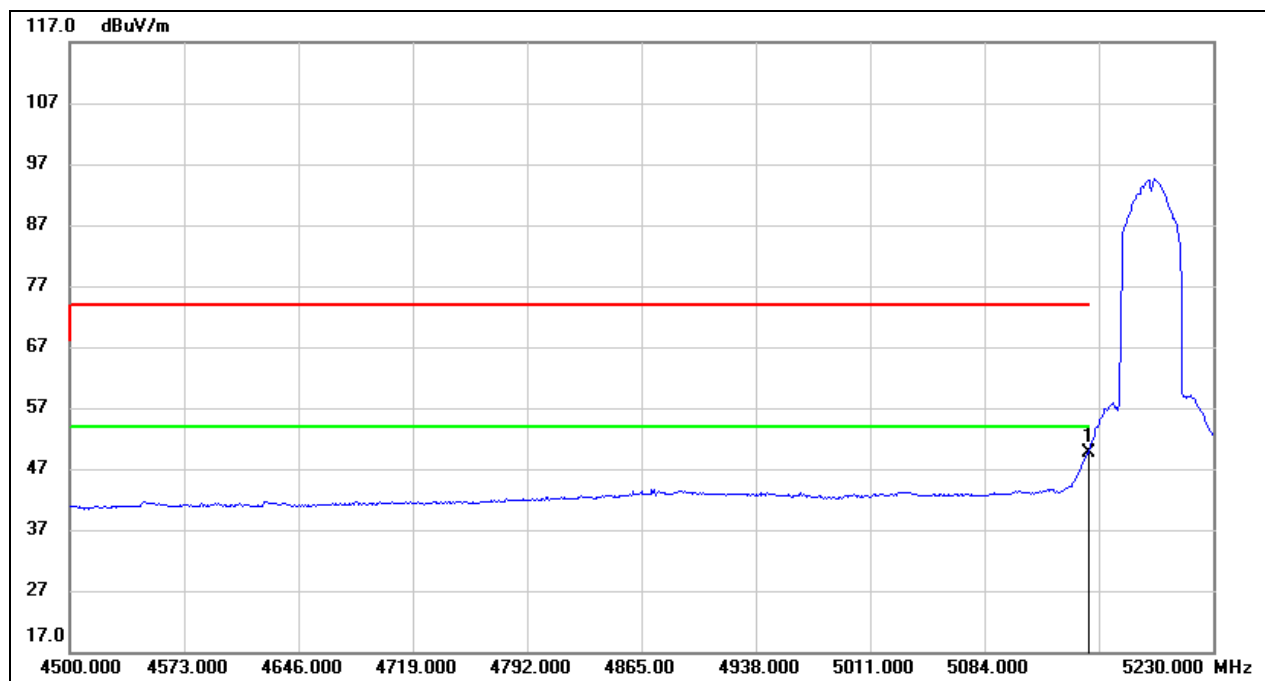

| No. | Frequency (MHz) | Reading (dBuV) | Correct (dB/m) | Result (dBuV/m) | Limit (dBuV/m) | Margin (dB) | Remark |
|-----|-----------------|----------------|----------------|-----------------|----------------|-------------|--------|
| 1 | 5150.000 | 9.44 | 40.27 | 49.71 | 54.00 | -4.29 | AVG |

| | | | |
|------------|-----------------|-----------------|----------|
| Test Mode: | 802.11n HT40 PK | Frequency(MHz): | 5230 |
| Polarity: | Horizontal | Test Voltage: | DC 3.3 V |

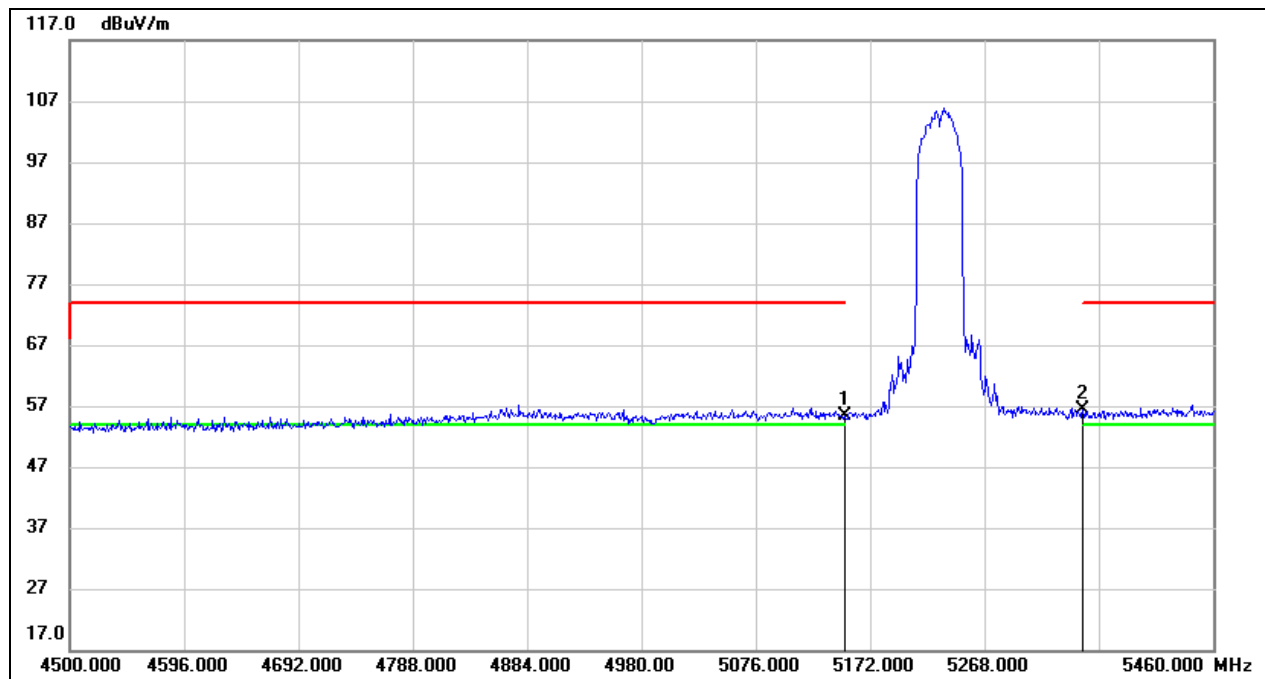

| No. | Frequency (MHz) | Reading (dBuV) | Correct (dB/m) | Result (dBuV/m) | Limit (dBuV/m) | Margin (dB) | Remark |
|-----|-----------------|----------------|----------------|-----------------|----------------|-------------|--------|
| 1 | 5150.000 | 15.20 | 40.27 | 55.47 | 74.00 | -18.53 | peak |
| 2 | 5350.000 | 15.77 | 40.49 | 56.26 | 74.00 | -17.74 | peak |

| | | | |
|------------|-----------------|-----------------|----------|
| Test Mode: | 802.11n HT40 AV | Frequency(MHz): | 5230 |
| Polarity: | Horizontal | Test Voltage: | DC 3.3 V |

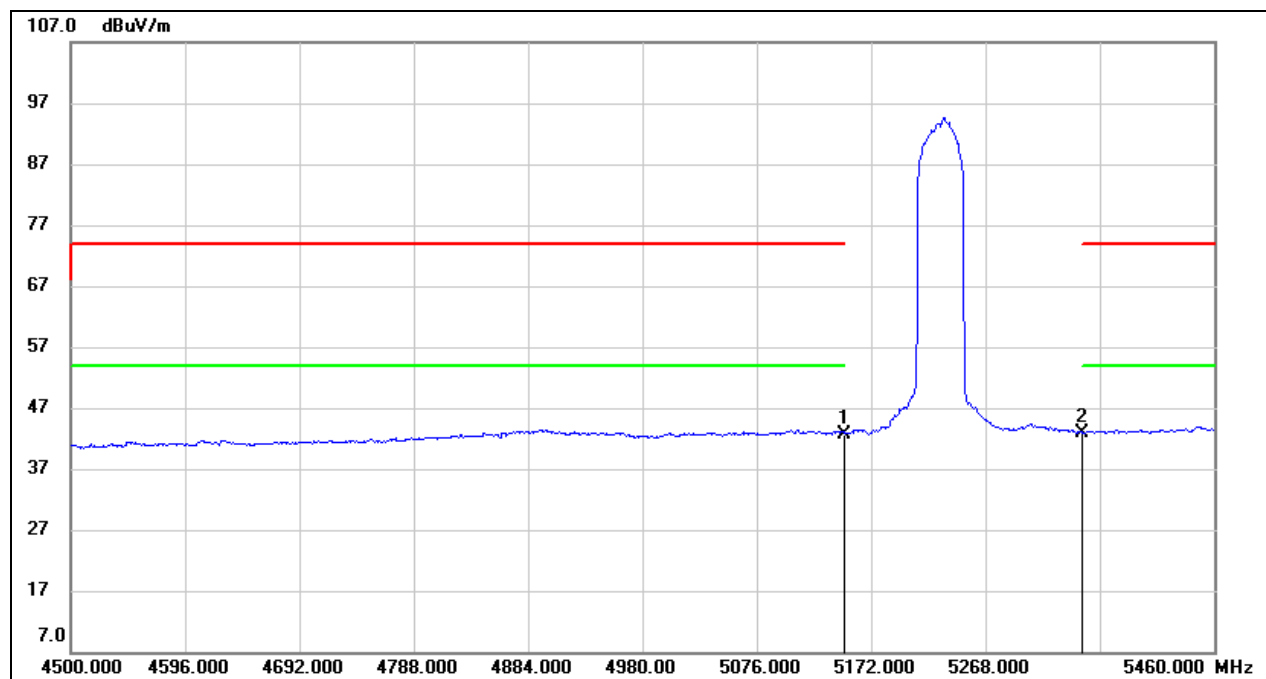

| No. | Frequency (MHz) | Reading (dBuV) | Correct (dB/m) | Result (dBuV/m) | Limit (dBuV/m) | Margin (dB) | Remark |
|-----|-----------------|----------------|----------------|-----------------|----------------|-------------|--------|
| 1 | 5150.000 | 2.48 | 40.27 | 42.75 | 54.00 | -11.25 | AVG |
| 2 | 5350.000 | 2.46 | 40.49 | 42.95 | 54.00 | -11.05 | AVG |

| | | | |
|------------|-----------------|-----------------|----------|
| Test Mode: | 802.11n HT40 PK | Frequency(MHz): | 5270 |
| Polarity: | Horizontal | Test Voltage: | DC 3.3 V |

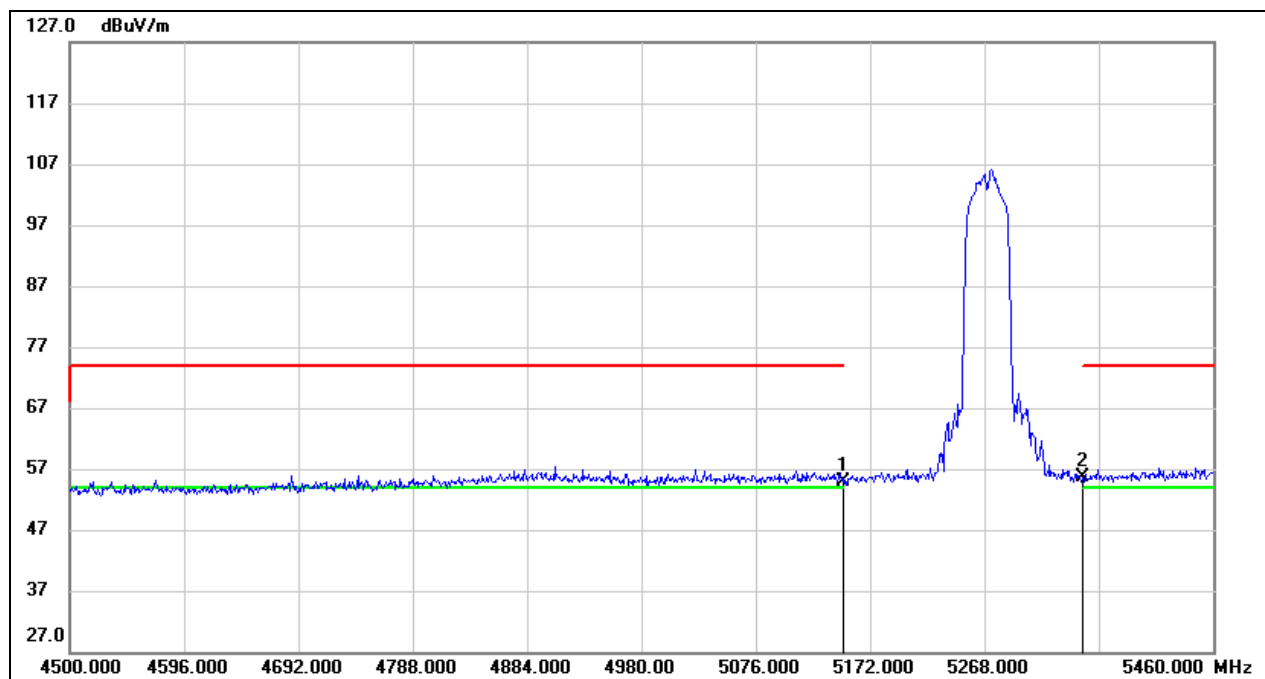

| No. | Frequency (MHz) | Reading (dBuV) | Correct (dB/m) | Result (dBuV/m) | Limit (dBuV/m) | Margin (dB) | Remark |
|-----|-----------------|----------------|----------------|-----------------|----------------|-------------|--------|
| 1 | 5150.000 | 14.57 | 40.27 | 54.84 | 74.00 | -19.16 | peak |
| 2 | 5350.000 | 15.04 | 40.49 | 55.53 | 74.00 | -18.47 | peak |

| | | | |
|------------|-----------------|-----------------|----------|
| Test Mode: | 802.11n HT40 AV | Frequency(MHz): | 5270 |
| Polarity: | Horizontal | Test Voltage: | DC 3.3 V |

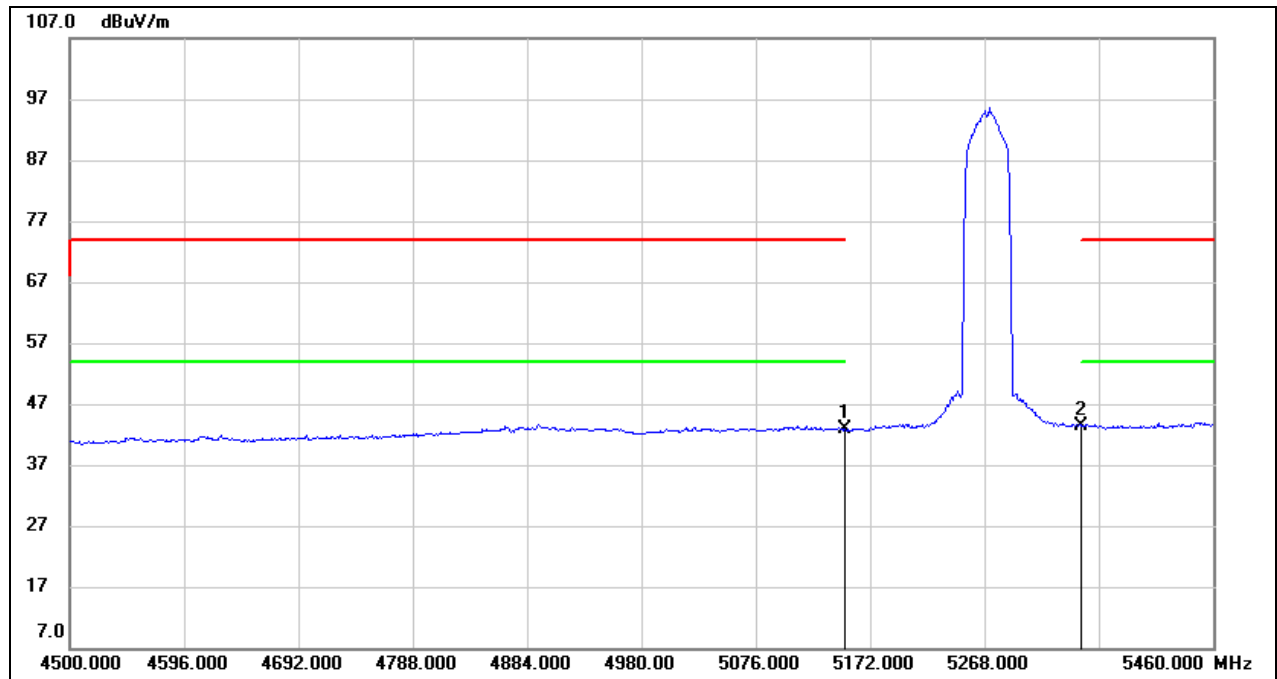

| No. | Frequency (MHz) | Reading (dBuV) | Correct (dB/m) | Result (dBuV/m) | Limit (dBuV/m) | Margin (dB) | Remark |
|-----|-----------------|----------------|----------------|-----------------|----------------|-------------|--------|
| 1 | 5150.000 | 2.53 | 40.27 | 42.80 | 54.00 | -11.20 | AVG |
| 2 | 5350.000 | 2.87 | 40.49 | 43.36 | 54.00 | -10.64 | AVG |

| | | | |
|------------|-----------------|-----------------|----------|
| Test Mode: | 802.11n HT40 PK | Frequency(MHz): | 5310 |
| Polarity: | Horizontal | Test Voltage: | DC 3.3 V |

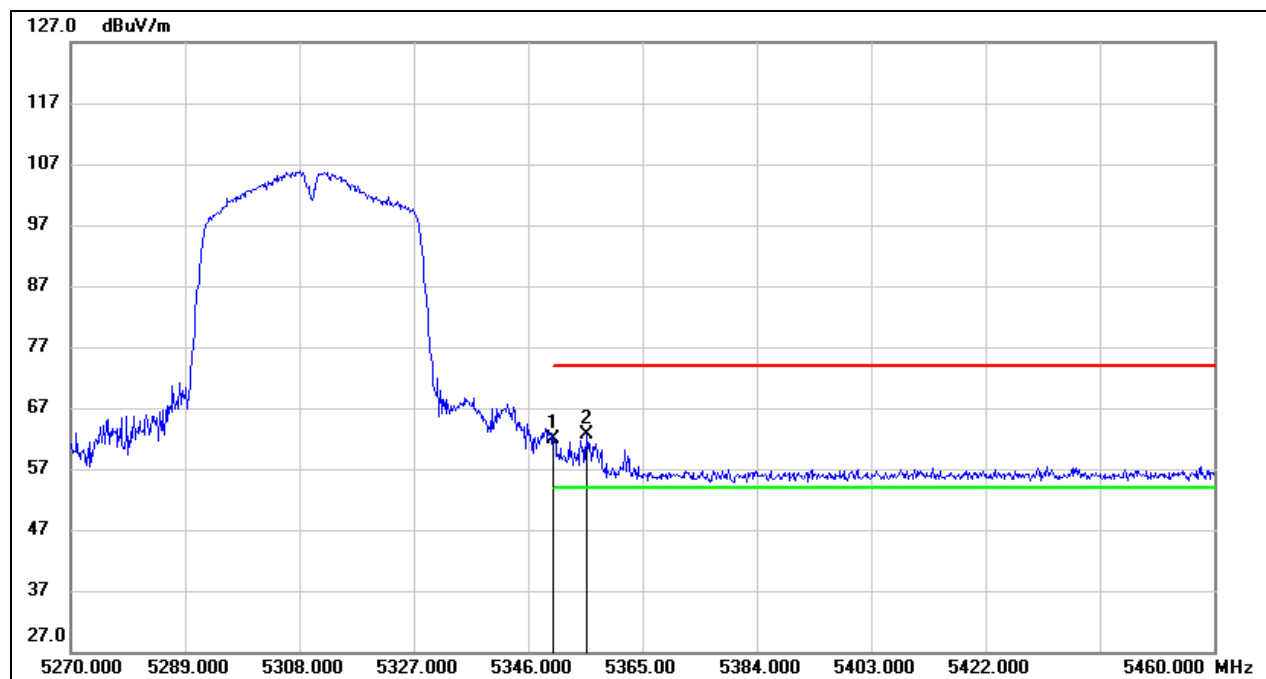

| No. | Frequency (MHz) | Reading (dBuV) | Correct (dB/m) | Result (dBuV/m) | Limit (dBuV/m) | Margin (dB) | Remark |
|-----|-----------------|----------------|----------------|-----------------|----------------|-------------|--------|
| 1 | 5350.000 | 21.28 | 40.49 | 61.77 | 74.00 | -12.23 | peak |
| 2 | 5355.690 | 22.07 | 40.50 | 62.57 | 74.00 | -11.43 | peak |

| | | | |
|------------|-----------------|-----------------|----------|
| Test Mode: | 802.11n HT40 AV | Frequency(MHz): | 5310 |
| Polarity: | Horizontal | Test Voltage: | DC 3.3 V |

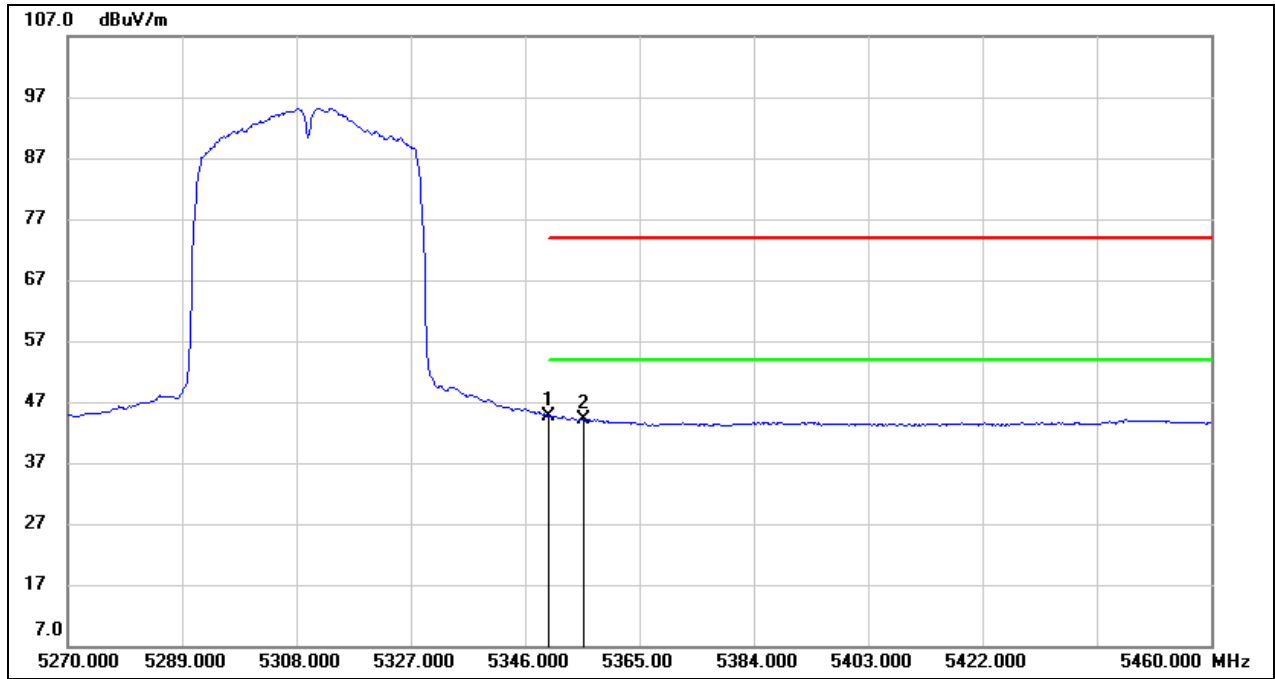

| No. | Frequency (MHz) | Reading (dBuV) | Correct (dB/m) | Result (dBuV/m) | Limit (dBuV/m) | Margin (dB) | Remark |
|-----|-----------------|----------------|----------------|-----------------|----------------|-------------|--------|
| 1 | 5350.000 | 4.19 | 40.49 | 44.68 | 54.00 | -9.32 | AVG |
| 2 | 5355.690 | 3.69 | 40.50 | 44.19 | 54.00 | -9.81 | AVG |

| | | | |
|------------|-----------------|-----------------|----------|
| Test Mode: | 802.11n HT40 PK | Frequency(MHz): | 5510 |
| Polarity: | Horizontal | Test Voltage: | DC 3.3 V |

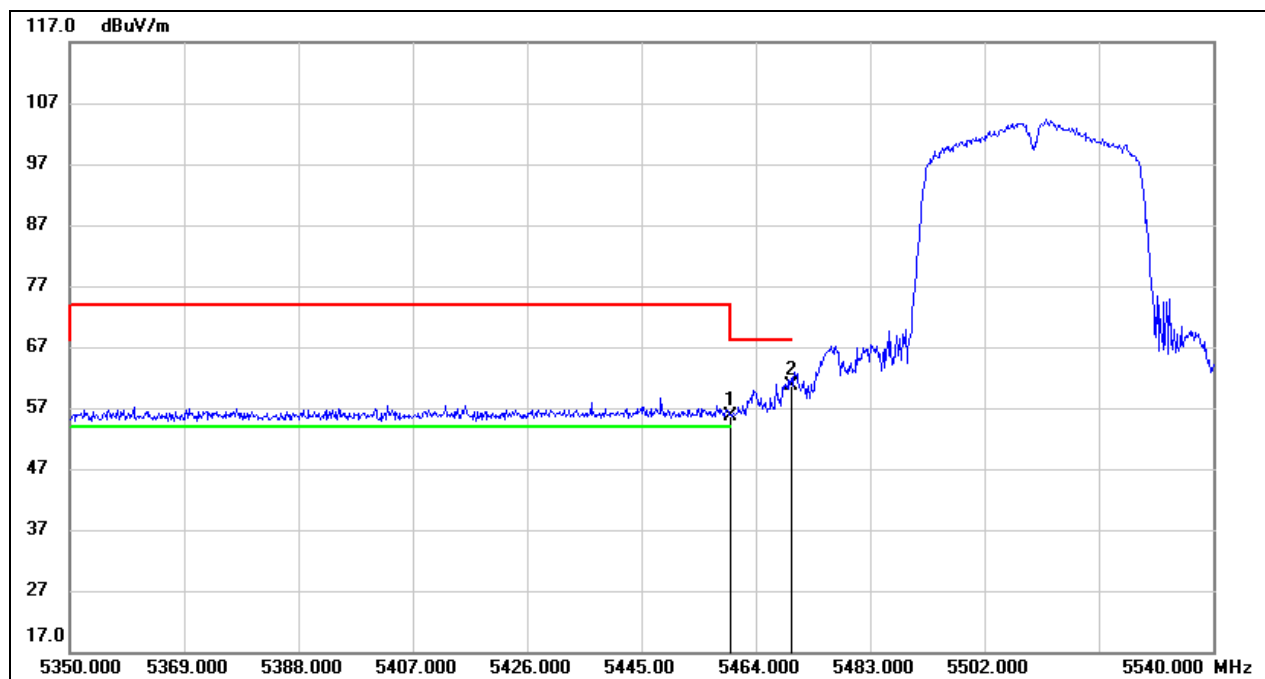

| No. | Frequency (MHz) | Reading (dBuV) | Correct (dB/m) | Result (dBuV/m) | Limit (dBuV/m) | Margin (dB) | Remark |
|-----|-----------------|----------------|----------------|-----------------|----------------|-------------|--------|
| 1 | 5460.000 | 15.10 | 40.62 | 55.72 | 74.00 | -18.28 | peak |
| 2 | 5470.000 | 20.00 | 40.63 | 60.63 | 68.20 | -7.57 | peak |

| | | | |
|------------|-----------------|-----------------|----------|
| Test Mode: | 802.11n HT40 AV | Frequency(MHz): | 5510 |
| Polarity: | Horizontal | Test Voltage: | DC 3.3 V |

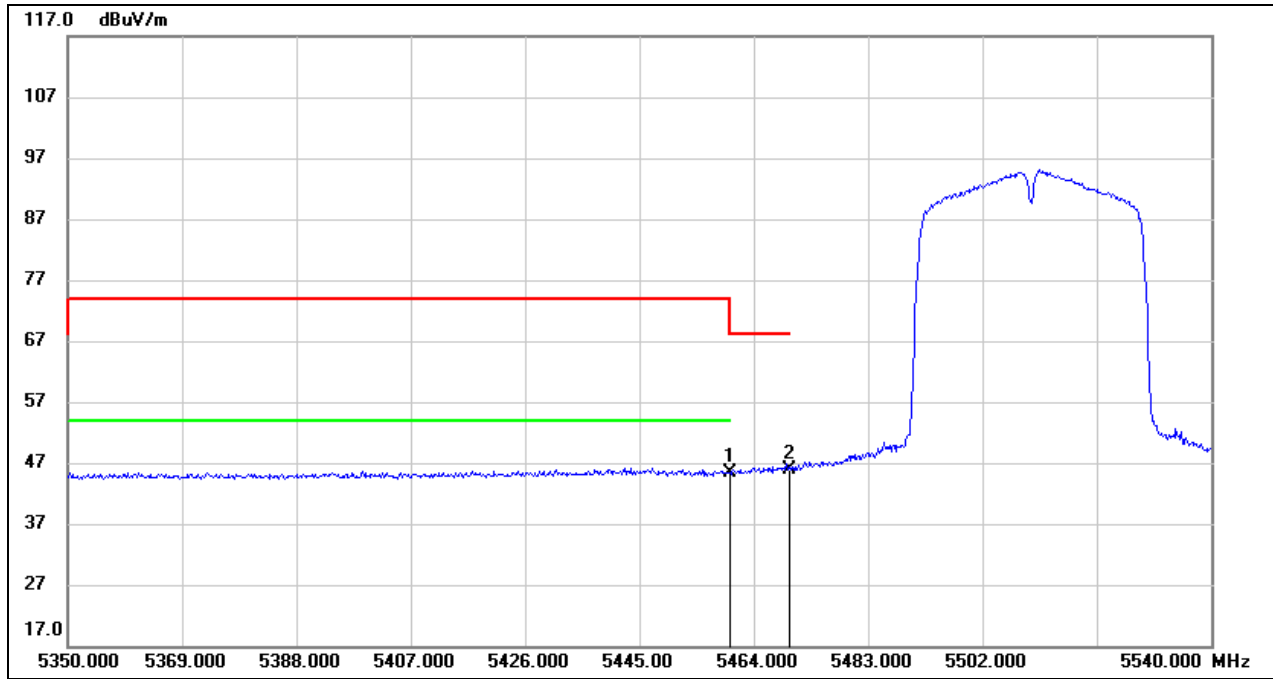

| No. | Frequency (MHz) | Reading (dBuV) | Correct (dB/m) | Result (dBuV/m) | Limit (dBuV/m) | Margin (dB) | Remark |
|-----|-----------------|----------------|----------------|-----------------|----------------|-------------|--------|
| 1 | 5460.000 | 4.70 | 40.62 | 45.32 | 54.00 | -8.68 | AVG |
| 2 | 5470.000 | 5.31 | 40.63 | 45.94 | / | / | AVG |

| | | | |
|------------|-----------------|-----------------|----------|
| Test Mode: | 802.11n HT40 PK | Frequency(MHz): | 5670 |
| Polarity: | Horizontal | Test Voltage: | DC 3.3 V |

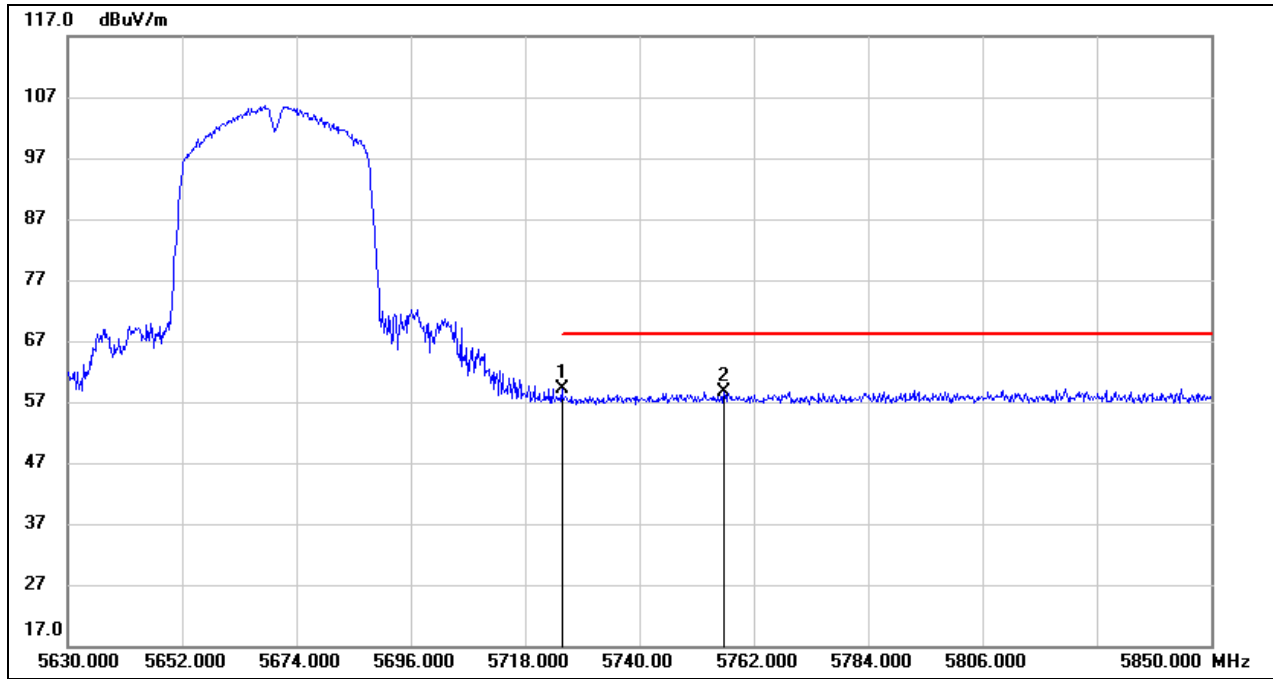

| No. | Frequency (MHz) | Reading (dBuV) | Correct (dB/m) | Result (dBuV/m) | Limit (dBuV/m) | Margin (dB) | Remark |
|-----|-----------------|----------------|----------------|-----------------|----------------|-------------|--------|
| 1 | 5725.000 | 17.83 | 41.27 | 59.10 | 68.20 | -9.10 | peak |
| 2 | 5756.280 | 17.36 | 41.35 | 58.71 | 68.20 | -9.49 | peak |

| | | | |
|------------|-----------------|-----------------|----------|
| Test Mode: | 802.11n HT40 PK | Frequency(MHz): | 5755 |
| Polarity: | Horizontal | Test Voltage: | DC 3.3 V |

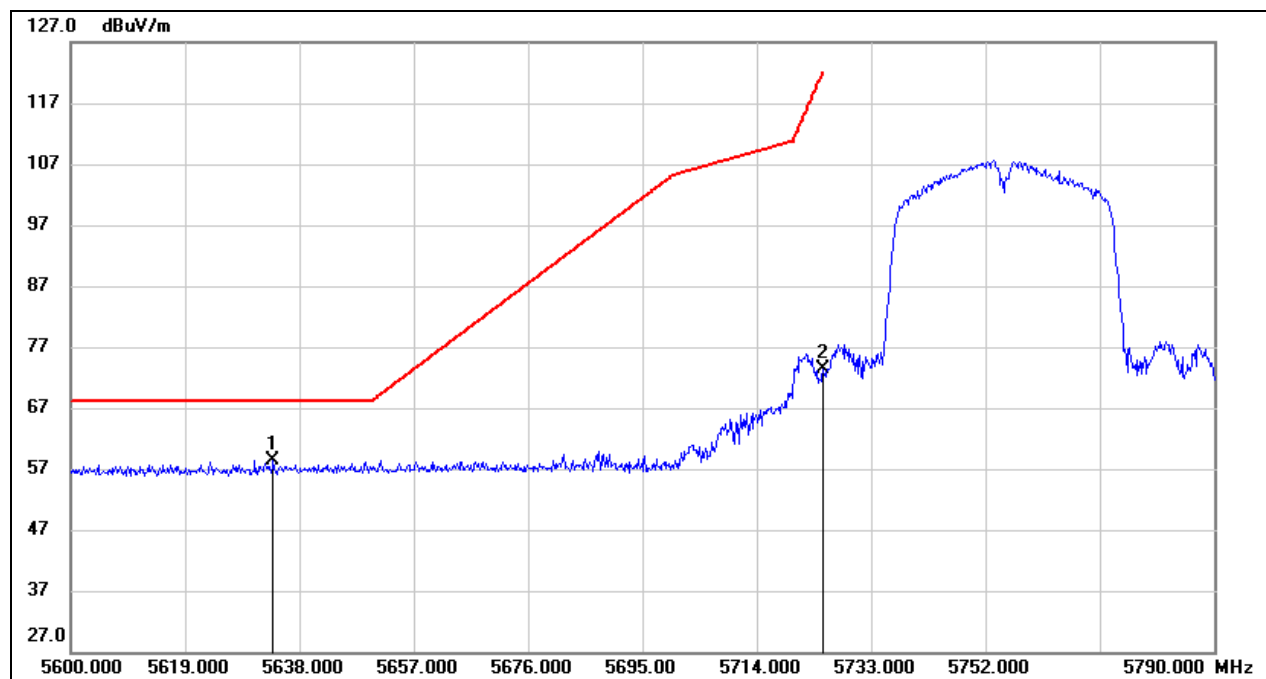

| No. | Frequency (MHz) | Reading (dBuV) | Correct (dB/m) | Result (dBuV/m) | Limit (dBuV/m) | Margin (dB) | Remark |
|-----|-----------------|----------------|----------------|-----------------|----------------|-------------|--------|
| 1 | 5633.630 | 17.32 | 41.01 | 58.33 | 68.20 | -9.87 | peak |
| 2 | 5725.000 | 32.14 | 41.27 | 73.41 | 122.20 | -48.79 | peak |

| | | | |
|------------|-----------------|-----------------|----------|
| Test Mode: | 802.11n HT40 PK | Frequency(MHz): | 5795 |
| Polarity: | Horizontal | Test Voltage: | DC 3.3 V |

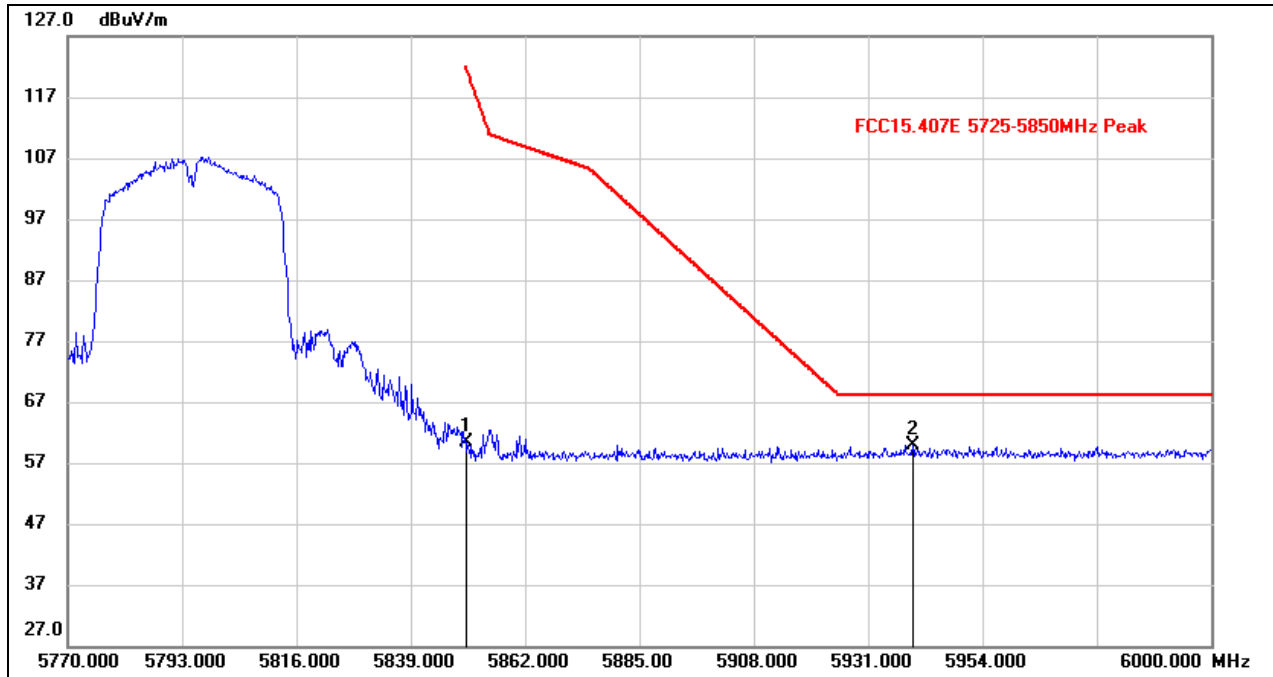

| No. | Frequency (MHz) | Reading (dBuV) | Correct (dB/m) | Result (dBuV/m) | Limit (dBuV/m) | Margin (dB) | Remark |
|-----|-----------------|----------------|----------------|-----------------|----------------|-------------|--------|
| 1 | 5850.000 | 18.88 | 41.60 | 60.48 | 122.20 | -61.72 | peak |
| 2 | 5939.970 | 17.98 | 41.84 | 59.82 | 68.20 | -8.38 | peak |

8.2. SPURIOUS EMISSIONS(1 GHZ~7 GHZ)

| | | | |
|------------|------------|-----------------|----------|
| Test Mode: | 802.11a 20 | Frequency(MHz): | 5180 |
| Polarity: | Horizontal | Test Voltage: | DC 3.3 V |

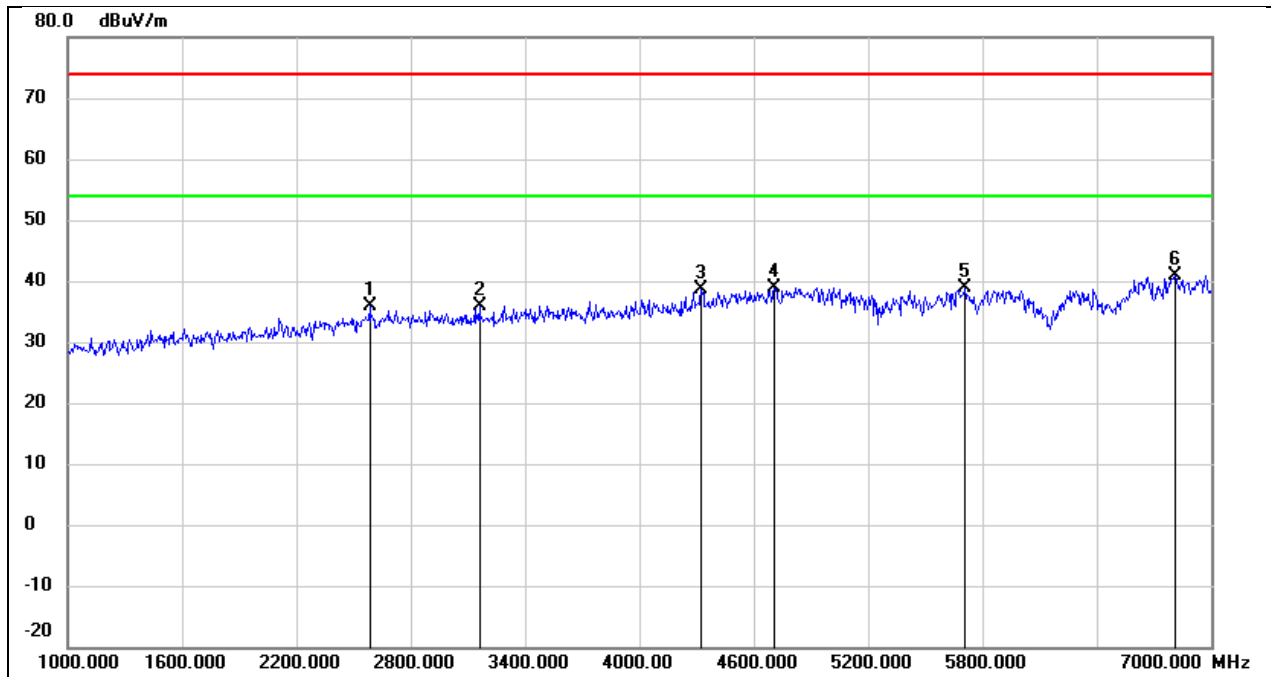

| No. | Frequency (MHz) | Reading (dBuV) | Correct (dB/m) | Result (dBuV/m) | Limit (dBuV/m) | Margin (dB) | Remark |
|-----|-----------------|----------------|----------------|-----------------|----------------|-------------|--------|
| 1 | 2584.000 | 44.07 | -8.24 | 35.83 | 74.00 | -38.17 | peak |
| 2 | 3160.000 | 42.59 | -6.61 | 35.98 | 74.00 | -38.02 | peak |
| 3 | 4324.000 | 41.62 | -2.96 | 38.66 | 74.00 | -35.34 | peak |
| 4 | 4708.000 | 40.25 | -1.31 | 38.94 | 74.00 | -35.06 | peak |
| 5 | 5710.000 | 37.76 | 1.02 | 38.78 | 74.00 | -35.22 | peak |
| 6 | 6808.000 | 35.64 | 5.24 | 40.88 | 74.00 | -33.12 | peak |

| | | | |
|------------|------------|-----------------|----------|
| Test Mode: | 802.11a 20 | Frequency(MHz): | 5180 |
| Polarity: | Vertical | Test Voltage: | DC 3.3 V |

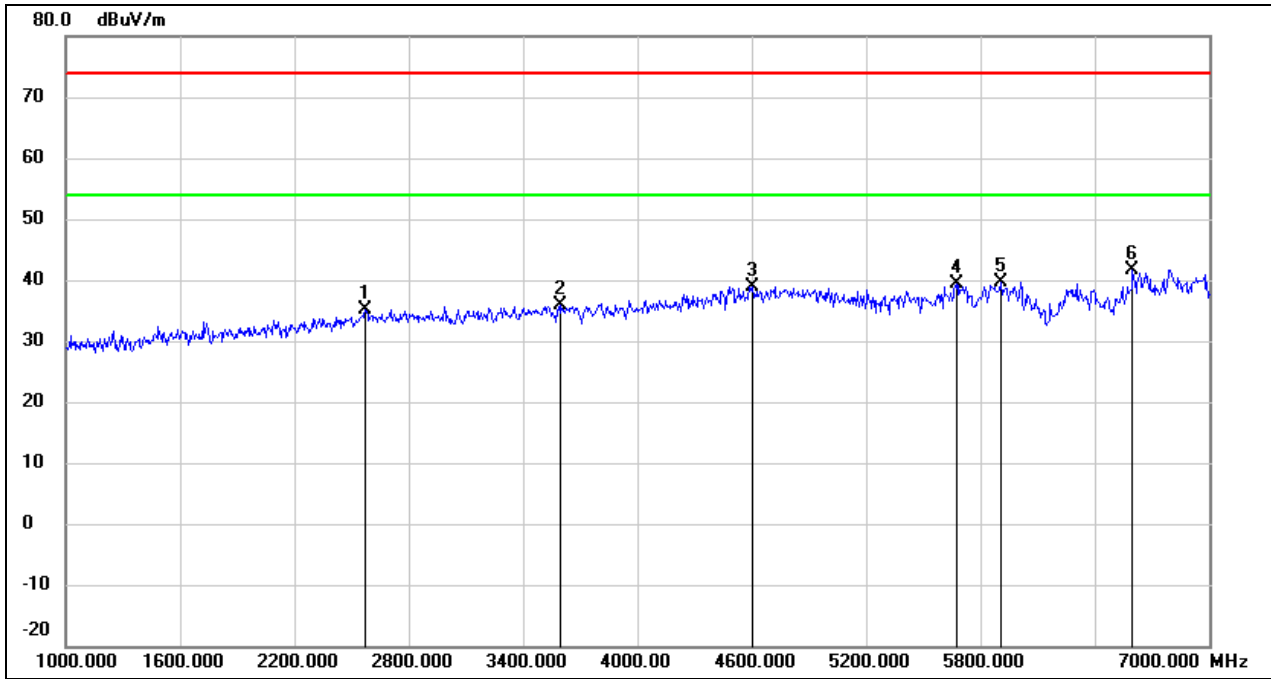

| No. | Frequency (MHz) | Reading (dBuV) | Correct (dB/m) | Result (dBuV/m) | Limit (dBuV/m) | Margin (dB) | Remark |
|-----|-----------------|----------------|----------------|-----------------|----------------|-------------|--------|
| 1 | 2572.000 | 43.35 | -8.27 | 35.08 | 74.00 | -38.92 | peak |
| 2 | 3598.000 | 41.49 | -5.58 | 35.91 | 74.00 | -38.09 | peak |
| 3 | 4606.000 | 40.72 | -1.72 | 39.00 | 74.00 | -35.00 | peak |
| 4 | 5674.000 | 38.41 | 0.92 | 39.33 | 74.00 | -34.67 | peak |
| 5 | 5908.000 | 37.96 | 1.59 | 39.55 | 74.00 | -34.45 | peak |
| 6 | 6598.000 | 37.49 | 4.21 | 41.70 | 74.00 | -32.30 | peak |

| | | | |
|------------|------------|-----------------|----------|
| Test Mode: | 802.11a 20 | Frequency(MHz): | 5200 |
| Polarity: | Horizontal | Test Voltage: | DC 3.3 V |

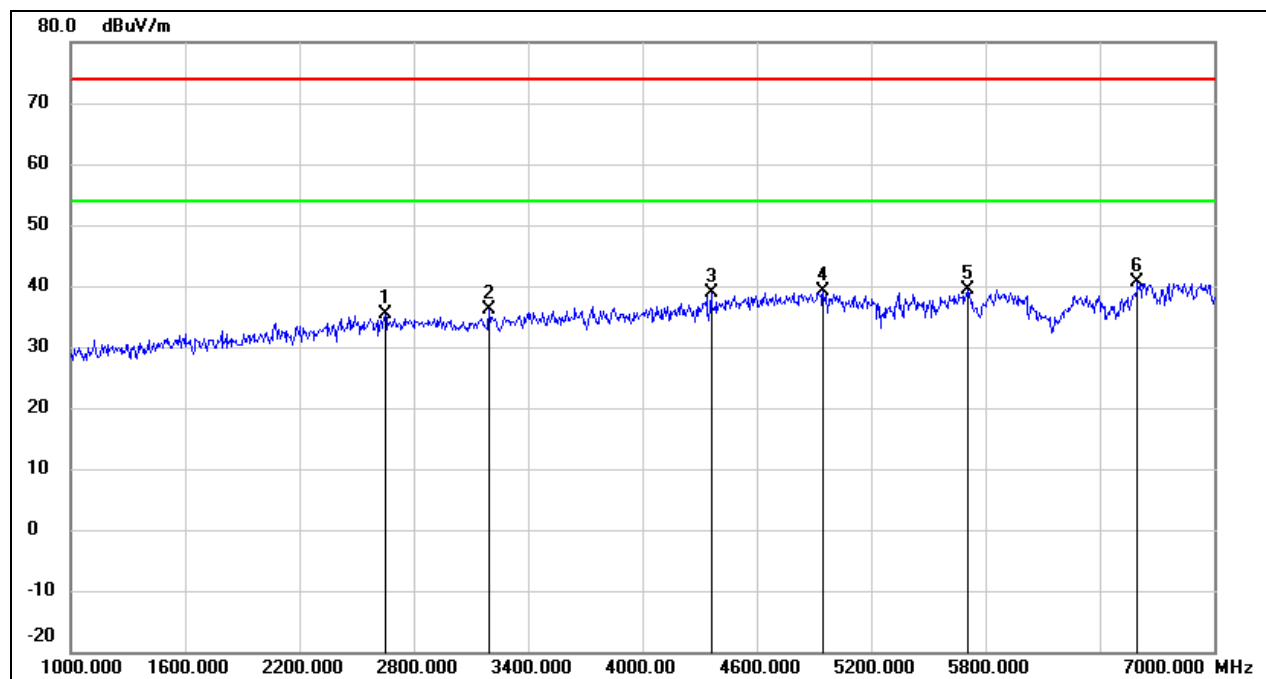

| No. | Frequency (MHz) | Reading (dBuV) | Correct (dB/m) | Result (dBuV/m) | Limit (dBuV/m) | Margin (dB) | Remark |
|-----|-----------------|----------------|----------------|-----------------|----------------|-------------|--------|
| 1 | 2650.000 | 43.48 | -8.03 | 35.45 | 74.00 | -38.55 | peak |
| 2 | 3196.000 | 42.57 | -6.54 | 36.03 | 74.00 | -37.97 | peak |
| 3 | 4360.000 | 41.57 | -2.80 | 38.77 | 74.00 | -35.23 | peak |
| 4 | 4948.000 | 39.55 | -0.36 | 39.19 | 74.00 | -34.81 | peak |
| 5 | 5704.000 | 38.44 | 1.00 | 39.44 | 74.00 | -34.56 | peak |
| 6 | 6598.000 | 36.50 | 4.21 | 40.71 | 74.00 | -33.29 | peak |

| | | | |
|------------|------------|-----------------|----------|
| Test Mode: | 802.11a 20 | Frequency(MHz): | 5200 |
| Polarity: | Vertical | Test Voltage: | DC 3.3 V |

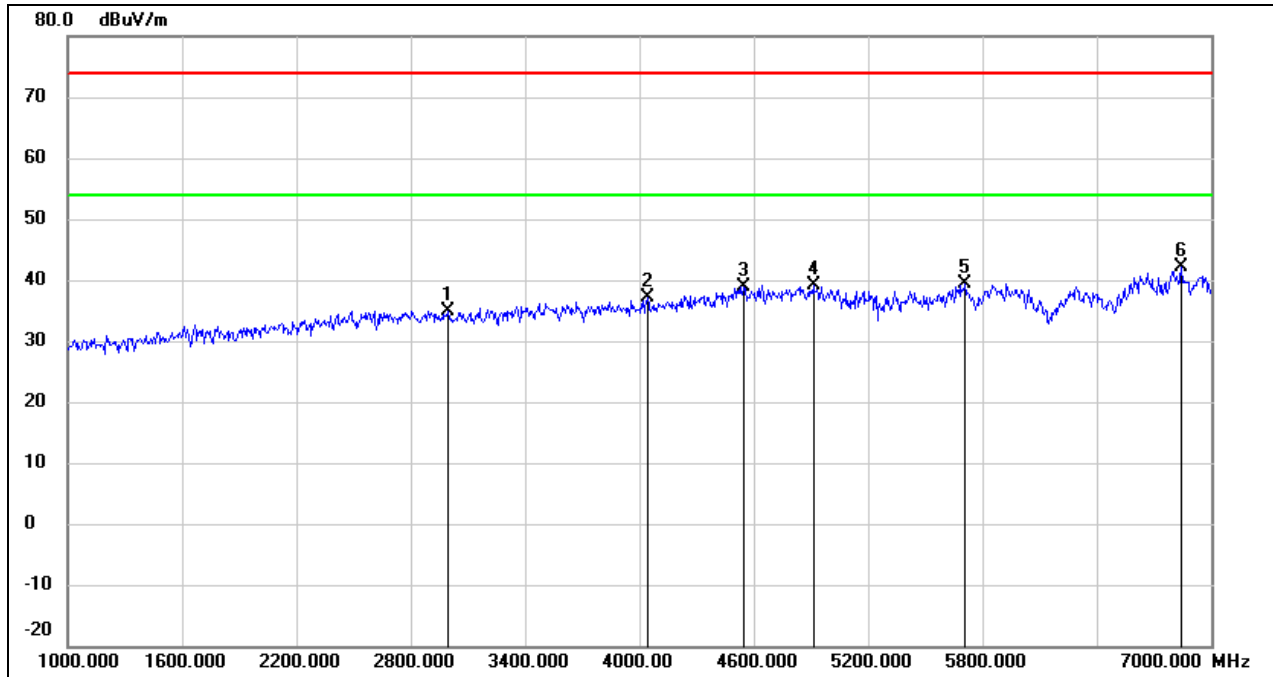

| No. | Frequency (MHz) | Reading (dBuV) | Correct (dB/m) | Result (dBuV/m) | Limit (dBuV/m) | Margin (dB) | Remark |
|-----|-----------------|----------------|----------------|-----------------|----------------|-------------|--------|
| 1 | 2998.000 | 41.96 | -6.98 | 34.98 | 74.00 | -39.02 | peak |
| 2 | 4042.000 | 41.45 | -4.29 | 37.16 | 74.00 | -36.84 | peak |
| 3 | 4546.000 | 40.95 | -1.96 | 38.99 | 74.00 | -35.01 | peak |
| 4 | 4912.000 | 39.55 | -0.50 | 39.05 | 74.00 | -34.95 | peak |
| 5 | 5710.000 | 38.43 | 1.02 | 39.45 | 74.00 | -34.55 | peak |
| 6 | 6844.000 | 36.59 | 5.43 | 42.02 | 74.00 | -31.98 | peak |

| | | | |
|------------|------------|-----------------|----------|
| Test Mode: | 802.11a 20 | Frequency(MHz): | 5240 |
| Polarity: | Horizontal | Test Voltage: | DC 3.3 V |

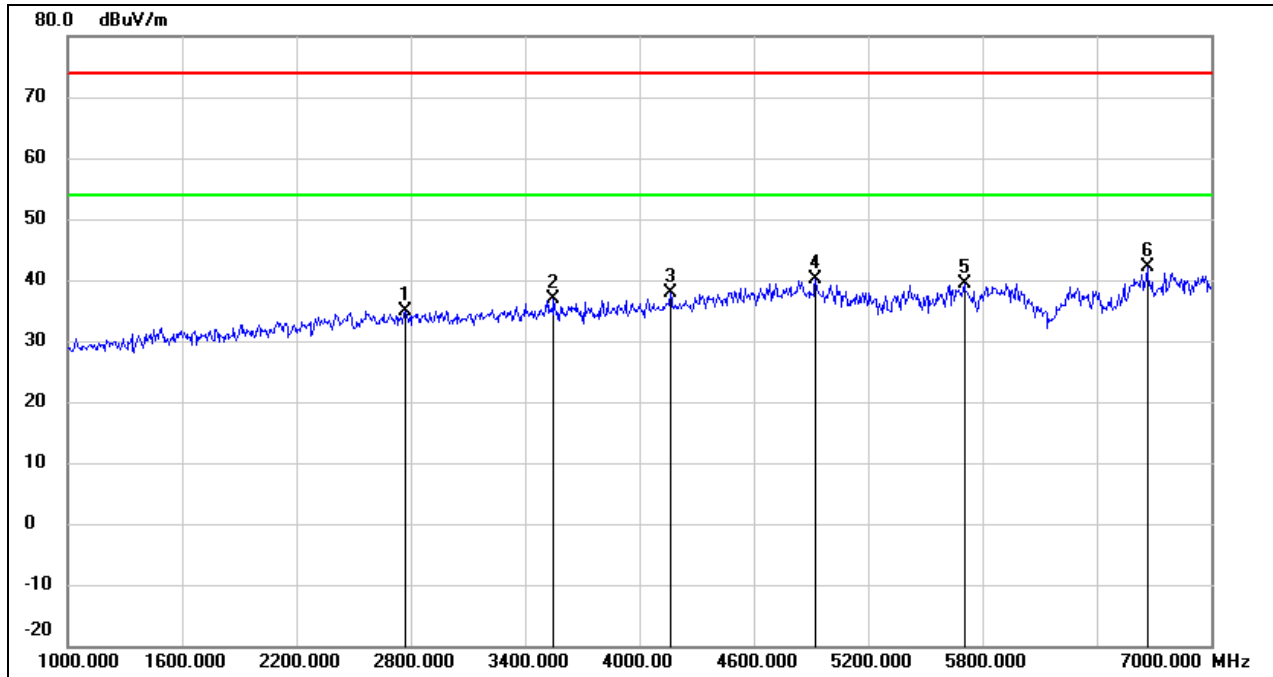

| No. | Frequency (MHz) | Reading (dBuV) | Correct (dB/m) | Result (dBuV/m) | Limit (dBuV/m) | Margin (dB) | Remark |
|-----|-----------------|----------------|----------------|-----------------|----------------|-------------|--------|
| 1 | 2770.000 | 42.62 | -7.67 | 34.95 | 74.00 | -39.05 | peak |
| 2 | 3550.000 | 42.52 | -5.71 | 36.81 | 74.00 | -37.19 | peak |
| 3 | 4162.000 | 41.63 | -3.73 | 37.90 | 74.00 | -36.10 | peak |
| 4 | 4924.000 | 40.51 | -0.45 | 40.06 | 74.00 | -33.94 | peak |
| 5 | 5704.000 | 38.49 | 1.00 | 39.49 | 74.00 | -34.51 | peak |
| 6 | 6664.000 | 37.53 | 4.54 | 42.07 | 74.00 | -31.93 | peak |

| | | | |
|------------|------------|-----------------|----------|
| Test Mode: | 802.11a 20 | Frequency(MHz): | 5240 |
| Polarity: | Vertical | Test Voltage: | DC 3.3 V |

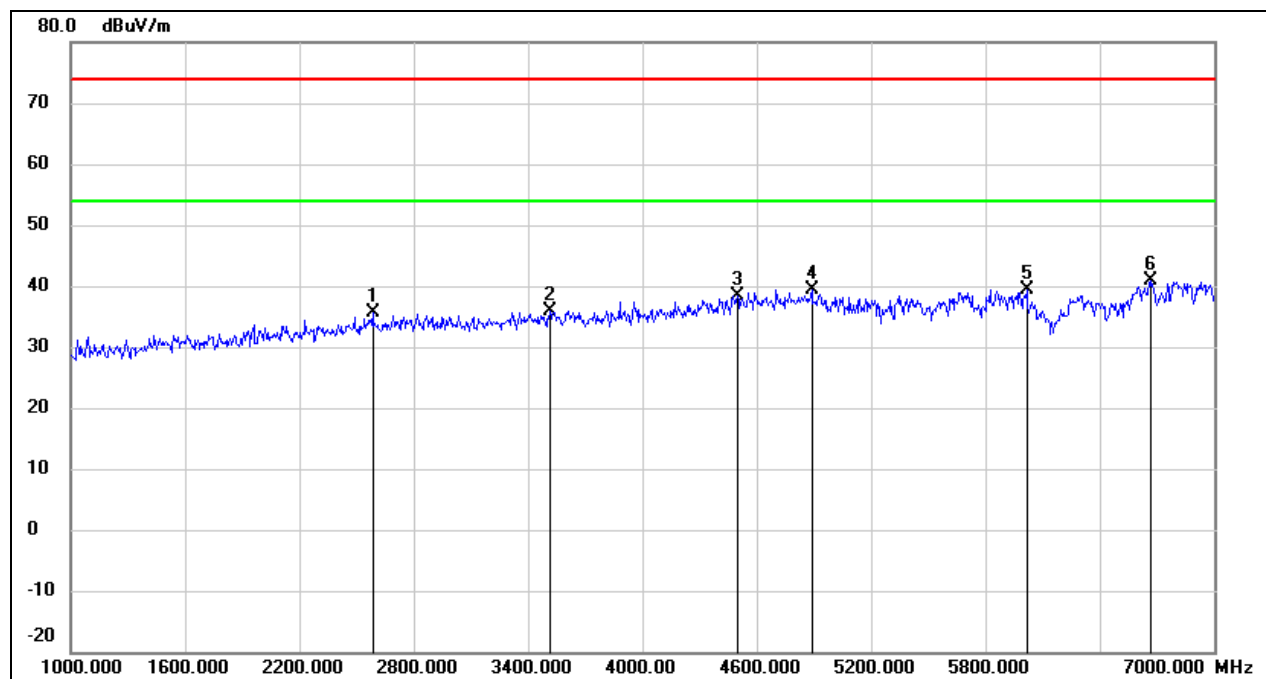

| No. | Frequency (MHz) | Reading (dBuV) | Correct (dB/m) | Result (dBuV/m) | Limit (dBuV/m) | Margin (dB) | Remark |
|-----|-----------------|----------------|----------------|-----------------|----------------|-------------|--------|
| 1 | 2584.000 | 43.75 | -8.24 | 35.51 | 74.00 | -38.49 | peak |
| 2 | 3514.000 | 41.77 | -5.81 | 35.96 | 74.00 | -38.04 | peak |
| 3 | 4498.000 | 40.52 | -2.14 | 38.38 | 74.00 | -35.62 | peak |
| 4 | 4888.000 | 39.96 | -0.60 | 39.36 | 74.00 | -34.64 | peak |
| 5 | 6016.000 | 37.46 | 1.91 | 39.37 | 74.00 | -34.63 | peak |
| 6 | 6664.000 | 36.32 | 4.54 | 40.86 | 74.00 | -33.14 | peak |

| | | | |
|------------|------------|-----------------|----------|
| Test Mode: | 802.11a 20 | Frequency(MHz): | 5260 |
| Polarity: | Horizontal | Test Voltage: | DC 3.3 V |

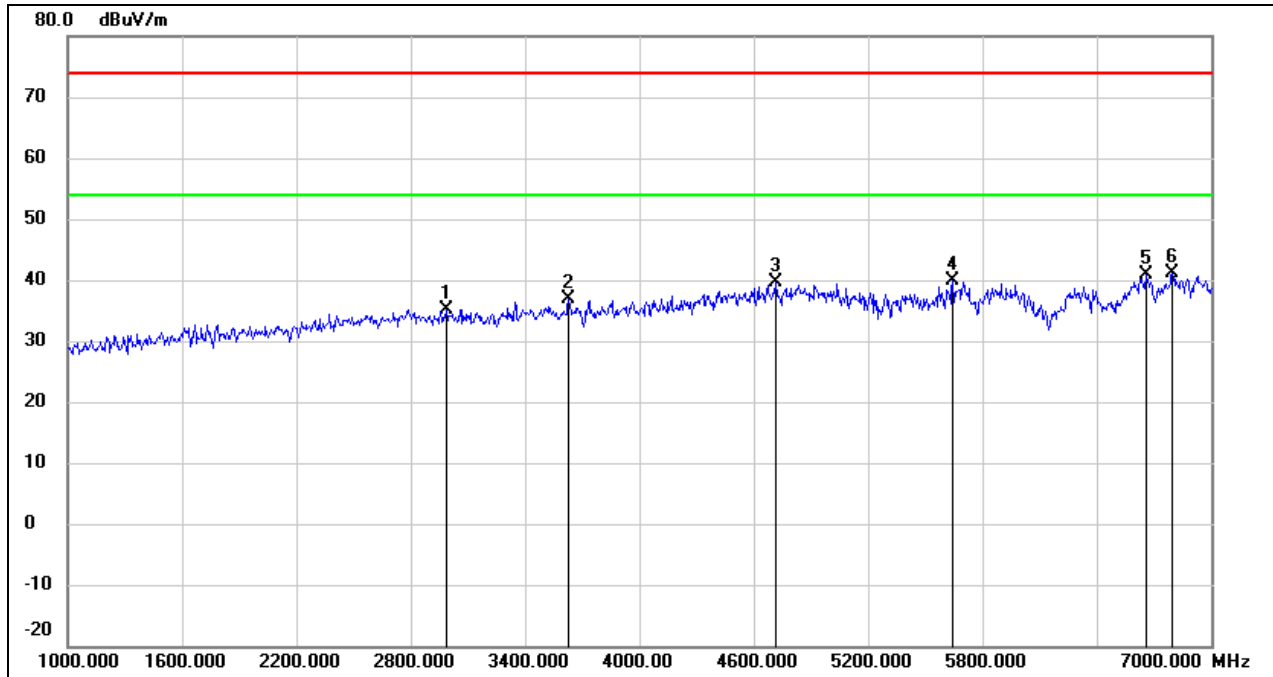

| No. | Frequency (MHz) | Reading (dBuV) | Correct (dB/m) | Result (dBuV/m) | Limit (dBuV/m) | Margin (dB) | Remark |
|-----|-----------------|----------------|----------------|-----------------|----------------|-------------|--------|
| 1 | 2986.000 | 42.27 | -7.03 | 35.24 | 74.00 | -38.76 | peak |
| 2 | 3628.000 | 42.47 | -5.50 | 36.97 | 74.00 | -37.03 | peak |
| 3 | 4714.000 | 40.86 | -1.29 | 39.57 | 74.00 | -34.43 | peak |
| 4 | 5644.000 | 39.12 | 0.82 | 39.94 | 74.00 | -34.06 | peak |
| 5 | 6658.000 | 36.38 | 4.49 | 40.87 | 74.00 | -33.13 | peak |
| 6 | 6796.000 | 35.90 | 5.19 | 41.09 | 74.00 | -32.91 | peak |

| | | | |
|------------|------------|-----------------|----------|
| Test Mode: | 802.11a 20 | Frequency(MHz): | 5260 |
| Polarity: | Vertical | Test Voltage: | DC 3.3 V |

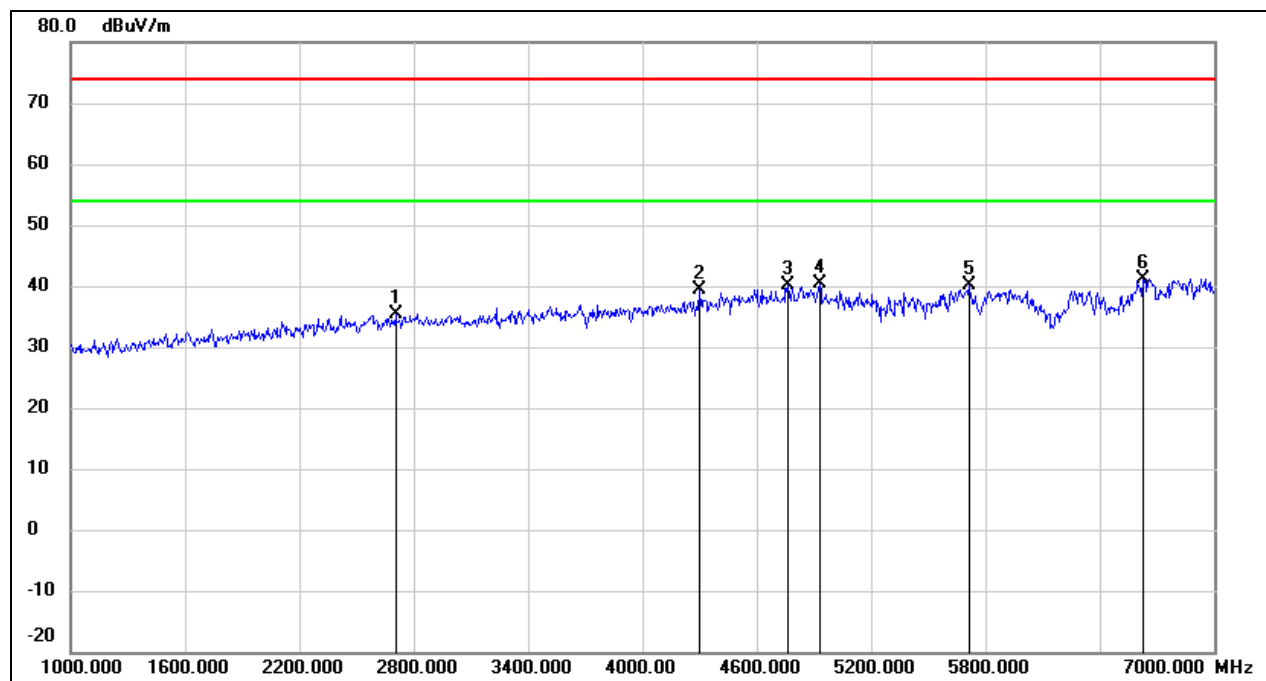

| No. | Frequency (MHz) | Reading (dBuV) | Correct (dB/m) | Result (dBuV/m) | Limit (dBuV/m) | Margin (dB) | Remark |
|-----|-----------------|----------------|----------------|-----------------|----------------|-------------|--------|
| 1 | 2704.000 | 43.36 | -7.87 | 35.49 | 74.00 | -38.51 | peak |
| 2 | 4300.000 | 42.47 | -3.08 | 39.39 | 74.00 | -34.61 | peak |
| 3 | 4762.000 | 41.17 | -1.10 | 40.07 | 74.00 | -33.93 | peak |
| 4 | 4930.000 | 40.81 | -0.43 | 40.38 | 74.00 | -33.62 | peak |
| 5 | 5716.000 | 39.18 | 1.04 | 40.22 | 74.00 | -33.78 | peak |
| 6 | 6628.000 | 36.87 | 4.36 | 41.23 | 74.00 | -32.77 | peak |

| | | | |
|------------|------------|-----------------|----------|
| Test Mode: | 802.11a 20 | Frequency(MHz): | 5280 |
| Polarity: | Horizontal | Test Voltage: | DC 3.3 V |

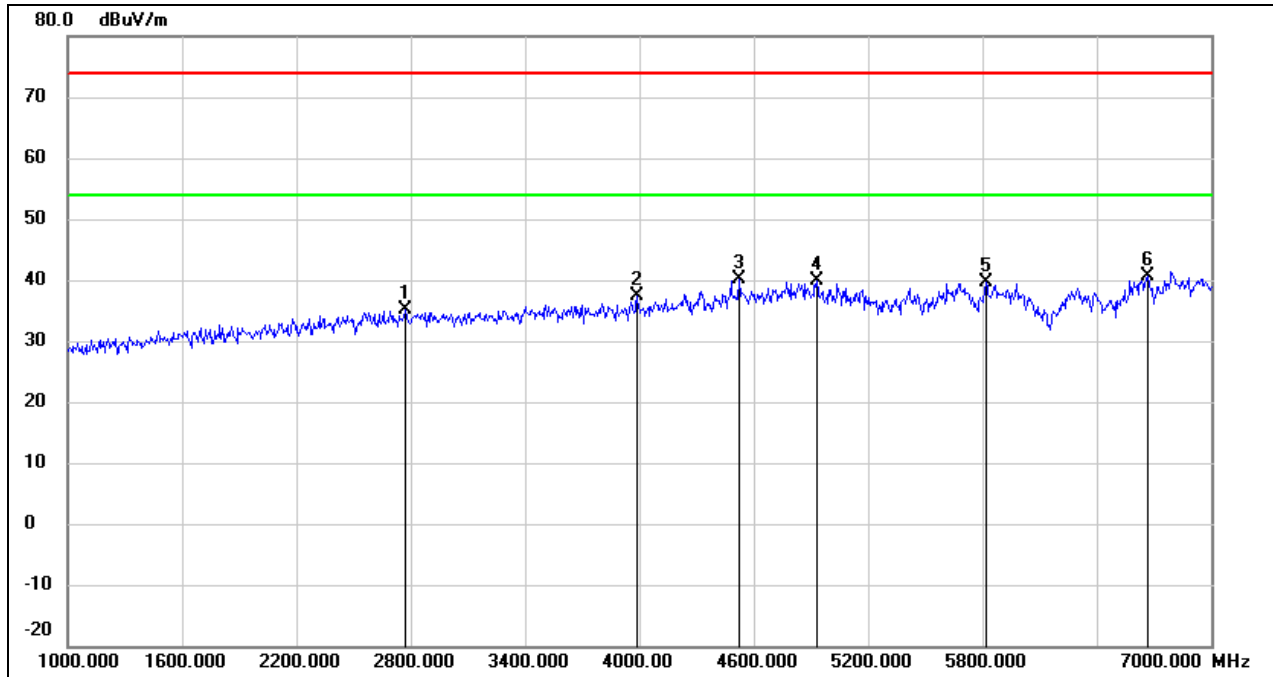

| No. | Frequency (MHz) | Reading (dBuV) | Correct (dB/m) | Result (dBuV/m) | Limit (dBuV/m) | Margin (dB) | Remark |
|-----|-----------------|----------------|----------------|-----------------|----------------|-------------|--------|
| 1 | 2770.000 | 42.73 | -7.67 | 35.06 | 74.00 | -38.94 | peak |
| 2 | 3988.000 | 41.81 | -4.51 | 37.30 | 74.00 | -36.70 | peak |
| 3 | 4522.000 | 42.19 | -2.05 | 40.14 | 74.00 | -33.86 | peak |
| 4 | 4930.000 | 40.23 | -0.43 | 39.80 | 74.00 | -34.20 | peak |
| 5 | 5818.000 | 38.41 | 1.33 | 39.74 | 74.00 | -34.26 | peak |
| 6 | 6670.000 | 36.12 | 4.57 | 40.69 | 74.00 | -33.31 | peak |

| | | | |
|------------|------------|-----------------|----------|
| Test Mode: | 802.11a 20 | Frequency(MHz): | 5280 |
| Polarity: | Vertical | Test Voltage: | DC 3.3 V |

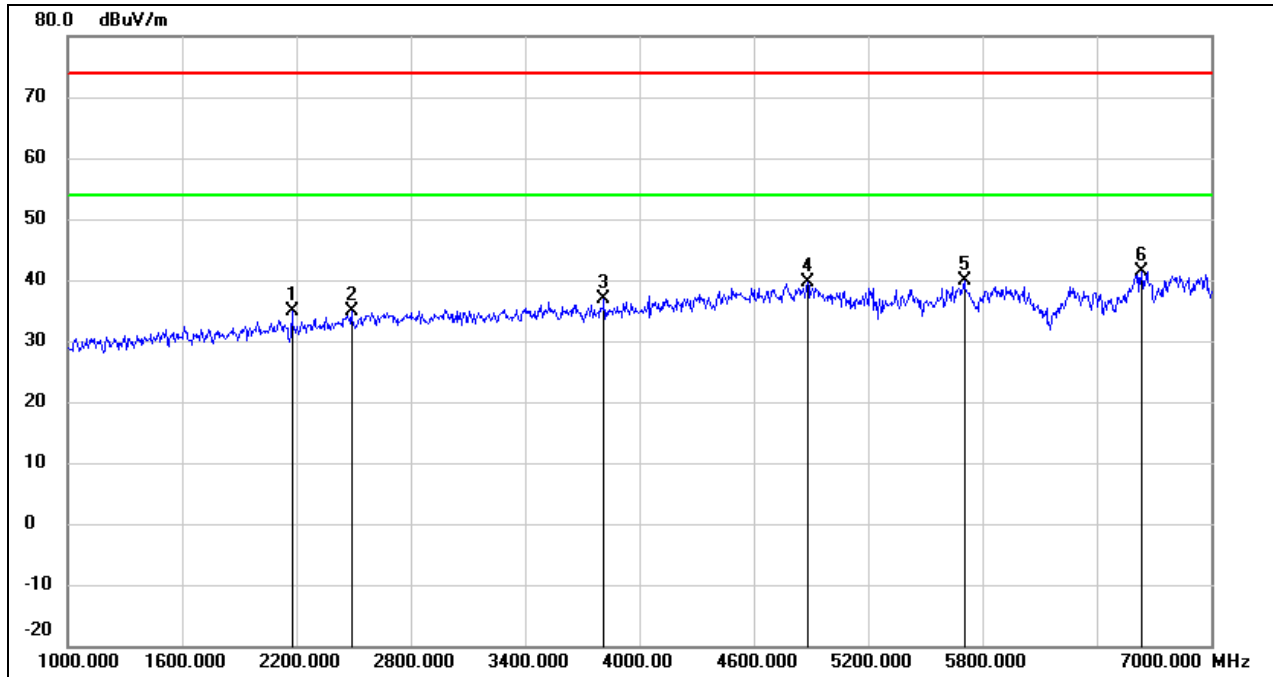

| No. | Frequency (MHz) | Reading (dBuV) | Correct (dB/m) | Result (dBuV/m) | Limit (dBuV/m) | Margin (dB) | Remark |
|-----|-----------------|----------------|----------------|-----------------|----------------|-------------|--------|
| 1 | 2176.000 | 45.03 | -10.16 | 34.87 | 74.00 | -39.13 | peak |
| 2 | 2488.000 | 43.46 | -8.55 | 34.91 | 74.00 | -39.09 | peak |
| 3 | 3814.000 | 41.78 | -4.99 | 36.79 | 74.00 | -37.21 | peak |
| 4 | 4882.000 | 40.28 | -0.62 | 39.66 | 74.00 | -34.34 | peak |
| 5 | 5704.000 | 38.76 | 1.00 | 39.76 | 74.00 | -34.24 | peak |
| 6 | 6634.000 | 37.09 | 4.38 | 41.47 | 74.00 | -32.53 | peak |

| | | | |
|------------|------------|-----------------|----------|
| Test Mode: | 802.11a 20 | Frequency(MHz): | 5320 |
| Polarity: | Horizontal | Test Voltage: | DC 3.3 V |

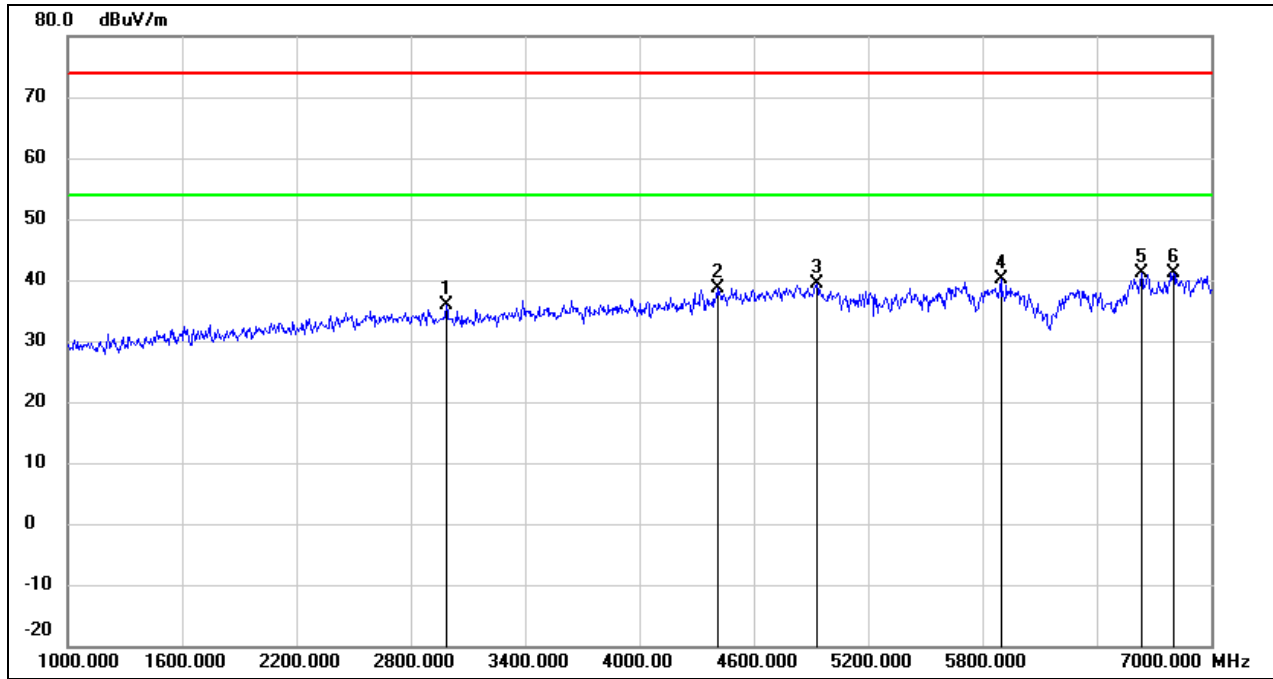

| No. | Frequency (MHz) | Reading (dBuV) | Correct (dB/m) | Result (dBuV/m) | Limit (dBuV/m) | Margin (dB) | Remark |
|-----|-----------------|----------------|----------------|-----------------|----------------|-------------|--------|
| 1 | 2986.000 | 43.03 | -7.03 | 36.00 | 74.00 | -38.00 | peak |
| 2 | 4408.000 | 41.22 | -2.56 | 38.66 | 74.00 | -35.34 | peak |
| 3 | 4930.000 | 39.93 | -0.43 | 39.50 | 74.00 | -34.50 | peak |
| 4 | 5896.000 | 38.53 | 1.56 | 40.09 | 74.00 | -33.91 | peak |
| 5 | 6634.000 | 36.66 | 4.38 | 41.04 | 74.00 | -32.96 | peak |
| 6 | 6802.000 | 35.88 | 5.21 | 41.09 | 74.00 | -32.91 | peak |

| | | | |
|------------|------------|-----------------|----------|
| Test Mode: | 802.11a 20 | Frequency(MHz): | 5320 |
| Polarity: | Vertical | Test Voltage: | DC 3.3 V |

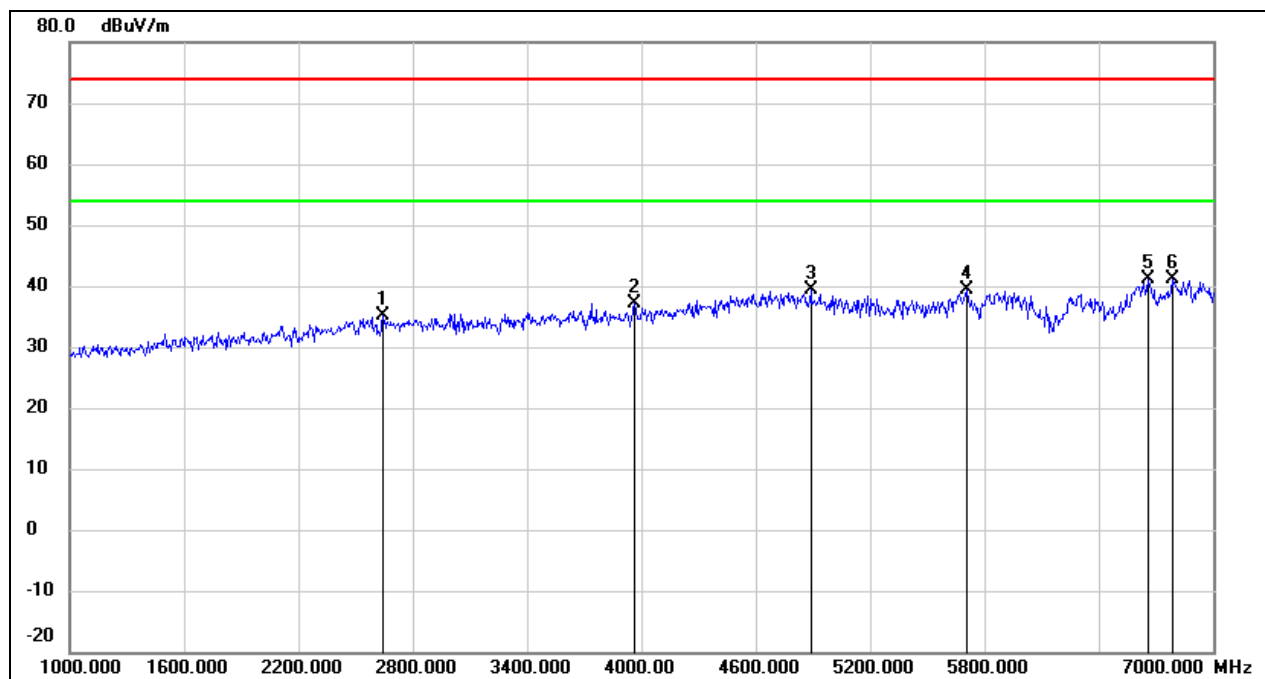

| No. | Frequency (MHz) | Reading (dBuV) | Correct (dB/m) | Result (dBuV/m) | Limit (dBuV/m) | Margin (dB) | Remark |
|-----|-----------------|----------------|----------------|-----------------|----------------|-------------|--------|
| 1 | 2644.000 | 43.13 | -8.06 | 35.07 | 74.00 | -38.93 | peak |
| 2 | 3964.000 | 41.62 | -4.58 | 37.04 | 74.00 | -36.96 | peak |
| 3 | 4888.000 | 39.91 | -0.60 | 39.31 | 74.00 | -34.69 | peak |
| 4 | 5710.000 | 38.47 | 1.02 | 39.49 | 74.00 | -34.51 | peak |
| 5 | 6658.000 | 36.59 | 4.49 | 41.08 | 74.00 | -32.92 | peak |
| 6 | 6784.000 | 36.08 | 5.13 | 41.21 | 74.00 | -32.79 | peak |

| | | | |
|------------|------------|-----------------|----------|
| Test Mode: | 802.11a 20 | Frequency(MHz): | 5500 |
| Polarity: | Horizontal | Test Voltage: | DC 3.3 V |

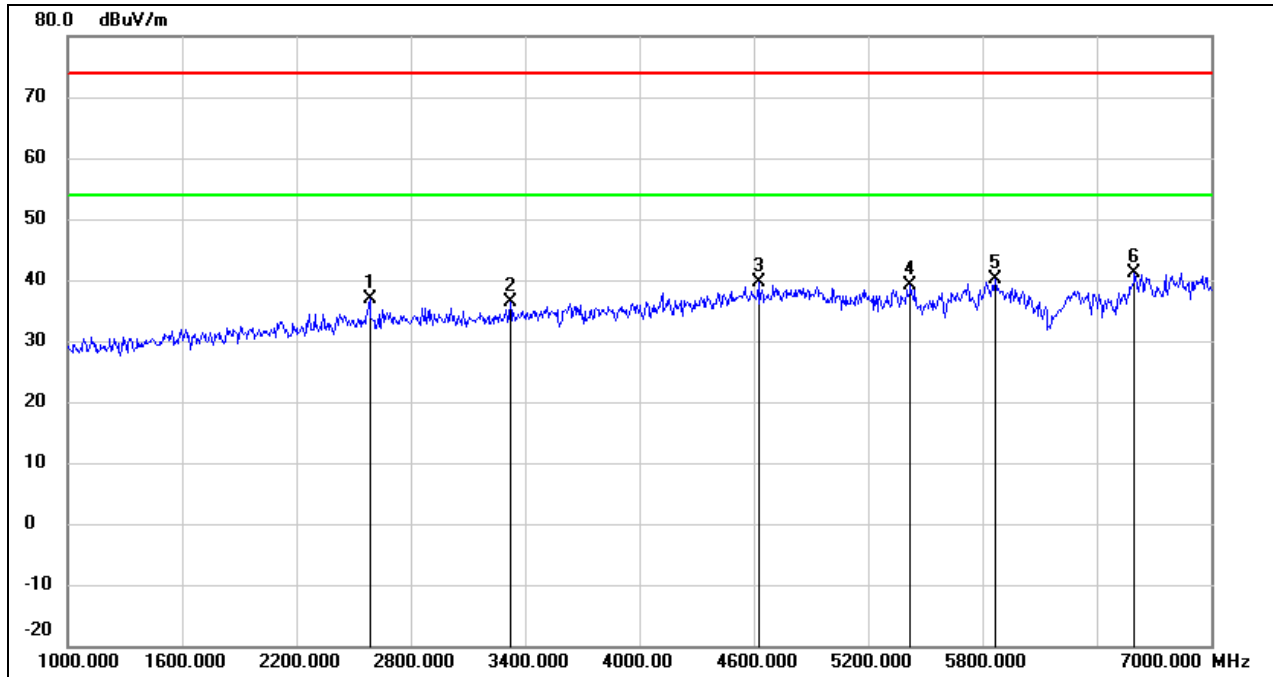

| No. | Frequency (MHz) | Reading (dBuV) | Correct (dB/m) | Result (dBuV/m) | Limit (dBuV/m) | Margin (dB) | Remark |
|-----|-----------------|----------------|----------------|-----------------|----------------|-------------|--------|
| 1 | 2584.000 | 45.04 | -8.24 | 36.80 | 74.00 | -37.20 | peak |
| 2 | 3322.000 | 42.56 | -6.25 | 36.31 | 74.00 | -37.69 | peak |
| 3 | 4624.000 | 41.22 | -1.65 | 39.57 | 74.00 | -34.43 | peak |
| 4 | 5422.000 | 38.92 | 0.32 | 39.24 | 74.00 | -34.76 | peak |
| 5 | 5866.000 | 38.69 | 1.47 | 40.16 | 74.00 | -33.84 | peak |
| 6 | 6598.000 | 37.03 | 4.21 | 41.24 | 74.00 | -32.76 | peak |

| | | | |
|------------|------------|-----------------|----------|
| Test Mode: | 802.11a 20 | Frequency(MHz): | 5500 |
| Polarity: | Vertical | Test Voltage: | DC 3.3 V |

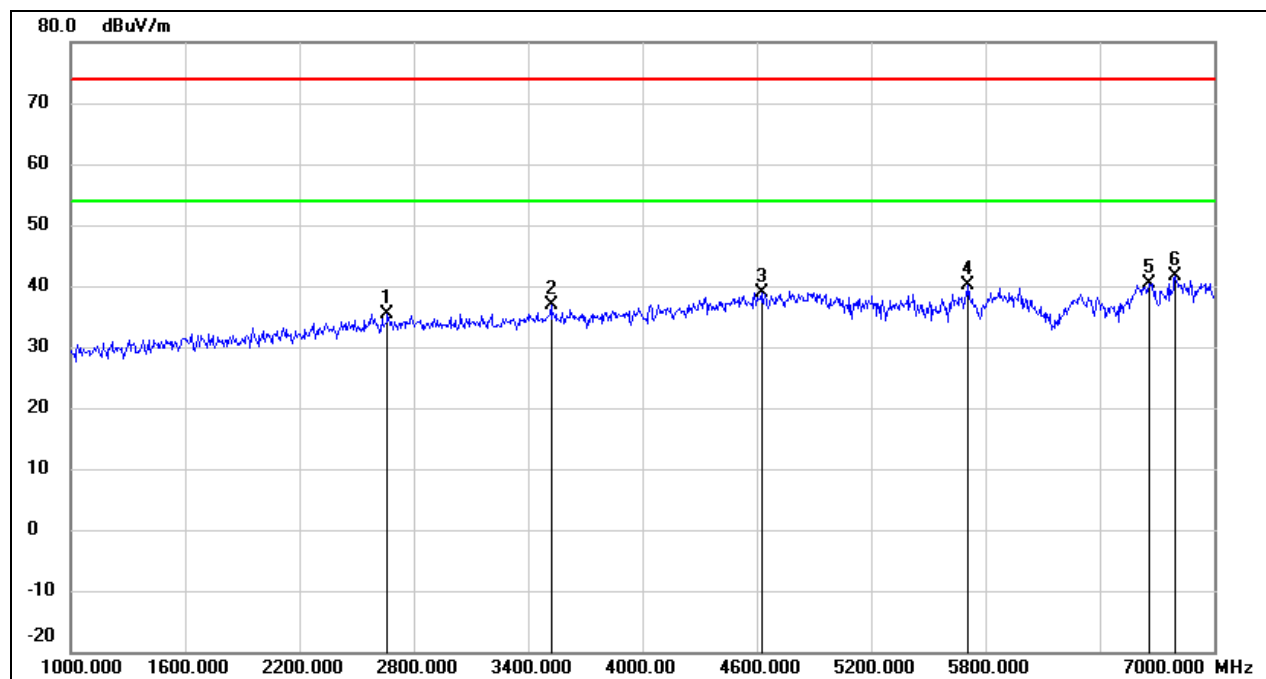

| No. | Frequency (MHz) | Reading (dBuV) | Correct (dB/m) | Result (dBuV/m) | Limit (dBuV/m) | Margin (dB) | Remark |
|-----|-----------------|----------------|----------------|-----------------|----------------|-------------|--------|
| 1 | 2662.000 | 43.45 | -8.01 | 35.44 | 74.00 | -38.56 | peak |
| 2 | 3520.000 | 42.64 | -5.80 | 36.84 | 74.00 | -37.16 | peak |
| 3 | 4624.000 | 40.60 | -1.65 | 38.95 | 74.00 | -35.05 | peak |
| 4 | 5710.000 | 39.06 | 1.02 | 40.08 | 74.00 | -33.92 | peak |
| 5 | 6658.000 | 35.82 | 4.49 | 40.31 | 74.00 | -33.69 | peak |
| 6 | 6796.000 | 36.39 | 5.19 | 41.58 | 74.00 | -32.42 | peak |

| | | | |
|------------|------------|-----------------|----------|
| Test Mode: | 802.11a 20 | Frequency(MHz): | 5580 |
| Polarity: | Horizontal | Test Voltage: | DC 3.3 V |

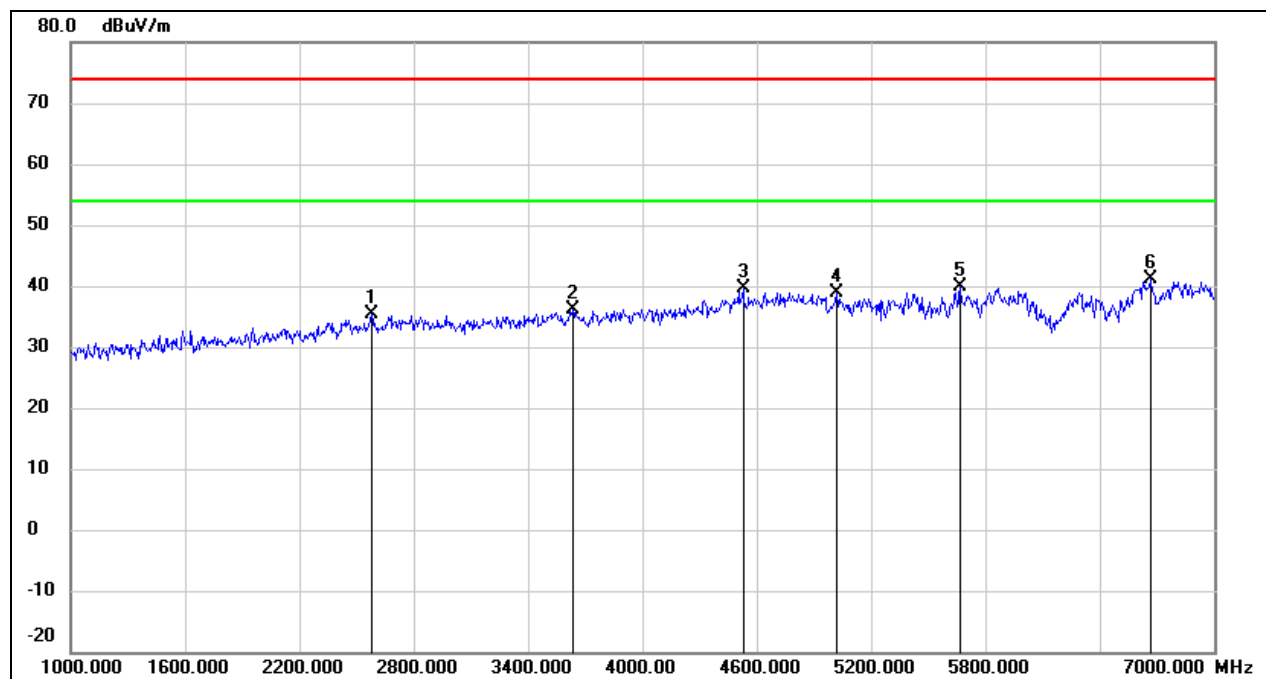

| No. | Frequency (MHz) | Reading (dBuV) | Correct (dB/m) | Result (dBuV/m) | Limit (dBuV/m) | Margin (dB) | Remark |
|-----|-----------------|----------------|----------------|-----------------|----------------|-------------|--------|
| 1 | 2578.000 | 43.63 | -8.26 | 35.37 | 74.00 | -38.63 | peak |
| 2 | 3634.000 | 41.69 | -5.48 | 36.21 | 74.00 | -37.79 | peak |
| 3 | 4528.000 | 41.66 | -2.03 | 39.63 | 74.00 | -34.37 | peak |
| 4 | 5020.000 | 39.11 | -0.13 | 38.98 | 74.00 | -35.02 | peak |
| 5 | 5668.000 | 38.96 | 0.91 | 39.87 | 74.00 | -34.13 | peak |
| 6 | 6664.000 | 36.51 | 4.54 | 41.05 | 74.00 | -32.95 | peak |

| | | | |
|------------|------------|-----------------|----------|
| Test Mode: | 802.11a 20 | Frequency(MHz): | 5580 |
| Polarity: | Vertical | Test Voltage: | DC 3.3 V |

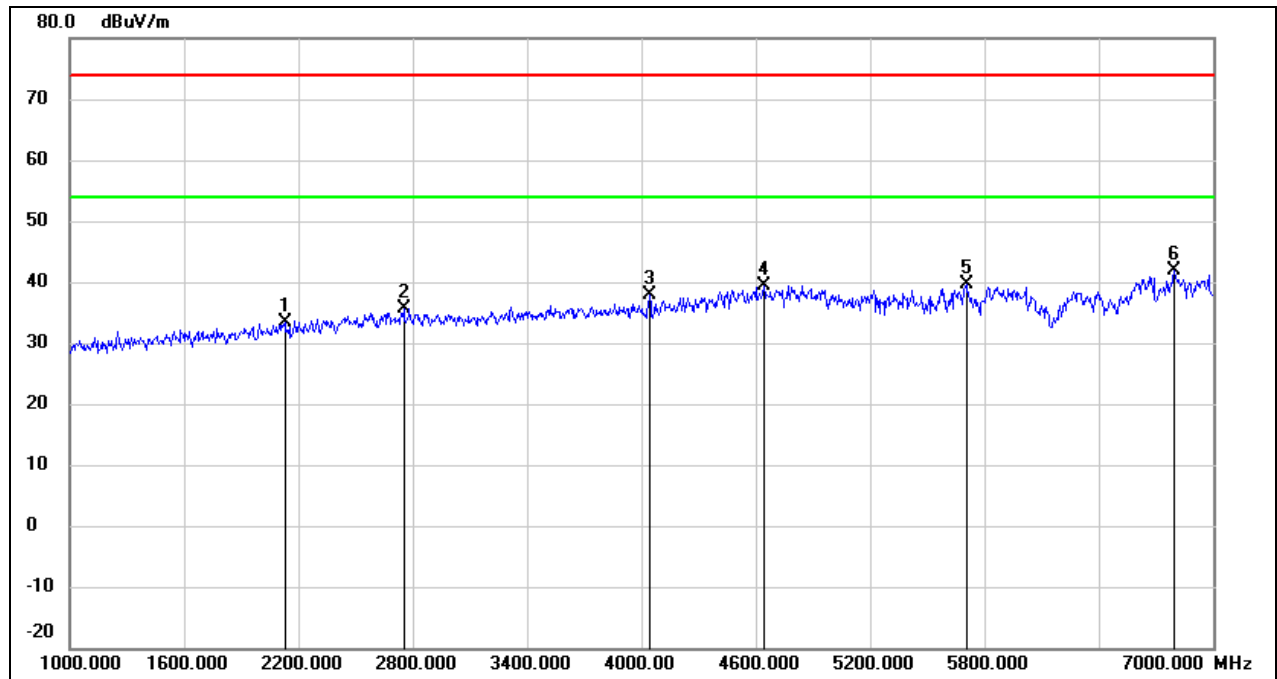

| No. | Frequency (MHz) | Reading (dBuV) | Correct (dB/m) | Result (dBuV/m) | Limit (dBuV/m) | Margin (dB) | Remark |
|-----|-----------------|----------------|----------------|-----------------|----------------|-------------|--------|
| 1 | 2128.000 | 43.82 | -10.40 | 33.42 | 74.00 | -40.58 | peak |
| 2 | 2752.000 | 43.33 | -7.73 | 35.60 | 74.00 | -38.40 | peak |
| 3 | 4042.000 | 42.09 | -4.29 | 37.80 | 74.00 | -36.20 | peak |
| 4 | 4642.000 | 40.97 | -1.57 | 39.40 | 74.00 | -34.60 | peak |
| 5 | 5704.000 | 38.51 | 1.00 | 39.51 | 74.00 | -34.49 | peak |
| 6 | 6796.000 | 36.70 | 5.19 | 41.89 | 74.00 | -32.11 | peak |

| | | | |
|------------|------------|-----------------|----------|
| Test Mode: | 802.11a 20 | Frequency(MHz): | 5700 |
| Polarity: | Horizontal | Test Voltage: | DC 3.3 V |

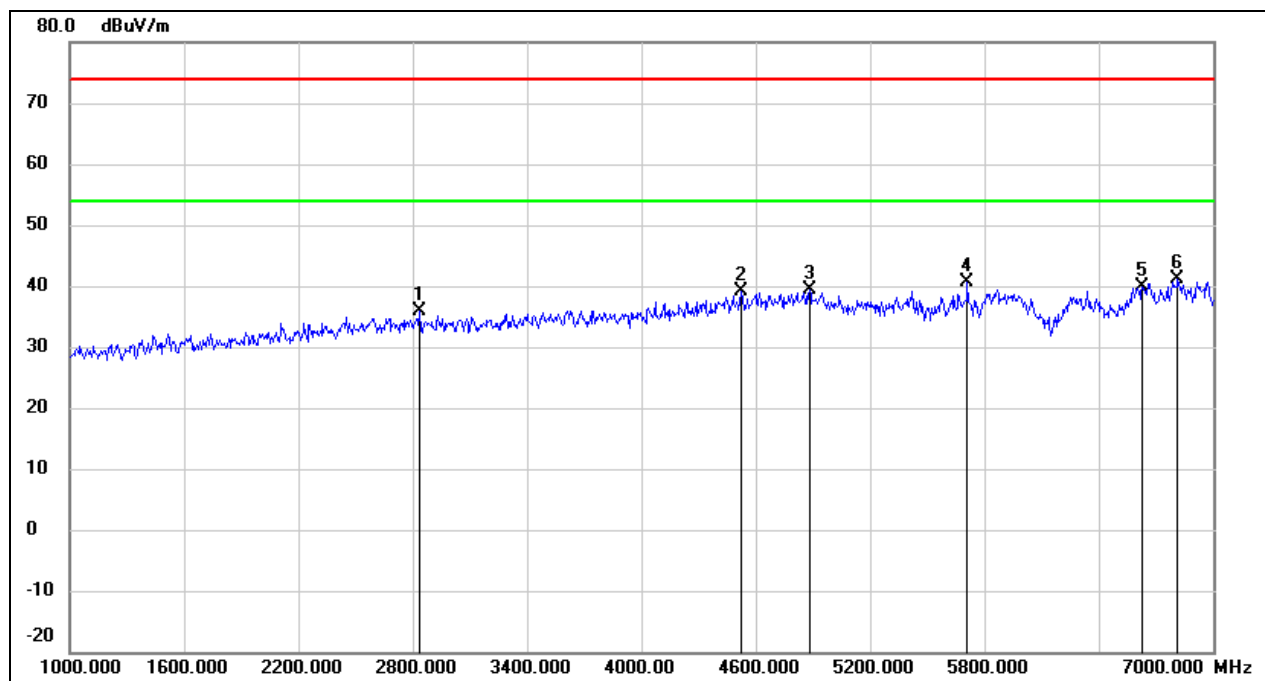

| No. | Frequency (MHz) | Reading (dBuV) | Correct (dB/m) | Result (dBuV/m) | Limit (dBuV/m) | Margin (dB) | Remark |
|-----|-----------------|----------------|----------------|-----------------|----------------|-------------|--------|
| 1 | 2836.000 | 43.29 | -7.48 | 35.81 | 74.00 | -38.19 | peak |
| 2 | 4522.000 | 41.10 | -2.05 | 39.05 | 74.00 | -34.95 | peak |
| 3 | 4882.000 | 39.98 | -0.62 | 39.36 | 74.00 | -34.64 | peak |
| 4 | 5710.000 | 39.62 | 1.02 | 40.64 | 74.00 | -33.36 | peak |
| 5 | 6628.000 | 35.40 | 4.36 | 39.76 | 74.00 | -34.24 | peak |
| 6 | 6814.000 | 35.77 | 5.28 | 41.05 | 74.00 | -32.95 | peak |

| | | | |
|------------|------------|-----------------|----------|
| Test Mode: | 802.11a 20 | Frequency(MHz): | 5700 |
| Polarity: | Vertical | Test Voltage: | DC 3.3 V |

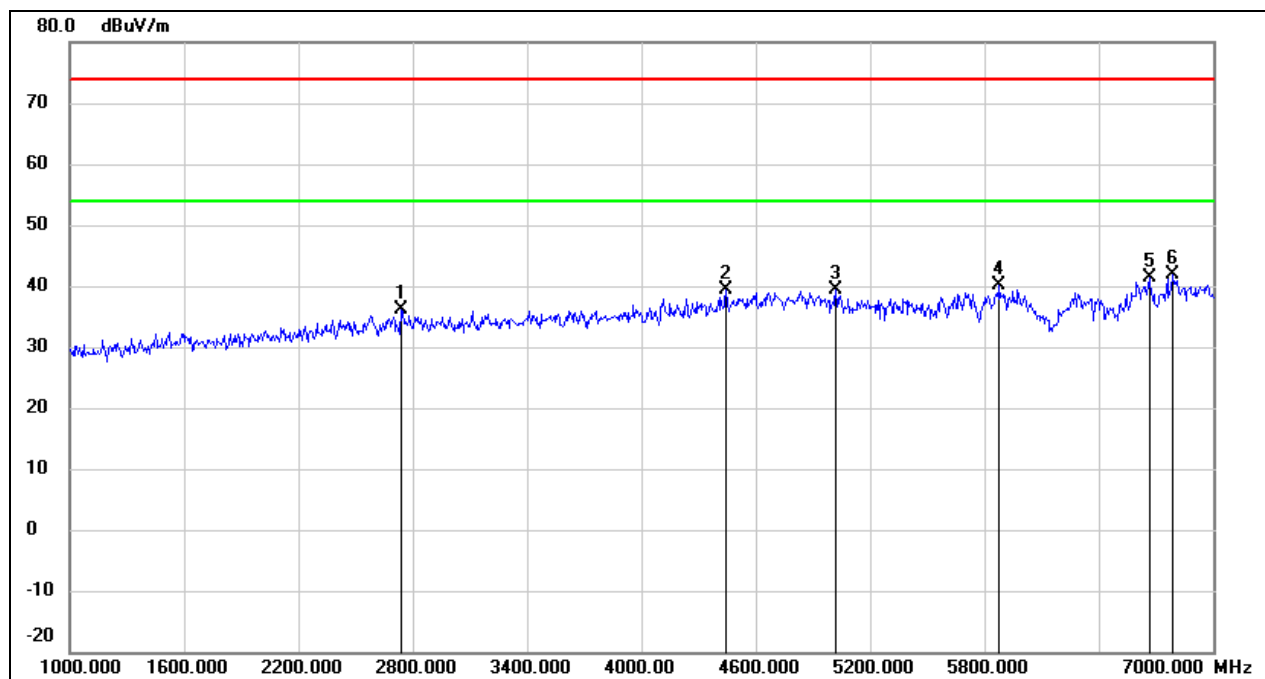

| No. | Frequency (MHz) | Reading (dBuV) | Correct (dB/m) | Result (dBuV/m) | Limit (dBuV/m) | Margin (dB) | Remark |
|-----|-----------------|----------------|----------------|-----------------|----------------|-------------|--------|
| 1 | 2740.000 | 43.95 | -7.77 | 36.18 | 74.00 | -37.82 | peak |
| 2 | 4444.000 | 41.69 | -2.40 | 39.29 | 74.00 | -34.71 | peak |
| 3 | 5020.000 | 39.45 | -0.13 | 39.32 | 74.00 | -34.68 | peak |
| 4 | 5878.000 | 38.50 | 1.51 | 40.01 | 74.00 | -33.99 | peak |
| 5 | 6664.000 | 36.91 | 4.54 | 41.45 | 74.00 | -32.55 | peak |
| 6 | 6790.000 | 36.76 | 5.15 | 41.91 | 74.00 | -32.09 | peak |

| | | | |
|------------|------------|-----------------|----------|
| Test Mode: | 802.11a 20 | Frequency(MHz): | 5720 |
| Polarity: | Horizontal | Test Voltage: | DC 3.3 V |

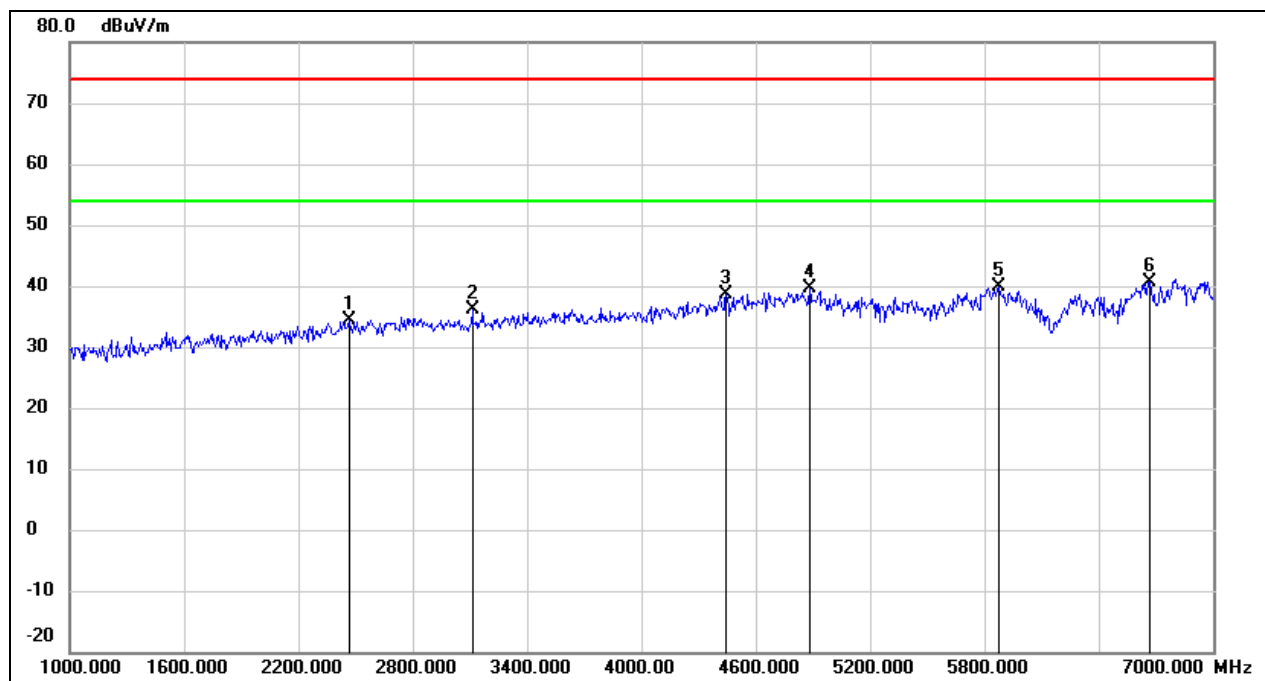

| No. | Frequency (MHz) | Reading (dBuV) | Correct (dB/m) | Result (dBuV/m) | Limit (dBuV/m) | Margin (dB) | Remark |
|-----|-----------------|----------------|----------------|-----------------|----------------|-------------|--------|
| 1 | 2464.000 | 42.98 | -8.68 | 34.30 | 74.00 | -39.70 | peak |
| 2 | 3112.000 | 42.93 | -6.73 | 36.20 | 74.00 | -37.80 | peak |
| 3 | 4444.000 | 41.07 | -2.40 | 38.67 | 74.00 | -35.33 | peak |
| 4 | 4882.000 | 40.19 | -0.62 | 39.57 | 74.00 | -34.43 | peak |
| 5 | 5878.000 | 38.43 | 1.51 | 39.94 | 74.00 | -34.06 | peak |
| 6 | 6670.000 | 36.10 | 4.57 | 40.67 | 74.00 | -33.33 | peak |

| | | | |
|------------|------------|-----------------|----------|
| Test Mode: | 802.11a 20 | Frequency(MHz): | 5720 |
| Polarity: | Vertical | Test Voltage: | DC 3.3 V |

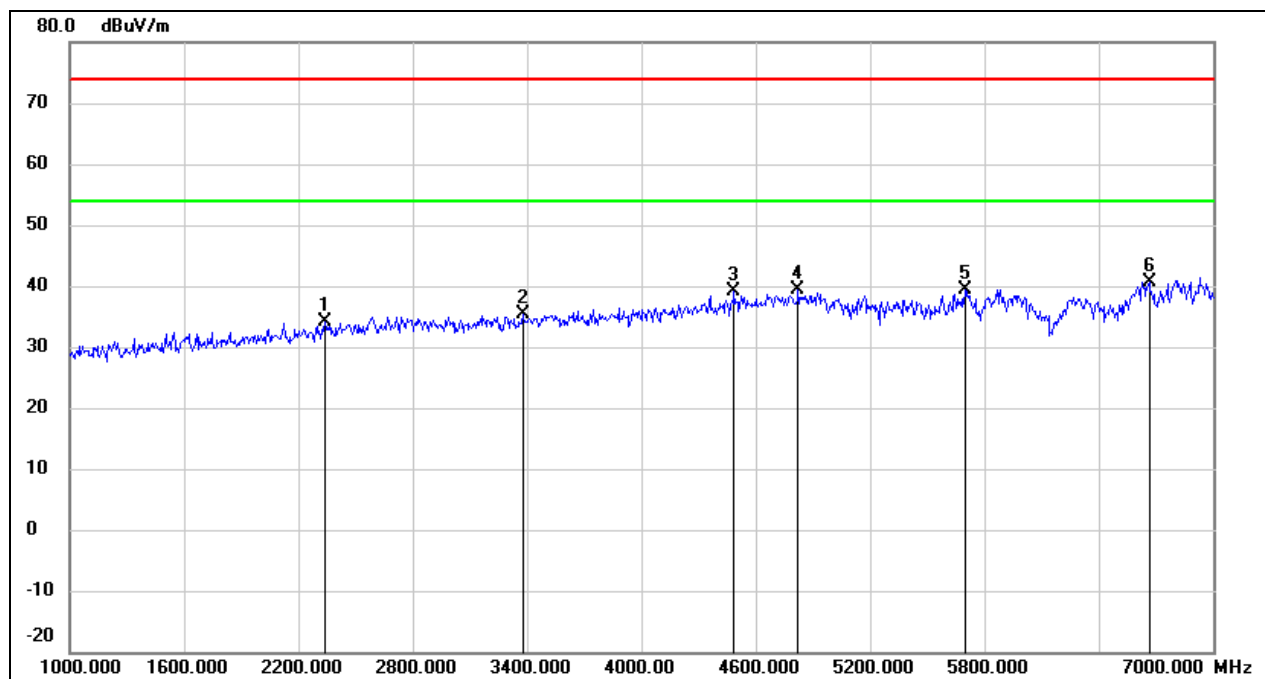

| No. | Frequency (MHz) | Reading (dBuV) | Correct (dB/m) | Result (dBuV/m) | Limit (dBuV/m) | Margin (dB) | Remark |
|-----|-----------------|----------------|----------------|-----------------|----------------|-------------|--------|
| 1 | 2338.000 | 43.48 | -9.32 | 34.16 | 74.00 | -39.84 | peak |
| 2 | 3376.000 | 41.48 | -6.13 | 35.35 | 74.00 | -38.65 | peak |
| 3 | 4486.000 | 41.27 | -2.21 | 39.06 | 74.00 | -34.94 | peak |
| 4 | 4822.000 | 40.19 | -0.85 | 39.34 | 74.00 | -34.66 | peak |
| 5 | 5698.000 | 38.41 | 0.99 | 39.40 | 74.00 | -34.60 | peak |
| 6 | 6664.000 | 36.02 | 4.54 | 40.56 | 74.00 | -33.44 | peak |

| | | | |
|------------|------------|-----------------|----------|
| Test Mode: | 802.11a 20 | Frequency(MHz): | 5745 |
| Polarity: | Horizontal | Test Voltage: | DC 3.3 V |

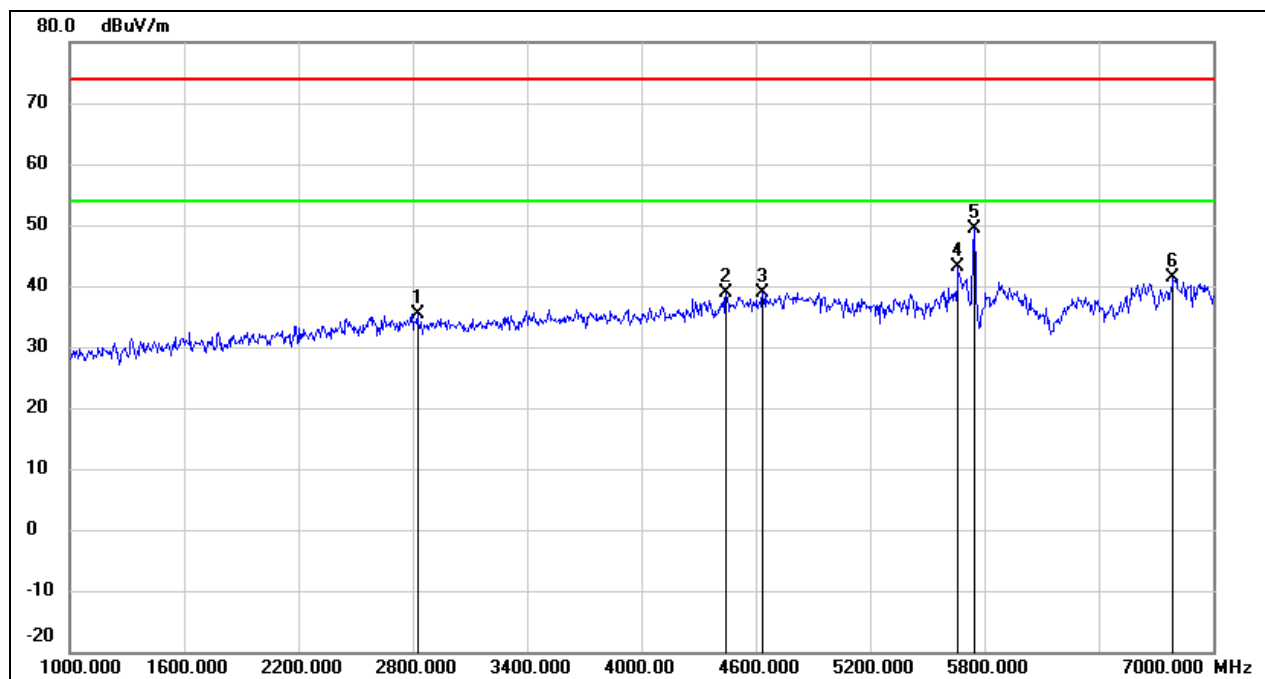

| No. | Frequency (MHz) | Reading (dBuV) | Correct (dB/m) | Result (dBuV/m) | Limit (dBuV/m) | Margin (dB) | Remark |
|-----|-----------------|----------------|----------------|-----------------|----------------|-------------|-------------|
| 1 | 2824.000 | 42.89 | -7.51 | 35.38 | 74.00 | -38.62 | peak |
| 2 | 4444.000 | 41.27 | -2.40 | 38.87 | 74.00 | -35.13 | peak |
| 3 | 4636.000 | 40.47 | -1.59 | 38.88 | 74.00 | -35.12 | peak |
| 4 | 5662.000 | 42.14 | 0.89 | 43.03 | 74.00 | -30.97 | peak |
| 5 | 5745.000 | 48.21 | 1.12 | 49.33 | / | / | fundamental |
| 6 | 6790.000 | 36.32 | 5.15 | 41.47 | 74.00 | -32.53 | peak |

| | | | |
|------------|------------|-----------------|----------|
| Test Mode: | 802.11a 20 | Frequency(MHz): | 5745 |
| Polarity: | Vertical | Test Voltage: | DC 3.3 V |

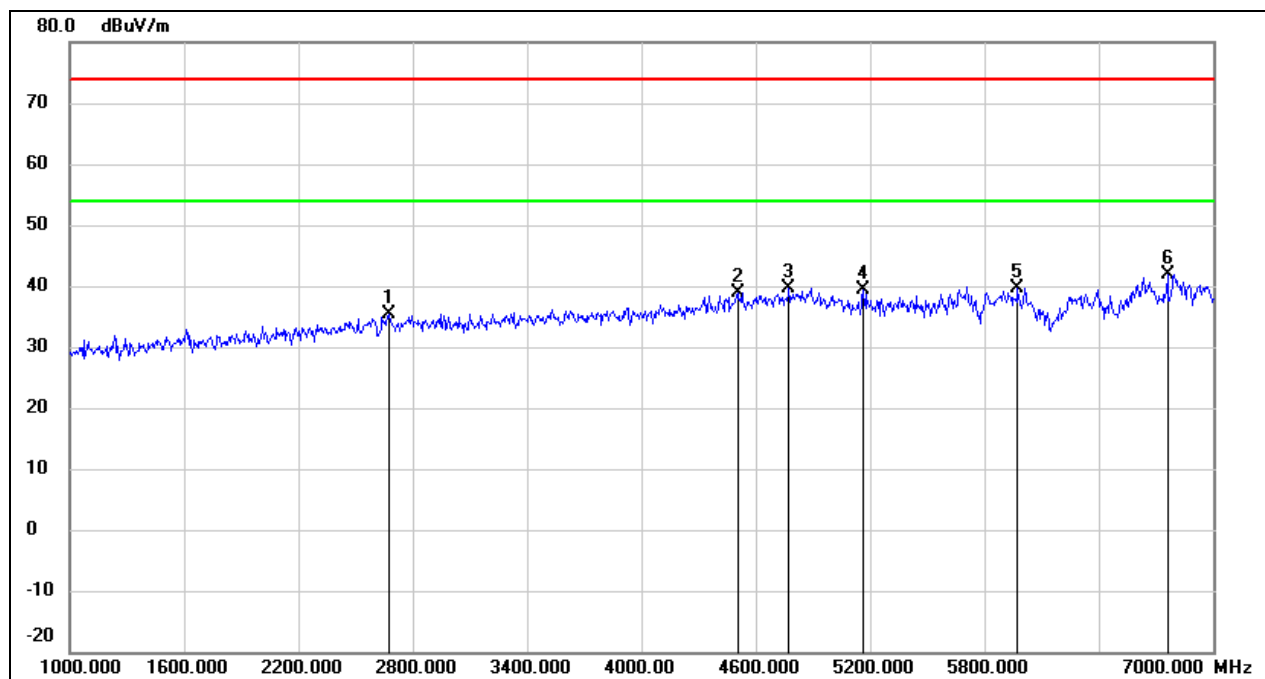

| No. | Frequency (MHz) | Reading (dBuV) | Correct (dB/m) | Result (dBuV/m) | Limit (dBuV/m) | Margin (dB) | Remark |
|-----|-----------------|----------------|----------------|-----------------|----------------|-------------|--------|
| 1 | 2674.000 | 43.27 | -7.97 | 35.30 | 74.00 | -38.70 | peak |
| 2 | 4504.000 | 41.06 | -2.12 | 38.94 | 74.00 | -35.06 | peak |
| 3 | 4774.000 | 40.71 | -1.05 | 39.66 | 74.00 | -34.34 | peak |
| 4 | 5164.000 | 39.38 | 0.04 | 39.42 | 74.00 | -34.58 | peak |
| 5 | 5974.000 | 37.86 | 1.77 | 39.63 | 74.00 | -34.37 | peak |
| 6 | 6760.000 | 36.87 | 5.02 | 41.89 | 74.00 | -32.11 | peak |

| | | | |
|------------|------------|-----------------|----------|
| Test Mode: | 802.11a 20 | Frequency(MHz): | 5785 |
| Polarity: | Horizontal | Test Voltage: | DC 3.3 V |

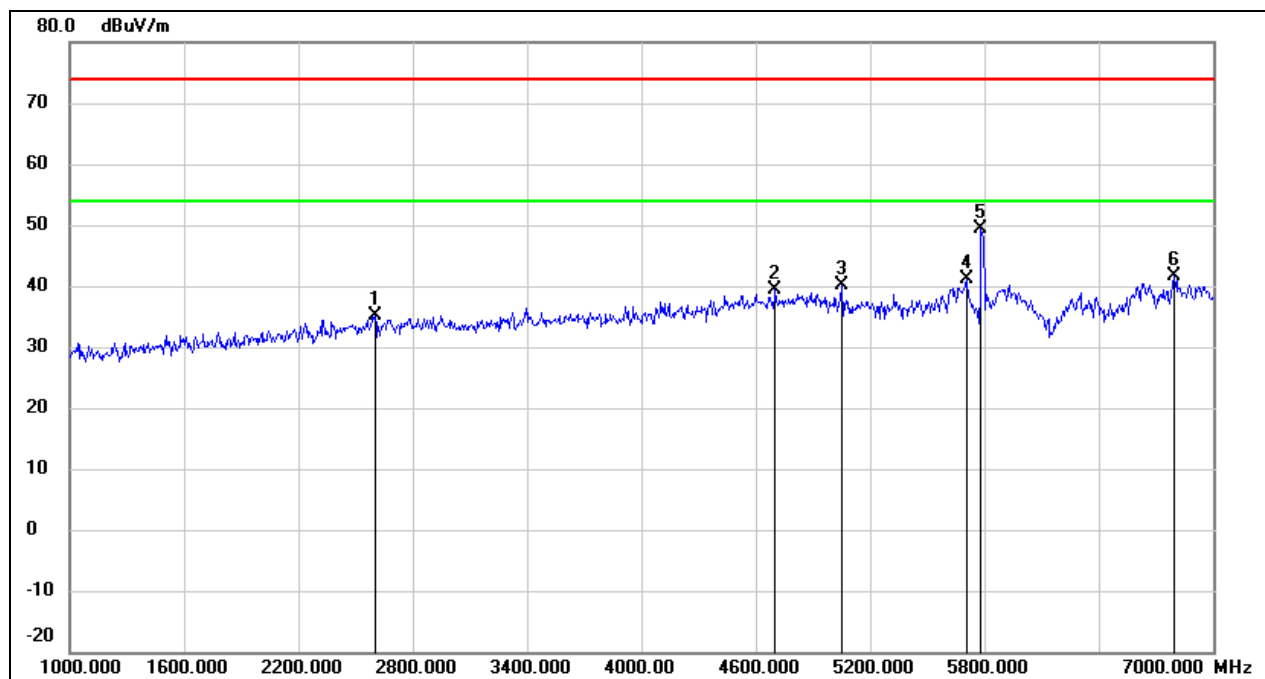

| No. | Frequency (MHz) | Reading (dBuV) | Correct (dB/m) | Result (dBuV/m) | Limit (dBuV/m) | Margin (dB) | Remark |
|-----|-----------------|----------------|----------------|-----------------|----------------|-------------|-------------|
| 1 | 2602.000 | 43.28 | -8.19 | 35.09 | 74.00 | -38.91 | peak |
| 2 | 4702.000 | 40.71 | -1.34 | 39.37 | 74.00 | -34.63 | peak |
| 3 | 5050.000 | 40.19 | -0.09 | 40.10 | 74.00 | -33.90 | peak |
| 4 | 5704.000 | 40.23 | 1.00 | 41.23 | 74.00 | -32.77 | peak |
| 5 | 5785.000 | 48.03 | 1.23 | 49.26 | / | / | fundamental |
| 6 | 6796.000 | 36.48 | 5.19 | 41.67 | 74.00 | -32.33 | peak |

| | | | |
|------------|------------|-----------------|----------|
| Test Mode: | 802.11a 20 | Frequency(MHz): | 5785 |
| Polarity: | Vertical | Test Voltage: | DC 3.3 V |

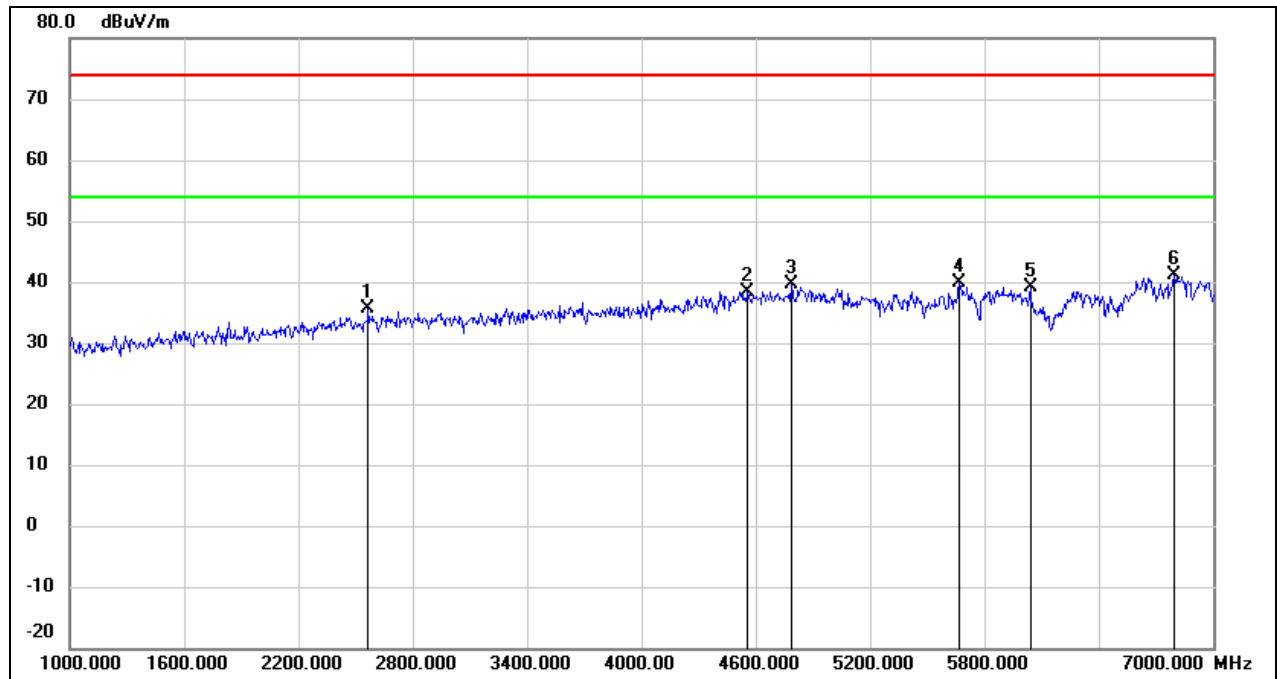

| No. | Frequency (MHz) | Reading (dBuV) | Correct (dB/m) | Result (dBuV/m) | Limit (dBuV/m) | Margin (dB) | Remark |
|-----|-----------------|----------------|----------------|-----------------|----------------|-------------|--------|
| 1 | 2566.000 | 43.87 | -8.29 | 35.58 | 74.00 | -38.42 | peak |
| 2 | 4558.000 | 40.32 | -1.91 | 38.41 | 74.00 | -35.59 | peak |
| 3 | 4786.000 | 40.67 | -1.00 | 39.67 | 74.00 | -34.33 | peak |
| 4 | 5668.000 | 39.00 | 0.91 | 39.91 | 74.00 | -34.09 | peak |
| 5 | 6040.000 | 37.20 | 1.99 | 39.19 | 74.00 | -34.81 | peak |
| 6 | 6796.000 | 35.95 | 5.19 | 41.14 | 74.00 | -32.86 | peak |

| | | | |
|------------|------------|-----------------|----------|
| Test Mode: | 802.11a 20 | Frequency(MHz): | 5825 |
| Polarity: | Horizontal | Test Voltage: | DC 3.3 V |

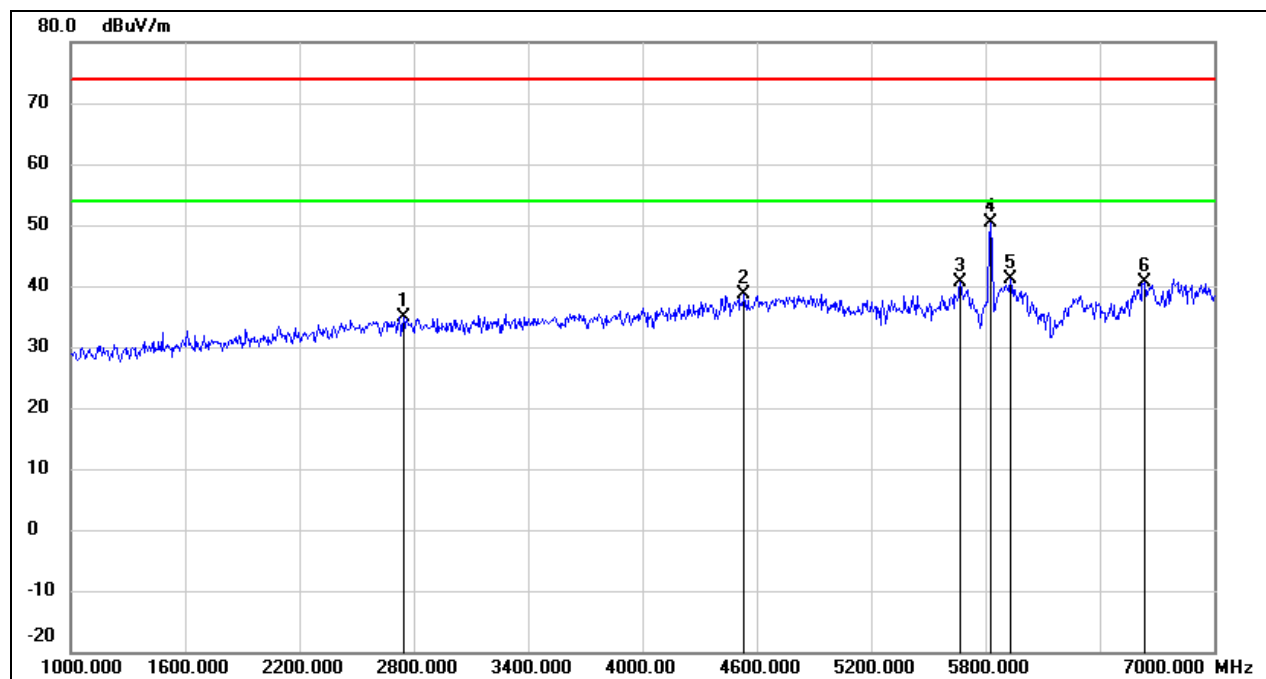

| No. | Frequency (MHz) | Reading (dBuV) | Correct (dB/m) | Result (dBuV/m) | Limit (dBuV/m) | Margin (dB) | Remark |
|-----|-----------------|----------------|----------------|-----------------|----------------|-------------|-------------|
| 1 | 2746.000 | 42.68 | -7.75 | 34.93 | 74.00 | -39.07 | peak |
| 2 | 4534.000 | 40.61 | -2.01 | 38.60 | 74.00 | -35.40 | peak |
| 3 | 5668.000 | 39.64 | 0.91 | 40.55 | 74.00 | -33.45 | peak |
| 4 | 5825.000 | 49.04 | 1.36 | 50.40 | / | / | fundamental |
| 5 | 5932.000 | 39.36 | 1.65 | 41.01 | 74.00 | -32.99 | peak |
| 6 | 6634.000 | 36.25 | 4.38 | 40.63 | 74.00 | -33.37 | peak |

| | | | |
|------------|------------|-----------------|----------|
| Test Mode: | 802.11a 20 | Frequency(MHz): | 5825 |
| Polarity: | Vertical | Test Voltage: | DC 3.3 V |

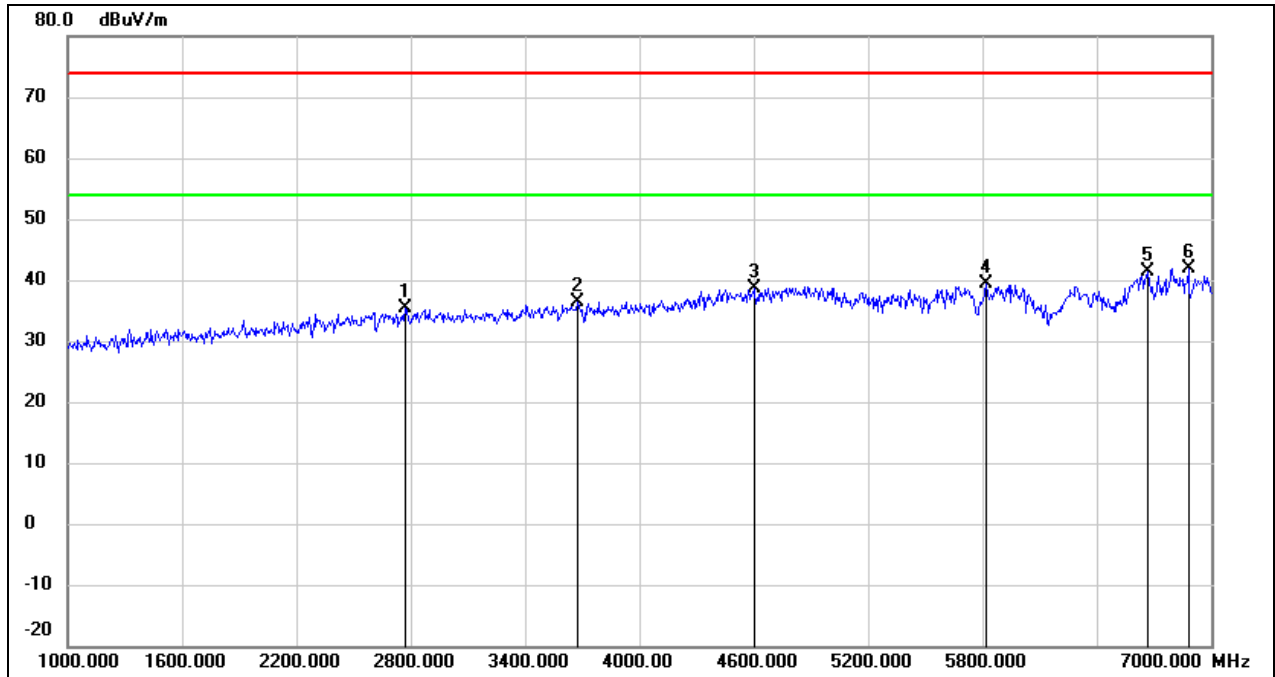

| No. | Frequency (MHz) | Reading (dBuV) | Correct (dB/m) | Result (dBuV/m) | Limit (dBuV/m) | Margin (dB) | Remark |
|-----|-----------------|----------------|----------------|-----------------|----------------|-------------|-------------|
| 1 | 2770.000 | 42.97 | -7.67 | 35.30 | 74.00 | -38.70 | peak |
| 2 | 3676.000 | 41.82 | -5.37 | 36.45 | 74.00 | -37.55 | peak |
| 3 | 4600.000 | 40.41 | -1.74 | 38.67 | 74.00 | -35.33 | peak |
| 4 | 5825.000 | 38.12 | 1.33 | 39.45 | / | / | fundamental |
| 5 | 6670.000 | 36.76 | 4.57 | 41.33 | 74.00 | -32.67 | peak |
| 6 | 6880.000 | 36.28 | 5.60 | 41.88 | 74.00 | -32.12 | peak |

8.3. SPURIOUS EMISSIONS(7 GHZ~18 GHZ)

| | | | |
|------------|------------|-----------------|----------|
| Test Mode: | 802.11a 20 | Frequency(MHz): | 5180 |
| Polarity: | Horizontal | Test Voltage: | DC 3.3 V |

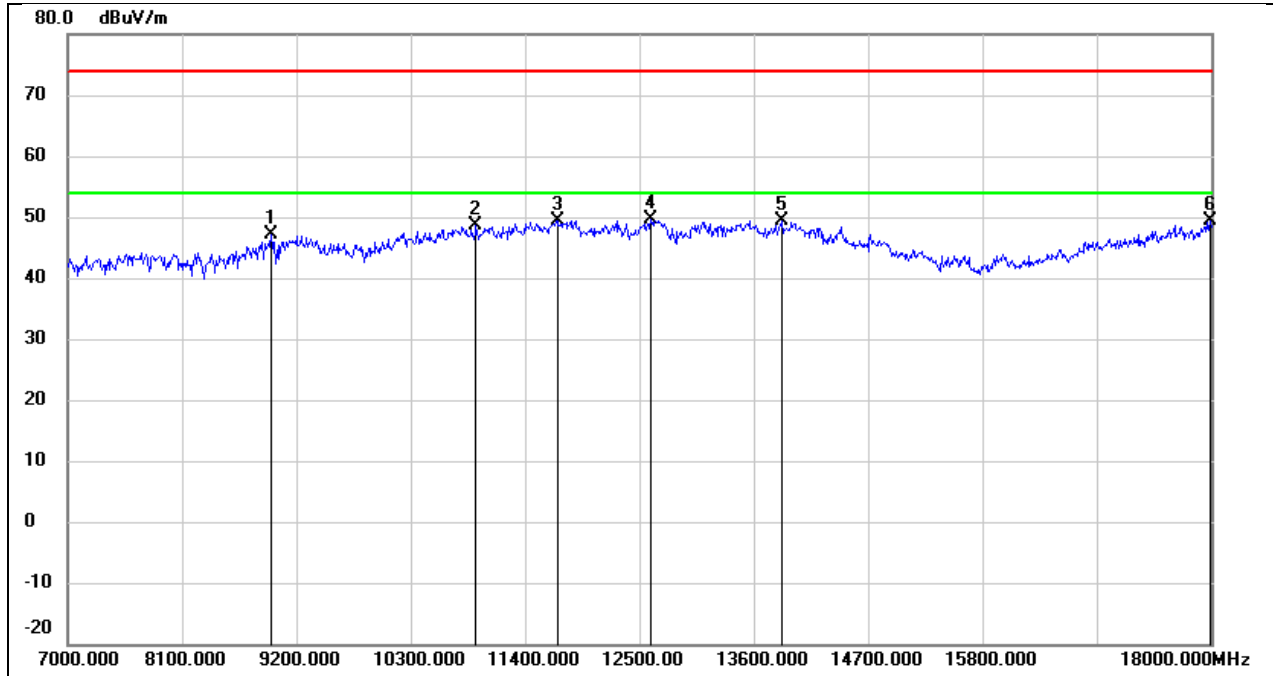

| No. | Frequency (MHz) | Reading (dBuV) | Correct (dB/m) | Result (dBuV/m) | Limit (dBuV/m) | Margin (dB) | Remark |
|-----|-----------------|----------------|----------------|-----------------|----------------|-------------|--------|
| 1 | 8958.000 | 37.08 | 10.05 | 47.13 | 74.00 | -26.87 | peak |
| 2 | 10927.000 | 34.27 | 14.45 | 48.72 | 74.00 | -25.28 | peak |
| 3 | 11708.000 | 32.31 | 17.16 | 49.47 | 74.00 | -24.53 | peak |
| 4 | 12610.000 | 31.67 | 17.97 | 49.64 | 74.00 | -24.36 | peak |
| 5 | 13875.000 | 27.89 | 21.57 | 49.46 | 74.00 | -24.54 | peak |
| 6 | 17989.000 | 23.36 | 26.04 | 49.40 | 74.00 | -24.60 | peak |

| | | | |
|------------|------------|-----------------|----------|
| Test Mode: | 802.11a 20 | Frequency(MHz): | 5180 |
| Polarity: | Vertical | Test Voltage: | DC 3.3 V |

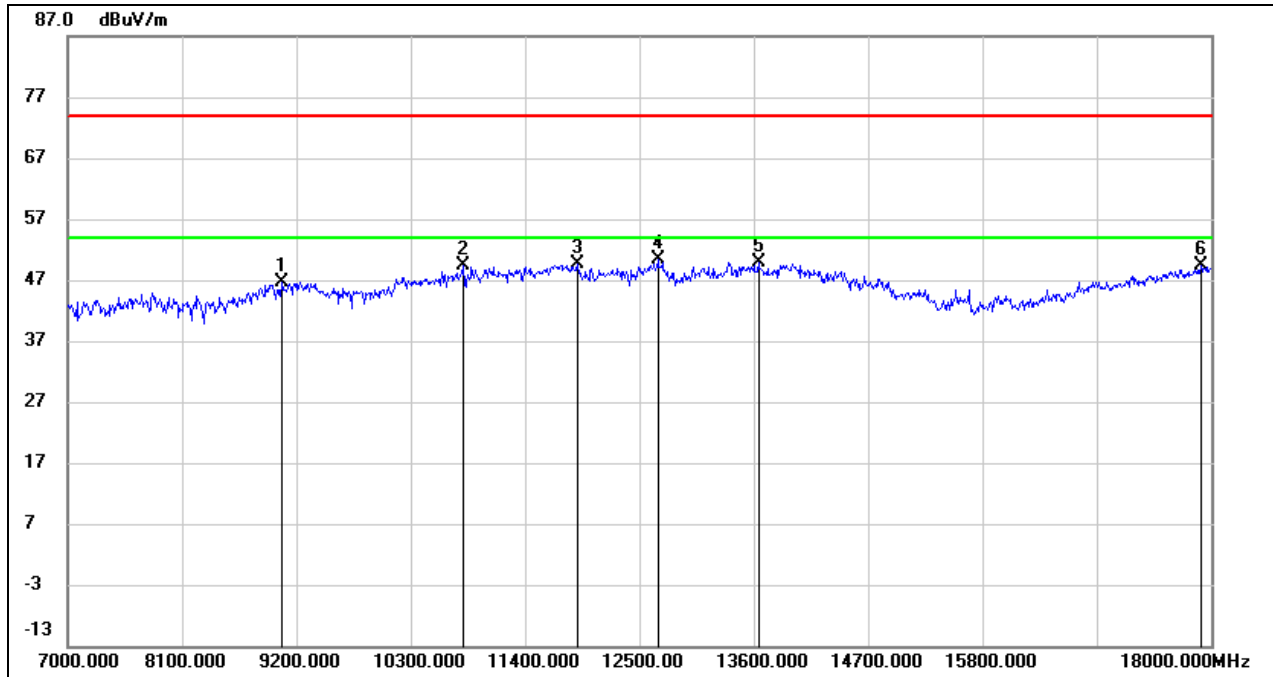

| No. | Frequency (MHz) | Reading (dBuV) | Correct (dB/m) | Result (dBuV/m) | Limit (dBuV/m) | Margin (dB) | Remark |
|-----|-----------------|----------------|----------------|-----------------|----------------|-------------|--------|
| 1 | 9057.000 | 36.34 | 10.38 | 46.72 | 74.00 | -27.28 | peak |
| 2 | 10806.000 | 35.44 | 13.98 | 49.42 | 74.00 | -24.58 | peak |
| 3 | 11906.000 | 32.04 | 17.52 | 49.56 | 74.00 | -24.44 | peak |
| 4 | 12676.000 | 32.40 | 18.05 | 50.45 | 74.00 | -23.55 | peak |
| 5 | 13644.000 | 28.79 | 20.99 | 49.78 | 74.00 | -24.22 | peak |
| 6 | 17901.000 | 23.86 | 25.45 | 49.31 | 74.00 | -24.69 | peak |

| | | | |
|------------|------------|-----------------|----------|
| Test Mode: | 802.11a 20 | Frequency(MHz): | 5200 |
| Polarity: | Horizontal | Test Voltage: | DC 3.3 V |

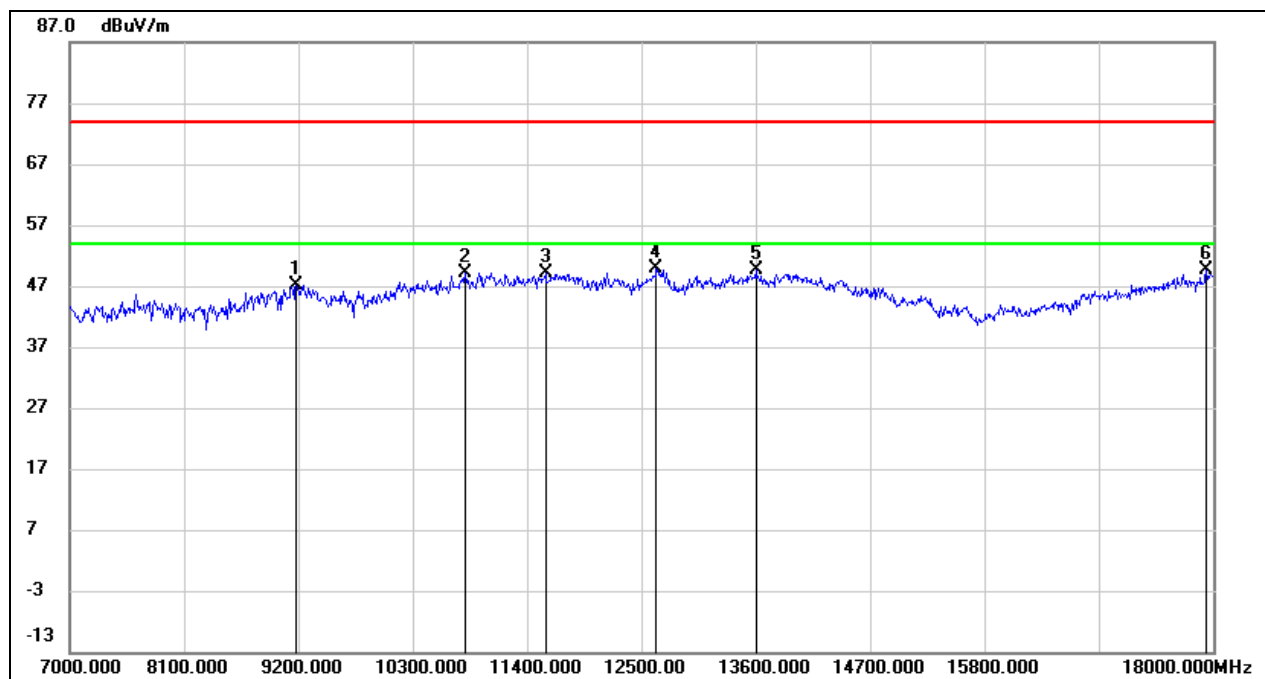

| No. | Frequency (MHz) | Reading (dBuV) | Correct (dB/m) | Result (dBuV/m) | Limit (dBuV/m) | Margin (dB) | Remark |
|-----|-----------------|----------------|----------------|-----------------|----------------|-------------|--------|
| 1 | 9178.000 | 36.68 | 10.45 | 47.13 | 74.00 | -26.87 | peak |
| 2 | 10806.000 | 35.08 | 13.98 | 49.06 | 74.00 | -24.94 | peak |
| 3 | 11576.000 | 32.11 | 16.91 | 49.02 | 74.00 | -24.98 | peak |
| 4 | 12643.000 | 31.79 | 18.01 | 49.80 | 74.00 | -24.20 | peak |
| 5 | 13600.000 | 28.85 | 20.89 | 49.74 | 74.00 | -24.26 | peak |
| 6 | 17934.000 | 23.95 | 25.67 | 49.62 | 74.00 | -24.38 | peak |

| | | | |
|------------|------------|-----------------|----------|
| Test Mode: | 802.11a 20 | Frequency(MHz): | 5200 |
| Polarity: | Vertical | Test Voltage: | DC 3.3 V |

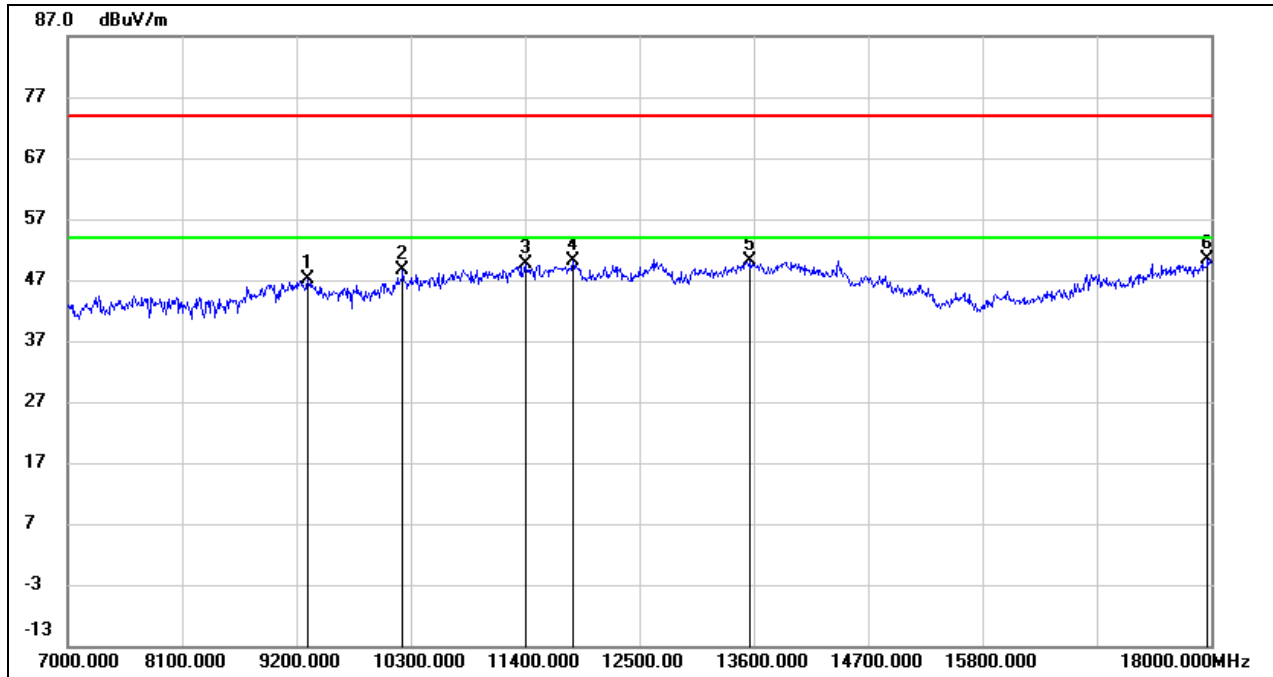

| No. | Frequency (MHz) | Reading (dBuV) | Correct (dB/m) | Result (dBuV/m) | Limit (dBuV/m) | Margin (dB) | Remark |
|-----|-----------------|----------------|----------------|-----------------|----------------|-------------|--------|
| 1 | 9310.000 | 36.69 | 10.54 | 47.23 | 74.00 | -26.77 | peak |
| 2 | 10223.000 | 36.38 | 12.24 | 48.62 | 74.00 | -25.38 | peak |
| 3 | 11400.000 | 33.19 | 16.36 | 49.55 | 74.00 | -24.45 | peak |
| 4 | 11862.000 | 32.57 | 17.45 | 50.02 | 74.00 | -23.98 | peak |
| 5 | 13567.000 | 29.36 | 20.80 | 50.16 | 74.00 | -23.84 | peak |
| 6 | 17967.000 | 24.59 | 25.89 | 50.48 | 74.00 | -23.52 | peak |

| | | | |
|------------|------------|-----------------|----------|
| Test Mode: | 802.11a 20 | Frequency(MHz): | 5240 |
| Polarity: | Horizontal | Test Voltage: | DC 3.3 V |

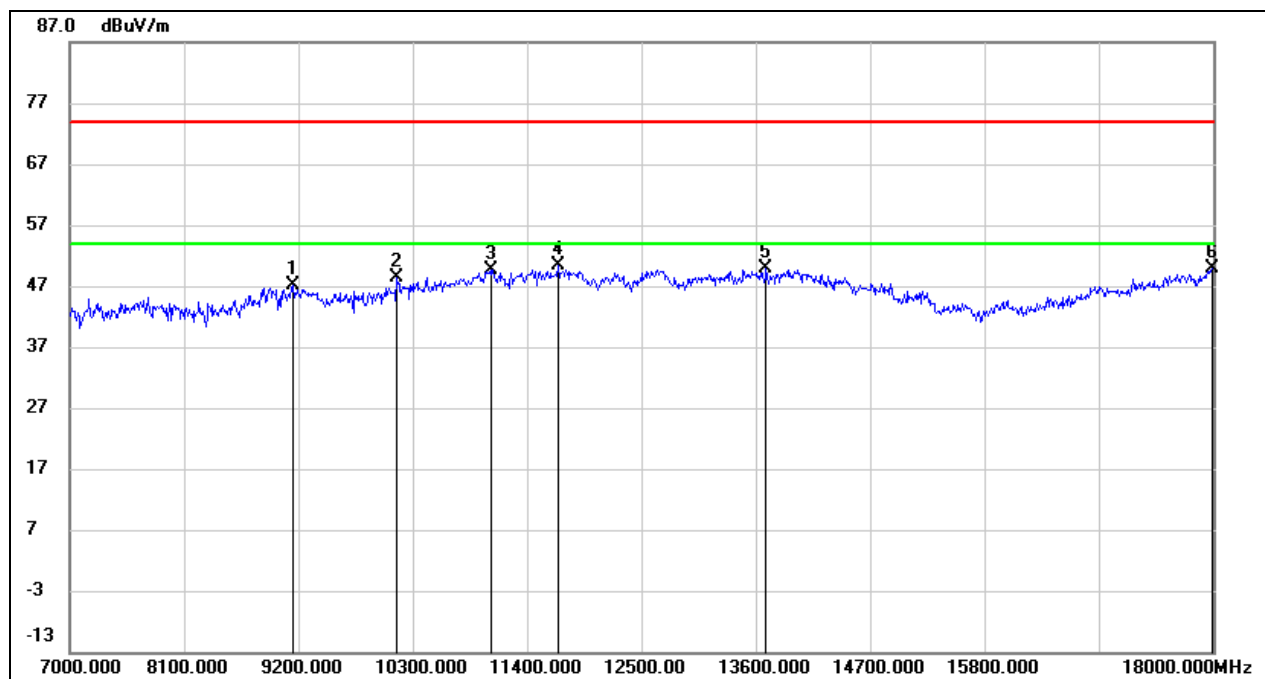

| No. | Frequency (MHz) | Reading (dBuV) | Correct (dB/m) | Result (dBuV/m) | Limit (dBuV/m) | Margin (dB) | Remark |
|-----|-----------------|----------------|----------------|-----------------|----------------|-------------|--------|
| 1 | 9145.000 | 36.73 | 10.43 | 47.16 | 74.00 | -26.84 | peak |
| 2 | 10146.000 | 36.32 | 12.07 | 48.39 | 74.00 | -25.61 | peak |
| 3 | 11048.000 | 34.75 | 14.91 | 49.66 | 74.00 | -24.34 | peak |
| 4 | 11697.000 | 33.35 | 17.13 | 50.48 | 74.00 | -23.52 | peak |
| 5 | 13699.000 | 28.84 | 21.14 | 49.98 | 74.00 | -24.02 | peak |
| 6 | 17989.000 | 23.87 | 26.04 | 49.91 | 74.00 | -24.09 | peak |

| | | | |
|------------|------------|-----------------|----------|
| Test Mode: | 802.11a 20 | Frequency(MHz): | 5240 |
| Polarity: | Vertical | Test Voltage: | DC 3.3 V |

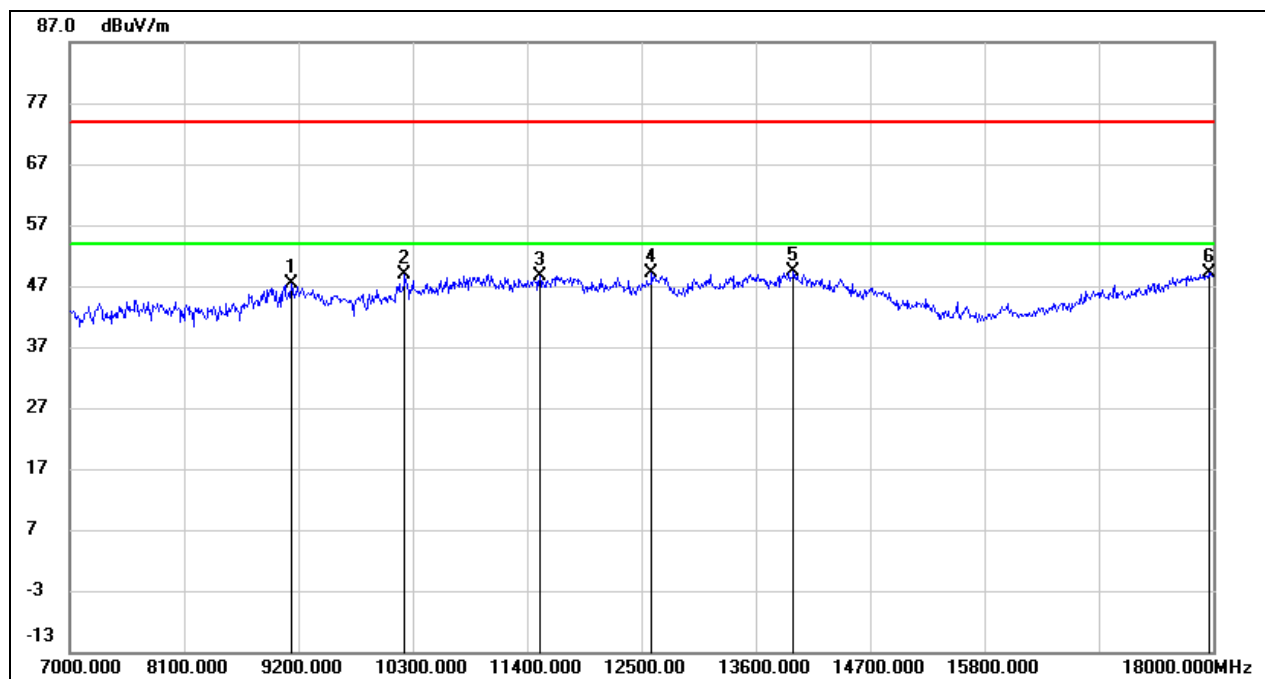

| No. | Frequency (MHz) | Reading (dBuV) | Correct (dB/m) | Result (dBuV/m) | Limit (dBuV/m) | Margin (dB) | Remark |
|-----|-----------------|----------------|----------------|-----------------|----------------|-------------|--------|
| 1 | 9134.000 | 36.95 | 10.41 | 47.36 | 74.00 | -26.64 | peak |
| 2 | 10223.000 | 36.54 | 12.24 | 48.78 | 74.00 | -25.22 | peak |
| 3 | 11521.000 | 31.79 | 16.82 | 48.61 | 74.00 | -25.39 | peak |
| 4 | 12599.000 | 31.10 | 17.95 | 49.05 | 74.00 | -24.95 | peak |
| 5 | 13963.000 | 27.51 | 21.78 | 49.29 | 74.00 | -24.71 | peak |
| 6 | 17956.000 | 23.34 | 25.82 | 49.16 | 74.00 | -24.84 | peak |

| | | | |
|------------|------------|-----------------|----------|
| Test Mode: | 802.11a 20 | Frequency(MHz): | 5260 |
| Polarity: | Horizontal | Test Voltage: | DC 3.3 V |

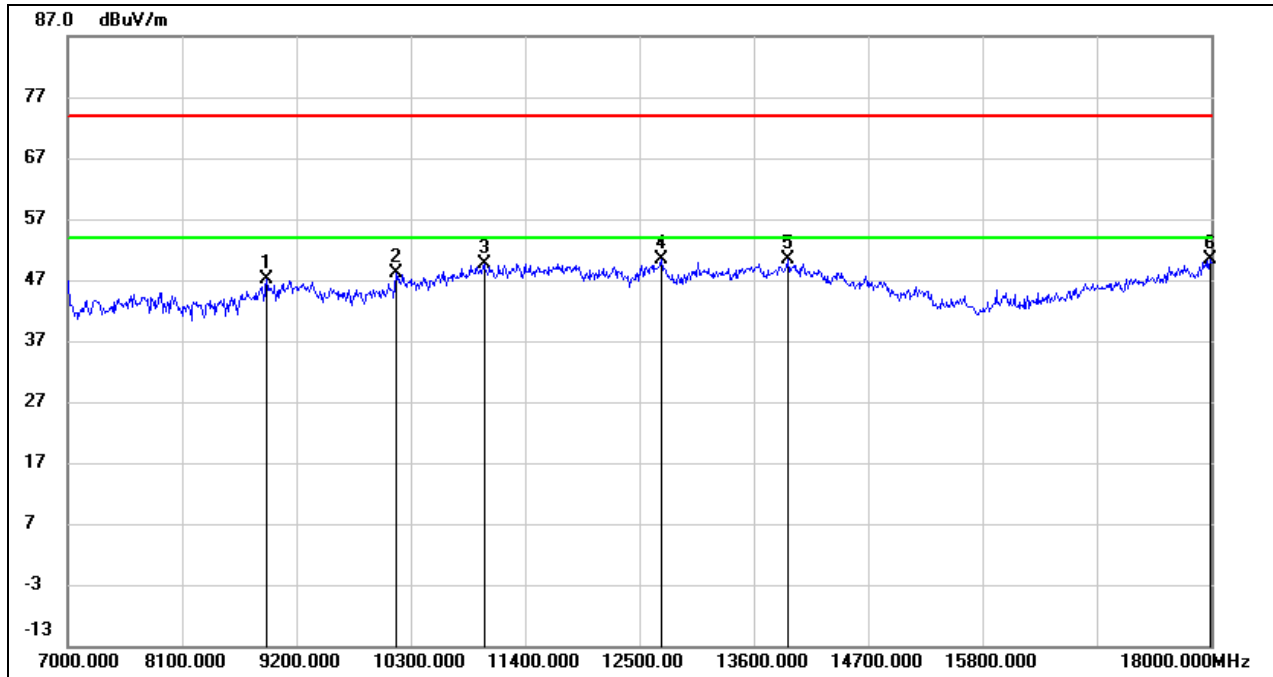

| No. | Frequency (MHz) | Reading (dBuV) | Correct (dB/m) | Result (dBuV/m) | Limit (dBuV/m) | Margin (dB) | Remark |
|-----|-----------------|----------------|----------------|-----------------|----------------|-------------|--------|
| 1 | 8914.000 | 37.26 | 9.75 | 47.01 | 74.00 | -26.99 | peak |
| 2 | 10157.000 | 36.04 | 12.10 | 48.14 | 74.00 | -25.86 | peak |
| 3 | 11004.000 | 35.00 | 14.74 | 49.74 | 74.00 | -24.26 | peak |
| 4 | 12709.000 | 32.19 | 18.09 | 50.28 | 74.00 | -23.72 | peak |
| 5 | 13930.000 | 28.56 | 21.71 | 50.27 | 74.00 | -23.73 | peak |
| 6 | 17989.000 | 24.37 | 26.04 | 50.41 | 74.00 | -23.59 | peak |

| | | | |
|------------|------------|-----------------|----------|
| Test Mode: | 802.11a 20 | Frequency(MHz): | 5260 |
| Polarity: | Vertical | Test Voltage: | DC 3.3 V |

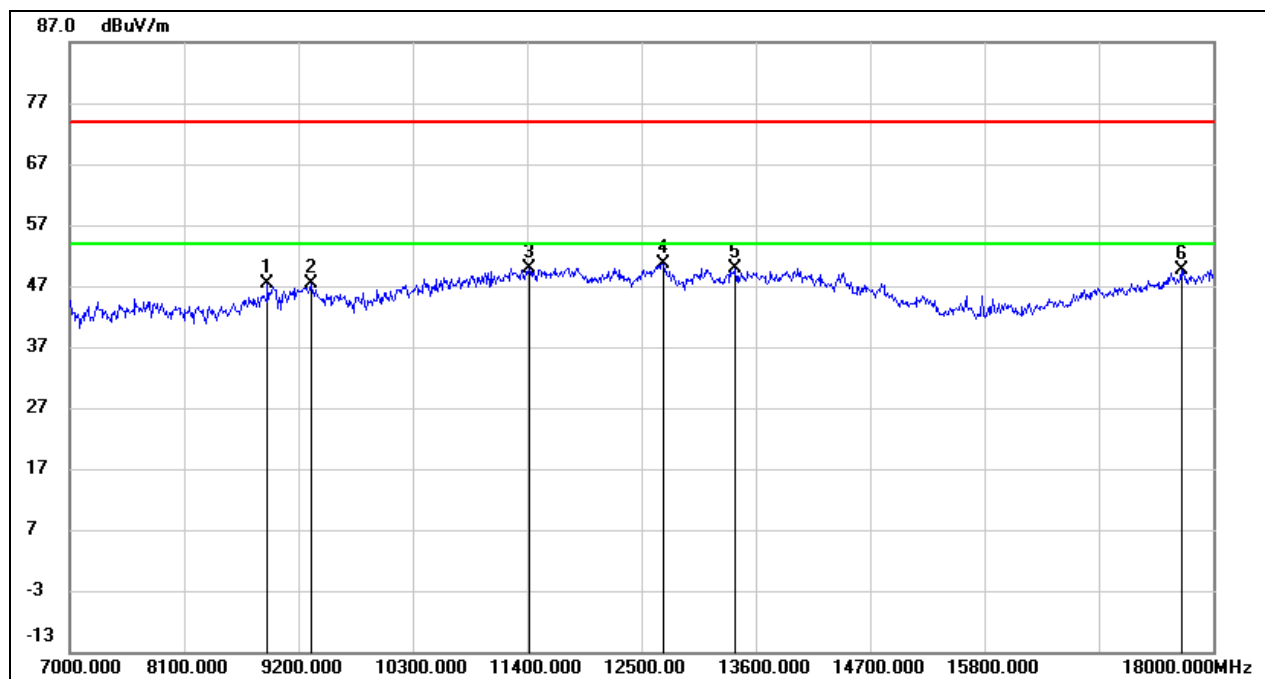

| No. | Frequency (MHz) | Reading (dBuV) | Correct (dB/m) | Result (dBuV/m) | Limit (dBuV/m) | Margin (dB) | Remark |
|-----|-----------------|----------------|----------------|-----------------|----------------|-------------|--------|
| 1 | 8903.000 | 37.63 | 9.66 | 47.29 | 74.00 | -26.71 | peak |
| 2 | 9321.000 | 36.76 | 10.53 | 47.29 | 74.00 | -26.71 | peak |
| 3 | 11422.000 | 33.52 | 16.46 | 49.98 | 74.00 | -24.02 | peak |
| 4 | 12709.000 | 32.57 | 18.09 | 50.66 | 74.00 | -23.34 | peak |
| 5 | 13402.000 | 29.61 | 20.20 | 49.81 | 74.00 | -24.19 | peak |
| 6 | 17692.000 | 25.62 | 24.01 | 49.63 | 74.00 | -24.37 | peak |

| | | | |
|------------|------------|-----------------|----------|
| Test Mode: | 802.11a 20 | Frequency(MHz): | 5280 |
| Polarity: | Horizontal | Test Voltage: | DC 3.3 V |

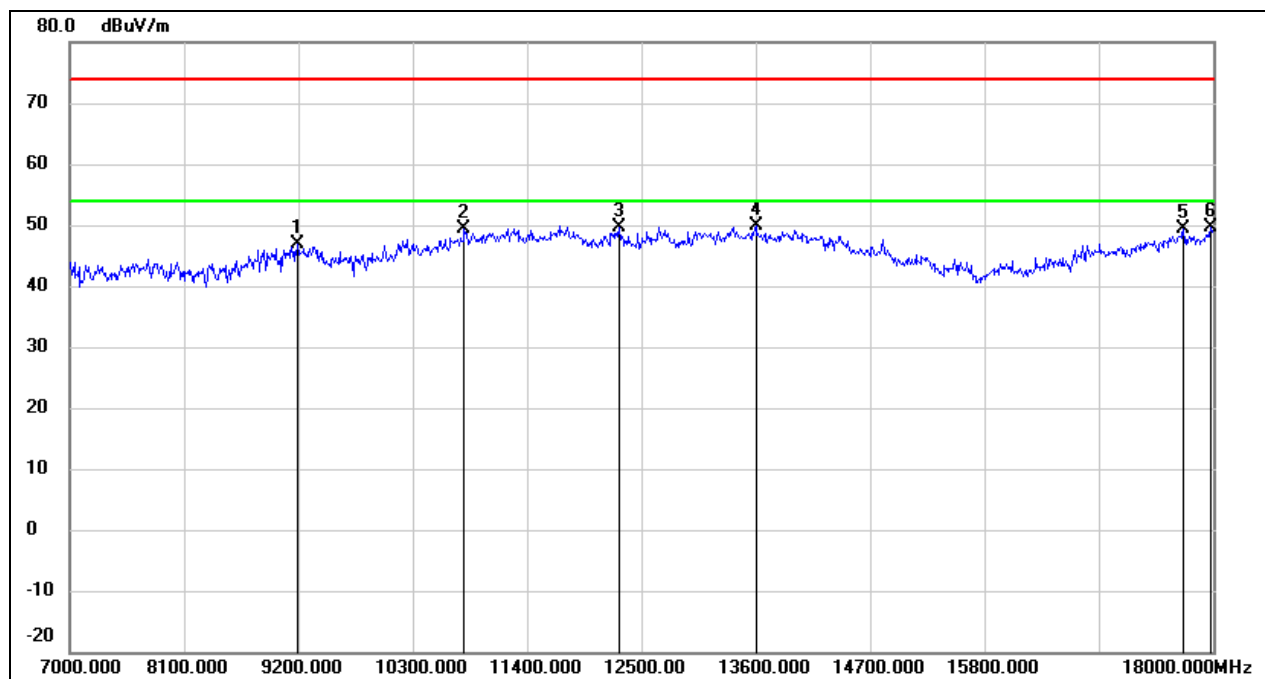

| No. | Frequency (MHz) | Reading (dBuV) | Correct (dB/m) | Result (dBuV/m) | Limit (dBuV/m) | Margin (dB) | Remark |
|-----|-----------------|----------------|----------------|-----------------|----------------|-------------|--------|
| 1 | 9189.000 | 36.35 | 10.46 | 46.81 | 74.00 | -27.19 | peak |
| 2 | 10795.000 | 35.40 | 13.94 | 49.34 | 74.00 | -24.66 | peak |
| 3 | 12280.000 | 31.79 | 17.77 | 49.56 | 74.00 | -24.44 | peak |
| 4 | 13600.000 | 29.02 | 20.89 | 49.91 | 74.00 | -24.09 | peak |
| 5 | 17714.000 | 25.25 | 24.16 | 49.41 | 74.00 | -24.59 | peak |
| 6 | 17978.000 | 23.63 | 25.97 | 49.60 | 74.00 | -24.40 | peak |

| | | | |
|------------|------------|-----------------|----------|
| Test Mode: | 802.11a 20 | Frequency(MHz): | 5280 |
| Polarity: | Vertical | Test Voltage: | DC 3.3 V |

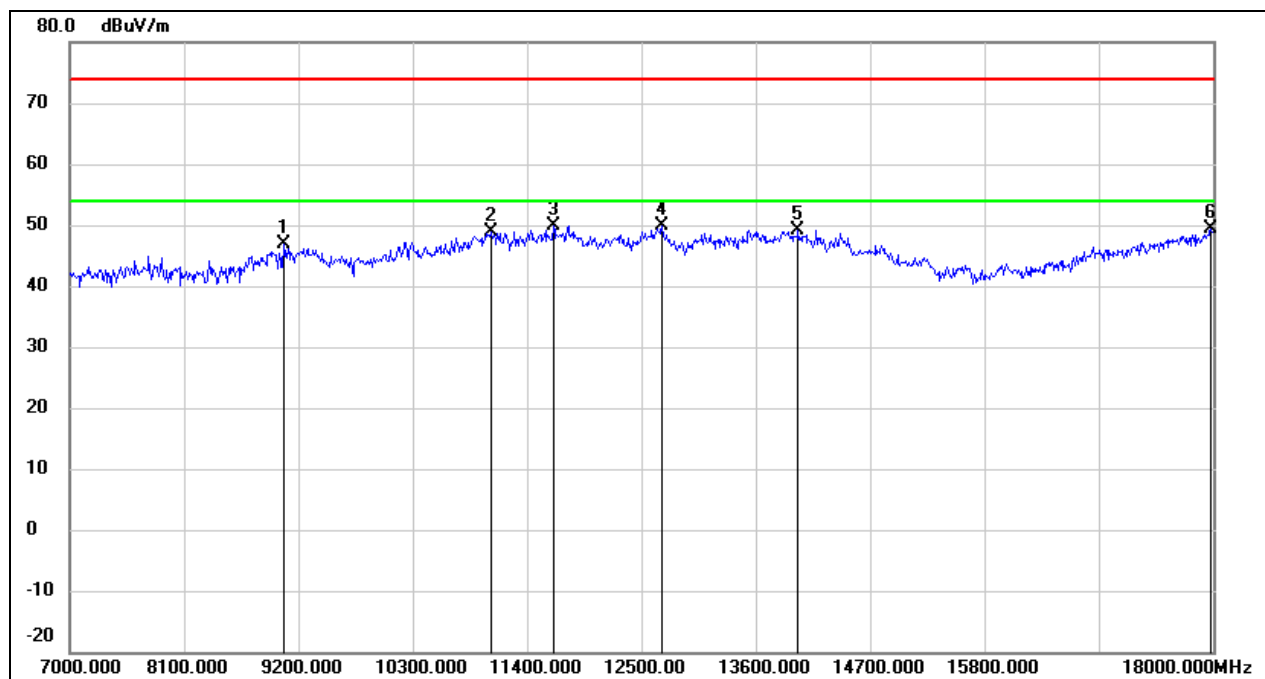

| No. | Frequency (MHz) | Reading (dBuV) | Correct (dB/m) | Result (dBuV/m) | Limit (dBuV/m) | Margin (dB) | Remark |
|-----|-----------------|----------------|----------------|-----------------|----------------|-------------|--------|
| 1 | 9057.000 | 36.55 | 10.38 | 46.93 | 74.00 | -27.07 | peak |
| 2 | 11048.000 | 34.04 | 14.91 | 48.95 | 74.00 | -25.05 | peak |
| 3 | 11653.000 | 32.80 | 17.05 | 49.85 | 74.00 | -24.15 | peak |
| 4 | 12698.000 | 31.79 | 18.08 | 49.87 | 74.00 | -24.13 | peak |
| 5 | 14007.000 | 27.26 | 21.85 | 49.11 | 74.00 | -24.89 | peak |
| 6 | 17978.000 | 23.33 | 25.97 | 49.30 | 74.00 | -24.70 | peak |

| | | | |
|------------|------------|-----------------|----------|
| Test Mode: | 802.11a 20 | Frequency(MHz): | 5320 |
| Polarity: | Horizontal | Test Voltage: | DC 3.3 V |

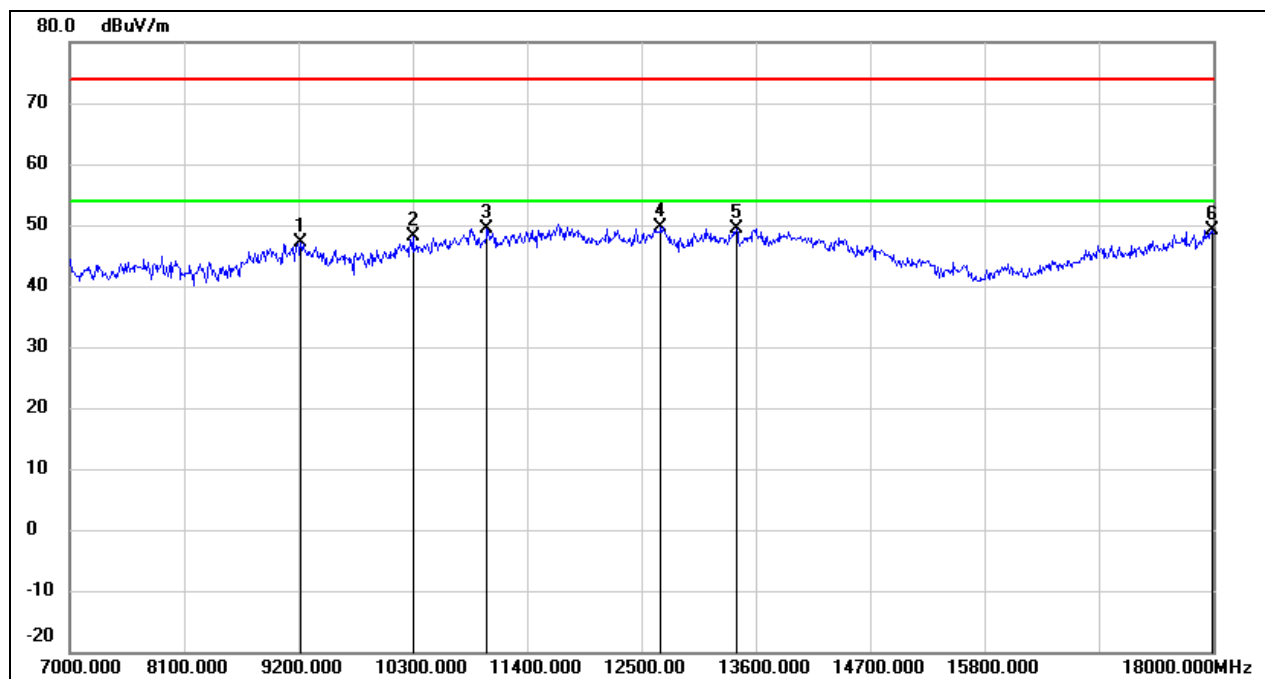

| No. | Frequency (MHz) | Reading (dBuV) | Correct (dB/m) | Result (dBuV/m) | Limit (dBuV/m) | Margin (dB) | Remark |
|-----|-----------------|----------------|----------------|-----------------|----------------|-------------|--------|
| 1 | 9222.000 | 36.61 | 10.48 | 47.09 | 74.00 | -26.91 | peak |
| 2 | 10300.000 | 35.61 | 12.40 | 48.01 | 74.00 | -25.99 | peak |
| 3 | 11015.000 | 34.67 | 14.79 | 49.46 | 74.00 | -24.54 | peak |
| 4 | 12687.000 | 31.54 | 18.05 | 49.59 | 74.00 | -24.41 | peak |
| 5 | 13413.000 | 29.10 | 20.26 | 49.36 | 74.00 | -24.64 | peak |
| 6 | 17989.000 | 23.21 | 26.04 | 49.25 | 74.00 | -24.75 | peak |

| | | | |
|------------|------------|-----------------|----------|
| Test Mode: | 802.11a 20 | Frequency(MHz): | 5320 |
| Polarity: | Vertical | Test Voltage: | DC 3.3 V |

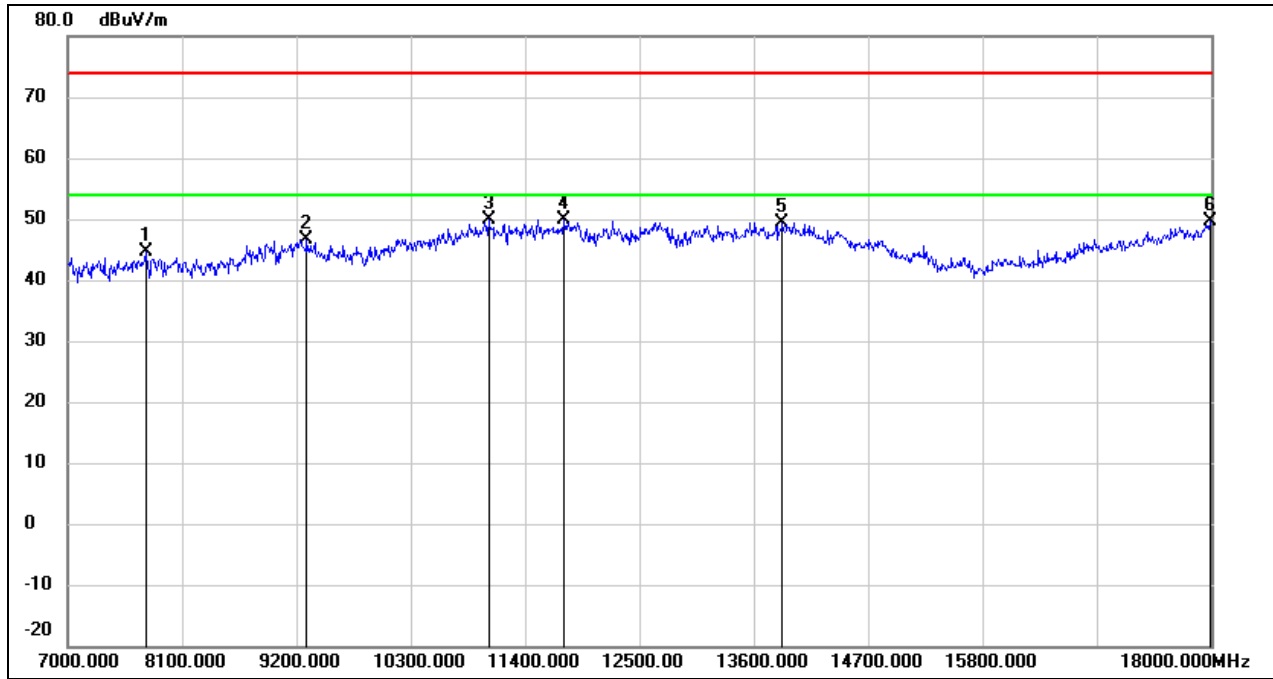

| No. | Frequency (MHz) | Reading (dBuV) | Correct (dB/m) | Result (dBuV/m) | Limit (dBuV/m) | Margin (dB) | Remark |
|-----|-----------------|----------------|----------------|-----------------|----------------|-------------|--------|
| 1 | 7748.000 | 37.99 | 6.66 | 44.65 | 74.00 | -29.35 | peak |
| 2 | 9299.000 | 36.11 | 10.53 | 46.64 | 74.00 | -27.36 | peak |
| 3 | 11048.000 | 35.06 | 14.91 | 49.97 | 74.00 | -24.03 | peak |
| 4 | 11774.000 | 32.68 | 17.28 | 49.96 | 74.00 | -24.04 | peak |
| 5 | 13875.000 | 27.84 | 21.57 | 49.41 | 74.00 | -24.59 | peak |
| 6 | 17989.000 | 23.49 | 26.04 | 49.53 | 74.00 | -24.47 | peak |

| | | | |
|------------|------------|-----------------|----------|
| Test Mode: | 802.11a 20 | Frequency(MHz): | 5500 |
| Polarity: | Horizontal | Test Voltage: | DC 3.3 V |

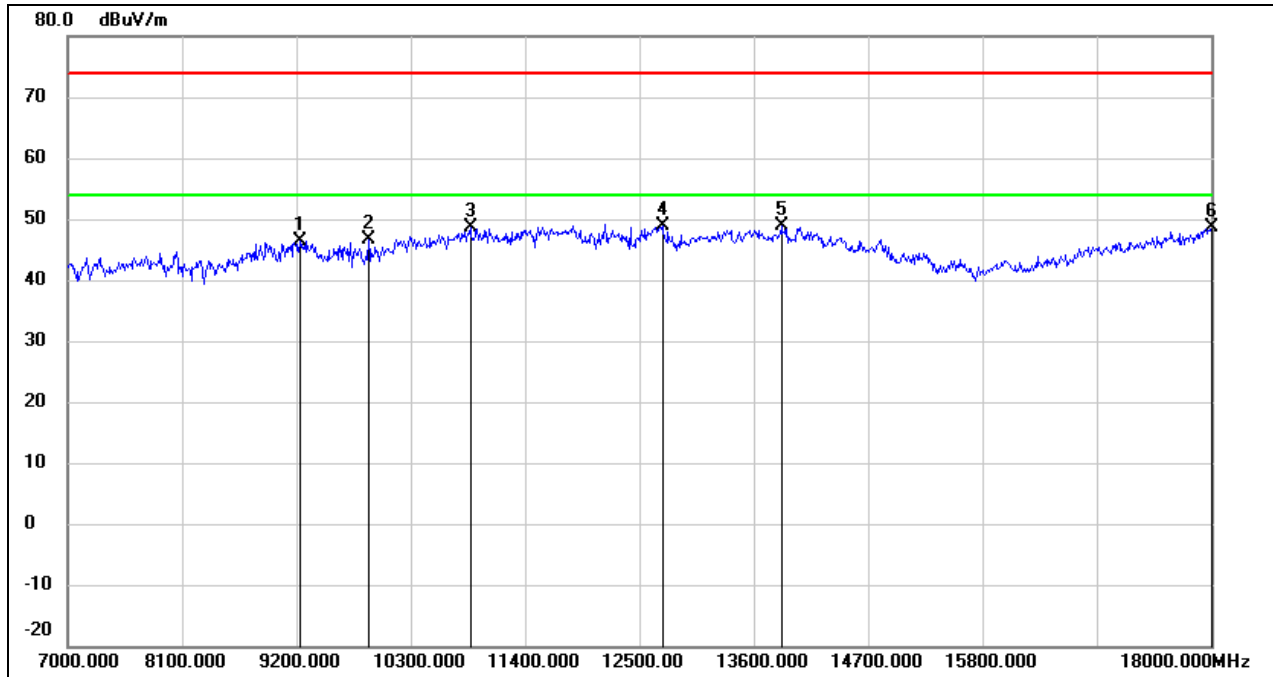

| No. | Frequency (MHz) | Reading (dBuV) | Correct (dB/m) | Result (dBuV/m) | Limit (dBuV/m) | Margin (dB) | Remark |
|-----|-----------------|----------------|----------------|-----------------|----------------|-------------|--------|
| 1 | 9233.000 | 35.94 | 10.48 | 46.42 | 74.00 | -27.58 | peak |
| 2 | 9893.000 | 35.00 | 11.52 | 46.52 | 74.00 | -27.48 | peak |
| 3 | 10872.000 | 34.37 | 14.23 | 48.60 | 74.00 | -25.40 | peak |
| 4 | 12720.000 | 30.91 | 18.09 | 49.00 | 74.00 | -25.00 | peak |
| 5 | 13864.000 | 27.44 | 21.53 | 48.97 | 74.00 | -25.03 | peak |
| 6 | 18000.000 | 22.51 | 26.12 | 48.63 | 74.00 | -25.37 | peak |

| | | | |
|------------|------------|-----------------|----------|
| Test Mode: | 802.11a 20 | Frequency(MHz): | 5500 |
| Polarity: | Vertical | Test Voltage: | DC 3.3 V |

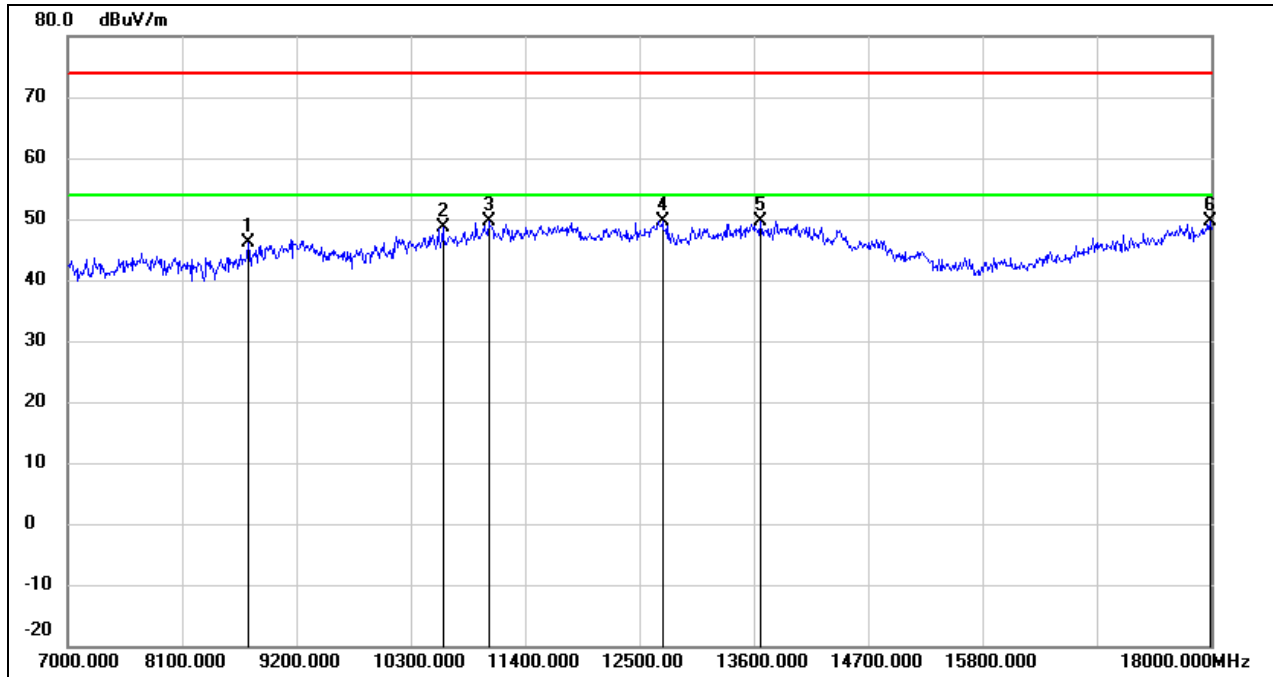

| No. | Frequency (MHz) | Reading (dBuV) | Correct (dB/m) | Result (dBuV/m) | Limit (dBuV/m) | Margin (dB) | Remark |
|-----|-----------------|----------------|----------------|-----------------|----------------|-------------|--------|
| 1 | 8738.000 | 37.62 | 8.53 | 46.15 | 74.00 | -27.85 | peak |
| 2 | 10608.000 | 35.41 | 13.23 | 48.64 | 74.00 | -25.36 | peak |
| 3 | 11048.000 | 34.60 | 14.91 | 49.51 | 74.00 | -24.49 | peak |
| 4 | 12720.000 | 31.61 | 18.09 | 49.70 | 74.00 | -24.30 | peak |
| 5 | 13666.000 | 28.63 | 21.05 | 49.68 | 74.00 | -24.32 | peak |
| 6 | 17989.000 | 23.65 | 26.04 | 49.69 | 74.00 | -24.31 | peak |

| | | | |
|------------|------------|-----------------|----------|
| Test Mode: | 802.11a 20 | Frequency(MHz): | 5580 |
| Polarity: | Horizontal | Test Voltage: | DC 3.3 V |

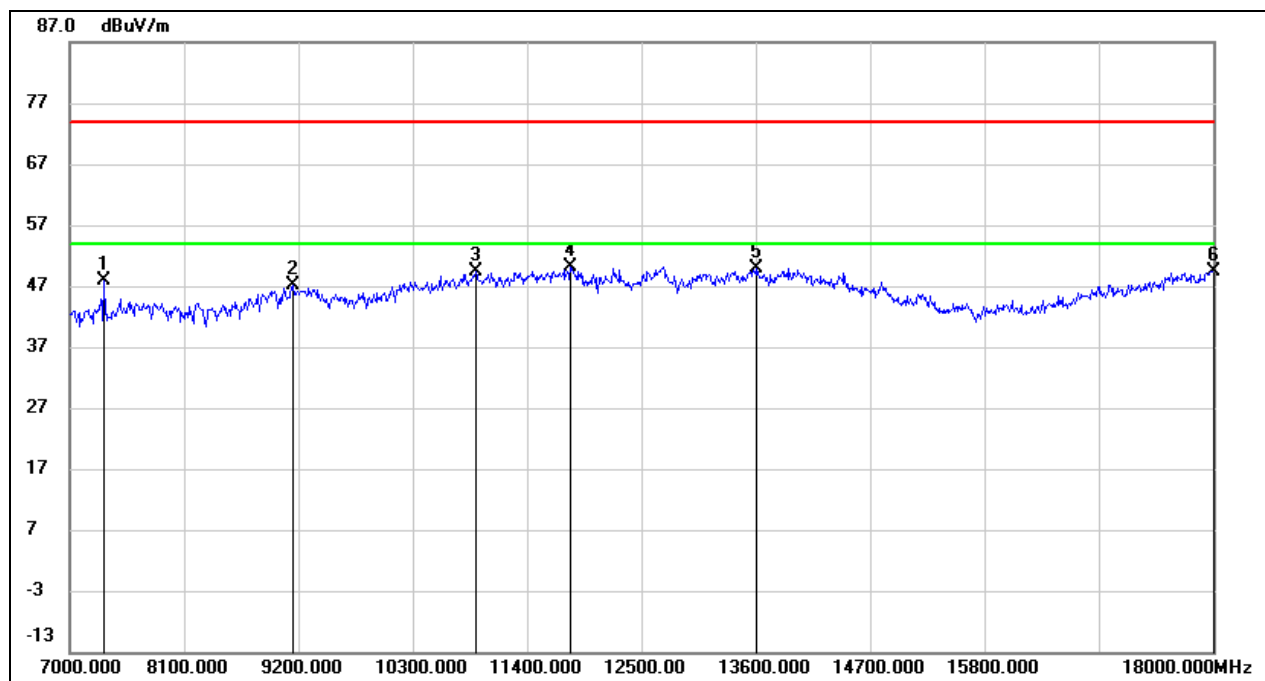

| No. | Frequency (MHz) | Reading (dBuV) | Correct (dB/m) | Result (dBuV/m) | Limit (dBuV/m) | Margin (dB) | Remark |
|-----|-----------------|----------------|----------------|-----------------|----------------|-------------|--------|
| 1 | 7330.000 | 40.83 | 6.94 | 47.77 | 74.00 | -26.23 | peak |
| 2 | 9145.000 | 36.67 | 10.43 | 47.10 | 74.00 | -26.90 | peak |
| 3 | 10905.000 | 34.91 | 14.36 | 49.27 | 74.00 | -24.73 | peak |
| 4 | 11818.000 | 32.78 | 17.36 | 50.14 | 74.00 | -23.86 | peak |
| 5 | 13611.000 | 28.95 | 20.92 | 49.87 | 74.00 | -24.13 | peak |
| 6 | 18000.000 | 23.28 | 26.12 | 49.40 | 74.00 | -24.60 | peak |

| | | | |
|------------|------------|-----------------|----------|
| Test Mode: | 802.11a 20 | Frequency(MHz): | 5580 |
| Polarity: | Vertical | Test Voltage: | DC 3.3 V |

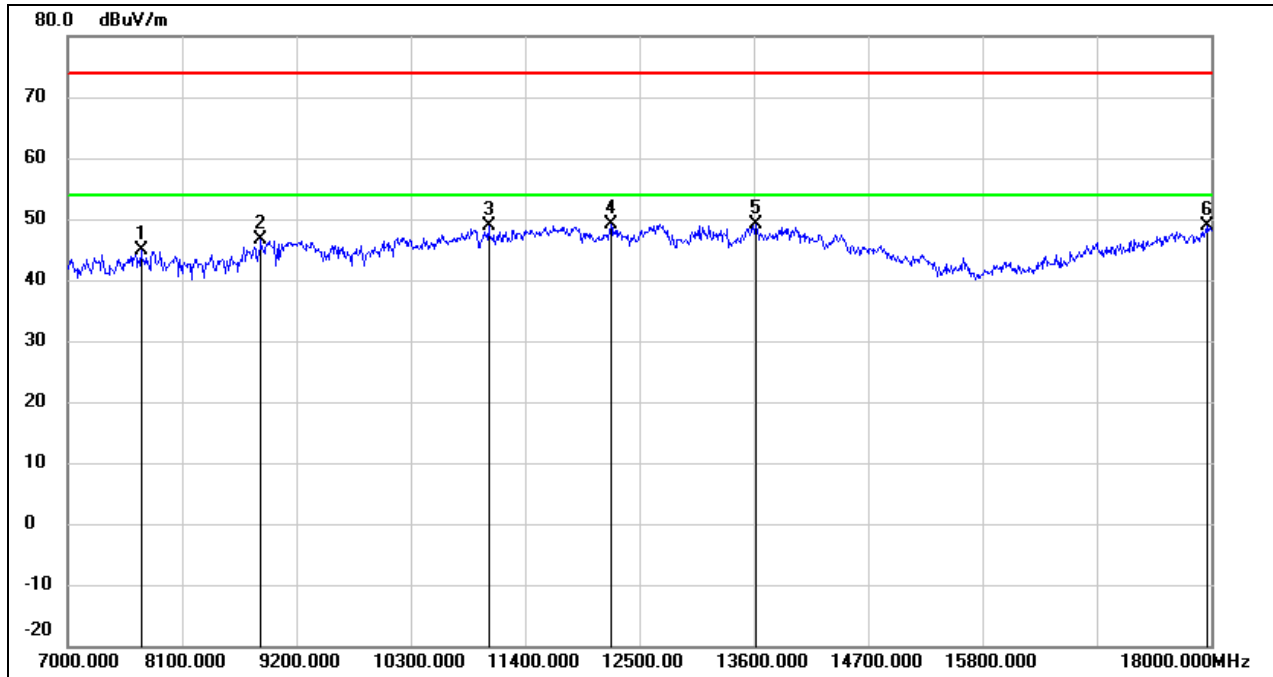

| No. | Frequency (MHz) | Reading (dBuV) | Correct (dB/m) | Result (dBuV/m) | Limit (dBuV/m) | Margin (dB) | Remark |
|-----|-----------------|----------------|----------------|-----------------|----------------|-------------|--------|
| 1 | 7704.000 | 38.13 | 6.69 | 44.82 | 74.00 | -29.18 | peak |
| 2 | 8859.000 | 37.34 | 9.36 | 46.70 | 74.00 | -27.30 | peak |
| 3 | 11048.000 | 34.04 | 14.91 | 48.95 | 74.00 | -25.05 | peak |
| 4 | 12225.000 | 31.28 | 17.75 | 49.03 | 74.00 | -24.97 | peak |
| 5 | 13622.000 | 28.14 | 20.95 | 49.09 | 74.00 | -24.91 | peak |
| 6 | 17967.000 | 23.06 | 25.89 | 48.95 | 74.00 | -25.05 | peak |

| | | | |
|------------|------------|-----------------|----------|
| Test Mode: | 802.11a 20 | Frequency(MHz): | 5700 |
| Polarity: | Horizontal | Test Voltage: | DC 3.3 V |

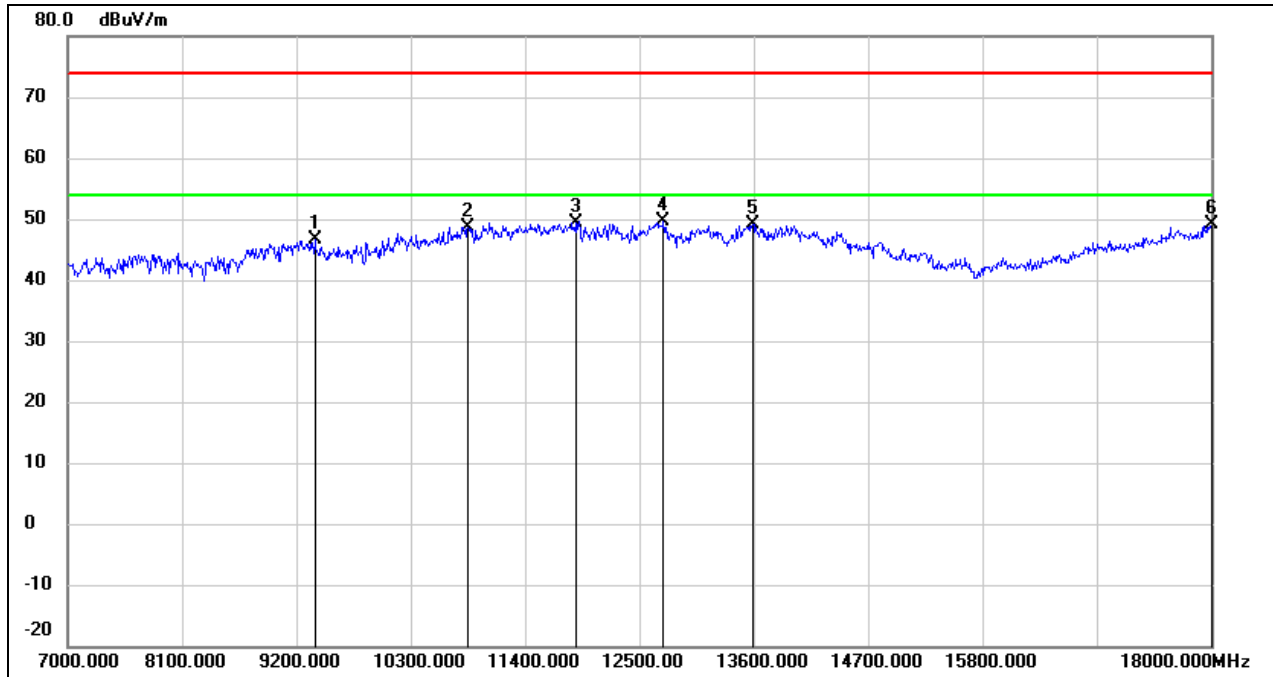

| No. | Frequency (MHz) | Reading (dBuV) | Correct (dB/m) | Result (dBuV/m) | Limit (dBuV/m) | Margin (dB) | Remark |
|-----|-----------------|----------------|----------------|-----------------|----------------|-------------|--------|
| 1 | 9376.000 | 36.15 | 10.58 | 46.73 | 74.00 | -27.27 | peak |
| 2 | 10850.000 | 34.57 | 14.15 | 48.72 | 74.00 | -25.28 | peak |
| 3 | 11884.000 | 31.99 | 17.48 | 49.47 | 74.00 | -24.53 | peak |
| 4 | 12731.000 | 31.52 | 18.12 | 49.64 | 74.00 | -24.36 | peak |
| 5 | 13589.000 | 28.24 | 20.86 | 49.10 | 74.00 | -24.90 | peak |
| 6 | 18000.000 | 23.04 | 26.12 | 49.16 | 74.00 | -24.84 | peak |

| | | | |
|------------|------------|-----------------|----------|
| Test Mode: | 802.11a 20 | Frequency(MHz): | 5700 |
| Polarity: | Vertical | Test Voltage: | DC 3.3 V |

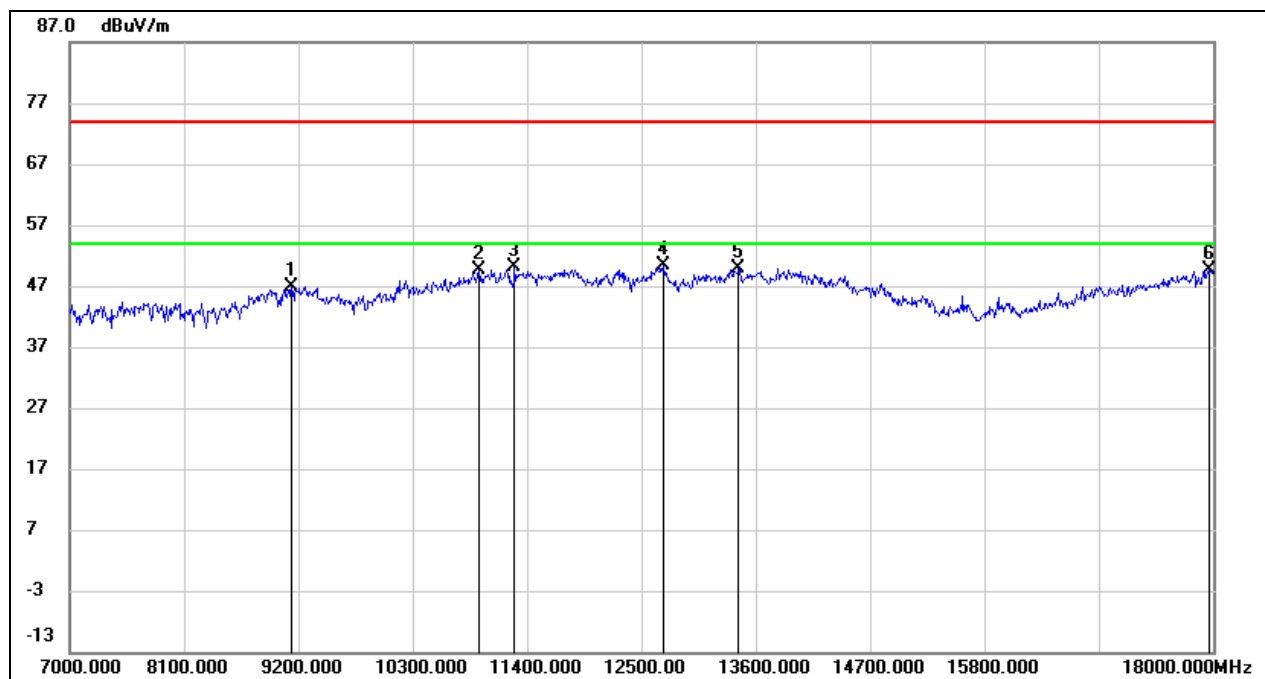

| No. | Frequency (MHz) | Reading (dBuV) | Correct (dB/m) | Result (dBuV/m) | Limit (dBuV/m) | Margin (dB) | Remark |
|-----|-----------------|----------------|----------------|-----------------|----------------|-------------|--------|
| 1 | 9134.000 | 36.50 | 10.41 | 46.91 | 74.00 | -27.09 | peak |
| 2 | 10938.000 | 35.25 | 14.48 | 49.73 | 74.00 | -24.27 | peak |
| 3 | 11279.000 | 34.27 | 15.86 | 50.13 | 74.00 | -23.87 | peak |
| 4 | 12709.000 | 32.31 | 18.09 | 50.40 | 74.00 | -23.60 | peak |
| 5 | 13435.000 | 29.55 | 20.35 | 49.90 | 74.00 | -24.10 | peak |
| 6 | 17967.000 | 23.85 | 25.89 | 49.74 | 74.00 | -24.26 | peak |

| | | | |
|------------|------------|-----------------|----------|
| Test Mode: | 802.11a 20 | Frequency(MHz): | 5720 |
| Polarity: | Horizontal | Test Voltage: | DC 3.3 V |

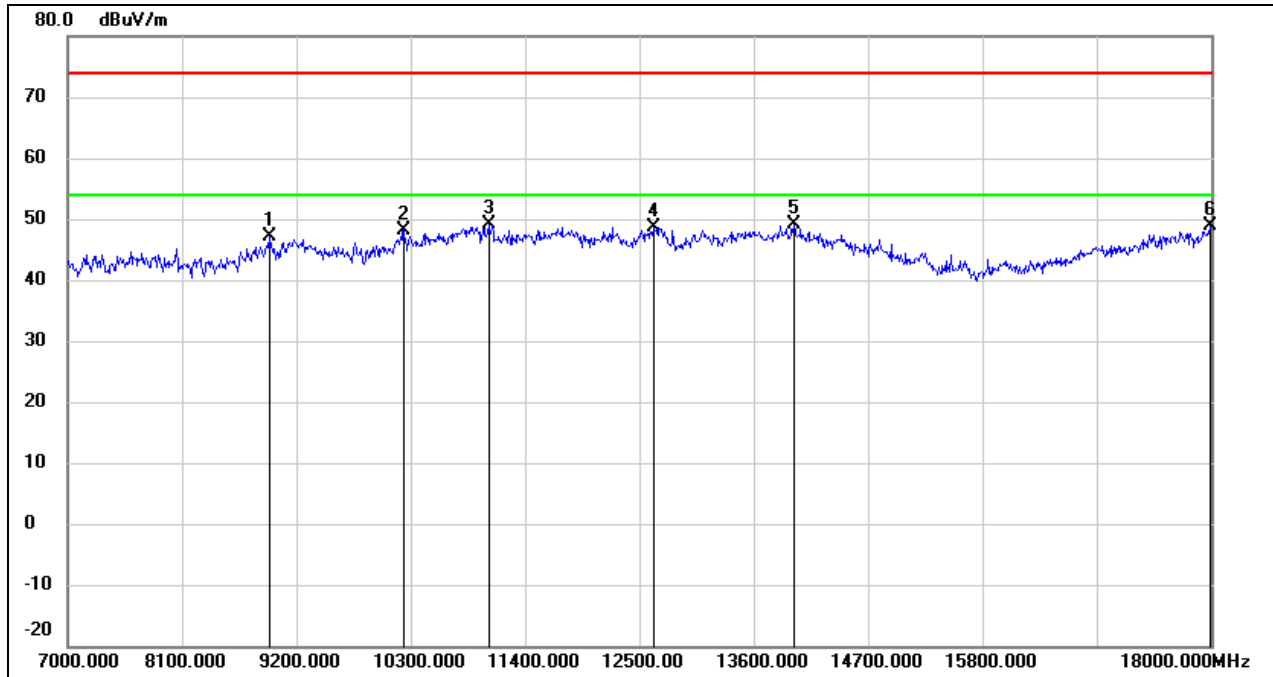

| No. | Frequency (MHz) | Reading (dBuV) | Correct (dB/m) | Result (dBuV/m) | Limit (dBuV/m) | Margin (dB) | Remark |
|-----|-----------------|----------------|----------------|-----------------|----------------|-------------|--------|
| 1 | 8936.000 | 37.13 | 9.90 | 47.03 | 74.00 | -26.97 | peak |
| 2 | 10234.000 | 35.98 | 12.26 | 48.24 | 74.00 | -25.76 | peak |
| 3 | 11048.000 | 34.11 | 14.91 | 49.02 | 74.00 | -24.98 | peak |
| 4 | 12632.000 | 30.75 | 17.99 | 48.74 | 74.00 | -25.26 | peak |
| 5 | 13985.000 | 27.25 | 21.85 | 49.10 | 74.00 | -24.90 | peak |
| 6 | 17989.000 | 22.74 | 26.04 | 48.78 | 74.00 | -25.22 | peak |

| | | | |
|------------|------------|-----------------|----------|
| Test Mode: | 802.11a 20 | Frequency(MHz): | 5720 |
| Polarity: | Vertical | Test Voltage: | DC 3.3 V |

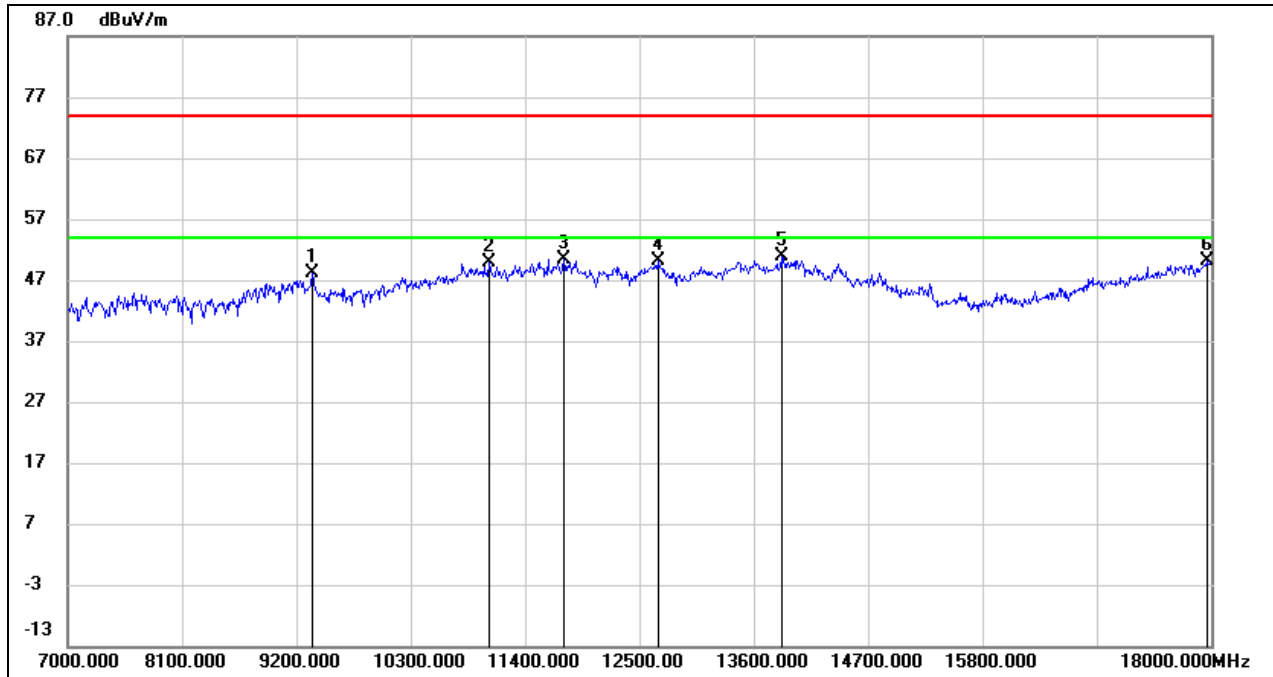

| No. | Frequency (MHz) | Reading (dBuV) | Correct (dB/m) | Result (dBuV/m) | Limit (dBuV/m) | Margin (dB) | Remark |
|-----|-----------------|----------------|----------------|-----------------|----------------|-------------|--------|
| 1 | 9354.000 | 37.50 | 10.56 | 48.06 | 74.00 | -25.94 | peak |
| 2 | 11059.000 | 35.01 | 14.96 | 49.97 | 74.00 | -24.03 | peak |
| 3 | 11774.000 | 33.16 | 17.28 | 50.44 | 74.00 | -23.56 | peak |
| 4 | 12676.000 | 32.03 | 18.05 | 50.08 | 74.00 | -23.92 | peak |
| 5 | 13864.000 | 29.27 | 21.53 | 50.80 | 74.00 | -23.20 | peak |
| 6 | 17956.000 | 24.39 | 25.82 | 50.21 | 74.00 | -23.79 | peak |

| | | | |
|------------|------------|-----------------|----------|
| Test Mode: | 802.11a 20 | Frequency(MHz): | 5745 |
| Polarity: | Horizontal | Test Voltage: | DC 3.3 V |

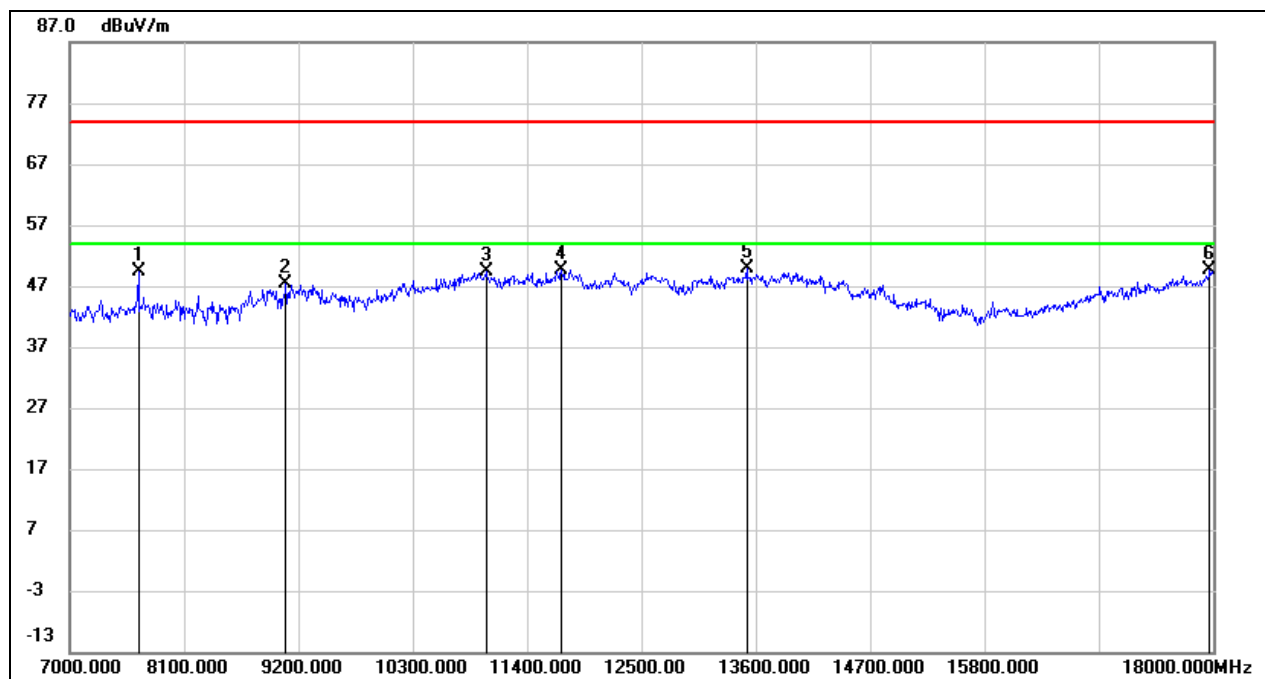

| No. | Frequency (MHz) | Reading (dBuV) | Correct (dB/m) | Result (dBuV/m) | Limit (dBuV/m) | Margin (dB) | Remark |
|-----|-----------------|----------------|----------------|-----------------|----------------|-------------|--------|
| 1 | 7660.000 | 42.68 | 6.73 | 49.41 | 74.00 | -24.59 | peak |
| 2 | 9079.000 | 36.91 | 10.39 | 47.30 | 74.00 | -26.70 | peak |
| 3 | 11004.000 | 34.69 | 14.74 | 49.43 | 74.00 | -24.57 | peak |
| 4 | 11730.000 | 32.42 | 17.19 | 49.61 | 74.00 | -24.39 | peak |
| 5 | 13512.000 | 29.25 | 20.68 | 49.93 | 74.00 | -24.07 | peak |
| 6 | 17967.000 | 23.63 | 25.89 | 49.52 | 74.00 | -24.48 | peak |

| | | | |
|------------|------------|-----------------|----------|
| Test Mode: | 802.11a 20 | Frequency(MHz): | 5745 |
| Polarity: | Vertical | Test Voltage: | DC 3.3 V |

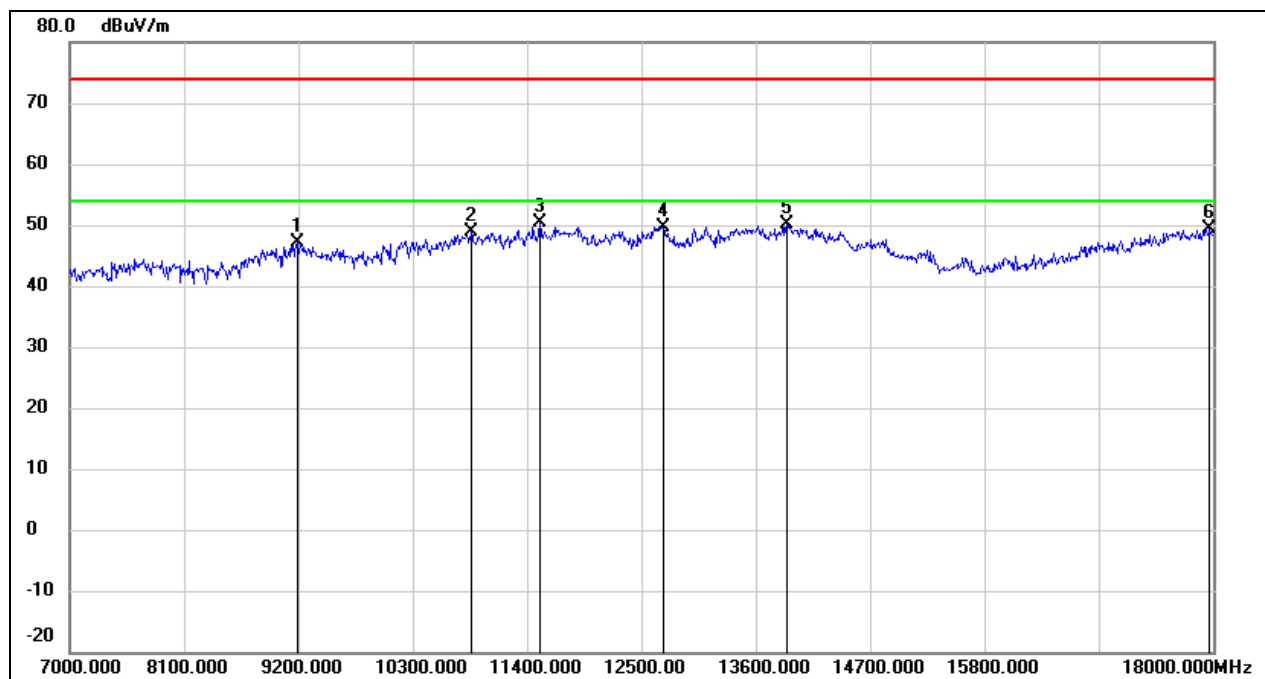

| No. | Frequency (MHz) | Reading (dBuV) | Correct (dB/m) | Result (dBuV/m) | Limit (dBuV/m) | Margin (dB) | Remark |
|-----|-----------------|----------------|----------------|-----------------|----------------|-------------|--------|
| 1 | 9189.000 | 36.68 | 10.46 | 47.14 | 74.00 | -26.86 | peak |
| 2 | 10861.000 | 34.59 | 14.20 | 48.79 | 74.00 | -25.21 | peak |
| 3 | 11521.000 | 33.61 | 16.82 | 50.43 | 74.00 | -23.57 | peak |
| 4 | 12709.000 | 31.50 | 18.09 | 49.59 | 74.00 | -24.41 | peak |
| 5 | 13897.000 | 28.52 | 21.62 | 50.14 | 74.00 | -23.86 | peak |
| 6 | 17967.000 | 23.42 | 25.89 | 49.31 | 74.00 | -24.69 | peak |

| | | | |
|------------|------------|-----------------|----------|
| Test Mode: | 802.11a 20 | Frequency(MHz): | 5785 |
| Polarity: | Horizontal | Test Voltage: | DC 3.3 V |

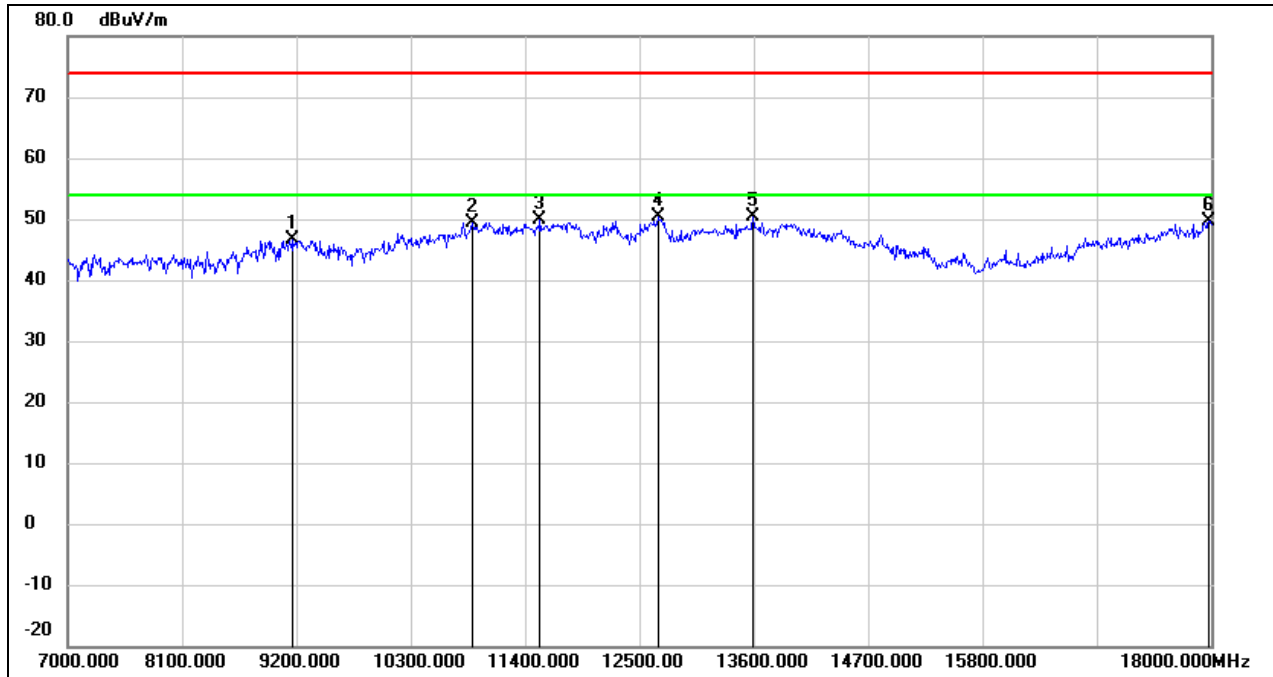

| No. | Frequency (MHz) | Reading (dBuV) | Correct (dB/m) | Result (dBuV/m) | Limit (dBuV/m) | Margin (dB) | Remark |
|-----|-----------------|----------------|----------------|-----------------|----------------|-------------|--------|
| 1 | 9167.000 | 36.18 | 10.45 | 46.63 | 74.00 | -27.37 | peak |
| 2 | 10894.000 | 35.10 | 14.32 | 49.42 | 74.00 | -24.58 | peak |
| 3 | 11543.000 | 33.07 | 16.84 | 49.91 | 74.00 | -24.09 | peak |
| 4 | 12676.000 | 32.24 | 18.05 | 50.29 | 74.00 | -23.71 | peak |
| 5 | 13589.000 | 29.43 | 20.86 | 50.29 | 74.00 | -23.71 | peak |
| 6 | 17978.000 | 23.78 | 25.97 | 49.75 | 74.00 | -24.25 | peak |

| | | | |
|------------|------------|-----------------|----------|
| Test Mode: | 802.11a 20 | Frequency(MHz): | 5785 |
| Polarity: | Vertical | Test Voltage: | DC 3.3 V |

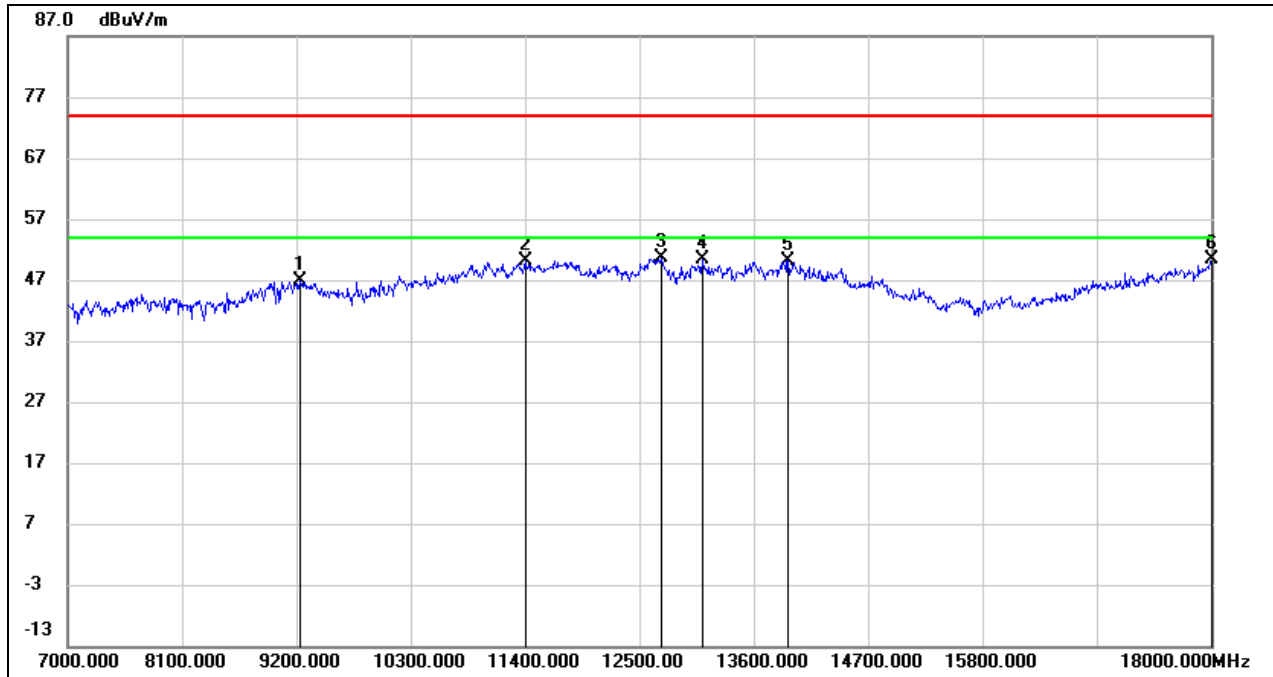

| No. | Frequency (MHz) | Reading (dBuV) | Correct (dB/m) | Result (dBuV/m) | Limit (dBuV/m) | Margin (dB) | Remark |
|-----|-----------------|----------------|----------------|-----------------|----------------|-------------|--------|
| 1 | 9233.000 | 36.36 | 10.48 | 46.84 | 74.00 | -27.16 | peak |
| 2 | 11400.000 | 33.83 | 16.36 | 50.19 | 74.00 | -23.81 | peak |
| 3 | 12709.000 | 32.63 | 18.09 | 50.72 | 74.00 | -23.28 | peak |
| 4 | 13105.000 | 31.42 | 18.91 | 50.33 | 74.00 | -23.67 | peak |
| 5 | 13930.000 | 28.37 | 21.71 | 50.08 | 74.00 | -23.92 | peak |
| 6 | 18000.000 | 24.30 | 26.12 | 50.42 | 74.00 | -23.58 | peak |

| | | | |
|------------|------------|-----------------|----------|
| Test Mode: | 802.11a 20 | Frequency(MHz): | 5825 |
| Polarity: | Horizontal | Test Voltage: | DC 3.3 V |

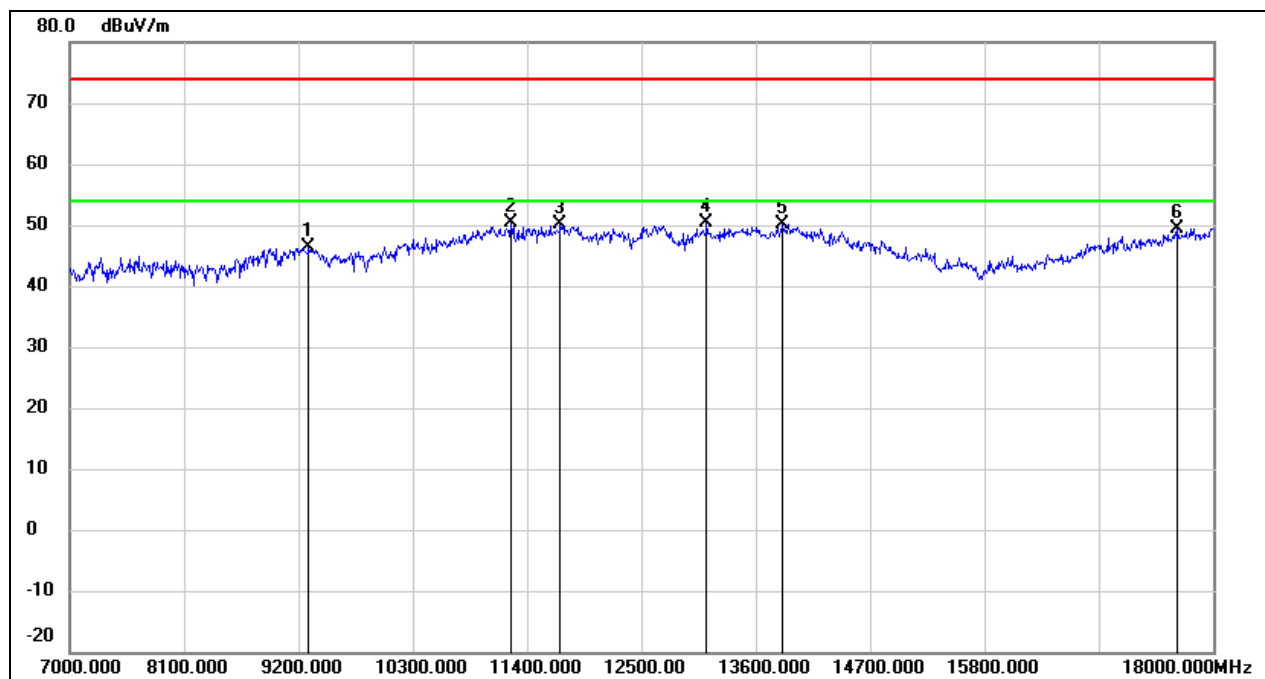

| No. | Frequency (MHz) | Reading (dBuV) | Correct (dB/m) | Result (dBuV/m) | Limit (dBuV/m) | Margin (dB) | Remark |
|-----|-----------------|----------------|----------------|-----------------|----------------|-------------|--------|
| 1 | 9299.000 | 35.79 | 10.53 | 46.32 | 74.00 | -27.68 | peak |
| 2 | 11246.000 | 34.53 | 15.73 | 50.26 | 74.00 | -23.74 | peak |
| 3 | 11719.000 | 33.03 | 17.18 | 50.21 | 74.00 | -23.79 | peak |
| 4 | 13127.000 | 31.37 | 19.01 | 50.38 | 74.00 | -23.62 | peak |
| 5 | 13853.000 | 28.60 | 21.52 | 50.12 | 74.00 | -23.88 | peak |
| 6 | 17659.000 | 25.71 | 23.78 | 49.49 | 74.00 | -24.51 | peak |

| | | | |
|------------|------------|-----------------|----------|
| Test Mode: | 802.11a 20 | Frequency(MHz): | 5825 |
| Polarity: | Vertical | Test Voltage: | DC 3.3 V |

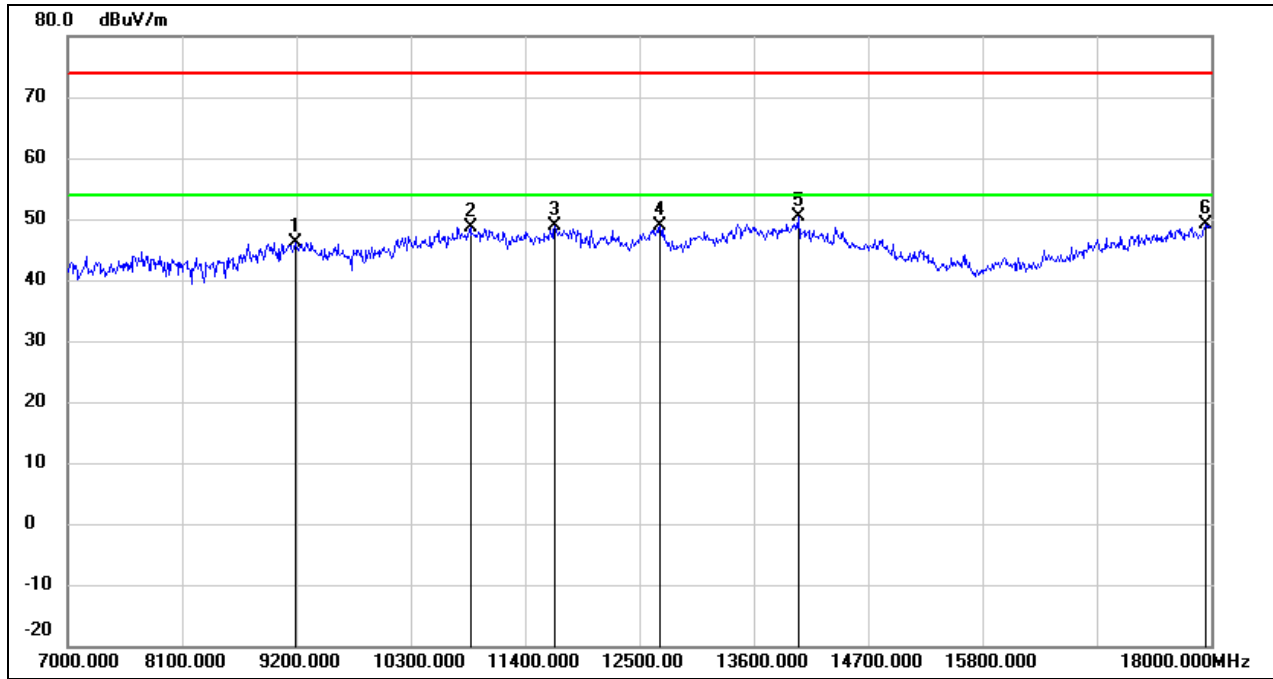

| No. | Frequency (MHz) | Reading (dBuV) | Correct (dB/m) | Result (dBuV/m) | Limit (dBuV/m) | Margin (dB) | Remark |
|-----|-----------------|----------------|----------------|-----------------|----------------|-------------|--------|
| 1 | 9189.000 | 35.74 | 10.46 | 46.20 | 74.00 | -27.80 | peak |
| 2 | 10872.000 | 34.41 | 14.23 | 48.64 | 74.00 | -25.36 | peak |
| 3 | 11686.000 | 31.67 | 17.12 | 48.79 | 74.00 | -25.21 | peak |
| 4 | 12698.000 | 30.70 | 18.08 | 48.78 | 74.00 | -25.22 | peak |
| 5 | 14029.000 | 28.67 | 21.76 | 50.43 | 74.00 | -23.57 | peak |
| 6 | 17945.000 | 23.44 | 25.75 | 49.19 | 74.00 | -24.81 | peak |

| | | | |
|------------|--------------|-----------------|----------|
| Test Mode: | 802.11n HT20 | Frequency(MHz): | 5180 |
| Polarity: | Horizontal | Test Voltage: | DC 3.3 V |

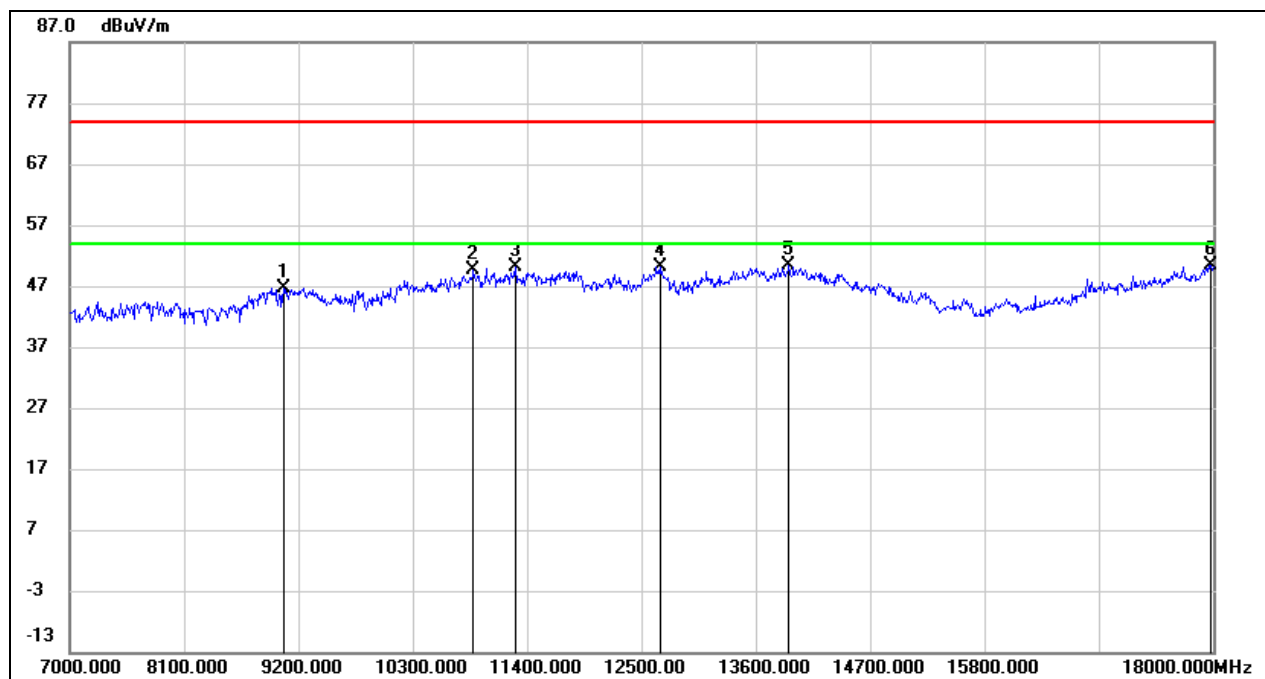

| No. | Frequency (MHz) | Reading (dBuV) | Correct (dB/m) | Result (dBuV/m) | Limit (dBuV/m) | Margin (dB) | Remark |
|-----|-----------------|----------------|----------------|-----------------|----------------|-------------|--------|
| 1 | 9057.000 | 36.36 | 10.38 | 46.74 | 74.00 | -27.26 | peak |
| 2 | 10883.000 | 35.28 | 14.27 | 49.55 | 74.00 | -24.45 | peak |
| 3 | 11290.000 | 34.32 | 15.90 | 50.22 | 74.00 | -23.78 | peak |
| 4 | 12676.000 | 31.99 | 18.05 | 50.04 | 74.00 | -23.96 | peak |
| 5 | 13919.000 | 28.64 | 21.68 | 50.32 | 74.00 | -23.68 | peak |
| 6 | 17978.000 | 24.45 | 25.97 | 50.42 | 74.00 | -23.58 | peak |

| | | | |
|------------|--------------|-----------------|----------|
| Test Mode: | 802.11n HT20 | Frequency(MHz): | 5180 |
| Polarity: | Vertical | Test Voltage: | DC 3.3 V |

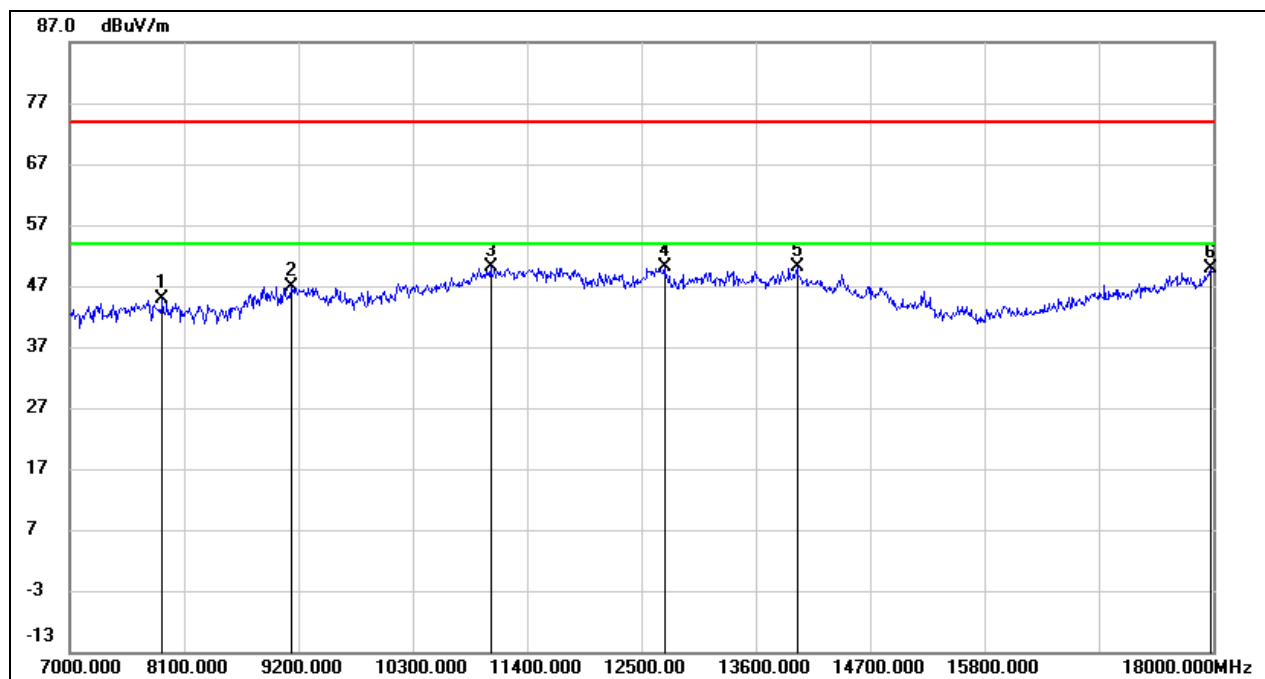

| No. | Frequency (MHz) | Reading (dBuV) | Correct (dB/m) | Result (dBuV/m) | Limit (dBuV/m) | Margin (dB) | Remark |
|-----|-----------------|----------------|----------------|-----------------|----------------|-------------|--------|
| 1 | 7891.000 | 38.29 | 6.52 | 44.81 | 74.00 | -29.19 | peak |
| 2 | 9134.000 | 36.52 | 10.41 | 46.93 | 74.00 | -27.07 | peak |
| 3 | 11048.000 | 35.22 | 14.91 | 50.13 | 74.00 | -23.87 | peak |
| 4 | 12720.000 | 31.92 | 18.09 | 50.01 | 74.00 | -23.99 | peak |
| 5 | 13996.000 | 28.31 | 21.87 | 50.18 | 74.00 | -23.82 | peak |
| 6 | 17978.000 | 23.81 | 25.97 | 49.78 | 74.00 | -24.22 | peak |

| | | | |
|------------|--------------|-----------------|----------|
| Test Mode: | 802.11n HT20 | Frequency(MHz): | 5200 |
| Polarity: | Horizontal | Test Voltage: | DC 3.3 V |

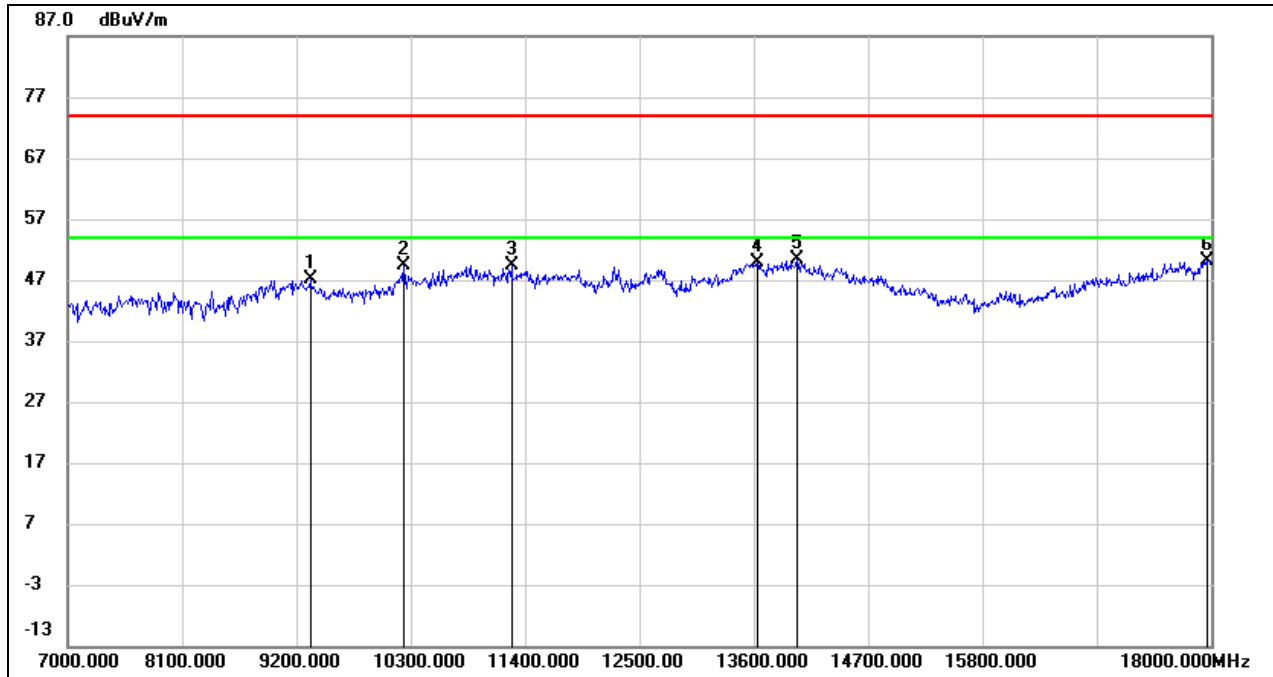

| No. | Frequency (MHz) | Reading (dBuV) | Correct (dB/m) | Result (dBuV/m) | Limit (dBuV/m) | Margin (dB) | Remark |
|-----|-----------------|----------------|----------------|-----------------|----------------|-------------|--------|
| 1 | 9332.000 | 36.63 | 10.54 | 47.17 | 74.00 | -26.83 | peak |
| 2 | 10234.000 | 37.00 | 12.26 | 49.26 | 74.00 | -24.74 | peak |
| 3 | 11268.000 | 33.64 | 15.83 | 49.47 | 74.00 | -24.53 | peak |
| 4 | 13633.000 | 28.95 | 20.97 | 49.92 | 74.00 | -24.08 | peak |
| 5 | 14018.000 | 28.67 | 21.80 | 50.47 | 74.00 | -23.53 | peak |
| 6 | 17956.000 | 24.30 | 25.82 | 50.12 | 74.00 | -23.88 | peak |

| | | | |
|------------|--------------|-----------------|----------|
| Test Mode: | 802.11n HT20 | Frequency(MHz): | 5200 |
| Polarity: | Vertical | Test Voltage: | DC 3.3 V |

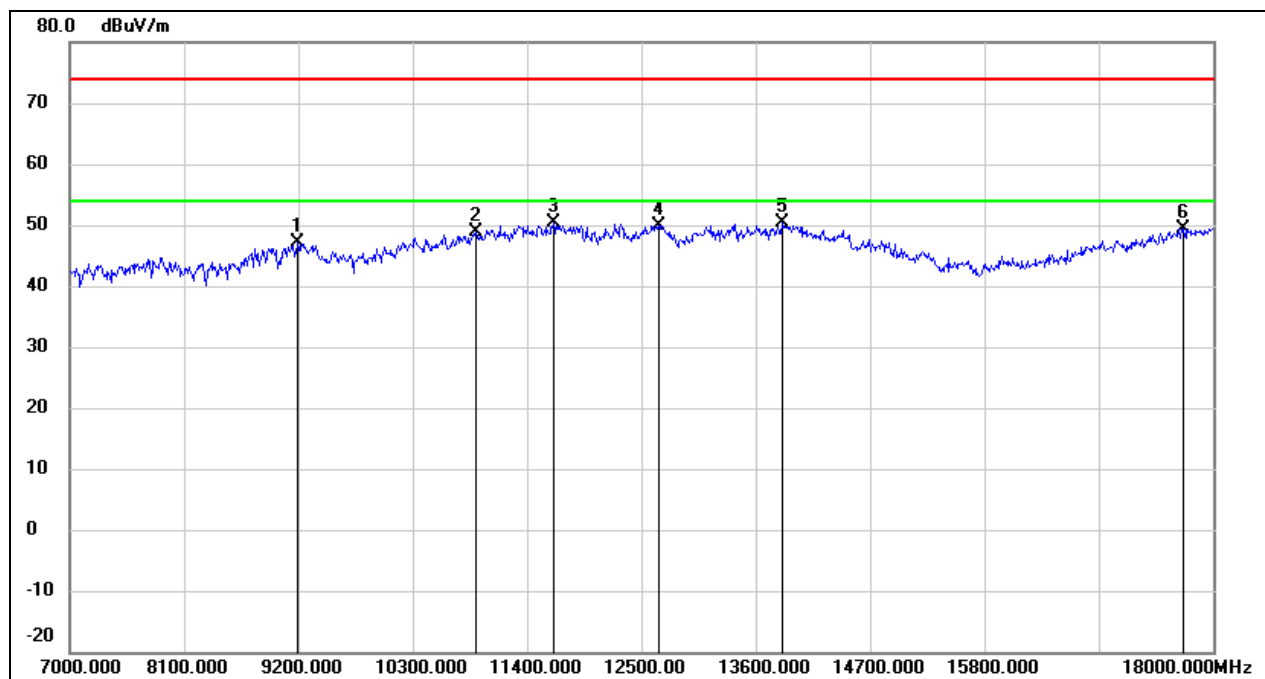

| No. | Frequency (MHz) | Reading (dBuV) | Correct (dB/m) | Result (dBuV/m) | Limit (dBuV/m) | Margin (dB) | Remark |
|-----|-----------------|----------------|----------------|-----------------|----------------|-------------|--------|
| 1 | 9189.000 | 36.62 | 10.46 | 47.08 | 74.00 | -26.92 | peak |
| 2 | 10905.000 | 34.62 | 14.36 | 48.98 | 74.00 | -25.02 | peak |
| 3 | 11653.000 | 33.26 | 17.05 | 50.31 | 74.00 | -23.69 | peak |
| 4 | 12665.000 | 31.93 | 18.04 | 49.97 | 74.00 | -24.03 | peak |
| 5 | 13853.000 | 28.81 | 21.52 | 50.33 | 74.00 | -23.67 | peak |
| 6 | 17714.000 | 25.19 | 24.16 | 49.35 | 74.00 | -24.65 | peak |

| | | | |
|------------|--------------|-----------------|----------|
| Test Mode: | 802.11n HT20 | Frequency(MHz): | 5240 |
| Polarity: | Horizontal | Test Voltage: | DC 3.3 V |

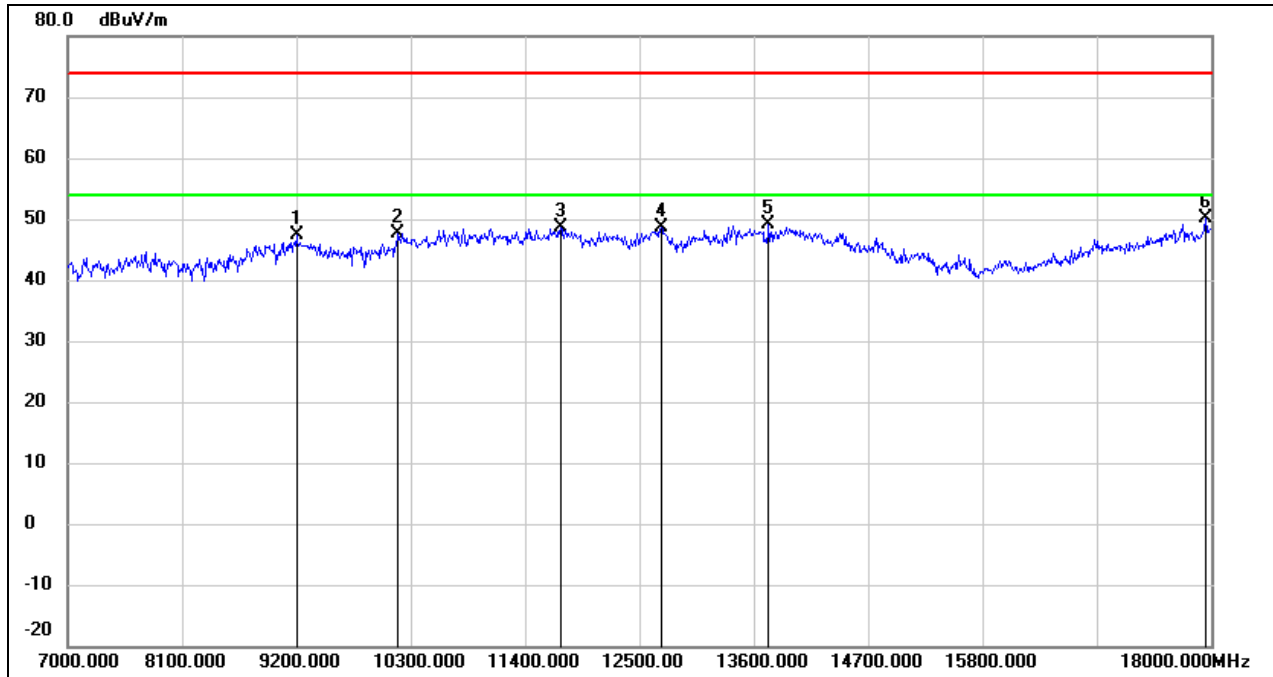

| No. | Frequency (MHz) | Reading (dBuV) | Correct (dB/m) | Result (dBuV/m) | Limit (dBuV/m) | Margin (dB) | Remark |
|-----|-----------------|----------------|----------------|-----------------|----------------|-------------|--------|
| 1 | 9200.000 | 36.81 | 10.46 | 47.27 | 74.00 | -26.73 | peak |
| 2 | 10179.000 | 35.44 | 12.14 | 47.58 | 74.00 | -26.42 | peak |
| 3 | 11741.000 | 31.30 | 17.22 | 48.52 | 74.00 | -25.48 | peak |
| 4 | 12709.000 | 30.48 | 18.09 | 48.57 | 74.00 | -25.43 | peak |
| 5 | 13743.000 | 27.93 | 21.24 | 49.17 | 74.00 | -24.83 | peak |
| 6 | 17945.000 | 24.26 | 25.75 | 50.01 | 74.00 | -23.99 | peak |

| | | | |
|------------|--------------|-----------------|----------|
| Test Mode: | 802.11n HT20 | Frequency(MHz): | 5240 |
| Polarity: | Vertical | Test Voltage: | DC 3.3 V |

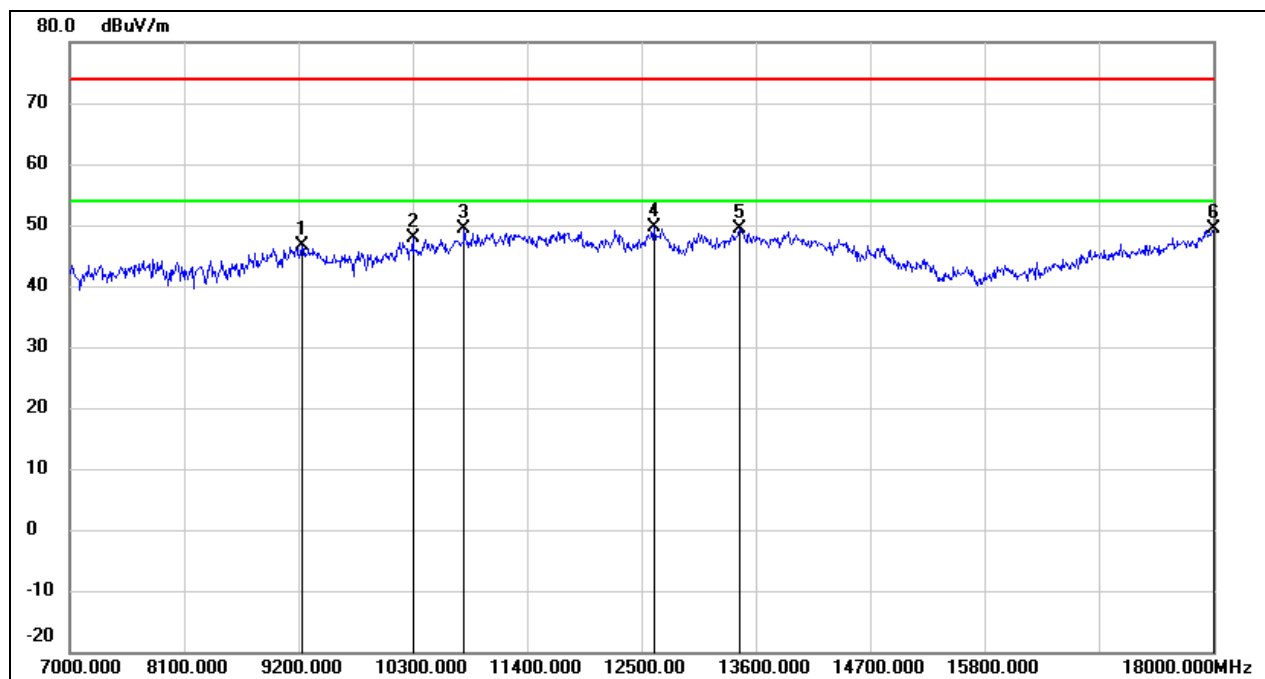

| No. | Frequency (MHz) | Reading (dBuV) | Correct (dB/m) | Result (dBuV/m) | Limit (dBuV/m) | Margin (dB) | Remark |
|-----|-----------------|----------------|----------------|-----------------|----------------|-------------|--------|
| 1 | 9233.000 | 36.23 | 10.48 | 46.71 | 74.00 | -27.29 | peak |
| 2 | 10300.000 | 35.60 | 12.40 | 48.00 | 74.00 | -26.00 | peak |
| 3 | 10795.000 | 35.39 | 13.94 | 49.33 | 74.00 | -24.67 | peak |
| 4 | 12621.000 | 31.70 | 17.98 | 49.68 | 74.00 | -24.32 | peak |
| 5 | 13446.000 | 28.85 | 20.41 | 49.26 | 74.00 | -24.74 | peak |
| 6 | 18000.000 | 23.28 | 26.12 | 49.40 | 74.00 | -24.60 | peak |

| | | | |
|------------|--------------|-----------------|----------|
| Test Mode: | 802.11n HT20 | Frequency(MHz): | 5260 |
| Polarity: | Horizontal | Test Voltage: | DC 3.3 V |

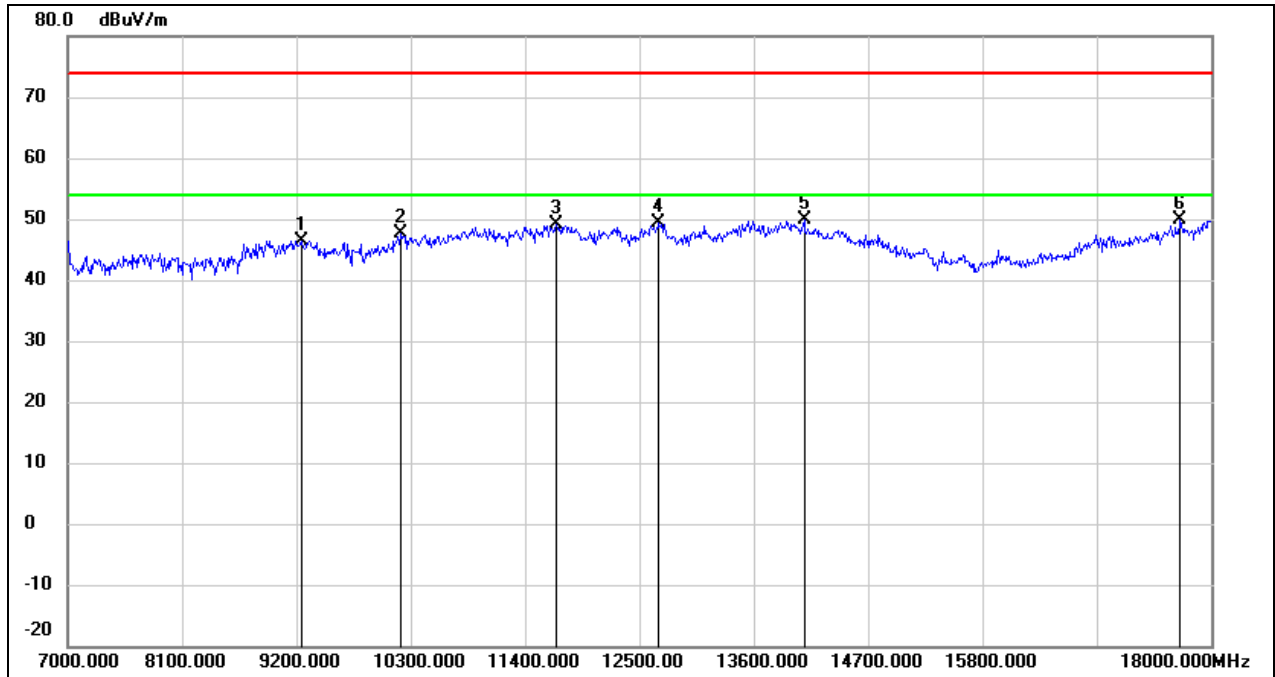

| No. | Frequency (MHz) | Reading (dBuV) | Correct (dB/m) | Result (dBuV/m) | Limit (dBuV/m) | Margin (dB) | Remark |
|-----|-----------------|----------------|----------------|-----------------|----------------|-------------|--------|
| 1 | 9244.000 | 35.98 | 10.49 | 46.47 | 74.00 | -27.53 | peak |
| 2 | 10201.000 | 35.49 | 12.19 | 47.68 | 74.00 | -26.32 | peak |
| 3 | 11697.000 | 32.12 | 17.13 | 49.25 | 74.00 | -24.75 | peak |
| 4 | 12687.000 | 31.29 | 18.05 | 49.34 | 74.00 | -24.66 | peak |
| 5 | 14084.000 | 28.25 | 21.52 | 49.77 | 74.00 | -24.23 | peak |
| 6 | 17703.000 | 25.85 | 24.09 | 49.94 | 74.00 | -24.06 | peak |

| | | | |
|------------|--------------|-----------------|----------|
| Test Mode: | 802.11n HT20 | Frequency(MHz): | 5260 |
| Polarity: | Vertical | Test Voltage: | DC 3.3 V |

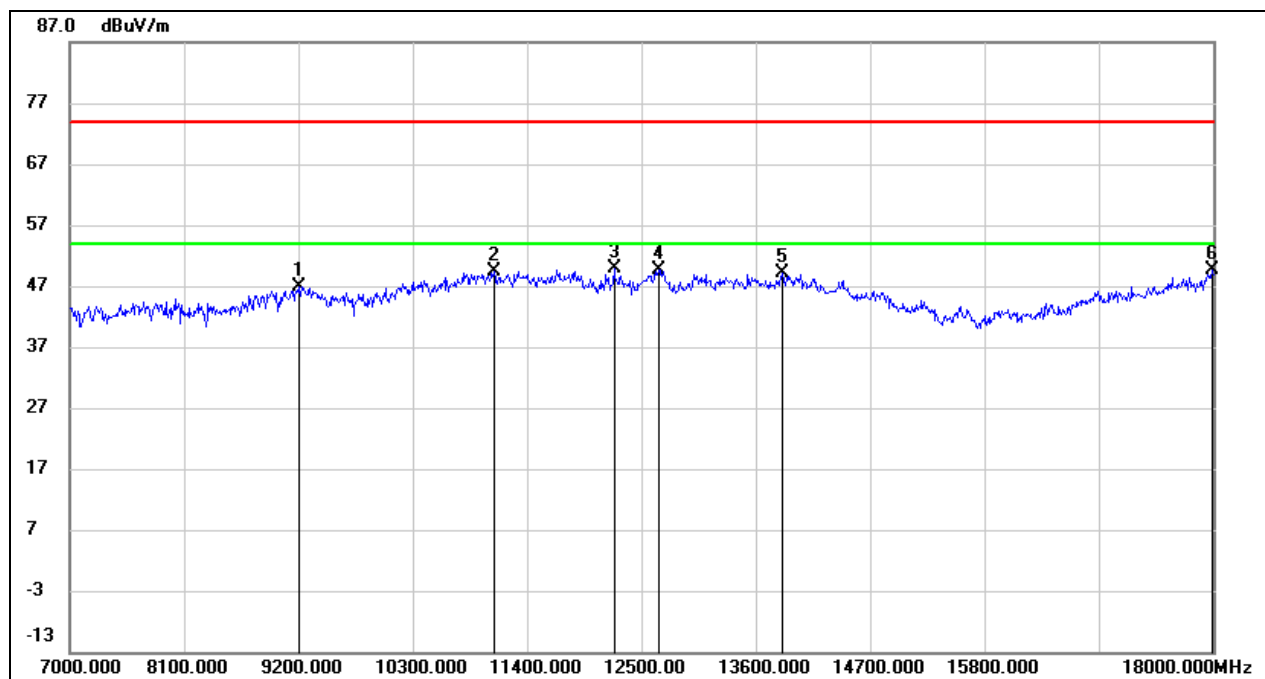

| No. | Frequency (MHz) | Reading (dBuV) | Correct (dB/m) | Result (dBuV/m) | Limit (dBuV/m) | Margin (dB) | Remark |
|-----|-----------------|----------------|----------------|-----------------|----------------|-------------|--------|
| 1 | 9200.000 | 36.36 | 10.46 | 46.82 | 74.00 | -27.18 | peak |
| 2 | 11081.000 | 34.39 | 15.05 | 49.44 | 74.00 | -24.56 | peak |
| 3 | 12236.000 | 32.24 | 17.76 | 50.00 | 74.00 | -24.00 | peak |
| 4 | 12665.000 | 31.64 | 18.04 | 49.68 | 74.00 | -24.32 | peak |
| 5 | 13853.000 | 27.68 | 21.52 | 49.20 | 74.00 | -24.80 | peak |
| 6 | 17989.000 | 23.47 | 26.04 | 49.51 | 74.00 | -24.49 | peak |

| | | | |
|------------|--------------|-----------------|----------|
| Test Mode: | 802.11n HT20 | Frequency(MHz): | 5280 |
| Polarity: | Horizontal | Test Voltage: | DC 3.3 V |

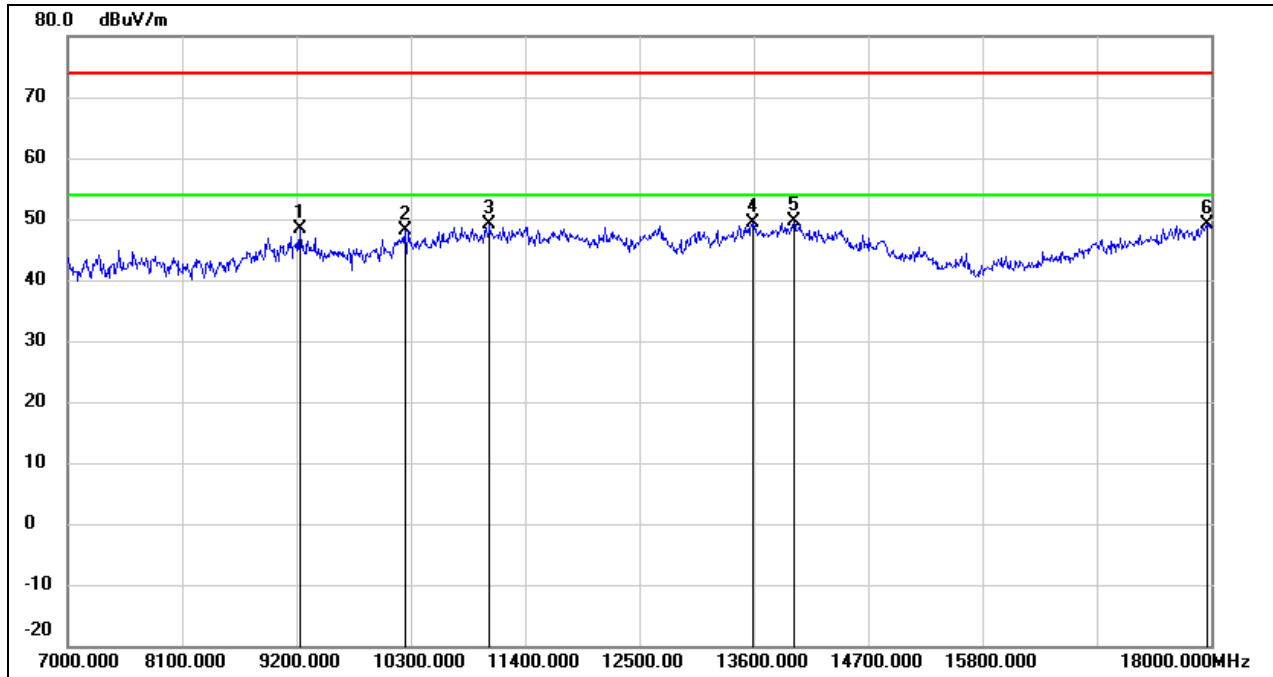

| No. | Frequency (MHz) | Reading (dBuV) | Correct (dB/m) | Result (dBuV/m) | Limit (dBuV/m) | Margin (dB) | Remark |
|-----|-----------------|----------------|----------------|-----------------|----------------|-------------|--------|
| 1 | 9233.000 | 37.78 | 10.48 | 48.26 | 74.00 | -25.74 | peak |
| 2 | 10245.000 | 35.96 | 12.28 | 48.24 | 74.00 | -25.76 | peak |
| 3 | 11059.000 | 34.29 | 14.96 | 49.25 | 74.00 | -24.75 | peak |
| 4 | 13589.000 | 28.50 | 20.86 | 49.36 | 74.00 | -24.64 | peak |
| 5 | 13985.000 | 27.70 | 21.85 | 49.55 | 74.00 | -24.45 | peak |
| 6 | 17967.000 | 23.24 | 25.89 | 49.13 | 74.00 | -24.87 | peak |

| | | | |
|------------|--------------|-----------------|----------|
| Test Mode: | 802.11n HT20 | Frequency(MHz): | 5280 |
| Polarity: | Vertical | Test Voltage: | DC 3.3 V |

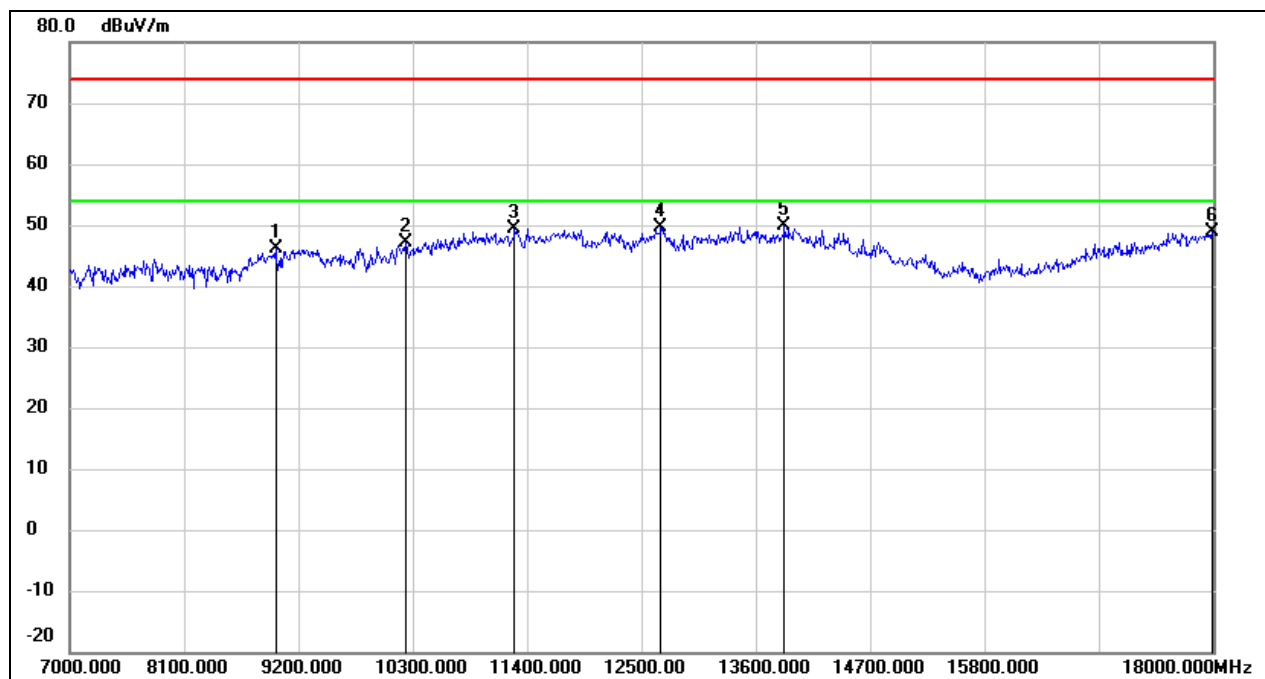

| No. | Frequency (MHz) | Reading (dBuV) | Correct (dB/m) | Result (dBuV/m) | Limit (dBuV/m) | Margin (dB) | Remark |
|-----|-----------------|----------------|----------------|-----------------|----------------|-------------|--------|
| 1 | 8980.000 | 35.88 | 10.21 | 46.09 | 74.00 | -27.91 | peak |
| 2 | 10234.000 | 34.91 | 12.26 | 47.17 | 74.00 | -26.83 | peak |
| 3 | 11279.000 | 33.60 | 15.86 | 49.46 | 74.00 | -24.54 | peak |
| 4 | 12687.000 | 31.46 | 18.05 | 49.51 | 74.00 | -24.49 | peak |
| 5 | 13875.000 | 28.28 | 21.57 | 49.85 | 74.00 | -24.15 | peak |
| 6 | 17989.000 | 22.73 | 26.04 | 48.77 | 74.00 | -25.23 | peak |

| | | | |
|------------|--------------|-----------------|----------|
| Test Mode: | 802.11n HT20 | Frequency(MHz): | 5320 |
| Polarity: | Horizontal | Test Voltage: | DC 3.3 V |

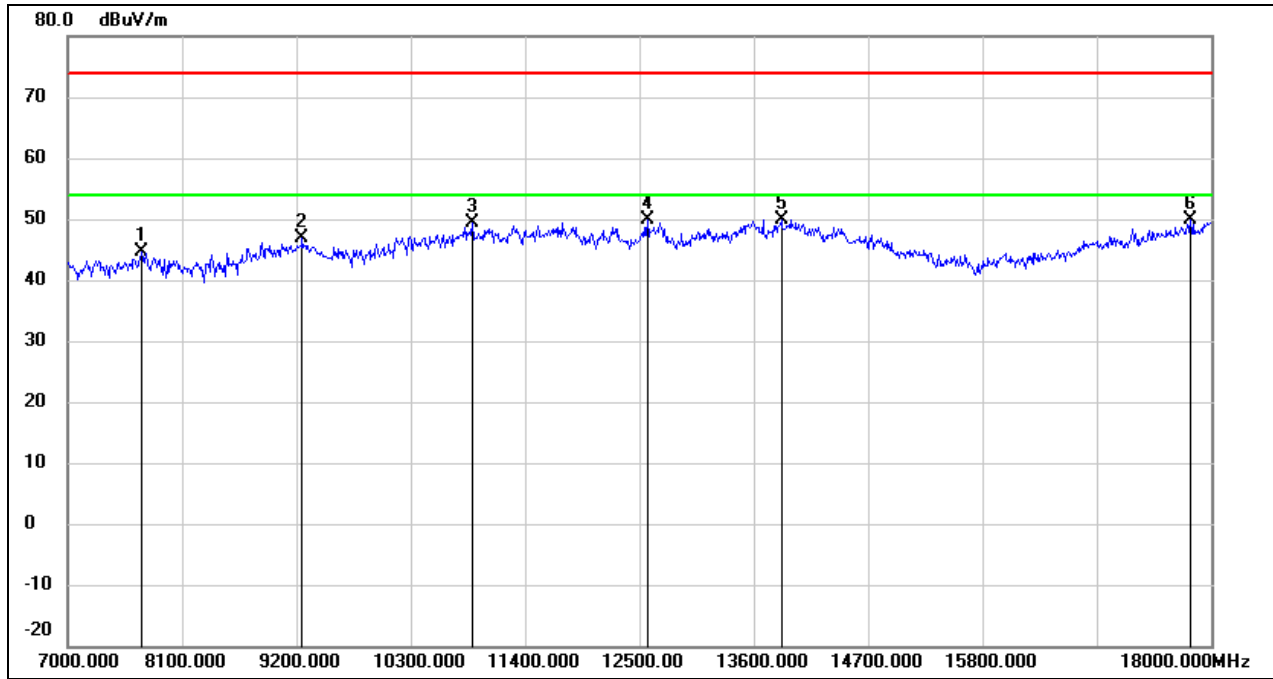

| No. | Frequency (MHz) | Reading (dBuV) | Correct (dB/m) | Result (dBuV/m) | Limit (dBuV/m) | Margin (dB) | Remark |
|-----|-----------------|----------------|----------------|-----------------|----------------|-------------|--------|
| 1 | 7715.000 | 37.91 | 6.68 | 44.59 | 74.00 | -29.41 | peak |
| 2 | 9255.000 | 36.49 | 10.51 | 47.00 | 74.00 | -27.00 | peak |
| 3 | 10894.000 | 35.09 | 14.32 | 49.41 | 74.00 | -24.59 | peak |
| 4 | 12577.000 | 31.87 | 17.93 | 49.80 | 74.00 | -24.20 | peak |
| 5 | 13864.000 | 28.27 | 21.53 | 49.80 | 74.00 | -24.20 | peak |
| 6 | 17802.000 | 25.10 | 24.76 | 49.86 | 74.00 | -24.14 | peak |

| | | | |
|------------|--------------|-----------------|----------|
| Test Mode: | 802.11n HT20 | Frequency(MHz): | 5320 |
| Polarity: | Vertical | Test Voltage: | DC 3.3 V |

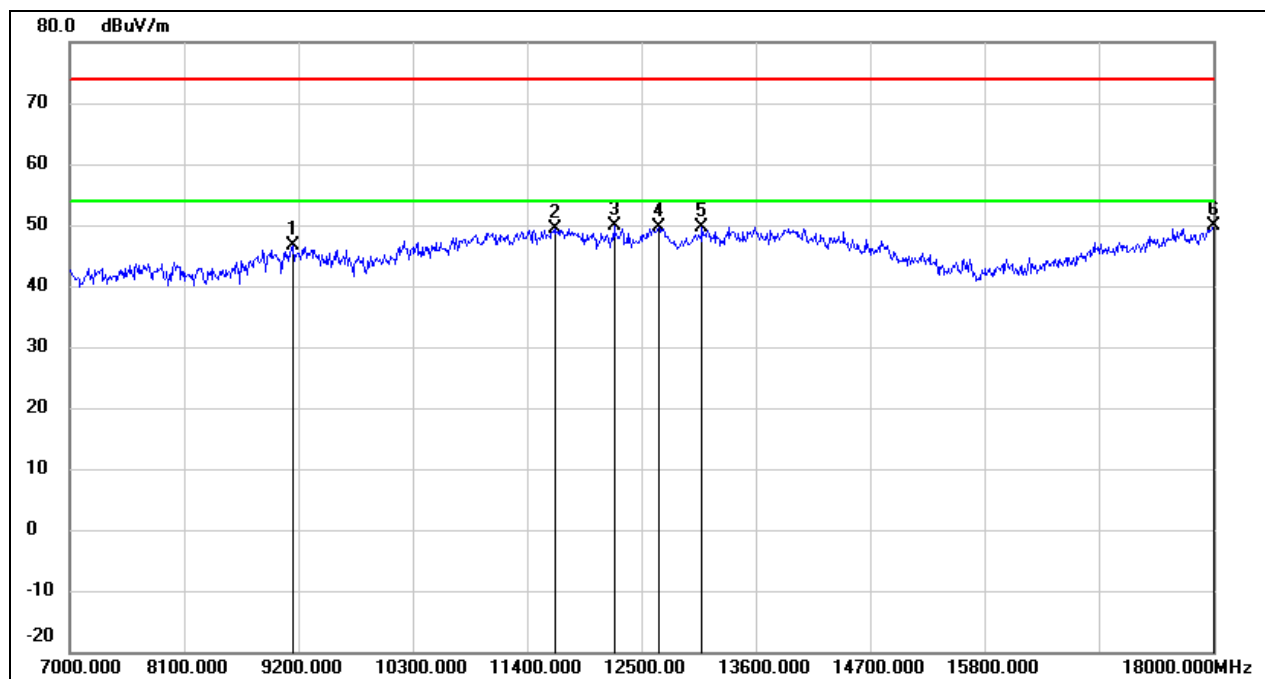

| No. | Frequency (MHz) | Reading (dBuV) | Correct (dB/m) | Result (dBuV/m) | Limit (dBuV/m) | Margin (dB) | Remark |
|-----|-----------------|----------------|----------------|-----------------|----------------|-------------|--------|
| 1 | 9145.000 | 36.17 | 10.43 | 46.60 | 74.00 | -27.40 | peak |
| 2 | 11675.000 | 32.29 | 17.10 | 49.39 | 74.00 | -24.61 | peak |
| 3 | 12236.000 | 32.08 | 17.76 | 49.84 | 74.00 | -24.16 | peak |
| 4 | 12665.000 | 31.55 | 18.04 | 49.59 | 74.00 | -24.41 | peak |
| 5 | 13083.000 | 30.85 | 18.81 | 49.66 | 74.00 | -24.34 | peak |
| 6 | 18000.000 | 23.68 | 26.12 | 49.80 | 74.00 | -24.20 | peak |

| | | | |
|------------|--------------|-----------------|----------|
| Test Mode: | 802.11n HT20 | Frequency(MHz): | 5500 |
| Polarity: | Horizontal | Test Voltage: | DC 3.3 V |

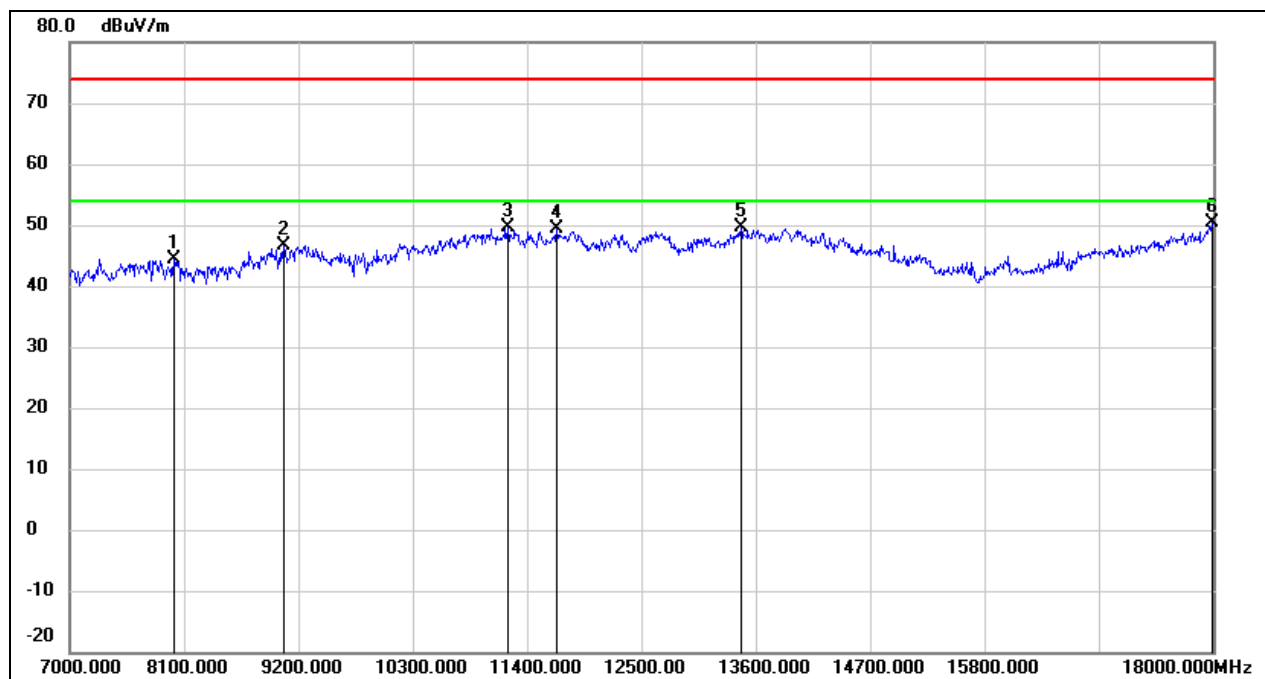

| No. | Frequency (MHz) | Reading (dBuV) | Correct (dB/m) | Result (dBuV/m) | Limit (dBuV/m) | Margin (dB) | Remark |
|-----|-----------------|----------------|----------------|-----------------|----------------|-------------|--------|
| 1 | 8001.000 | 37.91 | 6.43 | 44.34 | 74.00 | -29.66 | peak |
| 2 | 9057.000 | 36.32 | 10.38 | 46.70 | 74.00 | -27.30 | peak |
| 3 | 11213.000 | 34.07 | 15.59 | 49.66 | 74.00 | -24.34 | peak |
| 4 | 11686.000 | 32.32 | 17.12 | 49.44 | 74.00 | -24.56 | peak |
| 5 | 13457.000 | 29.13 | 20.46 | 49.59 | 74.00 | -24.41 | peak |
| 6 | 17989.000 | 24.25 | 26.04 | 50.29 | 74.00 | -23.71 | peak |

| | | | |
|------------|--------------|-----------------|----------|
| Test Mode: | 802.11n HT20 | Frequency(MHz): | 5500 |
| Polarity: | Vertical | Test Voltage: | DC 3.3 V |

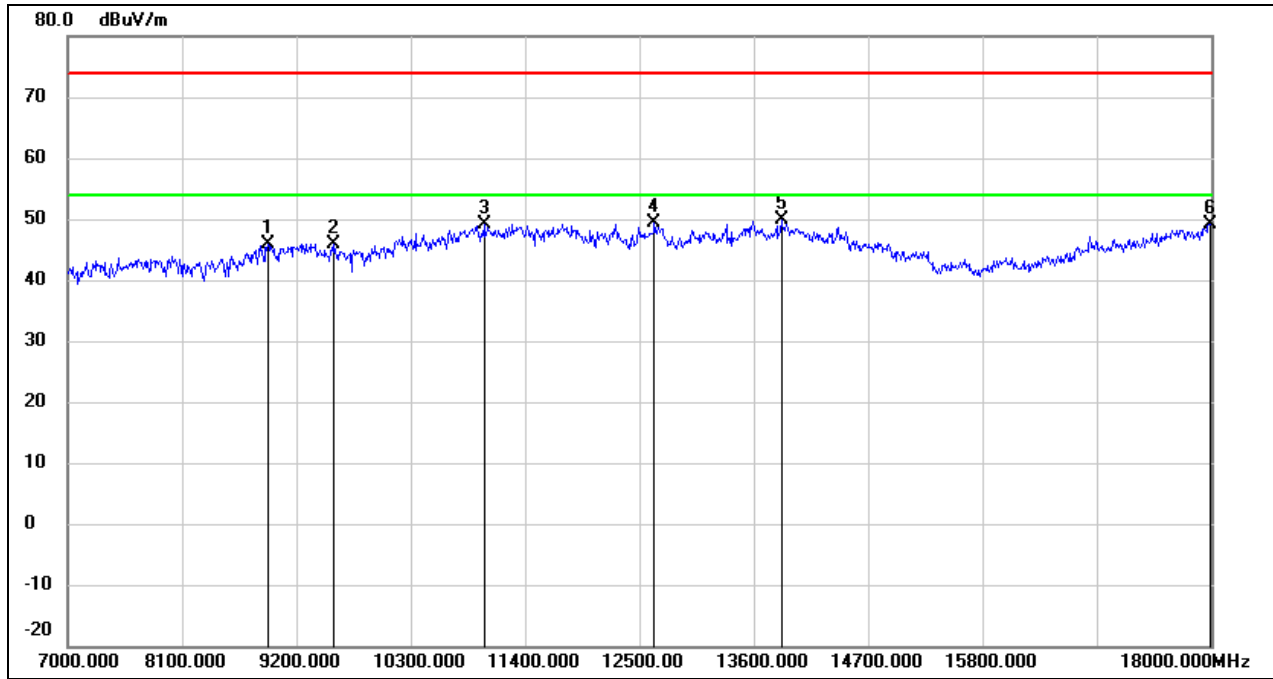

| No. | Frequency (MHz) | Reading (dBuV) | Correct (dB/m) | Result (dBuV/m) | Limit (dBuV/m) | Margin (dB) | Remark |
|-----|-----------------|----------------|----------------|-----------------|----------------|-------------|--------|
| 1 | 8925.000 | 35.97 | 9.82 | 45.79 | 74.00 | -28.21 | peak |
| 2 | 9552.000 | 35.23 | 10.76 | 45.99 | 74.00 | -28.01 | peak |
| 3 | 11004.000 | 34.35 | 14.74 | 49.09 | 74.00 | -24.91 | peak |
| 4 | 12643.000 | 31.29 | 18.01 | 49.30 | 74.00 | -24.70 | peak |
| 5 | 13864.000 | 28.39 | 21.53 | 49.92 | 74.00 | -24.08 | peak |
| 6 | 17989.000 | 23.19 | 26.04 | 49.23 | 74.00 | -24.77 | peak |

| | | | |
|------------|--------------|-----------------|----------|
| Test Mode: | 802.11n HT20 | Frequency(MHz): | 5580 |
| Polarity: | Horizontal | Test Voltage: | DC 3.3 V |

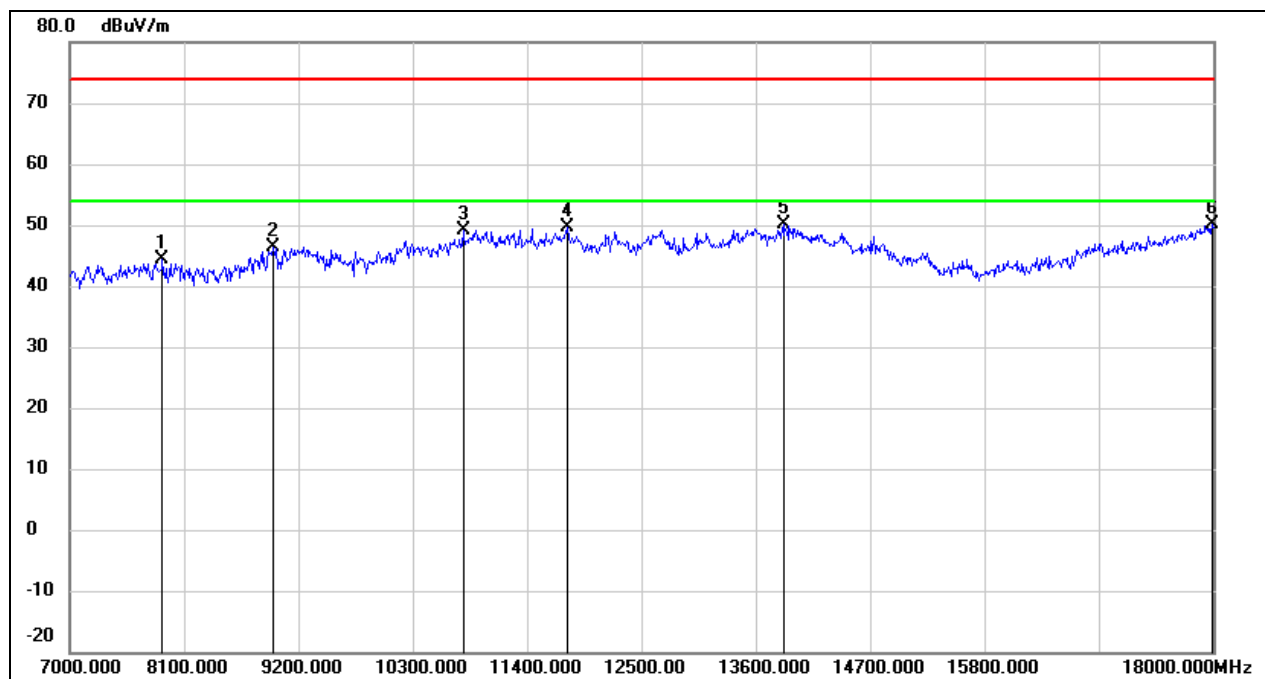

| No. | Frequency (MHz) | Reading (dBuV) | Correct (dB/m) | Result (dBuV/m) | Limit (dBuV/m) | Margin (dB) | Remark |
|-----|-----------------|----------------|----------------|-----------------|----------------|-------------|--------|
| 1 | 7891.000 | 37.97 | 6.52 | 44.49 | 74.00 | -29.51 | peak |
| 2 | 8958.000 | 36.39 | 10.05 | 46.44 | 74.00 | -27.56 | peak |
| 3 | 10784.000 | 35.24 | 13.91 | 49.15 | 74.00 | -24.85 | peak |
| 4 | 11785.000 | 32.40 | 17.30 | 49.70 | 74.00 | -24.30 | peak |
| 5 | 13864.000 | 28.65 | 21.53 | 50.18 | 74.00 | -23.82 | peak |
| 6 | 17989.000 | 24.09 | 26.04 | 50.13 | 74.00 | -23.87 | peak |

| | | | |
|------------|--------------|-----------------|----------|
| Test Mode: | 802.11n HT20 | Frequency(MHz): | 5580 |
| Polarity: | Vertical | Test Voltage: | DC 3.3 V |

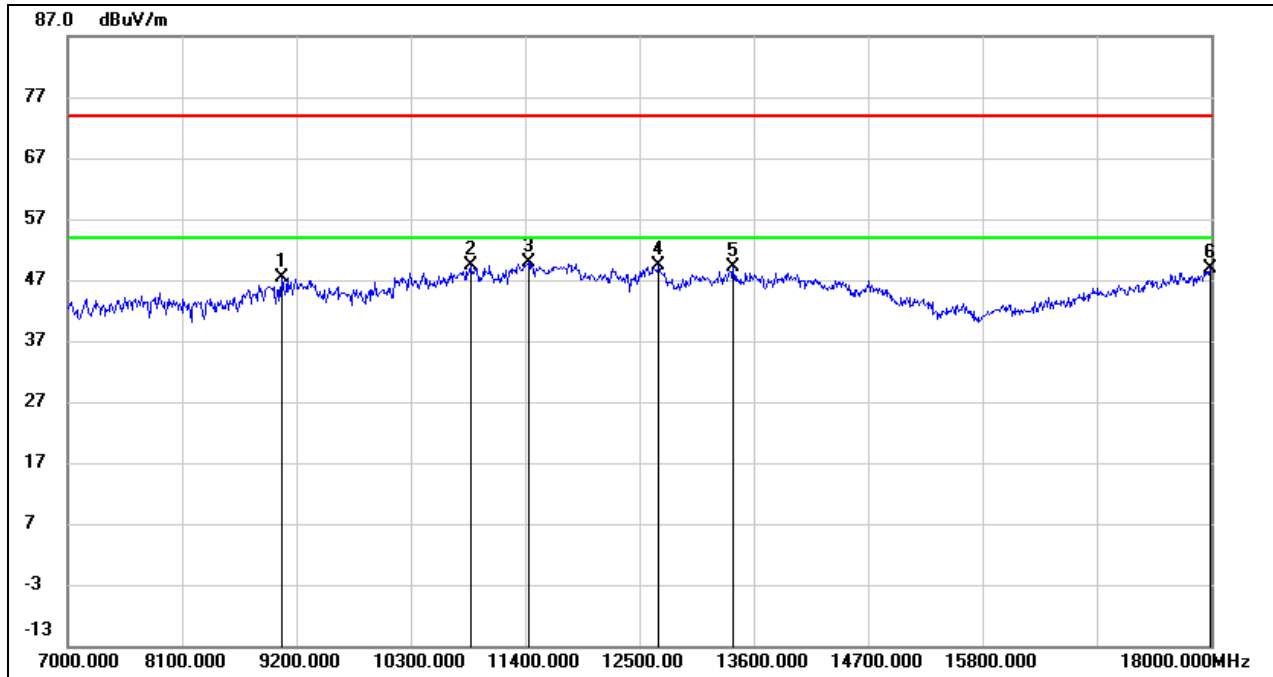

| No. | Frequency (MHz) | Reading (dBuV) | Correct (dB/m) | Result (dBuV/m) | Limit (dBuV/m) | Margin (dB) | Remark |
|-----|-----------------|----------------|----------------|-----------------|----------------|-------------|--------|
| 1 | 9057.000 | 36.97 | 10.38 | 47.35 | 74.00 | -26.65 | peak |
| 2 | 10872.000 | 35.24 | 14.23 | 49.47 | 74.00 | -24.53 | peak |
| 3 | 11433.000 | 33.47 | 16.50 | 49.97 | 74.00 | -24.03 | peak |
| 4 | 12687.000 | 31.26 | 18.05 | 49.31 | 74.00 | -24.69 | peak |
| 5 | 13402.000 | 28.83 | 20.20 | 49.03 | 74.00 | -24.97 | peak |
| 6 | 17989.000 | 22.87 | 26.04 | 48.91 | 74.00 | -25.09 | peak |

| | | | |
|------------|--------------|-----------------|----------|
| Test Mode: | 802.11n HT20 | Frequency(MHz): | 5700 |
| Polarity: | Horizontal | Test Voltage: | DC 3.3 V |

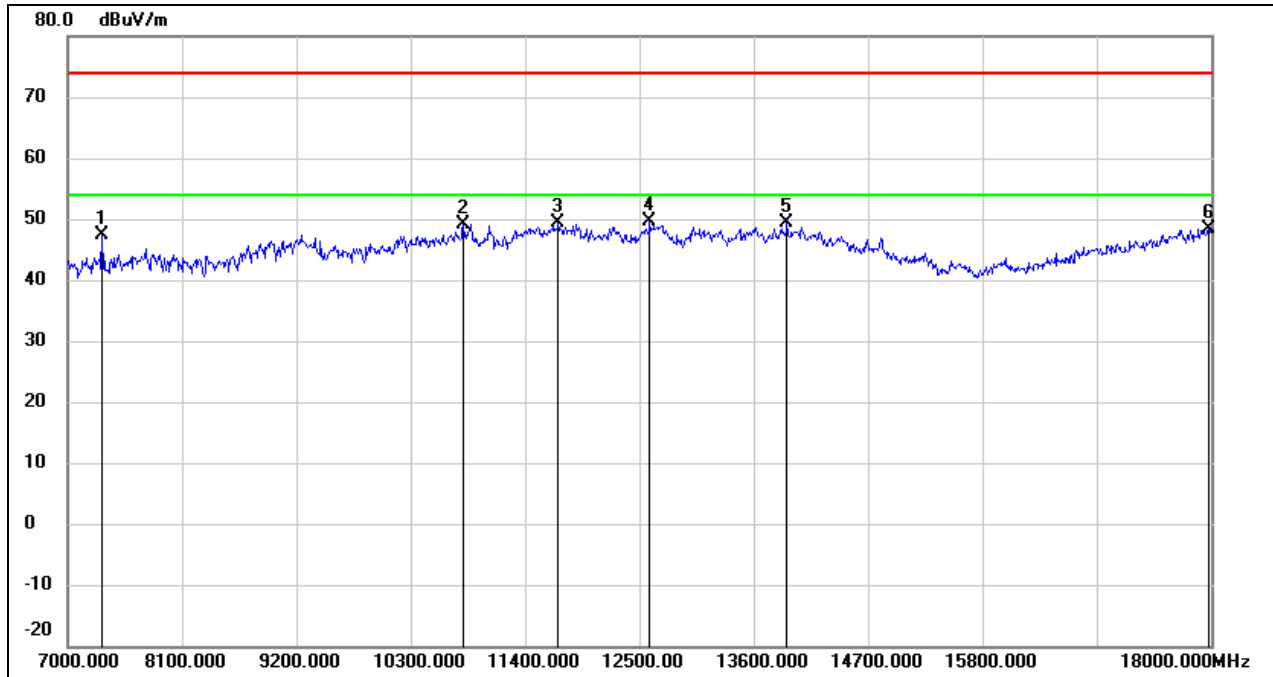

| No. | Frequency (MHz) | Reading (dBuV) | Correct (dB/m) | Result (dBuV/m) | Limit (dBuV/m) | Margin (dB) | Remark |
|-----|-----------------|----------------|----------------|-----------------|----------------|-------------|--------|
| 1 | 7330.000 | 40.43 | 6.94 | 47.37 | 74.00 | -26.63 | peak |
| 2 | 10806.000 | 35.25 | 13.98 | 49.23 | 74.00 | -24.77 | peak |
| 3 | 11719.000 | 32.21 | 17.18 | 49.39 | 74.00 | -24.61 | peak |
| 4 | 12599.000 | 31.66 | 17.95 | 49.61 | 74.00 | -24.39 | peak |
| 5 | 13919.000 | 27.75 | 21.68 | 49.43 | 74.00 | -24.57 | peak |
| 6 | 17978.000 | 22.48 | 25.97 | 48.45 | 74.00 | -25.55 | peak |

| | | | |
|------------|--------------|-----------------|----------|
| Test Mode: | 802.11n HT20 | Frequency(MHz): | 5700 |
| Polarity: | Vertical | Test Voltage: | DC 3.3 V |

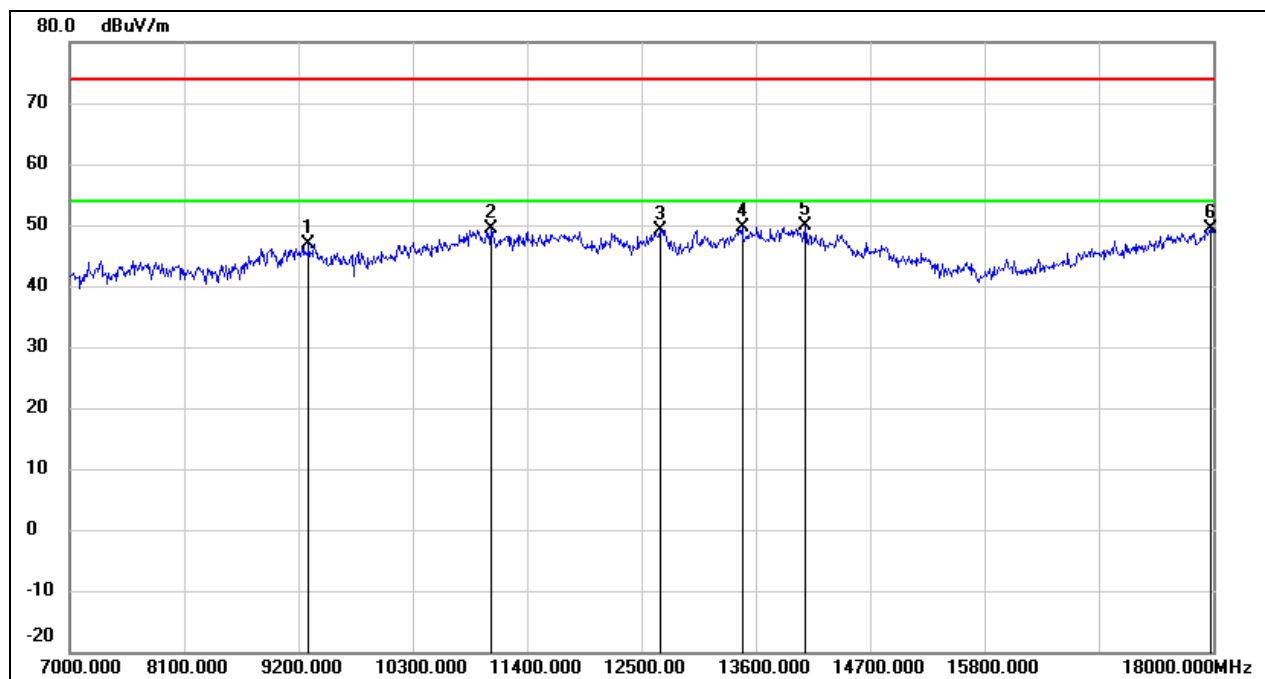

| No. | Frequency (MHz) | Reading (dBuV) | Correct (dB/m) | Result (dBuV/m) | Limit (dBuV/m) | Margin (dB) | Remark |
|-----|-----------------|----------------|----------------|-----------------|----------------|-------------|--------|
| 1 | 9299.000 | 36.35 | 10.53 | 46.88 | 74.00 | -27.12 | peak |
| 2 | 11048.000 | 34.55 | 14.91 | 49.46 | 74.00 | -24.54 | peak |
| 3 | 12676.000 | 31.07 | 18.05 | 49.12 | 74.00 | -24.88 | peak |
| 4 | 13468.000 | 29.07 | 20.50 | 49.57 | 74.00 | -24.43 | peak |
| 5 | 14073.000 | 28.25 | 21.57 | 49.82 | 74.00 | -24.18 | peak |
| 6 | 17978.000 | 23.49 | 25.97 | 49.46 | 74.00 | -24.54 | peak |

| | | | |
|------------|--------------|-----------------|----------|
| Test Mode: | 802.11n HT20 | Frequency(MHz): | 5720 |
| Polarity: | Horizontal | Test Voltage: | DC 3.3 V |

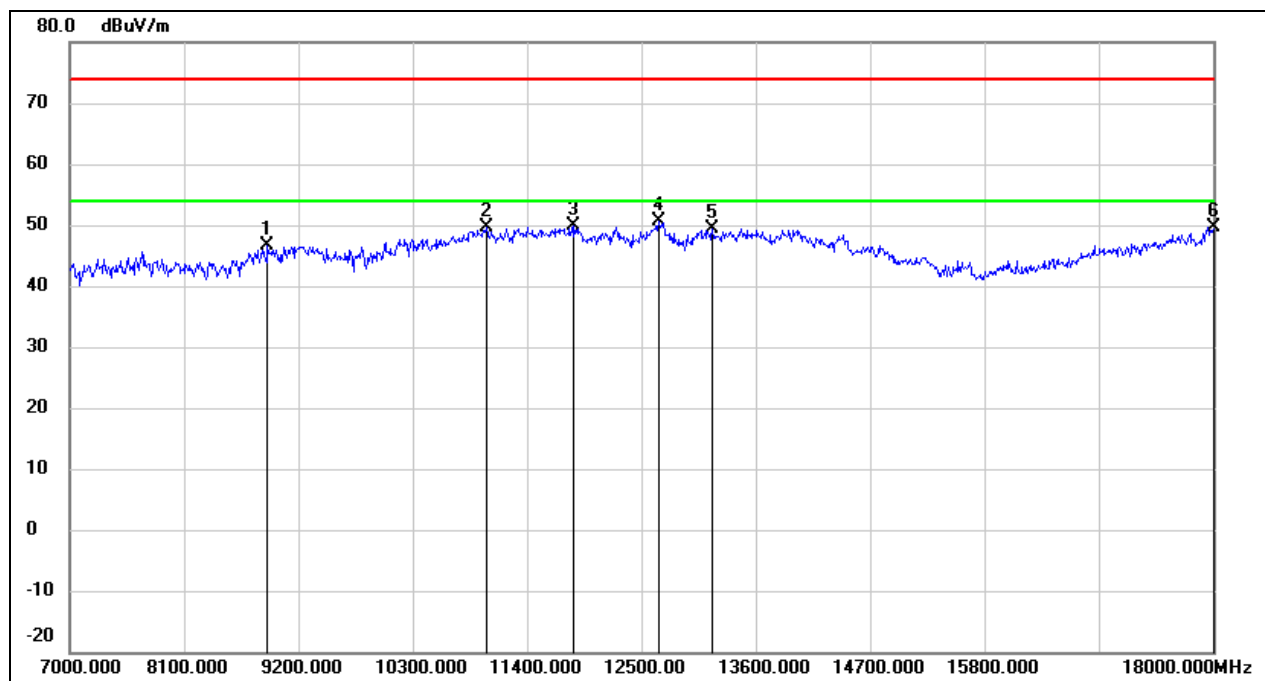

| No. | Frequency (MHz) | Reading (dBuV) | Correct (dB/m) | Result (dBuV/m) | Limit (dBuV/m) | Margin (dB) | Remark |
|-----|-----------------|----------------|----------------|-----------------|----------------|-------------|--------|
| 1 | 8903.000 | 37.08 | 9.66 | 46.74 | 74.00 | -27.26 | peak |
| 2 | 11015.000 | 34.81 | 14.79 | 49.60 | 74.00 | -24.40 | peak |
| 3 | 11851.000 | 32.49 | 17.43 | 49.92 | 74.00 | -24.08 | peak |
| 4 | 12665.000 | 32.47 | 18.04 | 50.51 | 74.00 | -23.49 | peak |
| 5 | 13182.000 | 30.18 | 19.24 | 49.42 | 74.00 | -24.58 | peak |
| 6 | 18000.000 | 23.43 | 26.12 | 49.55 | 74.00 | -24.45 | peak |

| | | | |
|------------|--------------|-----------------|----------|
| Test Mode: | 802.11n HT20 | Frequency(MHz): | 5720 |
| Polarity: | Vertical | Test Voltage: | DC 3.3 V |

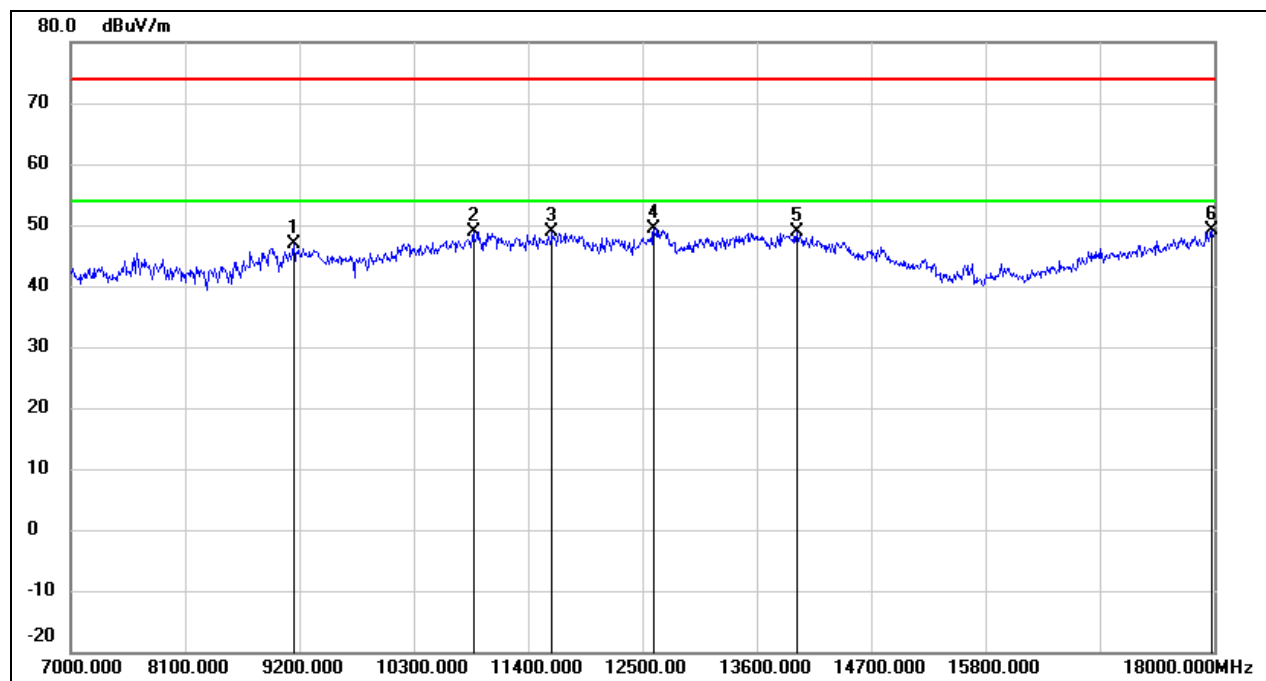

| No. | Frequency (MHz) | Reading (dBuV) | Correct (dB/m) | Result (dBuV/m) | Limit (dBuV/m) | Margin (dB) | Remark |
|-----|-----------------|----------------|----------------|-----------------|----------------|-------------|--------|
| 1 | 9145.000 | 36.55 | 10.43 | 46.98 | 74.00 | -27.02 | peak |
| 2 | 10872.000 | 34.76 | 14.23 | 48.99 | 74.00 | -25.01 | peak |
| 3 | 11631.000 | 31.93 | 17.01 | 48.94 | 74.00 | -25.06 | peak |
| 4 | 12610.000 | 31.37 | 17.97 | 49.34 | 74.00 | -24.66 | peak |
| 5 | 13985.000 | 26.95 | 21.85 | 48.80 | 74.00 | -25.20 | peak |
| 6 | 17978.000 | 23.17 | 25.97 | 49.14 | 74.00 | -24.86 | peak |

| | | | |
|------------|--------------|-----------------|----------|
| Test Mode: | 802.11n HT20 | Frequency(MHz): | 5745 |
| Polarity: | Horizontal | Test Voltage: | DC 3.3 V |

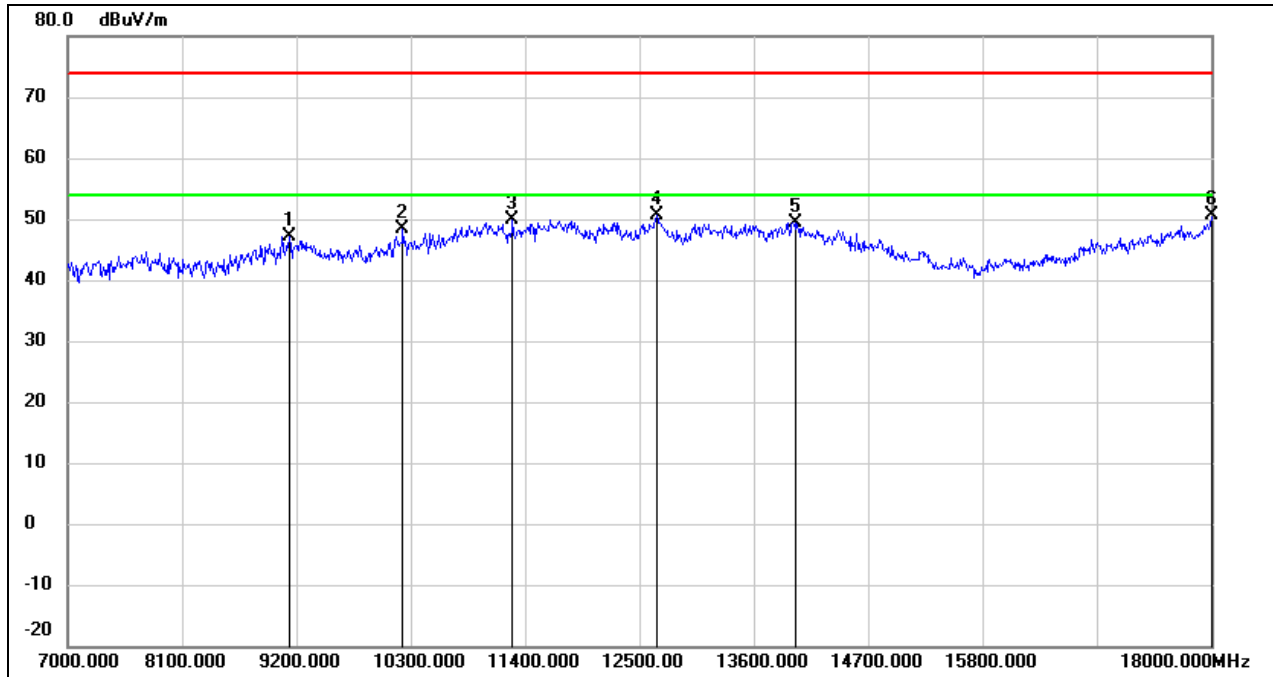

| No. | Frequency (MHz) | Reading (dBuV) | Correct (dB/m) | Result (dBuV/m) | Limit (dBuV/m) | Margin (dB) | Remark |
|-----|-----------------|----------------|----------------|-----------------|----------------|-------------|--------|
| 1 | 9134.000 | 36.65 | 10.41 | 47.06 | 74.00 | -26.94 | peak |
| 2 | 10223.000 | 36.25 | 12.24 | 48.49 | 74.00 | -25.51 | peak |
| 3 | 11279.000 | 34.08 | 15.86 | 49.94 | 74.00 | -24.06 | peak |
| 4 | 12665.000 | 32.49 | 18.04 | 50.53 | 74.00 | -23.47 | peak |
| 5 | 14007.000 | 27.53 | 21.85 | 49.38 | 74.00 | -24.62 | peak |
| 6 | 18000.000 | 24.39 | 26.12 | 50.51 | 74.00 | -23.49 | peak |

| | | | |
|------------|--------------|-----------------|----------|
| Test Mode: | 802.11n HT20 | Frequency(MHz): | 5745 |
| Polarity: | Vertical | Test Voltage: | DC 3.3 V |

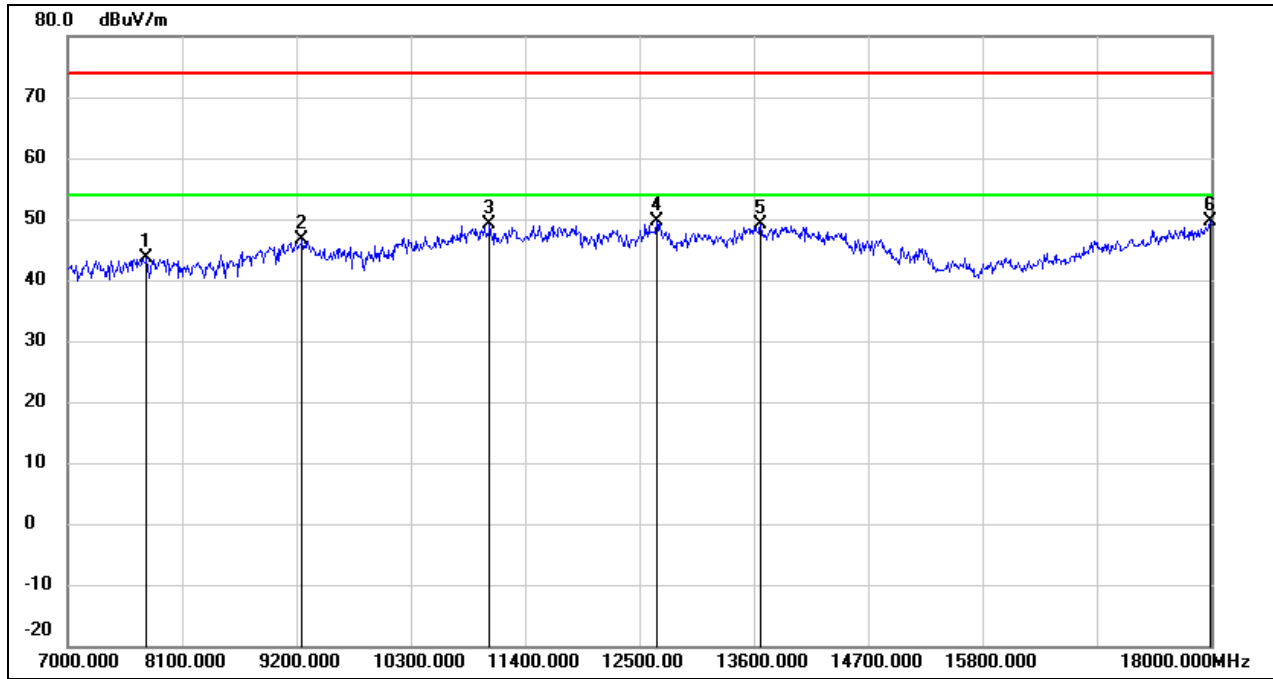

| No. | Frequency (MHz) | Reading (dBuV) | Correct (dB/m) | Result (dBuV/m) | Limit (dBuV/m) | Margin (dB) | Remark |
|-----|-----------------|----------------|----------------|-----------------|----------------|-------------|--------|
| 1 | 7759.000 | 36.95 | 6.64 | 43.59 | 74.00 | -30.41 | peak |
| 2 | 9255.000 | 36.04 | 10.51 | 46.55 | 74.00 | -27.45 | peak |
| 3 | 11059.000 | 34.16 | 14.96 | 49.12 | 74.00 | -24.88 | peak |
| 4 | 12665.000 | 31.55 | 18.04 | 49.59 | 74.00 | -24.41 | peak |
| 5 | 13666.000 | 28.03 | 21.05 | 49.08 | 74.00 | -24.92 | peak |
| 6 | 17989.000 | 23.49 | 26.04 | 49.53 | 74.00 | -24.47 | peak |

| | | | |
|------------|--------------|-----------------|----------|
| Test Mode: | 802.11n HT20 | Frequency(MHz): | 5785 |
| Polarity: | Horizontal | Test Voltage: | DC 3.3 V |

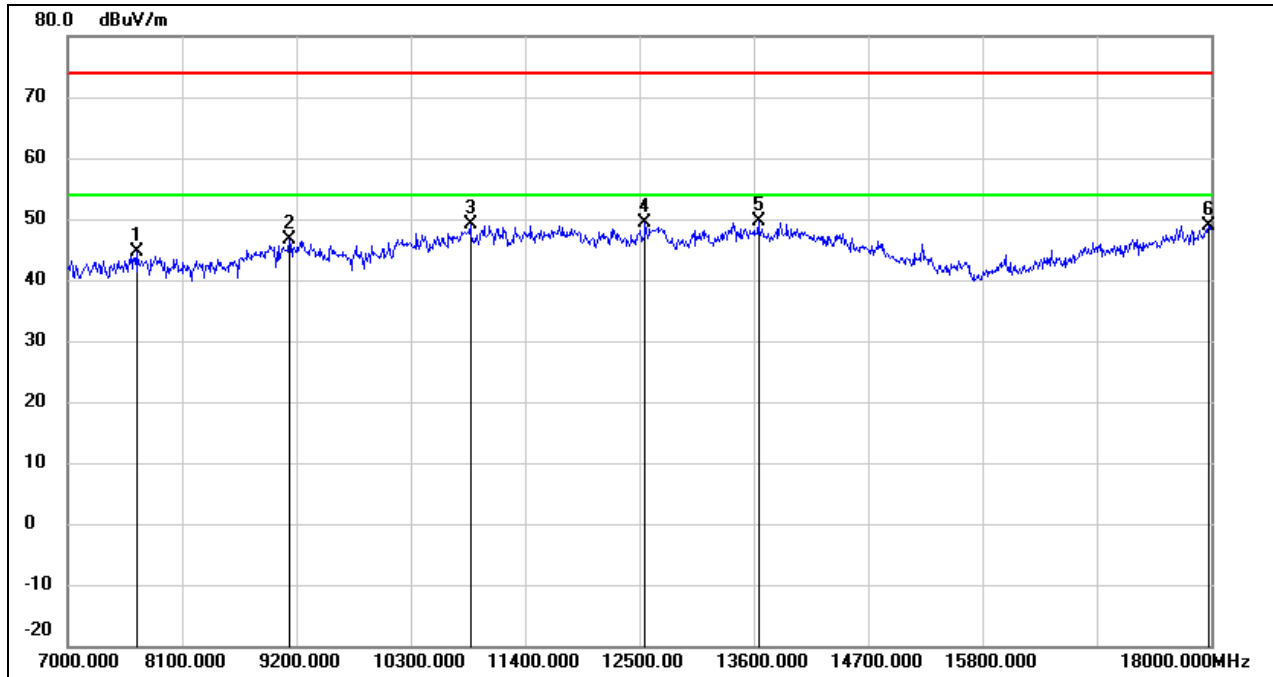

| No. | Frequency (MHz) | Reading (dBuV) | Correct (dB/m) | Result (dBuV/m) | Limit (dBuV/m) | Margin (dB) | Remark |
|-----|-----------------|----------------|----------------|-----------------|----------------|-------------|--------|
| 1 | 7660.000 | 37.93 | 6.73 | 44.66 | 74.00 | -29.34 | peak |
| 2 | 9134.000 | 36.34 | 10.41 | 46.75 | 74.00 | -27.25 | peak |
| 3 | 10872.000 | 34.96 | 14.23 | 49.19 | 74.00 | -24.81 | peak |
| 4 | 12555.000 | 31.46 | 17.90 | 49.36 | 74.00 | -24.64 | peak |
| 5 | 13644.000 | 28.57 | 20.99 | 49.56 | 74.00 | -24.44 | peak |
| 6 | 17978.000 | 22.93 | 25.97 | 48.90 | 74.00 | -25.10 | peak |

| | | | |
|------------|--------------|-----------------|----------|
| Test Mode: | 802.11n HT20 | Frequency(MHz): | 5785 |
| Polarity: | Vertical | Test Voltage: | DC 3.3 V |

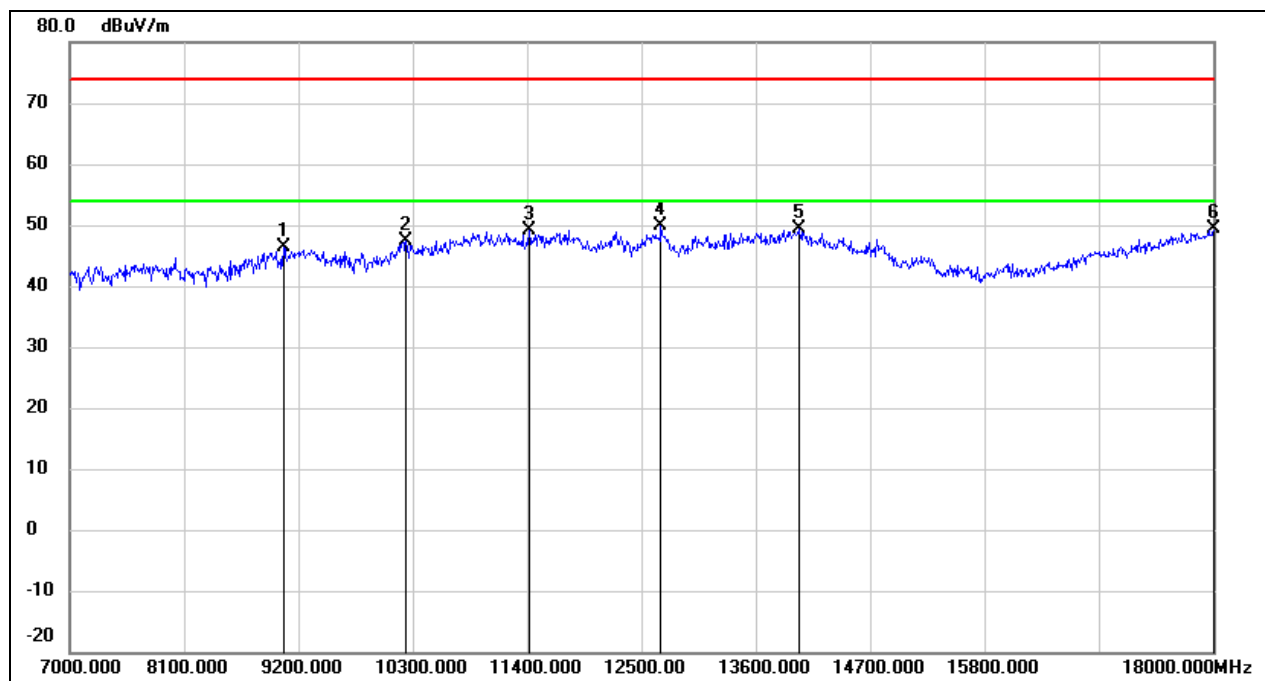

| No. | Frequency (MHz) | Reading (dBuV) | Correct (dB/m) | Result (dBuV/m) | Limit (dBuV/m) | Margin (dB) | Remark |
|-----|-----------------|----------------|----------------|-----------------|----------------|-------------|--------|
| 1 | 9057.000 | 35.98 | 10.38 | 46.36 | 74.00 | -27.64 | peak |
| 2 | 10234.000 | 35.11 | 12.26 | 47.37 | 74.00 | -26.63 | peak |
| 3 | 11422.000 | 32.64 | 16.46 | 49.10 | 74.00 | -24.90 | peak |
| 4 | 12687.000 | 31.85 | 18.05 | 49.90 | 74.00 | -24.10 | peak |
| 5 | 14018.000 | 27.58 | 21.80 | 49.38 | 74.00 | -24.62 | peak |
| 6 | 18000.000 | 23.33 | 26.12 | 49.45 | 74.00 | -24.55 | peak |

| | | | |
|------------|--------------|-----------------|----------|
| Test Mode: | 802.11n HT20 | Frequency(MHz): | 5825 |
| Polarity: | Horizontal | Test Voltage: | DC 3.3 V |

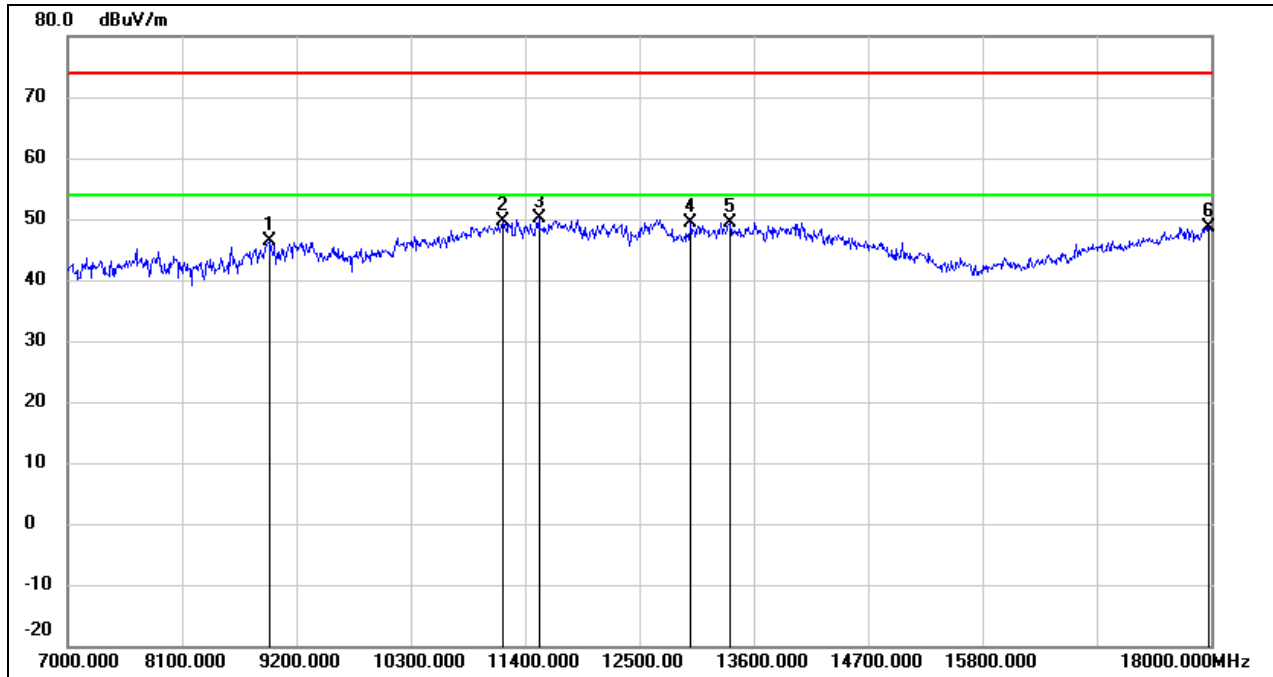

| No. | Frequency (MHz) | Reading (dBuV) | Correct (dB/m) | Result (dBuV/m) | Limit (dBuV/m) | Margin (dB) | Remark |
|-----|-----------------|----------------|----------------|-----------------|----------------|-------------|--------|
| 1 | 8936.000 | 36.38 | 9.90 | 46.28 | 74.00 | -27.72 | peak |
| 2 | 11191.000 | 34.13 | 15.50 | 49.63 | 74.00 | -24.37 | peak |
| 3 | 11532.000 | 33.19 | 16.83 | 50.02 | 74.00 | -23.98 | peak |
| 4 | 12995.000 | 30.98 | 18.44 | 49.42 | 74.00 | -24.58 | peak |
| 5 | 13369.000 | 29.35 | 20.06 | 49.41 | 74.00 | -24.59 | peak |
| 6 | 17978.000 | 22.74 | 25.97 | 48.71 | 74.00 | -25.29 | peak |

| | | | |
|------------|--------------|-----------------|----------|
| Test Mode: | 802.11n HT20 | Frequency(MHz): | 5825 |
| Polarity: | Vertical | Test Voltage: | DC 3.3 V |

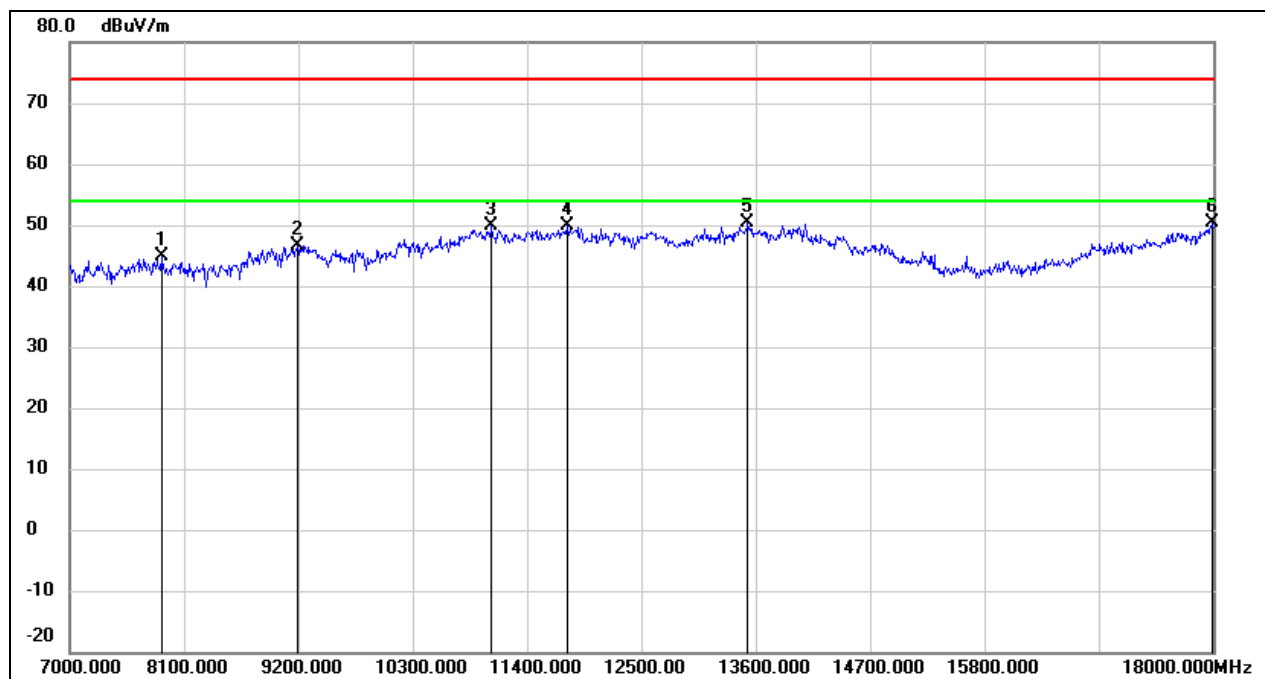

| No. | Frequency (MHz) | Reading (dBuV) | Correct (dB/m) | Result (dBuV/m) | Limit (dBuV/m) | Margin (dB) | Remark |
|-----|-----------------|----------------|----------------|-----------------|----------------|-------------|--------|
| 1 | 7880.000 | 38.39 | 6.54 | 44.93 | 74.00 | -29.07 | peak |
| 2 | 9189.000 | 36.20 | 10.46 | 46.66 | 74.00 | -27.34 | peak |
| 3 | 11059.000 | 34.95 | 14.96 | 49.91 | 74.00 | -24.09 | peak |
| 4 | 11785.000 | 32.54 | 17.30 | 49.84 | 74.00 | -24.16 | peak |
| 5 | 13523.000 | 29.62 | 20.70 | 50.32 | 74.00 | -23.68 | peak |
| 6 | 17989.000 | 24.26 | 26.04 | 50.30 | 74.00 | -23.70 | peak |

| | | | |
|------------|--------------|-----------------|----------|
| Test Mode: | 802.11n HT40 | Frequency(MHz): | 5190 |
| Polarity: | Horizontal | Test Voltage: | DC 3.3 V |

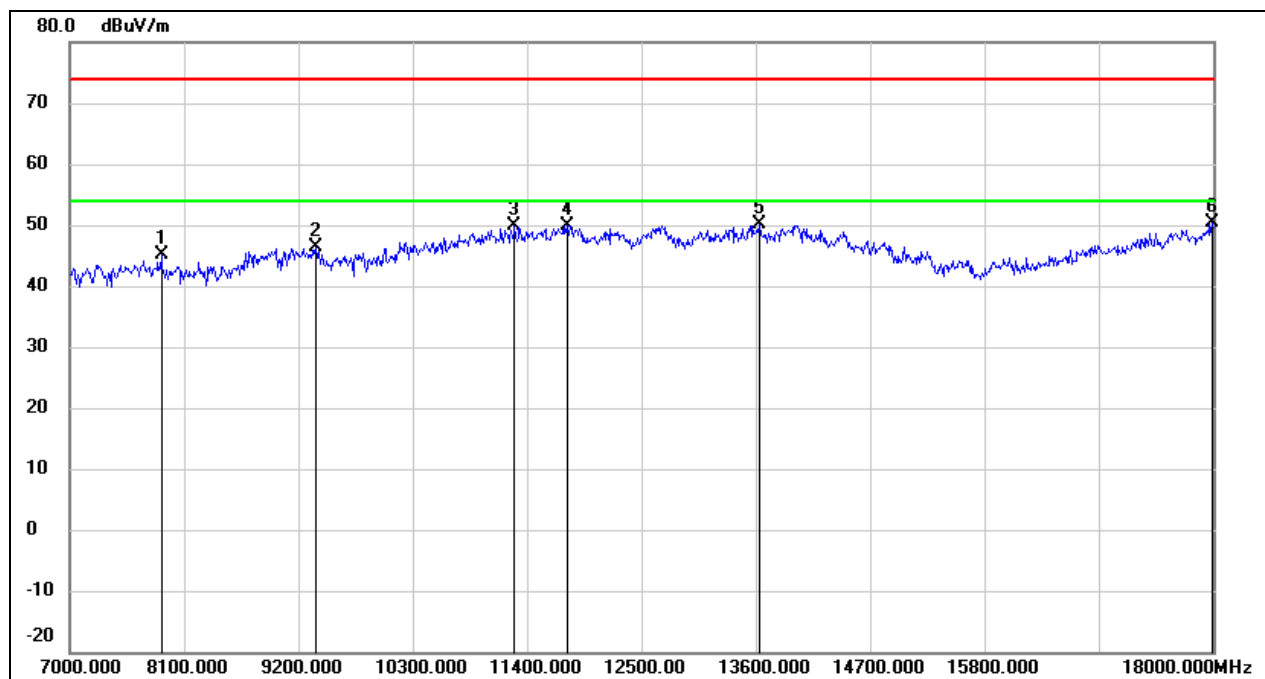

| No. | Frequency (MHz) | Reading (dBuV) | Correct (dB/m) | Result (dBuV/m) | Limit (dBuV/m) | Margin (dB) | Remark |
|-----|-----------------|----------------|----------------|-----------------|----------------|-------------|--------|
| 1 | 7880.000 | 38.52 | 6.54 | 45.06 | 74.00 | -28.94 | peak |
| 2 | 9365.000 | 35.85 | 10.57 | 46.42 | 74.00 | -27.58 | peak |
| 3 | 11279.000 | 34.06 | 15.86 | 49.92 | 74.00 | -24.08 | peak |
| 4 | 11785.000 | 32.65 | 17.30 | 49.95 | 74.00 | -24.05 | peak |
| 5 | 13633.000 | 29.05 | 20.97 | 50.02 | 74.00 | -23.98 | peak |
| 6 | 17989.000 | 24.24 | 26.04 | 50.28 | 74.00 | -23.72 | peak |

| | | | |
|------------|--------------|-----------------|----------|
| Test Mode: | 802.11n HT40 | Frequency(MHz): | 5190 |
| Polarity: | Vertical | Test Voltage: | DC 3.3 V |

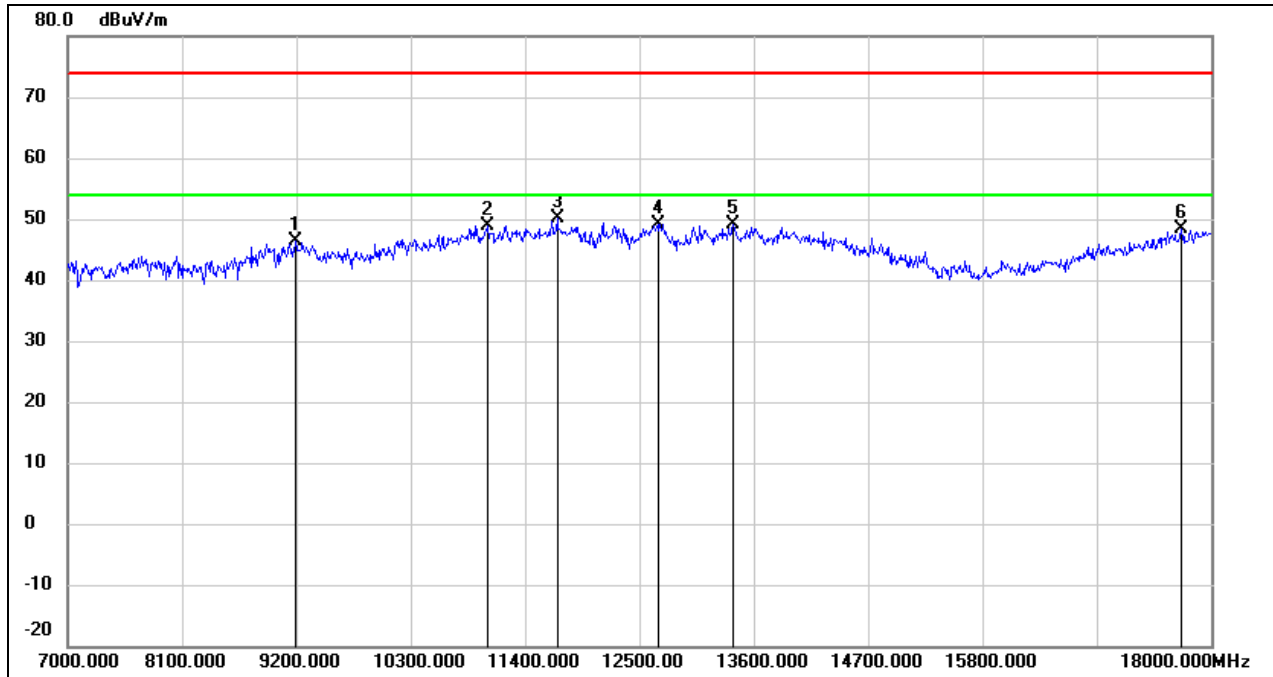

| No. | Frequency (MHz) | Reading (dBuV) | Correct (dB/m) | Result (dBuV/m) | Limit (dBuV/m) | Margin (dB) | Remark |
|-----|-----------------|----------------|----------------|-----------------|----------------|-------------|--------|
| 1 | 9189.000 | 35.91 | 10.46 | 46.37 | 74.00 | -27.63 | peak |
| 2 | 11037.000 | 34.12 | 14.87 | 48.99 | 74.00 | -25.01 | peak |
| 3 | 11708.000 | 32.96 | 17.16 | 50.12 | 74.00 | -23.88 | peak |
| 4 | 12676.000 | 31.16 | 18.05 | 49.21 | 74.00 | -24.79 | peak |
| 5 | 13402.000 | 28.94 | 20.20 | 49.14 | 74.00 | -24.86 | peak |
| 6 | 17714.000 | 24.29 | 24.16 | 48.45 | 74.00 | -25.55 | peak |

| | | | |
|------------|--------------|-----------------|----------|
| Test Mode: | 802.11n HT40 | Frequency(MHz): | 5230 |
| Polarity: | Horizontal | Test Voltage: | DC 3.3 V |

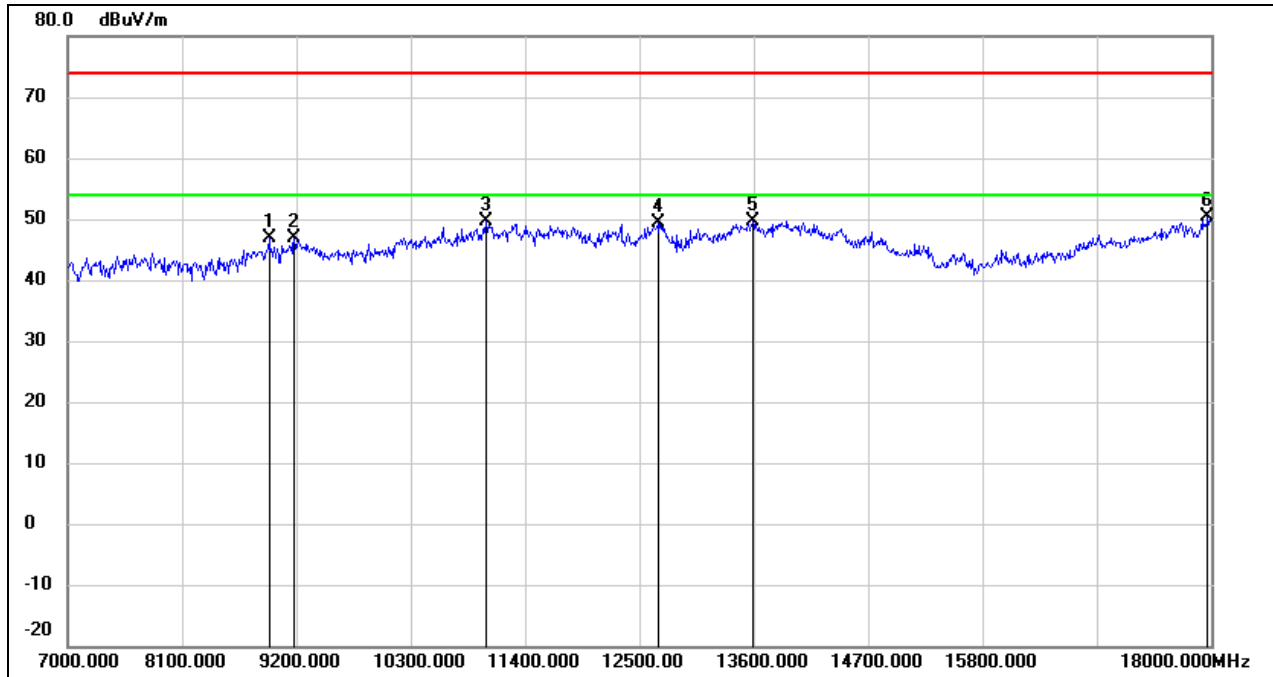

| No. | Frequency (MHz) | Reading (dBuV) | Correct (dB/m) | Result (dBuV/m) | Limit (dBuV/m) | Margin (dB) | Remark |
|-----|-----------------|----------------|----------------|-----------------|----------------|-------------|--------|
| 1 | 8936.000 | 36.88 | 9.90 | 46.78 | 74.00 | -27.22 | peak |
| 2 | 9178.000 | 36.33 | 10.45 | 46.78 | 74.00 | -27.22 | peak |
| 3 | 11026.000 | 34.74 | 14.82 | 49.56 | 74.00 | -24.44 | peak |
| 4 | 12676.000 | 31.40 | 18.05 | 49.45 | 74.00 | -24.55 | peak |
| 5 | 13589.000 | 28.74 | 20.86 | 49.60 | 74.00 | -24.40 | peak |
| 6 | 17967.000 | 24.49 | 25.89 | 50.38 | 74.00 | -23.62 | peak |

| | | | |
|------------|--------------|-----------------|----------|
| Test Mode: | 802.11n HT40 | Frequency(MHz): | 5230 |
| Polarity: | Vertical | Test Voltage: | DC 3.3 V |

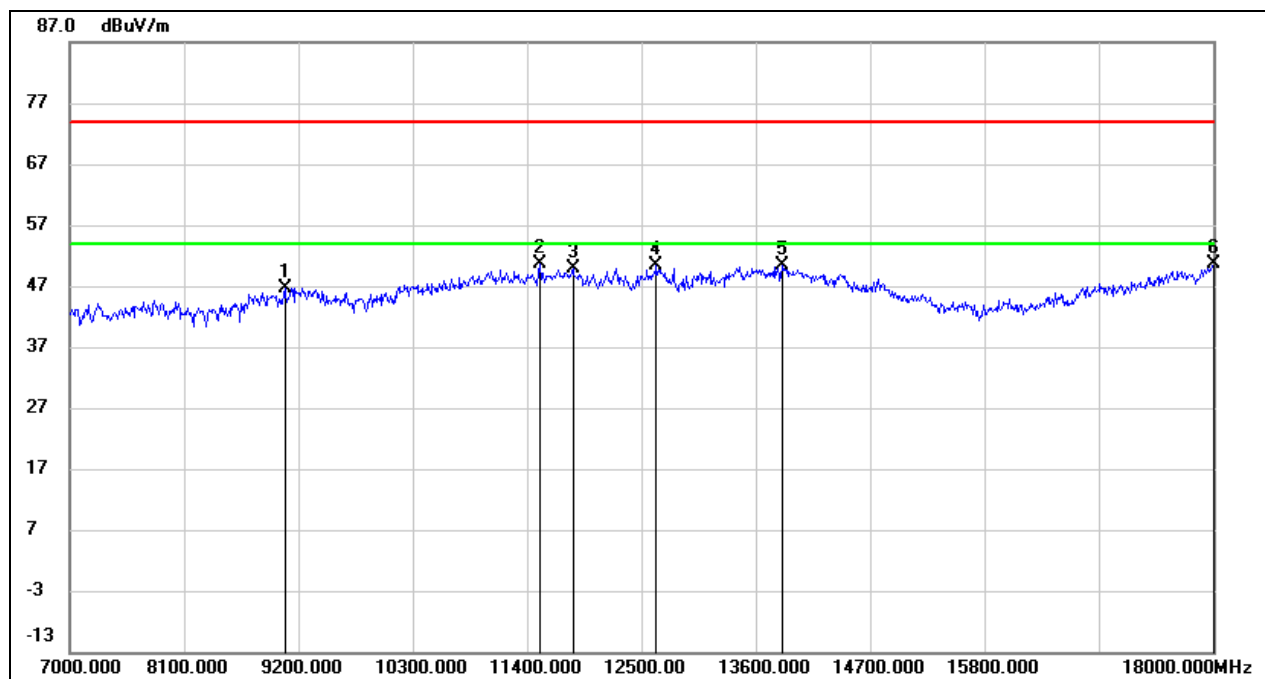

| No. | Frequency (MHz) | Reading (dBuV) | Correct (dB/m) | Result (dBuV/m) | Limit (dBuV/m) | Margin (dB) | Remark |
|-----|-----------------|----------------|----------------|-----------------|----------------|-------------|--------|
| 1 | 9068.000 | 36.33 | 10.39 | 46.72 | 74.00 | -27.28 | peak |
| 2 | 11521.000 | 33.75 | 16.82 | 50.57 | 74.00 | -23.43 | peak |
| 3 | 11840.000 | 32.36 | 17.40 | 49.76 | 74.00 | -24.24 | peak |
| 4 | 12643.000 | 32.45 | 18.01 | 50.46 | 74.00 | -23.54 | peak |
| 5 | 13853.000 | 28.80 | 21.52 | 50.32 | 74.00 | -23.68 | peak |
| 6 | 18000.000 | 24.43 | 26.12 | 50.55 | 74.00 | -23.45 | peak |

| | | | |
|------------|--------------|-----------------|----------|
| Test Mode: | 802.11n HT40 | Frequency(MHz): | 5270 |
| Polarity: | Horizontal | Test Voltage: | DC 3.3 V |

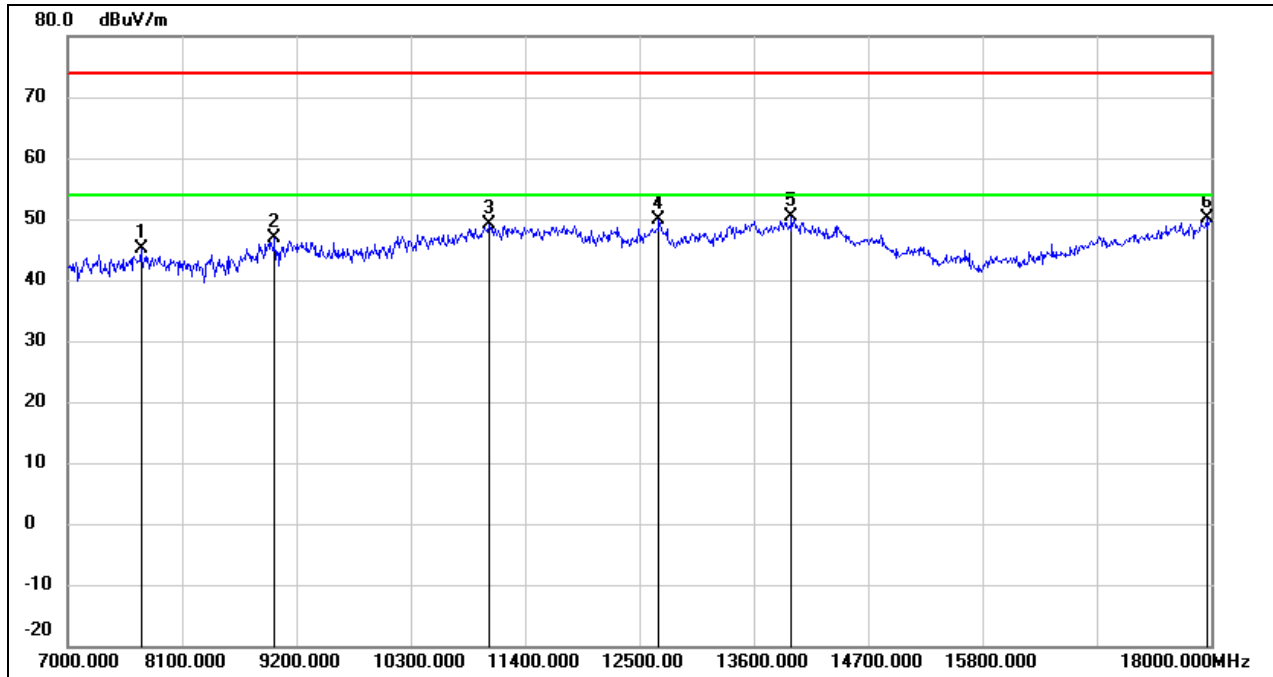

| No. | Frequency (MHz) | Reading (dBuV) | Correct (dB/m) | Result (dBuV/m) | Limit (dBuV/m) | Margin (dB) | Remark |
|-----|-----------------|----------------|----------------|-----------------|----------------|-------------|--------|
| 1 | 7704.000 | 38.44 | 6.69 | 45.13 | 74.00 | -28.87 | peak |
| 2 | 8991.000 | 36.48 | 10.28 | 46.76 | 74.00 | -27.24 | peak |
| 3 | 11059.000 | 34.21 | 14.96 | 49.17 | 74.00 | -24.83 | peak |
| 4 | 12687.000 | 31.83 | 18.05 | 49.88 | 74.00 | -24.12 | peak |
| 5 | 13963.000 | 28.53 | 21.78 | 50.31 | 74.00 | -23.69 | peak |
| 6 | 17956.000 | 24.22 | 25.82 | 50.04 | 74.00 | -23.96 | peak |

| | | | |
|------------|--------------|-----------------|----------|
| Test Mode: | 802.11n HT40 | Frequency(MHz): | 5270 |
| Polarity: | Vertical | Test Voltage: | DC 3.3 V |

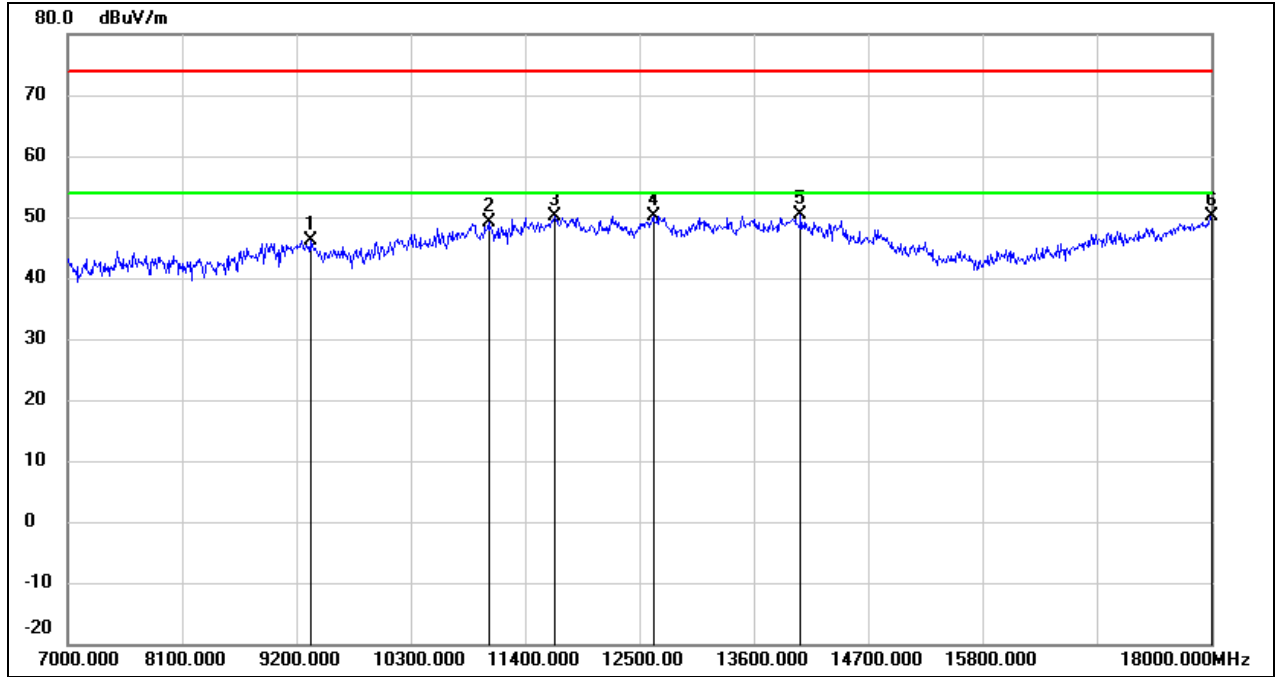

| No. | Frequency (MHz) | Reading (dBuV) | Correct (dB/m) | Result (dBuV/m) | Limit (dBuV/m) | Margin (dB) | Remark |
|-----|-----------------|----------------|----------------|-----------------|----------------|-------------|--------|
| 1 | 9332.000 | 35.69 | 10.54 | 46.23 | 74.00 | -27.77 | peak |
| 2 | 11048.000 | 34.24 | 14.91 | 49.15 | 74.00 | -24.85 | peak |
| 3 | 11686.000 | 33.01 | 17.12 | 50.13 | 74.00 | -23.87 | peak |
| 4 | 12632.000 | 32.07 | 17.99 | 50.06 | 74.00 | -23.94 | peak |
| 5 | 14051.000 | 28.71 | 21.67 | 50.38 | 74.00 | -23.62 | peak |
| 6 | 18000.000 | 24.02 | 26.12 | 50.14 | 74.00 | -23.86 | peak |

| | | | |
|------------|--------------|-----------------|----------|
| Test Mode: | 802.11n HT40 | Frequency(MHz): | 5310 |
| Polarity: | Horizontal | Test Voltage: | DC 3.3 V |

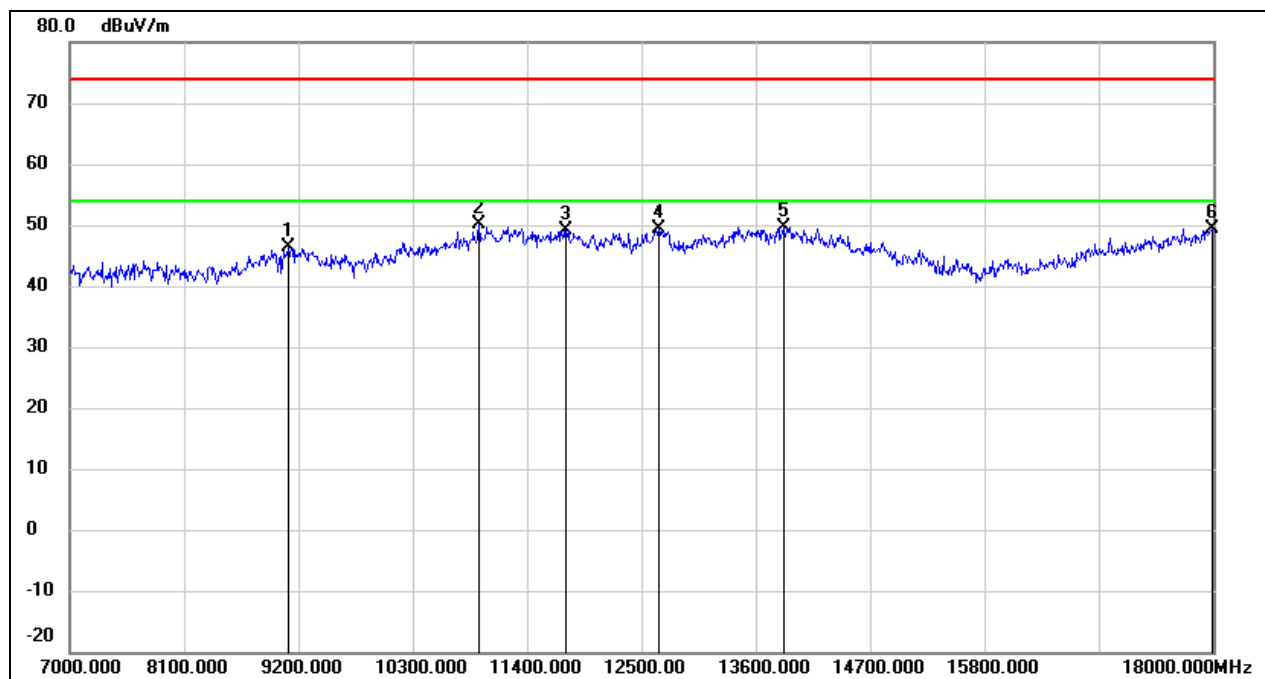

| No. | Frequency (MHz) | Reading (dBuV) | Correct (dB/m) | Result (dBuV/m) | Limit (dBuV/m) | Margin (dB) | Remark |
|-----|-----------------|----------------|----------------|-----------------|----------------|-------------|--------|
| 1 | 9101.000 | 36.05 | 10.40 | 46.45 | 74.00 | -27.55 | peak |
| 2 | 10938.000 | 35.62 | 14.48 | 50.10 | 74.00 | -23.90 | peak |
| 3 | 11774.000 | 31.91 | 17.28 | 49.19 | 74.00 | -24.81 | peak |
| 4 | 12665.000 | 31.45 | 18.04 | 49.49 | 74.00 | -24.51 | peak |
| 5 | 13864.000 | 28.18 | 21.53 | 49.71 | 74.00 | -24.29 | peak |
| 6 | 17989.000 | 23.29 | 26.04 | 49.33 | 74.00 | -24.67 | peak |

| | | | |
|------------|--------------|-----------------|----------|
| Test Mode: | 802.11n HT40 | Frequency(MHz): | 5310 |
| Polarity: | Vertical | Test Voltage: | DC 3.3 V |

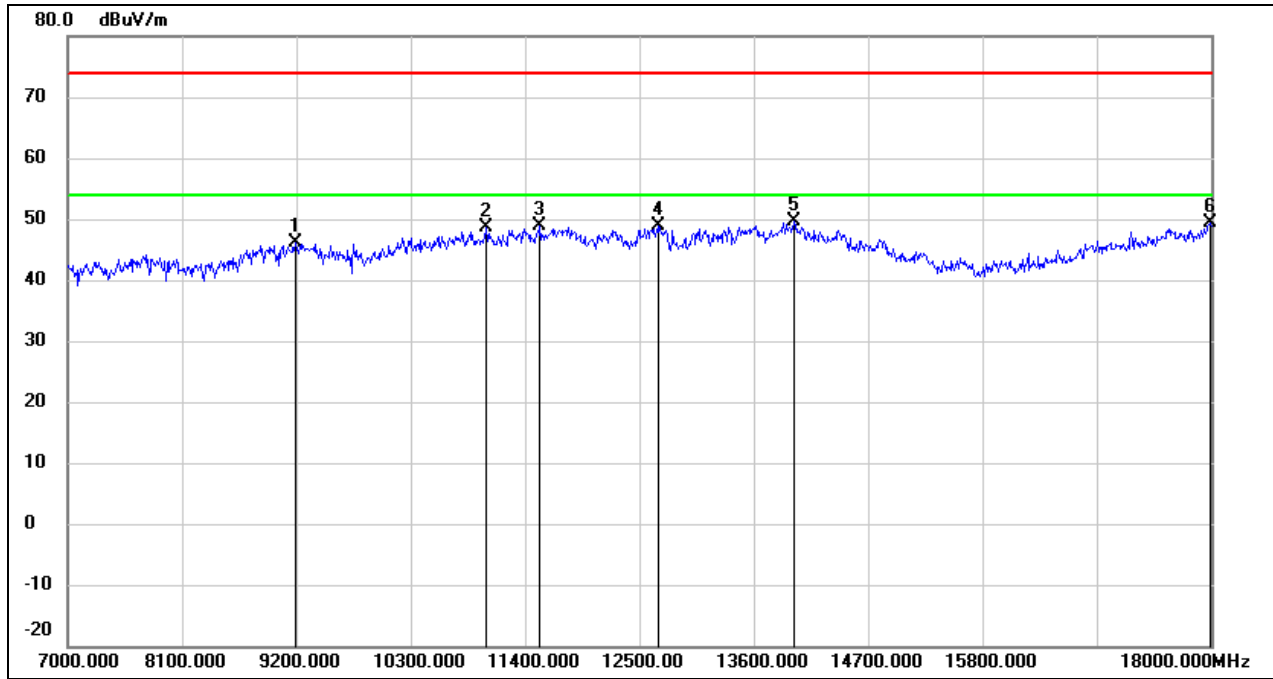

| No. | Frequency (MHz) | Reading (dBuV) | Correct (dB/m) | Result (dBuV/m) | Limit (dBuV/m) | Margin (dB) | Remark |
|-----|-----------------|----------------|----------------|-----------------|----------------|-------------|--------|
| 1 | 9189.000 | 35.55 | 10.46 | 46.01 | 74.00 | -27.99 | peak |
| 2 | 11026.000 | 33.70 | 14.82 | 48.52 | 74.00 | -25.48 | peak |
| 3 | 11543.000 | 32.14 | 16.84 | 48.98 | 74.00 | -25.02 | peak |
| 4 | 12687.000 | 30.75 | 18.05 | 48.80 | 74.00 | -25.20 | peak |
| 5 | 13985.000 | 27.82 | 21.85 | 49.67 | 74.00 | -24.33 | peak |
| 6 | 17989.000 | 23.45 | 26.04 | 49.49 | 74.00 | -24.51 | peak |