



**CFR 47 FCC PART 15 SUBPART C  
ISED RSS-247 ISSUE 2**

**CERTIFICATION TEST REPORT**

*For*

**WIFI+BT Module**

**MODEL NUMBER: DCT92G1001**

**FCC ID: 2AC23-DCT92**

**IC: 12290A-DCT92**

**REPORT NUMBER: 4790156624-2**

**ISSUE DATE: March 17, 2022**

**Prepared for**

**Hui Zhou Gaoshengda Technology Co.,LTD  
NNO.75 Zhongkai Development Area, Huizhou Guangdong China**

*Prepared by*

**UL Verification Services (Guangzhou) Co., Ltd, Song Shan Lake Branch**

**Building 10, Innovation Technology Park, No. 1, Li Bin Road, Song Shan Lake  
Hi-Tech Development Zone Dongguan, 523808, People's Republic of China**

**Tel: +86 769 22038881**

**Fax: +86 769 33244054**

**Website: [www.ul.com](http://www.ul.com)**



Revision History

| <u>Rev.</u> | <u>Issue Date</u> | <u>Revisions</u> | <u>Revised By</u> |
|-------------|-------------------|------------------|-------------------|
| V0          | 3/17/2022         | Initial Issue    |                   |



| Summary of Test Results                                                                                                                                                                                                                                                                                                                        |                                           |                                                                                                               |              |
|------------------------------------------------------------------------------------------------------------------------------------------------------------------------------------------------------------------------------------------------------------------------------------------------------------------------------------------------|-------------------------------------------|---------------------------------------------------------------------------------------------------------------|--------------|
| Clause                                                                                                                                                                                                                                                                                                                                         | Test Items                                | FCC/ISED Rules                                                                                                | Test Results |
| 1                                                                                                                                                                                                                                                                                                                                              | 20dB Bandwidth and 99% Occupied Bandwidth | FCC 15.247 (a) (1)<br>RSS-247 Clause 5.1 (a)<br>RSS-Gen Clause 6.7                                            | Pass         |
| 2                                                                                                                                                                                                                                                                                                                                              | Conducted Output Power                    | FCC 15.247 (b) (1)<br>RSS-247 Clause 5.1 (b)                                                                  | Pass         |
| 3                                                                                                                                                                                                                                                                                                                                              | Carrier Hopping Channel Separation        | FCC 15.247 (a) (1)<br>RSS-247 Clause 5.1 (b)                                                                  | Pass         |
| 4                                                                                                                                                                                                                                                                                                                                              | Number of Hopping Frequency               | 15.247 (a) (1) III<br>RSS-247 Clause 5.1 (d)                                                                  | Pass         |
| 5                                                                                                                                                                                                                                                                                                                                              | Time of Occupancy (Dwell Time)            | 15.247 (a) (1) III<br>RSS-247 Clause 5.1 (d)                                                                  | Pass         |
| 6                                                                                                                                                                                                                                                                                                                                              | Conducted Bandedge                        | FCC 15.247 (d)<br>RSS-247 Clause 5.5                                                                          | Pass         |
| 7                                                                                                                                                                                                                                                                                                                                              | Radiated Bandedge and Spurious            | FCC 15.247 (d)<br>FCC 15.209<br>FCC 15.205<br>RSS-247 Clause 5.5<br>RSS-GEN Clause 8.9<br>RSS-GEN Clause 8.10 | Pass         |
| 8                                                                                                                                                                                                                                                                                                                                              | Conducted Emission Test for AC Power Port | FCC 15.207<br>RSS-GEN Clause 8.8                                                                              | Pass         |
| 9                                                                                                                                                                                                                                                                                                                                              | Antenna Requirement                       | FCC 15.203<br>RSS-GEN Clause 6.8                                                                              | Pass         |
| <p>Note:</p> <p>1. This test report is only published to and used by the applicant, and it is not for evidence purpose in China.</p> <p>2. The measurement result for the sample received is &lt;Pass&gt; according to &lt; CFR 47 FCC PART 15 SUBPART C &gt;&lt; ISED RSS-247 &gt; when &lt;Accuracy Method&gt; decision rule is applied.</p> |                                           |                                                                                                               |              |



## TABLE OF CONTENTS

|                                                               |           |
|---------------------------------------------------------------|-----------|
| <b>1. ATTESTATION OF TEST RESULTS .....</b>                   | <b>6</b>  |
| <b>2. TEST METHODOLOGY .....</b>                              | <b>7</b>  |
| <b>3. FACILITIES AND ACCREDITATION .....</b>                  | <b>7</b>  |
| <b>4. CALIBRATION AND UNCERTAINTY .....</b>                   | <b>8</b>  |
| 4.1. <i>MEASURING INSTRUMENT CALIBRATION .....</i>            | <i>8</i>  |
| 4.2. <i>MEASUREMENT UNCERTAINTY.....</i>                      | <i>8</i>  |
| <b>5. EQUIPMENT UNDER TEST .....</b>                          | <b>9</b>  |
| 5.1. <i>DESCRIPTION OF EUT .....</i>                          | <i>9</i>  |
| 5.2. <i>MAXIMUM PEAK OUTPUT POWER .....</i>                   | <i>9</i>  |
| 5.3. <i>PACKET TYPE CONFIGURATION .....</i>                   | <i>9</i>  |
| 5.4. <i>CHANNEL LIST.....</i>                                 | <i>10</i> |
| 5.5. <i>TEST CHANNEL CONFIGURATION.....</i>                   | <i>10</i> |
| 5.6. <i>WORST-CASE CONFIGURATIONS.....</i>                    | <i>10</i> |
| 5.7. <i>THE WORSE CASE POWER SETTING PARAMETER.....</i>       | <i>11</i> |
| 5.8. <i>DESCRIPTION OF AVAILABLE ANTENNAS .....</i>           | <i>11</i> |
| 5.9. <i>DESCRIPTION OF TEST SETUP.....</i>                    | <i>12</i> |
| <b>6. MEASURING INSTRUMENT AND SOFTWARE USED .....</b>        | <b>13</b> |
| <b>7. ANTENNA PORT TEST RESULTS .....</b>                     | <b>15</b> |
| 7.1. <i>ON TIME AND DUTY CYCLE.....</i>                       | <i>15</i> |
| 7.2. <i>20 dB BANDWIDTH AND 99 % OCCUPIED BANDWIDTH .....</i> | <i>16</i> |
| 7.3. <i>CONDUCTED OUTPUT POWER.....</i>                       | <i>18</i> |
| 7.4. <i>CARRIER FREQUENCY SEPARATION.....</i>                 | <i>19</i> |
| 7.5. <i>NUMBER OF HOPPING FREQUENCIES .....</i>               | <i>21</i> |
| 7.6. <i>TIME OF OCCUPANCY (DWELL TIME).....</i>               | <i>23</i> |
| 7.7. <i>CONDUCTED BANDEDGE AND SPURIOUS EMISSION.....</i>     | <i>25</i> |
| <b>8. RADIATED TEST RESULTS.....</b>                          | <b>27</b> |
| 8.1. <i>RESTRICTED BANDEDGE .....</i>                         | <i>33</i> |
| 8.1.1. <i>GFSK MODE .....</i>                                 | <i>33</i> |
| 8.1.2. <i>8DPSK MODE .....</i>                                | <i>36</i> |
| 8.2. <i>SPURIOUS EMISSIONS (1 GHz ~ 3 GHz).....</i>           | <i>39</i> |
| 8.2.1. <i>GFSK MODE .....</i>                                 | <i>39</i> |
| 8.3. <i>SPURIOUS EMISSIONS (3 GHz ~ 18 GHz).....</i>          | <i>45</i> |
| 8.3.1. <i>GFSK MODE .....</i>                                 | <i>45</i> |



|            |                                                              |           |
|------------|--------------------------------------------------------------|-----------|
| 8.3.2.     | 8DPSK MODE .....                                             | 51        |
| 8.4.       | <i>SPURIOUS EMISSIONS (18 GHz ~ 26 GHz)</i> .....            | 57        |
| 8.4.1.     | 8DPSK MODE .....                                             | 57        |
| 8.5.       | <i>SPURIOUS EMISSIONS (30 MHz ~ 1 GHz)</i> .....             | 59        |
| 8.5.1.     | 8DPSK MODE .....                                             | 59        |
| 8.6.       | <i>SPURIOUS EMISSIONS BELOW 30 MHz</i> .....                 | 61        |
| 8.6.1.     | 8DPSK MODE .....                                             | 61        |
| <b>9.</b>  | <b>AC POWER LINE CONDUCTED EMISSIONS</b> .....               | <b>64</b> |
| 9.1.       | 8DPSK MODE .....                                             | 65        |
| <b>10.</b> | <b>ANTENNA REQUIREMENTS</b> .....                            | <b>67</b> |
| <b>11.</b> | <b>Appendix</b> .....                                        | <b>68</b> |
| 11.1.      | <i>Appendix A: 20dB Emission Bandwidth</i> .....             | 68        |
| 11.1.1.    | Test Result .....                                            | 68        |
| 11.1.2.    | Test Graphs .....                                            | 69        |
| 11.2.      | <i>Appendix B: Occupied Channel Bandwidth</i> .....          | 71        |
| 11.2.1.    | Test Result .....                                            | 71        |
| 11.2.2.    | Test Graphs .....                                            | 72        |
| 11.3.      | <i>Appendix C: Maximum Peak Conducted Output Power</i> ..... | 74        |
| 11.3.1.    | Test Result .....                                            | 74        |
| 11.4.      | <i>Appendix D: Carrier Frequency Separation</i> .....        | 75        |
| 11.4.1.    | Test Result .....                                            | 75        |
| 11.4.2.    | Test Graphs .....                                            | 76        |
| 11.5.      | <i>Appendix E: Time of Occupancy</i> .....                   | 77        |
| 11.5.1.    | Test Result .....                                            | 77        |
| 11.5.2.    | Test Graphs .....                                            | 78        |
| 11.6.      | <i>Appendix F: Number of Hopping Channels</i> .....          | 80        |
| 11.6.1.    | Test Result .....                                            | 80        |
| 11.6.2.    | Test Graphs .....                                            | 81        |
| 11.7.      | <i>Appendix G: Band Edge Measurements</i> .....              | 82        |
| 11.7.1.    | Test Result .....                                            | 82        |
| 11.7.2.    | Test Graphs .....                                            | 83        |
| 11.8.      | <i>Appendix H: Conducted Spurious Emission</i> .....         | 86        |
| 11.8.1.    | Test Result .....                                            | 86        |
| 11.8.2.    | Test Graphs .....                                            | 87        |
| 11.9.      | <i>Appendix I: Duty Cycle</i> .....                          | 93        |
| 11.9.1.    | Test Result .....                                            | 93        |
| 11.9.2.    | Test Graphs .....                                            | 94        |



# 1. ATTESTATION OF TEST RESULTS

## Applicant Information

Company Name: Hui Zhou Gaoshengda Technology Co.,LTD  
Address: NO.75 Zhongkai Development Area, Huizhou Guangdong  
China

## Manufacturer Information

Company Name: Hui Zhou Gaoshengda Technology Co.,LTD  
Address: NO.75 Zhongkai Development Area, Huizhou Guangdong  
China

## EUT Information

EUT Name: WIFI+BT Module  
Model: DCT92G1001  
Sample Received Date: November 1, 2021  
Sample Status: Normal  
Sample ID: 4355081  
Date of Tested: November 8, 2021 ~ March 11, 2022

| APPLICABLE STANDARDS         |              |
|------------------------------|--------------|
| STANDARD                     | TEST RESULTS |
| CFR 47 FCC PART 15 SUBPART C | PASS         |
| ISED RSS-247 Issue 2         | PASS         |
| ISED RSS-GEN Issue 5         | PASS         |

Prepared By:

Denny Huang  
Project Engineer

Checked By:

Shawn Wen  
Laboratory Leader

Approved By:

Stephen Guo  
Laboratory Manager



## 2. TEST METHODOLOGY

The tests documented in this report were performed in accordance with KDB 558074 D01 15.247 Meas Guidance v05r02, 414788 D01 Radiated Test Site v01r01, CFR 47 FCC Part 2, CFR 47 FCC Part 15, ANSI C63.10-2013, ISED RSS-247 Issue 2 and ISED RSS-GEN Issue 5.

## 3. FACILITIES AND ACCREDITATION

|                           |                                                                                                                                                                                                                                                                                                                                                                                                                                                                                                                                                                                                                                                                                                                                                                                                                                                                                                                                                                                                                                                                                                                                                                        |
|---------------------------|------------------------------------------------------------------------------------------------------------------------------------------------------------------------------------------------------------------------------------------------------------------------------------------------------------------------------------------------------------------------------------------------------------------------------------------------------------------------------------------------------------------------------------------------------------------------------------------------------------------------------------------------------------------------------------------------------------------------------------------------------------------------------------------------------------------------------------------------------------------------------------------------------------------------------------------------------------------------------------------------------------------------------------------------------------------------------------------------------------------------------------------------------------------------|
| Accreditation Certificate | <p><b>A2LA (Certificate No.: 4102.01)</b><br/>UL Verification Services (Guangzhou) Co., Ltd. Song Shan Lake Branch. has been assessed and proved to be in compliance with A2LA.</p> <p><b>FCC (FCC Designation No.: CN1187)</b><br/>UL Verification Services (Guangzhou) Co., Ltd. Song Shan Lake Branch. Has been recognized to perform compliance testing on equipment subject to the Commission's Declaration of Conformity (DoC) and Certification rules</p> <p><b>ISED (Company No.: 21320)</b><br/>UL Verification Services (Guangzhou) Co., Ltd. Song Shan Lake Branch. has been registered and fully described in a report filed with ISED. The Company Number is 21320 and the test lab Conformity Assessment Body Identifier (CABID) is CN0046.</p> <p><b>VCCI (Registration No.: G-20019, R-20004, C-20012 and T-20011)</b><br/>UL Verification Services (Guangzhou) Co., Ltd. Song Shan Lake Branch. has been assessed and proved to be in compliance with VCCI, the Membership No. is 3793.<br/>Facility Name:<br/>Chamber D, the VCCI registration No. is G-20019 and R-20004<br/>Shielding Room B, the VCCI registration No. is C-20012 and T-20011</p> |
|---------------------------|------------------------------------------------------------------------------------------------------------------------------------------------------------------------------------------------------------------------------------------------------------------------------------------------------------------------------------------------------------------------------------------------------------------------------------------------------------------------------------------------------------------------------------------------------------------------------------------------------------------------------------------------------------------------------------------------------------------------------------------------------------------------------------------------------------------------------------------------------------------------------------------------------------------------------------------------------------------------------------------------------------------------------------------------------------------------------------------------------------------------------------------------------------------------|

Note 1: All tests measurement facilities use to collect the measurement data are located at Building 10, Innovation Technology Park, Song Shan Lake Hi tech Development Zone, Dongguan, 523808, China

Note 2: The test anechoic chamber in UL Verification Services (Guangzhou) Co., Ltd. Song Shan Lake Branch had been calibrated and compared to the open field sites and the test anechoic chamber is shown to be equivalent to or worst case from the open field site.

Note 3: For below 30 MHz, lab had performed measurements at test anechoic chamber and comparing to measurements obtained on an open field site. And these measurements below 30 MHz had been correlated to measurements performed on an OFS.

## 4. CALIBRATION AND UNCERTAINTY

### 4.1. MEASURING INSTRUMENT CALIBRATION

The measuring equipment utilized to perform the tests documented in this report has been calibrated in accordance with the manufacturer's recommendations and is traceable to recognized national standards.

### 4.2. MEASUREMENT UNCERTAINTY

Where relevant, the following measurement uncertainty levels have been estimated for tests performed on the apparatus:

| Test Item                                                                                                                                      | Uncertainty               |
|------------------------------------------------------------------------------------------------------------------------------------------------|---------------------------|
| Conduction emission                                                                                                                            | 3.62 dB                   |
| Radiated Emission<br>(Included Fundamental Emission) (9 kHz ~ 30 MHz)                                                                          | 2.2 dB                    |
| Radiated Emission<br>(Included Fundamental Emission) (30 MHz ~ 1 GHz)                                                                          | 4.00 dB                   |
| Radiated Emission<br>(Included Fundamental Emission) (1 GHz to 26 GHz)                                                                         | 5.78 dB (1 GHz ~ 18 GHz)  |
|                                                                                                                                                | 5.23 dB (18 GHz ~ 26 GHz) |
| Note: This uncertainty represents an expanded uncertainty expressed at approximately the 95 % confidence level using a coverage factor of k=2. |                           |





## 5. EQUIPMENT UNDER TEST

### 5.1. DESCRIPTION OF EUT

|                                |                      |                    |        |
|--------------------------------|----------------------|--------------------|--------|
| EUT Name                       | WIFI+BT Module       |                    |        |
| Model                          | DCT92G1001           |                    |        |
| Technology                     | Bluetooth – BR & EDR |                    |        |
| Transmit Frequency Range       | 2402 MHz ~ 2480 MHz  |                    |        |
| Mode                           | Basic Rate           | Enhanced Data Rate |        |
| Modulation                     | GFSK                 | π/4-DQPSK          | 8DPSK  |
| Packet Type (Maximum Payload): | DH5                  | 2DH5               | 3DH5   |
| Data Rate                      | 1 Mbps               | 2 Mbps             | 3 Mbps |
| Ratings                        | DC 3.3 V             |                    |        |

### 5.2. MAXIMUM PEAK OUTPUT POWER

| Test Mode | Frequency (MHz) | Channel Number | Maximum Peak Output Power (dBm) |
|-----------|-----------------|----------------|---------------------------------|
| DH5       | 2402 ~ 2480     | 0-78[79]       | -4.30                           |
| 3DH5      | 2402 ~ 2480     | 0-78[79]       | -1.51                           |

### 5.3. PACKET TYPE CONFIGURATION

| Modulation Type | Packet Type | Setting (Packet Length) |
|-----------------|-------------|-------------------------|
| GFSK            | DH1         | 27                      |
|                 | DH3         | 183                     |
|                 | DH5         | 339                     |
| π/4-DQPSK       | 2-DH1       | 54                      |
|                 | 2-DH3       | 367                     |
|                 | 2-DH5       | 679                     |
| 3DH5            | 3-DH1       | 83                      |
|                 | 3-DH3       | 552                     |
|                 | 3-DH5       | 1021                    |

### 5.4. CHANNEL LIST

| Channel | Frequency (MHz) | Channel | Frequency (MHz) | Channel | Frequency (MHz) | Channel | Frequency (MHz) |
|---------|-----------------|---------|-----------------|---------|-----------------|---------|-----------------|
| 00      | 2402            | 20      | 2422            | 40      | 2442            | 60      | 2462            |
| 01      | 2403            | 21      | 2423            | 41      | 2443            | 61      | 2463            |
| 02      | 2404            | 22      | 2424            | 42      | 2444            | 62      | 2464            |
| 03      | 2405            | 23      | 2425            | 43      | 2445            | 63      | 2465            |
| 04      | 2406            | 24      | 2426            | 44      | 2446            | 64      | 2466            |
| 05      | 2407            | 25      | 2427            | 45      | 2447            | 65      | 2467            |
| 06      | 2408            | 26      | 2428            | 46      | 2448            | 66      | 2468            |
| 07      | 2409            | 27      | 2429            | 47      | 2449            | 67      | 2469            |
| 08      | 2410            | 28      | 2430            | 48      | 2450            | 68      | 2470            |
| 09      | 2411            | 29      | 2431            | 49      | 2451            | 69      | 2471            |
| 10      | 2412            | 30      | 2432            | 50      | 2452            | 70      | 2472            |
| 11      | 2413            | 31      | 2433            | 51      | 2453            | 71      | 2473            |
| 12      | 2414            | 32      | 2434            | 52      | 2454            | 72      | 2474            |
| 13      | 2415            | 33      | 2435            | 53      | 2455            | 73      | 2475            |
| 14      | 2416            | 34      | 2436            | 54      | 2456            | 74      | 2476            |
| 15      | 2417            | 35      | 2437            | 55      | 2457            | 75      | 2477            |
| 16      | 2418            | 36      | 2438            | 56      | 2458            | 76      | 2478            |
| 17      | 2419            | 37      | 2439            | 57      | 2459            | 77      | 2479            |
| 18      | 2420            | 38      | 2440            | 58      | 2460            | 78      | 2480            |
| 19      | 2421            | 39      | 2441            | 59      | 2461            | /       | /               |

### 5.5. TEST CHANNEL CONFIGURATION

| Test Mode | Test Channel                                               | Frequency                    |
|-----------|------------------------------------------------------------|------------------------------|
| DH5       | CH 0(Low Channel), CH 39(MID Channel), CH 78(High Channel) | 2402 MHz, 2441 MHz, 2480 MHz |
| 3DH5      | CH 0(Low Channel), CH 39(MID Channel), CH 78(High Channel) | 2402 MHz, 2441 MHz, 2480 MHz |

### 5.6. WORST-CASE CONFIGURATIONS

| Bluetooth Mode | Modulation Technology | Modulation Type | Data Rate (Mbps) |
|----------------|-----------------------|-----------------|------------------|
| BR             | FHSS                  | GFSK            | 1Mbit/s          |
| EDR            | FHSS                  | 8DPSK           | 3Mbit/s          |

Note: Pre-Scan has been conducted to determine the worst-case mode from all possible combinations between available modulations, data rates.



### 5.7. THE WORSE CASE POWER SETTING PARAMETER

| The Worst Case Power Setting Parameter under 2400 ~ 2483.5MHz Band |                         |                             |         |         |
|--------------------------------------------------------------------|-------------------------|-----------------------------|---------|---------|
| Test Software                                                      |                         | CMD                         |         |         |
| Modulation Type                                                    | Transmit Antenna Number | Test Software setting value |         |         |
|                                                                    |                         | CH 00                       | CH 39   | CH 78   |
| GFSK                                                               | 1                       | default                     | default | default |
| 8DPSK                                                              | 1                       | default                     | default | default |

### 5.8. DESCRIPTION OF AVAILABLE ANTENNAS

| Antenna | Frequency (MHz) | Antenna Type | MAX Antenna Gain (dBi) |
|---------|-----------------|--------------|------------------------|
| 1       | 2402-2480       | PIFA         | 2                      |

| Modulation Type | Transmit and Receive Mode                    | Description                                              |
|-----------------|----------------------------------------------|----------------------------------------------------------|
| GFSK            | <input checked="" type="checkbox"/> 1TX, 1RX | Antenna 1 can be used as transmitting/receiving antenna. |
| 8DPSK           | <input checked="" type="checkbox"/> 1TX, 1RX | Antenna 1 can be used as transmitting/receiving antenna. |

## 5.9. DESCRIPTION OF TEST SETUP

### SUPPORT EQUIPMENT

| Item | Equipment  | Brand Name | Model Name   | Remarks                                                          |
|------|------------|------------|--------------|------------------------------------------------------------------|
| 1    | Laptop     | Lenovo     | XIAOXIN 5000 | /                                                                |
| 2    | AC Adapter | Lenovo     | 42T4434      | Input: AC 100 ~ 240 V, 1.5 A, 50-60 Hz<br>Output: DC 20 V, 4.5 A |

### I/O CABLES

| Cable No | Port | Connector Type | Cable Type | Cable Length(m) | Remarks |
|----------|------|----------------|------------|-----------------|---------|
| 1        | USB  | /              | /          | 0.3             | /       |

### ACCESSORIES

| Item | Accessory | Brand Name | Model Name | Description |
|------|-----------|------------|------------|-------------|
| 1    | /         | /          | /          | /           |

Note: The cable is provided by customer.

### TEST SETUP

The EUT can work in engineering mode with a software through a Laptop.

### SETUP DIAGRAM FOR TESTS

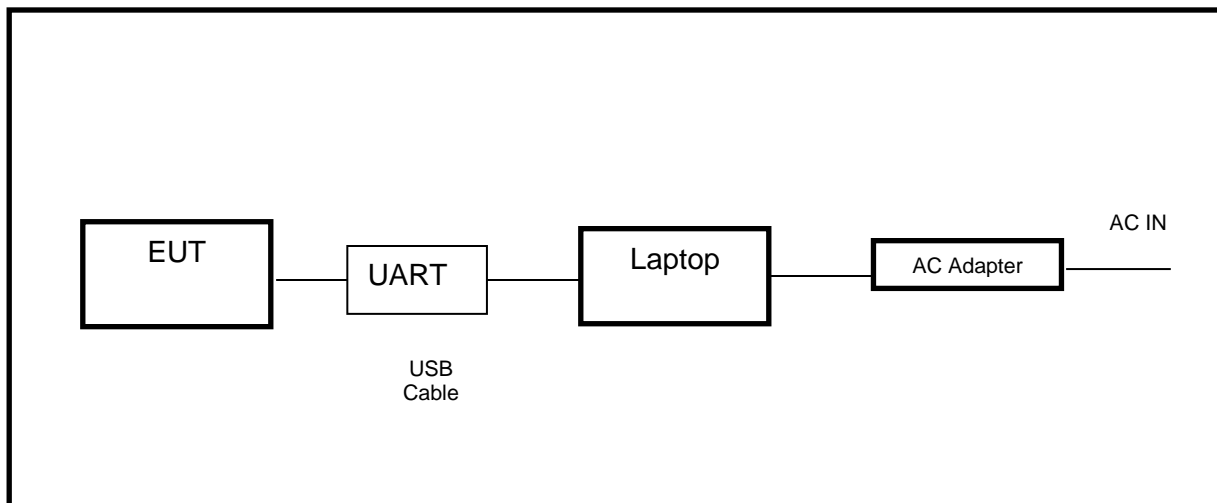

**6. MEASURING INSTRUMENT AND SOFTWARE USED**

| Conducted Emissions                   |              |           |              |              |              |
|---------------------------------------|--------------|-----------|--------------|--------------|--------------|
| Equipment                             | Manufacturer | Model No. | Serial No.   | Last Cal.    | Due Date     |
| EMI Test Receiver                     | R&S          | ESR3      | 101961       | Oct.30, 2021 | Oct.29, 2022 |
| Two-Line V-Network                    | R&S          | ENV216    | 101983       | Oct.30, 2021 | Oct.29, 2022 |
| Artificial Mains Networks             | Schwarzbeck  | NSLK 8126 | 8126465      | Oct.30, 2021 | Oct.29, 2022 |
| Software                              |              |           |              |              |              |
| Description                           |              |           | Manufacturer | Name         | Version      |
| Test Software for Conducted Emissions |              |           | Farad        | EZ-EMC       | Ver. UL-3A1  |

| Radiated Emissions                   |              |                                     |               |               |               |
|--------------------------------------|--------------|-------------------------------------|---------------|---------------|---------------|
| Equipment                            | Manufacturer | Model No.                           | Serial No.    | Last Cal.     | Due Date      |
| MXE EMI Receiver                     | KESIGHT      | N9038A                              | MY56400036    | Oct.30, 2021  | Oct.29, 2022  |
| Hybrid Log Periodic Antenna          | TDK          | HLP-3003C                           | 130959        | Aug.02, 2021  | Aug.01, 2024  |
| Preamplifier                         | HP           | 8447D                               | 2944A09099    | Oct.30, 2021  | Oct.29, 2022  |
| EMI Measurement Receiver             | R&S          | ESR26                               | 101377        | Oct.30, 2021  | Oct.29, 2022  |
| Horn Antenna                         | TDK          | HRN-0118                            | 130940        | July 20, 2021 | July 19, 2024 |
| Preamplifier                         | TDK          | PA-02-0118                          | TRS-305-00067 | Oct.30, 2021  | Oct.29, 2022  |
| Horn Antenna                         | Schwarzbeck  | BBHA9170                            | 697           | July 20, 2021 | July 19, 2024 |
| Preamplifier                         | TDK          | PA-02-2                             | TRS-307-00003 | Oct.31, 2021  | Oct.30, 2022  |
| Preamplifier                         | TDK          | PA-02-3                             | TRS-308-00002 | Oct.31, 2021  | Oct.30, 2022  |
| Loop antenna                         | Schwarzbeck  | 1519B                               | 00008         | Dec.14, 2021  | Dec.13, 2024  |
| Preamplifier                         | TDK          | PA-02-001-3000                      | TRS-302-00050 | Oct.31, 2021  | Oct.30, 2022  |
| High Pass Filter                     | Wi           | WHKX10-2700-3000-18000-40SS         | 23            | Oct.31, 2021  | Oct.30, 2022  |
| Band Reject Filter                   | Wainwright   | WRCJV8-2350-2400-2483.5-2533.5-40SS | 4             | Oct.31, 2021  | Oct.30, 2022  |
| Software                             |              |                                     |               |               |               |
| Description                          |              |                                     | Manufacturer  | Name          | Version       |
| Test Software for Radiated Emissions |              |                                     | Farad         | EZ-EMC        | Ver. UL-3A1   |



| Other Instruments        |              |                           |            |              |              |
|--------------------------|--------------|---------------------------|------------|--------------|--------------|
| Equipment                | Manufacturer | Model No.                 | Serial No. | Last Cal.    | Next Cal.    |
| Signal Analyzer          | R&S          | FSV40                     | 101118     | Oct.30, 2021 | Oct.29, 2022 |
| Dual Channel Power Meter | Keysight     | N1912A                    | MY55416024 | Oct.30, 2021 | Oct.29, 2022 |
| Power Sensor             | Keysight     | USB Wideband Power Sensor | MY5100022  | Oct.30, 2021 | Oct.29, 2022 |

## 7. ANTENNA PORT TEST RESULTS

### 7.1. ON TIME AND DUTY CYCLE

#### LIMITS

None; for reporting purposes only.

#### PROCEDURE

Refer to ANSI C63.10-2013 Zero – Span Spectrum Analyzer method.

#### TEST SETUP

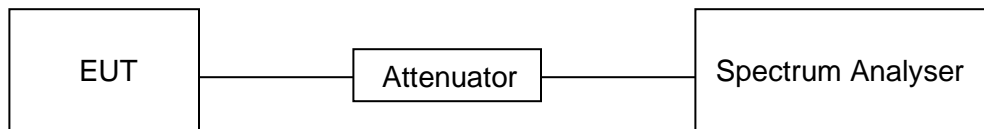

#### TEST ENVIRONMENT

|                     |         |                   |          |
|---------------------|---------|-------------------|----------|
| Temperature         | 24.3 °C | Relative Humidity | 57.1 %   |
| Atmosphere Pressure | 101 kPa | Test Voltage      | DC 3.3 V |

#### RESULTS

Please refer to appendix I.

## 7.2. 20 dB BANDWIDTH AND 99 % OCCUPIED BANDWIDTH

### LIMITS

| CFR 47FCC Part15 (15.247) Subpart C<br>ISED RSS-247 ISSUE 2 |                         |                                    |                       |
|-------------------------------------------------------------|-------------------------|------------------------------------|-----------------------|
| Section                                                     | Test Item               | Limit                              | Frequency Range (MHz) |
| CFR 47 FCC 15.247 (a) (1)<br>RSS-247 Clause 5.1 (a)         | 20 dB Bandwidth         | None; for reporting purposes only. | 2400-2483.5           |
| ISED RSS-Gen Clause 6.7                                     | 99 % Occupied Bandwidth | None; for reporting purposes only. | 2400-2483.5           |

### TEST PROCEDURE

Refer to ANSI C63.10-2013 clause 6.9.2.

Connect the EUT to the spectrum analyser and use the following settings:

|                  |                                                                                                                             |
|------------------|-----------------------------------------------------------------------------------------------------------------------------|
| Center Frequency | The center frequency of the channel under test                                                                              |
| Detector         | Peak                                                                                                                        |
| RBW              | For 20 dB Bandwidth: 1 % to 5 % of the 20 dB bandwidth<br>For 99 % Occupied Bandwidth: 1 % to 5 % of the occupied bandwidth |
| VBW              | For 20 dB Bandwidth: approximately 3×RBW<br>For 99 % Occupied Bandwidth: ≥ 3×RBW                                            |
| Span             | Approximately 2 to 3 times the 20dB bandwidth                                                                               |
| Trace            | Max hold                                                                                                                    |
| Sweep            | Auto couple                                                                                                                 |

a) Use the occupied bandwidth function of the instrument, allow the trace to stabilize and report the measured 99 % occupied bandwidth and 20 dB Bandwidth.

### TEST SETUP

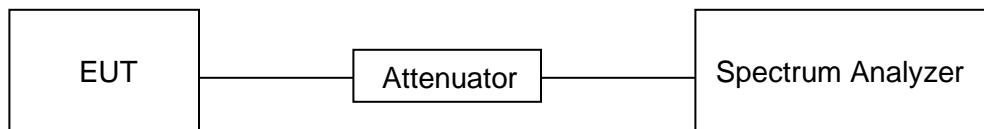





**TEST ENVIRONMENT**

|                     |         |                   |          |
|---------------------|---------|-------------------|----------|
| Temperature         | 24.3 °C | Relative Humidity | 57.1 %   |
| Atmosphere Pressure | 101 kPa | Test Voltage      | DC 3.3 V |

**RESULTS**

Please refer to appendix A and B.

### 7.3. CONDUCTED OUTPUT POWER

**LIMITS**

| CFR 47 FCC Part15 (15.247), Subpart C<br>ISED RSS-247 ISSUE 2  |                             |                                                                                                                                                                                                                                                                                         |                       |
|----------------------------------------------------------------|-----------------------------|-----------------------------------------------------------------------------------------------------------------------------------------------------------------------------------------------------------------------------------------------------------------------------------------|-----------------------|
| Section                                                        | Test Item                   | Limit                                                                                                                                                                                                                                                                                   | Frequency Range (MHz) |
| CFR 47 FCC<br>15.247 (b) (1)<br>ISED RSS-247<br>Clause 5.4 (b) | Peak Conducted Output Power | Hopping channel carrier frequencies separated by a minimum of 25 kHz or the 20 dB bandwidth of the hopping channel: 1 watt or 30 dBm;<br>Hopping channel carrier frequencies that are separated by 25 kHz or two-thirds of the 20 dB bandwidth of the hopping channel: 125 mW or 21 dBm | 2400-2483.5           |

**TEST PROCEDURE**

Connect the EUT to a low loss RF cable from the antenna port to the power sensor (video bandwidth is greater than the occupied bandwidth).  
Measure peak emission level, the indicated level is the peak output power, after any corrections for external attenuators and cables.

**TEST SETUP**

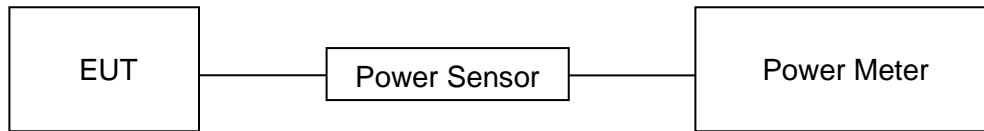

**TEST ENVIRONMENT**

|                     |         |                   |          |
|---------------------|---------|-------------------|----------|
| Temperature         | 24.3 °C | Relative Humidity | 57.1 %   |
| Atmosphere Pressure | 101 kPa | Test Voltage      | DC 3.3 V |

**RESULTS**

Please refer to appendix C.

## 7.4. CARRIER FREQUENCY SEPARATION

### LIMITS

| CFR 47 FCC Part15 (15.247),<br>Subpart C ISSED RSS-247 ISSUE 2 |                                    |                                                                                                                                                                                                                                                                                                                                                                                                         |                       |
|----------------------------------------------------------------|------------------------------------|---------------------------------------------------------------------------------------------------------------------------------------------------------------------------------------------------------------------------------------------------------------------------------------------------------------------------------------------------------------------------------------------------------|-----------------------|
| Section                                                        | Test Item                          | Limit                                                                                                                                                                                                                                                                                                                                                                                                   | Frequency Range (MHz) |
| CFR 47 FCC<br>15.247 (a) (1)<br>ISED RSS-247<br>Clause 5.1 (b) | Carrier<br>Frequency<br>Separation | Frequency hopping systems shall have hopping channel carrier frequencies separated by a minimum of 25 kHz or the 20 dB bandwidth of the hopping channel, whichever is greater.<br>Alternatively, frequency hopping systems operating in the 2400-2483.5 MHz band may have hopping channel carrier frequencies that are separated by 25 kHz or two-thirds of the 20 dB bandwidth of the hopping channel. | 2400-2483.5           |

### TEST PROCEDURE

Refer to ANSI C63.10-2013 clause 7.8.2.

Connect the EUT to the spectrum analyzer and use the following settings:

|                  |                                                                                                                                                  |
|------------------|--------------------------------------------------------------------------------------------------------------------------------------------------|
| Center Frequency | The center frequency of the channel under test                                                                                                   |
| Span             | wide enough to capture the peaks of two adjacent channels                                                                                        |
| Detector         | Peak                                                                                                                                             |
| RBW              | Start with the RBW set to approximately 30 % of the channel spacing; adjust as necessary to best identify the center of each individual channel. |
| VBW              | $\geq$ RBW                                                                                                                                       |
| Trace            | Max hold                                                                                                                                         |
| Sweep time       | Auto couple                                                                                                                                      |

Allow the trace to stabilize and use the marker-delta function to determine the separation between the peaks of the adjacent channels.

Compliance of an EUT with the appropriate regulatory limit shall be determined.

### TEST SETUP

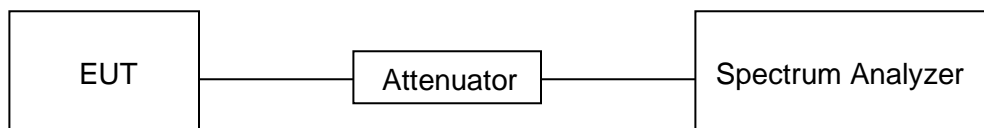



**TEST ENVIRONMENT**

|                     |         |                   |          |
|---------------------|---------|-------------------|----------|
| Temperature         | 24.3 °C | Relative Humidity | 57.1 %   |
| Atmosphere Pressure | 101 kPa | Test Voltage      | DC 3.3 V |

**RESULTS**

Please refer to Appendix D.

## 7.5. NUMBER OF HOPPING FREQUENCIES

### LIMITS

| CFR 47 FCC Part15 (15.247), Subpart C<br>ISED RSS-247 ISSUE 2 |                             |                              |
|---------------------------------------------------------------|-----------------------------|------------------------------|
| Section                                                       | Test Item                   | Limit                        |
| CFR 47 15.247 (a) (1) III<br>ISED RSS-247 Clause 5.1 (d)      | Number of Hopping Frequency | at least 15 hopping channels |

### TEST PROCEDURE

Refer to ANSI C63.10-2013 clause 7.8.3.

Connect the EUT to the spectrum Analyzer and use the following settings:

|            |                                                                                                                                                                                                                                      |
|------------|--------------------------------------------------------------------------------------------------------------------------------------------------------------------------------------------------------------------------------------|
| Detector   | Peak                                                                                                                                                                                                                                 |
| RBW        | To identify clearly the individual channels, set the RBW to less than 30% of the channel spacing or the 20 dB bandwidth, whichever is smaller.                                                                                       |
| VBW        | $\geq$ RBW                                                                                                                                                                                                                           |
| Span       | The frequency band of operation. Depending on the number of channels the device supports, it may be necessary to divide the frequency range of operation across multiple spans, to allow the individual channels to be clearly seen. |
| Trace      | Max hold                                                                                                                                                                                                                             |
| Sweep time | Auto couple                                                                                                                                                                                                                          |

Set EUT to transmit maximum output power and switch on frequency hopping function. then set enough count time (larger than 5000 times) to get all the hopping frequency channel displayed on the screen of spectrum analyzer, count the quantity of peaks to get the number of hopping channels.

### TEST SETUP

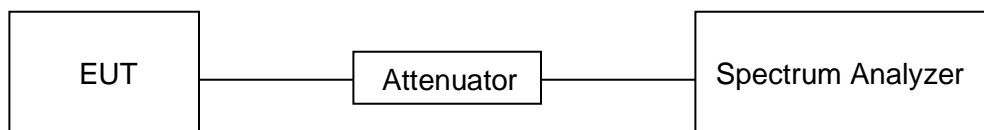



**TEST ENVIRONMENT**

|                     |         |                   |          |
|---------------------|---------|-------------------|----------|
| Temperature         | 24.3 °C | Relative Humidity | 57.1 %   |
| Atmosphere Pressure | 101 kPa | Test Voltage      | DC 3.3 V |

**RESULTS**

Please refer to appendix F.



## 7.6. TIME OF OCCUPANCY (DWELL TIME)

### LIMITS

| CFR 47 FCC Part15 (15.247), Subpart C<br>ISED RSS-247 ISSUE 2 |                                   |                                                                                                                                                                           |
|---------------------------------------------------------------|-----------------------------------|---------------------------------------------------------------------------------------------------------------------------------------------------------------------------|
| Section                                                       | Test Item                         | Limit                                                                                                                                                                     |
| CFR 47 15.247 (a) (1) III<br>ISED RSS-247 Clause<br>5.1 (d)   | Time of Occupancy<br>(Dwell Time) | The average time of occupancy on any channel shall not be greater than 0.4 seconds within a period of 0.4 seconds, multiplied by the number of hopping channels employed. |

### TEST PROCEDURE

Refer to ANSI C63.10-2013 clause 7.8.4.

Connect the EUT to the spectrum Analyzer and use the following settings:

|                  |                                                                                                                                                                                                                                                                                                                                |
|------------------|--------------------------------------------------------------------------------------------------------------------------------------------------------------------------------------------------------------------------------------------------------------------------------------------------------------------------------|
| Center Frequency | The center frequency of the channel under test                                                                                                                                                                                                                                                                                 |
| Detector         | Peak                                                                                                                                                                                                                                                                                                                           |
| RBW              | 1 MHz                                                                                                                                                                                                                                                                                                                          |
| VBW              | ≥RBW                                                                                                                                                                                                                                                                                                                           |
| Span             | Zero span, centered on a hopping channel                                                                                                                                                                                                                                                                                       |
| Trace            | Max hold                                                                                                                                                                                                                                                                                                                       |
| Sweep time       | As necessary to capture the entire dwell time per hopping channel; where possible use a video trigger and trigger delay so that the transmitted signal starts a little to the right of the start of the plot. The trigger level might need slight adjustment to prevent triggering when the system hops on an adjacent channel |

Use the marker-delta function to determine the transmit time per hop (Burst Width). If this value varies with different modes of operation (data rate, modulation format, number of hopping channels, etc.), then repeat this test for each variation in transmit time.

For FHSS Mode (79 Channel):

DH1/3DH1 Dwell Time: Burst Width \* (1600/2) \* 31.6 / (channel number)

DH3/3DH3 Dwell Time: Burst Width \* (1600/4) \* 31.6 / (channel number)

DH5/3DH5 Dwell Time: Burst Width \* (1600/6) \* 31.6 / (channel number)

For AFHSS Mode (20 Channel):

DH1/3DH1 Dwell Time: Burst Width \* (800/2) \* 8 / (channel number)

DH3/3DH3 Dwell Time: Burst Width \* (800/4) \* 8 / (channel number)

DH5/3DH5 Dwell Time: Burst Width \* (800/6) \* 8 / (channel number)



**TEST SETUP**

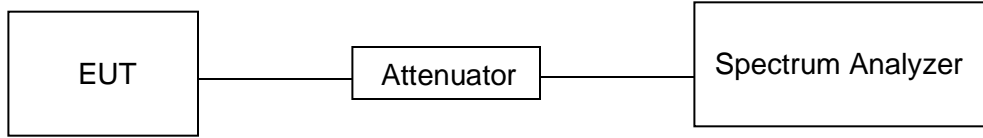

**TEST ENVIRONMENT**

|                     |         |                   |          |
|---------------------|---------|-------------------|----------|
| Temperature         | 24.3 °C | Relative Humidity | 57.1 %   |
| Atmosphere Pressure | 101 kPa | Test Voltage      | DC 3.3 V |

**RESULTS**

Please refer to appendix E.





## 7.7. CONDUCTED BANDEGE AND SPURIOUS EMISSION

### LIMITS

| CFR 47 FCC Part15 (15.247), Subpart C<br>ISED RSS-247 ISSUE 2 |                                |                                                                                                                         |
|---------------------------------------------------------------|--------------------------------|-------------------------------------------------------------------------------------------------------------------------|
| Section                                                       | Test Item                      | Limit                                                                                                                   |
| CFR 47 FCC §15.247 (d)<br>ISED RSS-247 5.5                    | Conducted<br>Spurious Emission | at least 20 dB below that in the 100 kHz bandwidth within the band that contains the highest level of the desired power |

### TEST PROCEDURE

Refer to ANSI C63.10-2013 clause 7.8.6 and 7.8.8.

Connect the EUT to the spectrum analyser and use the following settings for reference level measurement:

|                  |                                                |
|------------------|------------------------------------------------|
| Center Frequency | The center frequency of the channel under test |
| Detector         | Peak                                           |
| RBW              | 100 kHz                                        |
| VBW              | $\geq 3 \times \text{RBW}$                     |
| Span             | 1.5 x DTS bandwidth                            |
| Trace            | Max hold                                       |
| Sweep time       | Auto couple.                                   |

Allow trace to fully stabilize and use the peak marker function to determine the maximum PSD level.

Change the settings for emission level measurement:

|                    |                                                                               |
|--------------------|-------------------------------------------------------------------------------|
| Span               | Set the center frequency and span to encompass frequency range to be measured |
| Detector           | Peak                                                                          |
| RBW                | 100 kHz                                                                       |
| VBW                | $\geq 3 \times \text{RBW}$                                                    |
| measurement points | $\geq \text{span}/\text{RBW}$                                                 |
| Trace              | Max hold                                                                      |
| Sweep time         | Auto couple.                                                                  |

Allow trace to fully stabilize and use the peak marker function to determine the maximum PSD level. Ensure that the amplitude of all unwanted emissions outside of the authorized frequency band (excluding restricted frequency bands) is attenuated by at least the minimum requirements.



**TEST SETUP**

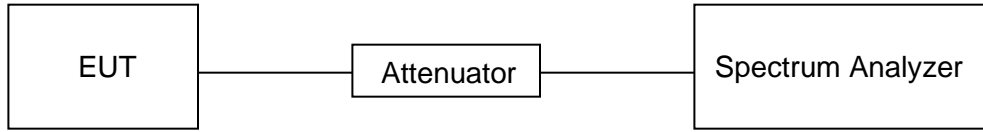

**TEST ENVIRONMENT**

|                     |         |                   |          |
|---------------------|---------|-------------------|----------|
| Temperature         | 24.3 °C | Relative Humidity | 57.1 %   |
| Atmosphere Pressure | 101 kPa | Test Voltage      | DC 3.3 V |

**RESULTS**

Please refer to appendix G & H.

## 8. RADIATED TEST RESULTS

### LIMITS

Please refer to CFR 47 FCC §15.205 and §15.209.

Please refer to ISED RSS-GEN Clause 8.9 and Clause 8.10.

Radiation Disturbance Test Limit for FCC (Class B) (9 kHz-1 GHz)

| Emissions radiated outside of the specified frequency bands above 30 MHz |                                    |                                      |
|--------------------------------------------------------------------------|------------------------------------|--------------------------------------|
| Frequency Range (MHz)                                                    | Field Strength Limit (uV/m) at 3 m | Field Strength Limit (dBuV/m) at 3 m |
|                                                                          |                                    | Quasi-Peak                           |
| 30 - 88                                                                  | 100                                | 40                                   |
| 88 - 216                                                                 | 150                                | 43.5                                 |
| 216 - 960                                                                | 200                                | 46                                   |
| Above 960                                                                | 500                                | 54                                   |
| Above 1000                                                               | 500                                | Peak                                 |
|                                                                          |                                    | Average                              |
|                                                                          |                                    | 74                                   |
|                                                                          |                                    | 54                                   |

| FCC Emissions radiated outside of the specified frequency bands below 30 MHz |                                   |                               |
|------------------------------------------------------------------------------|-----------------------------------|-------------------------------|
| Frequency (MHz)                                                              | Field strength (microvolts/meter) | Measurement distance (meters) |
| 0.009-0.490                                                                  | 2400/F(kHz)                       | 300                           |
| 0.490-1.705                                                                  | 24000/F(kHz)                      | 30                            |
| 1.705-30.0                                                                   | 30                                | 30                            |

ISED General field strength limits at frequencies below 30 MHz

| Table 6 – General field strength limits at frequencies below 30 MHz |                                          |                          |
|---------------------------------------------------------------------|------------------------------------------|--------------------------|
| Frequency                                                           | Magnetic field strength (H-Field) (µA/m) | Measurement distance (m) |
| 9 - 490 kHz <sup>Note 1</sup>                                       | 6.37/F (F in kHz)                        | 300                      |
| 490 - 1705 kHz                                                      | 63.7/F (F in kHz)                        | 30                       |
| 1.705 - 30 MHz                                                      | 0.08                                     | 30                       |

**Note 1:** The emission limits for the ranges 9-90 kHz and 110-490 kHz are based on measurements employing a linear average detector.



ISED Restricted bands please refer to ISED RSS-GEN Clause 8.10

| Table 7 – Restricted frequency bands <sup>Note 1</sup> |                       |               |
|--------------------------------------------------------|-----------------------|---------------|
| MHz                                                    | MHz                   | GHz           |
| 0.090 - 0.110                                          | 149.9 - 150.05        | 9.0 - 9.2     |
| 0.495 - 0.505                                          | 156.52475 - 156.52525 | 9.3 - 9.5     |
| 2.1735 - 2.1905                                        | 156.7 - 156.9         | 10.6 - 12.7   |
| 3.020 - 3.026                                          | 162.0125 - 167.17     | 13.25 - 13.4  |
| 4.125 - 4.128                                          | 167.72 - 173.2        | 14.47 - 14.5  |
| 4.17725 - 4.17775                                      | 240 - 285             | 15.35 - 16.2  |
| 4.20725 - 4.20775                                      | 322 - 335.4           | 17.7 - 21.4   |
| 5.677 - 5.683                                          | 399.9 - 410           | 22.01 - 23.12 |
| 6.215 - 6.218                                          | 608 - 614             | 23.6 - 24.0   |
| 6.26775 - 6.26825                                      | 960 - 1427            | 31.2 - 31.8   |
| 6.31175 - 6.31225                                      | 1435 - 1626.5         | 36.43 - 36.5  |
| 8.291 - 8.294                                          | 1645.5 - 1646.5       | Above 38.6    |
| 8.362 - 8.366                                          | 1660 - 1710           |               |
| 8.37625 - 8.38675                                      | 1718.8 - 1722.2       |               |
| 8.41425 - 8.41475                                      | 2200 - 2300           |               |
| 12.29 - 12.293                                         | 2310 - 2390           |               |
| 12.51975 - 12.52025                                    | 2483.5 - 2500         |               |
| 12.57675 - 12.57725                                    | 2655 - 2900           |               |
| 13.36 - 13.41                                          | 3260 - 3267           |               |
| 16.42 - 16.423                                         | 3332 - 3339           |               |
| 16.69475 - 16.69525                                    | 3345.8 - 3358         |               |
| 16.80425 - 16.80475                                    | 3500 - 4400           |               |
| 25.5 - 25.67                                           | 4500 - 5150           |               |
| 37.5 - 38.25                                           | 5350 - 5460           |               |
| 73 - 74.6                                              | 7250 - 7750           |               |
| 74.8 - 75.2                                            | 8025 - 8500           |               |
| 108 - 138                                              |                       |               |

**Note 1:** Certain frequency bands listed in table 7 and in bands above 38.6 GHz are designated for licence-exempt applications. These frequency bands and the requirements that apply to related devices are set out in the 200 and 300 series of RSSs.

FCC Restricted bands of operation refer to FCC §15.205 (a):

| MHz                      | MHz                 | MHz           | GHz              |
|--------------------------|---------------------|---------------|------------------|
| 0.090-0.110              | 16.42-16.423        | 399.9-410     | 4.5-5.15         |
| <sup>1</sup> 0.495-0.505 | 16.69475-16.69525   | 608-614       | 5.35-5.46        |
| 2.1735-2.1905            | 16.80425-16.80475   | 960-1240      | 7.25-7.75        |
| 4.125-4.128              | 25.5-25.67          | 1300-1427     | 8.025-8.5        |
| 4.17725-4.17775          | 37.5-38.25          | 1435-1626.5   | 9.0-9.2          |
| 4.20725-4.20775          | 73-74.6             | 1645.5-1646.5 | 9.3-9.5          |
| 6.215-6.218              | 74.8-75.2           | 1660-1710     | 10.6-12.7        |
| 6.26775-6.26825          | 108-121.94          | 1718.8-1722.2 | 13.25-13.4       |
| 6.31175-6.31225          | 123-138             | 2200-2300     | 14.47-14.5       |
| 8.291-8.294              | 149.9-150.05        | 2310-2390     | 15.35-16.2       |
| 8.362-8.366              | 156.52475-156.52525 | 2483.5-2500   | 17.7-21.4        |
| 8.37625-8.38675          | 156.7-156.9         | 2690-2900     | 22.01-23.12      |
| 8.41425-8.41475          | 162.0125-167.17     | 3260-3267     | 23.6-24.0        |
| 12.29-12.293             | 167.72-173.2        | 3332-3339     | 31.2-31.8        |
| 12.51975-12.52025        | 240-285             | 3345.8-3358   | 36.43-36.5       |
| 12.57675-12.57725        | 322-335.4           | 3600-4400     | ( <sup>2</sup> ) |
| 13.36-13.41              |                     |               |                  |

Note: <sup>1</sup>Until February 1, 1999, this restricted band shall be 0.490-0.510 MHz.

<sup>2</sup>Above 38.6c

**TEST SETUP AND PROCEDURE**

Below 30 MHz

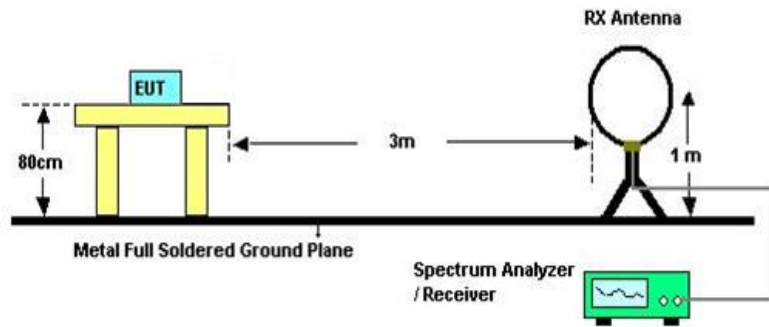

The setting of the spectrum analyser

|       |                                                                  |
|-------|------------------------------------------------------------------|
| RBW   | 200 Hz (From 9 kHz to 0.15 MHz)/ 9 kHz (From 0.15 MHz to 30 MHz) |
| VBW   | 200 Hz (From 9 kHz to 0.15 MHz)/ 9 kHz (From 0.15 MHz to 30 MHz) |
| Sweep | Auto                                                             |
| Trace | Max hold                                                         |

1. The testing follows the guidelines in ANSI C63.10-2013 clause 11.11.
2. The EUT was arranged to its worst case and then turntable (from 0 degree to 360 degrees) to find the maximum reading. A pre-amp and a high pass filter are used for the test in order to get better signal level. Both Horizontal, Face-on and Face-off polarizations of the antenna are set to make the measurement.
3. The EUT was placed on a turntable with 80 cm above ground.
4. The EUT was set 3 meters from the interference receiving antenna, which was mounted on the top of a 1 m height antenna tower.
5. The radiated emission limits are based on measurements employing a CISPR quasi-peak detector except for the frequency bands 9-90 kHz, 110-490 kHz and above 1000 MHz. Radiated emission limits in these three bands are based on measurements employing an average detector.
6. For measurement below 1 GHz, the initial step in collecting conducted emission data is a spectrum analyzer peak detector mode pre-scanning the measurement frequency range. Significant peaks are then marked and then Quasi Peak and average detector mode re-measured. If the emission level of the EUT measured by the peak detector is 3 dB lower than the applicable limit, the peak emission level will be reported. Otherwise, the emission measurement will be repeated using the quasi-peak and average detector and reported.
7. Although these tests were performed other than open field site, adequate comparison measurements were confirmed against 30m open field site. Therefore sufficient tests were made to demonstrate that the alternative site produces results that correlate with the ones of tests made in an open field site based on KDB 414788.
8. The limits in CFR 47, Part 15, Subpart C, paragraph 15.209 (a), are identical to those in RSS-GEN Section 8.9, Table 6, since the measurements are performed in terms of magnetic field strength and converted to electric field strength levels (as reported in the table) using the free space impedance of  $377 \Omega$ ; For example, the measurement frequency X kHz resulted in a level of Y dBuV/m, which is equivalent to  $Y-51.5 = Z$  dBuA/m, which has the same margin, W dB, to the corresponding RSS-GEN Table 6 limit as it has to be 15.209(a) limit.

Below 1 GHz and above 30 MHz

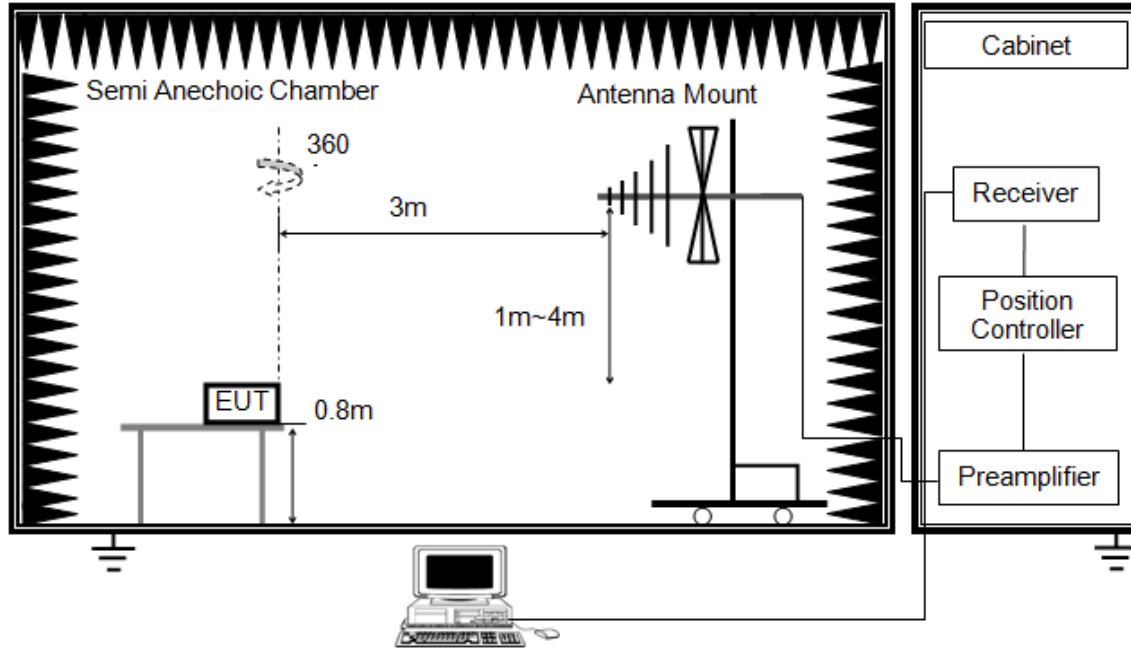

The setting of the spectrum analyser

|          |          |
|----------|----------|
| RBW      | 120 kHz  |
| VBW      | 300 kHz  |
| Sweep    | Auto     |
| Detector | Peak/QP  |
| Trace    | Max hold |

1. The testing follows the guidelines in ANSI C63.10-2013 clause 6.5.
2. The EUT was arranged to its worst case and then tune the antenna tower (from 1 m to 4 m) and turntable (from 0 degree to 360 degrees) to find the maximum reading. A pre-amp and a high pass filter are used for the test in order to get better signal level. Both horizontal and vertical polarizations of the antenna are set to make the measurement.
3. The EUT was placed on a turntable with 80 cm above ground.
4. The EUT was set 3 meters from the interference receiving antenna, which was mounted on the top of a variable height antenna tower.
5. For measurement below 1 GHz, the initial step in collecting conducted emission data is a spectrum analyzer peak detector mode pre-scanning the measurement frequency range. Significant peaks are then marked and then Quasi Peak detector mode re-measured. If the emission level of the EUT measured by the peak detector is 3 dB lower than the applicable limit, the peak emission level will be reported. Otherwise, the emission measurement will be repeated using the quasi-peak detector and reported.

Above 1 GHz



The setting of the spectrum analyser

|          |                                |
|----------|--------------------------------|
| RBW      | 1 MHz                          |
| VBW      | PEAK: 3 MHz<br>AVG: see note 6 |
| Sweep    | Auto                           |
| Detector | Peak                           |
| Trace    | Max hold                       |

1. The testing follows the guidelines in ANSI C63.10-2013 clause 6.6.
2. The EUT was arranged to its worst case and then tune the antenna tower (1.5 m) and turntable (from 0 degree to 360 degrees) to find the maximum reading. A pre-amp and a high pass filter are used for the test in order to get better signal level. Both horizontal and vertical polarizations of the antenna are set to make the measurement.
3. The EUT was placed on a turntable with 1.5 m above ground.
4. The EUT was set 3 meters from the interference receiving antenna, which was mounted on the top of a variable height antenna tower.
5. For measurement above 1 GHz, the emission measurement will be measured by the peak detector. This peak level, once corrected, must comply with the limit specified in Section 15.209.
6. For measurements above 1 GHz the resolution bandwidth is set to 1 MHz, then the video bandwidth is set to 3 MHz for peak measurements and 1 MHz resolution bandwidth with 1/T video bandwidth with peak detector for average measurements. For the Duty Cycle please refer to clause 7.1.ON TIME AND DUTY CYCLE.

X axis, Y axis, Z axis positions:

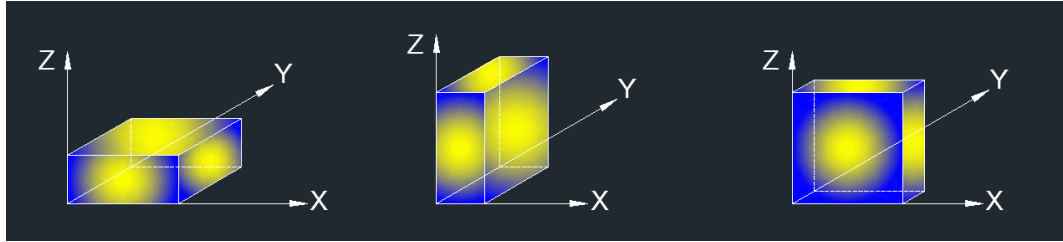

Note 1: For all radiated test, EUT in each of three orthogonal axis emissions had been tested, but only the worst case (X axis) data recorded in the report.

Note 2: The EUT was fully exercised with external accessories during the test. In the case of multiple accessory external ports, an external accessory shall be connected to one of each type of port.

### **TEST ENVIRONMENT**

|                     |         |                   |          |
|---------------------|---------|-------------------|----------|
| Temperature         | 22.3°C  | Relative Humidity | 43 %     |
| Atmosphere Pressure | 101 kPa | Test Voltage      | DC 3.3 V |

### **RESULTS**



## 8.1. RESTRICTED BANDEDGE

### 8.1.1. GFSK MODE

#### RESTRICTED BANDEDGE (LOW CHANNEL, VERTICAL)

#### PEAK

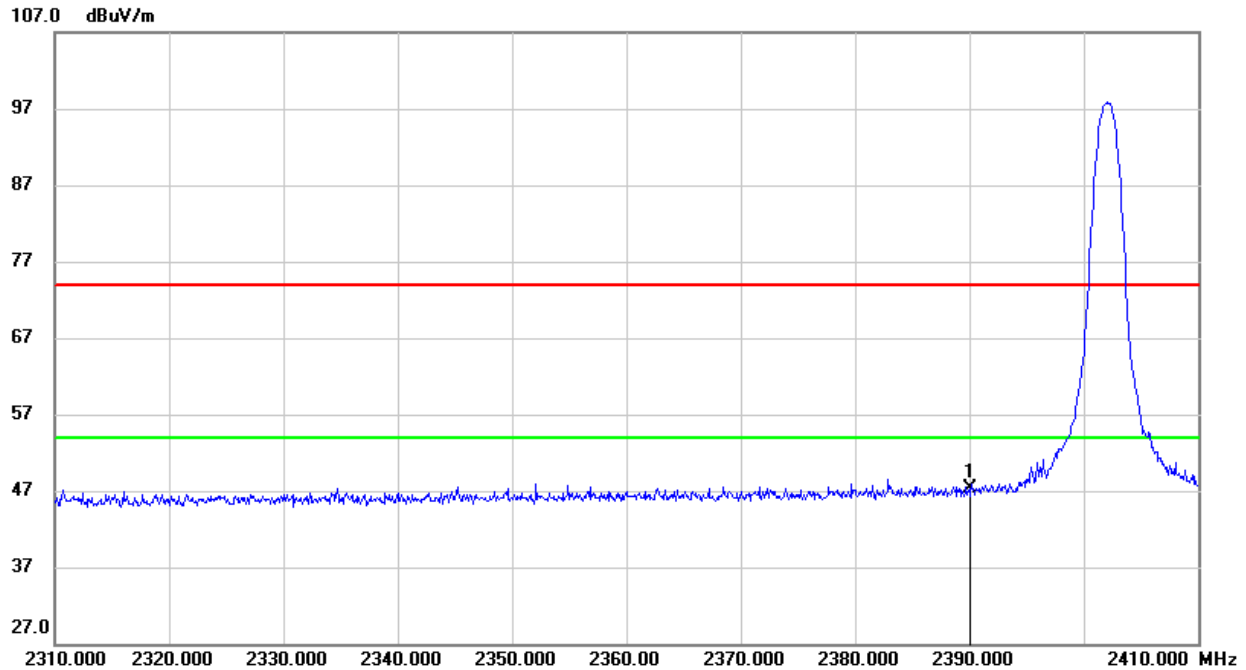

| No. | Frequency<br>(MHz) | Reading<br>(dBuV) | Correct<br>(dB/m) | Result<br>(dBuV/m) | Limit<br>(dBuV/m) | Margin<br>(dB) | Remark |
|-----|--------------------|-------------------|-------------------|--------------------|-------------------|----------------|--------|
| 1   | 2390.000           | 14.59             | 32.66             | 47.25              | 74.00             | -26.75         | peak   |

- Note: 1. Measurement = Reading Level + Correct Factor.  
 2. If Peak Result complies with AV limit, AV Result is deemed to comply with AV limit.  
 3. Peak: Peak detector.  
 4. Only the worst data was recorded, if it complies with the limit, the other emissions deemed to comply with the limit.



**RESTRICTED BANDEDGE (HIGH CHANNEL, VERTICAL)**

**PEAK**

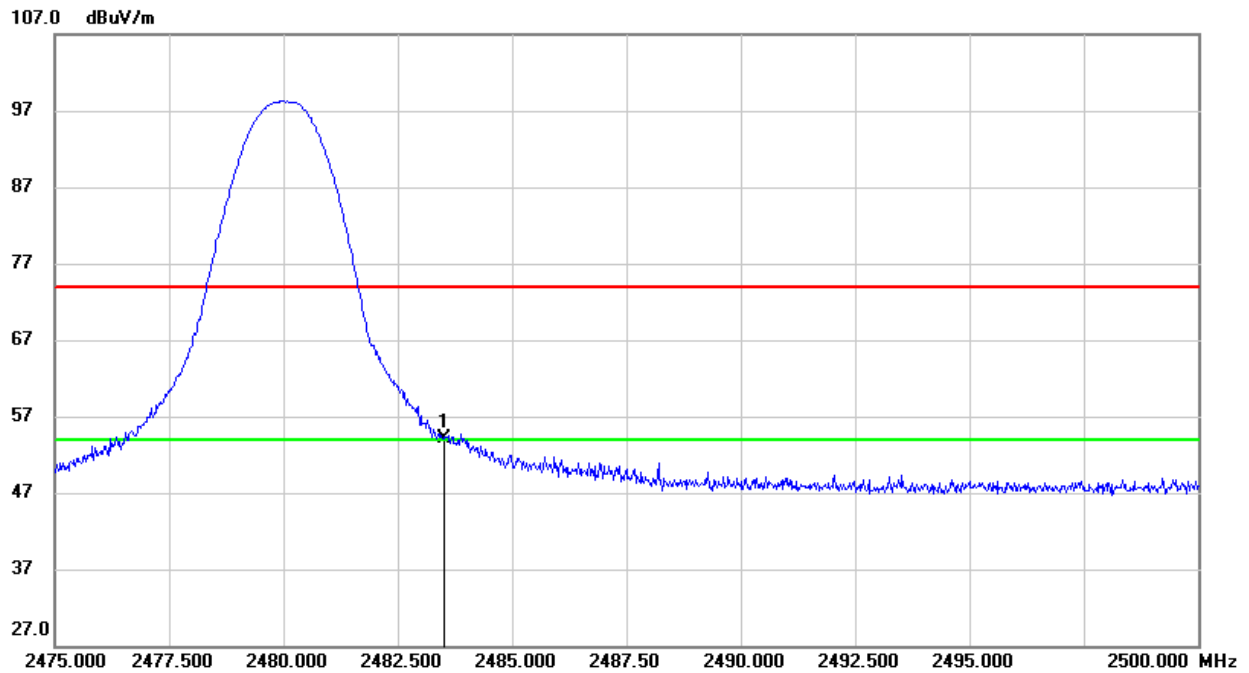

| No. | Frequency (MHz) | Reading (dBuV) | Correct (dB/m) | Result (dBuV/m) | Limit (dBuV/m) | Margin (dB) | Remark |
|-----|-----------------|----------------|----------------|-----------------|----------------|-------------|--------|
| 1   | 2483.500        | 21.01          | 33.10          | 54.11           | 74.00          | -19.89      | peak   |

- Note: 1. Measurement = Reading Level + Correct Factor.  
 2. If Peak Result complies with AV limit, AV Result is deemed to comply with AV limit.  
 3. Peak: Peak detector.  
 4. Only the worst data was recorded, if it complies with the limit, the other emissions deemed to comply with the limit.

**AVG**

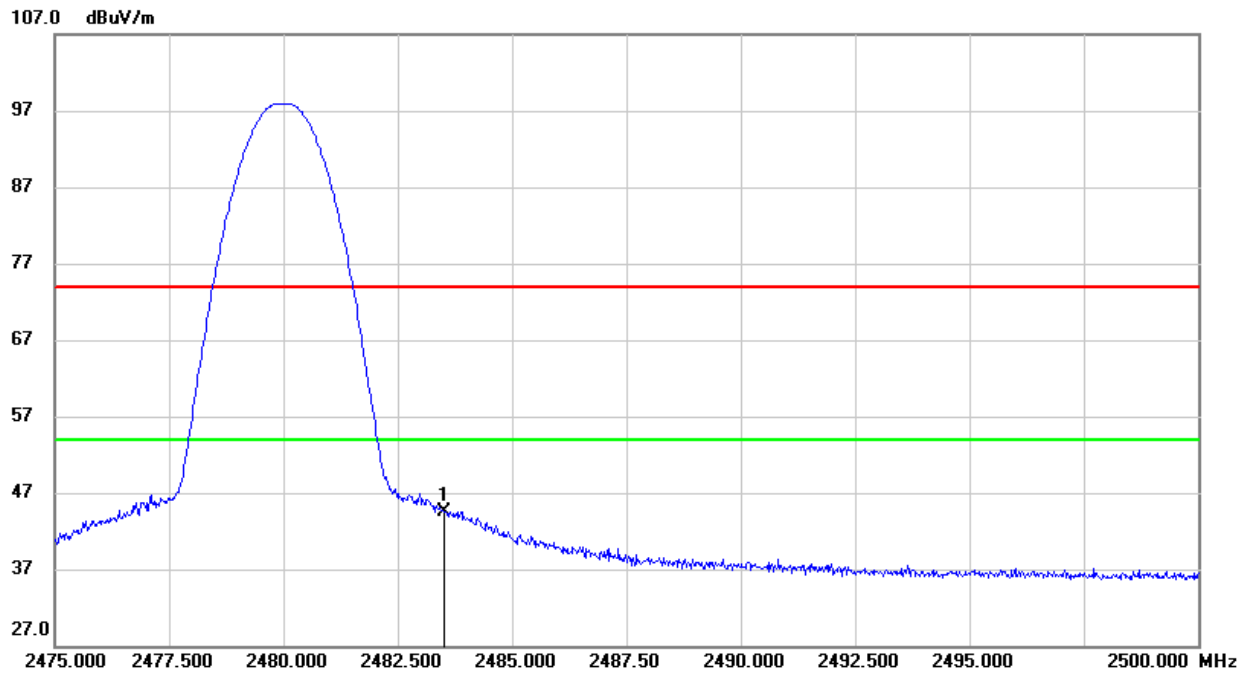

| No. | Frequency (MHz) | Reading (dBuV) | Correct (dB/m) | Result (dBuV/m) | Limit (dBuV/m) | Margin (dB) | Remark |
|-----|-----------------|----------------|----------------|-----------------|----------------|-------------|--------|
| 1   | 2483.500        | 11.41          | 33.10          | 44.51           | 54.00          | -9.49       | AVG    |

Note: 1. Measurement = Reading Level + Correct Factor.  
 2. AVG:  $VBW=1/T_{on}$ , where:  $T_{on}$  is the transmitting duration.  
 3. For the transmitting duration, please refer to clause 7.1.  
 4. Only the worst data was recorded, if it complies with the limit, the other emissions deemed to comply with the limit.

Note: All the polarities (Vertical & Horizontal) had been tested, only the worst data was recorded in the report.



8.1.2. 8DPSK MODE

RESTRICTED BANDEDGE (LOW CHANNEL, VERTICAL)

PEAK

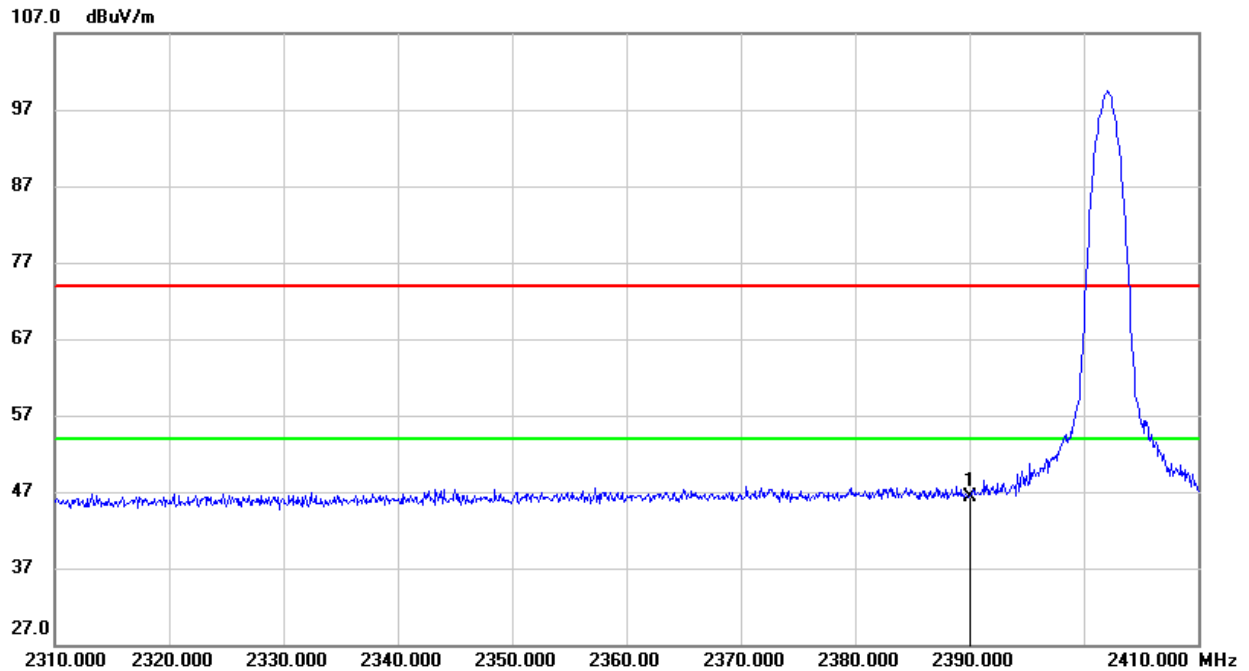

| No. | Frequency<br>(MHz) | Reading<br>(dBuV) | Correct<br>(dB/m) | Result<br>(dBuV/m) | Limit<br>(dBuV/m) | Margin<br>(dB) | Remark |
|-----|--------------------|-------------------|-------------------|--------------------|-------------------|----------------|--------|
| 1   | 2390.000           | 13.74             | 32.66             | 46.40              | 74.00             | -27.60         | peak   |

- Note: 1. Measurement = Reading Level + Correct Factor.  
 2. If Peak Result complies with AV limit, AV Result is deemed to comply with AV limit.  
 3. Peak: Peak detector.  
 4. Only the worst data was recorded, if it complies with the limit, the other emissions deemed to comply with the limit.



**RESTRICTED BANDEDGE (HIGH CHANNEL, VERTICAL)**

**PEAK**

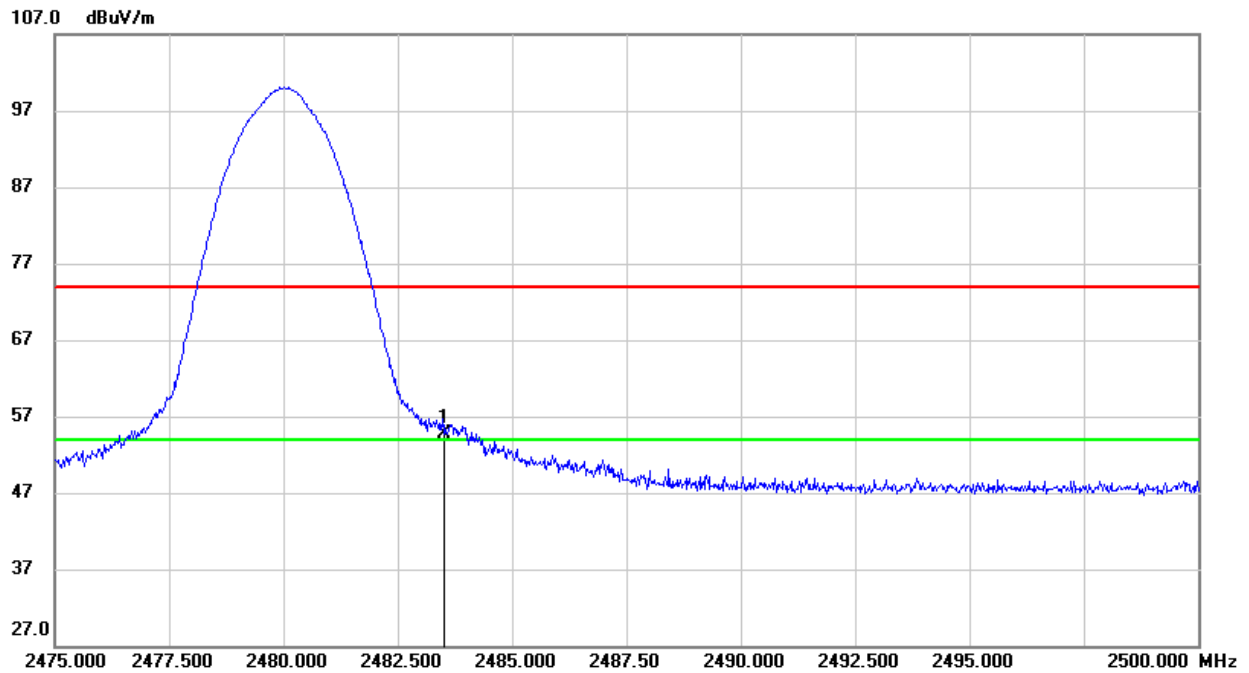

| No. | Frequency (MHz) | Reading (dBuV) | Correct (dB/m) | Result (dBuV/m) | Limit (dBuV/m) | Margin (dB) | Remark |
|-----|-----------------|----------------|----------------|-----------------|----------------|-------------|--------|
| 1   | 2483.500        | 21.67          | 33.10          | 54.77           | 74.00          | -19.23      | peak   |

- Note: 1. Measurement = Reading Level + Correct Factor.  
 2. If Peak Result complies with AV limit, AV Result is deemed to comply with AV limit.  
 3. Peak: Peak detector.  
 4. Only the worst data was recorded, if it complies with the limit, the other emissions deemed to comply with the limit.

**AVG**

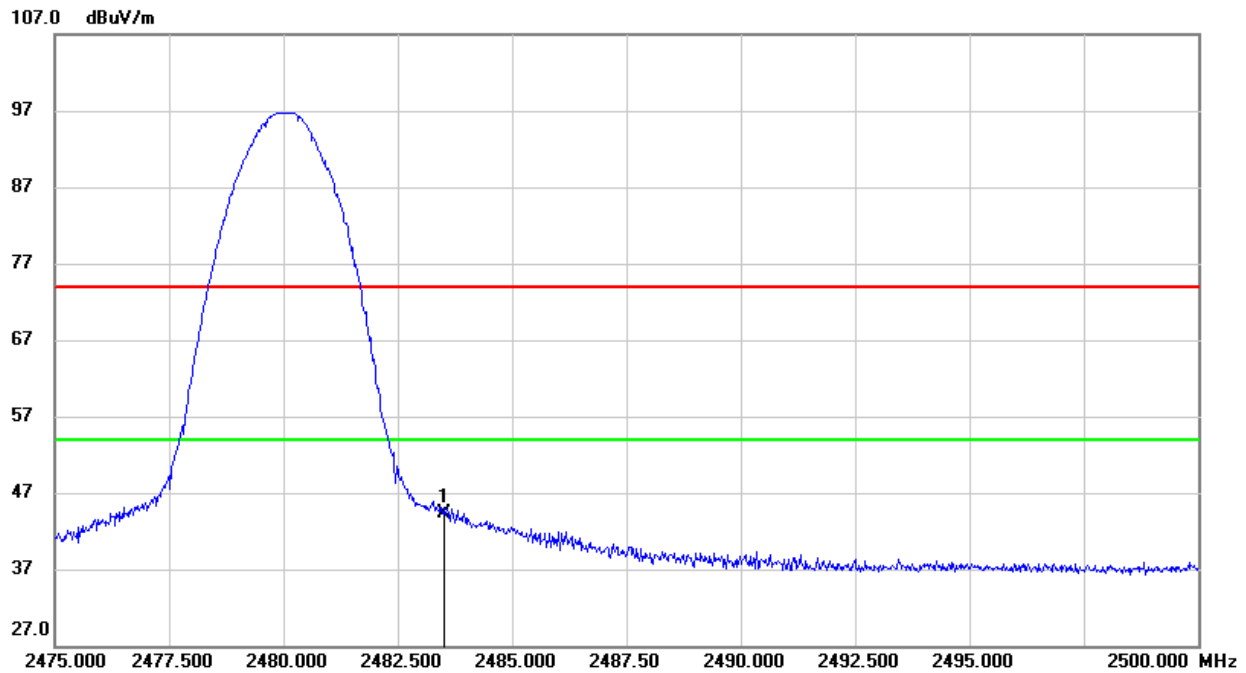

| No. | Frequency (MHz) | Reading (dBuV) | Correct (dB/m) | Result (dBuV/m) | Limit (dBuV/m) | Margin (dB) | Remark |
|-----|-----------------|----------------|----------------|-----------------|----------------|-------------|--------|
| 1   | 2483.500        | 11.20          | 33.10          | 44.30           | 54.00          | -9.70       | AVG    |

- Note:
1. Measurement = Reading Level + Correct Factor.
  2. AVG:  $VBW=1/T_{on}$ , where:  $T_{on}$  is the transmitting duration.
  3. For the transmitting duration, please refer to clause 7.1.
  4. Only the worst data was recorded, if it complies with the limit, the other emissions deemed to comply with the limit.

Note: All the polarities (Vertical & Horizontal) had been tested, only the worst data was recorded in the report.

## 8.2. SPURIOUS EMISSIONS (1 GHz ~ 3 GHz)

### 8.2.1. GFSK MODE

#### HARMONICS AND SPURIOUS EMISSIONS (LOW CHANNEL, HORIZONTAL)

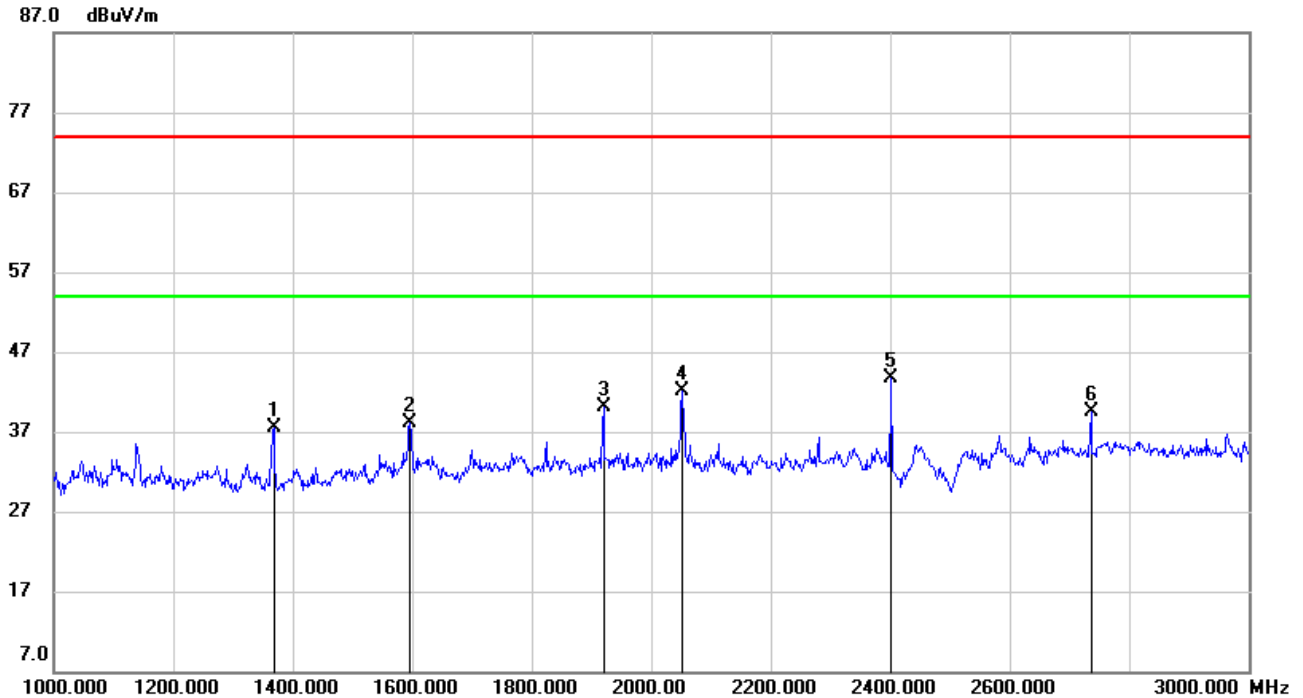

| No. | Frequency (MHz) | Reading (dBuV) | Correct (dB/m) | Result (dBuV/m) | Limit (dBuV/m) | Margin (dB) | Remark      |
|-----|-----------------|----------------|----------------|-----------------|----------------|-------------|-------------|
| 1   | 1368.000        | 50.70          | -13.27         | 37.43           | 74.00          | -36.57      | peak        |
| 2   | 1596.000        | 50.20          | -12.02         | 38.18           | 74.00          | -35.82      | peak        |
| 3   | 1920.000        | 51.08          | -11.02         | 40.06           | 74.00          | -33.94      | peak        |
| 4   | 2052.000        | 52.88          | -10.85         | 42.03           | 74.00          | -31.97      | peak        |
| 5   | 2402.000        | 52.75          | -9.06          | 43.69           | /              | /           | Fundamental |
| 6   | 2736.000        | 47.43          | -8.00          | 39.43           | 74.00          | -34.57      | peak        |

- Note:
1. Peak Result = Reading Level + Correct Factor.
  2. If Peak Result complies with AV limit, AV Result is deemed to comply with AV limit.
  3. Peak: Peak detector.
  4. Filter losses were only considered in then spurious frequency bands and the authorized band was not corrected for Band reject filter losses.
  5. Proper operation of the transmitter prior to adding the filter to the measurement chain.

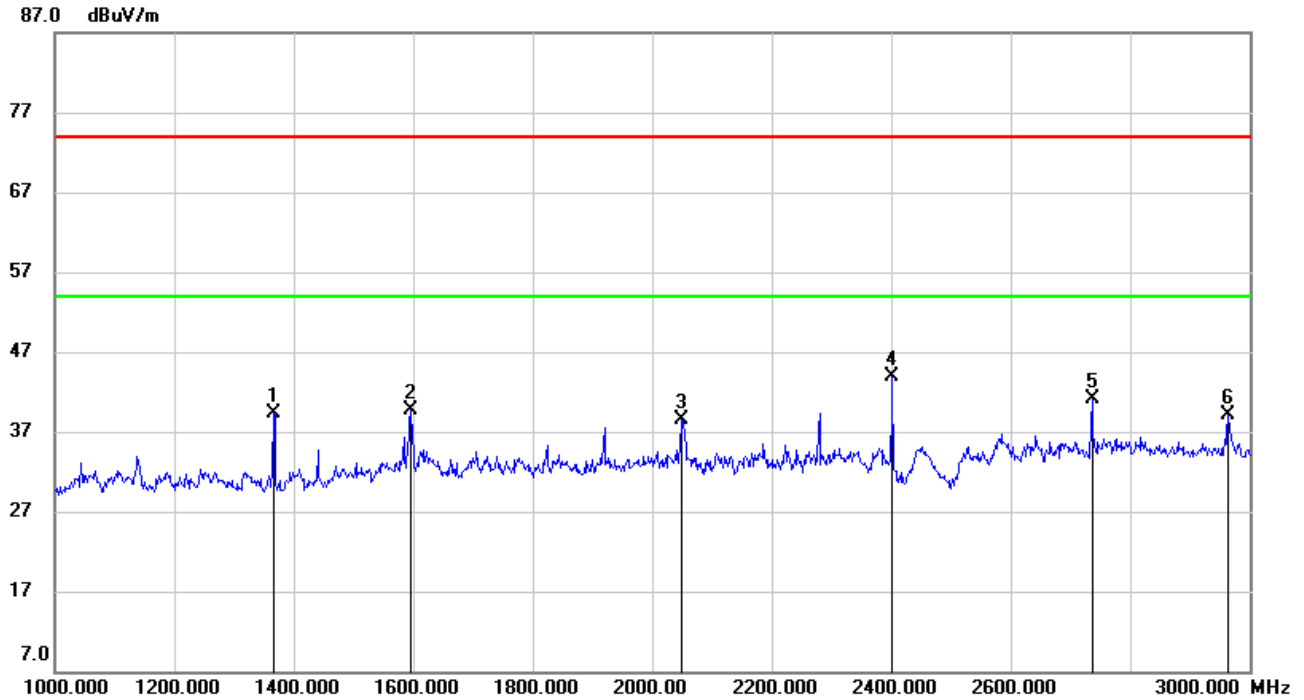
**HARMONICS AND SPURIOUS EMISSIONS (LOW CHANNEL, VERTICAL)**

| No. | Frequency (MHz) | Reading (dBuV) | Correct (dB/m) | Result (dBuV/m) | Limit (dBuV/m) | Margin (dB) | Remark      |
|-----|-----------------|----------------|----------------|-----------------|----------------|-------------|-------------|
| 1   | 1367.000        | 52.64          | -13.27         | 39.37           | 74.00          | -34.63      | peak        |
| 2   | 1596.000        | 51.73          | -12.02         | 39.71           | 74.00          | -34.29      | peak        |
| 3   | 2051.000        | 49.33          | -10.86         | 38.47           | 74.00          | -35.53      | peak        |
| 4   | 2402.000        | 53.03          | -9.06          | 43.97           | /              | /           | Fundamental |
| 5   | 2736.000        | 49.07          | -8.00          | 41.07           | 74.00          | -32.93      | peak        |
| 6   | 2964.000        | 46.24          | -7.19          | 39.05           | 74.00          | -34.95      | peak        |

- Note: 1. Peak Result = Reading Level + Correct Factor.  
 2. If Peak Result complies with AV limit, AV Result is deemed to comply with AV limit.  
 3. Peak: Peak detector.  
 4. Filter losses were only considered in then spurious frequency bands and the authorized band was not corrected for Band reject filter losses.  
 5. Proper operation of the transmitter prior to adding the filter to the measurement chain.

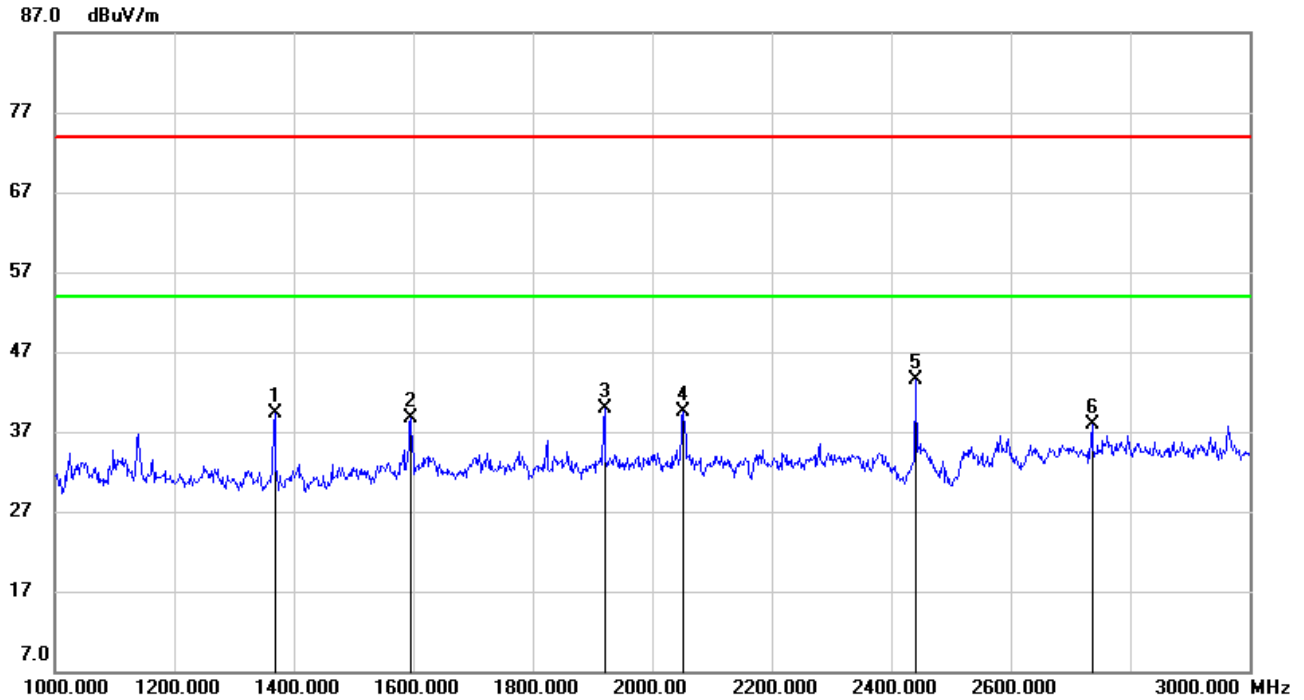

**HARMONICS AND SPURIOUS EMISSIONS (MID CHANNEL, HORIZONTAL)**

| No. | Frequency (MHz) | Reading (dBuV) | Correct (dB/m) | Result (dBuV/m) | Limit (dBuV/m) | Margin (dB) | Remark      |
|-----|-----------------|----------------|----------------|-----------------|----------------|-------------|-------------|
| 1   | 1368.000        | 52.65          | -13.27         | 39.38           | 74.00          | -34.62      | peak        |
| 2   | 1596.000        | 50.68          | -12.02         | 38.66           | 74.00          | -35.34      | peak        |
| 3   | 1920.000        | 51.01          | -11.02         | 39.99           | 74.00          | -34.01      | peak        |
| 4   | 2052.000        | 50.44          | -10.85         | 39.59           | 74.00          | -34.41      | peak        |
| 5   | 2441.000        | 52.49          | -8.97          | 43.52           | /              | /           | Fundamental |
| 6   | 2736.000        | 45.82          | -8.00          | 37.82           | 74.00          | -36.18      | peak        |

- Note:
1. Peak Result = Reading Level + Correct Factor.
  2. If Peak Result complies with AV limit, AV Result is deemed to comply with AV limit.
  3. Peak: Peak detector.
  4. Filter losses were only considered in then spurious frequency bands and the authorized band was not corrected for Band reject filter losses.
  5. Proper operation of the transmitter prior to adding the filter to the measurement chain.

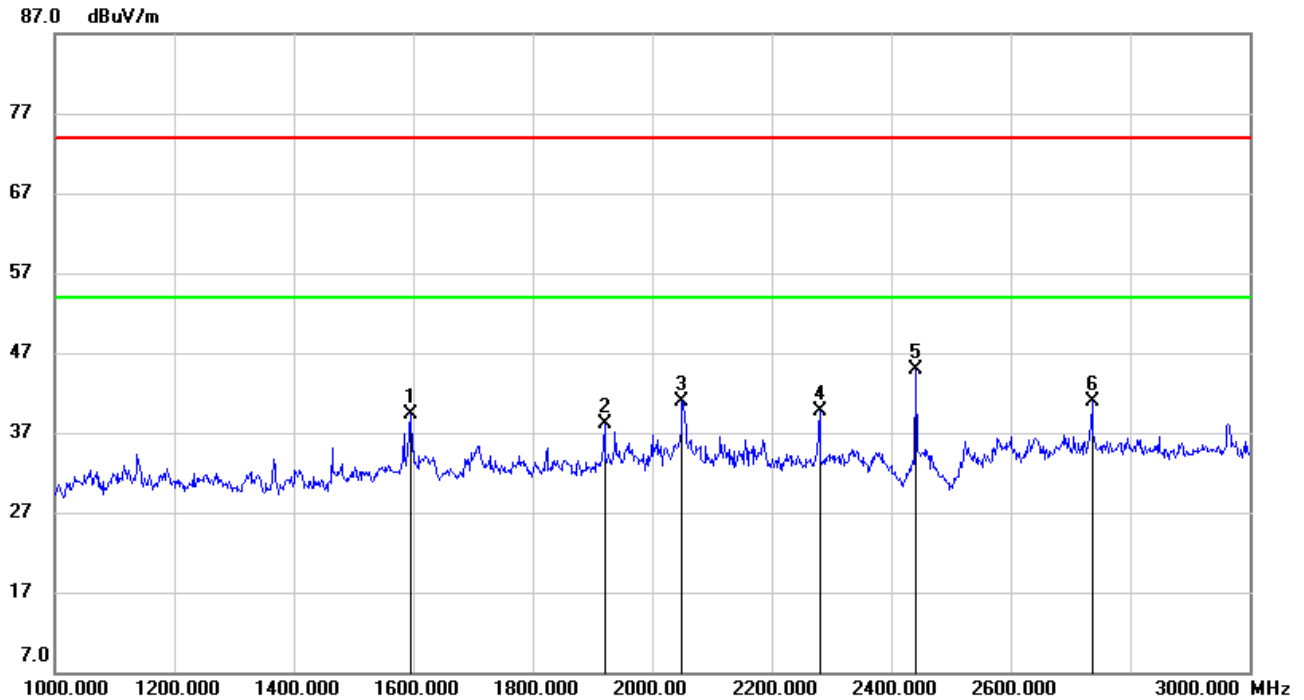
**HARMONICS AND SPURIOUS EMISSIONS (MID CHANNEL, VERTICAL)**

| No. | Frequency (MHz) | Reading (dBuV) | Correct (dB/m) | Result (dBuV/m) | Limit (dBuV/m) | Margin (dB) | Remark      |
|-----|-----------------|----------------|----------------|-----------------|----------------|-------------|-------------|
| 1   | 1596.000        | 51.30          | -12.02         | 39.28           | 74.00          | -34.72      | peak        |
| 2   | 1920.000        | 49.08          | -11.02         | 38.06           | 74.00          | -35.94      | peak        |
| 3   | 2051.000        | 51.84          | -10.86         | 40.98           | 74.00          | -33.02      | peak        |
| 4   | 2280.000        | 49.24          | -9.56          | 39.68           | 74.00          | -34.32      | peak        |
| 5   | 2441.000        | 53.96          | -8.97          | 44.99           | /              | /           | Fundamental |
| 6   | 2736.000        | 48.83          | -8.00          | 40.83           | 74.00          | -33.17      | peak        |

- Note:
1. Peak Result = Reading Level + Correct Factor.
  2. If Peak Result complies with AV limit, AV Result is deemed to comply with AV limit.
  3. Peak: Peak detector.
  4. Filter losses were only considered in then spurious frequency bands and the authorized band was not corrected for Band reject filter losses.
  5. Proper operation of the transmitter prior to adding the filter to the measurement chain.

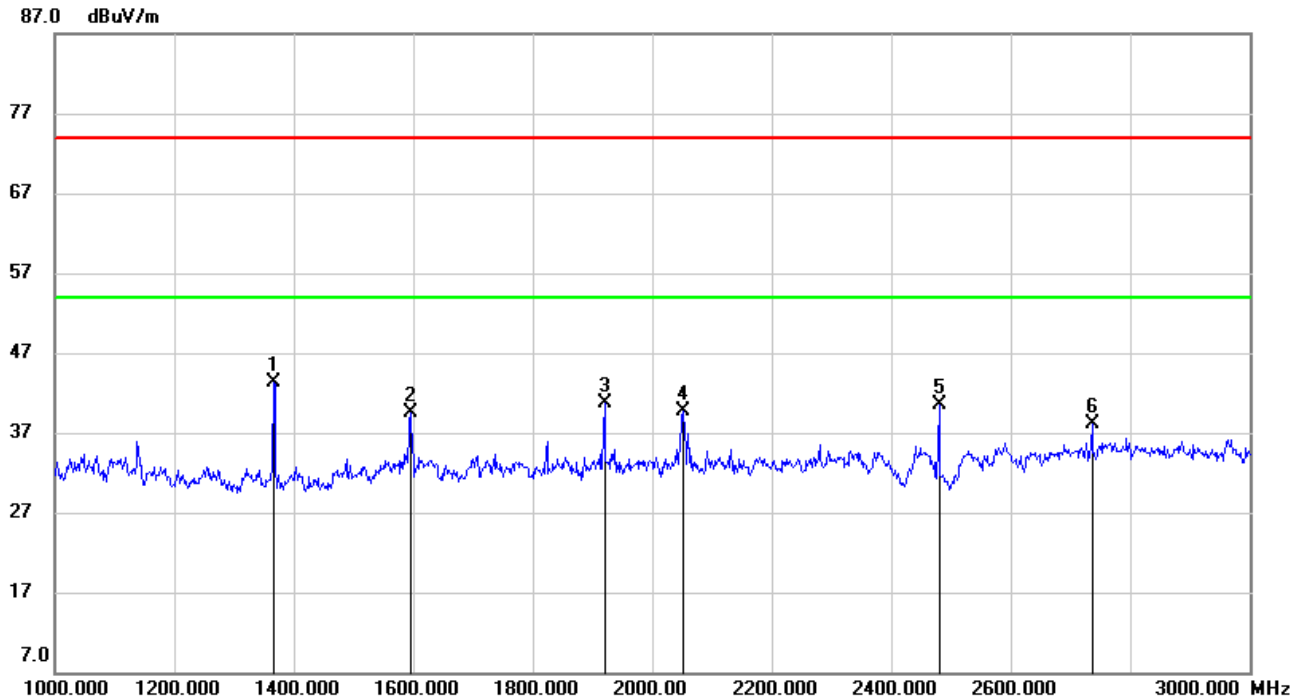
**HARMONICS AND SPURIOUS EMISSIONS (HIGH CHANNEL, HORIZONTAL)**

| No. | Frequency (MHz) | Reading (dBuV) | Correct (dB/m) | Result (dBuV/m) | Limit (dBuV/m) | Margin (dB) | Remark      |
|-----|-----------------|----------------|----------------|-----------------|----------------|-------------|-------------|
| 1   | 1367.000        | 56.57          | -13.27         | 43.30           | 74.00          | -30.70      | peak        |
| 2   | 1596.000        | 51.47          | -12.02         | 39.45           | 74.00          | -34.55      | peak        |
| 3   | 1920.000        | 51.66          | -11.02         | 40.64           | 74.00          | -33.36      | peak        |
| 4   | 2052.000        | 50.46          | -10.85         | 39.61           | 74.00          | -34.39      | peak        |
| 5   | 2480.000        | 49.46          | -8.87          | 40.59           | /              | /           | Fundamental |
| 6   | 2736.000        | 46.09          | -8.00          | 38.09           | 74.00          | -35.91      | peak        |

- Note:
1. Peak Result = Reading Level + Correct Factor.
  2. If Peak Result complies with AV limit, AV Result is deemed to comply with AV limit.
  3. Peak: Peak detector.
  4. Filter losses were only considered in then spurious frequency bands and the authorized band was not corrected for Band reject filter losses.
  5. Proper operation of the transmitter prior to adding the filter to the measurement chain.

**HARMONICS AND SPURIOUS EMISSIONS (HIGH CHANNEL, VERTICAL)**

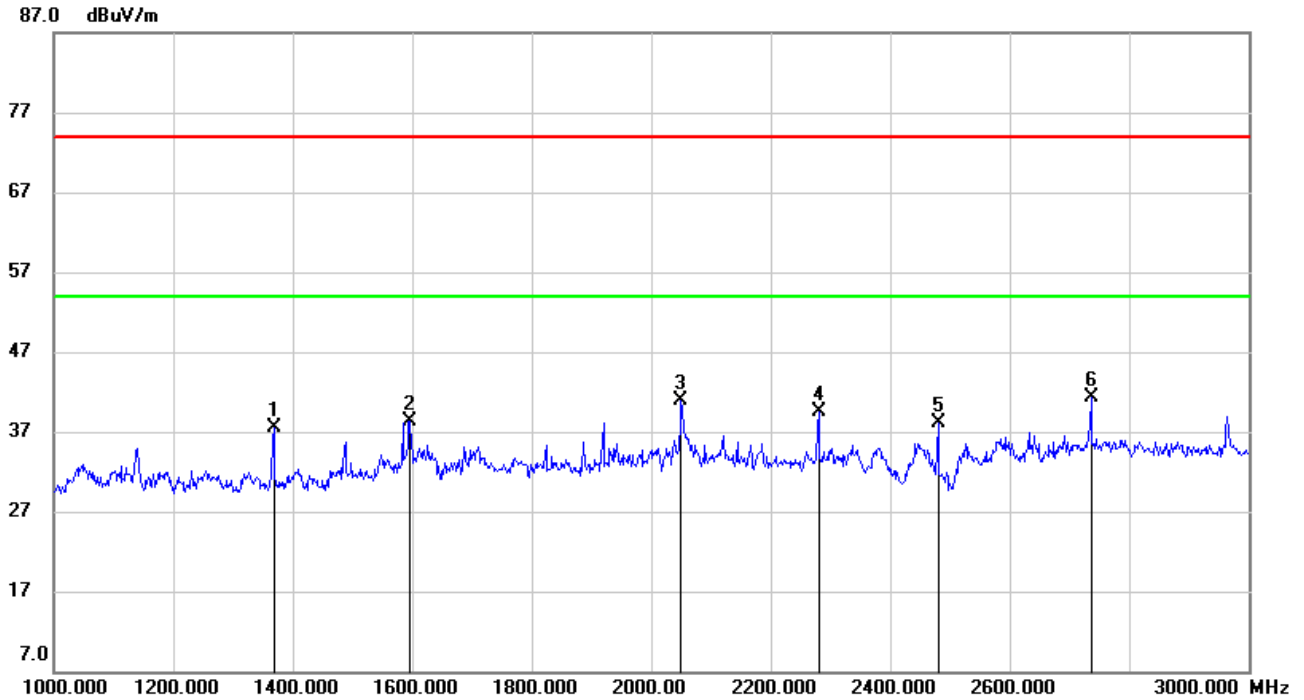

| No. | Frequency (MHz) | Reading (dBuV) | Correct (dB/m) | Result (dBuV/m) | Limit (dBuV/m) | Margin (dB) | Remark      |
|-----|-----------------|----------------|----------------|-----------------|----------------|-------------|-------------|
| 1   | 1368.000        | 50.80          | -13.27         | 37.53           | 74.00          | -36.47      | peak        |
| 2   | 1596.000        | 50.41          | -12.02         | 38.39           | 74.00          | -35.61      | peak        |
| 3   | 2051.000        | 51.85          | -10.86         | 40.99           | 74.00          | -33.01      | peak        |
| 4   | 2280.000        | 49.10          | -9.56          | 39.54           | 74.00          | -34.46      | peak        |
| 5   | 2480.000        | 46.89          | -8.87          | 38.02           | /              | /           | Fundamental |
| 6   | 2736.000        | 49.32          | -8.00          | 41.32           | 74.00          | -32.68      | peak        |

- Note: 1. Peak Result = Reading Level + Correct Factor.  
 2. If Peak Result complies with AV limit, AV Result is deemed to comply with AV limit.  
 3. Peak: Peak detector.  
 4. Filter losses were only considered in then spurious frequency bands and the authorized band was not corrected for Band reject filter losses.  
 5. Proper operation of the transmitter prior to adding the filter to the measurement chain.

Note: All the modes and channels had been tested, but only the worst data was recorded in the report.

### 8.3. SPURIOUS EMISSIONS (3 GHz ~ 18 GHz)

#### 8.3.1. GFSK MODE

##### HARMONICS AND SPURIOUS EMISSIONS (LOW CHANNEL, HORIZONTAL)

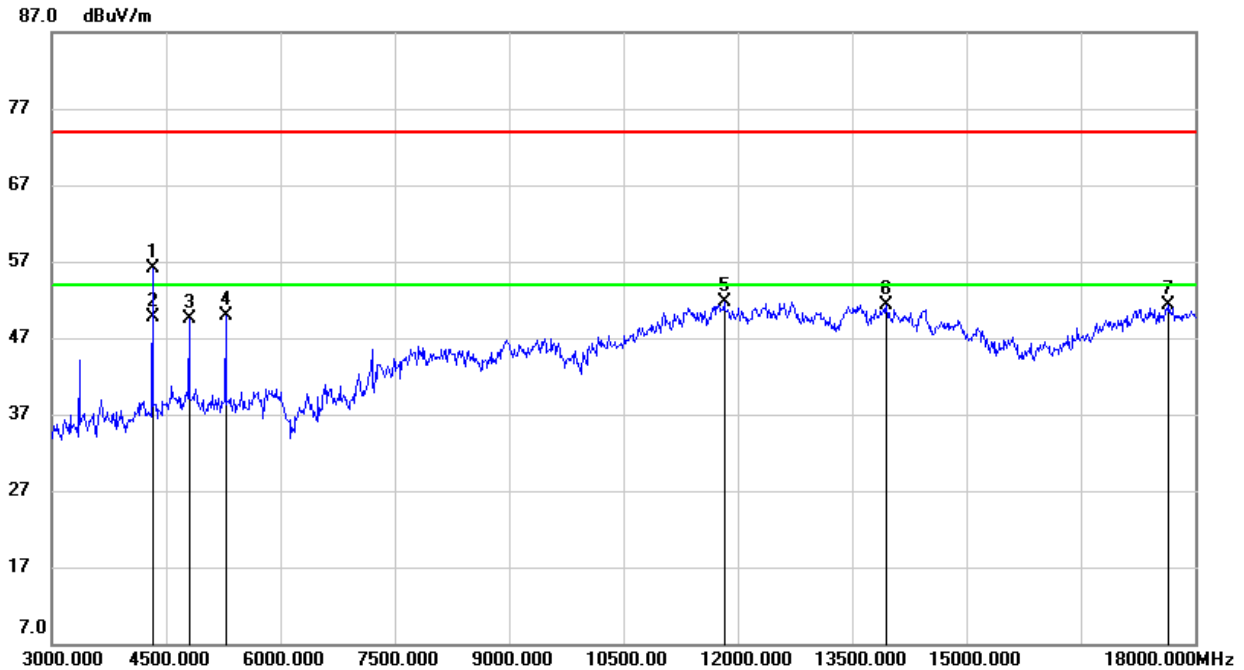

| No. | Frequency (MHz) | Reading (dBuV) | Correct (dB/m) | Result (dBuV/m) | Limit (dBuV/m) | Margin (dB) | Remark |
|-----|-----------------|----------------|----------------|-----------------|----------------|-------------|--------|
| 1   | 4320.000        | 58.89          | -2.82          | 56.07           | 74.00          | -17.93      | peak   |
| 2   | 4320.000        | 52.60          | -2.82          | 49.78           | 54.00          | -4.22       | AVG    |
| 3   | 4800.000        | 50.18          | -0.65          | 49.53           | 74.00          | -24.47      | peak   |
| 4   | 5280.000        | 49.07          | 0.84           | 49.91           | 74.00          | -24.09      | peak   |
| 5   | 11820.000       | 34.43          | 17.32          | 51.75           | 74.00          | -22.25      | peak   |
| 6   | 13957.500       | 32.76          | 18.60          | 51.36           | 74.00          | -22.64      | peak   |
| 7   | 17655.000       | 29.90          | 21.33          | 51.23           | 74.00          | -22.77      | peak   |

Note: 1. Peak Result = Reading Level + Correct Factor.

2. If Peak Result complies with AV limit, AV Result is deemed to comply with AV limit.

3. Peak: Peak detector.

4. Filter losses were only considered in the spurious frequency bands and the authorized band was not corrected for High Pass Filter losses.

5. Proper operation of the transmitter prior to adding the filter to the measurement chain.



**HARMONICS AND SPURIOUS EMISSIONS (LOW CHANNEL, VERTICAL)**

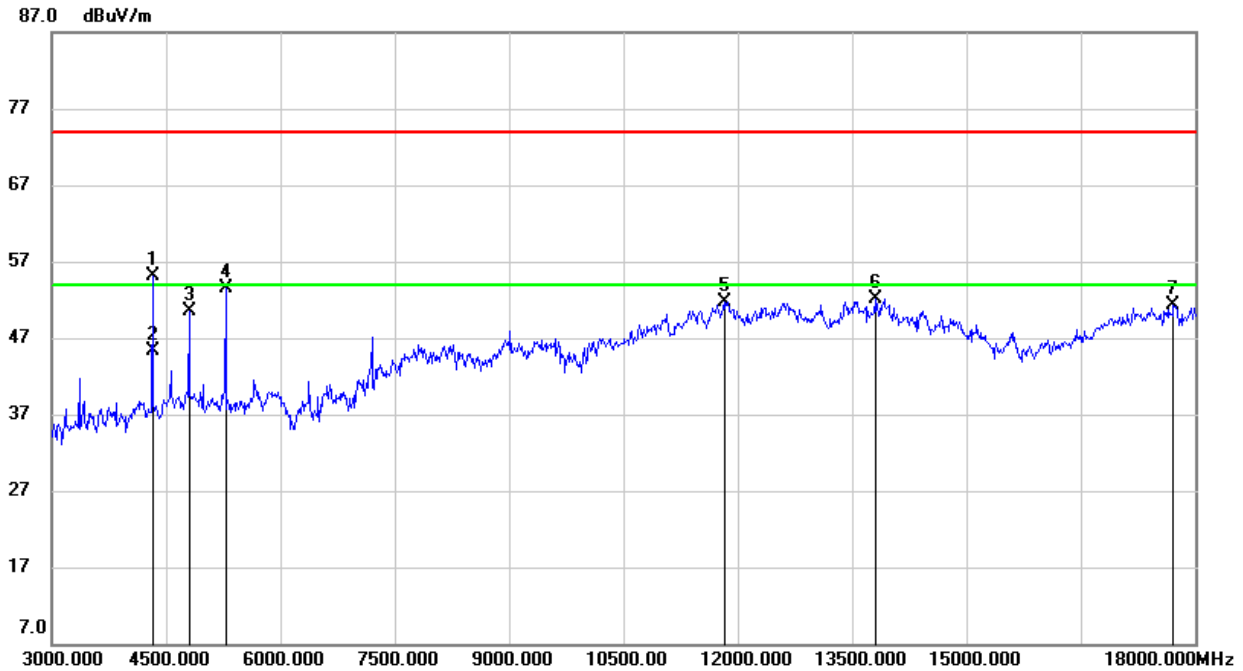

| No. | Frequency (MHz) | Reading (dBuV) | Correct (dB/m) | Result (dBuV/m) | Limit (dBuV/m) | Margin (dB) | Remark |
|-----|-----------------|----------------|----------------|-----------------|----------------|-------------|--------|
| 1   | 4320.000        | 57.87          | -2.82          | 55.05           | 74.00          | -18.95      | peak   |
| 2   | 4320.000        | 48.20          | -2.82          | 45.38           | 54.00          | -8.62       | AVG    |
| 3   | 4800.000        | 51.23          | -0.65          | 50.58           | 74.00          | -23.42      | peak   |
| 4   | 5280.000        | 52.68          | 0.84           | 53.52           | 74.00          | -20.48      | peak   |
| 5   | 11827.500       | 34.44          | 17.30          | 51.74           | 74.00          | -22.26      | peak   |
| 6   | 13807.500       | 33.29          | 18.77          | 52.06           | 74.00          | -21.94      | peak   |
| 7   | 17715.000       | 29.31          | 21.96          | 51.27           | 74.00          | -22.73      | peak   |

- Note: 1. Peak Result = Reading Level + Correct Factor.  
 2. If Peak Result complies with AV limit, AV Result is deemed to comply with AV limit.  
 3. Peak: Peak detector.  
 4. Filter losses were only considered in the spurious frequency bands and the authorized band was not corrected for High Pass Filter losses.  
 5. Proper operation of the transmitter prior to adding the filter to the measurement chain.



**HARMONICS AND SPURIOUS EMISSIONS (MID CHANNEL, HORIZONTAL)**

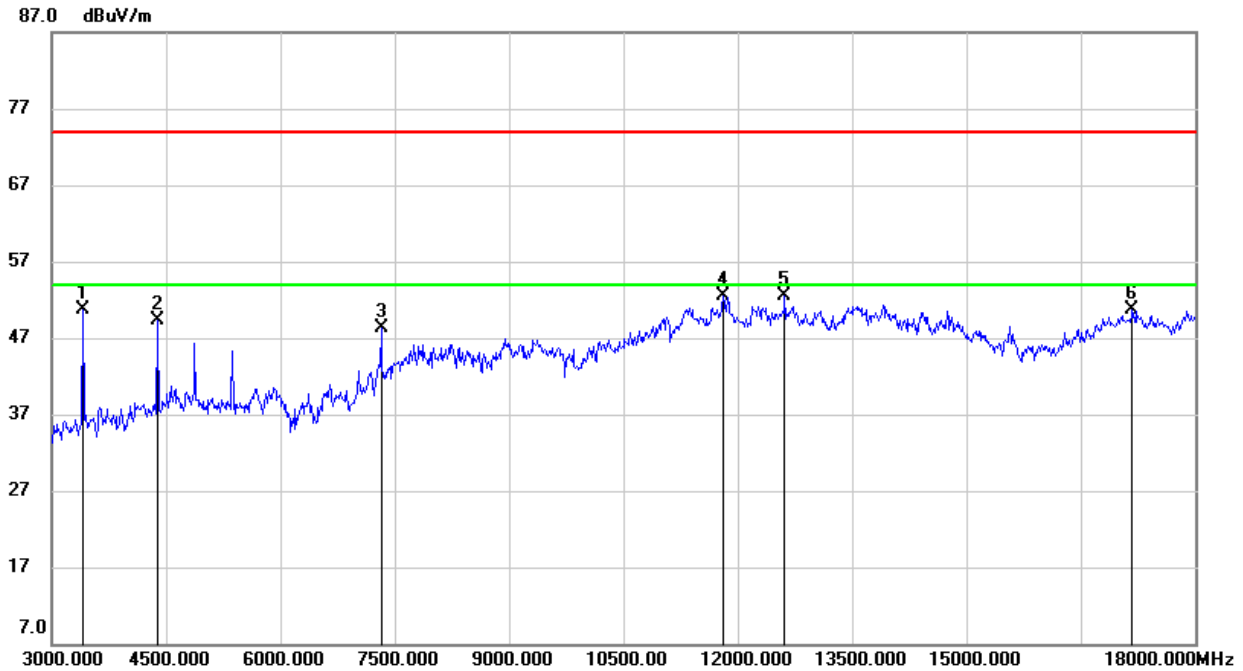

| No. | Frequency (MHz) | Reading (dBuV) | Correct (dB/m) | Result (dBuV/m) | Limit (dBuV/m) | Margin (dB) | Remark |
|-----|-----------------|----------------|----------------|-----------------|----------------|-------------|--------|
| 1   | 3412.500        | 56.99          | -6.23          | 50.76           | 74.00          | -23.24      | peak   |
| 2   | 4387.500        | 52.11          | -2.88          | 49.23           | 74.00          | -24.77      | peak   |
| 3   | 7320.000        | 41.73          | 6.62           | 48.35           | 74.00          | -25.65      | peak   |
| 4   | 11812.500       | 35.20          | 17.33          | 52.53           | 74.00          | -21.47      | peak   |
| 5   | 12615.000       | 35.84          | 16.66          | 52.50           | 74.00          | -21.50      | peak   |
| 6   | 17182.500       | 31.04          | 19.63          | 50.67           | 74.00          | -23.33      | peak   |

- Note: 1. Peak Result = Reading Level + Correct Factor.  
 2. If Peak Result complies with AV limit, AV Result is deemed to comply with AV limit.  
 3. Peak: Peak detector.  
 4. Filter losses were only considered in the spurious frequency bands and the authorized band was not corrected for High Pass Filter losses.  
 5. Proper operation of the transmitter prior to adding the filter to the measurement chain.



**HARMONICS AND SPURIOUS EMISSIONS (MID CHANNEL, VERTICAL)**

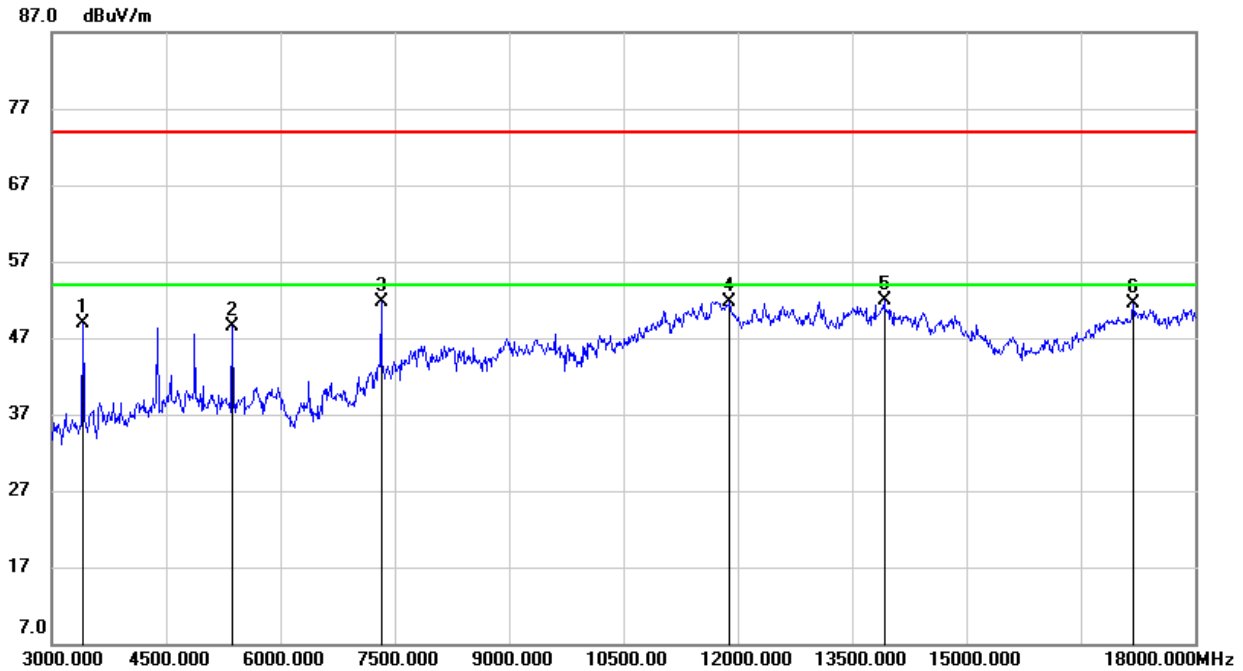

| No. | Frequency (MHz) | Reading (dBuV) | Correct (dB/m) | Result (dBuV/m) | Limit (dBuV/m) | Margin (dB) | Remark |
|-----|-----------------|----------------|----------------|-----------------|----------------|-------------|--------|
| 1   | 3412.500        | 55.08          | -6.23          | 48.85           | 74.00          | -25.15      | peak   |
| 2   | 5370.000        | 47.70          | 0.80           | 48.50           | 74.00          | -25.50      | peak   |
| 3   | 7320.000        | 45.04          | 6.62           | 51.66           | 74.00          | -22.34      | peak   |
| 4   | 11895.000       | 34.58          | 17.20          | 51.78           | 74.00          | -22.22      | peak   |
| 5   | 13927.500       | 33.32          | 18.63          | 51.95           | 74.00          | -22.05      | peak   |
| 6   | 17190.000       | 31.83          | 19.68          | 51.51           | 74.00          | -22.49      | peak   |

- Note: 1. Peak Result = Reading Level + Correct Factor.  
 2. If Peak Result complies with AV limit, AV Result is deemed to comply with AV limit.  
 3. Peak: Peak detector.  
 4. Filter losses were only considered in the spurious frequency bands and the authorized band was not corrected for High Pass Filter losses.  
 5. Proper operation of the transmitter prior to adding the filter to the measurement chain.



### HARMONICS AND SPURIOUS EMISSIONS (HIGH CHANNEL, HORIZONTAL)

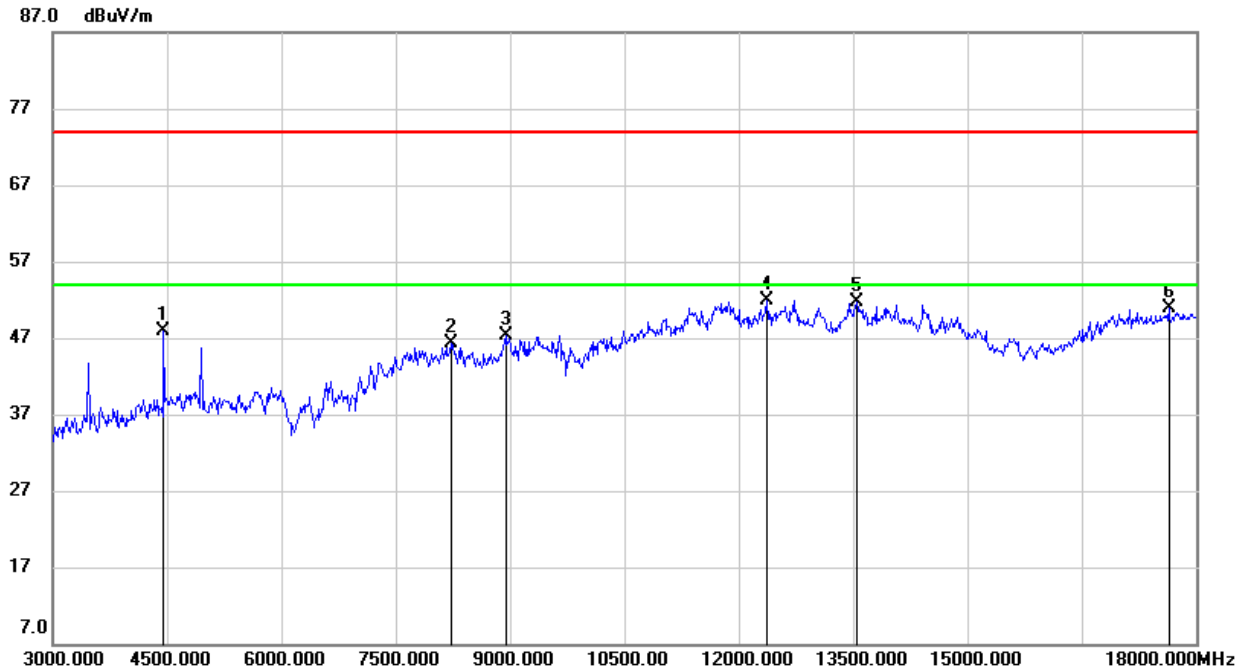

| No. | Frequency (MHz) | Reading (dBuV) | Correct (dB/m) | Result (dBuV/m) | Limit (dBuV/m) | Margin (dB) | Remark |
|-----|-----------------|----------------|----------------|-----------------|----------------|-------------|--------|
| 1   | 4462.500        | 50.45          | -2.47          | 47.98           | 74.00          | -26.02      | peak   |
| 2   | 8220.000        | 37.61          | 8.64           | 46.25           | 74.00          | -27.75      | peak   |
| 3   | 8947.500        | 37.68          | 9.56           | 47.24           | 74.00          | -26.76      | peak   |
| 4   | 12360.000       | 35.16          | 16.84          | 52.00           | 74.00          | -22.00      | peak   |
| 5   | 13545.000       | 33.27          | 18.39          | 51.66           | 74.00          | -22.34      | peak   |
| 6   | 17640.000       | 29.65          | 21.17          | 50.82           | 74.00          | -23.18      | peak   |

Note: 1. Peak Result = Reading Level + Correct Factor.

2. If Peak Result complies with AV limit, AV Result is deemed to comply with AV limit.

3. Peak: Peak detector.

4. Filter losses were only considered in the spurious frequency bands and the authorized band was not corrected for High Pass Filter losses.

5. Proper operation of the transmitter prior to adding the filter to the measurement chain.

**HARMONICS AND SPURIOUS EMISSIONS (HIGH CHANNEL, VERTICAL)**

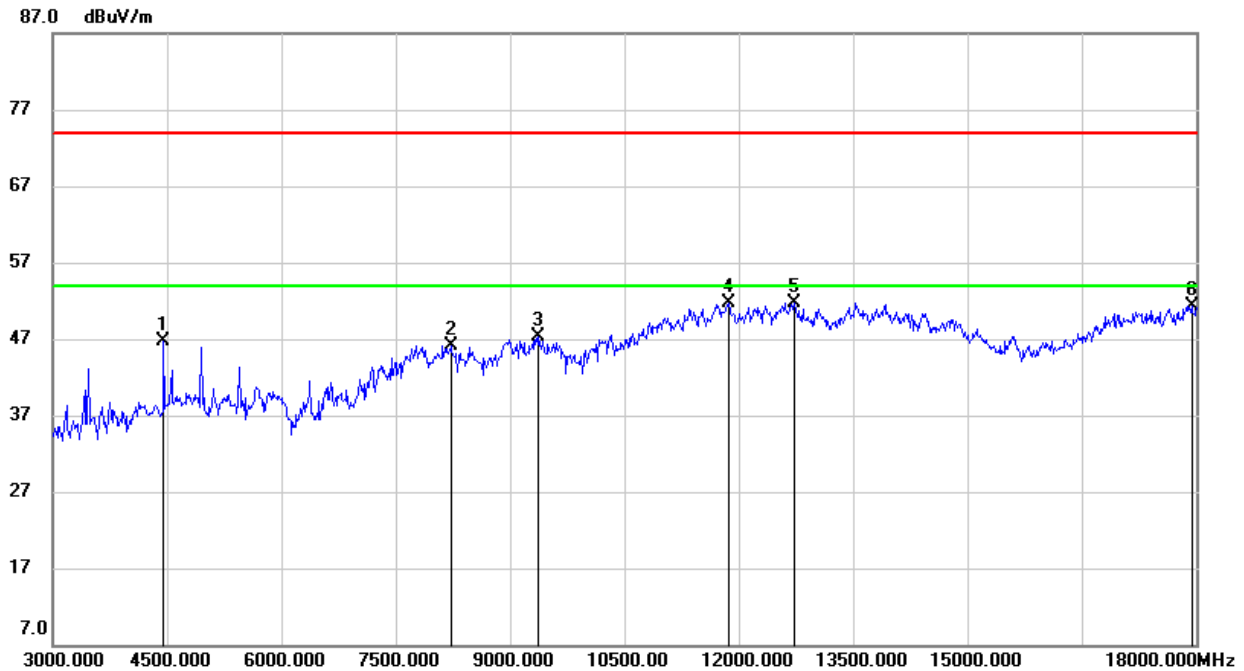

| No. | Frequency (MHz) | Reading (dBuV) | Correct (dB/m) | Result (dBuV/m) | Limit (dBuV/m) | Margin (dB) | Remark |
|-----|-----------------|----------------|----------------|-----------------|----------------|-------------|--------|
| 1   | 4462.500        | 49.15          | -2.47          | 46.68           | 74.00          | -27.32      | peak   |
| 2   | 8227.500        | 37.57          | 8.61           | 46.18           | 74.00          | -27.82      | peak   |
| 3   | 9382.500        | 37.29          | 10.03          | 47.32           | 74.00          | -26.68      | peak   |
| 4   | 11865.000       | 34.42          | 17.24          | 51.66           | 74.00          | -22.34      | peak   |
| 5   | 12720.000       | 34.90          | 16.89          | 51.79           | 74.00          | -22.21      | peak   |
| 6   | 17940.000       | 28.10          | 23.22          | 51.32           | 74.00          | -22.68      | peak   |

- Note: 1. Peak Result = Reading Level + Correct Factor.  
 2. If Peak Result complies with AV limit, AV Result is deemed to comply with AV limit.  
 3. Peak: Peak detector.  
 4. Filter losses were only considered in the spurious frequency bands and the authorized band was not corrected for High Pass Filter losses.  
 5. Proper operation of the transmitter prior to adding the filter to the measurement chain.

### 8.3.2. 8DPSK MODE

#### HARMONICS AND SPURIOUS EMISSIONS (LOW CHANNEL, HORIZONTAL)

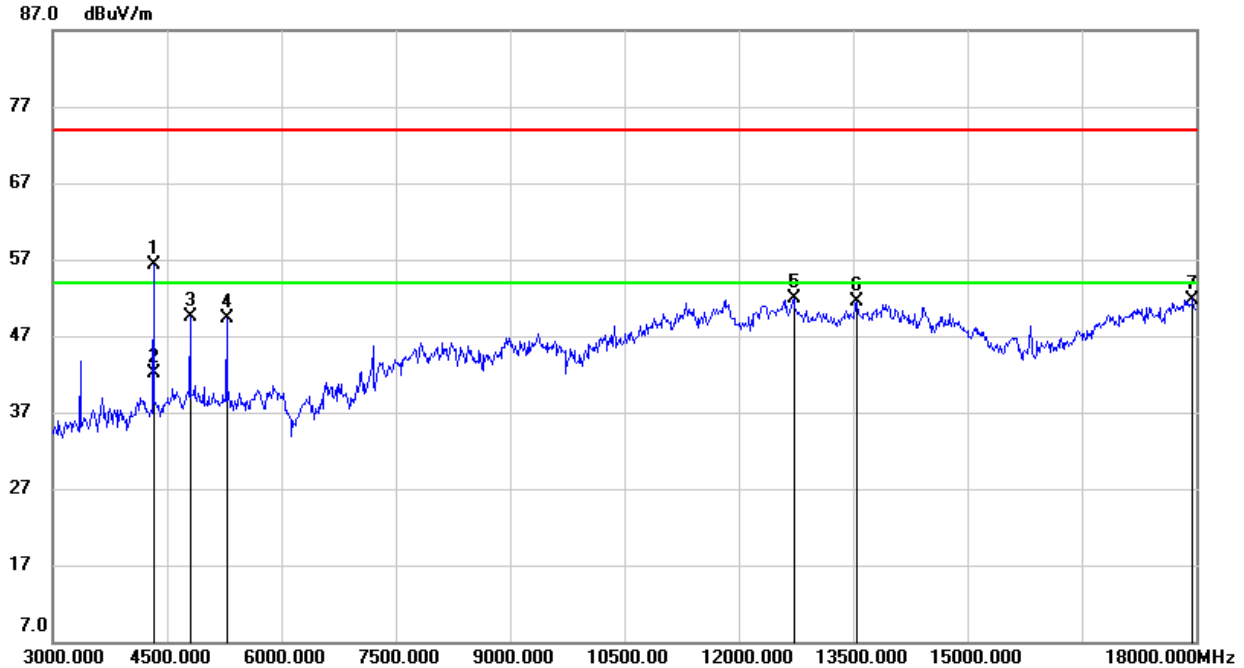

| No. | Frequency (MHz) | Reading (dBuV) | Correct (dB/m) | Result (dBuV/m) | Limit (dBuV/m) | Margin (dB) | Remark |
|-----|-----------------|----------------|----------------|-----------------|----------------|-------------|--------|
| 1   | 4320.000        | 59.16          | -2.82          | 56.34           | 74.00          | -17.66      | peak   |
| 2   | 4320.000        | 45.00          | -2.82          | 42.18           | 54.00          | -11.82      | AVG    |
| 3   | 4800.000        | 50.10          | -0.65          | 49.45           | 74.00          | -24.55      | peak   |
| 4   | 5280.000        | 48.55          | 0.84           | 49.39           | 74.00          | -24.61      | peak   |
| 5   | 12727.500       | 34.94          | 16.91          | 51.85           | 74.00          | -22.15      | peak   |
| 6   | 13545.000       | 33.17          | 18.39          | 51.56           | 74.00          | -22.44      | peak   |
| 7   | 17962.500       | 28.53          | 23.27          | 51.80           | 74.00          | -22.20      | peak   |

- Note: 1. Peak Result = Reading Level + Correct Factor.  
 2. If Peak Result complies with AV limit, AV Result is deemed to comply with AV limit.  
 3. Peak: Peak detector.  
 4. Filter losses were only considered in the spurious frequency bands and the authorized band was not corrected for High Pass Filter losses.  
 5. Proper operation of the transmitter prior to adding the filter to the measurement chain.

**HARMONICS AND SPURIOUS EMISSIONS (LOW CHANNEL, VERTICAL)**

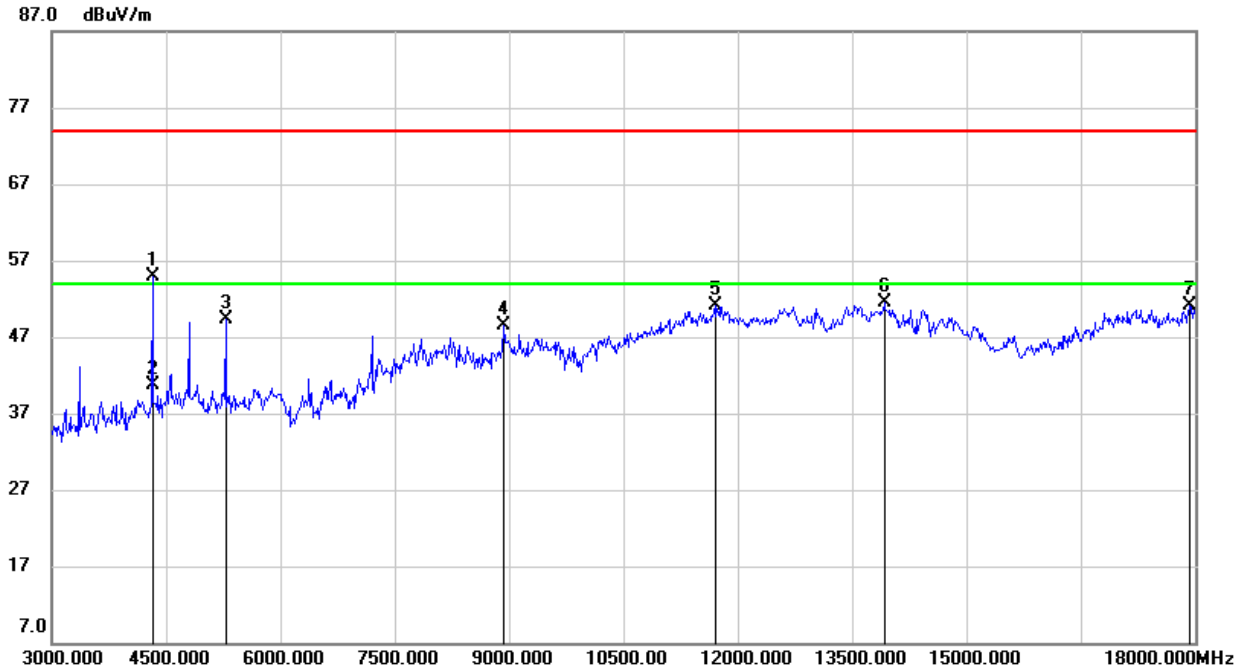

| No. | Frequency (MHz) | Reading (dBuV) | Correct (dB/m) | Result (dBuV/m) | Limit (dBuV/m) | Margin (dB) | Remark |
|-----|-----------------|----------------|----------------|-----------------|----------------|-------------|--------|
| 1   | 4320.000        | 57.70          | -2.82          | 54.88           | 74.00          | -19.12      | peak   |
| 2   | 4320.000        | 43.60          | -2.82          | 40.78           | 54.00          | -13.22      | AVG    |
| 3   | 5280.000        | 48.53          | 0.84           | 49.37           | 74.00          | -24.63      | peak   |
| 4   | 8932.500        | 39.02          | 9.39           | 48.41           | 74.00          | -25.59      | peak   |
| 5   | 11707.500       | 34.30          | 16.86          | 51.16           | 74.00          | -22.84      | peak   |
| 6   | 13920.000       | 32.87          | 18.64          | 51.51           | 74.00          | -22.49      | peak   |
| 7   | 17925.000       | 28.01          | 23.18          | 51.19           | 74.00          | -22.81      | peak   |

- Note: 1. Peak Result = Reading Level + Correct Factor.  
 2. If Peak Result complies with AV limit, AV Result is deemed to comply with AV limit.  
 3. Peak: Peak detector.  
 4. Filter losses were only considered in the spurious frequency bands and the authorized band was not corrected for High Pass Filter losses.  
 5. Proper operation of the transmitter prior to adding the filter to the measurement chain.

**HARMONICS AND SPURIOUS EMISSIONS (MID CHANNEL, HORIZONTAL)**

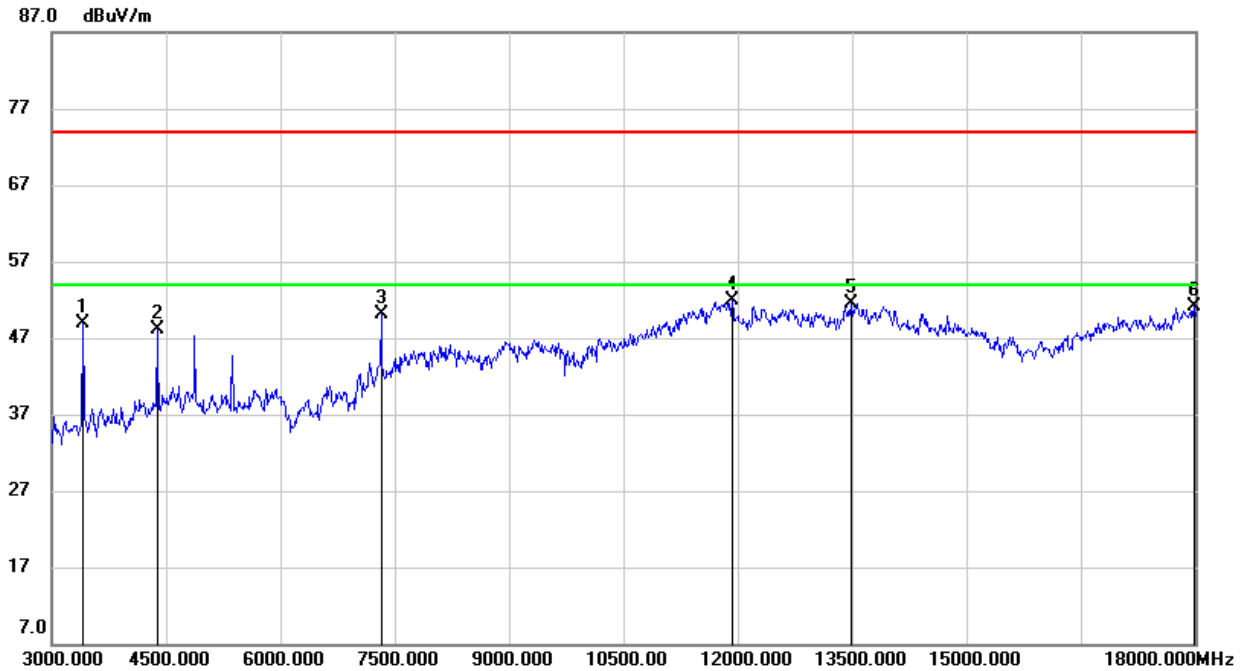

| No. | Frequency (MHz) | Reading (dBuV) | Correct (dB/m) | Result (dBuV/m) | Limit (dBuV/m) | Margin (dB) | Remark |
|-----|-----------------|----------------|----------------|-----------------|----------------|-------------|--------|
| 1   | 3412.500        | 55.21          | -6.23          | 48.98           | 74.00          | -25.02      | peak   |
| 2   | 4387.500        | 50.90          | -2.88          | 48.02           | 74.00          | -25.98      | peak   |
| 3   | 7320.000        | 43.50          | 6.62           | 50.12           | 74.00          | -23.88      | peak   |
| 4   | 11932.500       | 34.83          | 17.14          | 51.97           | 74.00          | -22.03      | peak   |
| 5   | 13492.500       | 33.14          | 18.40          | 51.54           | 74.00          | -22.46      | peak   |
| 6   | 17992.500       | 27.81          | 23.35          | 51.16           | 74.00          | -22.84      | peak   |

- Note: 1. Peak Result = Reading Level + Correct Factor.  
 2. If Peak Result complies with AV limit, AV Result is deemed to comply with AV limit.  
 3. Peak: Peak detector.  
 4. Filter losses were only considered in the spurious frequency bands and the authorized band was not corrected for High Pass Filter losses.  
 5. Proper operation of the transmitter prior to adding the filter to the measurement chain.

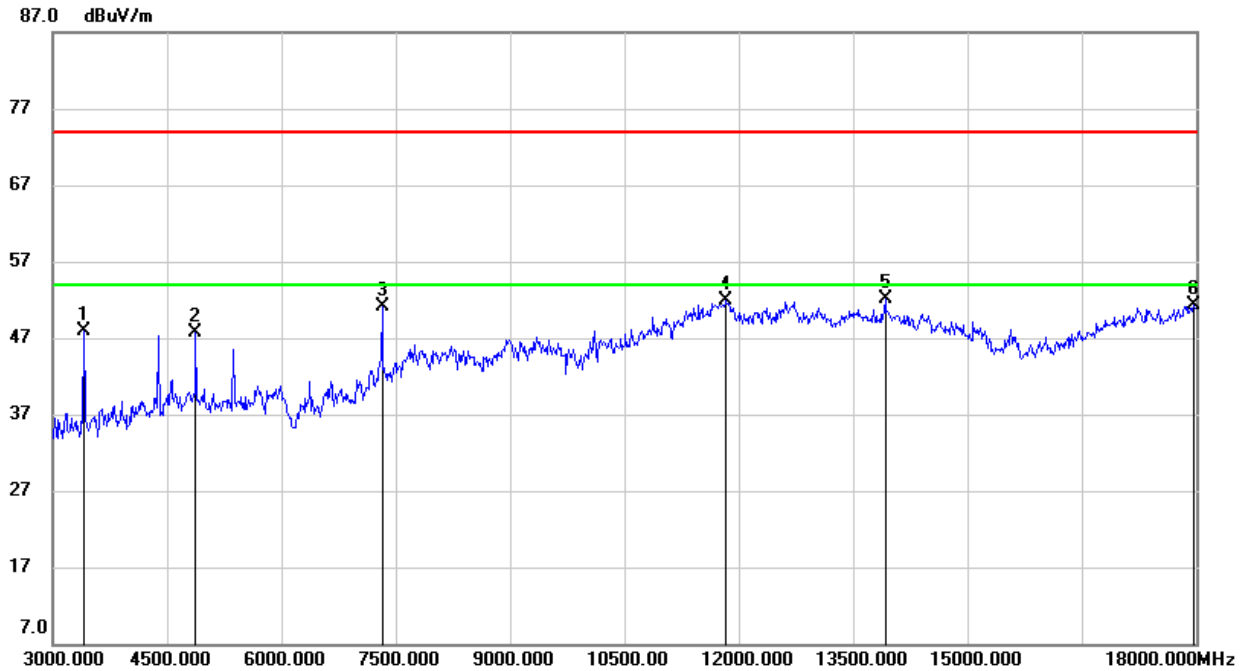
**HARMONICS AND SPURIOUS EMISSIONS (MID CHANNEL, VERTICAL)**

| No. | Frequency (MHz) | Reading (dBuV) | Correct (dB/m) | Result (dBuV/m) | Limit (dBuV/m) | Margin (dB) | Remark |
|-----|-----------------|----------------|----------------|-----------------|----------------|-------------|--------|
| 1   | 3412.500        | 54.06          | -6.23          | 47.83           | 74.00          | -26.17      | peak   |
| 2   | 4882.500        | 48.33          | -0.59          | 47.74           | 74.00          | -26.26      | peak   |
| 3   | 7320.000        | 44.39          | 6.62           | 51.01           | 74.00          | -22.99      | peak   |
| 4   | 11842.500       | 34.56          | 17.28          | 51.84           | 74.00          | -22.16      | peak   |
| 5   | 13920.000       | 33.47          | 18.64          | 52.11           | 74.00          | -21.89      | peak   |
| 6   | 17970.000       | 27.94          | 23.29          | 51.23           | 74.00          | -22.77      | peak   |

- Note: 1. Peak Result = Reading Level + Correct Factor.  
 2. If Peak Result complies with AV limit, AV Result is deemed to comply with AV limit.  
 3. Peak: Peak detector.  
 4. Filter losses were only considered in the spurious frequency bands and the authorized band was not corrected for High Pass Filter losses.  
 5. Proper operation of the transmitter prior to adding the filter to the measurement chain.

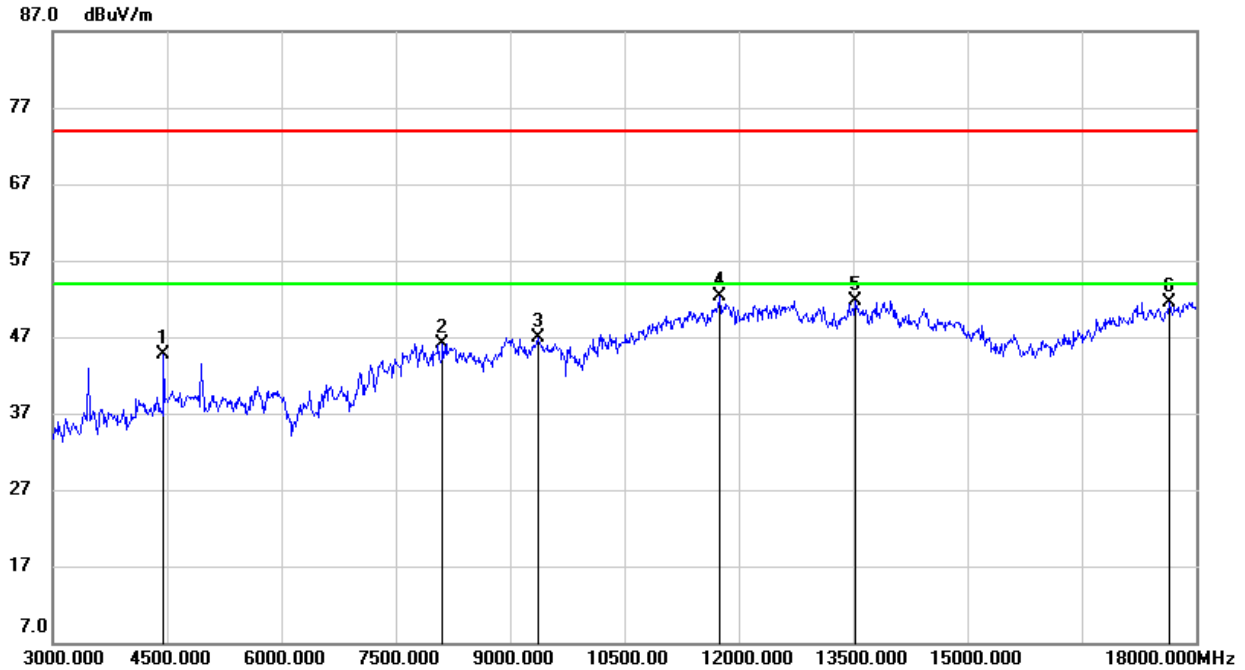
**HARMONICS AND SPURIOUS EMISSIONS (HIGH CHANNEL, HORIZONTAL)**

| No. | Frequency (MHz) | Reading (dBuV) | Correct (dB/m) | Result (dBuV/m) | Limit (dBuV/m) | Margin (dB) | Remark |
|-----|-----------------|----------------|----------------|-----------------|----------------|-------------|--------|
| 1   | 4462.500        | 47.11          | -2.47          | 44.64           | 74.00          | -29.36      | peak   |
| 2   | 8122.500        | 38.06          | 8.08           | 46.14           | 74.00          | -27.86      | peak   |
| 3   | 9382.500        | 36.86          | 10.03          | 46.89           | 74.00          | -27.11      | peak   |
| 4   | 11745.000       | 35.14          | 17.07          | 52.21           | 74.00          | -21.79      | peak   |
| 5   | 13537.500       | 33.32          | 18.39          | 51.71           | 74.00          | -22.29      | peak   |
| 6   | 17640.000       | 30.40          | 21.17          | 51.57           | 74.00          | -22.43      | peak   |

- Note: 1. Peak Result = Reading Level + Correct Factor.  
 2. If Peak Result complies with AV limit, AV Result is deemed to comply with AV limit.  
 3. Peak: Peak detector.  
 4. Filter losses were only considered in the spurious frequency bands and the authorized band was not corrected for High Pass Filter losses.  
 5. Proper operation of the transmitter prior to adding the filter to the measurement chain.

**HARMONICS AND SPURIOUS EMISSIONS (HIGH CHANNEL, VERTICAL)**

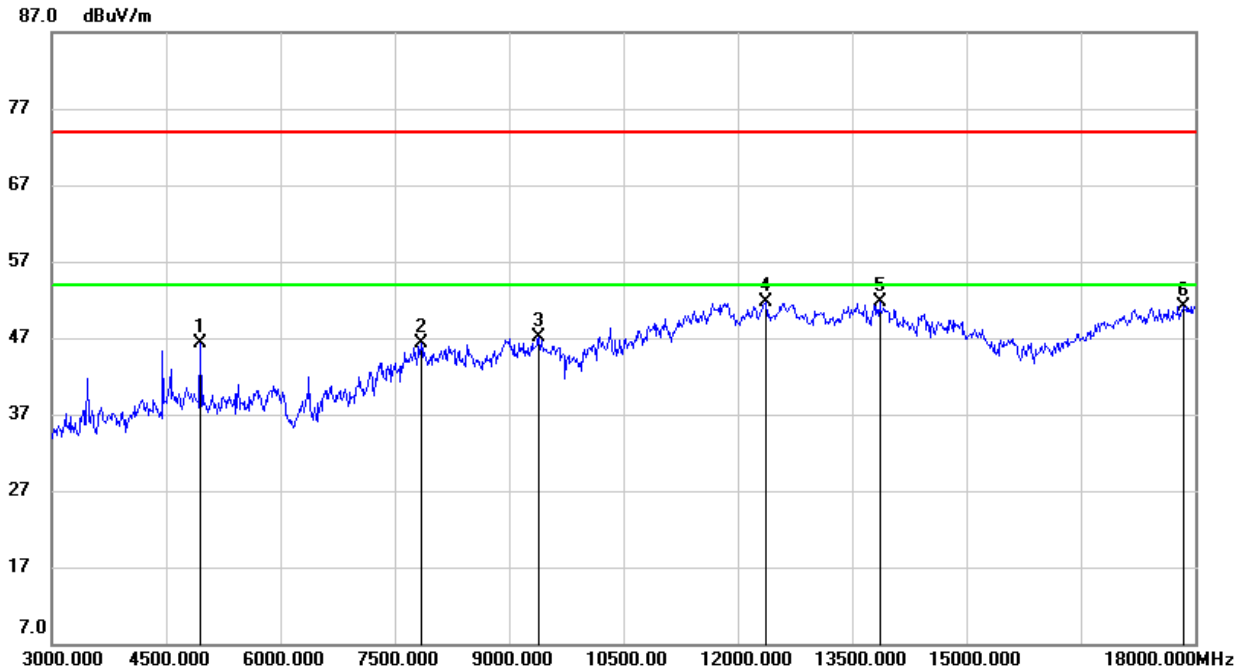

| No. | Frequency (MHz) | Reading (dBuV) | Correct (dB/m) | Result (dBuV/m) | Limit (dBuV/m) | Margin (dB) | Remark |
|-----|-----------------|----------------|----------------|-----------------|----------------|-------------|--------|
| 1   | 4957.500        | 46.77          | -0.54          | 46.23           | 74.00          | -27.77      | peak   |
| 2   | 7845.000        | 38.87          | 7.49           | 46.36           | 74.00          | -27.64      | peak   |
| 3   | 9390.000        | 37.04          | 10.07          | 47.11           | 74.00          | -26.89      | peak   |
| 4   | 12375.000       | 34.84          | 16.85          | 51.69           | 74.00          | -22.31      | peak   |
| 5   | 13860.000       | 33.06          | 18.71          | 51.77           | 74.00          | -22.23      | peak   |
| 6   | 17857.500       | 28.16          | 23.01          | 51.17           | 74.00          | -22.83      | peak   |

- Note: 1. Peak Result = Reading Level + Correct Factor.  
 2. If Peak Result complies with AV limit, AV Result is deemed to comply with AV limit.  
 3. Peak: Peak detector.  
 4. Filter losses were only considered in the spurious frequency bands and the authorized band was not corrected for High Pass Filter losses.  
 5. Proper operation of the transmitter prior to adding the filter to the measurement chain.



### 8.4. SPURIOUS EMISSIONS (18 GHz ~ 26 GHz)

#### 8.4.1. 8DPSK MODE

##### SPURIOUS EMISSIONS (HIGHT CHANNEL, WORST-CASE CONFIGURATION, HORIZONTAL)

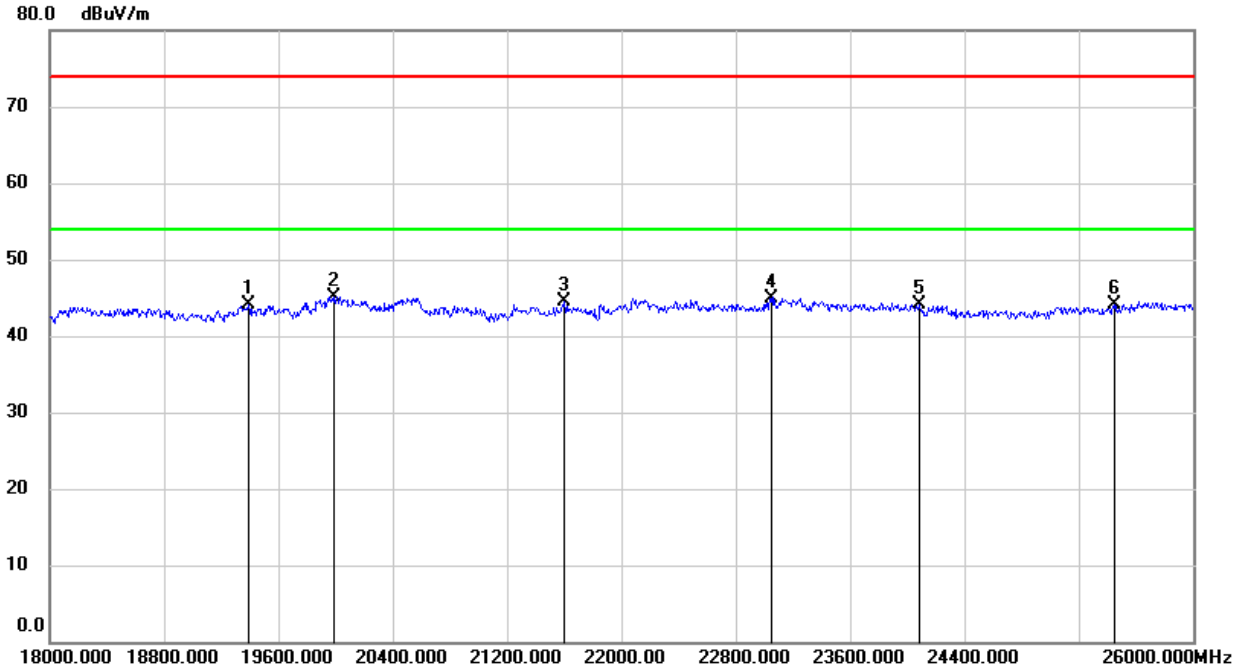

| No. | Frequency (MHz) | Reading (dBuV) | Correct (dB/m) | Result (dBuV/m) | Limit (dBuV/m) | Margin (dB) | Remark |
|-----|-----------------|----------------|----------------|-----------------|----------------|-------------|--------|
| 1   | 19392.000       | 49.62          | -5.57          | 44.05           | 74.00          | -29.95      | peak   |
| 2   | 19992.000       | 50.65          | -5.45          | 45.20           | 74.00          | -28.80      | peak   |
| 3   | 21600.000       | 49.02          | -4.54          | 44.48           | 74.00          | -29.52      | peak   |
| 4   | 23048.000       | 48.43          | -3.43          | 45.00           | 74.00          | -29.00      | peak   |
| 5   | 24080.000       | 46.80          | -2.78          | 44.02           | 74.00          | -29.98      | peak   |
| 6   | 25448.000       | 45.83          | -1.76          | 44.07           | 74.00          | -29.93      | peak   |

- Note: 1. Peak Result = Reading Level + Correct Factor.  
 2. If Peak Result complies with AV limit, AV Result is deemed to comply with AV limit.  
 3. Peak: Peak detector.



**SPURIOUS EMISSIONS (HIGHT CHANNEL, WORST-CASE CONFIGURATION, VERTICAL)**

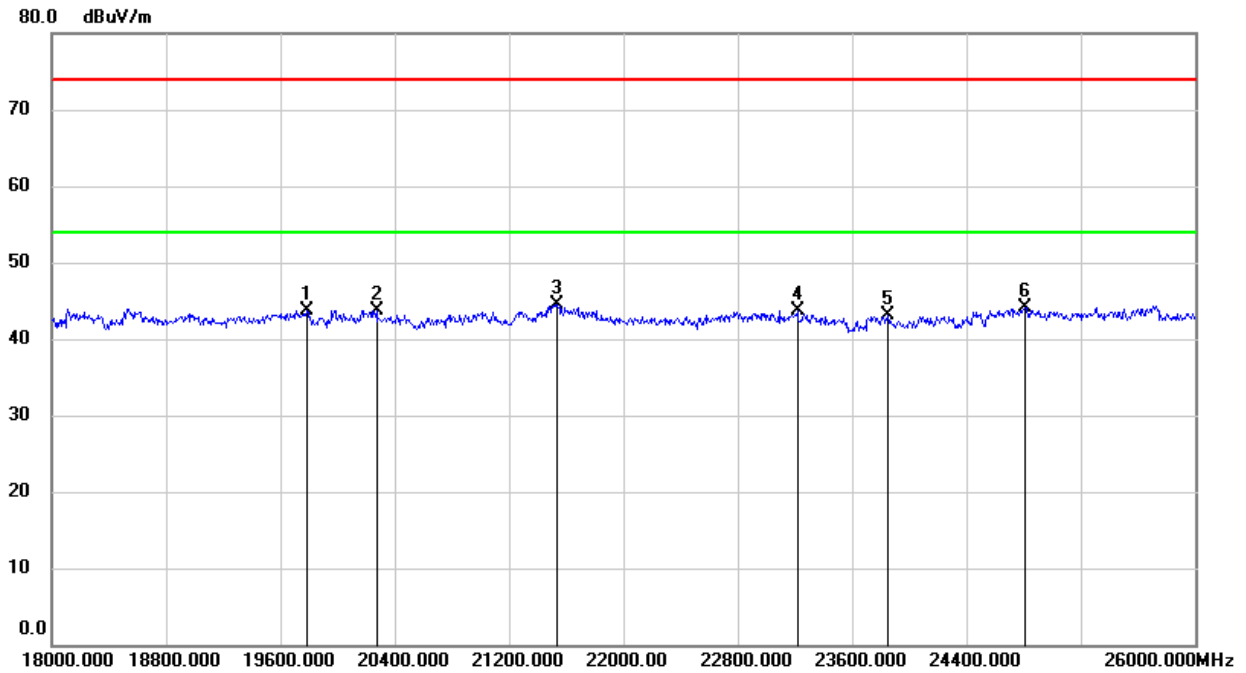

| No. | Frequency (MHz) | Reading (dBuV) | Correct (dB/m) | Result (dBuV/m) | Limit (dBuV/m) | Margin (dB) | Remark |
|-----|-----------------|----------------|----------------|-----------------|----------------|-------------|--------|
| 1   | 19784.000       | 49.07          | -5.28          | 43.79           | 74.00          | -30.21      | peak   |
| 2   | 20272.000       | 49.27          | -5.60          | 43.67           | 74.00          | -30.33      | peak   |
| 3   | 21536.000       | 49.18          | -4.64          | 44.54           | 74.00          | -29.46      | peak   |
| 4   | 23216.000       | 47.01          | -3.38          | 43.63           | 74.00          | -30.37      | peak   |
| 5   | 23848.000       | 46.18          | -3.03          | 43.15           | 74.00          | -30.85      | peak   |
| 6   | 24808.000       | 46.43          | -2.27          | 44.16           | 74.00          | -29.84      | peak   |

Note: 1. Peak Result = Reading Level + Correct Factor.  
 2. If Peak Result complies with AV limit, AV Result is deemed to comply with AV limit.  
 3. Peak: Peak detector.

Note: All the modes have been tested, only the worst data was recorded in the report.

## 8.5. SPURIOUS EMISSIONS (30 MHz ~ 1 GHz)

### 8.5.1. 8DPSK MODE

#### SPURIOUS EMISSIONS (HIGHT CHANNEL, WORST-CASE CONFIGURATION, HORIZONTAL)

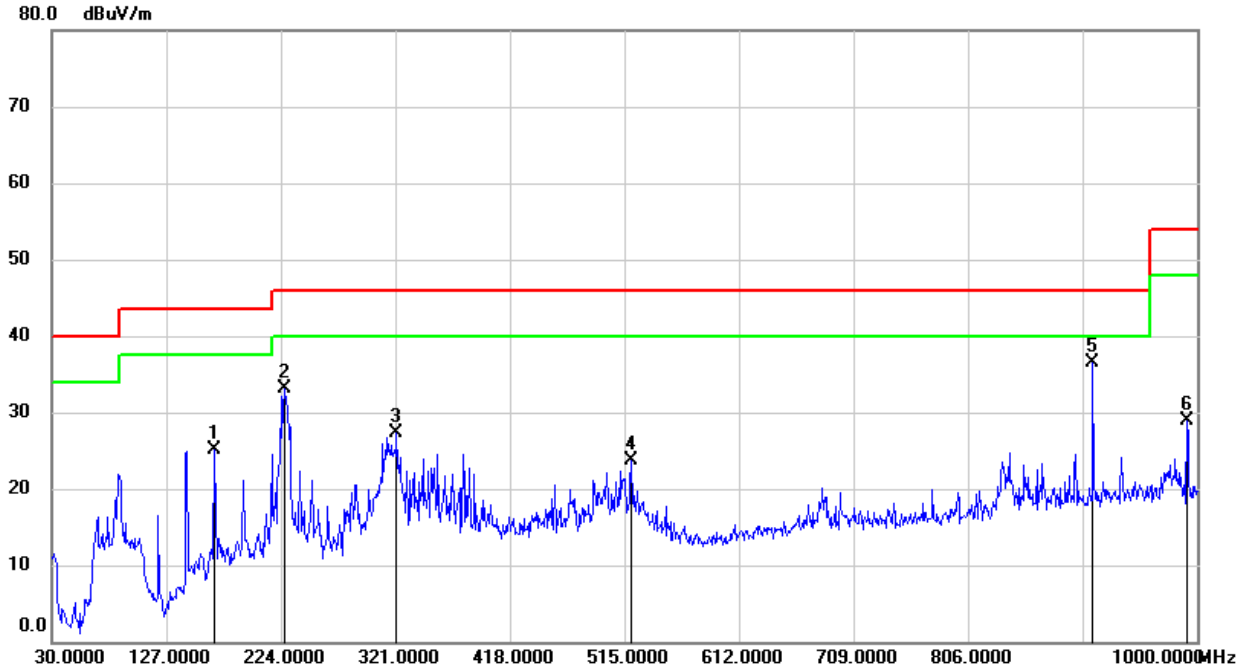

| No. | Frequency (MHz) | Reading (dBuV) | Correct (dB/m) | Result (dBuV/m) | Limit (dBuV/m) | Margin (dB) | Remark |
|-----|-----------------|----------------|----------------|-----------------|----------------|-------------|--------|
| 1   | 167.7400        | 42.49          | -17.41         | 25.08           | 43.50          | -18.42      | QP     |
| 2   | 226.9100        | 51.60          | -18.51         | 33.09           | 46.00          | -12.91      | QP     |
| 3   | 321.9700        | 42.04          | -14.75         | 27.29           | 46.00          | -18.71      | QP     |
| 4   | 520.8200        | 34.72          | -11.07         | 23.65           | 46.00          | -22.35      | QP     |
| 5   | 911.7300        | 41.50          | -4.93          | 36.57           | 46.00          | -9.43       | QP     |
| 6   | 991.2700        | 33.25          | -4.26          | 28.99           | 54.00          | -25.01      | QP     |

- Note: 1. Result Level = Read Level + Antenna Factor + Cable loss.  
 2. If Peak Result complies with QP limit, QP Result is deemed to comply with QP limit.  
 3. Test setup: RBW: 120 kHz, VBW: 300 kHz, Sweep time: auto.



**SPURIOUS EMISSIONS (HIGHT CHANNEL, WORST-CASE CONFIGURATION, VERTICAL)**

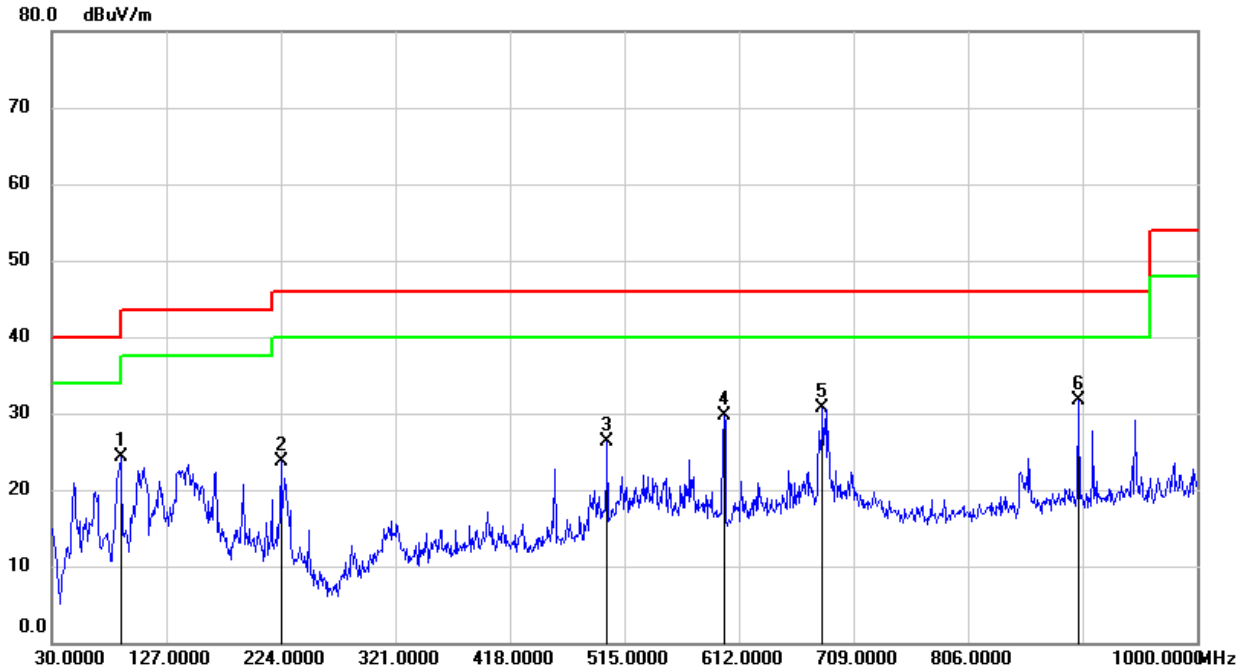

| No. | Frequency (MHz) | Reading (dBuV) | Correct (dB/m) | Result (dBuV/m) | Limit (dBuV/m) | Margin (dB) | Remark |
|-----|-----------------|----------------|----------------|-----------------|----------------|-------------|--------|
| 1   | 88.2000         | 46.06          | -21.85         | 24.21           | 43.50          | -19.29      | QP     |
| 2   | 224.0000        | 41.98          | -18.37         | 23.61           | 46.00          | -22.39      | QP     |
| 3   | 500.4500        | 37.83          | -11.46         | 26.37           | 46.00          | -19.63      | QP     |
| 4   | 599.3900        | 39.25          | -9.56          | 29.69           | 46.00          | -16.31      | QP     |
| 5   | 682.8100        | 39.29          | -8.52          | 30.77           | 46.00          | -15.23      | QP     |
| 6   | 899.1200        | 36.92          | -5.21          | 31.71           | 46.00          | -14.29      | QP     |

- Note: 1. Result Level = Read Level + Antenna Factor + Cable loss.  
 2. If Peak Result complies with QP limit, QP Result is deemed to comply with QP limit.  
 3. Test setup: RBW: 120 kHz, VBW: 300 kHz, Sweep time: auto

Note: All the modes have been tested, only the worst data was recorded in the report.

## 8.6. SPURIOUS EMISSIONS BELOW 30 MHz

### 8.6.1. 8DPSK MODE

(HIGHT CHANNEL, LOOP ANTENNA FACE ON TO THE EUT, WORST-CASE CONFIGURATION)

9 kHz ~ 150 kHz

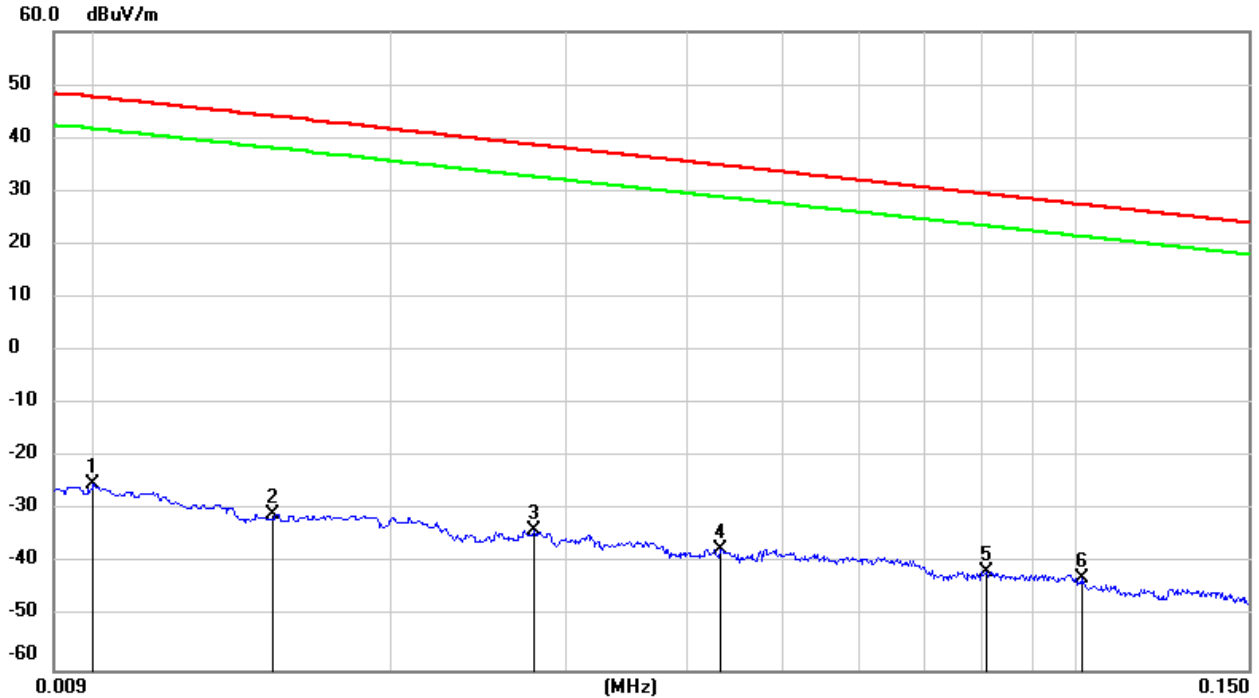

| No. | Frequency<br>(MHz) | Reading<br>(dBuV) | Correct<br>(dB/m) | FCC<br>Result<br>(dBuV/m) | FCC Limit<br>(dBuV/m) | ISED<br>Result<br>(dBuA/m) | ISED<br>Limit<br>(dBuA/m) | Margin<br>(dB) | Remark |
|-----|--------------------|-------------------|-------------------|---------------------------|-----------------------|----------------------------|---------------------------|----------------|--------|
| 1   | 0.0100             | 76.22             | -101.40           | -25.18                    | 47.6                  | -76.68                     | -3.90                     | -72.78         | peak   |
| 2   | 0.0151             | 70.71             | -101.37           | -30.66                    | 44.02                 | -82.16                     | -7.48                     | -74.68         | peak   |
| 3   | 0.0279             | 67.67             | -101.38           | -33.71                    | 38.69                 | -85.21                     | -12.81                    | -72.40         | peak   |
| 4   | 0.0432             | 64.07             | -101.45           | -37.38                    | 34.89                 | -88.88                     | -16.61                    | -72.27         | peak   |
| 5   | 0.0806             | 60.18             | -101.63           | -41.45                    | 29.47                 | -92.95                     | -22.03                    | -70.92         | peak   |
| 6   | 0.1014             | 59.06             | -101.79           | -42.73                    | 27.48                 | -94.23                     | -24.02                    | -70.21         | peak   |

Note: 1. Measurement = Reading Level + Correct Factor (dBuA/m= dBuV/m- 20Log10[120π] = dBuV/m- 51.5).

2. If Peak Result complies with AV and QP limit, AV and QP Result are deemed to comply with AV limit.

3. All 3 polarizations(Horizontal, Face-on and Face-off) of the loop antenna had been tested, but only the worst data recorded in the report.



**150 kHz ~ 490 kHz**

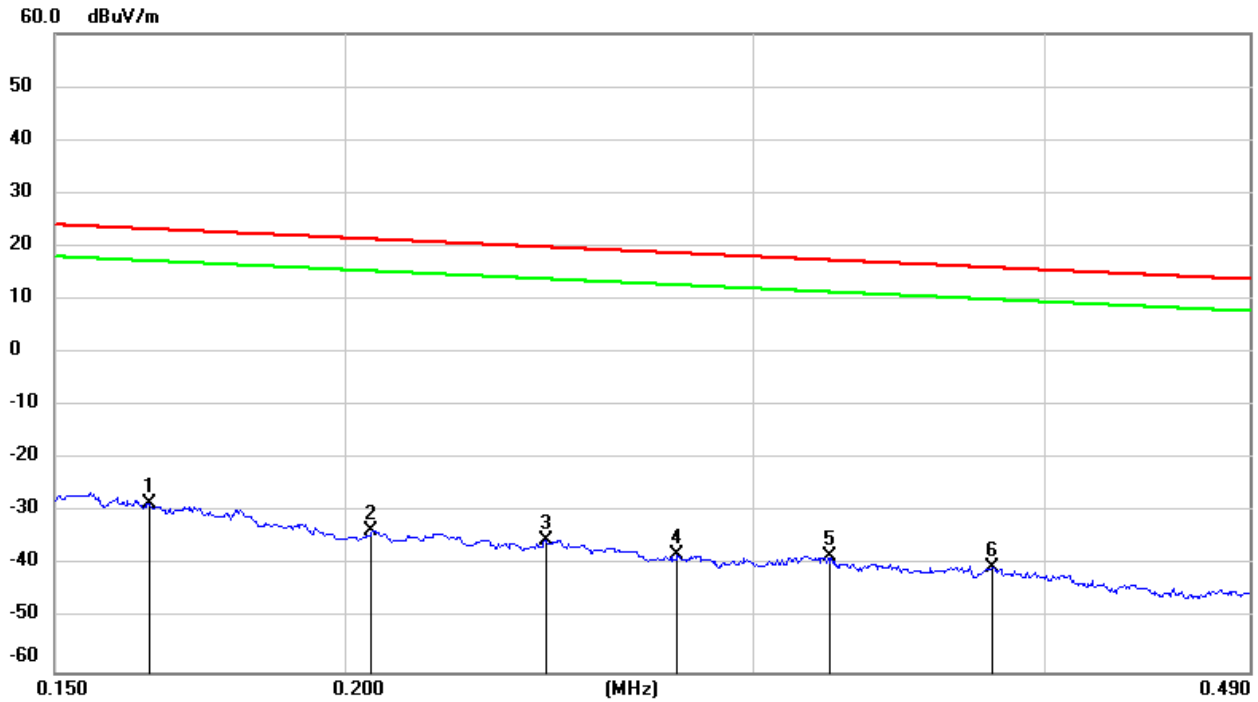

| No. | Frequency<br>(MHz) | Reading<br>(dBuV) | Correct<br>(dB/m) | FCC<br>Result<br>(dBuV/m) | FCC<br>Limit<br>(dBuV/m) | ISED<br>Result<br>(dBuA/m) | ISED<br>Limit<br>(dBuA/m) | Margin<br>(dB) | Remark |
|-----|--------------------|-------------------|-------------------|---------------------------|--------------------------|----------------------------|---------------------------|----------------|--------|
| 1   | 0.1647             | 73.26             | -101.66           | -28.4                     | 23.27                    | -79.90                     | -28.23                    | -51.67         | peak   |
| 2   | 0.2053             | 68.29             | -101.73           | -33.44                    | 21.35                    | -84.94                     | -30.15                    | -54.79         | peak   |
| 3   | 0.2442             | 66.53             | -101.79           | -35.26                    | 19.85                    | -86.76                     | -31.65                    | -55.11         | peak   |
| 4   | 0.2782             | 63.79             | -101.83           | -38.04                    | 18.71                    | -89.54                     | -32.79                    | -56.75         | peak   |
| 5   | 0.3234             | 63.48             | -101.88           | -38.4                     | 17.41                    | -89.90                     | -34.09                    | -55.81         | peak   |
| 6   | 0.3800             | 61.52             | -101.94           | -40.42                    | 16.01                    | -91.92                     | -35.49                    | -56.43         | peak   |

Note: 1. Measurement = Reading Level + Correct Factor (dBuA/m= dBuV/m- 20Log10[120π] = dBuV/m- 51.5).

2. If Peak Result complies with AV and QP limit, AV and QP Result are deemed to comply with AV limit.

3. All 3 polarizations(Horizontal, Face-on and Face-off) of the loop antenna had been tested, but only the worst data recorded in the report.

**490 kHz ~ 30 MHz**

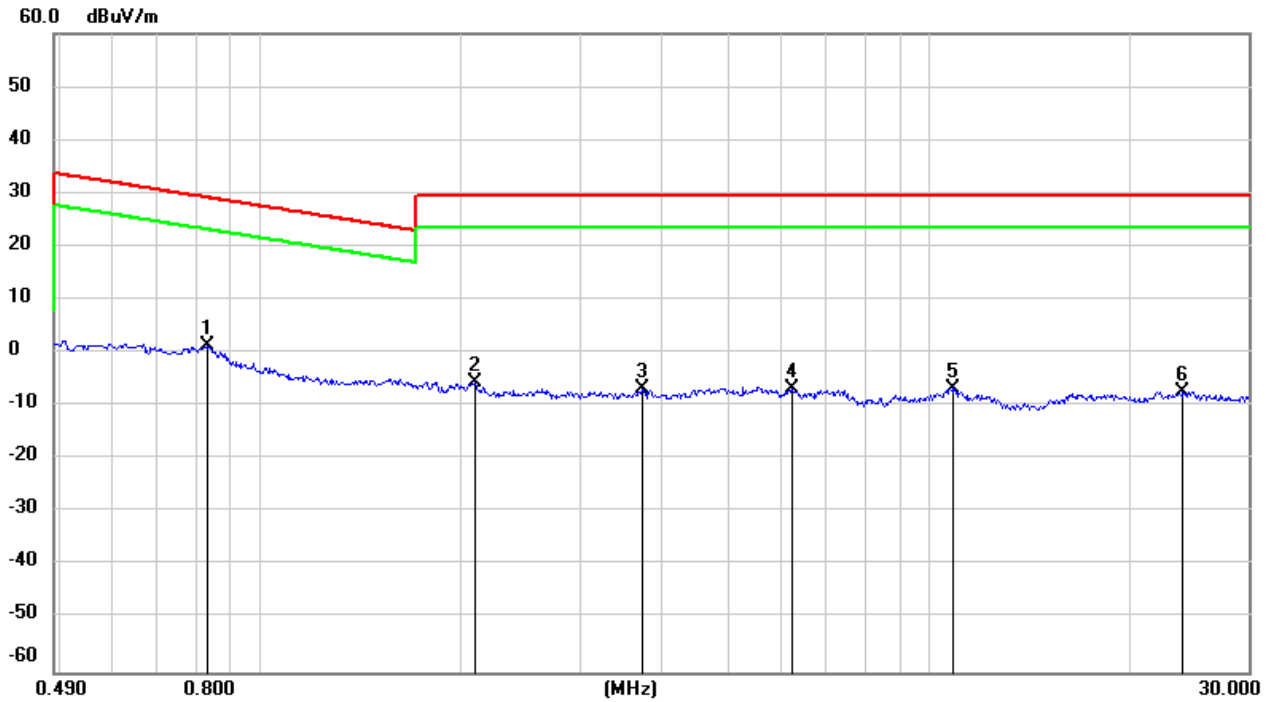

| No. | Frequency<br>(MHz) | Reading<br>(dBuV) | Correct<br>(dB/m) | FCC Result<br>(dBuV/m) | FCC Limit<br>(dBuV/m) | ISED Result<br>(dBuA/m) | ISED Limit<br>(dBuA/m) | Margin<br>(dB) | Remark |
|-----|--------------------|-------------------|-------------------|------------------------|-----------------------|-------------------------|------------------------|----------------|--------|
| 1   | 0.8296             | 63.44             | -62.17            | 1.27                   | 29.23                 | -50.23                  | -22.27                 | -27.96         | peak   |
| 2   | 2.0939             | 56.39             | -61.79            | -5.4                   | 29.54                 | -56.90                  | -21.96                 | -34.94         | peak   |
| 3   | 3.7100             | 54.70             | -61.41            | -6.71                  | 29.54                 | -58.21                  | -21.96                 | -36.25         | peak   |
| 4   | 6.2445             | 54.63             | -61.32            | -6.69                  | 29.54                 | -58.19                  | -21.96                 | -36.23         | peak   |
| 5   | 10.8772            | 54.24             | -60.84            | -6.6                   | 29.54                 | -58.10                  | -21.96                 | -36.14         | peak   |
| 6   | 23.9800            | 53.17             | -60.53            | -7.36                  | 29.54                 | -58.86                  | -21.96                 | -36.90         | peak   |

Note: 1. Measurement = Reading Level + Correct Factor (dBuA/m= dBuV/m- 20Log10[120π] = dBuV/m- 51.5).

2. If Peak Result complies with AV and QP limit, AV and QP Result are deemed to comply with AV limit.

3. All 3 polarizations(Horizontal, Face-on and Face-off) of the loop antenna had been tested, but only the worst data recorded in the report.

Note: All the modes have been tested, only the worst data was recorded in the report.

## 9. AC POWER LINE CONDUCTED EMISSIONS

### LIMITS

Please refer to CFR 47 FCC §15.207 (a) and ISED RSS-Gen Clause 8.8

| FREQUENCY (MHz) | Quasi-peak | Average   |
|-----------------|------------|-----------|
| 0.15 -0.5       | 66 - 56 *  | 56 - 46 * |
| 0.50 -5.0       | 56.00      | 46.00     |
| 5.0 -30.0       | 60.00      | 50.00     |

### TEST SETUP AND PROCEDURE

Refer to ANSI C63.10-2013 clause 6.2.

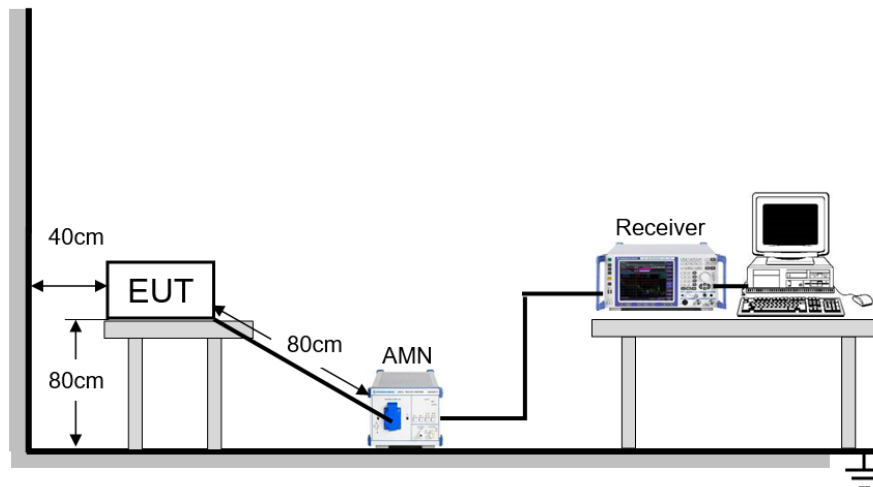

The EUT is put on a table of non-conducting material that is 80 cm high. The vertical conducting wall of shielding is located 40 cm to the rear of the EUT. The power line of the EUT is connected to the AC mains through a Artificial Mains Network (A.M.N.). A EMI Measurement Receiver (R&S Test Receiver ESR3) is used to test the emissions from both sides of AC line. According to the requirements in Section 6.2 of ANSI C63.10-2013. Conducted emissions from the EUT measured in the frequency range between 0.15 MHz and 30 MHz using CISPR Quasi-Peak and average detector mode. The bandwidth of EMI test receiver is set at 9 kHz.

The arrangement of the equipment is installed to meet the standards and operating in a manner, which tends to maximize its emission characteristics in a normal application.

### TEST ENVIRONMENT

|                     |         |                   |                |
|---------------------|---------|-------------------|----------------|
| Temperature         | 20.6 °C | Relative Humidity | 62.1 %         |
| Atmosphere Pressure | 101 kPa | Test Voltage      | AC 120 V/60 Hz |





**TEST RESULTS**

**9.1. 8DPSK MODE**

**LINE L RESULTS (HIGHT CHANNEL, WORST-CASE CONFIGURATION)**

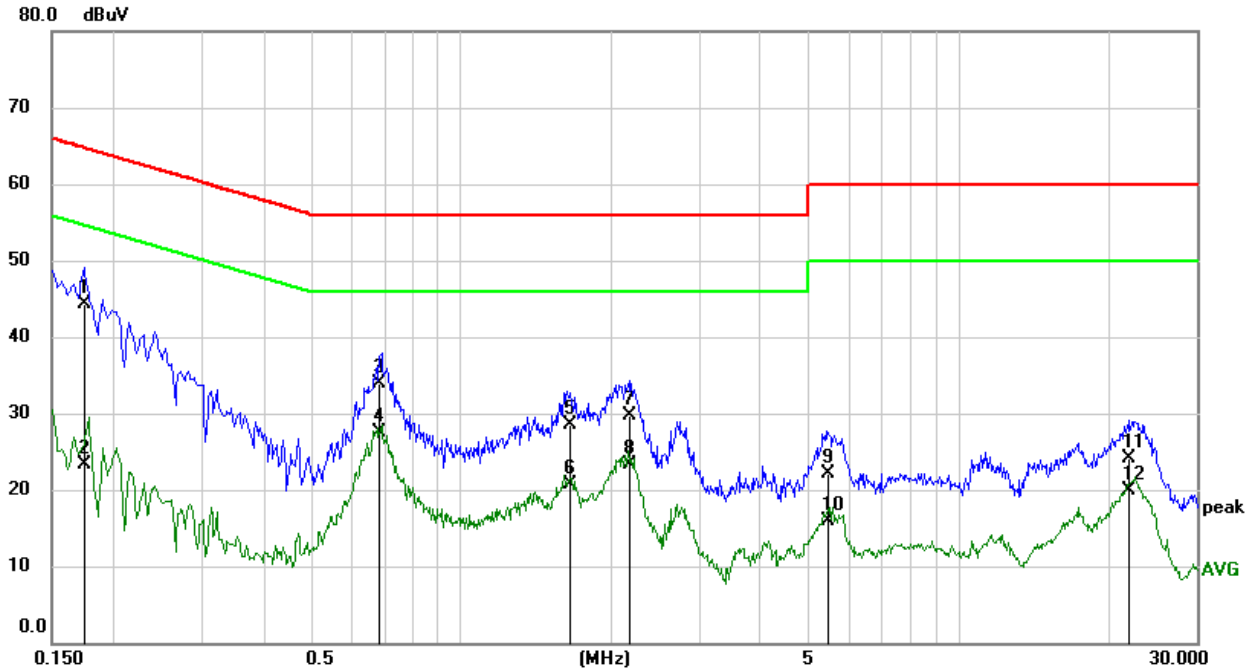

| No. | Frequency (MHz) | Reading (dBuV) | Correct (dB) | Result (dBuV) | Limit (dBuV) | Margin (dB) | Remark |
|-----|-----------------|----------------|--------------|---------------|--------------|-------------|--------|
| 1   | 0.1742          | 34.70          | 9.59         | 44.29         | 64.76        | -20.47      | QP     |
| 2   | 0.1742          | 13.74          | 9.59         | 23.33         | 54.76        | -31.43      | AVG    |
| 3   | 0.6837          | 24.25          | 9.58         | 33.83         | 56.00        | -22.17      | QP     |
| 4   | 0.6837          | 17.88          | 9.58         | 27.46         | 46.00        | -18.54      | AVG    |
| 5   | 1.6417          | 18.91          | 9.62         | 28.53         | 56.00        | -27.47      | QP     |
| 6   | 1.6417          | 11.09          | 9.62         | 20.71         | 46.00        | -25.29      | AVG    |
| 7   | 2.1738          | 20.09          | 9.63         | 29.72         | 56.00        | -26.28      | QP     |
| 8   | 2.1738          | 13.67          | 9.63         | 23.30         | 46.00        | -22.70      | AVG    |
| 9   | 5.4934          | 12.44          | 9.63         | 22.07         | 60.00        | -37.93      | QP     |
| 10  | 5.4934          | 6.31           | 9.63         | 15.94         | 50.00        | -34.06      | AVG    |
| 11  | 22.0626         | 14.46          | 9.74         | 24.20         | 60.00        | -35.80      | QP     |
| 12  | 22.0626         | 10.22          | 9.74         | 19.96         | 50.00        | -30.04      | AVG    |

- Note: 1. Result = Reading + Correct Factor.  
 2. If QP Result complies with AV limit, AV Result is deemed to comply with AV limit.  
 3. Test setup: RBW: 200 Hz (9 kHz ~ 150 kHz), 9 kHz (150 kHz ~ 30 MHz).  
 4. Step size: 80 Hz (0.009 MHz ~ 0.15 MHz), 4 kHz (0.15 MHz ~ 30 MHz), Scan time: auto.

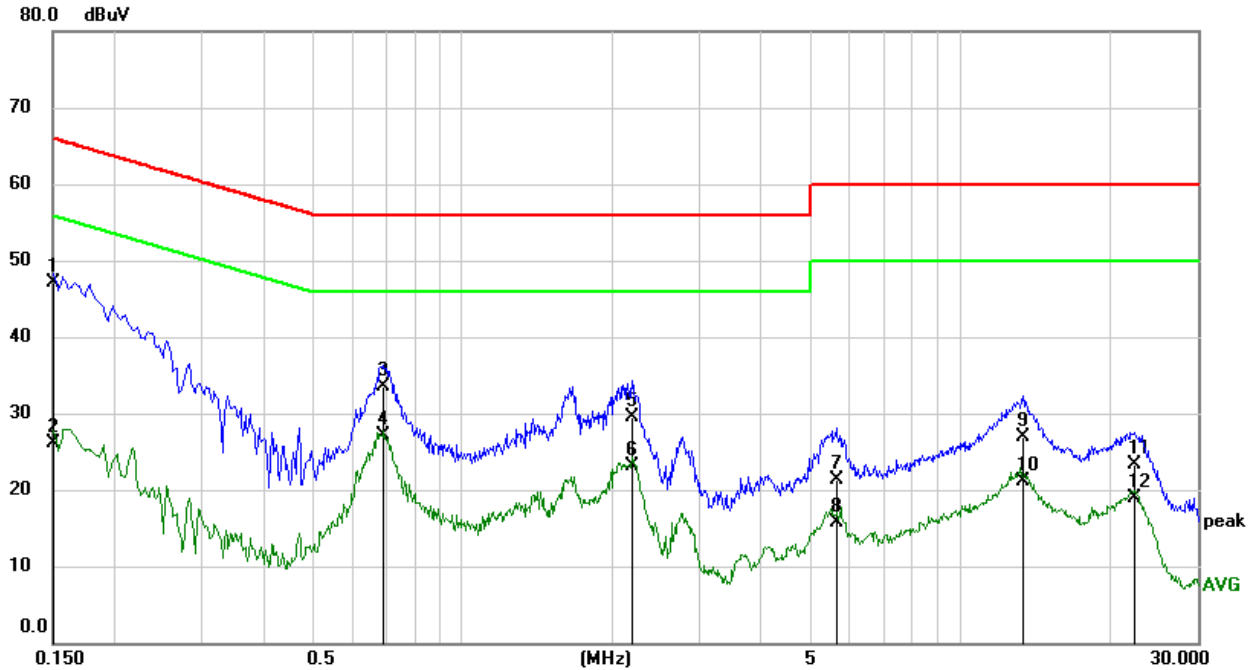
**LINE N RESULTS (HIGHT CHANNEL, WORST-CASE CONFIGURATION)**

| No. | Frequency (MHz) | Reading (dBuV) | Correct (dB) | Result (dBuV) | Limit (dBuV) | Margin (dB) | Remark |
|-----|-----------------|----------------|--------------|---------------|--------------|-------------|--------|
| 1   | 0.1502          | 37.56          | 9.49         | 47.05         | 65.99        | -18.94      | QP     |
| 2   | 0.1502          | 16.67          | 9.49         | 26.16         | 55.99        | -29.83      | AVG    |
| 3   | 0.6914          | 24.02          | 9.50         | 33.52         | 56.00        | -22.48      | QP     |
| 4   | 0.6914          | 17.69          | 9.50         | 27.19         | 46.00        | -18.81      | AVG    |
| 5   | 2.1891          | 19.83          | 9.63         | 29.46         | 56.00        | -26.54      | QP     |
| 6   | 2.1891          | 13.51          | 9.63         | 23.14         | 46.00        | -22.86      | AVG    |
| 7   | 5.6376          | 11.96          | 9.30         | 21.26         | 60.00        | -38.74      | QP     |
| 8   | 5.6376          | 6.39           | 9.30         | 15.69         | 50.00        | -34.31      | AVG    |
| 9   | 13.3400         | 17.27          | 9.66         | 26.93         | 60.00        | -33.07      | QP     |
| 10  | 13.3400         | 11.35          | 9.66         | 21.01         | 50.00        | -28.99      | AVG    |
| 11  | 22.4072         | 13.45          | 9.76         | 23.21         | 60.00        | -36.79      | QP     |
| 12  | 22.4072         | 9.21           | 9.76         | 18.97         | 50.00        | -31.03      | AVG    |

Note: 1. Result = Reading + Correct Factor.

2. If QP Result complies with AV limit, AV Result is deemed to comply with AV limit.

3. Test setup: RBW: 200 Hz (9 kHz ~ 150 kHz), 9 kHz (150 kHz ~ 30 MHz).

4. Step size: 80 Hz (0.009 MHz ~ 0.15 MHz), 4 kHz (0.15 MHz ~ 30 MHz), Scan time: auto.

Note: All the modes have been tested, only the worst data was recorded in the report.



## 10. ANTENNA REQUIREMENTS

### APPLICABLE REQUIREMENTS

Please refer to FCC §15.203

An intentional radiator shall be designed to ensure that no antenna other than that furnished by the responsible party shall be used with the device. The use of a permanently attached antenna or of an antenna that uses a unique coupling to the intentional radiator shall be considered sufficient to comply with the provisions of this section. The manufacturer may design the unit so that a broken antenna can be replaced by the user, but the use of a standard antenna jack or electrical connector is prohibited.

Please refer to FCC §15.247(b)(4)

The conducted output power limit specified in paragraph (b) of this section is based on the use of antennas with directional gains that do not exceed 6 dBi. Except as shown in paragraph (c) of this section, if transmitting antennas of directional gain greater than 6 dBi are used, the conducted output power from the intentional radiator shall be reduced below the stated values in paragraphs (b)(1), (b)(2), and (b)(3) of this section, as appropriate, by the amount in dB that the directional gain of the antenna exceeds 6 dBi.

### RESULTS

Complies



## 11. Appendix

### 11.1. Appendix A: 20dB Emission Bandwidth

#### 11.1.1. Test Result

| Test Mode | Antenna | Channel | 20db EBW[MHz] | FL[MHz] | FH[MHz] | Verdict |
|-----------|---------|---------|---------------|---------|---------|---------|
| DH5       | Ant1    | 2402    | 0.94          | 2401.54 | 2402.48 | PASS    |
|           |         | 2441    | 0.94          | 2440.54 | 2441.48 | PASS    |
|           |         | 2480    | 0.94          | 2479.54 | 2480.48 | PASS    |
| 3DH5      | Ant1    | 2402    | 1.29          | 2401.35 | 2402.64 | PASS    |
|           |         | 2441    | 1.30          | 2440.35 | 2441.65 | PASS    |
|           |         | 2480    | 1.29          | 2479.35 | 2480.64 | PASS    |

### 11.1.2. Test Graphs

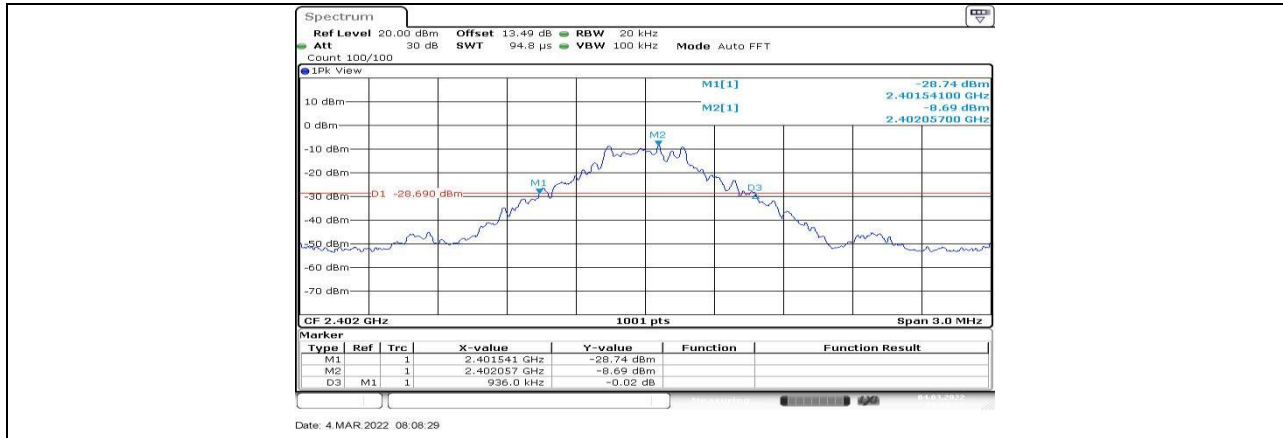

DH5\_Ant1\_2402

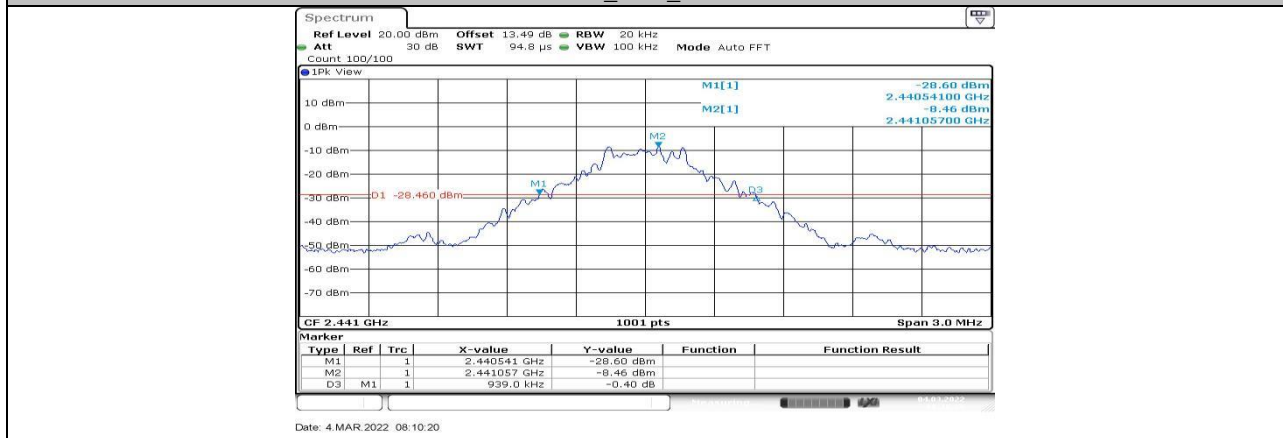

DH5\_Ant1\_2441



DH5\_Ant1\_2480



3DH5\_Ant1\_2402

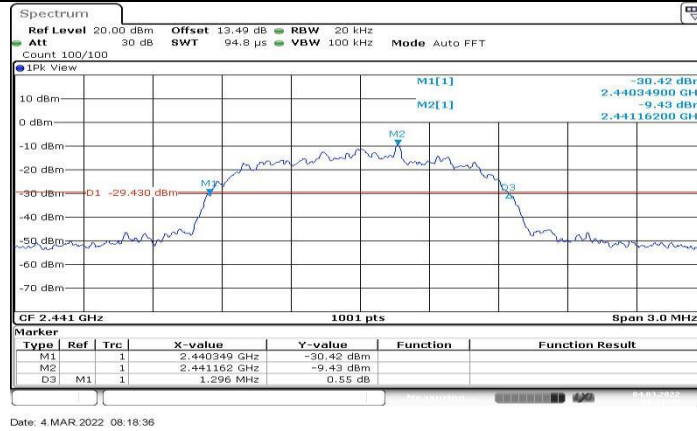

3DH5\_Ant1\_2441

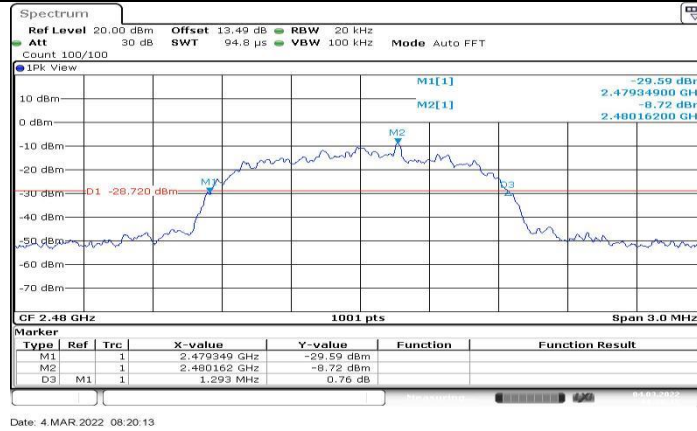

3DH5\_Ant1\_2480



## 11.2. Appendix B: Occupied Channel Bandwidth

### 11.2.1. Test Result

| Test Mode | Antenna | Channel | OCB [MHz] | FL[MHz]  | FH[MHz]  | Verdict |
|-----------|---------|---------|-----------|----------|----------|---------|
| DH5       | Ant1    | 2402    | 0.851     | 2401.571 | 2402.423 | PASS    |
|           |         | 2441    | 0.854     | 2440.568 | 2441.423 | PASS    |
|           |         | 2480    | 0.851     | 2479.571 | 2480.423 | PASS    |
| 3DH5      | Ant1    | 2402    | 1.187     | 2401.404 | 2402.590 | PASS    |
|           |         | 2441    | 1.19      | 2440.401 | 2441.590 | PASS    |
|           |         | 2480    | 1.19      | 2479.401 | 2480.590 | PASS    |



### 11.2.2. Test Graphs

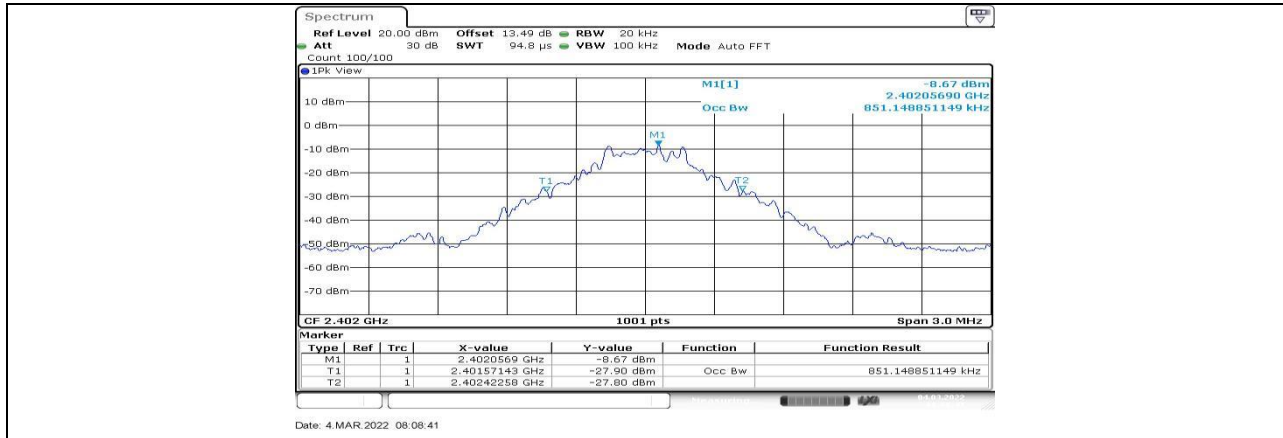

DH5\_Ant1\_2402

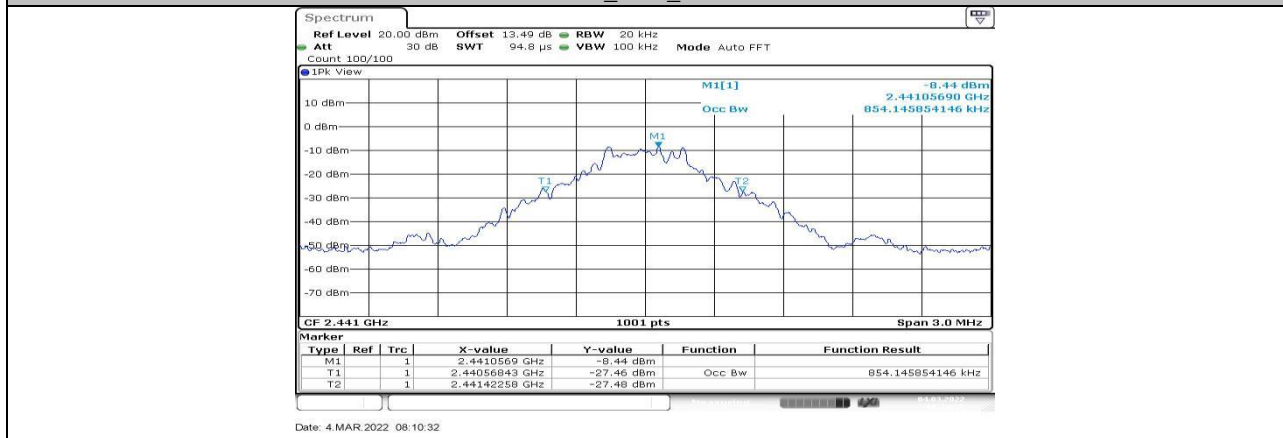

DH5\_Ant1\_2441

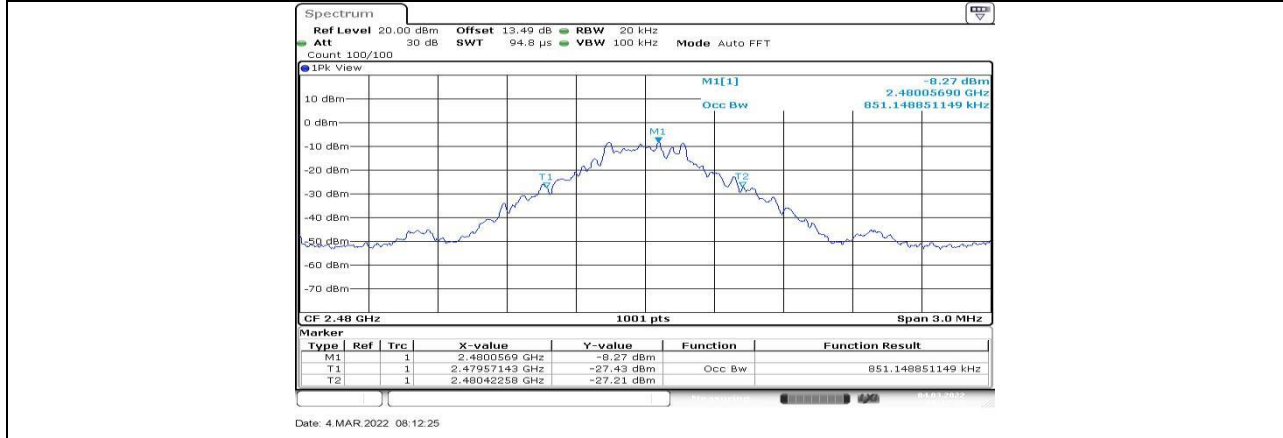

DH5\_Ant1\_2480



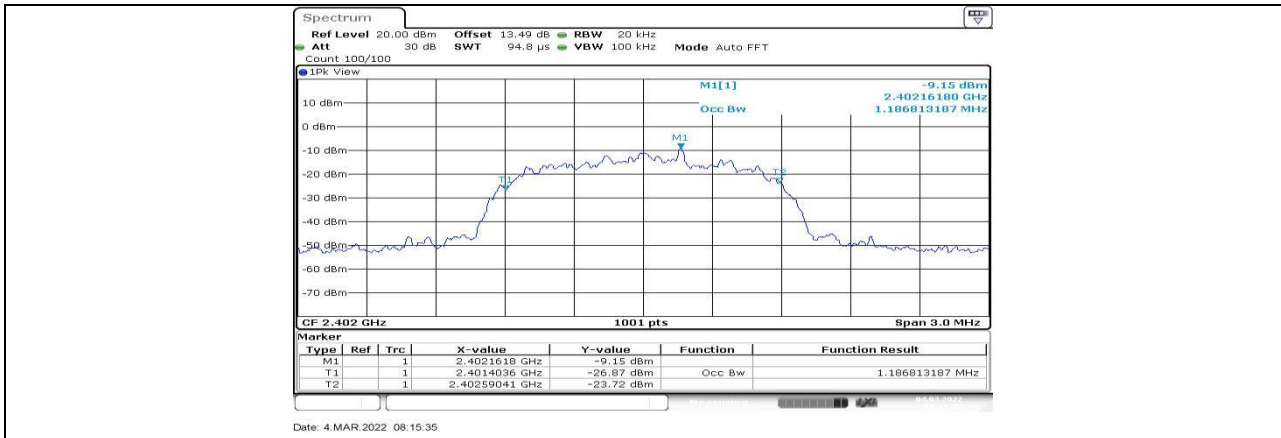

3DH5\_Ant1\_2402

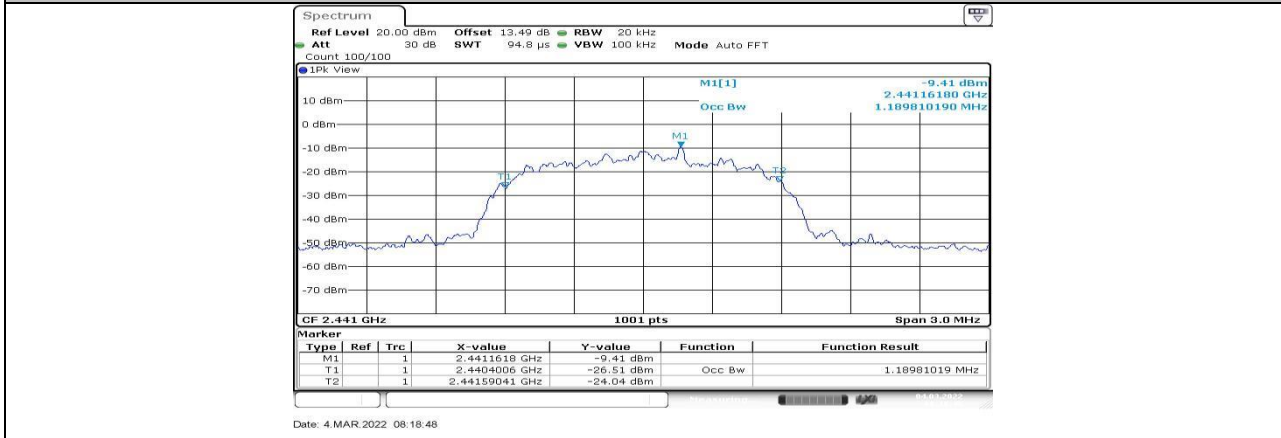

3DH5\_Ant1\_2441

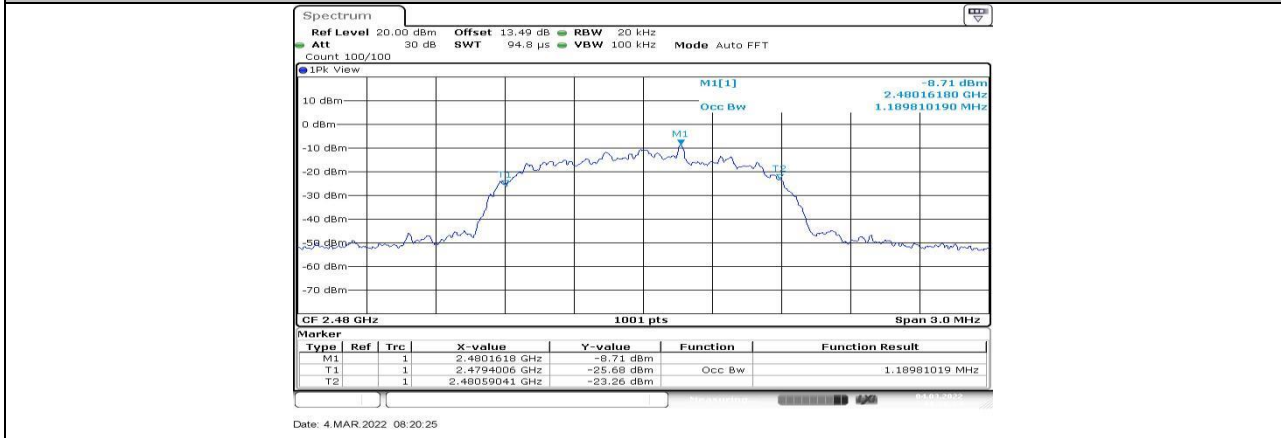

3DH5\_Ant1\_2480



### 11.3. Appendix C: Maximum Peak Conducted Output Power

#### 11.3.1. Test Result

| Test Mode | Antenna | Channel | Result[dBm] | Limit[dBm] | Verdict |
|-----------|---------|---------|-------------|------------|---------|
| DH5       | Ant1    | 2402    | -4.71       | ≤30        | PASS    |
|           |         | 2441    | -4.48       | ≤30        | PASS    |
|           |         | 2480    | -4.30       | ≤30        | PASS    |
| 3DH5      | Ant1    | 2402    | -1.99       | ≤20.97     | PASS    |
|           |         | 2441    | -1.75       | ≤20.97     | PASS    |
|           |         | 2480    | -1.51       | ≤20.97     | PASS    |



## 11.4. Appendix D: Carrier Frequency Separation

### 11.4.1. Test Result

| Test Mode | Antenna | Channel | Result[MHz] | Limit[MHz]   | Verdict |
|-----------|---------|---------|-------------|--------------|---------|
| DH5       | Ant1    | Hop     | 1.009       | $\geq 0.940$ | PASS    |
| 3DH5      | Ant1    | Hop     | 1.020       | $\geq 0.867$ | PASS    |

### 11.4.2. Test Graphs

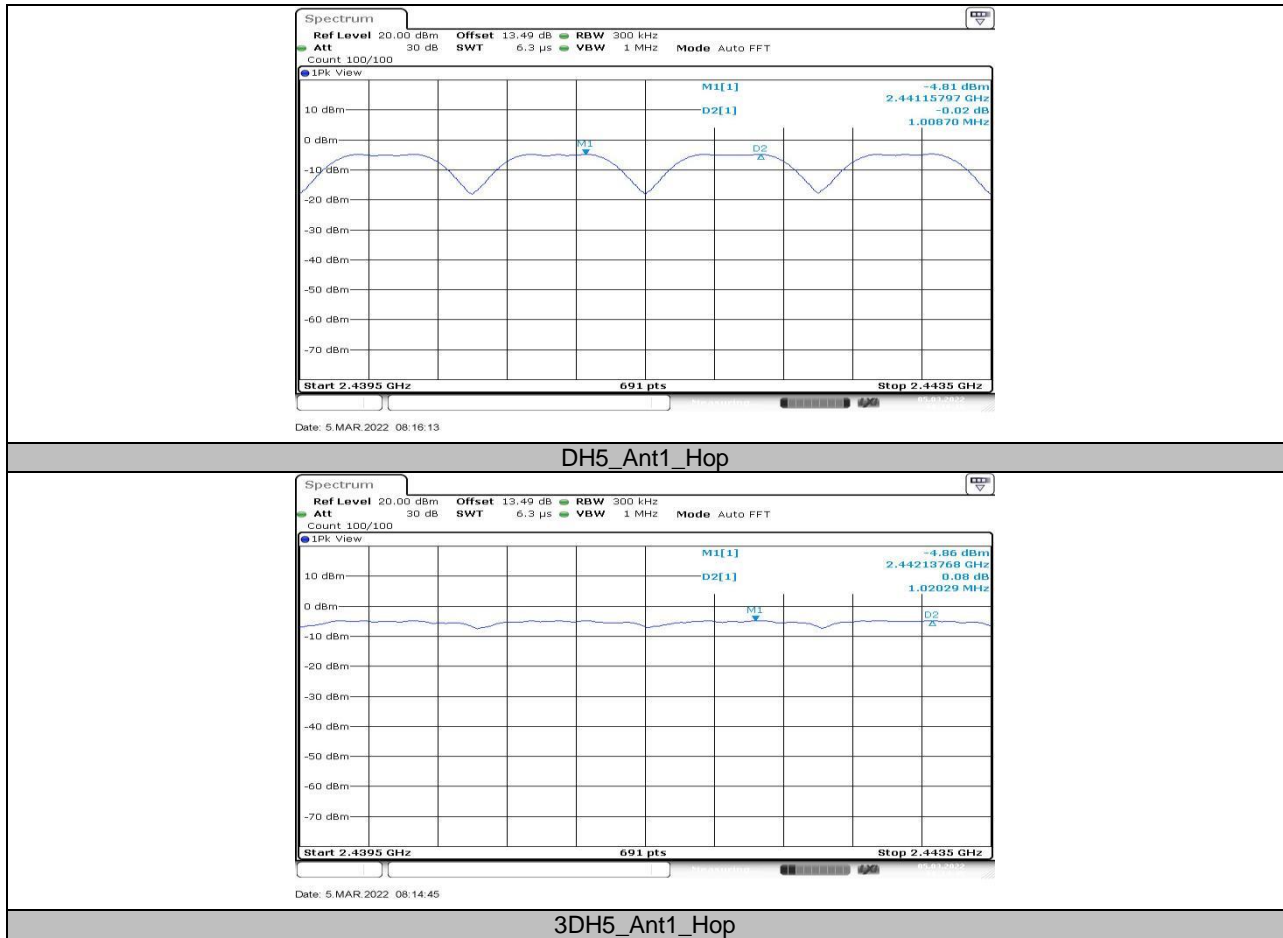

## 11.5. Appendix E: Time of Occupancy

### 11.5.1. Test Result

| FHSS Mode |         |         |             |           |          |         |
|-----------|---------|---------|-------------|-----------|----------|---------|
| Test Mode | Antenna | Channel | Burst Width | Result[s] | Limit[s] | Verdict |
|           |         |         | [ms]        |           |          |         |
| DH1       | Ant1    | Hop     | 0.42        | 0.134     | <=0.4    | PASS    |
| DH3       | Ant1    | Hop     | 1.67        | 0.267     | <=0.4    | PASS    |
| DH5       | Ant1    | Hop     | 2.91        | 0.310     | <=0.4    | PASS    |
| 3DH1      | Ant1    | Hop     | 0.41        | 0.131     | <=0.4    | PASS    |
| 3DH3      | Ant1    | Hop     | 1.65        | 0.264     | <=0.4    | PASS    |
| 3DH5      | Ant1    | Hop     | 2.90        | 0.309     | <=0.4    | PASS    |

| AFHSS Mode |         |         |             |           |          |         |
|------------|---------|---------|-------------|-----------|----------|---------|
| Test Mode  | Antenna | Channel | Burst Width | Result[s] | Limit[s] | Verdict |
|            |         |         | [ms]        |           |          |         |
| DH1        | Ant1    | Hop     | 0.42        | 0.067     | <=0.4    | PASS    |
| DH3        | Ant1    | Hop     | 1.67        | 0.134     | <=0.4    | PASS    |
| DH5        | Ant1    | Hop     | 2.91        | 0.155     | <=0.4    | PASS    |
| 3DH1       | Ant1    | Hop     | 0.41        | 0.066     | <=0.4    | PASS    |
| 3DH3       | Ant1    | Hop     | 1.65        | 0.132     | <=0.4    | PASS    |
| 3DH5       | Ant1    | Hop     | 2.90        | 0.155     | <=0.4    | PASS    |

### 11.5.2. Test Graphs

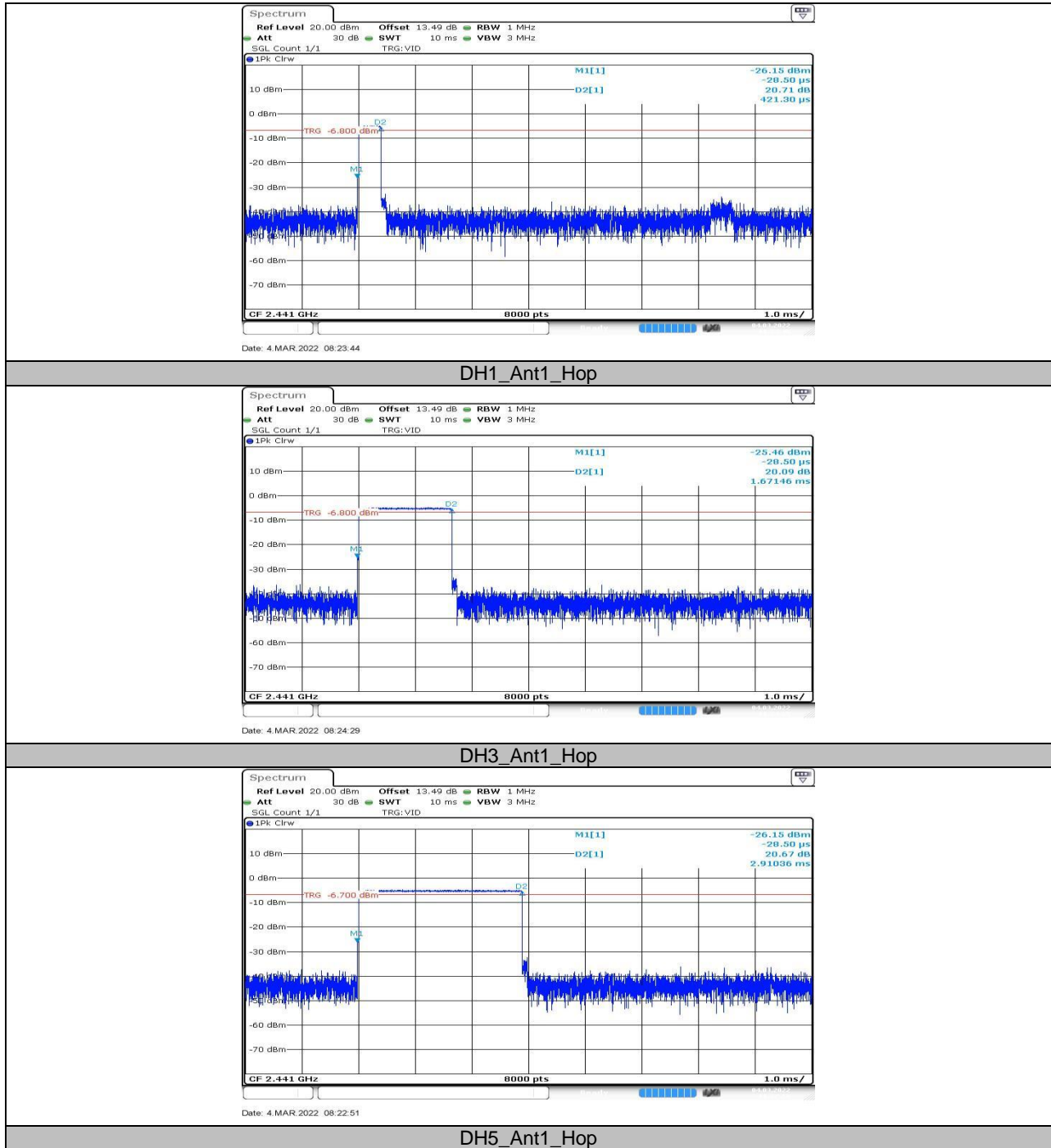

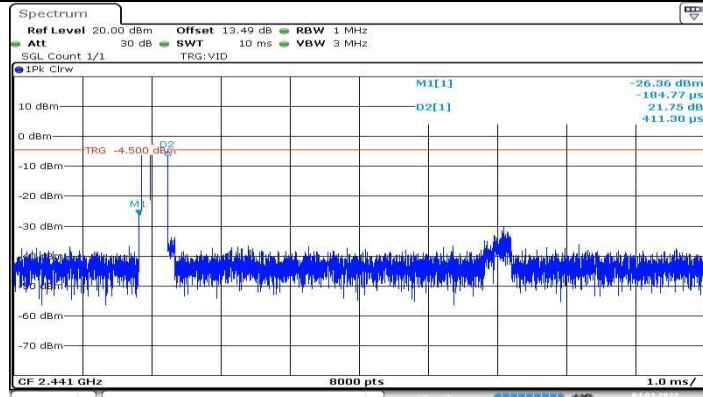

Date: 4.MAR.2022 08:27:23

### 3DH1\_Ant1\_Hop

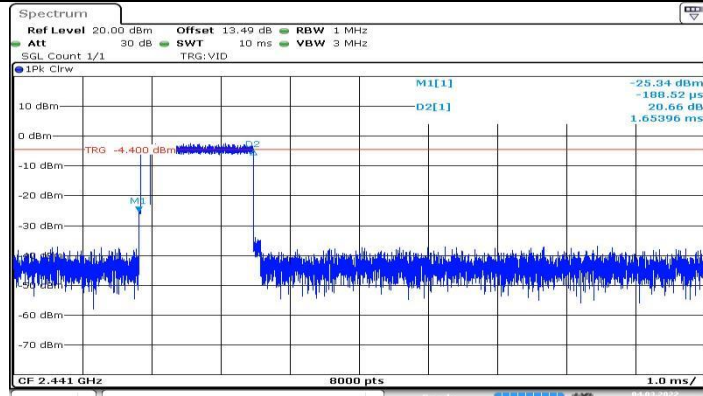

Date: 4.MAR.2022 08:27:59

### 3DH3\_Ant1\_Hop

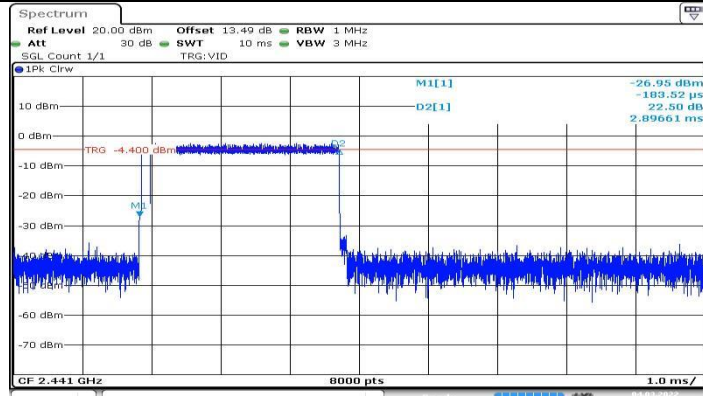

Date: 4.MAR.2022 08:26:33

### 3DH5\_Ant1\_Hop



## 11.6. Appendix F: Number of Hopping Channels

### 11.6.1. Test Result

| Test Mode | Antenna | Channel | Result[Num] | Limit[Num] | Verdict |
|-----------|---------|---------|-------------|------------|---------|
| DH5       | Ant1    | Hop     | 79          | $\geq 15$  | PASS    |
| 3DH5      | Ant1    | Hop     | 79          | $\geq 15$  | PASS    |



### 11.6.2. Test Graphs

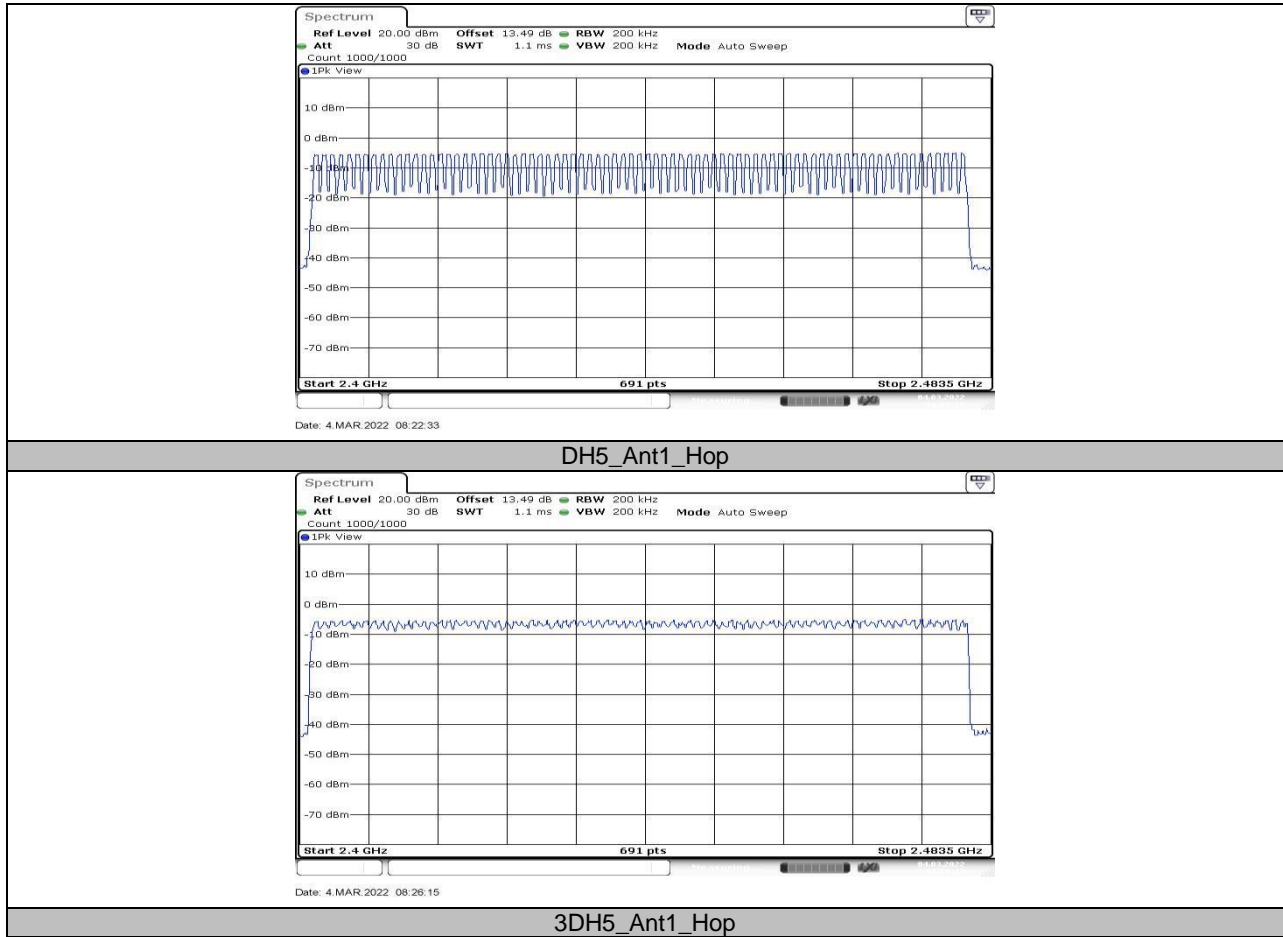



## 11.7. Appendix G: Band Edge Measurements

### 11.7.1. Test Result

| Test Mode | Antenna | ChName | Channel  | RefLevel [dBm] | Result [dBm] | Limit [dBm]   | Verdict |
|-----------|---------|--------|----------|----------------|--------------|---------------|---------|
| DH5       | Ant1    | Low    | 2402     | -5.10          | -45.39       | $\leq -25.1$  | PASS    |
|           |         | High   | 2480     | -4.70          | -43.68       | $\leq -24.7$  | PASS    |
|           |         | Low    | Hop_2402 | -5.26          | -45.27       | $\leq -25.26$ | PASS    |
|           |         | High   | Hop_2480 | -4.74          | -44.99       | $\leq -24.74$ | PASS    |
| 3DH5      | Ant1    | Low    | 2402     | -5.18          | -45.5        | $\leq -25.18$ | PASS    |
|           |         | High   | 2480     | -4.83          | -44.32       | $\leq -24.83$ | PASS    |
|           |         | Low    | Hop_2402 | -5.81          | -45.05       | $\leq -25.81$ | PASS    |
|           |         | High   | Hop_2480 | -4.97          | -44.31       | $\leq -24.97$ | PASS    |



### 11.7.2. Test Graphs

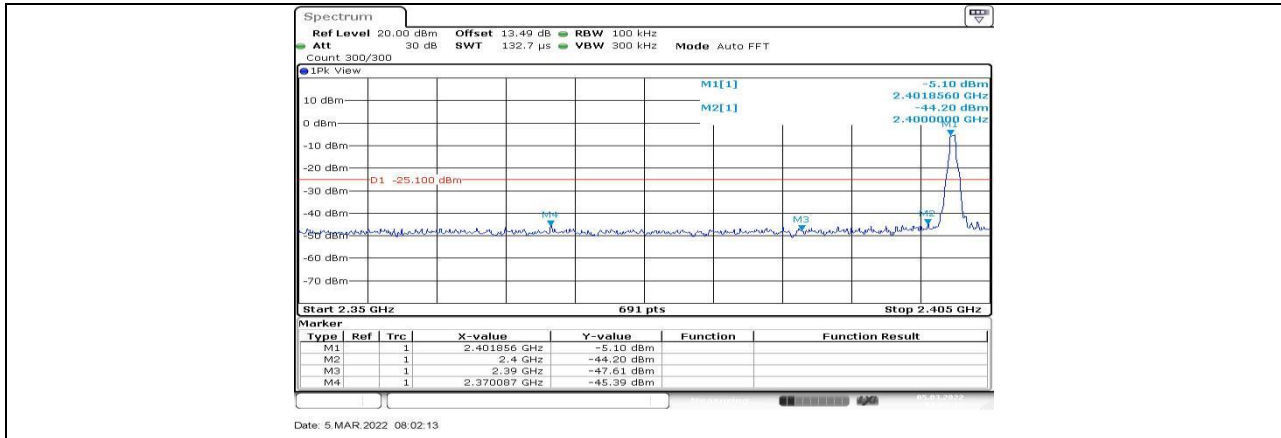

DH5\_Ant1\_Low\_2402

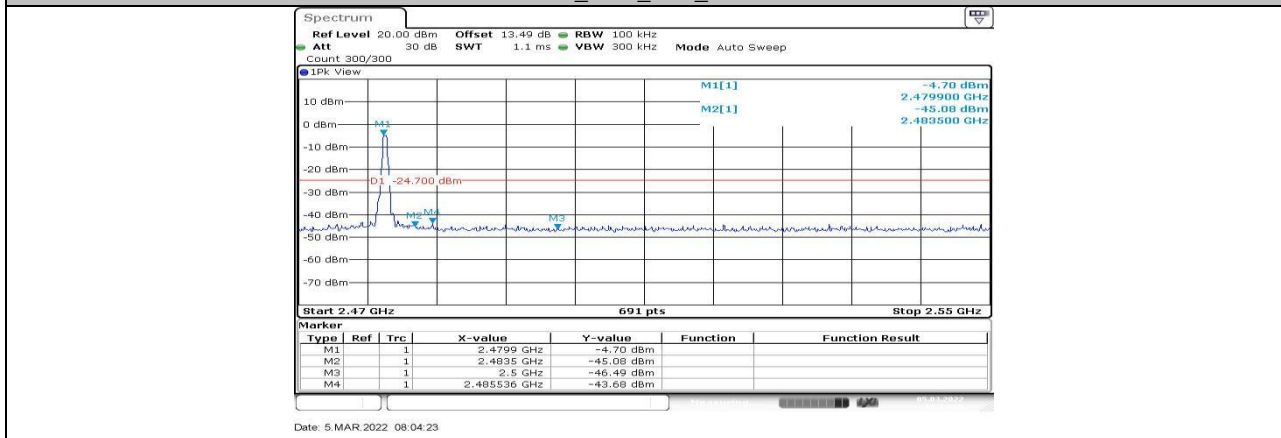

DH5\_Ant1\_High\_2480

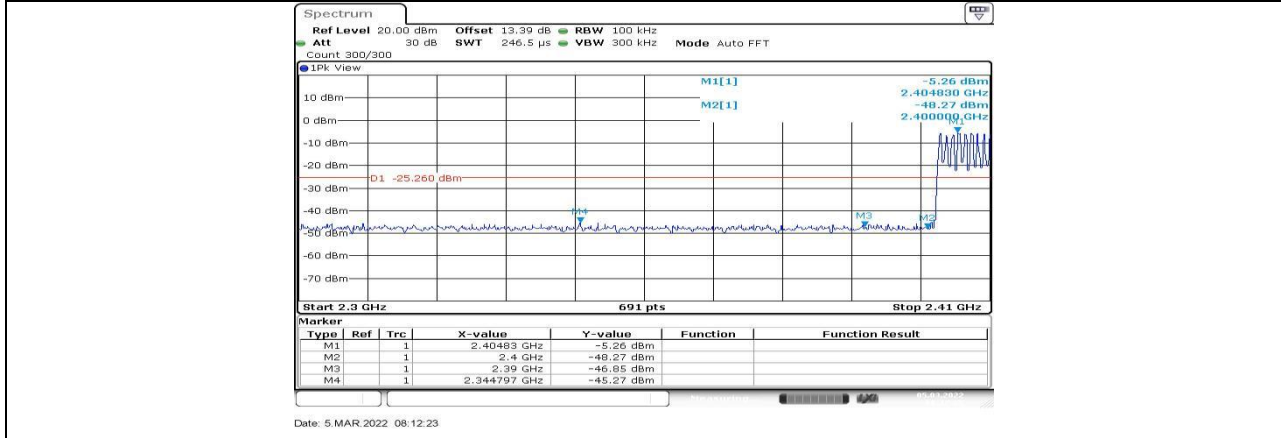

DH5\_Ant1\_Low\_Hop\_2402

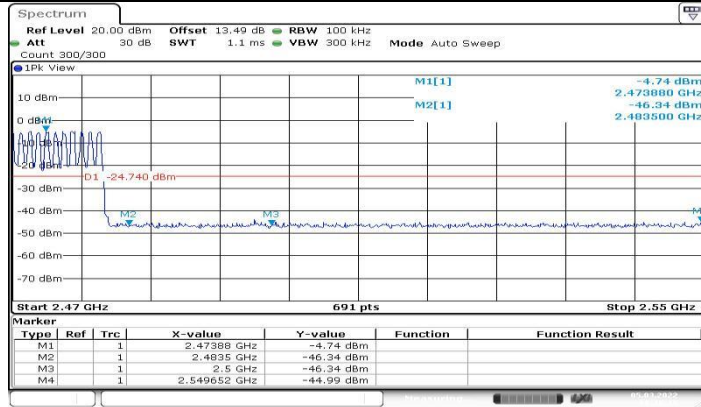

Date: 5.MAR.2022 08:10:13

### DH5\_Ant1\_High\_Hop\_2480

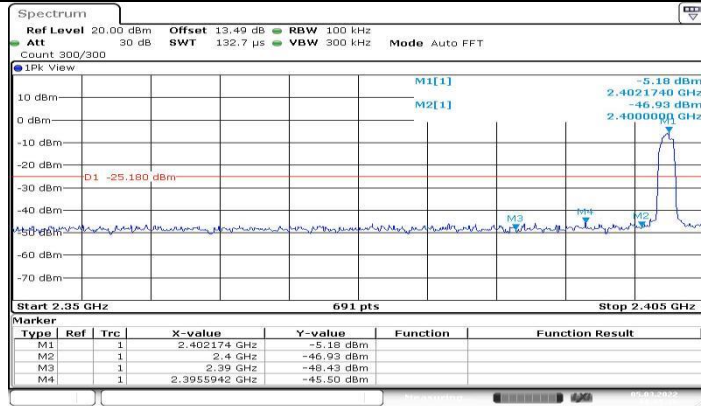

Date: 5.MAR.2022 08:05:36

### 3DH5\_Ant1\_Low\_2402

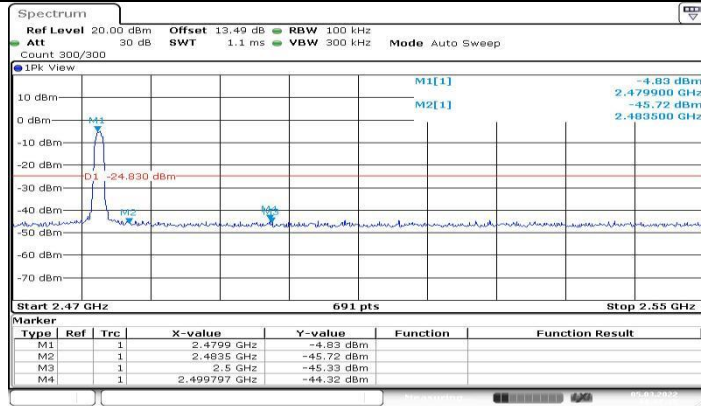

Date: 5.MAR.2022 08:07:40

### 3DH5\_Ant1\_High\_2480

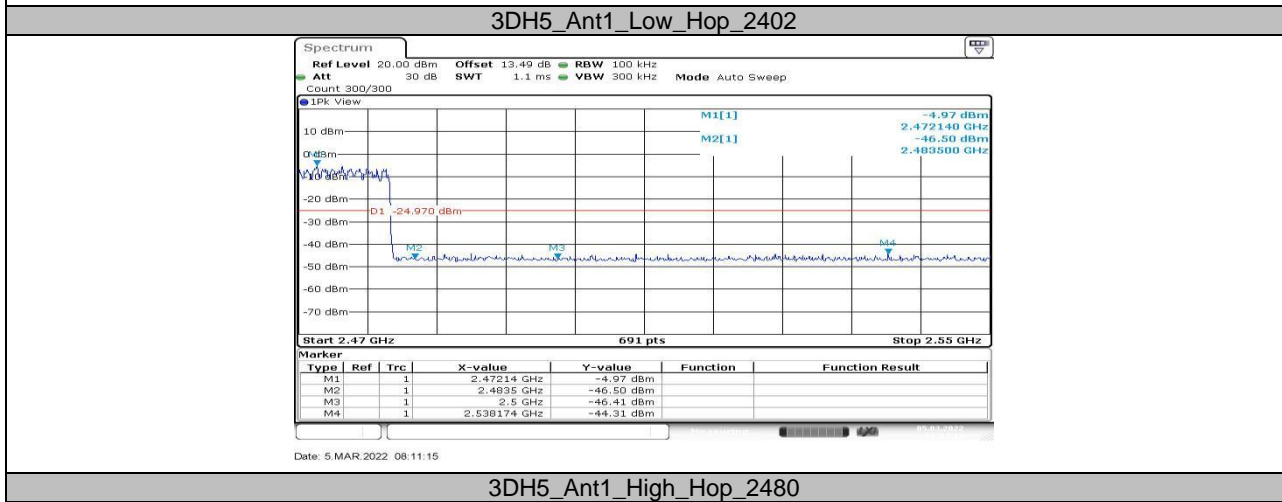
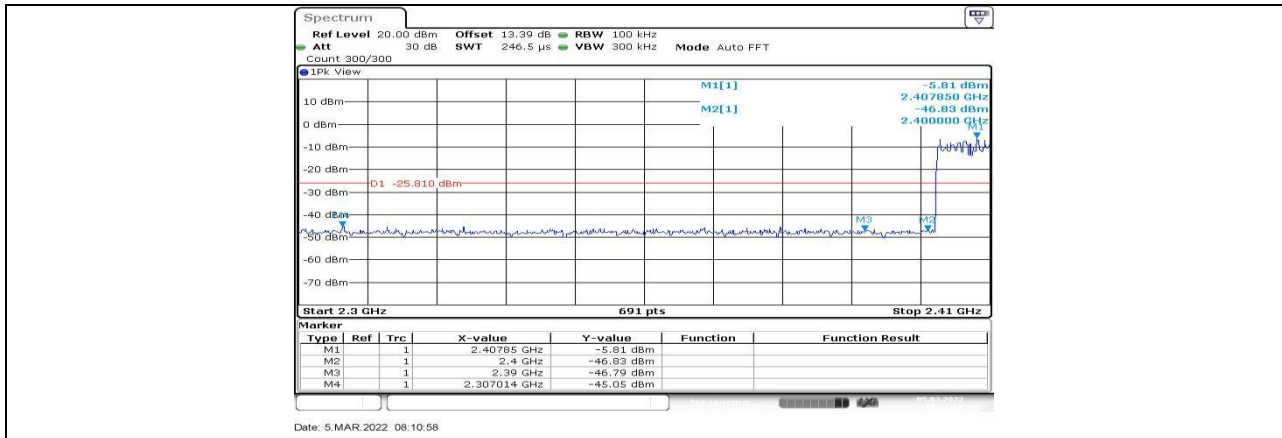

**11.8. Appendix H: Conducted Spurious Emission**  
**11.8.1. Test Result**

| Test Mode | Antenna | Channel | FreqRange [MHz] | RefLevel [dBm] | Result [dBm] | Limit [dBm] | Verdict |
|-----------|---------|---------|-----------------|----------------|--------------|-------------|---------|
| DH5       | Ant1    | 2402    | Reference       | -5.09          | -5.09        | ---         | PASS    |
|           |         |         | 30~1000         | -5.09          | -53.83       | ≤-25.09     | PASS    |
|           |         |         | 1000~26500      | -5.09          | -47.4        | ≤-25.09     | PASS    |
|           |         | 2441    | Reference       | -4.82          | -4.82        | ---         | PASS    |
|           |         |         | 30~1000         | -4.82          | -54.28       | ≤-24.82     | PASS    |
|           |         |         | 1000~26500      | -4.82          | -46.71       | ≤-24.82     | PASS    |
|           |         | 2480    | Reference       | -4.64          | -4.64        | ---         | PASS    |
|           |         |         | 30~1000         | -4.64          | -53.3        | ≤-24.64     | PASS    |
|           |         |         | 1000~26500      | -4.64          | -48.63       | ≤-24.64     | PASS    |
| 3DH5      | Ant1    | 2402    | Reference       | -5.14          | -5.14        | ---         | PASS    |
|           |         |         | 30~1000         | -5.14          | -54.82       | ≤-25.14     | PASS    |
|           |         |         | 1000~26500      | -5.14          | -48.46       | ≤-25.14     | PASS    |
|           |         | 2441    | Reference       | -4.87          | -4.87        | ---         | PASS    |
|           |         |         | 30~1000         | -4.87          | -54.64       | ≤-24.87     | PASS    |
|           |         |         | 1000~26500      | -4.87          | -49.29       | ≤-24.87     | PASS    |
|           |         | 2480    | Reference       | -4.69          | -4.69        | ---         | PASS    |
|           |         |         | 30~1000         | -4.69          | -54.43       | ≤-24.69     | PASS    |
|           |         |         | 1000~26500      | -4.69          | -49.14       | ≤-24.69     | PASS    |

### 11.8.2. Test Graphs

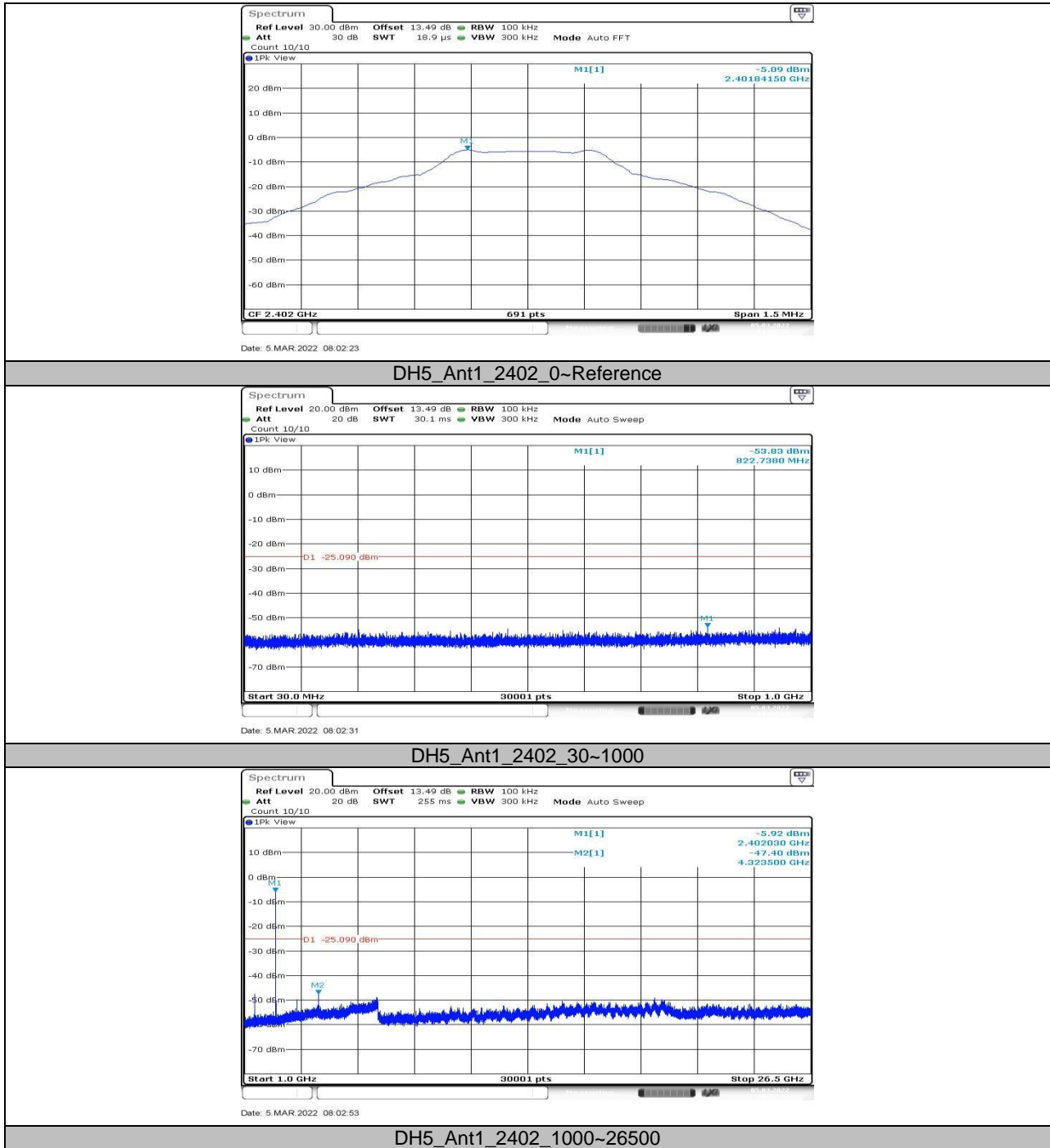

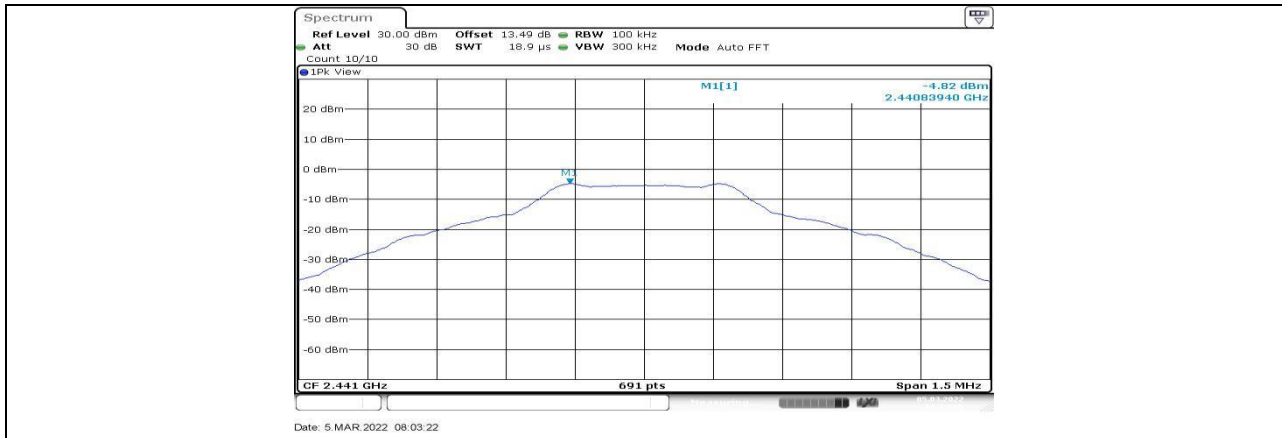

DH5\_Ant1\_2441\_0~Reference

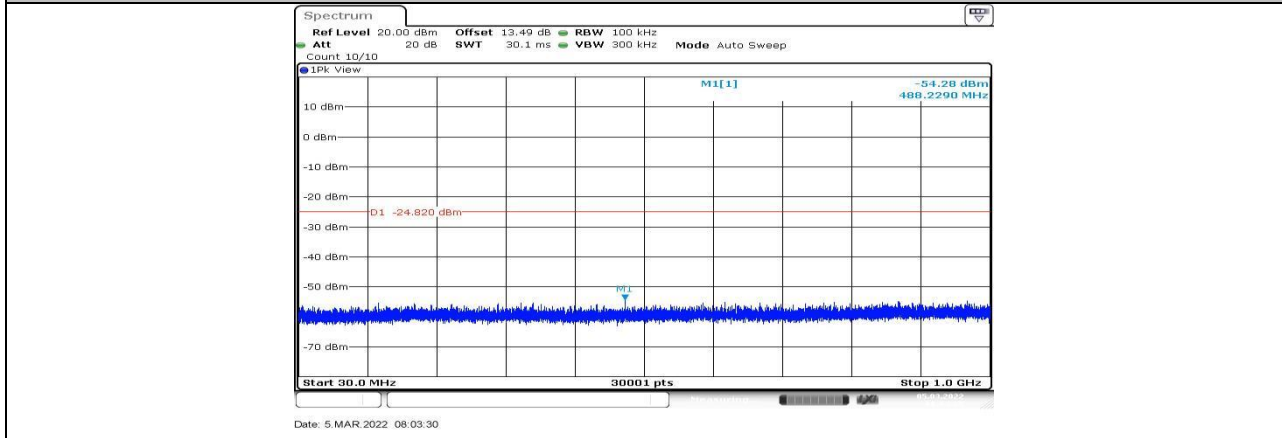

DH5\_Ant1\_2441\_30~1000

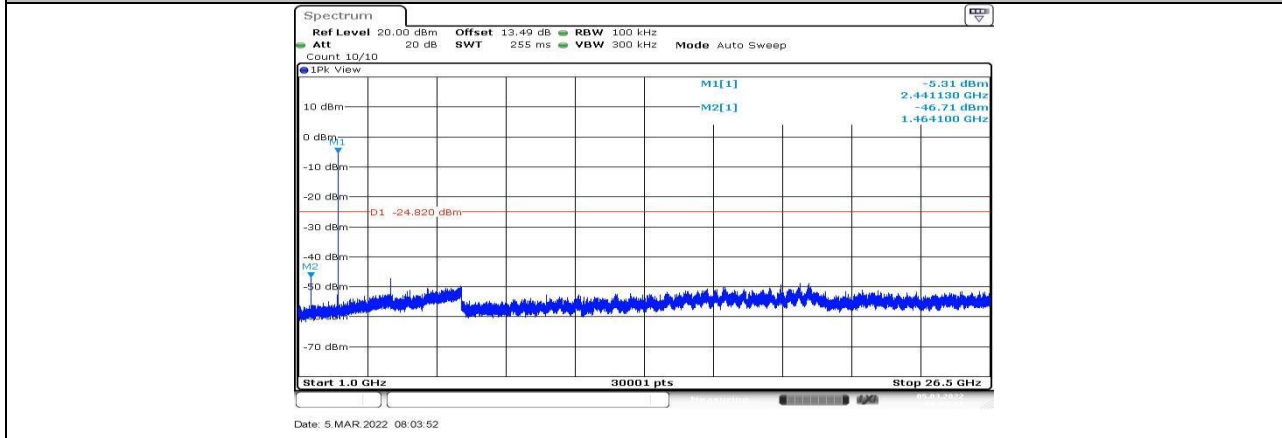

DH5\_Ant1\_2441\_1000~26500



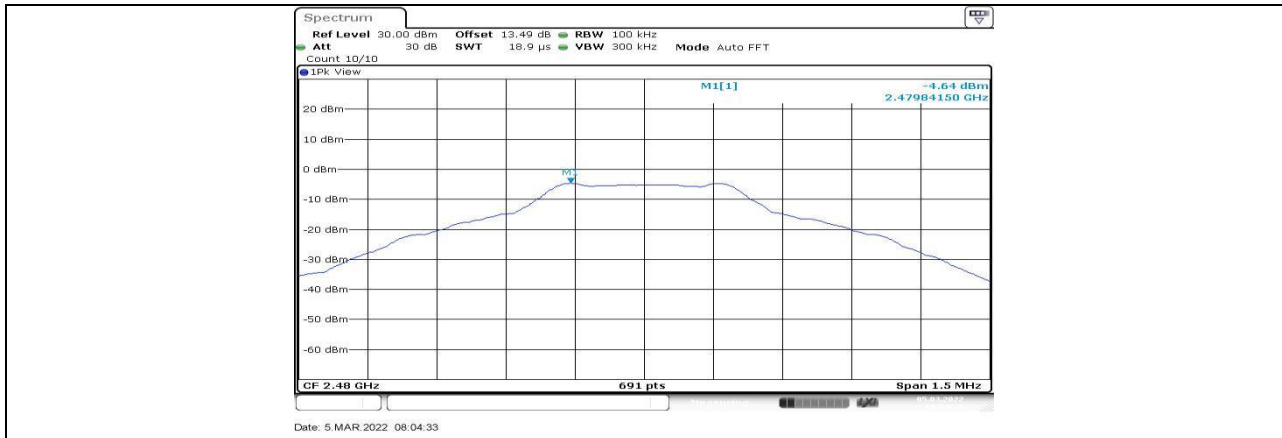

DH5\_Ant1\_2480\_0-Reference

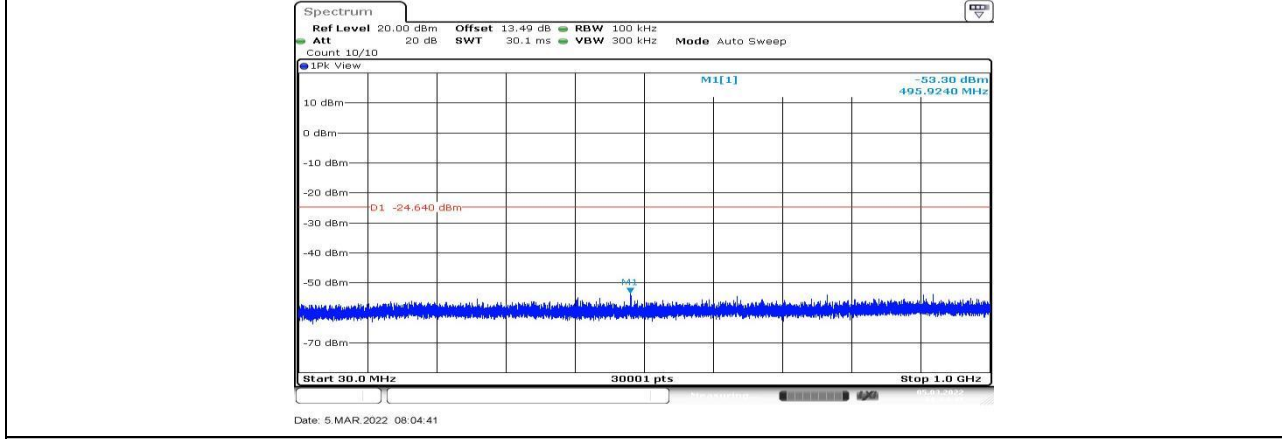

DH5\_Ant1\_2480\_30~1000

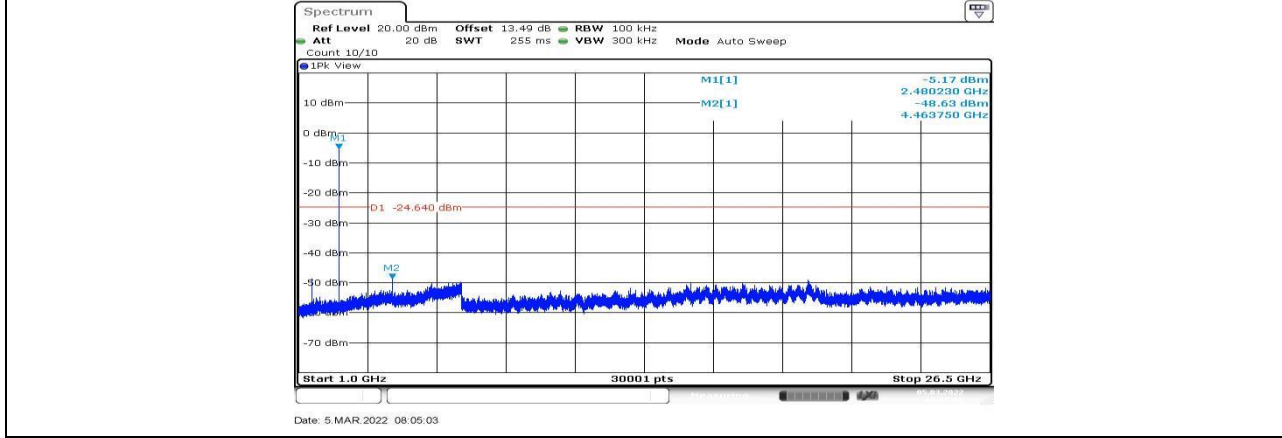

DH5\_Ant1\_2480\_1000~26500

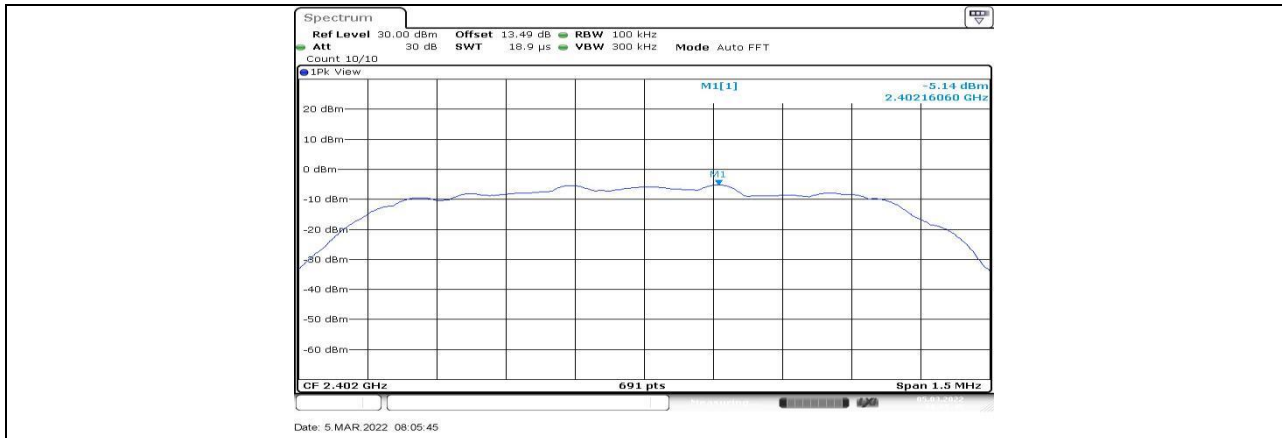

3DH5\_Ant1\_2402\_0~Reference

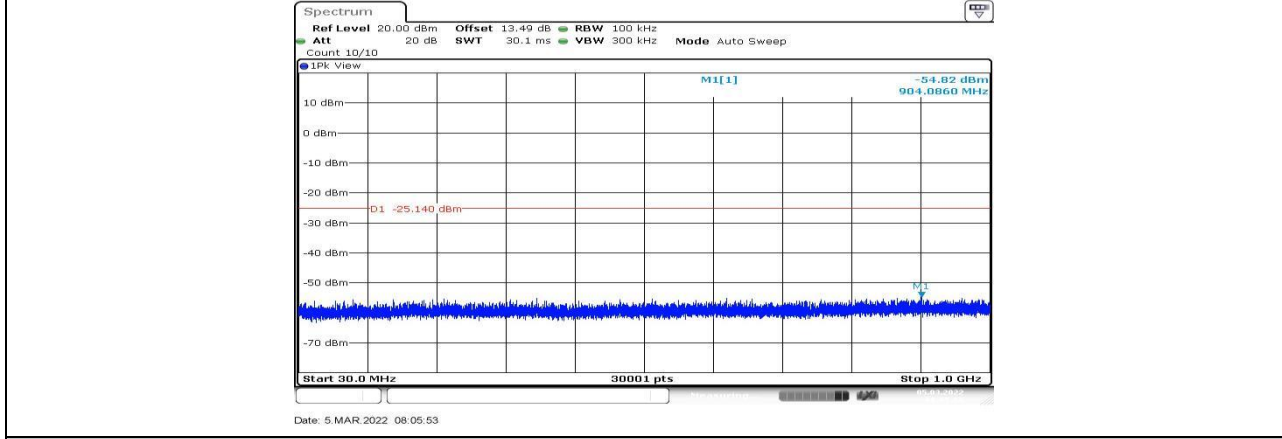

3DH5\_Ant1\_2402\_30~1000

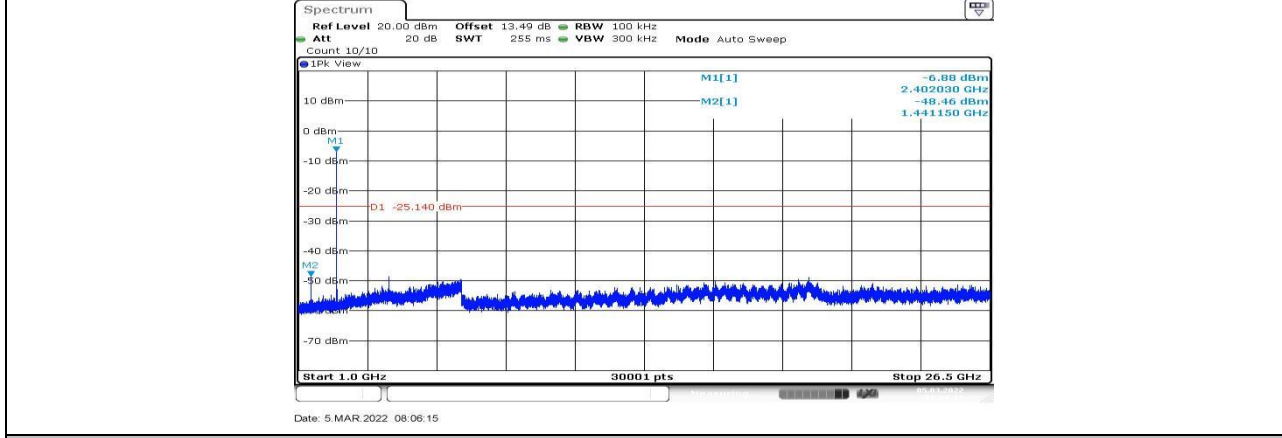

3DH5\_Ant1\_2402\_1000~26500

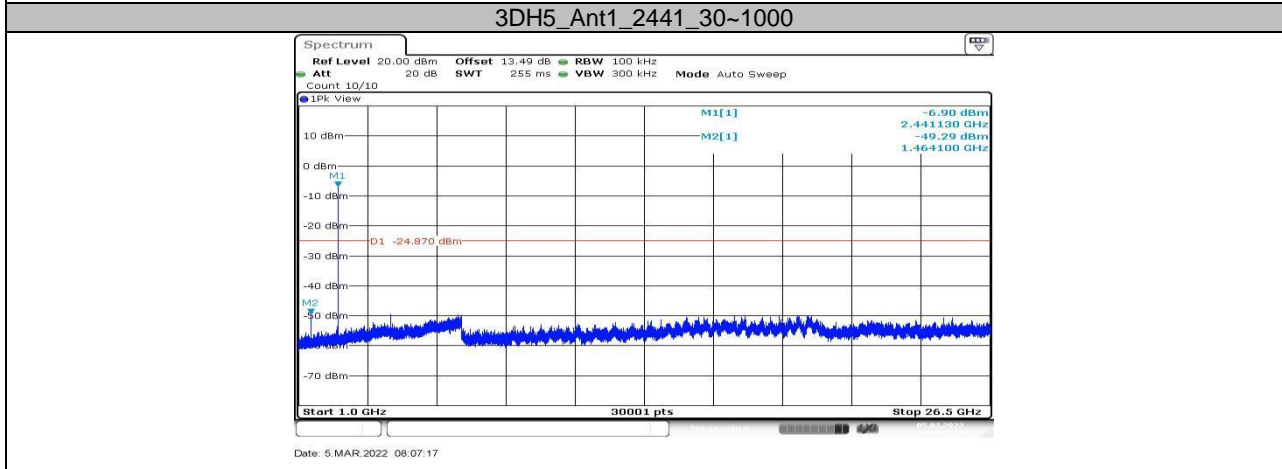
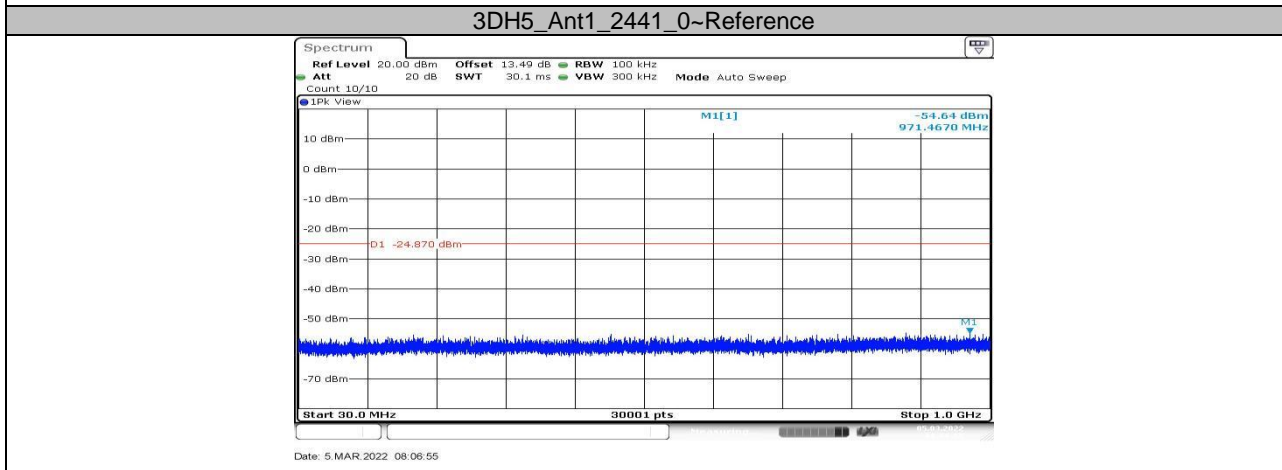
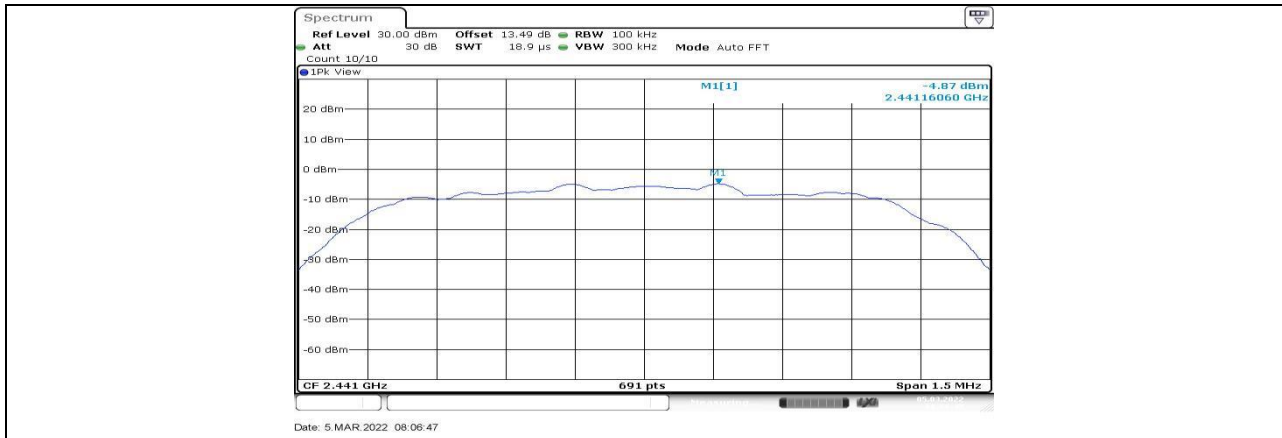

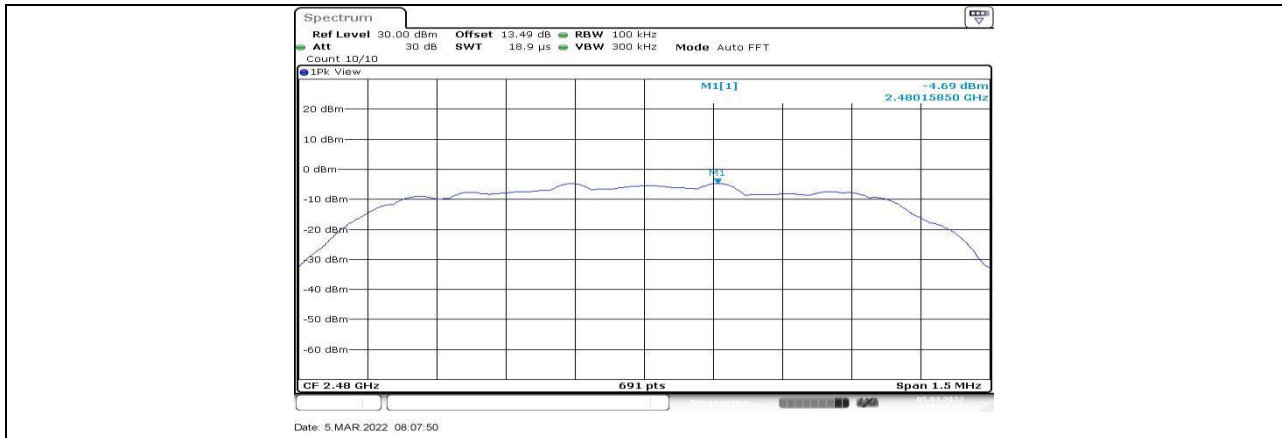

3DH5\_Ant1\_2480\_0~Reference

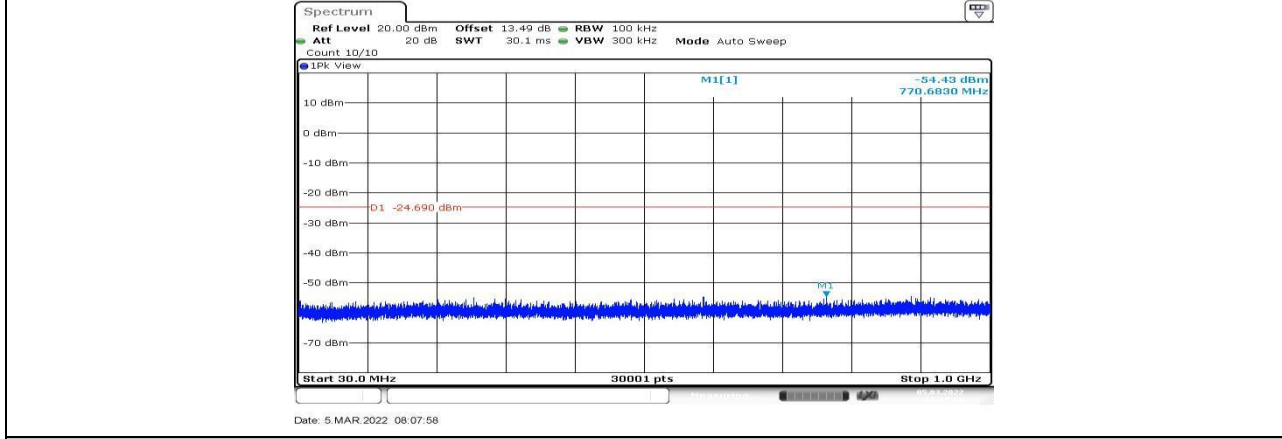

3DH5\_Ant1\_2480\_30~100

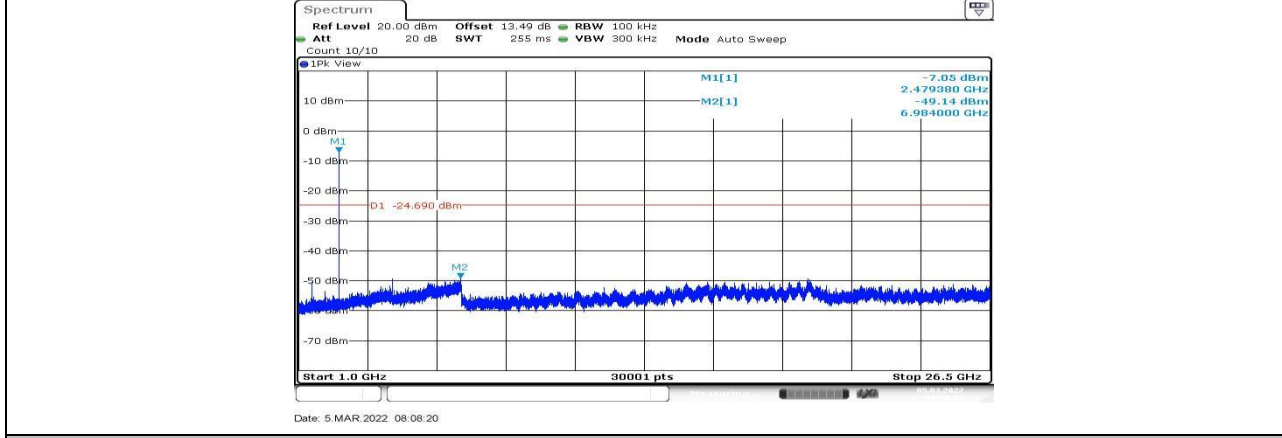

3DH5\_Ant1\_2480\_1000~26500



## 11.9. Appendix I: Duty Cycle

### 11.9.1. Test Result

| Test Mode | On Time (msec) | Period (msec) | Duty Cycle x (Linear) | Duty Cycle (%) | Duty Cycle Correction Factor (dB) | 1/T Minimum VBW (kHz) | Final setting For VBW (kHz) |
|-----------|----------------|---------------|-----------------------|----------------|-----------------------------------|-----------------------|-----------------------------|
| DH5       | 2.9            | 3.75          | 0.7733                | 77.33          | 1.12                              | 0.34                  | 0.5                         |
| 3DH5      | 2.88           | 3.75          | 0.7680                | 76.80          | 1.15                              | 0.35                  | 0.5                         |

Note:

Duty Cycle Correction Factor=10log (1/x).

Where: x is Duty Cycle (Linear)

Where: T is On Time

If that calculated VBW is not available on the analyzer then the next higher value should be used.

### 11.9.2. Test Graphs

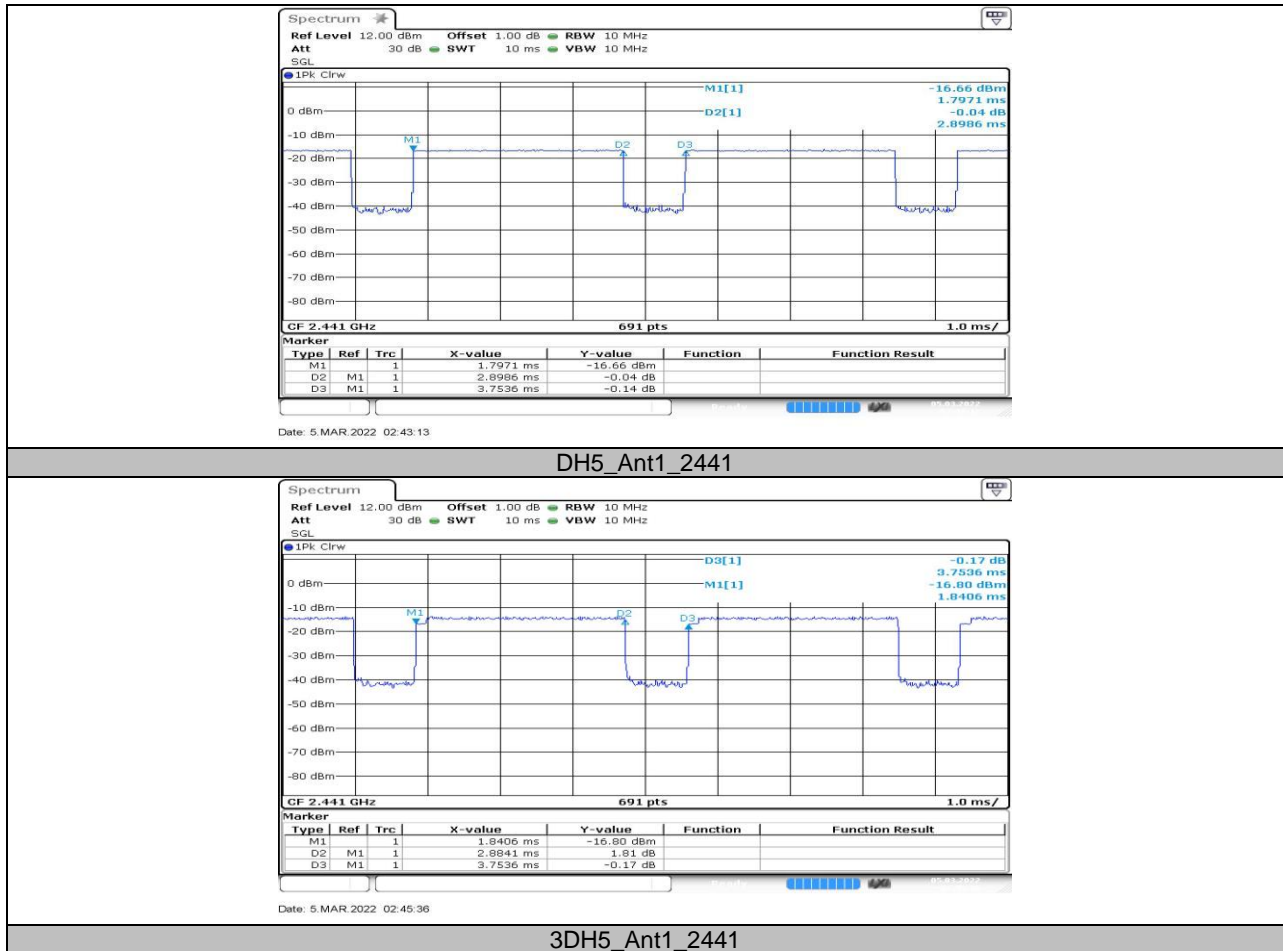

**END OF REPORT**