



**CFR 47 FCC PART 15 SUBPART E
ISED RSS-247 ISSUE 2**

CERTIFICATION TEST REPORT

For

WIFI+BT Module

MODEL NUMBER: DCT2SM2501

FCC ID: 2AC23-DCT2S

IC: 12290A-DCT2S

REPORT NUMBER: 4790335848-1

ISSUE DATE: April 20, 2022

Prepared for

**Hui Zhou Gaoshengda Technology Co.,LTD
No.2,Jin-da Road,Huinan High-tech Industrial Park, Huizhou, Guangdong, China**

Prepared by

UL Verification Services (Guangzhou) Co., Ltd, Song Shan Lake Branch

Building 10, Innovation Technology Park, No. 1, Li Bin Road, Song Shan Lake Hi-Tech Development Zone Dongguan, 523808, People's Republic of China

Tel: +86 769 22038881

Fax: +86 769 33244054

Website: www.ul.com



Revision History

| <u>Rev.</u> | <u>Issue Date</u> | <u>Revisions</u> | <u>Revised By</u> |
|-------------|-------------------|------------------|-------------------|
| V0 | 04/20/2022 | Initial Issue | |

Note: This is a report base on 4790089699.2-4 which is issued by UL Verification Services (Guangzhou) Co., Ltd, Song Shan Lake Branch on October 22, 2021. The module DCT2RM2501 had already applied for single module approval and the FCC ID is 2AC23-DCT2S and IC is 12290A-DCT2S. Now the customer want to open UNII-2A and UNII-2C but the module remain unchanged. So we added all UNII-2A and UNII-2C test but other data refer to the original test report.



| Summary of Test Results | | | |
|--|---|--|--------------|
| Clause | Test Items | FCC/IC Rules | Test Results |
| 1 | 6dB/26dB Bandwidth | FCC 15.407 (a)&(e) RSS-247 Clause 6.2 | PASS |
| 2 | 99% Occupied Bandwidth | RSS-Gen Clause 6.7 | PASS |
| 3 | Conducted Output Power | FCC 15.407 (a) RSS-247 Clause 6.2 | PASS |
| 4 | Power Spectral Density | FCC 15.407 (a) RSS-247 Clause 6.2 | PASS |
| 5 | Radiated Bandedge and Spurious Emission | FCC 15.407 (b) FCC 15.209 FCC 15.205 RSS-247 Clause 6.2 RSS-GEN Clause 8.9 | PASS |
| 6 | Conducted Emission Test for AC Power Port | FCC 15.207 RSS-GEN Clause 8.8 | PASS |
| 7 | Frequency Stability | FCC 15.407 (g) | PASS |
| 8 | Dynamic Frequency Selection | FCC 15.407 (h) RSS-247 Clause 6.3 | PASS |
| 9 | Antenna Requirement | FCC 15.203 RSS-GEN Clause 6.8 | PASS |
| Note: 1. This test report is only published to and used by the applicant, and it is not for evidence purpose in China. 2. The measurement result for the sample received is <Pass> according to < CFR 47 FCC PART 15 SUBPART E >< ISED RSS-247 > when <Accuracy Method> decision rule is applied. | | | |



TABLE OF CONTENTS

| | |
|--|-----------|
| 1. ATTESTATION OF TEST RESULTS | 7 |
| 2. TEST METHODOLOGY | 8 |
| 3. FACILITIES AND ACCREDITATION | 8 |
| 4. CALIBRATION AND UNCERTAINTY | 9 |
| 4.1. <i>MEASURING INSTRUMENT CALIBRATION</i> | <i>9</i> |
| 4.2. <i>MEASUREMENT UNCERTAINTY</i> | <i>9</i> |
| 5. EQUIPMENT UNDER TEST | 10 |
| 5.1. <i>DESCRIPTION OF EUT</i> | <i>10</i> |
| 5.2. <i>MAXIMUM OUTPUT POWER.....</i> | <i>11</i> |
| 5.3. <i>CHANNEL LIST</i> | <i>12</i> |
| 5.4. <i>DESCRIPTION OF AVAILABLE ANTENNAS</i> | <i>13</i> |
| 5.5. <i>THE WORSE CASE POWER SETTING PARAMETER.....</i> | <i>14</i> |
| 5.6. <i>THE WORSE CASE CONFIGURATIONS</i> | <i>16</i> |
| 5.7. <i>DESCRIPTION OF TEST SETUP.....</i> | <i>17</i> |
| 6. MEASURING INSTRUMENT AND SOFTWARE USED | 18 |
| 7. ANTENNA PORT TEST RESULTS | 21 |
| 7.1. <i>ON TIME AND DUTY CYCLE.....</i> | <i>21</i> |
| 7.2. <i>6/26 dB EMISSION BANDWIDTH AND 99 % OCCUPIED BANDWIDTH</i> | <i>22</i> |
| 7.3. <i>CONDUCTED OUTPUT POWER</i> | <i>24</i> |
| 7.4. <i>POWER SPECTRAL DENSITY</i> | <i>27</i> |
| 8. RADIATED TEST RESULTS..... | 29 |
| 8.1. <i>RESTRICTED BANDEDGE.....</i> | <i>36</i> |
| 8.1.1. <i>802.11a 20 MODE</i> | <i>36</i> |
| UNII-1 BAND | 36 |
| UNII-2A BAND | 40 |
| UNII-2C BAND..... | 42 |
| UNII-3 BAND | 45 |
| 8.1.1. <i>802.11n HT20 MIMO MODE.....</i> | <i>47</i> |
| UNII-1 BAND | 47 |
| UNII-2A BAND | 51 |
| UNII-2C BAND..... | 53 |
| UNII-3 BAND | 56 |
| 8.1.2. <i>802.11n HT40 MIMO MODE.....</i> | <i>58</i> |
| UNII-1 BAND | 58 |
| UNII-2A BAND | 62 |
| UNII-2C BAND..... | 64 |



| | |
|--|------------|
| UNII-3 BAND | 67 |
| 8.1.3. 802.11ac VHT80 MIMO MODE..... | 69 |
| UNII-1 BAND | 69 |
| UNII-2A BAND | 71 |
| UNII-2C BAND..... | 73 |
| UNII-3 BAND | 76 |
| 8.2. SPURIOUS EMISSIONS (1 GHz ~ 7 GHz)..... | 77 |
| 8.2.1. 802.11n HT40 MIMO MODE..... | 77 |
| UNII-1 BAND | 77 |
| UNII-2A BAND | 81 |
| UNII-2C BAND..... | 85 |
| STRADDLE CHANNEL 142..... | 91 |
| UNII-3 BAND | 93 |
| 8.3. SPURIOUS EMISSIONS (7 GHz ~ 18 GHz)..... | 97 |
| 8.3.1. 802.11a 20 MODE | 97 |
| UNII-1 BAND | 97 |
| UNII-2A BAND | 103 |
| UNII-2C BAND..... | 109 |
| STRADDLE CHANNEL 144..... | 115 |
| UNII-3 BAND | 117 |
| 8.3.2. 802.11n HT20 MIMO MODE..... | 123 |
| UNII-1 BAND | 123 |
| UNII-2A BAND | 129 |
| UNII-2C BAND..... | 135 |
| STRADDLE CHANNEL 144..... | 141 |
| UNII-3 BAND | 143 |
| 8.3.3. 802.11n HT40 MIMO MODE..... | 149 |
| UNII-1 BAND | 149 |
| UNII-2A BAND | 153 |
| UNII-2C BAND..... | 157 |
| STRADDLE CHANNEL 142..... | 163 |
| UNII-3 BAND | 165 |
| 8.3.4. 802.11ac VHT80 MIMO MODE..... | 169 |
| UNII-1 BAND | 169 |
| UNII-2A BAND | 171 |
| UNII-2C BAND..... | 173 |
| STRADDLE CHANNEL 138..... | 177 |
| UNII-3 BAND | 179 |
| 8.4. SPURIOUS EMISSIONS (18 GHz ~ 26 GHz)..... | 181 |
| 8.4.1. 802.11n HT40 MIMO MODE..... | 181 |
| 8.5. SPURIOUS EMISSIONS (26 GHz ~ 40 GHz)..... | 183 |
| 8.5.1. 802.11n HT40 MIMO MODE..... | 183 |
| 8.6. SPURIOUS EMISSIONS (30 MHz ~ 1 GHz)..... | 185 |
| 8.6.1. 802.11n HT40 MIMO MODE..... | 185 |
| 8.7. SPURIOUS EMISSIONS BELOW 30 MHz | 187 |
| 8.7.1. 802.11n HT40 MIMO MODE..... | 187 |
| 9. AC POWER LINE CONDUCTED EMISSIONS..... | 190 |
| 9.1.1. 802.11n HT40 MIMO MODE..... | 191 |



| | | |
|------------|--|------------|
| 10. | FREQUENCY STABILITY..... | 193 |
| 11. | ANTENNA REQUIREMENTS | 195 |
| 11.1. | <i>Appendix A1: Emission Bandwidth</i> | <i>196</i> |
| 11.1.1. | Test Result..... | 196 |
| 11.1.2. | Test Graphs | 199 |
| 11.2. | <i>Appendix A2: Occupied Channel Bandwidth</i> | <i>227</i> |
| 11.2.1. | Test Result..... | 227 |
| 11.2.2. | Test Graphs | 230 |
| 11.3. | <i>Appendix A3: Minimum Emission Bandwidth.....</i> | <i>260</i> |
| 11.3.1. | Test Result..... | 260 |
| 11.3.2. | Test Graphs | 261 |
| 11.4. | <i>Appendix B: Maximum Average Conducted Output Power.....</i> | <i>270</i> |
| 11.4.1. | Test Result..... | 270 |
| 11.4.2. | Test Graphs | 272 |
| 11.5. | <i>Appendix C: Maximum Power Spectral Density.....</i> | <i>278</i> |
| 11.5.1. | Test Result..... | 278 |
| 11.5.2. | Test Graphs | 280 |
| 11.6. | <i>Appendix D: Duty Cycle.....</i> | <i>311</i> |
| 11.6.1. | Test Result..... | 311 |
| 11.6.2. | Test Graphs | 312 |
| 11.7. | <i>Appendix E: Frequency Stability.....</i> | <i>314</i> |
| 11.7.1. | Test Result..... | 314 |
| 11.1. | <i>Appendix F: Dynamic Frequency Selection</i> | <i>316</i> |



1. ATTESTATION OF TEST RESULTS

Applicant Information

Company Name: Hui Zhou Gaoshengda Technology Co.,LTD
Address: No.2,Jin-da Road,Huinan High-tech Industrial Park, Huizhou, Guangdong, China

Manufacturer Information

Company Name: Hui Zhou Gaoshengda Technology Co.,LTD
Address: No.2,Jin-da Road,Huinan High-tech Industrial Park, Huizhou, Guangdong, China

EUT Information

EUT Name: WIFI+BT Module
Model: DCT2SM2501
Brand: GSD
Sample Received Date: September 2, 2021
Sample Status: Normal
Sample ID: 4194933
Date of Tested: September 6, 2021 ~ April 20, 2022

| APPLICABLE STANDARDS | |
|------------------------------|--------------|
| STANDARD | TEST RESULTS |
| CFR 47 FCC PART 15 SUBPART E | PASS |
| ISED RSS-247 Issue 2 | PASS |
| ISED RSS-GEN Issue 5 | PASS |

Prepared By:

Denny Huang
Project Engineer

Checked By:

Shawn Wen
Laboratory Leader

Approved By:

Stephen Guo
Laboratory Manager



2. TEST METHODOLOGY

The tests documented in this report were performed in accordance with ANSI C63.10-2013, CFR 47 FCC Part 2, CFR 47 FCC Part 15, KDB 789033 D02 v02r01, KDB414788 D01 Radiated Test Site v01r01, KDB 662911 D01 Multiple Transmitter Output v02r01, KDB 905462 D02 UNII DFS Compliance Procedures New Rules v02, KDB 905462 D03 UNII clients without radar detection New Rules v01r02, KDB 905462 D04 Operational Modes for DFS Testing New Rules v01 and KDB 905462 D06 802 11 Channel Plans New Rules v02, RSS-GEN Issue 5, RSS-247 Issue 2.

3. FACILITIES AND ACCREDITATION

| | |
|---------------------------|---|
| Accreditation Certificate | <p>A2LA (Certificate No.: 4102.01) UL Verification Services (Guangzhou) Co., Ltd. Song Shan Lake Branch. has been assessed and proved to be in compliance with A2LA.</p> <p>FCC (FCC Designation No.: CN1187) UL Verification Services (Guangzhou) Co., Ltd. Song Shan Lake Branch. Has been recognized to perform compliance testing on equipment subject to the Commission's Declaration of Conformity (DoC) and Certification rules</p> <p>ISED (Company No.: 21320) UL Verification Services (Guangzhou) Co., Ltd. Song Shan Lake Branch. has been registered and fully described in a report filed with ISED. The Company Number is 21320 and the test lab Conformity Assessment Body Identifier (CABID) is CN0046.</p> <p>VCCI (Registration No.: G-20019, R-20004, C-20012 and T-20011) UL Verification Services (Guangzhou) Co., Ltd. Song Shan Lake Branch. has been assessed and proved to be in compliance with VCCI, the Membership No. is 3793. Facility Name: Chamber D, the VCCI registration No. is G-20019 and R-20004 Shielding Room B , the VCCI registration No. is C-20012 and T-20011</p> |
|---------------------------|---|

Note 1: All tests measurement facilities use to collect the measurement data are located at Building 10, Innovation Technology Park, Song Shan Lake Hi tech Development Zone, Dongguan, 523808, China

Note 2: The test anechoic chamber in UL Verification Services (Guangzhou) Co., Ltd. Song Shan Lake Branch had been calibrated and compared to the open field sites and the test anechoic chamber is shown to be equivalent to or worst case from the open field site.

Note 3: For below 30 MHz, lab had performed measurements at test anechoic chamber and comparing to measurements obtained on an open field site. And these measurements below 30 MHz had been correlated to measurements performed on an OFS.

4. CALIBRATION AND UNCERTAINTY

4.1. MEASURING INSTRUMENT CALIBRATION

The measuring equipment utilized to perform the tests documented in this report has been calibrated in accordance with the manufacturer's recommendations and is traceable to recognize national standards.

4.2. MEASUREMENT UNCERTAINTY

Where relevant, the following measurement uncertainty levels have been estimated for tests performed on the apparatus:

| Test Item | Uncertainty |
|--|-------------------------|
| Conduction emission | 3.62 dB |
| Radiated Emission (Included Fundamental Emission) (9 kHz ~ 30 MHz) | 2.2 dB |
| Radiated Emission (Included Fundamental Emission) (30 MHz ~ 1 GHz) | 4.00 dB |
| Radiated Emission (Included Fundamental Emission) (1 GHz to 40 GHz) | 5.78 dB (1 GHz-18 GHz) |
| | 5.23dB (18 GHz-26 GHz) |
| | 5.64 dB (26 GHz-40 GHz) |
| Note: This uncertainty represents an expanded uncertainty expressed at approximately the 95 % confidence level using a coverage factor of k=2. | |



5. EQUIPMENT UNDER TEST

5.1. DESCRIPTION OF EUT

| | |
|---------------------|---|
| EUT Name | WIFI+BT Module |
| Model | DCT2SM2501 |
| Radio Technology | WLAN (IEEE 802.11a/n HT20/n HT40/ac VHT20/VHT 40/VHT 80) |
| Operation frequency | UNII-1: 5150 ~ 5250 MHz UNII-2A: 5250 ~ 5350 MHz UNII-2C: 5470 ~ 5725 MHz UNII-3: 5725 ~ 5850 MHz |
| Modulation | IEEE 802.11a: OFDM (64QAM, 16QAM, QPSK, BPSK) IEEE 802.11n HT20: OFDM (64QAM, 16QAM, QPSK, BPSK) IEEE 802.11n HT40: OFDM (64QAM, 16QAM, QPSK, BPSK) IEEE 802.11ac VHT20: OFDM (256QAM, 64QAM, 16QAM, QPSK, BPSK) IEEE 802.11ac VHT40: OFDM (256QAM, 64QAM, 16QAM, QPSK, BPSK) IEEE 802.11ac VHT80: OFDM (256QAM, 64QAM, 16QAM, QPSK, BPSK) |
| Power Supply | DC 3.3 V |

**5.2. MAXIMUM OUTPUT POWER****UNII-1 BAND**

| IEEE Std. 802.11 | Frequency (MHz) | Maximum Average Conducted Power (dBm) | Max Average EIRP (dBm) |
|------------------|-----------------|---------------------------------------|------------------------|
| a 20 | 5150 ~ 5250 | 14.30 | 16.60 |
| n HT20 | | 14.03 | 16.33 |
| n HT40 | | 16.68 | 18.98 |
| ac VHT80 | | 15.35 | 17.65 |

UNII-2A BAND

| IEEE Std. 802.11 | Frequency (MHz) | Maximum Average Conducted Power (dBm) |
|------------------|-----------------|---------------------------------------|
| a | 5250 ~ 5350 | 15.02 |
| n HT20 | | 16.17 |
| n HT40 | | 16.62 |
| ac VHT80 | | 15.36 |

UNII-2C BAND

| IEEE Std. 802.11 | Frequency (MHz) | Maximum Average Conducted Power (dBm) |
|------------------|-----------------|---------------------------------------|
| a | 5470 ~ 5725 | 14.61 |
| n HT20 | | 15.40 |
| n HT40 | | 15.46 |
| ac VHT80 | | 13.69 |

UNII-3 BAND

| IEEE Std. 802.11 | Frequency (MHz) | Maximum Average Conducted Power (dBm) |
|------------------|-----------------|---------------------------------------|
| a 20 | 5725 ~ 5850 | 12.62 |
| n HT20 | | 14.73 |
| n HT40 | | 15.15 |
| ac VHT80 | | 12.10 |

**5.3. CHANNEL LIST**

| UNII-1 (For Bandwidth=20MHz) | | UNII-1 (For Bandwidth=40MHz) | | UNII-1 (For Bandwidth=80MHz) | |
|---------------------------------|--------------------|---------------------------------|--------------------|---------------------------------|--------------------|
| Channel | Frequency (MHz) | Channel | Frequency (MHz) | Channel | Frequency (MHz) |
| 36 | 5180 | 38 | 5190 | 42 | 5210 |
| 40 | 5200 | 46 | 5230 | | |
| 44 | 5220 | | | | |
| 48 | 5240 | | | | |

| UNII-2A (For Bandwidth=20MHz) | | UNII-2A (For Bandwidth=40MHz) | | UNII-2A (For Bandwidth=80MHz) | |
|----------------------------------|--------------------|----------------------------------|--------------------|----------------------------------|--------------------|
| Channel | Frequency (MHz) | Channel | Frequency (MHz) | Channel | Frequency (MHz) |
| 52 | 5260 | 54 | 5270 | 58 | 5290 |
| 56 | 5280 | 62 | 5310 | | |
| 60 | 5300 | | | | |
| 64 | 5320 | | | | |

| UNII-2C (For Bandwidth=20MHz) | | UNII-2C (For Bandwidth=40MHz) | | UNII-2C (For Bandwidth=80MHz) | |
|----------------------------------|--------------------|----------------------------------|--------------------|----------------------------------|--------------------|
| Channel | Frequency (MHz) | Channel | Frequency (MHz) | Channel | Frequency (MHz) |
| 100 | 5500 | 102 | 5510 | 106 | 5530 |
| 104 | 5520 | 110 | 5550 | 122 | 5610 |
| 108 | 5540 | 118 | 5590 | 138 | 5690 |
| 112 | 5560 | 126 | 5630 | | |
| 116 | 5580 | 134 | 5670 | | |
| 120 | 5600 | 142 | 5710 | | |
| 124 | 5620 | | | | |
| 128 | 5640 | | | | |
| 132 | 5660 | | | | |
| 136 | 5680 | | | | |
| 140 | 5700 | | | | |
| 144 | 5720 | | | | |

| UNII-3 (For Bandwidth=20MHz) | | UNII-3 (For Bandwidth=40MHz) | | UNII-3 (For Bandwidth=80MHz) | |
|---------------------------------|--------------------|---------------------------------|--------------------|---------------------------------|--------------------|
| Channel | Frequency (MHz) | Channel | Frequency (MHz) | Channel | Frequency (MHz) |
| 149 | 5745 | 151 | 5755 | 155 | 5775 |
| 153 | 5765 | 159 | 5795 | | |
| 157 | 5785 | | | | |
| 161 | 5805 | | | | |
| 165 | 5825 | | | | |

Note: All channels in the 5600-5650MHz band were not operational in Canada.

5.4. DESCRIPTION OF AVAILABLE ANTENNAS

| Antenna No. | Frequency Band | Antenna Type | Max Antenna Gain (dBi) |
|-------------|----------------|--------------|------------------------|
| 1 | 5180 ~ 5825 | PCB | 2.3 |
| 2 | 5180 ~ 5825 | PCB | 2.3 |

The EUT support Cyclic Shift Diversity (CDD) mode.

MIMO output power port and MIMO PSD port summing was performed in accordance with KDB 662911 D01. For the CDD results the Directional Gain was calculated in accordance with the following method.

For output power measurements:

Directional gain= $G_{ANT} + \text{Array Gain} = 2.3 \text{ dBi}$

G_{ANT} : equal to the gain of the antenna having the highest gain

Array Gain = 0 dB (i.e., no array gain) for $N_{ANT} \leq 4$

For power spectral density (PSD) measurements:

Directional gain= $G_{ANT} + \text{Array Gain} = 5.31 \text{ dBi}$

Array Gain = $10 \log (N_{ANT}/N_{SS}) \text{ dB}$.

N_{ANT} : number of transmit antennas

N_{SS} : number of spatial streams, the worst case directional gain will occur when $N_{SS} = 1$

| IEEE Std. 802.11 | Transmit and Receive Mode | Description |
|--|--|---|
| a 20 | <input checked="" type="checkbox"/> 2TX, 2RX | ANT 1, 2 can be used as transmitting/receiving antenna. |
| n HT20 | <input checked="" type="checkbox"/> 2TX, 2RX | ANT 1, 2 can be used as transmitting/receiving antenna. |
| n HT40 | <input checked="" type="checkbox"/> 2TX, 2RX | ANT 1, 2 can be used as transmitting/receiving antenna. |
| ac VHT20 | <input checked="" type="checkbox"/> 2TX, 2RX | ANT 1, 2 can be used as transmitting/receiving antenna. |
| ac VHT40 | <input checked="" type="checkbox"/> 2TX, 2RX | ANT 1, 2 can be used as transmitting/receiving antenna. |
| ac VHT80 | <input checked="" type="checkbox"/> 2TX, 2RX | ANT 1, 2 can be used as transmitting/receiving antenna. |
| <p>Note:</p> <p>1. 802.11a mode don't support MIMO mode.</p> <p>2. BT&WLAN 2.4G, BT & WLAN 5G, WLAN 2.4G & WLAN 5G can't transmit simultaneously. (declared by client)</p> | | |

Note: The value of the antenna gain was declared by customer.

**5.5. THE WORSE CASE POWER SETTING PARAMETER**

| The Worse Case Power Setting Parameter | |
|--|---------|
| Test Software | QA tool |

UNII-1

| Mode | Rate | Channel | Soft set value | |
|------------|------|---------|----------------|-------|
| | | | ANT 1 | ANT 2 |
| 11a 20 | 6M | 36 | 1D | 1D |
| | | 40 | 1D | 1D |
| | | 48 | 1D | 1D |
| 11n HT20 | MCS0 | 36 | 19 | 19 |
| | | 40 | 19 | 19 |
| | | 48 | 19 | 19 |
| 11n HT40 | MCS0 | 38 | 1D | 1D |
| | | 46 | 1D | 1D |
| 11ac VHT80 | MCS0 | 42 | 1D | 1D |

UNII-2A

| IEEE Std. 802.11 | Rate | Channel | Soft set value | |
|------------------|------|---------|----------------|---------|
| | | | ANT 1 | ANT 2 |
| a | 6M | 52 | Default | Default |
| | | 60 | Default | Default |
| | | 64 | Default | Default |
| n HT20 | MCS0 | 52 | Default | Default |
| | | 60 | Default | Default |
| | | 64 | Default | Default |
| n HT40 | MCS0 | 54 | Default | Default |
| | | 62 | Default | Default |
| ac VHT80 | MCS0 | 58 | Default | Default |

UNII-2C

| IEEE Std. 802.11 | Rate | Channel | Soft set value | |
|------------------|------|---------|----------------|---------|
| | | | ANT 1 | ANT 2 |
| a | 6M | 100 | Default | Default |
| | | 120 | Default | Default |
| | | 140 | Default | Default |
| n HT20 | MCS0 | 100 | Default | Default |
| | | 120 | Default | Default |
| | | 140 | Default | Default |
| n HT40 | MCS0 | 102 | Default | Default |
| | | 118 | Default | Default |
| | | 134 | Default | Default |
| ac VHT80 | MCS0 | 106 | Default | Default |
| | | 122 | Default | Default |
| ac VHT160 | MCS0 | 114 | Default | Default |



UNII-3

| Mode | Rate | Channel | Soft set value | |
|------------|------|---------|----------------|-------|
| | | | ANT 1 | ANT 2 |
| 11a 20 | 6M | 149 | 1A | 1A |
| | | 157 | 1A | 1A |
| | | 165 | 1A | 1A |
| 11n HT20 | MCS0 | 149 | 1A | 1A |
| | | 157 | 1A | 1A |
| | | 165 | 1A | 1A |
| 11n HT40 | MCS0 | 151 | 1A | 1A |
| | | 159 | 1A | 1A |
| 11ac VHT80 | MCS0 | 155 | 1A | 1A |



5.6. THE WORSE CASE CONFIGURATIONS

The EUT was tested in the following configuration(s):

Controlled in test mode using a software application on the EUT supplied by customer. The application was used to enable a continuous transmission and to select the mode, test channels, bandwidth, data rates as required.

Test channels referring to section 5.3.

Maximum power setting referring to section 5.5.

Worst case Data Rates declared by the customer:

802.11a 20 mode: 6 Mbps
802.11n HT20 mode: MCS0
802.11n HT40 mode: MCS0
802.11ac VHT20 mode: MCS0
802.11ac VHT40 mode: MCS0
802.11ac VHT80 mode: MCS0

802.11ac VHT20 and VHT40 mode are different from 802.11n HT20 and HT40 only in control messages, so for these 4 modes, only worst mode's data was recorded in the report.

SISO mode and MIMO mode have the same power setting, so only the worst case power mode (MIMO) will be recorded in the report.

The EUT has 2 separate antennas which correspond to 2 separate antenna ports. Core 1 and Core 2 correspond to antenna 1 and antenna 2 respectively.

Antenna 0 and Antenna 1 have the same power setting, but the power test data are different. (Declared by customer.)

The measured additional path loss was included in any path loss calculations for all RF cable used during tested.

The EUT support Cyclic Shift Diversity (CDD), They use the same conducted power per chain in any given mode, so we only chose the worst-case mode CDD 2TX for final testing.

5.7. DESCRIPTION OF TEST SETUP

SUPPORT EQUIPMENT

| Item | Equipment | Brand Name | Model Name | Remarks |
|------|---------------|------------|--------------|---|
| 1 | Laptop | Lenovo | XIAOXIN 5000 | / |
| 2 | Power Adapter | Lenovo | ADLX65YAC3A | Input: AC 100 ~ 240 V, 1.8 A Output: DC 20 V, 2.25 A |

I/O CABLES

| Cable No | Port | Connector Type | Cable Type | Cable Length(m) | Remarks |
|----------|------|----------------|------------|-----------------|---------|
| 1 | USB | / | / | 0.3 | / |

ACCESSORIES

| Item | Accessory | Brand Name | Model Name | Description |
|------|-----------|------------|------------|-------------|
| 1 | / | / | / | / |

Note: The cable is provided by customer.

TEST SETUP

The EUT can work in engineering mode with a software through a Laptop.

SETUP DIAGRAM FOR TESTS

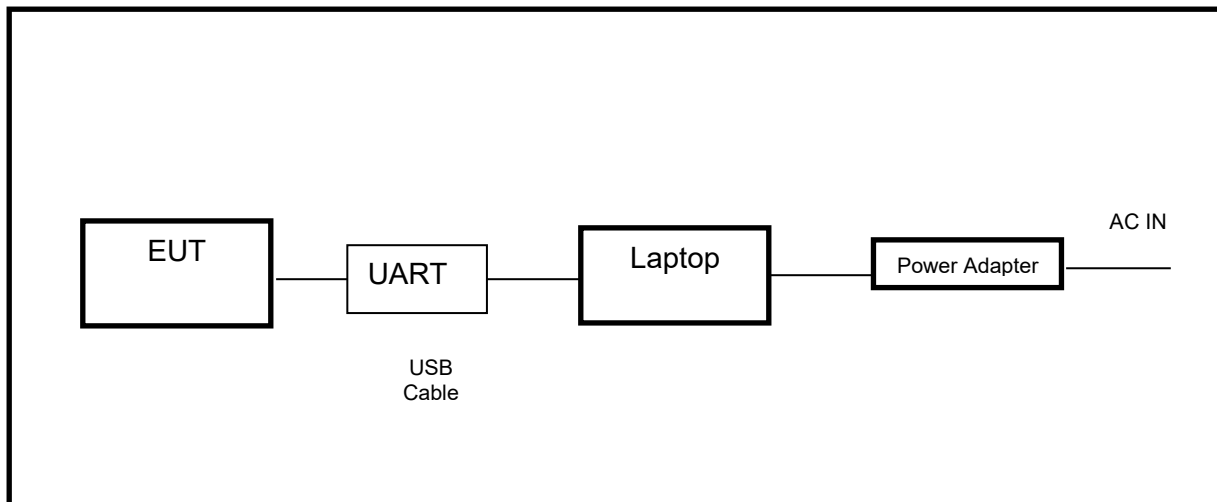

**6. MEASURING INSTRUMENT AND SOFTWARE USED**

| Conducted Emissions | | | | | | |
|---------------------------------------|--------------|-----------|--------------|-----------------|--------------|--------------|
| Equipment | Manufacturer | Model No. | Serial No. | Upper Last Cal. | Last Cal. | Due Date |
| EMI Test Receiver | R&S | ESR3 | 101961 | Nov. 12, 2020 | Oct.30, 2021 | Oct.29, 2022 |
| Two-Line V-Network | R&S | ENV216 | 101983 | Nov. 12, 2020 | Oct.30, 2021 | Oct.29, 2022 |
| Software | | | | | | |
| Description | | | Manufacturer | Name | Version | |
| Test Software for Conducted Emissions | | | Farad | EZ-EMC | Ver. UL-3A1 | |

| Radiated Emissions | | | | | | |
|-----------------------------|---------------|----------------------------|---------------|-----------------|---------------|---------------|
| Equipment | Manufacturer | Model No. | Serial No. | Upper Last Cal. | Last Cal. | Due Date |
| MXE EMI Receiver | KESIGHT | N9038A | MY56400036 | Nov. 12, 2020 | Oct.30, 2021 | Oct.29, 2022 |
| Hybrid Log Periodic Antenna | TDK | HLP-3003C | 130960 | / | Aug.02, 2021 | Aug.01, 2024 |
| Preamplifier | HP | 8447D | 2944A09099 | Nov. 12, 2020 | Oct.30, 2021 | Oct.29, 2022 |
| EMI Measurement Receiver | R&S | ESR26 | 101377 | Nov. 12, 2020 | Oct.30, 2021 | Oct.29, 2022 |
| Horn Antenna | TDK | HRN-0118 | 130940 | / | July 20, 2021 | July 19, 2024 |
| Preamplifier | TDK | PA-02-0118 | TRS-305-00067 | Nov. 20, 2020 | Oct.30, 2021 | Oct.29, 2022 |
| Horn Antenna | Schwarzbeck | BBHA9170 | #691 | / | July 20, 2021 | July 19, 2024 |
| Preamplifier | TDK | PA-02-2 | TRS-307-00003 | Nov. 12, 2020 | Oct.31, 2021 | Oct.30, 2022 |
| Preamplifier | TDK | PA-02-3 | TRS-308-00002 | Nov. 12, 2020 | Oct.31, 2021 | Oct.30, 2022 |
| Loop antenna | Schwarzbeck | 1519B | 00008 | Jan.17, 2019 | Dec.14, 2021 | Dec.13, 2024 |
| Preamplifier | TDK | PA-02-001-3000 | TRS-302-00050 | Nov. 12, 2020 | Oct.31, 2021 | Oct.30, 2022 |
| Preamplifier | Mini-Circuits | ZX60-83LN-S+ | SUP01201941 | Nov. 20, 2020 | Oct.31, 2021 | Oct.30, 2022 |
| Highpass Filter | Wainwright | WHKX10-5850-6500-1800-40SS | 4 | Nov. 12, 2020 | Oct.31, 2021 | Oct.30, 2022 |
| Band Reject Filter | Wainwright | WRCJV12-5695-5725-5850- | 4 | Nov. 12, 2020 | Oct.31, 2021 | Oct.30, 2022 |



| | | | | | | |
|--------------------------------------|------------|----------------------------------|--------|---------------|--------------|--------------|
| | | 5880-40SS | | | | |
| Band Reject Filter | Wainwright | WRCJV20-5120-5150-5350-5380-60SS | 2 | Nov. 12, 2020 | Oct.31, 2021 | Oct.30, 2022 |
| Band Reject Filter | Wainwright | WRCJV20-5440-5470-5725-5755-60SS | 1 | Nov. 12, 2020 | Oct.31, 2021 | Oct.30, 2022 |
| Software | | | | | | |
| Description | | Manufacturer | Name | Version | | |
| Test Software for Radiated Emissions | | Farad | EZ-EMC | Ver. UL-3A1 | | |

| Tonsend RF Test System | | | | | | |
|-------------------------------------|--------------|-------------------------|------------|-----------------|--------------|--------------|
| Equipment | Manufacturer | Model No. | Serial No. | Upper Last Cal. | Last Cal. | Due. Date |
| Wideband Radio Communication Tester | R&S | CMW500 | 155523 | Nov.20,2020 | Oct.30, 2021 | Oct.29, 2022 |
| PXA Signal Analyzer | Keysight | N9030A | MY55410512 | Nov.20,2020 | Oct.30, 2021 | Oct.29, 2022 |
| MXG Vector Signal Generator | Keysight | N5182B | MY56200284 | Nov.20,2020 | Oct.30, 2021 | Oct.29, 2022 |
| MXG Vector Signal Generator | Keysight | N5172B | MY56200301 | Nov.20,2020 | Oct.30, 2021 | Oct.29, 2022 |
| DC power supply | Keysight | E3642A | MY55159130 | Nov.24,2020 | Oct.30, 2021 | Oct.29, 2022 |
| Temperature & Humidity Chamber | SANMOOD | SG-80-CC-2 | 2088 | Nov.20,2020 | Oct.30, 2021 | Nov.19,2022 |
| Software | | | | | | |
| Description | Manufacturer | Name | | Version | | |
| Tonsend SRD Test System | Tonsend | JS1120-3 RF Test System | | 2.6.77.0518 | | |



| Other Instruments | | | | | | |
|----------------------------|--------------|---------------------------|------------------------|-----------------|--------------|--------------|
| Equipment | Manufacturer | Model No. | Serial No. | Upper Last Cal. | Last Cal. | Next Cal. |
| Dual Channel Power Meter | Keysight | N1912A | MY55416024 | Nov. 20, 2020 | Oct.30, 2021 | Oct.29, 2022 |
| Power Sensor | Keysight | USB Wideband Power Sensor | MY5100022 | Nov. 20, 2020 | Oct.30, 2021 | Oct.29, 2022 |
| Signal & Spectrum analyzer | R&S | FSW | 1312.8000K26-103950-sj | Nov.20,2020 | Oct.31, 2021 | Oct.30, 2022 |

7. ANTENNA PORT TEST RESULTS

7.1. ON TIME AND DUTY CYCLE

LIMITS

None; for reporting purposes only.

PROCEDURE

Refer to KDB 789033 D02 General U-NII Test Procedures New Rules v02r01 section II.B.

The zero-span mode on a spectrum analyzer or EMI receiver, if the response time and spacing between bins on the sweep are sufficient to permit accurate measurements of the on and off times of the transmitted signal. Set the center frequency of the instrument to the center frequency of the transmission. Set $RBW \geq EBW$ if possible; otherwise, set RBW to the largest available value. Set $VBW \geq RBW$. Set detector = peak or average. The zero-span measurement method shall not be used unless both RBW and VBW are $> 50/T$, where T is defined in II.B.1.a), and the number of sweep points across duration T exceeds 100. (For example, if VBW and/or RBW are limited to 3 MHz, then the zero-span method of measuring duty cycle shall not be used if $T \leq 16.7$ microseconds.)

TEST SETUP

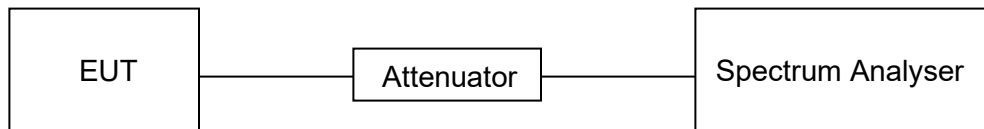

TEST ENVIRONMENT

| | | | |
|---------------------|---------|-------------------|----------|
| Temperature | 25.9 °C | Relative Humidity | 56.1% |
| Atmosphere Pressure | 101 kPa | Test Voltage | DC 3.3 V |

RESULTS

Please refer to appendix D.



7.2. 6/26 dB EMISSION BANDWIDTH AND 99 % OCCUPIED BANDWIDTH

LIMITS

| CFR 47 FCC Part15, Subpart E ISED RSS-247 ISSUE 2 | | |
|--|---|---|
| Test Item | Limit | Frequency Range (MHz) |
| 26 dB Emission Bandwidth | For reporting purposes only. | 5150 ~ 5250 |
| 26 dB Emission Bandwidth | For reporting purposes only. | 5250 ~ 5350 |
| 26 dB Emission Bandwidth | For reporting purposes only. | 5470 ~ 5725 (For FCC) 5470 ~ 5600 (For ISED) 5650 ~ 5725 (For ISED) |
| 6 dB Emission Bandwidth | The minimum 6 dB emission bandwidth shall be 500 kHz. | 5725 ~ 5850 |
| 99 % Occupied Bandwidth | For reporting purposes only. | 5150 ~ 5825 (For ISED) |

TEST PROCEDURE

Refer to KDB 789033 D02 General U-NII Test Procedures New Rules v02r01 section II.C1. for 26 dB Emission Bandwidth; section II.C2. for 6 dB Emission Bandwidth; section II.D. for 99 % Occupied Bandwidth.

Connect the EUT to the spectrum analyser and use the following settings:

| | |
|------------------|---|
| Center Frequency | The center frequency of the channel under test |
| Detector | Peak |
| RBW | For 6 dB Emission Bandwidth: RBW=100 kHz For 26 dB Emission bandwidth: approximately 1 % of the EBW. For 99 % Occupied Bandwidth: approximately 1 % ~ 5 % of the OBW. |
| VBW | For 6 dB Bandwidth: $\geq 3 \times \text{RBW}$ For 26 dB Bandwidth: $> 3 \times \text{RBW}$ For 99 % Bandwidth: $> 3 \times \text{RBW}$ |
| Trace | Max hold |
| Sweep | Auto couple |

- a) Use the 99 % power bandwidth function of the instrument, allow the trace to stabilize and report the measured bandwidth.
- b) Allow the trace to stabilize and measure the maximum width of the emission that is constrained by the frequencies associated with the two outermost amplitude points (upper and lower frequencies) that are attenuated by 6/26 dB relative to the maximum level measured in the fundamental emission.

Calculation for 99 % Bandwidth of UNII-2C and UNII-3 Straddle Channel:

For Example: Fundamental Frequency: 5720 MHz

99 % OBW: 21.00 MHz

Turning Frequency: 5725 MHz

99 % Bandwidth of UNII-2C Band Portion = $(5725 - (5720 - (21.00/2))) = 15.50$ MHz

99 % Bandwidth of UNII-3 Band Portion = $(5720 + (21.00/2) - 5725) = 5.50$ MHz

Calculation for 26 dB Bandwidth of UNII-2C Straddle Channel:

For Example: Fundamental frequency: 5720 MHz

26 dB BW: 20.00 MHz

FL: 5710.16 MHz

FH: 5730.16 MHz

Turning Frequency: 5725 MHz

26 dB Bandwidth of UNII-2C Band Portion = $5725 - 5710.16 = 14.84$ MHz

Calculation for 6dB Bandwidth of UNII-3 Straddle Channel:

For Example: Fundamental frequency: 5720 MHz

6 dB BW: 16.44 MHz

FL: 5711.76 MHz

FH: 5728.2 MHz

Turning Frequency: 5725 MHz

6 dB Bandwidth of UNII-3 band Portion = $5728.2 - 5725 = 3.2$ MHz

TEST SETUP

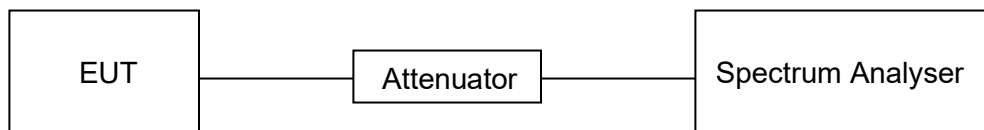

TEST ENVIRONMENT

| | | | |
|---------------------|---------|-------------------|----------|
| Temperature | 25.9 °C | Relative Humidity | 56.1% |
| Atmosphere Pressure | 101 kPa | Test Voltage | DC 3.3 V |

RESULTS

Please refer to Appendix A1&A2&A3.



7.3. CONDUCTED OUTPUT POWER

LIMITS

| CFR 47 FCC Part15, Subpart E | | |
|------------------------------|---|----------------------------|
| Test Item | Limit | Frequency Range (MHz) |
| Conducted Output Power | <input type="checkbox"/> Outdoor Access Point: 1 W (30 dBm) <input type="checkbox"/> Indoor Access Point: 1 W (30 dBm) <input type="checkbox"/> Fixed Point-To-Point Access Points: 1 W (30 dBm) <input checked="" type="checkbox"/> Client Devices: 250 mW (24 dBm) | 5150 ~ 5250 |
| | Shall not exceed the lesser of 250 mW (24dBm) or 11 dBm + 10 log B, where B is the 26 dB emission bandwidth in megahertz. | 5250 ~ 5350 5470 ~ 5725 |
| | Shall not exceed 1 Watt (30 dBm). | 5725 ~ 5850 |

| ISED RSS-247 ISSUE 2 | | |
|------------------------------------|--|---|
| Test Item | Limit | Frequency Range (MHz) |
| Conducted Output Power or e.i.r.p. | The maximum e.i.r.p. shall not exceed 200 mW (23 dBm) or 10 + 10 log ₁₀ B, dBm, whichever power is less. B is the 99 % emission bandwidth in megahertz. | 5150 ~ 5250 |
| | a. The maximum conducted output power shall not exceed 250 mW (24 dBm) or 11 + 10 log ₁₀ B dBm, whichever is less. b. The maximum e.i.r.p. shall not exceed 1.0 W (30 dBm) or 17 + 10 log ₁₀ B dBm, whichever is less. B is the 99 % emission bandwidth in megahertz. Note that devices with a maximum e.i.r.p. greater than 500 mW shall implement TPC in order to have the capability to operate at least 6 dB below the maximum permitted e.i.r.p. of 1 W. | 5250 ~ 5350 5470 ~ 5600 5650 ~ 5725 |
| | Shall not exceed 1 Watt (30 dBm). The e.i.r.p. shall not exceed 4 W | 5725 ~ 5850 |

Note:

The above limits are based upon the maximum antenna gain does not exceed 6 dBi. If transmitting antennas of directional gain greater than 6 dBi are used, the maximum conducted output power shall be reduced by the amount in dB that the directional gain of the antenna exceeds 6 dBi.

TEST PROCEDURE

Refer to KDB 789033 D02 General U-NII Test Procedures New Rules v02r01 section II.E.

Method SA-1 (trace averaging with the EUT transmitting at full power throughout each sweep):

- (i) Set span to encompass the entire emission bandwidth (EBW) (or, alternatively, the entire 99% occupied bandwidth) of the signal.
- (ii) Set RBW = 1 MHz.
- (iii) Set VBW \geq 3 MHz.
- (iv) Number of points in sweep $\geq 2 \times$ span / RBW. (This ensures that bin-to-bin spacing is \leq RBW/2, so that narrowband signals are not lost between frequency bins.)
- (v) Sweep time = auto.
- (vi) Detector = power averaging (rms), if available. Otherwise, use sample detector mode.
- (vii) If transmit duty cycle $<$ 98 %, use a video trigger with the trigger level set to enable triggering only on full power pulses. Transmitter must operate at maximum power control level for the entire duration of every sweep. If the EUT transmits continuously (i.e., with no off intervals) or at duty cycle \geq 98 %, and if each transmission is entirely at the maximum power control level, then the trigger shall be set to “free run.”
- (viii) Trace average at least 100 traces in power averaging (rms) mode.
- (ix) Compute power by integrating the spectrum across the EBW (or, alternatively, the entire 99% occupied bandwidth) of the signal using the instrument’s band power measurement function with band limits set equal to the EBW (or occupied bandwidth) band edges. If the instrument does not have a band power function, sum the spectrum levels (in power units) at 1 MHz intervals extending across the EBW (or, alternatively, the entire 99% occupied bandwidth) of the spectrum.

Method PM (Measurement using an RF average power meter):

- (i) Measurements may be performed using a wideband RF power meter with a thermocouple detector or equivalent if all of the following conditions are satisfied:
 - a. The EUT is configured to transmit continuously or to transmit with a constant duty cycle.
 - b. At all times when the EUT is transmitting, it must be transmitting at its maximum power control level.
 - c. The integration period of the power meter exceeds the repetition period of the transmitted signal by at least a factor of five.
- (ii) If the transmitter does not transmit continuously, measure the duty cycle, x , of the transmitter output signal as described in II.B.
- (iii) Measure the average power of the transmitter. This measurement is an average over both the on and off periods of the transmitter.
- (iv) Adjust the measurement in dBm by adding $10 \log (1/x)$ where x is the duty cycle (e.g., $10 \log (1/0.25)$ if the duty cycle is 25 %).

Straddle channel power was measured using spectrum analyzer.

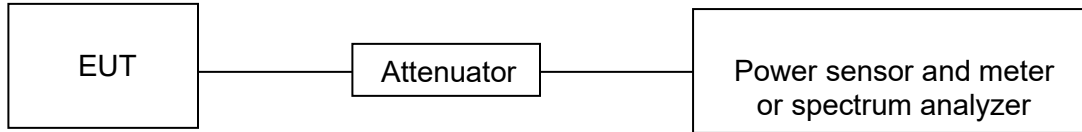
TEST SETUP**TEST ENVIRONMENT**

| | | | |
|---------------------|---------|-------------------|----------|
| Temperature | 25.9 °C | Relative Humidity | 56.1% |
| Atmosphere Pressure | 101 kPa | Test Voltage | DC 3.3 V |

RESULTS

Please refer to Appendix B.



7.4. POWER SPECTRAL DENSITY

LIMITS

| CFR 47 FCC Part15, Subpart E | | |
|------------------------------|--|----------------------------|
| Test Item | Limit | Frequency Range (MHz) |
| Power Spectral Density | <input type="checkbox"/> Outdoor Access Point: 17 dBm/MHz <input type="checkbox"/> Indoor Access Point: 17 dBm/MHz <input type="checkbox"/> Fixed Point-To-Point Access Points: 17 dBm/MHz <input checked="" type="checkbox"/> Client Devices: 11 dBm/MHz | 5150 ~ 5250 |
| | 11 dBm/MHz | 5250 ~ 5350 5470 ~ 5725 |
| | 30 dBm/500kHz | 5725 ~ 5850 |

| ISED RSS-247 ISSUE 2 | | |
|------------------------|--|---|
| Test Item | Limit | Frequency Range (MHz) |
| Power Spectral Density | The e.i.r.p. spectral density shall not exceed 10 dBm in any 1.0 MHz band. | 5150 ~ 5250 |
| | The power spectral density shall not exceed 11 dBm in any 1.0 MHz band. | 5250 ~ 5350 5470 ~ 5600 5650 ~ 5725 |
| | 30 dBm / 500 kHz | 5725 ~ 5850 |

Note:

The above limits are based upon the maximum antenna gain does not exceed 6 dBi. If transmitting antennas of directional gain greater than 6 dBi are used, maximum power spectral density shall be reduced by the amount in dB that the directional gain of the antenna exceeds 6 dBi.

TEST PROCEDURE

Refer to KDB 789033 D02 General U-NII Test Procedures New Rules v02r01 section II.F.

Connect the EUT to the spectrum analyser and use the following settings:

For U-NII-1, U-NII-2A and U-NII-2C band:

| | |
|------------------|--|
| Center Frequency | The center frequency of the channel under test |
| Detector | RMS |
| RBW | 1 MHz |
| VBW | $\geq 3 \times \text{RBW}$ |
| Span | Encompass the entire emissions bandwidth (EBW) of the signal |
| Trace | Max hold |
| Sweep time | Auto |

For U-NII-3:

| | |
|------------------|--|
| Center Frequency | The center frequency of the channel under test |
| Detector | RMS |
| RBW | 500 kHz |
| VBW | $\geq 3 \times \text{RBW}$ |
| Span | Encompass the entire emissions bandwidth (EBW) of the signal |
| Trace | Max hold |
| Sweep time | Auto |

Allow trace to fully stabilize and Use the peak search function on the instrument to find the peak of the spectrum and record its value.

Add $10 \log(1/x)$, where x is the duty cycle, to the peak of the spectrum, the result is the Maximum PSD over 1 MHz / 500 kHz reference bandwidth.

TEST SETUP

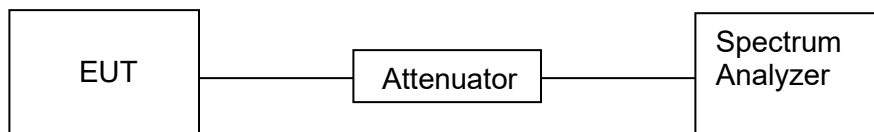

TEST ENVIRONMENT

| | | | |
|---------------------|---------|-------------------|----------|
| Temperature | 25.9 °C | Relative Humidity | 56.1% |
| Atmosphere Pressure | 101 kPa | Test Voltage | DC 3.3 V |

RESULTS

Please refer to Appendix C.

8. RADIATED TEST RESULTS

LIMITS

Refer to CFR 47 FCC §15.205, §15.209 and §15.407 (b).

Refer to ISED RSS-GEN Clause 8.9, Clause 8.10 and ISED RSS-247 6.2.

Radiation Disturbance Test Limit for FCC (Class B) (9 kHz ~ 1 GHz)

| Emissions radiated outside of the specified frequency bands above 30 MHz | | | |
|--|------------------------------------|--------------------------------------|---------|
| Frequency Range (MHz) | Field Strength Limit (uV/m) at 3 m | Field Strength Limit (dBuV/m) at 3 m | |
| | | Quasi-Peak | |
| 30 - 88 | 100 | 40 | |
| 88 - 216 | 150 | 43.5 | |
| 216 - 960 | 200 | 46 | |
| Above 960 | 500 | 54 | |
| Above 1000 | 500 | Peak | Average |
| | | 74 | 54 |

| FCC Emissions radiated outside of the specified frequency bands below 30 MHz | | |
|--|-----------------------------------|-------------------------------|
| Frequency (MHz) | Field strength (microvolts/meter) | Measurement distance (meters) |
| 0.009-0.490 | 2400/F(kHz) | 300 |
| 0.490-1.705 | 24000/F(kHz) | 30 |
| 1.705-30.0 | 30 | 30 |

ISED General field strength limits at frequencies below 30 MHz

| Table 6 – General field strength limits at frequencies below 30 MHz | | |
|---|--|--------------------------|
| Frequency | Magnetic field strength (H-Field) (µA/m) | Measurement distance (m) |
| 9 - 490 kHz ^{Note 1} | 6.37/F (F in kHz) | 300 |
| 490 - 1705 kHz | 63.7/F (F in kHz) | 30 |
| 1.705 - 30 MHz | 0.08 | 30 |

Note 1: The emission limits for the ranges 9-90 kHz and 110-490 kHz are based on measurements employing a linear average detector.



ISED Restricted bands refer to ISED RSS-GEN Clause 8.10

Table 7 – Restricted frequency bands^{Note 1}

| MHz | MHz | GHz |
|---------------------|-----------------------|---------------|
| 0.090 - 0.110 | 149.9 - 150.05 | 9.0 - 9.2 |
| 0.495 - 0.505 | 156.52475 - 156.52525 | 9.3 - 9.5 |
| 2.1735 - 2.1905 | 156.7 - 156.9 | 10.6 - 12.7 |
| 3.020 - 3.026 | 162.0125 - 167.17 | 13.25 - 13.4 |
| 4.125 - 4.128 | 167.72 - 173.2 | 14.47 - 14.5 |
| 4.17725 - 4.17775 | 240 - 285 | 15.35 - 16.2 |
| 4.20725 - 4.20775 | 322 - 335.4 | 17.7 - 21.4 |
| 5.677 - 5.683 | 399.9 - 410 | 22.01 - 23.12 |
| 6.215 - 6.218 | 608 - 614 | 23.6 - 24.0 |
| 6.26775 - 6.26825 | 960 - 1427 | 31.2 - 31.8 |
| 6.31175 - 6.31225 | 1435 - 1626.5 | 36.43 - 36.5 |
| 8.291 - 8.294 | 1645.5 - 1646.5 | Above 38.6 |
| 8.362 - 8.366 | 1660 - 1710 | |
| 8.37625 - 8.38675 | 1718.8 - 1722.2 | |
| 8.41425 - 8.41475 | 2200 - 2300 | |
| 12.29 - 12.293 | 2310 - 2390 | |
| 12.51975 - 12.52025 | 2483.5 - 2500 | |
| 12.57675 - 12.57725 | 2655 - 2900 | |
| 13.36 - 13.41 | 3260 - 3267 | |
| 16.42 - 16.423 | 3332 - 3339 | |
| 16.89475 - 16.89525 | 3345.8 - 3358 | |
| 16.80425 - 16.80475 | 3500 - 4400 | |
| 25.5 - 25.67 | 4500 - 5150 | |
| 37.5 - 38.25 | 5350 - 5480 | |
| 73 - 74.6 | 7250 - 7750 | |
| 74.8 - 75.2 | 8025 - 8500 | |
| 108 - 138 | | |

Note 1: Certain frequency bands listed in table 7 and in bands above 38.6 GHz are designated for licence-exempt applications. These frequency bands and the requirements that apply to related devices are set out in the 200 and 300 series of RSSs.

FCC Restricted bands of operation refer to FCC §15.205 (a):

| MHz | MHz | MHz | GHz |
|--------------------------|---------------------|---------------|------------------|
| 0.090-0.110 | 16.42-16.423 | 399.9-410 | 4.5-5.15 |
| ¹ 0.495-0.505 | 16.69475-16.69525 | 608-614 | 5.35-5.46 |
| 2.1735-2.1905 | 16.80425-16.80475 | 960-1240 | 7.25-7.75 |
| 4.125-4.128 | 25.5-25.67 | 1300-1427 | 8.025-8.5 |
| 4.17725-4.17775 | 37.5-38.25 | 1435-1626.5 | 9.0-9.2 |
| 4.20725-4.20775 | 73-74.6 | 1645.5-1646.5 | 9.3-9.5 |
| 6.215-6.218 | 74.8-75.2 | 1660-1710 | 10.6-12.7 |
| 6.26775-6.26825 | 108-121.94 | 1718.8-1722.2 | 13.25-13.4 |
| 6.31175-6.31225 | 123-138 | 2200-2300 | 14.47-14.5 |
| 8.291-8.294 | 149.9-150.05 | 2310-2390 | 15.35-16.2 |
| 8.362-8.366 | 156.52475-156.52525 | 2483.5-2500 | 17.7-21.4 |
| 8.37625-8.38675 | 156.7-156.9 | 2690-2900 | 22.01-23.12 |
| 8.41425-8.41475 | 162.0125-167.17 | 3260-3267 | 23.6-24.0 |
| 12.29-12.293 | 167.72-173.2 | 3332-3339 | 31.2-31.8 |
| 12.51975-12.52025 | 240-285 | 3345.8-3358 | 36.43-36.5 |
| 12.57675-12.57725 | 322-335.4 | 3600-4400 | (²) |
| 13.36-13.41 | | | |

Note: ¹Until February 1, 1999, this restricted band shall be 0.490-0.510 MHz.

²Above 38.6c



Limits of unwanted/undesirable emission out of the restricted bands refer to CFR 47 FCC §15.407 (b) and ISED RSS-247 6.2.

| LIMITS OF RADIATED EMISSION MEASUREMENT (Above 1GHz) | | |
|---|---|---|
| Frequency Range (MHz) | EIRP Limit | Field Strength Limit (dBuV/m) at 3 m |
| 5150~5250 MHz | PK: -27 (dBm/MHz) | PK:68.2(dBμV/m) |
| 5250~5350 MHz | | |
| 5470~5725 MHz | | |
| 5725~5850 MHz | PK: -27 (dBm/MHz) *1 PK: 10 (dBm/MHz) *2 PK: 15.6 (dBm/MHz) *3 PK: 27 (dBm/MHz) *4 | PK: 68.2(dBμV/m) *1 PK: 105.2 (dBμV/m) *2 PK: 110.8(dBμV/m) *3 PK: 122.2 (dBμV/m) *4 |
| <p>Note:</p> <p>*1 beyond 75 MHz or more above of the band edge.</p> <p>*2 below the band edge increasing linearly to 10 dBm/MHz at 25 MHz above.</p> <p>*3 below the band edge increasing linearly to a level of 15.6 dBm/MHz at 5 MHz above.</p> <p>*4 from 5 MHz above or below the band edge increasing linearly to a level of 27 dBm/MHz at the band edge.</p> | | |

TEST SETUP AND PROCEDURE

Below 30 MHz

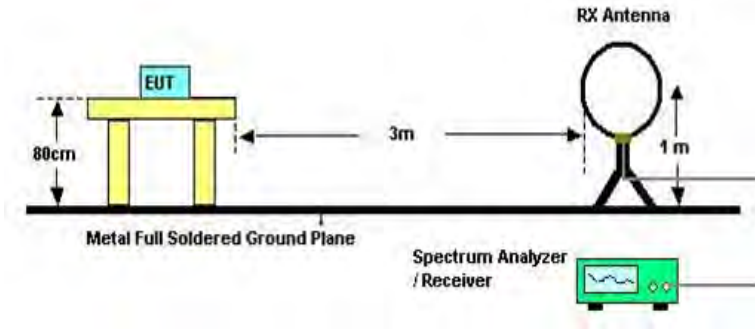

The setting of the spectrum analyser

| | |
|-------|--|
| RBW | 200 Hz (From 9 kHz to 0.15 MHz)/ 9 kHz (From 0.15 MHz to 30 MHz) |
| VBW | 200 Hz (From 9 kHz to 0.15 MHz)/ 9 kHz (From 0.15 MHz to 30 MHz) |
| Sweep | Auto |
| Trace | Max hold |

1. The testing follows the guidelines in ANSI C63.10-2013 clause 11.11 & 11.12.
2. The EUT was arranged to its worst case and then turntable (from 0 degree to 360 degrees) to find the maximum reading. A pre-amp and a high pass filter are used for the test in order to get better signal level. Both Horizontal, Face-on and Face-off polarizations of the antenna are set to make the measurement.
3. The EUT was placed on a turntable with 80 cm above ground.
4. The EUT was set 3 meters from the interference receiving antenna, which was mounted on the top of a 1 m height antenna tower.
5. The radiated emission limits are based on measurements employing a CISPR quasi-peak detector except for the frequency bands 9-90 kHz, 110-490 kHz and above 1000 MHz. Radiated emission limits in these three bands are based on measurements employing an average detector.
6. For measurement below 1 GHz, the initial step in collecting conducted emission data is a spectrum analyzer peak detector mode pre-scanning the measurement frequency range. Significant peaks are then marked and then Quasi Peak and average detector mode re-measured. If the emission level of the EUT measured by the peak detector is 3 dB lower than the applicable limit, the peak emission level will be reported. Otherwise, the emission measurement will be repeated using the quasi-peak and average detector and reported.
7. Although these tests were performed other than open field site, adequate comparison measurements were confirmed against 30m open field site. Therefore sufficient tests were made to demonstrate that the alternative site produces results that correlate with the ones of tests made in an open field site based on KDB 414788.
8. The limits in CFR 47, Part 15, Subpart C, paragraph 15.209 (a), are identical to those in RSS-GEN Section 8.9, Table 6, since the measurements are performed in terms of magnetic field strength and converted to electric field strength levels (as reported in the table) using the free space impedance of 377 ohm; For example, the measurement frequency X kHz resulted in a level of Y dBuV/m, which is equivalent to $Y-51.5 = Z$ dBuA/m, which has the same margin, W dB, to the corresponding RSS-GEN Table 6 limit as it has to be 15.209(a) limit.

Below 1 GHz and above 30 MHz

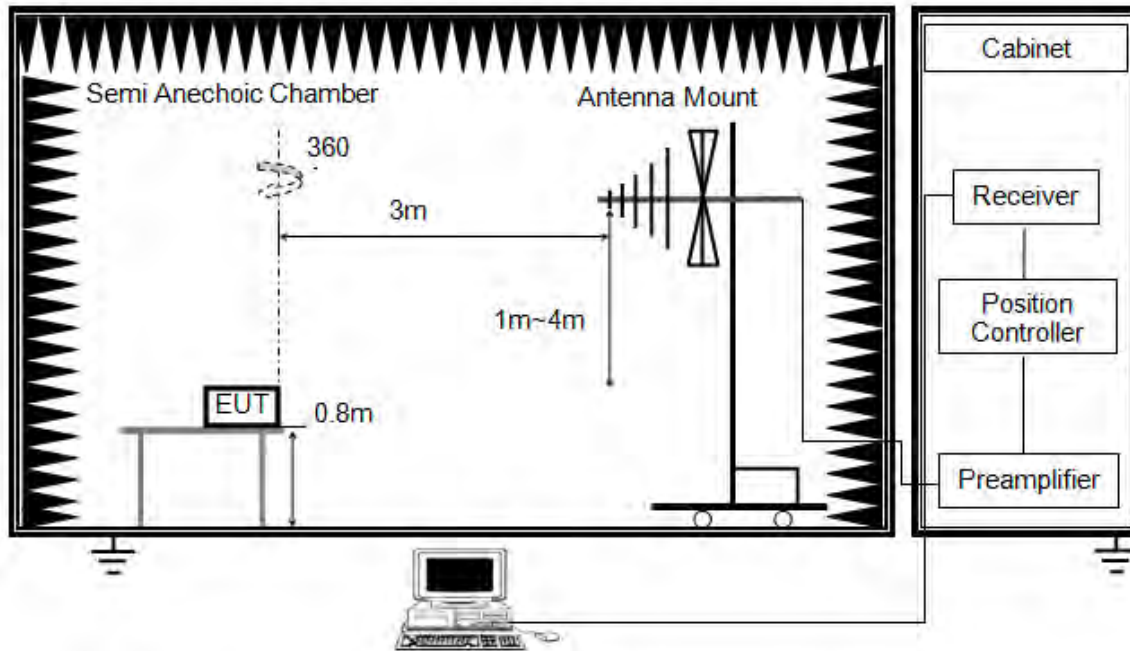

The setting of the spectrum analyser

| | |
|----------|----------|
| RBW | 120 kHz |
| VBW | 300 kHz |
| Sweep | Auto |
| Detector | Peak/QP |
| Trace | Max hold |

1. The testing follows the guidelines in ANSI C63.10-2013 clause 11.11 & 11.12.
2. The EUT was arranged to its worst case and then tune the antenna tower (from 1 m to 4 m) and turntable (from 0 degree to 360 degrees) to find the maximum reading. A pre-amp and a high pass filter are used for the test in order to get better signal level. Both horizontal and vertical polarizations of the antenna are set to make the measurement.
3. The EUT was placed on a turntable with 80 cm above ground.
4. The EUT was set 3 meters from the interference receiving antenna, which was mounted on the top of a variable height antenna tower.
5. For measurement below 1 GHz, the initial step in collecting conducted emission data is a spectrum analyzer peak detector mode pre-scanning the measurement frequency range. Significant peaks are then marked and then Quasi Peak detector mode re-measured. If the emission level of the EUT measured by the peak detector is 3 dB lower than the applicable limit, the peak emission level will be reported. Otherwise, the emission measurement will be repeated using the quasi-peak detector and reported.

Above 1 GHz

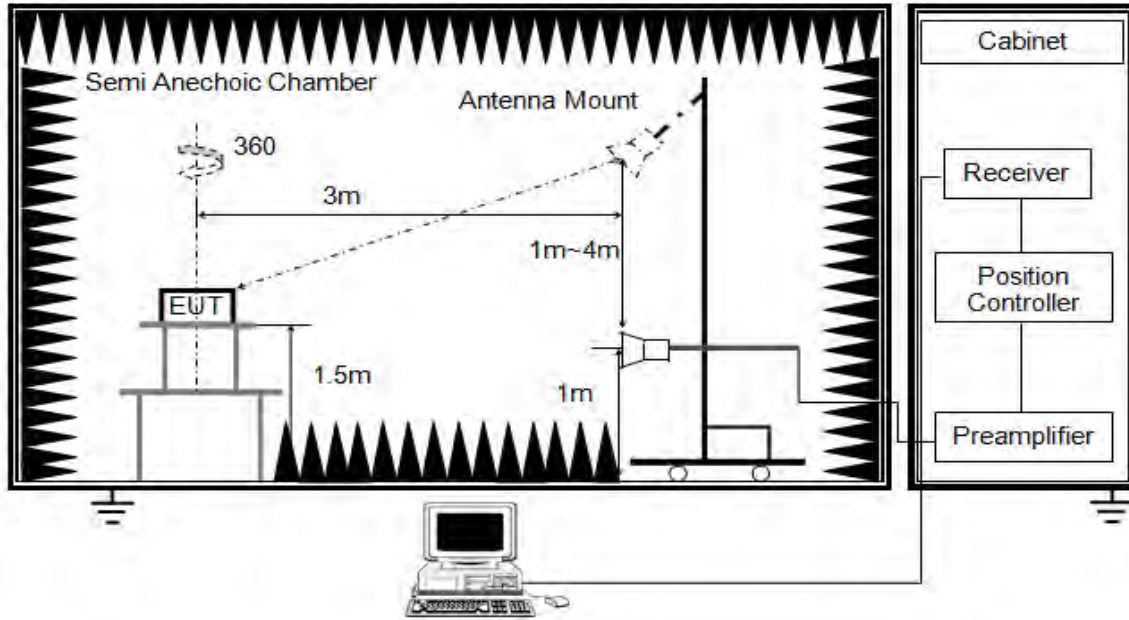

The setting of the spectrum analyser

| | |
|----------|--------------------------------|
| RBW | 1 MHz |
| VBW | PEAK: 3 MHz AVG: see note 6 |
| Sweep | Auto |
| Detector | Peak |
| Trace | Max hold |

1. The testing follows the guidelines in KDB 789033 D02 General U-NII Test Procedures New Rules v02r01 section II.G.3 ~ II.G.6.
2. The EUT was arranged to its worst case and then tune the antenna tower (from 1 m to 4 m) and turntable (from 0 degree to 360 degrees) to find the maximum reading. A pre-amp and a high pass filter are used for the test in order to get better signal level. Both horizontal and vertical polarizations of the antenna are set to make the measurement.
3. The EUT was placed on a turntable with 1.5 m above ground.
4. The EUT was set 3 meters from the interference receiving antenna, which was mounted on the top of a variable height antenna tower.
5. For measurement above 1 GHz, the emission measurement will be measured by the peak detector. This peak level, once corrected, must comply with the limit specified in Section 15.209.
6. For measurements above 1 GHz the resolution bandwidth is set to 1 MHz, then the video bandwidth is set to 3 MHz for peak measurements and 1 MHz resolution bandwidth with 1/T video bandwidth with peak detector for average measurements. For the Duty Cycle please refer to clause 7.1.ON TIME AND DUTY CYCLE.



Note 1: For all radiated test, EUT in each of three orthogonal axis emissions had been tested, but only the worst case (X axis) data recorded in the report.

Note 2: The EUT was fully exercised with external accessories during the test. In the case of multiple accessory external ports, an external accessory shall be connected to one of each type of port.

TEST ENVIRONMENT

| | | | |
|---------------------|---------|-------------------|----------|
| Temperature | 25.2 °C | Relative Humidity | 48 % |
| Atmosphere Pressure | 101 kPa | Test Voltage | DC 3.3 V |

RESULTS



8.1. RESTRICTED BANDEGE

8.1.1. 802.11a 20 MODE

UNII-1 BAND

RESTRICTED BANDEGE (LOW CHANNEL, VERTICAL)

PEAK

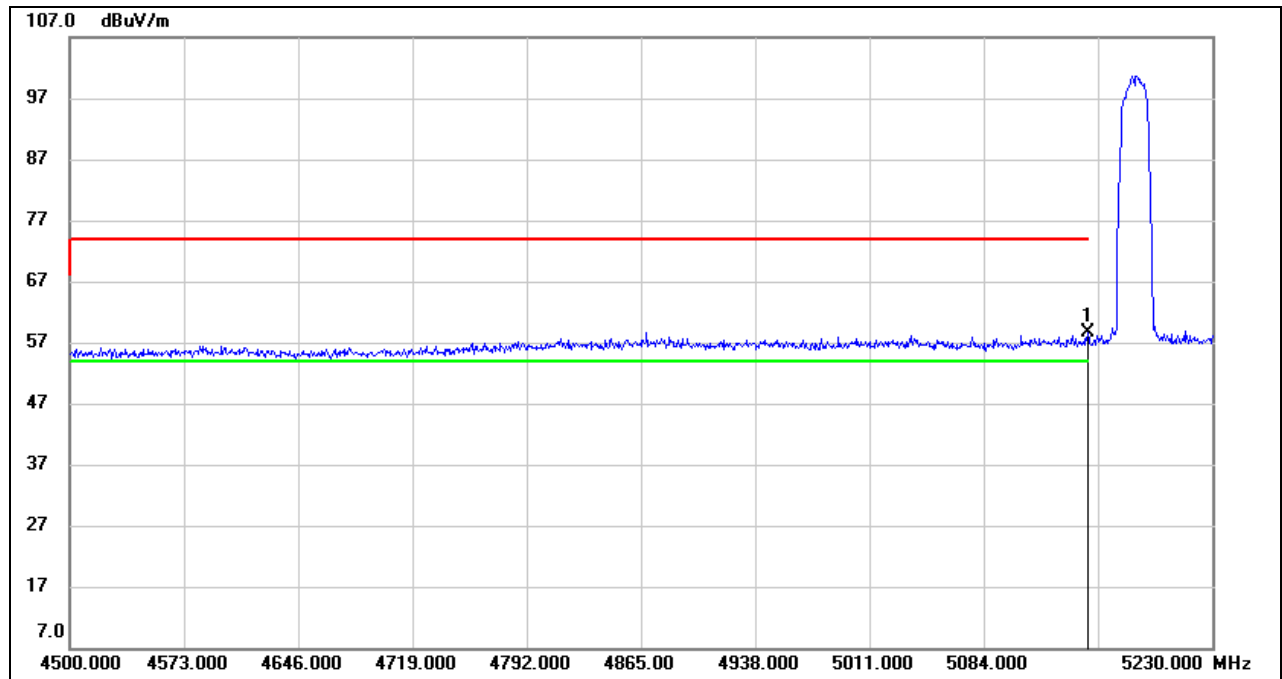

| No. | Frequency (MHz) | Reading (dBuV) | Correct (dB/m) | Result (dBuV/m) | Limit (dBuV/m) | Margin (dB) | Remark |
|-----|--------------------|-------------------|-------------------|--------------------|-------------------|----------------|--------|
| 1 | 5150.000 | 17.46 | 41.19 | 58.65 | 74.00 | -15.35 | peak |

- Note:
1. Measurement = Reading Level + Correct Factor.
 2. If Peak Result complies with AV limit, AV Result is deemed to comply with AV limit.
 3. Peak: Peak detector.
 4. Only the worst data was recorded, if it complies with the limit, the other emissions deemed to comply with the limit.

AVG

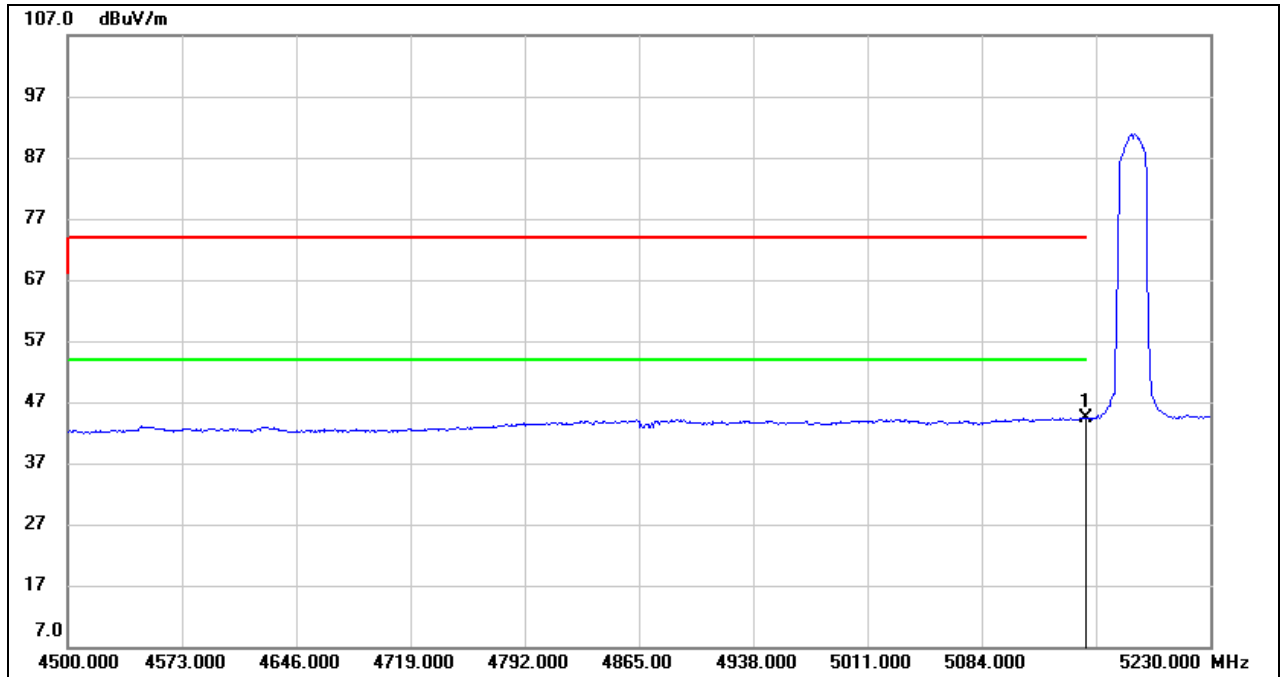

| No. | Frequency (MHz) | Reading (dBuV) | Correct (dB/m) | Result (dBuV/m) | Limit (dBuV/m) | Margin (dB) | Remark |
|-----|-----------------|----------------|----------------|-----------------|----------------|-------------|--------|
| 1 | 5150.000 | 3.11 | 41.19 | 44.30 | 54.00 | -9.70 | AVG |

- Note:
1. Measurement = Reading Level + Correct Factor.
 2. If Peak Result complies with AV limit, AV Result is deemed to comply with AV limit.
 3. AVG: $VBW=1/T_{on}$, where: T_{on} is the transmitting duration.
 4. For the transmitting duration, please refer to clause 7.1.
 5. Only the worst data was recorded, if it complies with the limit, the other emissions deemed to comply with the limit.



RESTRICTED BANDEDGE (HIGH CHANNEL, VERTICAL)

PEAK

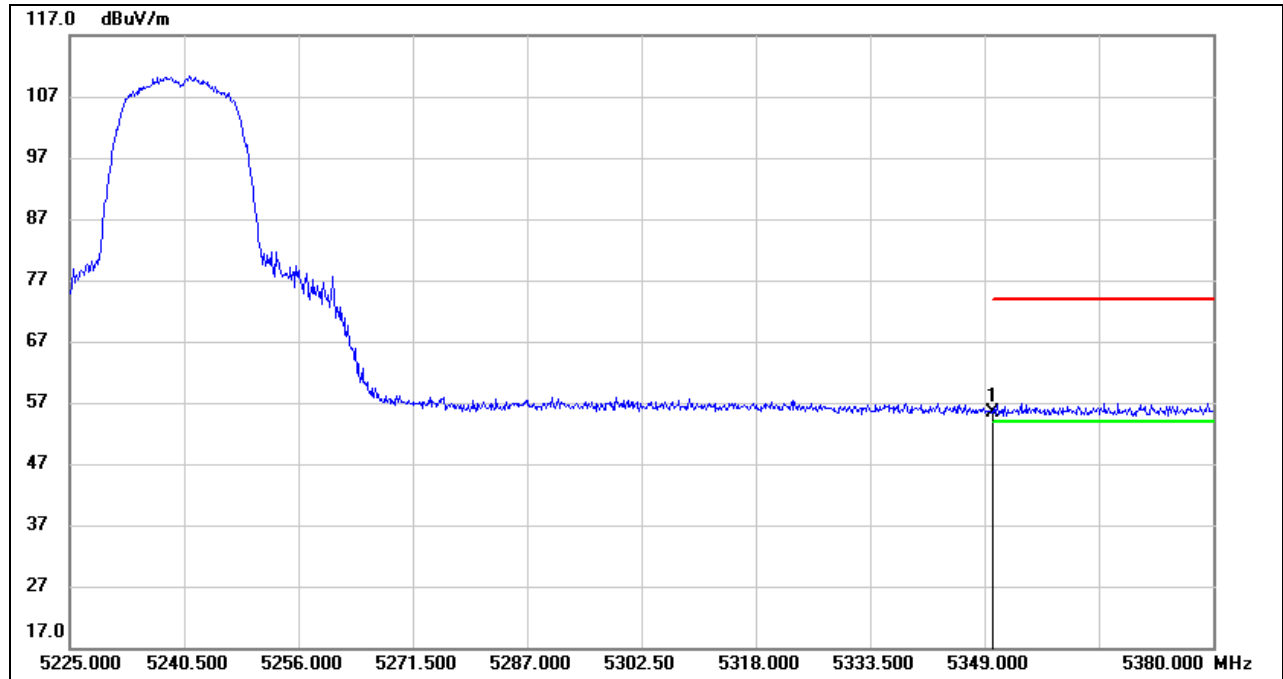

| No. | Frequency (MHz) | Reading (dBuV) | Correct (dB/m) | Result (dBuV/m) | Limit (dBuV/m) | Margin (dB) | Remark |
|-----|-----------------|----------------|----------------|-----------------|----------------|-------------|--------|
| 1 | 5350.000 | 15.39 | 40.08 | 55.47 | 74.00 | -18.53 | peak |

- Note: 1. Measurement = Reading Level + Correct Factor.
 2. If Peak Result complies with AV limit, AV Result is deemed to comply with AV limit.
 3. Peak: Peak detector.
 4. Only the worst data was recorded, if it complies with the limit, the other emissions deemed to comply with the limit.
 5. Since non-restricted band peak emissions are less than the average limit, they also comply with the -27dBm/MHz (68.2dBuV/m) limit.



AVG

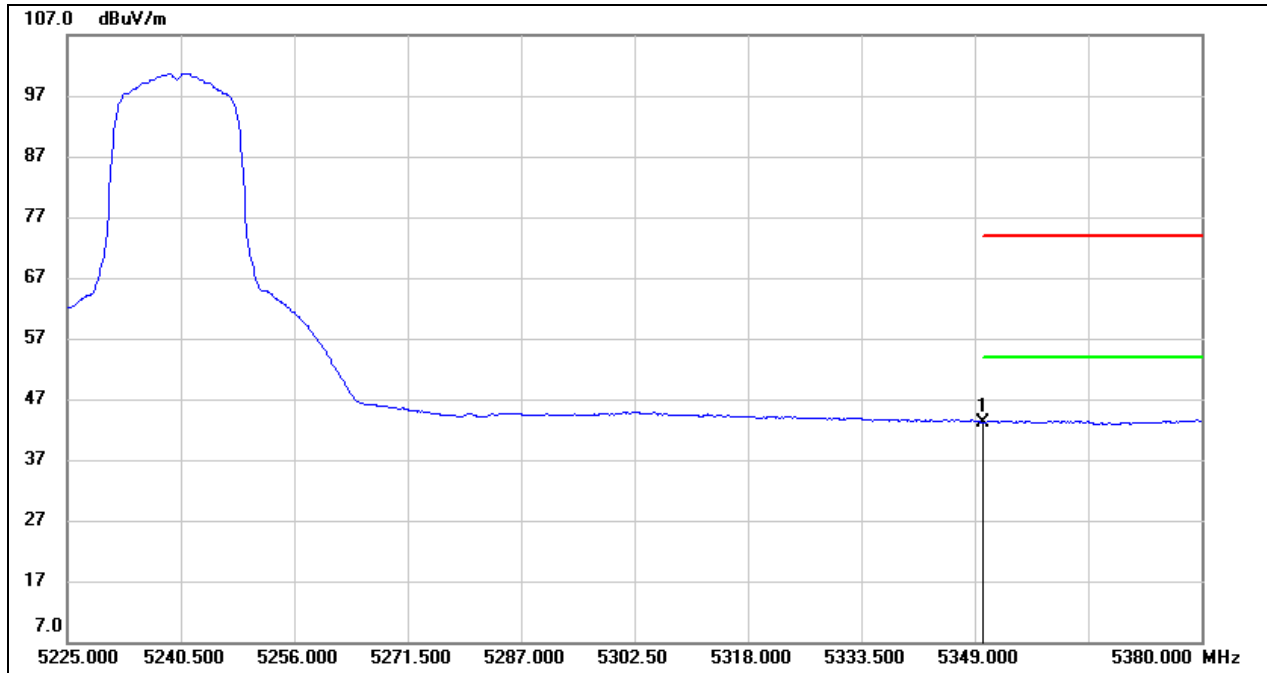

| No. | Frequency (MHz) | Reading (dBuV) | Correct (dB/m) | Result (dBuV/m) | Limit (dBuV/m) | Margin (dB) | Remark |
|-----|-----------------|----------------|----------------|-----------------|----------------|-------------|--------|
| 1 | 5350.000 | 3.07 | 40.08 | 43.15 | 54.00 | -10.85 | AVG |

- Note:
1. Measurement = Reading Level + Correct Factor.
 2. If Peak Result complies with AV limit, AV Result is deemed to comply with AV limit.
 3. AVG: $VBW=1/Ton$, where: Ton is the transmitting duration.
 4. For the transmitting duration, please refer to clause 7.1.
 5. Only the worst data was recorded, if it complies with the limit, the other emissions deemed to comply with the limit.

Note: All the polarities (Vertical & Horizontal) had been tested, only the worst data was recorded in the report.

UNII-2A BAND

RESTRICTED BANDEDGE (HIGH CHANNEL, VERTICAL)

PEAK

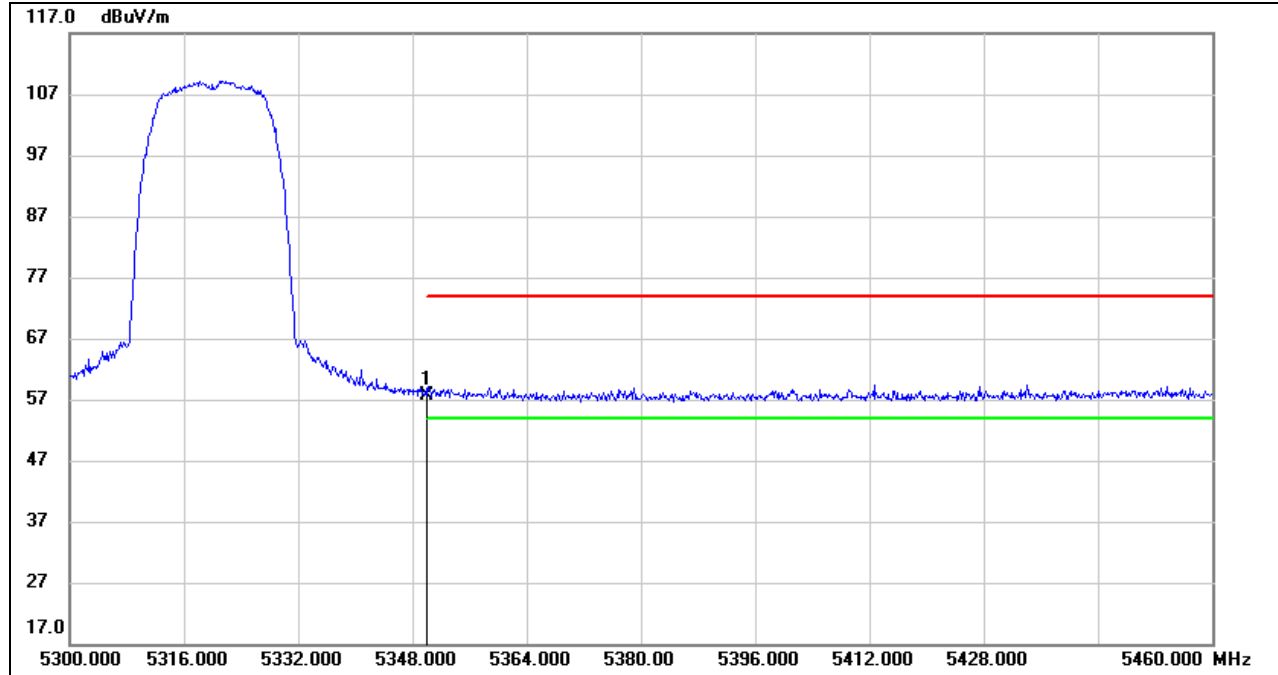

| No. | Frequency (MHz) | Reading (dBuV) | Correct (dB/m) | Result (dBuV/m) | Limit (dBuV/m) | Margin (dB) | Remark |
|-----|-----------------|----------------|----------------|-----------------|----------------|-------------|--------|
| 1 | 5350.000 | 16.46 | 41.20 | 57.66 | 74.00 | -16.34 | peak |

- Note:
1. Measurement = Reading Level + Correct Factor.
 2. If Peak Result complies with AV limit, AV Result is deemed to comply with AV limit.
 3. Peak: Peak detector.
 4. Only the worst data was recorded, if it complies with the limit, the other emissions deemed to comply with the limit.



AVG

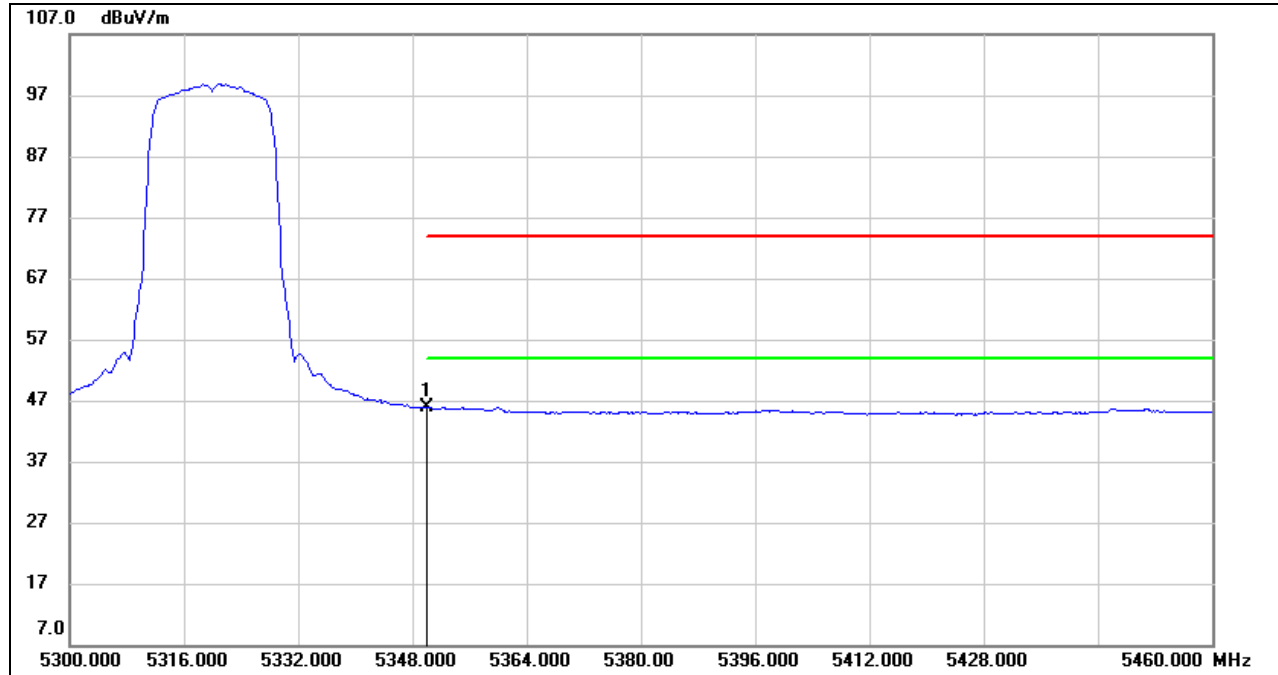

| No. | Frequency (MHz) | Reading (dBuV) | Correct (dB/m) | Result (dBuV/m) | Limit (dBuV/m) | Margin (dB) | Remark |
|-----|-----------------|----------------|----------------|-----------------|----------------|-------------|--------|
| 1 | 5350.000 | 4.71 | 41.20 | 45.91 | 54.00 | -8.09 | AVG |

- Note:
1. Measurement = Reading Level + Correct Factor.
 2. If Peak Result complies with AV limit, AV Result is deemed to comply with AV limit.
 3. AVG: $VBW=1/Ton$, where: Ton is the transmitting duration.
 4. For the transmitting duration, please refer to clause 7.1.
 5. Only the worst data was recorded, if it complies with the limit, the other emissions deemed to comply with the limit.

Note: All the polarities (Vertical & Horizontal) had been tested, only the worst data was recorded in the report.



UNII-2C BAND

RESTRICTED BANDEDGE (LOW CHANNEL, VERTICAL)

PEAK

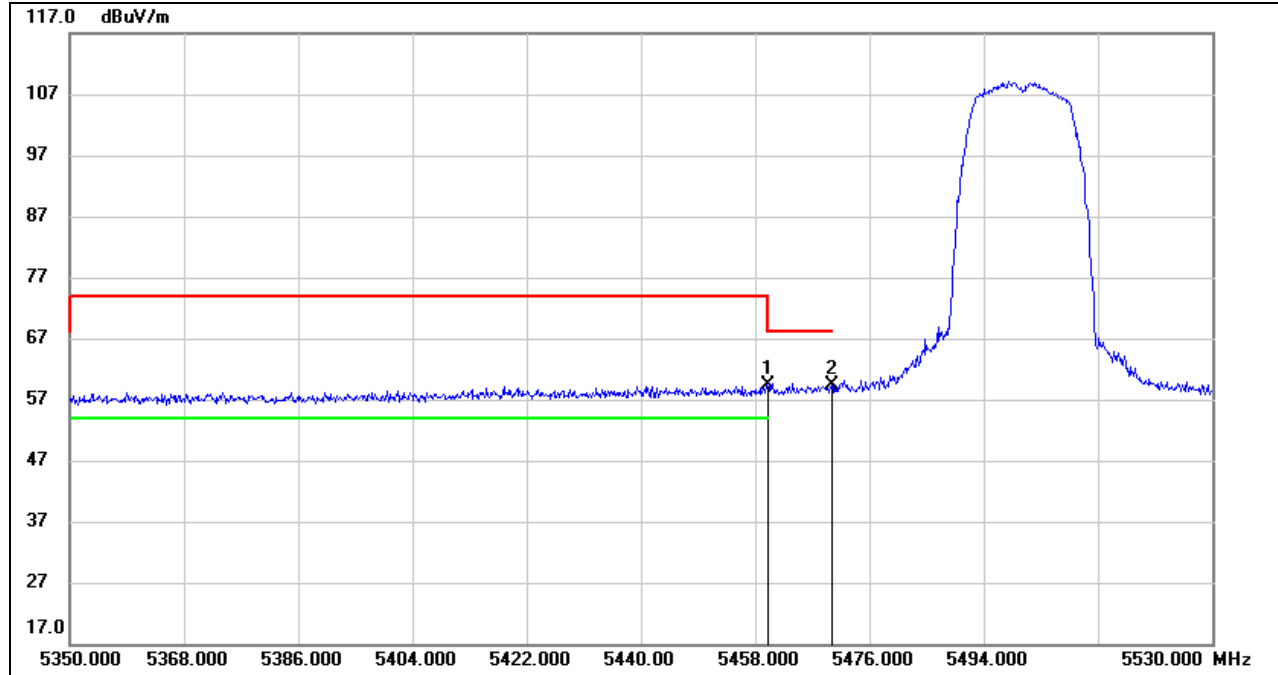

| No. | Frequency (MHz) | Reading (dBuV) | Correct (dB/m) | Result (dBuV/m) | Limit (dBuV/m) | Margin (dB) | Remark |
|-----|-----------------|----------------|----------------|-----------------|----------------|-------------|--------|
| 1 | 5460.000 | 17.52 | 41.82 | 59.34 | 68.20 | -8.86 | peak |
| 2 | 5470.000 | 17.39 | 41.87 | 59.26 | 68.20 | -8.94 | peak |

- Note: 1. Measurement = Reading Level + Correct Factor.
 2. If Peak Result complies with AV limit, AV Result is deemed to comply with AV limit.
 3. Peak: Peak detector.
 4. Only the worst data was recorded, if it complies with the limit, the other emissions deemed to comply with the limit.



AVG

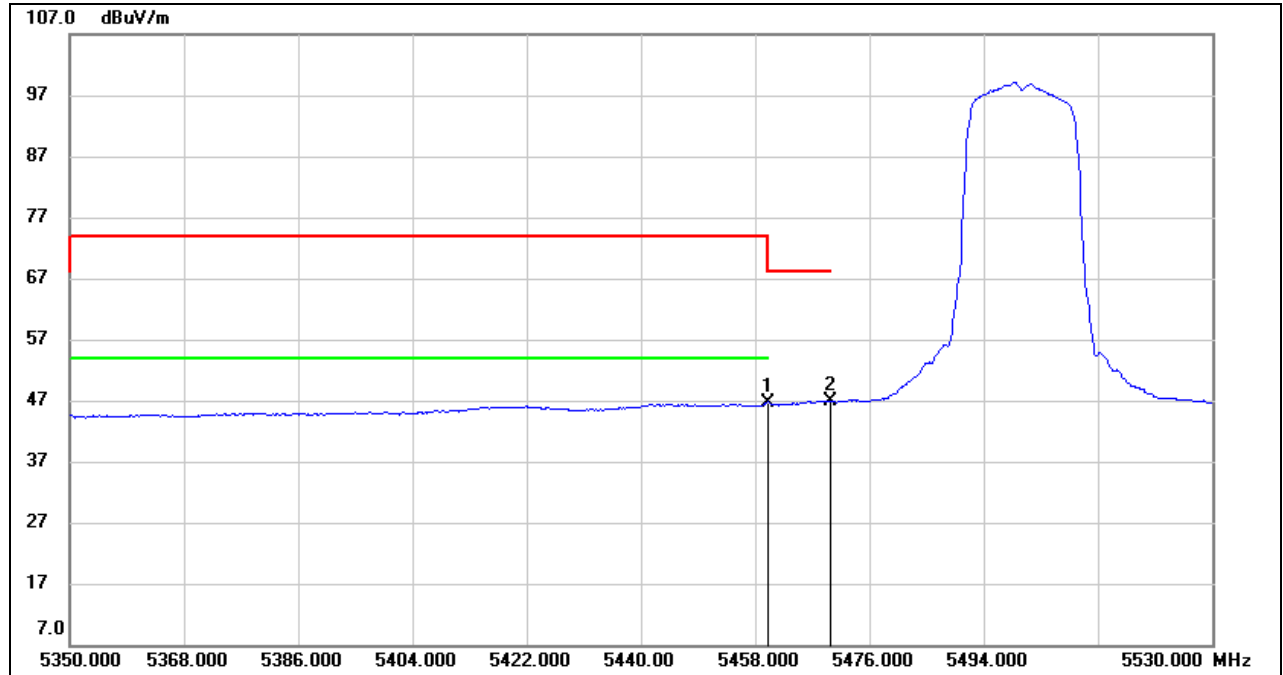

| No. | Frequency (MHz) | Reading (dBuV) | Correct (dB/m) | Result (dBuV/m) | Limit (dBuV/m) | Margin (dB) | Remark |
|-----|-----------------|----------------|----------------|-----------------|----------------|-------------|--------|
| 1 | 5460.000 | 4.90 | 41.82 | 46.72 | 54.00 | -7.28 | AVG |
| 2 | 5470.000 | 4.96 | 41.87 | 46.83 | / | / | AVG |

- Note:
1. Measurement = Reading Level + Correct Factor.
 2. If Peak Result complies with AV limit, AV Result is deemed to comply with AV limit.
 3. AVG: $VBW=1/Ton$, where: Ton is the transmitting duration.
 4. For the transmitting duration, please refer to clause 7.1.
 5. Only the worst data was recorded, if it complies with the limit, the other emissions deemed to comply with the limit.



RESTRICTED BANDEDGE (HIGH CHANNEL, VERTICAL)

PEAK

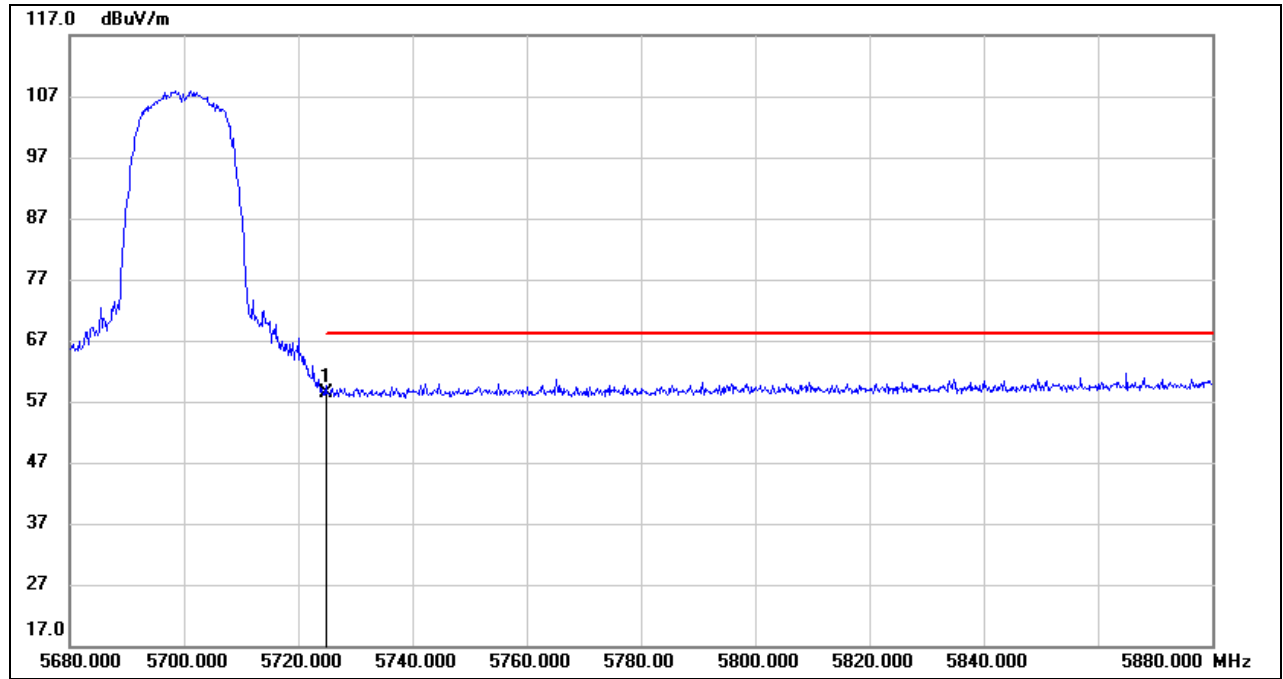

| No. | Frequency (MHz) | Reading (dBuV) | Correct (dB/m) | Result (dBuV/m) | Limit (dBuV/m) | Margin (dB) | Remark |
|-----|-----------------|----------------|----------------|-----------------|----------------|-------------|--------|
| 1 | 5725.000 | 16.69 | 41.67 | 58.36 | 68.20 | -9.84 | peak |

- Note: 1. Measurement = Reading Level + Correct Factor.
 2. If Peak Result complies with AV limit, AV Result is deemed to comply with AV limit.
 3. Peak: Peak detector.
 4. Only the worst data was recorded, if it complies with the limit, the other emissions deemed to comply with the limit.

Note: All the polarities (Vertical & Horizontal) had been tested, only the worst data was recorded in the report.

UNII-3 BAND

RESTRICTED BANDEDGE (LOW CHANNEL, VERTICAL)

PEAK

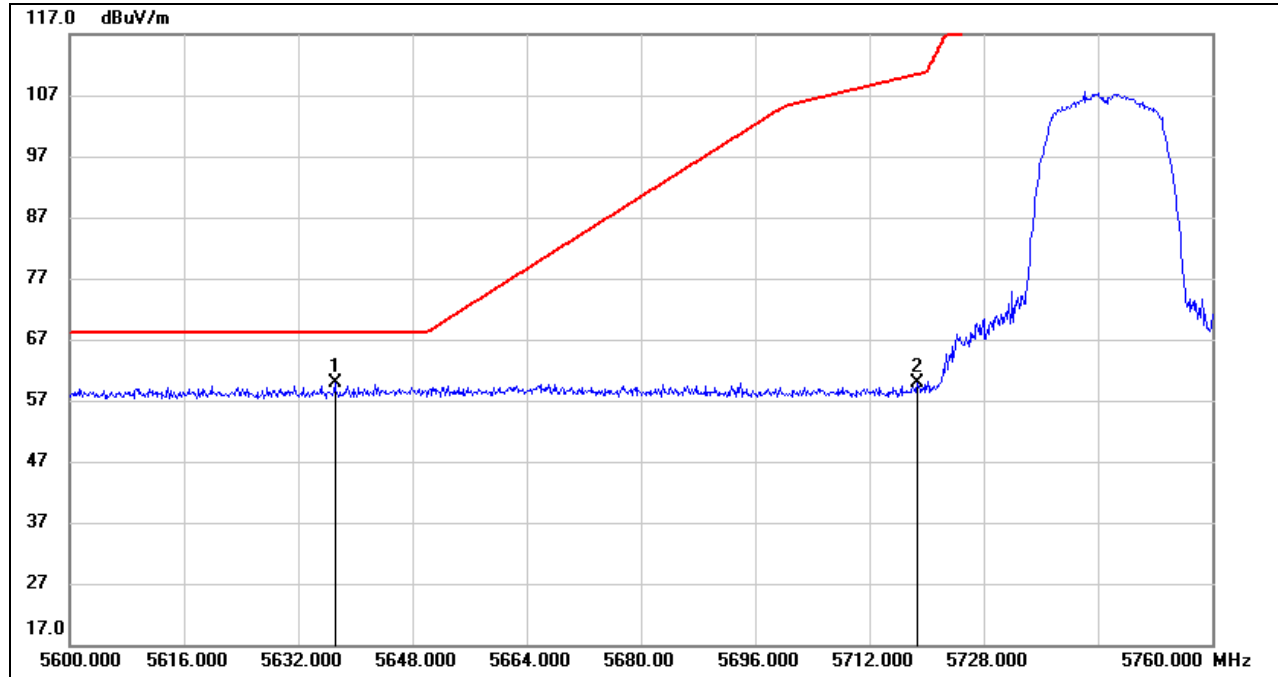

| No. | Frequency (MHz) | Reading (dBuV) | Correct (dB/m) | Result (dBuV/m) | Limit (dBuV/m) | Margin (dB) | Remark |
|-----|-----------------|----------------|----------------|-----------------|----------------|-------------|--------|
| 1 | 5637.120 | 18.13 | 41.66 | 59.79 | 68.20 | -8.41 | peak |
| 2 | 5718.720 | 18.30 | 41.64 | 59.94 | 110.44 | -50.50 | peak |

- Note: 1. Measurement = Reading Level + Correct Factor.
 2. If Peak Result complies with AV limit, AV Result is deemed to comply with AV limit.
 3. Peak: Peak detector.
 4. Only the worst data was recorded, if it complies with the limit, the other emissions deemed to comply with the limit.

RESTRICTED BANDEDGE (HIGH CHANNEL, VERTICAL)

PEAK

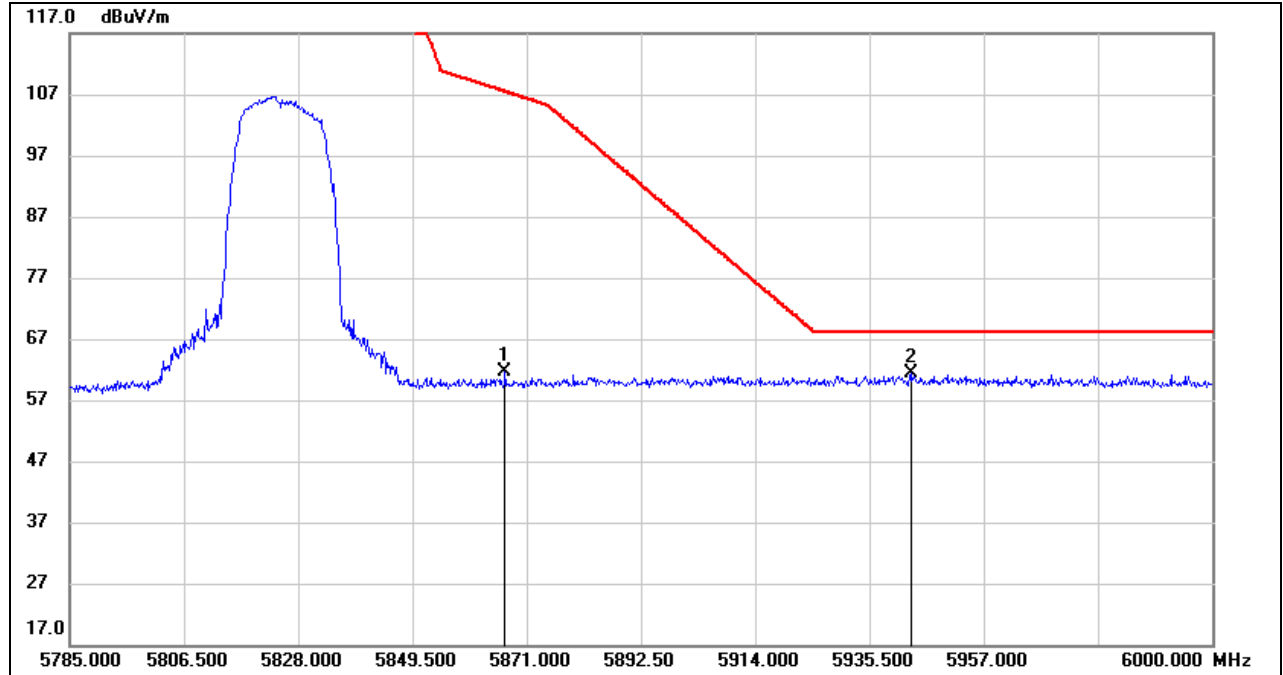

| No. | Frequency (MHz) | Reading (dBuV) | Correct (dB/m) | Result (dBuV/m) | Limit (dBuV/m) | Margin (dB) | Remark |
|-----|-----------------|----------------|----------------|-----------------|----------------|-------------|--------|
| 1 | 5866.915 | 18.94 | 42.70 | 61.64 | 107.46 | -45.82 | peak |
| 2 | 5943.240 | 18.52 | 42.82 | 61.34 | 68.20 | -6.86 | peak |

- Note: 1. Measurement = Reading Level + Correct Factor.
 2. If Peak Result complies with AV limit, AV Result is deemed to comply with AV limit.
 3. Peak: Peak detector.
 4. Only the worst data was recorded, if it complies with the limit, the other emissions deemed to comply with the limit.

Note: All the polarities (Vertical & Horizontal) had been tested, only the worst data was recorded in the report.



8.1.1. 802.11n HT20 MIMO MODE

UNII-1 BAND

RESTRICTED BANDEDGE (LOW CHANNEL, VERTICAL)

PEAK

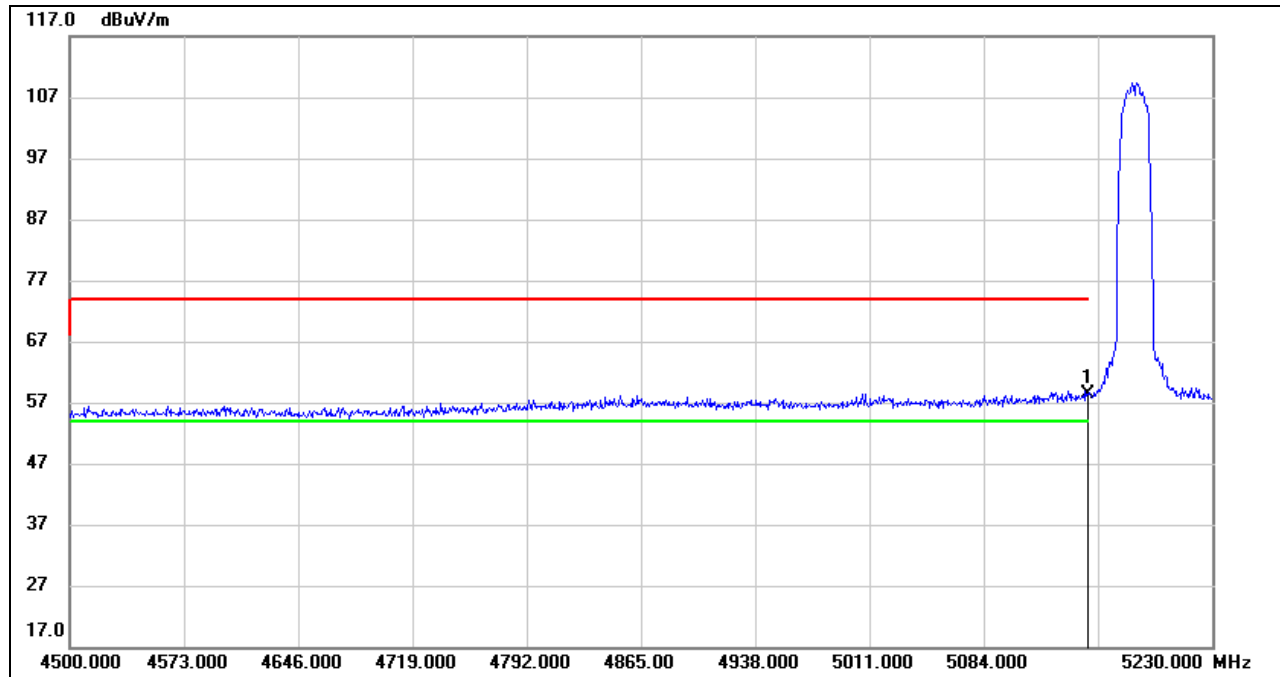

| No. | Frequency (MHz) | Reading (dBuV) | Correct (dB/m) | Result (dBuV/m) | Limit (dBuV/m) | Margin (dB) | Remark |
|-----|-----------------|----------------|----------------|-----------------|----------------|-------------|--------|
| 1 | 5150.000 | 17.28 | 41.19 | 58.47 | 74.00 | -15.53 | peak |

- Note: 1. Measurement = Reading Level + Correct Factor.
 2. If Peak Result complies with AV limit, AV Result is deemed to comply with AV limit.
 3. Peak: Peak detector.
 4. Only the worst data was recorded, if it complies with the limit, the other emissions deemed to comply with the limit.

AVG

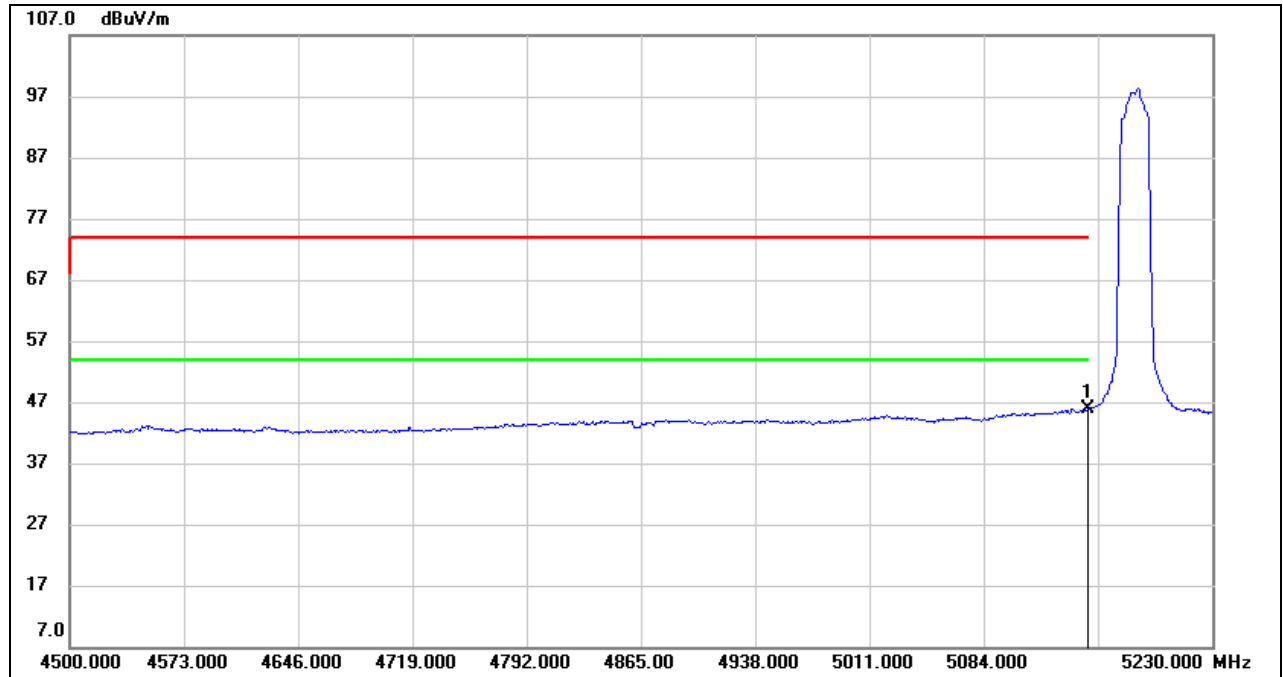

| No. | Frequency (MHz) | Reading (dBuV) | Correct (dB/m) | Result (dBuV/m) | Limit (dBuV/m) | Margin (dB) | Remark |
|-----|-----------------|----------------|----------------|-----------------|----------------|-------------|--------|
| 1 | 5150.000 | 4.68 | 41.19 | 45.87 | 54.00 | -8.13 | AVG |

- Note:
1. Measurement = Reading Level + Correct Factor.
 2. If Peak Result complies with AV limit, AV Result is deemed to comply with AV limit.
 3. AVG: $VBW=1/T_{on}$, where: T_{on} is the transmitting duration.
 4. For the transmitting duration, please refer to clause 7.1.
 5. Only the worst data was recorded, if it complies with the limit, the other emissions deemed to comply with the limit.



RESTRICTED BANDEDGE (HIGH CHANNEL, VERTICAL)

PEAK

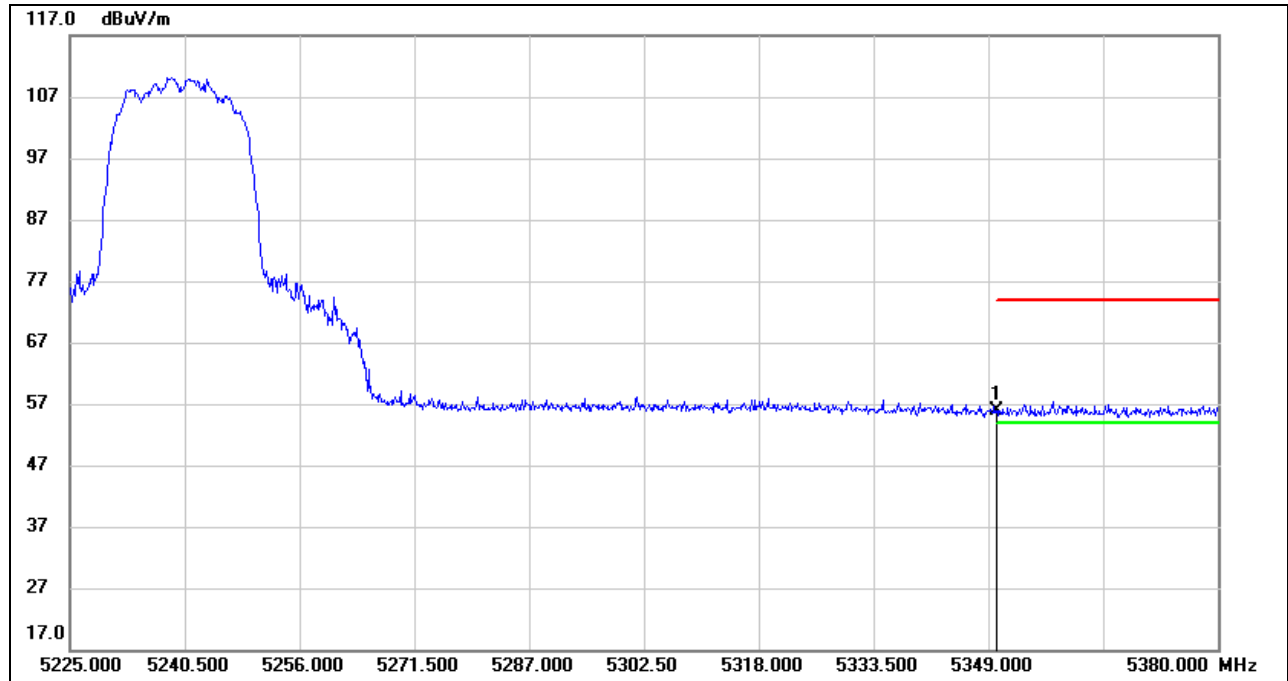

| No. | Frequency (MHz) | Reading (dBuV) | Correct (dB/m) | Result (dBuV/m) | Limit (dBuV/m) | Margin (dB) | Remark |
|-----|-----------------|----------------|----------------|-----------------|----------------|-------------|--------|
| 1 | 5350.000 | 15.77 | 40.08 | 55.85 | 74.00 | -18.15 | peak |

- Note:
1. Measurement = Reading Level + Correct Factor.
 2. If Peak Result complies with AV limit, AV Result is deemed to comply with AV limit.
 3. Peak: Peak detector.
 4. Only the worst data was recorded, if it complies with the limit, the other emissions deemed to comply with the limit.
 5. Since non-restricted band peak emissions are less than the average limit, they also comply with the -27dBm/MHz (68.2dBuV/m) limit.

AVG

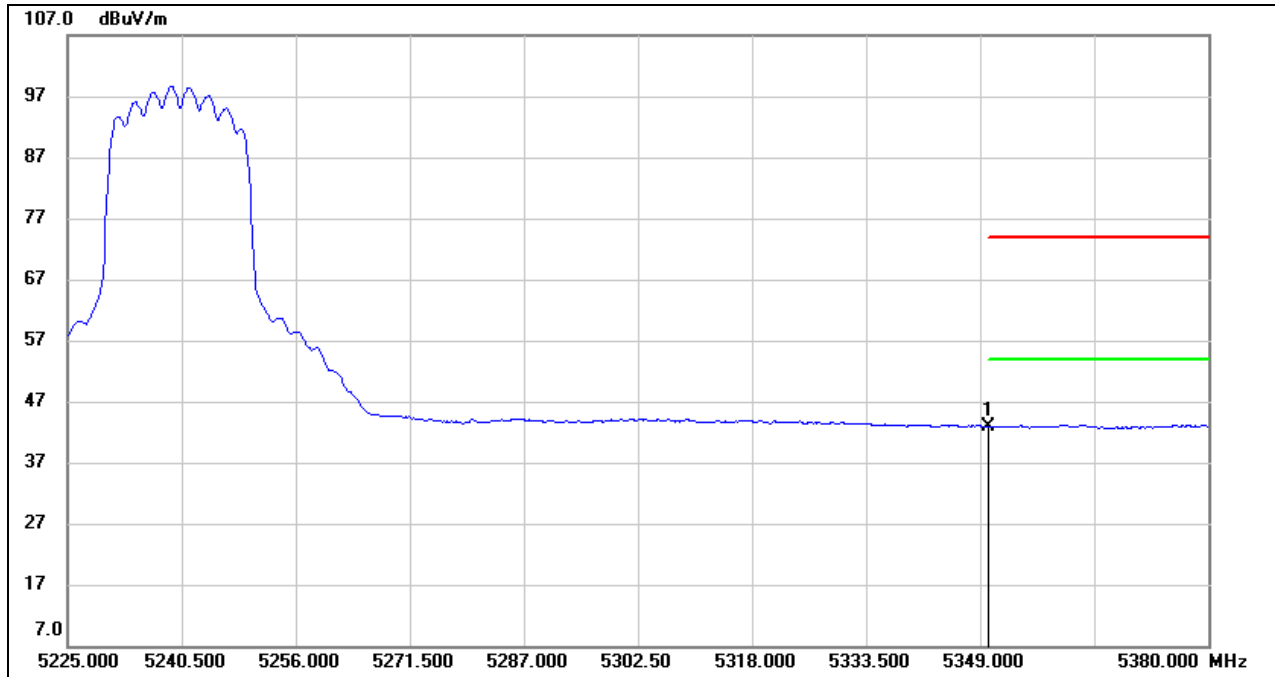

| No. | Frequency (MHz) | Reading (dBuV) | Correct (dB/m) | Result (dBuV/m) | Limit (dBuV/m) | Margin (dB) | Remark |
|-----|-----------------|----------------|----------------|-----------------|----------------|-------------|--------|
| 1 | 5350.000 | 2.69 | 40.08 | 42.77 | 54.00 | -11.23 | AVG |

- Note:
1. Measurement = Reading Level + Correct Factor.
 2. If Peak Result complies with AV limit, AV Result is deemed to comply with AV limit.
 3. AVG: $VBW=1/Ton$, where: Ton is the transmitting duration.
 4. For the transmitting duration, please refer to clause 7.1.
 5. Only the worst data was recorded, if it complies with the limit, the other emissions deemed to comply with the limit.

Note: All the polarities (Vertical & Horizontal) had been tested, only the worst data was recorded in the report.

UNII-2A BAND

RESTRICTED BANDEDGE (HIGH CHANNEL, VERTICAL)

PEAK

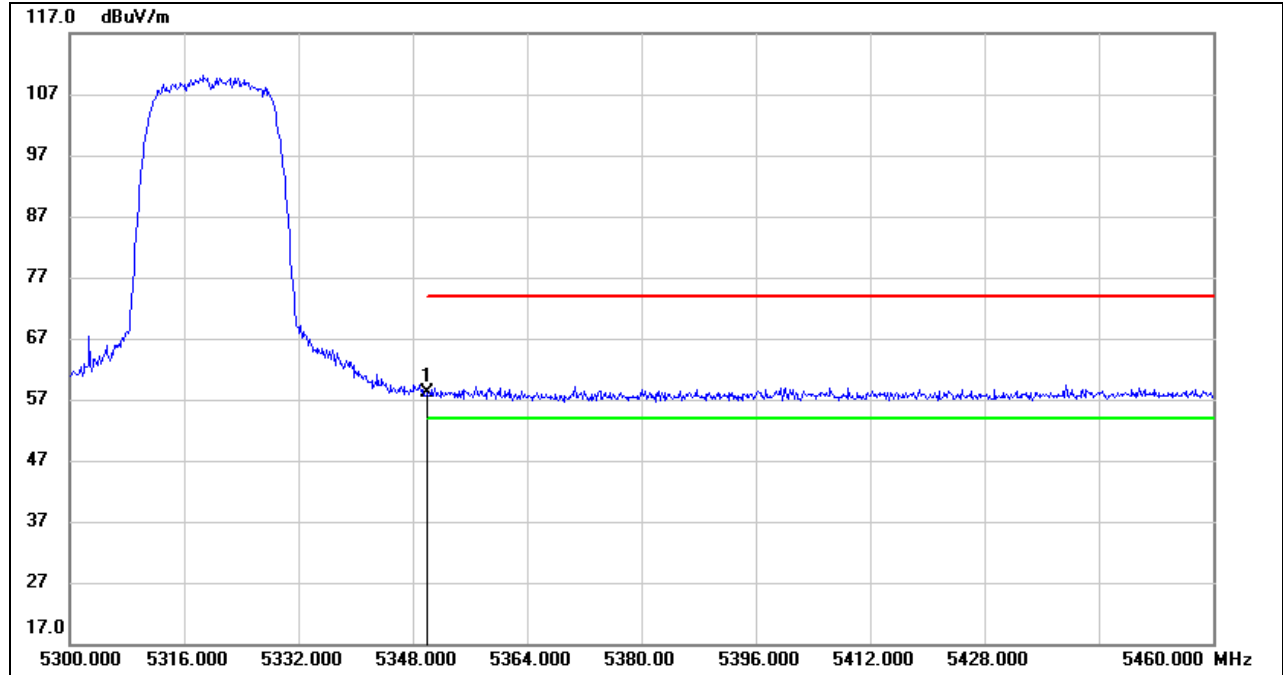

| No. | Frequency (MHz) | Reading (dBuV) | Correct (dB/m) | Result (dBuV/m) | Limit (dBuV/m) | Margin (dB) | Remark |
|-----|-----------------|----------------|----------------|-----------------|----------------|-------------|--------|
| 1 | 5350.000 | 16.86 | 41.20 | 58.06 | 74.00 | -15.94 | peak |

- Note: 1. Measurement = Reading Level + Correct Factor.
 2. If Peak Result complies with AV limit, AV Result is deemed to comply with AV limit.
 3. Peak: Peak detector.
 4. Only the worst data was recorded, if it complies with the limit, the other emissions deemed to comply with the limit.

AVG

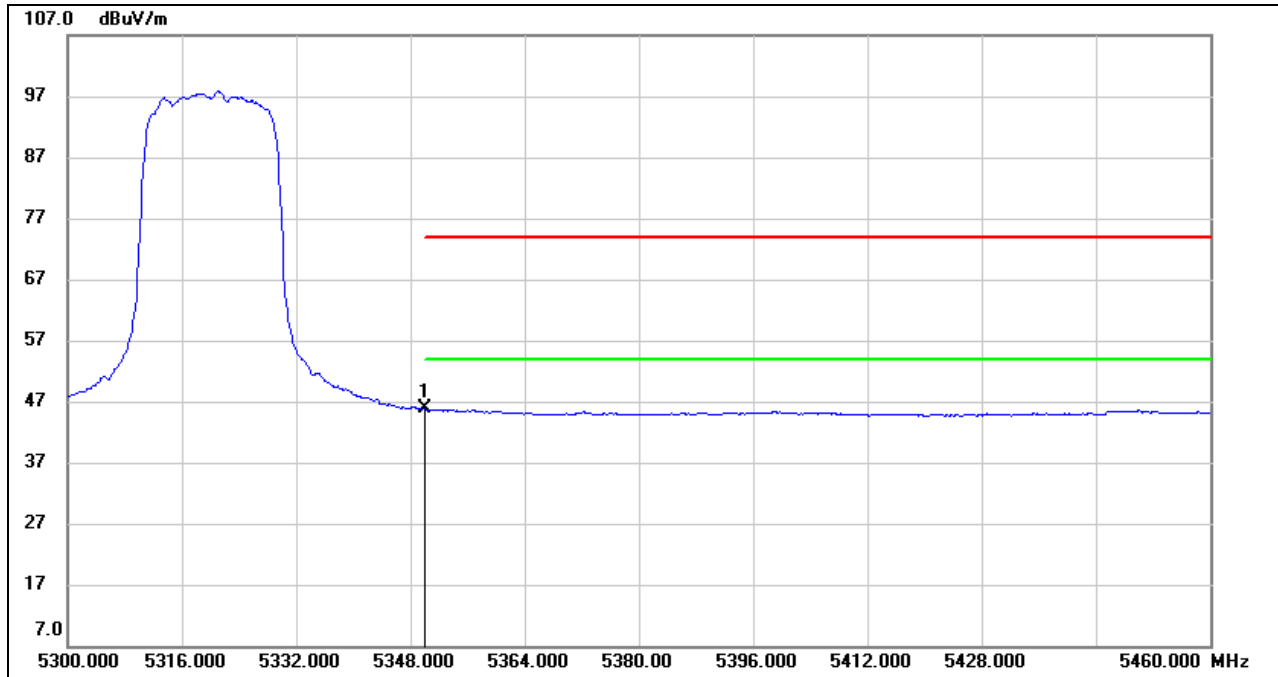

| No. | Frequency (MHz) | Reading (dBuV) | Correct (dB/m) | Result (dBuV/m) | Limit (dBuV/m) | Margin (dB) | Remark |
|-----|-----------------|----------------|----------------|-----------------|----------------|-------------|--------|
| 1 | 5350.000 | 4.68 | 41.20 | 45.88 | 54.00 | -8.12 | AVG |

- Note:
1. Measurement = Reading Level + Correct Factor.
 2. If Peak Result complies with AV limit, AV Result is deemed to comply with AV limit.
 3. AVG: $VBW=1/Ton$, where: Ton is the transmitting duration.
 4. For the transmitting duration, please refer to clause 7.1.
 5. Only the worst data was recorded, if it complies with the limit, the other emissions deemed to comply with the limit.

Note: All the polarities (Vertical & Horizontal) had been tested, only the worst data was recorded in the report.



UNII-2C BAND

RESTRICTED BANDEDGE (LOW CHANNEL, VERTICAL)

PEAK

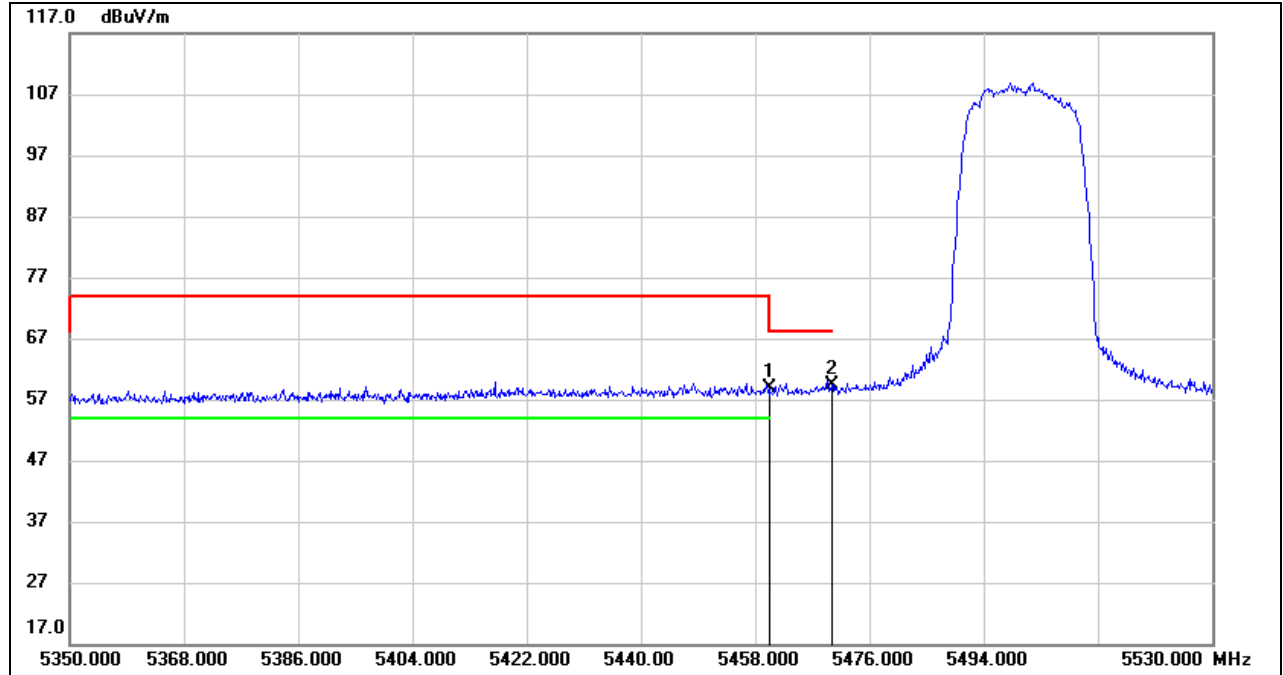

| No. | Frequency (MHz) | Reading (dBuV) | Correct (dB/m) | Result (dBuV/m) | Limit (dBuV/m) | Margin (dB) | Remark |
|-----|-----------------|----------------|----------------|-----------------|----------------|-------------|--------|
| 1 | 5460.000 | 16.97 | 41.82 | 58.79 | 68.20 | -9.41 | peak |
| 2 | 5470.000 | 17.40 | 41.87 | 59.27 | 68.20 | -8.93 | peak |

- Note: 1. Measurement = Reading Level + Correct Factor.
 2. If Peak Result complies with AV limit, AV Result is deemed to comply with AV limit.
 3. Peak: Peak detector.
 4. Only the worst data was recorded, if it complies with the limit, the other emissions deemed to comply with the limit.

AVG

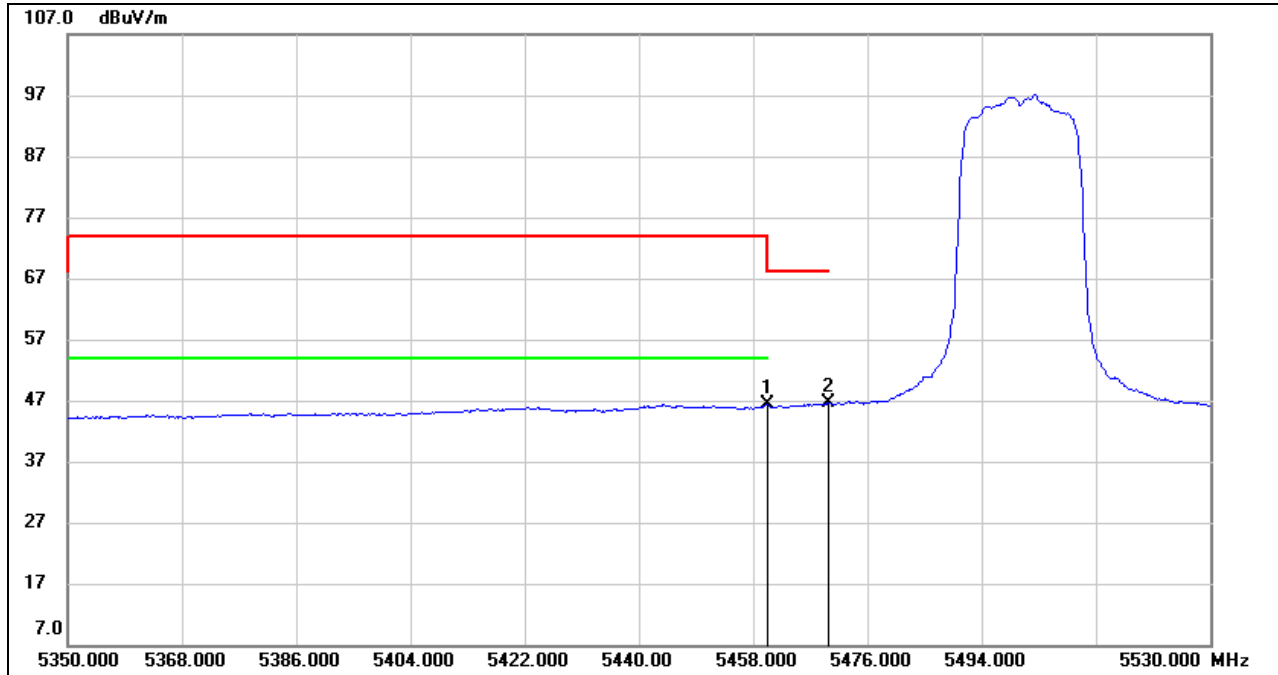

| No. | Frequency (MHz) | Reading (dBuV) | Correct (dB/m) | Result (dBuV/m) | Limit (dBuV/m) | Margin (dB) | Remark |
|-----|-----------------|----------------|----------------|-----------------|----------------|-------------|--------|
| 1 | 5460.000 | 4.55 | 41.82 | 46.37 | 54.00 | -7.63 | AVG |
| 2 | 5470.000 | 4.66 | 41.87 | 46.53 | / | / | AVG |

- Note:
1. Measurement = Reading Level + Correct Factor.
 2. If Peak Result complies with AV limit, AV Result is deemed to comply with AV limit.
 3. AVG: $VBW=1/Ton$, where: Ton is the transmitting duration.
 4. For the transmitting duration, please refer to clause 7.1.
 5. Only the worst data was recorded, if it complies with the limit, the other emissions deemed to comply with the limit.



RESTRICTED BANDEDGE (HIGH CHANNEL, VERTICAL)

PEAK

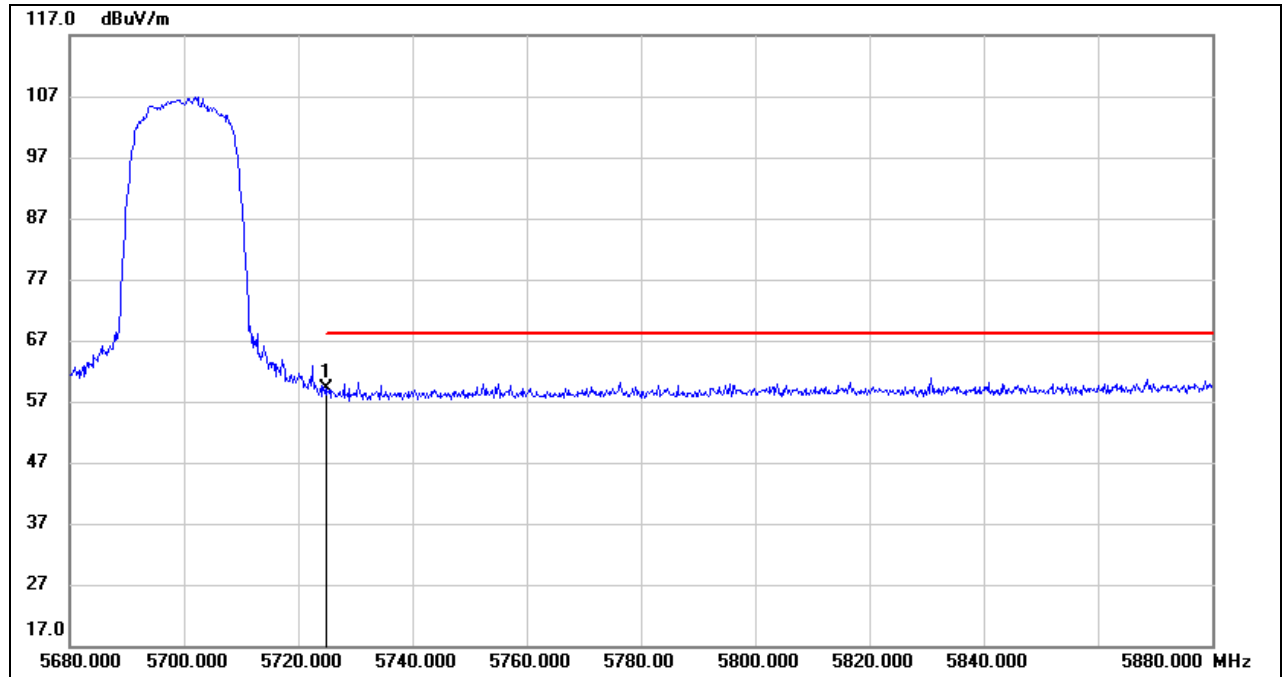

| No. | Frequency (MHz) | Reading (dBuV) | Correct (dB/m) | Result (dBuV/m) | Limit (dBuV/m) | Margin (dB) | Remark |
|-----|--------------------|-------------------|-------------------|--------------------|-------------------|----------------|--------|
| 1 | 5725.000 | 17.40 | 41.67 | 59.07 | 68.20 | -9.13 | peak |

- Note: 1. Measurement = Reading Level + Correct Factor.
 2. If Peak Result complies with AV limit, AV Result is deemed to comply with AV limit.
 3. Peak: Peak detector.
 4. Only the worst data was recorded, if it complies with the limit, the other emissions deemed to comply with the limit.

Note: All the polarities (Vertical & Horizontal) had been tested, only the worst data was recorded in the report.



UNII-3 BAND

RESTRICTED BANDEDGE (LOW CHANNEL, VERTICAL)

PEAK

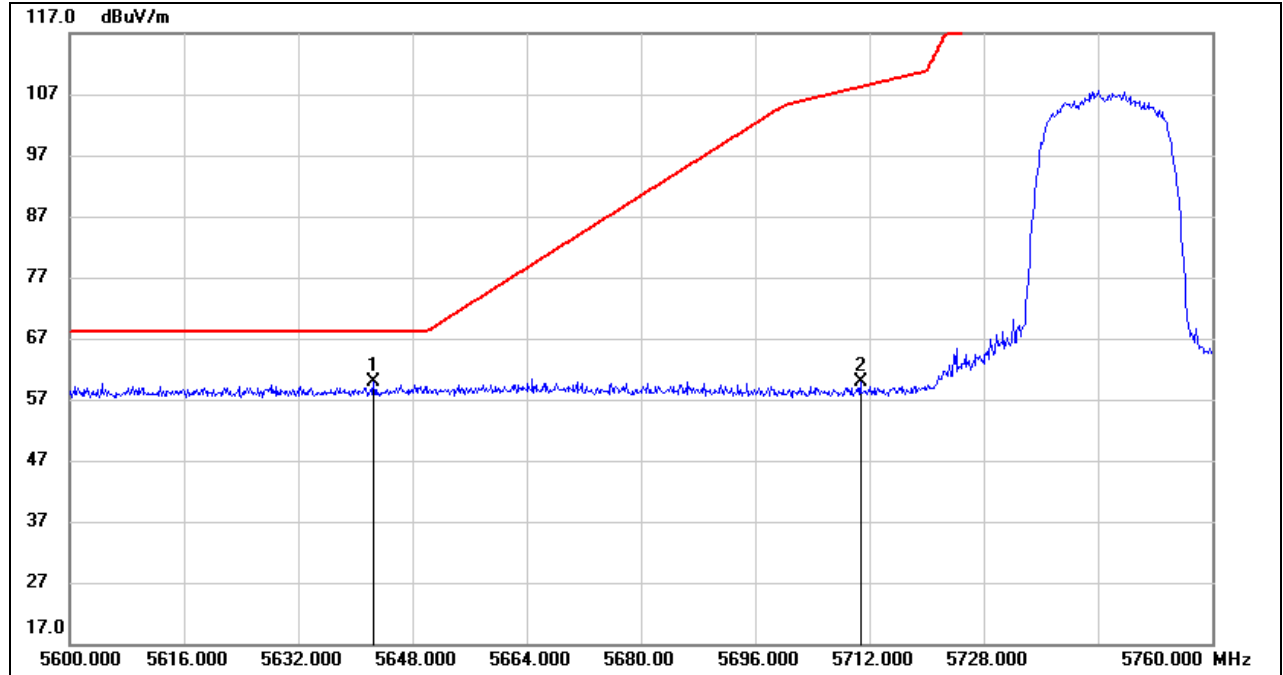

| No. | Frequency (MHz) | Reading (dBuV) | Correct (dB/m) | Result (dBuV/m) | Limit (dBuV/m) | Margin (dB) | Remark |
|-----|-----------------|----------------|----------------|-----------------|----------------|-------------|--------|
| 1 | 5642.560 | 18.17 | 41.65 | 59.82 | 68.20 | -8.38 | peak |
| 2 | 5710.720 | 18.19 | 41.60 | 59.79 | 108.20 | -48.41 | peak |

- Note: 1. Measurement = Reading Level + Correct Factor.
 2. If Peak Result complies with AV limit, AV Result is deemed to comply with AV limit.
 3. Peak: Peak detector.
 4. Only the worst data was recorded, if it complies with the limit, the other emissions deemed to comply with the limit.

RESTRICTED BANDEDGE (HIGH CHANNEL, VERTICAL)

PEAK

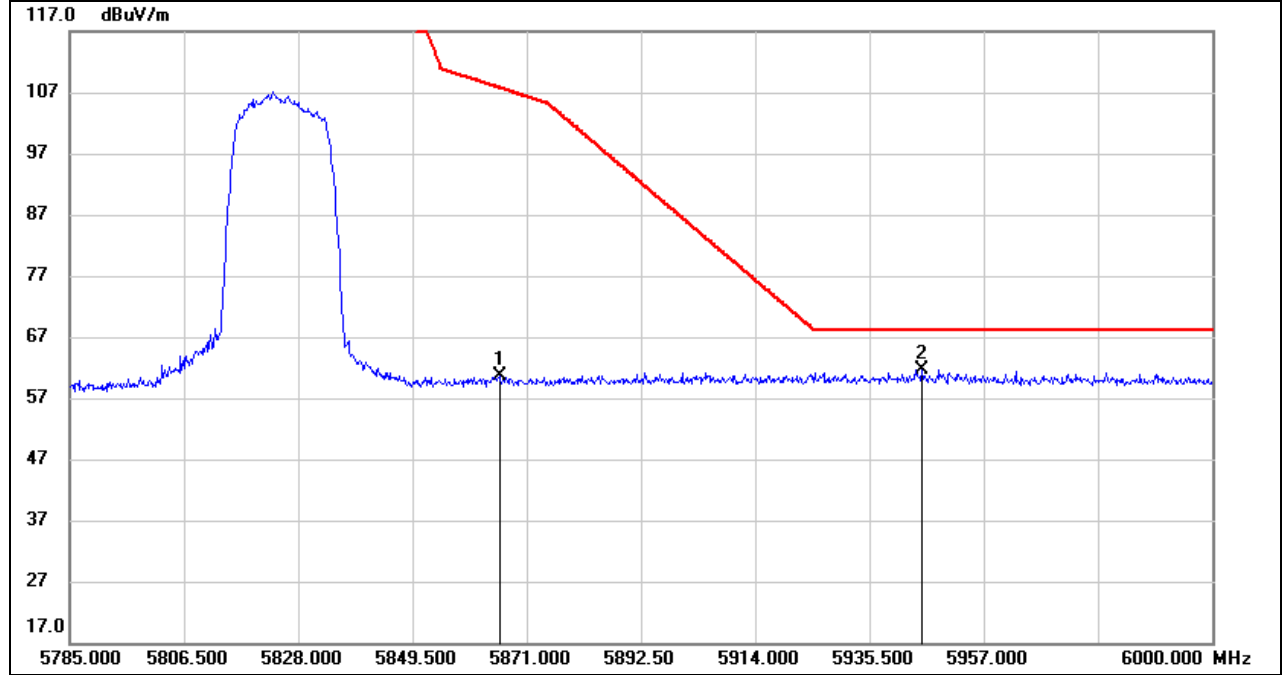

| No. | Frequency (MHz) | Reading (dBuV) | Correct (dB/m) | Result (dBuV/m) | Limit (dBuV/m) | Margin (dB) | Remark |
|-----|-----------------|----------------|----------------|-----------------|----------------|-------------|--------|
| 1 | 5865.840 | 18.04 | 42.69 | 60.73 | 107.76 | -47.03 | peak |
| 2 | 5945.390 | 18.83 | 42.81 | 61.64 | 68.20 | -6.56 | peak |

- Note: 1. Measurement = Reading Level + Correct Factor.
 2. If Peak Result complies with AV limit, AV Result is deemed to comply with AV limit.
 3. Peak: Peak detector.
 4. Only the worst data was recorded, if it complies with the limit, the other emissions deemed to comply with the limit.

Note: All the polarities (Vertical & Horizontal) had been tested, only the worst data was recorded in the report.

8.1.2. 802.11n HT40 MIMO MODE

UNII-1 BAND

RESTRICTED BANDEDGE (LOW CHANNEL, VERTICAL)

PEAK

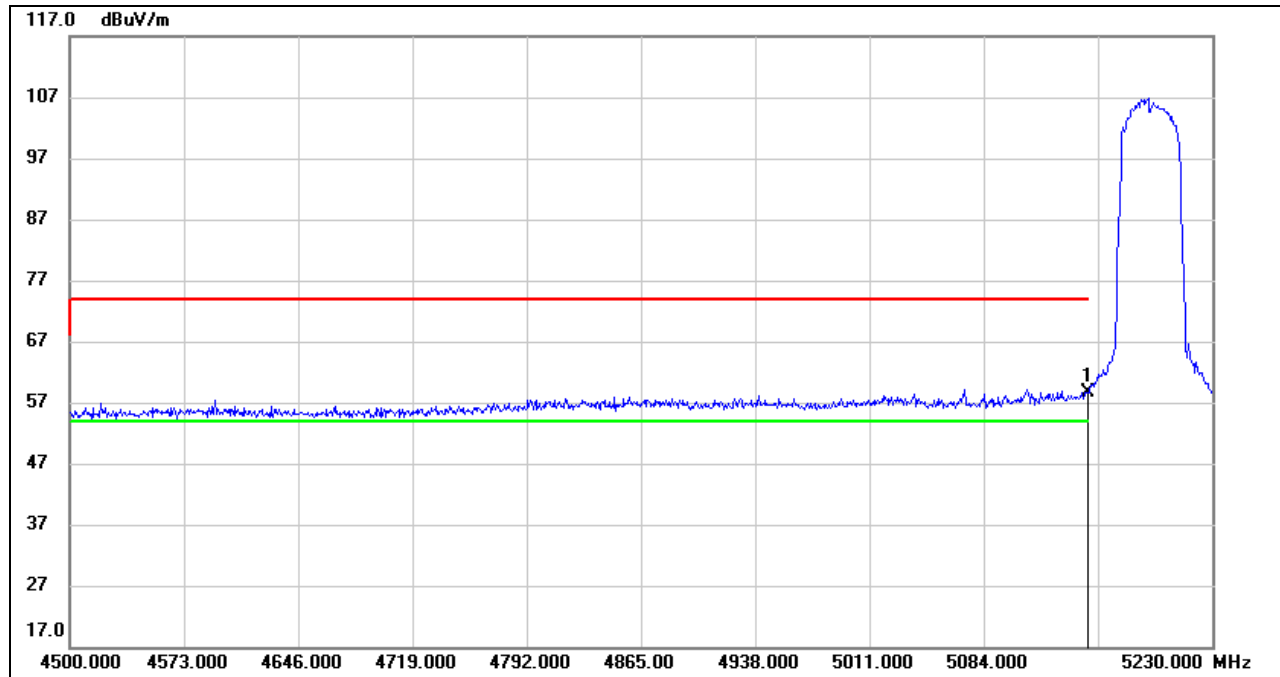

| No. | Frequency (MHz) | Reading (dBuV) | Correct (dB/m) | Result (dBuV/m) | Limit (dBuV/m) | Margin (dB) | Remark |
|-----|-----------------|----------------|----------------|-----------------|----------------|-------------|--------|
| 1 | 5150.000 | 17.41 | 41.19 | 58.60 | 74.00 | -15.40 | peak |

- Note: 1. Measurement = Reading Level + Correct Factor.
 2. If Peak Result complies with AV limit, AV Result is deemed to comply with AV limit.
 3. Peak: Peak detector.
 4. Only the worst data was recorded, if it complies with the limit, the other emissions deemed to comply with the limit.

AVG

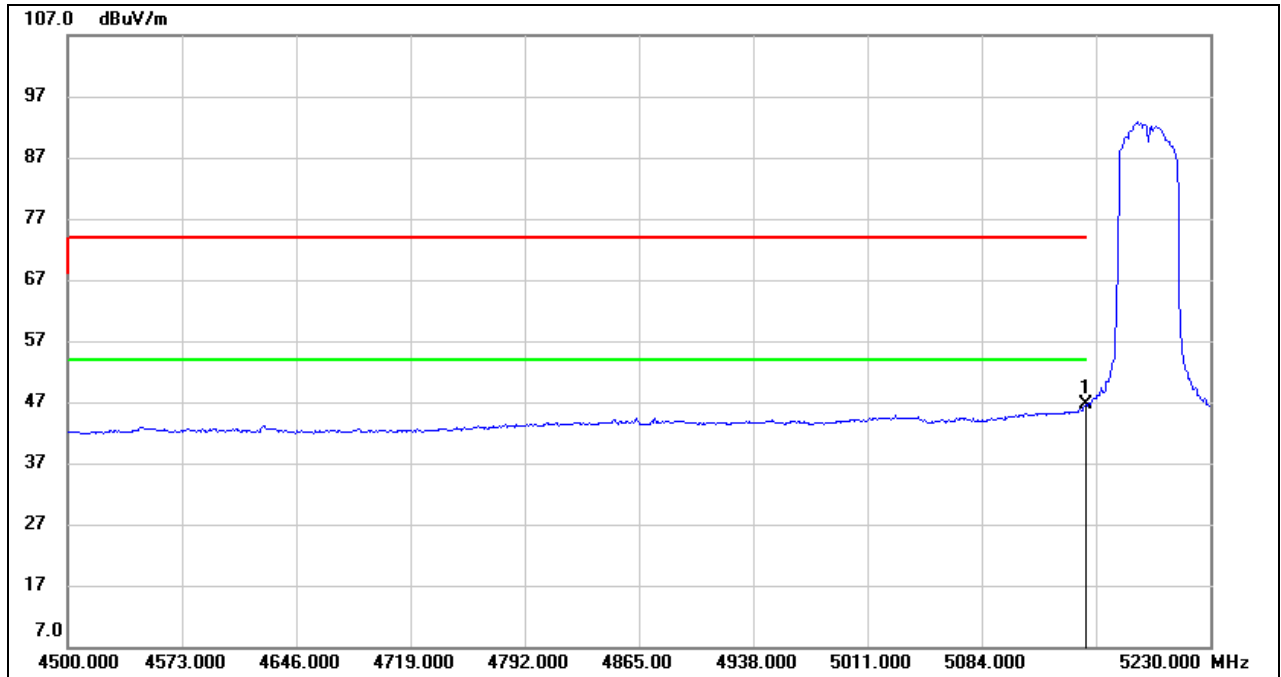

| No. | Frequency (MHz) | Reading (dBuV) | Correct (dB/m) | Result (dBuV/m) | Limit (dBuV/m) | Margin (dB) | Remark |
|-----|-----------------|----------------|----------------|-----------------|----------------|-------------|--------|
| 1 | 5150.000 | 5.37 | 41.19 | 46.56 | 54.00 | -7.44 | AVG |

- Note:
1. Measurement = Reading Level + Correct Factor.
 2. If Peak Result complies with AV limit, AV Result is deemed to comply with AV limit.
 3. AVG: $VBW=1/T_{on}$, where: T_{on} is the transmitting duration.
 4. For the transmitting duration, please refer to clause 7.1.
 5. Only the worst data was recorded, if it complies with the limit, the other emissions deemed to comply with the limit.



RESTRICTED BANDEDGE (HIGH CHANNEL, VERTICAL)

PEAK

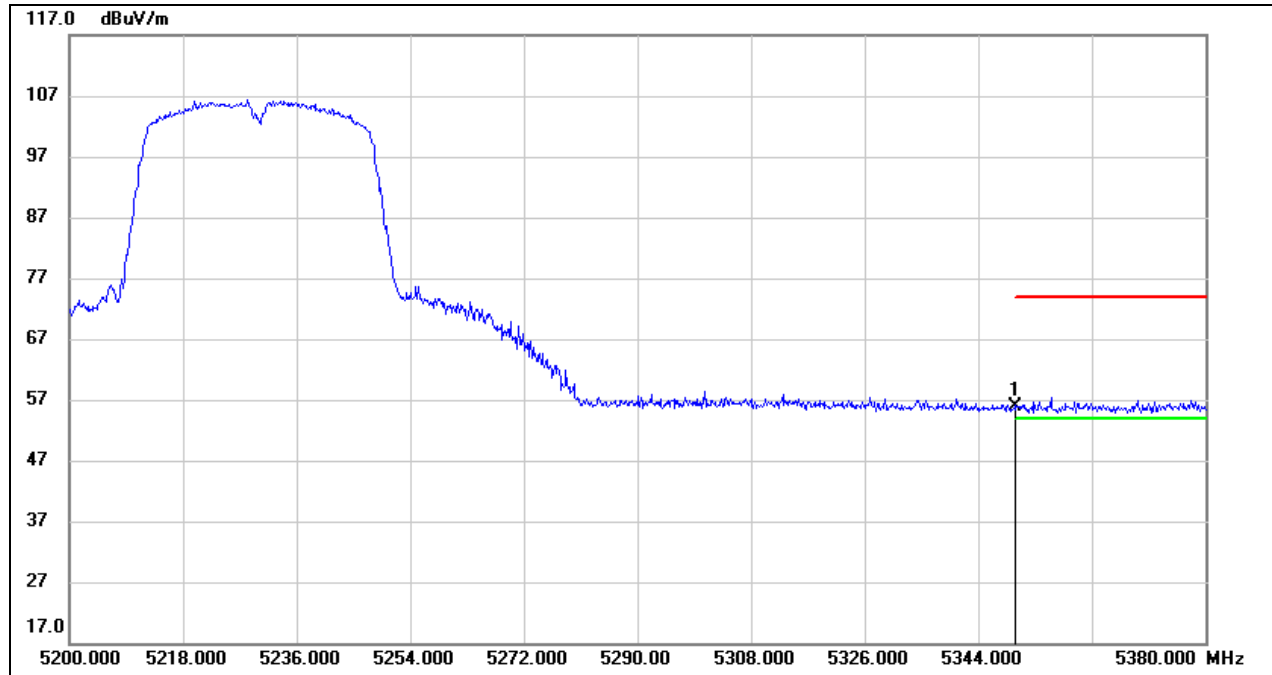

| No. | Frequency (MHz) | Reading (dBuV) | Correct (dB/m) | Result (dBuV/m) | Limit (dBuV/m) | Margin (dB) | Remark |
|-----|-----------------|----------------|----------------|-----------------|----------------|-------------|--------|
| 1 | 5350.000 | 15.79 | 40.08 | 55.87 | 74.00 | -18.13 | peak |

- Note: 1. Measurement = Reading Level + Correct Factor.
 2. If Peak Result complies with AV limit, AV Result is deemed to comply with AV limit.
 3. Peak: Peak detector.
 4. Only the worst data was recorded, if it complies with the limit, the other emissions deemed to comply with the limit.
 5. Since non-restricted band peak emissions are less than the average limit, they also comply with the -27dBm/MHz (68.2dBuV/m) limit.

AVG

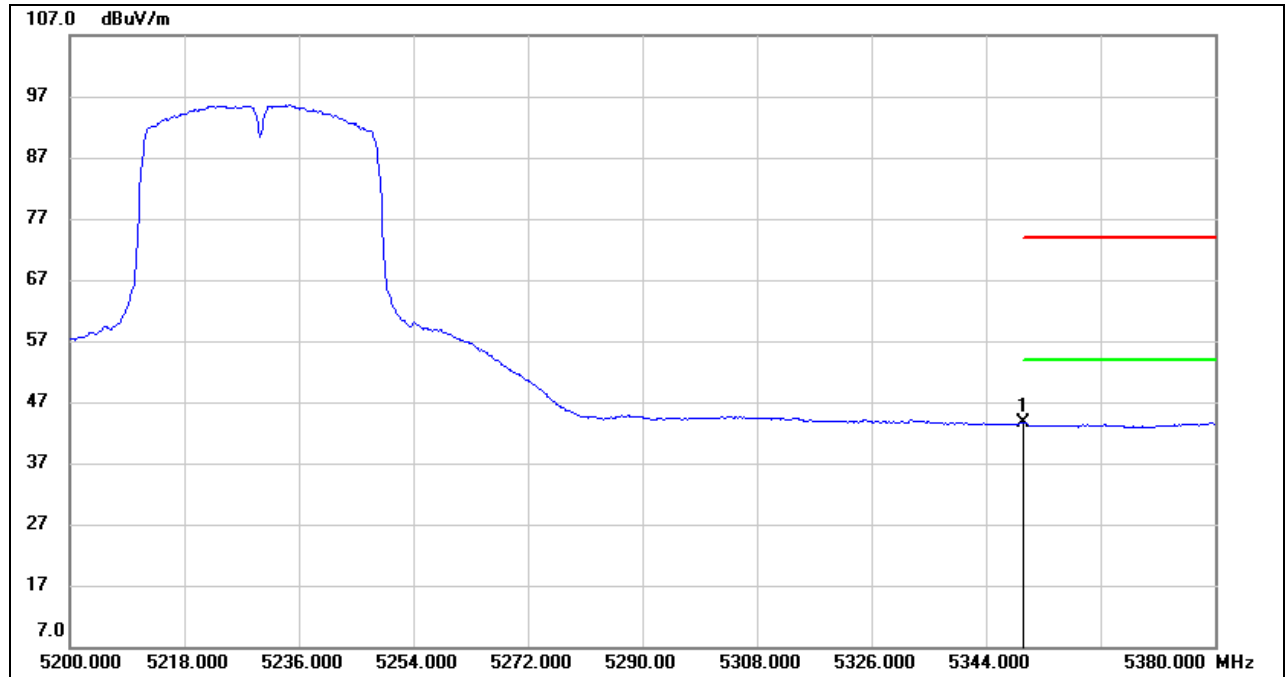

| No. | Frequency (MHz) | Reading (dBuV) | Correct (dB/m) | Result (dBuV/m) | Limit (dBuV/m) | Margin (dB) | Remark |
|-----|-----------------|----------------|----------------|-----------------|----------------|-------------|--------|
| 1 | 5350.000 | 3.47 | 40.08 | 43.55 | 54.00 | -10.45 | AVG |

- Note:
1. Measurement = Reading Level + Correct Factor.
 2. If Peak Result complies with AV limit, AV Result is deemed to comply with AV limit.
 3. AVG: $VBW=1/Ton$, where: Ton is the transmitting duration.
 4. For the transmitting duration, please refer to clause 7.1.
 5. Only the worst data was recorded, if it complies with the limit, the other emissions deemed to comply with the limit.

All the polarities (Horizontal and vertical) had been tested, only the worst data was recorded in the report



UNII-2A BAND

RESTRICTED BANDEDGE (HIGH CHANNEL, VERTICAL)

PEAK

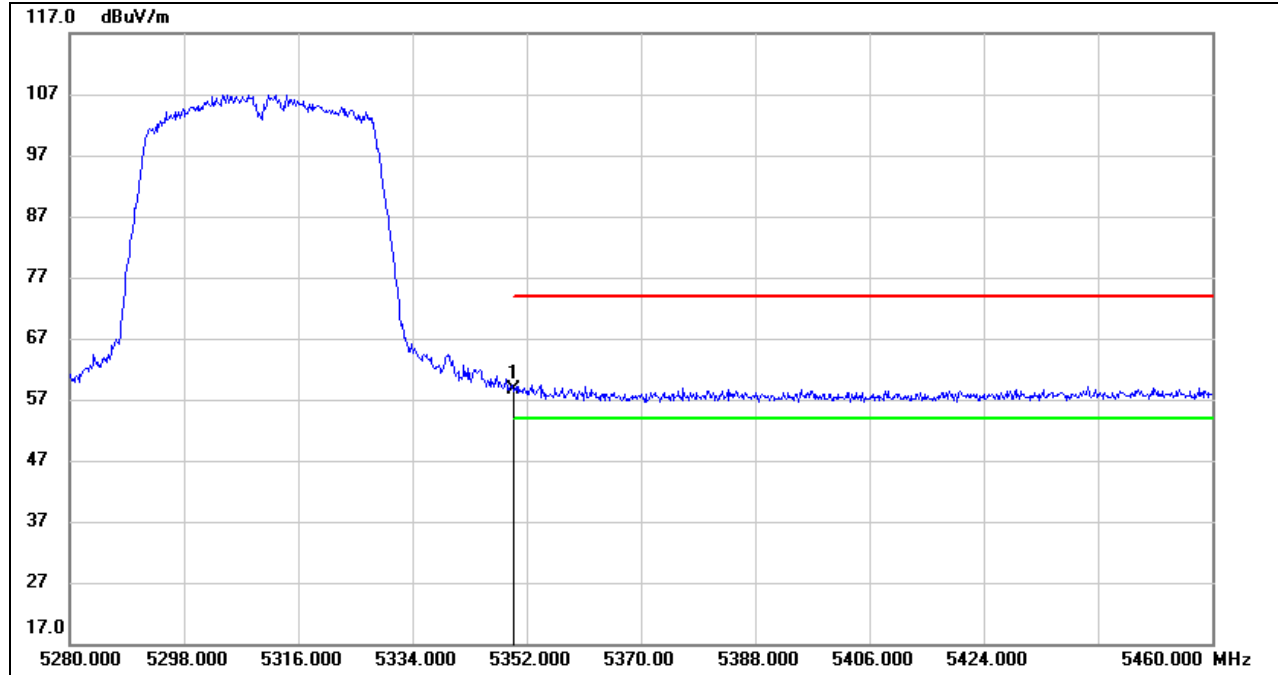

| No. | Frequency (MHz) | Reading (dBuV) | Correct (dB/m) | Result (dBuV/m) | Limit (dBuV/m) | Margin (dB) | Remark |
|-----|-----------------|----------------|----------------|-----------------|----------------|-------------|--------|
| 1 | 5350.000 | 17.52 | 41.20 | 58.72 | 74.00 | -15.28 | peak |

- Note: 1. Measurement = Reading Level + Correct Factor.
 2. If Peak Result complies with AV limit, AV Result is deemed to comply with AV limit.
 3. Peak: Peak detector.
 4. Only the worst data was recorded, if it complies with the limit, the other emissions deemed to comply with the limit.



AVG

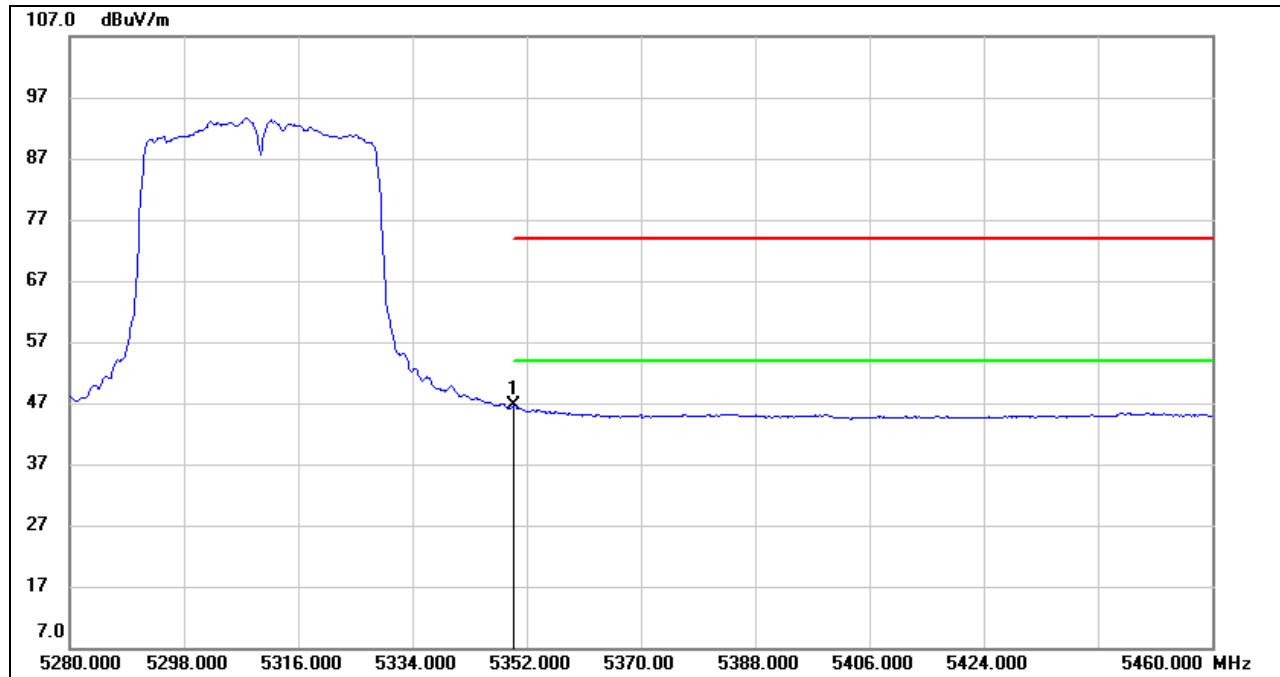

| No. | Frequency (MHz) | Reading (dBuV) | Correct (dB/m) | Result (dBuV/m) | Limit (dBuV/m) | Margin (dB) | Remark |
|-----|-----------------|----------------|----------------|-----------------|----------------|-------------|--------|
| 1 | 5350.000 | 5.36 | 41.20 | 46.56 | 54.00 | -7.44 | AVG |

- Note:
1. Measurement = Reading Level + Correct Factor.
 2. If Peak Result complies with AV limit, AV Result is deemed to comply with AV limit.
 3. AVG: $VBW=1/T_{on}$, where: T_{on} is the transmitting duration.
 4. For the transmitting duration, please refer to clause 7.1.
 5. Only the worst data was recorded, if it complies with the limit, the other emissions deemed to comply with the limit.

Note: All the polarities (Vertical & Horizontal) had been tested, only the worst data was recorded in the report.

UNII-2C BAND

RESTRICTED BANDEDGE (LOW CHANNEL, VERTICAL)

PEAK

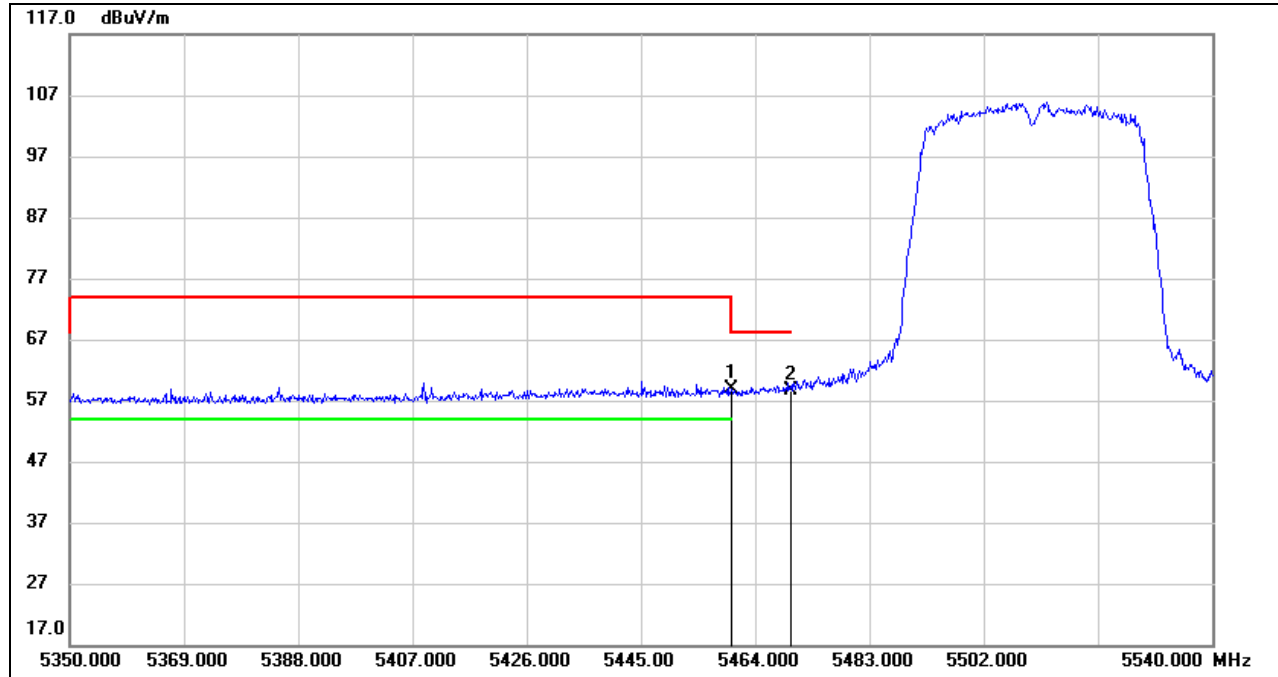

| No. | Frequency (MHz) | Reading (dBuV) | Correct (dB/m) | Result (dBuV/m) | Limit (dBuV/m) | Margin (dB) | Remark |
|-----|-----------------|----------------|----------------|-----------------|----------------|-------------|--------|
| 1 | 5460.000 | 17.04 | 41.82 | 58.86 | 68.20 | -9.34 | peak |
| 2 | 5470.000 | 16.73 | 41.87 | 58.60 | 68.20 | -9.60 | peak |

Note: 1. Measurement = Reading Level + Correct Factor.
 2. If Peak Result complies with AV limit, AV Result is deemed to comply with AV limit.
 3. Peak: Peak detector.
 4. Only the worst data was recorded, if it complies with the limit, the other emissions deemed to comply with the limit.



AVG

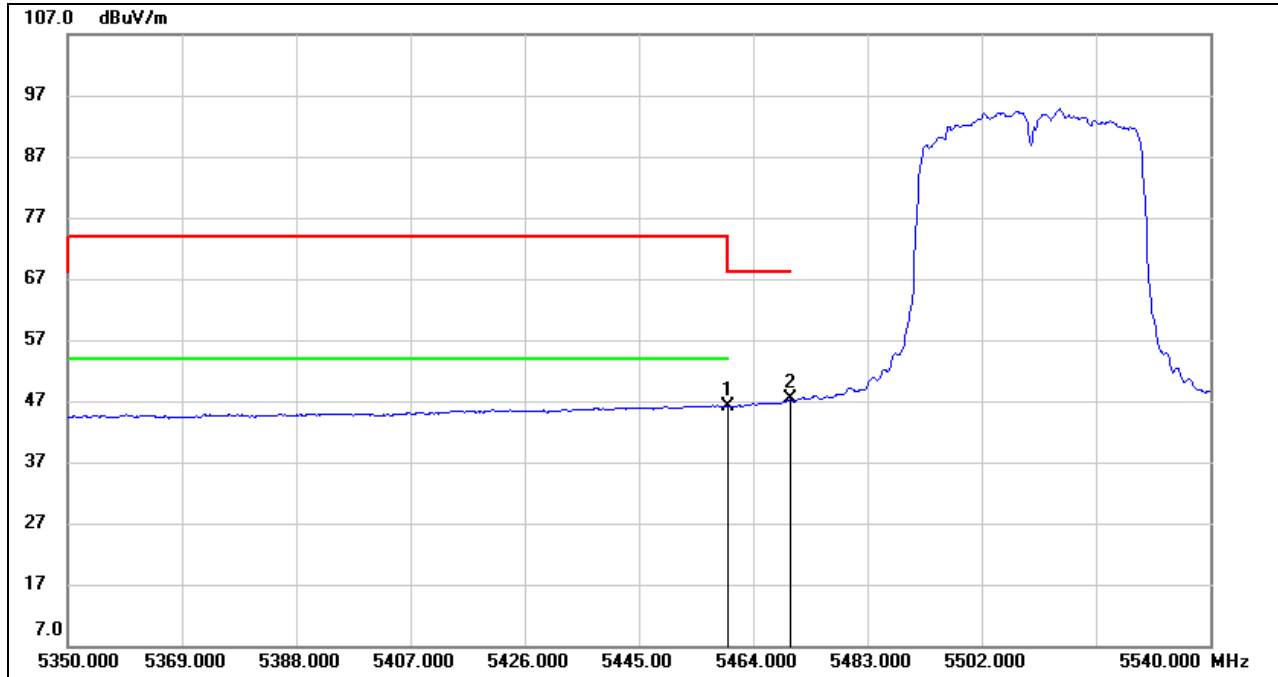

| No. | Frequency (MHz) | Reading (dBuV) | Correct (dB/m) | Result (dBuV/m) | Limit (dBuV/m) | Margin (dB) | Remark |
|-----|-----------------|----------------|----------------|-----------------|----------------|-------------|--------|
| 1 | 5460.000 | 4.27 | 41.82 | 46.09 | 54.00 | -7.91 | AVG |
| 2 | 5470.000 | 5.45 | 41.87 | 47.32 | / | / | AVG |

- Note:
1. Measurement = Reading Level + Correct Factor.
 2. If Peak Result complies with AV limit, AV Result is deemed to comply with AV limit.
 3. AVG: $VBW=1/T_{on}$, where: T_{on} is the transmitting duration.
 4. For the transmitting duration, please refer to clause 7.1.
 5. Only the worst data was recorded, if it complies with the limit, the other emissions deemed to comply with the limit.



RESTRICTED BANDEDGE (HIGH CHANNEL, VERTICAL)

PEAK

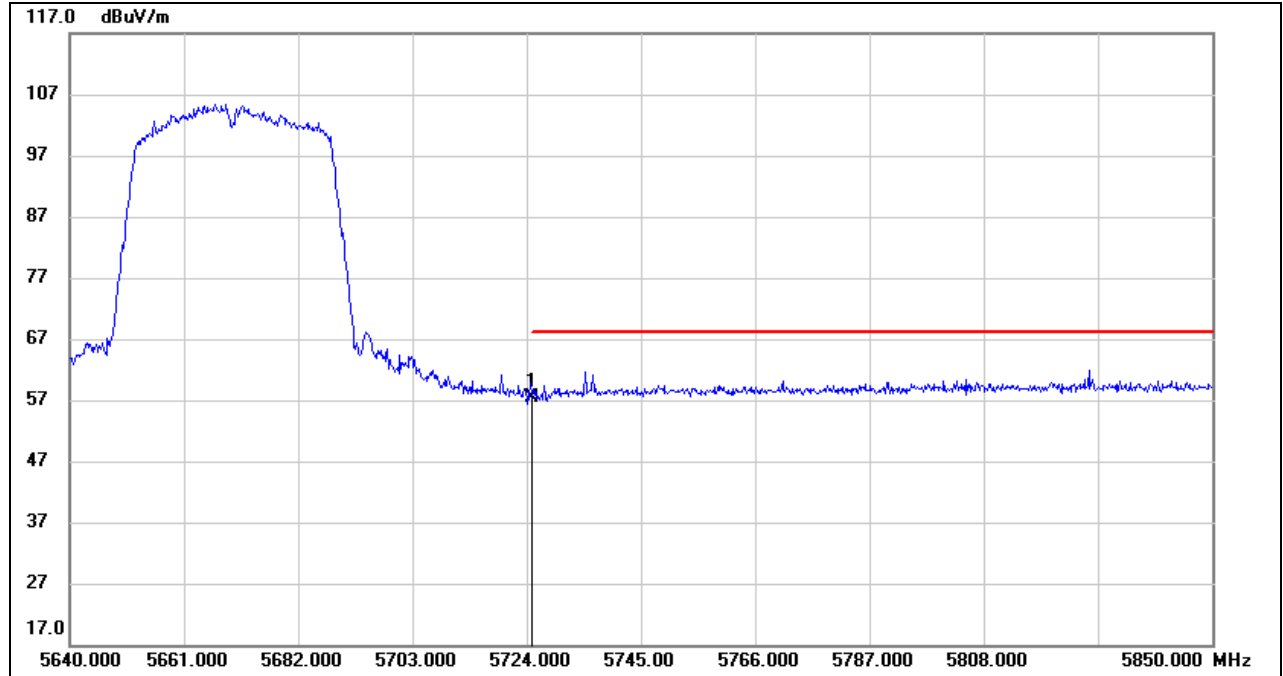

| No. | Frequency (MHz) | Reading (dBuV) | Correct (dB/m) | Result (dBuV/m) | Limit (dBuV/m) | Margin (dB) | Remark |
|-----|-----------------|----------------|----------------|-----------------|----------------|-------------|--------|
| 1 | 5725.000 | 15.80 | 41.67 | 57.47 | 68.20 | -10.73 | peak |

- Note:
1. Measurement = Reading Level + Correct Factor.
 2. If Peak Result complies with AV limit, AV Result is deemed to comply with AV limit.
 3. Peak: Peak detector.
 4. Only the worst data was recorded, if it complies with the limit, the other emissions deemed to comply with the limit.

Note: All the polarities (Vertical & Horizontal) had been tested, only the worst data was recorded in the report.

UNII-3 BAND

RESTRICTED BANDEDGE (LOW CHANNEL, VERTICAL)

PEAK

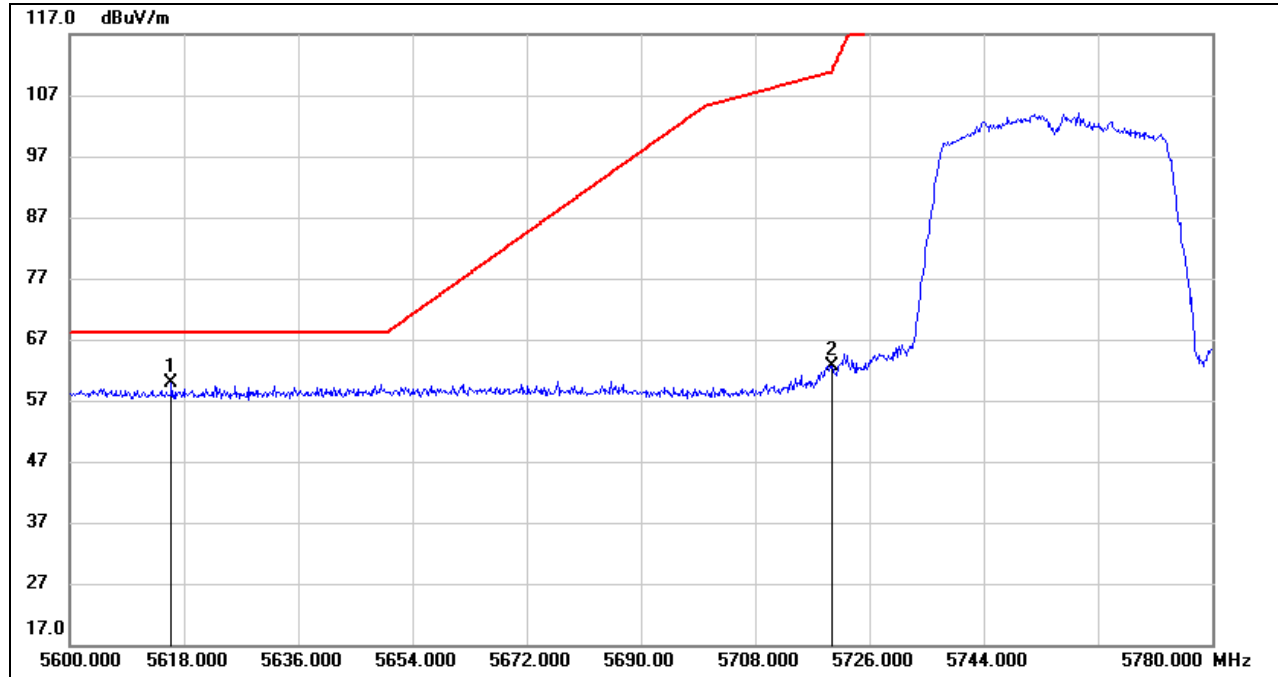

| No. | Frequency (MHz) | Reading (dBuV) | Correct (dB/m) | Result (dBuV/m) | Limit (dBuV/m) | Margin (dB) | Remark |
|-----|-----------------|----------------|----------------|-----------------|----------------|-------------|--------|
| 1 | 5616.020 | 18.08 | 41.70 | 59.78 | 68.20 | -8.42 | peak |
| 2 | 5720.060 | 20.95 | 41.64 | 62.59 | 110.94 | -48.35 | peak |

- Note: 1. Measurement = Reading Level + Correct Factor.
 2. If Peak Result complies with AV limit, AV Result is deemed to comply with AV limit.
 3. Peak: Peak detector.
 4. Only the worst data was recorded, if it complies with the limit, the other emissions deemed to comply with the limit.

RESTRICTED BANDEDGE (HIGH CHANNEL, VERTICAL)

PEAK

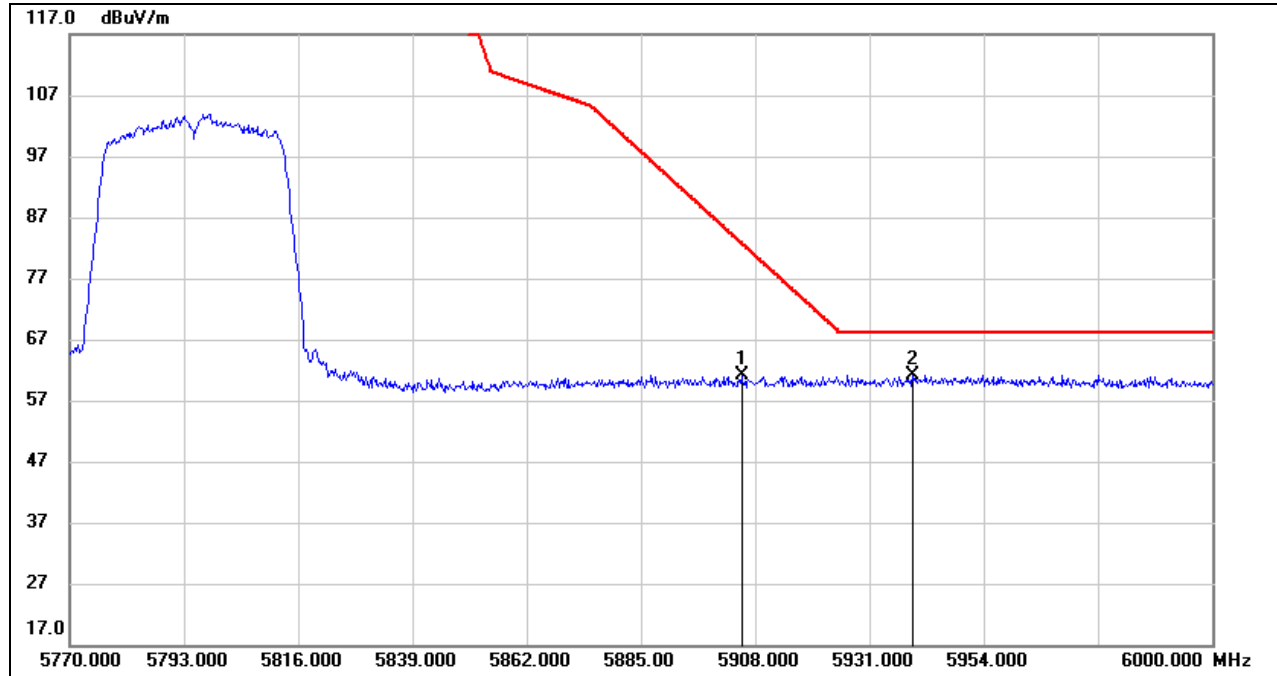

| No. | Frequency (MHz) | Reading (dBuV) | Correct (dB/m) | Result (dBuV/m) | Limit (dBuV/m) | Margin (dB) | Remark |
|-----|-----------------|----------------|----------------|-----------------|----------------|-------------|--------|
| 1 | 5905.240 | 18.24 | 43.01 | 61.25 | 82.78 | -21.53 | peak |
| 2 | 5939.740 | 18.38 | 42.85 | 61.23 | 68.20 | -6.97 | peak |

Note: 1. Measurement = Reading Level + Correct Factor.
 2. If Peak Result complies with AV limit, AV Result is deemed to comply with AV limit.
 3. Peak: Peak detector.
 4. Only the worst data was recorded, if it complies with the limit, the other emissions deemed to comply with the limit.

Note: All the polarities (Vertical & Horizontal) had been tested, only the worst data was recorded in the report.



8.1.3. 802.11ac VHT80 MIMO MODE

UNII-1 BAND

RESTRICTED BANDEDGE (LOW CHANNEL, VERTICAL)

PEAK

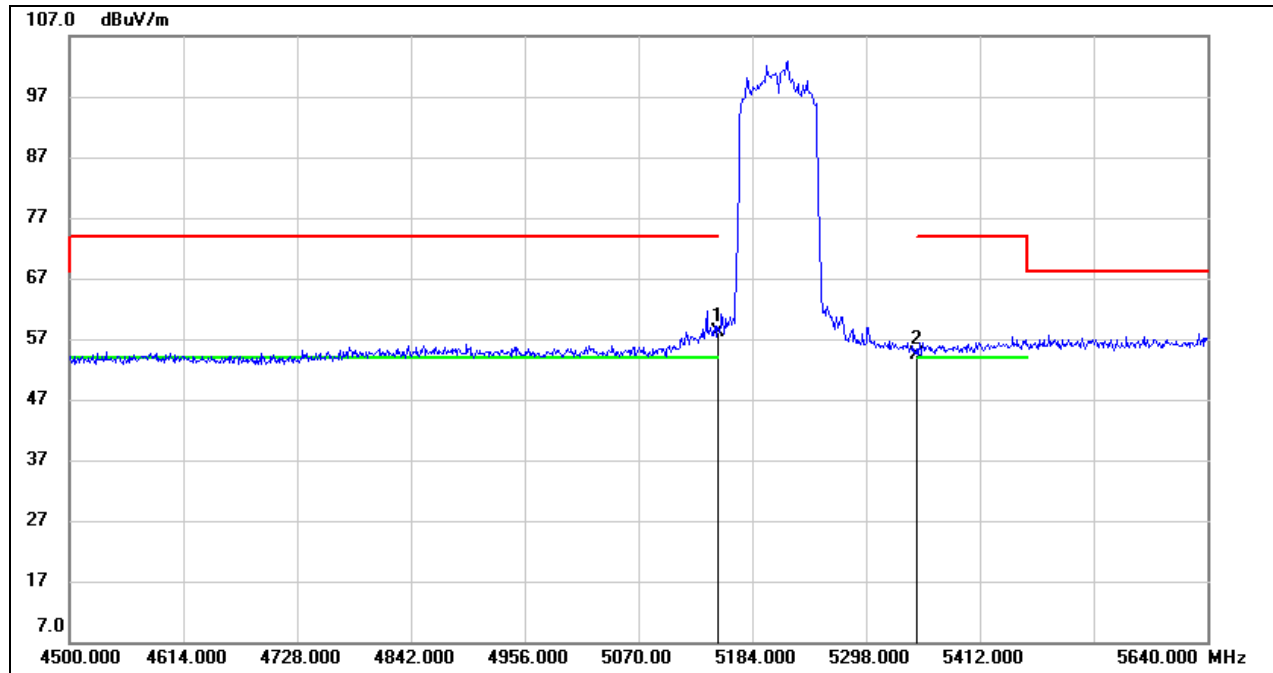

| No. | Frequency (MHz) | Reading (dBuV) | Correct (dB/m) | Result (dBuV/m) | Limit (dBuV/m) | Margin (dB) | Remark |
|-----|-----------------|----------------|----------------|-----------------|----------------|-------------|--------|
| 1 | 5150.000 | 18.31 | 39.91 | 58.22 | 74.00 | -15.78 | peak |
| 2 | 5350.000 | 14.32 | 40.08 | 54.40 | 74.00 | -19.60 | peak |

- Note: 1. Measurement = Reading Level + Correct Factor.
 2. If Peak Result complies with AV limit, AV Result is deemed to comply with AV limit.
 3. Peak: Peak detector.
 4. Only the worst data was recorded, if it complies with the limit, the other emissions deemed to comply with the limit.
 5. Since non-restricted band peak emissions are less than the average limit, they also comply with the -27dBm/MHz (68.2dBuV/m) limit.

AVG

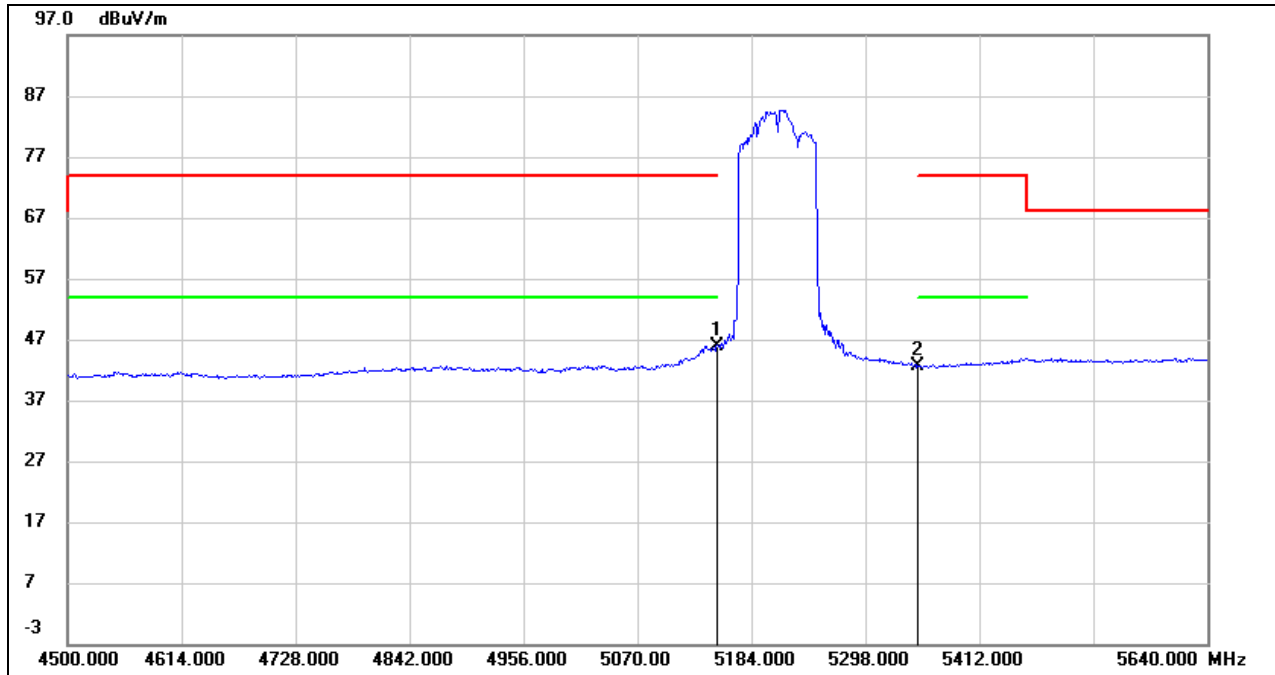

| No. | Frequency (MHz) | Reading (dBuV) | Correct (dB/m) | Result (dBuV/m) | Limit (dBuV/m) | Margin (dB) | Remark |
|-----|-----------------|----------------|----------------|-----------------|----------------|-------------|--------|
| 1 | 5150.000 | 6.03 | 39.91 | 45.94 | 54.00 | -8.06 | AVG |
| 2 | 5350.000 | 2.47 | 40.08 | 42.55 | 54.00 | -11.45 | AVG |

- Note: 1. Measurement = Reading Level + Correct Factor.
 2. If Peak Result complies with AV limit, AV Result is deemed to comply with AV limit.
 3. AVG: $VBW=1/Ton$, where: Ton is the transmitting duration.
 4. For the transmitting duration, please refer to clause 7.1.
 5. Only the worst data was recorded, if it complies with the limit, the other emissions deemed to comply with the limit.

All the polarities (Horizontal and vertical) had been tested, only the worst data was recorded in the report

UNII-2A BAND

RESTRICTED BANDEDGE (LOW CHANNEL, VERTICAL)

PEAK

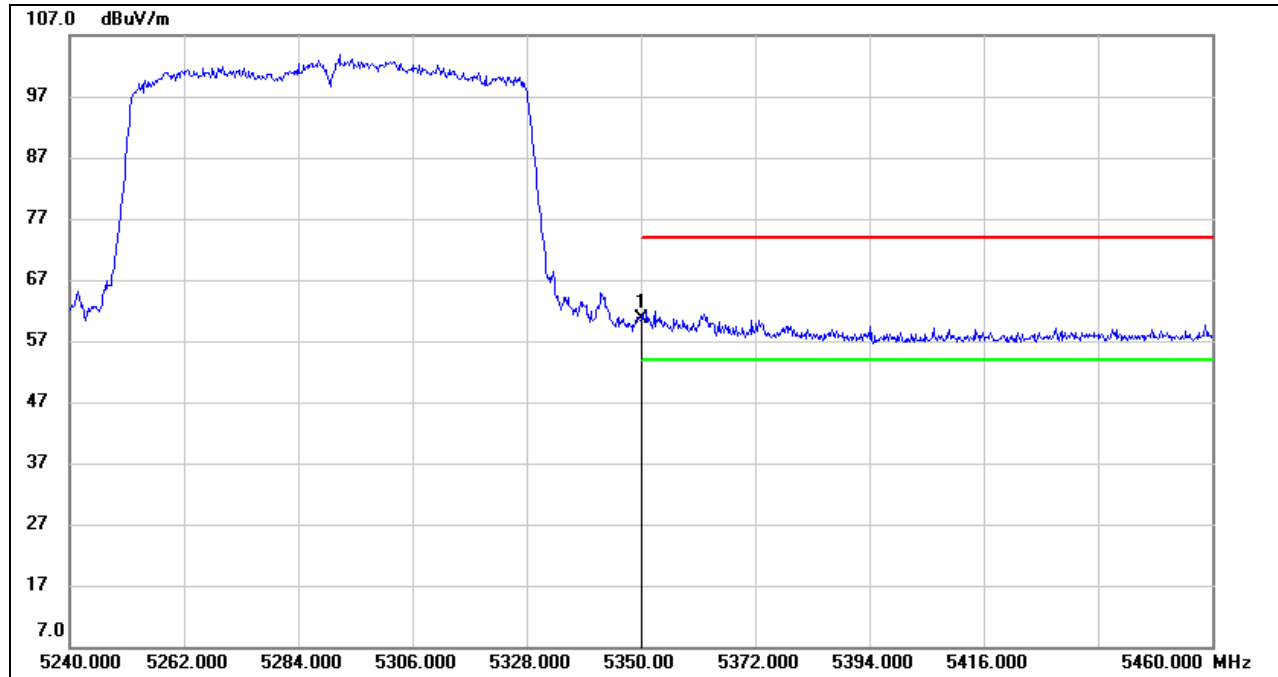

| No. | Frequency (MHz) | Reading (dBuV) | Correct (dB/m) | Result (dBuV/m) | Limit (dBuV/m) | Margin (dB) | Remark |
|-----|-----------------|----------------|----------------|-----------------|----------------|-------------|--------|
| 1 | 5350.000 | 19.53 | 41.20 | 60.73 | 74.00 | -13.27 | peak |

- Note:
1. Measurement = Reading Level + Correct Factor.
 2. If Peak Result complies with AV limit, AV Result is deemed to comply with AV limit.
 3. Peak: Peak detector.
 4. Only the worst data was recorded, if it complies with the limit, the other emissions deemed to comply with the limit.

AVG

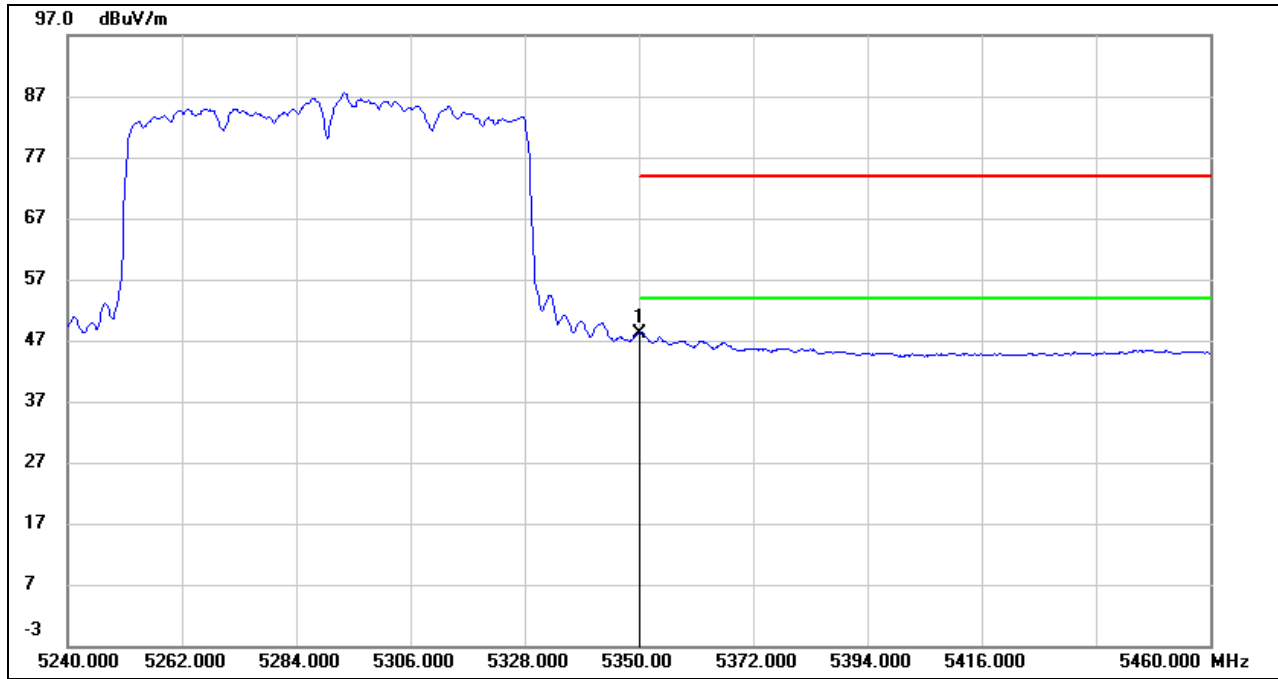

| No. | Frequency (MHz) | Reading (dBuV) | Correct (dB/m) | Result (dBuV/m) | Limit (dBuV/m) | Margin (dB) | Remark |
|-----|-----------------|----------------|----------------|-----------------|----------------|-------------|--------|
| 1 | 5350.000 | 6.90 | 41.20 | 48.10 | 54.00 | -5.90 | AVG |

- Note:
1. Measurement = Reading Level + Correct Factor
 2. AVG: $VBW=1/Ton$ where: ton is transmit duration.
 3. For duty cycle, please refer to clause 7.1.
 4. Only the worst case emission will be recorder, if it complies with the limit, the other emissions deemed to comply with the limit.

Note: All the polarities (Vertical & Horizontal) had been tested, only the worst data was recorded in the report.

UNII-2C BAND

RESTRICTED BANDEDGE (LOW CHANNEL, VERTICAL)

PEAK

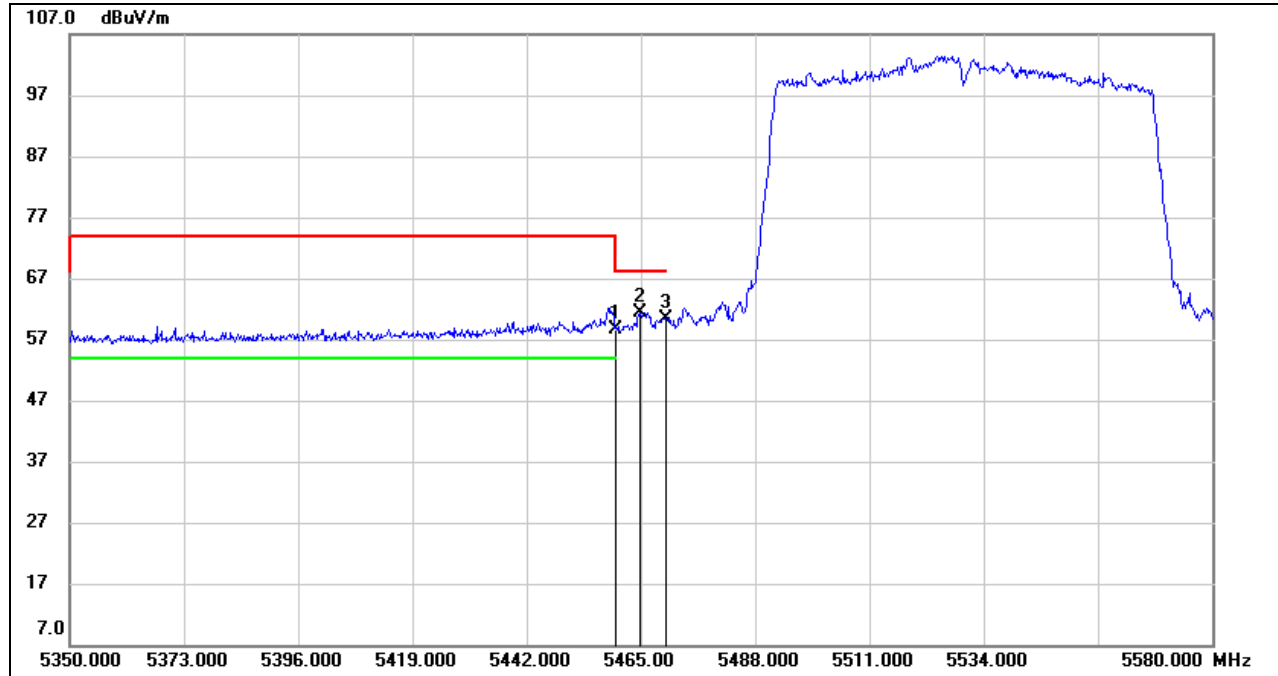

| No. | Frequency (MHz) | Reading (dBuV) | Correct (dB/m) | Result (dBuV/m) | Limit (dBuV/m) | Margin (dB) | Remark |
|-----|-----------------|----------------|----------------|-----------------|----------------|-------------|--------|
| 1 | 5460.000 | 16.76 | 41.82 | 58.58 | 68.20 | -9.62 | peak |
| 2 | 5464.770 | 19.58 | 41.85 | 61.43 | 68.20 | -6.77 | peak |
| 3 | 5470.000 | 18.49 | 41.87 | 60.36 | 68.20 | -7.84 | peak |

Note: 1. Measurement = Reading Level + Correct Factor.
 2. If Peak Result complies with AV limit, AV Result is deemed to comply with AV limit.
 3. Peak: Peak detector.
 4. Only the worst data was recorded, if it complies with the limit, the other emissions deemed to comply with the limit.

AVG

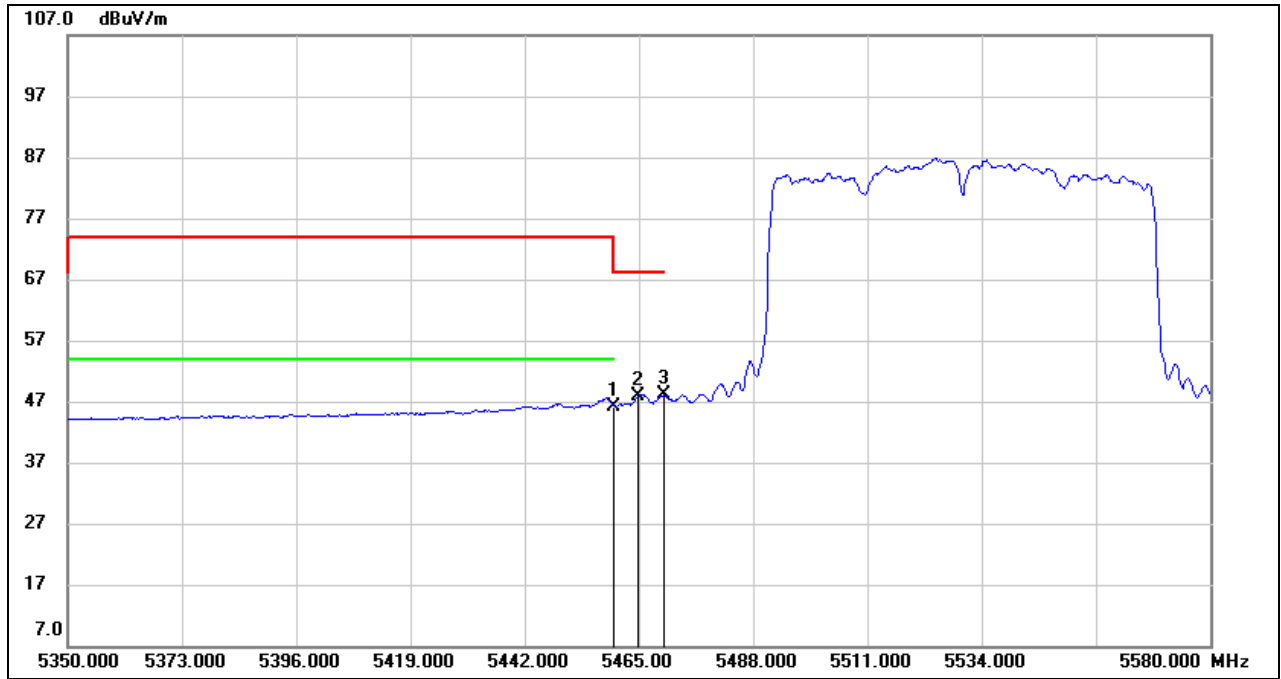

| No. | Frequency (MHz) | Reading (dBuV) | Correct (dB/m) | Result (dBuV/m) | Limit (dBuV/m) | Margin (dB) | Remark |
|-----|-----------------|----------------|----------------|-----------------|----------------|-------------|--------|
| 1 | 5460.000 | 4.37 | 41.82 | 46.19 | 54.00 | -7.81 | AVG |
| 2 | 5464.770 | 5.99 | 41.85 | 47.84 | / | / | AVG |
| 3 | 5470.000 | 6.15 | 41.87 | 48.02 | / | / | AVG |

- Note:
1. Measurement = Reading Level + Correct Factor.
 2. If Peak Result complies with AV limit, AV Result is deemed to comply with AV limit.
 3. AVG: $VBW=1/Ton$, where: Ton is the transmitting duration.
 4. For the transmitting duration, please refer to clause 7.1.
 5. Only the worst data was recorded, if it complies with the limit, the other emissions deemed to comply with the limit.

RESTRICTED BANDEDGE (HIGH CHANNEL, VERTICAL)

PEAK

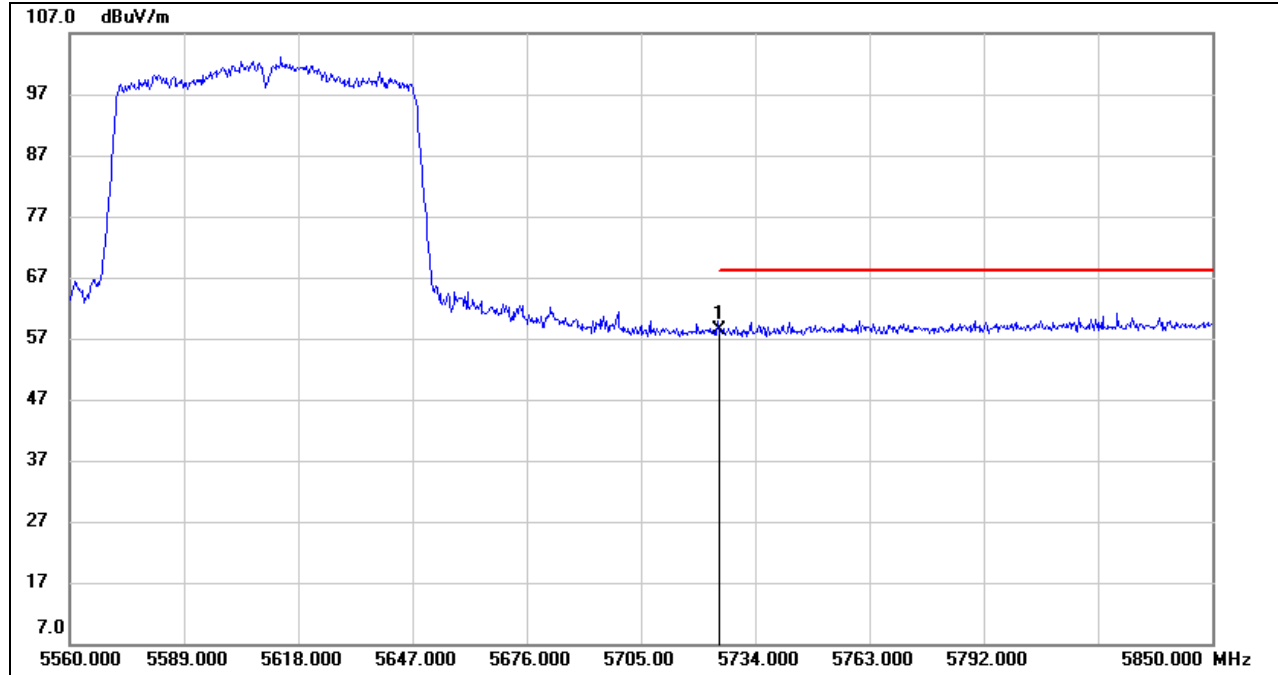

| No. | Frequency (MHz) | Reading (dBuV) | Correct (dB/m) | Result (dBuV/m) | Limit (dBuV/m) | Margin (dB) | Remark |
|-----|-----------------|----------------|----------------|-----------------|----------------|-------------|--------|
| 1 | 5725.000 | 16.75 | 41.67 | 58.42 | 68.20 | -9.78 | peak |

Note: 1. Measurement = Reading Level + Correct Factor.
 2. If Peak Result complies with AV limit, AV Result is deemed to comply with AV limit.
 3. Peak: Peak detector.
 4. Only the worst data was recorded, if it complies with the limit, the other emissions deemed to comply with the limit.

Note: All the polarities (Vertical & Horizontal) had been tested, only the worst data was recorded in the report.

UNII-3 BAND

RESTRICTED BANDEDGE (LOW CHANNEL, VERTICAL)

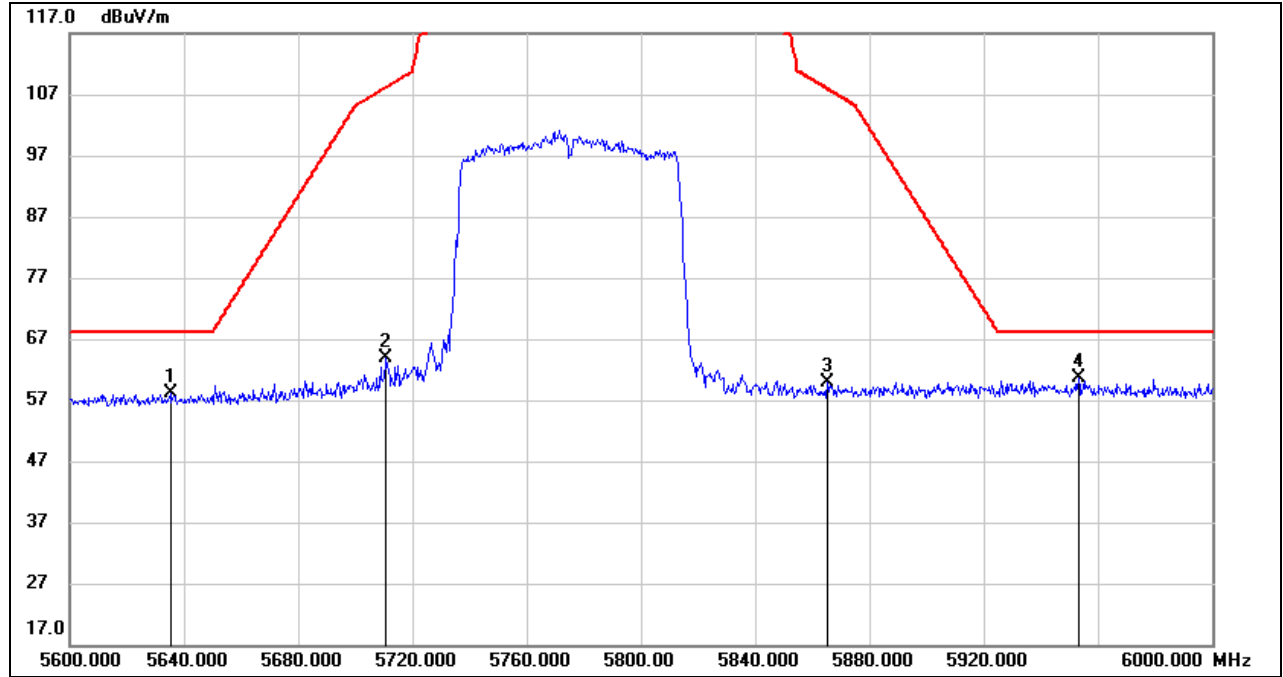

| No. | Frequency (MHz) | Reading (dBuV) | Correct (dB/m) | Result (dBuV/m) | Limit (dBuV/m) | Margin (dB) | Remark |
|-----|-----------------|----------------|----------------|-----------------|----------------|-------------|--------|
| 1 | 5635.200 | 16.47 | 41.66 | 58.13 | 68.20 | -10.07 | peak |
| 2 | 5710.800 | 22.40 | 41.60 | 64.00 | 108.23 | -44.23 | peak |
| 3 | 5865.200 | 17.21 | 42.68 | 59.89 | 107.94 | -48.05 | peak |
| 4 | 5953.200 | 17.74 | 42.78 | 60.52 | 68.20 | -7.68 | peak |

Note: 1. Measurement = Reading Level + Correct Factor.
 2. If Peak Result complies with AV limit, AV Result is deemed to comply with AV limit.
 3. Peak: Peak detector.
 4. Only the worst data was recorded, if it complies with the limit, the other emissions deemed to comply with the limit.

Note: All the polarities (Vertical & Horizontal) had been tested, only the worst data was recorded in the report.

8.2. SPURIOUS EMISSIONS (1 GHz ~ 7 GHz)

8.2.1. 802.11n HT40 MIMO MODE

UNII-1 BAND

HARMONICS AND SPURIOUS EMISSIONS (LOW CHANNEL, HORIZONTAL)

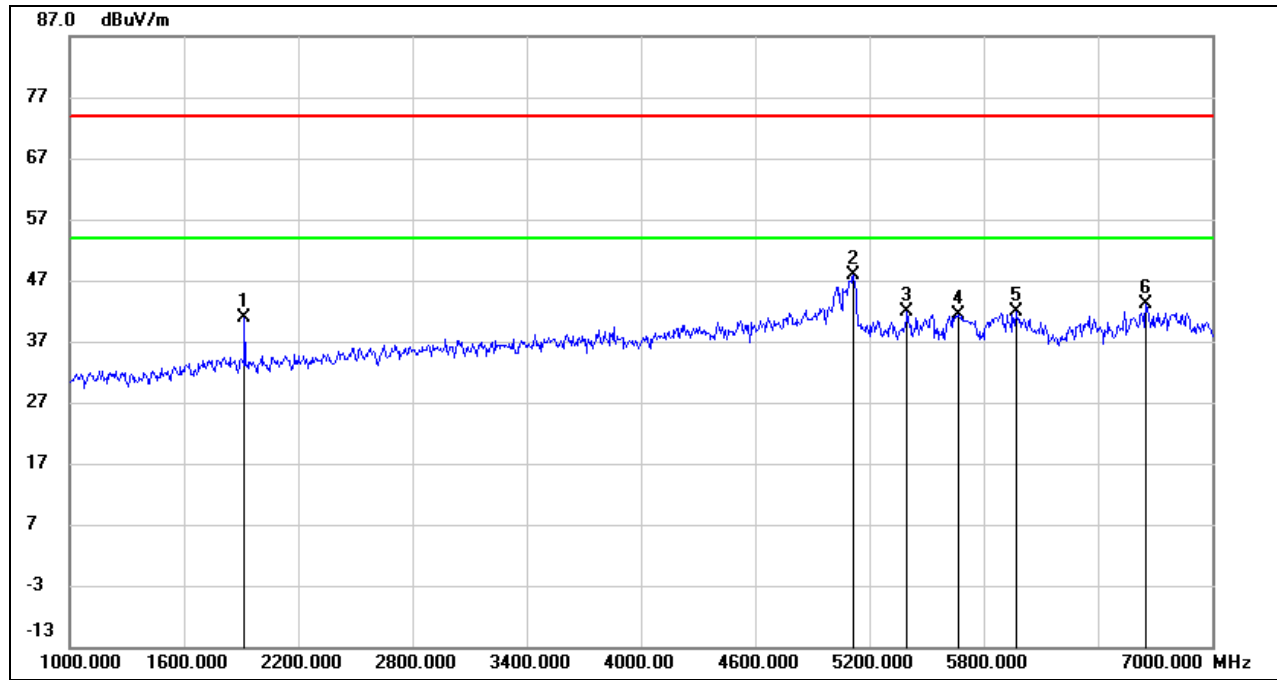

| No. | Frequency (MHz) | Reading (dBuV) | Correct (dB/m) | Result (dBuV/m) | Limit (dBuV/m) | Margin (dB) | Remark |
|-----|-----------------|----------------|----------------|-----------------|----------------|-------------|--------|
| 1 | 1918.000 | 50.96 | -10.13 | 40.83 | 74.00 | -33.17 | peak |
| 2 | 5116.000 | 46.37 | 1.60 | 47.97 | 74.00 | -26.03 | peak |
| 3 | 5398.000 | 40.05 | 1.88 | 41.93 | 74.00 | -32.07 | peak |
| 4 | 5668.000 | 39.01 | 2.47 | 41.48 | 74.00 | -32.52 | peak |
| 5 | 5968.000 | 38.81 | 3.17 | 41.98 | 74.00 | -32.02 | peak |
| 6 | 6652.000 | 37.59 | 5.52 | 43.11 | 74.00 | -30.89 | peak |

Note: 1. Measurement = Reading Level + Correct Factor.
 2. If Peak Result complies with AV limit, AV Result is deemed to comply with AV limit.
 3. Peak: Peak detector.
 4. Filter losses were only considered in the spurious frequency bands and the authorized band was not corrected for Band reject filter losses.
 5. Proper operation of the transmitter prior to adding the filter to the measurement chain.
 6. Since non-restricted band peak emissions are less than the average limit, they also comply with the -27dBm/MHz (68.2dBuV/m) limit.

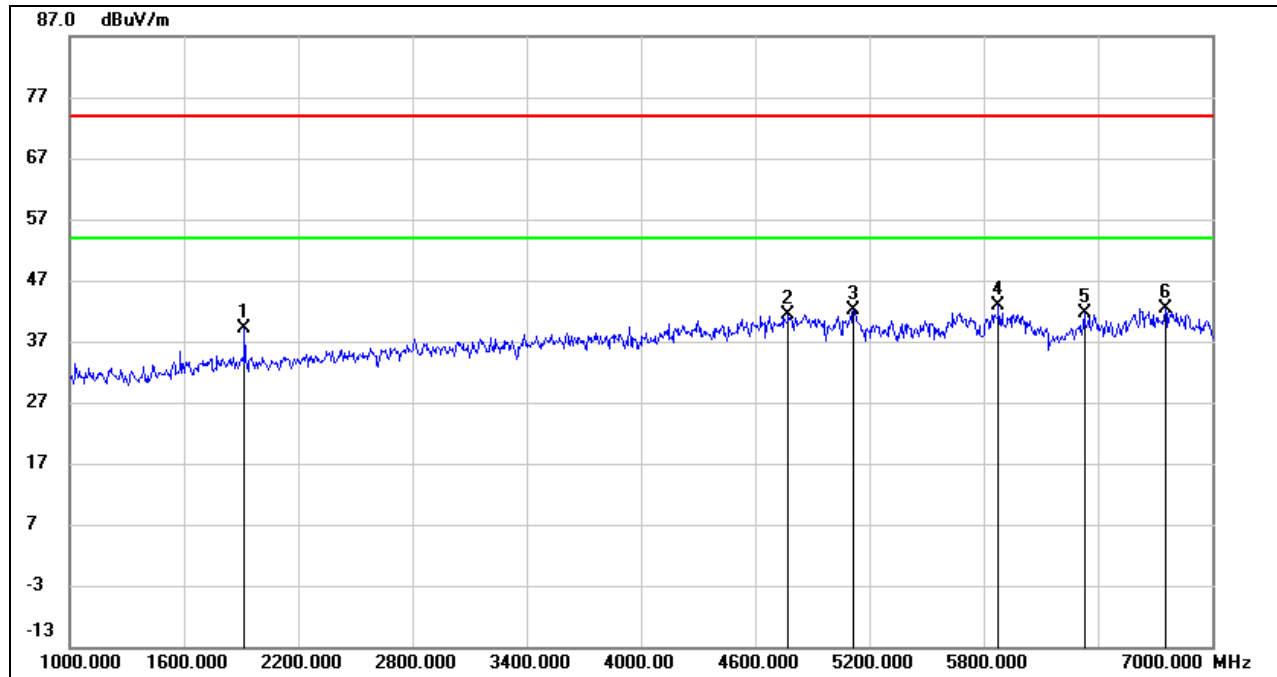
**HARMONICS AND SPURIOUS EMISSIONS (LOW CHANNEL, VERTICAL)**

| No. | Frequency (MHz) | Reading (dBuV) | Correct (dB/m) | Result (dBuV/m) | Limit (dBuV/m) | Margin (dB) | Remark |
|-----|-----------------|----------------|----------------|-----------------|----------------|-------------|--------|
| 1 | 1918.000 | 49.31 | -10.13 | 39.18 | 74.00 | -34.82 | peak |
| 2 | 4774.000 | 40.93 | 0.43 | 41.36 | 74.00 | -32.64 | peak |
| 3 | 5116.000 | 40.54 | 1.60 | 42.14 | 74.00 | -31.86 | peak |
| 4 | 5878.000 | 40.05 | 2.81 | 42.86 | 74.00 | -31.14 | peak |
| 5 | 6328.000 | 37.59 | 3.97 | 41.56 | 74.00 | -32.44 | peak |
| 6 | 6754.000 | 36.86 | 5.56 | 42.42 | 74.00 | -31.58 | peak |

Note: 1. Measurement = Reading Level + Correct Factor.

2. If Peak Result complies with AV limit, AV Result is deemed to comply with AV limit.

3. Peak: Peak detector.

4. Filter losses were only considered in the spurious frequency bands and the authorized band was not corrected for Band reject filter losses.

5. Proper operation of the transmitter prior to adding the filter to the measurement chain.

6. Since non-restricted band peak emissions are less than the average limit, they also comply with the -27dBm/MHz (68.2dBuV/m) limit.

HARMONICS AND SPURIOUS EMISSIONS (HIGH CHANNEL, HORIZONTAL)

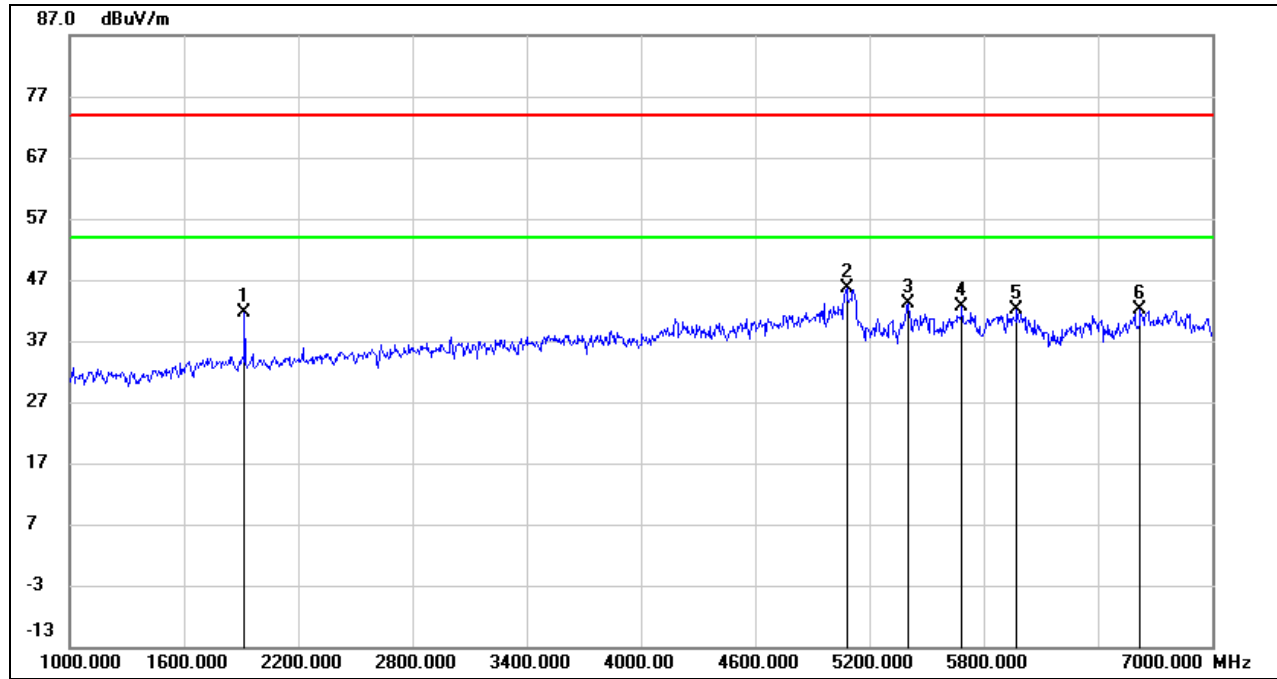

| No. | Frequency (MHz) | Reading (dBuV) | Correct (dB/m) | Result (dBuV/m) | Limit (dBuV/m) | Margin (dB) | Remark |
|-----|-----------------|----------------|----------------|-----------------|----------------|-------------|--------|
| 1 | 1918.000 | 51.70 | -10.13 | 41.57 | 74.00 | -32.43 | peak |
| 2 | 5080.000 | 44.16 | 1.38 | 45.54 | 74.00 | -28.46 | peak |
| 3 | 5404.000 | 41.22 | 1.89 | 43.11 | 74.00 | -30.89 | peak |
| 4 | 5686.000 | 40.06 | 2.47 | 42.53 | 74.00 | -31.47 | peak |
| 5 | 5974.000 | 38.87 | 3.20 | 42.07 | 74.00 | -31.93 | peak |
| 6 | 6622.000 | 36.63 | 5.51 | 42.14 | 74.00 | -31.86 | peak |

Note: 1. Measurement = Reading Level + Correct Factor.
 2. If Peak Result complies with AV limit, AV Result is deemed to comply with AV limit.
 3. Peak: Peak detector.
 4. Filter losses were only considered in the spurious frequency bands and the authorized band was not corrected for Band reject filter losses.
 5. Proper operation of the transmitter prior to adding the filter to the measurement chain.
 6. Since non-restricted band peak emissions are less than the average limit, they also comply with the -27dBm/MHz (68.2dBuV/m) limit.

HARMONICS AND SPURIOUS EMISSIONS (HIGH CHANNEL, VERTICAL)

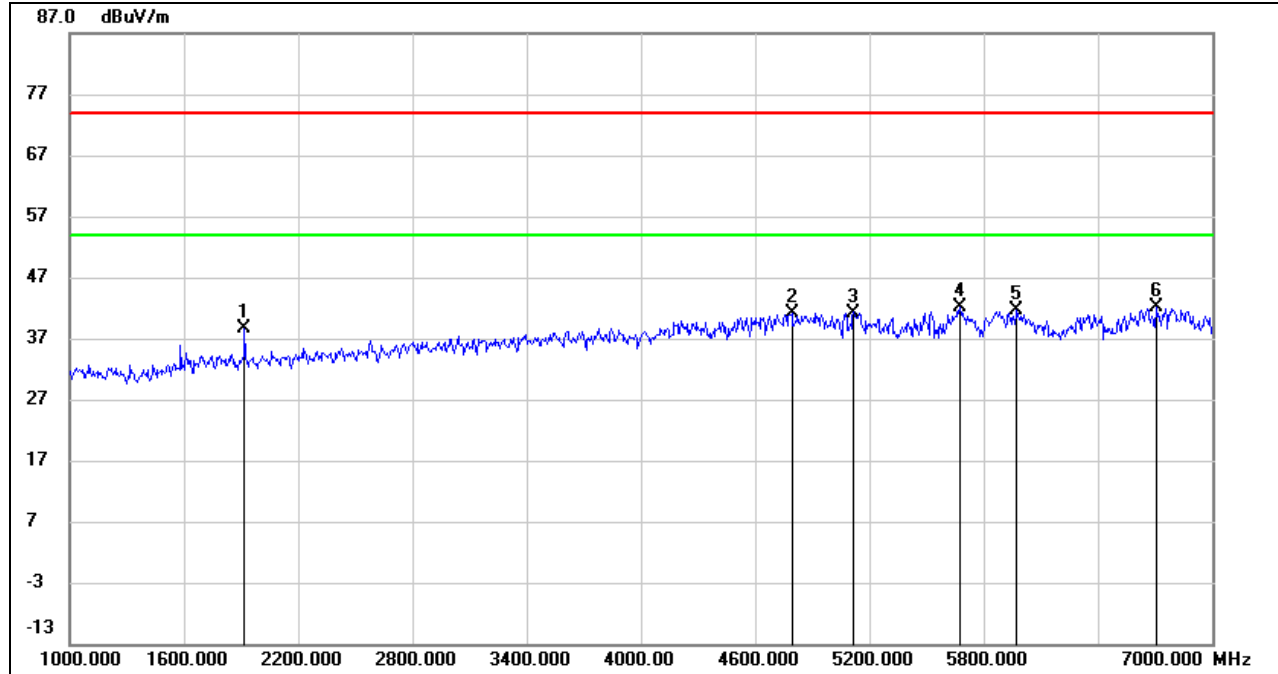

| No. | Frequency (MHz) | Reading (dBuV) | Correct (dB/m) | Result (dBuV/m) | Limit (dBuV/m) | Margin (dB) | Remark |
|-----|-----------------|----------------|----------------|-----------------|----------------|-------------|--------|
| 1 | 1918.000 | 48.72 | -10.13 | 38.59 | 74.00 | -35.41 | peak |
| 2 | 4792.000 | 40.63 | 0.54 | 41.17 | 74.00 | -32.83 | peak |
| 3 | 5116.000 | 39.65 | 1.60 | 41.25 | 74.00 | -32.75 | peak |
| 4 | 5674.000 | 39.62 | 2.48 | 42.10 | 74.00 | -31.90 | peak |
| 5 | 5974.000 | 38.48 | 3.20 | 41.68 | 74.00 | -32.32 | peak |
| 6 | 6706.000 | 36.48 | 5.54 | 42.02 | 74.00 | -31.98 | peak |

- Note: 1. Measurement = Reading Level + Correct Factor.
 2. If Peak Result complies with AV limit, AV Result is deemed to comply with AV limit.
 3. Peak: Peak detector.
 4. Filter losses were only considered in the spurious frequency bands and the authorized band was not corrected for Band reject filter losses.
 5. Proper operation of the transmitter prior to adding the filter to the measurement chain.
 6. Since non-restricted band peak emissions are less than the average limit, they also comply with the -27dBm/MHz (68.2dBuV/m) limit.



UNII-2A BAND

HARMONICS AND SPURIOUS EMISSIONS (LOW CHANNEL, HORIZONTAL)

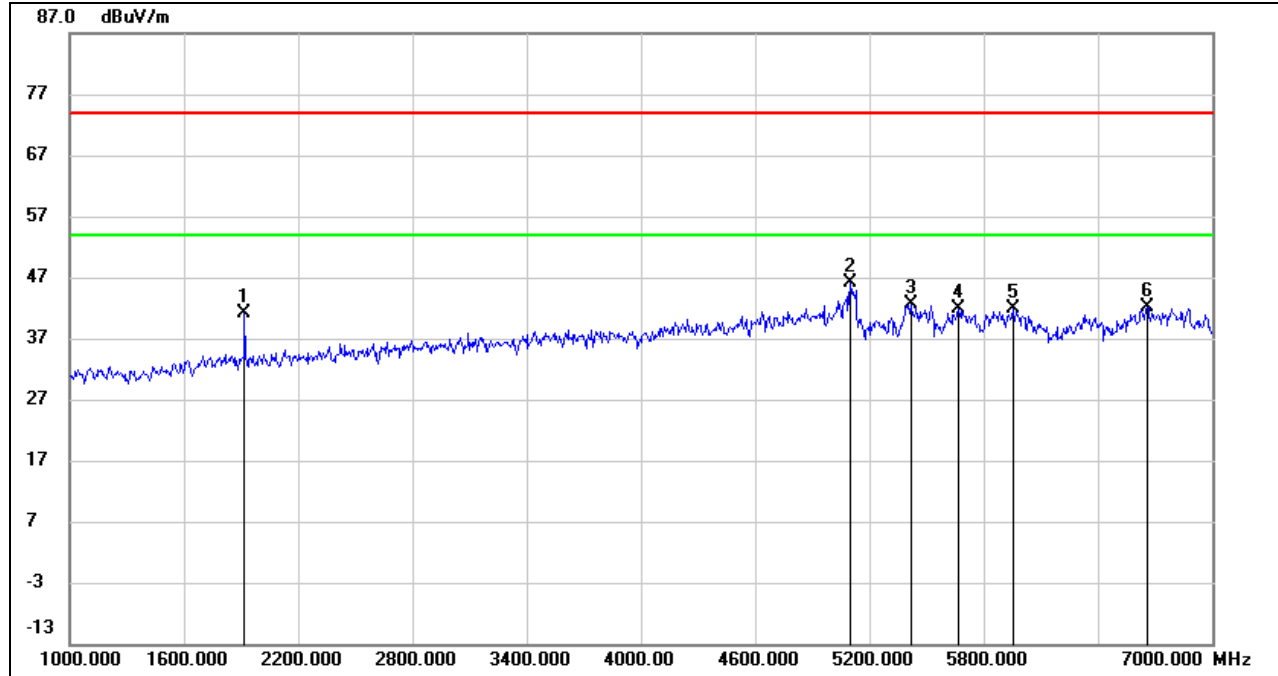

| No. | Frequency (MHz) | Reading (dBuV) | Correct (dB/m) | Result (dBuV/m) | Limit (dBuV/m) | Margin (dB) | Remark |
|-----|-----------------|----------------|----------------|-----------------|----------------|-------------|--------|
| 1 | 1918.000 | 51.33 | -10.13 | 41.20 | 74.00 | -32.80 | peak |
| 2 | 5098.000 | 44.58 | 1.49 | 46.07 | 74.00 | -27.93 | peak |
| 3 | 5416.000 | 40.76 | 1.92 | 42.68 | 74.00 | -31.32 | peak |
| 4 | 5668.000 | 39.52 | 2.47 | 41.99 | 74.00 | -32.01 | peak |
| 5 | 5956.000 | 38.67 | 3.13 | 41.80 | 74.00 | -32.20 | peak |
| 6 | 6658.000 | 36.74 | 5.51 | 42.25 | 74.00 | -31.75 | peak |

Note: 1. Measurement = Reading Level + Correct Factor.
 2. If Peak Result complies with AV limit, AV Result is deemed to comply with AV limit.
 3. Peak: Peak detector.
 4. Filter losses were only considered in the spurious frequency bands and the authorized band was not corrected for High Pass Filter losses.
 5. Proper operation of the transmitter prior to adding the filter to the measurement chain.
 6. Since non-restricted band peak emissions are less than the average limit, they also comply with the -27dBm/MHz (68.2dBuV/m) limit.

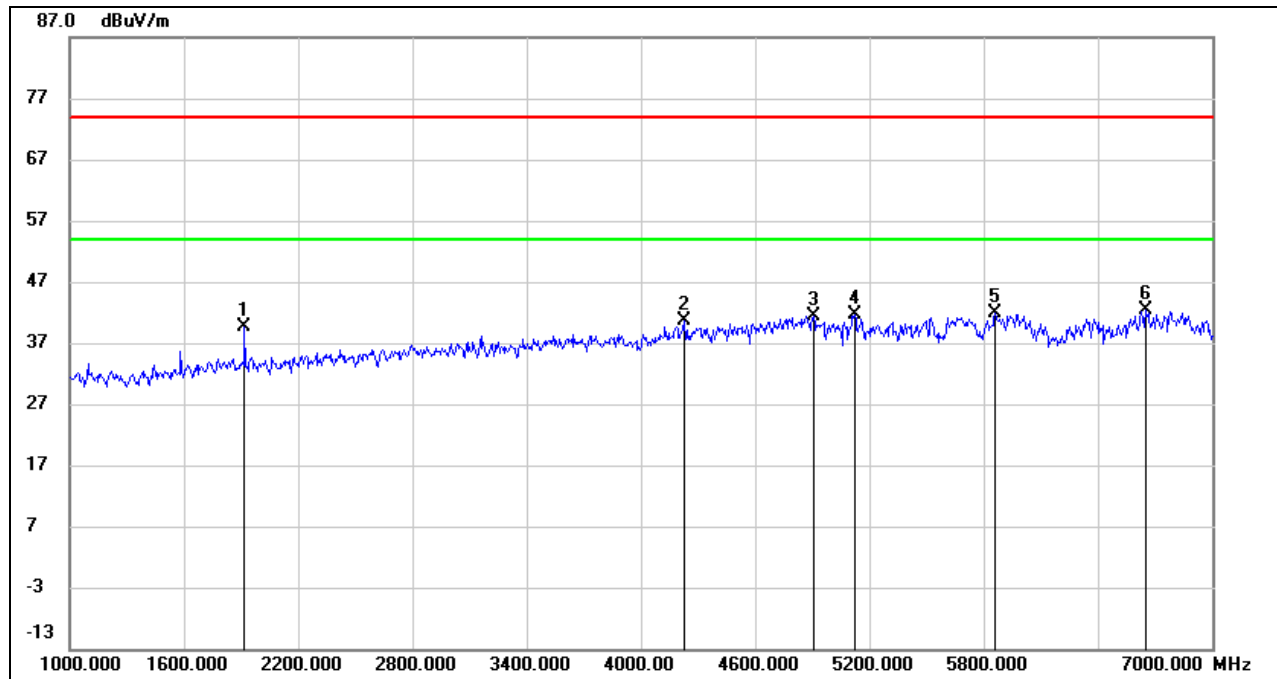
**HARMONICS AND SPURIOUS EMISSIONS (LOW CHANNEL, VERTICAL)**

| No. | Frequency (MHz) | Reading (dBuV) | Correct (dB/m) | Result (dBuV/m) | Limit (dBuV/m) | Margin (dB) | Remark |
|-----|-----------------|----------------|----------------|-----------------|----------------|-------------|--------|
| 1 | 1918.000 | 49.65 | -10.13 | 39.52 | 74.00 | -34.48 | peak |
| 2 | 4228.000 | 42.41 | -1.70 | 40.71 | 74.00 | -33.29 | peak |
| 3 | 4906.000 | 40.73 | 0.75 | 41.48 | 74.00 | -32.52 | peak |
| 4 | 5122.000 | 39.99 | 1.64 | 41.63 | 74.00 | -32.37 | peak |
| 5 | 5860.000 | 39.20 | 2.75 | 41.95 | 74.00 | -32.05 | peak |
| 6 | 6652.000 | 36.81 | 5.52 | 42.33 | 74.00 | -31.67 | peak |

- Note:
1. Measurement = Reading Level + Correct Factor.
 2. If Peak Result complies with AV limit, AV Result is deemed to comply with AV limit.
 3. Peak: Peak detector.
 4. AVG: $VBW=1/Ton$, where: Ton is the transmitting duration.
 5. For the transmitting duration, please refer to clause 7.1.
 6. Filter losses were only considered in the spurious frequency bands and the authorized band was not corrected for High Pass Filter losses.
 7. Proper operation of the transmitter prior to adding the filter to the measurement chain.
 8. Since non-restricted band peak emissions are less than the average limit, they also comply with the -27dBm/MHz (68.2dBuV/m) limit.

HARMONICS AND SPURIOUS EMISSIONS (HIGH CHANNEL, HORIZONTAL)

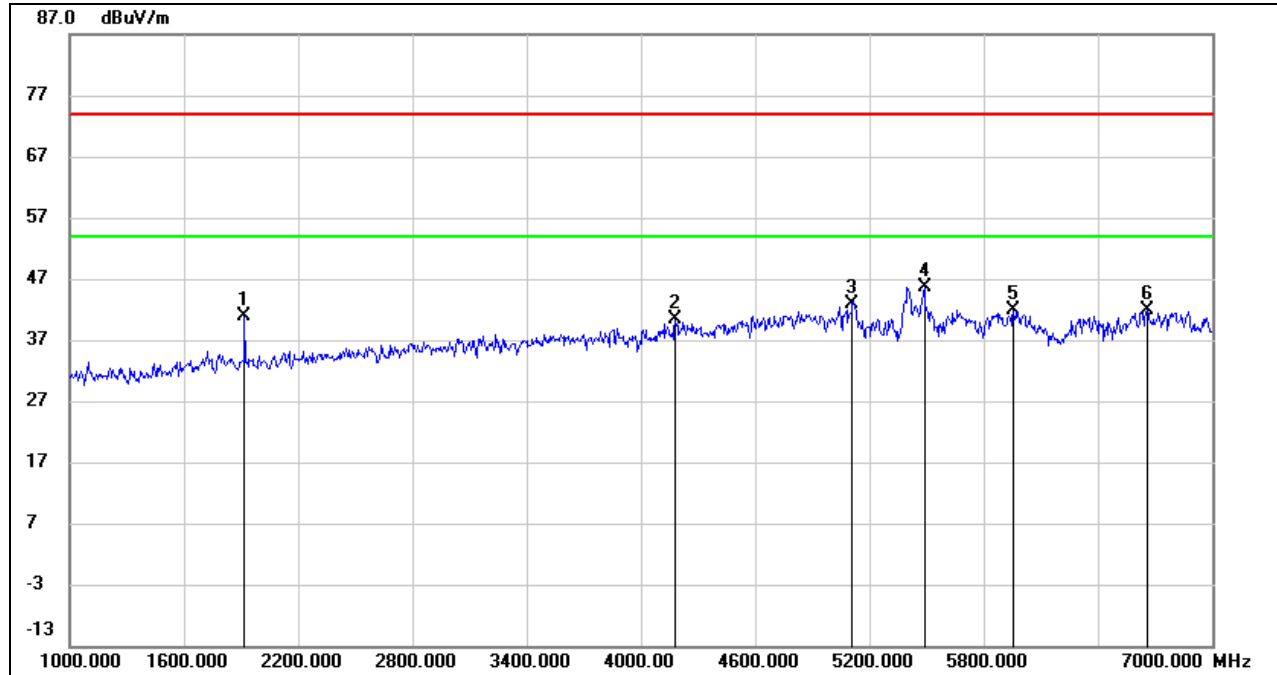

| No. | Frequency (MHz) | Reading (dBuV) | Correct (dB/m) | Result (dBuV/m) | Limit (dBuV/m) | Margin (dB) | Remark |
|-----|-----------------|----------------|----------------|-----------------|----------------|-------------|--------|
| 1 | 1918.000 | 50.93 | -10.13 | 40.80 | 74.00 | -33.20 | peak |
| 2 | 4180.000 | 42.25 | -1.87 | 40.38 | 74.00 | -33.62 | peak |
| 3 | 5110.000 | 41.29 | 1.55 | 42.84 | 74.00 | -31.16 | peak |
| 4 | 5488.000 | 43.55 | 2.13 | 45.68 | 74.00 | -28.32 | peak |
| 5 | 5956.000 | 38.85 | 3.13 | 41.98 | 74.00 | -32.02 | peak |
| 6 | 6658.000 | 36.31 | 5.51 | 41.82 | 74.00 | -32.18 | peak |

Note: 1. Measurement = Reading Level + Correct Factor.

2. If Peak Result complies with AV limit, AV Result is deemed to comply with AV limit.

3. Peak: Peak detector.

4. Filter losses were only considered in the spurious frequency bands and the authorized band was not corrected for High Pass Filter losses.

5. Proper operation of the transmitter prior to adding the filter to the measurement chain.

6. Since non-restricted band peak emissions are less than the average limit, they also comply with the -27dBm/MHz (68.2dBuV/m) limit.

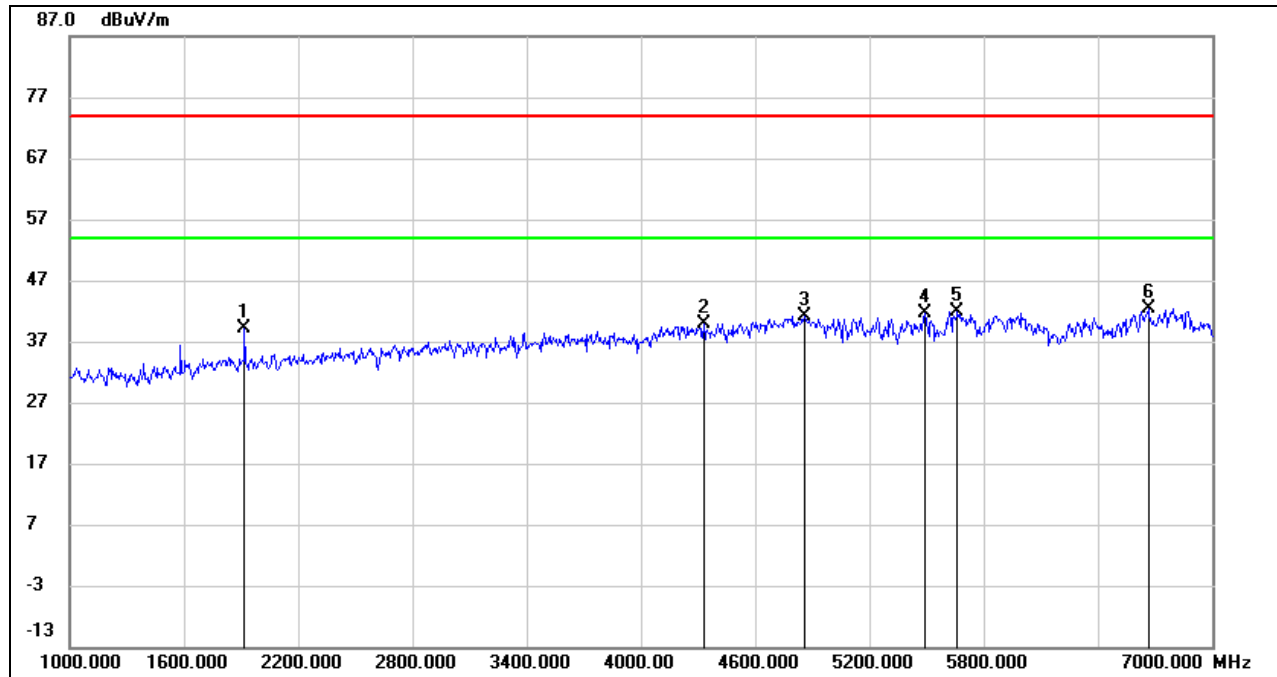
**HARMONICS AND SPURIOUS EMISSIONS (HIGH CHANNEL, VERTICAL)**

| No. | Frequency (MHz) | Reading (dBuV) | Correct (dB/m) | Result (dBuV/m) | Limit (dBuV/m) | Margin (dB) | Remark |
|-----|-----------------|----------------|----------------|-----------------|----------------|-------------|--------|
| 1 | 1918.000 | 49.35 | -10.13 | 39.22 | 74.00 | -34.78 | peak |
| 2 | 4330.000 | 41.72 | -1.80 | 39.92 | 74.00 | -34.08 | peak |
| 3 | 4858.000 | 40.48 | 0.68 | 41.16 | 74.00 | -32.84 | peak |
| 4 | 5494.000 | 39.54 | 2.14 | 41.68 | 74.00 | -32.32 | peak |
| 5 | 5662.000 | 39.51 | 2.47 | 41.98 | 74.00 | -32.02 | peak |
| 6 | 6664.000 | 36.93 | 5.53 | 42.46 | 74.00 | -31.54 | peak |

Note: 1. Measurement = Reading Level + Correct Factor.

2. If Peak Result complies with AV limit, AV Result is deemed to comply with AV limit.

3. Peak: Peak detector.

4. AVG: $VBW=1/Ton$, where: Ton is the transmitting duration.

5. For the transmitting duration, please refer to clause 7.1.

6. Filter losses were only considered in the spurious frequency bands and the authorized band was not corrected for High Pass Filter losses.

7. Proper operation of the transmitter prior to adding the filter to the measurement chain.

8. Since non-restricted band peak emissions are less than the average limit, they also comply with the -27dBm/MHz (68.2dBuV/m) limit.

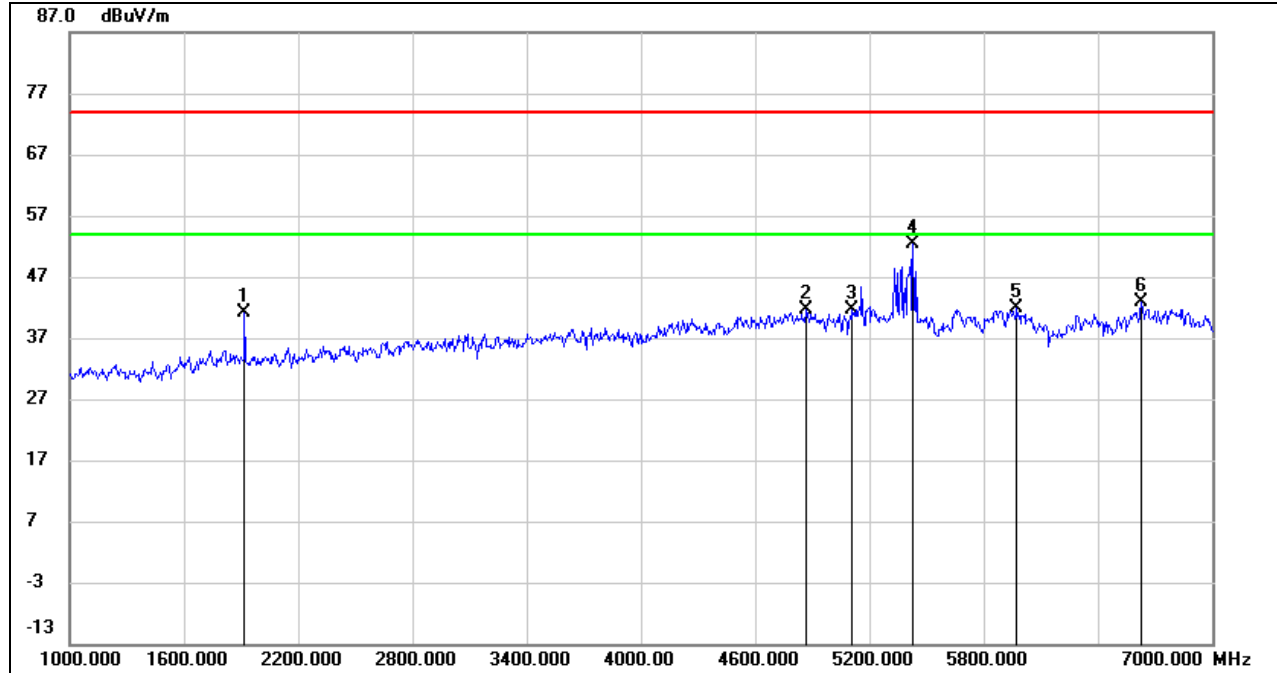
UNII-2C BAND
HARMONICS AND SPURIOUS EMISSIONS (LOW CHANNEL, HORIZONTAL)

| No. | Frequency (MHz) | Reading (dBuV) | Correct (dB/m) | Result (dBuV/m) | Limit (dBuV/m) | Margin (dB) | Remark |
|-----|-----------------|----------------|----------------|-----------------|----------------|-------------|--------|
| 1 | 1918.000 | 51.35 | -10.13 | 41.22 | 74.00 | -32.78 | peak |
| 2 | 4870.000 | 40.90 | 0.69 | 41.59 | 74.00 | -32.41 | peak |
| 3 | 5110.000 | 40.05 | 1.55 | 41.60 | 74.00 | -32.40 | peak |
| 4 | 5428.000 | 50.32 | 1.95 | 52.27 | 74.00 | -21.73 | peak |
| 5 | 5974.000 | 38.62 | 3.20 | 41.82 | 74.00 | -32.18 | peak |
| 6 | 6628.000 | 37.47 | 5.50 | 42.97 | 74.00 | -31.03 | peak |

Note: 1. Measurement = Reading Level + Correct Factor.

2. If Peak Result complies with AV limit, AV Result is deemed to comply with AV limit.

3. Peak: Peak detector.

4. Filter losses were only considered in the spurious frequency bands and the authorized band was not corrected for High Pass Filter losses.

5. Proper operation of the transmitter prior to adding the filter to the measurement chain.

6. Since non-restricted band peak emissions are less than the average limit, they also comply with the -27dBm/MHz (68.2dBuV/m) limit.

HARMONICS AND SPURIOUS EMISSIONS (LOW CHANNEL, VERTICAL)

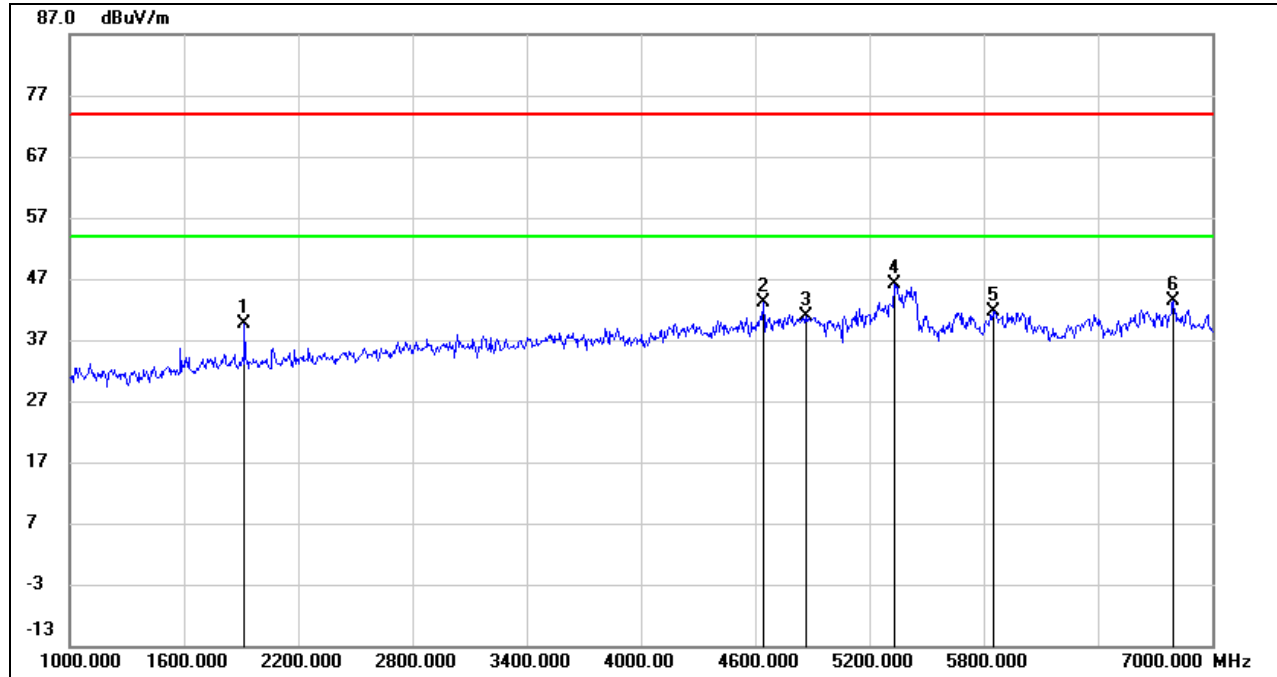

| No. | Frequency (MHz) | Reading (dBuV) | Correct (dB/m) | Result (dBuV/m) | Limit (dBuV/m) | Margin (dB) | Remark |
|-----|-----------------|----------------|----------------|-----------------|----------------|-------------|--------|
| 1 | 1918.000 | 49.67 | -10.13 | 39.54 | 74.00 | -34.46 | peak |
| 2 | 4642.000 | 43.46 | -0.33 | 43.13 | 74.00 | -30.87 | peak |
| 3 | 4864.000 | 40.11 | 0.69 | 40.80 | 74.00 | -33.20 | peak |
| 4 | 5332.000 | 44.13 | 1.95 | 46.08 | 74.00 | -27.92 | peak |
| 5 | 5848.000 | 38.99 | 2.70 | 41.69 | 74.00 | -32.31 | peak |
| 6 | 6796.000 | 37.81 | 5.57 | 43.38 | 74.00 | -30.62 | peak |

Note: 1. Measurement = Reading Level + Correct Factor.
 2. If Peak Result complies with AV limit, AV Result is deemed to comply with AV limit.
 3. Peak: Peak detector.
 4. Filter losses were only considered in the spurious frequency bands and the authorized band was not corrected for High Pass Filter losses.
 5. Proper operation of the transmitter prior to adding the filter to the measurement chain.
 6. Since non-restricted band peak emissions are less than the average limit, they also comply with the -27dBm/MHz (68.2dBuV/m) limit.

HARMONICS AND SPURIOUS EMISSIONS (MID CHANNEL, HORIZONTAL)

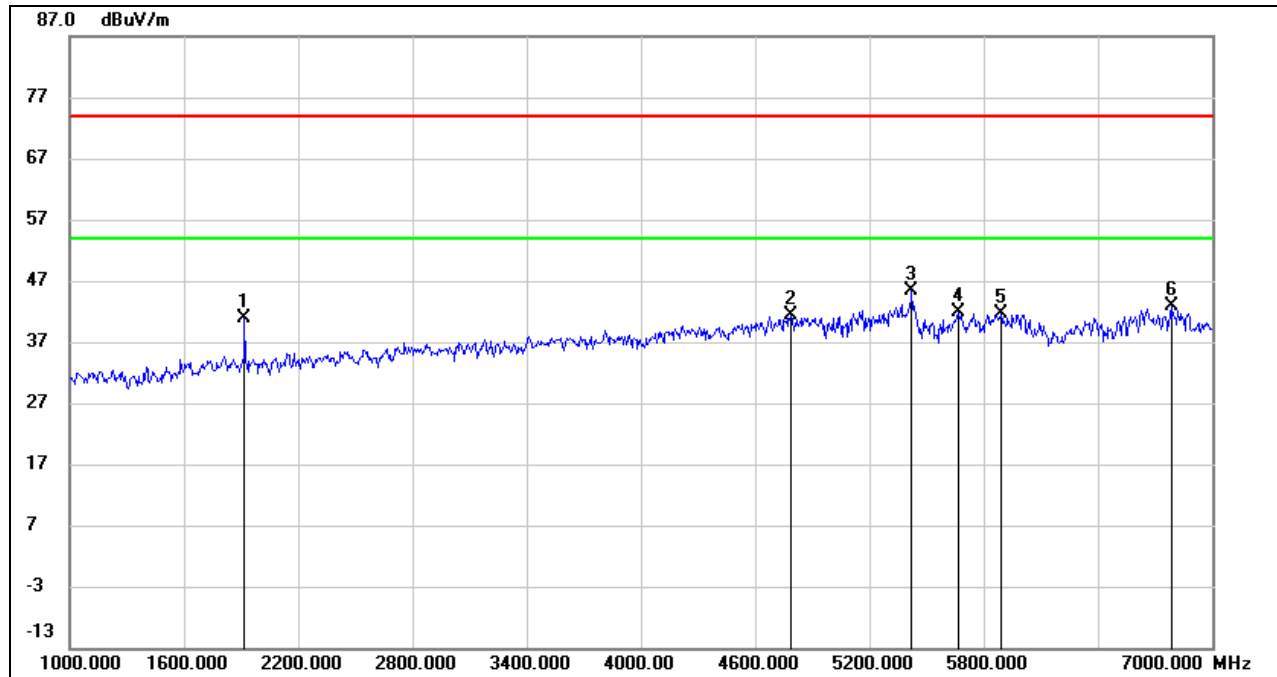

| No. | Frequency (MHz) | Reading (dBuV) | Correct (dB/m) | Result (dBuV/m) | Limit (dBuV/m) | Margin (dB) | Remark |
|-----|-----------------|----------------|----------------|-----------------|----------------|-------------|--------|
| 1 | 1918.000 | 51.07 | -10.13 | 40.94 | 74.00 | -33.06 | peak |
| 2 | 4786.000 | 40.80 | 0.51 | 41.31 | 74.00 | -32.69 | peak |
| 3 | 5422.000 | 43.34 | 1.94 | 45.28 | 74.00 | -28.72 | peak |
| 4 | 5668.000 | 39.36 | 2.47 | 41.83 | 74.00 | -32.17 | peak |
| 5 | 5890.000 | 38.86 | 2.87 | 41.73 | 74.00 | -32.27 | peak |
| 6 | 6784.000 | 37.40 | 5.56 | 42.96 | 74.00 | -31.04 | peak |

Note: 1. Measurement = Reading Level + Correct Factor.

2. If Peak Result complies with AV limit, AV Result is deemed to comply with AV limit.

3. Peak: Peak detector.

4. Filter losses were only considered in the spurious frequency bands and the authorized band was not corrected for High Pass Filter losses.

5. Proper operation of the transmitter prior to adding the filter to the measurement chain.

6. Since non-restricted band peak emissions are less than the average limit, they also comply with the -27dBm/MHz (68.2dBuV/m) limit.

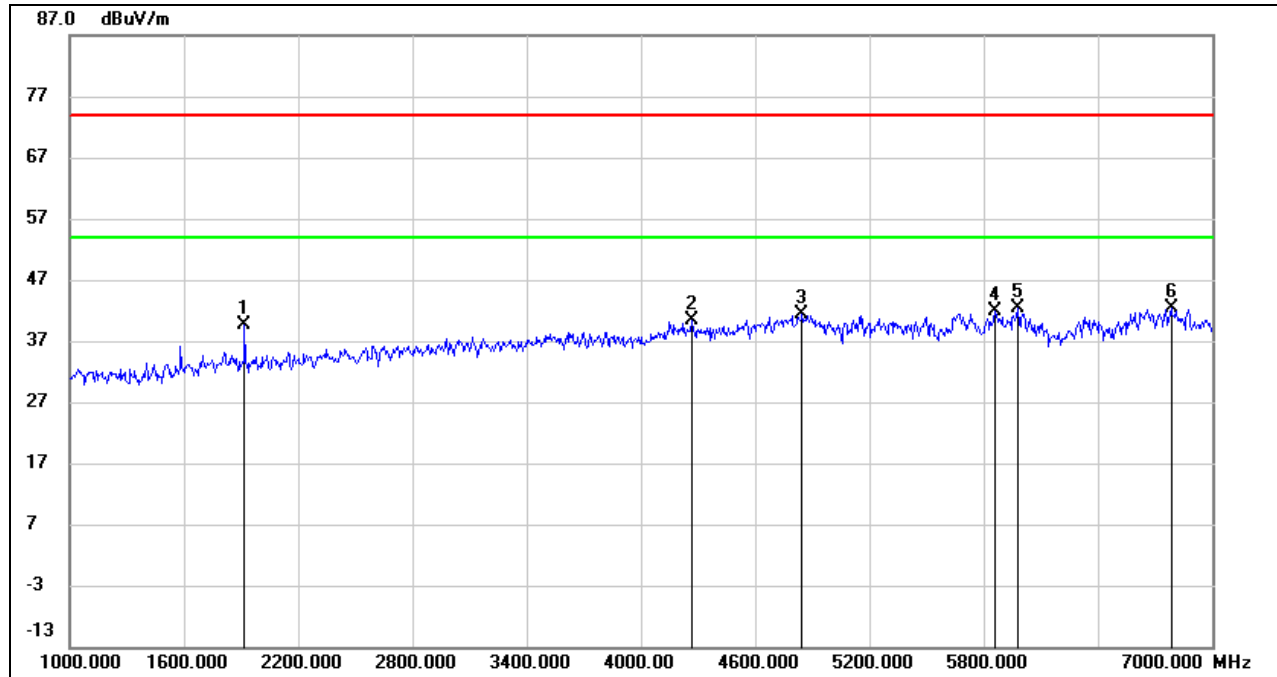
**HARMONICS AND SPURIOUS EMISSIONS (MID CHANNEL, VERTICAL)**

| No. | Frequency (MHz) | Reading (dBuV) | Correct (dB/m) | Result (dBuV/m) | Limit (dBuV/m) | Margin (dB) | Remark |
|-----|-----------------|----------------|----------------|-----------------|----------------|-------------|--------|
| 1 | 1918.000 | 49.80 | -10.13 | 39.67 | 74.00 | -34.33 | peak |
| 2 | 4264.000 | 42.03 | -1.73 | 40.30 | 74.00 | -33.70 | peak |
| 3 | 4846.000 | 40.65 | 0.66 | 41.31 | 74.00 | -32.69 | peak |
| 4 | 5860.000 | 39.21 | 2.75 | 41.96 | 74.00 | -32.04 | peak |
| 5 | 5980.000 | 39.04 | 3.22 | 42.26 | 74.00 | -31.74 | peak |
| 6 | 6784.000 | 36.77 | 5.56 | 42.33 | 74.00 | -31.67 | peak |

Note: 1. Measurement = Reading Level + Correct Factor.

2. If Peak Result complies with AV limit, AV Result is deemed to comply with AV limit.

3. Peak: Peak detector.

4. Filter losses were only considered in the spurious frequency bands and the authorized band was not corrected for High Pass Filter losses.

5. Proper operation of the transmitter prior to adding the filter to the measurement chain.

6. Since non-restricted band peak emissions are less than the average limit, they also comply with the -27dBm/MHz (68.2dBuV/m) limit.

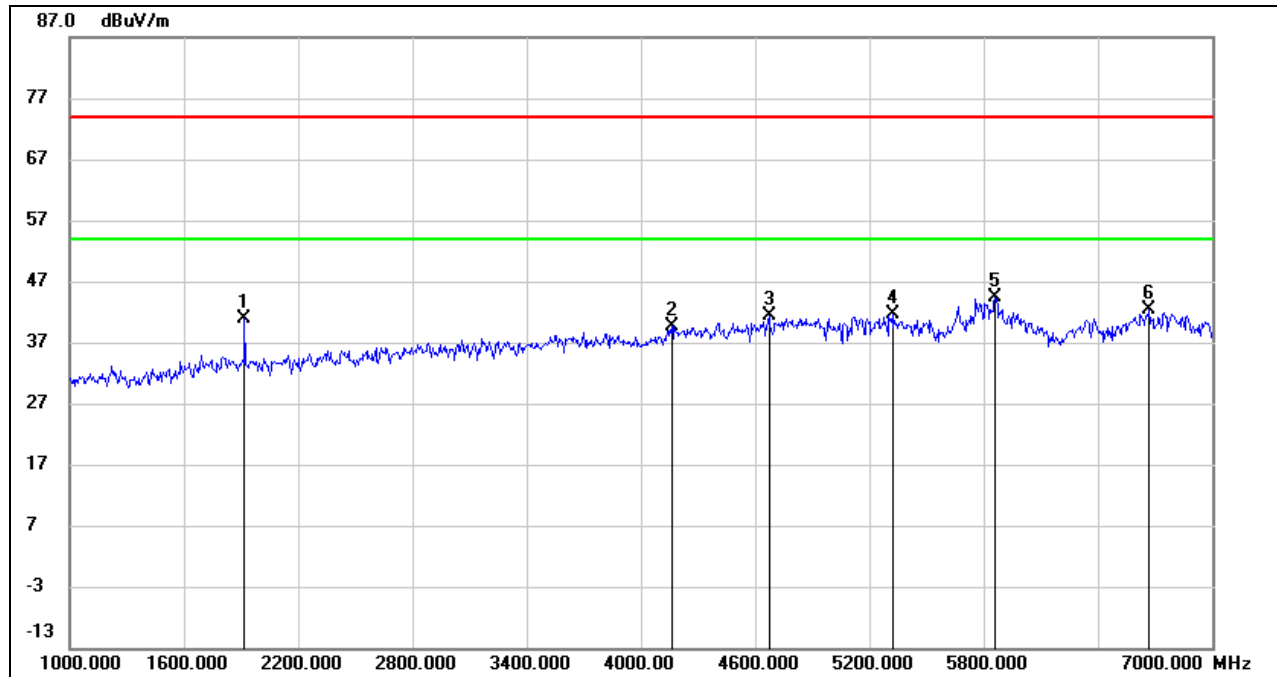
**HARMONICS AND SPURIOUS EMISSIONS (HIGH CHANNEL, HORIZONTAL)**

| No. | Frequency (MHz) | Reading (dBuV) | Correct (dB/m) | Result (dBuV/m) | Limit (dBuV/m) | Margin (dB) | Remark |
|-----|-----------------|----------------|----------------|-----------------|----------------|-------------|--------|
| 1 | 1918.000 | 50.94 | -10.13 | 40.81 | 74.00 | -33.19 | peak |
| 2 | 4162.000 | 41.78 | -2.04 | 39.74 | 74.00 | -34.26 | peak |
| 3 | 4672.000 | 41.63 | -0.15 | 41.48 | 74.00 | -32.52 | peak |
| 4 | 5320.000 | 39.70 | 1.96 | 41.66 | 74.00 | -32.34 | peak |
| 5 | 5860.000 | 41.72 | 2.75 | 44.47 | 74.00 | -29.53 | peak |
| 6 | 6670.000 | 36.74 | 5.53 | 42.27 | 74.00 | -31.73 | peak |

- Note: 1. Measurement = Reading Level + Correct Factor.
 2. If Peak Result complies with AV limit, AV Result is deemed to comply with AV limit.
 3. Peak: Peak detector.
 4. Filter losses were only considered in the spurious frequency bands and the authorized band was not corrected for High Pass Filter losses.
 5. Proper operation of the transmitter prior to adding the filter to the measurement chain.
 6. Since non-restricted band peak emissions are less than the average limit, they also comply with the -27dBm/MHz (68.2dBuV/m) limit.

HARMONICS AND SPURIOUS EMISSIONS (HIGH CHANNEL, VERTICAL)

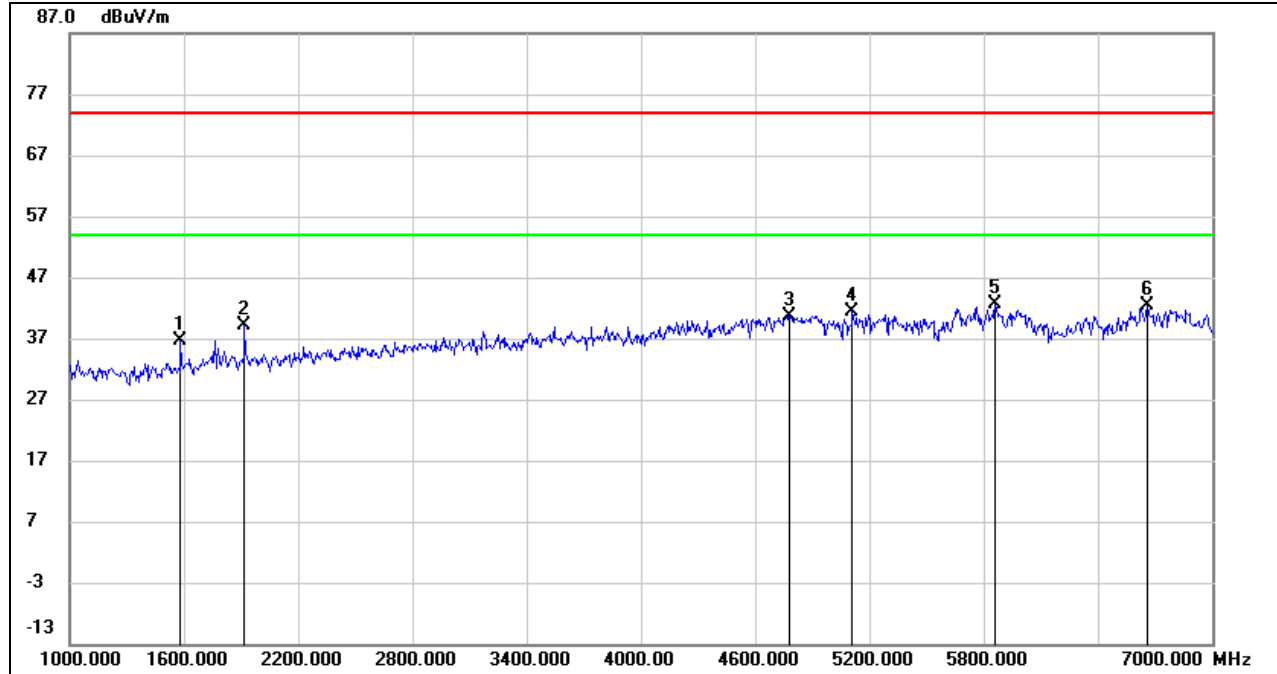

| No. | Frequency (MHz) | Reading (dBuV) | Correct (dB/m) | Result (dBuV/m) | Limit (dBuV/m) | Margin (dB) | Remark |
|-----|-----------------|----------------|----------------|-----------------|----------------|-------------|--------|
| 1 | 1582.000 | 48.40 | -11.68 | 36.72 | 74.00 | -37.28 | peak |
| 2 | 1918.000 | 49.29 | -10.13 | 39.16 | 74.00 | -34.84 | peak |
| 3 | 4780.000 | 40.21 | 0.48 | 40.69 | 74.00 | -33.31 | peak |
| 4 | 5110.000 | 39.95 | 1.55 | 41.50 | 74.00 | -32.50 | peak |
| 5 | 5860.000 | 39.95 | 2.75 | 42.70 | 74.00 | -31.30 | peak |
| 6 | 6658.000 | 36.77 | 5.51 | 42.28 | 74.00 | -31.72 | peak |

- Note:
1. Measurement = Reading Level + Correct Factor.
 2. If Peak Result complies with AV limit, AV Result is deemed to comply with AV limit.
 3. Peak: Peak detector.
 4. AVG: VBW=1/Ton, where: Ton is the transmitting duration.
 5. For the transmitting duration, please refer to clause 7.1.
 6. Filter losses were only considered in the spurious frequency bands and the authorized band was not corrected for High Pass Filter losses.
 7. Proper operation of the transmitter prior to adding the filter to the measurement chain.
 8. Since non-restricted band peak emissions are less than the average limit, they also comply with the -27dBm/MHz (68.2dBuV/m) limit.



STRADDLE CHANNEL 142

HARMONICS AND SPURIOUS EMISSIONS (HORIZONTAL)

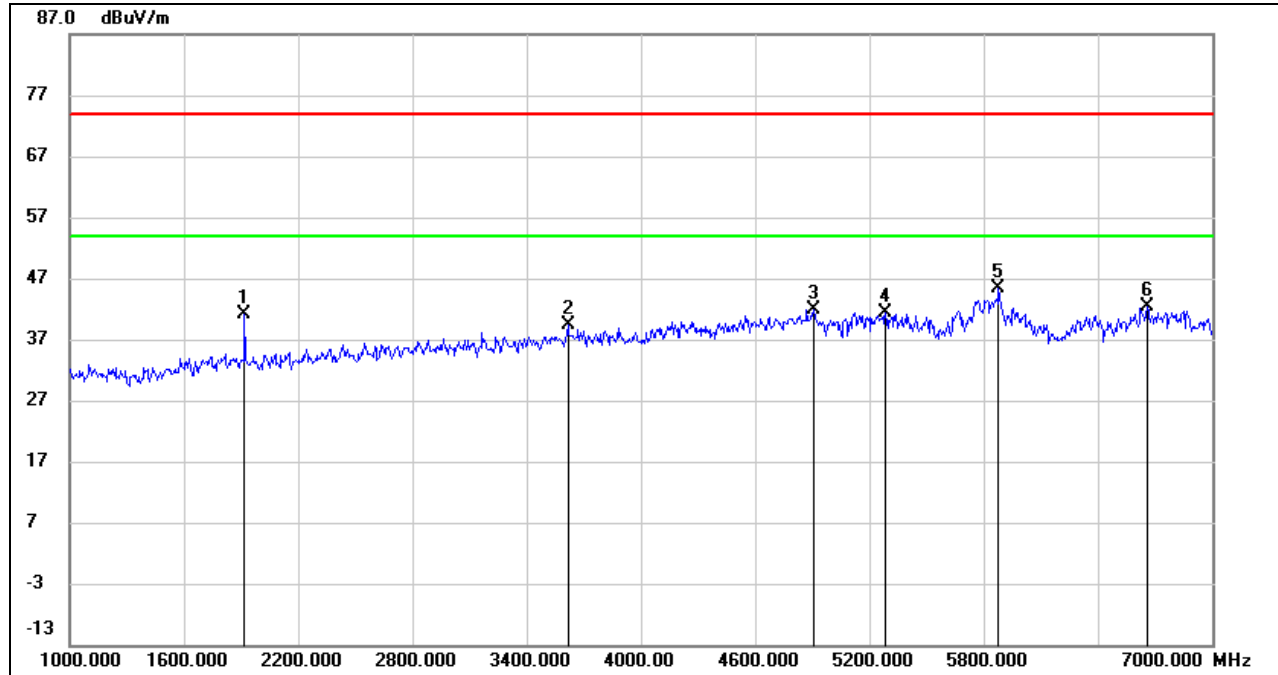

| No. | Frequency (MHz) | Reading (dBuV) | Correct (dB/m) | Result (dBuV/m) | Limit (dBuV/m) | Margin (dB) | Remark |
|-----|-----------------|----------------|----------------|-----------------|----------------|-------------|--------|
| 1 | 1918.000 | 51.22 | -10.13 | 41.09 | 74.00 | -32.91 | peak |
| 2 | 3616.000 | 43.41 | -4.12 | 39.29 | 74.00 | -34.71 | peak |
| 3 | 4906.000 | 41.03 | 0.75 | 41.78 | 74.00 | -32.22 | peak |
| 4 | 5284.000 | 39.47 | 2.01 | 41.48 | 74.00 | -32.52 | peak |
| 5 | 5878.000 | 42.68 | 2.81 | 45.49 | 74.00 | -28.51 | peak |
| 6 | 6658.000 | 36.85 | 5.51 | 42.36 | 74.00 | -31.64 | peak |

Note: 1. Measurement = Reading Level + Correct Factor.
 2. If Peak Result complies with AV limit, AV Result is deemed to comply with AV limit.
 3. Peak: Peak detector.
 4. Filter losses were only considered in the spurious frequency bands and the authorized band was not corrected for High Pass Filter losses.
 5. Proper operation of the transmitter prior to adding the filter to the measurement chain.
 6. Since non-restricted band peak emissions are less than the average limit, they also comply with the -27dBm/MHz (68.2dBuV/m) limit.

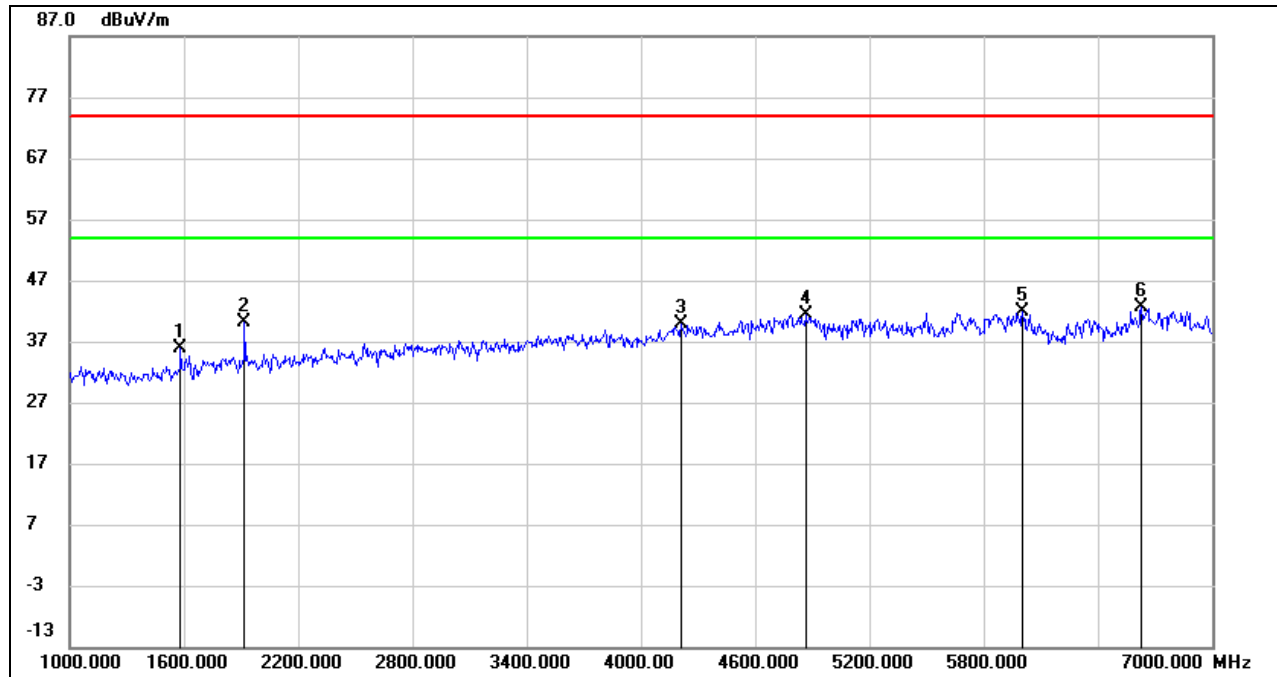
**HARMONICS AND SPURIOUS EMISSIONS (VERTICAL)**

| No. | Frequency (MHz) | Reading (dBuV) | Correct (dB/m) | Result (dBuV/m) | Limit (dBuV/m) | Margin (dB) | Remark |
|-----|-----------------|----------------|----------------|-----------------|----------------|-------------|--------|
| 1 | 1582.000 | 47.50 | -11.68 | 35.82 | 74.00 | -38.18 | peak |
| 2 | 1918.000 | 50.28 | -10.13 | 40.15 | 74.00 | -33.85 | peak |
| 3 | 4210.000 | 41.55 | -1.67 | 39.88 | 74.00 | -34.12 | peak |
| 4 | 4864.000 | 40.78 | 0.69 | 41.47 | 74.00 | -32.53 | peak |
| 5 | 6004.000 | 38.46 | 3.30 | 41.76 | 74.00 | -32.24 | peak |
| 6 | 6628.000 | 37.09 | 5.50 | 42.59 | 74.00 | -31.41 | peak |

Note: 1. Measurement = Reading Level + Correct Factor.

2. If Peak Result complies with AV limit, AV Result is deemed to comply with AV limit.

3. Peak: Peak detector.

4. Filter losses were only considered in the spurious frequency bands and the authorized band was not corrected for High Pass Filter losses.

5. Proper operation of the transmitter prior to adding the filter to the measurement chain.

6. Since non-restricted band peak emissions are less than the average limit, they also comply with the -27dBm/MHz (68.2dBuV/m) limit.

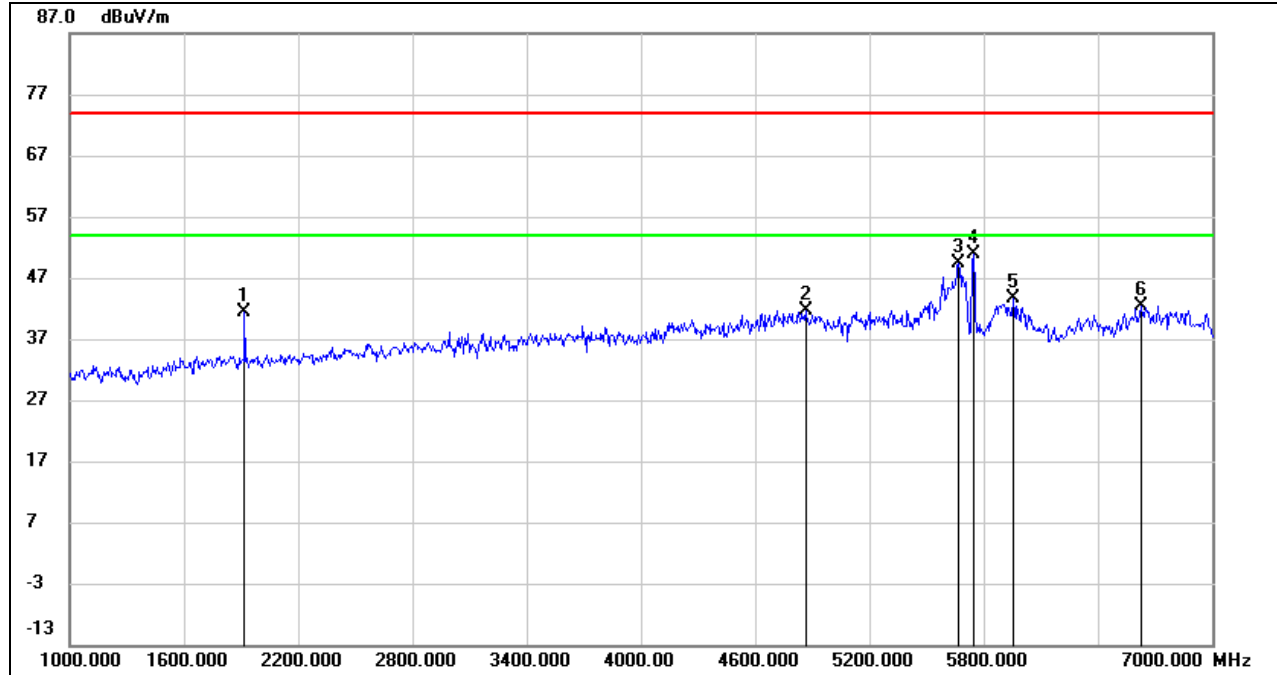
**UNII-3 BAND****HARMONICS AND SPURIOUS EMISSIONS (LOW CHANNEL, HORIZONTAL)**

| No. | Frequency (MHz) | Reading (dBuV) | Correct (dB/m) | Result (dBuV/m) | Limit (dBuV/m) | Margin (dB) | Remark |
|-----|-----------------|----------------|----------------|-----------------|----------------|-------------|--------|
| 1 | 1918.000 | 51.46 | -10.13 | 41.33 | 74.00 | -32.67 | peak |
| 2 | 4864.000 | 41.03 | 0.69 | 41.72 | 74.00 | -32.28 | peak |
| 3 | 5668.000 | 46.87 | 2.47 | 49.34 | 74.00 | -24.66 | peak |
| 4 | 5746.000 | 48.45 | 2.50 | 50.95 | 74.00 | -23.05 | peak |
| 5 | 5956.000 | 40.45 | 3.13 | 43.58 | 74.00 | -30.42 | peak |
| 6 | 6628.000 | 36.83 | 5.50 | 42.33 | 74.00 | -31.67 | peak |

Note: 1. Measurement = Reading Level + Correct Factor.

2. If Peak Result complies with AV limit, AV Result is deemed to comply with AV limit.

3. Peak: Peak detector.

4. Filter losses were only considered in the spurious frequency bands and the authorized band was not corrected for Band reject filter losses.

5. Proper operation of the transmitter prior to adding the filter to the measurement chain.

6. Since non-restricted band peak emissions are less than the average limit, they also comply with the -27dBm/MHz (68.2dBuV/m) limit.

HARMONICS AND SPURIOUS EMISSIONS (LOW CHANNEL, VERTICAL)

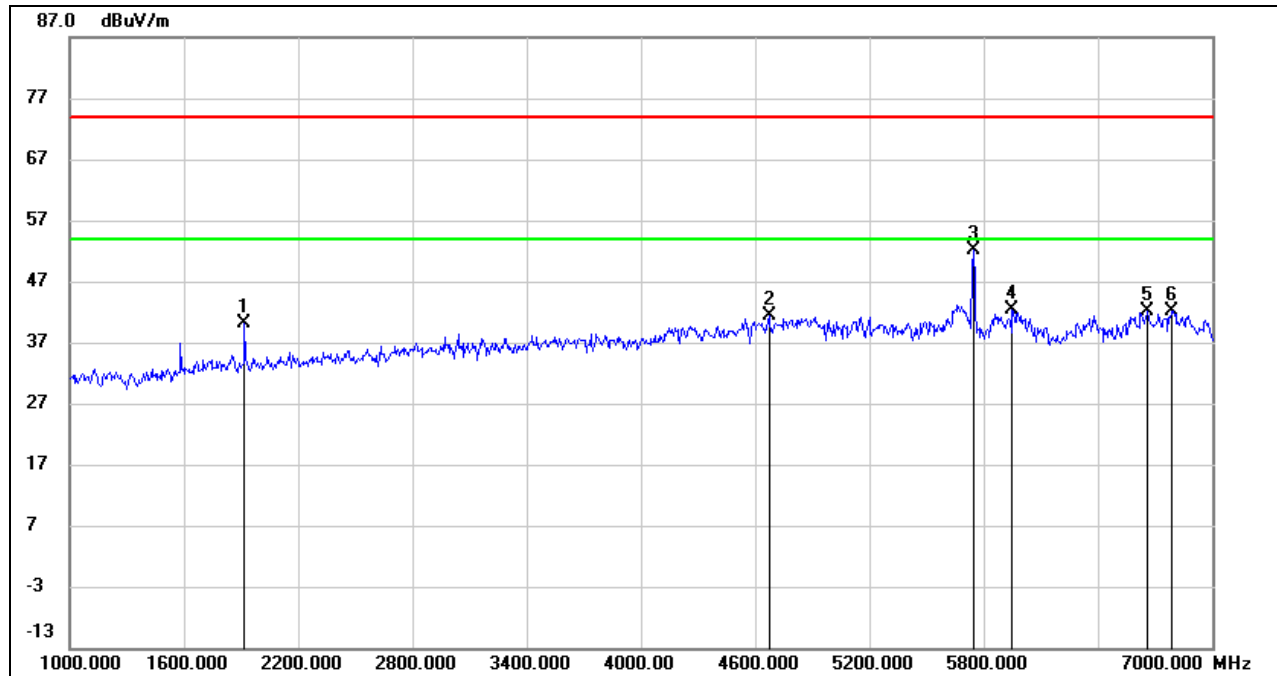

| No. | Frequency (MHz) | Reading (dBuV) | Correct (dB/m) | Result (dBuV/m) | Limit (dBuV/m) | Margin (dB) | Remark |
|-----|-----------------|----------------|----------------|-----------------|----------------|-------------|--------|
| 1 | 1918.000 | 50.14 | -10.13 | 40.01 | 74.00 | -33.99 | peak |
| 2 | 4672.000 | 41.52 | -0.15 | 41.37 | 74.00 | -32.63 | peak |
| 3 | 5746.000 | 49.74 | 2.50 | 52.24 | 74.00 | -21.76 | peak |
| 4 | 5950.000 | 39.18 | 3.10 | 42.28 | 74.00 | -31.72 | peak |
| 5 | 6658.000 | 36.53 | 5.51 | 42.04 | 74.00 | -31.96 | peak |
| 6 | 6790.000 | 36.50 | 5.57 | 42.07 | 74.00 | -31.93 | peak |

Note: 1. Measurement = Reading Level + Correct Factor.

2. If Peak Result complies with AV limit, AV Result is deemed to comply with AV limit.

3. Peak: Peak detector.

4. Filter losses were only considered in the spurious frequency bands and the authorized band was not corrected for Band reject filter losses.

5. Proper operation of the transmitter prior to adding the filter to the measurement chain.

6. Since non-restricted band peak emissions are less than the average limit, they also comply with the -27dBm/MHz (68.2dBuV/m) limit.

HARMONICS AND SPURIOUS EMISSIONS (HIGH CHANNEL, HORIZONTAL)

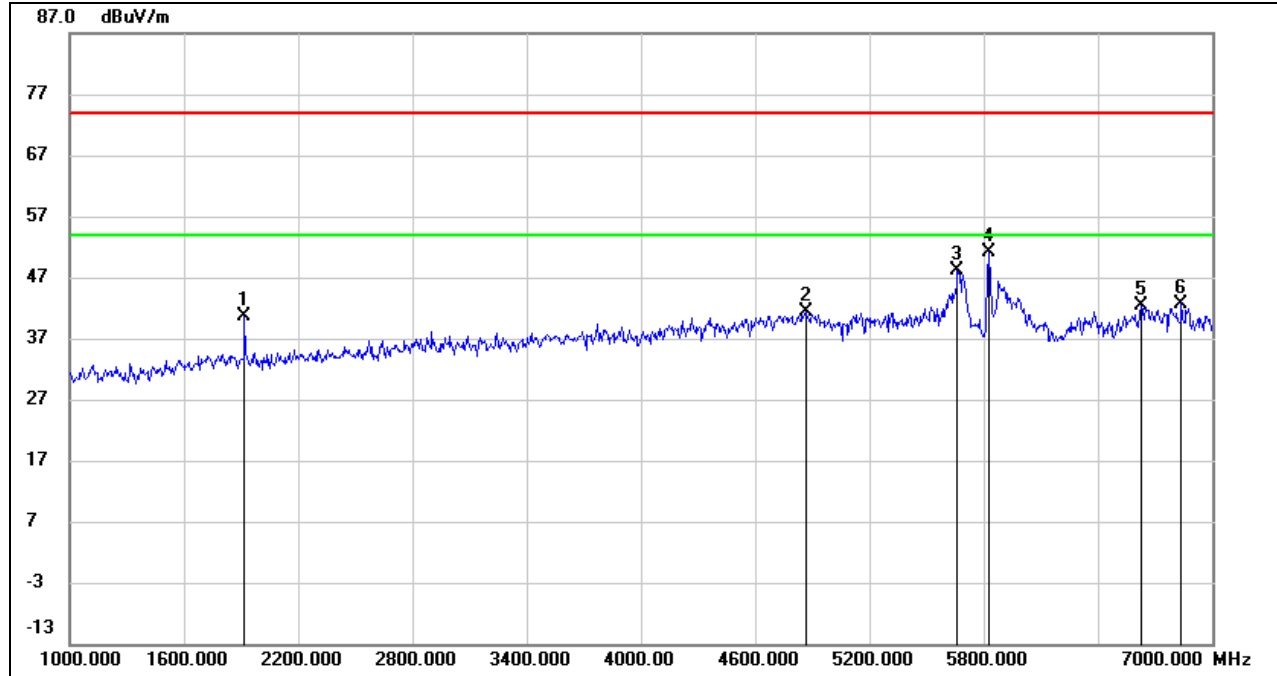

| No. | Frequency (MHz) | Reading (dBuV) | Correct (dB/m) | Result (dBuV/m) | Limit (dBuV/m) | Margin (dB) | Remark |
|-----|-----------------|----------------|----------------|-----------------|----------------|-------------|--------|
| 1 | 1918.000 | 50.75 | -10.13 | 40.62 | 74.00 | -33.38 | peak |
| 2 | 4864.000 | 40.61 | 0.69 | 41.30 | 74.00 | -32.70 | peak |
| 3 | 5662.000 | 45.55 | 2.47 | 48.02 | 74.00 | -25.98 | peak |
| 4 | 5825.000 | 48.47 | 2.61 | 51.08 | 74.00 | -22.92 | peak |
| 5 | 6628.000 | 36.99 | 5.50 | 42.49 | 74.00 | -31.51 | peak |
| 6 | 6838.000 | 37.06 | 5.69 | 42.75 | 74.00 | -31.25 | peak |

- Note: 1. Measurement = Reading Level + Correct Factor.
 2. If Peak Result complies with AV limit, AV Result is deemed to comply with AV limit.
 3. Peak: Peak detector.
 4. Filter losses were only considered in the spurious frequency bands and the authorized band was not corrected for Band reject filter losses.
 5. Proper operation of the transmitter prior to adding the filter to the measurement chain.
 6. Since non-restricted band peak emissions are less than the average limit, they also comply with the -27dBm/MHz (68.2dBuV/m) limit.

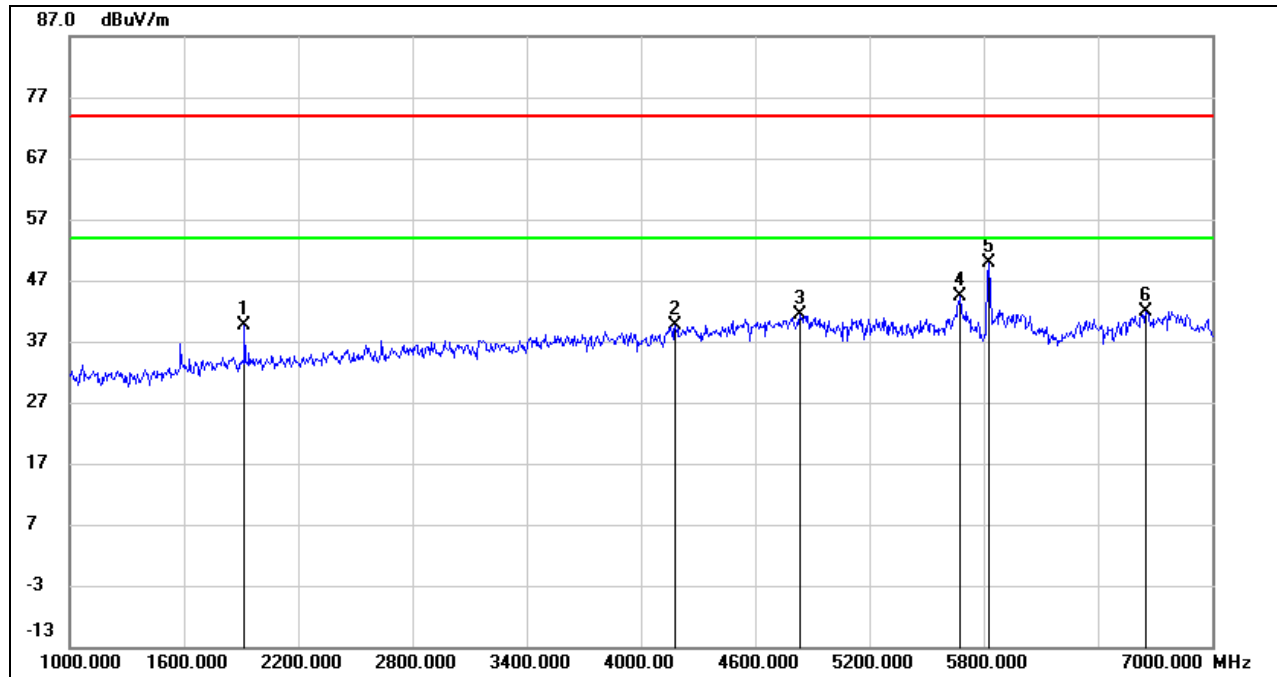
**HARMONICS AND SPURIOUS EMISSIONS (HIGH CHANNEL, VERTICAL)**

| No. | Frequency (MHz) | Reading (dBuV) | Correct (dB/m) | Result (dBuV/m) | Limit (dBuV/m) | Margin (dB) | Remark |
|-----|-----------------|----------------|----------------|-----------------|----------------|-------------|--------|
| 1 | 1918.000 | 49.72 | -10.13 | 39.59 | 74.00 | -34.41 | peak |
| 2 | 4180.000 | 41.41 | -1.87 | 39.54 | 74.00 | -34.46 | peak |
| 3 | 4834.000 | 40.71 | 0.63 | 41.34 | 74.00 | -32.66 | peak |
| 4 | 5674.000 | 41.80 | 2.48 | 44.28 | 74.00 | -29.72 | peak |
| 5 | 5825.000 | 47.18 | 2.61 | 49.79 | 74.00 | -24.21 | peak |
| 6 | 6652.000 | 36.33 | 5.52 | 41.85 | 74.00 | -32.15 | peak |

Note: 1. Measurement = Reading Level + Correct Factor.

2. If Peak Result complies with AV limit, AV Result is deemed to comply with AV limit.

3. Peak: Peak detector.

4. Filter losses were only considered in the spurious frequency bands and the authorized band was not corrected for Band reject filter losses.

5. Proper operation of the transmitter prior to adding the filter to the measurement chain.

6. Since non-restricted band peak emissions are less than the average limit, they also comply with the -27dBm/MHz (68.2dBuV/m) limit.

Note: All the modes and bands had been tested, but only the worst data was recorded in the report.

8.3. SPURIOUS EMISSIONS (7 GHz ~ 18 GHz)

8.3.1. 802.11a 20 MODE

UNII-1 BAND

HARMONICS AND SPURIOUS EMISSIONS (LOW CHANNEL, HORIZONTAL)

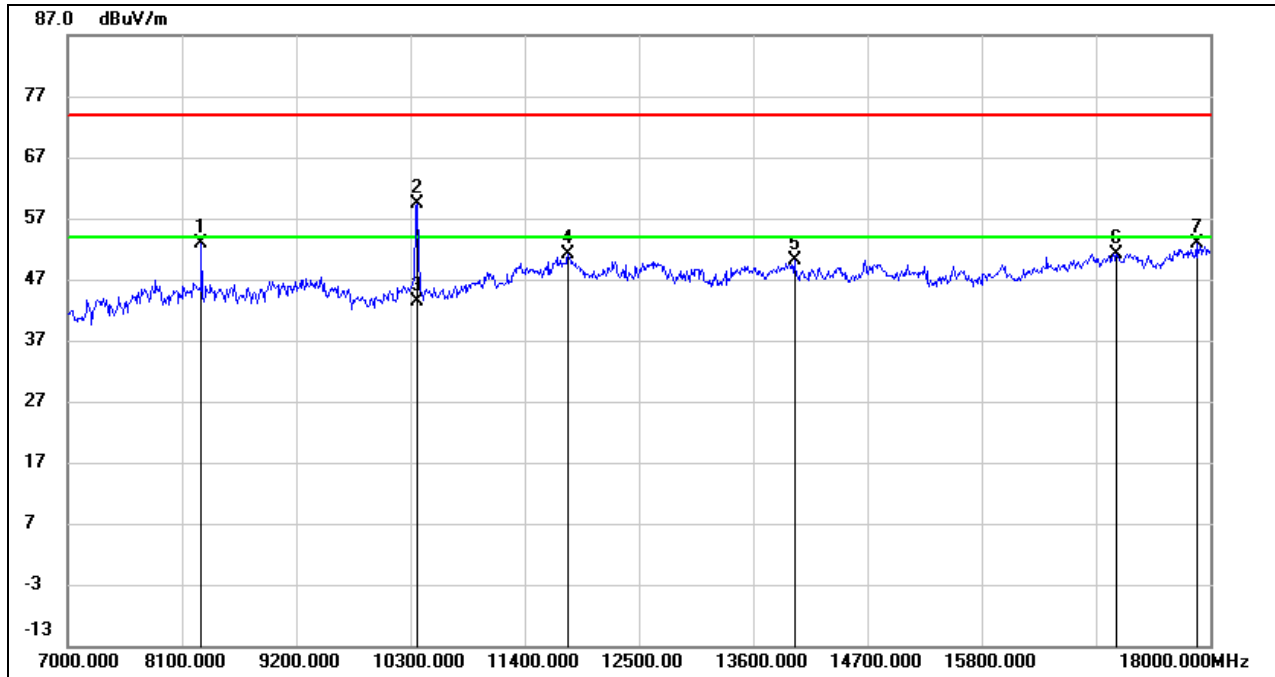

| No. | Frequency (MHz) | Reading (dBuV) | Correct (dB/m) | Result (dBuV/m) | Limit (dBuV/m) | Margin (dB) | Remark |
|-----|-----------------|----------------|----------------|-----------------|----------------|-------------|--------|
| 1 | 8287.000 | 43.82 | 9.02 | 52.84 | 74.00 | -21.16 | peak |
| 2 | 10366.000 | 48.02 | 11.33 | 59.35 | 74.00 | -14.65 | peak |
| 3 | 10366.000 | 32.12 | 11.33 | 43.45 | 54.00 | -10.55 | AVG |
| 4 | 11818.000 | 35.46 | 15.58 | 51.04 | 74.00 | -22.96 | peak |
| 5 | 13996.000 | 33.39 | 16.85 | 50.24 | 74.00 | -23.76 | peak |
| 6 | 17098.000 | 30.60 | 20.63 | 51.23 | 74.00 | -22.77 | peak |
| 7 | 17868.000 | 30.05 | 22.71 | 52.76 | 74.00 | -21.24 | peak |

Note: 1. Measurement = Reading Level + Correct Factor.
 2. If Peak Result complies with AV limit, AV Result is deemed to comply with AV limit.
 3. Peak: Peak detector.
 4. Filter losses were only considered in the spurious frequency bands and the authorized band was not corrected for High Pass Filter losses.
 5. Proper operation of the transmitter prior to adding the filter to the measurement chain.
 6. Since non-restricted band peak emissions are less than the average limit, they also comply with the -27dBm/MHz (68.2dBuV/m) limit.

HARMONICS AND SPURIOUS EMISSIONS (LOW CHANNEL, VERTICAL)

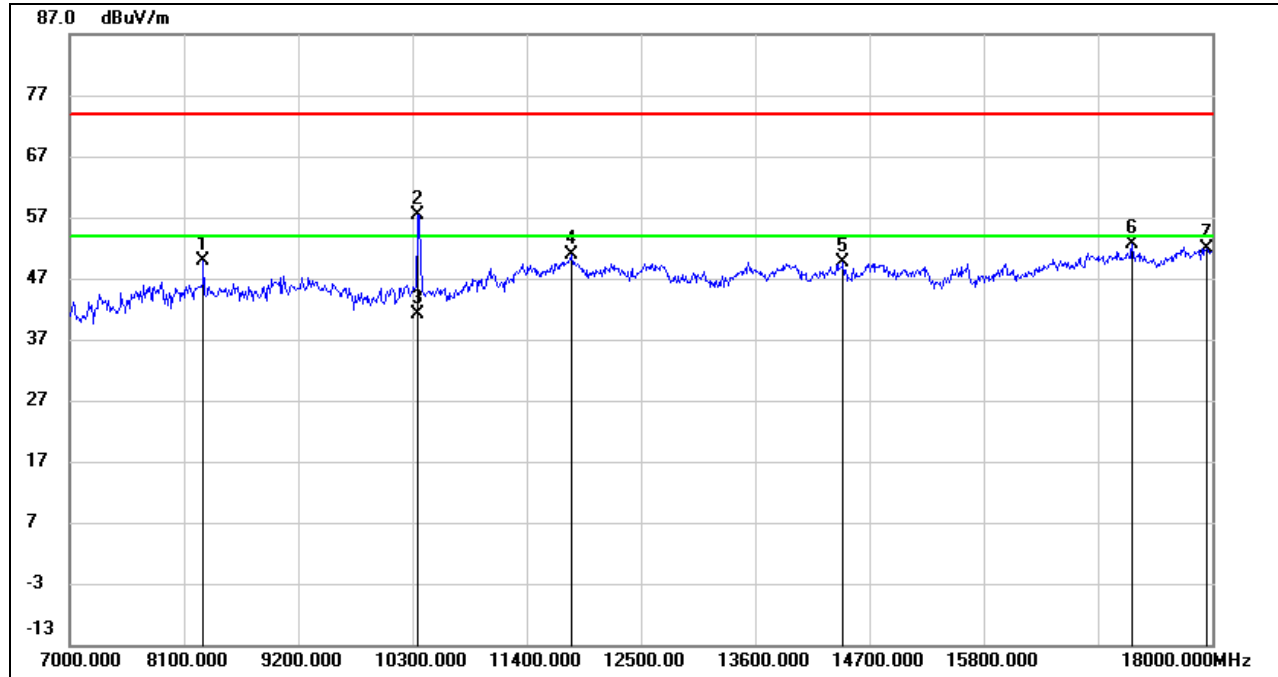

| No. | Frequency (MHz) | Reading (dBuV) | Correct (dB/m) | Result (dBuV/m) | Limit (dBuV/m) | Margin (dB) | Remark |
|-----|-----------------|----------------|----------------|-----------------|----------------|-------------|--------|
| 1 | 8287.000 | 40.78 | 9.02 | 49.80 | 74.00 | -24.20 | peak |
| 2 | 10355.000 | 46.14 | 11.29 | 57.43 | 74.00 | -16.57 | peak |
| 3 | 10355.000 | 29.86 | 11.29 | 41.15 | 54.00 | -12.85 | AVG |
| 4 | 11829.000 | 35.20 | 15.57 | 50.77 | 74.00 | -23.23 | peak |
| 5 | 14447.000 | 32.81 | 16.77 | 49.58 | 74.00 | -24.42 | peak |
| 6 | 17230.000 | 31.72 | 20.99 | 52.71 | 74.00 | -21.29 | peak |
| 7 | 17945.000 | 29.16 | 22.68 | 51.84 | 74.00 | -22.16 | peak |

Note: 1. Measurement = Reading Level + Correct Factor.
 2. If Peak Result complies with AV limit, AV Result is deemed to comply with AV limit.
 3. Peak: Peak detector.
 4. Filter losses were only considered in the spurious frequency bands and the authorized band was not corrected for High Pass Filter losses.
 5. Proper operation of the transmitter prior to adding the filter to the measurement chain.
 6. Since non-restricted band peak emissions are less than the average limit, they also comply with the -27dBm/MHz (68.2dBuV/m) limit.

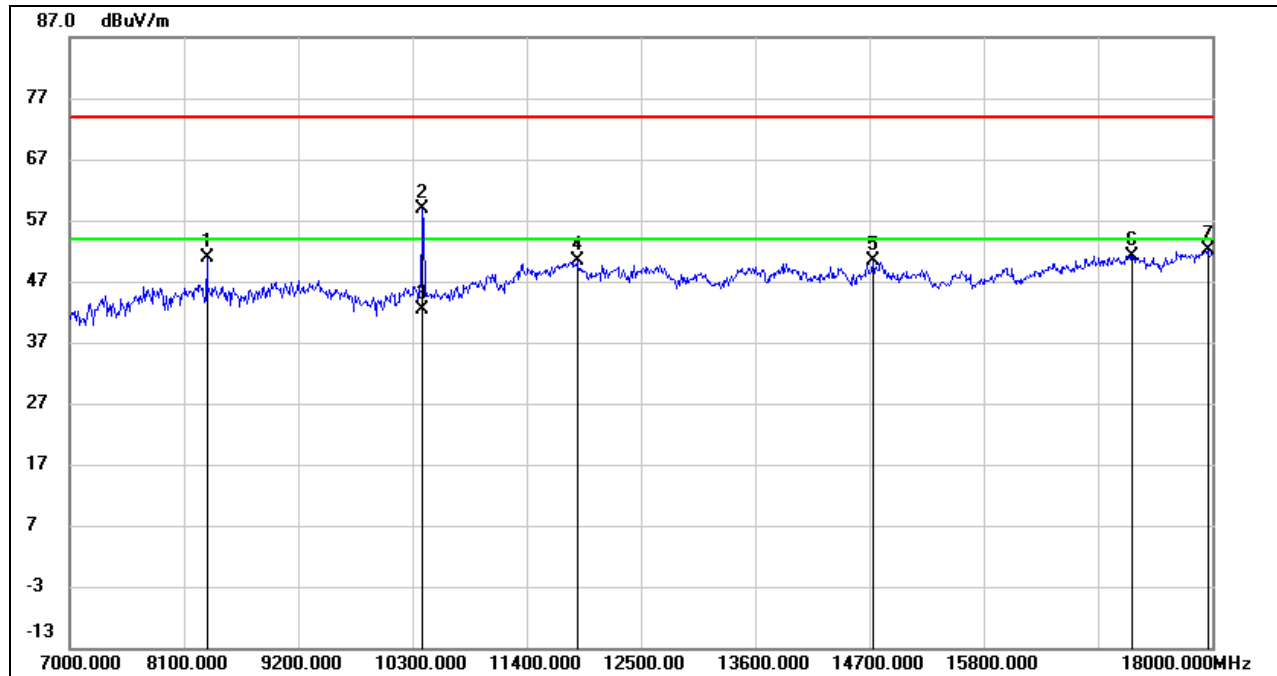
**HARMONICS AND SPURIOUS EMISSIONS (MID CHANNEL, HORIZONTAL)**

| No. | Frequency (MHz) | Reading (dBuV) | Correct (dB/m) | Result (dBuV/m) | Limit (dBuV/m) | Margin (dB) | Remark |
|-----|-----------------|----------------|----------------|-----------------|----------------|-------------|--------|
| 1 | 8320.000 | 41.98 | 8.90 | 50.88 | 74.00 | -23.12 | peak |
| 2 | 10399.000 | 47.46 | 11.45 | 58.91 | 74.00 | -15.09 | peak |
| 3 | 10399.000 | 30.90 | 11.45 | 42.35 | 54.00 | -11.65 | AVG |
| 4 | 11884.000 | 34.83 | 15.49 | 50.32 | 74.00 | -23.68 | peak |
| 5 | 14733.000 | 33.78 | 16.69 | 50.47 | 74.00 | -23.53 | peak |
| 6 | 17230.000 | 30.25 | 20.99 | 51.24 | 74.00 | -22.76 | peak |
| 7 | 17956.000 | 29.50 | 22.68 | 52.18 | 74.00 | -21.82 | peak |

Note: 1. Measurement = Reading Level + Correct Factor.

2. If Peak Result complies with AV limit, AV Result is deemed to comply with AV limit.

3. Peak: Peak detector.

4. Filter losses were only considered in the spurious frequency bands and the authorized band was not corrected for High Pass Filter losses.

5. Proper operation of the transmitter prior to adding the filter to the measurement chain.

6. Since non-restricted band peak emissions are less than the average limit, they also comply with the -27dBm/MHz (68.2dBuV/m) limit.

HARMONICS AND SPURIOUS EMISSIONS (MID CHANNEL, VERTICAL)

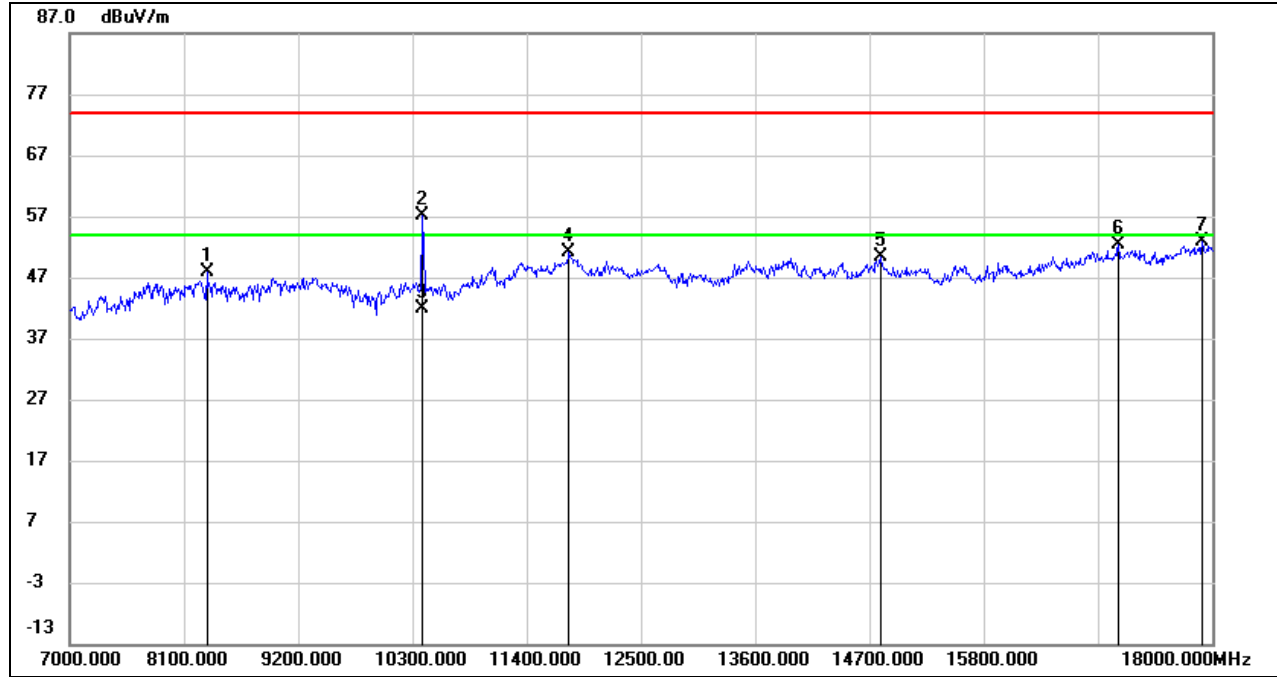

| No. | Frequency (MHz) | Reading (dBuV) | Correct (dB/m) | Result (dBuV/m) | Limit (dBuV/m) | Margin (dB) | Remark |
|-----|-----------------|----------------|----------------|-----------------|----------------|-------------|--------|
| 1 | 8320.000 | 39.08 | 8.90 | 47.98 | 74.00 | -26.02 | peak |
| 2 | 10399.000 | 45.75 | 11.45 | 57.20 | 74.00 | -16.80 | peak |
| 3 | 10399.000 | 30.48 | 11.45 | 41.93 | 54.00 | -12.07 | AVG |
| 4 | 11807.000 | 35.59 | 15.61 | 51.20 | 74.00 | -22.80 | peak |
| 5 | 14810.000 | 33.69 | 16.80 | 50.49 | 74.00 | -23.51 | peak |
| 6 | 17098.000 | 31.68 | 20.63 | 52.31 | 74.00 | -21.69 | peak |
| 7 | 17901.000 | 30.08 | 22.69 | 52.77 | 74.00 | -21.23 | peak |

- Note: 1. Measurement = Reading Level + Correct Factor.
 2. If Peak Result complies with AV limit, AV Result is deemed to comply with AV limit.
 3. Peak: Peak detector.
 4. Filter losses were only considered in the spurious frequency bands and the authorized band was not corrected for High Pass Filter losses.
 5. Proper operation of the transmitter prior to adding the filter to the measurement chain.
 6. Since non-restricted band peak emissions are less than the average limit, they also comply with the -27dBm/MHz (68.2dBuV/m) limit.



HARMONICS AND SPURIOUS EMISSIONS (HIGH CHANNEL, HORIZONTAL)

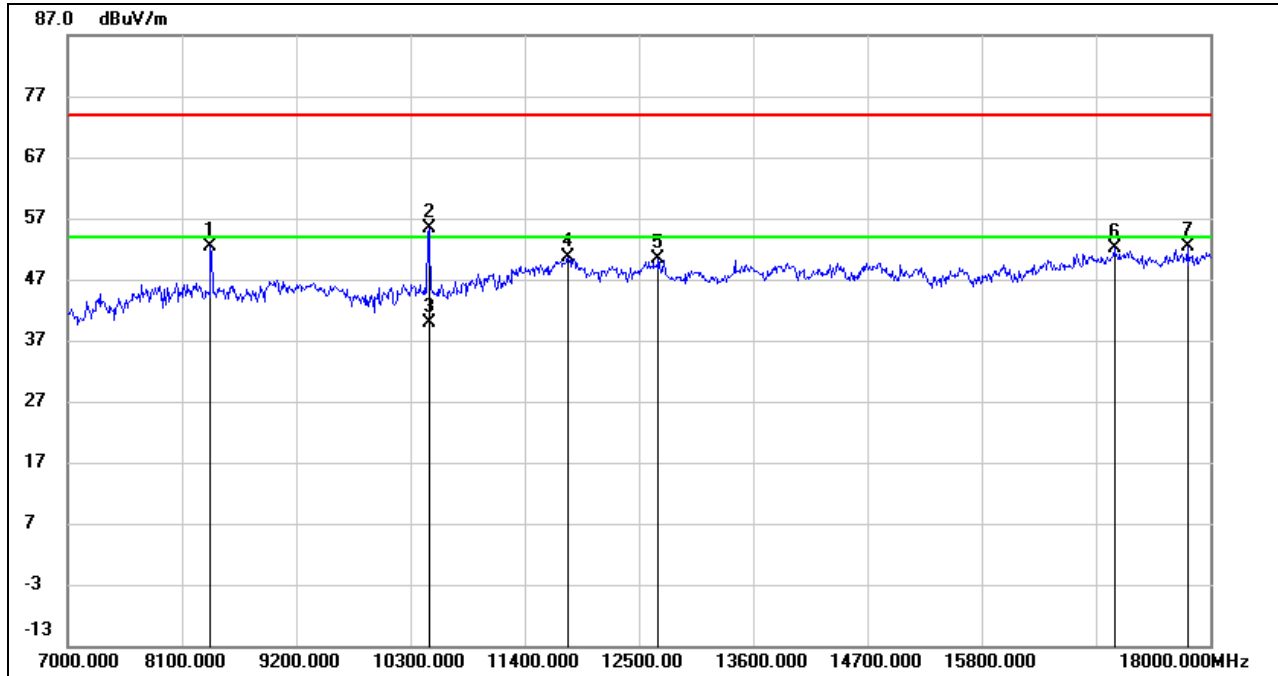

| No. | Frequency (MHz) | Reading (dBuV) | Correct (dB/m) | Result (dBuV/m) | Limit (dBuV/m) | Margin (dB) | Remark |
|-----|-----------------|----------------|----------------|-----------------|----------------|-------------|--------|
| 1 | 8375.000 | 43.79 | 8.68 | 52.47 | 74.00 | -21.53 | peak |
| 2 | 10476.000 | 43.55 | 11.83 | 55.38 | 74.00 | -18.62 | peak |
| 3 | 10476.000 | 28.04 | 11.83 | 39.87 | 54.00 | -14.13 | AVG |
| 4 | 11818.000 | 35.04 | 15.58 | 50.62 | 74.00 | -23.38 | peak |
| 5 | 12687.000 | 35.00 | 15.45 | 50.45 | 74.00 | -23.55 | peak |
| 6 | 17076.000 | 31.58 | 20.54 | 52.12 | 74.00 | -21.88 | peak |
| 7 | 17780.000 | 29.87 | 22.57 | 52.44 | 74.00 | -21.56 | peak |

Note: 1. Measurement = Reading Level + Correct Factor.
 2. If Peak Result complies with AV limit, AV Result is deemed to comply with AV limit.
 3. Peak: Peak detector.
 4. Filter losses were only considered in the spurious frequency bands and the authorized band was not corrected for High Pass Filter losses.
 5. Proper operation of the transmitter prior to adding the filter to the measurement chain.
 6. Since non-restricted band peak emissions are less than the average limit, they also comply with the -27dBm/MHz (68.2dBuV/m) limit.

HARMONICS AND SPURIOUS EMISSIONS (HIGH CHANNEL, VERTICAL)

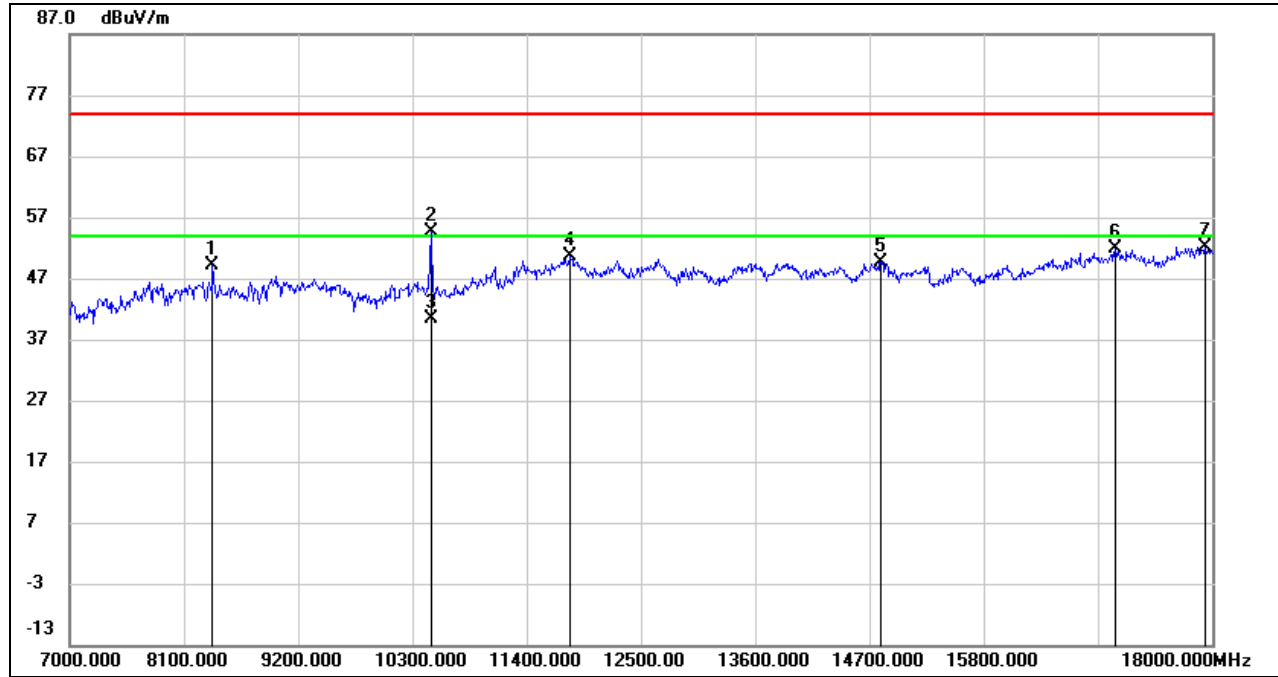

| No. | Frequency (MHz) | Reading (dBuV) | Correct (dB/m) | Result (dBuV/m) | Limit (dBuV/m) | Margin (dB) | Remark |
|-----|-----------------|----------------|----------------|-----------------|----------------|-------------|--------|
| 1 | 8375.000 | 40.44 | 8.68 | 49.12 | 74.00 | -24.88 | peak |
| 2 | 10476.000 | 42.88 | 11.83 | 54.71 | 74.00 | -19.29 | peak |
| 3 | 10476.000 | 28.63 | 11.83 | 40.46 | 54.00 | -13.54 | AVG |
| 4 | 11818.000 | 35.02 | 15.58 | 50.60 | 74.00 | -23.40 | peak |
| 5 | 14810.000 | 32.93 | 16.80 | 49.73 | 74.00 | -24.27 | peak |
| 6 | 17065.000 | 31.37 | 20.49 | 51.86 | 74.00 | -22.14 | peak |
| 7 | 17934.000 | 29.51 | 22.69 | 52.20 | 74.00 | -21.80 | peak |

Note: 1. Measurement = Reading Level + Correct Factor.
 2. If Peak Result complies with AV limit, AV Result is deemed to comply with AV limit.
 3. Peak: Peak detector.
 4. Filter losses were only considered in the spurious frequency bands and the authorized band was not corrected for High Pass Filter losses.
 5. Proper operation of the transmitter prior to adding the filter to the measurement chain.
 6. Since non-restricted band peak emissions are less than the average limit, they also comply with the -27dBm/MHz (68.2dBuV/m) limit.

UNII-2A BAND

HARMONICS AND SPURIOUS EMISSIONS (LOW CHANNEL, HORIZONTAL)

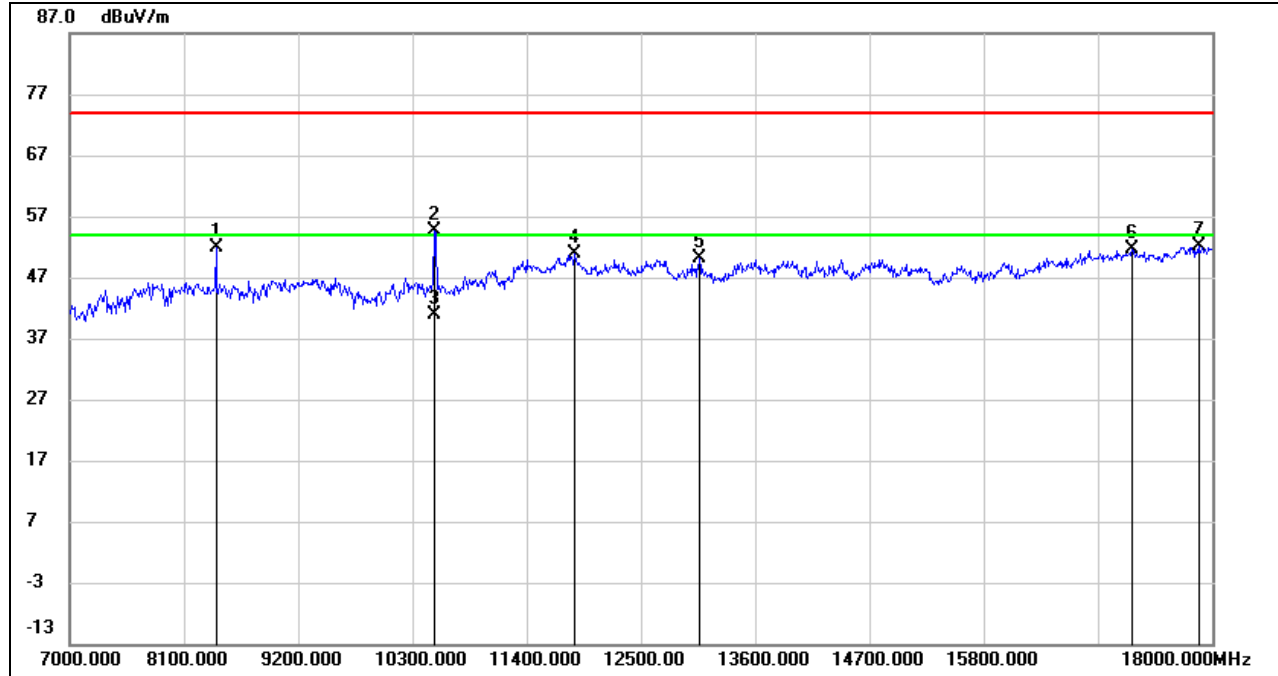

| No. | Frequency (MHz) | Reading (dBuV) | Correct (dB/m) | Result (dBuV/m) | Limit (dBuV/m) | Margin (dB) | Remark |
|-----|-----------------|----------------|----------------|-----------------|----------------|-------------|--------|
| 1 | 8408.000 | 43.31 | 8.59 | 51.90 | 74.00 | -22.10 | peak |
| 2 | 10509.000 | 42.52 | 11.99 | 54.51 | 74.00 | -19.49 | peak |
| 3 | 10509.000 | 28.77 | 11.99 | 40.76 | 54.00 | -13.24 | AVG |
| 4 | 11862.000 | 35.46 | 15.52 | 50.98 | 74.00 | -23.02 | peak |
| 5 | 13061.000 | 34.65 | 15.47 | 50.12 | 74.00 | -23.88 | peak |
| 6 | 17230.000 | 30.61 | 20.99 | 51.60 | 74.00 | -22.40 | peak |
| 7 | 17868.000 | 29.48 | 22.71 | 52.19 | 74.00 | -21.81 | peak |

Note: 1. Measurement = Reading Level + Correct Factor.
 2. If Peak Result complies with AV limit, AV Result is deemed to comply with AV limit.
 3. Peak: Peak detector.
 4. Filter losses were only considered in the spurious frequency bands and the authorized band was not corrected for High Pass Filter losses.
 5. Proper operation of the transmitter prior to adding the filter to the measurement chain.
 6. Since non-restricted band peak emissions are less than the average limit, they also comply with the -27dBm/MHz (68.2dBuV/m) limit.

HARMONICS AND SPURIOUS EMISSIONS (LOW CHANNEL, VERTICAL)

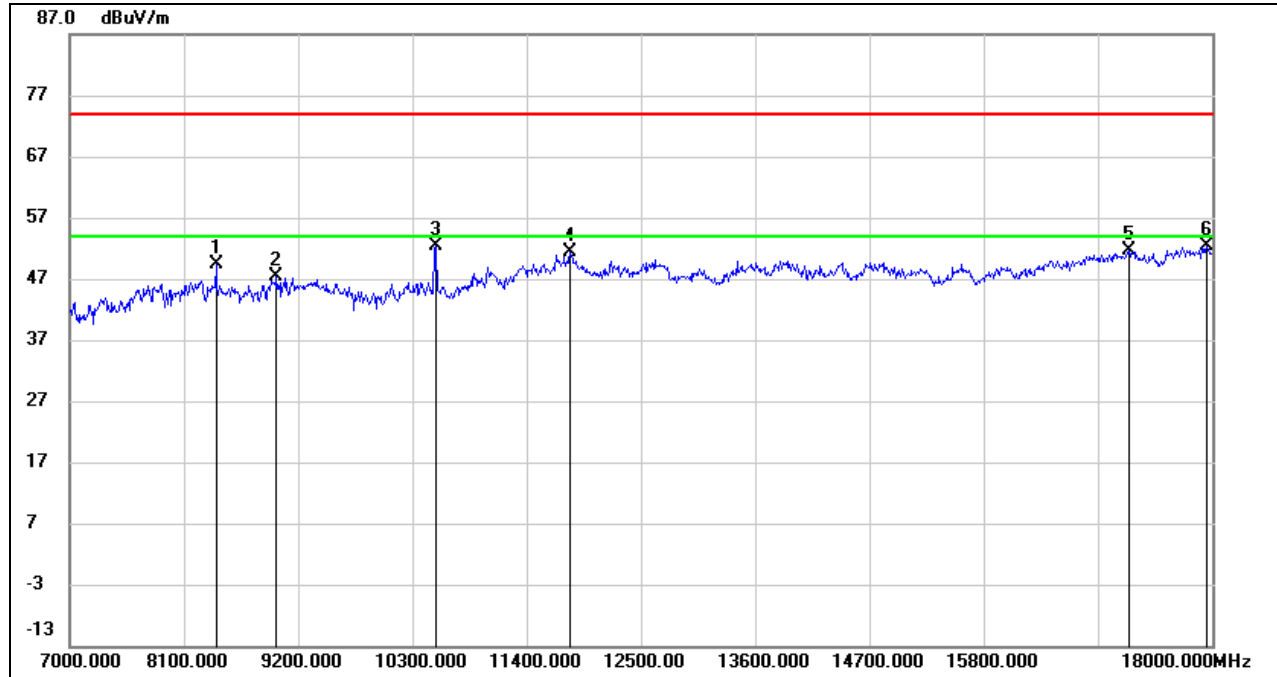

| No. | Frequency (MHz) | Reading (dBuV) | Correct (dB/m) | Result (dBuV/m) | Limit (dBuV/m) | Margin (dB) | Remark |
|-----|-----------------|----------------|----------------|-----------------|----------------|-------------|--------|
| 1 | 8408.000 | 40.81 | 8.59 | 49.40 | 74.00 | -24.60 | peak |
| 2 | 8991.000 | 36.95 | 10.53 | 47.48 | 74.00 | -26.52 | peak |
| 3 | 10520.000 | 40.30 | 12.04 | 52.34 | 74.00 | -21.66 | peak |
| 4 | 11818.000 | 35.76 | 15.58 | 51.34 | 74.00 | -22.66 | peak |
| 5 | 17197.000 | 30.59 | 21.03 | 51.62 | 74.00 | -22.38 | peak |
| 6 | 17945.000 | 29.77 | 22.68 | 52.45 | 74.00 | -21.55 | peak |

- Note:
1. Measurement = Reading Level + Correct Factor.
 2. If Peak Result complies with AV limit, AV Result is deemed to comply with AV limit.
 3. Peak: Peak detector.
 4. AVG: $VBW=1/Ton$, where: Ton is the transmitting duration.
 5. For the transmitting duration, please refer to clause 7.1.
 6. Filter losses were only considered in the spurious frequency bands and the authorized band was not corrected for High Pass Filter losses.
 7. Proper operation of the transmitter prior to adding the filter to the measurement chain.
 8. Since non-restricted band peak emissions are less than the average limit, they also comply with the -27dBm/MHz (68.2dBuV/m) limit.

HARMONICS AND SPURIOUS EMISSIONS (MID CHANNEL, HORIZONTAL)

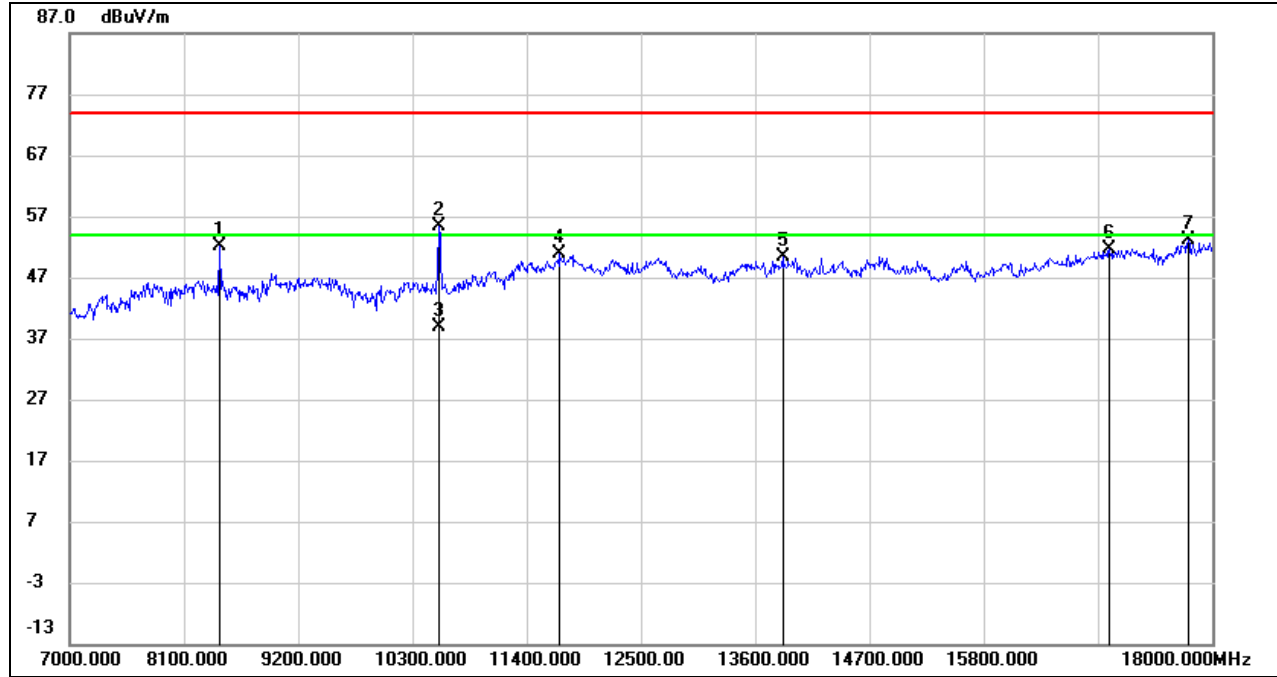

| No. | Frequency (MHz) | Reading (dBuV) | Correct (dB/m) | Result (dBuV/m) | Limit (dBuV/m) | Margin (dB) | Remark |
|-----|-----------------|----------------|----------------|-----------------|----------------|-------------|--------|
| 1 | 8441.000 | 43.60 | 8.56 | 52.16 | 74.00 | -21.84 | peak |
| 2 | 10553.000 | 43.20 | 12.17 | 55.37 | 74.00 | -18.63 | peak |
| 3 | 10553.000 | 26.59 | 12.17 | 38.76 | 54.00 | -15.24 | AVG |
| 4 | 11719.000 | 35.60 | 15.17 | 50.77 | 74.00 | -23.23 | peak |
| 5 | 13864.000 | 33.44 | 16.92 | 50.36 | 74.00 | -23.64 | peak |
| 6 | 17010.000 | 31.35 | 20.27 | 51.62 | 74.00 | -22.38 | peak |
| 7 | 17769.000 | 30.71 | 22.48 | 53.19 | 74.00 | -20.81 | peak |

Note: 1. Measurement = Reading Level + Correct Factor.
 2. If Peak Result complies with AV limit, AV Result is deemed to comply with AV limit.
 3. Peak: Peak detector.
 4. Filter losses were only considered in the spurious frequency bands and the authorized band was not corrected for High Pass Filter losses.
 5. Proper operation of the transmitter prior to adding the filter to the measurement chain.
 6. Since non-restricted band peak emissions are less than the average limit, they also comply with the -27dBm/MHz (68.2dBuV/m) limit.



HARMONICS AND SPURIOUS EMISSIONS (MID CHANNEL, VERTICAL)

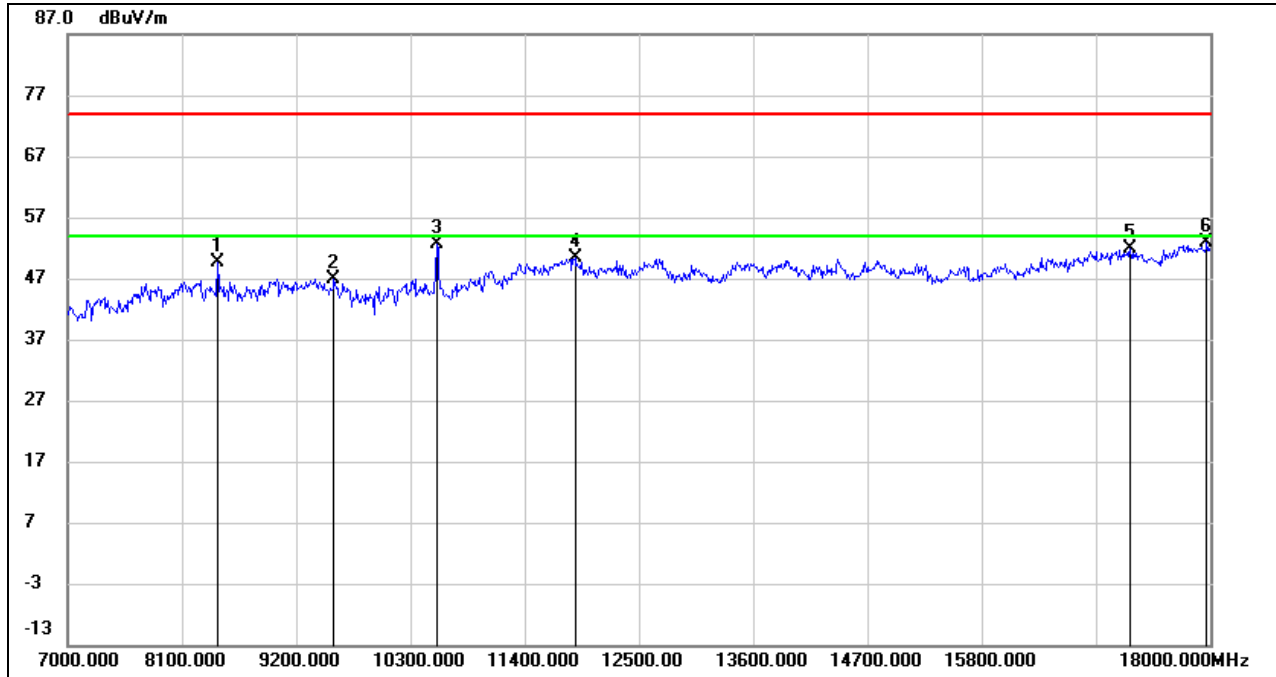

| No. | Frequency (MHz) | Reading (dBuV) | Correct (dB/m) | Result (dBuV/m) | Limit (dBuV/m) | Margin (dB) | Remark |
|-----|-----------------|----------------|----------------|-----------------|----------------|-------------|--------|
| 1 | 8441.000 | 41.07 | 8.56 | 49.63 | 74.00 | -24.37 | peak |
| 2 | 9563.000 | 36.46 | 10.45 | 46.91 | 74.00 | -27.09 | peak |
| 3 | 10553.000 | 40.34 | 12.17 | 52.51 | 74.00 | -21.49 | peak |
| 4 | 11884.000 | 34.97 | 15.49 | 50.46 | 74.00 | -23.54 | peak |
| 5 | 17230.000 | 30.79 | 20.99 | 51.78 | 74.00 | -22.22 | peak |
| 6 | 17967.000 | 30.29 | 22.67 | 52.96 | 74.00 | -21.04 | peak |

- Note:
1. Measurement = Reading Level + Correct Factor.
 2. If Peak Result complies with AV limit, AV Result is deemed to comply with AV limit.
 3. Peak: Peak detector.
 4. AVG: $VBW=1/Ton$, where: Ton is the transmitting duration.
 5. For the transmitting duration, please refer to clause 7.1.
 6. Filter losses were only considered in the spurious frequency bands and the authorized band was not corrected for High Pass Filter losses.
 7. Proper operation of the transmitter prior to adding the filter to the measurement chain.
 8. Since non-restricted band peak emissions are less than the average limit, they also comply with the -27dBm/MHz (68.2dBuV/m) limit.

HARMONICS AND SPURIOUS EMISSIONS (HIGH CHANNEL, HORIZONTAL)

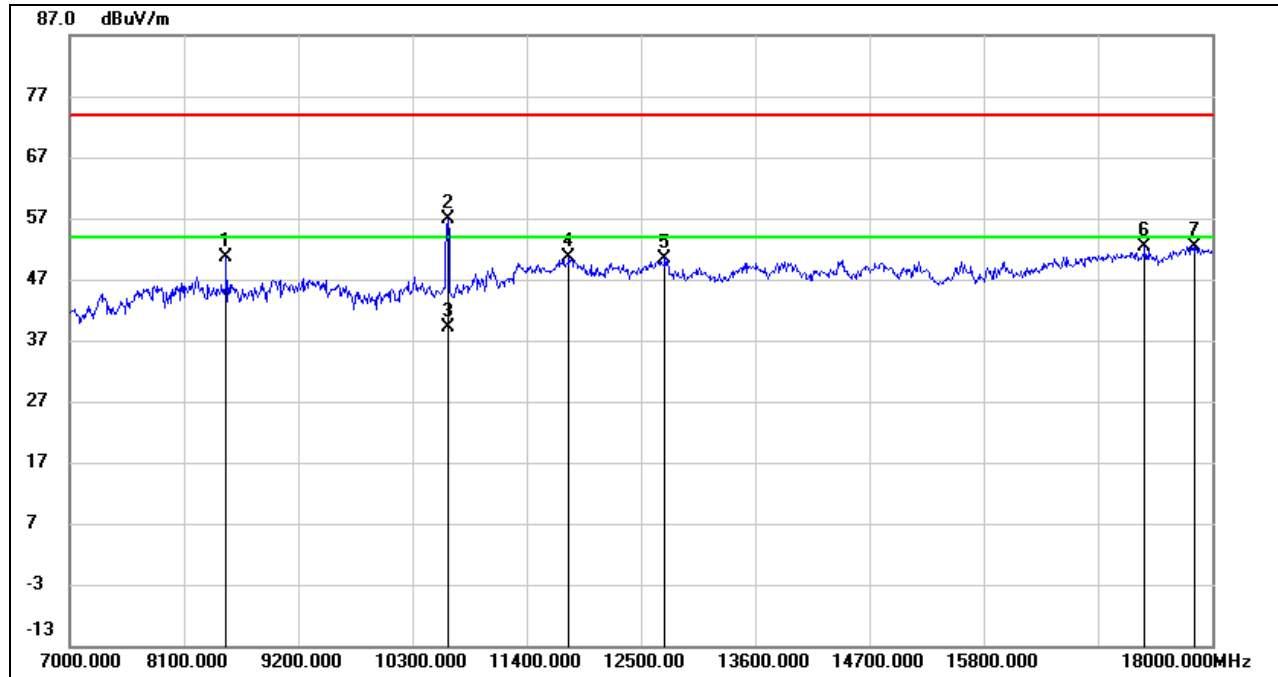

| No. | Frequency (MHz) | Reading (dBuV) | Correct (dB/m) | Result (dBuV/m) | Limit (dBuV/m) | Margin (dB) | Remark |
|-----|-----------------|----------------|----------------|-----------------|----------------|-------------|--------|
| 1 | 8507.000 | 42.15 | 8.54 | 50.69 | 74.00 | -23.31 | peak |
| 2 | 10641.000 | 44.55 | 12.42 | 56.97 | 74.00 | -17.03 | peak |
| 3 | 10641.000 | 26.73 | 12.42 | 39.15 | 54.00 | -14.85 | AVG |
| 4 | 11807.000 | 35.02 | 15.61 | 50.63 | 74.00 | -23.37 | peak |
| 5 | 12731.000 | 34.97 | 15.53 | 50.50 | 74.00 | -23.50 | peak |
| 6 | 17351.000 | 31.67 | 20.81 | 52.48 | 74.00 | -21.52 | peak |
| 7 | 17835.000 | 29.69 | 22.71 | 52.40 | 74.00 | -21.60 | peak |

Note: 1. Measurement = Reading Level + Correct Factor.
 2. If Peak Result complies with AV limit, AV Result is deemed to comply with AV limit.
 3. Peak: Peak detector.
 4. Filter losses were only considered in the spurious frequency bands and the authorized band was not corrected for High Pass Filter losses.
 5. Proper operation of the transmitter prior to adding the filter to the measurement chain.
 6. Since non-restricted band peak emissions are less than the average limit, they also comply with the -27dBm/MHz (68.2dBuV/m) limit.

HARMONICS AND SPURIOUS EMISSIONS (HIGH CHANNEL, VERTICAL)

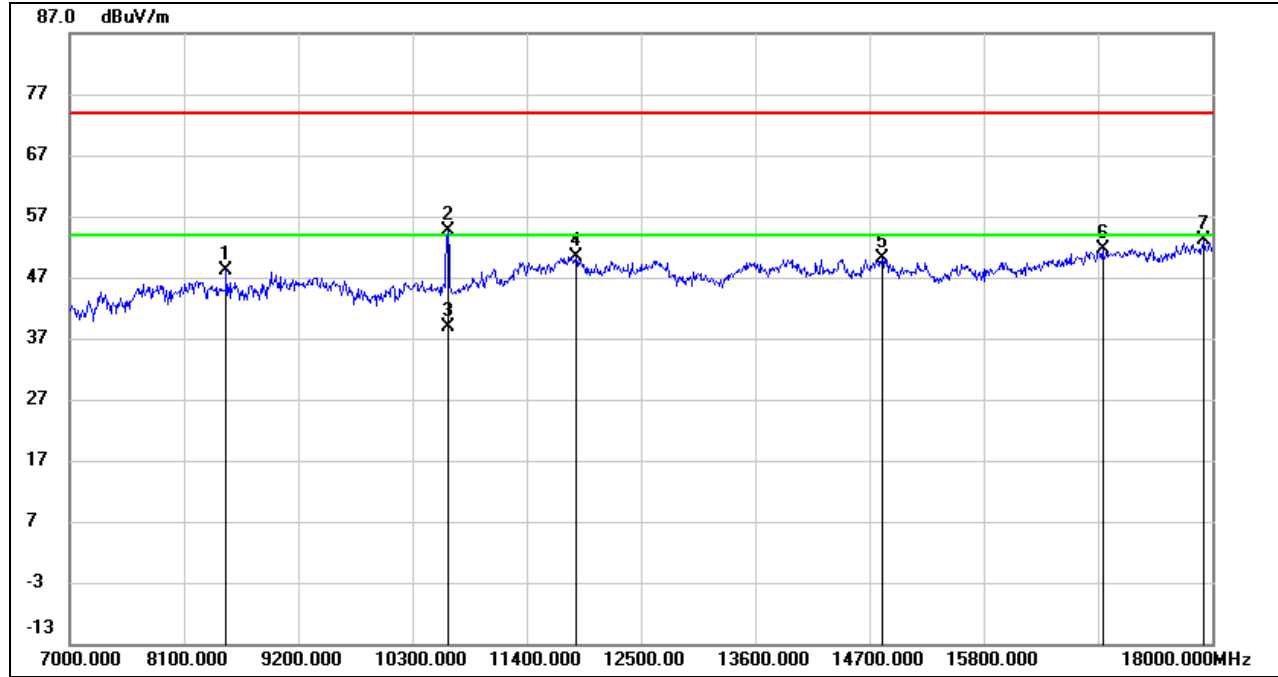

| No. | Frequency (MHz) | Reading (dBuV) | Correct (dB/m) | Result (dBuV/m) | Limit (dBuV/m) | Margin (dB) | Remark |
|-----|-----------------|----------------|----------------|-----------------|----------------|-------------|--------|
| 1 | 8507.000 | 39.58 | 8.54 | 48.12 | 74.00 | -25.88 | peak |
| 2 | 10641.000 | 42.21 | 12.42 | 54.63 | 74.00 | -19.37 | peak |
| 3 | 10641.000 | 26.44 | 12.42 | 38.86 | 54.00 | -15.14 | AVG |
| 4 | 11873.000 | 34.89 | 15.50 | 50.39 | 74.00 | -23.61 | peak |
| 5 | 14821.000 | 33.29 | 16.81 | 50.10 | 74.00 | -23.90 | peak |
| 6 | 16944.000 | 31.52 | 20.10 | 51.62 | 74.00 | -22.38 | peak |
| 7 | 17923.000 | 30.37 | 22.69 | 53.06 | 74.00 | -20.94 | peak |

Note: 1. Measurement = Reading Level + Correct Factor.
 2. If Peak Result complies with AV limit, AV Result is deemed to comply with AV limit.
 3. Peak: Peak detector.
 4. AVG: VBW=1/Ton, where: Ton is the transmitting duration.
 5. For the transmitting duration, please refer to clause 7.1.
 6. Filter losses were only considered in the spurious frequency bands and the authorized band was not corrected for High Pass Filter losses.
 7. Proper operation of the transmitter prior to adding the filter to the measurement chain.
 8. Since non-restricted band peak emissions are less than the average limit, they also comply with the -27dBm/MHz (68.2dBuV/m) limit.

UNII-2C BAND

HARMONICS AND SPURIOUS EMISSIONS (LOW CHANNEL, HORIZONTAL)

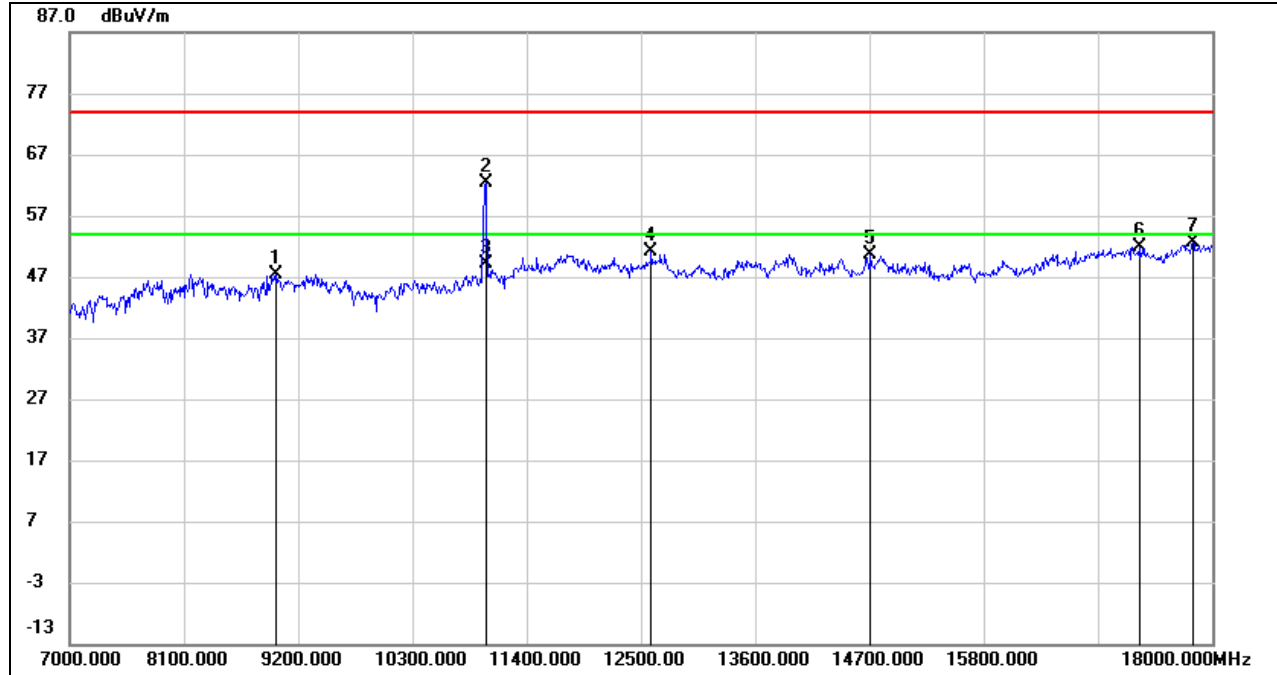

| No. | Frequency (MHz) | Reading (dBuV) | Correct (dB/m) | Result (dBuV/m) | Limit (dBuV/m) | Margin (dB) | Remark |
|-----|-----------------|----------------|----------------|-----------------|----------------|-------------|--------|
| 1 | 8991.000 | 36.92 | 10.53 | 47.45 | 74.00 | -26.55 | peak |
| 2 | 11004.000 | 49.19 | 13.26 | 62.45 | 74.00 | -11.55 | peak |
| 3 | 11004.000 | 35.89 | 13.26 | 49.15 | 54.00 | -4.85 | AVG |
| 4 | 12599.000 | 35.79 | 15.29 | 51.08 | 74.00 | -22.92 | peak |
| 5 | 14711.000 | 33.94 | 16.65 | 50.59 | 74.00 | -23.41 | peak |
| 6 | 17307.000 | 31.11 | 20.88 | 51.99 | 74.00 | -22.01 | peak |
| 7 | 17813.000 | 29.93 | 22.72 | 52.65 | 74.00 | -21.35 | peak |

Note: 1. Measurement = Reading Level + Correct Factor.
 2. If Peak Result complies with AV limit, AV Result is deemed to comply with AV limit.
 3. Peak: Peak detector.
 4. Filter losses were only considered in the spurious frequency bands and the authorized band was not corrected for High Pass Filter losses.
 5. Proper operation of the transmitter prior to adding the filter to the measurement chain.
 6. Since non-restricted band peak emissions are less than the average limit, they also comply with the -27dBm/MHz (68.2dBuV/m) limit.

HARMONICS AND SPURIOUS EMISSIONS (LOW CHANNEL, VERTICAL)

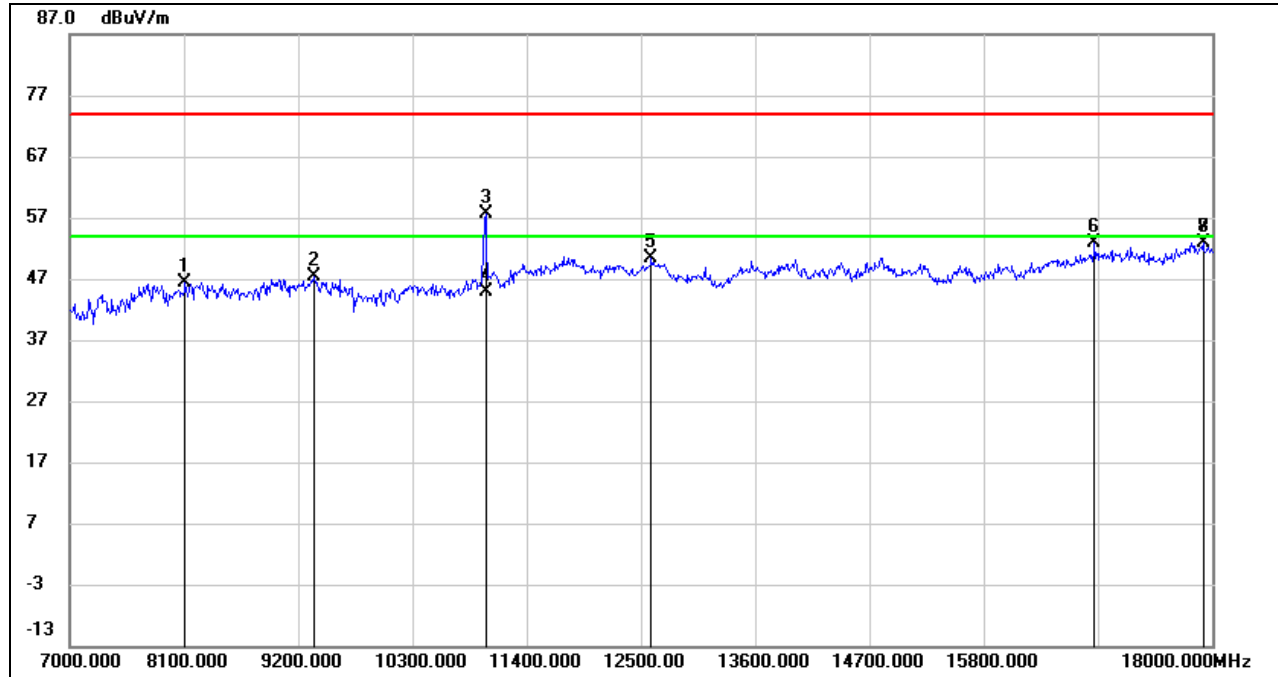

| No. | Frequency (MHz) | Reading (dBuV) | Correct (dB/m) | Result (dBuV/m) | Limit (dBuV/m) | Margin (dB) | Remark |
|-----|-----------------|----------------|----------------|-----------------|----------------|-------------|--------|
| 1 | 8111.000 | 37.84 | 8.61 | 46.45 | 74.00 | -27.55 | peak |
| 2 | 9354.000 | 37.25 | 10.07 | 47.32 | 74.00 | -26.68 | peak |
| 3 | 11004.000 | 44.32 | 13.26 | 57.58 | 74.00 | -16.42 | peak |
| 4 | 11004.000 | 31.60 | 13.26 | 44.86 | 54.00 | -9.14 | AVG |
| 5 | 12599.000 | 35.02 | 15.29 | 50.31 | 74.00 | -23.69 | peak |
| 6 | 16867.000 | 32.98 | 19.90 | 52.88 | 74.00 | -21.12 | peak |
| 7 | 17912.000 | 30.24 | 22.69 | 52.93 | 74.00 | -21.07 | peak |
| 8 | 17912.000 | 30.24 | 22.69 | 52.93 | 74.00 | -21.07 | peak |

Note: 1. Measurement = Reading Level + Correct Factor.
 2. If Peak Result complies with AV limit, AV Result is deemed to comply with AV limit.
 3. Peak: Peak detector.
 4. Filter losses were only considered in the spurious frequency bands and the authorized band was not corrected for High Pass Filter losses.
 5. Proper operation of the transmitter prior to adding the filter to the measurement chain.
 6. Since non-restricted band peak emissions are less than the average limit, they also comply with the -27dBm/MHz (68.2dBuV/m) limit.

HARMONICS AND SPURIOUS EMISSIONS (MID CHANNEL, HORIZONTAL)

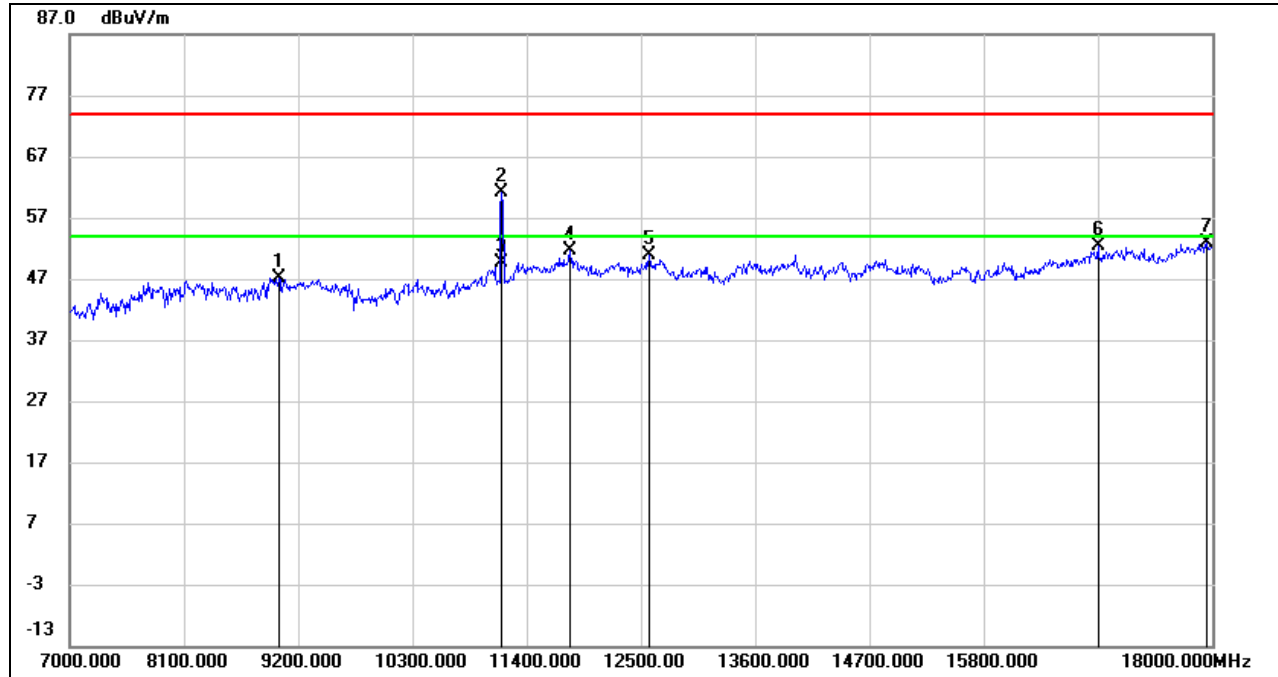

| No. | Frequency (MHz) | Reading (dBuV) | Correct (dB/m) | Result (dBuV/m) | Limit (dBuV/m) | Margin (dB) | Remark |
|-----|-----------------|----------------|----------------|-----------------|----------------|-------------|--------|
| 1 | 9013.000 | 36.71 | 10.54 | 47.25 | 74.00 | -26.75 | peak |
| 2 | 11158.000 | 47.64 | 13.56 | 61.20 | 74.00 | -12.80 | peak |
| 3 | 11158.000 | 36.09 | 13.56 | 49.65 | 54.00 | -4.35 | AVG |
| 4 | 11818.000 | 36.03 | 15.58 | 51.61 | 74.00 | -22.39 | peak |
| 5 | 12577.000 | 35.51 | 15.31 | 50.82 | 74.00 | -23.18 | peak |
| 6 | 16900.000 | 32.41 | 19.98 | 52.39 | 74.00 | -21.61 | peak |
| 7 | 17945.000 | 30.10 | 22.68 | 52.78 | 74.00 | -21.22 | peak |

Note: 1. Measurement = Reading Level + Correct Factor.
 2. If Peak Result complies with AV limit, AV Result is deemed to comply with AV limit.
 3. Peak: Peak detector.
 4. Filter losses were only considered in the spurious frequency bands and the authorized band was not corrected for High Pass Filter losses.
 5. Proper operation of the transmitter prior to adding the filter to the measurement chain.
 6. Since non-restricted band peak emissions are less than the average limit, they also comply with the -27dBm/MHz (68.2dBuV/m) limit.

HARMONICS AND SPURIOUS EMISSIONS (MID CHANNEL, VERTICAL)

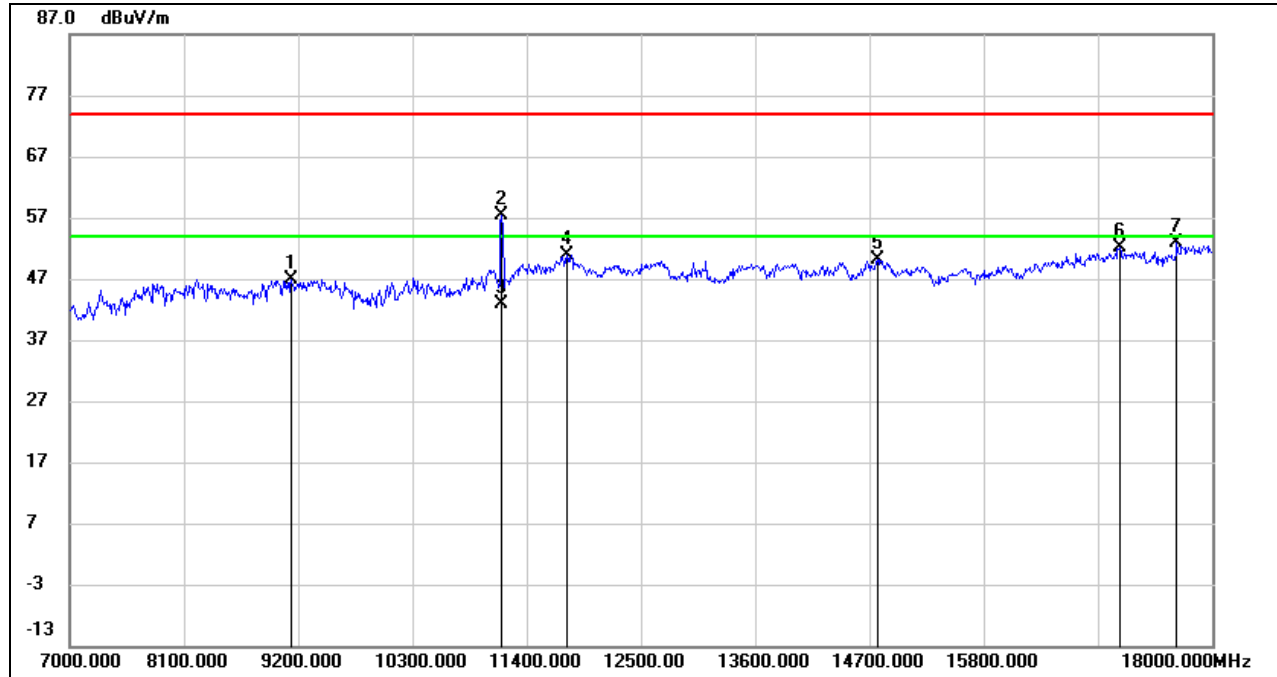

| No. | Frequency (MHz) | Reading (dBuV) | Correct (dB/m) | Result (dBuV/m) | Limit (dBuV/m) | Margin (dB) | Remark |
|-----|-----------------|----------------|----------------|-----------------|----------------|-------------|--------|
| 1 | 9134.000 | 37.12 | 9.73 | 46.85 | 74.00 | -27.15 | peak |
| 2 | 11158.000 | 43.87 | 13.56 | 57.43 | 74.00 | -16.57 | peak |
| 3 | 11158.000 | 29.39 | 13.56 | 42.95 | 54.00 | -11.05 | AVG |
| 4 | 11785.000 | 35.31 | 15.52 | 50.83 | 74.00 | -23.17 | peak |
| 5 | 14777.000 | 33.45 | 16.76 | 50.21 | 74.00 | -23.79 | peak |
| 6 | 17109.000 | 31.45 | 20.67 | 52.12 | 74.00 | -21.88 | peak |
| 7 | 17659.000 | 31.16 | 21.63 | 52.79 | 74.00 | -21.21 | peak |

Note: 1. Measurement = Reading Level + Correct Factor.
 2. If Peak Result complies with AV limit, AV Result is deemed to comply with AV limit.
 3. Peak: Peak detector.
 4. Filter losses were only considered in the spurious frequency bands and the authorized band was not corrected for High Pass Filter losses.
 5. Proper operation of the transmitter prior to adding the filter to the measurement chain.
 6. Since non-restricted band peak emissions are less than the average limit, they also comply with the -27dBm/MHz (68.2dBuV/m) limit.

HARMONICS AND SPURIOUS EMISSIONS (HIGH CHANNEL, HORIZONTAL)

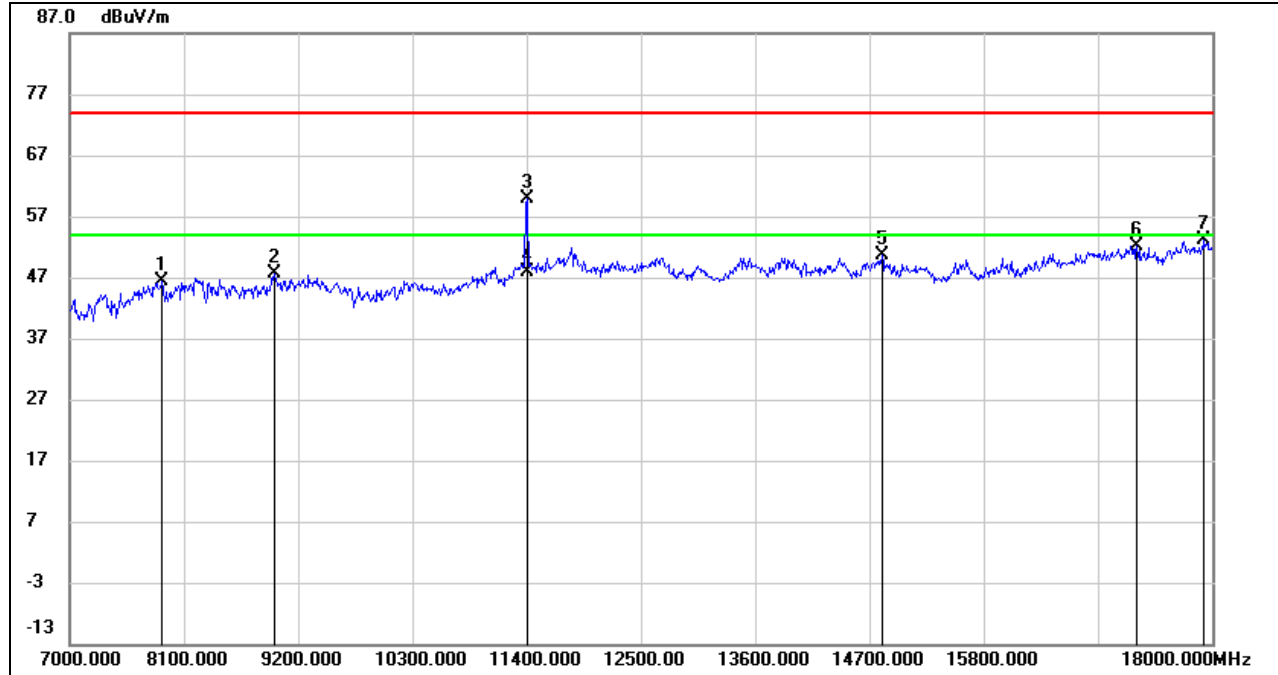

| No. | Frequency (MHz) | Reading (dBuV) | Correct (dB/m) | Result (dBuV/m) | Limit (dBuV/m) | Margin (dB) | Remark |
|-----|-----------------|----------------|----------------|-----------------|----------------|-------------|--------|
| 1 | 7891.000 | 38.28 | 7.98 | 46.26 | 74.00 | -27.74 | peak |
| 2 | 8969.000 | 37.24 | 10.31 | 47.55 | 74.00 | -26.45 | peak |
| 3 | 11400.000 | 45.63 | 14.22 | 59.85 | 74.00 | -14.15 | peak |
| 4 | 11400.000 | 33.76 | 14.22 | 47.98 | 54.00 | -6.02 | AVG |
| 5 | 14821.000 | 33.71 | 16.81 | 50.52 | 74.00 | -23.48 | peak |
| 6 | 17274.000 | 31.14 | 20.93 | 52.07 | 74.00 | -21.93 | peak |
| 7 | 17923.000 | 30.52 | 22.69 | 53.21 | 74.00 | -20.79 | peak |

Note: 1. Measurement = Reading Level + Correct Factor.
 2. If Peak Result complies with AV limit, AV Result is deemed to comply with AV limit.
 3. Peak: Peak detector.
 4. Filter losses were only considered in the spurious frequency bands and the authorized band was not corrected for High Pass Filter losses.
 5. Proper operation of the transmitter prior to adding the filter to the measurement chain.
 6. Since non-restricted band peak emissions are less than the average limit, they also comply with the -27dBm/MHz (68.2dBuV/m) limit.

HARMONICS AND SPURIOUS EMISSIONS (HIGH CHANNEL, VERTICAL)

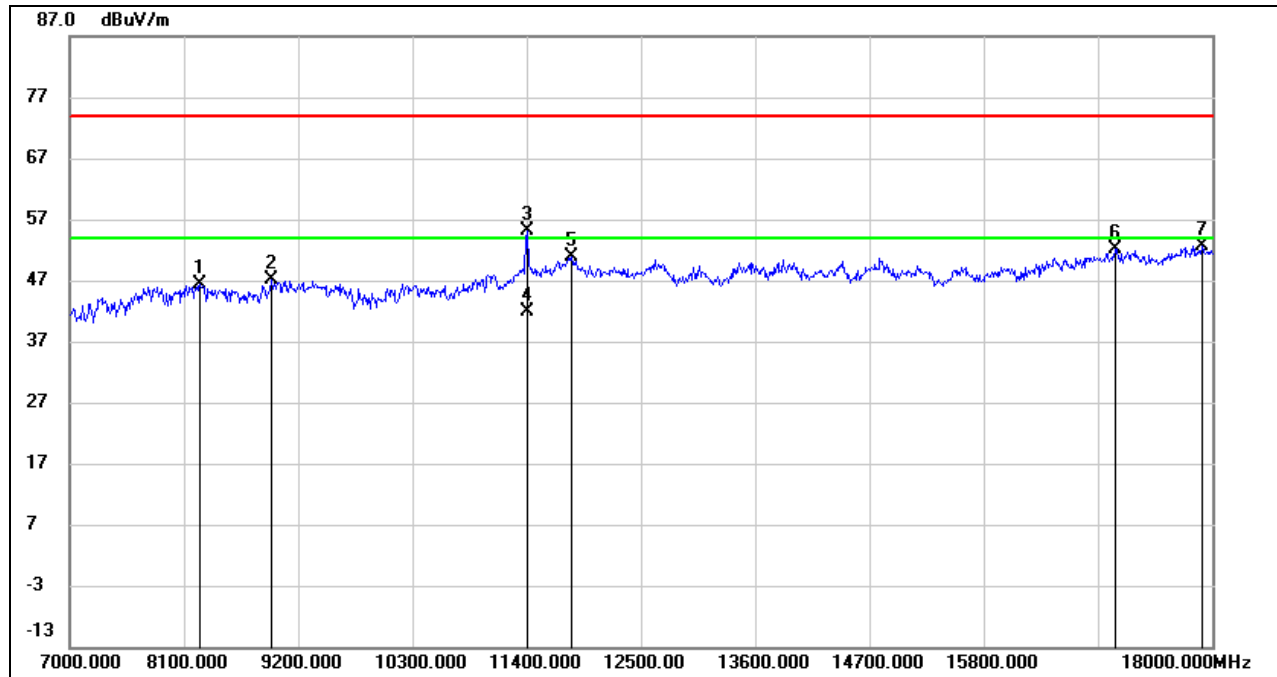

| No. | Frequency (MHz) | Reading (dBuV) | Correct (dB/m) | Result (dBuV/m) | Limit (dBuV/m) | Margin (dB) | Remark |
|-----|-----------------|----------------|----------------|-----------------|----------------|-------------|--------|
| 1 | 8254.000 | 37.23 | 9.15 | 46.38 | 74.00 | -27.62 | peak |
| 2 | 8947.000 | 37.03 | 10.07 | 47.10 | 74.00 | -26.90 | peak |
| 3 | 11411.000 | 40.84 | 14.23 | 55.07 | 74.00 | -18.93 | peak |
| 4 | 11411.000 | 27.72 | 14.23 | 41.95 | 54.00 | -12.05 | AVG |
| 5 | 11829.000 | 35.28 | 15.57 | 50.85 | 74.00 | -23.15 | peak |
| 6 | 17065.000 | 31.72 | 20.49 | 52.21 | 74.00 | -21.79 | peak |
| 7 | 17901.000 | 29.97 | 22.69 | 52.66 | 74.00 | -21.34 | peak |

- Note:
1. Measurement = Reading Level + Correct Factor.
 2. If Peak Result complies with AV limit, AV Result is deemed to comply with AV limit.
 3. Peak: Peak detector.
 4. AVG: $VBW=1/Ton$, where: Ton is the transmitting duration.
 5. For the transmitting duration, please refer to clause 7.1.
 6. Filter losses were only considered in the spurious frequency bands and the authorized band was not corrected for High Pass Filter losses.
 7. Proper operation of the transmitter prior to adding the filter to the measurement chain.
 8. Since non-restricted band peak emissions are less than the average limit, they also comply with the -27dBm/MHz (68.2dBuV/m) limit.

STRADDLE CHANNEL 144

HARMONICS AND SPURIOUS EMISSIONS (HORIZONTAL)

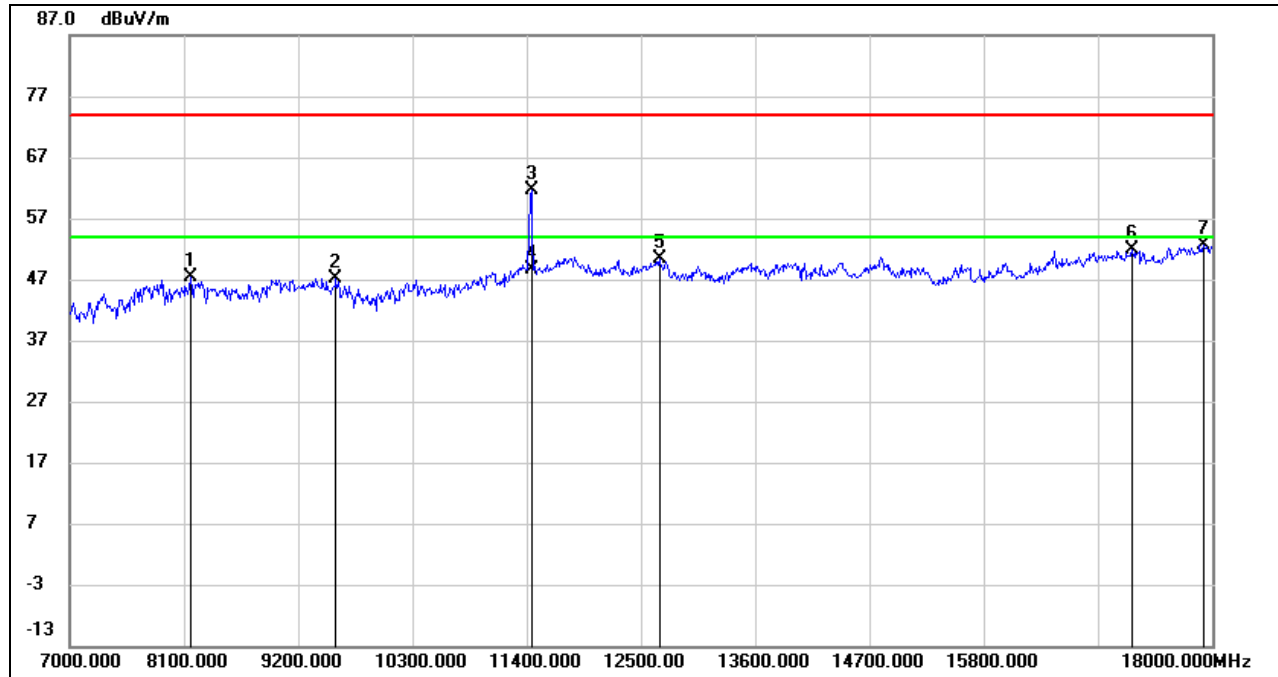

| No. | Frequency (MHz) | Reading (dBuV) | Correct (dB/m) | Result (dBuV/m) | Limit (dBuV/m) | Margin (dB) | Remark |
|-----|-----------------|----------------|----------------|-----------------|----------------|-------------|--------|
| 1 | 8166.000 | 38.31 | 9.07 | 47.38 | 74.00 | -26.62 | peak |
| 2 | 9563.000 | 36.68 | 10.45 | 47.13 | 74.00 | -26.87 | peak |
| 3 | 11444.000 | 47.29 | 14.28 | 61.57 | 74.00 | -12.43 | peak |
| 4 | 11444.000 | 34.37 | 14.28 | 48.65 | 54.00 | -5.35 | AVG |
| 5 | 12676.000 | 34.92 | 15.42 | 50.34 | 74.00 | -23.66 | peak |
| 6 | 17230.000 | 30.93 | 20.99 | 51.92 | 74.00 | -22.08 | peak |
| 7 | 17923.000 | 29.84 | 22.69 | 52.53 | 74.00 | -21.47 | peak |

Note: 1. Measurement = Reading Level + Correct Factor.
 2. If Peak Result complies with AV limit, AV Result is deemed to comply with AV limit.
 3. Peak: Peak detector.
 4. Filter losses were only considered in the spurious frequency bands and the authorized band was not corrected for High Pass Filter losses.
 5. Proper operation of the transmitter prior to adding the filter to the measurement chain.
 6. Since non-restricted band peak emissions are less than the average limit, they also comply with the -27dBm/MHz (68.2dBuV/m) limit.

HARMONICS AND SPURIOUS EMISSIONS (VERTICAL)

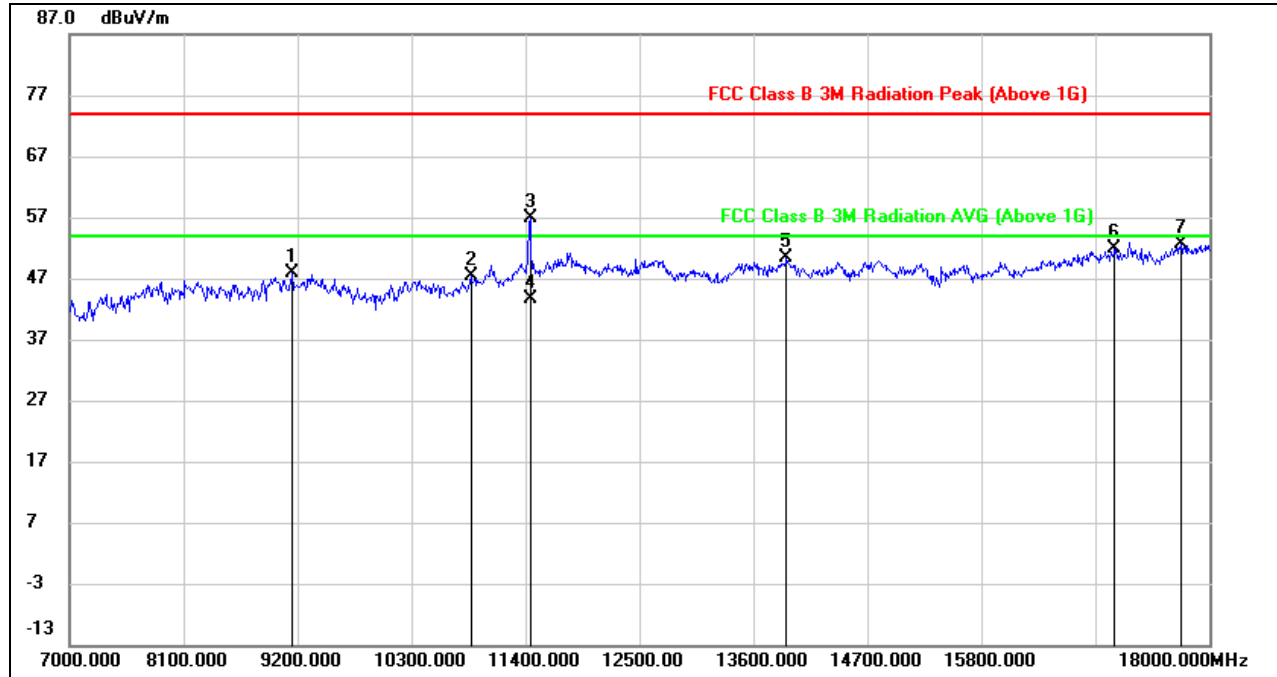

| No. | Frequency (MHz) | Reading (dBuV) | Correct (dB/m) | Result (dBuV/m) | Limit (dBuV/m) | Margin (dB) | Remark |
|-----|-----------------|----------------|----------------|-----------------|----------------|-------------|--------|
| 1 | 9145.000 | 38.21 | 9.66 | 47.87 | 74.00 | -26.13 | peak |
| 2 | 10872.000 | 34.39 | 12.89 | 47.28 | 74.00 | -26.72 | peak |
| 3 | 11444.000 | 42.52 | 14.28 | 56.80 | 74.00 | -17.20 | peak |
| 4 | 11444.000 | 29.37 | 14.28 | 43.65 | 54.00 | -10.35 | AVG |
| 5 | 13919.000 | 33.49 | 16.89 | 50.38 | 74.00 | -23.62 | peak |
| 6 | 17087.000 | 31.36 | 20.58 | 51.94 | 74.00 | -22.06 | peak |
| 7 | 17725.000 | 30.54 | 22.13 | 52.67 | 74.00 | -21.33 | peak |

Note: 1. Measurement = Reading Level + Correct Factor.
 2. If Peak Result complies with AV limit, AV Result is deemed to comply with AV limit.
 3. Peak: Peak detector.
 4. Filter losses were only considered in the spurious frequency bands and the authorized band was not corrected for High Pass Filter losses.
 5. Proper operation of the transmitter prior to adding the filter to the measurement chain.
 6. Since non-restricted band peak emissions are less than the average limit, they also comply with the -27dBm/MHz (68.2dBuV/m) limit.



UNII-3 BAND

HARMONICS AND SPURIOUS EMISSIONS (LOW CHANNEL, HORIZONTAL)

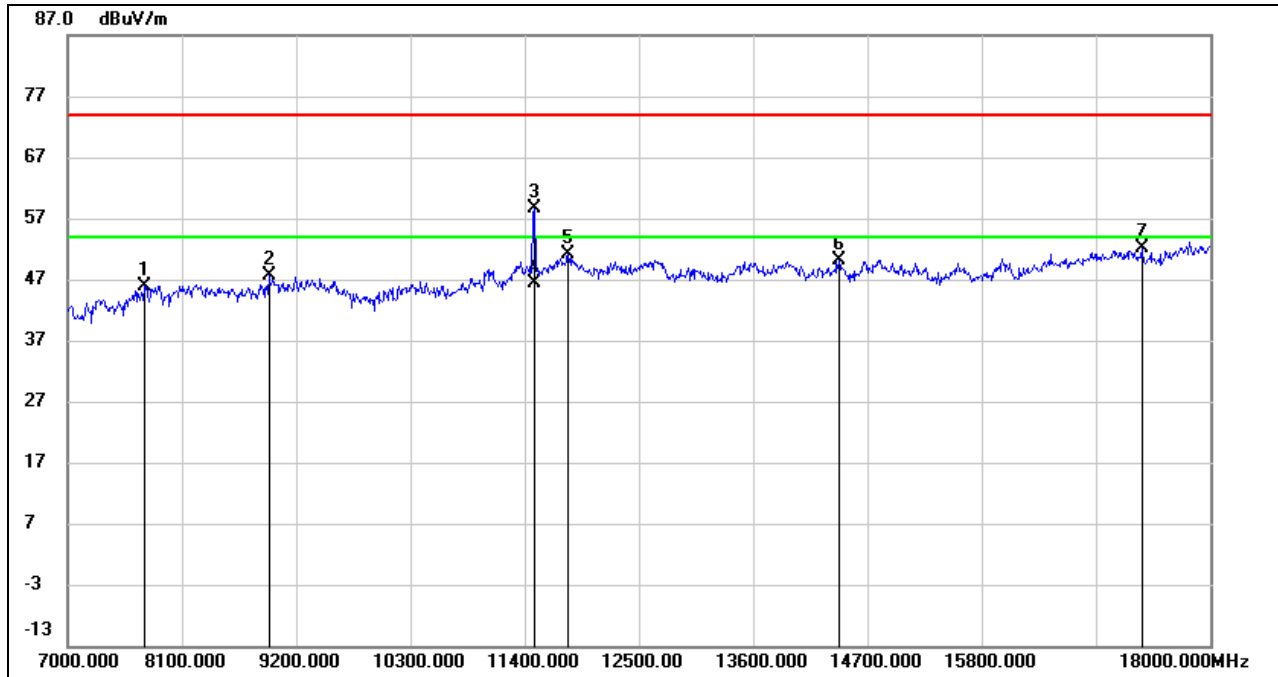

| No. | Frequency (MHz) | Reading (dBuV) | Correct (dB/m) | Result (dBuV/m) | Limit (dBuV/m) | Margin (dB) | Remark |
|-----|-----------------|----------------|----------------|-----------------|----------------|-------------|--------|
| 1 | 7737.000 | 37.98 | 8.00 | 45.98 | 74.00 | -28.02 | peak |
| 2 | 8936.000 | 37.71 | 9.96 | 47.67 | 74.00 | -26.33 | peak |
| 3 | 11488.000 | 44.37 | 14.34 | 58.71 | 74.00 | -15.29 | peak |
| 4 | 11488.000 | 31.94 | 14.34 | 46.28 | 54.00 | -7.72 | AVG |
| 5 | 11818.000 | 35.59 | 15.58 | 51.17 | 74.00 | -22.83 | peak |
| 6 | 14425.000 | 33.22 | 16.80 | 50.02 | 74.00 | -23.98 | peak |
| 7 | 17340.000 | 31.42 | 20.82 | 52.24 | 74.00 | -21.76 | peak |

Note: 1. Measurement = Reading Level + Correct Factor.
 2. If Peak Result complies with AV limit, AV Result is deemed to comply with AV limit.
 3. Peak: Peak detector.
 4. Filter losses were only considered in the spurious frequency bands and the authorized band was not corrected for High Pass Filter losses.
 5. Proper operation of the transmitter prior to adding the filter to the measurement chain.
 6. Since non-restricted band peak emissions are less than the average limit, they also comply with the -27dBm/MHz (68.2dBuV/m) limit.



HARMONICS AND SPURIOUS EMISSIONS (LOW CHANNEL, VERTICAL)

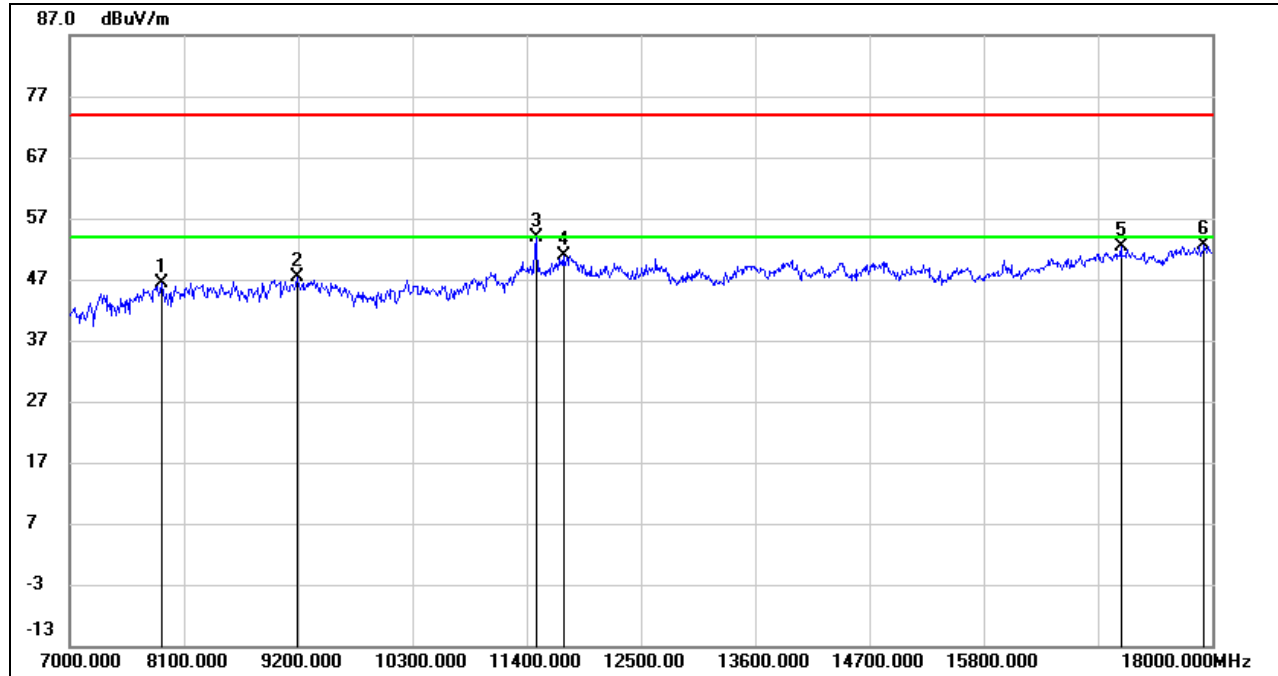

| No. | Frequency (MHz) | Reading (dBuV) | Correct (dB/m) | Result (dBuV/m) | Limit (dBuV/m) | Margin (dB) | Remark |
|-----|-----------------|----------------|----------------|-----------------|----------------|-------------|--------|
| 1 | 7880.000 | 38.39 | 8.01 | 46.40 | 74.00 | -27.60 | peak |
| 2 | 9189.000 | 38.05 | 9.36 | 47.41 | 74.00 | -26.59 | peak |
| 3 | 11488.000 | 39.60 | 14.34 | 53.94 | 74.00 | -20.06 | peak |
| 4 | 11752.000 | 35.59 | 15.35 | 50.94 | 74.00 | -23.06 | peak |
| 5 | 17120.000 | 31.58 | 20.72 | 52.30 | 74.00 | -21.70 | peak |
| 6 | 17923.000 | 29.86 | 22.69 | 52.55 | 74.00 | -21.45 | peak |

- Note: 1. Measurement = Reading Level + Correct Factor.
 2. If Peak Result complies with AV limit, AV Result is deemed to comply with AV limit.
 3. Peak: Peak detector.
 4. AVG: $VBW=1/Ton$, where: Ton is the transmitting duration.
 5. For the transmitting duration, please refer to clause 7.1.
 6. Filter losses were only considered in the spurious frequency bands and the authorized band was not corrected for High Pass Filter losses.
 7. Proper operation of the transmitter prior to adding the filter to the measurement chain.
 8. Since non-restricted band peak emissions are less than the average limit, they also comply with the -27dBm/MHz (68.2dBuV/m) limit.

HARMONICS AND SPURIOUS EMISSIONS (MID CHANNEL, HORIZONTAL)

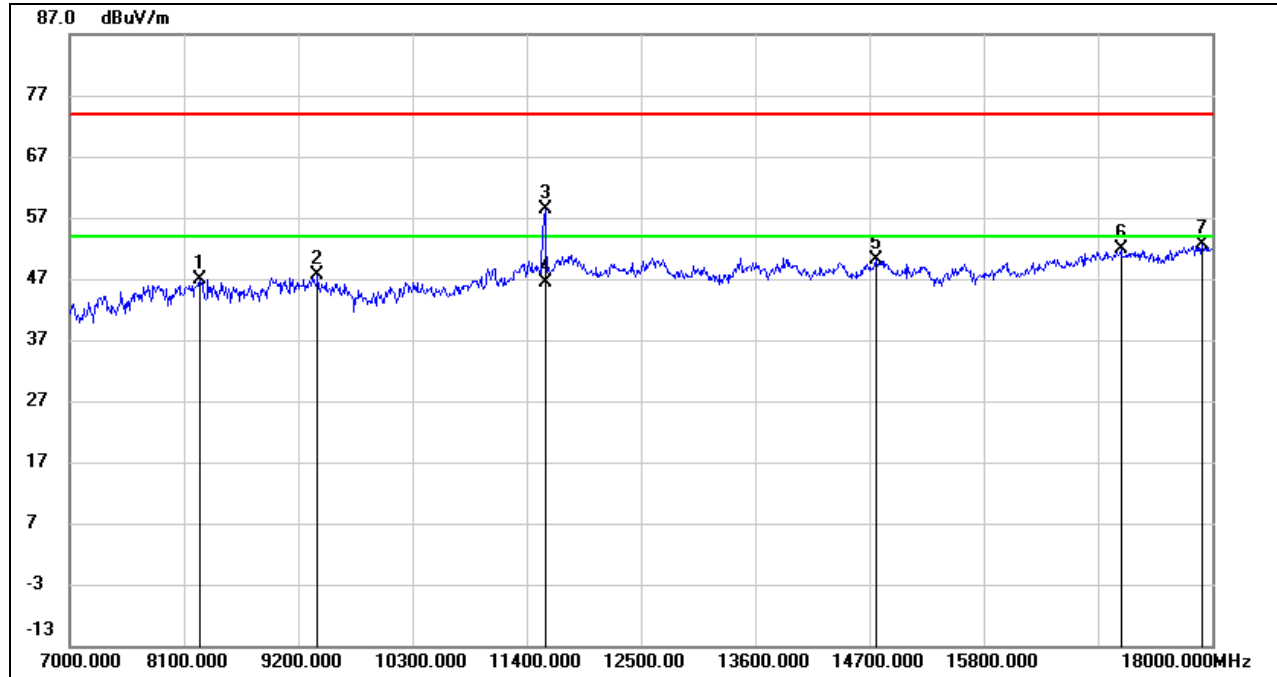

| No. | Frequency (MHz) | Reading (dBuV) | Correct (dB/m) | Result (dBuV/m) | Limit (dBuV/m) | Margin (dB) | Remark |
|-----|-----------------|----------------|----------------|-----------------|----------------|-------------|--------|
| 1 | 8254.000 | 37.77 | 9.15 | 46.92 | 74.00 | -27.08 | peak |
| 2 | 9387.000 | 37.38 | 10.24 | 47.62 | 74.00 | -26.38 | peak |
| 3 | 11576.000 | 43.89 | 14.48 | 58.37 | 74.00 | -15.63 | peak |
| 4 | 11576.000 | 31.87 | 14.48 | 46.35 | 54.00 | -7.65 | AVG |
| 5 | 14766.000 | 33.28 | 16.74 | 50.02 | 74.00 | -23.98 | peak |
| 6 | 17120.000 | 31.05 | 20.72 | 51.77 | 74.00 | -22.23 | peak |
| 7 | 17901.000 | 29.84 | 22.69 | 52.53 | 74.00 | -21.47 | peak |

- Note: 1. Measurement = Reading Level + Correct Factor.
 2. If Peak Result complies with AV limit, AV Result is deemed to comply with AV limit.
 3. Peak: Peak detector.
 4. Filter losses were only considered in the spurious frequency bands and the authorized band was not corrected for High Pass Filter losses.
 5. Proper operation of the transmitter prior to adding the filter to the measurement chain.
 6. Since non-restricted band peak emissions are less than the average limit, they also comply with the -27dBm/MHz (68.2dBuV/m) limit.

HARMONICS AND SPURIOUS EMISSIONS (MID CHANNEL, VERTICAL)

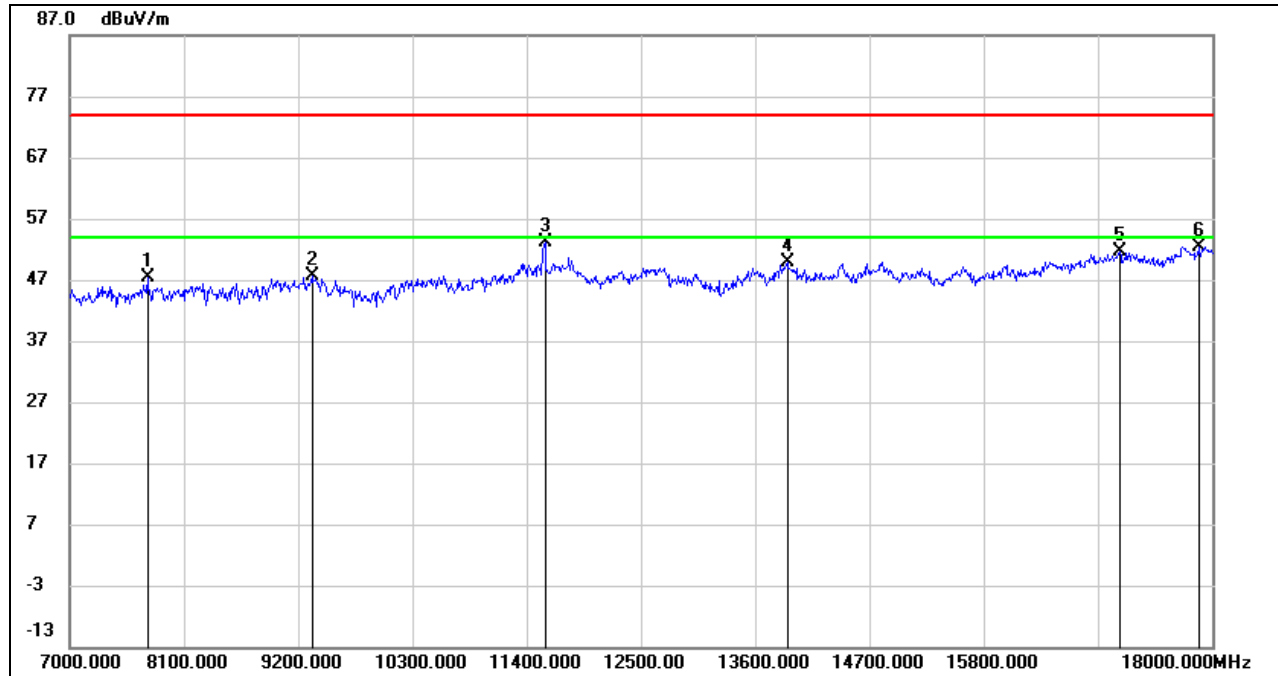

| No. | Frequency (MHz) | Reading (dBuV) | Correct (dB/m) | Result (dBuV/m) | Limit (dBuV/m) | Margin (dB) | Remark |
|-----|-----------------|----------------|----------------|-----------------|----------------|-------------|--------|
| 1 | 7748.000 | 39.43 | 8.05 | 47.48 | 74.00 | -26.52 | peak |
| 2 | 9332.000 | 37.59 | 9.97 | 47.56 | 74.00 | -26.44 | peak |
| 3 | 11576.000 | 38.54 | 14.48 | 53.02 | 74.00 | -20.98 | peak |
| 4 | 13908.000 | 32.98 | 16.90 | 49.88 | 74.00 | -24.12 | peak |
| 5 | 17109.000 | 30.84 | 20.67 | 51.51 | 74.00 | -22.49 | peak |
| 6 | 17868.000 | 29.64 | 22.71 | 52.35 | 74.00 | -21.65 | peak |

- Note: 1. Measurement = Reading Level + Correct Factor.
 2. If Peak Result complies with AV limit, AV Result is deemed to comply with AV limit.
 3. Peak: Peak detector.
 4. AVG: $VBW=1/Ton$, where: Ton is the transmitting duration.
 5. For the transmitting duration, please refer to clause 7.1.
 6. Filter losses were only considered in the spurious frequency bands and the authorized band was not corrected for High Pass Filter losses.
 7. Proper operation of the transmitter prior to adding the filter to the measurement chain.
 8. Since non-restricted band peak emissions are less than the average limit, they also comply with the -27dBm/MHz (68.2dBuV/m) limit.

HARMONICS AND SPURIOUS EMISSIONS (HIGH CHANNEL, HORIZONTAL)

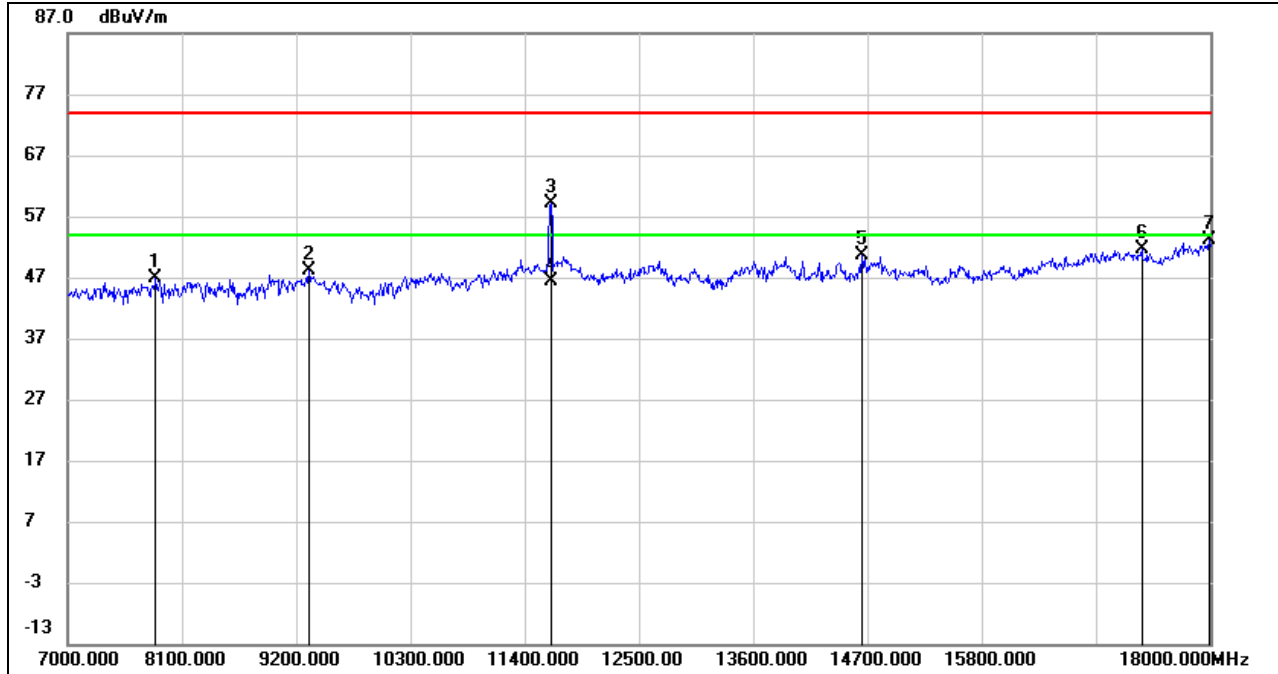

| No. | Frequency (MHz) | Reading (dBuV) | Correct (dB/m) | Result (dBuV/m) | Limit (dBuV/m) | Margin (dB) | Remark |
|-----|-----------------|----------------|----------------|-----------------|----------------|-------------|--------|
| 1 | 7847.000 | 38.65 | 8.11 | 46.76 | 74.00 | -27.24 | peak |
| 2 | 9321.000 | 38.32 | 9.91 | 48.23 | 74.00 | -25.77 | peak |
| 3 | 11653.000 | 44.24 | 14.80 | 59.04 | 74.00 | -14.96 | peak |
| 4 | 11653.000 | 31.52 | 14.80 | 46.32 | 54.00 | -7.68 | AVG |
| 5 | 14645.000 | 34.00 | 16.54 | 50.54 | 74.00 | -23.46 | peak |
| 6 | 17340.000 | 30.74 | 20.82 | 51.56 | 74.00 | -22.44 | peak |
| 7 | 17989.000 | 30.34 | 22.67 | 53.01 | 74.00 | -20.99 | peak |

Note: 1. Measurement = Reading Level + Correct Factor.
 2. If Peak Result complies with AV limit, AV Result is deemed to comply with AV limit.
 3. Peak: Peak detector.
 4. Filter losses were only considered in the spurious frequency bands and the authorized band was not corrected for High Pass Filter losses.
 5. Proper operation of the transmitter prior to adding the filter to the measurement chain.
 6. Since non-restricted band peak emissions are less than the average limit, they also comply with the -27dBm/MHz (68.2dBuV/m) limit.



HARMONICS AND SPURIOUS EMISSIONS (HIGH CHANNEL, VERTICAL)

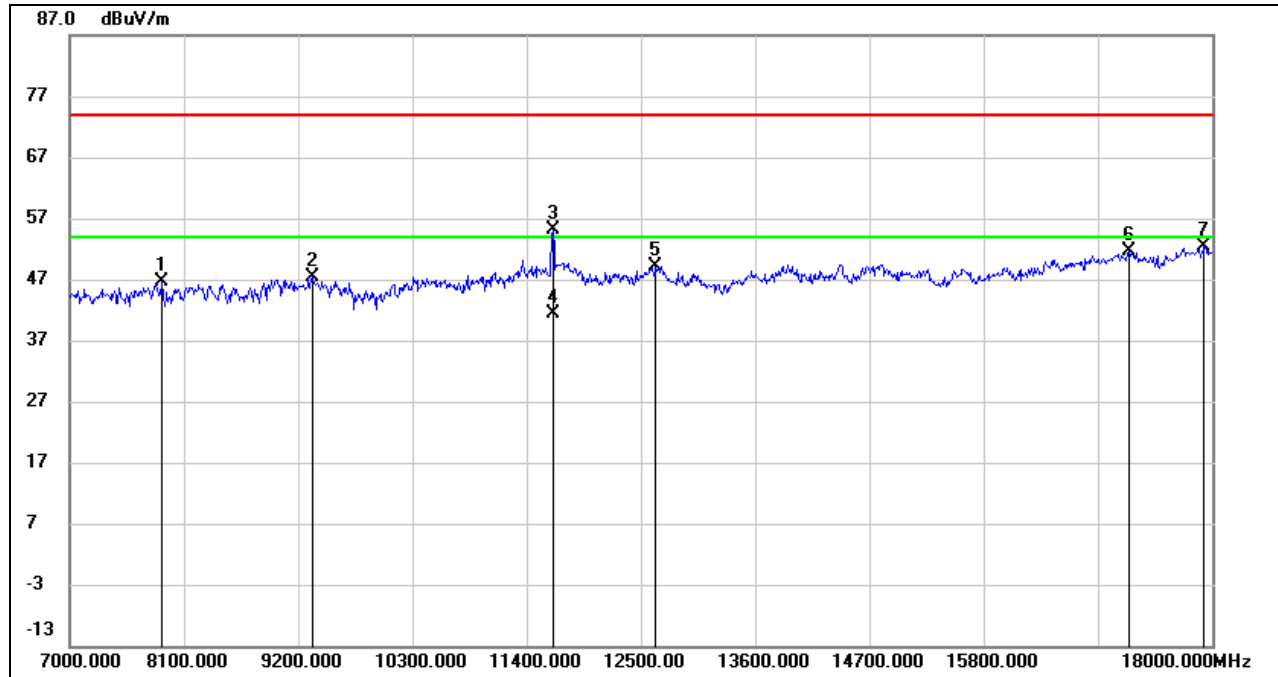

| No. | Frequency (MHz) | Reading (dBuV) | Correct (dB/m) | Result (dBuV/m) | Limit (dBuV/m) | Margin (dB) | Remark |
|-----|-----------------|----------------|----------------|-----------------|----------------|-------------|--------|
| 1 | 7891.000 | 38.76 | 7.98 | 46.74 | 74.00 | -27.26 | peak |
| 2 | 9343.000 | 37.44 | 10.02 | 47.46 | 74.00 | -26.54 | peak |
| 3 | 11653.000 | 40.26 | 14.80 | 55.06 | 74.00 | -18.94 | peak |
| 4 | 11653.000 | 26.55 | 14.80 | 41.35 | 54.00 | -12.65 | AVG |
| 5 | 12643.000 | 33.77 | 15.36 | 49.13 | 74.00 | -24.87 | peak |
| 6 | 17197.000 | 30.55 | 21.03 | 51.58 | 74.00 | -22.42 | peak |
| 7 | 17923.000 | 29.61 | 22.69 | 52.30 | 74.00 | -21.70 | peak |

- Note:
1. Measurement = Reading Level + Correct Factor.
 2. If Peak Result complies with AV limit, AV Result is deemed to comply with AV limit.
 3. Peak: Peak detector.
 4. AVG: $VBW=1/Ton$, where: Ton is the transmitting duration.
 5. For the transmitting duration, please refer to clause 7.1.
 6. Filter losses were only considered in the spurious frequency bands and the authorized band was not corrected for High Pass Filter losses.
 7. Proper operation of the transmitter prior to adding the filter to the measurement chain.
 8. Since non-restricted band peak emissions are less than the average limit, they also comply with the -27dBm/MHz (68.2dBuV/m) limit.

8.3.2. 802.11n HT20 MIMO MODE

UNII-1 BAND

HARMONICS AND SPURIOUS EMISSIONS (LOW CHANNEL, HORIZONTAL)

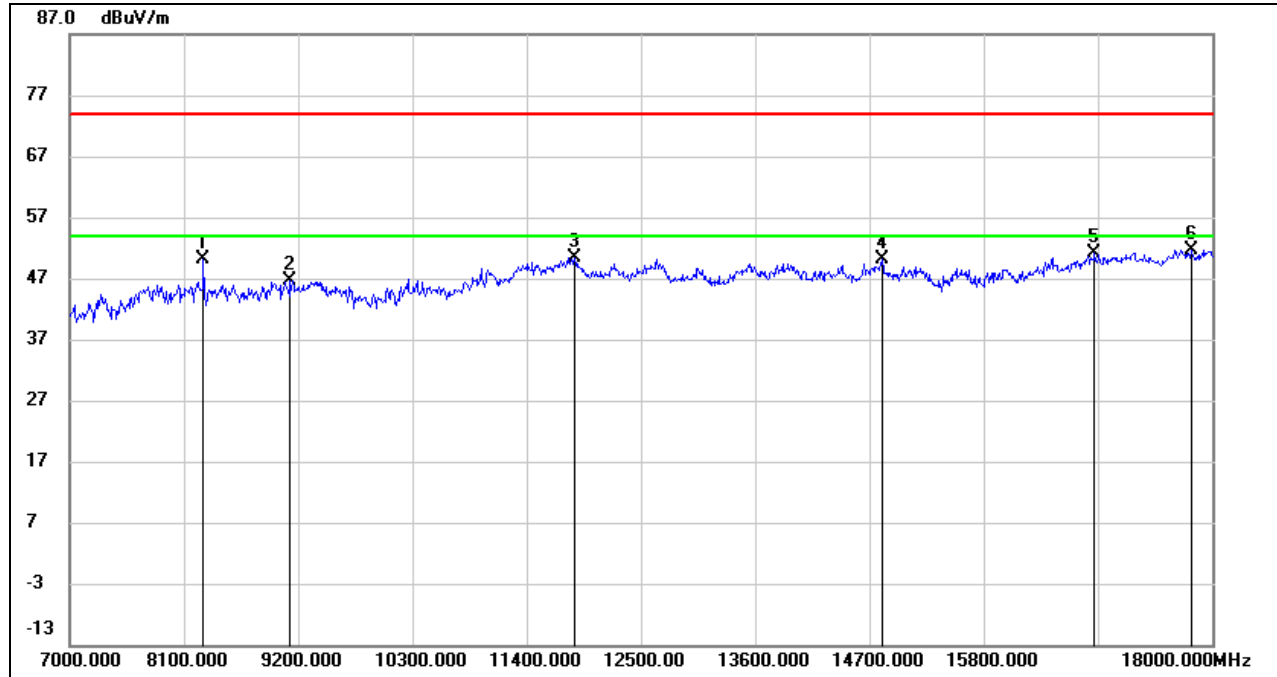

| No. | Frequency (MHz) | Reading (dBuV) | Correct (dB/m) | Result (dBuV/m) | Limit (dBuV/m) | Margin (dB) | Remark |
|-----|-----------------|----------------|----------------|-----------------|----------------|-------------|--------|
| 1 | 8287.000 | 41.14 | 9.02 | 50.16 | 74.00 | -23.84 | peak |
| 2 | 9123.000 | 36.84 | 9.81 | 46.65 | 74.00 | -27.35 | peak |
| 3 | 11862.000 | 34.92 | 15.52 | 50.44 | 74.00 | -23.56 | peak |
| 4 | 14821.000 | 33.37 | 16.81 | 50.18 | 74.00 | -23.82 | peak |
| 5 | 16867.000 | 31.19 | 19.90 | 51.09 | 74.00 | -22.91 | peak |
| 6 | 17802.000 | 28.89 | 22.72 | 51.61 | 74.00 | -22.39 | peak |

Note: 1. Measurement = Reading Level + Correct Factor.
 2. If Peak Result complies with AV limit, AV Result is deemed to comply with AV limit.
 3. Peak: Peak detector.
 4. Filter losses were only considered in the spurious frequency bands and the authorized band was not corrected for High Pass Filter losses.
 5. Proper operation of the transmitter prior to adding the filter to the measurement chain.
 6. Since non-restricted band peak emissions are less than the average limit, they also comply with the -27dBm/MHz (68.2dBuV/m) limit.



HARMONICS AND SPURIOUS EMISSIONS (LOW CHANNEL, VERTICAL)

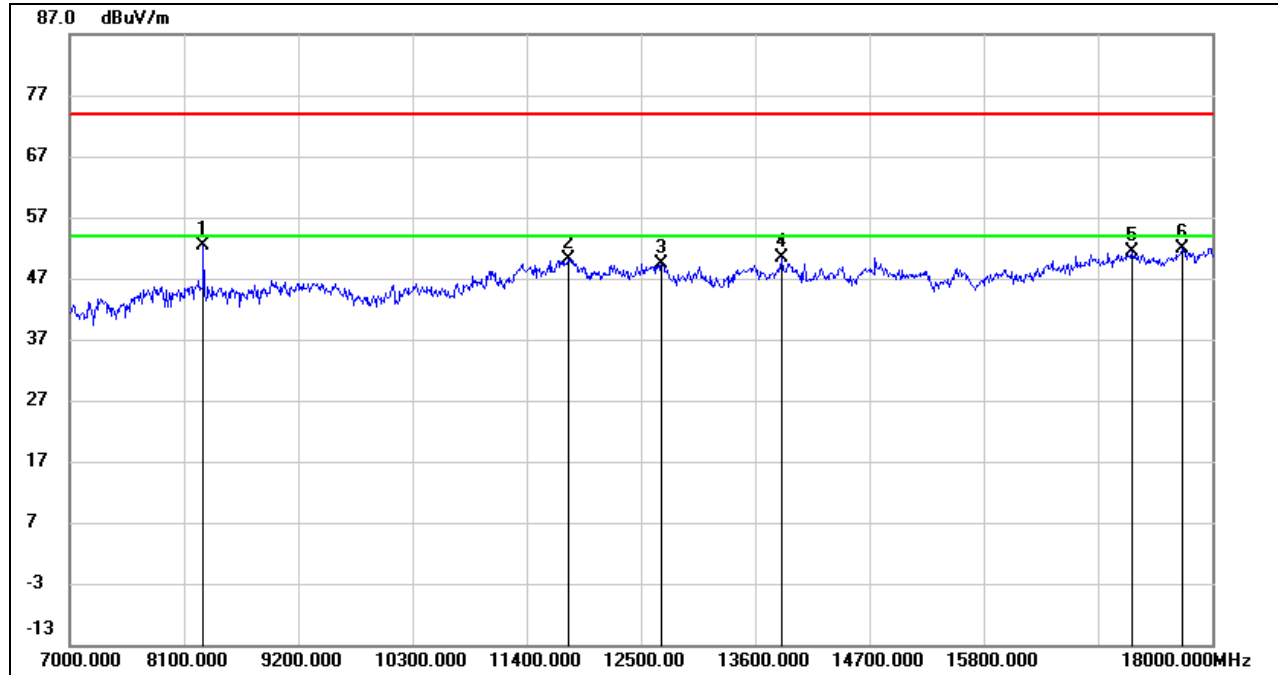

| No. | Frequency (MHz) | Reading (dBuV) | Correct (dB/m) | Result (dBuV/m) | Limit (dBuV/m) | Margin (dB) | Remark |
|-----|-----------------|----------------|----------------|-----------------|----------------|-------------|--------|
| 1 | 8287.000 | 43.36 | 9.02 | 52.38 | 74.00 | -21.62 | peak |
| 2 | 11807.000 | 34.54 | 15.61 | 50.15 | 74.00 | -23.85 | peak |
| 3 | 12698.000 | 33.90 | 15.47 | 49.37 | 74.00 | -24.63 | peak |
| 4 | 13853.000 | 33.49 | 16.93 | 50.42 | 74.00 | -23.58 | peak |
| 5 | 17230.000 | 30.50 | 20.99 | 51.49 | 74.00 | -22.51 | peak |
| 6 | 17714.000 | 29.86 | 22.04 | 51.90 | 74.00 | -22.10 | peak |

- Note: 1. Measurement = Reading Level + Correct Factor.
 2. If Peak Result complies with AV limit, AV Result is deemed to comply with AV limit.
 3. Peak: Peak detector.
 4. Filter losses were only considered in the spurious frequency bands and the authorized band was not corrected for High Pass Filter losses.
 5. Proper operation of the transmitter prior to adding the filter to the measurement chain.
 6. Since non-restricted band peak emissions are less than the average limit, they also comply with the -27dBm/MHz (68.2dBuV/m) limit.



HARMONICS AND SPURIOUS EMISSIONS (MID CHANNEL, HORIZONTAL)

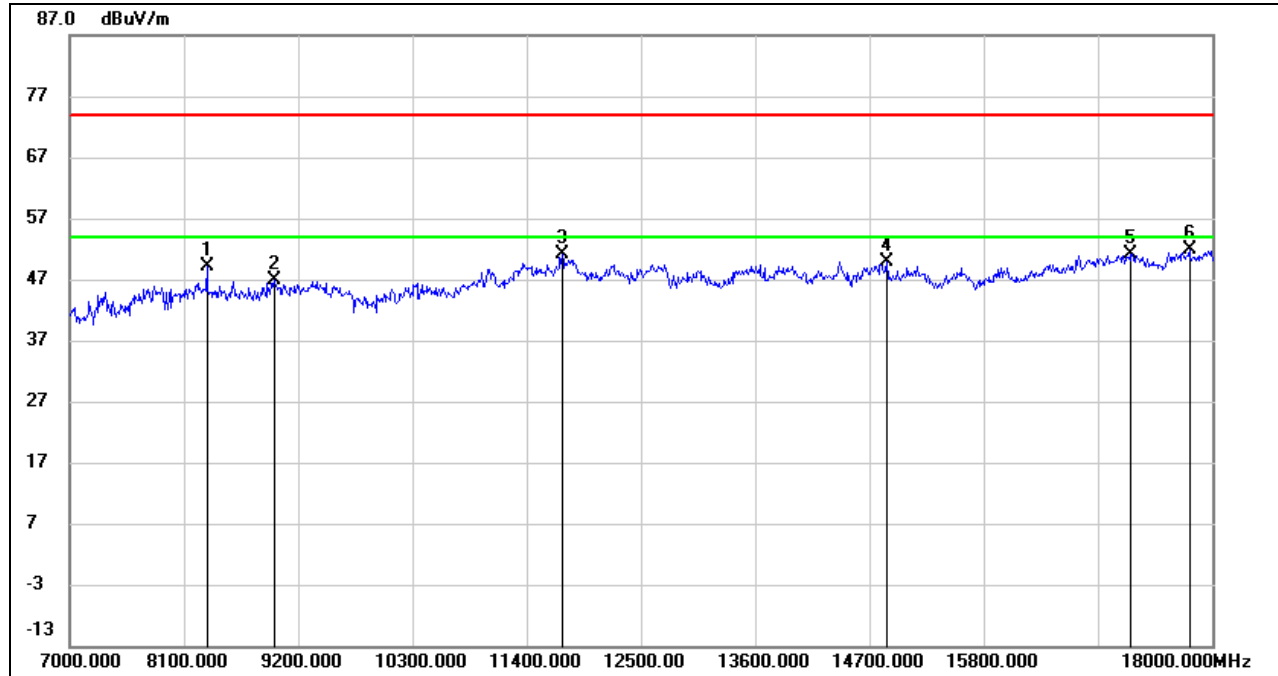

| No. | Frequency (MHz) | Reading (dBuV) | Correct (dB/m) | Result (dBuV/m) | Limit (dBuV/m) | Margin (dB) | Remark |
|-----|-----------------|----------------|----------------|-----------------|----------------|-------------|--------|
| 1 | 8320.000 | 40.15 | 8.90 | 49.05 | 74.00 | -24.95 | peak |
| 2 | 8969.000 | 36.59 | 10.31 | 46.90 | 74.00 | -27.10 | peak |
| 3 | 11741.000 | 35.85 | 15.28 | 51.13 | 74.00 | -22.87 | peak |
| 4 | 14865.000 | 33.05 | 16.83 | 49.88 | 74.00 | -24.12 | peak |
| 5 | 17219.000 | 30.15 | 21.01 | 51.16 | 74.00 | -22.84 | peak |
| 6 | 17780.000 | 29.20 | 22.57 | 51.77 | 74.00 | -22.23 | peak |

Note: 1. Measurement = Reading Level + Correct Factor.
 2. If Peak Result complies with AV limit, AV Result is deemed to comply with AV limit.
 3. Peak: Peak detector.
 4. Filter losses were only considered in the spurious frequency bands and the authorized band was not corrected for High Pass Filter losses.
 5. Proper operation of the transmitter prior to adding the filter to the measurement chain.
 6. Since non-restricted band peak emissions are less than the average limit, they also comply with the -27dBm/MHz (68.2dBuV/m) limit.

HARMONICS AND SPURIOUS EMISSIONS (MID CHANNEL, VERTICAL)

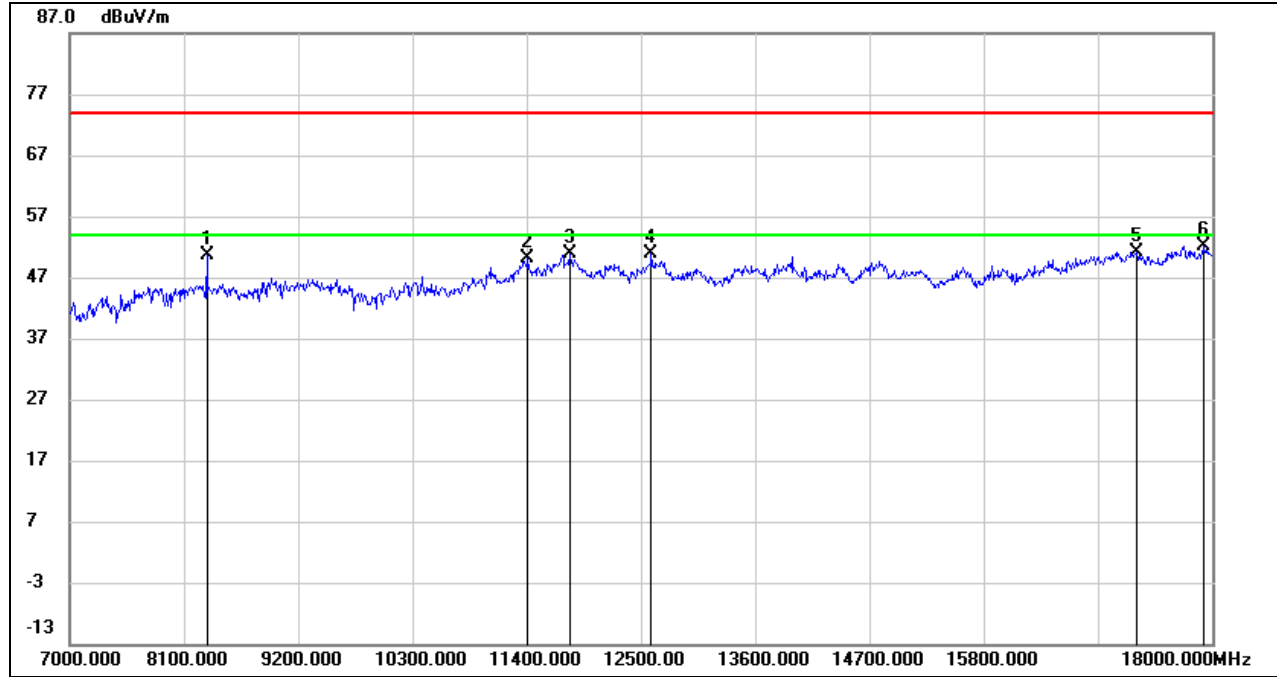

| No. | Frequency (MHz) | Reading (dBuV) | Correct (dB/m) | Result (dBuV/m) | Limit (dBuV/m) | Margin (dB) | Remark |
|-----|-----------------|----------------|----------------|-----------------|----------------|-------------|--------|
| 1 | 8320.000 | 41.76 | 8.90 | 50.66 | 74.00 | -23.34 | peak |
| 2 | 11411.000 | 35.79 | 14.23 | 50.02 | 74.00 | -23.98 | peak |
| 3 | 11818.000 | 35.37 | 15.58 | 50.95 | 74.00 | -23.05 | peak |
| 4 | 12599.000 | 35.55 | 15.29 | 50.84 | 74.00 | -23.16 | peak |
| 5 | 17274.000 | 30.30 | 20.93 | 51.23 | 74.00 | -22.77 | peak |
| 6 | 17923.000 | 29.40 | 22.69 | 52.09 | 74.00 | -21.91 | peak |

- Note:
1. Measurement = Reading Level + Correct Factor.
 2. If Peak Result complies with AV limit, AV Result is deemed to comply with AV limit.
 3. Peak: Peak detector.
 4. AVG: VBW=1/Ton, where: Ton is the transmitting duration.
 5. For the transmitting duration, please refer to clause 7.1.
 6. Filter losses were only considered in the spurious frequency bands and the authorized band was not corrected for High Pass Filter losses.
 7. Proper operation of the transmitter prior to adding the filter to the measurement chain.
 8. Since non-restricted band peak emissions are less than the average limit, they also comply with the -27dBm/MHz (68.2dBuV/m) limit.



HARMONICS AND SPURIOUS EMISSIONS (HIGH CHANNEL, HORIZONTAL)

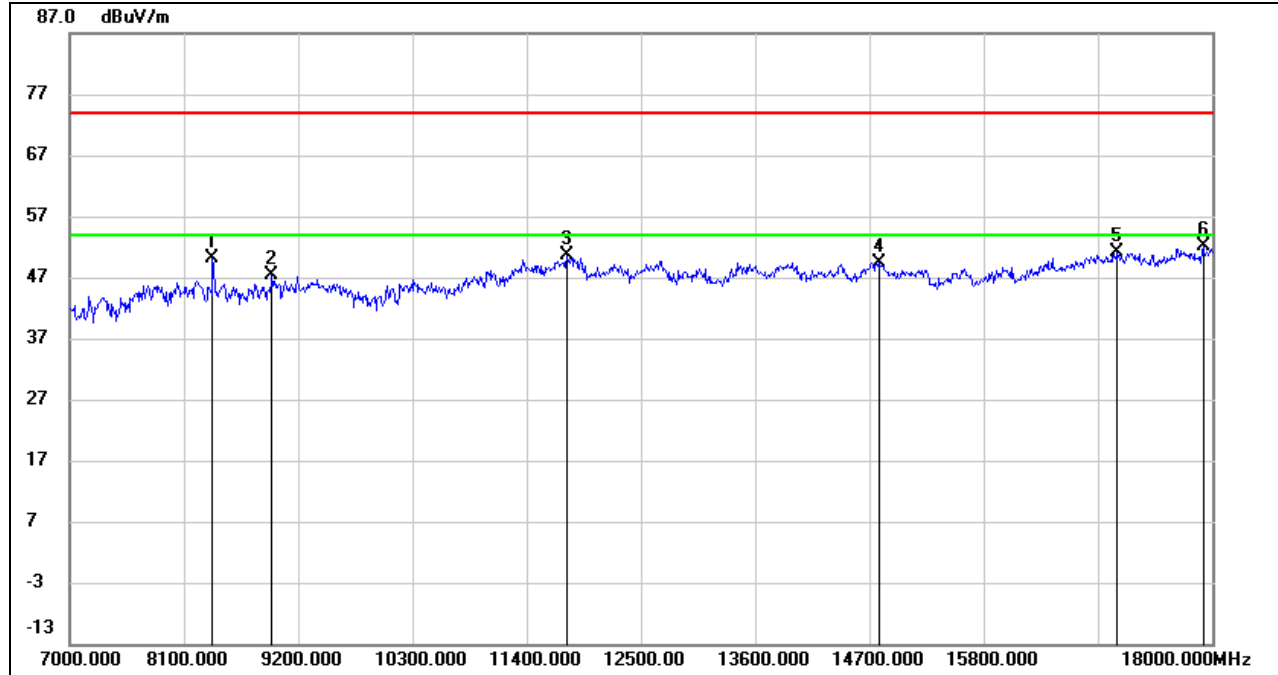

| No. | Frequency (MHz) | Reading (dBuV) | Correct (dB/m) | Result (dBuV/m) | Limit (dBuV/m) | Margin (dB) | Remark |
|-----|-----------------|----------------|----------------|-----------------|----------------|-------------|--------|
| 1 | 8375.000 | 41.51 | 8.68 | 50.19 | 74.00 | -23.81 | peak |
| 2 | 8947.000 | 37.35 | 10.07 | 47.42 | 74.00 | -26.58 | peak |
| 3 | 11785.000 | 35.17 | 15.52 | 50.69 | 74.00 | -23.31 | peak |
| 4 | 14799.000 | 32.60 | 16.80 | 49.40 | 74.00 | -24.60 | peak |
| 5 | 17087.000 | 30.50 | 20.58 | 51.08 | 74.00 | -22.92 | peak |
| 6 | 17912.000 | 29.36 | 22.69 | 52.05 | 74.00 | -21.95 | peak |

- Note: 1. Measurement = Reading Level + Correct Factor.
 2. If Peak Result complies with AV limit, AV Result is deemed to comply with AV limit.
 3. Peak: Peak detector.
 4. Filter losses were only considered in the spurious frequency bands and the authorized band was not corrected for High Pass Filter losses.
 5. Proper operation of the transmitter prior to adding the filter to the measurement chain.
 6. Since non-restricted band peak emissions are less than the average limit, they also comply with the -27dBm/MHz (68.2dBuV/m) limit.



HARMONICS AND SPURIOUS EMISSIONS (HIGH CHANNEL, VERTICAL)

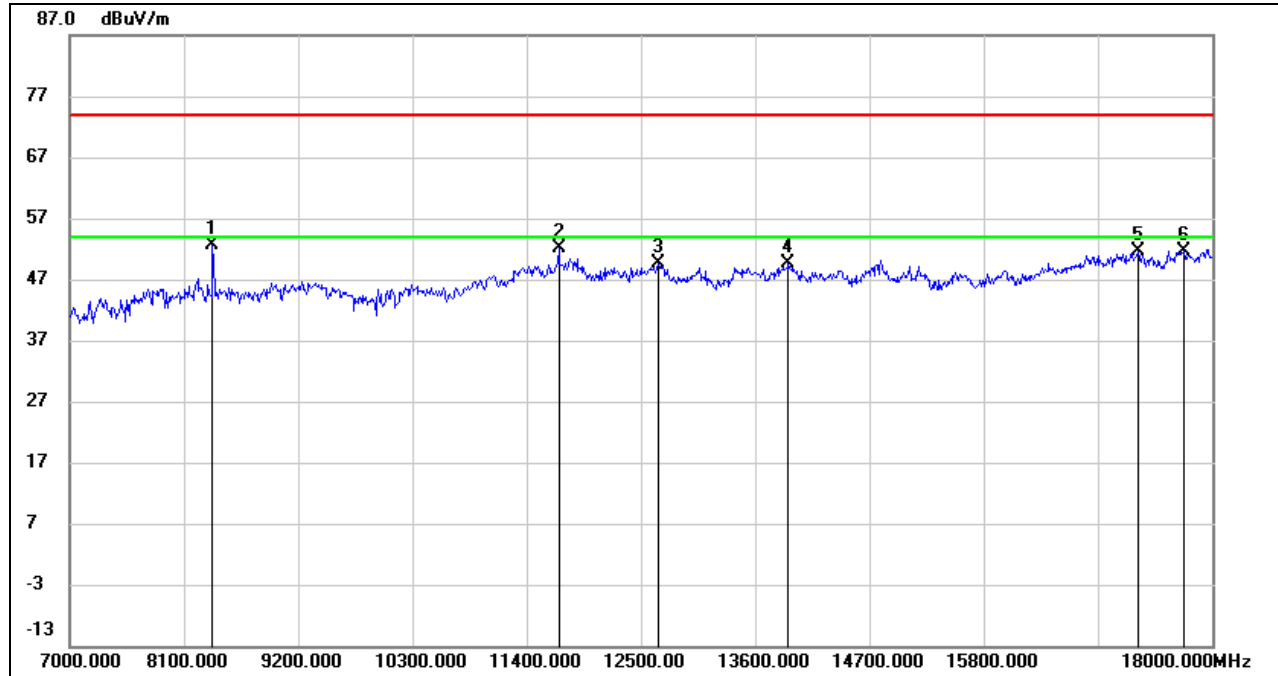

| No. | Frequency (MHz) | Reading (dBuV) | Correct (dB/m) | Result (dBuV/m) | Limit (dBuV/m) | Margin (dB) | Remark |
|-----|-----------------|----------------|----------------|-----------------|----------------|-------------|--------|
| 1 | 8375.000 | 44.06 | 8.68 | 52.74 | 74.00 | -21.26 | peak |
| 2 | 11708.000 | 37.00 | 15.11 | 52.11 | 74.00 | -21.89 | peak |
| 3 | 12665.000 | 34.12 | 15.41 | 49.53 | 74.00 | -24.47 | peak |
| 4 | 13919.000 | 32.71 | 16.89 | 49.60 | 74.00 | -24.40 | peak |
| 5 | 17285.000 | 30.68 | 20.92 | 51.60 | 74.00 | -22.40 | peak |
| 6 | 17725.000 | 29.52 | 22.13 | 51.65 | 74.00 | -22.35 | peak |

- Note: 1. Measurement = Reading Level + Correct Factor.
 2. If Peak Result complies with AV limit, AV Result is deemed to comply with AV limit.
 3. Peak: Peak detector.
 4. AVG: VBW=1/Ton, where: Ton is the transmitting duration.
 5. For the transmitting duration, please refer to clause 7.1.
 6. Filter losses were only considered in the spurious frequency bands and the authorized band was not corrected for High Pass Filter losses.
 7. Proper operation of the transmitter prior to adding the filter to the measurement chain.
 8. Since non-restricted band peak emissions are less than the average limit, they also comply with the -27dBm/MHz (68.2dBuV/m) limit.

UNII-2A BAND

HARMONICS AND SPURIOUS EMISSIONS (LOW CHANNEL, HORIZONTAL)

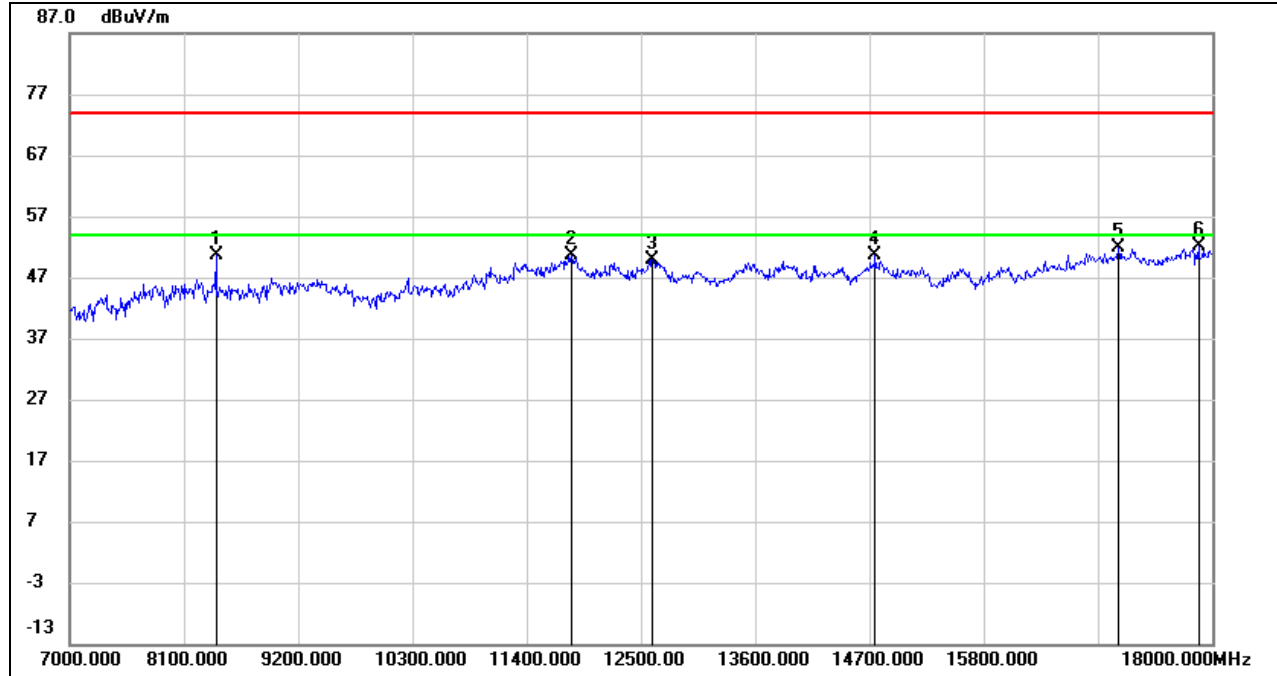

| No. | Frequency (MHz) | Reading (dBuV) | Correct (dB/m) | Result (dBuV/m) | Limit (dBuV/m) | Margin (dB) | Remark |
|-----|-----------------|----------------|----------------|-----------------|----------------|-------------|--------|
| 1 | 8408.000 | 41.95 | 8.59 | 50.54 | 74.00 | -23.46 | peak |
| 2 | 11829.000 | 34.97 | 15.57 | 50.54 | 74.00 | -23.46 | peak |
| 3 | 12610.000 | 34.62 | 15.30 | 49.92 | 74.00 | -24.08 | peak |
| 4 | 14755.000 | 33.83 | 16.72 | 50.55 | 74.00 | -23.45 | peak |
| 5 | 17098.000 | 31.15 | 20.63 | 51.78 | 74.00 | -22.22 | peak |
| 6 | 17868.000 | 29.35 | 22.71 | 52.06 | 74.00 | -21.94 | peak |

- Note: 1. Measurement = Reading Level + Correct Factor.
 2. If Peak Result complies with AV limit, AV Result is deemed to comply with AV limit.
 3. Peak: Peak detector.
 4. Filter losses were only considered in the spurious frequency bands and the authorized band was not corrected for High Pass Filter losses.
 5. Proper operation of the transmitter prior to adding the filter to the measurement chain.
 6. Since non-restricted band peak emissions are less than the average limit, they also comply with the -27dBm/MHz (68.2dBuV/m) limit.



HARMONICS AND SPURIOUS EMISSIONS (LOW CHANNEL, VERTICAL)

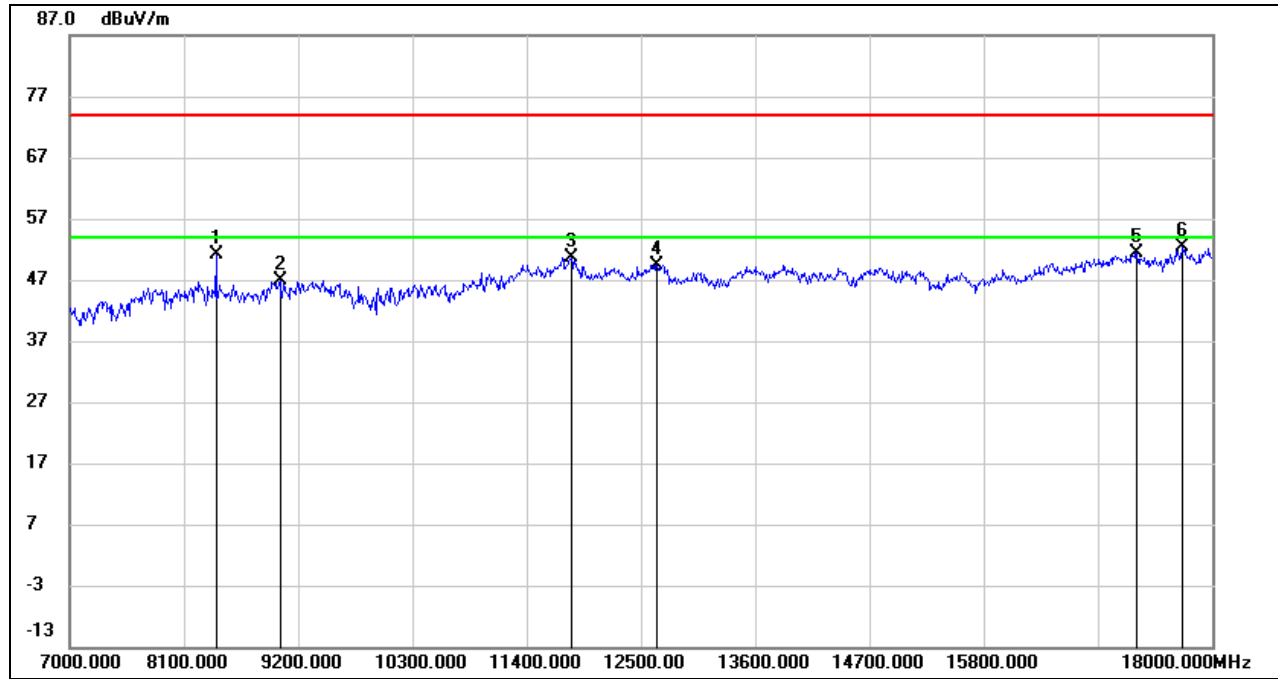

| No. | Frequency (MHz) | Reading (dBuV) | Correct (dB/m) | Result (dBuV/m) | Limit (dBuV/m) | Margin (dB) | Remark |
|-----|-----------------|----------------|----------------|-----------------|----------------|-------------|--------|
| 1 | 8408.000 | 42.49 | 8.59 | 51.08 | 74.00 | -22.92 | peak |
| 2 | 9024.000 | 36.50 | 10.47 | 46.97 | 74.00 | -27.03 | peak |
| 3 | 11829.000 | 35.01 | 15.57 | 50.58 | 74.00 | -23.42 | peak |
| 4 | 12654.000 | 34.12 | 15.38 | 49.50 | 74.00 | -24.50 | peak |
| 5 | 17274.000 | 30.48 | 20.93 | 51.41 | 74.00 | -22.59 | peak |
| 6 | 17714.000 | 30.45 | 22.04 | 52.49 | 74.00 | -21.51 | peak |

- Note:
1. Measurement = Reading Level + Correct Factor.
 2. If Peak Result complies with AV limit, AV Result is deemed to comply with AV limit.
 3. Peak: Peak detector.
 4. AVG: VBW=1/Ton, where: Ton is the transmitting duration.
 5. For the transmitting duration, please refer to clause 7.1.
 6. Filter losses were only considered in the spurious frequency bands and the authorized band was not corrected for High Pass Filter losses.
 7. Proper operation of the transmitter prior to adding the filter to the measurement chain.
 8. Since non-restricted band peak emissions are less than the average limit, they also comply with the -27dBm/MHz (68.2dBuV/m) limit.

HARMONICS AND SPURIOUS EMISSIONS (MID CHANNEL, HORIZONTAL)

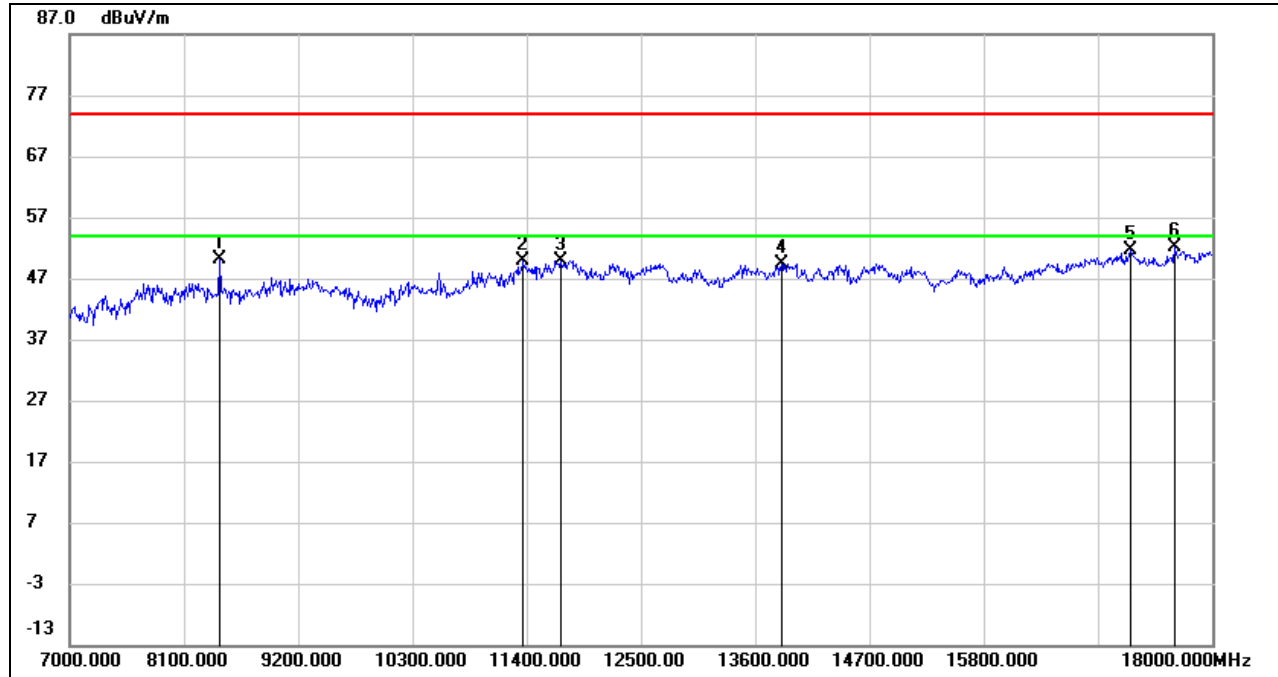

| No. | Frequency (MHz) | Reading (dBuV) | Correct (dB/m) | Result (dBuV/m) | Limit (dBuV/m) | Margin (dB) | Remark |
|-----|-----------------|----------------|----------------|-----------------|----------------|-------------|--------|
| 1 | 8441.000 | 41.56 | 8.56 | 50.12 | 74.00 | -23.88 | peak |
| 2 | 11367.000 | 35.66 | 14.11 | 49.77 | 74.00 | -24.23 | peak |
| 3 | 11730.000 | 34.72 | 15.23 | 49.95 | 74.00 | -24.05 | peak |
| 4 | 13853.000 | 32.54 | 16.93 | 49.47 | 74.00 | -24.53 | peak |
| 5 | 17219.000 | 30.68 | 21.01 | 51.69 | 74.00 | -22.31 | peak |
| 6 | 17637.000 | 30.63 | 21.46 | 52.09 | 74.00 | -21.91 | peak |

Note: 1. Measurement = Reading Level + Correct Factor.
 2. If Peak Result complies with AV limit, AV Result is deemed to comply with AV limit.
 3. Peak: Peak detector.
 4. Filter losses were only considered in the spurious frequency bands and the authorized band was not corrected for High Pass Filter losses.
 5. Proper operation of the transmitter prior to adding the filter to the measurement chain.
 6. Since non-restricted band peak emissions are less than the average limit, they also comply with the -27dBm/MHz (68.2dBuV/m) limit.

HARMONICS AND SPURIOUS EMISSIONS (MID CHANNEL, VERTICAL)

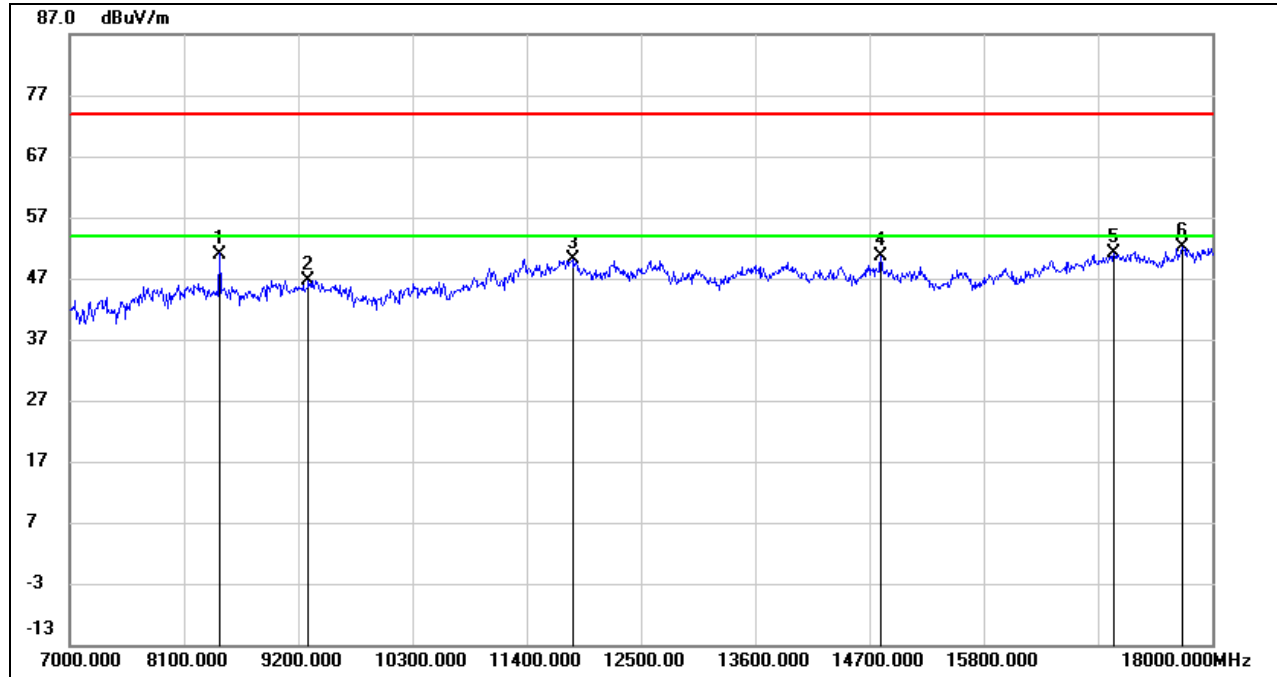

| No. | Frequency (MHz) | Reading (dBuV) | Correct (dB/m) | Result (dBuV/m) | Limit (dBuV/m) | Margin (dB) | Remark |
|-----|-----------------|----------------|----------------|-----------------|----------------|-------------|--------|
| 1 | 8441.000 | 42.44 | 8.56 | 51.00 | 74.00 | -23.00 | peak |
| 2 | 9299.000 | 36.95 | 9.80 | 46.75 | 74.00 | -27.25 | peak |
| 3 | 11840.000 | 34.56 | 15.56 | 50.12 | 74.00 | -23.88 | peak |
| 4 | 14810.000 | 33.72 | 16.80 | 50.52 | 74.00 | -23.48 | peak |
| 5 | 17054.000 | 30.77 | 20.45 | 51.22 | 74.00 | -22.78 | peak |
| 6 | 17714.000 | 30.10 | 22.04 | 52.14 | 74.00 | -21.86 | peak |

- Note:
1. Measurement = Reading Level + Correct Factor.
 2. If Peak Result complies with AV limit, AV Result is deemed to comply with AV limit.
 3. Peak: Peak detector.
 4. AVG: $VBW=1/Ton$, where: Ton is the transmitting duration.
 5. For the transmitting duration, please refer to clause 7.1.
 6. Filter losses were only considered in the spurious frequency bands and the authorized band was not corrected for High Pass Filter losses.
 7. Proper operation of the transmitter prior to adding the filter to the measurement chain.
 8. Since non-restricted band peak emissions are less than the average limit, they also comply with the -27dBm/MHz (68.2dBuV/m) limit.



HARMONICS AND SPURIOUS EMISSIONS (HIGH CHANNEL, HORIZONTAL)

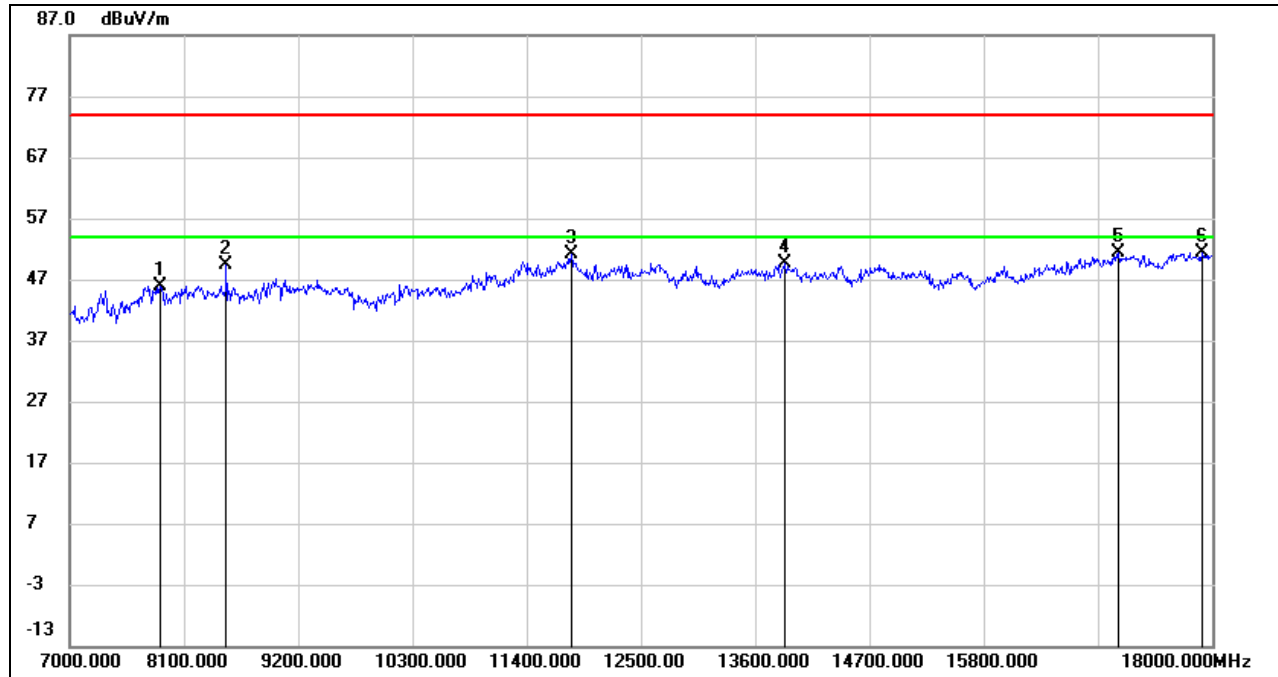

| No. | Frequency (MHz) | Reading (dBuV) | Correct (dB/m) | Result (dBuV/m) | Limit (dBuV/m) | Margin (dB) | Remark |
|-----|-----------------|----------------|----------------|-----------------|----------------|-------------|--------|
| 1 | 7869.000 | 37.78 | 8.05 | 45.83 | 74.00 | -28.17 | peak |
| 2 | 8507.000 | 40.93 | 8.54 | 49.47 | 74.00 | -24.53 | peak |
| 3 | 11829.000 | 35.51 | 15.57 | 51.08 | 74.00 | -22.92 | peak |
| 4 | 13886.000 | 32.62 | 16.91 | 49.53 | 74.00 | -24.47 | peak |
| 5 | 17098.000 | 30.65 | 20.63 | 51.28 | 74.00 | -22.72 | peak |
| 6 | 17901.000 | 28.76 | 22.69 | 51.45 | 74.00 | -22.55 | peak |

Note: 1. Measurement = Reading Level + Correct Factor.
 2. If Peak Result complies with AV limit, AV Result is deemed to comply with AV limit.
 3. Peak: Peak detector.
 4. Filter losses were only considered in the spurious frequency bands and the authorized band was not corrected for High Pass Filter losses.
 5. Proper operation of the transmitter prior to adding the filter to the measurement chain.
 6. Since non-restricted band peak emissions are less than the average limit, they also comply with the -27dBm/MHz (68.2dBuV/m) limit.

HARMONICS AND SPURIOUS EMISSIONS (HIGH CHANNEL, VERTICAL)

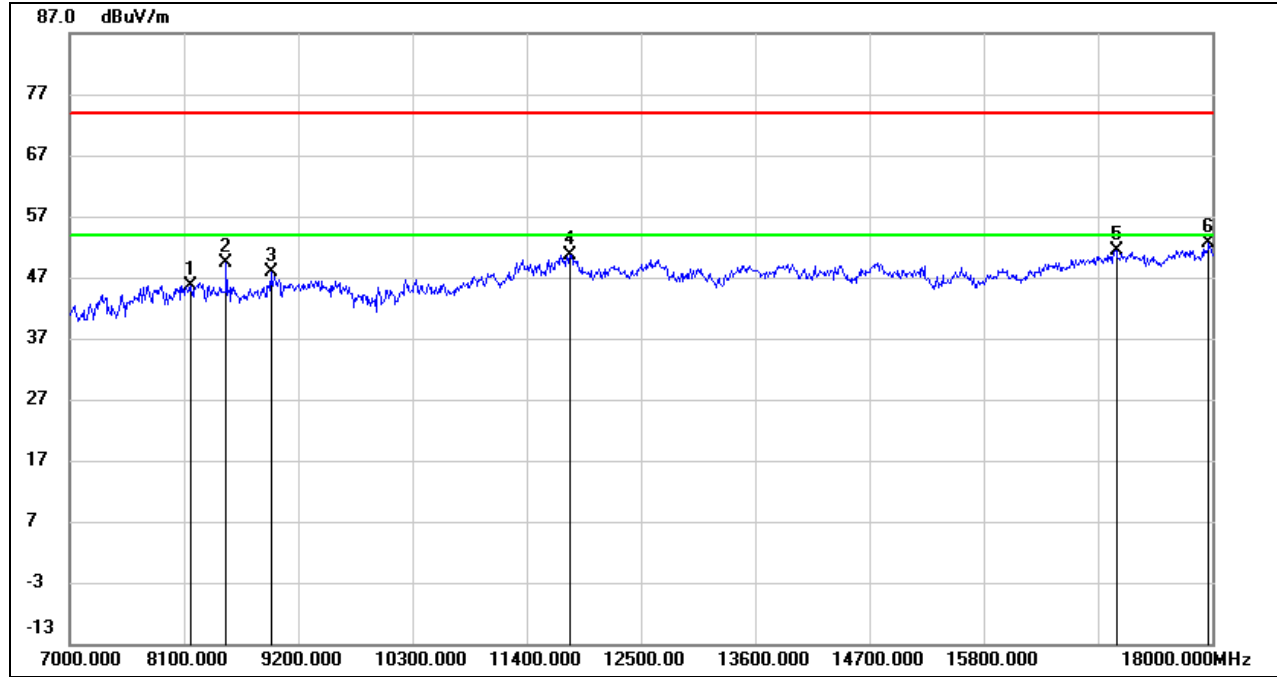

| No. | Frequency (MHz) | Reading (dBuV) | Correct (dB/m) | Result (dBuV/m) | Limit (dBuV/m) | Margin (dB) | Remark |
|-----|-----------------|----------------|----------------|-----------------|----------------|-------------|--------|
| 1 | 8166.000 | 36.64 | 9.07 | 45.71 | 74.00 | -28.29 | peak |
| 2 | 8507.000 | 40.82 | 8.54 | 49.36 | 74.00 | -24.64 | peak |
| 3 | 8936.000 | 37.95 | 9.96 | 47.91 | 74.00 | -26.09 | peak |
| 4 | 11818.000 | 35.07 | 15.58 | 50.65 | 74.00 | -23.35 | peak |
| 5 | 17076.000 | 30.78 | 20.54 | 51.32 | 74.00 | -22.68 | peak |
| 6 | 17967.000 | 29.86 | 22.67 | 52.53 | 74.00 | -21.47 | peak |

- Note:
1. Measurement = Reading Level + Correct Factor.
 2. If Peak Result complies with AV limit, AV Result is deemed to comply with AV limit.
 3. Peak: Peak detector.
 4. AVG: $VBW=1/Ton$, where: Ton is the transmitting duration.
 5. For the transmitting duration, please refer to clause 7.1.
 6. Filter losses were only considered in the spurious frequency bands and the authorized band was not corrected for High Pass Filter losses.
 7. Proper operation of the transmitter prior to adding the filter to the measurement chain.
 8. Since non-restricted band peak emissions are less than the average limit, they also comply with the -27dBm/MHz (68.2dBuV/m) limit.

UNII-2C BAND

HARMONICS AND SPURIOUS EMISSIONS (LOW CHANNEL, HORIZONTAL)

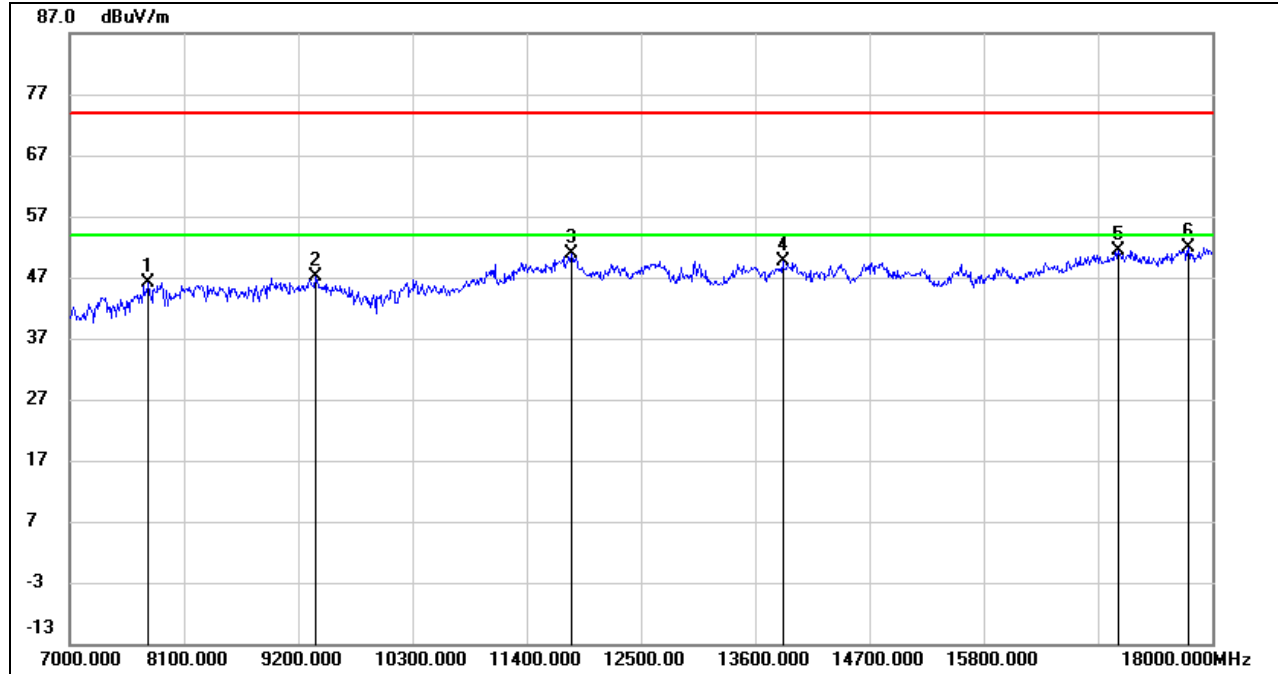

| No. | Frequency (MHz) | Reading (dBuV) | Correct (dB/m) | Result (dBuV/m) | Limit (dBuV/m) | Margin (dB) | Remark |
|-----|-----------------|----------------|----------------|-----------------|----------------|-------------|--------|
| 1 | 7759.000 | 38.04 | 8.09 | 46.13 | 74.00 | -27.87 | peak |
| 2 | 9365.000 | 37.00 | 10.13 | 47.13 | 74.00 | -26.87 | peak |
| 3 | 11829.000 | 35.36 | 15.57 | 50.93 | 74.00 | -23.07 | peak |
| 4 | 13864.000 | 32.71 | 16.92 | 49.63 | 74.00 | -24.37 | peak |
| 5 | 17098.000 | 30.67 | 20.63 | 51.30 | 74.00 | -22.70 | peak |
| 6 | 17769.000 | 29.42 | 22.48 | 51.90 | 74.00 | -22.10 | peak |

Note: 1. Measurement = Reading Level + Correct Factor.
 2. If Peak Result complies with AV limit, AV Result is deemed to comply with AV limit.
 3. Peak: Peak detector.
 4. Filter losses were only considered in the spurious frequency bands and the authorized band was not corrected for High Pass Filter losses.
 5. Proper operation of the transmitter prior to adding the filter to the measurement chain.
 6. Since non-restricted band peak emissions are less than the average limit, they also comply with the -27dBm/MHz (68.2dBuV/m) limit.



HARMONICS AND SPURIOUS EMISSIONS (LOW CHANNEL, VERTICAL)

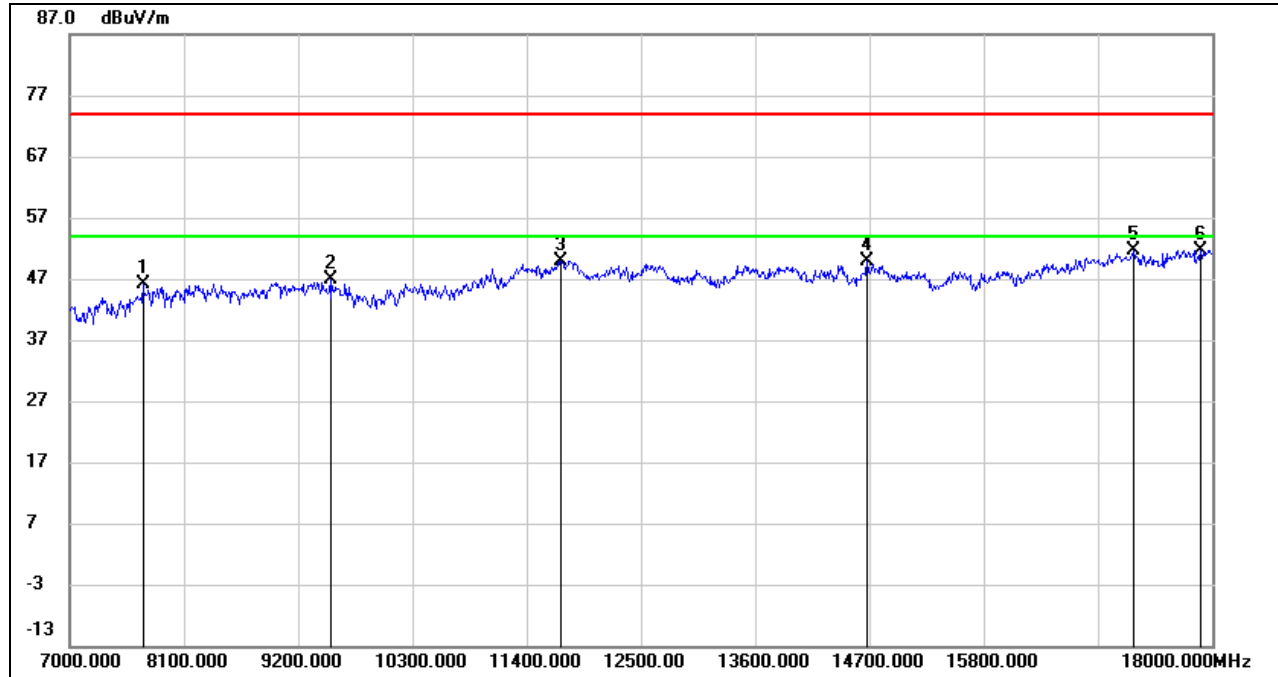

| No. | Frequency (MHz) | Reading (dBuV) | Correct (dB/m) | Result (dBuV/m) | Limit (dBuV/m) | Margin (dB) | Remark |
|-----|-----------------|----------------|----------------|-----------------|----------------|-------------|--------|
| 1 | 7704.000 | 38.21 | 7.87 | 46.08 | 74.00 | -27.92 | peak |
| 2 | 9508.000 | 36.47 | 10.45 | 46.92 | 74.00 | -27.08 | peak |
| 3 | 11730.000 | 34.69 | 15.23 | 49.92 | 74.00 | -24.08 | peak |
| 4 | 14678.000 | 33.27 | 16.59 | 49.86 | 74.00 | -24.14 | peak |
| 5 | 17241.000 | 30.59 | 20.97 | 51.56 | 74.00 | -22.44 | peak |
| 6 | 17890.000 | 29.04 | 22.70 | 51.74 | 74.00 | -22.26 | peak |

Note: 1. Measurement = Reading Level + Correct Factor.
 2. If Peak Result complies with AV limit, AV Result is deemed to comply with AV limit.
 3. Peak: Peak detector.
 4. Filter losses were only considered in the spurious frequency bands and the authorized band was not corrected for High Pass Filter losses.
 5. Proper operation of the transmitter prior to adding the filter to the measurement chain.
 6. Since non-restricted band peak emissions are less than the average limit, they also comply with the -27dBm/MHz (68.2dBuV/m) limit.

HARMONICS AND SPURIOUS EMISSIONS (MID CHANNEL, HORIZONTAL)

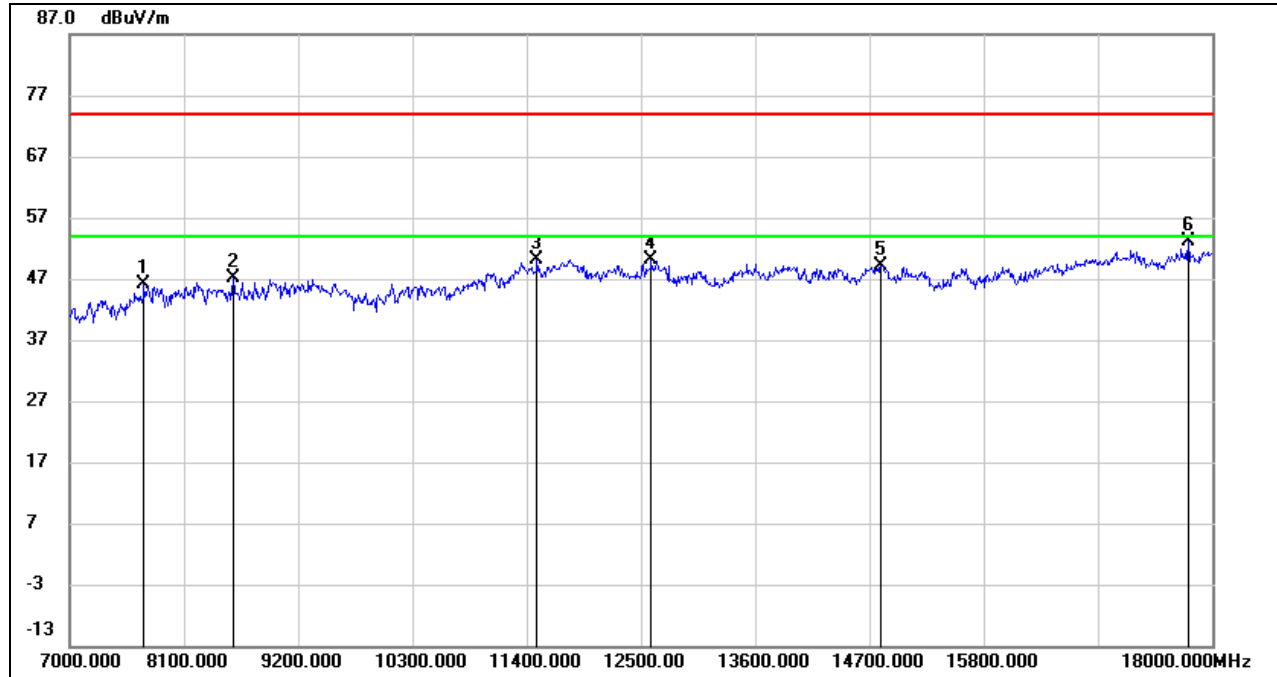

| No. | Frequency (MHz) | Reading (dBuV) | Correct (dB/m) | Result (dBuV/m) | Limit (dBuV/m) | Margin (dB) | Remark |
|-----|-----------------|----------------|----------------|-----------------|----------------|-------------|--------|
| 1 | 7715.000 | 38.10 | 7.92 | 46.02 | 74.00 | -27.98 | peak |
| 2 | 8573.000 | 38.47 | 8.55 | 47.02 | 74.00 | -26.98 | peak |
| 3 | 11499.000 | 35.81 | 14.36 | 50.17 | 74.00 | -23.83 | peak |
| 4 | 12599.000 | 34.84 | 15.29 | 50.13 | 74.00 | -23.87 | peak |
| 5 | 14810.000 | 32.43 | 16.80 | 49.23 | 74.00 | -24.77 | peak |
| 6 | 17769.000 | 30.64 | 22.48 | 53.12 | 74.00 | -20.88 | peak |

Note: 1. Measurement = Reading Level + Correct Factor.
 2. If Peak Result complies with AV limit, AV Result is deemed to comply with AV limit.
 3. Peak: Peak detector.
 4. Filter losses were only considered in the spurious frequency bands and the authorized band was not corrected for High Pass Filter losses.
 5. Proper operation of the transmitter prior to adding the filter to the measurement chain.
 6. Since non-restricted band peak emissions are less than the average limit, they also comply with the -27dBm/MHz (68.2dBuV/m) limit.

HARMONICS AND SPURIOUS EMISSIONS (MID CHANNEL, VERTICAL)

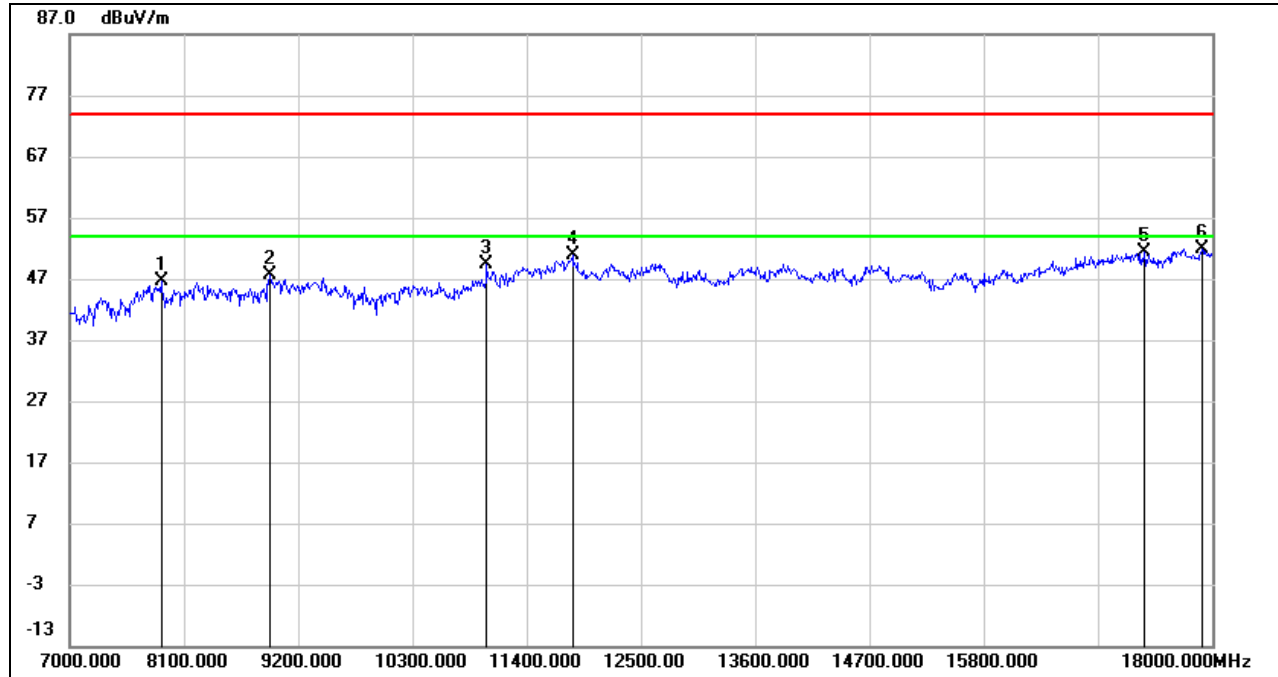

| No. | Frequency (MHz) | Reading (dBuV) | Correct (dB/m) | Result (dBuV/m) | Limit (dBuV/m) | Margin (dB) | Remark |
|-----|-----------------|----------------|----------------|-----------------|----------------|-------------|--------|
| 1 | 7880.000 | 38.54 | 8.01 | 46.55 | 74.00 | -27.45 | peak |
| 2 | 8925.000 | 37.83 | 9.84 | 47.67 | 74.00 | -26.33 | peak |
| 3 | 11015.000 | 36.16 | 13.29 | 49.45 | 74.00 | -24.55 | peak |
| 4 | 11840.000 | 35.34 | 15.56 | 50.90 | 74.00 | -23.10 | peak |
| 5 | 17351.000 | 30.50 | 20.81 | 51.31 | 74.00 | -22.69 | peak |
| 6 | 17901.000 | 29.27 | 22.69 | 51.96 | 74.00 | -22.04 | peak |

Note: 1. Measurement = Reading Level + Correct Factor.
 2. If Peak Result complies with AV limit, AV Result is deemed to comply with AV limit.
 3. Peak: Peak detector.
 4. Filter losses were only considered in the spurious frequency bands and the authorized band was not corrected for High Pass Filter losses.
 5. Proper operation of the transmitter prior to adding the filter to the measurement chain.
 6. Since non-restricted band peak emissions are less than the average limit, they also comply with the -27dBm/MHz (68.2dBuV/m) limit.



HARMONICS AND SPURIOUS EMISSIONS (HIGH CHANNEL, HORIZONTAL)

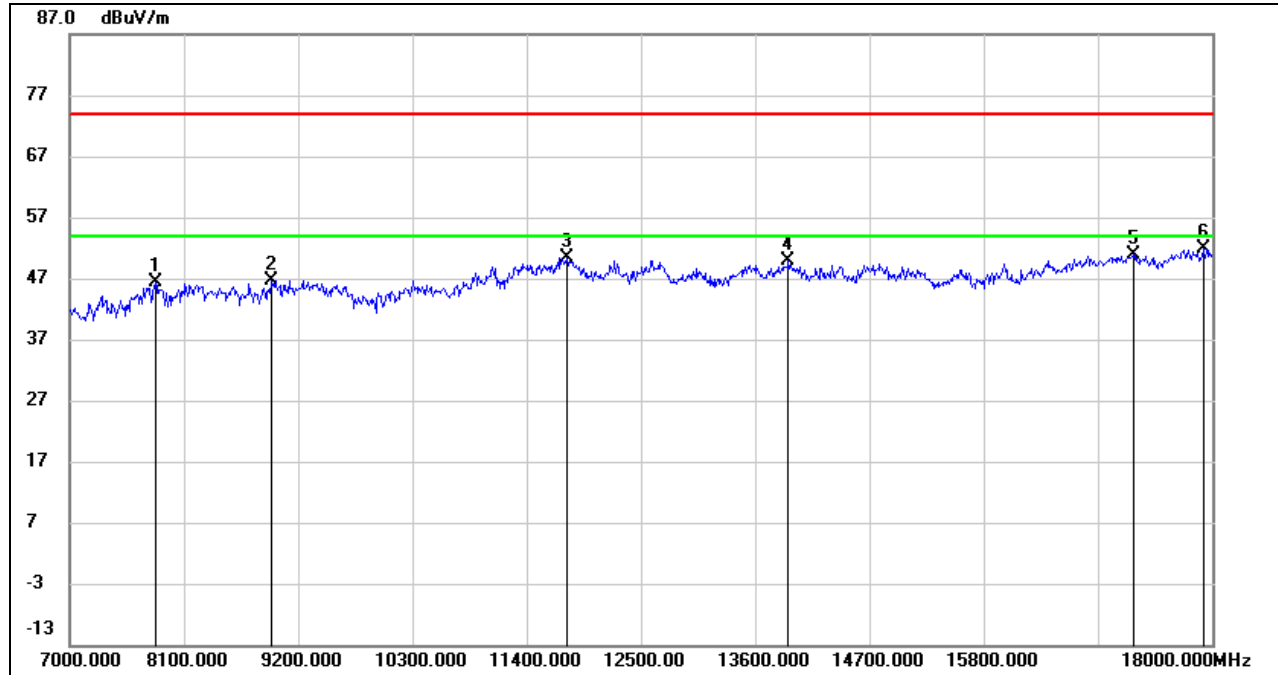

| No. | Frequency (MHz) | Reading (dBuV) | Correct (dB/m) | Result (dBuV/m) | Limit (dBuV/m) | Margin (dB) | Remark |
|-----|-----------------|----------------|----------------|-----------------|----------------|-------------|--------|
| 1 | 7825.000 | 38.17 | 8.18 | 46.35 | 74.00 | -27.65 | peak |
| 2 | 8947.000 | 36.59 | 10.07 | 46.66 | 74.00 | -27.34 | peak |
| 3 | 11785.000 | 34.93 | 15.52 | 50.45 | 74.00 | -23.55 | peak |
| 4 | 13919.000 | 32.90 | 16.89 | 49.79 | 74.00 | -24.21 | peak |
| 5 | 17241.000 | 29.98 | 20.97 | 50.95 | 74.00 | -23.05 | peak |
| 6 | 17923.000 | 29.16 | 22.69 | 51.85 | 74.00 | -22.15 | peak |

- Note: 1. Measurement = Reading Level + Correct Factor.
 2. If Peak Result complies with AV limit, AV Result is deemed to comply with AV limit.
 3. Peak: Peak detector.
 4. Filter losses were only considered in the spurious frequency bands and the authorized band was not corrected for High Pass Filter losses.
 5. Proper operation of the transmitter prior to adding the filter to the measurement chain.
 6. Since non-restricted band peak emissions are less than the average limit, they also comply with the -27dBm/MHz (68.2dBuV/m) limit.



HARMONICS AND SPURIOUS EMISSIONS (HIGH CHANNEL, VERTICAL)

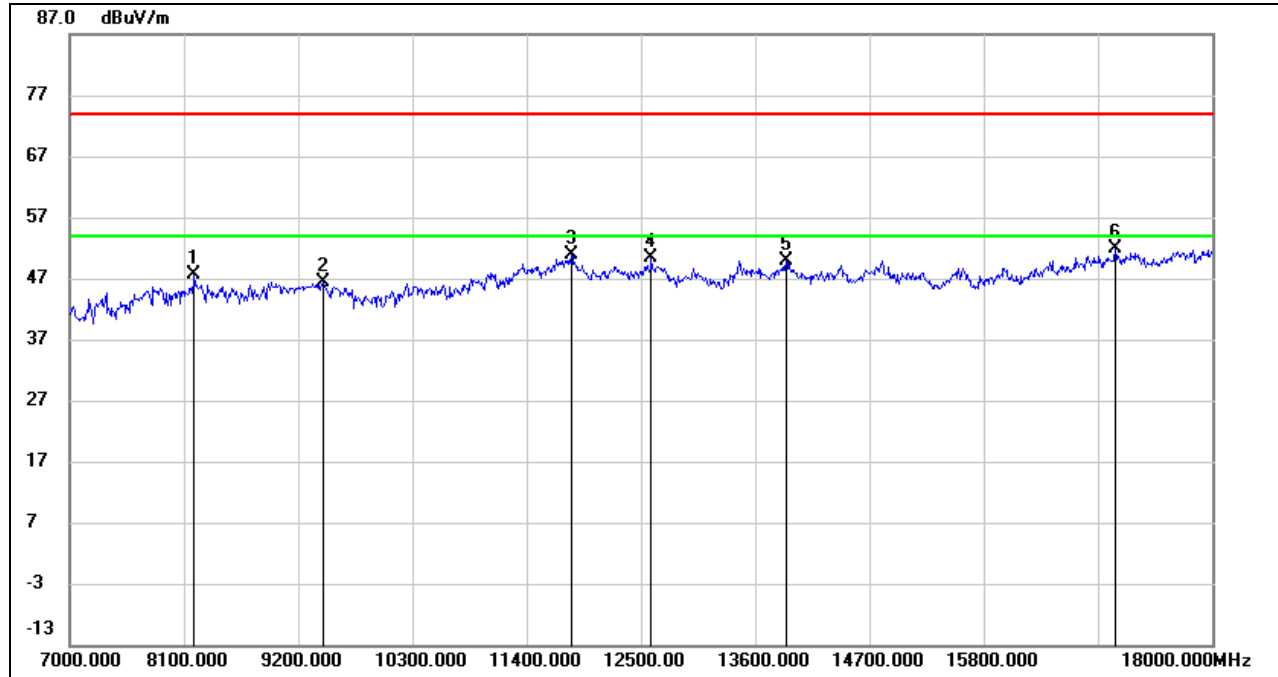

| No. | Frequency (MHz) | Reading (dBuV) | Correct (dB/m) | Result (dBuV/m) | Limit (dBuV/m) | Margin (dB) | Remark |
|-----|-----------------|----------------|----------------|-----------------|----------------|-------------|--------|
| 1 | 8199.000 | 38.18 | 9.35 | 47.53 | 74.00 | -26.47 | peak |
| 2 | 9442.000 | 36.05 | 10.37 | 46.42 | 74.00 | -27.58 | peak |
| 3 | 11829.000 | 35.22 | 15.57 | 50.79 | 74.00 | -23.21 | peak |
| 4 | 12599.000 | 35.01 | 15.29 | 50.30 | 74.00 | -23.70 | peak |
| 5 | 13897.000 | 33.09 | 16.90 | 49.99 | 74.00 | -24.01 | peak |
| 6 | 17065.000 | 31.27 | 20.49 | 51.76 | 74.00 | -22.24 | peak |

- Note:
1. Measurement = Reading Level + Correct Factor.
 2. If Peak Result complies with AV limit, AV Result is deemed to comply with AV limit.
 3. Peak: Peak detector.
 4. AVG: $VBW=1/Ton$, where: Ton is the transmitting duration.
 5. For the transmitting duration, please refer to clause 7.1.
 6. Filter losses were only considered in the spurious frequency bands and the authorized band was not corrected for High Pass Filter losses.
 7. Proper operation of the transmitter prior to adding the filter to the measurement chain.
 8. Since non-restricted band peak emissions are less than the average limit, they also comply with the -27dBm/MHz (68.2dBuV/m) limit.

STRADDLE CHANNEL 144

HARMONICS AND SPURIOUS EMISSIONS (HORIZONTAL)

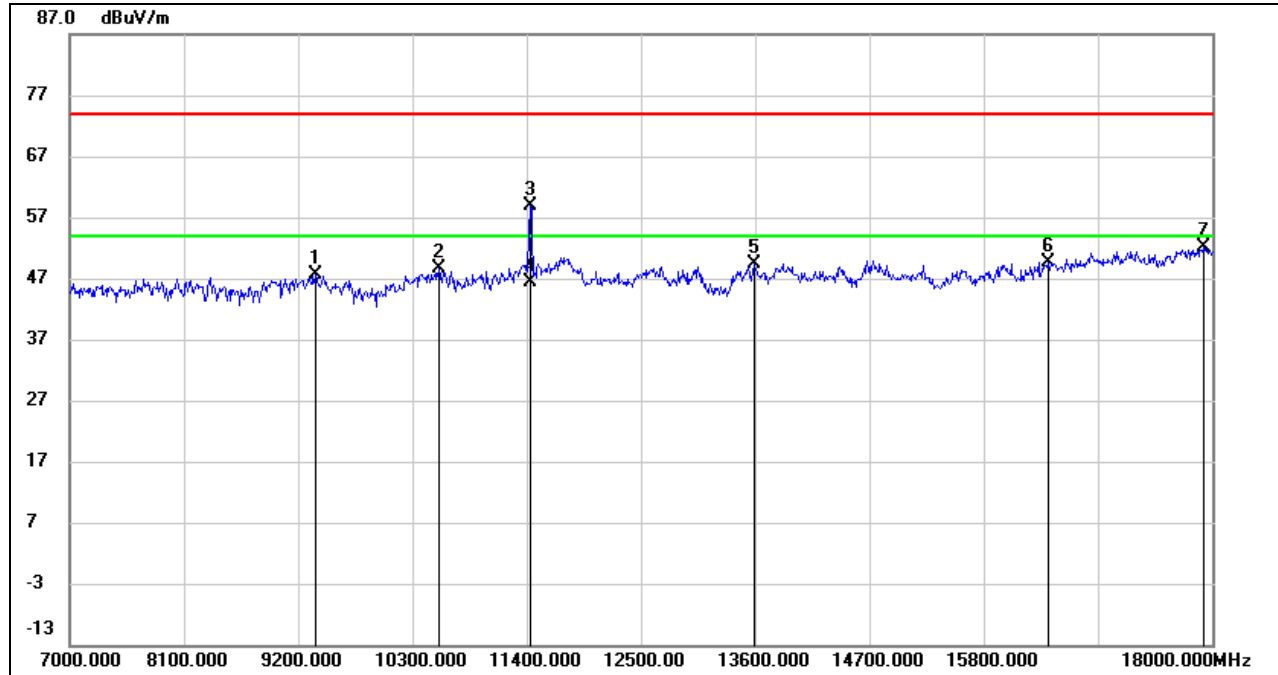

| No. | Frequency (MHz) | Reading (dBuV) | Correct (dB/m) | Result (dBuV/m) | Limit (dBuV/m) | Margin (dB) | Remark |
|-----|-----------------|----------------|----------------|-----------------|----------------|-------------|--------|
| 1 | 9365.000 | 37.57 | 10.13 | 47.70 | 74.00 | -26.30 | peak |
| 2 | 10553.000 | 36.55 | 12.17 | 48.72 | 74.00 | -25.28 | peak |
| 3 | 11433.000 | 44.56 | 14.27 | 58.83 | 74.00 | -15.17 | peak |
| 4 | 11433.000 | 32.15 | 14.27 | 46.42 | 54.00 | -7.58 | AVG |
| 5 | 13589.000 | 32.90 | 16.42 | 49.32 | 74.00 | -24.68 | peak |
| 6 | 16416.000 | 30.95 | 18.77 | 49.72 | 74.00 | -24.28 | peak |
| 7 | 17912.000 | 29.45 | 22.69 | 52.14 | 74.00 | -21.86 | peak |

- Note: 1. Measurement = Reading Level + Correct Factor.
 2. If Peak Result complies with AV limit, AV Result is deemed to comply with AV limit.
 3. Peak: Peak detector.
 4. Filter losses were only considered in the spurious frequency bands and the authorized band was not corrected for High Pass Filter losses.
 5. Proper operation of the transmitter prior to adding the filter to the measurement chain.
 6. Since non-restricted band peak emissions are less than the average limit, they also comply with the -27dBm/MHz (68.2dBuV/m) limit.

HARMONICS AND SPURIOUS EMISSIONS (VERTICAL)

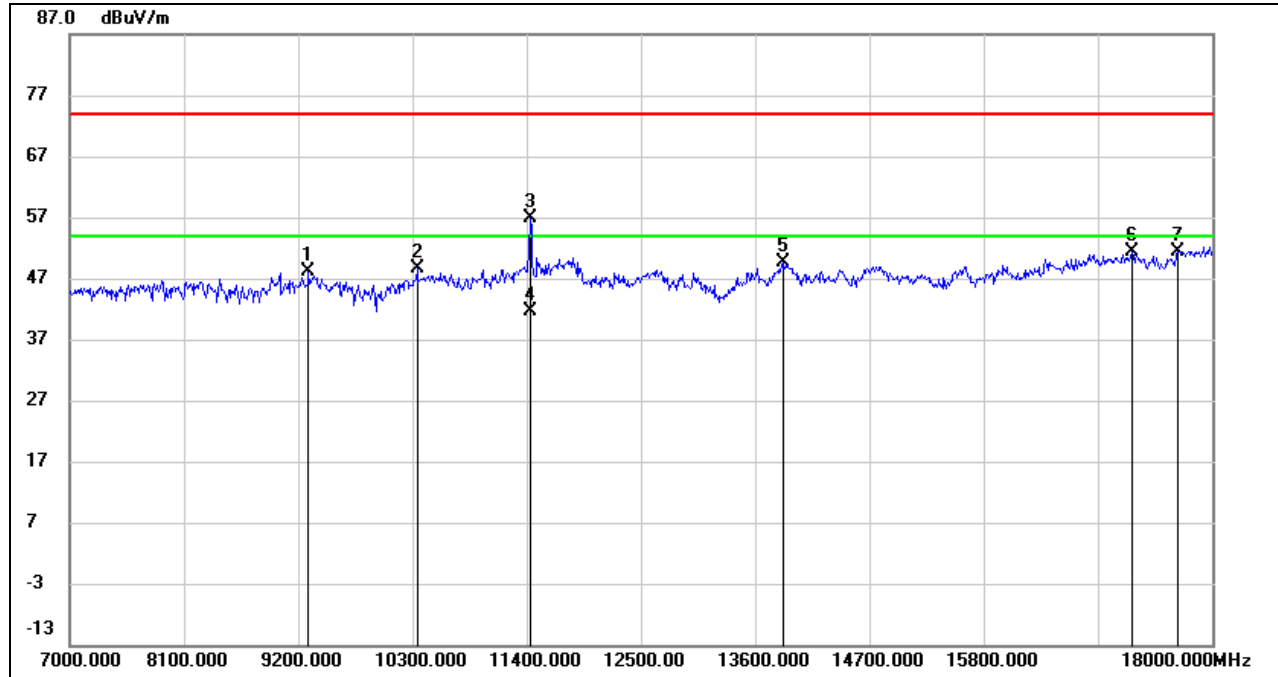

| No. | Frequency (MHz) | Reading (dBuV) | Correct (dB/m) | Result (dBuV/m) | Limit (dBuV/m) | Margin (dB) | Remark |
|-----|-----------------|----------------|----------------|-----------------|----------------|-------------|--------|
| 1 | 9299.000 | 38.39 | 9.80 | 48.19 | 74.00 | -25.81 | peak |
| 2 | 10344.000 | 37.38 | 11.25 | 48.63 | 74.00 | -25.37 | peak |
| 3 | 11433.000 | 42.55 | 14.27 | 56.82 | 74.00 | -17.18 | peak |
| 4 | 11433.000 | 27.38 | 14.27 | 41.65 | 54.00 | -12.35 | AVG |
| 5 | 13875.000 | 32.77 | 16.92 | 49.69 | 74.00 | -24.31 | peak |
| 6 | 17230.000 | 30.32 | 20.99 | 51.31 | 74.00 | -22.69 | peak |
| 7 | 17670.000 | 29.70 | 21.70 | 51.40 | 74.00 | -22.60 | peak |

Note: 1. Measurement = Reading Level + Correct Factor.
 2. If Peak Result complies with AV limit, AV Result is deemed to comply with AV limit.
 3. Peak: Peak detector.
 4. Filter losses were only considered in the spurious frequency bands and the authorized band was not corrected for High Pass Filter losses.
 5. Proper operation of the transmitter prior to adding the filter to the measurement chain.
 6. Since non-restricted band peak emissions are less than the average limit, they also comply with the -27dBm/MHz (68.2dBuV/m) limit.

UNII-3 BAND

HARMONICS AND SPURIOUS EMISSIONS (LOW CHANNEL, HORIZONTAL)

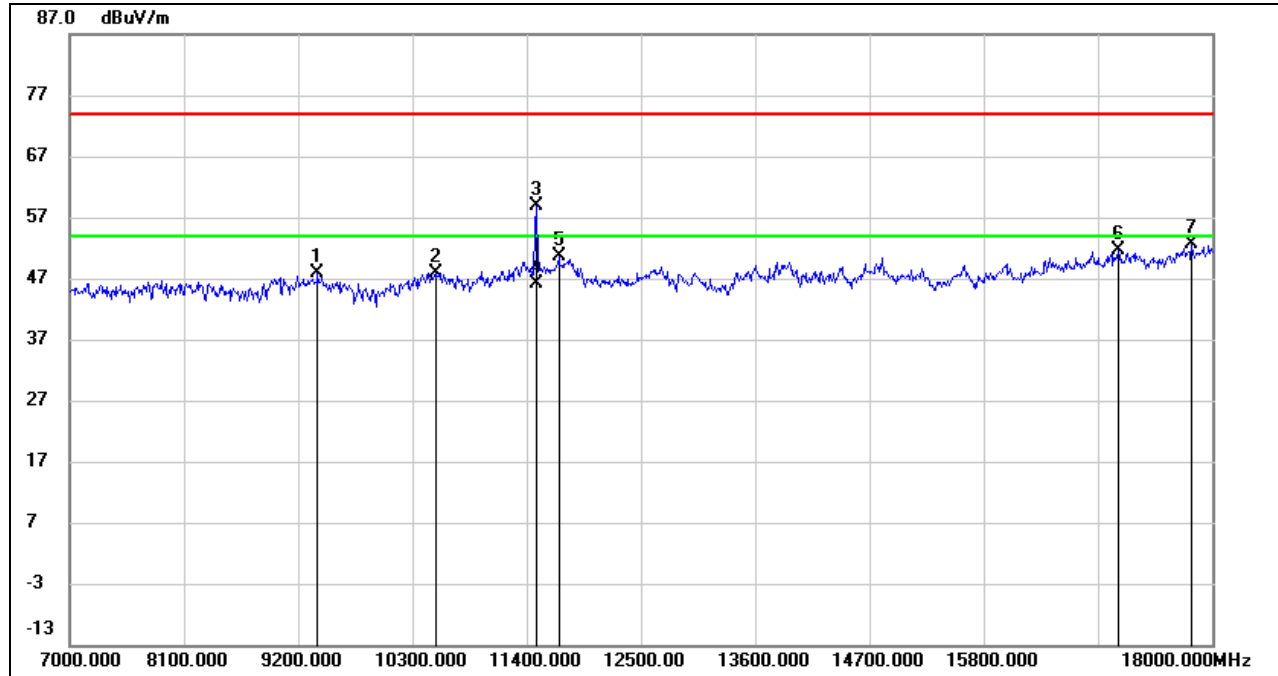

| No. | Frequency (MHz) | Reading (dBuV) | Correct (dB/m) | Result (dBuV/m) | Limit (dBuV/m) | Margin (dB) | Remark |
|-----|-----------------|----------------|----------------|-----------------|----------------|-------------|--------|
| 1 | 9387.000 | 37.54 | 10.24 | 47.78 | 74.00 | -26.22 | peak |
| 2 | 10520.000 | 35.95 | 12.04 | 47.99 | 74.00 | -26.01 | peak |
| 3 | 11488.000 | 44.50 | 14.34 | 58.84 | 74.00 | -15.16 | peak |
| 4 | 11488.000 | 31.81 | 14.34 | 46.15 | 54.00 | -7.85 | AVG |
| 5 | 11708.000 | 35.41 | 15.11 | 50.52 | 74.00 | -23.48 | peak |
| 6 | 17098.000 | 31.08 | 20.63 | 51.71 | 74.00 | -22.29 | peak |
| 7 | 17802.000 | 29.89 | 22.72 | 52.61 | 74.00 | -21.39 | peak |

Note: 1. Measurement = Reading Level + Correct Factor.
 2. If Peak Result complies with AV limit, AV Result is deemed to comply with AV limit.
 3. Peak: Peak detector.
 4. Filter losses were only considered in the spurious frequency bands and the authorized band was not corrected for High Pass Filter losses.
 5. Proper operation of the transmitter prior to adding the filter to the measurement chain.
 6. Since non-restricted band peak emissions are less than the average limit, they also comply with the -27dBm/MHz (68.2dBuV/m) limit.

HARMONICS AND SPURIOUS EMISSIONS (LOW CHANNEL, VERTICAL)

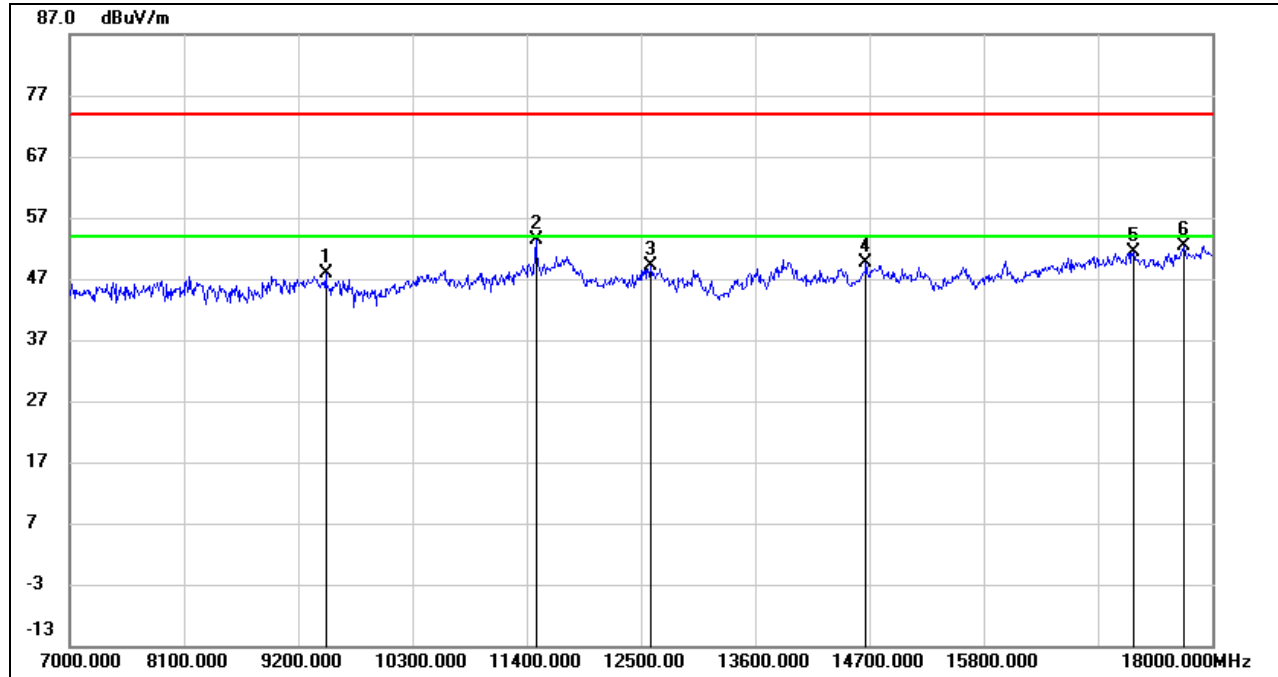

| No. | Frequency (MHz) | Reading (dBuV) | Correct (dB/m) | Result (dBuV/m) | Limit (dBuV/m) | Margin (dB) | Remark |
|-----|-----------------|----------------|----------------|-----------------|----------------|-------------|--------|
| 1 | 9464.000 | 37.43 | 10.40 | 47.83 | 74.00 | -26.17 | peak |
| 2 | 11488.000 | 39.02 | 14.34 | 53.36 | 74.00 | -20.64 | peak |
| 3 | 12599.000 | 33.92 | 15.29 | 49.21 | 74.00 | -24.79 | peak |
| 4 | 14667.000 | 33.05 | 16.57 | 49.62 | 74.00 | -24.38 | peak |
| 5 | 17241.000 | 30.30 | 20.97 | 51.27 | 74.00 | -22.73 | peak |
| 6 | 17725.000 | 30.32 | 22.13 | 52.45 | 74.00 | -21.55 | peak |

- Note:
1. Measurement = Reading Level + Correct Factor.
 2. If Peak Result complies with AV limit, AV Result is deemed to comply with AV limit.
 3. Peak: Peak detector.
 4. AVG: $VBW=1/Ton$, where: Ton is the transmitting duration.
 5. For the transmitting duration, please refer to clause 7.1.
 6. Filter losses were only considered in the spurious frequency bands and the authorized band was not corrected for High Pass Filter losses.
 7. Proper operation of the transmitter prior to adding the filter to the measurement chain.
 8. Since non-restricted band peak emissions are less than the average limit, they also comply with the -27dBm/MHz (68.2dBuV/m) limit.

HARMONICS AND SPURIOUS EMISSIONS (MID CHANNEL, HORIZONTAL)

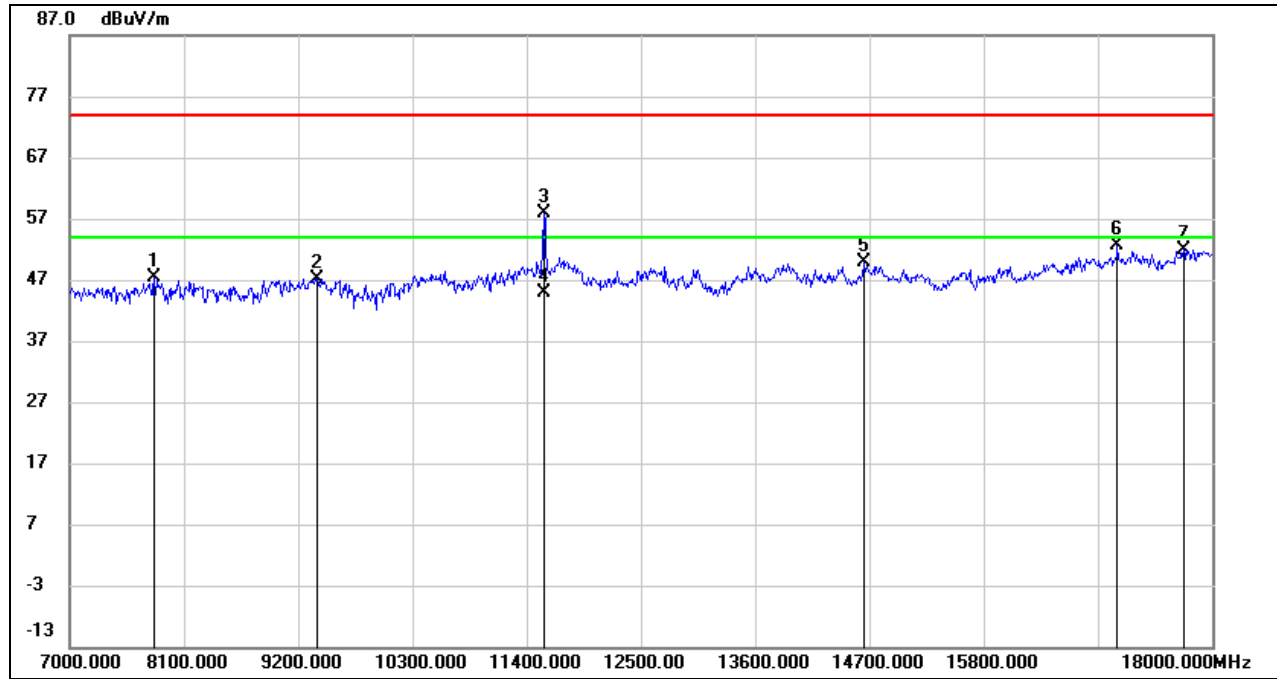

| No. | Frequency (MHz) | Reading (dBuV) | Correct (dB/m) | Result (dBuV/m) | Limit (dBuV/m) | Margin (dB) | Remark |
|-----|-----------------|----------------|----------------|-----------------|----------------|-------------|--------|
| 1 | 7814.000 | 39.06 | 8.21 | 47.27 | 74.00 | -26.73 | peak |
| 2 | 9376.000 | 36.94 | 10.19 | 47.13 | 74.00 | -26.87 | peak |
| 3 | 11565.000 | 43.40 | 14.45 | 57.85 | 74.00 | -16.15 | peak |
| 4 | 11565.000 | 30.31 | 14.45 | 44.76 | 54.00 | -9.24 | AVG |
| 5 | 14645.000 | 33.32 | 16.54 | 49.86 | 74.00 | -24.14 | peak |
| 6 | 17087.000 | 31.93 | 20.58 | 52.51 | 74.00 | -21.49 | peak |
| 7 | 17725.000 | 29.87 | 22.13 | 52.00 | 74.00 | -22.00 | peak |

Note: 1. Measurement = Reading Level + Correct Factor.
 2. If Peak Result complies with AV limit, AV Result is deemed to comply with AV limit.
 3. Peak: Peak detector.
 4. Filter losses were only considered in the spurious frequency bands and the authorized band was not corrected for High Pass Filter losses.
 5. Proper operation of the transmitter prior to adding the filter to the measurement chain.
 6. Since non-restricted band peak emissions are less than the average limit, they also comply with the -27dBm/MHz (68.2dBuV/m) limit.

HARMONICS AND SPURIOUS EMISSIONS (MID CHANNEL, VERTICAL)

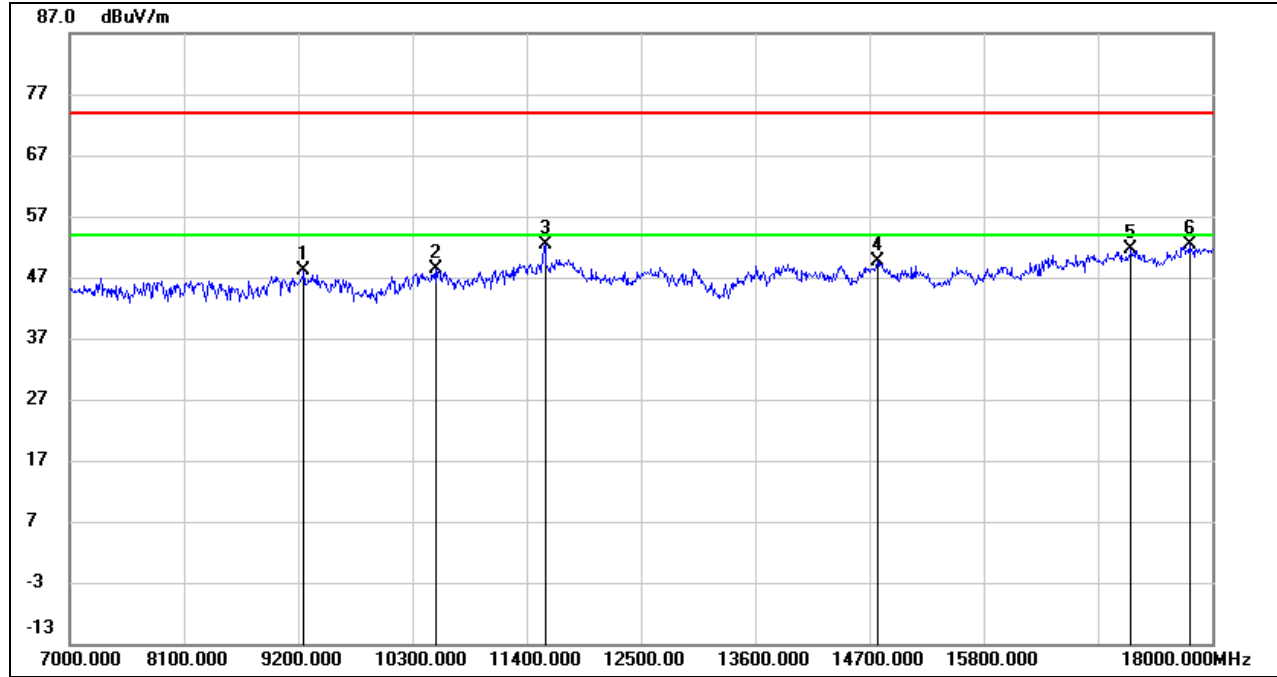

| No. | Frequency (MHz) | Reading (dBuV) | Correct (dB/m) | Result (dBuV/m) | Limit (dBuV/m) | Margin (dB) | Remark |
|-----|-----------------|----------------|----------------|-----------------|----------------|-------------|--------|
| 1 | 9255.000 | 38.69 | 9.56 | 48.25 | 74.00 | -25.75 | peak |
| 2 | 10520.000 | 36.45 | 12.04 | 48.49 | 74.00 | -25.51 | peak |
| 3 | 11576.000 | 37.91 | 14.48 | 52.39 | 74.00 | -21.61 | peak |
| 4 | 14777.000 | 32.96 | 16.76 | 49.72 | 74.00 | -24.28 | peak |
| 5 | 17219.000 | 30.56 | 21.01 | 51.57 | 74.00 | -22.43 | peak |
| 6 | 17780.000 | 29.81 | 22.57 | 52.38 | 74.00 | -21.62 | peak |

- Note:
1. Measurement = Reading Level + Correct Factor.
 2. If Peak Result complies with AV limit, AV Result is deemed to comply with AV limit.
 3. Peak: Peak detector.
 4. AVG: $VBW=1/Ton$, where: Ton is the transmitting duration.
 5. For the transmitting duration, please refer to clause 7.1.
 6. Filter losses were only considered in the spurious frequency bands and the authorized band was not corrected for High Pass Filter losses.
 7. Proper operation of the transmitter prior to adding the filter to the measurement chain.
 8. Since non-restricted band peak emissions are less than the average limit, they also comply with the -27dBm/MHz (68.2dBuV/m) limit.

HARMONICS AND SPURIOUS EMISSIONS (HIGH CHANNEL, HORIZONTAL)

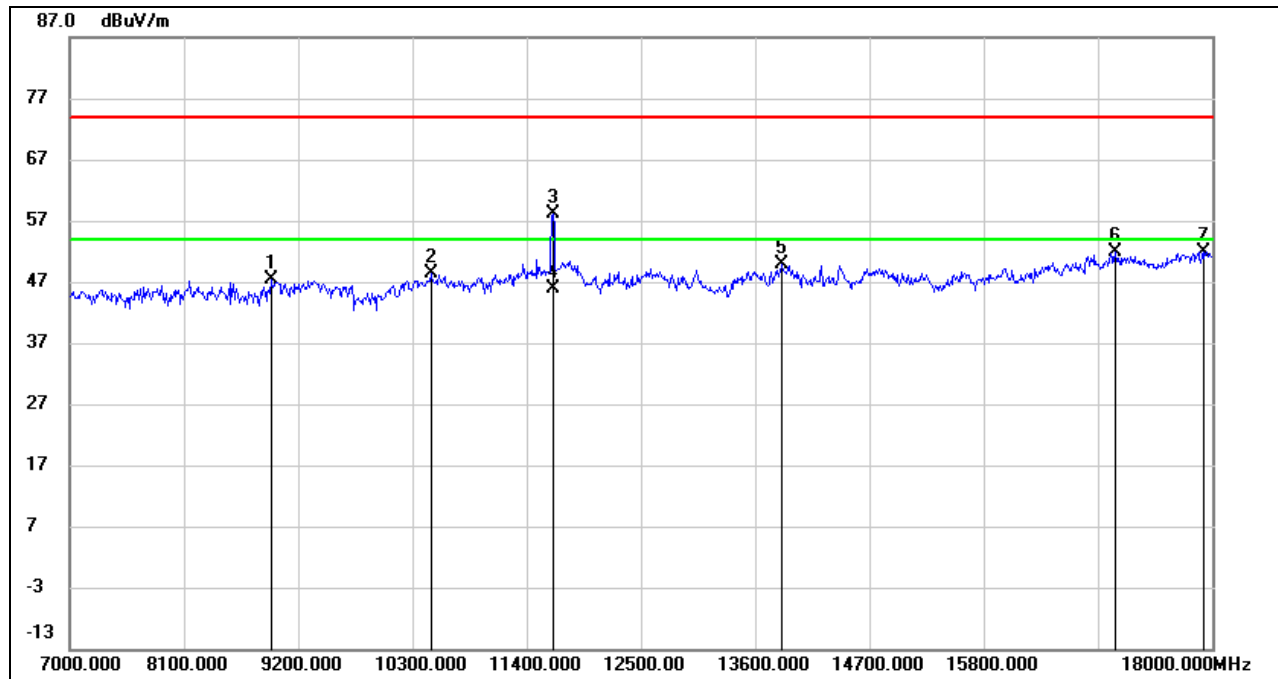

| No. | Frequency (MHz) | Reading (dBuV) | Correct (dB/m) | Result (dBuV/m) | Limit (dBuV/m) | Margin (dB) | Remark |
|-----|-----------------|----------------|----------------|-----------------|----------------|-------------|--------|
| 1 | 8936.000 | 37.51 | 9.96 | 47.47 | 74.00 | -26.53 | peak |
| 2 | 10476.000 | 36.59 | 11.83 | 48.42 | 74.00 | -25.58 | peak |
| 3 | 11653.000 | 43.45 | 14.80 | 58.25 | 74.00 | -15.75 | peak |
| 4 | 11653.000 | 30.96 | 14.80 | 45.76 | 54.00 | -8.24 | AVG |
| 5 | 13853.000 | 32.91 | 16.93 | 49.84 | 74.00 | -24.16 | peak |
| 6 | 17065.000 | 31.31 | 20.49 | 51.80 | 74.00 | -22.20 | peak |
| 7 | 17912.000 | 29.29 | 22.69 | 51.98 | 74.00 | -22.02 | peak |

Note: 1. Measurement = Reading Level + Correct Factor.
 2. If Peak Result complies with AV limit, AV Result is deemed to comply with AV limit.
 3. Peak: Peak detector.
 4. AVG: $VBW=1/Ton$, where: Ton is the transmitting duration.
 5. For the transmitting duration, please refer to clause 7.1.
 6. Filter losses were only considered in the spurious frequency bands and the authorized band was not corrected for High Pass Filter losses.
 7. Proper operation of the transmitter prior to adding the filter to the measurement chain.
 8. Since non-restricted band peak emissions are less than the average limit, they also comply with the -27dBm/MHz (68.2dBuV/m) limit.

HARMONICS AND SPURIOUS EMISSIONS (HIGH CHANNEL, VERTICAL)

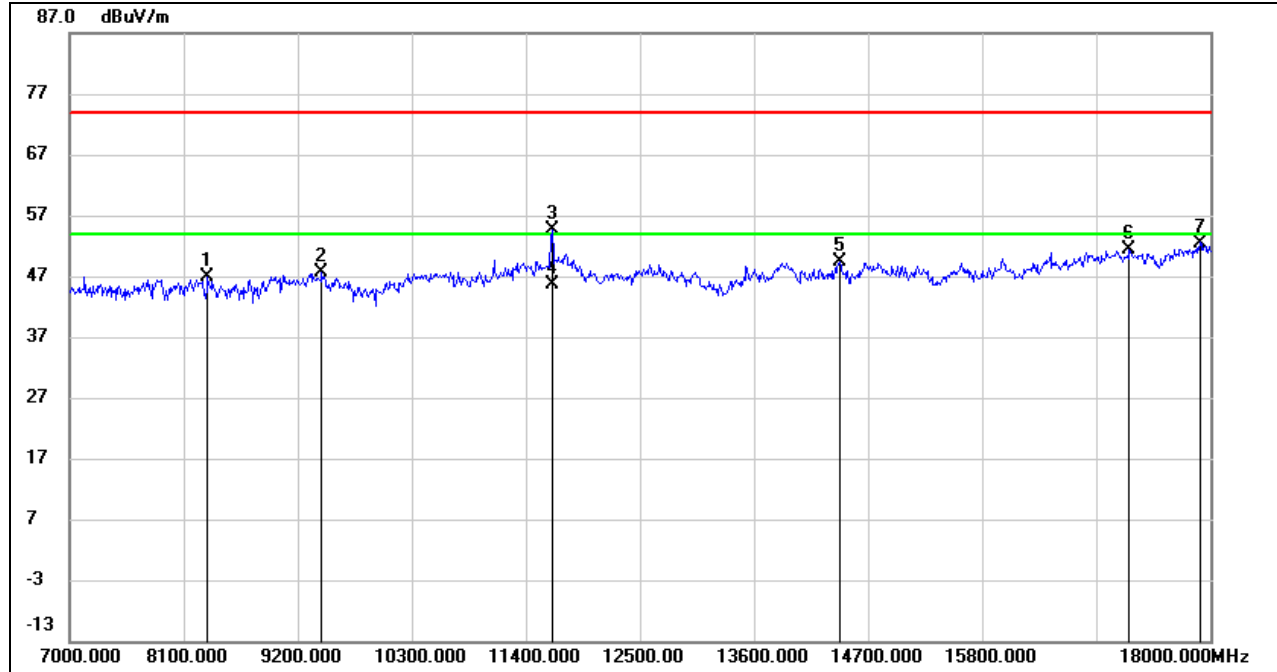

| No. | Frequency (MHz) | Reading (dBuV) | Correct (dB/m) | Result (dBuV/m) | Limit (dBuV/m) | Margin (dB) | Remark |
|-----|-----------------|----------------|----------------|-----------------|----------------|-------------|--------|
| 1 | 8331.000 | 37.98 | 8.85 | 46.83 | 74.00 | -27.17 | peak |
| 2 | 9431.000 | 37.29 | 10.35 | 47.64 | 74.00 | -26.36 | peak |
| 3 | 11653.000 | 39.73 | 14.80 | 54.53 | 74.00 | -19.47 | peak |
| 4 | 11653.000 | 30.95 | 14.80 | 45.75 | 54.00 | -8.25 | AVG |
| 5 | 14425.000 | 32.57 | 16.80 | 49.37 | 74.00 | -24.63 | peak |
| 6 | 17219.000 | 30.41 | 21.01 | 51.42 | 74.00 | -22.58 | peak |
| 7 | 17901.000 | 29.81 | 22.69 | 52.50 | 74.00 | -21.50 | peak |

- Note: 1. Measurement = Reading Level + Correct Factor.
 2. If Peak Result complies with AV limit, AV Result is deemed to comply with AV limit.
 3. Peak: Peak detector.
 4. AVG: $VBW=1/T_{on}$, where: T_{on} is the transmitting duration.
 5. For the transmitting duration, please refer to clause 7.1.
 6. Filter losses were only considered in the spurious frequency bands and the authorized band was not corrected for High Pass Filter losses.
 7. Proper operation of the transmitter prior to adding the filter to the measurement chain.
 8. Since non-restricted band peak emissions are less than the average limit, they also comply with the -27dBm/MHz (68.2dBuV/m) limit.

8.3.3. 802.11n HT40 MIMO MODE

UNII-1 BAND

HARMONICS AND SPURIOUS EMISSIONS (LOW CHANNEL, HORIZONTAL)

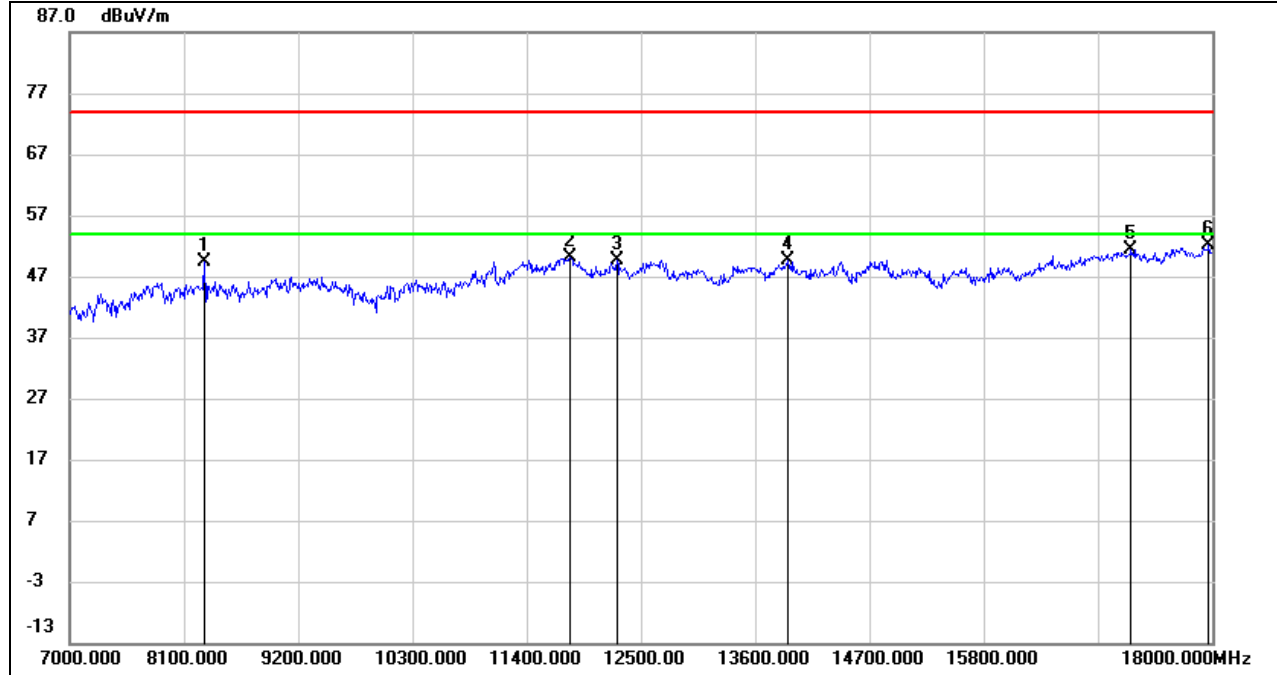

| No. | Frequency (MHz) | Reading (dBuV) | Correct (dB/m) | Result (dBuV/m) | Limit (dBuV/m) | Margin (dB) | Remark |
|-----|-----------------|----------------|----------------|-----------------|----------------|-------------|--------|
| 1 | 8298.000 | 40.30 | 8.98 | 49.28 | 74.00 | -24.72 | peak |
| 2 | 11818.000 | 34.60 | 15.58 | 50.18 | 74.00 | -23.82 | peak |
| 3 | 12269.000 | 34.48 | 15.24 | 49.72 | 74.00 | -24.28 | peak |
| 4 | 13919.000 | 32.62 | 16.89 | 49.51 | 74.00 | -24.49 | peak |
| 5 | 17219.000 | 30.28 | 21.01 | 51.29 | 74.00 | -22.71 | peak |
| 6 | 17967.000 | 29.56 | 22.67 | 52.23 | 74.00 | -21.77 | peak |

Note: 1. Measurement = Reading Level + Correct Factor.
 2. If Peak Result complies with AV limit, AV Result is deemed to comply with AV limit.
 3. Peak: Peak detector.
 4. Filter losses were only considered in the spurious frequency bands and the authorized band was not corrected for High Pass Filter losses.
 5. Proper operation of the transmitter prior to adding the filter to the measurement chain.
 6. Since non-restricted band peak emissions are less than the average limit, they also comply with the -27dBm/MHz (68.2dBuV/m) limit.



HARMONICS AND SPURIOUS EMISSIONS (LOW CHANNEL, VERTICAL)

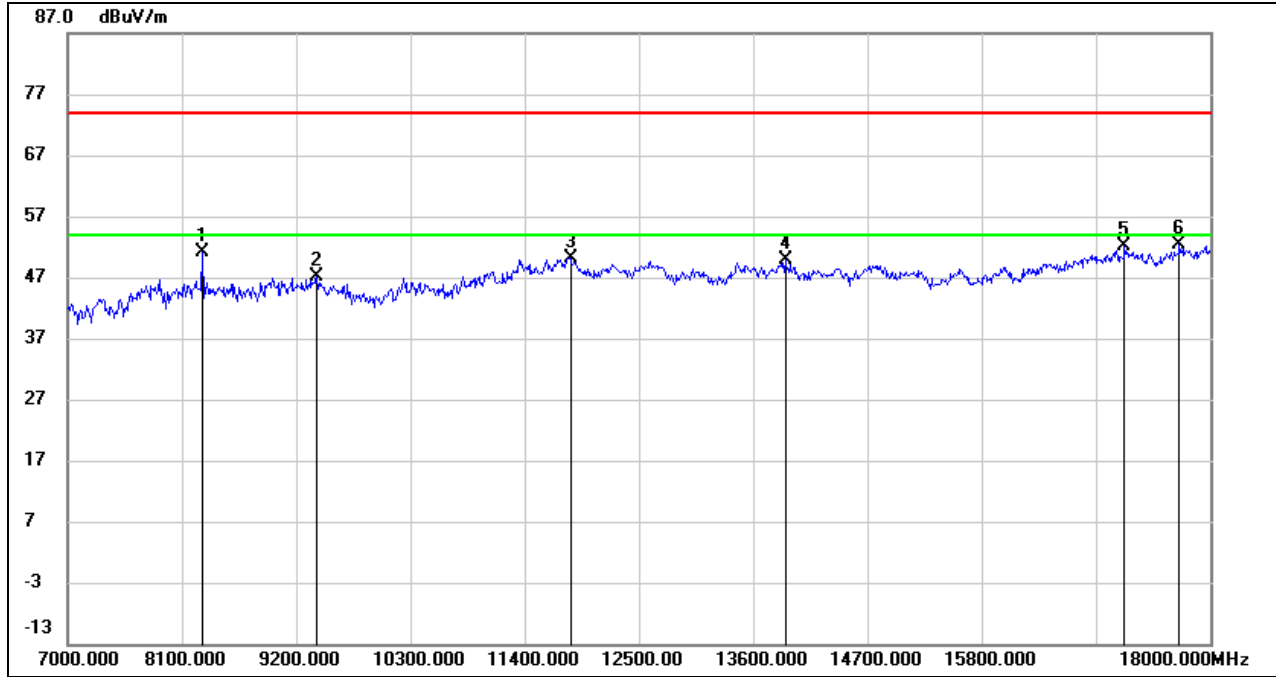

| No. | Frequency (MHz) | Reading (dBuV) | Correct (dB/m) | Result (dBuV/m) | Limit (dBuV/m) | Margin (dB) | Remark |
|-----|-----------------|----------------|----------------|-----------------|----------------|-------------|--------|
| 1 | 8298.000 | 42.22 | 8.98 | 51.20 | 74.00 | -22.80 | peak |
| 2 | 9398.000 | 36.80 | 10.30 | 47.10 | 74.00 | -26.90 | peak |
| 3 | 11840.000 | 34.59 | 15.56 | 50.15 | 74.00 | -23.85 | peak |
| 4 | 13908.000 | 32.89 | 16.90 | 49.79 | 74.00 | -24.21 | peak |
| 5 | 17175.000 | 31.08 | 20.94 | 52.02 | 74.00 | -21.98 | peak |
| 6 | 17703.000 | 30.43 | 21.96 | 52.39 | 74.00 | -21.61 | peak |

Note: 1. Measurement = Reading Level + Correct Factor.
 2. If Peak Result complies with AV limit, AV Result is deemed to comply with AV limit.
 3. Peak: Peak detector.
 4. Filter losses were only considered in the spurious frequency bands and the authorized band was not corrected for High Pass Filter losses.
 5. Proper operation of the transmitter prior to adding the filter to the measurement chain.
 6. Since non-restricted band peak emissions are less than the average limit, they also comply with the -27dBm/MHz (68.2dBuV/m) limit.

HARMONICS AND SPURIOUS EMISSIONS (HIGH CHANNEL, HORIZONTAL)

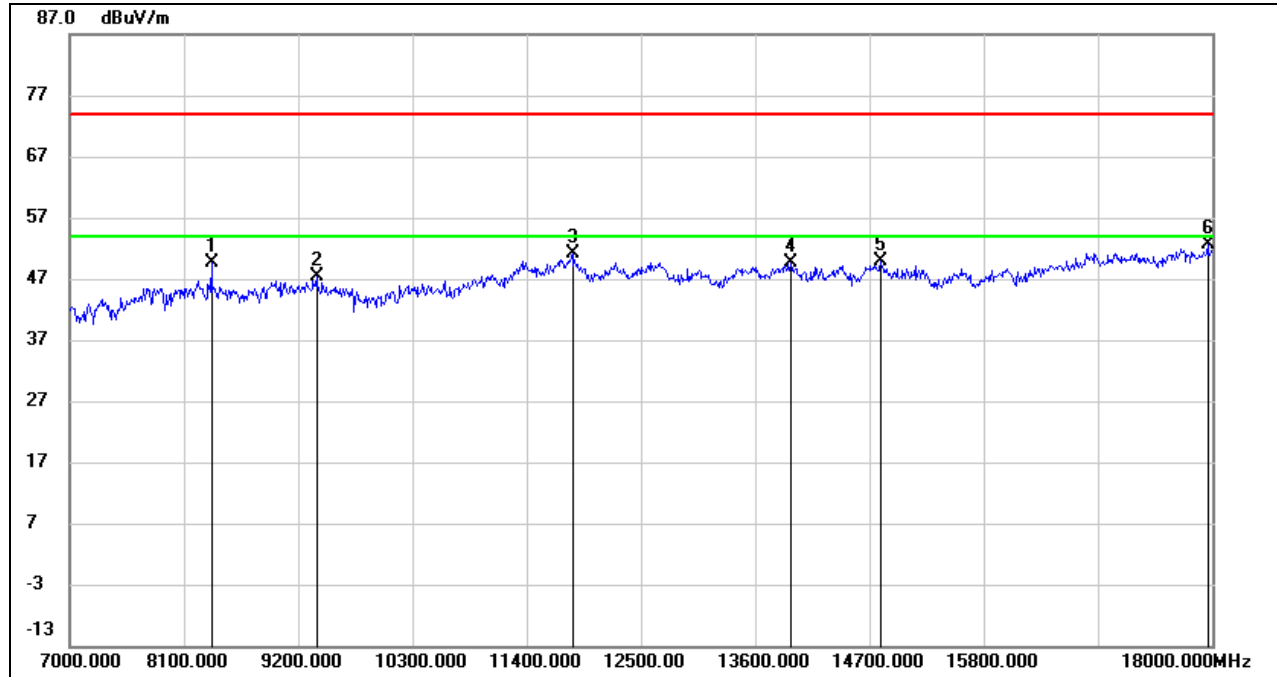

| No. | Frequency (MHz) | Reading (dBuV) | Correct (dB/m) | Result (dBuV/m) | Limit (dBuV/m) | Margin (dB) | Remark |
|-----|-----------------|----------------|----------------|-----------------|----------------|-------------|--------|
| 1 | 8364.000 | 40.95 | 8.73 | 49.68 | 74.00 | -24.32 | peak |
| 2 | 9376.000 | 37.15 | 10.19 | 47.34 | 74.00 | -26.66 | peak |
| 3 | 11840.000 | 35.57 | 15.56 | 51.13 | 74.00 | -22.87 | peak |
| 4 | 13941.000 | 32.74 | 16.88 | 49.62 | 74.00 | -24.38 | peak |
| 5 | 14810.000 | 32.97 | 16.80 | 49.77 | 74.00 | -24.23 | peak |
| 6 | 17956.000 | 29.99 | 22.68 | 52.67 | 74.00 | -21.33 | peak |

Note: 1. Measurement = Reading Level + Correct Factor.
 2. If Peak Result complies with AV limit, AV Result is deemed to comply with AV limit.
 3. Peak: Peak detector.
 4. Filter losses were only considered in the spurious frequency bands and the authorized band was not corrected for High Pass Filter losses.
 5. Proper operation of the transmitter prior to adding the filter to the measurement chain.
 6. Since non-restricted band peak emissions are less than the average limit, they also comply with the -27dBm/MHz (68.2dBuV/m) limit.

HARMONICS AND SPURIOUS EMISSIONS (HIGH CHANNEL, VERTICAL)

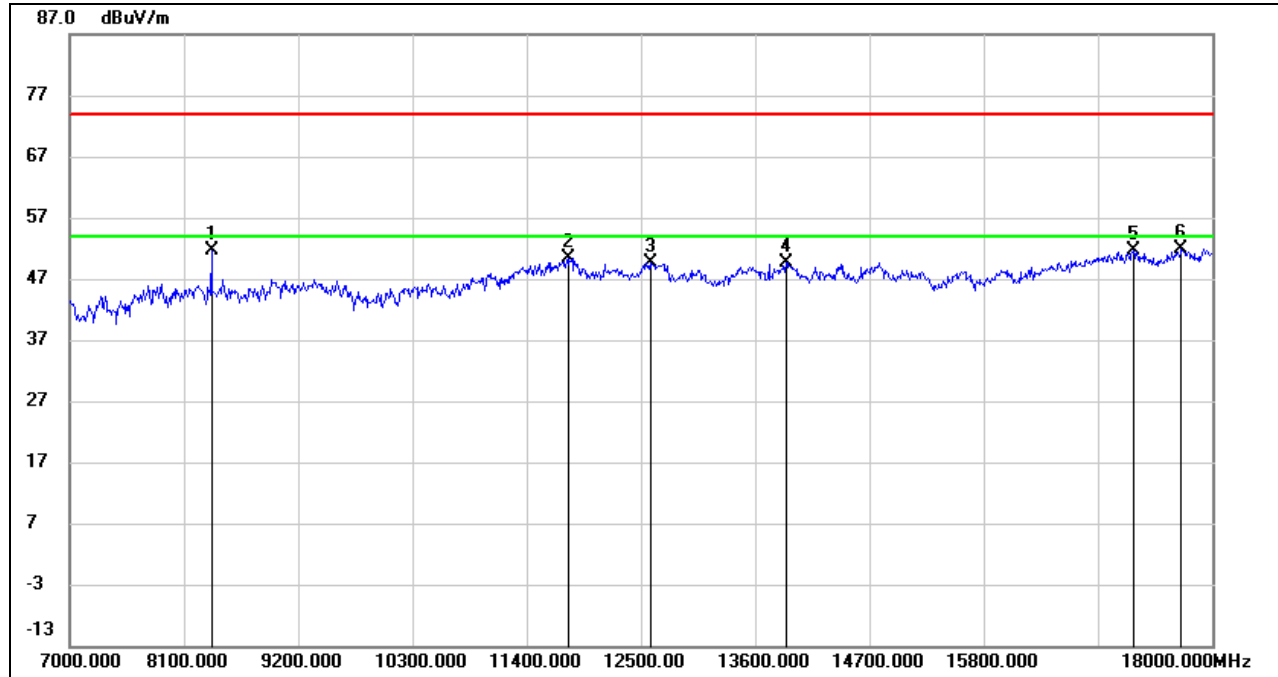

| No. | Frequency (MHz) | Reading (dBuV) | Correct (dB/m) | Result (dBuV/m) | Limit (dBuV/m) | Margin (dB) | Remark |
|-----|-----------------|----------------|----------------|-----------------|----------------|-------------|--------|
| 1 | 8364.000 | 42.95 | 8.73 | 51.68 | 74.00 | -22.32 | peak |
| 2 | 11796.000 | 34.69 | 15.59 | 50.28 | 74.00 | -23.72 | peak |
| 3 | 12588.000 | 34.42 | 15.29 | 49.71 | 74.00 | -24.29 | peak |
| 4 | 13897.000 | 32.72 | 16.90 | 49.62 | 74.00 | -24.38 | peak |
| 5 | 17241.000 | 30.65 | 20.97 | 51.62 | 74.00 | -22.38 | peak |
| 6 | 17703.000 | 29.92 | 21.96 | 51.88 | 74.00 | -22.12 | peak |

Note: 1. Measurement = Reading Level + Correct Factor.
 2. If Peak Result complies with AV limit, AV Result is deemed to comply with AV limit.
 3. Peak: Peak detector.
 4. Filter losses were only considered in the spurious frequency bands and the authorized band was not corrected for High Pass Filter losses.
 5. Proper operation of the transmitter prior to adding the filter to the measurement chain.
 6. Since non-restricted band peak emissions are less than the average limit, they also comply with the -27dBm/MHz (68.2dBuV/m) limit.



UNII-2A BAND

HARMONICS AND SPURIOUS EMISSIONS (LOW CHANNEL, HORIZONTAL)

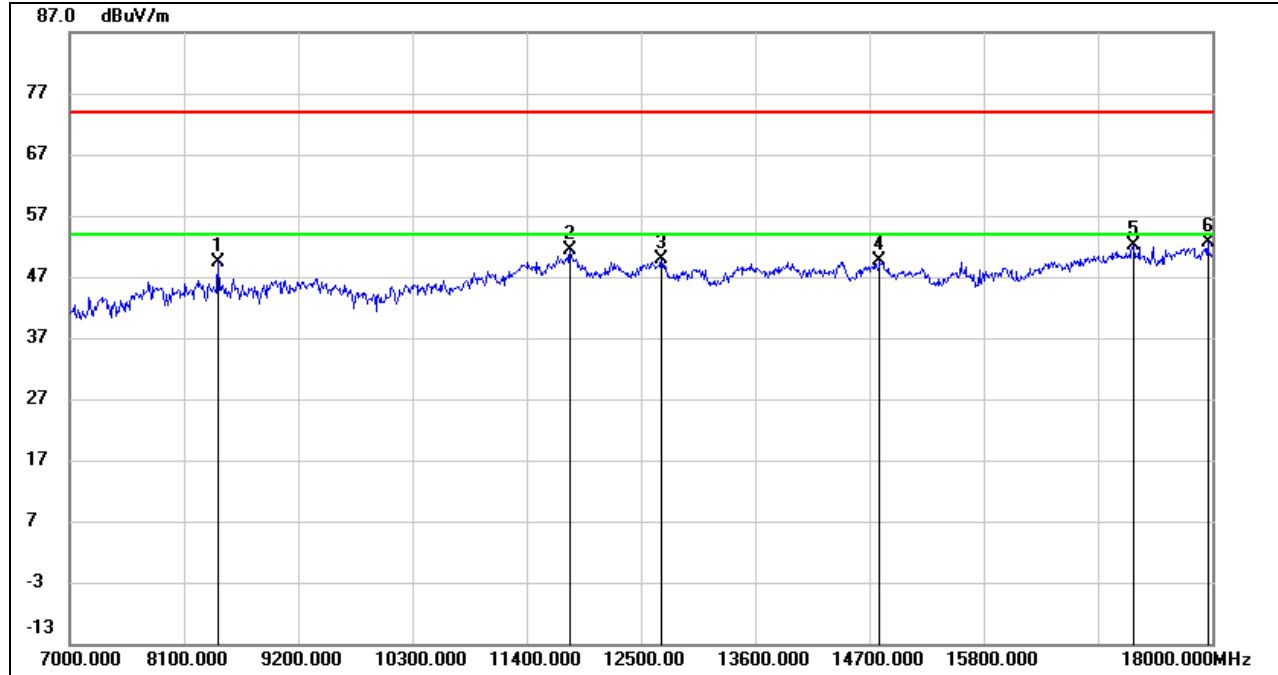

| No. | Frequency (MHz) | Reading (dBuV) | Correct (dB/m) | Result (dBuV/m) | Limit (dBuV/m) | Margin (dB) | Remark |
|-----|-----------------|----------------|----------------|-----------------|----------------|-------------|--------|
| 1 | 8430.000 | 40.90 | 8.57 | 49.47 | 74.00 | -24.53 | peak |
| 2 | 11818.000 | 35.71 | 15.58 | 51.29 | 74.00 | -22.71 | peak |
| 3 | 12698.000 | 34.46 | 15.47 | 49.93 | 74.00 | -24.07 | peak |
| 4 | 14799.000 | 32.75 | 16.80 | 49.55 | 74.00 | -24.45 | peak |
| 5 | 17241.000 | 31.09 | 20.97 | 52.06 | 74.00 | -21.94 | peak |
| 6 | 17956.000 | 30.02 | 22.68 | 52.70 | 74.00 | -21.30 | peak |

Note: 1. Measurement = Reading Level + Correct Factor.
 2. If Peak Result complies with AV limit, AV Result is deemed to comply with AV limit.
 3. Peak: Peak detector.
 4. Filter losses were only considered in the spurious frequency bands and the authorized band was not corrected for High Pass Filter losses.
 5. Proper operation of the transmitter prior to adding the filter to the measurement chain.
 6. Since non-restricted band peak emissions are less than the average limit, they also comply with the -27dBm/MHz (68.2dBuV/m) limit.



HARMONICS AND SPURIOUS EMISSIONS (LOW CHANNEL, VERTICAL)

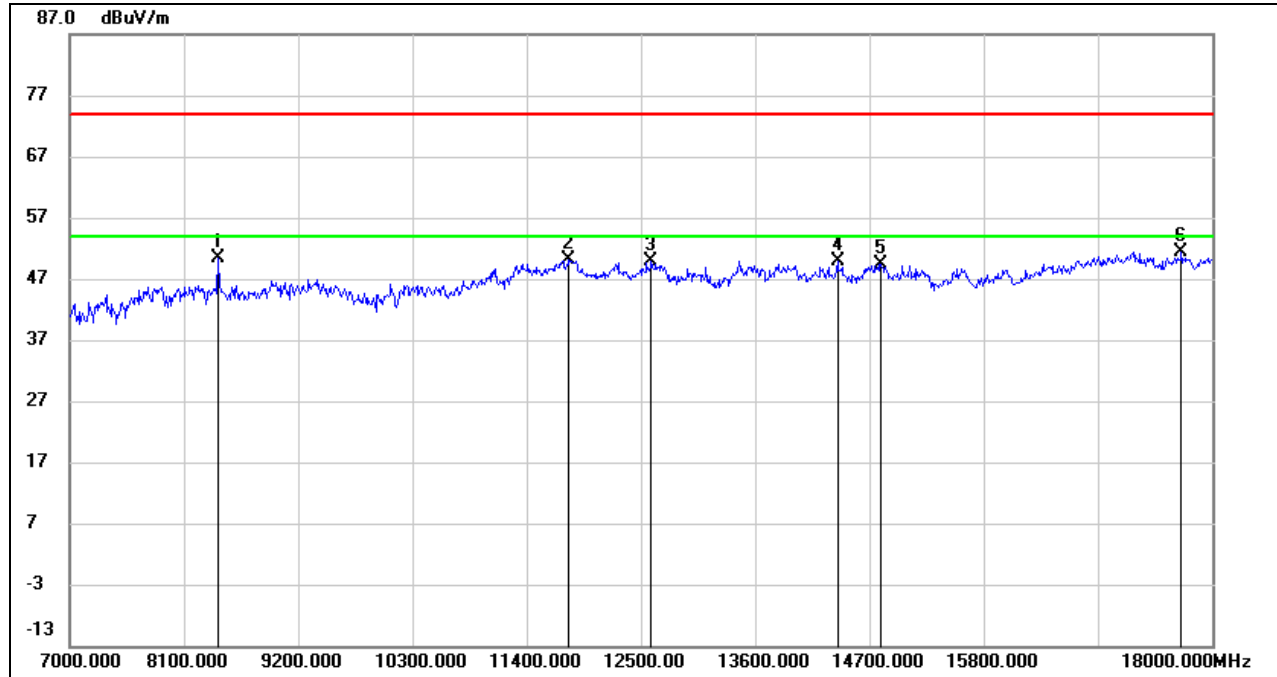

| No. | Frequency (MHz) | Reading (dBuV) | Correct (dB/m) | Result (dBuV/m) | Limit (dBuV/m) | Margin (dB) | Remark |
|-----|-----------------|----------------|----------------|-----------------|----------------|-------------|--------|
| 1 | 8430.000 | 41.76 | 8.57 | 50.33 | 74.00 | -23.67 | peak |
| 2 | 11807.000 | 34.52 | 15.61 | 50.13 | 74.00 | -23.87 | peak |
| 3 | 12599.000 | 34.65 | 15.29 | 49.94 | 74.00 | -24.06 | peak |
| 4 | 14392.000 | 33.15 | 16.84 | 49.99 | 74.00 | -24.01 | peak |
| 5 | 14810.000 | 32.66 | 16.80 | 49.46 | 74.00 | -24.54 | peak |
| 6 | 17703.000 | 29.38 | 21.96 | 51.34 | 74.00 | -22.66 | peak |

Note: 1. Measurement = Reading Level + Correct Factor.
 2. If Peak Result complies with AV limit, AV Result is deemed to comply with AV limit.
 3. Peak: Peak detector.
 4. Filter losses were only considered in the spurious frequency bands and the authorized band was not corrected for High Pass Filter losses.
 5. Proper operation of the transmitter prior to adding the filter to the measurement chain.
 6. Since non-restricted band peak emissions are less than the average limit, they also comply with the -27dBm/MHz (68.2dBuV/m) limit.

HARMONICS AND SPURIOUS EMISSIONS (HIGH CHANNEL, HORIZONTAL)

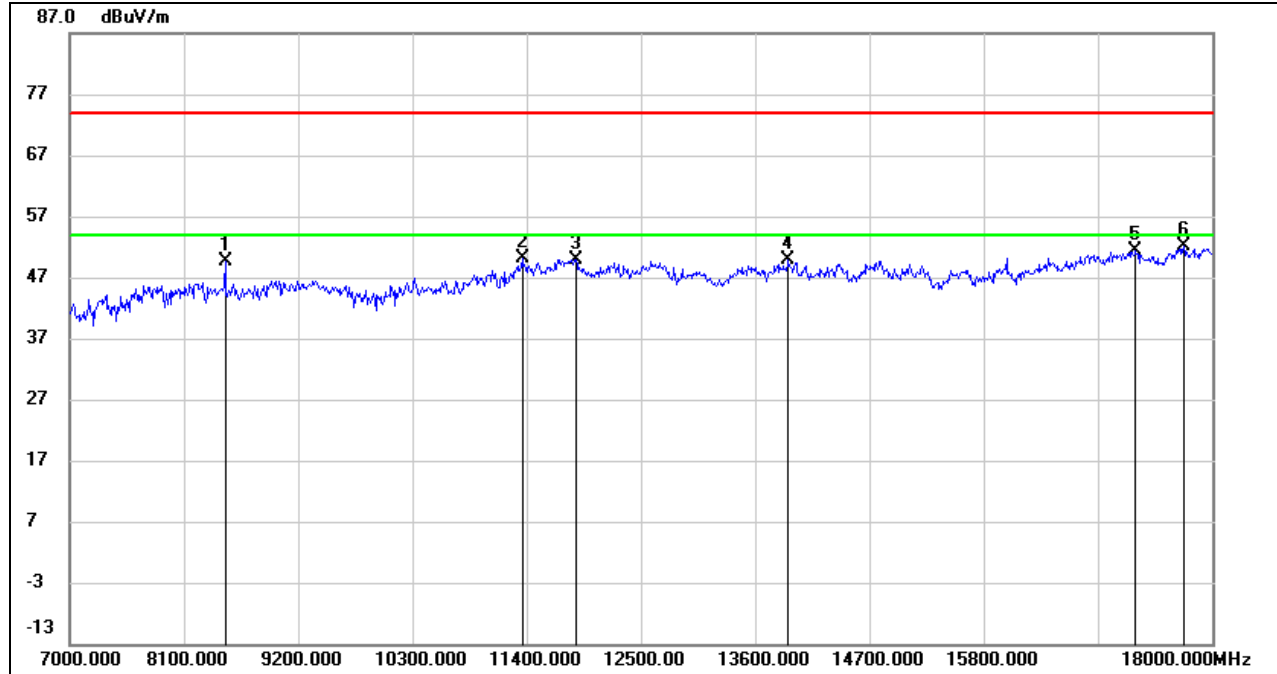

| No. | Frequency (MHz) | Reading (dBuV) | Correct (dB/m) | Result (dBuV/m) | Limit (dBuV/m) | Margin (dB) | Remark |
|-----|-----------------|----------------|----------------|-----------------|----------------|-------------|--------|
| 1 | 8496.000 | 41.02 | 8.53 | 49.55 | 74.00 | -24.45 | peak |
| 2 | 11356.000 | 35.93 | 14.09 | 50.02 | 74.00 | -23.98 | peak |
| 3 | 11873.000 | 34.39 | 15.50 | 49.89 | 74.00 | -24.11 | peak |
| 4 | 13919.000 | 32.90 | 16.89 | 49.79 | 74.00 | -24.21 | peak |
| 5 | 17263.000 | 30.48 | 20.95 | 51.43 | 74.00 | -22.57 | peak |
| 6 | 17725.000 | 29.94 | 22.13 | 52.07 | 74.00 | -21.93 | peak |

Note: 1. Measurement = Reading Level + Correct Factor.
 2. If Peak Result complies with AV limit, AV Result is deemed to comply with AV limit.
 3. Peak: Peak detector.
 4. Filter losses were only considered in the spurious frequency bands and the authorized band was not corrected for High Pass Filter losses.
 5. Proper operation of the transmitter prior to adding the filter to the measurement chain.
 6. Since non-restricted band peak emissions are less than the average limit, they also comply with the -27dBm/MHz (68.2dBuV/m) limit.



HARMONICS AND SPURIOUS EMISSIONS (HIGH CHANNEL, VERTICAL)

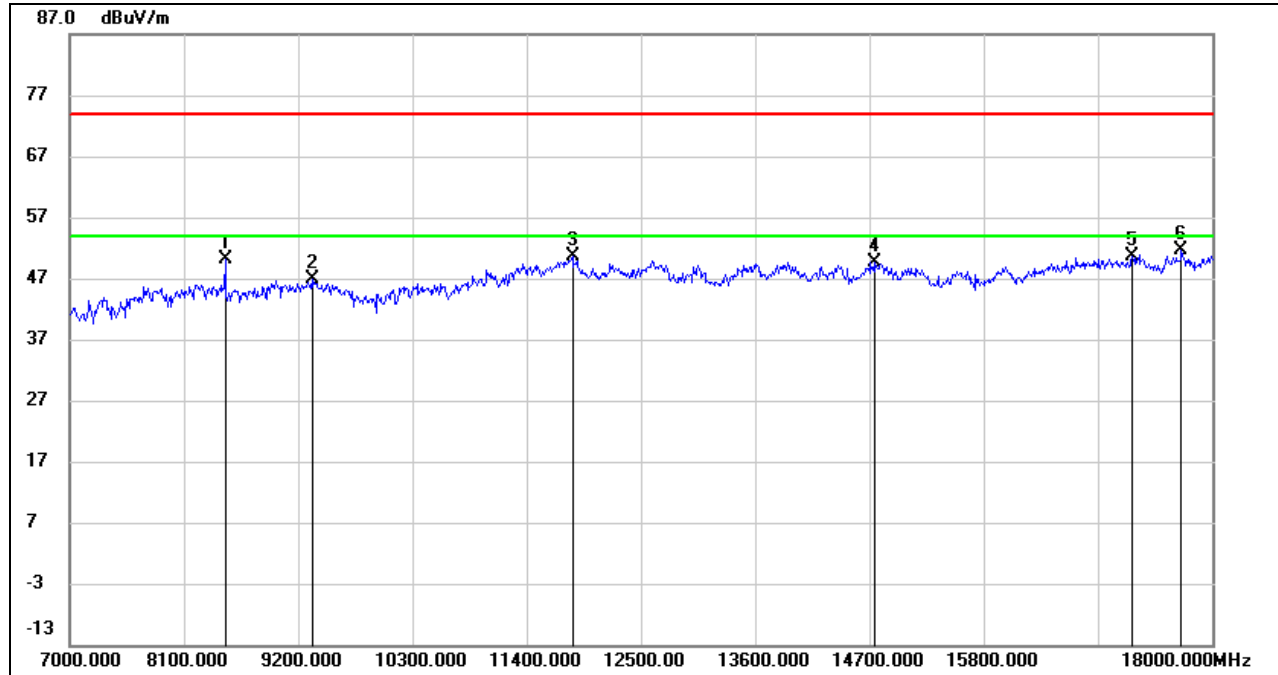

| No. | Frequency (MHz) | Reading (dBuV) | Correct (dB/m) | Result (dBuV/m) | Limit (dBuV/m) | Margin (dB) | Remark |
|-----|-----------------|----------------|----------------|-----------------|----------------|-------------|--------|
| 1 | 8496.000 | 41.70 | 8.53 | 50.23 | 74.00 | -23.77 | peak |
| 2 | 9332.000 | 37.00 | 9.97 | 46.97 | 74.00 | -27.03 | peak |
| 3 | 11840.000 | 34.95 | 15.56 | 50.51 | 74.00 | -23.49 | peak |
| 4 | 14744.000 | 32.97 | 16.70 | 49.67 | 74.00 | -24.33 | peak |
| 5 | 17230.000 | 29.62 | 20.99 | 50.61 | 74.00 | -23.39 | peak |
| 6 | 17703.000 | 29.56 | 21.96 | 51.52 | 74.00 | -22.48 | peak |

Note: 1. Measurement = Reading Level + Correct Factor.
 2. If Peak Result complies with AV limit, AV Result is deemed to comply with AV limit.
 3. Peak: Peak detector.
 4. Filter losses were only considered in the spurious frequency bands and the authorized band was not corrected for High Pass Filter losses.
 5. Proper operation of the transmitter prior to adding the filter to the measurement chain.
 6. Since non-restricted band peak emissions are less than the average limit, they also comply with the -27dBm/MHz (68.2dBuV/m) limit.

UNII-2C BAND

HARMONICS AND SPURIOUS EMISSIONS (LOW CHANNEL, HORIZONTAL)

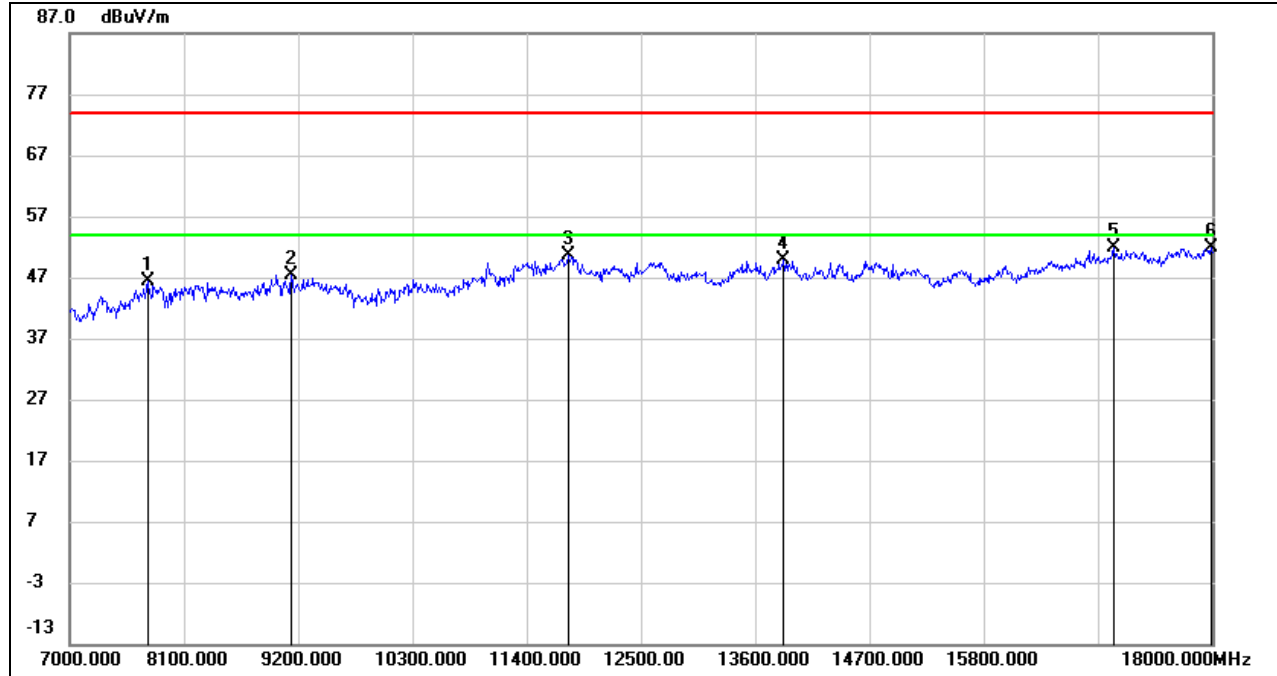

| No. | Frequency (MHz) | Reading (dBuV) | Correct (dB/m) | Result (dBuV/m) | Limit (dBuV/m) | Margin (dB) | Remark |
|-----|-----------------|----------------|----------------|-----------------|----------------|-------------|--------|
| 1 | 7748.000 | 38.30 | 8.05 | 46.35 | 74.00 | -27.65 | peak |
| 2 | 9134.000 | 37.64 | 9.73 | 47.37 | 74.00 | -26.63 | peak |
| 3 | 11807.000 | 34.90 | 15.61 | 50.51 | 74.00 | -23.49 | peak |
| 4 | 13875.000 | 33.00 | 16.92 | 49.92 | 74.00 | -24.08 | peak |
| 5 | 17054.000 | 31.35 | 20.45 | 51.80 | 74.00 | -22.20 | peak |
| 6 | 17989.000 | 29.09 | 22.67 | 51.76 | 74.00 | -22.24 | peak |

Note: 1. Measurement = Reading Level + Correct Factor.
 2. If Peak Result complies with AV limit, AV Result is deemed to comply with AV limit.
 3. Peak: Peak detector.
 4. Filter losses were only considered in the spurious frequency bands and the authorized band was not corrected for High Pass Filter losses.
 5. Proper operation of the transmitter prior to adding the filter to the measurement chain.
 6. Since non-restricted band peak emissions are less than the average limit, they also comply with the -27dBm/MHz (68.2dBuV/m) limit.



HARMONICS AND SPURIOUS EMISSIONS (LOW CHANNEL, VERTICAL)

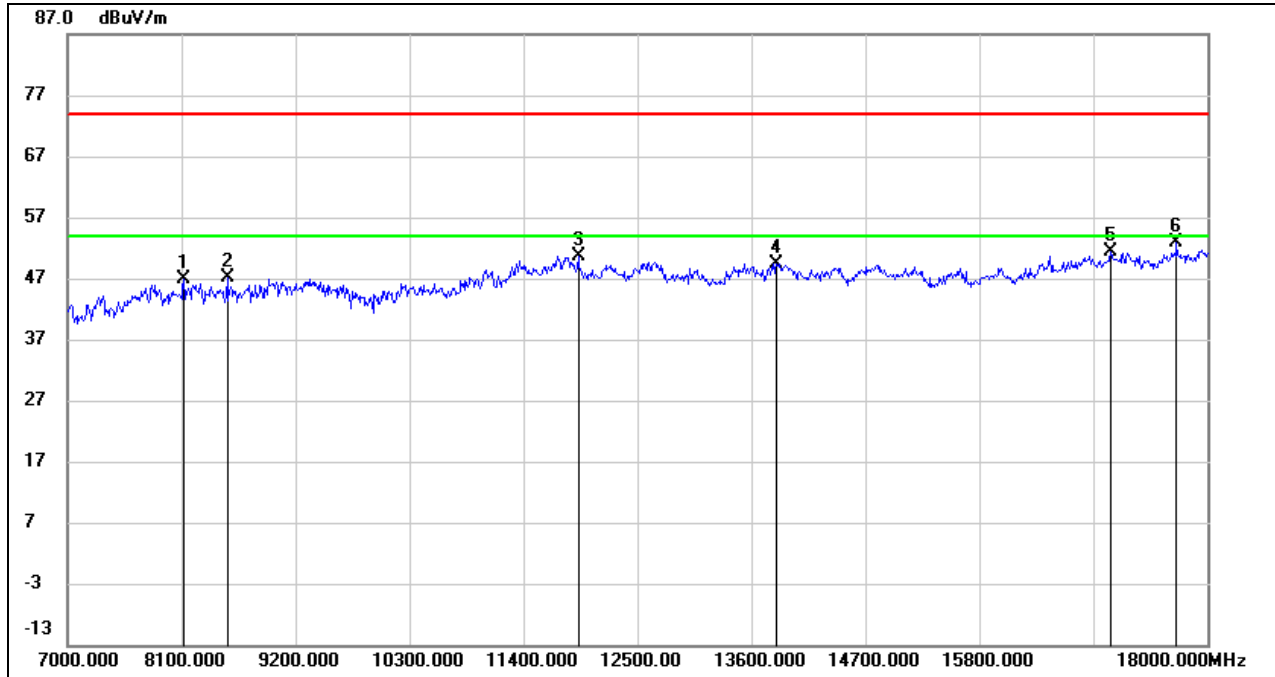

| No. | Frequency (MHz) | Reading (dBuV) | Correct (dB/m) | Result (dBuV/m) | Limit (dBuV/m) | Margin (dB) | Remark |
|-----|-----------------|----------------|----------------|-----------------|----------------|-------------|--------|
| 1 | 8122.000 | 38.06 | 8.70 | 46.76 | 74.00 | -27.24 | peak |
| 2 | 8540.000 | 38.70 | 8.53 | 47.23 | 74.00 | -26.77 | peak |
| 3 | 11928.000 | 35.16 | 15.42 | 50.58 | 74.00 | -23.42 | peak |
| 4 | 13842.000 | 32.49 | 16.94 | 49.43 | 74.00 | -24.57 | peak |
| 5 | 17065.000 | 30.95 | 20.49 | 51.44 | 74.00 | -22.56 | peak |
| 6 | 17703.000 | 30.86 | 21.96 | 52.82 | 74.00 | -21.18 | peak |

Note: 1. Measurement = Reading Level + Correct Factor.
 2. If Peak Result complies with AV limit, AV Result is deemed to comply with AV limit.
 3. Peak: Peak detector.
 4. Filter losses were only considered in the spurious frequency bands and the authorized band was not corrected for High Pass Filter losses.
 5. Proper operation of the transmitter prior to adding the filter to the measurement chain.
 6. Since non-restricted band peak emissions are less than the average limit, they also comply with the -27dBm/MHz (68.2dBuV/m) limit.