

SPECIFICATION

SHEET FOR APPROVAL

(Revision: R: A2)

CUSTOMER(客户名称)	高盛达	
CS P/N(客户机种)	WC0D	
PART NAME(品名)	WIFI 天线组件	L=300mm
FREQUENCY(频率)	2400-2500MHz / 5150-5850 MHz	
ZTX NO.(物料编号)	2.00001341	
DATE(日期)	2020-03-28	

CUSTOMER			
QA CHECKED	ME CHECKED	RF CHECKED	MANAGER CHECKED

Remark(备注):

Sign(客户确认签字盖章): _____

ZHONG TIAN XUN TECHNOLOGY CO., LTD				
MANAGER CHECKED	MANAGER CHECKED	ME CHECKED	RF CHECKED	LISTER
		邹一麟	刘蒋军	



深圳市中天迅通信科技股份有限公司

SHENZHEN ZHONGTIAN XUN Communication Technology Co.,Ltd.

地址: 深圳市宝安区石岩镇石龙大道 34 号(腾达工业园) 邮编: 518000
电话: 0755-27588320 传真: 0755-27588045 <http://www.chinaztx.com>

ANTENNA SPECIFICATION

CUS P/N :WC0D

ZTX P/N :WC0D

ApplicationDate:Mar,28,2020

Editor:

Rev: R:A2

Page 1 of 11

Revision history

版本	日期	状态
A1	2017-08-30	首版
A2	2020-03-28	更新出货标签



ANTENNA SPECIFICATION

CUS P/N :WC0D

ZTX P/N :WC0D

ApplicationDate:Mar,28,2020

Editor:

Rev: R:A2

Page 2 of 11

Index

		Revision history	1
1		Test equipment	3
2		Electrical Specifications	4
	2-1	Frequency Band	4
	2-2	VSWR And GAIN	4
3		Antenna test data	4
	3-1	VSWR	4
	3-2	mith Chart	5
	3-3	Matching circuit	5
	3-4	No-source test data	5
	3-5	Directional drawing of horizontal plane of	6
4		Mechanical Specification	7
	4-1	Mechanical Specification (WIFI2.4G/5.8G)	7
	4-2	Mechanical Specification (WIFI 组件)	8
5		Environment Characteristic	9
6		Material list	9
7		The packing way	10
		附页： 出货标签模板	11



ANTENNA SPECIFICATION

CUS P/N :WC0D
ZTX P/N :WC0D

ApplicationDate:Mar,28,2020
Editor:

Rev: R:A2
Page 3 of 11

1. Test equipment

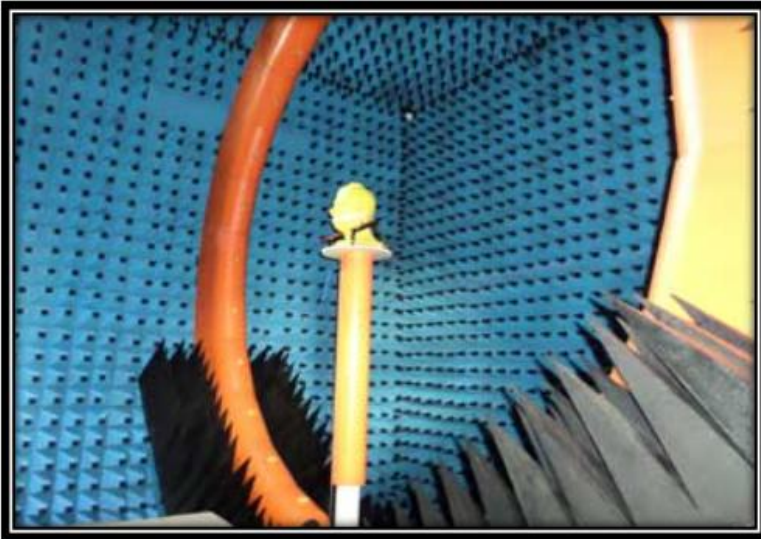

Owned 6 microwave dark room, equipped 2 sets world leading France Satimo SG24 OTA certification test systems (one in SHENZHEN, another one in Shanghai), ETS OTA Standard test system, Blue test reverberation test system which is High repeatability, high accuracy and high resolution. It can quickly provide accurate test reports, fully meet the CITA standards.

Testing range:

Support active, passive testing of
GSM/CDMA/WCDMA/TD-
SCDMA/LTE/WIFI/WLAN/WiMax/BT
/GPS/MIMO/UWB within 0.4-6G.

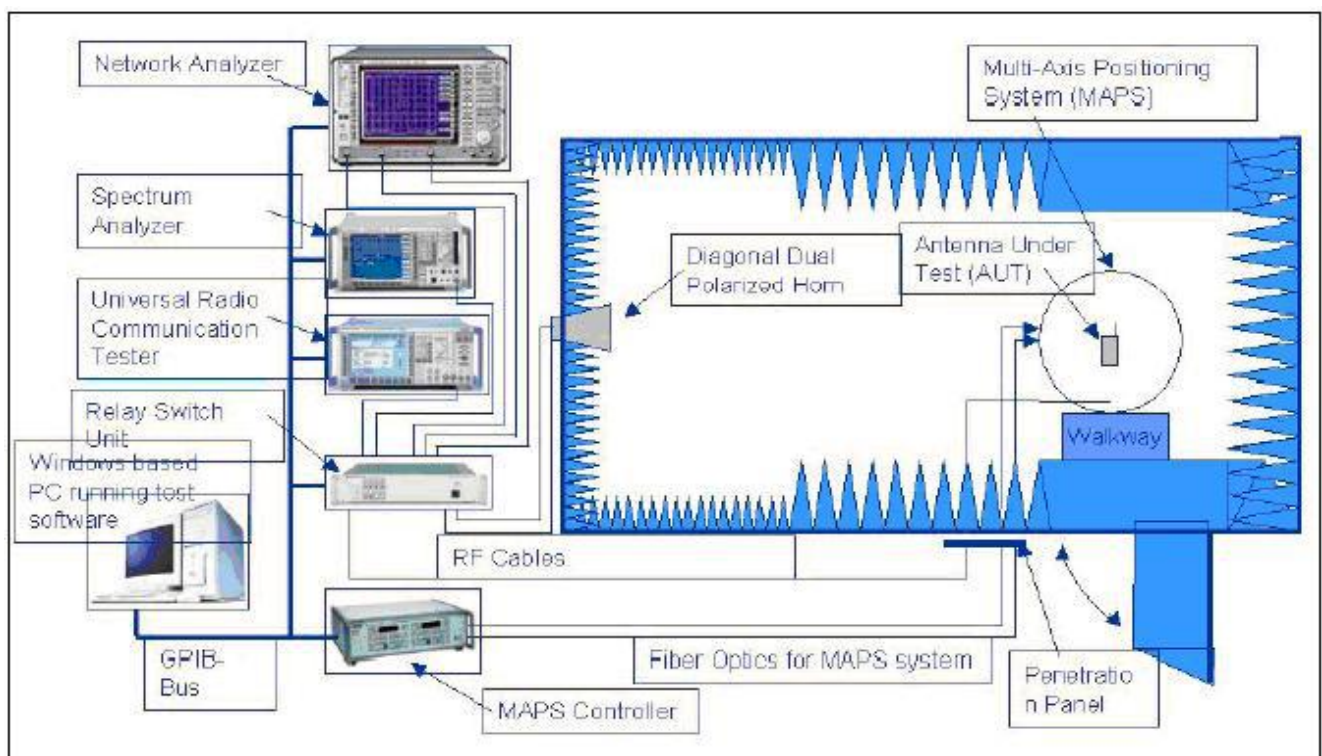

Test standard:

Antenna performance	Radiation efficiency	IEEE Standard Test Procedures for Antennas	ANSI/IEEE Std 149-2021
---------------------	----------------------	--	------------------------

Equipment list:

Equipment	Manufacturer	Model No.	Last Cal.	Due Date
Network Analyzer	Agilent	E5071C	2020.01.20	2022.01.19

Test Procedure

Test Step Flow

1. Maintain the test ambient temperature of 23 ± 2 C, the instrument is powered on and preheated for more than 30 minutes
2. Turn on the darkroom power supply, connect the test cable, and set up the sample according to the standard
3. Outline sets the test content objectives and conducts calibration tests
4. Run the EMQuest OTA software, the test is complete, export the corresponding test diagram and test data, and save to the corresponding directory

Test Principle

The test principle can be seen in accordance with the standard ANSI/IEEE std 149-2021

Test Conditions

1. The analyte, the network analyzer for testing, the test equipment and the test cable connector should have good reliability, stability, dynamic range and measurement accuracy to ensure the correctness of the measurement accuracy
2. The measuring instrument should have a certificate of conformity and be within the effective calibration period
3. The analyte should be complete and undamaged, and the test environment should be kept clean

ANTENNA SPECIFICATION

CUS P/N :WC0D
ZTX P/N :WC0D

ApplicationDate:Mar,28,2020
Editor:

Rev: R:A2
Page 4 of 11

2. Electrical Specifications

2-1 Frequency Band

Frequency Band	Frequency
BT & 2.4G WIFI	2400-2500MHZ
WIFI 5.8G	5150-5850MHZ

2-2 VSWR And GAIN

VSWR		GAIN	
Freq. Band	OPEN SPEC	Band Freq.	OPEN SPEC
2400MHz	≦ 2.0	2400MHz	≧ -1.0dBi
2500MHz	≦ 2.0	2500MHz	≧ -1.0dBi
5150MHz	≦ 2.0	5150MHz	≧ -1.0dBi
5850MHz	≦ 2.0	5850MHz	≧ -1.0dBi

※Measuring a 50 Ω test jig is connected to a network analyzer to measure the VSWR.

※※All test value is done in customer approval fixture.

3. Antenna test data

3-1 VSWR

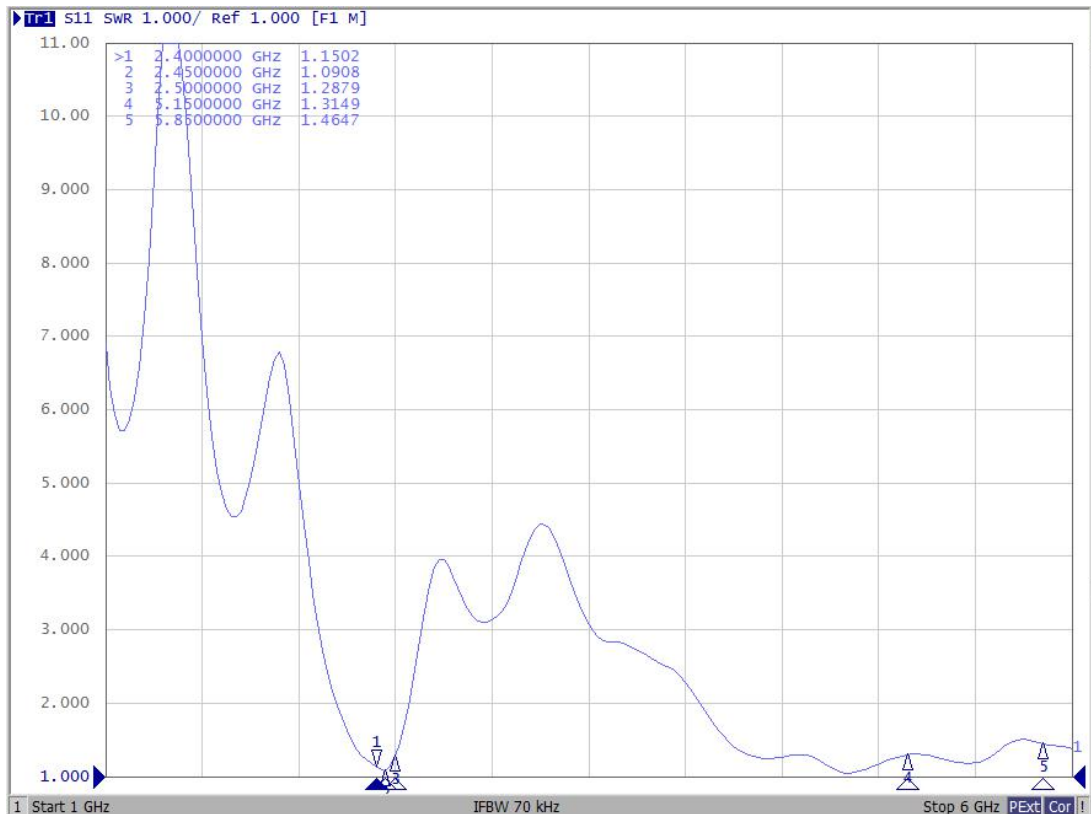

ANTENNA SPECIFICATION

CUS P/N :WC0D
ZTX P/N :WC0D

ApplicationDate:Mar,28,2020
Editor:

Rev: R:A2
Page 5 of 11

3-2 Smith Chart

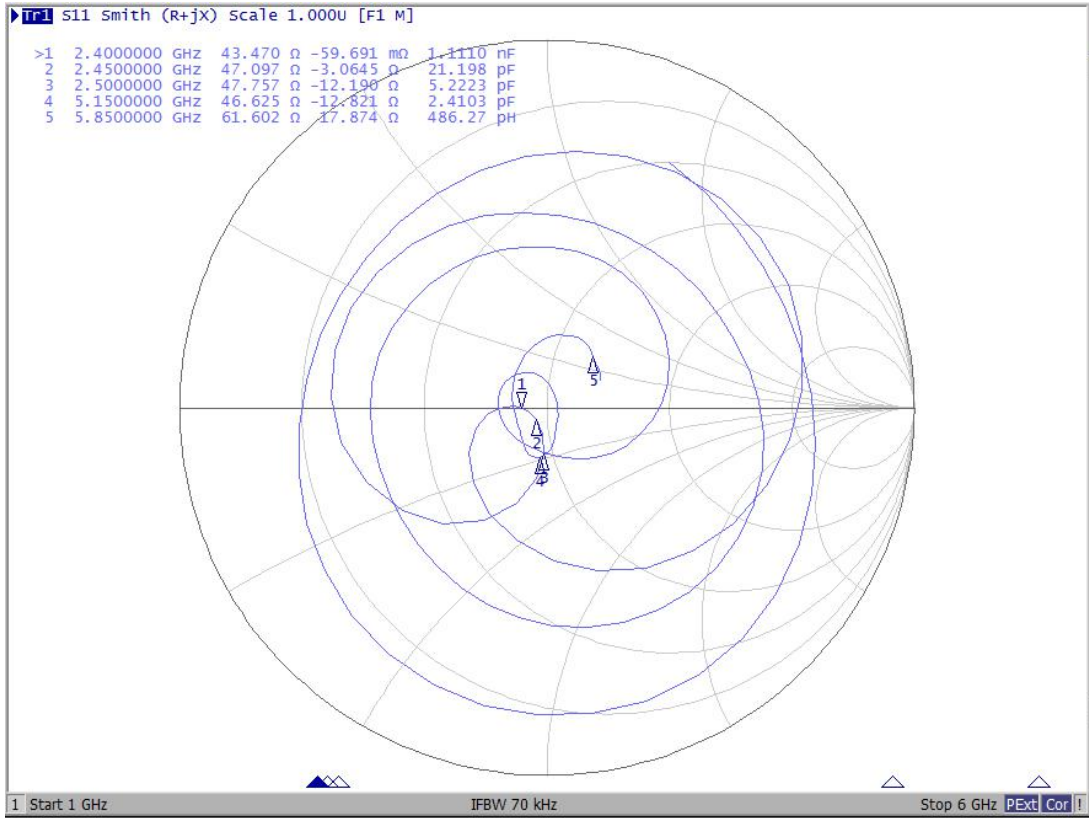

3-3 Matching circuit

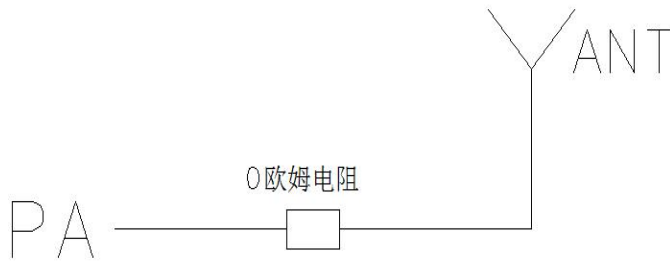

3-4 No-source test data

Frequency (MHz)	2400	2450	2500	5150	5850
Average Gain	1.42	1.72	1.65	2.34	2.57
Efficiency (dB)	(44%)	(48%)	(45%)	(61%)	(66%)

ANTENNA SPECIFICATION

CUS P/N :WC0D
ZTX P/N :WC0D

ApplicationDate:Mar,28,2020
Editor:

Rev: R:A2
Page 6 of 11

3-5 Directional drawing of horizontal plane of

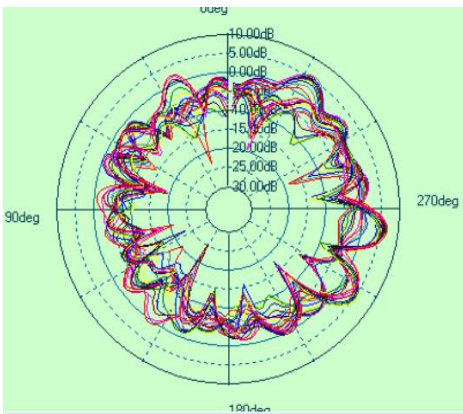

Theta 90deg

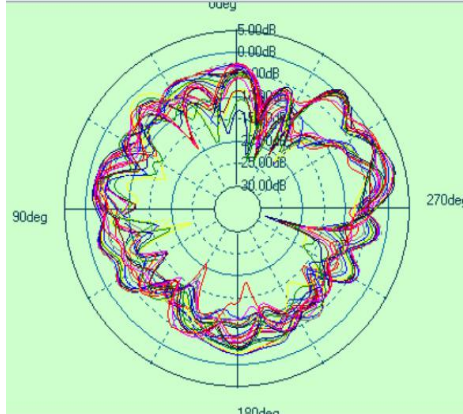

Phi 0deg

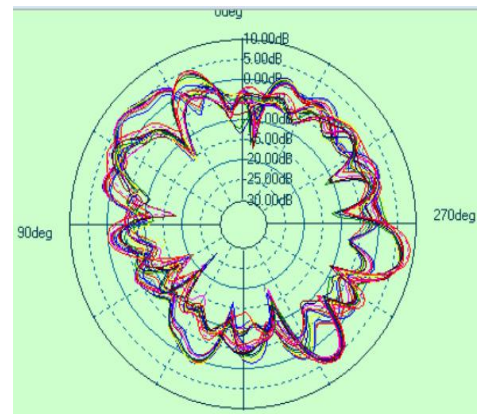

Phi 90deg

ANTENNA SPECIFICATION

CUS P/N :WC0D
ZTX P/N :WC0D

ApplicationDate:Mar,28,2020
Editor:

Rev: R:A2
Page 7 of 11

4. Mechanical Specification

4-1 Mechanical Configuration(WIFI2.4G/5.8G)

版本	说明	审核	日期	批准	日期

展开图

立体图

备注:

1. 角度尺寸模具设计时依图纸尺寸作参照,样品及量产实配即可;
2. 打"*"为严格控制尺寸 (IQC必测等级A) ;
3. 字符说明(采用宋体,要求字迹清晰,弹片无变形);
4. 产品不能有油污、毛刺、利边、缺料、变形、压印过深等不良;
5. 需通过48小时盐雾测试;
6. 包装时需用吸塑盒摆放整齐,运输过程中产品不能挤压碰撞等;
7. 未经过ZTX公司确认,材料不能随意更改;

未注明公差	5 UND	±0.08	制图	邹一麟	日期	2017-02-04
			制图	邹一麟	日期	2017-02-04
			审核	李方森	日期	2017-02-04
			批准	邹一麟	日期	2017-02-04
			材料	SUS304	厚度	0.30mm (镀银)
			单位	mm	比例	1:1
			物料编号	1.01.003550		
			版本号	1/1		
			产品名称	WC0D (WIFI)		
			图号	ZTX-Q0-00-029		

ANTENNA SPECIFICATION

CUS P/N :WC0D
ZTX P/N :WC0D

ApplicationDate:Mar,28,2020
Editor:

Rev: R:A2
Page 8 of 11

4-2 Mechanical Configuration(天线组件)

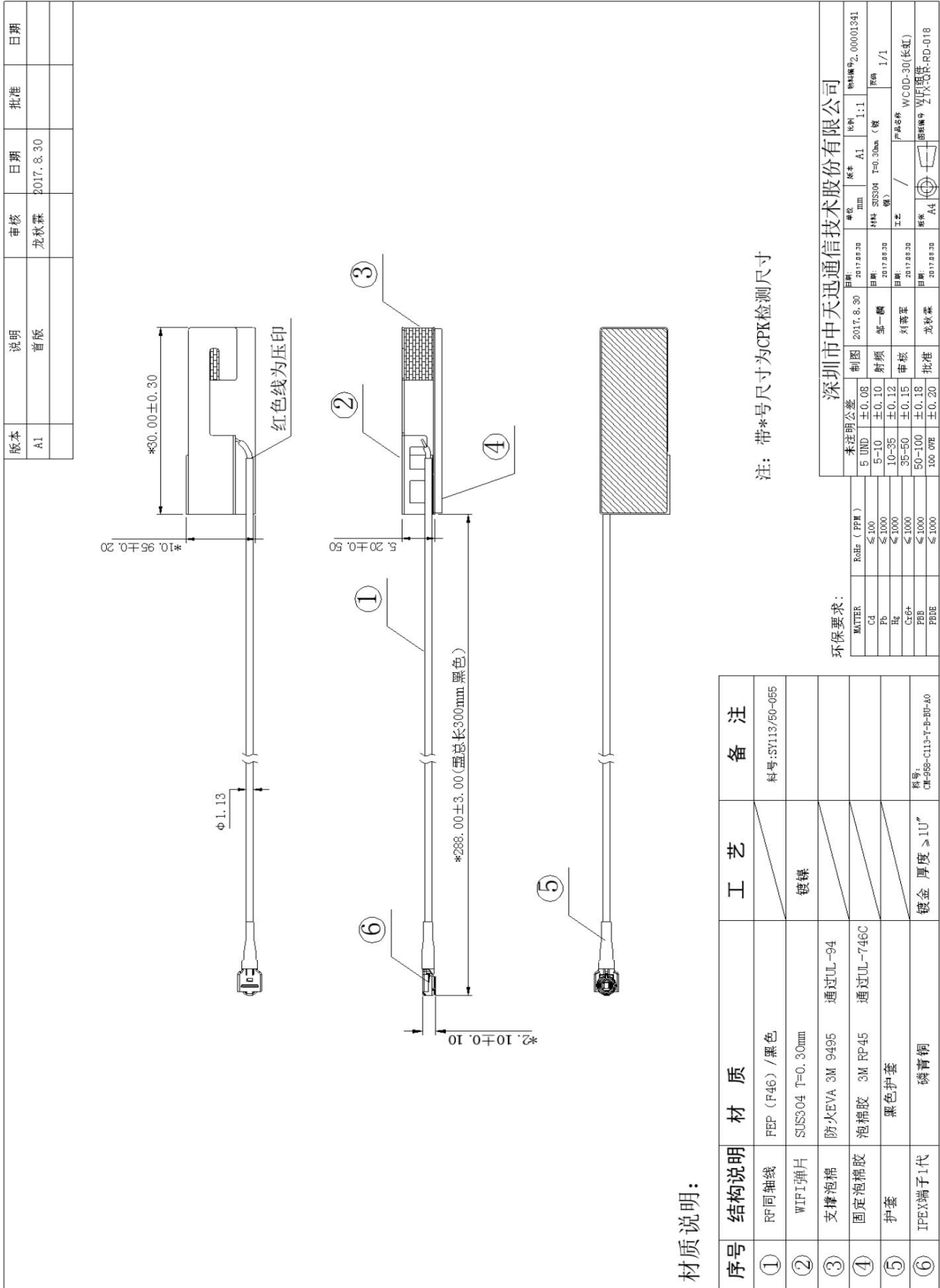

ANTENNA SPECIFICATION

CUS P/N :WC0D

ZTX P/N :WC0D

ApplicationDate:Mar,28,2020

Editor:

Rev: R:A2

Page 9 of 11

5. Environment Characteristic

NO.	ITEM	TEST CONDITION	SPECIFICATION
5-1	High Temperature/Humidity Storage Test(non operating)	1.Temperature: $+80 \pm 2^{\circ}\text{C}$ 2.Humidity: $90\sim 95\%RH$ 3.Time: 48hrs	No material deformation is allowed.
5-2	Low Temperature/Humidity Storage Test(non operating)	1.Temperature: $-30 \pm 2^{\circ}\text{C}$ 2.Humidity: $0\%RH$ 3.Time:48hrs	The VSWR, Gain, Radiation Pattern must be met specifications after these test.

6.Material list

序号	材料(原料) 名称	第三方公证化学报 告测试编号	第三方公证化学报 告测试单位	第三方公证化学 报告测试日期	状态	文档
1	SUS304	SZXEC1800784502	SGS	2019/5/23	有效	PDF
2	泡棉	C190319038001	SGS	2019/03/07	有效	PDF
3	3M 背胶	SHAEC1700965201	SGS	2019/3/25	有效	PDF
4	I-PEX	CANEC1907229906	SGS	2020/5/5	有效	PDF
		A2180247064101002	SGS	2019/12/17	有效	PDF
		A2180247064101001	SGS	2019/12/17	有效	PDF
		CE201876126	SGS	2019/8/6	有效	PDF
5	镀锡铜线	A2180105069201	CTI	2019/6/26	有效	PDF
6	热缩套管	CANEC1925862106	CTI	2020/06/02	有效	PDF



ANTENNA SPECIFICATION

CUS P/N :WC0D
ZTX P/N :WC0D

ApplicationDate:Mar,28,2020
Editor:

Rev: R:A2
Page 10 of 11

7.The packing way

深圳市中天迅通信技术股份有限公司 SHENZHEN ZHONGTIAN XUN Communication Technology Co.,Ltd.		包装规范		文件编号		版本		工序序号/名称		工序工时		日产量																																					
产品名称 WIFI天线		产品型号 WC0D-30(长虹)		ZTX-QD-WI-		A1		包装/装箱		/		/																																					
<p>作业方法 (自检验工序作业合格后,方能流入下一道工序)</p> <ol style="list-style-type: none"> 每40pcs产品整齐、橡皮筋包扎,用PE开口胶袋包装,贴物料标签(打印内容P/N, QTY, Part Name, 数量、周期, 二维码等信息); 将独立包装好的产品,每9袋(360PCS)装入(38*28cm) PE封口胶袋中,贴物料标签(打印内容P/N, QTY, Part Name, 数量、周期, 二维码等信息); 装箱,纸箱规格(38*26*9cm) 每小箱装2袋(720pcs) 贴物料标签(打印内容P/N, QTY, Part Name, 数量、周期, 二维码等信息); 装箱,纸箱规格(45*32.5*42cm) 每大箱装5小箱(3600pcs)尾数除外; 外箱的右上角贴合格证,标签内容包括(供货厂家,长虹物料代码,物资名称,型号规格,订单号,订单总数量,数量,箱号/箱数,市场日期,净重/毛重,加盖公章, VENDOR, QTY, PART DESC等信息);不可有漏写,写错现象; 箱子用胶纸以“工”字型封箱。 																																																	
<p>注意事项:</p> <p>注意标签有无贴错,漏贴,箱子有无破损; 物料标签内容及格式按(长虹)要求。</p>																																																	
<table border="1"> <tr> <th>物料名称</th> <th>物料编码</th> <th>用量</th> <th>规格尺寸</th> </tr> <tr> <td>PE开口袋</td> <td></td> <td>90</td> <td>240*160mm</td> </tr> <tr> <td>PE封口袋</td> <td></td> <td>15</td> <td>360*280mm</td> </tr> <tr> <td>橡皮筋</td> <td></td> <td>90</td> <td></td> </tr> <tr> <td>纸箱</td> <td></td> <td>5</td> <td>38*26*9cm</td> </tr> <tr> <td>纸箱</td> <td></td> <td>1</td> <td>45*32.5*42cm</td> </tr> <tr> <td>小标签</td> <td></td> <td></td> <td>70*50mm</td> </tr> <tr> <td>内外箱标签</td> <td></td> <td></td> <td>100*80mm</td> </tr> <tr> <td>外箱条形码</td> <td></td> <td></td> <td>100*50mm</td> </tr> </table>														物料名称	物料编码	用量	规格尺寸	PE开口袋		90	240*160mm	PE封口袋		15	360*280mm	橡皮筋		90		纸箱		5	38*26*9cm	纸箱		1	45*32.5*42cm	小标签			70*50mm	内外箱标签			100*80mm	外箱条形码			100*50mm
物料名称	物料编码	用量	规格尺寸																																														
PE开口袋		90	240*160mm																																														
PE封口袋		15	360*280mm																																														
橡皮筋		90																																															
纸箱		5	38*26*9cm																																														
纸箱		1	45*32.5*42cm																																														
小标签			70*50mm																																														
内外箱标签			100*80mm																																														
外箱条形码			100*50mm																																														
<table border="1"> <tr> <td>物料名称</td> <td>物料编码</td> <td>用量</td> <td>规格尺寸</td> </tr> <tr> <td>PE开口袋</td> <td></td> <td>90</td> <td>240*160mm</td> </tr> <tr> <td>PE封口袋</td> <td></td> <td>15</td> <td>360*280mm</td> </tr> <tr> <td>橡皮筋</td> <td></td> <td>90</td> <td></td> </tr> <tr> <td>纸箱</td> <td></td> <td>5</td> <td>38*26*9cm</td> </tr> <tr> <td>纸箱</td> <td></td> <td>1</td> <td>45*32.5*42cm</td> </tr> <tr> <td>小标签</td> <td></td> <td></td> <td>70*50mm</td> </tr> <tr> <td>内外箱标签</td> <td></td> <td></td> <td>100*80mm</td> </tr> <tr> <td>外箱条形码</td> <td></td> <td></td> <td>100*50mm</td> </tr> </table>														物料名称	物料编码	用量	规格尺寸	PE开口袋		90	240*160mm	PE封口袋		15	360*280mm	橡皮筋		90		纸箱		5	38*26*9cm	纸箱		1	45*32.5*42cm	小标签			70*50mm	内外箱标签			100*80mm	外箱条形码			100*50mm
物料名称	物料编码	用量	规格尺寸																																														
PE开口袋		90	240*160mm																																														
PE封口袋		15	360*280mm																																														
橡皮筋		90																																															
纸箱		5	38*26*9cm																																														
纸箱		1	45*32.5*42cm																																														
小标签			70*50mm																																														
内外箱标签			100*80mm																																														
外箱条形码			100*50mm																																														
<table border="1"> <tr> <td>物料名称</td> <td>物料编码</td> <td>用量</td> <td>规格尺寸</td> </tr> <tr> <td>PE开口袋</td> <td></td> <td>90</td> <td>240*160mm</td> </tr> <tr> <td>PE封口袋</td> <td></td> <td>15</td> <td>360*280mm</td> </tr> <tr> <td>橡皮筋</td> <td></td> <td>90</td> <td></td> </tr> <tr> <td>纸箱</td> <td></td> <td>5</td> <td>38*26*9cm</td> </tr> <tr> <td>纸箱</td> <td></td> <td>1</td> <td>45*32.5*42cm</td> </tr> <tr> <td>小标签</td> <td></td> <td></td> <td>70*50mm</td> </tr> <tr> <td>内外箱标签</td> <td></td> <td></td> <td>100*80mm</td> </tr> <tr> <td>外箱条形码</td> <td></td> <td></td> <td>100*50mm</td> </tr> </table>														物料名称	物料编码	用量	规格尺寸	PE开口袋		90	240*160mm	PE封口袋		15	360*280mm	橡皮筋		90		纸箱		5	38*26*9cm	纸箱		1	45*32.5*42cm	小标签			70*50mm	内外箱标签			100*80mm	外箱条形码			100*50mm
物料名称	物料编码	用量	规格尺寸																																														
PE开口袋		90	240*160mm																																														
PE封口袋		15	360*280mm																																														
橡皮筋		90																																															
纸箱		5	38*26*9cm																																														
纸箱		1	45*32.5*42cm																																														
小标签			70*50mm																																														
内外箱标签			100*80mm																																														
外箱条形码			100*50mm																																														
<table border="1"> <tr> <td>物料名称</td> <td>物料编码</td> <td>用量</td> <td>规格尺寸</td> </tr> <tr> <td>PE开口袋</td> <td></td> <td>90</td> <td>240*160mm</td> </tr> <tr> <td>PE封口袋</td> <td></td> <td>15</td> <td>360*280mm</td> </tr> <tr> <td>橡皮筋</td> <td></td> <td>90</td> <td></td> </tr> <tr> <td>纸箱</td> <td></td> <td>5</td> <td>38*26*9cm</td> </tr> <tr> <td>纸箱</td> <td></td> <td>1</td> <td>45*32.5*42cm</td> </tr> <tr> <td>小标签</td> <td></td> <td></td> <td>70*50mm</td> </tr> <tr> <td>内外箱标签</td> <td></td> <td></td> <td>100*80mm</td> </tr> <tr> <td>外箱条形码</td> <td></td> <td></td> <td>100*50mm</td> </tr> </table>														物料名称	物料编码	用量	规格尺寸	PE开口袋		90	240*160mm	PE封口袋		15	360*280mm	橡皮筋		90		纸箱		5	38*26*9cm	纸箱		1	45*32.5*42cm	小标签			70*50mm	内外箱标签			100*80mm	外箱条形码			100*50mm
物料名称	物料编码	用量	规格尺寸																																														
PE开口袋		90	240*160mm																																														
PE封口袋		15	360*280mm																																														
橡皮筋		90																																															
纸箱		5	38*26*9cm																																														
纸箱		1	45*32.5*42cm																																														
小标签			70*50mm																																														
内外箱标签			100*80mm																																														
外箱条形码			100*50mm																																														
<table border="1"> <tr> <td>物料名称</td> <td>物料编码</td> <td>用量</td> <td>规格尺寸</td> </tr> <tr> <td>PE开口袋</td> <td></td> <td>90</td> <td>240*160mm</td> </tr> <tr> <td>PE封口袋</td> <td></td> <td>15</td> <td>360*280mm</td> </tr> <tr> <td>橡皮筋</td> <td></td> <td>90</td> <td></td> </tr> <tr> <td>纸箱</td> <td></td> <td>5</td> <td>38*26*9cm</td> </tr> <tr> <td>纸箱</td> <td></td> <td>1</td> <td>45*32.5*42cm</td> </tr> <tr> <td>小标签</td> <td></td> <td></td> <td>70*50mm</td> </tr> <tr> <td>内外箱标签</td> <td></td> <td></td> <td>100*80mm</td> </tr> <tr> <td>外箱条形码</td> <td></td> <td></td> <td>100*50mm</td> </tr> </table>														物料名称	物料编码	用量	规格尺寸	PE开口袋		90	240*160mm	PE封口袋		15	360*280mm	橡皮筋		90		纸箱		5	38*26*9cm	纸箱		1	45*32.5*42cm	小标签			70*50mm	内外箱标签			100*80mm	外箱条形码			100*50mm
物料名称	物料编码	用量	规格尺寸																																														
PE开口袋		90	240*160mm																																														
PE封口袋		15	360*280mm																																														
橡皮筋		90																																															
纸箱		5	38*26*9cm																																														
纸箱		1	45*32.5*42cm																																														
小标签			70*50mm																																														
内外箱标签			100*80mm																																														
外箱条形码			100*50mm																																														
<table border="1"> <tr> <td>物料名称</td> <td>物料编码</td> <td>用量</td> <td>规格尺寸</td> </tr> <tr> <td>PE开口袋</td> <td></td> <td>90</td> <td>240*160mm</td> </tr> <tr> <td>PE封口袋</td> <td></td> <td>15</td> <td>360*280mm</td> </tr> <tr> <td>橡皮筋</td> <td></td> <td>90</td> <td></td> </tr> <tr> <td>纸箱</td> <td></td> <td>5</td> <td>38*26*9cm</td> </tr> <tr> <td>纸箱</td> <td></td> <td>1</td> <td>45*32.5*42cm</td> </tr> <tr> <td>小标签</td> <td></td> <td></td> <td>70*50mm</td> </tr> <tr> <td>内外箱标签</td> <td></td> <td></td> <td>100*80mm</td> </tr> <tr> <td>外箱条形码</td> <td></td> <td></td> <td>100*50mm</td> </tr> </table>														物料名称	物料编码	用量	规格尺寸	PE开口袋		90	240*160mm	PE封口袋		15	360*280mm	橡皮筋		90		纸箱		5	38*26*9cm	纸箱		1	45*32.5*42cm	小标签			70*50mm	内外箱标签			100*80mm	外箱条形码			100*50mm
物料名称	物料编码	用量	规格尺寸																																														
PE开口袋		90	240*160mm																																														
PE封口袋		15	360*280mm																																														
橡皮筋		90																																															
纸箱		5	38*26*9cm																																														
纸箱		1	45*32.5*42cm																																														
小标签			70*50mm																																														
内外箱标签			100*80mm																																														
外箱条形码			100*50mm																																														
<table border="1"> <tr> <td>物料名称</td> <td>物料编码</td> <td>用量</td> <td>规格尺寸</td> </tr> <tr> <td>PE开口袋</td> <td></td> <td>90</td> <td>240*160mm</td> </tr> <tr> <td>PE封口袋</td> <td></td> <td>15</td> <td>360*280mm</td> </tr> <tr> <td>橡皮筋</td> <td></td> <td>90</td> <td></td> </tr> <tr> <td>纸箱</td> <td></td> <td>5</td> <td>38*26*9cm</td> </tr> <tr> <td>纸箱</td> <td></td> <td>1</td> <td>45*32.5*42cm</td> </tr> <tr> <td>小标签</td> <td></td> <td></td> <td>70*50mm</td> </tr> <tr> <td>内外箱标签</td> <td></td> <td></td> <td>100*80mm</td> </tr> <tr> <td>外箱条形码</td> <td></td> <td></td> <td>100*50mm</td> </tr> </table>														物料名称	物料编码	用量	规格尺寸	PE开口袋		90	240*160mm	PE封口袋		15	360*280mm	橡皮筋		90		纸箱		5	38*26*9cm	纸箱		1	45*32.5*42cm	小标签			70*50mm	内外箱标签			100*80mm	外箱条形码			100*50mm
物料名称	物料编码	用量	规格尺寸																																														
PE开口袋		90	240*160mm																																														
PE封口袋		15	360*280mm																																														
橡皮筋		90																																															
纸箱		5	38*26*9cm																																														
纸箱		1	45*32.5*42cm																																														
小标签			70*50mm																																														
内外箱标签			100*80mm																																														
外箱条形码			100*50mm																																														
<table border="1"> <tr> <td>物料名称</td> <td>物料编码</td> <td>用量</td> <td>规格尺寸</td> </tr> <tr> <td>PE开口袋</td> <td></td> <td>90</td> <td>240*160mm</td> </tr> <tr> <td>PE封口袋</td> <td></td> <td>15</td> <td>360*280mm</td> </tr> <tr> <td>橡皮筋</td> <td></td> <td>90</td> <td></td> </tr> <tr> <td>纸箱</td> <td></td> <td>5</td> <td>38*26*9cm</td> </tr> <tr> <td>纸箱</td> <td></td> <td>1</td> <td>45*32.5*42cm</td> </tr> <tr> <td>小标签</td> <td></td> <td></td> <td>70*50mm</td> </tr> <tr> <td>内外箱标签</td> <td></td> <td></td> <td>100*80mm</td> </tr> <tr> <td>外箱条形码</td> <td></td> <td></td> <td>100*50mm</td> </tr> </table>														物料名称	物料编码	用量	规格尺寸	PE开口袋		90	240*160mm	PE封口袋		15	360*280mm	橡皮筋		90		纸箱		5	38*26*9cm	纸箱		1	45*32.5*42cm	小标签			70*50mm	内外箱标签			100*80mm	外箱条形码			100*50mm
物料名称	物料编码	用量	规格尺寸																																														
PE开口袋		90	240*160mm																																														
PE封口袋		15	360*280mm																																														
橡皮筋		90																																															
纸箱		5	38*26*9cm																																														
纸箱		1	45*32.5*42cm																																														
小标签			70*50mm																																														
内外箱标签			100*80mm																																														
外箱条形码			100*50mm																																														
<table border="1"> <tr> <td>物料名称</td> <td>物料编码</td> <td>用量</td> <td>规格尺寸</td> </tr> <tr> <td>PE开口袋</td> <td></td> <td>90</td> <td>240*160mm</td> </tr> <tr> <td>PE封口袋</td> <td></td> <td>15</td> <td>360*280mm</td> </tr> <tr> <td>橡皮筋</td> <td></td> <td>90</td> <td></td> </tr> <tr> <td>纸箱</td> <td></td> <td>5</td> <td>38*26*9cm</td> </tr> <tr> <td>纸箱</td> <td></td> <td>1</td> <td>45*32.5*42cm</td> </tr> <tr> <td>小标签</td> <td></td> <td></td> <td>70*50mm</td> </tr> <tr> <td>内外箱标签</td> <td></td> <td></td> <td>100*80mm</td> </tr> <tr> <td>外箱条形码</td> <td></td> <td></td> <td>100*50mm</td> </tr> </table>														物料名称	物料编码	用量	规格尺寸	PE开口袋		90	240*160mm	PE封口袋		15	360*280mm	橡皮筋		90		纸箱		5	38*26*9cm	纸箱		1	45*32.5*42cm	小标签			70*50mm	内外箱标签			100*80mm	外箱条形码			100*50mm
物料名称	物料编码	用量	规格尺寸																																														
PE开口袋		90	240*160mm																																														
PE封口袋		15	360*280mm																																														
橡皮筋		90																																															
纸箱		5	38*26*9cm																																														
纸箱		1	45*32.5*42cm																																														
小标签			70*50mm																																														
内外箱标签			100*80mm																																														
外箱条形码			100*50mm																																														
<table border="1"> <tr> <td>物料名称</td> <td>物料编码</td> <td>用量</td> <td>规格尺寸</td> </tr> <tr> <td>PE开口袋</td> <td></td> <td>90</td> <td>240*160mm</td> </tr> <tr> <td>PE封口袋</td> <td></td> <td>15</td> <td>360*280mm</td> </tr> <tr> <td>橡皮筋</td> <td></td> <td>90</td> <td></td> </tr> <tr> <td>纸箱</td> <td></td> <td>5</td> <td>38*26*9cm</td> </tr> <tr> <td>纸箱</td> <td></td> <td>1</td> <td>45*32.5*42cm</td> </tr> <tr> <td>小标签</td> <td></td> <td></td> <td>70*50mm</td> </tr> <tr> <td>内外箱标签</td> <td></td> <td></td> <td>100*80mm</td> </tr> <tr> <td>外箱条形码</td> <td></td> <td></td> <td>100*50mm</td> </tr> </table>														物料名称	物料编码	用量	规格尺寸	PE开口袋		90	240*160mm	PE封口袋		15	360*280mm	橡皮筋		90		纸箱		5	38*26*9cm	纸箱		1	45*32.5*42cm	小标签			70*50mm	内外箱标签			100*80mm	外箱条形码			100*50mm
物料名称	物料编码	用量	规格尺寸																																														
PE开口袋		90	240*160mm																																														
PE封口袋		15	360*280mm																																														
橡皮筋		90																																															
纸箱		5	38*26*9cm																																														
纸箱		1	45*32.5*42cm																																														
小标签			70*50mm																																														
内外箱标签			100*80mm																																														
外箱条形码			100*50mm																																														
<table border="1"> <tr> <td>物料名称</td> <td>物料编码</td> <td>用量</td> <td>规格尺寸</td> </tr> <tr> <td>PE开口袋</td> <td></td> <td>90</td> <td>240*160mm</td> </tr> <tr> <td>PE封口袋</td> <td></td> <td>15</td> <td>360*280mm</td> </tr> <tr> <td>橡皮筋</td> <td></td> <td>90</td> <td></td> </tr> <tr> <td>纸箱</td> <td></td> <td>5</td> <td>38*26*9cm</td> </tr> <tr> <td>纸箱</td> <td></td> <td>1</td> <td>45*32.5*42cm</td> </tr> <tr> <td>小标签</td> <td></td> <td></td> <td>70*50mm</td> </tr> <tr> <td>内外箱标签</td> <td></td> <td></td> <td>100*80mm</td> </tr> <tr> <td>外箱条形码</td> <td></td> <td></td> <td>100*50mm</td> </tr> </table>														物料名称	物料编码	用量	规格尺寸	PE开口袋		90	240*160mm	PE封口袋		15	360*280mm	橡皮筋		90		纸箱		5	38*26*9cm	纸箱		1	45*32.5*42cm	小标签			70*50mm	内外箱标签			100*80mm	外箱条形码			100*50mm
物料名称	物料编码	用量	规格尺寸																																														
PE开口袋		90	240*160mm																																														
PE封口袋		15	360*280mm																																														
橡皮筋		90																																															
纸箱		5	38*26*9cm																																														
纸箱		1	45*32.5*42cm																																														
小标签			70*50mm																																														
内外箱标签			100*80mm																																														
外箱条形码			100*50mm																																														
<table border="1"> <tr> <td>物料名称</td> <td>物料编码</td> <td>用量</td> <td>规格尺寸</td> </tr> <tr> <td>PE开口袋</td> <td></td> <td>90</td> <td>240*160mm</td> </tr> <tr> <td>PE封口袋</td> <td></td> <td>15</td> <td>360*280mm</td> </tr> <tr> <td>橡皮筋</td> <td></td> <td>90</td> <td></td> </tr> <tr> <td>纸箱</td> <td></td> <td>5</td> <td>38*26*9cm</td> </tr> <tr> <td>纸箱</td> <td></td> <td>1</td> <td>45*32.5*42cm</td> </tr> <tr> <td>小标签</td> <td></td> <td></td> <td>70*50mm</td> </tr> <tr> <td>内外箱标签</td> <td></td> <td></td> <td>100*80mm</td> </tr> <tr> <td>外箱条形码</td> <td></td> <td></td> <td>100*50mm</td> </tr> </table>														物料名称	物料编码	用量	规格尺寸	PE开口袋		90	240*160mm	PE封口袋		15	360*280mm	橡皮筋		90		纸箱		5	38*26*9cm	纸箱		1	45*32.5*42cm	小标签			70*50mm	内外箱标签			100*80mm	外箱条形码			100*50mm
物料名称	物料编码	用量	规格尺寸																																														
PE开口袋		90	240*160mm																																														
PE封口袋		15	360*280mm																																														
橡皮筋		90																																															
纸箱		5	38*26*9cm																																														
纸箱		1	45*32.5*42cm																																														
小标签			70*50mm																																														
内外箱标签			100*80mm																																														
外箱条形码			100*50mm																																														
<table border="1"> <tr> <td>物料名称</td> <td>物料编码</td> <td>用量</td> <td>规格尺寸</td> </tr> <tr> <td>PE开口袋</td> <td></td> <td>90</td> <td>240*160mm</td> </tr> <tr> <td>PE封口袋</td> <td></td> <td>15</td> <td>360*280mm</td> </tr> <tr> <td>橡皮筋</td> <td></td> <td>90</td> <td></td> </tr> <tr> <td>纸箱</td> <td></td> <td>5</td> <td>38*26*9cm</td> </tr> <tr> <td>纸箱</td> <td></td> <td>1</td> <td>45*32.5*42cm</td> </tr> <tr> <td>小标签</td> <td></td> <td></td> <td>70*50mm</td> </tr> <tr> <td>内外箱标签</td> <td></td> <td></td> <td>100*80mm</td> </tr> <tr> <td>外箱条形码</td> <td></td> <td></td> <td>100*50mm</td> </tr> </table>														物料名称	物料编码	用量	规格尺寸	PE开口袋		90	240*160mm	PE封口袋		15	360*280mm	橡皮筋		90		纸箱		5	38*26*9cm	纸箱		1	45*32.5*42cm	小标签			70*50mm	内外箱标签			100*80mm	外箱条形码			100*50mm
物料名称	物料编码	用量	规格尺寸																																														
PE开口袋		90	240*160mm																																														
PE封口袋		15	360*280mm																																														
橡皮筋		90																																															
纸箱		5	38*26*9cm																																														
纸箱		1	45*32.5*42cm																																														
小标签			70*50mm																																														
内外箱标签			100*80mm																																														
外箱条形码			100*50mm																																														
<table border="1"> <tr> <td>物料名称</td> <td>物料编码</td> <td>用量</td> <td>规格尺寸</td> </tr> <tr> <td>PE开口袋</td> <td></td> <td>90</td> <td>240*160mm</td> </tr> <tr> <td>PE封口袋</td> <td></td> <td>15</td> <td>360*280mm</td> </tr> <tr> <td>橡皮筋</td> <td></td> <td>90</td> <td></td> </tr> <tr> <td>纸箱</td> <td></td> <td>5</td> <td>38*26*9cm</td> </tr> <tr> <td>纸箱</td> <td></td> <td>1</td> <td>45*32.5*42cm</td> </tr> <tr> <td>小标签</td> <td></td> <td></td> <td>70*50mm</td> </tr> <tr> <td>内外箱标签</td> <td></td> <td></td> <td>100*80mm</td> </tr> <tr> <td>外箱条形码</td> <td></td> <td></td> <td>100*50mm</td> </tr> </table>														物料名称	物料编码	用量	规格尺寸	PE开口袋		90	240*160mm	PE封口袋		15	360*280mm	橡皮筋		90		纸箱		5	38*26*9cm	纸箱		1	45*32.5*42cm	小标签			70*50mm	内外箱标签			100*80mm	外箱条形码			100*50mm
物料名称	物料编码	用量	规格尺寸																																														
PE开口袋		90	240*160mm																																														
PE封口袋		15	360*280mm																																														
橡皮筋		90																																															
纸箱		5	38*26*9cm																																														
纸箱		1	45*32.5*42cm																																														
小标签			70*50mm																																														
内外箱标签			100*80mm																																														
外箱条形码			100*50mm																																														
<table border="1"> <tr> <td>物料名称</td> <td>物料编码</td> <td>用量</td> <td>规格尺寸</td> </tr> <tr> <td>PE开口袋</td> <td></td> <td>90</td> <td>240*160mm</td> </tr> <tr> <td>PE封口袋</td> <td></td> <td>15</td> <td>360*280mm</td> </tr> <tr> <td>橡皮筋</td> <td></td> <td>90</td> <td></td> </tr> <tr> <td>纸箱</td> <td></td> <td>5</td> <td>38*26*9cm</td> </tr> <tr> <td>纸箱</td> <td></td> <td>1</td> <td>45*32.5*42cm</td> </tr> <tr> <td>小标签</td> <td></td> <td></td> <td>70*50mm</td> </tr> <tr> <td>内外箱标签</td> <td></td> <td></td> <td>100*80mm</td> </tr> <tr> <td>外箱条形码</td> <td></td> <td></td> <td>100*50mm</td> </tr> </table>														物料名称	物料编码	用量	规格尺寸	PE开口袋		90	240*160mm	PE封口袋		15	360*280mm	橡皮筋		90		纸箱		5	38*26*9cm	纸箱		1	45*32.5*42cm	小标签			70*50mm	内外箱标签			100*80mm	外箱条形码			100*50mm
物料名称	物料编码	用量	规格尺寸																																														
PE开口袋		90	240*160mm																																														
PE封口袋		15	360*280mm																																														
橡皮筋		90																																															
纸箱		5	38*26*9cm																																														
纸箱		1	45*32.5*42cm																																														
小标签			70*50mm																																														
内外箱标签			100*80mm																																														
外箱条形码			100*50mm																																														
<table border="1"> <tr> <td>物料名称</td> <td>物料编码</td> <td>用量</td> <td>规格尺寸</td> </tr> <tr> <td>PE开口袋</td> <td></td> <td>90</td> <td>240*160mm</td> </tr> <tr> <td>PE封口袋</td> <td></td> <td>15</td> <td>360*280mm</td> </tr> <tr> <td>橡皮筋</td> <td></td> <td>90</td> <td></td> </tr> <tr> <td>纸箱</td> <td></td> <td>5</td> <td>38*26*9cm</td> </tr> <tr> <td>纸箱</td> <td></td> <td>1</td> <td>45*32.5*42cm</td> </tr> <tr> <td>小标签</td> <td></td> <td></td> <td>70*50mm</td> </tr> <tr> <td>内外箱标签</td> <td></td> <td></td> <td>100*80mm</td> </tr> <tr> <td>外箱条形码</td> <td></td> <td></td> <td>100*50mm</td> </tr> </table>														物料名称	物料编码	用量	规格尺寸	PE开口袋		90	240*160mm	PE封口袋		15	360*280mm	橡皮筋		90		纸箱		5	38*26*9cm	纸箱		1	45*32.5*42cm	小标签			70*50mm	内外箱标签			100*80mm	外箱条形码			100*50mm
物料名称	物料编码	用量	规格尺寸																																														
PE开口袋		90	240*160mm																																														
PE封口袋		15	360*280mm																																														
橡皮筋		90																																															
纸箱		5	38*26*9cm																																														
纸箱		1	45*32.5*42cm																																														
小标签			70*50mm																																														
内外箱标签			100*80mm																																														
外箱条形码			100*50mm																																														
<table border="1"> <tr> <td>物料名称</td> <td>物料编码</td> <td>用量</td> <td>规格尺寸</td> </tr> <tr> <td>PE开口袋</td> <td></td> <td>90</td> <td>240*160mm</td> </tr> <tr> <td>PE封口袋</td> <td></td> <td>15</td> <td>360*280mm</td> </tr> <tr> <td>橡皮筋</td> <td></td> <td>90</td> <td></td> </tr> <tr> <td>纸箱</td> <td></td> <td>5</td> <td>38*26*9cm</td> </tr> <tr> <td>纸箱</td> <td></td> <td>1</td> <td>45*32.5*42cm</td> </tr> <tr> <td>小标签</td> <td></td> <td></td> <td>70*50mm</td> </tr> <tr> <td>内外箱标签</td> <td></td> <td></td> <td>100*80mm</td> </tr> <tr> <td>外箱条形码</td> <td></td> <td></td> <td>100*50mm</td> </tr> </table>														物料名称	物料编码	用量	规格尺寸	PE开口袋		90	240*160mm	PE封口袋		15	360*280mm	橡皮筋		90		纸箱		5	38*26*9cm	纸箱		1	45*32.5*42cm	小标签			70*50mm	内外箱标签			100*80mm	外箱条形码			100*50mm
物料名称	物料编码	用量	规格尺寸																																														
PE开口袋		90	240*160mm																																														
PE封口袋		15	360*280mm																																														
橡皮筋		90																																															
纸箱		5	38*26*9cm																																														
纸箱		1	45*32.5*42cm																																														
小标签			70*50mm																																														
内外箱标签			100*80mm																																														
外箱条形码			100*50mm																																														
<table border="1"> <tr> <td>物料名称</td> <td>物料编码</td> <td>用量</td> <td>规格尺寸</td> </tr> <tr> <td>PE开口袋</td> <td></td> <td>90</td> <td>240*160mm</td> </tr> <tr> <td>PE封口袋</td> <td></td> <td>15</td> <td>360*280mm</td> </tr> <tr> <td>橡皮筋</td> <td></td> <td>90</td> <td></td> </tr> <tr> <td>纸箱</td> <td></td> <td>5</td> <td>38*26*9cm</td> </tr> <tr> <td>纸箱</td> <td></td> <td>1</td> <td>45*32.5*42cm</td> </tr> <tr> <td>小标签</td> <td></td> <td></td> <td>70*50mm</td> </tr> <tr> <td>内外箱标签</td> <td></td> <td></td> <td>100*80mm</td> </tr> <tr> <td>外箱条形码</td> <td></td> <td></td> <td>100*50mm</td> </tr> </table>														物料名称	物料编码	用量	规格尺寸	PE开口袋		90	240*160mm	PE封口袋		15	360*280mm	橡皮筋		90		纸箱		5	38*26*9cm	纸箱		1	45*32.5*42cm	小标签			70*50mm	内外箱标签			100*80mm	外箱条形码			100*50mm
物料名称	物料编码	用量	规格尺寸																																														
PE开口袋		90	240*160mm																																														
PE封口袋		15	360*280mm																																														
橡皮筋		90																																															
纸箱		5	38*26*9cm																																														
纸箱		1	45*32.5*42cm																																														
小标签			70*50mm																																														
内外箱标签			100*80mm																																														
外箱条形码			100*50mm																																														
<table border="1"> <tr> <td>物料名称</td> <td>物料编码</td> <td>用量</td> <td>规格尺寸</td> </tr> <tr> <td>PE开口袋</td> <td></td> <td>90</td> <td>240*160mm</td> </tr> <tr> <td>PE封口袋</td> <td></td> <td>15</td> <td>360*280mm</td> </tr> <tr> <td>橡皮筋</td> <td></td> <td>90</td> <td></td> </tr> <tr> <td>纸箱</td> <td></td> <td>5</td> <td>38*26*9cm</td> </tr> <tr> <td>纸箱</td> <td></td> <td>1</td> <td>45*32.5*42cm</td> </tr> <tr> <td>小标签</td> <td></td> <td></td> <td>70*50mm</td> </tr> <tr> <td>内外箱标签</td> <td></td> <td></td> <td>100*80mm</td> </tr> <tr> <td>外箱条形码</td> <td></td> <td></td> <td>100*50mm</td> </tr> </table>														物料名称	物料编码	用量	规格尺寸	PE开口袋		90	240*160mm	PE封口袋		15	360*280mm	橡皮筋		90		纸箱		5	38*26*9cm	纸箱		1	45*32.5*42cm	小标签			70*50mm	内外箱标签			100*80mm	外箱条形码			100*50mm
物料名称	物料编码	用量	规格尺寸																																														
PE开口袋		90	240*160mm																																														
PE封口袋		15	360*280mm																																														
橡皮筋		90																																															
纸箱		5	38*26*9cm																																														
纸箱		1	45*32.5*42cm																																														
小标签			70*50mm																																														
内外箱标签			100*80mm																																														
外箱条形码			100*50mm																																														
<table border="1"> <tr> <td>物料名称</td> <td>物料编码</td> <td>用量</td> <td>规格尺寸</td> </tr> <tr> <td>PE开口袋</td> <td></td> <td>90</td> <td>240*160mm</td> </tr> <tr> <td>PE封口袋</td> <td></td> <td>15</td> <td>360*280mm</td> </tr> <tr> <td>橡皮筋</td> <td></td> <td>90</td> <td></td> </tr> <tr> <td>纸箱</td> <td></td> <td>5</td> <td>38*26*9cm</td> </tr> <tr> <td>纸箱</td> <td></td> <td>1</td> <td>45*32.5*42cm</td> </tr> <tr> <td>小标签</td> <td></td> <td></td> <td>70*50mm</td> </tr> <tr> <td>内外箱标签</td> <td></td> <td></td> <td>100*80mm</td> </tr> <tr> <td>外箱条形码</td> <td></td> <td></td> <td>100*50mm</td> </tr> </table>														物料名称	物料编码	用量	规格尺寸	PE开口袋		90	240*160mm	PE封口袋		15	360*280mm	橡皮筋		90		纸箱		5	38*26*9cm	纸箱		1	45*32.5*42cm	小标签			70*50mm	内外箱标签			100*80mm	外箱条形码			100*50mm
物料名称	物料编码	用量	规格尺寸																																														
PE开口袋		90	240*160mm																																														
PE封口袋		15	360*280mm																																														
橡皮筋		90																																															
纸箱		5	38*26*9cm																																														
纸箱		1	45*32.5*42cm																																														
小标签			70*50mm																																														
内外箱标签			100*80mm																																														
外箱条形码			100*50mm																																														
<table border="1"> <tr> <td>物料名称</td> <td>物料编码</td> <td>用量</td> <td>规格尺寸</td> </tr> <tr> <td>PE开口袋</td> <td></td> <td>90</td> <td>240*160mm</td> </tr> <tr> <td>PE封口袋</td> <td></td> <td>15</td> <td>360*280mm</td> </tr> <tr> <td>橡皮筋</td> <td></td> <td>90</td> <td></td> </tr> <tr> <td>纸箱</td> <td></td> <td>5</td> <td>38*26*9cm</td> </tr> <tr> <td>纸箱</td> <td></td> <td>1</td> <td>45*32.5*42cm</td> </tr> <tr> <td>小标签</td> <td></td> <td></td> <td>70*50mm</td> </tr> <tr> <td>内外箱标签</td> <td></td> <td></td> <td>100*80mm</td> </tr> <tr> <td>外箱条形码</td> <td></td> <td></td> <td>100*50mm</td> </tr> </table>														物料名称	物料编码	用量	规格尺寸	PE开口袋		90	240*160mm	PE封口袋		15	360*280mm	橡皮筋		90		纸箱		5	38*26*9cm	纸箱		1	45*32.5*42cm	小标签			70*50mm	内外箱标签			100*80mm	外箱条形码			100*50mm
物料名称	物料编码	用量	规格尺寸																																														
PE开口袋		90	240*160mm																																														
PE封口袋		15	360*280mm																																														
橡皮筋		90																																															
纸箱		5	38*26*9cm																																														
纸箱		1	45*32.5*42cm																																														
小标签			70*50mm																																														
内外箱标签			100*80mm																																														
外箱条形码			100*50mm																																														
<table border="1"> <tr> <td>物料名称</td> <td>物料编码</td> <td>用量</td> <td>规格尺寸</td> </tr> <tr> <td>PE开口袋</td> <td></td> <td>90</td> <td>240*160mm</td> </tr> <tr> <td>PE封口袋</td> <td></td> <td>15</td> <td>360*280mm</td> </tr> <tr> <td>橡皮筋</td> <td></td> <td>90</td> <td></td> </tr> <tr> <td>纸箱</td> <td></td> <td>5</td> <td>38*26*9cm</td> </tr> <tr> <td>纸箱</td> <td></td> <td>1</td> <td>45*32.5*42cm</td> </tr> <tr> <td>小标签</td> <td></td> <td></td> <td>70*50mm</td> </tr> <tr> <td>内外箱标签</td> <td></td> <td></td> <td>100*80mm</td> </tr> <tr> <td>外箱条形码</td> <td></td> <td></td> <td>100*50mm</td> </tr> </table>														物料名称	物料编码	用量	规格尺寸	PE开口袋		90	240*160mm	PE封口袋		15	360*280mm	橡皮筋		90		纸箱		5	38*26*9cm	纸箱		1	45*32.5*42cm	小标签			70*50mm	内外箱标签			100*80mm	外箱条形码			100*50mm
物料名称	物料编码	用量	规格尺寸																																														
PE开口袋		90	240*160mm																																														
PE封口袋		15	360*280mm																																														
橡皮筋		90																																															
纸箱		5	38*26*9cm																																														
纸箱		1	45*32.5*42cm																																														
小标签			70*50mm																																														
内外箱标签			100*80mm																																														
外箱条形码			100*50mm																																														
<table border="1"> <tr> <td>物料名称</td> <td>物料编码</td> <td>用量</td> <td>规格尺寸</td> </tr> <tr> <td>PE开口袋</td> <td></td> <td>90</td> <td>240*160mm</td> </tr> <tr> <td>PE封口袋</td> <td></td> <td>15</td> <td>360*280mm</td> </tr> <tr> <td>橡皮筋</td> <td></td> <td>90</td> <td></td> </tr> <tr> <td>纸箱</td> <td></td> <td>5</td> <td>38*26*9cm</td> </tr> <tr> <td>纸箱</td> <td></td> <td>1</td> <td>45*32.5*42cm</td> </tr> <tr> <td>小标签</td> <td></td> <td></td> <td>70*50mm</td> </tr> <tr> <td>内外箱标签</td> <td></td> <td></td> <td>100*80mm</td> </tr> <tr> <td>外箱条形码</td> <td></td> <td></td> <td>100*50mm</td> </tr> </table>														物料名称	物料编码	用量	规格尺寸	PE开口袋		90	240*160mm	PE封口袋		15	360*280mm	橡皮筋		90		纸箱		5	38*26*9cm	纸箱		1	45*32.5*42cm	小标签			70*50mm	内外箱标签			100*80mm	外箱条形码			100*50mm
物料名称	物料编码	用量	规格尺寸																																														
PE开口袋		90	240*160mm																																														
PE封口袋		15	360*280mm																																														
橡皮筋		90																																															
纸箱		5	38*26*9cm																																														
纸箱		1	45*32.5*42cm																																														
小标签			70*50mm																																														
内外箱标签			100*80mm																																														
外箱条形码			100*50mm																																														
<table border="1"> <tr> <td>物料名称</td> <td>物料编码</td> <td>用量</td> <td>规格尺寸</td> </tr> <tr> <td>PE开口袋</td> <td></td> <td>90</td> <td>240*160mm</td> </tr> <tr> <td>PE封口袋</td> <td></td> <td>15</td> <td>360*280mm</td> </tr> <tr> <td>橡皮筋</td> <td></td> <td>90</td> <td></td> </tr> <tr> <td>纸箱</td> <td></td> <td>5</td> <td>38*26*9cm</td> </tr> <tr> <td>纸箱</td> <td></td> <td>1</td> <td>45*32.5*42cm</td> </tr> <tr> <td>小标签</td> <td></td> <td></td> <td>70*50mm</td> </tr> <tr> <td>内外箱标签</td> <td></td> <td></td> <td>100*80mm</td> </tr> <tr> <td>外箱条形码</td> <td></td> <td></td> <td>100*50mm</td> </tr> </table>														物料名称	物料编码	用量	规格尺寸	PE开口袋		90	240*160mm	PE封口袋		15	360*280mm	橡皮筋		90		纸箱		5	38*26*9cm	纸箱		1	45*32.5*42cm	小标签			70*50mm	内外箱标签			100*80mm	外箱条形码			100*50mm
物料名称	物料编码	用量	规格尺寸																																														
PE开口袋		90	240*160mm																																														
PE封口袋		15	360*280mm																																														
橡皮筋		90																																															
纸箱		5	38*26*9cm																																														
纸箱		1	45*32.5*42cm																																														
小标签			70*50mm																																														
内外箱标签			100*80mm																																														
外箱条形码			100*50mm																																														
<table border="1"> <tr> <td>物料名称</td> <td>物料编码</td> <td>用量</td> <td>规格尺寸</td> </tr> <tr> <td>PE开口袋</td> <td></td> <td>90</td> <td>240*160mm</td> </tr> <tr> <td>PE封口袋</td> <td></td> <td>15</td> <td>360*280mm</td> </tr> <tr> <td>橡皮筋</td> <td></td> <td>90</td> <td></td> </tr> <tr> <td>纸箱</td> <td></td> <td>5</td> <td>38*26*9cm</td> </tr> <tr> <td>纸箱</td> <td></td> <td>1</td> <td>45*32.5*42cm</td> </tr> <tr> <td>小标签</td> <td></td> <td></td> <td>70*50mm</td> </tr> <tr> <td>内外箱标签</td> <td></td> <td></td> <td>100*80mm</td> </tr> <tr> <td>外箱条形码</td> <td></td> <td></td> <td>100*50mm</td> </tr> </table>														物料名称	物料编码	用量	规格尺寸	PE开口袋		90	240*160mm	PE封口袋		15	360*280mm	橡皮筋		90		纸箱		5	38*26*9cm	纸箱		1	45*32.5*42cm	小标签			70*50mm	内外箱标签			100*80mm	外箱条形码			100*50mm
物料名称	物料编码	用量	规格尺寸																																														
PE开口袋		90	240*160mm																																														
PE封口袋		15	360*280mm																																														
橡皮筋		90																																															
纸箱		5	38*26*9cm																																														
纸箱		1	45*32.5*42cm																																														
小标签			70*50mm																																														
内外箱标签			100*80mm																																														
外箱条形码			100*50mm																																														
<table border="1"> <tr> <td>物料名称</td> <td>物料编码</td> <td>用量</td> <td>规格尺寸</td> </tr> <tr> <td>PE开口袋</td> <td></td> <td>90</td> <td>240*160mm</td> </tr> <tr> <td>PE封口袋</td> <td></td> <td>15</td> <td>360*280mm</td> </tr> <tr> <td>橡皮筋</td> <td></td> <td>90</td> <td></td> </tr> <tr> <td>纸箱</td> <td></td> <td>5</td> <td>38*26*9cm</td> </tr> <tr> <td>纸箱</td> <td></td> <td>1</td> <td>45*32.5*42cm</td> </tr> <tr> <td>小标签</td> <td></td> <td></td> <td>70*50mm</td> </tr> <tr> <td>内外箱标签</td> <td></td> <td></td> <td>100*80mm</td> </tr> <tr> <td>外箱条形码</td> <td></td> <td></td> <td>100*50mm</td> </tr> </table>														物料名称	物料编码	用量	规格尺寸	PE开口袋		90	240*160mm	PE封口袋		15	360*280mm	橡皮筋		90		纸箱		5	38*26*9cm	纸箱		1	45*32.5*42cm	小标签			70*50mm	内外箱标签			100*80mm	外箱条形码			100*50mm
物料名称	物料编码	用量	规格尺寸																																														
PE开口袋		90	240*160mm																																														
PE封口袋		15	360*280mm																																														
橡皮筋		90																																															
纸箱		5	38*26*9cm																																														
纸箱		1	45*32.5*42cm																																														
小标签			70*50mm																																														
内外箱标签			100*80mm																																														
外箱条形码			100*50mm																																														
<table border="1"> <tr> <td>物料名称</td> <td>物料编码</td> <td>用量</td> <td>规格尺寸</td> </tr> <tr> <td>PE开口袋</td> <td></td> <td>90</td> <td>240*160mm</td> </tr> <tr> <td>PE封口袋</td> <td></td> <td>15</td> <td>360*280mm</td> </tr> <tr> <td>橡皮筋</td> <td></td> <td>90</td> <td></td> </tr> <tr> <td>纸箱</td> <td></td> <td>5</td> <td>38*26*9cm</td> </tr> <tr> <td>纸箱</td> <td></td> <td>1</td> <td>45*32.5*42cm</td> </tr> <tr> <td>小标签</td> <td></td> <td></td> <td>70*50mm</td> </tr> <tr> <td>内外箱标签</td> <td></td> <td></td> <td>100*80mm</td> </tr> <tr> <td>外箱条形码</td> <td></td> <td></td> <td>100*50mm</td> </tr> </table>														物料名称	物料编码	用量	规格尺寸	PE开口袋		90	240*160mm	PE封口袋		15	360*280mm	橡皮筋		90		纸箱		5	38*26*9cm	纸箱		1	45*32.5*42cm	小标签			70*50mm	内外箱标签			100*80mm	外箱条形码			100*50mm
物料名称	物料编码	用量	规格尺寸																																														
PE开口袋		90	240*160mm																																														
PE封口袋		15	360*280mm																																														
橡皮筋		90																																															
纸箱		5	38*26*9cm																																														
纸箱		1	45*32.5*42cm																																														
小标签			70*50mm																																														
内外箱标签			100*80mm																																														
外箱条形码			100*50mm																																														
<table border="1"> <tr> <td>物料名称</td> <td>物料编码</td> <td>用量</td> <td>规格尺寸</td> </tr> <tr> <td>PE开口袋</td> <td></td> <td>90</td> <td>240*160mm</td> </tr> <tr> <td>PE封口袋</td> <td></td> <td>15</td> <td>360*280mm</td> </tr> <tr> <td>橡皮筋</td> <td></td> <td>90</td> <td></td> </tr> <tr> <td>纸箱</td> <td></td> <td>5</td> <td>38*26*9cm</td> </tr> <tr> <td>纸箱</td> <td></td> <td>1</td> <td>45*32.5*42cm</td> </tr> <tr> <td>小标签</td> <td></td> <td></td> <td>70*50mm</td> </tr> <tr> <td>内外箱标签</td> <td></td> <td></td> <td>100*80mm</td> </tr> <tr> <td>外箱条形码</td> <td></td> <td></td> <td>100*50mm</td> </tr> </table>														物料名称	物料编码	用量	规格尺寸	PE开口袋		90	240*160mm	PE封口袋		15	360*280mm	橡皮筋		90		纸箱		5	38*26*9cm	纸箱		1	45*32.5*42cm	小标签			70*50mm	内外箱标签			100*80mm	外箱条形码			100*50mm
物料名称	物料编码	用量	规格尺寸																																														
PE开口袋		90	240*160mm																																														
PE封口袋		15	360*280mm																																														
橡皮筋		90																																															
纸箱		5	38*26*9cm																																														
纸箱		1	45*32.5*42cm																																														
小标签			70*50mm																																														
内外箱标签			100*80mm																																														
外箱条形码			100*50mm																																														
<table border="1"> <tr> <td>物料名称</td> <td>物料编码</td> <td>用量</td> <td>规格尺寸</td> </tr> <tr> <td>PE开口袋</td> <td></td> <td>90</td> <td>240*160mm</td> </tr> <tr> <td>PE封口袋</td> <td></td> <td>15</td> <td>360*280mm</td> </tr> <tr> <td>橡皮筋</td> <td></td> <td>90</td> <td></td> </tr> <tr> <td>纸箱</td> <td></td> <td>5</td> <td>38*26*9cm</td> </tr> <tr> <td>纸箱</td> <td></td> <td>1</td> <td>45*32.5*42cm</td> </tr> <tr> <td>小标签</td> <td></td> <td></td> <td>70*50mm</td> </tr> <tr> <td>内外箱标签</td> <td></td> <td></td> <td>100*80mm</td> </tr> <tr> <td>外箱条形码</td> <td></td> <td></td> <td>100*50mm</td> </tr> </table>														物料名称	物料编码	用量	规格尺寸	PE开口袋		90	240*160mm	PE封口袋		15	360*280mm	橡皮筋		90		纸箱		5	38*26*9cm	纸箱		1	45*32.5*42cm	小标签			70*50mm	内外箱标签			100*80mm	外箱条形码			100*50mm
物料名称	物料编码	用量	规格尺寸																																														
PE开口袋		90	240*160mm																																														
PE封口袋		15	360*280mm																																														
橡皮筋		90																																															
纸箱		5	38*26*9cm																																														
纸箱		1	45*32.5*42cm																																														
小标签			70*50mm																																														
内外箱标签			100*80mm																																														
外箱条形码			100*50mm																																														
<table border="1"> <tr> <td>物料名称</td> <td>物料编码</td> <td>用量</td> <td>规格尺寸</td> </tr> <tr> <td>PE开口袋</td> <td></td> <td>90</td> <td>240*160mm</td> </tr> <tr> <td>PE封口袋</td> <td></td> <td>15</td> <td>360*280mm</td> </tr> <tr> <td>橡皮筋</td> <td></td> <td>90</td> <td></td> </tr> <tr> <td>纸箱</td> <td></td> <td>5</td> <td>38*26*9cm</td> </tr> <tr> <td>纸箱</td> <td></td> <td>1</td> <td>45*32.5*42cm</td> </tr> <tr> <td>小标签</td> <td></td> <td></td> <td>70*50mm</td> </tr> <tr> <td>内外箱标签</td> <td></td> <td></td> <td>100*80mm</td> </tr> <tr> <td>外箱条形码</td> <td></td> <td></td> <td>100*50mm</td> </tr> </table>														物料名称	物料编码	用量	规格尺寸	PE开口袋		90	240*160mm	PE封口袋		15	360*280mm	橡皮筋		90		纸箱		5	38*26*9cm	纸箱		1	45*32.5*42cm	小标签			70*50mm	内外箱标签			100*80mm	外箱条形码			100*50mm
物料名称	物料编码	用量	规格尺寸																																														
PE开口袋		90	240*160mm																																														
PE封口袋		15	360*280mm																																														
橡皮筋		90																																															
纸箱		5	38*26*9cm																																														
纸箱		1	45*32.5*42cm																																														
小标签			70*50mm																																														
内外箱标签			100*80mm																																														
外箱条形码			100*50mm																																														

ANTENNA SPECIFICATION

CUS P/N :WC0D
ZTX P/N :WC0D

ApplicationDate:Mar,28,2020
Editor:



Rev: R:A2
Page 11 of 11



附页：出货标签模板



[1] Y001 TYJ-202003 20-03-28 09:11:48		合格证		
供货厂家	惠州高盛达科技有限公司(18450)			
长虹物料代码	850186575	供方物料代码		
物资名称	R-射频连接线	型号规格	WC0D/PIFA/2.4G+5G/外拉/300mm\$WC0D/PIFA/2.4G+5G/外拉/300mm/长虹	
订单号	4502587576	订单总数量	95000	
数量	3600	箱号/箱数	第18箱(包),共10箱(包)	
生产日期 供方批次	2020/3/28	净重/毛重	11.12KG / 11.9KG	
检验员	1	备注		
盖检验合格章				



PN: G. 5. 13. WC0DXXBXX
 LOT NO:1205-1905060006 Date Code: 200327
 VENDOR: ZTX
 QTY: 3600
 REEL NO: 201004420032790000
 PART DESC: WC0D-30(长虹) WIFI天线组件
 深圳市中天迅通信技术股份有限公司

P/N:	850186575	
QTY:	720	
Part Name:	R-Connecting line of RF WC0D/PIFA/2.4G+5G/ /300mm\$WC0D/PIFA/2.4G+5G/ /300mm/	
Supplier:	GaoShengDa	
2020/3/27	18450	2664

P/N:	850186575	
QTY:	360	
Part Name:	R-Connecting line of RF WC0D/PIFA/2.4G+5G/ /300mm\$WC0D/PIFA/2.4G+5G/ /300mm/	
Supplier:	GaoShengDa	
2020/3/27	18450	2663

P/N:	850186575	
QTY:	40	
Part Name:	R-Connecting line of RF WC0D/PIFA/2.4G+5G/ /300mm\$WC0D/PIFA/2.4G+5G/ /300mm/	
Supplier:	GaoShengDa	
2020/3/27	18450	2662