

**CFR 47 FCC PART 15 SUBPART C  
ISED RSS-247 Issue 3**

**TEST REPORT**

*For*

**WIFI+BT Module**

**MODEL NUMBER: DCT14R2501**

**REPORT NUMBER: 4791158664-1-RF-3**

**ISSUE DATE: February 22, 2024**

**FCC ID:2AC23-DCT14  
IC:12290A-DCT14**

*Prepared for*

**Hui Zhou Gaoshengda Technology Co.,LTD  
No.2, Jin-da Road, Huinan High-tech Industrial Park, Huizhou, Guangdong, China**

*Prepared by*

**UL Verification Services (Guangzhou) Co., Ltd, Song Shan Lake Branch**

**Building 10, Innovation Technology Park, No. 1, Li Bin Road, Song Shan Lake Hi-Tech Development Zone Dongguan, 523808, People's Republic of China**

**Tel: +86 769 22038881**

**Fax: +86 769 33244054**

**Website: [www.ul.com](http://www.ul.com)**

## Revision History

Rev.	Issue Date	Revisions	Revised By
V0	February 22, 2024	Initial Issue	

### Summary of Test Results

Test Item	Clause	Limit/Requirement	Result
Antenna Requirement	N/A	FCC Part 15.203/15.247 (c) RSS-GEN Clause 6.8	Pass
AC Power Line Conducted Emission	ANSI C63.10-2013, Clause 6.2	FCC Part 15.207 RSS-GEN Clause 8.8	Pass
Conducted Output Power	ANSI C63.10-2013, Clause 11.9.2.3.1	FCC Part 15.247 (b)(3) RSS-247 Clause 5.4 (d)	Pass
6dB Bandwidth and 99% Occupied Bandwidth	ANSI C63.10-2013, Clause 11.8.1	FCC Part 15.247 (a)(2) RSS-247 Clause 5.2 (a) ISED RSS-Gen Clause 6.7	Pass
Power Spectral Density	ANSI C63.10-2013, Clause 11.10.5	FCC Part 15.247 (e) RSS-247 Clause 5.2 (b)	Pass
Conducted Band edge and spurious emission	ANSI C63.10-2013, Clause 11.11	FCC Part 15.247(d) RSS-247 Clause 5.5	Pass
Radiated Band edge and Spurious Emission	ANSI C63.10-2013, Clause 11.12 & Clause 11.13	FCC Part 15.247 (d) FCC Part 15.205/15.209 RSS-247 Clause 5.5 RSS-GEN Clause 8.9	Pass
Duty Cycle	ANSI C63.10-2013, Clause 11.6	None; for reporting purposes only.	Pass

\*This test report is only published to and used by the applicant, and it is not for evidence purpose in China.

\*The measurement result for the sample received is <Pass> according to <CFR 47 FCC PART 15 SUBPART C ISED RSS-247 Issue 3> when <Simple Acceptance> decision rule is applied.

## CONTENTS

<b>1.</b>	<b>ATTESTATION OF TEST RESULTS</b> .....	<b>6</b>
<b>2.</b>	<b>TEST METHODOLOGY</b> .....	<b>7</b>
<b>3.</b>	<b>FACILITIES AND ACCREDITATION</b> .....	<b>7</b>
<b>4.</b>	<b>CALIBRATION AND UNCERTAINTY</b> .....	<b>8</b>
4.1.	<i>MEASURING INSTRUMENT CALIBRATION</i> .....	8
4.2.	<i>MEASUREMENT UNCERTAINTY</i> .....	8
<b>5.</b>	<b>EQUIPMENT UNDER TEST</b> .....	<b>9</b>
5.1.	<i>DESCRIPTION OF EUT</i> .....	9
5.2.	<i>CHANNEL LIST</i> .....	9
5.3.	<i>MAXIMUM POWER</i> .....	9
5.4.	<i>TEST CHANNEL CONFIGURATION</i> .....	10
5.5.	<i>THE WORSE CASE POWER SETTING PARAMETER</i> .....	10
5.6.	<i>WORST-CASE CONFIGURATIONS</i> .....	11
5.7.	<i>DESCRIPTION OF AVAILABLE ANTENNAS</i> .....	12
5.8.	<i>SUPPORT UNITS FOR SYSTEM TEST</i> .....	13
<b>6.</b>	<b>MEASURING EQUIPMENT AND SOFTWARE USED</b> .....	<b>14</b>
<b>7.</b>	<b>ANTENNA PORT TEST RESULTS</b> .....	<b>17</b>
7.1.	<i>CONDUCTED OUTPUT POWER</i> .....	17
7.2.	<i>6DB BANDWIDTH AND 99% OCCUPIED BANDWIDTH</i> .....	18
7.3.	<i>POWER SPECTRAL DENSITY</i> .....	20
7.4.	<i>CONDUCTED BAND EDGE AND SPURIOUS EMISSION</i> .....	22
7.5.	<i>DUTY CYCLE</i> .....	24
<b>8.</b>	<b>RADIATED TEST RESULTS</b> .....	<b>25</b>
8.1.	<i>RESTRICTED BANDEDGE</i> .....	33
8.2.	<i>SPURIOUS EMISSIONS(1 GHZ~3 GHZ)</i> .....	49
8.3.	<i>SPURIOUS EMISSIONS(3 GHZ~18 GHZ)</i> .....	55
8.4.	<i>SPURIOUS EMISSIONS(9 KHZ~30 MHZ)</i> .....	79
8.5.	<i>SPURIOUS EMISSIONS(18 GHZ~26 GHZ)</i> .....	82
8.6.	<i>SPURIOUS EMISSIONS(30 MHZ~1 GHZ)</i> .....	84
<b>9.</b>	<b>ANTENNA REQUIREMENT</b> .....	<b>86</b>
<b>10.</b>	<b>AC POWER LINE CONDUCTED EMISSION</b> .....	<b>87</b>
<b>11.</b>	<b>TEST DATA</b> .....	<b>90</b>
11.1.	<i>APPENDIX A: DTS BANDWIDTH</i> .....	90

11.1.1.	Test Result .....	90
11.1.2.	Test Graphs .....	91
11.2.	<i>APPENDIX B: OCCUPIED CHANNEL BANDWIDTH</i> .....	98
11.2.1.	Test Result .....	98
11.2.2.	Test Graphs .....	99
11.3.	<i>APPENDIX C: MAXIMUM CONDUCTED OUTPUT POWER</i> .....	106
11.3.1.	Test Result .....	106
11.4.	<i>APPENDIX D: MAXIMUM POWER SPECTRAL DENSITY</i> .....	107
11.4.1.	Test Result .....	107
11.4.2.	Test Graphs .....	108
11.5.	<i>APPENDIX E: BAND EDGE MEASUREMENTS</i> .....	115
11.5.1.	Test Result .....	115
11.5.2.	Test Graphs .....	116
11.6.	<i>APPENDIX F: CONDUCTED SPURIOUS EMISSION</i> .....	121
11.6.1.	Test Result .....	121
11.6.2.	Test Graphs .....	123
11.7.	<i>APPENDIX G: DUTY CYCLE</i> .....	144
11.7.1.	Test Result .....	144
11.7.2.	Test Graphs .....	145

# 1. ATTESTATION OF TEST RESULTS

## Applicant Information

Company Name: Hui Zhou Gaoshengda Technology Co.,LTD  
Address: No.2, Jin-da Road, Huinan High-tech Industrial Park, Huizhou, Guangdong, China

## Manufacturer Information

Company Name: Hui Zhou Gaoshengda Technology Co.,LTD  
Address: No.2, Jin-da Road, Huinan High-tech Industrial Park, Huizhou, Guangdong, China

## EUT Information

EUT Name: WIFI+BT Module  
Model: DCT14R2501  
Brand: GSD  
Sample Received Date: January 11, 2024  
Sample Status: Normal  
Sample ID: 6825178  
Date of Tested: January 22, 2024 to February 22, 2024

APPLICABLE STANDARDS	
STANDARD	TEST RESULTS
CFR 47 FCC PART 15 SUBPART C ISED RSS-247 Issue 3	Pass

Prepared By:



Fanny Huang  
Engineer Project Associate

Checked By:



Denny Huang  
Senior Project Engineer

Approved By:



Stephen Guo  
Operations Manager

## 2. TEST METHODOLOGY

All tests were performed in accordance with the standard CFR 47 FCC PART 15 SUBPART C ISED RSS-247 Issue 3, KDB 558074 D01 15.247 Meas Guidance v05r02, KDB 414788 D01 Radiated Test Site v01r01, KDB 662911 D01 Multiple Transmitter Output v02r01, CFR 47 FCC Part 2, ANSI C63.10-2013 and ISED RSS-GEN Issue 5

## 3. FACILITIES AND ACCREDITATION

Accreditation Certificate	<p><b>A2LA (Certificate No.: 4102.01)</b> UL Verification Services (Guangzhou) Co., Ltd. Song Shan Lake Branch. has been assessed and proved to be in compliance with A2LA.</p> <p><b>FCC (FCC Designation No.: CN1187)</b> UL Verification Services (Guangzhou) Co., Ltd. Song Shan Lake Branch. Has been recognized to perform compliance testing on equipment subject to the Commission's Declaration of Conformity (DoC) and Certification rules</p> <p><b>ISED (Company No.: 21320)</b> UL Verification Services (Guangzhou) Co., Ltd. Song Shan Lake Branch. has been registered and fully described in a report filed with ISED. The Company Number is 21320 and the test lab Conformity Assessment Body Identifier (CABID) is CN0046.</p> <p><b>VCCI (Registration No.: G-20192, C-20153, T-20155 and R-20202)</b> UL Verification Services (Guangzhou) Co., Ltd. Song Shan Lake Branch. has been assessed and proved to be in compliance with VCCI, the Membership No. is 3793. Facility Name: Chamber D, the VCCI registration No. is G-20192 and R-20202 Shielding Room B, the VCCI registration No. is C-20153 and T-20155</p>
---------------------------	--

Note 1:

All tests measurement facilities use to collect the measurement data are located at Building 10, Innovation Technology Park, No. 1, Li Bin Road, Song Shan Lake Hi-Tech Development Zone Dongguan, 523808, People's Republic of China.

Note 2:

The test anechoic chamber in UL Verification Services (Guangzhou) Co., Ltd. Song Shan Lake Branch had been calibrated and compared to the open field sites and the test anechoic chamber is shown to be equivalent to or worst case from the open field site.

Note 3:

For below 30 MHz, lab had performed measurements at test anechoic chamber and comparing to measurements obtained on an open field site. And these measurements below 30 MHz had been correlated to measurements performed on an OFS.

## 4. CALIBRATION AND UNCERTAINTY

### 4.1. MEASURING INSTRUMENT CALIBRATION

The measuring equipment utilized to perform the tests documented in this report has been calibrated in accordance with the manufacturer's recommendations and is traceable to recognized national standards.

### 4.2. MEASUREMENT UNCERTAINTY

Where relevant, the following measurement uncertainty levels have been estimated for tests performed on the apparatus:

Test Item	Uncertainty
Conduction emission	3.62 dB
Radiated Emission (Included Fundamental Emission) (9 kHz ~ 30 MHz)	2.2 dB
Radiated Emission (Included Fundamental Emission) (30 MHz ~ 1 GHz)	4.00 dB
Radiated Emission (Included Fundamental Emission) (1 GHz to 26 GHz)	5.78 dB (1 GHz ~ 18 GHz)
	5.23 dB (18 GHz ~ 26 GHz)
Duty Cycle	±0.028%
DTS and 99% Occupied Bandwidth	±0.0196%
Maximum Conducted Output Power	±0.686 dB
Maximum Power Spectral Density Level	±0.743 dB
Conducted Band-edge Compliance	±1.328 dB
Conducted Unwanted Emissions In Non-restricted Frequency Bands	±0.746 dB (9 kHz ~ 1 GHz)
	±1.328dB (1 GHz ~ 26 GHz)
Note: This uncertainty represents an expanded uncertainty expressed at approximately the 95% confidence level using a coverage factor of k=2.	



## 5. EQUIPMENT UNDER TEST

### 5.1. DESCRIPTION OF EUT

EUT Name	WIFI+BT Module
Model	DCT14R2501

Frequency Range:	2412 MHz to 2462 MHz
Type of Modulation:	IEEE 802.11b: DSSS(CCK, DQPSK, DBPSK) IEEE 802.11g/n: OFDM(64-QAM, 16-QAM, QPSK, BPSK)
Radio Technology:	IEEE 802.11b/g/n HT20/11n HT40
Normal Test Voltage:	3.3 Vdc

### 5.2. CHANNEL LIST

Channel List For Bandwidth=20 MHz							
Channel	Frequency (MHz)	Channel	Frequency (MHz)	Channel	Frequency (MHz)	Channel	Frequency (MHz)
1	2412	4	2427	7	2442	10	2457
2	2417	5	2432	8	2447	11	2462
3	2422	6	2437	9	2452	/	/

Channel List For Bandwidth=40 MHz							
Channel	Frequency (MHz)	Channel	Frequency (MHz)	Channel	Frequency (MHz)	Channel	Frequency (MHz)
3	2422	5	2432	7	2442	9	2452
4	2427	6	2437	8	2447	/	/

### 5.3. MAXIMUM POWER

IEEE Std. 802.11	Frequency (MHz)	Channel Number	Maximum Conducted AVG Output Power (dBm)
b	2412 ~ 2462	1-11[11]	17.37
g	2412 ~ 2462	1-11[11]	15.67
n HT20	2412 ~ 2462	1-11[11]	16.47
n HT40	2422 ~ 2452	3-9[7]	13.77

#### 5.4. TEST CHANNEL CONFIGURATION

IEEE Std. 802.11	Test Channel Number	Frequency
b	CH 1(Low Channel), CH 6(MID Channel), CH 11(High Channel)	2412 MHz, 2437 MHz, 2462 MHz
g	CH 1(Low Channel), CH 6(MID Channel), CH 11(High Channel)	2412 MHz, 2437 MHz, 2462 MHz
n HT20	CH 1(Low Channel), CH 6(MID Channel), CH 11(High Channel)	2412 MHz, 2437 MHz, 2462 MHz
n HT40	CH 3(Low Channel), CH 6(MID Channel), CH 9(High Channel)	2422 MHz, 2437 MHz, 2452 MHz

#### 5.5. THE WORSE CASE POWER SETTING PARAMETER

The Worst Case Power Setting Parameter under 2400 ~ 2483.5MHz Band										
Test Software		QA Tool								
Modulation Mode	Transmit Antenna Number	Test Channel								
		NCB: 20MHz			NCB: 40MHz					
		CH 1	CH 6	CH 11	CH 3	CH 6	CH 9			
802.11b	1	73	72	72	/					
	2	79	79	78						
802.11g	1	74	73	72						
	2	81	76	76						
802.11n HT20	1	69	66	61						
	2	76	69	65						
802.11n HT40	1	/						56	52	51
	2	/						63	53	51

## 5.6. WORST-CASE CONFIGURATIONS

The EUT was tested in the following configuration(s):

Controlled in test mode using a software application on the EUT supplied by customer. The application was used to enable a continuous transmission and to select the mode, test channels, bandwidth, data rates as required.

Test channels referring to section 5.4.

Maximum power setting referring to section 5.5.

Worst-case data rates as provided by the client were:

802.11b mode: 1 Mbps  
802.11g mode: 6 Mbps  
802.11n HT20 mode: MCS0  
802.11n HT40 mode: MCS0

802.11b/g only support SISO mode.  
802.11n HT20/HT40 support SISO and MIMO mode.

802.11n SISO mode and MIMO mode have the same power setting, so only the worst case power mode(MIMO) will be record in the report.

The EUT has 2 separate antennas which correspond to 2 separate antenna ports. Core 1 and Core 2 correspond to antenna 1 and antenna 2 respectively.

The measured additional path loss was included in any path loss calculations for all RF cable used during tested.

Conducted output power, power spectral density tests separately on each port with all supported SISO & MIMO port combinations.

Conducted bandedge and spurious emissions tests were performed with SISO mode, as this port was found to have the worst case in terms of power settings amongst all supported possible SISO & MIMO port combinations.

Radiated emissions tests were performed with the MIMO modes. These were found to be the worst modulation scheme with regards to emissions after preliminary investigations and, as this mode emits the highest conducted output power level, it was deemed to be the worst case.

The EUT support Cyclic Shift Diversity(CDD), Space Time Coding(STBC), Spatial Division Multiplexing(SDM) modes. They use the same conducted power per chain in any given mode, so we only chose the worst case mode CDD for final testing.

## 5.7. DESCRIPTION OF AVAILABLE ANTENNAS

Antenna	Frequency (MHz)	Antenna Type	MAX Antenna Gain (dBi)
1	2412-2462	PCB	1.92
2	2412-2462	PCB	2.13

The EUT support Cyclic Shift Diversity(CDD) mode.

MIMO output power port and MIMO PSD port summing were performed in accordance with KDB 662911 D01. For the CDD results the Directional Gain was calculated in accordance with the following method.

For output power measurements:

Directional gain=  $G_{ANT} + \text{Array Gain} = 2.13 \text{ dBi}$

$G_{ANT}$  : equal to the gain of the antenna having the highest gain

Array Gain = 0 dB (i.e., no array gain) for  $N_{ANT} \leq 4$

For power spectral density (PSD) measurements:

Directional gain=  $G_{ANT} + \text{Array Gain} = 5.14 \text{ dBi}$

Array Gain =  $10 \log(N_{ANT}/N_{SS}) \text{ dB}$ .

$N_{ANT}$  : number of transmit antennas

$N_{SS}$  : number of spatial streams, The worst case directional gain will occur when  $N_{SS} = 1$

Test Mode	Transmit and Receive Mode	Description
IEEE 802.11b	<input checked="" type="checkbox"/> 2TX, 2RX	ANT 1 and ANT 2 can be used as transmitting/receiving antenna.
IEEE 802.11g	<input checked="" type="checkbox"/> 2TX, 2RX	ANT 1 and ANT 2 can be used as transmitting/receiving antenna.
IEEE 802.11n HT20	<input checked="" type="checkbox"/> 2TX, 2RX	ANT 1 and ANT 2 can be used as transmitting/receiving antenna.
IEEE 802.11n HT40	<input checked="" type="checkbox"/> 2TX, 2RX	ANT 1 and ANT 2 can be used as transmitting/receiving antenna.
Note: 1.BT&WLAN 2.4G, BT & WLAN 5G, WLAN 2.4G & WLAN 5G can't transmit simultaneously. (declared by client)		

## 5.8. SUPPORT UNITS FOR SYSTEM TEST

### SUPPORT EQUIPMENT

Item	Equipment	Brand Name	Model Name	Remarks
1	Laptop	Lenovo	E42-80	R303U5AG
2	AC Adaptor	Lenovo	MACS-1201001202	Input: 100-240 V~50/60 Hz, 0.35 A Output: DC 12V1A

### I/O CABLES

Cable No	Port	Connector Type	Cable Type	Cable Length(m)	Remarks
1	USB	/	/	1.0	/

### ACCESSORIES

Item	Accessory	Brand Name	Model Name	Description
/	/	/	/	/

### TEST SETUP

The EUT can work in engineering mode with a software through a Laptop.

### SETUP DIAGRAM FOR TESTS

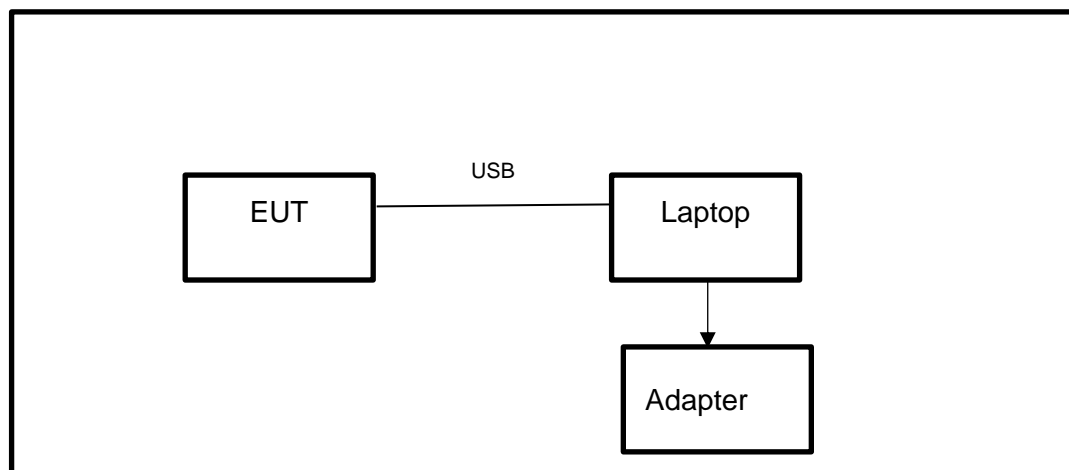

Note: Adapter only use for AC Power Line Conducted Emission testing.

## 6. MEASURING EQUIPMENT AND SOFTWARE USED

R&S TS 8997 Test System					
Equipment	Manufacturer	Model No.	Serial No.	Last Cal.	Due. Date
Power sensor, Power Meter	R&S	OSP120	100921	Mar.31,2023	Mar.30,2024
Vector Signal Generator	R&S	SMBV100A	261637	Oct.12, 2023	Oct.11, 2024
Signal Generator	R&S	SMB100A	178553	Oct.12, 2023	Oct.11, 2024
Signal Analyzer	R&S	FSV40	101118	Oct.12, 2023	Oct.11, 2024
Software					
Description	Manufacturer	Name		Version	
For R&S TS 8997 Test System	Rohde & Schwarz	EMC 32		10.60.10	
Tonsend RF Test System					
Equipment	Manufacturer	Model No.	Serial No.	Last Cal.	Due. Date
Wideband Radio Communication Tester	R&S	CMW500	155523	Oct.12, 2023	Oct.11, 2024
Wireless Connectivity Tester	R&S	CMW270	1201.0002N75-102	Sep.25, 2023	Sep.24, 2024
PXA Signal Analyzer	Keysight	N9030A	MY55410512	Oct.12, 2023	Oct.11, 2024
MXG Vector Signal Generator	Keysight	N5182B	MY56200284	Oct.12, 2023	Oct.11, 2024
MXG Vector Signal Generator	Keysight	N5172B	MY56200301	Oct.12, 2023	Oct.11, 2024
DC power supply	Keysight	E3642A	MY55159130	Oct.12, 2023	Oct.11, 2024
Temperature & Humidity Chamber	SANMOOD	SG-80-CC-2	2088	Oct.12, 2023	Oct.11, 2024
Attenuator	Aglient	8495B	2814a12853	Oct.12, 2023	Oct.11, 2024
RF Control Unit	Tonscend	JS0806-2	23B80620666	April 18, 2023	April 17, 2024
Software					
Description	Manufacturer	Name		Version	
Tonsend SRD Test System	Tonsend	JS1120-3 RF Test System		V3.2.22	

Conducted Emissions					
Equipment	Manufacturer	Model No.	Serial No.	Last Cal.	Due Date
EMI Test Receiver	R&S	ESR3	101961	Oct.13, 2023	Oct.12, 2024
Two-Line V-Network	R&S	ENV216	101983	Oct.13, 2023	Oct.12, 2024
Artificial Mains Networks	Schwarzbeck	NSLK 8126	8126465	Oct.13, 2023	Oct.12, 2024
Software					
Description			Manufacturer	Name	Version
Test Software for Conducted Emissions			Farad	EZ-EMC	Ver. UL-3A1

Radiated Emissions					
Equipment	Manufacturer	Model No.	Serial No.	Last Cal.	Due Date
MXE EMI Receiver	KESIGHT	N9038A	MY56400036	Oct.12, 2023	Oct.11, 2024
Hybrid Log Periodic Antenna	TDK	HLP-3003C	130959	Aug.02, 2021	Aug.01, 2024
Preamplifier	HP	8447D	2944A09099	Oct.12, 2023	Oct.11, 2024
EMI Measurement Receiver	R&S	ESR26	101377	Oct.12, 2023	Oct.11, 2024
Horn Antenna	TDK	HRN-0118	130940	July 20, 2021	July 19, 2024
Preamplifier	TDK	PA-02-0118	TRS-305-00067	Oct.12, 2023	Oct.11, 2024
Horn Antenna	Schwarzbeck	BBHA9170	697	July 20, 2021	July 19, 2024
Preamplifier	TDK	PA-02-2	TRS-307-00003	Oct.12, 2023	Oct.11, 2024
Preamplifier	TDK	PA-02-3	TRS-308-00002	Oct.12, 2023	Oct.11, 2024
Loop antenna	Schwarzbeck	1519B	00008	Dec.14, 2021	Dec.13, 2024
Preamplifier	TDK	PA-02-001-3000	TRS-302-00050	Oct.12, 2023	Oct.11, 2024
High Pass Filter	Wi	WHKX10-2700-3000-18000-40SS	23	Oct.12, 2023	Oct.11, 2024
Band Reject Filter	Wainwright	WRCJV8-2350-2400-2483.5-2533.5-40SS	4	Oct.12, 2023	Oct.11, 2024
Software					
Description			Manufacturer	Name	Version
Test Software for Radiated Emissions			Farad	EZ-EMC	Ver. UL-3A1

Other Instrument					
Equipment	Manufacturer	Model No.	Serial No.	Last Cal.	Due Date
Temperature humidity probe	OMEGA	ITHX-SD-5	18470007	Oct.21, 2023	Oct.20, 2024
Barometer	Yiyi	Baro	N/A	Oct.19, 2023	Oct.18, 2024
Attenuator	Agilent	8495B	2814a12853	Oct.12, 2023	Oct.11, 2024



## 7. ANTENNA PORT TEST RESULTS

### 7.1. CONDUCTED OUTPUT POWER

#### LIMITS

CFR 47 FCC Part15 (15.247) Subpart C ISED RSS-247 ISSUE 3			
Section	Test Item	Limit	Frequency Range (MHz)
CFR 47 FCC 15.247(b)(3) ISED RSS-247 5.4 (d)	AVG Output Power	1 watt or 30 dBm	2400-2483.5

#### TEST PROCEDURE

Refer to ANSI C63.10-2013 clause 11.9.2.3.1.

Connect the EUT to a low loss RF cable from the antenna port to the power sensor (video bandwidth is greater than the occupied bandwidth).

Measure peak emission level, the indicated level is the average output power, after any corrections for external attenuators and cables.

The test result in dBm by adding  $[10 \log (1 / D)]$ , where D is the duty cycle.

#### TEST SETUP

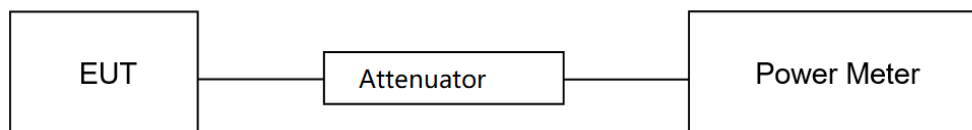

#### TEST ENVIRONMENT

Temperature	25.4°C	Relative Humidity	56.6%
Atmosphere Pressure	101kPa	Test Voltage	DC 3.3 V

#### TEST DATE / ENGINEER

Test Date	January 18, 2024	Test By	Johnson Liu
-----------	------------------	---------	-------------

#### TEST RESULTS

Please refer to section "Test Data" - Appendix C

## 7.2. 6DB BANDWIDTH AND 99% OCCUPIED BANDWIDTH

### LIMITS

CFR 47 FCC Part15 (15.247) Subpart C ISED RSS-247 ISSUE 3			
Section	Test Item	Limit	Frequency Range (MHz)
CFR 47 FCC 15.247(a)(2) ISED RSS-247 5.2 (a)	6 dB Bandwidth	≥ 500 kHz	2400-2483.5
ISED RSS-Gen Clause 6.7	99 % Occupied Bandwidth	For reporting purposes only.	2400-2483.5

### TEST PROCEDURE

Refer to ANSI C63.10-2013 clause 11.8 for DTS bandwidth and clause 6.9 for Occupied Bandwidth.

Connect the EUT to the spectrum analyzer and use the following settings:

Center Frequency	The center frequency of the channel under test
Frequency Span	For 6 dB Bandwidth: Enough to capture all products of the modulation carrier emission For 99 % Occupied Bandwidth: Between 1.5 times and 5.0 times the OBW
Detector	Peak
RBW	For 6 dB Bandwidth: 100 kHz For 99 % Occupied Bandwidth: 1 % to 5 % of the occupied bandwidth
VBW	For 6 dB Bandwidth: ≥3 × RBW For 99 % Occupied Bandwidth: ≥3 × RBW
Trace	Max hold
Sweep	Auto couple

a) Use the 99 % power bandwidth function of the instrument, allow the trace to stabilize and report the measured bandwidth.

b) Allow the trace to stabilize and measure the maximum width of the emission that is constrained by the frequencies associated with the two outermost amplitude points (upper and lower frequencies) that are attenuated by 6 dB relative to the maximum level measured in the fundamental emission.

### TEST SETUP

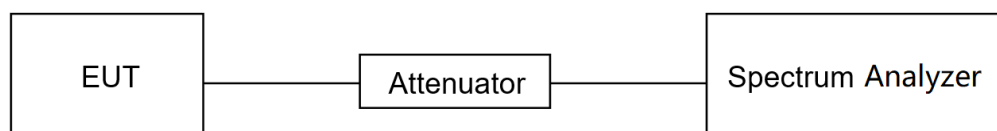

**TEST ENVIRONMENT**

Temperature	25.4°C	Relative Humidity	56.6%
Atmosphere Pressure	101kPa	Test Voltage	DC 3.3 V

**TEST DATE / ENGINEER**

Test Date	January 18, 2024	Test By	Johnson Liu
-----------	------------------	---------	-------------

**TEST RESULTS**

Please refer to section "Test Data" - Appendix A&B

### 7.3. POWER SPECTRAL DENSITY

#### LIMITS

CFR 47 FCC Part15 (15.247) Subpart C ISED RSS-247 ISSUE 3			
Section	Test Item	Limit	Frequency Range (MHz)
CFR 47 FCC §15.247 (e) ISED RSS-247 5.2 (b)	Power Spectral Density	8 dBm in any 3 kHz band	2400-2483.5

#### TEST PROCEDURE

Refer to ANSI C63.10-2013 clause 11.10.5.

Connect the EUT to the spectrum analyzer and use the following settings:

Center Frequency	The center frequency of the channel under test
Detector	power averaging (rms)
RBW	$3 \text{ kHz} \leq \text{RBW} \leq 100 \text{ kHz}$
VBW	$\geq 3 \times \text{RBW}$
Span	1.5 x OBW bandwidth
Trace	Employ trace averaging(rms)mode over a minimum of 100 traces
Sweep time	Auto couple

Allow trace to fully stabilize and use the peak marker function to determine the maximum amplitude level within the RBW.

If measured value exceeds limit, reduce RBW (no less than 3 kHz) and repeat.

#### TEST SETUP

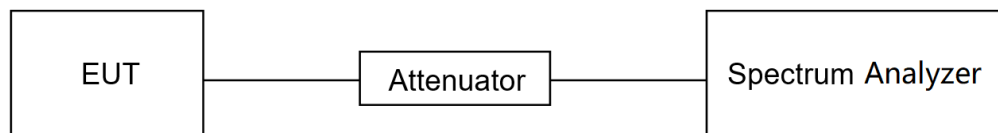

#### TEST ENVIRONMENT

Temperature	25.4°C	Relative Humidity	56.6%
Atmosphere Pressure	101kPa	Test Voltage	DC 3.3 V

#### TEST DATE / ENGINEER

Test Date	January 18, 2024	Test By	Johnson Liu
-----------	------------------	---------	-------------

**TEST RESULTS**

Please refer to section "Test Data" - Appendix D

## 7.4. CONDUCTED BAND EDGE AND SPURIOUS EMISSION

### TEST PROCEDURE

Refer to ANSI C63.10-2013 clause 11.11 and 11.13.

Connect the EUT to the spectrum analyzer and use the following settings for reference level measurement:

Center Frequency	The center frequency of the channel under test
Detector	Peak
RBW	100 kHz
VBW	$\geq 3 \times \text{RBW}$
Span	1.5 x DTS bandwidth
Trace	Max hold
Sweep time	Auto couple.

Allow trace to fully stabilize and use the peak marker function to determine the maximum PSD level.

Change the settings for emission level measurement:

Span	Set the center frequency and span to encompass frequency range to be measured
Detector	Peak
RBW	100 kHz
VBW	$\geq 3 \times \text{RBW}$
measurement points	$\geq \text{span}/\text{RBW}$
Trace	Max hold
Sweep time	Auto couple.

Allow trace to fully stabilize and use the peak marker function to determine the maximum PSD level. Ensure that the amplitude of all unwanted emissions outside of the authorized frequency band (excluding restricted frequency bands) is attenuated by at least the minimum requirements specified in 11.11.

### TEST SETUP

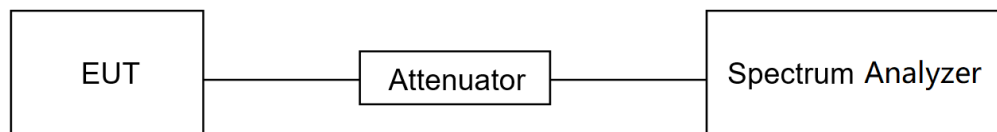

### TEST ENVIRONMENT

Temperature	25.4°C	Relative Humidity	56.6%
Atmosphere Pressure	101kPa	Test Voltage	DC 3.3 V

### TEST DATE / ENGINEER

Test Date	January 18, 2024	Test By	Johnson Liu
-----------	------------------	---------	-------------

**TEST RESULTS**

Please refer to section "Test Data" - Appendix E&F

## 7.5. DUTY CYCLE

### LIMITS

None; for reporting purposes only.

### TEST PROCEDURE

Refer to ANSI C63.10-2013 clause 11.6 Zero – Span Spectrum Analyzer method.

### TEST SETUP

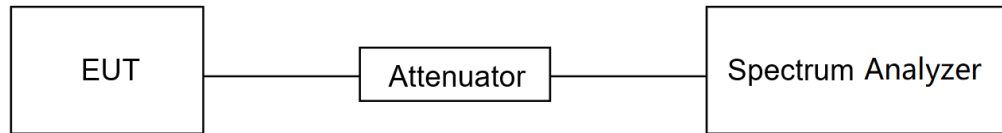

### TEST ENVIRONMENT

Temperature	25.4°C	Relative Humidity	56.6%
Atmosphere Pressure	101kPa	Test Voltage	DC 3.3 V

### TEST DATE / ENGINEER

Test Date	January 18, 2024	Test By	Johnson Liu
-----------	------------------	---------	-------------

### TEST RESULTS

Please refer to section "Test Data" - Appendix G



## 8. RADIATED TEST RESULTS

### LIMITS

Please refer to CFR 47 FCC §15.205 and §15.209.

Please refer to ISED RSS-GEN Clause 8.9 and Clause 8.10.

Radiation Disturbance Test Limit for FCC (Class B) (9 kHz ~ 1 GHz)

Emissions radiated outside of the specified frequency bands above 30 MHz			
Frequency Range (MHz)	Field Strength Limit (uV/m) at 3 m	Field Strength Limit (dBuV/m) at 3 m	
		Quasi-Peak	
30 - 88	100	40	
88 - 216	150	43.5	
216 - 960	200	46	
Above 960	500	54	
Above 1000	500	Peak	Average
		74	54

FCC Emissions radiated outside of the specified frequency bands below 30 MHz		
Frequency (MHz)	Field strength (microvolts/meter)	Measurement distance (meters)
0.009-0.490	2400/F(kHz)	300
0.490-1.705	24000/F(kHz)	30
1.705-30.0	30	30

ISED General field strength limits at frequencies below 30 MHz

Table 6 – General field strength limits at frequencies below 30 MHz		
Frequency	Magnetic field strength (H-Field) (uA/m)	Measurement distance (m)
9 - 490 kHz <sup>Note 1</sup>	6.37/F (F in kHz)	300
490 - 1705 kHz	63.7/F (F in kHz)	30
1.705 - 30 MHz	0.08	30

**Note 1:** The emission limits for the ranges 9-90 kHz and 110-490 kHz are based on measurements employing a linear average detector.

ISED Restricted bands please refer to ISED RSS-GEN Clause 8.10

Table 7 – Restricted frequency bands <sup>Note 1</sup>		
MHz	MHz	GHz
0.090 - 0.110	149.9 - 150.05	9.0 - 9.2
0.495 - 0.505	156.52475 - 156.52525	9.3 - 9.5
2.1735 - 2.1905	156.7 - 156.9	10.6 - 12.7
3.020 - 3.026	162.0125 - 167.17	13.25 - 13.4
4.125 - 4.128	167.72 - 173.2	14.47 - 14.5
4.17725 - 4.17775	240 - 285	15.35 - 16.2
4.20725 - 4.20775	322 - 335.4	17.7 - 21.4
5.677 - 5.683	399.9 - 410	22.01 - 23.12
6.215 - 6.218	608 - 614	23.6 - 24.0
6.26775 - 6.26825	960 - 1427	31.2 - 31.8
6.31175 - 6.31225	1435 - 1626.5	36.43 - 36.5
8.291 - 8.294	1645.5 - 1646.5	Above 38.6
8.362 - 8.366	1660 - 1710	
8.37625 - 8.38675	1718.8 - 1722.2	
8.41425 - 8.41475	2200 - 2300	
12.29 - 12.293	2310 - 2390	
12.51975 - 12.52025	2483.5 - 2500	
12.57675 - 12.57725	2655 - 2900	
13.36 - 13.41	3260 - 3267	
16.42 - 16.423	3332 - 3339	
16.69475 - 16.69525	3345.8 - 3358	
16.80425 - 16.80475	3500 - 4400	
25.5 - 25.67	4500 - 5150	
37.5 - 38.25	5350 - 5460	
73 - 74.6	7250 - 7750	
74.8 - 75.2	8025 - 8500	
108 - 138		

**Note 1:** Certain frequency bands listed in table 7 and in bands above 38.6 GHz are designated for licence-exempt applications. These frequency bands and the requirements that apply to related devices are set out in the 200 and 300 series of RSSs.

FCC Restricted bands of operation refer to FCC §15.205 (a):

MHz	MHz	MHz	GHz
0.090-0.110	16.42-16.423	399.9-410	4.5-5.15
<sup>1</sup> 0.495-0.505	16.69475-16.69525	608-614	5.35-5.46
2.1735-2.1905	16.80425-16.80475	960-1240	7.25-7.75
4.125-4.128	25.5-25.67	1300-1427	8.025-8.5
4.17725-4.17775	37.5-38.25	1435-1626.5	9.0-9.2
4.20725-4.20775	73-74.6	1645.5-1646.5	9.3-9.5
6.215-6.218	74.8-75.2	1660-1710	10.6-12.7
6.26775-6.26825	108-121.94	1718.8-1722.2	13.25-13.4
6.31175-6.31225	123-138	2200-2300	14.47-14.5
8.291-8.294	149.9-150.05	2310-2390	15.35-16.2
8.362-8.366	156.52475-156.52525	2483.5-2500	17.7-21.4
8.37625-8.38675	156.7-156.9	2690-2900	22.01-23.12
8.41425-8.41475	162.0125-167.17	3260-3267	23.6-24.0
12.29-12.293	167.72-173.2	3332-3339	31.2-31.8
12.51975-12.52025	240-285	3345.8-3358	36.43-36.5
12.57675-12.57725	322-335.4	3600-4400	( <sup>2</sup> )
13.36-13.41			

Note: <sup>1</sup>Until February 1, 1999, this restricted band shall be 0.490-0.510 MHz.

<sup>2</sup>Above 38.6c

## TEST PROCEDURE

Below 30 MHz

The setting of the spectrum analyzer

RBW	200 Hz (From 9 kHz to 0.15 MHz)/ 9 kHz (From 0.15 MHz to 30 MHz)
VBW	200 Hz (From 9 kHz to 0.15 MHz)/ 9 kHz (From 0.15 MHz to 30 MHz)
Sweep	Auto

1. The testing follows the guidelines in ANSI C63.10-2013 clause 6.4.
2. The EUT was arranged to its worst case and then turntable (from 0 degree to 360 degrees) to find the maximum reading. A pre-amp and a high pass filter are used for the test in order to get better signal level. Both Horizontal, Face-on and Face-off polarizations of the antenna are set to make the measurement.
3. The EUT was placed on a turntable with 80 cm above ground.
4. The EUT was set 3 meters from the interference receiving antenna, which was mounted on the top of a 1 m height antenna tower.
5. The radiated emission limits are based on measurements employing a CISPR quasi-peak detector except for the frequency bands 9-90 kHz, 110-490 kHz and above 1000 MHz Radiated emission limits in these three bands are based on measurements employing an average detector.
6. For measurement below 1 GHz, the initial step in collecting conducted emission data is a spectrum analyzer peak detector mode pre-scanning the measurement frequency range. Significant peaks are then marked and then Quasi Peak and average detector mode re-measured. If the emission level of the EUT measured by the peak detector is 3 dB lower than the applicable limit, the peak emission level will be reported. Otherwise, the emission measurement will be repeated using the quasi-peak and average detector and reported.
7. Although these tests were performed other than open field site, adequate comparison measurements were confirmed against 30m open field site. Therefore sufficient tests were made to demonstrate that the alternative site produces results that correlate with the ones of tests made in an open field site based on KDB 414788.
8. The limits in CFR 47, Part 15, Subpart C, paragraph 15.209 (a), are identical to those in RSS-GEN Section 8.9, Table 6, since the measurements are performed in terms of magnetic field strength and converted to electric field strength levels (as reported in the table) using the free space impedance of  $377\Omega$ . For example, the measurement frequency X kHz resulted in a level of Y dBuV/m, which is equivalent to  $Y-51.5 = Z$  dBuA/m, which has the same margin, W dB, to the corresponding RSS-GEN Table 6 limit as it has to be 15.209(a) limit.

Below 1 GHz and above 30 MHz

The setting of the spectrum analyzer

RBW	120 kHz
VBW	300 kHz
Sweep	Auto
Detector	Peak/QP
Trace	Max hold

1. The testing follows the guidelines in ANSI C63.10-2013 clause 6.5.
2. The EUT was arranged to its worst case and then tune the antenna tower (from 1 m to 4 m) and turntable (from 0 degree to 360 degrees) to find the maximum reading. A pre-amp and a high pass filter are used for the test in order to get better signal level. Both horizontal and vertical polarizations of the antenna are set to make the measurement.
3. The EUT was placed on a turntable with 80 cm above ground.
4. The EUT was set 3 meters from the interference receiving antenna, which was mounted on the top of a variable height antenna tower.
5. For measurement below 1 GHz, the initial step in collecting conducted emission data is a spectrum analyzer peak detector mode pre-scanning the measurement frequency range. Significant peaks are then marked and then Quasi Peak detector mode re-measured. If the emission level of the EUT measured by the peak detector is 3 dB lower than the applicable limit, the peak emission level will be reported. Otherwise, the emission measurement will be repeated using the quasi-peak detector and reported.

Above 1 GHz

The setting of the spectrum analyzer

RBW	1 MHz
VBW	PEAK: 3 MHz AVG: see note 6
Sweep	Auto
Detector	Peak
Trace	Max hold

1. The testing follows the guidelines in ANSI C63.10-2013 clause 6.6.
2. The EUT was arranged to its worst case and then tune the antenna tower (from 1 m to 4 m) and turntable (from 0 degree to 360 degrees) to find the maximum reading. A pre-amp and a high pass filter are used for the test in order to get better signal level. Both horizontal and vertical polarizations of the antenna are set to make the measurement.
3. The EUT was placed on a turntable with 1.5 m above ground.
4. The EUT was set 3 meters from the interference receiving antenna, which was mounted on the top of a variable height antenna tower.
5. For measurement above 1 GHz, the emission measurement will be measured by the peak detector. This peak level, once corrected, must comply with the limit specified in Section 15.209.
6. For measurements above 1 GHz the resolution bandwidth is set to 1 MHz, then the video bandwidth is set to 3 MHz for peak measurements and 1 MHz resolution bandwidth with 1/T video bandwidth with peak detector for average measurements. For the Duty Cycle please refer to clause 7.5. ON TIME AND DUTY CYCLE.

X axis, Y axis, Z axis positions:

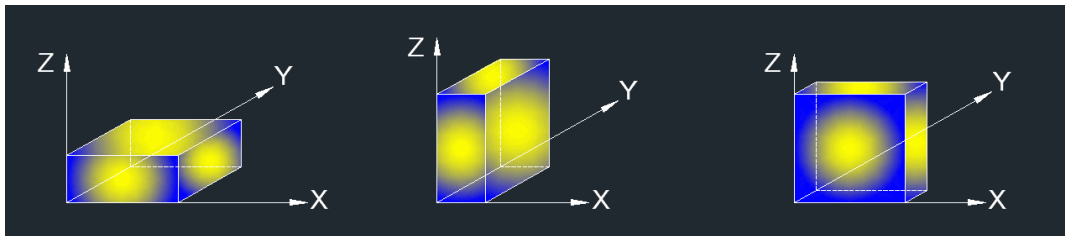

Note 1: For all radiated test, EUT in each of three orthogonal axis emissions had been tested, but only the worst case (X axis) data recorded in the report.

For Restricted Bandedge:

Note:

1. Measurement = Reading Level + Correct Factor.
2. If the peak values are less than the average limit of 54 dBuV/m, the average result is deemed to comply with average limit.
3. PK=Peak: Peak detector.
4. AV=Average: VBW=1/Ton, where: Ton is the transmitting duration.
5. For the transmitting duration, please refer to clause 7.5.
6. Only the worst data was recorded, if it complies with the limit, the other emissions deemed to comply with the limit.
7. Both horizontal and vertical have been tested, only the worst data was recorded in the report.
8. All modes have been tested, but only the worst data was recorded in the report.

For Radiate Spurious emission (9 kHz ~ 30 MHz):

Note:

1. Measurement = Reading Level + Correct Factor.
2. If the peak values are less than the QP limit, the QP result is deemed to comply with QP limit.
3. All 3 polarizations (Horizontal, Face-on and Face-off) of the loop antenna had been tested, but only the worst data recorded in the report.
4. All modes have been tested, but only the worst data was recorded in the report.
5.  $\text{dBuA/m} = \text{dBuV/m} - 20\text{Log}_{10}[120\pi] = \text{dBuV/m} - 51.5$

For Radiate Spurious Emission (30 MHz ~ 1 GHz):

Note:

1. Result Level = Read Level + Correct Factor.
2. If the peak values are less than the QP limit, the QP result is deemed to comply with QP limit.
3. All modes have been tested, but only the worst data was recorded in the report.

For Radiate Spurious Emission (1 GHz ~ 3 GHz):

Note:

1. Measurement = Reading Level + Correct Factor.
2. If the peak values are less than the average limit of 54 dBuV/m, the average result is deemed to comply with average limit.
3. Peak: Peak detector.
4. AVG: VBW=1/Ton, where: Ton is the transmitting duration.
5. For the transmitting duration, please refer to clause 7.5.
6. Filter losses were only considered in the spurious frequency bands and the authorized band was not corrected for Band reject filter losses.
7. Proper operation of the transmitter prior to adding the filter to the measurement chain.
8. All modes have been tested, but only the worst data was recorded in the report.

For Radiate Spurious Emission (3 GHz ~ 18 GHz):

Note:

1. Peak Result = Reading Level + Correct Factor.
2. If the peak values are less than the average limit of 54 dBuV/m, the average result is deemed to comply with average limit.
3. Peak: Peak detector.
4. AVG:  $VBW=1/T_{on}$ , where:  $T_{on}$  is the transmitting duration.
5. For the transmitting duration, please refer to clause 7.5.
6. Filter losses were only considered in the spurious frequency bands and the authorized band was not corrected for High Pass Filter losses.
7. Proper operation of the transmitter prior to adding the filter to the measurement chain.
8. All modes have been tested, but only the worst data was recorded in the report.

For Radiate Spurious emission (18 GHz ~ 26 GHz):

Note:

1. Measurement = Reading Level + Correct Factor.
2. If the peak values are less than the average limit of 54 dBuV/m, the average result is deemed to comply with average limit.
3. Peak: Peak detector.
4. All modes have been tested, but only the worst data was recorded in the report.

### TEST SETUP

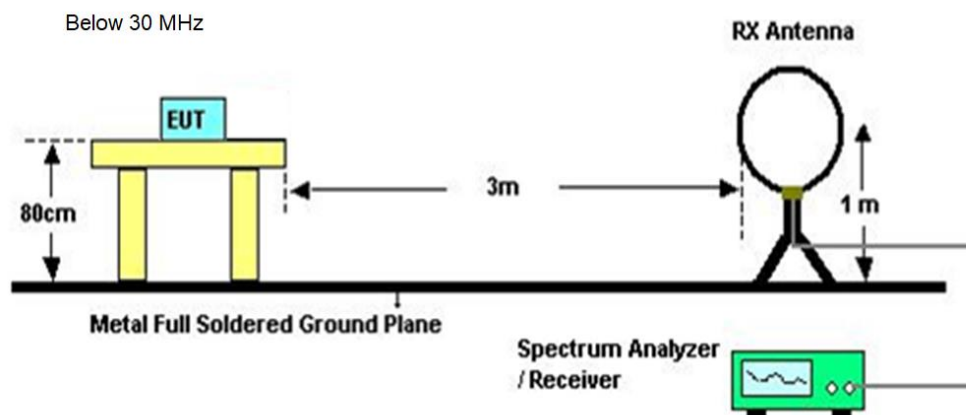

Below 1 GHz and above 30 MHz

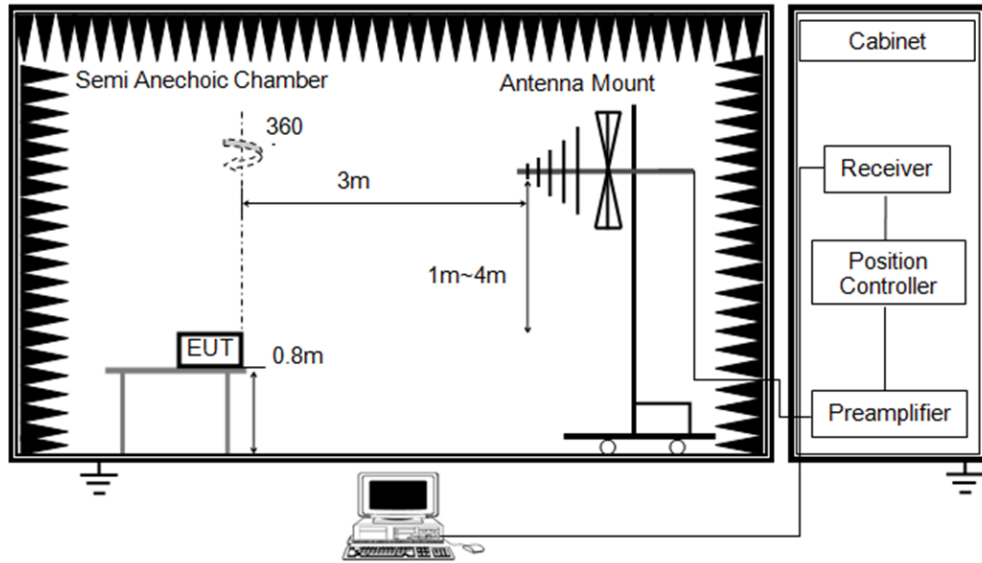

Above 1 GHz

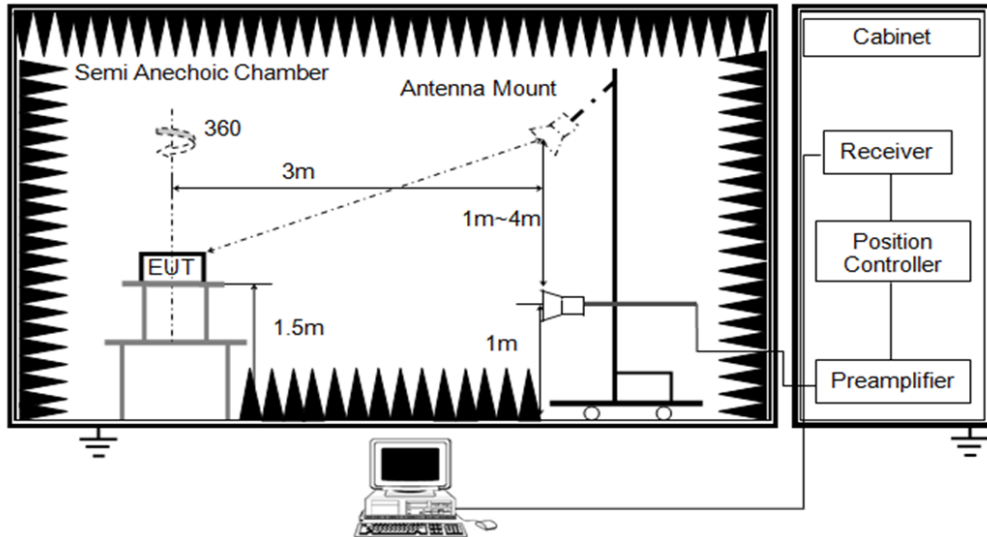

**TEST ENVIRONMENT**

Temperature	24.8°C	Relative Humidity	63%
Atmosphere Pressure	101kPa	Test Voltage	

**TEST DATE / ENGINEER**

Test Date	January 30, 2024	Test By	Rex Huang
-----------	------------------	---------	-----------

**TEST RESULTS**



## 8.1. RESTRICTED BANDEDGE

Test Mode:	802.11b PK	Frequency(MHz):	2412
Polarity:	Horizontal	Test Voltage:	DC 3.3 V

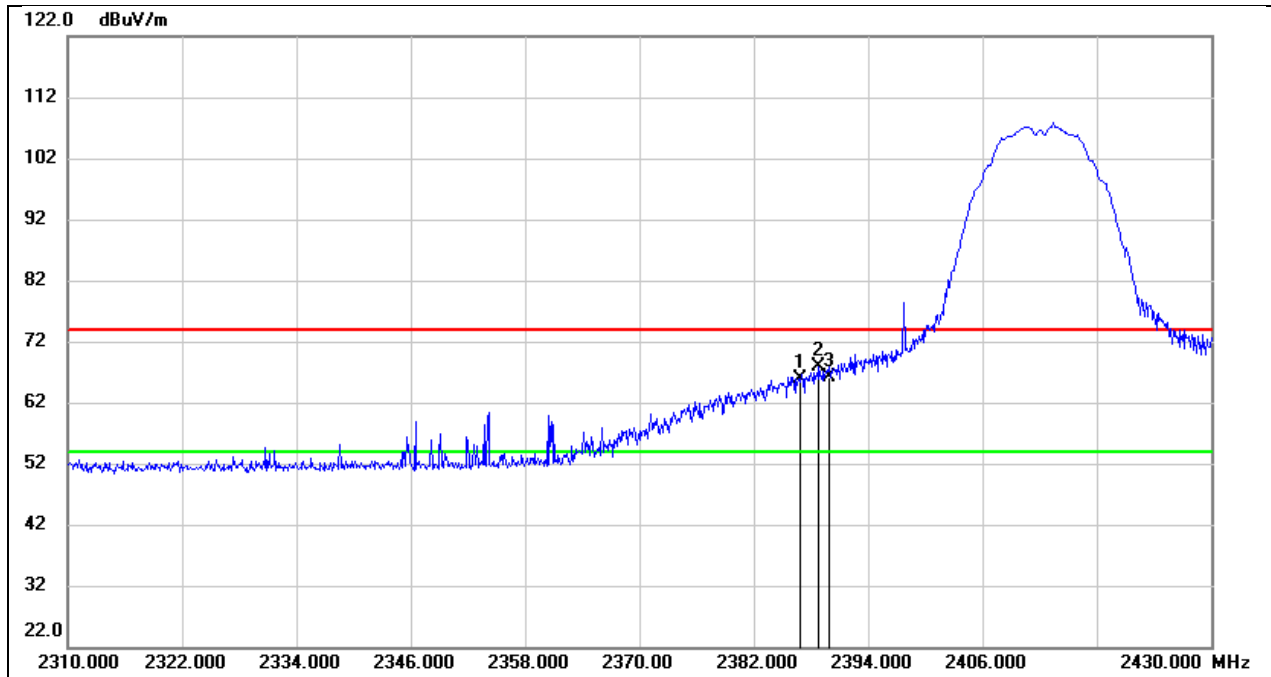

No.	Frequency (MHz)	Reading (dBuV)	Correct (dB/m)	Result (dBuV/m)	Limit (dBuV/m)	Margin (dB)	Remark
1	2386.800	33.75	32.15	65.90	74.00	-8.10	peak
2	2388.840	35.83	32.16	67.99	74.00	-6.01	peak
3	2390.000	33.97	32.16	66.13	74.00	-7.87	peak

Test Mode:	802.11b AV	Frequency(MHz):	2412
Polarity:	Horizontal	Test Voltage:	DC 3.3 V

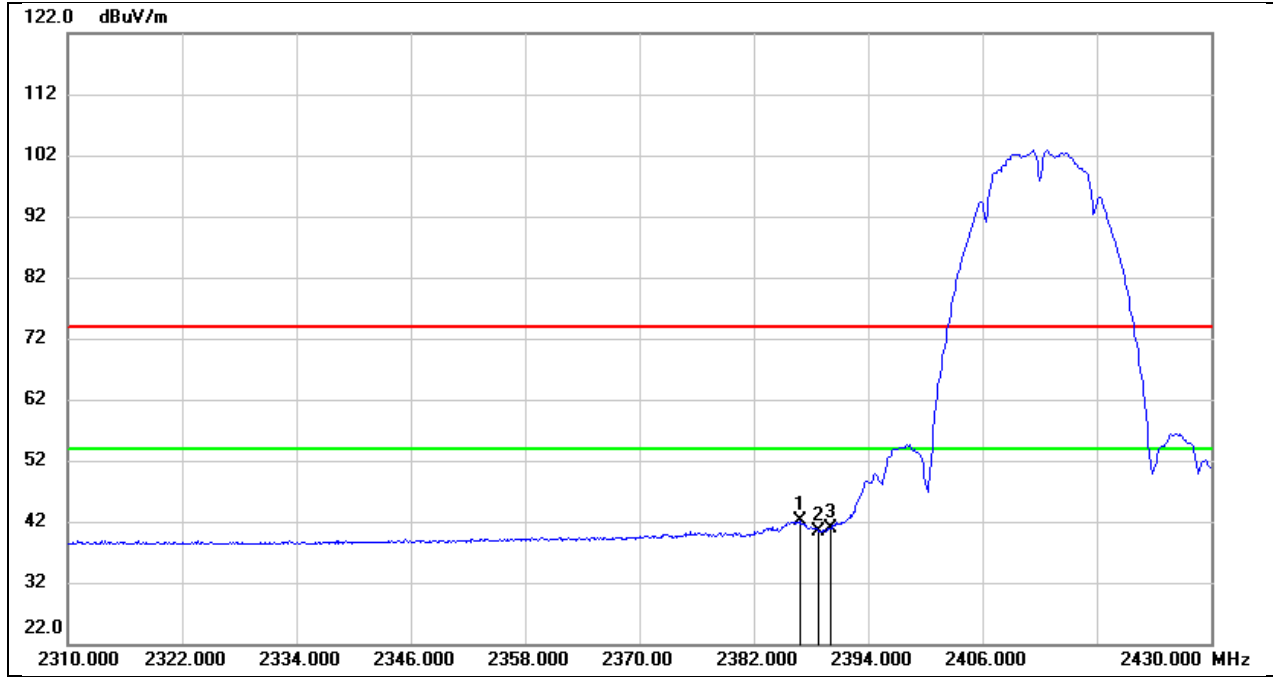

No.	Frequency (MHz)	Reading (dBuV)	Correct (dB/m)	Result (dBuV/m)	Limit (dBuV/m)	Margin (dB)	Remark
1	2386.800	9.88	32.15	42.03	54.00	-11.97	AVG
2	2388.840	8.21	32.16	40.37	54.00	-13.63	AVG
3	2390.000	8.78	32.16	40.94	54.00	-13.06	AVG

Test Mode:	802.11b PK	Frequency(MHz):	2462
Polarity:	Horizontal	Test Voltage:	DC 3.3 V

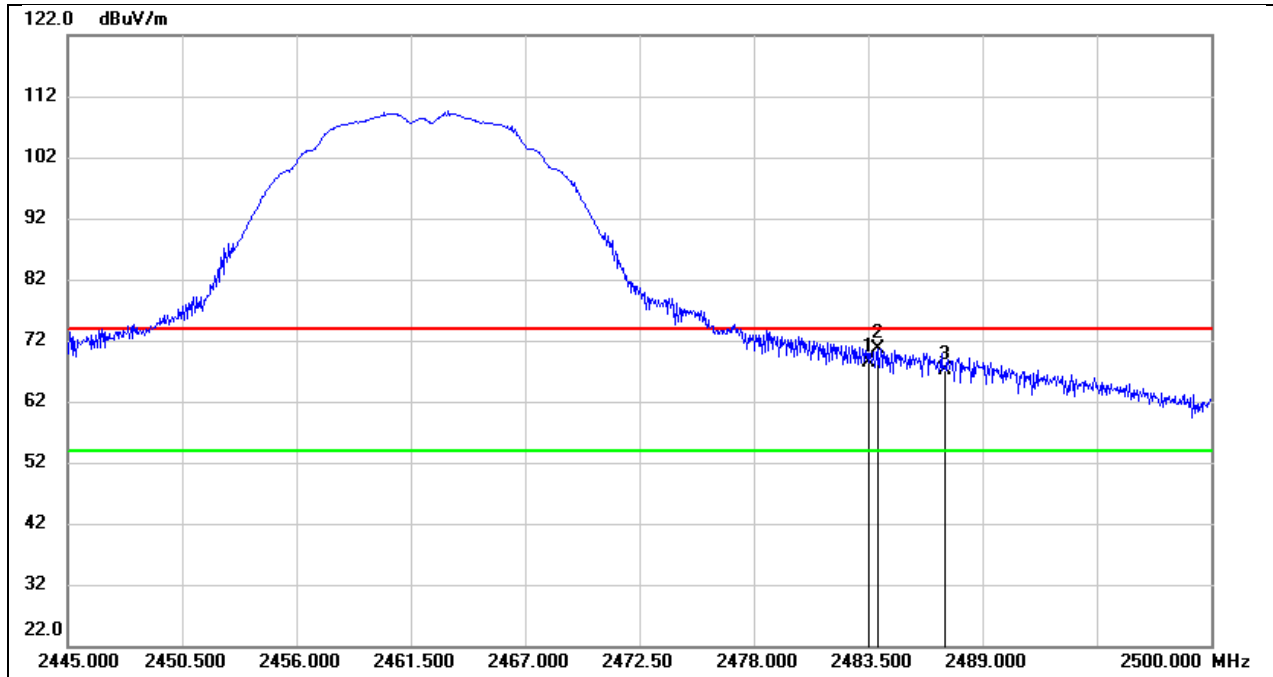

No.	Frequency (MHz)	Reading (dBuV)	Correct (dB/m)	Result (dBuV/m)	Limit (dBuV/m)	Margin (dB)	Remark
1	2483.500	35.85	32.44	68.29	74.00	-5.71	peak
2	2483.940	38.13	32.44	70.57	74.00	-3.43	peak
3	2487.185	34.73	32.45	67.18	74.00	-6.82	peak

Test Mode:	802.11b AV	Frequency(MHz):	2462
Polarity:	Horizontal	Test Voltage:	DC 3.3 V

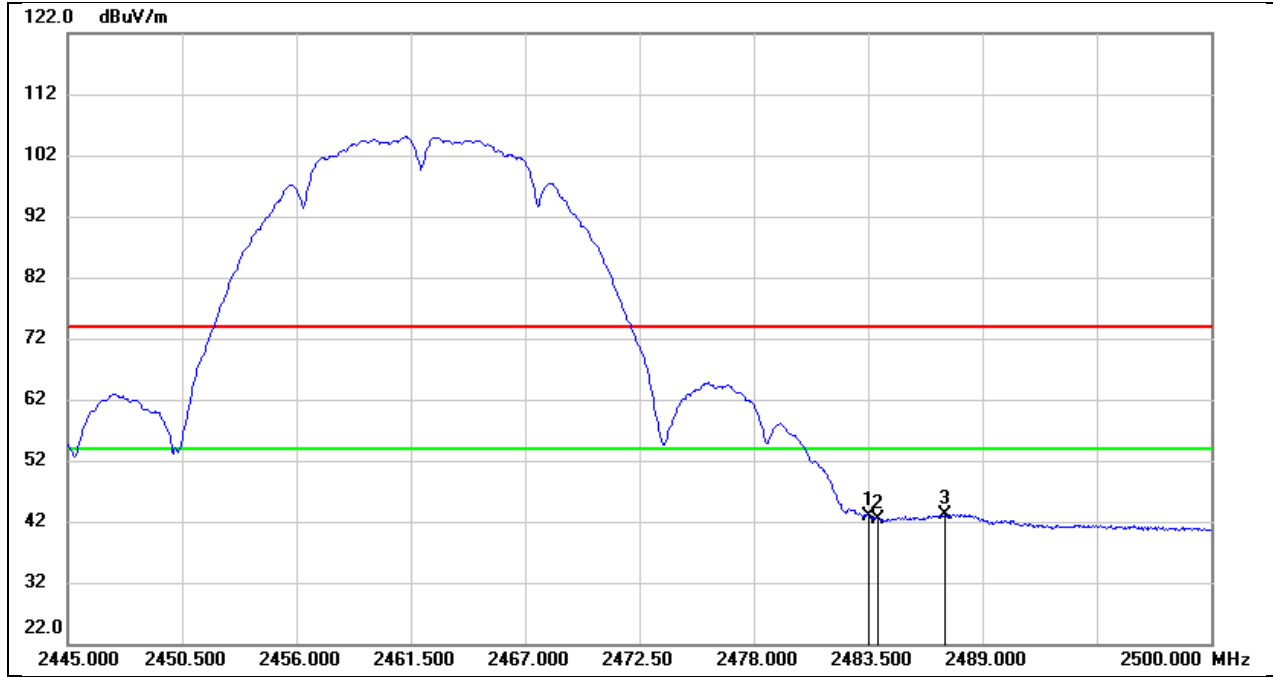

No.	Frequency (MHz)	Reading (dBuV)	Correct (dB/m)	Result (dBuV/m)	Limit (dBuV/m)	Margin (dB)	Remark
1	2483.500	10.46	32.44	42.90	54.00	-11.10	AVG
2	2483.940	10.00	32.44	42.44	54.00	-11.56	AVG
3	2487.185	10.76	32.45	43.21	54.00	-10.79	AVG

Test Mode:	802.11g PK	Frequency(MHz):	2412
Polarity:	Horizontal	Test Voltage:	DC 3.3 V

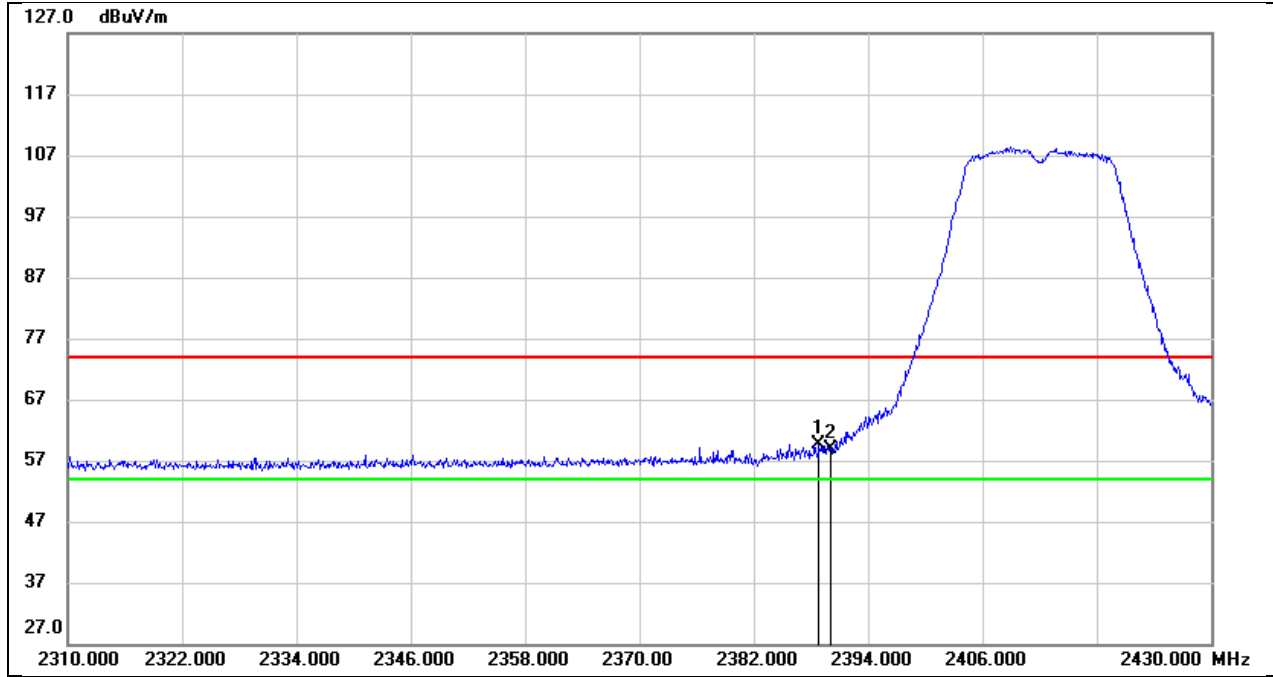

No.	Frequency (MHz)	Reading (dBuV)	Correct (dB/m)	Result (dBuV/m)	Limit (dBuV/m)	Margin (dB)	Remark
1	2388.840	27.59	32.16	59.75	74.00	-14.25	peak
2	2390.000	26.63	32.16	58.79	74.00	-15.21	peak

Test Mode:	802.11g AV	Frequency(MHz):	2412
Polarity:	Horizontal	Test Voltage:	DC 3.3 V

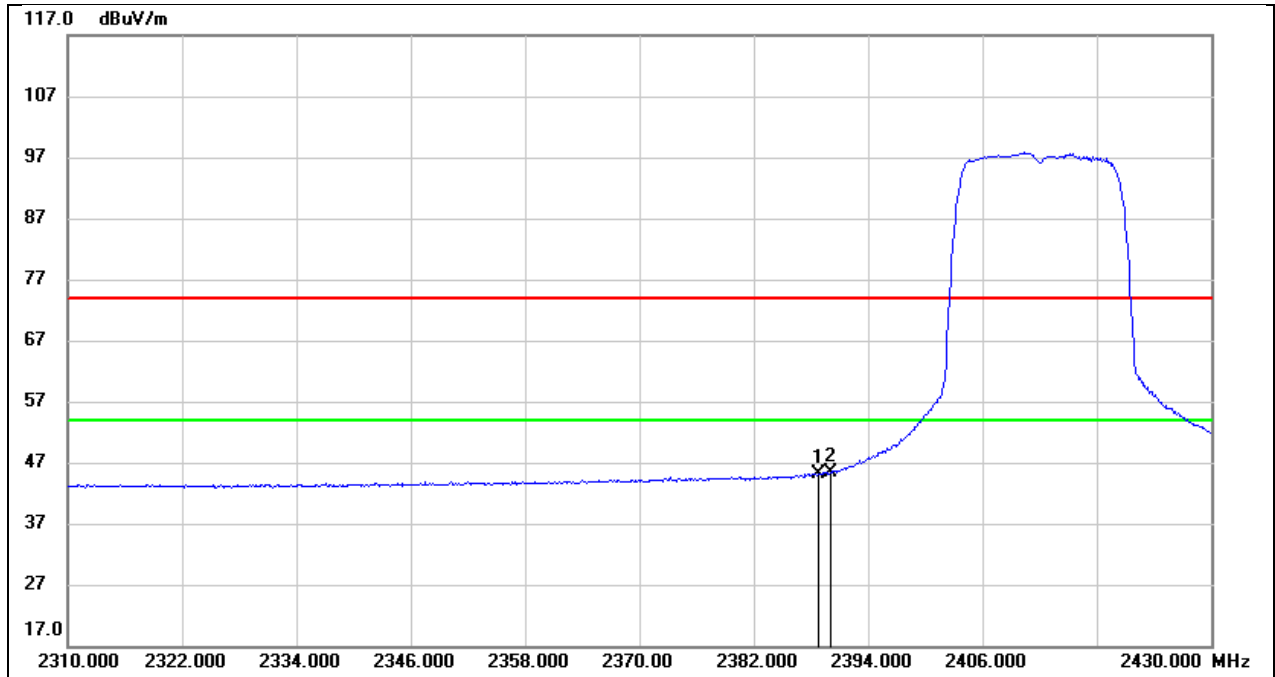

No.	Frequency (MHz)	Reading (dBuV)	Correct (dB/m)	Result (dBuV/m)	Limit (dBuV/m)	Margin (dB)	Remark
1	2388.840	12.95	32.16	45.11	54.00	-8.89	AVG
2	2390.000	13.21	32.16	45.37	54.00	-8.63	AVG

Test Mode:	802.11g PK	Frequency(MHz):	2462
Polarity:	Horizontal	Test Voltage:	DC 3.3 V

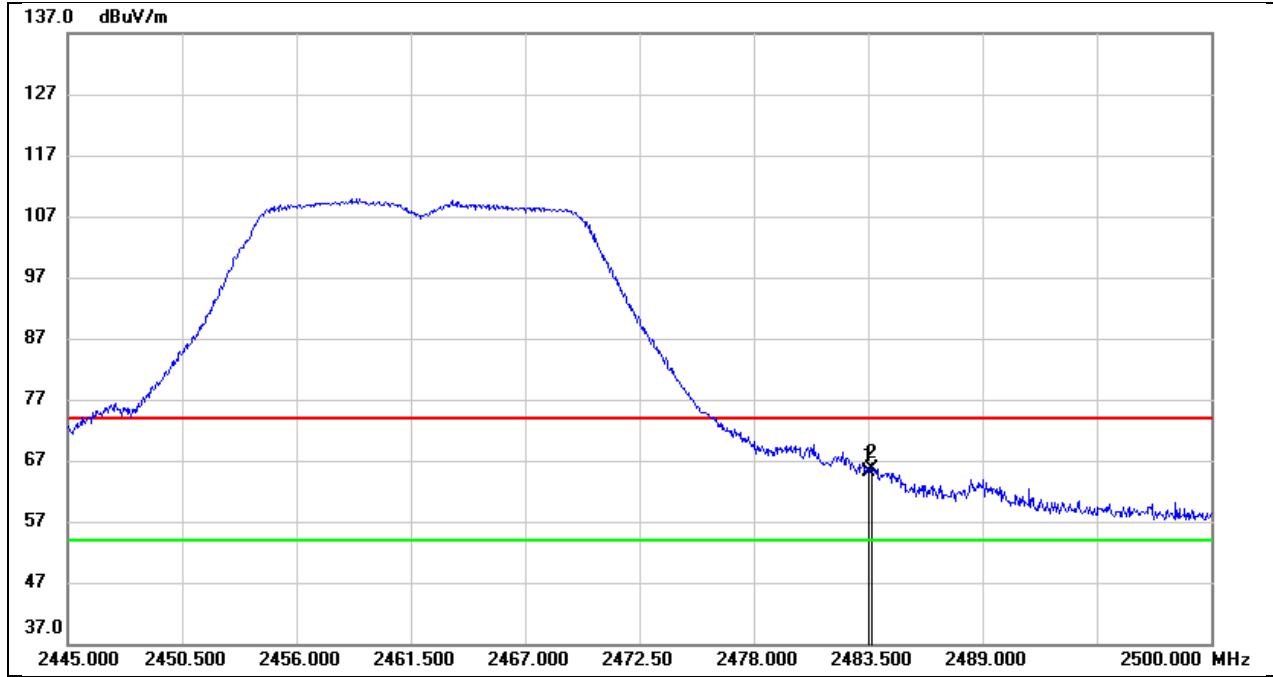

No.	Frequency (MHz)	Reading (dBuV)	Correct (dB/m)	Result (dBuV/m)	Limit (dBuV/m)	Margin (dB)	Remark
1	2483.500	32.74	32.44	65.18	74.00	-8.82	peak
2	2483.665	33.31	32.44	65.75	74.00	-8.25	peak

Test Mode:	802.11g AV	Frequency(MHz):	2462
Polarity:	Horizontal	Test Voltage:	DC 3.3 V

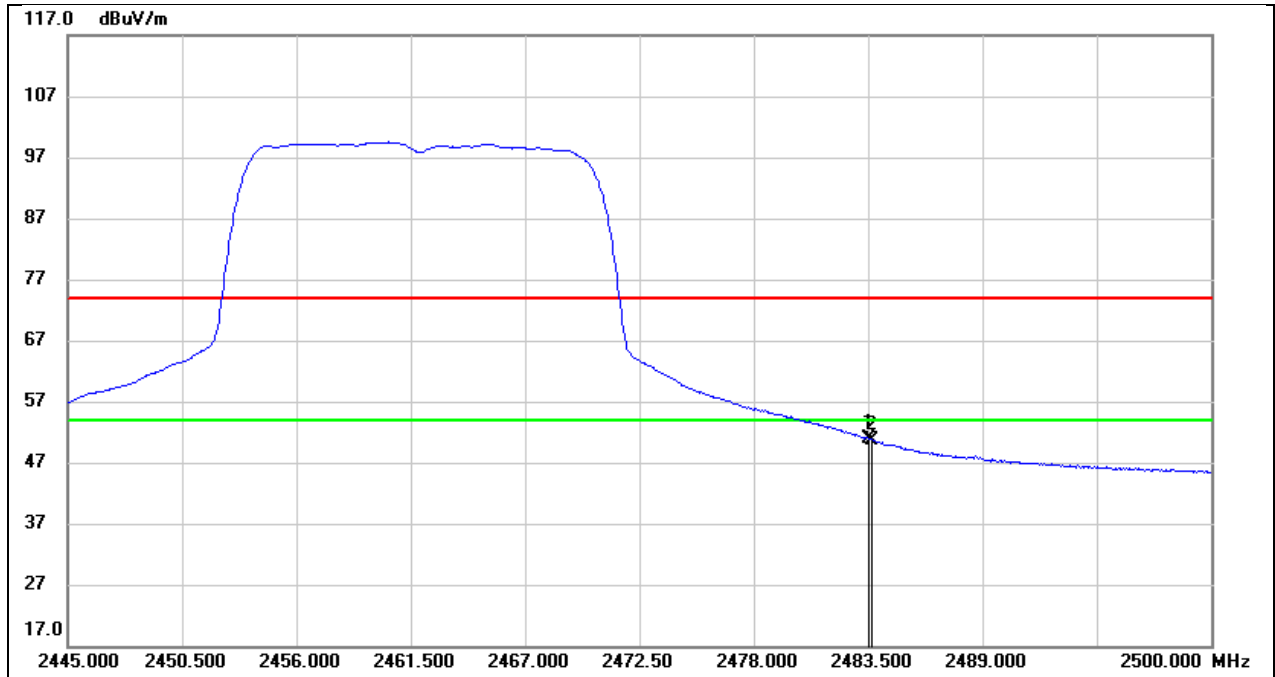

No.	Frequency (MHz)	Reading (dBuV)	Correct (dB/m)	Result (dBuV/m)	Limit (dBuV/m)	Margin (dB)	Remark
1	2483.500	18.49	32.44	50.93	54.00	-3.07	AVG
2	2483.665	18.21	32.44	50.65	54.00	-3.35	AVG



Test Mode:	802.11n HT20 PK	Frequency(MHz):	2412
Polarity:	Horizontal	Test Voltage:	DC 3.3 V

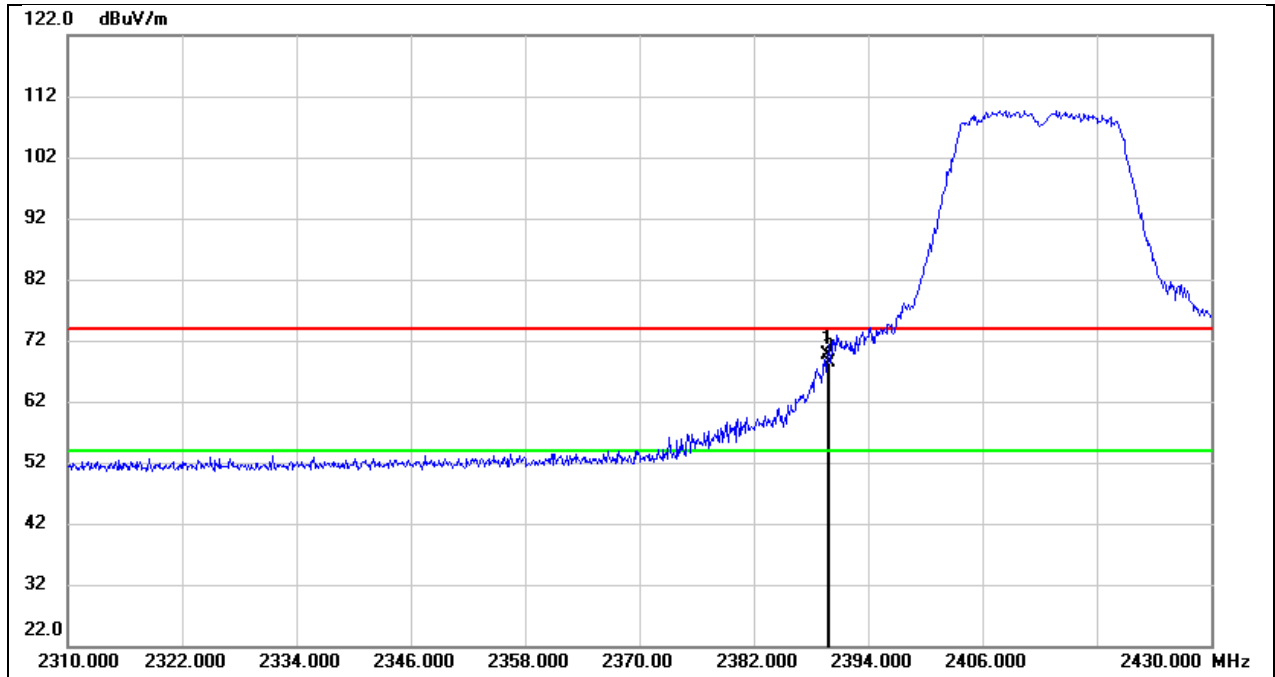

No.	Frequency (MHz)	Reading (dBuV)	Correct (dB/m)	Result (dBuV/m)	Limit (dBuV/m)	Margin (dB)	Remark
1	2389.680	37.37	32.16	69.53	74.00	-4.47	peak
2	2390.000	36.34	32.16	68.50	74.00	-5.50	peak

Test Mode:	802.11n HT20 AV	Frequency(MHz):	2412
Polarity:	Horizontal	Test Voltage:	DC 3.3 V

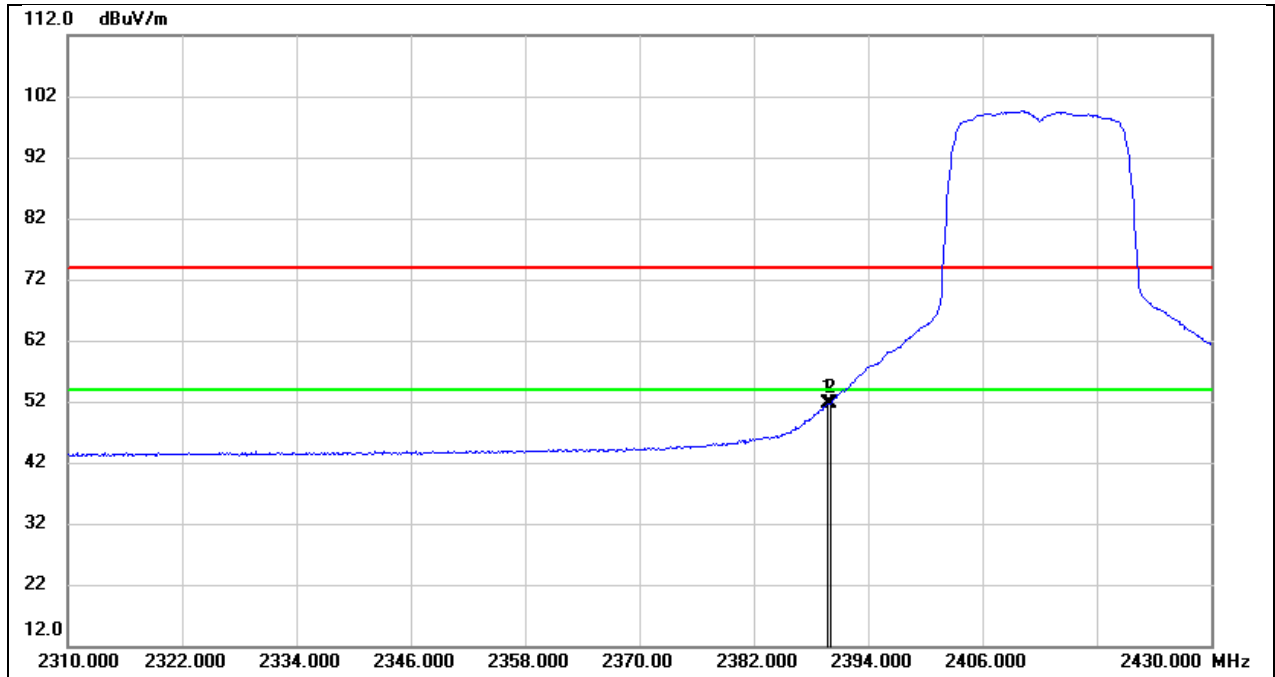

No.	Frequency (MHz)	Reading (dBuV)	Correct (dB/m)	Result (dBuV/m)	Limit (dBuV/m)	Margin (dB)	Remark
1	2389.680	19.40	32.16	51.56	54.00	-2.44	AVG
2	2390.000	19.50	32.16	51.66	54.00	-2.34	AVG

Test Mode:	802.11n HT20 PK	Frequency(MHz):	2462
Polarity:	Horizontal	Test Voltage:	DC 3.3 V

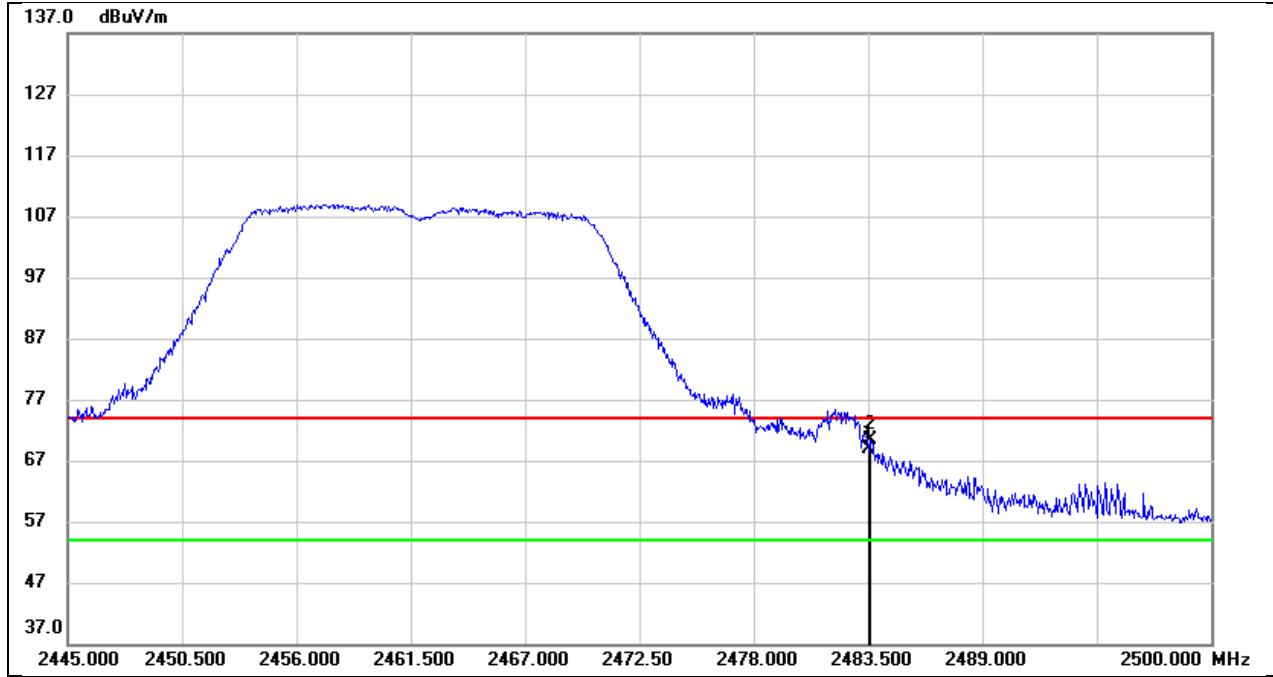

No.	Frequency (MHz)	Reading (dBuV)	Correct (dB/m)	Result (dBuV/m)	Limit (dBuV/m)	Margin (dB)	Remark
1	2483.500	36.54	32.44	68.98	74.00	-5.02	peak
2	2483.610	38.00	32.44	70.44	74.00	-3.56	peak

Test Mode:	802.11n HT20 AV	Frequency(MHz):	2462
Polarity:	Horizontal	Test Voltage:	DC 3.3 V

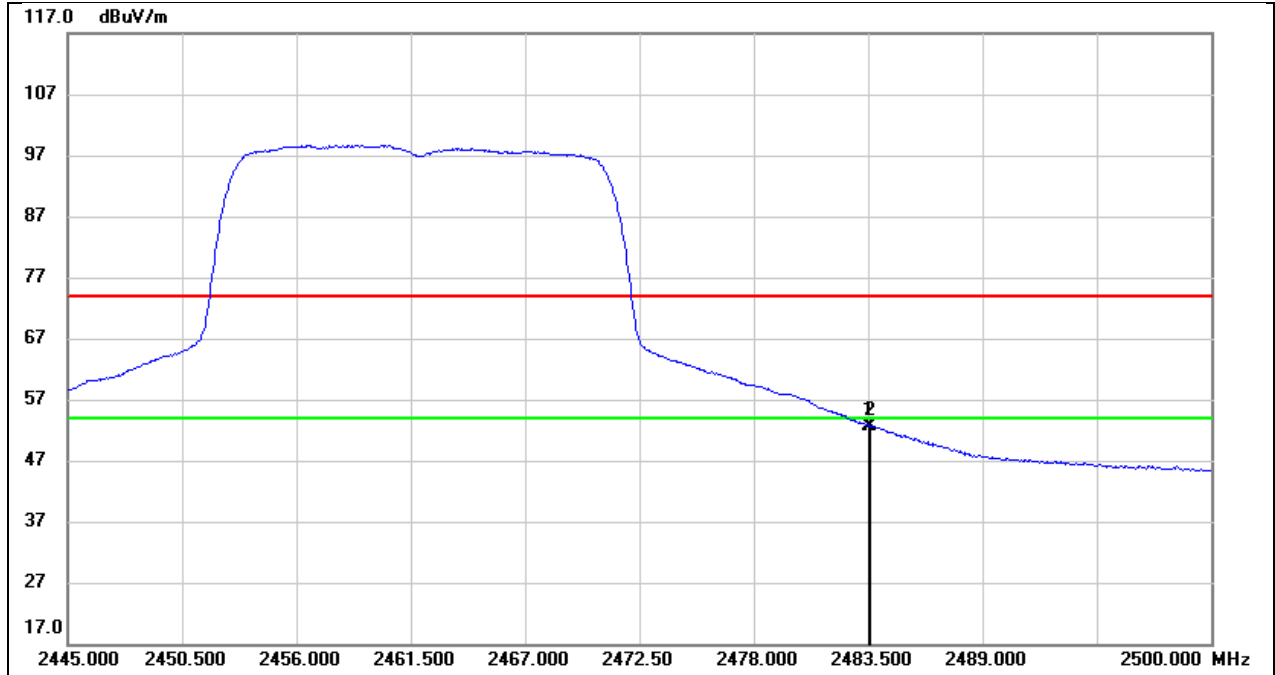

No.	Frequency (MHz)	Reading (dBuV)	Correct (dB/m)	Result (dBuV/m)	Limit (dBuV/m)	Margin (dB)	Remark
1	2483.500	20.29	32.44	52.73	54.00	-1.27	AVG
2	2483.610	20.23	32.44	52.67	54.00	-1.33	AVG

Test Mode:	802.11n HT40 PK	Frequency(MHz):	2422
Polarity:	Horizontal	Test Voltage:	DC 3.3 V

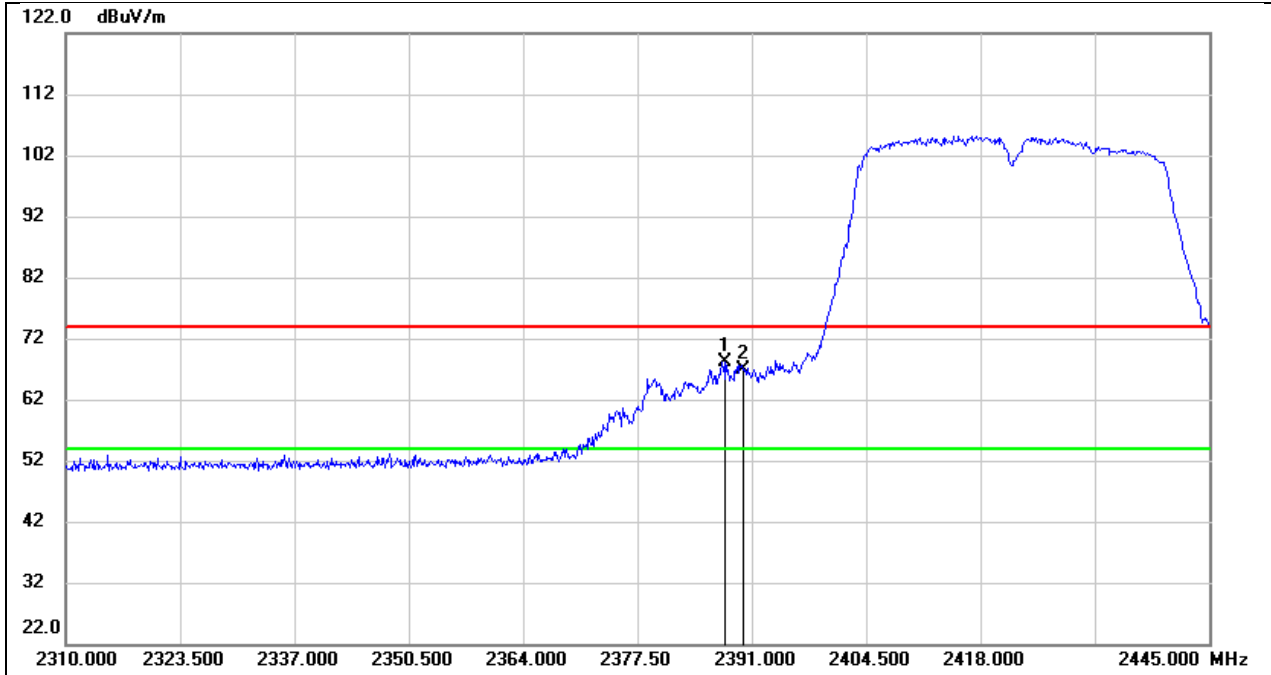

No.	Frequency (MHz)	Reading (dBuV)	Correct (dB/m)	Result (dBuV/m)	Limit (dBuV/m)	Margin (dB)	Remark
1	2387.760	35.91	32.16	68.07	74.00	-5.93	peak
2	2390.000	34.81	32.16	66.97	74.00	-7.03	peak

Test Mode:	802.11n HT40 AV	Frequency(MHz):	2422
Polarity:	Horizontal	Test Voltage:	DC 3.3 V

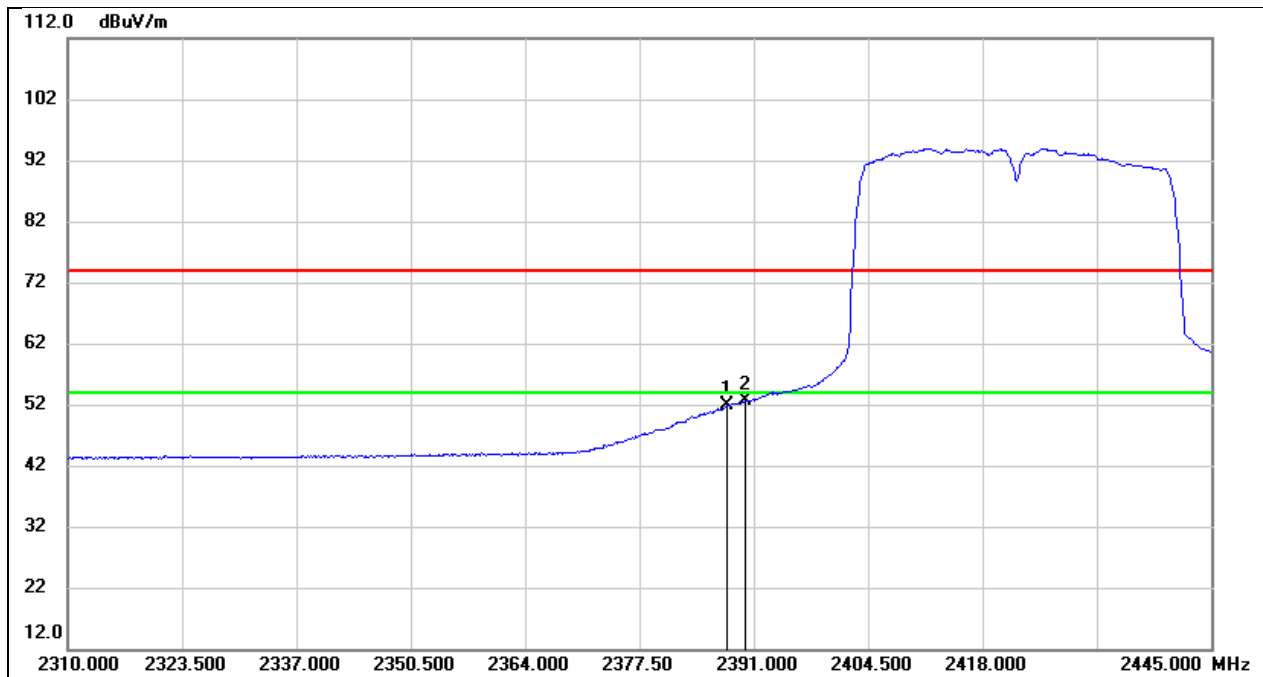

No.	Frequency (MHz)	Reading (dBuV)	Correct (dB/m)	Result (dBuV/m)	Limit (dBuV/m)	Margin (dB)	Remark
1	2387.760	19.61	32.16	51.77	54.00	-2.23	AVG
2	2390.000	20.40	32.16	52.56	54.00	-1.44	AVG

Test Mode:	802.11n HT40 PK	Frequency(MHz):	2452
Polarity:	Horizontal	Test Voltage:	DC 3.3 V

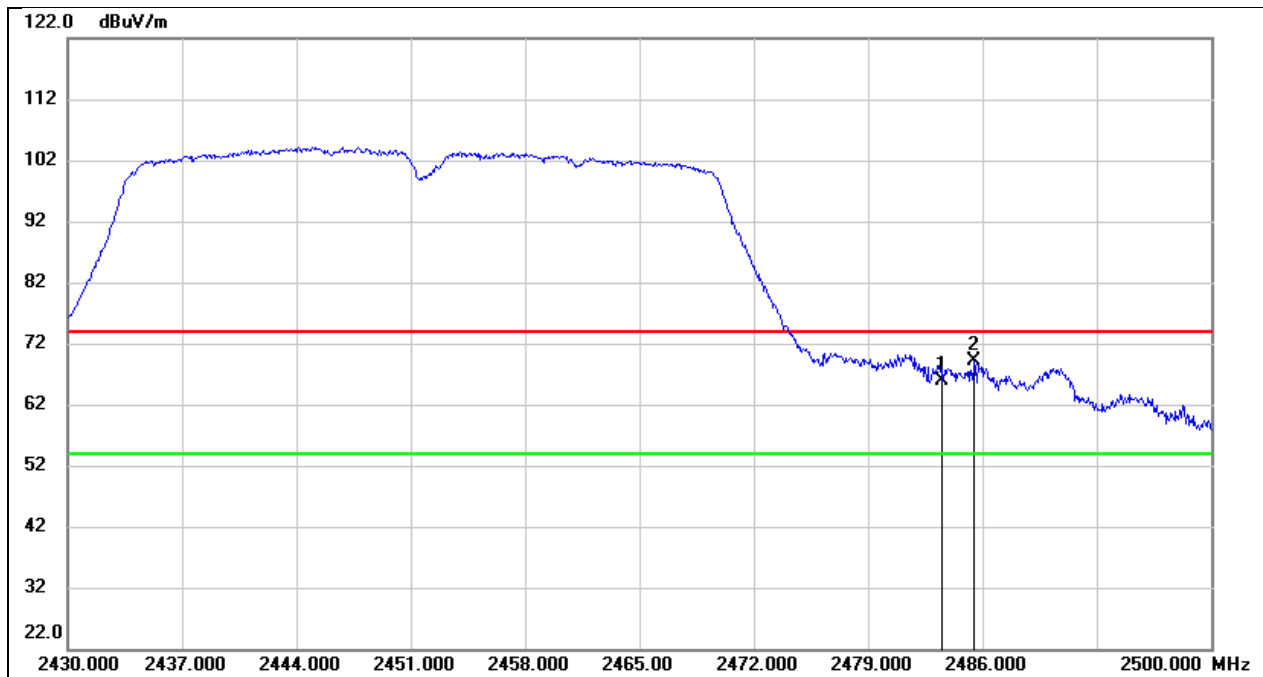

No.	Frequency (MHz)	Reading (dBuV)	Correct (dB/m)	Result (dBuV/m)	Limit (dBuV/m)	Margin (dB)	Remark
1	2483.500	33.43	32.44	65.87	74.00	-8.13	peak
2	2485.510	36.60	32.44	69.04	74.00	-4.96	peak

Test Mode:	802.11n HT40 AV	Frequency(MHz):	2452
Polarity:	Horizontal	Test Voltage:	DC 3.3 V

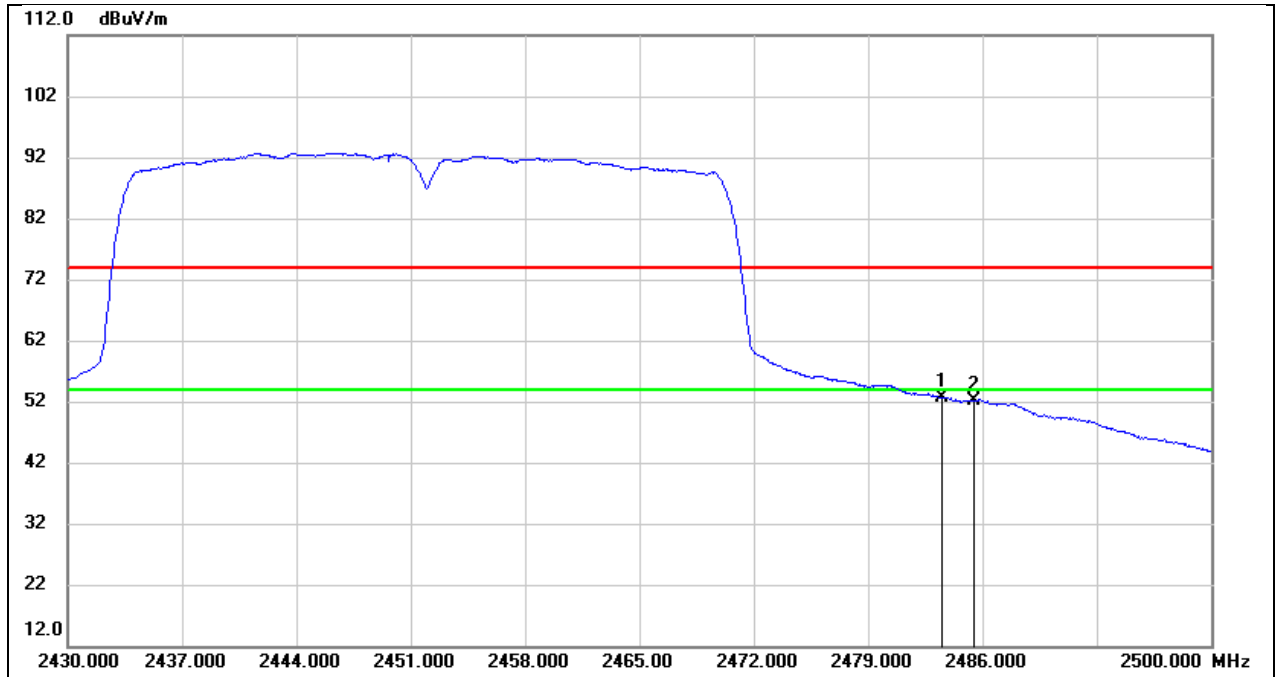

No.	Frequency (MHz)	Reading (dBuV)	Correct (dB/m)	Result (dBuV/m)	Limit (dBuV/m)	Margin (dB)	Remark
1	2483.500	20.24	32.44	52.68	54.00	-1.32	AVG
2	2485.510	19.65	32.44	52.09	54.00	-1.91	AVG



## 8.2. SPURIOUS EMISSIONS(1 GHZ~3 GHZ)

Test Mode:	802.11b	Frequency(MHz):	2412
Polarity:	Horizontal	Test Voltage:	DC 3.3 V

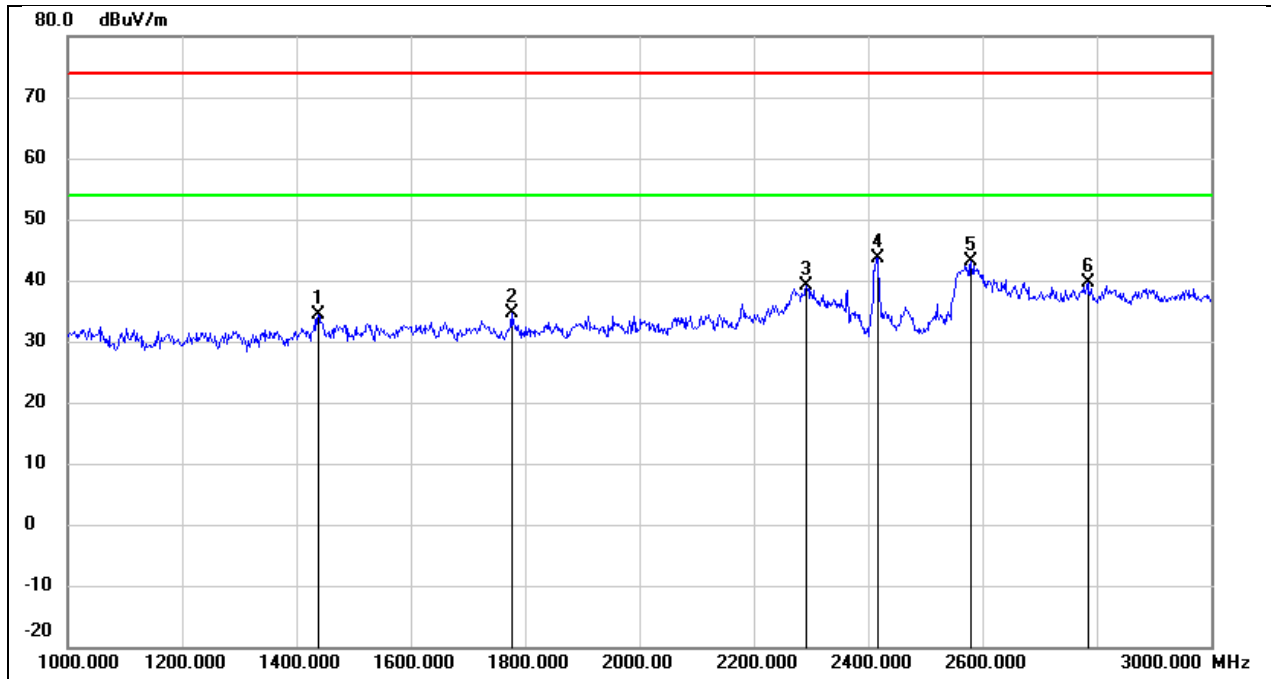

No.	Frequency (MHz)	Reading (dBuV)	Correct (dB/m)	Result (dBuV/m)	Limit (dBuV/m)	Margin (dB)	Remark
1	1438.000	47.40	-13.00	34.40	74.00	-39.60	peak
2	1776.000	46.32	-11.80	34.52	74.00	-39.48	peak
3	2292.000	48.79	-9.56	39.23	74.00	-34.77	peak
4	2412.000	52.45	-8.92	43.53	/	/	fundamental
5	2580.000	51.23	-8.09	43.14	74.00	-30.86	peak
6	2784.000	46.65	-7.06	39.59	74.00	-34.41	peak

Test Mode:	802.11b	Frequency(MHz):	2412
Polarity:	Vertical	Test Voltage:	DC 3.3 V

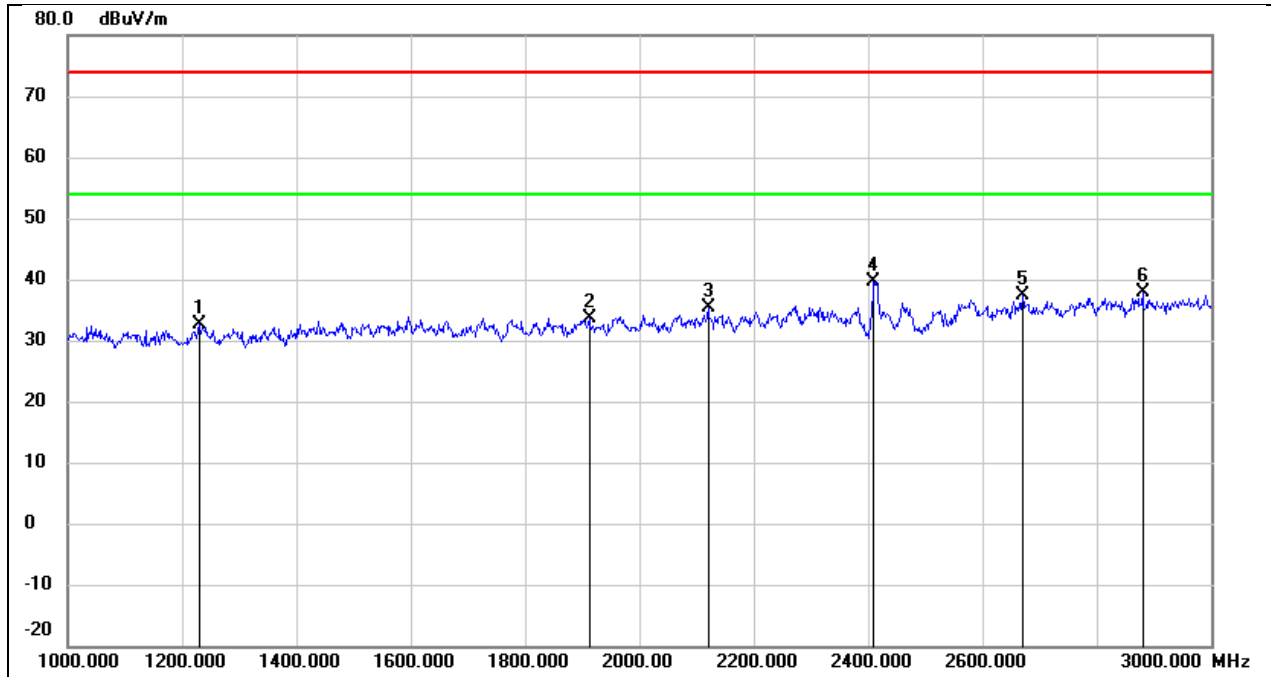

No.	Frequency (MHz)	Reading (dBuV)	Correct (dB/m)	Result (dBuV/m)	Limit (dBuV/m)	Margin (dB)	Remark
1	1230.000	46.69	-13.96	32.73	74.00	-41.27	peak
2	1912.000	45.09	-11.35	33.74	74.00	-40.26	peak
3	2120.000	45.86	-10.45	35.41	74.00	-38.59	peak
4	2412.000	48.64	-8.95	39.69	/	/	fundamental
5	2670.000	44.90	-7.63	37.27	74.00	-36.73	peak
6	2880.000	44.35	-6.58	37.77	74.00	-36.23	peak

Test Mode:	802.11b	Frequency(MHz):	2437
Polarity:	Horizontal	Test Voltage:	DC 3.3 V

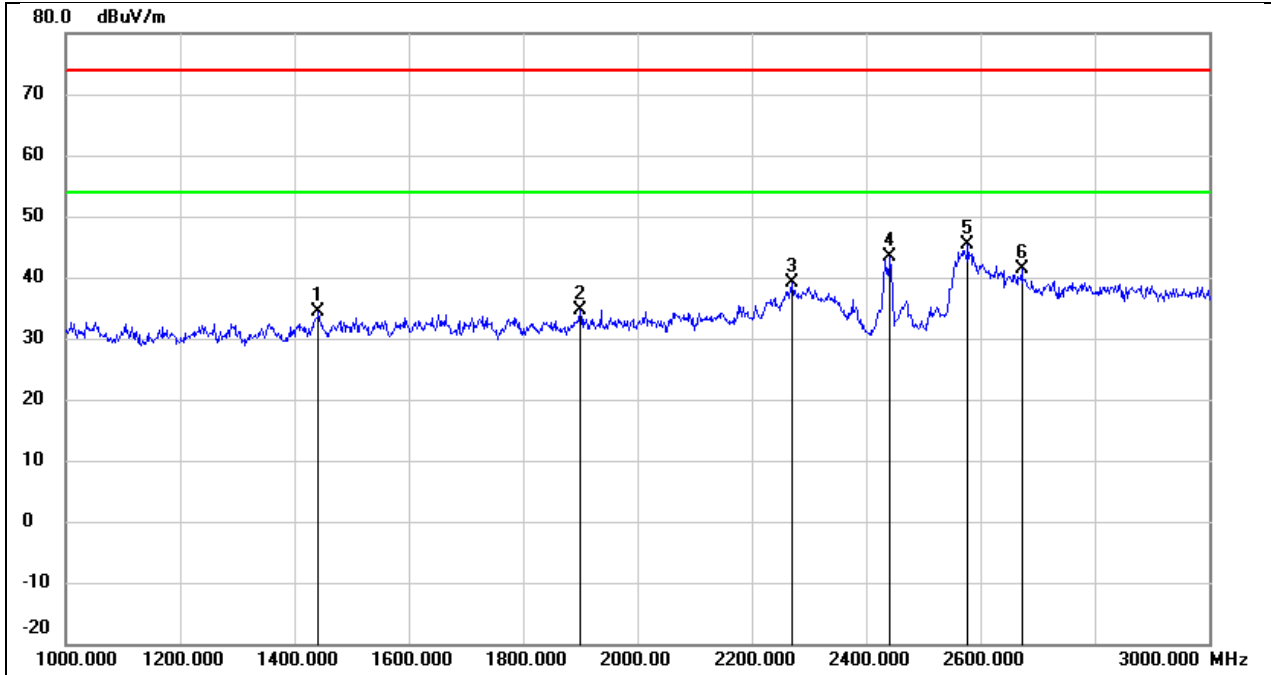

No.	Frequency (MHz)	Reading (dBuV)	Correct (dB/m)	Result (dBuV/m)	Limit (dBuV/m)	Margin (dB)	Remark
1	1442.000	47.44	-12.98	34.46	74.00	-39.54	peak
2	1900.000	46.03	-11.39	34.64	74.00	-39.36	peak
3	2270.000	48.84	-9.67	39.17	74.00	-34.83	peak
4	2437.000	52.11	-8.79	43.32	/	/	fundamental
5	2578.000	53.46	-8.10	45.36	74.00	-28.64	peak
6	2672.000	48.93	-7.63	41.30	74.00	-32.70	peak

Test Mode:	802.11b	Frequency(MHz):	2437
Polarity:	Vertical	Test Voltage:	DC 3.3 V

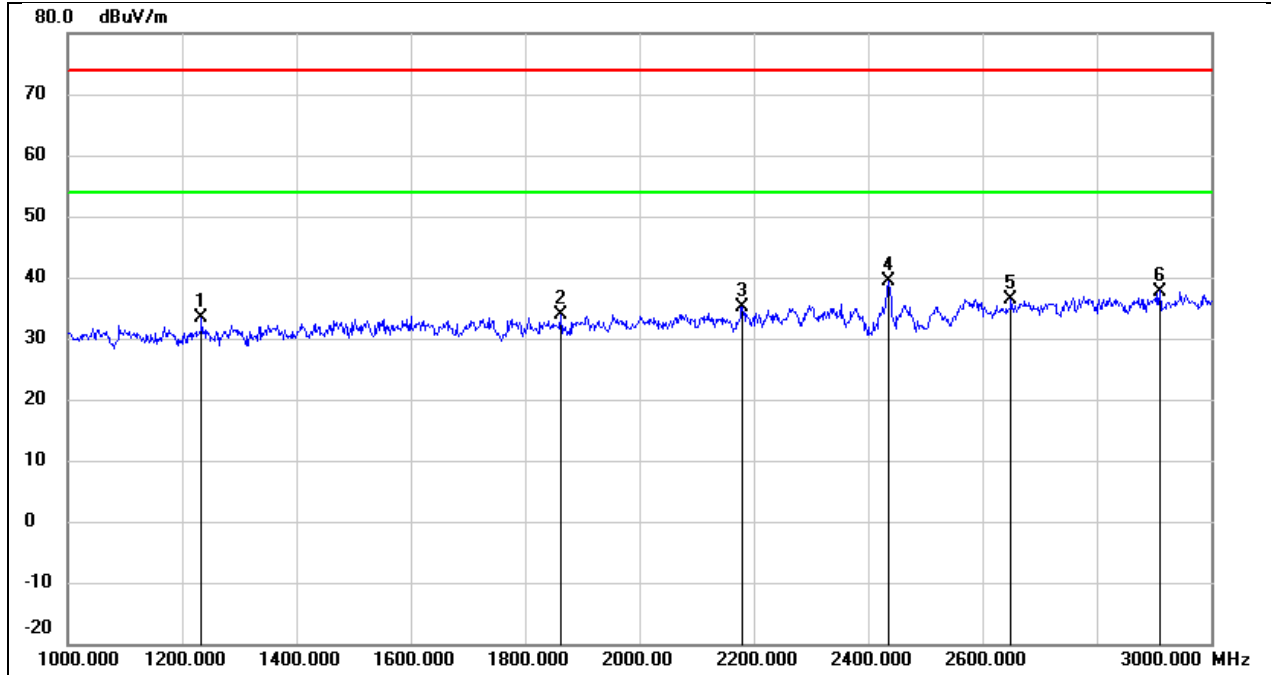

No.	Frequency (MHz)	Reading (dBuV)	Correct (dB/m)	Result (dBuV/m)	Limit (dBuV/m)	Margin (dB)	Remark
1	1234.000	47.40	-13.94	33.46	74.00	-40.54	peak
2	1862.000	45.38	-11.51	33.87	74.00	-40.13	peak
3	2180.000	45.24	-10.13	35.11	74.00	-38.89	peak
4	2437.000	48.11	-8.82	39.29	/	/	fundamental
5	2650.000	44.16	-7.73	36.43	74.00	-37.57	peak
6	2910.000	44.18	-6.43	37.75	74.00	-36.25	peak

Test Mode:	802.11b	Frequency(MHz):	2462
Polarity:	Horizontal	Test Voltage:	DC 3.3 V

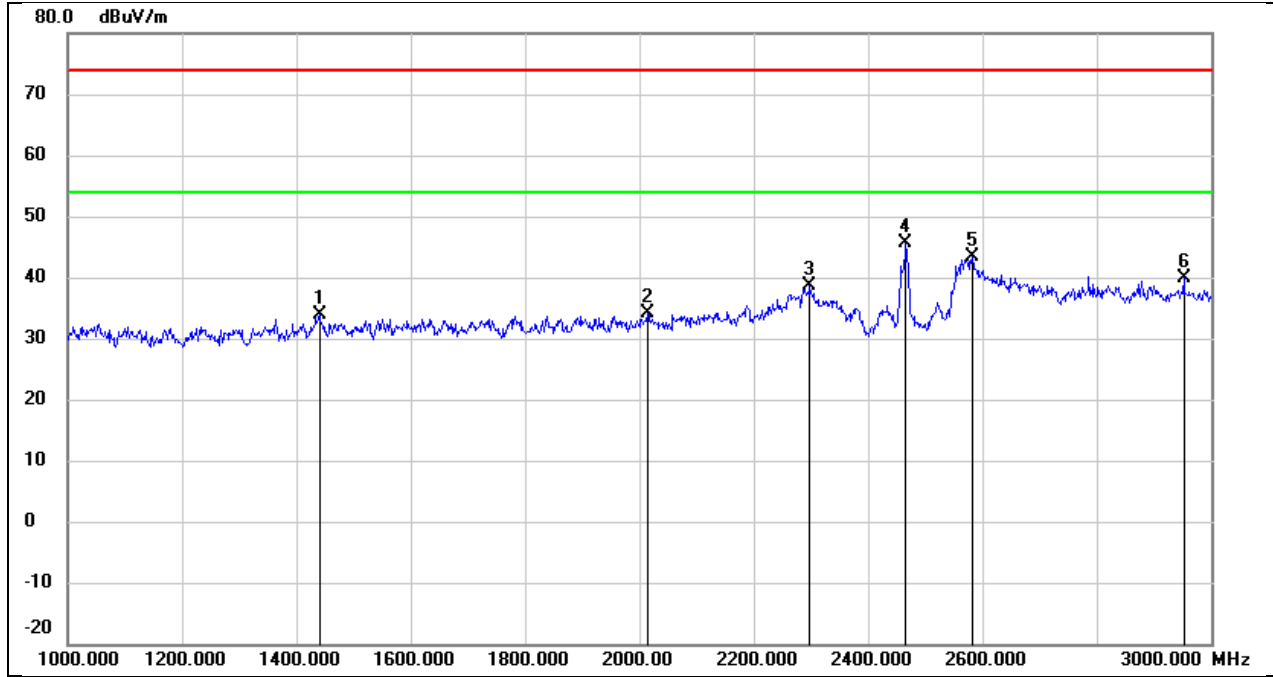

No.	Frequency (MHz)	Reading (dBuV)	Correct (dB/m)	Result (dBuV/m)	Limit (dBuV/m)	Margin (dB)	Remark
1	1440.000	46.76	-12.98	33.78	74.00	-40.22	peak
2	2014.000	45.23	-10.98	34.25	74.00	-39.75	peak
3	2298.000	48.22	-9.53	38.69	74.00	-35.31	peak
4	2462.000	54.39	-8.66	45.73	/	/	fundamental
5	2582.000	51.52	-8.07	43.45	74.00	-30.55	peak
6	2952.000	46.08	-6.22	39.86	74.00	-34.14	peak

Test Mode:	802.11b	Frequency(MHz):	2462
Polarity:	Vertical	Test Voltage:	DC 3.3 V

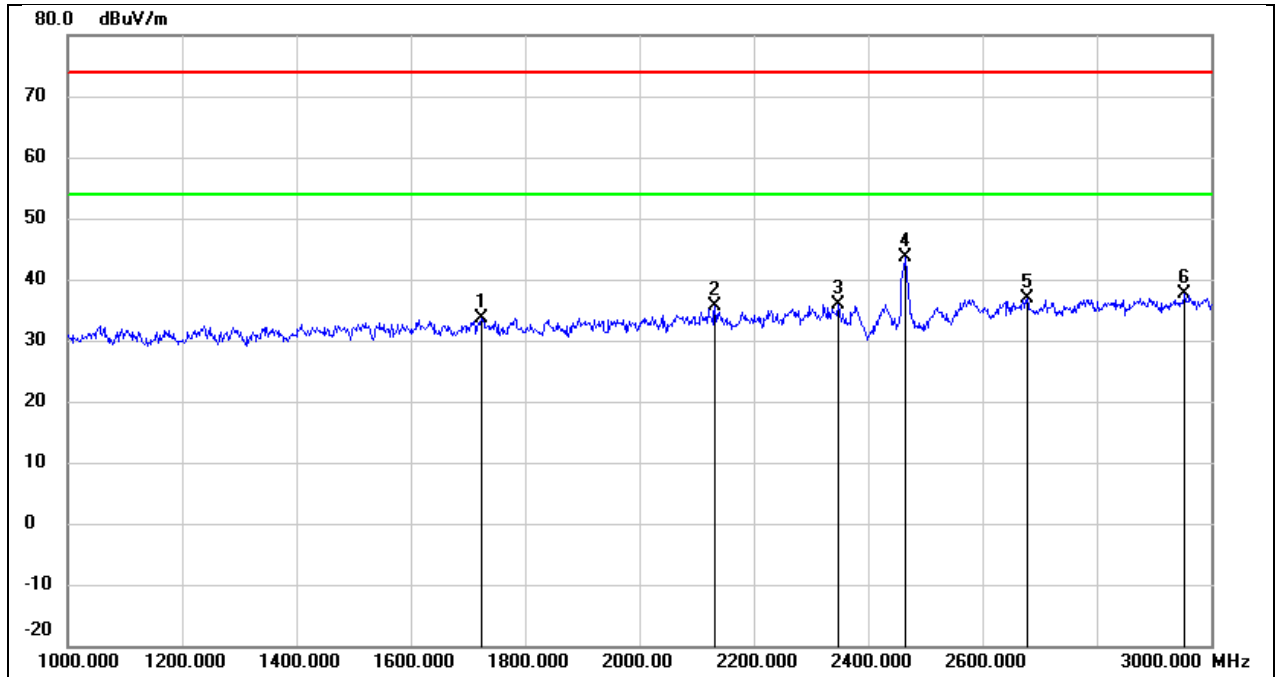

No.	Frequency (MHz)	Reading (dBuV)	Correct (dB/m)	Result (dBuV/m)	Limit (dBuV/m)	Margin (dB)	Remark
1	1724.000	45.57	-11.97	33.60	74.00	-40.40	peak
2	2132.000	46.03	-10.39	35.64	74.00	-38.36	peak
3	2348.000	45.12	-9.28	35.84	74.00	-38.16	peak
4	2462.000	52.24	-8.68	43.56	/	/	fundamental
5	2678.000	44.38	-7.60	36.78	74.00	-37.22	peak
6	2954.000	43.78	-6.21	37.57	74.00	-36.43	peak

### 8.3. SPURIOUS EMISSIONS(3 GHZ~18 GHZ)

Test Mode:	802.11b	Frequency(MHz):	2412
Polarity:	Horizontal	Test Voltage:	DC 3.3 V

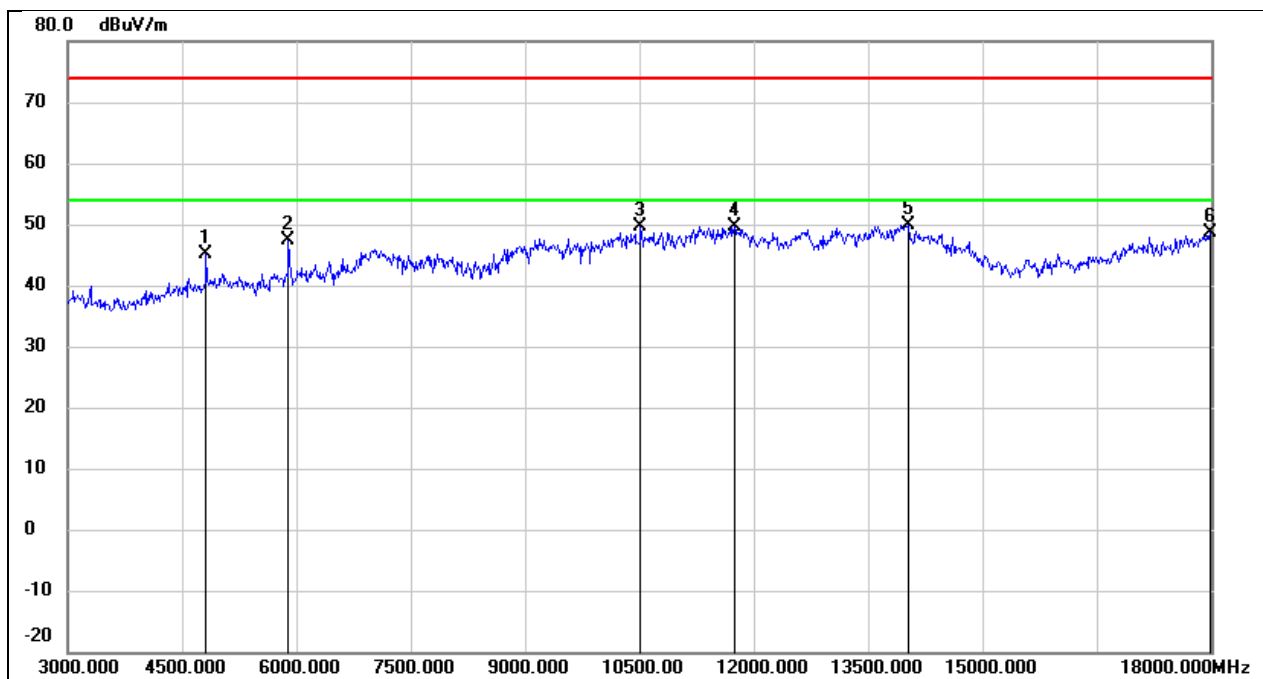

No.	Frequency (MHz)	Reading (dBuV)	Correct (dB/m)	Result (dBuV/m)	Limit (dBuV/m)	Margin (dB)	Remark
1	4815.000	45.27	-0.26	45.01	74.00	-28.99	peak
2	5895.000	45.52	1.96	47.48	74.00	-26.52	peak
3	10515.000	36.51	13.04	49.55	74.00	-24.45	peak
4	11745.000	32.43	17.27	49.70	74.00	-24.30	peak
5	14025.000	27.97	21.86	49.83	74.00	-24.17	peak
6	17985.000	22.97	25.60	48.57	74.00	-25.43	peak

Test Mode:	802.11b	Frequency(MHz):	2412
Polarity:	Vertical	Test Voltage:	DC 3.3 V

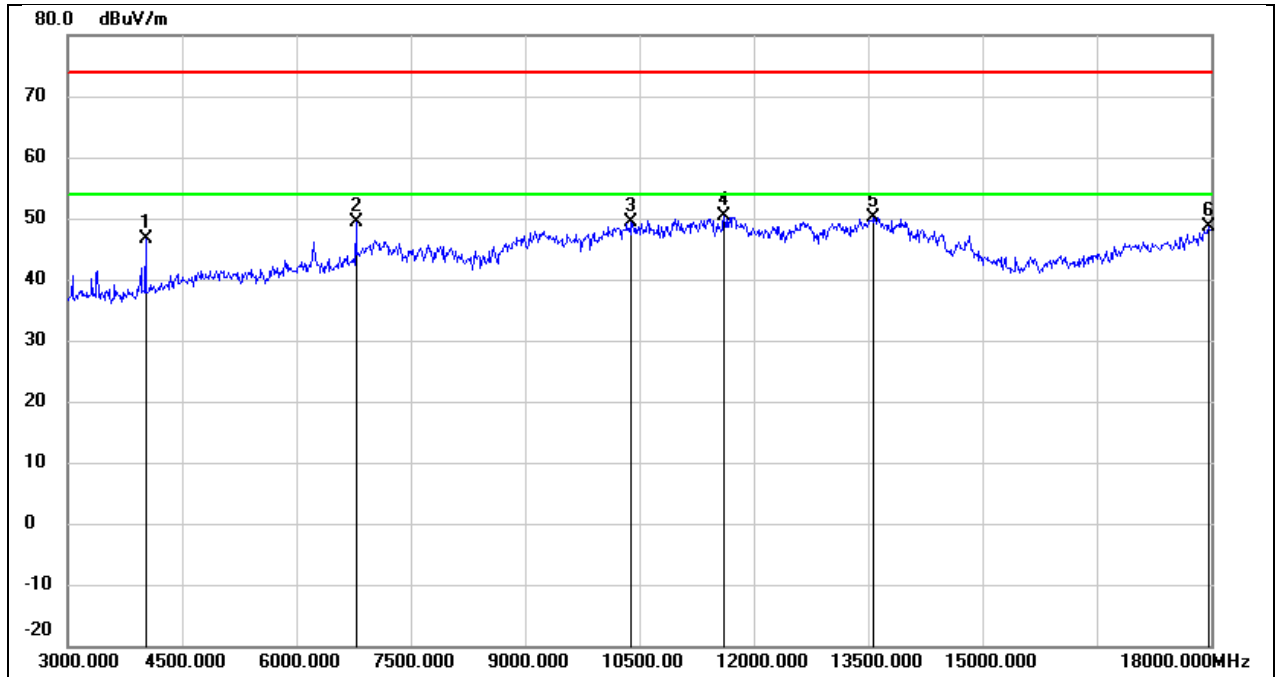

No.	Frequency (MHz)	Reading (dBuV)	Correct (dB/m)	Result (dBuV/m)	Limit (dBuV/m)	Margin (dB)	Remark
1	4020.000	50.37	-3.71	46.66	74.00	-27.34	peak
2	6780.000	43.81	5.60	49.41	74.00	-24.59	peak
3	10395.000	36.48	12.78	49.26	74.00	-24.74	peak
4	11610.000	33.37	16.90	50.27	74.00	-23.73	peak
5	13575.000	29.02	21.06	50.08	74.00	-23.92	peak
6	17970.000	23.03	25.51	48.54	74.00	-25.46	peak



Test Mode:	802.11b	Frequency(MHz):	2437
Polarity:	Horizontal	Test Voltage:	DC 3.3 V

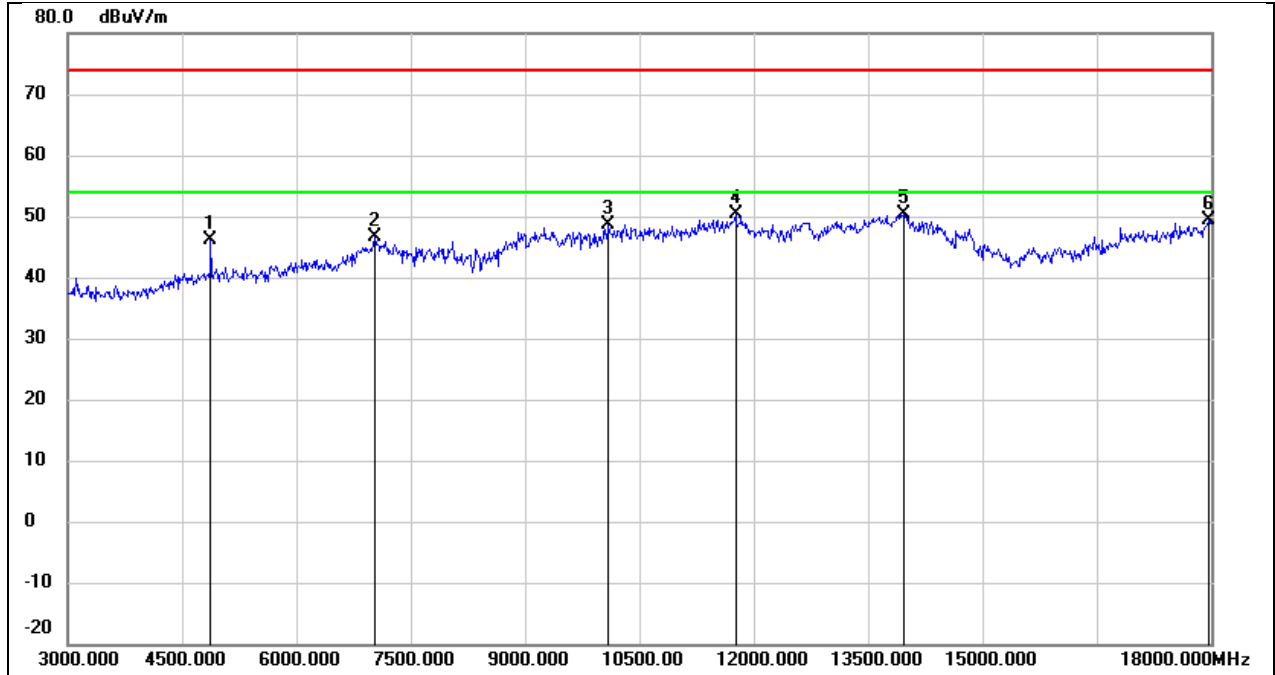

No.	Frequency (MHz)	Reading (dBuV)	Correct (dB/m)	Result (dBuV/m)	Limit (dBuV/m)	Margin (dB)	Remark
1	4875.000	46.17	-0.03	46.14	74.00	-27.86	peak
2	7035.000	39.97	6.67	46.64	74.00	-27.36	peak
3	10095.000	36.43	12.19	48.62	74.00	-25.38	peak
4	11760.000	33.10	17.31	50.41	74.00	-23.59	peak
5	13965.000	28.57	21.89	50.46	74.00	-23.54	peak
6	17970.000	23.80	25.51	49.31	74.00	-24.69	peak

Test Mode:	802.11b	Frequency(MHz):	2437
Polarity:	Vertical	Test Voltage:	DC 3.3 V

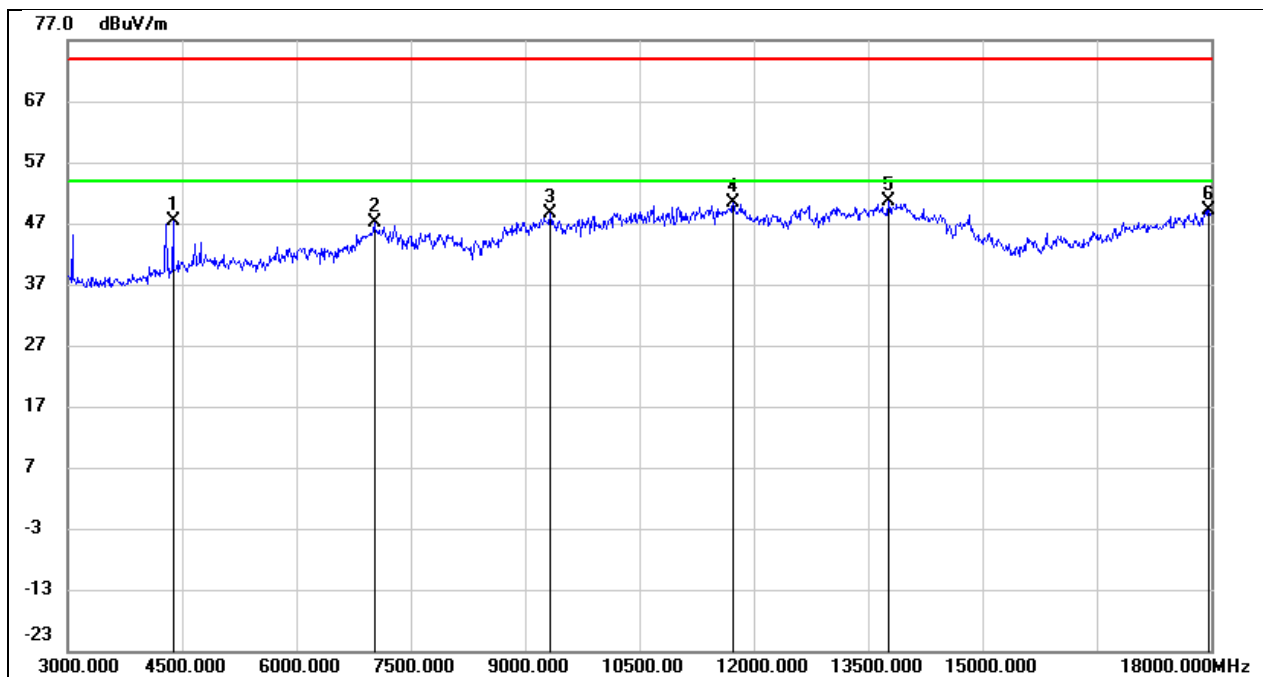

No.	Frequency (MHz)	Reading (dBuV)	Correct (dB/m)	Result (dBuV/m)	Limit (dBuV/m)	Margin (dB)	Remark
1	4380.000	49.35	-2.02	47.33	74.00	-26.67	peak
2	7020.000	40.47	6.67	47.14	74.00	-26.86	peak
3	9330.000	37.90	10.62	48.52	74.00	-25.48	peak
4	11730.000	33.10	17.22	50.32	74.00	-23.68	peak
5	13770.000	29.04	21.47	50.51	74.00	-23.49	peak
6	17970.000	23.65	25.51	49.16	74.00	-24.84	peak

Test Mode:	802.11b	Frequency(MHz):	2462
Polarity:	Horizontal	Test Voltage:	DC 3.3 V

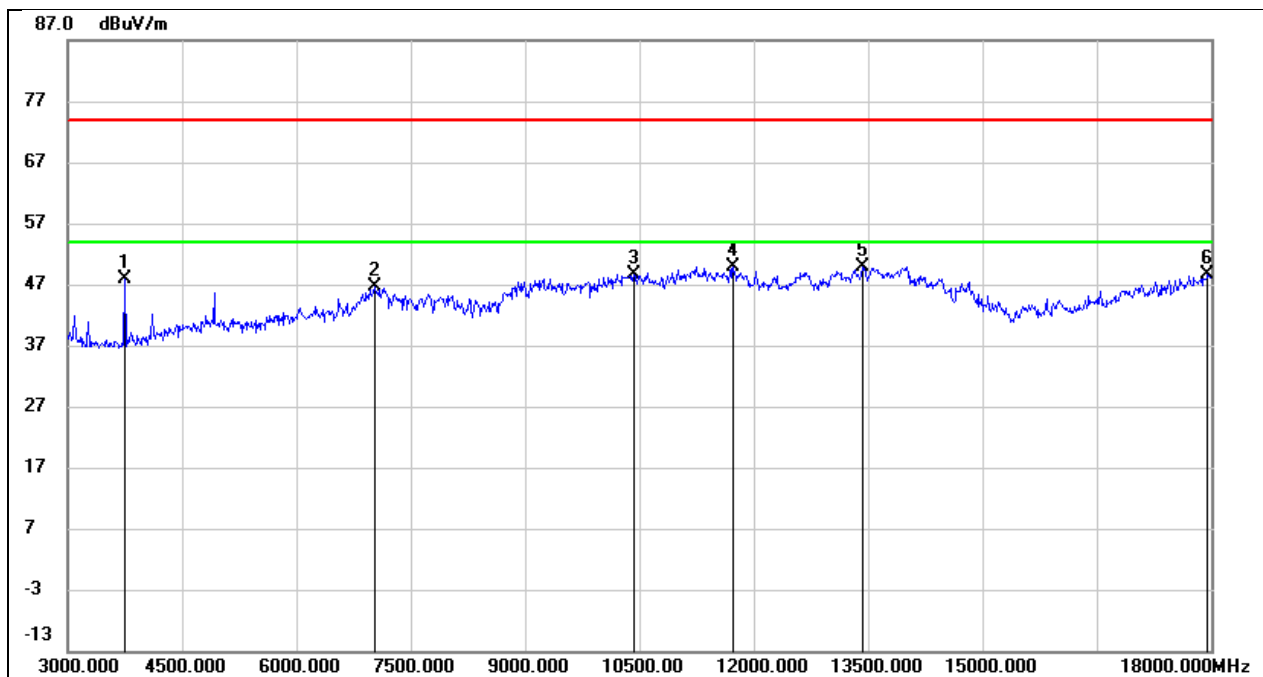

No.	Frequency (MHz)	Reading (dBuV)	Correct (dB/m)	Result (dBuV/m)	Limit (dBuV/m)	Margin (dB)	Remark
1	3750.000	52.14	-4.38	47.76	74.00	-26.24	peak
2	7020.000	39.89	6.67	46.56	74.00	-27.44	peak
3	10425.000	35.84	12.84	48.68	74.00	-25.32	peak
4	11730.000	32.77	17.22	49.99	74.00	-24.01	peak
5	13425.000	29.37	20.58	49.95	74.00	-24.05	peak
6	17955.000	23.20	25.42	48.62	74.00	-25.38	peak

Test Mode:	802.11b	Frequency(MHz):	2462
Polarity:	Vertical	Test Voltage:	DC 3.3 V

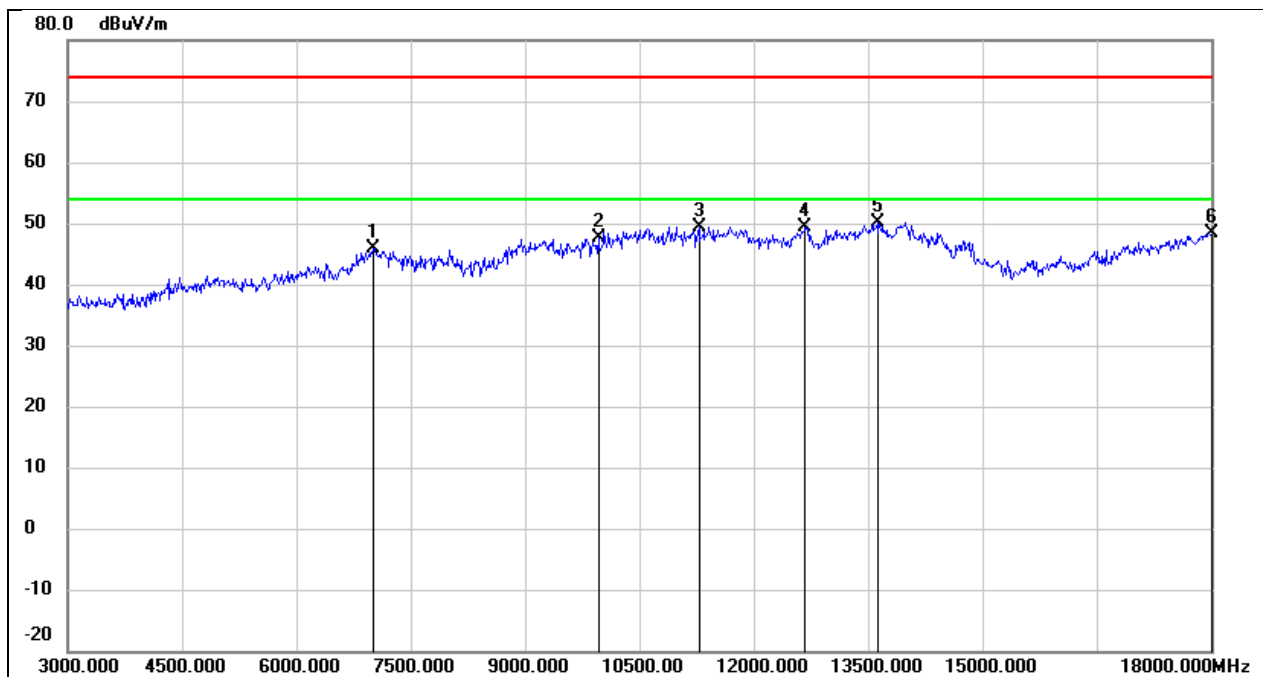

No.	Frequency (MHz)	Reading (dBuV)	Correct (dB/m)	Result (dBuV/m)	Limit (dBuV/m)	Margin (dB)	Remark
1	7005.000	39.18	6.69	45.87	74.00	-28.13	peak
2	9960.000	35.72	11.90	47.62	74.00	-26.38	peak
3	11280.000	33.52	15.80	49.32	74.00	-24.68	peak
4	12675.000	31.34	17.99	49.33	74.00	-24.67	peak
5	13620.000	29.05	21.15	50.20	74.00	-23.80	peak
6	18000.000	22.79	25.69	48.48	74.00	-25.52	peak

Test Mode:	802.11g	Frequency(MHz):	2412
Polarity:	Horizontal	Test Voltage:	DC 3.3 V

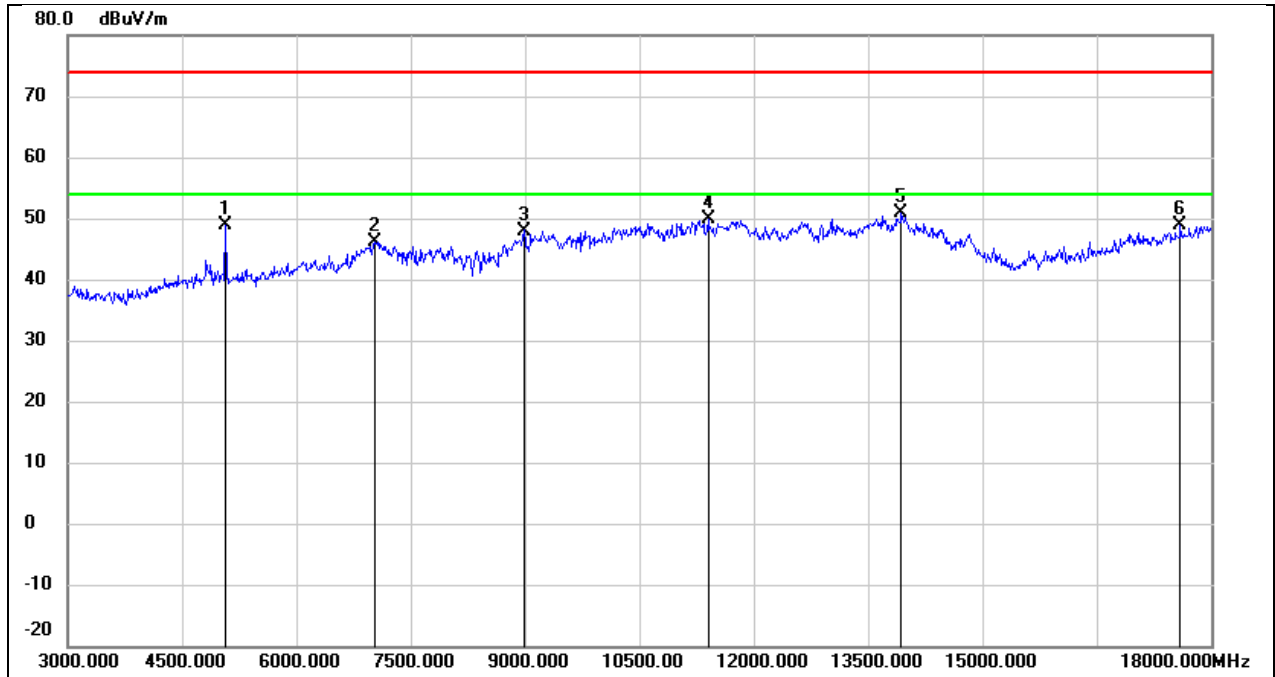

No.	Frequency (MHz)	Reading (dBuV)	Correct (dB/m)	Result (dBuV/m)	Limit (dBuV/m)	Margin (dB)	Remark
1	5070.000	48.42	0.51	48.93	74.00	-25.07	peak
2	7035.000	39.49	6.67	46.16	74.00	-27.84	peak
3	8985.000	37.63	10.37	48.00	74.00	-26.00	peak
4	11400.000	33.54	16.23	49.77	74.00	-24.23	peak
5	13935.000	29.17	21.82	50.99	74.00	-23.01	peak
6	17595.000	25.49	23.29	48.78	74.00	-25.22	peak

Test Mode:	802.11g	Frequency(MHz):	2412
Polarity:	Vertical	Test Voltage:	DC 3.3 V

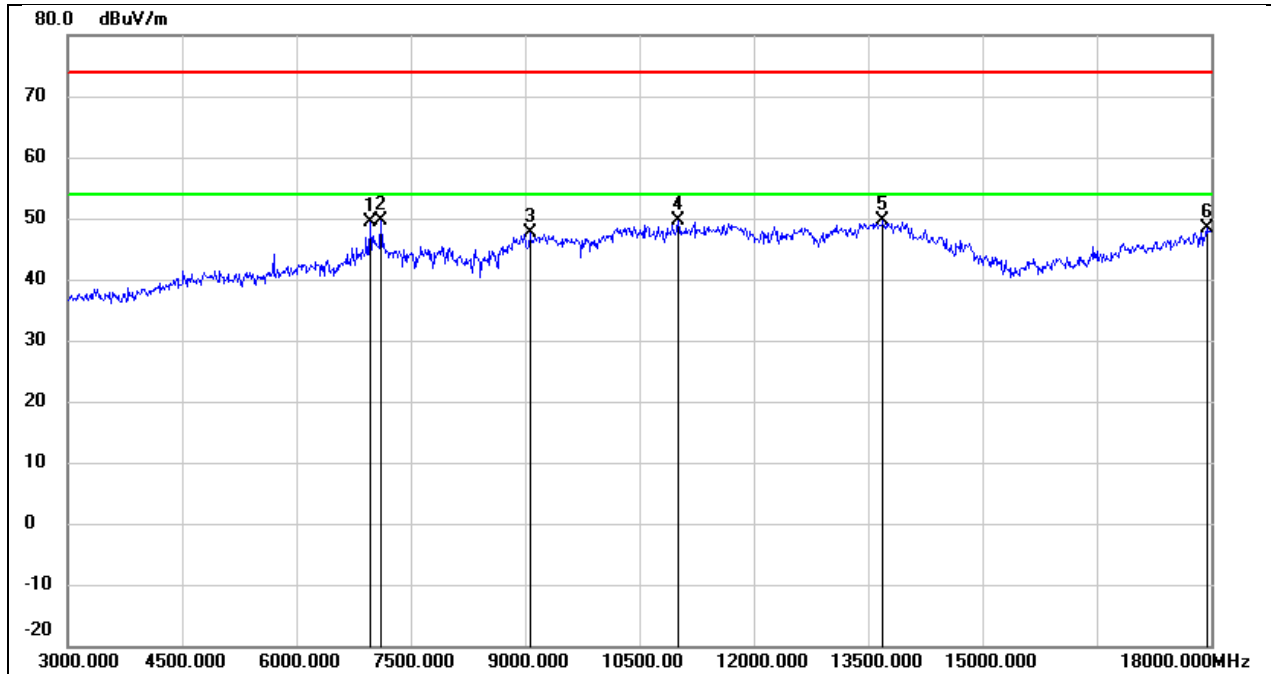

No.	Frequency (MHz)	Reading (dBuV)	Correct (dB/m)	Result (dBuV/m)	Limit (dBuV/m)	Margin (dB)	Remark
1	6960.000	42.91	6.50	49.41	74.00	-24.59	peak
2	7110.000	42.93	6.61	49.54	74.00	-24.46	peak
3	9060.000	37.10	10.51	47.61	74.00	-26.39	peak
4	11010.000	34.75	14.81	49.56	74.00	-24.44	peak
5	13695.000	28.28	21.31	49.59	74.00	-24.41	peak
6	17940.000	23.12	25.34	48.46	74.00	-25.54	peak

Test Mode:	802.11g	Frequency(MHz):	2437
Polarity:	Horizontal	Test Voltage:	DC 3.3 V

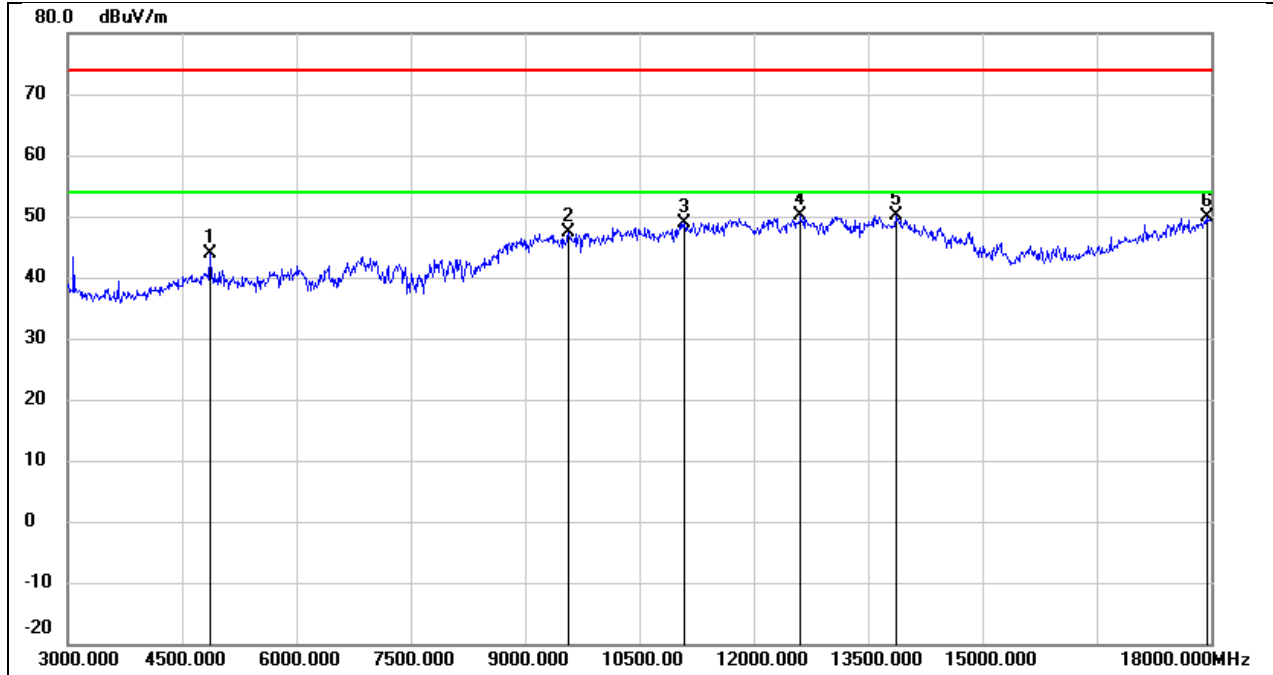

No.	Frequency (MHz)	Reading (dBuV)	Correct (dB/m)	Result (dBuV/m)	Limit (dBuV/m)	Margin (dB)	Remark
1	4860.000	43.87	-0.09	43.78	74.00	-30.22	peak
2	9570.000	36.39	10.87	47.26	74.00	-26.74	peak
3	11085.000	33.91	15.08	48.99	74.00	-25.01	peak
4	12615.000	32.33	17.86	50.19	74.00	-23.81	peak
5	13875.000	28.33	21.70	50.03	74.00	-23.97	peak
6	17940.000	24.47	25.34	49.81	74.00	-24.19	peak

Test Mode:	802.11g	Frequency(MHz):	2437
Polarity:	Vertical	Test Voltage:	DC 3.3 V

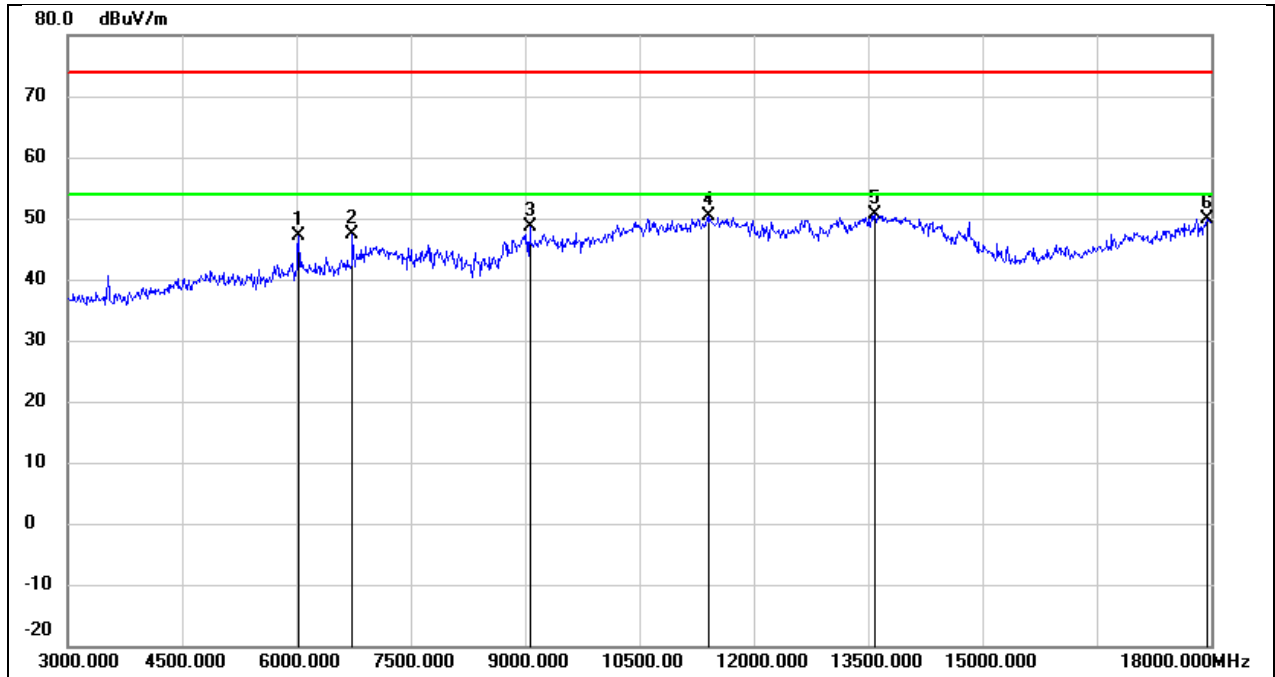

No.	Frequency (MHz)	Reading (dBuV)	Correct (dB/m)	Result (dBuV/m)	Limit (dBuV/m)	Margin (dB)	Remark
1	6030.000	44.72	2.37	47.09	74.00	-26.91	peak
2	6735.000	42.03	5.38	47.41	74.00	-26.59	peak
3	9060.000	38.15	10.51	48.66	74.00	-25.34	peak
4	11415.000	34.19	16.29	50.48	74.00	-23.52	peak
5	13590.000	29.42	21.09	50.51	74.00	-23.49	peak
6	17940.000	24.54	25.34	49.88	74.00	-24.12	peak



Test Mode:	802.11g	Frequency(MHz):	2462
Polarity:	Horizontal	Test Voltage:	DC 3.3 V

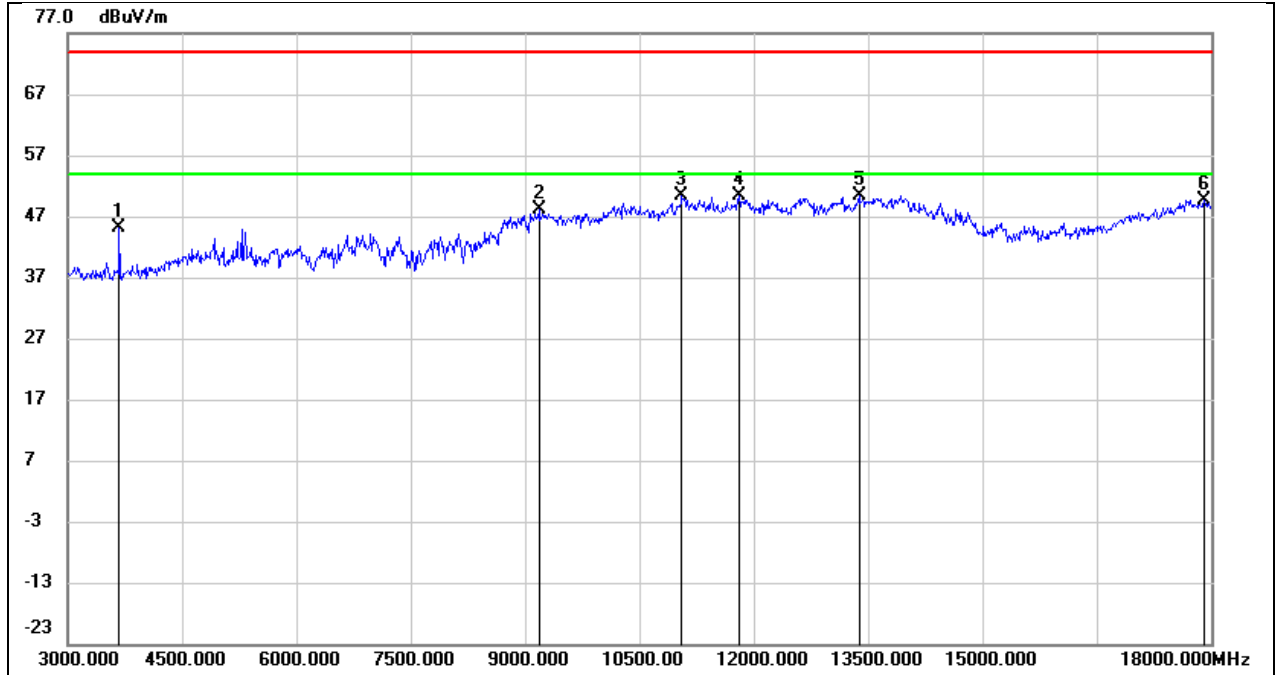

No.	Frequency (MHz)	Reading (dBuV)	Correct (dB/m)	Result (dBuV/m)	Limit (dBuV/m)	Margin (dB)	Remark
1	3675.000	49.75	-4.55	45.20	74.00	-28.80	peak
2	9180.000	37.62	10.56	48.18	74.00	-25.82	peak
3	11055.000	35.33	14.96	50.29	74.00	-23.71	peak
4	11805.000	32.92	17.43	50.35	74.00	-23.65	peak
5	13380.000	30.11	20.38	50.49	74.00	-23.51	peak
6	17910.000	24.51	25.16	49.67	74.00	-24.33	peak

Test Mode:	802.11g	Frequency(MHz):	2462
Polarity:	Vertical	Test Voltage:	DC 3.3 V

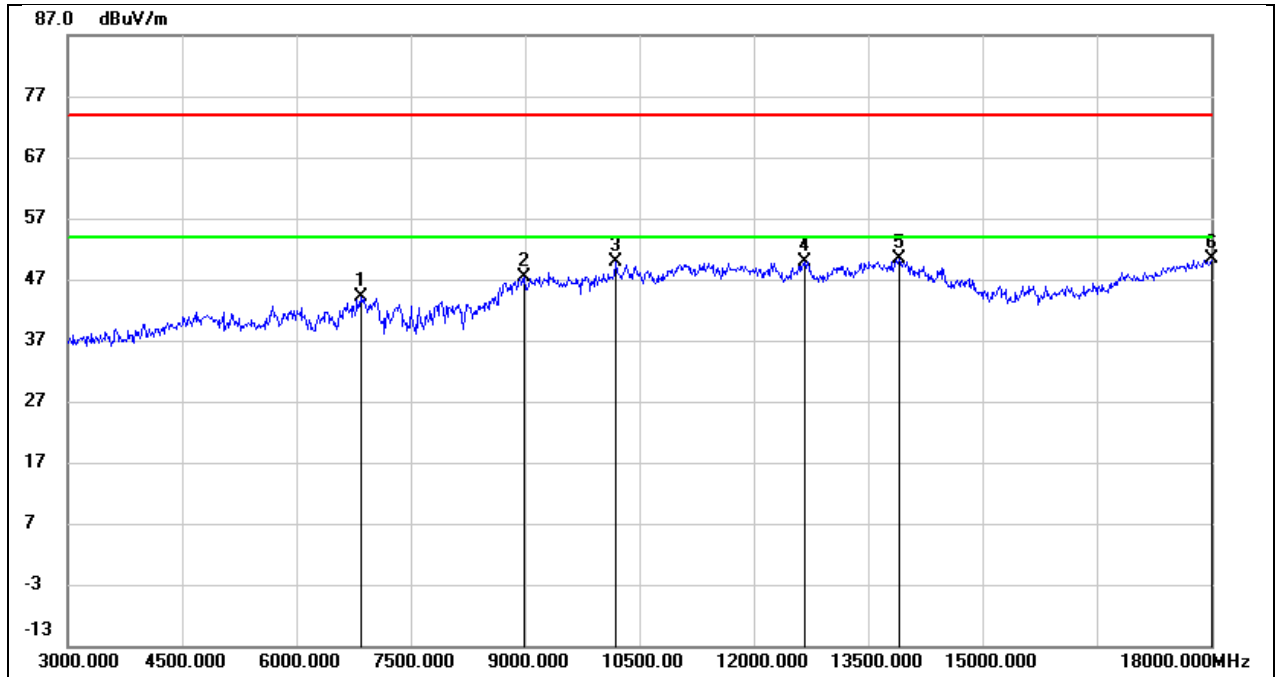

No.	Frequency (MHz)	Reading (dBuV)	Correct (dB/m)	Result (dBuV/m)	Limit (dBuV/m)	Margin (dB)	Remark
1	6840.000	38.29	5.89	44.18	74.00	-29.82	peak
2	8985.000	36.99	10.37	47.36	74.00	-26.64	peak
3	10185.000	37.52	12.38	49.90	74.00	-24.10	peak
4	12675.000	31.94	17.99	49.93	74.00	-24.07	peak
5	13905.000	28.69	21.76	50.45	74.00	-23.55	peak
6	18000.000	24.66	25.69	50.35	74.00	-23.65	peak

Test Mode:	802.11n HT20	Frequency(MHz):	2412
Polarity:	Horizontal	Test Voltage:	DC 3.3 V

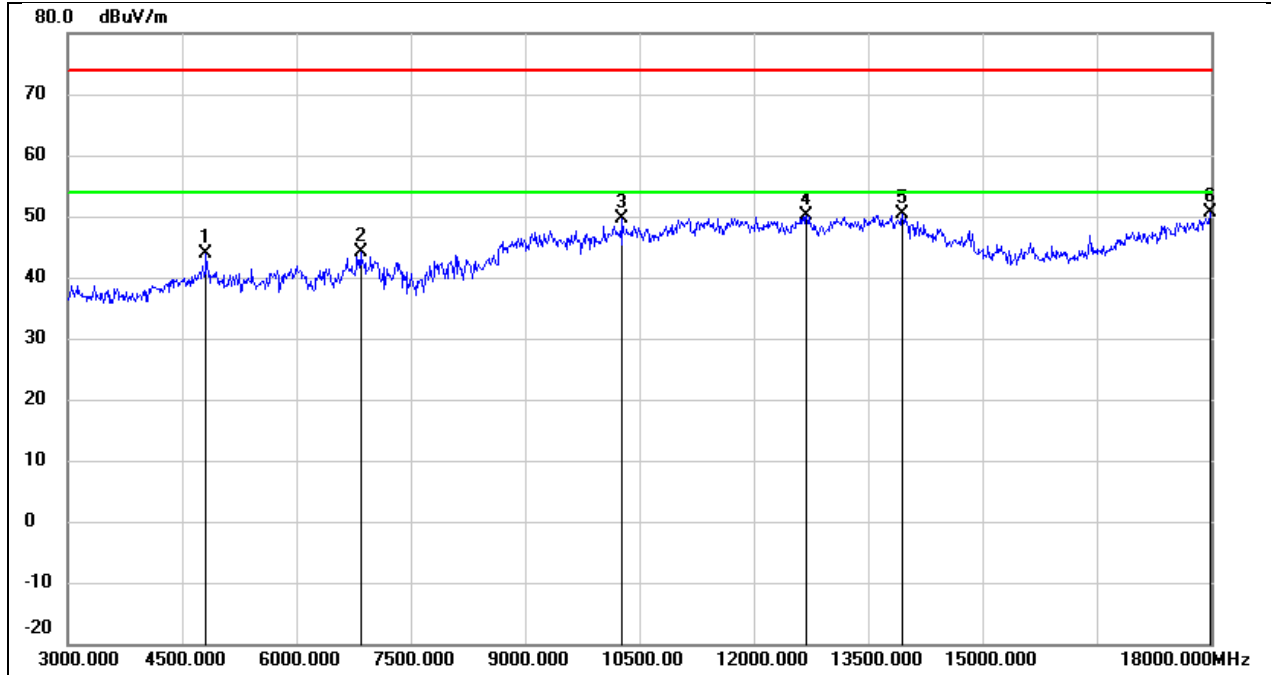

No.	Frequency (MHz)	Reading (dBuV)	Correct (dB/m)	Result (dBuV/m)	Limit (dBuV/m)	Margin (dB)	Remark
1	4815.000	44.21	-0.26	43.95	74.00	-30.05	peak
2	6840.000	38.32	5.89	44.21	74.00	-29.79	peak
3	10275.000	37.04	12.54	49.58	74.00	-24.42	peak
4	12690.000	32.04	18.02	50.06	74.00	-23.94	peak
5	13950.000	28.49	21.86	50.35	74.00	-23.65	peak
6	17985.000	24.95	25.60	50.55	74.00	-23.45	peak

Test Mode:	802.11n HT20	Frequency(MHz):	2412
Polarity:	Vertical	Test Voltage:	DC 3.3 V

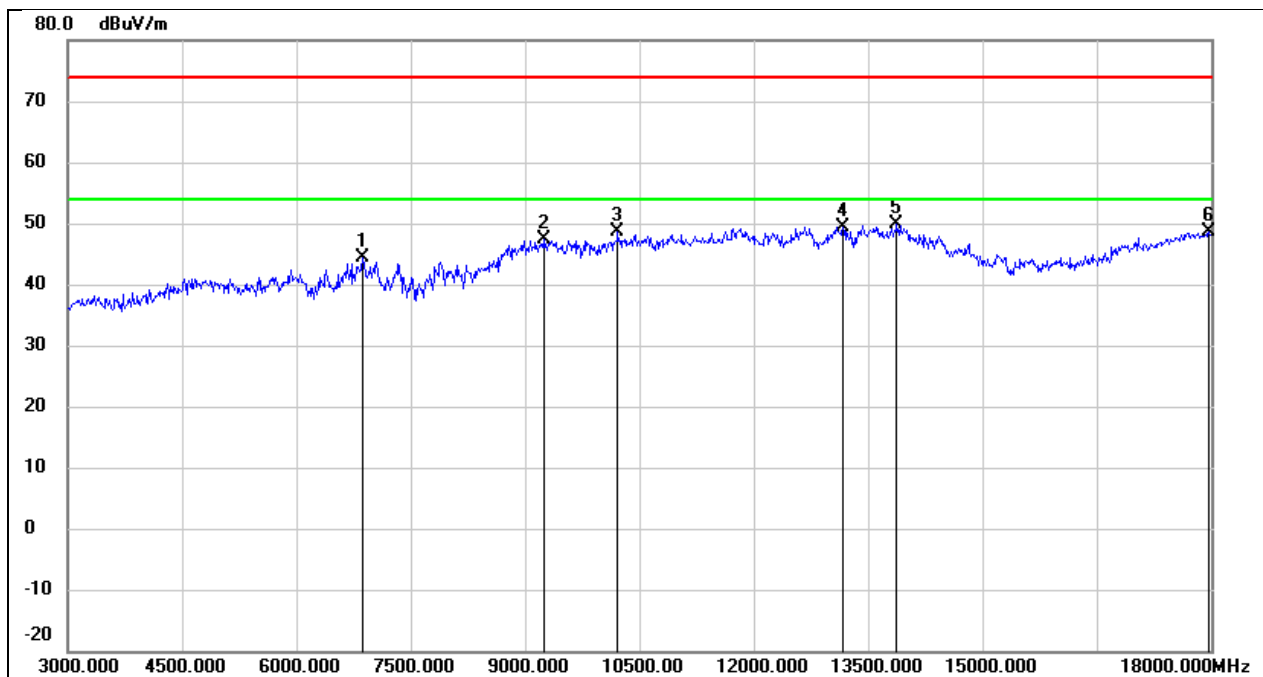

No.	Frequency (MHz)	Reading (dBuV)	Correct (dB/m)	Result (dBuV/m)	Limit (dBuV/m)	Margin (dB)	Remark
1	6870.000	38.25	6.05	44.30	74.00	-29.70	peak
2	9240.000	36.82	10.58	47.40	74.00	-26.60	peak
3	10215.000	36.16	12.43	48.59	74.00	-25.41	peak
4	13170.000	29.96	19.46	49.42	74.00	-24.58	peak
5	13875.000	28.27	21.70	49.97	74.00	-24.03	peak
6	17970.000	23.01	25.51	48.52	74.00	-25.48	peak

Test Mode:	802.11n HT20	Frequency(MHz):	2437
Polarity:	Horizontal	Test Voltage:	DC 3.3 V

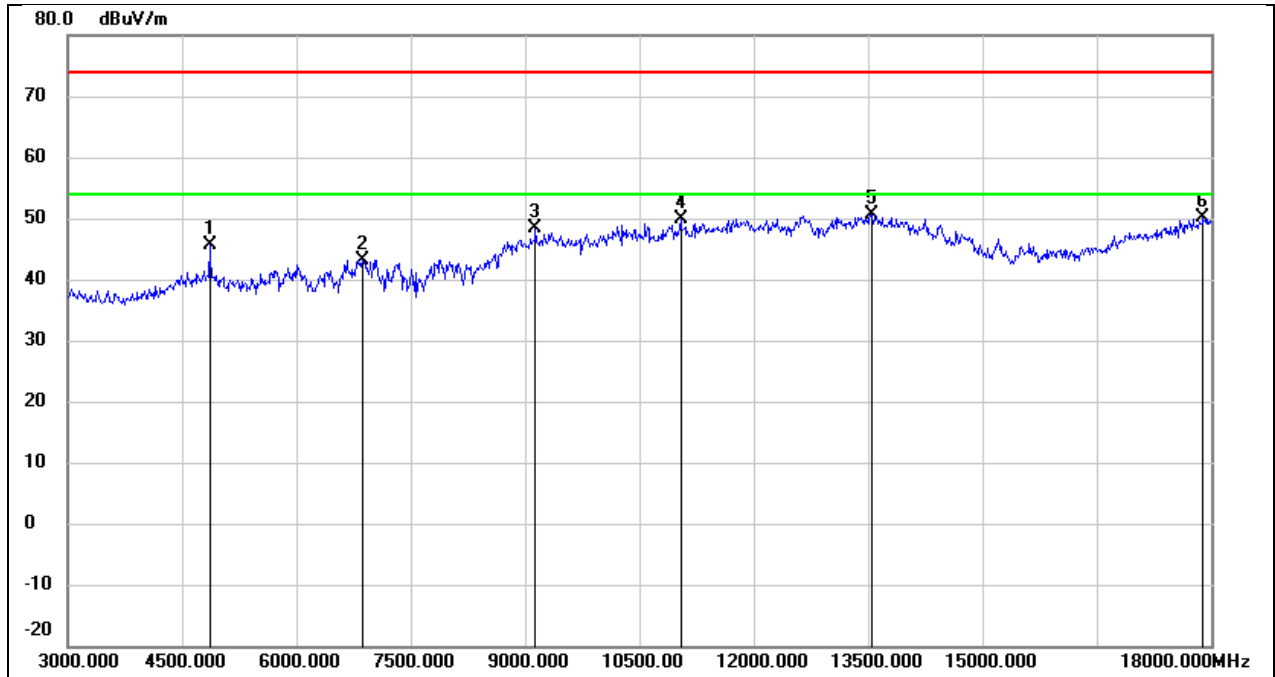

No.	Frequency (MHz)	Reading (dBuV)	Correct (dB/m)	Result (dBuV/m)	Limit (dBuV/m)	Margin (dB)	Remark
1	4860.000	45.68	-0.09	45.59	74.00	-28.41	peak
2	6870.000	37.20	6.05	43.25	74.00	-30.75	peak
3	9135.000	37.92	10.55	48.47	74.00	-25.53	peak
4	11040.000	34.92	14.91	49.83	74.00	-24.17	peak
5	13545.000	29.59	20.99	50.58	74.00	-23.42	peak
6	17895.000	25.08	25.07	50.15	74.00	-23.85	peak

Test Mode:	802.11n HT20	Frequency(MHz):	2437
Polarity:	Vertical	Test Voltage:	DC 3.3 V

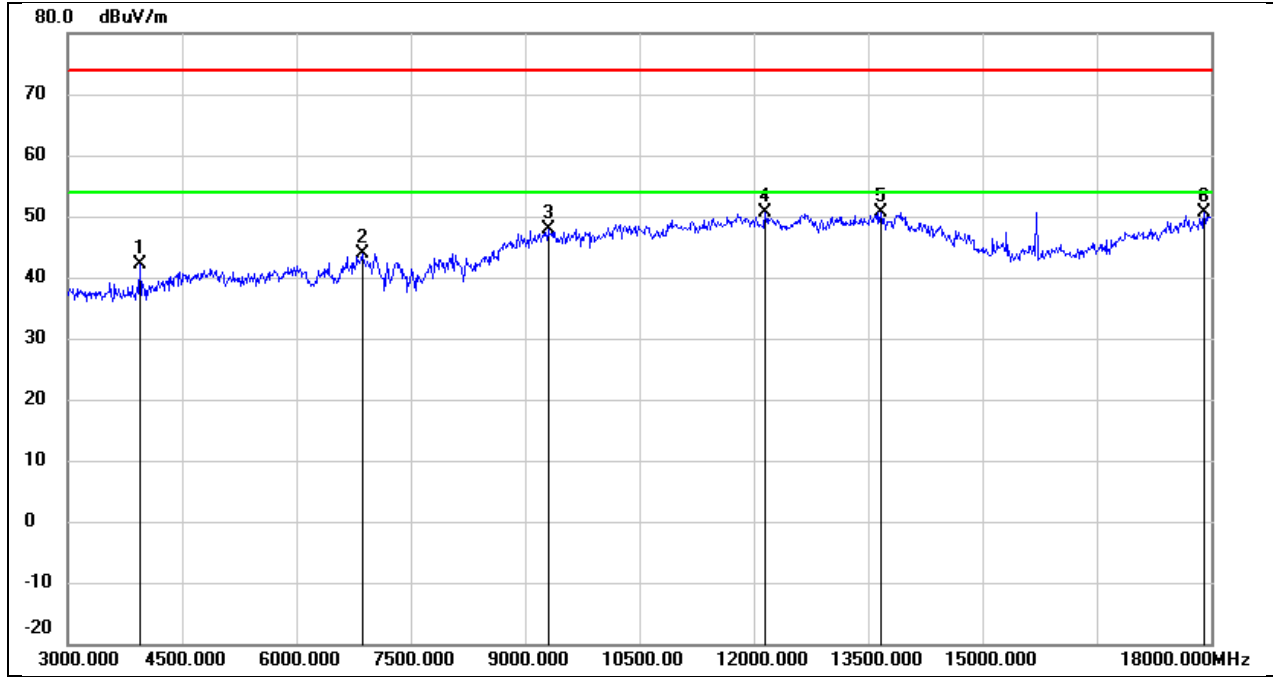

No.	Frequency (MHz)	Reading (dBuV)	Correct (dB/m)	Result (dBuV/m)	Limit (dBuV/m)	Margin (dB)	Remark
1	3945.000	46.05	-3.93	42.12	74.00	-31.88	peak
2	6870.000	37.90	6.05	43.95	74.00	-30.05	peak
3	9300.000	37.23	10.61	47.84	74.00	-26.16	peak
4	12150.000	32.83	17.86	50.69	74.00	-23.31	peak
5	13665.000	29.49	21.25	50.74	74.00	-23.26	peak
6	17910.000	25.48	25.16	50.64	74.00	-23.36	peak

Test Mode:	802.11n HT20	Frequency(MHz):	2462
Polarity:	Horizontal	Test Voltage:	DC 3.3 V

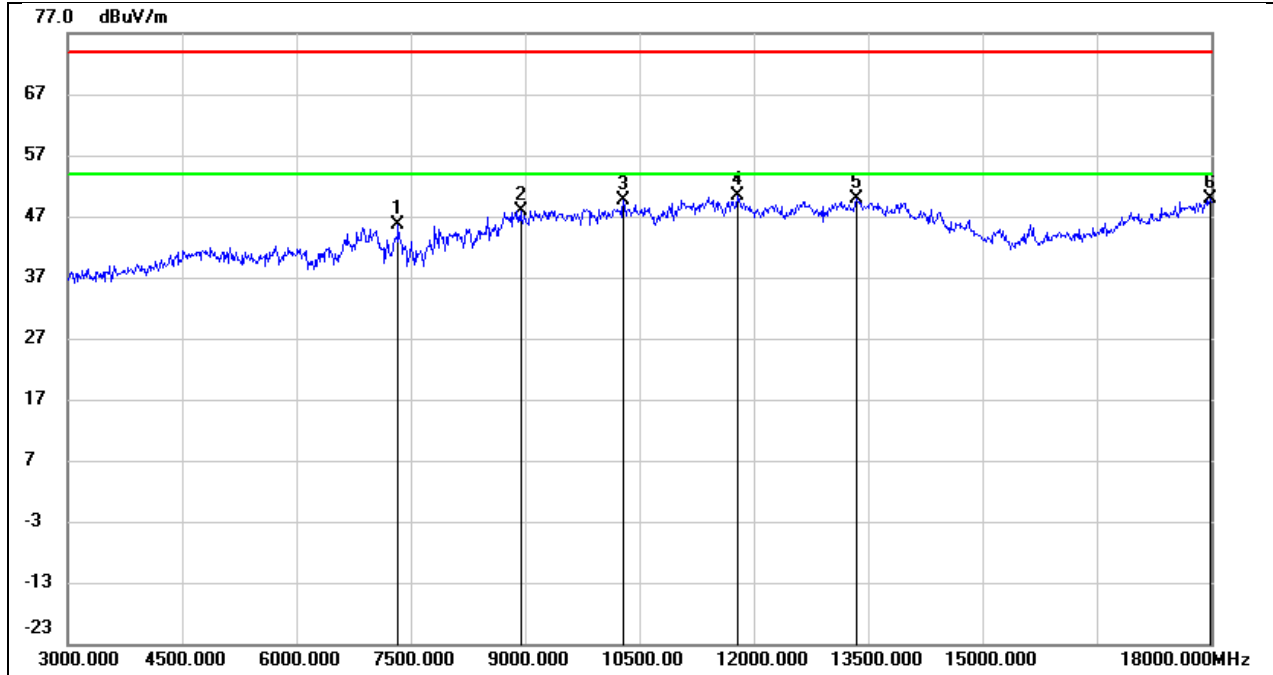

No.	Frequency (MHz)	Reading (dBuV)	Correct (dB/m)	Result (dBuV/m)	Limit (dBuV/m)	Margin (dB)	Remark
1	7335.000	39.18	6.45	45.63	74.00	-28.37	peak
2	8940.000	37.89	10.04	47.93	74.00	-26.07	peak
3	10290.000	37.04	12.59	49.63	74.00	-24.37	peak
4	11790.000	32.90	17.38	50.28	74.00	-23.72	peak
5	13350.000	29.76	20.24	50.00	74.00	-24.00	peak
6	17985.000	24.20	25.60	49.80	74.00	-24.20	peak

Test Mode:	802.11n HT20	Frequency(MHz):	2462
Polarity:	Vertical	Test Voltage:	DC 3.3 V

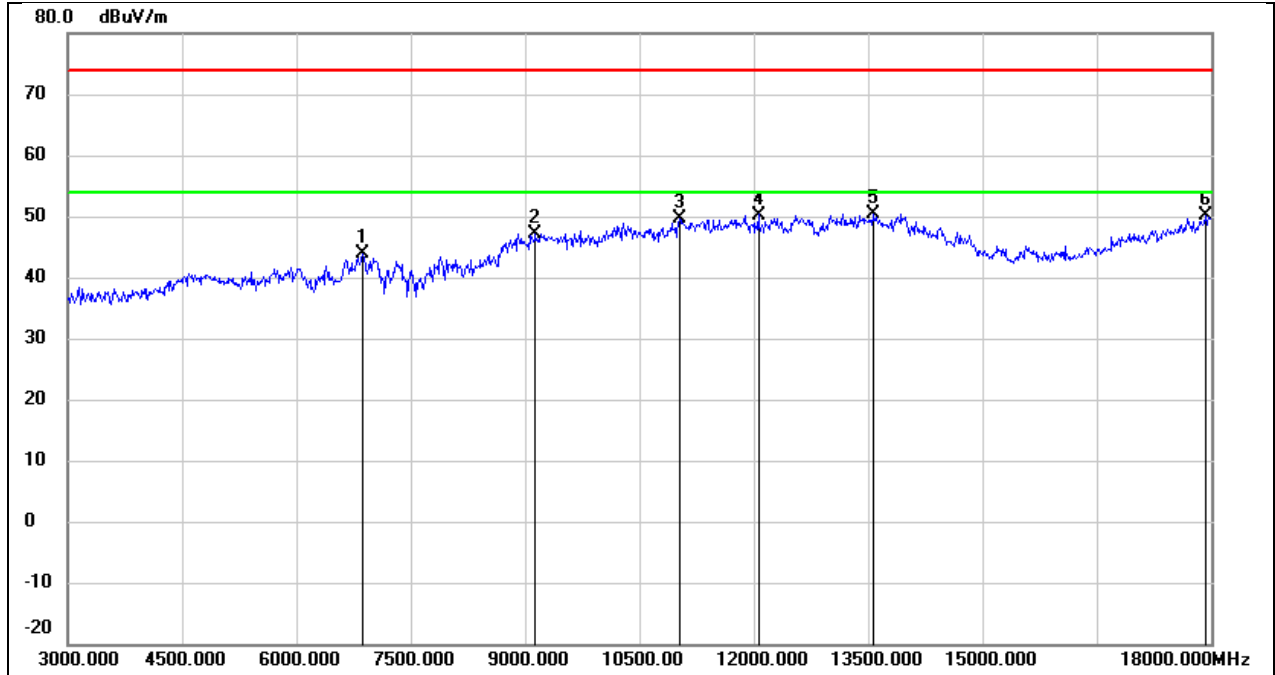

No.	Frequency (MHz)	Reading (dBuV)	Correct (dB/m)	Result (dBuV/m)	Limit (dBuV/m)	Margin (dB)	Remark
1	6870.000	37.85	6.05	43.90	74.00	-30.10	peak
2	9135.000	36.66	10.55	47.21	74.00	-26.79	peak
3	11025.000	34.75	14.85	49.60	74.00	-24.40	peak
4	12060.000	32.34	17.91	50.25	74.00	-23.75	peak
5	13560.000	29.44	21.04	50.48	74.00	-23.52	peak
6	17925.000	24.82	25.25	50.07	74.00	-23.93	peak



Test Mode:	802.11n HT40	Frequency(MHz):	2422
Polarity:	Horizontal	Test Voltage:	DC 3.3 V

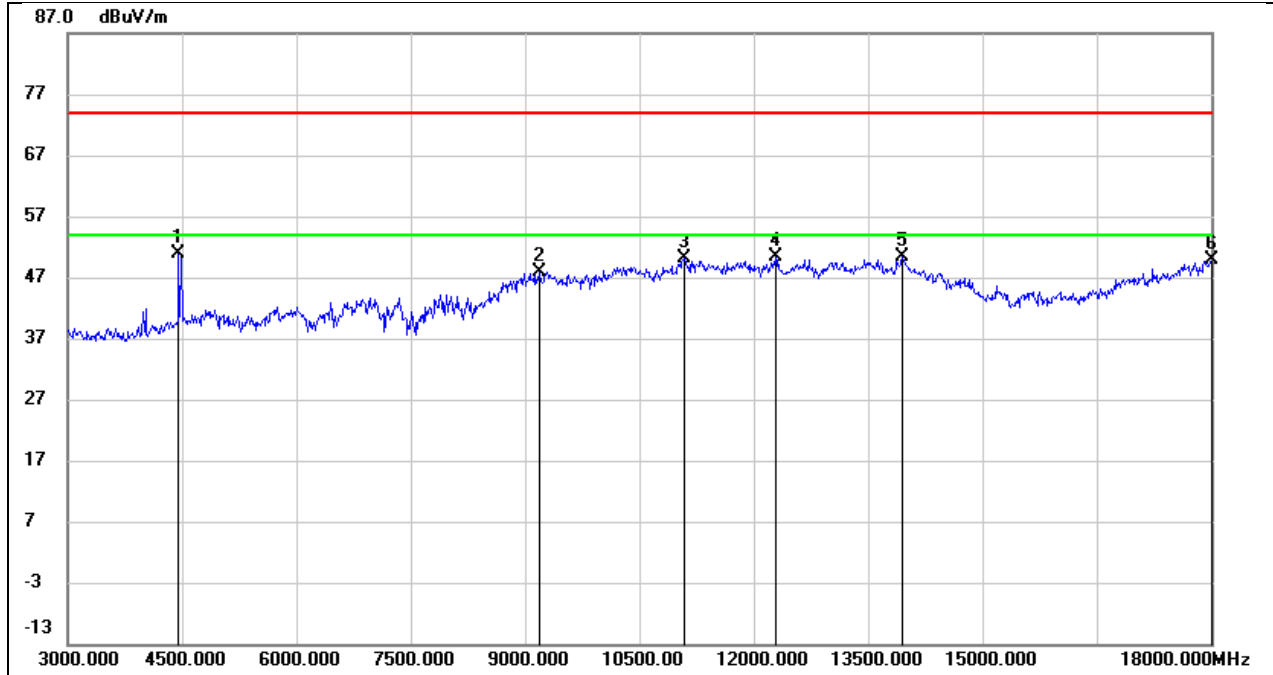

No.	Frequency (MHz)	Reading (dBuV)	Correct (dB/m)	Result (dBuV/m)	Limit (dBuV/m)	Margin (dB)	Remark
1	4455.000	52.43	-1.67	50.76	74.00	-23.24	peak
2	9180.000	37.42	10.56	47.98	74.00	-26.02	peak
3	11085.000	34.98	15.08	50.06	74.00	-23.94	peak
4	12285.000	32.75	17.75	50.50	74.00	-23.50	peak
5	13950.000	28.49	21.86	50.35	74.00	-23.65	peak
6	18000.000	24.10	25.69	49.79	74.00	-24.21	peak

Test Mode:	802.11n HT40	Frequency(MHz):	2422
Polarity:	Vertical	Test Voltage:	DC 3.3 V

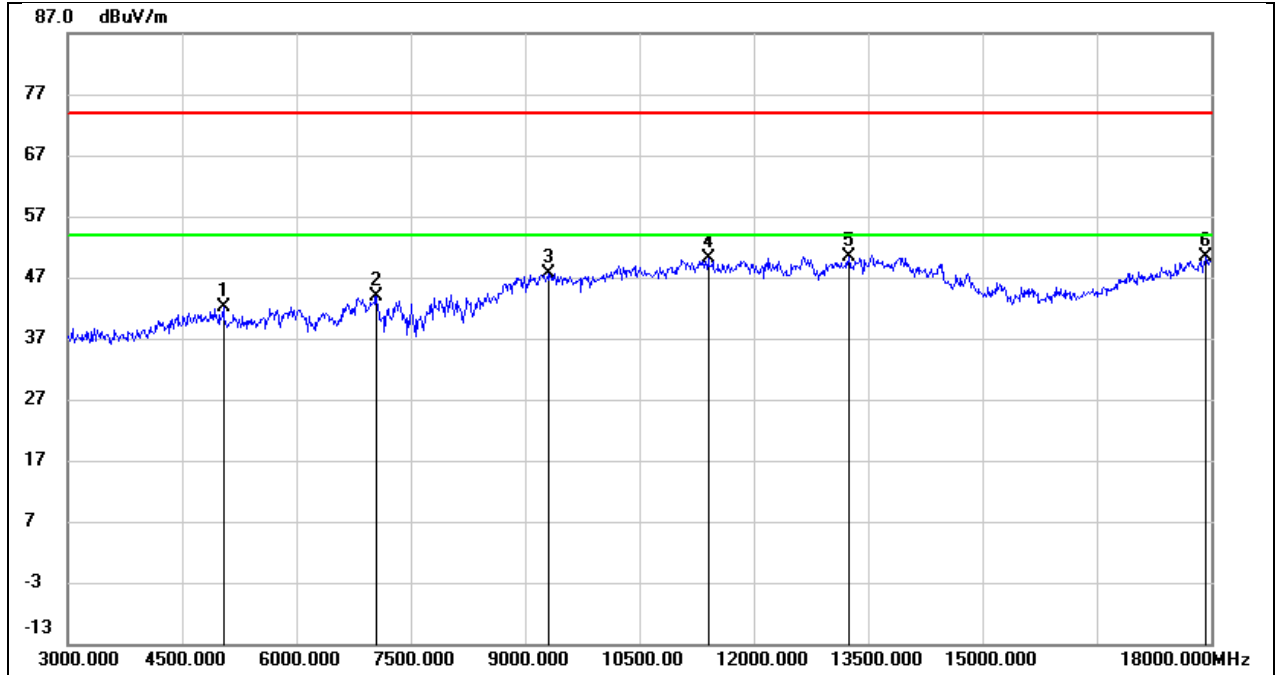

No.	Frequency (MHz)	Reading (dBuV)	Correct (dB/m)	Result (dBuV/m)	Limit (dBuV/m)	Margin (dB)	Remark
1	5040.000	41.59	0.48	42.07	74.00	-31.93	peak
2	7050.000	37.28	6.66	43.94	74.00	-30.06	peak
3	9315.000	37.08	10.61	47.69	74.00	-26.31	peak
4	11400.000	34.02	16.23	50.25	74.00	-23.75	peak
5	13245.000	30.62	19.78	50.40	74.00	-23.60	peak
6	17925.000	25.22	25.25	50.47	74.00	-23.53	peak

Test Mode:	802.11n HT40	Frequency(MHz):	2437
Polarity:	Horizontal	Test Voltage:	DC 3.3 V

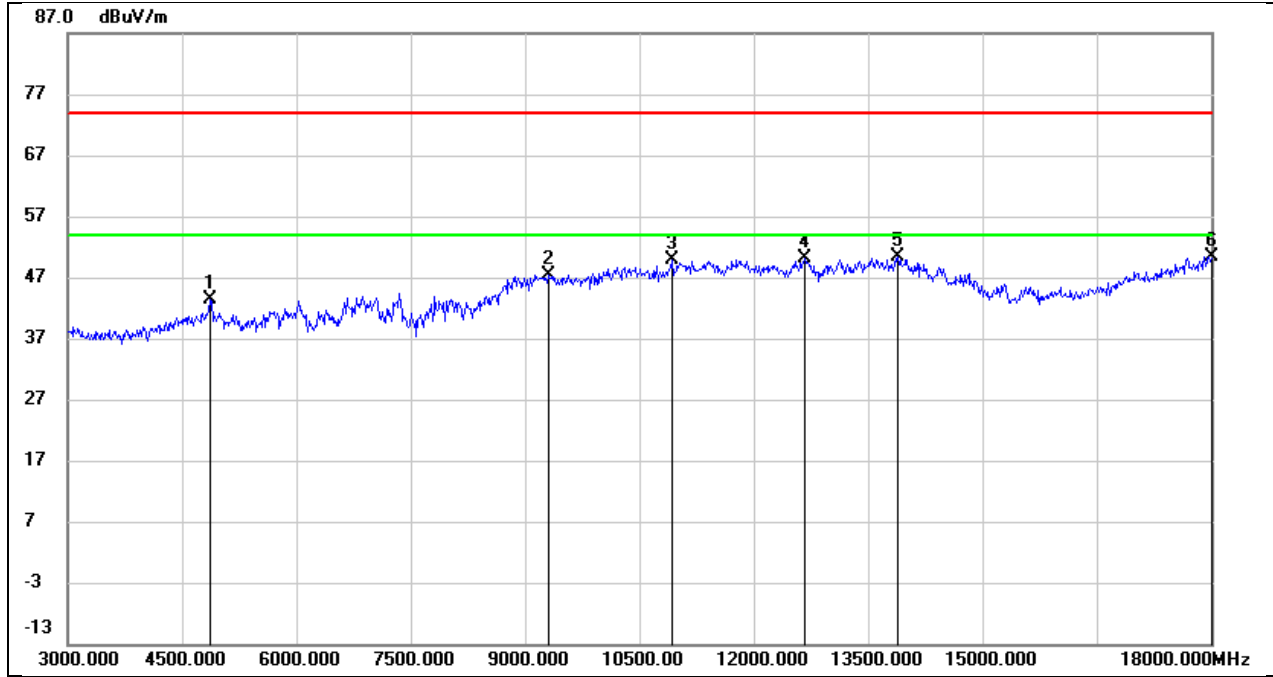

No.	Frequency (MHz)	Reading (dBuV)	Correct (dB/m)	Result (dBuV/m)	Limit (dBuV/m)	Margin (dB)	Remark
1	4860.000	43.46	-0.09	43.37	74.00	-30.63	peak
2	9315.000	36.66	10.61	47.27	74.00	-26.73	peak
3	10935.000	35.30	14.54	49.84	74.00	-24.16	peak
4	12675.000	32.18	17.99	50.17	74.00	-23.83	peak
5	13890.000	28.58	21.72	50.30	74.00	-23.70	peak
6	18000.000	24.75	25.69	50.44	74.00	-23.56	peak

Test Mode:	802.11n HT40	Frequency(MHz):	2437
Polarity:	Vertical	Test Voltage:	DC 3.3 V

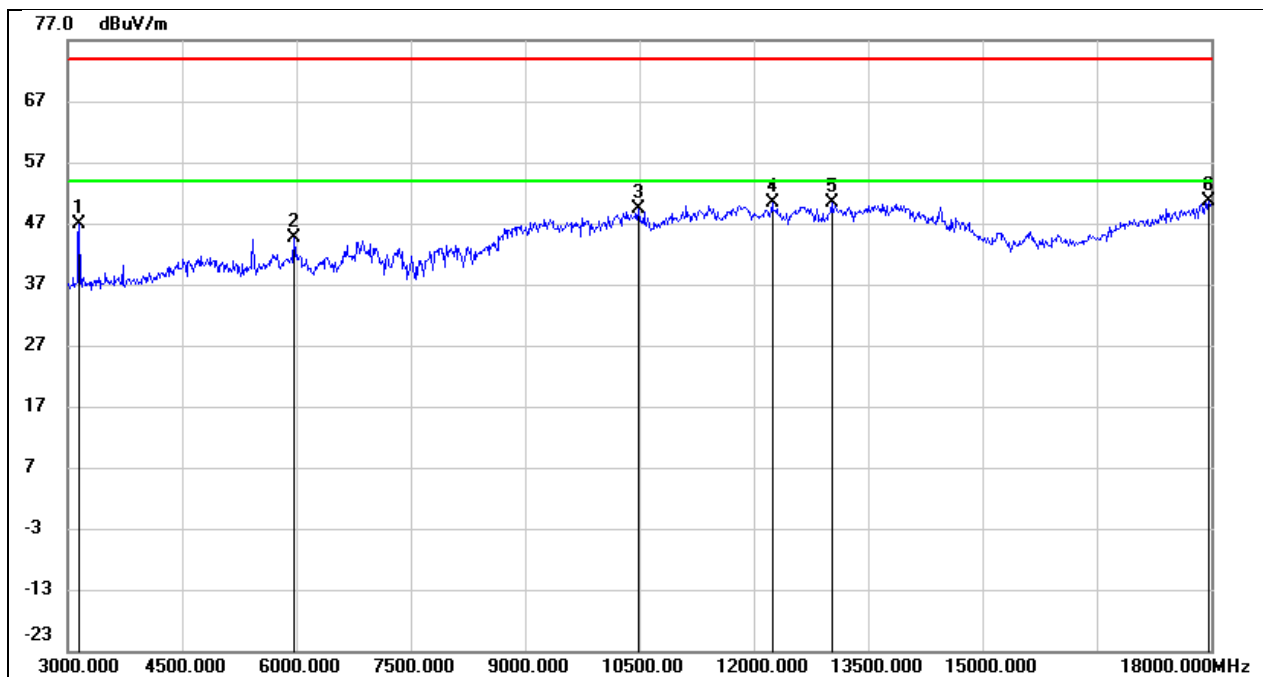

No.	Frequency (MHz)	Reading (dBuV)	Correct (dB/m)	Result (dBuV/m)	Limit (dBuV/m)	Margin (dB)	Remark
1	3150.000	52.03	-5.16	46.87	74.00	-27.13	peak
2	5970.000	42.39	2.17	44.56	74.00	-29.44	peak
3	10485.000	36.47	12.97	49.44	74.00	-24.56	peak
4	12240.000	32.70	17.79	50.49	74.00	-23.51	peak
5	13020.000	31.51	18.80	50.31	74.00	-23.69	peak
6	17970.000	25.00	25.51	50.51	74.00	-23.49	peak

Test Mode:	802.11n HT40	Frequency(MHz):	2452
Polarity:	Horizontal	Test Voltage:	DC 3.3 V

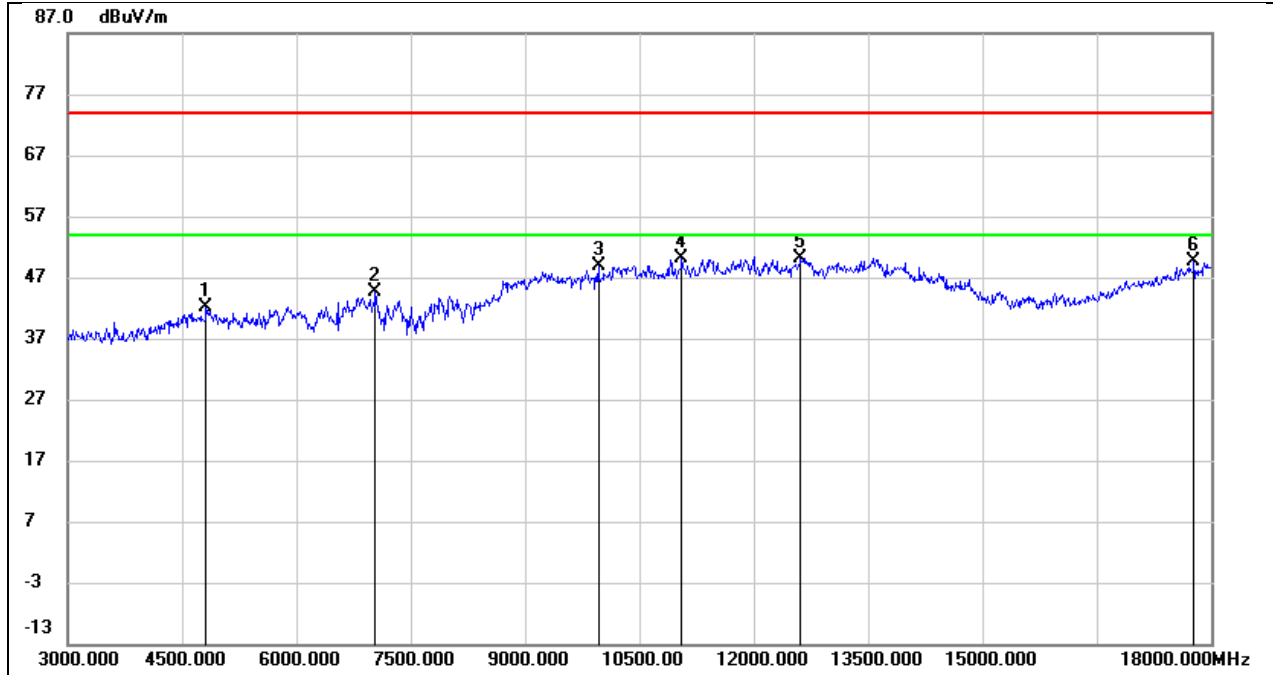

No.	Frequency (MHz)	Reading (dBuV)	Correct (dB/m)	Result (dBuV/m)	Limit (dBuV/m)	Margin (dB)	Remark
1	4815.000	42.37	-0.26	42.11	74.00	-31.89	peak
2	7035.000	37.94	6.67	44.61	74.00	-29.39	peak
3	9960.000	37.02	11.90	48.92	74.00	-25.08	peak
4	11055.000	35.12	14.96	50.08	74.00	-23.92	peak
5	12615.000	32.38	17.86	50.24	74.00	-23.76	peak
6	17775.000	25.27	24.36	49.63	74.00	-24.37	peak

Test Mode:	802.11n HT40	Frequency(MHz):	2452
Polarity:	Vertical	Test Voltage:	DC 3.3 V

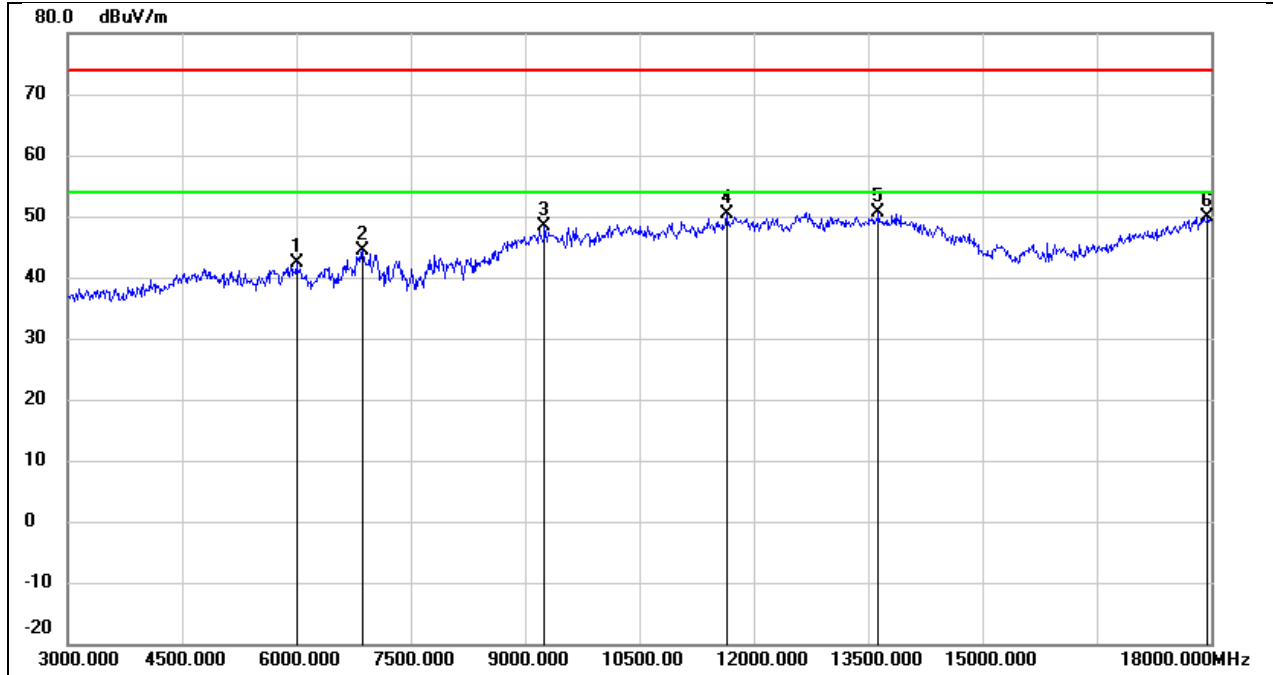

No.	Frequency (MHz)	Reading (dBuV)	Correct (dB/m)	Result (dBuV/m)	Limit (dBuV/m)	Margin (dB)	Remark
1	6000.000	40.09	2.25	42.34	74.00	-31.66	peak
2	6870.000	38.32	6.05	44.37	74.00	-29.63	peak
3	9255.000	37.75	10.59	48.34	74.00	-25.66	peak
4	11640.000	33.45	16.98	50.43	74.00	-23.57	peak
5	13635.000	29.34	21.19	50.53	74.00	-23.47	peak
6	17955.000	24.40	25.42	49.82	74.00	-24.18	peak

### 8.4. SPURIOUS EMISSIONS(9 KHZ~30 MHZ)

Test Mode:	802.11b	Frequency(MHz):	2412
Polarity:	Horizontal	Test Voltage:	DC 3.3 V

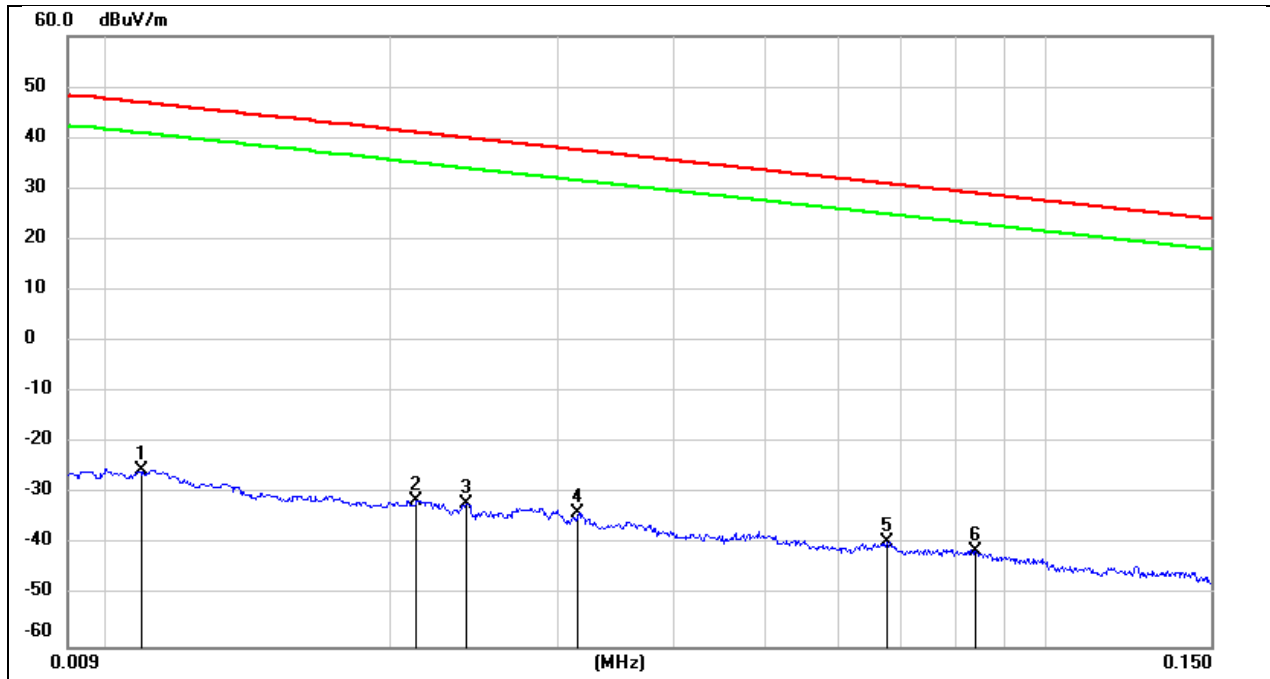

No.	Frequency (MHz)	Reading (dBuV)	Correct (dB/m)	FCC Result (dBuV/m)	FCC Limit (dBuV/m)	ISED Result (dBuA/m)	ISED Limit (dBuA/m)	Margin (dB)	Remark
1	0.0108	76.01	-101.39	-25.38	46.93	-76.88	-4.57	-72.31	peak
2	0.0212	70.04	-101.35	-31.31	41.07	-82.81	-10.43	-72.38	peak
3	0.0240	69.32	-101.36	-32.04	40.00	-83.54	-11.50	-72.04	peak
4	0.0316	67.74	-101.40	-33.66	37.61	-85.16	-13.89	-71.27	peak
5	0.0675	62.14	-101.56	-39.42	31.02	-90.92	-20.48	-70.44	peak
6	0.0840	60.51	-101.67	-41.16	29.12	-92.66	-22.38	-70.28	peak

Test Mode:	802.11b	Frequency(MHz):	2412
Polarity:	Horizontal	Test Voltage:	DC 3.3 V

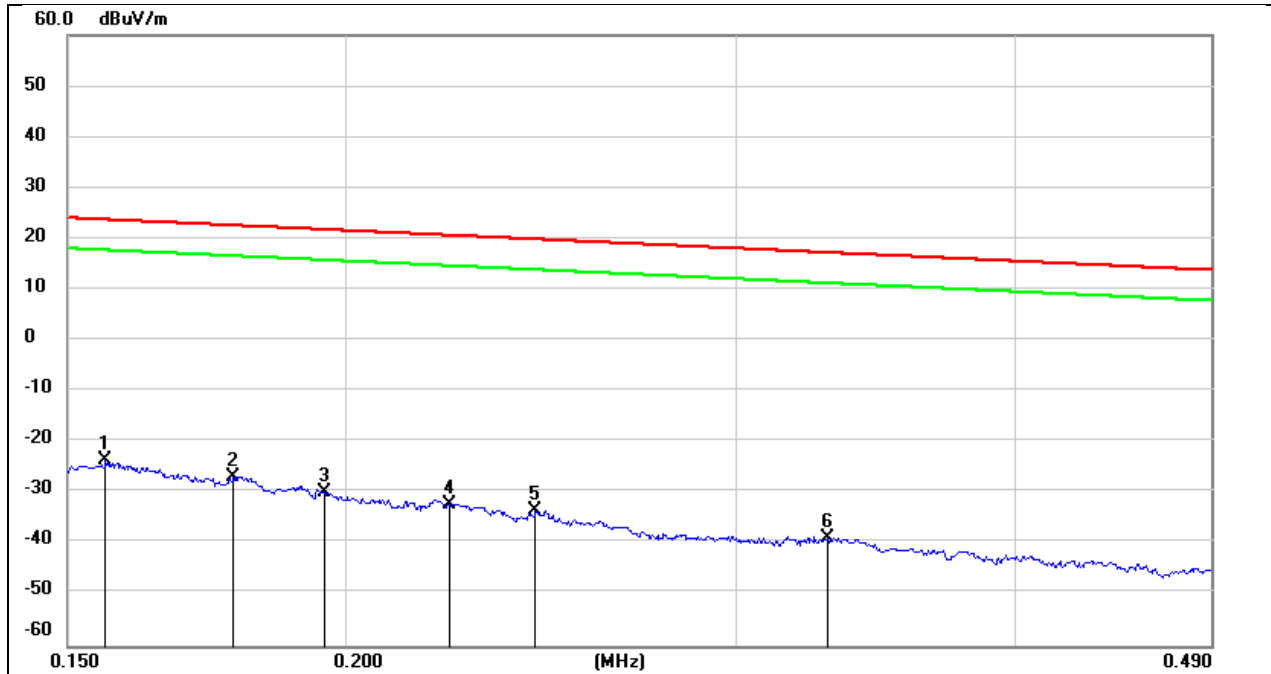

No.	Frequency (MHz)	Reading (dBuV)	Correct (dB/m)	FCC Result (dBuV/m)	FCC Limit (dBuV/m)	ISED Result (dBuA/m)	ISED Limit (dBuA/m)	Margin (dB)	Remark
1	0.1559	78.15	-101.65	-23.50	23.74	-75.00	-27.76	-47.24	peak
2	0.1781	74.87	-101.68	-26.81	22.59	-78.31	-28.91	-49.40	peak
3	0.1955	71.85	-101.71	-29.86	21.78	-81.36	-29.72	-51.64	peak
4	0.2227	69.65	-101.75	-32.10	20.65	-83.60	-30.85	-52.75	peak
5	0.2434	68.38	-101.79	-33.41	19.87	-84.91	-31.63	-53.28	peak
6	0.3300	62.97	-101.88	-38.91	17.23	-90.41	-34.27	-56.14	peak



Test Mode:	802.11b	Frequency(MHz):	2412
Polarity:	Horizontal	Test Voltage:	DC 3.3 V

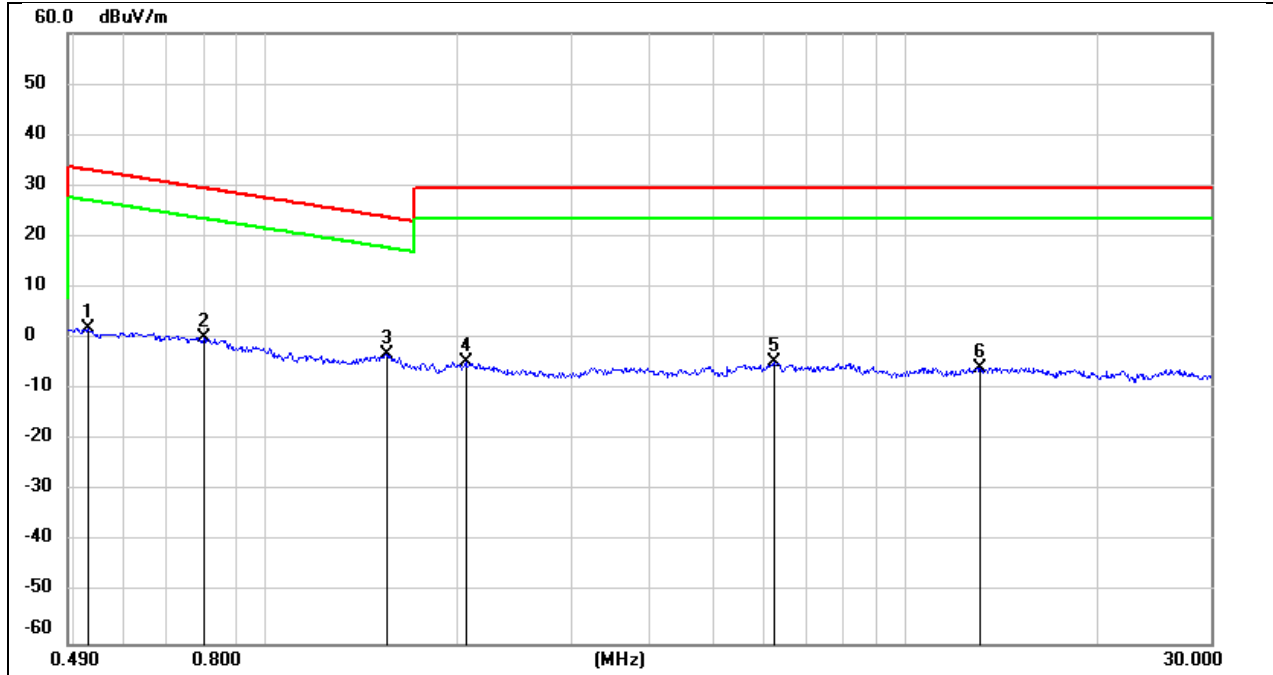

No.	Frequency (MHz)	Reading (dBuV)	Correct (dB/m)	FCC Result (dBuV/m)	FCC Limit (dBuV/m)	ISED Result (dBuA/m)	ISED Limit (dBuA/m)	Margin (dB)	Remark
1	0.5272	64.04	-62.07	1.97	33.16	-49.53	-18.34	-31.19	peak
2	0.7993	62.22	-62.15	0.07	29.55	-51.43	-21.95	-29.48	peak
3	1.5443	58.85	-62.03	-3.18	23.83	-54.68	-27.67	-27.01	peak
4	2.0539	57.20	-61.81	-4.61	29.54	-56.11	-21.96	-34.15	peak
5	6.2445	56.63	-61.32	-4.69	29.54	-56.19	-21.96	-34.23	peak
6	13.0907	55.13	-60.93	-5.80	29.54	-57.30	-21.96	-35.34	peak

### 8.5. SPURIOUS EMISSIONS(18 GHZ~26 GHZ)

Test Mode:	802.11b	Frequency(MHz):	2412
Polarity:	Horizontal	Test Voltage:	DC 3.3 V

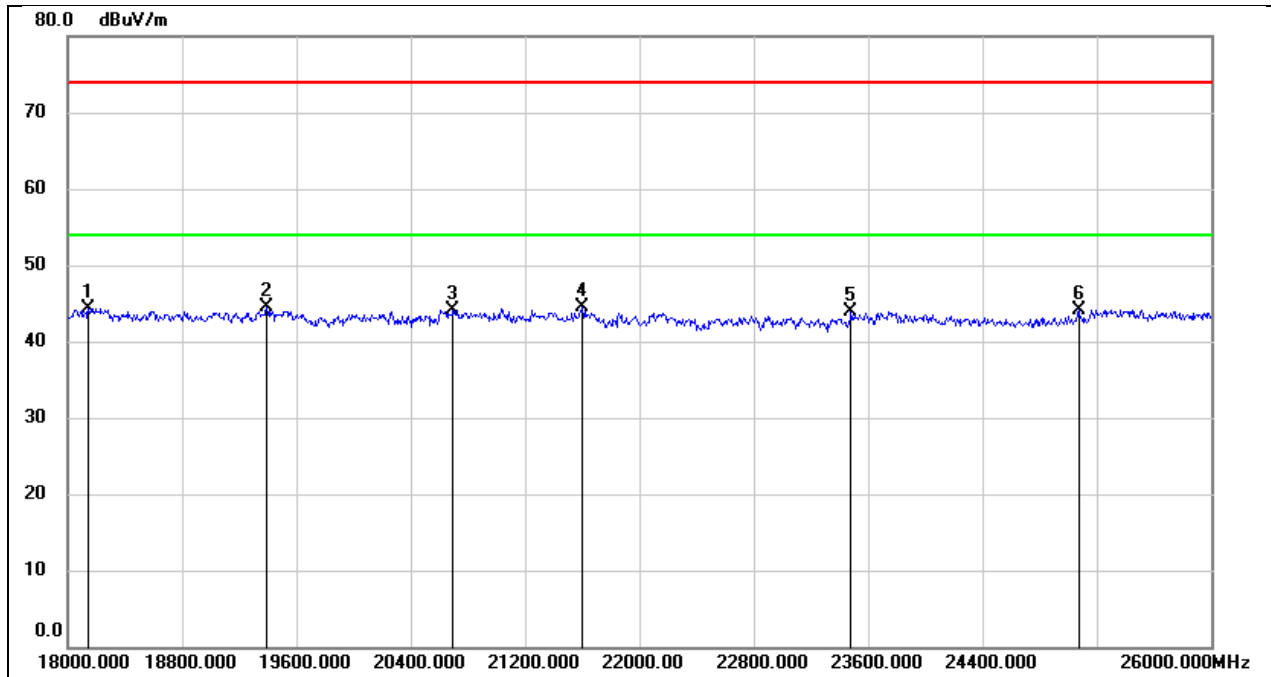

No.	Frequency (MHz)	Reading (dBuV)	Correct (dB/m)	Result (dBuV/m)	Limit (dBuV/m)	Margin (dB)	Remark
1	18144.000	49.77	-5.48	44.29	74.00	-29.71	peak
2	19392.000	50.12	-5.57	44.55	74.00	-29.45	peak
3	20696.000	49.21	-5.16	44.05	74.00	-29.95	peak
4	21600.000	49.02	-4.54	44.48	74.00	-29.52	peak
5	23480.000	47.04	-3.16	43.88	74.00	-30.12	peak
6	25072.000	46.17	-1.97	44.20	74.00	-29.80	peak

Test Mode:	802.11b	Frequency(MHz):	2412
Polarity:	Vertical	Test Voltage:	DC 3.3 V

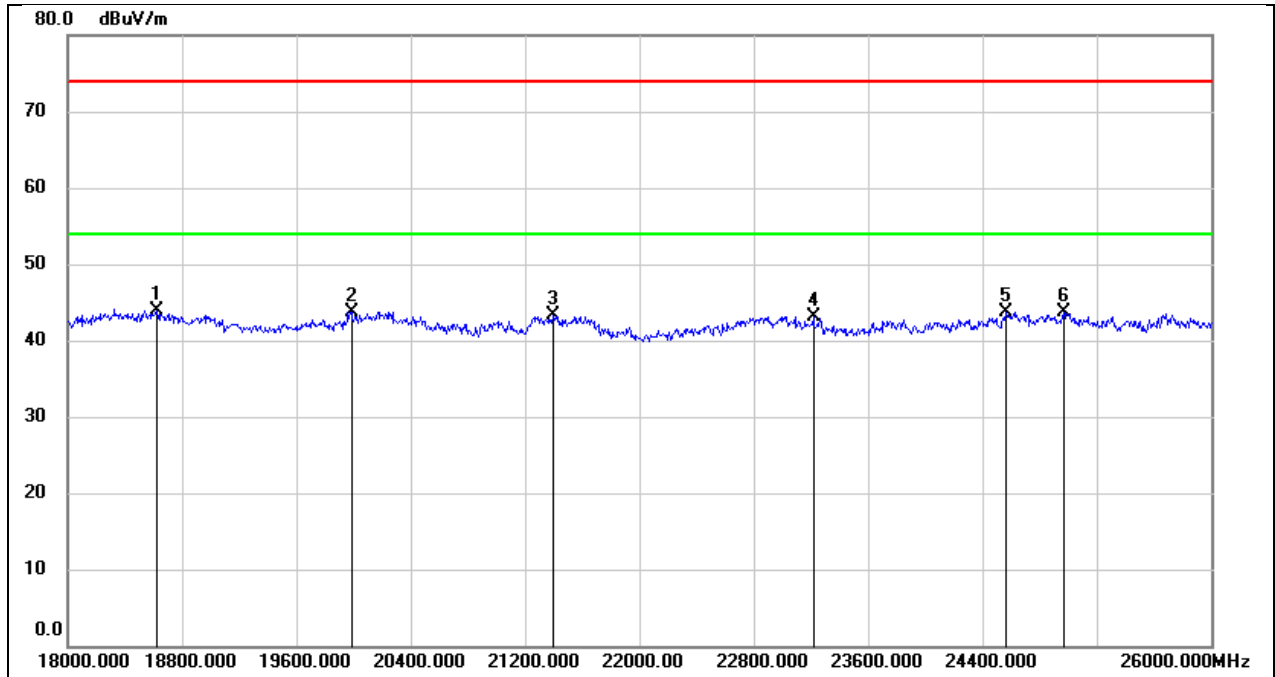

No.	Frequency (MHz)	Reading (dBuV)	Correct (dB/m)	Result (dBuV/m)	Limit (dBuV/m)	Margin (dB)	Remark
1	18624.000	49.33	-5.34	43.99	74.00	-30.01	peak
2	19984.000	49.21	-5.44	43.77	74.00	-30.23	peak
3	21400.000	48.04	-4.72	43.32	74.00	-30.68	peak
4	23216.000	46.51	-3.38	43.13	74.00	-30.87	peak
5	24568.000	46.10	-2.33	43.77	74.00	-30.23	peak
6	24968.000	45.76	-2.14	43.62	74.00	-30.38	peak

## 8.6. SPURIOUS EMISSIONS(30 MHZ~1 GHZ)

Test Mode:	802.11b	Frequency(MHz):	2412
Polarity:	Horizontal	Test Voltage:	DC 3.3 V

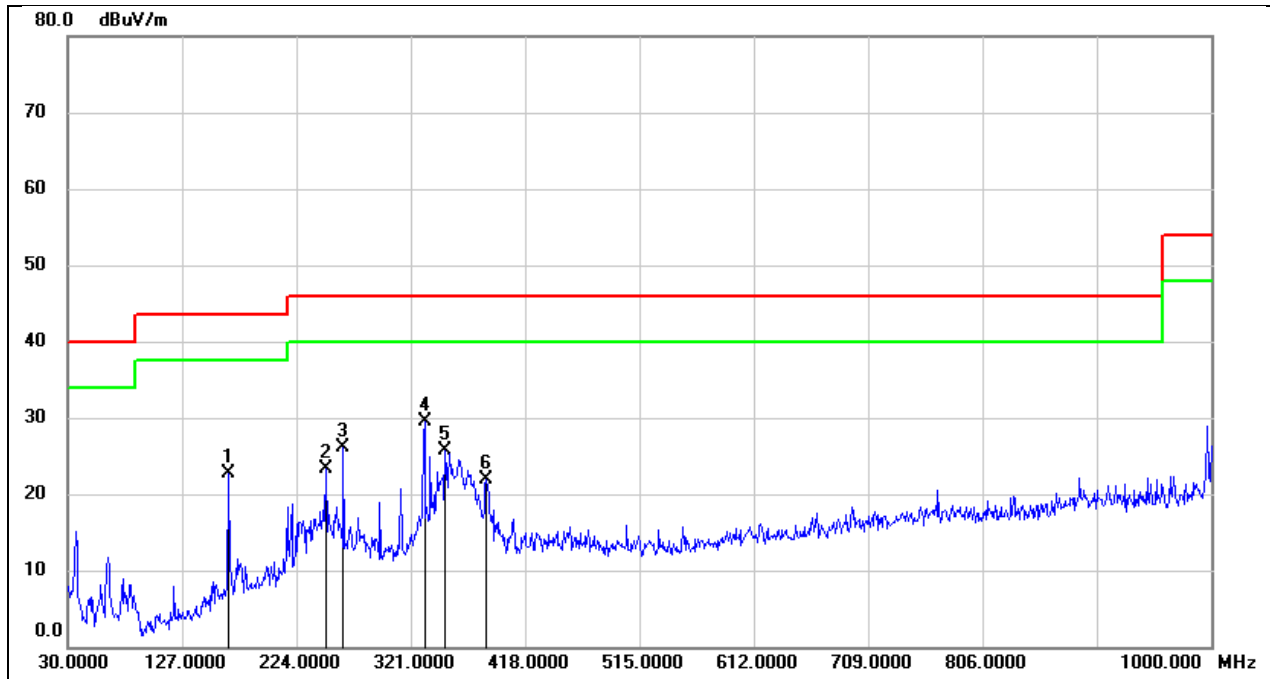

No.	Frequency (MHz)	Reading (dBuV)	Correct (dB/m)	Result (dBuV/m)	Limit (dBuV/m)	Margin (dB)	Remark
1	166.7700	39.25	-16.55	22.70	43.50	-20.80	QP
2	249.2200	41.59	-18.32	23.27	46.00	-22.73	QP
3	263.7700	43.55	-17.39	26.16	46.00	-19.84	QP
4	332.6400	42.84	-13.30	29.54	46.00	-16.46	QP
5	350.1000	38.23	-12.49	25.74	46.00	-20.26	QP
6	385.0200	34.30	-12.48	21.82	46.00	-24.18	QP

Test Mode:	802.11b	Frequency(MHz):	2412
Polarity:	Vertical	Test Voltage:	DC 3.3 V

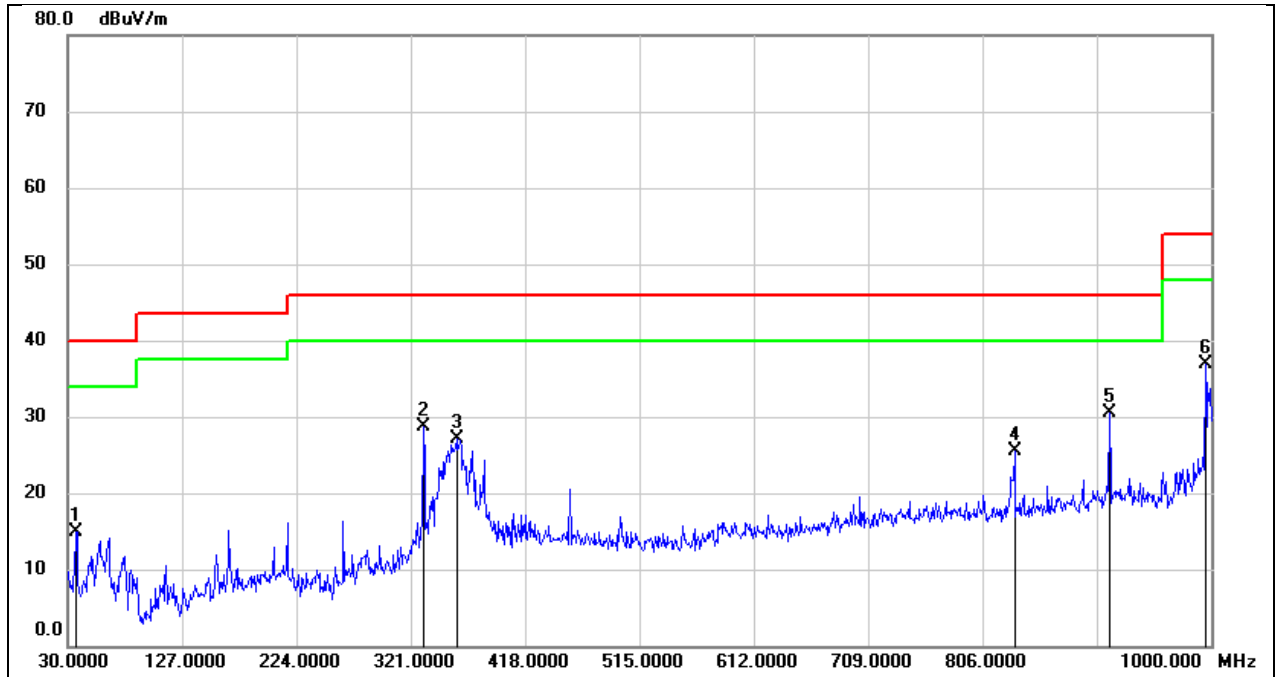

No.	Frequency (MHz)	Reading (dBuV)	Correct (dB/m)	Result (dBuV/m)	Limit (dBuV/m)	Margin (dB)	Remark
1	36.7900	33.78	-18.83	14.95	40.00	-25.05	QP
2	331.6700	42.13	-13.34	28.79	46.00	-17.21	QP
3	359.8000	39.52	-12.43	27.09	46.00	-18.91	QP
4	833.1599	31.52	-6.06	25.46	46.00	-20.54	QP
5	913.6700	34.91	-4.47	30.44	46.00	-15.56	QP
6	995.1500	40.68	-3.74	36.94	54.00	-17.06	QP

## 9. ANTENNA REQUIREMENT

### REQUIREMENT

Please refer to FCC part 15.203

An intentional radiator shall be designed to ensure that no antenna other than that furnished by the responsible party shall be used with the device. The use of a permanently attached antenna or of an antenna that uses a unique coupling to the intentional radiator shall be considered sufficient to comply with the provisions of this section. The manufacturer may design the unit so that a broken antenna can be replaced by the user, but the use of a standard antenna jack or electrical connector is prohibited.

Please refer to FCC part 15.247(b)(4)

The conducted output power limit specified in paragraph (b) of this section is based on the use of antennas with directional gains that do not exceed 6 dBi. Except as shown in paragraph (c) of this section, if transmitting antennas of directional gain greater than 6 dBi are used, the conducted output power from the intentional radiator shall be reduced below the stated values in paragraphs (b)(1), (b)(2), and (b)(3) of this section, as appropriate, by the amount in dB that the directional gain of the antenna exceeds 6 dBi.

### DESCRIPTION

Pass

## 10. AC POWER LINE CONDUCTED EMISSION

### LIMITS

Please refer to CFR 47 FCC §15.207 (a) and ISED RSS-Gen Clause 8.8

FREQUENCY (MHz)	Quasi-peak	Average
0.15 -0.5	66 - 56 *	56 - 46 *
0.50 -5.0	56.00	46.00
5.0 -30.0	60.00	50.00

### TEST PROCEDURE

The EUT is put on a table of non-conducting material that is 80 cm high. The vertical conducting wall of shielding is located 40 cm to the rear of the EUT. The power line of the EUT is connected to the AC mains through a Artificial Mains Network (A.M.N.). A EMI Measurement Receiver (R&S Test Receiver ESR3) is used to test the emissions from both sides of AC line. According to the requirements in Section 6.2 of ANSI C63.10-2013. Conducted emissions from the EUT measured in the frequency range between 0.15 MHz and 30 MHz using CISPR Quasi-Peak and average detector mode. The bandwidth of EMI test receiver is set at 9 kHz.

The arrangement of the equipment is installed to meet the standards and operating in a manner, which tends to maximize its emission characteristics in a normal application.

### TEST SETUP

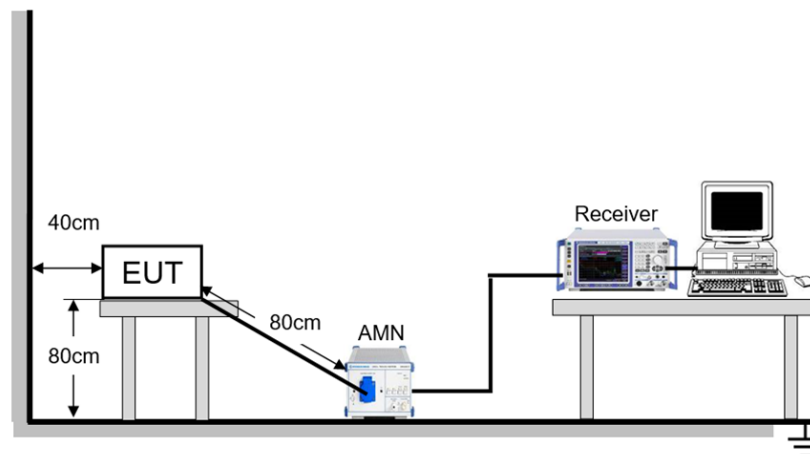

### TEST ENVIRONMENT

Temperature	22.9°C	Relative Humidity	58.3%
Atmosphere Pressure	101kPa	Test Voltage	AC 120 V, 60 Hz

### TEST DATE / ENGINEER

Test Date	February 6, 2024	Test By	Wite Chen
-----------	------------------	---------	-----------

**TEST RESULTS**

Test Mode:	802.11b	Frequency(MHz):	2412
Line:	Line		

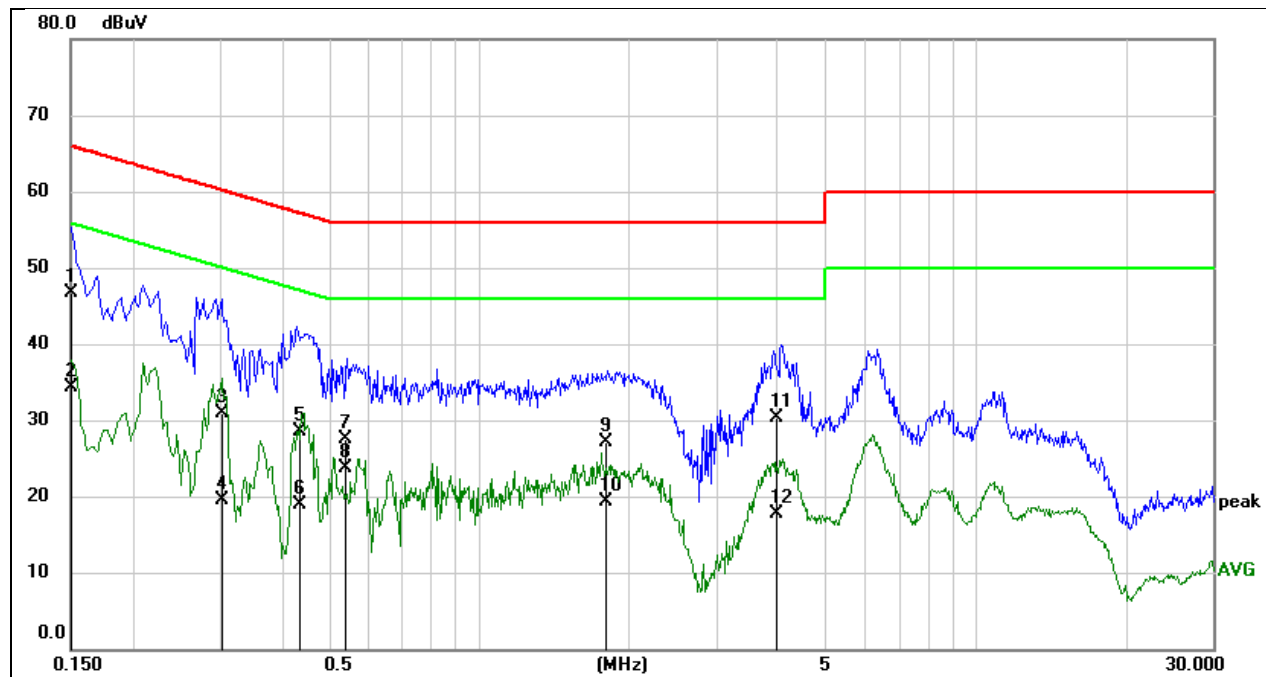

No.	Frequency (MHz)	Reading (dBuV)	Correct (dB)	Result (dBuV)	Limit (dBuV)	Margin (dB)	Remark
1	0.1505	37.18	9.49	46.67	65.97	-19.30	QP
2	0.1505	24.73	9.49	34.22	55.97	-21.75	AVG
3	0.3025	21.38	9.56	30.94	60.17	-29.23	QP
4	0.3025	10.01	9.56	19.57	50.17	-30.60	AVG
5	0.4339	19.05	9.52	28.57	57.18	-28.61	QP
6	0.4339	9.42	9.52	18.94	47.18	-28.24	AVG
7	0.5379	18.01	9.50	27.51	56.00	-28.49	QP
8	0.5379	14.17	9.50	23.67	46.00	-22.33	AVG
9	1.8053	17.48	9.60	27.08	56.00	-28.92	QP
10	1.8053	9.67	9.60	19.27	46.00	-26.73	AVG
11	4.0002	20.65	9.60	30.25	56.00	-25.75	QP
12	4.0002	8.16	9.60	17.76	46.00	-28.24	AVG

Note:

1. Result = Reading + Correct Factor.
2. If QP Result complies with AV limit, AV Result is deemed to comply with AV limit.
3. Test setup: RBW: 200 Hz (9 kHz ~ 150 kHz), 9 kHz (150 kHz ~ 30 MHz).
4. Step size: 80 Hz (0.009 MHz ~ 0.15 MHz), 4 kHz (0.15 MHz ~ 30 MHz), Scan time: auto.

Note: All the modes have been tested, only the worst data was recorded in the report.



Test Mode:	802.11b	Frequency(MHz):	2412
Line:	Neutral		

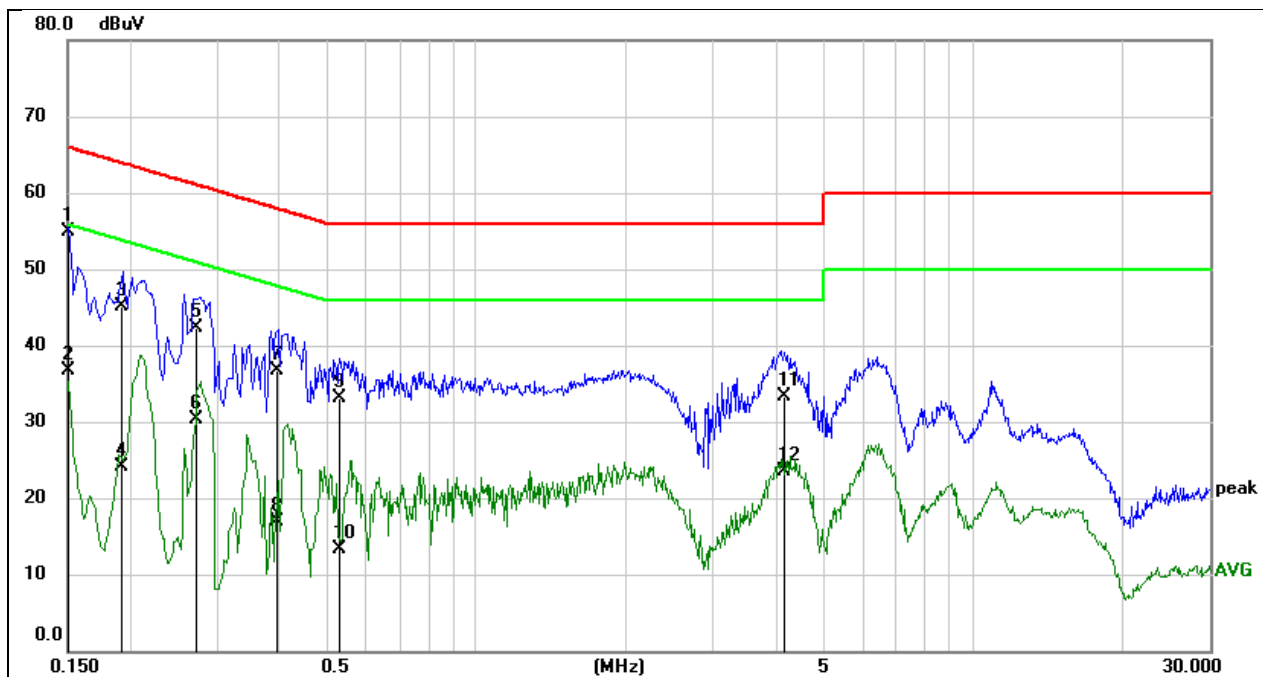

No.	Frequency (MHz)	Reading (dBuV)	Correct (dB)	Result (dBuV)	Limit (dBuV)	Margin (dB)	Remark
1	0.1500	45.46	9.49	54.95	66.00	-11.05	QP
2	0.1500	27.26	9.49	36.75	56.00	-19.25	AVG
3	0.1913	35.56	9.57	45.13	63.98	-18.85	QP
4	0.1913	14.59	9.57	24.16	53.98	-29.82	AVG
5	0.2730	32.70	9.57	42.27	61.03	-18.76	QP
6	0.2730	20.71	9.57	30.28	51.03	-20.75	AVG
7	0.3951	27.24	9.52	36.76	57.96	-21.20	QP
8	0.3951	7.44	9.52	16.96	47.96	-31.00	AVG
9	0.5305	23.55	9.50	33.05	56.00	-22.95	QP
10	0.5305	3.86	9.50	13.36	46.00	-32.64	AVG
11	4.1900	23.72	9.60	33.32	56.00	-22.68	QP
12	4.1900	13.88	9.60	23.48	46.00	-22.52	AVG

**Note:**

1. Result = Reading + Correct Factor.
2. If QP Result complies with AV limit, AV Result is deemed to comply with AV limit.
3. Test setup: RBW: 200 Hz (9 kHz ~ 150 kHz), 9 kHz (150 kHz ~ 30 MHz).
4. Step size: 80 Hz (0.009 MHz ~ 0.15 MHz), 4 kHz (0.15 MHz ~ 30 MHz), Scan time: auto.

Note: All the modes have been tested, only the worst data was recorded in the report.

## 11. TEST DATA

### 11.1. APPENDIX A: DTS BANDWIDTH

#### 11.1.1. Test Result

Test Mode	Antenna	Frequency[MHz]	DTS BW [MHz]	FL[MHz]	FH[MHz]	Limit[MHz]	Verdict
11B	Ant1	2412	10.12	2406.96	2417.08	≥0.5	PASS
	Ant2	2412	10.08	2406.96	2417.04	≥0.5	PASS
	Ant1	2437	10.12	2431.96	2442.08	≥0.5	PASS
	Ant2	2437	10.08	2432.00	2442.08	≥0.5	PASS
	Ant1	2462	10.12	2456.96	2467.08	≥0.5	PASS
	Ant2	2462	10.12	2456.96	2467.08	≥0.5	PASS
11G	Ant1	2412	16.36	2403.84	2420.20	≥0.5	PASS
	Ant2	2412	16.32	2403.84	2420.16	≥0.5	PASS
	Ant1	2437	16.32	2428.84	2445.16	≥0.5	PASS
	Ant2	2437	16.36	2428.84	2445.20	≥0.5	PASS
	Ant1	2462	16.28	2453.88	2470.16	≥0.5	PASS
	Ant2	2462	16.28	2453.88	2470.16	≥0.5	PASS
11N20MIMO	Ant1	2412	17.56	2403.24	2420.80	≥0.5	PASS
	Ant2	2412	17.56	2403.24	2420.80	≥0.5	PASS
	Ant1	2437	17.56	2428.24	2445.80	≥0.5	PASS
	Ant2	2437	17.56	2428.24	2445.80	≥0.5	PASS
	Ant1	2462	17.56	2453.24	2470.80	≥0.5	PASS
	Ant2	2462	17.32	2453.48	2470.80	≥0.5	PASS
11N40MIMO	Ant1	2422	35.44	2404.16	2439.60	≥0.5	PASS
	Ant2	2422	35.84	2403.84	2439.68	≥0.5	PASS
	Ant1	2437	35.44	2419.16	2454.60	≥0.5	PASS
	Ant2	2437	35.92	2419.08	2455.00	≥0.5	PASS
	Ant1	2452	35.44	2434.16	2469.60	≥0.5	PASS
	Ant2	2452	35.44	2434.16	2469.60	≥0.5	PASS

## 11.1.2. Test Graphs

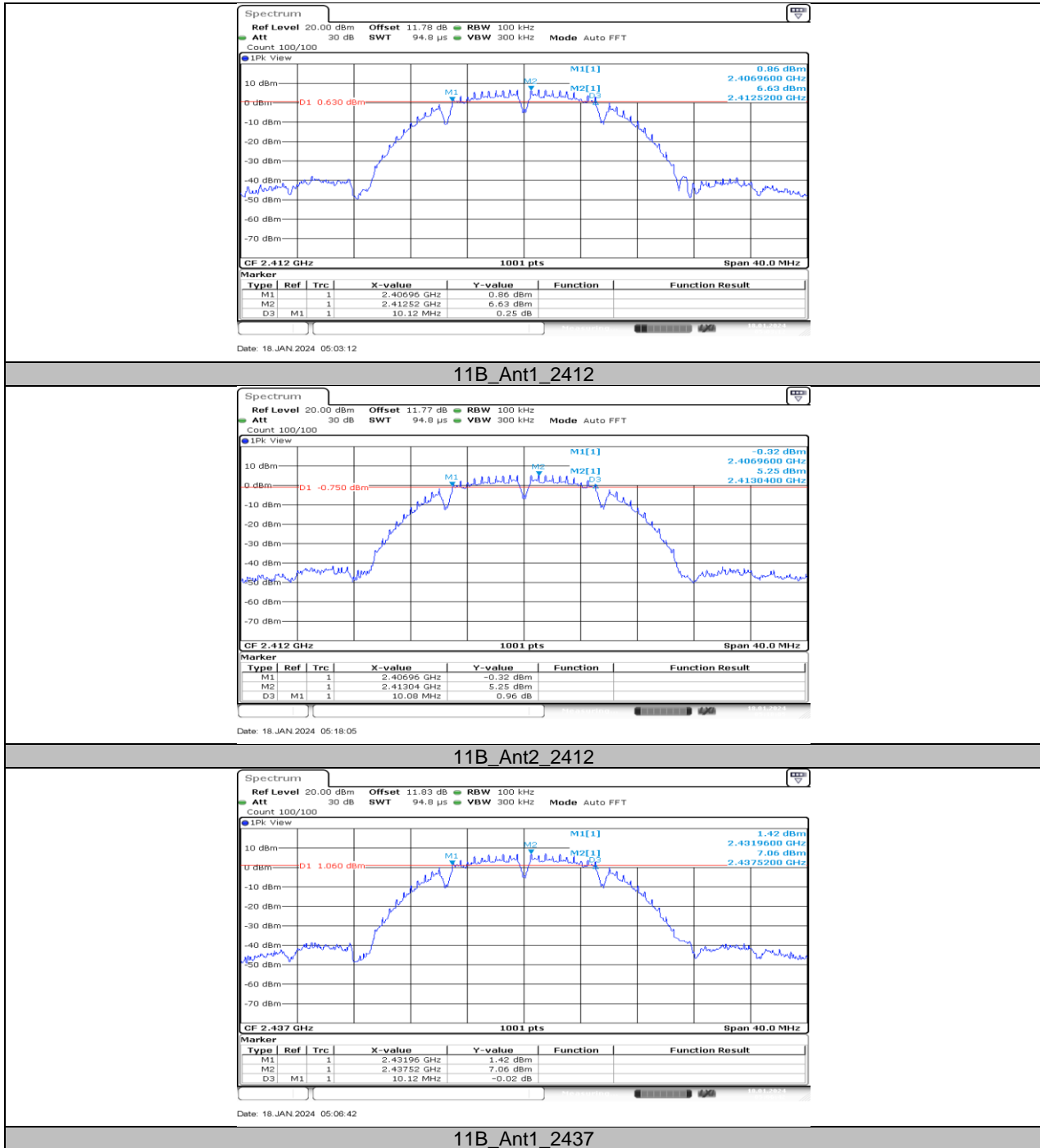

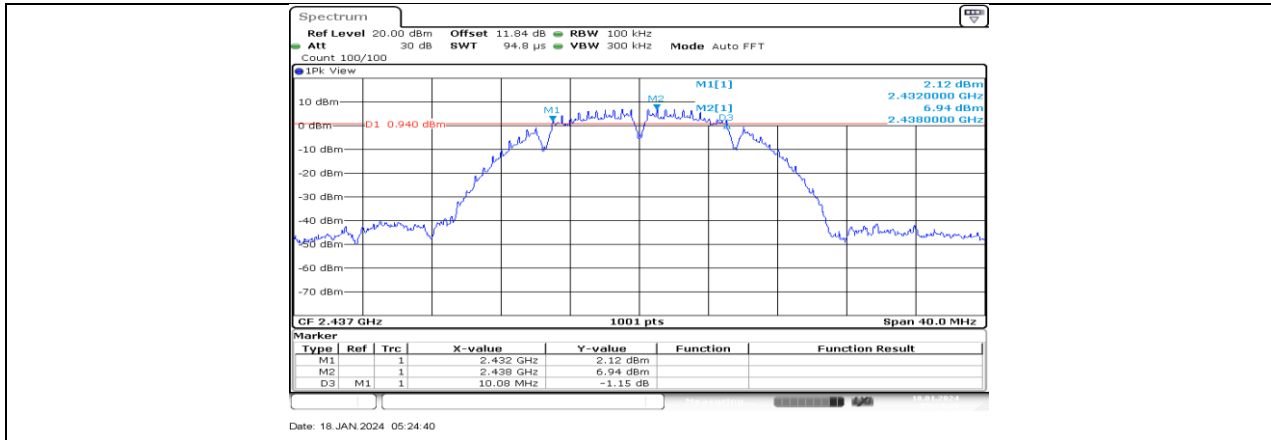

11B\_Ant2\_2437

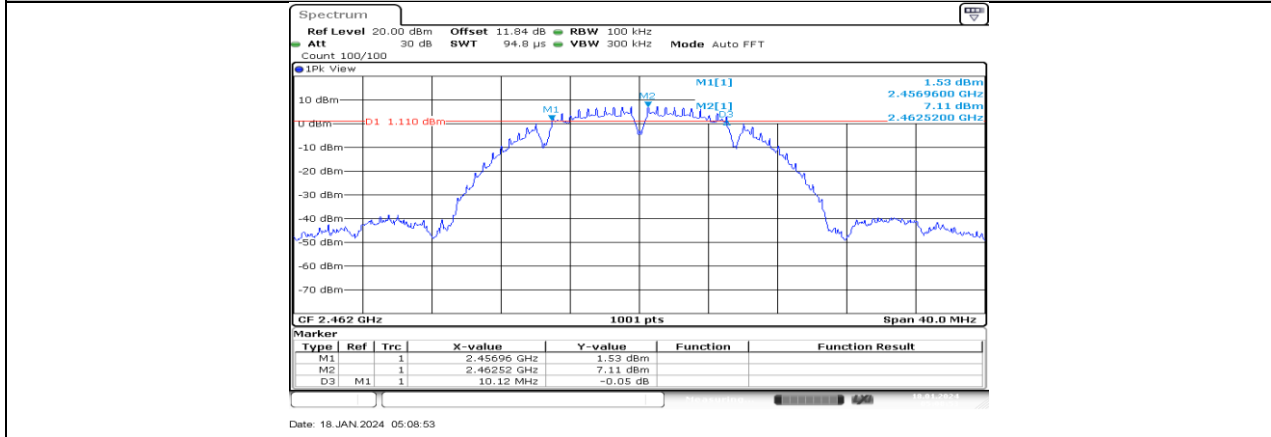

11B\_Ant1\_2462

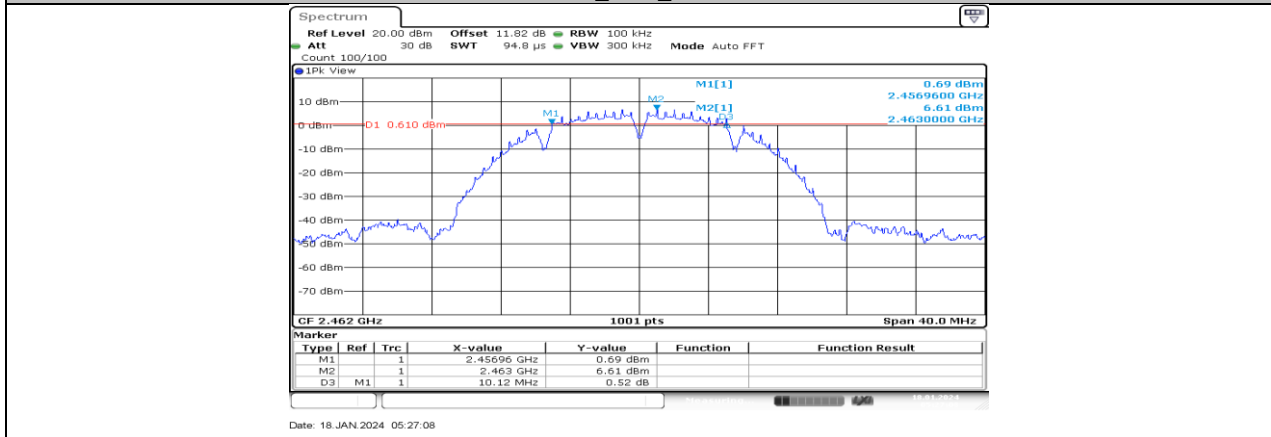

11B\_Ant2\_2462

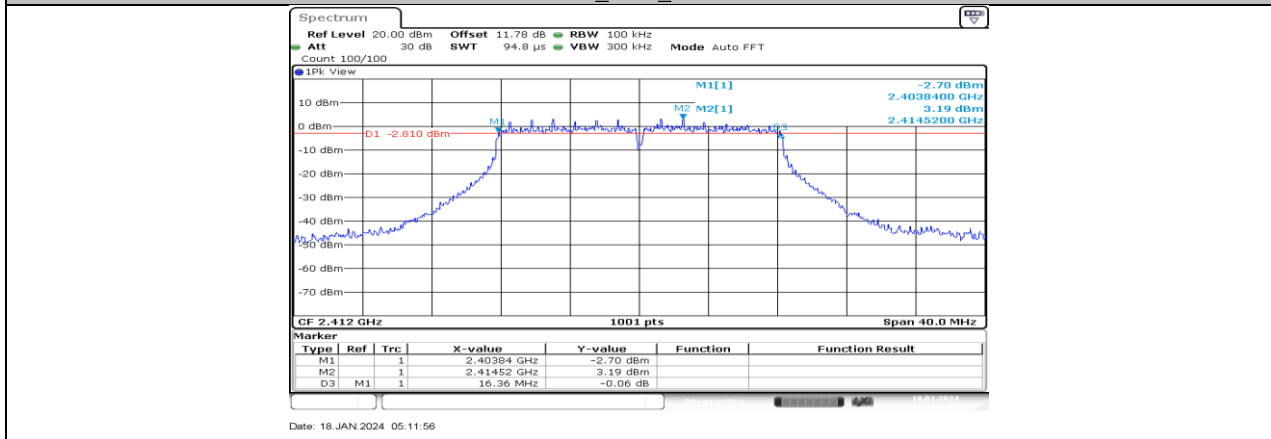

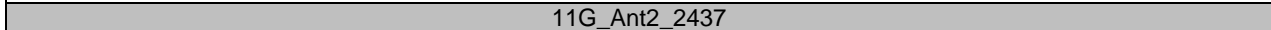
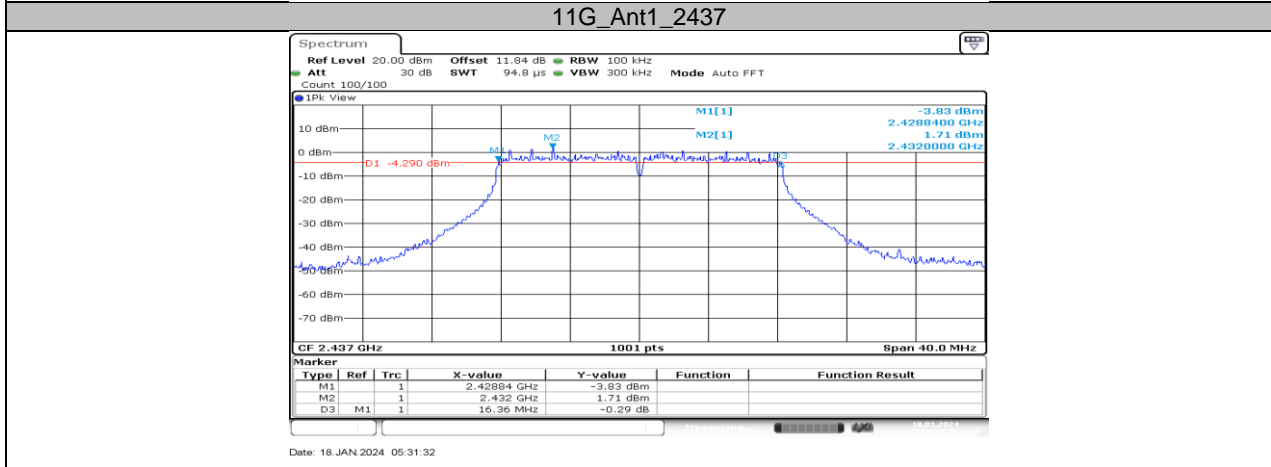
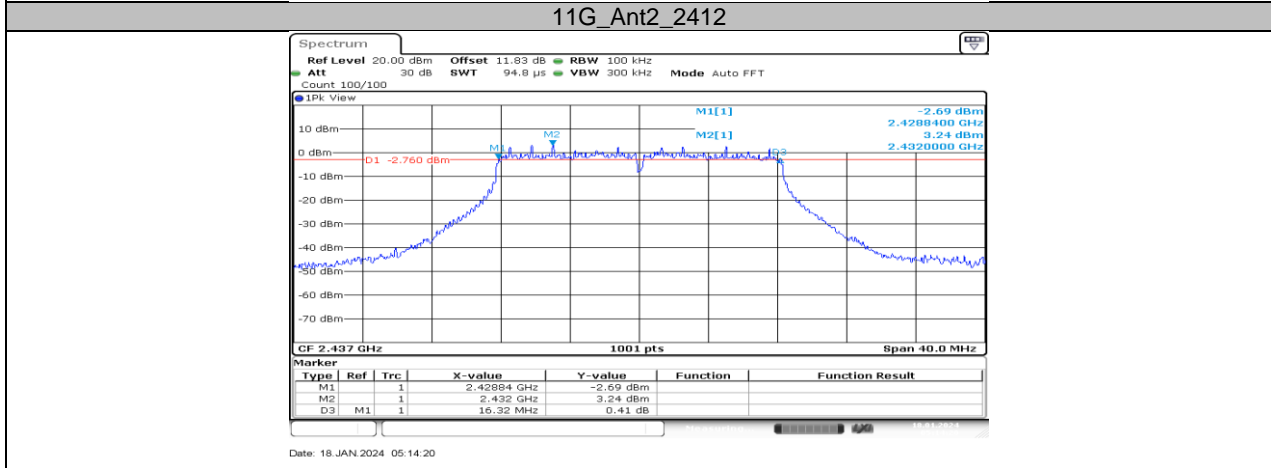
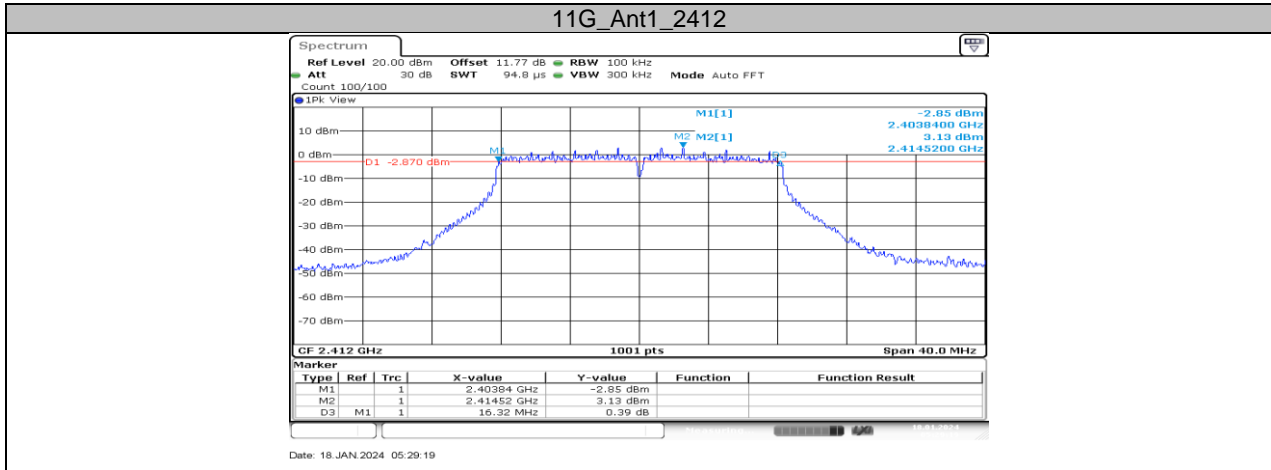

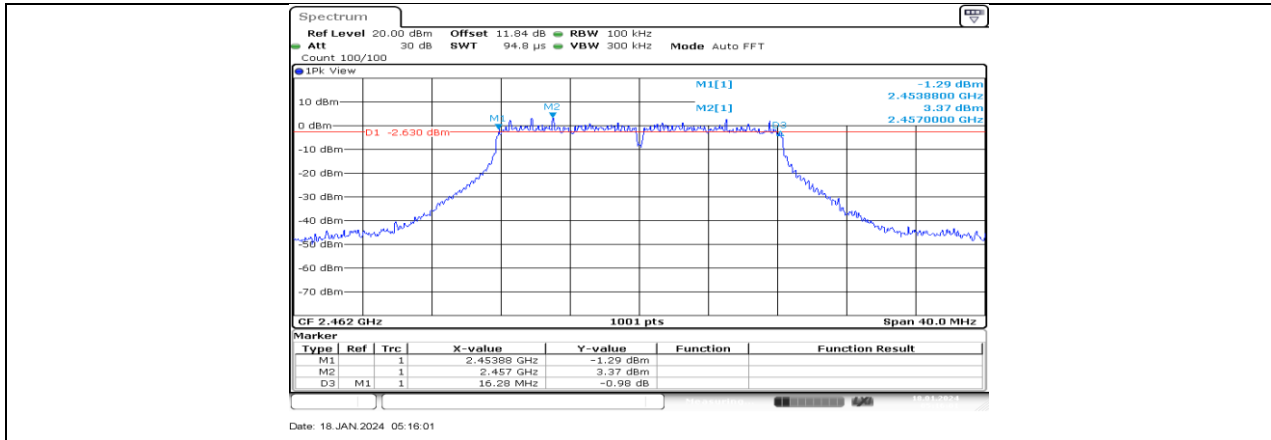

Date: 18.JAN.2024 05:16:01

11G\_Ant1\_2462

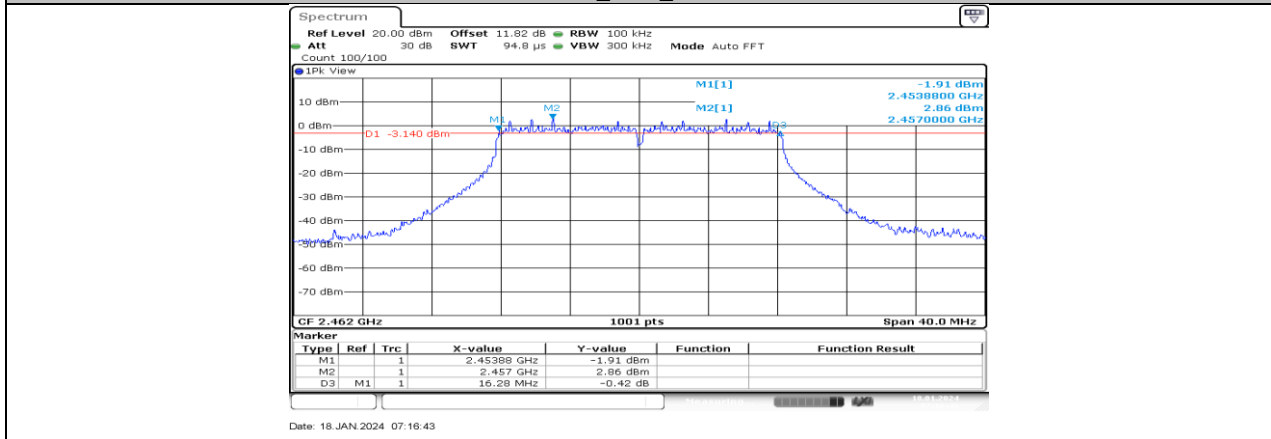

Date: 18.JAN.2024 07:16:43

11G\_Ant2\_2462

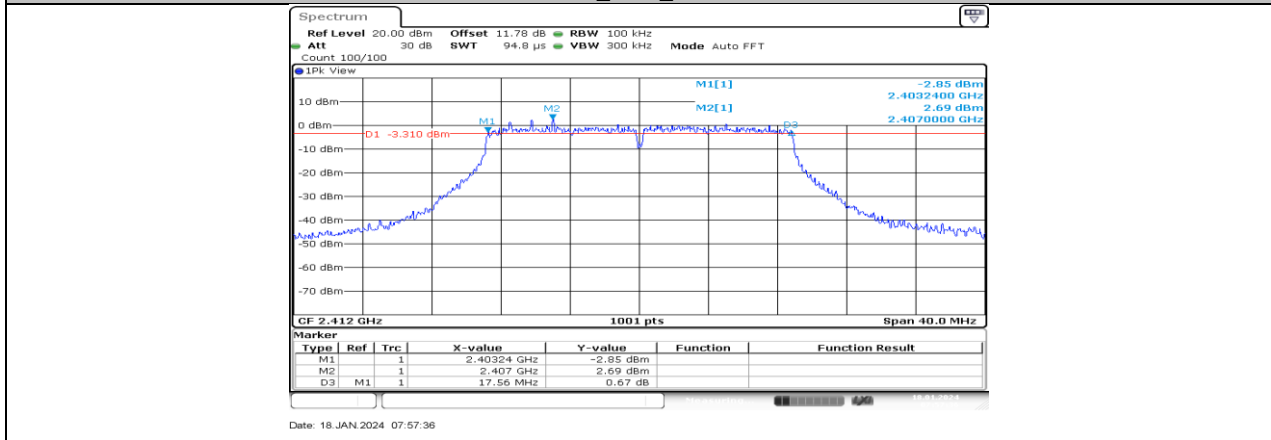

Date: 18.JAN.2024 07:57:36

11N20MIMO\_Ant1\_2412

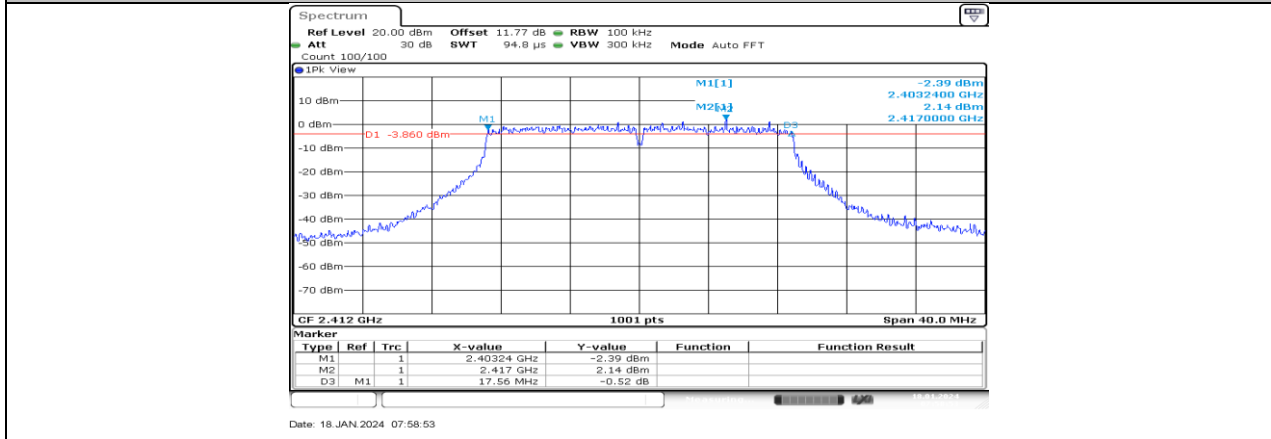

Date: 18.JAN.2024 07:58:53

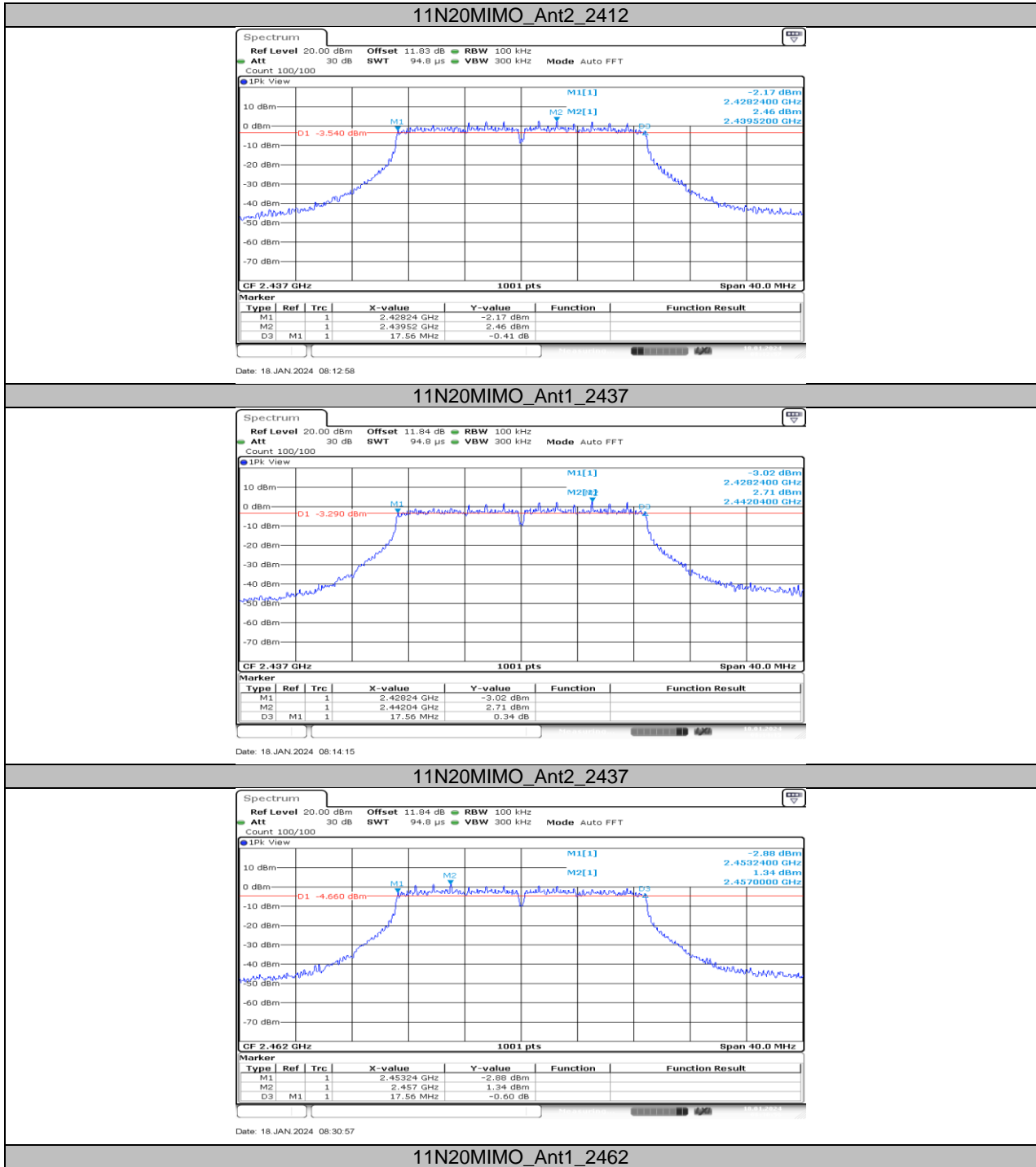

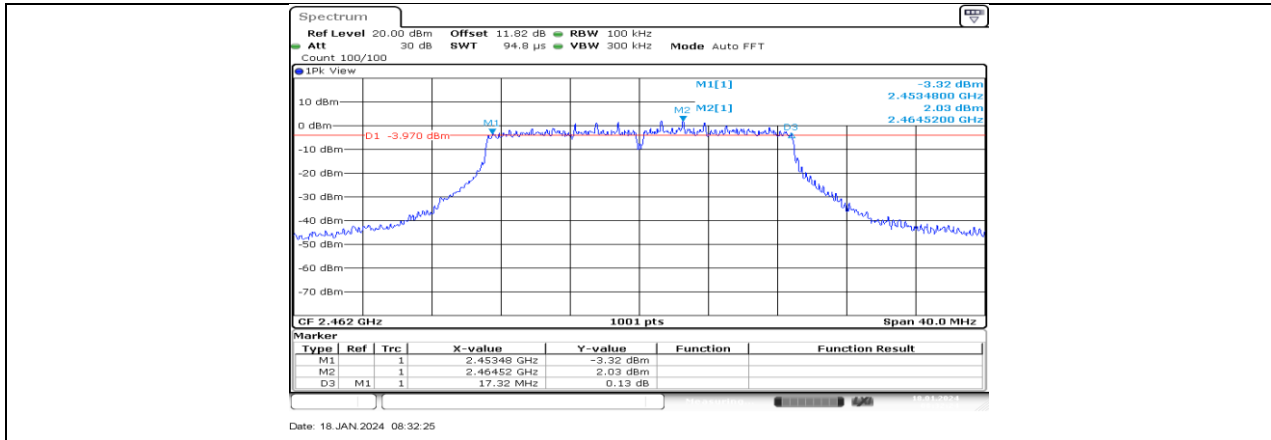

Date: 18.JAN.2024 08:32:25

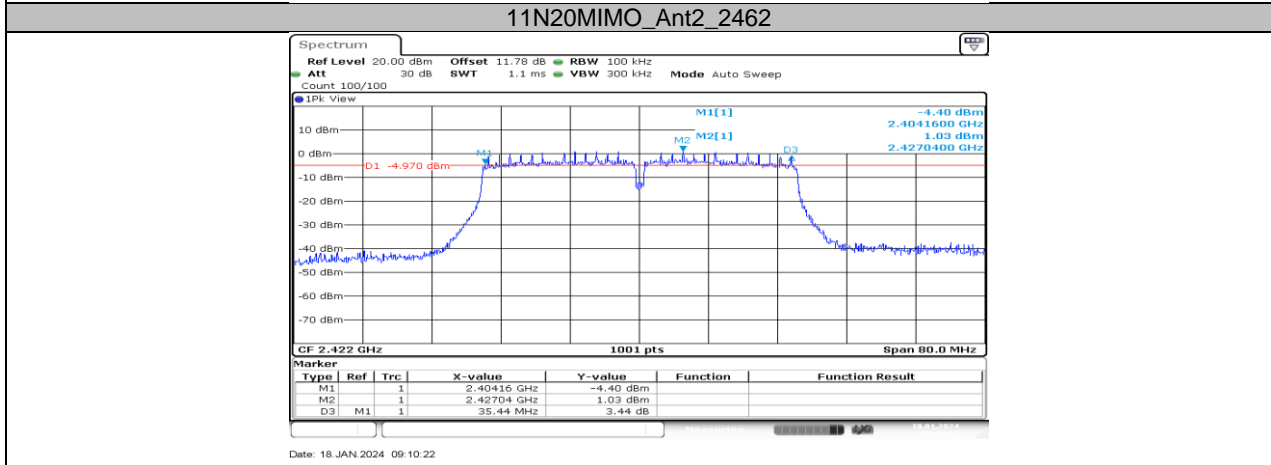

Date: 18.JAN.2024 09:10:22

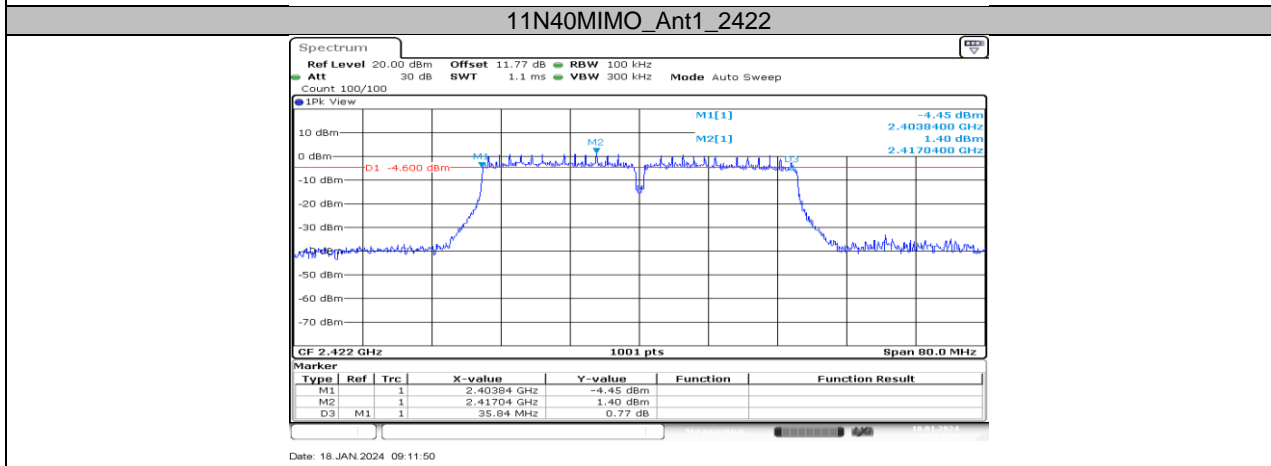

Date: 18.JAN.2024 09:11:50

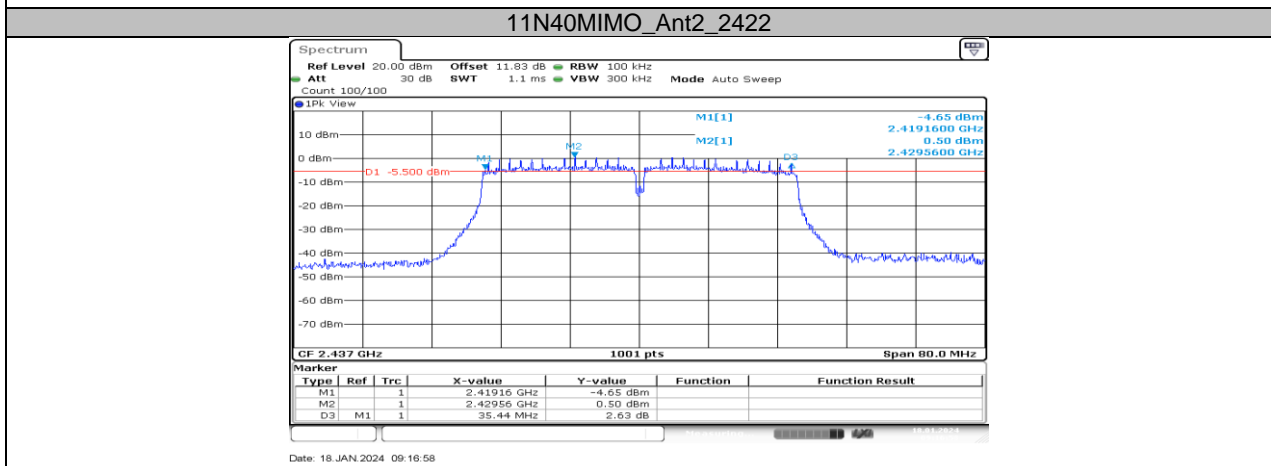

Date: 18.JAN.2024 09:16:58



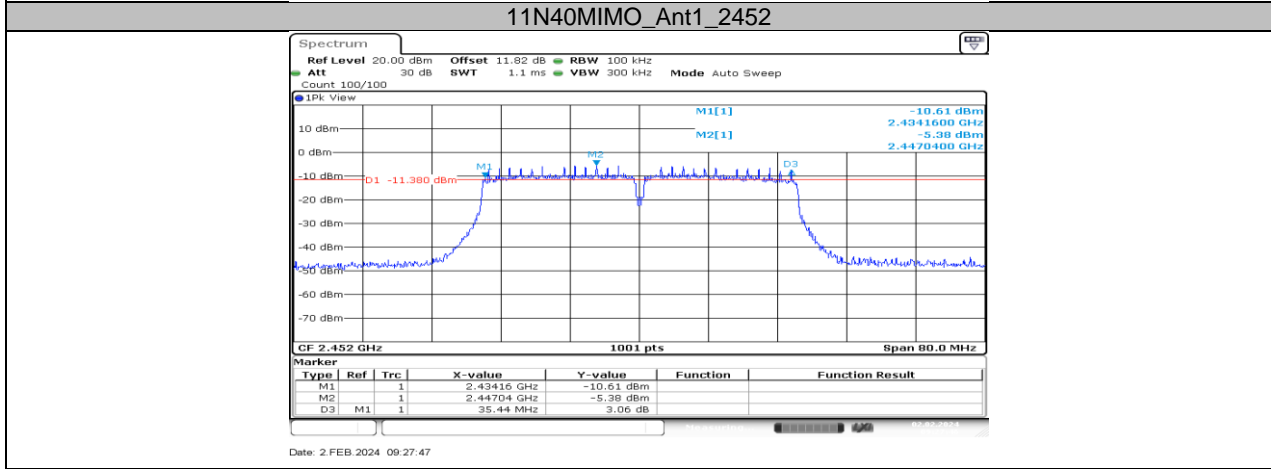
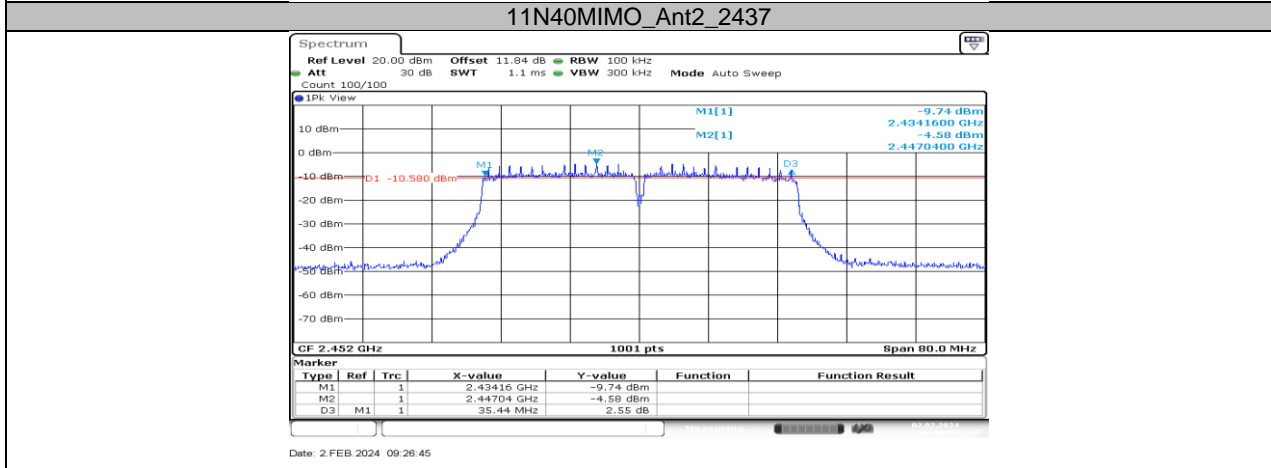
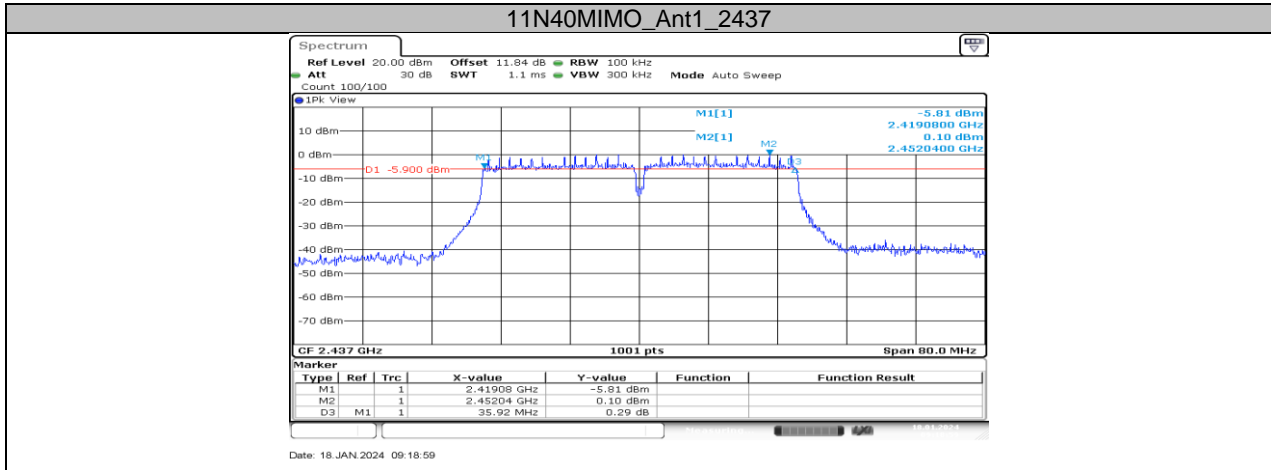

### 11N40MIMO\_Ant2\_2452

## 11.2. APPENDIX B: OCCUPIED CHANNEL BANDWIDTH

### 11.2.1. Test Result

Test Mode	Antenna	Frequency[MHz]	OCB [MHz]	FL[MHz]	FH[MHz]	Verdict
11B	Ant1	2412	14.745	2404.6474	2419.3926	PASS
	Ant2	2412	14.665	2404.7672	2419.4326	PASS
	Ant1	2437	14.705	2429.7273	2444.4326	PASS
	Ant2	2437	14.625	2429.7672	2444.3926	PASS
	Ant1	2462	14.665	2454.7273	2469.3926	PASS
	Ant2	2462	14.625	2454.6873	2469.3127	PASS
11G	Ant1	2412	17.263	2403.4486	2420.7113	PASS
	Ant2	2412	17.223	2403.4486	2420.6713	PASS
	Ant1	2437	17.263	2428.4086	2445.6713	PASS
	Ant2	2437	17.303	2428.4086	2445.7113	PASS
	Ant1	2462	17.263	2453.4086	2470.6713	PASS
	Ant2	2462	17.263	2453.4486	2470.7113	PASS
11N20MIMO	Ant1	2412	18.422	2402.8092	2421.2308	PASS
	Ant2	2412	18.422	2402.7692	2421.1908	PASS
	Ant1	2437	18.422	2427.7692	2446.1908	PASS
	Ant2	2437	18.462	2427.8092	2446.2707	PASS
	Ant1	2462	18.422	2452.7293	2471.1508	PASS
	Ant2	2462	18.422	2452.8492	2471.2707	PASS
11N40MIMO	Ant1	2422	36.523	2403.6983	2440.2218	PASS
	Ant2	2422	36.843	2403.3786	2440.2218	PASS
	Ant1	2437	36.523	2418.6184	2455.1419	PASS
	Ant2	2437	36.763	2418.6184	2455.3816	PASS
	Ant1	2452	36.523	2433.6184	2470.1419	PASS
	Ant2	2452	36.603	2433.6184	2470.2218	PASS

## 11.2.2. Test Graphs

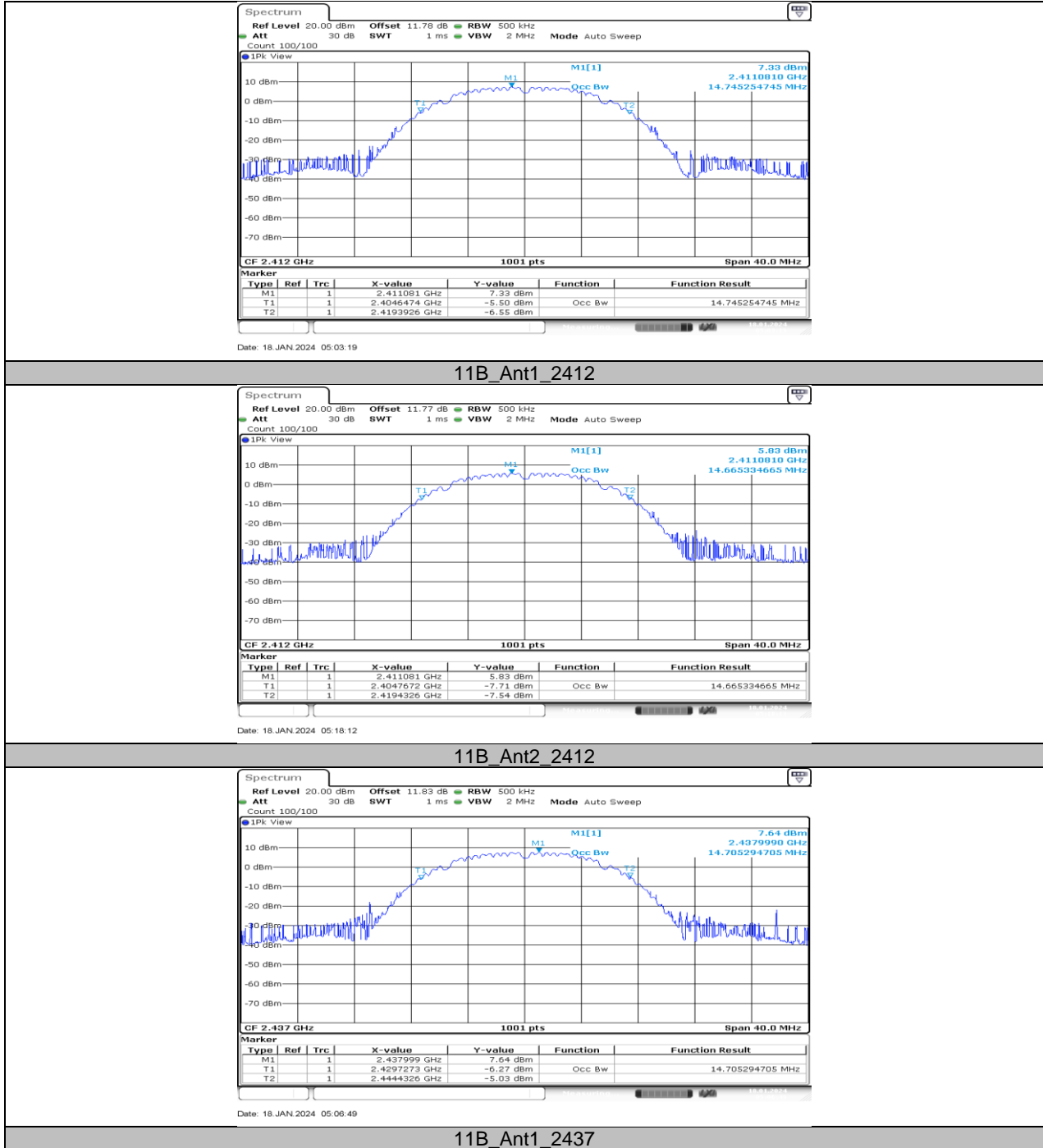

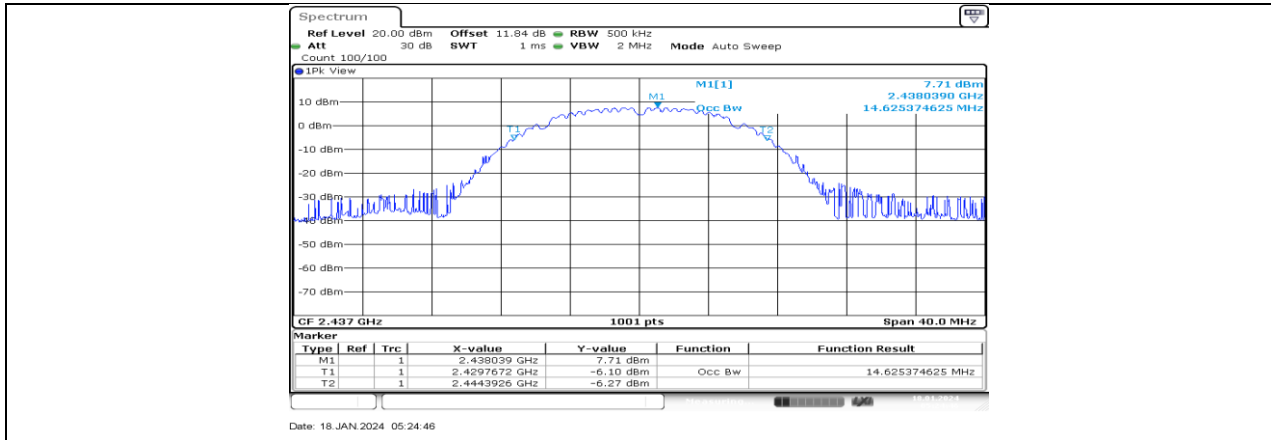

11B\_Ant2\_2437

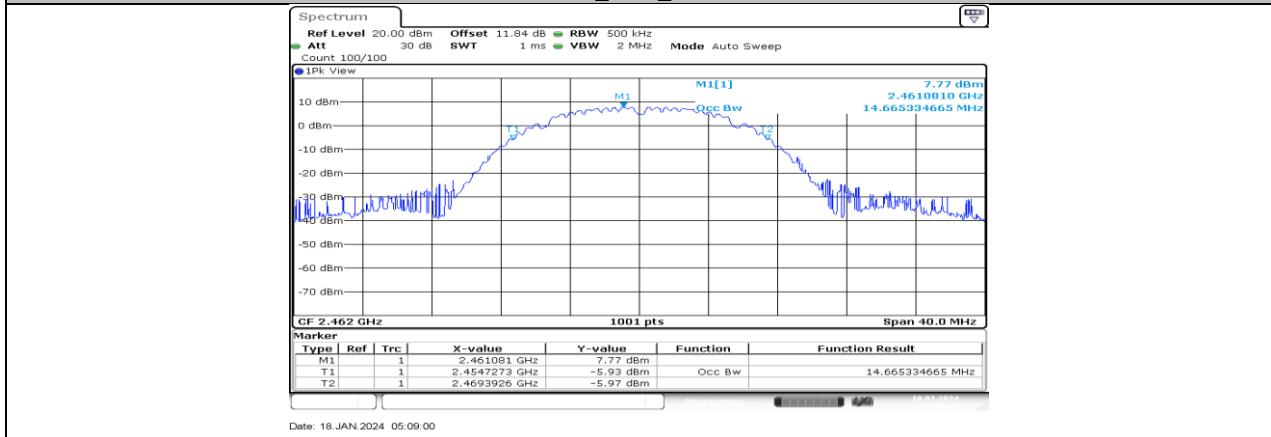

11B\_Ant1\_2462

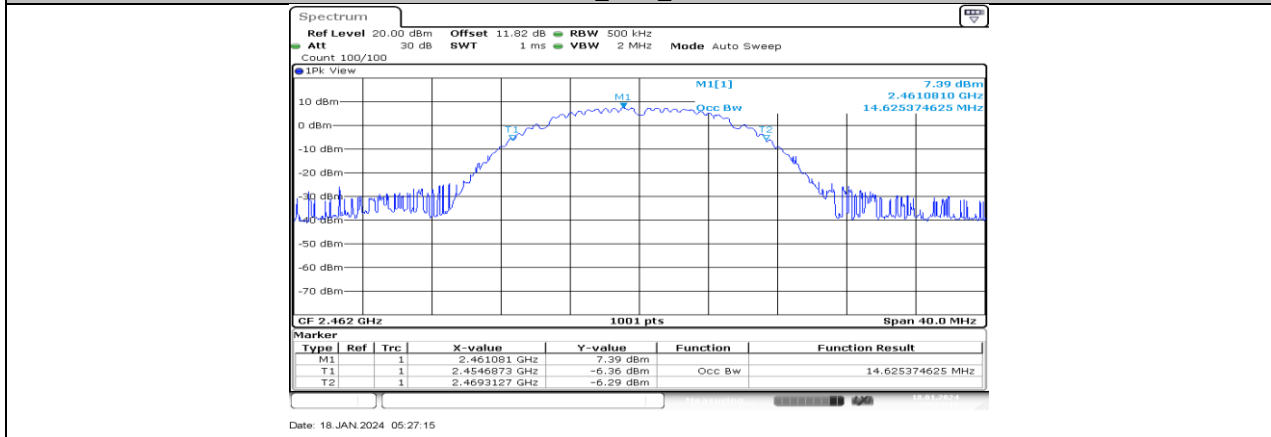

11B\_Ant2\_2462

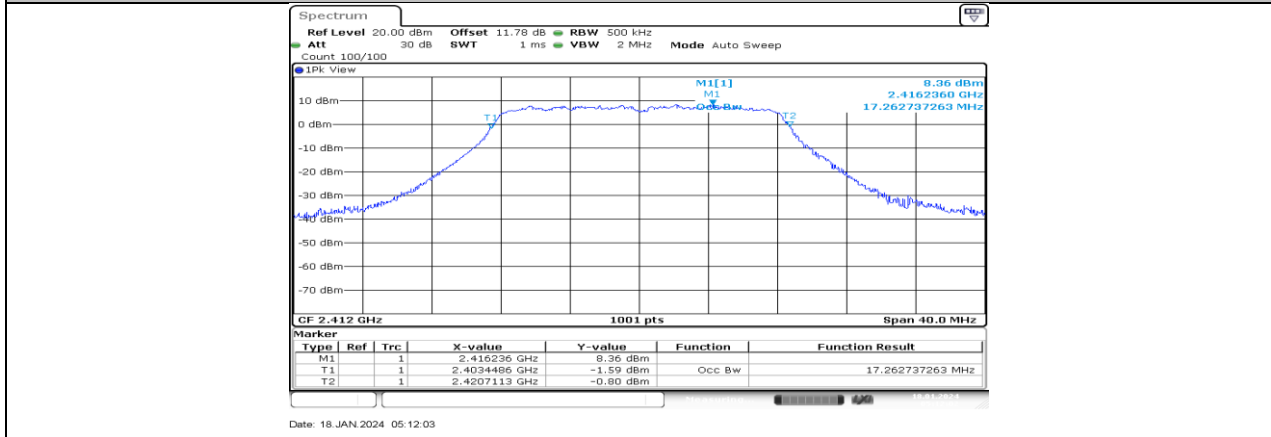

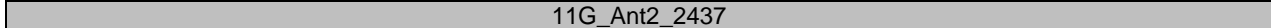
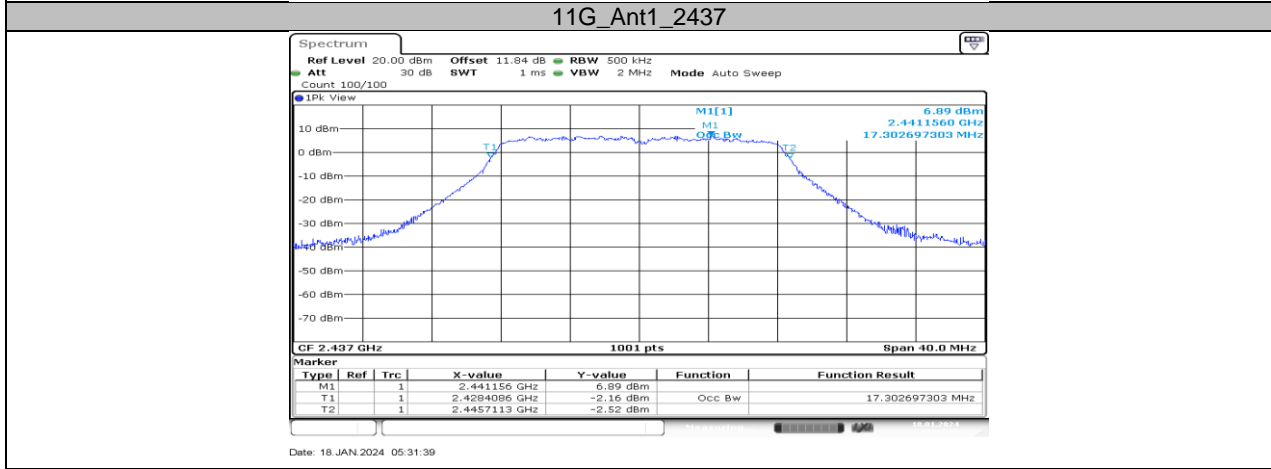
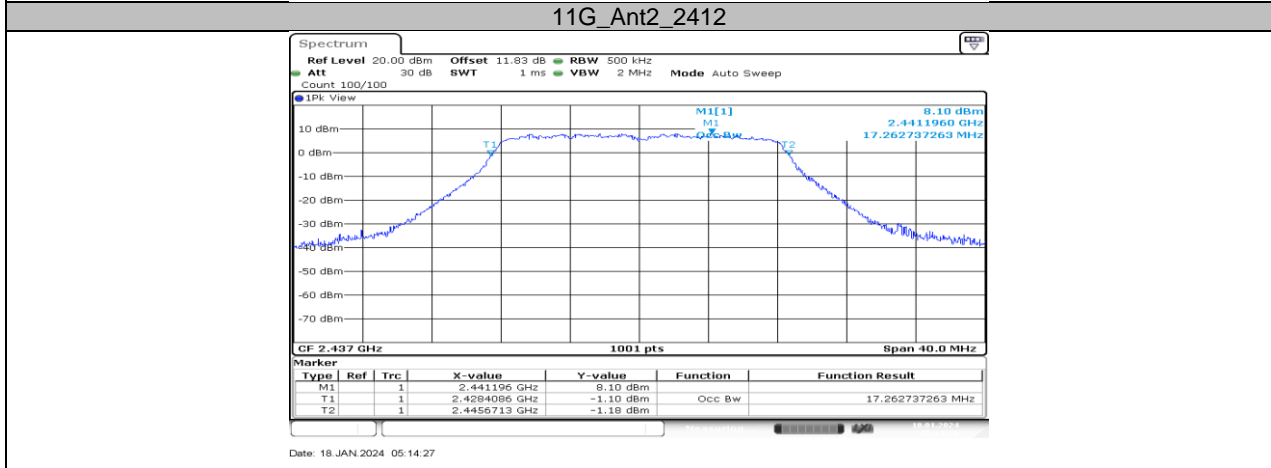
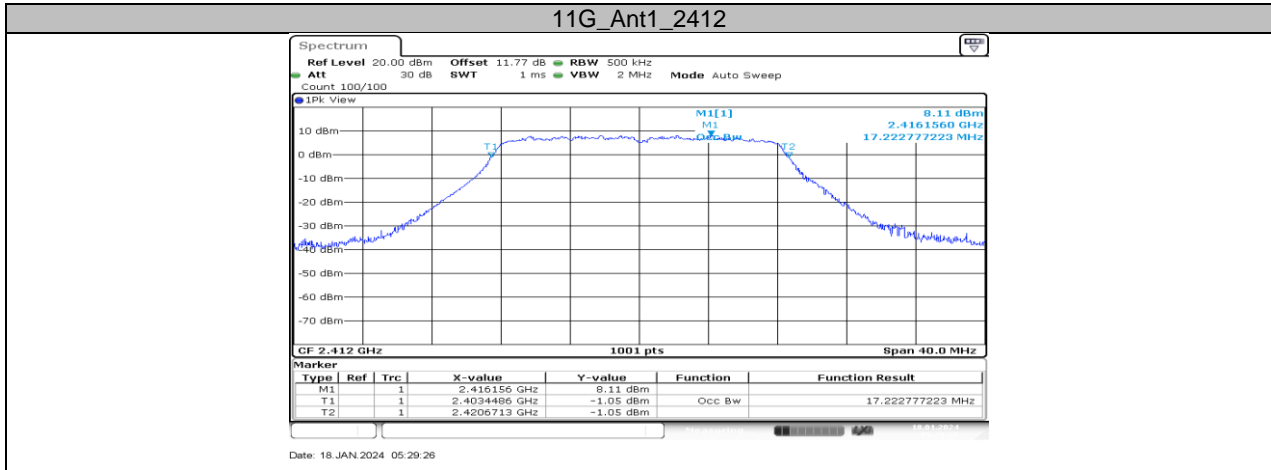

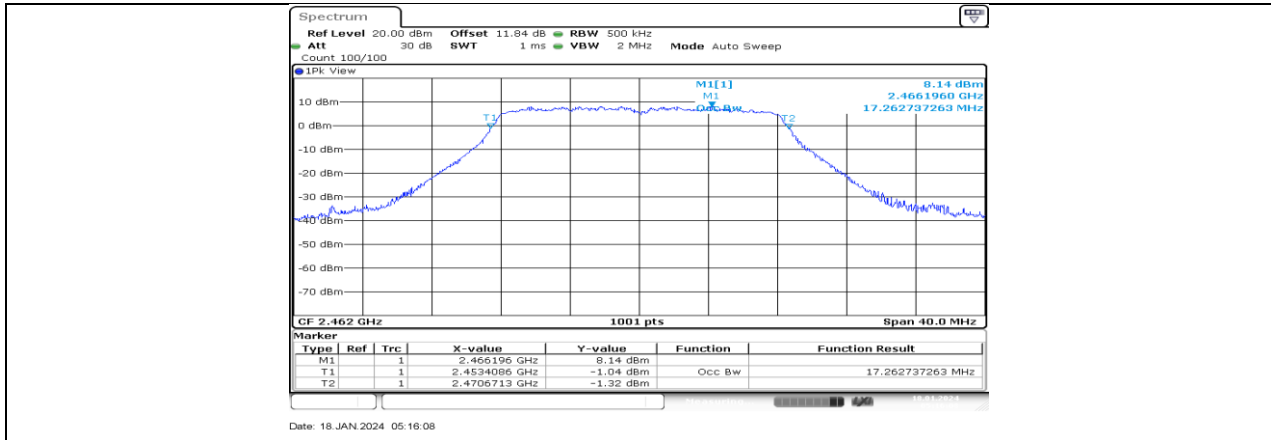

11G\_Ant1\_2462

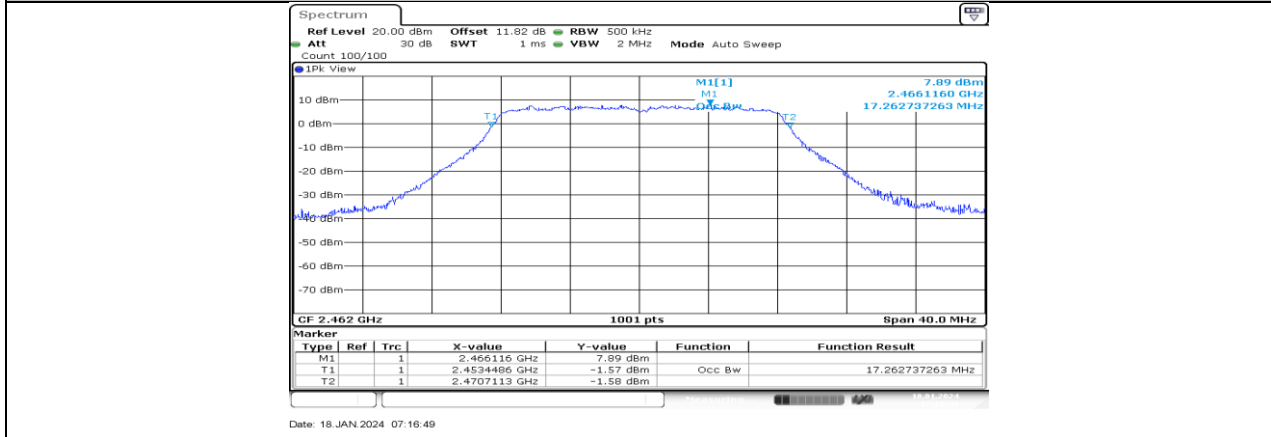

11G\_Ant2\_2462

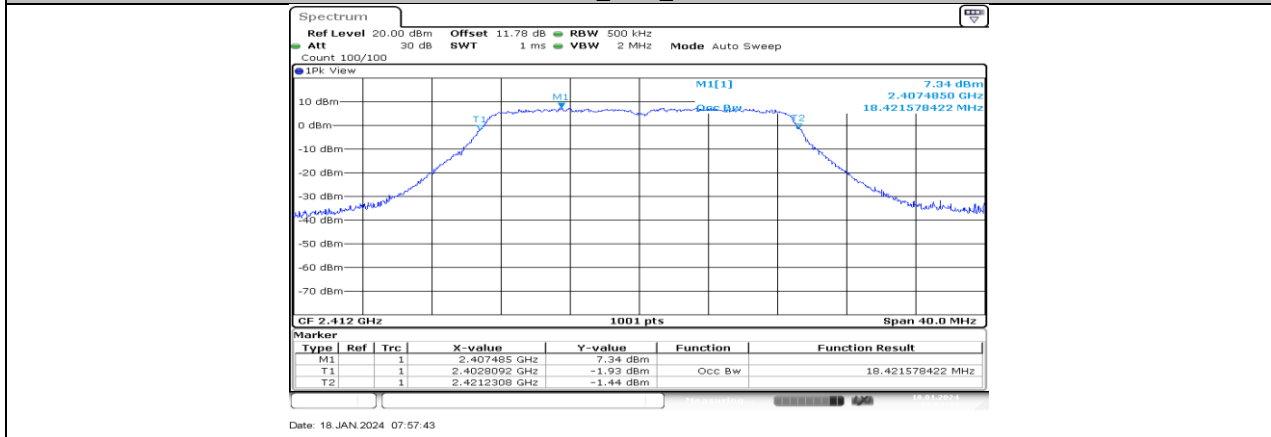

11N20MIMO\_Ant1\_2412

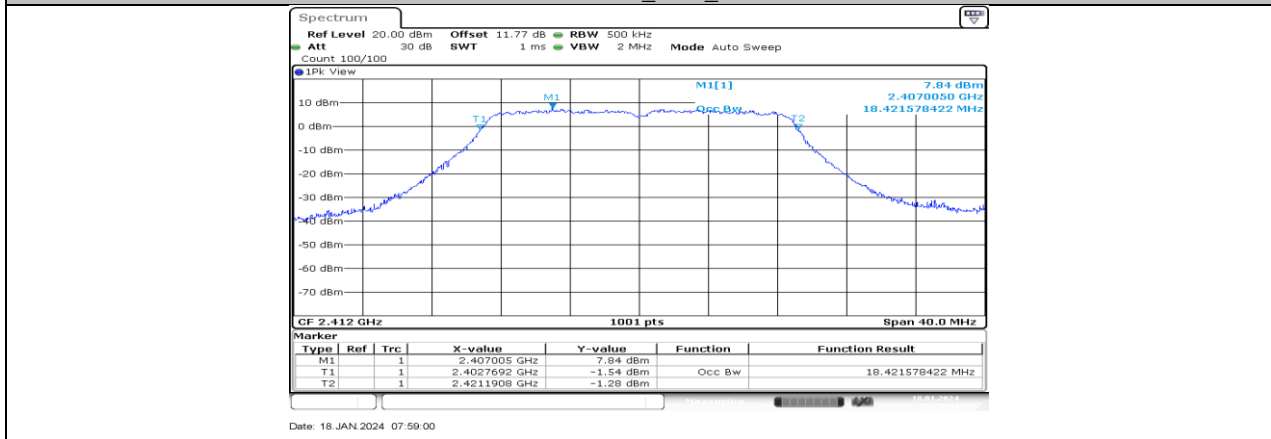

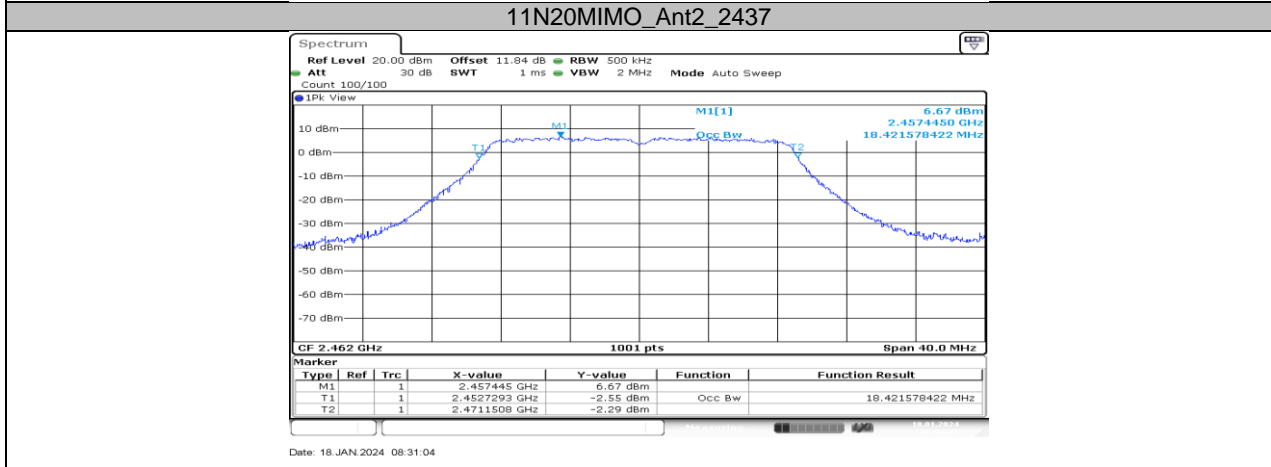
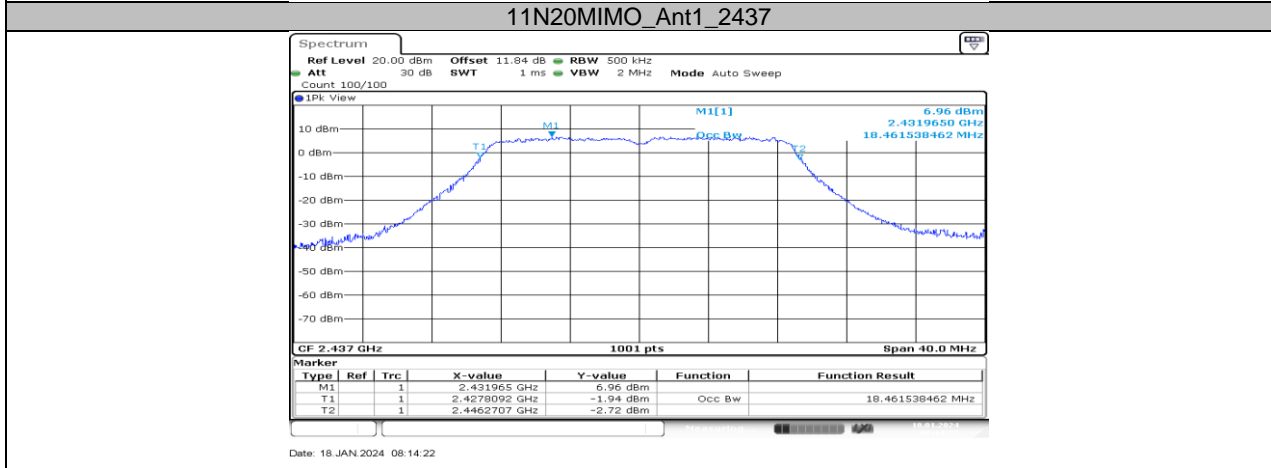
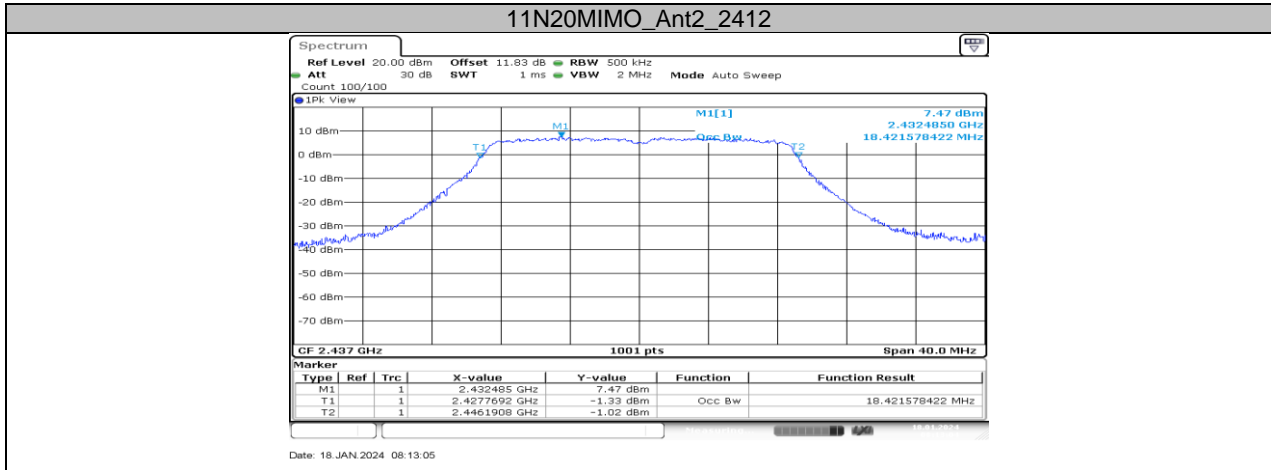

### 11N20MIMO\_Ant1\_2462