

FCC TEST REPORT
FOR
SHENZHEN MIZAR TECHNOLOGY CO., LTD.
BLUETOOTH KARAOKE SPEAKER
Model No.: MA-2873

Prepared for : SHENZHEN MIZAR TECHNOLOGY CO., LTD.
Address : 3F, Building B, NO.34 Gongyuan Road, Jiabao Block 22, Bao an District, Shenzhen, China

Prepared by : Shenzhen LCS Compliance Testing Laboratory Ltd.
Address : 1/F., Xingyuan Industrial Park, Tongda Road, Bao'an Avenue, Bao'an District, Shenzhen, Guangdong, China

Tel : (+86)755-82591330
Fax : (+86)755-82591332
Web : www.LCS-cert.com
Mail : webmaster@LCS-cert.com

Date of receipt of test sample : November 08, 2016
Number of tested samples : 1
Serial number : Prototype
Date of Test : November 08, 2016~November 30, 2016
Date of Report : November 30, 2016

FCC TEST REPORT

FCC CFR 47 PART 15 C(15.247): 2015

Report Reference No. : **LCS1611080785E**

Date of Issue..... : November 30, 2016

Testing Laboratory Name..... : **Shenzhen LCS Compliance Testing Laboratory Ltd.**

Address..... : 1/F., Xingyuan Industrial Park, Tongda Road, Bao'an Avenue, Bao'an District, Shenzhen, Guangdong, China

Testing Location/ Procedure : Full application of Harmonised standards ■
 Partial application of Harmonised standards □
 Other standard testing method □

Applicant's Name..... : **SHENZHEN MIZAR TECHNOLOGY CO., LTD.**

Address..... : 3F, Building B, NO.34 Gongyuan Road, Jiabao Block 22, Bao an District, Shenzhen, China

Test Specification

Standard : FCC CFR 47 PART 15 C(15.247): 2015

Test Report Form No. : LCSEMC-1.0

TRF Originator : Shenzhen LCS Compliance Testing Laboratory Ltd.

Master TRF : Dated 2011-03

Shenzhen LCS Compliance Testing Laboratory Ltd. All rights reserved.

This publication may be reproduced in whole or in part for non-commercial purposes as long as the Shenzhen LCS Compliance Testing Laboratory Ltd. is acknowledged as copyright owner and source of the material. Shenzhen LCS Compliance Testing Laboratory Ltd. takes no responsibility for and will not assume liability for damages resulting from the reader's interpretation of the reproduced material due to its placement and context.

Test Item Description. : **BLUETOOTH KARAOKE SPEAKER**

Trade Mark..... : N/A

Model/ Type reference : MA-2873

Ratings..... : DC 3.7V by battery(2000mAh);
 Charging voltage: DC 5V, 1.0A

Result : **Positive**

Compiled by:



Jacky Li/ File administrators

Supervised by:



Glin Lu/ Technique principal

Approved by:



Gavin Liang/ Manager

FCC -- TEST REPORT

Test Report No. : LCS1611080785E	<u>November 30, 2016</u> Date of issue
---	---

Type / Model..... : MA-2873 EUT..... : BLUETOOTH KARAOKE SPEAKER
Applicant..... : SHENZHEN MIZAR TECHNOLOGY CO., LTD. Address..... : 3F, Building B, NO.34 Gongyuan Road, Jiabao Block 22, Bao an District, Shenzhen, China Telephone..... : 18926037653 Fax..... : 0755-27847295
Manufacturer..... : SHENZHEN MIZAR TECHNOLOGY CO., LTD. Address..... : 3F, Building B, NO.34 Gongyuan Road, Jiabao Block 22, Bao an District, Shenzhen, China Telephone..... : 18926037653 Fax..... : 0755-27847295
Factory..... : SHENZHEN MIZAR TECHNOLOGY CO., LTD. Address..... : 3F, Building B, NO.34 Gongyuan Road, Jiabao Block 22, Bao an District, Shenzhen, China Telephone..... : 18926037653 Fax..... : 0755-27847295

Test Result	Positive
--------------------	-----------------

The test report merely corresponds to the test sample.
 It is not permitted to copy extracts of these test result without the written permission of the test laboratory.

Revision History

Revision	Issue Date	Revisions	Revised By
00	2016-11-30	Initial Issue	Gavin Liang

TABLE OF CONTENTS

Description	Page
1. GENERAL INFORMATION	6
1.1 Description of Device (EUT)	6
1.2 Support equipment List	6
1.3 External I/O Cable	6
1.4 Description of Test Facility	6
1.5 Statement of The Measurement Uncertainty	7
1.6 Measurement Uncertainty	7
1.7 Description Of Test Modes	7
2. TEST METHODOLOGY	8
2.1 EUT Configuration	8
2.2 EUT Exercise	8
2.3 General Test Procedures	8
3. SYSTEM TEST CONFIGURATION	9
3.1 Justification	9
3.2 EUT Exercise Software	9
3.3 Special Accessories	9
3.4 Block Diagram/Schematics	9
3.5 Equipment Modifications	9
3.6 Test Setup	9
4. SUMMARY OF TEST RESULTS.....	10
5. SUMMARY OF TEST EQUIPMENT	11
6. ANTENNA PORT MEASUREMENT	12
6.1 Peak Power	12
6.2 Frequency Separation And 20 dB Bandwidth	14
6.3 Number Of Hopping Frequency	18
6.4 Time Of Occupancy (Dwell Time)	20
6.5 Conducted Spurious Emissions and Band Edges Test	24
7.1 Block Diagram of Test Setup	29
7.2 Restricted Band Emission Limit	30
7.3 Instruments Setting	31
7.4 Test Procedures	32
7.5 Results for Restricted Band Radiated Emissions Testing	35
7.6 Results for Restricted Band edge Testing	38
7.7. Power line conducted emissions	40
8. ANTENNA REQUIREMENT	43
8.1 Standard Applicable	43
8.2 Antenna Connected Construction	43
9. TEST SETUP PHOTOGRAPHS OF EUT	45
10. EXTERIOR PHOTOGRAPHS OF THE EUT	45
11. INTERIOR PHOTOGRAPHS OF THE EUT	45

1. GENERAL INFORMATION

1.1 Description of Device (EUT)

EUT	: BLUETOOTH KARAOKE SPEAKER
Model Number	: MA-2873
Model Declaration	: /
Test Model	: MA-2873
Power Supply	: DC 3.7V by battery(2000mAh); Charging voltage: DC 5V, 1.0A
Frequency Range	: 2402~2480MHz
Bluetooth Version	: V2.1+EDR
Channel Number	: 79 Channels
Modulation Technology	: BT V3.0: FHSS(GFSK, π /4-DQPSK)
Data Rates	: BT V3.0: 1~2Mbps
Antenna Type And Gain	: PCB antenna, 3.3 dBi

1.2 Support equipment List

Manufacturer	Description	Model	Serial Number	Certificate
Lenovo	PC	B470	--	DoC

1.3 External I/O Cable

I/O Port Description	Quantity	Cable
USB	1	0.8m, Unshielded

1.4 Description of Test Facility

CNAS Registration Number. is L4595.
 FCC Registration Number. is 899208.
 Industry Canada Registration Number. is 9642A-1.
 VCCI Registration Number. is C-4260 and R-3804.
 ESMD Registration Number. is ARCB0108.
 UL Registration Number. is 100571-492.
 TUV SUD Registration Number. is SCN1081.
 TUV RH Registration Number. is UA 50296516-001

The 3m-Semi anechoic test site fulfils CISPR 16-1-4 according to ANSI C63.4:2014 and CISPR 16-1-4:2010 SVSWR requirement for radiated emission above 1GHz.

1.5 Statement of The Measurement Uncertainty

The data and results referenced in this document are true and accurate. The reader is cautioned that there may be errors within the calibration limits of the equipment and facilities. The measurement uncertainty was calculated for all measurements listed in this test report acc. To CISPR 16 – 4 “Specification for radio disturbance and immunity measuring apparatus and methods – Part 4: Uncertainty in EMC Measurements” and is documented in the LCS quality system acc. To DIN EN ISO/IEC 17025. Furthermore, component and process variability of devices similar to that tested may result in additional deviation. The manufacturer has the sole responsibility of continued compliance of the device.

1.6 Measurement Uncertainty

Test Item	Frequency Range	Uncertainty	Note
Radiation Uncertainty	9KHz~30MHz	3.10dB	(1)
	30MHz~200MHz	2.96dB	(1)
	200MHz~1000MHz	3.10dB	(1)
	1GHz~26.5GHz	3.80dB	(1)
	26.5GHz~40GHz	3.90dB	(1)
Conduction Uncertainty	150kHz~30MHz	1.63dB	(1)
Power disturbance	30MHz~300MHz	1.60dB	(1)

(1). This uncertainty represents an expanded uncertainty expressed at approximately the 95% confidence level using a coverage factor of k=2.

1.7 Description Of Test Modes

Bluetooth operates in the unlicensed ISM Band at 2.4GHz. With basic data rate feature, the data rates can be up to 1 Mb/s by modulating the RF carrier using GFSK techniques. The EUT works in the X-axis, Y-axis, Z-axis. The following operating modes were applied for the related test items. All test modes were tested, only the result of the worst case was recorded in the report.

Mode of Operations	Frequency Range (MHz)	Data Rate (Mbps)
BT V 3.0	2402	1/2/3
	2441	1/2/3
	2480	1/2/3
For Conducted Emission		
Test Mode		TX Mode
For Radiated Emission		
Test Mode		TX Mode

Worst-case mode and channel used for 150kHz-30 MHz power line conducted emissions was the mode and channel with the highest output power, that was determined to be TX(1Mbps).

Worst-case mode and channel used for 9kHz-1000 MHz radiated emissions was the mode and channel with the highest output power, that was determined to be TX(1Mbps-Low Channel).

2. TEST METHODOLOGY

The tests documented in this report were performed in accordance with ANSI C63.10-2013, FCC CFR PART 15C 15.207, 15.209, 15.247 and DA 00-705.

2.1 EUT Configuration

The EUT configuration for testing is installed on RF field strength measurement to meet the Commissions requirement and operating in a manner that intends to maximize its emission characteristics in a continuous normal application.

2.2 EUT Exercise

The EUT was operated in the engineering mode to fix the TX frequency that was for the purpose of the measurements.

According to its specifications, the EUT must comply with the requirements of the Section 15.207, 15.209, 15.247 under the FCC Rules Part 15 Subpart C.

2.3 General Test Procedures

2.3.1 Conducted Emissions

The EUT is directly placed on the ground. According to the requirements in Section 6.2.1 of ANSI C63.10-2013 Conducted emissions from the EUT measured in the frequency range between 0.15 MHz and 30MHz using Quasi-peak and average detector modes.

2.3.2 Radiated Emissions

The EUT is placed on a turntable, which is directly placed on the ground. The turntable shall rotate 360 degrees to determine the position of maximum emission level. EUT is set 3m away from the receiving antenna, which varied from 1m to 4m to find out the highest emission. And also, each emission was to be maximized by changing the polarization of receiving antenna both horizontal and vertical. In order to find out the maximum emissions, exploratory radiated emission measurements were made according to the requirements in Section 6.3 of ANSI C63.10-2013

3. SYSTEM TEST CONFIGURATION

3.1 Justification

The system was configured for testing in a continuous transmit condition.

3.2 EUT Exercise Software

N/A.

3.3 Special Accessories

N/A.

3.4 Block Diagram/Schematics

Please refer to the related document.

3.5 Equipment Modifications

Shenzhen LCS Compliance Testing Laboratory Ltd. has not done any modification on the EUT.

3.6 Test Setup

Please refer to the test setup photo.

4. SUMMARY OF TEST RESULTS

Applied Standard: FCC Part 15 Subpart C		
FCC Rules	Description of Test	Result
§15.247(b)(1)	Maximum Conducted Output Power	Compliant
§15.247(c)	Frequency Separation And 20 dB Bandwidth	Compliant
§15.247(a)(1)(ii)	Number Of Hopping Frequency	Compliant
§15.247(a)(1)(iii)	Time Of Occupancy (Dwell Time)	Compliant
§15.209, §15.205	Conducted Spurious Emissions and Band Edges Test	Compliant
§15.209, §15.247(d)	Radiated and Conducted Spurious Emissions	Compliant
§15.205	Emissions at Restricted Band	Compliant
§15.207(a)	Conducted Emissions	Compliant
§15.203	Antenna Requirements	Compliant
§15.247(i)§2.1093	RF Exposure	Compliant

5. SUMMARY OF TEST EQUIPMENT

Item	Equipment	Manufacturer	Model No.	Serial No.	Last Cal.	Next Cal.
1	Power Sensor	R&S	NRV-Z51	100458	2016-06-18	2017-06-17
2	Power Sensor	R&S	NRV-Z32	10057	2016-06-18	2017-06-17
3	Power Meter	R&S	NRVS	100444	2016-06-18	2017-06-17
4	DC Filter	MPE	23872C	N/A	2016-06-18	2017-06-17
5	RF Cable	Harbour Industries	1452	N/A	2016-06-18	2017-06-17
6	SMA Connector	Harbour Industries	9625	N/A	2016-06-18	2017-06-17
7	Spectrum Analyzer	Agilent	N9020A	MY50510140	2016-10-27	2017-10-26
8	Signal analyzer	Agilent	E4448A(External mixers to 40GHz)	US44300469	2016-06-16	2017-06-15
9	RF Cable	Hubersuhne	Sucoflex104	FP2RX2	2016-06-18	2017-06-17
10	3m Semi Anechoic Chamber	SIDT FRANKONIA	SAC-3M	03CH03-HY	2016-06-18	2017-06-17
11	Amplifier	SCHAFFNER	COA9231A	18667	2016-06-18	2017-06-17
12	Amplifier	Agilent	8449B	3008A02120	2016-06-16	2017-06-15
13	Amplifier	MITEQ	AMF-6F-260400	9121372	2016-06-16	2017-06-15
14	Loop Antenna	R&S	HFH2-Z2	860004/001	2016-06-18	2017-06-17
15	By-log Antenna	SCHWARZBECK	VULB9163	9163-470	2016-06-10	2017-06-09
16	Horn Antenna	EMCO	3115	6741	2016-06-10	2017-06-09
17	Horn Antenna	SCHWARZBECK	BBHA9170	BBHA9170154	2016-06-10	2017-06-09
18	RF Cable-R03m	Jye Bao	RG142	CB021	2016-06-18	2017-06-17
19	RF Cable-HIGH	SUHNER	SUCOFLEX 106	03CH03-HY	2016-06-18	2017-06-17
20	EMI Test Receiver	ROHDE & SCHWARZ	ESCI	101142	2016-06-18	2017-06-17
21	Artificial Mains	ROHDE & SCHWARZ	ENV216	101288	2016-06-18	2017-06-17
22	EMI Test Software	AUDIX	E3	N/A	2016-06-18	2017-06-17

6. ANTENNA PORT MEASUREMENT

6.1 Peak Power

6.1.1 Block Diagram of Test Setup

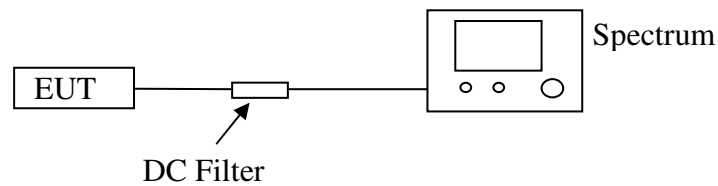

6.1.2 Limit

According to §15.247(b)(1), For frequency hopping systems operating in the 2400–2483.5 MHz band employing at least 75 non-overlapping hopping channels, and all frequency hopping systems in the 5725–5850 MHz band: 1 watt. For all other frequency hopping systems in the 2400–2483.5 MHz band: 0.125 watts.

6.1.3 Test Procedure

Use the following spectrum analyzer settings:

Span = approximately 5 times the 20 dB bandwidth, centered on a hopping channel

RBW > the 20 dB bandwidth of the emission being measured

VBW \geq RBW

Sweep = auto

Detector function = peak

Trace = max hold

Allow the trace to stabilize. Use the marker-to-peak function to set the marker to the peak of the emission. The indicated level is the peak output power

6.1.4 Test Results

Channel	Frequency (MHz)	Peak Output Power (dBm)	Peak Output Power (mw)	Limit (mW)	Result
GFSK	2402	-2.363	0.5804	1000	Pass
	2441	-1.931	0.6411	1000	Pass
	2480	-1.963	0.6364	1000	Pass
$\pi/4$ -DQPSK	2402	-3.318	0.4658	125	Pass
	2441	-2.052	0.6234	125	Pass
	2480	-0.936	0.8061	125	Pass

Test plot of Peak Output Power

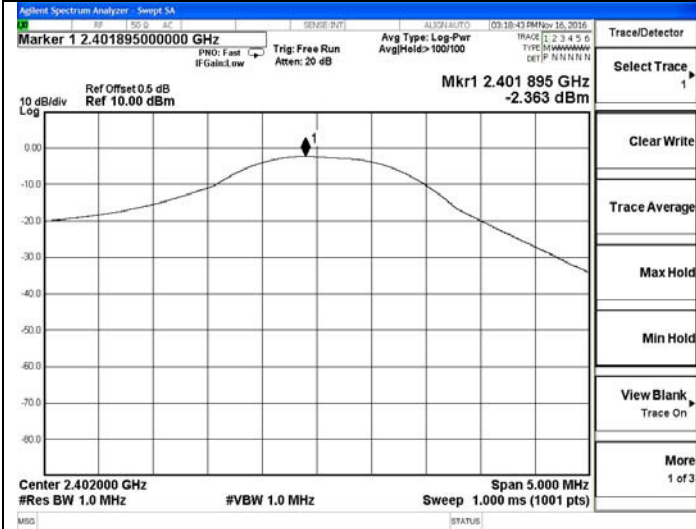

DH1-Low channel

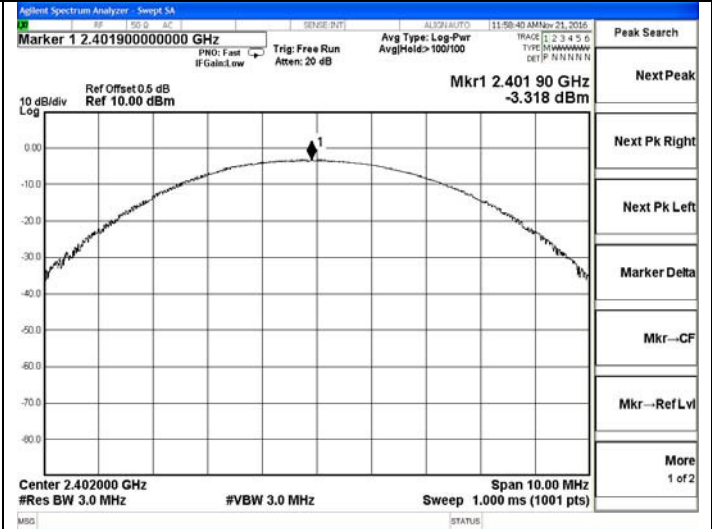

2DH1-Low channel

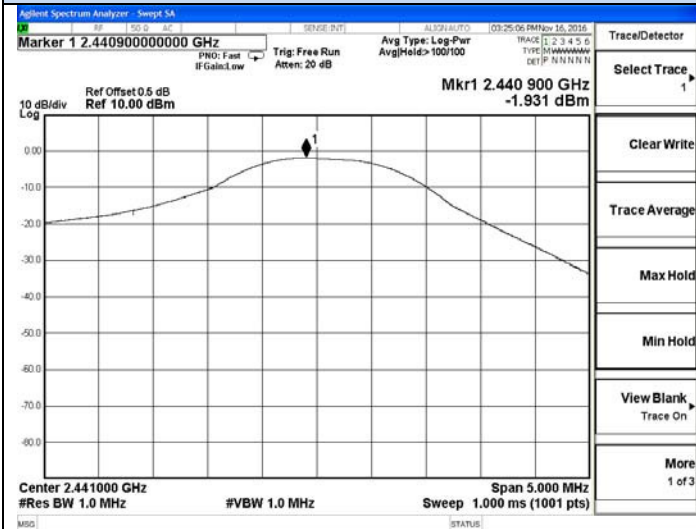

DH1-Middle channel

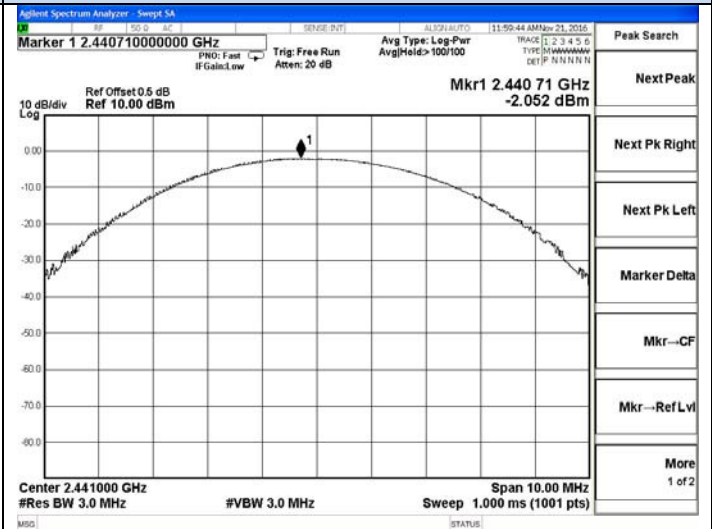

2DH1-Middle channel

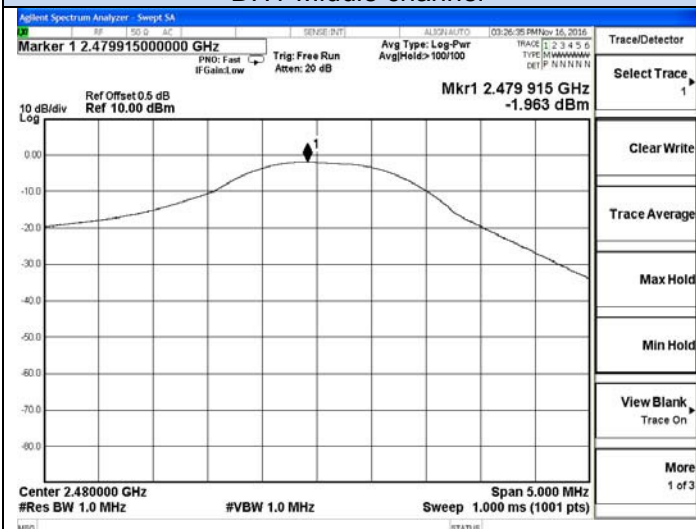

DH1-High channel

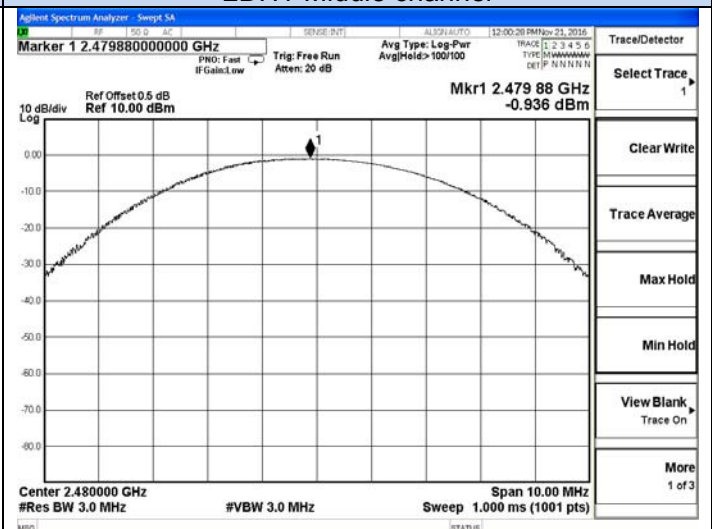

2DH1-High channel

6.2 Frequency Separation And 20 dB Bandwidth

6.2.1 Limit

According to §15.247(c) or A8.1(a), in any 100 kHz bandwidth outside the frequency bands in which the spread spectrum intentional radiator is operating, the radio frequency power that is produced by the intentional radiator shall be at least 20dB below that in the 100kHz bandwidth within the band that contains the highest level of the desired power. In addition, radiated emissions which fall in the restricted bands, as defined in §15.205(a), must also comply with the radiated emission limits specified in 15.209(a).

6.2.2 Block Diagram of Test Setup

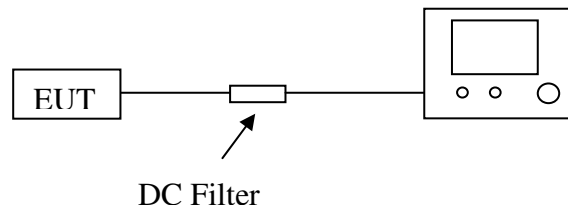

6.2.3 Test Procedure

Frequency separation test procedure :

- 1). Place the EUT on the table and set it in transmitting mode.
- 2). Remove the antenna from the EUT and then connect a low loss RF cable from the antenna port to the Spectrum Analyzer.
- 3). Set center frequency of Spectrum Analyzer = middle of hopping channel.
- 4). Set the Spectrum Analyzer as RBW = 100kHz, VBW = 300kHz, Span = wide enough to capture the peaks of two adjacent channels, Sweep = auto.
- 5). Max hold, mark 2 peaks of hopping channel and record the 2 peaks frequency.

20dB bandwidth test procedure :

- 1). Span = approximately 2 to 3 times the 20 dB bandwidth, centered on a hopping channel.
- 2). RBW \geq 1% of the 20 dB bandwidth, VBW \geq RBW.
- 3). Detector function = peak.
- 4). Trace = max hold.

6.2.4 Test Results

The Measurement Result With 1Mbps For GFSK Modulation				
Channel	20dB Bandwidth (KHz)	Channel Separation (MHz)	Limit (MHz)	Result
Low	887.00	1.000	≥ 25 KHz or 20 dB BW	Pass
Middle	888.40		≥ 25 KHz or 20 dB BW	Pass
High	886.10		≥ 25 KHz or 20 dB BW	Pass
The Measurement Result With 2Mbps For $\pi/4$ -DQPSK Modulation				
Channel	20dB Bandwidth (MHz)	Channel Separation (MHz)	Limit (MHz)	Result
Low	1.262	1.000	≥ 25 KHz or 2/3 20 dB BW	Pass
Middle	1.257		≥ 25 KHz or 2/3 20 dB BW	Pass
High	1.260		≥ 25 KHz or 2/3 20 dB BW	Pass

Note: The test data refer to the following page.

Test Plot of Test Result

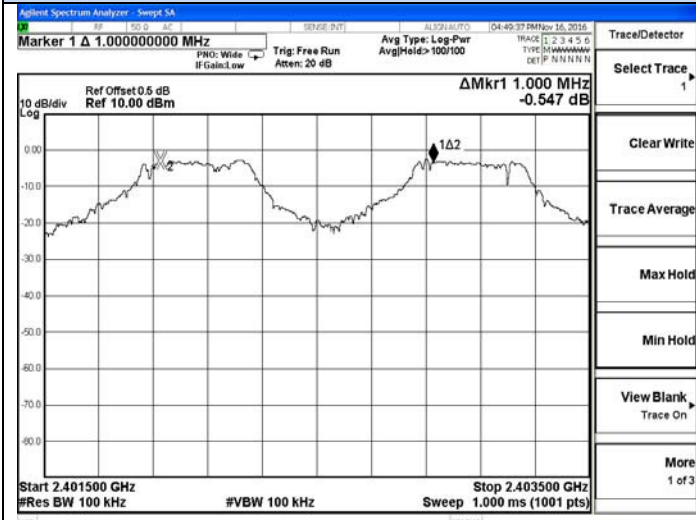

Frequency Separation GFSK-Low channel

20dB Bandwidth GFSK-Low channel

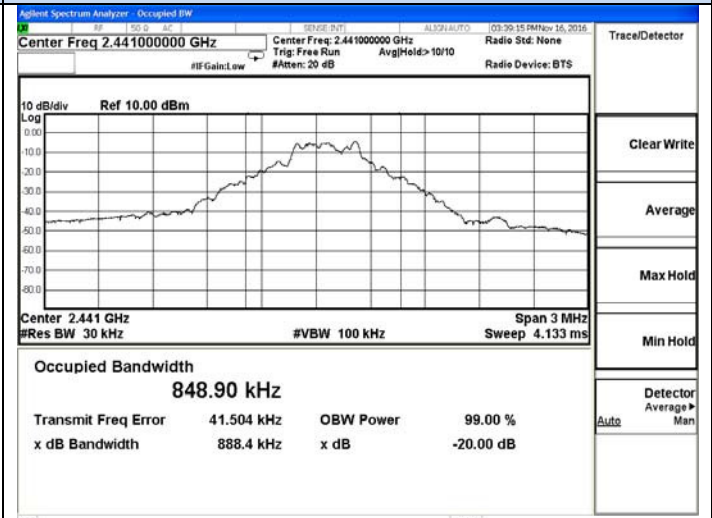
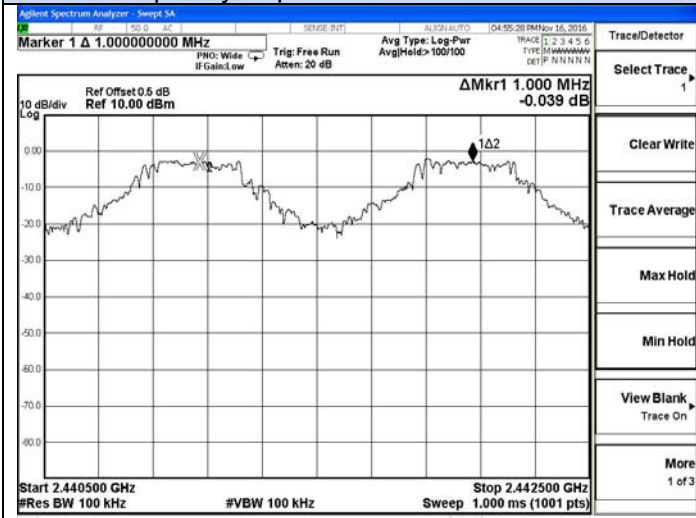

Frequency Separation GFSK-Middle channel

20dB Bandwidth GFSK-Middle channel

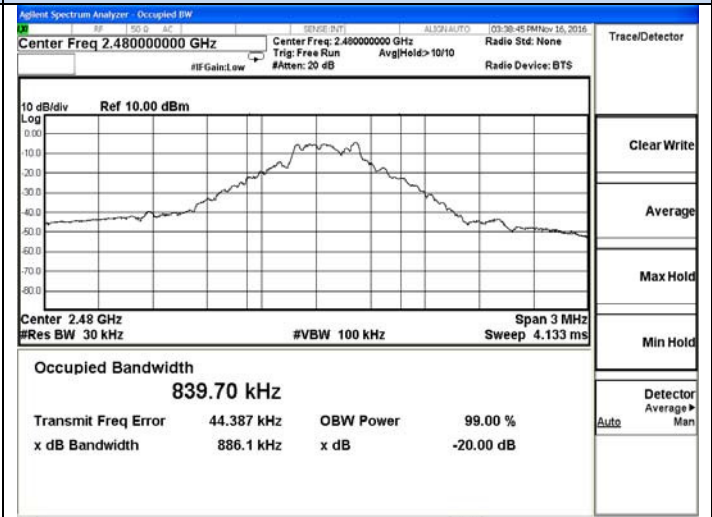
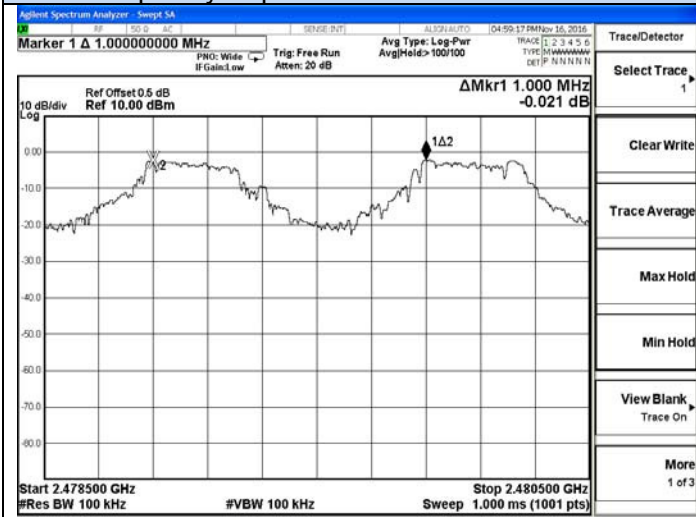

Frequency Separation GFSK-High channel

20dB Bandwidth GFSK-High channel

Test Plot of Test Result

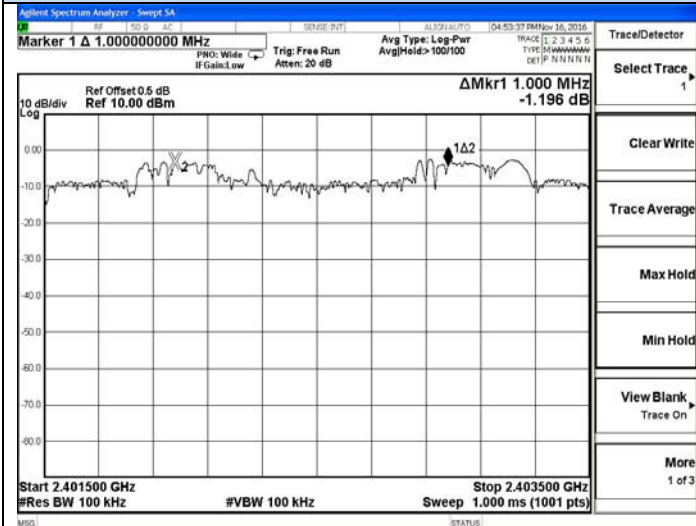

Frequency Separation $\pi/4$ -DQPSK-Low channel

20dB Bandwidth $\pi/4$ -DQPSK-Low channel

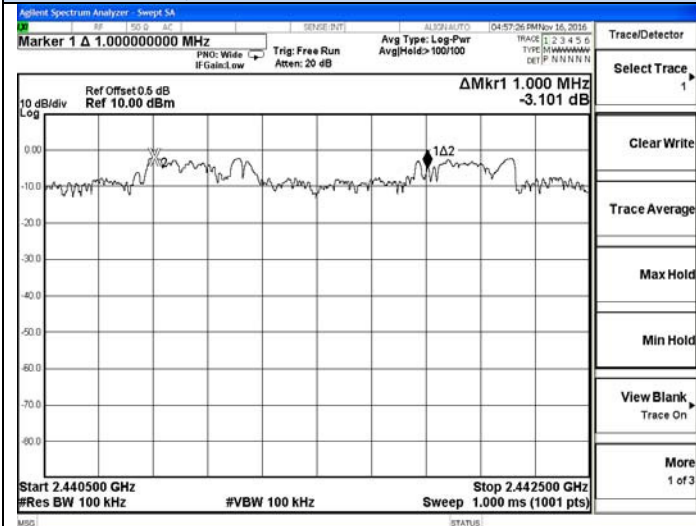

Frequency Separation $\pi/4$ -DQPSK-Middle channel

20dB Bandwidth $\pi/4$ -DQPSK-Middle channel

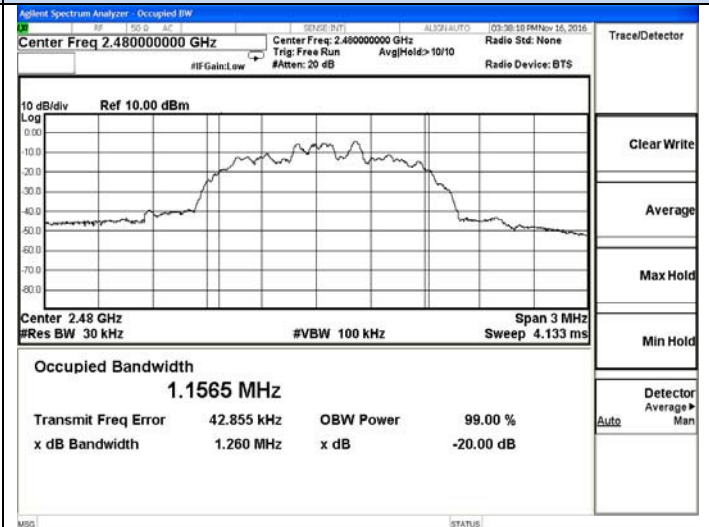
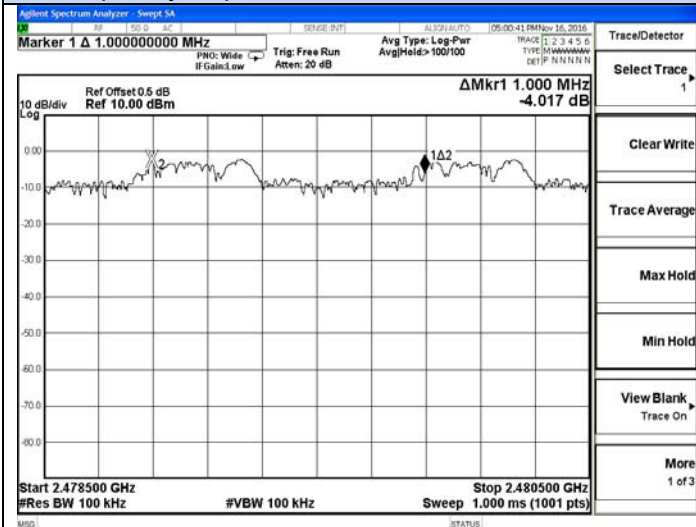

Frequency Separation $\pi/4$ -DQPSK-High channel

20dB Bandwidth $\pi/4$ -DQPSK-High channel

6.3 Number Of Hopping Frequency

6.3.1 Limit

According to §15.247(a)(1)(ii) or A8.1 (d), Frequency hopping systems operating in the band 2400-2483.5 MHz shall use at least 15 hopping channels.

6.3.2 Block Diagram of Test Setup

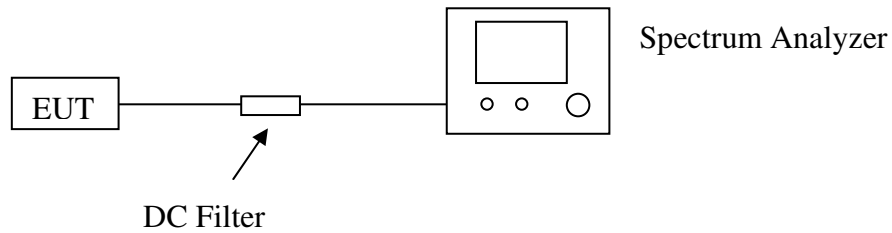

6.3.3 Test Procedure

- 1). Place the EUT on the table and set it in transmitting mode.
- 2). Remove the antenna from the EUT and then connect a low loss RF cable from the antenna port to the Spectrum Analyzer.
- 3). Set Spectrum Analyzer Start=2400MHz, Stop = 2483.5MHz, Sweep = auto.
- 4). Set the Spectrum Analyzer as RBW, VBW=1MHz.
- 5). Max hold, view and count how many channel in the band.

6.3.4 Test Results

The Measurement Result With The Worst Case of 1Mbps For GFSK Modulation			
Total No. of Hopping Channel	Measurement Result (No. of Ch)	Limit (MHz)	Result
	79	≥15	Pass

Note: The test data refer to the following page.

Test plot of Number Of Hopping Frequency

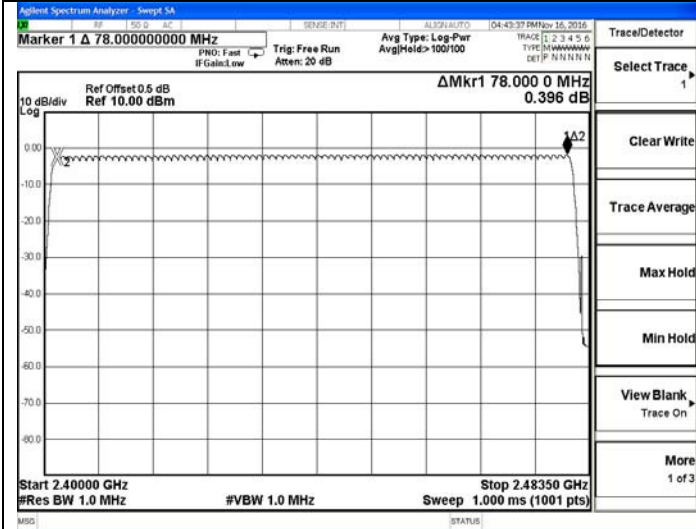

6.4 Time Of Occupancy (Dwell Time)

6.4.1 Limit

According to §15.247(a)(1)(iii) or A8.1 (d), Frequency hopping systems operating in the 2400MHz-2483.5 MHz bands. The average time of occupancy on any channels shall not greater than 0.4 s within a period 0.4 s multiplied by the number of hopping channels employed.

6.4.2 Block Diagram of Test Setup

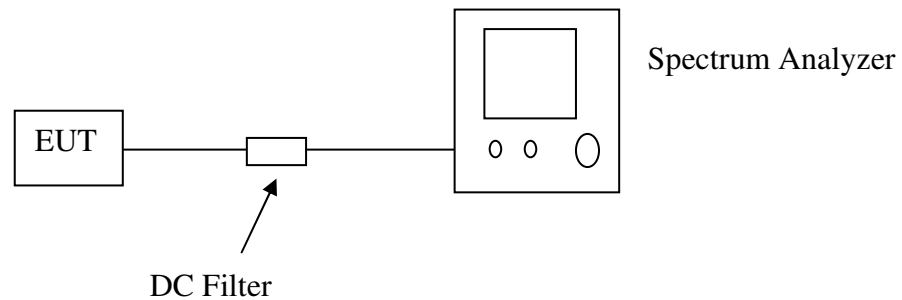

6.4.3 Test Procedure

- 1). Place the EUT on the table and set it in transmitting mode.
- 2). Remove the antenna from the EUT and then connect a low loss RF cable from the antenna port to the Spectrum Analyzer.
- 3). Set center frequency of Spectrum Analyzer = operating frequency.
- 4). Set the Spectrum Analyzer as RBW, VBW=1MHz, Span = 0Hz, Sweep = auto.
- 5). Repeat above procedures until all frequency measured were complete.

6.4.4 Test Results

The Measurement Result				
Test Mode	Time of Pulse (ms)	Number of Pulse in 31.6s Period Time	Dwell Time (ms)	Limit (ms)
DH1-2441MHz	0.370	307	113.590	400
DH3-2441MHz	1.632	163	266.016	400
DH5-2441MHz	2.880	118	339.840	400
2DH1-2441MHz	0.380	302	114.760	400
2DH3-2441MHz	1.624	160	259.840	400
2DH5-2441MHz	2.850	120	342.000	400

Note:

Dwell time= Time of Pulse * Numbers of Pulse in 31.6s Period Time

Test plot of Dwell time

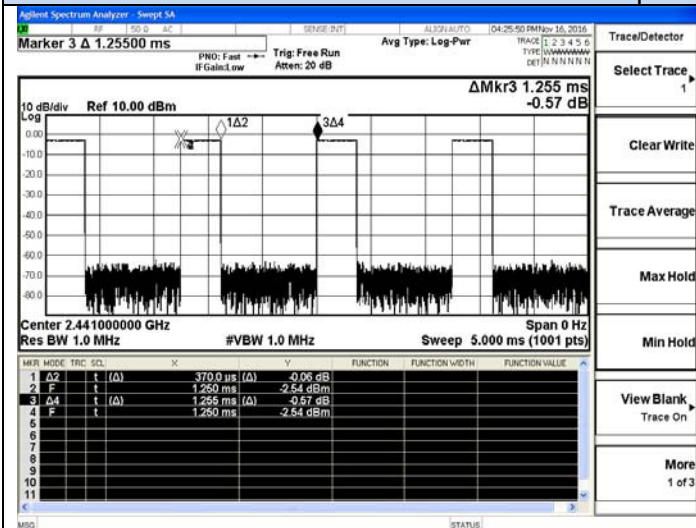

DH1-2441MHz

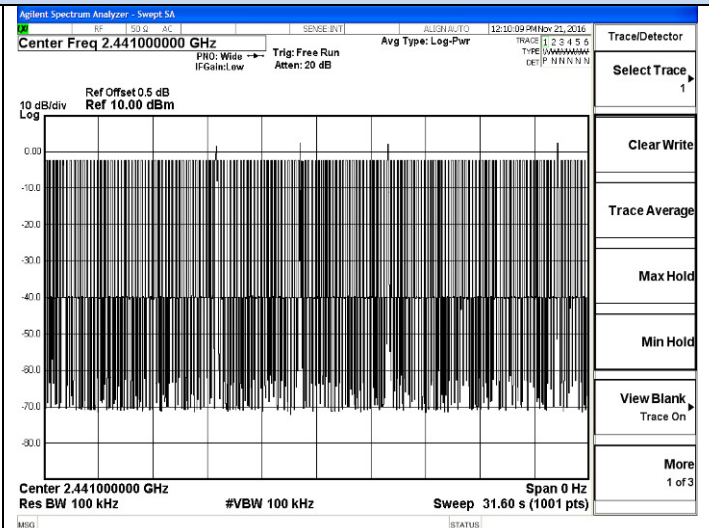

Number of Pulse in 31.6s Period Time

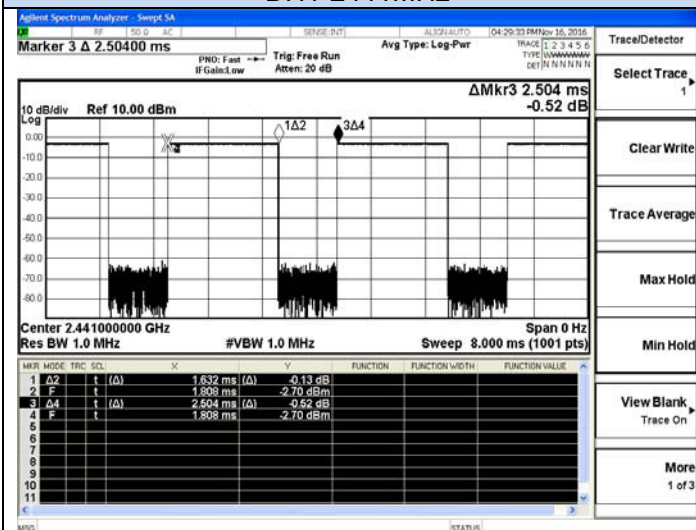

DH3-2441MHz

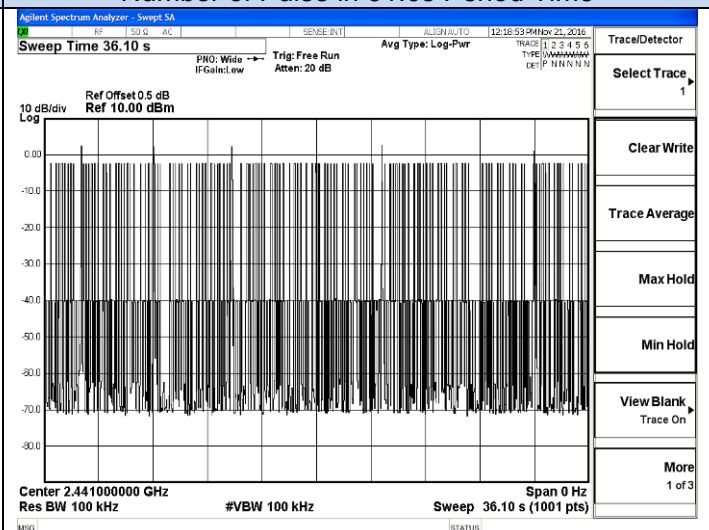

Number of Pulse in 31.6s Period Time

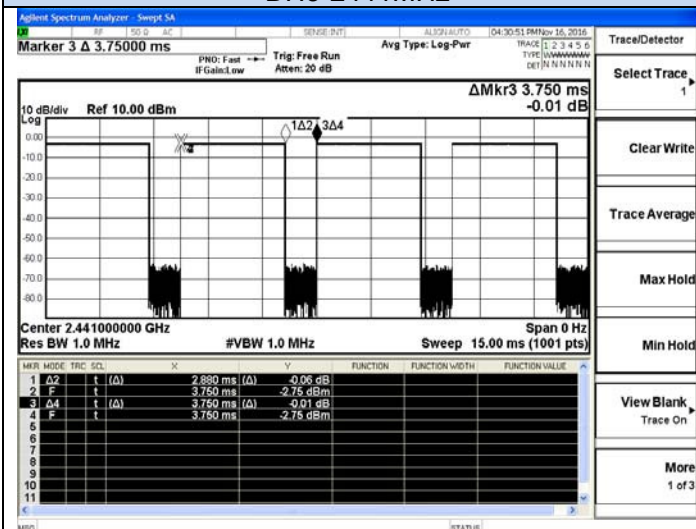

DH5-2441MHz

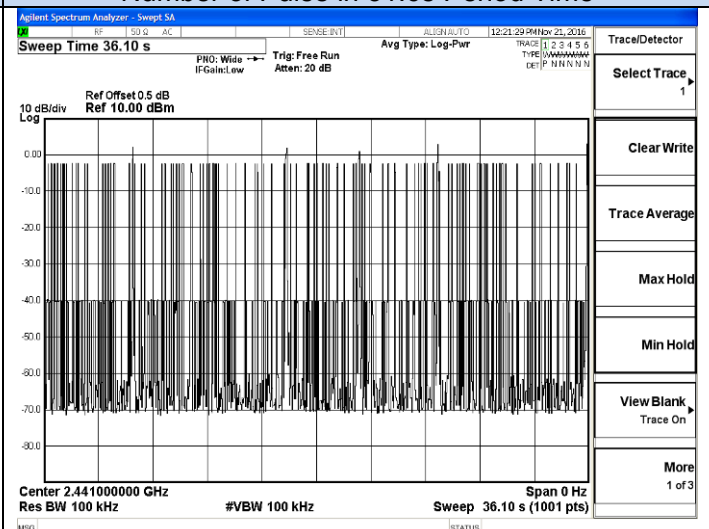

Number of Pulse in 31.6s Period Time

Test plot of Dwell time

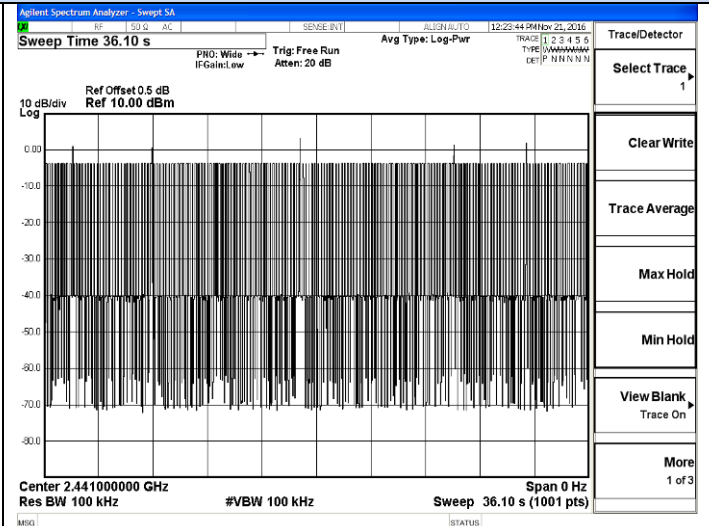
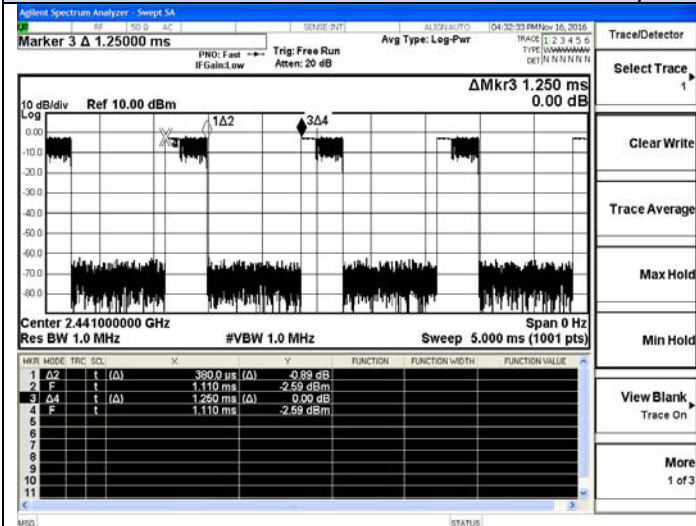

2DH1-2441MHz

Number of Pulse in 31.6s Period Time

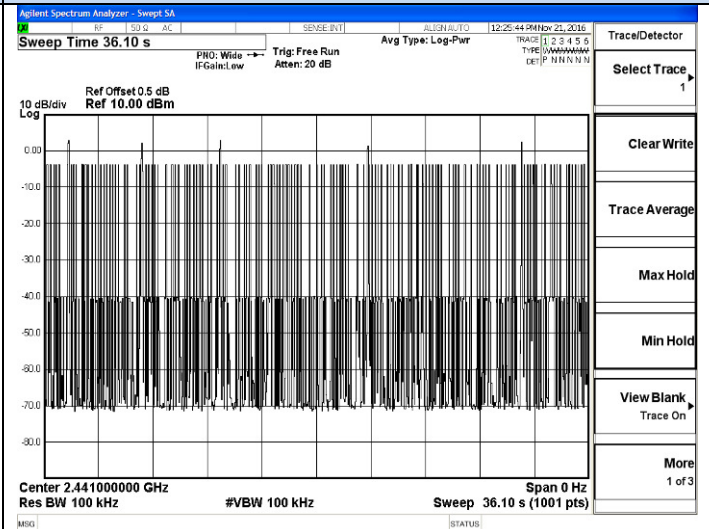
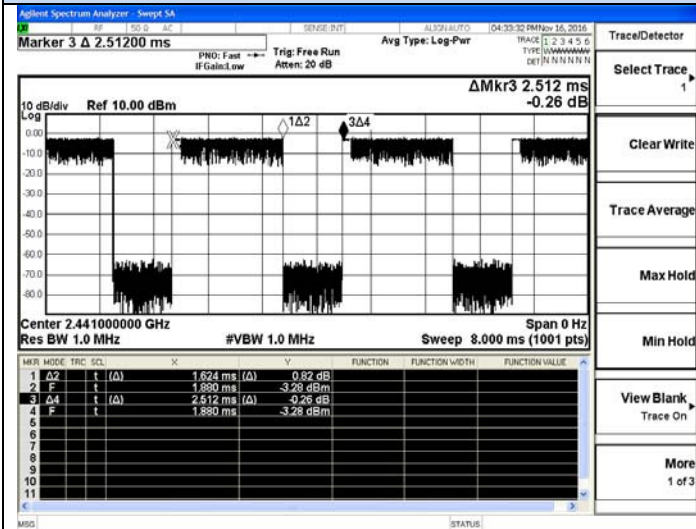

2DH3-2441MHz

Number of Pulse in 31.6s Period Time

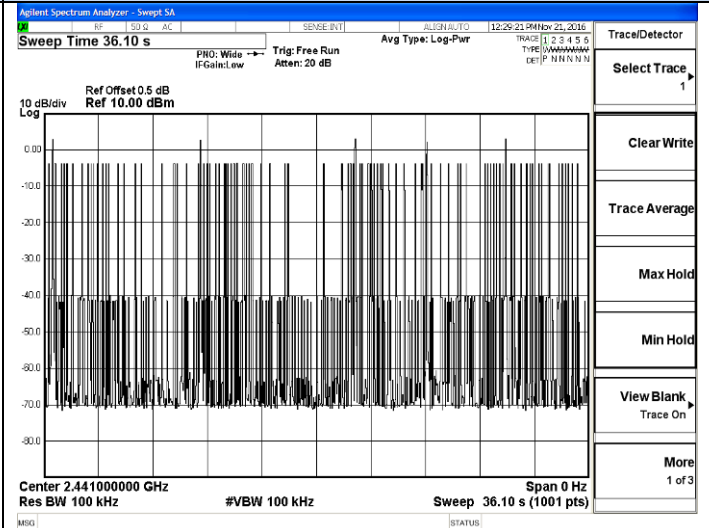
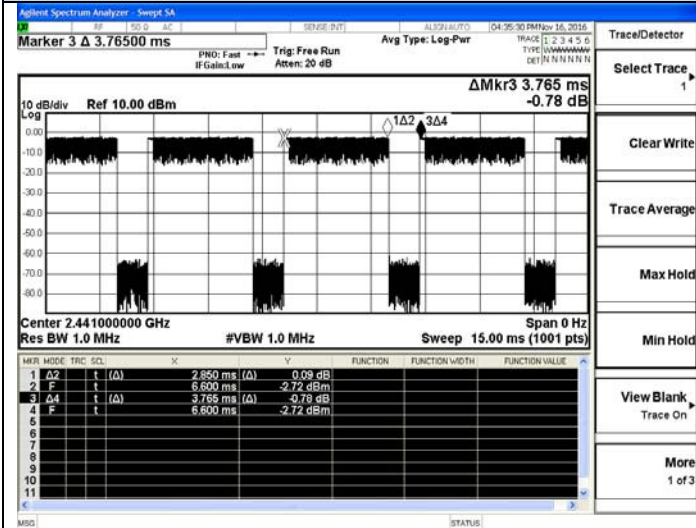

2DH5-2441MHz

Number of Pulse in 31.6s Period Time

6.5 Conducted Spurious Emissions and Band Edges Test

6.5.1 Limit

In any 100 kHz bandwidth outside the frequency band in which the spread spectrum or digitally modulated intentional radiator is operating, the radio frequency power that is produced by the intentional radiator shall be at least 20 dB below that in the 100 kHz bandwidth within the band that contains the highest level of the desired power, based on either an RF conducted or a radiated measurement. Attenuation below the general limits specified in Section 15.209(a) is not required.

6.5.2 Block Diagram of Test Setup

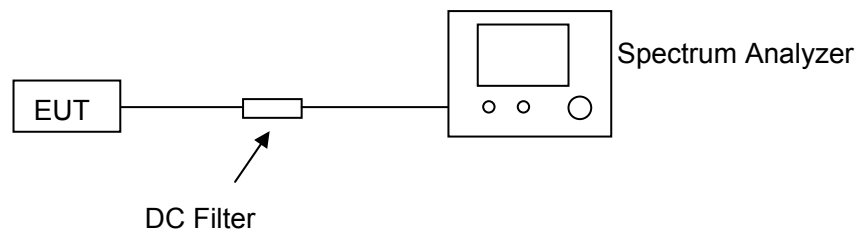

6.5.3 Test Procedure

Conducted RF measurements of the transmitter output were made to confirm that the EUT antenna port conducted emissions meet the specified limit and to identify any spurious signals that require further investigation or measurements on the radiated emissions site.

The transmitter output is connected to the spectrum analyzer. The resolution bandwidth is set to 100 KHz. The video bandwidth is set to 300 KHz.

Measurements are made over the 9kHz to 26.5GHz range with the transmitter set to the lowest, middle, and highest channels

6.5.4 Test Results of Conducted Spurious Emissions

No non-compliance noted. Only record the worst test result in this report. The test data refer to the following page.

Test plot of Conducted Emission(9kHz~ 26.5GHz)

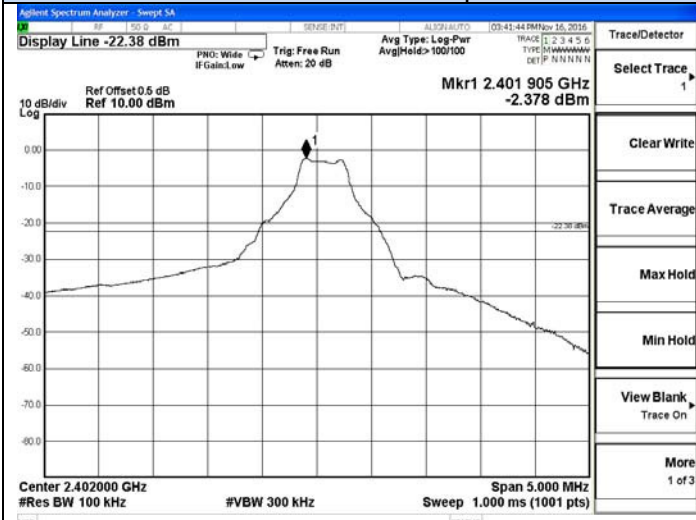

Reference of DH1-Low channel

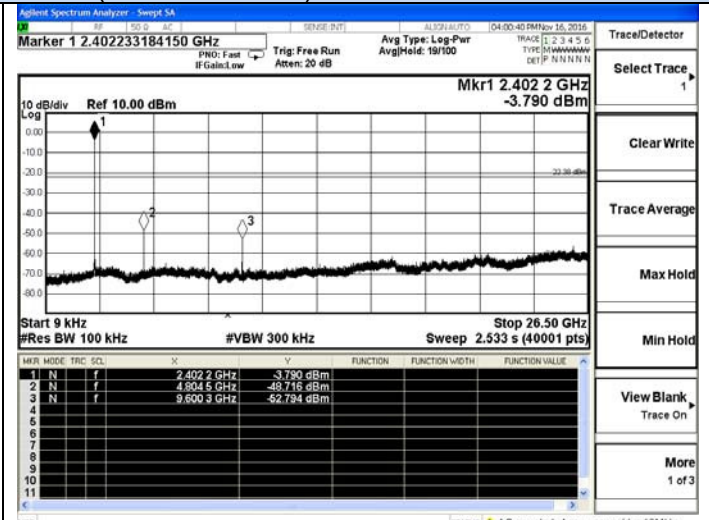

DH1-Low channel

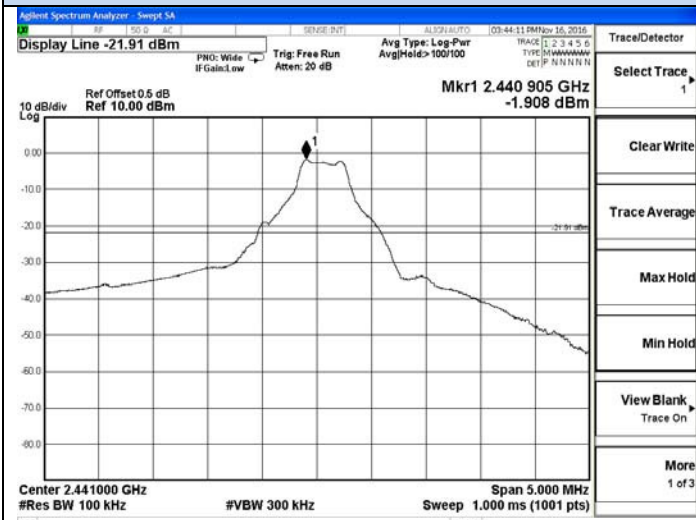

Reference of DH1-Middle channel

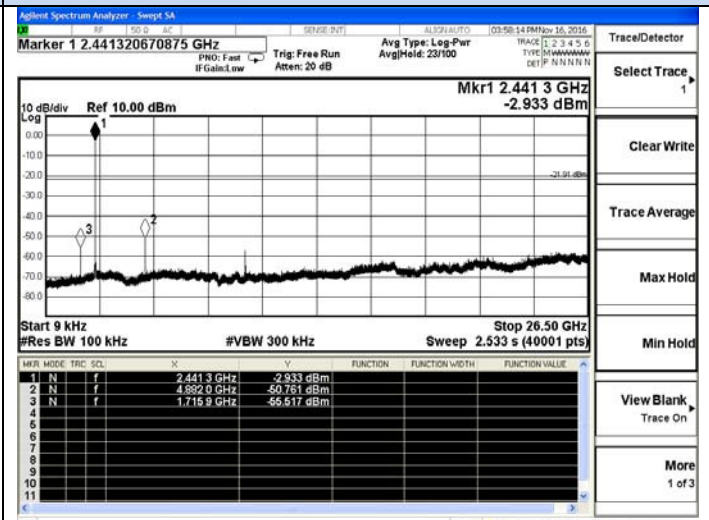

DH1-Middle channel

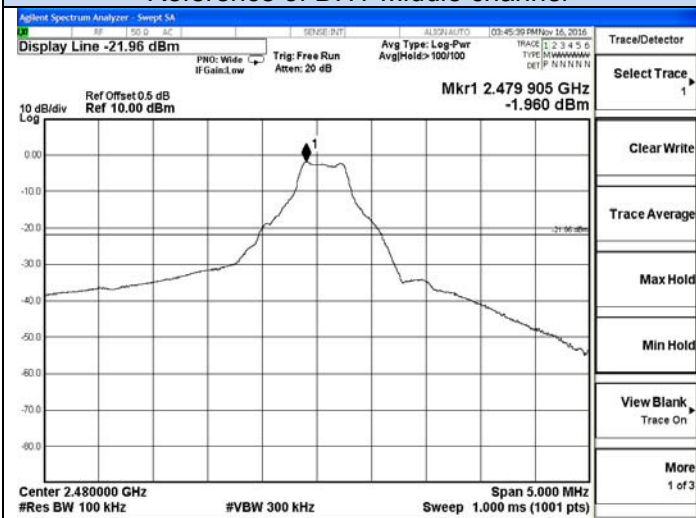

Reference of DH1-High channel

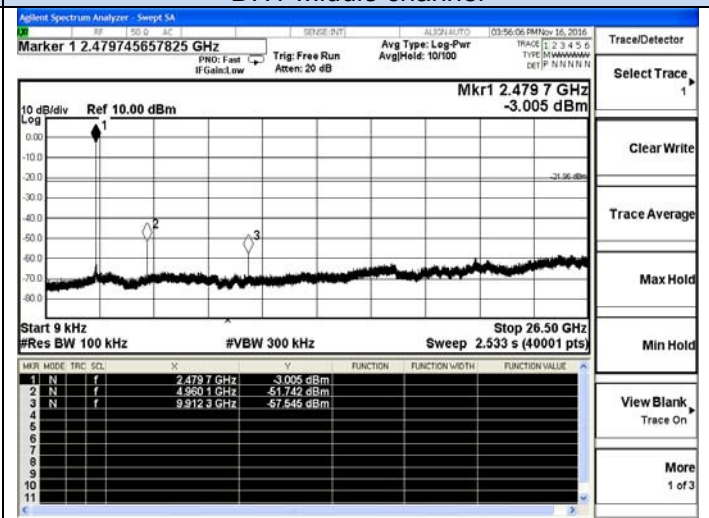

DH1-High channel

Test plot of Conducted Emission(9kHz~ 26.5GHz)

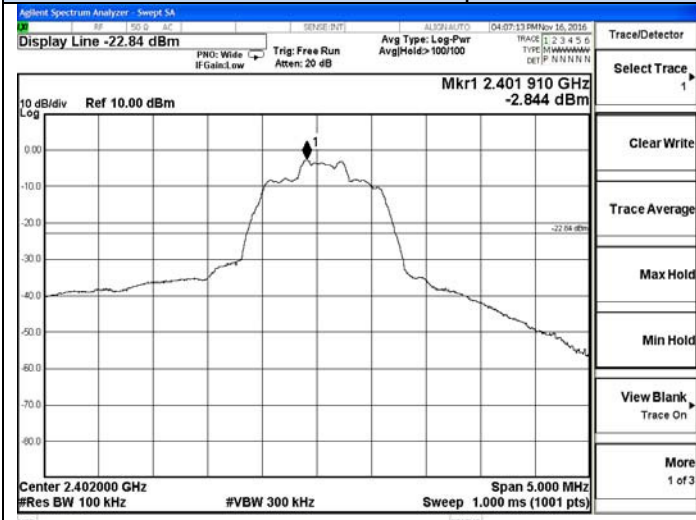

Reference of 2DH1-Low channel

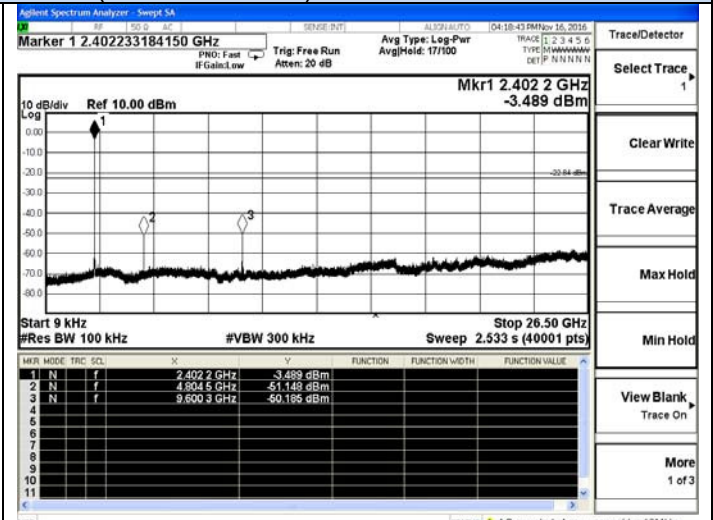

2DH1-Low channel

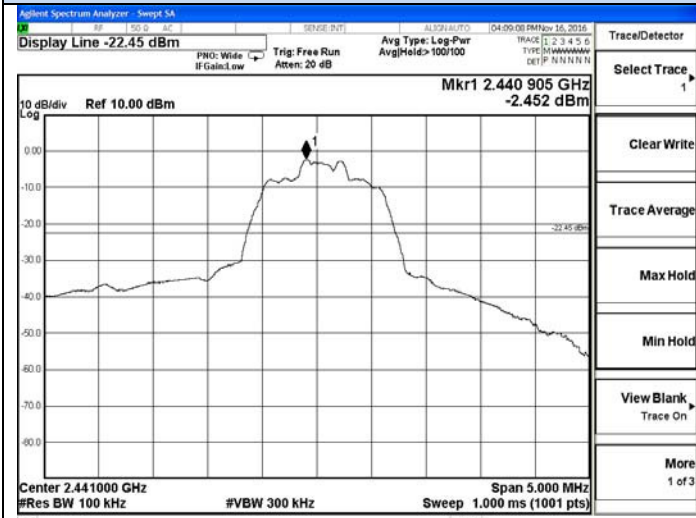

Reference of 2DH1-Middle channel

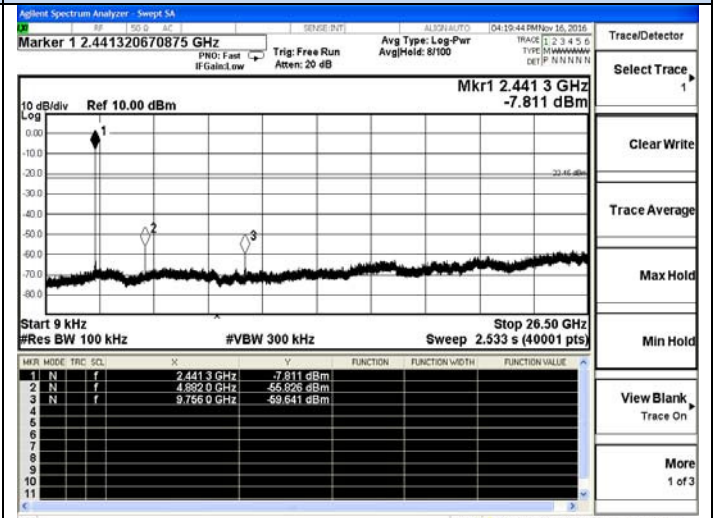

2DH1-Middle channel

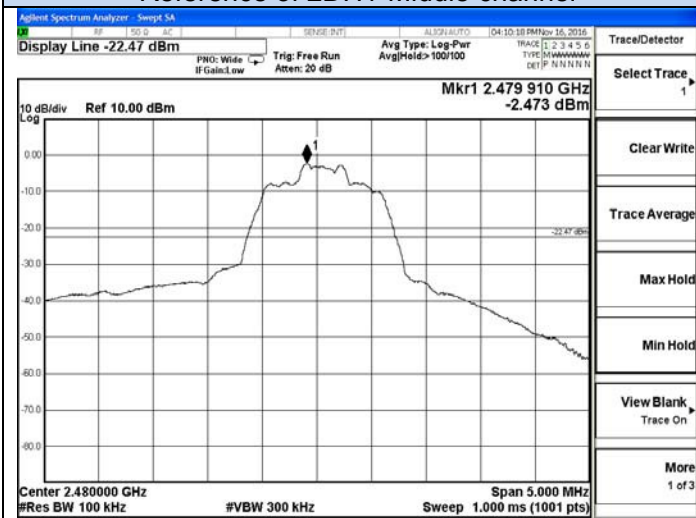

Reference of 2DH1-High channel

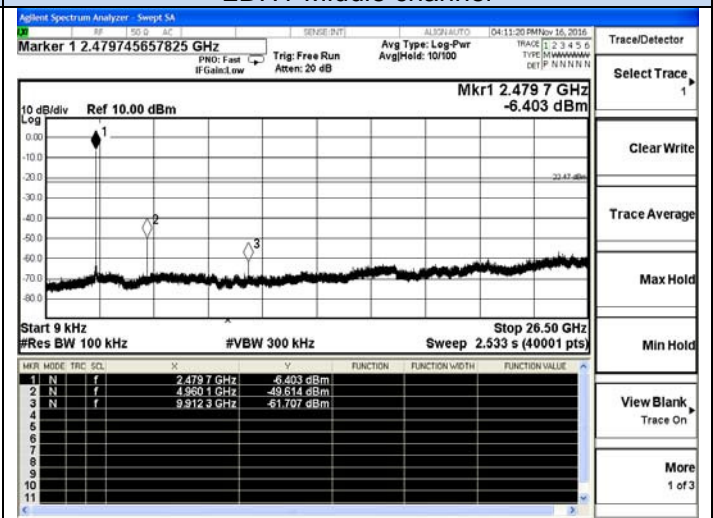

2DH1-High channel

6.5.5 Test Results of Band Edges Test

Test plot of Band Edges

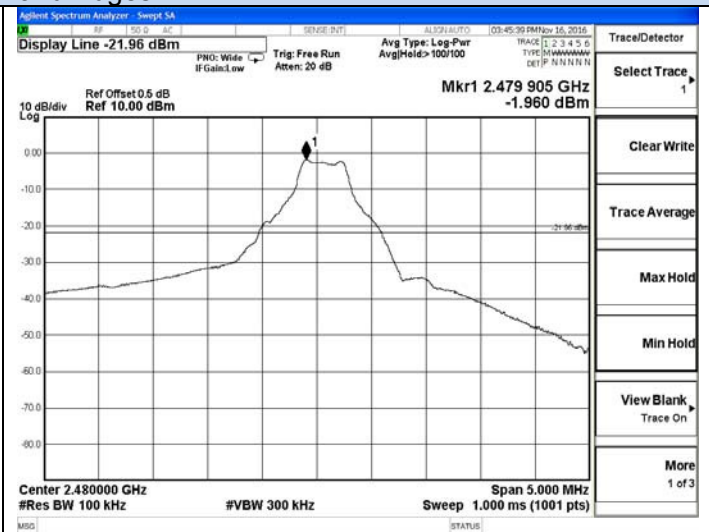
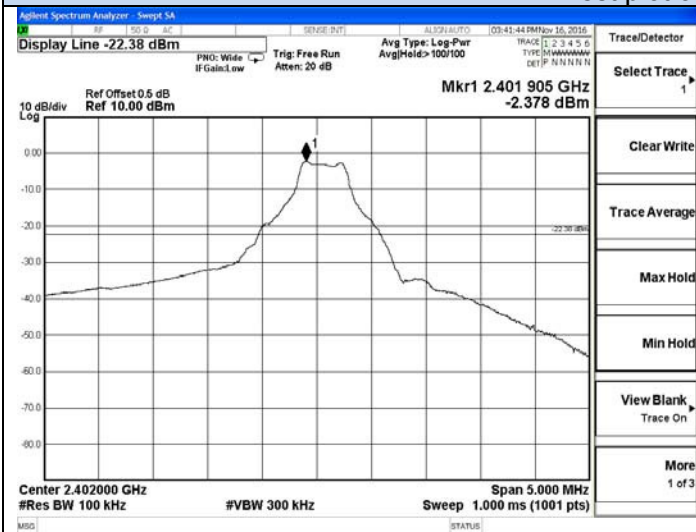

Reference of GFSK-Low channel

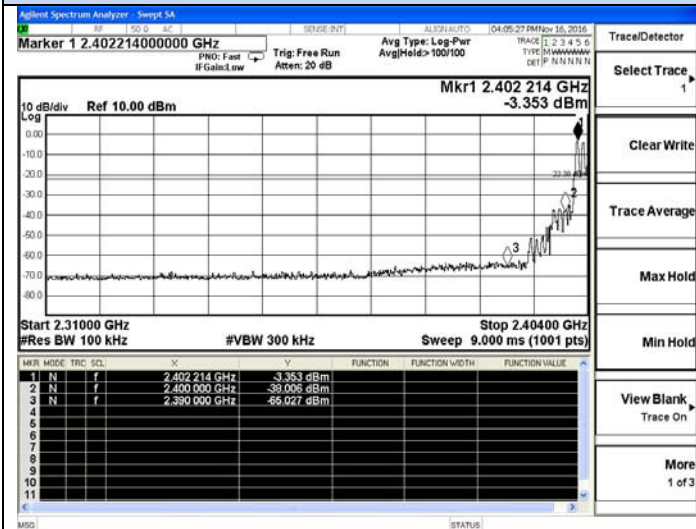

Reference of GFSK-High channel

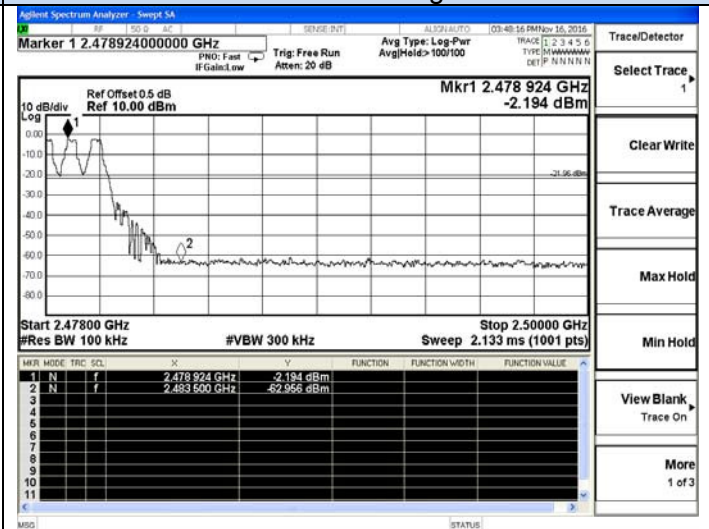

Hopping On-GFSK-Low channel

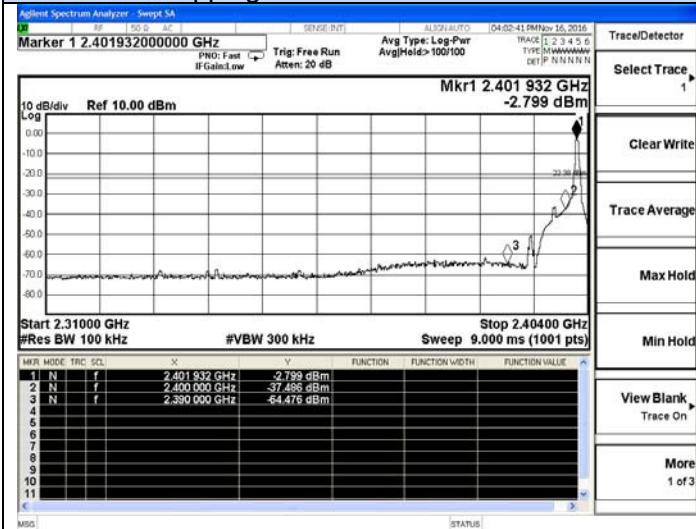

Hopping On-GFSK-High channel

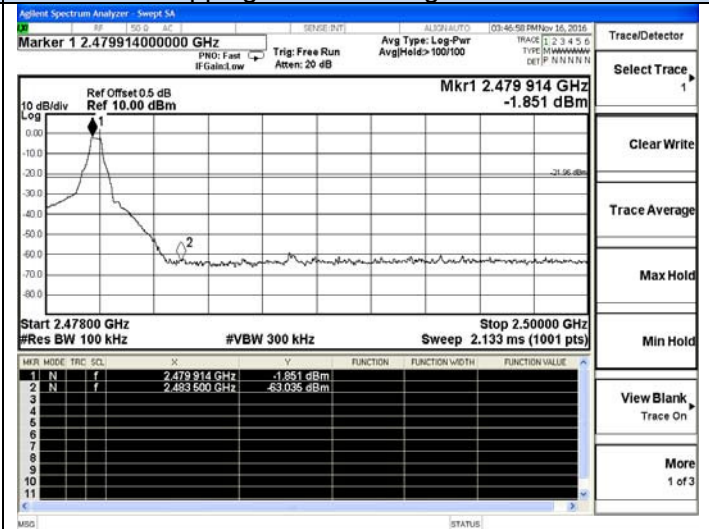

Hopping Off-GFSK-Low channel

Hopping Off-GFSK-High channel

Test plot of Band Edges

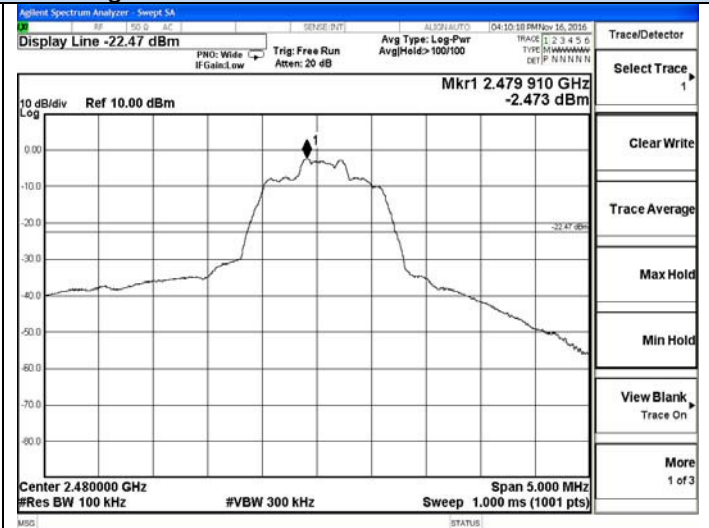
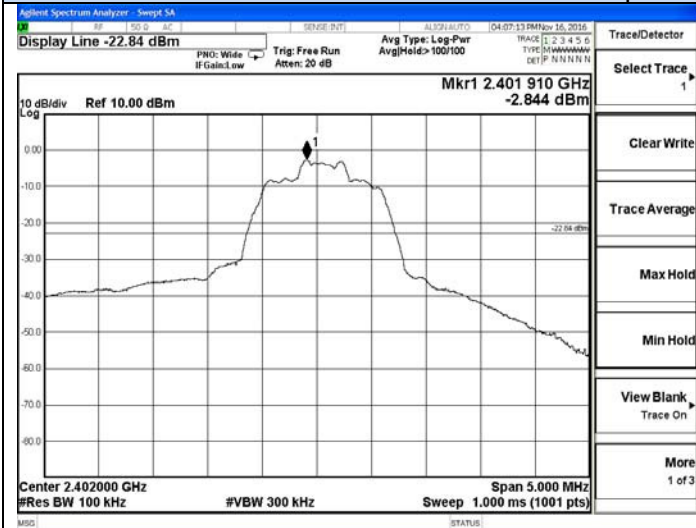

Reference of $\pi/4$ -DQPSK-Low channel

Reference of $\pi/4$ -DQPSK-High channel

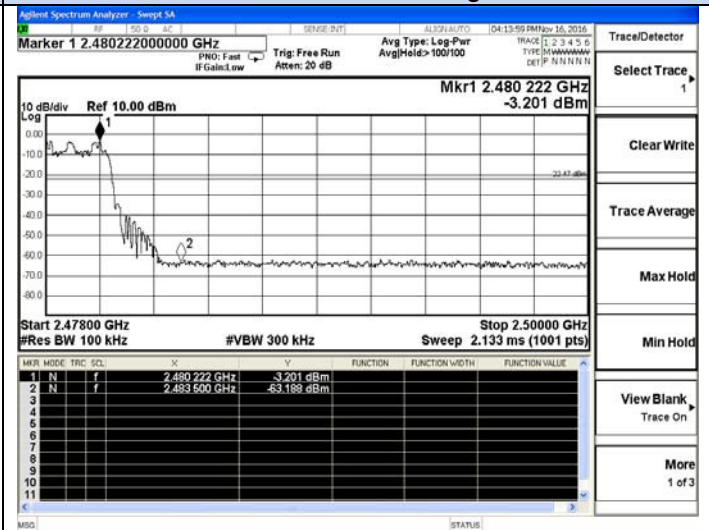
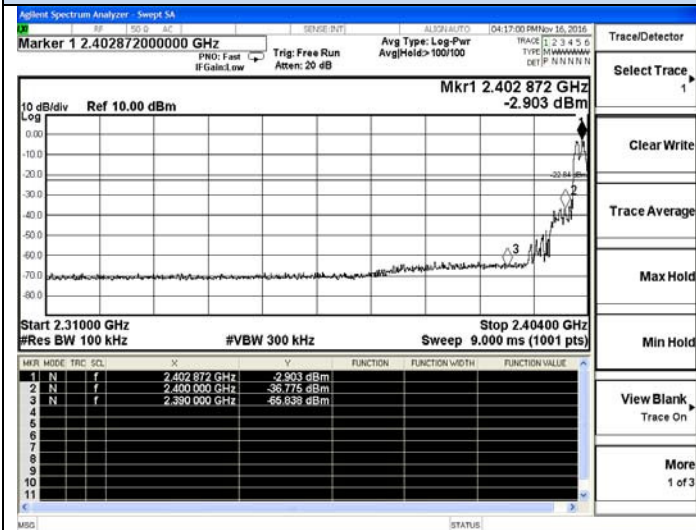

Hopping On- $\pi/4$ -DQPSK-Low channel

Hopping On- $\pi/4$ -DQPSK-High channel

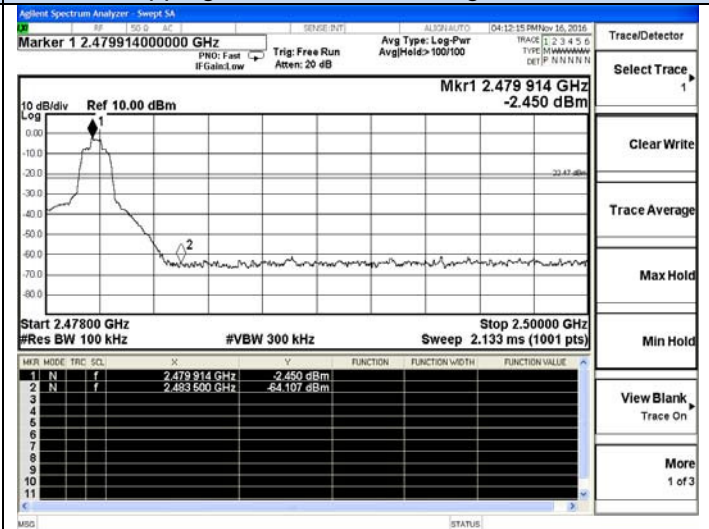
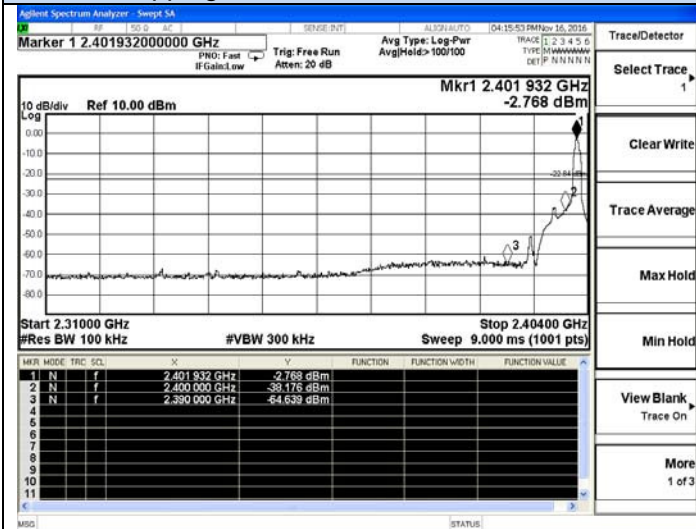

Hopping Off- $\pi/4$ -DQPSK-Low channel

Hopping Off- $\pi/4$ -DQPSK-High channel

7. Radiated Measurement

7.1 Block Diagram of Test Setup

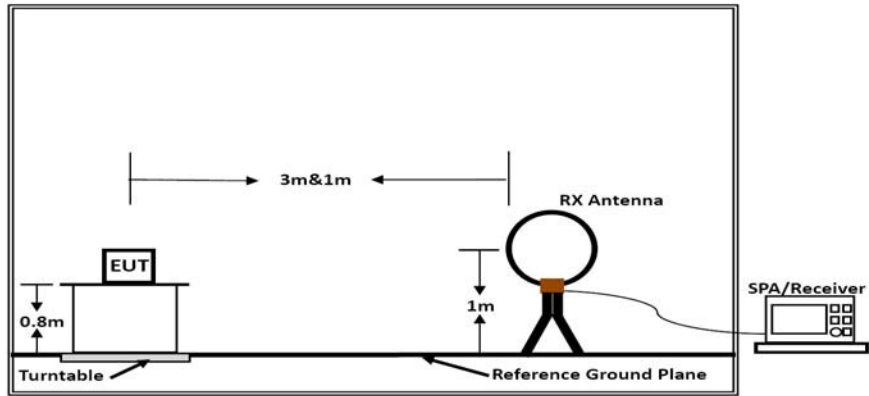

Below 30MHz

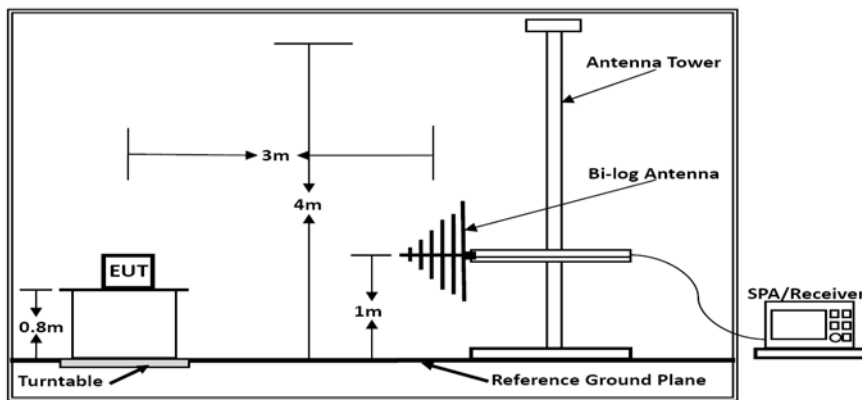

Below 1GHz

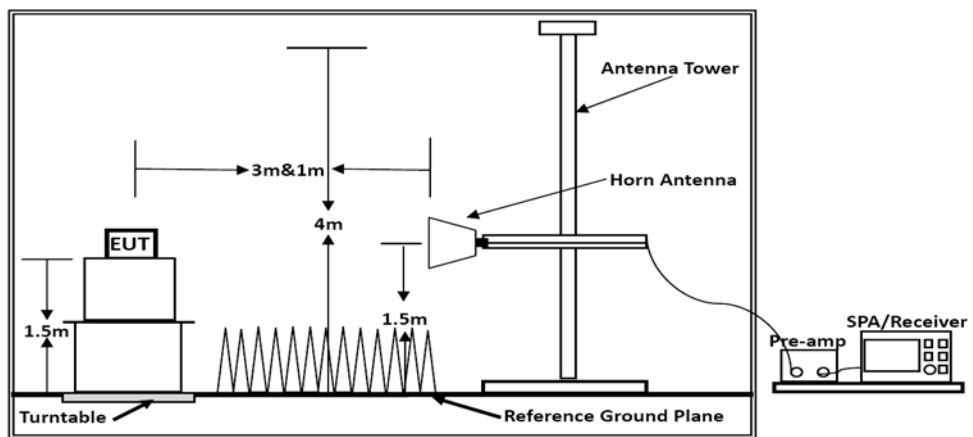

Above 1GHz

7.2 Restricted Band Emission Limit

15.205 (a) Except as shown in paragraph (d) of this section, only spurious emissions are permitted in any of the frequency bands listed below:

MHz	MHz	MHz	GHz
0.090-0.110	16.42-16.423	399.9-410	4.5-5.15
\1\ 0.495-0.505	16.69475-16.69525	608-614	5.35-5.46
2.1735-2.1905	16.80425-16.80475	960-1240	7.25-7.75
4.125-4.128	25.5-25.67	1300-1427	8.025-8.5
4.17725-4.17775	37.5-38.25	1435-1626.5	9.0-9.2
4.20725-4.20775	73-74.6	1645.5-1646.5	9.3-9.5
6.215-6.218	74.8-75.2	1660-1710	10.6-12.7
6.26775-6.26825	108-121.94	1718.8-1722.2	13.25-13.4
6.31175-6.31225	123-138	2200-2300	14.47-14.5
8.291-8.294	149.9-150.05	2310-2390	15.35-16.2
8.362-8.366	156.52475-156.52525	2483.5-2500	17.7-21.4
8.37625-8.38675	156.7-156.9	2690-2900	22.01-23.12
8.41425-8.41475	162.0125-167.17	3260-3267	23.6-24.0
12.29-12.293	167.72-173.2	3332-3339	31.2-31.8
12.51975-12.52025	240-285	3345.8-3358	36.43-36.5
12.57675-12.57725	322-335.4	3600-4400	(\2)
13.36-13.41			

\1\ Until February 1, 1999, this restricted band shall be 0.490-0.510 MHz.

\2\ Above 38.6

Part 15.205 (b) Except as provided in paragraphs (d) and (e), the field strength of emissions appearing within these frequency bands shall not exceed the limits shown in Section 15.209. At frequencies equal to or less than 1000 MHz, compliance with the limits in Section 15.209 shall be demonstrated using measurement instrumentation employing a CISPR quasi-peak detector.

Above 1000 MHz, compliance with the emission limits in Section 15.209 shall be demonstrated based on the average value of the measured emissions. The provisions in Section 15.35 apply to these measurements.

Part 15.209 (a) Except as provided elsewhere in this Subpart, the emissions from an intentional radiator shall not exceed the field strength levels specified in the following table:

Frequency (MHz)	Field strength (microvolts/meter)	Measurement distance (meters)
0.009-0.490	2400/F(kHz)	300
0.490-1.705	24000/F(kHz)	30
1.705-30.0	30	30
30-88	100**	3
88-216	150**	3
216-960	200**	3
Above 960	500	3

7.3 Instruments Setting

The following table is the setting of spectrum analyzer and receiver.

Spectrum Parameter	Setting
Attenuation	Auto
Start Frequency	1000 MHz
Stop Frequency	10th carrier harmonic
RB / VB (Emission in restricted band)	1MHz / 1MHz for Peak, 1 MHz / 20log(Dwell Time/100ms) kHz for Average
RB / VB (Emission in non-restricted band)	1MHz / 1MHz for Peak, 1 MHz / 20log(Dwell Time/100ms) kHz for Average

Receiver Parameter	Setting
Attenuation	Auto
Start ~ Stop Frequency	9kHz~150kHz / RB 200Hz for QP/AVG
Start ~ Stop Frequency	150kHz~30MHz / RB 9kHz for QP/AVG
Start ~ Stop Frequency	30MHz~1000MHz / RB 100kHz for QP

7.4 Test Procedures

1) Sequence of testing 9 kHz to 30 MHz

Setup:

- The equipment was set up to simulate a typical usage like described in the user manual or described by manufacturer.
- If the EUT is a tabletop system, a rotatable table with 0.8 m height is used.
- If the EUT is a floor standing device, it is placed on the ground.
- Auxiliary equipment and cables were positioned to simulate normal operation conditions.
- The AC power port of the EUT (if available) is connected to a power outlet below the turntable.
- The measurement distance is 3 meter.
- The EUT was set into operation.

Premeasurement:

- The turntable rotates from 0° to 315° using 45° steps.
- The antenna height is 0.8 meter.
- At each turntable position the analyzer sweeps with peak detection to find the maximum of all emissions

Final measurement:

- Identified emissions during the premeasurement the software maximizes by rotating the turntable position (0° to 360°) and by rotating the elevation axes (0° to 360°).
- The final measurement will be done in the position (turntable and elevation) causing the highest emissions with QPK detector.
- The final levels, frequency, measuring time, bandwidth, turntable position, correction factor, margin to the limit and limit will be recorded. Also a plot with the graph of the premeasurement and the limit will be stored.

2) Sequence of testing 30 MHz to 1 GHz

Setup:

- The equipment was set up to simulate a typical usage like described in the user manual or described by manufacturer.
- If the EUT is a tabletop system, a table with 0.8 m height is used, which is placed on the ground plane.
- If the EUT is a floor standing device, it is placed on the ground plane with insulation between both.
- Auxiliary equipment and cables were positioned to simulate normal operation conditions
- The AC power port of the EUT (if available) is connected to a power outlet below the turntable.
- The measurement distance is 3 meter.
- The EUT was set into operation.

Premeasurement:

- The turntable rotates from 0° to 315° using 45° steps.
- The antenna is polarized vertical and horizontal.
- The antenna height changes from 1 to 3 meter.
- At each turntable position, antenna polarization and height the analyzer sweeps three times in peak to find the maximum of all emissions.

Final measurement:

- The final measurement will be performed with minimum the six highest peaks.
- According to the maximum antenna and turntable positions of premeasurement the software maximize the peaks by changing turntable position ($\pm 45^\circ$) and antenna movement between 1 and 4 meter.
- The final measurement will be done with QP detector with an EMI receiver.
- The final levels, frequency, measuring time, bandwidth, antenna height, antenna polarization, turntable angle, correction factor, margin to the limit and limit will be recorded. Also a plot with the graph of the premeasurement with marked maximum final measurements and the limit will be stored.

3) Sequence of testing 1 GHz to 18 GHz

Setup:

- The equipment was set up to simulate a typical usage like described in the user manual or described by manufacturer.
- If the EUT is a tabletop system, a rotatable table with 1.5 m height is used.
- If the EUT is a floor standing device, it is placed on the ground plane with insulation between both.
- Auxiliary equipment and cables were positioned to simulate normal operation conditions
- The AC power port of the EUT (if available) is connected to a power outlet below the turntable.
- The measurement distance is 3 meter.
- The EUT was set into operation.

Premeasurement:

- The turntable rotates from 0° to 315° using 45° steps.
- The antenna is polarized vertical and horizontal.
- The antenna height scan range is 1 meter to 2.5 meter.
- At each turntable position and antenna polarization the analyzer sweeps with peak detection to find the maximum of all emissions.

Final measurement:

- The final measurement will be performed with minimum the six highest peaks.
- According to the maximum antenna and turntable positions of premeasurement the software maximize the peaks by changing turntable position ($\pm 45^\circ$) and antenna movement between 1 and 4 meter. This procedure is repeated for both antenna polarizations.
- The final measurement will be done in the position (turntable, EUT-table and antenna polarization) causing the highest emissions with Peak and Average detector.
- The final levels, frequency, measuring time, bandwidth, turntable position, EUT-table position, antenna polarization, correction factor, margin to the limit and limit will be recorded. Also a plot with the graph of the premeasurement with marked maximum final measurements and the limit will be stored.

4) Sequence of testing above 18 GHz

Setup:

- The equipment was set up to simulate a typical usage like described in the user manual or described by manufacturer.
- If the EUT is a tabletop system, a rotatable table with 1.5 m height is used.
- If the EUT is a floor standing device, it is placed on the ground plane with insulation between both.
- Auxiliary equipment and cables were positioned to simulate normal operation conditions
- The AC power port of the EUT (if available) is connected to a power outlet below the turntable.
- The measurement distance is 1 meter.
- The EUT was set into operation.

Premeasurement:

- The antenna is moved spherical over the EUT in different polarisations of the antenna.

Final measurement:

- The final measurement will be performed at the position and antenna orientation for all detected emissions that were found during the premeasurements with Peak and Average detector.
- The final levels, frequency, measuring time, bandwidth, correction factor, margin to the limit and limit will be recorded. Also a plot with the graph of the premeasurement and the limit will be stored.

7.5 Results for Restricted Band Radiated Emissions Testing

PASS.

Only record the worst test result in this report.

The test data please refer to following page.

Below 1GHz (Low Channel)

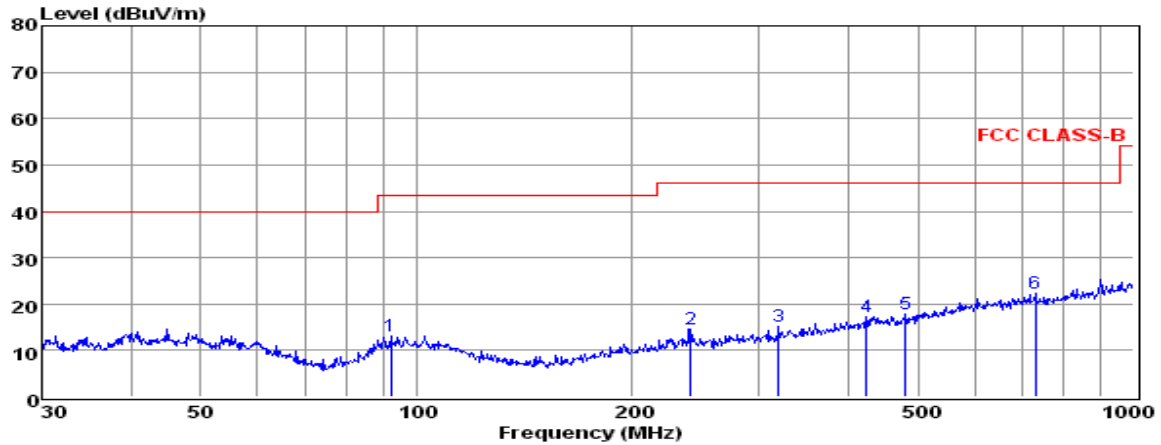

Env. /Ins: 24°C/56%
 pol: VERTICAL

	Freq	Reading	CabLos	AntFac	PreFac	Measured	Limit	Over	Remark
	MHz	dBuV	dB	dB/m	dB	dBuV/m	dBuV/m	dB	
1	92.14	0.09	0.56	12.30	0.00	12.95	43.50	-30.55	QP
2	240.83	1.58	1.01	12.09	0.00	14.68	46.00	-31.32	QP
3	319.94	0.75	1.16	13.33	0.00	15.24	46.00	-30.76	QP
4	423.54	0.66	1.16	15.49	0.00	17.31	46.00	-28.69	QP
5	480.53	0.57	1.31	16.08	0.00	17.96	46.00	-28.04	QP
6	729.36	1.35	1.70	19.18	0.00	22.23	46.00	-23.77	QP

Note: 1. All readings are Quasi-peak values.
 2. Measured = Reading + Antenna Factor + Cable Loss - Amp Factor.
 3. The emission levels that are 20dB below the official limit are not reported.

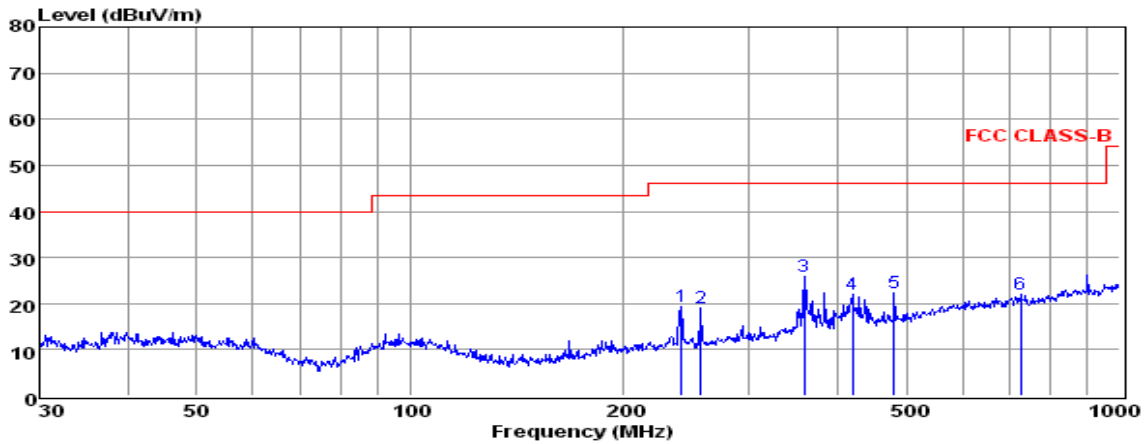

Env. /Ins: 24°C/56%
 pol: HORIZONTAL

	Freq	Reading	CabLos	AntFac	PreFac	Measured	Limit	Over	Remark
	MHz	dBuV	dB	dB/m	dB	dBuV/m	dBuV/m	dB	
1	240.83	6.13	1.01	12.09	0.00	19.23	46.00	-26.77	QP
2	256.52	6.05	1.02	12.06	0.00	19.13	46.00	-26.87	QP
3	359.19	10.31	1.18	14.42	0.00	25.91	46.00	-20.09	QP
4	420.58	5.10	1.33	15.47	0.00	21.90	46.00	-24.10	QP
5	480.53	4.82	1.31	16.08	0.00	22.21	46.00	-23.79	QP
6	724.26	1.07	1.72	19.11	0.00	21.90	46.00	-24.10	QP

Note: 1. All readings are Quasi-peak values.
 2. Measured = Reading + Antenna Factor + Cable Loss - Amp Factor.
 3. The emission levels that are 20dB below the official limit are not reported.

Above 1GHz

The worst test result for GFSK, Tx-Low Channel:

Freq. MHz	Reading dBuv	Ant. Fac dB/m	Pre. Fac. dB	Cab. Loss dB	Measured dBuv/m	Limit dBuv/m	Margin dB	Remark	Pol.
4804.00	59.83	33.06	35.04	3.94	61.79	74	-12.21	Peak	Horizontal
4804.00	44.12	33.06	35.04	3.94	46.08	54	-7.92	Average	Horizontal
4804.00	58.16	33.06	35.04	3.94	60.12	74	-13.88	Peak	Vertical
4804.00	43.71	33.06	35.04	3.94	45.67	54	-8.33	Average	Vertical

The worst test result for GFSK, Tx-Middle Channel:

Freq. MHz	Reading dBuv	Ant. Fac dB/m	Pre. Fac. dB	Cab. Loss dB	Measured dBuv/m	Limit dBuv/m	Margin dB	Remark	Pol.
4882.00	59.22	33.16	35.15	3.96	61.19	74	-12.81	Peak	Horizontal
4882.00	44.37	33.16	35.15	3.96	46.34	54	-7.66	Average	Horizontal
4882.00	58.61	33.16	35.15	3.96	60.58	74	-13.42	Peak	Vertical
4882.00	43.10	33.16	35.15	3.96	45.07	54	-8.93	Average	Vertical

The worst test result for GFSK, Tx-High Channel:

Freq. MHz	Reading dBuv	Ant. Fac dB/m	Pre. Fac. dB	Cab. Los dB	Measured dBuv/m	Limit dBuv/m	Margin dB	Remark	Pol.
4960.00	59.26	33.26	35.14	3.98	61.36	74	-12.64	Peak	Horizontal
4960.00	44.04	33.26	35.14	3.98	46.14	54	-7.86	Average	Horizontal
4960.00	57.94	33.26	35.14	3.98	60.04	74	-13.96	Peak	Vertical
4960.00	43.68	33.26	35.14	3.98	45.78	54	-8.22	Average	Vertical

Notes:

- 1). Measuring frequencies from 9k~10th harmonic (ex. 26GHz), No emission found between lowest internal used/generated frequency to 30 MHz.
- 2). Radiated emissions measured in frequency range from 9k~10th harmonic (ex. 26GHz) were made with an instrument using Peak detector mode.
- 3). 18~25GHz at least have 20dB margin. No recording in the test report.

7.6 Results for Restricted Band edge Testing

GFSK						
Freq.MHz	Reading Level dBm	Antenna Gain dBi	Measured E dBuV/m	Limit dBuV/m	Margin dB	Remark
2310.000	-62.489	3.30	36.111	74	-37.889	Peak
2310.000	-72.984	3.30	25.616	54	-28.384	Average
2390.000	-61.017	3.30	37.583	74	-36.417	Peak
2390.000	-72.634	3.30	25.966	54	-28.034	Average
2483.500	-58.360	3.30	40.240	74	-33.760	Peak
2483.500	-72.350	3.30	26.250	54	-27.750	Average
2500.000	-62.006	3.30	36.594	74	-37.406	Peak
2500.000	-72.954	3.30	25.646	54	-28.354	Average

Note:

- 1). All modes have been tested and we only record the worst test result;

Test plot of Restricted Bands

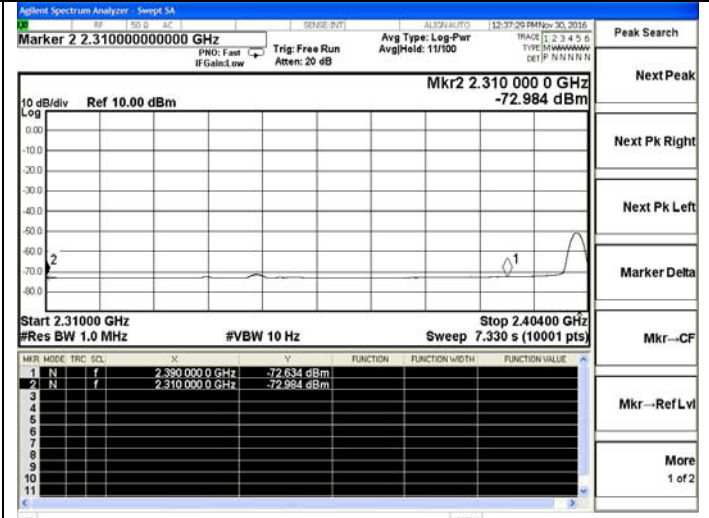
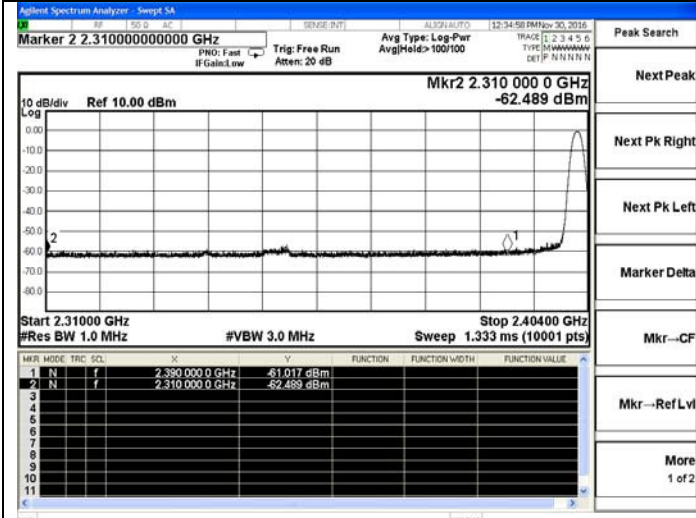

GFSK-Low channel(Peak)

GFSK -Low channel(Average)

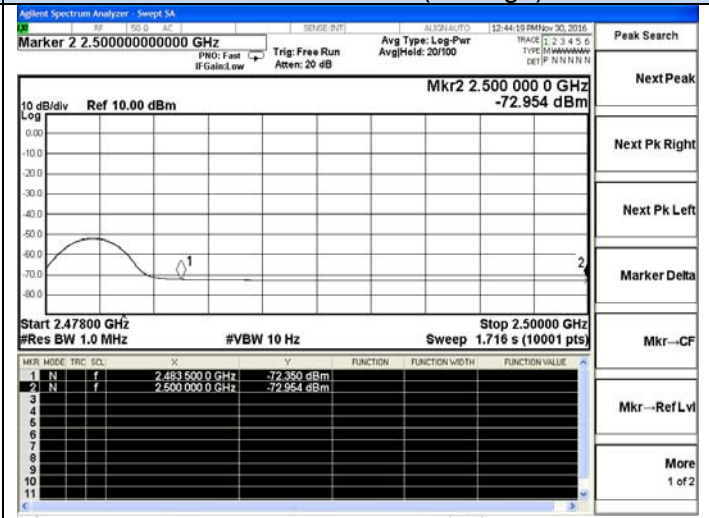
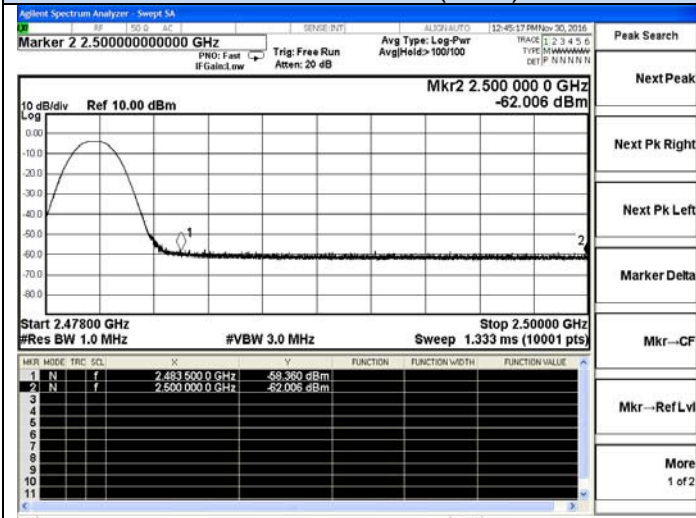

GFSK -High channel(Peak)

GFSK -High channel(Average)

7.7. Power line conducted emissions

7.7.1 Standard Applicable

According to §15.207 (a): For an intentional radiator which is designed to be connected to the public utility (AC) power line, the radio frequency voltage that is conducted back onto the AC power line on any frequency or frequencies within the band 150 kHz to 30 MHz shall not exceed 250 microvolts (The limit decreases linearly with the logarithm of the frequency in the range 0.15 MHz to 0.50 MHz). The limits at specific frequency range is listed as follows:

Frequency Range (MHz)	Limits (dBµV)	
	Quasi-peak	Average
0.15 to 0.50	66 to 56	56 to 46
0.50 to 5	56	46
5 to 30	60	50

7.7.2 Block Diagram of Test Setup

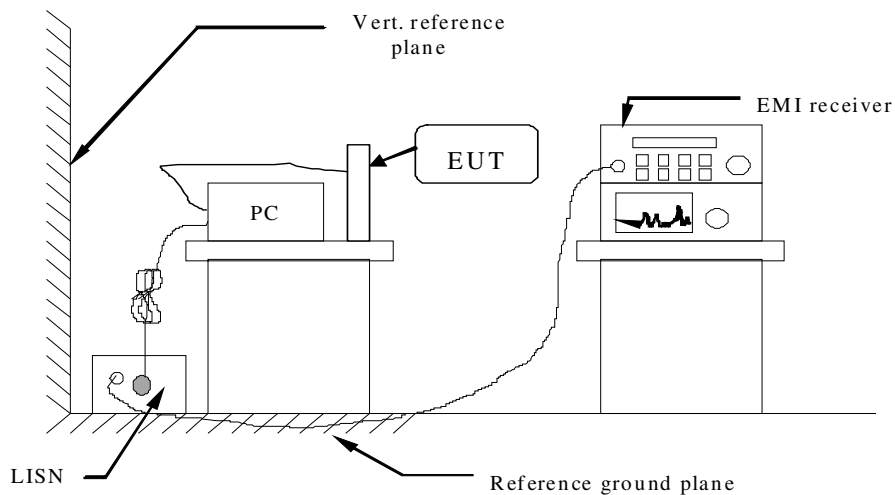

7.7.3 Test Results

PASS.

The test data please refer to following page.

Test result for GFSK-AC 120V

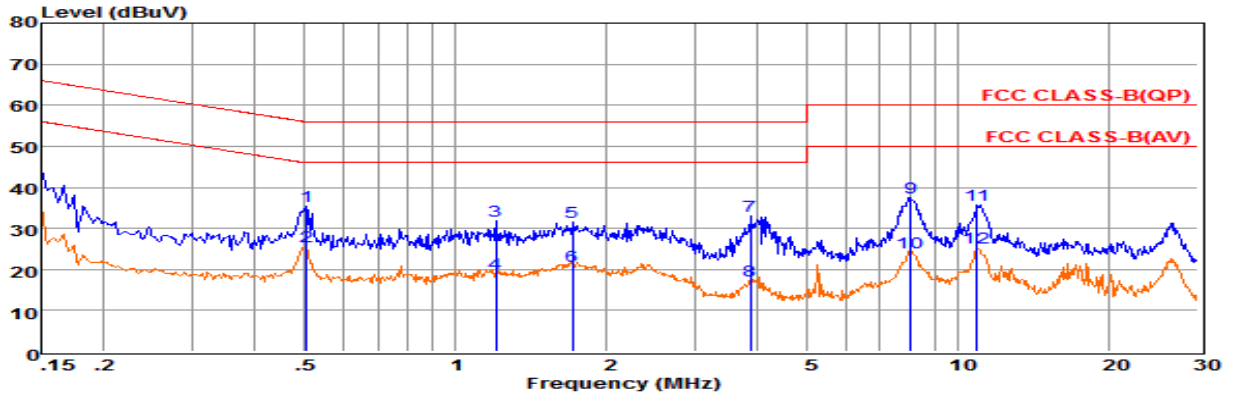

Env. Ins: 24*/56%
 Pol: NEUTRAL

	Freq	Reading	LISNFac	CabLos	Aux2Fac	Measured	Limit	Over	Remark
	MHz	dBuV	dB	dB	dB	dB	dBuV	dBuV	dB
1	0.50	15.79	9.62	0.04	10.00	35.45	56.00	-20.55	QP
2	0.50	5.85	9.62	0.04	10.00	25.51	46.00	-20.49	Average
3	1.20	12.21	9.63	0.05	10.00	31.89	56.00	-24.11	QP
4	1.20	-0.75	9.63	0.05	10.00	18.93	46.00	-27.07	Average
5	1.71	11.78	9.63	0.05	10.00	31.46	56.00	-24.54	QP
6	1.71	1.04	9.63	0.05	10.00	20.72	46.00	-25.28	Average
7	3.86	13.21	9.65	0.06	10.00	32.92	56.00	-23.08	QP
8	3.86	-2.34	9.65	0.06	10.00	17.37	46.00	-28.63	Average
9	8.06	17.76	9.70	0.07	10.00	37.53	60.00	-22.47	QP
10	8.06	4.22	9.70	0.07	10.00	23.99	50.00	-26.01	Average
11	10.90	15.86	9.72	0.08	10.00	35.66	60.00	-24.34	QP
12	10.90	5.33	9.72	0.08	10.00	25.13	50.00	-24.87	Average

Remarks: 1. Measured = Reading +Cable Loss +Aux2 Fac.
 2. The emission levels that are 20dB below the official limit are not reported.

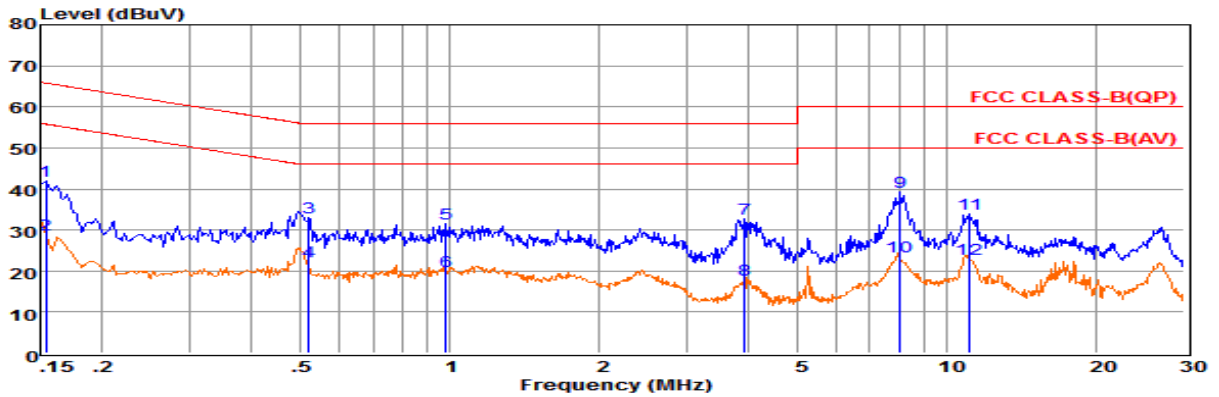

Env. Ins: 24*/56%
 Pol: LINE

	Freq	Reading	LISNFac	CabLos	Aux2Fac	Measured	Limit	Over	Remark
	MHz	dBuV	dB	dB	dB	dB	dBuV	dBuV	dB
1	0.15	22.20	9.58	0.02	10.00	41.80	65.78	-23.98	QP
2	0.15	9.19	9.58	0.02	10.00	28.79	55.77	-26.98	Average
3	0.52	13.28	9.62	0.04	10.00	32.94	56.00	-23.06	QP
4	0.52	2.52	9.62	0.04	10.00	22.18	46.00	-23.82	Average
5	0.98	11.92	9.63	0.05	10.00	31.60	56.00	-24.40	QP
6	0.98	0.19	9.63	0.05	10.00	19.87	46.00	-26.13	Average
7	3.92	13.15	9.65	0.06	10.00	32.86	56.00	-23.14	QP
8	3.92	-1.73	9.65	0.06	10.00	17.98	46.00	-28.02	Average
9	8.06	19.59	9.68	0.07	10.00	39.34	60.00	-20.66	QP
10	8.06	3.79	9.68	0.07	10.00	23.54	50.00	-26.46	Average
11	11.14	14.23	9.70	0.09	10.00	34.02	60.00	-25.98	QP
12	11.14	3.04	9.70	0.09	10.00	22.83	50.00	-27.17	Average

Remarks: 1. Measured = Reading +Cable Loss +Aux2 Fac.
 2. The emission levels that are 20dB below the official limit are not reported.

Test result for GFSK-AC 240V

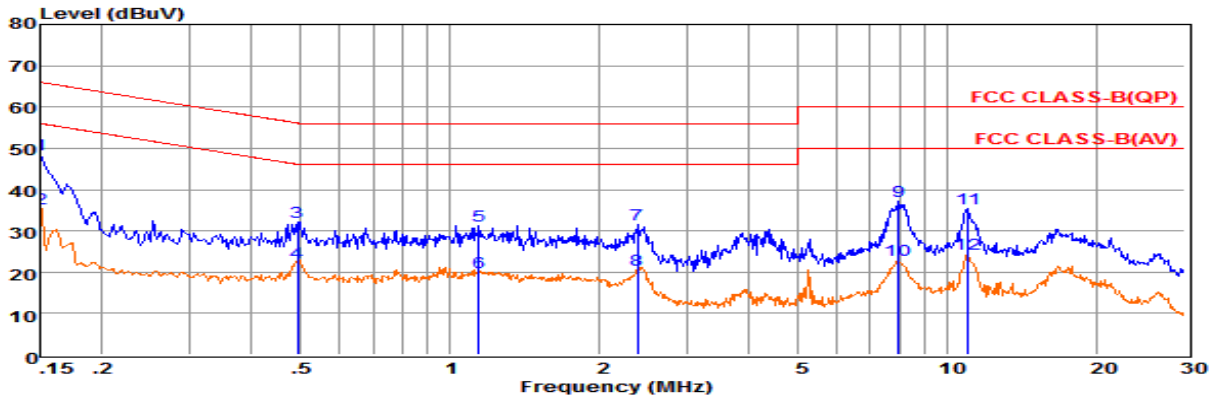

Env. Ins: 24*/56%
 Pol: LINE

Freq	Reading	LISNFac	CabLos	Aux2Fac	Measured	Limit	Over	Remark	
MHz	dBuV	dB	dB	dB	dB	dBuV	dBuV	dB	
1	0.15	29.02	9.57	0.02	10.00	48.61	66.00	-17.39	QP
2	0.15	15.90	9.57	0.02	10.00	35.49	55.99	-20.50	Average
3	0.49	12.53	9.62	0.04	10.00	32.19	56.10	-23.91	QP
4	0.49	2.69	9.62	0.04	10.00	22.35	46.10	-23.75	Average
5	1.14	11.44	9.63	0.05	10.00	31.12	56.00	-24.88	QP
6	1.14	0.35	9.63	0.05	10.00	20.03	46.00	-25.97	Average
7	2.38	11.75	9.64	0.05	10.00	31.44	56.00	-24.56	QP
8	2.38	0.86	9.64	0.05	10.00	20.55	46.00	-25.45	Average
9	7.98	17.53	9.68	0.07	10.00	37.28	60.00	-22.72	QP
10	7.98	3.13	9.68	0.07	10.00	22.88	50.00	-27.12	Average
11	11.02	15.72	9.70	0.09	10.00	35.51	60.00	-24.49	QP
12	11.02	4.45	9.70	0.09	10.00	24.24	50.00	-25.76	Average

Remarks: 1. Measured = Reading +Cable Loss +Aux2 Fac.
 2. The emission levels that are 20dB below the official limit are not reported.

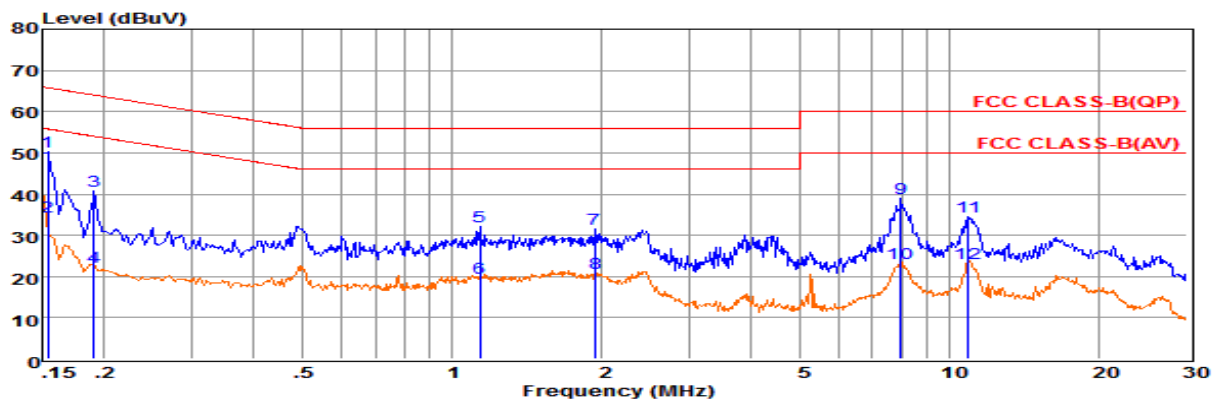

Env. Ins: 24*/56%
 Pol: NEUTRAL

Freq	Reading	LISNFac	CabLos	Aux2Fac	Measured	Limit	Over	Remark	
MHz	dBuV	dB	dB	dB	dB	dBuV	dBuV	dB	
1	0.15	30.43	9.69	0.02	10.00	50.14	65.78	-15.64	QP
2	0.15	14.68	9.69	0.02	10.00	34.39	55.77	-21.38	Average
3	0.19	21.10	9.61	0.02	10.00	40.73	64.02	-23.29	QP
4	0.19	2.56	9.61	0.02	10.00	22.19	54.02	-31.83	Average
5	1.14	12.38	9.63	0.05	10.00	32.06	56.00	-23.94	QP
6	1.14	0.09	9.63	0.05	10.00	19.77	46.00	-26.23	Average
7	1.94	11.97	9.63	0.05	10.00	31.65	56.00	-24.35	QP
8	1.94	1.05	9.63	0.05	10.00	20.73	46.00	-25.27	Average
9	7.98	19.19	9.70	0.07	10.00	38.96	60.00	-21.04	QP
10	7.98	3.39	9.70	0.07	10.00	23.16	50.00	-26.84	Average
11	10.90	14.79	9.72	0.08	10.00	34.59	60.00	-25.41	QP
12	10.91	3.34	9.72	0.08	10.00	23.14	50.00	-26.86	Average

Remarks: 1. Measured = Reading +Cable Loss +Aux2 Fac.
 2. The emission levels that are 20dB below the official limit are not reported.

8. ANTENNA REQUIREMENT

8.1 Standard Applicable

According to antenna requirement of §15.203.

An intentional radiator shall be designed to ensure that no antenna other than that furnished by the responsible party shall be used with the device. The use of a permanently attached antenna or of an antenna that uses a unique coupling to the intentional radiator shall be considered sufficient to comply with the provisions of this Section. The manufacturer may design the unit so that a broken antenna can be re-placed by the user, but the use of a standard antenna jack or electrical connector is prohibited. This requirement does not apply to carrier current devices or to devices operated under the provisions of Sections 15.211, 15.213, 15.217, 15.219, or 15.221. Further, this requirement does not apply to intentional radiators that must be professionally installed, such as perimeter protection systems and some field disturbance sensors, or to other intentional radiators which, in accordance with Section 15.31(d), must be measured at the installation site. However, the installer shall be responsible for ensuring that the proper antenna is employed so that the limits in this Part are not exceeded.

And according to §15.247(4)(1), system operating in the 2400-2483.5MHz bands that are used exclusively for fixed, point-to-point operations may employ transmitting antennas with directional gain greater than 6dBi provided the maximum peak output power of the intentional radiator is reduced by 1 dB for every 3 dB that the directional gain of the antenna exceeds 6dBi.

8.2 Antenna Connected Construction

8.2.1. Standard Applicable

According to § 15.203 & RSS-Gen, an intentional radiator shall be designed to ensure that no antenna other than that furnished by the responsible party shall be used with the device.

8.2.2. Antenna Connector Construction

The directional gains of antenna used for transmitting is 3.3 dBi, and the antenna is an PCB antenna connect to PCB board and no consideration of replacement. Please see EUT photo for details.

8.2.3. Results: Compliance.

Measurement

The antenna gain of the complete system is calculated by the difference of radiated power in EIRP and the conducted power of the module.

Conducted power refers ANSI C63.10:2013 Output power test procedure for DTS devices.

Radiated power refers to ANSI C63.10:2013 Radiated emissions tests.

Measurement parameters

Measurement parameter	
Detector:	Peak
Sweep Time:	Auto
Resolution bandwidth:	1MHz
Video bandwidth:	3MHz
Trace-Mode:	Max hold

Limits

FCC	IC
Antenna Gain	
6 dBi	

Note: The antenna gain of the complete system is calculated by the difference of radiated power in EIRP and the conducted power of the module. For Bluetooth 3.0 devices, the FHSS mode is used;

T_{nom}	V_{nom}	Lowest Channel 2402 MHz	Middle Channel 2441 MHz	Highest Channel 2480 MHz
Conducted power [dBm] Measured with GFSK modulation		-2.363	-1.931	-1.963
Radiated power [dBm] Measured with GFSK modulation		0.752	1.273	1.221
Gain [dBi] Calculated		3.115	3.204	3.184
Measurement uncertainty			± 1.6 dB (cond.) / ± 3.8 dB (rad.)	

9. TEST SETUP PHOTOGRAPHS OF EUT

10. EXTERIOR PHOTOGRAPHS OF THE EUT

11. INTERIOR PHOTOGRAPHS OF THE EUT

-----THE END OF REPORT-----