

IP-COM

User Guide



W175AP

1350M 11AC High Power Ceiling Access Point

Copyright Statement

©2015 IP-COM Networks Co., Ltd. All rights reserved.

IP-COM is the registered trademark of IP-COM Networks Co., Ltd. Other brand and product names mentioned herein are trademarks or registered trademarks of their respective holders. Copyright of the whole product as integration, including its accessories and software, belongs to IP-COM Networks Co., Ltd. No part of this publication can be reproduced, transmitted, transcribed, stored in a retrieval system, or translated into any language in any form or by any means without the prior written permission of IP-COM Networks Co., Ltd.

Disclaimer

Pictures, images and product specifications herein are for references only. To improve internal design, operational function, and/or reliability, IP-COM reserves the right to make changes to the products described in this document without obligation to notify any person or organization of such revisions or changes. IP-COM does not assume any liability that may occur due to the use or application of the product or circuit layout(s) described herein. Every effort has been made in the preparation of this document to ensure accuracy of the contents, but all statements, information and recommendations in this document do not constitute the warranty of any kind, express or implied.

Preface

Thank you for purchasing this IP-COM product! Reading this User Guide will be helpful for you to configure, manage and maintain this product.

Intended Readers

This User Guide is intended for technicians who have basic knowledge related to Internet and network terminology.



Conventions

If not specifically indicated, “AP”, “this device” or “this product” mentioned in this User Guide stands for W175AP.

Typographical conventions in this User Guide:

Item	Presentation	Example
Button	Bold	“Click the Save button” can be simplified as “Click Save ”.
Menu	Bold	“The menu Basic” can be simplified as Basic .
Continuous Menus	>	Click Wireless > Basic

Symbols in this User Guide:

Item	Meaning
 Note	This format is used to highlight information of importance or special interest. Ignoring this type of note may result in ineffective configurations, loss of data or damage to device.
 Tip	This format is used to highlight a procedure that will save time or resources.

Overview of this User Guide

Contents of all chapters in this User Guide are arranged as shown below:

Chapter	Content
1 Product Overview	General introduction of product features and its physical appearance
2 Device Installation	Introduction of device installation
3 Web Manager Introduction	Introduction of web manager of this device
4 Advanced Functions	Introduction of advanced settings about this device
5 Appendix	Introduction of troubleshootings, TCP/IP settings and safety & emission statement.

Contents

1 Product Overview	2
Overview	2
Features.....	2
Package Contents.....	3
Product Appearance	3
Interface & Button	3
Label	4
2 Device Installation	5
Preparations	5
Installation Considerations	5
Environmental Requirements	5
Tools You Need to Prepare	6
Hardware Installation	6
Device Checking.....	9
3 Web Manager Introduction	11
Web Login	11
Layout of Web Manager	11
Configuration Requirements.....	12
4 Advanced Functions	13
Status	13
System Status.....	13
Wireless Status.....	13
Traffic Statistics	14
Wireless Clients	15
Quick Setup	17
AP Mode.....	17
WDS Mode.....	18
APClient Mode	22
Network	24
LAN Setup	24
DHCP Server	25
Wireless	26

Basic	26
Radio.....	31
Channel Scan	33
Advanced	34
Access Control.....	36
QVLAN	37
SNMP	39
Tools	40
Maintenance.....	40
Time & Date	41
Logs	42
Configuration.....	45
Username & Password.....	46
Diagnostics	47
Reboot.....	47
LED	49
5 Appendix.....	50
Troubleshooting.....	50
Technical Support	50
Configure PC	51
Windows 8	51
Windows 7	53
Windows XP.....	55
Safety and Emission Statement	57

1 Product Overview

Overview

This Wi-Fi access point is mainly designed for hotels, especially for star-rated hotels and commercial hotels for wireless extension. With its ceiling design and existing construction, it saves a lot of time and costs for wireless networking. Meanwhile, it is an ideal choice for WiFi extension.

Features

- Support 2.4GHz: IEEE 802.11n/g/b
- Support 5GHz: IEEE 802.11ac/n/a
- 2.4GHz wireless transmission rate: Up to 450Mbps;
5GHz wireless transmission rate: Up to 900Mbps
- Support multiple SSIDs: 2.4GHz: 8 SSIDs; 5GHz: 4 SSIDs
- Support QVLAN, which can isolate traffic flow among different SSIDs
- Support DHCP server, which can automatically assign IP addresses to clients
- Compliant with IEEE 802.3at PoE PDs, thus it can connect to the rated standard PoE injector or an IEEE 802.3at-compliant PoE_PSE switch for power supply
- One 10/100/1000Mbps auto-negotiation, IEEE 802.3ab, IEEE 802.3u, IEEE 802.3-compliant PoE port for data transmission and power supply
- Support multiple cipher types, including WEP, WPA-PSK, WPA2-PSK, Mixed WPA/WPA2-PSK, WPA and WPA2 to block unknown access
- Support automatic channel selection
- Support transmission power adjustment
- Support 3 working modes: AP mode, WDS mode and AP Client mode
- Support the diagnostic tool: ping
- Support SNMP v1/v2c
- Support LED ON/OFF

Package Contents

Unpack the package carefully and verify that the following items are included:

- Wireless Access Point *1
- Power Adapter *1
- Ethernet Cable *2
- KA3 Screw *3
- Bracket A *1
- Plastic Bolt *8
- Position Paster *1
- Power Cord*1
- PoE Injector *1
- PA3 Screw *8
- Magnet *4
- Bracket B *1
- Install Guide *1

If any item is incorrect, missing, or damaged, please contact your dealer for immediate replacement.

Product Appearance

Interface & Button

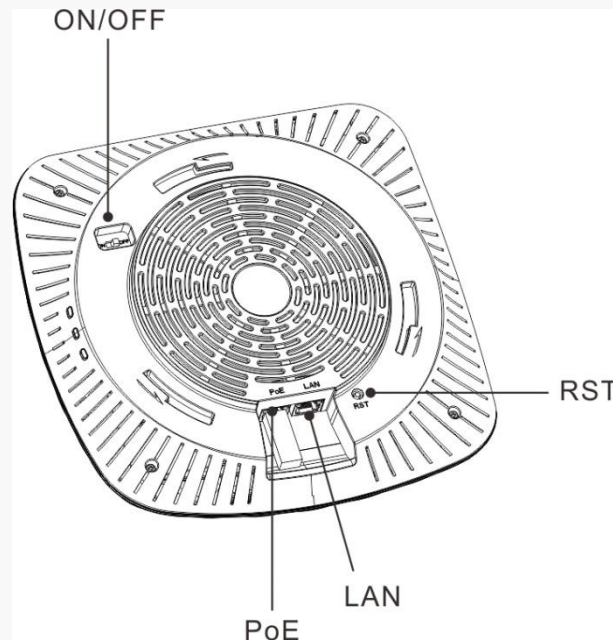

1. **RST**: Pressing it for 7 seconds restores this device to factory default settings.
2. **ON / OFF**: LED hardware switch for turning on/off LED lights

3. **PoE**: PoE port for connecting to the PoE injector or a PoE switch for power supply
4. **LAN**: 10/100/1000Mbps auto-negotiation RJ45 port for connecting to a PC, switch or any other Ethernet device

Label



1. Default login IP address for web login of this device
2. Default login user name and password
3. Power specification of this device

2 Device Installation

Preparations

Before installing this device, please peruse this part carefully.

Installation Considerations

- Do not remove the housing of this device.
- Put this device in a dry and flat place to avoid dampness and a fall.
- Please keep the device clean.

Environmental Requirements

As this device must be used indoors, when it is mounted onto the ceiling, the following requirements should be met:

- Try to choose a location that minimizes obstacles between this device and its connected wireless devices. Open corridors and other spacious locations will typically provide better conditions for performance than a crowded room.
- Try to position your device away from electrical devices that are potential sources of interference, such as ceiling fans, home security systems, microwaves, PCs, refrigerators, etc.
- Install this device in a position as hidden as possible to avoid affecting your daily life and work.

To ensure normal operation, the following environmental requirements should also be met:

Item	Requirement
Temperature	0°C~ 45°C
Humidity	10% ~ 90% RH (non-condensing)

Tools You Need to Prepare

While installing this device, prepare the following tools by yourself.

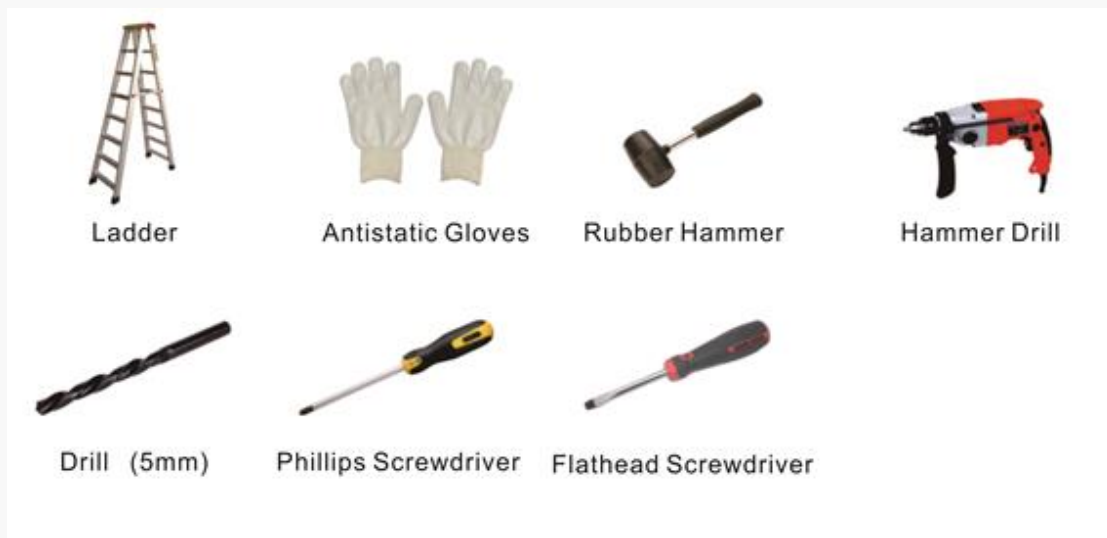

Hardware Installation

Step 1: Install the bracket

Method One: Ceiling/Wall Installation

- 1 Paste the position paster onto the wall or ceiling, wear anti-static gloves and use the hammer drill to drill three holes with a diameter of 5mm on the wall or ceiling according to holes on the position paster.
- 2 Use the rubber hammer to knock the three plastic bolts onto the wall or ceiling where you've drilled the holes.
- 3 Maneuver the bracket until it fits in the plastic bolts on the wall or ceiling and then fix the bracket onto the wall or ceiling with the screwdriver and included screws.

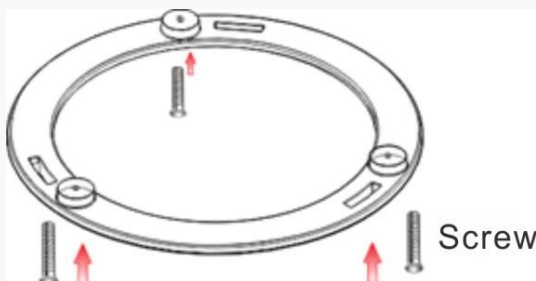

(Bracket A)

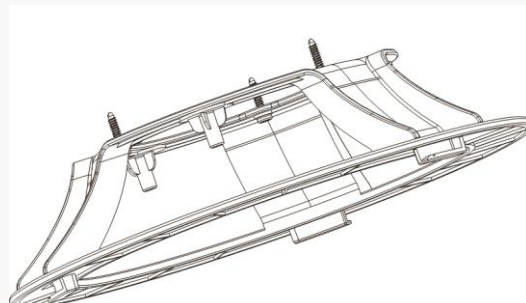

(Bracket B)

Method Two: Magnet Installation (Bracket B)

- 1 Place three magnets on corresponding concave surfaces of Bracket B, fix magnets onto the Bracket B with screws.

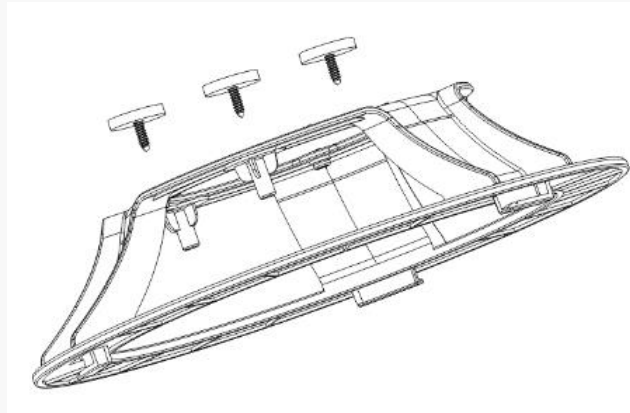

- 2 Then attach the bracket (installed with magnets) vertically onto the ironwork surface.

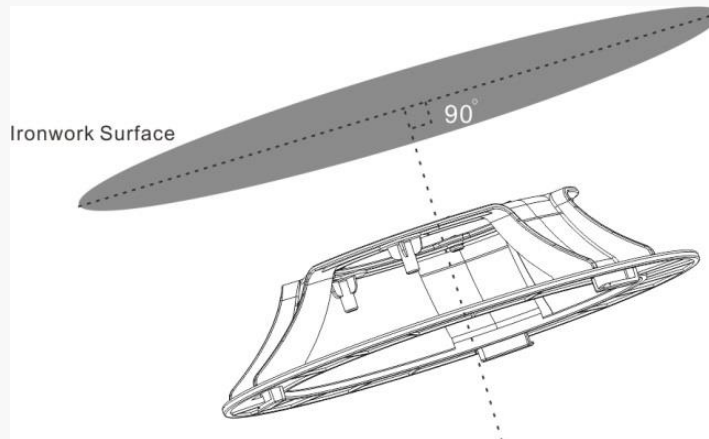
**Step 2: Install the device**

- 1 Connect one end of the Ethernet cable (Cat5 or higher is recommended) to the PoE port of this device.

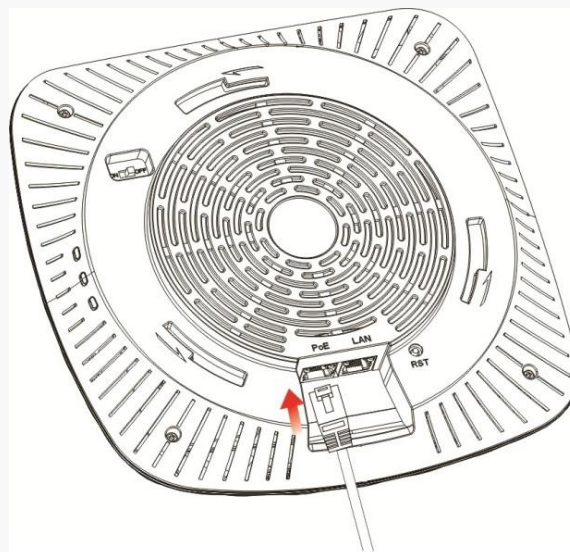

- ② Maneuver the device until it fits in the bracket, and then refer to the following figure to rotate the device until the device is fixed tightly onto the bracket.

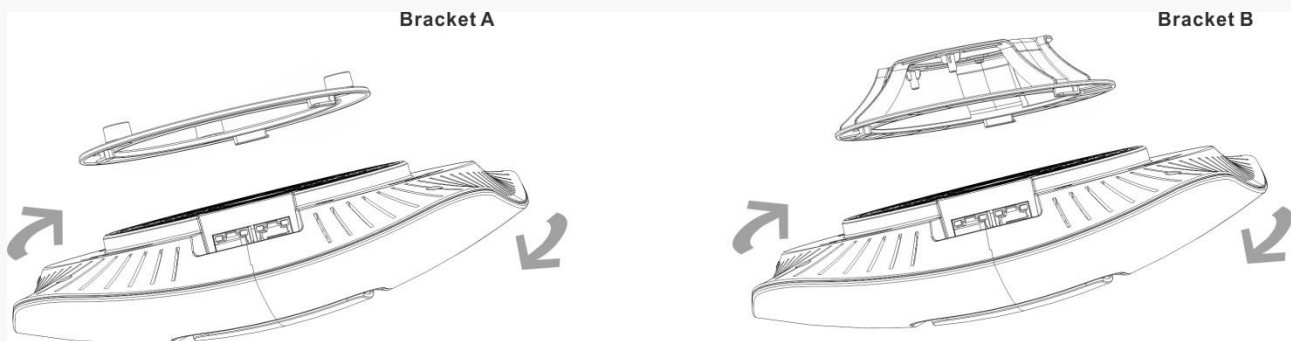

Step 3: Connect to power supply

Method One: Connect to a PoE device

Connect the other end of the Ethernet cable from the PoE port of this device to the PoE port of a PoE switch.

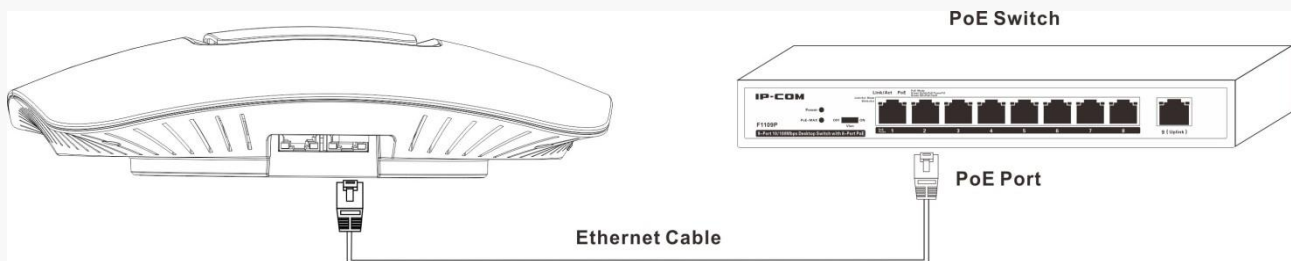

Method Two: Connect to the included PoE injector

- ① Connect the other end of the Ethernet cable from the PoE port of this device to the AP port of the PoE injector.
- ② Connect the switch port of the PoE injector to a switch with an Ethernet cable.
- ③ Connect the power cord to a socket.

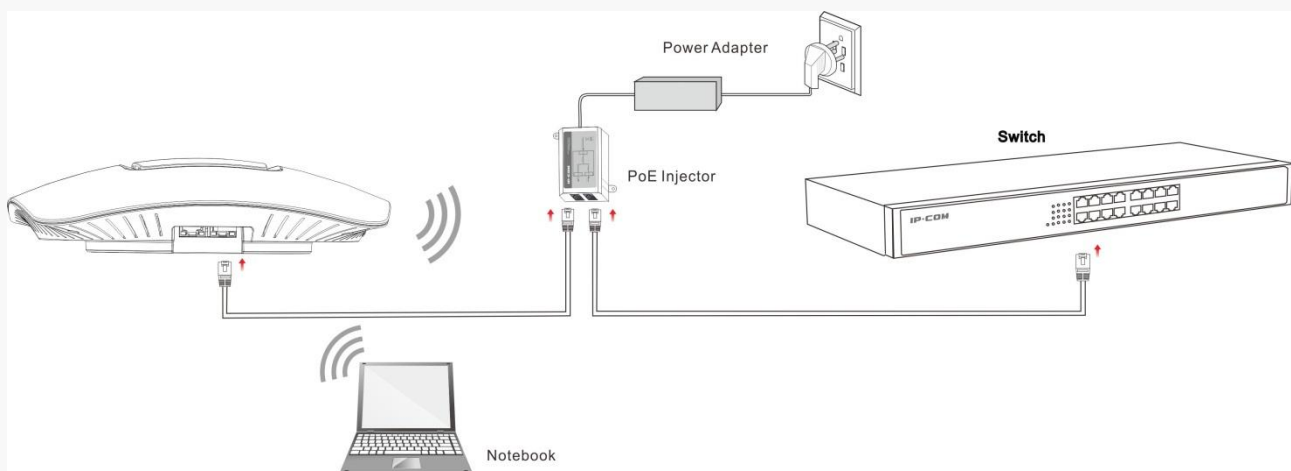

Device Checking

When this device is powered on, you can know whether it works normally or not according to LED designations.

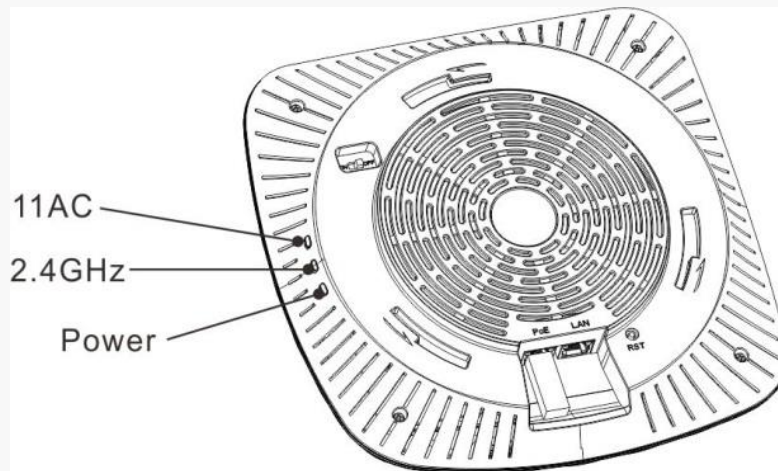

LED Light	Status	Description
Power	Solid	Proper connection to power supply
	Blinking	The device is functioning normally.
	Off	The following three circumstances may occur: <ul style="list-style-type: none"> ➤ Improper connection to power supply ➤ Malfunction occurs. ➤ The LED is turned off manually.
2.4GHz	Solid	2.4G WiFi is enabled.
	Blinking	Data is being transmitted (2.4GHz).
	Off	The following three circumstances may occur: <ul style="list-style-type: none"> ➤ Improper connection to power supply ➤ 2.4G WiFi is disabled. ➤ The LED is turned off manually.

11AC	Solid	5G WiFi is enabled.
	Blinking	Data is being transmitted at the 5G radio.
	Off	<p>The following three circumstances may occur:</p> <ul style="list-style-type: none">➤ Improper connection to power supply➤ 5G WiFi is disabled <p>The LED is turned off manually.</p>

3 Web Manager Introduction

Web Login

Step 1: Connect your PC to the switch which has been connected to this AP or to the LAN port of this AP directly.

Step 2: Set your PC to a static IP address within the following range: 192.168.0.X (1~253). Note that the IP address of your PC should be a different one but on the same network segment as the LAN IP address of this device. For more details, see [Configure PC](#).

Step 3: Launch a web browser, input the LAN IP address of your AP (The default one is 192.168.0.254.) in the address bar and then press **Enter** or **Return** on your keyboard.

Step 4: Enter the default username and password (**admin** for both) on the pop-out page and click **Login**.

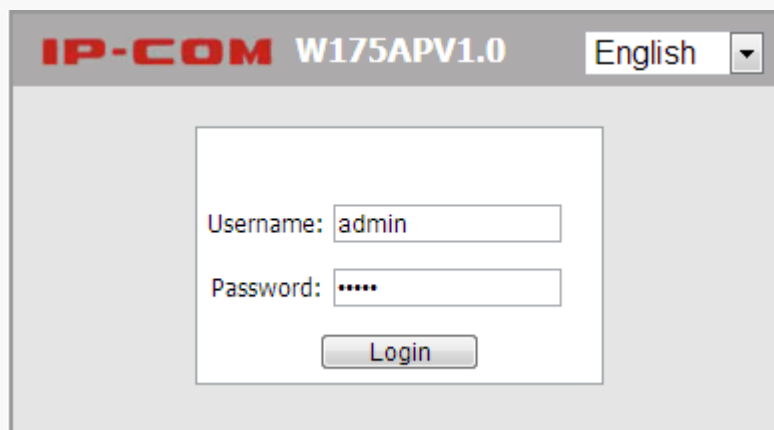

The screenshot displays the login interface for the IP-COM W175APV1.0 device. At the top, the device name and version are shown in red and black text. To the right, there is a language selection dropdown menu currently set to 'English'. The main content area contains a white box with a login form. The form has two input fields: 'Username:' with the text 'admin' entered, and 'Password:' with a masked password represented by six dots. Below the password field is a 'Login' button.

Then you can log in to this device's web page to configure settings for your device.

Layout of Web Manager

The Web page can be divided into two parts: navigation bar and the configuration section.

The screenshot shows the IP-COM web management interface. On the left is a 'Navigation Bar' with a tree structure. The main content area is titled 'System Status' and contains two sections: 'System Status' and 'LAN Status'. A blue box highlights the 'Configuration Section' within the 'System Status' table.

System Status	
Device Name	W175APV1.0
System Time	2015-01-23 16:06:57
Up Time	00h 02m 46s
Number of Wireless Clients	0
Firmware Version	V2.0.0.7(647)
Hardware Version	V1.0

LAN Status	
MAC Address	00:B0:C6:2B:D7:6F
IP Address	192.168.0.254
Subnet Mask	255.255.255.0
Primary DNS Server	192.168.0.1
Secondary DNS Server	

1 Navigation Bar: The navigation bar presents web administration functions to you in the form of navigation tree. This section allows you to select function menus.

2 Configuration Section: This section allows you to configure and view settings.



Note:

Only web administration features that this device supports will be displayed on navigation bars. Specifically, please refer to the actual software of your device.

Configuration Requirements

- Operation System: Windows XP / 2000 / Vista / 7 / 8, Windows Server 2003 enterprise edition, Windows Server 2003 standard edition, Linux, MAC OS, etc.
- Web Browser: Microsoft Internet Explorer 8.0 SP2 or higher, Mozilla Firefox 3.0 or higher, Google Chrome 2.0.174.0 or higher, Opera 9.64 or higher, Safari 3.1.1 or higher, etc.
- The firewall of your PC should be disabled.
- When the firmware version of your device is upgraded, it is advisable to clear your web browser cache first.

4 Advanced Functions

Status

This section gives you an overview of device status and basic information. The following 4 parts are included:

[System Status](#): Display the AP's current system status and LAN information

[Wireless Status](#): Display connected devices' radio status and SSID status information

[Traffic Statistics](#): Display traffic statistics of all SSIDs

[Wireless Clients](#): Display information of connected devices

System Status

This page displays system status information and LAN information of this AP, including device name, system time, up time, number of wireless clients, firmware version, hardware version, MAC address, IP address, etc.

The screenshot shows the IP-COM web interface. The top header includes the IP-COM logo and the website URL www.ip-com.com.cn. A left sidebar contains a navigation menu with categories: Status (expanded), Quick Setup, Network, Wireless, SNMP, and Tools. Under the Status category, the following items are listed: System Status (selected), Wireless Status, Traffic Statistics, and Wireless Clients. The main content area is titled 'System Status' and contains a table of system information. A 'Help' button is located in the top right corner of the system status section.

System Status	
Device Name	W175APV1.0
System Time	2015-01-23 16:09:05
Up Time	00h 04m 55s
Number of Wireless Clients	0
Firmware Version	V2.0.0.7(647)
Hardware Version	V1.0

LAN Status	
MAC Address	00:B0:C6:2B:D7:6F
IP Address	192.168.0.254
Subnet Mask	255.255.255.0
Primary DNS Server	192.168.0.1
Secondary DNS Server	

Wireless Status

This page displays 2.4GHz or 5 GHz radio status, SSID status and WDS status of this device. As for the 5GHz radio, your wireless clients must be compatible with 5GHz. Click **Status > Wireless Status** to enter page below:

IP-COM www.ip-com.com.cn

2.4GHz Wireless Status **5GHz Wireless Status**

▶ Status

- System Status
- ▶ Wireless Status
- Traffic Statistics
- Wireless Clients

Quick Setup

Network

Wireless

SNMP

Tools

Radio Status	
Radio (On/Off)	On
Network Mode	b/g/n
Channel	2

[Help](#)

SSID Status			
SSID	MAC Address	Working Status	Security Mode
ZL_zhouya	00:B0:C6:3A:C6:E4	Enabled	WPA-PSK
IP-COM_3AC6E5	00:B0:C6:3A:C6:E5	Disabled	None
IP-COM_3AC6E6	00:B0:C6:3A:C6:E6	Disabled	None
IP-COM_3AC6E7	00:B0:C6:3A:C6:E7	Disabled	None
IP-COM_3AC6E8	00:B0:C6:3A:C6:E0	Disabled	None
IP-COM_3AC6E9	00:B0:C6:3A:C6:E1	Disabled	None
IP-COM_3AC6EA	00:B0:C6:3A:C6:E2	Disabled	None

Copyright (c) 2014 by SHENZHEN IP-COM NETWORKS CO., LTD. All rights reserved.

IP-COM www.ip-com.com.cn

2.4GHz Wireless Status **5GHz Wireless Status**

▶ Status

- System Status
- ▶ Wireless Status
- Traffic Statistics
- Wireless Clients

Quick Setup

Network

Wireless

SNMP

Tools

Radio Status	
Radio (On/Off)	On
Network Mode	ac
Channel	149

[Help](#)

SSID Status			
SSID	MAC Address	Working Status	Security Mode
IP-COM-5G_009DA0	C8:3A:35:00:9D:A0	Enabled	None
IP-COM-5G_009DA1	C8:3A:35:00:9D:A1	Disabled	None
IP-COM-5G_009DA2	C8:3A:35:00:9D:A2	Disabled	None
IP-COM-5G_009DA3	C8:3A:35:00:9D:A3	Disabled	None

Traffic Statistics

This page displays traffic statistics of corresponding SSIDs. Click **Status** > **Traffic Statistics** to enter page below:

IP-COM www.ip-com.com.cn

2.4GHz Traffic Statistics **5GHz Traffic Statistics**

SSID	Total RX Traffic (MB)	Total RX Packets (Num)	Total TX Traffic (MB)	Total TX Packets (Num)
ZL_zhouya	0.00MB	0	0.00MB	0
IP-COM_3AC6E5	0.00MB	0	0.00MB	0
IP-COM_3AC6E6	0.00MB	0	0.00MB	0
IP-COM_3AC6E7	0.00MB	0	0.00MB	0
IP-COM_3AC6E8	0.00MB	0	0.00MB	0
IP-COM_3AC6E9	0.00MB	0	0.00MB	0
IP-COM_3AC6EA	0.00MB	0	0.00MB	0
IP-COM_3AC6EB	0.00MB	0	0.00MB	0

Help Refresh

IP-COM www.ip-com.com.cn

2.4GHz Traffic Statistics **5GHz Traffic Statistics**

SSID	Total RX Traffic (MB)	Total RX Packets (Num)	Total TX Traffic (MB)	Total TX Packets (Num)
IP-COM-5G_009DA0	0.00MB	0	0.05MB	700
IP-COM-5G_009DA1	0.00MB	0	0.00MB	0
IP-COM-5G_009DA2	0.00MB	0	0.00MB	0
IP-COM-5G_009DA3	0.00MB	0	0.00MB	0

Help Refresh

- **SSID:** WiFi name.
- **Total RX Traffic:** Total traffic which the corresponding SSID has received.
- **Total RX Packets:** Total packets which the corresponding SSID has received.
- **Total TX Traffic:** Total traffic which the corresponding SSID has transmitted.
- **Total TX Packets:** Total packets the corresponding SSID has transmitted.

Wireless Clients

This page displays information, like MAC address, IP, connection duration and link speed of connected clients.

Click **Status > Wireless Clients** to enter page below:

The screenshot shows the IP-COM web interface. The top navigation bar includes the IP-COM logo and the website URL www.ip-com.com.cn. A left-hand navigation menu lists various system settings: Status, System Status, Wireless Status, Traffic Statistics, Wireless Clients (highlighted), Quick Setup, Network, Wireless, SNMP, and Tools. The main content area has two tabs: '2.4GHz Client List' (selected) and '5GHz Client List'. Below the tabs, a message states: 'This section displays information of connected clients (if any).' A 'Help' button is located to the right. Below this message, there is a dropdown menu labeled 'Host(s) Connected Currently:' with the value 'IP-COM_3AC6E5' selected. A table with the following structure is displayed:

ID	MAC Address	IP	Connection Duration	Send Speed	Receive Speed
No clients connected!					

- **MAC Address:** MAC address of the connected device
- **IP:** IP address that the connected device has obtained
- **Connection Duration:** Display connection duration which the SSID has connected to.
- **Send Speed:** Transmission speed of the wireless client
- **Receive Speed:** Receiving speed of the wireless client

Quick Setup

There are three working modes on this device: AP mode, WDS mode and AP Client mode. Click **Quick Setup** to enter page below:

The screenshot displays the IP-COM Quick Setup interface. On the left is a navigation menu with options: Status, Quick Setup (selected), Network, Wireless, SNMP, and Tools. The main content area is titled 'Quick Setup' and contains the following configuration fields:

- WIFI Radio: 2.4GHz
- Mode: AP Mode, WDS Mode, APClient Mode
- SSID: IP-COM_3AC6E5
- Security Mode: WPA - PSK
- Cipher Type: AES, TKIP, TKIP&AES
- Security Key: 12345678

On the right side of the form, there are three buttons: Save, Restore, and Help.

AP Mode: In this mode, the AP connects to the remote device via an Ethernet cable and then clients can connect to the AP wirelessly, thus achieving the conversion between wired networking and wireless networking.

WDS Mode: In the WDS mode, the AP and the remote device should support WDS feature. By scanning each other and keeping their SSIDs, channels, security modes and keys the same, they can bridge successfully. Then clients can connect to the AP wirelessly for Internet access.

AP Client Mode: In this mode, what you need to do is to scan the remote device's signal and bridge it successfully without any configuration on the remote device. Then clients can connect to the AP wirelessly for Internet access.

AP Mode

In this mode, this device works as an access point and you can configure the SSID and its encryption mode.

This screenshot is identical to the one above, showing the IP-COM Quick Setup page with the 'AP Mode' selected. The configuration details are the same: WIFI Radio (2.4GHz), Mode (AP Mode), SSID (IP-COM_3AC6E5), Security Mode (WPA-PSK), Cipher Type (AES), and Security Key (12345678). The Save, Restore, and Help buttons are also present.

Configuration Steps:

- 1 **Mode:** Select **AP Mode**.
- 2 **SSID:** Modify the SSID (optional). The SSID is the WiFi name you need to connect to for Internet access.
- 3 **Security Mode:** WPA-PSK is recommended.
- 4 **Cipher Type:** AES is recommended.
- 5 **Security Key:** Configure a WiFi password as you like. When your device is connecting to the WiFi, the WiFi password (security key) will be needed.
- 6 Click **Save** to apply your settings.

WDS Mode

The screenshot shows the IP-COM Quick Setup interface. On the left is a navigation menu with options: Status, Quick Setup (selected), Network, Wireless, SNMP, and Tools. The main content area is titled 'Quick Setup' and contains the following configuration fields:

- WIFI Radio:** 2.4GHz
- Mode:** Radio buttons for AP Mode, WDS Mode (selected), and APClient Mode.
- SSID:** IP-COM_3AC8E5
- Security Mode:** WPA - PSK
- Cipher Type:** Radio buttons for AES (selected), TKIP, and TKIP&AES.
- Security Key:** 12345678
- MAC Address:** Four empty input fields, each with '(Status:Unknow)' to its right.
- The Uplinked AP's Network Mode:** Empty input field.
- The Uplinked AP's channel:** Empty input field.
- The Uplink AP's Channel Bandwidth:** Empty input field.
- The Uplinked AP's Extension Channel:** Empty input field.

Buttons for 'Save', 'Restore', and 'Help' are on the right. An 'Enable Scan' button is at the bottom center.

- **SSID:** Display SSID of this device. When multiple SSIDs are selected, the first SSID among remote devices will be displayed here.
- **Security Mode:** Display security mode of the remote device. In the WDS mode, all devices' encryption modes and security keys should be kept the same.
- **MAC Address:** Display the remote device's MAC address. 4 remote devices are supported in this mode.
- **The Uplink AP'S Channel:** Display channel of the first remote device. In the WDS mode, channels for all devices should be kept the same.

- **Enable Scan:** Click it to scan SSIDs.

Application Scenario:

There's already an AP (Hereinafter referred as the remote AP) installed on the second floor of a hotel. Due to limited WiFi coverage or other objects' interference, some rooms of the hotel on the second floor may be unable to enjoy WiFi smoothly. Then you can install one more AP or multiple APs (≤ 4) in those rooms where WiFi signal is not strong enough for WiFi extension. In this mode, both this AP and the remote AP need to scan each other for WDS settings.

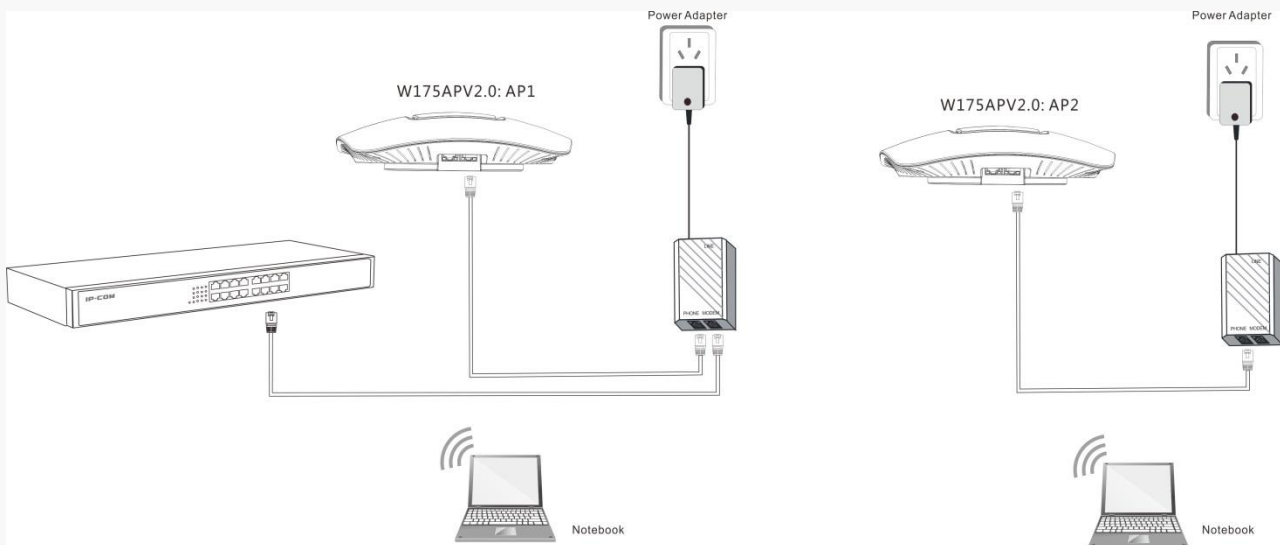

Before configuring WDS settings, verify the following information of the remote SSID: SSID (WiFi name), channel and encryption information.

Assuming information of the remote device (AP 2) is as below:

SSID: IP-COM_130518

Channel: 6

IP Address: 192.168.0.254

Security Mode: Mixed WPA/WPA2-PSK

Cipher Type: AES

Security Key: 12345678

Note:

1. In the WDS mode, both the AP and the remote device should support WDS feature.
2. As for IP addresses, they should not be the same but on the same network segment.
3. This AP's and the remote device's SSID, channel, security mode and security key should be kept the same.
4. Up to 4 APs can be bridged at the same time.

Configuration Steps:

1 Click **Network > LAN Setup** to set the LAN IP address of **AP 1** to one that is different from **AP 2** but on the same network segment. Here we change it to 192.168.0.253.

The screenshot shows the IP-COM web interface with the 'LAN Setup' page. The left sidebar contains a navigation menu with 'Network' selected and 'LAN Setup' highlighted. The main content area displays the following configuration fields:

- MAC Address: 00:B0:C6:28:D7:6F
- Address Mode: Static IP
- IP Address: 192.168.0.253 (For example: 192.168.1.1)
- Subnet Mask: 255.255.255.0 (For example: 255.255.255.0)
- Gateway: 192.168.0.1
- Primary DNS Server: 192.168.0.1
- Secondary DNS Server (optional):
- Device Name: W175APV1.0

Buttons for 'Save', 'Restore', and 'Help' are located on the right side of the form.

2 Select **WDS Mode** and click **Enable Scan**.

The screenshot shows the IP-COM web interface with the 'Quick Setup' page. The left sidebar contains a navigation menu with 'Quick Setup' selected. The main content area displays the following configuration fields:

- WIFI Radio: 2.4GHz
- Mode: AP Mode WDS Mode APClient Mode
- SSID: IP-COM_3AC6E5
- Security Mode: None
- MAC Address: (Status:Unknown)
- MAC Address: (Status:Unknown)
- MAC Address: (Status:Unknown)
- MAC Address: (Status:Unknown)
- The Uplinked AP's Network Mode:
- The Uplinked AP's channel:
- The Uplink AP's Channel Bandwidth:
- The Uplinked AP's Extension Channel:

Buttons for 'Save', 'Restore', 'Help', and 'Enable Scan' are visible on the right side of the form.

3 Select the remote SSID (WiFi name), type in encryption information (including security mode, cipher type and security key) of the remote device and then click **Save**. Then SSID of AP 1 will be the same as that of the remote device (AP 2).

IP-COM www.ip-com.com.cn

Quick Setup

WIFI Radio: 2.4GHz

Mode: AP Mode WDS Mode APClient Mode

SSID: IP-COM_130518

Security Mode: Mixed WPA/WPA2 - PSK

Cipher Type: AES TKIP TKIP&AES

Security Key: 12345678

MAC Address: 00:B0:C8:C8:DC:40 (Status:Unknown)

MAC Address: (Status:Unknown)

MAC Address: (Status:Unknown)





MAC Address: (Status:Unknown)

The Uplinked AP's Network Mode: bg

The Uplinked AP's channel: 6

The Uplink AP's Channel Bandwidth: 20

The Uplinked AP's Extension Channel: none

Select	SSID	MAC Address	Network Mode	Channel Bandwidth	Channel	Extension Channel	Security	Signal Strength
<input type="radio"/>	JY_F1203_ljuli	C8:3A:35:00:9F:F8	bgn	20	11	none	wpa&wpa2/aes	-46dBm 
<input type="radio"/>	IP-COM_028F5C	C8:3A:35:02:8F:5C	bgn	20	10	none	none	-34dBm 
<input type="radio"/>	JY_FH1203_SD7B08	C8:3A:35:5D:7B:08	bgn	20	10	none	wpa&wpa2/aes	-47dBm 
<input type="radio"/>	Link_One_1F2930	C8:3A:35:1F:29:30	bgn	40	11	upper	none	-42dBm 
<input checked="" type="radio"/>	IP-COM_130518	00:B0:C6:C8:DC:40	bg	20	6	none	wpa&wpa2/aes	-53dBm 

4 Refer to **Steps 2~3** to configure similar settings on the remote device (AP 2).

5 After completing all settings mentioned above, refresh the page. When the corresponding MAC address' status displays **Connected**, WDS settings are activated successfully.

IP-COMwww.ip-com.com.cn

Quick Setup

Status

Quick Setup

Network

Wireless

SNMP

Tools

WIFI Radio	2.4GHz	Save
Mode	<input type="radio"/> AP Mode <input checked="" type="radio"/> WDS Mode <input type="radio"/> APClient Mode	
SSID	IP-COM_130518	Restore
Security Mode	Mixed WPA/WPA2 - PSK	Help
Cipher Type	<input checked="" type="radio"/> AES <input type="radio"/> TKIP <input type="radio"/> TKIP&AES	
Security Key	12345678	
MAC Address	00:B0:C6:C8:DC:40 (Status: Connected)	
MAC Address	(Status: Unknow)	
MAC Address	(Status: Unknow)	
MAC Address	(Status: Unknow)	
The Uplinked AP's Network Mode	bg	
The Uplinked AP's channel	6	
The Uplink AP's Channel Bandwidth	20	
The Uplinked AP's Extension Channel	none	

APClient Mode

In this mode, the AP negotiates with the remote device firstly and then it can provide access to clients. What you need to do is to scan the remote device's signal and bridge it successfully without any configuration on the remote device. To some extent, this is the biggest difference between the WDS mode and AP Client mode. Then clients can connect to the AP wirelessly for Internet access.

Application Scenario:

There's already an AP (Hereinafter referred as the remote AP) installed on the second floor of a hotel. Due to limited WiFi coverage or other objects' interference, some rooms of the hotel on the second floor may be unable to enjoy WiFi smoothly. Then you can install one more AP in the room where WiFi signal is not strong enough for WiFi extension. In this mode, you have no need to configure any WDS settings on the remote AP.

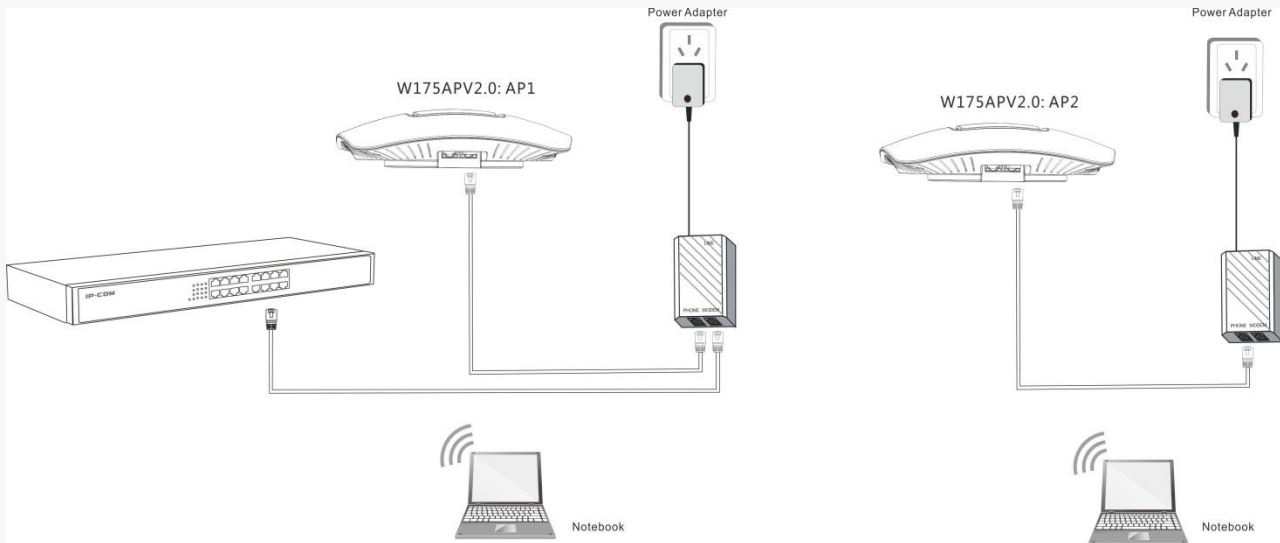

Before configuring AP Client settings, verify the following information of the remote SSID: SSID (WiFi name), channel and encryption information.

Assuming information of the remote device is as below:

SSID: IP-COM_130518

Channel: 6

Security Mode: Mixed WPA/WPA2-PSK

Cipher Type: AES

Security Key: 12345678

Configuration Steps:

- 1 Select **APClient Mode** and click **Enable Scan**.



- 2 Select the remote SSID “IP-COM_130518” and click **Save**.

IP-COM www.ip-com.com.cn

Quick Setup

WIFI Radio: 2.4GHz

Mode: AP Mode WDS Mode APClient Mode

SSID: IP-COM_130518

Security Mode: Mixed WPA/WPA2 - PSK

Cipher Type: AES TKIP TKIP&AES

Security Key: 12345678

The Uplinked AP's channel: 6

Select	SSID	MAC Address	Network Mode	Channel Bandwidth	Channel	Extension Channel	Security	Signal Strength
<input checked="" type="checkbox"/>	IP-COM_130518	00:90:4C:C8:DC:40	bg	20	6	none	wpa&wpa2/aes	-18dBm

! Note:

Verify that the DHCP server on the remote AP (AP 2) is disabled.

Network

LAN Setup

Click **Network > LAN Setup** to configure LAN parameters.

IP-COM www.ip-com.com.cn

LAN Setup

MAC Address: 00:B0:C6:2B:D7:6F

Address Mode: Static IP

IP Address: 192.168.0.254 For example: 192.168.1.1

Subnet Mask: 255.255.255.0 For example: 255.255.255.0

Gateway: 192.168.0.1

Primary DNS Server: 192.168.0.1

Secondary DNS Server(optional):

Device Name: W175APV1.0

- **MAC Address:** LAN MAC address of the device.
- **Address Mode:** Static IP: The default address mode of your device. You can modify the LAN IP address manually. Once the LAN IP address of the device is changed, you need to use the new IP address to re-log in to its web page. Dynamic IP: Your device obtains IP address information automatically.
- **IP Address:** The default LAN IP address of the device is 192.168.0.254. You can modify it here.

- **Subnet Mask:** Subnet mask of the device. The default one is 255.255.255.0.
- **Gateway:** Gateway of the device. Usually, it is advisable to enter the LAN IP address of the remote device.
- **Device Name:** Modify the device name.

DHCP Server

DHCP Server

If you enable the built-in DHCP server on the device, it will automatically configure the TCP/IP settings for all your LAN computers (including IP address, subnet mask, gateway and DNS etc.), eliminating the need of manual intervention. Just be sure to set all computers on your LAN to be DHCP clients by selecting **Obtain an IP Address Automatically** respectively on each PC. When turned on, these PCs will automatically load IP information from the DHCP server. By default, the DHCP server on this device is disabled. The first time you connected to the AP, you need to set your PC to **Use the following IP address**. For more details, see [Configure PC](#). Click **Network > DHCP Server** to enter page below:

- **DHCP Server:** Check/Uncheck it to enable/disable the DHCP server.
- **Start IP:** The start IP address that the DHCP server has automatically assigned.
- **End IP:** The end IP address that the DHCP server has automatically assigned.
- **Lease Time:** How long the IP address can be used by the client device.
- **Primary DNS Server:** Primary DNS server address.
- **Secondary DNS Server:** Secondary DNS server address.

DHCP Client List

Click **Network** > **DHCP Server** > **DHCP Client List** to view DHCP clients information.

IP-COM www.ip-com.com.cn

DHCP Server **DHCP Client List**

Once DHCP is enabled, client list will be refreshed automatically every five seconds.

ID	Hostname	IP Address	MAC Address	Lease Time

Wireless

Basic

Click **Wireless** to configure basic wireless settings. It is advisable to configure the SSID, security mode and security key, and leave other settings unchanged.

IP-COM www.ip-com.com.cn

2.4GHz Basic **5GHz Basic**

SSID: IP-COM_3AC6E5

Enable:

Hide SSID automatically:

Broadcast SSID: Enable

AP isolation: Disable Enable

Maximum clients: 25 (Range:1-64)

SSID: IP-COM_3AC6E5

Chinese SSID Encode: UTF-8

Security Mode: None

The screenshot shows the IP-COM web interface for configuring the 5GHz Basic settings. The sidebar on the left lists various configuration categories, with 'Wireless' and 'Basic' highlighted. The main configuration area includes the following fields and options:

- SSID:** A dropdown menu set to 'IP-COM-5G_3AC6EC'.
- Enable:** A checked checkbox.
- Hide SSID automatically:** An unchecked checkbox.
- Broadcast SSID:** A dropdown menu set to 'Enable'.
- AP isolation:** Radio buttons for 'Disable' (selected) and 'Enable'.
- Maximum clients:** A text input field with '25' and a note '(Range:1-64)'.
- SSID:** A text input field with 'IP-COM-5G_3AC6EC'.
- Chinese SSID Encode:** A dropdown menu set to 'UTF-8'.
- Security Mode:** A dropdown menu set to 'None'.

On the right side of the configuration area, there are three buttons: 'Save', 'Restore', and 'Help'.

- **SSID:** Up to 8 SSIDs at the 2.4G radio and 4 SSIDs at the 5G radio can be supported on this device.
- **Enable:** When you check it, Wi-Fi will be allowed for the selected SSID.
- **Hide SSID automatically:** When the maximum number of clients is exceeded, the SSID will be hidden automatically.
- **Broadcast SSID:** When it is enabled, wireless clients are able to scan the SSID; when it is disabled, wireless clients are unable to scan the SSID. At this time, if you want to connect to it wirelessly, you have to type in the SSID and select the encryption mode manually.
- **AP Isolation:** When this function is enabled, wireless clients connected to the SSID won't be able to communicate with each other, which can enhance wireless network security.
- **Maximum Clients:** The maximum number of wireless clients which can connect to the SSID.
- **SSID:** WiFi name. Different SSIDs can have different configurations.
- **Chinese SSID Encode:** Select Chinese SSID encodes to match wireless clients with different code formats in a better way.
- **Security Mode:** Display wireless encryption information of the current SSID. Available security modes are: None, WEP, WPA-PSK, WPA2-PSK, Mixed WPA/WPA2-PSK, WPA, and WPA2.

Configuration Steps:

- ① **SSID:** Select the SSID (WiFi name) you wish to configure.
- ② **Enable:** Check it to enable the selected SSID.
- ③ **Maximum Clients:** Configure the number of wireless clients

- 4 **SSID:** Modify your SSID.
- 5 **Security Mode, Cipher Type, Key:** Choose WPA-PSK as priority and configure wireless encryption information for your SSID.
- 6 Click **Save**.

WEP

WEP (Wired Equivalent Privacy): WEP is a security mode for data which is delivered between two devices to protect wireless network from illegal users. WEP is the RSA data encryption technology based on RC4. Compared with WEP, WPA-PSK and WPA2-PSK are more secure.

The screenshot shows the IP-COM web interface for configuring wireless settings. The left sidebar contains a navigation menu with options: Status, Quick Setup, Network, Wireless (selected), Basic (selected), Radio, Channel Scan, Advanced, Access Control, QVLAN, SNMP, and Tools. The main content area is titled '2.4GHz Basic' and '5GHz Basic'. The '2.4GHz Basic' tab is active, showing the following configuration options:

- SSID: IP-COM_3AC6E5 (dropdown)
- Enable:
- Hide SSID automatically:
- Broadcast SSID: Enable (dropdown)
- AP isolation: Disable Enable
- Maximum clients: 25 (Range:1-64)
- SSID: IP-COM_3AC6E5 (text input)
- Chinese SSID Encode: UTF-8 (dropdown)
- Security Mode: WEP (dropdown)
- Encryption Type: Open (dropdown)
- Default Key: Security Key 1 (dropdown)
- WEP Key 1: 12345 (text input) ASCII (dropdown)
- WEP Key 2: 12345 (text input) ASCII (dropdown)
- WEP Key 3: 12345 (text input) ASCII (dropdown)
- WEP Key 4: 12345 (text input) ASCII (dropdown)

Buttons for 'Save', 'Restore', and 'Help' are located on the right side of the configuration area.

- **Default Key:** Four Security Keys are available. You can choose one from them.
- **Open:** Uses "no authentication" + WEP Encryption. Wireless clients can associate with the device without going through authentication. Only data in transmission is encrypted with WEP encryption.
- **Shared:** Uses shared key authentication + WEP Encryption. A WEP key that is mutually agreed in advance is required from both sides while wireless clients try to associate with the device. Association is established only if the two sides provide the same WEP key.
- **Default Key:** Specify a WEP key from the preset keys for current use. For example, if you select Key 2, wireless clients must join your wireless network using this Key 2.
- **WEP Keys:** ASCII and Hex are provided for you to configure. When you configure ASCII, you can

choose 5 or 13 ASCII codes (only “0~9, a~z, A~Z, @, *, -, _” can be allowed). When you configure Hex, you can choose 10 or 26 hexadecimal numbers. One English letter or an Arabic numeral takes up one ASCII code.

WPA-PSK

Wi-Fi Protected Access (WPA) and Wi-Fi Protected Access II (WPA2) are two security protocols and security certification programs developed by the Wi-Fi Alliance to secure wireless computer networks. Only authorized network users can access the wireless network. WPA-PSK adopts enhanced encryption algorithm over WEP.

The screenshot shows the IP-COM web interface for configuring wireless settings. The left sidebar contains a navigation menu with options: Status, Quick Setup, Network, Wireless (selected), Basic (selected), Radio, Channel Scan, Advanced, Access Control, QVLAN, SNMP, and Tools. The main content area is titled '2.4GHz Basic' and '5GHz Basic'. The configuration fields are as follows:

SSID	IP-COM_3AC6E5	Save
Enable	<input type="checkbox"/>	Restore
Hide SSID automatically	<input type="checkbox"/>	Help
Broadcast SSID	Enable	
AP isolation	<input checked="" type="radio"/> Disable <input type="radio"/> Enable	
Maximum clients	25 (Range:1-64)	
SSID	IP-COM_3AC6E5	
Chinese SSID Encode	UTF-8	
Security Mode	WPA - PSK	
Cipher Type	<input checked="" type="radio"/> AES <input type="radio"/> TKIP <input type="radio"/> TKIP&AES	
Key	12345678	
Key Update Interval	0 s (Range: 60-99999 seconds. If set to 0, key will not be updated.)	

- **Cipher Type:** AES (Advanced Encryption Standard), TKIP (Temporal Key Integrity Protocol) and TKIP&AES are available. The default is AES.
- **Key:** Specify the security key you wish to configure (8~63 ASCII characters). Only “0~9, a~z, A~Z, @, *, -, _” can be included. And one English letter or an Arabic numeral takes up one ASCII code.

WPA2-PSK

WPA2 (Wi-Fi Protected Access version 2)-PSK is more secure than WEP (Wireless Equivalent Privacy) or WPA (Wi-Fi Protected Access). Apart from TKIP, AES is also available.

IP-COM www.ip-com.com.cn

2.4GHz Basic 5GHz Basic

Status

Quick Setup

Network

Wireless

Basic

Radio

Channel Scan

Advanced

Access Control

QVLAN

SNMP

Tools

SSID: IP-COM_3AC8E5 [Save]

Enable:

Hide SSID automatically: [Restore]

Broadcast SSID: Enable [Help]

AP isolation: Disable Enable

Maximum clients: 25 (Range:1-64)

SSID: IP-COM_3AC8E5

Chinese SSID Encode: UTF-8

Security Mode: WPA2 - PSK

Cipher Type: AES TKIP TKIP&AES

Key: 12345678

Key Update Interval: 0 s (Range: 60—99999 seconds. If set to 0, key will not be updated.)

- **Cipher Type:** AES (Advanced Encryption Standard), TKIP (Temporal Key Integrity Protocol) and AES&TKIP are available. The default is AES.
- **Key:** Specify the security key you wish to configure (8~63 ASCII characters). Only “0~9, a~z, A~Z, @, *, -, , _” can be included. And one English letter or an Arabic numeral takes up one ASCII code.

Mixed WPA/WPA2-PSK

IP-COM www.ip-com.com.cn

2.4GHz Basic 5GHz Basic

Status

Quick Setup

Network

Wireless

Basic

Radio

Channel Scan

Advanced

Access Control

QVLAN

SNMP

Tools

SSID: IP-COM_3AC8E5 [Save]

Enable:

Hide SSID automatically: [Restore]

Broadcast SSID: Enable [Help]

AP isolation: Disable Enable

Maximum clients: 25 (Range:1-64)

SSID: IP-COM_3AC8E5

Chinese SSID Encode: UTF-8

Security Mode: Mixed WPA/WPA2 - PSK

Cipher Type: AES TKIP TKIP&AES

Key: 12345678

Key Update Interval: 0 s (Range: 60—99999 seconds. If set to 0, key will not be updated.)

- **Cipher Type:** AES (Advanced Encryption Standard), TKIP (Temporal Key Integrity Protocol) and AES&TKIP are available. The default is AES.
- **Key:** Specify the security key you wish to configure (8~63 ASCII characters). Only “0~9, a~z, A~Z, @, *, -, , _” can be included. And one English letter or an Arabic numeral takes up one ASCII code.

WPA/WPA2

Adopt 802.1X and RADIUS authentication for data encryption.

The screenshot shows the IP-COM web interface for configuring wireless settings. The left sidebar contains a navigation menu with options: Status, Quick Setup, Network, Wireless (selected), Basic, Radio, Channel Scan, Advanced, Access Control, QVLAN, SNMP, and Tools. The main content area is titled '2.4GHz Basic' and '5GHz Basic'. The '2.4GHz Basic' tab is active, showing the following configuration options:

- SSID: IP-COM_3AC6E5 (dropdown menu)
- Enable:
- Hide SSID automatically:
- Broadcast SSID: Enable (dropdown menu)
- AP isolation: Disable Enable
- Maximum clients: 25 (Range: 1-64)
- SSID: IP-COM_3AC6E5 (text input)
- Chinese SSID Encode: UTF-8 (dropdown menu)
- Security Mode: WPA (dropdown menu)
- RADIUS Server: (text input)
- RADIUS Port: 1812 (Range: 1-65535, default: 1812)
- RADIUS Password: (text input)
- Cipher Type: AES TKIP TKIP&AES
- Key Update Interval: 0 s (Range: 60-99999 seconds. If set to 0, key will not be updated.)

Buttons for 'Save', 'Restore', and 'Help' are located on the right side of the configuration area.

- **RADIUS Server:** IP address of the RADIUS server.
- **RADIUS Port:** Port for RADIUS authentication.
- **RADIUS Password:** Password for accessing the RADIUS server.
- **Cipher Type:** AES (Advanced Encryption Standard), TKIP (Temporal Key Integrity Protocol) and AES&TKIP are available. The default is AES.

Radio

Click **Wireless > Radio** to configure radio settings. If you are new to networking and have never configured these settings before, we recommend you to leave the default settings unchanged.

The image displays two screenshots of the IP-COM web interface for configuring wireless settings. Both screenshots show a sidebar menu on the left with options like Status, Quick Setup, Network, Wireless, Basic, Radio, Channel Scan, Advanced, Access Control, QVLAN, SNMP, and Tools. The main content area is divided into '2.4GHz Radio' and '5GHz Radio' tabs.

2.4GHz Radio Configuration (Top Screenshot):

- Enable Wireless:
- Country: China
- Network Mode: 11b/g/n mixed
- Channel: Auto
- Channel Bandwidth: 20 40 20/40
- Extension Channel: Auto
- Channel Lockout:
- SSID isolation: Disable Enable
- WMM Capable: Enable Disable
- APSD Capable: Enable Disable

5GHz Radio Configuration (Bottom Screenshot):

- Enable Wireless:
- Country: China
- Network Mode: 11ac
- Channel: Auto
- Channel Bandwidth: 20MHz 40MHz 80MHz
- Channel Lockout:
- SSID isolation: Disable Enable
- WMM Capable: Enable Disable
- APSD Capable: Enable Disable

- **Enable Wireless:** Check it to enable WiFi function.
- **Country:** Select the country where your device works,
- **Network Mode:** Select a proper network mode for your device. In 2.4G radio, the default mode is 11b/g/n mixed. In 5G radio, the default mode is 11ac.
- **Channel:** Select a proper channel for your wireless network.
- **Channel Bandwidth:** Select a proper channel bandwidth to enhance wireless performance. When the network mode is not 802.11n mode, only 20M can be selected. When the network mode is 802.11n mode, it is advisable to select 20/40M for better wireless performance.
- **Extension Channel:** This is used to ensure radio frequency for 802.11n devices on the network.
- **Channel Lockout:** Once this option is enabled, you can't modify the channel manually.
- **WMM Capable:** WMM is QoS for your wireless network. Enabling this option may ensure better online stream wireless multimedia data such as video or audio (recommended).

- **APSD Capable:** Automatic power save delivery. It is disabled by default.

Channel Scan

Click **Wireless > Channel Scan** to get an overview of wireless signals nearby. And then you can select a channel which is the least used by neighboring networks (i.e. the channel with least interference) for your device for better network performance.

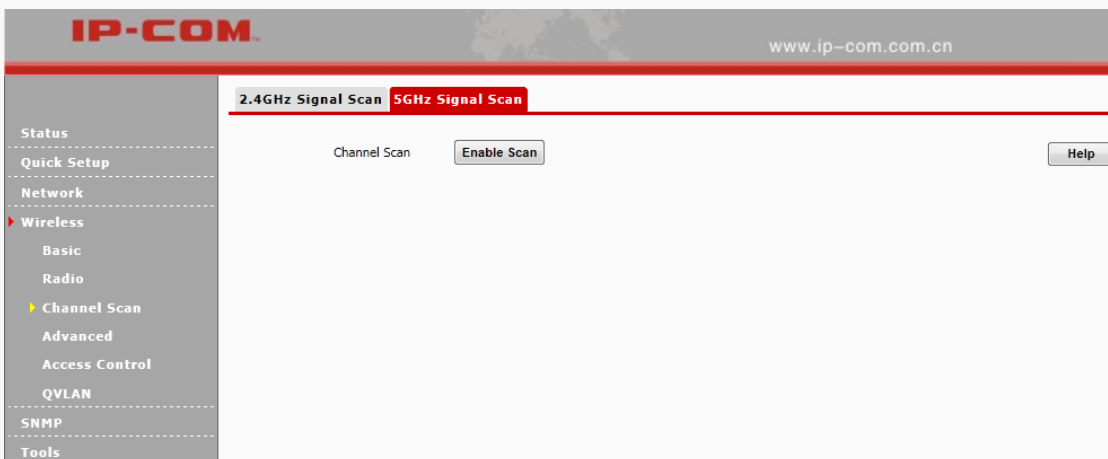
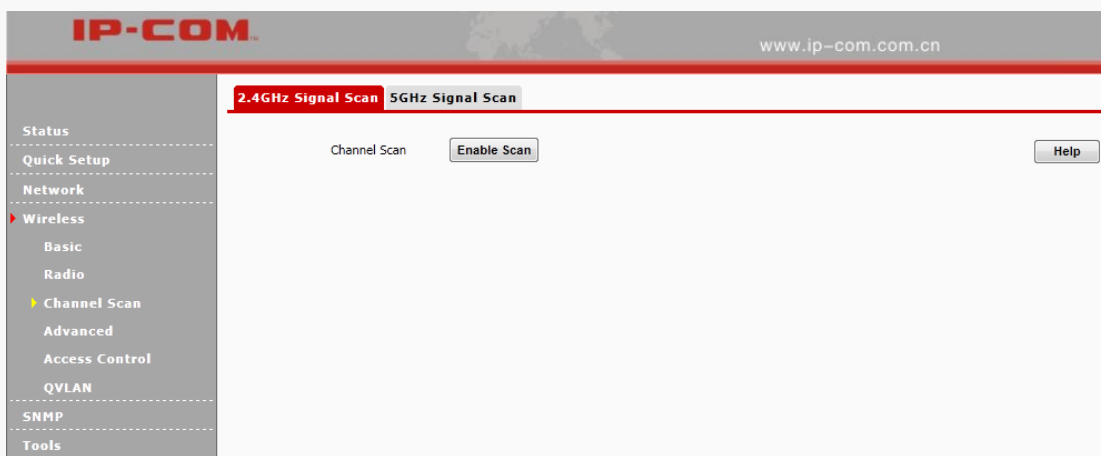

Click **Enable Scan** to view channels of wireless signals nearby.

ID	SSID	MAC Address	Network Mode	Channel	Bandwidth	Security	Signal Strength
1	JY_FH1203_5D7B08	C8:3A:35:5D:7B:08	bgn	10	20	wpa&wpa2/aes	-42dBm
2	JY_up_houyinghui	C8:3A:35:12:6B:B9	bgn	11	20	wpa&wpa2/tkip&aes	-46dBm
3	JY_F1203_liuli	C8:3A:35:00:9F:F8	bgn	11	20	wpa&wpa2/aes	-47dBm
4	SY-85	C8:3A:35:00:9E:20	bgn	13	20	wpa/aes	-57dBm
5	JY_00FF78	C8:3A:35:00:FF:78	bgn	13	20	none	-54dBm
6	BX_Liguangqian	C8:3A:35:03:1A:B1	bgn	1	20	wpa2/aes	-66dBm
7	DSL_PUJIN_DH301_A	C8:3A:35:25:C9:29	bgn	1	40	none	-47dBm

ID	SSID	MAC Address	Network Mode	Channel	Bandwidth	Security	Signal Strength
1	IP-COM-5G_009E28	C8:3A:35:00:9E:28	ac	149	80	none	-76dBm
2	5G-IP-COM-X3-0	C8:3A:35:52:60:20	ac	149	80	none	-86dBm
3	jy_00FF78_5G	C8:3A:35:00:FF:7C	ac	161	80	none	-62dBm
4	JY_FH1203_5D7B08_5G	00:90:4C:88:88:8C	ac	149	80	wpa&wpa2/aes	-63dBm
5	JY_F1203_Jiuli_5G	C8:3A:35:00:9F:FC	ac	149	80	wpa&wpa2/aes	-71dBm
6	Boyaa-Staff	B4:C7:99:EA:92:60	an	149	20	wpa&wpa2/tkip&aes	-87dBm
7	boyaa-guest	B4:C7:99:EA:92:61	an	149	20	wpa&wpa2/tkip&aes	-87dBm

Advanced

Click **Wireless > Advanced** to configure advanced wireless settings. If you are not familiar with these settings, keep the default settings unchanged.

➤ **Beacon Interval:** This is a time interval between any two consecutive Beacon packets sent by an Access

Point to synchronize a wireless network. Specify a valid value between 20 and 999. The default setting is 100. It is advisable to leave the default value unchanged.

- **Fragment Threshold:** Specify a valid Fragment Threshold value between 256 and 2346. The default is 2346. Any wireless packet exceeding the preset value will be divided into several fragments before transmission.
- **RTS Threshold:** Specify a valid value between 1 and 2347. The default is 2347. If a packet exceeds the preset value, RTS/CTS scheme will be used to reduce collisions. Set it to a smaller value provided that there are distant clients and interference. For SOHO users, it is suggested to keep the default value unchanged.
- **DTIM Interval:** A DTIM (Delivery Traffic Indication Message) Interval is a countdown informing clients of the next window for listening to broadcast and multicast messages. When such packets arrive in the router's buffer, the router will send DTIM (delivery traffic indication message) and DTIM interval to alert clients of the receiving packets. Specify a valid value between 1 and 255. The default is 1.
- **Receive Signal Strength:** Configure signal strength for connected clients. When the wireless client's signal strength is lower than the setting value, the wireless client will not be allowed to connect to the AP.
- **Interference Mitigation:** Mainly used for reducing wireless or some non-wireless interference to enhance transmission rate of your device.

Interference mitigation: interference mitigation mode, range: 0-4. The default is 2.

(1) Mode 0: All interference mitigation is disabled.

(2) Mode 1: Non-wireless LAN Interference mitigation is enabled.

(3) Mode 2: Wireless LAN Interference mitigation is enabled.

(4) Mode 3: Auto Wireless LAN Interference mitigation is enabled and active.

(5) Mode 4: Auto Wireless LAN Interference mitigation is enabled and noise reduction is enabled.

- **TX Power:** Used for configuring wireless transmission power. You can change the value according to your actual network environment.
- **Power Lockout:** Once this option is enabled, you can't modify power manually.
- **Preamble:** Mainly used for preamble synchronization. It is advisable to keep the default value unchanged.

Access Control

Click **Wireless > Access Control** to enter page below. This page allows you to specify a list of devices to allow or disallow a connection to your wireless network via the device's MAC addresses. To deactivate this feature, select "Disable"; to activate it, select "Allow" or "Deny".

The screenshot shows the IP-COM web interface for the 2.4GHz Control page. The left sidebar contains a navigation menu with options: Status, Quick Setup, Network, Wireless (selected), Basic, Radio, Channel Scan, Advanced, Access Control (selected), QVLAN, SNMP, and Tools. The main content area has a header with '2.4GHz Control' and '5GHz Control' tabs. Below the header, there is a text instruction: 'Specify a list of devices to allow or disallow a connection to your wireless network via the devices' MAC addresses. This can be set separately on each SSID.' There are 'Save', 'Restore', and 'Help' buttons. The SSID is set to 'IP-COM_3AC6E5' and the MAC Filter Mode is set to 'Disable'. Below this, there is a table with columns: ID, MAC Address, IP, Connection Duration, and Add to List. The table is currently empty, displaying 'No clients connected!'.

The screenshot shows the IP-COM web interface for the 5GHz Control page. The left sidebar contains a navigation menu with options: Status, Quick Setup, Network, Wireless (selected), Basic, Radio, Channel Scan, Advanced, Access Control (selected), QVLAN, SNMP, and Tools. The main content area has a header with '2.4GHz Control' and '5GHz Control' tabs. Below the header, there is a text instruction: 'Specify a list of devices to allow or disallow a connection to your wireless network via the devices' MAC addresses. This can be set separately on each SSID.' There are 'Save', 'Restore', and 'Help' buttons. The SSID is set to 'IP-COM-5G_3AC6EC' and the MAC Filter Mode is set to 'Disable'. Below this, there is a table with columns: ID, MAC Address, IP, Connection Duration, and Add to List. The table is currently empty, displaying 'No clients connected!'.

- **SSID:** Select the SSID you wish to configure access control setting.
- **MAC Filter Mode:** Select **Disable** to disable **Access Control** function. **Allow:** Only MAC addresses in the access control list are allowed to connect to the SSID. **Deny:** MAC addresses in the access control list are not allowed to connect to the SSID.

Configuration Steps:

- 1 Select the SSID you wish to configure from the drop-down list.
- 2 Select the MAC Filter mode.
- 3 Enter the MAC address of the wireless client.
- 4 Click **Add**.
- 5 Click **Save**.

The screenshot shows the IP-COM web interface for MAC Filter configuration. The left sidebar contains navigation options: Status, Quick Setup, Network, Wireless (selected), Basic, Radio, Channel Scan, Advanced, Access Control, QVLAN, SNMP, and Tools. The main content area is titled '2.4GHz Control' and '5GHz Control'. It includes a 'Save' button, a 'Restore' button, and a 'Help' button. The configuration fields are: SSID (ZL_zhouya), MAC Filter Mode (Allow), and a table for connected clients. The table has columns for ID, MAC Address, IP, Connection Duration, and Add to List. Below the table, there is a form to add a new MAC address with fields for each octet and an 'Add' button. A single entry is shown in the table with ID 1, MAC Address 00:B0:C6:E7:54:C9, and an 'Enable' checkbox checked, with a 'Delete' button.

QVLAN

When QVLAN is enabled, you can tag different SSIDs to different VLANs. Used with the managed switch, you can establish different VLANs and different Internet Access rights.

- **SSID:** WiFi name. Up to 32 characters can be supported.
- **VLAN ID:** Specify a value between 2 and 4094.

The screenshot shows the IP-COM web interface for QVLAN Setup. The left sidebar is the same as in the previous screenshot. The main content area is titled '2.4GHz QVLAN Setup' and '5GHz QVLAN Setup'. It includes an 'Enable' checkbox, a 'Save' button, a 'Restore' button, and a 'Help' button. The configuration table has columns for SSID and VLAN ID (2-4095). The table contains 8 rows of SSIDs, all with a VLAN ID of 1000.

SSID	VLAN ID (2-4095)
IP-COM_3AC6E4	1000
IP-COM_3AC6E5	1000
IP-COM_3AC6E6	1000
IP-COM_3AC6E7	1000
IP-COM_3AC6E8	1000
IP-COM_3AC6E9	1000
IP-COM_3AC6EA	1000
IP-COM_3AC6EB	1000

For instance:

People in a hotel are generally classified into three kinds: hotel executives, hotel stuffs and customers. They all access the internal network via this device.

1. Hotel executives can access both the Internet and internal network in the hotel.
2. Hotel stuffs can only have the access to internal network in the hotel,
3. Customers can only access the Internet. The network diagram is shown below:

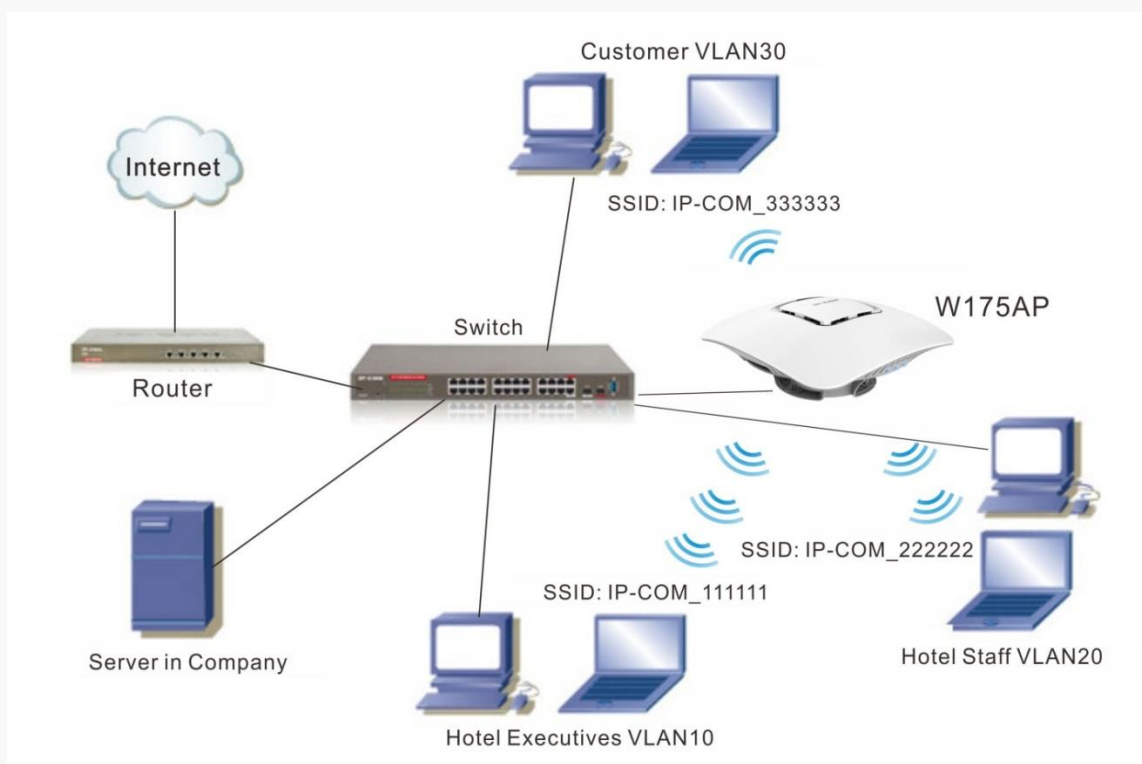

After the above-mentioned physical installation, follow below steps:

1 Enable 3 SSIDs on the device and name these SSIDs differently. As shown in the diagram, SSID used by internal members is hidden (Once QVLAN is enabled, we can only configure security key for one SSID. Hiding SSID secures the internal network in the hotel).

2 Enable QVLAN and bind the three different SSIDs as shown below.

3 Configure the switch:

A. Configure the port on the switch connected to the AP as the Trunk port, PVID=1 and all VLANs allowed;

B. Configure the port on the switch connected to the server in the hotel to be VLAN1 tagged, VLAN10 tagged and VLAN20 tagged;

C. Configure the port on the switch connected to the router as the Trunk port, VLAN1, VLAN10 and VLAN30 allowed;

D. Configure the port on the switch connected to hotel executives to be VLAN10 tagged, the port connected to hotel stuffs to be VLAN20 tagged and the port connected to customers to be VLAN30 tagged.

The screenshot shows the IP-COM web interface for QVLAN Setup. The left sidebar has a menu with 'QVLAN' selected. The main content area has two tabs: '2.4GHz QVLAN Setup' (active) and '5GHz QVLAN Setup'. An 'Enable' checkbox is checked. Below is a table with columns 'SSID' and 'VLAN ID (2-4095)'. The table contains the following rows:

SSID	VLAN ID (2-4095)
IP-COM_111111	10
IP-COM_222222	20
IP-COM_333333	30
IP-COM_2BD773	1000
IP-COM_2BD774	1000
IP-COM_2BD775	1000
IP-COM_2BD776	1000

Buttons for 'Save', 'Restore', and 'Help' are visible on the right side of the configuration area.

SNMP

The Simple Network Management Protocol (SNMP) is widely used in local area networks (LANs) for collecting information, managing, and monitoring network devices, such as servers, printers, hubs, switches, and routers. Specialized software in each SNMP capable device, known as an Agent, continuously monitors the status of the device and reports the results to the SNMP Manager software, which can then act on the report.

Click **SNMP** to enter screen below:

The screenshot shows the IP-COM web interface for SNMP configuration. The left sidebar has a menu with 'SNMP' selected. The main content area has a title 'SNMP' and a description: 'Here you can configure SNMP settings. SNMP v1 and v2c are supported.' Below this are several configuration fields:

- SNMP: Disable Enable
- Administrator Name:
- Device Name:
- Location:
- Read Community:
- Read/Write Community:

Buttons for 'Save', 'Restore', and 'Help' are visible on the right side of the configuration area.

- **SNMP:** Disable or Enable the SNMP function.
- **Read Community:** Indicates the community string for read access to permit reading this AP's SNMP information. The default is Public.
- **Write/Read Community:** Indicates the community string for write/read access to permit reading and re-writing this AP's SNMP information. The default is Private.

Tools

This section will instruct you how to maintain your device.

The following eight parts are included: Maintenance, Time & Date, Logs, Configuration, Username & Password, Diagnostics, Reboot and LED.

Maintenance

If your device is in normal operation, it is not advisable to upgrade your device. If you want to acquire the latest software version or better value-added functions for your device, you can access our official website www.ip-com.com.cn to download the latest software for upgrading. Click **Tools > Maintenance > Firmware Upgrade** to enter screen below:

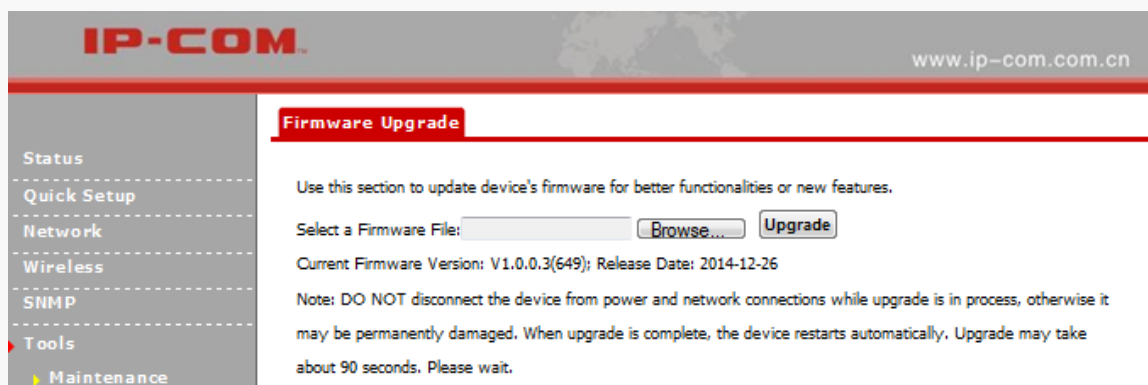

Configuration Steps for Firmware Upgrade:

- 1 Launch a web browser and go to <http://www.ip-com.com.cn> to download the latest firmware.
- 2 Unzip the compressed upgrade file in the corresponding directory.
- 3 Click **Browse** to locate and select the upgrade file in the corresponding directory on your hard disk.
- 4 Click **Upgrade** to upgrade device firmware.

Note:

- 1 While upgrading, please verify that your PC is connected to the device with an Ethernet cable and power is delivered on this device. And the upgrading process will take several minutes, please be patient.
- 2 When the upgrading is completed, your device will be restored to factory default settings automatically and you need to reconfigure your device.

Time & Date

System Time

Click **Tools > Time & Date > System Time** to enter the System Time screen. This page is used to set the device's system time. System time can be configured using the following 2 methods:

- **Sync with Internet time servers:** If enabled, system automatically connects to NTP server on the Internet to synchronize the time.
- **Set Time and Date Manually:** Specify the time and date manually or click **Sync with Your PC** to automatically copy your current PC's time to the device.

Configuration Steps for Setting Time and Date Manually:

- ① Uncheck **Sync with Internet time servers**.
- ② Click **Sync with your PC** or enter the correct date and time in the input fields.
- ③ Click **Save**.

And then you can go to the **Status** screen to make sure the system time is correctly updated.

Note:

Once power is not delivered on this device, the time settings will be lost. By default, **Sync with Internet time servers** is enabled. When the device is able to access the Internet, it will automatically connect to the NTP server on the Internet to synchronize the time.

Login Timeout

Click **Tools > Time & Date > Login Timeout** and here you can configure the web login timeout (1~60 minutes). The default is 5 minutes. Device returns to login window automatically depending on the specified login timeout and user name/password will be required.

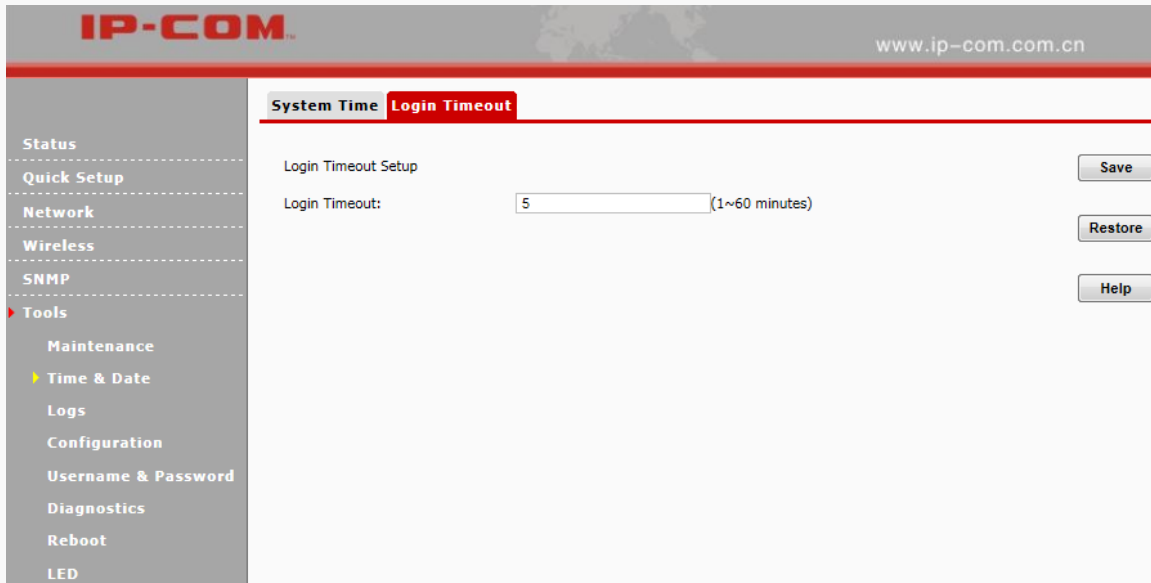

The screenshot shows the IP-COM web interface. The top header features the IP-COM logo and the website URL www.ip-com.com.cn. A left-hand navigation menu lists various system functions: Status, Quick Setup, Network, Wireless, SNMP, Tools (highlighted with a red arrow), Maintenance, Time & Date (highlighted with a yellow arrow), Logs, Configuration, Username & Password, Diagnostics, Reboot, and LED. The main content area is titled 'System Time' and 'Login Timeout'. It contains a 'Login Timeout Setup' section with a 'Login Timeout:' label, a text input field containing the value '5', and a unit indicator '(1~60 minutes)'. To the right of the input field are three buttons: 'Save', 'Restore', and 'Help'.

Logs

View Logs

Click **Tools > Logs > View Logs** to enter screen below. Here you can view the history of the device's actions. Three types of logs are supported on this device: All, System and LAN. You can select any one of them from the drop-down list. Click **Refresh** to update current log info or click **Clear** to clear all logs.

IP-COM
www.ip-com.com.cn

View Logs Log Setup

Type of logs to display: All Refresh

Index	Time	Type	Log Content
150	2015-01-07 16:27:34	system	discovery packet length:32.
149	2015-01-07 16:27:34	system	recv msg is error gWTPDiscoveryCount:80.
148	2015-01-07 16:27:34	system	AP receive discovery response packet is failure.
147	2015-01-07 16:27:24	system	discovery packet length:32.
146	2015-01-07 16:27:24	system	recv msg is error gWTPDiscoveryCount:79.
145	2015-01-07 16:27:24	system	AP receive discovery response packet is failure.
144	2015-01-07 16:27:14	system	discovery packet length:32.
143	2015-01-07 16:27:14	system	recv msg is error gWTPDiscoveryCount:78.
142	2015-01-07 16:27:14	system	AP receive discovery response packet is failure.
141	2015-01-07 16:27:04	system	discovery packet length:32.
140	2015-01-07 16:27:04	system	recv msg is error gWTPDiscoveryCount:77.
139	2015-01-07 16:27:04	system	AP receive discovery response packet is failure.
138	2015-01-07 16:26:54	system	discovery packet length:32.
137	2015-01-07 16:26:54	system	recv msg is error gWTPDiscoveryCount:76.
136	2015-01-07 16:26:54	system	AP receive discovery response packet is failure.

Clear

Page 10 9 8 7 6 5 4 3 2 1

Log Setup

Click **Tools > Logs > Log Setup** to configure system logs. Here you can set up the number of logs and rules of log settings. Up to 300 entries can be logged. The default is 150.

Configuration Steps:

- 1 Click **Add**.

IP-COM
www.ip-com.com.cn

View Logs Log Setup

Number of Logs 150 (Default:150,Range:100~300) Save

Enable(To use the following rules, you must check this box.)

ID	Log Server IP	Log Server Port	Enable	Action
----	---------------	-----------------	--------	--------

Add Restore Help

- ② **Log Server IP:** Specify the IP address of the syslog server in your LAN.
- ③ **Log Server Port:** Specify the port of the syslog server in your LAN (If not allowed to configure a port on your server, enter the default value 514, or enter the remote server's port number.).
- ④ Check **Enable**.
- ⑤ Click **Save**.

IP-COM
www.ip-com.com.cn

View Logs Log Setup

Log Server IP Save

Log Server Port Restore

Enable Help

- ⑥ Check the "To use the following rules, you must check this box." option.

If configured successfully, the system will begin to log events and simultaneously send them to the specified log server in your LAN. You can view all logs there.

IP-COM
www.ip-com.com.cn

View Logs Log Setup

Number of Logs (Default:150,Range:100~300) Save

Enable (To use the following rules, you must check this box.) Restore

ID	Log Server IP	Log Server Port	Enable	Action
1	192.168.0.6	514	Enable	Edit Delete

Add Help

Configuration

Backup & Restore

If you configure many settings on this device, which will make this device work in good status and suitable environment, it's suggested to backup settings for this device, which will be convenient for troubleshooting and saving time for next time's configuration. Click **Tools > Configuration > Backup & Restore** to enter screen below:

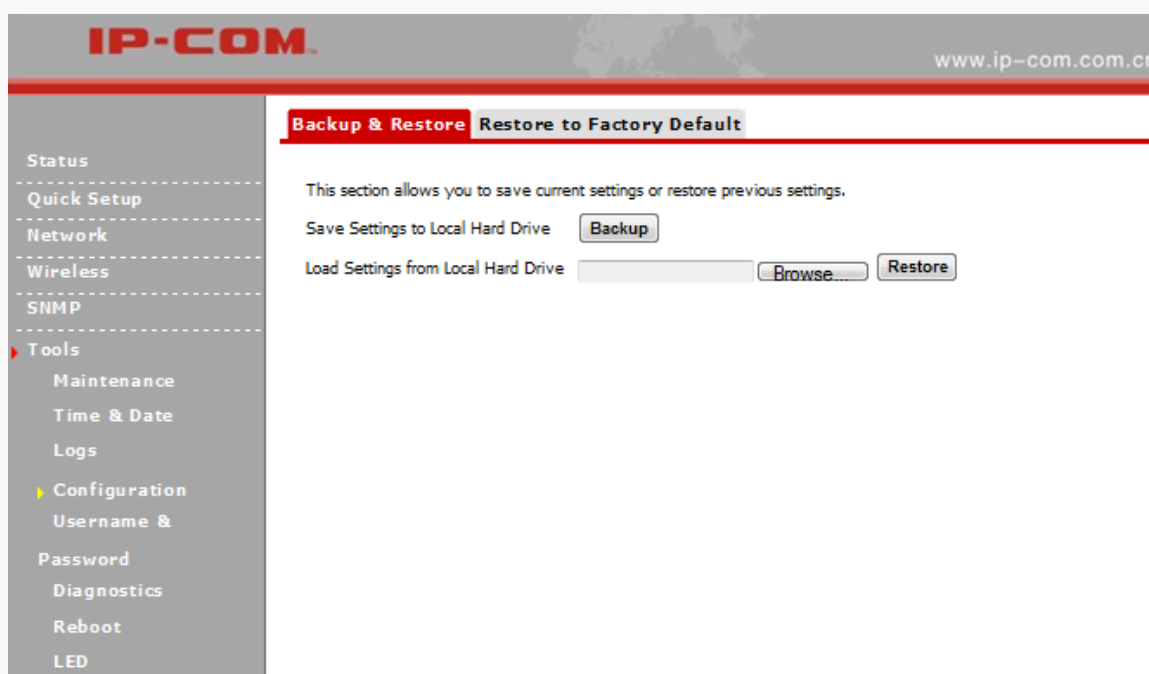

Configuration Steps for Backup:

- 1 Click **Backup**.
- 2 Follow onscreen instructions to specify a directory to save settings on your local hardware.

Configuration Steps for Restore:

- 1 Click **Browse** to load configuration files which you have stored on your hardware disk previously.
- 2 Click **Restore** and then wait until the progress indicator displays 100% completed.

Restore to Factory Default

If the device or client connected to the device fails to access the Internet due to incorrect configurations and you cannot solve the problem, click **Tools > Configuration > Restore to Factory Default** to reset the device and then reconfigure it.

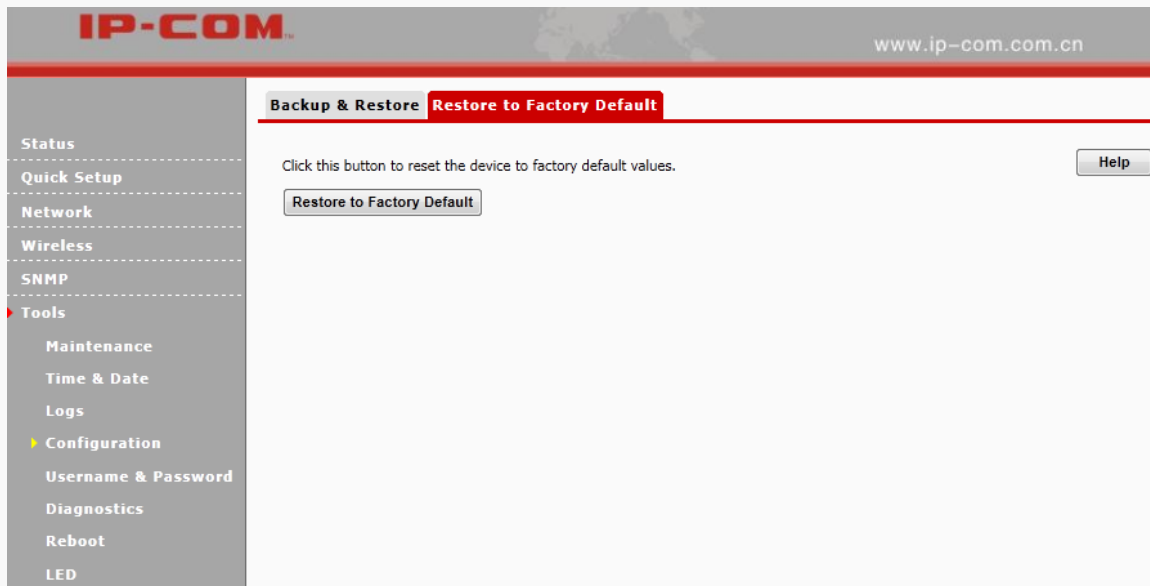

Factory Default Settings:

- User Name: admin
- Password: admin
- IP Address: 192.168.0. 254
- Subnet mask: 255.255.255.0

Username & Password

Click **Tools > Username & Password** to enter screen below. Here you can change the user name and password for web login. We suggest that you change this password to a more secure one.

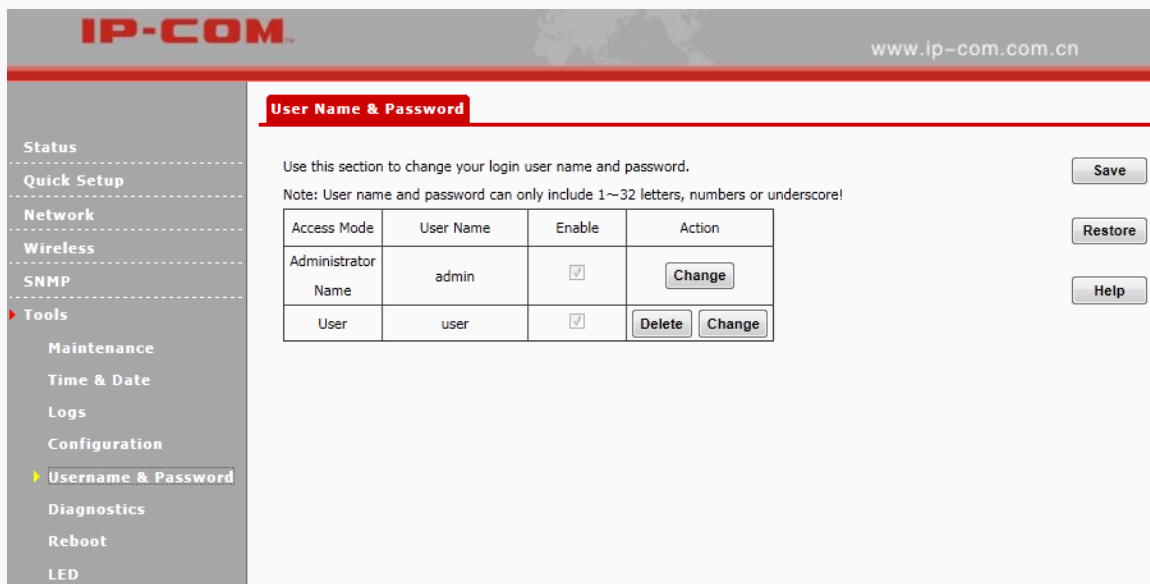

Click **Change** to modify username and password for the corresponding account.

Diagnostics

This page allows you to test your network connection. If your network is malfunctioning, click **Tools > Diagnostics** to use the ping utility to test your network and find out where the problem is.

IP-COM™

Diagnostics

Input an IP(eg: 192.168.0.254) address or a domain name(eg: www.google.com):

Please enter:

```

PING 192.168.0.254 (192.168.0.254): 56 data bytes
64 bytes from 192.168.0.254: seq=0 ttl=64 time=0.306 ms
64 bytes from 192.168.0.254: seq=1 ttl=64 time=0.160 ms
64 bytes from 192.168.0.254: seq=2 ttl=64 time=0.149 ms

--- 192.168.0.254 ping statistics ---
3 packets transmitted, 3 packets received, 0% packet loss
round-trip min/avg/max = 0.149/0.205/0.306 ms
  
```

Status

Quick Setup

Network

Wireless

SNMP

Tools

Maintenance

Time & Date

Logs

Configuration

Username & Password

Diagnostics

Reboot

Reboot

When some settings you have configured cannot be activated or your device is functioning improperly, please reboot your device.

IP-COM™ www.ip-com.com.cn

User Name & Password

Use this section to change your login user name and password.

Note: User name and password can only include 1~32 letters, numbers or underscore!

Access Mode	User Name	Enable	Action
Administrator	admin	<input checked="" type="checkbox"/>	<input type="button" value="Change"/>
User	user	<input checked="" type="checkbox"/>	<input type="button" value="Delete"/> <input type="button" value="Change"/>

Status

Quick Setup

Network

Wireless

SNMP

Tools

Maintenance

Time & Date

Logs

Configuration

Username & Password

Diagnostics

Reboot

LED

Time Reboot

Click **Tools > Time Reboot** to enter page below. Here you can reboot your device regularly. Once this function is enabled, please make sure that your device is synchronized with the Internet time server.

Two methods for time reboot are available: As Interval and As Scheduled.

- **As Interval:** The device will reboot automatically at intervals according to the interval you've configured.
- **As Scheduled:** The device will reboot regularly according to the time you've configured.

The screenshot shows the IP-COM web interface. The top header includes the IP-COM logo and the URL www.ip-com.com.cn. A sidebar menu on the left lists various system functions, with 'Tools' expanded to show 'Reboot'. The main content area is titled 'Time Reboot' and contains the following configuration options:

- Enable Auto Reboot:** A checkbox that is currently unchecked.
- AUTO Reboot Type:** A dropdown menu with 'As Interval' selected.
- Reboot Interval:** A text input field containing the value '1440', with a note '(minute, Range: 10-7200)'.

On the right side of the configuration area, there are three buttons: 'Save', 'Restore', and 'Help'.

Configuration Steps for As Interval:

- 1 Check **Enable Auto Reboot**.
- 2 Select **As Interval** from the **AUTO Reboot Type** drop-down list.
- 3 Specify the reboot interval.
- 4 Click **Save**.

The screenshot shows the IP-COM web interface. The left sidebar has a menu with 'Tools' expanded, showing 'Reboot' selected. The main content area is titled 'Reboot' and 'Time Reboot'. The configuration options are:

- Enable Auto Reboot:
- AUTO Reboot Type: As Scheduled (dropdown)
- Time Reboot on: Everyday Mon Tue Wed Thur Fri Sat Sun
- Time Reboot at: 23:59 eg: 23:59

Buttons for 'Save', 'Restore', and 'Help' are located on the right side of the configuration area.

Configuration Steps for AS Scheduled:

- 1 Check **Enable Auto Reboot**.
- 2 Select **As Scheduled** from the **AUTO Reboot Type** drop-down list.
- 3 Check corresponding dates from Monday to Sunday to specify the reboot date.
- 4 Specify the reboot time.
- 5 Click **Save**.

LED

Click **Tools > LED** to enter screen below. Here you can turn on/off all LEDs.

The screenshot shows the IP-COM web interface with the 'LED' configuration page. The left sidebar has 'Tools > LED' selected. The main content area is titled 'LED' and contains the following elements:

- LED Control (text label)
- Help (button)
- Disable all LEDs (button)

5 Appendix

Troubleshooting

Q1: Power LED troubleshooting

You can know whether the power system of this AP is functioning normally or not in terms of its power LED status. If the system is functioning normally, the Power LED should be lighted or blinking; if the Power LED is off, please verify that:

1. Power cord is correctly connected and the Power ON/OFF switch is on.
2. The power supply accords with the rated power input.
3. The AP is connected to its PoE injector correctly.

Q2: I enter the device's LAN IP address in the web browser but cannot access this device's web page.

What should I do?

1. Check the TCP/IP settings on your PC and verify that IP address is 192.168.0.X (2-253);
2. Clear the browser cache or try another web browser;
3. Ensure the wireless NIC is functioning properly.

If you are still unable to login, please restore the device to factory default settings and follow this user guide to configure your settings again.

Technical Support

Website: <http://www.ip-com.com.cn>

Tel: (86 755) 2765 3089

Email: info@ip-com.com.cn

Skype: IP-COM.Support



Configure PC

Windows 8

Step 1: Right click the icon  or  on the bottom right corner of your desktop.



Tips:

If you cannot find the icon  or  on the bottom right corner of your desktop, follow steps below: Move your cursor to the top right corner of your desktop, select **Settings > Control Panel > Network and Internet > Network and Sharing Center**.

Step 2: Click **Open Network and Sharing Center**.

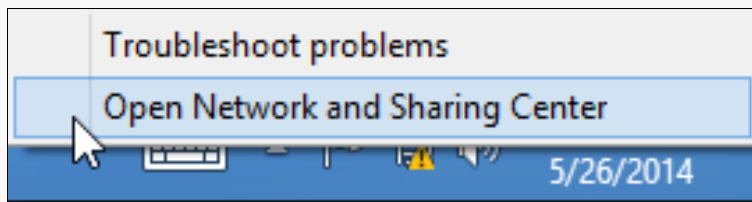

Step 3: Click **Ethernet > Properties**.

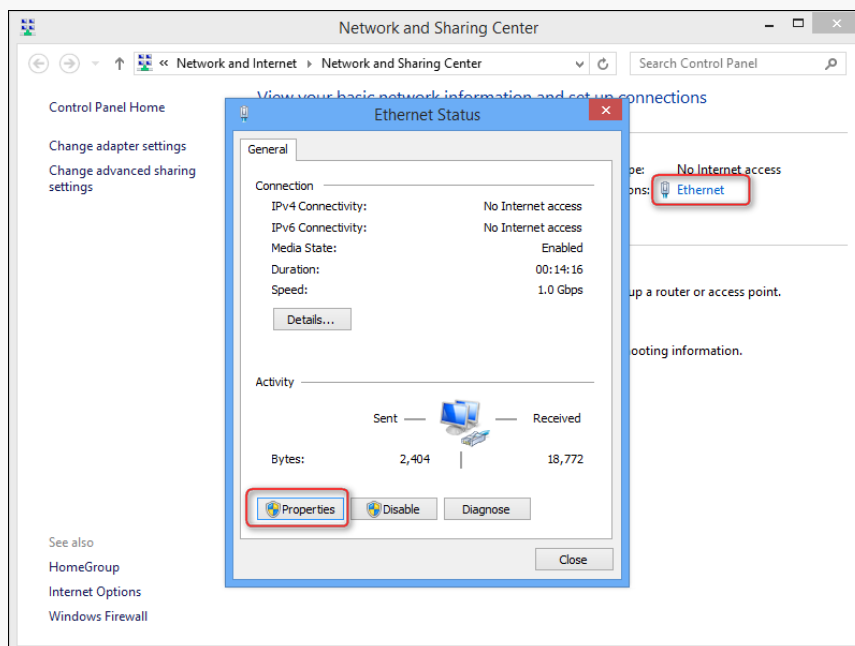

Step 4: Find and double click **Internet Protocol Version 4(TCP/IPv4)**.

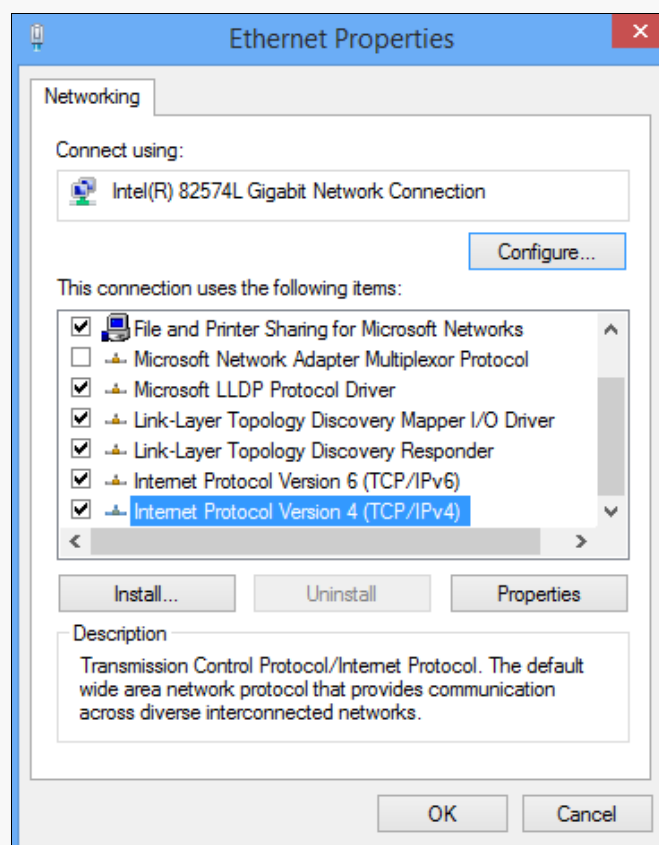

Step 5: Select **Use the following IP address**, type in the IP address: **192.168.0.x** (2~253); subnet mask: **255.255.255.0** and click **OK**.

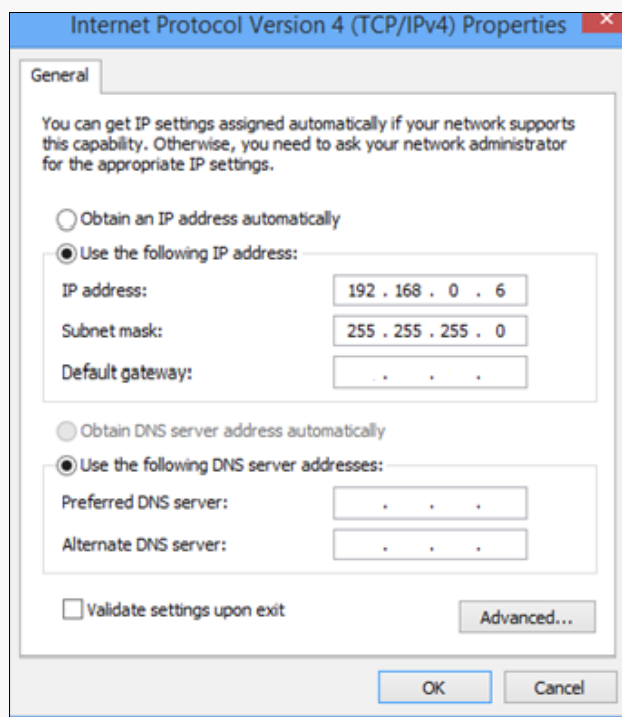

Step 6: Click **OK** on the **Ethernet Properties** window (see **Step 4** for the screenshot).

Windows 7

Step 1: Click the icon  on the bottom right corner of your desktop.

Step 2: Click **Open Network and Sharing Center**.

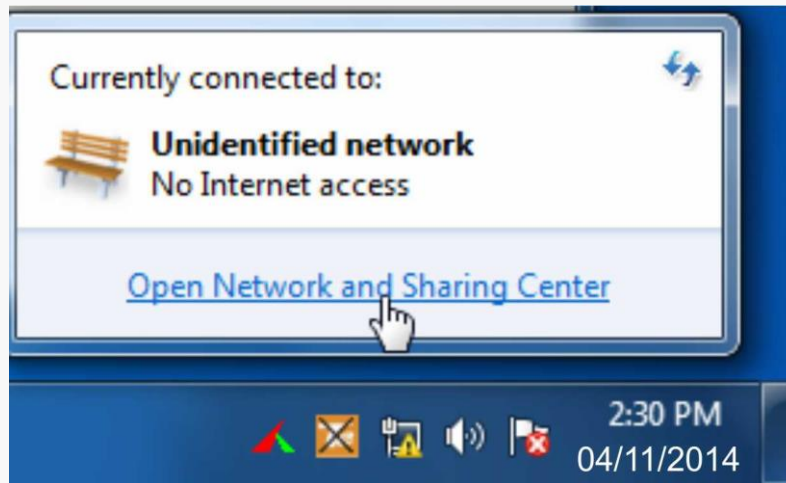

Tip:

If you cannot find the icon  on the bottom right corner of your desktop, follow steps below: Click **Start > Control Panel > Network and Internet > Network and Sharing Center**.

Step 3: Click **Local Area Connection > Properties**.

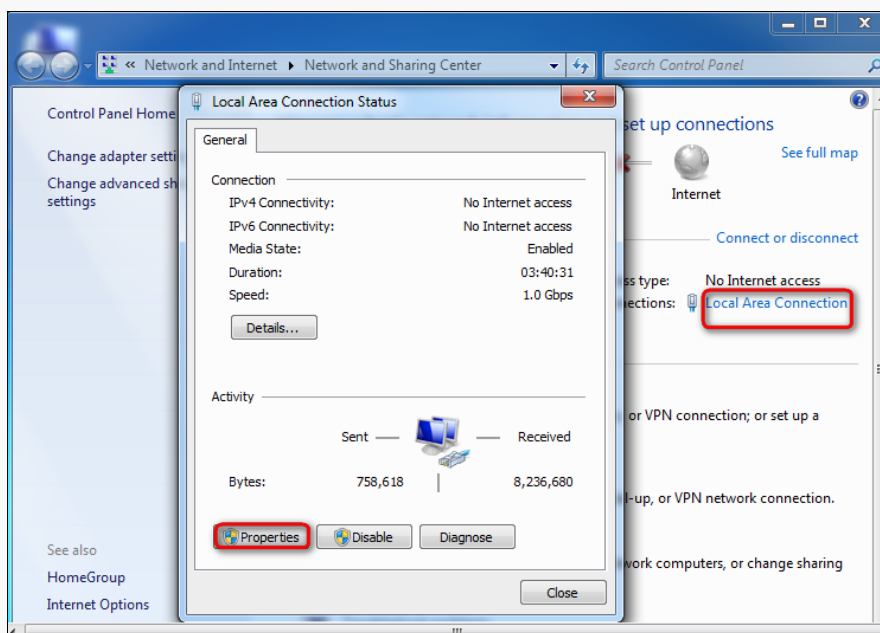

Step 4: Find and double click **Internet Protocol Version 4(TCP/IPv4)**.

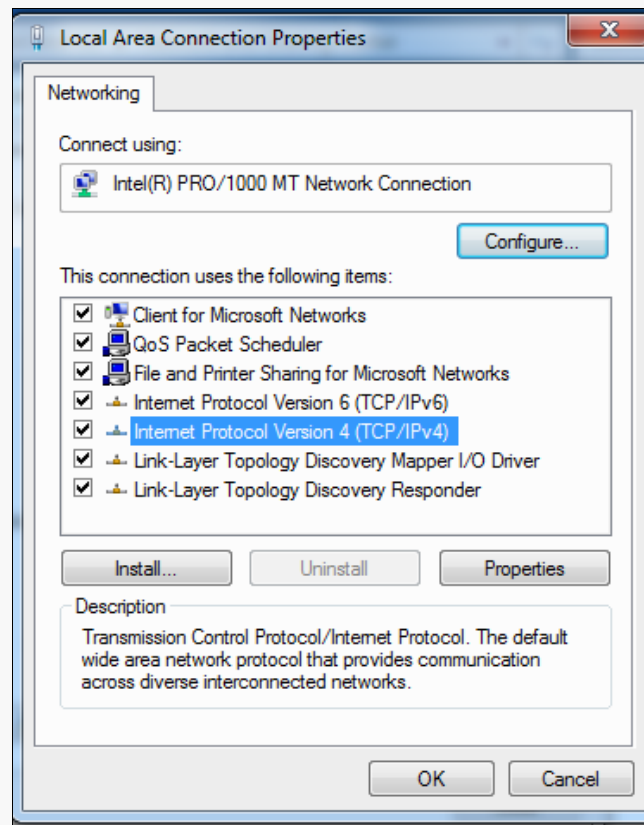

Step 5: Select **Use the following IP address**, type in the IP address: **192.168.0.x** (2~253); subnet mask: **255.255.255.0** and click **OK**.

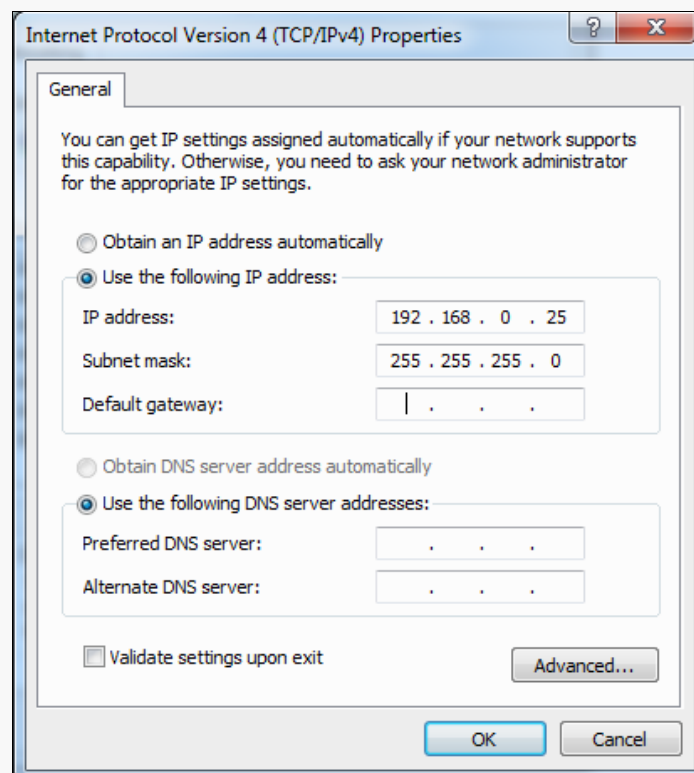

Step 6: Click **OK** on the **Local Area Connection Properties** window (see **Step 4** for the screenshot).

Windows XP

Step 1: Right click **My Network Places** on your desktop and select **Properties**.



Step 2: Right click **Local Area Connection** and select **Properties**.

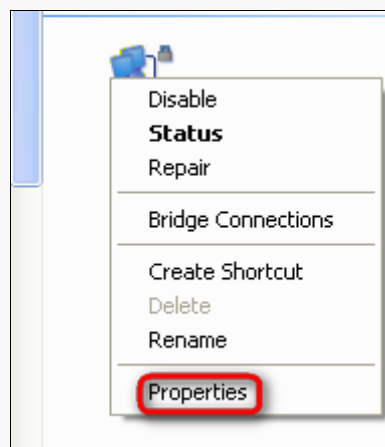

Step 3: Scroll down to find and double click **Internet Protocol (TCP/IP)**.

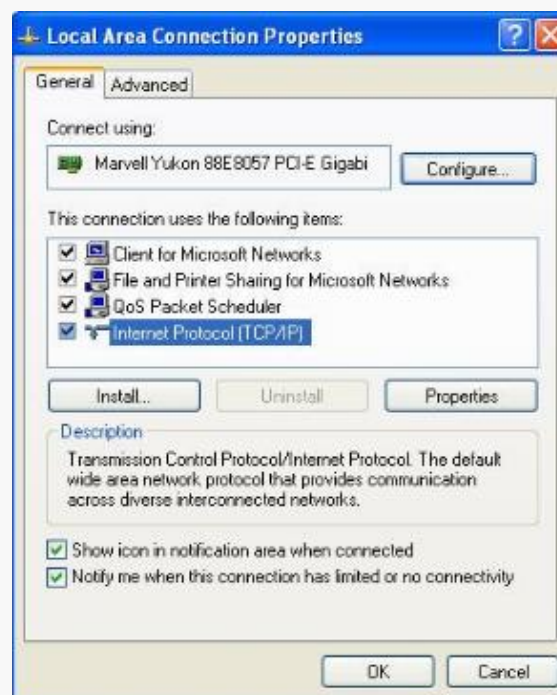

Step 4: Select **Use the following IP address**, type in the IP address: **192.168.0.x** (2~253); subnet mask: **255.255.255.0** and click **OK**.

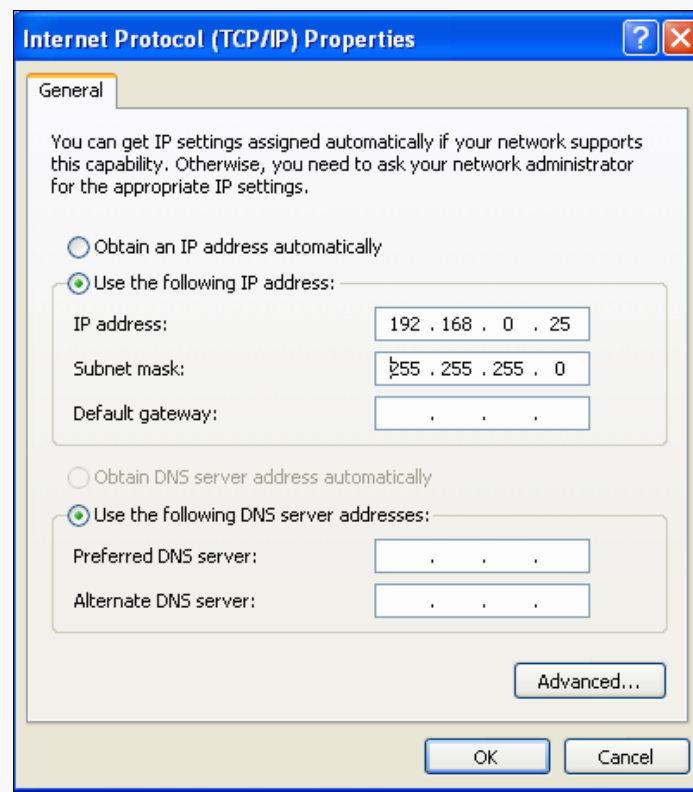

Step 5: Click **OK** on the **Local Area Connection Properties** window (see **Step 3** for the screenshot).

Safety and Emission Statement



CE Mark Warning

Operations in the 5.15-5.25GHz band are restricted to indoor usage only.

This is a Class B product. In a domestic environment, this product may cause radio interference, in which case the user may be required to take adequate measures.

NOTE: (1) The manufacturer is not responsible for any radio or TV interference caused by unauthorized modifications to this equipment. (2) To avoid unnecessary radiation interference, it is recommended to use a shielded RJ45 cable.



FCC Statement

This device is restricted to be used in the indoor.

This device complies with Part 15 of the FCC Rules. Operation is subject to the following two conditions: (1)

This device may not cause harmful interference, and (2) this device must accept any interference received, including interference that may cause undesired operation.

This equipment has been tested and found to comply with the limits for a Class B digital device, pursuant to Part 15 of the FCC Rules. These limits are designed to provide reasonable protection against harmful interference in a residential installation. This equipment generates uses and can radiate radio frequency energy and, if not installed and used in accordance with the instructions, may cause harmful interference to radio communications. However, there is no guarantee that interference will not occur in a particular installation. If this equipment does cause harmful interference to radio or television reception, which can be determined by turning the equipment off and on, the user is encouraged to try to correct the interference by one of the following measures:

- Reorient or relocate the receiving antenna.
- Increase the separation between the equipment and receiver.

- Connect the equipment into an outlet on a circuit different from that to which the receiver is connected.
- Consult the dealer or an experienced radio/TV technician for help.

FCC Caution: Any changes or modifications not expressly approved by the party responsible for compliance could void the user's authority to operate this equipment.

This transmitter must not be co-located or operating in conjunction with any other antenna or transmitter.

Radiation Exposure Statement

This equipment complies with FCC radiation exposure limits set forth for an uncontrolled environment. This equipment should be installed and operated with minimum distance 20cm between the radiator & your body.

NOTE: (1) The manufacturer is not responsible for any radio or TV interference caused by unauthorized modifications to this equipment. (2) To avoid unnecessary radiation interference, it is recommended to use a shielded RJ45 cable.