

FCC Radio Test Report

FCC ID: 2ABZMEP9

This report concerns (check one): Original Grant Class I Change Class II Change

Project No. : 1809C096
Equipment : AC1200 Enterprise Mesh WiFi System
Test Model : EP9
Series Model : N/A
Applicant : SHENZHEN IP-COM NETWORKS CO.,LTD
Address : Room 101, Unit A, First Floor, Tower E3, No. 1001,
Zhongshanyuan Road, Nanshan District, Shenzhen,
China. 518052

Date of Receipt : Sep. 13, 2018
Date of Test : Sep. 17, 2018 ~ Oct. 16, 2018
Issued Date : Oct. 18, 2018
Tested by : BTL Inc.

Testing Engineer : Vincent Tan
(Vincent Tan)

Technical Manager : David Mao
(David Mao)

Authorized Signatory : Steven Lu
(Steven Lu)

B T L I N C .

No.3, Jinshagang 1st Road, Shixia, Dalang Town, Dongguan,
Guangdong, China.

TEL: +86-769-8318-3000 FAX: +86-769-8319-6000



Certificate #5123.02

Declaration

BTL represents to the client that testing is done in accordance with standard procedures as applicable and that test instruments used has been calibrated with standards traceable to international standard(s) and/or national standard(s).

BTL's reports apply only to the specific samples tested under conditions. It is manufacture's responsibility to ensure that additional production units of this model are manufactured with the identical electrical and mechanical components. **BTL** shall have no liability for any declarations, inferences or generalizations drawn by the client or others from **BTL** issued reports.

The report must not be used by the client to claim product certification, approval, or endorsement by NVLAP, NIST, or any agency of the U.S. Government.

This report is the confidential property of the client. As a mutual protection to the clients, the public and ourselves, the test report shall not be reproduced, except in full, without our written approval.

BTL's laboratory quality assurance procedures are in compliance with the **ISO Guide 17025** requirements, and accredited by the conformity assessment authorities listed in this test report.

BTL is not responsible for the sampling stage, so the results only apply to the sample as received.

The information, data and test plan are provided by manufacturer, so it is manufacturer's responsibility to ensure that the apparatus meets the essential requirements in all the possible configurations as representative of its intended use.

Limitation

For the use of the authority's logo is limited unless the Test Standard(s)/Scope(s)/Item(s) mentioned in this test report is (are) included in the conformity assessment authorities acceptance respective.

Table of Contents	Page
1 . CERTIFICATION	6
2 . SUMMARY OF TEST RESULTS	7
2.1 TEST FACILITY	8
2.2 MEASUREMENT UNCERTAINTY	8
3 . GENERAL INFORMATION	9
3.1 GENERAL DESCRIPTION OF EUT	9
3.2 DESCRIPTION OF TEST MODES	12
3.3 TABLE OF PARAMETERS OF TEST SOFTWARE SETTING	14
3.4 BLOCK DIAGRAM SHOWING THE CONFIGURATION OF SYSTEM TESTED	16
3.5 DESCRIPTION OF SUPPORT UNITS	16
4 . EMC EMISSION TEST	17
4.1 CONDUCTED EMISSION MEASUREMENT	17
4.1.1 POWER LINE CONDUCTED EMISSION	17
4.1.2 TEST PROCEDURE	17
4.1.3 DEVIATION FROM TEST STANDARD	17
4.1.4 TEST SETUP	18
4.1.5 EUT OPERATING CONDITIONS	18
4.1.6 EUT TEST CONDITIONS	18
4.1.7 TEST RESULTS	18
4.2 RADIATED EMISSION MEASUREMENT	19
4.2.1 RADIATED EMISSION LIMITS	19
4.2.2 TEST PROCEDURE	20
4.2.3 DEVIATION FROM TEST STANDARD	20
4.2.4 TEST SETUP	20
4.2.5 EUT OPERATING CONDITIONS	21
4.2.6 EUT TEST CONDITIONS	21
4.2.7 TEST RESULTS (9 kHz TO 30 MHz)	22
4.2.8 TEST RESULTS (30 MHz TO 1000 MHz)	22
4.2.9 TEST RESULTS (ABOVE 1000 MHz)	22
5 . SPECTRUM BANDWIDTH	23
5.1 APPLIED PROCEDURES / LIMIT	23
5.1.1 TEST PROCEDURE	23
5.1.2 DEVIATION FROM STANDARD	23
5.1.3 TEST SETUP	24
5.1.4 EUT OPERATION CONDITIONS	24
5.1.5 EUT TEST CONDITIONS	24
5.1.6 TEST RESULTS	24
6 . MAXIMUM OUTPUT POWER	25

Table of Contents	Page
6.1 APPLIED PROCEDURES / LIMIT	25
6.1.1 TEST PROCEDURE	25
6.1.2 DEVIATION FROM STANDARD	26
6.1.3 TEST SETUP	26
6.1.4 EUT OPERATION CONDITIONS	26
6.1.5 EUT TEST CONDITIONS	26
6.1.6 TEST RESULTS	26
7 . POWER SPECTRAL DENSITY TEST	27
7.1 APPLIED PROCEDURES / LIMIT	27
7.1.1 TEST PROCEDURE	27
7.1.2 DEVIATION FROM STANDARD	28
7.1.3 TEST SETUP	28
7.1.4 EUT OPERATION CONDITIONS	28
7.1.5 EUT TEST CONDITIONS	28
7.1.6 TEST RESULTS	28
8 . FREQUENCY STABILITY MEASUREMENT	29
8.1 APPLIED PROCEDURES / LIMIT	29
8.1.1 TEST PROCEDURE	29
8.1.2 DEVIATION FROM STANDARD	29
8.1.3 TEST SETUP	30
8.1.4 EUT OPERATION CONDITIONS	30
8.1.5 EUT TEST CONDITIONS	30
8.1.6 TEST RESULTS	30
9 . MEASUREMENT INSTRUMENTS LIST	31
10 . EUT TEST PHOTOS	33
APPENDIX A - CONDUCTED EMISSION	37
APPENDIX B - RADIATED EMISSION (9 KHZ TO 30 MHZ)	40
APPENDIX C - RADIATED EMISSION (30 MHZ TO 1000 MHZ)	45
APPENDIX D - RADIATED EMISSION (ABOVE 1000 MHZ)	58
APPENDIX E - BANDWIDTH	177
APPENDIX F - MAXIMUM OUTPUT POWER	218
APPENDIX G - POWER SPECTRAL DENSITY	241
APPENDIX H - FREQUENCY STABILITY	338

REPORT ISSUED HISTORY

Issued No.	Description	Issued Date
BTL-FCCP-2-1809C096	Original Issue.	Oct. 18, 2018

1. CERTIFICATION

Equipment : AC1200 Enterprise Mesh WiFi System
Brand Name : IP-COM
Test Model : EP9
Series Model : N/A
Applicant : SHENZHEN IP-COM NETWORKS CO.,LTD
Manufacturer : SHENZHEN IP-COM NETWORKS CO.,LTD
Address : Room 101, Unit A, First Floor, Tower E3, No. 1001, Zhongshanyuan Road,
Nanshan District, Shenzhen, China. 518052
Date of Test : Sep. 17, 2018 ~ Oct. 16, 2018
Test Sample : Engineering Sample No.: D180907707
Standard(s) : FCC Part15, Subpart E(15.407) / ANSI C63.10-2013

The above equipment has been tested and found compliance with the requirement of the relative standards by BTL Inc..

The test data, data evaluation, and equipment configuration contained in our test report (Ref No. BTL-FCCP-2-1809C096) were obtained utilizing the test procedures, test instruments, test sites that has been accredited by the Authority of A2LA according to the ISO-17025 quality assessment standard and technical standard(s).

Test results included in this report is only for the RLAN 5GHz UNII-1, UNII-3 part.

2. SUMMARY OF TEST RESULTS

Test procedures according to the technical standard(s):

FCC Part15, Subpart E(15.407)			
Standard(s) Section	Test Item	Judgment	Remark
15.207	AC Power Line Conducted Emissions	PASS	
15.407(a)	Spectrum Bandwidth	PASS	
15.407(a)	Maximum Output Power	PASS	
15.407(a)	Power Spectral Density	PASS	
15.407(a)	Radiated Emissions	PASS	
15.407(b)	Band Edge Emissions	PASS	
15.407(g)	Frequency Stability	PASS	
15.203	Antenna Requirements	PASS	

Note:

(1) "N/A" denotes test is not applicable in this test report.

2.1 TEST FACILITY

The test facilities used to collect the test data in this report is at the location of No.3,Jinshagang 1st Road, Shixia, Dalang Town, Dongguan, Guangdong, China.

BTL's test firm number for FCC: 854385

BTL's designation number for FCC: CN5020

2.2 MEASUREMENT UNCERTAINTY

The measurement uncertainty figures shall be calculated according the methods described in the ETSI TR 100 028 and shall correspond to an expansion factor (coverage factor) $k=1.96$ or $k=2$ (which provide confidence levels of respectively 90% and 95.45% in the case where the distributions characterizing the actual measurement uncertainties are normal (Gaussian)). Measurement Uncertainty for a Level of Confidence of 95 %, $U=2 \times U_c(y)$.

The BTL measurement uncertainty as below table:

A. Conducted Measurement:

Test Site	Method	Measurement Frequency Range	U, (dB)
DG-C02	CISPR	150 KHz ~ 30 MHz	2.32

B. Radiated Measurement:

Test Site	Method	Measurement Frequency Range	Ant. H / V	U, (dB)
DG-CB03	CISPR	9 kHz~30 MHz	V	3.79
		9 kHz~30 MHz	H	3.57
		30 MHz~200 MHz	V	3.82
		30 MHz~200 MHz	H	3.60
		200 MHz~1,000 MHz	V	3.86
		200 MHz~1,000 MHz	H	3.94
		1 GHz~18 GHz	V	3.12
		1 GHz~18 GHz	H	3.68
		18 GHz~40 GHz	V	4.15
		18 GHz~40 GHz	H	4.14

Note: Unless specifically mentioned, the uncertainty of measurement has not been taken into account to declare the compliance or non-compliance to the specification.

3. GENERAL INFORMATION

3.1 GENERAL DESCRIPTION OF EUT

Equipment	AC1200 Enterprise Mesh WiFi System	
Brand Name	IP-COM	
Test Model	EP9	
Series Model	N/A	
Model Difference(s)	N/A	
Product Description	Operation Frequency	UNII-1: 5150MHz ~ 5250MHz UNII-3: 5725MHz ~ 5850MHz
	Modulation Technology	OFDM
	Bit Rate of Transmitter	867 Mbps
	Output Power (Max.)for UNII-1 Non-Beamforming	802.11a: 25.75dBm 802.11n (20M): 26.36dBm 802.11n (40M): 23.99dBm 802.11ac (20M): 26.30dBm 802.11ac (40M): 25.49dBm 802.11ac (80M): 16.84dBm
	Output Power (Max.)for UNII-3 Non-Beamforming	802.11a: 25.87dBm 802.11n (20M): 26.37dBm 802.11n (40M): 26.38dBm 802.11ac (20M): 26.25dBm 802.11ac (40M): 26.26dBm 802.11ac (80M): 25.69dBm
	Output Power (Max.)for UNII-1 Beamforming	802.11n (20M): 26.25dBm 802.11n (40M): 23.89dBm 802.11ac (20M): 26.08dBm 802.11ac (40M): 25.38dBm 802.11ac (80M): 16.75dBm
	Output Power (Max.)for UNII-3 Beamforming	802.11n (20M): 26.12dBm 802.11n (40M): 26.20dBm 802.11ac (20M): 25.99dBm 802.11ac (40M): 25.96dBm 802.11ac (80M): 25.47dBm
Power Source	DC Voltage supplied from AC/DC adapter. Model: BN036-A12012U	
Power Rating	I/P:100-240V~ 50/60Hz 0.4A O/P:12V --- 1.0A	

Note:

- For a more detailed features description, please refer to the manufacturer's specifications or the user's manual.

2. Channel List:

802.11a 802.11n(20 MHz) 802.11ac(20 MHz)		802.11n(40 MHz) 802.11ac(40 MHz)		802.11ac(80 MHz)	
UNII-1		UNII-1		UNII-1	
Channel	Frequency (MHz)	Channel	Frequency (MHz)	Channel	Frequency (MHz)
36	5180	38	5190	42	5210
40	5200	46	5230		
44	5220				
48	5240				

802.11a 802.11n(20 MHz) 802.11ac(20 MHz)		802.11n(40 MHz) 802.11ac(40 MHz)		802.11ac(80 MHz)	
UNII-3		UNII-3		UNII-3	
Channel	Frequency (MHz)	Channel	Frequency (MHz)	Channel	Frequency (MHz)
149	5745	151	5755	155	5775
153	5765	159	5795		
157	5785				
161	5805				
165	5825				

3. Antenna Specification:

Ant.	Brand	Model Name	Antenna Type	Connector	Gain(dBi)	Note
1	N/A	N/A	PCB	N/A	4.0	UNII-1
1	N/A	N/A	PCB	N/A	4.5	UNII-3
2	N/A	N/A	PCB	N/A	4.0	UNII-1
2	N/A	N/A	PCB	N/A	4.5	UNII-3

Note:

- (1) This EUT supports MIMO 2X2, any transmit signals are correlated with each other, so , Directional gain = $G_{ANT}+10\log(N)$ dBi.
 For UNII-1, Directional gain= $4.0+10\log(2)$ dBi=7.01, the UNII-1 output power limit is $30-7.01+6=28.99$, power density limit is $17-7.01+6=15.99$.
 For UNII-3, Directional gain = $4.5+10\log(2)$ dBi=7.51, the UNII-1 output power limit is $30-7.51+6=28.49$, power density limit is $30-7.51+6=28.49$.
- (2) Beamforming Gain: 3.0 dBi.
 For UNII-1, Directional gain= $3.0+4.0$ dBi=7.0. Then, the UNII-1 output power limit is $30-7.0+6=29.00$, power density limit is $17-7.0+6=16.00$.
 For UNII-3, Directional gain= $3.0+4.5$ dBi=7.5. Then, the UNII-3 output power limit is $30-7.5+6=28.50$, power density limit is $30-7.5+6=28.50$.

4. The worst case for 1TX/2TX as follow:

Operating Mode	TX Mode	1TX	2TX
802.11a		V (ANT 2)	-
802.11n (20 MHz)		-	V (ANT 1+ANT 2)
802.11n (40 MHz)		-	V (ANT 1+ANT 2)
802.11ac (20 MHz)		-	V (ANT 1+ANT 2)
802.11ac (40 MHz)		-	V (ANT 1+ANT 2)
802.11ac (80 MHz)		-	V (ANT 1+ANT 2)

3.2 DESCRIPTION OF TEST MODES

To investigate the maximum EMI emission characteristics generates from EUT, the test system was pre-scanning tested base on the consideration of following EUT operation mode or test configuration mode which possible have effect on EMI emission level. Each of these EUT operation mode(s) or test configuration mode(s) mentioned above was evaluated respectively.

Pretest Mode	Description
Mode 1	TX A Mode / CH36, CH40, CH48 (UNII-1)
Mode 2	TX N20 Mode / CH36, CH40, CH48 (UNII-1)
Mode 3	TX N40 Mode / CH38, CH46 (UNII-1)
Mode 4	TX AC20 Mode / CH36, CH40, CH48 (UNII-1)
Mode 5	TX AC40 Mode / CH38, CH46 (UNII-1)
Mode 6	TX AC80 Mode / CH42 (UNII-1)
Mode 7	TX A Mode / CH149,CH157,CH165 (UNII-3)
Mode 8	TX N20 Mode / CH149,CH157,CH165 (UNII-3)
Mode 9	TX N40 Mode / CH151,CH159 (UNII-3)
Mode 10	TX AC20 Mode / CH149,CH157,CH165 (UNII-3)
Mode 11	TX AC40 Mode / CH151,CH159 (UNII-3)
Mode 12	TX AC80 Mode / CH155 (UNII-3)
Mode 13	TX Mode

The EUT system operated these modes were found to be the worst case during the pre-scanning test as following:

For Conducted Test	
Final Test Mode	Description
Mode 13	TX Mode

For Radiated Test	
Final Test Mode	Description
Mode 1	TX A Mode / CH36, CH40, CH48 (UNII-1)
Mode 2	TX N20 Mode / CH36, CH40, CH48 (UNII-1)
Mode 3	TX N40 Mode / CH38, CH46 (UNII-1)
Mode 4	TX AC20 Mode / CH36, CH40, CH48 (UNII-1)
Mode 5	TX AC40 Mode / CH38, CH46 (UNII-1)
Mode 6	TX AC80 Mode / CH42 (UNII-1)
Mode 7	TX A Mode / CH149,CH157,CH165 (UNII-3)
Mode 8	TX N20 Mode / CH149,CH157,CH165 (UNII-3)
Mode 9	TX N40 Mode / CH151,CH159 (UNII-3)
Mode 10	TX AC20 Mode / CH149,CH157,CH165 (UNII-3)
Mode 11	TX AC40 Mode / CH151,CH159 (UNII-3)
Mode 12	TX AC80 Mode / CH155 (UNII-3)

Note:

- (1) For radiated 30 MHz to 1000 MHz test, the 802.11a mode is found to be the worst case and recorded.

3.3 TABLE OF PARAMETERS OF TEST SOFTWARE SETTING

During testing channel & power controlling software provided by the customer was used to control the operating channel as well as the output power level. The RF output power selection is for the setting of RF output power expected by the customer and is going to be fixed on the firmware of the final end product

Non-Beamforming

UNII-1			
Test Software Version	MP-v3.4		
Frequency (MHz)	5180	5200	5240
A Mode	38	50	58
N20 Mode	45/36	55/46	55/50
AC20 Mode	45/38	56/49	55/51
Frequency (MHz)	5190	5230	
N40 Mode	35/28	52/45	
AC40 Mode	35/28	50/43	
Frequency (MHz)	5210		
AC80 Mode	33/24		

UNII-3			
Test Software Version	MP-v3.4		
Frequency (MHz)	5745	5785	5825
A Mode	58	58	58
N20 Mode	55/50	55/50	53/50
AC20 Mode	55/51	54/50	53/50
Frequency (MHz)	5755	5795	
N40 Mode	55/50	54/50	
AC40 Mode	55/50	54/50	
Frequency (MHz)	5775		
AC80 Mode	51/45		

Beamforming

UNII-1			
Test Software Version	MP-v3.4		
Frequency (MHz)	5180	5200	5240
N20 Mode	45/36	55/46	55/50
AC20 Mode	45/38	56/49	55/51
Frequency (MHz)	5190	5230	
N40 Mode	35/28	52/45	
AC40 Mode	35/28	50/43	
Frequency (MHz)	5210		
AC80 Mode	33/24		

UNII-3			
Test Software Version	MP-v3.4		
Frequency (MHz)	5745	5785	5825
N20 Mode	55/50	55/50	53/50
AC20 Mode	55/51	54/50	53/50
Frequency (MHz)	5755	5795	
N40 Mode	55/50	54/50	
AC40 Mode	55/50	54/50	
Frequency (MHz)	5775		
AC80 Mode	51/45		

3.4 BLOCK DIAGRAM SHOWING THE CONFIGURATION OF SYSTEM TESTED

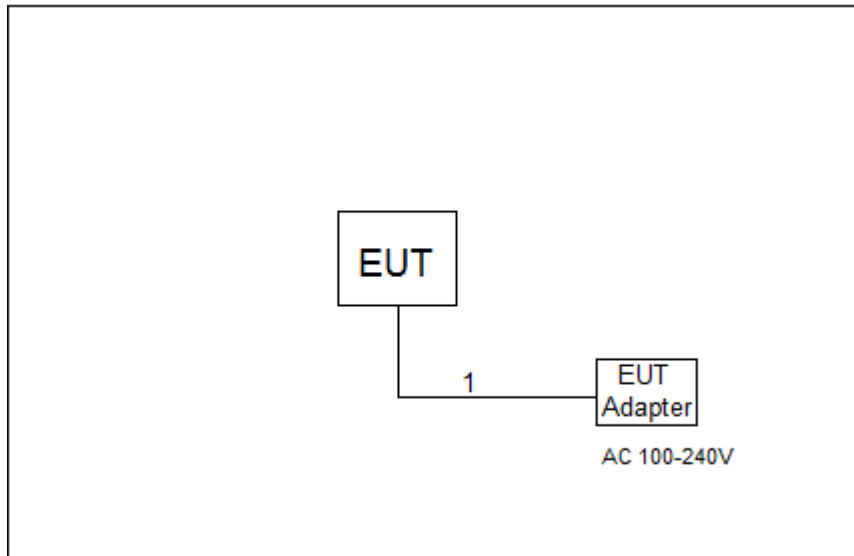

3.5 DESCRIPTION OF SUPPORT UNITS

The EUT has been tested as an independent unit together with other necessary accessories or support units. The following support units or accessories were used to form a representative test configuration during the tests.

Item	Equipment	Mfr/Brand	Model/Type No.	FCC ID	Series No.
-	-	-	-	-	-

Item	Shielded Type	Ferrite Core	Length	Note
1	NO	NO	1.2m	DC Cable

4. EMC EMISSION TEST

4.1 CONDUCTED EMISSION MEASUREMENT

4.1.1 POWER LINE CONDUCTED EMISSION (Frequency Range 150 kHz-30 MHz)

Frequency of Emission (MHz)	Conducted Limit (dB μ V)	
	Quasi-peak	Average
0.15 -0.50	66to 56*	56 to 46*
0.50 -5.0	56	46
5.0 -30.0	60	50

Note:

- (1) The tighter limit applies at the band edges.
- (2) The test result calculated as following:
 Measurement Value = Reading Level + Correct Factor
 Correct Factor = Insertion Loss + Cable Loss + Attenuator Factor(if use)
 Margin Level = Measurement Value - Limit Value

The following table is the setting of the receiver

Receiver Parameters	Setting
Attenuation	10 dB
Start Frequency	0.15 MHz
Stop Frequency	30 MHz
IF Bandwidth	9 kHz

4.1.2 TEST PROCEDURE

- a. The EUT was placed 0.8 meters from the horizontal ground plane with EUT being connected to the power mains through a line impedance stabilization network (LISN). All other support equipment powered from additional LISN(s). The LISN provide 50 Ohm/ 50uH of coupling impedance for the measuring instrument.
- b. Interconnecting cables that hang closer than 40 cm to the ground plane shall be folded back and forth in the center forming a bundle 30 to 40 cm long.
- c. I/O cables that are not connected to a peripheral shall be bundled in the center. The end of the cable may be terminated, if required, using the correct terminating impedance. The overall length shall not exceed 1 m.
- d. LISN at least 80 cm from nearest part of EUT chassis.
- e. For the actual test configuration, please refer to the related Item -EUT Test Photos.

4.1.3 DEVIATION FROM TEST STANDARD

No deviation

4.1.4 TEST SETUP

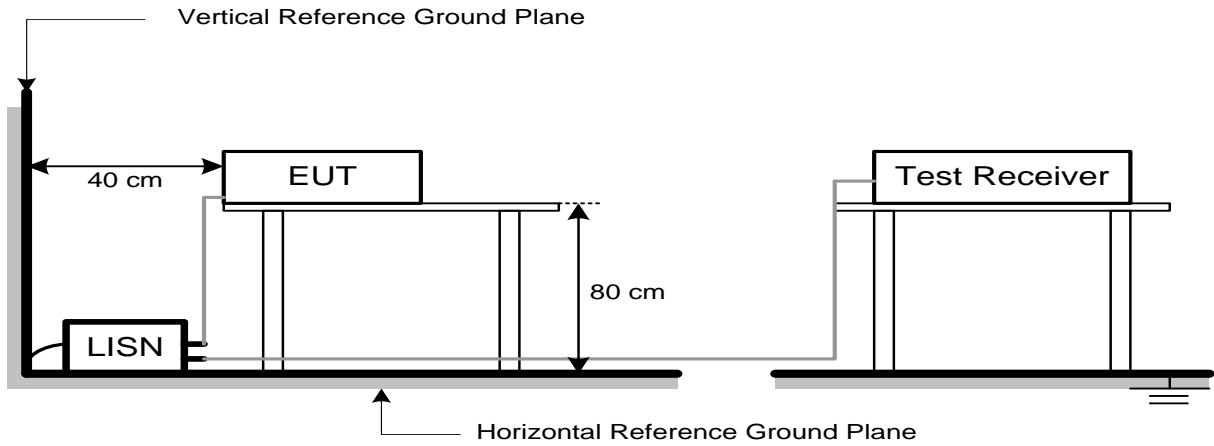

4.1.5 EUT OPERATING CONDITIONS

The EUT was configured for testing in a typical fashion (as a customer would normally use it). The EUT has been programmed to continuously transmit during test. This operating condition was tested and used to collect the included data.

The EUT was programmed to be in continuously transmitting/TX Mode mode.

4.1.6 EUT TEST CONDITIONS

Temperature: 25°C Relative Humidity: 52% Test Voltage: AC 120V/60Hz

4.1.7 TEST RESULTS

Please refer to the Appendix A.

Remark:

- (1) All readings are QP Mode value unless otherwise stated AVG in column of『Note』. If the QP Mode Measured value compliance with the QP Limits and lower than AVG Limits, the EUT shall be deemed to meet both QP & AVG Limits and then only QP Mode was measured, but AVG Mode didn't perform. In this case, a “ * ” marked in AVG Mode column of Interference Voltage Measured.
- (2) Measuring frequency range from 150 kHz to 30 MHz.

4.2 RADIATED EMISSION MEASUREMENT

4.2.1 RADIATED EMISSION LIMITS

In case the emission fall within the restricted band specified on 15.205(a), then the 15.209(a) limit in the table below has to be followed.

Frequencies (MHz)	Field Strength (microrvolts/meter)	Measurement Distance (meters)
0.009~0.490	2400/F(kHz)	300
0.490~1.705	24000/F(kHz)	30
1.705~30.0	30	30
30~88	100	3
88~216	150	3
216~960	200	3
Above 960	500	3

Frequencies (MHz)	EIRP Limit (dBm)	Equivalent Field Strength at 3m (dBμV/m)
5150-5250	-27	68.3
5725-5850	-27(Note 2)	68.3
	10(Note 2)	105.3
	15.6(Note 2)	110.9
	27(Note 2)	122.3

Note:

1. The following formula is used to convert the equipment isotropic radiated power (eirp) to

field strength: $E = \frac{1000000\sqrt{30P}}{3} \mu\text{V/m}$, where P is the eirp (Watts)

2. According to FCC 16-24, All emissions shall be limited to a level of -27 dBm/MHz at 75 MHz or more above or below the band edge increasing linearly to 10 dBm/MHz at 25 MHz above or below the band edge, and from 25MHz above or below the band edge increasing linearly to a level of 15.6 dBm/MHz at 5 MHz above or below the band edge, and from 5 MHz above or below the band edge increasing linearly to a level of 27dBm/MHz at the band edge.

4.2.2 TEST PROCEDURE

- a. The measuring distance of 3 m shall be used for measurements. The EUT was placed on the top of a rotating table 0.8 meter above the ground at a 3 meter semi-anechoic chamber. The table was rotated 360 degrees to determine the position of the highest radiation.(below 1GHz)
- b. The measuring distance of 3 m shall be used for measurements. The EUT was placed on the top of a rotating table 1.5 meter above the ground at a 3 meter semi-anechoic chamber. The table was rotated 360 degrees to determine the position of the highest radiation.(above 1GHz)
- c. The height of the equipment or of the substitution antenna shall be 0.8m or 1.5m; the height of the test antenna shall vary between 1 m to 4 m. Both horizontal and vertical polarizations of the antenna are set to make the measurement.
- d. For each suspected emission, the EUT was arranged to its worst case and then the antenna was tuned to heights find the maximum reading (used Bore sight function).
- e. The receiver system was set to peak and average detect function and specified bandwidth with maximum hold mode when the test frequency is above 1 GHz.
- f. The initial step in collecting radiated emission data is a receiver peak detector mode pre-scanning the measurement frequency range. Significant peaks are then marked and then Quasi Peak detector mode re-measured.
- g. All readings are Peak unless otherwise stated QP in column of Note. Peak denotes that the Peak reading compliance with the QP Limits and then QP Mode measurement didn't perform. (below 1 GHz)
- h. All readings are Peak Mode value unless otherwise stated AVG in column of Note. If the Peak Mode Measured value compliance with the Peak Limits and lower than AVG Limits, the EUT shall be deemed to meet both Peak & AVG Limits and then only Peak Mode was measured, but AVG Mode didn't perform. (above 1 GHz)
- i. For the actual test configuration, please refer to the related Item –EUT Test Photos.

4.2.3 DEVIATION FROM TEST STANDARD

No deviation

4.2.4 TEST SETUP

(A)Radiated Emission Test Set-Up Frequency 30 MHz-1000 MHz

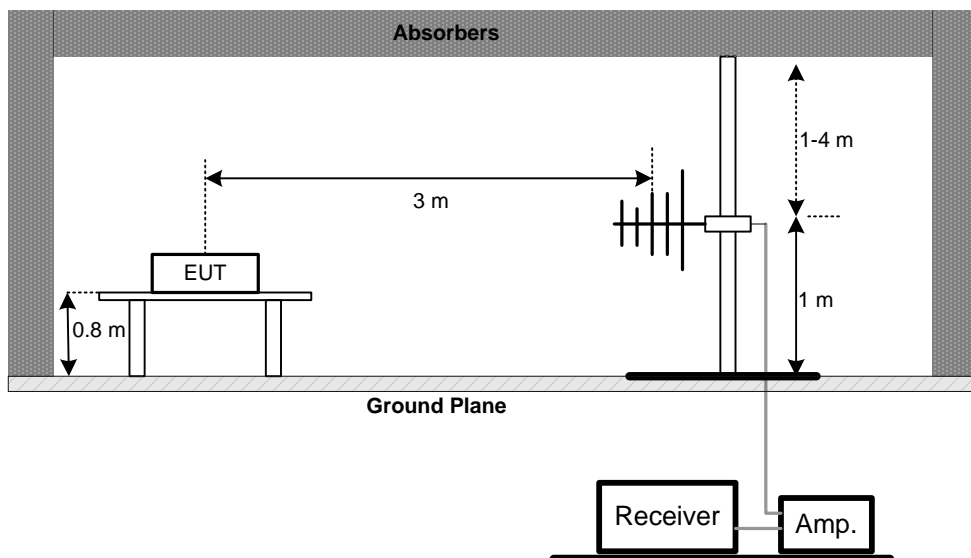

(B) Radiated Emission Test Set-Up Frequency Above 1 GHz

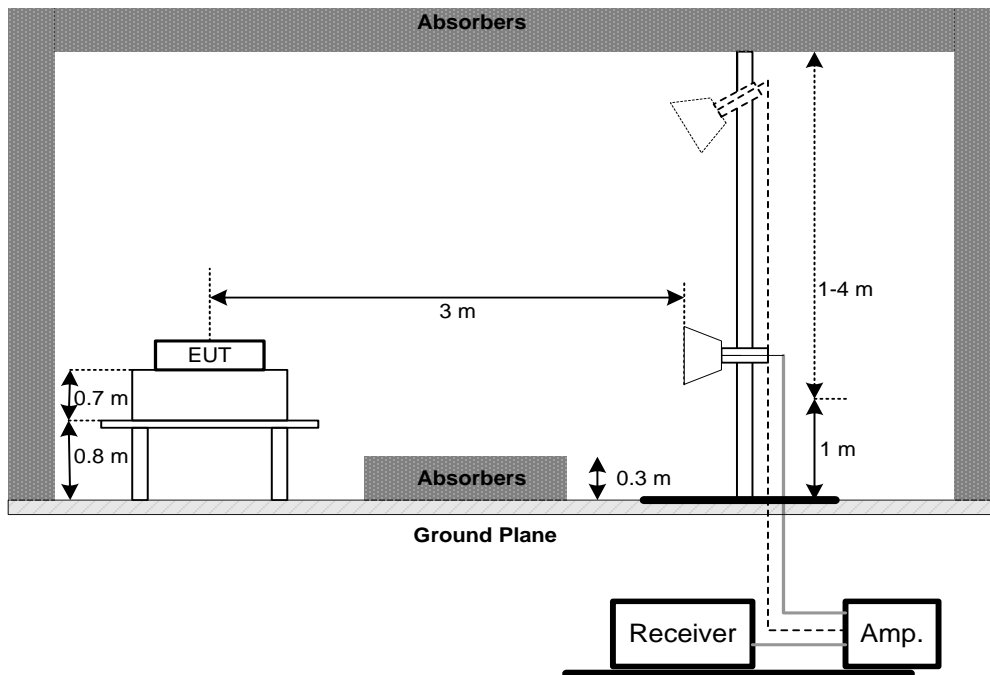

(C) Radiated emissions below 30 MHz

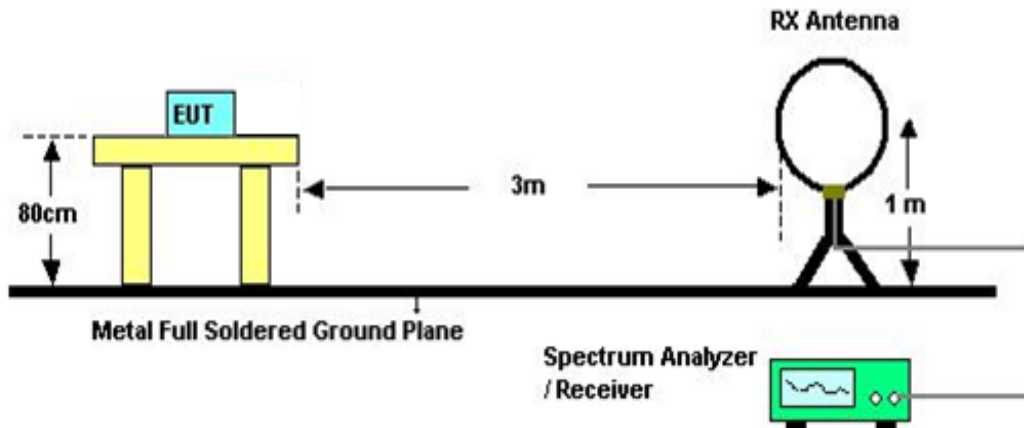

4.2.5 EUT OPERATING CONDITIONS

The EUT tested system was configured as the statements of 4.1.5 unless otherwise a special operating condition is specified in the follows during the testing.

4.2.6 EUT TEST CONDITIONS

Temperature: 25°C Relative Humidity: 60% Test Voltage: AC 120V/60Hz

4.2.7 TEST RESULTS (9 kHz TO 30 MHz)

Please refer to the Appendix B

Remark:

- (1) The amplitude of spurious emissions which are attenuated by more than 20 dB below the permissible value has no need to be reported.
- (2) Distance extrapolation factor = $40 \log(\text{specific distance} / \text{test distance})$ (dB).
- (3) Limit line = specific limits (dBuV) + distance extrapolation factor.

4.2.8 TEST RESULTS (30 MHz TO 1000 MHz)

Please refer to the Appendix C.

4.2.9 TEST RESULTS (ABOVE 1000 MHz)

Please refer to the Appendix D.

Remark:

- (1) No limit: This is fundamental signal, the judgment is not applicable.
For fundamental signal judgment was referred to Peak output test.

5. SPECTRUM BANDWIDTH

5.1 APPLIED PROCEDURES / LIMIT

FCC Part15, Subpart E			
Test Item	Limit	Frequency Range (MHz)	Result
Bandwidth	26 dB Bandwidth	5150-5250	PASS
	Minimum 500kHz 6 dB Bandwidth	5725-5850	PASS

5.1.1 TEST PROCEDURE

a. The EUT was directly connected to the spectrum analyzer and antenna output port as show in the block diagram below

b.

Spectrum Parameters	Setting
Attenuation	Auto
Span Frequency	> 26 dB Bandwidth
RBW	300 kHz(Bandwidth 20 MHz) 1 MHz(Bandwidth 40 MHz and 80 MHz)
VBW	1 MHz(Bandwidth 20 MHz) 3 MHz(Bandwidth 40 MHz and 80 MHz)
Span Frequency	6 dB Bandwidth
RBW	100 kHz
VBW	300 kHz
Detector	Peak
Trace	Max Hold
Sweep Time	Auto

c. Measured the spectrum width with power higher than 26 dB below carrier

5.1.2 DEVIATION FROM STANDARD

No deviation.

5.1.3 TEST SETUP



5.1.4 EUT OPERATION CONDITIONS

The EUT tested system was configured as the statements of 4.1.5 unless otherwise a special operating condition is specified in the follows during the testing.

5.1.5 EUT TEST CONDITIONS

Temperature: 25°C Relative Humidity: 52% Test Voltage: AC 120V/60Hz

5.1.6 TEST RESULTS

Please refer to the Appendix E.

6. MAXIMUM OUTPUT POWER

6.1 APPLIED PROCEDURES / LIMIT

FCC Part15, Subpart E			
Test Item	Limit	Frequency Range (MHz)	Result
Maximum Output Power	Fixed:1 Watt (30 dBm)	5150-5250	PASS
	Mobile and portable: 250 mW (24 dBm)	5150-5250	PASS
	1 Watt (30 dBm)	5725-5850	PASS

Note: The maximum e.i.r.p at anyelevation angle above 30 degrees as measured from the horizon must not exceed 125 mW(21 dBm)

6.1.1 TEST PROCEDURE

- a. The EUT was directly connected to the spectrum analyzer and antenna output port as show in the block diagram below.
- b. Used spectrum analyzer band power measurement function.
- c.

Spectrum Parameter	Setting
Attenuation	Auto
Span Frequency	Encompass the entire emissions bandwidth (EBW) of the signal
RBW	= 1 MHz.
VBW	≥ 3 MHz.
Sweep points	≥ 2 x span / RBW
Detector	RMS
Trace	Trace average at least 100 traces in power averaging(rms) mode.
Sweep Time	auto

- c. Test was performed in accordance with method of KDB 789033 D02.

6.1.2 DEVIATION FROM STANDARD

No deviation.

6.1.3 TEST SETUP



6.1.4 EUT OPERATION CONDITIONS

The EUT tested system was configured as the statements of 4.1.5 unless otherwise a special operating condition is specified in the follows during the testing.

6.1.5 EUT TEST CONDITIONS

Temperature: 25°C Relative Humidity: 52% Test Voltage: AC 120V/60Hz

6.1.6 TEST RESULTS

Please refer to the Appendix F.

7. POWER SPECTRAL DENSITY TEST

7.1 APPLIED PROCEDURES / LIMIT

FCC Part15, Subpart E			
Test Item	Limit	Frequency Range (MHz)	Result
Power Spectral Density	Other then Mobile and portable: 17 dBm/MHz	5150-5250	PASS
	Mobile and portable:11 dBm/MHz	5150-5250	PASS
	30 dBm/500kHz	5725-5850	PASS

7.1.1 TEST PROCEDURE

- a. The EUT was directly connected to the spectrum analyzer and antenna output port as show in the block diagram below.
- b.

Spectrum Parameter	Setting
Attenuation	Auto
Span Frequency	Encompass the entire emissions bandwidth (EBW) of the signal
RBW	= 1 MHz.
VBW	≥ 3 MHz.
Detector	RMS
Trace average	100 trace
Sweep Time	Auto

Note:

1. For UNII-3, according to KDB publication 789033 D02 General UNII Test Procedures New Rules v01r02, section II.F.5., it is acceptable to set RBW at 1 MHz and VBW at 3 MHz if the spectrum analyzer does not have 500 kHz RBW.
2. The value measured with RBW=1 MHz is to be added with $10\log(500\text{ kHz}/1\text{ MHz})$ which is -3 dB. For example, if the measured value is +10dBm using RBW=1 MHz (that is +10 dBm/MHz), then the converted value will be +7dBm/500kHz.

7.1.2 DEVIATION FROM STANDARD

No deviation.

7.1.3 TEST SETUP



7.1.4 EUT OPERATION CONDITIONS

The EUT tested system was configured as the statements of 4.1.5 unless otherwise a special operating condition is specified in the follows during the testing.

7.1.5 EUT TEST CONDITIONS

Temperature: 25°C Relative Humidity: 52% Test Voltage: AC 120V/60Hz

7.1.6 TEST RESULTS

Please refer to the Appendix H.

8. FREQUENCY STABILITY MEASUREMENT

8.1 APPLIED PROCEDURES / LIMIT

FCC Part15, Subpart E			
Test Item	Limit	Frequency Range (MHz)	Result
Frequency Stability	Specified in the user's manual	5150-5250	PASS
		5725-5850	PASS

8.1.1 TEST PROCEDURE

a. The EUT was directly connected to the spectrum analyzer and antenna output port as show in the block diagram below.

b.

Spectrum Parameter	Setting
Attenuation	Auto
Span Frequency	Entire absence of modulation emissions bandwidth
RBW	10 kHz
VBW	10 kHz
Sweep Time	Auto

c. The test extreme voltage is to change the primary supply voltage from 85 to 115 percent of the nominal value.

d. User manual temperature is 0°C~40°C.

8.1.2 DEVIATION FROM STANDARD

No deviation.

8.1.3 TEST SETUP

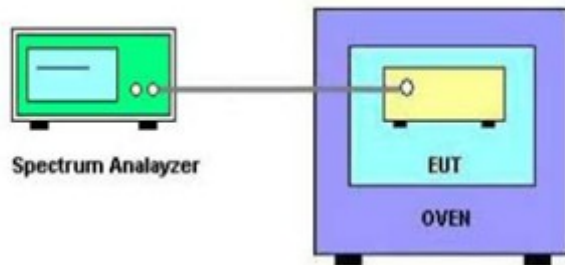

8.1.4 EUT OPERATION CONDITIONS

The EUT tested system was configured as the statements of 4.1.5 unless otherwise a special operating condition is specified in the follows during the testing.

8.1.5 EUT TEST CONDITIONS

Temperature: 25°C Relative Humidity: 52% Test Voltage: AC 120V/60Hz

8.1.6 TEST RESULTS

Please refer to the Appendix I.

9. MEASUREMENT INSTRUMENTS LIST

Conducted Emission Measurement					
Item	Kind of Equipment	Manufacturer	Type No.	Serial No.	Calibrated until
1	EMI Test Receiver	R&S	ESCI	100382	Mar. 11, 2019
2	LISN	EMCO	3816/2	52765	Mar. 11, 2019
3	50Ω Terminator	SHX	TF2-3G-A	8122901	Mar. 11, 2019
4	TWO-LINE V-NETWORK	R&S	ENV216	101447	Mar. 11, 2019
5	Measurement Software	Farad	EZ-EMC Ver.NB-03A1-01	N/A	N/A
6	Cable	N/A	RG223	12m	Mar. 23, 2019

Radiated Emission Measurement-9 kHz TO 30 MHz					
Item	Kind of Equipment	Manufacturer	Type No.	Serial No.	Calibrated until
1	Loop Antenna	EM	EM-6876-1	230	Feb. 07, 2019
2	Cable	N/A	RG 213/U	C-102	Jun. 01, 2019
3	EMI Test Receiver	R&S	ESCI	100382	Mar. 11, 2019
4	Measurement Software	Farad	EZ-EMC Ver.NB-03A1-01	N/A	N/A

Radiated Emission Measurement-30 MHz TO 1000 MHz					
Item	Kind of Equipment	Manufacturer	Type No.	Serial No.	Calibrated until
1	Antenna	Schwarbeck	VULB9160	9160-3232	Mar. 11, 2019
2	Amplifier	HP	8447D	2944A09673	Aug. 11, 2019
3	Receiver	Agilent	N9038A	MY52130039	Aug. 11, 2019
4	Cable	emci	LMR-400(30MHz-1 GHz)(8m+5m)	N/A	May 25, 2019
5	Controller	CT	SC100	N/A	N/A
6	Controller	MF	MF-7802	MF780208416	N/A
7	Measurement Software	Farad	EZ-EMC Ver.NB-03A1-01	N/A	N/A

Radiated Emission Measurement - Above 1GHz					
Item	Kind of Equipment	Manufacturer	Type No.	Serial No.	Calibrated until
1	Double Ridged Guide Antenna	ETS	3115	75789	Mar. 11, 2019
2	Broad-Band Horn Antenna	Schwarzbeck	BBHA 9170	9170319	Jun. 30, 2019
3	Amplifier	Agilent	8449B	3008A02274	Mar. 11, 2019
4	Microwave Preamplifier With Adaptor	EMC INSTRUMENT	EMC2654045	980039 & HA01	Mar. 11, 2019
5	Receiver	Agilent	N9038A	MY52130039	Aug. 11, 2019
6	Controller	CT	SC100	N/A	N/A
7	Controller	MF	MF-7802	MF780208416	N/A
8	Cable	mitron	B10-01-01-12M	18072744	Jul. 30, 2019
9	Measurement Software	Farad	EZ-EMC Ver.NB-03A1-01	N/A	N/A

Spectrum Bandwidth Measurement					
Item	Kind of Equipment	Manufacturer	Type No.	Serial No.	Calibrated until
1	Spectrum Analyzer	R&S	FSP40	100185	Aug. 11, 2019

Maximum Output Power Measurement					
Item	Kind of Equipment	Manufacturer	Type No.	Serial No.	Calibrated until
1	Spectrum Analyzer	R&S	FSP40	100185	Aug. 11, 2019

Power Spectral Density Measurement					
Item	Kind of Equipment	Manufacturer	Type No.	Serial No.	Calibrated until
1	Spectrum Analyzer	R&S	FSP40	100185	Aug. 11, 2019

Frequency Stability Measurement					
Item	Kind of Equipment	Manufacturer	Type No.	Serial No.	Calibrated until
1	Spectrum Analyzer	R&S	FSP40	100185	Aug. 11, 2019
2	Precision Oven Tester	Bell	BTH-50C	20170306001	Mar. 11, 2019

Remark: "N/A" denotes no model name, serial no. or calibration specified.
 All calibration period of equipment list is one year.

10. EUT TEST PHOTOS

Conducted Measurement Photos



Radiated Measurement Photos

9 kHz to 30 MHz



Radiated Measurement Photos

30 MHz to 1000 MHz



Radiated Measurement Photos

Above 1000 MHz

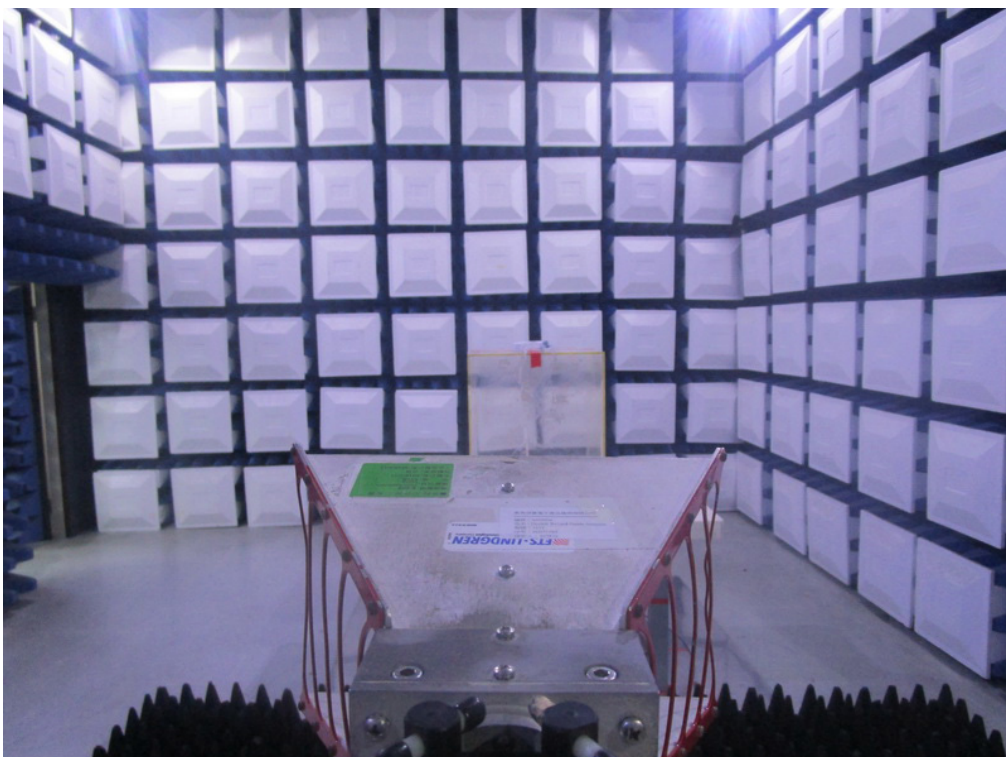

APPENDIX A - CONDUCTED EMISSION

Test Mode: TX Mode

Line

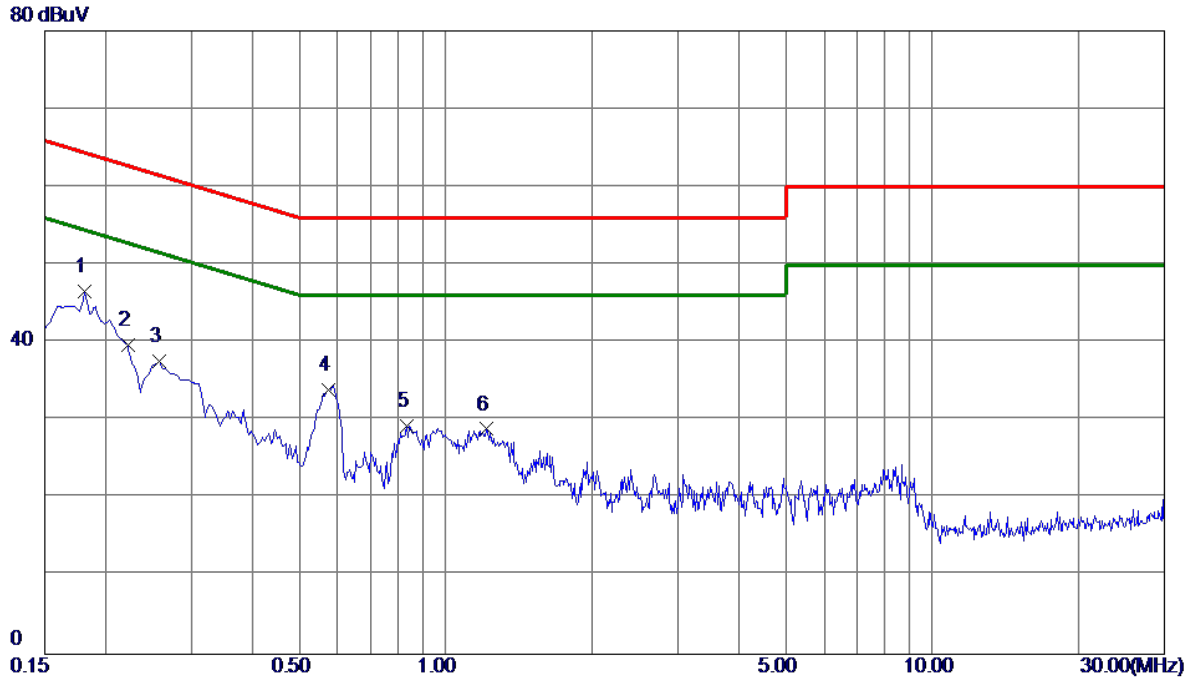

No.	Freq. MHz	Reading Level dBuV	Correct Factor dB	Measure ment dBuV	Limit dBuV	Margin dB	Detector	Comment
1 *	0.1815	36.70	9.82	46.52	64.42	-17.90	Peak	
2	0.2220	29.81	9.82	39.63	62.74	-23.11	Peak	
3	0.2580	27.72	9.82	37.54	61.50	-23.96	Peak	
4	0.5730	24.16	9.82	33.98	56.00	-22.02	Peak	
5	0.8340	19.43	9.91	29.34	56.00	-26.66	Peak	
6	1.2120	18.95	9.93	28.88	56.00	-27.12	Peak	

Note: The test result has included the cable loss.

Test Mode: TX Mode

Neutral

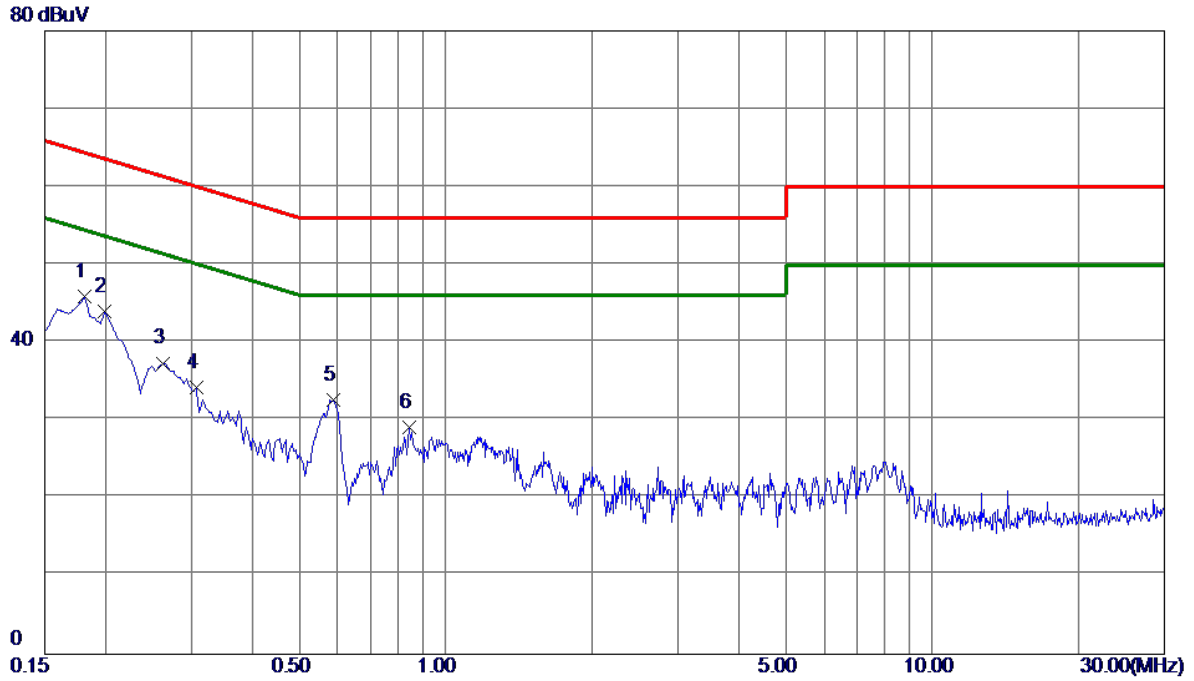

No.	Freq. MHz	Reading Level dBuV	Correct Factor dB	Measure ment dBuV	Limit dBuV	Margin dB	Detector	Comment
1 *	0.1815	35.96	9.91	45.87	64.42	-18.55	Peak	
2	0.1995	34.15	9.91	44.06	63.63	-19.57	Peak	
3	0.2625	27.44	9.92	37.36	61.35	-23.99	Peak	
4	0.3075	24.30	9.93	34.23	60.04	-25.81	Peak	
5	0.5865	22.74	9.97	32.71	56.00	-23.29	Peak	
6	0.8430	19.02	10.09	29.11	56.00	-26.89	Peak	

Note: The test result has included the cable loss.

APPENDIX B - RADIATED EMISSION (9 KHZ TO 30 MHZ)

Test Mode: TX Mode

Ant 0°

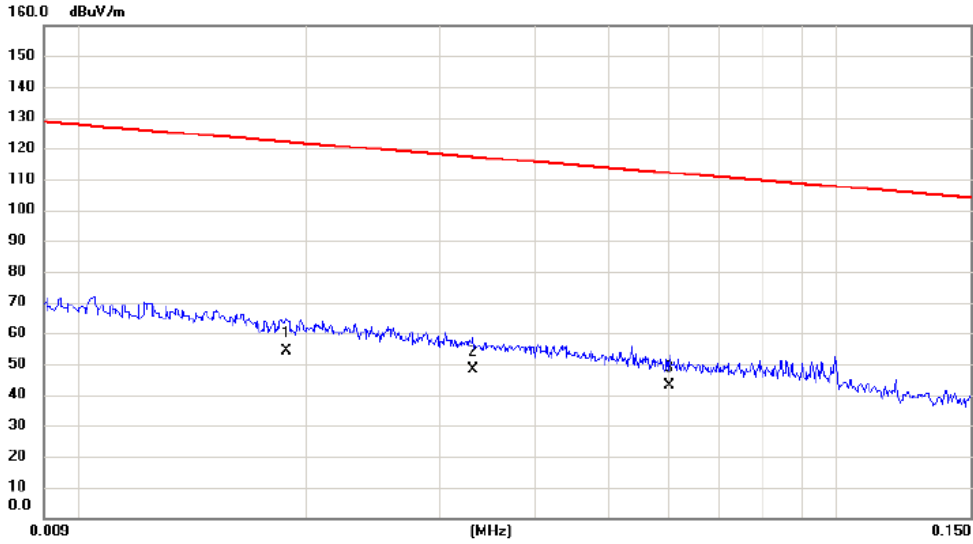

No.	Mk.	Freq. MHz	Reading Level dBuV	Correct Factor dB	Measure- ment dBuV/m	Limit dBuV/m	Margin dB	Detector	Comment
1	*	0.0188	33.90	20.19	54.09	122.12	-68.03	AVG	
2		0.0331	28.60	19.80	48.40	117.21	-68.81	AVG	
3		0.0601	23.70	19.33	43.03	112.03	-69.00	AVG	

Test Mode: TX Mode

Ant 0°

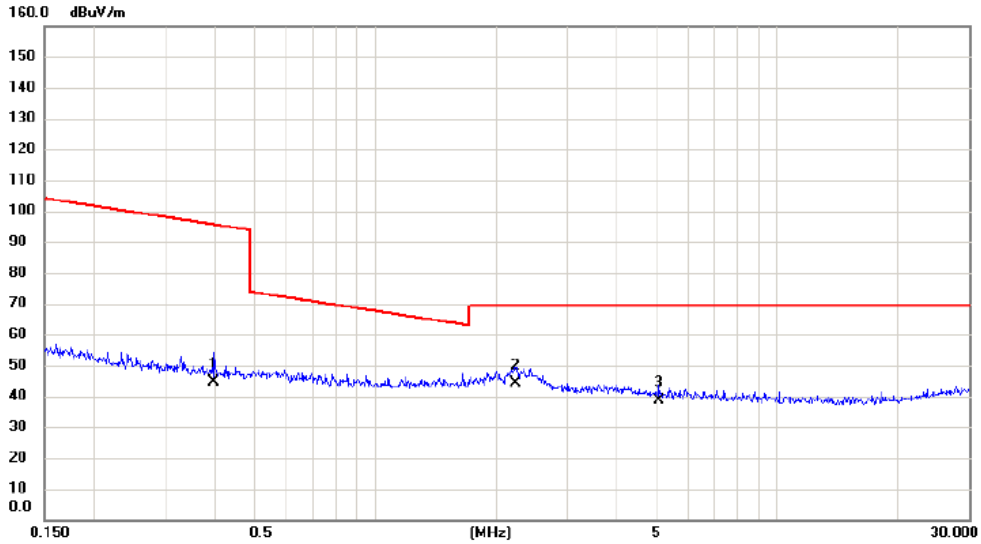

No. Mk.	Freq. MHz	Reading Level dBuV	Correct Factor dB	Measure- ment dBuV/m	Limit dBuV/m	Margin dB	Detector	Comment
1	0.3976	27.50	17.00	44.50	95.62	-51.12	AVG	
2 *	2.2367	27.30	16.97	44.27	69.54	-25.27	QP	
3	5.0580	23.60	15.16	38.76	69.54	-30.78	QP	

Test Mode: TX Mode

Ant 90°

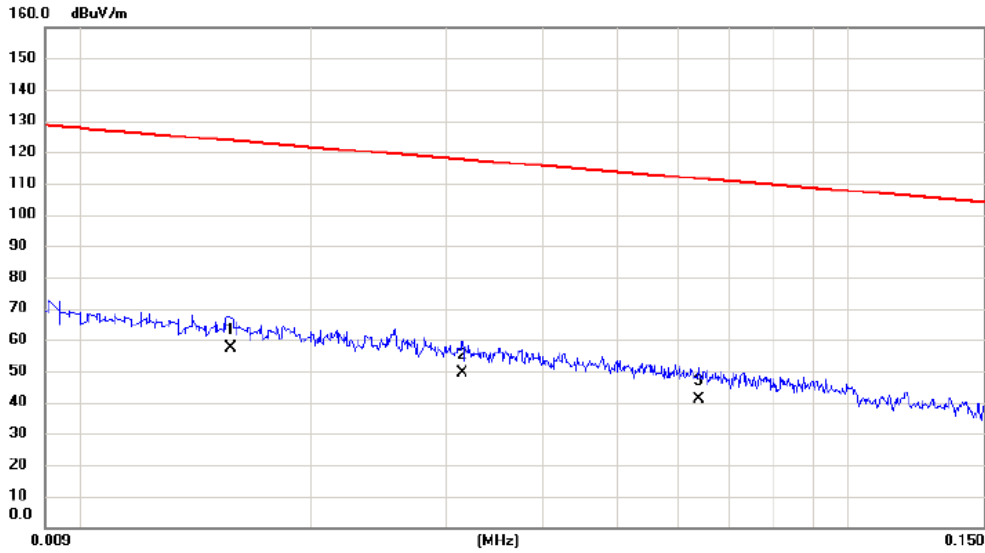

No.	Mk.	Freq. MHz	Reading Level dBuV	Correct Factor dB	Measure- ment dBuV/m	Limit dBuV/m	Margin dB	Detector	Comment
1	*	0.0157	36.80	20.62	57.42	123.69	-66.27	AVG	
2		0.0314	29.50	19.83	49.33	117.67	-68.34	AVG	
3		0.0640	21.60	19.25	40.85	111.48	-70.63	AVG	

Test Mode: TX Mode

Ant 90°

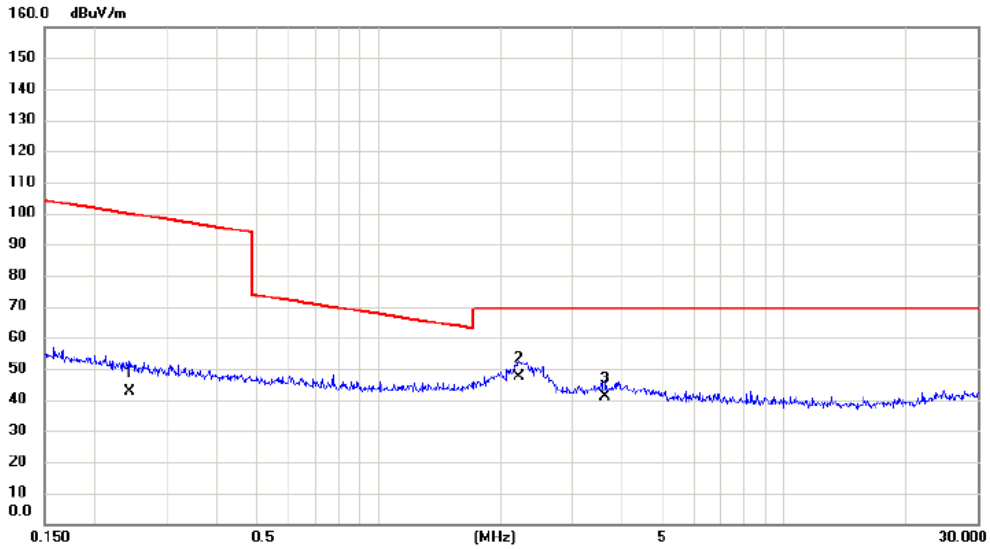

No.	Mk.	Freq. MHz	Reading Level dBuV	Correct Factor dB	Measure- ment dBuV/m	Limit dBuV/m	Margin dB	Detector	Comment
1		0.2430	25.60	17.07	42.67	99.89	-57.22	AVG	
2	*	2.2250	30.51	16.97	47.48	69.54	-22.06	QP	
3		3.6225	25.10	16.04	41.14	69.54	-28.40	QP	

APPENDIX C - RADIATED EMISSION (30 MHZ TO 1000 MHZ)

Test Mode: UNII-1/TX A Mode 5180 MHz

Vertical

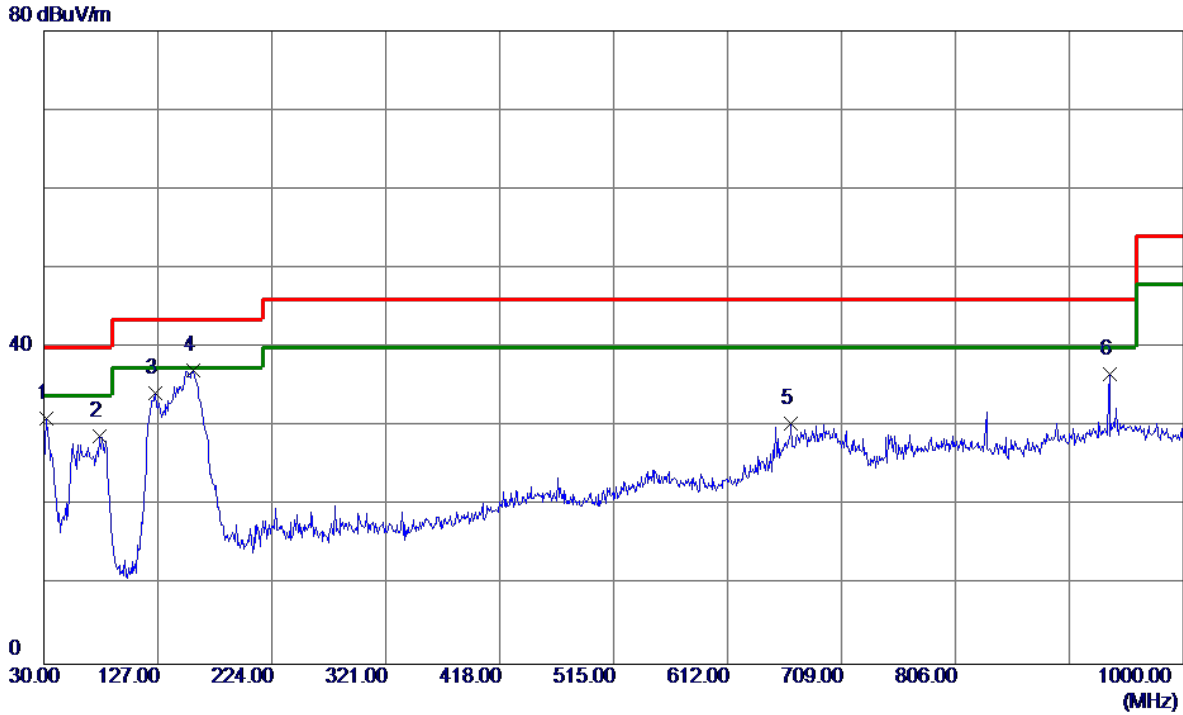

No.	Freq. MHz	Reading Level dBuV/m	Correct Factor dB	Measure ment dBuV/m	Limit dBuV/m	Margin dB	Detector	Comment
1	32.4250	45.99	-14.99	31.00	40.00	-9.00	Peak	
2	77.5300	47.25	-18.50	28.75	40.00	-11.25	Peak	
3	125.0600	48.25	-14.03	34.22	43.50	-9.28	Peak	
4 *	157.0700	47.91	-10.86	37.05	43.50	-6.45	Peak	
5	666.3200	34.76	-4.38	30.38	46.00	-15.62	Peak	
6	936.9500	35.78	0.89	36.67	46.00	-9.33	Peak	

Test Mode: UNII-1/TX A Mode 5180 MHz

Horizontal

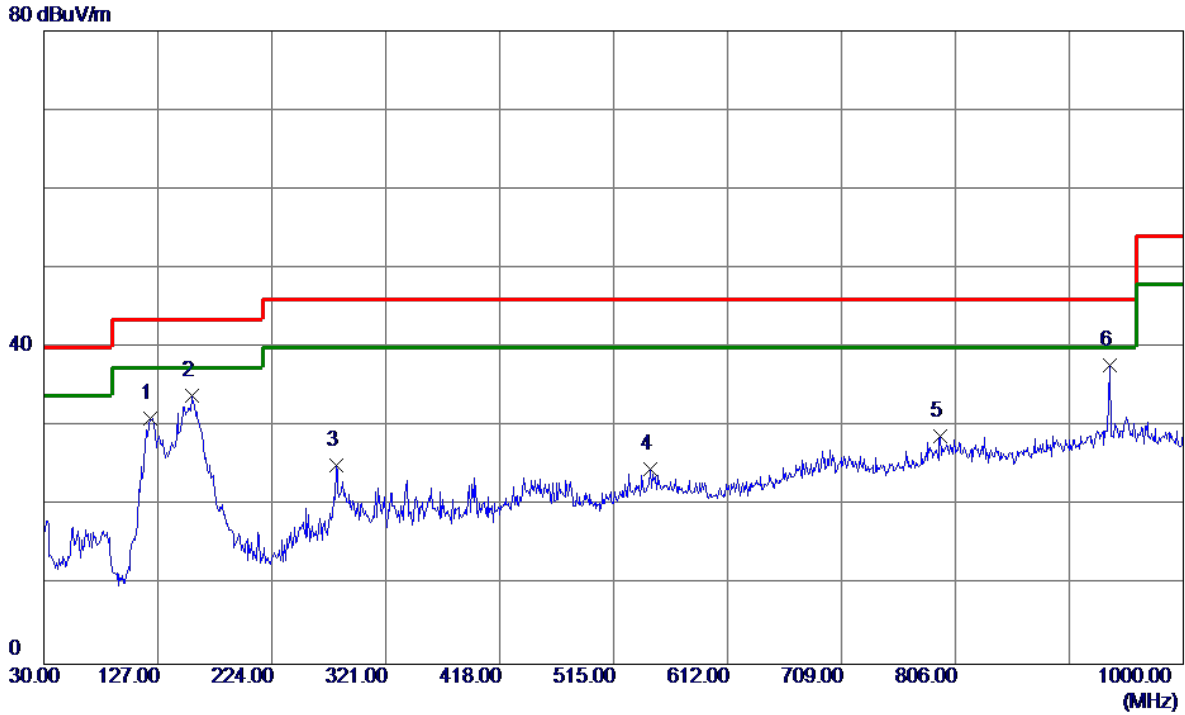

No.	Freq. MHz	Reading Level dBuV/m	Correct Factor dB	Measure ment dBuV/m	Limit dBuV/m	Margin dB	Detector	Comment
1	120.2100	45.68	-14.66	31.02	43.50	-12.48	Peak	
2	156.1000	44.88	-10.95	33.93	43.50	-9.57	Peak	
3	278.8050	36.64	-11.48	25.16	46.00	-20.84	Peak	
4	546.5250	30.34	-5.68	24.66	46.00	-21.34	Peak	
5	793.3900	30.25	-1.44	28.81	46.00	-17.19	Peak	
6 *	936.9500	36.87	0.89	37.76	46.00	-8.24	Peak	

Test Mode: UNII-1/TX A Mode 5200 MHz

Vertical

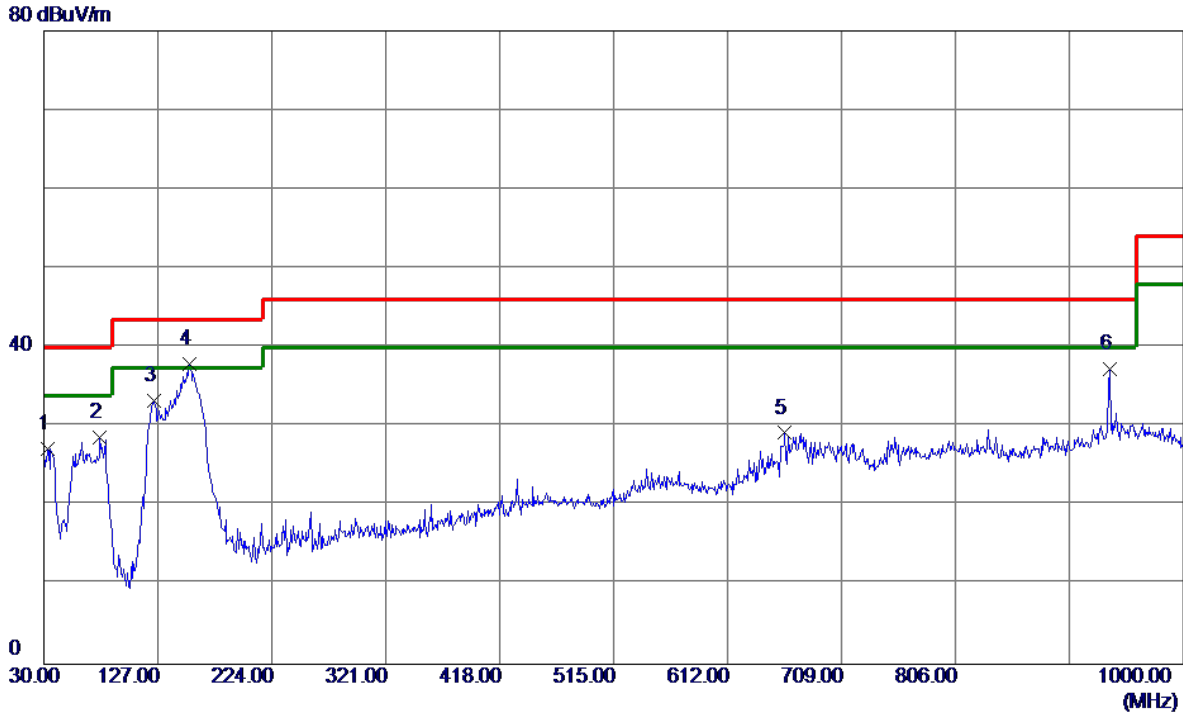

No.	Freq. MHz	Reading Level dBuV/m	Correct Factor dB	Measure ment dBuV/m	Limit dBuV/m	Margin dB	Detector	Comment
1	32.9100	42.19	-14.94	27.25	40.00	-12.75	Peak	
2	77.5300	47.17	-18.50	28.67	40.00	-11.33	Peak	
3	123.6050	47.48	-14.22	33.26	43.50	-10.24	Peak	
4 *	154.1600	49.02	-11.12	37.90	43.50	-5.60	Peak	
5	660.5000	33.86	-4.66	29.20	46.00	-16.80	Peak	
6	936.9500	36.43	0.89	37.32	46.00	-8.68	Peak	

Test Mode: UNII-1/TX A Mode 5200 MHz

Horizontal

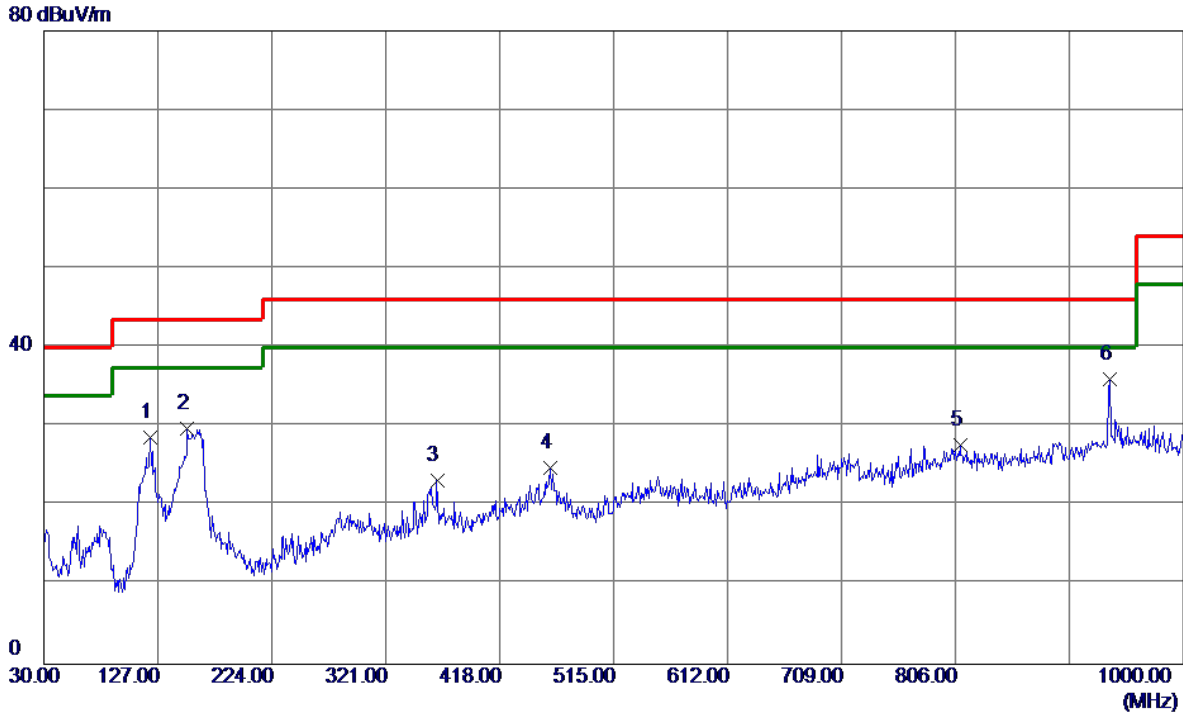

No.	Freq. MHz	Reading Level dBuV/m	Correct Factor dB	Measure ment dBuV/m	Limit dBuV/m	Margin dB	Detector	Comment
1	120.2100	43.27	-14.66	28.61	43.50	-14.89	Peak	
2	152.2200	41.07	-11.30	29.77	43.50	-13.73	Peak	
3	364.6500	33.76	-10.58	23.18	46.00	-22.82	Peak	
4	461.1650	32.47	-7.66	24.81	46.00	-21.19	Peak	
5	809.8800	28.80	-1.19	27.61	46.00	-18.39	Peak	
6 *	936.9500	35.13	0.89	36.02	46.00	-9.98	Peak	

Test Mode: UNII-1/TX A Mode 5240 MHz

Vertical

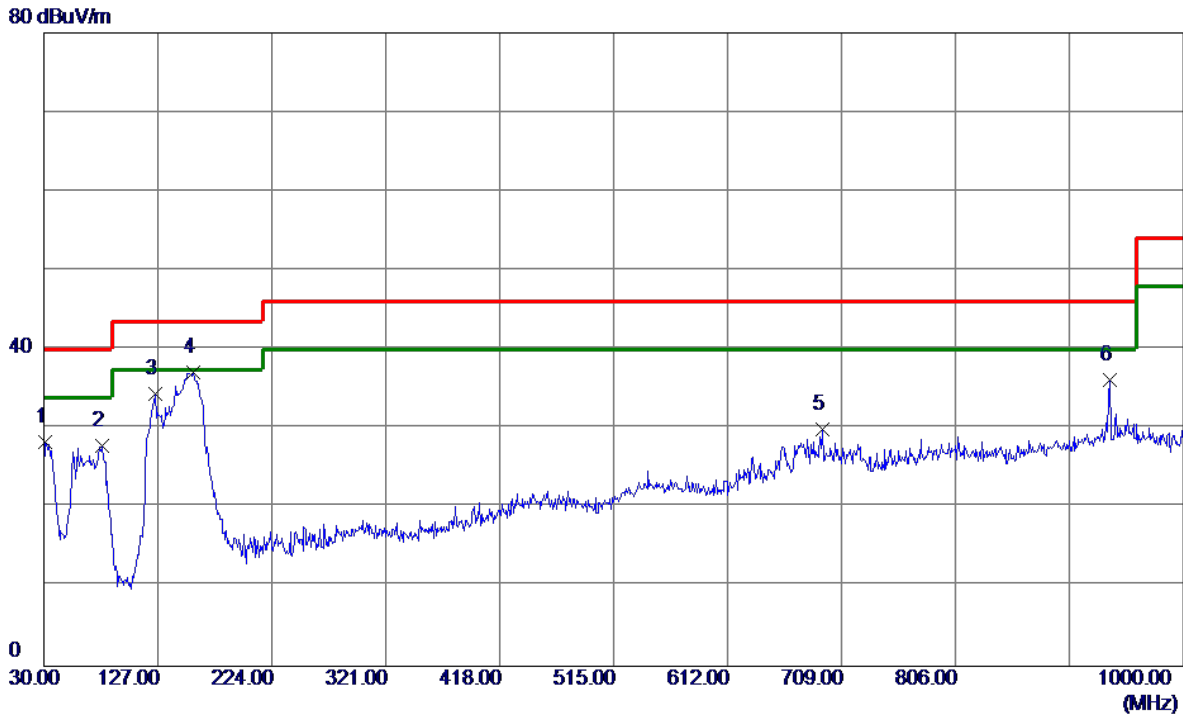

No.	Freq. MHz	Reading Level dBuV/m	Correct Factor dB	Measure ment dBuV/m	Limit dBuV/m	Margin dB	Detector	Comment
1	30.9700	43.36	-15.00	28.36	40.00	-11.64	Peak	
2	79.9550	46.34	-18.57	27.77	40.00	-12.23	Peak	
3	125.0600	48.49	-14.03	34.46	43.50	-9.04	Peak	
4 *	157.5549	47.97	-10.82	37.15	43.50	-6.35	Peak	
5	692.5100	32.97	-3.11	29.86	46.00	-16.14	Peak	
6	936.9500	35.32	0.89	36.21	46.00	-9.79	Peak	

Test Mode: UNII-1/TX A Mode 5240 MHz

Horizontal

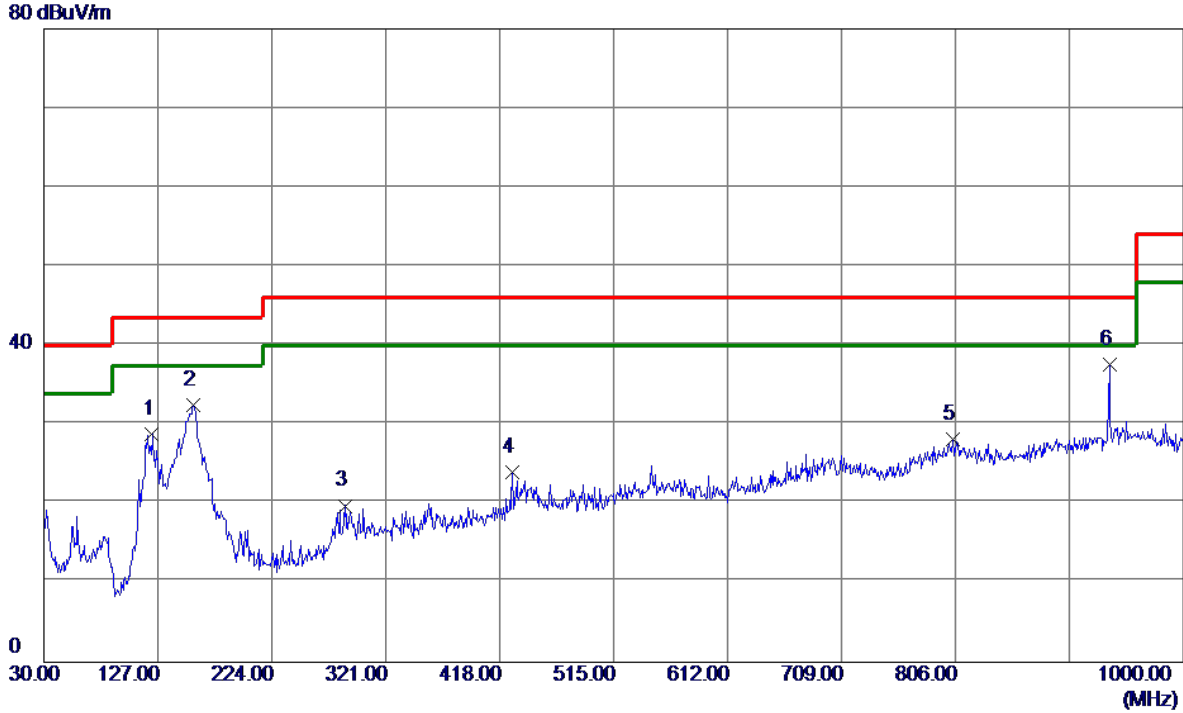

No.	Freq. MHz	Reading Level dBuV/m	Correct Factor dB	Measure ment dBuV/m	Limit dBuV/m	Margin dB	Detector	Comment
1	122.1500	43.24	-14.41	28.83	43.50	-14.67	Peak	
2	157.0700	43.33	-10.86	32.47	43.50	-11.03	Peak	
3	286.0799	30.86	-11.10	19.76	46.00	-26.24	Peak	
4	429.1550	32.16	-8.23	23.93	46.00	-22.07	Peak	
5	804.0600	29.24	-1.10	28.14	46.00	-17.86	Peak	
6 *	936.9500	36.75	0.89	37.64	46.00	-8.36	Peak	

Test Mode: UNII-3/TX A Mode 5745 MHz

Vertical

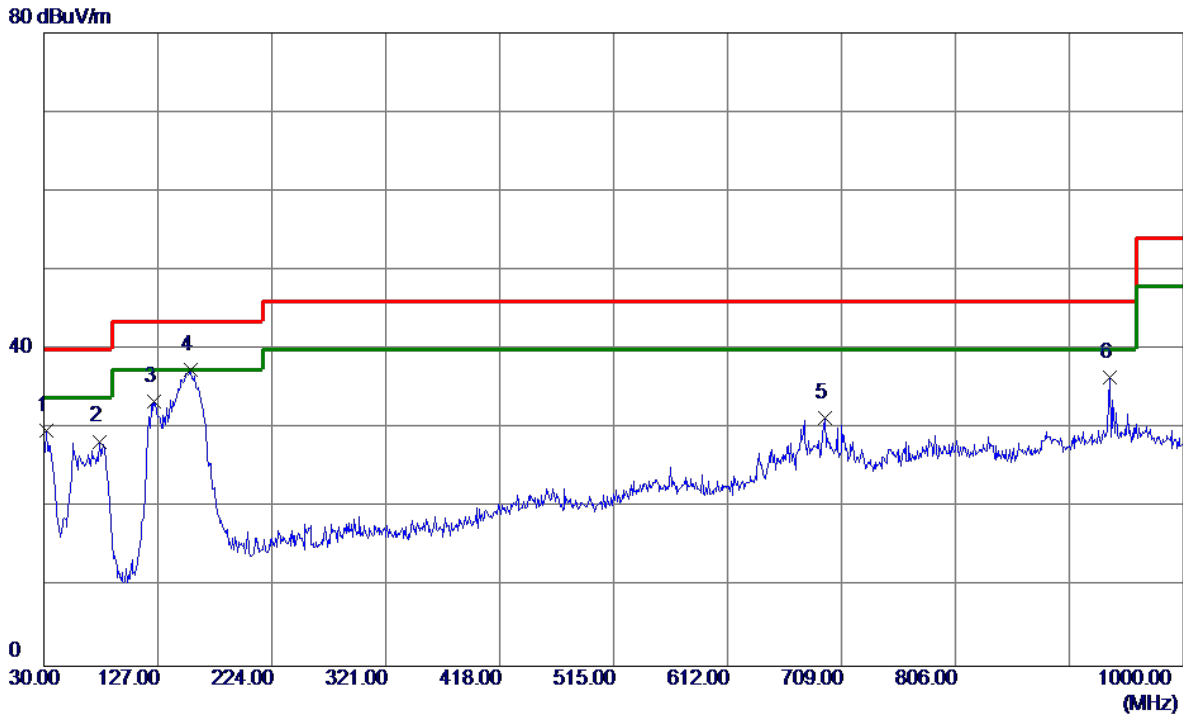

No.	Freq. MHz	Reading Level dBuV/m	Correct Factor dB	Measure ment dBuV/m	Limit dBuV/m	Margin dB	Detector	Comment
1	32.4250	44.69	-14.99	29.70	40.00	-10.30	Peak	
2	77.5300	46.90	-18.50	28.40	40.00	-11.60	Peak	
3	124.0900	47.55	-14.16	33.39	43.50	-10.11	Peak	
4 *	154.6450	48.52	-11.08	37.44	43.50	-6.06	Peak	
5	694.9350	34.40	-2.99	31.41	46.00	-14.59	Peak	
6	936.9500	35.55	0.89	36.44	46.00	-9.56	Peak	

Test Mode: UNII-3/TX A Mode 5745 MHz

Horizontal

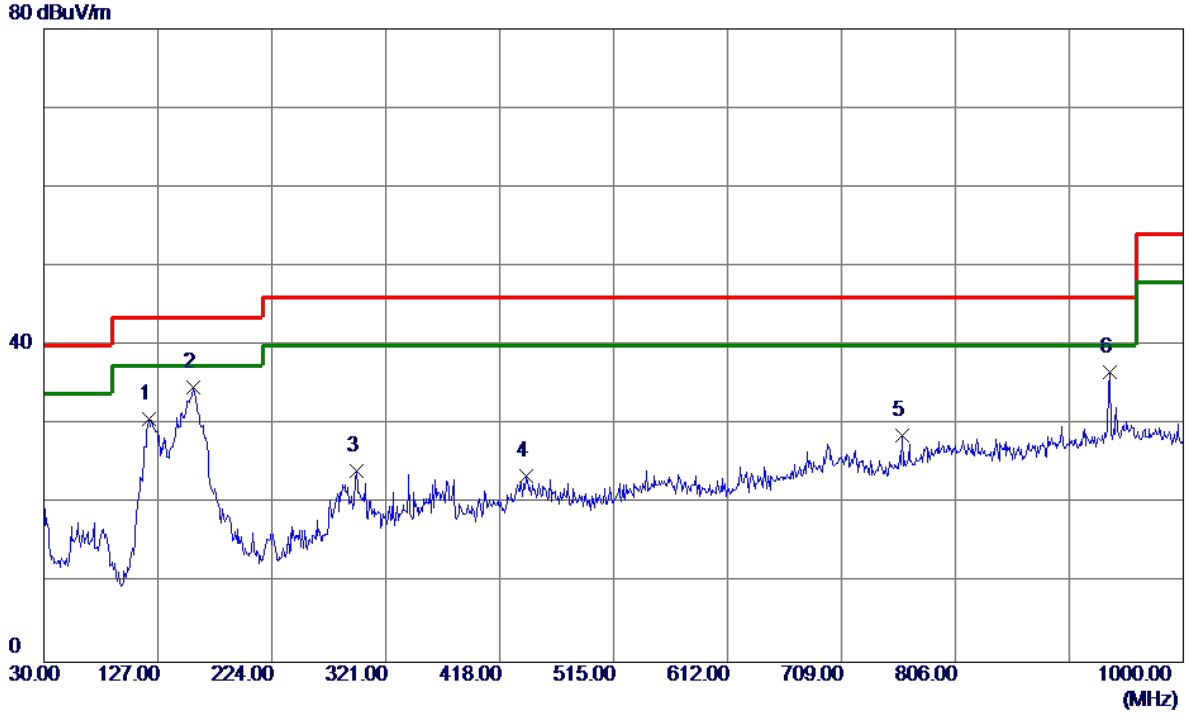

No.	Freq. MHz	Reading Level dBuV/m	Correct Factor dB	Measure ment dBuV/m	Limit dBuV/m	Margin dB	Detector	Comment
1	119.7250	45.49	-14.73	30.76	43.50	-12.74	Peak	
2 *	157.0700	45.52	-10.86	34.66	43.50	-8.84	Peak	
3	295.7800	34.81	-10.62	24.19	46.00	-21.81	Peak	
4	440.3100	31.25	-7.79	23.46	46.00	-22.54	Peak	
5	760.8950	31.96	-3.39	28.57	46.00	-17.43	Peak	
6	936.9500	35.70	0.89	36.59	46.00	-9.41	Peak	

Test Mode: UNII-3/TX A Mode 5785 MHz

Vertical

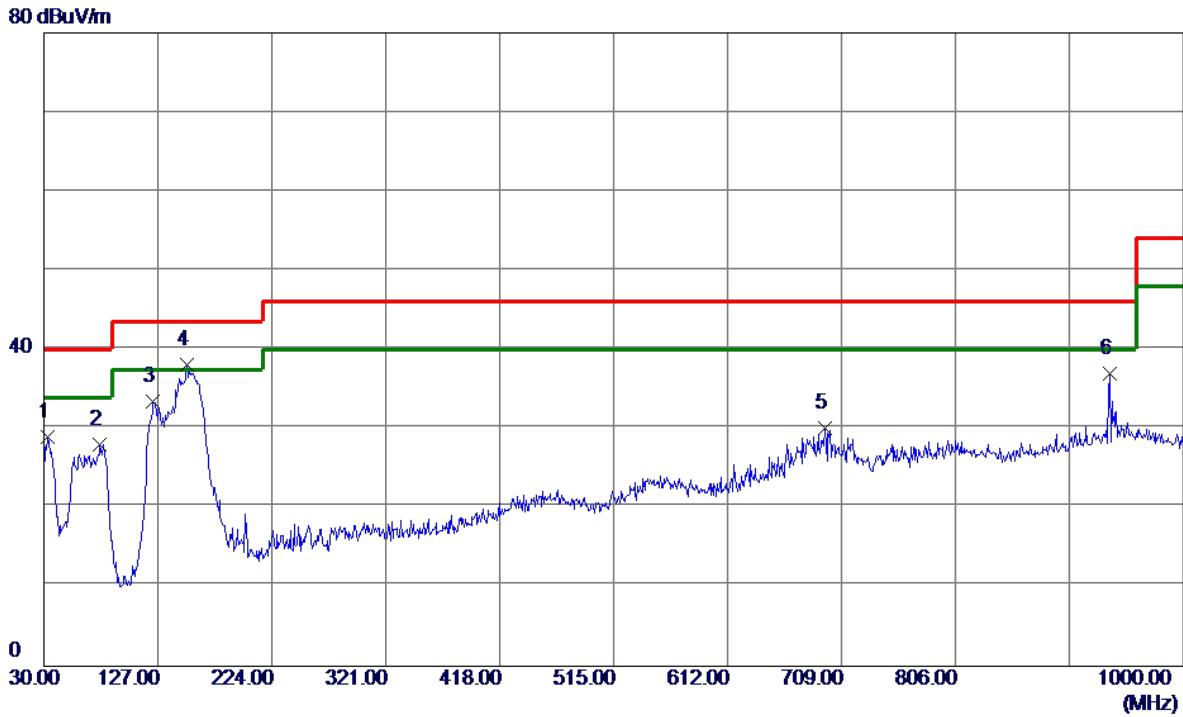

No.	Freq. MHz	Reading Level dBuV/m	Correct Factor dB	Measure ment dBuV/m	Limit dBuV/m	Margin dB	Detector	Comment
1	33.3950	43.82	-14.88	28.94	40.00	-11.06	Peak	
2	77.5300	46.50	-18.50	28.00	40.00	-12.00	Peak	
3	123.1200	47.69	-14.28	33.41	43.50	-10.09	Peak	
4 *	152.2200	49.38	-11.30	38.08	43.50	-5.42	Peak	
5	694.4500	33.15	-3.01	30.14	46.00	-15.86	Peak	
6	936.9500	36.05	0.89	36.94	46.00	-9.06	Peak	

Test Mode: UNII-3/TX A Mode 5785 MHz

Horizontal

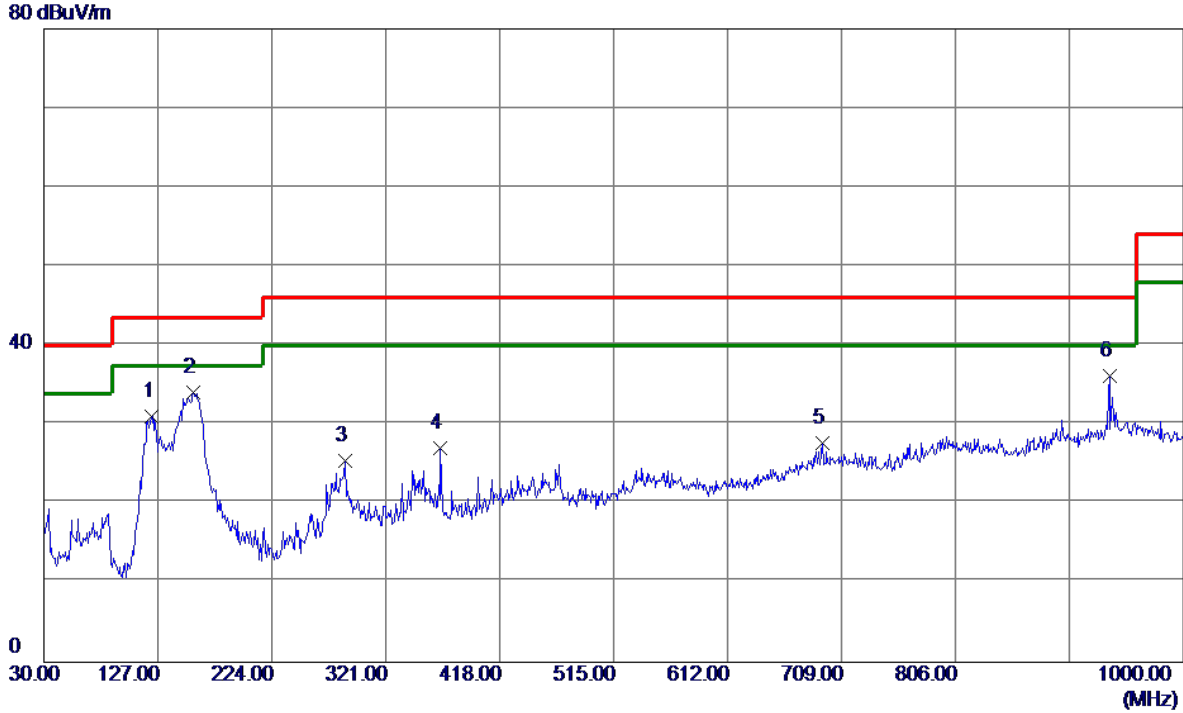

No.	Freq. MHz	Reading Level dBuV/m	Correct Factor dB	Measure ment dBuV/m	Limit dBuV/m	Margin dB	Detector	Comment
1	122.1500	45.46	-14.41	31.05	43.50	-12.45	Peak	
2 *	157.5549	44.94	-10.82	34.12	43.50	-9.38	Peak	
3	286.0799	36.53	-11.10	25.43	46.00	-20.57	Peak	
4	367.5600	37.51	-10.48	27.03	46.00	-18.97	Peak	
5	692.5100	30.73	-3.11	27.62	46.00	-18.38	Peak	
6	936.9500	35.28	0.89	36.17	46.00	-9.83	Peak	

Test Mode: UNII-3/TX A Mode 5825 MHz

Vertical

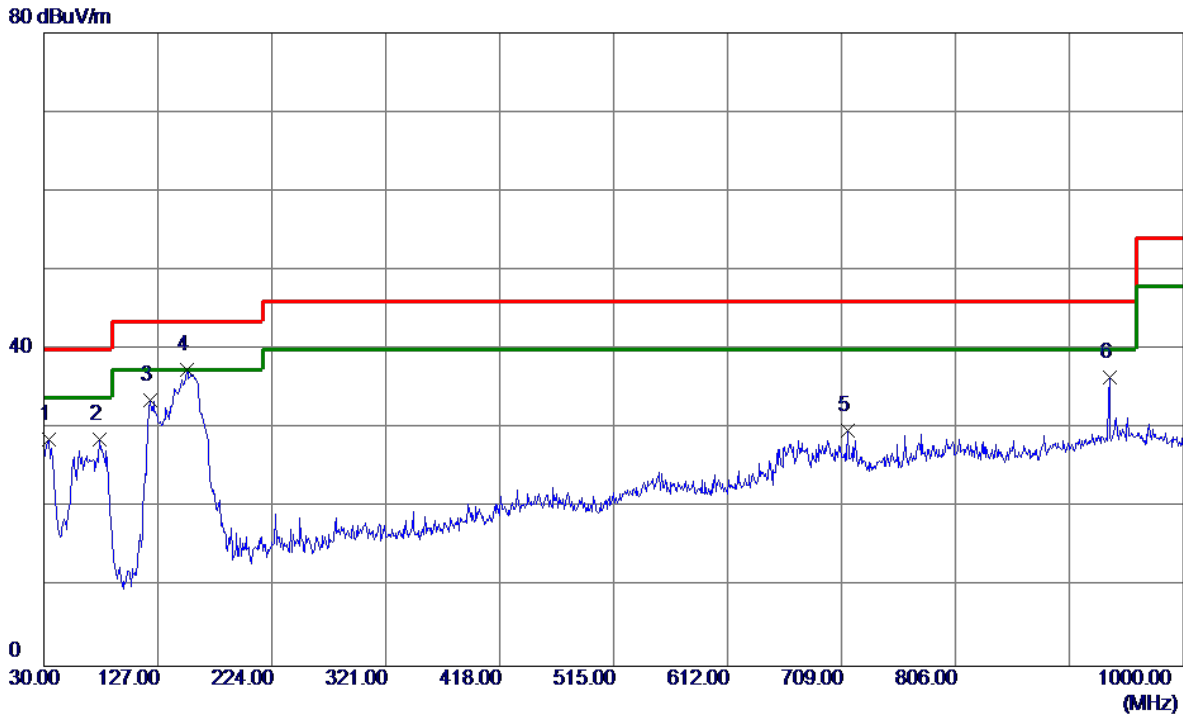

No.	Freq. MHz	Reading Level dBuV/m	Correct Factor dB	Measure ment dBuV/m	Limit dBuV/m	Margin dB	Detector	Comment
1	33.8800	43.41	-14.83	28.58	40.00	-11.42	Peak	
2	77.5300	47.19	-18.50	28.69	40.00	-11.31	Peak	
3	120.6950	48.16	-14.60	33.56	43.50	-9.94	Peak	
4 *	151.7350	48.79	-11.34	37.45	43.50	-6.05	Peak	
5	714.8200	32.96	-3.13	29.83	46.00	-16.17	Peak	
6	936.9500	35.62	0.89	36.51	46.00	-9.49	Peak	

Test Mode: UNII-3/TX A Mode 5825 MHz

Horizontal

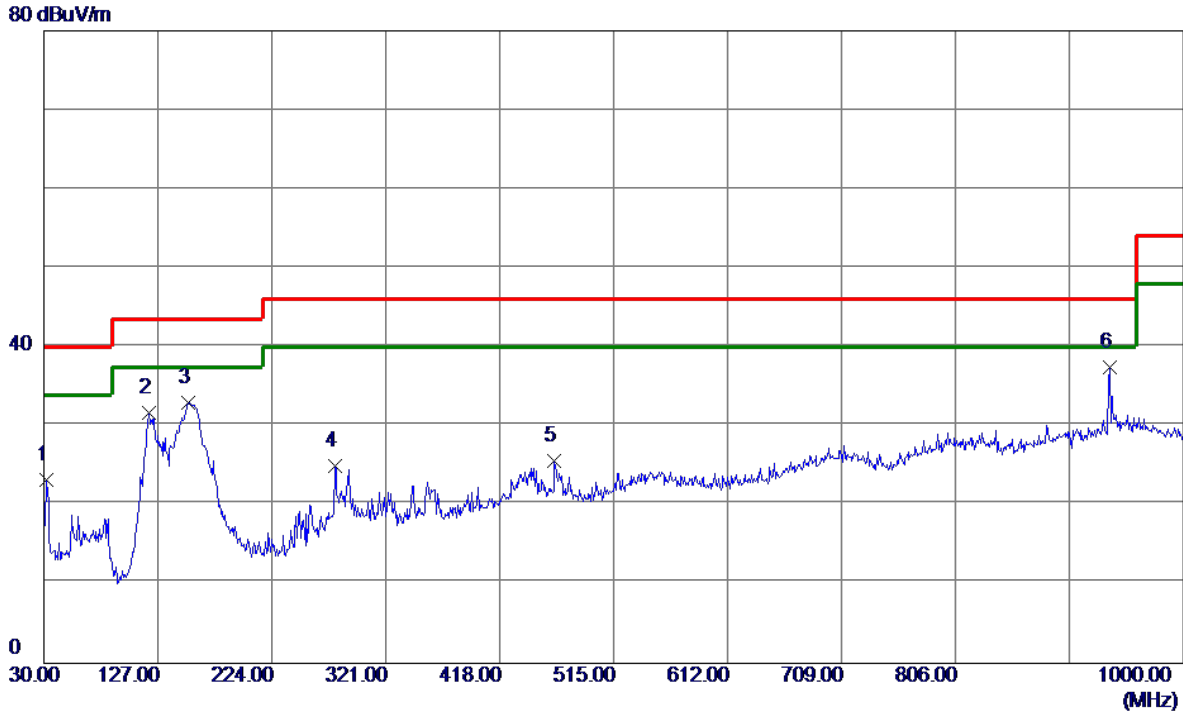

No.	Freq. MHz	Reading Level dBuV/m	Correct Factor dB	Measure ment dBuV/m	Limit dBuV/m	Margin dB	Detector	Comment
1	32.4250	38.22	-14.99	23.23	40.00	-16.77	Peak	
2	119.2400	46.43	-14.81	31.62	43.50	-11.88	Peak	
3	153.1900	44.22	-11.21	33.01	43.50	-10.49	Peak	
4	277.8350	36.50	-11.59	24.91	46.00	-21.09	Peak	
5	464.5600	33.29	-7.73	25.56	46.00	-20.44	Peak	
6 *	936.9500	36.54	0.89	37.43	46.00	-8.57	Peak	

APPENDIX D - RADIATED EMISSION (ABOVE 1000 MHZ)

Orthogonal Axis:	X
Test Mode:	UNII-1/ TX A Mode 5180 MHz

Vertical

130 dBuV/m

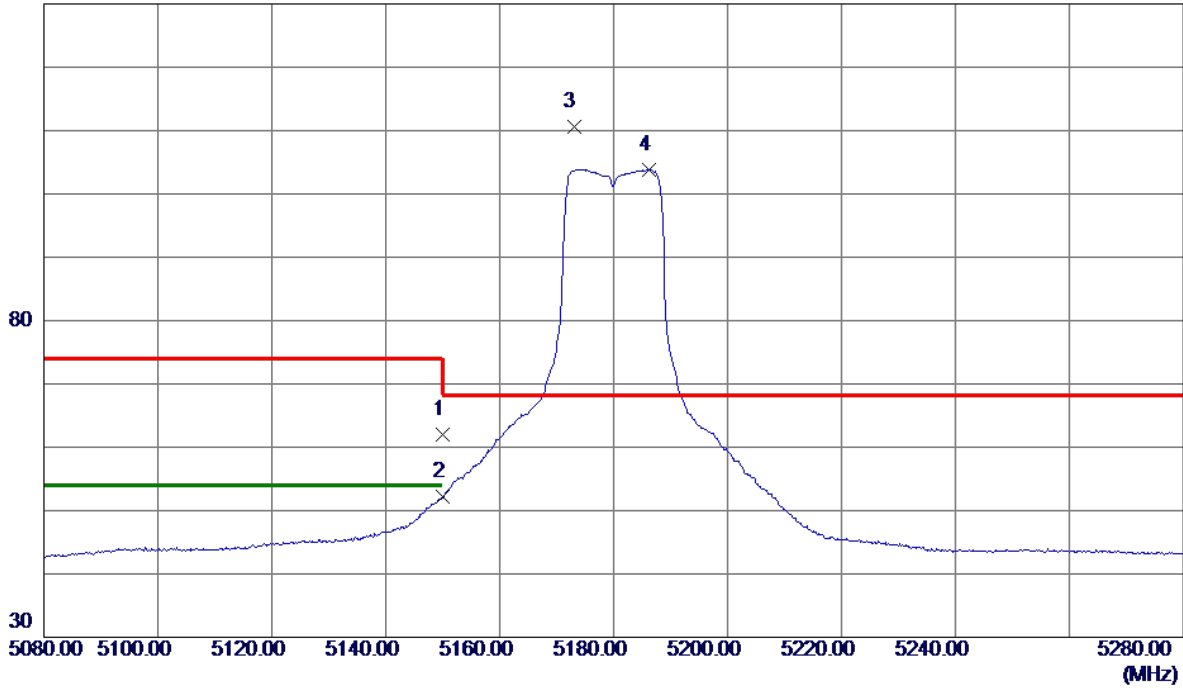

No.	Freq. MHz	Reading Level dBuV/m	Correct Factor dB	Measure ment dBuV/m	Limit dBuV/m	Margin dB	Detector	Comment
1	5150.0000	47.58	14.35	61.93	74.00	-12.07	Peak	
2	5150.0000	37.78	14.35	52.13	54.00	-1.87	AVG	
3 *	5173.0000	96.26	14.40	110.66	68.30	42.36	Peak	No Limit
4	5186.2000	89.42	14.44	103.86	999.00	-895.14	AVG	No Limit

Orthogonal Axis:	X
Test Mode:	UNII-1/ TX A Mode 5180 MHz

Vertical

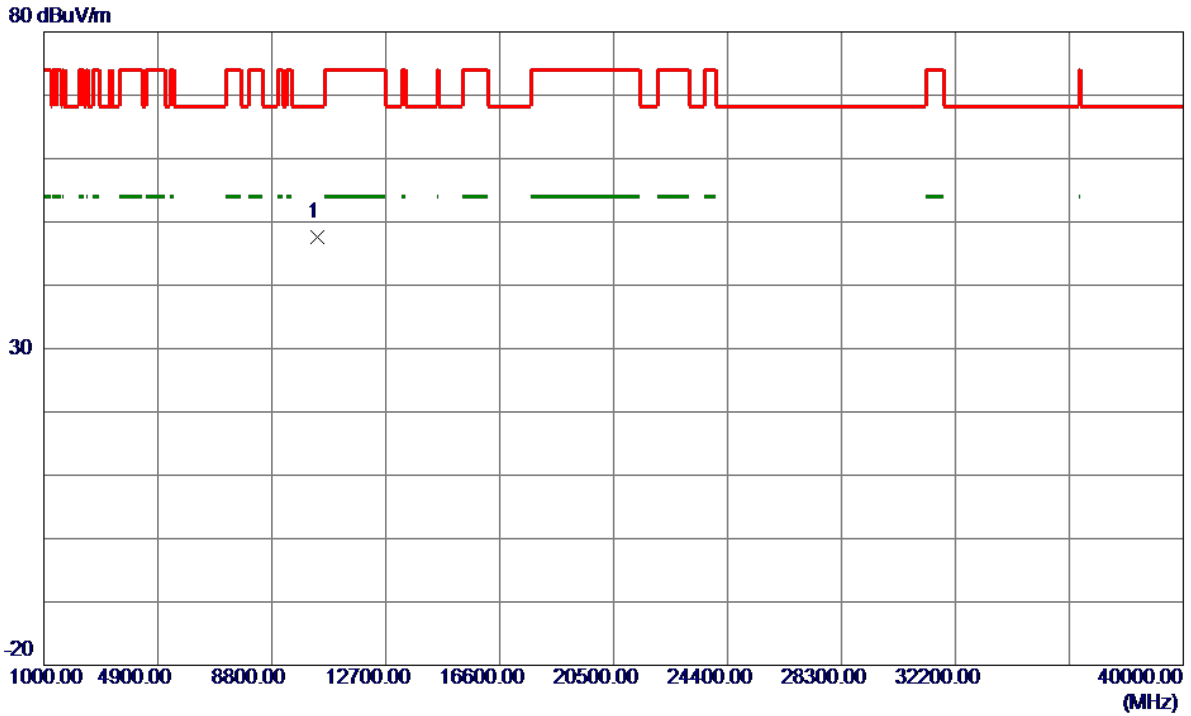

No.	Freq. MHz	Reading Level dBuV/m	Correct Factor dB	Measure ment dBuV/m	Limit dBuV/m	Margin dB	Detector	Comment
1 *	10364.0550	35.94	11.71	47.65	68.30	-20.65	Peak	

Orthogonal Axis:	X
Test Mode:	UNII-1/ TX A Mode 5180 MHz

Horizontal

130 dBuV/m

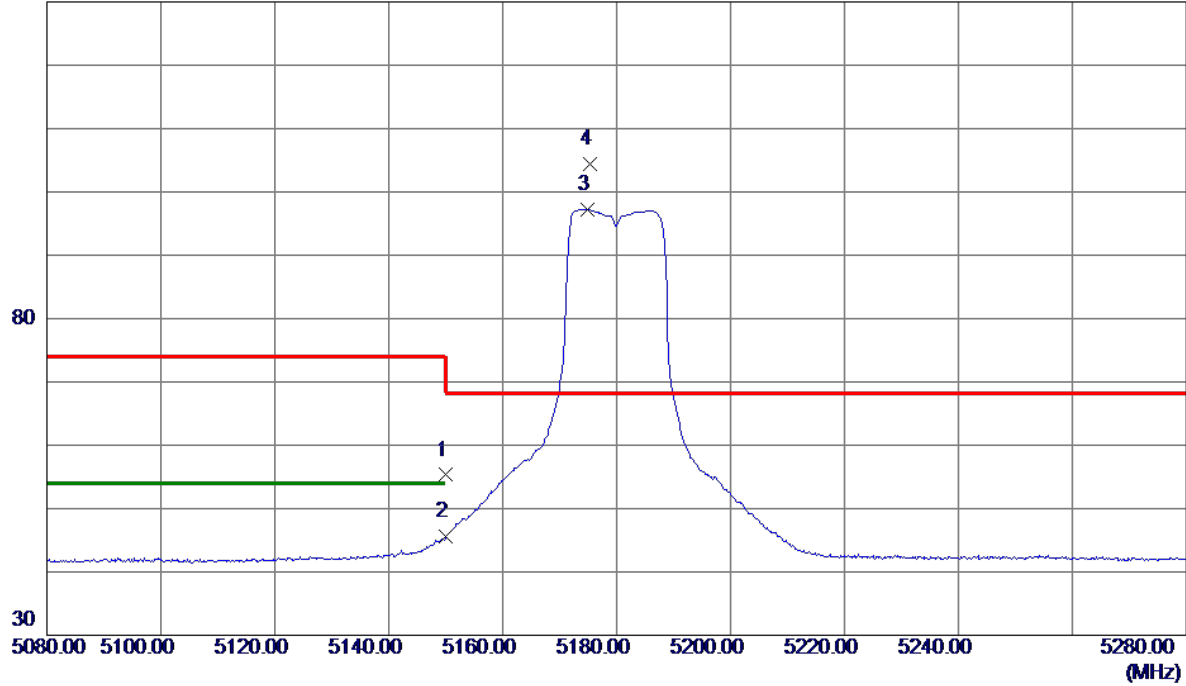

No.	Freq. MHz	Reading Level dBuV/m	Correct Factor dB	Measure ment dBuV/m	Limit dBuV/m	Margin dB	Detector	Comment
1	5150.0000	40.95	14.35	55.30	74.00	-18.70	Peak	
2	5150.0000	31.23	14.35	45.58	54.00	-8.42	AVG	
3	5174.8000	82.83	14.41	97.24	999.00	-901.76	AVG	No Limit
4 *	5175.4000	89.92	14.41	104.33	68.30	36.03	Peak	No Limit

Orthogonal Axis:	X
Test Mode:	UNII-1/ TX A Mode 5180 MHz

Horizontal

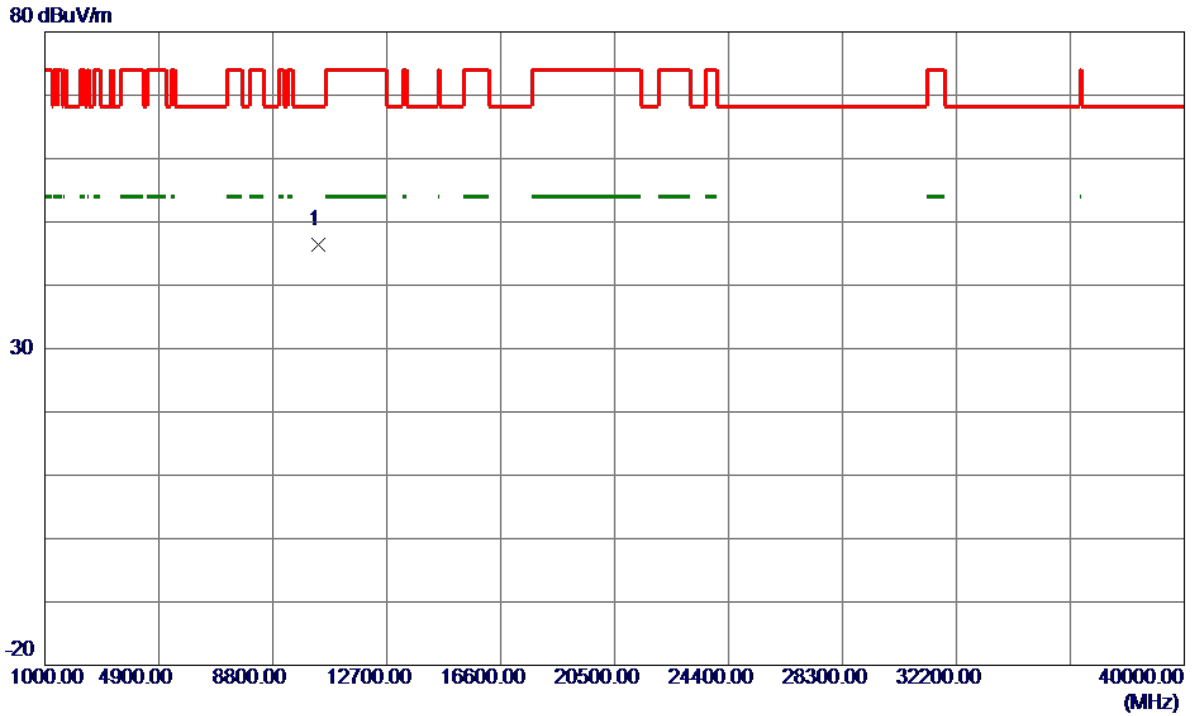

No.	Freq. MHz	Reading Level dBuV/m	Correct Factor dB	Measure ment dBuV/m	Limit dBuV/m	Margin dB	Detector	Comment
1 *	10357.1100	34.77	11.69	46.46	68.30	-21.84	Peak	

Orthogonal Axis:	X
Test Mode:	UNII-1/ TX A Mode 5200 MHz

Vertical

130 dBuV/m

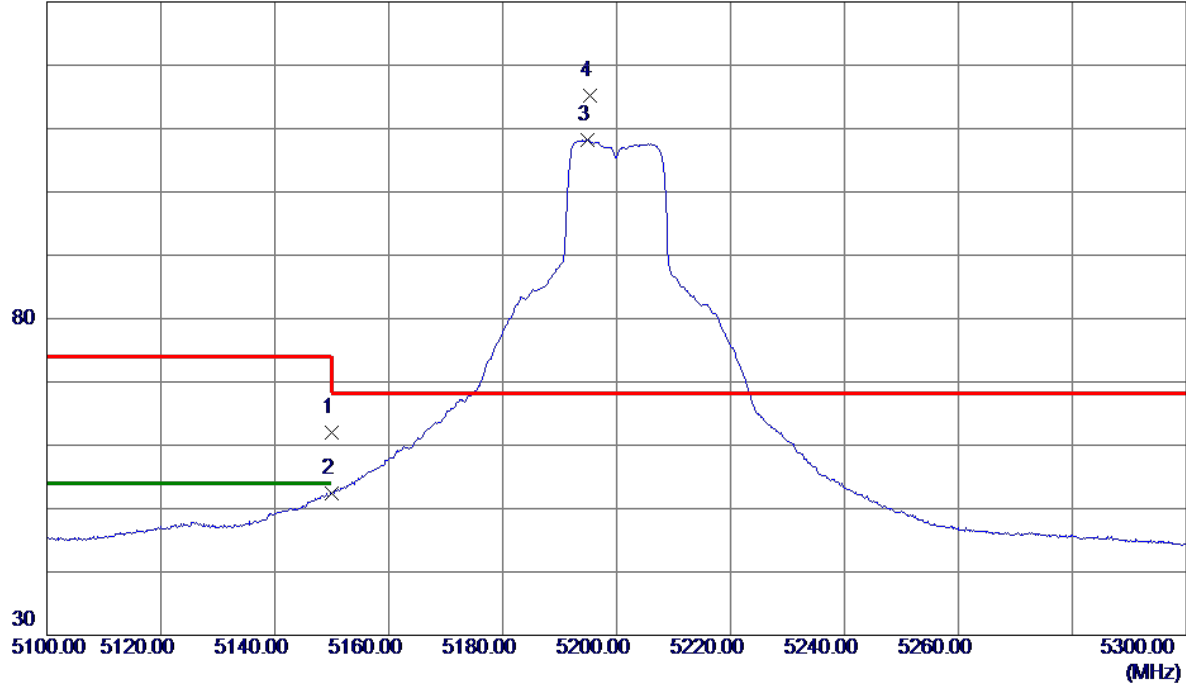

No.	Freq. MHz	Reading Level dBuV/m	Correct Factor dB	Measure ment dBuV/m	Limit dBuV/m	Margin dB	Detector	Comment
1	5150.0000	47.71	14.35	62.06	74.00	-11.94	Peak	
2	5150.0000	38.00	14.35	52.35	54.00	-1.65	AVG	
3	5194.9000	93.80	14.46	108.26	999.00	-890.74	AVG	No Limit
4 *	5195.4000	100.77	14.46	115.23	68.30	46.93	Peak	No Limit

Orthogonal Axis:	X
Test Mode:	UNII-1/ TX A Mode 5200 MHz

Vertical

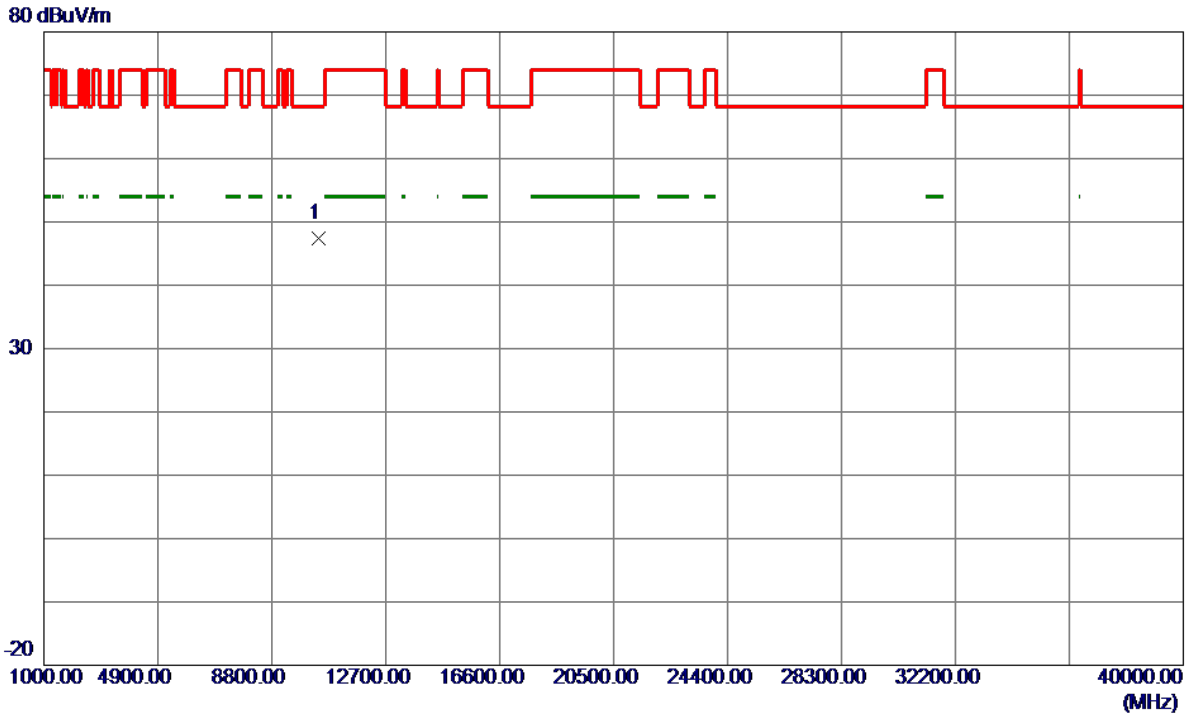

No.	Freq. MHz	Reading Level dBuV/m	Correct Factor dB	Measure ment dBuV/m	Limit dBuV/m	Margin dB	Detector	Comment
1 *	10398.2400	35.62	11.76	47.38	68.30	-20.92	Peak	

Orthogonal Axis:	X
Test Mode:	UNII-1/ TX A Mode 5200 MHz

Horizontal

130 dBuV/m

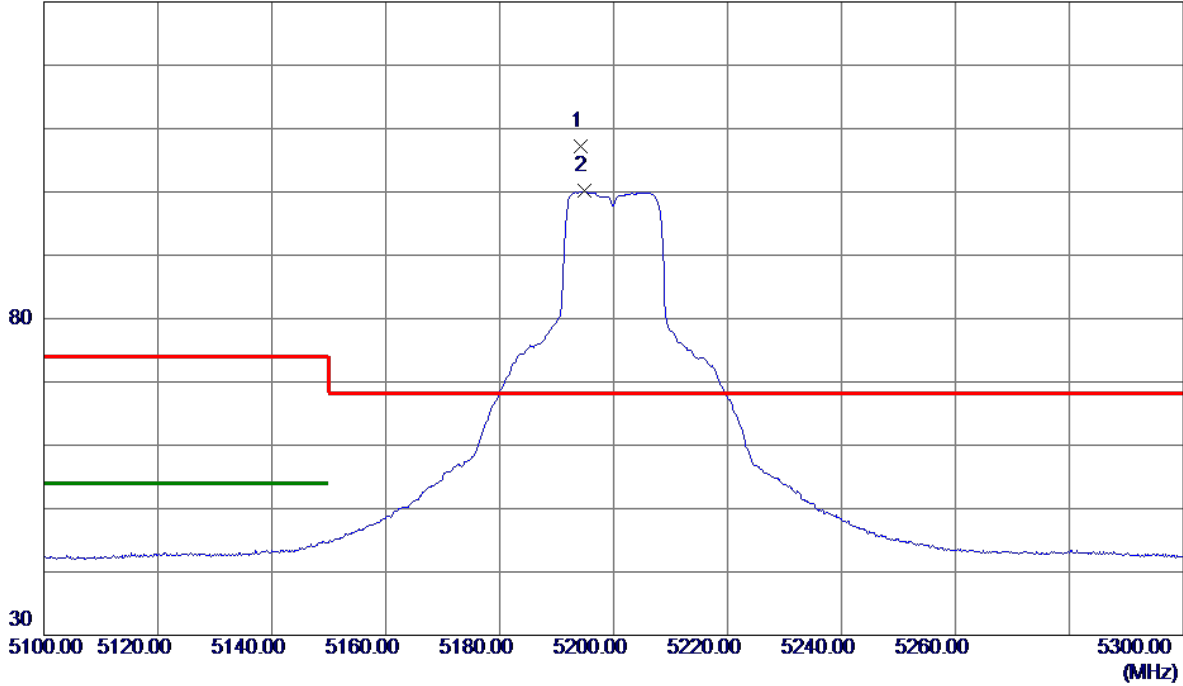

No.	Freq. MHz	Reading Level dBuV/m	Correct Factor dB	Measure ment dBuV/m	Limit dBuV/m	Margin dB	Detector	Comment
1 *	5194.2000	92.79	14.46	107.25	68.30	38.95	Peak	No Limit
2	5194.8000	85.66	14.46	100.12	999.00	-898.88	AVG	No Limit

Orthogonal Axis:	X
Test Mode:	UNII-1/ TX A Mode 5200 MHz

Horizontal

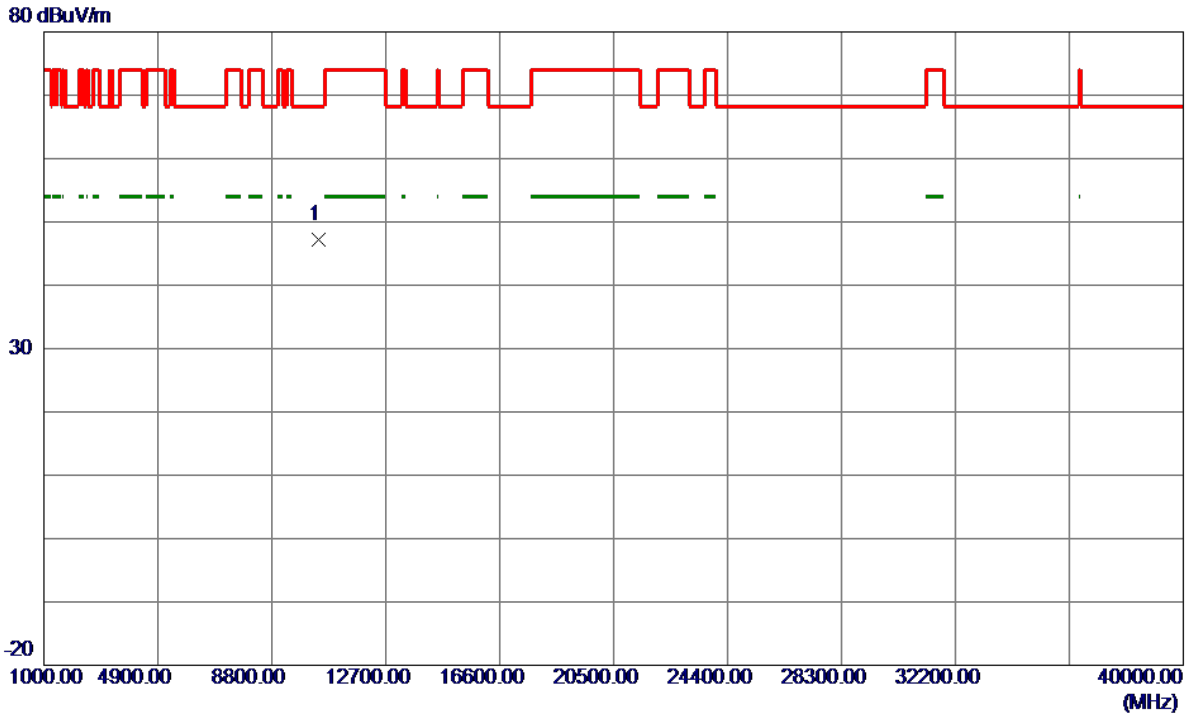

No.	Freq. MHz	Reading Level dBuV/m	Correct Factor dB	Measure ment dBuV/m	Limit dBuV/m	Margin dB	Detector	Comment
1 *	10403.9500	35.41	11.77	47.18	68.30	-21.12	Peak	

Orthogonal Axis:	X
Test Mode:	UNII-1/ TX A Mode 5240 MHz

Vertical

130 dBuV/m

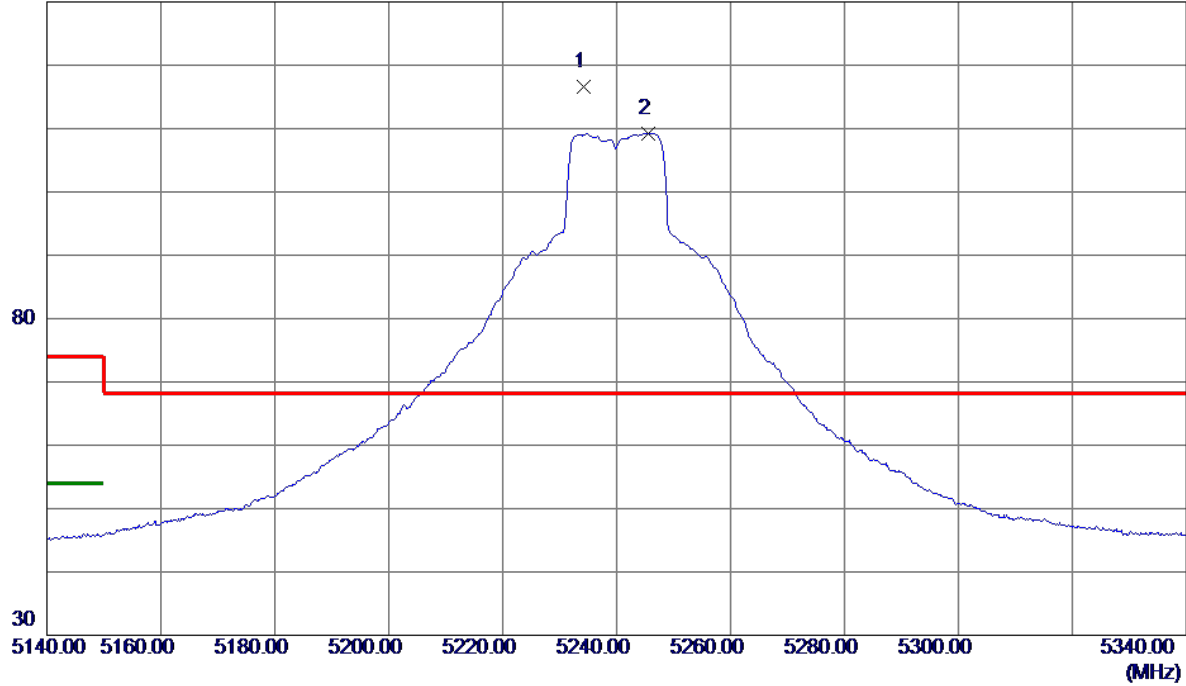

No.	Freq. MHz	Reading Level dBuV/m	Correct Factor dB	Measure ment dBuV/m	Limit dBuV/m	Margin dB	Detector	Comment
1 *	5234.2000	102.12	14.56	116.68	68.30	48.38	Peak	No Limit
2	5245.6000	94.63	14.59	109.22	999.00	-889.78	AVG	No Limit

Orthogonal Axis:	X
Test Mode:	UNII-1/ TX A Mode 5240 MHz

Vertical

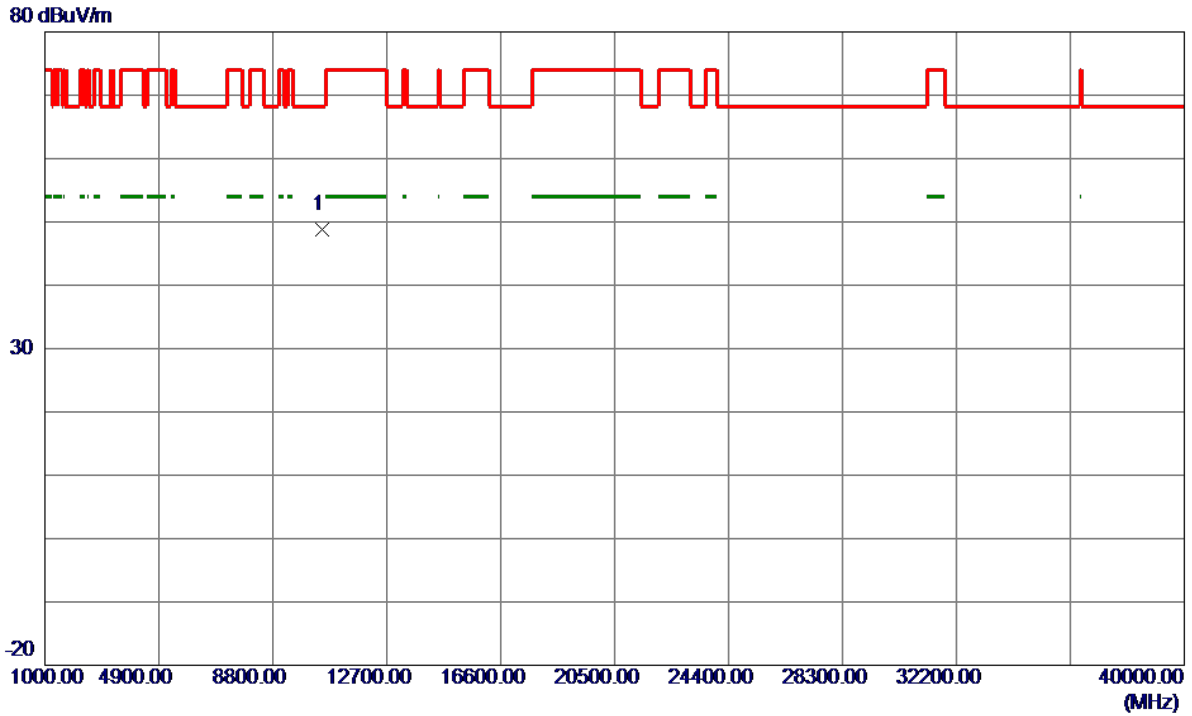

No.	Freq. MHz	Reading Level dBuV/m	Correct Factor dB	Measure ment dBuV/m	Limit dBuV/m	Margin dB	Detector	Comment
1 *	10479.5950	36.98	11.90	48.88	68.30	-19.42	Peak	

Orthogonal Axis:	X
Test Mode:	UNII-1/ TX A Mode 5240 MHz

Horizontal

130 dBuV/m

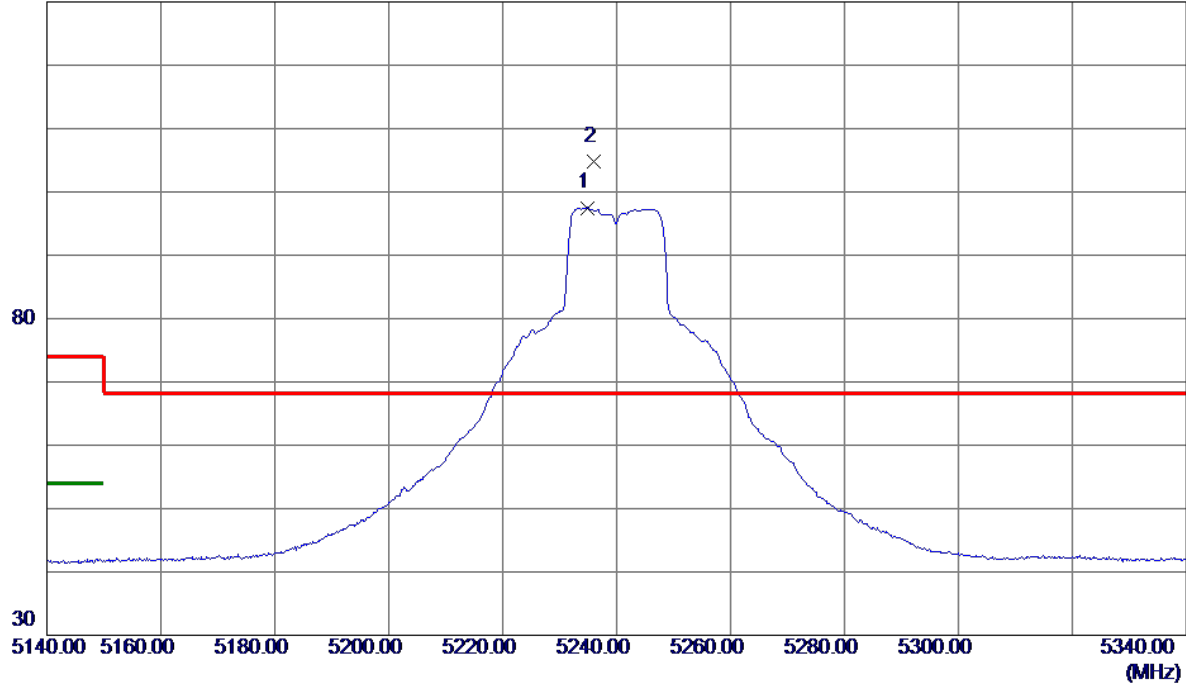

No.	Freq. MHz	Reading Level dBuV/m	Correct Factor dB	Measure ment dBuV/m	Limit dBuV/m	Margin dB	Detector	Comment
1	5234.9000	82.94	14.56	97.50	999.00	-901.50	AVG	No Limit
2 *	5236.0000	90.23	14.57	104.80	68.30	36.50	Peak	No Limit

Orthogonal Axis:	X
Test Mode:	UNII-1/ TX A Mode 5240 MHz

Horizontal

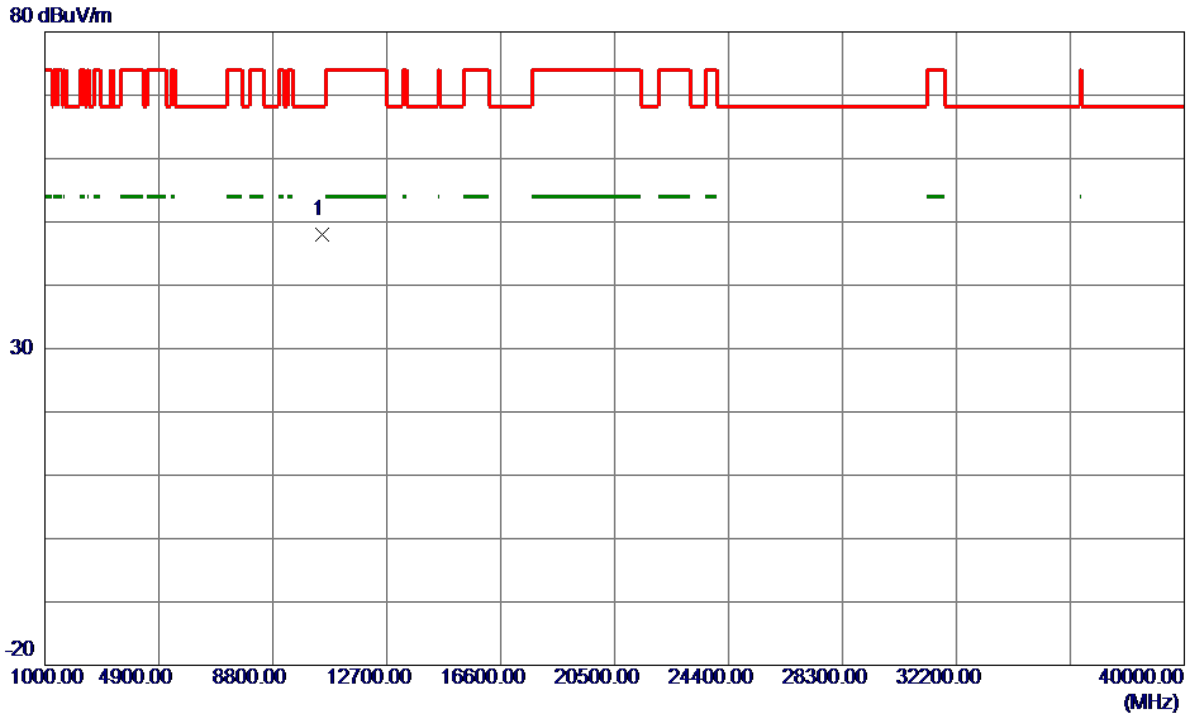

No.	Freq. MHz	Reading Level dBuV/m	Correct Factor dB	Measure ment dBuV/m	Limit dBuV/m	Margin dB	Detector	Comment
1 *	10478.6600	36.18	11.90	48.08	68.30	-20.22	Peak	

Orthogonal Axis:	X
Test Mode:	UNII-1/ TX N20 Mode 5180 MHz

Vertical

130 dBuV/m

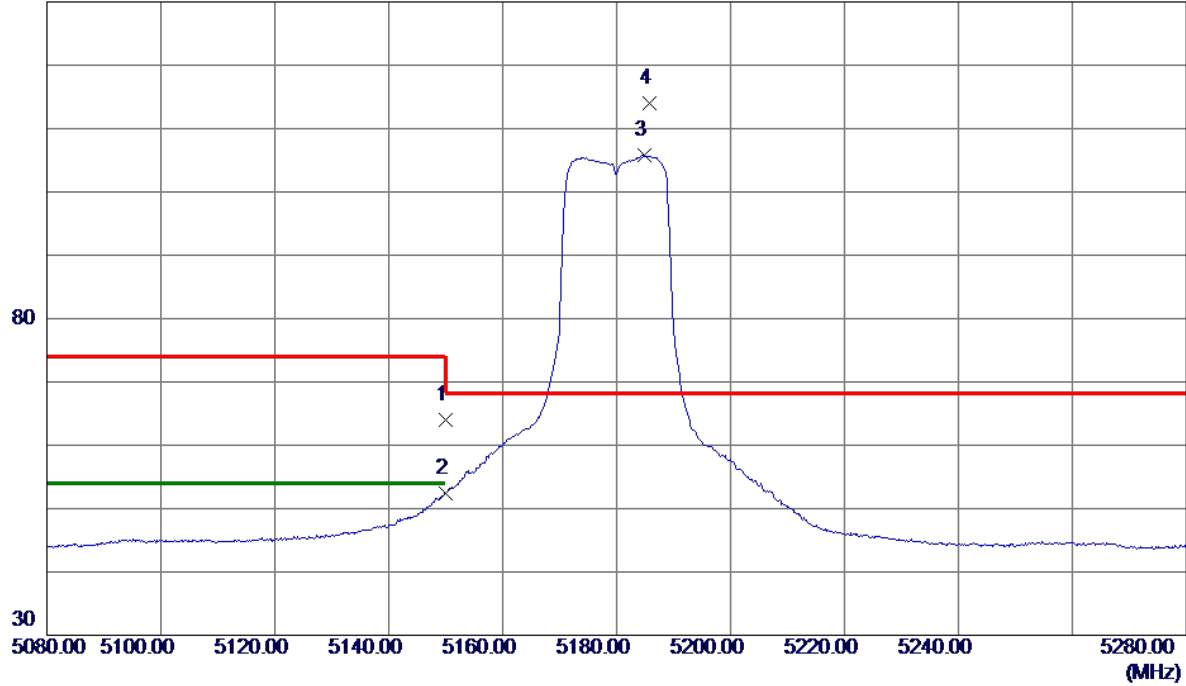

No.	Freq. MHz	Reading Level dBuV/m	Correct Factor dB	Measure ment dBuV/m	Limit dBuV/m	Margin dB	Detector	Comment
1	5150.0000	49.65	14.35	64.00	74.00	-10.00	Peak	
2	5150.0000	38.10	14.35	52.45	54.00	-1.55	AVG	
3	5184.8000	91.30	14.43	105.73	999.00	-893.27	AVG	No Limit
4 *	5185.7000	99.50	14.44	113.94	68.30	45.64	Peak	No Limit

Orthogonal Axis:	X
Test Mode:	UNII-1/ TX N20 Mode 5180 MHz

Vertical

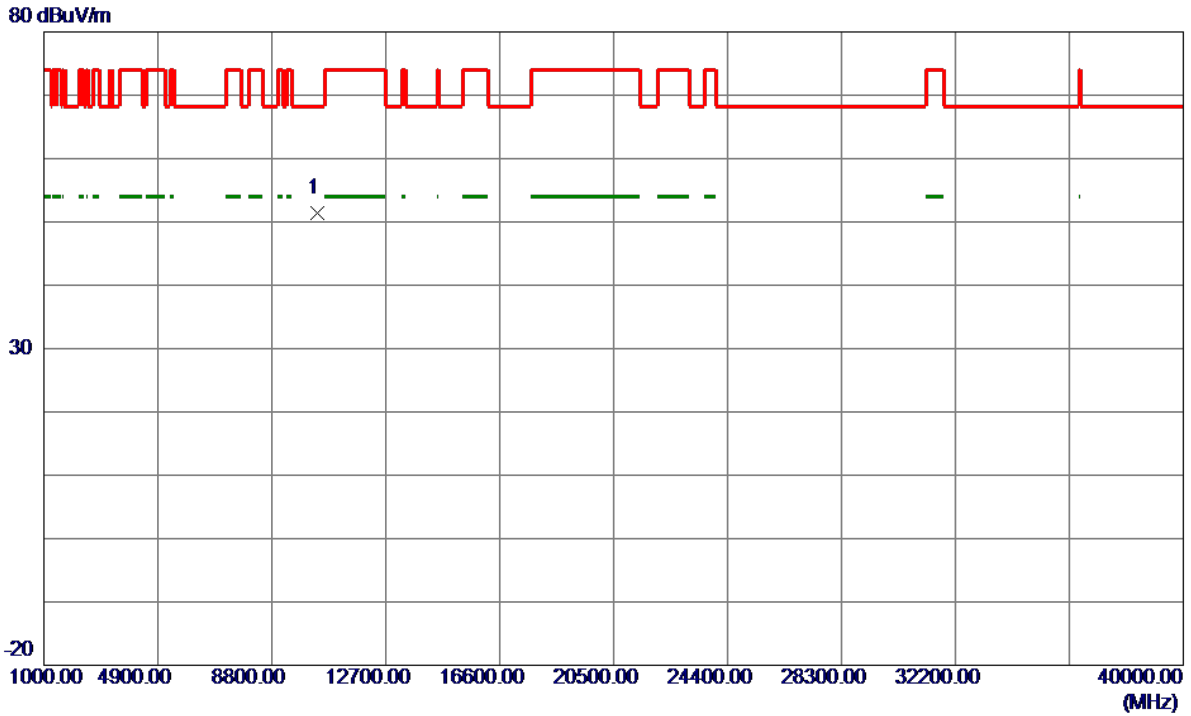

No.	Freq. MHz	Reading Level dBuV/m	Correct Factor dB	Measure ment dBuV/m	Limit dBuV/m	Margin dB	Detector	Comment
1 *	10360.1000	39.78	11.70	51.48	68.30	-16.82	Peak	

Orthogonal Axis:	X
Test Mode:	UNII-1/ TX N20 Mode 5180 MHz

Horizontal

130 dBuV/m

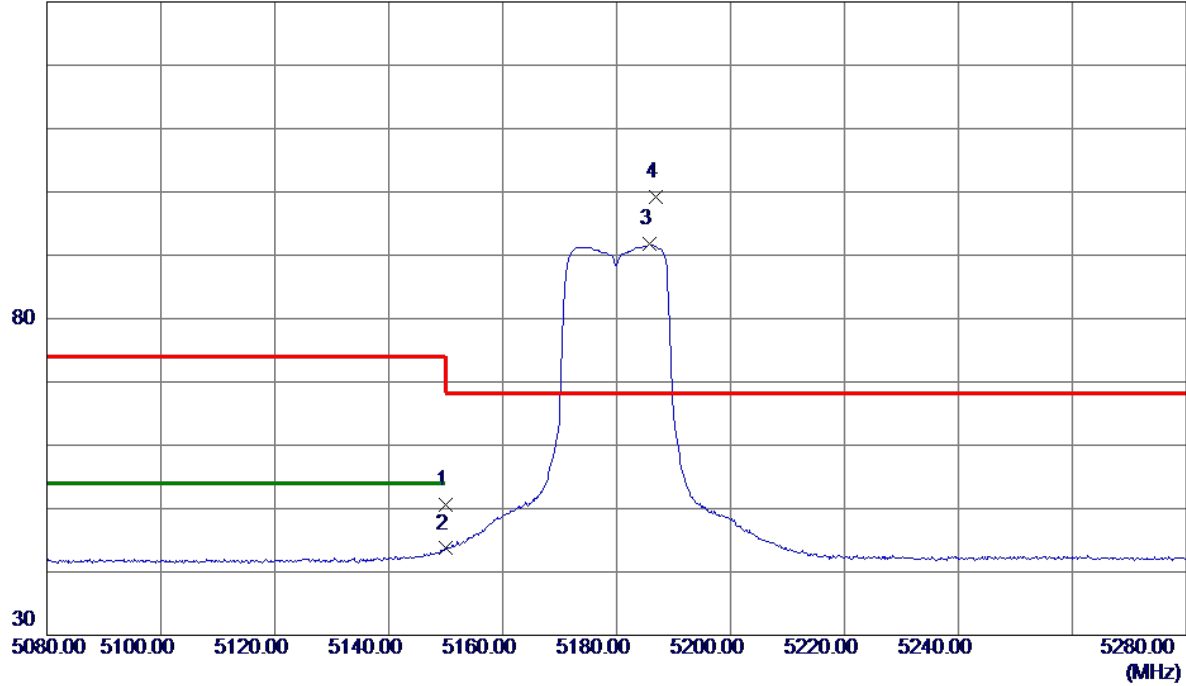

No.	Freq. MHz	Reading Level dBuV/m	Correct Factor dB	Measure ment dBuV/m	Limit dBuV/m	Margin dB	Detector	Comment
1	5150.0000	36.33	14.35	50.68	74.00	-23.32	Peak	
2	5150.0000	29.35	14.35	43.70	54.00	-10.30	AVG	
3	5185.8000	77.27	14.44	91.71	999.00	-907.29	AVG	No Limit
4 *	5186.8000	84.72	14.44	99.16	68.30	30.86	Peak	No Limit

Orthogonal Axis:	X
Test Mode:	UNII-1/ TX N20 Mode 5180 MHz

Horizontal

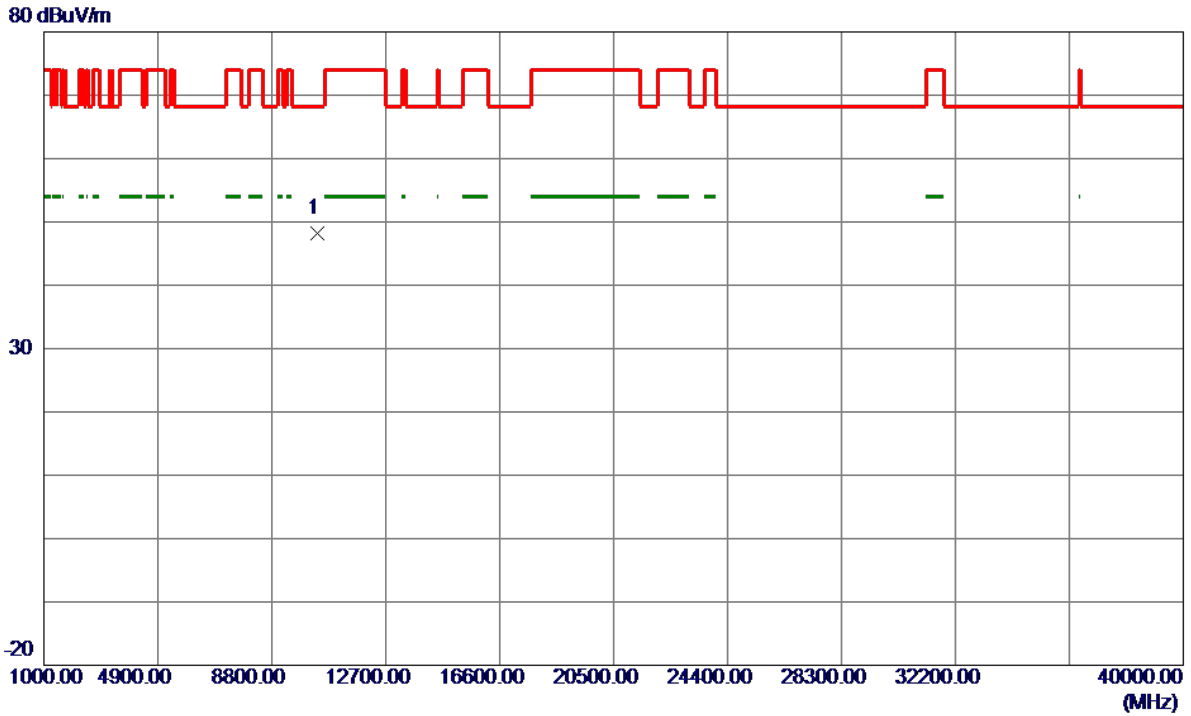

No.	Freq. MHz	Reading Level dBuV/m	Correct Factor dB	Measure ment dBuV/m	Limit dBuV/m	Margin dB	Detector	Comment
1 *	10364.7250	36.50	11.71	48.21	68.30	-20.09	Peak	

Orthogonal Axis:	X
Test Mode:	UNII-1/ TX N20 Mode 5200 MHz

Vertical

130 dBuV/m

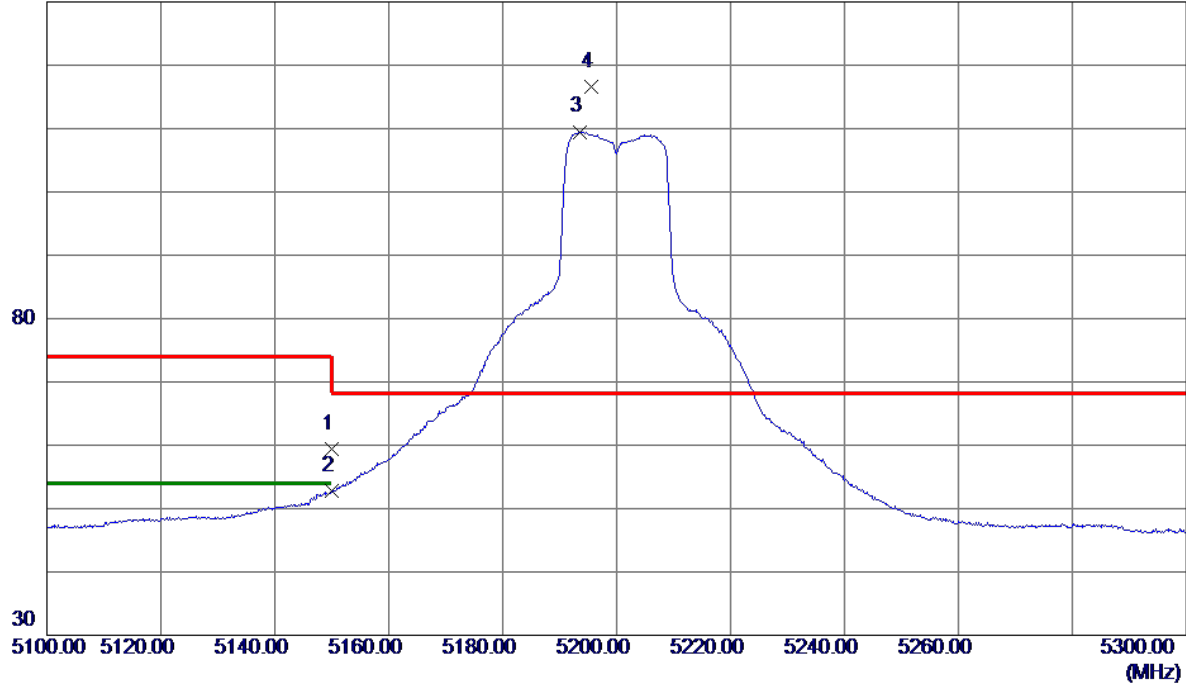

No.	Freq. MHz	Reading Level dBuV/m	Correct Factor dB	Measure ment dBuV/m	Limit dBuV/m	Margin dB	Detector	Comment
1	5150.0000	45.09	14.35	59.44	74.00	-14.56	Peak	
2	5150.0000	38.45	14.35	52.80	54.00	-1.20	AVG	
3	5193.6000	95.04	14.46	109.50	999.00	-889.50	AVG	No Limit
4 *	5195.5000	102.09	14.46	116.55	68.30	48.25	Peak	No Limit

Orthogonal Axis:	X
Test Mode:	UNII-1/ TX N20 Mode 5200 MHz

Vertical

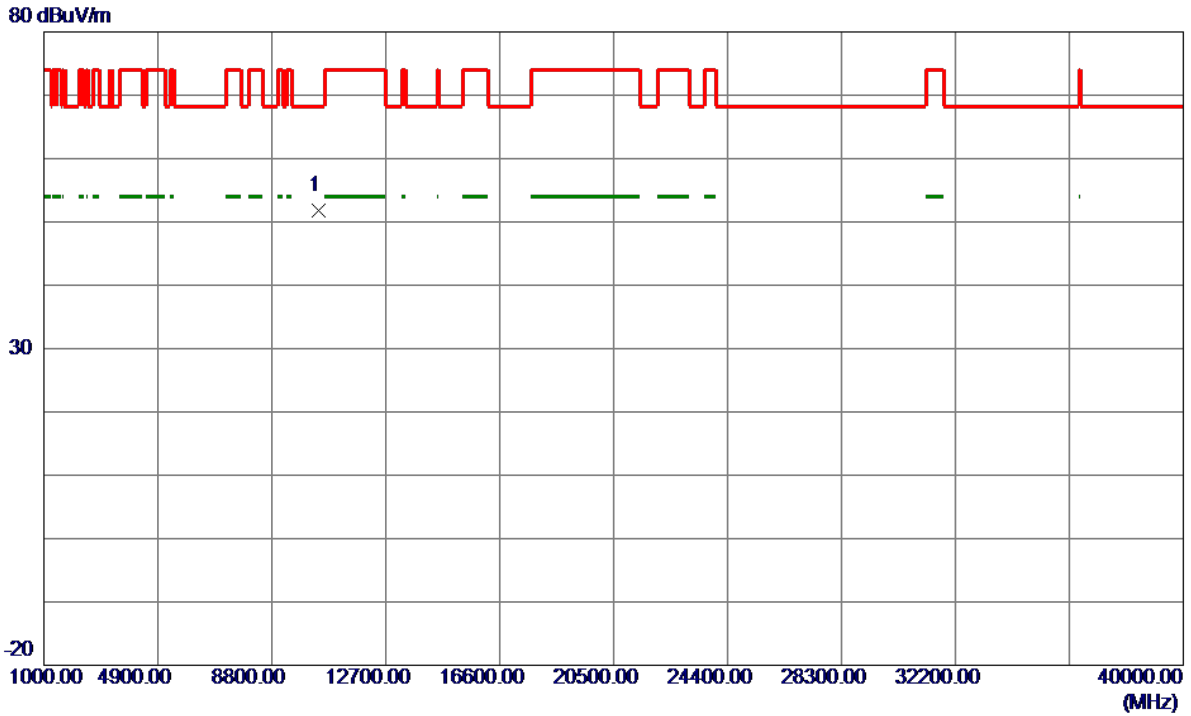

No.	Freq. MHz	Reading Level dBuV/m	Correct Factor dB	Measure ment dBuV/m	Limit dBuV/m	Margin dB	Detector	Comment
1 *	10400.1500	39.94	11.77	51.71	68.30	-16.59	Peak	

Orthogonal Axis:	X
Test Mode:	UNII-1/ TX N20 Mode 5200 MHz

Horizontal

130 dBuV/m

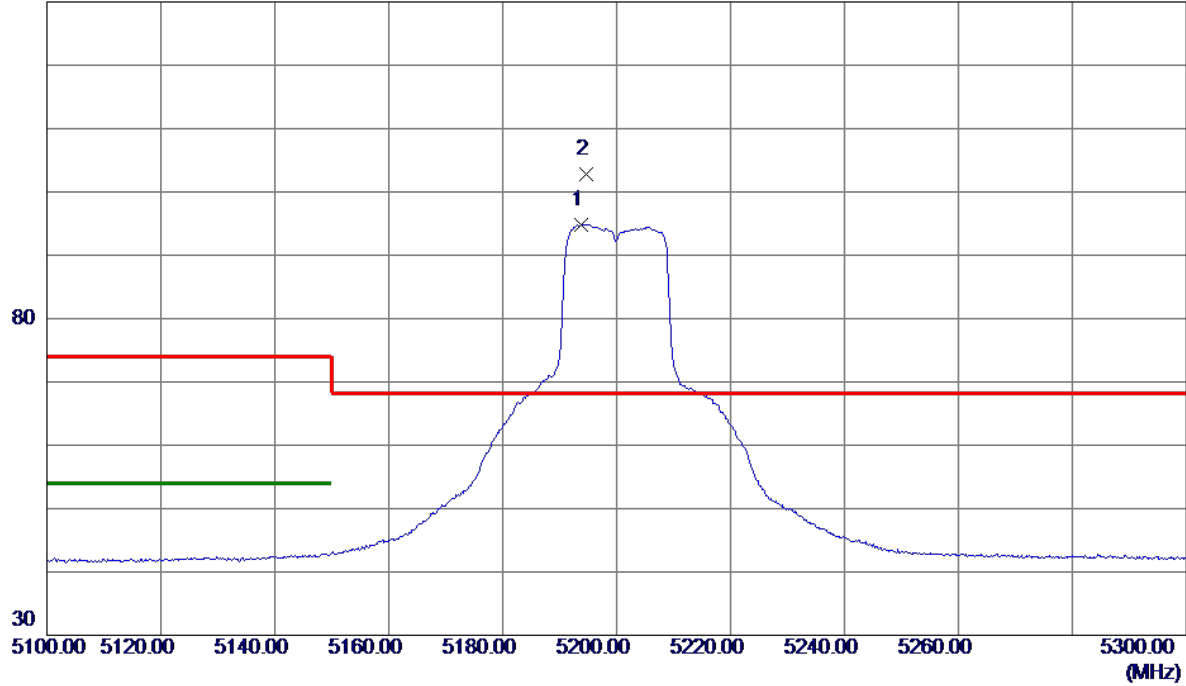

No.	Freq. MHz	Reading Level dBuV/m	Correct Factor dB	Measure ment dBuV/m	Limit dBuV/m	Margin dB	Detector	Comment
1	5193.8000	80.34	14.46	94.80	999.00	-904.20	AVG	No Limit
2 *	5194.7000	88.25	14.46	102.71	68.30	34.41	Peak	No Limit

Orthogonal Axis:	X
Test Mode:	UNII-1/ TX N20 Mode 5200 MHz

Horizontal

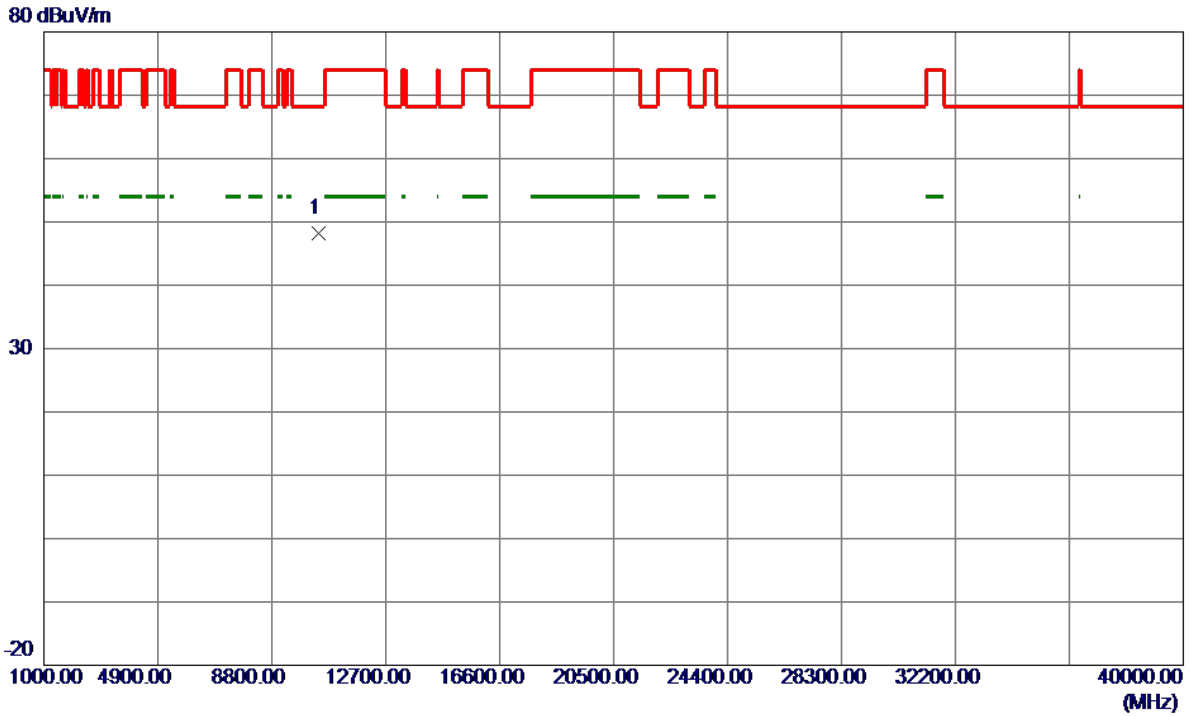

No.	Freq. MHz	Reading Level dBuV/m	Correct Factor dB	Measure ment dBuV/m	Limit dBuV/m	Margin dB	Detector	Comment
1 *	10396.7250	36.52	11.76	48.28	68.30	-20.02	Peak	

Orthogonal Axis:	X
Test Mode:	UNII-1/ TX N20 Mode 5240 MHz

Vertical

130 dBuV/m

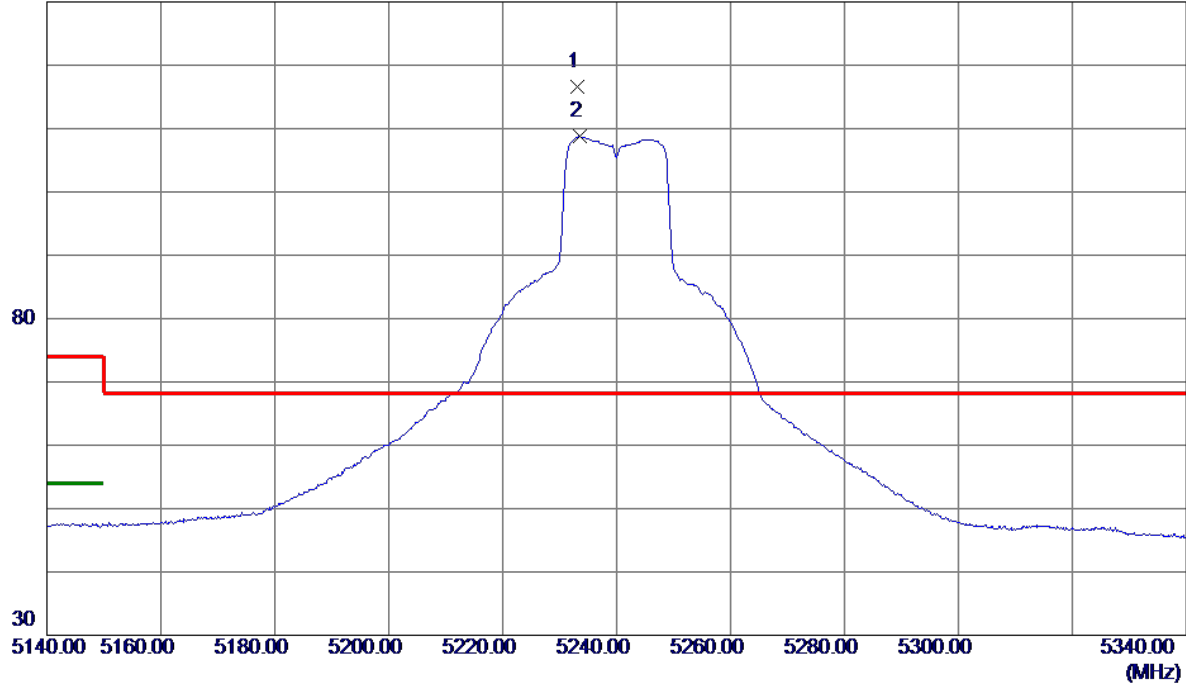

No.	Freq. MHz	Reading Level dBuV/m	Correct Factor dB	Measure ment dBuV/m	Limit dBuV/m	Margin dB	Detector	Comment
1 *	5233.1000	101.97	14.56	116.53	68.30	48.23	Peak	No Limit
2	5233.6000	94.28	14.56	108.84	999.00	-890.16	AVG	No Limit

Orthogonal Axis:	X
Test Mode:	UNII-1/ TX N20 Mode 5240 MHz

Vertical

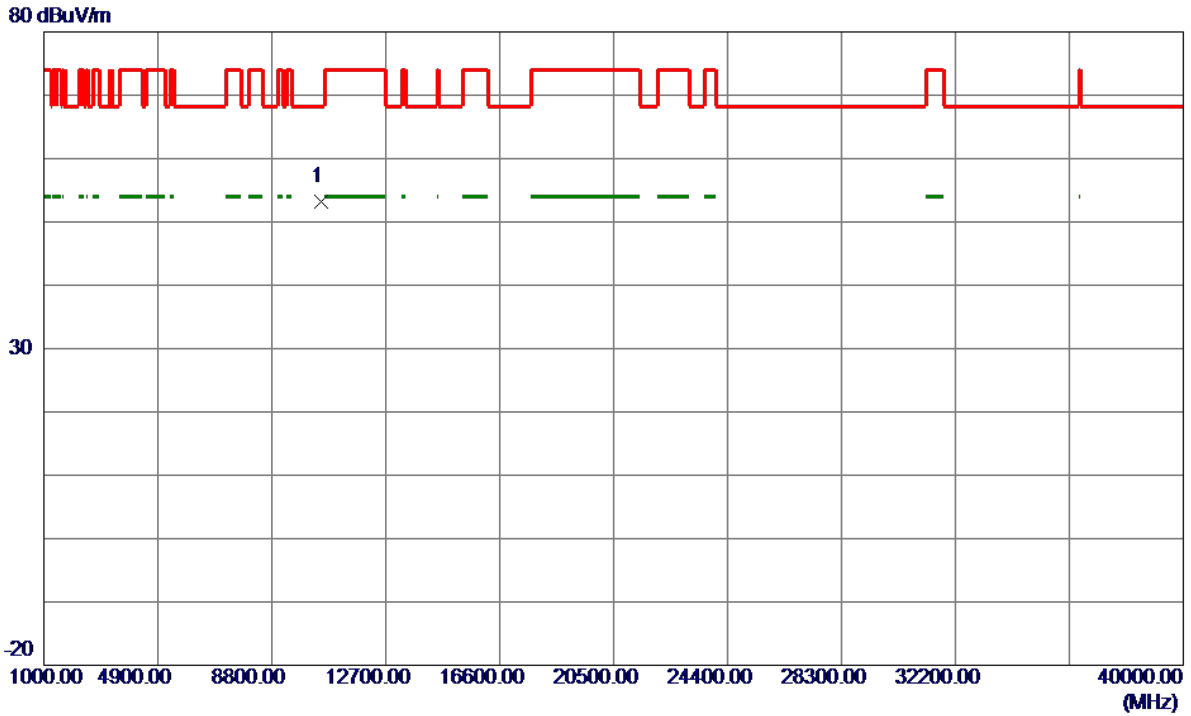

No.	Freq. MHz	Reading Level dBuV/m	Correct Factor dB	Measure ment dBuV/m	Limit dBuV/m	Margin dB	Detector	Comment
1 *	10476.8750	41.37	11.90	53.27	68.30	-15.03	Peak	

Orthogonal Axis:	X
Test Mode:	UNII-1/ TX N20 Mode 5240 MHz

Horizontal

130 dBuV/m

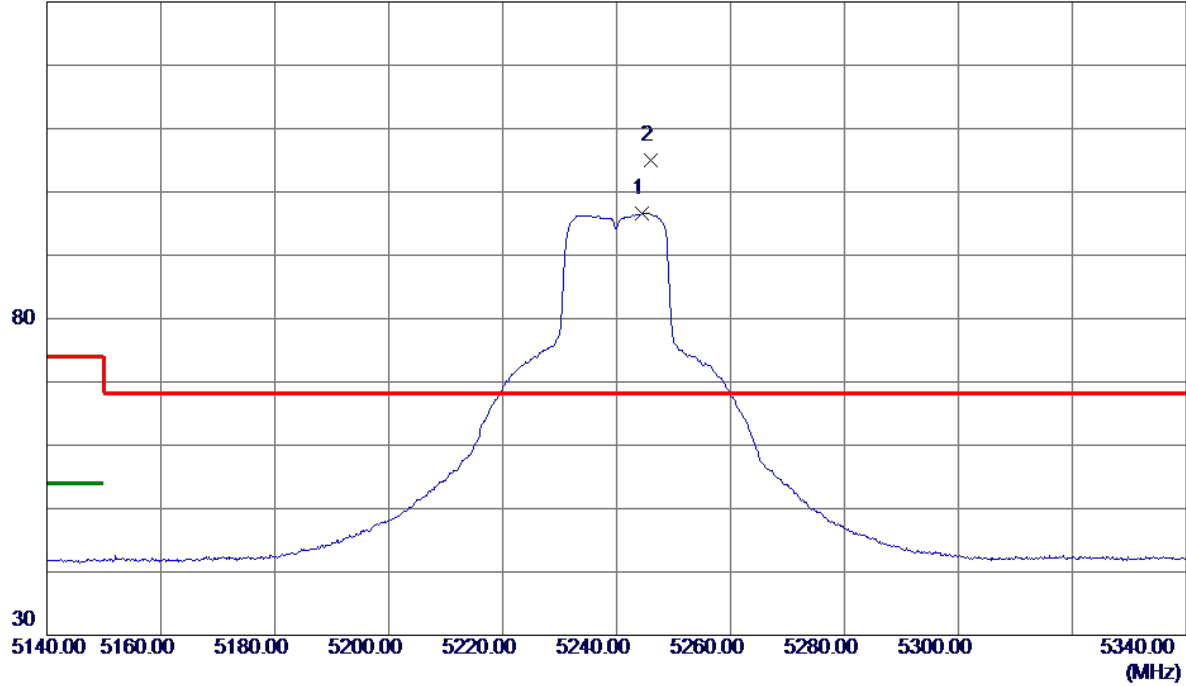

No.	Freq. MHz	Reading Level dBuV/m	Correct Factor dB	Measure ment dBuV/m	Limit dBuV/m	Margin dB	Detector	Comment
1	5244.5000	82.04	14.59	96.63	999.00	-902.37	AVG	No Limit
2 *	5246.0000	90.40	14.59	104.99	68.30	36.69	Peak	No Limit

Orthogonal Axis:	X
Test Mode:	UNII-1/ TX N20 Mode 5240 MHz

Horizontal

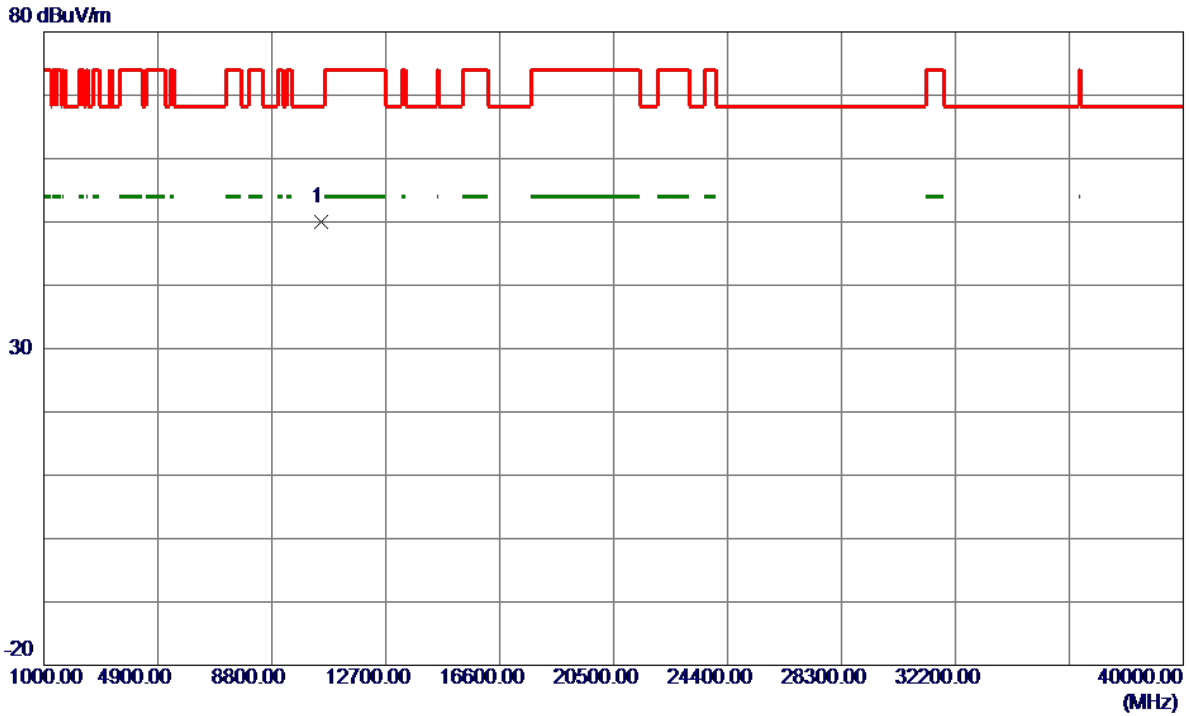

No.	Freq. MHz	Reading Level dBuV/m	Correct Factor dB	Measure ment dBuV/m	Limit dBuV/m	Margin dB	Detector	Comment
1 *	10482.1750	38.03	11.90	49.93	68.30	-18.37	Peak	

Orthogonal Axis:	X
Test Mode:	UNII-1/ TX N40 Mode 5190MHz

Vertical

130 dBuV/m

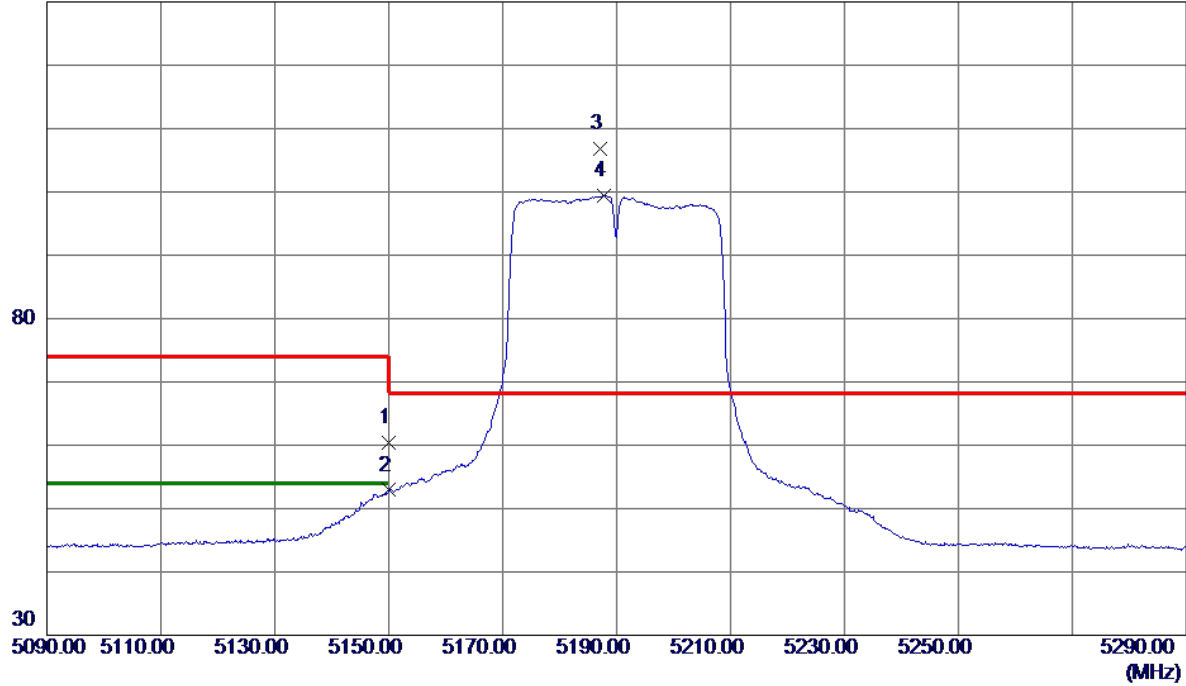

No.	Freq. MHz	Reading Level dBuV/m	Correct Factor dB	Measure ment dBuV/m	Limit dBuV/m	Margin dB	Detector	Comment
1	5150.0000	45.98	14.35	60.33	74.00	-13.67	Peak	
2	5150.0000	38.55	14.35	52.90	54.00	-1.10	AVG	
3 *	5187.1000	92.38	14.44	106.82	68.30	38.52	Peak	No Limit
4	5187.8000	85.02	14.44	99.46	999.00	-899.54	AVG	No Limit

Orthogonal Axis:	X
Test Mode:	UNII-1/ TX N40 Mode 5190MHz

Vertical

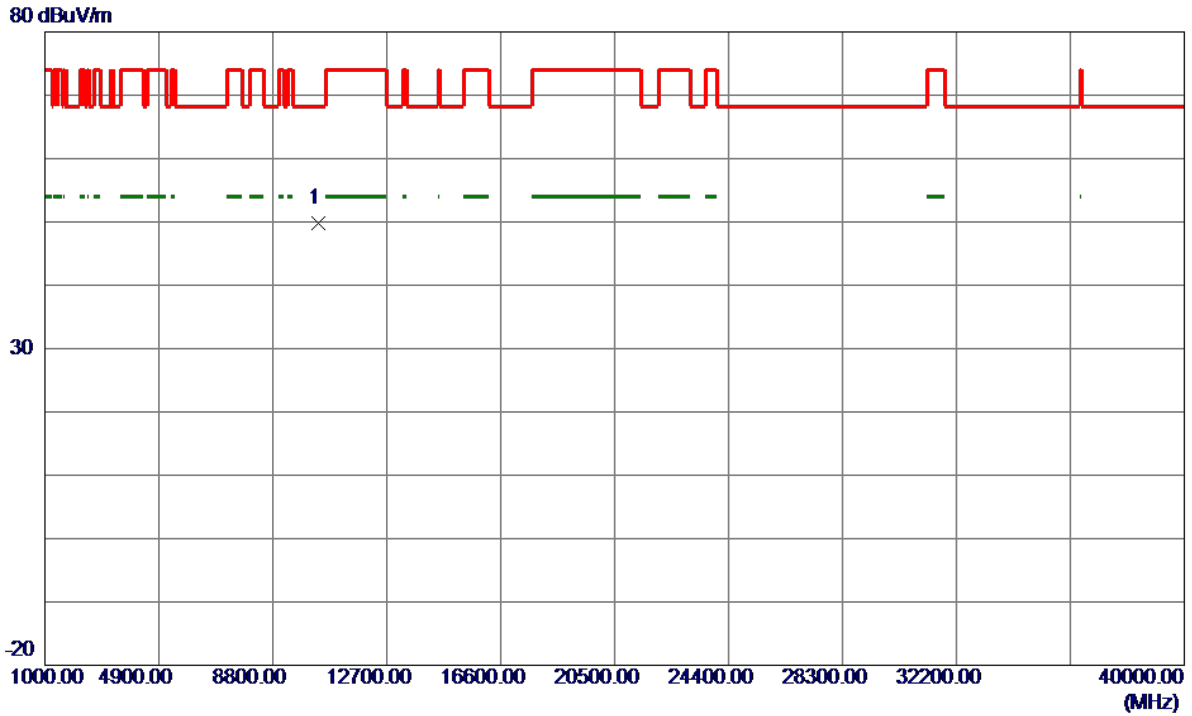

No.	Freq. MHz	Reading Level dBuV/m	Correct Factor dB	Measure ment dBuV/m	Limit dBuV/m	Margin dB	Detector	Comment
1 *	10375.0500	38.11	11.72	49.83	68.30	-18.47	Peak	

Orthogonal Axis:	X
Test Mode:	UNII-1/ TX N40 Mode 5190MHz

Horizontal

130 dBuV/m

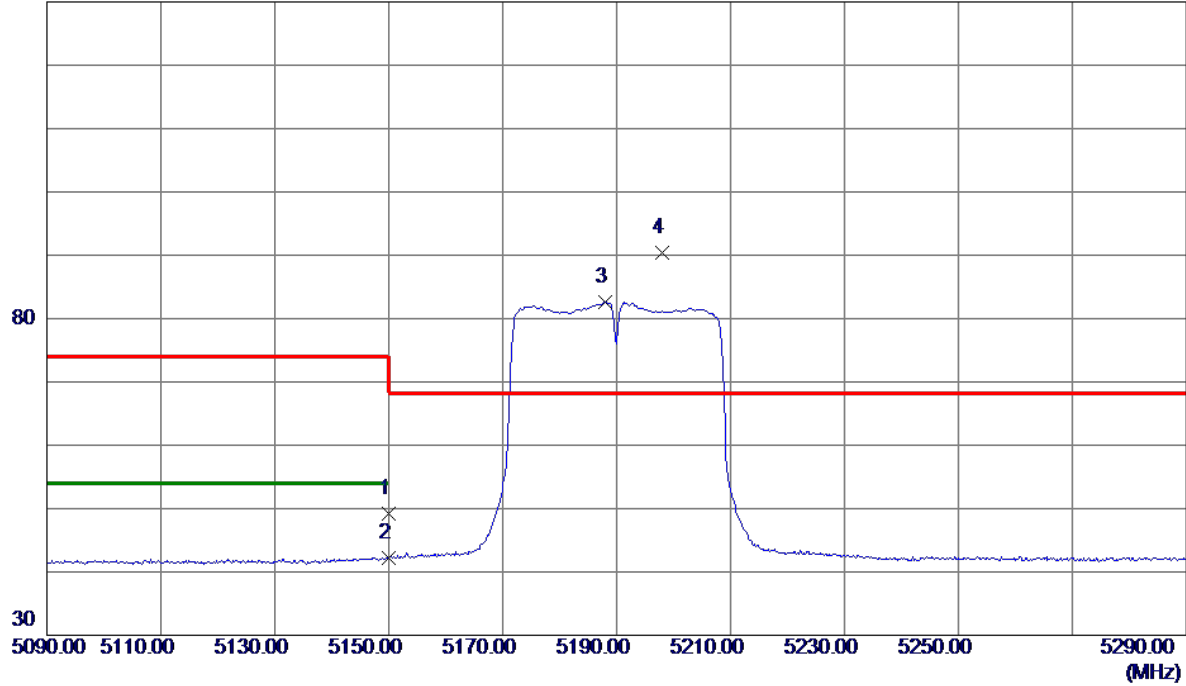

No.	Freq. MHz	Reading Level dBuV/m	Correct Factor dB	Measure ment dBuV/m	Limit dBuV/m	Margin dB	Detector	Comment
1	5150.0000	34.85	14.35	49.20	74.00	-24.80	Peak	
2	5150.0000	27.78	14.35	42.13	54.00	-11.87	AVG	
3	5187.9000	68.15	14.44	82.59	999.00	-916.41	AVG	No Limit
4 *	5197.9000	75.91	14.47	90.38	68.30	22.08	Peak	No Limit

Orthogonal Axis:	X
Test Mode:	UNII-1/ TX N40 Mode 5190MHz

Horizontal

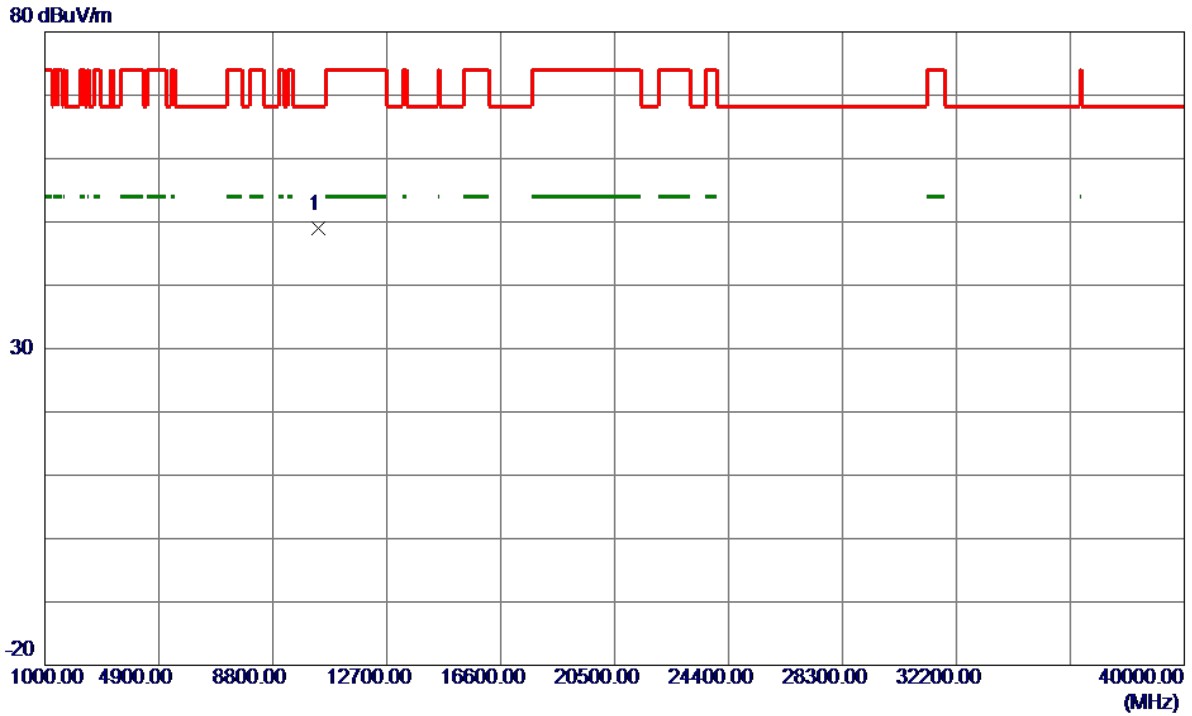

No.	Freq. MHz	Reading Level dBuV/m	Correct Factor dB	Measure ment dBuV/m	Limit dBuV/m	Margin dB	Detector	Comment
1 *	10374.9250	37.18	11.72	48.90	68.30	-19.40	Peak	

Orthogonal Axis:	X
Test Mode:	UNII-1/ TX N40 Mode 5230MHz

Vertical

130 dBuV/m

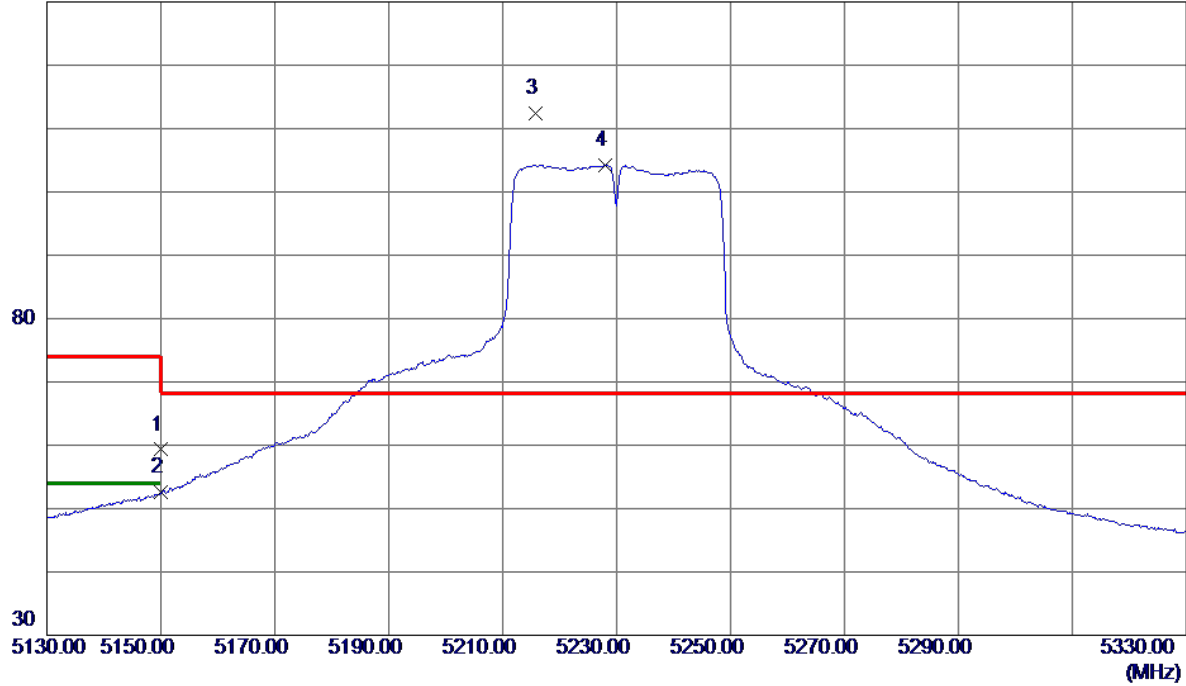

No.	Freq. MHz	Reading Level dBuV/m	Correct Factor dB	Measure ment dBuV/m	Limit dBuV/m	Margin dB	Detector	Comment
1	5150.0000	44.95	14.35	59.30	74.00	-14.70	Peak	
2	5150.0000	38.31	14.35	52.66	54.00	-1.34	AVG	
3 *	5215.7000	97.87	14.51	112.38	68.30	44.08	Peak	No Limit
4	5228.0000	89.74	14.55	104.29	999.00	-894.71	AVG	No Limit

Orthogonal Axis:	X
Test Mode:	UNII-1/ TX N40 Mode 5230MHz

Vertical

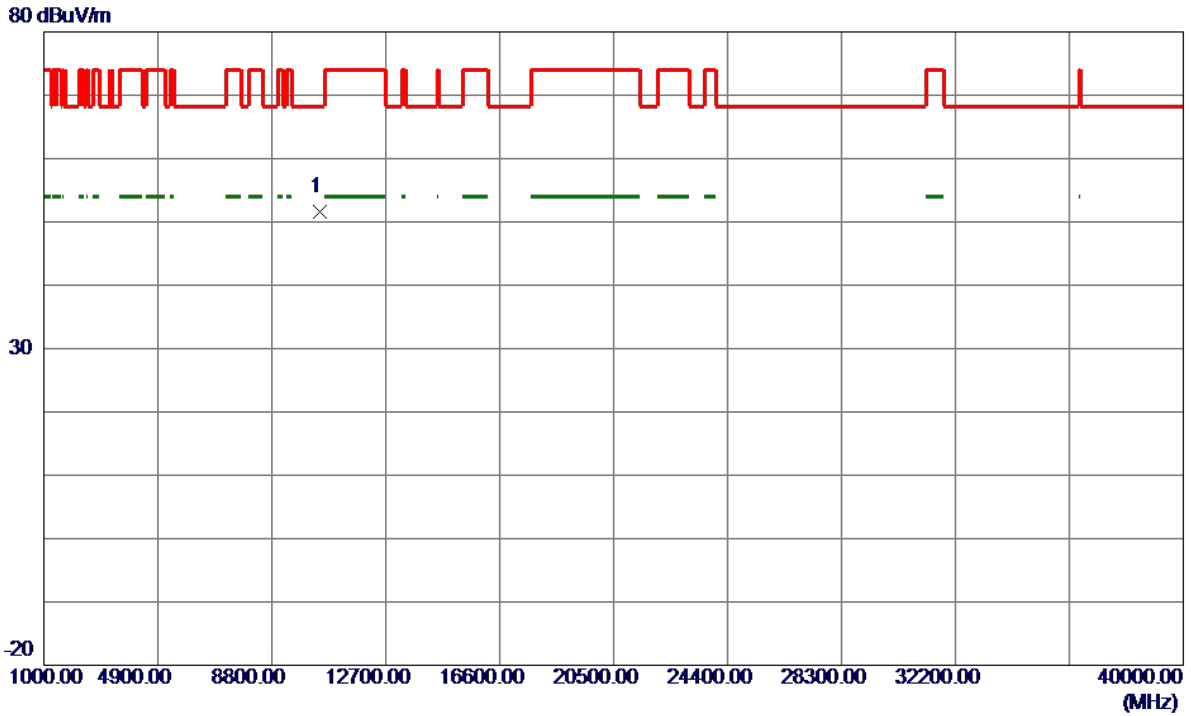

No.	Freq. MHz	Reading Level dBuV/m	Correct Factor dB	Measure ment dBuV/m	Limit dBuV/m	Margin dB	Detector	Comment
1 *	10458.9500	39.68	11.87	51.55	68.30	-16.75	Peak	

Orthogonal Axis:	X
Test Mode:	UNII-1/ TX N40 Mode 5230MHz

Horizontal

130 dBuV/m

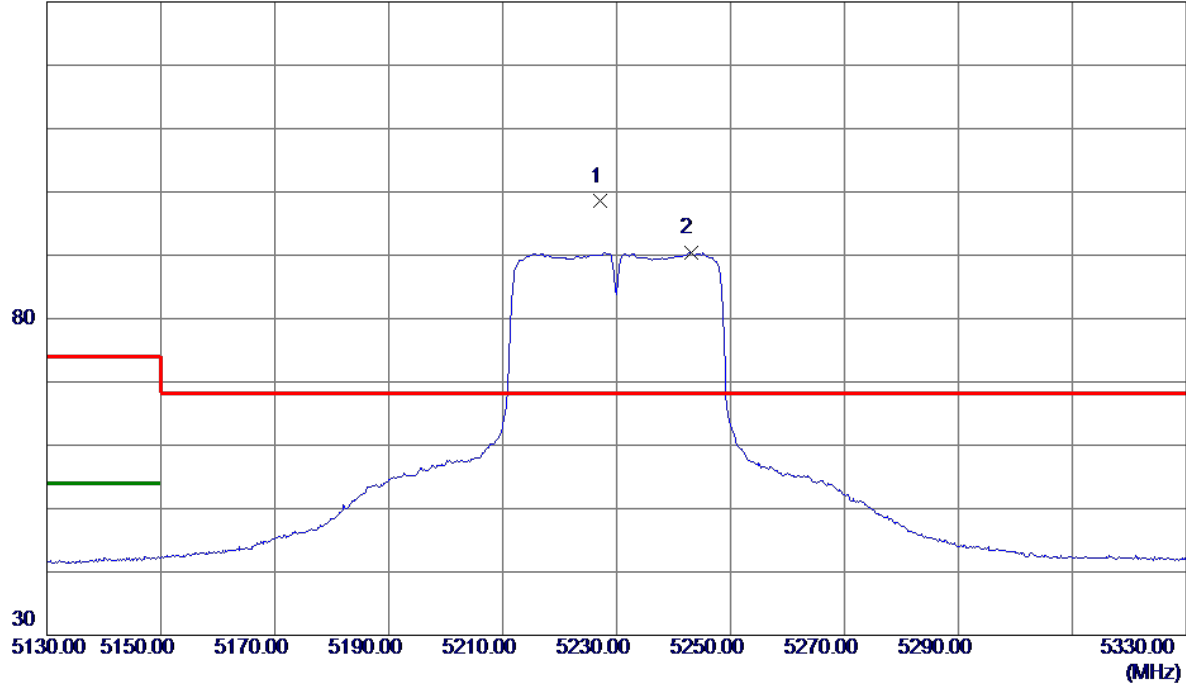

No.	Freq. MHz	Reading Level dBuV/m	Correct Factor dB	Measure ment dBuV/m	Limit dBuV/m	Margin dB	Detector	Comment
1 *	5227.1000	83.96	14.54	98.50	68.30	30.20	Peak	No Limit
2	5243.0000	75.91	14.58	90.49	999.00	-908.51	AVG	No Limit

Orthogonal Axis:	X
Test Mode:	UNII-1/ TX N40 Mode 5230MHz

Horizontal

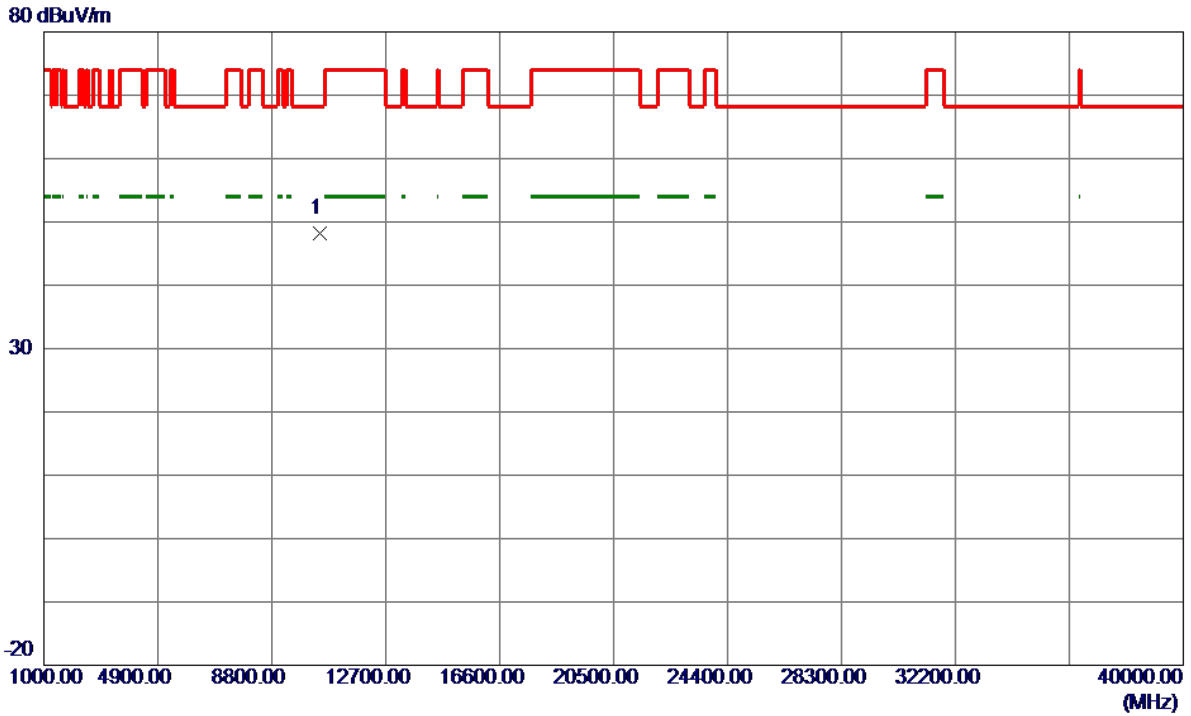

No.	Freq. MHz	Reading Level dBuV/m	Correct Factor dB	Measure ment dBuV/m	Limit dBuV/m	Margin dB	Detector	Comment
1 *	10457.3000	36.38	11.86	48.24	68.30	-20.06	Peak	

Orthogonal Axis:	X
Test Mode:	UNII-3/TX A Mode 5745 MHz

Vertical

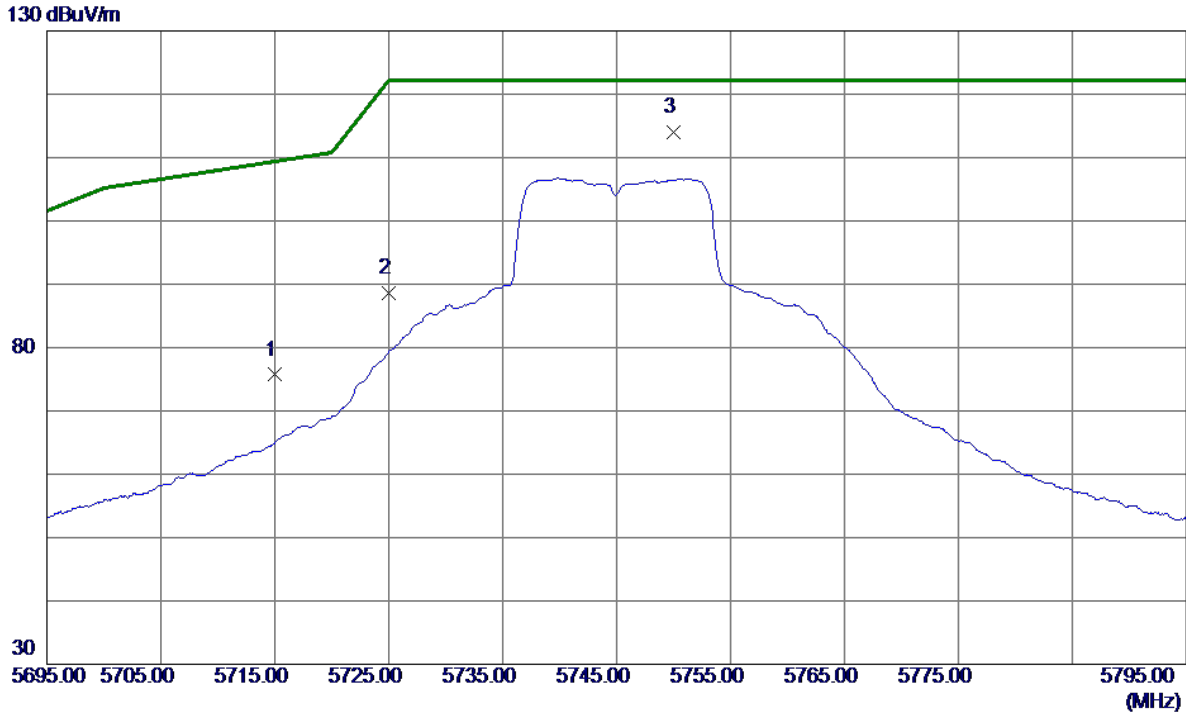

No.	Freq. MHz	Reading Level dBuV/m	Correct Factor dB	Measure ment dBuV/m	Limit dBuV/m	Margin dB	Detector	Comment
1	5715.0000	59.77	15.93	75.70	109.40	-33.70	Peak	
2	5725.0000	72.60	15.96	88.56	122.20	-33.64	Peak	
3 *	5750.0000	98.04	16.04	114.08	122.20	-8.12	Peak	No Limit

Orthogonal Axis:	X
Test Mode:	UNII-3/TX A Mode 5745 MHz

Vertical

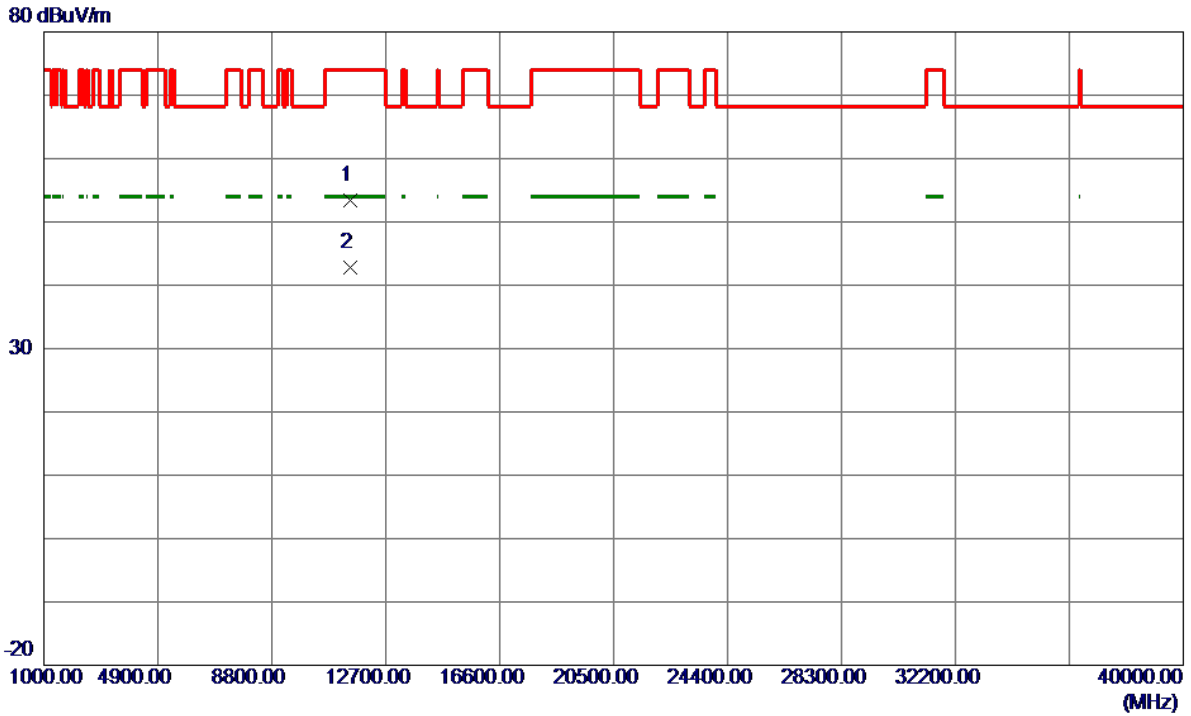

No.	Freq. MHz	Reading Level dBuV/m	Correct Factor dB	Measure ment dBuV/m	Limit dBuV/m	Margin dB	Detector	Comment
1	11487.5250	40.99	12.47	53.46	74.00	-20.54	Peak	
2 *	11489.9100	30.32	12.47	42.79	54.00	-11.21	AVG	

Orthogonal Axis:	X
Test Mode:	UNII-3/TX A Mode 5745 MHz

Horizontal

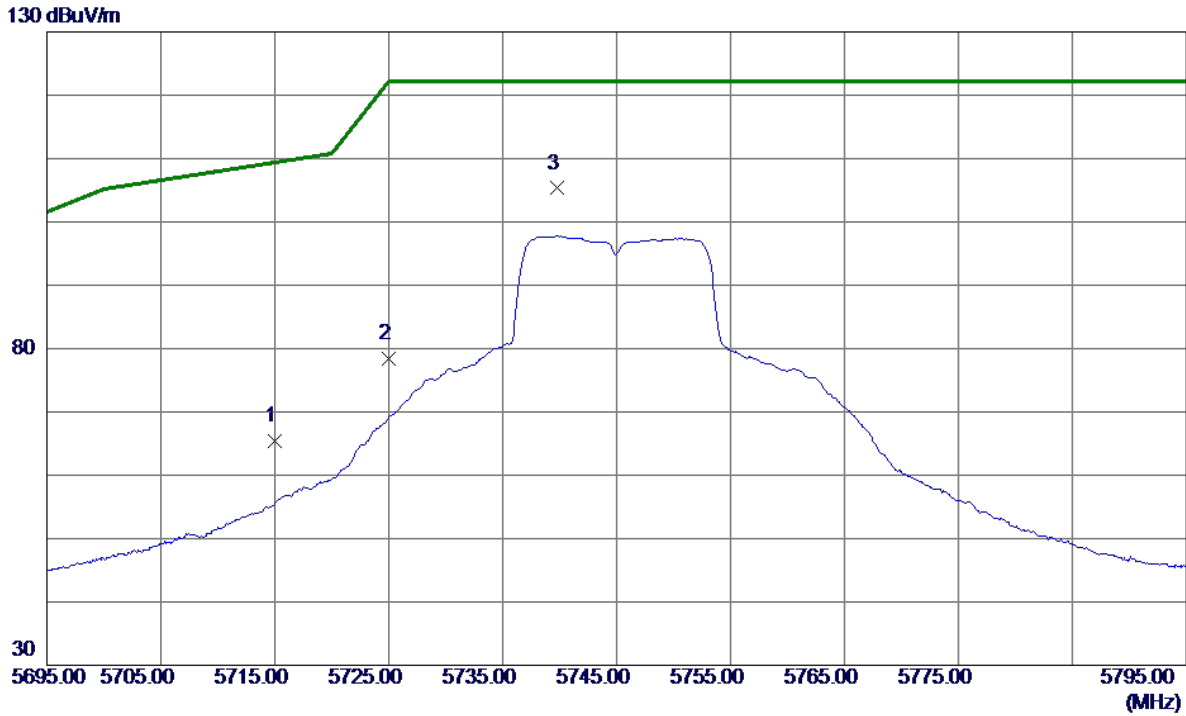

No.	Freq. MHz	Reading Level dBuV/m	Correct Factor dB	Measure ment dBuV/m	Limit dBuV/m	Margin dB	Detector	Comment
1	5715.0000	49.55	15.93	65.48	109.40	-43.92	Peak	
2	5725.0000	62.48	15.96	78.44	122.20	-43.76	Peak	
3 *	5739.8000	89.29	16.01	105.30	122.20	-16.90	Peak	No Limit

Orthogonal Axis:	X
Test Mode:	UNII-3/TX A Mode 5745 MHz

Horizontal

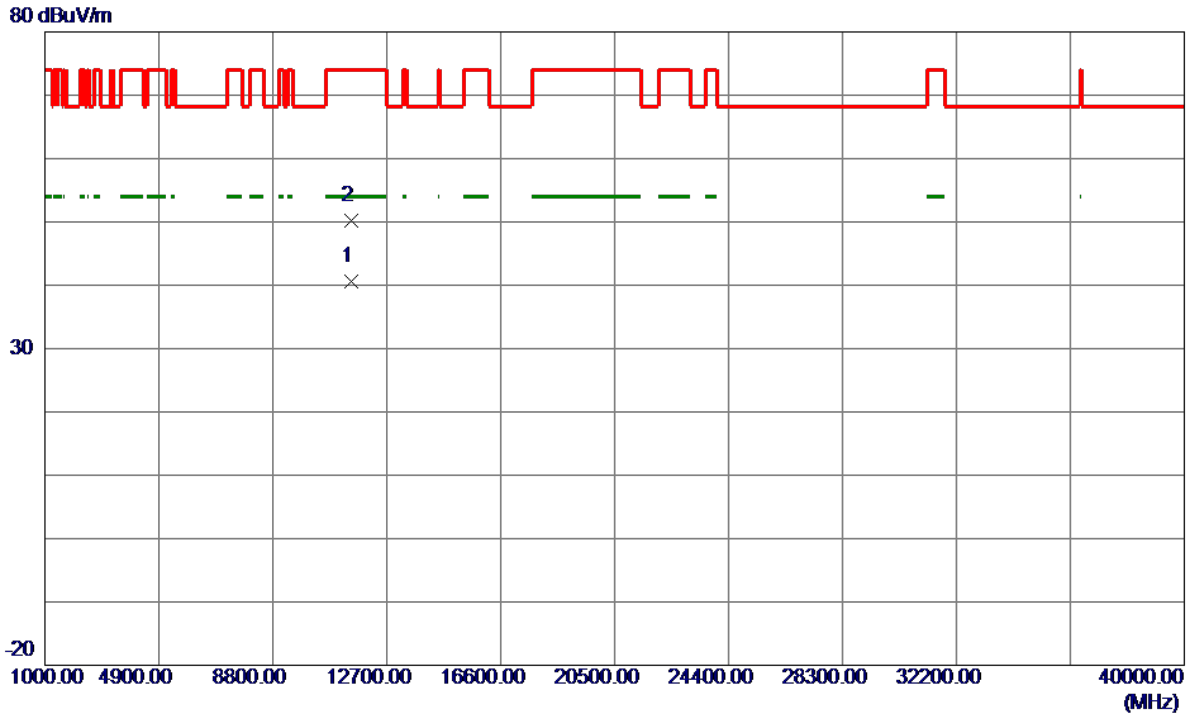

No.	Freq. MHz	Reading Level dBuV/m	Correct Factor dB	Measure ment dBuV/m	Limit dBuV/m	Margin dB	Detector	Comment
1 *	11490.0300	28.13	12.47	40.60	54.00	-13.40	AVG	
2	11491.6050	37.82	12.47	50.29	74.00	-23.71	Peak	

Orthogonal Axis:	X
Test Mode:	UNII-3/TX A Mode 5785 MHz

Vertical

130 dBuV/m

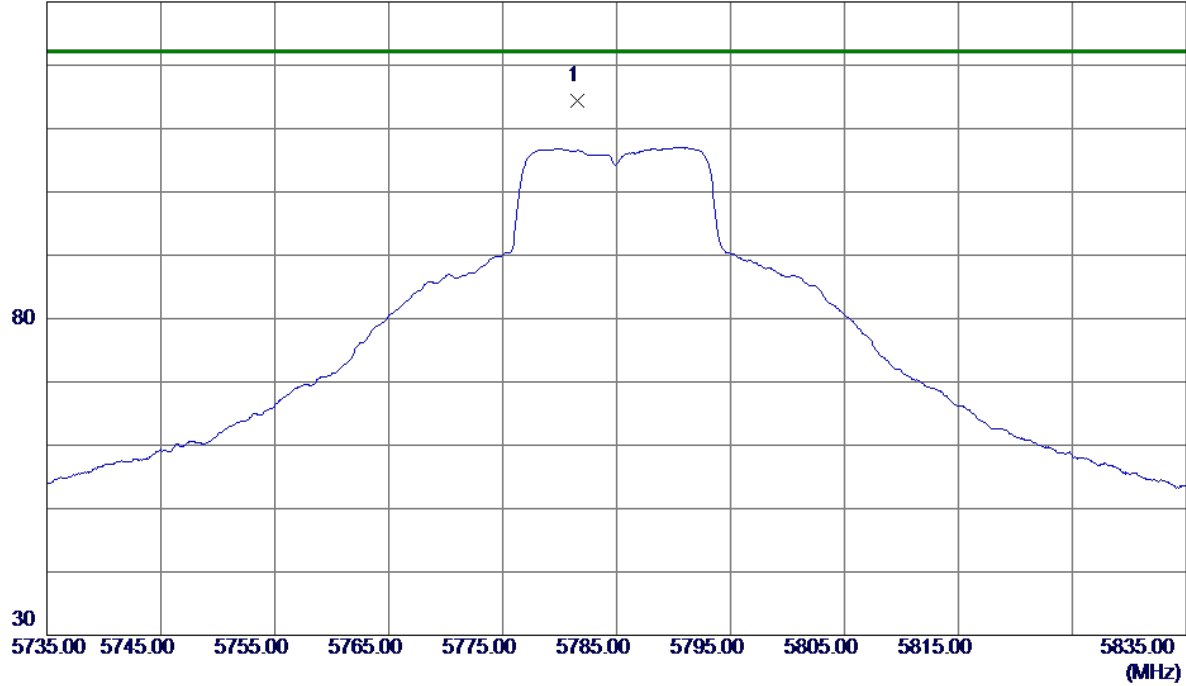

No.	Freq. MHz	Reading Level dBuV/m	Correct Factor dB	Measure ment dBuV/m	Limit dBuV/m	Margin dB	Detector	Comment
1 *	5781.6000	98.26	16.14	114.40	122.20	-7.80	Peak	No Limit

Orthogonal Axis:	X
Test Mode:	UNII-3/TX A Mode 5785 MHz

Vertical

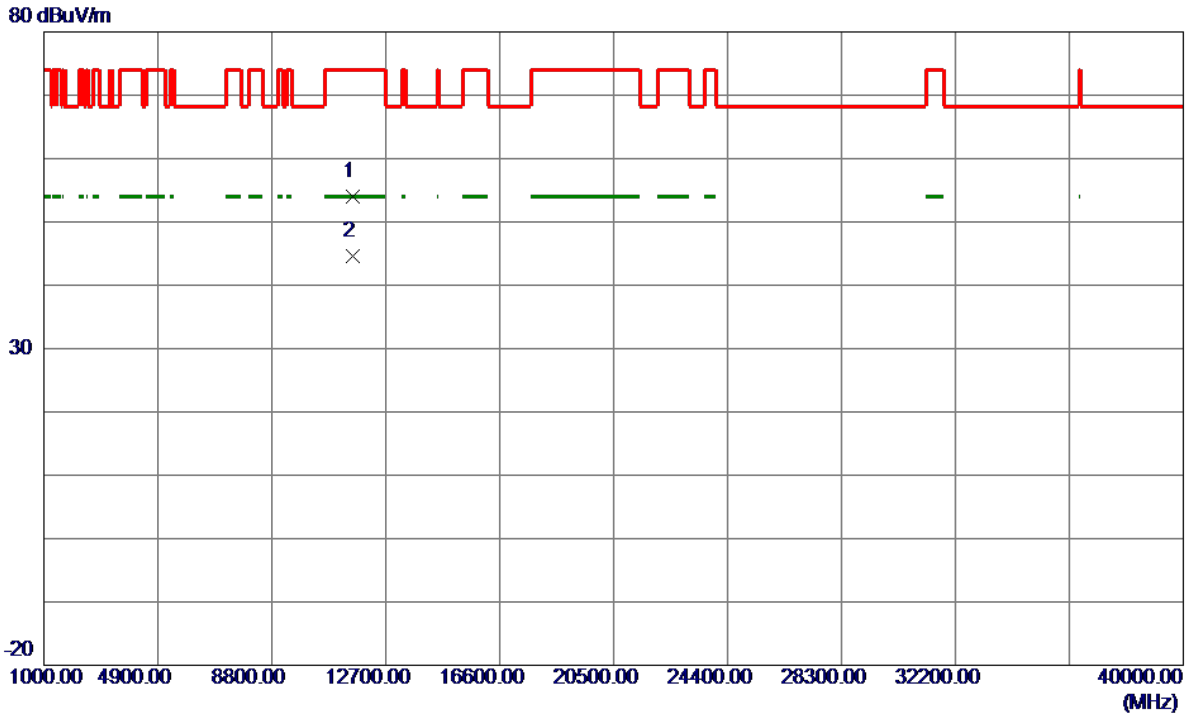

No.	Freq. MHz	Reading Level dBuV/m	Correct Factor dB	Measure ment dBuV/m	Limit dBuV/m	Margin dB	Detector	Comment
1	11567.1500	41.44	12.52	53.96	74.00	-20.04	Peak	
2 *	11570.0000	32.12	12.52	44.64	54.00	-9.36	AVG	

Orthogonal Axis:	X
Test Mode:	UNII-3/TX A Mode 5785 MHz

Horizontal

130 dBuV/m

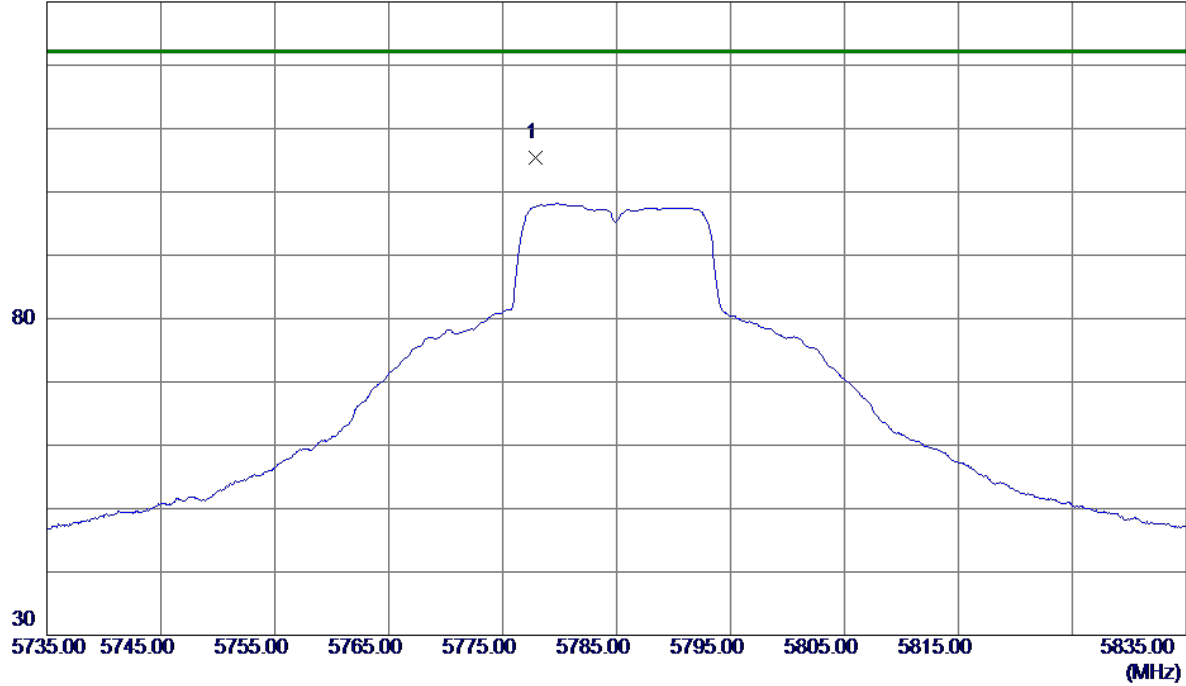

No.	Freq. MHz	Reading Level dBuV/m	Correct Factor dB	Measure ment dBuV/m	Limit dBuV/m	Margin dB	Detector	Comment
1 *	5777.8500	89.33	16.13	105.46	122.20	-16.74	Peak	No Limit

Orthogonal Axis:	X
Test Mode:	UNII-3/TX A Mode 5785 MHz

Horizontal

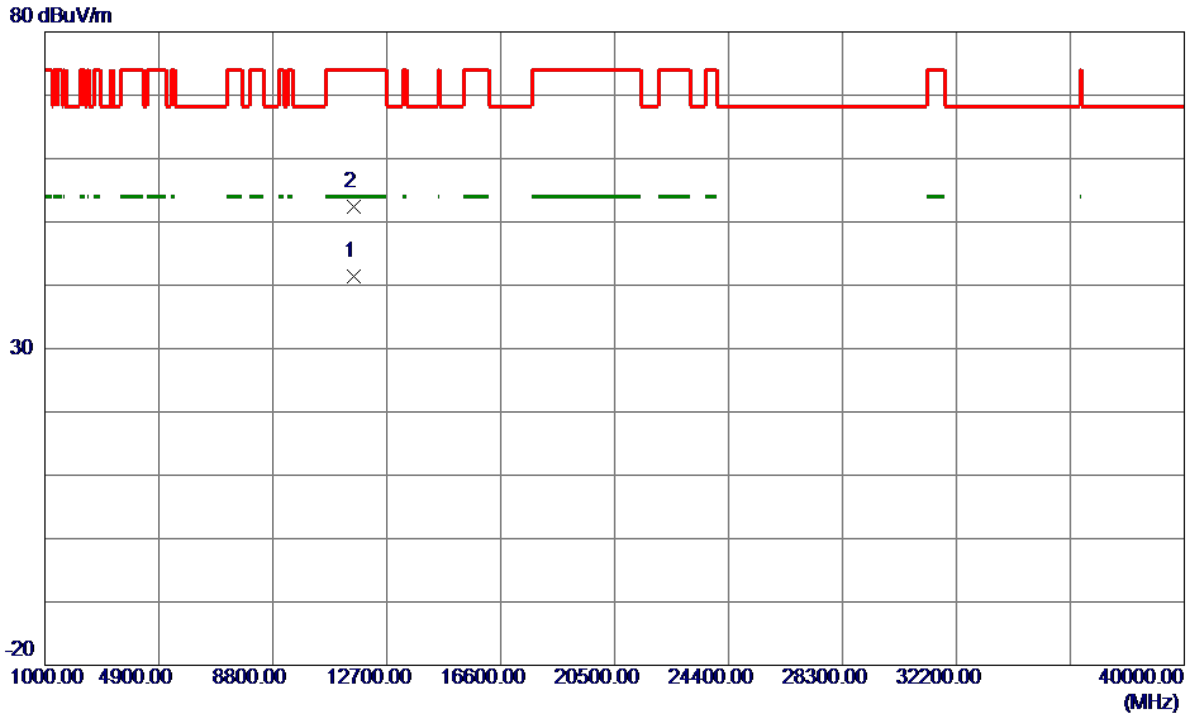

No.	Freq. MHz	Reading Level dBuV/m	Correct Factor dB	Measure ment dBuV/m	Limit dBuV/m	Margin dB	Detector	Comment
1 *	11569.9550	28.81	12.52	41.33	54.00	-12.67	AVG	
2	11572.0550	39.80	12.52	52.32	74.00	-21.68	Peak	

Orthogonal Axis:	X
Test Mode:	UNII-3/TX A Mode 5825 MHz

Vertical

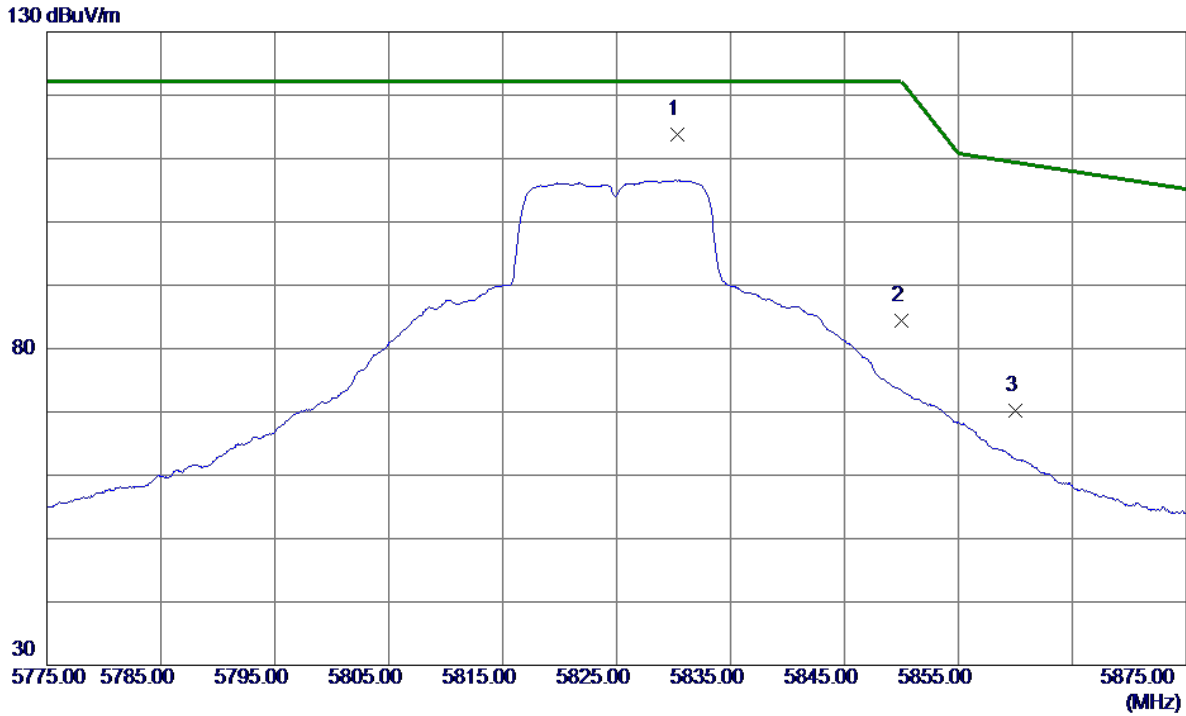

No.	Freq. MHz	Reading Level dBuV/m	Correct Factor dB	Measure ment dBuV/m	Limit dBuV/m	Margin dB	Detector	Comment
1 *	5830.3000	97.60	16.29	113.89	122.20	-8.31	Peak	No Limit
2	5850.0000	67.98	16.35	84.33	122.20	-37.87	Peak	
3	5860.0000	53.78	16.39	70.17	109.40	-39.23	Peak	

Orthogonal Axis:	X
Test Mode:	UNII-3/TX A Mode 5825 MHz

Vertical

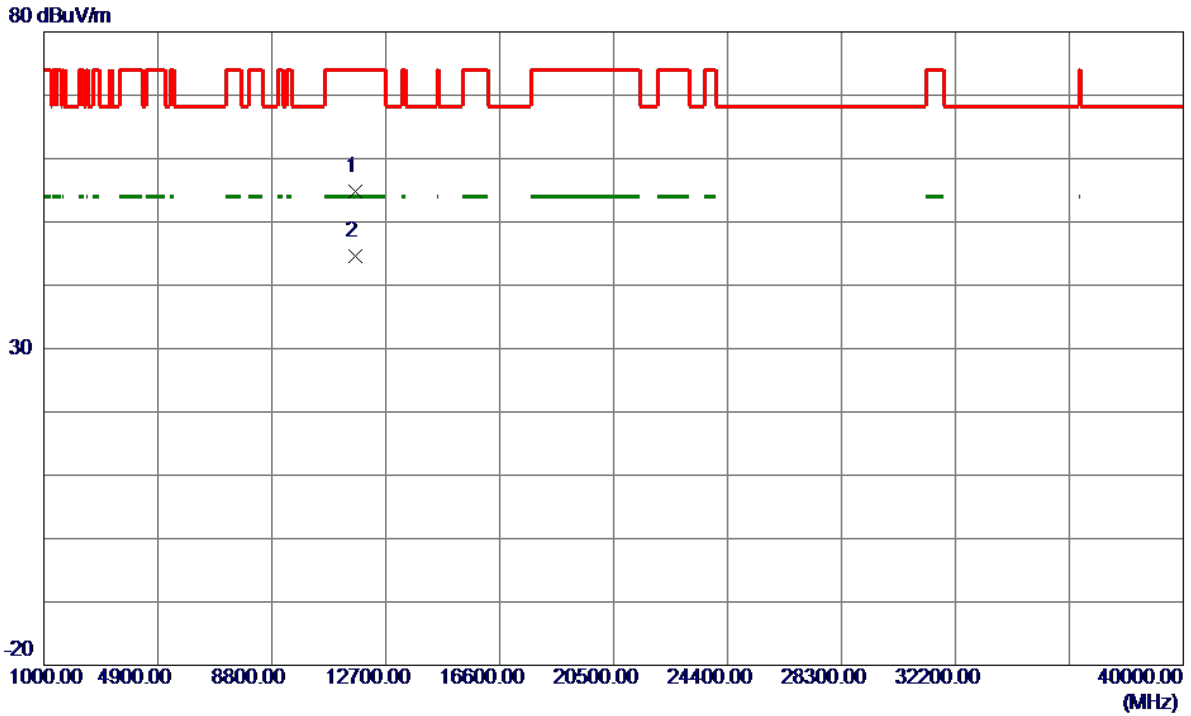

No.	Freq. MHz	Reading Level dBuV/m	Correct Factor dB	Measure ment dBuV/m	Limit dBuV/m	Margin dB	Detector	Comment
1	11646.3850	42.23	12.56	54.79	74.00	-19.21	Peak	
2 *	11649.8050	32.08	12.57	44.65	54.00	-9.35	AVG	

Orthogonal Axis:	X
Test Mode:	UNII-3/TX A Mode 5825 MHz

Horizontal

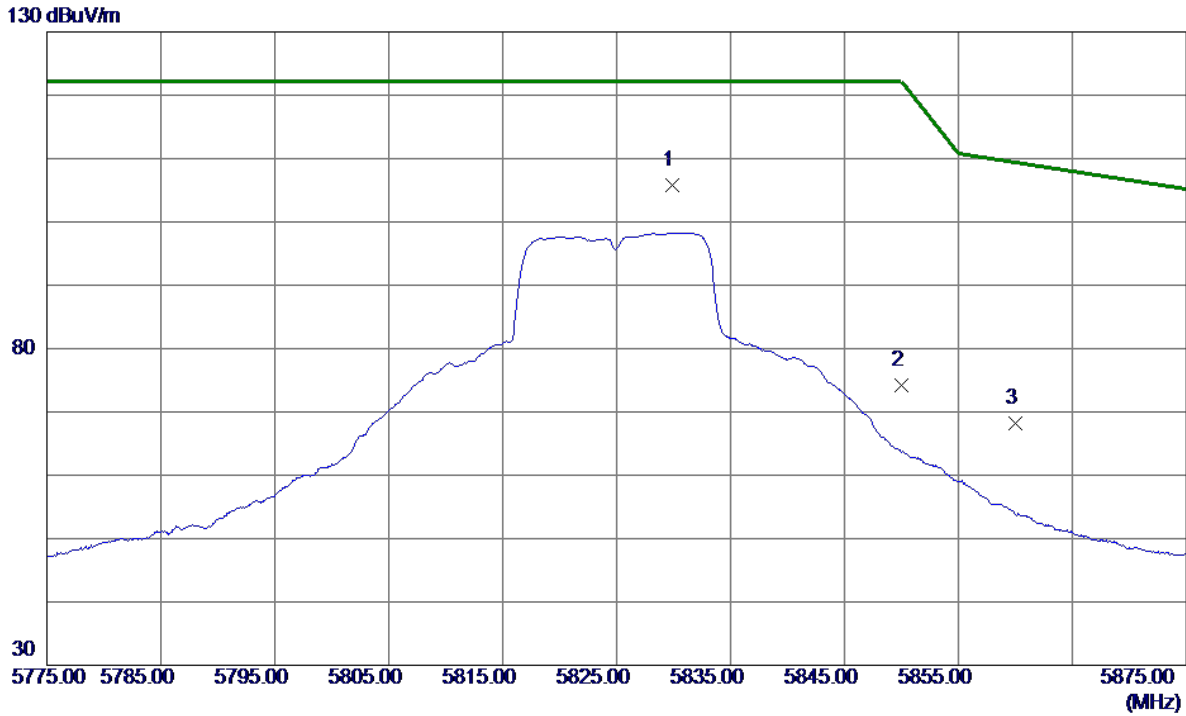

No.	Freq. MHz	Reading Level dBuV/m	Correct Factor dB	Measure ment dBuV/m	Limit dBuV/m	Margin dB	Detector	Comment
1 *	5829.9000	89.57	16.29	105.86	122.20	-16.34	Peak	No Limit
2	5850.0000	57.91	16.35	74.26	122.20	-47.94	Peak	
3	5860.0000	51.75	16.39	68.14	109.40	-41.26	Peak	

Orthogonal Axis:	X
Test Mode:	UNII-3/TX A Mode 5825 MHz

Horizontal

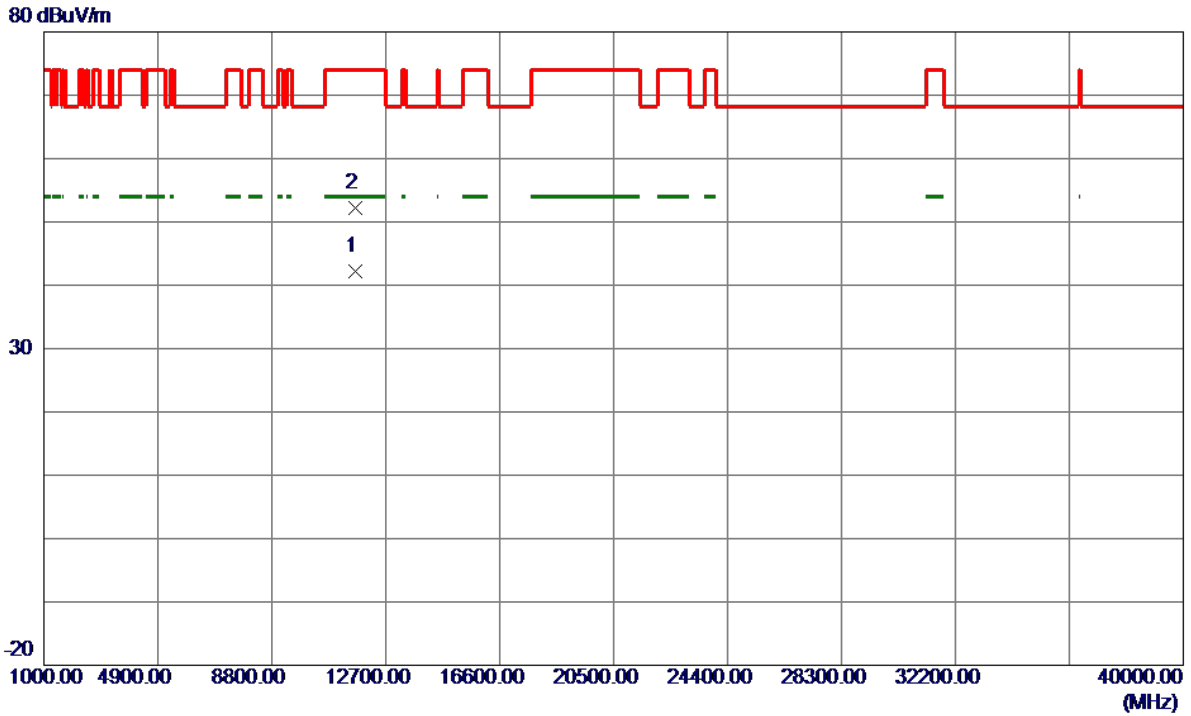

No.	Freq. MHz	Reading Level dBuV/m	Correct Factor dB	Measure ment dBuV/m	Limit dBuV/m	Margin dB	Detector	Comment
1 *	11649.6849	29.56	12.57	42.13	54.00	-11.87	AVG	
2	11651.4250	39.65	12.57	52.22	74.00	-21.78	Peak	

Orthogonal Axis:	X
Test Mode:	UNII-3/TX N20 Mode 5745 MHz

Vertical

130 dBuV/m

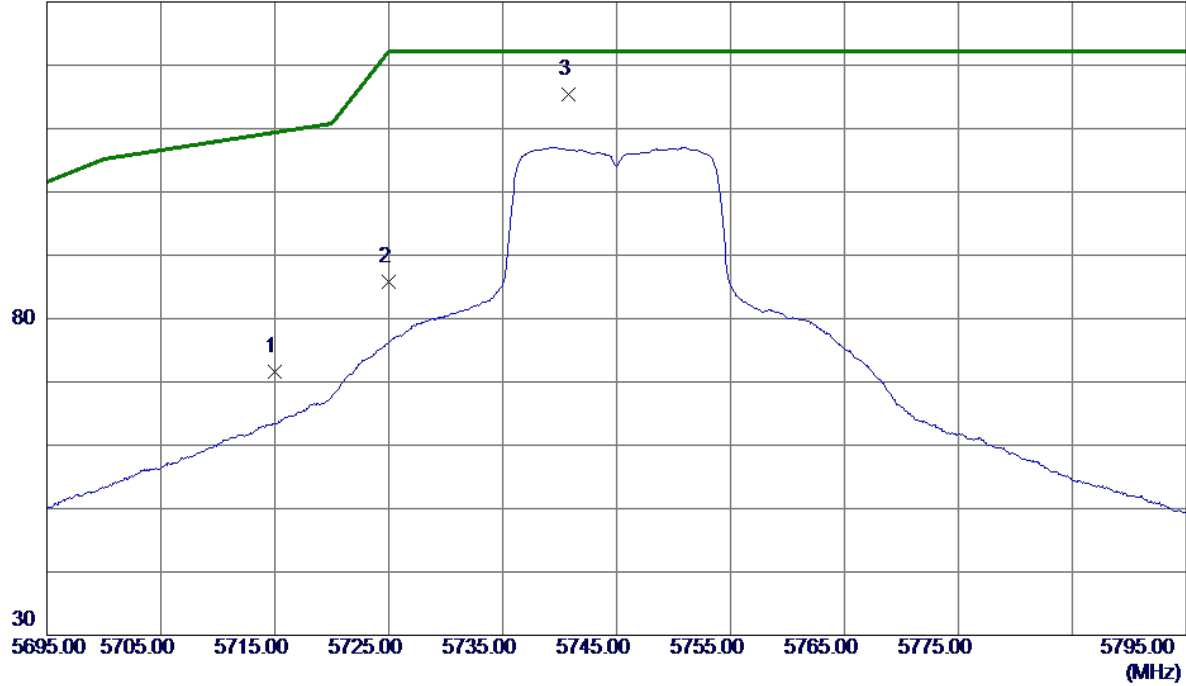

No.	Freq. MHz	Reading Level dBuV/m	Correct Factor dB	Measure ment dBuV/m	Limit dBuV/m	Margin dB	Detector	Comment
1	5715.0000	55.74	15.93	71.67	109.40	-37.73	Peak	
2	5725.0000	69.77	15.96	85.73	122.20	-36.47	Peak	
3 *	5740.7500	99.38	16.01	115.39	122.20	-6.81	Peak	No Limit

Orthogonal Axis:	X
Test Mode:	UNII-3/TX N20 Mode 5745 MHz

Vertical

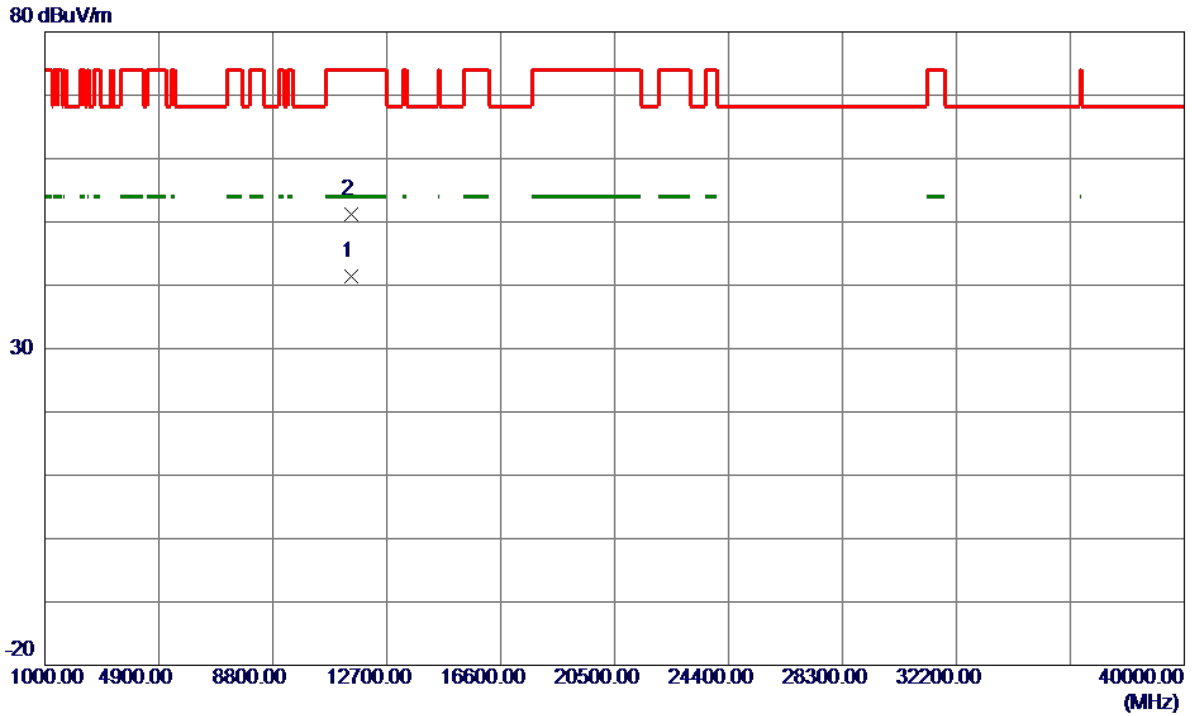

No.	Freq. MHz	Reading Level dBuV/m	Correct Factor dB	Measure ment dBuV/m	Limit dBuV/m	Margin dB	Detector	Comment
1 *	11489.1000	28.85	12.47	41.32	54.00	-12.68	AVG	
2	11491.6200	38.75	12.47	51.22	74.00	-22.78	Peak	

Orthogonal Axis:	X
Test Mode:	UNII-3/TX N20 Mode 5745 MHz

Horizontal

130 dBuV/m

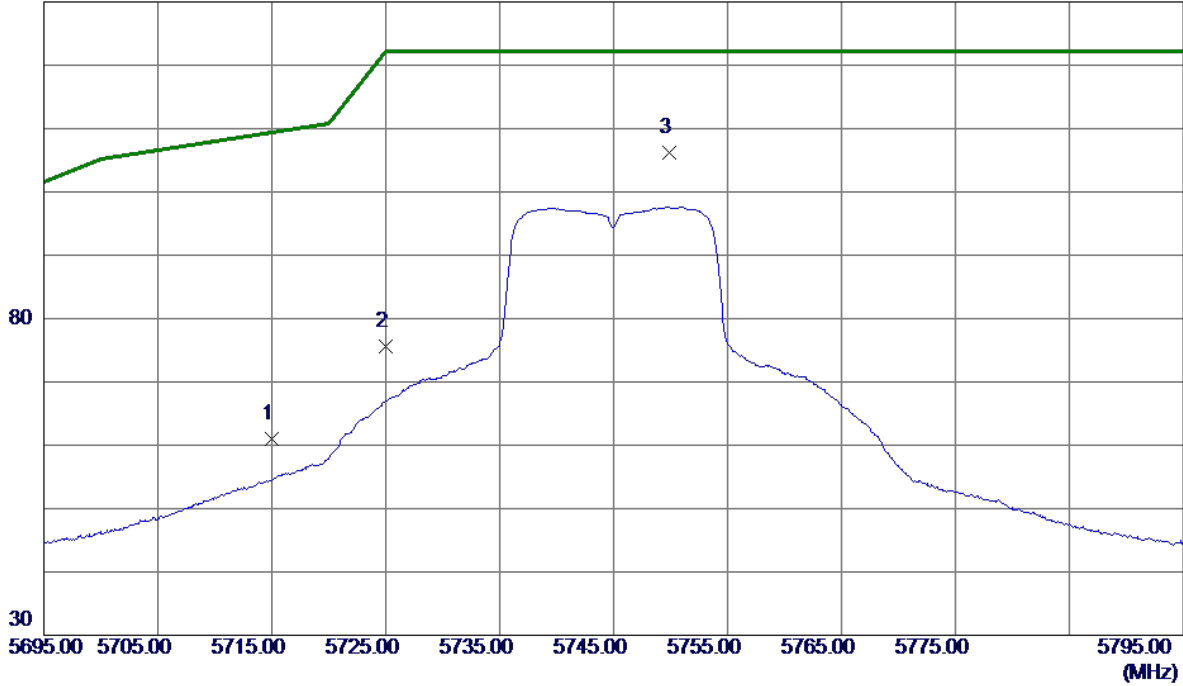

No.	Freq. MHz	Reading Level dBuV/m	Correct Factor dB	Measure ment dBuV/m	Limit dBuV/m	Margin dB	Detector	Comment
1	5715.0000	45.00	15.93	60.93	109.40	-48.47	Peak	
2	5725.0000	59.58	15.96	75.54	122.20	-46.66	Peak	
3 *	5749.9000	90.23	16.04	106.27	122.20	-15.93	Peak	No Limit

Orthogonal Axis:	X
Test Mode:	UNII-3/TX N20 Mode 5745 MHz

Horizontal

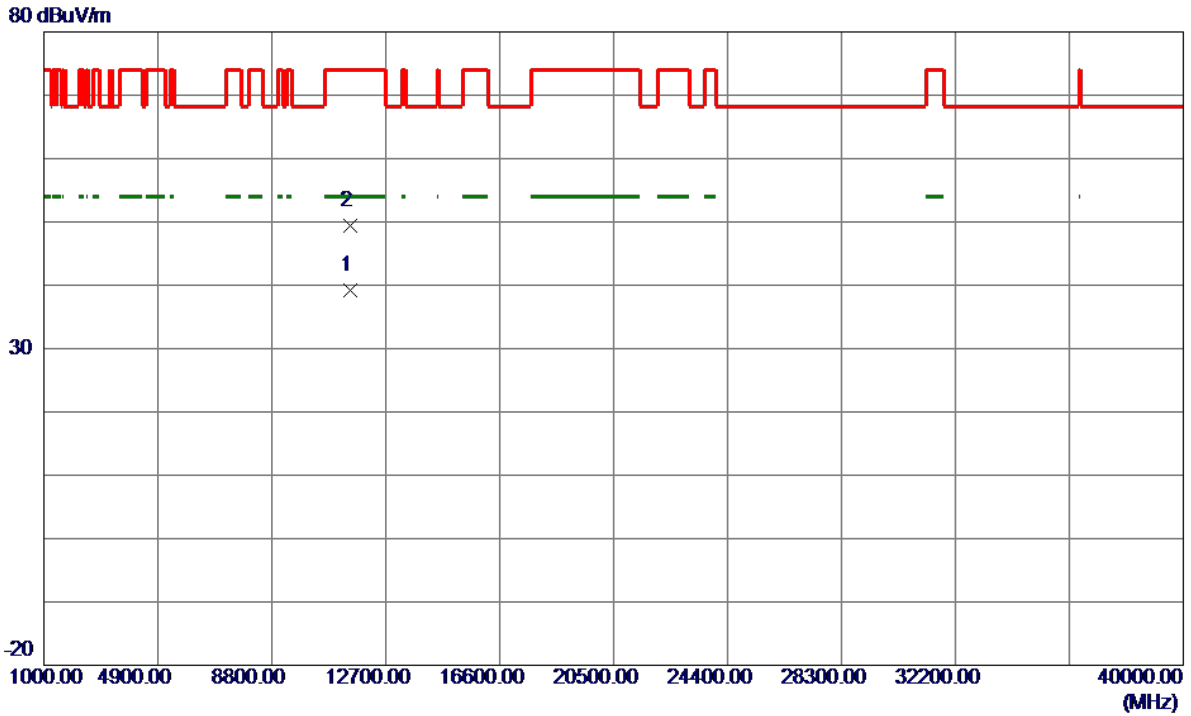

No.	Freq. MHz	Reading Level dBuV/m	Correct Factor dB	Measure ment dBuV/m	Limit dBuV/m	Margin dB	Detector	Comment
1 *	11488.9200	26.70	12.47	39.17	54.00	-14.83	AVG	
2	11492.4000	36.84	12.47	49.31	74.00	-24.69	Peak	

Orthogonal Axis:	X
Test Mode:	UNII-3/TX N20 Mode 5785 MHz

Vertical

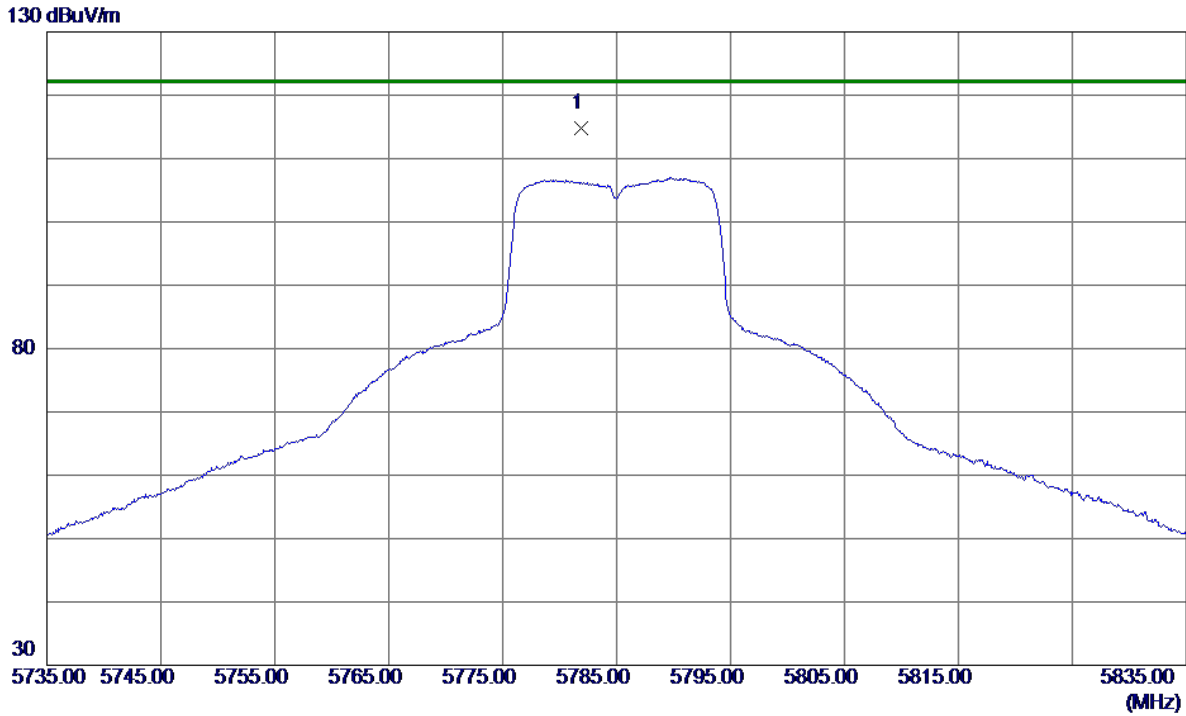

No.	Freq. MHz	Reading Level dBuV/m	Correct Factor dB	Measure ment dBuV/m	Limit dBuV/m	Margin dB	Detector	Comment
1 *	5781.9000	98.60	16.14	114.74	122.20	-7.46	Peak	No Limit

Orthogonal Axis:	X
Test Mode:	UNII-3/TX N20 Mode 5785 MHz

Vertical

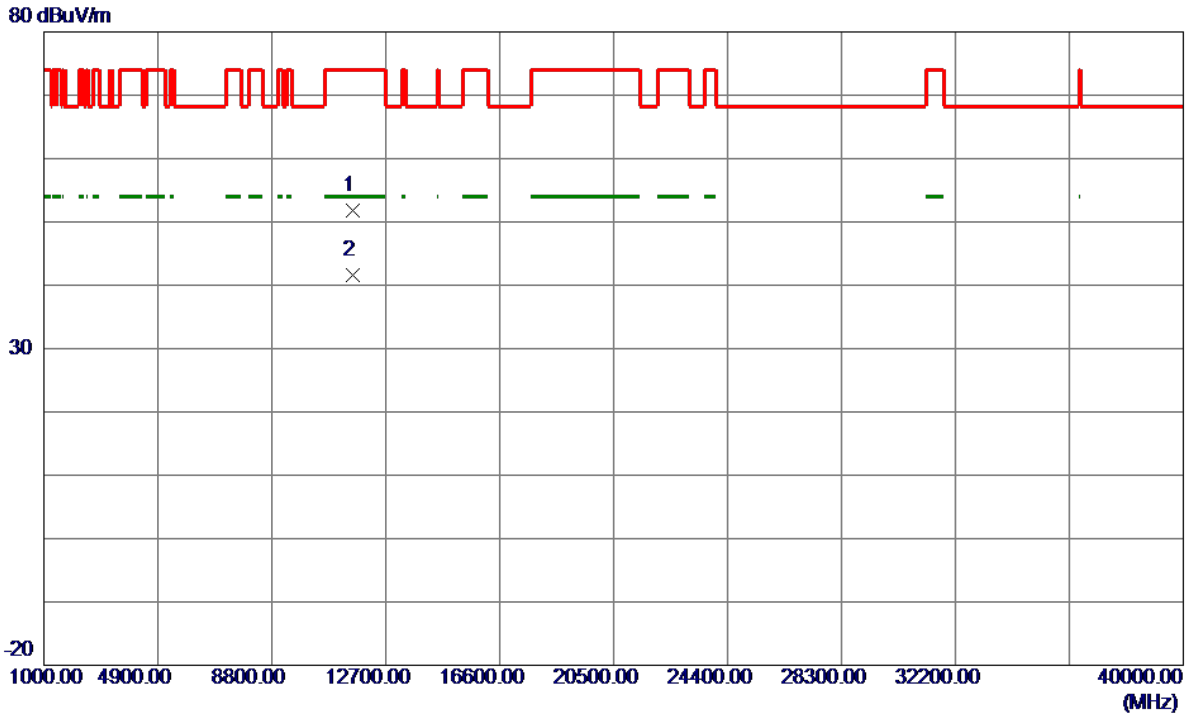

No.	Freq. MHz	Reading Level dBuV/m	Correct Factor dB	Measure ment dBuV/m	Limit dBuV/m	Margin dB	Detector	Comment
1	11568.1849	39.24	12.52	51.76	74.00	-22.24	Peak	
2 *	11569.0400	29.05	12.52	41.57	54.00	-12.43	AVG	

Orthogonal Axis:	X
Test Mode:	UNII-3/TX N20 Mode 5785 MHz

Horizontal

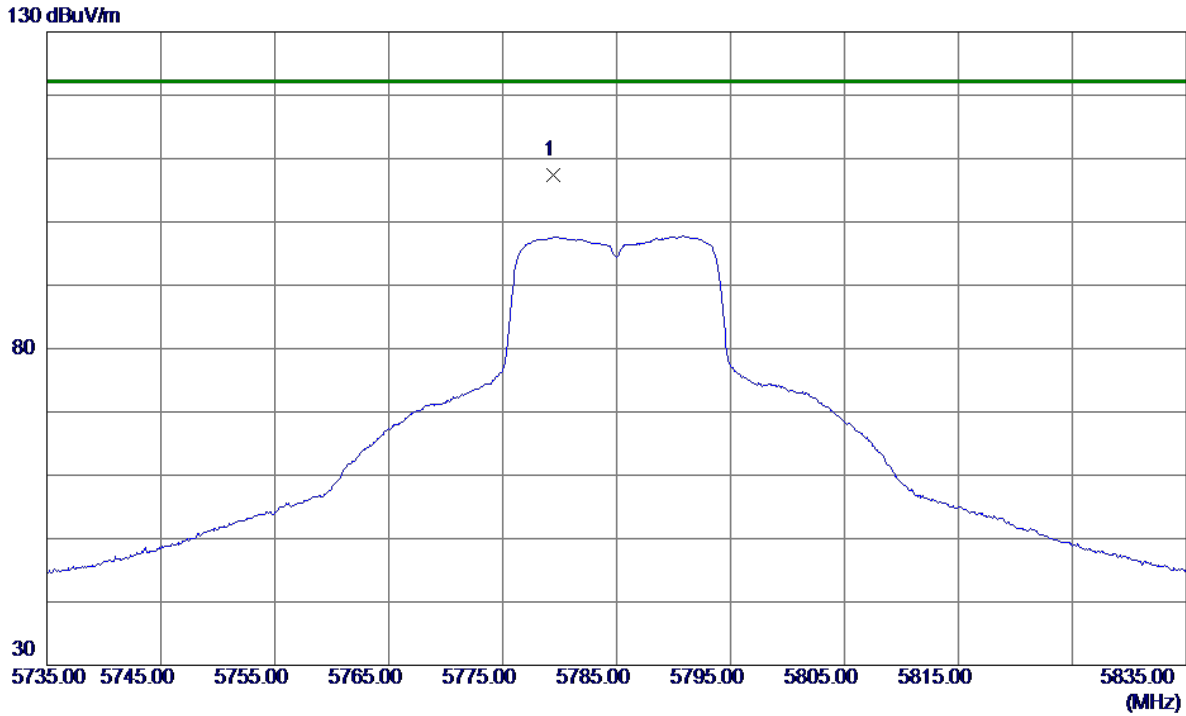

No.	Freq. MHz	Reading Level dBuV/m	Correct Factor dB	Measure ment dBuV/m	Limit dBuV/m	Margin dB	Detector	Comment
1 *	5779.4500	91.31	16.13	107.44	122.20	-14.76	Peak	No Limit

Orthogonal Axis:	X
Test Mode:	UNII-3/TX N20 Mode 5785 MHz

Horizontal

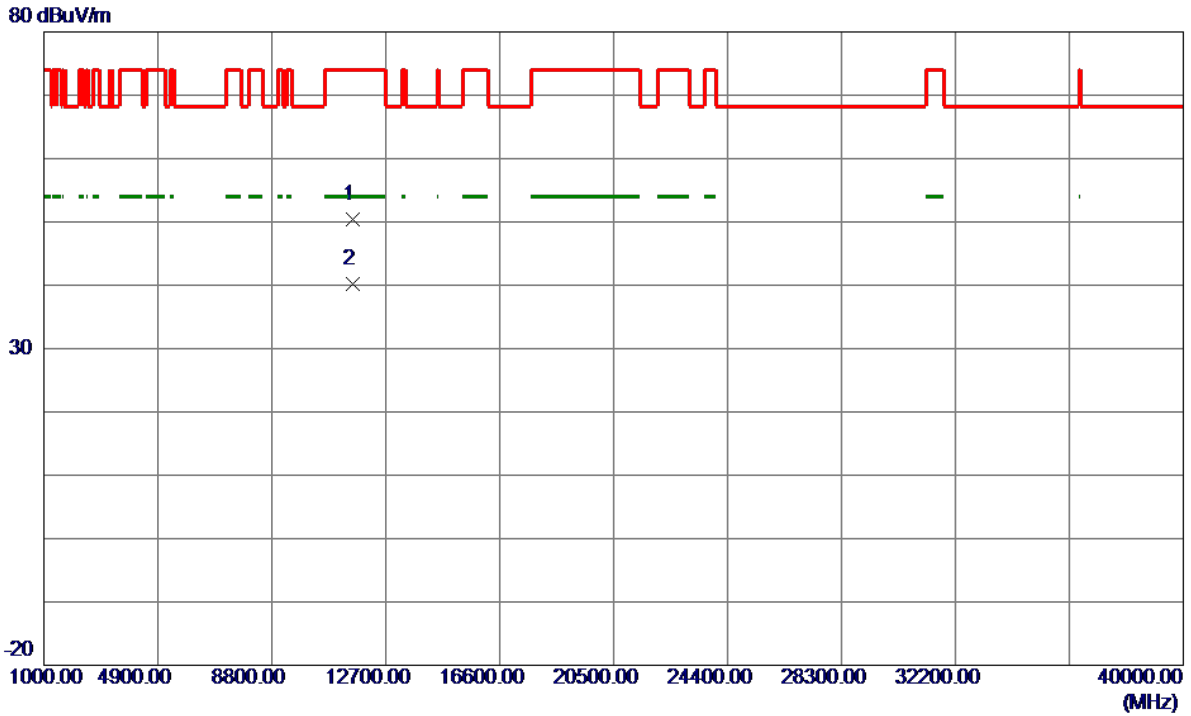

No.	Freq. MHz	Reading Level dBuV/m	Correct Factor dB	Measure ment dBuV/m	Limit dBuV/m	Margin dB	Detector	Comment
1	11571.0950	37.91	12.52	50.43	74.00	-23.57	Peak	
2 *	11571.5150	27.61	12.52	40.13	54.00	-13.87	AVG	

Orthogonal Axis:	X
Test Mode:	UNII-3/TX N20 Mode 5825 MHz

Vertical

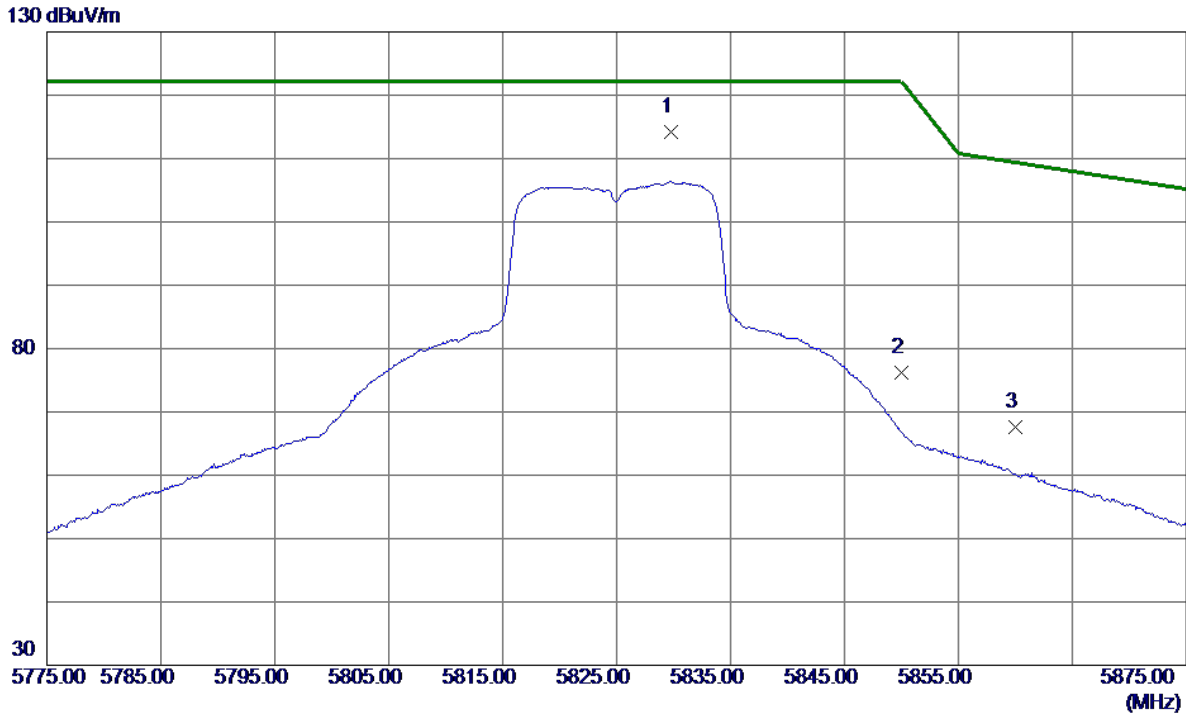

No.	Freq. MHz	Reading Level dBuV/m	Correct Factor dB	Measure ment dBuV/m	Limit dBuV/m	Margin dB	Detector	Comment
1 *	5829.8000	97.84	16.29	114.13	122.20	-8.07	Peak	No Limit
2	5850.0000	59.92	16.35	76.27	122.20	-45.93	Peak	
3	5860.0000	51.25	16.39	67.64	109.40	-41.76	Peak	

Orthogonal Axis:	X
Test Mode:	UNII-3/TX N20 Mode 5825 MHz

Vertical

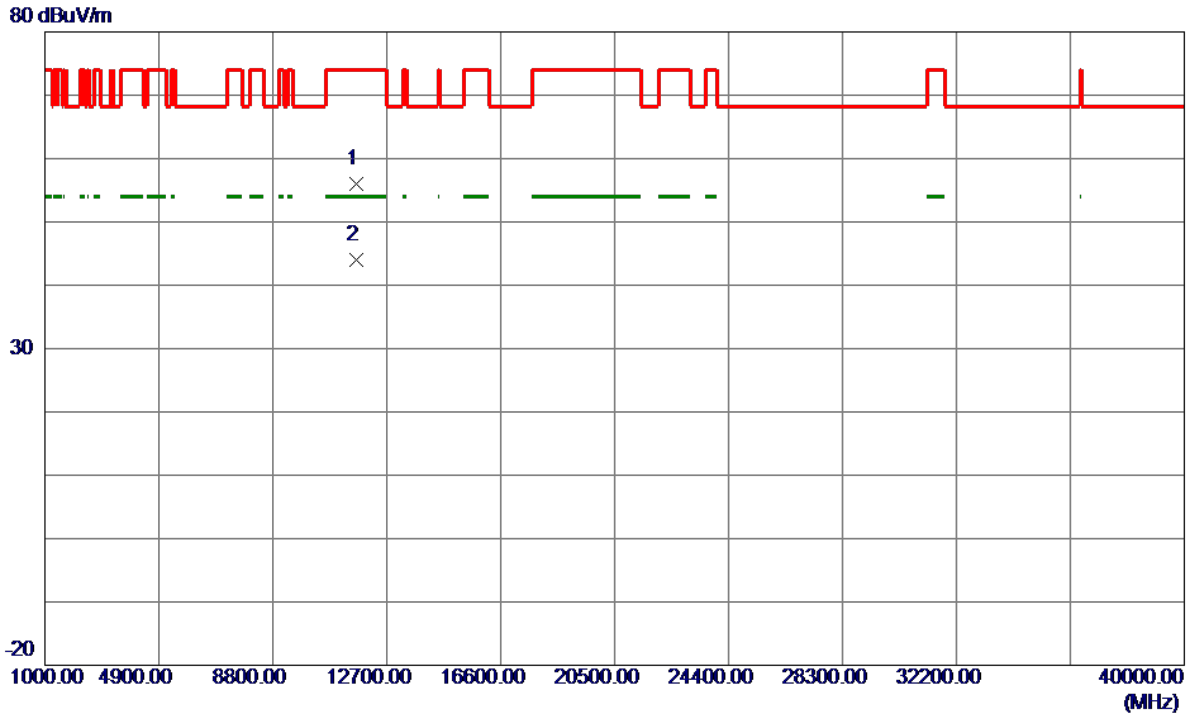

No.	Freq. MHz	Reading Level dBuV/m	Correct Factor dB	Measure ment dBuV/m	Limit dBuV/m	Margin dB	Detector	Comment
1	11648.3650	43.52	12.57	56.09	74.00	-17.91	Peak	
2 *	11650.9750	31.50	12.57	44.07	54.00	-9.93	AVG	

Orthogonal Axis:	X
Test Mode:	UNII-3/TX N20 Mode 5825 MHz

Horizontal

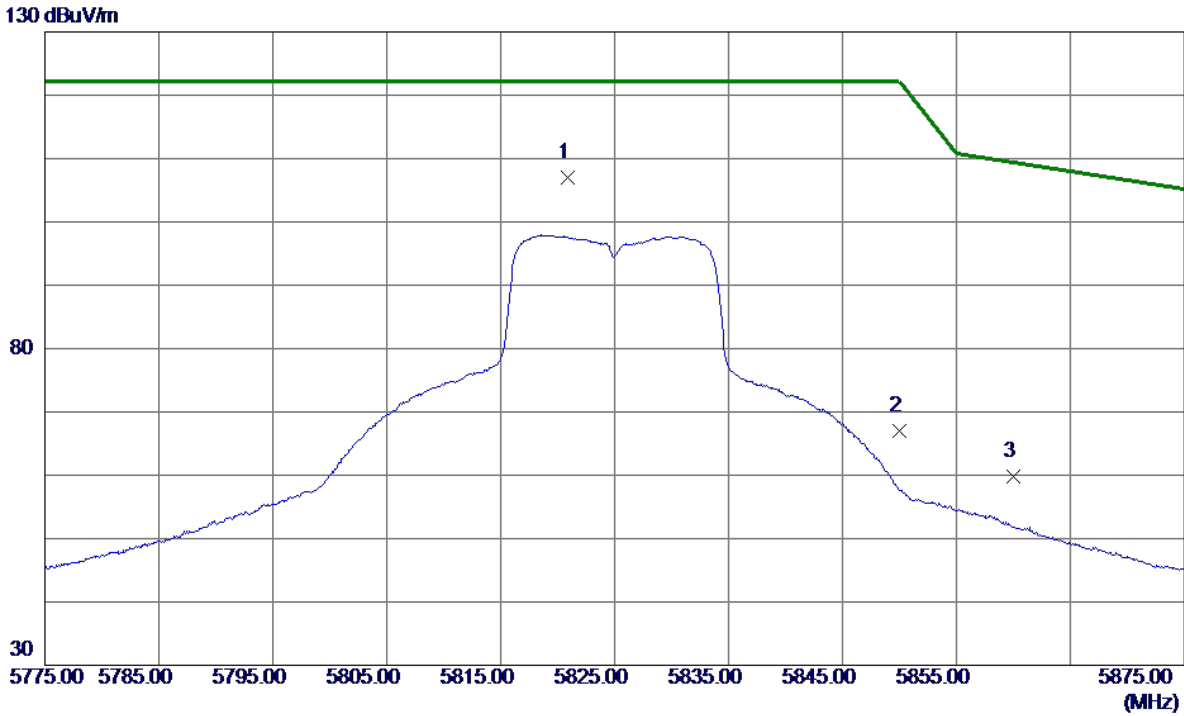

No.	Freq. MHz	Reading Level dBuV/m	Correct Factor dB	Measure ment dBuV/m	Limit dBuV/m	Margin dB	Detector	Comment
1 *	5820.8500	90.67	16.26	106.93	122.20	-15.27	Peak	No Limit
2	5850.0000	50.71	16.35	67.06	122.20	-55.14	Peak	
3	5860.0000	43.45	16.39	59.84	109.40	-49.56	Peak	

Orthogonal Axis:	X
Test Mode:	UNII-3/TX N20 Mode 5825 MHz

Horizontal

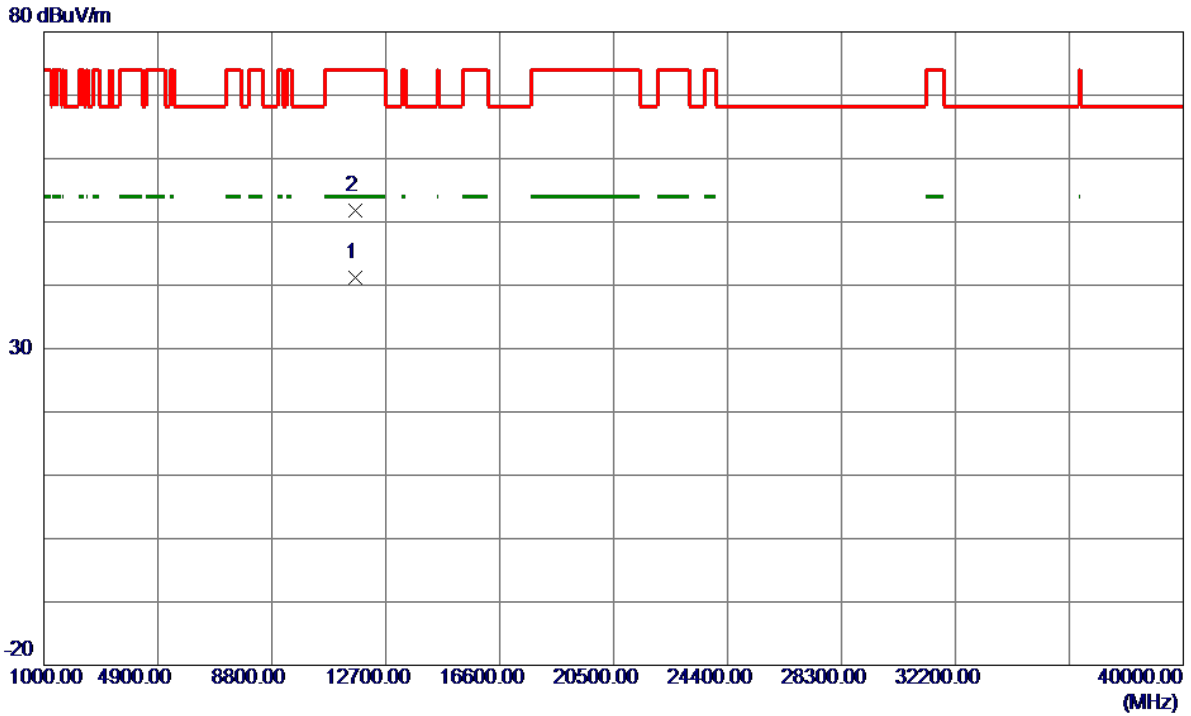

No.	Freq. MHz	Reading Level dBuV/m	Correct Factor dB	Measure ment dBuV/m	Limit dBuV/m	Margin dB	Detector	Comment
1 *	11648.8750	28.61	12.57	41.18	54.00	-12.82	AVG	
2	11650.2400	39.16	12.57	51.73	74.00	-22.27	Peak	

Orthogonal Axis:	X
Test Mode:	UNII-3/TX N40 Mode 5755MHz

Vertical

130 dBuV/m

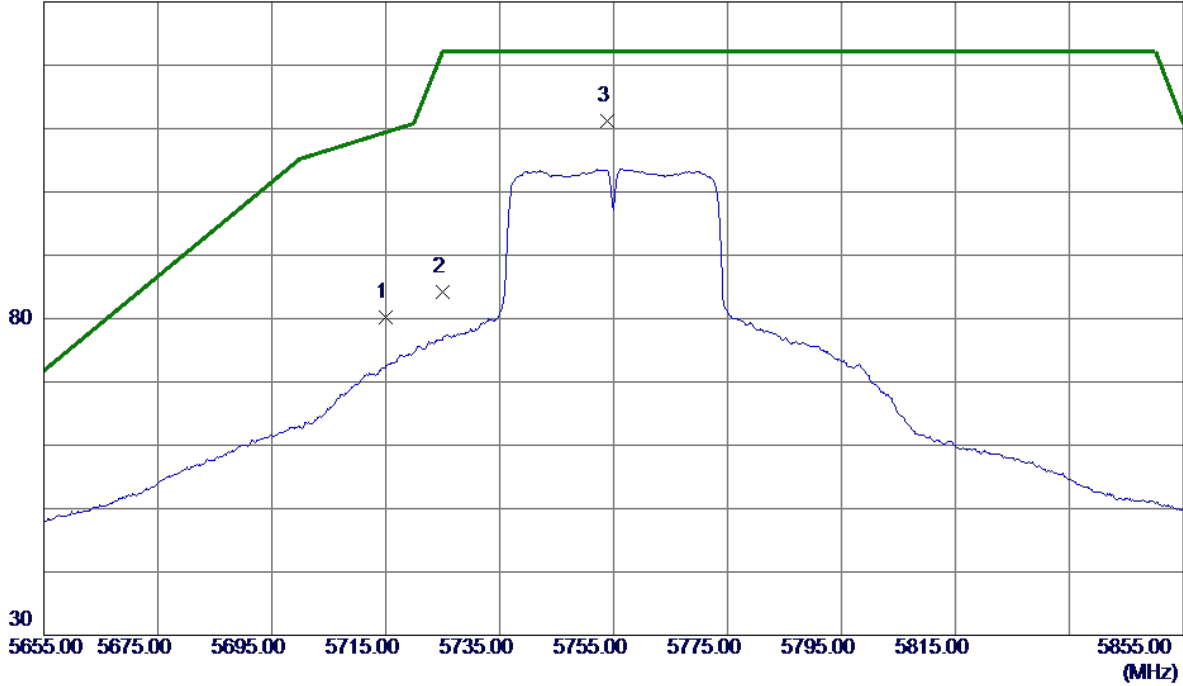

No.	Freq. MHz	Reading Level dBuV/m	Correct Factor dB	Measure ment dBuV/m	Limit dBuV/m	Margin dB	Detector	Comment
1	5715.0000	64.23	15.93	80.16	109.40	-29.24	Peak	
2	5725.0000	68.15	15.96	84.11	122.20	-38.09	Peak	
3 *	5753.9000	95.20	16.05	111.25	122.20	-10.95	Peak	No Limit

Orthogonal Axis:	X
Test Mode:	UNII-3/TX N40 Mode 5755MHz

Vertical

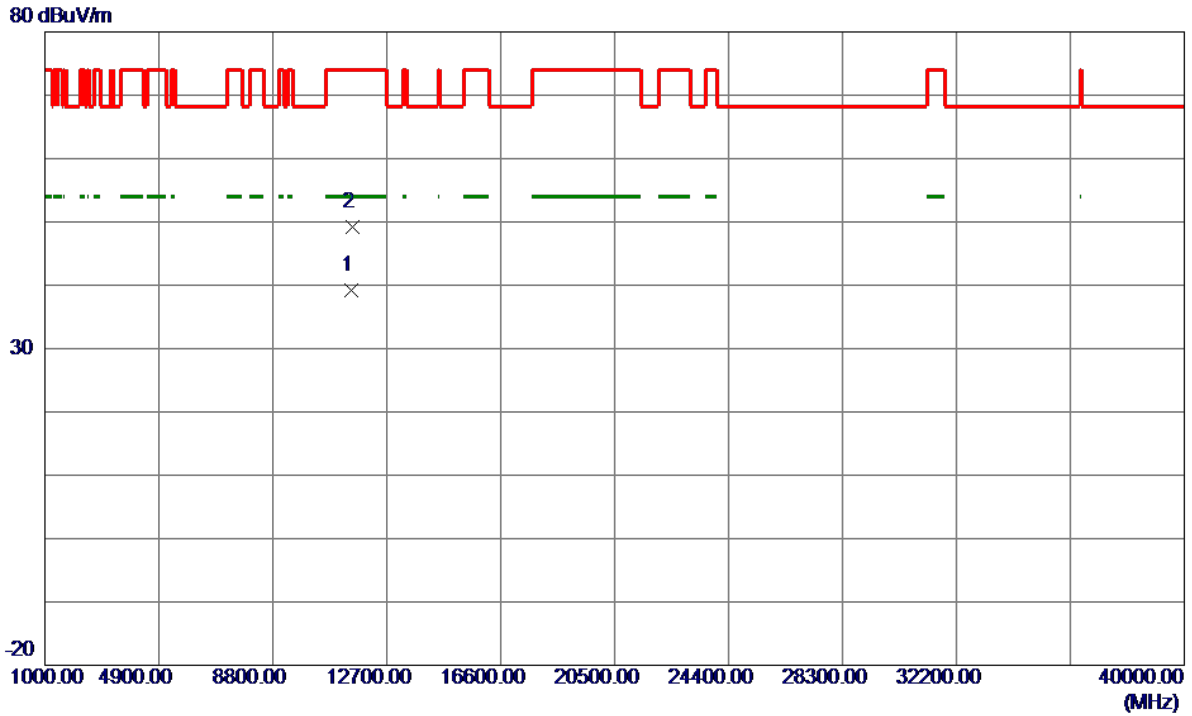

No.	Freq. MHz	Reading Level dBuV/m	Correct Factor dB	Measure ment dBuV/m	Limit dBuV/m	Margin dB	Detector	Comment
1 *	11503.5000	26.65	12.48	39.13	54.00	-14.87	AVG	
2	11514.1000	36.77	12.48	49.25	74.00	-24.75	Peak	

Orthogonal Axis:	X
Test Mode:	UNII-3/TX N40 Mode 5755MHz

Horizontal

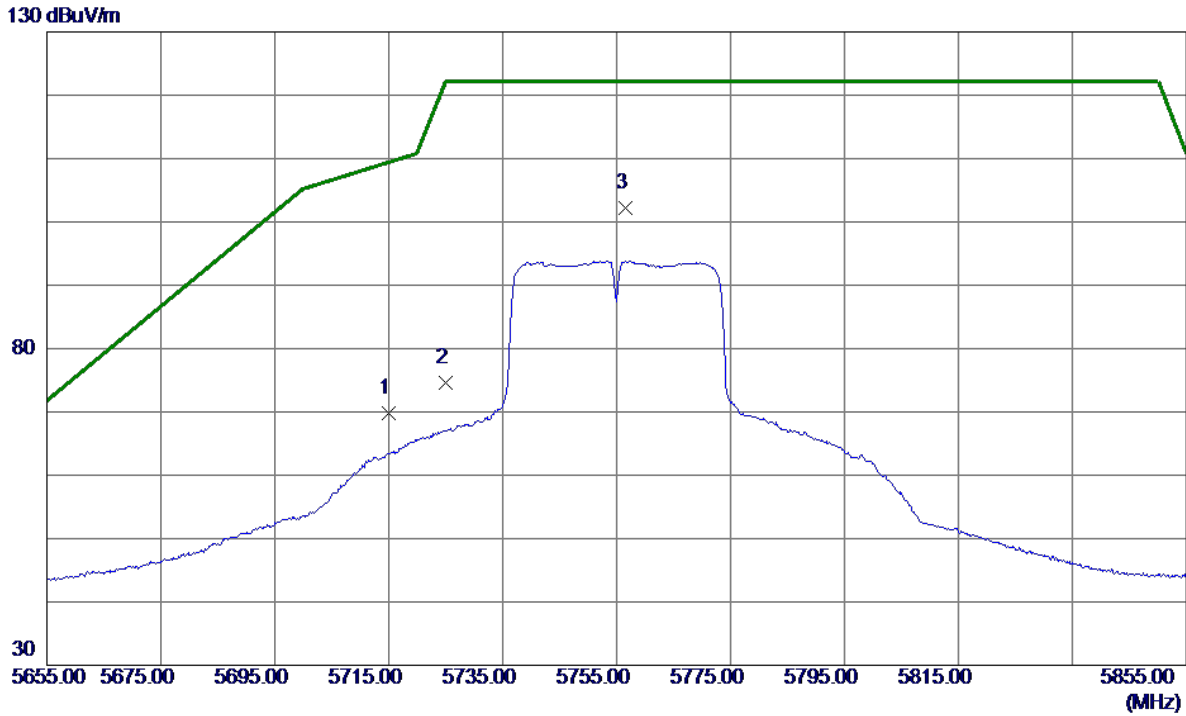

No.	Freq. MHz	Reading Level dBuV/m	Correct Factor dB	Measure ment dBuV/m	Limit dBuV/m	Margin dB	Detector	Comment
1	5715.0000	53.94	15.93	69.87	109.40	-39.53	Peak	
2	5725.0000	58.67	15.96	74.63	122.20	-47.57	Peak	
3 *	5756.5000	86.08	16.06	102.14	122.20	-20.06	Peak	No Limit

Orthogonal Axis:	X
Test Mode:	UNII-3/TX N40 Mode 5755MHz

Horizontal

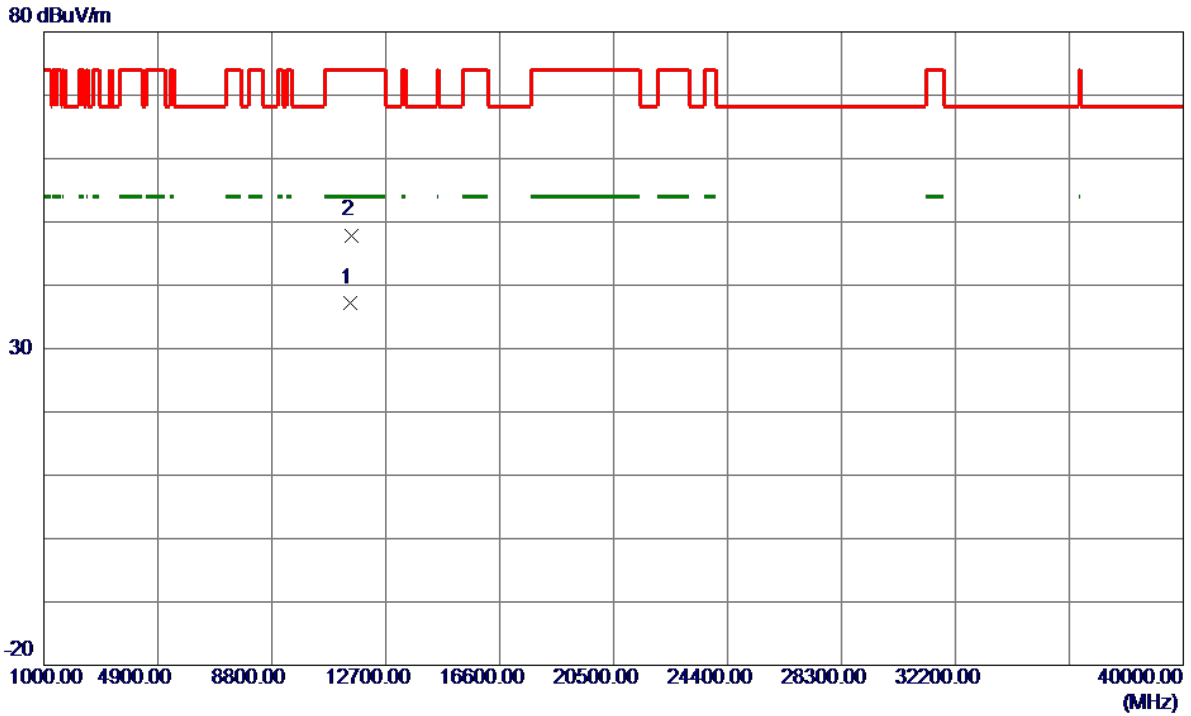

No.	Freq. MHz	Reading Level dBuV/m	Correct Factor dB	Measure ment dBuV/m	Limit dBuV/m	Margin dB	Detector	Comment
1 *	11508.3250	24.77	12.48	37.25	54.00	-16.75	AVG	
2	11512.8250	35.42	12.48	47.90	74.00	-26.10	Peak	

Orthogonal Axis:	X
Test Mode:	UNII-3/TX N40 Mode 5795MHz

Vertical

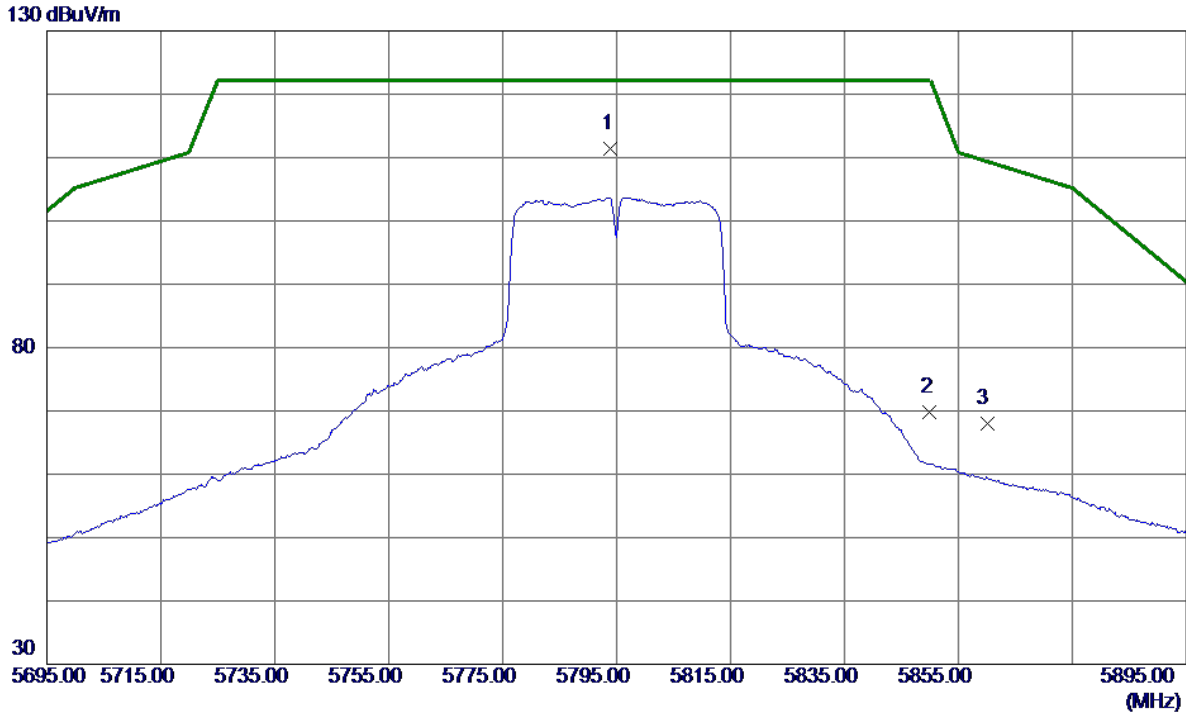

No.	Freq. MHz	Reading Level dBuV/m	Correct Factor dB	Measure ment dBuV/m	Limit dBuV/m	Margin dB	Detector	Comment
1 *	5794.0000	95.31	16.18	111.49	122.20	-10.71	Peak	No Limit
2	5850.0000	53.53	16.35	69.88	122.20	-52.32	Peak	
3	5860.0000	51.53	16.39	67.92	109.40	-41.48	Peak	

Orthogonal Axis:	X
Test Mode:	UNII-3/TX N40 Mode 5795MHz

Vertical

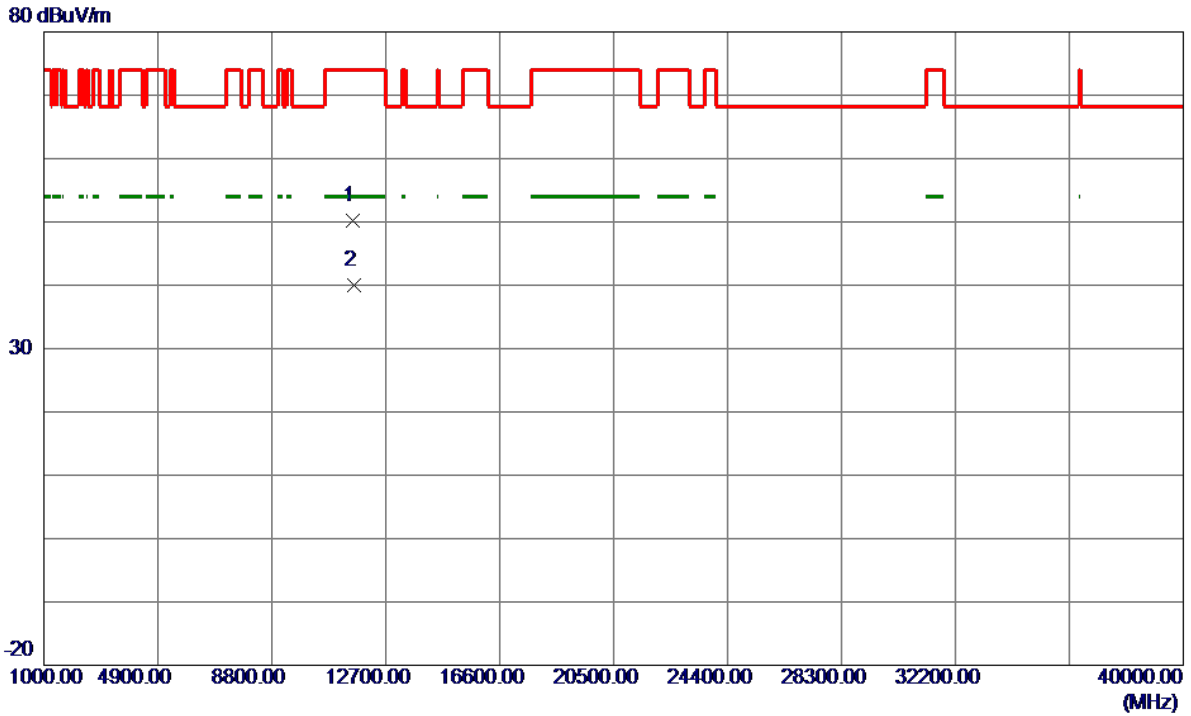

No.	Freq. MHz	Reading Level dBuV/m	Correct Factor dB	Measure ment dBuV/m	Limit dBuV/m	Margin dB	Detector	Comment
1	11592.1250	37.73	12.53	50.26	74.00	-23.74	Peak	
2 *	11596.7250	27.41	12.53	39.94	54.00	-14.06	AVG	

Orthogonal Axis:	X
Test Mode:	UNII-3/TX N40 Mode 5795MHz

Horizontal

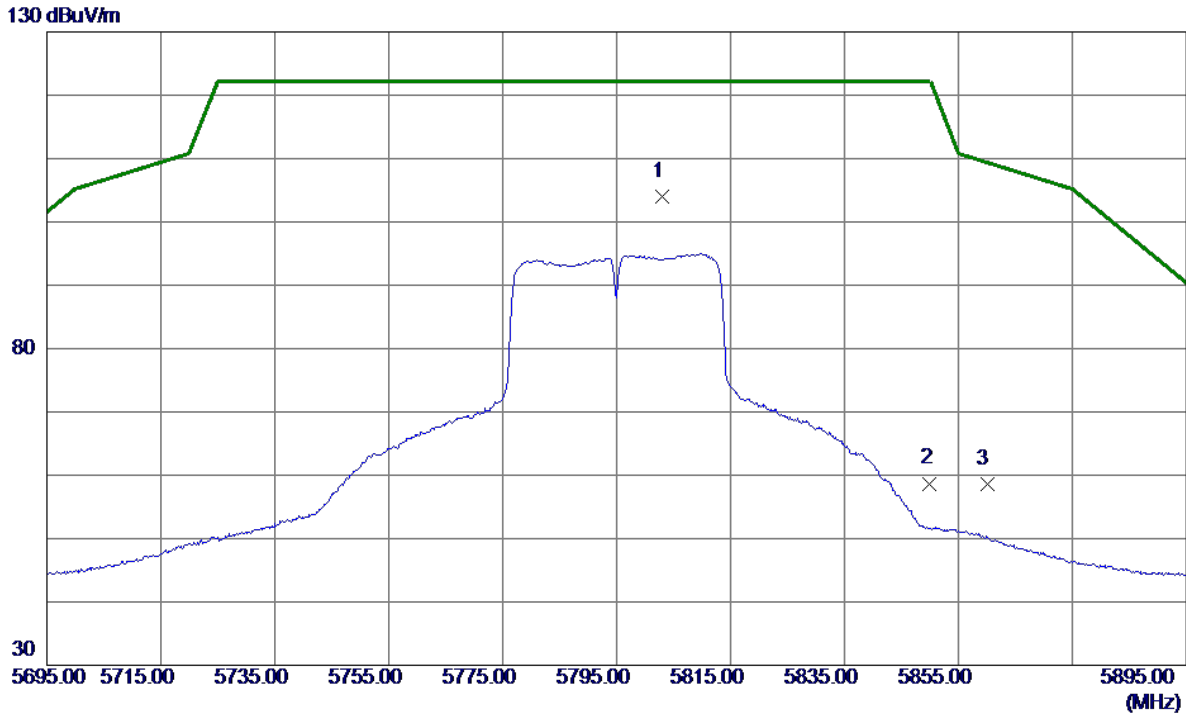

No.	Freq. MHz	Reading Level dBuV/m	Correct Factor dB	Measure ment dBuV/m	Limit dBuV/m	Margin dB	Detector	Comment
1 *	5803.1000	87.85	16.21	104.06	122.20	-18.14	Peak	No Limit
2	5850.0000	42.35	16.35	58.70	122.20	-63.50	Peak	
3	5860.0000	42.13	16.39	58.52	109.40	-50.88	Peak	

Orthogonal Axis:	X
Test Mode:	UNII-3/TX N40 Mode 5795MHz

Horizontal

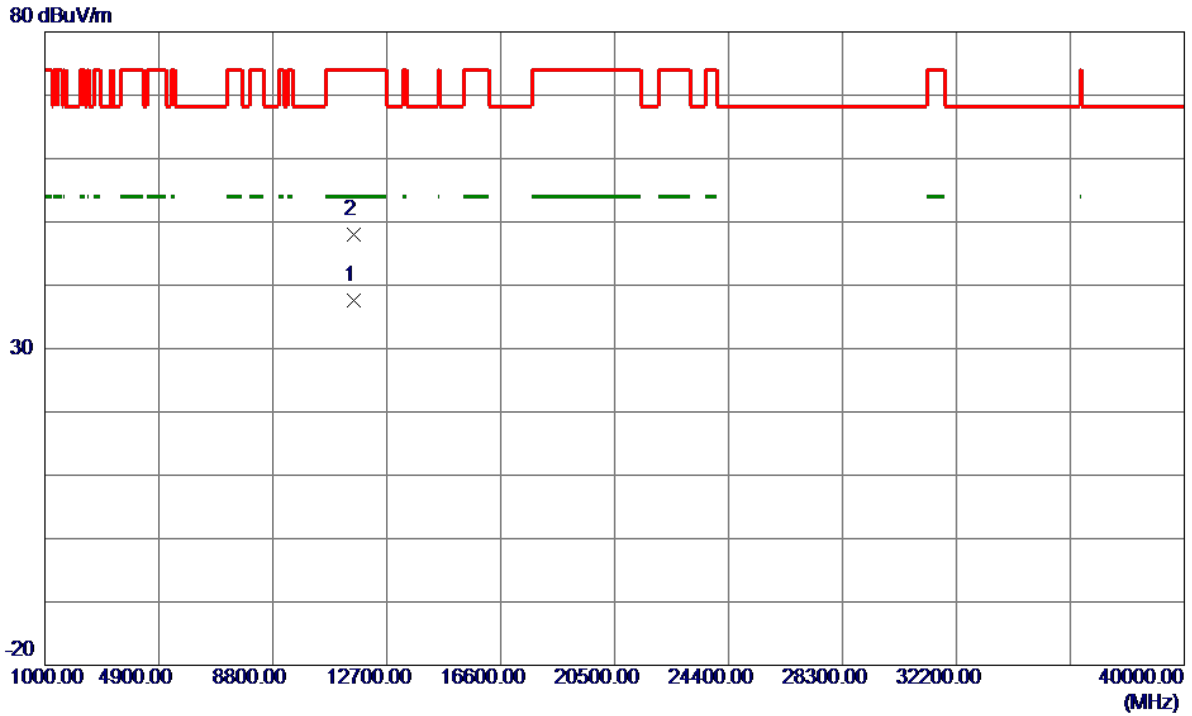

No.	Freq. MHz	Reading Level dBuV/m	Correct Factor dB	Measure ment dBuV/m	Limit dBuV/m	Margin dB	Detector	Comment
1 *	11581.3000	25.11	12.52	37.63	54.00	-16.37	AVG	
2	11594.6000	35.50	12.53	48.03	74.00	-25.97	Peak	

Orthogonal Axis:	X
Test Mode:	UNII-1/ TX AC20 Mode 5180 MHz

Vertical

130 dBuV/m

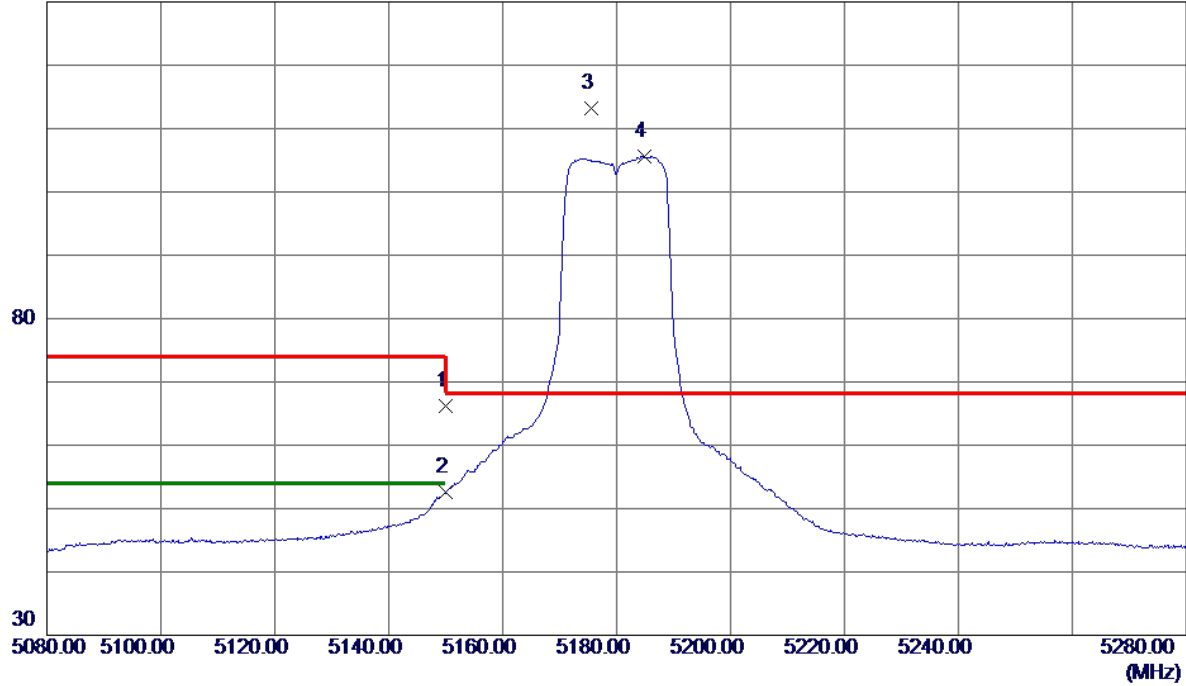

No.	Freq. MHz	Reading Level dBuV/m	Correct Factor dB	Measure ment dBuV/m	Limit dBuV/m	Margin dB	Detector	Comment
1	5150.0000	51.80	14.35	66.15	74.00	-7.85	Peak	
2	5150.0000	38.27	14.35	52.62	54.00	-1.38	AVG	
3 *	5175.6000	98.70	14.41	113.11	68.30	44.81	Peak	No Limit
4	5184.8000	91.25	14.43	105.68	999.00	-893.32	AVG	No Limit

Orthogonal Axis:	X
Test Mode:	UNII-1/ TX AC20 Mode 5180 MHz

Vertical

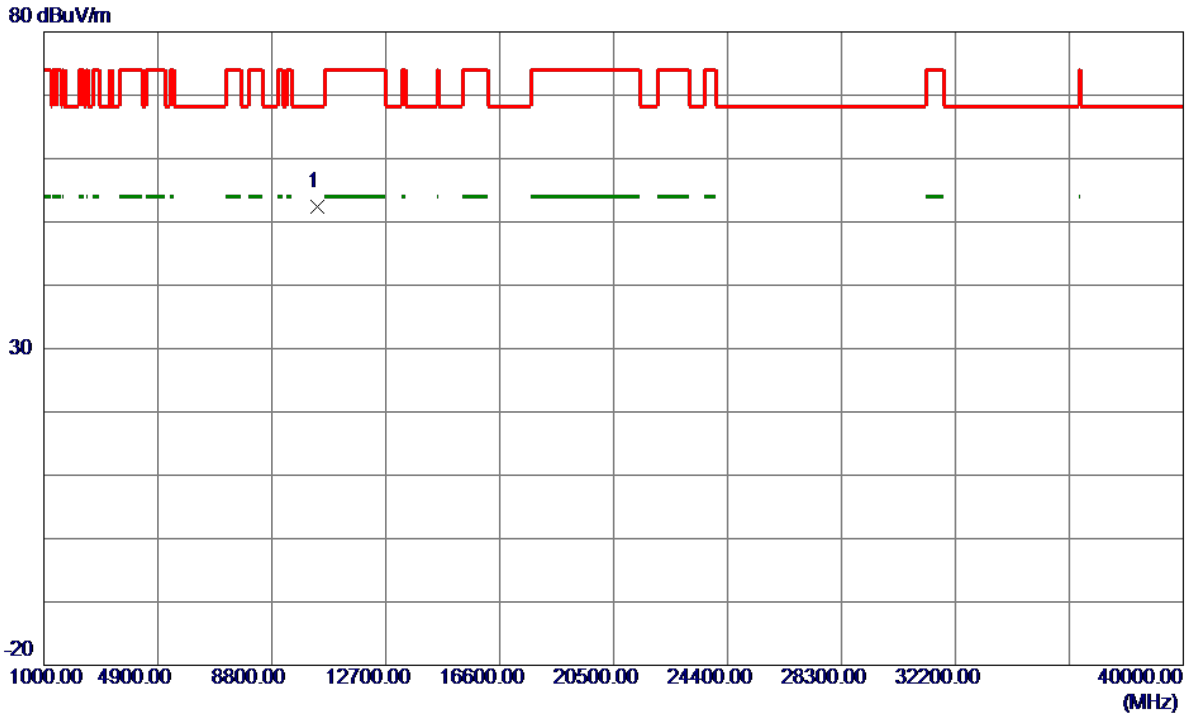

No.	Freq. MHz	Reading Level dBuV/m	Correct Factor dB	Measure ment dBuV/m	Limit dBuV/m	Margin dB	Detector	Comment
1 *	10368.8750	40.74	11.71	52.45	68.30	-15.85	Peak	

Orthogonal Axis:	X
Test Mode:	UNII-1/ TX AC20 Mode 5180 MHz

Horizontal

130 dBuV/m

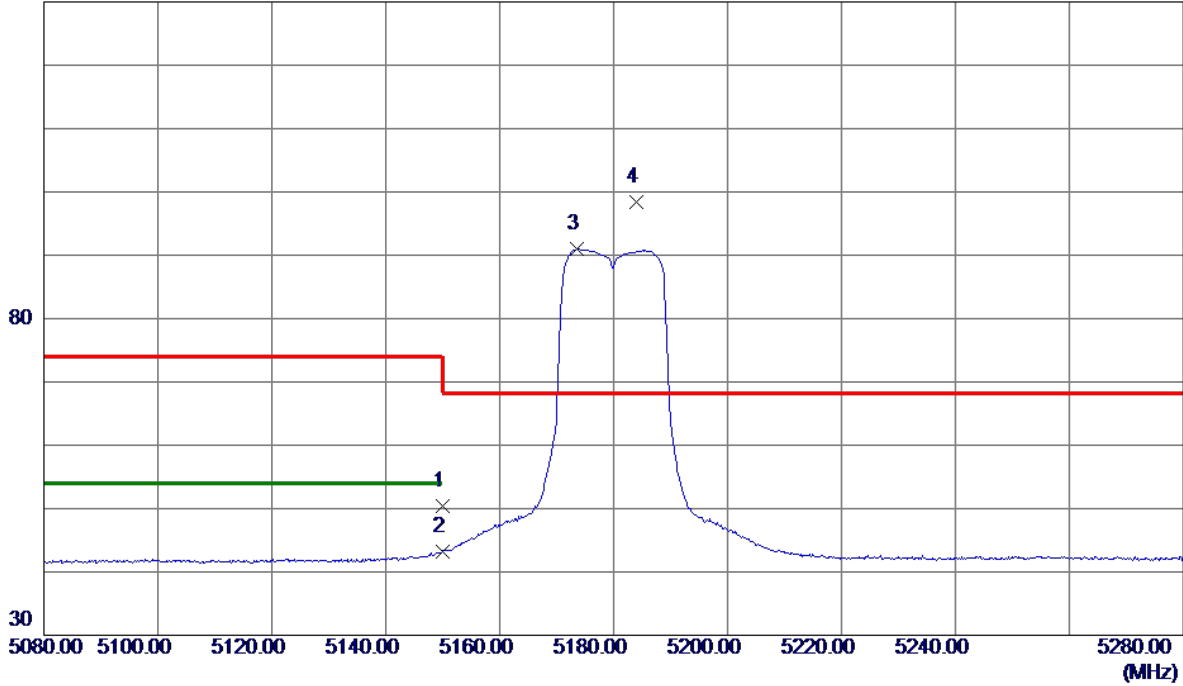

No.	Freq. MHz	Reading Level dBuV/m	Correct Factor dB	Measure ment dBuV/m	Limit dBuV/m	Margin dB	Detector	Comment
1	5150.0000	36.01	14.35	50.36	74.00	-23.64	Peak	
2	5150.0000	28.80	14.35	43.15	54.00	-10.85	AVG	
3	5173.6000	76.59	14.41	91.00	999.00	-908.00	AVG	No Limit
4 *	5184.1000	84.05	14.43	98.48	68.30	30.18	Peak	No Limit

Orthogonal Axis:	X
Test Mode:	UNII-1/ TX AC20 Mode 5180 MHz

Horizontal

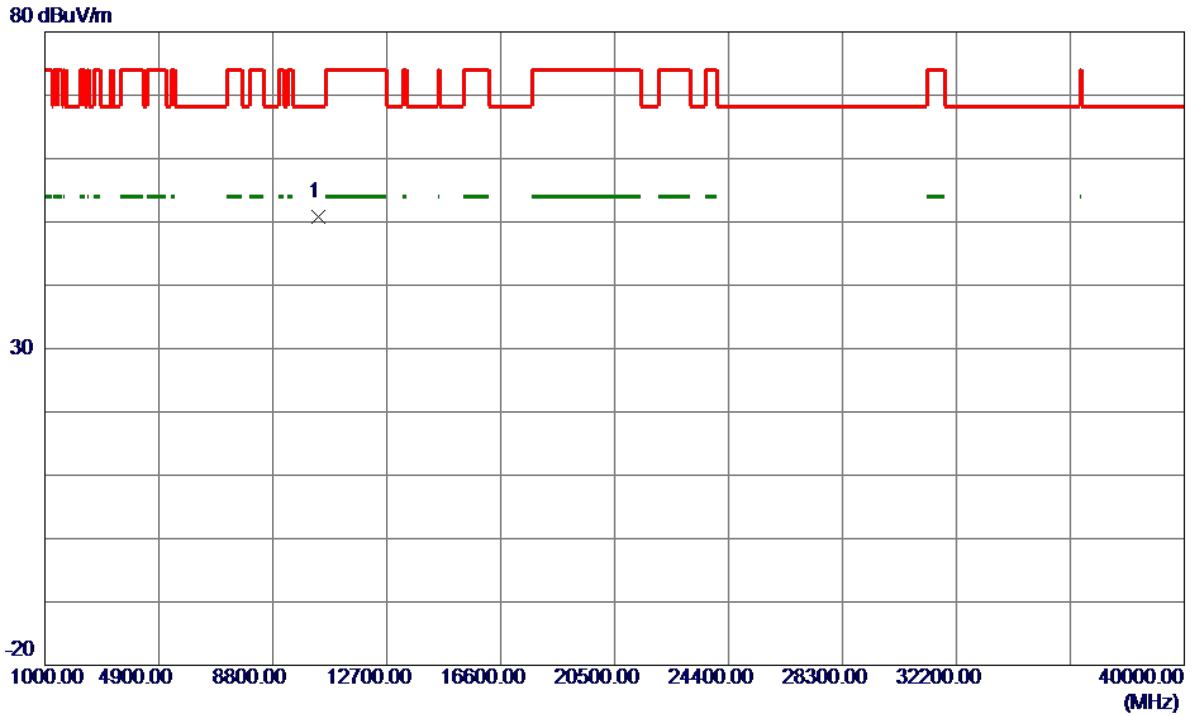

No.	Freq. MHz	Reading Level dBuV/m	Correct Factor dB	Measure ment dBuV/m	Limit dBuV/m	Margin dB	Detector	Comment
1 *	10364.6500	39.08	11.71	50.79	68.30	-17.51	Peak	

Orthogonal Axis:	X
Test Mode:	UNII-1/ TX AC20 Mode 5200 MHz

Vertical

130 dBuV/m

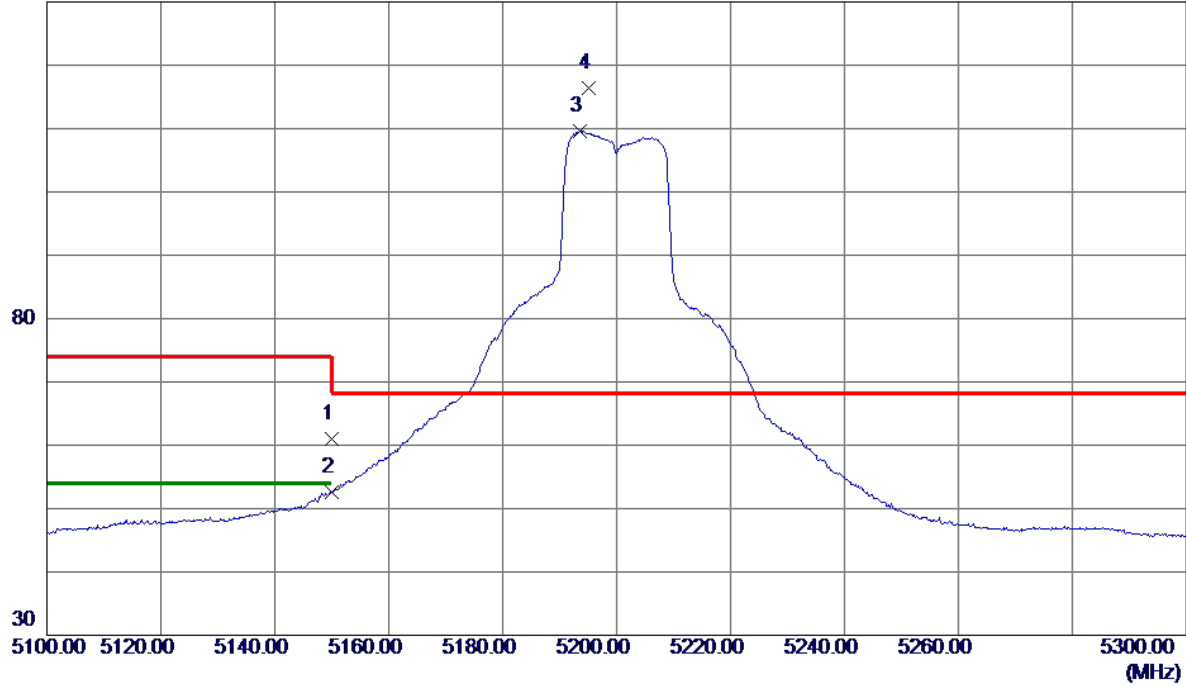

No.	Freq. MHz	Reading Level dBuV/m	Correct Factor dB	Measure ment dBuV/m	Limit dBuV/m	Margin dB	Detector	Comment
1	5150.0000	46.56	14.35	60.91	74.00	-13.09	Peak	
2	5150.0000	38.17	14.35	52.52	54.00	-1.48	AVG	
3	5193.6000	95.11	14.46	109.57	999.00	-889.43	AVG	No Limit
4 *	5195.2000	101.85	14.46	116.31	68.30	48.01	Peak	No Limit

Orthogonal Axis:	X
Test Mode:	UNII-1/ TX AC20 Mode 5200 MHz

Vertical

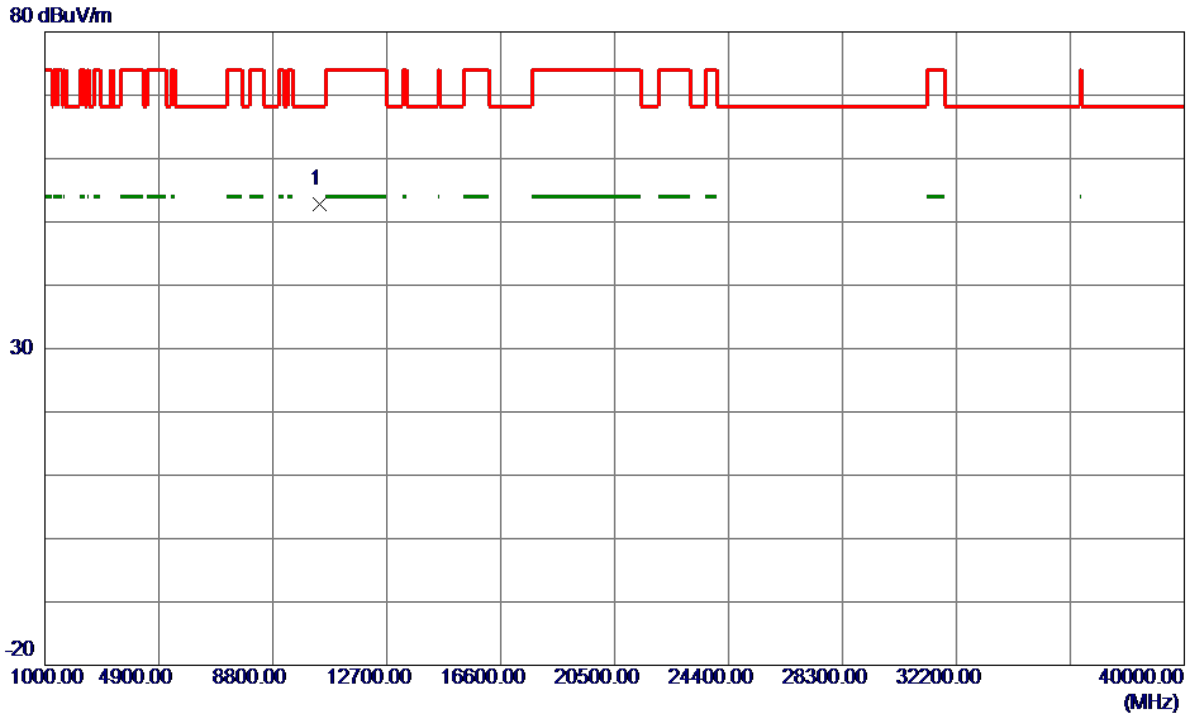

No.	Freq. MHz	Reading Level dBuV/m	Correct Factor dB	Measure ment dBuV/m	Limit dBuV/m	Margin dB	Detector	Comment
1 *	10398.1500	40.95	11.76	52.71	68.30	-15.59	Peak	

Orthogonal Axis:	X
Test Mode:	UNII-1/ TX AC20 Mode 5200 MHz

Horizontal

130 dBuV/m

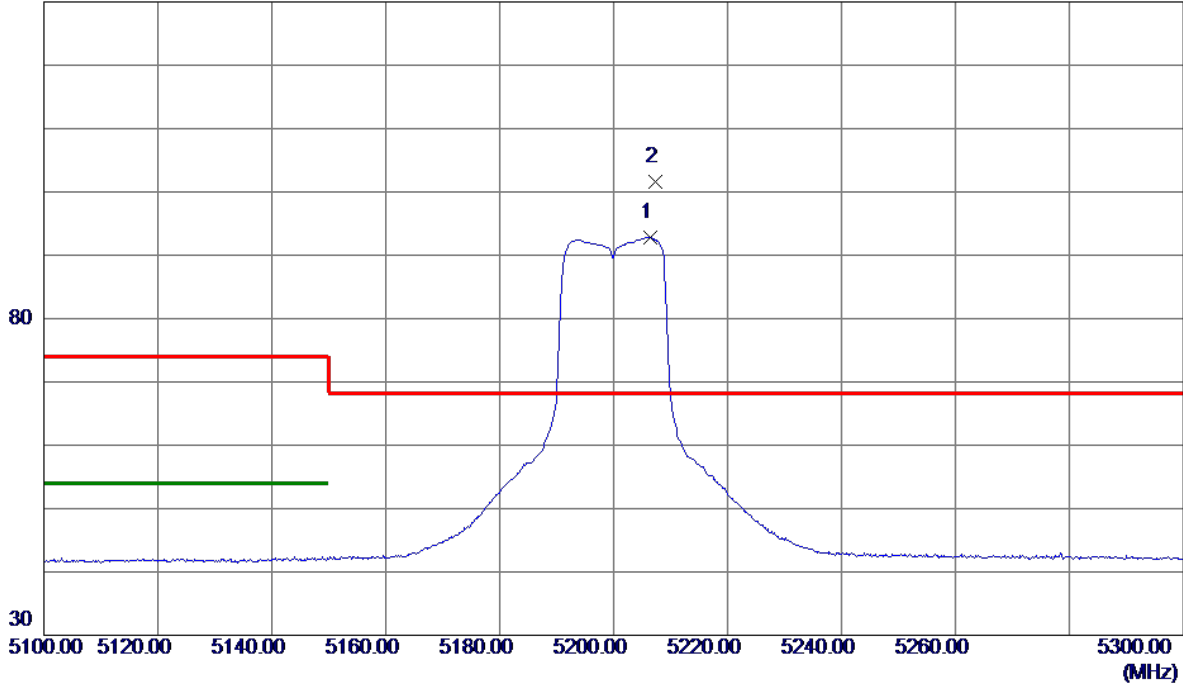

No.	Freq. MHz	Reading Level dBuV/m	Correct Factor dB	Measure ment dBuV/m	Limit dBuV/m	Margin dB	Detector	Comment
1	5206.4000	78.35	14.49	92.84	999.00	-906.16	AVG	No Limit
2 *	5207.3000	87.20	14.49	101.69	68.30	33.39	Peak	No Limit

Orthogonal Axis:	X
Test Mode:	UNII-1/ TX AC20 Mode 5200 MHz

Horizontal

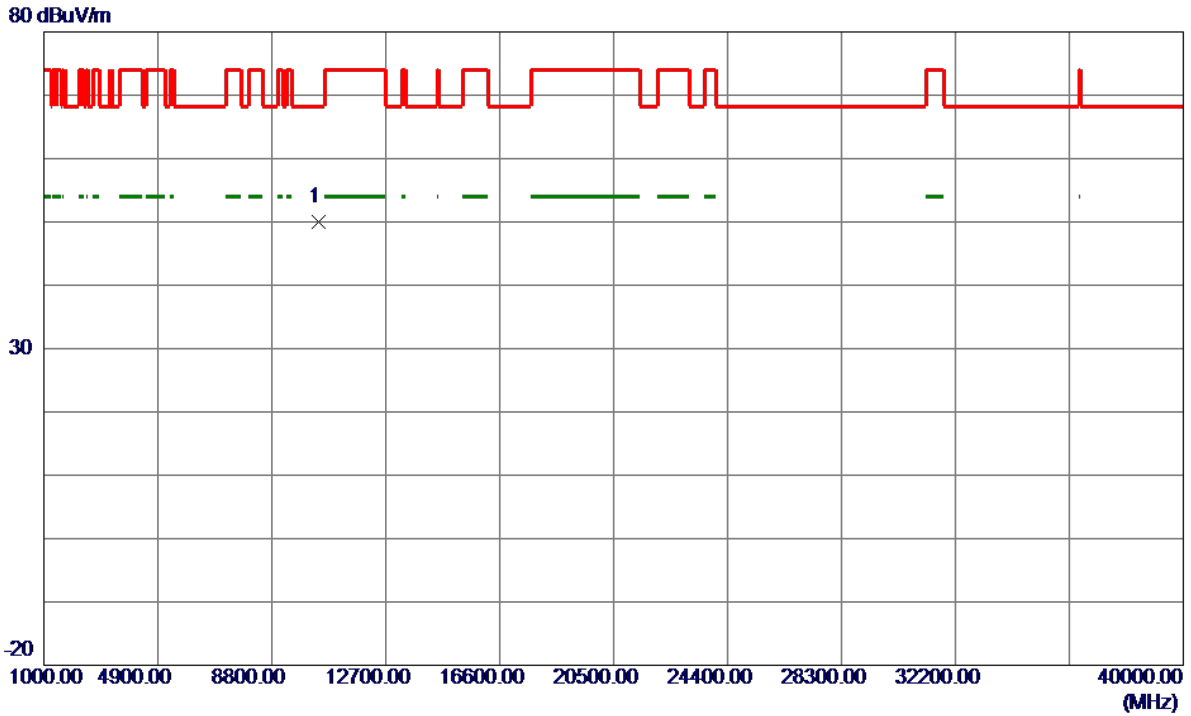

No.	Freq. MHz	Reading Level dBuV/m	Correct Factor dB	Measure ment dBuV/m	Limit dBuV/m	Margin dB	Detector	Comment
1 *	10397.6250	38.30	11.76	50.06	68.30	-18.24	Peak	

Orthogonal Axis:	X
Test Mode:	UNII-1/ TX AC20 Mode 5240 MHz

Vertical

130 dBuV/m

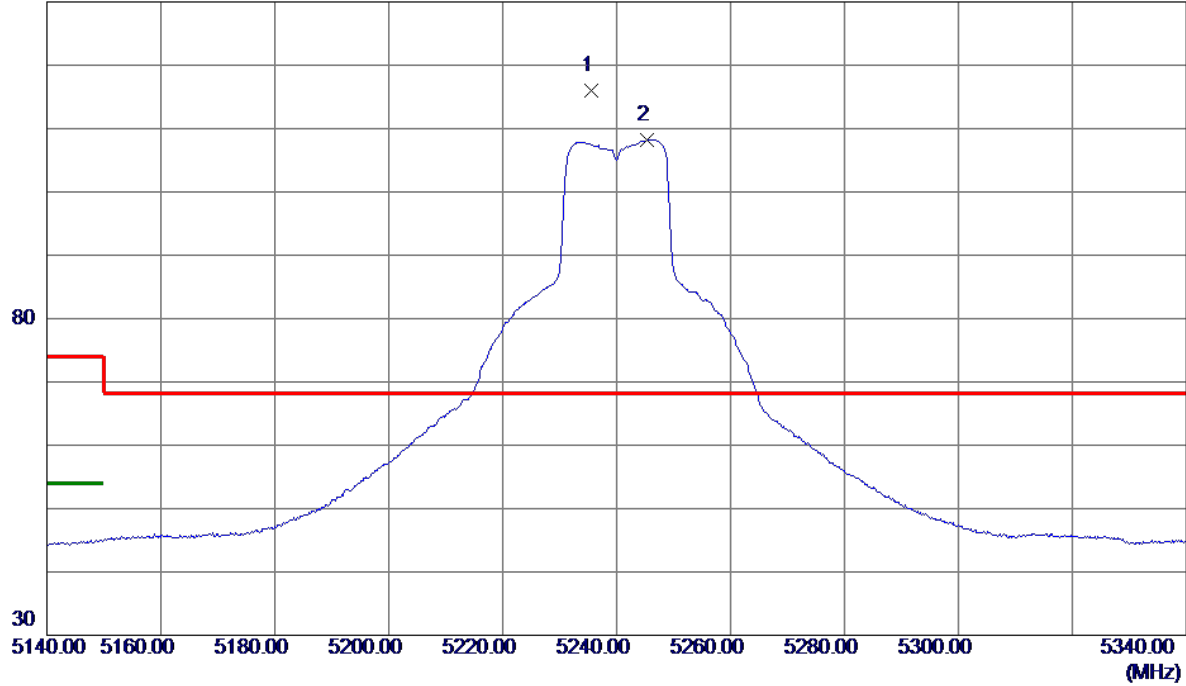

No.	Freq. MHz	Reading Level dBuV/m	Correct Factor dB	Measure ment dBuV/m	Limit dBuV/m	Margin dB	Detector	Comment
1 *	5235.6000	101.53	14.57	116.10	68.30	47.80	Peak	No Limit
2	5245.4000	93.61	14.59	108.20	999.00	-890.80	AVG	No Limit

Orthogonal Axis:	X
Test Mode:	UNII-1/ TX AC20 Mode 5240 MHz

Vertical

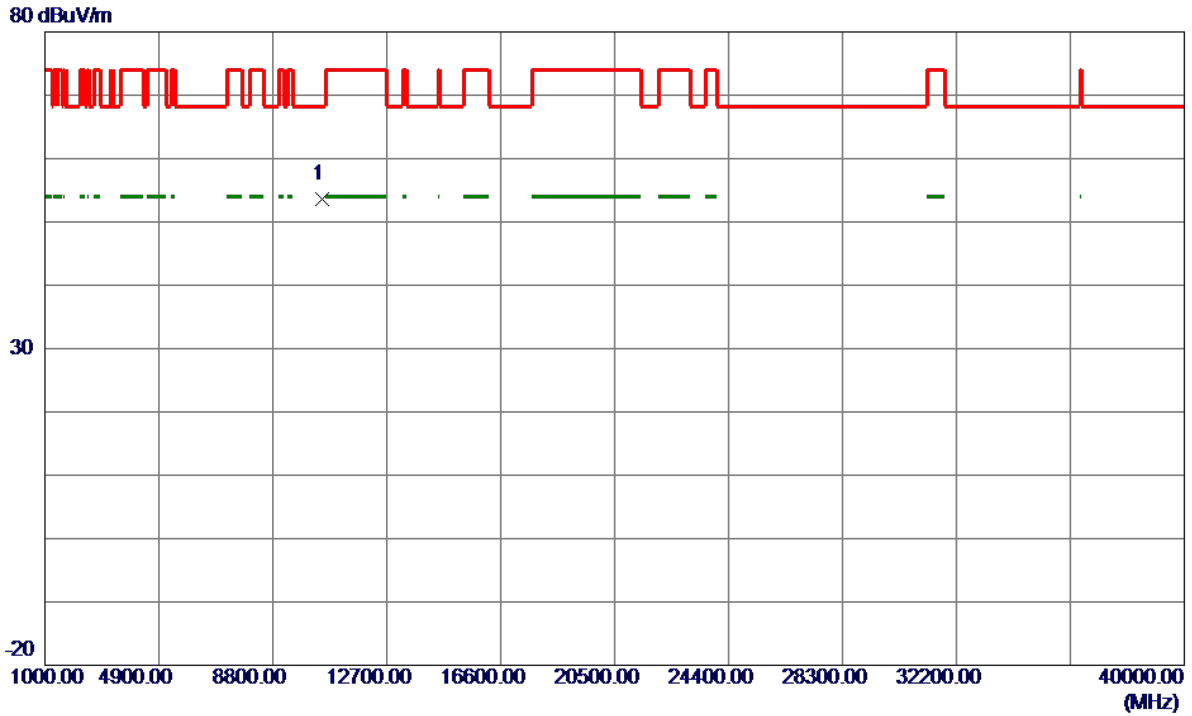

No.	Freq. MHz	Reading Level dBuV/m	Correct Factor dB	Measure ment dBuV/m	Limit dBuV/m	Margin dB	Detector	Comment
1 *	10483.0000	41.76	11.91	53.67	68.30	-14.63	Peak	

Orthogonal Axis:	X
Test Mode:	UNII-1/ TX AC20 Mode 5240 MHz

Horizontal

130 dBuV/m

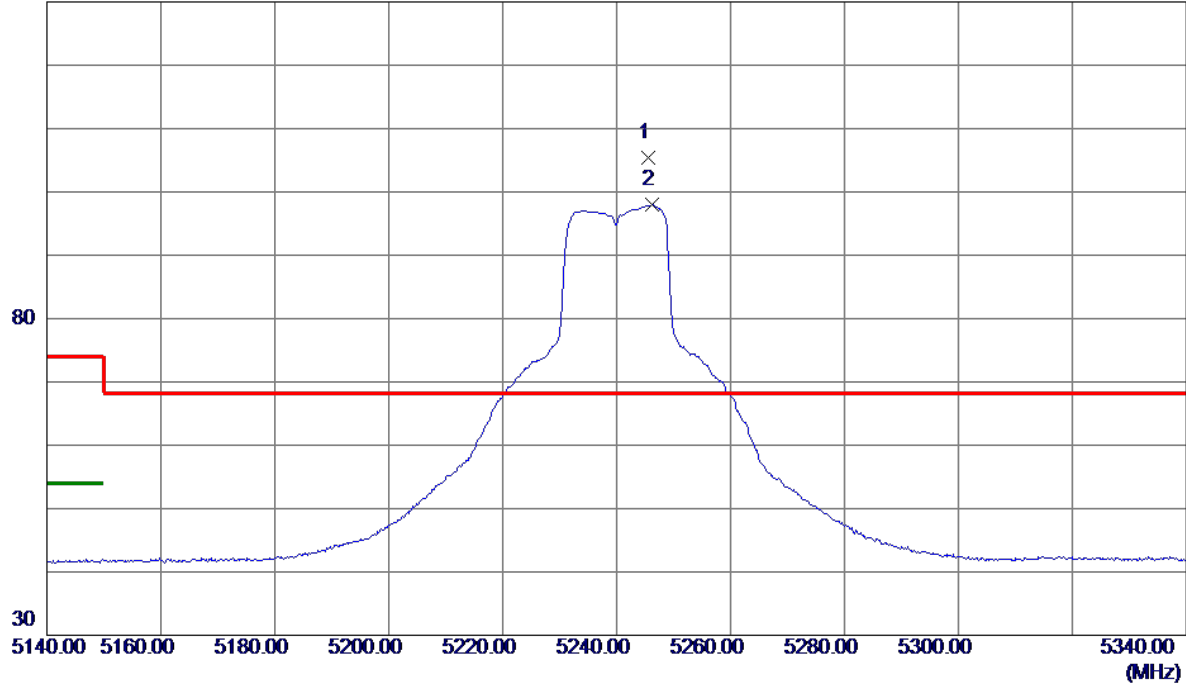

No.	Freq. MHz	Reading Level dBuV/m	Correct Factor dB	Measure ment dBuV/m	Limit dBuV/m	Margin dB	Detector	Comment
1 *	5245.5000	90.72	14.59	105.31	68.30	37.01	Peak	No Limit
2	5246.3000	83.36	14.59	97.95	999.00	-901.05	AVG	No Limit

Orthogonal Axis:	X
Test Mode:	UNII-1/ TX AC20 Mode 5240 MHz

Horizontal

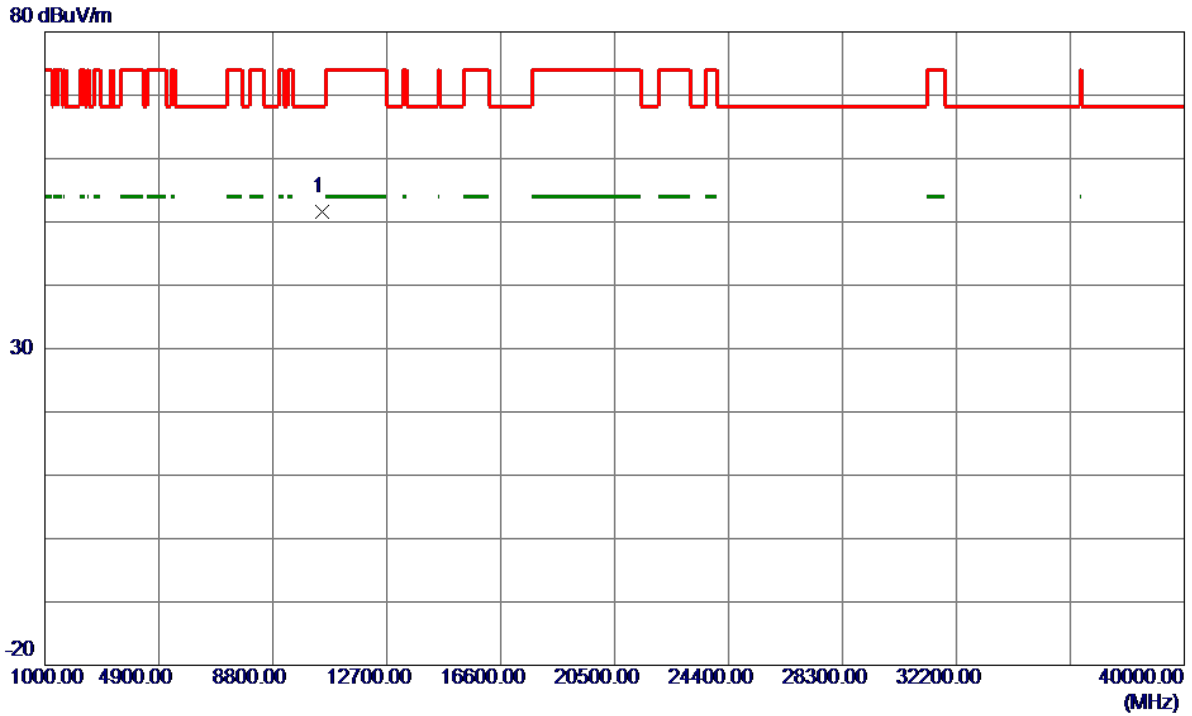

No.	Freq. MHz	Reading Level dBuV/m	Correct Factor dB	Measure ment dBuV/m	Limit dBuV/m	Margin dB	Detector	Comment
1 *	10479.9500	39.66	11.90	51.56	68.30	-16.74	Peak	

Orthogonal Axis:	X
Test Mode:	UNII-1/ TX AC40 Mode 5190MHz

Vertical

130 dBuV/m

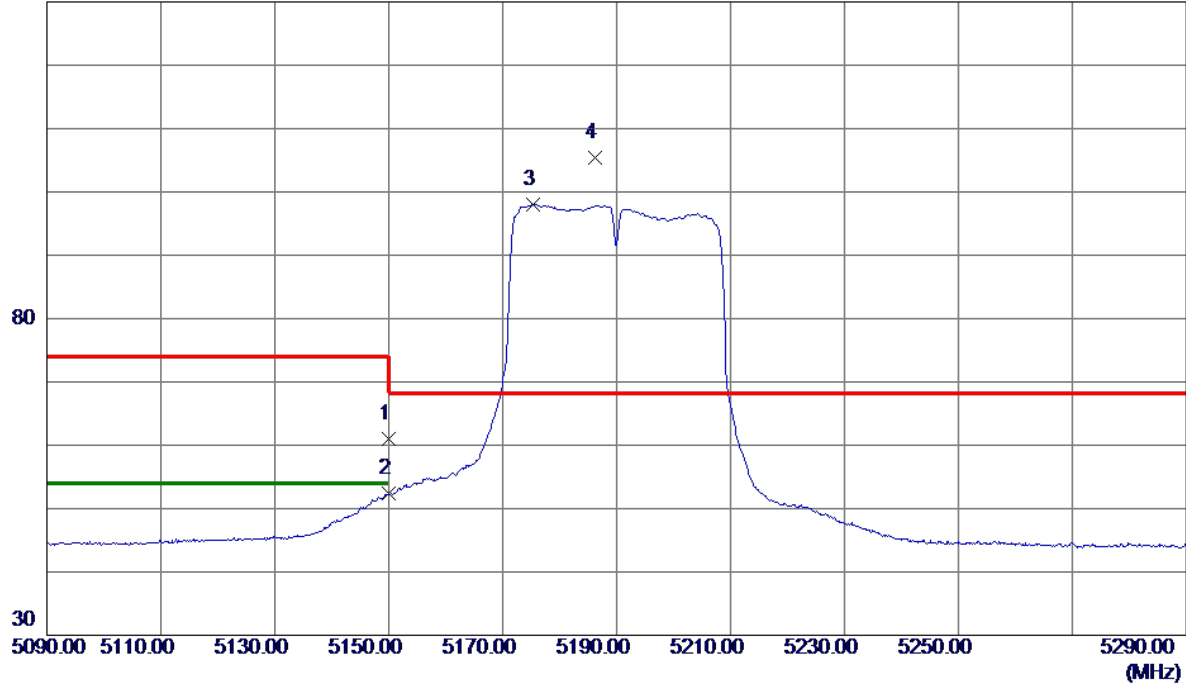

No.	Freq. MHz	Reading Level dBuV/m	Correct Factor dB	Measure ment dBuV/m	Limit dBuV/m	Margin dB	Detector	Comment
1	5150.0000	46.59	14.35	60.94	74.00	-13.06	Peak	
2	5150.0000	38.07	14.35	52.42	54.00	-1.58	AVG	
3	5175.4000	83.68	14.41	98.09	999.00	-900.91	AVG	No Limit
4 *	5186.2000	91.04	14.44	105.48	68.30	37.18	Peak	No Limit

Orthogonal Axis:	X
Test Mode:	UNII-1/ TX AC40 Mode 5190MHz

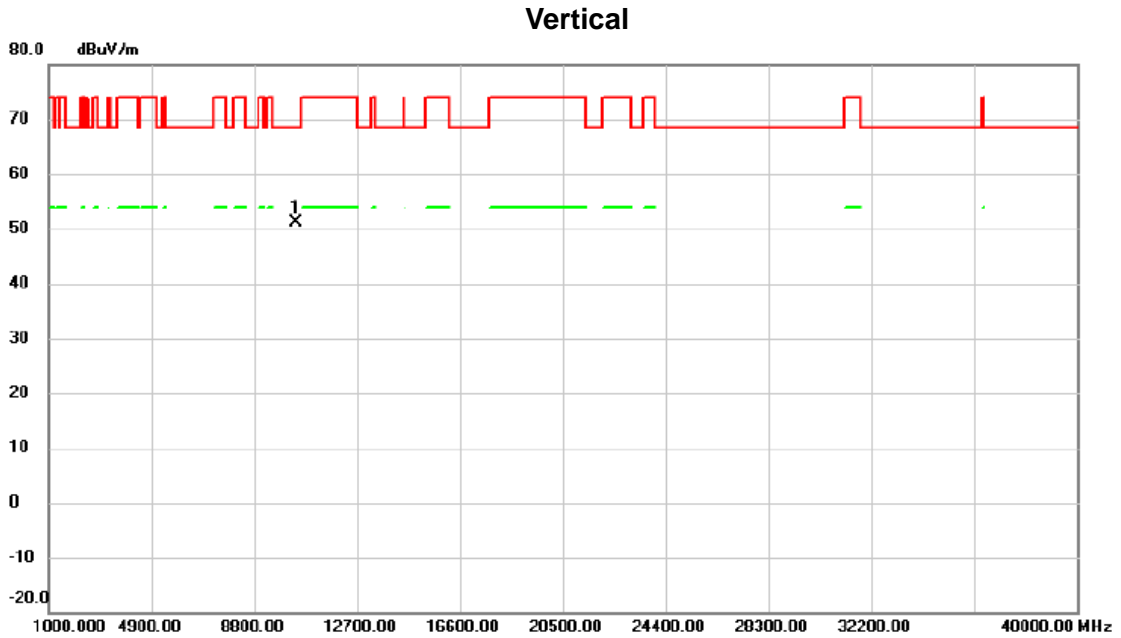

No.	Mk.	Freq.	Reading Level	Correct Factor	Measurement	Limit	Margin	Detector	Comment
		MHz	dBuV	dB	dBuV/m	dBuV/m	dB		
1	*	10381.150	39.36	11.74	51.10	68.30	-17.20	peak	

Orthogonal Axis:	X
Test Mode:	UNII-1/ TX AC40 Mode 5190MHz

Horizontal

130 dBuV/m

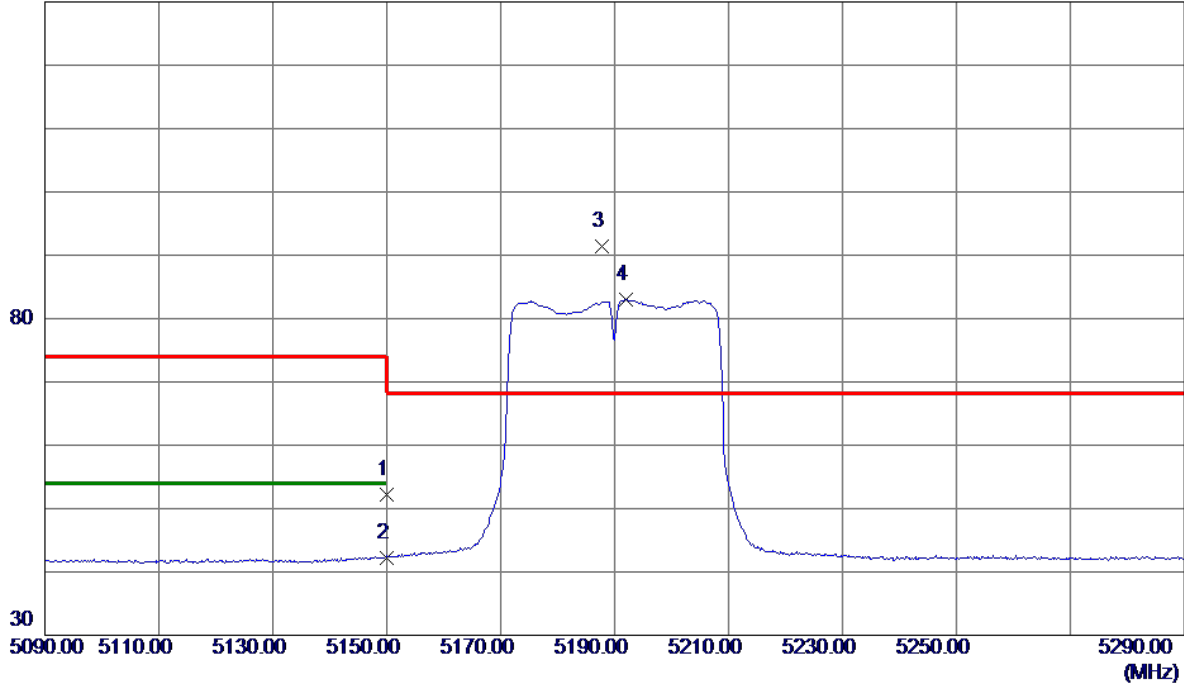

No.	Freq. MHz	Reading Level dBuV/m	Correct Factor dB	Measure ment dBuV/m	Limit dBuV/m	Margin dB	Detector	Comment
1	5150.0000	37.79	14.35	52.14	74.00	-21.86	Peak	
2	5150.0000	27.90	14.35	42.25	54.00	-11.75	AVG	
3 *	5187.8000	76.90	14.44	91.34	68.30	23.04	Peak	No Limit
4	5192.1000	68.57	14.45	83.02	999.00	-915.98	AVG	No Limit

Orthogonal Axis:	X
Test Mode:	UNII-1/ TX AC40 Mode 5190MHz

Horizontal

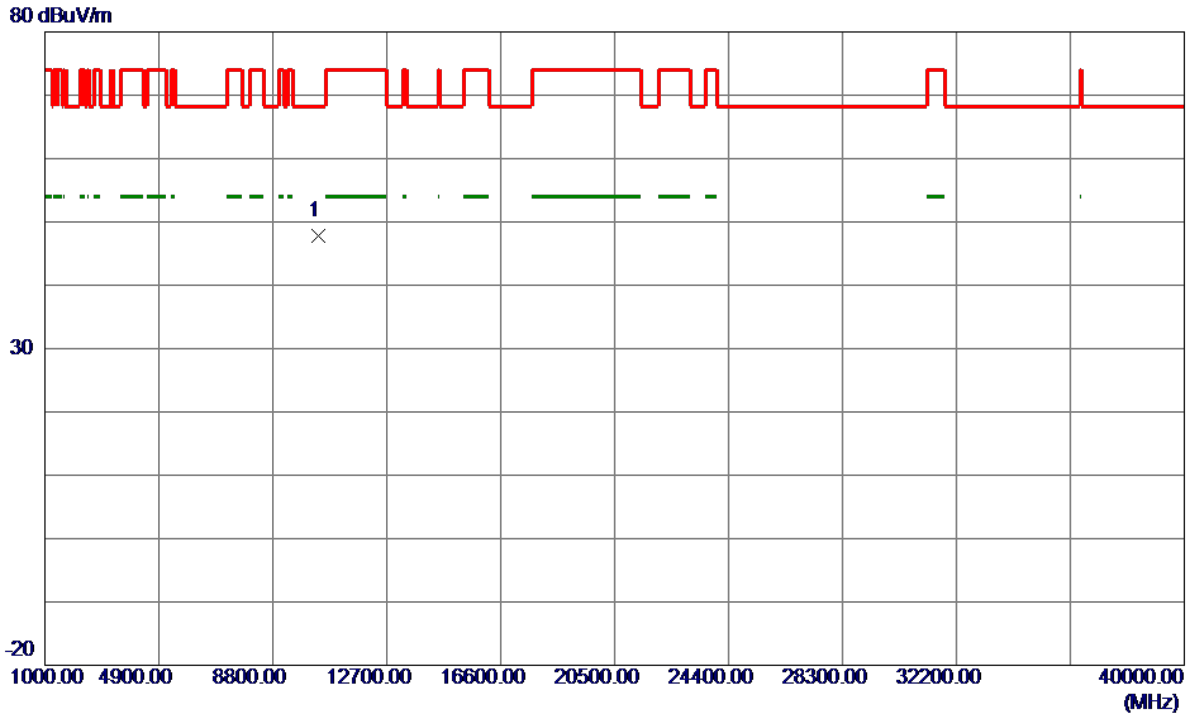

No.	Freq. MHz	Reading Level dBuV/m	Correct Factor dB	Measure ment dBuV/m	Limit dBuV/m	Margin dB	Detector	Comment
1 *	10375.0000	36.14	11.72	47.86	68.30	-20.44	Peak	

Orthogonal Axis:	X
Test Mode:	UNII-1/ TX AC40 Mode 5230MHz

Vertical

130 dBuV/m

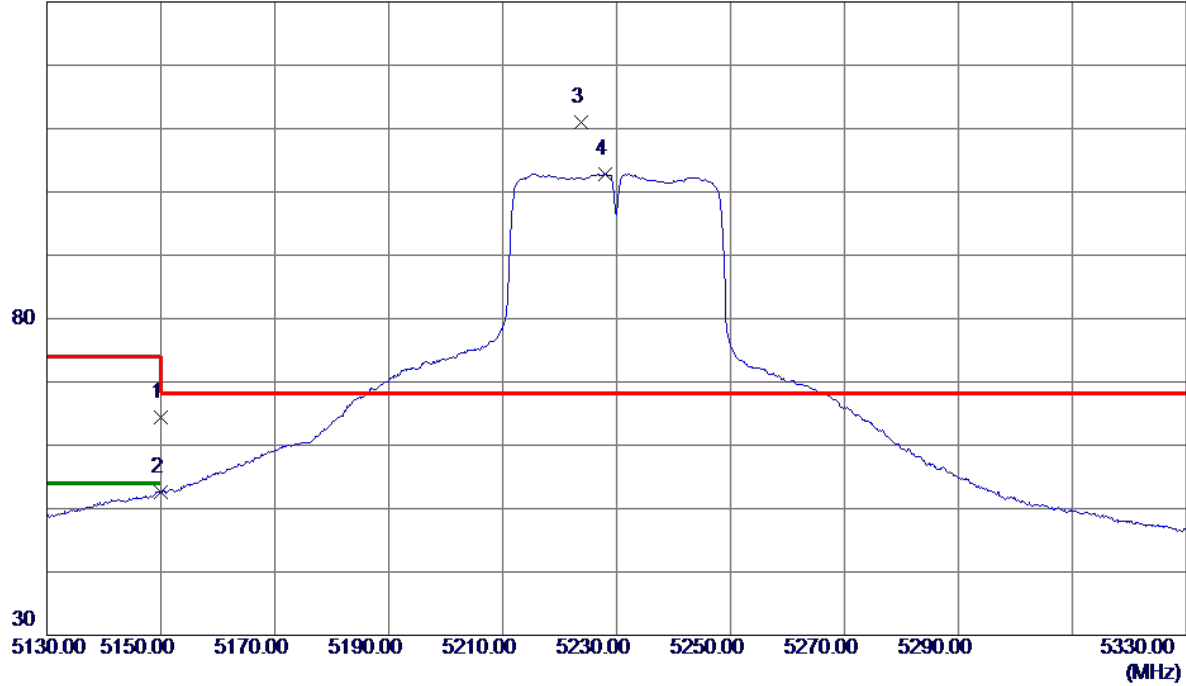

No.	Freq. MHz	Reading Level dBuV/m	Correct Factor dB	Measure ment dBuV/m	Limit dBuV/m	Margin dB	Detector	Comment
1	5150.0000	50.09	14.35	64.44	74.00	-9.56	Peak	
2	5150.0000	38.16	14.35	52.51	54.00	-1.49	AVG	
3 *	5223.8000	96.56	14.54	111.10	68.30	42.80	Peak	No Limit
4	5228.1000	88.30	14.55	102.85	999.00	-896.15	AVG	No Limit

Orthogonal Axis:	X
Test Mode:	UNII-1/ TX AC40 Mode 5230MHz

Vertical

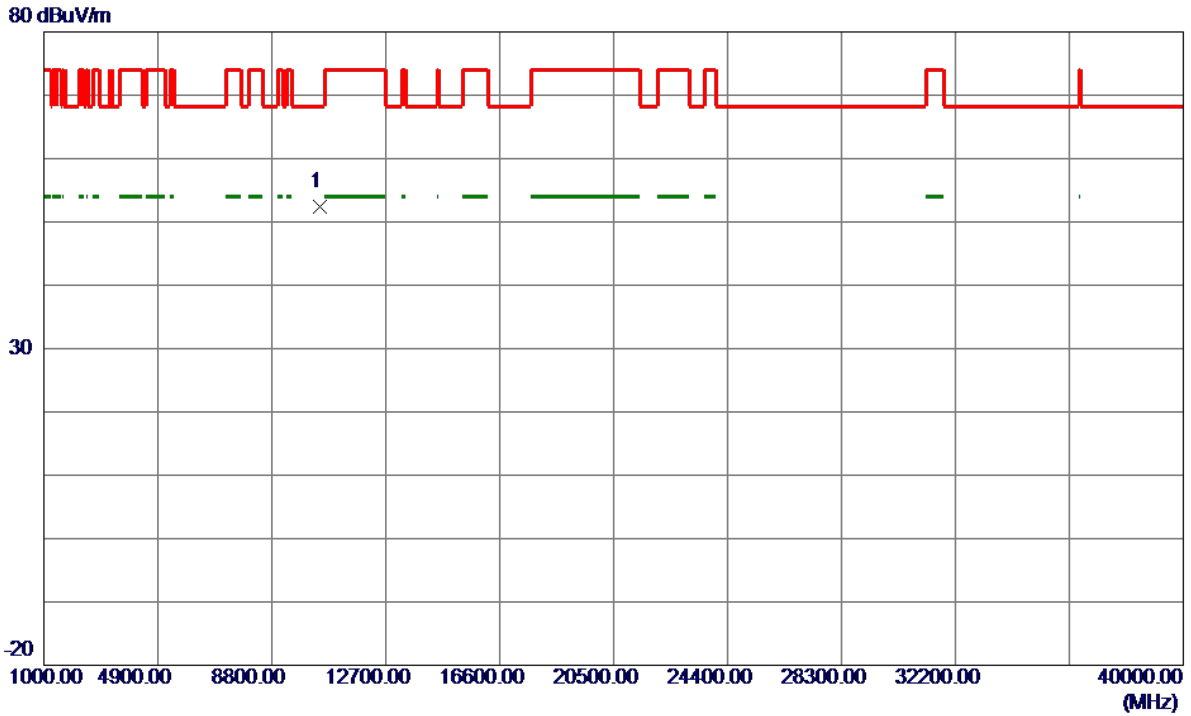

No.	Freq. MHz	Reading Level dBuV/m	Correct Factor dB	Measure ment dBuV/m	Limit dBuV/m	Margin dB	Detector	Comment
1 *	10457.0750	40.60	11.86	52.46	68.30	-15.84	Peak	

Orthogonal Axis:	X
Test Mode:	UNII-1/ TX AC40 Mode 5230MHz

Horizontal

130 dBuV/m

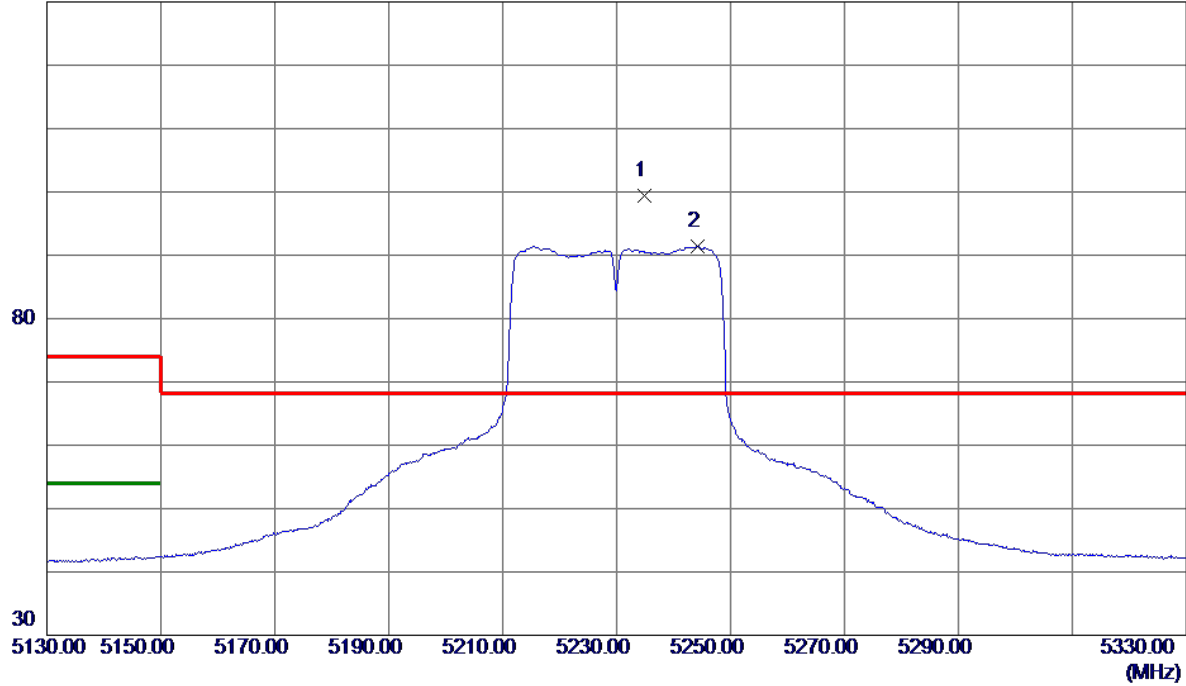

No.	Freq. MHz	Reading Level dBuV/m	Correct Factor dB	Measure ment dBuV/m	Limit dBuV/m	Margin dB	Detector	Comment
1 *	5234.9000	84.87	14.56	99.43	68.30	31.13	Peak	No Limit
2	5244.2000	76.85	14.59	91.44	999.00	-907.56	AVG	No Limit

Orthogonal Axis:	X
Test Mode:	UNII-1/ TX AC40 Mode 5230MHz

Horizontal

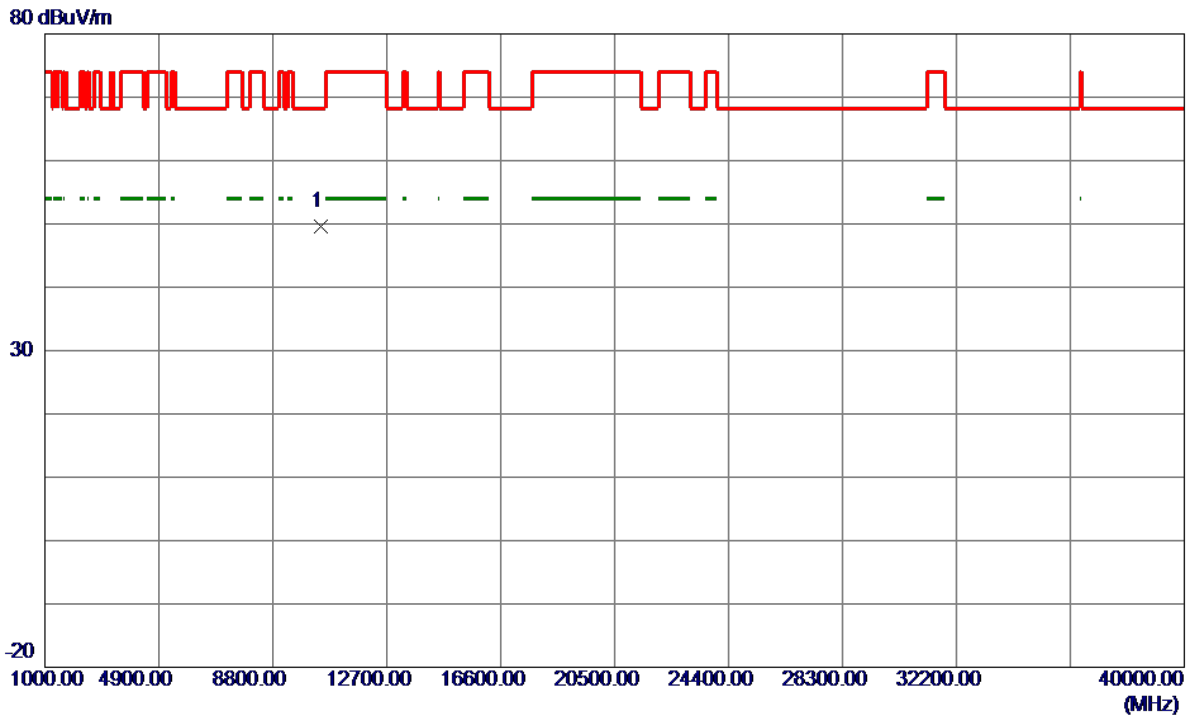

No.	Freq. MHz	Reading Level dBuV/m	Correct Factor dB	Measure ment dBuV/m	Limit dBuV/m	Margin dB	Detector	Comment
1 *	10462.0500	37.66	11.87	49.53	68.30	-18.77	Peak	

Orthogonal Axis:	X
Test Mode:	UNII-1/ TX AC80 Mode 5210MHz

Vertical

130 dBuV/m

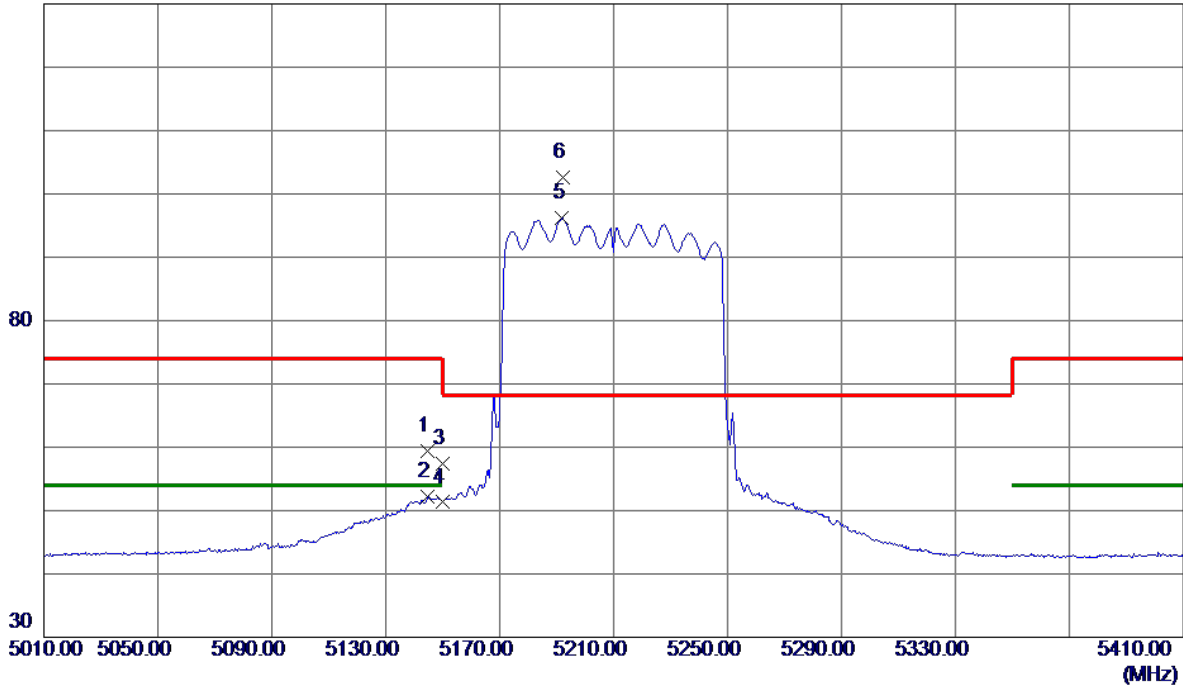

No.	Freq. MHz	Reading Level dBuV/m	Correct Factor dB	Measure ment dBuV/m	Limit dBuV/m	Margin dB	Detector	Comment
1	5144.8000	45.10	14.33	59.43	74.00	-14.57	Peak	
2	5144.8000	37.87	14.33	52.20	54.00	-1.80	AVG	
3	5150.0000	43.10	14.35	57.45	74.00	-16.55	Peak	
4	5150.0000	36.95	14.35	51.30	54.00	-2.70	AVG	
5	5192.0000	81.71	14.45	96.16	999.00	-902.84	AVG	No Limit
6 *	5192.4000	88.21	14.45	102.66	68.30	34.36	Peak	No Limit

Orthogonal Axis:	X
Test Mode:	UNII-1/ TX AC80 Mode 5210MHz

Vertical

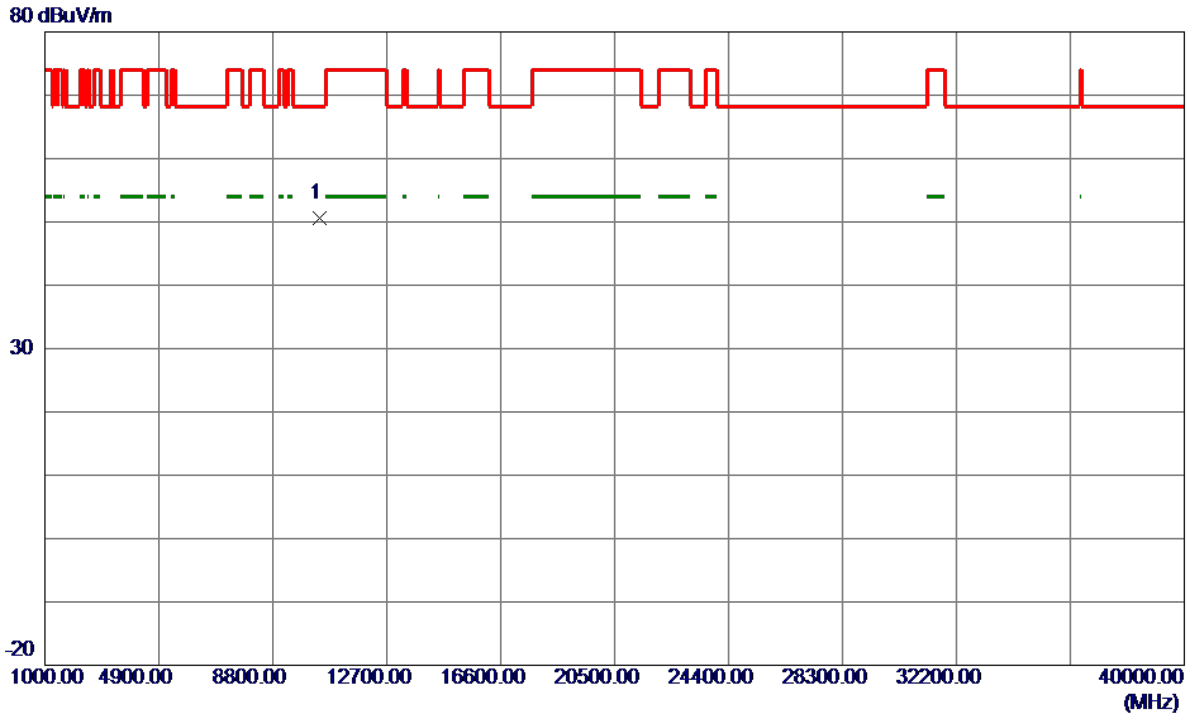

No.	Freq. MHz	Reading Level dBuV/m	Correct Factor dB	Measure ment dBuV/m	Limit dBuV/m	Margin dB	Detector	Comment
1 *	10420.5000	38.81	11.80	50.61	68.30	-17.69	Peak	

Orthogonal Axis:	X
Test Mode:	UNII-1/ TX AC80 Mode 5210MHz

Horizontal

130 dBuV/m

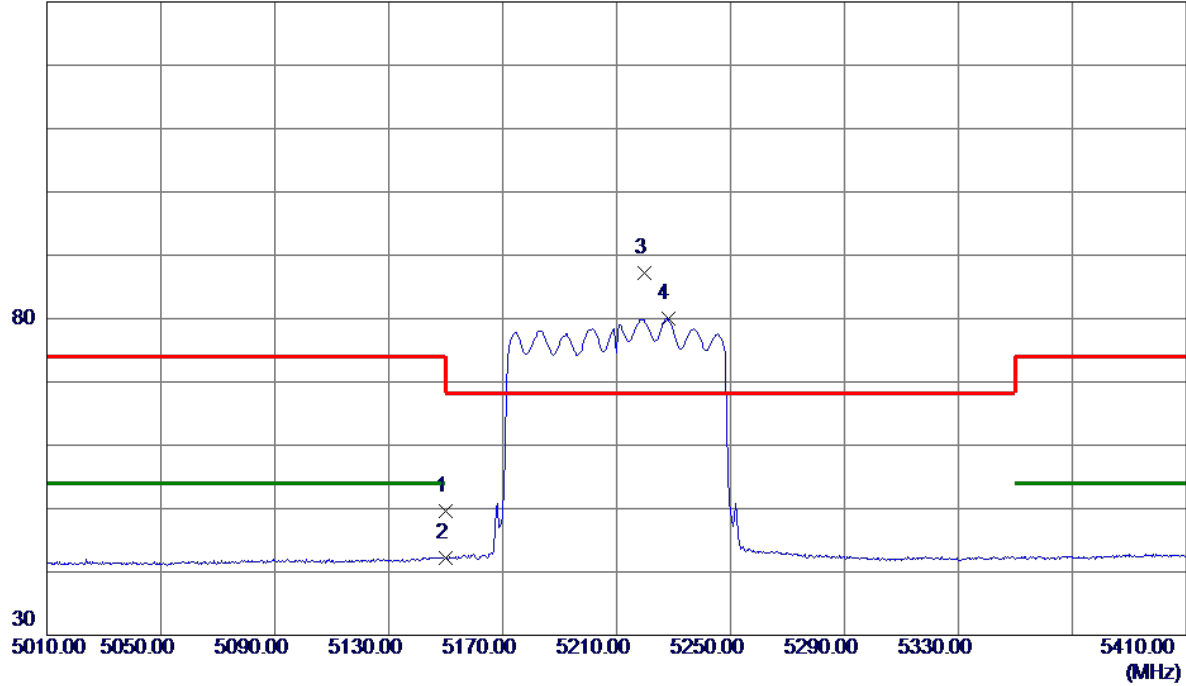

No.	Freq. MHz	Reading Level dBuV/m	Correct Factor dB	Measure ment dBuV/m	Limit dBuV/m	Margin dB	Detector	Comment
1	5150.0000	35.18	14.35	49.53	74.00	-24.47	Peak	
2	5150.0000	27.78	14.35	42.13	54.00	-11.87	AVG	
3 *	5219.8000	72.74	14.52	87.26	68.30	18.96	Peak	No Limit
4	5228.0000	65.52	14.55	80.07	999.00	-918.93	AVG	No Limit

Orthogonal Axis:	X
Test Mode:	UNII-1/ TX AC80 Mode 5210MHz

Horizontal

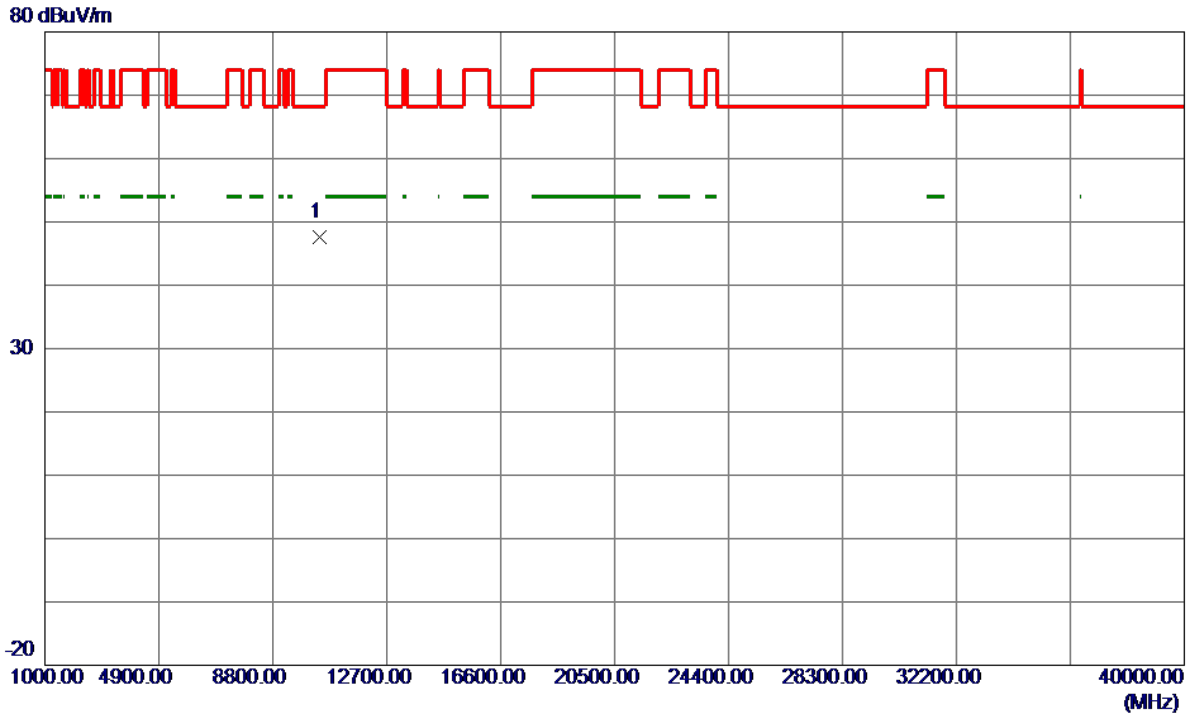

No.	Freq. MHz	Reading Level dBuV/m	Correct Factor dB	Measure ment dBuV/m	Limit dBuV/m	Margin dB	Detector	Comment
1 *	10421.1500	35.89	11.80	47.69	68.30	-20.61	Peak	

Orthogonal Axis:	X
Test Mode:	UNII-3/TX AC20 Mode 5745 MHz

Vertical

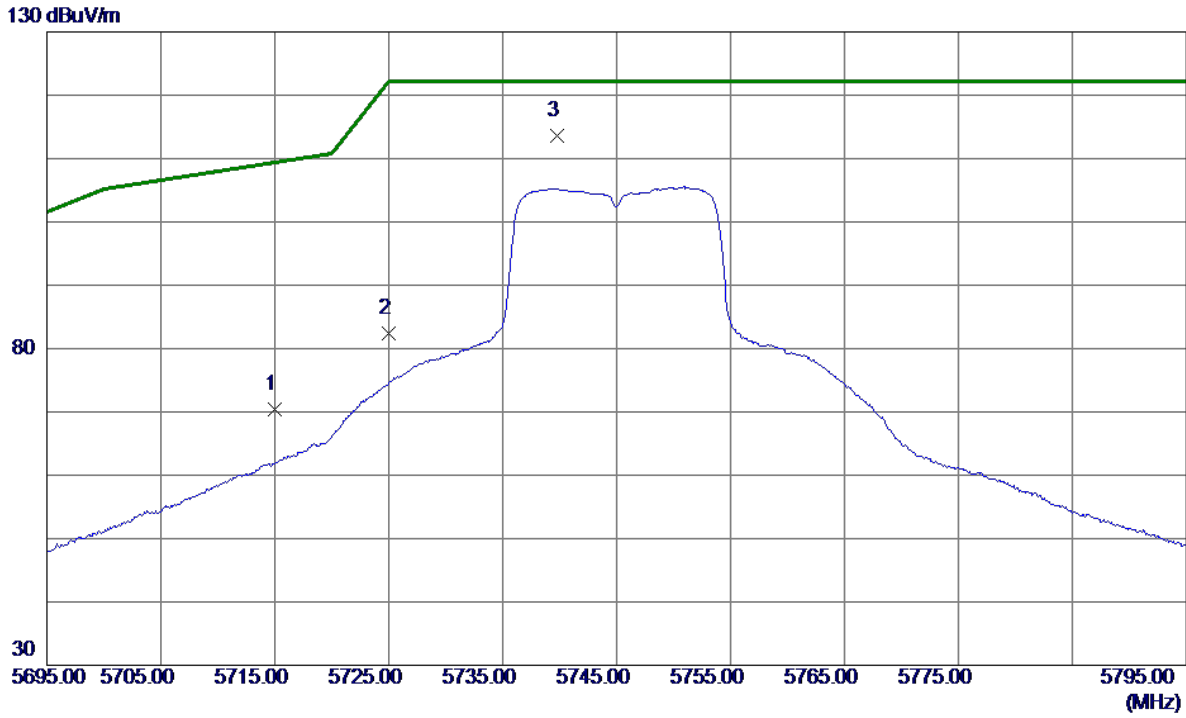

No.	Freq. MHz	Reading Level dBuV/m	Correct Factor dB	Measure ment dBuV/m	Limit dBuV/m	Margin dB	Detector	Comment
1	5715.0000	54.48	15.93	70.41	109.40	-38.99	Peak	
2	5725.0000	66.38	15.96	82.34	122.20	-39.86	Peak	
3 *	5739.8000	97.59	16.01	113.60	122.20	-8.60	Peak	No Limit

Orthogonal Axis:	X
Test Mode:	UNII-3/TX AC20 Mode 5745 MHz

Vertical

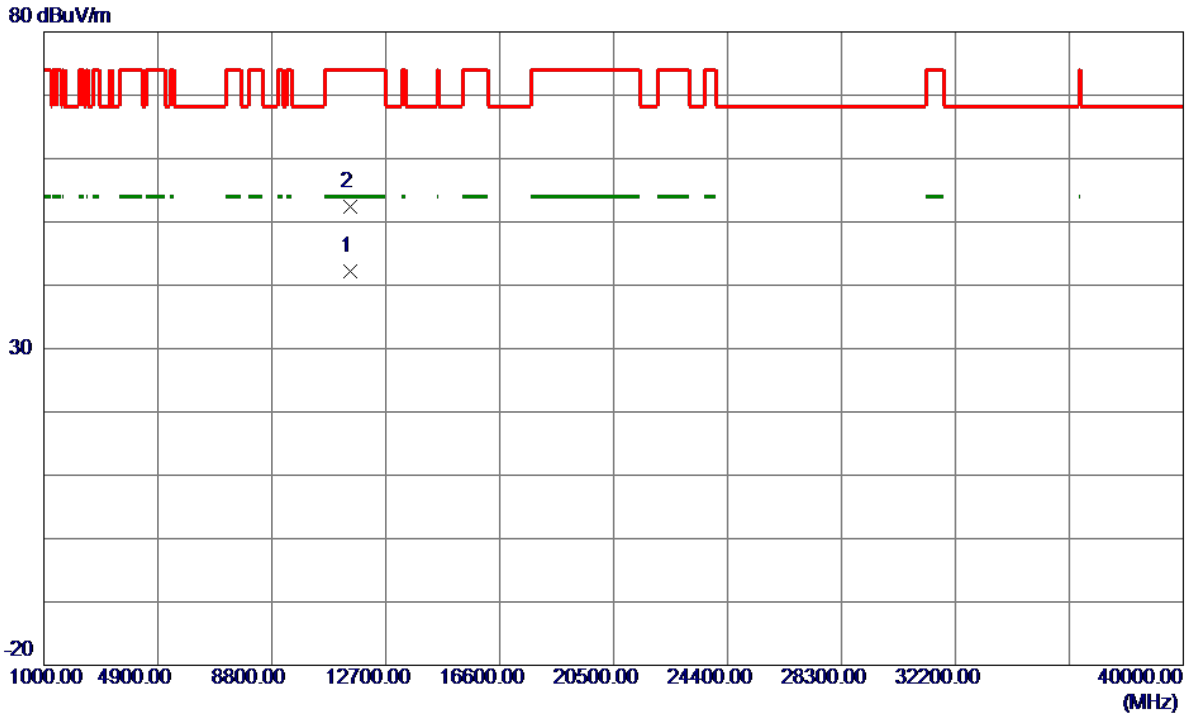

No.	Freq. MHz	Reading Level dBuV/m	Correct Factor dB	Measure ment dBuV/m	Limit dBuV/m	Margin dB	Detector	Comment
1 *	11490.0300	29.69	12.47	42.16	54.00	-11.84	AVG	
2	11490.2850	39.96	12.47	52.43	74.00	-21.57	Peak	

Orthogonal Axis:	X
Test Mode:	UNII-3/TX AC20 Mode 5745 MHz

Horizontal

130 dBuV/m

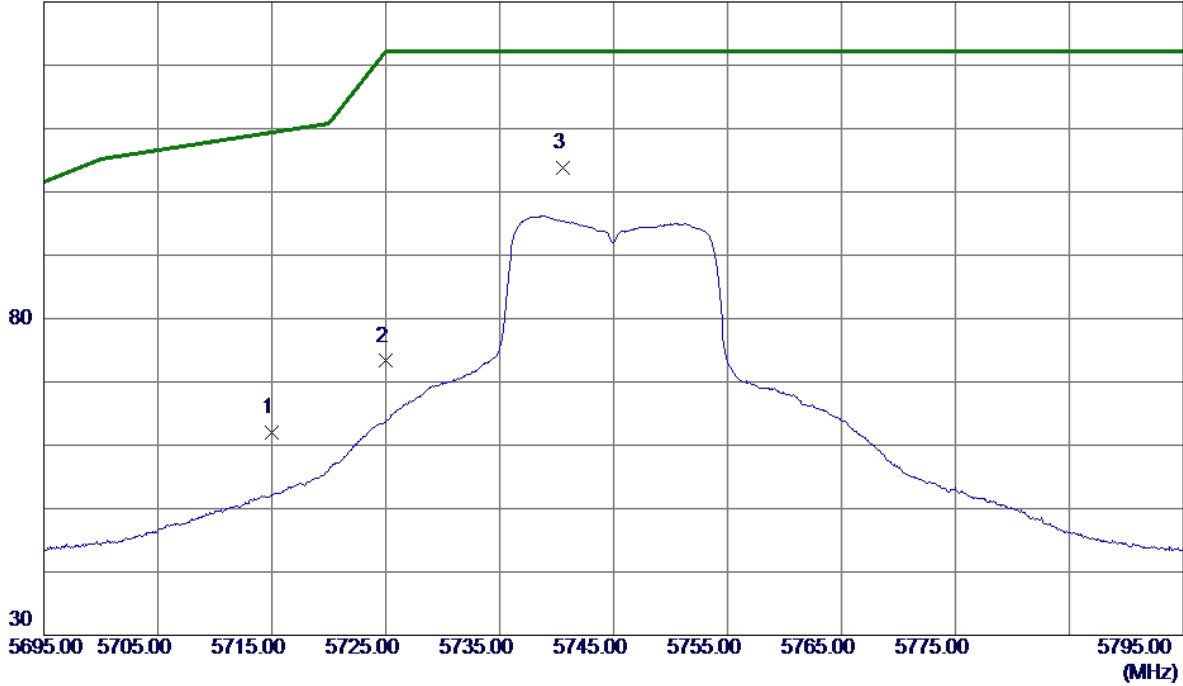

No.	Freq. MHz	Reading Level dBuV/m	Correct Factor dB	Measure ment dBuV/m	Limit dBuV/m	Margin dB	Detector	Comment
1	5715.0000	46.15	15.93	62.08	109.40	-47.32	Peak	
2	5725.0000	57.34	15.96	73.30	122.20	-48.90	Peak	
3 *	5740.5500	87.87	16.01	103.88	122.20	-18.32	Peak	No Limit

Orthogonal Axis:	X
Test Mode:	UNII-3/TX AC20 Mode 5745 MHz

Horizontal

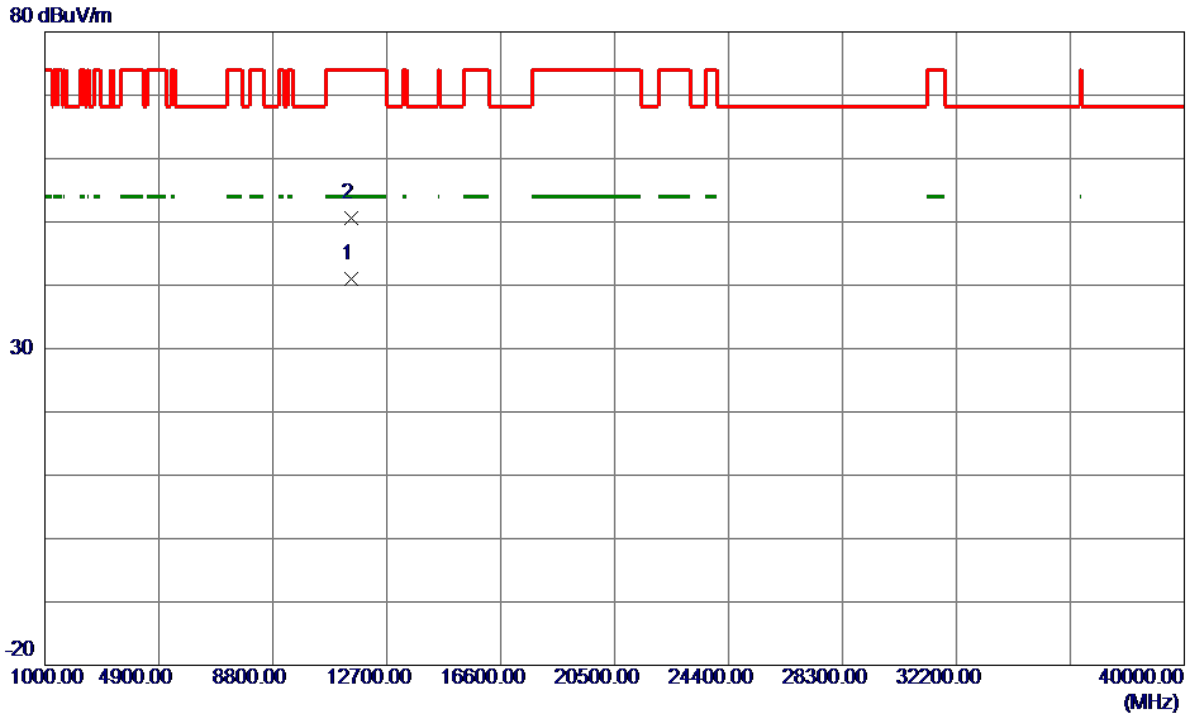

No.	Freq. MHz	Reading Level dBuV/m	Correct Factor dB	Measure ment dBuV/m	Limit dBuV/m	Margin dB	Detector	Comment
1 *	11489.8050	28.44	12.47	40.91	54.00	-13.09	AVG	
2	11499.3600	38.06	12.47	50.53	74.00	-23.47	Peak	

Orthogonal Axis:	X
Test Mode:	UNII-3/TX AC20 Mode 5785 MHz

Vertical

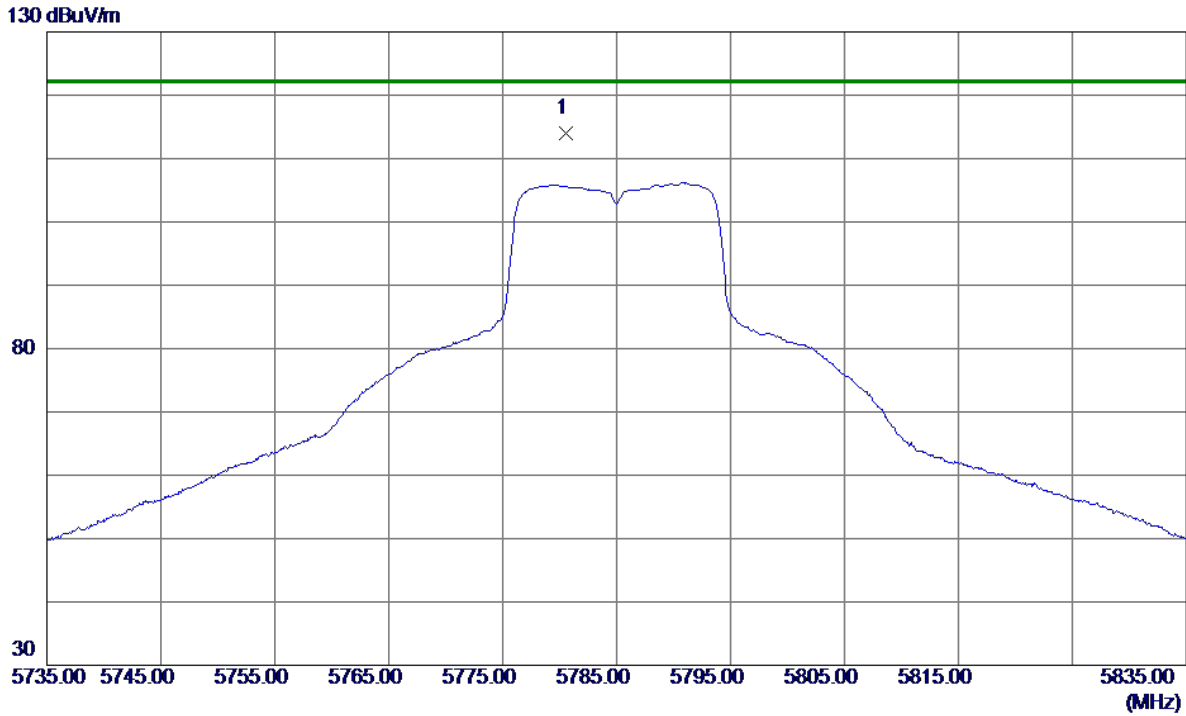

No.	Freq. MHz	Reading Level dBuV/m	Correct Factor dB	Measure ment dBuV/m	Limit dBuV/m	Margin dB	Detector	Comment
1 *	5780.6000	97.89	16.13	114.02	122.20	-8.18	Peak	No Limit

Orthogonal Axis:	X
Test Mode:	UNII-3/TX AC20 Mode 5785 MHz

Vertical

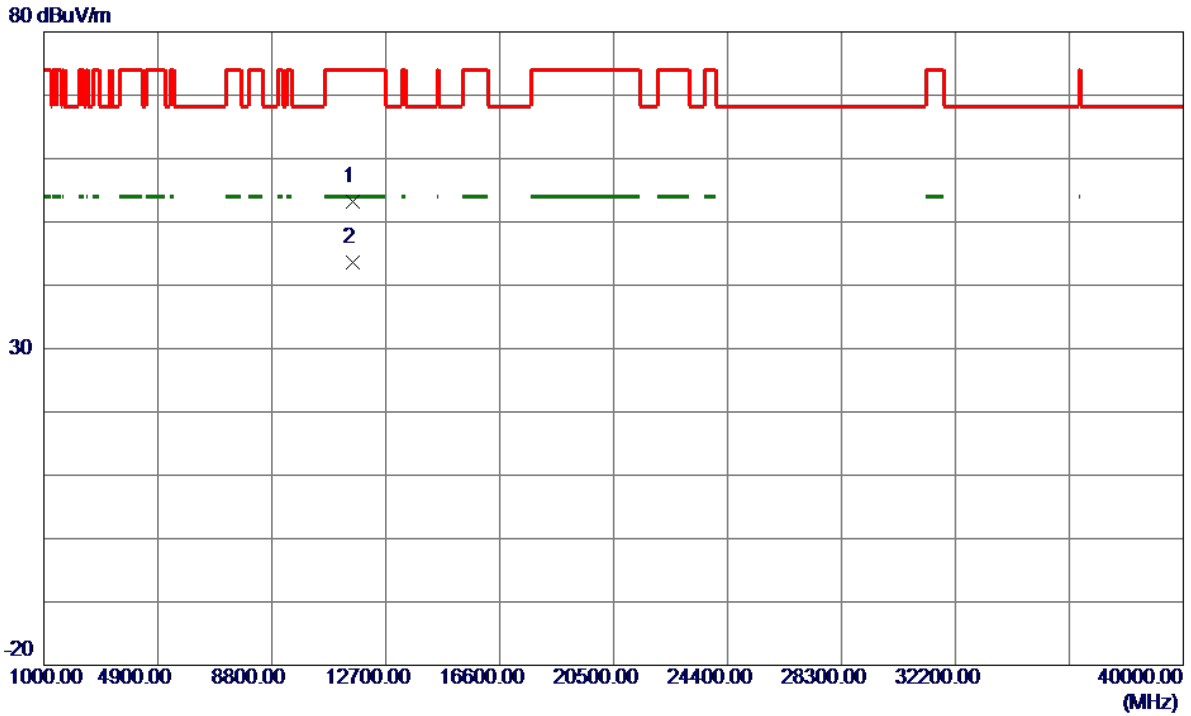

No.	Freq. MHz	Reading Level dBuV/m	Correct Factor dB	Measure ment dBuV/m	Limit dBuV/m	Margin dB	Detector	Comment
1	11566.9100	40.65	12.52	53.17	74.00	-20.83	Peak	
2 *	11569.9250	31.07	12.52	43.59	54.00	-10.41	AVG	

Orthogonal Axis:	X
Test Mode:	UNII-3/TX AC20 Mode 5785 MHz

Horizontal

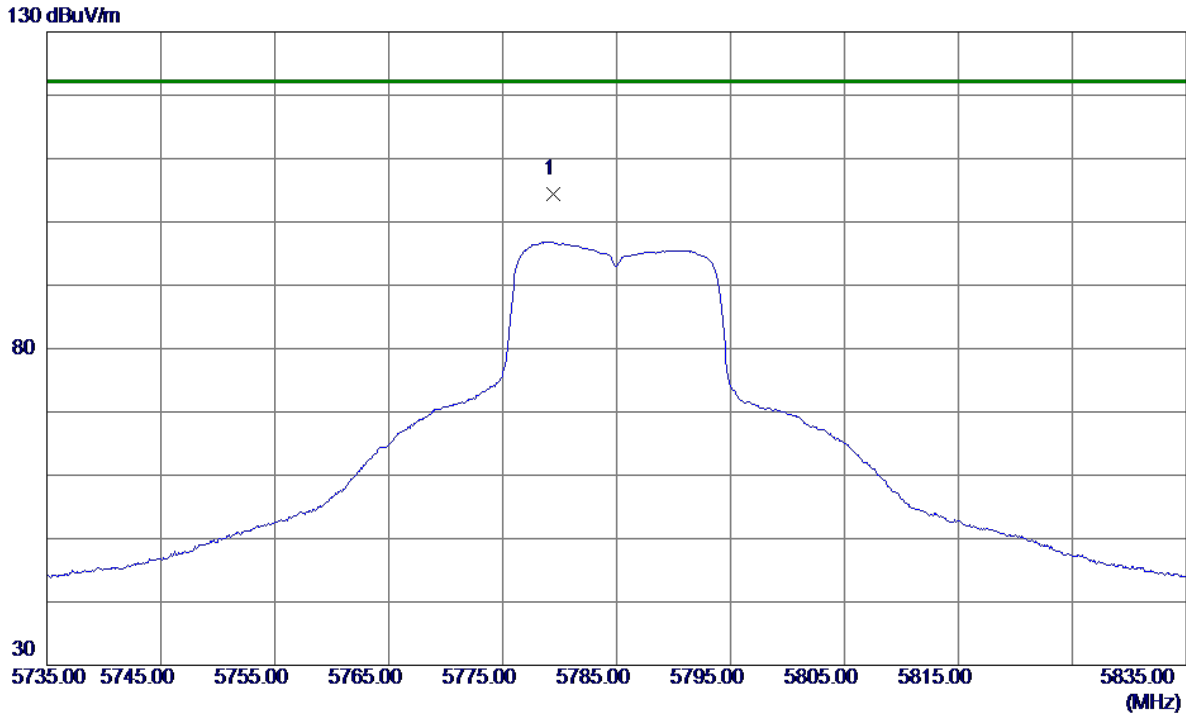

No.	Freq. MHz	Reading Level dBuV/m	Correct Factor dB	Measure ment dBuV/m	Limit dBuV/m	Margin dB	Detector	Comment
1 *	5779.4500	88.36	16.13	104.49	122.20	-17.71	Peak	No Limit

Orthogonal Axis:	X
Test Mode:	UNII-3/TX AC20 Mode 5785 MHz

Horizontal

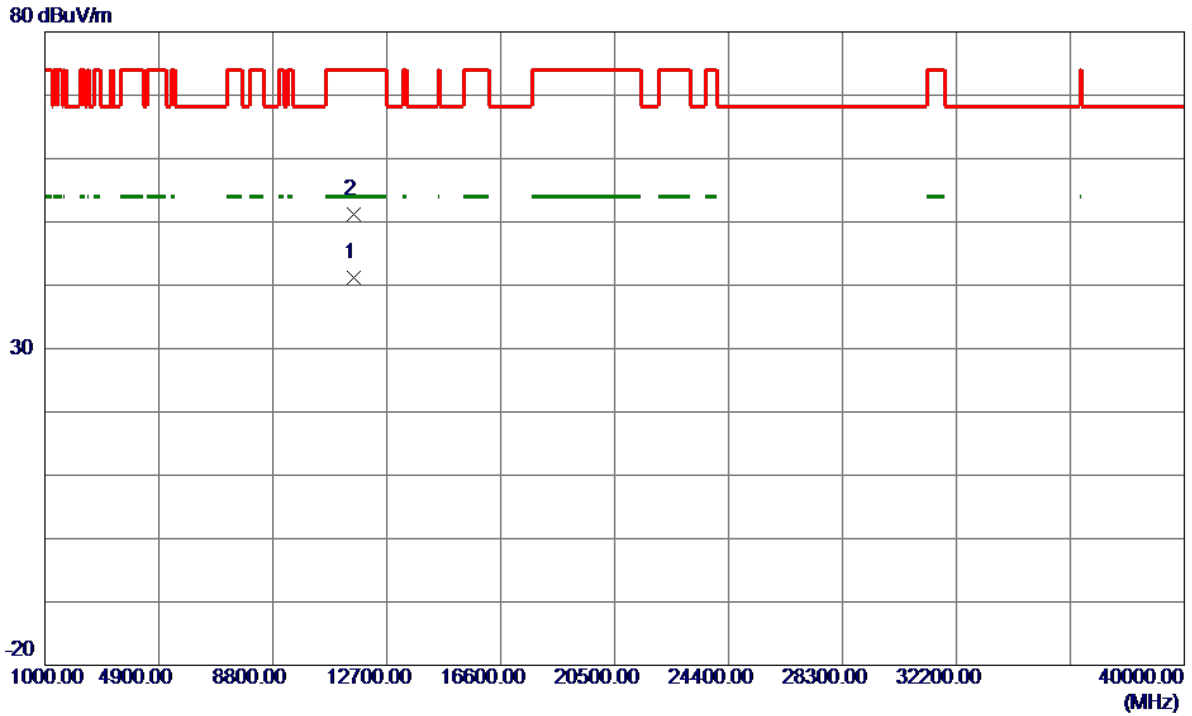

No.	Freq. MHz	Reading Level dBuV/m	Correct Factor dB	Measure ment dBuV/m	Limit dBuV/m	Margin dB	Detector	Comment
1 *	11570.1800	28.73	12.52	41.25	54.00	-12.75	AVG	
2	11572.1000	38.68	12.52	51.20	74.00	-22.80	Peak	

Orthogonal Axis:	X
Test Mode:	UNII-3/TX AC20 Mode 5825 MHz

Vertical

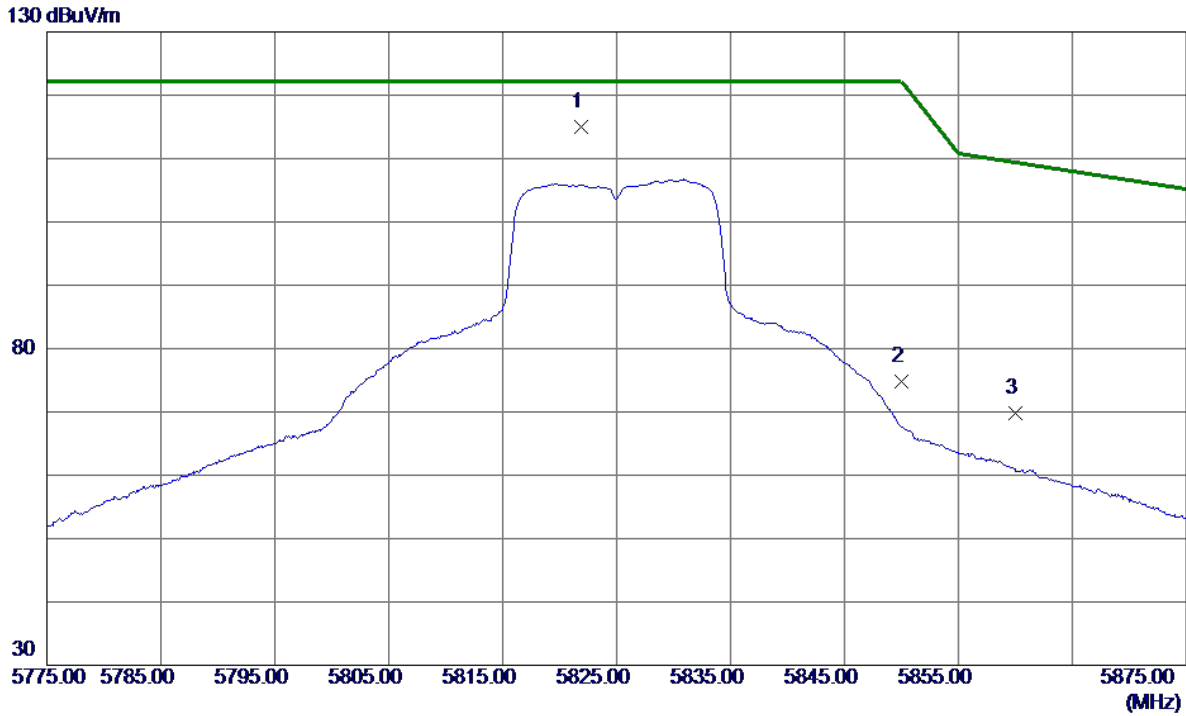

No.	Freq. MHz	Reading Level dBuV/m	Correct Factor dB	Measure ment dBuV/m	Limit dBuV/m	Margin dB	Detector	Comment
1 *	5821.8500	98.75	16.27	115.02	122.20	-7.18	Peak	No Limit
2	5850.0000	58.52	16.35	74.87	122.20	-47.33	Peak	
3	5860.0000	53.32	16.39	69.71	109.40	-39.69	Peak	

Orthogonal Axis:	X
Test Mode:	UNII-3/TX AC20 Mode 5825 MHz

Vertical

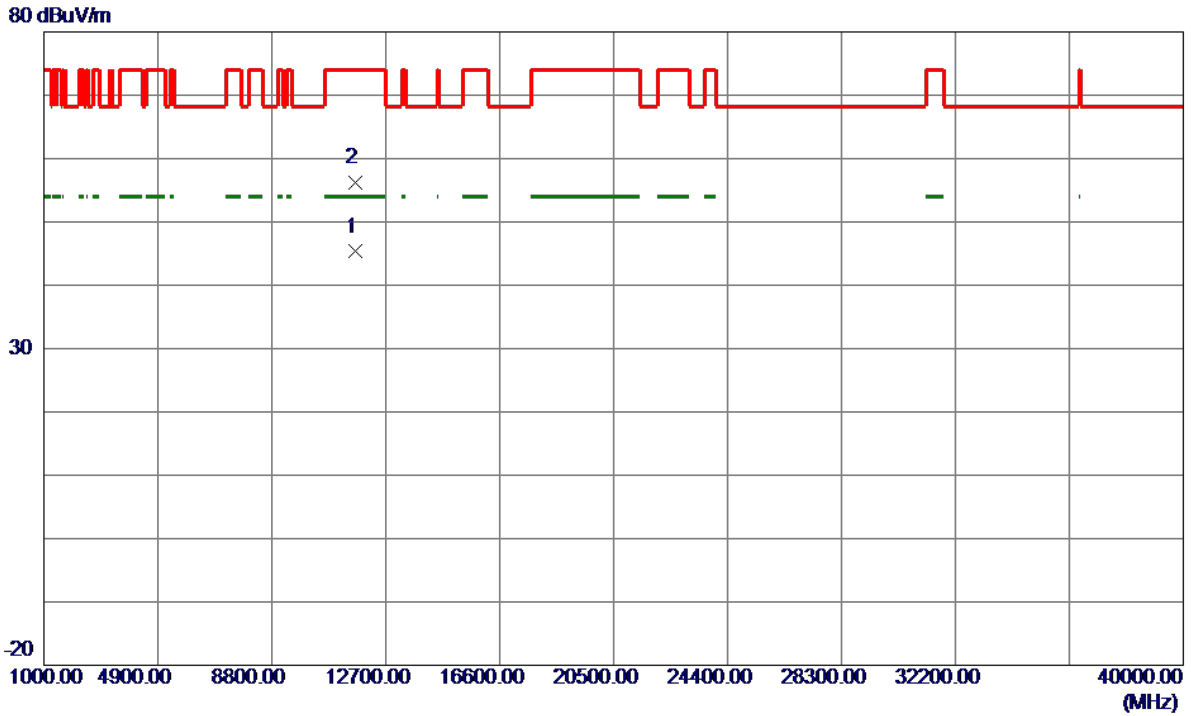

No.	Freq. MHz	Reading Level dBuV/m	Correct Factor dB	Measure ment dBuV/m	Limit dBuV/m	Margin dB	Detector	Comment
1 *	11650.0599	32.73	12.57	45.30	54.00	-8.70	AVG	
2	11650.2250	43.64	12.57	56.21	74.00	-17.79	Peak	

Orthogonal Axis:	X
Test Mode:	UNII-3/TX AC20 Mode 5825 MHz

Horizontal

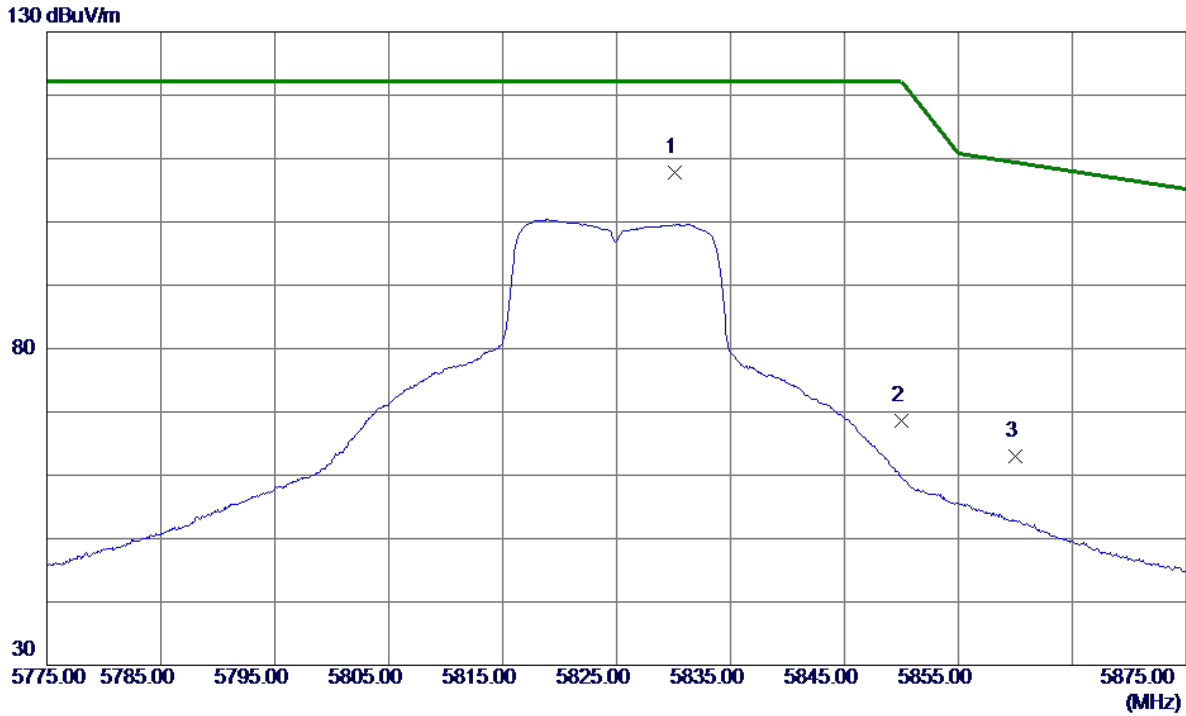

No.	Freq. MHz	Reading Level dBuV/m	Correct Factor dB	Measure ment dBuV/m	Limit dBuV/m	Margin dB	Detector	Comment
1 *	5830.1500	91.43	16.29	107.72	122.20	-14.48	Peak	No Limit
2	5850.0000	52.20	16.35	68.55	122.20	-53.65	Peak	
3	5860.0000	46.52	16.39	62.91	109.40	-46.49	Peak	

Orthogonal Axis:	X
Test Mode:	UNII-3/TX AC20 Mode 5825 MHz

Horizontal

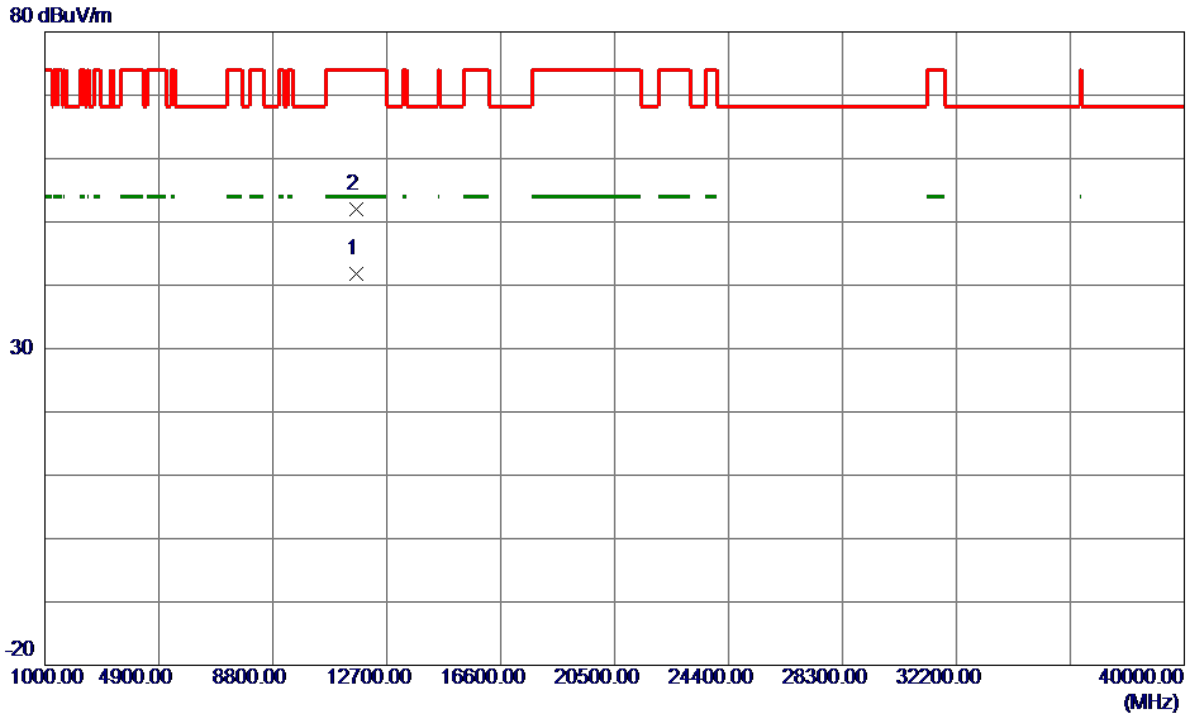

No.	Freq. MHz	Reading Level dBuV/m	Correct Factor dB	Measure ment dBuV/m	Limit dBuV/m	Margin dB	Detector	Comment
1 *	11649.6400	29.27	12.57	41.84	54.00	-12.16	AVG	
2	11650.4950	39.51	12.57	52.08	74.00	-21.92	Peak	

Orthogonal Axis:	X
Test Mode:	UNII-3/TX AC40 Mode 5755MHz

Vertical

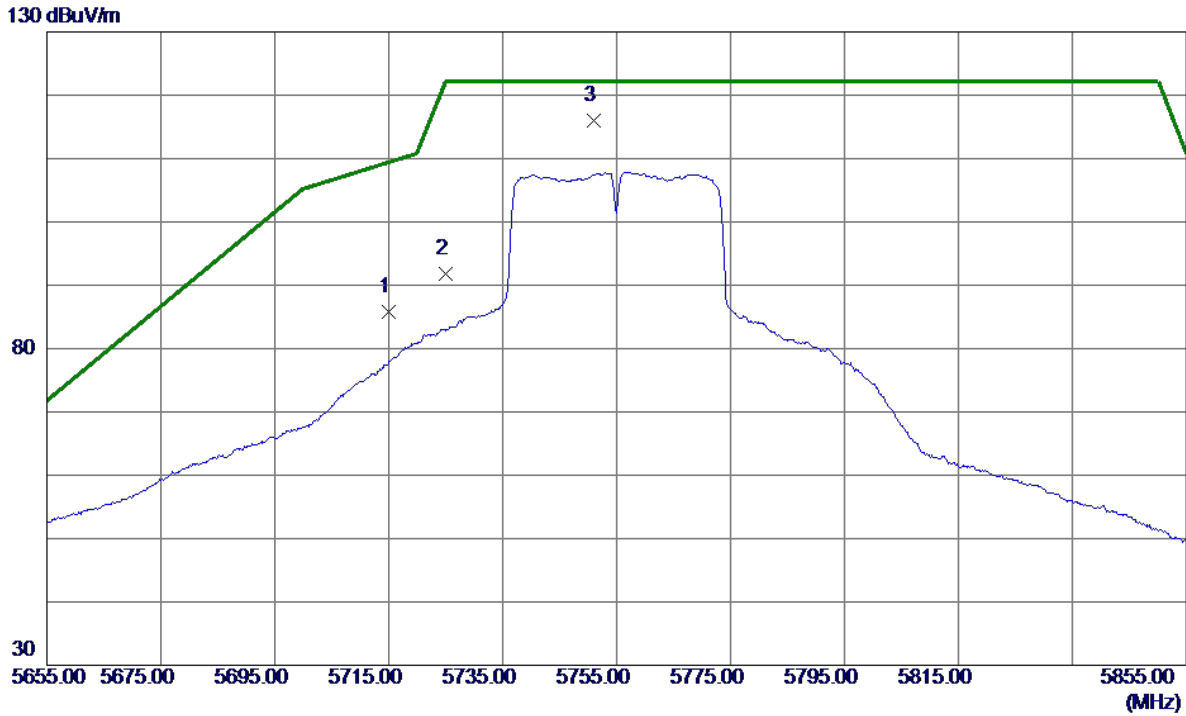

No.	Freq. MHz	Reading Level dBuV/m	Correct Factor dB	Measure ment dBuV/m	Limit dBuV/m	Margin dB	Detector	Comment
1	5715.0000	69.78	15.93	85.71	109.40	-23.69	Peak	
2	5725.0000	75.75	15.96	91.71	122.20	-30.49	Peak	
3 *	5751.1000	99.91	16.04	115.95	122.20	-6.25	Peak	No Limit

Orthogonal Axis:	X
Test Mode:	UNII-3/TX AC40 Mode 5755MHz

Vertical

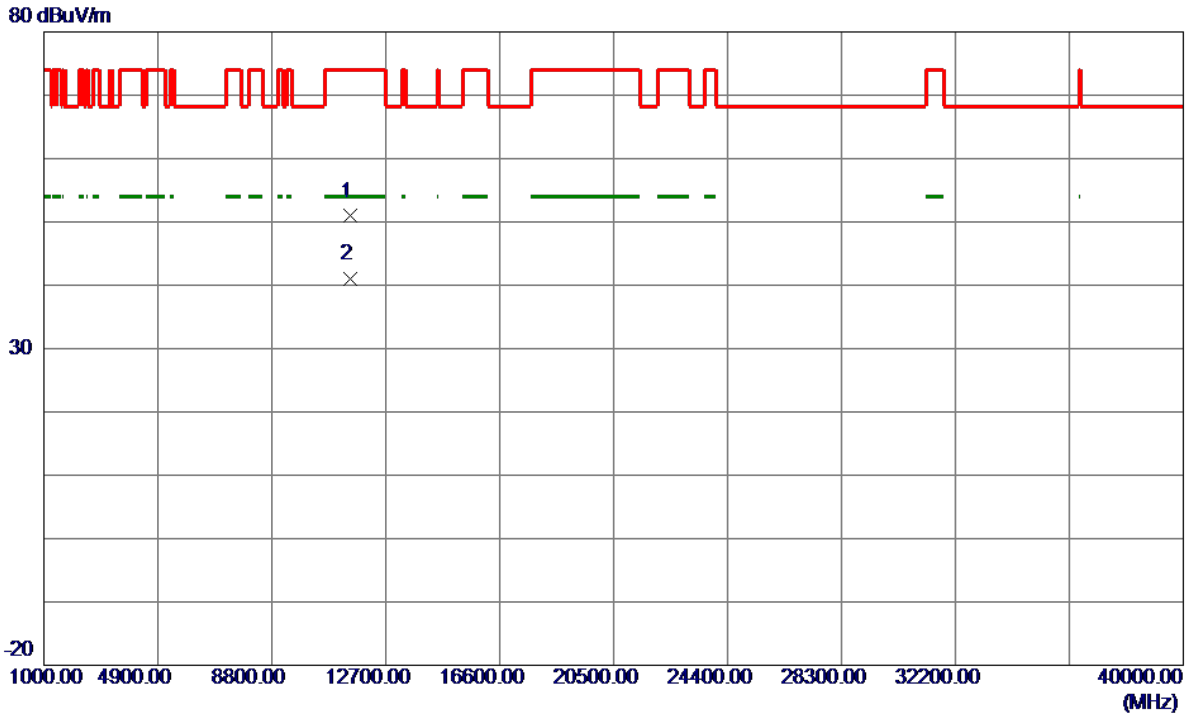

No.	Freq. MHz	Reading Level dBuV/m	Correct Factor dB	Measure ment dBuV/m	Limit dBuV/m	Margin dB	Detector	Comment
1	11499.4500	38.43	12.47	50.90	74.00	-23.10	Peak	
2 *	11505.0000	28.60	12.48	41.08	54.00	-12.92	AVG	

Orthogonal Axis:	X
Test Mode:	UNII-3/TX AC40 Mode 5755MHz

Horizontal

130 dBuV/m

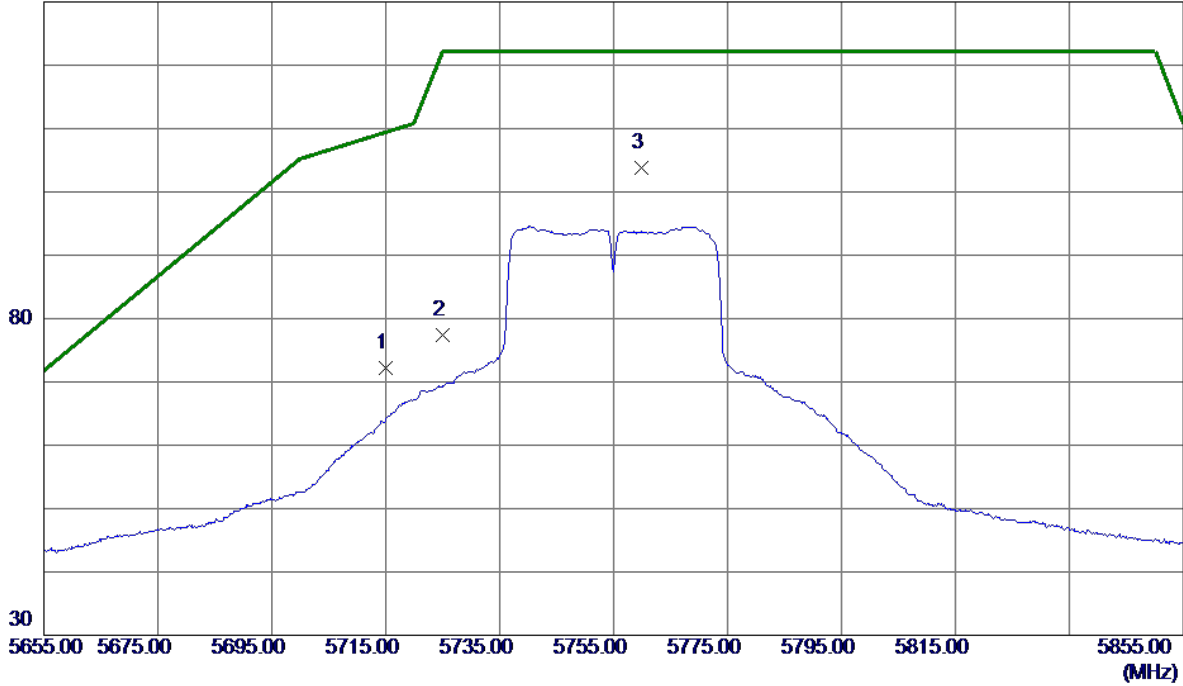

No.	Freq. MHz	Reading Level dBuV/m	Correct Factor dB	Measure ment dBuV/m	Limit dBuV/m	Margin dB	Detector	Comment
1	5715.0000	56.28	15.93	72.21	109.40	-37.19	Peak	
2	5725.0000	61.38	15.96	77.34	122.20	-44.86	Peak	
3 *	5759.8000	87.70	16.07	103.77	122.20	-18.43	Peak	No Limit

Orthogonal Axis:	X
Test Mode:	UNII-3/TX AC40 Mode 5755MHz

Horizontal

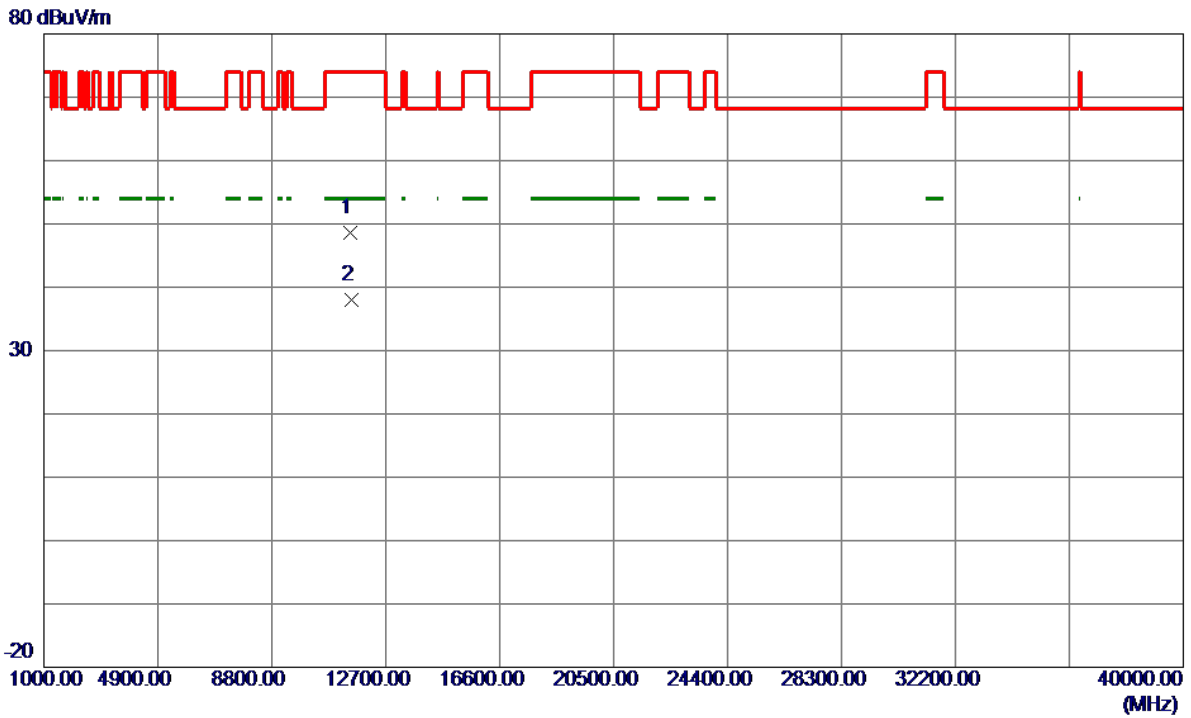

No.	Freq. MHz	Reading Level dBuV/m	Correct Factor dB	Measure ment dBuV/m	Limit dBuV/m	Margin dB	Detector	Comment
1	11497.2500	36.06	12.47	48.53	74.00	-25.47	Peak	
2 *	11509.2500	25.57	12.48	38.05	54.00	-15.95	AVG	

Orthogonal Axis:	X
Test Mode:	UNII-3/TX AC40 Mode 5795MHz

Vertical

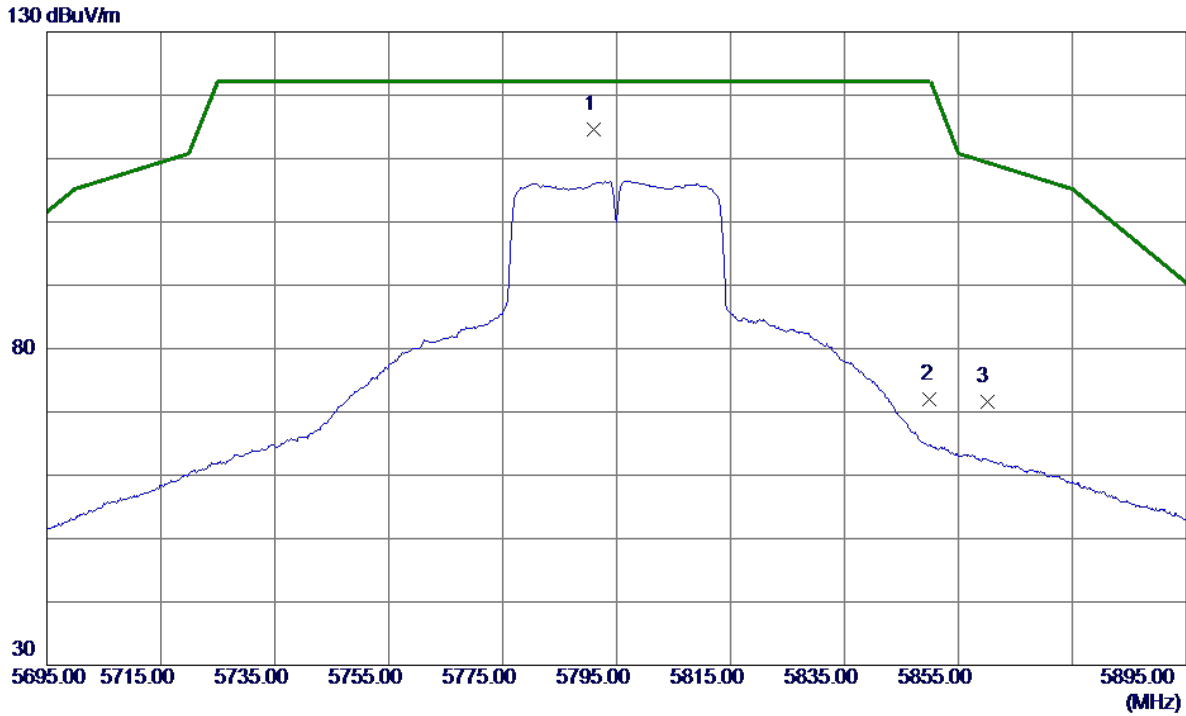

No.	Freq. MHz	Reading Level dBuV/m	Correct Factor dB	Measure ment dBuV/m	Limit dBuV/m	Margin dB	Detector	Comment
1 *	5791.1000	98.46	16.17	114.63	122.20	-7.57	Peak	No Limit
2	5850.0000	55.72	16.35	72.07	122.20	-50.13	Peak	
3	5860.0000	55.16	16.39	71.55	109.40	-37.85	Peak	

Orthogonal Axis:	X
Test Mode:	UNII-3/TX AC40 Mode 5795MHz

Vertical

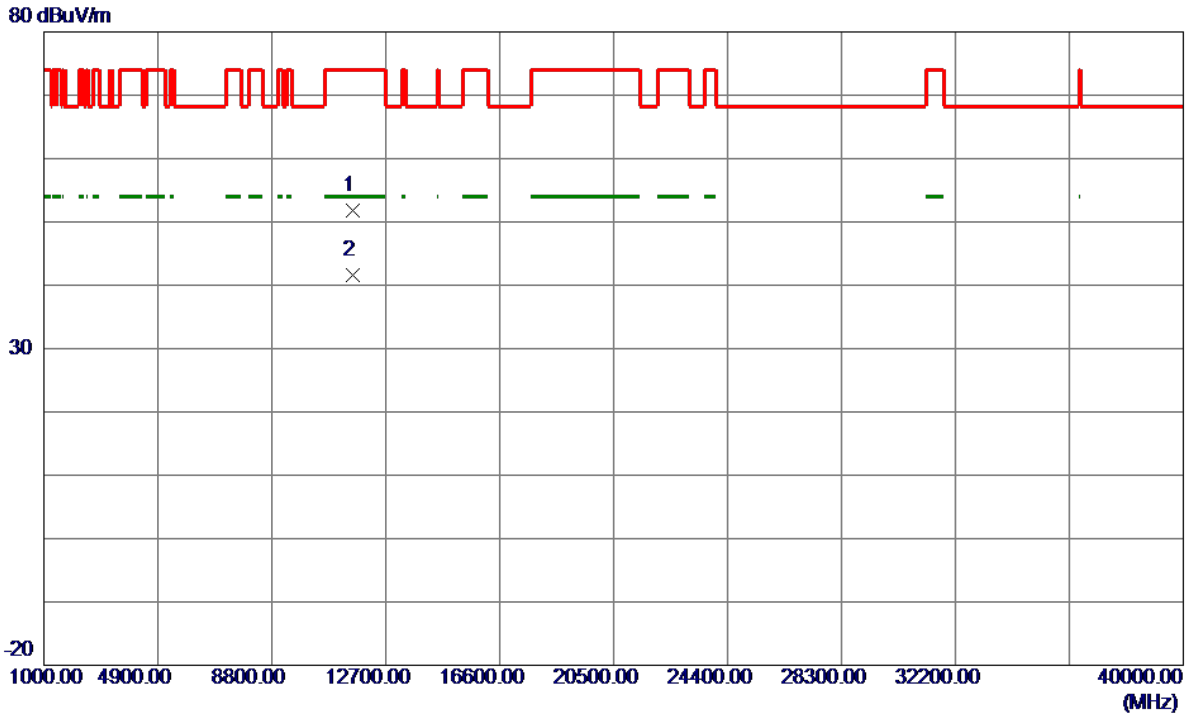

No.	Freq. MHz	Reading Level dBuV/m	Correct Factor dB	Measure ment dBuV/m	Limit dBuV/m	Margin dB	Detector	Comment
1	11579.6750	39.31	12.52	51.83	74.00	-22.17	Peak	
2 *	11588.4250	29.02	12.53	41.55	54.00	-12.45	AVG	

Orthogonal Axis:	X
Test Mode:	UNII-3/TX AC40 Mode 5795MHz

Horizontal

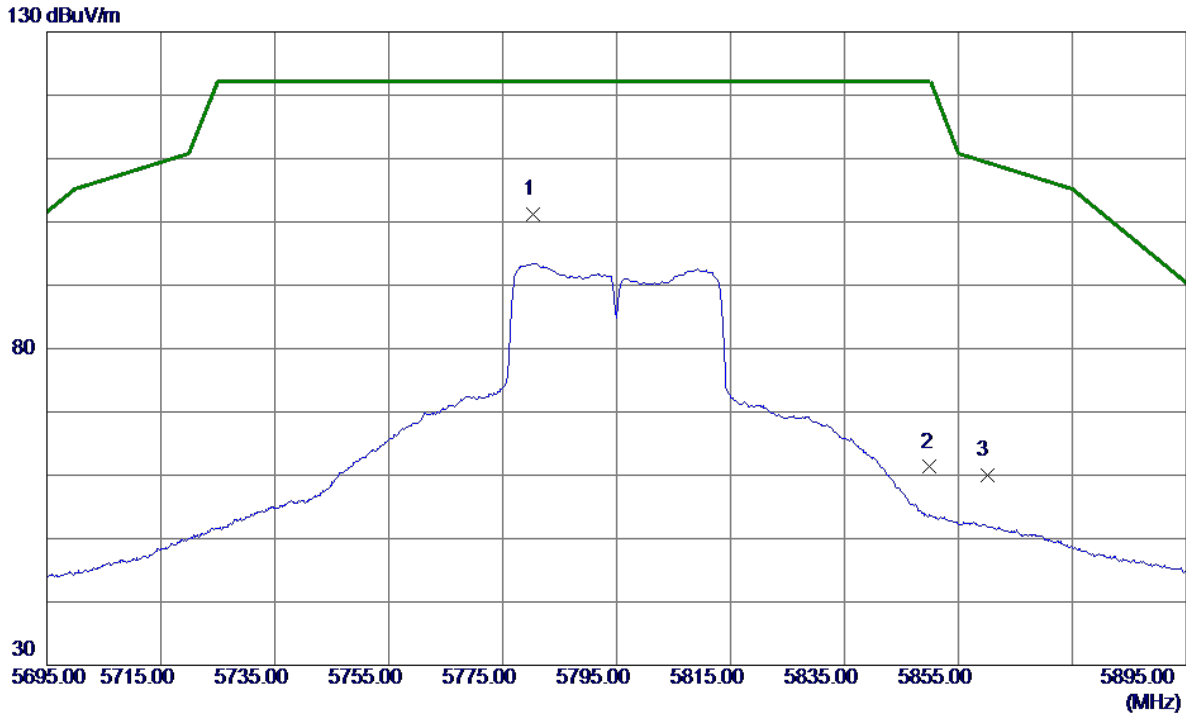

No.	Freq. MHz	Reading Level dBuV/m	Correct Factor dB	Measure ment dBuV/m	Limit dBuV/m	Margin dB	Detector	Comment
1 *	5780.4000	85.07	16.13	101.20	122.20	-21.00	Peak	No Limit
2	5850.0000	44.95	16.35	61.30	122.20	-60.90	Peak	
3	5860.0000	43.65	16.39	60.04	109.40	-49.36	Peak	

Orthogonal Axis:	X
Test Mode:	UNII-3/TX AC40 Mode 5795MHz

Horizontal

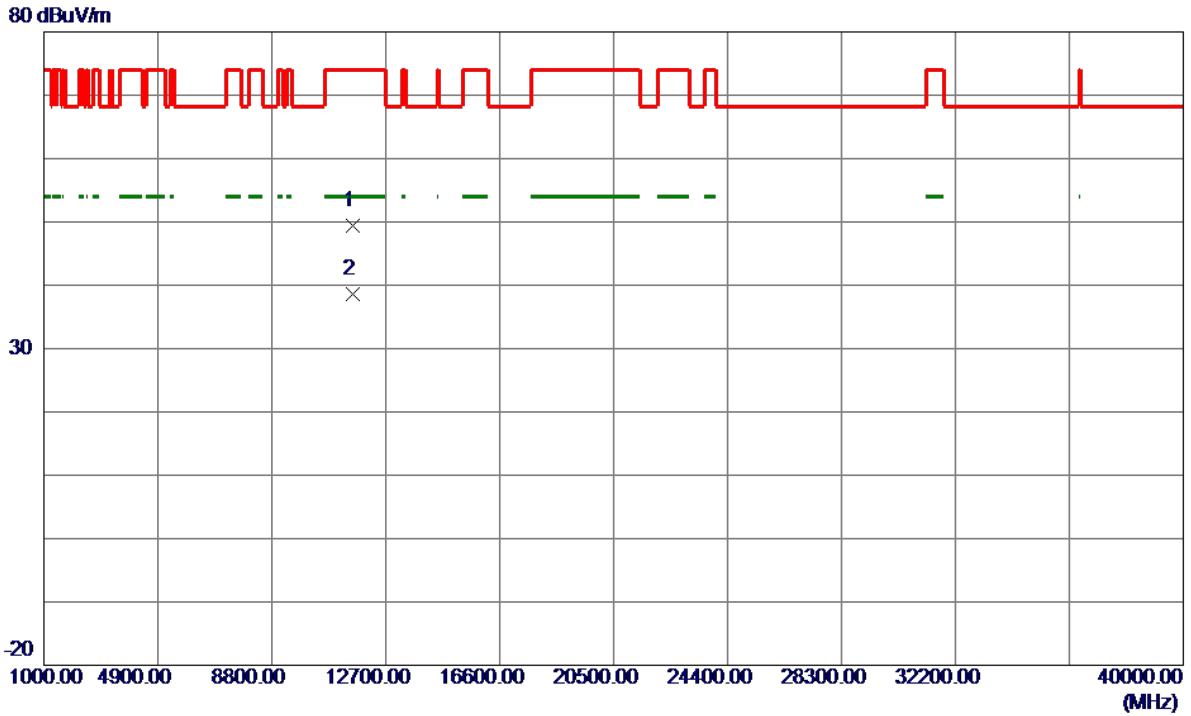

No.	Freq. MHz	Reading Level dBuV/m	Correct Factor dB	Measure ment dBuV/m	Limit dBuV/m	Margin dB	Detector	Comment
1	11579.1000	36.86	12.52	49.38	74.00	-24.62	Peak	
2 *	11584.9500	26.11	12.53	38.64	54.00	-15.36	AVG	

Orthogonal Axis:	X
Test Mode:	UNII-3/TX AC80 Mode 5775MHz

Vertical

130 dBuV/m

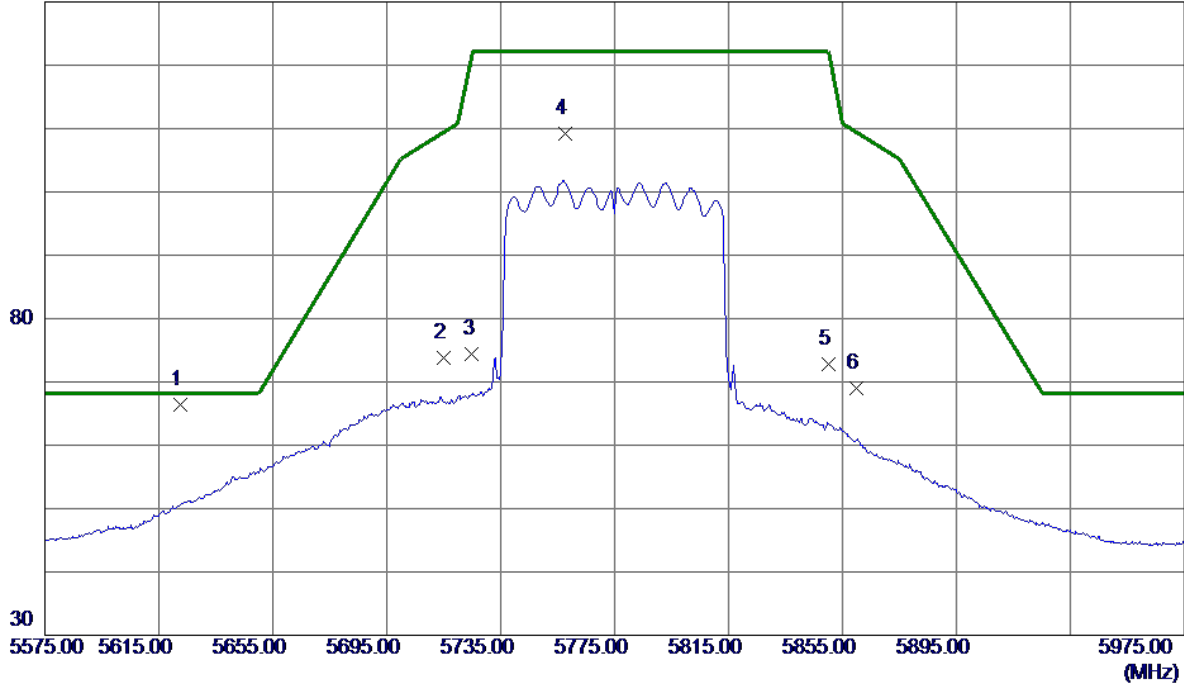

No.	Freq. MHz	Reading Level dBuV/m	Correct Factor dB	Measure ment dBuV/m	Limit dBuV/m	Margin dB	Detector	Comment
1 *	5622.4000	50.70	15.63	66.33	68.20	-1.87	Peak	
2	5715.0000	57.84	15.93	73.77	109.40	-35.63	Peak	
3	5725.0000	58.44	15.96	74.40	122.20	-47.80	Peak	
4	5757.6000	93.09	16.06	109.15	122.20	-13.05	Peak	No Limit
5	5850.0000	56.45	16.35	72.80	122.20	-49.40	Peak	
6	5860.0000	52.63	16.39	69.02	109.40	-40.38	Peak	

Orthogonal Axis:	X
Test Mode:	UNII-3/TX AC80 Mode 5775MHz

Vertical

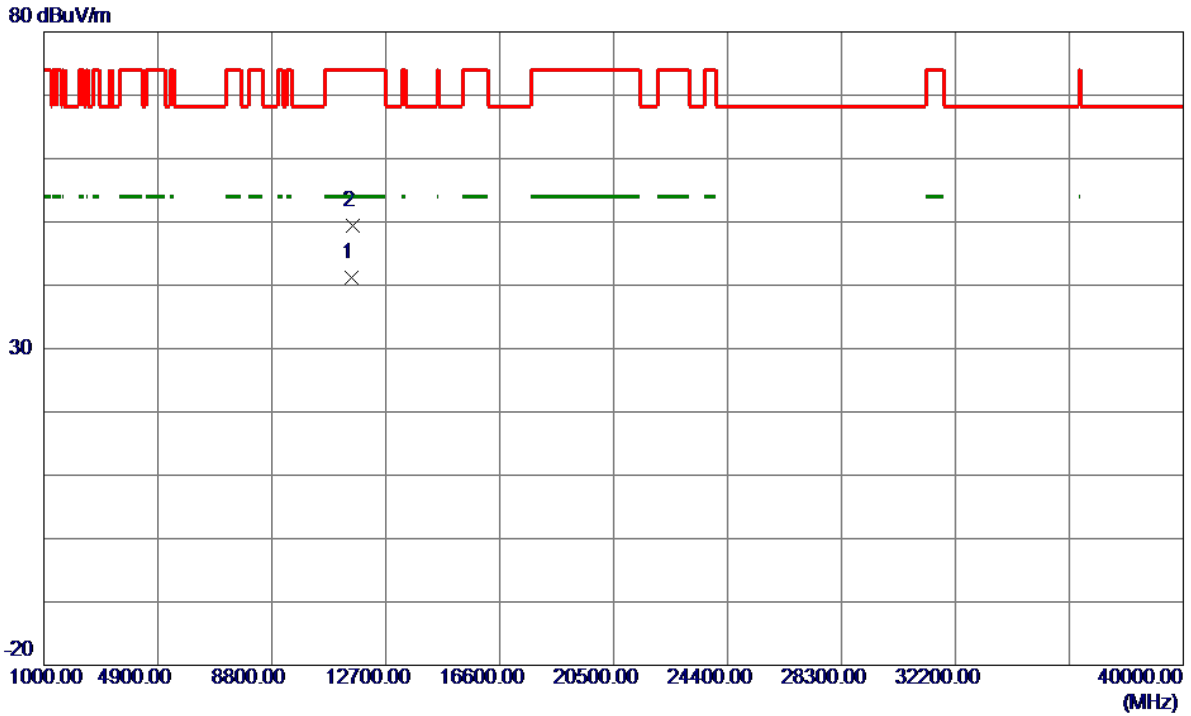

No.	Freq. MHz	Reading Level dBuV/m	Correct Factor dB	Measure ment dBuV/m	Limit dBuV/m	Margin dB	Detector	Comment
1 *	11550.4000	28.70	12.51	41.21	54.00	-12.79	AVG	
2	11556.1500	36.96	12.51	49.47	74.00	-24.53	Peak	

Orthogonal Axis:	X
Test Mode:	UNII-3/TX AC80 Mode 5775MHz

Horizontal

130 dBuV/m

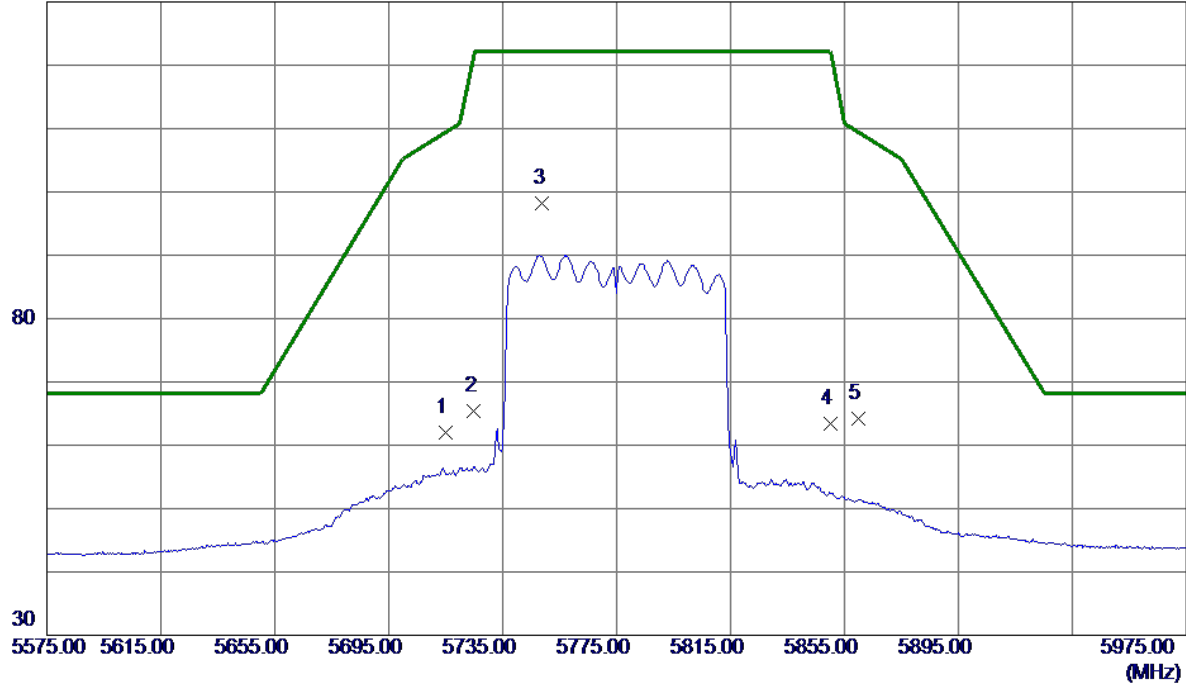

No.	Freq. MHz	Reading Level dBuV/m	Correct Factor dB	Measure ment dBuV/m	Limit dBuV/m	Margin dB	Detector	Comment
1	5715.0000	46.14	15.93	62.07	109.40	-47.33	Peak	
2	5725.0000	49.44	15.96	65.40	122.20	-56.80	Peak	
3 *	5749.0000	82.26	16.03	98.29	122.20	-23.91	Peak	No Limit
4	5850.0000	47.00	16.35	63.35	122.20	-58.85	Peak	
5	5860.0000	47.82	16.39	64.21	109.40	-45.19	Peak	

Orthogonal Axis:	X
Test Mode:	UNII-3/TX AC80 Mode 5775MHz

Horizontal

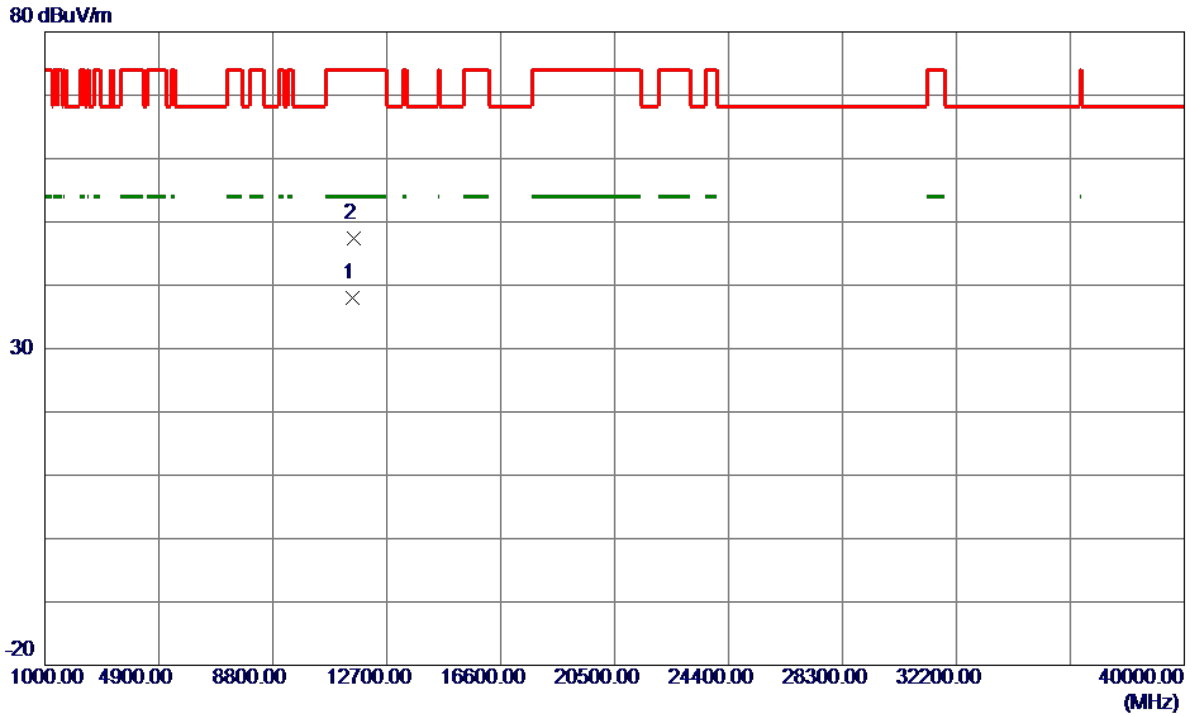

No.	Freq. MHz	Reading Level dBuV/m	Correct Factor dB	Measure ment dBuV/m	Limit dBuV/m	Margin dB	Detector	Comment
1 *	11551.6000	25.50	12.51	38.01	54.00	-15.99	AVG	
2	11565.1500	34.89	12.51	47.40	74.00	-26.60	Peak	

TX A Mode_DUTY CYCLE

Duty cycle = T_{ON} / T_{Total}

T_{ON} : 2.500 msec

T_{Total} : 2.500 msec

Duty cycle: 100%

Duty Factor = $10 \log(1/\text{Duty cycle})$

Duty Factor = 0.00

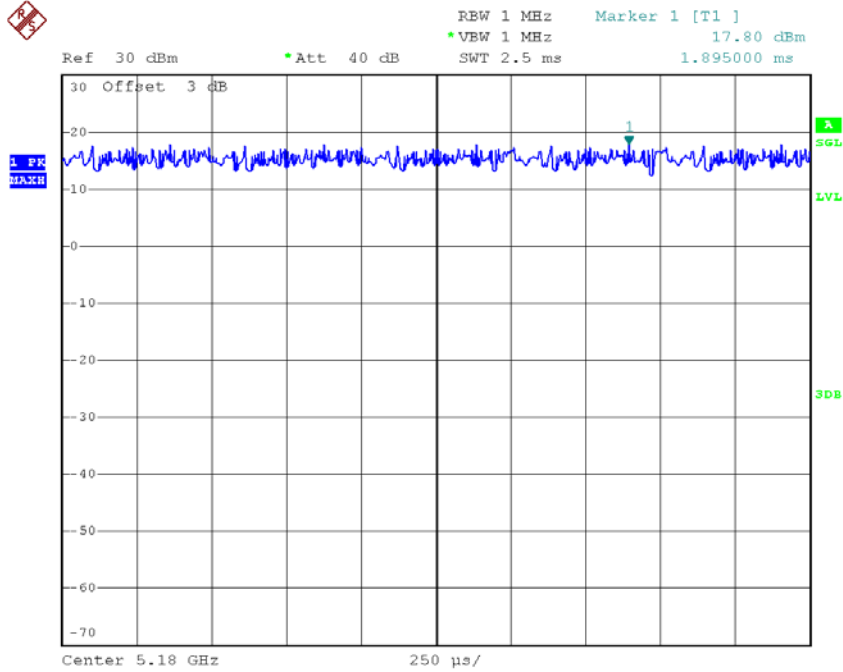

Date: 26.SEP.2018 15:28:53

Note: The duty cycle is $\geq 98\%$ no need to calculated as Duty Factor.