

FCC Radio Test Report

FCC ID: 2ABZMAP365

This report concerns (check one): Original Grant Class II Change

Project No. : 1502C010B
Equipment : Wireless Access Point
Model Name : AP365
Applicant : SHENZHEN IP-COM NETWORKS CO.,LTD.
Address : Room 101, Unit A, First Floor, Tower E3, No. 1001,
Zhongshanyuan Road, Nanshan District, Shenzhen,
China. 518052

Date of Receipt : Oct. 26, 2015
Date of Test : Oct. 26, 2015 ~ Nov. 27, 2015
Issued Date : Nov. 30, 2015
Tested by : BTL Inc.

Testing Engineer :

Shawn Xiao
(Shawn Xiao)

Technical Manager :

David Mao
(David Mao)

Authorized Signatory :

Steven Lu
(Steven Lu)

B T L I N C .

No.3, Jinshagang 1st Road, Shixia, Dalang Town, Dongguan,
Guangdong, China.

TEL: +86-769-8318-3000 FAX: +86-769-8319-6000

Declaration

BTL represents to the client that testing is done in accordance with standard procedures as applicable and that test instruments used has been calibrated with the standards traceable to National Measurement Laboratory (**NML**) of **R.O.C**, or National Institute of Standards and Technology (**NIST**) of **U.S.A**.

BTL's reports apply only to the specific samples tested under conditions. It is manufacture's responsibility to ensure that additional production units of this model are manufactured with the identical electrical and mechanical components. **BTL** shall have no liability for any declarations, inferences or generalizations drawn by the client or others from **BTL** issued reports.

BTL's report must not be used by the client to claim product certification, approval, or endorsement by NVLAP, NIST, or any agency of the Federal Government.

This report is the confidential property of the client. As a mutual protection to the clients, the public and **BTL-self**, extracts from the test report shall not be reproduced except in full with **BTL's** authorized written approval.

BTL's laboratory quality assurance procedures are in compliance with the **ISO Guide 17025** requirements, and accredited by the conformity assessment authorities listed in this test report.

Limitation

For the use of the authority's logo is limited unless the Test Standard(s)/Scope(s)/Item(s) mentioned in this test report is (are) included in the conformity assessment authorities acceptance respective.

Table of Contents	Page
1 . CERTIFICATION	6
2 . SUMMARY OF TEST RESULTS	7
2.1 TEST FACILITY	8
2.2 MEASUREMENT UNCERTAINTY	8
3 . GENERAL INFORMATION	9
3.1 GENERAL DESCRIPTION OF EUT	9
3.2 DESCRIPTION OF TEST MODES	11
3.3 TABLE OF PARAMETERS OF TEXT SOFTWARE SETTING	12
3.4 BLOCK DIAGRAM SHOWING THE CONFIGURATION OF SYSTEM TESTED	13
3.5 DESCRIPTION OF SUPPORT UNITS	13
4 . EMC EMISSION TEST	14
4.1 CONDUCTED EMISSION MEASUREMENT	14
4.1.1 POWER LINE CONDUCTED EMISSION LIMITS	14
4.1.2 TEST PROCEDURE	14
4.1.3 DEVIATION FROM TEST STANDARD	14
4.1.4 TEST SETUP	15
4.1.5 EUT OPERATING CONDITIONS	15
4.1.6 EUT TEST CONDITIONS	15
4.1.7 TEST RESULTS	15
4.2 RADIATED EMISSION MEASUREMENT	16
4.2.1 RADIATED EMISSION LIMITS	16
4.2.2 TEST PROCEDURE	17
4.2.3 DEVIATION FROM TEST STANDARD	17
4.2.4 TEST SETUP	18
4.2.5 EUT OPERATING CONDITIONS	19
4.2.6 EUT TEST CONDITIONS	19
4.2.7 TEST RESULTS (9KHZ TO 30MHZ)	19
4.2.8 TEST RESULTS (30MHZ TO 1000 MHZ)	19
4.2.9 TEST RESULTS (ABOVE 1000 MHZ)	19
5 . BANDWIDTH TEST	20
5.1 APPLIED PROCEDURES	20
5.1.1 TEST PROCEDURE	20
5.1.2 DEVIATION FROM STANDARD	20
5.1.3 TEST SETUP	20
5.1.4 EUT OPERATION CONDITIONS	20
5.1.5 EUT TEST CONDITIONS	20
5.1.6 TEST RESULTS	20
6 . MAXIMUM PEAK CONDUCTED OUTPUT POWER TEST	21

Table of Contents	Page
6.1 APPLIED PROCEDURES / LIMIT	21
6.1.1 TEST PROCEDURE	21
6.1.2 DEVIATION FROM STANDARD	21
6.1.3 TEST SETUP	21
6.1.4 EUT OPERATION CONDITIONS	21
6.1.5 EUT TEST CONDITIONS	21
6.1.6 TEST RESULTS	21
7 . ANTENNA CONDUCTED SPURIOUS EMISSION	22
7.1 APPLIED PROCEDURES / LIMIT	22
7.1.1 TEST PROCEDURE	22
7.1.2 DEVIATION FROM STANDARD	22
7.1.3 TEST SETUP	22
7.1.4 EUT OPERATION CONDITIONS	22
7.1.5 EUT TEST CONDITIONS	22
7.1.6 TEST RESULTS	22
8 . POWER SPECTRAL DENSITY TEST	23
8.1 APPLIED PROCEDURES / LIMIT	23
8.1.1 TEST PROCEDURE	23
8.1.2 DEVIATION FROM STANDARD	23
8.1.3 TEST SETUP	23
8.1.4 EUT OPERATION CONDITIONS	23
8.1.5 EUT TEST CONDITIONS	23
8.1.6 TEST RESULTS	23
9 . MEASUREMENT INSTRUMENTS LIST	24
10 . EUT TEST PHOTO	26
ATTACHMENT A - CONDUCTED EMISSION	30
ATTACHMENT B - RADIATED EMISSION (9KHZ TO 30MHZ)	33
ATTACHMENT C - RADIATED EMISSION (30MHZ TO 1000MHZ)	35
ATTACHMENT D - RADIATED EMISSION (ABOVE 1000MHZ)	42
ATTACHMENT E - BANDWIDTH	91
ATTACHMENT F – MAXIMUM PEAK CONDUCTED OUTPUT POWER	100
ATTACHMENT G - ANTENNA CONDUCTED SPURIOUS EMISSION	104
ATTACHMENT H - POWER SPECTRAL DENSITY	137

REPORT ISSUED HISTORY

Issued No.	Description	Issued Date
BTL-FCCP-1-1502C010B	Original Issue.	Nov. 30, 2015

1. CERTIFICATION

Equipment : Wireless Access Point
Brand Name : IP-COM
Model Name : AP365
Applicant : SHENZHEN IP-COM NETWORKS CO.,LTD.
Manufacturer : SHENZHEN IP-COM NETWORKS CO.,LTD.
Address : Room 101, Unit A, First Floor, Tower E3, No. 1001, Zhongshanyuan Road,
Nanshan District, Shenzhen, China. 518052
Date of Test : Oct. 26, 2015 ~ Nov. 27, 2015
Test Sample : Engineering Sample
Standard(s) : FCC Part15, Subpart C: 2014 (15.247) / ANSI C63.10-2013

The above equipment has been tested and found compliance with the requirement of the relative standards by BTL Inc.

The test data, data evaluation, and equipment configuration contained in our test report (Ref No. BTL-FCCP-1-1502C010B) were obtained utilizing the test procedures, test instruments, test sites that has been accredited by the Authority of TAF according to the ISO-17025 quality assessment standard and technical standard(s).

2. SUMMARY OF TEST RESULTS

Test procedures according to the technical standard(s):

Applied Standard(s): FCC Part15 (15.247) , Subpart C: 2014				
Standard(s)	Section	Test Item	Judgment	Remark
	15.207	Conducted Emission	PASS	
	15.247(d)	Antenna conducted Spurious Emission	PASS	
	15.247(a)(2)	6dB Bandwidth	PASS	
	15.247(b)(3)	Peak Output Power	PASS	
	15.247(e)	Power Spectral Density	PASS	
	15.203	Antenna Requirement	PASS	
	15.209/15.205	Transmitter Radiated Emissions	PASS	

NOTE:

(1) "N/A" denotes test is not applicable in this test report.

2.1 TEST FACILITY

The test facilities used to collect the test data in this report is at the location of No.3,Jinshagang 1st Road, Shixia, Dalang Town, Dongguan, Guangdong, China.
BTL's test firm number for FCC: 319330

2.2 MEASUREMENT UNCERTAINTY

Where relevant, the following measurement uncertainty levels have been estimated for tests performed on the EUT as specified in CISPR 16-4-2. The BTL measurement uncertainty is less than the CISPR 16-4-2 U_{cispr} requirement.

The reported uncertainty of measurement $y \pm U$, where expanded uncertainty U is based on a standard uncertainty multiplied by a coverage factor of $k=2$, providing a level of confidence of approximately 95 %.

A. Conducted Measurement:

Test Site	Method	Measurement Frequency Range	U, (dB)
DG-C02	CISPR	150 KHz ~ 30MHz	2.32

B. Radiated Measurement:

Test Site	Method	Measurement Frequency Range	Ant. H / V	U, (dB)
DG-CB03	CISPR	9KHz~30MHz	V	3.79
		9KHz~30MHz	H	3.57
		30MHz ~ 200MHz	V	3.82
		30MHz ~ 200MHz	H	3.78
		200MHz ~ 1,000MHz	V	4.10
		200MHz ~ 1,000MHz	H	4.06
		1GHz~18GHz	V	3.12
		1GHz~18GHz	H	3.68
		18GHz~40GHz	V	4.15
		18GHz~40GHz	H	4.14

Note: Unless specifically mentioned, the uncertainty of measurement has not been taken into account to declare the compliance or non-compliance to the specification.

3. GENERAL INFORMATION

3.1 GENERAL DESCRIPTION OF EUT

Equipment	Wireless Access Point	
Brand Name	IP-COM	
Model Name	AP365	
Model Difference	NA	
Product Description	Operation Frequency	2412~2462 MHz
	Modulation Technology	802.11b:DSSS 802.11g:OFDM 802.11n:OFDM
	Bit Rate of Transmitter	802.11b: 11/5.5/2/1 Mbps 802.11g: 54/48/36/24/18/12/9/6 Mbps 802.11n up to 450 Mbps
	Output Power (Max.)	802.11b: 29.25dBm 802.11g: 29.73dBm 802.11n(20MHz): 28.87dBm 802.11n(40MHz): 28.75dBm
Power Source	DC voltage Supplied from AC/DC adapter Brand/Model: SHENZHEN HEWEISHUN NETWORK TECHNOLOGY CO., LTD/BN031-A65051	
Power Rating	I/P: 100-240VAC 50/60Hz 1.5A O/P: 51V /1.25A	

Note:

1. For a more detailed features description, please refer to the manufacturer's specifications or the user's manual.
2. The product will be sold with 2 kinds of base plates, the test results would not be affected by the appearance difference.
3. Channel List:

CH01 – CH11 for 802.11b, 802.11g, 802.11n(20MHz) CH03 – CH11 for 802.11n(40MHz)							
Channel	Frequency (MHz)	Channel	Frequency (MHz)	Channel	Frequency (MHz)	Channel	Frequency (MHz)
01	2412	04	2427	07	2442	10	2457
02	2417	05	2432	08	2447	11	2462
03	2422	06	2437	09	2452		

4. Table for Filed Antenna

Ant.	Brand	Model Name	Antenna Type	Connector	Gain (dBi)	Note
1	N/A	N/A	Internal	Ipex	3.00	2.4G
2	N/A	N/A	Internal	Ipex	3.00	2.4G
3	N/A	N/A	Internal	Ipex	3.00	2.4G

Note:

- (1) The EUT incorporates a MIMO function. Physically, the EUT provides three completed transmitters and receivers (3T3R). All transmit signals are completely uncorrelated, then, Direction gain = G_{ANT} , that is Directional gain=3.
- (2) ANT 1 is the worst case for 1TX

5.

Operating Mode TX Mode	1TX	3TX
802.11b	V (ANT 1)	-
802.11g	V (ANT 1)	-
802.11n(20MHz)	-	V (ANT 1 + ANT 2+ANT 3)
802.11n(40MHz)	-	V (ANT 1 + ANT 2+ANT 3)

3.2 DESCRIPTION OF TEST MODES

To investigate the maximum EMI emission characteristics generated from EUT, the test system was pre-scanning tested based on the consideration of following EUT operation mode or test configuration mode which possibly have effect on EMI emission level. Each of these EUT operation mode(s) or test configuration mode(s) mentioned above was evaluated respectively.

Pretest Mode	Description
Mode 1	TX B MODE CHANNEL 01/06/11
Mode 2	TX G MODE CHANNEL 01/06/11
Mode 3	TX N-20MHZ MODE CHANNEL 01/06/11
Mode 4	TX N-40MHZ MODE CHANNEL 03/06/09
Mode 5	TX MODE

The EUT system operated these modes were found to be the worst case during the pre-scanning test as following:

For Conducted Test	
Final Test Mode	Description
Mode 5	TX MODE

For Radiated Test	
Final Test Mode	Description
Mode 1	TX B MODE CHANNEL 01/06/11
Mode 2	TX G MODE CHANNEL 01/06/11
Mode 3	TX N-20MHZ MODE CHANNEL 01/06/11
Mode 4	TX N-40MHZ MODE CHANNEL 03/06/09

Note:

- (1) The measurements are performed at the high, middle, low available channels.
- (2) 802.11b mode: DBPSK (1Mbps)
 802.11g mode: OFDM (6Mbps)
 802.11n HT20 mode : BPSK (19.50Mbps)
 802.11n HT40 mode : BPSK (40.50Mbps)
 For radiated emission tests, the highest output powers were set for final test.
- (3) For radiated below 1G test, the 802.11b is found to be the worst case and recorded.
- (4) The EUT was programmed to be in continuously transmitting mode and the transmit duty cycle is not less than 98%.

3.3 TABLE OF PARAMETERS OF TEXT SOFTWARE SETTING

During testing, channel & power controlling software provided by the customer was used to control the operating channel as well as the output power level. The RF output power selection is for the setting of RF output power expected by the customer and is going to be fixed on the firmware of the final end product power parameters of WLAN

Test software version	MTool		
Frequency (MHz)	2412	2437	2462
802.11b	88	100	90
802.11g	56	67	66
802.11n (20MHz)	46	46	46
Frequency	2422	2437	2452
802.11n (40MHz)	39	52	52

3.4 BLOCK DIAGRAM SHOWING THE CONFIGURATION OF SYSTEM TESTED

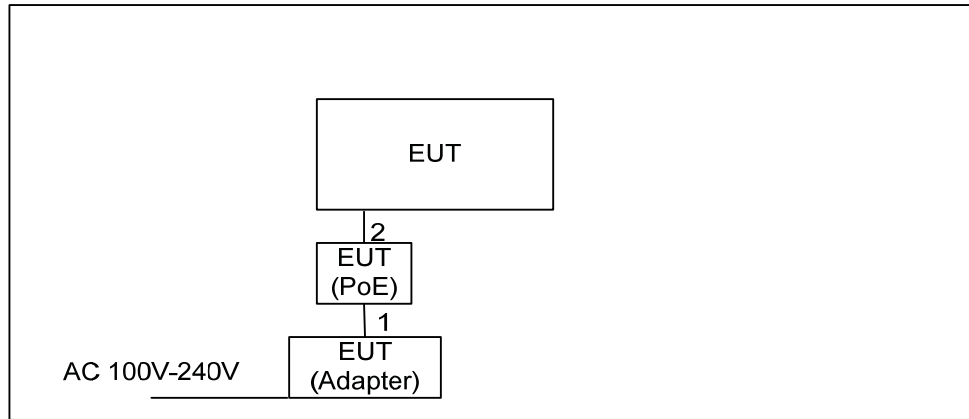

3.5 DESCRIPTION OF SUPPORT UNITS

The EUT has been tested as an independent unit together with other necessary accessories or support units. The following support units or accessories were used to form a representative test configuration during the tests.

Item	Equipment	Mfr/Brand	Model/Type No.	FCC ID/IC	Series No.
-	-	-	-	-	-

Item	Shielded Type	Ferrite Core	Length	Note
1	NO	NO	1m	DC cable
2	NO	NO	10m	RJ45 cable

4. EMC EMISSION TEST

4.1 CONDUCTED EMISSION MEASUREMENT

4.1.1 POWER LINE CONDUCTED EMISSION LIMITS (Frequency Range 150KHz-30MHz)

Frequency of Emission (MHz)	Conducted Limit (dB μ V)	
	Quasi-peak	Average \square
0.15 -0.50	66 to 56*	56 to 46*
0.50 -5.0	56	46
5.0 -30.0	60	50

Note:

- (1) The limit of " * " decreases with the logarithm of the frequency
- (2) The test result calculated as following:
 Measurement Value = Reading Level + Correct Factor
 Correct Factor = Insertion Loss + Cable Loss + Attenuator Factor(if use)
 Margin Level = Measurement Value - Limit Value

The following table is the setting of the receiver

Receiver Parameters	Setting
Attenuation	10 dB
Start Frequency	0.15 MHz
Stop Frequency	30 MHz
IF Bandwidth	9 KHz

4.1.2 TEST PROCEDURE

- a. The EUT was placed 0.8 meters from the horizontal ground plane with EUT being connected to the power mains through a line impedance stabilization network (LISN). All other support equipments powered from additional LISN(s). The LISN provide 50 Ohm/ 50uH of coupling impedance for the measuring instrument.
- b. Interconnecting cables that hang closer than 40 cm to the ground plane shall be folded back and forth in the center forming a bundle 30 to 40 cm long.
- c. I/O cables that are not connected to a peripheral shall be bundled in the center. The end of the cable may be terminated, if required, using the correct terminating impedance. The overall length shall not exceed 1 m.
- d. LISN at least 80 cm from nearest part of EUT chassis.
- e. For the actual test configuration, please refer to the related Item –EUT Test Photos.

4.1.3 DEVIATION FROM TEST STANDARD

No deviation

4.1.4 TEST SETUP

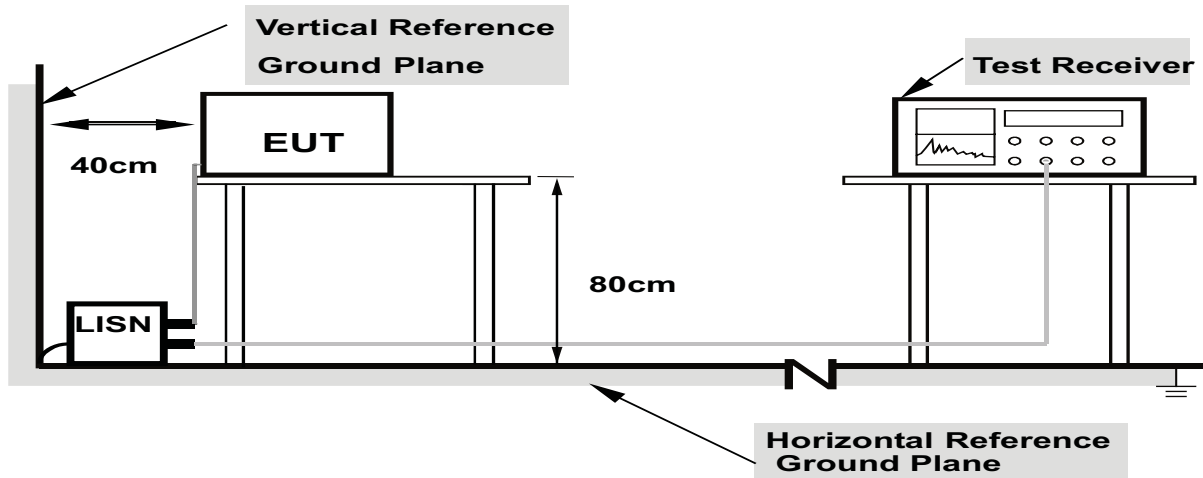

- Note:**
1. Support units were connected to second LISN.
 2. Both of LISNs (AMN) are 80 cm from EUT and at least 80 from other units and other metal planes

4.1.5 EUT OPERATING CONDITIONS

The EUT was placed on the test table and programmed in normal function.

4.1.6 EUT TEST CONDITIONS

Temperature: 25°C Relative Humidity: 55% Test Voltage: AC 120V/60Hz

4.1.7 TEST RESULTS

Please refer to the Attachment A.

4.2 RADIATED EMISSION MEASUREMENT

4.2.1 RADIATED EMISSION LIMITS

In case the emission fall within the restricted band specified on 15.205(a), then the 15.209(a) limit in the table below has to be followed.

LIMITS OF RADIATED EMISSION MEASUREMENT (9KHz-1000MHz)

Frequency (MHz)	Field Strength (microvolts/meter)	Measurement Distance (meters)
0.009~0.490	2400/F(KHz)	300
0.490~1.705	24000/F(KHz)	30
1.705~30.0	30	30
30~88	100	3
88~216	150	3
216~960	200	3
960~1000	500	3

LIMITS OF RADIATED EMISSION MEASUREMENT (Above 1000MHz)

Frequency (MHz)	(dBuV/m) (at 3 meters)	
	PEAK	AVERAGE
Above 1000	74	54

Notes:

- (1) The limit for radiated test was performed according to FCC PART 15C.
- (2) The tighter limit applies at the band edges.
- (3) Emission level (dBuV/m)=20log Emission level (uV/m).
- (4) The test result calculated as following:
 Measurement Value = Reading Level + Correct Factor
 Correct Factor = Antenna Factor + Cable Loss - Amplifier Gain(if use)
 Margin Level = Measurement Value - Limit Value

Spectrum Parameter	Setting
Attenuation	Auto
Start Frequency	1000 MHz
Stop Frequency	10th carrier harmonic
RBW / VBW (Emission in restricted band)	1MHz / 3MHz for Peak, 1MHz / 1/T for Average

Receiver Parameter	Setting
Attenuation	Auto
Start ~ Stop Frequency	9KHz~90KHz for PK/AVG detector
Start ~ Stop Frequency	90KHz~110KHz for QP detector
Start ~ Stop Frequency	110KHz~490KHz for PK/AVG detector
Start ~ Stop Frequency	490KHz~30MHz for QP detector
Start ~ Stop Frequency	30MHz~1000MHz for QP detector

4.2.2 TEST PROCEDURE

- a. The measuring distance of 3 m shall be used for measurements. The EUT was placed on the top of a rotating table 0.8 meter above the ground at a 3 meter semi-anechoic chamber. The table was rotated 360 degrees to determine the position of the highest radiation.(below 1GHz)
- b. The measuring distance of 3 m shall be used for measurements. The EUT was placed on the top of a rotating table 1.5 meter above the ground at a 3 meter semi-anechoic chamber. The table was rotated 360 degrees to determine the position of the highest radiation.(above 1GHz)
- c. The height of the equipment or of the substitution antenna shall be 0.8 m or 1.5m, the height of the test antenna shall vary between 1 m to 4 m. Both horizontal and vertical polarizations of the antenna are set to make the measurement.
- d. The initial step in collecting radiated emission data is a receiver peak detector mode pre-scanning the measurement frequency range. Significant peaks are then marked and then Quasi Peak detector mode re-measured.
- e. All readings are Peak unless otherwise stated QP in column of Note. Peak denotes that the Peak reading compliance with the QP Limits and then QP Mode measurement didn't perform. (below 1GHz)
- f. All readings are Peak Mode value unless otherwise stated AVG in column of Note. If the Peak Mode Measured value compliance with the Peak Limits and lower than AVG Limits, the EUT shall be deemed to meet both Peak & AVG Limits and then only Peak Mode was measured, but AVG Mode didn't perform. (above 1GHz)
- g. For the actual test configuration, please refer to the related Item –EUT Test Photos.

4.2.3 DEVIATION FROM TEST STANDARD

No deviation

4.2.4 TEST SETUP

(A) Radiated Emission Test Set-Up Frequency Below 1 GHz

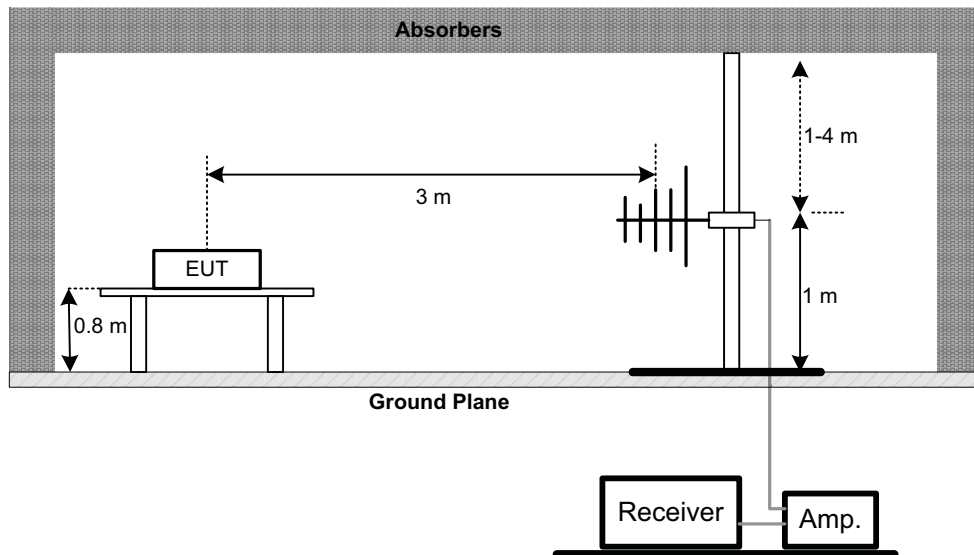

(B) Radiated Emission Test Set-Up Frequency Above 1 GHz

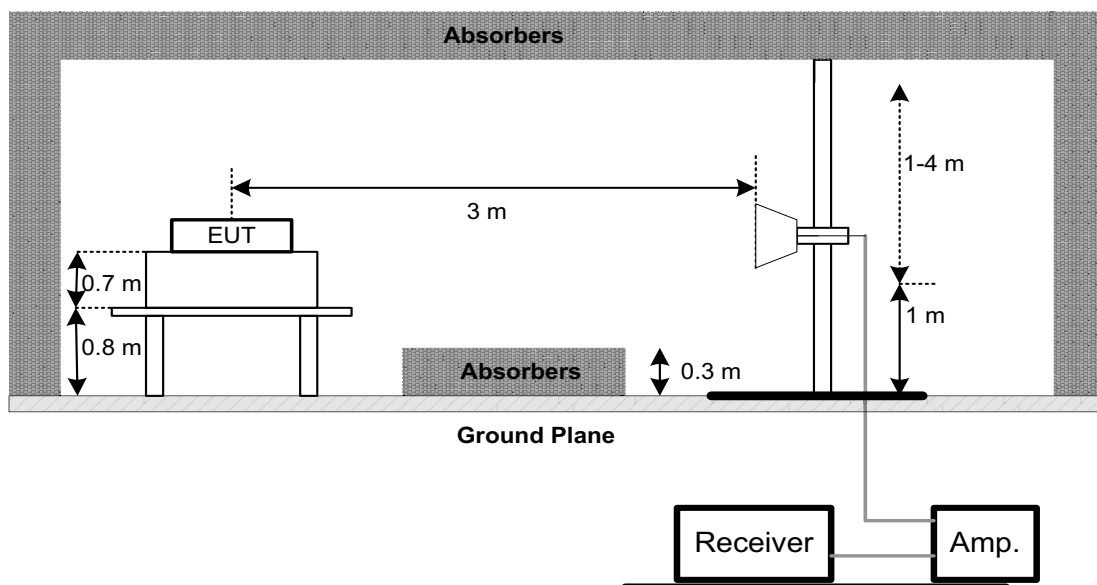

(C) For Radiated Emissions Below 30MHz

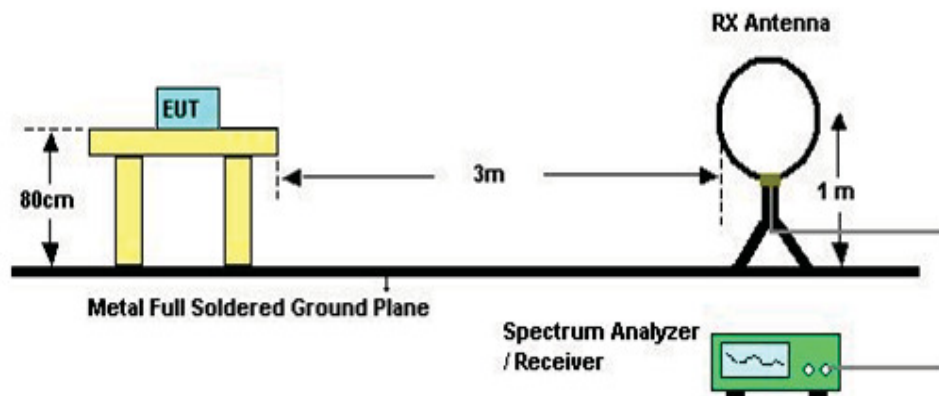

4.2.5 EUT OPERATING CONDITIONS

The EUT was programmed to be in continuously transmitting mode.

4.2.6 EUT TEST CONDITIONS

Temperature: 25°C Relative Humidity: 55% Test Voltage: AC 120V/60Hz

4.2.7 TEST RESULTS (9KHZ TO 30MHZ)

Please refer to the Attachment B

Remark:

- (1) The amplitude of spurious emissions which are attenuated by more than 20 dB below the permissible value has no need to be reported.
- (2) Distance extrapolation factor = $40 \log(\text{specific distance} / \text{test distance})$ (dB).
- (3) Limit line = specific limits (dBuV) + distance extrapolation factor.

4.2.8 TEST RESULTS (30MHZ TO 1000 MHZ)

Please refer to the Attachment C.

4.2.9 TEST RESULTS (ABOVE 1000 MHZ)

Please refer to the Attachment D.

Remark:

- (1) No limit: This is fundamental signal, the judgment is not applicable.
For fundamental signal judgment was referred to Peak output test.

5. BANDWIDTH TEST

5.1 APPLIED PROCEDURES

FCC Part15 (15.247) , Subpart C			
Section	Test Item	Frequency Range (MHz)	Result
15.247(a)(2)	Bandwidth	2400-2483.5	PASS

5.1.1 TEST PROCEDURE

- a. The EUT was directly connected to the spectrum analyzer and antenna output port as show in the block diagram below,
- b. Spectrum Setting: RBW= 100KHz, VBW=300KHz, Sweep time = 2.5 ms.

5.1.2 DEVIATION FROM STANDARD

No deviation.

5.1.3 TEST SETUP

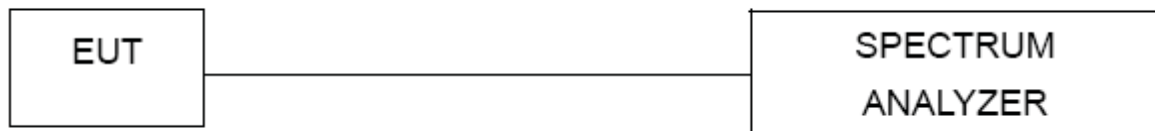

5.1.4 EUT OPERATION CONDITIONS

The EUT was programmed to be in continuously transmitting mode.

5.1.5 EUT TEST CONDITIONS

Temperature: 25°C Relative Humidity: 55% Test Voltage: AC 120V/60Hz

5.1.6 TEST RESULTS

Please refer to the Attachment E.

6. MAXIMUM PEAK CONDUCTED OUTPUT POWER TEST

6.1 APPLIED PROCEDURES / LIMIT

FCC Part15 (15.247) , Subpart C				
Section	Test Item	Limit	Frequency Range (MHz)	Result
15.247(b)(3)	Maximum Output Power	1 Watt or 30dBm	2400-2483.5	PASS

6.1.1 TEST PROCEDURE

- a. The EUT was directly connected to the power meter and antenna output port as show in the block diagram below,
- b. The maximum peak conducted output power was performed in accordance with method 9.1.2 of FCC KDB 558074 D01 DTS Meas Guidance v03r03.

6.1.2 DEVIATION FROM STANDARD

No deviation.

6.1.3 TEST SETUP

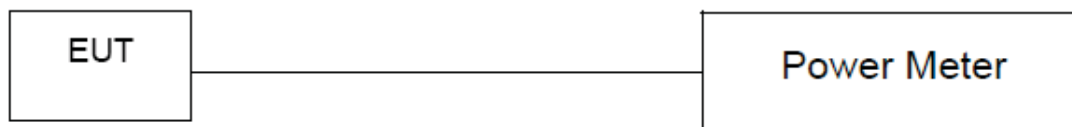

6.1.4 EUT OPERATION CONDITIONS

The EUT was programmed to be in continuously transmitting mode.

6.1.5 EUT TEST CONDITIONS

Temperature: 25°C Relative Humidity: 55% Test Voltage: AC 120V/60Hz

6.1.6 TEST RESULTS

Please refer to the Attachment F.

7. ANTENNA CONDUCTED SPURIOUS EMISSION

7.1 APPLIED PROCEDURES / LIMIT

In any 100 kHz bandwidth outside the frequency band in which the spread spectrum or digitally modulated device is operating, the RF power that is produced shall be at least 20 dB below that in the 100 kHz bandwidth within the band that contains the highest level of the desired power, based on either an RF conducted or a radiated measurement, provided that the transmitter demonstrates compliance with the peak conducted power limits.

7.1.1 TEST PROCEDURE

- a. The EUT was directly connected to the spectrum analyzer and antenna output port as show in the block diagram below,
- b. Spectrum Setting: RBW= 100KHz, VBW=300KHz, Sweep time = Auto.
- c. Offset=antenna gain+cable loss

7.1.2 DEVIATION FROM STANDARD

No deviation.

7.1.3 TEST SETUP

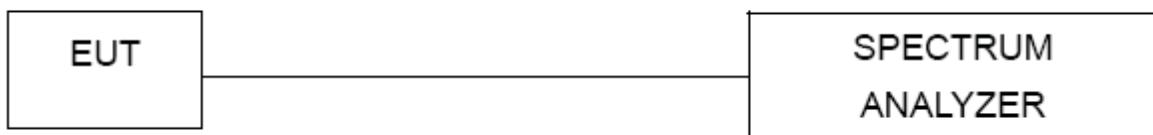

7.1.4 EUT OPERATION CONDITIONS

The EUT was programmed to be in continuously transmitting mode.

7.1.5 EUT TEST CONDITIONS

Temperature: 25°C Relative Humidity: 55% Test Voltage: AC 120V/60Hz

7.1.6 TEST RESULTS

Please refer to the Attachment G.

8. POWER SPECTRAL DENSITY TEST

8.1 APPLIED PROCEDURES / LIMIT

FCC Part15 (15.247) , Subpart C				
Section	Test Item	Limit	Frequency Range (MHz)	Result
15.247(e)	Power Spectral Density	8 dBm (in any 3KHz)	2400-2483.5	PASS

8.1.1 TEST PROCEDURE

- a. The EUT was directly connected to the spectrum analyzer and antenna output port as show in the block diagram below,
- b. Spectrum Setting: RBW=3KHz, VBW=10KHz, Sweep time = Auto.

8.1.2 DEVIATION FROM STANDARD

No deviation.

8.1.3 TEST SETUP

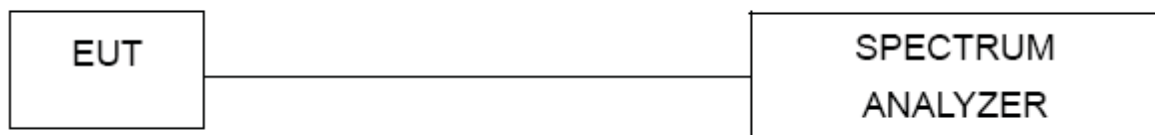

8.1.4 EUT OPERATION CONDITIONS

The EUT was programmed to be in continuously transmitting mode.

8.1.5 EUT TEST CONDITIONS

Temperature: 25°C Relative Humidity: 55% Test Voltage: AC 120V/60Hz

8.1.6 TEST RESULTS

Please refer to the Attachment H.

9. MEASUREMENT INSTRUMENTS LIST

Conducted Emission Measurement					
Item	Kind of Equipment	Manufacturer	Type No.	Serial No.	Calibrated until
1	LISN	EMCO	699837	0052765	Mar. 28, 2016
2	LISN	R&S	ENV216	101447	Mar. 28, 2016
3	Test Cable	emci	RG223(9KHz-30MHz)	C_17	Mar. 13, 2016
4	EMI Test Receiver	R&S	ESCS30	826547/022	Mar. 28, 2016
5	50Ω Terminator	SHX	TF2-3G-A	08122901	Mar. 28, 2016
6	Measurement Software	Farad	EZ-EMC Ver.NB-03A1-01	N/A	N/A

Radiated Emission Measurement					
Item	Kind of Equipment	Manufacturer	Type No.	Serial No.	Calibrated until
1	Antenna	Schwarbeck	VULB9160	9160-3232	Mar. 28, 2016
2	Amplifier	HP	8447D	2944A09673	Nov. 09, 2016
3	Receiver	AGILENT	N9038A	MY52130039	Oct. 11, 2016
4	Test Cable	emci	LMR-400(30MHz-1GHz)	C-01	Jun. 28, 2016
5	Controller	CT	SC100	N/A	N/A
6	Measurement Software	Farad	EZ-EMC Ver.NB-03A1-01	N/A	N/A
7	Antenna	ETS	3115	00075789	Mar. 28, 2016
8	Amplifier	Agilent	8449B	3008A02274	Nov. 01, 2016
9	Receiver	AGILENT	N9038A	MY52130039	Oct. 11, 2016
10	Test Cable	emci	EMC104-SM-S M-10000(1GHz-26.5GHz)	C-68	Jun. 28, 2016
11	Broad-Band Horn Antenna	Schwarzbeck	BBHA 9170	9170319	Mar. 28, 2016
12	Microwave Pre-amplifier With Adaptor	EMC INSTRUMENT	EMC2654045	980039 & HA01	Mar. 28, 2016
13	Active Loop Antenna	R&S	HFH2-Z2	830749/020	Sep. 07, 2016

6dB Bandwidth Measurement					
Item	Kind of Equipment	Manufacturer	Type No.	Serial No.	Calibrated until
1	Spectrum Analyzer	R&S	FSP 40	100185	Oct. 11, 2016

Peak Output Power Measurement					
Item	Kind of Equipment	Manufacturer	Type No.	Serial No.	Calibrated until
1	power Meter	ANRITSU	ML2495A	1128009	Mar. 28, 2016
2	Pulse Power Sensor	ANRITSU	MA 2411B	1027500	Mar. 28, 2016

Antenna Conducted Spurious Emission Measurement					
Item	Kind of Equipment	Manufacturer	Type No.	Serial No.	Calibrated until
1	Spectrum Analyzer	R&S	FSP 40	100185	Oct. 11, 2016

Power Spectral Density Measurement					
Item	Kind of Equipment	Manufacturer	Type No.	Serial No.	Calibrated until
1	Spectrum Analyzer	R&S	FSP 40	100185	Oct. 11, 2016

Remark: "N/A" denotes no model name, serial no. or calibration specified.
 All calibration period of equipment list is one year.

10. EUT TEST PHOTO

Conducted Measurement Photos



Radiated Measurement Photos**9KHz to 30MHz**

Radiated Measurement Photos

30MHz to 1000MHz



Radiated Measurement Photos

Above 1000MHz



ATTACHMENT A - CONDUCTED EMISSION

Test Mode : TX MODE

Line

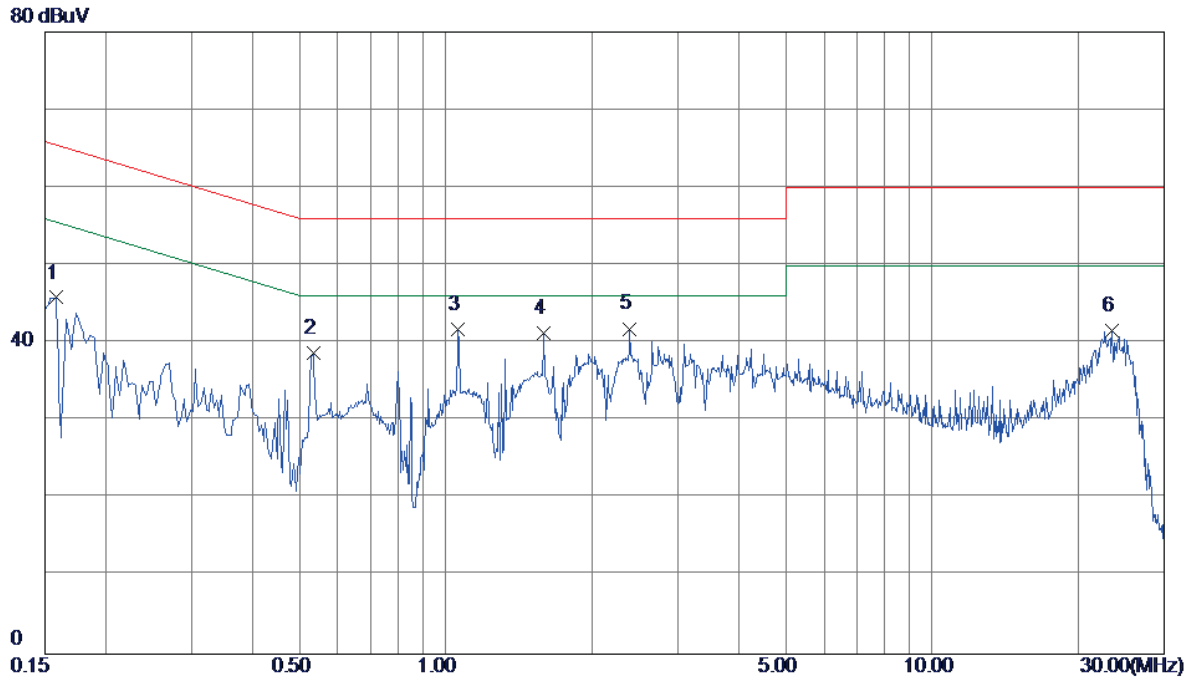

No.	Freq. MHz	Reading Level dBuV	Correct Factor dB	Measure ment dBuV	Limit dBuV	Margin dB	Detector	Comment
1	0.1580	36.29	9.55	45.84	65.57	-19.73	Peak	
2	0.5340	29.07	9.69	38.76	56.00	-17.24	Peak	
3	1.0620	32.03	9.80	41.83	56.00	-14.17	Peak	
4	1.5940	31.40	9.85	41.25	56.00	-14.75	Peak	
5	2.3900	31.86	9.98	41.84	56.00	-14.16	Peak	
6	23.4260	31.75	9.92	41.67	60.00	-18.33	Peak	

Test Mode : TX MODE

Neutral

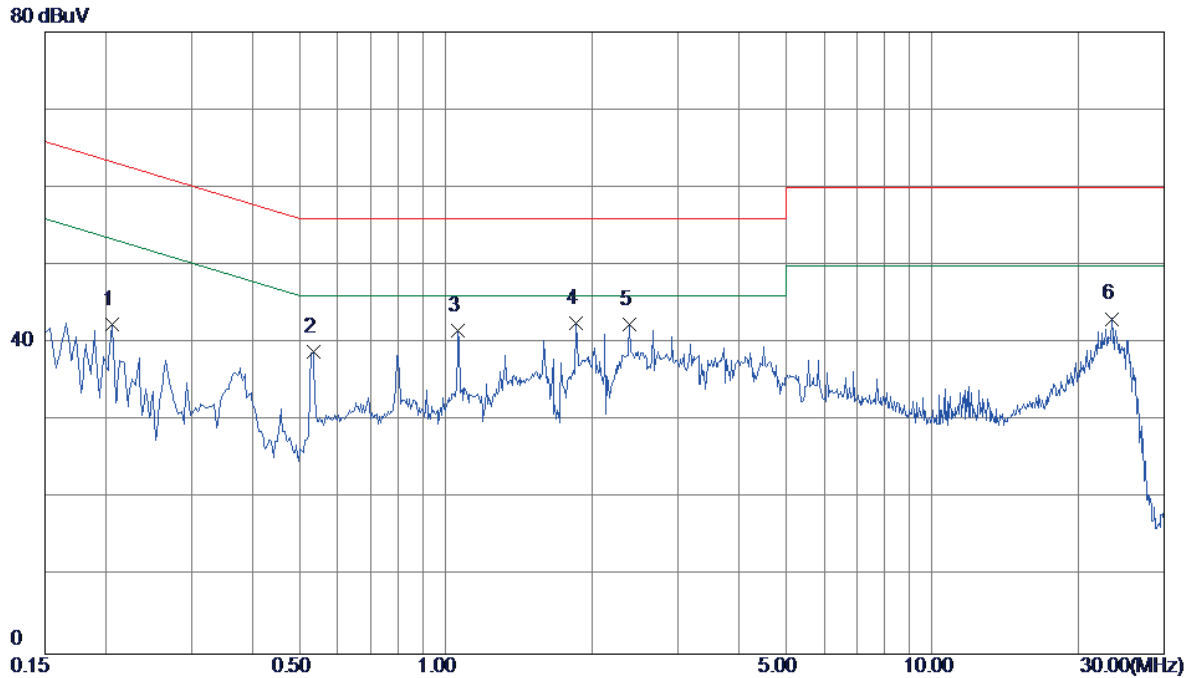

No.	Freq. MHz	Reading Level dBuV	Correct Factor dB	Measure ment dBuV	Limit dBuV	Margin dB	Detector	Comment
1	0.2060	32.94	9.50	42.44	63.37	-20.93	Peak	
2	0.5340	29.26	9.56	38.82	56.00	-17.18	Peak	
3	1.0620	32.01	9.59	41.60	56.00	-14.40	Peak	
4	1.8580	32.81	9.70	42.51	56.00	-13.49	Peak	
5	2.3900	32.60	9.76	42.36	56.00	-13.64	Peak	
6	23.4180	33.13	9.99	43.12	60.00	-16.88	Peak	

ATTACHMENT B - RADIATED EMISSION (9KHZ TO 30MHZ)

Frequency (MHz)	Ant 0°/90°	Read level dBuV/m	Factor (dB)	Measured(FS) (dBuV/m)	Limit (dBuV/m)	Margin (dB)	Note
0.0123	0°	13.56	24.7877	38.3477	125.8061	-87.4585	AVG
0.0123	0°	14.39	24.7877	39.1777	145.8061	-106.6285	PEAK
0.0267	0°	6.31	23.8757	30.1857	119.0740	-88.8883	AVG
0.0267	0°	8.21	23.8757	32.0857	139.0740	-106.9883	PEAK
0.0353	0°	3.26	23.3310	26.5910	116.6487	-90.0577	AVG
0.0353	0°	5.33	23.3310	28.6610	136.6487	-107.9877	PEAK
0.0542	0°	1.27	22.3160	23.5860	112.9242	-89.3382	AVG
0.0542	0°	2.69	22.3160	25.0060	132.9242	-107.9182	PEAK
0.5012	0°	19.35	19.8038	39.1538	73.6040	-34.4502	QP
1.9586	0°	23.62	19.5041	43.1241	69.5400	-26.4159	QP

Frequency (MHz)	Ant 0°/90°	Read level dBuV/m	Factor (dB)	Measured(FS) (dBuV/m)	Limit (dBuV/m)	Margin (dB)	Note
0.0125	90°	13.16	24.3000	37.4600	125.6660	-88.2060	AVG
0.0125	90°	14.51	24.3000	38.8100	145.6660	-106.8560	PEAK
0.0253	90°	7.41	23.9643	31.3743	119.5418	-88.1675	AVG
0.0253	90°	8.78	23.9643	32.7443	139.5418	-106.7975	PEAK
0.0423	90°	5.38	22.8877	28.2677	115.0774	-86.8098	AVG
0.0423	90°	6.33	22.8877	29.2177	135.0774	-105.8598	PEAK
0.0564	90°	1.46	22.2720	23.7320	112.5786	-88.8466	AVG
0.0564	90°	2.53	22.2720	24.8020	132.5786	-107.7766	PEAK
0.6232	90°	22.31	20.1942	42.5042	71.7117	-29.2074	QP
2.0523	90°	24.46	19.4686	43.9286	69.5400	-25.6114	QP

ATTACHMENT C - RADIATED EMISSION (30MHZ TO 1000MHZ)

Test Mode: TX B MODE CHANNEL 01

Vertical

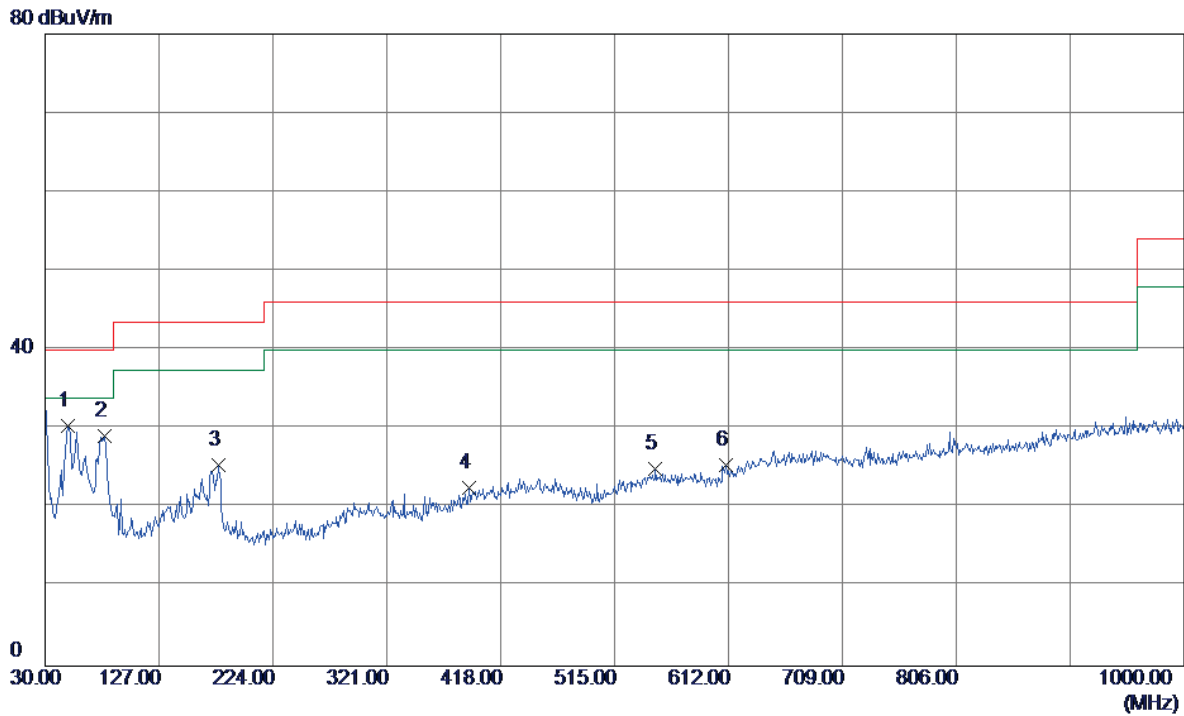

No.	Freq. MHz	Reading Level dBuV/m	Correct Factor dB	Measure ment dBuV/m	Limit dBuV/m	Margin dB	Detector	Comment
1	49.4000	42.79	-12.43	30.36	40.00	-9.64	Peak	
2	80.4400	44.79	-15.72	29.07	40.00	-10.93	Peak	
3	177.4400	36.75	-11.38	25.37	43.50	-18.13	Peak	
4	390.8400	30.38	-7.75	22.63	46.00	-23.37	Peak	
5	549.9200	29.58	-4.62	24.96	46.00	-21.04	Peak	
6	610.0600	29.49	-4.04	25.45	46.00	-20.55	Peak	

Test Mode: TX B MODE CHANNEL 01

Horizontal

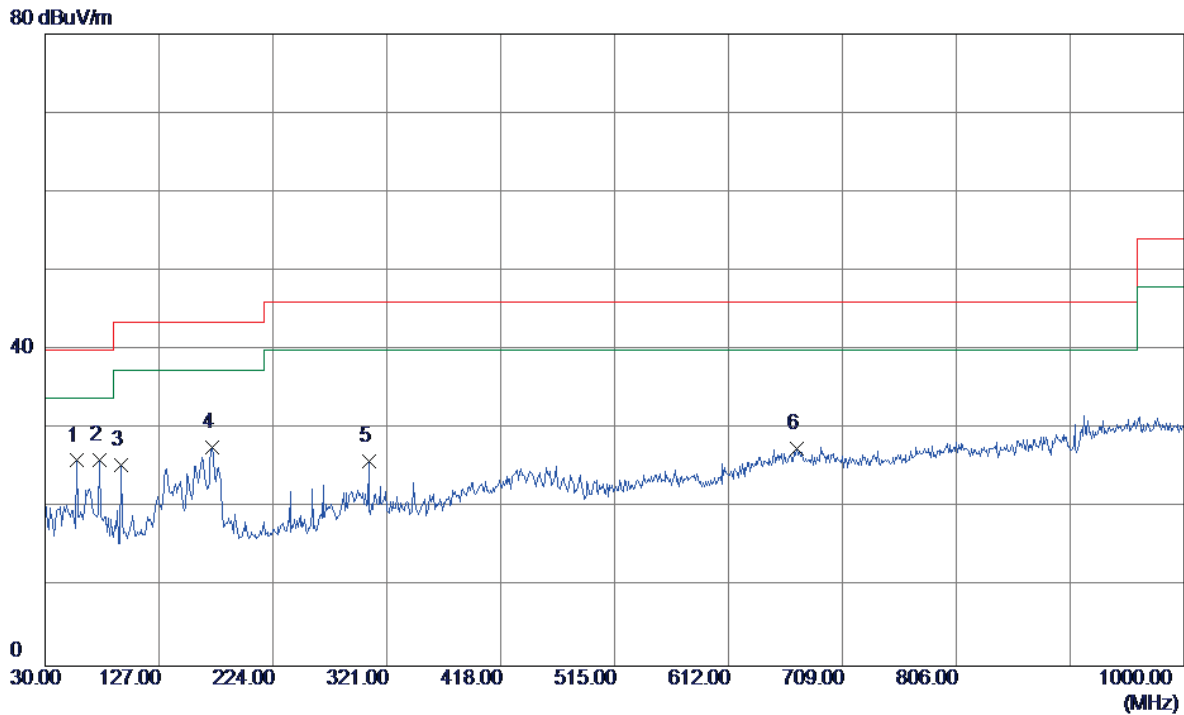

No.	Freq. MHz	Reading Level dBuV/m	Correct Factor dB	Measure ment dBuV/m	Limit dBuV/m	Margin dB	Detector	Comment
1	57.1600	39.02	-13.02	26.00	40.00	-14.00	Peak	
2	76.5600	41.43	-15.39	26.04	40.00	-13.96	Peak	
3	94.9900	40.88	-15.51	25.37	43.50	-18.13	Peak	
4	172.5900	38.95	-11.21	27.74	43.50	-15.76	Peak	
5	305.4800	35.56	-9.62	25.94	46.00	-20.06	Peak	
6	670.2000	29.14	-1.57	27.57	46.00	-18.43	Peak	

Test Mode: TX B MODE CHANNEL 06

Vertical

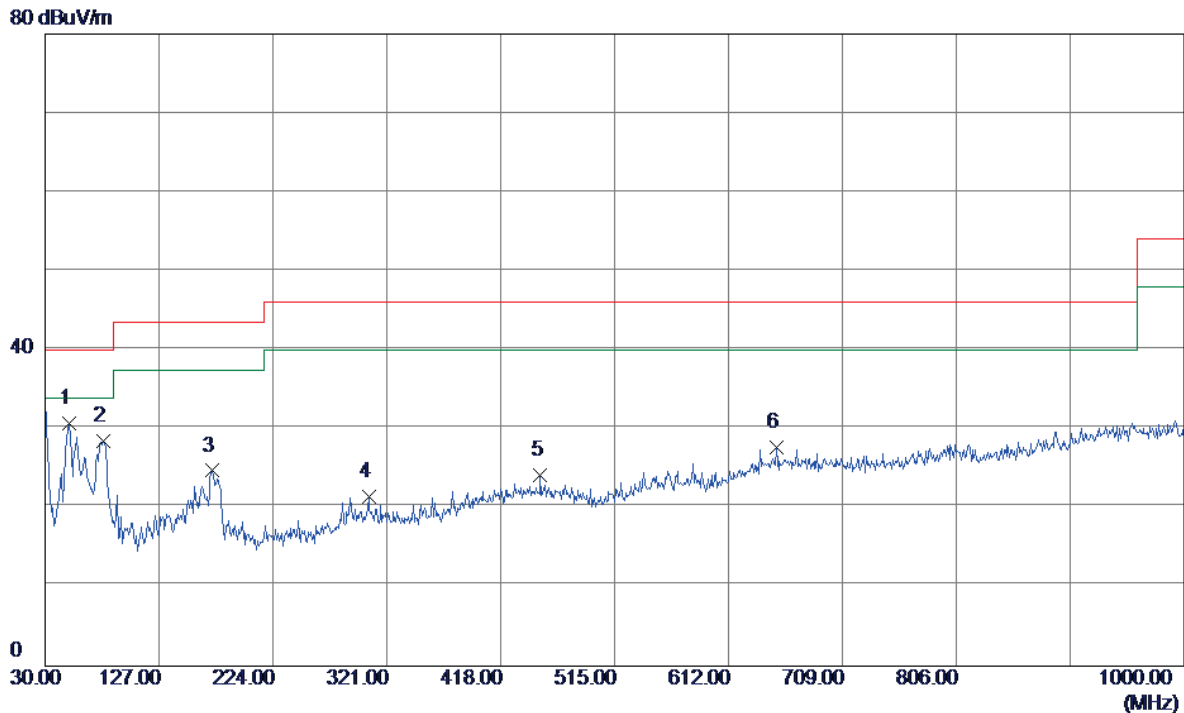

No.	Freq. MHz	Reading Level dBuV/m	Correct Factor dB	Measure ment dBuV/m	Limit dBuV/m	Margin dB	Detector	Comment
1	50.3700	43.14	-12.48	30.66	40.00	-9.34	Peak	
2	79.4700	44.19	-15.66	28.53	40.00	-11.47	Peak	
3	172.5900	35.93	-11.21	24.72	43.50	-18.78	Peak	
4	305.4800	31.04	-9.62	21.42	46.00	-24.58	Peak	
5	451.9500	30.12	-5.95	24.17	46.00	-21.83	Peak	
6	652.7400	29.29	-1.63	27.66	46.00	-18.34	Peak	

Test Mode: TX B MODE CHANNEL 06

Horizontal

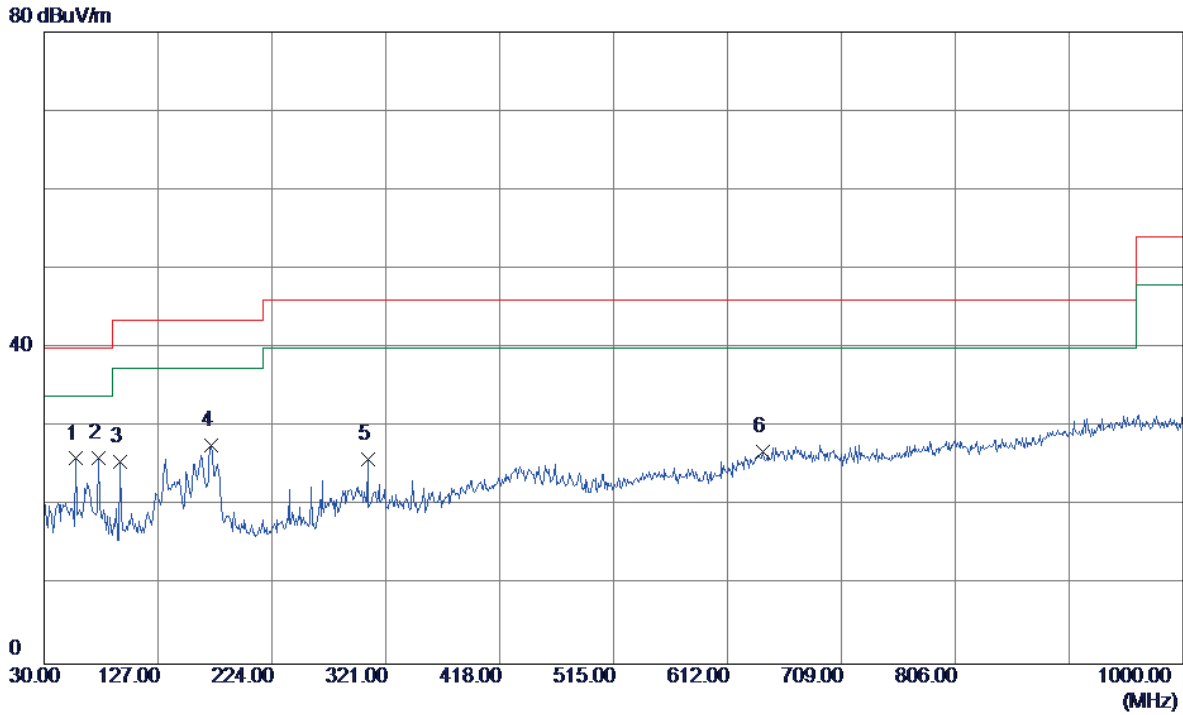

No.	Freq. MHz	Reading Level dBuV/m	Correct Factor dB	Measure ment dBuV/m	Limit dBuV/m	Margin dB	Detector	Comment
1	57.1600	39.02	-13.02	26.00	40.00	-14.00	Peak	
2	76.5600	41.54	-15.39	26.15	40.00	-13.85	Peak	
3	94.9900	41.10	-15.51	25.59	43.50	-17.91	Peak	
4	172.5900	38.95	-11.21	27.74	43.50	-15.76	Peak	
5	305.4800	35.56	-9.62	25.94	46.00	-20.06	Peak	
6	642.0700	29.06	-2.12	26.94	46.00	-19.06	Peak	

Test Mode: TX B MODE CHANNEL 11

Vertical

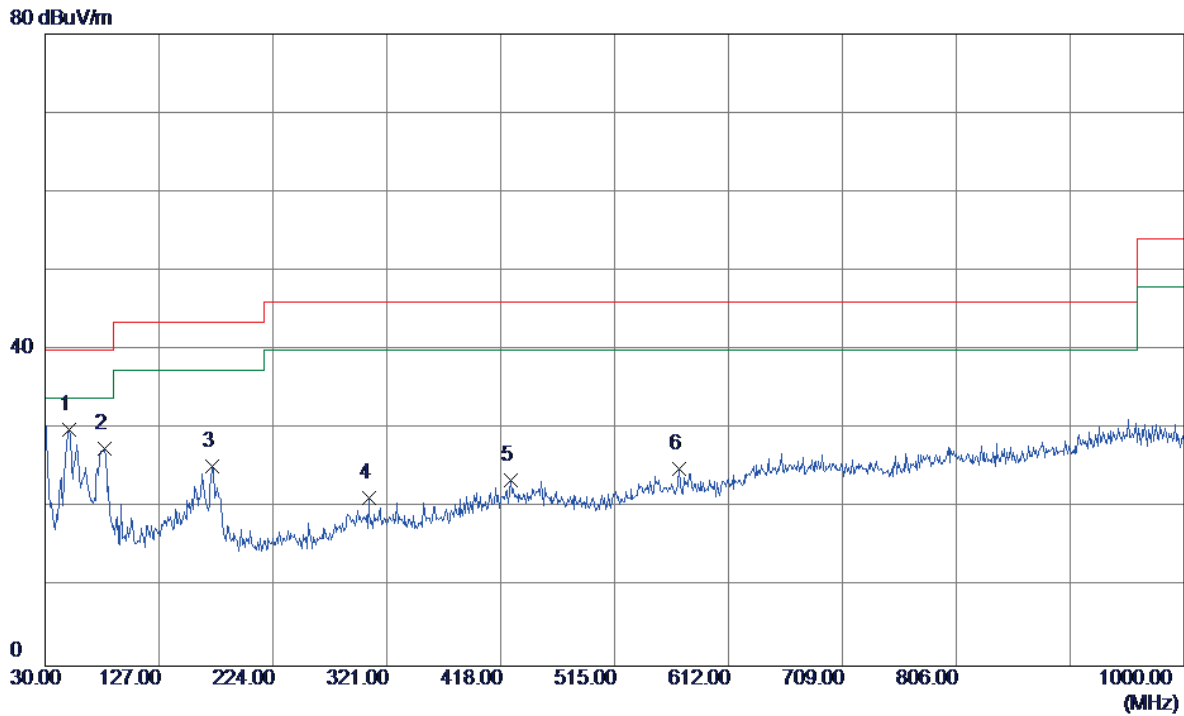

No.	Freq. MHz	Reading Level dBuV/m	Correct Factor dB	Measure ment dBuV/m	Limit dBuV/m	Margin dB	Detector	Comment
1	50.3700	42.38	-12.48	29.90	40.00	-10.10	Peak	
2	80.4400	43.29	-15.72	27.57	40.00	-12.43	Peak	
3	172.5900	36.48	-11.21	25.27	43.50	-18.23	Peak	
4	305.4800	30.84	-9.62	21.22	46.00	-24.78	Peak	
5	426.7300	30.03	-6.53	23.50	46.00	-22.50	Peak	
6	570.2900	29.54	-4.63	24.91	46.00	-21.09	Peak	

Test Mode: TX B MODE CHANNEL 11

Horizontal

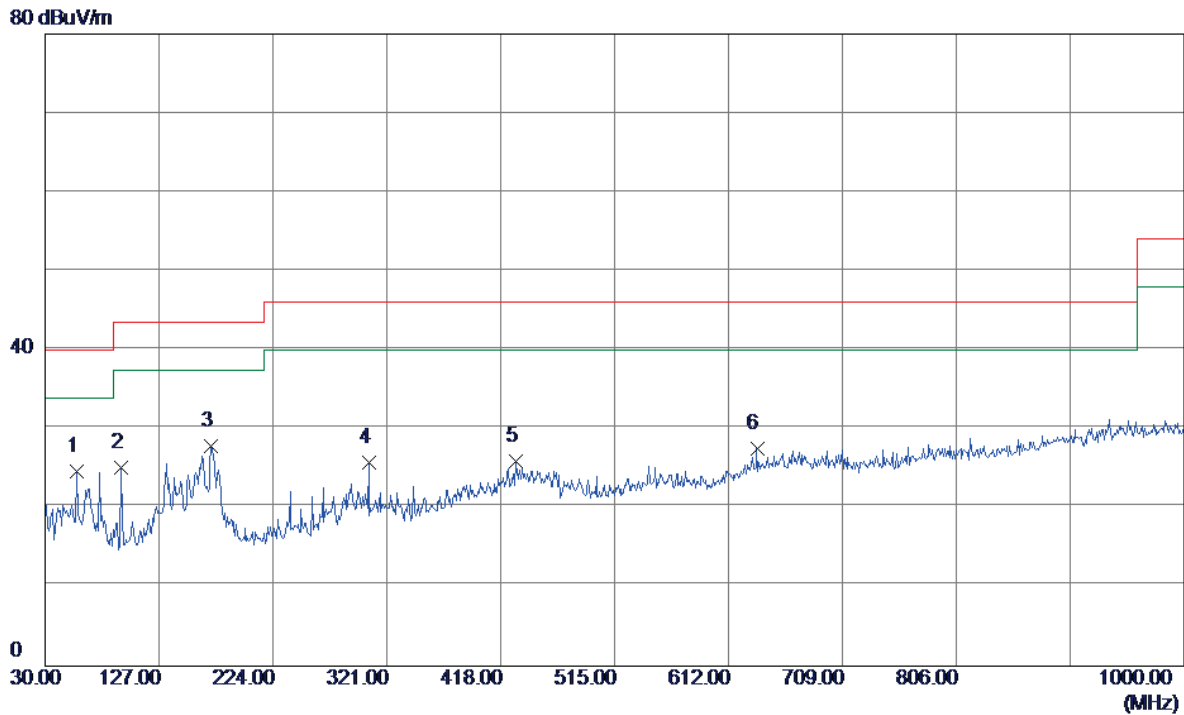

No.	Freq. MHz	Reading Level dBuV/m	Correct Factor dB	Measure ment dBuV/m	Limit dBuV/m	Margin dB	Detector	Comment
1	57.1600	37.62	-13.02	24.60	40.00	-15.40	Peak	
2	94.9900	40.58	-15.51	25.07	43.50	-18.43	Peak	
3	171.6200	39.07	-11.18	27.89	43.50	-15.61	Peak	
4	305.4800	35.45	-9.62	25.83	46.00	-20.17	Peak	
5	430.6100	32.30	-6.43	25.87	46.00	-20.13	Peak	
6	636.2500	29.97	-2.47	27.50	46.00	-18.50	Peak	

ATTACHMENT D - RADIATED EMISSION (ABOVE 1000MHZ)

Orthogonal Axis :	X
Test Mode :	TX B MODE 2412MHz

Vertical

125 dBuV/m

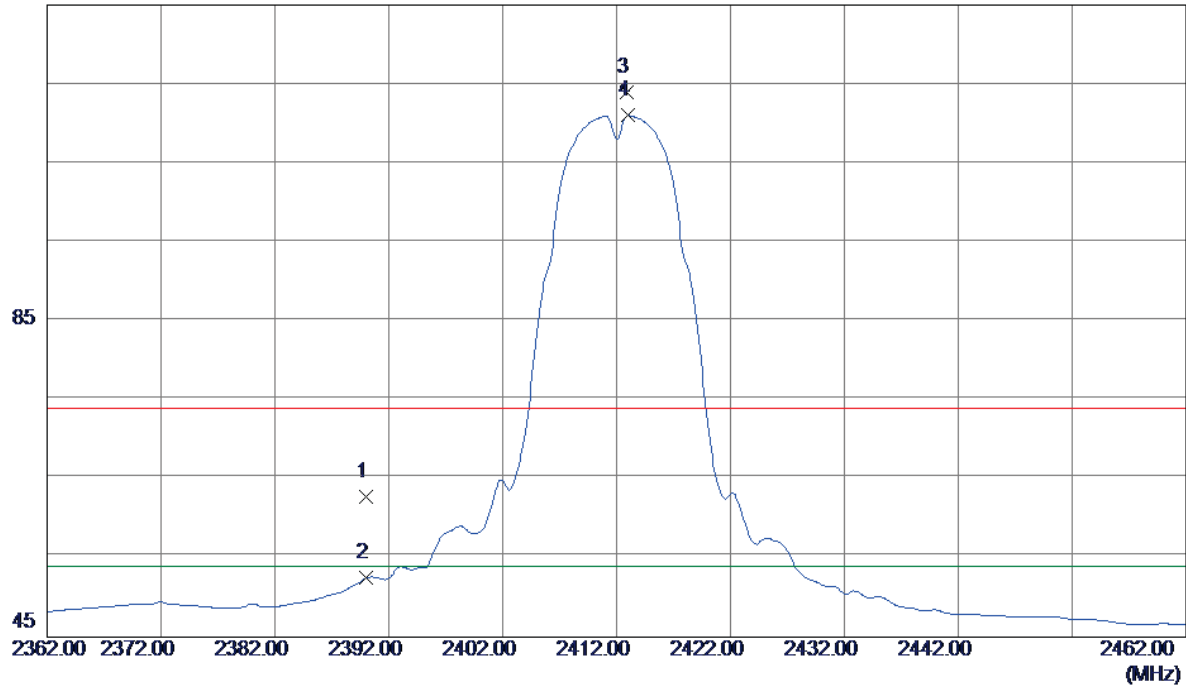

No.	Freq. MHz	Reading Level dBuV/m	Correct Factor dB	Measure ment dBuV/m	Limit dBuV/m	Margin dB	Detector	Comment
1	2390.0000	28.48	34.23	62.71	74.00	-11.29	Peak	
2	2390.0000	18.26	34.23	52.49	54.00	-1.51	AVG	
3	2412.9000	79.60	34.36	113.96	74.00	39.96	Peak	No Limit
4	2413.0000	76.67	34.37	111.04	54.00	57.04	AVG	No Limit

Orthogonal Axis :	X
Test Mode :	TX B MODE 2412MHz

Vertical

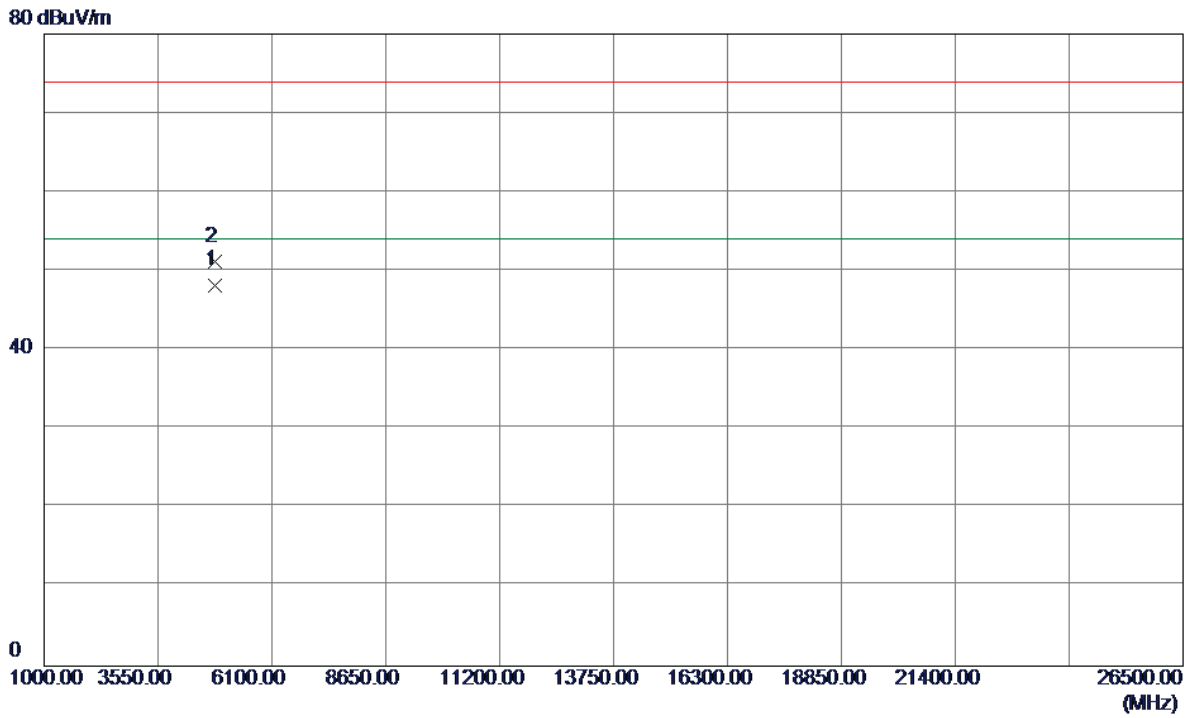

No.	Freq. MHz	Reading Level dBuV/m	Correct Factor dB	Measure ment dBuV/m	Limit dBuV/m	Margin dB	Detector	Comment
1	4823.9600	45.24	3.00	48.24	54.00	-5.76	AVG	
2	4823.9200	48.24	3.00	51.24	74.00	-22.76	Peak	

Orthogonal Axis :	X
Test Mode :	TX B MODE 2412MHz

Horizontal

115 dBuV/m

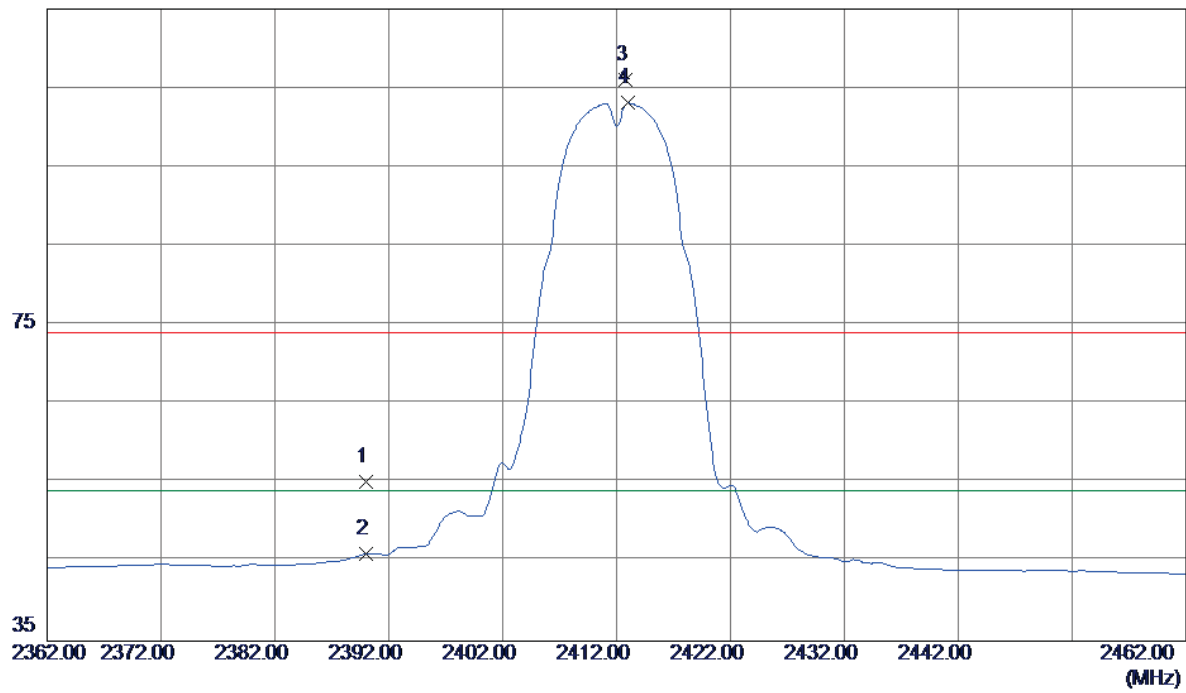

No.	Freq. MHz	Reading Level dBuV/m	Correct Factor dB	Measure ment dBuV/m	Limit dBuV/m	Margin dB	Detector	Comment
1	2390.0000	20.98	34.23	55.21	74.00	-18.79	Peak	
2	2390.0000	11.83	34.23	46.06	54.00	-7.94	AVG	
3	2412.8000	71.66	34.36	106.02	74.00	32.02	Peak	No Limit
4	2413.0000	68.76	34.37	103.13	54.00	49.13	AVG	No Limit

Orthogonal Axis :	X
Test Mode :	TX B MODE 2412MHz

Horizontal

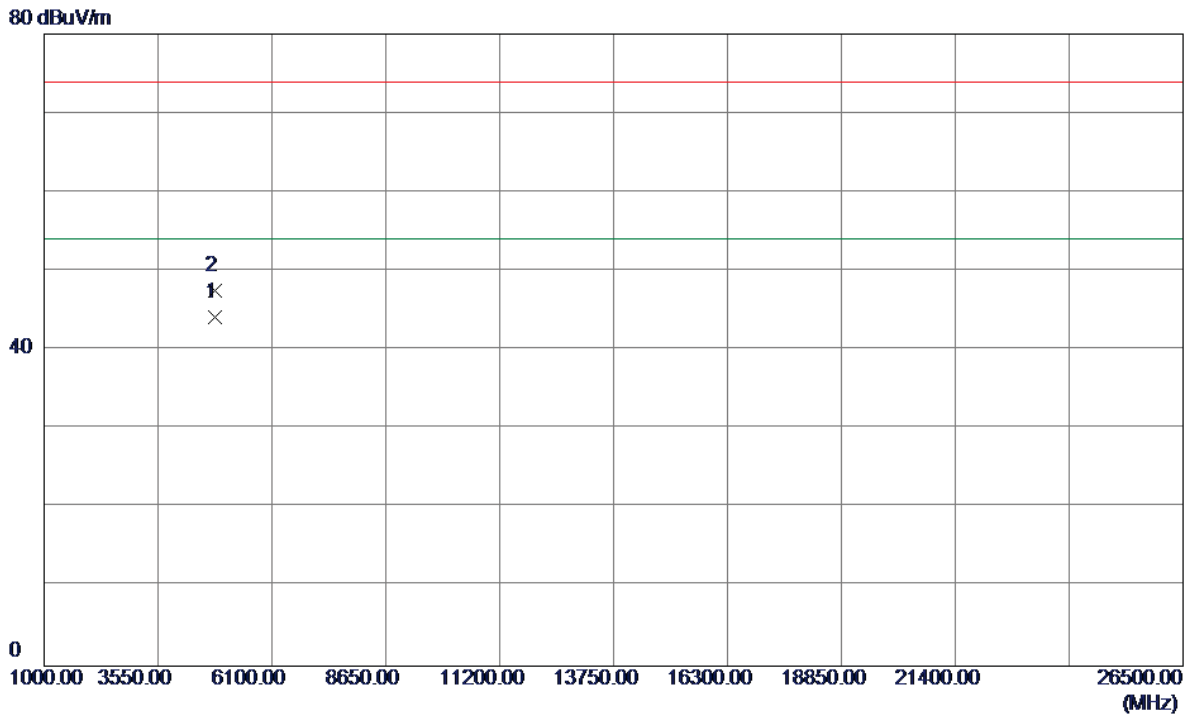

No.	Freq. MHz	Reading Level dBuV/m	Correct Factor dB	Measure ment dBuV/m	Limit dBuV/m	Margin dB	Detector	Comment
1	4823.9600	41.16	3.00	44.16	54.00	-9.84	AVG	
2	4824.0000	44.51	3.00	47.51	74.00	-26.49	Peak	

Orthogonal Axis :	X
Test Mode :	TX B MODE 2437MHz

Vertical

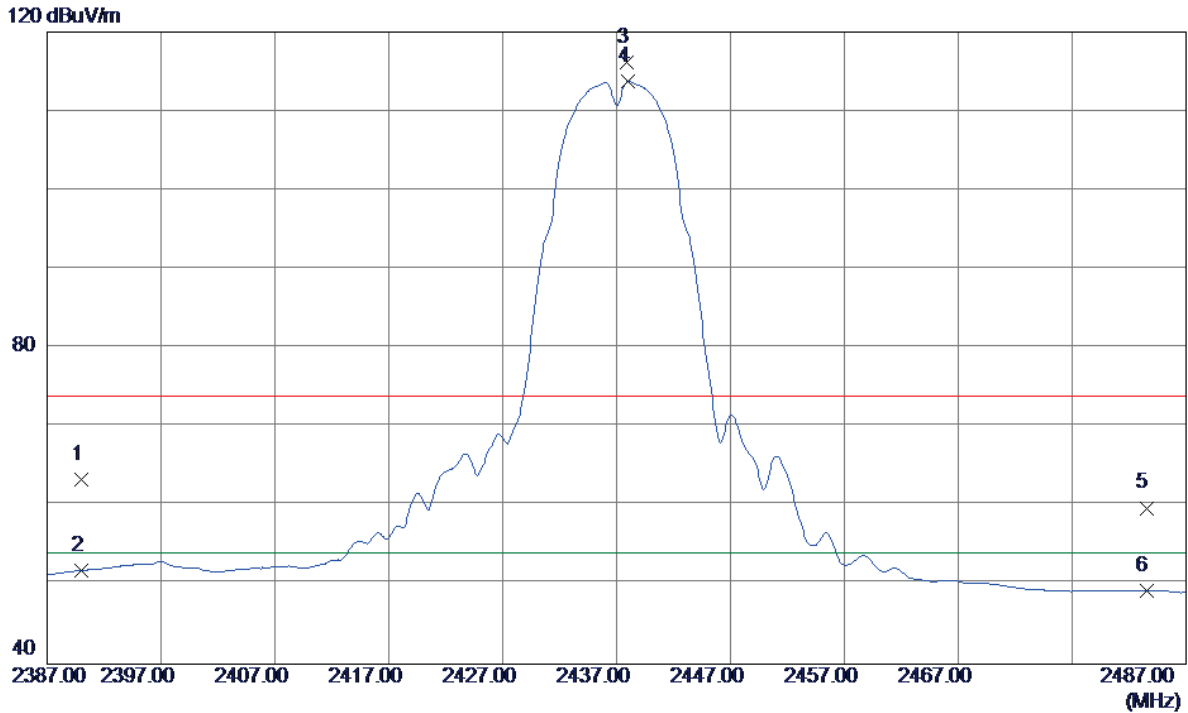

No.	Freq. MHz	Reading Level dBuV/m	Correct Factor dB	Measure ment dBuV/m	Limit dBuV/m	Margin dB	Detector	Comment
1	2390.0000	29.14	34.23	63.37	74.00	-10.63	Peak	
2	2390.0000	17.62	34.23	51.85	54.00	-2.15	AVG	
3	2437.9000	81.60	34.51	116.11	74.00	42.11	Peak	No Limit
4	2438.0000	79.25	34.51	113.76	54.00	59.76	AVG	No Limit
5	2483.5000	24.99	34.77	59.76	74.00	-14.24	Peak	
6	2483.5000	14.48	34.77	49.25	54.00	-4.75	AVG	

Orthogonal Axis :	X
Test Mode :	TX B MODE 2437MHz

Vertical

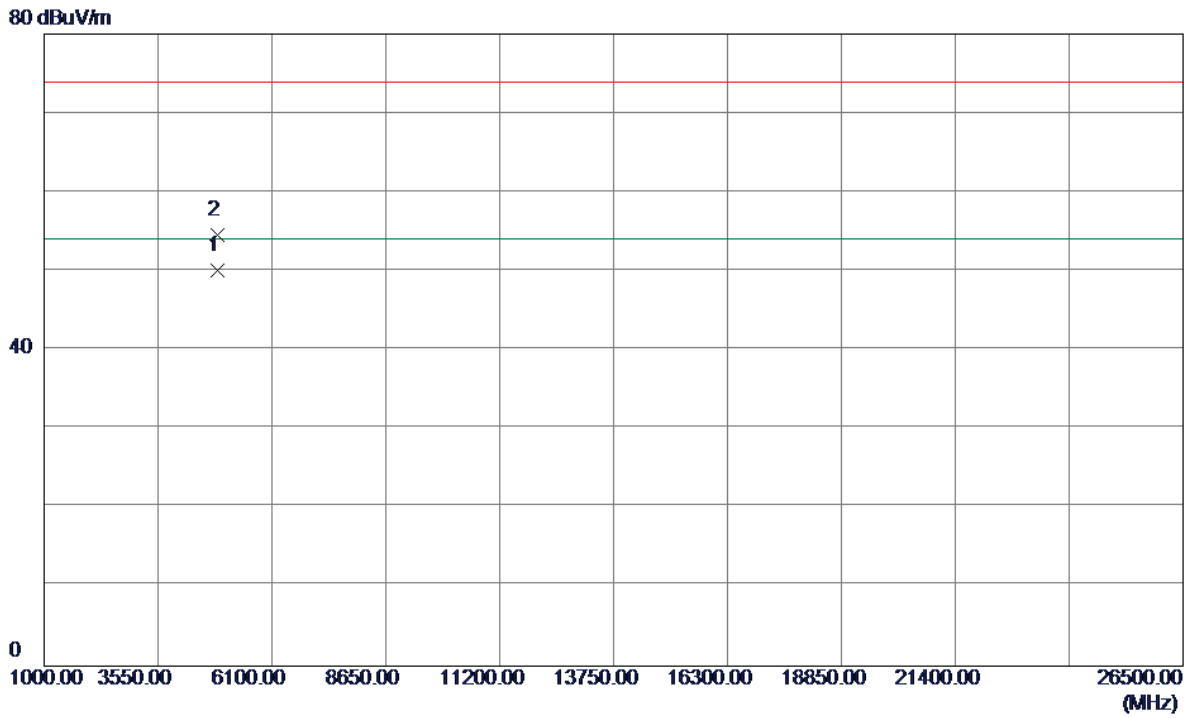

No.	Freq. MHz	Reading Level dBuV/m	Correct Factor dB	Measure ment dBuV/m	Limit dBuV/m	Margin dB	Detector	Comment
1	4873.9200	47.01	3.03	50.04	54.00	-3.96	AVG	
2	4873.9600	51.58	3.03	54.61	74.00	-19.39	Peak	

Orthogonal Axis :	X
Test Mode :	TX B MODE 2437MHz

Horizontal

115 dBuV/m

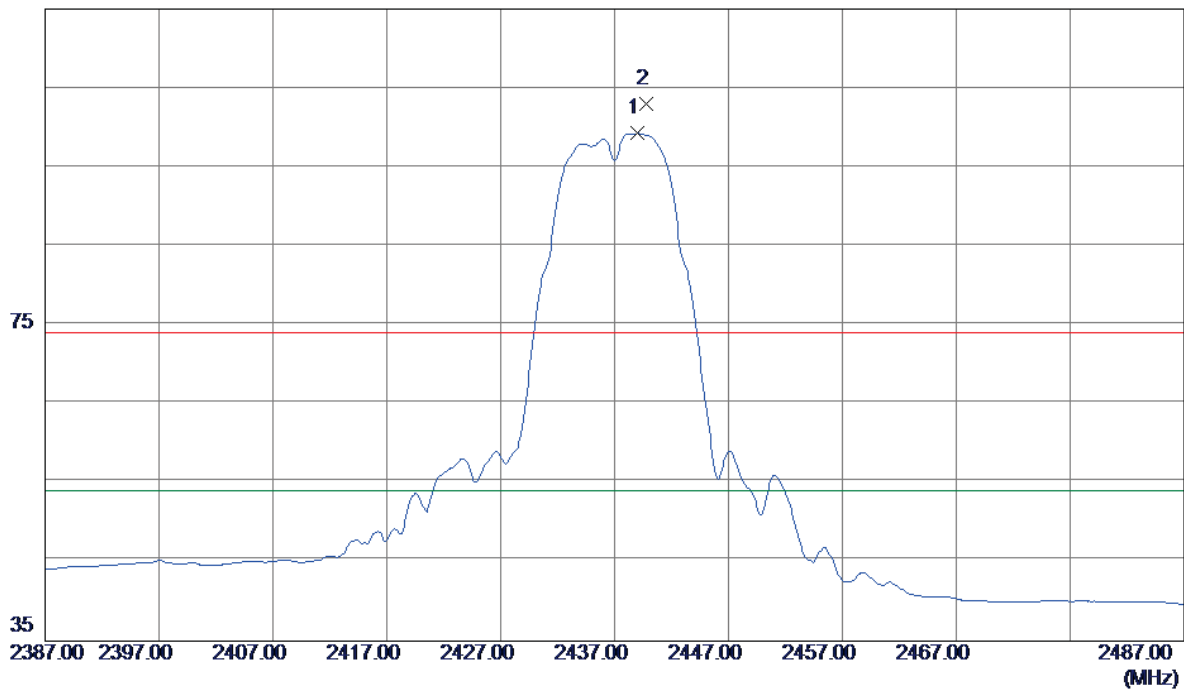

No.	Freq. MHz	Reading Level dBuV/m	Correct Factor dB	Measure ment dBuV/m	Limit dBuV/m	Margin dB	Detector	Comment
1	2439.0000	64.73	34.52	99.25	54.00	45.25	AVG	No Limit
2	2439.8000	68.46	34.52	102.98	74.00	28.98	Peak	No Limit

Orthogonal Axis :	X
Test Mode :	TX B MODE 2437MHz

Horizontal

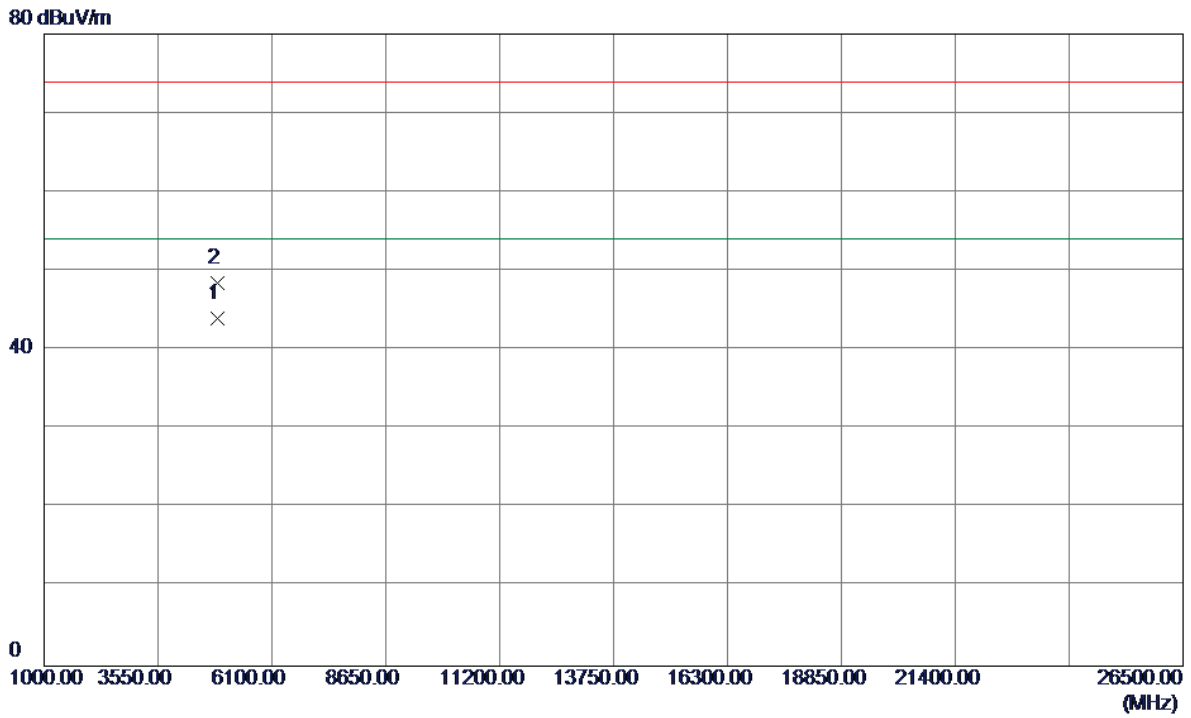

No.	Freq. MHz	Reading Level dBuV/m	Correct Factor dB	Measure ment dBuV/m	Limit dBuV/m	Margin dB	Detector	Comment
1	4873.9600	41.03	3.03	44.06	54.00	-9.94	AVG	
2	4874.0800	45.51	3.03	48.54	74.00	-25.46	Peak	

Orthogonal Axis :	X
Test Mode :	TX B MODE 2462MHz

Vertical

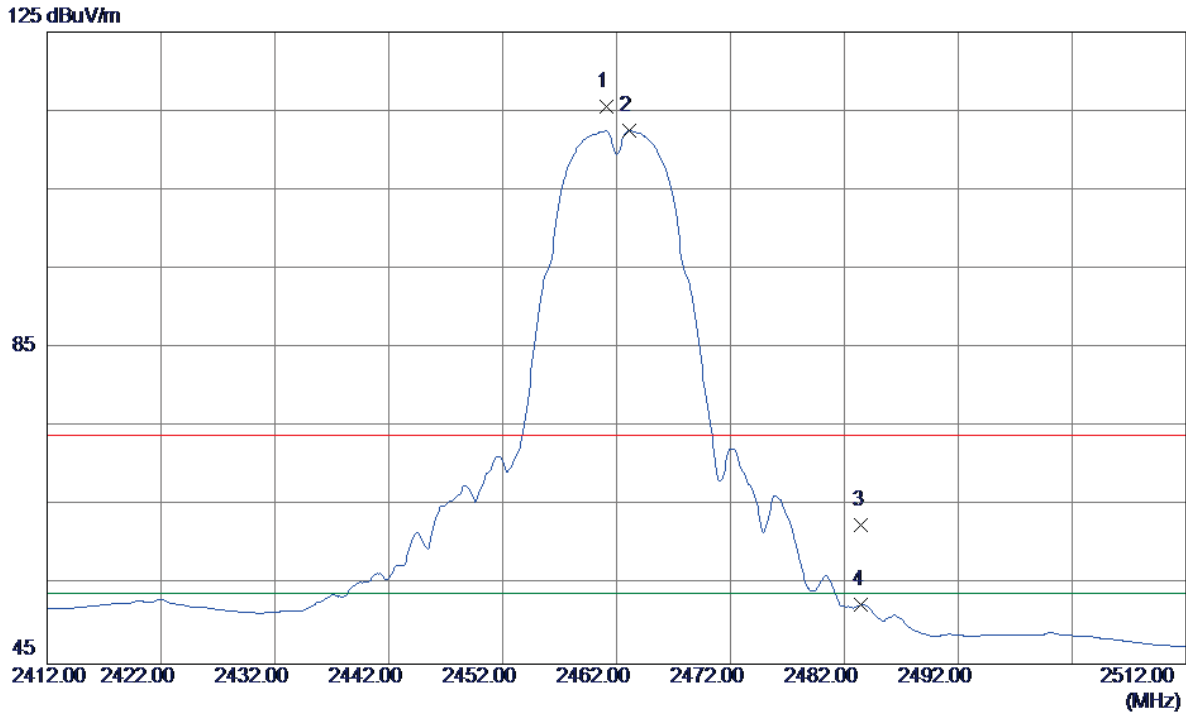

No.	Freq. MHz	Reading Level dBuV/m	Correct Factor dB	Measure ment dBuV/m	Limit dBuV/m	Margin dB	Detector	Comment
1	2461.1000	80.91	34.64	115.55	74.00	41.55	Peak	No Limit
2	2463.1000	77.85	34.66	112.51	54.00	58.51	AVG	No Limit
3	2483.5000	27.78	34.77	62.55	74.00	-11.45	Peak	
4	2483.5000	17.72	34.77	52.49	54.00	-1.51	AVG	

Orthogonal Axis :	X
Test Mode :	TX B MODE 2462MHz

Vertical

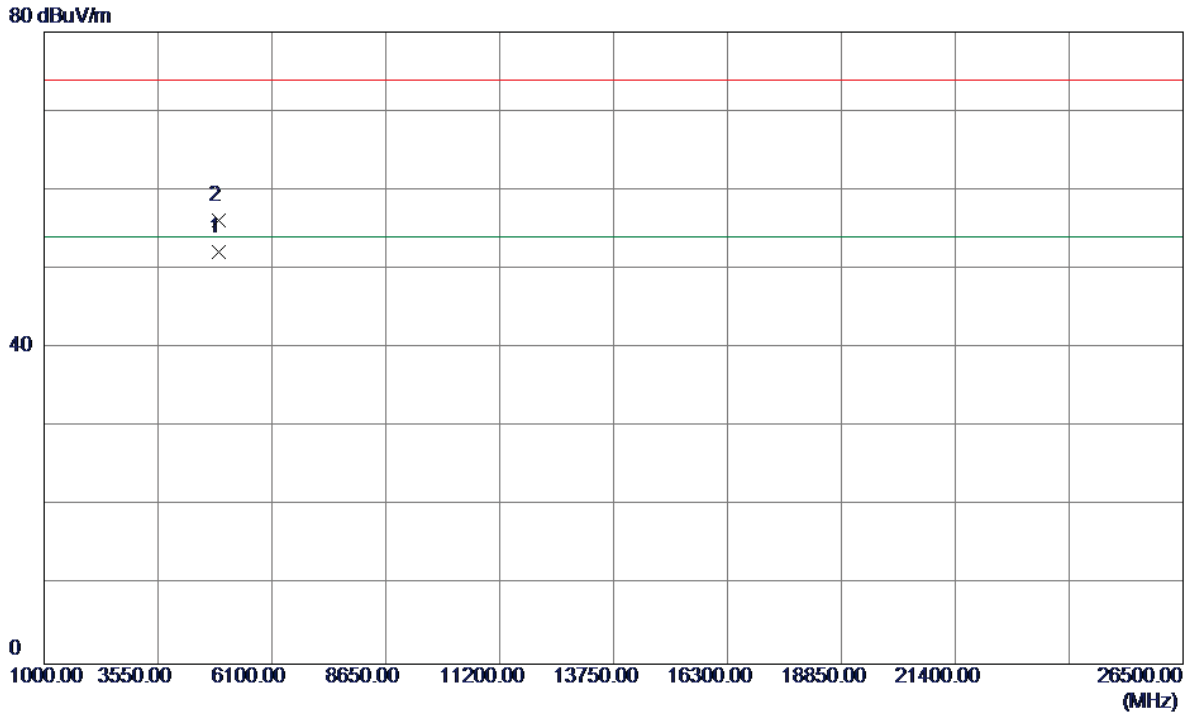

No.	Freq. MHz	Reading Level dBuV/m	Correct Factor dB	Measure ment dBuV/m	Limit dBuV/m	Margin dB	Detector	Comment
1	4923.9600	49.04	3.05	52.09	54.00	-1.91	AVG	
2	4923.9400	53.14	3.05	56.19	74.00	-17.81	Peak	

Orthogonal Axis :	X
Test Mode :	TX B MODE 2462MHz

Horizontal

115 dBuV/m

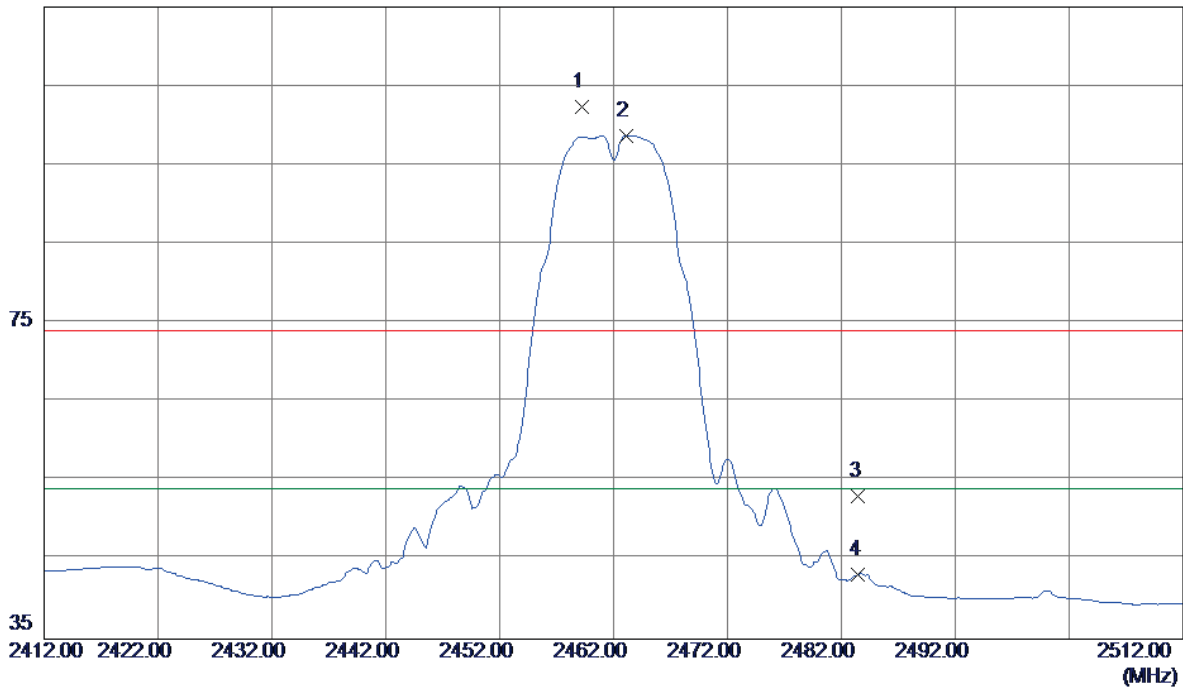

No.	Freq. MHz	Reading Level dBuV/m	Correct Factor dB	Measure ment dBuV/m	Limit dBuV/m	Margin dB	Detector	Comment
1	2459.2000	67.70	34.63	102.33	74.00	28.33	Peak	No Limit
2	2463.1000	64.06	34.66	98.72	54.00	44.72	AVG	No Limit
3	2483.5000	18.35	34.77	53.12	74.00	-20.88	Peak	
4	2483.5000	8.45	34.77	43.22	54.00	-10.78	AVG	

Orthogonal Axis :	X
Test Mode :	TX B MODE 2462MHz

Horizontal

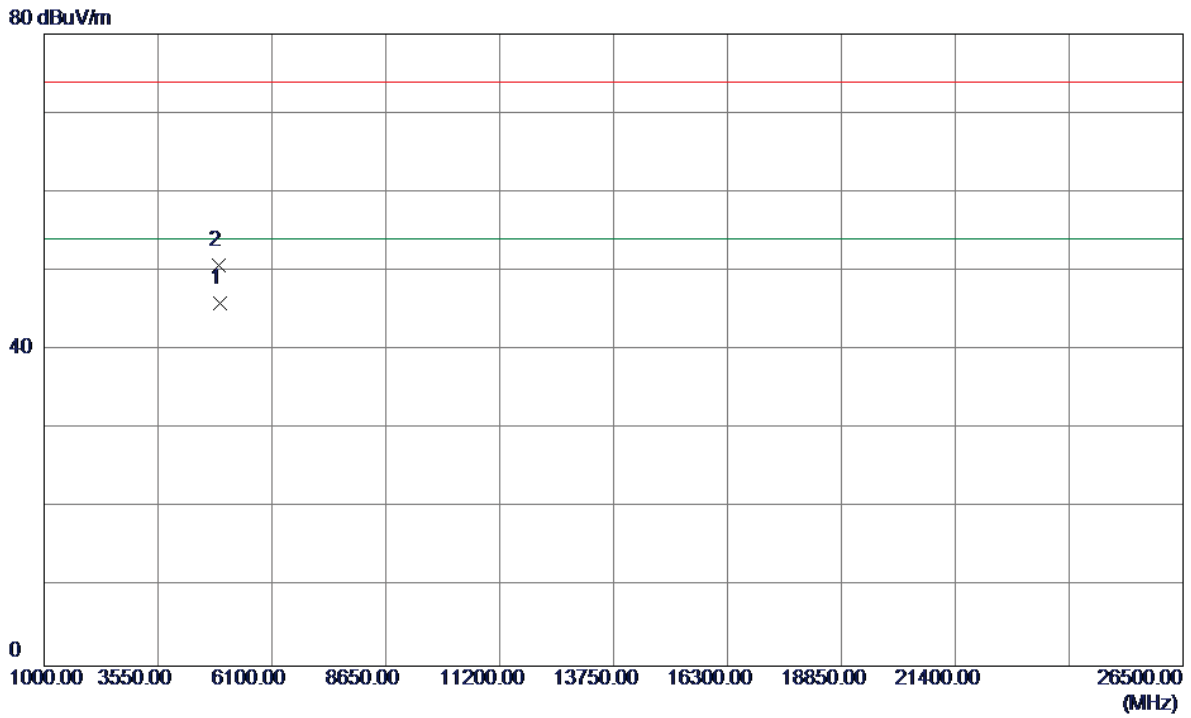

No.	Freq. MHz	Reading Level dBuV/m	Correct Factor dB	Measure ment dBuV/m	Limit dBuV/m	Margin dB	Detector	Comment
1	4924.5000	42.87	3.05	45.92	54.00	-8.08	AVG	
2	4923.5000	47.66	3.05	50.71	74.00	-23.29	Peak	

Orthogonal Axis :	X
Test Mode :	TX G MODE 2412MHz

Vertical

120 dBuV/m

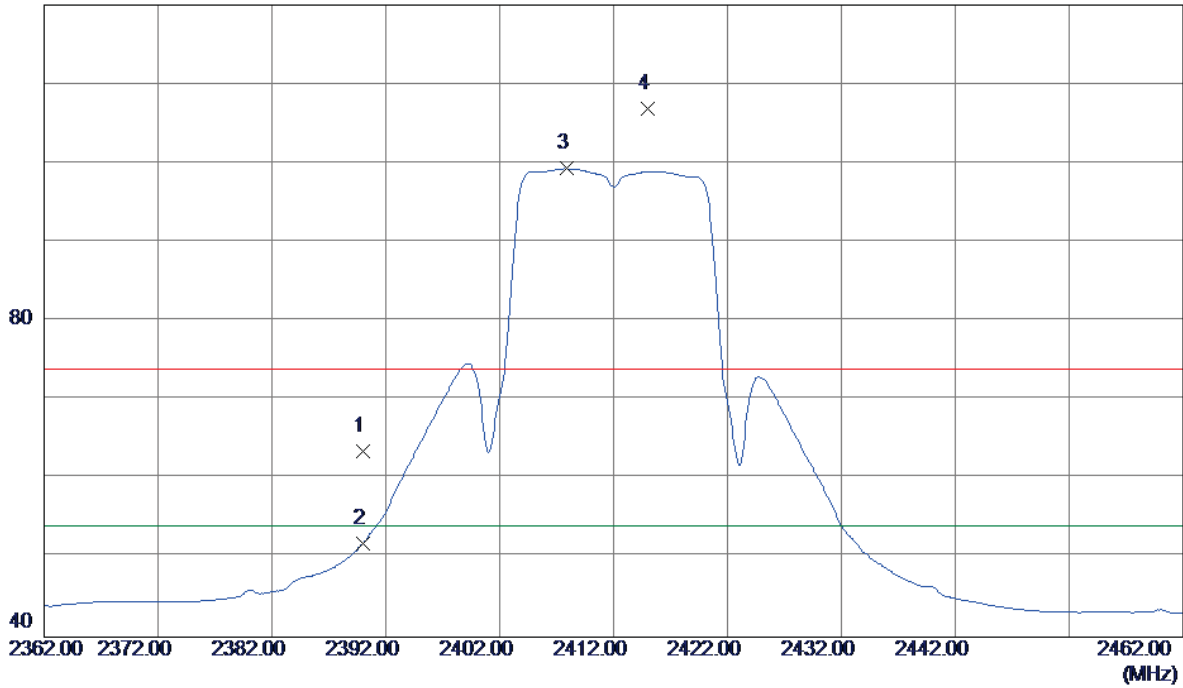

No.	Freq. MHz	Reading Level dBuV/m	Correct Factor dB	Measure ment dBuV/m	Limit dBuV/m	Margin dB	Detector	Comment
1	2390.0000	29.26	34.23	63.49	74.00	-10.51	Peak	
2	2390.0000	17.66	34.23	51.89	54.00	-2.11	AVG	
3	2407.9000	64.95	34.34	99.29	54.00	45.29	AVG	No Limit
4	2415.0000	72.57	34.38	106.95	74.00	32.95	Peak	No Limit

Orthogonal Axis :	X
Test Mode :	TX G MODE 2412MHz

Vertical

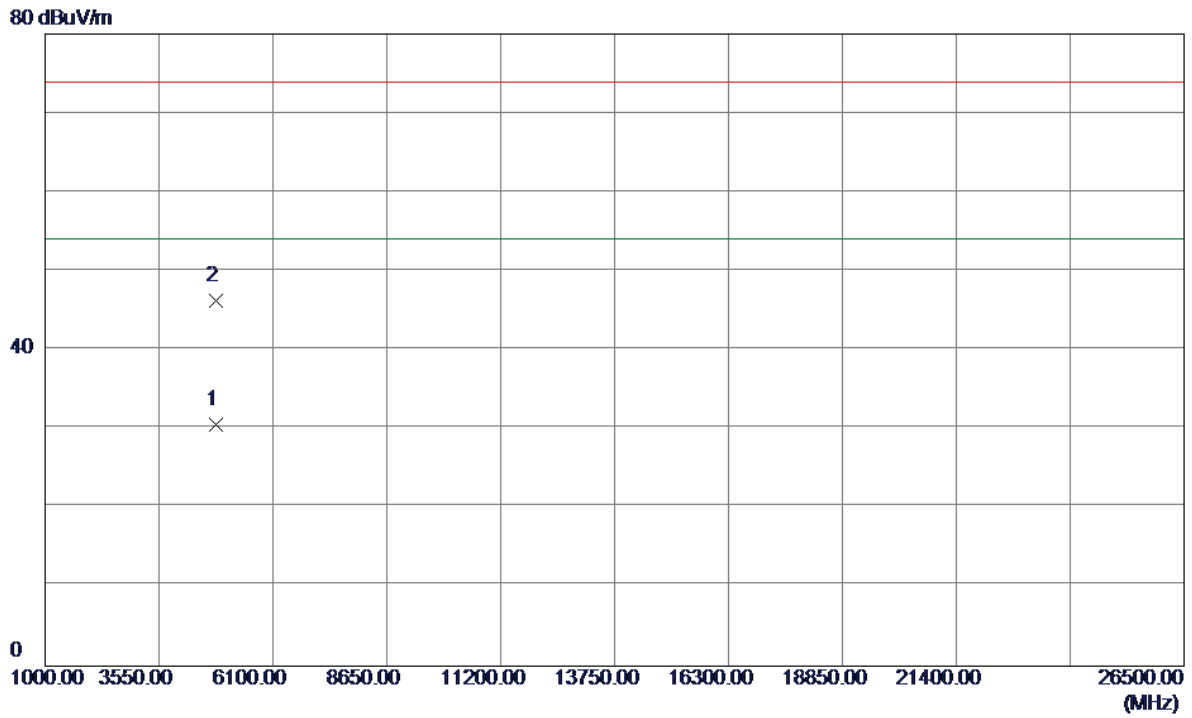

No.	Freq. MHz	Reading Level dBuV/m	Correct Factor dB	Measure ment dBuV/m	Limit dBuV/m	Margin dB	Detector	Comment
1	4823.9600	27.50	3.00	30.50	54.00	-23.50	AVG	
2	4823.9200	43.24	3.00	46.24	74.00	-27.76	Peak	

Orthogonal Axis :	X
Test Mode :	TX G MODE 2412MHz

Horizontal

115 dBuV/m

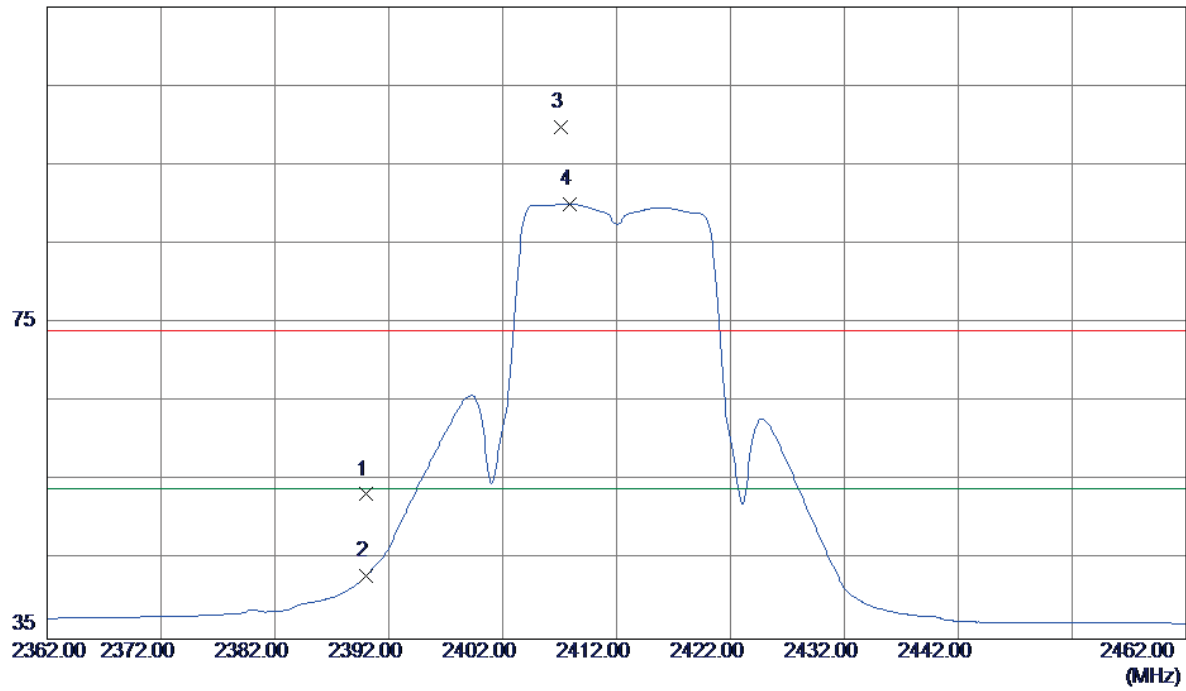

No.	Freq. MHz	Reading Level dBuV/m	Correct Factor dB	Measure ment dBuV/m	Limit dBuV/m	Margin dB	Detector	Comment
1	2390.0000	19.09	34.23	53.32	74.00	-20.68	Peak	
2	2390.0000	8.73	34.23	42.96	54.00	-11.04	AVG	
3	2407.1000	65.47	34.33	99.80	74.00	25.80	Peak	No Limit
4	2407.9000	55.73	34.34	90.07	54.00	36.07	AVG	No Limit

Orthogonal Axis :	X
Test Mode :	TX G MODE 2412MHz

Horizontal

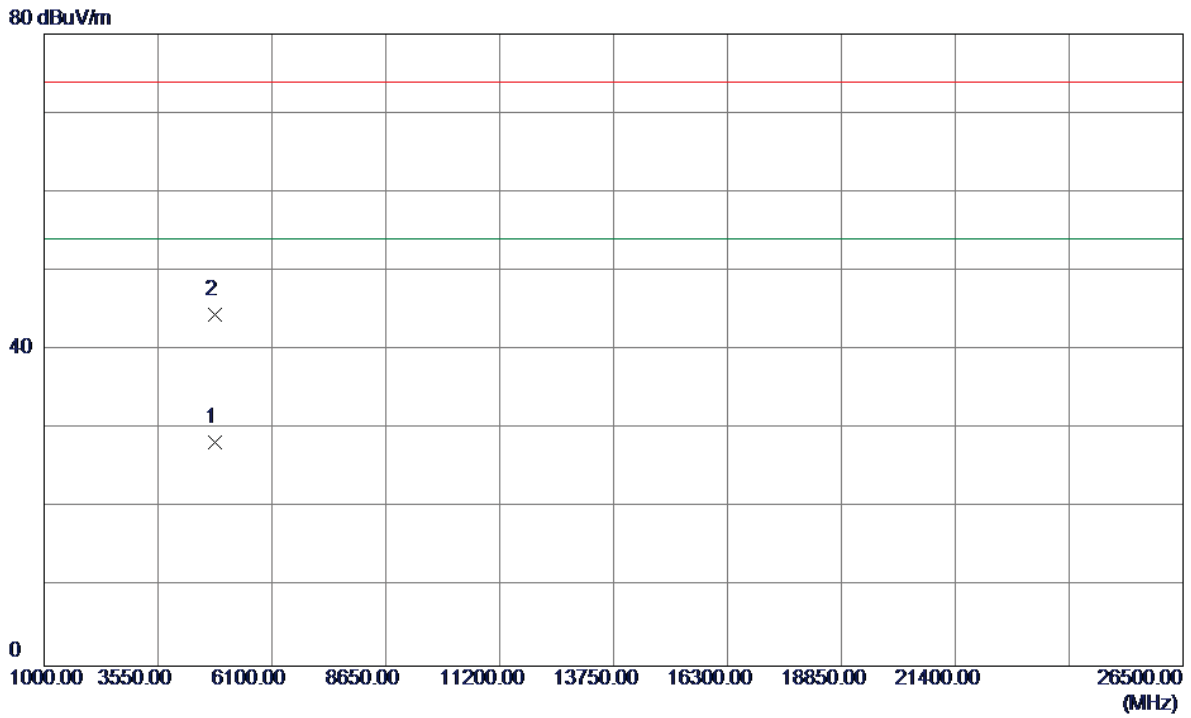

No.	Freq. MHz	Reading Level dBuV/m	Correct Factor dB	Measure ment dBuV/m	Limit dBuV/m	Margin dB	Detector	Comment
1	4823.9600	25.37	3.00	28.37	54.00	-25.63	AVG	
2	4824.0000	41.51	3.00	44.51	74.00	-29.49	Peak	

Orthogonal Axis :	X
Test Mode :	TX G MODE 2437MHz

Vertical

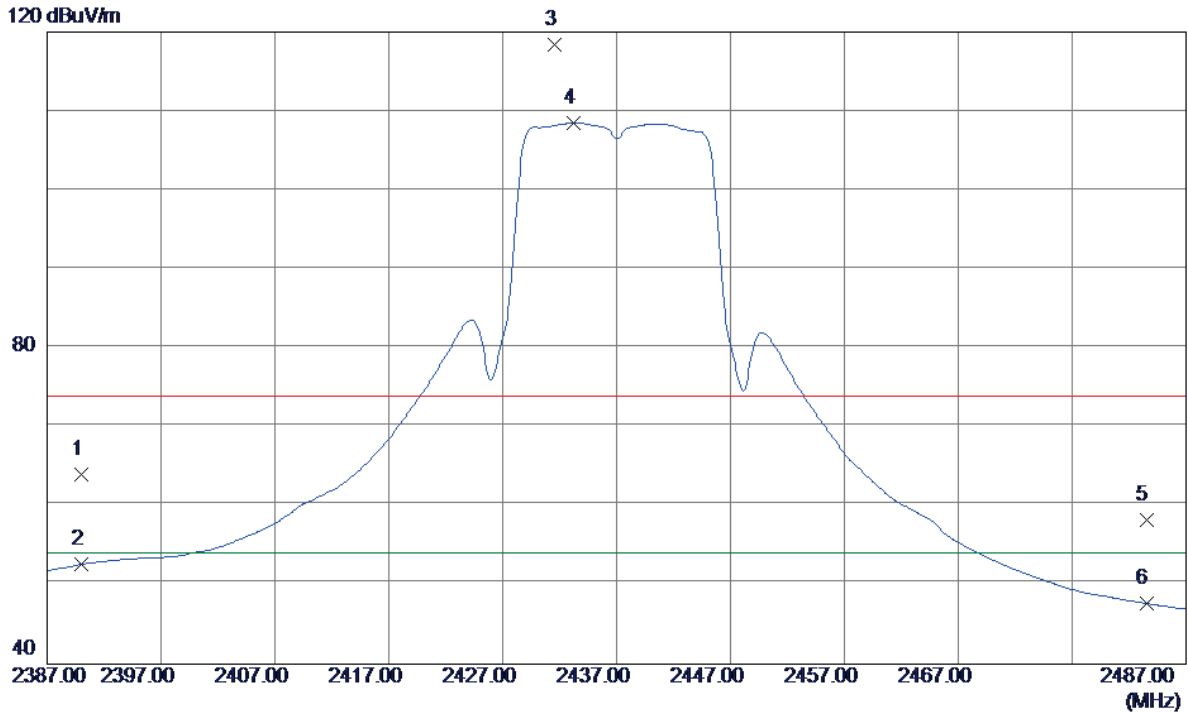

No.	Freq. MHz	Reading Level dBuV/m	Correct Factor dB	Measure ment dBuV/m	Limit dBuV/m	Margin dB	Detector	Comment
1	2390.0000	29.70	34.23	63.93	74.00	-10.07	Peak	
2	2390.0000	18.40	34.23	52.63	54.00	-1.37	AVG	
3	2431.6000	83.92	34.47	118.39	74.00	44.39	Peak	No Limit
4	2433.2000	74.01	34.48	108.49	54.00	54.49	AVG	No Limit
5	2483.5000	23.52	34.77	58.29	74.00	-15.71	Peak	
6	2483.5000	12.89	34.77	47.66	54.00	-6.34	AVG	

Orthogonal Axis :	X
Test Mode :	TX G MODE 2437MHz

Vertical

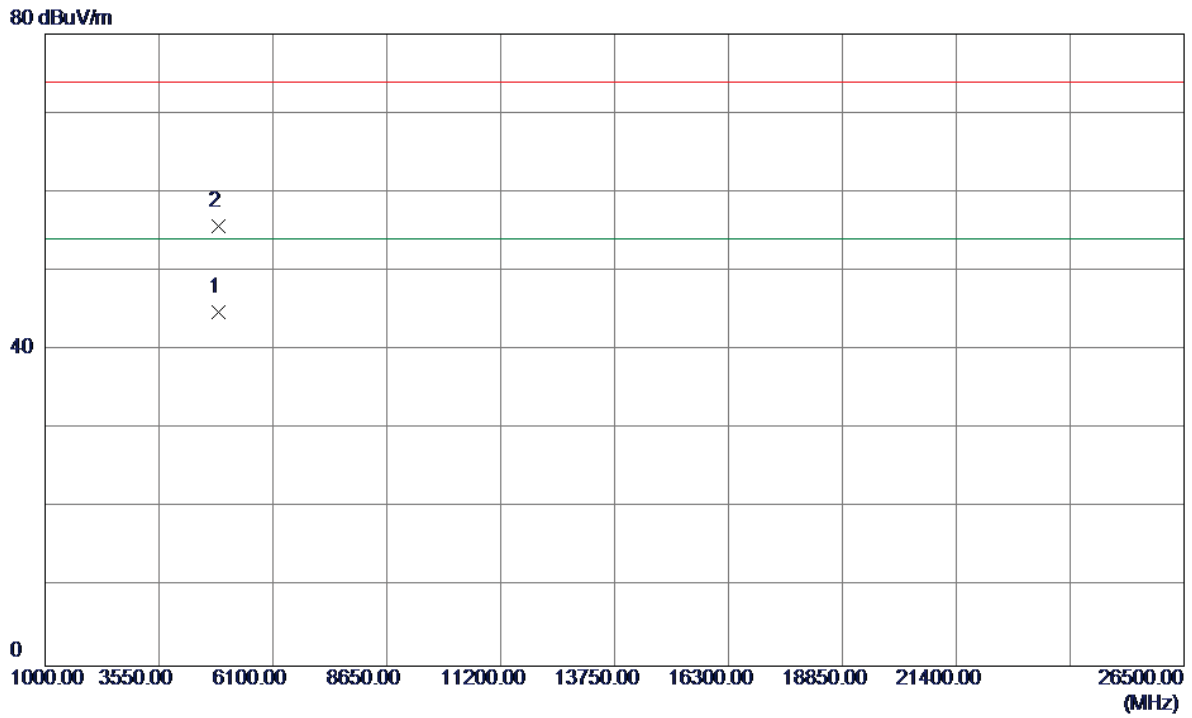

No.	Freq. MHz	Reading Level dBuV/m	Correct Factor dB	Measure ment dBuV/m	Limit dBuV/m	Margin dB	Detector	Comment
1	4875.0000	41.72	3.03	44.75	54.00	-9.25	AVG	
2	4877.0000	52.58	3.03	55.61	74.00	-18.39	Peak	

Orthogonal Axis :	X
Test Mode :	TX G MODE 2437MHz

Horizontal

115 dBuV/m

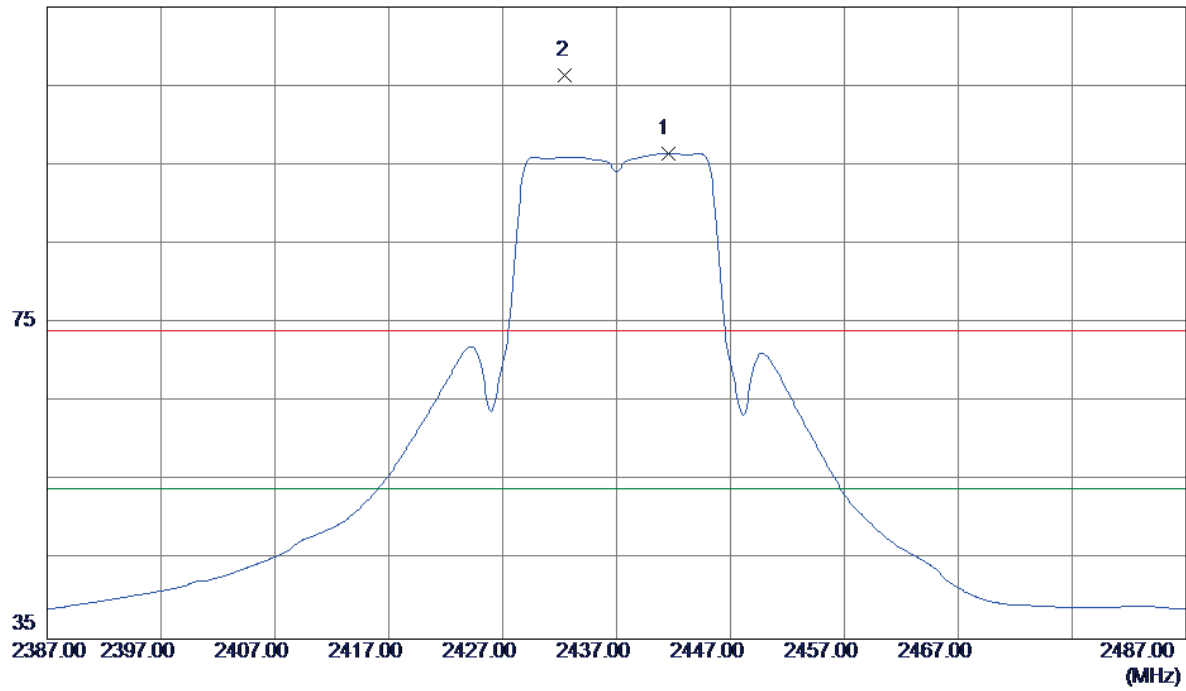

No.	Freq. MHz	Reading Level dBuV/m	Correct Factor dB	Measure ment dBuV/m	Limit dBuV/m	Margin dB	Detector	Comment
1	2441.5000	61.94	34.53	96.47	54.00	42.47	AVG	No Limit
2	2432.5000	71.87	34.48	106.35	74.00	32.35	Peak	No Limit

Orthogonal Axis :	X
Test Mode :	TX G MODE 2437MHz

Horizontal

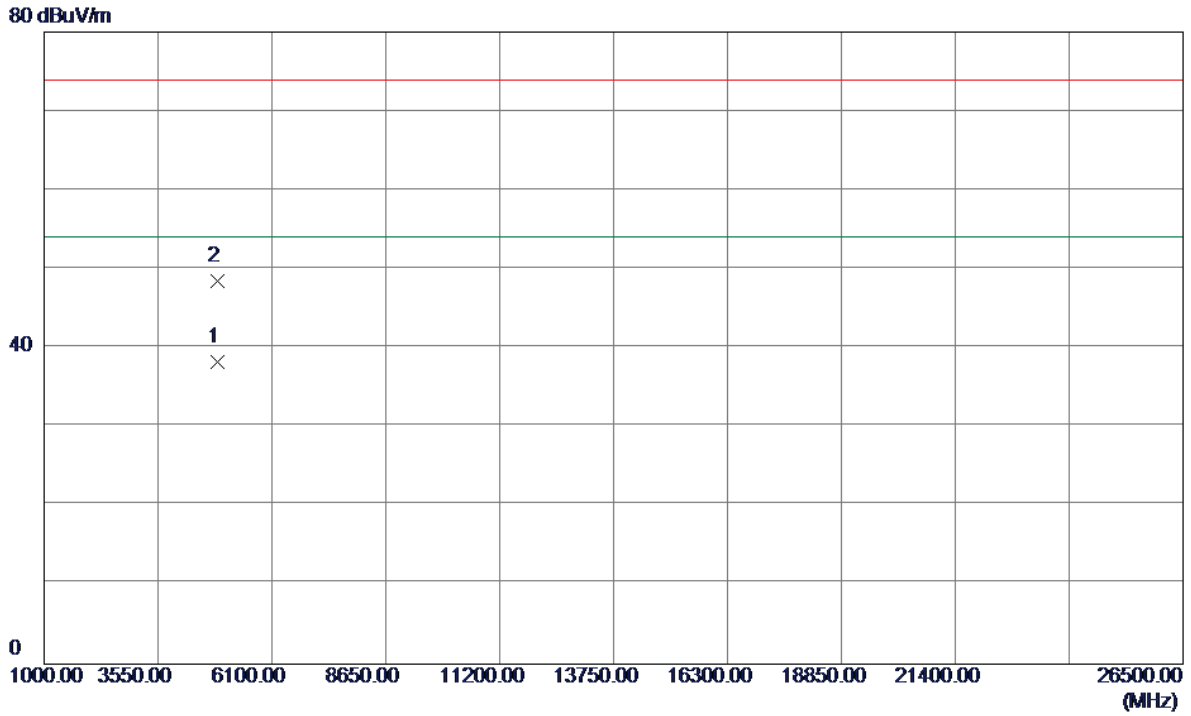

No.	Freq. MHz	Reading Level dBuV/m	Correct Factor dB	Measure ment dBuV/m	Limit dBuV/m	Margin dB	Detector	Comment
1	4873.9600	35.15	3.03	38.18	54.00	-15.82	AVG	
2	4874.0800	45.51	3.03	48.54	74.00	-25.46	Peak	

Orthogonal Axis :	X
Test Mode :	TX G MODE 2462MHz

Vertical

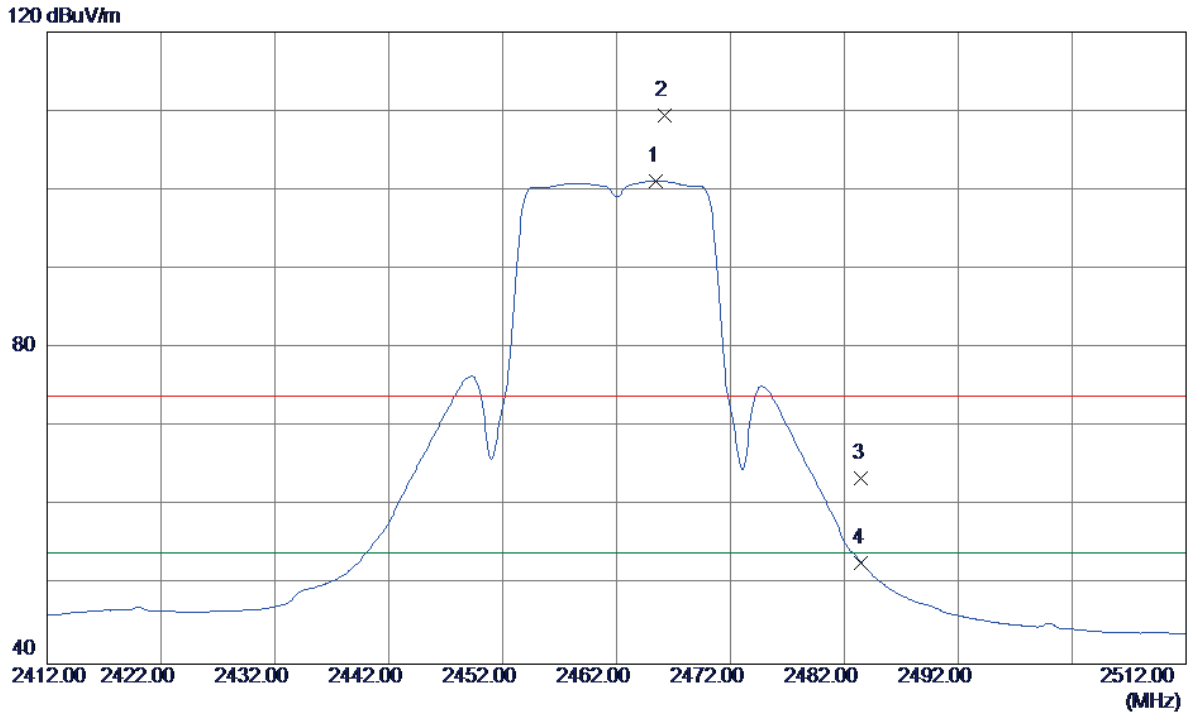

No.	Freq. MHz	Reading Level dBuV/m	Correct Factor dB	Measure ment dBuV/m	Limit dBuV/m	Margin dB	Detector	Comment
1	2465.5000	66.49	34.67	101.16	54.00	47.16	AVG	No Limit
2	2466.2000	74.76	34.67	109.43	74.00	35.43	Peak	No Limit
3	2483.5000	28.74	34.77	63.51	74.00	-10.49	Peak	
4	2483.5000	18.04	34.77	52.81	54.00	-1.19	AVG	

Orthogonal Axis :	X
Test Mode :	TX G MODE 2462MHz

Vertical

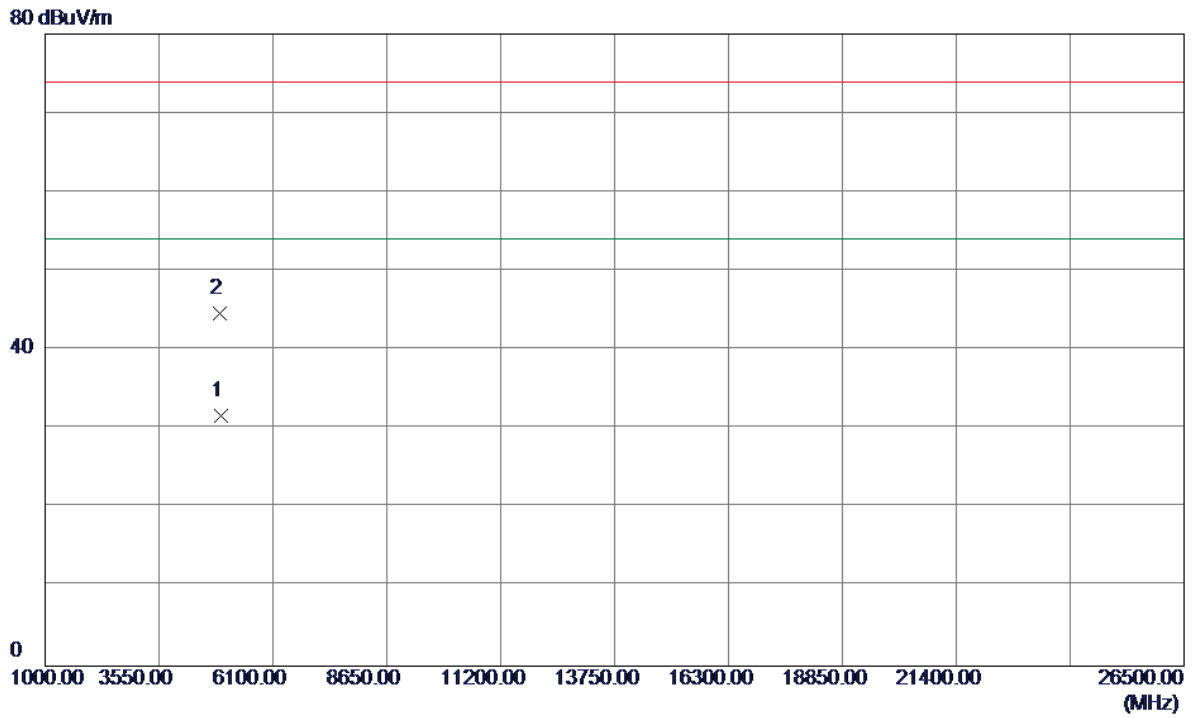

No.	Freq. MHz	Reading Level dBuV/m	Correct Factor dB	Measure ment dBuV/m	Limit dBuV/m	Margin dB	Detector	Comment
1	4924.5000	28.58	3.05	31.63	54.00	-22.37	AVG	
2	4923.5000	41.61	3.05	44.66	74.00	-29.34	Peak	

Orthogonal Axis :	X
Test Mode :	TX G MODE 2462MHz

Horizontal

115 dBuV/m

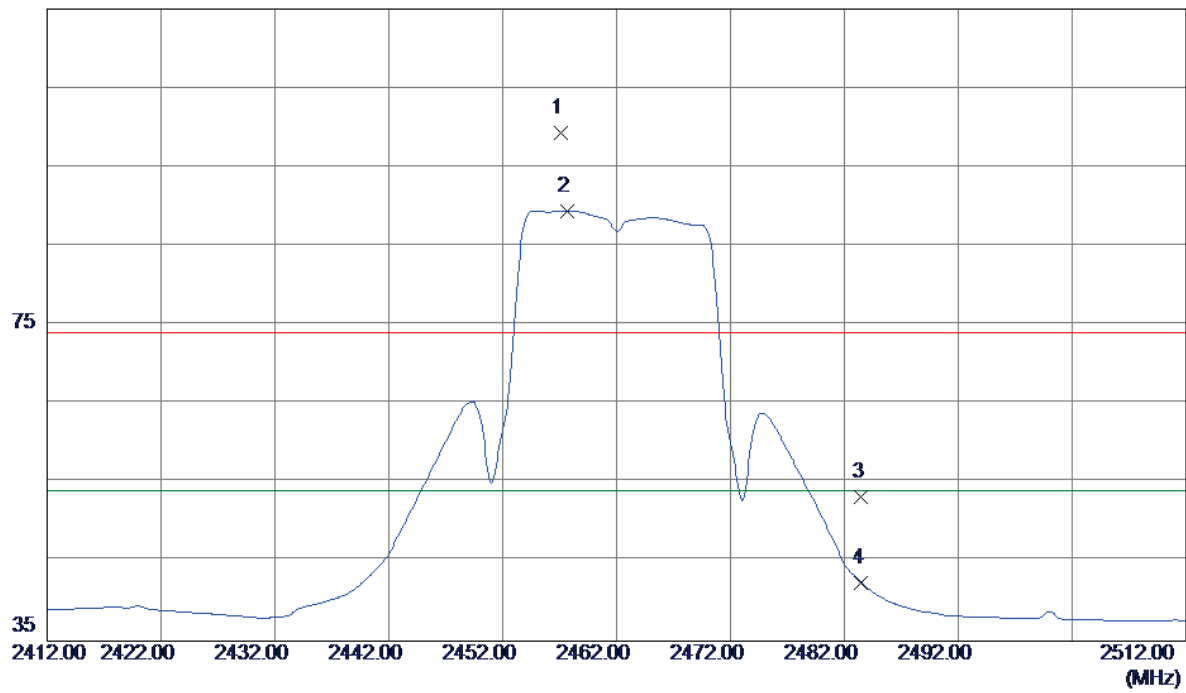

No.	Freq. MHz	Reading Level dBuV/m	Correct Factor dB	Measure ment dBuV/m	Limit dBuV/m	Margin dB	Detector	Comment
1	2457.1000	64.72	34.62	99.34	74.00	25.34	Peak	No Limit
2	2457.7000	54.84	34.62	89.46	54.00	35.46	AVG	No Limit
3	2483.5000	18.53	34.77	53.30	74.00	-20.70	Peak	
4	2483.5000	7.64	34.77	42.41	54.00	-11.59	AVG	

Orthogonal Axis :	X
Test Mode :	TX G MODE 2462MHz

Horizontal

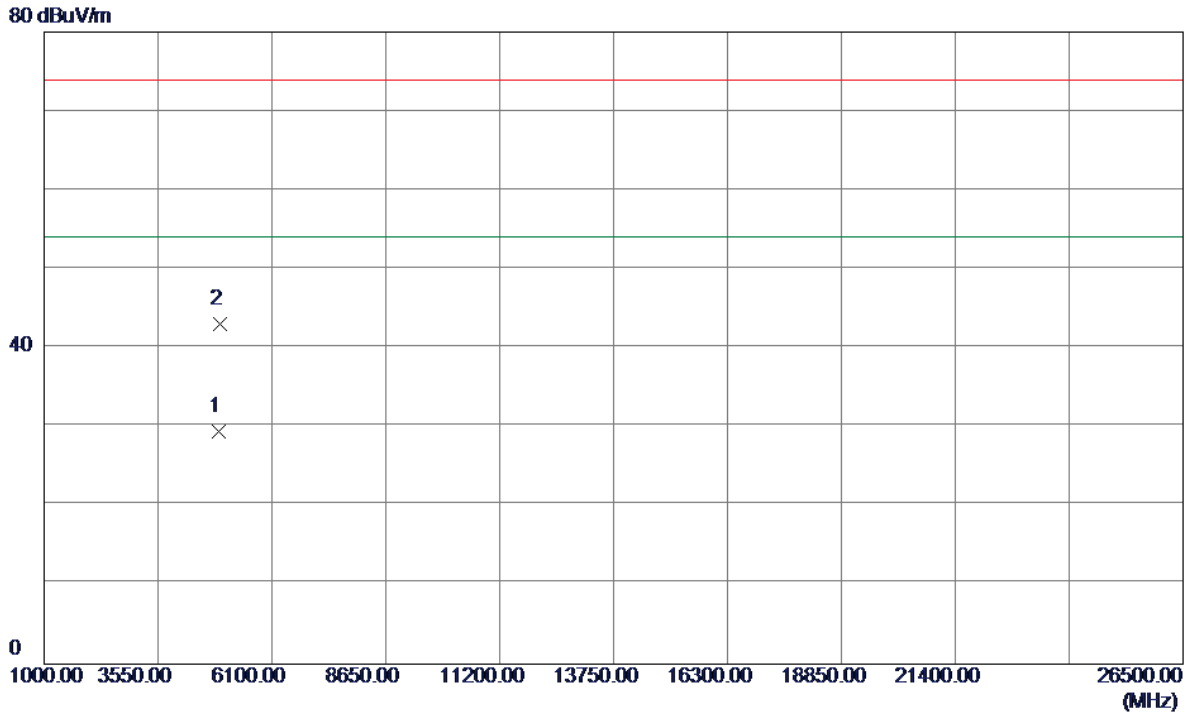

No.	Freq. MHz	Reading Level dBuV/m	Correct Factor dB	Measure ment dBuV/m	Limit dBuV/m	Margin dB	Detector	Comment
1	4923.5000	26.39	3.05	29.44	54.00	-24.56	AVG	
2	4924.5000	39.97	3.05	43.02	74.00	-30.98	Peak	

Orthogonal Axis :	X
Test Mode :	TX N-20M MODE 2412MHz

Vertical

120 dBuV/m

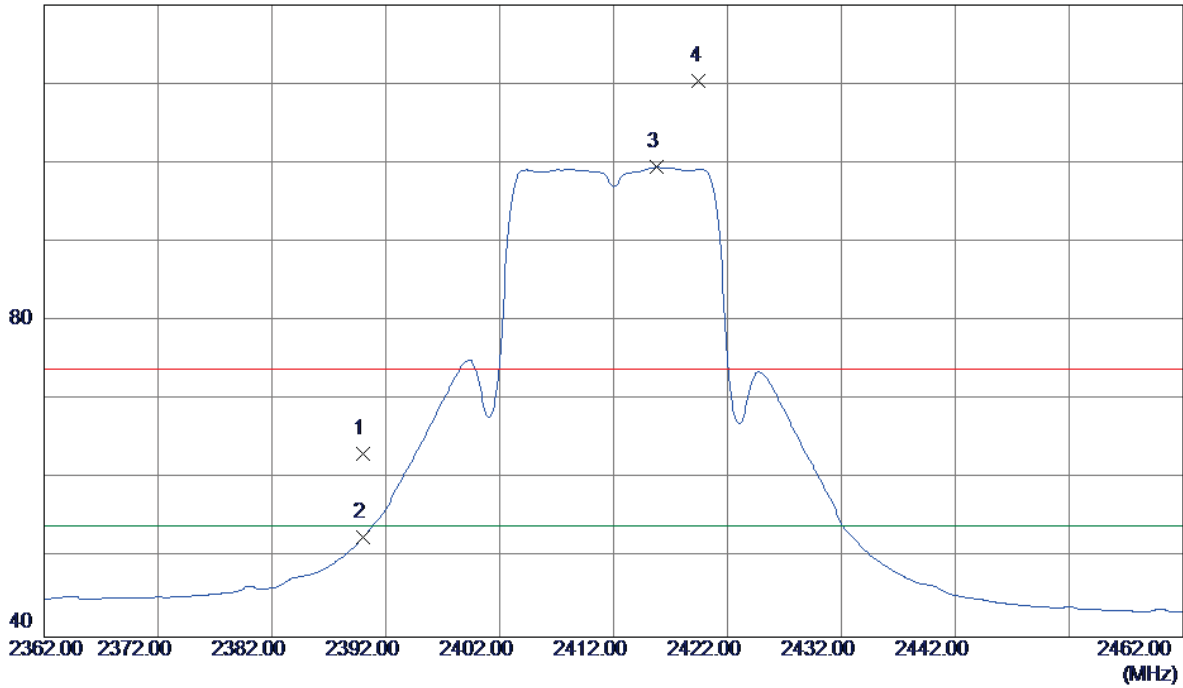

No.	Freq. MHz	Reading Level dBuV/m	Correct Factor dB	Measure ment dBuV/m	Limit dBuV/m	Margin dB	Detector	Comment
1	2390.0000	29.04	34.23	63.27	74.00	-10.73	Peak	
2	2390.0000	18.35	34.23	52.58	54.00	-1.42	AVG	
3	2415.8000	65.08	34.38	99.46	54.00	45.46	AVG	No Limit
4	2419.5000	75.94	34.40	110.34	74.00	36.34	Peak	No Limit

Orthogonal Axis :	X
Test Mode :	TX N-20M MODE 2412MHz

Vertical

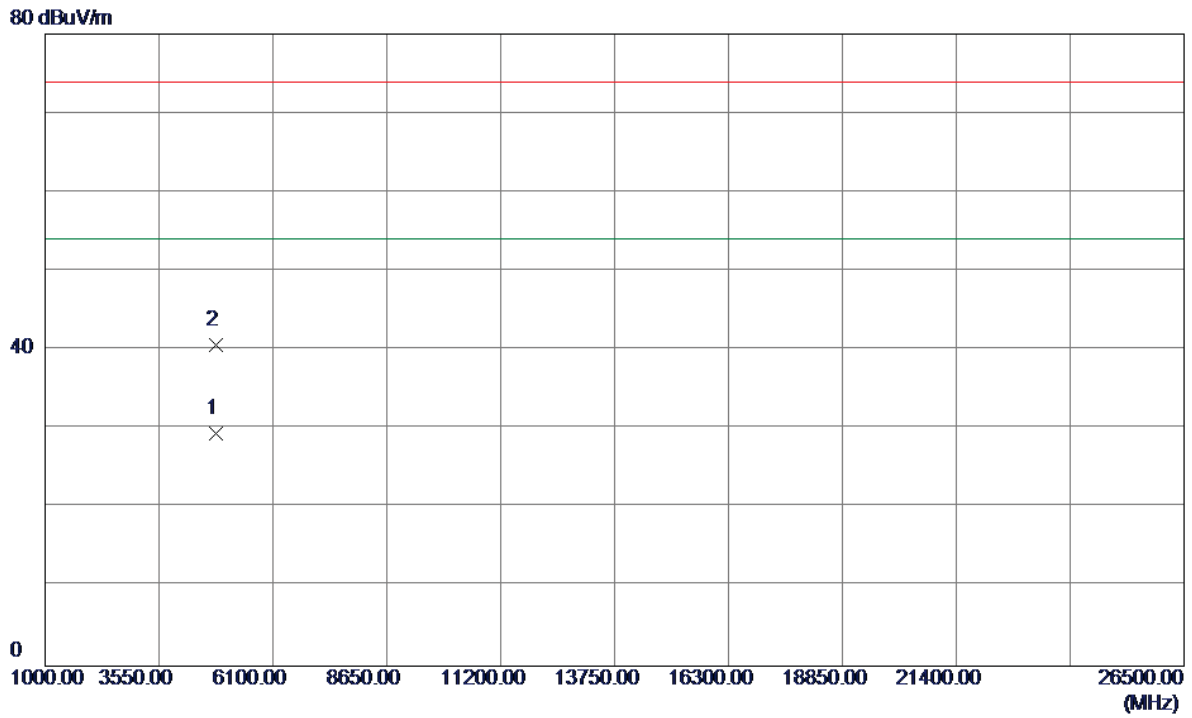

No.	Freq. MHz	Reading Level dBuV/m	Correct Factor dB	Measure ment dBuV/m	Limit dBuV/m	Margin dB	Detector	Comment
1	4823.8600	26.40	3.00	29.40	54.00	-24.60	AVG	
2	4824.1000	37.67	3.00	40.67	74.00	-33.33	Peak	

Orthogonal Axis :	X
Test Mode :	TX N-20M MODE 2412MHz

Horizontal

115 dBuV/m

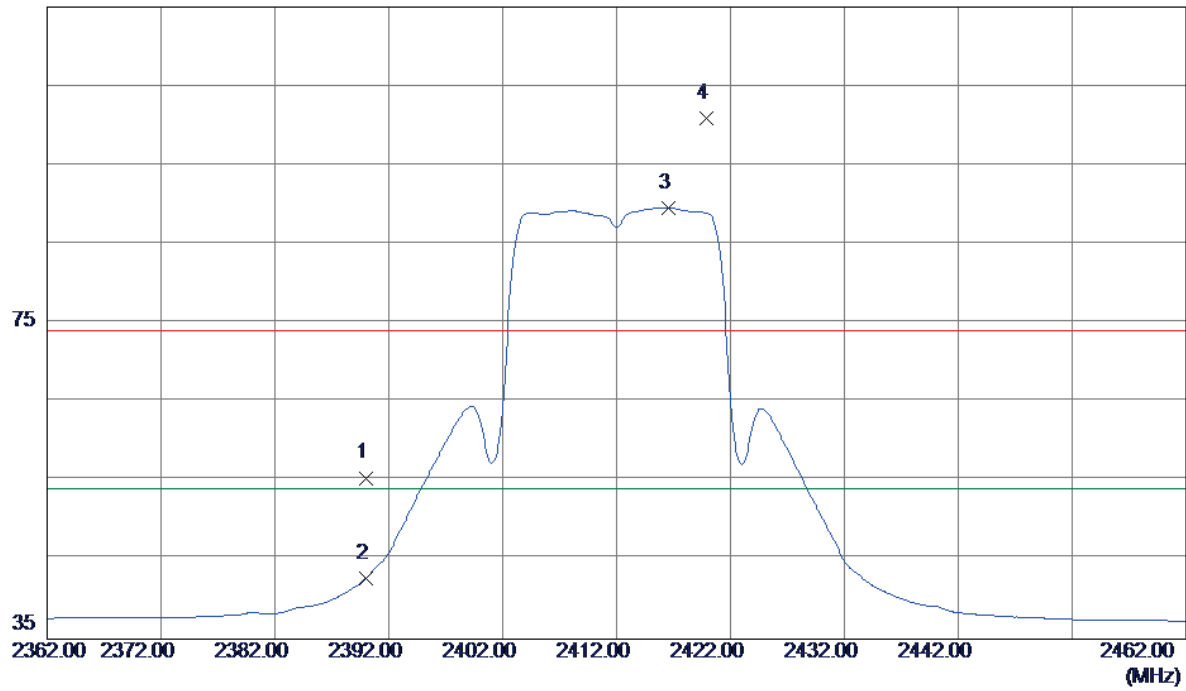

No.	Freq. MHz	Reading Level dBuV/m	Correct Factor dB	Measure ment dBuV/m	Limit dBuV/m	Margin dB	Detector	Comment
1	2390.0000	21.17	34.23	55.40	74.00	-18.60	Peak	
2	2390.0000	8.50	34.23	42.73	54.00	-11.27	AVG	
3	2416.6000	55.19	34.39	89.58	54.00	35.58	AVG	No Limit
4	2419.9000	66.47	34.41	100.88	74.00	26.88	Peak	No Limit

Orthogonal Axis :	X
Test Mode :	TX N-20M MODE 2412MHz

Horizontal

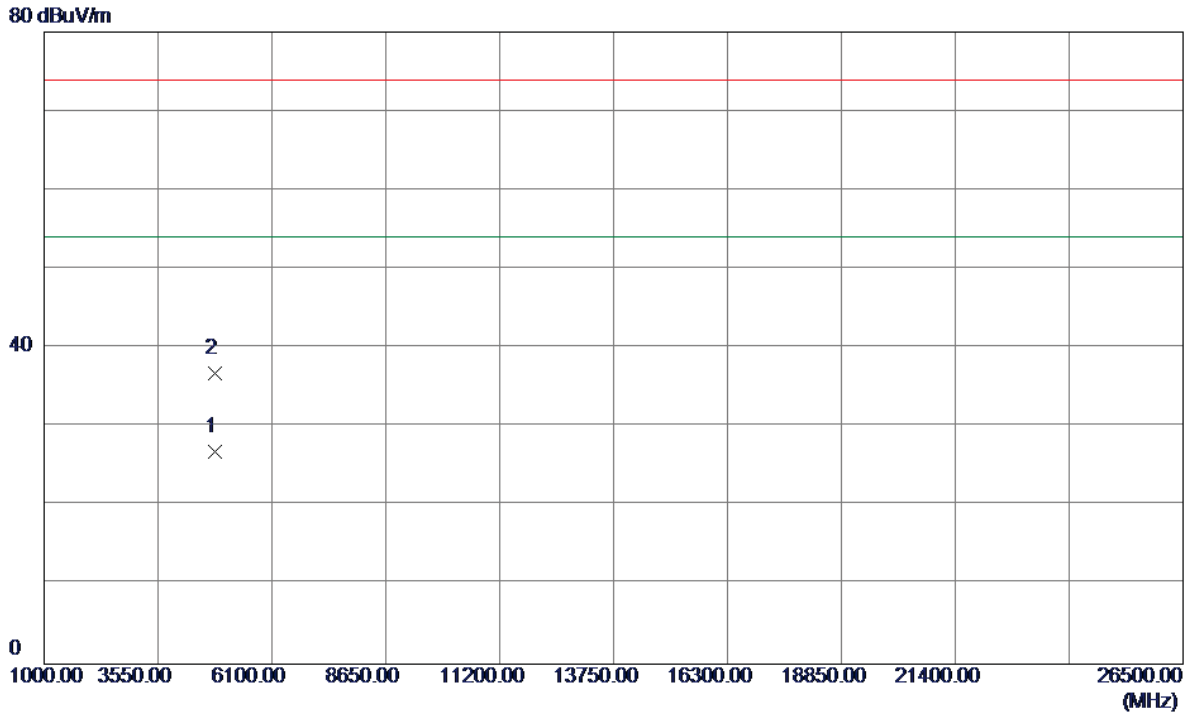

No.	Freq. MHz	Reading Level dBuV/m	Correct Factor dB	Measure ment dBuV/m	Limit dBuV/m	Margin dB	Detector	Comment
1	4823.9600	23.92	3.00	26.92	54.00	-27.08	AVG	
2	4823.9200	33.77	3.00	36.77	74.00	-37.23	Peak	

Orthogonal Axis :	X
Test Mode :	TX N-20M MODE 2437MHz

Vertical

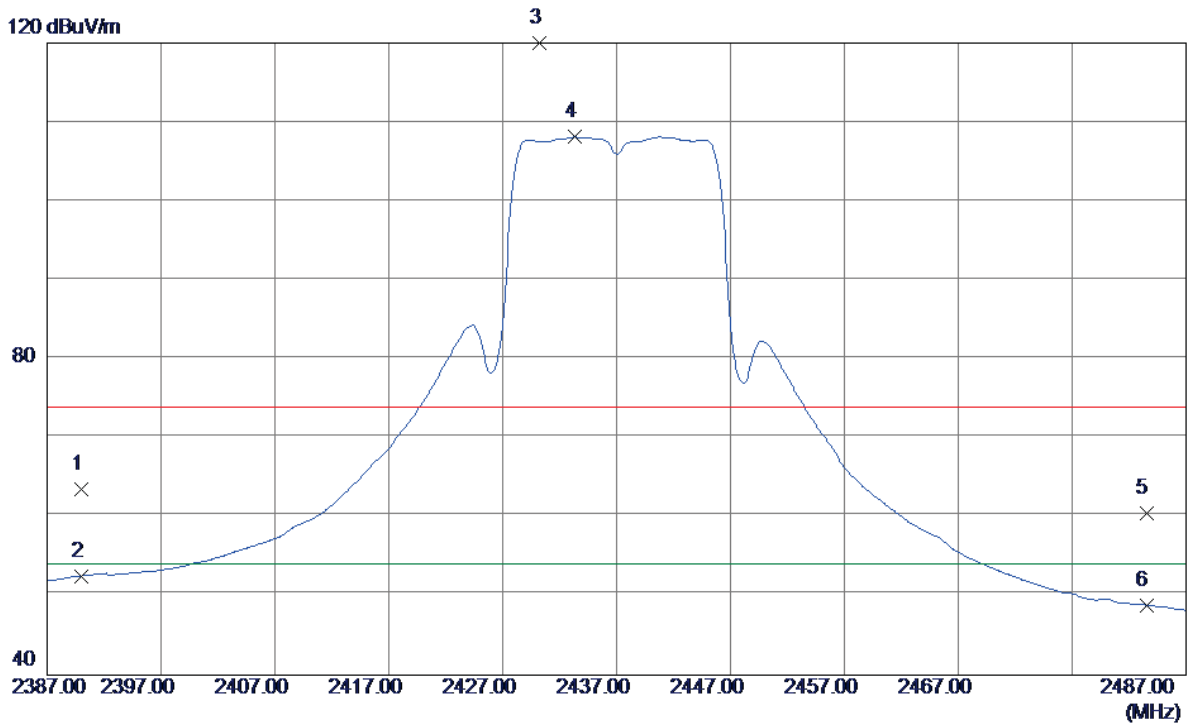

No.	Freq. MHz	Reading Level dBuV/m	Correct Factor dB	Measure ment dBuV/m	Limit dBuV/m	Margin dB	Detector	Comment
1	2390.0000	29.30	34.23	63.53	74.00	-10.47	Peak	
2	2390.0000	18.32	34.23	52.55	54.00	-1.45	AVG	
3	2430.2000	85.47	34.47	119.94	74.00	45.94	Peak	No Limit
4	2433.3000	73.62	34.48	108.10	54.00	54.10	AVG	No Limit
5	2483.5000	25.71	34.77	60.48	74.00	-13.52	Peak	
6	2483.5000	14.08	34.77	48.85	54.00	-5.15	AVG	

Orthogonal Axis :	X
Test Mode :	TX N-20M MODE 2437MHz

Vertical

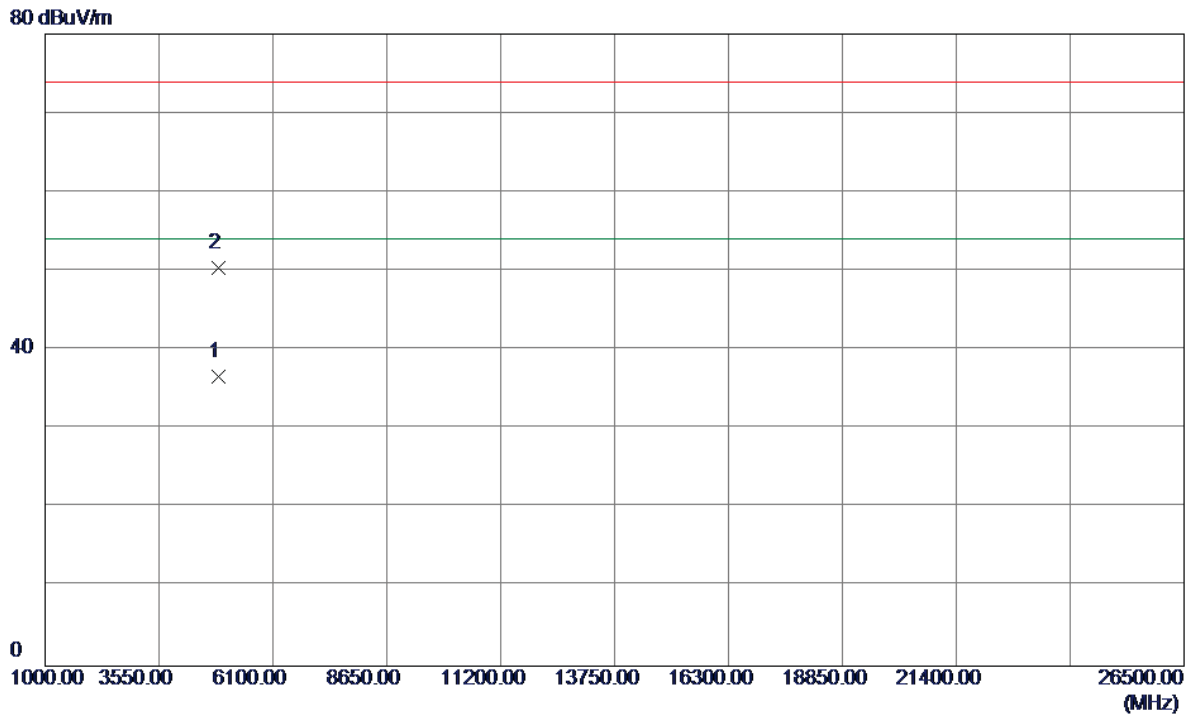

No.	Freq. MHz	Reading Level dBuV/m	Correct Factor dB	Measure ment dBuV/m	Limit dBuV/m	Margin dB	Detector	Comment
1	4873.5000	33.67	3.03	36.70	54.00	-17.30	AVG	
2	4871.0000	47.44	3.02	50.46	74.00	-23.54	Peak	

Orthogonal Axis :	X
Test Mode :	TX N-20M MODE 2437MHz

Horizontal

115 dBuV/m

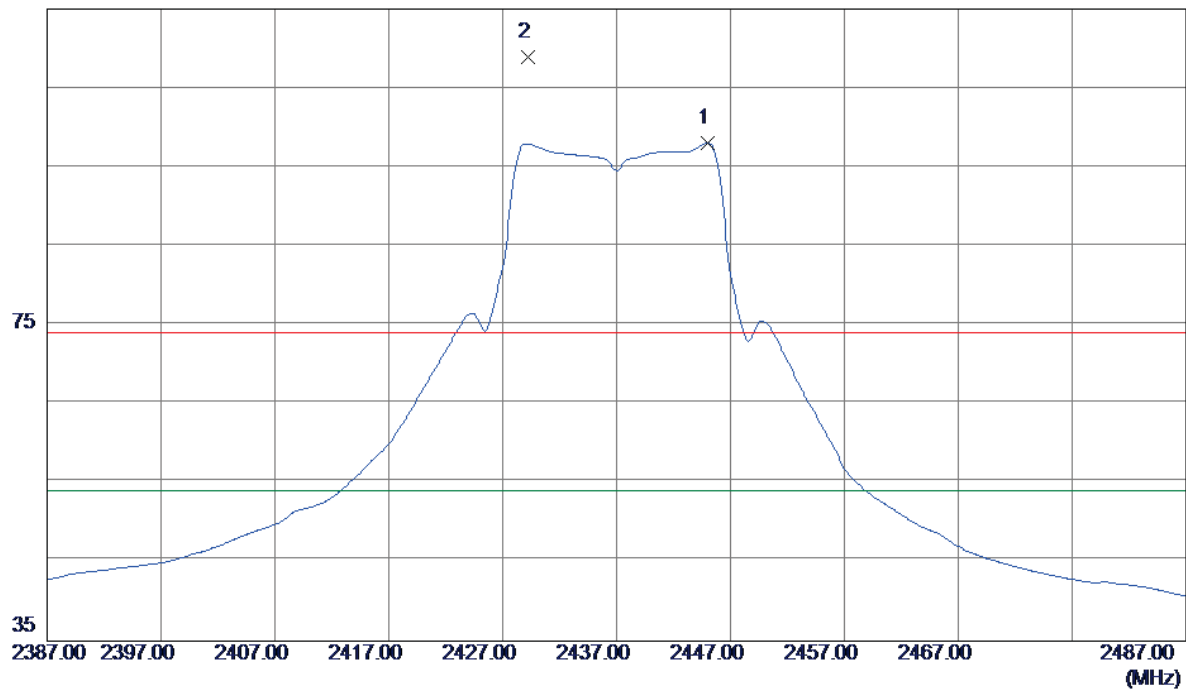

No.	Freq. MHz	Reading Level dBuV/m	Correct Factor dB	Measure ment dBuV/m	Limit dBuV/m	Margin dB	Detector	Comment
1	2445.0000	63.47	34.55	98.02	54.00	44.02	AVG	No Limit
2	2429.2000	74.42	34.46	108.88	74.00	34.88	Peak	No Limit

Orthogonal Axis :	X
Test Mode :	TX N-20M MODE 2437MHz

Horizontal

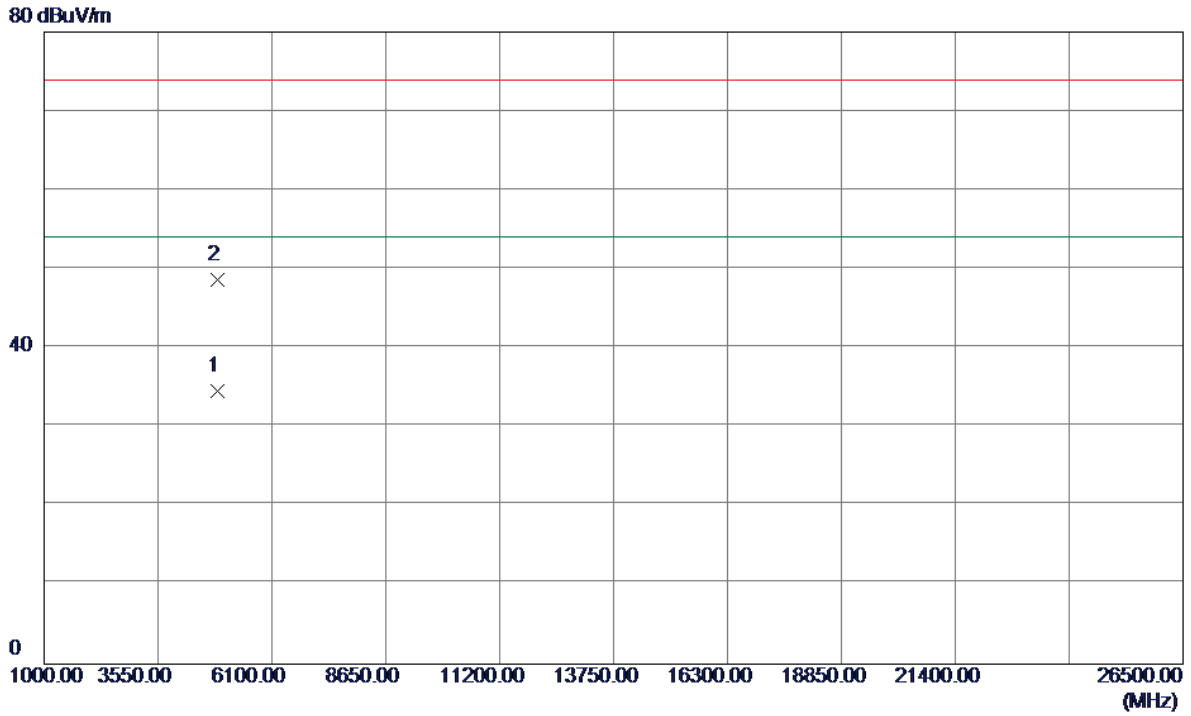

No.	Freq. MHz	Reading Level dBuV/m	Correct Factor dB	Measure ment dBuV/m	Limit dBuV/m	Margin dB	Detector	Comment
1	4873.3000	31.53	3.03	34.56	54.00	-19.44	AVG	
2	4871.4000	45.69	3.02	48.71	74.00	-25.29	Peak	

Orthogonal Axis :	X
Test Mode :	TX N-20M MODE 2462MHz

Vertical

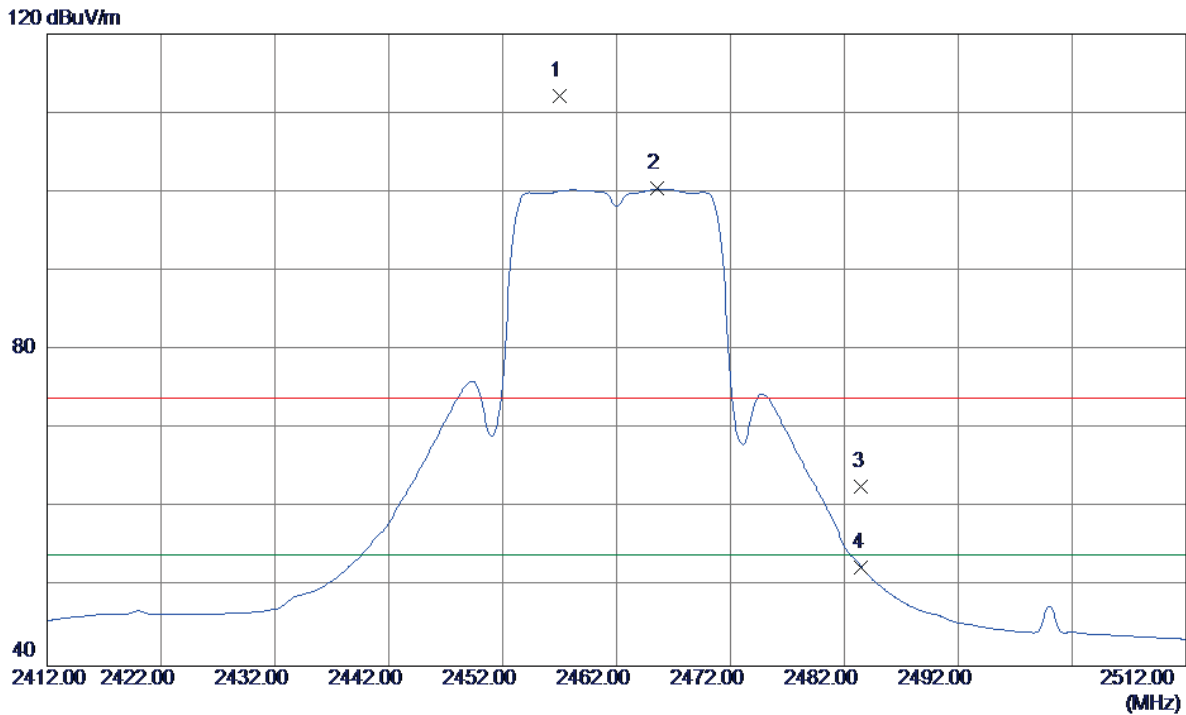

No.	Freq. MHz	Reading Level dBuV/m	Correct Factor dB	Measure ment dBuV/m	Limit dBuV/m	Margin dB	Detector	Comment
1	2457.0000	77.51	34.62	112.13	74.00	38.13	Peak	No Limit
2	2465.6000	65.73	34.67	100.40	54.00	46.40	AVG	No Limit
3	2483.5000	27.95	34.77	62.72	74.00	-11.28	Peak	
4	2483.5000	17.75	34.77	52.52	54.00	-1.48	AVG	

Orthogonal Axis :	X
Test Mode :	TX N-20M MODE 2462MHz

Vertical

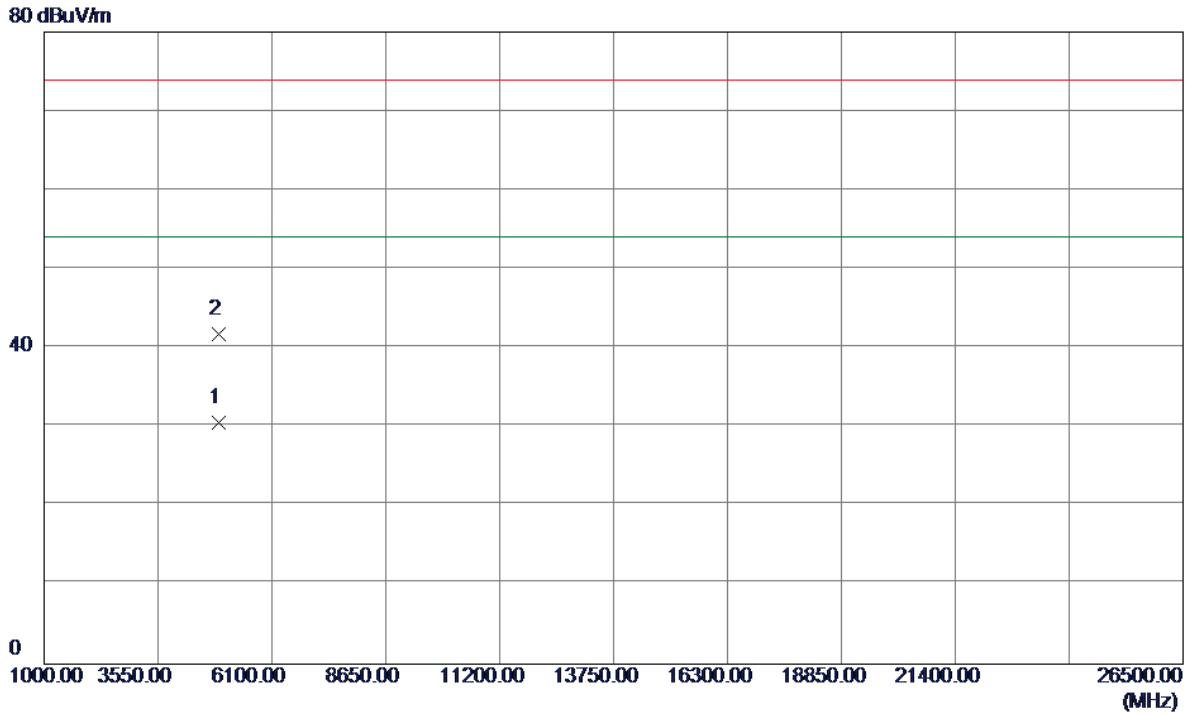

No.	Freq. MHz	Reading Level dBuV/m	Correct Factor dB	Measure ment dBuV/m	Limit dBuV/m	Margin dB	Detector	Comment
1	4923.5000	27.55	3.05	30.60	54.00	-23.40	AVG	
2	4921.0000	38.72	3.05	41.77	74.00	-32.23	Peak	

Orthogonal Axis :	X
Test Mode :	TX N-20M MODE 2462MHz

Horizontal

115 dBuV/m

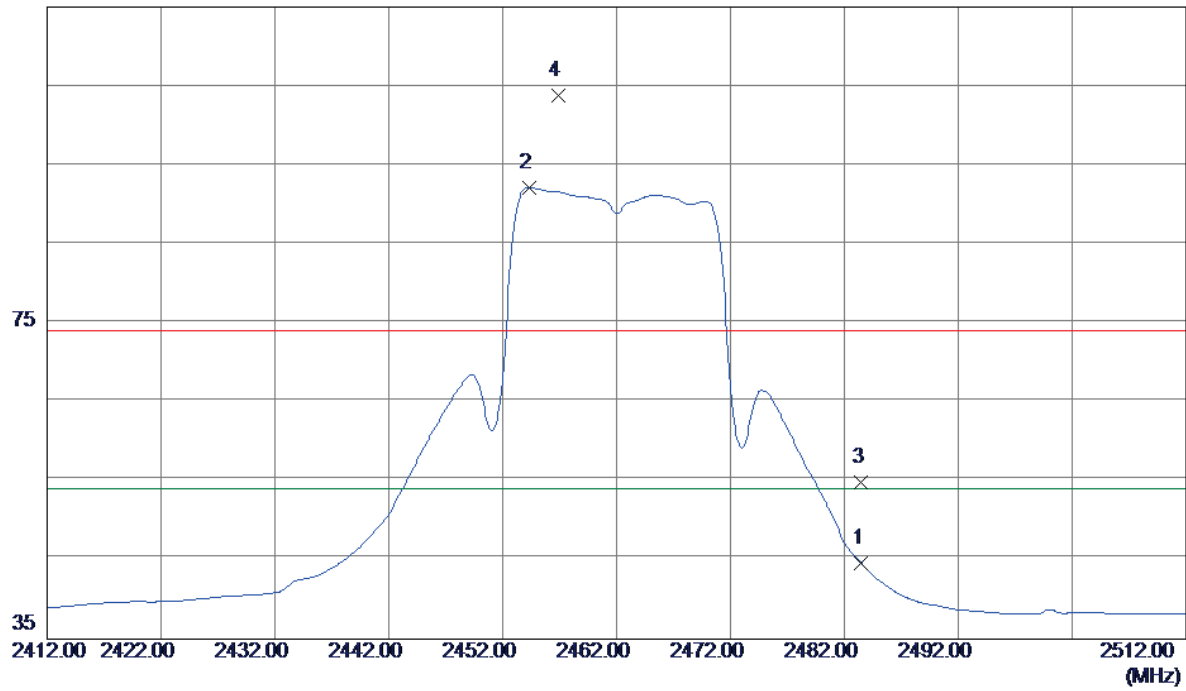

No.	Freq. MHz	Reading Level dBuV/m	Correct Factor dB	Measure ment dBuV/m	Limit dBuV/m	Margin dB	Detector	Comment
1	2483.5000	9.83	34.77	44.60	54.00	-9.40	AVG	
2	2454.3000	57.57	34.60	92.17	54.00	38.17	AVG	No Limit
3	2483.5000	20.02	34.77	54.79	74.00	-19.21	Peak	
4	2456.9000	69.19	34.62	103.81	74.00	29.81	Peak	No Limit

Orthogonal Axis :	X
Test Mode :	TX N-20M MODE 2462MHz

Horizontal

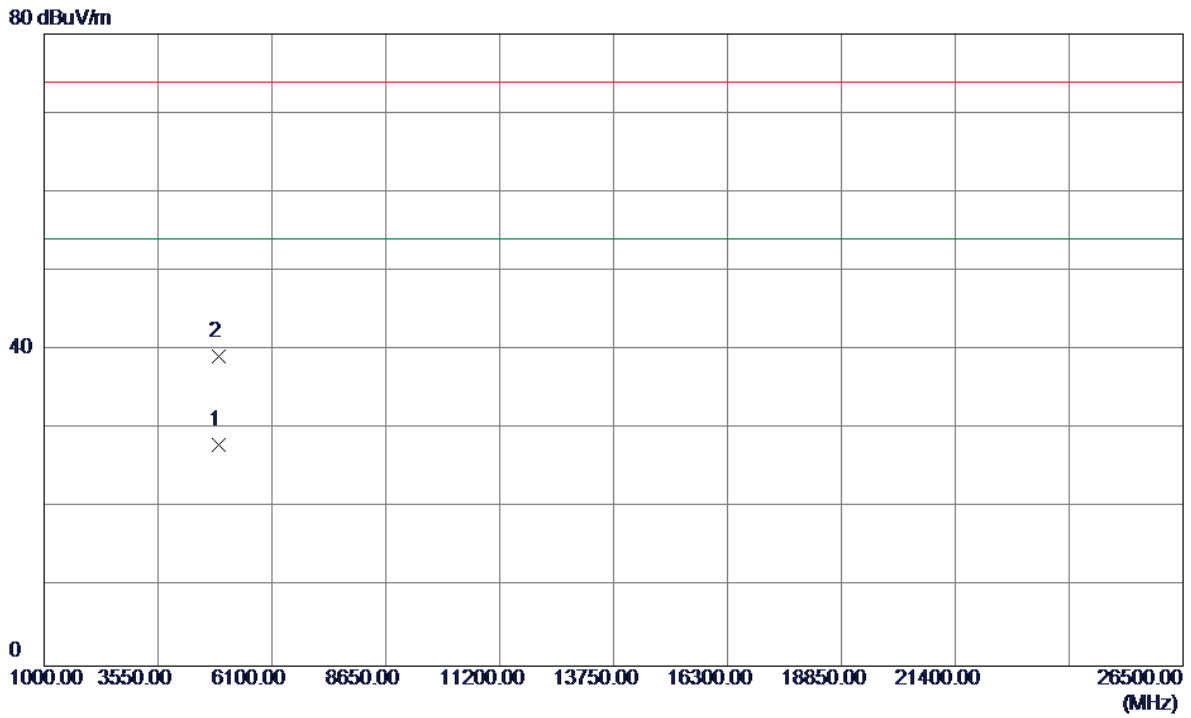

No.	Freq. MHz	Reading Level dBuV/m	Correct Factor dB	Measure ment dBuV/m	Limit dBuV/m	Margin dB	Detector	Comment
1	4923.4900	24.93	3.05	27.98	54.00	-26.02	AVG	
2	4921.0000	36.08	3.05	39.13	74.00	-34.87	Peak	

Orthogonal Axis :	X
Test Mode :	TX N-40M MODE 2422MHz

Vertical

120 dBuV/m

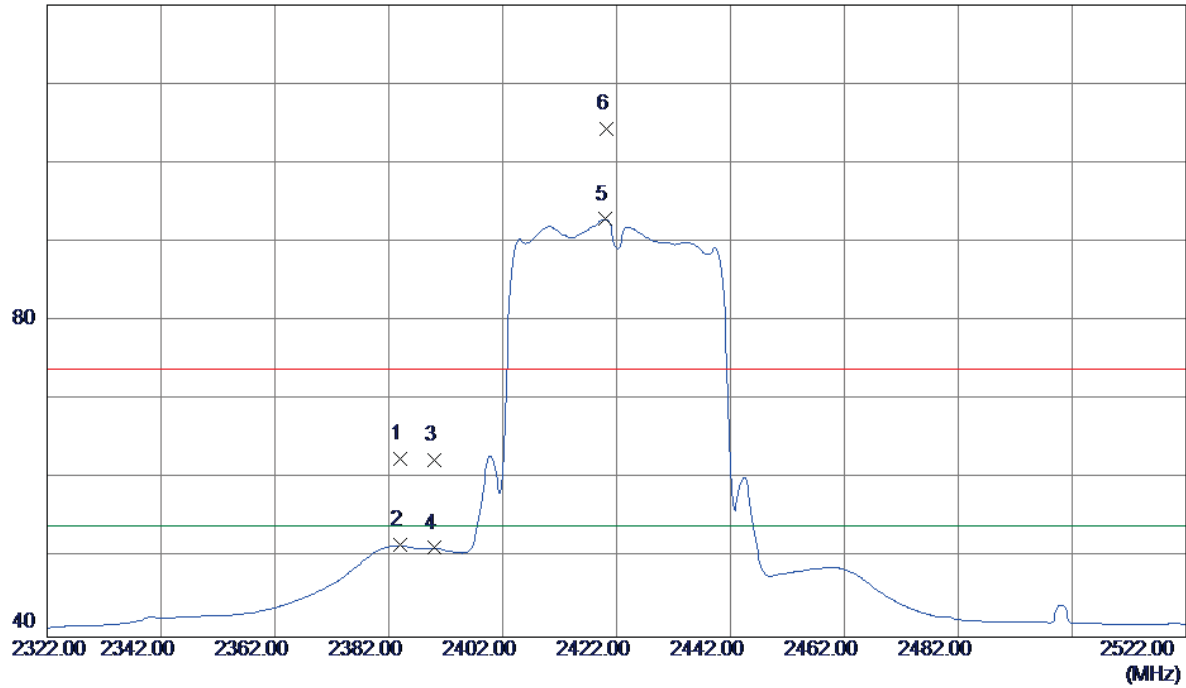

No.	Freq. MHz	Reading Level dBuV/m	Correct Factor dB	Measure ment dBuV/m	Limit dBuV/m	Margin dB	Detector	Comment
1	2384.0000	28.33	34.20	62.53	74.00	-11.47	Peak	
2	2384.0000	17.41	34.20	51.61	54.00	-2.39	AVG	
3	2390.0000	28.16	34.23	62.39	74.00	-11.61	Peak	
4	2390.0000	17.05	34.23	51.28	54.00	-2.72	AVG	
5	2420.0000	58.47	34.41	92.88	54.00	38.88	AVG	No Limit
6	2420.2000	69.93	34.41	104.34	74.00	30.34	Peak	No Limit

Orthogonal Axis :	X
Test Mode :	TX N-40M MODE 2422MHz

Vertical

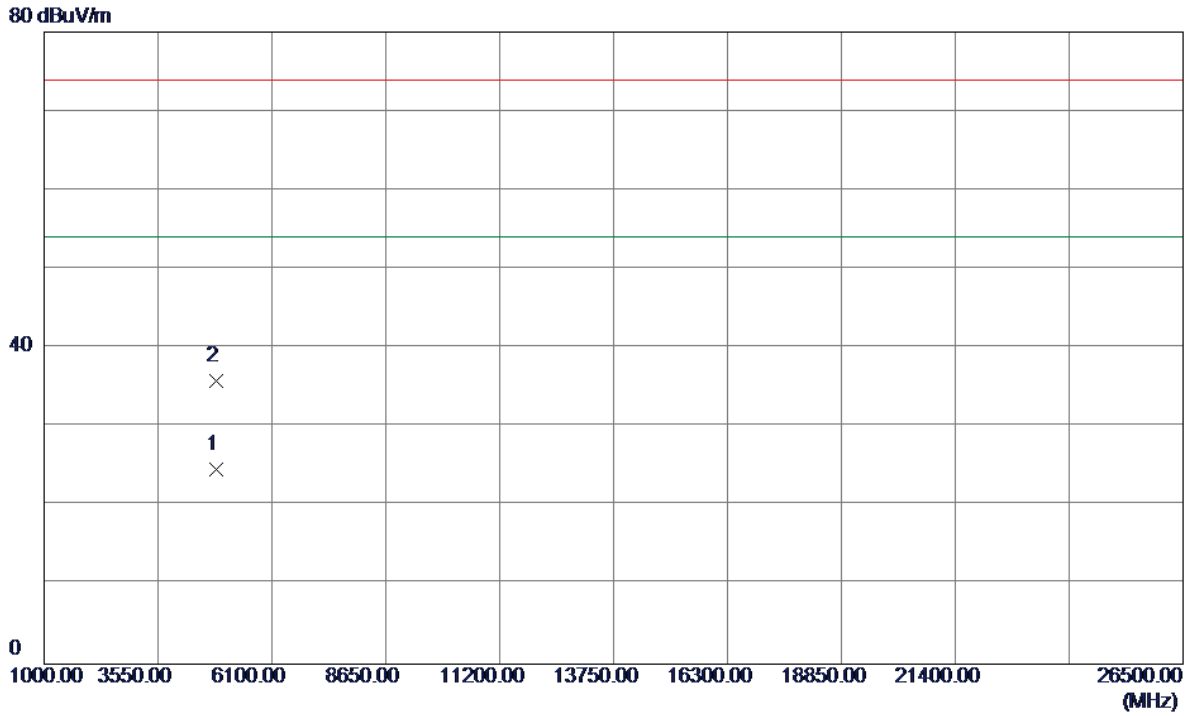

No.	Freq. MHz	Reading Level dBuV/m	Correct Factor dB	Measure ment dBuV/m	Limit dBuV/m	Margin dB	Detector	Comment
1	4843.5400	21.69	3.01	24.70	54.00	-29.30	AVG	
2	4843.9200	32.85	3.01	35.86	74.00	-38.14	Peak	

Orthogonal Axis :	X
Test Mode :	TX N-40M MODE 2422MHz

Horizontal

115 dBuV/m

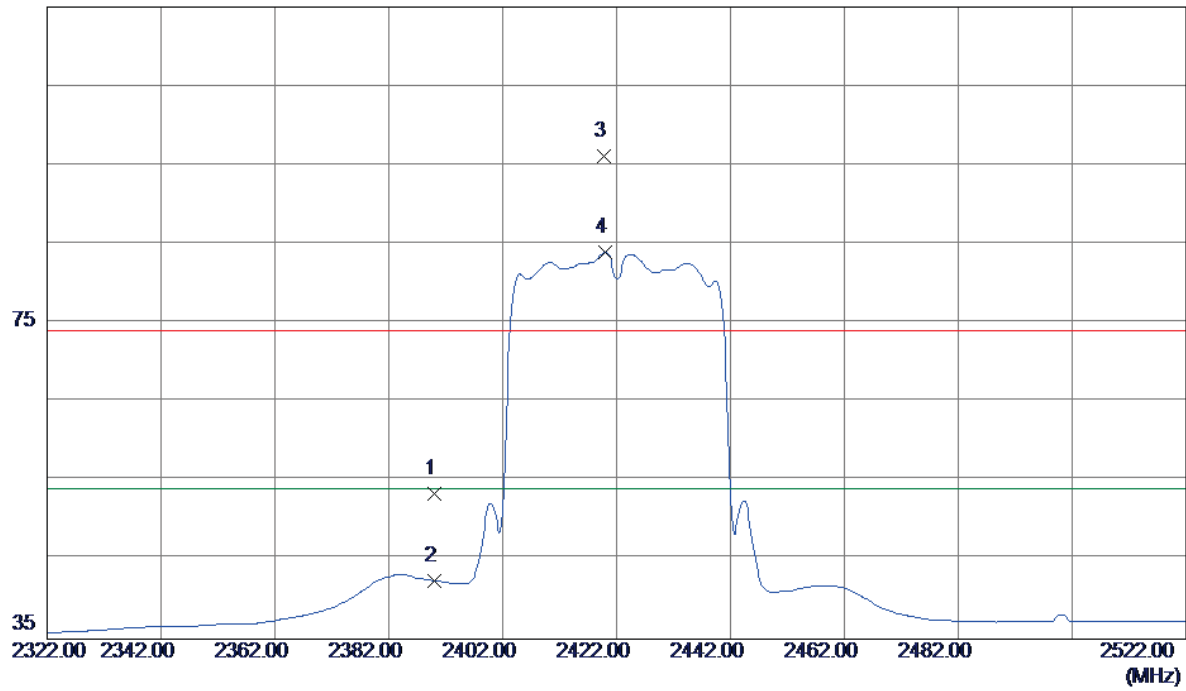

No.	Freq. MHz	Reading Level dBuV/m	Correct Factor dB	Measure ment dBuV/m	Limit dBuV/m	Margin dB	Detector	Comment
1	2390.0000	19.15	34.23	53.38	74.00	-20.62	Peak	
2	2390.0000	8.18	34.23	42.41	54.00	-11.59	AVG	
3	2419.8000	61.79	34.40	96.19	74.00	22.19	Peak	No Limit
4	2420.0000	49.53	34.41	83.94	54.00	29.94	AVG	No Limit

Orthogonal Axis :	X
Test Mode :	TX N-40M MODE 2422MHz

Horizontal

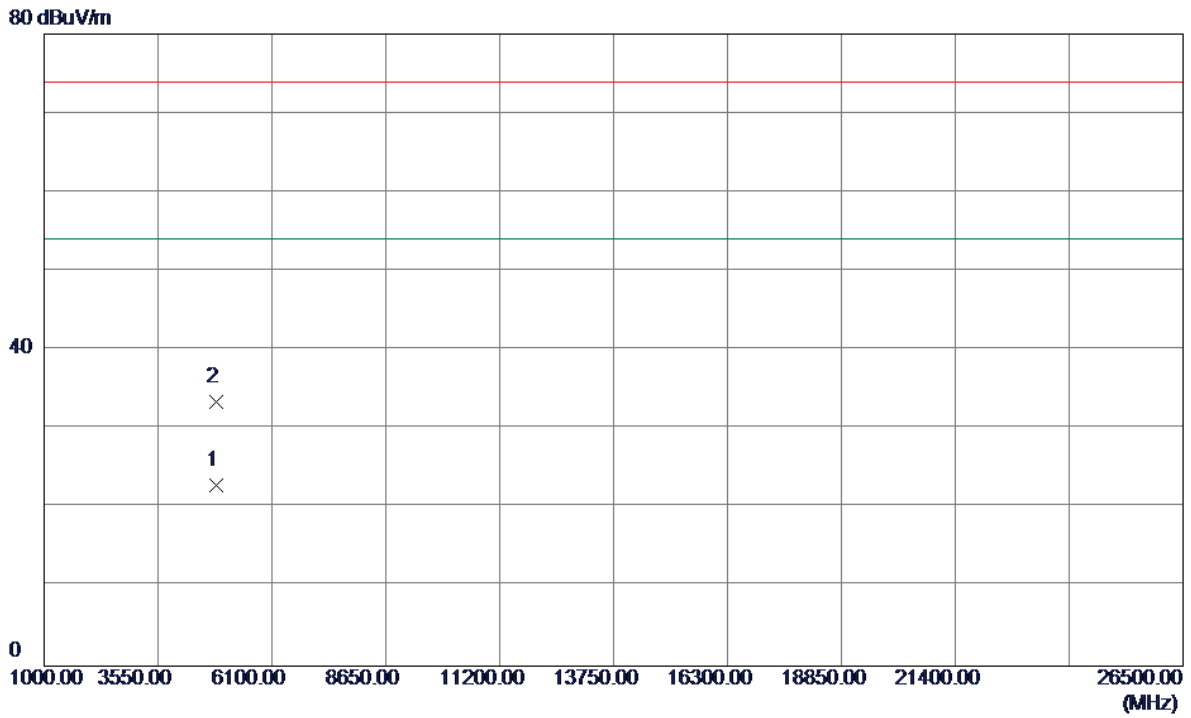

No.	Freq. MHz	Reading Level dBuV/m	Correct Factor dB	Measure ment dBuV/m	Limit dBuV/m	Margin dB	Detector	Comment
1	4843.1000	19.89	3.01	22.90	54.00	-31.10	AVG	
2	4844.0000	30.36	3.01	33.37	74.00	-40.63	Peak	

Orthogonal Axis :	X
Test Mode :	TX N-40M MODE 2437MHz

Vertical

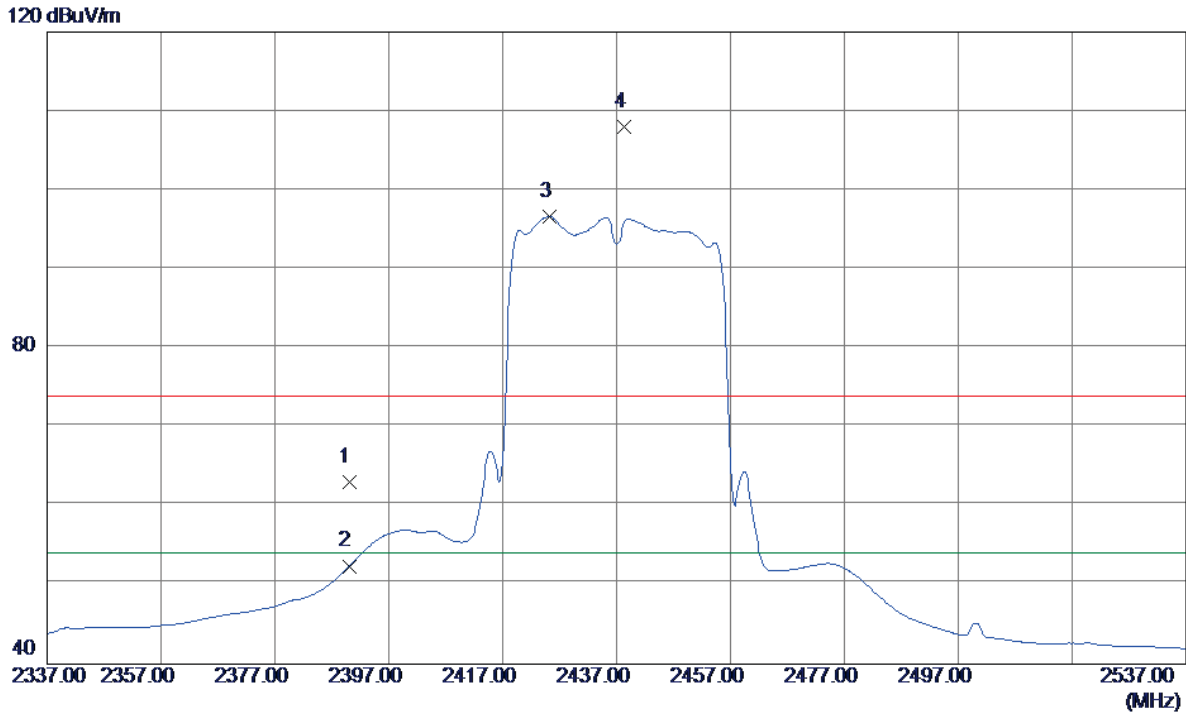

No.	Freq. MHz	Reading Level dBuV/m	Correct Factor dB	Measure ment dBuV/m	Limit dBuV/m	Margin dB	Detector	Comment
1	2390.0000	28.88	34.23	63.11	74.00	-10.89	Peak	
2	2390.0000	18.17	34.23	52.40	54.00	-1.60	AVG	
3	2425.2000	62.24	34.44	96.68	54.00	42.68	AVG	No Limit
4	2438.4000	73.48	34.51	107.99	74.00	33.99	Peak	No Limit

Orthogonal Axis :	X
Test Mode :	TX N-40M MODE 2437MHz

Vertical

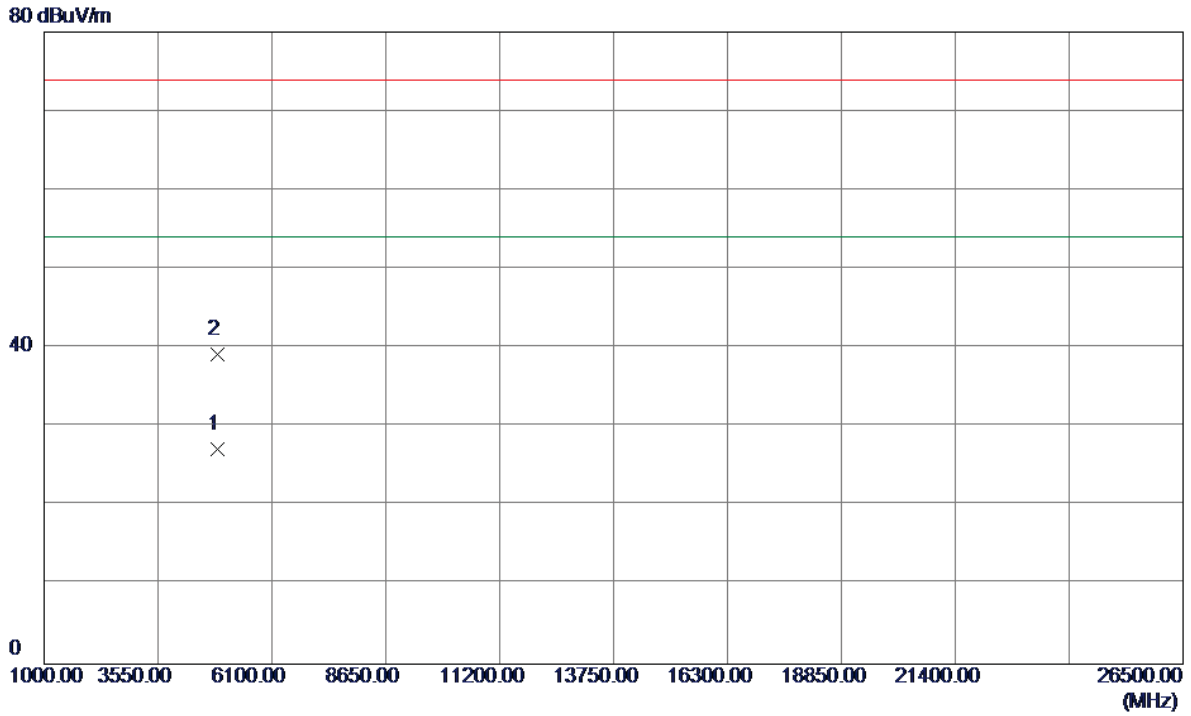

No.	Freq. MHz	Reading Level dBuV/m	Correct Factor dB	Measure ment dBuV/m	Limit dBuV/m	Margin dB	Detector	Comment
1	4873.7599	24.21	3.03	27.24	54.00	-26.76	AVG	
2	4873.8300	36.15	3.03	39.18	74.00	-34.82	Peak	

Orthogonal Axis :	X
Test Mode :	TX N-40M MODE 2437MHz

Horizontal

115 dBuV/m

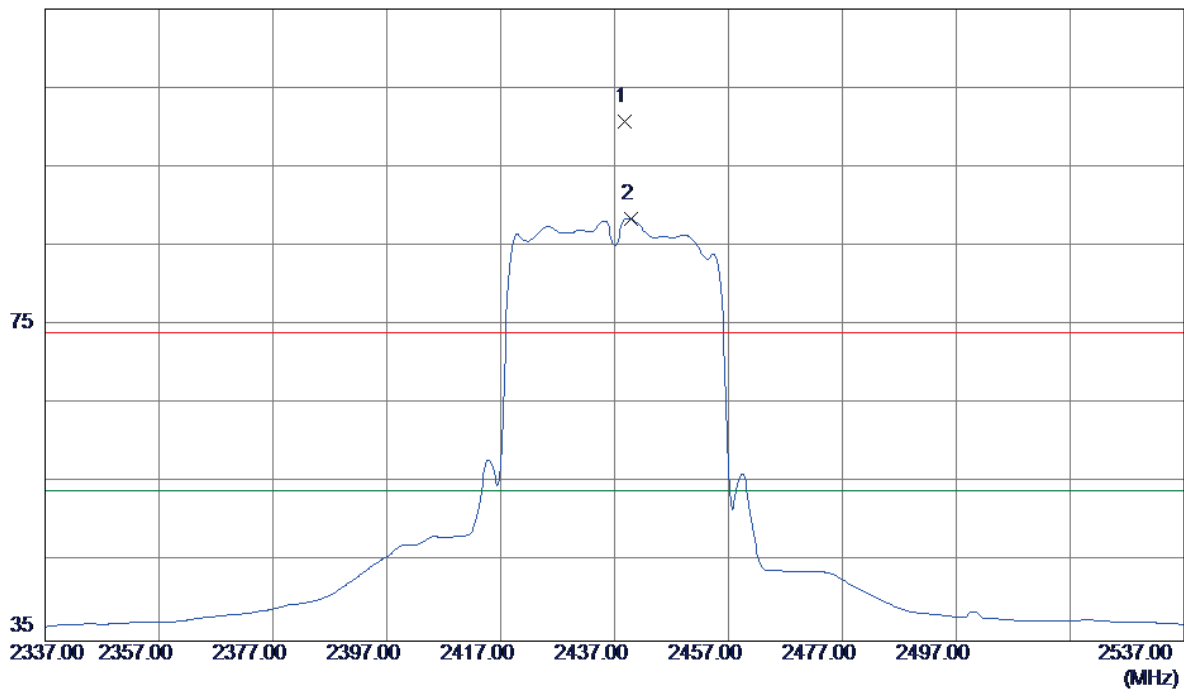

No.	Freq. MHz	Reading Level dBuV/m	Correct Factor dB	Measure ment dBuV/m	Limit dBuV/m	Margin dB	Detector	Comment
1	2438.8000	66.28	34.52	100.80	74.00	26.80	Peak	No Limit
2	2439.8000	53.99	34.52	88.51	54.00	34.51	AVG	No Limit

Orthogonal Axis :	X
Test Mode :	TX N-40M MODE 2437MHz

Horizontal

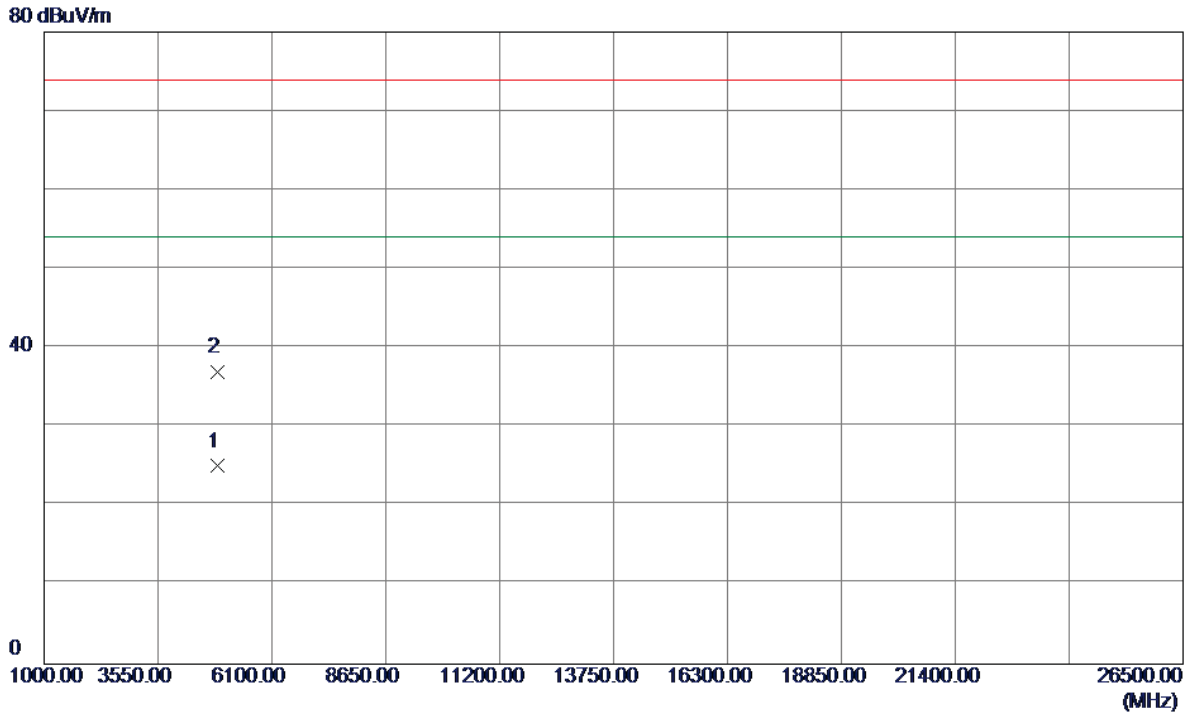

No.	Freq. MHz	Reading Level dBuV/m	Correct Factor dB	Measure ment dBuV/m	Limit dBuV/m	Margin dB	Detector	Comment
1	4873.9000	22.01	3.03	25.04	54.00	-28.96	AVG	
2	4873.8300	33.97	3.03	37.00	74.00	-37.00	Peak	

Orthogonal Axis :	X
Test Mode :	TX N-40M MODE 2452MHz

Vertical

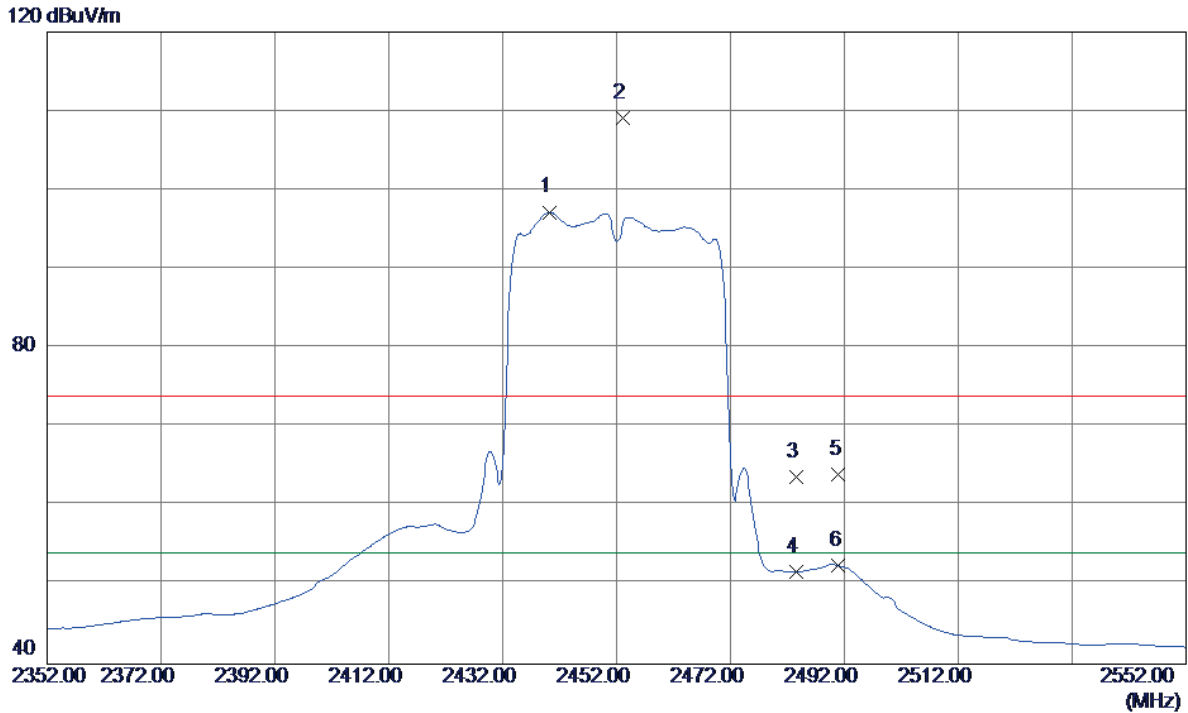

No.	Freq. MHz	Reading Level dBuV/m	Correct Factor dB	Measure ment dBuV/m	Limit dBuV/m	Margin dB	Detector	Comment
1	2440.2000	62.68	34.52	97.20	54.00	43.20	AVG	No Limit
2	2453.2000	74.49	34.60	109.09	74.00	35.09	Peak	No Limit
3	2483.5000	28.96	34.77	63.73	74.00	-10.27	Peak	
4	2483.5000	16.98	34.77	51.75	54.00	-2.25	AVG	
5	2491.0000	29.19	34.82	64.01	74.00	-9.99	Peak	
6	2491.0000	17.62	34.82	52.44	54.00	-1.56	AVG	

Orthogonal Axis :	X
Test Mode :	TX N-40M MODE 2452MHz

Vertical

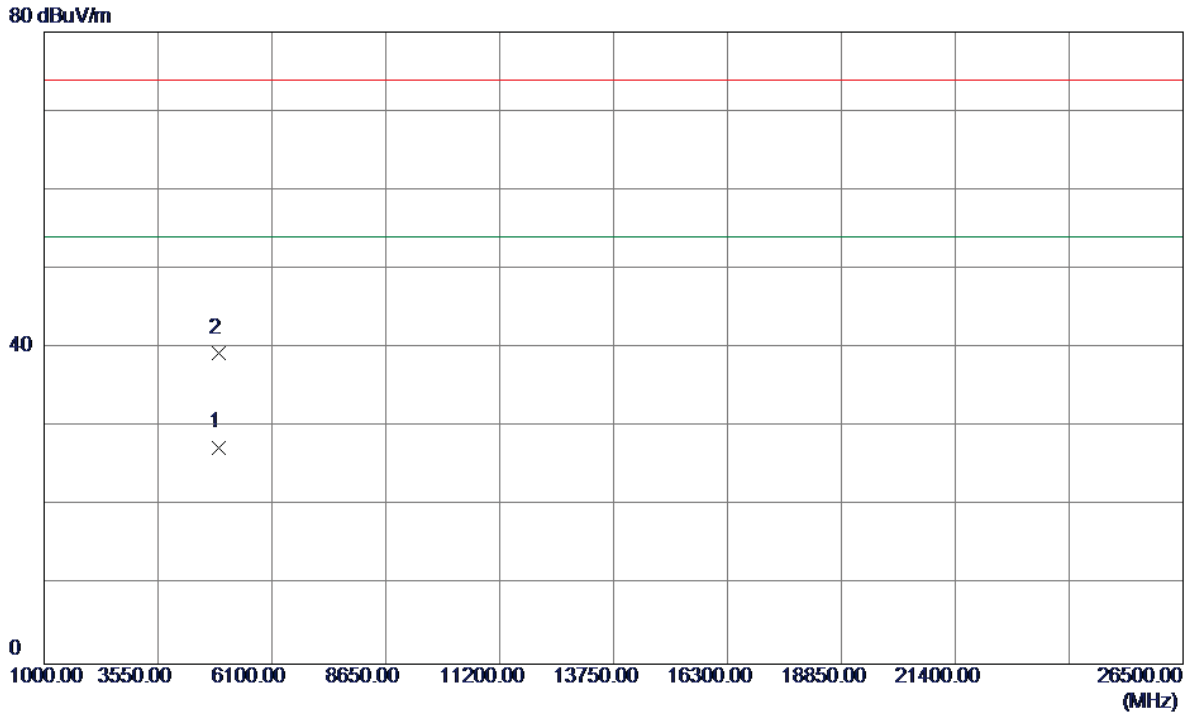

No.	Freq. MHz	Reading Level dBuV/m	Correct Factor dB	Measure ment dBuV/m	Limit dBuV/m	Margin dB	Detector	Comment
1	4903.5000	24.40	3.04	27.44	54.00	-26.56	AVG	
2	4904.0000	36.34	3.04	39.38	74.00	-34.62	Peak	

Orthogonal Axis :	X
Test Mode :	TX N-40M MODE 2452MHz

Horizontal

115 dBuV/m

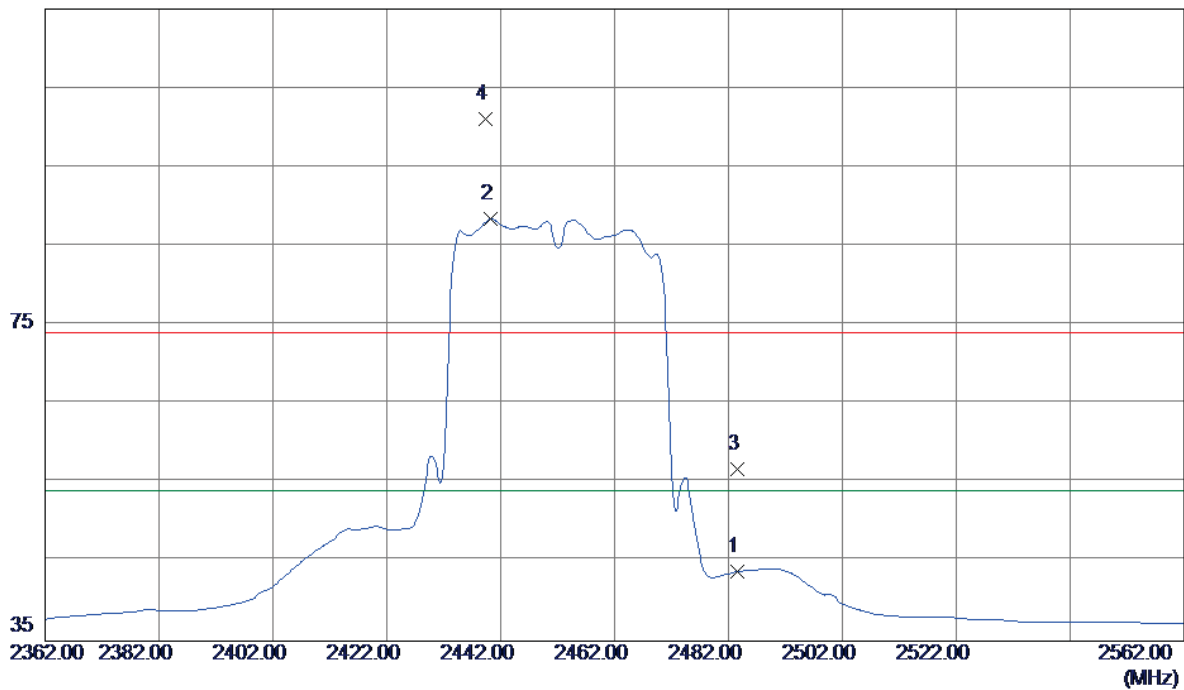

No.	Freq. MHz	Reading Level dBuV/m	Correct Factor dB	Measure ment dBuV/m	Limit dBuV/m	Margin dB	Detector	Comment
1	2483.5000	9.03	34.77	43.80	54.00	-10.20	AVG	
2	2440.2000	53.89	34.52	88.41	54.00	34.41	AVG	No Limit
3	2483.5000	22.06	34.77	56.83	74.00	-17.17	Peak	
4	2439.4000	66.63	34.52	101.15	74.00	27.15	Peak	No Limit

Orthogonal Axis :	X
Test Mode :	TX N-40M MODE 2452MHz

Horizontal

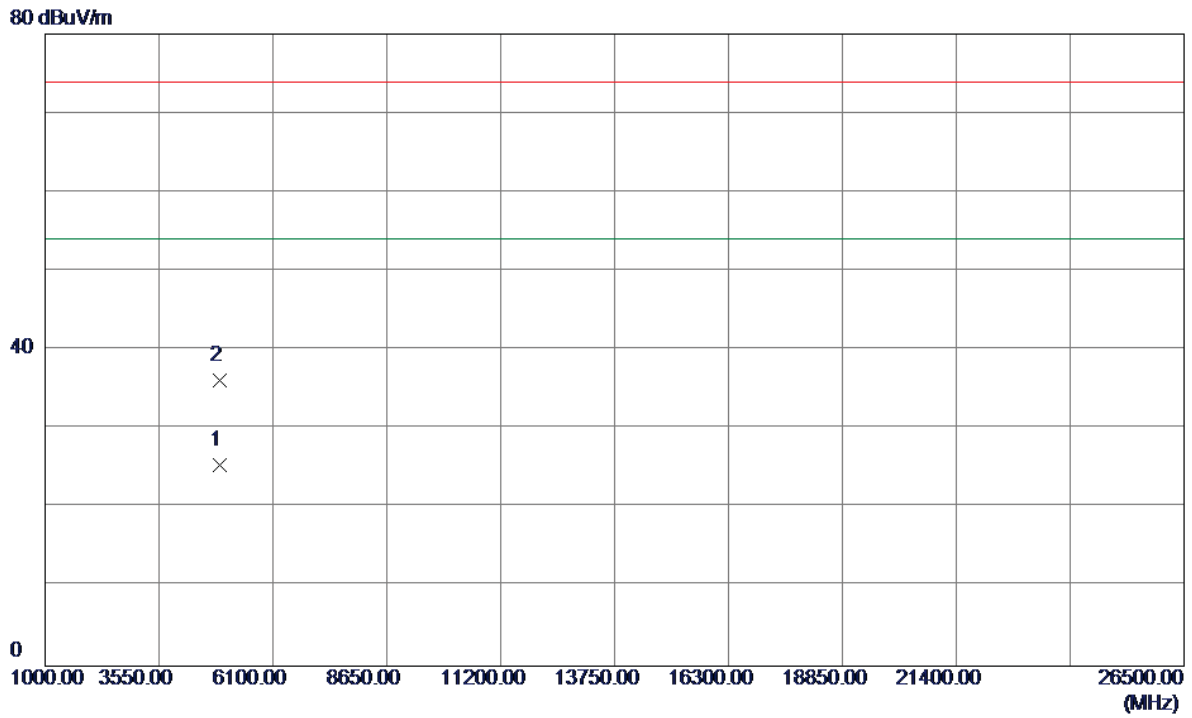

No.	Freq. MHz	Reading Level dBuV/m	Correct Factor dB	Measure ment dBuV/m	Limit dBuV/m	Margin dB	Detector	Comment
1	4903.8100	22.34	3.04	25.38	54.00	-28.62	AVG	
2	4903.9400	33.19	3.04	36.23	74.00	-37.77	Peak	

ATTACHMENT E - BANDWIDTH

Test Mode : TX B Mode_CH01/06/11

Frequency (MHz)	6dB Bandwidth (MHz)	99% Occupied BW (MHz)	Min. Limit (kHz)	Test Result
2412	8.07	10.12	500	Complies
2437	8.10	10.16	500	Complies
2462	8.15	10.12	500	Complies

TX CH01

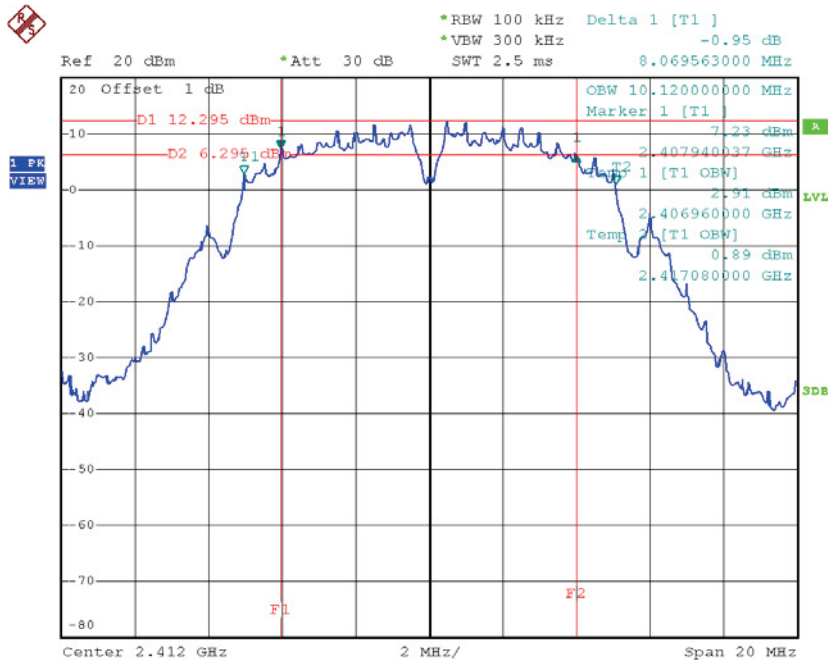

Date: 22.NOV.2015 15:35:21

TX CH06

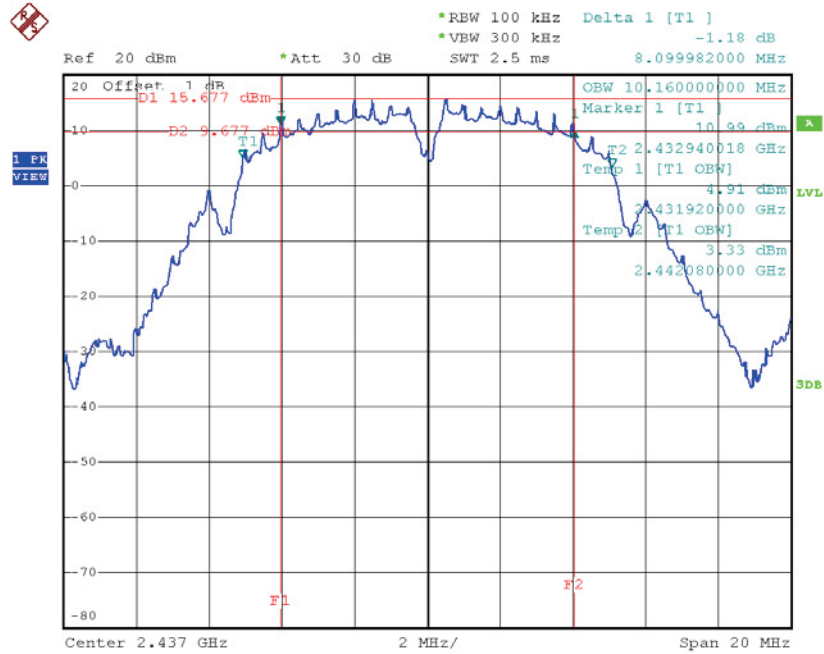

Date: 22.NOV.2015 15:37:40

TX CH11

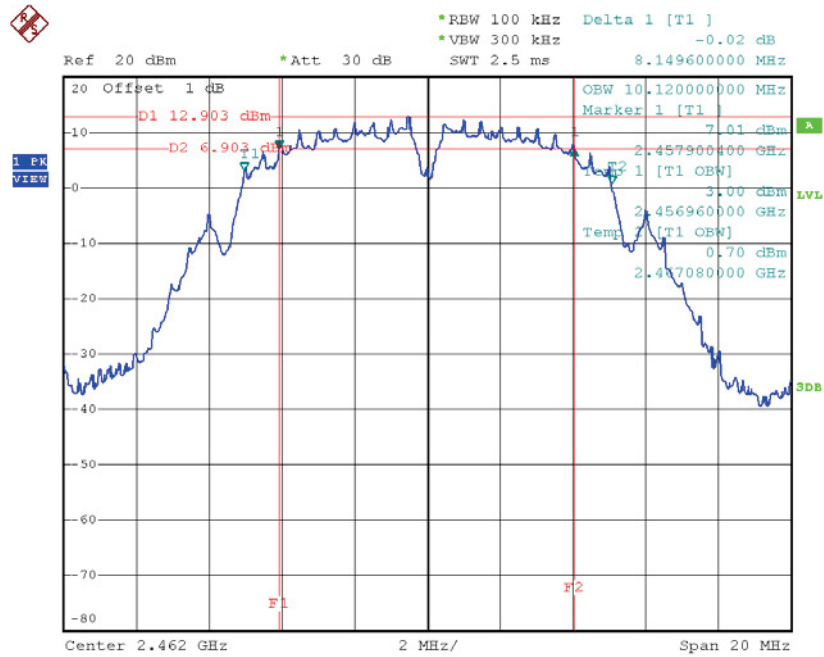

Date: 22.NOV.2015 15:39:20

Test Mode: TX G Mode_CH01/06/11

Frequency (MHz)	6dB Bandwidth (MHz)	99% Occupied BW (MHz)	Min. Limit (kHz)	Test Result
2412	16.47	16.56	500	Complies
2437	16.52	16.56	500	Complies
2462	16.42	16.56	500	Complies

TX CH01

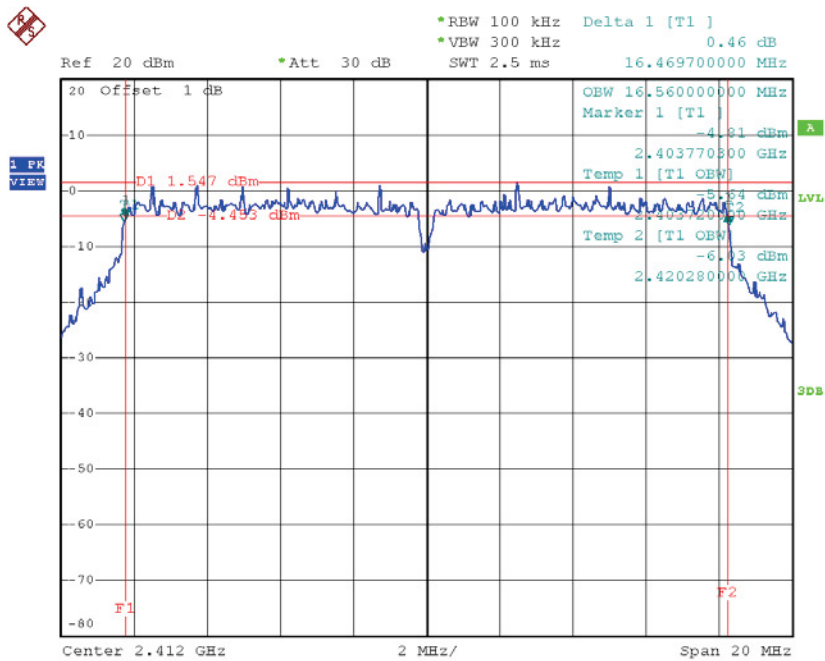

Date: 22.NOV.2015 15:42:31

TX CH06

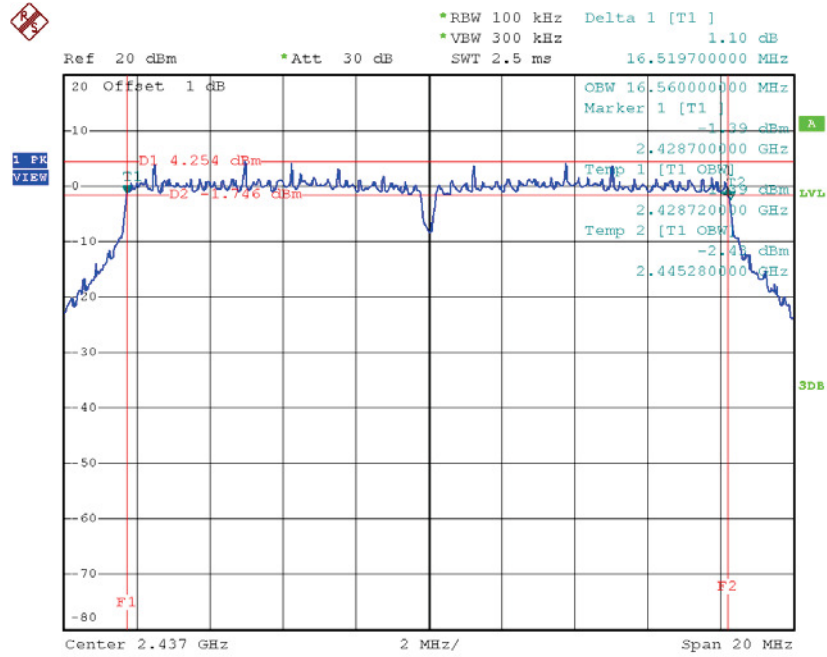

Date: 22.NOV.2015 15:43:53

TX CH11

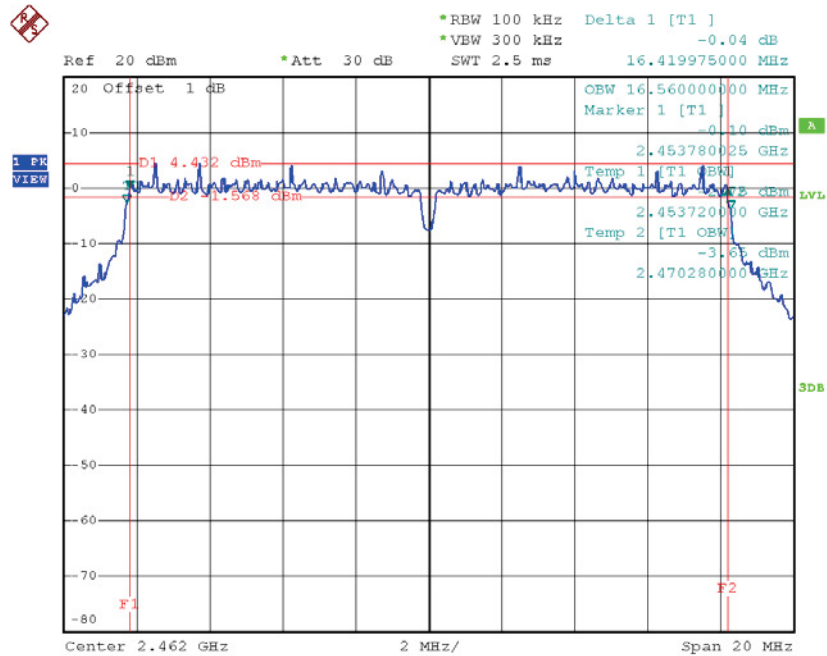

Date: 22.NOV.2015 15:44:53

Test Mode : TX N-20MHz Mode_CH01/06/11

Frequency (MHz)	6dB Bandwidth (MHz)	99% Occupied BW (MHz)	Min. Limit (kHz)	Test Result
2412	17.68	17.68	500	Complies
2437	17.68	17.68	500	Complies
2462	17.68	17.68	500	Complies

TX CH01

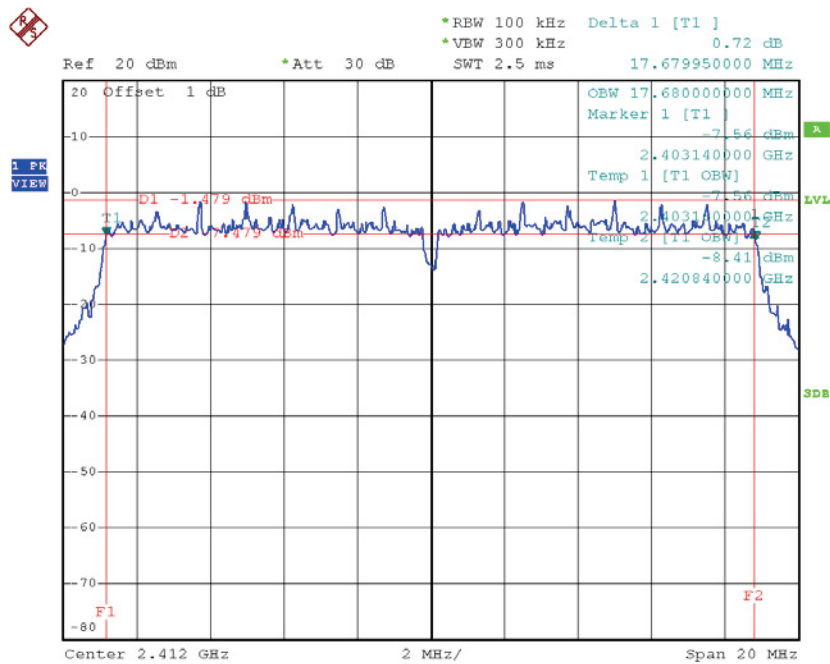

Date: 22.NOV.2015 15:47:09

TX CH06

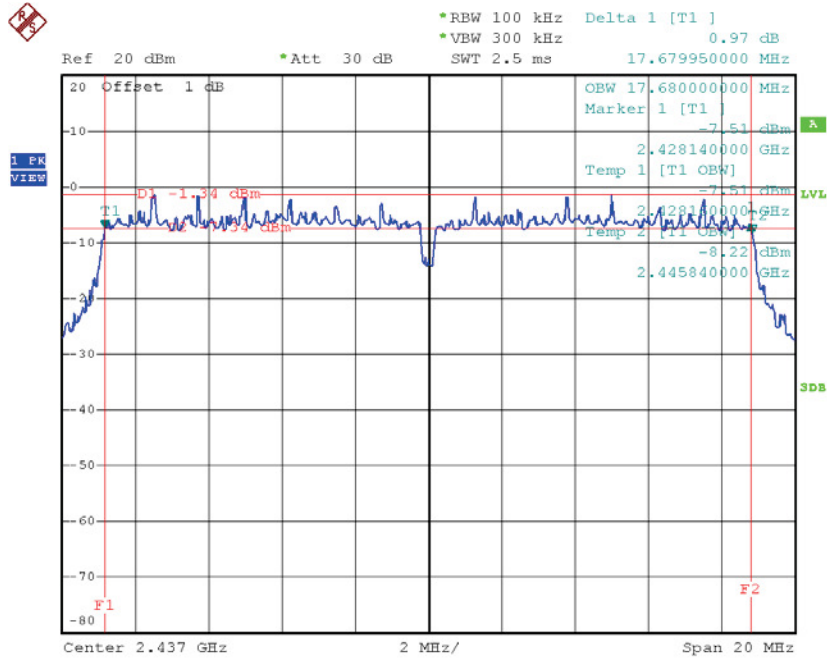

Date: 22.NOV.2015 15:48:22

TX CH11

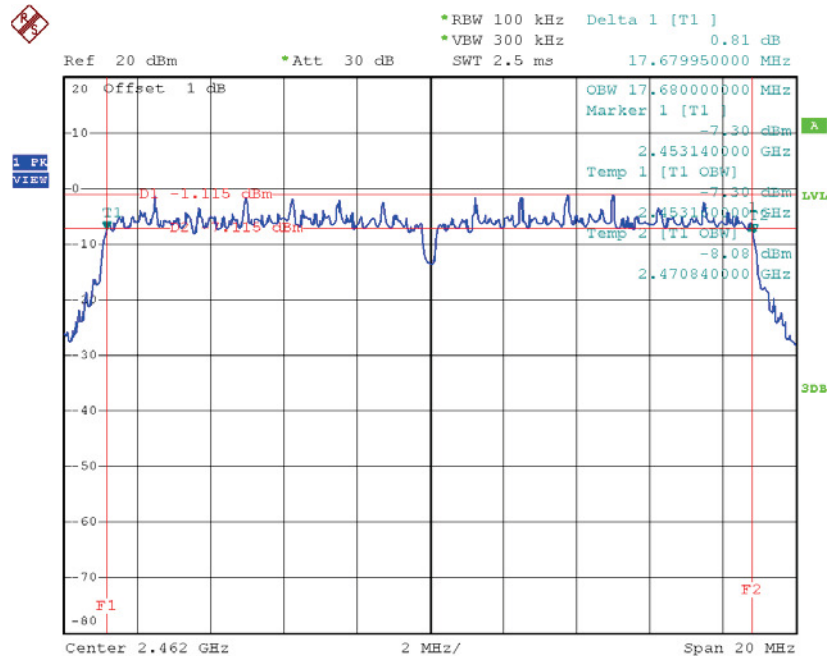

Date: 22.NOV.2015 15:49:15

Test Mode : TX N-40MHz Mode_CH03/06/09

Frequency (MHz)	6dB Bandwidth (MHz)	99% Occupied BW (MHz)	Min. Limit (kHz)	Test Result
2422	36.36	36.32	500	Complies
2437	36.48	36.24	500	Complies
2452	36.40	36.32	500	Complies

TX CH03

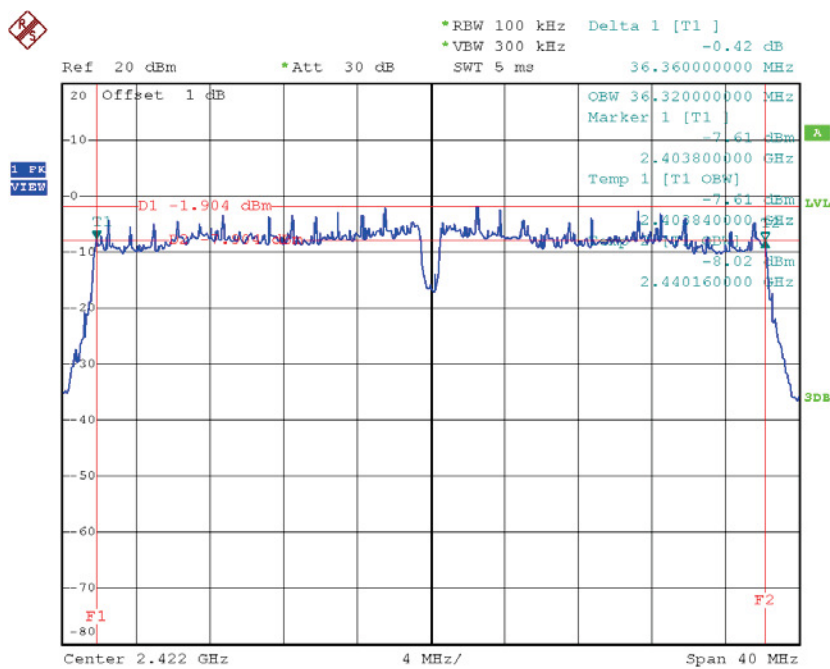

Date: 22.NOV.2015 15:50:24

TX CH06

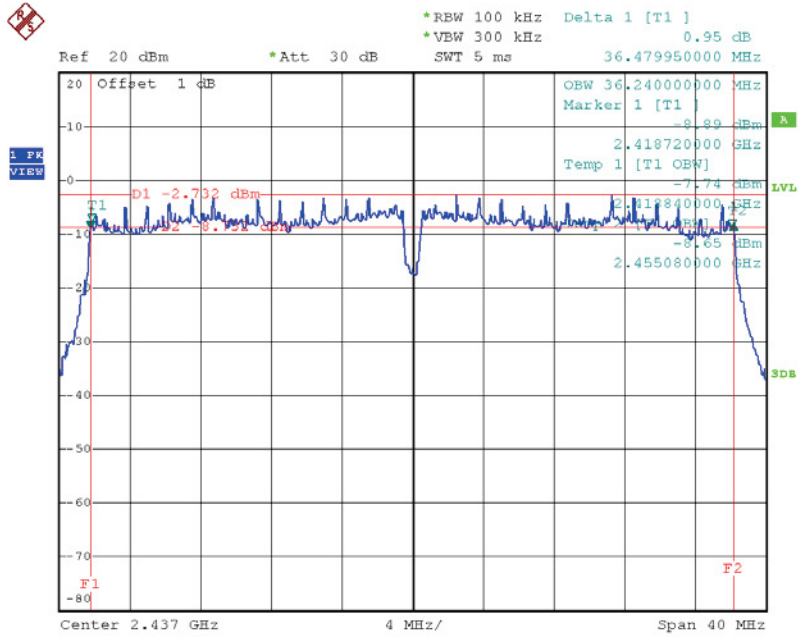

Date: 22.NOV.2015 15:51:29

TX CH09

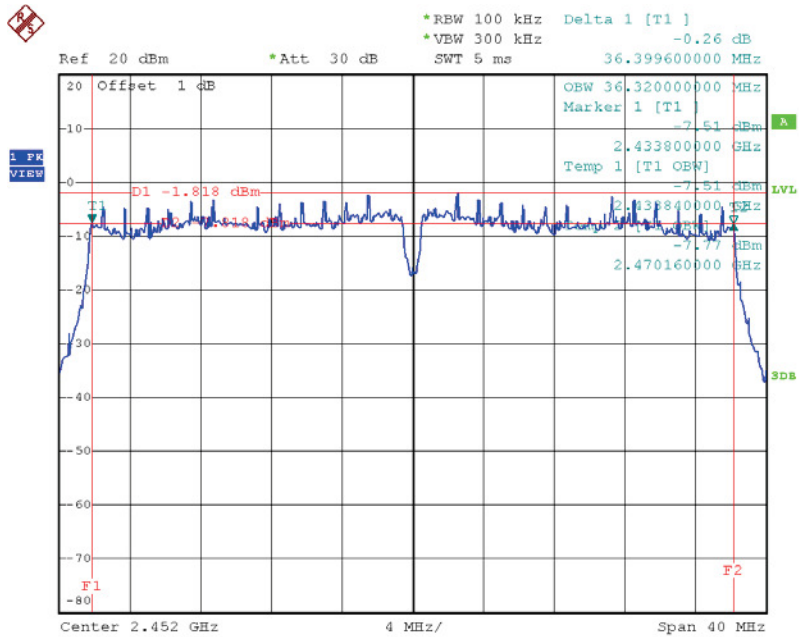

Date: 22.NOV.2015 15:52:22

ATTACHMENT F – MAXIMUM PEAK CONDUCTED OUTPUT POWER

Test Mode :TX B Mode_CH01/06/11_ANT 1					
Frequency (MHz)	Conducted Power (dBm)	Conducted Power (W)	Max. Limit (dBm)	Max. Limit (W)	Result
2412	26.53	0.45	30.00	1.00	Complies
2437	29.25	0.84	30.00	1.00	Complies
2462	26.93	0.49	30.00	1.00	Complies

Test Mode :TX G Mode_CH01/06/11_ANT 1					
Frequency (MHz)	Conducted Power (dBm)	Conducted Power (W)	Max. Limit (dBm)	Max. Limit (W)	Result
2412	27.15	0.52	30.00	1.00	Complies
2437	29.54	0.90	30.00	1.00	Complies
2462	29.73	0.94	30.00	1.00	Complies

Test Mode :TX N20 Mode_CH01/06/11_ANT 1					
Frequency (MHz)	Conducted Power (dBm)	Conducted Power (W)	Max. Limit (dBm)	Max. Limit (W)	Result
2412	23.17	0.21	30.00	1.00	Complies
2437	23.38	0.22	30.00	1.00	Complies
2462	23.71	0.23	30.00	1.00	Complies

Test Mode :TX N20 Mode_CH01/06/11_ANT 2					
Frequency (MHz)	Conducted Power (dBm)	Conducted Power (W)	Max. Limit (dBm)	Max. Limit (W)	Result
2412	24.63	0.29	30.00	1.00	Complies
2437	24.55	0.29	30.00	1.00	Complies
2462	24.91	0.31	30.00	1.00	Complies

Test Mode :TX N20 Mode_CH01/06/11_ANT 3					
Frequency (MHz)	Conducted Power (dBm)	Conducted Power (W)	Max. Limit (dBm)	Max. Limit (W)	Result
2412	23.22	0.21	30.00	1.00	Complies
2437	23.88	0.24	30.00	1.00	Complies
2462	23.56	0.23	30.00	1.00	Complies

Test Mode :TX N20 Mode_CH01/06/11_Total					
Frequency (MHz)	Conducted Power (dBm)	Conducted Power (W)	Max. Limit (dBm)	Max. Limit (W)	Result
2412	28.50	0.71	30.00	1.00	Complies
2437	28.73	0.75	30.00	1.00	Complies
2462	28.87	0.77	30.00	1.00	Complies

Test Mode :TX N40 Mode_CH01/06/11_ANT 1					
Frequency (MHz)	Conducted Power (dBm)	Conducted Power (W)	Max. Limit (dBm)	Max. Limit (W)	Result
2422	16.82	0.05	30.00	1.00	Complies
2437	22.64	0.18	30.00	1.00	Complies
2452	23.01	0.20	30.00	1.00	Complies

Test Mode :TX N40 Mode_CH03/06/09_ANT 2					
Frequency (MHz)	Conducted Power (dBm)	Conducted Power (W)	Max. Limit (dBm)	Max. Limit (W)	Result
2422	17.92	0.06	30.00	1.00	Complies
2437	24.60	0.29	30.00	1.00	Complies
2452	24.53	0.28	30.00	1.00	Complies

Test Mode :TX N40 Mode_CH03/06/09_ANT 3					
Frequency (MHz)	Conducted Power (dBm)	Conducted Power (W)	Max. Limit (dBm)	Max. Limit (W)	Result
2422	17.03	0.05	30.00	1.00	Complies
2437	23.86	0.24	30.00	1.00	Complies
2452	24.26	0.27	30.00	1.00	Complies

Test Mode :TX N40 Mode_CH03/06/09_Total					
Frequency (MHz)	Conducted Power (dBm)	Conducted Power (W)	Max. Limit (dBm)	Max. Limit (W)	Result
2422	22.05	0.16	30.00	1.00	Complies
2437	28.54	0.72	30.00	1.00	Complies
2452	28.75	0.75	30.00	1.00	Complies

**ATTACHMENT G - ANTENNA CONDUCTED SPURIOUS
EMISSION**

Test Mode :	TX B Mode
--------------------	------------------

TX B mode CH01

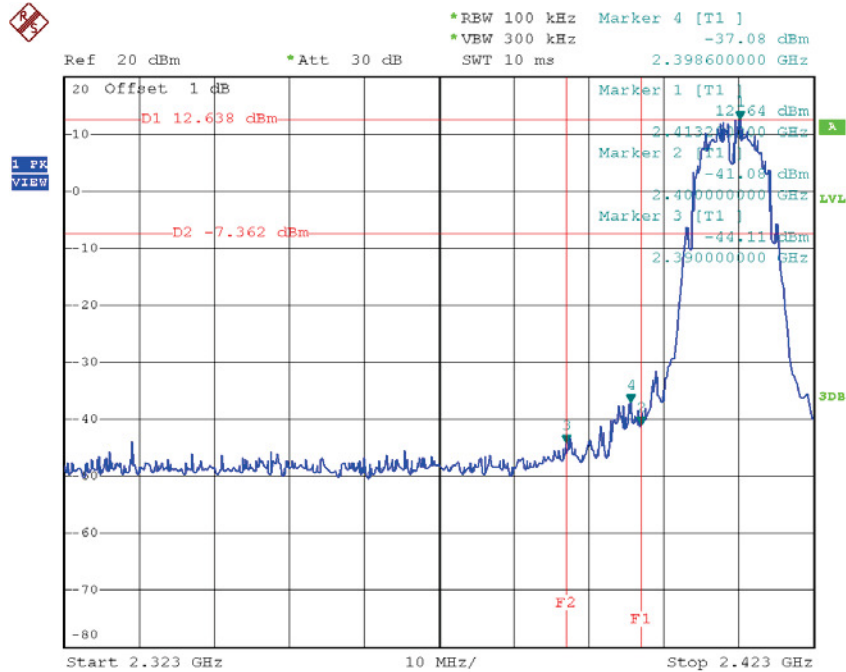

Date: 22.NOV.2015 15:35:46

TX B mode CH11

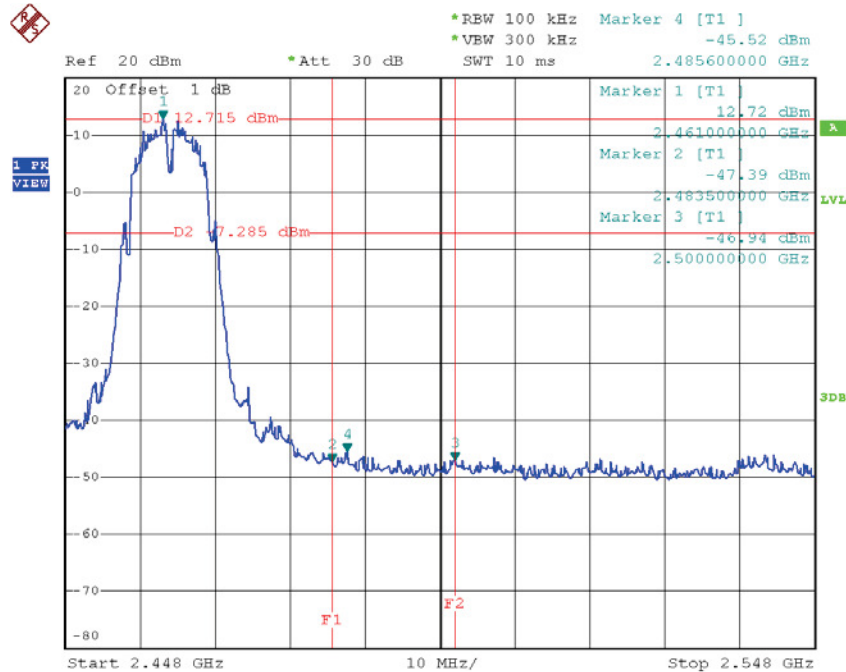

Date: 22.NOV.2015 15:39:43

TX B mode CH01 (10 Harmonic of the frequency)

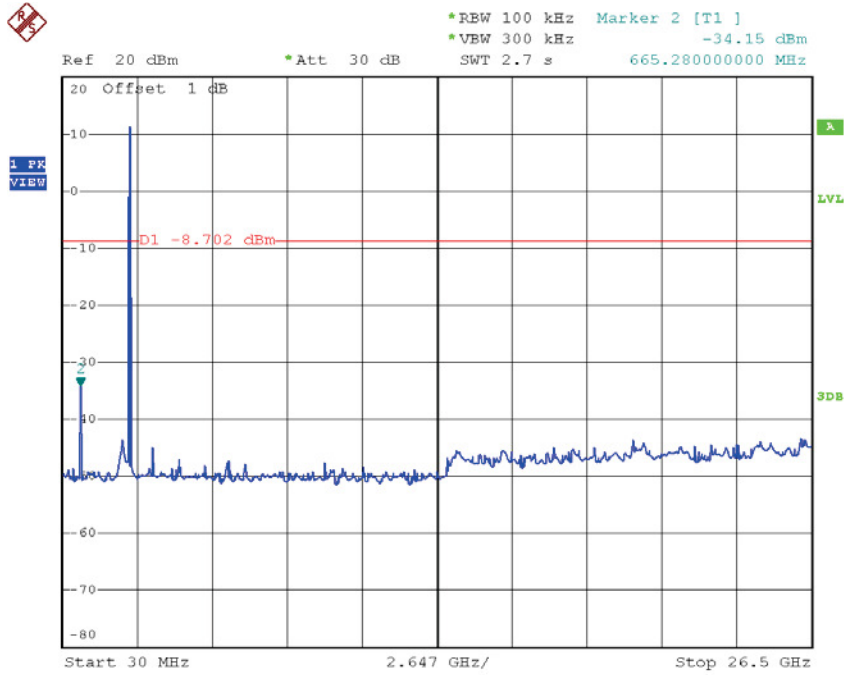

Date: 22.NOV.2015 15:35:38

TX B mode CH06 (10 Harmonic of the frequency)

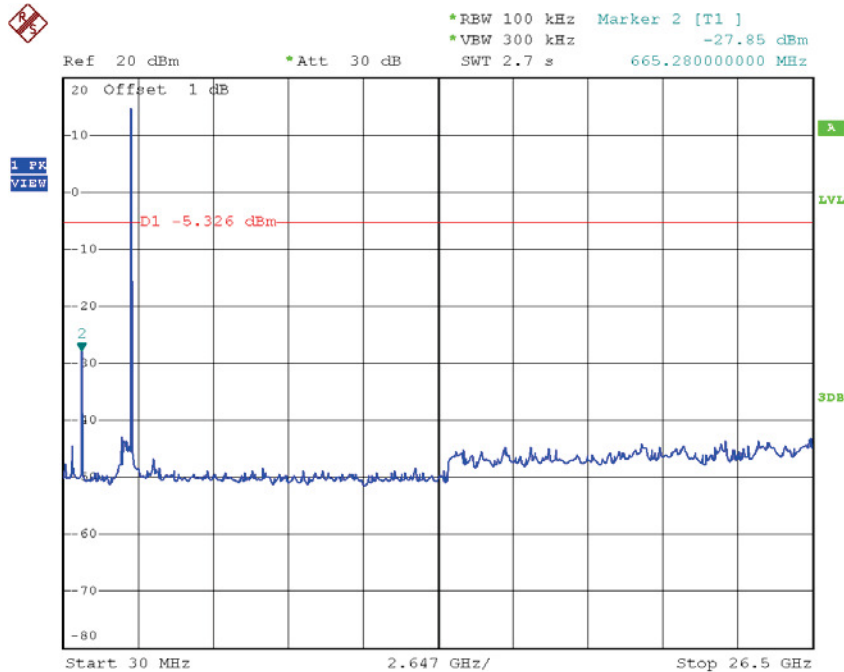

Date: 22.NOV.2015 15:37:55

TX B mode CH11 (10 Harmonic of the frequency)

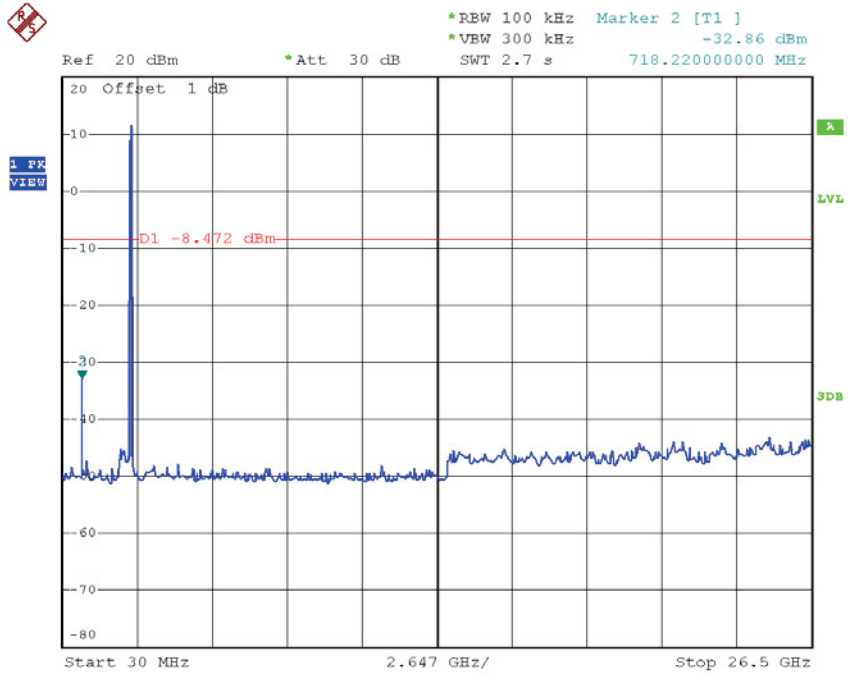

Date: 22.NOV.2015 15:39:35

Test Mode :	TX G Mode
--------------------	------------------

TX G mode CH01

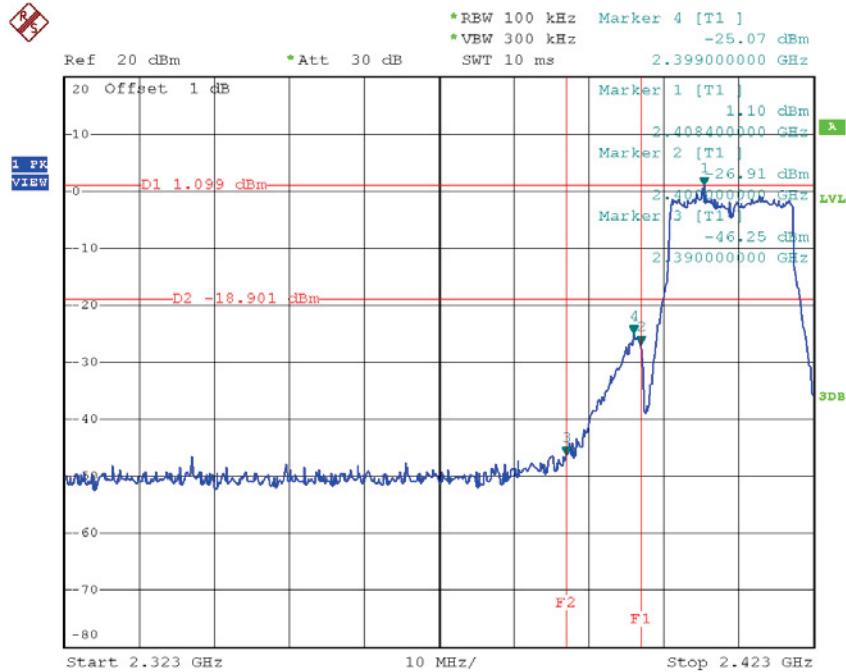

Date: 22.NOV.2015 15:42:54

TX G mode CH11

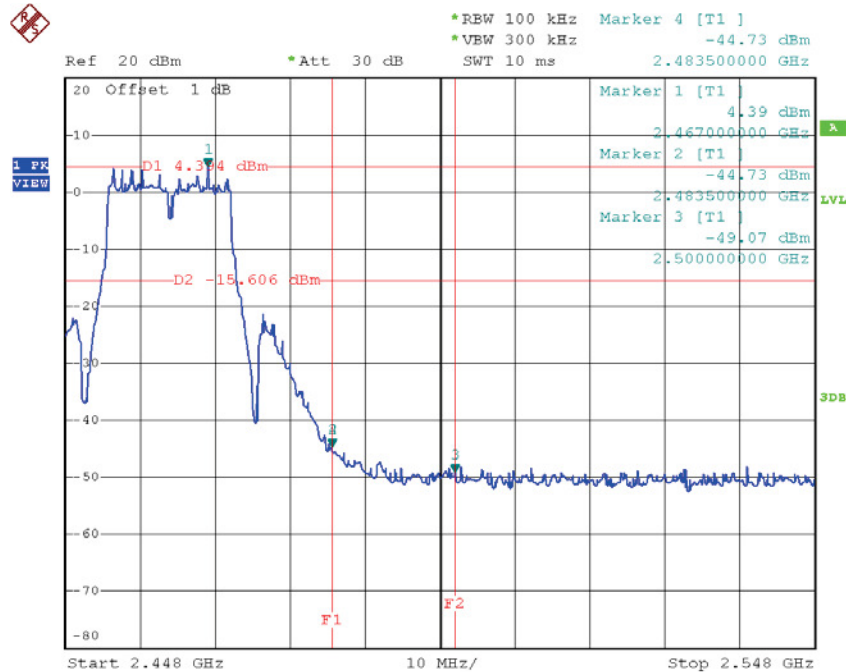

Date: 22.NOV.2015 15:46:00

TX G mode CH01 (10 Harmonic of the frequency)

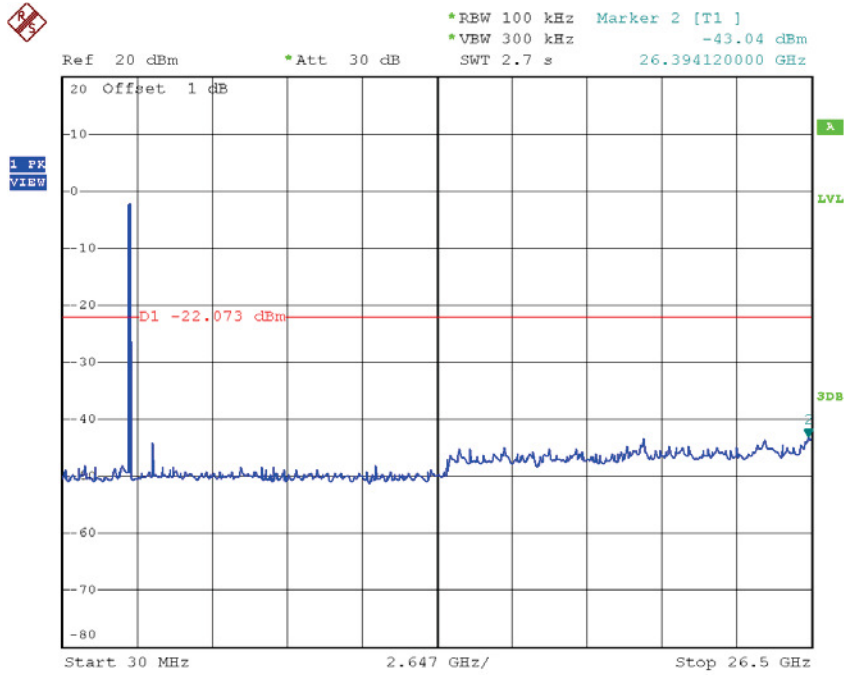

Date: 22.NOV.2015 15:42:46

TX G mode CH06 (10 Harmonic of the frequency)

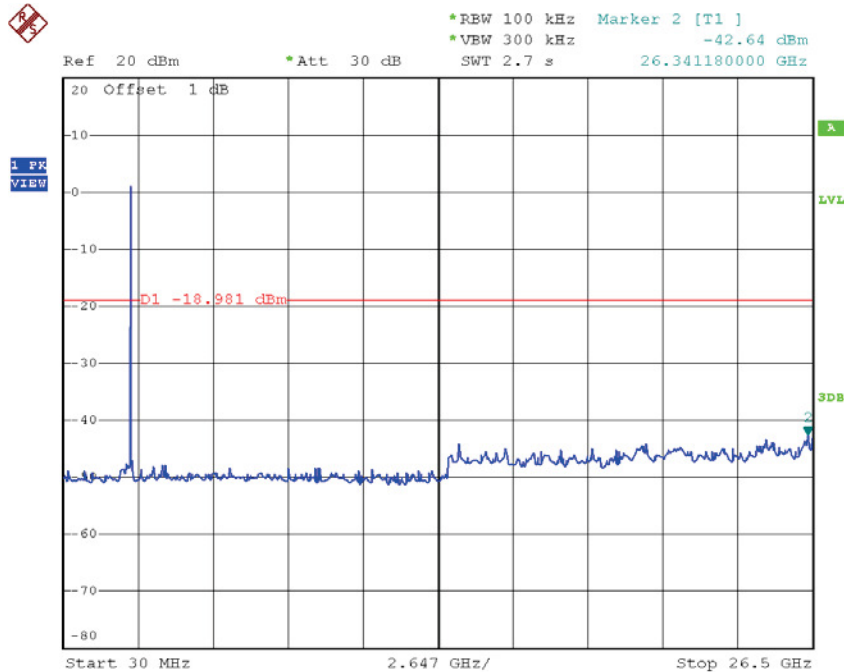

Date: 22.NOV.2015 15:44:08

TX G mode CH11 (10 Harmonic of the frequency)

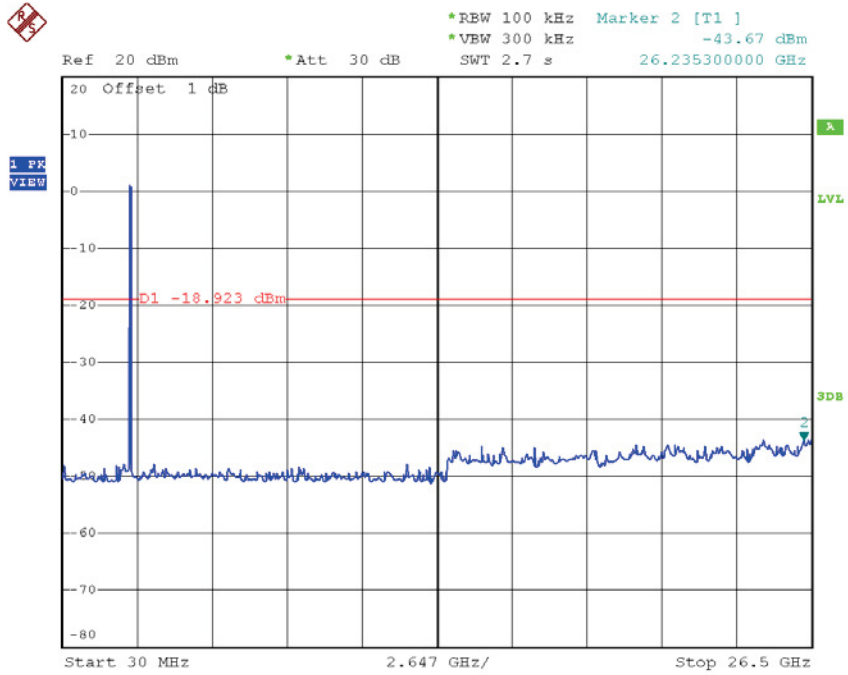

Date: 22.NOV.2015 15:45:08

Test Mode :	TX N-20M Mode_ANT 1
-------------	---------------------

TX HT20 mode CH01

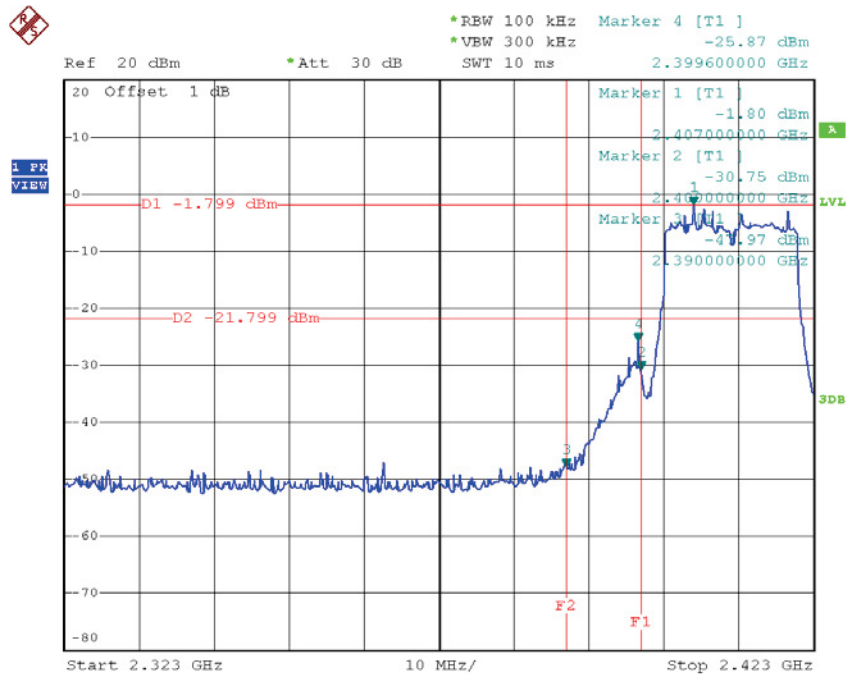

Date: 22.NOV.2015 15:47:32

TX HT20 mode CH11

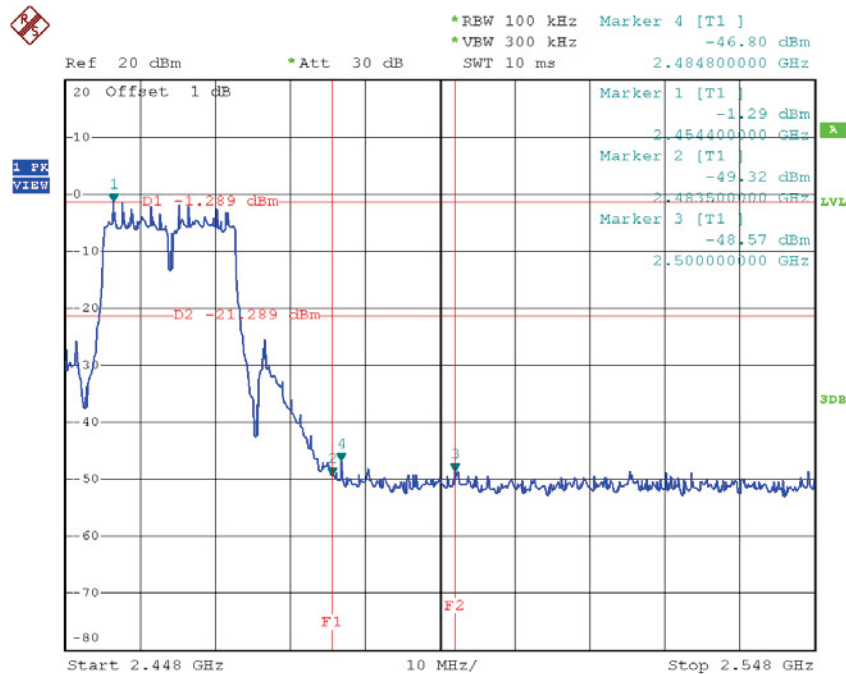

Date: 22.NOV.2015 15:49:38

TX HT20 mode CH01 (10 Harmonic of the frequency)

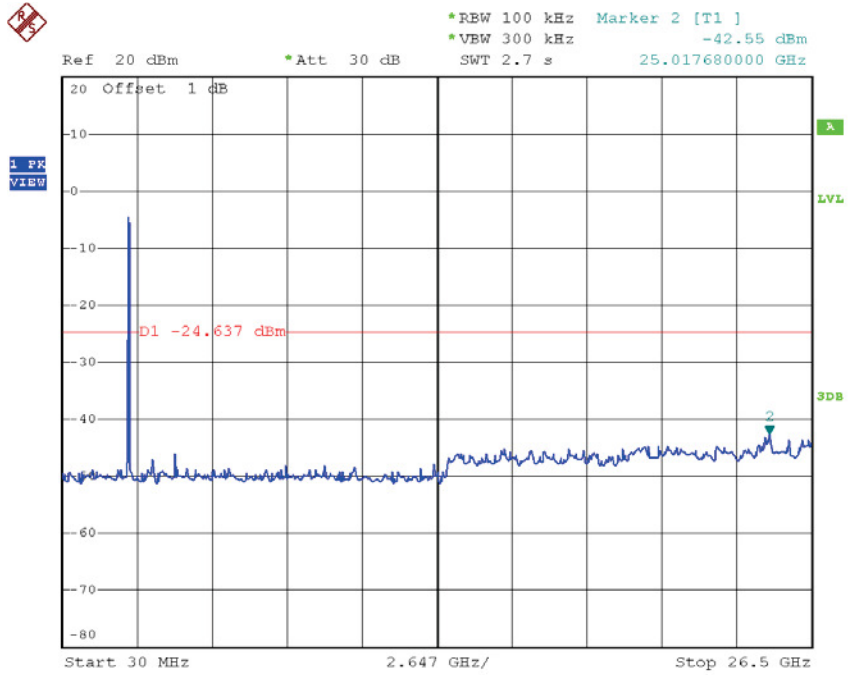

Date: 22.NOV.2015 15:47:24

TX HT20 mode CH06 (10 Harmonic of the frequency)

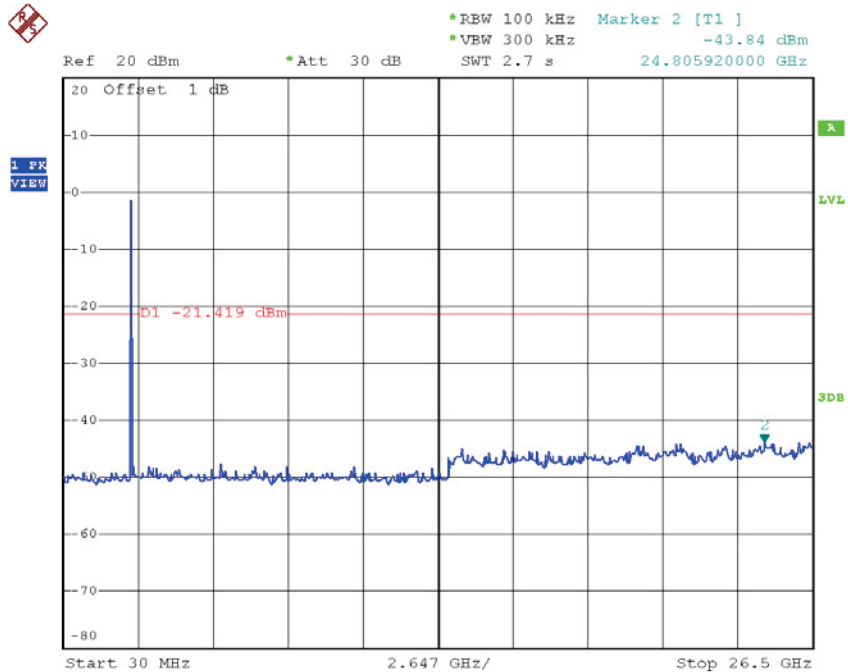

Date: 22.NOV.2015 15:48:37

TX HT20 mode CH11 (10 Harmonic of the frequency)

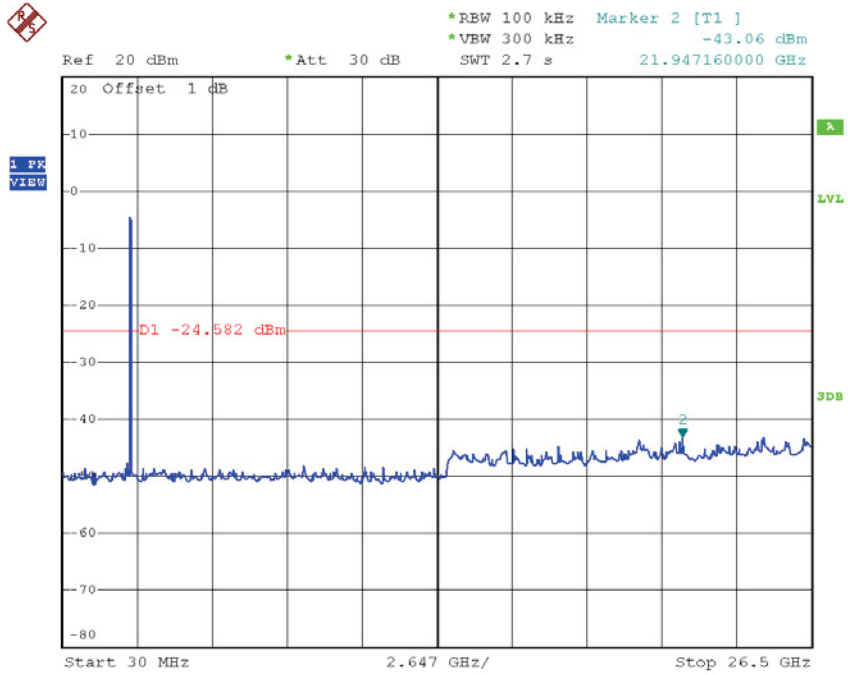

Date: 22.NOV.2015 15:49:30

Test Mode :	TX N-20M Mode_ANT 2
--------------------	----------------------------

TX HT20 mode CH01

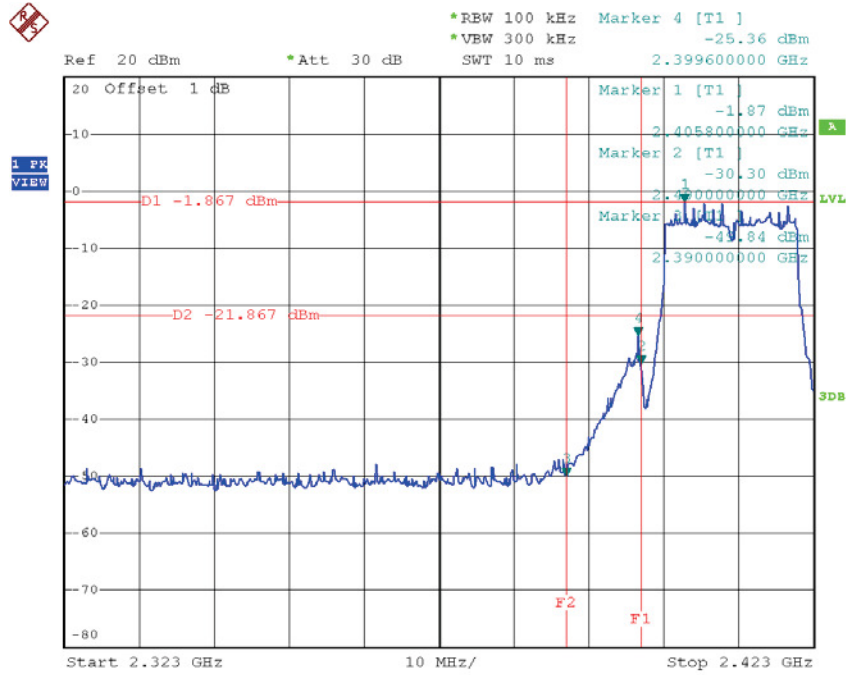

Date: 22.NOV.2015 15:55:30

TX HT20 mode CH11

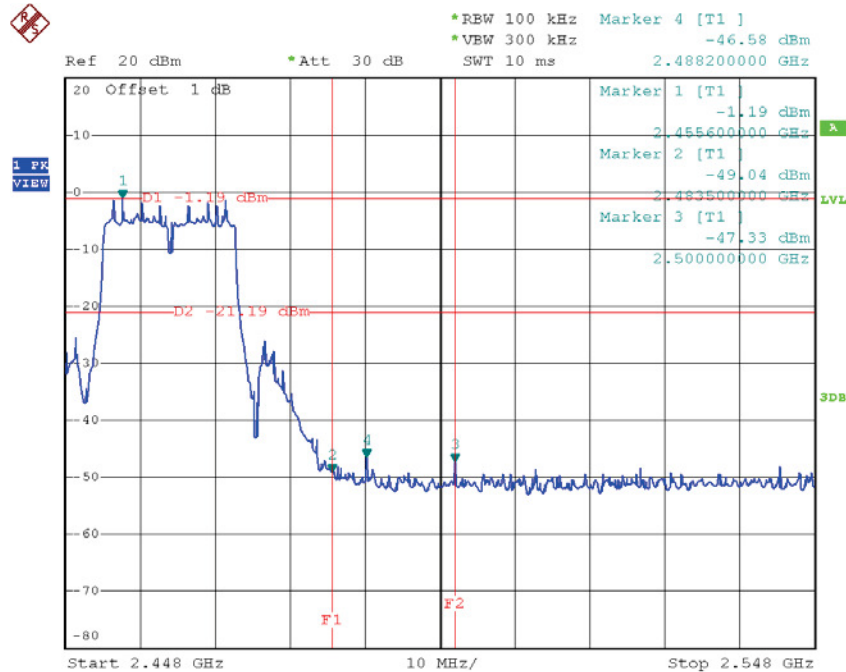

Date: 22.NOV.2015 15:57:23

TX HT20 mode CH01 (10 Harmonic of the frequency)

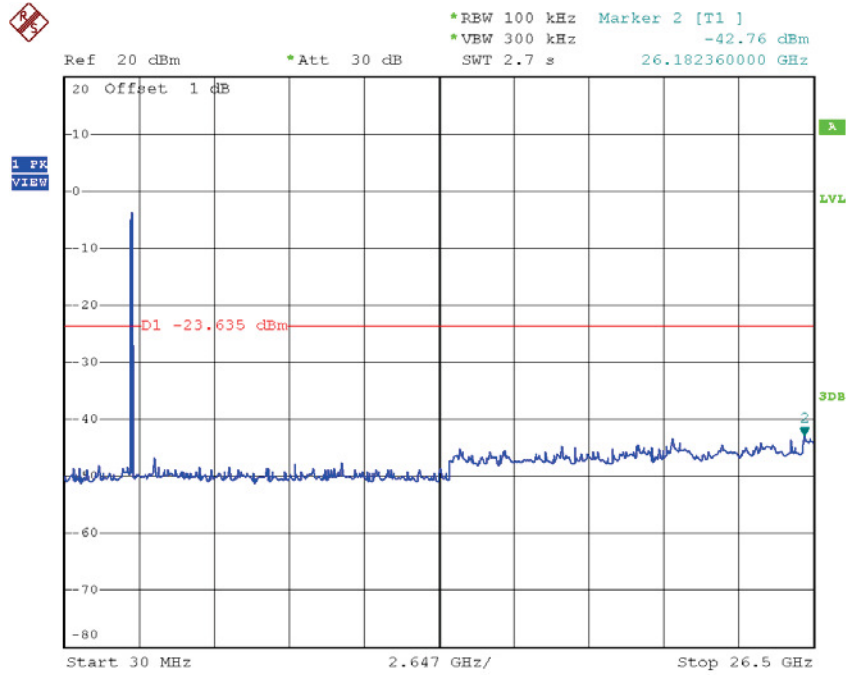

Date: 22.NOV.2015 15:55:21

TX HT20 mode CH06 (10 Harmonic of the frequency)

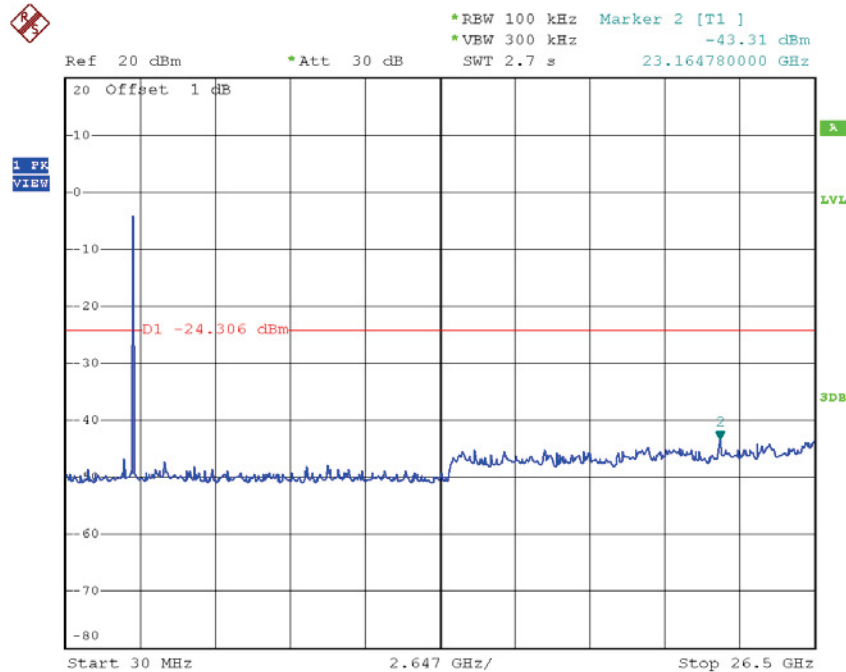

Date: 22.NOV.2015 15:56:23

TX HT20 mode CH11 (10 Harmonic of the frequency)

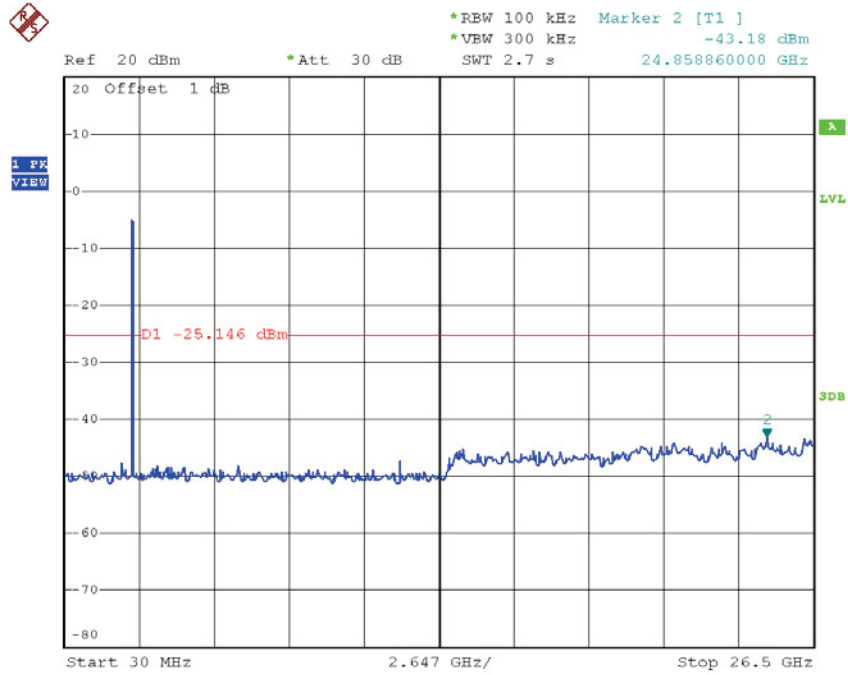

Date: 22.NOV.2015 15:57:14

Test Mode :	TX N-20M Mode_ANT 3
--------------------	----------------------------

TX HT20 mode CH01

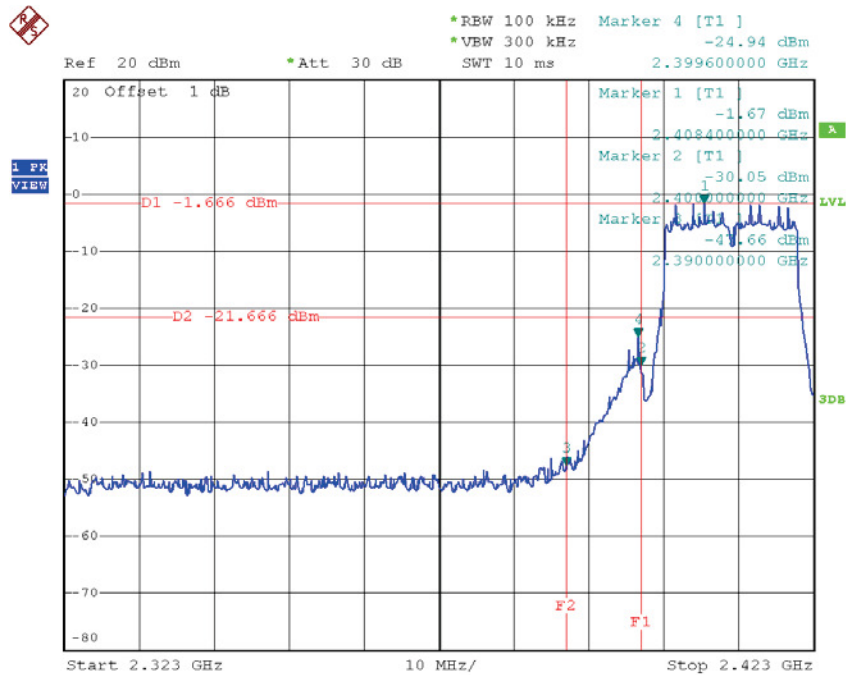

Date: 22.NOV.2015 16:04:40

TX HT20 mode CH11

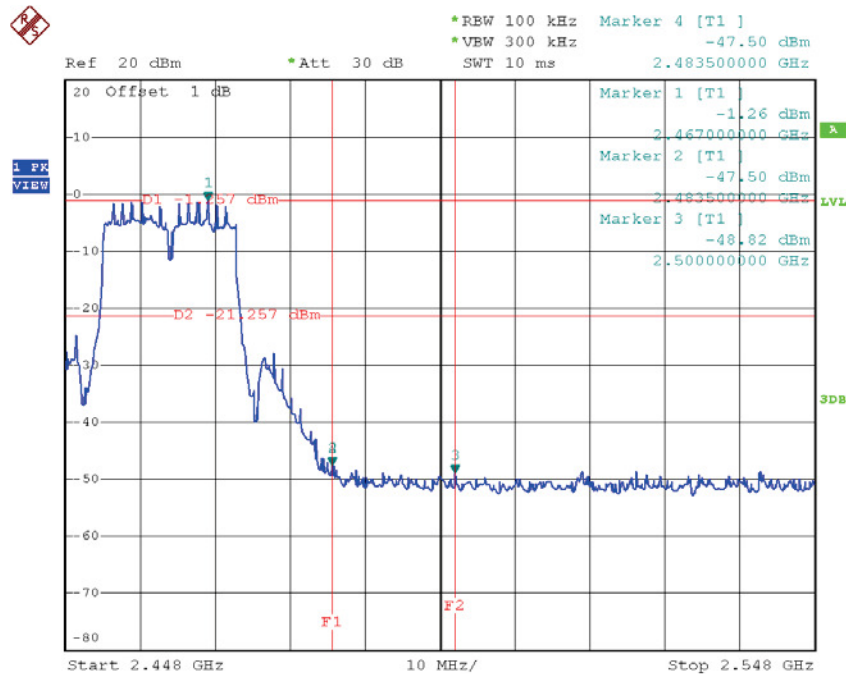

Date: 22.NOV.2015 16:06:35

TX HT20 mode CH01 (10 Harmonic of the frequency)

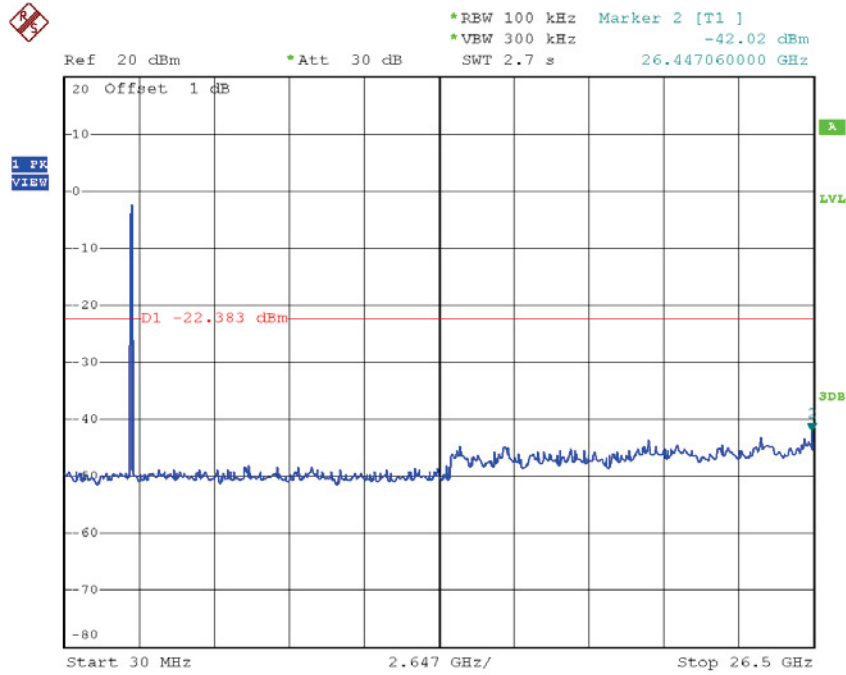

Date: 22.NOV.2015 16:04:32

TX HT20 mode CH06 (10 Harmonic of the frequency)

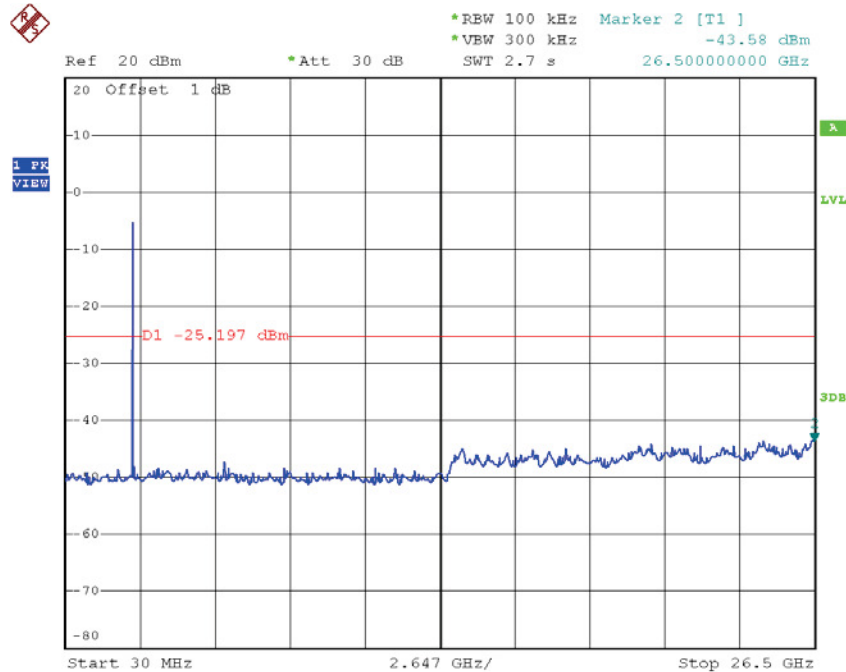

Date: 22.NOV.2015 16:05:36

TX HT20 mode CH11 (10 Harmonic of the frequency)

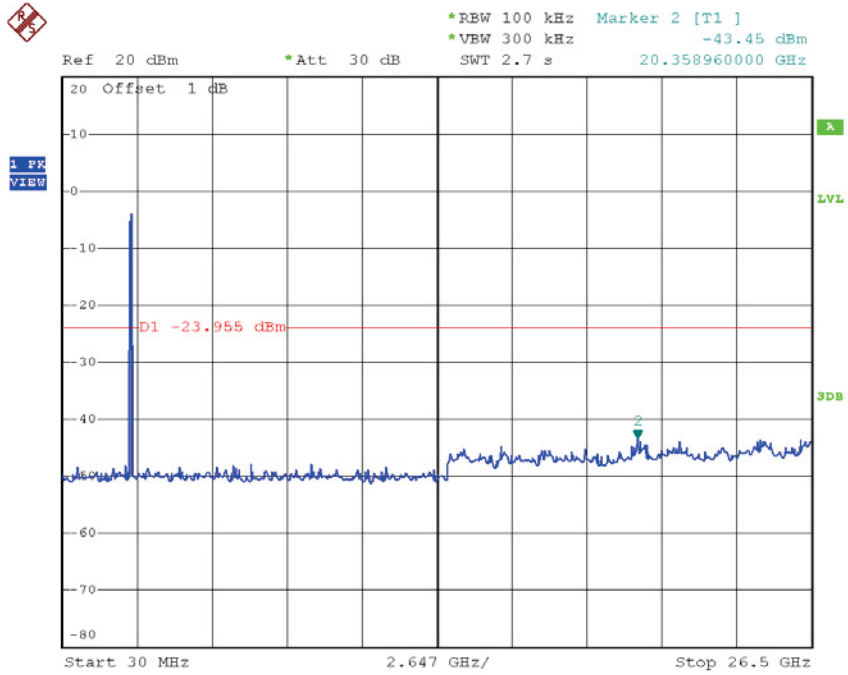

Date: 22.NOV.2015 16:06:27

Test Mode :	TX N-40M Mode_ANT 1
--------------------	----------------------------

TX HT40 mode CH03

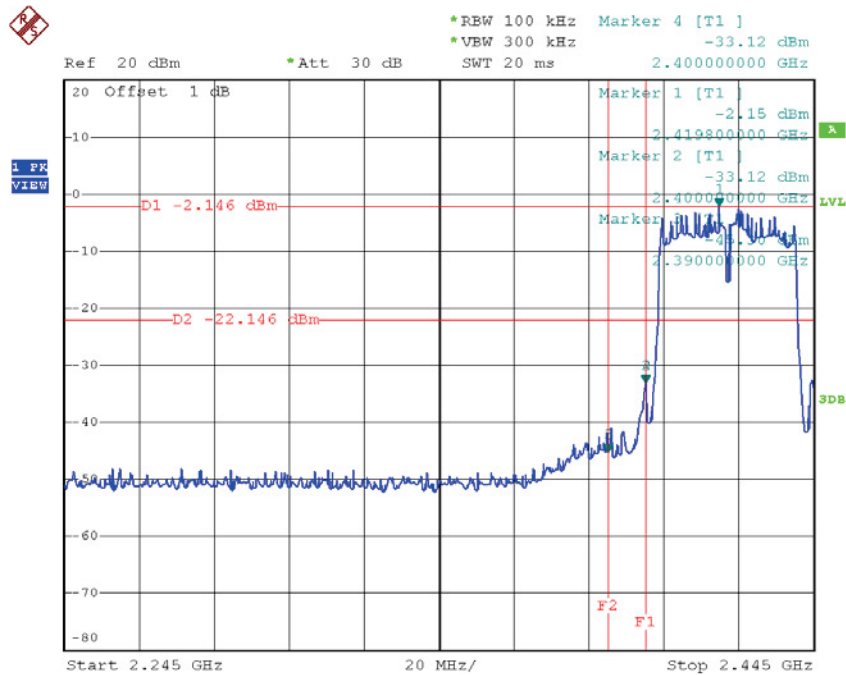

Date: 22.NOV.2015 15:50:47

TX HT40 mode CH09

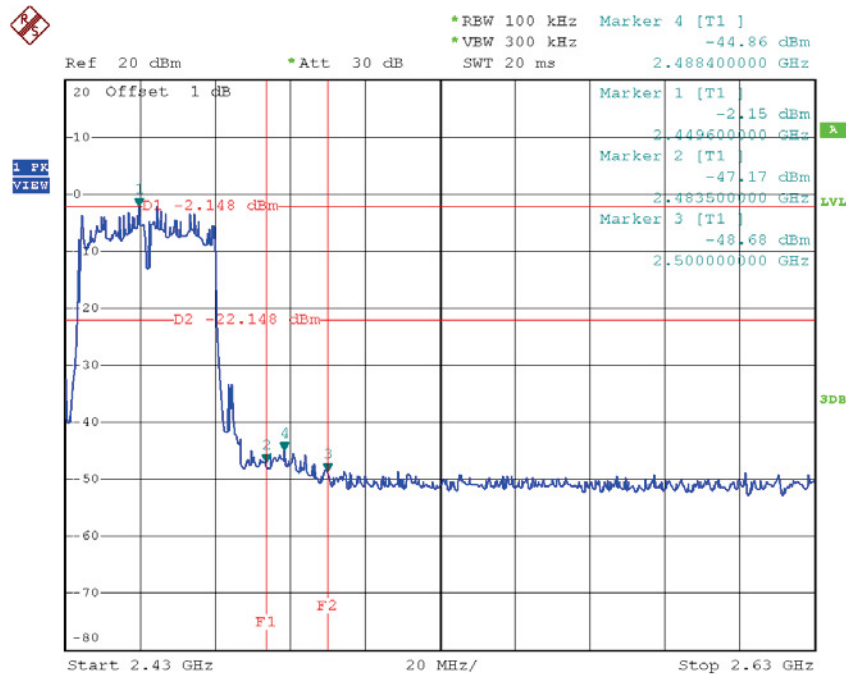

Date: 22.NOV.2015 15:52:45

TX HT40 mode CH03 (10 Harmonic of the frequency)

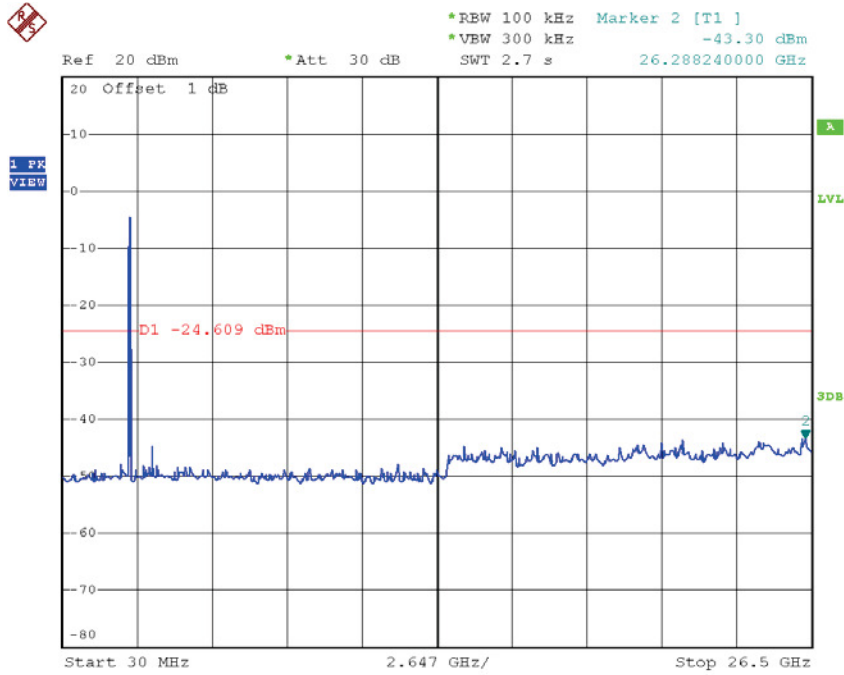

Date: 22.NOV.2015 15:50:39

TX HT40 mode CH06 (10 Harmonic of the frequency)

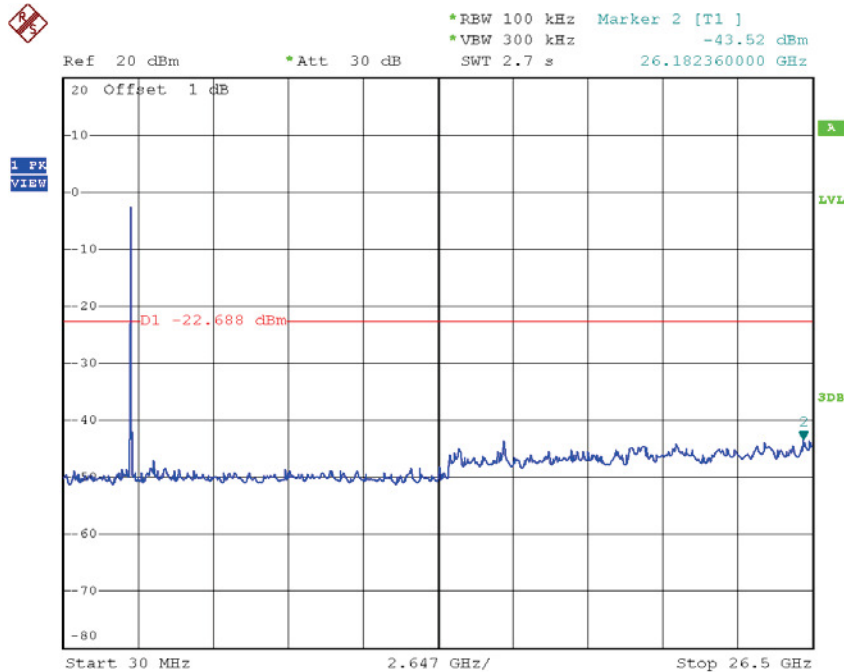

Date: 22.NOV.2015 15:51:44

TX HT40 mode CH09 (10 Harmonic of the frequency)

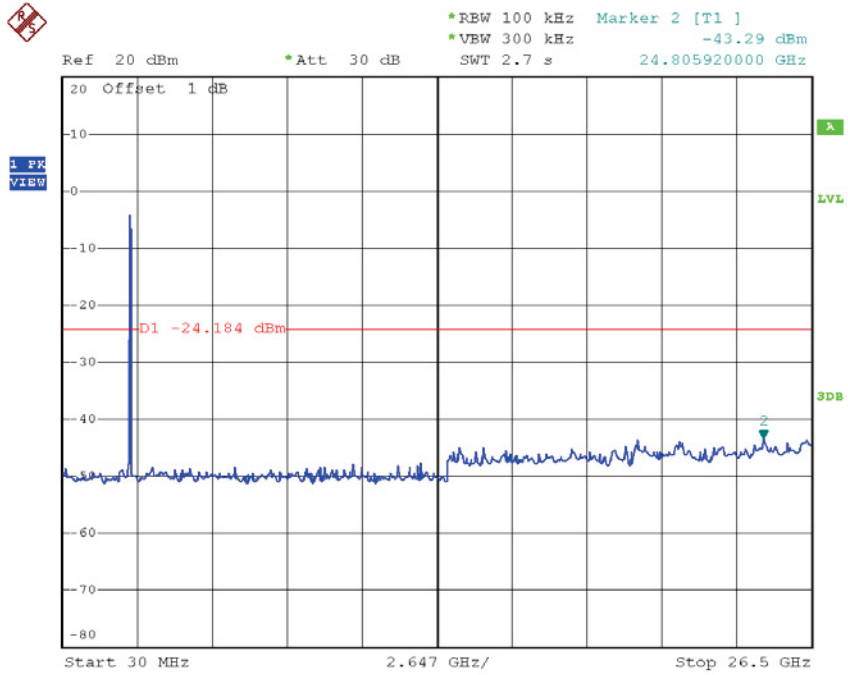

Date: 22.NOV.2015 15:52:36

Test Mode :	TX N-40M Mode_ANT 2
--------------------	----------------------------

TX HT40 mode CH03

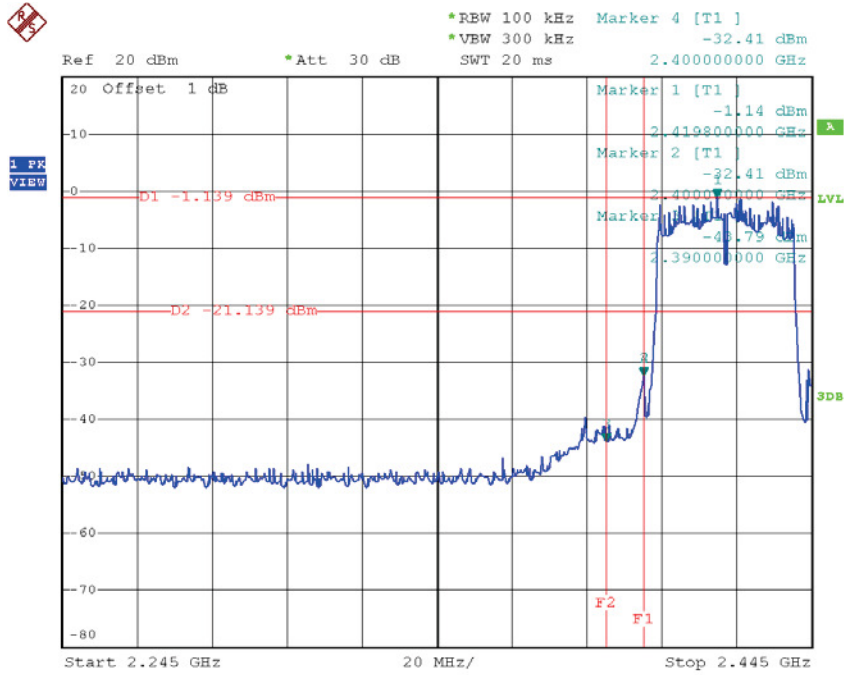

Date: 22.NOV.2015 15:58:29

TX HT40 mode CH09

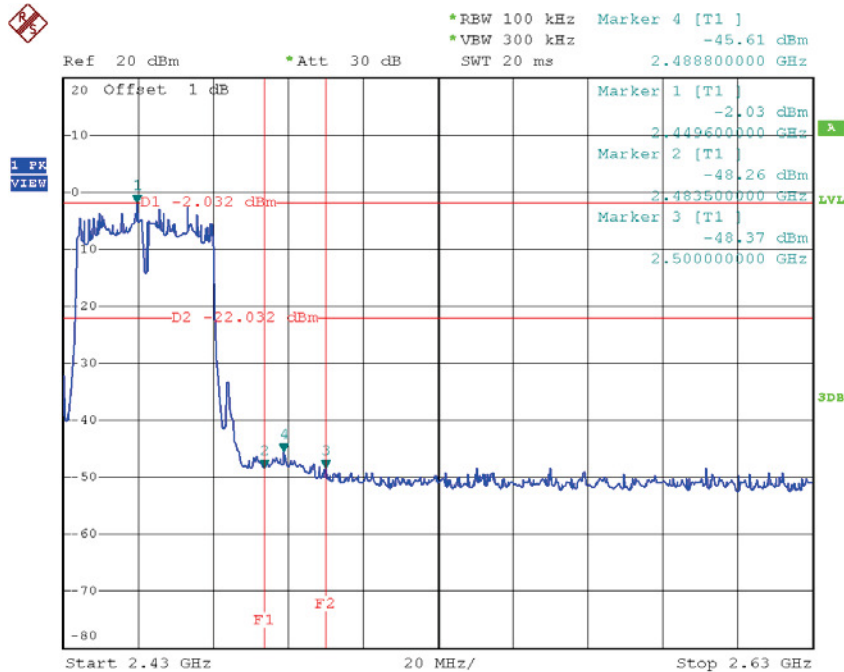

Date: 22.NOV.2015 16:00:27

TX HT40 mode CH03 (10 Harmonic of the frequency)

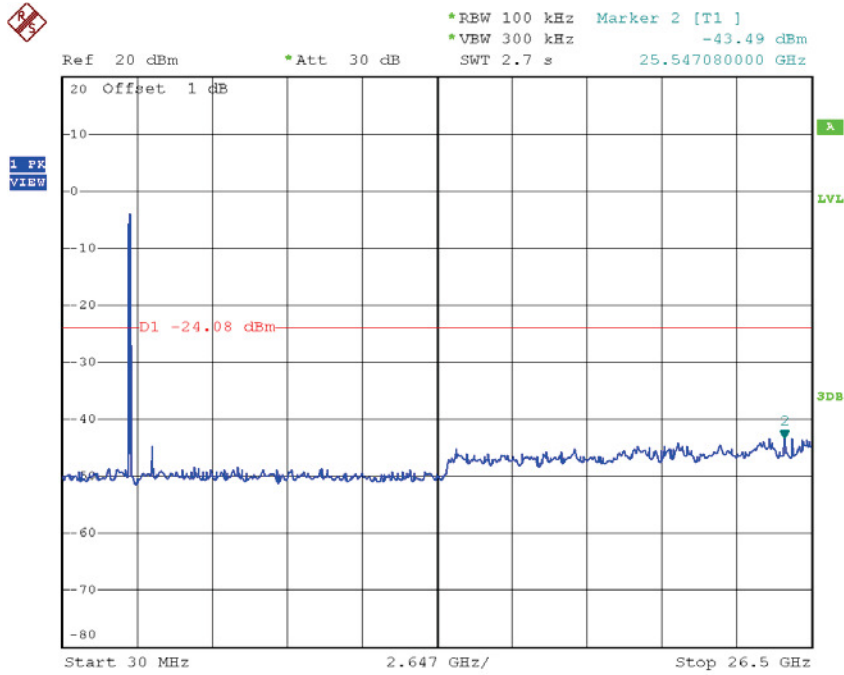

Date: 22.NOV.2015 15:58:21

TX HT40 mode CH06 (10 Harmonic of the frequency)

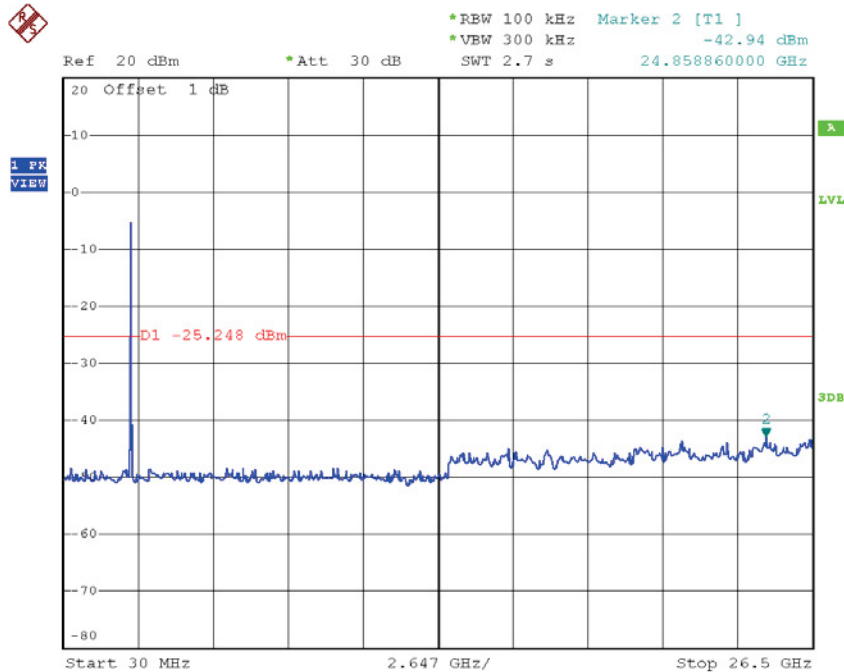

Date: 22.NOV.2015 15:59:22

TX HT40 mode CH09 (10 Harmonic of the frequency)

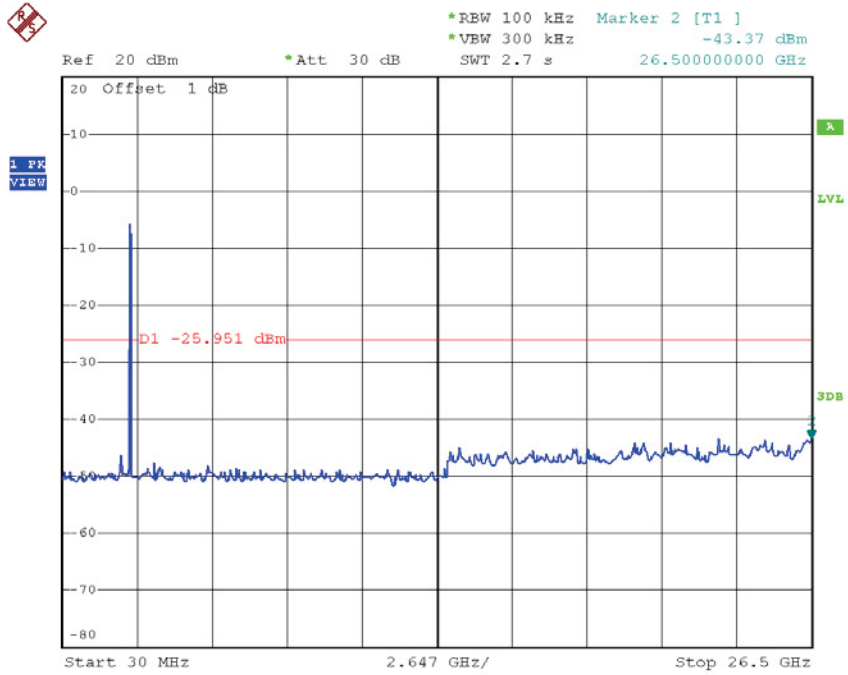

Date: 22.NOV.2015 16:00:19

Test Mode :	TX N-40M Mode_ANT 3
--------------------	----------------------------

TX HT40 mode CH03

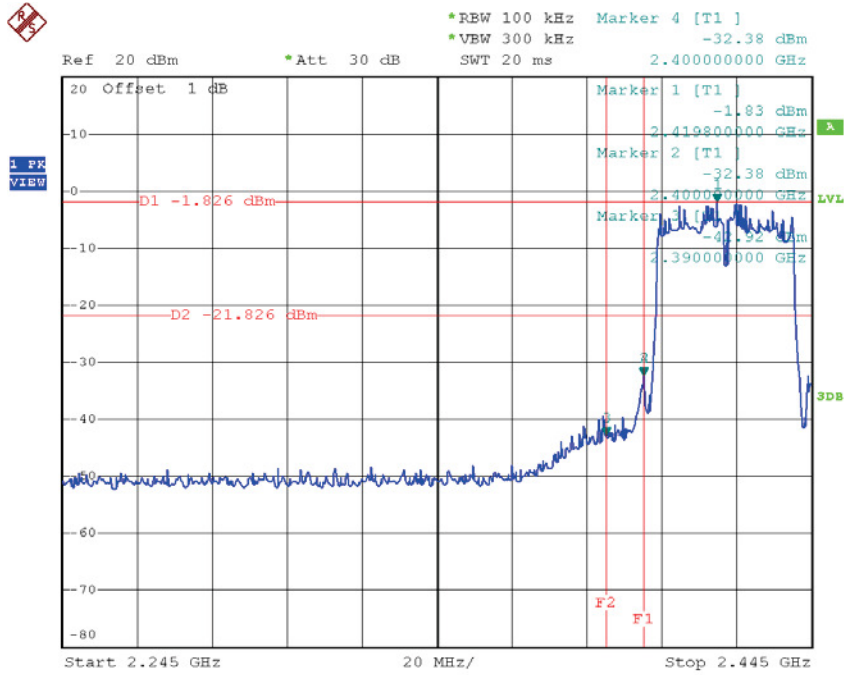

Date: 22.NOV.2015 16:07:41

TX HT40 mode CH09

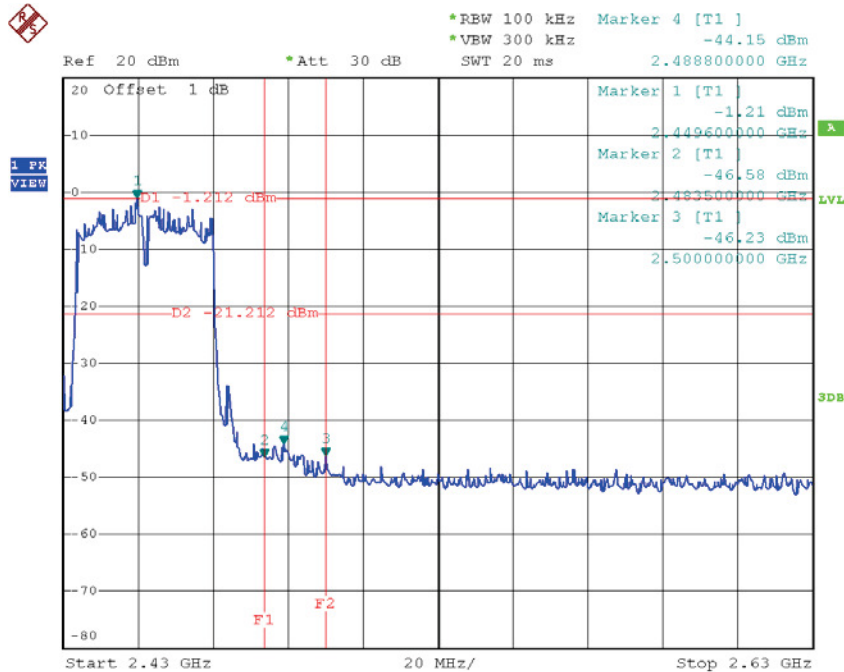

Date: 22.NOV.2015 16:09:58

TX HT40 mode CH03 (10 Harmonic of the frequency)

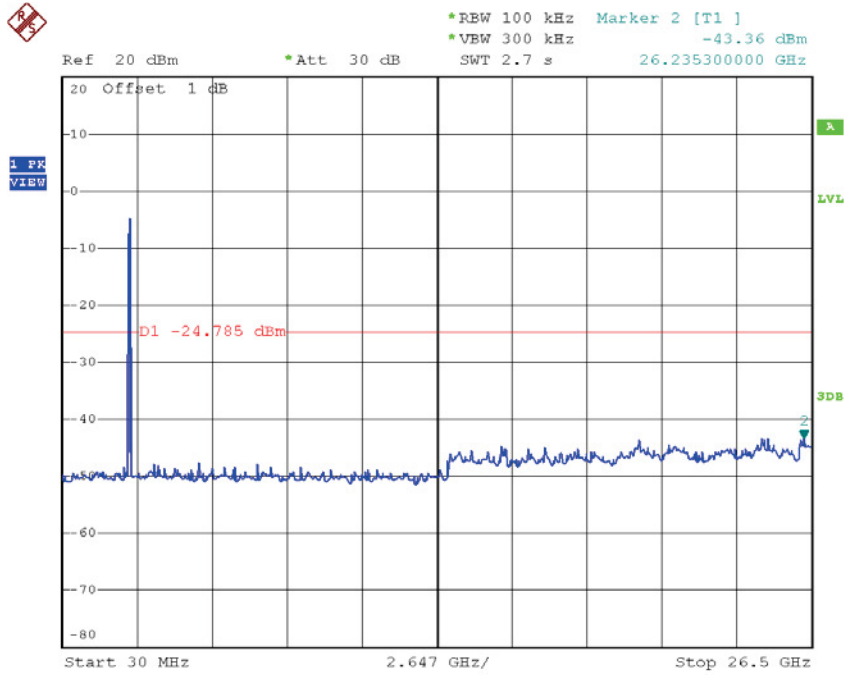

Date: 22.NOV.2015 16:07:33

TX HT40 mode CH06 (10 Harmonic of the frequency)

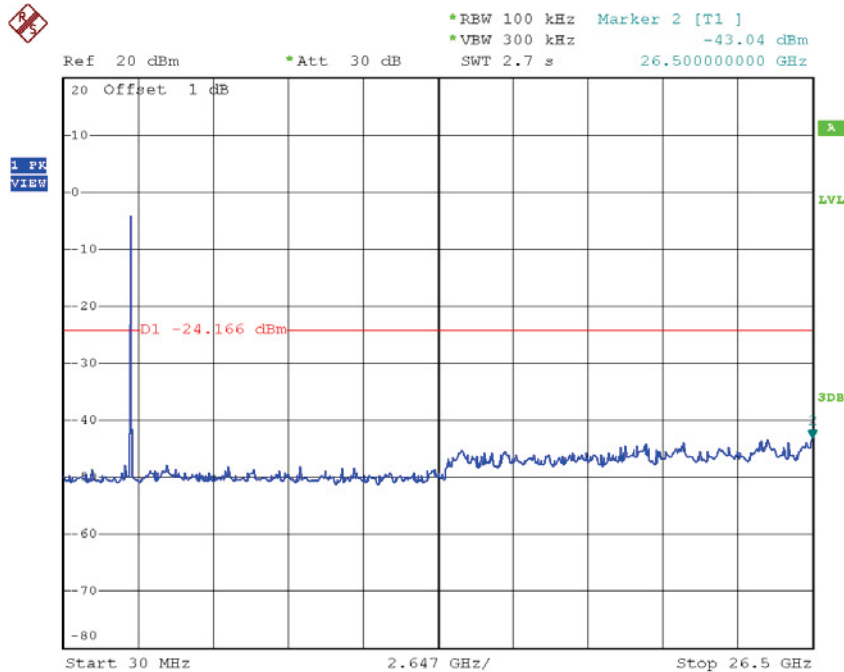

Date: 22.NOV.2015 16:08:46

TX HT40 mode CH09 (10 Harmonic of the frequency)

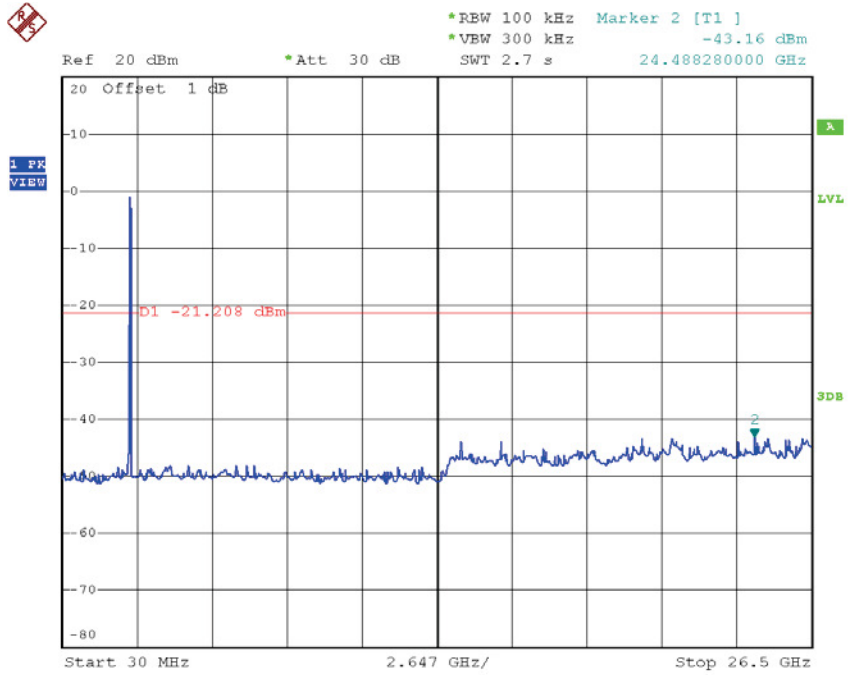

Date: 22.NOV.2015 16:09:49

ATTACHMENT H - POWER SPECTRAL DENSITY

Test Mode :TX B Mode_CH01/06/11

Frequency (MHz)	Power Density (dBm/3kHz)	Power Density (mW/3kHz)	Max. Limit (dBm/3kHz)	Result
2412	-1.74	0.67	8.00	Complies
2437	2.63	1.83	8.00	Complies
2462	-1.31	0.74	8.00	Complies

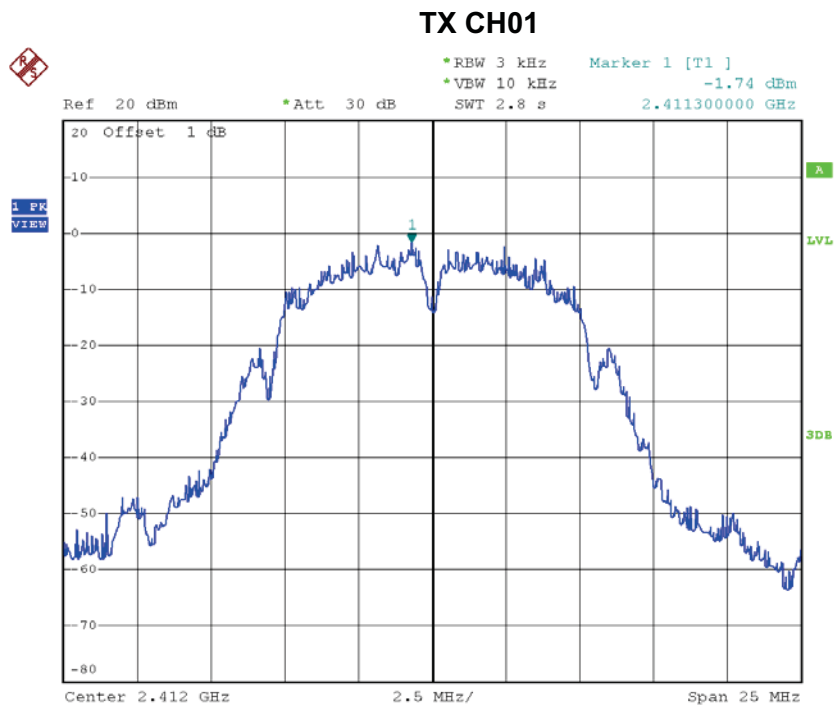

Date: 22.NOV.2015 15:35:56

TX CH06

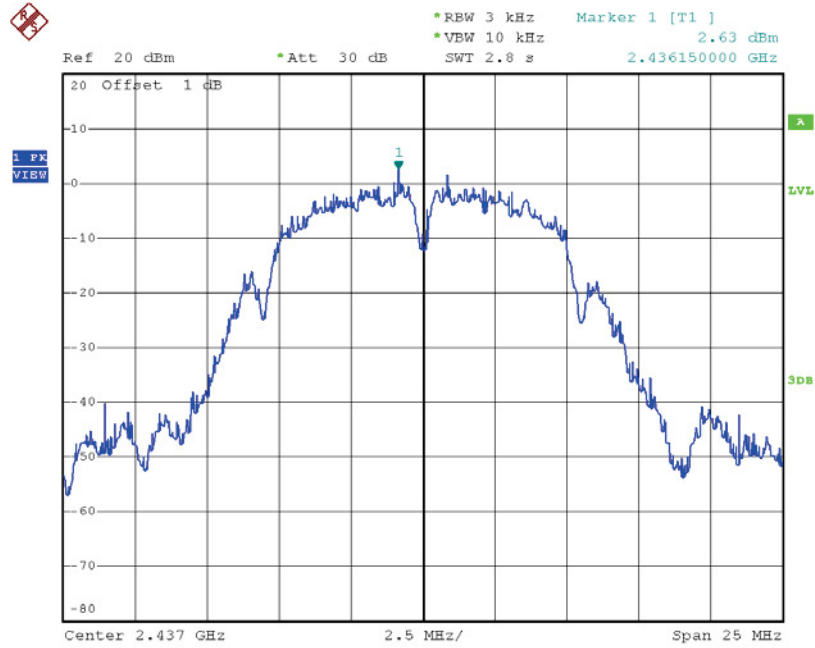

Date: 22.NOV.2015 15:38:05

TX CH11

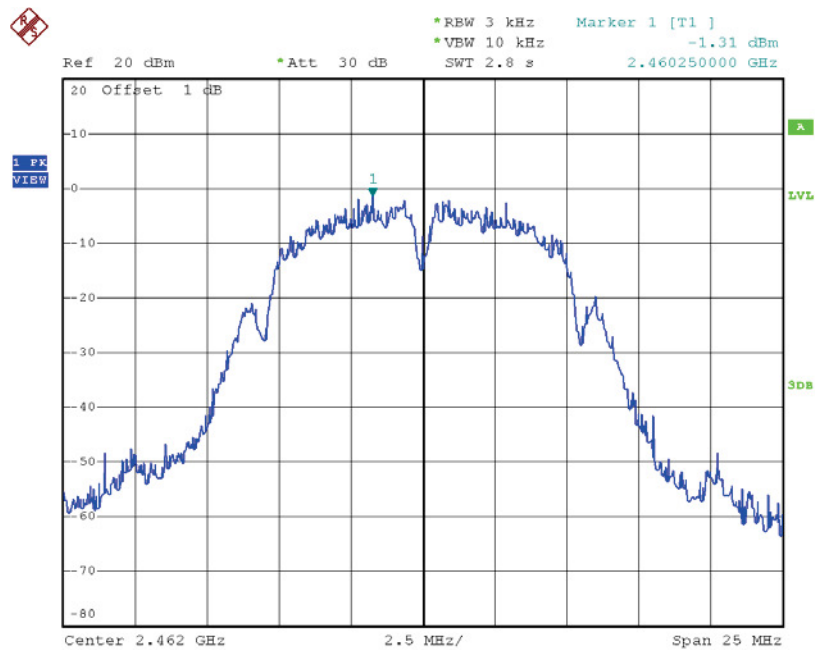

Date: 22.NOV.2015 15:39:53

Test Mode :TX G Mode_CH01/06/11

Frequency (MHz)	Power Density (dBm/3kHz)	Power Density (mW/3kHz)	Max. Limit (dBm/3kHz)	Result
2412	-12.60	0.05	8.00	Complies
2437	-10.78	0.08	8.00	Complies
2462	-10.12	0.10	8.00	Complies

TX CH01

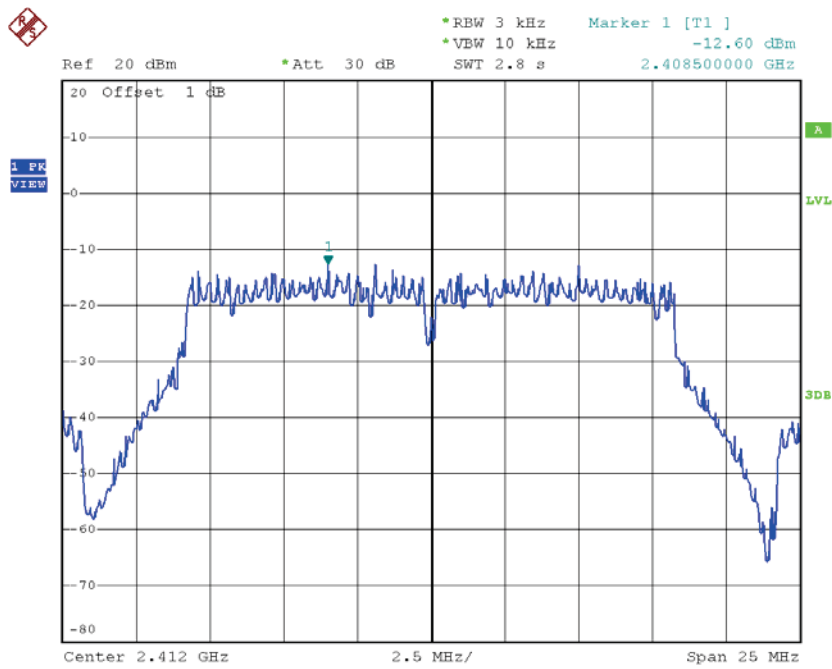

Date: 22.NOV.2015 15:43:04

TX CH06

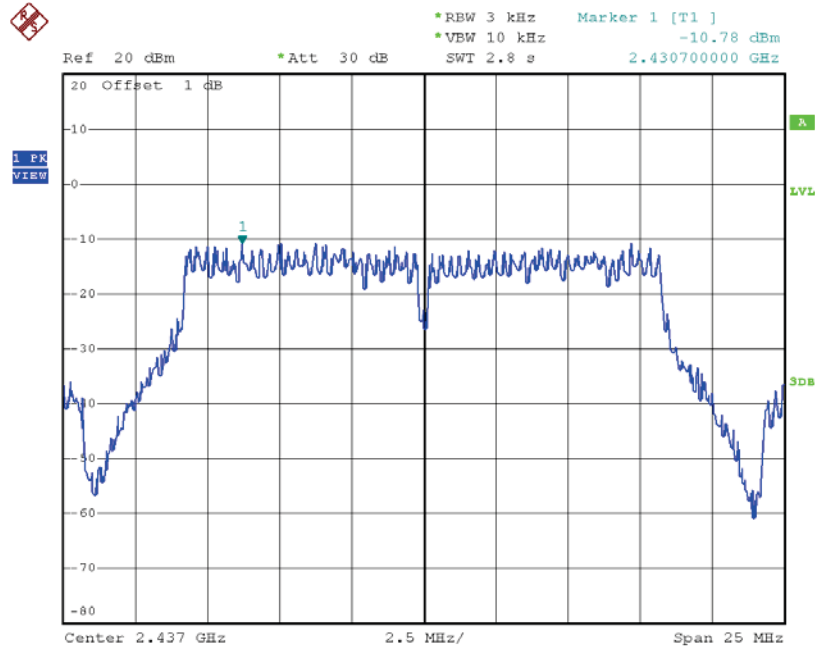

Date: 22.NOV.2015 15:44:18

TX CH11

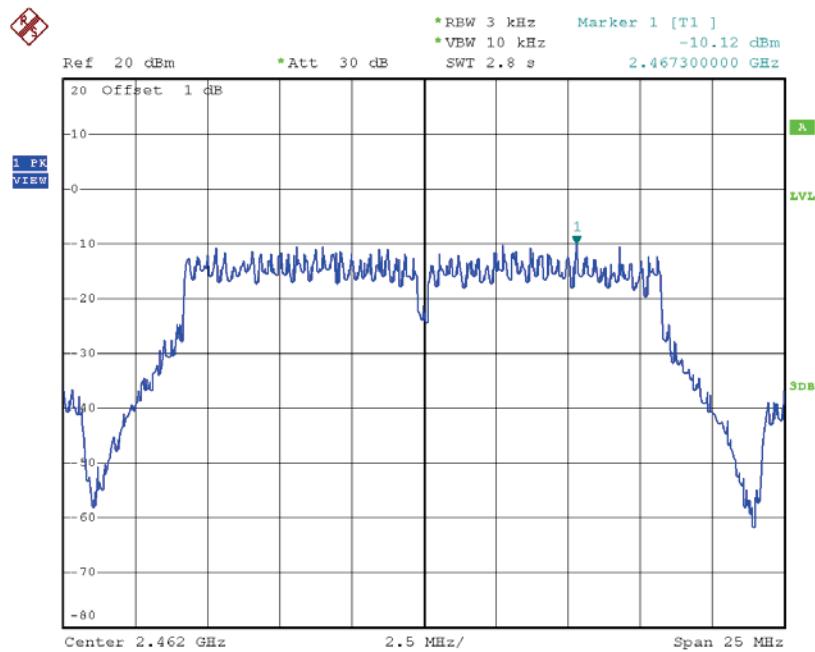

Date: 22.NOV.2015 15:45:26

Test Mode : TX N-20M Mode_CH01/06/11_ANT 1

Frequency (MHz)	Power Density (dBm/3kHz)	Power Density (mW/3kHz)	Max. Limit (dBm/3kHz)	Result
2412	-14.29	0.04	8.00	Complies
2437	-16.43	0.02	8.00	Complies
2462	-16.13	0.02	8.00	Complies

TX CH01

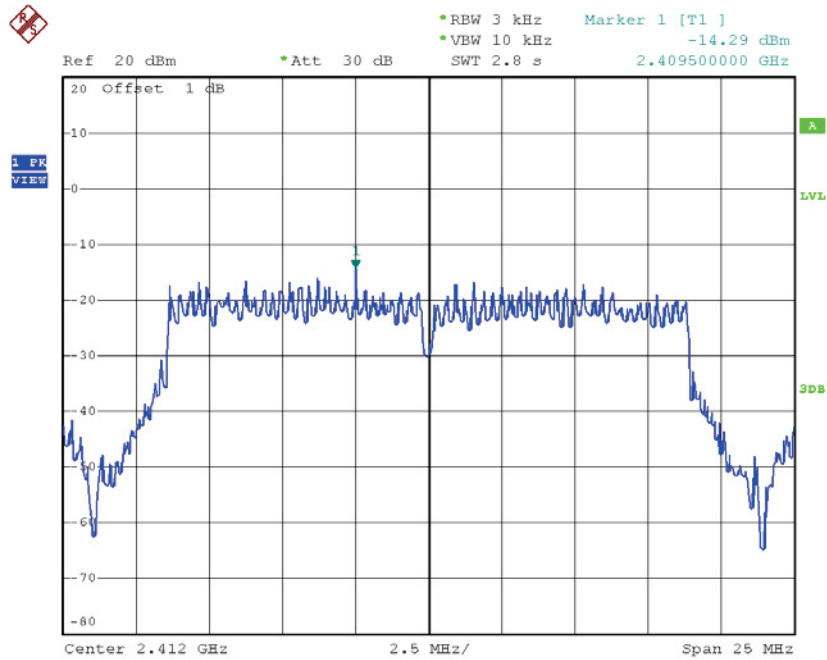

Date: 22.NOV.2015 15:47:42

TX CH06

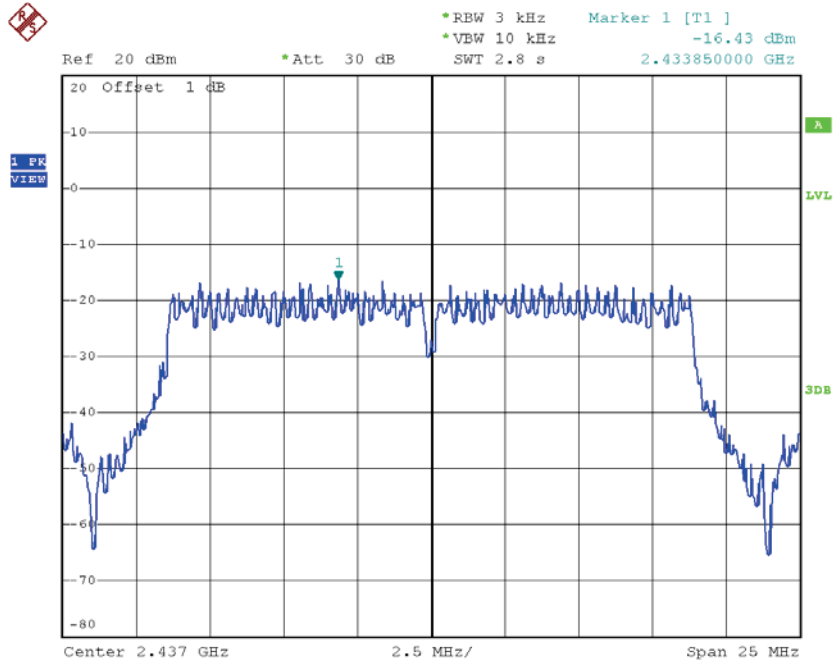

Date: 22.NOV.2015 15:48:47

TX CH11

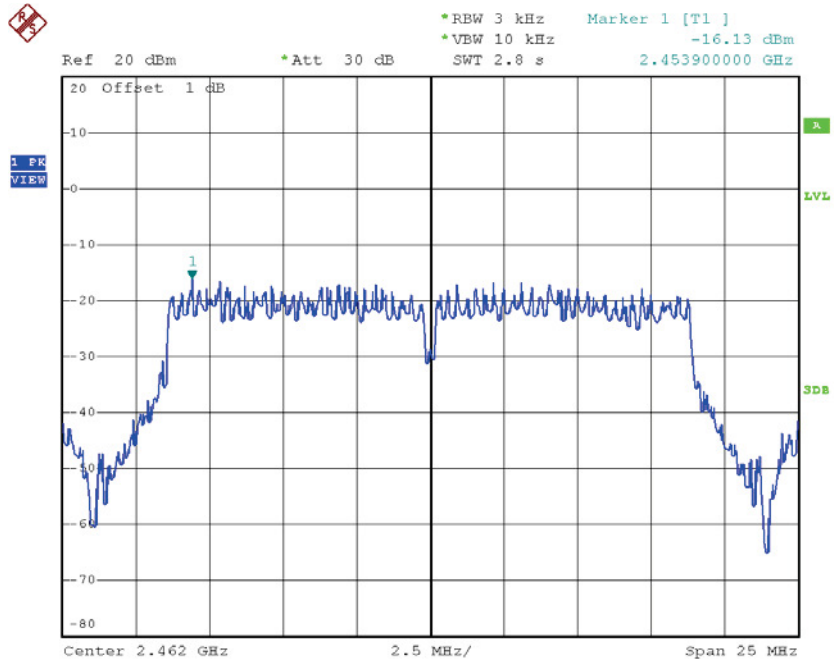

Date: 22.NOV.2015 15:49:48

Test Mode : TX N-20M Mode_CH01/06/11_ANT 2

Frequency (MHz)	Power Density (dBm/3kHz)	Power Density (mW/3kHz)	Max. Limit (dBm/3kHz)	Result
2412	-15.83	0.03	8.00	Complies
2437	-15.77	0.03	8.00	Complies
2462	-16.73	0.02	8.00	Complies

TX CH01

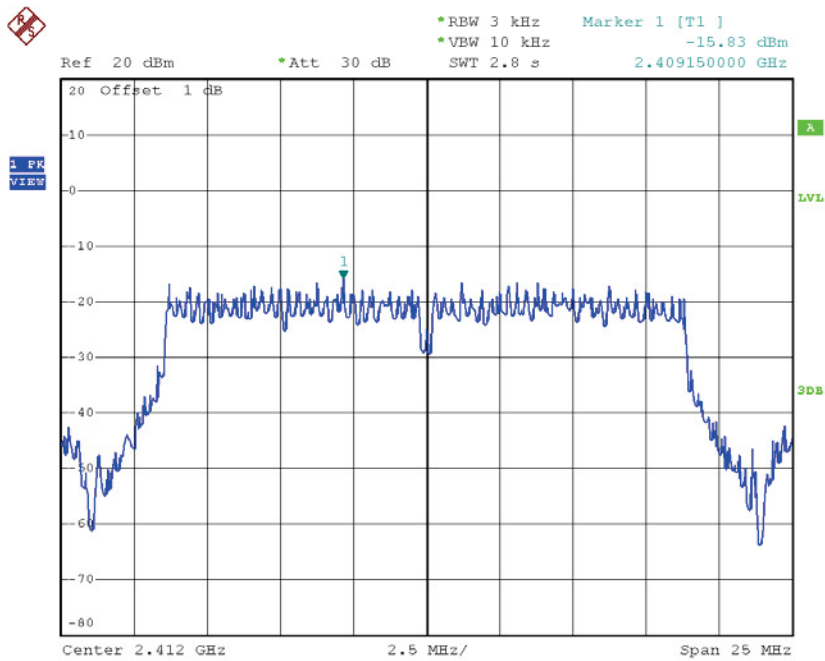

Date: 22.NOV.2015 15:55:40

TX CH06

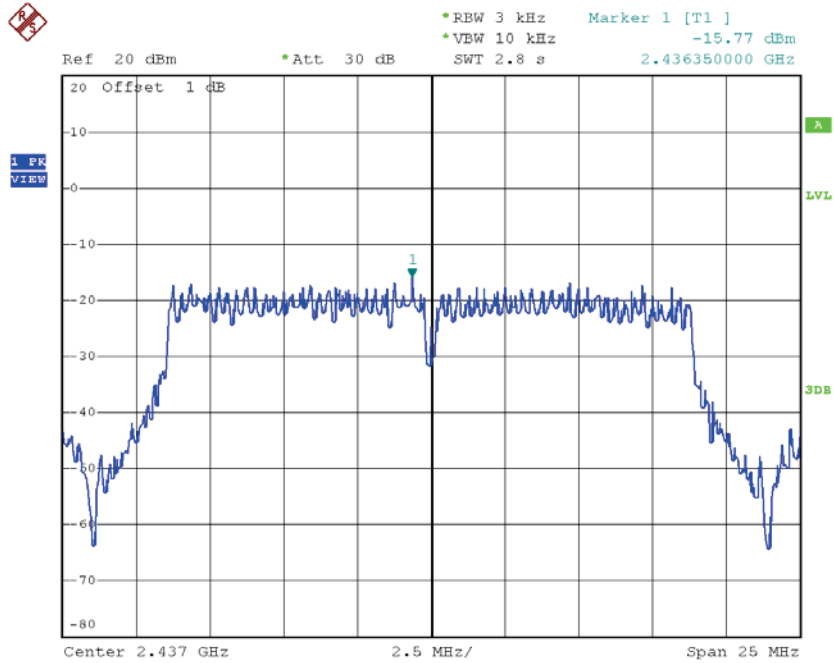

Date: 22.NOV.2015 15:56:33

TX CH11

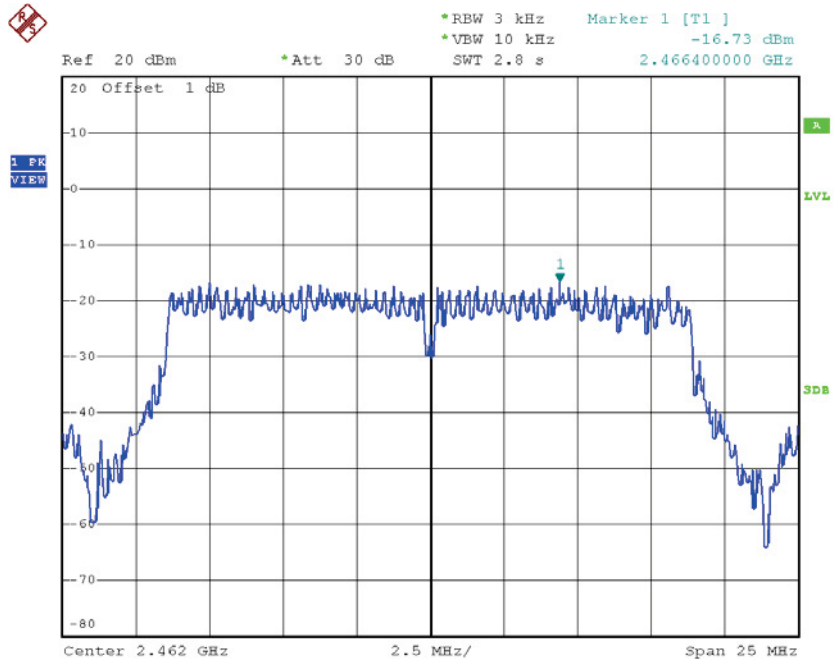

Date: 22.NOV.2015 15:57:33

Test Mode : TX N-20M Mode_CH01/06/11_ANT 3

Frequency (MHz)	Power Density (dBm/3kHz)	Power Density (mW/3kHz)	Max. Limit (dBm/3kHz)	Result
2412	-15.59	0.03	8.00	Complies
2437	-16.79	0.02	8.00	Complies
2462	-15.73	0.03	8.00	Complies

TX CH01

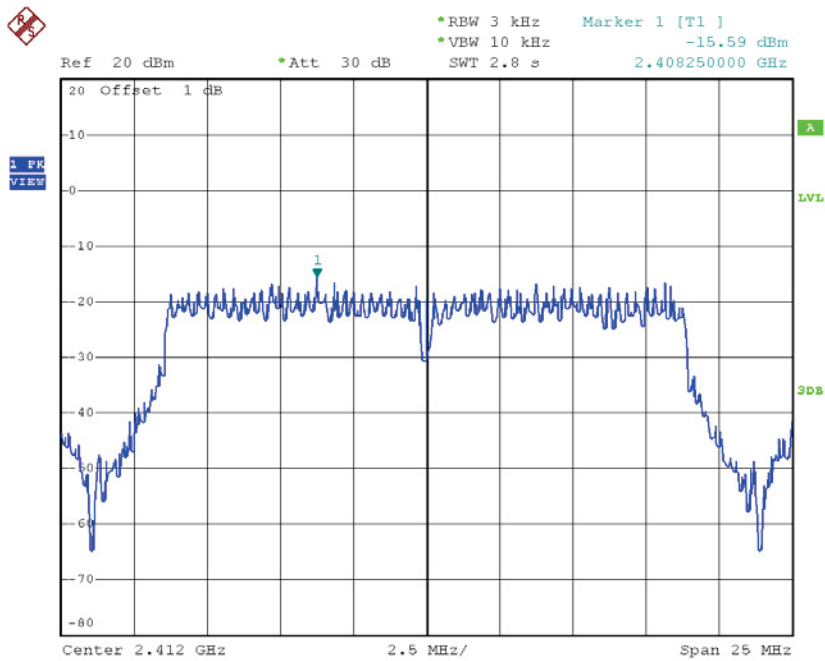

Date: 22.NOV.2015 16:04:50

TX CH06

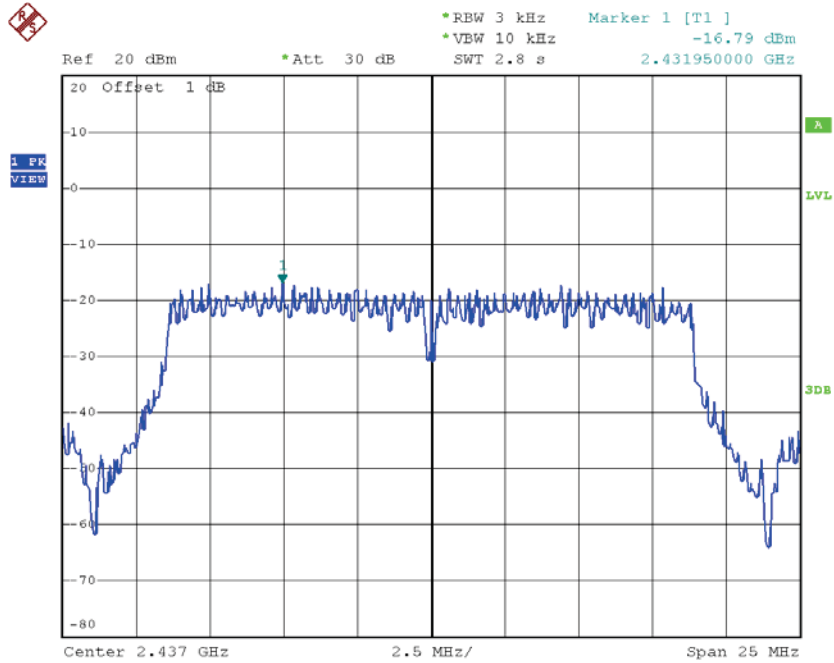

Date: 22.NOV.2015 16:05:46

TX CH11

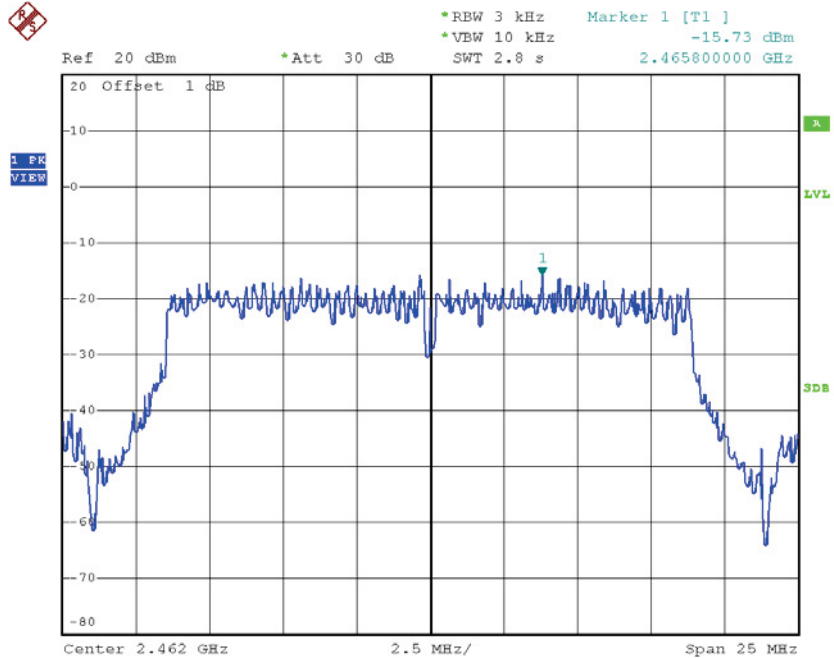

Date: 22.NOV.2015 16:06:45

Test Mode : TX N-20M Mode_CH01/06/11_Total

Frequency (MHz)	Power Density (dBm/3kHz)	Power Density (mW/3kHz)	Max. Limit (dBm/3kHz)	Result
2412	-10.00	0.10	8.00	Complies
2437	-11.55	0.07	8.00	Complies
2462	-11.55	0.07	8.00	Complies

Test Mode : TX N-40M Mode_CH03/06/09_ANT 1

Frequency (MHz)	Power Density (dBm/3kHz)	Power Density (mW/3kHz)	Max. Limit (dBm/3kHz)	Result
2422	-16.99	0.02	8.00	Complies
2437	-17.15	0.02	8.00	Complies
2452	-16.86	0.02	8.00	Complies

TX CH03

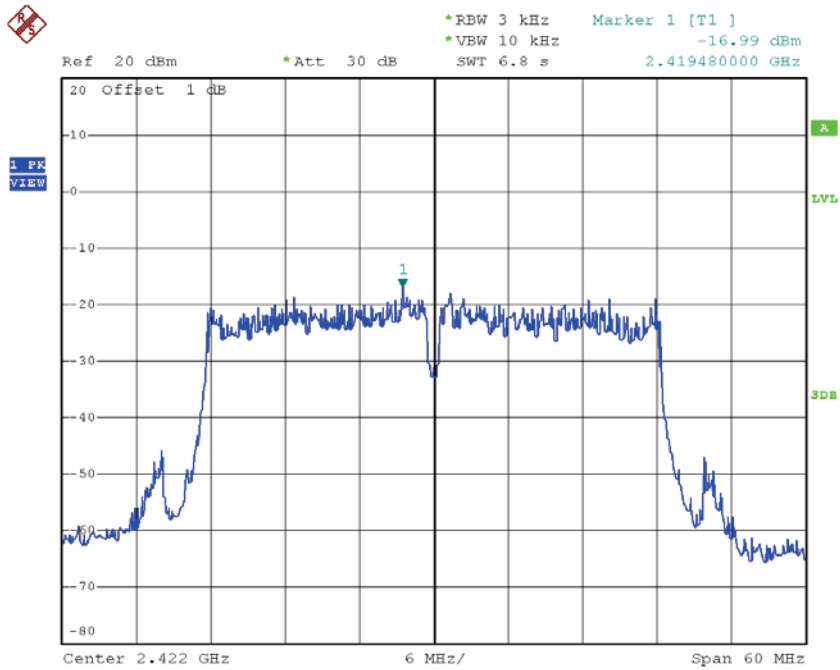

Date: 22.NOV.2015 15:51:00

TX CH06

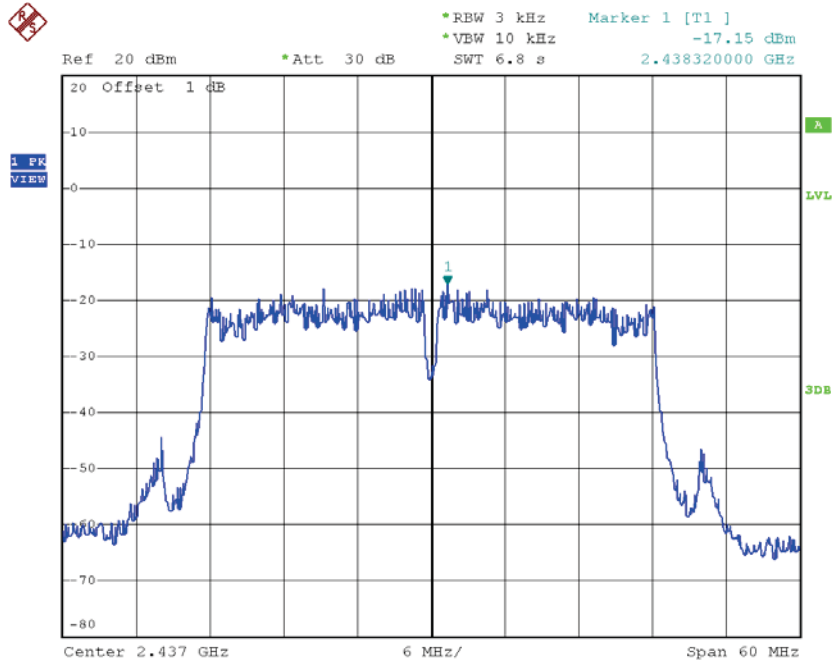

Date: 22.NOV.2015 15:51:57

TX CH09

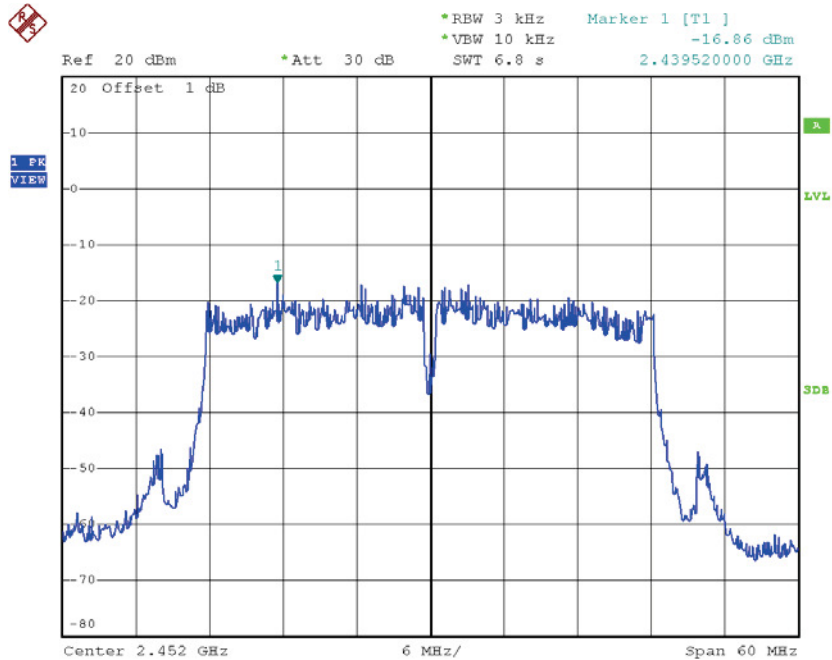

Date: 22.NOV.2015 15:52:58

TX CH06

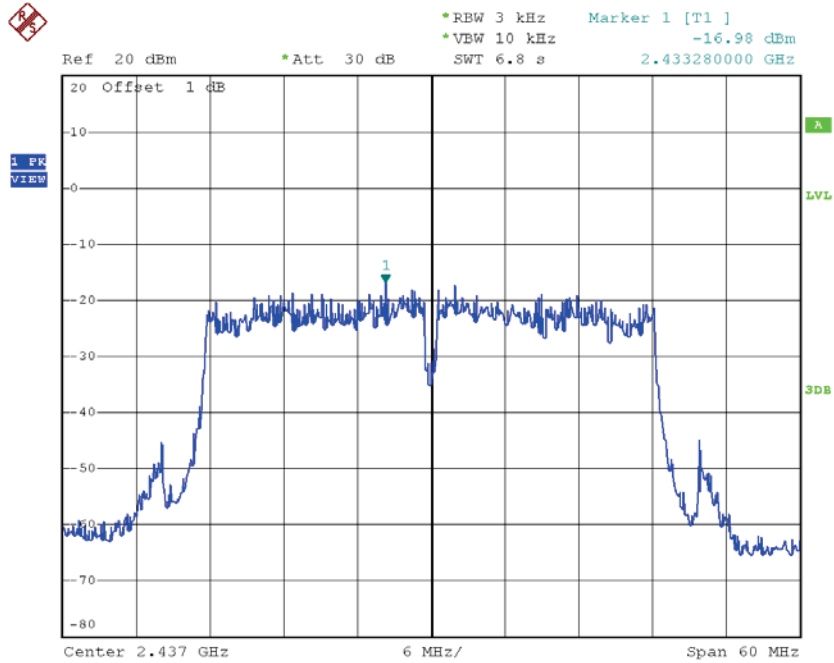

Date: 22.NOV.2015 15:59:35

TX CH09

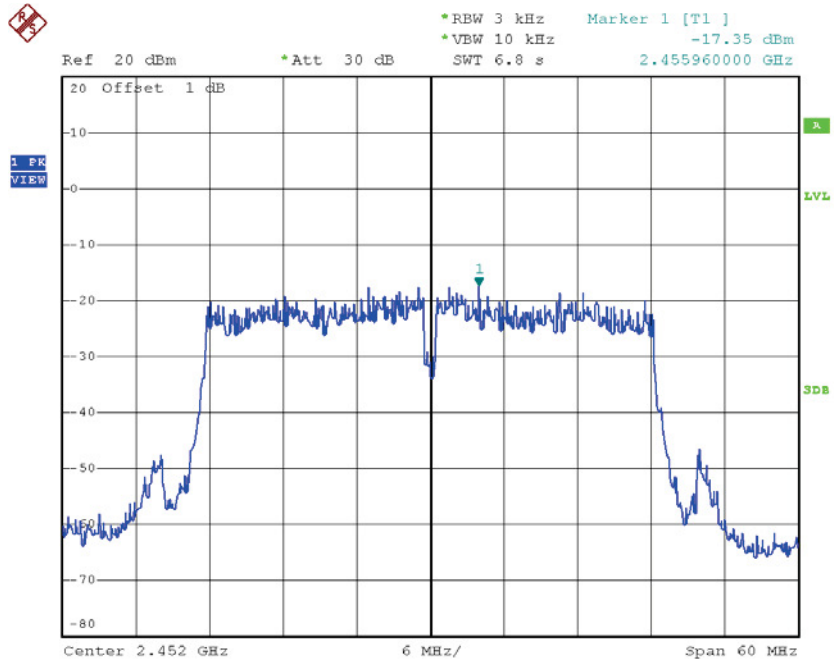

Date: 22.NOV.2015 16:00:40

Test Mode : TX N-40M Mode_CH03/06/09_ANT 3

Frequency (MHz)	Power Density (dBm/3kHz)	Power Density (mW/3kHz)	Max. Limit (dBm/3kHz)	Result
2422	-17.59	0.02	8.00	Complies
2437	-16.49	0.02	8.00	Complies
2452	-16.00	0.03	8.00	Complies

TX CH03

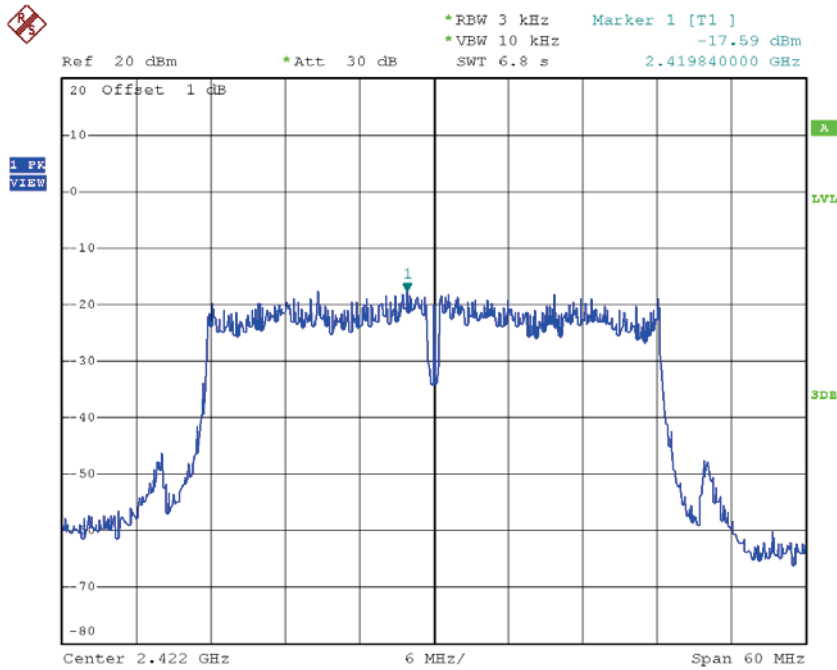

Date: 22.NOV.2015 16:07:54

TX CH06

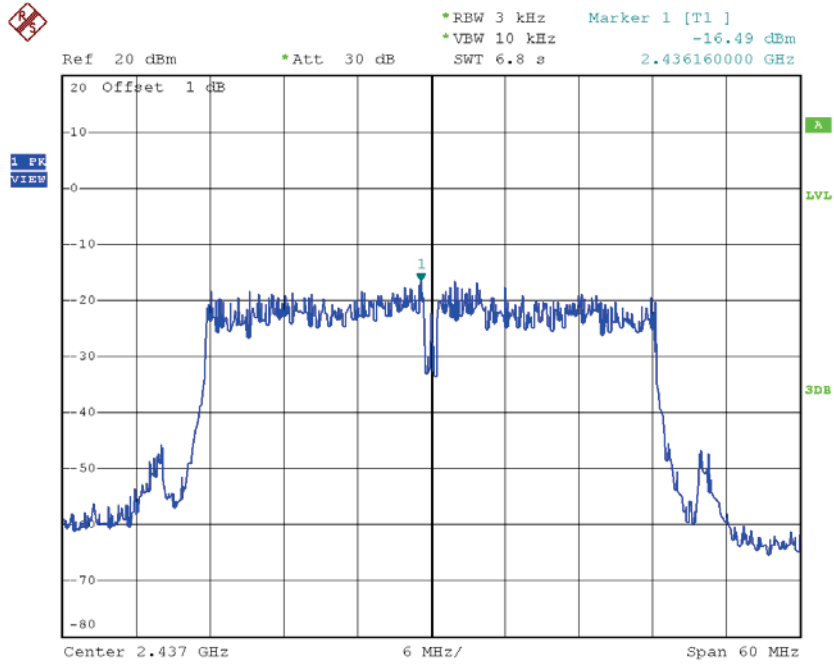

Date: 22.NOV.2015 16:08:59

TX CH09

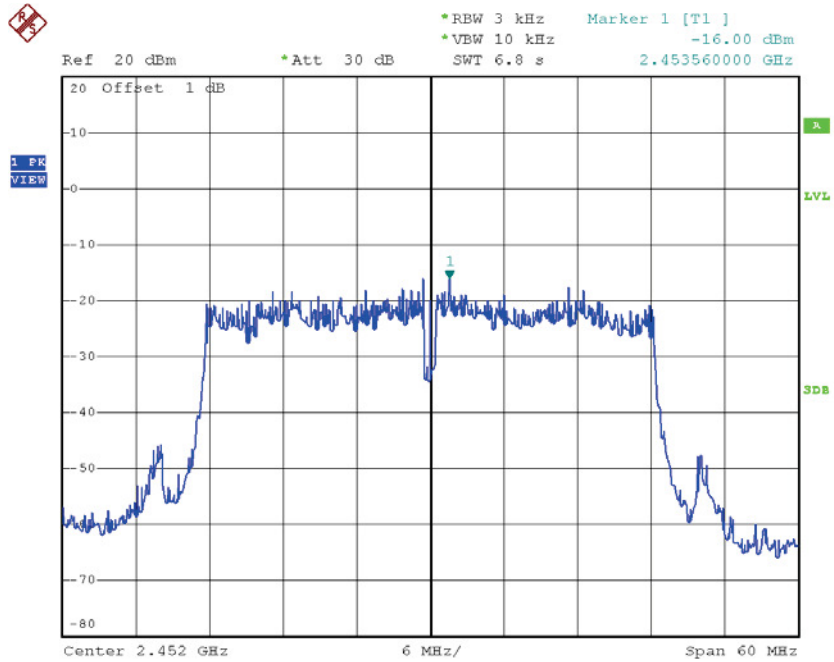

Date: 22.NOV.2015 16:10:11

Test Mode : TX N-40M Mode_CH03/06/09_Total

Frequency (MHz)	Power Density (dBm/3kHz)	Power Density (mW/3kHz)	Max. Limit (dBm/3kHz)	Result
2422	-11.55	0.07	8.00	Complies
2437	-12.22	0.06	8.00	Complies
2452	-11.55	0.07	8.00	Complies