

IP-COM

Quick Installation Guide

Ceiling AP Series
IUAP-AC-LR/IUAP-AC-LITE/IUAP-AC-PRO/IUAP-AX-LR
(IUAP-AC-LR is used for illustration in this guide)

The Quick Installation Guide walks you through installation and how to perform first-time configurations. For product or function details, please go to www.ip-com.com

Package contents

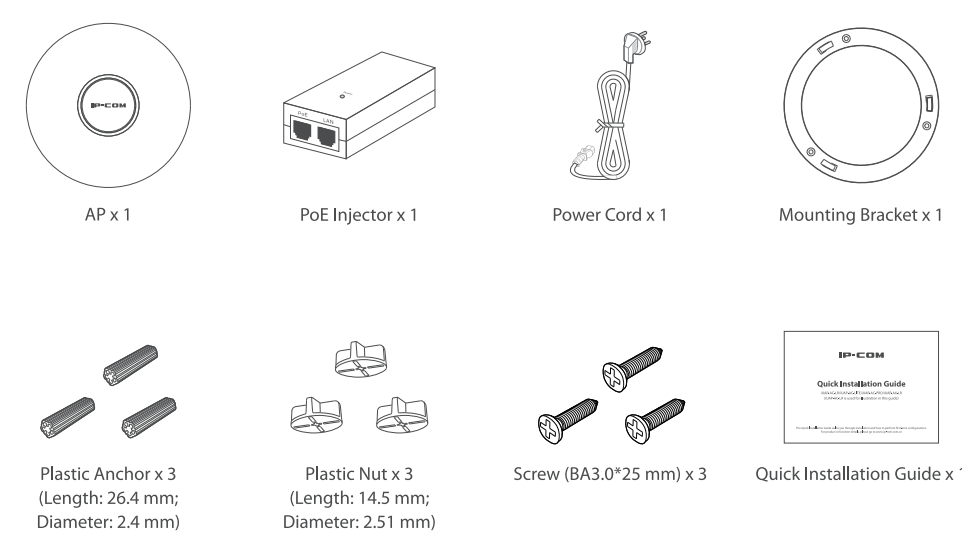

Get to know your device

LED Indicator

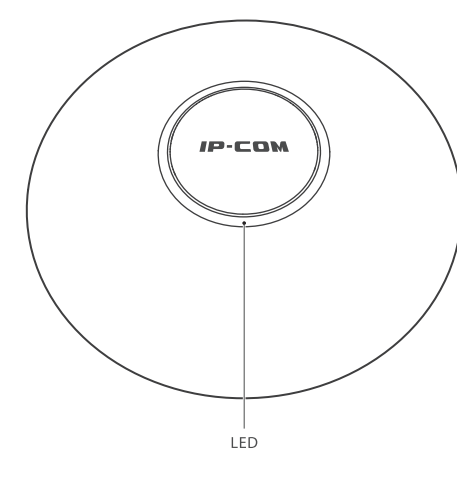

LED Indicator	Status	Description
Flashing white		The system is starting up.
Solid white		AP is in default status and is waiting to be managed by IMS platform or iUniFi Controller.
Alternating White/Blue		AP is busy, for example, with Firmware upgrade. Do not touch or unplug it.
Solid blue		AP is managed by IMS platform or iUniFi Controller and is working properly.
Fast blinking blue		The AP Locate feature was activated in the iUniFi Controller.
Slowly blinking blue		AP is locked (all WLANs are brought down until an uplink is found).

Port/button

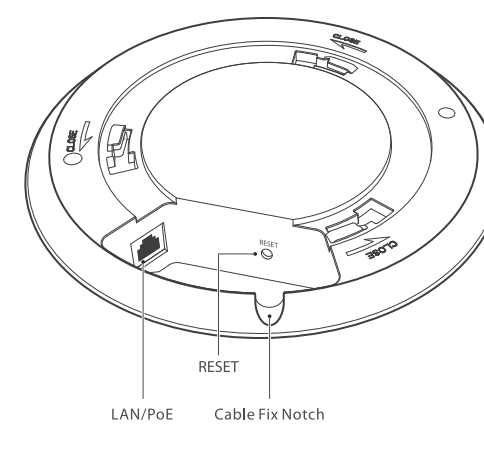

Port/Button	Description
LAN/PoE	It is a gigabit PoE port used to supply power or transmit data. Use the included PoE injector or a PoE switch compliant with IEEE 802.3af or to supply power to the device. CAT5e or better Ethernet cables are recommended, and the permissible distance for switch is 100 meters and 35 meters for the PoE injector.
RESET	Reset button. When AP is not busy, hold down this button for about 8 seconds and release it. When the LED indicator is blinking white, AP is restored to factory settings.
Cable Fix Notch	It is used to fix the Ethernet cable from a PoE switch compliant with IEEE 802.3af or the included PoE injector to the LAN/PoE port.

Install the device

Tip: You may need a marker, a hammer drill, a 3 mm drill bit, a rubber hammer, a screwdriver, and a ladder for the installation. Please prepare them yourself.

Tip: Option 1 applies to most general cases. For ceilings with weak strength (such as plasterboard), please choose Option 2.

1 Position the bracket on the ceiling and mark screw holes with the marker.

2 Drill holes in the marked positions using a hammer drill.

3 Option 1: Knock the plastic anchors (Length: 26.4 mm; Diameter: 2.4 mm) into the holes using the rubber hammer. Align the screw holes in the bracket with the holes on the ceiling, and use the included screws (Length: 25 mm; Diameter: 3 mm) to fix the bracket.

Option 2: Align the plastic nuts (Length: 14.5 mm; Diameter: 2.51 mm) with the holes on the ceiling, and then use the included screws (Length: 25 mm; Diameter: 3 mm) to fix the bracket.

4 Connect a PoE switch compliant with IEEE 802.3af/at or a power injector with a CAT5 or better cable to the LAN/PoE port to supply power for the AP. Before powering on, check whether the power sourcing equipment you use complies with your AP.

5 Align the slots of the AP with the hooks of the bracket.

6 Ensure that the AP is firmly seated onto the bracket. Turn the AP clockwise until it is fixed securely into the bracket.

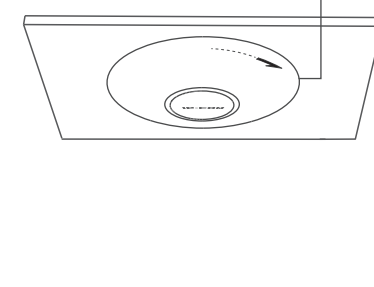
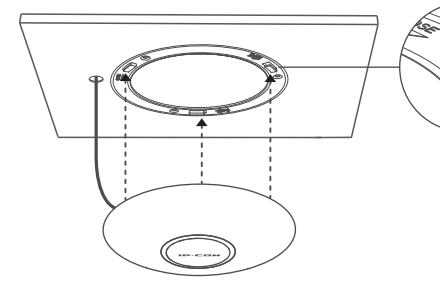
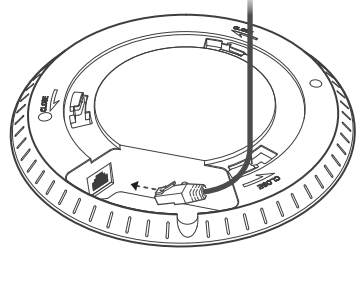
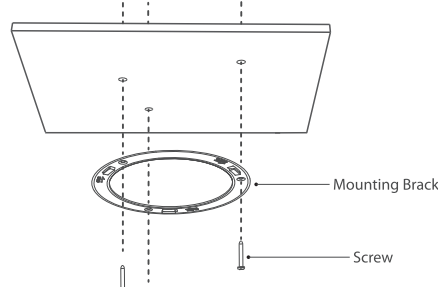
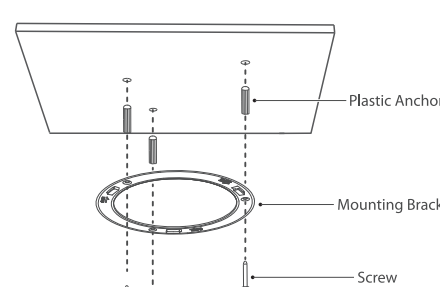
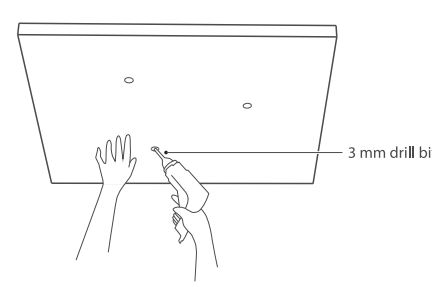
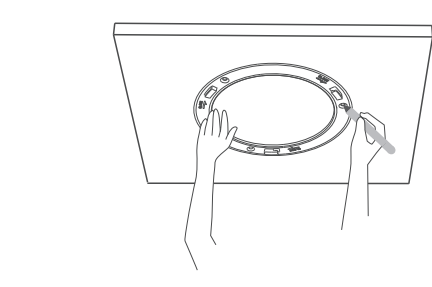

Power the AP

Option 1 Connect to a PoE injector

- 1 Connect the AP to the PoE port of the PoE injector with an Ethernet cable.
- 2 (Optional for wired connection) Connect an Ethernet cable from the LAN, for example, a switch or a computer, to the LAN port of the PoE injector.
- 3 Connect the power cord to the injector and then plug the power cord to a power source.

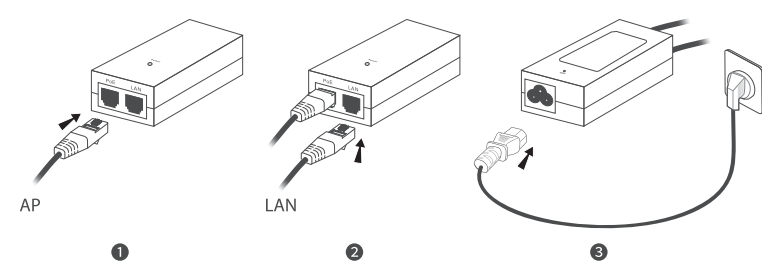

Option 2 Connect to a PoE switch

Connect an Ethernet cable from the AP to a PoE port on a PoE switch compliant with IEEE 802.3af/at. The switch will automatically supply power to the AP.

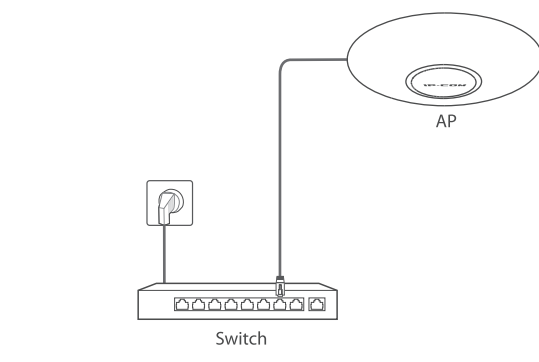

Configure your APs

You can configure the AP through the web UI of the AP iUniFi Controller, or the IMS platform. This part mainly describes the configuration methods of using the web UI and the iUniFi Controller. For details about the IMS platform configuration method, refer to the user guides of target products.

Scenario 1: Through the iUniFi Controller

The network topology diagram for configuration through the iUniFi Controller is shown as below. For details about how to configure APs through the iUniFi Controller, refer to its user guide.

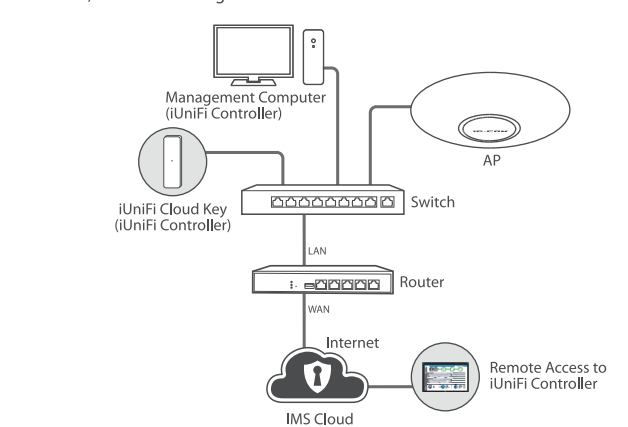

Scenario 2: Through the Web UI of the AP

Tip: Connect and configure your APs one by one. That is to say, connect one AP to your switch and configure it. When you finish, connect the second AP and repeat steps 4 and 5.

1 Connect devices. For details about how to connect other devices, see the following figure.

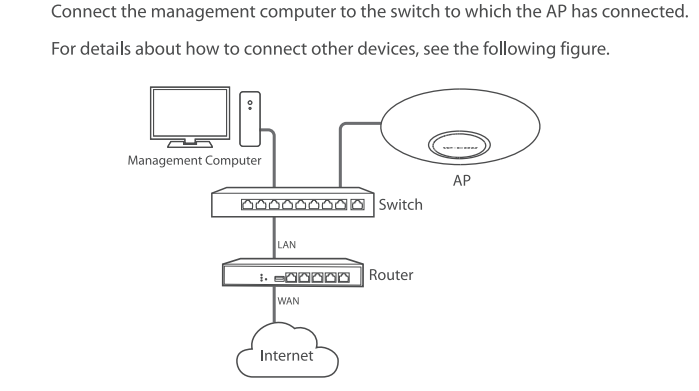

2 Configure the IP address of the management computer (Example: Windows 10)

On the computer desktop, click **Start** > **Settings** > **Change adapter options**.

Right-click Ethernet, click **Properties**, and double-click **Internet Protocol Version 4 (TCP/IPv4)**. Choose **Use the following IP address**, set **IP address** to 192.168.0.2, **Subnet mask** to 255.255.255.0, and **Default gateway** to 192.168.0.1, and click **OK**.

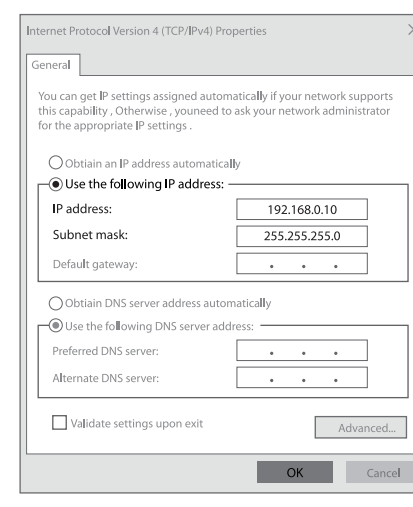

1 Log in to the web UI of the AP

Start a web browser on the management computer, and access 192.168.0.254. Follow the on-screen instructions for login.

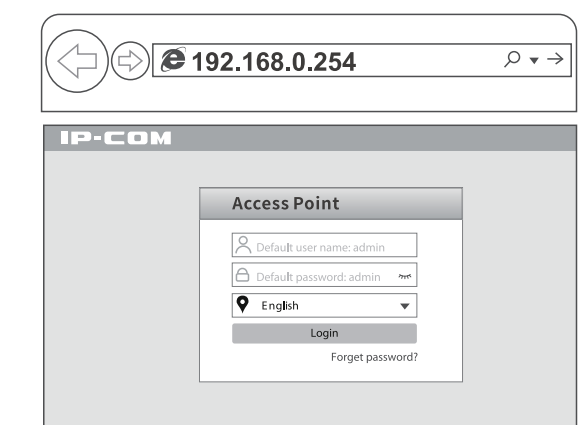

Tip: If you cannot log in to the web UI of the AP, refer to Q1 in FAQ.

2 Modify the SSID and password

Choose **Quick Setup**, configure the **SSID** (WiFi name), **Security Mode** (WPA2-PSK is recommended), **Key**, and click **Save**.

Then select **5GHz** from the **Radio Band** drop-down list and repeat the above operations.

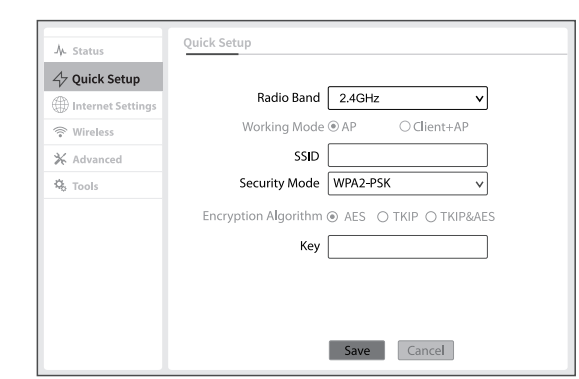

3 Modify the IP address of the AP

Choose **Internet Settings** > **LAN Setup**. Modify the IP address of the AP to 192.168.0.2, and ensure that the new IP address has not been occupied in this network, then click **Save**.

Example: You can set the new IP address of the first AP to 192.168.0.201, and the new IP address of the second AP to 192.168.0.202.

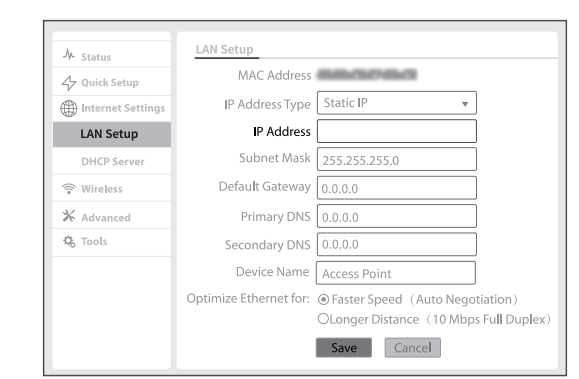

Done. WiFi name: The SSID you set in step 4. Modify the SSID and password. WiFi password: The Key you set in step 4. Modify the SSID and password.

(Optional) AP wireless bridge

Tip: If you want to connect an AP to a network in a wireless manner, please refer to this part. The AP supports wireless bridge under only one radio band at a time. Please select 2.4 GHz or 5 GHz as required. This part uses 2.4 GHz as an example for illustration.

1 Connect devices

Assign your AP as AP2. Connect the management computer to AP2. For details about how to connect other devices, see the following figure.

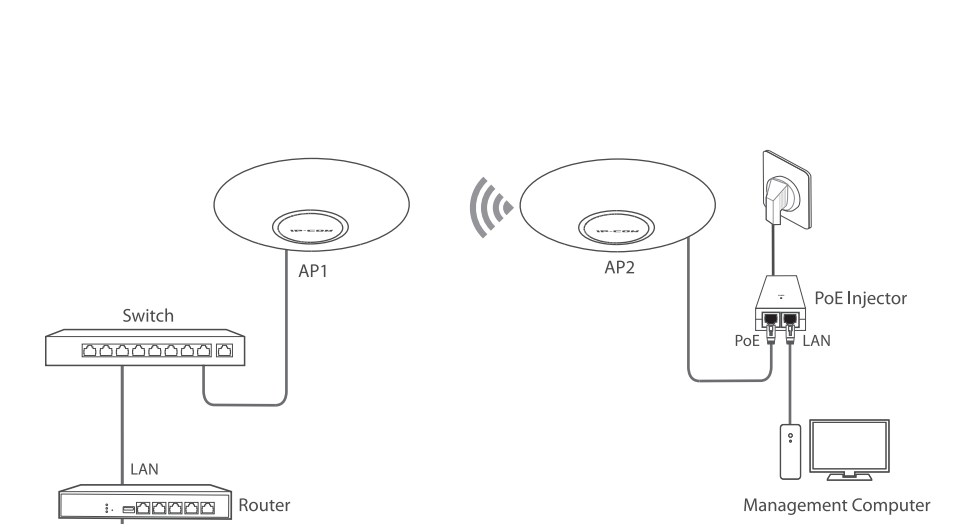

2 Configure the IP address of the management computer & log in to the web UI of AP2

Refer to steps 2 to 3 in Scenario 2: Through the Web UI of the AP in Configure your APs.

3 Configure AP2

Set the **Working Mode** of AP2 to **Client+AP**, and click **Scan**.

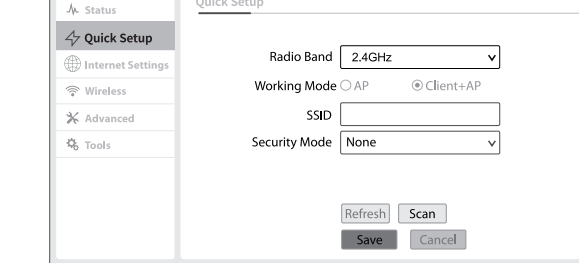

Select the wireless network of AP1 and its SSID, Security Mode, and Encryption Algorithm are filled in automatically, which are IP-COM_123456, WPA2-PSK, and AES in this example. Enter the Key for the wireless network of AP1, and click **Save**.

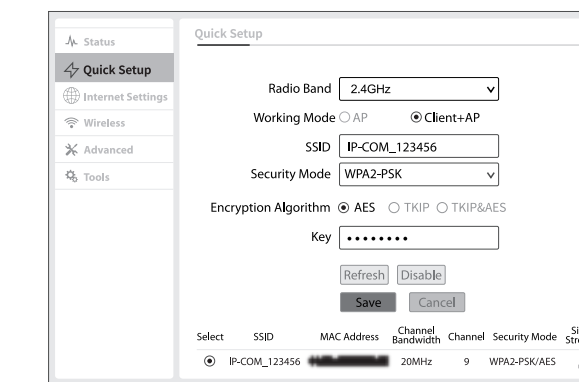

4 Check the bridge status

Choose **Tools**, click **Diagnostic Tool**, and ping the IP address of AP1. If there are responses from AP1, the bridge is successful. Otherwise, refer to Q3 in FAQ.

FAQ

Q1: What should I do if I cannot access the web UI of the AP after entering 192.168.0.254?

- A1. Try the following solutions:
- Verify that your Ethernet cables are connected properly.
 - Ensure that the IP address of your computer has been set to 192.168.0.X (X: 2 to 253), and the IP address is not occupied by any other device in the network.
 - Clear the cache of your web browser, or replace the web browser.
 - Disable the firewall of your computer, or replace the computer.
 - If two or more APs are connected in the network without iUniFi Controller or IMS platform, you should leave only one AP in the network first and configure the AP's IP address. Then repeat this procedure to change the IP addresses of other APs.
 - The AP may be managed by iUniFi Controller or IMS platform and therefore its IP address is no longer 192.168.0.254. In this case, go to the web UI of the iUniFi Controller or IMS platform to view the new IP address of the AP, and then log in to the AP's web UI using the new IP address.
 - Verify that the IP address of the management computer is in the same network segment with AP's new IP addresses.
 - If the problem persists, reset the AP.

Q2: How to reset my AP?

- A2. **Option 1:** Reset using the RESET button. When AP is not busy, hold down this button for about 8 seconds and release it. When the LED indicator is blinking white, AP is restored to factory settings.
- Option 2:** Reset using the web UI. Log in to the web UI of the AP, choose **Tools** > **Maintenance**, and navigate to the **Reset** section, then follow the on-screen instruction to reset it.
- Note:** Resetting clears all configurations of your AP.

Q3: What should I do if AP wireless bridge failed?

- A3. Try the following solutions:
- Verify that the **Key** for the wireless network of the uplink device (AP1 in this guide) is correct.
 - Check whether the signal of the wireless network of the uplink device (AP1 in this guide) is too weak. If so, move the local AP (AP2 in this guide) closer to the uplink device.



RECYCLING
This product bears the selective sorting symbol for Waste electrical and electronic equipment (WEEE). This means that this product must be handled pursuant to European directive 2012/19/EU in order to be recycled or dismantled to minimize its impact on the environment. User has the choice to give this product to a competent recycling organization or to the retailer when he buys a new electrical or electronic equipment.

Declaration of Conformity
Hereby, SHENZHEN IP-COM Networks Co., Ltd. declares that the radio equipment type IUAP-AC-LR is in compliance with Directive 2014/53/EU.
Hereby, SHENZHEN IP-COM Networks Co., Ltd. declares that the radio equipment type IUAP-AC-LITE is in compliance with Directive 2014/53/EU.
Hereby, SHENZHEN IP-COM Networks Co., Ltd. declares that the radio equipment type IUAP-AC-PRO is in compliance with Directive 2014/53/EU.
Hereby, SHENZHEN IP-COM Networks Co., Ltd. declares that the radio equipment type IUAP-AX-LR is in compliance with Directive 2014/53/EU.

The full text of the EU declaration of conformity is available at the following internet address: <http://ip-com.com.cn/en/ce.html>

Operating Frequency: 2.4GHz EU/2400-2483.5MHz (CH1-CH13)
ERP Power (Max.): 2.4GHz: <20dBm
5GHz: <23dBm
Software Version: V1.0.0.3



FCC Statement
This equipment has been tested and found to comply with the limits for a Class B digital device, pursuant to Part 15 of the FCC Rules. These limits are designed to provide reasonable protection against harmful interference in a residential installation. This equipment generates, uses and can radiate radio frequency energy and, if not installed and used in accordance with the instructions, may cause harmful interference to radio communications. However, there is no guarantee that interference will not occur in a particular installation. If this equipment does cause harmful interference to radio or television reception, which can be determined by turning the equipment off and on, the user is encouraged to try to correct the interference by one or more of the following measures:
— Reorient or relocate the receiving antenna.
— Increase the separation between the equipment and receiver.
— Connect the equipment into an outlet on a circuit different from that to which the receiver is connected.
— Consult the dealer or an experienced radio/TV technician for help.
The device is for indoor usage only.
Operation is subject to the following two conditions: (1) this device may not cause harmful interference, and (2) this device must accept any interference received, including interference that may cause undesired operation.

Radiation Exposure Statement
This device complies with FCC radiation exposure limits set forth for an uncontrolled environment and it also complies with Part 15 of the FCC RF Rules. This equipment should be installed and operated with minimum distance 20cm between the device and your body.

Caution: Any changes or modifications not expressly approved by the party responsible for compliance could void the user's authority to operate this equipment. This transmitter must not be co-located or operating in conjunction with any other antenna or transmitter.

Operating frequency: 2412-2462MHz, 5150-5250MHz, 5725-5850MHz

NOTE: (1) The manufacturer is not responsible for any radio or TV interference caused by unauthorized modifications to this equipment. (2) To avoid unnecessary radiation interference, it is recommended to use a shielded RJ45 cable.



CE Mark Warning
This is a Class B product. In a domestic environment, this product may cause radio interference, in which case the user may be required to take adequate measures. Operations in the 5.15-5.25GHz band are restricted to indoor use only. The main plug is used as disconnect device; the disconnect device shall remain readily operable.

NOTE: (1) The manufacturer is not responsible for any radio or TV interference caused by unauthorized modifications to this equipment. (2) To avoid unnecessary radiation interference, it is recommended to use a shielded RJ45 cable.



Caution
Adapter Model: BR060P1204
Manufacturer: SHENZHEN HEWESHEN NETWORK TECHNOLOGY CO., LTD.
Input: 100-240V AC, 50/60Hz 0.3A
Output: 5V DC, 3.5A
⚡: DC Voltage

For EUI/RETA, this product can be used in the following countries:



Operating temperature: -10°C ~45°C
Operating humidity: (10%~93%)RH, non-condensing

Technical Support
Address: Room 101, Unit A, First Floor, Tower E3, No.1001, Zhongshanyuan Road, Nanshan District, Shenzhen, China, 518052
Tel: 86753 2763 2089
Email: info@ip-com.com
Website: www.ip-com.com.cn

Copyright
©2020 IP-COM Networks Co., Ltd. All rights reserved.
This documentation (including pictures, images, and product specifications, etc.) is for reference only. To improve internal design, operational function, and/or reliability, IP-COM reserves the right to make changes to the products described in this document without obligation to notify any person or organization of such revisions or changes.