

FCC DFS TEST REPORT

FCC ID: 2ABZJ-100-00111

Product : C6x

Trade Mark : *mimosa*
by Airspan

Model Name : C6x

Family Model : iBridge C6x

Report No. : S22051400107002

Prepared for

Mimosa Networks, Inc.

777 Yamato Road, Boca Raton, FL 33431 USA

Prepared by

Shenzhen NTEK Testing Technology Co., Ltd.

1/F, Building E, Fenda Science Park, Sanwei Community, Xixiang
Street, Bao'an District, Shenzhen 518126 P.R.China.

Tel. 400-800-6106, 0755-2320 0050, 0755-2320 0090

Website: <http://www.ntek.org.cn>

TEST RESULT CERTIFICATION

Applicant's name Mimosa Networks, Inc.
Address 777 Yamato Road, Boca Raton, FL 33431 USA
Manufacturer's Name Mimosa Networks, Inc.
Address 777 Yamato Road, Boca Raton, FL 33431 USA

Product description

Product name C6x
Model and/or type reference C6x
Family Model..... mimosa by Airspan

Standards FCC Part15.407

Test procedure KDB 905462 D02 UNII DFS Compliance Procedures New Rules v02
KDB 905462 D04 Operational Modes for DFS Testing New Rules v01

This device described above has been tested by NTEK, and the test results show that the equipment under test (EUT) is in compliance with the FCC requirements/ the Industry Canada requirements.. And it is applicable only to the tested sample identified in the report.

This report shall not be reproduced except in full, without the written approval of NTEK, this document may be altered or revised by NTEK, personnel only, and shall be noted in the revision of the document.

Date of Test

Date (s) of performance of tests 14 May. 2022 ~ 17 Jul. 2022

Date of Issue..... 19 Jul. 2022

Test Result..... Pass

Testing Engineer : [Signature]
(Cheng Jiawen)

Authorized Signatory : [Signature]
(Alex Li)

Table of Contents

	Page
1 . SUMMARY OF TEST RESULTS	6
1.1 FACILITIES AND ACCREDITATIONS	7
1.2 MEASUREMENT UNCERTAINTY	7
2 . GENERAL INFORMATION	8
2.1 GENERAL DESCRIPTION OF EUT	8
2.2 EQUIPMENTS LIST FOR ALL TEST ITEMS	12
3 . DYNAMIC FREQUENCY SELECTION(DFS) TEST REQUIREMENTS AND RESULTS	13
3.1 APPLICABILITY OF DFS REQUIREMENTS	13
3.2 DFS DETECTION THRESHOLDS	13
3.3 DFS RESPONSE REQUIREMENT VALUES	14
3.4 USER ACCESS RESTRICTIONS	14
3.5 CONDUCTED SETUP FOR MASTER WITH INJECTION AT THE MASTER	14
3.6 RADAR TEST WAVEFORM CALIBRATION	15
3.6.1 SHORT PULSE RADAR TEST WAVEFORMS	15
3.6.2 LONG PULSE RADAR TEST WAVEFORM	15
3.6.3 FREQUENCY HOPPING RADAR TEST WAVEFORM	16
3.6.4 DFS THRESHOLD LEVEL	17
3.6.5 RADAR WAVEFORM CALIBRATION RESULTS	17
3.7 CHANNEL AVAILABILITY CHECK TIME	21
3.7.1 LIMIT	21
3.7.2 TEST PROCEDURES	21
3.7.3 CAC INITIAL	21
3.7.4 CAC BEGIN	22
3.7.5 CAC END	23
3.8 DATA TRAFFIC CHANNEL LOADING AND NOISE FLOOR PLOTS	24
3.9 IN-SERVICE MONITORING FOR CHANNEL MOVE TIME, CHANNEL CLOSING TRANSMISSION TIME AND NON-OCCUPANCY PERIOD	26
3.9.1 IN-SERVICE MONITORING LIMIT	26
3.9.2 TEST PROCEDURES	26
3.9.3 CHANNEL MOVE TIME AND CHANNEL CLOSING TRANSMISSION TIME TEST RESULTS	26
3.9.4 NON-OCCUPANCY PERIOD TEST RESULTS	28
3.10 U-NII DETECTION BANDWIDTH	29
3.10.1 TEST PROCEDURES	29
3.10.2 TEST RESULTS	29

Table of Contents

	Page
3.11 STATISTICAL PERFORMANCE CHECK	33
3.11.1 STATISTICAL PERFORMANCE CHECK LIMIT	33
3.11.2 TEST PROCEDURES	33
3.11.3 U-NII-2C 20MHZ TEST RESULTS AND WAVEFORMS DETAILS	34
3.11.4 U-NII-2C 40MHZ TEST RESULTS AND WAVEFORMS DETAILS	83
3.11.5 U-NII-2C 80MHZ TEST RESULTS AND WAVEFORMS DETAILS	132
3.11.6 U-NII-2C 160MHZ TEST RESULTS AND WAVEFORMS DETAILS	181

Revision History

Report No.	Version	Description	Issued Date
S22051400107002	Rev.01	Initial issue of report	19 Jul. 2022

1. SUMMARY OF TEST RESULTS

Test procedures according to the technical standards:

KDB 905462 D02			
Standard Section	Test Item	Judgment	Remark
7.8.1	U-NII Detection Bandwidth	PASS	
7.8.2.1	Initial Channel Availability Check Time	PASS	
7.8.2.2	Radar Burst at the Beginning of the Channel Availability Check Time	PASS	
7.8.2.3	Radar Burst at the End of the Channel Availability Check Time	PASS	
7.8.3	In-Service Monitoring for Channel Move Time	PASS	
7.8.3	In-Service Monitoring for Channel Closing Transmission Time	PASS	
7.8.3	In-Service Monitoring for Non-Occupancy Period	PASS	
7.8.4	Statistical Performance Check	PASS	

NOTE:

(1) "N/A" denotes test is not applicable in this Test Report

1.1 FACILITIES AND ACCREDITATIONS

FACILITIES

All measurement facilities used to collect the measurement data are located at 1/F, Building E, Fenda Science Park, Sanwei Community, Xixiang Street, Bao'an District, Shenzhen 518126 P.R. China.

The sites are constructed in conformance with the requirements of ANSI C63.7, ANSI C63.10 and CISPR Publication 22.

LABORATORY ACCREDITATIONS AND LISTINGS

Site Description

CNAS-Lab. : The Certificate Registration Number is L5516.

IC-Registration : The Certificate Registration Number is 9270A.
CAB identifier:CN0074

FCC- Accredited : Test Firm Registration Number: 463705.
Designation Number: CN1184

A2LA-Lab. : The Certificate Registration Number is 4298.01

Name of Firm : Shenzhen NTEK Testing Technology Co., Ltd.

Site Location : 1/F, Building E, Fenda Science Park, Sanwei Community, Xixiang Street, Bao'an District, Shenzhen 518126 P.R.China.

1.2 MEASUREMENT UNCERTAINTY

The reported uncertainty of measurement $y \pm U$, where expanded uncertainty U is based on a standard uncertainty multiplied by a coverage factor of $k=2$, providing a level of confidence of approximately 95 %.

No.	Item	Uncertainty
1	Conducted Emission Test	$\pm 2.80\text{dB}$
2	RF power, conducted	$\pm 0.16\text{dB}$
3	Spurious emissions, conducted	$\pm 0.21\text{dB}$
4	All emissions, radiated(30MHz~1GHz)	$\pm 2.64\text{dB}$
5	All emissions, radiated(1GHz~6GHz)	$\pm 2.40\text{dB}$
6	All emissions, radiated(> 6GHz)	$\pm 2.52\text{dB}$
7	Temperature	$\pm 0.5^\circ\text{C}$
8	Humidity	$\pm 2\%$

2. GENERAL INFORMATION
2.1 GENERAL DESCRIPTION OF EUT

Equipment	C6x	
Trade Mark		
Model Name	C6x	
Family Model	iBridge C6x	
Model Difference	All the model are the same circuit and RF module, except the model names.	
FCC ID	2ABZJ-100-00111	
Product Description	IEEE 802.11 WLAN Mode Supported	<input checked="" type="checkbox"/> 802.11ac/ax (20MHz channel bandwidth) <input checked="" type="checkbox"/> 802.11ac/ax (40MHz channel bandwidth) <input checked="" type="checkbox"/> 802.11ac/ax (80MHz channel bandwidth) <input checked="" type="checkbox"/> 802.11ac/ax (160MHz channel bandwidth)
	Modulation	OFDM/OFDMA (BPSK/1024QAM)
	Operating Frequency Range	<input checked="" type="checkbox"/> U-NII-1: 5180-5240MHz for 802.11ac/ax(20MHz); 5190-5230MHz for 802.11ac/ax(40MHz); 5210MHz for 802.11ac/ax(80MHz) 5250MHz for 802.11ac/ax(160MHz) <input checked="" type="checkbox"/> U-NII-2A: 5260-5320MHz for 802.11ac/ax(20MHz); 5270-5310MHz for 802.11ac/ax(40MHz); 5290MHz for 802.11ac/ax(80MHz) 5250MHz for 802.11ac/ax(160MHz) <input checked="" type="checkbox"/> U-NII-2C: 5500-5700MHz for 802.11ac/ax(20MHz); 5510-5670MHz for 802.11ac/ax(40MHz); 5530-5610MHz for 802.11ac/ax(80MHz) 5570MHz for 802.11ac/ax(160MHz) <input checked="" type="checkbox"/> U-NII-3: 5745-5825 MHz for 802.11ac/ax(20MHz); 5755-5795 MHz for 802.11ac/ax(40MHz); 5775MHz for 802.11ac/ax(80MHz)
	Number of Channels	<input checked="" type="checkbox"/> 4 channels for U-NII-1(ac/ax 20); 2 channels for U-NII-1(ac/ax 40); 1 channels for U-NII-1(ac/ax 80); 1 channels for U-NII-1(ac/ax 160); <input checked="" type="checkbox"/> 4 channels for U-NII-2A(ac/ax 20); 2 channels for U-NII-2A(ac/ax 40); 1 channels for U-NII-2A(ac/ax 80); 1 channels for U-NII-2A(ac/ax 160); <input checked="" type="checkbox"/> 11 channels for U-NII-2C(ac/ax 20); 5 channels for U-NII-2C(ac/ax 40); 2 channels for U-NII-2C(ac/ax 80); 1 channels for U-NII-2A(ac/ax 160); <input checked="" type="checkbox"/> 5 channels for U-NII-3(ac/ax 20); 2 channels for U-NII-3(ac/ax 40); 1 channels for U-NII-3(ac/ax 80);

Product Description	Function:	<input checked="" type="checkbox"/> Outdoor AP <input type="checkbox"/> Indoor AP <input type="checkbox"/> Fixed PTP <input type="checkbox"/> Client
	DFS operational mode	Master
	Smart system	<input checked="" type="checkbox"/> MIMO for 802.11ac/ax
	Communication Mode	IP Based (Load Based)
	TPC Function	With TPC
	Power-on cycle	210.3 seconds to complete its power-on cycle.
	Antenna Type	Internal: Integral Panel Antenna External (Screw on): Cassegrain
	Antenna Gain	Internal: 8dBi External (Screw on): Max. 25dBi
Based on the application, features, or specification exhibited in User's Manual, More details of EUT technical specification, please refer to the User's Manual.		
Ratings	DC 24V from PoE	
Adapter	N/A	
Connecting I/O Port(s)	Please refer to the User's Manual	
HW Version	N/A	
SW Version	N/A	

Note:

- For a more detailed features description, please refer to the manufacturer's specifications or the User's Manual.
-

Band	20MHz		40MHz		80MHz	
	Channel	Frequency	Channel	Frequency	Channel	Frequency
U-NII-1	36	5180 MHz	38	5190 MHz	42	5210 MHz
	40	5200 MHz	46	5230 MHz	-	-
	44	5220 MHz				
	48	5240 MHz				
U-NII-2A	52	5260 MHz	54	5270 MHz	58	5290 MHz
	56	5280 MHz	62	5310 MHz		
	60	5300 MHz				
	64	5320 MHz				
U-NII-2C	100	5500 MHz	102	5510 MHz	106	5530 MHz
	104	5520 MHz	110	5550 MHz	122	5610 MHz
	108	5540 MHz	118	5590 MHz		
	112	5560 MHz	126	5630 MHz		
	116	5580 MHz	134	5670 MHz		
	120	5600 MHz				
	124	5620 MHz				
	128	5640 MHz				
	132	5660 MHz				
	136	5680 MHz				
U-NII-3	149	5745 MHz	151	5755 MHz	155	5775 MHz
	153	5765 MHz	159	5795 MHz		
	157	5785 MHz				
	161	5805 MHz				
	165	5825 MHz				

-
-
-

Band	160MHz	
	Channel	Frequency
U-NII-1	50	5250 MHz
U-NII-2A	50	5250 MHz
U-NII-2C	114	5570 MHz

4. Max. output power result (with TPC)

Mode	Frequency (MHz)	Min Power (dBm)	Max Power (dBm)	Min EIRP (dBm)	Max EIRP (dBm)
802.11ax40 (8dBi Antenna Gain)	5270	10.92	16.92	18.92	24.92
802.11ax20 (25dBi Antenna Gain)	5260	-3.06	2.94	21.94	27.94
802.11ax160 (8dBi Antenna Gain)	5570	11.13	17.13	19.13	25.13
802.11ax20 (25dBi Antenna Gain)	5500	-3.19	2.81	21.81	27.81

Note: EUT employ a TPC mechanism and TPC have the capability to operate at least 6 dB below highest RF output power.

5. Conducted Tests: The antenna connector impedance usually is 50 Ohms, as follows:



2.2 EQUIPMENTS LIST FOR ALL TEST ITEMS

Radiation& Conducted Test equipment

Item	Kind of Equipment	Manufacturer	Type No.	Serial No.	Last calibration	Calibrated until	Calibration period
1	Spectrum Analyzer	Agilent	E4407B	MY45108040	2022.04.01	2023.03.31	1 year
2	Spectrum Analyzer	Agilent	N9020A	MY49100060	2021.07.01 2022.06.16	2022.06.30 2023.06.15	1 year
3	Spectrum Analyzer	R&S	FSV40	101417	2021.07.01 2022.06.16	2022.06.30 2023.06.15	1 year
4	Test Receiver	R&S	ESPI7	101318	2022.04.06	2023.04.05	1 year
5	Bilog Antenna	TESEQ	CBL6111D	31216	2022.03.30	2023.03.29	1 year
6	50Ω Coaxial Switch	Anritsu	MP59B	6200983705	2020.05.11	2023.05.10	3 year
7	Horn Antenna	EM	EM-AH-1018 0	2011071402	2022.03.31	2023.03.30	1 year
8	Amplifier	EMC	EMC051835 SE	980246	2021.07.01 2022.06.17	2022.06.30 2023.06.16	1 year
9	Active Loop Antenna	SCHWARZBECK	FMZB 1519 B	055	2021.11.07	2022.11.06	1 year
10	USB RF Power Sensor	DARE	RPR3006W	15I00041SN O84	2021.07.01 2022.06.16	2022.06.30 2023.06.15	1 year
11	Test Cable (9KHz-30MHz)	N/A	R-01	N/A	2019.08.06	2022.08.05	3 year
12	Test Cable (30MHz-1GHz)	N/A	R-02	N/A	2019.08.06	2022.08.05	3 year
13	High Test Cable(1G-40G Hz)	N/A	R-03	N/A	2019.08.06	2022.08.05	3 year
14	High Test Cable(1G-40G Hz)	N/A	R-04	N/A	2019.08.06	2022.08.05	3 year
15	temporary antenna connector (Note)	NTS	R001	N/A	N/A	N/A	N/A
16	Low Noise Amplifier	B&Z	BZ-P540-550 850-452727	16476-11729	2022.03.09	2023.03.08	1 year
17	Broadband Horn Antenna	SCHWARZBECK	BBHA 9170	803	2021.11.07	2022.11.06	1 year
18	Thermal Chamber	Ten Billion	TTC-B3C	TBN-960502	2020.08.07	2023.08.06	3 year
19	MXG Vector Signal Generator	Agilent	N5182A	MY47070317	2022.04.01	2023.03.31	1 year

Note:

We will use the temporary antenna connector (soldered on the PCB board) When conducted test
 And this temporary antenna connector is listed within the instrument list
 Each piece of equipment is scheduled for calibration once a year except the Test Cable& Aux Equipment which is scheduled for calibration every 3 years.

3. DYNAMIC FREQUENCY SELECTION(DFS) TEST REQUIREMENTS AND RESULTS

3.1 APPLICABILITY OF DFS REQUIREMENTS

Table 1: Applicability of DFS Requirements Prior to Use of a Channel

Requirement	Operational Mode		
	Master	Client Without Radar Detection	Client With Radar Detection
Non-Occupancy Period	Yes	Not required	Yes
DFS Detection Threshold	Yes	Not required	Yes
Channel Availability Check Time	Yes	Not required	Not required
U-NII Detection Bandwidth	Yes	Not required	Yes

Table 2: Applicability of DFS requirements during normal operation

Requirement	Operational Mode		
	Master	Client Without Radar Detection	Client With Radar Detection
DFS Detection Threshold	Yes	Not required	Yes
Channel Closing Transmission Time	Yes	Yes	Yes
Channel Move Time	Yes	Yes	Yes
U-NII Detection Bandwidth	Yes	Not required	Yes
Client Beacon Test	N/A	Yes	Yes

Additional requirements for devices with multiple bandwidth modes	Operational Mode	
	Master or Client With Radar Detection	Client Without Radar Detection
U-NII Detection Bandwidth and Statistical Performance Check	All BW modes must be tested	Not required
Channel Move Time and Channel Closing Transmission Time	Test using widest BW mode available	Test using the widest BW mode available for the link
All other tests	Any single BW mode	Not required
<p>Note Frequencies selected for statistical performance check (Section 7.8.4) should include several frequencies within the radar detection bandwidth and frequencies near the edge of the radar detection bandwidth. For 802.11 devices it is suggested to select frequencies in each of the bonded 20 MHz channels and the channel center frequency.</p>		

3.2 DFS DETECTION THRESHOLDS

Maximum Transmit Power	Value (see notes 1, 2, and 3)
EIRP \geq 200 milliwatt	-64 dBm
EIRP < 200 milliwatt and power spectral density < 10 dBm/MHz	-62 dBm
EIRP < 200 milliwatt that do not meet the power spectral density requirement	-64 dBm
<p>Note 1: This is the level at the input of the receiver assuming a 0 dBi receive antenna.</p> <p>Note 2: Throughout these test procedures an additional 1 dB has been added to the amplitude of the test transmission waveforms to account for variations in measurement equipment. This will ensure that the test signal is at or above the detection threshold level to trigger a DFS response.</p> <p>Note 3: EIRP is based on the highest antenna gain.</p>	

3.3 DFS RESPONSE REQUIREMENT VALUES

Parameter	Value
Non-occupancy period	Minimum 30 minutes
Channel Availability Check Time	60 seconds
Channel Move Time	10 seconds See Note 1.
Channel Closing Transmission Time	200 milliseconds + an aggregate of 60 milliseconds over remaining 10 second period. See Notes 1 and 2.
U-NII Detection Bandwidth	Minimum 100% of the 99% power bandwidth See Note 3.

Note 1: The instant that the Channel Move Time and the Channel Closing Transmission Time begins is as follows:

- For the Short pulse radar Test Signals this instant is the end of the Burst.
- For the Frequency Hopping radar Test Signal, this instant is the end of the last radar Burst generated.
- For the Long Pulse radar Test Signal this instant is the end of the 12 second period defining the radar transmission.

Note 2: The Channel Closing Transmission Time is comprised of 200 milliseconds starting at the beginning of the Channel Move Time plus any additional intermittent control signals required to facilitate Channel changes (an aggregate of 60 milliseconds) during the remainder of the 10 second period. The aggregate duration of control signals will not count quiet periods in between transmissions.

Note 3: During the U-NII Detection Bandwidth detection test, radar type 0 is used and for each frequency step the minimum percentage of detection is 90%. Measurements are performed with no data traffic.

3.4 USER ACCESS RESTRICTIONS

DFS controls (hardware or software) related to radar detection are NOT accessible to the user. Manufacturer statement confirming that information regarding the parameters of the detected Radar Waveforms is not available to the end user.

3.5 CONDUCTED SETUP FOR MASTER WITH INJECTION AT THE MASTER

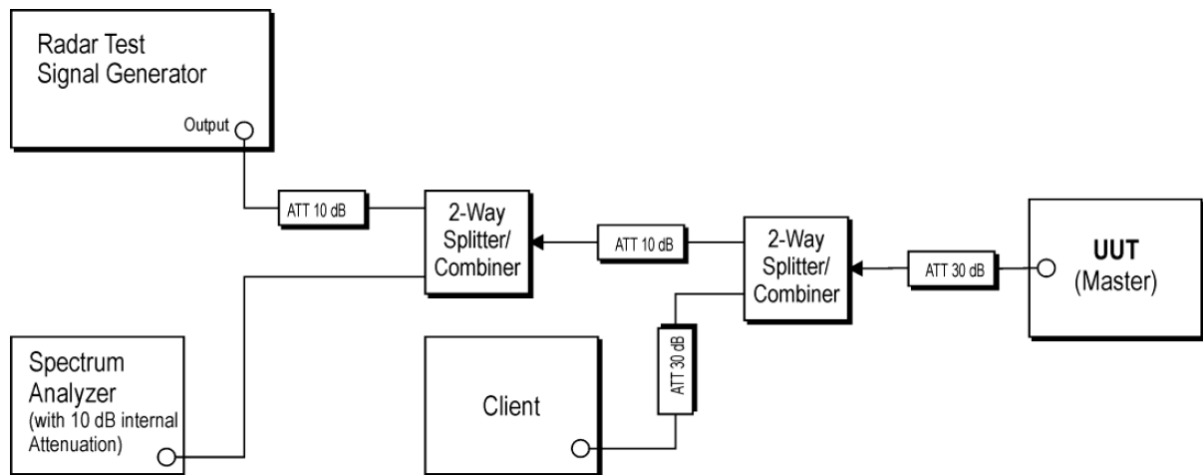

3.6 RADAR TEST WAVEFORM CALIBRATION

3.6.1 SHORT PULSE RADAR TEST WAVEFORMS

Radar Type	Pulse Width (µsec)	PRI (µsec)	Number of Pulses	Minimum Percentage of Successful Detection	Minimum Trials
0	1	1428	18	60%	30
1	1	Test A Test B	Roundup $\left(\frac{1}{360} \cdot \frac{19 \cdot 10^6}{PRI_{min}} \right)$	60%	30
2	1-5	150-230	23-29	60%	30
3	6-10	200-500	16-18	60%	30
4	11-20	200-500	12-16	60%	30
Aggregate (Radar Types 1-4)				80%	120
<p>Note 1: Short Pulse Radar Type 0 should be used for the detection bandwidth test, channel move time, and channel closing time tests.</p> <p>Test A: 15 unique PRI values randomly selected from the list of 23 PRI values.</p> <p>Test B: 15 unique PRI values randomly selected within the range of 518-3066 µsec, with a minimum increment of 1 µsec, excluding PRI values selected in Test A.</p> <p>A minimum of 30 unique waveforms are required for each of the Short Pulse Radar Types 2 through 4. If more than 30 waveforms are used for Short Pulse Radar Types 2 through 4, then each additional waveform must also be unique and not repeated from the previous waveforms. If more than 30 waveforms are used for Short Pulse Radar Type 1, then each additional waveform is generated with Test B and must also be unique and not repeated from the previous waveforms in Tests A or B.</p> <p>The aggregate is the average of the percentage of successful detections of short pulse radar types 1-4.</p>					

3.6.2 LONG PULSE RADAR TEST WAVEFORM

Radar Type	Pulse Width (µsec)	Chirp Width (MHz)	PRI (µsec)	Number of Pulses per Burst	Number of Bursts	Minimum Percentage of Successful Detection	Minimum Trials
5	50-100	5-20	1000-2000	1-3	8-20	80%	30

The parameters for this waveform are randomly chosen. Thirty unique waveforms are required for the Long Pulse Radar Type waveforms. If more than 30 waveforms are used for the Long Pulse Radar Type waveforms, then each additional waveform must also be unique and not repeated from the previous waveforms.

Each waveform is defined as follows:

- 1) The transmission period for the Long Pulse Radar test signal is 12 seconds.
- 2) There are a total of 8 to 20 Bursts in the 12 second period, with the number of Bursts being randomly chosen. This number is Burst Count.
- 3) Each Burst consists of 1 to 3 pulses, with the number of pulses being randomly chosen. Each Burst within the 12 second sequence may have a different number of pulses.
- 4) The pulse width is between 50 and 100 microseconds, with the pulse width being randomly chosen. Each pulse within a Burst will have the same pulse width. Pulses in different Bursts may have different pulse widths.

- 5) Each pulse has a linear frequency modulated chirp between 5 and 20 MHz, with the chirp width being randomly chosen. Each pulse within a transmission period will have the same chirp width. The chirp is centered on the pulse. For example, with a radar frequency of 5300 MHz and a 20 MHz chirped signal, the chirp starts at 5290 MHz and ends at 5310 MHz.
- 6) If more than one pulse is present in a Burst, the time between the pulses will be between 1000 and 2000 microseconds, with the time being randomly chosen. If three pulses are present in a Burst, the random time interval between the first and second pulses is chosen independently of the random time interval between the second and third pulses.
- 7) The 12 second transmission period is divided into even intervals. The number of intervals is equal to Burst Count. Each interval is of length $(12,000,000 / \text{Burst Count})$ microseconds. Each interval contains one Burst. The start time for the Burst, relative to the beginning of the interval, is between 1 and $[(12,000,000 / \text{Burst Count}) - (\text{Total Burst Length}) + (\text{One Random PRI Interval})]$ microseconds, with the start time being randomly chosen. The step interval for the start time is 1 microsecond. The start time for each Burst is chosen randomly.

A representative example of a Long Pulse Radar Type waveform:

- 1) The total test waveform length is 12 seconds.
 - 2) Eight (8) Bursts are randomly generated for the Burst Count.
 - 3) Burst 1 has 2 randomly generated pulses.
 - 4) The pulse width (for both pulses) is randomly selected to be 75 microseconds.
 - 5) The PRI is randomly selected to be at 1213 microseconds.
 - 6) Bursts 2 through 8 are generated using steps 3 – 5.
 - 7) Each Burst is contained in even intervals of 1,500,000 microseconds. The starting location for Pulse 1, Burst 1 is randomly generated (1 to 1,500,000 minus the total Burst 1 length + 1 random PRI interval) at the 325,001 microsecond step. Bursts 2 through 8 randomly fall in successive 1,500,000 microsecond intervals (i.e. Burst 2 falls in the 1,500,001 – 3,000,000 microsecond range).
- provides a graphical representation of the Long Pulse Radar Test Waveform.

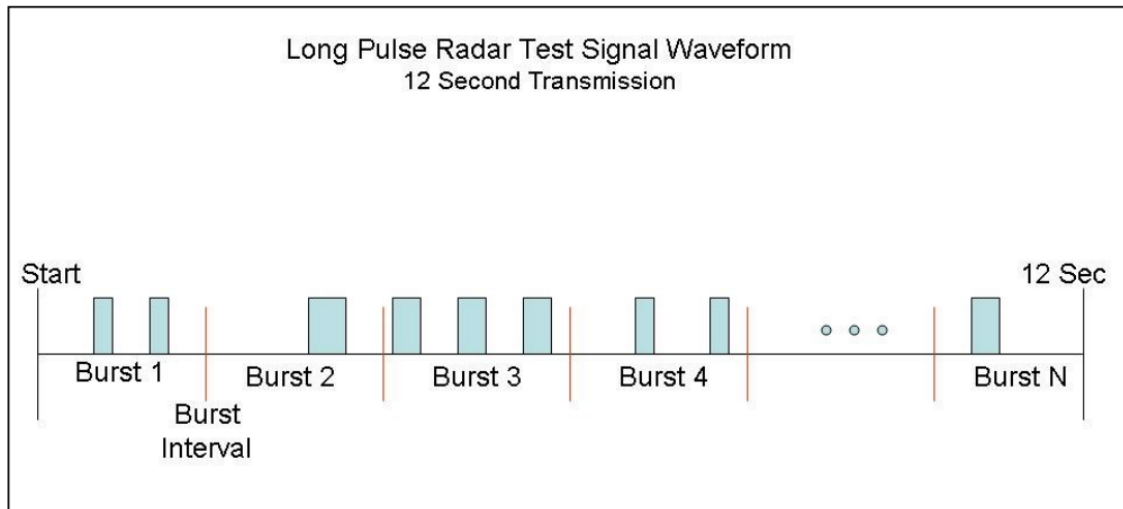

3.6.3 FREQUENCY HOPPING RADAR TEST WAVEFORM

Radar Type	Pulse Width (μsec)	PRI (μsec)	Pulses per Hop	Hopping Rate (kHz)	Hopping Sequence Length (msec)	Minimum Percentage of Successful Detection	Minimum Trials
6	1	333	9	0.333	300	70%	30

For the Frequency Hopping Radar Type, the same Burst parameters are used for each waveform. The hopping sequence is different for each waveform and a 100-length segment is selected from the hopping sequence defined by the following algorithm:

The first frequency in a hopping sequence is selected randomly from the group of 475 integer frequencies from 5250 – 5724 MHz. Next, the frequency that was just chosen is removed from the group and a frequency is randomly selected from the remaining 474 frequencies in the group. This process continues until all 475 frequencies are chosen for the set. For selection of a random frequency, the frequencies remaining within the group are always treated as equally likely.

3.6.4 DFS THRESHOLD LEVEL

DFS Threshold Level	Remark
-64 dBm	EIRP > 200 milliwatt

3.6.5 RADAR WAVEFORM CALIBRATION RESULTS

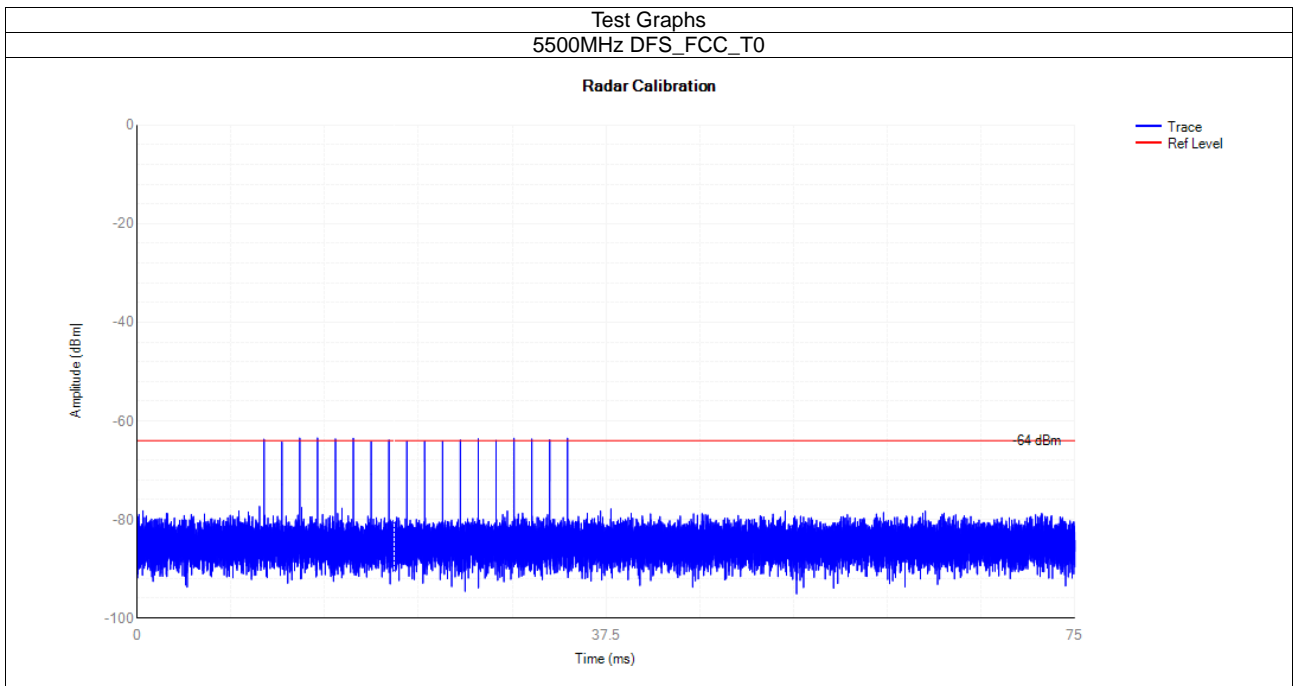

Test Graphs
5500MHz DFS_FCC_T1000

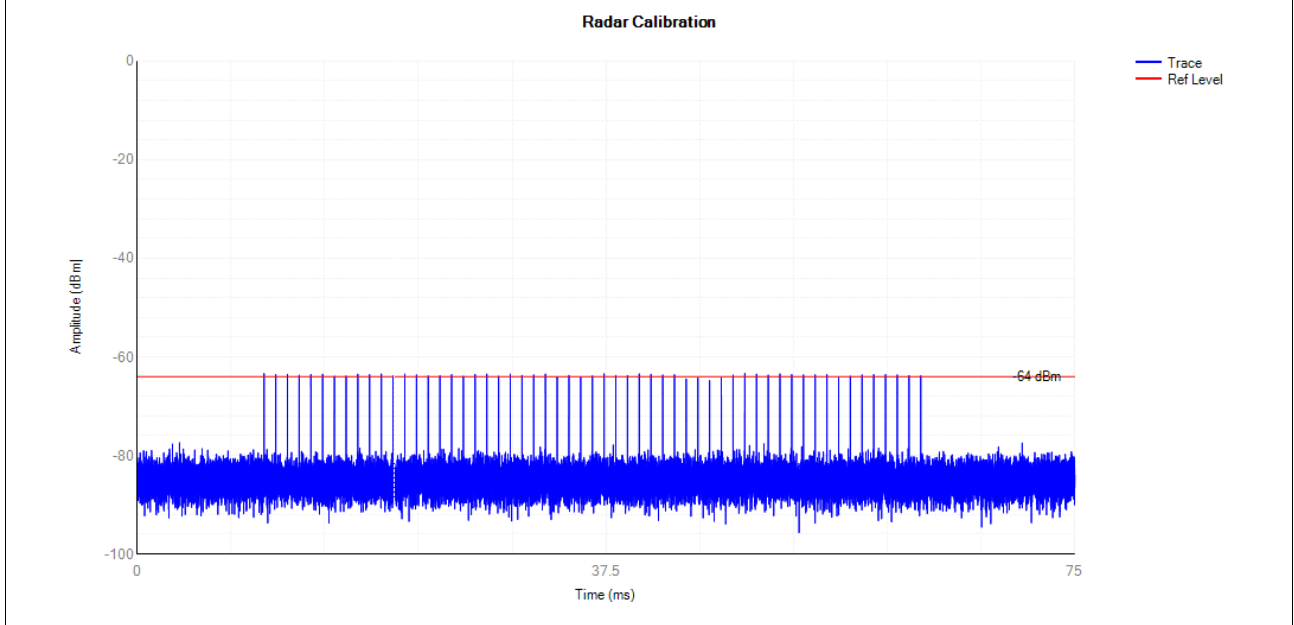

Test Graphs
5500MHz DFS_FCC_T2000

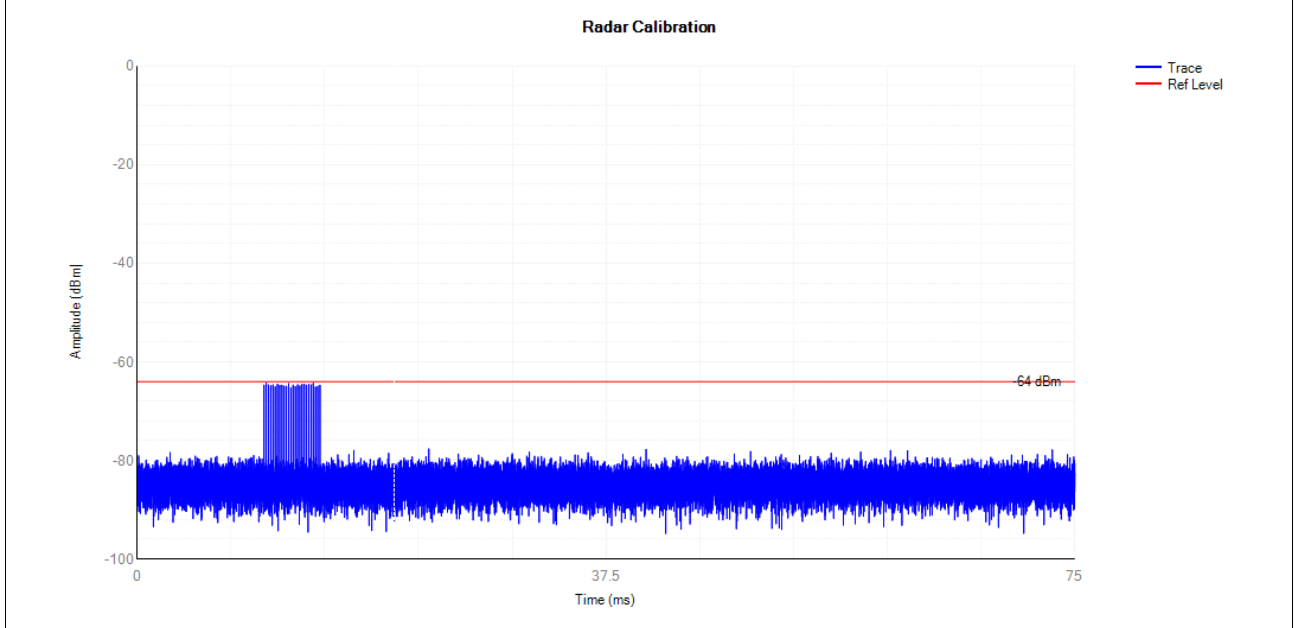

Test Graphs
5500MHz DFS_FCC_T3000

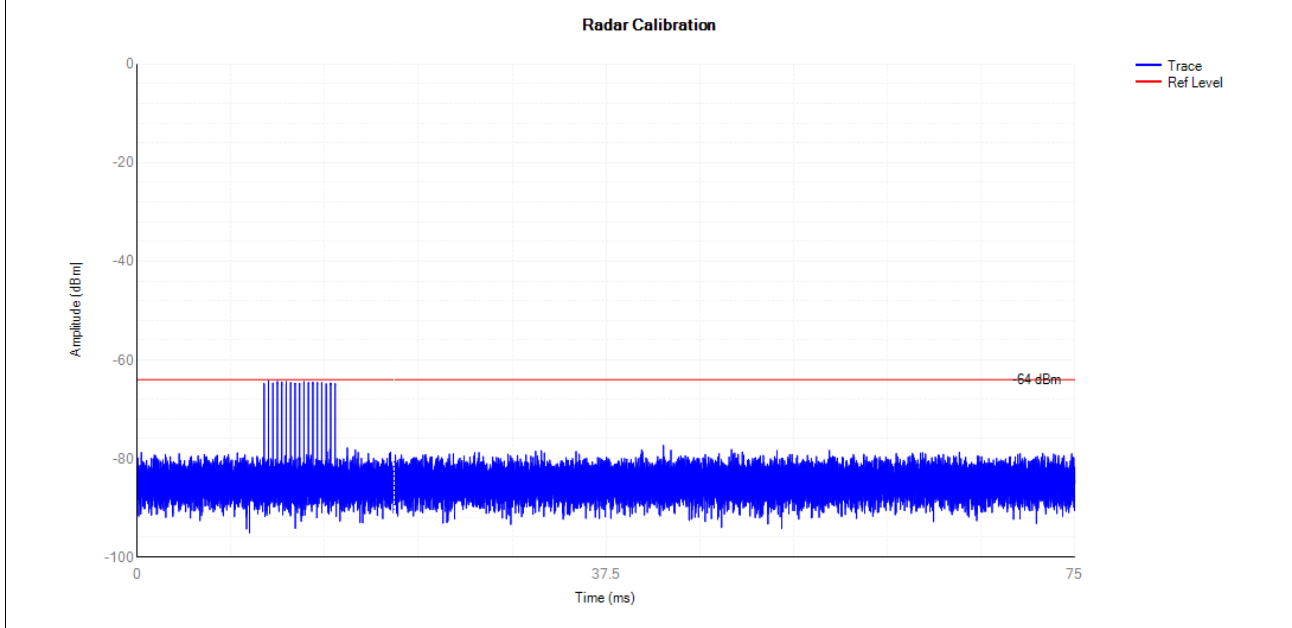

Test Graphs
5500MHz DFS_FCC_T4000

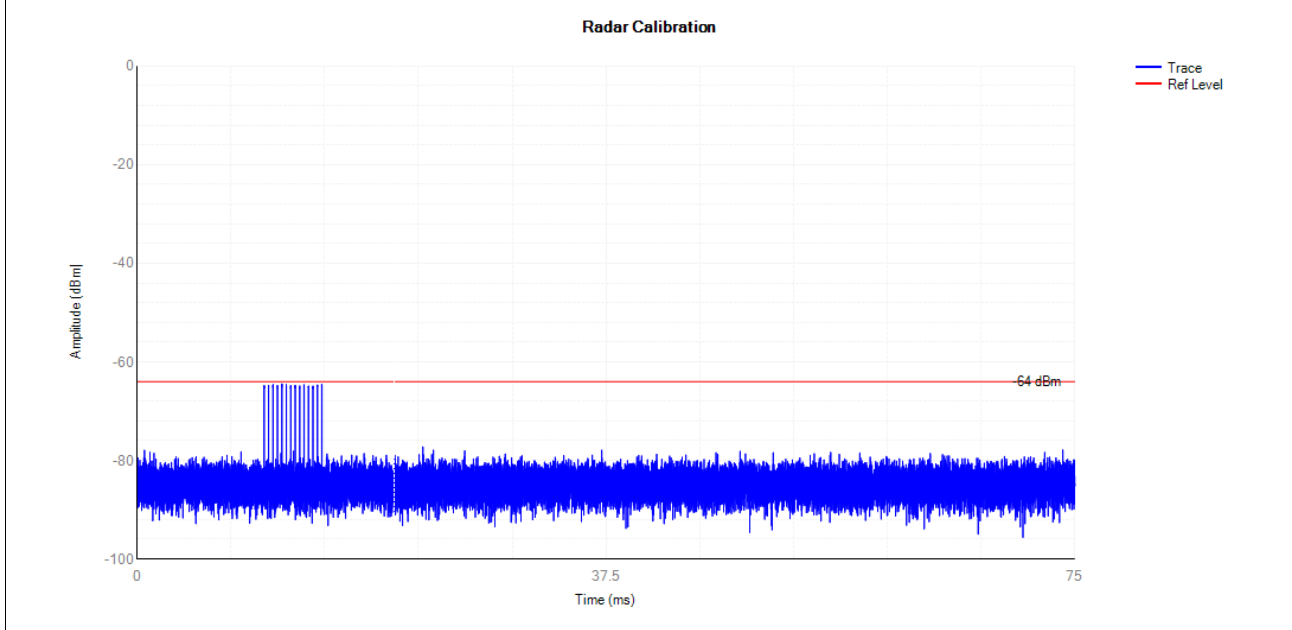

Test Graphs
5500MHz DFS_FCC_T5000

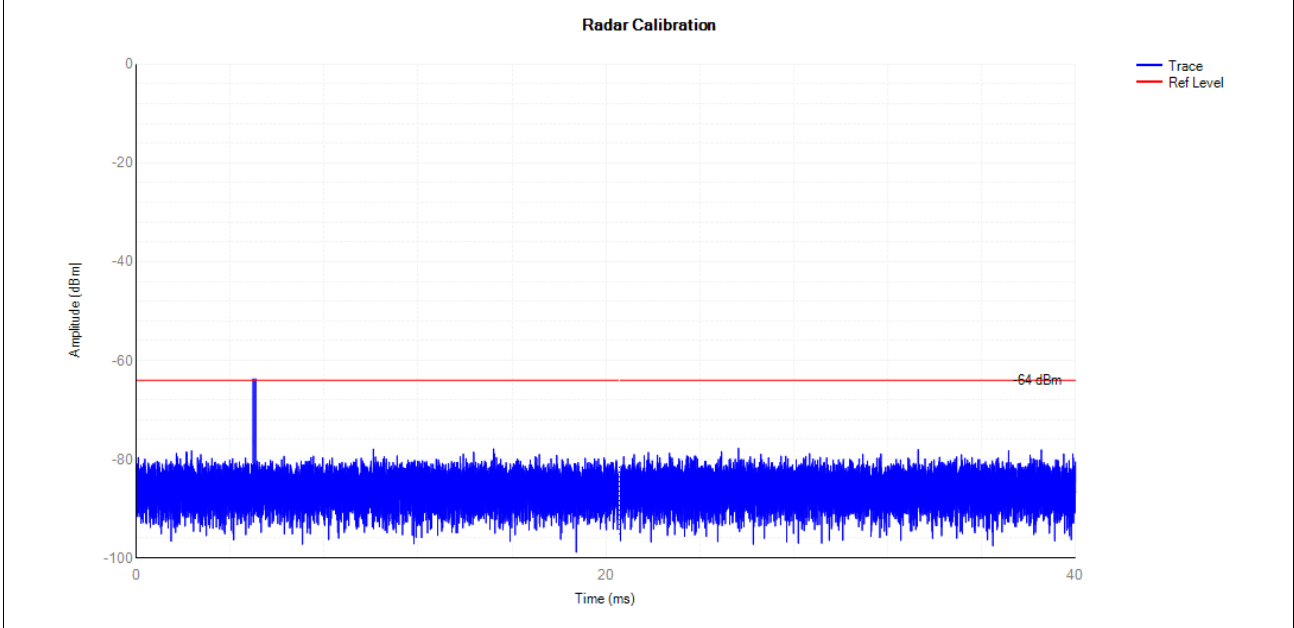

Test Graphs
5500MHz DFS_FCC_T6000

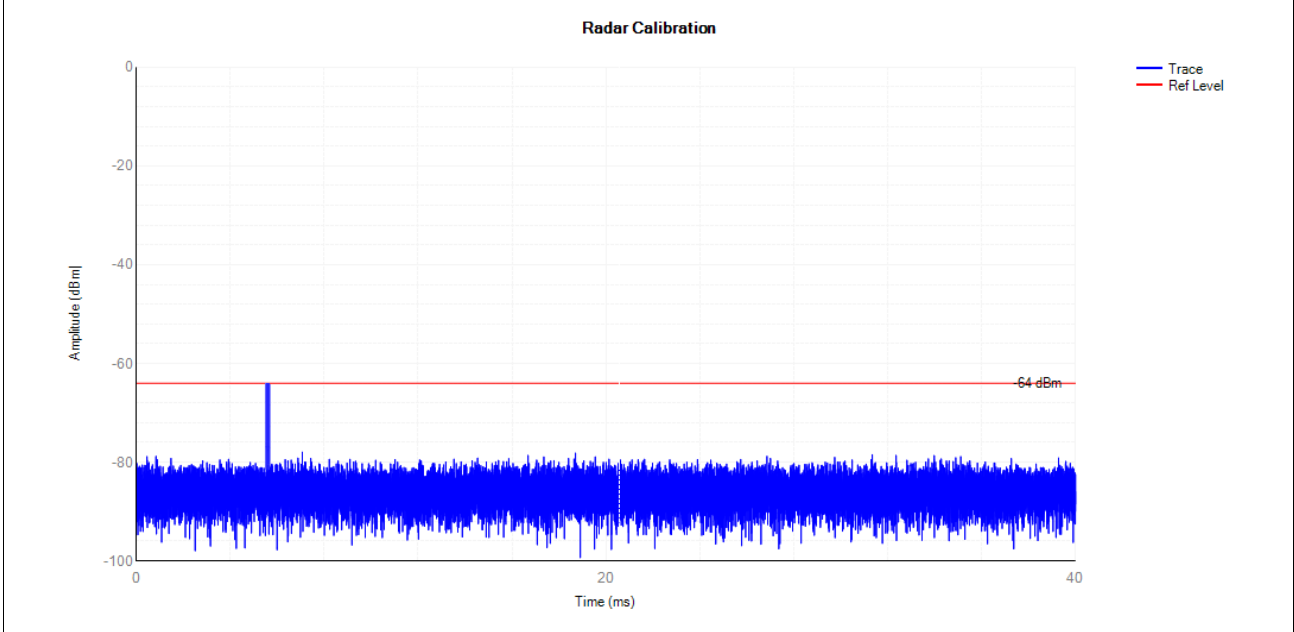

3.7 CHANNEL AVAILABILITY CHECK TIME

3.7.1 LIMIT

The EUT shall perform a Channel Availability Check to ensure that there is no radar operating on the channel. After power-up sequence, receive at least 1 minute (60 sec) on the intended operating frequency.

3.7.2 TEST PROCEDURES

For Initial Channel Availability Check Time. The EUT does not emit beacon, control, or data signals on the test Channel until the power-up sequence has been completed and the UNII device checks for Radar Waveforms for one minute on the test Channel. This test does not use any Radar Waveforms.

For Radar Burst at the Beginning of the Channel Availability Check Time. To verify successful radar detection on the selected Channel during a period equal to the Beginning of the Channel Availability Check Time.

For Radar Burst at the End of the Channel Availability Check Time. To verify successful radar detection on the selected Channel during a period equal to the End of the Channel Availability Check Time.

3.7.3 CAC INITIAL

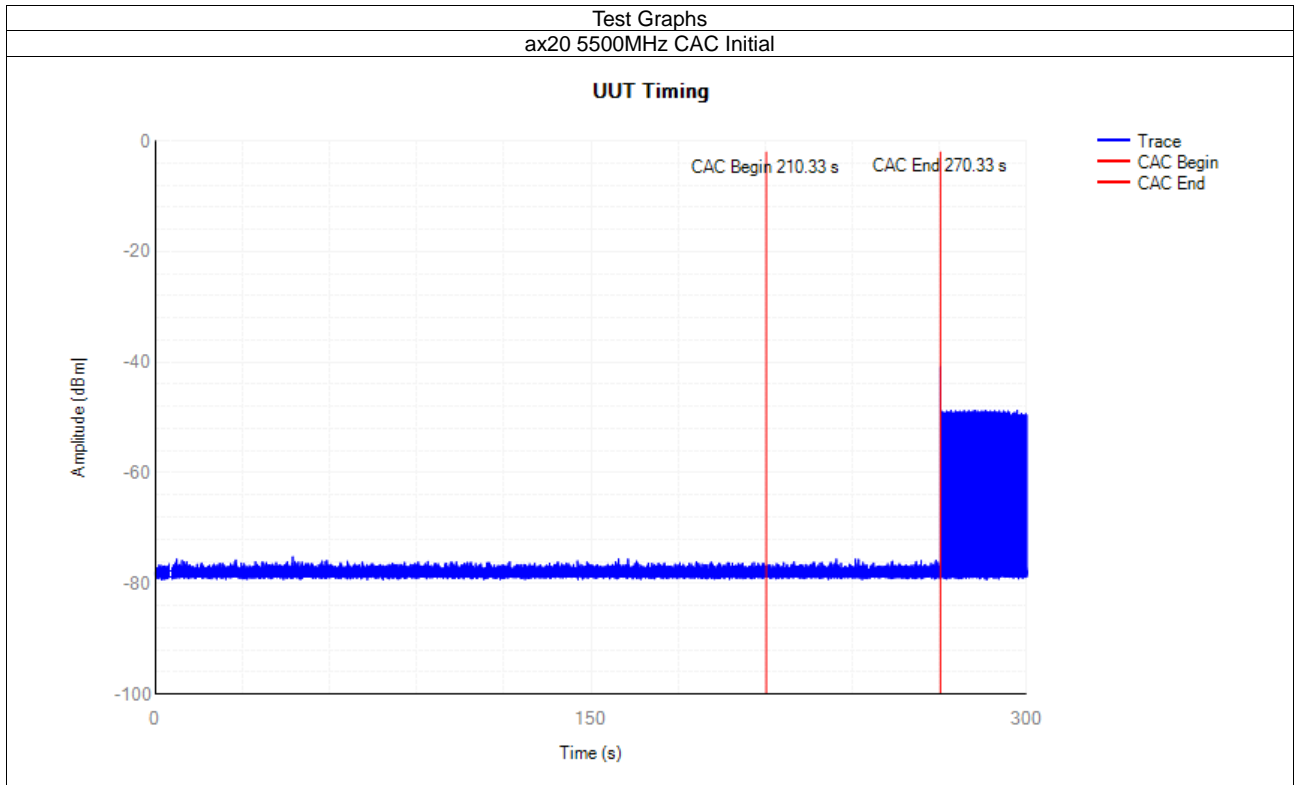

3.7.4 CAC BEGIN

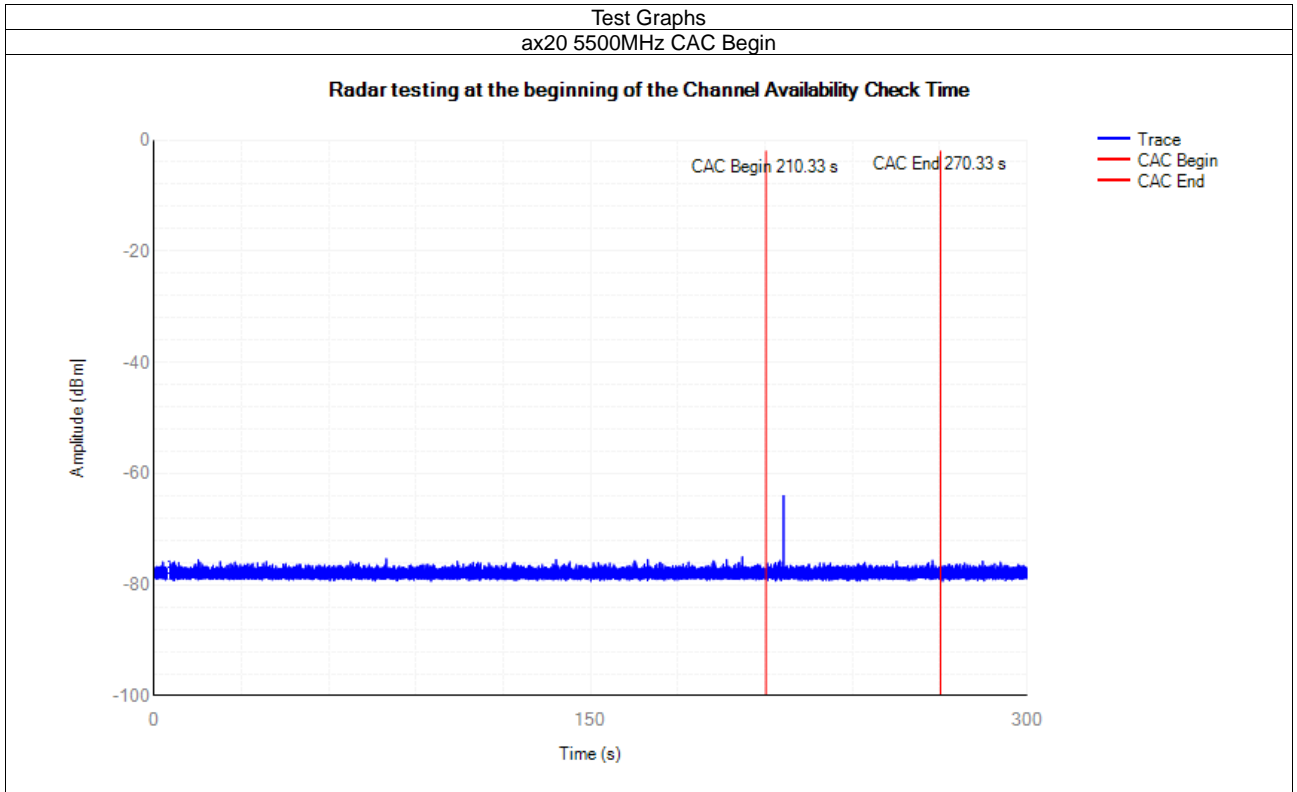

3.7.5 CAC END

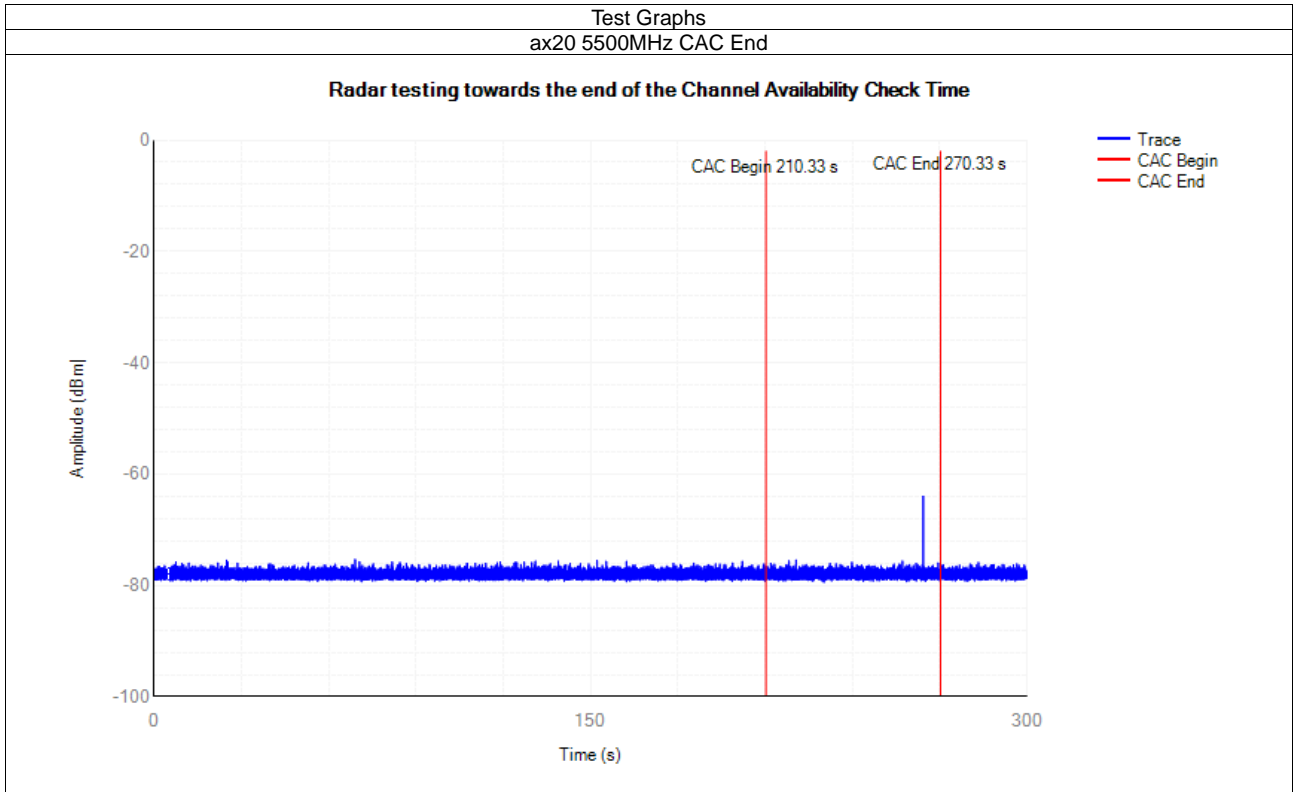

3.8 DATA TRAFFIC CHANNEL LOADING AND NOISE FLOOR PLOTS

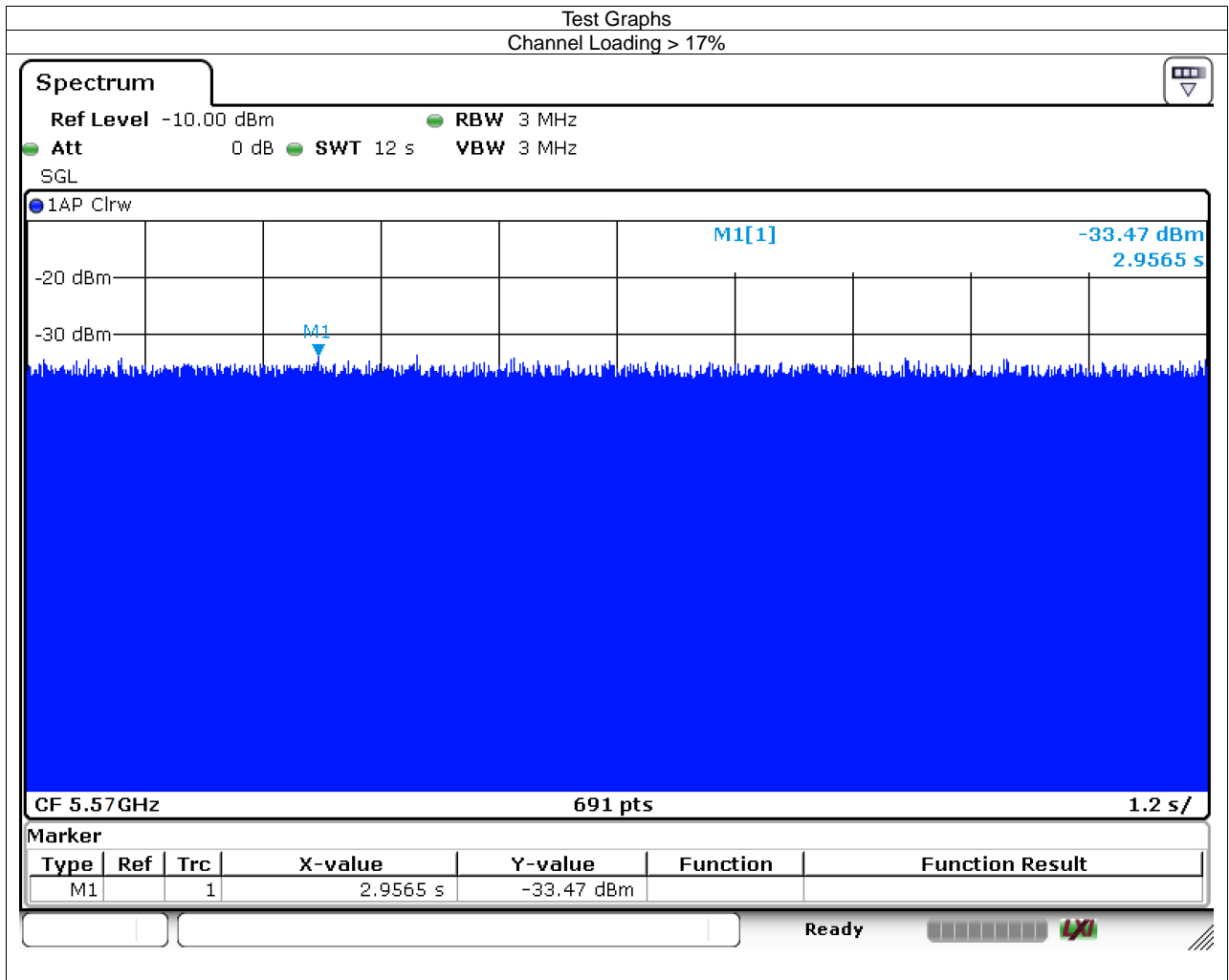

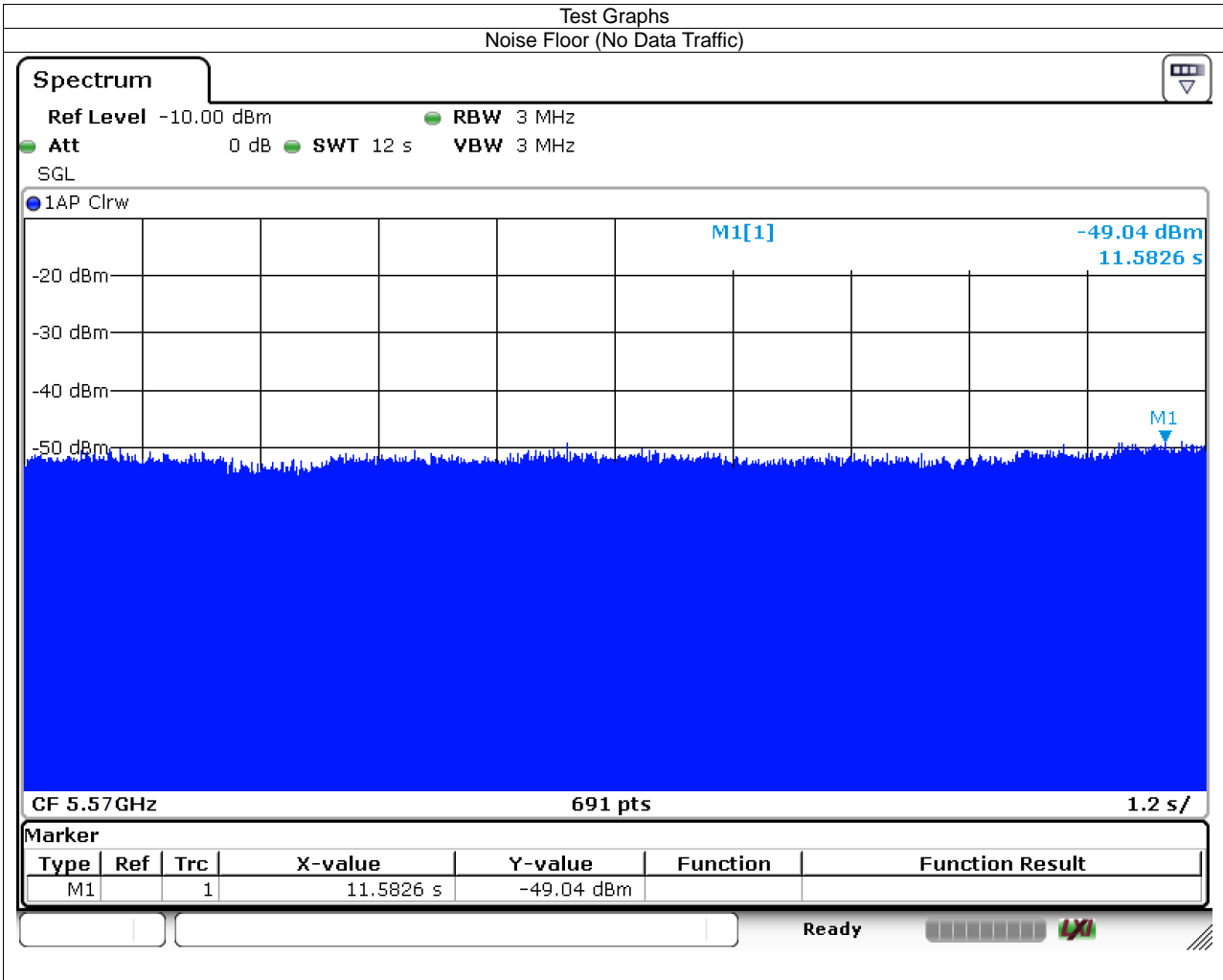

3.9 IN-SERVICE MONITORING FOR CHANNEL MOVE TIME, CHANNEL CLOSING TRANSMISSION TIME AND NON-OCCUPANCY PERIOD

3.9.1 IN-SERVICE MONITORING LIMIT

Parameter	Value
Non-occupancy period	Minimum 30 minutes
Channel Move Time	10 seconds
Channel Closing Transmission Time	200 milliseconds + an aggregate of 60 milliseconds over remaining 10 second period.

3.9.2 TEST PROCEDURES

Verified during In-Service Monitoring; Channel Closing Transmission Time, Channel Move Time. Client Device will associate with the EUT. Observe the transmissions of the EUT at the end of the radar Burst on the Operating Channel for duration greater than 10 seconds. Measure and record the transmissions from the EUT during the observation time (Channel Move Time). Compare the Channel Move Time and Channel Closing Transmission Time limits.

Verified during In-Service Monitoring; Channel Closing Transmission Time, Channel Move Time. One 12 sec plot needs to be reported for the Short Pulse Radar Types 0. And zoom-in a 60 ms plot verified channel closing time for the aggregate transmission time starting from 200ms after the end of the radar signal to the completion of the channel move.

Verified during In-Service Monitoring; Non-Occupancy Period. Client Device will associate with the EUT. Observe the transmissions of the EUT at the end of the radar Burst on the Operating Channel for duration greater than 10 seconds. Measure and record the transmissions from the EUT during the observation time (Non-Occupancy Period). Compare the Non-Occupancy Period limits.

3.9.3 CHANNEL MOVE TIME AND CHANNEL CLOSING TRANSMISSION TIME TEST RESULTS

Mode	Frequency (MHz)	Channel Move Time (s)	Limit Channel Move Time (s)	Close Transmission Time (s)	Limit Close Transmission Time (s)	Close Transmission Time after 200ms(s)	Limit Close Transmission Time after 200ms (s)	Verdict
ax160	5570	0.0873	10	0.0012	0.26	0	0.06	Pass

Test Graphs
ax160 5570MHz Shutdown

Channel Shutdown

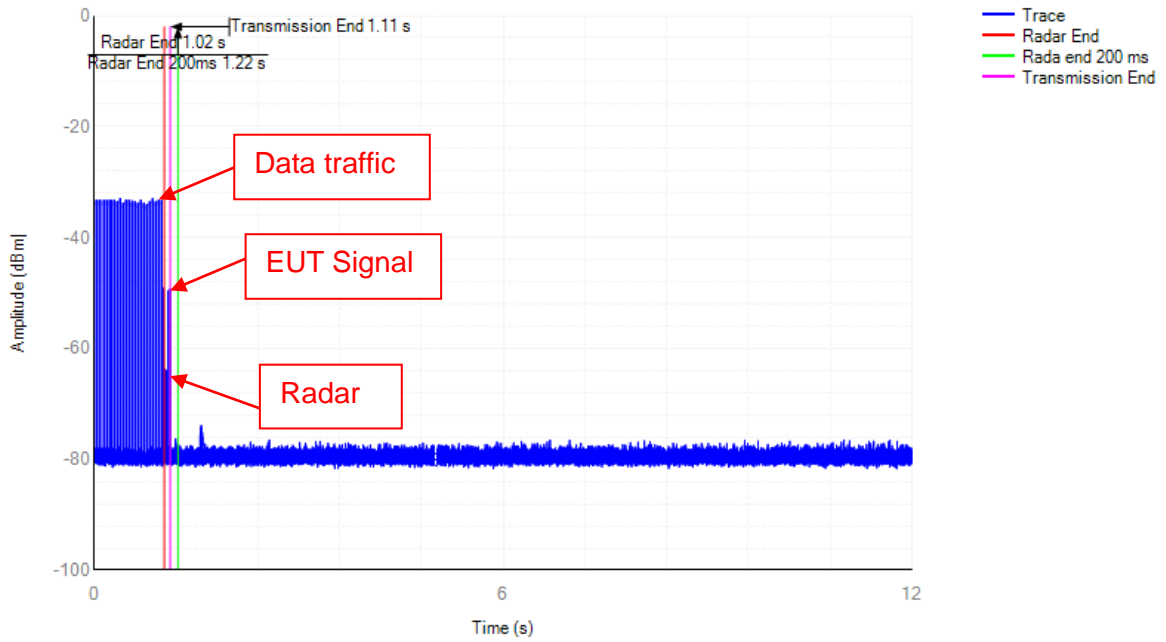

3.9.4 NON-OCCUPANCY PERIOD TEST RESULTS

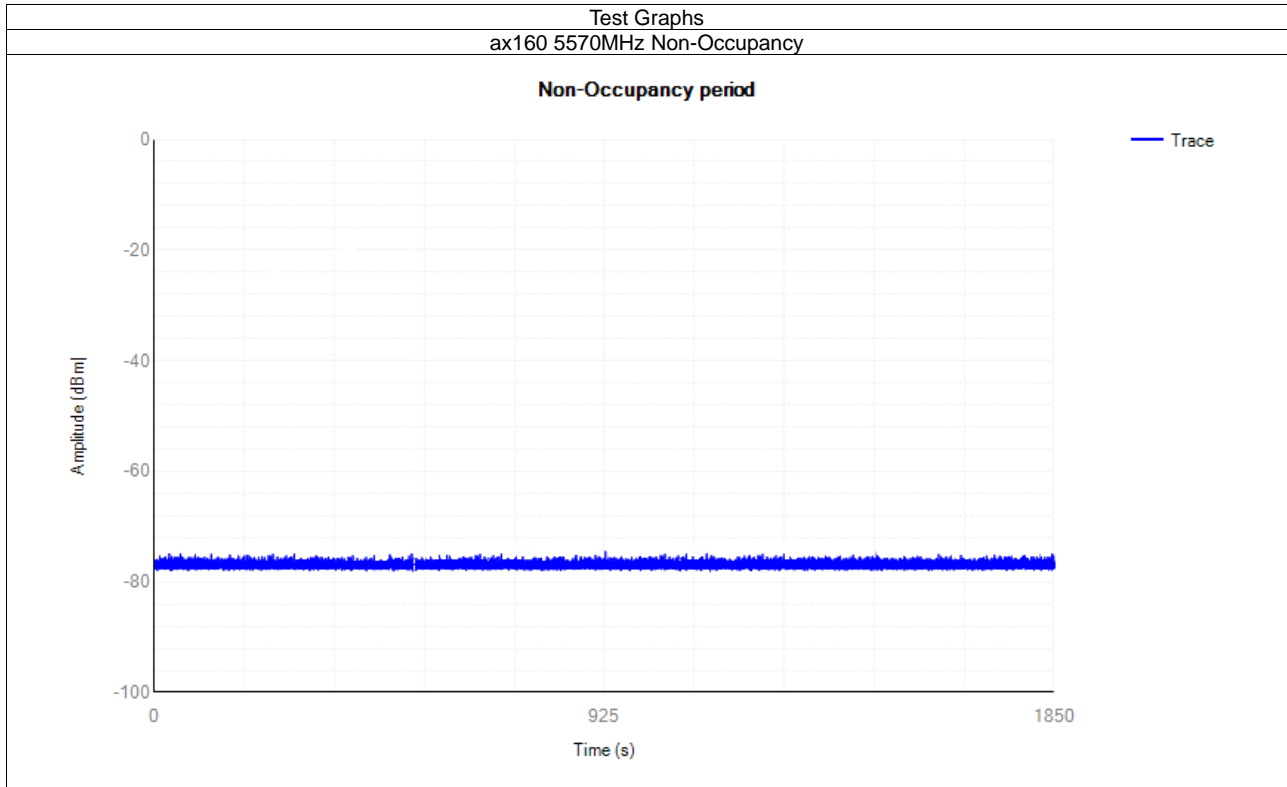

3.10 U-NII DETECTION BANDWIDTH

3.10.1 TEST PROCEDURES

During the U-NII Detection Bandwidth detection test, radar type 0 is used and for each frequency step the minimum percentage of detection is 90 percent. Measurements are performed with no data traffic. The EUT is set up as a standalone device (no associated Client and no traffic). The radar frequency is increased in 1 MHz steps, repeating the above test sequence, until the detection rate falls below 90%. The highest frequency at which detection is greater than or equal to 90% is denoted as FH. The radar frequency is decreased in 1 MHz steps, repeating the above test sequence, until the detection rate falls below 90%. The lowest frequency at which detection is greater than or equal to 90% is denoted as FL. UNII Detection Bandwidth = FH - FL.

3.10.2 TEST RESULTS

20MHz / 5500MHz														
Frequency (MHz)	Fc	Trial Number (Detection = Y, No Detection = N)										Rate (%)	F _H /F _L	
		1	2	3	4	5	6	7	8	9	10			
5489	-11	N	N	N	N	N	N	N	N	N	N	N	0	
5490	-10	Y	Y	N	Y	Y	Y	Y	Y	Y	Y	Y	90	FL
5491	-9	Y	Y	Y	Y	Y	Y	Y	Y	Y	Y	Y	100	
5492	-8	Y	Y	Y	Y	Y	Y	Y	Y	Y	Y	Y	100	
5493	-7	Y	Y	Y	Y	Y	Y	Y	Y	Y	Y	Y	100	
5494	-6	Y	Y	Y	Y	Y	Y	Y	Y	Y	Y	Y	100	
5495	-5	Y	Y	Y	Y	Y	Y	Y	Y	Y	Y	Y	100	
5500	0	Y	Y	Y	Y	Y	Y	Y	Y	Y	Y	Y	100	
5505	+5	Y	Y	Y	Y	Y	Y	Y	Y	Y	Y	Y	100	
5506	+6	Y	Y	Y	Y	Y	Y	Y	Y	Y	Y	Y	100	
5507	+7	Y	Y	Y	Y	Y	Y	Y	Y	Y	Y	Y	100	
5508	+8	Y	Y	Y	Y	Y	Y	Y	Y	Y	Y	Y	100	
5509	+9	Y	Y	Y	Y	Y	Y	Y	Y	Y	Y	Y	100	
5510	+10	Y	Y	Y	Y	Y	Y	Y	N	Y	Y	90	FH	
5511	+11	N	N	N	N	N	N	N	N	N	N	N	0	

Detection Bandwidth = F_H - FL = 5510 - 5490 = 20 MHz (Refer to channel 100)

40MHz / 5510MHz													
Frequency (MHz)	Fc	Trial Number (Detection = Y, No Detection = N)										Rate (%)	F _H /F _L
		1	2	3	4	5	6	7	8	9	10		
5489	-21	N	N	N	N	N	N	N	N	N	N	0	
5490	-20	N	N	N	N	N	N	N	N	N	N	0	
5491	-19	Y	Y	Y	N	Y	Y	Y	Y	Y	Y	90	FL
5492	-18	Y	Y	Y	Y	Y	Y	Y	Y	Y	Y	100	
5493	-17	Y	Y	Y	Y	Y	Y	Y	Y	Y	Y	100	
5494	-16	Y	Y	Y	Y	Y	Y	Y	Y	Y	Y	100	
5495	-15	Y	Y	Y	Y	Y	Y	Y	Y	Y	Y	100	
5500	-10	Y	Y	Y	Y	Y	Y	Y	Y	Y	Y	100	
5505	-5	Y	Y	Y	Y	Y	Y	Y	Y	Y	Y	100	
5510	0	Y	Y	Y	Y	Y	Y	Y	Y	Y	Y	100	
5515	+5	Y	Y	Y	Y	Y	Y	Y	Y	Y	Y	100	
5520	+10	Y	Y	Y	Y	Y	Y	Y	Y	Y	Y	100	
5525	+15	Y	Y	Y	Y	Y	Y	Y	Y	Y	Y	100	
5526	+16	Y	Y	Y	Y	Y	Y	Y	Y	Y	Y	100	
5527	+17	Y	Y	Y	Y	Y	Y	Y	Y	Y	Y	100	
5528	+18	Y	Y	Y	Y	Y	Y	Y	Y	Y	Y	100	
5529	+19	Y	Y	Y	Y	N	Y	Y	Y	Y	Y	90	FH
5530	+20	N	N	N	N	N	N	N	N	N	N	0	
5531	+21	N	N	N	N	N	N	N	N	N	N	0	

Detection Bandwidth = FH – FL = 5529 – 5491 = 38 MHz (Refer to channel 102)

80MHz / 5530MHz													
Frequency (MHz)	F _c	Trial Number (Detection = Y, No Detection = N)										Rate (%)	F _H /F _L
		1	2	3	4	5	6	7	8	9	10		
5489	-41	N	N	N	N	N	N	N	N	N	N	0	
5490	-40	N	N	N	N	N	N	N	N	N	N	0	
5491	-39	Y	Y	N	Y	Y	Y	Y	Y	Y	Y	90	FL
5492	-38	Y	Y	Y	Y	Y	Y	Y	Y	Y	Y	100	
5493	-37	Y	Y	Y	Y	Y	Y	Y	Y	Y	Y	100	
5494	-36	Y	Y	Y	Y	Y	Y	Y	Y	Y	Y	100	
5495	-35	Y	Y	Y	Y	Y	Y	Y	Y	Y	Y	100	
5500	-30	Y	Y	Y	Y	Y	Y	Y	Y	Y	Y	100	
5505	-25	Y	Y	Y	Y	Y	Y	Y	Y	Y	Y	100	
5510	-20	Y	Y	Y	Y	Y	Y	Y	Y	Y	Y	100	
5515	-15	Y	Y	Y	Y	Y	Y	Y	Y	Y	Y	100	
5520	-10	Y	Y	Y	Y	Y	Y	Y	Y	Y	Y	100	
5530	0	Y	Y	Y	Y	Y	Y	Y	Y	Y	Y	100	
5540	+10	Y	Y	Y	Y	Y	Y	Y	Y	Y	Y	100	
5545	+15	Y	Y	Y	Y	Y	Y	Y	Y	Y	Y	100	
5550	+20	Y	Y	Y	Y	Y	Y	Y	Y	Y	Y	100	
5555	+25	Y	Y	Y	Y	Y	Y	Y	Y	Y	Y	100	
5560	+30	Y	Y	Y	Y	Y	Y	Y	Y	Y	Y	100	
5565	+35	Y	Y	Y	Y	Y	Y	Y	Y	Y	Y	100	
5566	+36	Y	Y	Y	Y	Y	Y	Y	Y	Y	Y	100	
5567	+37	Y	Y	Y	Y	Y	Y	Y	Y	Y	Y	100	
5568	+38	Y	Y	Y	Y	Y	Y	Y	Y	Y	Y	100	
5569	+39	Y	Y	Y	Y	Y	Y	Y	Y	N	Y	90	FH
5570	+40	N	N	N	N	N	N	N	N	N	N	0	
5571	+41	N	N	N	N	N	N	N	N	N	N	0	

Detection Bandwidth = F_H - F_L = 5569 - 5491 = 78 MHz (Refer to channel 106)

160MHz / 5570MHz													
Frequency (MHz)	Fc	Trial Number (Detection = Y, No Detection = N)										Rate (%)	F _H /F _L
		1	2	3	4	5	6	7	8	9	10		
5489	-81	N	N	N	N	N	N	N	N	N	N	0	
5490	-80	N	N	N	N	N	N	N	N	N	N	0	
5491	-79	N	N	N	N	N	N	N	N	N	N	0	
5492	-78	Y	Y	N	Y	Y	Y	Y	Y	Y	Y	90	FL
5493	-77	Y	Y	Y	Y	Y	Y	Y	Y	Y	Y	100	
5494	-76	Y	Y	Y	Y	Y	Y	Y	Y	Y	Y	100	
5495	-75	Y	Y	Y	Y	Y	Y	Y	Y	Y	Y	100	
5500	-70	Y	Y	Y	Y	Y	Y	Y	Y	Y	Y	100	
5510	-60	Y	Y	Y	Y	Y	Y	Y	Y	Y	Y	100	
5520	-50	Y	Y	Y	Y	Y	Y	Y	Y	Y	Y	100	
5530	-40	Y	Y	Y	Y	Y	Y	Y	Y	Y	Y	100	
5540	-30	Y	Y	Y	Y	Y	Y	Y	Y	Y	Y	100	
5550	-20	Y	Y	Y	Y	Y	Y	Y	Y	Y	Y	100	
5560	-10	Y	Y	Y	Y	Y	Y	Y	Y	Y	Y	100	
5570	0	Y	Y	Y	Y	Y	Y	Y	Y	Y	Y	100	
5580	+10	Y	Y	Y	Y	Y	Y	Y	Y	Y	Y	100	
5590	+20	Y	Y	Y	Y	Y	Y	Y	Y	Y	Y	100	
5600	+30	Y	Y	Y	Y	Y	Y	Y	Y	Y	Y	100	
5610	+40	Y	Y	Y	Y	Y	Y	Y	Y	Y	Y	100	
5620	+50	Y	Y	Y	Y	Y	Y	Y	Y	Y	Y	100	
5630	+60	Y	Y	Y	Y	Y	Y	Y	Y	Y	Y	100	
5640	+70	Y	Y	Y	Y	Y	Y	Y	Y	Y	Y	100	
5645	+75	Y	Y	Y	Y	Y	Y	Y	Y	Y	Y	100	
5646	+76	Y	Y	Y	Y	Y	Y	Y	Y	Y	Y	100	
5647	+77	Y	Y	Y	Y	Y	Y	Y	Y	Y	Y	100	
5648	+78	Y	N	Y	Y	Y	Y	Y	Y	Y	Y	90	FH
5649	+79	N	N	N	N	N	N	N	N	N	N	0	
5650	+80	N	N	N	N	N	N	N	N	N	N	0	
5651	+81	N	N	N	N	N	N	N	N	N	N	0	

Detection Bandwidth = F_H - F_L = 5648 - 5492 = 156 MHz (Refer to channel 114)

3.11 STATISTICAL PERFORMANCE CHECK

3.11.1 STATISTICAL PERFORMANCE CHECK LIMIT

Radar Type	Minimum Percentage of Successful Detection (Pd)	Minimum Trials
1	60%	30
2	60%	30
3	60%	30
4	60%	30
Aggregate (Radar Types 1-4)	80%	120
5	80%	30
6	70%	30

The percentage of successful detection is calculated by:

$$\frac{\text{TotalWaveformDetections}}{\text{TotalWaveformTrails}} \times 100 = \text{Probability of Detection Radar Waveform}$$

In addition an aggregate minimum percentage of successful detection across all Short Pulse Radar Types 1-4 is required and is calculated as follows:

$$\frac{Pd1 + Pd2 + Pd3 + Pd4}{4}$$

3.11.2 TEST PROCEDURES

For Statistical Performance Check test. Observe the transmissions of the UUT at the end of the Burst on the Operating Channel for duration greater than 10 seconds for Short Pulse Radar Types 1-4 and 6 to ensure detection occurs. Then observe the transmissions of the UUT at the end of the Burst on the Operating Channel for duration greater than 22 seconds for Long Pulse Radar Type 5 to ensure detection occurs. The device can utilize a test mode to demonstrate when detection occurs to prevent the need to reset the device between trial runs.

3.11.3 U-NII-2C 20MHZ TEST RESULTS AND WAVEFORMS DETAILS

20MHz / 5500MHz						
(Detection = Y, No Detection = N)						
Trial Number	Type 1	Type 2	Type 3	Type 4	Type 5	Type 6
1	Y	Y	Y	Y	Y	Y
2	N	N	Y	Y	Y	Y
3	Y	Y	Y	Y	Y	Y
4	Y	Y	Y	N	Y	Y
5	Y	Y	N	Y	Y	Y
6	Y	Y	Y	N	Y	Y
7	Y	N	Y	Y	Y	Y
8	N	Y	Y	Y	Y	Y
9	Y	Y	N	N	N	Y
10	Y	Y	Y	Y	Y	Y
11	Y	Y	Y	Y	Y	Y
12	Y	Y	Y	N	Y	Y
13	Y	Y	Y	Y	Y	N
14	Y	Y	N	Y	Y	Y
15	Y	Y	Y	Y	Y	Y
16	Y	Y	Y	N	N	Y
17	Y	Y	Y	Y	Y	Y
18	Y	N	Y	Y	Y	Y
19	N	Y	Y	Y	Y	Y
20	Y	Y	N	N	Y	Y
21	Y	Y	Y	Y	N	Y
22	Y	Y	Y	Y	Y	Y
23	Y	Y	Y	Y	Y	Y
24	Y	Y	N	N	Y	Y
25	Y	Y	Y	Y	Y	Y
26	Y	Y	Y	Y	Y	Y
27	Y	Y	Y	Y	Y	Y
28	Y	N	N	Y	N	Y
29	N	Y	Y	N	Y	Y
30	Y	Y	Y	Y	Y	Y
Trial of Detection	26/30	26/30	24/30	22/30	26/30	29/30
Probability (%)	86.7%	86.7%	80%	73.3%	86.7%	96.7%
Limit (%)	>= 60%	>= 60%	>= 60%	>= 60%	>= 80%	>= 70%
Average Probability of Radar Type 1~4 (%)	81.7% (>=80%)					

Type 1 Short Pulse Radar Statistical Performance - Details

Trial Id	Radar Type	Pulse Width (us)	PRI (us)	Number of Pulses	Waveform Length (us)
1	Type 1	1.0	698.0	76	53048.0
2	Type 1	1.0	618.0	86	53148.0
3	Type 1	1.0	538.0	99	53262.0
4	Type 1	1.0	878.0	61	53558.0
5	Type 1	1.0	3066.0	18	55188.0
6	Type 1	1.0	638.0	83	52954.0
7	Type 1	1.0	918.0	58	53244.0
8	Type 1	1.0	838.0	63	52794.0
9	Type 1	1.0	858.0	62	53196.0
10	Type 1	1.0	798.0	67	53466.0
11	Type 1	1.0	718.0	74	53132.0
12	Type 1	1.0	578.0	92	53176.0
13	Type 1	1.0	598.0	89	53222.0
14	Type 1	1.0	558.0	95	53010.0
15	Type 1	1.0	2536.0	21	53256.0
16	Type 1	1.0	966.0	55	53130.0
17	Type 1	1.0	827.0	64	52928.0
18	Type 1	1.0	2501.0	22	55022.0
19	Type 1	1.0	2595.0	21	54495.0
20	Type 1	1.0	1114.0	48	53472.0
21	Type 1	1.0	1302.0	41	53382.0
22	Type 1	1.0	3045.0	18	54810.0
23	Type 1	1.0	1624.0	33	53592.0
24	Type 1	1.0	2878.0	19	54682.0
25	Type 1	1.0	1027.0	52	53404.0
26	Type 1	1.0	2485.0	22	54670.0
27	Type 1	1.0	1600.0	33	52800.0
28	Type 1	1.0	1172.0	46	53912.0
29	Type 1	1.0	1177.0	45	52965.0
30	Type 1	1.0	2171.0	25	54275.0

Type 2 Short Pulse Radar Statistical Performance - Details

Trial Id	Radar Type	Pulse Width (us)	PRI (us)	Number of Pulses	Waveform Length (us)
0	Type 2	3.2	179.0	26	4654.0
1	Type 2	1.1	207.0	23	4761.0
2	Type 2	2.1	230.0	24	5520.0
3	Type 2	4.8	200.0	29	5800.0
4	Type 2	3.9	214.0	28	5992.0
5	Type 2	2.9	222.0	26	5772.0
6	Type 2	3.2	204.0	26	5304.0
7	Type 2	2.5	192.0	25	4800.0
8	Type 2	3.1	164.0	26	4264.0
9	Type 2	1.2	156.0	23	3588.0
10	Type 2	3.9	210.0	27	5670.0
11	Type 2	4.6	201.0	29	5829.0
12	Type 2	3.2	162.0	26	4212.0
13	Type 2	2.2	197.0	25	4925.0
14	Type 2	4.5	163.0	29	4727.0
15	Type 2	3.0	203.0	26	5278.0
16	Type 2	5.0	168.0	29	4872.0
17	Type 2	2.4	217.0	25	5425.0
18	Type 2	2.9	191.0	26	4966.0
19	Type 2	2.3	166.0	25	4150.0
20	Type 2	3.7	150.0	27	4050.0
21	Type 2	2.2	176.0	25	4400.0
22	Type 2	4.9	195.0	29	5655.0
23	Type 2	2.9	202.0	26	5252.0
24	Type 2	2.5	178.0	25	4450.0
25	Type 2	1.1	206.0	23	4738.0
26	Type 2	3.8	155.0	27	4185.0
27	Type 2	4.7	157.0	29	4553.0
28	Type 2	2.4	224.0	25	5600.0
29	Type 2	4.2	159.0	28	4452.0
30	Type 2	3.6	175.0	27	4725.0

Type 3 Short Pulse Radar Statistical Performance - Details

Trial Id	Radar Type	Pulse Width (us)	PRI (us)	Number of Pulses	Waveform Length (us)
1	Type 3	6.1	487.0	16	7792.0
2	Type 3	7.1	344.0	16	5504.0
3	Type 3	9.8	288.0	18	5184.0
4	Type 3	8.9	230.0	18	4140.0
5	Type 3	7.9	432.0	17	7344.0
6	Type 3	8.2	207.0	17	3519.0
7	Type 3	7.5	443.0	17	7531.0
8	Type 3	8.1	439.0	17	7463.0
9	Type 3	6.2	223.0	16	3568.0
10	Type 3	8.9	208.0	18	3744.0
11	Type 3	9.6	463.0	18	8334.0
12	Type 3	8.2	441.0	17	7497.0
13	Type 3	7.2	323.0	16	5168.0
14	Type 3	9.5	297.0	18	5346.0
15	Type 3	8.0	412.0	17	7004.0
16	Type 3	10.0	324.0	18	5832.0
17	Type 3	7.4	271.0	17	4607.0
18	Type 3	7.9	349.0	17	5933.0
19	Type 3	7.3	409.0	16	6544.0
20	Type 3	8.7	373.0	18	6714.0
21	Type 3	7.2	254.0	16	4064.0
22	Type 3	9.9	274.0	18	4932.0
23	Type 3	7.9	278.0	17	4726.0
24	Type 3	7.5	317.0	17	5389.0
25	Type 3	6.1	260.0	16	4160.0
26	Type 3	8.8	211.0	18	3798.0
27	Type 3	9.7	272.0	18	4896.0
28	Type 3	7.4	264.0	17	4488.0
29	Type 3	9.2	284.0	18	5112.0
30	Type 3	8.6	474.0	17	8058.0

Type 4 Short Pulse Radar Statistical Performance - Details

Trial Id	Radar Type	Pulse Width (us)	PRI (us)	Number of Pulses	Waveform Length (us)
1	Type 4	11.3	487.0	12	5844.0
2	Type 4	13.5	344.0	13	4472.0
3	Type 4	19.4	288.0	16	4608.0
4	Type 4	17.5	230.0	15	3450.0
5	Type 4	15.3	432.0	14	6048.0
6	Type 4	15.9	207.0	14	2898.0
7	Type 4	14.3	443.0	13	5759.0
8	Type 4	15.8	439.0	14	6146.0
9	Type 4	11.5	223.0	12	2676.0
10	Type 4	17.4	208.0	15	3120.0
11	Type 4	19.0	463.0	16	7408.0
12	Type 4	16.0	441.0	14	6174.0
13	Type 4	13.8	323.0	13	4199.0
14	Type 4	18.9	297.0	16	4752.0
15	Type 4	15.5	412.0	14	5768.0
16	Type 4	19.9	324.0	16	5184.0
17	Type 4	14.1	271.0	13	3523.0
18	Type 4	15.2	349.0	14	4886.0
19	Type 4	13.8	409.0	13	5317.0
20	Type 4	17.1	373.0	15	5595.0
21	Type 4	13.8	254.0	13	3302.0
22	Type 4	19.8	274.0	16	4384.0
23	Type 4	15.3	278.0	14	3892.0
24	Type 4	14.5	317.0	13	4121.0
24	Type 4	14.5	317.0	13	4121.0
25	Type 4	11.3	260.0	12	3120.0
26	Type 4	17.3	211.0	15	3165.0
27	Type 4	19.2	272.0	16	4352.0
28	Type 4	14.2	264.0	13	3432.0
29	Type 4	18.2	284.0	15	4260.0
30	Type 4	16.8	474.0	15	7110.0

Type 5 Long Pulse Radar Statistical Performance - Details

Trial Id	Radar Type	Number of Bursts	Burst Period (s)	Waveform Length (s)	Center Frequency (GHz)			
1	Type 5	8	1.5000000	12.0000000	5.500000000			
	Burst ID	Burst Offset (us)	Pulse Width (us)	Chirp Width (MHz)	Number of Pulses per Burst	PRI-1 (us)	PRI-2 (us)	PRI-3 (us)
	0	653267.0	75.0	5	2	1766.0	1074.0	-
	1	1015342.0	99.4	5	3	1826.0	1363.0	1174.0
	2	1379673.0	67.4	5	2	1506.0	1129.0	-
	3	245381.0	73.6	5	2	1994.0	1155.0	-
	4	609211.0	65.9	5	1	1190.0	-	-
	5	970315.0	83.8	5	3	1600.0	1640.0	1656.0
	6	1335720.0	65.5	5	1	1761.0	-	-
	7	200392.0	98.6	5	3	1864.0	1409.0	1907.0
2	Type 5	11	1.0909091	12.0000000	5.500000000			
	Burst ID	Burst Offset (us)	Pulse Width (us)	Chirp Width (MHz)	Number of Pulses per Burst	PRI-1 (us)	PRI-2 (us)	PRI-3 (us)
	0	409465.0	73.8	9	2	1639.0	1970.0	-
	1	673541.0	69.5	9	2	1301.0	1709.0	-
	2	938405.0	51.9	9	1	1833.0	-	-
	3	113243.0	84.6	9	3	1346.0	1359.0	1246.0
	4	376706.0	95.4	9	3	1066.0	1801.0	1542.0
	5	640774.0	68.0	9	2	1679.0	1783.0	-
	6	903746.0	89.6	9	3	1637.0	1006.0	1743.0
	7	80813.0	81.9	9	2	1426.0	1951.0	-
	8	343904.0	88.3	9	3	1812.0	1727.0	1953.0
	9	609276.0	53.7	9	1	1695.0	-	-
	10	870628.0	91.3	9	3	1995.0	1858.0	1355.0
3	Type 5	20	0.6000000	12.0000000	5.500000000			
	Burst ID	Burst Offset (us)	Pulse Width (us)	Chirp Width (MHz)	Number of Pulses per Burst	PRI-1 (us)	PRI-2 (us)	PRI-3 (us)
	0	26552.0	68.1	19	2	1317.0	1127.0	-
	1	171871.0	58.7	19	1	1075.0	-	-
	2	316116.0	75.3	19	2	1671.0	1317.0	-
	3	461891.0	56.4	19	1	1718.0	-	-
	4	8664.0	99.7	19	3	1527.0	1631.0	1788.0
	5	153929.0	57.7	19	1	1269.0	-	-
	6	299079.0	59.5	19	1	1392.0	-	-
	7	442752.0	80.0	19	2	1491.0	1932.0	-
	8	587204.0	82.0	19	2	1934.0	1730.0	-
	9	135744.0	82.8	19	2	1467.0	1116.0	-
	10	279781.0	88.0	19	3	1108.0	1707.0	1589.0
	11	424346.0	93.2	19	3	1315.0	1373.0	1555.0
	12	569553.0	70.4	19	2	1593.0	1899.0	-
	13	117598.0	95.3	19	3	1229.0	1812.0	1052.0
	14	282325.0	81.9	19	2	1683.0	1955.0	-
	15	405781.0	98.5	19	3	1946.0	1977.0	1445.0
	16	553711.0	65.0	19	1	1353.0	-	-
	17	99809.0	85.4	19	3	1515.0	1218.0	1284.0
	18	244192.0	91.6	19	3	1576.0	1751.0	1083.0
	19	390174.0	67.3	19	2	1014.0	1047.0	-

Trial Id	Radar Type	Number of Bursts	Burst Period (s)	Waveform Length (s)	Center Frequency (GHz)				
4	Type 5	17	0.7058824	12.0000000	5.500000000				
		Burst ID	Burst Offset (us)	Pulse Width (us)	Chirp Width (MHz)	Number of Pulses per Burst	PRI-1 (us)	PRI-2 (us)	PRI-3 (us)
		0	628798.0	67.9	16	2	1997.0	1368.0	-
		1	96903.0	62.3	16	1	1616.0	-	-
		2	267849.0	53.3	16	1	1251.0	-	-
		3	437286.0	90.0	16	3	1496.0	1016.0	1081.0
		4	608043.0	77.1	16	2	1260.0	1836.0	-
		5	75592.0	83.9	16	3	1587.0	1287.0	1269.0
		6	245640.0	89.1	16	3	1040.0	1945.0	1574.0
		7	416504.0	81.8	16	2	1484.0	1774.0	-
		8	588726.0	50.3	16	1	1087.0	-	-
		9	54535.0	87.1	16	3	1908.0	1475.0	1949.0
		10	225137.0	71.3	16	2	1834.0	1325.0	-
		11	395073.0	97.5	16	3	1416.0	1046.0	1579.0
		12	565234.0	90.6	16	3	1419.0	1512.0	1182.0
		13	33645.0	86.3	16	3	1541.0	1359.0	1624.0
		14	203835.0	97.6	16	3	1575.0	1267.0	1378.0
		15	373694.0	84.7	16	3	1187.0	1979.0	1647.0
		16	543192.0	99.7	16	3	1735.0	1795.0	1972.0
5	Type 5	14	0.8571429	12.0000000	5.500000000				
		Burst ID	Burst Offset (us)	Pulse Width (us)	Chirp Width (MHz)	Number of Pulses per Burst	PRI-1 (us)	PRI-2 (us)	PRI-3 (us)
		0	15441.0	92.9	12	3	1423.0	1118.0	1358.0
		1	222649.0	67.7	12	2	1689.0	1176.0	-
		2	430620.0	65.8	12	1	1312.0	-	-
		3	637993.0	56.3	12	1	1571.0	-	-
		4	845422.0	53.7	12	1	1646.0	-	-
		5	196574.0	83.5	12	3	1802.0	1804.0	1663.0
		6	405116.0	65.8	12	1	1177.0	-	-
		7	610836.0	85.9	12	3	1540.0	1100.0	1162.0
		8	819293.0	76.3	12	2	1043.0	1199.0	-
		9	171555.0	81.5	12	2	1205.0	1918.0	-
		10	378184.0	89.4	12	3	1599.0	1571.0	1077.0
		11	587063.0	63.4	12	1	1295.0	-	-
		12	793149.0	69.6	12	2	1228.0	1665.0	-
		13	145983.0	74.5	12	2	1695.0	1775.0	-

Trial Id	Radar Type	Number of Bursts	Burst Period (s)	Waveform Length (s)	Center Frequency (GHz)			
6	Type 5	15	0.8000000	12.0000000	5.500000000			
	Burst ID	Burst Offset (us)	Pulse Width (us)	Chirp Width (MHz)	Number of Pulses per Burst	PRI-1 (us)	PRI-2 (us)	PRI-3 (us)
	0	328985.0	96.6	13	3	1567.0	1387.0	1506.0
	1	522498.0	96.7	13	3	1127.0	1354.0	1112.0
	2	714615.0	86.5	13	3	1505.0	1526.0	1715.0
	3	112383.0	73.3	13	2	1968.0	1729.0	-
	4	306212.0	55.8	13	1	1872.0	-	-
	5	500163.0	55.4	13	1	1266.0	-	-
	6	690552.0	85.3	13	3	1849.0	1867.0	1382.0
	7	88623.0	79.4	13	2	1739.0	1698.0	-
	8	282519.0	65.7	13	1	1447.0	-	-
	9	475743.0	68.6	13	2	1034.0	1167.0	-
	10	669102.0	77.7	13	2	1216.0	1143.0	-
	11	64844.0	79.6	13	2	1779.0	1441.0	-
	12	257701.0	94.9	13	3	1818.0	1196.0	1400.0
	13	452394.0	61.4	13	1	1345.0	-	-
	14	643963.0	90.6	13	3	1825.0	1130.0	1024.0
7	Type 5	12	1.0000000	12.0000000	5.500000000			
	Burst ID	Burst Offset (us)	Pulse Width (us)	Chirp Width (MHz)	Number of Pulses per Burst	PRI-1 (us)	PRI-2 (us)	PRI-3 (us)
	0	51432.0	52.6	10	1	1482.0	-	-
	1	292922.0	84.1	10	3	1539.0	1004.0	1258.0
	2	534275.0	97.7	10	3	1295.0	1677.0	1308.0
	3	776241.0	97.3	10	3	1064.0	1035.0	1575.0
	4	21547.0	98.8	10	3	1449.0	1076.0	1472.0
	5	263377.0	72.2	10	2	1334.0	1651.0	-
	6	504945.0	67.6	10	2	1752.0	1705.0	-
	7	746790.0	75.7	10	2	1696.0	1558.0	-
	8	990242.0	60.9	10	1	1531.0	-	-
	9	234006.0	64.2	10	1	1218.0	-	-
	10	475264.0	78.8	10	2	1661.0	1608.0	-
	11	716245.0	87.5	10	3	1351.0	1243.0	1728.0
8	Type 5	14	0.8571429	12.0000000	5.500000000			
	Burst ID	Burst Offset (us)	Pulse Width (us)	Chirp Width (MHz)	Number of Pulses per Burst	PRI-1 (us)	PRI-2 (us)	PRI-3 (us)
	0	822851.0	54.1	13	1	1687.0	-	-
	1	174900.0	50.7	13	1	1538.0	-	-
	2	382242.0	52.3	13	1	1917.0	-	-
	3	588103.0	99.8	13	3	1104.0	1181.0	1891.0
	4	795565.0	68.4	13	2	1838.0	1705.0	-
	5	149063.0	80.8	13	2	1390.0	1729.0	-
	6	356723.0	62.5	13	1	1844.0	-	-
	7	563598.0	74.8	13	2	1609.0	1087.0	-
	8	772302.0	50.8	13	1	1062.0	-	-
	9	123800.0	54.0	13	1	1389.0	-	-
	10	331350.0	63.0	13	1	1382.0	-	-
	11	536393.0	91.8	13	3	2000.0	1593.0	1768.0
	12	745583.0	79.3	13	2	1067.0	1307.0	-
	13	98268.0	64.3	13	1	1107.0	-	-

Trial Id	Radar Type	Number of Bursts	Burst Period (s)	Waveform Length (s)	Center Frequency (GHz)			
9	Type 5	8	1.5000000	12.0000000	5.500000000			
	Burst ID	Burst Offset (us)	Pulse Width (us)	Chirp Width (MHz)	Number of Pulses per Burst	PRI-1 (us)	PRI-2 (us)	PRI-3 (us)
	0	535571.0	63.4	6	1	1166.0	-	-
	1	898917.0	52.0	6	1	1446.0	-	-
	2	1259697.0	97.2	6	3	1696.0	1650.0	1267.0
	3	127089.0	78.7	6	2	1600.0	1807.0	-
	4	489947.0	74.2	6	2	1822.0	1933.0	-
	5	852558.0	88.7	6	3	1655.0	1015.0	1568.0
	6	1217152.0	54.3	6	1	1991.0	-	-
	7	82300.0	95.4	6	3	1772.0	1149.0	1932.0
10	Type 5	17	0.7058824	12.0000000	5.496400000			
	Burst ID	Burst Offset (us)	Pulse Width (us)	Chirp Width (MHz)	Number of Pulses per Burst	PRI-1 (us)	PRI-2 (us)	PRI-3 (us)
	0	209176.0	73.7	16	2	1394.0	1559.0	-
	1	378577.0	97.4	16	3	1240.0	1768.0	1946.0
	2	548594.0	91.7	16	3	1924.0	1909.0	1096.0
	3	17727.0	66.2	16	1	1609.0	-	-
	4	188261.0	70.8	16	2	1495.0	1142.0	-
	5	359227.0	52.3	16	1	1838.0	-	-
	6	529350.0	78.9	16	2	1662.0	1014.0	-
	7	699817.0	70.9	16	2	1584.0	1175.0	-
	8	167165.0	75.6	16	2	1421.0	1580.0	-
	9	338419.0	59.1	16	1	1371.0	-	-
	10	508194.0	77.0	16	2	1471.0	1410.0	-
	11	678428.0	67.9	16	2	1532.0	1624.0	-
	12	146139.0	81.2	16	2	1237.0	1899.0	-
	13	316473.0	78.7	16	2	1570.0	1797.0	-
	14	488365.0	63.3	16	1	1188.0	-	-
	15	657474.0	68.9	16	2	1593.0	1521.0	-
	16	125512.0	59.3	16	1	1072.0	-	-
11	Type 5	19	0.6315789	12.0000000	5.497600000			
	Burst ID	Burst Offset (us)	Pulse Width (us)	Chirp Width (MHz)	Number of Pulses per Burst	PRI-1 (us)	PRI-2 (us)	PRI-3 (us)
	0	264001.0	98.9	19	3	1619.0	1232.0	1068.0
	1	417231.0	82.3	19	2	1198.0	1209.0	-
	2	567901.0	86.7	19	3	1828.0	1541.0	1162.0
	3	92954.0	89.7	19	3	1243.0	1538.0	1600.0
	4	245112.0	98.6	19	3	1040.0	1773.0	1458.0
	5	397977.0	71.1	19	2	1971.0	1159.0	-
	6	551457.0	55.9	19	1	1918.0	-	-
	7	74391.0	67.9	19	2	1071.0	1841.0	-
	8	226484.0	84.4	19	3	1147.0	1411.0	1401.0
	9	380077.0	58.8	19	1	1680.0	-	-
	10	532981.0	65.6	19	1	1522.0	-	-
	11	55531.0	78.5	19	2	1864.0	1937.0	-
	12	208094.0	82.3	19	2	1003.0	1870.0	-
	13	359800.0	90.1	19	3	1376.0	1127.0	1721.0
	14	512124.0	90.2	19	3	1504.0	1088.0	1423.0
	15	36816.0	83.1	19	2	1524.0	1605.0	-
	16	189697.0	58.8	19	1	1594.0	-	-
	17	341619.0	77.0	19	2	1818.0	1374.0	-
	18	495472.0	55.0	19	1	1349.0	-	-

Trial Id	Radar Type	Number of Bursts	Burst Period (s)	Waveform Length (s)	Center Frequency (GHz)			
12	Type 5	15	0.8000000	12.0000000	5.495200000			
	Burst ID	Burst Offset (us)	Pulse Width (us)	Chirp Width (MHz)	Number of Pulses per Burst	PRI-1 (us)	PRI-2 (us)	PRI-3 (us)
	0	22912.0	58.1	13	1	1881.0	-	-
	1	216607.0	52.1	13	1	1417.0	-	-
	2	410438.0	59.9	13	1	1127.0	-	-
	3	603580.0	60.2	13	1	1934.0	-	-
	4	793918.0	95.9	13	3	1812.0	1491.0	1852.0
	5	192196.0	79.9	13	2	1781.0	1930.0	-
	6	385525.0	78.5	13	2	1410.0	1880.0	-
	7	580331.0	53.8	13	1	1116.0	-	-
	8	773468.0	64.7	13	1	1754.0	-	-
	9	168902.0	61.4	13	1	1373.0	-	-
	10	361910.0	83.2	13	2	1662.0	1218.0	-
	11	554151.0	84.7	13	3	1554.0	1548.0	1336.0
	12	746788.0	88.7	13	3	1274.0	1825.0	1672.0
	13	144765.0	78.3	13	2	1788.0	1116.0	-
	14	338082.0	69.3	13	2	1819.0	1095.0	-
13	Type 5	12	1.0000000	12.0000000	5.494000000			
	Burst ID	Burst Offset (us)	Pulse Width (us)	Chirp Width (MHz)	Number of Pulses per Burst	PRI-1 (us)	PRI-2 (us)	PRI-3 (us)
	0	664476.0	75.3	10	2	1954.0	1350.0	-
	1	907451.0	56.3	10	1	1935.0	-	-
	2	151297.0	67.7	10	2	1366.0	1567.0	-
	3	393839.0	55.6	10	1	1100.0	-	-
	4	634772.0	75.2	10	2	1699.0	1492.0	-
	5	876467.0	76.3	10	2	1267.0	1996.0	-
	6	121291.0	85.7	10	3	1273.0	1747.0	1712.0
	7	363058.0	98.4	10	3	1372.0	1084.0	1224.0
	8	603800.0	86.4	10	3	1942.0	1967.0	1248.0
	9	845154.0	93.6	10	3	1604.0	1751.0	1716.0
	10	91831.0	63.3	10	1	1762.0	-	-
	11	333386.0	92.4	10	3	1306.0	1050.0	1046.0

Trial Id	Radar Type	Number of Bursts	Burst Period (s)	Waveform Length (s)	Center Frequency (GHz)				
14	Type 5	19	0.6315789	12.0000000	5.497200000				
		Burst ID	Burst Offset (us)	Pulse Width (us)	Chirp Width (MHz)	Number of Pulses per Burst	PRI-1 (us)	PRI-2 (us)	PRI-3 (us)
		0	362087.0	93.3	18	3	1482.0	1099.0	1525.0
		1	515307.0	69.1	18	2	1209.0	1630.0	-
		2	38994.0	86.9	18	3	1010.0	1114.0	1716.0
		3	190922.0	84.9	18	3	1539.0	1502.0	1847.0
		4	343724.0	72.3	18	2	1563.0	1845.0	-
		5	497361.0	51.7	18	1	1780.0	-	-
		6	20319.0	58.3	18	1	1419.0	-	-
		7	173196.0	60.8	18	1	1262.0	-	-
		8	326148.0	57.1	18	1	1106.0	-	-
		9	475778.0	88.9	18	3	1668.0	1946.0	1808.0
		10	1488.0	72.0	18	2	1837.0	1965.0	-
		11	153567.0	90.9	18	3	1190.0	1601.0	1731.0
		12	306964.0	59.8	18	1	1822.0	-	-
		13	458779.0	70.0	18	2	1870.0	1214.0	-
		14	611697.0	67.2	18	2	1345.0	1237.0	-
		15	134832.0	91.2	18	3	1589.0	1629.0	1315.0
		16	288289.0	56.5	18	1	1520.0	-	-
		17	441028.0	51.2	18	1	1620.0	-	-
		18	591978.0	74.1	18	2	1599.0	1968.0	-
15	Type 5	14	0.8571429	12.0000000	5.494800000				
		Burst ID	Burst Offset (us)	Pulse Width (us)	Chirp Width (MHz)	Number of Pulses per Burst	PRI-1 (us)	PRI-2 (us)	PRI-3 (us)
		0	158254.0	76.9	12	2	1058.0	1366.0	-
		1	366047.0	50.2	12	1	1262.0	-	-
		2	573377.0	62.9	12	1	1632.0	-	-
		3	780532.0	64.7	12	1	1997.0	-	-
		4	132351.0	83.8	12	3	1835.0	1584.0	1378.0
		5	340432.0	65.4	12	1	1378.0	-	-
		6	548146.0	53.2	12	1	1122.0	-	-
		7	755450.0	51.7	12	1	1470.0	-	-
		8	107154.0	78.7	12	2	1184.0	1489.0	-
		9	314379.0	72.4	12	2	1610.0	1094.0	-
		10	522427.0	53.8	12	1	1361.0	-	-
		11	729049.0	73.6	12	2	1243.0	1210.0	-
		12	81555.0	66.7	12	2	1518.0	1911.0	-
		13	288616.0	82.5	12	2	1925.0	1479.0	-

Trial Id	Radar Type	Number of Bursts	Burst Period (s)	Waveform Length (s)	Center Frequency (GHz)			
16	Type 5	20	0.6000000	12.0000000	5.498000000			
	Burst ID	Burst Offset (us)	Pulse Width (us)	Chirp Width (MHz)	Number of Pulses per Burst	PRI-1 (us)	PRI-2 (us)	PRI-3 (us)
	0	345538.0	87.6	20	3	1809.0	1142.0	1902.0
	1	490101.0	85.2	20	3	1370.0	1301.0	1914.0
	2	39145.0	84.8	20	3	1217.0	1247.0	1324.0
	3	183993.0	77.9	20	2	1160.0	1822.0	-
	4	329141.0	76.5	20	2	1295.0	1048.0	-
	5	474918.0	60.9	20	1	1301.0	-	-
	6	21367.0	83.0	20	2	1684.0	1175.0	-
	7	166161.0	80.4	20	2	1841.0	1130.0	-
	8	311033.0	67.5	20	2	1607.0	1223.0	-
	9	456993.0	62.1	20	1	1352.0	-	-
	10	3520.0	86.4	20	3	1700.0	1399.0	1030.0
	11	147826.0	84.3	20	3	1858.0	1628.0	1494.0
	12	293433.0	76.9	20	2	1268.0	1072.0	-
	13	437093.0	95.8	20	3	1310.0	1101.0	1689.0
	14	584602.0	55.2	20	1	1043.0	-	-
	15	130793.0	59.0	20	1	1580.0	-	-
	16	274624.0	94.5	20	3	1558.0	1119.0	1732.0
	17	418777.0	91.9	20	3	1627.0	1533.0	1671.0
	18	563823.0	85.2	20	3	1161.0	1131.0	1800.0
	19	112710.0	69.5	20	2	1309.0	1364.0	-
17	Type 5	12	1.0000000	12.0000000	5.494000000			
	Burst ID	Burst Offset (us)	Pulse Width (us)	Chirp Width (MHz)	Number of Pulses per Burst	PRI-1 (us)	PRI-2 (us)	PRI-3 (us)
	0	429259.0	86.4	10	3	1194.0	1562.0	1794.0
	1	670979.0	92.2	10	3	1679.0	1068.0	1370.0
	2	913818.0	80.4	10	2	1387.0	1304.0	-
	3	158545.0	54.3	10	1	1702.0	-	-
	4	400895.0	53.1	10	1	1126.0	-	-
	5	642041.0	69.4	10	2	1109.0	1744.0	-
	6	883409.0	69.1	10	2	1871.0	1514.0	-
	7	128290.0	100.0	10	3	1674.0	1420.0	1951.0
	8	370659.0	79.6	10	2	1175.0	1014.0	-
	9	611891.0	88.4	10	3	1058.0	1132.0	1252.0
	10	855277.0	53.3	10	1	1469.0	-	-
	11	98894.0	65.3	10	1	1745.0	-	-

Trial Id	Radar Type	Number of Bursts	Burst Period (s)	Waveform Length (s)	Center Frequency (GHz)			
18	Type 5	14	0.8571429	12.0000000	5.494800000			
	Burst ID	Burst Offset (us)	Pulse Width (us)	Chirp Width (MHz)	Number of Pulses per Burst	PRI-1 (us)	PRI-2 (us)	PRI-3 (us)
	0	292264.0	55.3	12	1	1564.0	-	-
	1	499839.0	58.3	12	1	1444.0	-	-
	2	706241.0	72.3	12	2	1214.0	1599.0	-
	3	59016.0	84.8	12	3	1938.0	1061.0	1221.0
	4	266259.0	82.5	12	2	1902.0	1090.0	-
	5	474152.0	63.3	12	1	1667.0	-	-
	6	680785.0	80.0	12	2	1664.0	1066.0	-
	7	33532.0	90.3	12	3	1701.0	1591.0	1004.0
	8	240164.0	91.1	12	3	1941.0	1715.0	1385.0
	9	447244.0	96.6	12	3	1343.0	1453.0	1448.0
	10	654869.0	82.7	12	2	1376.0	1863.0	-
	11	8084.0	50.7	12	1	1112.0	-	-
	12	215195.0	78.4	12	2	1860.0	1251.0	-
	13	421414.0	99.5	12	3	1211.0	1957.0	1785.0
19	Type 5	12	1.0000000	12.0000000	5.494000000			
	Burst ID	Burst Offset (us)	Pulse Width (us)	Chirp Width (MHz)	Number of Pulses per Burst	PRI-1 (us)	PRI-2 (us)	PRI-3 (us)
	0	733776.0	88.6	10	3	1250.0	1232.0	1944.0
	1	978500.0	57.4	10	1	1092.0	-	-
	2	221259.0	96.6	10	3	1049.0	1114.0	1625.0
	3	463263.0	69.7	10	2	1156.0	1790.0	-
	4	705037.0	77.9	10	2	1367.0	1640.0	-
	5	947884.0	62.0	10	1	1907.0	-	-
	6	191445.0	88.4	10	3	1209.0	1654.0	1204.0
	7	432506.0	97.3	10	3	1852.0	1608.0	1720.0
	8	674848.0	96.2	10	3	1360.0	1171.0	1074.0
	9	915221.0	95.4	10	3	1344.0	1748.0	1910.0
	10	162187.0	54.8	10	1	1015.0	-	-
	11	403878.0	80.4	10	2	1296.0	1188.0	-

Trial Id	Radar Type	Number of Bursts	Burst Period (s)	Waveform Length (s)	Center Frequency (GHz)				
20	Type 5	16	0.7500000	12.0000000	5.504000000				
		Burst ID	Burst Offset (us)	Pulse Width (us)	Chirp Width (MHz)	Number of Pulses per Burst	PRI-1 (us)	PRI-2 (us)	PRI-3 (us)
		0	483824.0	74.7	15	2	1583.0	1101.0	-
		1	665910.0	57.1	15	1	1741.0	-	-
		2	98722.0	91.9	15	3	1686.0	1852.0	1265.0
		3	280148.0	83.1	15	2	1116.0	1841.0	-
		4	462269.0	50.7	15	1	1435.0	-	-
		5	641874.0	79.2	15	2	1722.0	1975.0	-
		6	76783.0	58.7	15	1	1652.0	-	-
		7	257866.0	71.0	15	2	1476.0	1380.0	-
		8	438568.0	79.0	15	2	1785.0	1927.0	-
		9	620389.0	68.5	15	2	1017.0	1704.0	-
		10	54344.0	73.5	15	2	1548.0	1239.0	-
		11	235380.0	70.5	15	2	1723.0	1658.0	-
		12	416942.0	76.6	15	2	1262.0	1252.0	-
		13	597534.0	81.2	15	2	1532.0	1852.0	-
		14	32065.0	61.8	15	1	1786.0	-	-
		15	212584.0	94.9	15	3	1710.0	1907.0	1485.0
21	Type 5	12	1.0000000	12.0000000	5.506400000				
		Burst ID	Burst Offset (us)	Pulse Width (us)	Chirp Width (MHz)	Number of Pulses per Burst	PRI-1 (us)	PRI-2 (us)	PRI-3 (us)
		0	526804.0	78.5	9	2	1033.0	1077.0	-
		1	766810.0	89.8	9	3	1754.0	1928.0	1041.0
		2	12967.0	59.4	9	1	1054.0	-	-
		3	254814.0	79.6	9	2	1048.0	1683.0	-
		4	496335.0	76.0	9	2	1789.0	1641.0	-
		5	739766.0	53.6	9	1	1092.0	-	-
		6	979583.0	80.9	9	2	1815.0	1770.0	-
		7	225383.0	61.6	9	1	1130.0	-	-
		8	467404.0	53.4	9	1	1634.0	-	-
		9	709942.0	59.9	9	1	1068.0	-	-
		10	951435.0	60.4	9	1	1885.0	-	-
		11	194882.0	91.4	9	3	1792.0	1291.0	1419.0

Trial Id	Radar Type	Number of Bursts	Burst Period (s)	Waveform Length (s)	Center Frequency (GHz)			
22	Type 5	20	0.6000000	12.0000000	5.502000000			
	Burst ID	Burst Offset (us)	Pulse Width (us)	Chirp Width (MHz)	Number of Pulses per Burst	PRI-1 (us)	PRI-2 (us)	PRI-3 (us)
	0	261690.0	77.0	20	2	1730.0	1206.0	-
	1	407496.0	58.1	20	1	1468.0	-	-
	2	553039.0	62.1	20	1	1057.0	-	-
	3	98971.0	76.9	20	2	1466.0	1926.0	-
	4	243693.0	80.0	20	2	1841.0	1488.0	-
	5	389821.0	52.0	20	1	1153.0	-	-
	6	531723.0	88.6	20	3	2000.0	1481.0	1407.0
	7	81080.0	72.9	20	2	1935.0	1952.0	-
	8	225051.0	98.5	20	3	1689.0	1898.0	1899.0
	9	371684.0	57.9	20	1	1550.0	-	-
	10	513892.0	95.9	20	3	1339.0	1731.0	1878.0
	11	63543.0	53.5	20	1	1336.0	-	-
	12	207470.0	92.0	20	3	1916.0	1909.0	1146.0
	13	353593.0	57.3	20	1	1910.0	-	-
	14	497722.0	70.5	20	2	1889.0	1132.0	-
	15	45525.0	70.0	20	2	1619.0	1464.0	-
	16	189563.0	84.0	20	3	1968.0	1995.0	1419.0
	17	334977.0	76.1	20	2	1488.0	1756.0	-
	18	478188.0	93.2	20	3	1828.0	1610.0	1697.0
	19	27659.0	96.8	20	3	1462.0	1116.0	1215.0
23	Type 5	14	0.8571429	12.0000000	5.505200000			
	Burst ID	Burst Offset (us)	Pulse Width (us)	Chirp Width (MHz)	Number of Pulses per Burst	PRI-1 (us)	PRI-2 (us)	PRI-3 (us)
	0	247197.0	50.1	12	1	1562.0	-	-
	1	453153.0	93.5	12	3	1529.0	1790.0	1159.0
	2	660655.0	68.8	12	2	1687.0	1881.0	-
	3	14128.0	56.3	12	1	1820.0	-	-
	4	220915.0	86.0	12	3	1442.0	1738.0	1170.0
	5	428528.0	75.2	12	2	1335.0	1453.0	-
	6	636648.0	54.4	12	1	1562.0	-	-
	7	842797.0	71.1	12	2	1542.0	1394.0	-
	8	195782.0	76.2	12	2	1291.0	1561.0	-
	9	402683.0	80.2	12	2	1912.0	1557.0	-
	10	610243.0	79.7	12	2	1037.0	1708.0	-
	11	815892.0	90.9	12	3	1871.0	1691.0	1032.0
	12	170136.0	68.7	12	2	1488.0	1990.0	-
	13	377546.0	67.4	12	2	1446.0	1195.0	-

Trial Id	Radar Type	Number of Bursts	Burst Period (s)	Waveform Length (s)	Center Frequency (GHz)			
24	Type 5	13	0.9230769	12.0000000	5.505600000			
	Burst ID	Burst Offset (us)	Pulse Width (us)	Chirp Width (MHz)	Number of Pulses per Burst	PRI-1 (us)	PRI-2 (us)	PRI-3 (us)
	0	828743.0	94.0	11	3	1862.0	1287.0	1201.0
	1	853454.0	70.8	11	2	1088.0	1222.0	-
	2	156136.0	56.3	11	1	1516.0	-	-
	3	378517.0	96.7	11	3	1316.0	1809.0	1126.0
	4	601369.0	90.6	11	3	1749.0	1461.0	1029.0
	5	825544.0	74.5	11	2	1068.0	1691.0	-
	6	126146.0	92.6	11	3	1862.0	1293.0	1633.0
	7	350649.0	89.0	11	3	1541.0	1858.0	1948.0
	8	574102.0	96.5	11	3	1361.0	1536.0	1049.0
	9	797240.0	70.5	11	2	1787.0	1906.0	-
	10	100771.0	94.0	11	3	1079.0	1508.0	1692.0
	11	324468.0	55.8	11	1	1840.0	-	-
	12	545941.0	87.7	11	3	1757.0	1673.0	1698.0
25	Type 5	8	1.5000000	12.0000000	5.508000000			
	Burst ID	Burst Offset (us)	Pulse Width (us)	Chirp Width (MHz)	Number of Pulses per Burst	PRI-1 (us)	PRI-2 (us)	PRI-3 (us)
	0	1253346.0	68.6	5	2	1434.0	1625.0	-
	1	119462.0	83.1	5	2	1582.0	1450.0	-
	2	482866.0	60.9	5	1	1970.0	-	-
	3	845899.0	77.7	5	2	1246.0	1231.0	-
	4	1209262.0	77.4	5	2	1046.0	1225.0	-
	5	74755.0	66.8	5	2	1587.0	1165.0	-
	6	438159.0	63.7	5	1	1813.0	-	-
	7	799839.0	91.2	5	3	1451.0	1528.0	1970.0

Trial Id	Radar Type	Number of Bursts	Burst Period (s)	Waveform Length (s)	Center Frequency (GHz)				
26	Type 5	17	0.7058824	12.0000000	5.503600000				
		Burst ID	Burst Offset (us)	Pulse Width (us)	Chirp Width (MHz)	Number of Pulses per Burst	PRI-1 (us)	PRI-2 (us)	PRI-3 (us)
		0	545416.0	83.6	16	3	1017.0	1990.0	1397.0
		1	14066.0	89.4	16	3	1401.0	1948.0	1131.0
		2	184961.0	55.8	16	1	1500.0	-	-
		3	354333.0	90.9	16	3	1835.0	1325.0	1237.0
		4	526694.0	54.7	16	1	1416.0	-	-
		5	695652.0	97.7	16	3	1183.0	1142.0	1007.0
		6	163430.0	67.5	16	2	1626.0	1970.0	-
		7	333465.0	96.7	16	3	1371.0	1076.0	1764.0
		8	504482.0	68.3	16	2	1596.0	1445.0	-
		9	675424.0	78.3	16	2	1109.0	1431.0	-
		10	142911.0	55.0	16	1	1324.0	-	-
		11	312370.0	84.9	16	3	1386.0	1310.0	1812.0
		12	483170.0	74.6	16	2	1723.0	1776.0	-
		13	655500.0	63.3	16	1	1371.0	-	-
		14	121408.0	99.8	16	3	1238.0	1335.0	1378.0
		15	292829.0	63.6	16	1	1111.0	-	-
		16	461438.0	87.3	16	3	1491.0	1704.0	1442.0
27	Type 5	19	0.6315789	12.0000000	5.502400000				
		Burst ID	Burst Offset (us)	Pulse Width (us)	Chirp Width (MHz)	Number of Pulses per Burst	PRI-1 (us)	PRI-2 (us)	PRI-3 (us)
		0	564587.0	85.6	19	3	1355.0	1726.0	1567.0
		1	89838.0	68.6	19	2	1936.0	1791.0	-
		2	243065.0	54.2	19	1	1256.0	-	-
		3	395965.0	61.2	19	1	1213.0	-	-
		4	546679.0	97.1	19	3	1554.0	1063.0	1088.0
		5	71022.0	98.3	19	3	1038.0	1601.0	1618.0
		6	224043.0	62.4	19	1	1796.0	-	-
		7	375811.0	80.2	19	2	1736.0	1688.0	-
		8	526524.0	87.5	19	3	1933.0	1524.0	1910.0
		9	52332.0	85.8	19	3	1558.0	1072.0	1014.0
		10	204270.0	88.1	19	3	1638.0	1320.0	1778.0
		11	358389.0	65.3	19	1	1059.0	-	-
		12	510583.0	52.5	19	1	1956.0	-	-
		13	33661.0	52.3	19	1	2000.0	-	-
		14	186091.0	74.1	19	2	1080.0	1807.0	-
		15	339568.0	54.9	19	1	1031.0	-	-
		16	490613.0	76.2	19	2	1518.0	1924.0	-
		17	14864.0	60.4	19	1	1527.0	-	-
		18	167448.0	81.5	19	2	1015.0	1351.0	-

Trial Id	Radar Type	Number of Bursts	Burst Period (s)	Waveform Length (s)	Center Frequency (GHz)			
28	Type 5	12	1.0000000	12.0000000	5.506000000			
	Burst ID	Burst Offset (us)	Pulse Width (us)	Chirp Width (MHz)	Number of Pulses per Burst	PRI-1 (us)	PRI-2 (us)	PRI-3 (us)
	0	508045.0	50.5	10	1	1196.0	-	-
	1	749937.0	55.7	10	1	1661.0	-	-
	2	989019.0	85.8	10	3	1656.0	1854.0	1218.0
	3	235517.0	76.9	10	2	1772.0	1323.0	-
	4	477346.0	75.1	10	2	1221.0	1773.0	-
	5	718529.0	92.3	10	3	1122.0	1158.0	1577.0
	6	960804.0	78.1	10	2	1503.0	1649.0	-
	7	205421.0	92.2	10	3	1446.0	1589.0	1583.0
	8	447174.0	89.0	10	3	1145.0	1370.0	1341.0
	9	689823.0	70.9	10	2	1088.0	1246.0	-
	10	932887.0	83.1	10	1	1157.0	-	-
	11	176194.0	55.3	10	1	1731.0	-	-
29	Type 5	18	0.6666667	12.0000000	5.503200000			
	Burst ID	Burst Offset (us)	Pulse Width (us)	Chirp Width (MHz)	Number of Pulses per Burst	PRI-1 (us)	PRI-2 (us)	PRI-3 (us)
	0	277683.0	83.4	17	3	1301.0	1213.0	1473.0
	1	438503.0	97.3	17	3	1258.0	1057.0	1522.0
	2	598617.0	90.4	17	3	1679.0	1090.0	1780.0
	3	97142.0	91.8	17	3	1385.0	1491.0	1272.0
	4	257779.0	98.2	17	3	1889.0	1055.0	1339.0
	5	420304.0	59.5	17	1	1301.0	-	-
	6	580095.0	80.0	17	2	1693.0	1417.0	-
	7	77238.0	86.5	17	3	1548.0	1656.0	1903.0
	8	237974.0	91.1	17	3	1379.0	1497.0	1433.0
	9	398356.0	93.5	17	3	1360.0	1444.0	1937.0
	10	561396.0	80.7	17	1	1778.0	-	-
	11	57672.0	67.2	17	2	1157.0	1676.0	-
	12	219189.0	61.8	17	1	1263.0	-	-
	13	379317.0	79.4	17	2	1952.0	1503.0	-
	14	540148.0	81.4	17	2	1926.0	1552.0	-
	15	37944.0	65.7	17	1	1005.0	-	-
	16	198981.0	76.0	17	2	1299.0	1065.0	-
	17	360068.0	81.0	17	2	1163.0	1251.0	-

Trial Id	Radar Type	Number of Bursts	Burst Period (s)	Waveform Length (s)	Center Frequency (GHz)			
30	Type 5	16	0.7500000	12.0000000	5.500000000			
	Burst ID	Burst Offset (us)	Pulse Width (us)	Chirp Width (MHz)	Number of Pulses per Burst	PRI-1 (us)	PRI-2 (us)	PRI-3 (us)
	0	586476.0	79.9	15	2	1445.0	1067.0	-
	1	20235.0	98.4	15	3	1798.0	1118.0	1157.0
	2	201928.0	52.9	15	1	1174.0	-	-
	3	382479.0	68.3	15	2	1721.0	1527.0	-
	4	564677.0	63.1	15	1	1808.0	-	-
	5	745231.0	81.6	15	2	1068.0	1649.0	-
	6	178670.0	99.8	15	3	1673.0	1700.0	1502.0
	7	359099.0	91.7	15	3	1830.0	1924.0	1717.0
	8	541506.0	79.2	15	2	1040.0	1899.0	-
	9	722438.0	68.9	15	2	1615.0	1586.0	-
	10	156628.0	68.9	15	2	1902.0	1935.0	-
	11	338832.0	56.1	15	1	1104.0	-	-
	12	519379.0	73.5	15	2	1122.0	1541.0	-
	13	701469.0	59.2	15	1	1770.0	-	-
	14	134407.0	74.4	15	2	1944.0	1504.0	-
	15	315939.0	80.5	15	2	1334.0	1002.0	-

Type 6 Frequency Hopping Radar Statistical Performance - Details

Trial Id	Radar Type	Pulse Width (us)	PRI (us)	Pulses per Hop	Hopping Rate (kHz)	Hopping Sequence Length (ms)	Visible Frequency Number
1	Type 6	1.0	333.3	9	0.3333	300.0000000	1
	Frequency List (MHz)	0	1	2	3	4	
	0	5619	5578	5270	5294	5354	
	5	5660	5710	5666	5399	5656	
	10	5297	5333	5642	5609	5709	
	15	5668	5527	5647	5547	5284	
	20	5375	5395	5384	5444	5705	
	25	5584	5536	5480	5658	5453	
	30	5403	5576	5588	5641	5465	
	35	5674	5580	5623	5559	5627	
	40	5553	5704	5673	5633	5724	
	45	5373	5348	5331	5513	5637	
	50	5544	5314	5585	5697	5257	
	55	5672	5471	5423	5424	5638	
	60	5644	5345	5569	5655	5413	
	65	5271	5415	5550	5371	5335	
	70	5382	5416	5533	5706	5558	
	75	5535	5692	5256	5436	5716	
	80	5385	5669	5458	5349	5456	
	85	5336	5634	5703	5352	5280	
	90	5506	5313	5690	5326	5631	
	95	5628	5546	5289	5490	5590	

Trial Id	Radar Type	Pulse Width (us)	PRI (us)	Pulses per Hop	Hopping Rate (kHz)	Hopping Sequence Length (ms)	Visible Frequency Number
2	Type 6	1.0	333.3	9	0.3333	300.0000000	4
	Frequency List (MHz)	0	1	2	3	4	
	0	5302	5342	5681	5455	5611	
	5	5493	5682	5310	5257	5606	
	10	5587	5561	5374	5362	5630	
	15	5322	5320	5502	5475	5364	
	20	5555	5353	5316	5387	5357	
	25	5332	5654	5312	5262	5409	
	30	5522	5547	5410	5618	5253	
	35	5311	5683	5556	5470	5258	
	40	5537	5398	5710	5491	5469	
	45	5670	5465	5704	5456	5406	
	50	5384	5400	5513	5720	5365	
	55	5296	5276	5641	5445	5626	
	60	5564	5620	5395	5334	5290	
	65	5401	5578	5359	5569	5586	
	70	5282	5649	5407	5368	5647	
	75	5643	5509	5592	5675	5678	
	80	5581	5275	5381	5512	5600	
	85	5304	5382	5389	5458	5666	
	90	5419	5642	5350	5526	5519	
	95	5709	5692	5418	5653	5354	

Trial Id	Radar Type	Pulse Width (us)	PRI (us)	Pulses per Hop	Hopping Rate (kHz)	Hopping Sequence Length (ms)	Visible Frequency Number
3	Type 6	1.0	333.3	9	0.3333	300.0000000	6
	Frequency List (MHz)	0	1	2	3	4	
	0	5557	5581	5617	5616	5356	
	5	5535	5704	5385	5420	5338	
	10	5518	5350	5415	5651	5313	
	15	5447	5605	5520	5653	5563	
	20	5519	5257	5476	5330	5598	
	25	5506	5515	5366	5443	5661	
	30	5533	5367	5358	5502	5606	
	35	5347	5647	5266	5411	5451	
	40	5334	5332	5709	5667	5394	
	45	5684	5539	5464	5437	5665	
	50	5389	5421	5416	5574	5488	
	55	5536	5580	5279	5439	5324	
	60	5499	5710	5708	5404	5305	
	65	5295	5525	5589	5359	5452	
	70	5576	5272	5492	5388	5551	
	75	5547	5323	5724	5256	5721	
	80	5293	5379	5584	5361	5508	
	85	5479	5693	5341	5655	5715	
	90	5629	5494	5401	5637	5423	
	95	5280	5316	5662	5281	5649	

Trial Id	Radar Type	Pulse Width (us)	PRI (us)	Pulses per Hop	Hopping Rate (kHz)	Hopping Sequence Length (ms)	Visible Frequency Number
4	Type 6	1.0	333.3	9	0.3333	300.0000000	2
	Frequency List (MHz)	0	1	2	3	4	
	0	5337	5345	5553	5302	5673	
	5	5577	5629	5460	5583	5642	
	10	5352	5614	5456	5655	5672	
	15	5401	5574	5611	5565	5370	
	20	5571	5588	5295	5468	5303	
	25	5486	5358	5718	5470	5380	
	30	5703	5422	5324	5573	5654	
	35	5426	5263	5634	5661	5462	
	40	5648	5498	5270	5474	5664	
	45	5701	5622	5425	5490	5552	
	50	5265	5597	5467	5300	5432	
	55	5724	5437	5469	5258	5715	
	60	5453	5277	5637	5705	5348	
	65	5593	5262	5561	5251	5255	
	70	5275	5341	5364	5510	5516	
	75	5346	5712	5504	5549	5356	
	80	5527	5376	5264	5447	5442	
	85	5454	5658	5428	5544	5374	
	90	5343	5663	5478	5689	5384	
	95	5372	5707	5274	5292	5466	

Trial Id	Radar Type	Pulse Width (us)	PRI (us)	Pulses per Hop	Hopping Rate (kHz)	Hopping Sequence Length (ms)	Visible Frequency Number
5	Type 6	1.0	333.3	9	0.3333	300.000000	1
	Frequency List (MHz)	0	1	2	3	4	
	0	5592	5584	5489	5463	5418	
	5	5619	5651	5535	5271	5374	
	10	5283	5500	5594	5375	5693	
	15	5604	5714	5610	5562	5482	
	20	5279	5711	5557	5276	5277	
	25	5307	5446	5574	5414	5270	
	30	5408	5281	5691	5428	5624	
	35	5625	5354	5430	5339	5376	
	40	5487	5581	5683	5617	5630	
	45	5644	5705	5483	5342	5519	
	50	5298	5518	5563	5598	5437	
	55	5391	5659	5455	5686	5582	
	60	5697	5469	5628	5294	5319	
	65	5597	5631	5521	5436	5423	
	70	5278	5665	5340	5485	5466	
	75	5438	5315	5275	5614	5330	
	80	5520	5590	5596	5264	5289	
	85	5405	5646	5526	5346	5676	
	90	5267	5539	5349	5600	5258	
	95	5671	5533	5345	5587	5523	

Trial Id	Radar Type	Pulse Width (us)	PRI (us)	Pulses per Hop	Hopping Rate (kHz)	Hopping Sequence Length (ms)	Visible Frequency Number
6	Type 6	1.0	333.3	9	0.3333	300.000000	4
	Frequency List (MHz)	0	1	2	3	4	
	0	5372	5348	5425	5624	5260	
	5	5283	5576	5610	5434	5581	
	10	5689	5289	5635	5570	5714	
	15	5577	5256	5342	5558	5279	
	20	5490	5652	5549	5724	5640	
	25	5634	5552	5300	5448	5409	
	30	5297	5713	5431	5580	5444	
	35	5667	5445	5701	5492	5290	
	40	5326	5286	5621	5382	5280	
	45	5559	5313	5541	5499	5704	
	50	5395	5474	5569	5274	5421	
	55	5698	5625	5345	5374	5657	
	60	5711	5519	5642	5301	5454	
	65	5715	5520	5536	5366	5413	
	70	5414	5378	5417	5316	5428	
	75	5357	5586	5484	5296	5430	
	80	5627	5684	5653	5273	5606	
	85	5465	5363	5491	5352	5355	
	90	5518	5631	5688	5588	5329	
	95	5485	5502	5590	5390	5531	

Trial Id	Radar Type	Pulse Width (us)	PRI (us)	Pulses per Hop	Hopping Rate (kHz)	Hopping Sequence Length (ms)	Visible Frequency Number
7	Type 6	1.0	333.3	9	0.3333	300.0000000	6
	Frequency List (MHz)	0	1	2	3	4	
	0	5530	5587	5361	5310	5480	
	5	5325	5598	5685	5500	5410	
	10	5523	5553	5676	5290	5260	
	15	5568	5383	5445	5603	5471	
	20	5498	5514	5690	5638	5697	
	25	5431	5583	5280	5404	5482	
	30	5451	5661	5670	5646	5354	
	35	5642	5331	5633	5594	5267	
	40	5301	5640	5369	5559	5622	
	45	5277	5391	5507	5396	5502	
	50	5552	5494	5271	5650	5620	
	55	5363	5719	5545	5338	5299	
	60	5564	5628	5268	5684	5608	
	65	5283	5343	5584	5572	5673	
	70	5683	5517	5492	5381	5266	
	75	5292	5387	5326	5706	5627	
	80	5682	5262	5367	5276	5716	
	85	5270	5511	5428	5458	5359	
	90	5351	5600	5285	5394	5571	
	95	5400	5265	5327	5643	5313	

Trial Id	Radar Type	Pulse Width (us)	PRI (us)	Pulses per Hop	Hopping Rate (kHz)	Hopping Sequence Length (ms)	Visible Frequency Number
8	Type 6	1.0	333.3	9	0.3333	300.000000	5
	Frequency List (MHz)	0	1	2	3	4	
	0	5310	5351	5297	5374	5322	
	5	5367	5523	5285	5663	5617	
	10	5454	5342	5717	5485	5281	
	15	5656	5510	5548	5648	5409	
	20	5680	5631	5630	5670	5319	
	25	5435	5483	5508	5516	5493	
	30	5647	5627	5386	5506	5462	
	35	5470	5724	5390	5420	5690	
	40	5576	5452	5497	5387	5274	
	45	5320	5487	5479	5560	5605	
	50	5381	5622	5671	5445	5489	
	55	5526	5253	5279	5502	5397	
	60	5629	5440	5678	5704	5544	
	65	5533	5608	5408	5478	5655	
	70	5481	5590	5268	5346	5673	
	75	5254	5295	5258	5459	5372	
	80	5623	5401	5267	5706	5545	
	85	5488	5650	5324	5305	5373	
	90	5559	5464	5660	5344	5698	
	95	5394	5378	5363	5321	5311	

Trial Id	Radar Type	Pulse Width (us)	PRI (us)	Pulses per Hop	Hopping Rate (kHz)	Hopping Sequence Length (ms)	Visible Frequency Number
9	Type 6	1.0	333.3	9	0.3333	300.0000000	1
	Frequency List (MHz)	0	1	2	3	4	
	0	5565	5590	5708	5535	5542	
	5	5409	5545	5360	5351	5349	
	10	5288	5606	5283	5583	5302	
	15	5269	5637	5554	5693	5380	
	20	5417	5274	5572	5719	5643	
	25	5682	5287	5686	5612	5550	
	30	5632	5536	5584	5504	5280	
	35	5660	5512	5340	5661	5573	
	40	5604	5415	5435	5530	5271	
	45	5627	5467	5562	5618	5658	
	50	5646	5401	5527	5722	5541	
	55	5268	5336	5714	5372	5473	
	60	5526	5539	5574	5369	5650	
	65	5367	5482	5547	5715	5370	
	70	5598	5252	5464	5484	5439	
	75	5622	5305	5642	5374	5341	
	80	5711	5385	5404	5264	5523	
	85	5448	5326	5451	5270	5667	
	90	5356	5621	5303	5724	5470	
	95	5639	5386	5361	5278	5378	

Trial Id	Radar Type	Pulse Width (us)	PRI (us)	Pulses per Hop	Hopping Rate (kHz)	Hopping Sequence Length (ms)	Visible Frequency Number
10	Type 6	1.0	333.3	9	0.3333	300.0000000	4
	Frequency List (MHz)	0	1	2	3	4	
	0	5345	5354	5644	5696	5384	
	5	5548	5470	5435	5514	5653	
	10	5694	5492	5324	5303	5323	
	15	5357	5667	5657	5641	5572	
	20	5425	5440	5610	5711	5616	
	25	5473	5414	5338	5584	5674	
	30	5541	5719	5432	5480	5651	
	35	5431	5457	5348	5615	5254	
	40	5715	5373	5295	5365	5556	
	45	5447	5645	5579	5533	5277	
	50	5703	5298	5252	5566	5280	
	55	5330	5636	5562	5403	5444	
	60	5655	5704	5519	5676	5427	
	65	5596	5568	5583	5450	5640	
	70	5304	5421	5547	5288	5598	
	75	5264	5494	5484	5695	5488	
	80	5495	5660	5293	5527	5639	
	85	5718	5351	5643	5511	5462	
	90	5632	5310	5394	5501	5476	
	95	5576	5327	5378	5333	5362	

Trial Id	Radar Type	Pulse Width (us)	PRI (us)	Pulses per Hop	Hopping Rate (kHz)	Hopping Sequence Length (ms)	Visible Frequency Number
11	Type 6	1.0	333.3	9	0.3333	300.0000000	8
	Frequency List (MHz)	0	1	2	3	4	
	0	5503	5593	5580	5382	5604	
	5	5590	5492	5510	5385	5625	
	10	5281	5365	5498	5344	5348	
	15	5319	5285	5686	5386	5336	
	20	5509	5551	5325	5589	5361	
	25	5563	5520	5442	5618	5716	
	30	5411	5459	5681	5300	5315	
	35	5522	5350	5501	5529	5568	
	40	5323	5689	5535	5362	5485	
	45	5427	5253	5637	5667	5628	
	50	5404	5349	5341	5389	5602	
	55	5518	5277	5697	5415	5309	
	60	5394	5464	5508	5639	5391	
	65	5380	5282	5532	5582	5493	
	70	5533	5587	5515	5574	5698	
	75	5483	5614	5530	5676	5265	
	80	5605	5441	5360	5636	5438	
	85	5351	5474	5654	5500	5642	
	90	5321	5579	5482	5610	5684	
	95	5388	5443	5547	5581	5527	

Trial Id	Radar Type	Pulse Width (us)	PRI (us)	Pulses per Hop	Hopping Rate (kHz)	Hopping Sequence Length (ms)	Visible Frequency Number
12	Type 6	1.0	333.3	9	0.3333	300.0000000	5
	Frequency List (MHz)	0	1	2	3	4	
	0	5283	5357	5516	5543	5446	
	5	5632	5417	5585	5268	5592	
	10	5459	5545	5406	5693	5365	
	15	5436	5388	5256	5578	5344	
	20	5675	5492	5317	5562	5627	
	25	5512	5723	5546	5652	5380	
	30	5300	5455	5674	5358	5498	
	35	5454	5710	5621	5654	5443	
	40	5504	5678	5359	5407	5336	
	45	5695	5720	5685	5580	5400	
	50	5430	5687	5706	5544	5467	
	55	5419	5289	5438	5559	5506	
	60	5340	5554	5329	5558	5327	
	65	5385	5662	5519	5590	5364	
	70	5550	5657	5355	5259	5673	
	75	5420	5618	5697	5524	5275	
	80	5633	5254	5424	5534	5274	
	85	5465	5315	5415	5269	5488	
	90	5547	5566	5616	5509	5427	
	95	5445	5560	5636	5347	5432	

Trial Id	Radar Type	Pulse Width (us)	PRI (us)	Pulses per Hop	Hopping Rate (kHz)	Hopping Sequence Length (ms)	Visible Frequency Number
13	Type 6	1.0	333.3	9	0.3333	300.000000	5
	Frequency List (MHz)	0	1	2	3	4	
	0	5538	5596	5452	5704	5666	
	5	5674	5439	5660	5431	5324	
	10	5390	5334	5544	5413	5386	
	15	5524	5573	5491	5301	5295	
	20	5352	5269	5530	5406	5535	
	25	5515	5364	5451	5650	5686	
	30	5422	5664	5412	5317	5607	
	35	5318	5496	5326	5417	5429	
	40	5454	5343	5489	5565	5443	
	45	5356	5721	5387	5419	5656	
	50	5298	5475	5283	5281	5519	
	55	5393	5498	5657	5713	5260	
	60	5470	5724	5647	5477	5531	
	65	5278	5594	5597	5663	5259	
	70	5505	5690	5688	5526	5282	
	75	5719	5638	5672	5253	5478	
	80	5338	5630	5450	5632	5266	
	85	5497	5466	5333	5366	5339	
	90	5434	5591	5581	5351	5250	
	95	5411	5442	5264	5545	5527	

Trial Id	Radar Type	Pulse Width (us)	PRI (us)	Pulses per Hop	Hopping Rate (kHz)	Hopping Sequence Length (ms)	Visible Frequency Number
14	Type 6	1.0	333.3	9	0.3333	300.0000000	4
	Frequency List (MHz)	0	1	2	3	4	
	0	5318	5360	5388	5390	5508	
	5	5338	5364	5260	5594	5628	
	10	5321	5598	5585	5511	5407	
	15	5612	5700	5497	5724	5487	
	20	5263	5435	5471	5398	5306	
	25	5691	5654	5279	5720	5464	
	30	5650	5369	5532	5284	5516	
	35	5635	5417	5310	5582	5368	
	40	5657	5669	5503	5683	5353	
	45	5553	5270	5502	5714	5351	
	50	5362	5634	5457	5608	5711	
	55	5337	5607	5452	5372	5706	
	60	5599	5414	5396	5576	5303	
	65	5574	5616	5702	5533	5534	
	70	5489	5466	5428	5588	5693	
	75	5537	5478	5293	5402	5387	
	80	5716	5449	5266	5259	5377	
	85	5401	5627	5645	5632	5583	
	90	5557	5561	5298	5320	5339	
	95	5597	5518	5708	5262	5543	

Trial Id	Radar Type	Pulse Width (us)	PRI (us)	Pulses per Hop	Hopping Rate (kHz)	Hopping Sequence Length (ms)	Visible Frequency Number
15	Type 6	1.0	333.3	9	0.3333	300.000000	6
	Frequency List (MHz)	0	1	2	3	4	
	0	5573	5599	5324	5551	5253	
	5	5380	5386	5335	5660	5360	
	10	5630	5484	5626	5706	5428	
	15	5603	5255	5600	5294	5679	
	20	5271	5504	5412	5487	5481	
	25	5669	5640	5382	5480	5279	
	30	5506	5539	5326	5272	5533	
	35	5336	5299	5508	5581	5260	
	40	5282	5496	5277	5441	5448	
	45	5447	5482	5250	5585	5297	
	50	5404	5627	5510	5633	5553	
	55	5319	5534	5659	5320	5406	
	60	5562	5351	5677	5579	5438	
	65	5408	5604	5520	5342	5651	
	70	5569	5366	5284	5647	5500	
	75	5574	5318	5289	5381	5437	
	80	5522	5530	5697	5701	5376	
	85	5515	5444	5561	5624	5365	
	90	5535	5278	5641	5371	5587	
	95	5357	5552	5493	5560	5608	

Trial Id	Radar Type	Pulse Width (us)	PRI (us)	Pulses per Hop	Hopping Rate (kHz)	Hopping Sequence Length (ms)	Visible Frequency Number
16	Type 6	1.0	333.3	9	0.3333	300.0000000	2
	Frequency List (MHz)	0	1	2	3	4	
	0	5256	5460	5260	5615	5570	
	5	5422	5311	5410	5348	5567	
	10	5561	5273	5667	5426	5449	
	15	5691	5382	5703	5339	5396	
	20	5279	5670	5353	5479	5454	
	25	5557	5492	5488	5584	5313	
	30	5645	5525	5283	5487	5685	
	35	5534	5341	5599	5377	5413	
	40	5671	5335	5360	5379	5591	
	45	5444	5411	5705	5668	5258	
	50	5457	5514	5289	5334	5604	
	55	5408	5357	5603	5263	5655	
	60	5548	5551	5269	5383	5715	
	65	5527	5466	5640	5600	5508	
	70	5576	5651	5450	5669	5560	
	75	5321	5613	5609	5642	5678	
	80	5478	5486	5296	5608	5624	
	85	5524	5438	5364	5580	5470	
	90	5606	5325	5555	5489	5375	
	95	5480	5674	5663	5282	5573	

Trial Id	Radar Type	Pulse Width (us)	PRI (us)	Pulses per Hop	Hopping Rate (kHz)	Hopping Sequence Length (ms)	Visible Frequency Number
17	Type 6	1.0	333.3	9	0.3333	300.0000000	5
	Frequency List (MHz)	0	1	2	3	4	
	0	5511	5699	5671	5301	5315	
	5	5464	5333	5485	5396	5492	
	10	5537	5708	5621	5470	5304	
	15	5509	5331	5287	5588	5665	
	20	5264	5391	5568	5427	5348	
	25	5441	5691	5688	5347	5687	
	30	5414	5715	5605	5459	5354	
	35	5480	5312	5648	5663	5682	
	40	5271	5540	5317	5356	5718	
	45	5685	5276	5316	5413	5640	
	50	5510	5655	5497	5558	5450	
	55	5599	5692	5370	5367	5522	
	60	5434	5328	5547	5353	5412	
	65	5366	5549	5544	5408	5446	
	70	5253	5266	5546	5421	5462	
	75	5355	5481	5719	5659	5633	
	80	5499	5552	5297	5521	5280	
	85	5438	5681	5543	5565	5474	
	90	5279	5608	5375	5619	5712	
	95	5523	5257	5541	5507	5261	

Trial Id	Radar Type	Pulse Width (us)	PRI (us)	Pulses per Hop	Hopping Rate (kHz)	Hopping Sequence Length (ms)	Visible Frequency Number
18	Type 6	1.0	333.3	9	0.3333	300.0000000	4
	Frequency List (MHz)	0	1	2	3	4	
	0	5291	5463	5607	5462	5632	
	5	5603	5258	5560	5674	5326	
	10	5274	5341	5491	5392	5636	
	15	5434	5332	5305	5673	5430	
	20	5400	5711	5293	5419	5317	
	25	5381	5254	5303	5672	5345	
	30	5611	5649	5619	5403	5541	
	35	5596	5585	5623	5633	5438	
	40	5647	5665	5359	5374	5466	
	45	5666	5516	5589	5706	5586	
	50	5394	5312	5646	5661	5493	
	55	5543	5599	5273	5476	5276	
	60	5455	5664	5498	5580	5618	
	65	5338	5531	5435	5629	5424	
	70	5311	5309	5314	5450	5310	
	75	5290	5640	5410	5609	5333	
	80	5461	5275	5518	5572	5620	
	85	5506	5282	5342	5330	5573	
	90	5718	5557	5517	5601	5708	
	95	5298	5525	5405	5304	5682	

Trial Id	Radar Type	Pulse Width (us)	PRI (us)	Pulses per Hop	Hopping Rate (kHz)	Hopping Sequence Length (ms)	Visible Frequency Number
19	Type 6	1.0	333.3	9	0.3333	300.000000	5
	Frequency List (MHz)	0	1	2	3	4	
	0	5546	5702	5543	5623	5377	
	5	5645	5280	5635	5265	5335	
	10	5257	5590	5315	5439	5512	
	15	5383	5288	5440	5594	5681	
	20	5596	5273	5649	5373	5502	
	25	5620	5622	5518	5415	5393	
	30	5289	5629	5560	5385	5372	
	35	5283	5494	5337	5510	5424	
	40	5706	5571	5361	5435	5479	
	45	5442	5519	5456	5392	5290	
	50	5282	5297	5679	5716	5500	
	55	5600	5275	5464	5672	5308	
	60	5577	5401	5390	5447	5450	
	65	5608	5334	5507	5615	5524	
	70	5285	5322	5430	5433	5621	
	75	5662	5719	5589	5528	5515	
	80	5292	5462	5566	5307	5284	
	85	5296	5474	5724	5399	5710	
	90	5250	5353	5509	5303	5597	
	95	5407	5428	5562	5678	5300	

Trial Id	Radar Type	Pulse Width (us)	PRI (us)	Pulses per Hop	Hopping Rate (kHz)	Hopping Sequence Length (ms)	Visible Frequency Number
20	Type 6	1.0	333.3	9	0.3333	300.000000	5
	Frequency List (MHz)	0	1	2	3	4	
	0	5704	5466	5479	5309	5597	
	5	5687	5680	5710	5428	5639	
	10	5566	5379	5356	5634	5533	
	15	5471	5318	5543	5422	5311	
	20	5592	5665	5641	5443	5390	
	25	5569	5350	5622	5449	5435	
	30	5653	5586	5300	5537	5667	
	35	5325	5585	5608	5269	5521	
	40	5263	5314	5509	5504	5529	
	45	5408	5528	5525	5393	5572	
	50	5343	5646	5333	5386	5502	
	55	5660	5688	5554	5465	5677	
	60	5338	5326	5454	5260	5615	
	65	5403	5347	5591	5396	5555	
	70	5515	5579	5601	5527	5387	
	75	5261	5707	5291	5550	5602	
	80	5439	5257	5370	5692	5498	
	85	5512	5487	5719	5401	5650	
	90	5335	5402	5255	5659	5722	
	95	5364	5493	5676	5510	5700	

Trial Id	Radar Type	Pulse Width (us)	PRI (us)	Pulses per Hop	Hopping Rate (kHz)	Hopping Sequence Length (ms)	Visible Frequency Number
21	Type 6	1.0	333.3	9	0.3333	300.000000	8
	Frequency List (MHz)	0	1	2	3	4	
	0	5484	5705	5415	5470	5439	
	5	5351	5702	5310	5591	5371	
	10	5497	5265	5494	5354	5554	
	15	5559	5445	5646	5370	5503	
	20	5600	5356	5252	5255	5416	
	25	5656	5421	5456	5251	5483	
	30	5477	5542	5543	5418	5311	
	35	5390	5464	5676	5501	5422	
	40	5435	5674	5447	5269	5526	
	45	5337	5508	5608	5451	5625	
	50	5522	5642	5384	5475	5703	
	55	5507	5401	5655	5496	5309	
	60	5455	5619	5680	5326	5414	
	65	5345	5492	5295	5318	5273	
	70	5587	5530	5711	5615	5666	
	75	5638	5670	5622	5583	5691	
	80	5367	5626	5381	5561	5412	
	85	5682	5718	5589	5286	5289	
	90	5553	5314	5329	5261	5465	
	95	5541	5463	5574	5671	5458	

Trial Id	Radar Type	Pulse Width (us)	PRI (us)	Pulses per Hop	Hopping Rate (kHz)	Hopping Sequence Length (ms)	Visible Frequency Number
22	Type 6	1.0	333.3	9	0.3333	300.000000	5
	Frequency List (MHz)	0	1	2	3	4	
	0	5264	5469	5351	5631	5659	
	5	5393	5627	5385	5279	5578	
	10	5428	5529	5535	5549	5575	
	15	5647	5572	5274	5415	5695	
	20	5608	5425	5668	5722	5389	
	25	5544	5370	5355	5517	5616	
	30	5528	5500	5633	5463	5685	
	35	5603	5292	5297	5349	5513	
	40	5577	5509	5523	5644	5488	
	45	5691	5412	5678	5495	5398	
	50	5343	5435	5564	5526	5451	
	55	5589	5462	5315	5280	5584	
	60	5309	5625	5336	5615	5294	
	65	5530	5702	5565	5596	5345	
	70	5670	5630	5560	5591	5607	
	75	5693	5468	5477	5407	5545	
	80	5721	5409	5402	5525	5552	
	85	5381	5483	5340	5326	5609	
	90	5494	5364	5499	5423	5465	
	95	5518	5558	5569	5716	5718	

Trial Id	Radar Type	Pulse Width (us)	PRI (us)	Pulses per Hop	Hopping Rate (kHz)	Hopping Sequence Length (ms)	Visible Frequency Number
23	Type 6	1.0	333.3	9	0.3333	300.0000000	2
	Frequency List (MHz)	0	1	2	3	4	
	0	5519	5708	5287	5695	5501	
	5	5435	5649	5460	5442	5407	
	10	5262	5318	5576	5269	5596	
	15	5638	5699	5377	5412	5591	
	20	5706	5336	5362	5432	5697	
	25	5387	5556	5454	5658	5417	
	30	5457	5373	5712	5408	5645	
	35	5480	5568	5350	5360	5352	
	40	5660	5323	5652	5520	5573	
	45	5468	5299	5470	5634	5285	
	50	5274	5486	5275	5349	5298	
	55	5680	5416	5463	5512	5251	
	60	5713	5474	5667	5683	5453	
	65	5282	5438	5718	5566	5534	
	70	5399	5514	5656	5633	5409	
	75	5567	5584	5338	5545	5623	
	80	5490	5663	5612	5309	5406	
	85	5694	5525	5499	5448	5294	
	90	5574	5332	5659	5370	5436	
	95	5477	5415	5542	5467	5319	

Trial Id	Radar Type	Pulse Width (us)	PRI (us)	Pulses per Hop	Hopping Rate (kHz)	Hopping Sequence Length (ms)	Visible Frequency Number
24	Type 6	1.0	333.3	9	0.3333	300.000000	3
	Frequency List (MHz)	0	1	2	3	4	
	0	5299	5472	5698	5381	5721	
	5	5477	5574	5535	5508	5614	
	10	5668	5582	5617	5367	5251	
	15	5351	5383	5505	5604	5527	
	20	5660	5647	5328	5335	5549	
	25	5590	5488	5700	5403	5414	
	30	5588	5389	5703	5309	5571	
	35	5364	5503	5274	5666	5365	
	40	5261	5417	5517	5405	5448	
	45	5382	5528	5687	5695	5537	
	50	5717	5393	5370	5653	5331	
	55	5600	5270	5639	5612	5515	
	60	5376	5667	5269	5252	5677	
	65	5586	5642	5258	5636	5543	
	70	5458	5479	5623	5400	5444	
	75	5301	5372	5428	5341	5575	
	80	5290	5316	5345	5347	5627	
	85	5349	5470	5565	5432	5628	
	90	5676	5447	5672	5552	5468	
	95	5469	5359	5321	5325	5678	

Trial Id	Radar Type	Pulse Width (us)	PRI (us)	Pulses per Hop	Hopping Rate (kHz)	Hopping Sequence Length (ms)	Visible Frequency Number
25	Type 6	1.0	333.3	9	0.3333	300.000000	3
	Frequency List (MHz)	0	1	2	3	4	
	0	5457	5711	5634	5542	5563	
	5	5616	5596	5610	5671	5346	
	10	5599	5371	5658	5562	5638	
	15	5339	5381	5486	5453	5321	
	20	5535	5351	5588	5417	5308	
	25	5586	5498	5318	5289	5522	
	30	5364	5292	5706	5426	5448	
	35	5662	5257	5656	5663	5505	
	40	5674	5657	5514	5334	5428	
	45	5465	5489	5265	5437	5404	
	50	5396	5373	5564	5581	5324	
	55	5368	5625	5571	5399	5329	
	60	5557	5347	5677	5271	5462	
	65	5541	5576	5383	5280	5250	
	70	5261	5485	5519	5502	5578	
	75	5525	5604	5652	5613	5700	
	80	5435	5400	5609	5331	5635	
	85	5385	5281	5299	5595	5350	
	90	5382	5407	5695	5546	5683	
	95	5607	5263	5655	5550	5459	

Trial Id	Radar Type	Pulse Width (us)	PRI (us)	Pulses per Hop	Hopping Rate (kHz)	Hopping Sequence Length (ms)	Visible Frequency Number
26	Type 6	1.0	333.3	9	0.3333	300.0000000	4
	Frequency List (MHz)	0	1	2	3	4	
	0	5712	5475	5570	5703	5308	
	5	5658	5521	5685	5359	5650	
	10	5433	5257	5699	5282	5659	
	15	5427	5508	5589	5498	5610	
	20	5446	5420	5626	5409	5281	
	25	5377	5350	5424	5393	5556	
	30	5406	5656	5328	5315	5721	
	35	5587	5278	5528	5431	5674	
	40	5441	5531	5515	5422	5608	
	45	5263	5408	5548	5547	5318	
	50	5324	5280	5572	5639	5542	
	55	5671	5294	5558	5347	5494	
	60	5502	5654	5600	5692	5663	
	65	5662	5577	5311	5414	5661	
	70	5352	5711	5361	5334	5398	
	75	5461	5289	5698	5668	5585	
	80	5429	5723	5481	5629	5595	
	85	5300	5329	5331	5597	5598	
	90	5624	5368	5645	5679	5485	
	95	5707	5563	5591	5636	5537	

Trial Id	Radar Type	Pulse Width (us)	PRI (us)	Pulses per Hop	Hopping Rate (kHz)	Hopping Sequence Length (ms)	Visible Frequency Number
27	Type 6	1.0	333.3	9	0.3333	300.000000	5
	Frequency List (MHz)	0	1	2	3	4	
	0	5492	5714	5506	5389	5625	
	5	5700	5543	5285	5522	5382	
	10	5364	5521	5265	5477	5680	
	15	5418	5635	5692	5327	5454	
	20	5586	5567	5498	5254	5299	
	25	5627	5594	5590	5448	5642	
	30	5661	5564	5541	5629	5369	
	35	5324	5584	5588	5280	5614	
	40	5453	5565	5605	5570	5291	
	45	5631	5371	5589	5534	5273	
	50	5690	5494	5355	5482	5707	
	55	5641	5513	5657	5659	5544	
	60	5486	5426	5638	5611	5516	
	65	5618	5684	5464	5697	5658	
	70	5374	5420	5258	5721	5566	
	75	5681	5358	5262	5696	5297	
	80	5621	5709	5439	5672	5304	
	85	5616	5368	5491	5475	5341	
	90	5580	5318	5281	5380	5519	
	95	5537	5362	5645	5524	5325	

Trial Id	Radar Type	Pulse Width (us)	PRI (us)	Pulses per Hop	Hopping Rate (kHz)	Hopping Sequence Length (ms)	Visible Frequency Number
28	Type 6	1.0	333.3	9	0.3333	300.0000000	7
	Frequency List (MHz)	0	1	2	3	4	
	0	5272	5478	5539	5550	5370	
	5	5267	5565	5360	5588	5589	
	10	5295	5310	5306	5672	5701	
	15	5506	5287	5320	5491	5519	
	20	5462	5655	5508	5490	5702	
	25	5531	5626	5355	5698	5624	
	30	5717	5401	5716	5264	5293	
	35	5557	5692	5262	5502	5594	
	40	5319	5391	5330	5602	5499	
	45	5271	5336	5663	5424	5476	
	50	5410	5449	5266	5342	5317	
	55	5299	5670	5564	5463	5460	
	60	5387	5311	5349	5489	5415	
	65	5252	5681	5687	5560	5552	
	70	5353	5576	5593	5683	5464	
	75	5507	5350	5379	5605	5366	
	80	5382	5547	5361	5371	5518	
	85	5385	5721	5294	5341	5612	
	90	5378	5621	5389	5457	5292	
	95	5534	5497	5412	5374	5597	

Trial Id	Radar Type	Pulse Width (us)	PRI (us)	Pulses per Hop	Hopping Rate (kHz)	Hopping Sequence Length (ms)	Visible Frequency Number
29	Type 6	1.0	333.3	9	0.3333	300.0000000	3
	Frequency List (MHz)	0	1	2	3	4	
	0	5430	5717	5475	5711	5687	
	5	5406	5490	5435	5276	5321	
	10	5604	5574	5444	5295	5722	
	15	5594	5414	5326	5536	5373	
	20	5346	5546	5579	5675	5419	
	25	5478	5558	5327	5658	5629	
	30	5420	5674	5519	5559	5432	
	35	5648	5488	5512	5513	5433	
	40	5402	5329	5570	5599	5331	
	45	5251	5624	5477	5266	5286	
	50	5625	5317	5431	5518	5621	
	55	5653	5279	5358	5343	5514	
	60	5434	5650	5627	5413	5509	
	65	5491	5660	5371	5545	5665	
	70	5291	5467	5259	5338	5486	
	75	5428	5528	5613	5481	5299	
	80	5549	5309	5612	5695	5681	
	85	5581	5422	5540	5386	5699	
	90	5503	5446	5256	5462	5640	
	95	5427	5377	5487	5398	5307	

Trial Id	Radar Type	Pulse Width (us)	PRI (us)	Pulses per Hop	Hopping Rate (kHz)	Hopping Sequence Length (ms)	Visible Frequency Number
30	Type 6	1.0	333.3	9	0.3333	300.0000000	3
	Frequency List (MHz)	0	1	2	3	4	
	0	5685	5481	5411	5397	5432	
	5	5448	5512	5510	5439	5625	
	10	5535	5363	5485	5490	5268	
	15	5682	5444	5429	5581	5428	
	20	5381	5487	5571	5648	5307	
	25	5427	5286	5431	5692	5671	
	30	5406	5631	5259	5642	5282	
	35	5474	5264	5284	5665	5369	
	40	5267	5335	5596	5260	5706	
	45	5502	5433	5628	5637	5326	
	50	5368	5520	5341	5565	5472	
	55	5271	5476	5329	5679	5554	
	60	5573	5711	5458	5527	5492	
	65	5641	5348	5359	5277	5470	
	70	5583	5302	5297	5446	5606	
	75	5509	5390	5591	5555	5713	
	80	5469	5288	5256	5515	5537	
	85	5644	5676	5290	5263	5313	
	90	5681	5389	5383	5516	5253	
	95	5483	5721	5325	5356	5590	

3.11.4 U-NII-2C 40MHZ TEST RESULTS AND WAVEFORMS DETAILS

40MHz / 5510MHz						
(Detection = Y, No Detection = N)						
Trial Number	Type 1	Type 2	Type 3	Type 4	Type 5	Type 6
1	Y	Y	Y	Y	Y	Y
2	Y	Y	Y	Y	Y	Y
3	N	Y	Y	Y	Y	Y
4	Y	N	Y	N	Y	Y
5	Y	Y	N	Y	N	Y
6	Y	Y	Y	Y	Y	Y
7	Y	Y	Y	Y	Y	Y
8	N	Y	Y	Y	Y	Y
9	Y	Y	Y	N	Y	Y
10	Y	N	Y	Y	Y	Y
11	Y	Y	N	Y	Y	Y
12	Y	Y	Y	Y	N	Y
13	Y	Y	Y	Y	Y	Y
14	Y	Y	Y	N	Y	N
15	Y	N	N	Y	N	Y
16	Y	Y	Y	Y	Y	Y
17	Y	Y	Y	Y	Y	Y
18	N	Y	Y	Y	Y	Y
19	Y	Y	Y	Y	Y	Y
20	Y	Y	Y	N	Y	Y
21	Y	N	N	Y	Y	Y
22	Y	Y	Y	Y	Y	Y
23	Y	Y	Y	Y	Y	Y
24	N	N	Y	Y	Y	Y
25	Y	Y	Y	N	Y	N
26	Y	Y	Y	Y	Y	Y
27	Y	N	Y	Y	N	Y
28	Y	Y	N	Y	Y	Y
29	Y	Y	Y	N	Y	Y
30	Y	Y	Y	Y	Y	Y
Trial of Detection	26/30	24/30	25/30	24/30	26/30	28/30
Probability (%)	86.7%	80%	83.3%	80%	86.7%	93.3%
Limit (%)	>= 60%	>= 60%	>= 60%	>= 60%	>= 80%	>= 70%
Average Probability of Radar Type 1~4 (%)	82.5% (>=80%)					

Type 1 Short Pulse Radar Statistical Performance - Details

Trial Id	Radar Type	Pulse Width (us)	PRI (us)	Number of Pulses	Waveform Length (us)
1	Type 1	1.0	698.0	76	53048.0
2	Type 1	1.0	618.0	86	53148.0
3	Type 1	1.0	538.0	99	53262.0
4	Type 1	1.0	878.0	61	53558.0
5	Type 1	1.0	3066.0	18	55188.0
6	Type 1	1.0	638.0	83	52954.0
7	Type 1	1.0	918.0	58	53244.0
8	Type 1	1.0	838.0	63	52794.0
9	Type 1	1.0	858.0	62	53196.0
10	Type 1	1.0	798.0	67	53466.0
11	Type 1	1.0	718.0	74	53132.0
12	Type 1	1.0	578.0	92	53176.0
13	Type 1	1.0	598.0	89	53222.0
14	Type 1	1.0	558.0	95	53010.0
15	Type 1	1.0	2536.0	21	53256.0
16	Type 1	1.0	966.0	55	53130.0
17	Type 1	1.0	827.0	64	52928.0
18	Type 1	1.0	2501.0	22	55022.0
19	Type 1	1.0	2595.0	21	54495.0
20	Type 1	1.0	1114.0	48	53472.0
21	Type 1	1.0	1302.0	41	53382.0
22	Type 1	1.0	3045.0	18	54810.0
23	Type 1	1.0	1624.0	33	53592.0
24	Type 1	1.0	2878.0	19	54682.0
25	Type 1	1.0	1027.0	52	53404.0
26	Type 1	1.0	2485.0	22	54670.0
27	Type 1	1.0	1600.0	33	52800.0
28	Type 1	1.0	1172.0	46	53912.0
29	Type 1	1.0	1177.0	45	52965.0
30	Type 1	1.0	2171.0	25	54275.0

Type 2 Short Pulse Radar Statistical Performance - Details

Trial Id	Radar Type	Pulse Width (us)	PRI (us)	Number of Pulses	Waveform Length (us)
0	Type 2	3.2	179.0	26	4654.0
1	Type 2	1.1	207.0	23	4761.0
2	Type 2	2.1	230.0	24	5520.0
3	Type 2	4.8	200.0	29	5800.0
4	Type 2	3.9	214.0	28	5992.0
5	Type 2	2.9	222.0	26	5772.0
6	Type 2	3.2	204.0	26	5304.0
7	Type 2	2.5	192.0	25	4800.0
8	Type 2	3.1	164.0	26	4264.0
9	Type 2	1.2	156.0	23	3588.0
10	Type 2	3.9	210.0	27	5670.0
11	Type 2	4.6	201.0	29	5829.0
12	Type 2	3.2	162.0	26	4212.0
13	Type 2	2.2	197.0	25	4925.0
14	Type 2	4.5	163.0	29	4727.0
15	Type 2	3.0	203.0	26	5278.0
16	Type 2	5.0	168.0	29	4872.0
17	Type 2	2.4	217.0	25	5425.0
18	Type 2	2.9	191.0	26	4966.0
19	Type 2	2.3	166.0	25	4150.0
20	Type 2	3.7	150.0	27	4050.0
21	Type 2	2.2	176.0	25	4400.0
22	Type 2	4.9	195.0	29	5655.0
23	Type 2	2.9	202.0	26	5252.0
24	Type 2	2.5	178.0	25	4450.0
25	Type 2	1.1	206.0	23	4738.0
26	Type 2	3.8	155.0	27	4185.0
27	Type 2	4.7	157.0	29	4553.0
28	Type 2	2.4	224.0	25	5600.0
29	Type 2	4.2	159.0	28	4452.0
30	Type 2	3.6	175.0	27	4725.0

Type 3 Short Pulse Radar Statistical Performance - Details

Trial Id	Radar Type	Pulse Width (us)	PRI (us)	Number of Pulses	Waveform Length (us)
1	Type 3	6.1	487.0	16	7792.0
2	Type 3	7.1	344.0	16	5504.0
3	Type 3	9.8	288.0	18	5184.0
4	Type 3	8.9	230.0	18	4140.0
5	Type 3	7.9	432.0	17	7344.0
6	Type 3	8.2	207.0	17	3519.0
7	Type 3	7.5	443.0	17	7531.0
8	Type 3	8.1	439.0	17	7463.0
9	Type 3	6.2	223.0	16	3568.0
10	Type 3	8.9	208.0	18	3744.0
11	Type 3	9.6	463.0	18	8334.0
12	Type 3	8.2	441.0	17	7497.0
13	Type 3	7.2	323.0	16	5168.0
14	Type 3	9.5	297.0	18	5346.0
15	Type 3	8.0	412.0	17	7004.0
16	Type 3	10.0	324.0	18	5832.0
17	Type 3	7.4	271.0	17	4607.0
18	Type 3	7.9	349.0	17	5933.0
19	Type 3	7.3	409.0	16	6544.0
20	Type 3	8.7	373.0	18	6714.0
21	Type 3	7.2	254.0	16	4064.0
22	Type 3	9.9	274.0	18	4932.0
23	Type 3	7.9	278.0	17	4726.0
24	Type 3	7.5	317.0	17	5389.0
25	Type 3	6.1	260.0	16	4160.0
26	Type 3	8.8	211.0	18	3798.0
27	Type 3	9.7	272.0	18	4896.0
28	Type 3	7.4	264.0	17	4488.0
29	Type 3	9.2	284.0	18	5112.0
30	Type 3	8.6	474.0	17	8058.0

Type 4 Short Pulse Radar Statistical Performance - Details

Trial Id	Radar Type	Pulse Width (us)	PRI (us)	Number of Pulses	Waveform Length (us)
1	Type 4	11.3	487.0	12	5844.0
2	Type 4	13.5	344.0	13	4472.0
3	Type 4	19.4	288.0	16	4608.0
4	Type 4	17.5	230.0	15	3450.0
5	Type 4	15.3	432.0	14	6048.0
6	Type 4	15.9	207.0	14	2898.0
7	Type 4	14.3	443.0	13	5759.0
8	Type 4	15.8	439.0	14	6146.0
9	Type 4	11.5	223.0	12	2676.0
10	Type 4	17.4	208.0	15	3120.0
11	Type 4	19.0	463.0	16	7408.0
12	Type 4	16.0	441.0	14	6174.0
13	Type 4	13.8	323.0	13	4199.0
14	Type 4	18.9	297.0	16	4752.0
15	Type 4	15.5	412.0	14	5768.0
16	Type 4	19.9	324.0	16	5184.0
17	Type 4	14.1	271.0	13	3523.0
18	Type 4	15.2	349.0	14	4886.0
19	Type 4	13.8	409.0	13	5317.0
20	Type 4	17.1	373.0	15	5595.0
21	Type 4	13.8	254.0	13	3302.0
22	Type 4	19.8	274.0	16	4384.0
23	Type 4	15.3	278.0	14	3892.0
24	Type 4	14.5	317.0	13	4121.0
24	Type 4	14.5	317.0	13	4121.0
25	Type 4	11.3	260.0	12	3120.0
26	Type 4	17.3	211.0	15	3165.0
27	Type 4	19.2	272.0	16	4352.0
28	Type 4	14.2	264.0	13	3432.0
29	Type 4	18.2	284.0	15	4260.0
30	Type 4	16.8	474.0	15	7110.0

Type 5 Long Pulse Radar Statistical Performance - Details

Trial Id	Radar Type	Number of Bursts	Burst Period (s)	Waveform Length (s)	Center Frequency (GHz)			
1	Type 5	8	1.5000000	12.0000000	5.510000000			
	Burst ID	Burst Offset (us)	Pulse Width (us)	Chirp Width (MHz)	Number of Pulses per Burst	PRI-1 (us)	PRI-2 (us)	PRI-3 (us)
	0	653267.0	75.0	5	2	1766.0	1074.0	-
	1	1015342.0	99.4	5	3	1826.0	1363.0	1174.0
	2	1379673.0	67.4	5	2	1506.0	1129.0	-
	3	245381.0	73.6	5	2	1994.0	1155.0	-
	4	609211.0	65.9	5	1	1190.0	-	-
	5	970315.0	83.8	5	3	1600.0	1640.0	1656.0
	6	1335720.0	65.5	5	1	1761.0	-	-
	7	200392.0	98.6	5	3	1864.0	1409.0	1907.0
2	Type 5	11	1.0909091	12.0000000	5.510000000			
	Burst ID	Burst Offset (us)	Pulse Width (us)	Chirp Width (MHz)	Number of Pulses per Burst	PRI-1 (us)	PRI-2 (us)	PRI-3 (us)
	0	409465.0	73.8	9	2	1639.0	1970.0	-
	1	673541.0	69.5	9	2	1301.0	1709.0	-
	2	938405.0	51.9	9	1	1833.0	-	-
	3	113243.0	84.6	9	3	1346.0	1359.0	1246.0
	4	376706.0	95.4	9	3	1066.0	1801.0	1542.0
	5	640774.0	68.0	9	2	1679.0	1783.0	-
	6	903746.0	89.6	9	3	1637.0	1006.0	1743.0
	7	80813.0	81.9	9	2	1426.0	1951.0	-
	8	343904.0	88.3	9	3	1812.0	1727.0	1953.0
	9	609276.0	53.7	9	1	1695.0	-	-
	10	870628.0	91.3	9	3	1995.0	1858.0	1355.0
3	Type 5	20	0.6000000	12.0000000	5.510000000			
	Burst ID	Burst Offset (us)	Pulse Width (us)	Chirp Width (MHz)	Number of Pulses per Burst	PRI-1 (us)	PRI-2 (us)	PRI-3 (us)
	0	26552.0	68.1	19	2	1317.0	1127.0	-
	1	171871.0	58.7	19	1	1075.0	-	-
	2	316116.0	75.3	19	2	1671.0	1317.0	-
	3	461891.0	56.4	19	1	1718.0	-	-
	4	8664.0	99.7	19	3	1527.0	1631.0	1788.0
	5	153929.0	57.7	19	1	1269.0	-	-
	6	299079.0	59.5	19	1	1392.0	-	-
	7	442752.0	80.0	19	2	1491.0	1932.0	-
	8	587204.0	82.0	19	2	1934.0	1730.0	-
	9	135744.0	82.8	19	2	1467.0	1116.0	-
	10	279781.0	88.0	19	3	1108.0	1707.0	1589.0
	11	424346.0	93.2	19	3	1315.0	1373.0	1555.0
	12	569553.0	70.4	19	2	1593.0	1899.0	-
	13	117598.0	95.3	19	3	1229.0	1812.0	1052.0
	14	262325.0	81.9	19	2	1683.0	1955.0	-
	15	405781.0	98.5	19	3	1946.0	1977.0	1445.0
	16	553711.0	65.0	19	1	1353.0	-	-
	17	99809.0	85.4	19	3	1515.0	1218.0	1284.0
	18	244192.0	91.6	19	3	1576.0	1751.0	1083.0
	19	390174.0	67.3	19	2	1014.0	1047.0	-

Trial Id	Radar Type	Number of Bursts	Burst Period (s)	Waveform Length (s)	Center Frequency (GHz)				
4	Type 5	17	0.7058824	12.0000000	5.510000000				
		Burst ID	Burst Offset (us)	Pulse Width (us)	Chirp Width (MHz)	Number of Pulses per Burst	PRI-1 (us)	PRI-2 (us)	PRI-3 (us)
		0	626798.0	67.9	16	2	1997.0	1368.0	-
		1	96903.0	62.3	16	1	1616.0	-	-
		2	267849.0	53.3	16	1	1251.0	-	-
		3	437286.0	90.0	16	3	1496.0	1016.0	1081.0
		4	606043.0	77.1	16	2	1260.0	1836.0	-
		5	75592.0	83.9	16	3	1587.0	1287.0	1269.0
		6	245640.0	89.1	16	3	1040.0	1945.0	1574.0
		7	416504.0	81.8	16	2	1484.0	1774.0	-
		8	588726.0	50.3	16	1	1087.0	-	-
		9	54535.0	87.1	16	3	1908.0	1475.0	1949.0
		10	225137.0	71.3	16	2	1834.0	1325.0	-
		11	395073.0	97.5	16	3	1416.0	1046.0	1579.0
		12	565234.0	90.6	16	3	1419.0	1512.0	1182.0
		13	33645.0	86.3	16	3	1541.0	1359.0	1624.0
		14	203835.0	97.6	16	3	1575.0	1267.0	1378.0
		15	373694.0	84.7	16	3	1187.0	1979.0	1647.0
		16	543192.0	99.7	16	3	1735.0	1795.0	1972.0
5	Type 5	14	0.8571429	12.0000000	5.510000000				
		Burst ID	Burst Offset (us)	Pulse Width (us)	Chirp Width (MHz)	Number of Pulses per Burst	PRI-1 (us)	PRI-2 (us)	PRI-3 (us)
		0	15441.0	92.9	12	3	1423.0	1118.0	1358.0
		1	222649.0	67.7	12	2	1689.0	1176.0	-
		2	430620.0	65.8	12	1	1312.0	-	-
		3	637993.0	56.3	12	1	1571.0	-	-
		4	845422.0	53.7	12	1	1646.0	-	-
		5	196574.0	83.5	12	3	1802.0	1804.0	1663.0
		6	405116.0	65.8	12	1	1177.0	-	-
		7	610836.0	85.9	12	3	1540.0	1100.0	1162.0
		8	819293.0	76.3	12	2	1043.0	1199.0	-
		9	171555.0	81.5	12	2	1205.0	1918.0	-
		10	378184.0	89.4	12	3	1599.0	1571.0	1077.0
		11	587063.0	63.4	12	1	1295.0	-	-
		12	793149.0	69.6	12	2	1228.0	1665.0	-
		13	145983.0	74.5	12	2	1695.0	1775.0	-
6	Type 5	15	0.8000000	12.0000000	5.510000000				
		Burst ID	Burst Offset (us)	Pulse Width (us)	Chirp Width (MHz)	Number of Pulses per Burst	PRI-1 (us)	PRI-2 (us)	PRI-3 (us)
		0	328985.0	96.6	13	3	1567.0	1387.0	1506.0
		1	522498.0	96.7	13	3	1127.0	1354.0	1112.0
		2	714615.0	86.5	13	3	1505.0	1526.0	1715.0
		3	112383.0	73.3	13	2	1968.0	1729.0	-
		4	306212.0	55.8	13	1	1872.0	-	-
		5	500163.0	55.4	13	1	1266.0	-	-
		6	690552.0	85.3	13	3	1849.0	1867.0	1382.0
		7	88623.0	79.4	13	2	1739.0	1698.0	-
		8	282519.0	65.7	13	1	1447.0	-	-
		9	475743.0	68.6	13	2	1034.0	1187.0	-
		10	669102.0	77.7	13	2	1216.0	1143.0	-
		11	64844.0	79.6	13	2	1779.0	1441.0	-
		12	257701.0	94.9	13	3	1818.0	1196.0	1400.0
		13	452394.0	61.4	13	1	1345.0	-	-
		14	643963.0	90.6	13	3	1825.0	1130.0	1024.0

Trial Id	Radar Type	Number of Bursts	Burst Period (s)	Waveform Length (s)	Center Frequency (GHz)			
7	Type 5	12	1.0000000	12.0000000	5.510000000			
	Burst ID	Burst Offset (us)	Pulse Width (us)	Chirp Width (MHz)	Number of Pulses per Burst	PRI-1 (us)	PRI-2 (us)	PRI-3 (us)
	0	51432.0	52.6	10	1	1482.0	-	-
	1	292922.0	84.1	10	3	1539.0	1004.0	1258.0
	2	534275.0	97.7	10	3	1295.0	1677.0	1308.0
	3	776241.0	97.3	10	3	1064.0	1035.0	1575.0
	4	21547.0	98.8	10	3	1449.0	1076.0	1472.0
	5	263377.0	72.2	10	2	1334.0	1651.0	-
	6	504945.0	67.6	10	2	1752.0	1705.0	-
	7	746790.0	75.7	10	2	1696.0	1558.0	-
	8	990242.0	60.9	10	1	1531.0	-	-
	9	234006.0	64.2	10	1	1218.0	-	-
	10	475264.0	78.8	10	2	1661.0	1608.0	-
	11	716245.0	87.5	10	3	1351.0	1243.0	1728.0
8	Type 5	14	0.8571429	12.0000000	5.510000000			
	Burst ID	Burst Offset (us)	Pulse Width (us)	Chirp Width (MHz)	Number of Pulses per Burst	PRI-1 (us)	PRI-2 (us)	PRI-3 (us)
	0	822851.0	54.1	13	1	1687.0	-	-
	1	174900.0	50.7	13	1	1538.0	-	-
	2	382242.0	52.3	13	1	1917.0	-	-
	3	588103.0	99.8	13	3	1104.0	1181.0	1891.0
	4	795565.0	68.4	13	2	1838.0	1705.0	-
	5	149063.0	80.8	13	2	1390.0	1729.0	-
	6	356723.0	62.5	13	1	1844.0	-	-
	7	563598.0	74.8	13	2	1609.0	1087.0	-
	8	772302.0	50.8	13	1	1062.0	-	-
	9	123800.0	54.0	13	1	1389.0	-	-
	10	331350.0	63.0	13	1	1382.0	-	-
	11	536393.0	91.8	13	3	2000.0	1593.0	1768.0
	12	745583.0	79.3	13	2	1067.0	1307.0	-
	13	98268.0	64.3	13	1	1107.0	-	-
9	Type 5	8	1.5000000	12.0000000	5.510000000			
	Burst ID	Burst Offset (us)	Pulse Width (us)	Chirp Width (MHz)	Number of Pulses per Burst	PRI-1 (us)	PRI-2 (us)	PRI-3 (us)
	0	535571.0	63.4	6	1	1166.0	-	-
	1	898917.0	52.0	6	1	1446.0	-	-
	2	1259697.0	97.2	6	3	1696.0	1650.0	1267.0
	3	127089.0	78.7	6	2	1600.0	1807.0	-
	4	489947.0	74.2	6	2	1822.0	1933.0	-
	5	852558.0	86.7	6	3	1655.0	1015.0	1568.0
	6	1217152.0	54.3	6	1	1991.0	-	-
	7	82300.0	95.4	6	3	1772.0	1149.0	1932.0

Trial Id	Radar Type	Number of Bursts	Burst Period (s)	Waveform Length (s)	Center Frequency (GHz)			
10	Type 5	17	0.7058824	12.0000000	5.496400000			
	Burst ID	Burst Offset (us)	Pulse Width (us)	Chirp Width (MHz)	Number of Pulses per Burst	PRI-1 (us)	PRI-2 (us)	PRI-3 (us)
	0	209176.0	73.7	16	2	1394.0	1559.0	-
	1	378577.0	97.4	16	3	1240.0	1768.0	1946.0
	2	548594.0	91.7	16	3	1924.0	1909.0	1096.0
	3	17727.0	66.2	16	1	1609.0	-	-
	4	188261.0	70.8	16	2	1495.0	1142.0	-
	5	359227.0	52.3	16	1	1838.0	-	-
	6	529350.0	78.9	16	2	1662.0	1014.0	-
	7	699817.0	70.9	16	2	1584.0	1175.0	-
	8	167165.0	75.6	16	2	1421.0	1580.0	-
	9	338419.0	59.1	16	1	1371.0	-	-
	10	508194.0	77.0	16	2	1471.0	1410.0	-
	11	678428.0	67.9	16	2	1532.0	1624.0	-
	12	146139.0	81.2	16	2	1237.0	1899.0	-
	13	316473.0	78.7	16	2	1570.0	1797.0	-
	14	488365.0	63.3	16	1	1188.0	-	-
	15	657474.0	68.9	16	2	1593.0	1521.0	-
	16	125512.0	59.3	16	1	1072.0	-	-
11	Type 5	19	0.6315789	12.0000000	5.497600000			
	Burst ID	Burst Offset (us)	Pulse Width (us)	Chirp Width (MHz)	Number of Pulses per Burst	PRI-1 (us)	PRI-2 (us)	PRI-3 (us)
	0	264001.0	98.9	19	3	1619.0	1232.0	1068.0
	1	417231.0	82.3	19	2	1198.0	1209.0	-
	2	567901.0	86.7	19	3	1828.0	1541.0	1162.0
	3	92954.0	89.7	19	3	1243.0	1538.0	1600.0
	4	245112.0	98.6	19	3	1040.0	1773.0	1458.0
	5	397977.0	71.1	19	2	1971.0	1159.0	-
	6	551457.0	55.9	19	1	1918.0	-	-
	7	74391.0	67.9	19	2	1071.0	1841.0	-
	8	226484.0	84.4	19	3	1147.0	1411.0	1401.0
	9	380077.0	58.8	19	1	1680.0	-	-
	10	532981.0	65.6	19	1	1522.0	-	-
	11	55531.0	78.5	19	2	1864.0	1937.0	-
	12	208094.0	82.3	19	2	1003.0	1870.0	-
	13	359800.0	90.1	19	3	1376.0	1127.0	1721.0
	14	512124.0	90.2	19	3	1504.0	1086.0	1423.0
	15	36816.0	83.1	19	2	1524.0	1605.0	-
	16	189697.0	58.8	19	1	1594.0	-	-
	17	341619.0	77.0	19	2	1818.0	1374.0	-
	18	495472.0	55.0	19	1	1349.0	-	-

Trial Id	Radar Type	Number of Bursts	Burst Period (s)	Waveform Length (s)	Center Frequency (GHz)			
12	Type 5	15	0.8000000	12.0000000	5.495200000			
	Burst ID	Burst Offset (us)	Pulse Width (us)	Chirp Width (MHz)	Number of Pulses per Burst	PRI-1 (us)	PRI-2 (us)	PRI-3 (us)
	0	22912.0	58.1	13	1	1881.0	-	-
	1	218607.0	52.1	13	1	1417.0	-	-
	2	410438.0	59.9	13	1	1127.0	-	-
	3	603580.0	60.2	13	1	1934.0	-	-
	4	793918.0	95.9	13	3	1812.0	1491.0	1852.0
	5	192196.0	79.9	13	2	1781.0	1930.0	-
	6	385525.0	78.5	13	2	1410.0	1880.0	-
	7	580331.0	53.8	13	1	1116.0	-	-
	8	773468.0	64.7	13	1	1754.0	-	-
	9	168902.0	61.4	13	1	1373.0	-	-
	10	361910.0	83.2	13	2	1662.0	1218.0	-
	11	554151.0	84.7	13	3	1554.0	1548.0	1336.0
	12	746788.0	88.7	13	3	1274.0	1825.0	1672.0
	13	144765.0	78.3	13	2	1788.0	1116.0	-
	14	338082.0	69.3	13	2	1819.0	1095.0	-
13	Type 5	12	1.0000000	12.0000000	5.494000000			
	Burst ID	Burst Offset (us)	Pulse Width (us)	Chirp Width (MHz)	Number of Pulses per Burst	PRI-1 (us)	PRI-2 (us)	PRI-3 (us)
	0	664476.0	75.3	10	2	1954.0	1350.0	-
	1	907451.0	56.3	10	1	1935.0	-	-
	2	151297.0	67.7	10	2	1366.0	1567.0	-
	3	393839.0	55.6	10	1	1100.0	-	-
	4	634772.0	75.2	10	2	1699.0	1492.0	-
	5	876467.0	76.3	10	2	1267.0	1996.0	-
	6	121291.0	85.7	10	3	1273.0	1747.0	1712.0
	7	363058.0	98.4	10	3	1372.0	1084.0	1224.0
	8	603800.0	86.4	10	3	1942.0	1967.0	1248.0
	9	845154.0	93.6	10	3	1604.0	1751.0	1716.0
	10	91831.0	63.3	10	1	1762.0	-	-
	11	333386.0	92.4	10	3	1306.0	1050.0	1046.0

Trial Id	Radar Type	Number of Bursts	Burst Period (s)	Waveform Length (s)	Center Frequency (GHz)			
14	Type 5	19	0.6315789	12.0000000	5.497200000			
	Burst ID	Burst Offset (us)	Pulse Width (us)	Chirp Width (MHz)	Number of Pulses per Burst	PRI-1 (us)	PRI-2 (us)	PRI-3 (us)
	0	382087.0	93.3	18	3	1482.0	1099.0	1525.0
	1	515307.0	69.1	18	2	1209.0	1630.0	-
	2	38994.0	86.9	18	3	1010.0	1114.0	1716.0
	3	190922.0	84.9	18	3	1539.0	1502.0	1847.0
	4	343724.0	72.3	18	2	1563.0	1845.0	-
	5	497361.0	51.7	18	1	1780.0	-	-
	6	20319.0	58.3	18	1	1419.0	-	-
	7	173196.0	60.6	18	1	1262.0	-	-
	8	326148.0	57.1	18	1	1106.0	-	-
	9	475778.0	88.9	18	3	1668.0	1946.0	1808.0
	10	1488.0	72.0	18	2	1837.0	1965.0	-
	11	153567.0	90.9	18	3	1190.0	1601.0	1731.0
	12	306964.0	59.8	18	1	1822.0	-	-
	13	458779.0	70.0	18	2	1870.0	1214.0	-
	14	611697.0	67.2	18	2	1345.0	1237.0	-
	15	134832.0	91.2	18	3	1589.0	1629.0	1315.0
	16	288289.0	56.5	18	1	1520.0	-	-
	17	441028.0	51.2	18	1	1620.0	-	-
	18	591978.0	74.1	18	2	1599.0	1968.0	-
15	Type 5	14	0.8571429	12.0000000	5.494800000			
	Burst ID	Burst Offset (us)	Pulse Width (us)	Chirp Width (MHz)	Number of Pulses per Burst	PRI-1 (us)	PRI-2 (us)	PRI-3 (us)
	0	158254.0	76.9	12	2	1058.0	1366.0	-
	1	366047.0	50.2	12	1	1262.0	-	-
	2	573377.0	62.9	12	1	1632.0	-	-
	3	780532.0	64.7	12	1	1997.0	-	-
	4	132351.0	83.8	12	3	1835.0	1584.0	1378.0
	5	340432.0	65.4	12	1	1378.0	-	-
	6	548146.0	53.2	12	1	1122.0	-	-
	7	755450.0	51.7	12	1	1470.0	-	-
	8	107154.0	78.7	12	2	1184.0	1489.0	-
	9	314379.0	72.4	12	2	1610.0	1094.0	-
	10	522427.0	53.8	12	1	1361.0	-	-
	11	729049.0	73.6	12	2	1243.0	1210.0	-
	12	81555.0	66.7	12	2	1518.0	1911.0	-
	13	288616.0	82.5	12	2	1925.0	1479.0	-

Trial Id	Radar Type	Number of Bursts	Burst Period (s)	Waveform Length (s)	Center Frequency (GHz)			
16	Type 5	20	0.6000000	12.0000000	5.498000000			
	Burst ID	Burst Offset (us)	Pulse Width (us)	Chirp Width (MHz)	Number of Pulses per Burst	PRI-1 (us)	PRI-2 (us)	PRI-3 (us)
	0	345538.0	87.6	20	3	1809.0	1142.0	1902.0
	1	490101.0	85.2	20	3	1370.0	1301.0	1914.0
	2	39145.0	84.8	20	3	1217.0	1247.0	1324.0
	3	183993.0	77.9	20	2	1160.0	1822.0	-
	4	329141.0	76.5	20	2	1295.0	1048.0	-
	5	474918.0	60.9	20	1	1301.0	-	-
	6	21367.0	83.0	20	2	1684.0	1175.0	-
	7	166161.0	80.4	20	2	1841.0	1130.0	-
	8	311033.0	67.5	20	2	1607.0	1223.0	-
	9	456993.0	62.1	20	1	1352.0	-	-
	10	3520.0	86.4	20	3	1700.0	1399.0	1030.0
	11	147826.0	84.3	20	3	1858.0	1628.0	1494.0
	12	293433.0	76.9	20	2	1268.0	1072.0	-
	13	437093.0	95.8	20	3	1310.0	1101.0	1689.0
	14	584602.0	55.2	20	1	1043.0	-	-
	15	130793.0	59.0	20	1	1580.0	-	-
	16	274624.0	94.5	20	3	1558.0	1119.0	1732.0
	17	418777.0	91.9	20	3	1627.0	1533.0	1671.0
	18	563823.0	85.2	20	3	1161.0	1131.0	1800.0
	19	112710.0	69.5	20	2	1309.0	1364.0	-
17	Type 5	12	1.0000000	12.0000000	5.494000000			
	Burst ID	Burst Offset (us)	Pulse Width (us)	Chirp Width (MHz)	Number of Pulses per Burst	PRI-1 (us)	PRI-2 (us)	PRI-3 (us)
	0	429259.0	86.4	10	3	1194.0	1562.0	1794.0
	1	670979.0	92.2	10	3	1679.0	1068.0	1370.0
	2	913818.0	80.4	10	2	1387.0	1304.0	-
	3	158545.0	54.3	10	1	1702.0	-	-
	4	400895.0	53.1	10	1	1126.0	-	-
	5	642041.0	69.4	10	2	1109.0	1744.0	-
	6	883409.0	69.1	10	2	1871.0	1514.0	-
	7	128290.0	100.0	10	3	1674.0	1420.0	1951.0
	8	370659.0	79.6	10	2	1175.0	1014.0	-
	9	611891.0	88.4	10	3	1058.0	1132.0	1252.0
	10	855277.0	53.3	10	1	1469.0	-	-
	11	98894.0	65.3	10	1	1745.0	-	-

Trial Id	Radar Type	Number of Bursts	Burst Period (s)	Waveform Length (s)	Center Frequency (GHz)				
18	Type 5	14	0.8571429	12.0000000	5.494800000				
		Burst ID	Burst Offset (us)	Pulse Width (us)	Chirp Width (MHz)	Number of Pulses per Burst	PRI-1 (us)	PRI-2 (us)	PRI-3 (us)
		0	292264.0	55.3	12	1	1564.0	-	-
		1	499839.0	58.3	12	1	1444.0	-	-
		2	706241.0	72.3	12	2	1214.0	1599.0	-
		3	59016.0	84.8	12	3	1938.0	1061.0	1221.0
		4	266259.0	82.5	12	2	1902.0	1090.0	-
		5	474152.0	63.3	12	1	1667.0	-	-
		6	680785.0	80.0	12	2	1664.0	1066.0	-
		7	33532.0	90.3	12	3	1701.0	1591.0	1004.0
		8	240164.0	91.1	12	3	1941.0	1715.0	1385.0
		9	447244.0	96.6	12	3	1343.0	1453.0	1448.0
		10	654869.0	82.7	12	2	1376.0	1863.0	-
		11	8084.0	50.7	12	1	1112.0	-	-
		12	215195.0	78.4	12	2	1860.0	1251.0	-
		13	421414.0	99.5	12	3	1211.0	1957.0	1785.0
19	Type 5	12	1.0000000	12.0000000	5.494000000				
		Burst ID	Burst Offset (us)	Pulse Width (us)	Chirp Width (MHz)	Number of Pulses per Burst	PRI-1 (us)	PRI-2 (us)	PRI-3 (us)
		0	733776.0	88.6	10	3	1250.0	1232.0	1944.0
		1	978500.0	57.4	10	1	1092.0	-	-
		2	221259.0	96.6	10	3	1049.0	1114.0	1625.0
		3	463263.0	69.7	10	2	1156.0	1790.0	-
		4	705037.0	77.9	10	2	1367.0	1640.0	-
		5	947884.0	62.0	10	1	1907.0	-	-
		6	191445.0	88.4	10	3	1209.0	1654.0	1204.0
		7	432506.0	97.3	10	3	1852.0	1608.0	1720.0
		8	674848.0	96.2	10	3	1360.0	1171.0	1074.0
		9	915221.0	95.4	10	3	1344.0	1748.0	1910.0
		10	162187.0	54.8	10	1	1015.0	-	-
		11	403878.0	80.4	10	2	1296.0	1188.0	-

Trial Id	Radar Type	Number of Bursts	Burst Period (s)	Waveform Length (s)	Center Frequency (GHz)				
20	Type 5	16	0.7500000	12.0000000	5.524000000				
		Burst ID	Burst Offset (us)	Pulse Width (us)	Chirp Width (MHz)	Number of Pulses per Burst	PRI-1 (us)	PRI-2 (us)	PRI-3 (us)
		0	483824.0	74.7	15	2	1583.0	1101.0	-
		1	865910.0	57.1	15	1	1741.0	-	-
		2	98722.0	91.9	15	3	1686.0	1852.0	1265.0
		3	280148.0	83.1	15	2	1116.0	1841.0	-
		4	462269.0	50.7	15	1	1435.0	-	-
		5	641874.0	79.2	15	2	1722.0	1975.0	-
		6	76783.0	58.7	15	1	1652.0	-	-
		7	257866.0	71.0	15	2	1476.0	1380.0	-
		8	438568.0	79.0	15	2	1785.0	1927.0	-
		9	620389.0	68.5	15	2	1017.0	1704.0	-
		10	54344.0	73.5	15	2	1548.0	1239.0	-
		11	235380.0	70.5	15	2	1723.0	1658.0	-
		12	416942.0	76.6	15	2	1262.0	1252.0	-
		13	597534.0	81.2	15	2	1532.0	1852.0	-
		14	32065.0	61.8	15	1	1786.0	-	-
		15	212584.0	94.9	15	3	1710.0	1907.0	1485.0
21	Type 5	12	1.0000000	12.0000000	5.526400000				
		Burst ID	Burst Offset (us)	Pulse Width (us)	Chirp Width (MHz)	Number of Pulses per Burst	PRI-1 (us)	PRI-2 (us)	PRI-3 (us)
		0	526804.0	78.5	9	2	1033.0	1077.0	-
		1	766810.0	89.8	9	3	1754.0	1928.0	1041.0
		2	12967.0	59.4	9	1	1054.0	-	-
		3	254814.0	79.6	9	2	1048.0	1683.0	-
		4	496335.0	76.0	9	2	1789.0	1641.0	-
		5	739766.0	53.6	9	1	1092.0	-	-
		6	979583.0	80.9	9	2	1815.0	1770.0	-
		7	225383.0	61.6	9	1	1130.0	-	-
		8	467404.0	53.4	9	1	1634.0	-	-
		9	709942.0	59.9	9	1	1068.0	-	-
		10	951435.0	60.4	9	1	1885.0	-	-
		11	194882.0	91.4	9	3	1792.0	1291.0	1419.0

Trial Id	Radar Type	Number of Bursts	Burst Period (s)	Waveform Length (s)	Center Frequency (GHz)			
22	Type 5	20	0.6000000	12.0000000	5.522000000			
	Burst ID	Burst Offset (us)	Pulse Width (us)	Chirp Width (MHz)	Number of Pulses per Burst	PRI-1 (us)	PRI-2 (us)	PRI-3 (us)
	0	261690.0	77.0	20	2	1730.0	1206.0	-
	1	407496.0	58.1	20	1	1468.0	-	-
	2	553039.0	62.1	20	1	1057.0	-	-
	3	98971.0	76.9	20	2	1466.0	1926.0	-
	4	243693.0	80.0	20	2	1841.0	1488.0	-
	5	389821.0	52.0	20	1	1153.0	-	-
	6	531723.0	88.6	20	3	2000.0	1481.0	1407.0
	7	81080.0	72.9	20	2	1935.0	1952.0	-
	8	225051.0	98.5	20	3	1689.0	1898.0	1899.0
	9	371684.0	57.9	20	1	1550.0	-	-
	10	513892.0	95.9	20	3	1339.0	1731.0	1878.0
	11	63543.0	53.5	20	1	1336.0	-	-
	12	207470.0	92.0	20	3	1916.0	1909.0	1146.0
	13	353593.0	57.3	20	1	1910.0	-	-
	14	497722.0	70.5	20	2	1889.0	1132.0	-
	15	45525.0	70.0	20	2	1619.0	1464.0	-
	16	189563.0	84.0	20	3	1968.0	1995.0	1419.0
	17	334977.0	76.1	20	2	1488.0	1756.0	-
	18	478188.0	93.2	20	3	1828.0	1610.0	1697.0
	19	27659.0	96.8	20	3	1462.0	1116.0	1215.0
23	Type 5	14	0.8571429	12.0000000	5.525200000			
	Burst ID	Burst Offset (us)	Pulse Width (us)	Chirp Width (MHz)	Number of Pulses per Burst	PRI-1 (us)	PRI-2 (us)	PRI-3 (us)
	0	247197.0	50.1	12	1	1562.0	-	-
	1	453153.0	93.5	12	3	1529.0	1790.0	1159.0
	2	660655.0	68.8	12	2	1687.0	1881.0	-
	3	14128.0	56.3	12	1	1820.0	-	-
	4	220915.0	86.0	12	3	1442.0	1738.0	1170.0
	5	428528.0	75.2	12	2	1335.0	1453.0	-
	6	636648.0	54.4	12	1	1562.0	-	-
	7	842797.0	71.1	12	2	1542.0	1394.0	-
	8	195782.0	76.2	12	2	1291.0	1561.0	-
	9	402683.0	80.2	12	2	1912.0	1557.0	-
	10	610243.0	79.7	12	2	1037.0	1708.0	-
	11	815692.0	90.9	12	3	1871.0	1691.0	1032.0
	12	170136.0	68.7	12	2	1488.0	1990.0	-
	13	377546.0	67.4	12	2	1446.0	1195.0	-

Trial Id	Radar Type	Number of Bursts	Burst Period (s)	Waveform Length (s)	Center Frequency (GHz)			
24	Type 5	13	0.9230769	12.0000000	5.525600000			
	Burst ID	Burst Offset (us)	Pulse Width (us)	Chirp Width (MHz)	Number of Pulses per Burst	PRI-1 (us)	PRI-2 (us)	PRI-3 (us)
	0	828743.0	94.0	11	3	1862.0	1287.0	1201.0
	1	853454.0	70.8	11	2	1088.0	1222.0	-
	2	156136.0	56.3	11	1	1516.0	-	-
	3	378517.0	96.7	11	3	1316.0	1809.0	1126.0
	4	601369.0	90.6	11	3	1749.0	1461.0	1029.0
	5	825544.0	74.5	11	2	1068.0	1691.0	-
	6	128146.0	92.6	11	3	1882.0	1293.0	1633.0
	7	350649.0	89.0	11	3	1541.0	1858.0	1948.0
	8	574102.0	96.5	11	3	1361.0	1536.0	1049.0
	9	797240.0	70.5	11	2	1787.0	1906.0	-
	10	100771.0	94.0	11	3	1079.0	1508.0	1692.0
	11	324468.0	55.8	11	1	1840.0	-	-
	12	545941.0	87.7	11	3	1757.0	1673.0	1698.0
25	Type 5	8	1.5000000	12.0000000	5.528000000			
	Burst ID	Burst Offset (us)	Pulse Width (us)	Chirp Width (MHz)	Number of Pulses per Burst	PRI-1 (us)	PRI-2 (us)	PRI-3 (us)
	0	1253346.0	68.6	5	2	1434.0	1625.0	-
	1	119462.0	83.1	5	2	1582.0	1450.0	-
	2	482866.0	60.9	5	1	1970.0	-	-
	3	845899.0	77.7	5	2	1246.0	1231.0	-
	4	1209262.0	77.4	5	2	1046.0	1225.0	-
	5	74755.0	66.8	5	2	1587.0	1165.0	-
	6	436159.0	63.7	5	1	1813.0	-	-
	7	799839.0	91.2	5	3	1451.0	1528.0	1970.0

Trial Id	Radar Type	Number of Bursts	Burst Period (s)	Waveform Length (s)	Center Frequency (GHz)				
26	Type 5	17	0.7058824	12.0000000	5.523600000				
		Burst ID	Burst Offset (us)	Pulse Width (us)	Chirp Width (MHz)	Number of Pulses per Burst	PRI-1 (us)	PRI-2 (us)	PRI-3 (us)
		0	545416.0	83.6	16	3	1017.0	1990.0	1397.0
		1	14066.0	89.4	16	3	1401.0	1948.0	1131.0
		2	184961.0	55.8	16	1	1500.0	-	-
		3	354333.0	90.9	16	3	1835.0	1325.0	1237.0
		4	526694.0	54.7	16	1	1416.0	-	-
		5	695652.0	97.7	16	3	1183.0	1142.0	1007.0
		6	163430.0	67.5	16	2	1626.0	1970.0	-
		7	333465.0	96.7	16	3	1371.0	1076.0	1764.0
		8	504482.0	68.3	16	2	1596.0	1445.0	-
		9	675424.0	78.3	16	2	1109.0	1431.0	-
		10	142911.0	55.0	16	1	1324.0	-	-
		11	312370.0	84.9	16	3	1386.0	1310.0	1812.0
		12	483170.0	74.6	16	2	1723.0	1776.0	-
		13	655500.0	63.3	16	1	1371.0	-	-
		14	121408.0	99.8	16	3	1238.0	1335.0	1378.0
		15	292829.0	63.6	16	1	1111.0	-	-
		16	461438.0	87.3	16	3	1491.0	1704.0	1442.0
27	Type 5	19	0.6315789	12.0000000	5.522400000				
		Burst ID	Burst Offset (us)	Pulse Width (us)	Chirp Width (MHz)	Number of Pulses per Burst	PRI-1 (us)	PRI-2 (us)	PRI-3 (us)
		0	564587.0	85.6	19	3	1355.0	1726.0	1567.0
		1	89838.0	68.6	19	2	1936.0	1791.0	-
		2	243065.0	54.2	19	1	1256.0	-	-
		3	395965.0	61.2	19	1	1213.0	-	-
		4	546679.0	97.1	19	3	1554.0	1063.0	1088.0
		5	71022.0	98.3	19	3	1038.0	1601.0	1618.0
		6	224043.0	62.4	19	1	1796.0	-	-
		7	375811.0	80.2	19	2	1736.0	1688.0	-
		8	526524.0	87.5	19	3	1933.0	1524.0	1910.0
		9	52332.0	85.8	19	3	1558.0	1072.0	1014.0
		10	204270.0	88.1	19	3	1638.0	1320.0	1778.0
		11	358389.0	65.3	19	1	1059.0	-	-
		12	510583.0	52.5	19	1	1956.0	-	-
		13	33661.0	52.3	19	1	2000.0	-	-
		14	186091.0	74.1	19	2	1080.0	1807.0	-
		15	339568.0	54.9	19	1	1031.0	-	-
		16	490613.0	76.2	19	2	1518.0	1924.0	-
		17	14864.0	60.4	19	1	1527.0	-	-
		18	167448.0	81.5	19	2	1015.0	1351.0	-

Trial Id	Radar Type	Number of Bursts	Burst Period (s)	Waveform Length (s)	Center Frequency (GHz)			
28	Type 5	12	1.0000000	12.0000000	5.526000000			
	Burst ID	Burst Offset (us)	Pulse Width (us)	Chirp Width (MHz)	Number of Pulses per Burst	PRI-1 (us)	PRI-2 (us)	PRI-3 (us)
	0	508045.0	50.5	10	1	1196.0	-	-
	1	749937.0	55.7	10	1	1661.0	-	-
	2	989019.0	85.8	10	3	1656.0	1854.0	1218.0
	3	235517.0	76.9	10	2	1772.0	1323.0	-
	4	477346.0	75.1	10	2	1221.0	1773.0	-
	5	718529.0	92.3	10	3	1122.0	1158.0	1577.0
	6	960804.0	78.1	10	2	1503.0	1649.0	-
	7	205421.0	92.2	10	3	1446.0	1589.0	1583.0
	8	447174.0	89.0	10	3	1145.0	1370.0	1341.0
	9	689823.0	70.9	10	2	1088.0	1246.0	-
	10	932887.0	63.1	10	1	1157.0	-	-
	11	176194.0	55.3	10	1	1731.0	-	-
29	Type 5	18	0.6666667	12.0000000	5.523200000			
	Burst ID	Burst Offset (us)	Pulse Width (us)	Chirp Width (MHz)	Number of Pulses per Burst	PRI-1 (us)	PRI-2 (us)	PRI-3 (us)
	0	277683.0	83.4	17	3	1301.0	1213.0	1473.0
	1	438503.0	97.3	17	3	1258.0	1057.0	1522.0
	2	598617.0	90.4	17	3	1679.0	1090.0	1780.0
	3	97142.0	91.8	17	3	1385.0	1491.0	1272.0
	4	257779.0	98.2	17	3	1869.0	1055.0	1339.0
	5	420304.0	59.5	17	1	1301.0	-	-
	6	580095.0	80.0	17	2	1693.0	1417.0	-
	7	77238.0	86.5	17	3	1548.0	1656.0	1903.0
	8	237974.0	91.1	17	3	1379.0	1497.0	1433.0
	9	398356.0	93.5	17	3	1360.0	1444.0	1937.0
	10	561396.0	60.7	17	1	1778.0	-	-
	11	57672.0	67.2	17	2	1157.0	1676.0	-
	12	219189.0	61.8	17	1	1263.0	-	-
	13	379317.0	79.4	17	2	1952.0	1503.0	-
	14	540148.0	81.4	17	2	1926.0	1552.0	-
	15	37944.0	65.7	17	1	1005.0	-	-
	16	198981.0	76.0	17	2	1299.0	1065.0	-
	17	360068.0	81.0	17	2	1163.0	1251.0	-

Trial Id	Radar Type	Number of Bursts	Burst Period (s)	Waveform Length (s)	Center Frequency (GHz)			
30	Type 5	16	0.7500000	12.0000000	5.510000000			
	Burst ID	Burst Offset (us)	Pulse Width (us)	Chirp Width (MHz)	Number of Pulses per Burst	PRI-1 (us)	PRI-2 (us)	PRI-3 (us)
	0	586476.0	79.9	15	2	1445.0	1067.0	-
	1	20235.0	98.4	15	3	1798.0	1118.0	1157.0
	2	201928.0	52.9	15	1	1174.0	-	-
	3	382479.0	68.3	15	2	1721.0	1527.0	-
	4	564677.0	63.1	15	1	1808.0	-	-
	5	745231.0	81.6	15	2	1068.0	1649.0	-
	6	178670.0	99.8	15	3	1673.0	1700.0	1502.0
	7	359099.0	91.7	15	3	1830.0	1924.0	1717.0
	8	541506.0	79.2	15	2	1040.0	1899.0	-
	9	722438.0	68.9	15	2	1615.0	1586.0	-
	10	156628.0	68.9	15	2	1902.0	1935.0	-
	11	338832.0	56.1	15	1	1104.0	-	-
	12	519379.0	73.5	15	2	1122.0	1541.0	-
	13	701469.0	59.2	15	1	1770.0	-	-
	14	134407.0	74.4	15	2	1944.0	1504.0	-
	15	315939.0	80.5	15	2	1334.0	1002.0	-

Type 6 Frequency Hopping Radar Statistical Performance - Details

Trial Id	Radar Type	Pulse Width (us)	PRI (us)	Pulses per Hop	Hopping Rate (kHz)	Hopping Sequence Length (ms)	Visible Frequency Number
1	Type 6	1.0	333.3	9	0.3333	300.0000000	1
	Frequency List (MHz)	0	1	2	3	4	
	0	5619	5578	5270	5294	5354	
	5	5660	5710	5666	5399	5656	
	10	5297	5333	5642	5609	5709	
	15	5668	5527	5647	5547	5284	
	20	5375	5395	5384	5444	5705	
	25	5584	5536	5480	5658	5453	
	30	5403	5576	5588	5641	5465	
	35	5674	5580	5623	5559	5627	
	40	5553	5704	5673	5633	5724	
	45	5373	5348	5331	5513	5637	
	50	5544	5314	5585	5697	5257	
	55	5672	5471	5423	5424	5638	
	60	5644	5345	5569	5655	5413	
	65	5271	5415	5550	5371	5335	
	70	5382	5416	5533	5706	5558	
	75	5535	5692	5256	5436	5716	
	80	5385	5669	5458	5349	5456	
	85	5336	5634	5703	5352	5280	
	90	5506	5313	5690	5326	5631	
	95	5628	5546	5289	5490	5590	

Trial Id	Radar Type	Pulse Width (us)	PRI (us)	Pulses per Hop	Hopping Rate (kHz)	Hopping Sequence Length (ms)	Visible Frequency Number
2	Type 6	1.0	333.3	9	0.3333	300.0000000	4
	Frequency List (MHz)	0	1	2	3	4	
	0	5302	5342	5681	5455	5611	
	5	5493	5682	5310	5257	5606	
	10	5587	5561	5374	5362	5630	
	15	5322	5320	5502	5475	5364	
	20	5555	5353	5316	5387	5357	
	25	5332	5654	5312	5262	5409	
	30	5522	5547	5410	5618	5253	
	35	5311	5683	5556	5470	5258	
	40	5537	5398	5710	5491	5469	
	45	5670	5465	5704	5456	5406	
	50	5384	5400	5513	5720	5365	
	55	5296	5276	5641	5445	5626	
	60	5564	5620	5395	5334	5290	
	65	5401	5578	5359	5569	5586	
	70	5282	5649	5407	5368	5647	
	75	5643	5509	5592	5675	5678	
	80	5581	5275	5381	5512	5600	
	85	5304	5382	5389	5458	5666	
	90	5419	5642	5350	5526	5519	
	95	5709	5692	5418	5653	5354	

Trial Id	Radar Type	Pulse Width (us)	PRI (us)	Pulses per Hop	Hopping Rate (kHz)	Hopping Sequence Length (ms)	Visible Frequency Number
3	Type 6	1.0	333.3	9	0.3333	300.0000000	6
	Frequency List (MHz)	0	1	2	3	4	
	0	5557	5581	5617	5616	5356	
	5	5535	5704	5385	5420	5338	
	10	5518	5350	5415	5651	5313	
	15	5447	5605	5520	5653	5563	
	20	5519	5257	5476	5330	5598	
	25	5506	5515	5366	5443	5661	
	30	5533	5367	5358	5502	5606	
	35	5347	5647	5266	5411	5451	
	40	5334	5332	5709	5667	5394	
	45	5684	5539	5464	5437	5665	
	50	5389	5421	5416	5574	5488	
	55	5536	5580	5279	5439	5324	
	60	5499	5710	5708	5404	5305	
	65	5295	5525	5589	5359	5452	
	70	5576	5272	5492	5388	5551	
	75	5547	5323	5724	5256	5721	
	80	5293	5379	5584	5361	5508	
	85	5479	5693	5341	5655	5715	
	90	5629	5494	5401	5637	5423	
	95	5280	5316	5662	5281	5649	

Trial Id	Radar Type	Pulse Width (us)	PRI (us)	Pulses per Hop	Hopping Rate (kHz)	Hopping Sequence Length (ms)	Visible Frequency Number
4	Type 6	1.0	333.3	9	0.3333	300.0000000	2
	Frequency List (MHz)	0	1	2	3	4	
	0	5337	5345	5553	5302	5673	
	5	5577	5629	5460	5583	5642	
	10	5352	5614	5456	5655	5672	
	15	5401	5574	5611	5565	5370	
	20	5571	5588	5295	5468	5303	
	25	5486	5358	5718	5470	5380	
	30	5703	5422	5324	5573	5654	
	35	5426	5263	5634	5661	5462	
	40	5648	5498	5270	5474	5664	
	45	5701	5622	5425	5490	5552	
	50	5265	5597	5467	5300	5432	
	55	5724	5437	5469	5258	5715	
	60	5453	5277	5637	5705	5348	
	65	5593	5262	5561	5251	5255	
	70	5275	5341	5364	5510	5516	
	75	5346	5712	5504	5549	5356	
	80	5527	5376	5264	5447	5442	
	85	5454	5658	5428	5544	5374	
	90	5343	5663	5478	5689	5384	
	95	5372	5707	5274	5292	5466	

Trial Id	Radar Type	Pulse Width (us)	PRI (us)	Pulses per Hop	Hopping Rate (kHz)	Hopping Sequence Length (ms)	Visible Frequency Number
5	Type 6	1.0	333.3	9	0.3333	300.000000	1
	Frequency List (MHz)	0	1	2	3	4	
	0	5592	5584	5489	5463	5418	
	5	5619	5651	5535	5271	5374	
	10	5283	5500	5594	5375	5693	
	15	5604	5714	5610	5562	5482	
	20	5279	5711	5557	5276	5277	
	25	5307	5446	5574	5414	5270	
	30	5408	5281	5691	5428	5624	
	35	5625	5354	5430	5339	5376	
	40	5487	5581	5683	5617	5630	
	45	5644	5705	5483	5342	5519	
	50	5298	5518	5563	5598	5437	
	55	5391	5659	5455	5686	5582	
	60	5697	5469	5628	5294	5319	
	65	5597	5631	5521	5436	5423	
	70	5278	5665	5340	5485	5466	
	75	5438	5315	5275	5614	5330	
	80	5520	5590	5596	5264	5289	
	85	5405	5646	5526	5346	5676	
	90	5267	5539	5349	5600	5258	
	95	5671	5533	5345	5587	5523	

Trial Id	Radar Type	Pulse Width (us)	PRI (us)	Pulses per Hop	Hopping Rate (kHz)	Hopping Sequence Length (ms)	Visible Frequency Number
6	Type 6	1.0	333.3	9	0.3333	300.000000	4
	Frequency List (MHz)	0	1	2	3	4	
	0	5372	5348	5425	5624	5260	
	5	5283	5576	5610	5434	5581	
	10	5689	5289	5635	5570	5714	
	15	5577	5256	5342	5558	5279	
	20	5490	5652	5549	5724	5640	
	25	5634	5552	5300	5448	5409	
	30	5297	5713	5431	5580	5444	
	35	5667	5445	5701	5492	5290	
	40	5326	5286	5621	5382	5280	
	45	5559	5313	5541	5499	5704	
	50	5395	5474	5569	5274	5421	
	55	5698	5625	5345	5374	5657	
	60	5711	5519	5642	5301	5454	
	65	5715	5520	5536	5366	5413	
	70	5414	5378	5417	5316	5428	
	75	5357	5586	5484	5296	5430	
	80	5627	5684	5653	5273	5606	
	85	5465	5363	5491	5352	5355	
	90	5518	5631	5688	5588	5329	
	95	5485	5502	5590	5390	5531	

Trial Id	Radar Type	Pulse Width (us)	PRI (us)	Pulses per Hop	Hopping Rate (kHz)	Hopping Sequence Length (ms)	Visible Frequency Number
7	Type 6	1.0	333.3	9	0.3333	300.000000	6
	Frequency List (MHz)	0	1	2	3	4	
	0	5530	5587	5361	5310	5480	
	5	5325	5598	5685	5500	5410	
	10	5523	5553	5676	5290	5260	
	15	5568	5383	5445	5603	5471	
	20	5498	5514	5690	5638	5697	
	25	5431	5583	5280	5404	5482	
	30	5451	5661	5670	5646	5354	
	35	5642	5331	5633	5594	5267	
	40	5301	5640	5369	5559	5622	
	45	5277	5391	5507	5396	5502	
	50	5552	5494	5271	5650	5620	
	55	5363	5719	5545	5338	5299	
	60	5564	5628	5268	5684	5608	
	65	5283	5343	5584	5572	5673	
	70	5683	5517	5492	5381	5266	
	75	5292	5387	5326	5706	5627	
	80	5682	5262	5367	5276	5716	
	85	5270	5511	5428	5458	5359	
	90	5351	5600	5285	5394	5571	
	95	5400	5265	5327	5643	5313	

Trial Id	Radar Type	Pulse Width (us)	PRI (us)	Pulses per Hop	Hopping Rate (kHz)	Hopping Sequence Length (ms)	Visible Frequency Number
8	Type 6	1.0	333.3	9	0.3333	300.000000	5
	Frequency List (MHz)	0	1	2	3	4	
	0	5310	5351	5297	5374	5322	
	5	5367	5523	5285	5663	5617	
	10	5454	5342	5717	5485	5281	
	15	5656	5510	5548	5648	5409	
	20	5680	5631	5630	5670	5319	
	25	5435	5483	5508	5516	5493	
	30	5647	5627	5386	5506	5462	
	35	5470	5724	5390	5420	5690	
	40	5576	5452	5497	5387	5274	
	45	5320	5487	5479	5560	5605	
	50	5381	5622	5671	5445	5489	
	55	5526	5253	5279	5502	5397	
	60	5629	5440	5678	5704	5544	
	65	5533	5608	5408	5478	5655	
	70	5481	5590	5268	5346	5673	
	75	5254	5295	5258	5459	5372	
	80	5623	5401	5267	5706	5545	
	85	5488	5650	5324	5305	5373	
	90	5559	5464	5660	5344	5698	
	95	5394	5378	5363	5321	5311	

Trial Id	Radar Type	Pulse Width (us)	PRI (us)	Pulses per Hop	Hopping Rate (kHz)	Hopping Sequence Length (ms)	Visible Frequency Number
9	Type 6	1.0	333.3	9	0.3333	300.0000000	1
	Frequency List (MHz)	0	1	2	3	4	
	0	5565	5590	5708	5535	5542	
	5	5409	5545	5360	5351	5349	
	10	5288	5606	5283	5583	5302	
	15	5269	5637	5554	5693	5380	
	20	5417	5274	5572	5719	5643	
	25	5682	5287	5686	5612	5550	
	30	5632	5536	5584	5504	5280	
	35	5660	5512	5340	5661	5573	
	40	5604	5415	5435	5530	5271	
	45	5627	5467	5562	5618	5658	
	50	5646	5401	5527	5722	5541	
	55	5268	5336	5714	5372	5473	
	60	5526	5539	5574	5369	5650	
	65	5367	5482	5547	5715	5370	
	70	5598	5252	5464	5484	5439	
	75	5622	5305	5642	5374	5341	
	80	5711	5385	5404	5264	5523	
	85	5448	5326	5451	5270	5667	
	90	5356	5621	5303	5724	5470	
	95	5639	5386	5361	5278	5378	

Trial Id	Radar Type	Pulse Width (us)	PRI (us)	Pulses per Hop	Hopping Rate (kHz)	Hopping Sequence Length (ms)	Visible Frequency Number
10	Type 6	1.0	333.3	9	0.3333	300.0000000	4
	Frequency List (MHz)	0	1	2	3	4	
	0	5345	5354	5644	5696	5384	
	5	5548	5470	5435	5514	5653	
	10	5694	5492	5324	5303	5323	
	15	5357	5667	5657	5641	5572	
	20	5425	5440	5610	5711	5616	
	25	5473	5414	5338	5584	5674	
	30	5541	5719	5432	5480	5651	
	35	5431	5457	5348	5615	5254	
	40	5715	5373	5295	5365	5556	
	45	5447	5645	5579	5533	5277	
	50	5703	5298	5252	5566	5280	
	55	5330	5636	5562	5403	5444	
	60	5655	5704	5519	5676	5427	
	65	5596	5568	5583	5450	5640	
	70	5304	5421	5547	5288	5598	
	75	5264	5494	5484	5695	5488	
	80	5495	5660	5293	5527	5639	
	85	5718	5351	5643	5511	5462	
	90	5632	5310	5394	5501	5476	
	95	5576	5327	5378	5333	5362	

Trial Id	Radar Type	Pulse Width (us)	PRI (us)	Pulses per Hop	Hopping Rate (kHz)	Hopping Sequence Length (ms)	Visible Frequency Number
11	Type 6	1.0	333.3	9	0.3333	300.0000000	8
	Frequency List (MHz)	0	1	2	3	4	
	0	5503	5593	5580	5382	5604	
	5	5590	5492	5510	5385	5625	
	10	5281	5365	5498	5344	5348	
	15	5319	5285	5686	5386	5336	
	20	5509	5551	5325	5589	5361	
	25	5563	5520	5442	5618	5716	
	30	5411	5459	5681	5300	5315	
	35	5522	5350	5501	5529	5568	
	40	5323	5689	5535	5362	5485	
	45	5427	5253	5637	5667	5628	
	50	5404	5349	5341	5389	5602	
	55	5518	5277	5697	5415	5309	
	60	5394	5464	5508	5639	5391	
	65	5380	5282	5532	5582	5493	
	70	5533	5587	5515	5574	5698	
	75	5483	5614	5530	5676	5265	
	80	5605	5441	5360	5636	5438	
	85	5351	5474	5654	5500	5642	
	90	5321	5579	5482	5610	5684	
	95	5388	5443	5547	5581	5527	

Trial Id	Radar Type	Pulse Width (us)	PRI (us)	Pulses per Hop	Hopping Rate (kHz)	Hopping Sequence Length (ms)	Visible Frequency Number
12	Type 6	1.0	333.3	9	0.3333	300.0000000	5
	Frequency List (MHz)	0	1	2	3	4	
	0	5283	5357	5516	5543	5446	
	5	5632	5417	5585	5268	5592	
	10	5459	5545	5406	5693	5365	
	15	5436	5388	5256	5578	5344	
	20	5675	5492	5317	5562	5627	
	25	5512	5723	5546	5652	5380	
	30	5300	5455	5674	5358	5498	
	35	5454	5710	5621	5654	5443	
	40	5504	5678	5359	5407	5336	
	45	5695	5720	5685	5580	5400	
	50	5430	5687	5706	5544	5467	
	55	5419	5289	5438	5559	5506	
	60	5340	5554	5329	5558	5327	
	65	5385	5662	5519	5590	5364	
	70	5550	5657	5355	5259	5673	
	75	5420	5618	5697	5524	5275	
	80	5633	5254	5424	5534	5274	
	85	5465	5315	5415	5269	5488	
	90	5547	5566	5616	5509	5427	
	95	5445	5560	5636	5347	5432	

Trial Id	Radar Type	Pulse Width (us)	PRI (us)	Pulses per Hop	Hopping Rate (kHz)	Hopping Sequence Length (ms)	Visible Frequency Number
13	Type 6	1.0	333.3	9	0.3333	300.000000	5
	Frequency List (MHz)	0	1	2	3	4	
	0	5538	5596	5452	5704	5666	
	5	5674	5439	5660	5431	5324	
	10	5390	5334	5544	5413	5386	
	15	5524	5573	5491	5301	5295	
	20	5352	5269	5530	5406	5535	
	25	5515	5364	5451	5650	5686	
	30	5422	5664	5412	5317	5607	
	35	5318	5496	5326	5417	5429	
	40	5454	5343	5489	5565	5443	
	45	5356	5721	5387	5419	5656	
	50	5298	5475	5283	5281	5519	
	55	5393	5498	5657	5713	5260	
	60	5470	5724	5647	5477	5531	
	65	5278	5594	5597	5663	5259	
	70	5505	5690	5688	5526	5282	
	75	5719	5638	5672	5253	5478	
	80	5338	5630	5450	5632	5266	
	85	5497	5466	5333	5366	5339	
	90	5434	5591	5581	5351	5250	
	95	5411	5442	5264	5545	5527	

Trial Id	Radar Type	Pulse Width (us)	PRI (us)	Pulses per Hop	Hopping Rate (kHz)	Hopping Sequence Length (ms)	Visible Frequency Number
14	Type 6	1.0	333.3	9	0.3333	300.0000000	4
	Frequency List (MHz)	0	1	2	3	4	
	0	5318	5360	5388	5390	5508	
	5	5338	5364	5260	5594	5628	
	10	5321	5598	5585	5511	5407	
	15	5612	5700	5497	5724	5487	
	20	5263	5435	5471	5398	5306	
	25	5691	5654	5279	5720	5464	
	30	5650	5369	5532	5284	5516	
	35	5635	5417	5310	5582	5368	
	40	5657	5669	5503	5683	5353	
	45	5553	5270	5502	5714	5351	
	50	5362	5634	5457	5608	5711	
	55	5337	5607	5452	5372	5706	
	60	5599	5414	5396	5576	5303	
	65	5574	5616	5702	5533	5534	
	70	5489	5466	5428	5588	5693	
	75	5537	5478	5293	5402	5387	
	80	5716	5449	5266	5259	5377	
	85	5401	5627	5645	5632	5583	
	90	5557	5561	5298	5320	5339	
	95	5597	5518	5708	5262	5543	

Trial Id	Radar Type	Pulse Width (us)	PRI (us)	Pulses per Hop	Hopping Rate (kHz)	Hopping Sequence Length (ms)	Visible Frequency Number
15	Type 6	1.0	333.3	9	0.3333	300.000000	6
	Frequency List (MHz)	0	1	2	3	4	
	0	5573	5599	5324	5551	5253	
	5	5380	5386	5335	5660	5360	
	10	5630	5484	5626	5706	5428	
	15	5803	5255	5600	5294	5679	
	20	5271	5504	5412	5487	5481	
	25	5669	5640	5382	5480	5279	
	30	5506	5539	5326	5272	5533	
	35	5336	5299	5508	5581	5260	
	40	5282	5496	5277	5441	5448	
	45	5447	5482	5250	5585	5297	
	50	5404	5627	5510	5633	5553	
	55	5319	5534	5659	5320	5406	
	60	5562	5351	5677	5579	5438	
	65	5408	5604	5520	5342	5651	
	70	5569	5366	5284	5647	5500	
	75	5574	5318	5289	5381	5437	
	80	5522	5530	5697	5701	5376	
	85	5515	5444	5561	5624	5365	
	90	5535	5278	5641	5371	5587	
	95	5357	5552	5493	5560	5608	

Trial Id	Radar Type	Pulse Width (us)	PRI (us)	Pulses per Hop	Hopping Rate (kHz)	Hopping Sequence Length (ms)	Visible Frequency Number
16	Type 6	1.0	333.3	9	0.3333	300.0000000	2
	Frequency List (MHz)	0	1	2	3	4	
	0	5256	5460	5260	5615	5570	
	5	5422	5311	5410	5348	5567	
	10	5561	5273	5667	5426	5449	
	15	5691	5382	5703	5339	5396	
	20	5279	5670	5353	5479	5454	
	25	5557	5492	5488	5584	5313	
	30	5645	5525	5283	5487	5685	
	35	5534	5341	5599	5377	5413	
	40	5671	5335	5360	5379	5591	
	45	5444	5411	5705	5668	5258	
	50	5457	5514	5289	5334	5604	
	55	5408	5357	5603	5263	5655	
	60	5548	5551	5269	5383	5715	
	65	5527	5466	5640	5600	5508	
	70	5576	5651	5450	5669	5560	
	75	5321	5613	5609	5642	5678	
	80	5478	5486	5296	5608	5624	
	85	5524	5438	5364	5580	5470	
	90	5606	5325	5555	5489	5375	
	95	5480	5674	5663	5282	5573	

Trial Id	Radar Type	Pulse Width (us)	PRI (us)	Pulses per Hop	Hopping Rate (kHz)	Hopping Sequence Length (ms)	Visible Frequency Number
17	Type 6	1.0	333.3	9	0.3333	300.0000000	5
	Frequency List (MHz)	0	1	2	3	4	
	0	5511	5699	5671	5301	5315	
	5	5464	5333	5485	5396	5492	
	10	5537	5708	5621	5470	5304	
	15	5509	5331	5287	5588	5665	
	20	5264	5391	5568	5427	5348	
	25	5441	5691	5688	5347	5687	
	30	5414	5715	5605	5459	5354	
	35	5480	5312	5648	5663	5682	
	40	5271	5540	5317	5356	5718	
	45	5685	5276	5316	5413	5640	
	50	5510	5655	5497	5558	5450	
	55	5599	5692	5370	5367	5522	
	60	5434	5328	5547	5353	5412	
	65	5366	5549	5544	5408	5446	
	70	5253	5266	5546	5421	5462	
	75	5355	5481	5719	5659	5633	
	80	5499	5552	5297	5521	5280	
	85	5438	5681	5543	5565	5474	
	90	5279	5608	5375	5619	5712	
	95	5523	5257	5541	5507	5261	

Trial Id	Radar Type	Pulse Width (us)	PRI (us)	Pulses per Hop	Hopping Rate (kHz)	Hopping Sequence Length (ms)	Visible Frequency Number
18	Type 6	1.0	333.3	9	0.3333	300.0000000	4
	Frequency List (MHz)	0	1	2	3	4	
	0	5291	5463	5607	5462	5632	
	5	5603	5258	5560	5674	5326	
	10	5274	5341	5491	5392	5636	
	15	5434	5332	5305	5673	5430	
	20	5400	5711	5293	5419	5317	
	25	5381	5254	5303	5672	5345	
	30	5611	5649	5619	5403	5541	
	35	5596	5585	5623	5633	5438	
	40	5647	5665	5359	5374	5466	
	45	5666	5516	5589	5706	5586	
	50	5394	5312	5646	5661	5493	
	55	5543	5599	5273	5476	5276	
	60	5455	5664	5498	5580	5618	
	65	5338	5531	5435	5629	5424	
	70	5311	5309	5314	5450	5310	
	75	5290	5640	5410	5609	5333	
	80	5461	5275	5518	5572	5620	
	85	5506	5282	5342	5330	5573	
	90	5718	5557	5517	5601	5708	
	95	5298	5525	5405	5304	5682	

Trial Id	Radar Type	Pulse Width (us)	PRI (us)	Pulses per Hop	Hopping Rate (kHz)	Hopping Sequence Length (ms)	Visible Frequency Number
19	Type 6	1.0	333.3	9	0.3333	300.000000	5
	Frequency List (MHz)	0	1	2	3	4	
	0	5546	5702	5543	5623	5377	
	5	5645	5280	5635	5265	5335	
	10	5257	5590	5315	5439	5512	
	15	5383	5288	5440	5594	5681	
	20	5596	5273	5649	5373	5502	
	25	5620	5622	5518	5415	5393	
	30	5289	5629	5560	5385	5372	
	35	5283	5494	5337	5510	5424	
	40	5706	5571	5361	5435	5479	
	45	5442	5519	5456	5392	5290	
	50	5282	5297	5679	5716	5500	
	55	5600	5275	5464	5672	5308	
	60	5577	5401	5390	5447	5450	
	65	5608	5334	5507	5615	5524	
	70	5285	5322	5430	5433	5621	
	75	5662	5719	5589	5528	5515	
	80	5292	5462	5566	5307	5284	
	85	5296	5474	5724	5399	5710	
	90	5250	5353	5509	5303	5597	
	95	5407	5428	5562	5678	5300	

Trial Id	Radar Type	Pulse Width (us)	PRI (us)	Pulses per Hop	Hopping Rate (kHz)	Hopping Sequence Length (ms)	Visible Frequency Number
20	Type 6	1.0	333.3	9	0.3333	300.000000	5
	Frequency List (MHz)	0	1	2	3	4	
	0	5704	5466	5479	5309	5597	
	5	5687	5680	5710	5428	5639	
	10	5566	5379	5356	5634	5533	
	15	5471	5318	5543	5422	5311	
	20	5592	5665	5641	5443	5390	
	25	5569	5350	5622	5449	5435	
	30	5653	5586	5300	5537	5667	
	35	5325	5585	5608	5269	5521	
	40	5263	5314	5509	5504	5529	
	45	5408	5528	5525	5393	5572	
	50	5343	5646	5333	5386	5502	
	55	5660	5688	5554	5465	5677	
	60	5338	5326	5454	5260	5615	
	65	5403	5347	5591	5396	5555	
	70	5515	5579	5601	5527	5387	
	75	5261	5707	5291	5550	5602	
	80	5439	5257	5370	5692	5498	
	85	5512	5487	5719	5401	5650	
	90	5335	5402	5255	5659	5722	
	95	5364	5493	5676	5510	5700	

Trial Id	Radar Type	Pulse Width (us)	PRI (us)	Pulses per Hop	Hopping Rate (kHz)	Hopping Sequence Length (ms)	Visible Frequency Number
21	Type 6	1.0	333.3	9	0.3333	300.000000	8
	Frequency List (MHz)	0	1	2	3	4	
	0	5484	5705	5415	5470	5439	
	5	5351	5702	5310	5591	5371	
	10	5497	5265	5494	5354	5554	
	15	5559	5445	5646	5370	5503	
	20	5600	5356	5252	5255	5416	
	25	5656	5421	5456	5251	5483	
	30	5477	5542	5543	5418	5311	
	35	5390	5464	5676	5501	5422	
	40	5435	5674	5447	5269	5526	
	45	5337	5508	5608	5451	5625	
	50	5522	5642	5384	5475	5703	
	55	5507	5401	5655	5496	5309	
	60	5455	5619	5680	5326	5414	
	65	5345	5492	5295	5318	5273	
	70	5587	5530	5711	5615	5666	
	75	5638	5670	5622	5583	5691	
	80	5367	5626	5381	5561	5412	
	85	5682	5718	5589	5286	5289	
	90	5553	5314	5329	5261	5465	
	95	5541	5463	5574	5671	5458	

Trial Id	Radar Type	Pulse Width (us)	PRI (us)	Pulses per Hop	Hopping Rate (kHz)	Hopping Sequence Length (ms)	Visible Frequency Number
22	Type 6	1.0	333.3	9	0.3333	300.000000	5
	Frequency List (MHz)	0	1	2	3	4	
	0	5264	5469	5351	5631	5659	
	5	5393	5627	5385	5279	5578	
	10	5428	5529	5535	5549	5575	
	15	5647	5572	5274	5415	5695	
	20	5608	5425	5668	5722	5389	
	25	5544	5370	5355	5517	5616	
	30	5528	5500	5633	5463	5685	
	35	5603	5292	5297	5349	5513	
	40	5577	5509	5523	5644	5488	
	45	5691	5412	5678	5495	5398	
	50	5343	5435	5564	5526	5451	
	55	5589	5462	5315	5280	5584	
	60	5309	5625	5336	5615	5294	
	65	5530	5702	5565	5596	5345	
	70	5670	5630	5560	5591	5607	
	75	5693	5468	5477	5407	5545	
	80	5721	5409	5402	5525	5552	
	85	5381	5483	5340	5326	5609	
	90	5494	5364	5499	5423	5465	
	95	5518	5558	5569	5716	5718	

Trial Id	Radar Type	Pulse Width (us)	PRI (us)	Pulses per Hop	Hopping Rate (kHz)	Hopping Sequence Length (ms)	Visible Frequency Number
23	Type 6	1.0	333.3	9	0.3333	300.0000000	2
	Frequency List (MHz)	0	1	2	3	4	
	0	5519	5708	5287	5695	5501	
	5	5435	5649	5460	5442	5407	
	10	5262	5318	5576	5269	5596	
	15	5638	5699	5377	5412	5591	
	20	5706	5336	5362	5432	5697	
	25	5387	5556	5454	5658	5417	
	30	5457	5373	5712	5408	5645	
	35	5480	5568	5350	5360	5352	
	40	5660	5323	5652	5520	5573	
	45	5468	5299	5470	5634	5285	
	50	5274	5486	5275	5349	5298	
	55	5680	5416	5463	5512	5251	
	60	5713	5474	5667	5683	5453	
	65	5282	5438	5718	5566	5534	
	70	5399	5514	5656	5633	5409	
	75	5567	5584	5338	5545	5623	
	80	5490	5663	5612	5309	5406	
	85	5694	5525	5499	5448	5294	
	90	5574	5332	5659	5370	5436	
	95	5477	5415	5542	5467	5319	

Trial Id	Radar Type	Pulse Width (us)	PRI (us)	Pulses per Hop	Hopping Rate (kHz)	Hopping Sequence Length (ms)	Visible Frequency Number
24	Type 6	1.0	333.3	9	0.3333	300.000000	3
	Frequency List (MHz)	0	1	2	3	4	
	0	5299	5472	5698	5381	5721	
	5	5477	5574	5535	5508	5614	
	10	5668	5582	5617	5367	5251	
	15	5351	5383	5505	5604	5527	
	20	5660	5647	5328	5335	5549	
	25	5590	5488	5700	5403	5414	
	30	5588	5389	5703	5309	5571	
	35	5364	5503	5274	5666	5365	
	40	5261	5417	5517	5405	5448	
	45	5382	5528	5687	5695	5537	
	50	5717	5393	5370	5653	5331	
	55	5600	5270	5639	5612	5515	
	60	5376	5667	5269	5252	5677	
	65	5586	5642	5258	5636	5543	
	70	5458	5479	5623	5400	5444	
	75	5301	5372	5428	5341	5575	
	80	5290	5316	5345	5347	5627	
	85	5349	5470	5565	5432	5628	
	90	5676	5447	5672	5552	5468	
	95	5469	5359	5321	5325	5678	

Trial Id	Radar Type	Pulse Width (us)	PRI (us)	Pulses per Hop	Hopping Rate (kHz)	Hopping Sequence Length (ms)	Visible Frequency Number
25	Type 6	1.0	333.3	9	0.3333	300.000000	3
	Frequency List (MHz)	0	1	2	3	4	
	0	5457	5711	5634	5542	5563	
	5	5616	5596	5610	5671	5346	
	10	5599	5371	5658	5562	5638	
	15	5339	5381	5486	5453	5321	
	20	5535	5351	5588	5417	5308	
	25	5586	5498	5318	5289	5522	
	30	5364	5292	5706	5426	5448	
	35	5662	5257	5656	5663	5505	
	40	5674	5657	5514	5334	5428	
	45	5465	5489	5265	5437	5404	
	50	5396	5373	5564	5581	5324	
	55	5368	5625	5571	5399	5329	
	60	5557	5347	5677	5271	5462	
	65	5541	5576	5383	5280	5250	
	70	5261	5485	5519	5502	5578	
	75	5525	5604	5652	5613	5700	
	80	5435	5400	5609	5331	5635	
	85	5385	5281	5299	5595	5350	
	90	5382	5407	5695	5546	5683	
	95	5607	5263	5655	5550	5459	

Trial Id	Radar Type	Pulse Width (us)	PRI (us)	Pulses per Hop	Hopping Rate (kHz)	Hopping Sequence Length (ms)	Visible Frequency Number
26	Type 6	1.0	333.3	9	0.3333	300.0000000	4
	Frequency List (MHz)	0	1	2	3	4	
	0	5712	5475	5570	5703	5308	
	5	5658	5521	5685	5359	5650	
	10	5433	5257	5699	5282	5659	
	15	5427	5508	5589	5498	5610	
	20	5446	5420	5626	5409	5281	
	25	5377	5350	5424	5393	5556	
	30	5406	5656	5328	5315	5721	
	35	5587	5278	5528	5431	5674	
	40	5441	5531	5515	5422	5608	
	45	5263	5408	5548	5547	5318	
	50	5324	5280	5572	5639	5542	
	55	5671	5294	5558	5347	5494	
	60	5502	5654	5600	5692	5663	
	65	5662	5577	5311	5414	5661	
	70	5352	5711	5361	5334	5398	
	75	5461	5289	5698	5668	5585	
	80	5429	5723	5481	5629	5595	
	85	5300	5329	5331	5597	5598	
	90	5624	5368	5645	5679	5485	
	95	5707	5563	5591	5636	5537	

Trial Id	Radar Type	Pulse Width (us)	PRI (us)	Pulses per Hop	Hopping Rate (kHz)	Hopping Sequence Length (ms)	Visible Frequency Number
27	Type 6	1.0	333.3	9	0.3333	300.000000	5
	Frequency List (MHz)	0	1	2	3	4	
	0	5492	5714	5506	5389	5625	
	5	5700	5543	5285	5522	5382	
	10	5364	5521	5265	5477	5680	
	15	5418	5635	5692	5327	5454	
	20	5586	5567	5498	5254	5299	
	25	5627	5594	5590	5448	5642	
	30	5661	5564	5541	5629	5369	
	35	5324	5584	5588	5280	5614	
	40	5453	5565	5605	5570	5291	
	45	5631	5371	5589	5534	5273	
	50	5690	5494	5355	5482	5707	
	55	5641	5513	5657	5659	5544	
	60	5486	5426	5638	5611	5516	
	65	5618	5684	5464	5697	5658	
	70	5374	5420	5258	5721	5566	
	75	5681	5358	5262	5696	5297	
	80	5621	5709	5439	5672	5304	
	85	5616	5368	5491	5475	5341	
	90	5580	5318	5281	5380	5519	
	95	5537	5362	5645	5524	5325	

Trial Id	Radar Type	Pulse Width (us)	PRI (us)	Pulses per Hop	Hopping Rate (kHz)	Hopping Sequence Length (ms)	Visible Frequency Number
28	Type 6	1.0	333.3	9	0.3333	300.0000000	7
	Frequency List (MHz)	0	1	2	3	4	
	0	5272	5478	5539	5550	5370	
	5	5267	5565	5360	5588	5589	
	10	5295	5310	5306	5672	5701	
	15	5506	5287	5320	5491	5519	
	20	5462	5655	5508	5490	5702	
	25	5531	5626	5355	5698	5624	
	30	5717	5401	5716	5264	5293	
	35	5557	5692	5262	5502	5594	
	40	5319	5391	5330	5602	5499	
	45	5271	5336	5663	5424	5476	
	50	5410	5449	5266	5342	5317	
	55	5299	5670	5564	5463	5460	
	60	5387	5311	5349	5489	5415	
	65	5252	5681	5687	5560	5552	
	70	5353	5576	5593	5683	5464	
	75	5507	5350	5379	5605	5366	
	80	5382	5547	5361	5371	5518	
	85	5385	5721	5294	5341	5612	
	90	5378	5621	5389	5457	5292	
	95	5534	5497	5412	5374	5597	

Trial Id	Radar Type	Pulse Width (us)	PRI (us)	Pulses per Hop	Hopping Rate (kHz)	Hopping Sequence Length (ms)	Visible Frequency Number
29	Type 6	1.0	333.3	9	0.3333	300.0000000	3
	Frequency List (MHz)	0	1	2	3	4	
	0	5430	5717	5475	5711	5687	
	5	5406	5490	5435	5276	5321	
	10	5604	5574	5444	5295	5722	
	15	5594	5414	5326	5536	5373	
	20	5346	5546	5579	5675	5419	
	25	5478	5558	5327	5658	5629	
	30	5420	5674	5519	5559	5432	
	35	5648	5488	5512	5513	5433	
	40	5402	5329	5570	5599	5331	
	45	5251	5624	5477	5266	5286	
	50	5625	5317	5431	5518	5621	
	55	5653	5279	5358	5343	5514	
	60	5434	5650	5627	5413	5509	
	65	5491	5660	5371	5545	5665	
	70	5291	5467	5259	5338	5486	
	75	5428	5528	5613	5481	5299	
	80	5549	5309	5612	5695	5681	
	85	5581	5422	5540	5386	5699	
	90	5503	5446	5256	5462	5640	
	95	5427	5377	5487	5398	5307	

Trial Id	Radar Type	Pulse Width (us)	PRI (us)	Pulses per Hop	Hopping Rate (kHz)	Hopping Sequence Length (ms)	Visible Frequency Number
30	Type 6	1.0	333.3	9	0.3333	300.0000000	3
	Frequency List (MHz)	0	1	2	3	4	
	0	5685	5481	5411	5397	5432	
	5	5448	5512	5510	5439	5625	
	10	5535	5363	5485	5490	5268	
	15	5682	5444	5429	5581	5428	
	20	5381	5487	5571	5648	5307	
	25	5427	5286	5431	5692	5671	
	30	5406	5631	5259	5642	5282	
	35	5474	5264	5284	5665	5369	
	40	5267	5335	5596	5260	5706	
	45	5502	5433	5628	5637	5326	
	50	5368	5520	5341	5565	5472	
	55	5271	5476	5329	5679	5554	
	60	5573	5711	5458	5527	5492	
	65	5641	5348	5359	5277	5470	
	70	5583	5302	5297	5446	5606	
	75	5509	5390	5591	5555	5713	
	80	5469	5288	5256	5515	5537	
	85	5644	5676	5290	5263	5313	
	90	5681	5389	5383	5516	5253	
	95	5483	5721	5325	5356	5590	

3.11.5 U-NII-2C 80MHZ TEST RESULTS AND WAVEFORMS DETAILS

80MHz / 5530MHz						
(Detection = Y, No Detection = N)						
Trial Number	Type 1	Type 2	Type 3	Type 4	Type 5	Type 6
1	Y	Y	Y	Y	Y	Y
2	Y	N	Y	Y	Y	Y
3	Y	Y	Y	Y	Y	Y
4	N	Y	N	Y	N	Y
5	Y	Y	Y	Y	Y	Y
6	Y	Y	Y	N	Y	Y
7	Y	N	Y	Y	Y	Y
8	Y	Y	Y	Y	Y	Y
9	N	Y	N	Y	N	Y
10	Y	Y	Y	Y	Y	Y
11	Y	Y	Y	N	Y	Y
12	Y	Y	Y	Y	Y	Y
13	Y	Y	Y	Y	Y	Y
14	N	Y	Y	Y	Y	Y
15	Y	Y	Y	Y	Y	Y
16	Y	N	Y	N	Y	Y
17	Y	Y	Y	Y	Y	Y
18	Y	Y	Y	Y	N	N
19	N	Y	Y	Y	Y	Y
20	Y	Y	Y	Y	Y	Y
21	Y	Y	Y	Y	Y	Y
22	Y	Y	Y	Y	Y	Y
23	Y	Y	N	Y	Y	Y
24	N	N	Y	Y	Y	Y
25	Y	Y	Y	Y	Y	Y
26	Y	Y	Y	N	N	Y
27	Y	Y	Y	Y	Y	Y
28	N	N	Y	Y	Y	Y
29	Y	Y	Y	Y	Y	Y
30	Y	Y	Y	Y	Y	Y
Trial of Detection	24/30	25/30	27/30	26/30	26/30	29/30
Probability (%)	80%	83.3%	90%	86.7%	86.7%	96.7%
Limit (%)	>= 60%	>= 60%	>= 60%	>= 60%	>= 80%	>= 70%
Average Probability of Radar Type 1~4 (%)	85% (>=80%)					

Type 1 Short Pulse Radar Statistical Performance - Details

Trial Id	Radar Type	Pulse Width (us)	PRI (us)	Number of Pulses	Waveform Length (us)
1	Type 1	1.0	698.0	76	53048.0
2	Type 1	1.0	618.0	86	53148.0
3	Type 1	1.0	538.0	99	53262.0
4	Type 1	1.0	878.0	61	53558.0
5	Type 1	1.0	3066.0	18	55188.0
6	Type 1	1.0	638.0	83	52954.0
7	Type 1	1.0	918.0	58	53244.0
8	Type 1	1.0	838.0	63	52794.0
9	Type 1	1.0	858.0	62	53196.0
10	Type 1	1.0	798.0	67	53466.0
11	Type 1	1.0	718.0	74	53132.0
12	Type 1	1.0	578.0	92	53176.0
13	Type 1	1.0	598.0	89	53222.0
14	Type 1	1.0	558.0	95	53010.0
15	Type 1	1.0	2536.0	21	53256.0
16	Type 1	1.0	966.0	55	53130.0
17	Type 1	1.0	827.0	64	52928.0
18	Type 1	1.0	2501.0	22	55022.0
19	Type 1	1.0	2595.0	21	54495.0
20	Type 1	1.0	1114.0	48	53472.0
21	Type 1	1.0	1302.0	41	53382.0
22	Type 1	1.0	3045.0	18	54810.0
23	Type 1	1.0	1624.0	33	53592.0
24	Type 1	1.0	2878.0	19	54682.0
25	Type 1	1.0	1027.0	52	53404.0
26	Type 1	1.0	2485.0	22	54670.0
27	Type 1	1.0	1600.0	33	52800.0
28	Type 1	1.0	1172.0	46	53912.0
29	Type 1	1.0	1177.0	45	52965.0
30	Type 1	1.0	2171.0	25	54275.0

Type 2 Short Pulse Radar Statistical Performance - Details

Trial Id	Radar Type	Pulse Width (us)	PRI (us)	Number of Pulses	Waveform Length (us)
0	Type 2	3.2	179.0	26	4654.0
1	Type 2	1.1	207.0	23	4761.0
2	Type 2	2.1	230.0	24	5520.0
3	Type 2	4.8	200.0	29	5800.0
4	Type 2	3.9	214.0	28	5992.0
5	Type 2	2.9	222.0	26	5772.0
6	Type 2	3.2	204.0	26	5304.0
7	Type 2	2.5	192.0	25	4800.0
8	Type 2	3.1	164.0	26	4264.0
9	Type 2	1.2	156.0	23	3588.0
10	Type 2	3.9	210.0	27	5670.0
11	Type 2	4.6	201.0	29	5829.0
12	Type 2	3.2	162.0	26	4212.0
13	Type 2	2.2	197.0	25	4925.0
14	Type 2	4.5	163.0	29	4727.0
15	Type 2	3.0	203.0	26	5278.0
16	Type 2	5.0	168.0	29	4872.0
17	Type 2	2.4	217.0	25	5425.0
18	Type 2	2.9	191.0	26	4966.0
19	Type 2	2.3	166.0	25	4150.0
20	Type 2	3.7	150.0	27	4050.0
21	Type 2	2.2	176.0	25	4400.0
22	Type 2	4.9	195.0	29	5655.0
23	Type 2	2.9	202.0	26	5252.0
24	Type 2	2.5	178.0	25	4450.0
25	Type 2	1.1	206.0	23	4738.0
26	Type 2	3.8	155.0	27	4185.0
27	Type 2	4.7	157.0	29	4553.0
28	Type 2	2.4	224.0	25	5600.0
29	Type 2	4.2	159.0	28	4452.0
30	Type 2	3.6	175.0	27	4725.0

Type 3 Short Pulse Radar Statistical Performance - Details

Trial Id	Radar Type	Pulse Width (us)	PRI (us)	Number of Pulses	Waveform Length (us)
1	Type 3	6.1	487.0	16	7792.0
2	Type 3	7.1	344.0	16	5504.0
3	Type 3	9.8	288.0	18	5184.0
4	Type 3	8.9	230.0	18	4140.0
5	Type 3	7.9	432.0	17	7344.0
6	Type 3	8.2	207.0	17	3519.0
7	Type 3	7.5	443.0	17	7531.0
8	Type 3	8.1	439.0	17	7463.0
9	Type 3	6.2	223.0	16	3568.0
10	Type 3	8.9	208.0	18	3744.0
11	Type 3	9.6	463.0	18	8334.0
12	Type 3	8.2	441.0	17	7497.0
13	Type 3	7.2	323.0	16	5168.0
14	Type 3	9.5	297.0	18	5346.0
15	Type 3	8.0	412.0	17	7004.0
16	Type 3	10.0	324.0	18	5832.0
17	Type 3	7.4	271.0	17	4607.0
18	Type 3	7.9	349.0	17	5933.0
19	Type 3	7.3	409.0	16	6544.0
20	Type 3	8.7	373.0	18	6714.0
21	Type 3	7.2	254.0	16	4064.0
22	Type 3	9.9	274.0	18	4932.0
23	Type 3	7.9	278.0	17	4726.0
24	Type 3	7.5	317.0	17	5389.0
25	Type 3	6.1	260.0	16	4160.0
26	Type 3	8.8	211.0	18	3798.0
27	Type 3	9.7	272.0	18	4896.0
28	Type 3	7.4	264.0	17	4488.0
29	Type 3	9.2	284.0	18	5112.0
30	Type 3	8.6	474.0	17	8058.0

Type 4 Short Pulse Radar Statistical Performance - Details

Trial Id	Radar Type	Pulse Width (us)	PRI (us)	Number of Pulses	Waveform Length (us)
1	Type 4	11.3	487.0	12	5844.0
2	Type 4	13.5	344.0	13	4472.0
3	Type 4	19.4	288.0	16	4608.0
4	Type 4	17.5	230.0	15	3450.0
5	Type 4	15.3	432.0	14	6048.0
6	Type 4	15.9	207.0	14	2898.0
7	Type 4	14.3	443.0	13	5759.0
8	Type 4	15.8	439.0	14	6146.0
9	Type 4	11.5	223.0	12	2676.0
10	Type 4	17.4	208.0	15	3120.0
11	Type 4	19.0	463.0	16	7408.0
12	Type 4	16.0	441.0	14	6174.0
13	Type 4	13.8	323.0	13	4199.0
14	Type 4	18.9	297.0	16	4752.0
15	Type 4	15.5	412.0	14	5768.0
16	Type 4	19.9	324.0	16	5184.0
17	Type 4	14.1	271.0	13	3523.0
18	Type 4	15.2	349.0	14	4886.0
19	Type 4	13.8	409.0	13	5317.0
20	Type 4	17.1	373.0	15	5595.0
21	Type 4	13.8	254.0	13	3302.0
22	Type 4	19.8	274.0	16	4384.0
23	Type 4	15.3	278.0	14	3892.0
24	Type 4	14.5	317.0	13	4121.0
24	Type 4	14.5	317.0	13	4121.0
25	Type 4	11.3	260.0	12	3120.0
26	Type 4	17.3	211.0	15	3165.0
27	Type 4	19.2	272.0	16	4352.0
28	Type 4	14.2	264.0	13	3432.0
29	Type 4	18.2	284.0	15	4260.0
30	Type 4	16.8	474.0	15	7110.0

Type 5 Long Pulse Radar Statistical Performance - Details

Trial Id	Radar Type	Number of Bursts	Burst Period (s)	Waveform Length (s)	Center Frequency (GHz)			
1	Type 5	8	1.5000000	12.0000000	5.530000000			
	Burst ID	Burst Offset (us)	Pulse Width (us)	Chirp Width (MHz)	Number of Pulses per Burst	PRI-1 (us)	PRI-2 (us)	PRI-3 (us)
	0	653267.0	75.0	5	2	1766.0	1074.0	-
	1	1015342.0	99.4	5	3	1826.0	1363.0	1174.0
	2	1379673.0	67.4	5	2	1506.0	1129.0	-
	3	245381.0	73.6	5	2	1994.0	1155.0	-
	4	609211.0	65.9	5	1	1190.0	-	-
	5	970315.0	83.8	5	3	1600.0	1640.0	1656.0
	6	1335720.0	65.5	5	1	1761.0	-	-
	7	200392.0	98.6	5	3	1864.0	1409.0	1907.0
2	Type 5	11	1.0909091	12.0000000	5.530000000			
	Burst ID	Burst Offset (us)	Pulse Width (us)	Chirp Width (MHz)	Number of Pulses per Burst	PRI-1 (us)	PRI-2 (us)	PRI-3 (us)
	0	409465.0	73.8	9	2	1639.0	1970.0	-
	1	673541.0	69.5	9	2	1301.0	1709.0	-
	2	938405.0	51.9	9	1	1833.0	-	-
	3	113243.0	84.6	9	3	1346.0	1359.0	1246.0
	4	376706.0	95.4	9	3	1066.0	1801.0	1542.0
	5	640774.0	68.0	9	2	1679.0	1783.0	-
	6	903746.0	89.6	9	3	1637.0	1006.0	1743.0
	7	80813.0	81.9	9	2	1426.0	1951.0	-
	8	343904.0	88.3	9	3	1812.0	1727.0	1953.0
	9	609276.0	53.7	9	1	1695.0	-	-
	10	870628.0	91.3	9	3	1995.0	1858.0	1355.0
3	Type 5	20	0.6000000	12.0000000	5.530000000			
	Burst ID	Burst Offset (us)	Pulse Width (us)	Chirp Width (MHz)	Number of Pulses per Burst	PRI-1 (us)	PRI-2 (us)	PRI-3 (us)
	0	26552.0	68.1	19	2	1317.0	1127.0	-
	1	171871.0	58.7	19	1	1075.0	-	-
	2	316116.0	75.3	19	2	1671.0	1317.0	-
	3	461891.0	56.4	19	1	1718.0	-	-
	4	8664.0	99.7	19	3	1527.0	1631.0	1788.0
	5	153929.0	57.7	19	1	1269.0	-	-
	6	299079.0	59.5	19	1	1392.0	-	-
	7	442752.0	80.0	19	2	1491.0	1932.0	-
	8	587204.0	82.0	19	2	1934.0	1730.0	-
	9	135744.0	82.6	19	2	1467.0	1116.0	-
	10	279781.0	88.0	19	3	1108.0	1707.0	1589.0
	11	424346.0	93.2	19	3	1315.0	1373.0	1555.0
	12	589553.0	70.4	19	2	1593.0	1899.0	-
	13	117598.0	95.3	19	3	1229.0	1812.0	1052.0
	14	262325.0	81.9	19	2	1683.0	1955.0	-
	15	405781.0	98.5	19	3	1946.0	1977.0	1445.0
	16	553711.0	65.0	19	1	1353.0	-	-
	17	99809.0	85.4	19	3	1515.0	1218.0	1284.0
	18	244192.0	91.6	19	3	1576.0	1751.0	1083.0
	19	390174.0	67.3	19	2	1014.0	1047.0	-

Trial Id	Radar Type	Number of Bursts	Burst Period (s)	Waveform Length (s)	Center Frequency (GHz)				
4	Type 5	17	0.7058824	12.0000000	5.530000000				
		Burst ID	Burst Offset (us)	Pulse Width (us)	Chirp Width (MHz)	Number of Pulses per Burst	PRI-1 (us)	PRI-2 (us)	PRI-3 (us)
		0	626798.0	67.9	16	2	1997.0	1368.0	-
		1	96903.0	62.3	16	1	1616.0	-	-
		2	267849.0	53.3	16	1	1251.0	-	-
		3	437286.0	90.0	16	3	1496.0	1016.0	1081.0
		4	606043.0	77.1	16	2	1260.0	1836.0	-
		5	75592.0	83.9	16	3	1587.0	1287.0	1269.0
		6	245640.0	89.1	16	3	1040.0	1945.0	1574.0
		7	416504.0	81.8	16	2	1484.0	1774.0	-
		8	588726.0	50.3	16	1	1087.0	-	-
		9	54535.0	87.1	16	3	1908.0	1475.0	1949.0
		10	225137.0	71.3	16	2	1834.0	1325.0	-
		11	395073.0	97.5	16	3	1416.0	1046.0	1579.0
		12	565234.0	90.6	16	3	1419.0	1512.0	1182.0
		13	33645.0	86.3	16	3	1541.0	1359.0	1624.0
		14	203835.0	97.6	16	3	1575.0	1267.0	1378.0
		15	373694.0	84.7	16	3	1187.0	1979.0	1647.0
		16	543192.0	99.7	16	3	1735.0	1795.0	1972.0
5	Type 5	14	0.8571429	12.0000000	5.530000000				
		Burst ID	Burst Offset (us)	Pulse Width (us)	Chirp Width (MHz)	Number of Pulses per Burst	PRI-1 (us)	PRI-2 (us)	PRI-3 (us)
		0	15441.0	92.9	12	3	1423.0	1118.0	1358.0
		1	222649.0	67.7	12	2	1689.0	1176.0	-
		2	430620.0	65.8	12	1	1312.0	-	-
		3	637993.0	56.3	12	1	1571.0	-	-
		4	845422.0	53.7	12	1	1646.0	-	-
		5	196574.0	83.5	12	3	1802.0	1804.0	1663.0
		6	405116.0	65.8	12	1	1177.0	-	-
		7	610836.0	85.9	12	3	1540.0	1100.0	1162.0
		8	819293.0	76.3	12	2	1043.0	1199.0	-
		9	171555.0	81.5	12	2	1205.0	1918.0	-
		10	378184.0	89.4	12	3	1599.0	1571.0	1077.0
		11	587063.0	63.4	12	1	1295.0	-	-
		12	793149.0	69.6	12	2	1228.0	1665.0	-
		13	145983.0	74.5	12	2	1695.0	1775.0	-

Trial Id	Radar Type	Number of Bursts	Burst Period (s)	Waveform Length (s)	Center Frequency (GHz)			
6	Type 5	15	0.8000000	12.0000000	5.530000000			
	Burst ID	Burst Offset (us)	Pulse Width (us)	Chirp Width (MHz)	Number of Pulses per Burst	PRI-1 (us)	PRI-2 (us)	PRI-3 (us)
	0	328985.0	96.6	13	3	1567.0	1387.0	1506.0
	1	522498.0	96.7	13	3	1127.0	1354.0	1112.0
	2	714615.0	86.5	13	3	1505.0	1526.0	1715.0
	3	112383.0	73.3	13	2	1968.0	1729.0	-
	4	306212.0	55.8	13	1	1872.0	-	-
	5	500163.0	55.4	13	1	1266.0	-	-
	6	690552.0	85.3	13	3	1849.0	1867.0	1382.0
	7	88623.0	79.4	13	2	1739.0	1698.0	-
	8	282519.0	65.7	13	1	1447.0	-	-
	9	475743.0	68.6	13	2	1034.0	1167.0	-
	10	669102.0	77.7	13	2	1216.0	1143.0	-
	11	64844.0	79.6	13	2	1779.0	1441.0	-
	12	257701.0	94.9	13	3	1818.0	1196.0	1400.0
	13	452394.0	61.4	13	1	1345.0	-	-
	14	643963.0	90.6	13	3	1825.0	1130.0	1024.0
7	Type 5	12	1.0000000	12.0000000	5.530000000			
	Burst ID	Burst Offset (us)	Pulse Width (us)	Chirp Width (MHz)	Number of Pulses per Burst	PRI-1 (us)	PRI-2 (us)	PRI-3 (us)
	0	51432.0	52.6	10	1	1482.0	-	-
	1	292922.0	84.1	10	3	1539.0	1004.0	1258.0
	2	534275.0	97.7	10	3	1295.0	1677.0	1308.0
	3	776241.0	97.3	10	3	1064.0	1035.0	1575.0
	4	21547.0	98.8	10	3	1449.0	1076.0	1472.0
	5	263377.0	72.2	10	2	1334.0	1651.0	-
	6	504945.0	67.6	10	2	1752.0	1705.0	-
	7	746790.0	75.7	10	2	1696.0	1558.0	-
	8	990242.0	60.9	10	1	1531.0	-	-
	9	234006.0	64.2	10	1	1218.0	-	-
	10	475264.0	78.8	10	2	1661.0	1608.0	-
	11	716245.0	87.5	10	3	1351.0	1243.0	1728.0

Trial Id	Radar Type	Number of Bursts	Burst Period (s)	Waveform Length (s)	Center Frequency (GHz)				
8	Type 5	14	0.8571429	12.0000000	5.530000000				
		Burst ID	Burst Offset (us)	Pulse Width (us)	Chirp Width (MHz)	Number of Pulses per Burst	PRI-1 (us)	PRI-2 (us)	PRI-3 (us)
		0	822851.0	54.1	13	1	1687.0	-	-
		1	174900.0	50.7	13	1	1538.0	-	-
		2	382242.0	52.3	13	1	1917.0	-	-
		3	588103.0	99.8	13	3	1104.0	1181.0	1891.0
		4	795565.0	68.4	13	2	1838.0	1705.0	-
		5	149063.0	80.8	13	2	1390.0	1729.0	-
		6	356723.0	62.5	13	1	1844.0	-	-
		7	563598.0	74.8	13	2	1609.0	1087.0	-
		8	772302.0	50.8	13	1	1062.0	-	-
		9	123800.0	54.0	13	1	1389.0	-	-
		10	331350.0	63.0	13	1	1382.0	-	-
		11	536393.0	91.8	13	3	2000.0	1593.0	1768.0
		12	745583.0	79.3	13	2	1067.0	1307.0	-
		13	98268.0	64.3	13	1	1107.0	-	-
9	Type 5	8	1.5000000	12.0000000	5.530000000				
		Burst ID	Burst Offset (us)	Pulse Width (us)	Chirp Width (MHz)	Number of Pulses per Burst	PRI-1 (us)	PRI-2 (us)	PRI-3 (us)
		0	535571.0	63.4	6	1	1166.0	-	-
		1	898917.0	52.0	6	1	1446.0	-	-
		2	1259697.0	97.2	6	3	1696.0	1650.0	1267.0
		3	127089.0	78.7	6	2	1600.0	1807.0	-
		4	489947.0	74.2	6	2	1822.0	1933.0	-
		5	852558.0	88.7	6	3	1655.0	1015.0	1568.0
		6	1217152.0	54.3	6	1	1991.0	-	-
		7	82300.0	95.4	6	3	1772.0	1149.0	1932.0

Trial Id	Radar Type	Number of Bursts	Burst Period (s)	Waveform Length (s)	Center Frequency (GHz)			
10	Type 5	17	0.7058824	12.0000000	5.496400000			
	Burst ID	Burst Offset (us)	Pulse Width (us)	Chirp Width (MHz)	Number of Pulses per Burst	PRI-1 (us)	PRI-2 (us)	PRI-3 (us)
	0	209176.0	73.7	16	2	1394.0	1559.0	-
	1	378577.0	97.4	16	3	1240.0	1768.0	1946.0
	2	548594.0	91.7	16	3	1924.0	1909.0	1096.0
	3	17727.0	66.2	16	1	1609.0	-	-
	4	188261.0	70.8	16	2	1495.0	1142.0	-
	5	359227.0	52.3	16	1	1838.0	-	-
	6	529350.0	78.9	16	2	1662.0	1014.0	-
	7	699817.0	70.9	16	2	1584.0	1175.0	-
	8	167165.0	75.6	16	2	1421.0	1580.0	-
	9	338419.0	59.1	16	1	1371.0	-	-
	10	508194.0	77.0	16	2	1471.0	1410.0	-
	11	678428.0	67.9	16	2	1532.0	1624.0	-
	12	146139.0	81.2	16	2	1237.0	1899.0	-
	13	316473.0	78.7	16	2	1570.0	1797.0	-
	14	488365.0	63.3	16	1	1188.0	-	-
	15	657474.0	68.9	16	2	1593.0	1521.0	-
	16	125512.0	59.3	16	1	1072.0	-	-
11	Type 5	19	0.6315789	12.0000000	5.497600000			
	Burst ID	Burst Offset (us)	Pulse Width (us)	Chirp Width (MHz)	Number of Pulses per Burst	PRI-1 (us)	PRI-2 (us)	PRI-3 (us)
	0	264001.0	98.9	19	3	1619.0	1232.0	1068.0
	1	417231.0	82.3	19	2	1198.0	1209.0	-
	2	567901.0	86.7	19	3	1828.0	1541.0	1162.0
	3	92954.0	89.7	19	3	1243.0	1538.0	1600.0
	4	245112.0	98.6	19	3	1040.0	1773.0	1458.0
	5	397977.0	71.1	19	2	1971.0	1159.0	-
	6	551457.0	55.9	19	1	1918.0	-	-
	7	74391.0	67.9	19	2	1071.0	1841.0	-
	8	226484.0	84.4	19	3	1147.0	1411.0	1401.0
	9	380077.0	58.8	19	1	1680.0	-	-
	10	532981.0	65.6	19	1	1522.0	-	-
	11	55531.0	78.5	19	2	1864.0	1937.0	-
	12	208094.0	82.3	19	2	1003.0	1870.0	-
	13	359800.0	90.1	19	3	1376.0	1127.0	1721.0
	14	512124.0	90.2	19	3	1504.0	1088.0	1423.0
	15	36816.0	83.1	19	2	1524.0	1605.0	-
	16	189697.0	58.8	19	1	1594.0	-	-
	17	341619.0	77.0	19	2	1818.0	1374.0	-
	18	495472.0	55.0	19	1	1349.0	-	-

Trial Id	Radar Type	Number of Bursts	Burst Period (s)	Waveform Length (s)	Center Frequency (GHz)			
12	Type 5	15	0.8000000	12.0000000	5.495200000			
	Burst ID	Burst Offset (us)	Pulse Width (us)	Chirp Width (MHz)	Number of Pulses per Burst	PRI-1 (us)	PRI-2 (us)	PRI-3 (us)
	0	22912.0	58.1	13	1	1881.0	-	-
	1	216607.0	52.1	13	1	1417.0	-	-
	2	410438.0	59.9	13	1	1127.0	-	-
	3	603580.0	60.2	13	1	1934.0	-	-
	4	793918.0	95.9	13	3	1812.0	1491.0	1852.0
	5	192196.0	79.9	13	2	1781.0	1930.0	-
	6	385525.0	78.5	13	2	1410.0	1880.0	-
	7	580331.0	53.8	13	1	1116.0	-	-
	8	773468.0	64.7	13	1	1754.0	-	-
	9	168902.0	61.4	13	1	1373.0	-	-
	10	361910.0	83.2	13	2	1662.0	1218.0	-
	11	554151.0	84.7	13	3	1554.0	1548.0	1336.0
	12	746788.0	88.7	13	3	1274.0	1825.0	1672.0
	13	144765.0	78.3	13	2	1788.0	1116.0	-
	14	338082.0	69.3	13	2	1819.0	1095.0	-
13	Type 5	12	1.0000000	12.0000000	5.494000000			
	Burst ID	Burst Offset (us)	Pulse Width (us)	Chirp Width (MHz)	Number of Pulses per Burst	PRI-1 (us)	PRI-2 (us)	PRI-3 (us)
	0	664476.0	75.3	10	2	1954.0	1350.0	-
	1	907451.0	56.3	10	1	1935.0	-	-
	2	151297.0	67.7	10	2	1366.0	1567.0	-
	3	393839.0	55.6	10	1	1100.0	-	-
	4	634772.0	75.2	10	2	1699.0	1492.0	-
	5	876467.0	76.3	10	2	1267.0	1996.0	-
	6	121291.0	85.7	10	3	1273.0	1747.0	1712.0
	7	363058.0	98.4	10	3	1372.0	1084.0	1224.0
	8	603800.0	86.4	10	3	1942.0	1967.0	1248.0
	9	845154.0	93.6	10	3	1604.0	1751.0	1716.0
	10	91831.0	63.3	10	1	1762.0	-	-
	11	333386.0	92.4	10	3	1306.0	1050.0	1046.0

Trial Id	Radar Type	Number of Bursts	Burst Period (s)	Waveform Length (s)	Center Frequency (GHz)			
14	Type 5	19	0.6315789	12.0000000	5.497200000			
	Burst ID	Burst Offset (us)	Pulse Width (us)	Chirp Width (MHz)	Number of Pulses per Burst	PRI-1 (us)	PRI-2 (us)	PRI-3 (us)
	0	362087.0	93.3	18	3	1482.0	1099.0	1525.0
	1	515307.0	69.1	18	2	1209.0	1630.0	-
	2	38994.0	86.9	18	3	1010.0	1114.0	1716.0
	3	190922.0	84.9	18	3	1539.0	1502.0	1847.0
	4	343724.0	72.3	18	2	1563.0	1845.0	-
	5	497361.0	51.7	18	1	1780.0	-	-
	6	20319.0	58.3	18	1	1419.0	-	-
	7	173196.0	60.8	18	1	1262.0	-	-
	8	326148.0	57.1	18	1	1106.0	-	-
	9	475778.0	88.9	18	3	1668.0	1946.0	1808.0
	10	1488.0	72.0	18	2	1837.0	1965.0	-
	11	153567.0	90.9	18	3	1190.0	1601.0	1731.0
	12	306964.0	59.8	18	1	1822.0	-	-
	13	458779.0	70.0	18	2	1870.0	1214.0	-
	14	611697.0	67.2	18	2	1345.0	1237.0	-
	15	134832.0	91.2	18	3	1589.0	1629.0	1315.0
	16	288289.0	56.5	18	1	1520.0	-	-
	17	441028.0	51.2	18	1	1620.0	-	-
	18	591978.0	74.1	18	2	1599.0	1968.0	-
15	Type 5	14	0.8571429	12.0000000	5.494800000			
	Burst ID	Burst Offset (us)	Pulse Width (us)	Chirp Width (MHz)	Number of Pulses per Burst	PRI-1 (us)	PRI-2 (us)	PRI-3 (us)
	0	158254.0	76.9	12	2	1058.0	1366.0	-
	1	366047.0	50.2	12	1	1262.0	-	-
	2	573377.0	62.9	12	1	1632.0	-	-
	3	780532.0	64.7	12	1	1997.0	-	-
	4	132351.0	83.8	12	3	1835.0	1584.0	1378.0
	5	340432.0	65.4	12	1	1378.0	-	-
	6	548146.0	53.2	12	1	1122.0	-	-
	7	755450.0	51.7	12	1	1470.0	-	-
	8	107154.0	78.7	12	2	1184.0	1489.0	-
	9	314379.0	72.4	12	2	1610.0	1094.0	-
	10	522427.0	53.8	12	1	1361.0	-	-
	11	729049.0	73.6	12	2	1243.0	1210.0	-
	12	81555.0	66.7	12	2	1518.0	1911.0	-
	13	288616.0	82.5	12	2	1925.0	1479.0	-

Trial Id	Radar Type	Number of Bursts	Burst Period (s)	Waveform Length (s)	Center Frequency (GHz)			
16	Type 5	20	0.6000000	12.0000000	5.498000000			
	Burst ID	Burst Offset (us)	Pulse Width (us)	Chirp Width (MHz)	Number of Pulses per Burst	PRI-1 (us)	PRI-2 (us)	PRI-3 (us)
	0	345538.0	87.6	20	3	1809.0	1142.0	1902.0
	1	490101.0	85.2	20	3	1370.0	1301.0	1914.0
	2	39145.0	84.8	20	3	1217.0	1247.0	1324.0
	3	183993.0	77.9	20	2	1160.0	1822.0	-
	4	329141.0	76.5	20	2	1295.0	1048.0	-
	5	474918.0	60.9	20	1	1301.0	-	-
	6	21367.0	83.0	20	2	1684.0	1175.0	-
	7	166161.0	80.4	20	2	1841.0	1130.0	-
	8	311033.0	67.5	20	2	1607.0	1223.0	-
	9	456993.0	62.1	20	1	1352.0	-	-
	10	3520.0	86.4	20	3	1700.0	1399.0	1030.0
	11	147826.0	84.3	20	3	1858.0	1628.0	1494.0
	12	293433.0	76.9	20	2	1268.0	1072.0	-
	13	437093.0	95.8	20	3	1310.0	1101.0	1689.0
	14	584602.0	55.2	20	1	1043.0	-	-
	15	130793.0	59.0	20	1	1580.0	-	-
	16	274624.0	94.5	20	3	1558.0	1119.0	1732.0
	17	418777.0	91.9	20	3	1627.0	1533.0	1671.0
	18	563823.0	85.2	20	3	1161.0	1131.0	1800.0
	19	112710.0	69.5	20	2	1309.0	1364.0	-
17	Type 5	12	1.0000000	12.0000000	5.494000000			
	Burst ID	Burst Offset (us)	Pulse Width (us)	Chirp Width (MHz)	Number of Pulses per Burst	PRI-1 (us)	PRI-2 (us)	PRI-3 (us)
	0	429259.0	86.4	10	3	1194.0	1562.0	1794.0
	1	670979.0	92.2	10	3	1679.0	1068.0	1370.0
	2	913818.0	80.4	10	2	1387.0	1304.0	-
	3	158545.0	54.3	10	1	1702.0	-	-
	4	400895.0	53.1	10	1	1126.0	-	-
	5	642041.0	69.4	10	2	1109.0	1744.0	-
	6	883409.0	69.1	10	2	1871.0	1514.0	-
	7	128290.0	100.0	10	3	1674.0	1420.0	1951.0
	8	370659.0	79.6	10	2	1175.0	1014.0	-
	9	611891.0	88.4	10	3	1058.0	1132.0	1252.0
	10	855277.0	53.3	10	1	1469.0	-	-
	11	98894.0	65.3	10	1	1745.0	-	-

Trial Id	Radar Type	Number of Bursts	Burst Period (s)	Waveform Length (s)	Center Frequency (GHz)				
18	Type 5	14	0.8571429	12.0000000	5.494800000				
		Burst ID	Burst Offset (us)	Pulse Width (us)	Chirp Width (MHz)	Number of Pulses per Burst	PRI-1 (us)	PRI-2 (us)	PRI-3 (us)
		0	292264.0	55.3	12	1	1564.0	-	-
		1	499839.0	58.3	12	1	1444.0	-	-
		2	706241.0	72.3	12	2	1214.0	1599.0	-
		3	59016.0	84.8	12	3	1938.0	1061.0	1221.0
		4	266259.0	82.5	12	2	1902.0	1090.0	-
		5	474152.0	63.3	12	1	1667.0	-	-
		6	680785.0	80.0	12	2	1664.0	1066.0	-
		7	33532.0	90.3	12	3	1701.0	1591.0	1004.0
		8	240164.0	91.1	12	3	1941.0	1715.0	1385.0
		9	447244.0	96.6	12	3	1343.0	1453.0	1448.0
		10	654869.0	82.7	12	2	1376.0	1863.0	-
		11	8084.0	50.7	12	1	1112.0	-	-
		12	215195.0	78.4	12	2	1860.0	1251.0	-
		13	421414.0	99.5	12	3	1211.0	1957.0	1785.0
19	Type 5	12	1.0000000	12.0000000	5.494000000				
		Burst ID	Burst Offset (us)	Pulse Width (us)	Chirp Width (MHz)	Number of Pulses per Burst	PRI-1 (us)	PRI-2 (us)	PRI-3 (us)
		0	733776.0	88.6	10	3	1250.0	1232.0	1944.0
		1	978500.0	57.4	10	1	1092.0	-	-
		2	221259.0	96.6	10	3	1049.0	1114.0	1625.0
		3	463263.0	69.7	10	2	1156.0	1790.0	-
		4	705037.0	77.9	10	2	1367.0	1640.0	-
		5	947884.0	62.0	10	1	1907.0	-	-
		6	191445.0	88.4	10	3	1209.0	1654.0	1204.0
		7	432506.0	97.3	10	3	1852.0	1608.0	1720.0
		8	674848.0	96.2	10	3	1360.0	1171.0	1074.0
		9	915221.0	95.4	10	3	1344.0	1748.0	1910.0
		10	162187.0	54.8	10	1	1015.0	-	-
		11	403878.0	80.4	10	2	1296.0	1188.0	-

Trial Id	Radar Type	Number of Bursts	Burst Period (s)	Waveform Length (s)	Center Frequency (GHz)			
20	Type 5	16	0.7500000	12.0000000	5.564000000			
	Burst ID	Burst Offset (us)	Pulse Width (us)	Chirp Width (MHz)	Number of Pulses per Burst	PRI-1 (us)	PRI-2 (us)	PRI-3 (us)
	0	483824.0	74.7	15	2	1583.0	1101.0	-
	1	665910.0	57.1	15	1	1741.0	-	-
	2	98722.0	91.9	15	3	1686.0	1852.0	1265.0
	3	280148.0	83.1	15	2	1116.0	1841.0	-
	4	462269.0	50.7	15	1	1435.0	-	-
	5	641874.0	79.2	15	2	1722.0	1975.0	-
	6	76783.0	58.7	15	1	1652.0	-	-
	7	257866.0	71.0	15	2	1476.0	1380.0	-
	8	438568.0	79.0	15	2	1785.0	1927.0	-
	9	620389.0	68.5	15	2	1017.0	1704.0	-
	10	54344.0	73.5	15	2	1548.0	1239.0	-
	11	235380.0	70.5	15	2	1723.0	1658.0	-
	12	416942.0	76.6	15	2	1262.0	1252.0	-
	13	597534.0	81.2	15	2	1532.0	1852.0	-
	14	32065.0	61.8	15	1	1786.0	-	-
	15	212584.0	94.9	15	3	1710.0	1907.0	1485.0
21	Type 5	12	1.0000000	12.0000000	5.566400000			
	Burst ID	Burst Offset (us)	Pulse Width (us)	Chirp Width (MHz)	Number of Pulses per Burst	PRI-1 (us)	PRI-2 (us)	PRI-3 (us)
	0	526804.0	78.5	9	2	1033.0	1077.0	-
	1	766810.0	89.8	9	3	1754.0	1928.0	1041.0
	2	12967.0	59.4	9	1	1054.0	-	-
	3	254814.0	79.6	9	2	1048.0	1683.0	-
	4	496335.0	76.0	9	2	1789.0	1641.0	-
	5	739766.0	53.6	9	1	1092.0	-	-
	6	979583.0	80.9	9	2	1815.0	1770.0	-
	7	225383.0	61.6	9	1	1130.0	-	-
	8	467404.0	53.4	9	1	1634.0	-	-
	9	709942.0	59.9	9	1	1068.0	-	-
	10	951435.0	60.4	9	1	1885.0	-	-
	11	194882.0	91.4	9	3	1792.0	1291.0	1419.0

Trial Id	Radar Type	Number of Bursts	Burst Period (s)	Waveform Length (s)	Center Frequency (GHz)				
22	Type 5	20	0.6000000	12.0000000	5.562000000				
		Burst ID	Burst Offset (us)	Pulse Width (us)	Chirp Width (MHz)	Number of Pulses per Burst	PRI-1 (us)	PRI-2 (us)	PRI-3 (us)
		0	261690.0	77.0	20	2	1730.0	1206.0	-
		1	407496.0	58.1	20	1	1468.0	-	-
		2	553039.0	62.1	20	1	1057.0	-	-
		3	98971.0	76.9	20	2	1466.0	1926.0	-
		4	243693.0	80.0	20	2	1841.0	1488.0	-
		5	389821.0	52.0	20	1	1153.0	-	-
		6	531723.0	88.6	20	3	2000.0	1481.0	1407.0
		7	81080.0	72.9	20	2	1935.0	1952.0	-
		8	225051.0	98.5	20	3	1689.0	1898.0	1899.0
		9	371684.0	57.9	20	1	1550.0	-	-
		10	513892.0	95.9	20	3	1339.0	1731.0	1878.0
		11	63543.0	53.5	20	1	1336.0	-	-
		12	207470.0	92.0	20	3	1916.0	1909.0	1146.0
		13	353593.0	57.3	20	1	1910.0	-	-
		14	497722.0	70.5	20	2	1889.0	1132.0	-
		15	45525.0	70.0	20	2	1619.0	1464.0	-
		16	189563.0	84.0	20	3	1968.0	1995.0	1419.0
		17	334977.0	76.1	20	2	1488.0	1756.0	-
		18	478188.0	93.2	20	3	1828.0	1610.0	1697.0
		19	27659.0	96.8	20	3	1462.0	1116.0	1215.0
23	Type 5	14	0.8571429	12.0000000	5.565200000				
		Burst ID	Burst Offset (us)	Pulse Width (us)	Chirp Width (MHz)	Number of Pulses per Burst	PRI-1 (us)	PRI-2 (us)	PRI-3 (us)
		0	247197.0	50.1	12	1	1562.0	-	-
		1	453153.0	93.5	12	3	1529.0	1790.0	1159.0
		2	660655.0	68.8	12	2	1687.0	1881.0	-
		3	14128.0	56.3	12	1	1820.0	-	-
		4	220915.0	86.0	12	3	1442.0	1738.0	1170.0
		5	428528.0	75.2	12	2	1335.0	1453.0	-
		6	636648.0	54.4	12	1	1562.0	-	-
		7	842797.0	71.1	12	2	1542.0	1394.0	-
		8	195782.0	76.2	12	2	1291.0	1561.0	-
		9	402683.0	80.2	12	2	1912.0	1557.0	-
		10	610243.0	79.7	12	2	1037.0	1708.0	-
		11	815892.0	90.9	12	3	1871.0	1691.0	1032.0
		12	170136.0	68.7	12	2	1488.0	1990.0	-
		13	377546.0	67.4	12	2	1446.0	1195.0	-

Trial Id	Radar Type	Number of Bursts	Burst Period (s)	Waveform Length (s)	Center Frequency (GHz)			
24	Type 5	13	0.9230769	12.0000000	5.565600000			
	Burst ID	Burst Offset (us)	Pulse Width (us)	Chirp Width (MHz)	Number of Pulses per Burst	PRI-1 (us)	PRI-2 (us)	PRI-3 (us)
	0	628743.0	94.0	11	3	1862.0	1287.0	1201.0
	1	853454.0	70.8	11	2	1088.0	1222.0	-
	2	156136.0	56.3	11	1	1516.0	-	-
	3	378517.0	96.7	11	3	1316.0	1809.0	1126.0
	4	601369.0	90.6	11	3	1749.0	1461.0	1029.0
	5	825544.0	74.5	11	2	1068.0	1691.0	-
	6	126146.0	92.6	11	3	1862.0	1293.0	1633.0
	7	350649.0	89.0	11	3	1541.0	1858.0	1948.0
	8	574102.0	96.5	11	3	1361.0	1536.0	1049.0
	9	797240.0	70.5	11	2	1787.0	1906.0	-
	10	100771.0	94.0	11	3	1079.0	1508.0	1692.0
	11	324468.0	55.8	11	1	1840.0	-	-
	12	545941.0	87.7	11	3	1757.0	1673.0	1698.0
25	Type 5	8	1.5000000	12.0000000	5.568000000			
	Burst ID	Burst Offset (us)	Pulse Width (us)	Chirp Width (MHz)	Number of Pulses per Burst	PRI-1 (us)	PRI-2 (us)	PRI-3 (us)
	0	1253346.0	68.6	5	2	1434.0	1625.0	-
	1	119462.0	83.1	5	2	1582.0	1450.0	-
	2	482866.0	60.9	5	1	1970.0	-	-
	3	845899.0	77.7	5	2	1246.0	1231.0	-
	4	1209262.0	77.4	5	2	1046.0	1225.0	-
	5	74755.0	66.8	5	2	1587.0	1165.0	-
	6	438159.0	63.7	5	1	1813.0	-	-
	7	799839.0	91.2	5	3	1451.0	1528.0	1970.0
26	Type 5	17	0.7058824	12.0000000	5.563600000			
	Burst ID	Burst Offset (us)	Pulse Width (us)	Chirp Width (MHz)	Number of Pulses per Burst	PRI-1 (us)	PRI-2 (us)	PRI-3 (us)
	0	545416.0	83.6	16	3	1017.0	1990.0	1397.0
	1	14066.0	89.4	16	3	1401.0	1948.0	1131.0
	2	184961.0	55.8	16	1	1500.0	-	-
	3	354333.0	90.9	16	3	1835.0	1325.0	1237.0
	4	526694.0	54.7	16	1	1416.0	-	-
	5	695652.0	97.7	16	3	1183.0	1142.0	1007.0
	6	163430.0	67.5	16	2	1626.0	1970.0	-
	7	333465.0	96.7	16	3	1371.0	1076.0	1764.0
	8	504482.0	68.3	16	2	1596.0	1445.0	-
	9	675424.0	78.3	16	2	1109.0	1431.0	-
	10	142911.0	55.0	16	1	1324.0	-	-
	11	312370.0	84.9	16	3	1366.0	1310.0	1812.0
	12	483170.0	74.6	16	2	1723.0	1776.0	-
	13	655500.0	63.3	16	1	1371.0	-	-
	14	121408.0	99.8	16	3	1238.0	1335.0	1378.0
	15	292829.0	63.6	16	1	1111.0	-	-
	16	461438.0	87.3	16	3	1491.0	1704.0	1442.0

Trial Id	Radar Type	Number of Bursts	Burst Period (s)	Waveform Length (s)	Center Frequency (GHz)				
27	Type 5	19	0.6315789	12.0000000	5.562400000				
		Burst ID	Burst Offset (us)	Pulse Width (us)	Chirp Width (MHz)	Number of Pulses per Burst	PRI-1 (us)	PRI-2 (us)	PRI-3 (us)
		0	564587.0	85.6	19	3	1355.0	1726.0	1567.0
		1	89838.0	68.6	19	2	1936.0	1791.0	-
		2	243065.0	54.2	19	1	1256.0	-	-
		3	395965.0	61.2	19	1	1213.0	-	-
		4	546679.0	97.1	19	3	1554.0	1063.0	1088.0
		5	71022.0	98.3	19	3	1038.0	1601.0	1618.0
		6	224043.0	62.4	19	1	1796.0	-	-
		7	375811.0	80.2	19	2	1736.0	1688.0	-
		8	526524.0	87.5	19	3	1933.0	1524.0	1910.0
		9	52332.0	85.8	19	3	1558.0	1072.0	1014.0
		10	204270.0	88.1	19	3	1638.0	1320.0	1778.0
		11	358389.0	65.3	19	1	1059.0	-	-
		12	510583.0	52.5	19	1	1956.0	-	-
		13	33661.0	52.3	19	1	2000.0	-	-
		14	186091.0	74.1	19	2	1080.0	1807.0	-
		15	339568.0	54.9	19	1	1031.0	-	-
		16	490613.0	76.2	19	2	1518.0	1924.0	-
		17	14864.0	60.4	19	1	1527.0	-	-
		18	167448.0	81.5	19	2	1015.0	1351.0	-
28	Type 5	12	1.0000000	12.0000000	5.566000000				
		Burst ID	Burst Offset (us)	Pulse Width (us)	Chirp Width (MHz)	Number of Pulses per Burst	PRI-1 (us)	PRI-2 (us)	PRI-3 (us)
		0	508045.0	50.5	10	1	1196.0	-	-
		1	749937.0	55.7	10	1	1661.0	-	-
		2	989019.0	85.8	10	3	1656.0	1854.0	1218.0
		3	235517.0	76.9	10	2	1772.0	1323.0	-
		4	477346.0	75.1	10	2	1221.0	1773.0	-
		5	718529.0	92.3	10	3	1122.0	1158.0	1577.0
		6	960804.0	78.1	10	2	1503.0	1649.0	-
		7	205421.0	92.2	10	3	1446.0	1589.0	1583.0
		8	447174.0	89.0	10	3	1145.0	1370.0	1341.0
		9	689823.0	70.9	10	2	1088.0	1246.0	-
		10	932887.0	63.1	10	1	1157.0	-	-
		11	176194.0	55.3	10	1	1731.0	-	-

Trial Id	Radar Type	Number of Bursts	Burst Period (s)	Waveform Length (s)	Center Frequency (GHz)				
29	Type 5	18	0.6666667	12.0000000	5.563200000				
		Burst ID	Burst Offset (us)	Pulse Width (us)	Chirp Width (MHz)	Number of Pulses per Burst	PRI-1 (us)	PRI-2 (us)	PRI-3 (us)
		0	277683.0	83.4	17	3	1301.0	1213.0	1473.0
		1	438503.0	97.3	17	3	1258.0	1057.0	1522.0
		2	598617.0	90.4	17	3	1679.0	1090.0	1780.0
		3	97142.0	91.8	17	3	1385.0	1491.0	1272.0
		4	257779.0	98.2	17	3	1869.0	1055.0	1339.0
		5	420304.0	59.5	17	1	1301.0	-	-
		6	580095.0	80.0	17	2	1693.0	1417.0	-
		7	77238.0	86.5	17	3	1548.0	1656.0	1903.0
		8	237974.0	91.1	17	3	1379.0	1497.0	1433.0
		9	398356.0	93.5	17	3	1360.0	1444.0	1937.0
		10	561396.0	60.7	17	1	1778.0	-	-
		11	57672.0	67.2	17	2	1157.0	1676.0	-
		12	219189.0	61.8	17	1	1263.0	-	-
		13	379317.0	79.4	17	2	1952.0	1503.0	-
		14	540148.0	81.4	17	2	1926.0	1552.0	-
		15	37944.0	65.7	17	1	1005.0	-	-
		16	198981.0	76.0	17	2	1299.0	1065.0	-
		17	360068.0	81.0	17	2	1163.0	1251.0	-
30	Type 5	16	0.7500000	12.0000000	5.530000000				
		Burst ID	Burst Offset (us)	Pulse Width (us)	Chirp Width (MHz)	Number of Pulses per Burst	PRI-1 (us)	PRI-2 (us)	PRI-3 (us)
		0	586476.0	79.9	15	2	1445.0	1067.0	-
		1	20235.0	98.4	15	3	1798.0	1118.0	1157.0
		2	201928.0	52.9	15	1	1174.0	-	-
		3	382479.0	68.3	15	2	1721.0	1527.0	-
		4	564677.0	63.1	15	1	1808.0	-	-
		5	745231.0	81.6	15	2	1068.0	1649.0	-
		6	178670.0	99.8	15	3	1673.0	1700.0	1502.0
		7	359099.0	91.7	15	3	1830.0	1924.0	1717.0
		8	541506.0	79.2	15	2	1040.0	1899.0	-
		9	722438.0	68.9	15	2	1615.0	1586.0	-
		10	156628.0	68.9	15	2	1902.0	1935.0	-
		11	338832.0	56.1	15	1	1104.0	-	-
		12	519379.0	73.5	15	2	1122.0	1541.0	-
		13	701469.0	59.2	15	1	1770.0	-	-
		14	134407.0	74.4	15	2	1944.0	1504.0	-
		15	315939.0	80.5	15	2	1334.0	1002.0	-

Type 6 Frequency Hopping Radar Statistical Performance - Details

Trial Id	Radar Type	Pulse Width (us)	PRI (us)	Pulses per Hop	Hopping Rate (kHz)	Hopping Sequence Length (ms)	Visible Frequency Number
1	Type 6	1.0	333.3	9	0.3333	300.0000000	1
	Frequency List (MHz)	0	1	2	3	4	
	0	5619	5578	5270	5294	5354	
	5	5660	5710	5666	5399	5656	
	10	5297	5333	5642	5609	5709	
	15	5668	5527	5647	5547	5284	
	20	5375	5395	5384	5444	5705	
	25	5584	5536	5480	5658	5453	
	30	5403	5576	5588	5641	5465	
	35	5674	5580	5623	5559	5627	
	40	5553	5704	5673	5633	5724	
	45	5373	5348	5331	5513	5637	
	50	5544	5314	5585	5697	5257	
	55	5672	5471	5423	5424	5638	
	60	5644	5345	5569	5655	5413	
	65	5271	5415	5550	5371	5335	
	70	5382	5416	5533	5706	5558	
	75	5535	5692	5256	5436	5716	
	80	5385	5669	5458	5349	5456	
	85	5336	5634	5703	5352	5280	
	90	5506	5313	5690	5326	5631	
	95	5628	5546	5289	5490	5590	

Trial Id	Radar Type	Pulse Width (us)	PRI (us)	Pulses per Hop	Hopping Rate (kHz)	Hopping Sequence Length (ms)	Visible Frequency Number
2	Type 6	1.0	333.3	9	0.3333	300.0000000	4
	Frequency List (MHz)	0	1	2	3	4	
	0	5302	5342	5681	5455	5611	
	5	5493	5682	5310	5257	5606	
	10	5587	5561	5374	5362	5630	
	15	5322	5320	5502	5475	5364	
	20	5555	5353	5316	5387	5357	
	25	5332	5654	5312	5262	5409	
	30	5522	5547	5410	5618	5253	
	35	5311	5683	5556	5470	5258	
	40	5537	5398	5710	5491	5469	
	45	5670	5465	5704	5456	5406	
	50	5384	5400	5513	5720	5365	
	55	5296	5276	5641	5445	5626	
	60	5564	5620	5395	5334	5290	
	65	5401	5578	5359	5569	5586	
	70	5282	5649	5407	5368	5647	
	75	5643	5509	5592	5675	5678	
	80	5581	5275	5381	5512	5600	
	85	5304	5382	5389	5458	5666	
	90	5419	5642	5350	5526	5519	
	95	5709	5692	5418	5653	5354	

Trial Id	Radar Type	Pulse Width (us)	PRI (us)	Pulses per Hop	Hopping Rate (kHz)	Hopping Sequence Length (ms)	Visible Frequency Number
3	Type 6	1.0	333.3	9	0.3333	300.000000	6
	Frequency List (MHz)	0	1	2	3	4	
	0	5557	5581	5617	5616	5356	
	5	5535	5704	5385	5420	5338	
	10	5518	5350	5415	5651	5313	
	15	5447	5605	5520	5653	5563	
	20	5519	5257	5476	5330	5598	
	25	5506	5515	5366	5443	5661	
	30	5533	5367	5358	5502	5606	
	35	5347	5647	5266	5411	5451	
	40	5334	5332	5709	5667	5394	
	45	5684	5539	5464	5437	5665	
	50	5389	5421	5416	5574	5488	
	55	5536	5580	5279	5439	5324	
	60	5499	5710	5708	5404	5305	
	65	5295	5525	5589	5359	5452	
	70	5576	5272	5492	5388	5551	
	75	5547	5323	5724	5256	5721	
	80	5293	5379	5584	5361	5508	
	85	5479	5693	5341	5655	5715	
	90	5629	5494	5401	5637	5423	
	95	5280	5316	5662	5281	5649	

Trial Id	Radar Type	Pulse Width (us)	PRI (us)	Pulses per Hop	Hopping Rate (kHz)	Hopping Sequence Length (ms)	Visible Frequency Number
4	Type 6	1.0	333.3	9	0.3333	300.0000000	2
	Frequency List (MHz)	0	1	2	3	4	
	0	5337	5345	5553	5302	5673	
	5	5577	5629	5460	5583	5642	
	10	5352	5614	5456	5655	5672	
	15	5401	5574	5611	5565	5370	
	20	5571	5588	5295	5468	5303	
	25	5486	5358	5718	5470	5380	
	30	5703	5422	5324	5573	5654	
	35	5426	5263	5634	5661	5462	
	40	5648	5498	5270	5474	5664	
	45	5701	5622	5425	5490	5552	
	50	5265	5597	5467	5300	5432	
	55	5724	5437	5469	5258	5715	
	60	5453	5277	5637	5705	5348	
	65	5593	5262	5561	5251	5255	
	70	5275	5341	5364	5510	5516	
	75	5346	5712	5504	5549	5356	
	80	5527	5376	5264	5447	5442	
	85	5454	5658	5428	5544	5374	
	90	5343	5663	5478	5689	5384	
	95	5372	5707	5274	5292	5466	

Trial Id	Radar Type	Pulse Width (us)	PRI (us)	Pulses per Hop	Hopping Rate (kHz)	Hopping Sequence Length (ms)	Visible Frequency Number
5	Type 6	1.0	333.3	9	0.3333	300.000000	1
	Frequency List (MHz)	0	1	2	3	4	
	0	5592	5584	5489	5463	5418	
	5	5619	5651	5535	5271	5374	
	10	5283	5500	5594	5375	5693	
	15	5604	5714	5610	5562	5482	
	20	5279	5711	5557	5276	5277	
	25	5307	5446	5574	5414	5270	
	30	5408	5281	5691	5428	5624	
	35	5625	5354	5430	5339	5376	
	40	5487	5581	5683	5617	5630	
	45	5644	5705	5483	5342	5519	
	50	5298	5518	5563	5598	5437	
	55	5391	5659	5455	5686	5582	
	60	5697	5469	5628	5294	5319	
	65	5597	5631	5521	5436	5423	
	70	5278	5665	5340	5485	5466	
	75	5438	5315	5275	5614	5330	
	80	5520	5590	5596	5264	5289	
	85	5405	5646	5526	5346	5676	
	90	5267	5539	5349	5600	5258	
	95	5671	5533	5345	5587	5523	

Trial Id	Radar Type	Pulse Width (us)	PRI (us)	Pulses per Hop	Hopping Rate (kHz)	Hopping Sequence Length (ms)	Visible Frequency Number
6	Type 6	1.0	333.3	9	0.3333	300.000000	4
	Frequency List (MHz)	0	1	2	3	4	
	0	5372	5348	5425	5624	5260	
	5	5283	5576	5610	5434	5581	
	10	5689	5289	5635	5570	5714	
	15	5577	5256	5342	5558	5279	
	20	5490	5652	5549	5724	5640	
	25	5634	5552	5300	5448	5409	
	30	5297	5713	5431	5580	5444	
	35	5667	5445	5701	5492	5290	
	40	5326	5286	5621	5382	5280	
	45	5559	5313	5541	5499	5704	
	50	5395	5474	5569	5274	5421	
	55	5698	5625	5345	5374	5657	
	60	5711	5519	5642	5301	5454	
	65	5715	5520	5536	5366	5413	
	70	5414	5378	5417	5316	5428	
	75	5357	5586	5484	5296	5430	
	80	5627	5684	5653	5273	5606	
	85	5465	5363	5491	5352	5355	
	90	5518	5631	5688	5588	5329	
	95	5485	5502	5590	5390	5531	

Trial Id	Radar Type	Pulse Width (us)	PRI (us)	Pulses per Hop	Hopping Rate (kHz)	Hopping Sequence Length (ms)	Visible Frequency Number
7	Type 6	1.0	333.3	9	0.3333	300.0000000	6
	Frequency List (MHz)	0	1	2	3	4	
	0	5530	5587	5361	5310	5480	
	5	5325	5598	5685	5500	5410	
	10	5523	5553	5676	5290	5260	
	15	5568	5383	5445	5603	5471	
	20	5498	5514	5690	5638	5697	
	25	5431	5583	5280	5404	5482	
	30	5451	5661	5670	5646	5354	
	35	5642	5331	5633	5594	5267	
	40	5301	5640	5369	5559	5622	
	45	5277	5391	5507	5396	5502	
	50	5552	5494	5271	5650	5620	
	55	5363	5719	5545	5338	5299	
	60	5564	5628	5268	5684	5608	
	65	5283	5343	5584	5572	5673	
	70	5683	5517	5492	5381	5266	
	75	5292	5387	5326	5706	5627	
	80	5682	5262	5367	5276	5716	
	85	5270	5511	5428	5458	5359	
	90	5351	5600	5285	5394	5571	
	95	5400	5265	5327	5643	5313	

Trial Id	Radar Type	Pulse Width (us)	PRI (us)	Pulses per Hop	Hopping Rate (kHz)	Hopping Sequence Length (ms)	Visible Frequency Number
8	Type 6	1.0	333.3	9	0.3333	300.000000	5
	Frequency List (MHz)	0	1	2	3	4	
	0	5310	5351	5297	5374	5322	
	5	5367	5523	5285	5663	5617	
	10	5454	5342	5717	5485	5281	
	15	5656	5510	5548	5648	5409	
	20	5680	5631	5630	5670	5319	
	25	5435	5483	5508	5516	5493	
	30	5647	5627	5386	5506	5462	
	35	5470	5724	5390	5420	5690	
	40	5576	5452	5497	5387	5274	
	45	5320	5487	5479	5560	5605	
	50	5381	5622	5671	5445	5489	
	55	5526	5253	5279	5502	5397	
	60	5629	5440	5678	5704	5544	
	65	5533	5608	5408	5478	5655	
	70	5481	5590	5268	5346	5673	
	75	5254	5295	5258	5459	5372	
	80	5623	5401	5267	5706	5545	
	85	5488	5650	5324	5305	5373	
	90	5559	5464	5660	5344	5698	
	95	5394	5378	5363	5321	5311	

Trial Id	Radar Type	Pulse Width (us)	PRI (us)	Pulses per Hop	Hopping Rate (kHz)	Hopping Sequence Length (ms)	Visible Frequency Number
9	Type 6	1.0	333.3	9	0.3333	300.0000000	1
	Frequency List (MHz)	0	1	2	3	4	
	0	5565	5590	5708	5535	5542	
	5	5409	5545	5360	5351	5349	
	10	5288	5606	5283	5583	5302	
	15	5269	5637	5554	5693	5380	
	20	5417	5274	5572	5719	5643	
	25	5682	5287	5686	5612	5550	
	30	5632	5536	5584	5504	5280	
	35	5660	5512	5340	5661	5573	
	40	5604	5415	5435	5530	5271	
	45	5627	5467	5562	5618	5658	
	50	5646	5401	5527	5722	5541	
	55	5268	5336	5714	5372	5473	
	60	5526	5539	5574	5369	5650	
	65	5367	5482	5547	5715	5370	
	70	5598	5252	5464	5484	5439	
	75	5622	5305	5642	5374	5341	
	80	5711	5385	5404	5264	5523	
	85	5448	5326	5451	5270	5667	
	90	5356	5621	5303	5724	5470	
	95	5639	5386	5361	5278	5378	

Trial Id	Radar Type	Pulse Width (us)	PRI (us)	Pulses per Hop	Hopping Rate (kHz)	Hopping Sequence Length (ms)	Visible Frequency Number
10	Type 6	1.0	333.3	9	0.3333	300.0000000	4
	Frequency List (MHz)	0	1	2	3	4	
	0	5345	5354	5644	5696	5384	
	5	5548	5470	5435	5514	5653	
	10	5694	5492	5324	5303	5323	
	15	5357	5667	5657	5641	5572	
	20	5425	5440	5610	5711	5616	
	25	5473	5414	5338	5584	5674	
	30	5541	5719	5432	5480	5651	
	35	5431	5457	5348	5615	5254	
	40	5715	5373	5295	5365	5556	
	45	5447	5645	5579	5533	5277	
	50	5703	5298	5252	5566	5280	
	55	5330	5636	5562	5403	5444	
	60	5655	5704	5519	5676	5427	
	65	5596	5568	5583	5450	5640	
	70	5304	5421	5547	5288	5598	
	75	5264	5494	5484	5695	5488	
	80	5495	5660	5293	5527	5639	
	85	5718	5351	5643	5511	5462	
	90	5632	5310	5394	5501	5476	
	95	5576	5327	5378	5333	5362	

Trial Id	Radar Type	Pulse Width (us)	PRI (us)	Pulses per Hop	Hopping Rate (kHz)	Hopping Sequence Length (ms)	Visible Frequency Number
11	Type 6	1.0	333.3	9	0.3333	300.0000000	8
	Frequency List (MHz)	0	1	2	3	4	
	0	5503	5593	5580	5382	5604	
	5	5590	5492	5510	5385	5625	
	10	5281	5365	5498	5344	5348	
	15	5319	5285	5686	5386	5336	
	20	5509	5551	5325	5589	5361	
	25	5563	5520	5442	5618	5716	
	30	5411	5459	5681	5300	5315	
	35	5522	5350	5501	5529	5568	
	40	5323	5689	5535	5362	5485	
	45	5427	5253	5637	5667	5628	
	50	5404	5349	5341	5389	5602	
	55	5518	5277	5697	5415	5309	
	60	5394	5464	5508	5639	5391	
	65	5380	5282	5532	5582	5493	
	70	5533	5587	5515	5574	5698	
	75	5483	5614	5530	5676	5265	
	80	5605	5441	5360	5636	5438	
	85	5351	5474	5654	5500	5642	
	90	5321	5579	5482	5610	5684	
	95	5388	5443	5547	5581	5527	

Trial Id	Radar Type	Pulse Width (us)	PRI (us)	Pulses per Hop	Hopping Rate (kHz)	Hopping Sequence Length (ms)	Visible Frequency Number
12	Type 6	1.0	333.3	9	0.3333	300.0000000	5
	Frequency List (MHz)	0	1	2	3	4	
	0	5283	5357	5516	5543	5446	
	5	5632	5417	5585	5268	5592	
	10	5459	5545	5406	5693	5365	
	15	5436	5388	5256	5578	5344	
	20	5675	5492	5317	5562	5627	
	25	5512	5723	5546	5652	5380	
	30	5300	5455	5674	5358	5498	
	35	5454	5710	5621	5654	5443	
	40	5504	5678	5359	5407	5336	
	45	5695	5720	5685	5580	5400	
	50	5430	5687	5706	5544	5467	
	55	5419	5289	5438	5559	5506	
	60	5340	5554	5329	5558	5327	
	65	5385	5662	5519	5590	5364	
	70	5550	5657	5355	5259	5673	
	75	5420	5618	5697	5524	5275	
	80	5633	5254	5424	5534	5274	
	85	5465	5315	5415	5269	5488	
	90	5547	5566	5616	5509	5427	
	95	5445	5560	5636	5347	5432	

Trial Id	Radar Type	Pulse Width (us)	PRI (us)	Pulses per Hop	Hopping Rate (kHz)	Hopping Sequence Length (ms)	Visible Frequency Number
13	Type 6	1.0	333.3	9	0.3333	300.000000	5
	Frequency List (MHz)	0	1	2	3	4	
	0	5538	5596	5452	5704	5666	
	5	5674	5439	5660	5431	5324	
	10	5390	5334	5544	5413	5386	
	15	5524	5573	5491	5301	5295	
	20	5352	5269	5530	5406	5535	
	25	5515	5364	5451	5650	5686	
	30	5422	5664	5412	5317	5607	
	35	5318	5496	5326	5417	5429	
	40	5454	5343	5489	5565	5443	
	45	5356	5721	5387	5419	5656	
	50	5298	5475	5283	5281	5519	
	55	5393	5498	5657	5713	5260	
	60	5470	5724	5647	5477	5531	
	65	5278	5594	5597	5663	5259	
	70	5505	5690	5688	5526	5282	
	75	5719	5638	5672	5253	5478	
	80	5338	5630	5450	5632	5266	
	85	5497	5466	5333	5366	5339	
	90	5434	5591	5581	5351	5250	
	95	5411	5442	5264	5545	5527	

Trial Id	Radar Type	Pulse Width (us)	PRI (us)	Pulses per Hop	Hopping Rate (kHz)	Hopping Sequence Length (ms)	Visible Frequency Number
14	Type 6	1.0	333.3	9	0.3333	300.0000000	4
	Frequency List (MHz)	0	1	2	3	4	
	0	5318	5360	5388	5390	5508	
	5	5338	5364	5260	5594	5628	
	10	5321	5598	5585	5511	5407	
	15	5612	5700	5497	5724	5487	
	20	5263	5435	5471	5398	5306	
	25	5691	5654	5279	5720	5464	
	30	5650	5369	5532	5284	5516	
	35	5635	5417	5310	5582	5368	
	40	5657	5669	5503	5683	5353	
	45	5553	5270	5502	5714	5351	
	50	5362	5634	5457	5608	5711	
	55	5337	5607	5452	5372	5706	
	60	5599	5414	5396	5576	5303	
	65	5574	5616	5702	5533	5534	
	70	5489	5466	5428	5588	5693	
	75	5537	5478	5293	5402	5387	
	80	5716	5449	5266	5259	5377	
	85	5401	5627	5645	5632	5583	
	90	5557	5561	5298	5320	5339	
	95	5597	5518	5708	5262	5543	

Trial Id	Radar Type	Pulse Width (us)	PRI (us)	Pulses per Hop	Hopping Rate (kHz)	Hopping Sequence Length (ms)	Visible Frequency Number
15	Type 6	1.0	333.3	9	0.3333	300.0000000	6
	Frequency List (MHz)	0	1	2	3	4	
	0	5573	5599	5324	5551	5253	
	5	5380	5386	5335	5660	5360	
	10	5630	5484	5626	5706	5428	
	15	5803	5255	5600	5294	5679	
	20	5271	5504	5412	5487	5481	
	25	5669	5640	5382	5480	5279	
	30	5506	5539	5326	5272	5533	
	35	5336	5299	5508	5581	5260	
	40	5282	5496	5277	5441	5448	
	45	5447	5482	5250	5585	5297	
	50	5404	5627	5510	5633	5553	
	55	5319	5534	5659	5320	5406	
	60	5562	5351	5677	5579	5438	
	65	5408	5604	5520	5342	5651	
	70	5569	5366	5284	5647	5500	
	75	5574	5318	5289	5381	5437	
	80	5522	5530	5697	5701	5376	
	85	5515	5444	5561	5624	5365	
	90	5535	5278	5641	5371	5587	
	95	5357	5552	5493	5560	5608	

Trial Id	Radar Type	Pulse Width (us)	PRI (us)	Pulses per Hop	Hopping Rate (kHz)	Hopping Sequence Length (ms)	Visible Frequency Number
16	Type 6	1.0	333.3	9	0.3333	300.0000000	2
	Frequency List (MHz)	0	1	2	3	4	
	0	5256	5460	5260	5615	5570	
	5	5422	5311	5410	5348	5567	
	10	5561	5273	5667	5426	5449	
	15	5691	5382	5703	5339	5396	
	20	5279	5670	5353	5479	5454	
	25	5557	5492	5488	5584	5313	
	30	5645	5525	5283	5487	5685	
	35	5534	5341	5599	5377	5413	
	40	5671	5335	5360	5379	5591	
	45	5444	5411	5705	5668	5258	
	50	5457	5514	5289	5334	5604	
	55	5408	5357	5603	5263	5655	
	60	5548	5551	5269	5383	5715	
	65	5527	5466	5640	5600	5508	
	70	5576	5651	5450	5669	5560	
	75	5321	5613	5609	5642	5678	
	80	5478	5486	5296	5608	5624	
	85	5524	5438	5364	5580	5470	
	90	5606	5325	5555	5489	5375	
	95	5480	5674	5663	5282	5573	

Trial Id	Radar Type	Pulse Width (us)	PRI (us)	Pulses per Hop	Hopping Rate (kHz)	Hopping Sequence Length (ms)	Visible Frequency Number
17	Type 6	1.0	333.3	9	0.3333	300.0000000	5
	Frequency List (MHz)	0	1	2	3	4	
	0	5511	5699	5671	5301	5315	
	5	5464	5333	5485	5396	5492	
	10	5537	5708	5621	5470	5304	
	15	5509	5331	5287	5588	5665	
	20	5264	5391	5568	5427	5348	
	25	5441	5691	5688	5347	5687	
	30	5414	5715	5605	5459	5354	
	35	5480	5312	5648	5663	5682	
	40	5271	5540	5317	5356	5718	
	45	5685	5276	5316	5413	5640	
	50	5510	5655	5497	5558	5450	
	55	5599	5692	5370	5367	5522	
	60	5434	5328	5547	5353	5412	
	65	5366	5549	5544	5408	5446	
	70	5253	5266	5546	5421	5462	
	75	5355	5481	5719	5659	5633	
	80	5499	5552	5297	5521	5280	
	85	5438	5681	5543	5565	5474	
	90	5279	5608	5375	5619	5712	
	95	5523	5257	5541	5507	5261	

Trial Id	Radar Type	Pulse Width (us)	PRI (us)	Pulses per Hop	Hopping Rate (kHz)	Hopping Sequence Length (ms)	Visible Frequency Number
18	Type 6	1.0	333.3	9	0.3333	300.0000000	4
	Frequency List (MHz)	0	1	2	3	4	
	0	5291	5463	5607	5462	5632	
	5	5603	5258	5560	5674	5326	
	10	5274	5341	5491	5392	5636	
	15	5434	5332	5305	5673	5430	
	20	5400	5711	5293	5419	5317	
	25	5381	5254	5303	5672	5345	
	30	5611	5649	5619	5403	5541	
	35	5596	5585	5623	5633	5438	
	40	5647	5665	5359	5374	5466	
	45	5666	5516	5589	5706	5586	
	50	5394	5312	5646	5661	5493	
	55	5543	5599	5273	5476	5276	
	60	5455	5664	5498	5580	5618	
	65	5338	5531	5435	5629	5424	
	70	5311	5309	5314	5450	5310	
	75	5290	5640	5410	5609	5333	
	80	5461	5275	5518	5572	5620	
	85	5506	5282	5342	5330	5573	
	90	5718	5557	5517	5601	5708	
	95	5298	5525	5405	5304	5682	

Trial Id	Radar Type	Pulse Width (us)	PRI (us)	Pulses per Hop	Hopping Rate (kHz)	Hopping Sequence Length (ms)	Visible Frequency Number
19	Type 6	1.0	333.3	9	0.3333	300.000000	5
	Frequency List (MHz)	0	1	2	3	4	
	0	5546	5702	5543	5623	5377	
	5	5645	5280	5635	5265	5335	
	10	5257	5590	5315	5439	5512	
	15	5383	5288	5440	5594	5681	
	20	5596	5273	5649	5373	5502	
	25	5620	5622	5518	5415	5393	
	30	5289	5629	5560	5385	5372	
	35	5283	5494	5337	5510	5424	
	40	5706	5571	5361	5435	5479	
	45	5442	5519	5456	5392	5290	
	50	5282	5297	5679	5716	5500	
	55	5600	5275	5464	5672	5308	
	60	5577	5401	5390	5447	5450	
	65	5608	5334	5507	5615	5524	
	70	5285	5322	5430	5433	5621	
	75	5662	5719	5589	5528	5515	
	80	5292	5462	5566	5307	5284	
	85	5296	5474	5724	5399	5710	
	90	5250	5353	5509	5303	5597	
	95	5407	5428	5562	5678	5300	

Trial Id	Radar Type	Pulse Width (us)	PRI (us)	Pulses per Hop	Hopping Rate (kHz)	Hopping Sequence Length (ms)	Visible Frequency Number
20	Type 6	1.0	333.3	9	0.3333	300.000000	5
	Frequency List (MHz)	0	1	2	3	4	
	0	5704	5466	5479	5309	5597	
	5	5687	5680	5710	5428	5639	
	10	5566	5379	5356	5634	5533	
	15	5471	5318	5543	5422	5311	
	20	5592	5665	5641	5443	5390	
	25	5569	5350	5622	5449	5435	
	30	5653	5586	5300	5537	5667	
	35	5325	5585	5608	5269	5521	
	40	5263	5314	5509	5504	5529	
	45	5408	5528	5525	5393	5572	
	50	5343	5646	5333	5386	5502	
	55	5660	5688	5554	5465	5677	
	60	5338	5326	5454	5260	5615	
	65	5403	5347	5591	5396	5555	
	70	5515	5579	5601	5527	5387	
	75	5261	5707	5291	5550	5602	
	80	5439	5257	5370	5692	5498	
	85	5512	5487	5719	5401	5650	
	90	5335	5402	5255	5659	5722	
	95	5364	5493	5676	5510	5700	

Trial Id	Radar Type	Pulse Width (us)	PRI (us)	Pulses per Hop	Hopping Rate (kHz)	Hopping Sequence Length (ms)	Visible Frequency Number
21	Type 6	1.0	333.3	9	0.3333	300.000000	8
	Frequency List (MHz)	0	1	2	3	4	
	0	5484	5705	5415	5470	5439	
	5	5351	5702	5310	5591	5371	
	10	5497	5265	5494	5354	5554	
	15	5559	5445	5646	5370	5503	
	20	5600	5356	5252	5255	5416	
	25	5656	5421	5456	5251	5483	
	30	5477	5542	5543	5418	5311	
	35	5390	5464	5676	5501	5422	
	40	5435	5674	5447	5269	5526	
	45	5337	5508	5608	5451	5625	
	50	5522	5642	5384	5475	5703	
	55	5507	5401	5655	5496	5309	
	60	5455	5619	5680	5326	5414	
	65	5345	5492	5295	5318	5273	
	70	5587	5530	5711	5615	5666	
	75	5638	5670	5622	5583	5691	
	80	5367	5626	5381	5561	5412	
	85	5682	5718	5589	5286	5289	
	90	5553	5314	5329	5261	5465	
	95	5541	5463	5574	5671	5458	

Trial Id	Radar Type	Pulse Width (us)	PRI (us)	Pulses per Hop	Hopping Rate (kHz)	Hopping Sequence Length (ms)	Visible Frequency Number
22	Type 6	1.0	333.3	9	0.3333	300.000000	5
	Frequency List (MHz)	0	1	2	3	4	
	0	5264	5469	5351	5631	5659	
	5	5393	5627	5385	5279	5578	
	10	5428	5529	5535	5549	5575	
	15	5647	5572	5274	5415	5695	
	20	5608	5425	5668	5722	5389	
	25	5544	5370	5355	5517	5616	
	30	5528	5500	5633	5463	5685	
	35	5603	5292	5297	5349	5513	
	40	5577	5509	5523	5644	5488	
	45	5691	5412	5678	5495	5398	
	50	5343	5435	5564	5526	5451	
	55	5589	5462	5315	5280	5584	
	60	5309	5625	5336	5615	5294	
	65	5530	5702	5565	5596	5345	
	70	5670	5630	5560	5591	5607	
	75	5693	5468	5477	5407	5545	
	80	5721	5409	5402	5525	5552	
	85	5381	5483	5340	5326	5609	
	90	5494	5364	5499	5423	5465	
	95	5518	5558	5569	5716	5718	

Trial Id	Radar Type	Pulse Width (us)	PRI (us)	Pulses per Hop	Hopping Rate (kHz)	Hopping Sequence Length (ms)	Visible Frequency Number
23	Type 6	1.0	333.3	9	0.3333	300.0000000	2
	Frequency List (MHz)	0	1	2	3	4	
	0	5519	5708	5287	5695	5501	
	5	5435	5649	5460	5442	5407	
	10	5262	5318	5576	5269	5596	
	15	5638	5699	5377	5412	5591	
	20	5706	5336	5362	5432	5697	
	25	5387	5556	5454	5658	5417	
	30	5457	5373	5712	5408	5645	
	35	5480	5568	5350	5360	5352	
	40	5660	5323	5652	5520	5573	
	45	5468	5299	5470	5634	5285	
	50	5274	5486	5275	5349	5298	
	55	5680	5416	5463	5512	5251	
	60	5713	5474	5667	5683	5453	
	65	5282	5438	5718	5566	5534	
	70	5399	5514	5656	5633	5409	
	75	5567	5584	5338	5545	5623	
	80	5490	5663	5612	5309	5406	
	85	5694	5525	5499	5448	5294	
	90	5574	5332	5659	5370	5436	
	95	5477	5415	5542	5467	5319	

Trial Id	Radar Type	Pulse Width (us)	PRI (us)	Pulses per Hop	Hopping Rate (kHz)	Hopping Sequence Length (ms)	Visible Frequency Number
24	Type 6	1.0	333.3	9	0.3333	300.000000	3
	Frequency List (MHz)	0	1	2	3	4	
	0	5299	5472	5698	5381	5721	
	5	5477	5574	5535	5508	5614	
	10	5668	5582	5617	5367	5251	
	15	5351	5383	5505	5604	5527	
	20	5660	5647	5328	5335	5549	
	25	5590	5488	5700	5403	5414	
	30	5588	5389	5703	5309	5571	
	35	5364	5503	5274	5666	5365	
	40	5261	5417	5517	5405	5448	
	45	5382	5528	5687	5695	5537	
	50	5717	5393	5370	5653	5331	
	55	5600	5270	5639	5612	5515	
	60	5376	5667	5269	5252	5677	
	65	5586	5642	5258	5636	5543	
	70	5458	5479	5623	5400	5444	
	75	5301	5372	5428	5341	5575	
	80	5290	5316	5345	5347	5627	
	85	5349	5470	5565	5432	5628	
	90	5676	5447	5672	5552	5468	
	95	5469	5359	5321	5325	5678	

Trial Id	Radar Type	Pulse Width (us)	PRI (us)	Pulses per Hop	Hopping Rate (kHz)	Hopping Sequence Length (ms)	Visible Frequency Number
25	Type 6	1.0	333.3	9	0.3333	300.000000	3
	Frequency List (MHz)	0	1	2	3	4	
	0	5457	5711	5634	5542	5563	
	5	5616	5596	5610	5671	5346	
	10	5599	5371	5658	5562	5638	
	15	5339	5381	5486	5453	5321	
	20	5535	5351	5588	5417	5308	
	25	5586	5498	5318	5289	5522	
	30	5364	5292	5706	5426	5448	
	35	5662	5257	5656	5663	5505	
	40	5674	5657	5514	5334	5428	
	45	5465	5489	5265	5437	5404	
	50	5396	5373	5564	5581	5324	
	55	5368	5625	5571	5399	5329	
	60	5557	5347	5677	5271	5462	
	65	5541	5576	5383	5280	5250	
	70	5261	5485	5519	5502	5578	
	75	5525	5604	5652	5613	5700	
	80	5435	5400	5609	5331	5635	
	85	5385	5281	5299	5595	5350	
	90	5382	5407	5695	5546	5683	
	95	5607	5263	5655	5550	5459	

Trial Id	Radar Type	Pulse Width (us)	PRI (us)	Pulses per Hop	Hopping Rate (kHz)	Hopping Sequence Length (ms)	Visible Frequency Number
26	Type 6	1.0	333.3	9	0.3333	300.000000	4
	Frequency List (MHz)	0	1	2	3	4	
	0	5712	5475	5570	5703	5308	
	5	5658	5521	5685	5359	5650	
	10	5433	5257	5699	5282	5659	
	15	5427	5508	5589	5498	5610	
	20	5446	5420	5626	5409	5281	
	25	5377	5350	5424	5393	5556	
	30	5406	5656	5328	5315	5721	
	35	5587	5278	5528	5431	5674	
	40	5441	5531	5515	5422	5608	
	45	5263	5408	5548	5547	5318	
	50	5324	5280	5572	5639	5542	
	55	5671	5294	5558	5347	5494	
	60	5502	5654	5600	5692	5663	
	65	5662	5577	5311	5414	5661	
	70	5352	5711	5361	5334	5398	
	75	5461	5289	5698	5668	5585	
	80	5429	5723	5481	5629	5595	
	85	5300	5329	5331	5597	5598	
	90	5624	5368	5645	5679	5485	
	95	5707	5563	5591	5636	5537	

Trial Id	Radar Type	Pulse Width (us)	PRI (us)	Pulses per Hop	Hopping Rate (kHz)	Hopping Sequence Length (ms)	Visible Frequency Number
27	Type 6	1.0	333.3	9	0.3333	300.000000	5
	Frequency List (MHz)	0	1	2	3	4	
	0	5492	5714	5506	5389	5625	
	5	5700	5543	5285	5522	5382	
	10	5364	5521	5265	5477	5680	
	15	5418	5635	5692	5327	5454	
	20	5586	5567	5498	5254	5299	
	25	5627	5594	5590	5448	5642	
	30	5661	5564	5541	5629	5369	
	35	5324	5584	5588	5280	5614	
	40	5453	5565	5605	5570	5291	
	45	5631	5371	5589	5534	5273	
	50	5690	5494	5355	5482	5707	
	55	5641	5513	5657	5659	5544	
	60	5486	5426	5638	5611	5516	
	65	5618	5684	5464	5697	5658	
	70	5374	5420	5258	5721	5566	
	75	5681	5358	5262	5696	5297	
	80	5621	5709	5439	5672	5304	
	85	5616	5368	5491	5475	5341	
	90	5580	5318	5281	5380	5519	
	95	5537	5362	5645	5524	5325	

Trial Id	Radar Type	Pulse Width (us)	PRI (us)	Pulses per Hop	Hopping Rate (kHz)	Hopping Sequence Length (ms)	Visible Frequency Number
28	Type 6	1.0	333.3	9	0.3333	300.0000000	7
	Frequency List (MHz)	0	1	2	3	4	
	0	5272	5478	5539	5550	5370	
	5	5267	5565	5360	5588	5589	
	10	5295	5310	5306	5672	5701	
	15	5506	5287	5320	5491	5519	
	20	5462	5655	5508	5490	5702	
	25	5531	5626	5355	5698	5624	
	30	5717	5401	5716	5264	5293	
	35	5557	5692	5262	5502	5594	
	40	5319	5391	5330	5602	5499	
	45	5271	5336	5663	5424	5476	
	50	5410	5449	5266	5342	5317	
	55	5299	5670	5564	5463	5460	
	60	5387	5311	5349	5489	5415	
	65	5252	5681	5687	5560	5552	
	70	5353	5576	5593	5683	5464	
	75	5507	5350	5379	5605	5366	
	80	5382	5547	5361	5371	5518	
	85	5385	5721	5294	5341	5612	
	90	5378	5621	5389	5457	5292	
	95	5534	5497	5412	5374	5597	

Trial Id	Radar Type	Pulse Width (us)	PRI (us)	Pulses per Hop	Hopping Rate (kHz)	Hopping Sequence Length (ms)	Visible Frequency Number
29	Type 6	1.0	333.3	9	0.3333	300.0000000	3
	Frequency List (MHz)	0	1	2	3	4	
	0	5430	5717	5475	5711	5687	
	5	5406	5490	5435	5276	5321	
	10	5604	5574	5444	5295	5722	
	15	5594	5414	5326	5536	5373	
	20	5346	5546	5579	5675	5419	
	25	5478	5558	5327	5658	5629	
	30	5420	5674	5519	5559	5432	
	35	5648	5488	5512	5513	5433	
	40	5402	5329	5570	5599	5331	
	45	5251	5624	5477	5266	5286	
	50	5625	5317	5431	5518	5621	
	55	5653	5279	5358	5343	5514	
	60	5434	5650	5627	5413	5509	
	65	5491	5660	5371	5545	5665	
	70	5291	5467	5259	5338	5486	
	75	5428	5528	5613	5481	5299	
	80	5549	5309	5612	5695	5681	
	85	5581	5422	5540	5386	5699	
	90	5503	5446	5256	5462	5640	
	95	5427	5377	5487	5398	5307	

Trial Id	Radar Type	Pulse Width (us)	PRI (us)	Pulses per Hop	Hopping Rate (kHz)	Hopping Sequence Length (ms)	Visible Frequency Number
30	Type 6	1.0	333.3	9	0.3333	300.0000000	3
	Frequency List (MHz)	0	1	2	3	4	
	0	5685	5481	5411	5397	5432	
	5	5448	5512	5510	5439	5625	
	10	5535	5363	5485	5490	5268	
	15	5682	5444	5429	5581	5428	
	20	5381	5487	5571	5648	5307	
	25	5427	5286	5431	5692	5671	
	30	5406	5631	5259	5642	5282	
	35	5474	5264	5284	5665	5369	
	40	5267	5335	5596	5260	5706	
	45	5502	5433	5628	5637	5326	
	50	5368	5520	5341	5565	5472	
	55	5271	5476	5329	5679	5554	
	60	5573	5711	5458	5527	5492	
	65	5641	5348	5359	5277	5470	
	70	5583	5302	5297	5446	5606	
	75	5509	5390	5591	5555	5713	
	80	5469	5288	5256	5515	5537	
	85	5644	5676	5290	5263	5313	
	90	5681	5389	5383	5516	5253	
	95	5483	5721	5325	5356	5590	

3.11.6 U-NII-2C 160MHZ TEST RESULTS AND WAVEFORMS DETAILS

160MHz / 5570MHz						
(Detection = Y, No Detection = N)						
Trial Number	Type 1	Type 2	Type 3	Type 4	Type 5	Type 6
1	Y	Y	Y	Y	Y	Y
2	Y	Y	Y	N	Y	Y
3	Y	Y	Y	Y	N	Y
4	N	Y	Y	Y	Y	Y
5	Y	Y	Y	Y	Y	Y
6	Y	N	Y	Y	Y	Y
7	Y	Y	Y	N	Y	Y
8	Y	Y	N	Y	Y	Y
9	Y	Y	Y	Y	Y	Y
10	N	Y	Y	Y	Y	N
11	Y	N	Y	Y	N	Y
12	Y	Y	Y	Y	Y	Y
13	N	Y	Y	N	Y	Y
14	Y	Y	Y	Y	Y	Y
15	Y	Y	N	Y	Y	Y
16	Y	Y	Y	Y	Y	Y
17	N	N	Y	Y	Y	Y
18	Y	Y	Y	Y	Y	Y
19	Y	Y	Y	Y	Y	Y
20	Y	Y	Y	Y	Y	Y
21	Y	Y	Y	Y	Y	Y
22	N	N	Y	Y	Y	Y
23	Y	Y	Y	Y	Y	Y
24	Y	Y	Y	Y	N	Y
25	Y	Y	N	Y	Y	Y
26	N	Y	Y	Y	Y	Y
27	Y	Y	Y	N	Y	N
28	Y	N	Y	Y	Y	Y
29	N	Y	Y	Y	Y	Y
30	Y	Y	Y	Y	Y	Y
Trial of Detection	23/30	25/30	27/30	26/30	27/30	28/30
Probability (%)	76.7%	83.3%	90%	86.7%	90%	93.3%
Limit (%)	>= 60%	>= 60%	>= 60%	>= 60%	>= 80%	>= 70%
Average Probability of Radar Type 1~4 (%)	84.2% (>=80%)					

Type 1 Short Pulse Radar Statistical Performance - Details

Trial Id	Radar Type	Pulse Width (us)	PRI (us)	Number of Pulses	Waveform Length (us)
1	Type 1	1.0	698.0	76	53048.0
2	Type 1	1.0	618.0	86	53148.0
3	Type 1	1.0	538.0	99	53262.0
4	Type 1	1.0	878.0	61	53558.0
5	Type 1	1.0	3066.0	18	55188.0
6	Type 1	1.0	638.0	83	52954.0
7	Type 1	1.0	918.0	58	53244.0
8	Type 1	1.0	838.0	63	52794.0
9	Type 1	1.0	858.0	62	53196.0
10	Type 1	1.0	798.0	67	53466.0
11	Type 1	1.0	718.0	74	53132.0
12	Type 1	1.0	578.0	92	53176.0
13	Type 1	1.0	598.0	89	53222.0
14	Type 1	1.0	558.0	95	53010.0
15	Type 1	1.0	2536.0	21	53256.0
16	Type 1	1.0	966.0	55	53130.0
17	Type 1	1.0	827.0	64	52928.0
18	Type 1	1.0	2501.0	22	55022.0
19	Type 1	1.0	2595.0	21	54495.0
20	Type 1	1.0	1114.0	48	53472.0
21	Type 1	1.0	1302.0	41	53382.0
22	Type 1	1.0	3045.0	18	54810.0
23	Type 1	1.0	1624.0	33	53592.0
24	Type 1	1.0	2878.0	19	54682.0
25	Type 1	1.0	1027.0	52	53404.0
26	Type 1	1.0	2485.0	22	54670.0
27	Type 1	1.0	1600.0	33	52800.0
28	Type 1	1.0	1172.0	46	53912.0
29	Type 1	1.0	1177.0	45	52965.0
30	Type 1	1.0	2171.0	25	54275.0

Type 2 Short Pulse Radar Statistical Performance - Details

Trial Id	Radar Type	Pulse Width (us)	PRI (us)	Number of Pulses	Waveform Length (us)
0	Type 2	3.2	179.0	26	4654.0
1	Type 2	1.1	207.0	23	4761.0
2	Type 2	2.1	230.0	24	5520.0
3	Type 2	4.8	200.0	29	5800.0
4	Type 2	3.9	214.0	28	5992.0
5	Type 2	2.9	222.0	26	5772.0
6	Type 2	3.2	204.0	26	5304.0
7	Type 2	2.5	192.0	25	4800.0
8	Type 2	3.1	164.0	26	4264.0
9	Type 2	1.2	156.0	23	3588.0
10	Type 2	3.9	210.0	27	5670.0
11	Type 2	4.6	201.0	29	5829.0
12	Type 2	3.2	162.0	26	4212.0
13	Type 2	2.2	197.0	25	4925.0
14	Type 2	4.5	163.0	29	4727.0
15	Type 2	3.0	203.0	26	5278.0
16	Type 2	5.0	168.0	29	4872.0
17	Type 2	2.4	217.0	25	5425.0
18	Type 2	2.9	191.0	26	4966.0
19	Type 2	2.3	166.0	25	4150.0
20	Type 2	3.7	150.0	27	4050.0
21	Type 2	2.2	176.0	25	4400.0
22	Type 2	4.9	195.0	29	5655.0
23	Type 2	2.9	202.0	26	5252.0
24	Type 2	2.5	178.0	25	4450.0
25	Type 2	1.1	206.0	23	4738.0
26	Type 2	3.8	155.0	27	4185.0
27	Type 2	4.7	157.0	29	4553.0
28	Type 2	2.4	224.0	25	5600.0
29	Type 2	4.2	159.0	28	4452.0
30	Type 2	3.6	175.0	27	4725.0

Type 3 Short Pulse Radar Statistical Performance - Details

Trial Id	Radar Type	Pulse Width (us)	PRI (us)	Number of Pulses	Waveform Length (us)
1	Type 3	6.1	487.0	16	7792.0
2	Type 3	7.1	344.0	16	5504.0
3	Type 3	9.8	288.0	18	5184.0
4	Type 3	8.9	230.0	18	4140.0
5	Type 3	7.9	432.0	17	7344.0
6	Type 3	8.2	207.0	17	3519.0
7	Type 3	7.5	443.0	17	7531.0
8	Type 3	8.1	439.0	17	7463.0
9	Type 3	6.2	223.0	16	3568.0
10	Type 3	8.9	208.0	18	3744.0
11	Type 3	9.6	463.0	18	8334.0
12	Type 3	8.2	441.0	17	7497.0
13	Type 3	7.2	323.0	16	5168.0
14	Type 3	9.5	297.0	18	5346.0
15	Type 3	8.0	412.0	17	7004.0
16	Type 3	10.0	324.0	18	5832.0
17	Type 3	7.4	271.0	17	4607.0
18	Type 3	7.9	349.0	17	5933.0
19	Type 3	7.3	409.0	16	6544.0
20	Type 3	8.7	373.0	18	6714.0
21	Type 3	7.2	254.0	16	4064.0
22	Type 3	9.9	274.0	18	4932.0
23	Type 3	7.9	278.0	17	4726.0
24	Type 3	7.5	317.0	17	5389.0
25	Type 3	6.1	260.0	16	4160.0
26	Type 3	8.8	211.0	18	3798.0
27	Type 3	9.7	272.0	18	4896.0
28	Type 3	7.4	264.0	17	4488.0
29	Type 3	9.2	284.0	18	5112.0
30	Type 3	8.6	474.0	17	8058.0

Type 4 Short Pulse Radar Statistical Performance - Details

Trial Id	Radar Type	Pulse Width (us)	PRI (us)	Number of Pulses	Waveform Length (us)
1	Type 4	11.3	487.0	12	5844.0
2	Type 4	13.5	344.0	13	4472.0
3	Type 4	19.4	288.0	16	4608.0
4	Type 4	17.5	230.0	15	3450.0
5	Type 4	15.3	432.0	14	6048.0
6	Type 4	15.9	207.0	14	2898.0
7	Type 4	14.3	443.0	13	5759.0
8	Type 4	15.8	439.0	14	6146.0
9	Type 4	11.5	223.0	12	2676.0
10	Type 4	17.4	208.0	15	3120.0
11	Type 4	19.0	463.0	16	7408.0
12	Type 4	16.0	441.0	14	6174.0
13	Type 4	13.8	323.0	13	4199.0
14	Type 4	18.9	297.0	16	4752.0
15	Type 4	15.5	412.0	14	5768.0
16	Type 4	19.9	324.0	16	5184.0
17	Type 4	14.1	271.0	13	3523.0
18	Type 4	15.2	349.0	14	4886.0
19	Type 4	13.8	409.0	13	5317.0
20	Type 4	17.1	373.0	15	5595.0
21	Type 4	13.8	254.0	13	3302.0
22	Type 4	19.8	274.0	16	4384.0
23	Type 4	15.3	278.0	14	3892.0
24	Type 4	14.5	317.0	13	4121.0
24	Type 4	14.5	317.0	13	4121.0
25	Type 4	11.3	260.0	12	3120.0
26	Type 4	17.3	211.0	15	3165.0
27	Type 4	19.2	272.0	16	4352.0
28	Type 4	14.2	264.0	13	3432.0
29	Type 4	18.2	284.0	15	4260.0
30	Type 4	16.8	474.0	15	7110.0

Type 5 Long Pulse Radar Statistical Performance - Details

Trial Id	Radar Type	Number of Bursts	Burst Period (s)	Waveform Length (s)	Center Frequency (GHz)			
1	Type 5	8	1.5000000	12.0000000	5.290000000			
	Burst ID	Burst Offset (us)	Pulse Width (us)	Chirp Width (MHz)	Number of Pulses per Burst	PRI-1 (us)	PRI-2 (us)	PRI-3 (us)
	0	653267.0	75.0	5	2	1766.0	1074.0	-
	1	1015342.0	99.4	5	3	1826.0	1363.0	1174.0
	2	1379673.0	67.4	5	2	1506.0	1129.0	-
	3	245381.0	73.6	5	2	1994.0	1155.0	-
	4	609211.0	65.9	5	1	1190.0	-	-
	5	970315.0	83.8	5	3	1600.0	1640.0	1656.0
	6	1335720.0	65.5	5	1	1761.0	-	-
	7	200392.0	98.6	5	3	1864.0	1409.0	1907.0
2	Type 5	11	1.0909091	12.0000000	5.290000000			
	Burst ID	Burst Offset (us)	Pulse Width (us)	Chirp Width (MHz)	Number of Pulses per Burst	PRI-1 (us)	PRI-2 (us)	PRI-3 (us)
	0	409465.0	73.8	9	2	1639.0	1970.0	-
	1	673541.0	69.5	9	2	1301.0	1709.0	-
	2	938405.0	51.9	9	1	1833.0	-	-
	3	113243.0	84.6	9	3	1346.0	1359.0	1246.0
	4	376706.0	95.4	9	3	1066.0	1801.0	1542.0
	5	640774.0	68.0	9	2	1679.0	1783.0	-
	6	903746.0	89.6	9	3	1637.0	1006.0	1743.0
	7	80813.0	81.9	9	2	1426.0	1951.0	-
	8	343904.0	88.3	9	3	1812.0	1727.0	1953.0
	9	609276.0	53.7	9	1	1695.0	-	-
	10	870628.0	91.3	9	3	1995.0	1858.0	1355.0
3	Type 5	20	0.6000000	12.0000000	5.290000000			
	Burst ID	Burst Offset (us)	Pulse Width (us)	Chirp Width (MHz)	Number of Pulses per Burst	PRI-1 (us)	PRI-2 (us)	PRI-3 (us)
	0	26552.0	68.1	19	2	1317.0	1127.0	-
	1	171871.0	58.7	19	1	1075.0	-	-
	2	316116.0	75.3	19	2	1671.0	1317.0	-
	3	461891.0	56.4	19	1	1718.0	-	-
	4	8664.0	99.7	19	3	1527.0	1631.0	1788.0
	5	153929.0	57.7	19	1	1269.0	-	-
	6	299079.0	59.5	19	1	1392.0	-	-
	7	442752.0	80.0	19	2	1491.0	1932.0	-
	8	587204.0	82.0	19	2	1934.0	1730.0	-
	9	135744.0	82.8	19	2	1467.0	1116.0	-
	10	279781.0	88.0	19	3	1108.0	1707.0	1589.0
	11	424346.0	93.2	19	3	1315.0	1373.0	1555.0
	12	569553.0	70.4	19	2	1593.0	1899.0	-
	13	117598.0	95.3	19	3	1229.0	1812.0	1052.0
	14	262325.0	81.9	19	2	1683.0	1955.0	-
	15	405781.0	98.5	19	3	1946.0	1977.0	1445.0
	16	553711.0	65.0	19	1	1353.0	-	-
	17	99809.0	85.4	19	3	1515.0	1218.0	1284.0
	18	244192.0	91.6	19	3	1576.0	1751.0	1083.0
	19	390174.0	67.3	19	2	1014.0	1047.0	-

Trial Id	Radar Type	Number of Bursts	Burst Period (s)	Waveform Length (s)	Center Frequency (GHz)				
4	Type 5	17	0.7058824	12.0000000	5.290000000				
		Burst ID	Burst Offset (us)	Pulse Width (us)	Chirp Width (MHz)	Number of Pulses per Burst	PRI-1 (us)	PRI-2 (us)	PRI-3 (us)
		0	628798.0	67.9	16	2	1997.0	1368.0	-
		1	96903.0	62.3	16	1	1616.0	-	-
		2	267849.0	53.3	16	1	1251.0	-	-
		3	437286.0	90.0	16	3	1496.0	1016.0	1081.0
		4	606043.0	77.1	16	2	1260.0	1836.0	-
		5	75592.0	83.9	16	3	1587.0	1287.0	1269.0
		6	245640.0	89.1	16	3	1040.0	1945.0	1574.0
		7	416504.0	81.8	16	2	1484.0	1774.0	-
		8	588726.0	50.3	16	1	1087.0	-	-
		9	54535.0	87.1	16	3	1908.0	1475.0	1949.0
		10	225137.0	71.3	16	2	1834.0	1325.0	-
		11	395073.0	97.5	16	3	1416.0	1046.0	1579.0
		12	565234.0	90.6	16	3	1419.0	1512.0	1182.0
		13	33645.0	86.3	16	3	1541.0	1359.0	1624.0
		14	203835.0	97.6	16	3	1575.0	1267.0	1378.0
		15	373694.0	84.7	16	3	1187.0	1979.0	1647.0
		16	543192.0	99.7	16	3	1735.0	1795.0	1972.0
5	Type 5	14	0.8571429	12.0000000	5.290000000				
		Burst ID	Burst Offset (us)	Pulse Width (us)	Chirp Width (MHz)	Number of Pulses per Burst	PRI-1 (us)	PRI-2 (us)	PRI-3 (us)
		0	15441.0	92.9	12	3	1423.0	1118.0	1358.0
		1	222649.0	67.7	12	2	1689.0	1176.0	-
		2	430620.0	65.8	12	1	1312.0	-	-
		3	637993.0	56.3	12	1	1571.0	-	-
		4	845422.0	53.7	12	1	1646.0	-	-
		5	196574.0	83.5	12	3	1802.0	1804.0	1663.0
		6	405116.0	65.8	12	1	1177.0	-	-
		7	610836.0	85.9	12	3	1540.0	1100.0	1162.0
		8	819293.0	76.3	12	2	1043.0	1199.0	-
		9	171555.0	81.5	12	2	1205.0	1918.0	-
		10	378184.0	89.4	12	3	1599.0	1571.0	1077.0
		11	587063.0	63.4	12	1	1295.0	-	-
		12	793149.0	69.6	12	2	1228.0	1665.0	-
		13	145983.0	74.5	12	2	1695.0	1775.0	-

Trial Id	Radar Type	Number of Bursts	Burst Period (s)	Waveform Length (s)	Center Frequency (GHz)			
6	Type 5	15	0.8000000	12.0000000	5.290000000			
	Burst ID	Burst Offset (us)	Pulse Width (us)	Chirp Width (MHz)	Number of Pulses per Burst	PRI-1 (us)	PRI-2 (us)	PRI-3 (us)
	0	328985.0	96.6	13	3	1567.0	1387.0	1506.0
	1	522498.0	96.7	13	3	1127.0	1354.0	1112.0
	2	714615.0	86.5	13	3	1505.0	1526.0	1715.0
	3	112383.0	73.3	13	2	1968.0	1729.0	-
	4	306212.0	55.8	13	1	1872.0	-	-
	5	500163.0	55.4	13	1	1266.0	-	-
	6	690552.0	85.3	13	3	1849.0	1867.0	1382.0
	7	88623.0	79.4	13	2	1739.0	1698.0	-
	8	282519.0	65.7	13	1	1447.0	-	-
	9	475743.0	68.6	13	2	1034.0	1167.0	-
	10	669102.0	77.7	13	2	1216.0	1143.0	-
	11	64844.0	79.6	13	2	1779.0	1441.0	-
	12	257701.0	94.9	13	3	1818.0	1196.0	1400.0
	13	452394.0	61.4	13	1	1345.0	-	-
	14	643963.0	90.6	13	3	1825.0	1130.0	1024.0
7	Type 5	12	1.0000000	12.0000000	5.290000000			
	Burst ID	Burst Offset (us)	Pulse Width (us)	Chirp Width (MHz)	Number of Pulses per Burst	PRI-1 (us)	PRI-2 (us)	PRI-3 (us)
	0	51432.0	52.6	10	1	1482.0	-	-
	1	292922.0	84.1	10	3	1539.0	1004.0	1258.0
	2	534275.0	97.7	10	3	1295.0	1677.0	1308.0
	3	776241.0	97.3	10	3	1064.0	1035.0	1575.0
	4	21547.0	98.8	10	3	1449.0	1076.0	1472.0
	5	263377.0	72.2	10	2	1334.0	1651.0	-
	6	504945.0	67.6	10	2	1752.0	1705.0	-
	7	746790.0	75.7	10	2	1696.0	1558.0	-
	8	990242.0	60.9	10	1	1531.0	-	-
	9	234006.0	64.2	10	1	1218.0	-	-
	10	475264.0	78.8	10	2	1661.0	1608.0	-
	11	716245.0	87.5	10	3	1351.0	1243.0	1728.0
8	Type 5	14	0.8571429	12.0000000	5.290000000			
	Burst ID	Burst Offset (us)	Pulse Width (us)	Chirp Width (MHz)	Number of Pulses per Burst	PRI-1 (us)	PRI-2 (us)	PRI-3 (us)
	0	822851.0	54.1	13	1	1687.0	-	-
	1	174900.0	50.7	13	1	1538.0	-	-
	2	382242.0	52.3	13	1	1917.0	-	-
	3	588103.0	99.8	13	3	1104.0	1181.0	1891.0
	4	795565.0	68.4	13	2	1838.0	1705.0	-
	5	149063.0	80.8	13	2	1390.0	1729.0	-
	6	356723.0	62.5	13	1	1844.0	-	-
	7	563598.0	74.8	13	2	1609.0	1087.0	-
	8	772302.0	50.8	13	1	1062.0	-	-
	9	123800.0	54.0	13	1	1389.0	-	-
	10	331350.0	63.0	13	1	1382.0	-	-
	11	536393.0	91.8	13	3	2000.0	1593.0	1768.0
	12	745583.0	79.3	13	2	1067.0	1307.0	-
	13	98268.0	64.3	13	1	1107.0	-	-

Trial Id	Radar Type	Number of Bursts	Burst Period (s)	Waveform Length (s)	Center Frequency (GHz)				
9	Type 5	8	1.5000000	12.0000000	5.290000000				
		Burst ID	Burst Offset (us)	Pulse Width (us)	Chirp Width (MHz)	Number of Pulses per Burst	PRI-1 (us)	PRI-2 (us)	PRI-3 (us)
		0	535571.0	63.4	6	1	1166.0	-	-
		1	898917.0	52.0	6	1	1446.0	-	-
		2	1259697.0	97.2	6	3	1696.0	1650.0	1267.0
		3	127089.0	78.7	6	2	1600.0	1807.0	-
		4	489947.0	74.2	6	2	1822.0	1933.0	-
		5	852558.0	88.7	6	3	1655.0	1015.0	1568.0
		6	1217152.0	54.3	6	1	1991.0	-	-
		7	82300.0	95.4	6	3	1772.0	1149.0	1932.0
10	Type 5	17	0.7058824	12.0000000	5.256400000				
		Burst ID	Burst Offset (us)	Pulse Width (us)	Chirp Width (MHz)	Number of Pulses per Burst	PRI-1 (us)	PRI-2 (us)	PRI-3 (us)
		0	209176.0	73.7	16	2	1394.0	1559.0	-
		1	378577.0	97.4	16	3	1240.0	1768.0	1946.0
		2	548594.0	91.7	16	3	1924.0	1909.0	1096.0
		3	17727.0	66.2	16	1	1609.0	-	-
		4	188261.0	70.8	16	2	1495.0	1142.0	-
		5	359227.0	52.3	16	1	1838.0	-	-
		6	529350.0	78.9	16	2	1662.0	1014.0	-
		7	699817.0	70.9	16	2	1584.0	1175.0	-
		8	167165.0	75.6	16	2	1421.0	1580.0	-
		9	338419.0	59.1	16	1	1371.0	-	-
		10	508194.0	77.0	16	2	1471.0	1410.0	-
		11	678428.0	67.9	16	2	1532.0	1624.0	-
		12	146139.0	81.2	16	2	1237.0	1899.0	-
		13	316473.0	78.7	16	2	1570.0	1797.0	-
		14	488365.0	63.3	16	1	1188.0	-	-
		15	657474.0	68.9	16	2	1593.0	1521.0	-
		16	125512.0	59.3	16	1	1072.0	-	-

Trial Id	Radar Type	Number of Bursts	Burst Period (s)	Waveform Length (s)	Center Frequency (GHz)			
11	Type 5	19	0.6315789	12.0000000	5.257600000			
	Burst ID	Burst Offset (us)	Pulse Width (us)	Chirp Width (MHz)	Number of Pulses per Burst	PRI-1 (us)	PRI-2 (us)	PRI-3 (us)
	0	264001.0	98.9	19	3	1619.0	1232.0	1068.0
	1	417231.0	82.3	19	2	1198.0	1209.0	-
	2	567901.0	86.7	19	3	1828.0	1541.0	1162.0
	3	92954.0	89.7	19	3	1243.0	1538.0	1600.0
	4	245112.0	98.6	19	3	1040.0	1773.0	1458.0
	5	397977.0	71.1	19	2	1971.0	1159.0	-
	6	551457.0	55.9	19	1	1918.0	-	-
	7	74391.0	67.9	19	2	1071.0	1841.0	-
	8	226484.0	84.4	19	3	1147.0	1411.0	1401.0
	9	380077.0	58.8	19	1	1680.0	-	-
	10	532981.0	65.6	19	1	1522.0	-	-
	11	55531.0	78.5	19	2	1864.0	1937.0	-
	12	208094.0	82.3	19	2	1003.0	1870.0	-
	13	359800.0	90.1	19	3	1376.0	1127.0	1721.0
	14	512124.0	90.2	19	3	1504.0	1088.0	1423.0
	15	36816.0	83.1	19	2	1524.0	1605.0	-
	16	189697.0	58.8	19	1	1594.0	-	-
	17	341619.0	77.0	19	2	1818.0	1374.0	-
	18	495472.0	55.0	19	1	1349.0	-	-
12	Type 5	15	0.8000000	12.0000000	5.255200000			
	Burst ID	Burst Offset (us)	Pulse Width (us)	Chirp Width (MHz)	Number of Pulses per Burst	PRI-1 (us)	PRI-2 (us)	PRI-3 (us)
	0	22912.0	58.1	13	1	1881.0	-	-
	1	216607.0	52.1	13	1	1417.0	-	-
	2	410438.0	59.9	13	1	1127.0	-	-
	3	603580.0	60.2	13	1	1934.0	-	-
	4	793918.0	95.9	13	3	1812.0	1491.0	1852.0
	5	192196.0	79.9	13	2	1781.0	1930.0	-
	6	385525.0	78.5	13	2	1410.0	1880.0	-
	7	580331.0	53.8	13	1	1116.0	-	-
	8	773468.0	64.7	13	1	1754.0	-	-
	9	168902.0	61.4	13	1	1373.0	-	-
	10	361910.0	83.2	13	2	1662.0	1218.0	-
	11	554151.0	84.7	13	3	1554.0	1548.0	1336.0
	12	746788.0	88.7	13	3	1274.0	1825.0	1672.0
	13	144765.0	78.3	13	2	1788.0	1116.0	-
	14	336082.0	69.3	13	2	1819.0	1095.0	-

Trial Id	Radar Type	Number of Bursts	Burst Period (s)	Waveform Length (s)	Center Frequency (GHz)				
13	Type 5	12	1.0000000	12.0000000	5.254000000				
		Burst ID	Burst Offset (us)	Pulse Width (us)	Chirp Width (MHz)	Number of Pulses per Burst	PRI-1 (us)	PRI-2 (us)	PRI-3 (us)
		0	664476.0	75.3	10	2	1954.0	1350.0	-
		1	907451.0	56.3	10	1	1935.0	-	-
		2	151297.0	67.7	10	2	1366.0	1567.0	-
		3	393839.0	55.6	10	1	1100.0	-	-
		4	634772.0	75.2	10	2	1699.0	1492.0	-
		5	876467.0	76.3	10	2	1267.0	1996.0	-
		6	121291.0	85.7	10	3	1273.0	1747.0	1712.0
		7	363058.0	98.4	10	3	1372.0	1084.0	1224.0
		8	603800.0	86.4	10	3	1942.0	1967.0	1248.0
		9	845154.0	93.6	10	3	1604.0	1751.0	1716.0
		10	91831.0	63.3	10	1	1762.0	-	-
		11	333386.0	92.4	10	3	1306.0	1050.0	1046.0
14	Type 5	19	0.6315789	12.0000000	5.257200000				
		Burst ID	Burst Offset (us)	Pulse Width (us)	Chirp Width (MHz)	Number of Pulses per Burst	PRI-1 (us)	PRI-2 (us)	PRI-3 (us)
		0	362087.0	93.3	18	3	1482.0	1099.0	1525.0
		1	515307.0	69.1	18	2	1209.0	1630.0	-
		2	38994.0	86.9	18	3	1010.0	1114.0	1716.0
		3	190922.0	84.9	18	3	1539.0	1502.0	1847.0
		4	343724.0	72.3	18	2	1563.0	1845.0	-
		5	497361.0	51.7	18	1	1780.0	-	-
		6	20319.0	58.3	18	1	1419.0	-	-
		7	173196.0	60.8	18	1	1262.0	-	-
		8	326148.0	57.1	18	1	1106.0	-	-
		9	475778.0	88.9	18	3	1668.0	1946.0	1808.0
		10	1488.0	72.0	18	2	1837.0	1965.0	-
		11	153567.0	90.9	18	3	1190.0	1601.0	1731.0
		12	306964.0	59.8	18	1	1822.0	-	-
		13	458779.0	70.0	18	2	1870.0	1214.0	-
		14	611697.0	67.2	18	2	1345.0	1237.0	-
		15	134832.0	91.2	18	3	1589.0	1629.0	1315.0
		16	288289.0	56.5	18	1	1520.0	-	-
		17	441028.0	51.2	18	1	1620.0	-	-
		18	591978.0	74.1	18	2	1599.0	1968.0	-
15	Type 5	14	0.8571429	12.0000000	5.254800000				
		Burst ID	Burst Offset (us)	Pulse Width (us)	Chirp Width (MHz)	Number of Pulses per Burst	PRI-1 (us)	PRI-2 (us)	PRI-3 (us)
		0	158254.0	76.9	12	2	1058.0	1366.0	-
		1	366047.0	50.2	12	1	1262.0	-	-
		2	573377.0	62.9	12	1	1632.0	-	-
		3	780532.0	64.7	12	1	1997.0	-	-
		4	132351.0	83.8	12	3	1835.0	1584.0	1378.0
		5	340432.0	65.4	12	1	1378.0	-	-
		6	548146.0	53.2	12	1	1122.0	-	-
		7	755450.0	51.7	12	1	1470.0	-	-
		8	107154.0	78.7	12	2	1184.0	1489.0	-
		9	314379.0	72.4	12	2	1610.0	1094.0	-
		10	522427.0	53.8	12	1	1361.0	-	-
		11	729049.0	73.6	12	2	1243.0	1210.0	-
		12	81555.0	66.7	12	2	1518.0	1911.0	-
		13	288616.0	82.5	12	2	1925.0	1479.0	-

Trial Id	Radar Type	Number of Bursts	Burst Period (s)	Waveform Length (s)	Center Frequency (GHz)				
16	Type 5	20	0.6000000	12.0000000	5.258000000				
		Burst ID	Burst Offset (us)	Pulse Width (us)	Chirp Width (MHz)	Number of Pulses per Burst	PRI-1 (us)	PRI-2 (us)	PRI-3 (us)
		0	345538.0	87.6	20	3	1809.0	1142.0	1902.0
		1	490101.0	85.2	20	3	1370.0	1301.0	1914.0
		2	39145.0	84.8	20	3	1217.0	1247.0	1324.0
		3	183993.0	77.9	20	2	1160.0	1822.0	-
		4	329141.0	76.5	20	2	1295.0	1048.0	-
		5	474918.0	60.9	20	1	1301.0	-	-
		6	21367.0	83.0	20	2	1684.0	1175.0	-
		7	166161.0	80.4	20	2	1841.0	1130.0	-
		8	311033.0	67.5	20	2	1607.0	1223.0	-
		9	456993.0	62.1	20	1	1352.0	-	-
		10	3520.0	86.4	20	3	1700.0	1399.0	1030.0
		11	147826.0	84.3	20	3	1858.0	1628.0	1494.0
		12	293433.0	76.9	20	2	1268.0	1072.0	-
		13	437093.0	95.8	20	3	1310.0	1101.0	1689.0
		14	584602.0	55.2	20	1	1043.0	-	-
		15	130793.0	59.0	20	1	1580.0	-	-
		16	274624.0	94.5	20	3	1558.0	1119.0	1732.0
		17	418777.0	91.9	20	3	1627.0	1533.0	1671.0
		18	563823.0	85.2	20	3	1161.0	1131.0	1800.0
		19	112710.0	69.5	20	2	1309.0	1364.0	-
Trial Id	Radar Type	Number of Bursts	Burst Period (s)	Waveform Length (s)	Center Frequency (GHz)				
17	Type 5	12	1.0000000	12.0000000	5.254000000				
		Burst ID	Burst Offset (us)	Pulse Width (us)	Chirp Width (MHz)	Number of Pulses per Burst	PRI-1 (us)	PRI-2 (us)	PRI-3 (us)
		0	429259.0	86.4	10	3	1194.0	1562.0	1794.0
		1	670979.0	92.2	10	3	1679.0	1068.0	1370.0
		2	913818.0	80.4	10	2	1387.0	1304.0	-
		3	158545.0	54.3	10	1	1702.0	-	-
		4	400895.0	53.1	10	1	1126.0	-	-
		5	642041.0	69.4	10	2	1109.0	1744.0	-
		6	883409.0	69.1	10	2	1871.0	1514.0	-
		7	128290.0	100.0	10	3	1674.0	1420.0	1951.0
		8	370659.0	79.6	10	2	1175.0	1014.0	-
		9	611891.0	88.4	10	3	1058.0	1132.0	1252.0
		10	855277.0	53.3	10	1	1469.0	-	-
		11	98894.0	65.3	10	1	1745.0	-	-

Trial Id	Radar Type	Number of Bursts	Burst Period (s)	Waveform Length (s)	Center Frequency (GHz)			
18	Type 5	14	0.8571429	12.0000000	5.254800000			
	Burst ID	Burst Offset (us)	Pulse Width (us)	Chirp Width (MHz)	Number of Pulses per Burst	PRI-1 (us)	PRI-2 (us)	PRI-3 (us)
	0	292264.0	55.3	12	1	1564.0	-	-
	1	499839.0	58.3	12	1	1444.0	-	-
	2	706241.0	72.3	12	2	1214.0	1599.0	-
	3	59016.0	84.8	12	3	1938.0	1061.0	1221.0
	4	266259.0	82.5	12	2	1902.0	1090.0	-
	5	474152.0	63.3	12	1	1667.0	-	-
	6	680785.0	80.0	12	2	1664.0	1066.0	-
	7	33532.0	90.3	12	3	1701.0	1591.0	1004.0
	8	240164.0	91.1	12	3	1941.0	1715.0	1385.0
	9	447244.0	96.6	12	3	1343.0	1453.0	1448.0
	10	654869.0	82.7	12	2	1376.0	1863.0	-
	11	8084.0	50.7	12	1	1112.0	-	-
	12	215195.0	78.4	12	2	1860.0	1251.0	-
	13	421414.0	99.5	12	3	1211.0	1957.0	1785.0
19	Type 5	12	1.0000000	12.0000000	5.254000000			
	Burst ID	Burst Offset (us)	Pulse Width (us)	Chirp Width (MHz)	Number of Pulses per Burst	PRI-1 (us)	PRI-2 (us)	PRI-3 (us)
	0	733776.0	88.6	10	3	1250.0	1232.0	1944.0
	1	978500.0	57.4	10	1	1092.0	-	-
	2	221259.0	96.6	10	3	1049.0	1114.0	1625.0
	3	463263.0	69.7	10	2	1156.0	1790.0	-
	4	705037.0	77.9	10	2	1367.0	1640.0	-
	5	947884.0	62.0	10	1	1907.0	-	-
	6	191445.0	88.4	10	3	1209.0	1654.0	1204.0
	7	432506.0	97.3	10	3	1852.0	1608.0	1720.0
	8	674848.0	96.2	10	3	1360.0	1171.0	1074.0
	9	915221.0	95.4	10	3	1344.0	1748.0	1910.0
	10	162187.0	54.8	10	1	1015.0	-	-
	11	403878.0	80.4	10	2	1296.0	1188.0	-

Trial Id	Radar Type	Number of Bursts	Burst Period (s)	Waveform Length (s)	Center Frequency (GHz)				
20	Type 5	16	0.7500000	12.0000000	5.324000000				
		Burst ID	Burst Offset (us)	Pulse Width (us)	Chirp Width (MHz)	Number of Pulses per Burst	PRI-1 (us)	PRI-2 (us)	PRI-3 (us)
		0	483824.0	74.7	15	2	1583.0	1101.0	-
		1	665910.0	57.1	15	1	1741.0	-	-
		2	98722.0	91.9	15	3	1686.0	1852.0	1265.0
		3	280148.0	83.1	15	2	1116.0	1841.0	-
		4	462269.0	50.7	15	1	1435.0	-	-
		5	641874.0	79.2	15	2	1722.0	1975.0	-
		6	76783.0	58.7	15	1	1652.0	-	-
		7	257866.0	71.0	15	2	1476.0	1380.0	-
		8	438568.0	79.0	15	2	1785.0	1927.0	-
		9	620389.0	68.5	15	2	1017.0	1704.0	-
		10	54344.0	73.5	15	2	1548.0	1239.0	-
		11	235380.0	70.5	15	2	1723.0	1658.0	-
		12	416942.0	76.6	15	2	1262.0	1252.0	-
		13	597534.0	81.2	15	2	1532.0	1852.0	-
		14	32065.0	61.8	15	1	1786.0	-	-
		15	212584.0	94.9	15	3	1710.0	1907.0	1485.0
21	Type 5	12	1.0000000	12.0000000	5.326400000				
		Burst ID	Burst Offset (us)	Pulse Width (us)	Chirp Width (MHz)	Number of Pulses per Burst	PRI-1 (us)	PRI-2 (us)	PRI-3 (us)
		0	526804.0	78.5	9	2	1033.0	1077.0	-
		1	766810.0	89.8	9	3	1754.0	1928.0	1041.0
		2	12967.0	59.4	9	1	1054.0	-	-
		3	254814.0	79.6	9	2	1048.0	1683.0	-
		4	496335.0	76.0	9	2	1789.0	1641.0	-
		5	739766.0	53.6	9	1	1092.0	-	-
		6	979583.0	80.9	9	2	1815.0	1770.0	-
		7	225383.0	61.6	9	1	1130.0	-	-
		8	467404.0	53.4	9	1	1634.0	-	-
		9	709942.0	59.9	9	1	1068.0	-	-
		10	951435.0	60.4	9	1	1885.0	-	-
		11	194882.0	91.4	9	3	1792.0	1291.0	1419.0

Trial Id	Radar Type	Number of Bursts	Burst Period (s)	Waveform Length (s)	Center Frequency (GHz)			
22	Type 5	20	0.6000000	12.0000000	5.322000000			
	Burst ID	Burst Offset (us)	Pulse Width (us)	Chirp Width (MHz)	Number of Pulses per Burst	PRI-1 (us)	PRI-2 (us)	PRI-3 (us)
	0	261690.0	77.0	20	2	1730.0	1206.0	-
	1	407496.0	58.1	20	1	1468.0	-	-
	2	553039.0	62.1	20	1	1057.0	-	-
	3	98971.0	76.9	20	2	1466.0	1926.0	-
	4	243693.0	80.0	20	2	1841.0	1488.0	-
	5	389821.0	52.0	20	1	1153.0	-	-
	6	531723.0	88.6	20	3	2000.0	1481.0	1407.0
	7	81080.0	72.9	20	2	1935.0	1952.0	-
	8	225051.0	98.5	20	3	1689.0	1898.0	1899.0
	9	371684.0	57.9	20	1	1550.0	-	-
	10	513892.0	95.9	20	3	1339.0	1731.0	1878.0
	11	63543.0	53.5	20	1	1336.0	-	-
	12	207470.0	92.0	20	3	1916.0	1909.0	1146.0
	13	353593.0	57.3	20	1	1910.0	-	-
	14	497722.0	70.5	20	2	1889.0	1132.0	-
	15	45525.0	70.0	20	2	1619.0	1464.0	-
	16	189563.0	84.0	20	3	1968.0	1995.0	1419.0
	17	334977.0	76.1	20	2	1468.0	1756.0	-
	18	478188.0	93.2	20	3	1828.0	1610.0	1697.0
	19	27659.0	96.8	20	3	1462.0	1116.0	1215.0
23	Type 5	14	0.8571429	12.0000000	5.325200000			
	Burst ID	Burst Offset (us)	Pulse Width (us)	Chirp Width (MHz)	Number of Pulses per Burst	PRI-1 (us)	PRI-2 (us)	PRI-3 (us)
	0	247197.0	50.1	12	1	1562.0	-	-
	1	453153.0	93.5	12	3	1529.0	1790.0	1159.0
	2	660655.0	68.8	12	2	1687.0	1881.0	-
	3	14128.0	56.3	12	1	1820.0	-	-
	4	220915.0	86.0	12	3	1442.0	1738.0	1170.0
	5	428528.0	75.2	12	2	1335.0	1453.0	-
	6	636648.0	54.4	12	1	1562.0	-	-
	7	842797.0	71.1	12	2	1542.0	1394.0	-
	8	195782.0	76.2	12	2	1291.0	1561.0	-
	9	402683.0	80.2	12	2	1912.0	1557.0	-
	10	610243.0	79.7	12	2	1037.0	1708.0	-
	11	815692.0	90.9	12	3	1871.0	1691.0	1032.0
	12	170136.0	68.7	12	2	1468.0	1990.0	-
	13	377546.0	67.4	12	2	1446.0	1195.0	-

Trial Id	Radar Type	Number of Bursts	Burst Period (s)	Waveform Length (s)	Center Frequency (GHz)			
24	Type 5	13	0.9230769	12.0000000	5.325600000			
	Burst ID	Burst Offset (us)	Pulse Width (us)	Chirp Width (MHz)	Number of Pulses per Burst	PRI-1 (us)	PRI-2 (us)	PRI-3 (us)
	0	628743.0	94.0	11	3	1862.0	1287.0	1201.0
	1	853454.0	70.8	11	2	1088.0	1222.0	-
	2	156136.0	56.3	11	1	1516.0	-	-
	3	378517.0	96.7	11	3	1316.0	1809.0	1126.0
	4	601369.0	90.6	11	3	1749.0	1461.0	1029.0
	5	825544.0	74.5	11	2	1068.0	1691.0	-
	6	128146.0	92.6	11	3	1882.0	1293.0	1633.0
	7	350649.0	89.0	11	3	1541.0	1858.0	1948.0
	8	574102.0	96.5	11	3	1361.0	1536.0	1049.0
	9	797240.0	70.5	11	2	1787.0	1906.0	-
	10	100771.0	94.0	11	3	1079.0	1508.0	1692.0
	11	324468.0	55.8	11	1	1840.0	-	-
	12	545941.0	87.7	11	3	1757.0	1673.0	1698.0
25	Type 5	8	1.5000000	12.0000000	5.328000000			
	Burst ID	Burst Offset (us)	Pulse Width (us)	Chirp Width (MHz)	Number of Pulses per Burst	PRI-1 (us)	PRI-2 (us)	PRI-3 (us)
	0	1253346.0	68.6	5	2	1434.0	1625.0	-
	1	119462.0	83.1	5	2	1582.0	1450.0	-
	2	482866.0	60.9	5	1	1970.0	-	-
	3	845899.0	77.7	5	2	1246.0	1231.0	-
	4	1209262.0	77.4	5	2	1046.0	1225.0	-
	5	74755.0	66.8	5	2	1587.0	1165.0	-
	6	438159.0	63.7	5	1	1813.0	-	-
	7	799839.0	91.2	5	3	1451.0	1528.0	1970.0

Trial Id	Radar Type	Number of Bursts	Burst Period (s)	Waveform Length (s)	Center Frequency (GHz)			
26	Type 5	17	0.7058824	12.0000000	5.323600000			
	Burst ID	Burst Offset (us)	Pulse Width (us)	Chirp Width (MHz)	Number of Pulses per Burst	PRI-1 (us)	PRI-2 (us)	PRI-3 (us)
	0	545416.0	83.6	16	3	1017.0	1990.0	1397.0
	1	14066.0	89.4	16	3	1401.0	1948.0	1131.0
	2	184961.0	55.8	16	1	1500.0	-	-
	3	354333.0	90.9	16	3	1835.0	1325.0	1237.0
	4	526694.0	54.7	16	1	1416.0	-	-
	5	695652.0	97.7	16	3	1183.0	1142.0	1007.0
	6	163430.0	67.5	16	2	1626.0	1970.0	-
	7	333465.0	96.7	16	3	1371.0	1076.0	1764.0
	8	504482.0	68.3	16	2	1596.0	1445.0	-
	9	675424.0	78.3	16	2	1109.0	1431.0	-
	10	142911.0	55.0	16	1	1324.0	-	-
	11	312370.0	84.9	16	3	1386.0	1310.0	1812.0
	12	483170.0	74.6	16	2	1723.0	1776.0	-
	13	655500.0	63.3	16	1	1371.0	-	-
	14	121408.0	99.8	16	3	1238.0	1335.0	1378.0
	15	292829.0	63.6	16	1	1111.0	-	-
	16	461438.0	87.3	16	3	1491.0	1704.0	1442.0
27	Type 5	19	0.6315789	12.0000000	5.322400000			
	Burst ID	Burst Offset (us)	Pulse Width (us)	Chirp Width (MHz)	Number of Pulses per Burst	PRI-1 (us)	PRI-2 (us)	PRI-3 (us)
	0	564587.0	85.6	19	3	1355.0	1726.0	1567.0
	1	89838.0	68.6	19	2	1936.0	1791.0	-
	2	243065.0	54.2	19	1	1256.0	-	-
	3	395965.0	61.2	19	1	1213.0	-	-
	4	546679.0	97.1	19	3	1554.0	1063.0	1088.0
	5	71022.0	98.3	19	3	1038.0	1601.0	1618.0
	6	224043.0	62.4	19	1	1796.0	-	-
	7	375811.0	80.2	19	2	1736.0	1688.0	-
	8	526524.0	87.5	19	3	1933.0	1524.0	1910.0
	9	52332.0	85.8	19	3	1558.0	1072.0	1014.0
	10	204270.0	88.1	19	3	1638.0	1320.0	1778.0
	11	358389.0	65.3	19	1	1059.0	-	-
	12	510583.0	52.5	19	1	1956.0	-	-
	13	33661.0	52.3	19	1	2000.0	-	-
	14	186091.0	74.1	19	2	1080.0	1807.0	-
	15	339568.0	54.9	19	1	1031.0	-	-
	16	490613.0	76.2	19	2	1518.0	1924.0	-
	17	14864.0	60.4	19	1	1527.0	-	-
	18	167448.0	81.5	19	2	1015.0	1351.0	-

Trial Id	Radar Type	Number of Bursts	Burst Period (s)	Waveform Length (s)	Center Frequency (GHz)			
28	Type 5	12	1.0000000	12.0000000	5.326000000			
	Burst ID	Burst Offset (us)	Pulse Width (us)	Chirp Width (MHz)	Number of Pulses per Burst	PRI-1 (us)	PRI-2 (us)	PRI-3 (us)
	0	508045.0	50.5	10	1	1196.0	-	-
	1	749937.0	55.7	10	1	1661.0	-	-
	2	989019.0	85.8	10	3	1656.0	1854.0	1218.0
	3	235517.0	76.9	10	2	1772.0	1323.0	-
	4	477346.0	75.1	10	2	1221.0	1773.0	-
	5	718529.0	92.3	10	3	1122.0	1158.0	1577.0
	6	960804.0	78.1	10	2	1503.0	1649.0	-
	7	205421.0	92.2	10	3	1446.0	1589.0	1583.0
	8	447174.0	89.0	10	3	1145.0	1370.0	1341.0
	9	689823.0	70.9	10	2	1088.0	1246.0	-
	10	932887.0	83.1	10	1	1157.0	-	-
	11	176194.0	55.3	10	1	1731.0	-	-
29	Type 5	18	0.6666667	12.0000000	5.323200000			
	Burst ID	Burst Offset (us)	Pulse Width (us)	Chirp Width (MHz)	Number of Pulses per Burst	PRI-1 (us)	PRI-2 (us)	PRI-3 (us)
	0	277683.0	83.4	17	3	1301.0	1213.0	1473.0
	1	438503.0	97.3	17	3	1258.0	1057.0	1522.0
	2	598617.0	90.4	17	3	1679.0	1090.0	1780.0
	3	97142.0	91.8	17	3	1385.0	1491.0	1272.0
	4	257779.0	98.2	17	3	1869.0	1055.0	1339.0
	5	420304.0	58.5	17	1	1301.0	-	-
	6	580095.0	80.0	17	2	1693.0	1417.0	-
	7	77238.0	86.5	17	3	1548.0	1656.0	1903.0
	8	237974.0	91.1	17	3	1379.0	1497.0	1433.0
	9	398356.0	93.5	17	3	1360.0	1444.0	1937.0
	10	561396.0	60.7	17	1	1778.0	-	-
	11	57672.0	87.2	17	2	1157.0	1676.0	-
	12	219189.0	61.8	17	1	1263.0	-	-
	13	379317.0	79.4	17	2	1952.0	1503.0	-
	14	540148.0	81.4	17	2	1926.0	1552.0	-
	15	37944.0	65.7	17	1	1005.0	-	-
	16	198981.0	76.0	17	2	1299.0	1065.0	-
	17	360068.0	81.0	17	2	1163.0	1251.0	-

Trial Id	Radar Type	Number of Bursts	Burst Period (s)	Waveform Length (s)	Center Frequency (GHz)			
30	Type 5	16	0.7500000	12.0000000	5.290000000			
	Burst ID	Burst Offset (us)	Pulse Width (us)	Chirp Width (MHz)	Number of Pulses per Burst	PRI-1 (us)	PRI-2 (us)	PRI-3 (us)
	0	586476.0	79.9	15	2	1445.0	1067.0	-
	1	20235.0	98.4	15	3	1798.0	1118.0	1157.0
	2	201928.0	52.9	15	1	1174.0	-	-
	3	382479.0	68.3	15	2	1721.0	1527.0	-
	4	564677.0	63.1	15	1	1808.0	-	-
	5	745231.0	81.6	15	2	1068.0	1649.0	-
	6	178670.0	99.8	15	3	1673.0	1700.0	1502.0
	7	359099.0	91.7	15	3	1830.0	1924.0	1717.0
	8	541506.0	79.2	15	2	1040.0	1899.0	-
	9	722438.0	68.9	15	2	1615.0	1586.0	-
	10	156628.0	68.9	15	2	1902.0	1935.0	-
	11	338832.0	56.1	15	1	1104.0	-	-
	12	519379.0	73.5	15	2	1122.0	1541.0	-
	13	701469.0	59.2	15	1	1770.0	-	-
	14	134407.0	74.4	15	2	1944.0	1504.0	-
	15	315939.0	80.5	15	2	1334.0	1002.0	-

Type 6 Frequency Hopping Radar Statistical Performance - Details

Trial Id	Radar Type	Pulse Width (us)	PRI (us)	Pulses per Hop	Hopping Rate (kHz)	Hopping Sequence Length (ms)	Visible Frequency Number
1	Type 6	1.0	333.3	9	0.3333	300.0000000	1
	Frequency List (MHz)	0	1	2	3	4	
	0	5619	5578	5270	5294	5354	
	5	5660	5710	5666	5399	5656	
	10	5297	5333	5642	5609	5709	
	15	5668	5527	5647	5547	5284	
	20	5375	5395	5384	5444	5705	
	25	5584	5536	5480	5658	5453	
	30	5403	5576	5588	5641	5465	
	35	5674	5580	5623	5559	5627	
	40	5553	5704	5673	5633	5724	
	45	5373	5348	5331	5513	5637	
	50	5544	5314	5585	5697	5257	
	55	5672	5471	5423	5424	5638	
	60	5644	5345	5569	5655	5413	
	65	5271	5415	5550	5371	5335	
	70	5382	5416	5533	5706	5558	
	75	5535	5692	5256	5436	5716	
	80	5385	5669	5458	5349	5456	
	85	5336	5634	5703	5352	5280	
	90	5506	5313	5690	5326	5631	
	95	5628	5546	5289	5490	5590	

Trial Id	Radar Type	Pulse Width (us)	PRI (us)	Pulses per Hop	Hopping Rate (kHz)	Hopping Sequence Length (ms)	Visible Frequency Number
2	Type 6	1.0	333.3	9	0.3333	300.0000000	4
	Frequency List (MHz)	0	1	2	3	4	
	0	5302	5342	5681	5455	5611	
	5	5493	5682	5310	5257	5606	
	10	5587	5561	5374	5362	5630	
	15	5322	5320	5502	5475	5364	
	20	5555	5353	5316	5387	5357	
	25	5332	5654	5312	5262	5409	
	30	5522	5547	5410	5618	5253	
	35	5311	5683	5556	5470	5258	
	40	5537	5398	5710	5491	5469	
	45	5670	5465	5704	5456	5406	
	50	5384	5400	5513	5720	5365	
	55	5296	5276	5641	5445	5626	
	60	5564	5620	5395	5334	5290	
	65	5401	5578	5359	5569	5586	
	70	5282	5649	5407	5368	5647	
	75	5643	5509	5592	5675	5678	
	80	5581	5275	5381	5512	5600	
	85	5304	5382	5389	5458	5666	
	90	5419	5642	5350	5526	5519	
	95	5709	5692	5418	5653	5354	

Trial Id	Radar Type	Pulse Width (us)	PRI (us)	Pulses per Hop	Hopping Rate (kHz)	Hopping Sequence Length (ms)	Visible Frequency Number
3	Type 6	1.0	333.3	9	0.3333	300.0000000	6
	Frequency List (MHz)	0	1	2	3	4	
	0	5557	5581	5617	5616	5356	
	5	5535	5704	5385	5420	5338	
	10	5518	5350	5415	5651	5313	
	15	5447	5605	5520	5653	5563	
	20	5519	5257	5476	5330	5598	
	25	5506	5515	5366	5443	5661	
	30	5533	5367	5358	5502	5606	
	35	5347	5647	5266	5411	5451	
	40	5334	5332	5709	5667	5394	
	45	5684	5539	5464	5437	5665	
	50	5389	5421	5416	5574	5488	
	55	5536	5580	5279	5439	5324	
	60	5499	5710	5708	5404	5305	
	65	5295	5525	5589	5359	5452	
	70	5576	5272	5492	5388	5551	
	75	5547	5323	5724	5256	5721	
	80	5293	5379	5584	5361	5508	
	85	5479	5693	5341	5655	5715	
	90	5629	5494	5401	5637	5423	
	95	5280	5316	5662	5281	5649	

Trial Id	Radar Type	Pulse Width (us)	PRI (us)	Pulses per Hop	Hopping Rate (kHz)	Hopping Sequence Length (ms)	Visible Frequency Number
4	Type 6	1.0	333.3	9	0.3333	300.0000000	2
	Frequency List (MHz)	0	1	2	3	4	
	0	5337	5345	5553	5302	5673	
	5	5577	5629	5460	5583	5642	
	10	5352	5614	5456	5655	5672	
	15	5401	5574	5611	5565	5370	
	20	5571	5588	5295	5468	5303	
	25	5486	5358	5718	5470	5380	
	30	5703	5422	5324	5573	5654	
	35	5426	5263	5634	5661	5462	
	40	5648	5498	5270	5474	5664	
	45	5701	5622	5425	5490	5552	
	50	5265	5597	5467	5300	5432	
	55	5724	5437	5469	5258	5715	
	60	5453	5277	5637	5705	5348	
	65	5593	5262	5561	5251	5255	
	70	5275	5341	5364	5510	5516	
	75	5346	5712	5504	5549	5356	
	80	5527	5376	5264	5447	5442	
	85	5454	5658	5428	5544	5374	
	90	5343	5663	5478	5689	5384	
	95	5372	5707	5274	5292	5466	

Trial Id	Radar Type	Pulse Width (us)	PRI (us)	Pulses per Hop	Hopping Rate (kHz)	Hopping Sequence Length (ms)	Visible Frequency Number
5	Type 6	1.0	333.3	9	0.3333	300.000000	1
	Frequency List (MHz)	0	1	2	3	4	
	0	5592	5584	5489	5463	5418	
	5	5619	5651	5535	5271	5374	
	10	5283	5500	5594	5375	5693	
	15	5604	5714	5610	5562	5482	
	20	5279	5711	5557	5276	5277	
	25	5307	5446	5574	5414	5270	
	30	5408	5281	5691	5428	5624	
	35	5625	5354	5430	5339	5376	
	40	5487	5581	5683	5617	5630	
	45	5644	5705	5483	5342	5519	
	50	5298	5518	5563	5598	5437	
	55	5391	5659	5455	5686	5582	
	60	5697	5469	5628	5294	5319	
	65	5597	5631	5521	5436	5423	
	70	5278	5665	5340	5485	5466	
	75	5438	5315	5275	5614	5330	
	80	5520	5590	5596	5264	5289	
	85	5405	5646	5526	5346	5676	
	90	5267	5539	5349	5600	5258	
	95	5671	5533	5345	5587	5523	

Trial Id	Radar Type	Pulse Width (us)	PRI (us)	Pulses per Hop	Hopping Rate (kHz)	Hopping Sequence Length (ms)	Visible Frequency Number
6	Type 6	1.0	333.3	9	0.3333	300.000000	4
	Frequency List (MHz)	0	1	2	3	4	
	0	5372	5348	5425	5624	5260	
	5	5283	5576	5610	5434	5581	
	10	5689	5289	5635	5570	5714	
	15	5577	5256	5342	5558	5279	
	20	5490	5652	5549	5724	5640	
	25	5634	5552	5300	5448	5409	
	30	5297	5713	5431	5580	5444	
	35	5667	5445	5701	5492	5290	
	40	5326	5286	5621	5382	5280	
	45	5559	5313	5541	5499	5704	
	50	5395	5474	5569	5274	5421	
	55	5698	5625	5345	5374	5657	
	60	5711	5519	5642	5301	5454	
	65	5715	5520	5536	5366	5413	
	70	5414	5378	5417	5316	5428	
	75	5357	5586	5484	5296	5430	
	80	5627	5684	5653	5273	5606	
	85	5465	5363	5491	5352	5355	
	90	5518	5631	5688	5588	5329	
	95	5485	5502	5590	5390	5531	

Trial Id	Radar Type	Pulse Width (us)	PRI (us)	Pulses per Hop	Hopping Rate (kHz)	Hopping Sequence Length (ms)	Visible Frequency Number
7	Type 6	1.0	333.3	9	0.3333	300.0000000	6
	Frequency List (MHz)	0	1	2	3	4	
	0	5530	5587	5361	5310	5480	
	5	5325	5598	5685	5500	5410	
	10	5523	5553	5676	5290	5260	
	15	5568	5383	5445	5603	5471	
	20	5498	5514	5690	5638	5697	
	25	5431	5583	5280	5404	5482	
	30	5451	5661	5670	5646	5354	
	35	5642	5331	5633	5594	5267	
	40	5301	5640	5369	5559	5622	
	45	5277	5391	5507	5396	5502	
	50	5552	5494	5271	5650	5620	
	55	5363	5719	5545	5338	5299	
	60	5564	5628	5268	5684	5608	
	65	5283	5343	5584	5572	5673	
	70	5683	5517	5492	5381	5266	
	75	5292	5387	5326	5706	5627	
	80	5682	5262	5367	5276	5716	
	85	5270	5511	5428	5458	5359	
	90	5351	5600	5285	5394	5571	
	95	5400	5265	5327	5643	5313	

Trial Id	Radar Type	Pulse Width (us)	PRI (us)	Pulses per Hop	Hopping Rate (kHz)	Hopping Sequence Length (ms)	Visible Frequency Number
8	Type 6	1.0	333.3	9	0.3333	300.000000	5
	Frequency List (MHz)	0	1	2	3	4	
	0	5310	5351	5297	5374	5322	
	5	5367	5523	5285	5663	5617	
	10	5454	5342	5717	5485	5281	
	15	5656	5510	5548	5648	5409	
	20	5680	5631	5630	5670	5319	
	25	5435	5483	5508	5516	5493	
	30	5647	5627	5386	5506	5462	
	35	5470	5724	5390	5420	5690	
	40	5576	5452	5497	5387	5274	
	45	5320	5487	5479	5560	5605	
	50	5381	5622	5671	5445	5489	
	55	5526	5253	5279	5502	5397	
	60	5629	5440	5678	5704	5544	
	65	5533	5608	5408	5478	5655	
	70	5481	5590	5268	5346	5673	
	75	5254	5295	5258	5459	5372	
	80	5623	5401	5267	5706	5545	
	85	5488	5650	5324	5305	5373	
	90	5559	5464	5660	5344	5698	
	95	5394	5378	5363	5321	5311	

Trial Id	Radar Type	Pulse Width (us)	PRI (us)	Pulses per Hop	Hopping Rate (kHz)	Hopping Sequence Length (ms)	Visible Frequency Number
9	Type 6	1.0	333.3	9	0.3333	300.0000000	1
	Frequency List (MHz)	0	1	2	3	4	
	0	5565	5590	5708	5535	5542	
	5	5409	5545	5360	5351	5349	
	10	5288	5606	5283	5583	5302	
	15	5269	5637	5554	5693	5380	
	20	5417	5274	5572	5719	5643	
	25	5682	5287	5686	5612	5550	
	30	5632	5536	5584	5504	5280	
	35	5660	5512	5340	5661	5573	
	40	5604	5415	5435	5530	5271	
	45	5627	5467	5562	5618	5658	
	50	5646	5401	5527	5722	5541	
	55	5268	5336	5714	5372	5473	
	60	5526	5539	5574	5369	5650	
	65	5367	5482	5547	5715	5370	
	70	5598	5252	5464	5484	5439	
	75	5622	5305	5642	5374	5341	
	80	5711	5385	5404	5264	5523	
	85	5448	5326	5451	5270	5667	
	90	5356	5621	5303	5724	5470	
	95	5639	5386	5361	5278	5378	

Trial Id	Radar Type	Pulse Width (us)	PRI (us)	Pulses per Hop	Hopping Rate (kHz)	Hopping Sequence Length (ms)	Visible Frequency Number
10	Type 6	1.0	333.3	9	0.3333	300.0000000	4
	Frequency List (MHz)	0	1	2	3	4	
	0	5345	5354	5644	5696	5384	
	5	5548	5470	5435	5514	5653	
	10	5694	5492	5324	5303	5323	
	15	5357	5667	5657	5641	5572	
	20	5425	5440	5610	5711	5616	
	25	5473	5414	5338	5584	5674	
	30	5541	5719	5432	5480	5651	
	35	5431	5457	5348	5615	5254	
	40	5715	5373	5295	5365	5556	
	45	5447	5645	5579	5533	5277	
	50	5703	5298	5252	5566	5280	
	55	5330	5636	5562	5403	5444	
	60	5655	5704	5519	5676	5427	
	65	5596	5568	5583	5450	5640	
	70	5304	5421	5547	5288	5598	
	75	5264	5494	5484	5695	5488	
	80	5495	5660	5293	5527	5639	
	85	5718	5351	5643	5511	5462	
	90	5632	5310	5394	5501	5476	
	95	5576	5327	5378	5333	5362	

Trial Id	Radar Type	Pulse Width (us)	PRI (us)	Pulses per Hop	Hopping Rate (kHz)	Hopping Sequence Length (ms)	Visible Frequency Number
11	Type 6	1.0	333.3	9	0.3333	300.0000000	8
	Frequency List (MHz)	0	1	2	3	4	
	0	5503	5593	5580	5382	5604	
	5	5590	5492	5510	5385	5625	
	10	5281	5365	5498	5344	5348	
	15	5319	5285	5686	5386	5336	
	20	5509	5551	5325	5589	5361	
	25	5563	5520	5442	5618	5716	
	30	5411	5459	5681	5300	5315	
	35	5522	5350	5501	5529	5568	
	40	5323	5689	5535	5362	5485	
	45	5427	5253	5637	5667	5628	
	50	5404	5349	5341	5389	5602	
	55	5518	5277	5697	5415	5309	
	60	5394	5464	5508	5639	5391	
	65	5380	5282	5532	5582	5493	
	70	5533	5587	5515	5574	5698	
	75	5483	5614	5530	5676	5265	
	80	5605	5441	5360	5636	5438	
	85	5351	5474	5654	5500	5642	
	90	5321	5579	5482	5610	5684	
	95	5388	5443	5547	5581	5527	

Trial Id	Radar Type	Pulse Width (us)	PRI (us)	Pulses per Hop	Hopping Rate (kHz)	Hopping Sequence Length (ms)	Visible Frequency Number
12	Type 6	1.0	333.3	9	0.3333	300.0000000	5
	Frequency List (MHz)	0	1	2	3	4	
	0	5283	5357	5516	5543	5446	
	5	5632	5417	5585	5268	5592	
	10	5459	5545	5406	5693	5365	
	15	5436	5388	5256	5578	5344	
	20	5675	5492	5317	5562	5627	
	25	5512	5723	5546	5652	5380	
	30	5300	5455	5674	5358	5498	
	35	5454	5710	5621	5654	5443	
	40	5504	5678	5359	5407	5336	
	45	5695	5720	5685	5580	5400	
	50	5430	5687	5706	5544	5467	
	55	5419	5289	5438	5559	5506	
	60	5340	5554	5329	5558	5327	
	65	5385	5662	5519	5590	5364	
	70	5550	5657	5355	5259	5673	
	75	5420	5618	5697	5524	5275	
	80	5633	5254	5424	5534	5274	
	85	5465	5315	5415	5269	5488	
	90	5547	5566	5616	5509	5427	
	95	5445	5560	5636	5347	5432	

Trial Id	Radar Type	Pulse Width (us)	PRI (us)	Pulses per Hop	Hopping Rate (kHz)	Hopping Sequence Length (ms)	Visible Frequency Number
13	Type 6	1.0	333.3	9	0.3333	300.000000	5
	Frequency List (MHz)	0	1	2	3	4	
	0	5538	5596	5452	5704	5666	
	5	5674	5439	5660	5431	5324	
	10	5390	5334	5544	5413	5386	
	15	5524	5573	5491	5301	5295	
	20	5352	5269	5530	5406	5535	
	25	5515	5364	5451	5650	5686	
	30	5422	5664	5412	5317	5607	
	35	5318	5496	5326	5417	5429	
	40	5454	5343	5489	5565	5443	
	45	5356	5721	5387	5419	5656	
	50	5298	5475	5283	5281	5519	
	55	5393	5498	5657	5713	5260	
	60	5470	5724	5647	5477	5531	
	65	5278	5594	5597	5663	5259	
	70	5505	5690	5688	5526	5282	
	75	5719	5638	5672	5253	5478	
	80	5338	5630	5450	5632	5266	
	85	5497	5466	5333	5366	5339	
	90	5434	5591	5581	5351	5250	
	95	5411	5442	5264	5545	5527	

Trial Id	Radar Type	Pulse Width (us)	PRI (us)	Pulses per Hop	Hopping Rate (kHz)	Hopping Sequence Length (ms)	Visible Frequency Number
14	Type 6	1.0	333.3	9	0.3333	300.0000000	4
	Frequency List (MHz)	0	1	2	3	4	
	0	5318	5360	5388	5390	5508	
	5	5338	5364	5260	5594	5628	
	10	5321	5598	5585	5511	5407	
	15	5612	5700	5497	5724	5487	
	20	5263	5435	5471	5398	5306	
	25	5691	5654	5279	5720	5464	
	30	5650	5369	5532	5284	5516	
	35	5635	5417	5310	5582	5368	
	40	5657	5669	5503	5683	5353	
	45	5553	5270	5502	5714	5351	
	50	5362	5634	5457	5608	5711	
	55	5337	5607	5452	5372	5706	
	60	5599	5414	5396	5576	5303	
	65	5574	5616	5702	5533	5534	
	70	5489	5466	5428	5588	5693	
	75	5537	5478	5293	5402	5387	
	80	5716	5449	5266	5259	5377	
	85	5401	5627	5645	5632	5583	
	90	5557	5561	5298	5320	5339	
	95	5597	5518	5708	5262	5543	

Trial Id	Radar Type	Pulse Width (us)	PRI (us)	Pulses per Hop	Hopping Rate (kHz)	Hopping Sequence Length (ms)	Visible Frequency Number
15	Type 6	1.0	333.3	9	0.3333	300.000000	6
	Frequency List (MHz)	0	1	2	3	4	
	0	5573	5599	5324	5551	5253	
	5	5380	5386	5335	5660	5360	
	10	5630	5484	5626	5706	5428	
	15	5803	5255	5600	5294	5679	
	20	5271	5504	5412	5487	5481	
	25	5669	5640	5382	5480	5279	
	30	5506	5539	5326	5272	5533	
	35	5336	5299	5508	5581	5260	
	40	5282	5496	5277	5441	5448	
	45	5447	5482	5250	5585	5297	
	50	5404	5627	5510	5633	5553	
	55	5319	5534	5659	5320	5406	
	60	5562	5351	5677	5579	5438	
	65	5408	5604	5520	5342	5651	
	70	5569	5366	5284	5647	5500	
	75	5574	5318	5289	5381	5437	
	80	5522	5530	5697	5701	5376	
	85	5515	5444	5561	5624	5365	
	90	5535	5278	5641	5371	5587	
	95	5357	5552	5493	5560	5608	

Trial Id	Radar Type	Pulse Width (us)	PRI (us)	Pulses per Hop	Hopping Rate (kHz)	Hopping Sequence Length (ms)	Visible Frequency Number
16	Type 6	1.0	333.3	9	0.3333	300.0000000	2
	Frequency List (MHz)	0	1	2	3	4	
	0	5256	5460	5260	5615	5570	
	5	5422	5311	5410	5348	5567	
	10	5561	5273	5667	5426	5449	
	15	5691	5382	5703	5339	5396	
	20	5279	5670	5353	5479	5454	
	25	5557	5492	5488	5584	5313	
	30	5645	5525	5283	5487	5685	
	35	5534	5341	5599	5377	5413	
	40	5671	5335	5360	5379	5591	
	45	5444	5411	5705	5668	5258	
	50	5457	5514	5289	5334	5604	
	55	5408	5357	5603	5263	5655	
	60	5548	5551	5269	5383	5715	
	65	5527	5466	5640	5600	5508	
	70	5576	5651	5450	5669	5560	
	75	5321	5613	5609	5642	5678	
	80	5478	5486	5296	5608	5624	
	85	5524	5438	5364	5580	5470	
	90	5606	5325	5555	5489	5375	
	95	5480	5674	5663	5282	5573	

Trial Id	Radar Type	Pulse Width (us)	PRI (us)	Pulses per Hop	Hopping Rate (kHz)	Hopping Sequence Length (ms)	Visible Frequency Number
17	Type 6	1.0	333.3	9	0.3333	300.0000000	5
	Frequency List (MHz)	0	1	2	3	4	
	0	5511	5699	5671	5301	5315	
	5	5464	5333	5485	5396	5492	
	10	5537	5708	5621	5470	5304	
	15	5509	5331	5287	5588	5665	
	20	5264	5391	5568	5427	5348	
	25	5441	5691	5688	5347	5687	
	30	5414	5715	5605	5459	5354	
	35	5480	5312	5648	5663	5682	
	40	5271	5540	5317	5356	5718	
	45	5685	5276	5316	5413	5640	
	50	5510	5655	5497	5558	5450	
	55	5599	5692	5370	5367	5522	
	60	5434	5328	5547	5353	5412	
	65	5366	5549	5544	5408	5446	
	70	5253	5266	5546	5421	5462	
	75	5355	5481	5719	5659	5633	
	80	5499	5552	5297	5521	5280	
	85	5438	5681	5543	5565	5474	
	90	5279	5608	5375	5619	5712	
	95	5523	5257	5541	5507	5261	

Trial Id	Radar Type	Pulse Width (us)	PRI (us)	Pulses per Hop	Hopping Rate (kHz)	Hopping Sequence Length (ms)	Visible Frequency Number
18	Type 6	1.0	333.3	9	0.3333	300.0000000	4
	Frequency List (MHz)	0	1	2	3	4	
	0	5291	5463	5607	5462	5632	
	5	5603	5258	5560	5674	5326	
	10	5274	5341	5491	5392	5636	
	15	5434	5332	5305	5673	5430	
	20	5400	5711	5293	5419	5317	
	25	5381	5254	5303	5672	5345	
	30	5611	5649	5619	5403	5541	
	35	5596	5585	5623	5633	5438	
	40	5647	5665	5359	5374	5466	
	45	5666	5516	5589	5706	5586	
	50	5394	5312	5646	5661	5493	
	55	5543	5599	5273	5476	5276	
	60	5455	5664	5498	5580	5618	
	65	5338	5531	5435	5629	5424	
	70	5311	5309	5314	5450	5310	
	75	5290	5640	5410	5609	5333	
	80	5461	5275	5518	5572	5620	
	85	5506	5282	5342	5330	5573	
	90	5718	5557	5517	5601	5708	
	95	5298	5525	5405	5304	5682	

Trial Id	Radar Type	Pulse Width (us)	PRI (us)	Pulses per Hop	Hopping Rate (kHz)	Hopping Sequence Length (ms)	Visible Frequency Number
19	Type 6	1.0	333.3	9	0.3333	300.000000	5
	Frequency List (MHz)	0	1	2	3	4	
	0	5546	5702	5543	5623	5377	
	5	5645	5280	5635	5265	5335	
	10	5257	5590	5315	5439	5512	
	15	5383	5288	5440	5594	5681	
	20	5596	5273	5649	5373	5502	
	25	5620	5622	5518	5415	5393	
	30	5289	5629	5560	5385	5372	
	35	5283	5494	5337	5510	5424	
	40	5706	5571	5361	5435	5479	
	45	5442	5519	5456	5392	5290	
	50	5282	5297	5679	5716	5500	
	55	5600	5275	5464	5672	5308	
	60	5577	5401	5390	5447	5450	
	65	5608	5334	5507	5615	5524	
	70	5285	5322	5430	5433	5621	
	75	5662	5719	5589	5528	5515	
	80	5292	5462	5566	5307	5284	
	85	5296	5474	5724	5399	5710	
	90	5250	5353	5509	5303	5597	
	95	5407	5428	5562	5678	5300	

Trial Id	Radar Type	Pulse Width (us)	PRI (us)	Pulses per Hop	Hopping Rate (kHz)	Hopping Sequence Length (ms)	Visible Frequency Number
20	Type 6	1.0	333.3	9	0.3333	300.000000	5
	Frequency List (MHz)	0	1	2	3	4	
	0	5704	5466	5479	5309	5597	
	5	5687	5680	5710	5428	5639	
	10	5566	5379	5356	5634	5533	
	15	5471	5318	5543	5422	5311	
	20	5592	5665	5641	5443	5390	
	25	5569	5350	5622	5449	5435	
	30	5653	5586	5300	5537	5667	
	35	5325	5585	5608	5269	5521	
	40	5263	5314	5509	5504	5529	
	45	5408	5528	5525	5393	5572	
	50	5343	5646	5333	5386	5502	
	55	5660	5688	5554	5465	5677	
	60	5338	5326	5454	5260	5615	
	65	5403	5347	5591	5396	5555	
	70	5515	5579	5601	5527	5387	
	75	5261	5707	5291	5550	5602	
	80	5439	5257	5370	5692	5498	
	85	5512	5487	5719	5401	5650	
	90	5335	5402	5255	5659	5722	
	95	5364	5493	5676	5510	5700	

Trial Id	Radar Type	Pulse Width (us)	PRI (us)	Pulses per Hop	Hopping Rate (kHz)	Hopping Sequence Length (ms)	Visible Frequency Number
21	Type 6	1.0	333.3	9	0.3333	300.000000	8
	Frequency List (MHz)	0	1	2	3	4	
	0	5484	5705	5415	5470	5439	
	5	5351	5702	5310	5591	5371	
	10	5497	5265	5494	5354	5554	
	15	5559	5445	5646	5370	5503	
	20	5600	5356	5252	5255	5416	
	25	5656	5421	5456	5251	5483	
	30	5477	5542	5543	5418	5311	
	35	5390	5464	5676	5501	5422	
	40	5435	5674	5447	5269	5526	
	45	5337	5508	5608	5451	5625	
	50	5522	5642	5384	5475	5703	
	55	5507	5401	5655	5496	5309	
	60	5455	5619	5680	5326	5414	
	65	5345	5492	5295	5318	5273	
	70	5587	5530	5711	5615	5666	
	75	5638	5670	5622	5583	5691	
	80	5367	5626	5381	5561	5412	
	85	5682	5718	5589	5286	5289	
	90	5553	5314	5329	5261	5465	
	95	5541	5463	5574	5671	5458	

Trial Id	Radar Type	Pulse Width (us)	PRI (us)	Pulses per Hop	Hopping Rate (kHz)	Hopping Sequence Length (ms)	Visible Frequency Number
22	Type 6	1.0	333.3	9	0.3333	300.000000	5
	Frequency List (MHz)	0	1	2	3	4	
	0	5264	5469	5351	5631	5659	
	5	5393	5627	5385	5279	5578	
	10	5428	5529	5535	5549	5575	
	15	5647	5572	5274	5415	5695	
	20	5608	5425	5668	5722	5389	
	25	5544	5370	5355	5517	5616	
	30	5528	5500	5633	5463	5685	
	35	5603	5292	5297	5349	5513	
	40	5577	5509	5523	5644	5488	
	45	5691	5412	5678	5495	5398	
	50	5343	5435	5564	5526	5451	
	55	5589	5462	5315	5280	5584	
	60	5309	5625	5336	5615	5294	
	65	5530	5702	5565	5596	5345	
	70	5670	5630	5560	5591	5607	
	75	5693	5468	5477	5407	5545	
	80	5721	5409	5402	5525	5552	
	85	5381	5483	5340	5326	5609	
	90	5494	5364	5499	5423	5465	
	95	5518	5558	5569	5716	5718	

Trial Id	Radar Type	Pulse Width (us)	PRI (us)	Pulses per Hop	Hopping Rate (kHz)	Hopping Sequence Length (ms)	Visible Frequency Number
23	Type 6	1.0	333.3	9	0.3333	300.0000000	2
	Frequency List (MHz)	0	1	2	3	4	
	0	5519	5708	5287	5695	5501	
	5	5435	5649	5460	5442	5407	
	10	5262	5318	5576	5269	5596	
	15	5638	5699	5377	5412	5591	
	20	5706	5336	5362	5432	5697	
	25	5387	5556	5454	5658	5417	
	30	5457	5373	5712	5408	5645	
	35	5480	5568	5350	5360	5352	
	40	5660	5323	5652	5520	5573	
	45	5468	5299	5470	5634	5285	
	50	5274	5486	5275	5349	5298	
	55	5680	5416	5463	5512	5251	
	60	5713	5474	5667	5683	5453	
	65	5282	5438	5718	5566	5534	
	70	5399	5514	5656	5633	5409	
	75	5567	5584	5338	5545	5623	
	80	5490	5663	5612	5309	5406	
	85	5694	5525	5499	5448	5294	
	90	5574	5332	5659	5370	5436	
	95	5477	5415	5542	5467	5319	

Trial Id	Radar Type	Pulse Width (us)	PRI (us)	Pulses per Hop	Hopping Rate (kHz)	Hopping Sequence Length (ms)	Visible Frequency Number
24	Type 6	1.0	333.3	9	0.3333	300.0000000	3
	Frequency List (MHz)	0	1	2	3	4	
	0	5299	5472	5698	5381	5721	
	5	5477	5574	5535	5508	5614	
	10	5668	5582	5617	5367	5251	
	15	5351	5383	5505	5604	5527	
	20	5660	5647	5328	5335	5549	
	25	5590	5488	5700	5403	5414	
	30	5588	5389	5703	5309	5571	
	35	5364	5503	5274	5666	5365	
	40	5261	5417	5517	5405	5448	
	45	5382	5528	5687	5695	5537	
	50	5717	5393	5370	5653	5331	
	55	5600	5270	5639	5612	5515	
	60	5376	5667	5269	5252	5677	
	65	5586	5642	5258	5636	5543	
	70	5458	5479	5623	5400	5444	
	75	5301	5372	5428	5341	5575	
	80	5290	5316	5345	5347	5627	
	85	5349	5470	5565	5432	5628	
	90	5676	5447	5672	5552	5468	
	95	5469	5359	5321	5325	5678	

Trial Id	Radar Type	Pulse Width (us)	PRI (us)	Pulses per Hop	Hopping Rate (kHz)	Hopping Sequence Length (ms)	Visible Frequency Number
25	Type 6	1.0	333.3	9	0.3333	300.0000000	3
	Frequency List (MHz)	0	1	2	3	4	
	0	5457	5711	5634	5542	5563	
	5	5616	5596	5610	5671	5346	
	10	5599	5371	5658	5562	5638	
	15	5339	5381	5486	5453	5321	
	20	5535	5351	5588	5417	5308	
	25	5586	5498	5318	5289	5522	
	30	5364	5292	5706	5426	5448	
	35	5662	5257	5656	5663	5505	
	40	5674	5657	5514	5334	5428	
	45	5465	5489	5265	5437	5404	
	50	5396	5373	5564	5581	5324	
	55	5368	5625	5571	5399	5329	
	60	5557	5347	5677	5271	5462	
	65	5541	5576	5383	5280	5250	
	70	5261	5485	5519	5502	5578	
	75	5525	5604	5652	5613	5700	
	80	5435	5400	5609	5331	5635	
	85	5385	5281	5299	5595	5350	
	90	5382	5407	5695	5546	5683	
	95	5607	5263	5655	5550	5459	

Trial Id	Radar Type	Pulse Width (us)	PRI (us)	Pulses per Hop	Hopping Rate (kHz)	Hopping Sequence Length (ms)	Visible Frequency Number
26	Type 6	1.0	333.3	9	0.3333	300.0000000	4
	Frequency List (MHz)	0	1	2	3	4	
	0	5712	5475	5570	5703	5308	
	5	5658	5521	5685	5359	5650	
	10	5433	5257	5699	5282	5659	
	15	5427	5508	5589	5498	5610	
	20	5446	5420	5626	5409	5281	
	25	5377	5350	5424	5393	5556	
	30	5406	5656	5328	5315	5721	
	35	5587	5278	5528	5431	5674	
	40	5441	5531	5515	5422	5608	
	45	5263	5408	5548	5547	5318	
	50	5324	5280	5572	5639	5542	
	55	5671	5294	5558	5347	5494	
	60	5502	5654	5600	5692	5663	
	65	5662	5577	5311	5414	5661	
	70	5352	5711	5361	5334	5398	
	75	5461	5289	5698	5668	5585	
	80	5429	5723	5481	5629	5595	
	85	5300	5329	5331	5597	5598	
	90	5624	5368	5645	5679	5485	
	95	5707	5563	5591	5636	5537	

Trial Id	Radar Type	Pulse Width (us)	PRI (us)	Pulses per Hop	Hopping Rate (kHz)	Hopping Sequence Length (ms)	Visible Frequency Number
27	Type 6	1.0	333.3	9	0.3333	300.000000	5
	Frequency List (MHz)	0	1	2	3	4	
	0	5492	5714	5506	5389	5625	
	5	5700	5543	5285	5522	5382	
	10	5364	5521	5265	5477	5680	
	15	5418	5635	5692	5327	5454	
	20	5586	5567	5498	5254	5299	
	25	5627	5594	5590	5448	5642	
	30	5661	5564	5541	5629	5369	
	35	5324	5584	5588	5280	5614	
	40	5453	5565	5605	5570	5291	
	45	5631	5371	5589	5534	5273	
	50	5690	5494	5355	5482	5707	
	55	5641	5513	5657	5659	5544	
	60	5486	5426	5638	5611	5516	
	65	5618	5684	5464	5697	5658	
	70	5374	5420	5258	5721	5566	
	75	5681	5358	5262	5696	5297	
	80	5621	5709	5439	5672	5304	
	85	5616	5368	5491	5475	5341	
	90	5580	5318	5281	5380	5519	
	95	5537	5362	5645	5524	5325	

Trial Id	Radar Type	Pulse Width (us)	PRI (us)	Pulses per Hop	Hopping Rate (kHz)	Hopping Sequence Length (ms)	Visible Frequency Number
28	Type 6	1.0	333.3	9	0.3333	300.0000000	7
	Frequency List (MHz)	0	1	2	3	4	
	0	5272	5478	5539	5550	5370	
	5	5267	5565	5360	5588	5589	
	10	5295	5310	5306	5672	5701	
	15	5506	5287	5320	5491	5519	
	20	5462	5655	5508	5490	5702	
	25	5531	5626	5355	5698	5624	
	30	5717	5401	5716	5264	5293	
	35	5557	5692	5262	5502	5594	
	40	5319	5391	5330	5602	5499	
	45	5271	5336	5663	5424	5476	
	50	5410	5449	5266	5342	5317	
	55	5299	5670	5564	5463	5460	
	60	5387	5311	5349	5489	5415	
	65	5252	5681	5687	5560	5552	
	70	5353	5576	5593	5683	5464	
	75	5507	5350	5379	5605	5366	
	80	5382	5547	5361	5371	5518	
	85	5385	5721	5294	5341	5612	
	90	5378	5621	5389	5457	5292	
	95	5534	5497	5412	5374	5597	

Trial Id	Radar Type	Pulse Width (us)	PRI (us)	Pulses per Hop	Hopping Rate (kHz)	Hopping Sequence Length (ms)	Visible Frequency Number
29	Type 6	1.0	333.3	9	0.3333	300.000000	3
	Frequency List (MHz)	0	1	2	3	4	
	0	5430	5717	5475	5711	5687	
	5	5406	5490	5435	5276	5321	
	10	5604	5574	5444	5295	5722	
	15	5594	5414	5326	5536	5373	
	20	5346	5546	5579	5675	5419	
	25	5478	5558	5327	5658	5629	
	30	5420	5674	5519	5559	5432	
	35	5648	5488	5512	5513	5433	
	40	5402	5329	5570	5599	5331	
	45	5251	5624	5477	5266	5286	
	50	5625	5317	5431	5518	5621	
	55	5653	5279	5358	5343	5514	
	60	5434	5650	5627	5413	5509	
	65	5491	5660	5371	5545	5665	
	70	5291	5467	5259	5338	5486	
	75	5428	5528	5613	5481	5299	
	80	5549	5309	5612	5695	5681	
	85	5581	5422	5540	5386	5699	
	90	5503	5446	5256	5462	5640	
	95	5427	5377	5487	5398	5307	

Trial Id	Radar Type	Pulse Width (us)	PRI (us)	Pulses per Hop	Hopping Rate (kHz)	Hopping Sequence Length (ms)	Visible Frequency Number
30	Type 6	1.0	333.3	9	0.3333	300.0000000	3
	Frequency List (MHz)	0	1	2	3	4	
	0	5685	5481	5411	5397	5432	
	5	5448	5512	5510	5439	5625	
	10	5535	5363	5485	5490	5268	
	15	5682	5444	5429	5581	5428	
	20	5381	5487	5571	5648	5307	
	25	5427	5286	5431	5692	5671	
	30	5406	5631	5259	5642	5282	
	35	5474	5264	5284	5665	5369	
	40	5267	5335	5596	5260	5706	
	45	5502	5433	5628	5637	5326	
	50	5368	5520	5341	5565	5472	
	55	5271	5476	5329	5679	5554	
	60	5573	5711	5458	5527	5492	
	65	5641	5348	5359	5277	5470	
	70	5583	5302	5297	5446	5606	
	75	5509	5390	5591	5555	5713	
	80	5469	5288	5256	5515	5537	
	85	5644	5676	5290	5263	5313	
	90	5681	5389	5383	5516	5253	
	95	5483	5721	5325	5356	5590	

END OF REPORT