

FCC RADIO TEST REPORT

FCC ID: 2ABZJ-100-00109

Product : Point to Point Wireless Device

Trade Mark : mimosa by Airspan

Model Name : B5x

Family Model : iBridge B5x

Report No. : S21050602207001

Prepared for

Mimosa Networks, Inc.

777 Yamato Road, Boca Raton, FL 33431 USA

Prepared by

Shenzhen NTEK Testing Technology Co., Ltd.

1/F, Building E, Fenda Science Park, Sanwei Community, Xixiang Street, Bao'an District, Shenzhen 518126 P.R.China.

Tel. 400-800-6106, 0755-2320 0050, 0755-2320 0090

Website: <http://www.ntek.org.cn>

TEST RESULT CERTIFICATION

Applicant's name Mimosa Networks, Inc.
Address 777 Yamato Road, Boca Raton, FL 33431 USA
Manufacturer's Name Mimosa Networks, Inc.
Address 777 Yamato Road, Boca Raton, FL 33431 USA

Product description

Product name Point to Point Wireless Device
Model and/or type reference B5x
Family Model..... iBridge B5x

Standards FCC Part15.407

Test procedure ANSI C63.10-2013;
KDB 789033 D02 General UNII Test Procedures New Rules v02r01
KDB 662911 D01 Multiple Transmitter Output v02r01
KDB 905462 D02 UNII DFS Compliance Procedures New Rules v02
KDB 905462 D04 Operational Modes for DFS Testing New Rules v01

This device described above has been tested by NTEK, and the test results show that the equipment under test (EUT) is in compliance with the FCC requirements/ the Industry Canada requirements.. And it is applicable only to the tested sample identified in the report.

This report shall not be reproduced except in full, without the written approval of NTEK, this document may be altered or revised by NTEK, personnel only, and shall be noted in the revision of the document.

Date of Test

Date (s) of performance of tests 06 May. 2021 ~ 30 Jun. 2021

Date of Issue..... 30 Jun. 2021

Test Result..... Pass

Testing Engineer : [Signature]
(Cheng Jiawen)

Technical Manager : [Signature]
(Jason Chen)

Authorized Signatory : [Signature]
(Alex Li)

Table of Contents

	Page
1 . SUMMARY OF TEST RESULTS	6
1.1 FACILITIES AND ACCREDITATIONS	7
1.2 MEASUREMENT UNCERTAINTY	7
2 . GENERAL INFORMATION	8
2.1 GENERAL DESCRIPTION OF EUT	8
2.2 DESCRIPTION OF TEST MODES	11
2.3 BLOCK DIGRAM SHOWING THE CONFIGURATION OF SYSTEM TESTED	19
2.4 DESCRIPTION OF SUPPORT UNITS(CONDUCTED MODE)	20
2.5 EQUIPMENTS LIST FOR ALL TEST ITEMS	21
3 . TEST REQUIREMENTS	23
3.1 CONDUCTED EMISSION MEASUREMENT	23
3.1.1 APPLICABLE STANDARD	23
3.1.2 CONFORMANCE LIMIT	23
3.1.3 TEST CONFIGURATION	23
3.1.4 TEST PROCEDURE	23
3.1.5 TEST RESULTS	24
3.2 RADIATED EMISSION MEASUREMENT	26
3.2.1 APPLICABLE STANDARD	26
3.2.2 CONFORMANCE LIMIT	26
3.2.3 MEASURING INSTRUMENTS	26
3.2.4 TEST CONFIGURATION	27
3.2.5 TEST PROCEDURE	28
3.2.6 TEST RESULTS (9KHZ – 30 MHZ)	29
3.2.7 TEST RESULTS (30MHZ – 1GHZ)	30
3.2.8 TEST RESULTS (1GHZ-18GHZ)	50
3.2.9 TEST RESULTS (18GHZ-40GHZ)	70
3.2.10 SPURIOUS EMISSION IN RESTRICTED BAND 4.5GHZ~5.150 GHZ& 5.350GHZ~5460GHZ	90
3.3 POWER SPECTRAL DENSITY TEST	98
3.3.1 APPLIED PROCEDURES / LIMIT	98
3.3.2 TEST PROCEDURE	99
3.3.3 DEVIATION FROM STANDARD	99
3.3.4 TEST SETUP	99
3.3.5 EUT OPERATION CONDITIONS	99
3.3.6 TEST RESULTS	100
3.4 26DB & 99% EMISSION BANDWIDTH	101
3.4.1 APPLIED PROCEDURES / LIMIT	101
3.4.2 TEST PROCEDURE	101

Table of Contents

	Page
3.4.3 EUT OPERATION CONDITIONS	102
3.4.4 TEST RESULTS	102
3.5 MINIMUM 6 DB BANDWIDTH	103
3.5.1 APPLIED PROCEDURES / LIMIT	103
3.5.2 TEST PROCEDURE	103
3.5.3 DEVIATION FROM STANDARD	103
3.5.4 TEST SETUP	103
3.5.5 EUT OPERATION CONDITIONS	103
3.5.6 TEST RESULTS	104
3.6 MAXIMUM CONDUCTED OUTPUT POWER	105
3.6.1 PPLIED PROCEDURES / LIMIT	105
3.6.2 TEST PROCEDURE	106
3.6.3 DEVIATION FROM STANDARD	108
3.6.5 EUT OPERATION CONDITIONS	108
3.6.6 TEST RESULTS	109
3.6.7 MASTER MODE ELEVATION ANGLE ABOVE 30 DEGREES MAXIMUM E.I.R.P. EVALUATION:	110
3.7 OUT OF BAND EMISSIONS	111
3.7.1 APPLICABLE STANDARD	111
3.7.2 TEST PROCEDURE	111
3.7.3 DEVIATION FROM STANDARD	112
3.7.4 TEST SETUP	112
3.7.5 EUT OPERATION CONDITIONS	112
3.7.6 TEST RESULTS	112
3.8 SPURIOUS RF CONDUCTED EMISSIONS	113
3.8.1 CONFORMANCE LIMIT	113
3.8.2 MEASURING INSTRUMENTS	113
3.8.3 TEST SETUP	113
3.8.4 TEST PROCEDURE	113
3.8.5 TEST RESULTS	113
3.9 FREQUENCY STABILITY	113
4. ANTENNA REQUIREMENT	114
4.1 STANDARD REQUIREMENT	114
4.2 EUT ANTENNA	114
5. DYNAMIC FREQUENCY SELECTION(DFS)	114

Revision History

Report No.	Version	Description	Issued Date
S21050602207001	Rev.01	Initial issue of report	30 Jun. 2021

1. SUMMARY OF TEST RESULTS

Test procedures according to the technical standards:

FCC Part15 (15.407) , Subpart E			
Standard Section	Test Item	Judgment	Remark
15.207	AC Power Line Conducted Emissions	PASS	
15.209(a) 15.407(b)	Spurious Radiated Emissions	PASS	
15.407(a)	26 dB and 99% Emission Bandwidth	PASS	
15.407(e)	Minimum 6 dB bandwidth	PASS	
15.407(a)	Maximum Conducted Output Power	PASS	
15.407(b)	Band Edge	PASS	
15.407(a)	Power Spectral Density	PASS	
15.407(b)	Spurious Emissions at Antenna Terminals	PASS	
15.407(h)	Dynamic Frequency Selection(DFS)	PASS	
15.203	Antenna Requirement	PASS	

NOTE:

(1) "N/A" denotes test is not applicable in this Test Report

1.1 FACILITIES AND ACCREDITATIONS

FACILITIES

All measurement facilities used to collect the measurement data are located at 1/F, Building E, Fenda Science Park, Sanwei Community, Xixiang Street, Bao'an District, Shenzhen 518126 P.R. China.

The sites are constructed in conformance with the requirements of ANSI C63.7, ANSI C63.10 and CISPR Publication 22.

LABORATORY ACCREDITATIONS AND LISTINGS

Site Description

CNAS-Lab. : The Certificate Registration Number is L5516.

IC-Registration : The Certificate Registration Number is 9270A.
CAB identifier:CN0074

FCC- Accredited : Test Firm Registration Number: 463705.
Designation Number: CN1184

A2LA-Lab. : The Certificate Registration Number is 4298.01

Name of Firm : Shenzhen NTEK Testing Technology Co., Ltd.

Site Location : 1/F, Building E, Fenda Science Park, Sanwei Community, Xixiang Street, Bao'an District, Shenzhen 518126 P.R.China.

1.2 MEASUREMENT UNCERTAINTY

The reported uncertainty of measurement $y \pm U$, where expended uncertainty U is based on a standard uncertainty multiplied by a coverage factor of $k=2$, providing a level of confidence of approximately 95 %.

No.	Item	Uncertainty
1	Conducted Emission Test	$\pm 2.80\text{dB}$
2	RF power, conducted	$\pm 0.16\text{dB}$
3	Spurious emissions, conducted	$\pm 0.21\text{dB}$
4	All emissions, radiated(30MHz~1GHz)	$\pm 2.64\text{dB}$
5	All emissions, radiated(1GHz~6GHz)	$\pm 2.40\text{dB}$
6	All emissions, radiated(> 6GHz)	$\pm 2.52\text{dB}$
7	Temperature	$\pm 0.5^\circ\text{C}$
8	Humidity	$\pm 2\%$

2. GENERAL INFORMATION
2.1 GENERAL DESCRIPTION OF EUT

Equipment	Point to Point Wireless Device	
Trade Mark	mimosa by Airspan	
Model Name	B5x	
Family Model	iBridge B5x	
Model Difference	All the model are the same circuit and RF module, except the model names.	
FCC ID	2ABZJ-100-00109	
Product Description	IEEE 802.11 WLAN Mode Supported	<input checked="" type="checkbox"/> 802.11ac (20MHz channel bandwidth) <input checked="" type="checkbox"/> 802.11ac (40MHz channel bandwidth) <input checked="" type="checkbox"/> 802.11ac (80MHz channel bandwidth)
	Data Rate	802.11ac(VHT20):MCS0-MCS8; 802.11ac(VHT40/VHT80):MCS0-MCS9;
	Modulation	OFDM up to 256QAM for 802.11ac;
	Operating Frequency Range	<input checked="" type="checkbox"/> U-NII-1: 5180-5240MHz for 802.11ac(VHT20); 5190-5230MHz for 802.11ac(VHT40); 5210MHz for 802.11ac(VHT80) <input checked="" type="checkbox"/> U-NII-2A: 5260-5320MHz for 802.11ac(VHT20); 5270-5310MHz for 802.11ac(VHT40); 5290MHz for 802.11ac(VHT80) <input checked="" type="checkbox"/> U-NII-2C: 5500-5700MHz for 802.11ac(VHT20); 5510-5670MHz for 802.11ac(VHT40); 5530-5610MHz for 802.11ac(VHT80) <input checked="" type="checkbox"/> U-NII-3: 5745-5825 MHz for 802.11ac(VHT20); 5755-5795 MHz for 802.11ac(VHT40); 5775MHz for 802.11ac(VHT80)
	Number of Channels	<input checked="" type="checkbox"/> 4 channels for U-NII-1(ac20); 2 channels for U-NII-1(ac40); 1 channels for U-NII-1(ac80); <input checked="" type="checkbox"/> 4 channels for U-NII-2A(ac20); 2 channels for U-NII-2A(ac40); 1 channels for U-NII-2A(ac80); <input checked="" type="checkbox"/> 11 channels for U-NII-2C(ac20); 5 channels for U-NII-2C(ac40); 2 channels for U-NII-2C(ac80); <input checked="" type="checkbox"/> 5 channels for U-NII-3(ac20); 2 channels for U-NII-3(ac40); 1 channels for U-NII-3(ac80);
	Function:	<input checked="" type="checkbox"/> Outdoor AP <input type="checkbox"/> Indoor AP <input checked="" type="checkbox"/> Fixed PTP <input type="checkbox"/> Client
	DFS operational mode	Master
	Smart system	<input checked="" type="checkbox"/> SISO for 802.11ac <input checked="" type="checkbox"/> MIMO for 802.11ac
	Antenna Type	Integral: Panel External (Screw on): Cassegrain
	Antenna Gain	Integral: 8dBi External: 25dBi
Based on the application, features, or specification exhibited in User's Manual, More details of EUT technical specification, please refer to the User's Manual.		

Ratings	DC 50V from PoE (AC 100~240V / 50~60Hz / 1.5A Max)
Adapter	N/A
Connecting I/O Port(s)	Please refer to the User's Manual
HW Version	004-00068-03-C2
SW Version	2.9.0

Note:

1. For a more detailed features description, please refer to the manufacturer's specifications or the User's Manual.
- 2.

Band	20MHz		40MHz		80MHz	
	Channel	Frequency	Channel	Frequency	Channel	Frequency
U-NII-1	36	5180 MHz	38	5190 MHz	42	5210 MHz
	40	5200 MHz	46	5230 MHz	-	-
	44	5220 MHz				
	48	5240 MHz				
U-NII-2A	52	5260 MHz	54	5270 MHz	58	5290 MHz
	56	5280 MHz	62	5310 MHz		
	60	5300 MHz				
	64	5320 MHz				
U-NII-2C	100	5500 MHz	102	5510 MHz	106	5530 MHz
	104	5520 MHz	110	5550 MHz	122	5610 MHz
	108	5540 MHz	118	5590 MHz		
	112	5560 MHz	126	5630 MHz		
	116	5580 MHz	134	5670 MHz		
	120	5600 MHz				
	124	5620 MHz				
	128	5640 MHz				
	132	5660 MHz				
	136	5680 MHz				
U-NII-3	149	5745 MHz	151	5755 MHz	155	5775 MHz
	153	5765 MHz	159	5795 MHz		
	157	5785 MHz				
	161	5805 MHz				
	165	5825 MHz				

2.2 DESCRIPTION OF TEST MODES

To investigate the maximum EMI emission characteristics generates from EUT, the test system was pre-scanning tested base on the consideration of following EUT operation mode or test configuration mode which possible have effect on EMI emission level. Each of these EUT operation mode(s) or test configuration mode(s) mentioned above was evaluated respectively.

Pretest Mode	Description
Mode 1	Normal Link Mode
Mode 2	802.11ac 20 CH36/ CH40/ CH 48 802.11ac 20 CH52/ CH56/ CH 64 802.11ac 20 CH100/ CH120/ CH 140 802.11ac 20 CH149/ CH157/ CH 165
Mode 3	802.11ac40 CH38/ CH 46 802.11ac40 CH54/ CH 62 802.11ac40 CH102/ CH 118/ CH 134 802.11ac 40 CH 151 / CH 159
Mode 4	802.11ac80 CH 42 802.11ac80 CH 58 802.11ac80 CH 106/ CH 122 802.11ac 80 CH 155

For Radiated Emission	
Final Test Mode	Description
Mode 1	Normal Link Mode
Mode 2	802.11ac 20 CH36/ CH40/ CH 48 802.11ac 20 CH52/ CH56/ CH 64 802.11ac 20 CH100/ CH120/ CH 140 802.11ac 20 CH149/ CH157/ CH 165
Mode 3	802.11ac40 CH38/ CH 46 802.11ac40 CH54/ CH 62 802.11ac40 CH102/ CH 118/ CH 134 802.11ac 40 CH 151 / CH 159
Mode 4	802.11ac80 CH 42 802.11ac80 CH 58 802.11ac80 CH 106/ CH 122 802.11ac 80 CH 155

Note:

- (1) The measurements are performed at the highest, middle, lowest available channels.
- (2) The measurements are performed at all Bit Rate of Transmitter, the worst data was reported

The EUT support MIMO modes, transmit mode what describe as following:

Mode	Tx / Rx
802.11ac(20MHz,40MHz,80MHz)	1TX, 1RX
802.11ac(20MHz,40MHz,80MHz)	2TX, 2RX

For 5GHz band, 802.11ac(20/40/80) has MIMO mode, Antenna 1,2 are simultaneous transmissions, each with the same directional gain.

8dBi Antenna

For power measurements: Directional gain= $G_{ANT} + \text{Array Gain} = 8\text{dBi} + 0 = 8\text{dBi}$

For power spectral density (PSD) measurements: Directional gain= $G_{ANT} + \text{Array Gain} = 8\text{dBi} + 3.01 = 11.01\text{dBi}$

25dBi Antenna

For power measurements: Directional gain= $G_{ANT} + \text{Array Gain} = 25\text{dBi} + 0 = 25\text{dBi}$

For power spectral density (PSD) measurements: Directional gain= $G_{ANT} + \text{Array Gain} = 25\text{dBi} + 3.01 = 28.01\text{dBi}$

Note: G_{ANT} means antenna gain for the same gain in dBi.

For power spectral density (PSD) measurements: Array Gain = $10\log(N_{ANT}/N_{SS})\text{dB}$.

Array Gain = 0 dB (i.e., no array gain) for $N_{ANT} \leq 4$;

Array Gain = 0 dB (i.e., no array gain) for channel widths ≥ 40 MHz for any N_{ANT} ;

Array Gain = $5 \log(N_{ANT}/N_{SS})$ dB or 3 dB, whichever is less, for 20-MHz channel widths with $N_{ANT} \geq 5$.

For power measurements:

N_{ANT} = number of transmit antennas and

N_{SS} = number of spatial streams. (Assume $N_{SS} = 1$ unless you have specific information to the contrary.)

8dBi Antenna

Modulation	Band	Frequency (MHz)	Antenna	Power Setting
802.11ac20	U-NII-1(outdoor AP)	5180	1	17
			2	12
		5200	1	17
			2	12
		5240	1	17
			2	12
	U-NII-1(Fixed point-to-point AP)	5180	1	19
			2	15
		5200	1	19
			2	15
		5240	1	19
			2	15
	U-NII-2A	5260	1	11
			2	7
		5280	1	11
			2	7
		5320	1	11
			2	7
	U-NII-2C	5500	1	11
			2	7
		5600	1	11
			2	7
		5700	1	11
			2	7
U-NII-3	5745	1	24	
		2	22	
	5785	1	24	
		2	22	
	5825	1	24	
		2	22	

8dBi Antenna

Modulation	Band	Frequency (MHz)	Antenna	Power Setting
802.11ac40	U-NII-1(outdoor AP)	5190	1	17
			2	12
		5230	1	17
			2	12
	U-NII-1(Fixed point-to-point AP)	5190	1	19
			2	15
		5230	1	19
			2	15
	U-NII-2A	5270	1	11
			2	7
		5310	1	11
			2	7
	U-NII-2C	5510	1	11
			2	7
		5590	1	11
			2	7
		5670	1	11
			2	7
	U-NII-3	5755	1	24
			2	22
5795		1	24	
		2	22	

8dBi Antenna

Modulation	Band	Frequency (MHz)	Antenna	Power Setting
802.11ac80	U-NII-1(outdoor AP)	5210	1	17
			2	12
	U-NII-1(Fixed point-to-point AP)	5210	1	19
			2	15
	U-NII-2A	5290	1	11
			2	7
	U-NII-2C	5530	1	11
			2	7
		5610	1	11
			2	7
	U-NII-3	5775	1	24
			2	22

25dBi Antenna

Modulation	Band	Frequency (MHz)	Antenna	Power Setting
802.11ac20	U-NII-1(outdoor AP)	5180	1	2
			2	-5
		5200	1	2
			2	-5
		5240	1	2
			2	-5
	U-NII-1(Fixed point-to-point AP)	5180	1	5
			2	2
		5200	1	5
			2	2
		5240	1	5
			2	2
	U-NII-2A	5260	1	-6
			2	-6
		5280	1	-6
			2	-6
		5320	1	-6
			2	-6
	U-NII-2C	5500	1	-6
			2	-6
		5600	1	-6
			2	-6
		5700	1	-6
			2	-6
U-NII-3	5745	1	2	
		2	4	
	5785	1	2	
		2	4	
	5825	1	2	
		2	4	

25dBi Antenna

Modulation	Band	Frequency (MHz)	Antenna	Power Setting
802.11ac40	U-NII-1(outdoor AP)	5190	1	2
			2	-5
		5230	1	2
			2	-5
	U-NII-1(Fixed point-to-point AP)	5190	1	5
			2	2
		5230	1	5
			2	2
	U-NII-2A	5270	1	-6
			2	-6
		5310	1	-6
			2	-6
	U-NII-2C	5510	1	-6
			2	-6
		5590	1	-6
			2	-6
		5670	1	-6
			2	-6
	U-NII-3	5755	1	2
			2	4
5795		1	2	
		2	4	

25dBi Antenna

Modulation	Band	Frequency (MHz)	Antenna	Power Setting
802.11ac80	U-NII-1(outdoor AP)	5210	1	2
			2	-5
	U-NII-1(Fixed point-to-point AP)	5210	1	5
			2	2
	U-NII-2A	5290	1	-6
			2	-6
	U-NII-2C	5530	1	-6
			2	-6
		5610	1	-6
			2	-6
	U-NII-3	5775	1	2
			2	4

2.3 BLOCK DIGRAM SHOWING THE CONFIGURATION OF SYSTEM TESTED

For AC Conducted Emission Mode

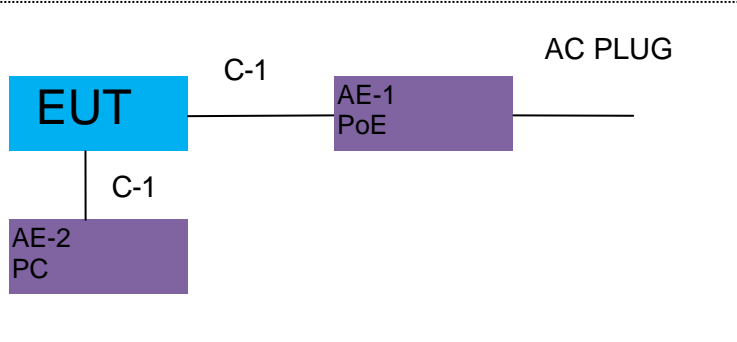

For Radiated Test Cases

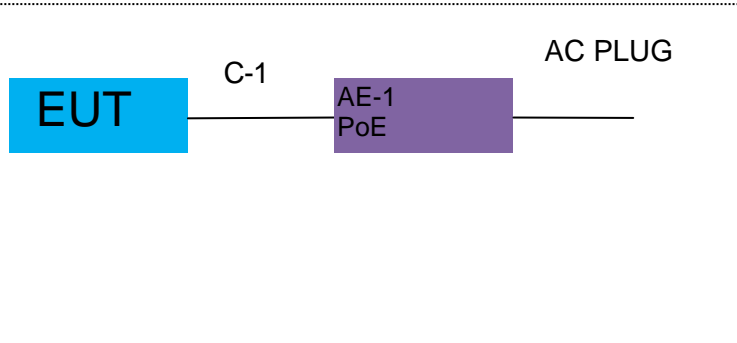

For Conducted Test Cases

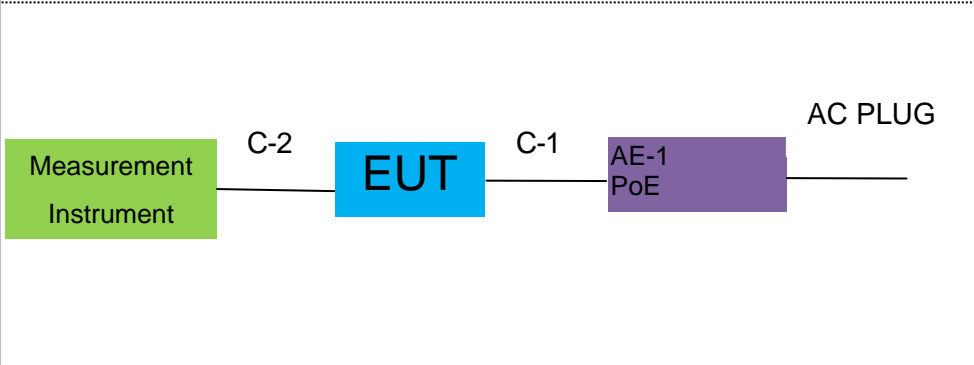

Note:1.The temporary antenna connector is soldered on the PCB board in order to perform conducted tests and this temporary antenna connector is listed in the equipment list.

2.4 DESCRIPTION OF SUPPORT UNITS(CONDUCTED MODE)

The EUT has been tested as an independent unit together with other necessary accessories or support units. The following support units or accessories were used to form a representative test configuration during the tests.

Item	Equipment	Brand	Model/Type No.	Series No.	Note
AE-1	PoE	N/A	N/A	N/A	Peripherals
AE-2	PC	N/A	N/A	N/A	Peripherals

Item	Cable Type	Shielded Type	Ferrite Core	Length
C-1	Ethernet Cable	YES	NO	2.0m
C-2	RF Cable	YES	NO	0.1m

Note:

- (1) The support equipment was authorized by Declaration of Confirmation.
- (2) For detachable type I/O cable should be specified the length in cm in 『Length』 column.

2.5 EQUIPMENTS LIST FOR ALL TEST ITEMS

Radiation& Conducted Test equipment

Item	Kind of Equipment	Manufacturer	Type No.	Serial No.	Last calibration	Calibrated until	Calibration period
1	Spectrum Analyzer	Agilent	E4407B	MY45108040	2021.04.27	2022.04.26	1 year
2	Spectrum Analyzer	Agilent	N9020A	MY49100060	2020.07.13	2021.07.12	1 year
3	Spectrum Analyzer	R&S	FSV40	101417	2020.08.07	2021.08.06	1 year
4	Test Receiver	R&S	ESPI7	101318	2021.04.27	2022.04.26	1 year
5	Bilog Antenna	TESEQ	CBL6111D	31216	2021.03.29	2022.03.28	1 year
6	50Ω Coaxial Switch	Anritsu	MP59B	6200983705	2020.05.11	2023.05.10	3 year
7	Horn Antenna	EM	EM-AH-10180	2011071402	2021.03.29	2022.03.28	1 year
8	Amplifier	EMC	EMC051835SE	980246	2020.07.13	2021.07.12	1 year
9	Active Loop Antenna	SCHWARZBECK	FMZB 1519B	055	2020.11.20	2021.11.19	1 year
10	USB RF Power Sensor	DARE	RPR3006W	15I00041SN084	2020.07.13	2021.07.12	1 year
11	Test Cable (9KHz-30MHz)	N/A	R-01	N/A	2019.08.06	2022.08.05	3 year
12	Test Cable (30MHz-1GHz)	N/A	R-02	N/A	2019.08.06	2022.08.05	3 year
13	High Test Cable(1G-40G Hz)	N/A	R-03	N/A	2019.08.06	2022.08.05	3 year
14	High Test Cable(1G-40G Hz)	N/A	R-04	N/A	2019.08.06	2022.08.05	3 year
15	temporary antenna connector (Note)	NTS	R001	N/A	N/A	N/A	N/A
16	Low Noise Amplifier	B&Z	BZ-P540-550850-452727	16476-11729	2021.04.01	2022.03.31	1 year
17	Broadband Horn Antenna	SCHWARZBECK	BBHA 9170	803	2020.11.20	2021.11.19	1 year
18	Thermal Chamber	Ten Billion	TTC-B3C	TBN-960502	2020.08.07	2023.08.06	1 year
19	MXG Vector Signal Generator	Agilent	N5182A	MY47070317	2021.04.27	2022.04.26	1 year

Note:

We will use the temporary antenna connector (soldered on the PCB board) When conducted test
And this temporary antenna connector is listed within the instrument list

AC Conduction Test equipment

Item	Kind of Equipment	Manufacturer	Type No.	Serial No.	Last calibration	Calibrated until	Calibration period
1	Test Receiver	R&S	ESCI	101160	2021.04.27	2022.04.26	1 year
2	LISN	R&S	ENV216	101313	2021.04.27	2022.04.26	1 year
3	LISN	SCHWARZBECK	NNLK 8129	8129245	2021.04.27	2022.04.26	1 year
4	50Ω Coaxial Switch	ANRITSU CORP	MP59B	6200983704	2020.05.11	2023.05.10	3 year
5	Test Cable (9KHz-30MHz)	N/A	C01	N/A	2020.05.11	2023.05.10	3 year
6	Test Cable (9KHz-30MHz)	N/A	C02	N/A	2020.05.11	2023.05.10	3 year
7	Test Cable (9KHz-30MHz)	N/A	C03	N/A	2020.05.11	2023.05.10	3 year

Note: Each piece of equipment is scheduled for calibration once a year except the Test Cable& Aux Equipment which is scheduled for calibration every 3 years.

3. TEST REQUIREMENTS

3.1 CONDUCTED EMISSION MEASUREMENT

3.1.1 APPLICABLE STANDARD

According to FCC Part 15.207(a)

3.1.2 CONFORMANCE LIMIT

Frequency(MHz)	Conducted Emission Limit	
	Quasi-peak	Average
0.15-0.5	66-56*	56-46*
0.5-5.0	56	46
5.0-30.0	60	50

Note: 1. *Decreases with the logarithm of the frequency
 2. The lower limit shall apply at the transition frequencies
 3. The limit decreases in line with the logarithm of the frequency in the range of 0.15 to 0.50MHz.

3.1.3 TEST CONFIGURATION

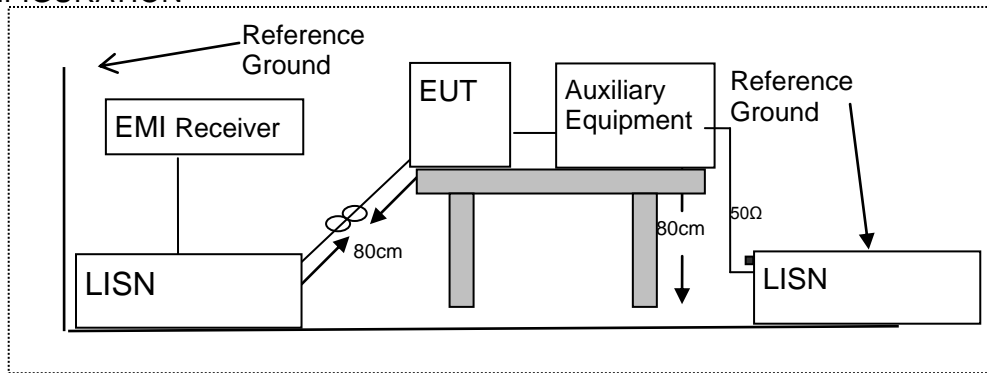

3.1.4 TEST PROCEDURE

According to the requirements in Section 13.1.4.1 of ANSI C63.10-2013 Conducted emissions the EUT measured in the frequency range between 0.15 MHz and 30 MHz using CISPR Quasi-Peak and average detector mode.

1. The EUT was placed 0.4 meter from the conducting wall of the shielding room.
2. The EUT was placed on a table which is 0.8m above ground plane.
3. Connect EUT to the power mains through a line impedance stabilization network (LISN). All other support equipments powered from additional LISN(s). The LISN provide 50 Ohm/ 50uH of coupling impedance for the measuring instrument.
4. Interconnecting cables that hang closer than 40 cm to the ground plane shall be folded back and forth in the center forming a bundle 30 to 40cm long.
5. I/O cables that are not connected to a peripheral shall be bundled in the center. The end of the cable may be terminated, if required, using the correct terminating impedance. The overall length shall not exceed 1 m.
6. LISN at least 80 cm from nearest part of EUT chassis.
7. The frequency range from 150KHz to 30MHz was searched.
8. Set the test-receiver system to Peak Detect Function and specified bandwidth(IF bandwidth=9KHz) with Maximum Hold Mode
9. For the actual test configuration, please refer to the related Item –EUT Test Photos.

3.1.5 TEST RESULTS

EUT :	Point to Point Wireless Device	Model Name :	B5x
Temperature :	26 °C	Relative Humidity :	54%
Pressure :	1010hPa	Phase :	L
Test Voltage :	DC 50V from PoE (AC 120V / 60Hz)	Test Mode :	Mode 1

Frequency (MHz)	Reading Level (dBμV)	Correct Factor (dB)	Measurement (dBμV)	Limits (dBμV)	Margin (dB)	Remark
0.1580	44.41	9.56	53.97	65.56	-11.59	QP
0.1580	38.03	9.56	47.59	55.56	-7.97	AVG
0.3260	39.48	9.54	49.02	59.55	-10.53	QP
0.3260	32.86	9.54	42.40	49.55	-7.15	AVG
0.4660	42.86	9.55	52.41	56.58	-4.17	QP
0.4660	34.69	9.55	44.24	46.58	-2.34	AVG
1.3300	35.71	9.56	45.27	56.00	-10.73	QP
1.3300	28.38	9.56	37.94	46.00	-8.06	AVG
13.6019	35.71	9.75	45.46	60.00	-14.54	QP
13.6019	27.46	9.75	37.21	50.00	-12.79	AVG
24.3500	27.88	9.94	37.82	60.00	-22.18	QP
24.3500	22.59	9.94	32.53	50.00	-17.47	AVG

Remark:

1. All readings are Quasi-Peak and Average values.
2. Factor = Insertion Loss + Cable Loss.

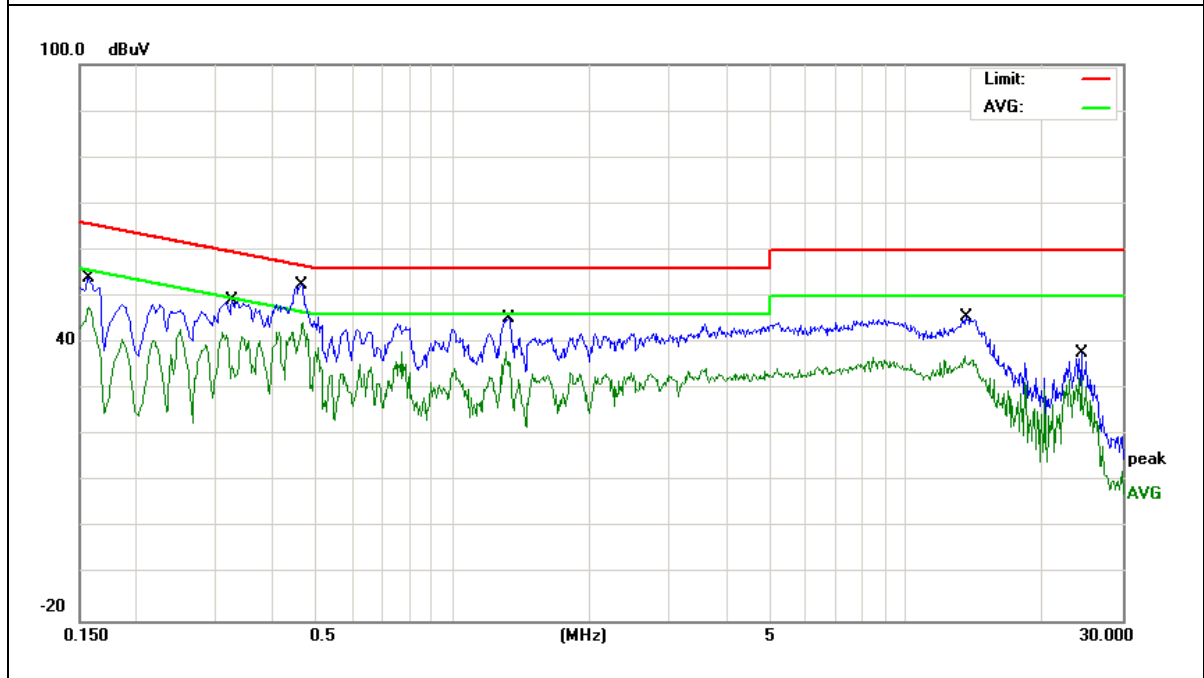

EUT :	Point to Point Wireless Device	Model Name :	B5x
Temperature :	26 °C	Relative Humidity :	54%
Pressure :	1010hPa	Phase :	N
Test Voltage :	DC 50V from PoE (AC 120V / 60Hz)	Test Mode :	Mode 1

Frequency (MHz)	Reading Level (dBμV)	Correct Factor (dB)	Measurement (dBμV)	Limits (dBμV)	Margin (dB)	Remark
0.1580	43.63	9.55	53.18	65.56	-12.38	QP
0.1580	36.27	9.55	45.82	55.56	-9.74	AVG
0.4858	43.79	9.54	53.33	56.24	-2.91	QP
0.4858	33.30	9.54	42.84	46.24	-3.40	AVG
1.3220	35.35	9.55	44.90	56.00	-11.10	QP
1.3220	26.67	9.55	36.22	46.00	-9.78	AVG
5.9179	34.92	9.63	44.55	60.00	-15.45	QP
5.9179	23.96	9.63	33.59	50.00	-16.41	AVG
13.8978	33.76	9.74	43.50	60.00	-16.50	QP
13.8978	24.85	9.74	34.59	50.00	-15.41	AVG
23.1299	28.60	9.91	38.51	60.00	-21.49	QP
23.1299	26.67	9.91	36.58	50.00	-13.42	AVG

Remark:

1. All readings are Quasi-Peak and Average values.
2. Factor = Insertion Loss + Cable Loss.

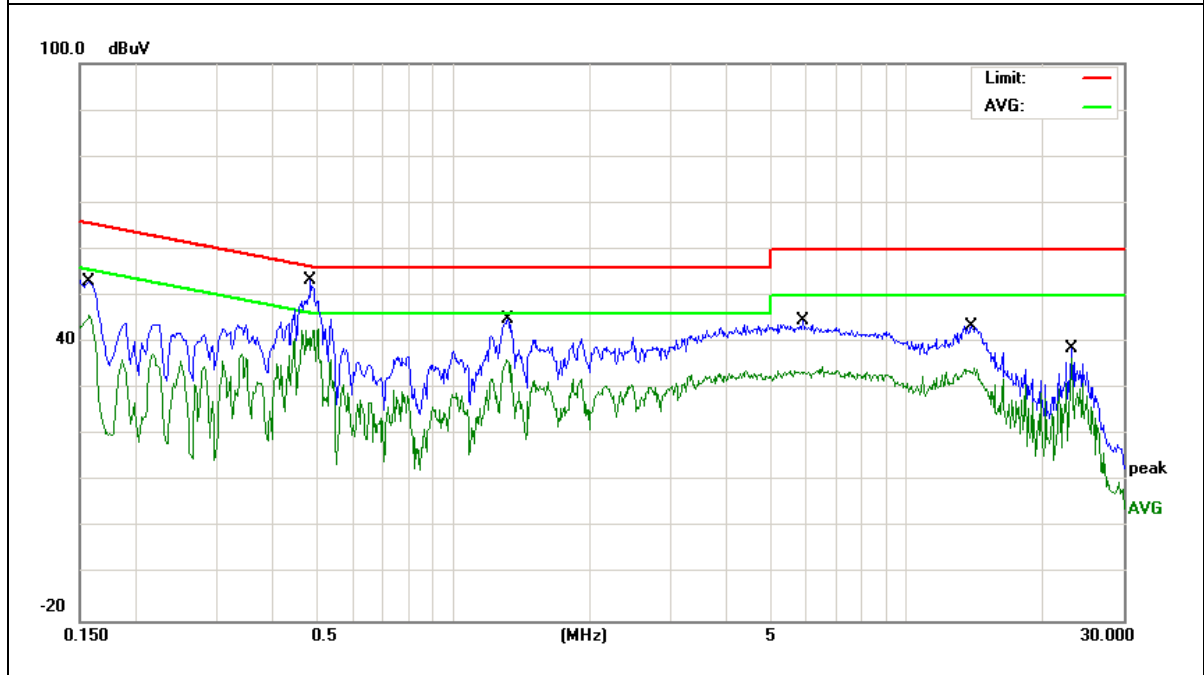

3.2 RADIATED EMISSION MEASUREMENT

3.2.1 APPLICABLE STANDARD

According to FCC Part 15.407(b) and 15.209

3.2.2 CONFORMANCE LIMIT

According to FCC Part 15.407(b)(7): radiated emissions which fall in the restricted bands, as defined in §15.205(a), must also comply with the radiated emission limits specified in §15.209(a) (see §15.205(c)).

According to FCC Part 15.205, Restricted bands

MHz	MHz	MHz	GHz
0.090-0.110	16.42-16.423	399.9-410	4.5-5.15
0.495-0.505	16.69475-16.69525	608-614	5.35-5.46
2.1735-2.1905	16.80425-16.80475	960-1240	7.25-7.75
4.125-4.128	25.5-25.67	1300-1427	8.025-8.5
4.17725-4.17775	37.5-38.25	1435-1626.5	9.0-9.2
4.20725-4.20775	73-74.6	1645.5-1646.5	9.3-9.5
6.215-6.218	74.8-75.2	1660-1710	10.6-12.7
6.26775-6.26825	123-138	2200-2300	14.47-14.5
8.291-8.294	149.9-150.05	2310-2390	15.35-16.2
8.362-8.366	156.52475-156.52525	2483.5-2500	17.7-21.4
8.37625-8.38675	156.7-156.9	2690-2900	22.01-23.12
8.41425-8.41475	162.0125-167.17	3260-3267	23.6-24.0
12.29-12.293	167.72-173.2	3332-3339	31.2-31.8
12.51975-12.52025	240-285	3345.8-3358	36.43-36.5
12.57675-12.57725	322-335.4	3600-4400	(2)
13.36-13.41			

20dBc in any 100 kHz bandwidth outside the operating frequency band. In case the emission fall within the restricted band specified on 15.205(a), then the 15.209(a) limit in the table below has to be followed.

Restricted Frequency(MHz)	Field Strength (µV/m)	Field Strength (dBµV/m)	Measurement Distance
0.009-0.490	2400/F(KHz)	20 log (uV/m)	300
0.490-1.705	24000/F(KHz)	20 log (uV/m)	30
1.705-30.0	30	29.5	30
30-88	100	40	3
88-216	150	43.5	3
216-960	200	46	3
Above 960	500	54	3

Limits of Radiated Emission Measurement(Above 1000MHz)

Frequency(MHz)	Class B (dBuV/m) (at 3M)	
	PEAK	AVERAGE
Above 1000	74	54

- Remark : 1. Emission level in dBuV/m=20 log (uV/m)
 2. Measurement was performed at an antenna to the closed point of EUT distance of meters.
 3. For Frequency 9kHz~30MHz:
 Distance extrapolation factor =40log(Specific distance/ test distance)(dB);
 Limit line=Specific limits(dBuV) + distance extrapolation factor.
 For Frequency above 30MHz:
 Distance extrapolation factor =20log(Specific distance/ test distance)(dB);
 Limit line=Specific limits(dBuV) + distance extrapolation factor.

3.2.3 MEASURING INSTRUMENTS

The Measuring equipment is listed in the section 6.3 of this test report.

3.2.4 TEST CONFIGURATION

(a) For radiated emissions below 30MHz

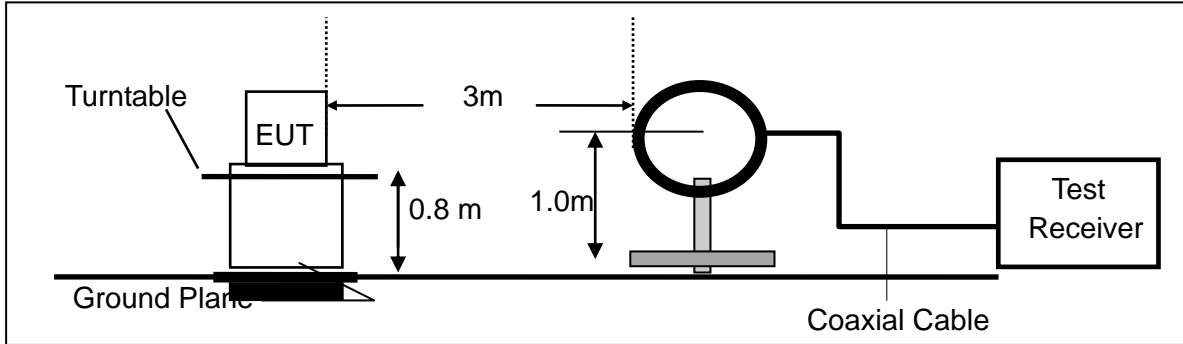

(b) For radiated emissions from 30MHz to 1000MHz

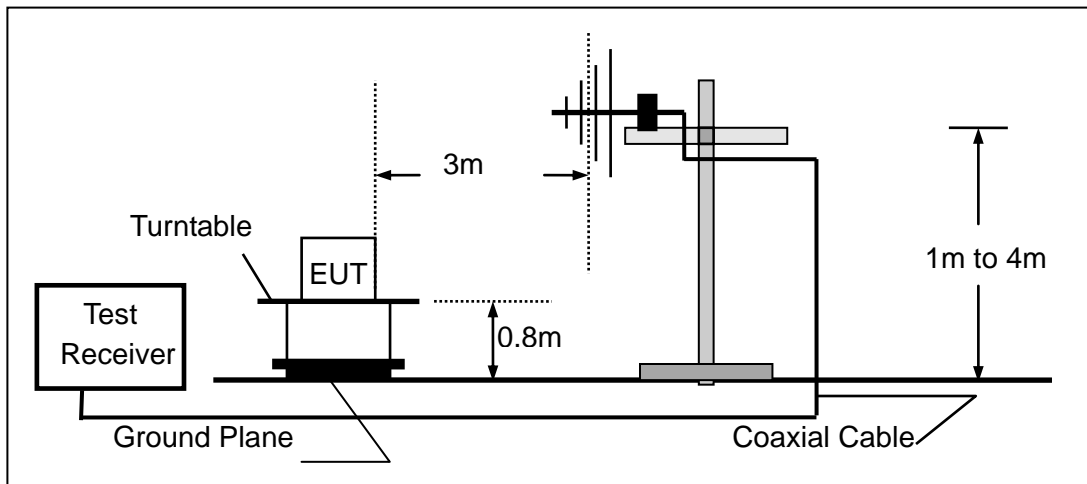

(c) For radiated emissions above 1000MHz

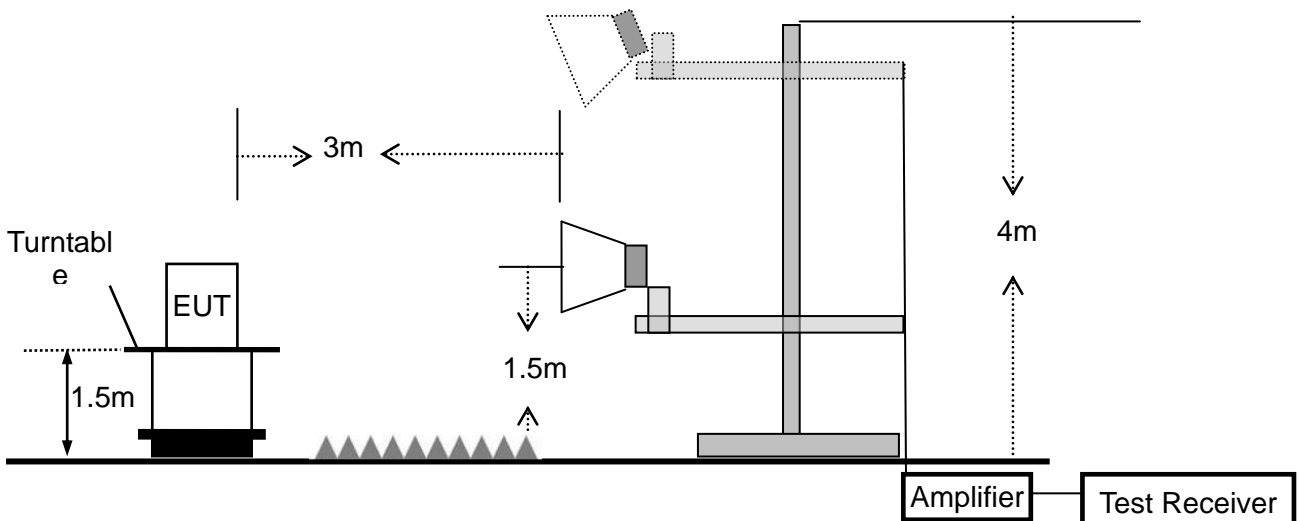

3.2.5 TEST PROCEDURE

The test site semi-anechoic chamber has met the requirement of NSA tolerance 4 dB according to the standards: ANSI C63.10-2013. The test distance is 3m. The setup is according to the requirements in Section 13.1.4.1 of ANSI C63.10-2013 and CAN/CSA-CEI/IEC CISPR 22.

This test is required for any spurious emission that falls in a Restricted Band, as defined in Section 15.205. It must be performed with the highest gain of each type of antenna proposed for use with the EUT.

Use the following spectrum analyzer settings:

Spectrum Parameter	Setting
Attenuation	Auto
Start Frequency	1000 MHz
Stop Frequency	10th carrier harmonic
RB / VB (emission in restricted band)	1 MHz / 1 MHz for Peak, 1 MHz / 1MHz for Average

Receiver Parameter	Setting
Attenuation	Auto
Start ~ Stop Frequency	9kHz~150kHz / RB 200Hz for QP
Start ~ Stop Frequency	150kHz~30MHz / RB 9kHz for QP
Start ~ Stop Frequency	30MHz~1000MHz / RB 120kHz for QP

- a. The measuring distance of at 3 m shall be used for measurements at frequency up to 1GHz. For frequencies above 1GHz, any suitable measuring distance may be used.
- b. The EUT was placed on the top of a rotating table 0.8 m for below 1GHz and 1.5m for above 1GHz the ground at a 3 meter. The table was rotated 360 degrees to determine the position of the highest radiation.
- c. The height of the equipment or of the substitution antenna shall be 0.8 m for below 1GHz and 1.5m for above 1GHz; the height of the test antenna shall vary between 1 m to 4 m. Both horizontal and vertical polarizations of the antenna are set to make the measurement.
- d. The initial step in collecting conducted emission data is a spectrum analyzer peak detector mode pre-scanning the measurement frequency range. Significant peaks are then marked and then Quasi Peak detector mode re-measured.
- e. If the Peak Mode measured value compliance with and lower than Quasi Peak Mode Limit, the EUT shall be deemed to meet QP Limits and then no additional QP Mode measurement performed.
- f. For the actual test configuration, please refer to the related Item –EUT Test Photos.

Note:

Both horizontal and vertical antenna polarities were tested and performed pretest to three orthogonal axis. The worst case emissions were reported

During the radiated emission test, the Spectrum Analyzer was set with the following configurations:

Frequency Band (MHz)	Function	Resolution bandwidth	Video Bandwidth
30 to 1000	QP	120 kHz	300 kHz
Above 1000	Peak	1 MHz	1 MHz
	Average	1 MHz	1 MHz

Note: for the frequency ranges below 30 MHz, a narrower RBW is used for these ranges but the measured value should add a RBW correction factor (RBWCF) where $RBWCF [dB] = 10 * \lg(100 [kHz] / \text{narrower RBW [kHz]})$. , the narrower RBW is 1 kHz and RBWCF is 20 dB for the frequency 9 kHz to 150 kHz, and the narrower RBW is 10 kHz and RBWCF is 10 dB for the frequency 150 kHz to 30 MHz.

3.2.6 TEST RESULTS (9KHZ – 30 MHZ)

EUT:	Point to Point Wireless Device	Model Name. :	B5x
Temperature:	20 °C	Relative Humidity:	48%
Pressure:	1010 hPa	Test Voltage :	DC 50V
Test Mode :	TX	Polarization :	--

Freq. (MHz)	Reading (dBuV/m)	Limit (dBuV/m)	Margin (dB)	State P/F
--	--	--	--	N/A
--	--	--	--	N/A

NOTE:

The amplitude of spurious emissions which are attenuated by more than 20dB below the permissible value has no need to be reported.

3.2.7 TEST RESULTS (30MHZ – 1GHZ)

EUT :	Point to Point Wireless Device	Model Name. :	B5x
Temperature :	20 °C	Relative Humidity :	48%
Pressure :	1010 hPa	Test Voltage :	DC 50V
Test Mode :	Mode 2 (5.2G ac20 CH36 - 8dBi Antenna - outdoor AP)		

Polar (H/V)	Frequency	Meter Reading	Factor	Emission Level	Limits	Margin	Remark
	(MHz)	(dBuV)	(dB)	(dBuV/m)	(dBuV/m)	(dB)	
V	42.8997	7.41	11.53	18.94	40.00	-21.06	QP
V	96.4361	7.05	10.49	17.54	43.50	-25.96	QP
V	142.8243	6.10	12.78	18.88	43.50	-24.62	QP
V	269.4284	6.32	15.33	21.65	46.00	-24.35	QP
V	511.8351	6.19	20.80	26.99	46.00	-19.01	QP
V	716.6820	8.15	23.84	31.99	46.00	-14.01	QP

Remark:

Emission Level = Meter Reading + Factor, Margin= Emission Level - Limit

All modes have been tested, just the 802.11ac20 CH36 MIMO worst mode has been recorded in the report.

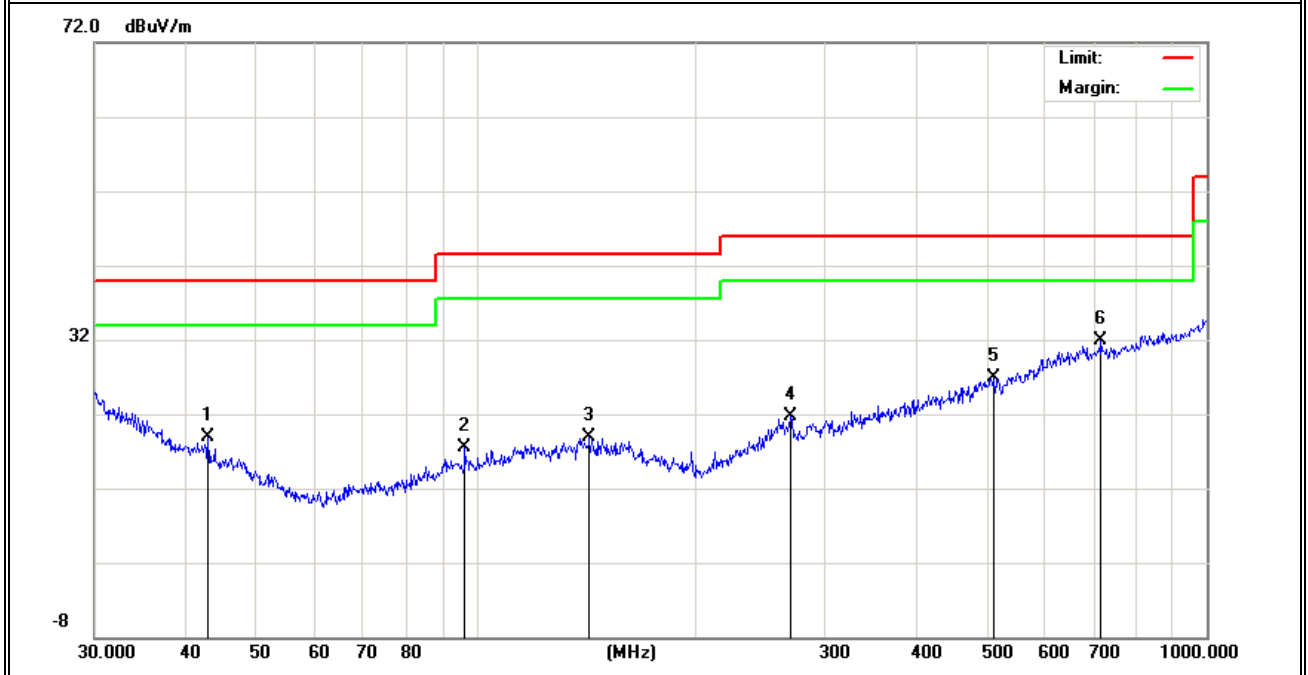

Polar (H/V)	Frequency	Meter Reading	Factor	Emission Level	Limits	Margin	Remark
	(MHz)	(dBuV)	(dB)	(dBuV/m)	(dBuV/m)	(dB)	
H	30.7454	6.55	18.63	25.18	40.00	-14.82	QP
H	53.5052	9.24	7.33	16.57	40.00	-23.43	QP
H	137.9028	6.85	12.92	19.77	43.50	-23.73	QP
H	271.3246	5.81	14.97	20.78	46.00	-25.22	QP
H	790.6186	7.43	24.98	32.41	46.00	-13.59	QP
H	890.7278	7.95	26.21	34.16	46.00	-11.84	QP

Remark:

Emission Level = Meter Reading + Factor, Margin= Emission Level - Limit

All modes have been tested, just the 802.11ac20 CH36 MIMO worst mode has been recorded in the report.

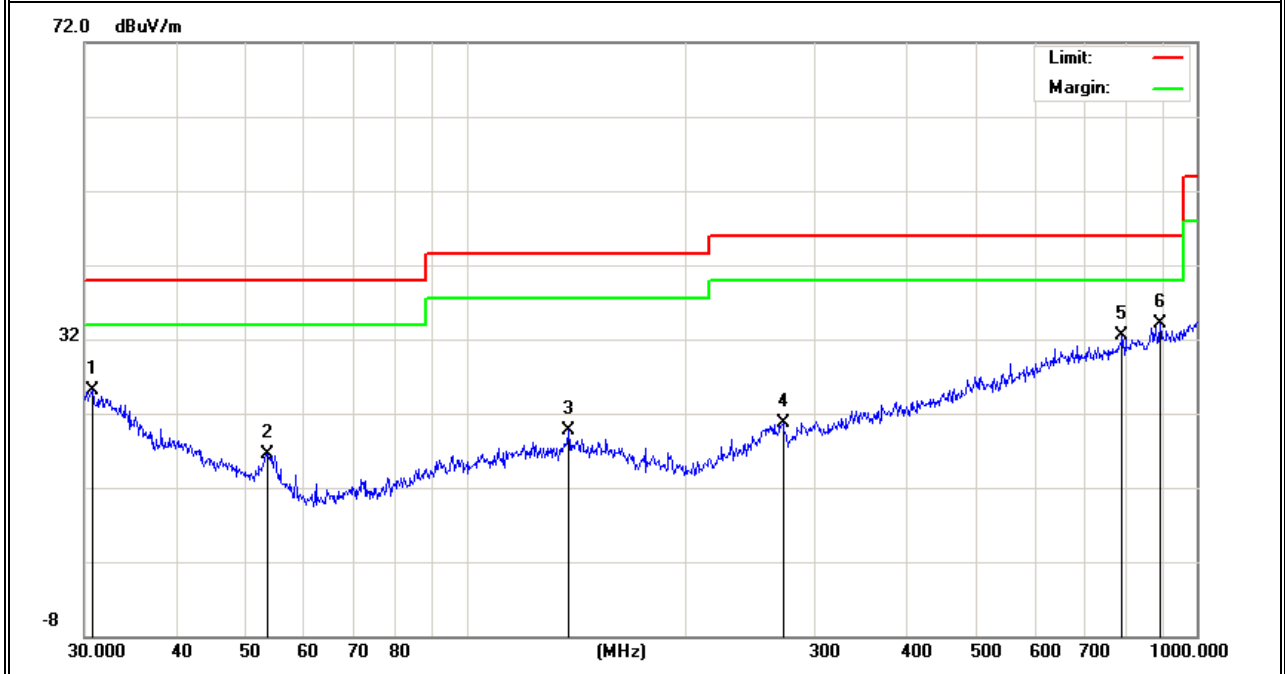

EUT :	Point to Point Wireless Device	Model Name. :	B5x
Temperature :	20 °C	Relative Humidity :	48%
Pressure :	1010 hPa	Test Voltage :	DC 50V
Test Mode :	Mode 2 (5.2G ac20 CH36 - 25dBi Antenna - outdoor AP)		

Polar (H/V)	Frequency	Meter Reading	Factor	Emission Level	Limits	Margin	Remark
	(MHz)	(dBuV)	(dB)	(dBuV/m)	(dBuV/m)	(dB)	
V	31.0704	5.38	18.28	23.66	40.00	-16.34	QP
V	141.8262	5.69	12.94	18.63	43.50	-24.87	QP
V	162.0414	6.67	12.01	18.68	43.50	-24.82	QP
V	261.0583	5.92	15.20	21.12	46.00	-24.88	QP
V	916.0687	7.37	26.34	33.71	46.00	-12.29	QP
V	986.0715	8.24	27.73	35.97	54.00	-18.03	QP

Remark:

Emission Level = Meter Reading + Factor, Margin= Emission Level - Limit

All modes have been tested, just the 802.11ac20 CH36 MIMO worst mode has been recorded in the report.

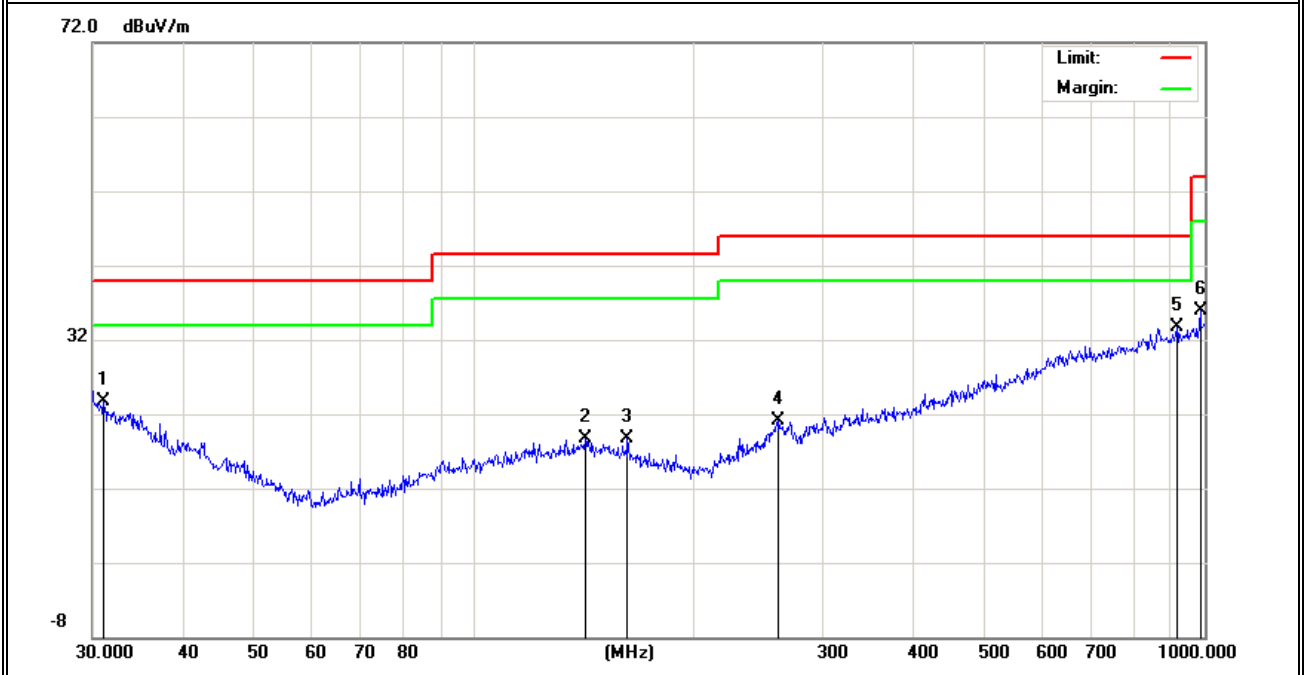

Polar (H/V)	Frequency	Meter Reading	Factor	Emission Level	Limits	Margin	Remark
	(MHz)	(dBuV)	(dB)	(dBuV/m)	(dBuV/m)	(dB)	
H	31.5093	7.46	17.81	25.27	40.00	-14.73	QP
H	53.5052	10.16	7.33	17.49	40.00	-22.51	QP
H	116.1321	15.59	12.01	27.60	43.50	-15.90	QP
H	230.9068	11.46	11.97	23.43	46.00	-22.57	QP
H	319.9370	8.07	15.86	23.93	46.00	-22.07	QP
H	407.5145	6.55	17.94	24.49	46.00	-21.51	QP

Remark:

Emission Level = Meter Reading + Factor, Margin= Emission Level - Limit

All modes have been tested, just the 802.11ac20 CH36 MIMO worst mode has been recorded in the report.

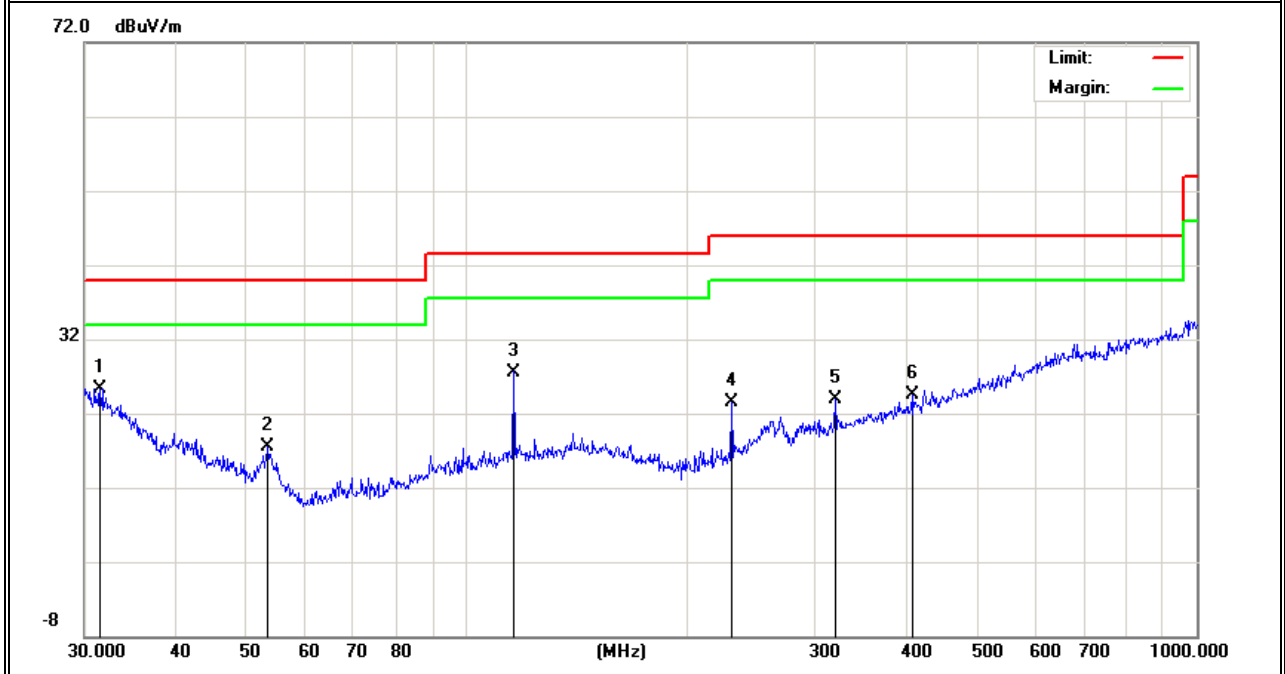

EUT :	Point to Point Wireless Device	Model Name. :	B5x
Temperature :	20 °C	Relative Humidity :	48%
Pressure :	1010 hPa	Test Voltage :	DC 50V
Test Mode :	Mode 2 (5.2G ac20 CH36 - 8dBi Antenna - point-to-point)		

Polar (H/V)	Frequency	Meter Reading	Factor	Emission Level	Limits	Margin	Remark
	(MHz)	(dBuV)	(dB)	(dBuV/m)	(dBuV/m)	(dB)	
V	35.3750	6.27	15.34	21.61	40.00	-18.39	QP
V	115.3204	6.52	11.95	18.47	43.50	-25.03	QP
V	154.8204	6.79	12.19	18.98	43.50	-24.52	QP
V	272.2776	5.90	14.67	20.57	46.00	-25.43	QP
V	863.0561	7.73	26.25	33.98	46.00	-12.02	QP
V	993.0113	7.03	28.01	35.04	54.00	-18.96	QP

Remark:

Emission Level = Meter Reading + Factor, Margin= Emission Level - Limit

All modes have been tested, just the 802.11ac20 CH36 MIMO worst mode has been recorded in the report.

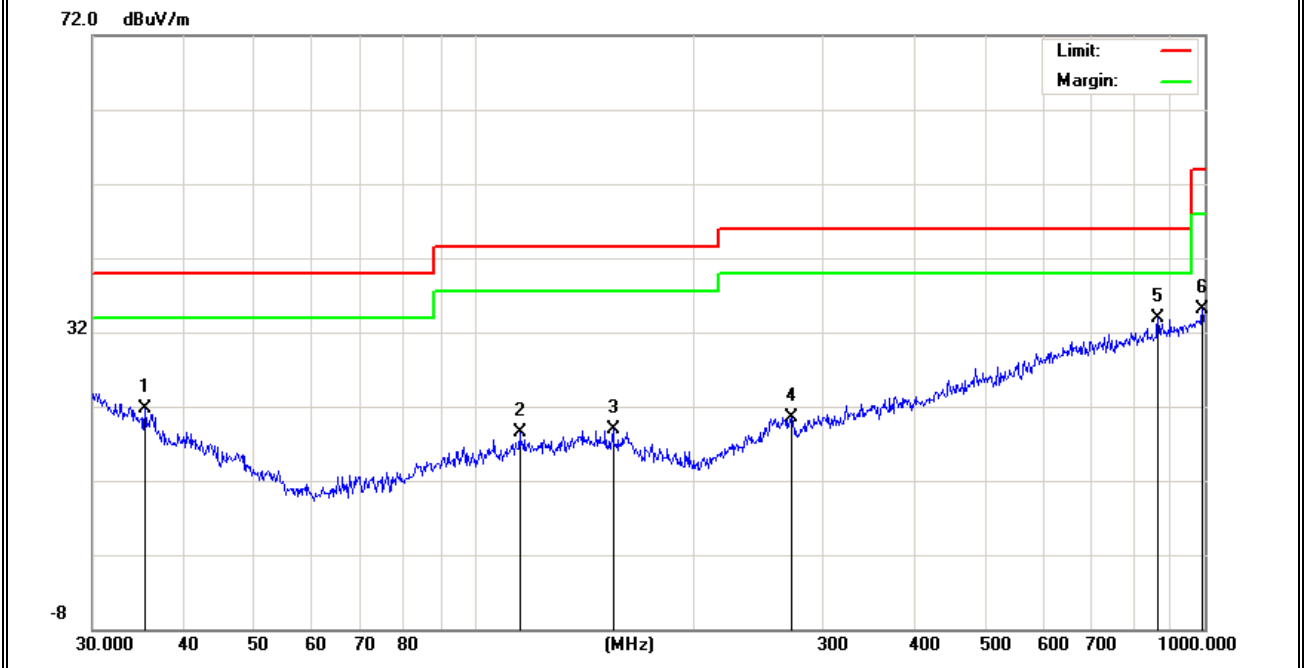

Polar (H/V)	Frequency	Meter Reading	Factor	Emission Level	Limits	Margin	Remark
	(MHz)	(dBuV)	(dB)	(dBuV/m)	(dBuV/m)	(dB)	
H	32.4059	7.96	17.07	25.03	40.00	-14.97	QP
H	42.1542	6.99	11.92	18.91	40.00	-21.09	QP
H	52.7599	9.17	7.74	16.91	40.00	-23.09	QP
H	158.1123	6.20	12.25	18.45	43.50	-25.05	QP
H	269.4284	5.63	15.33	20.96	46.00	-25.04	QP
H	821.7103	7.58	25.65	33.23	46.00	-12.77	QP

Remark:

Emission Level = Meter Reading + Factor, Margin= Emission Level - Limit

All modes have been tested, just the 802.11ac20 CH36 MIMO worst mode has been recorded in the report.

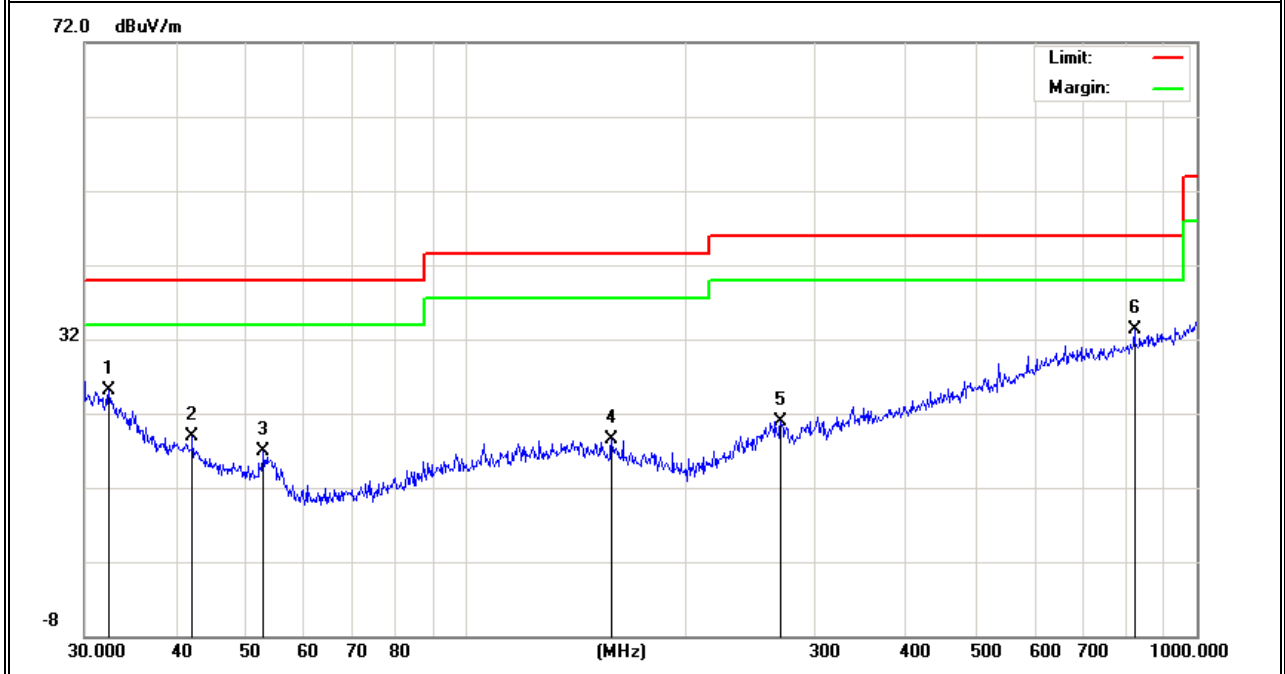

EUT :	Point to Point Wireless Device	Model Name. :	B5x
Temperature :	20 °C	Relative Humidity :	48%
Pressure :	1010 hPa	Test Voltage :	DC 50V
Test Mode :	Mode 2 (5.2G ac20 CH36 - 25dBi Antenna - point-to-point)		

Polar (H/V)	Frequency	Meter Reading	Factor	Emission Level	Limits	Margin	Remark
	(MHz)	(dBuV)	(dB)	(dBuV/m)	(dBuV/m)	(dB)	
V	31.3992	6.85	17.93	24.78	40.00	-15.22	QP
V	52.5752	9.17	7.84	17.01	40.00	-22.99	QP
V	104.9033	10.44	11.28	21.72	43.50	-21.78	QP
V	292.0583	6.59	14.97	21.56	46.00	-24.44	QP
V	810.2653	7.54	25.52	33.06	46.00	-12.94	QP
V	979.1802	7.12	27.52	34.64	54.00	-19.36	QP

Remark:

Emission Level = Meter Reading + Factor, Margin= Emission Level - Limit

All modes have been tested, just the 802.11ac20 CH36 MIMO worst mode has been recorded in the report.

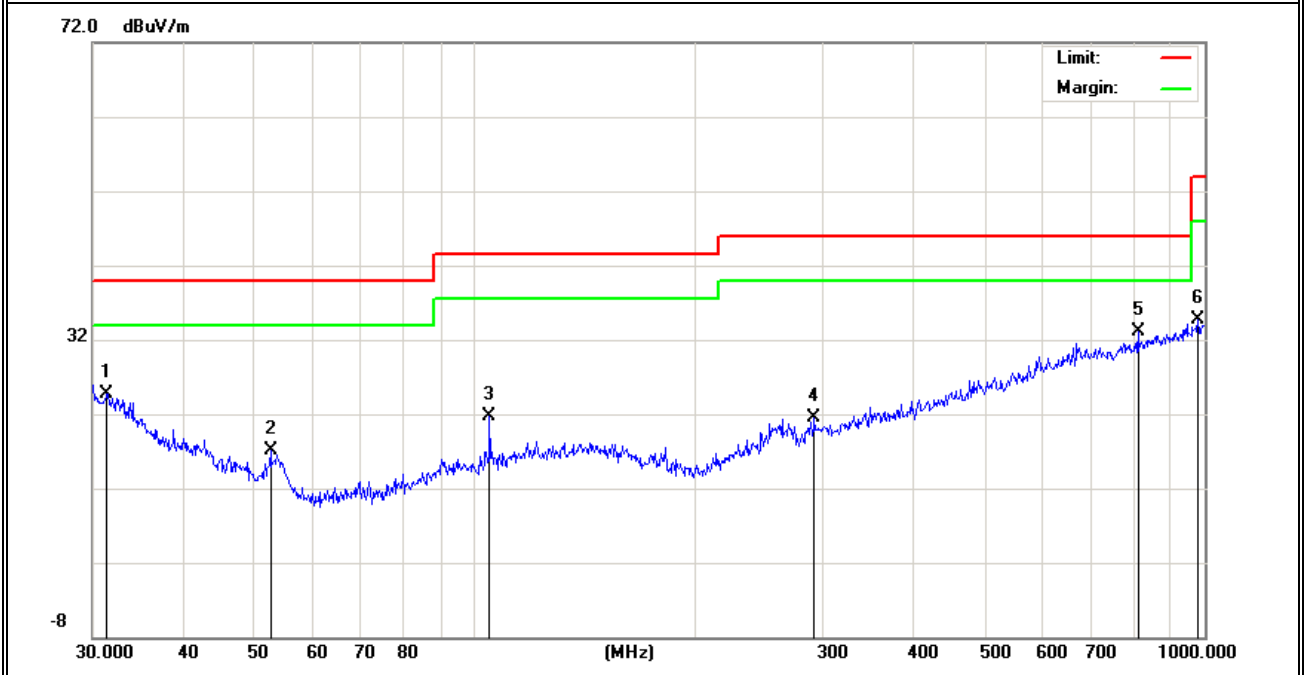

Polar (H/V)	Frequency	Meter Reading	Factor	Emission Level	Limits	Margin	Remark
	(MHz)	(dBuV)	(dB)	(dBuV/m)	(dBuV/m)	(dB)	
H	31.1798	5.93	18.16	24.09	40.00	-15.91	QP
H	34.7601	7.17	15.75	22.92	40.00	-17.08	QP
H	140.8351	6.14	13.09	19.23	43.50	-24.27	QP
H	269.4284	6.03	15.33	21.36	46.00	-24.64	QP
H	900.1473	7.10	26.41	33.51	46.00	-12.49	QP
H	982.6200	7.11	27.63	34.74	54.00	-19.26	QP

Remark:

Emission Level = Meter Reading + Factor, Margin= Emission Level - Limit

All modes have been tested, just the 802.11ac20 CH36 MIMO worst mode has been recorded in the report.

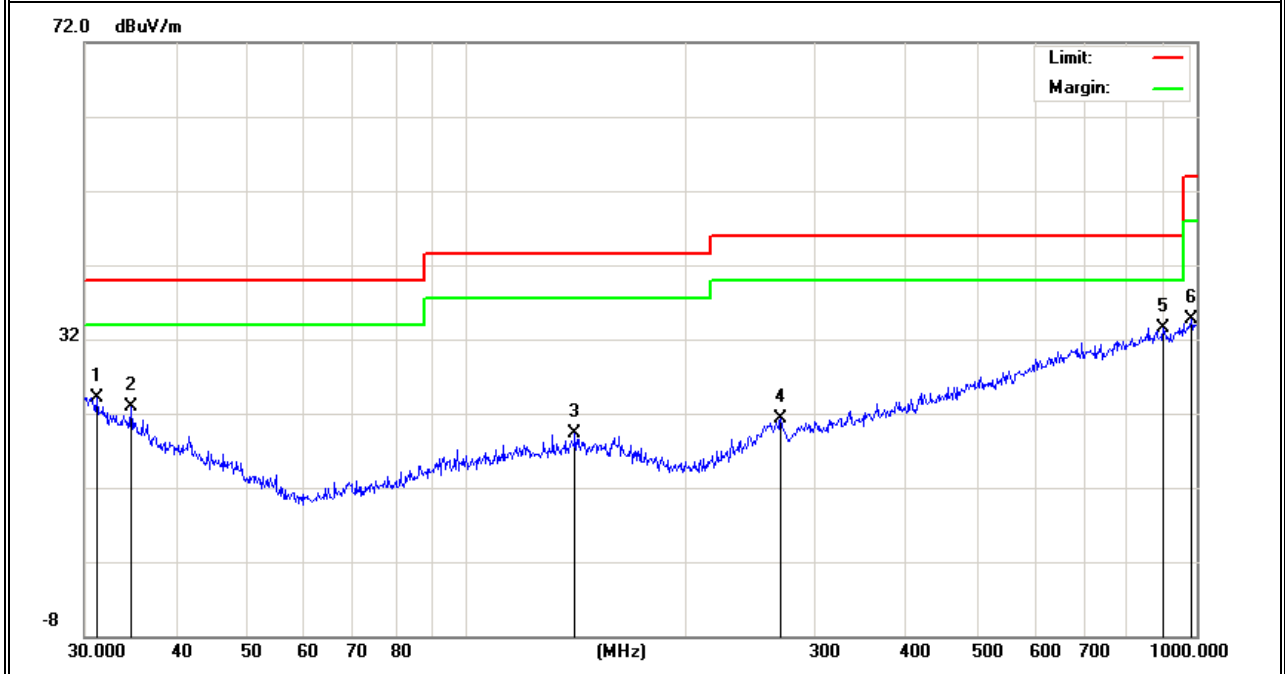

EUT :	Point to Point Wireless Device	Model Name. :	B5x
Temperature :	20 °C	Relative Humidity :	48%
Pressure :	1010 hPa	Test Voltage :	DC 50V
Test Mode :	Mode 2 (5.3G ac20 CH64 - 8dBi Antenna)		

Polar (H/V)	Frequency	Meter Reading	Factor	Emission Level	Limits	Margin	Remark
	(MHz)	(dBuV)	(dB)	(dBuV/m)	(dBuV/m)	(dB)	
V	30.5304	5.51	18.87	24.38	40.00	-15.62	QP
V	141.3298	6.55	13.02	19.57	43.50	-23.93	QP
V	261.0581	5.75	15.20	20.95	46.00	-25.05	QP
V	314.3765	5.89	15.41	21.30	46.00	-24.70	QP
V	682.3483	7.29	23.71	31.00	46.00	-15.00	QP
V	842.1295	7.52	25.78	33.30	46.00	-12.70	QP

Remark:

Emission Level = Meter Reading + Factor, Margin= Emission Level - Limit

All modes have been tested, just the 802.11ac20 CH64 MIMO worst mode has been recorded in the report.

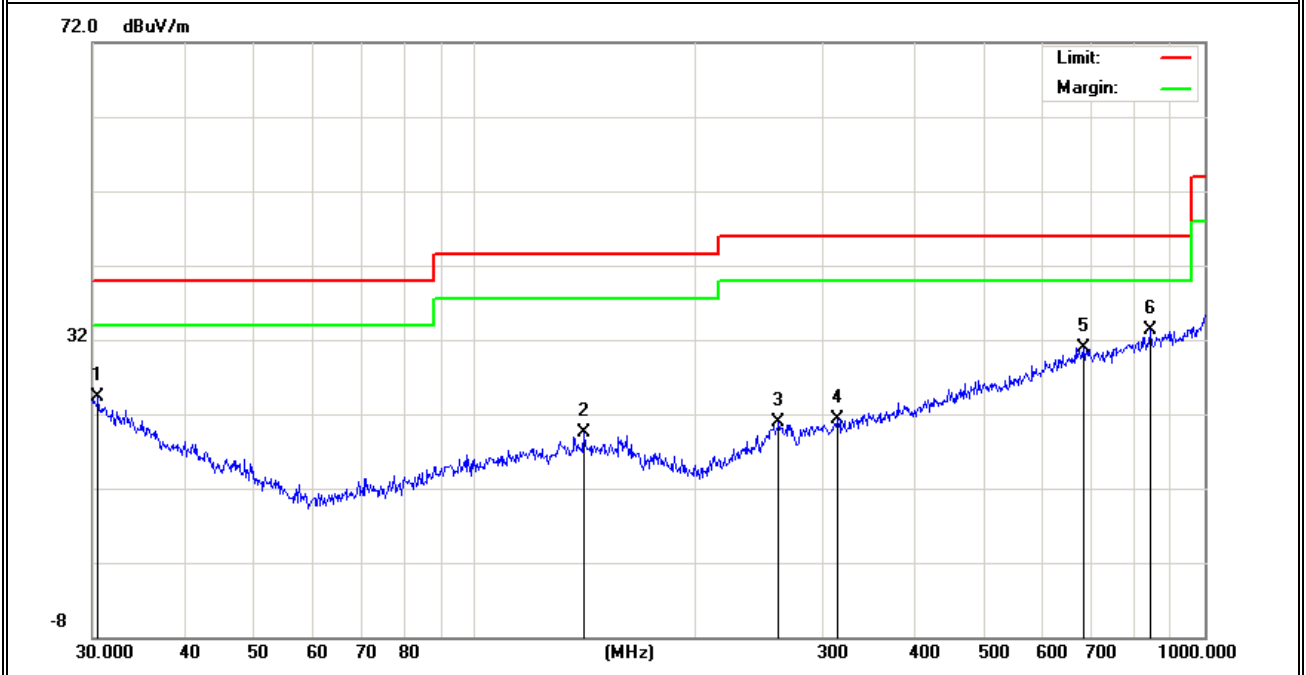

Polar (H/V)	Frequency	Meter Reading	Factor	Emission Level	Limits	Margin	Remark
	(MHz)	(dBuV)	(dB)	(dBuV/m)	(dBuV/m)	(dB)	
H	31.5092	7.46	17.81	25.27	40.00	-14.73	QP
H	53.8817	10.10	7.13	17.23	40.00	-22.77	QP
H	134.5592	7.58	12.47	20.05	43.50	-23.45	QP
H	301.4224	7.77	15.30	23.07	46.00	-22.93	QP
H	508.2581	6.37	20.81	27.18	46.00	-18.82	QP
H	679.9600	8.00	23.73	31.73	46.00	-14.27	QP

Remark:

Emission Level = Meter Reading + Factor, Margin= Emission Level - Limit

All modes have been tested, just the 802.11ac20 CH64 MIMO worst mode has been recorded in the report.

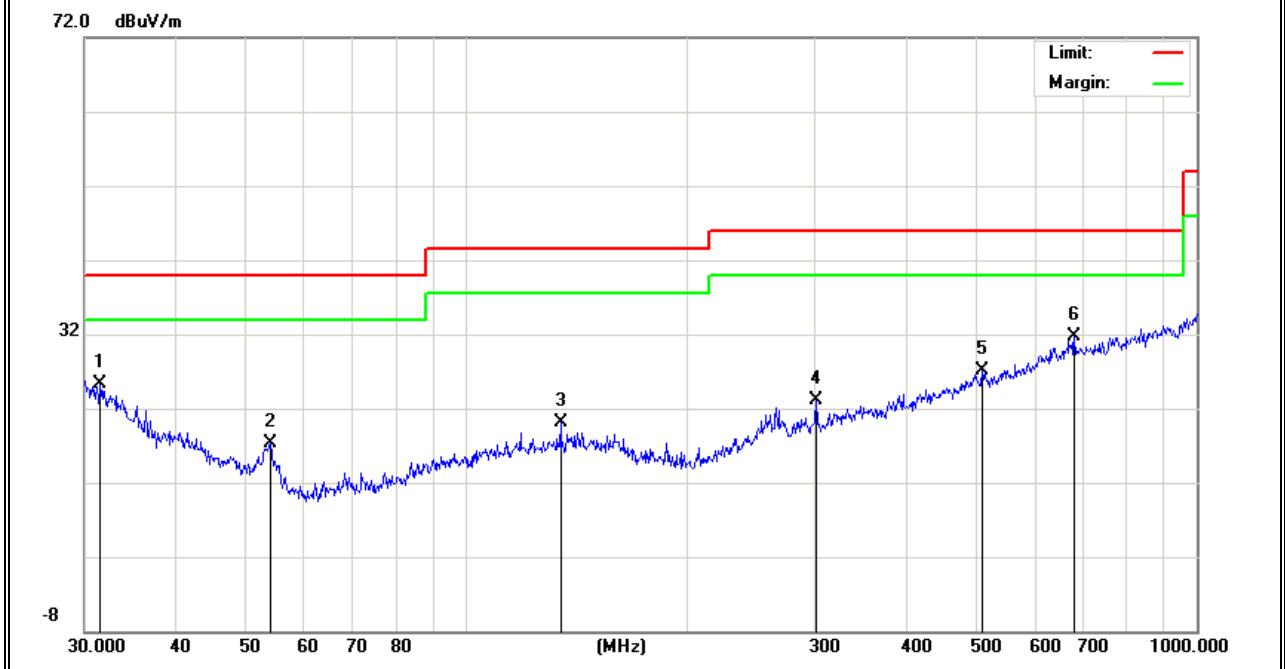

EUT :	Point to Point Wireless Device	Model Name. :	B5x
Temperature :	20 °C	Relative Humidity :	48%
Pressure :	1010 hPa	Test Voltage :	DC 50V
Test Mode :	Mode 2 (5.3G ac20 CH64 - 25dBi Antenna)		

Polar (H/V)	Frequency	Meter Reading	Factor	Emission Level	Limits	Margin	Remark
	(MHz)	(dBuV)	(dB)	(dBuV/m)	(dBuV/m)	(dB)	
V	30.4237	6.31	18.98	25.29	40.00	-14.71	QP
V	33.6802	7.79	16.39	24.18	40.00	-15.82	QP
V	53.3179	10.33	7.44	17.77	40.00	-22.23	QP
V	140.3421	5.69	13.16	18.85	43.50	-24.65	QP
V	182.5592	13.20	10.41	23.61	43.50	-19.89	QP
V	699.3046	7.65	23.74	31.39	46.00	-14.61	QP

Remark:

Emission Level = Meter Reading + Factor, Margin= Emission Level - Limit

All modes have been tested, just the 802.11ac20 CH64 MIMO worst mode has been recorded in the report.

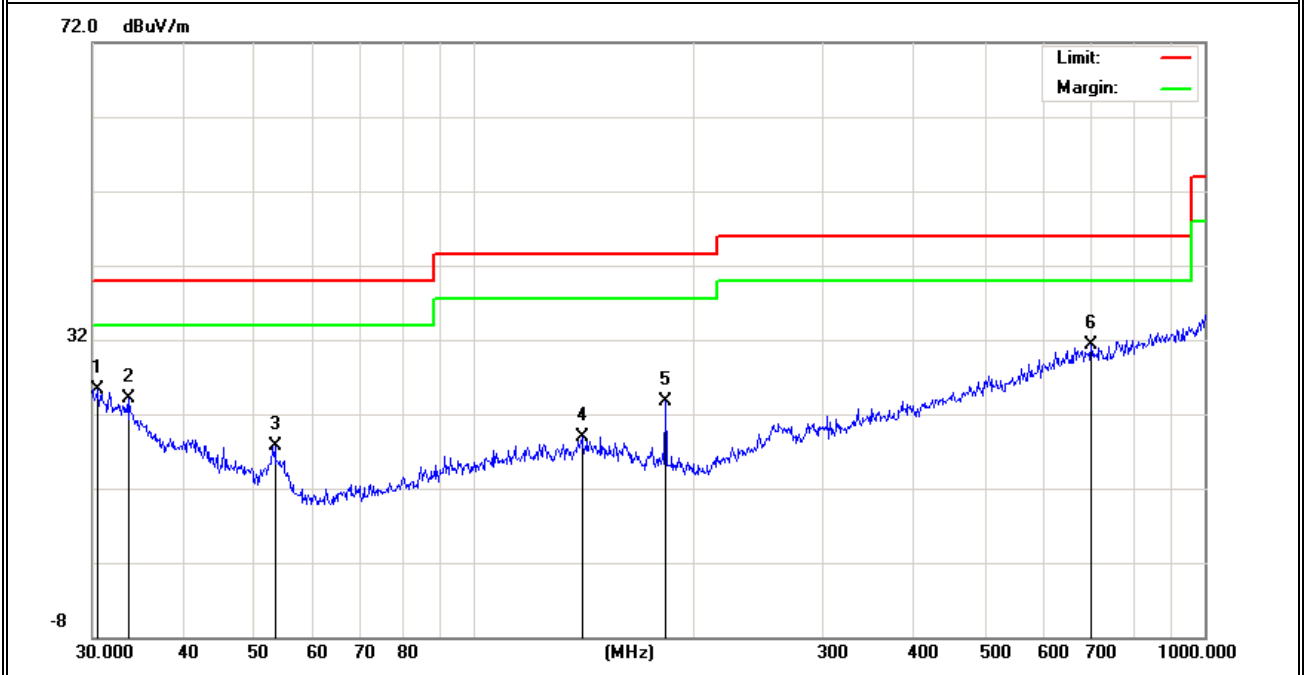

Polar (H/V)	Frequency	Meter Reading	Factor	Emission Level	Limits	Margin	Remark
	(MHz)	(dBuV)	(dB)	(dBuV/m)	(dBuV/m)	(dB)	
H	32.0667	7.36	17.24	24.60	40.00	-15.40	QP
H	53.6931	9.02	7.23	16.25	40.00	-23.75	QP
H	143.8295	6.23	12.63	18.86	43.50	-24.64	QP
H	224.5192	9.74	11.52	21.26	46.00	-24.74	QP
H	296.1836	12.91	14.87	27.78	46.00	-18.22	QP
H	701.7607	8.03	23.75	31.78	46.00	-14.22	QP

Remark:

Emission Level = Meter Reading + Factor, Margin= Emission Level - Limit

All modes have been tested, just the 802.11ac20 CH64 MIMO worst mode has been recorded in the report.

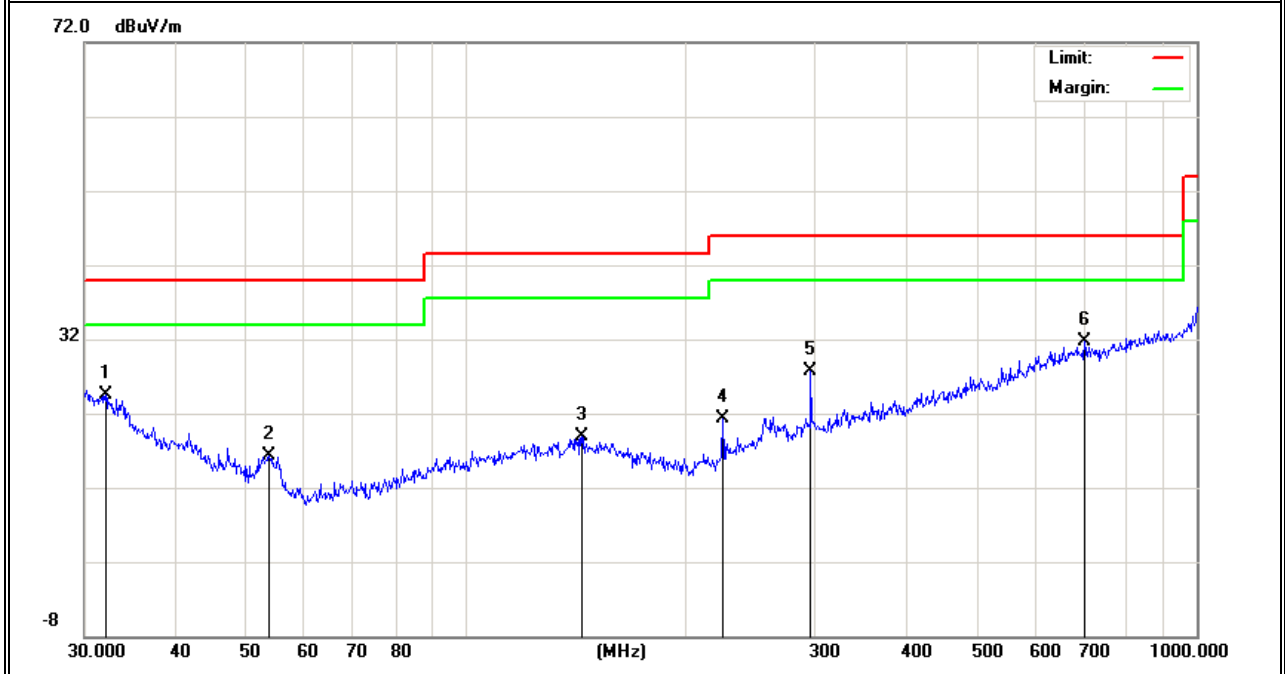

EUT :	Point to Point Wireless Device	Model Name. :	B5x
Temperature :	20 °C	Relative Humidity :	48%
Pressure :	1010 hPa	Test Voltage :	DC 50V
Test Mode :	Mode 2 (5.6G ac20 CH100 - 8dBi Antenna)		

Polar (H/V)	Frequency	Meter Reading	Factor	Emission Level	Limits	Margin	Remark
	(MHz)	(dBuV)	(dB)	(dBuV/m)	(dBuV/m)	(dB)	
V	31.7313	7.51	17.57	25.08	40.00	-14.92	QP
V	53.3179	9.44	7.44	16.88	40.00	-23.12	QP
V	71.8319	7.62	6.99	14.61	40.00	-25.39	QP
V	166.0680	7.09	11.42	18.51	43.50	-24.99	QP
V	270.3748	5.34	15.27	20.61	46.00	-25.39	QP
V	919.2866	7.53	26.34	33.87	46.00	-12.13	QP

Remark:

Emission Level = Meter Reading + Factor, Margin= Emission Level - Limit

All modes have been tested, just the 802.11ac20 CH100 MIMO worst mode has been recorded in the report.

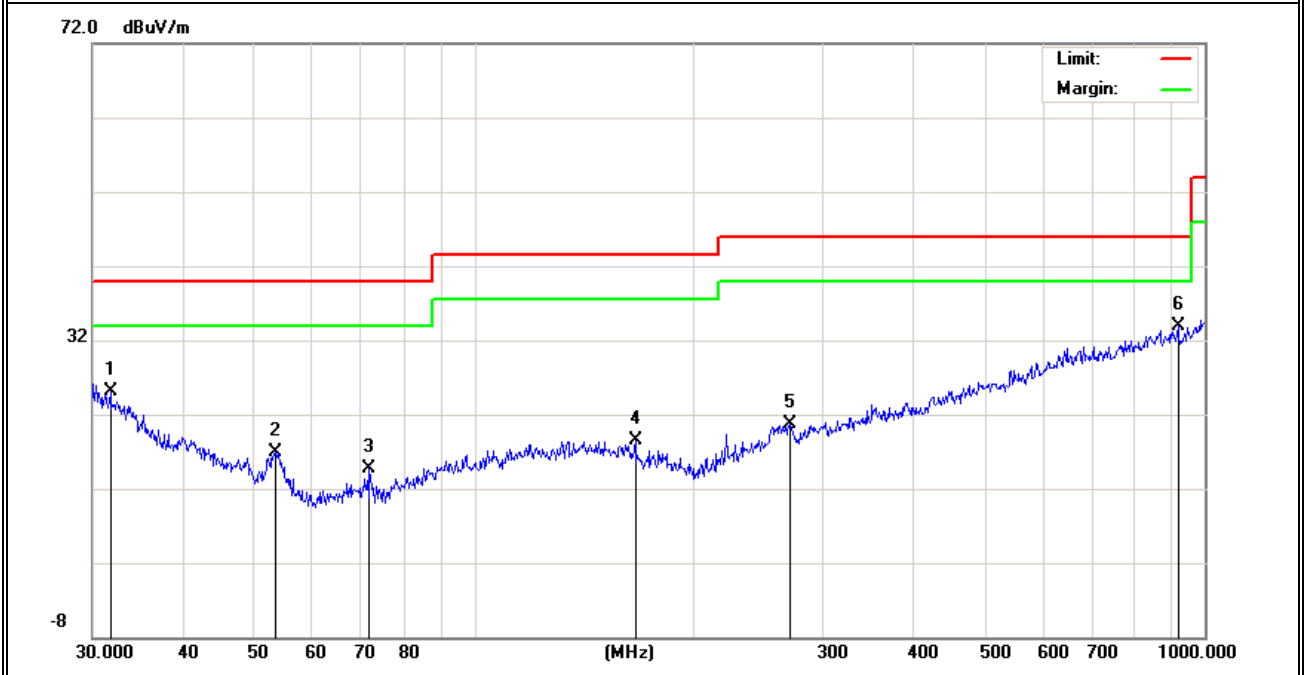

Polar (H/V)	Frequency	Meter Reading	Factor	Emission Level	Limits	Margin	Remark
	(MHz)	(dBuV)	(dB)	(dBuV/m)	(dBuV/m)	(dB)	
H	34.7601	7.56	15.75	23.31	40.00	-16.69	QP
H	137.9028	6.37	12.92	19.29	43.50	-24.21	QP
H	318.8170	6.20	15.78	21.98	46.00	-24.02	QP
H	510.0436	7.13	20.86	27.99	46.00	-18.01	QP
H	771.4486	7.78	24.77	32.55	46.00	-13.45	QP
H	906.4823	7.64	26.36	34.00	46.00	-12.00	QP

Remark:

Emission Level = Meter Reading + Factor, Margin= Emission Level - Limit

All modes have been tested, just the 802.11ac20 CH100 MIMO worst mode has been recorded in the report.

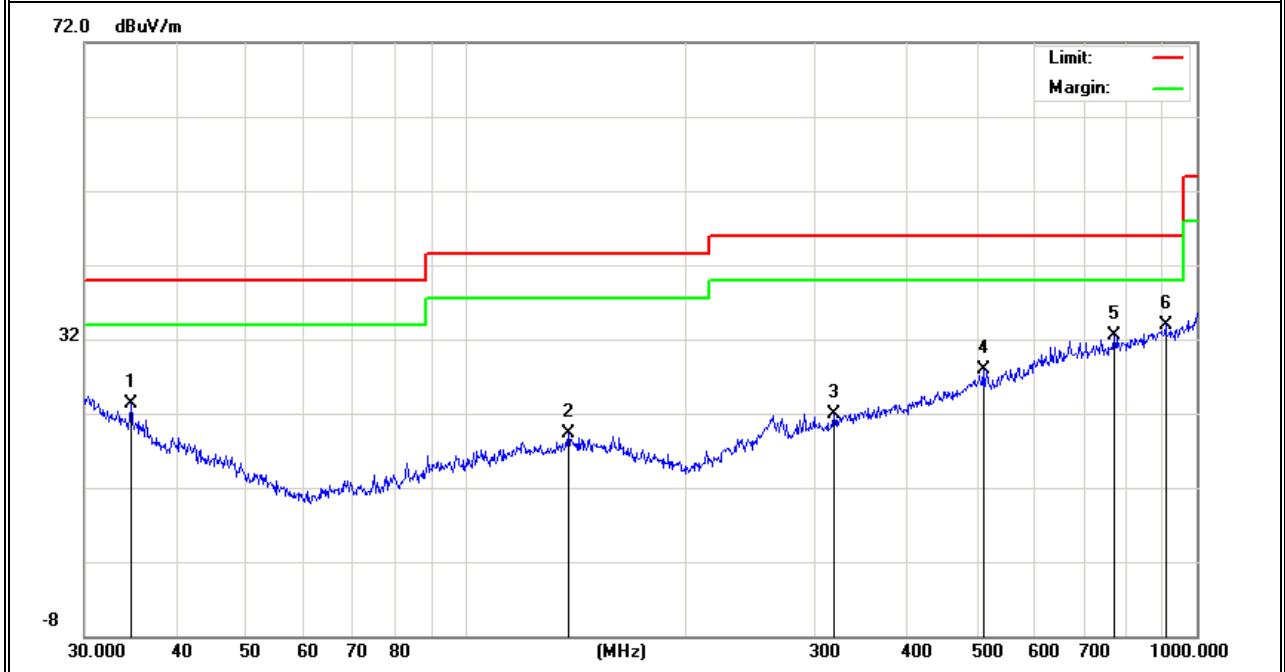

EUT :	Point to Point Wireless Device	Model Name. :	B5x
Temperature :	20 °C	Relative Humidity :	48%
Pressure :	1010 hPa	Test Voltage :	DC 50V
Test Mode :	Mode 2 (5.6G ac20 CH100 - 25dBi Antenna)		

Polar (H/V)	Frequency	Meter Reading	Factor	Emission Level	Limits	Margin	Remark
	(MHz)	(dBuV)	(dB)	(dBuV/m)	(dBuV/m)	(dB)	
V	30.7454	5.32	18.63	23.95	40.00	-16.05	QP
V	35.4992	6.54	15.26	21.80	40.00	-18.20	QP
V	162.0414	7.49	12.01	19.50	43.50	-24.00	QP
V	258.3264	6.22	15.14	21.36	46.00	-24.64	QP
V	763.3757	7.49	24.67	32.16	46.00	-13.84	QP
V	945.4397	7.36	26.84	34.20	46.00	-11.80	QP

Remark:

Emission Level = Meter Reading + Factor, Margin= Emission Level - Limit

All modes have been tested, just the 802.11ac20 CH100 MIMO worst mode has been recorded in the report.

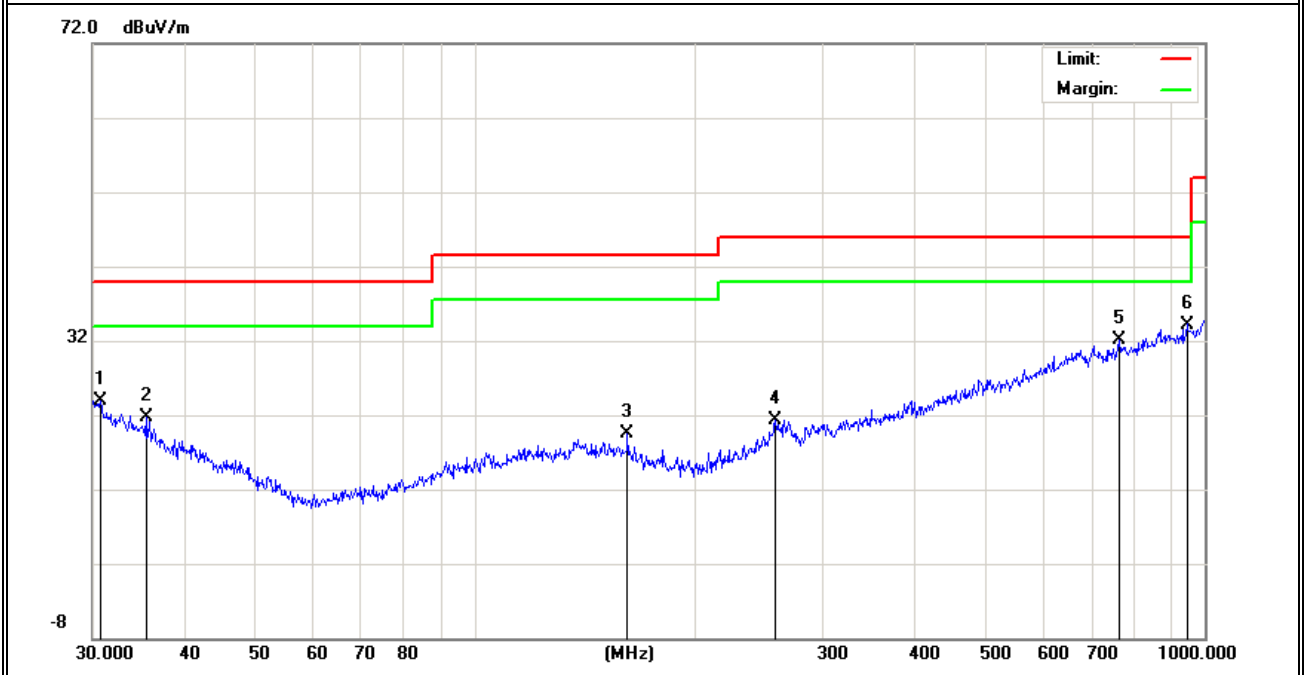

Polar (H/V)	Frequency	Meter Reading	Factor	Emission Level	Limits	Margin	Remark
	(MHz)	(dBuV)	(dB)	(dBuV/m)	(dBuV/m)	(dB)	
H	33.7986	5.82	16.33	22.15	40.00	-17.85	QP
H	119.8555	5.83	12.32	18.15	43.50	-25.35	QP
H	138.3873	6.18	12.98	19.16	43.50	-24.34	QP
H	261.9753	6.09	15.12	21.21	46.00	-24.79	QP
H	301.4224	6.26	15.30	21.56	46.00	-24.44	QP
H	979.1803	7.48	27.52	35.00	54.00	-19.00	QP

Remark:

Emission Level = Meter Reading + Factor, Margin= Emission Level - Limit

All modes have been tested, just the 802.11ac20 CH100 MIMO worst mode has been recorded in the report.

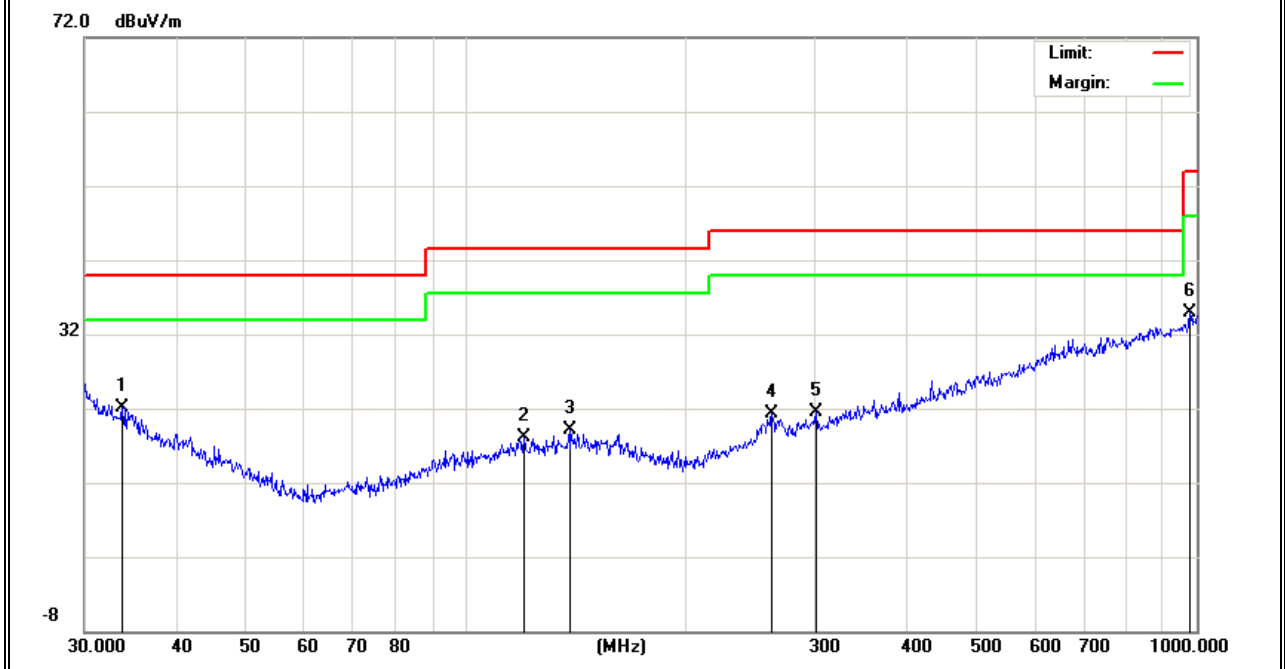

EUT :	Point to Point Wireless Device	Model Name. :	B5x
Temperature :	20 °C	Relative Humidity :	48%
Pressure :	1010 hPa	Test Voltage :	DC 50V
Test Mode :	Mode 2 (5.8G ac20 CH165 - 8dBi Antenna)		

Polar (H/V)	Frequency	Meter Reading	Factor	Emission Level	Limits	Margin	Remark
	(MHz)	(dBuV)	(dB)	(dBuV/m)	(dBuV/m)	(dB)	
V	30.7454	6.51	18.63	25.14	40.00	-14.86	QP
V	42.3021	7.51	11.84	19.35	40.00	-20.65	QP
V	53.1313	9.42	7.54	16.96	40.00	-23.04	QP
V	144.8418	7.21	12.47	19.68	43.50	-23.82	QP
V	286.9823	7.90	14.82	22.72	46.00	-23.28	QP
V	932.2714	7.66	26.54	34.20	46.00	-11.80	QP

Remark:

Emission Level = Meter Reading + Factor, Margin= Emission Level - Limit

All modes have been tested, just the 802.11ac20 CH165 MIMO worst mode has been recorded in the report.

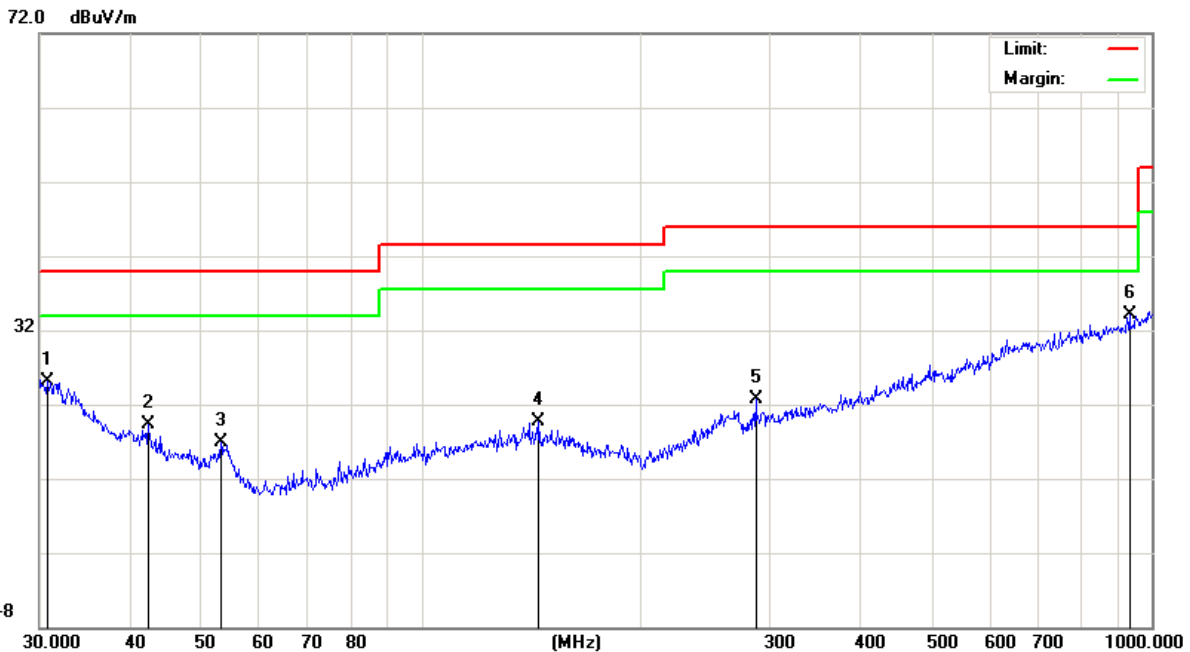

Polar (H/V)	Frequency	Meter Reading	Factor	Emission Level	Limits	Margin	Remark
	(MHz)	(dBuV)	(dB)	(dBuV/m)	(dBuV/m)	(dB)	
H	54.0711	9.97	7.04	17.01	40.00	-22.99	QP
H	80.0806	9.92	8.09	18.01	40.00	-21.99	QP
H	143.8295	6.80	12.63	19.43	43.50	-24.07	QP
H	322.1886	13.08	15.95	29.03	46.00	-16.97	QP
H	821.7103	7.16	25.65	32.81	46.00	-13.19	QP
H	972.3374	7.24	27.38	34.62	54.00	-19.38	QP

Remark:

Emission Level = Meter Reading + Factor, Margin= Emission Level - Limit

All modes have been tested, just the 802.11ac20 CH165 MIMO worst mode has been recorded in the report.

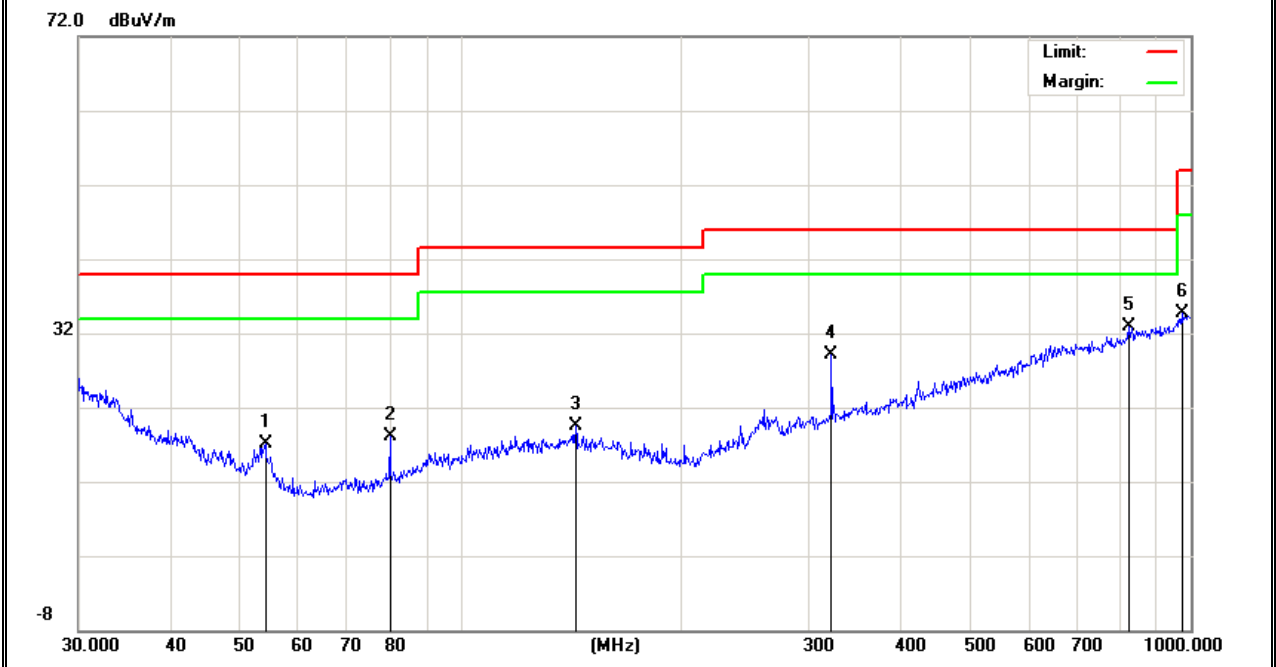

EUT :	Point to Point Wireless Device	Model Name. :	B5x
Temperature :	20 °C	Relative Humidity :	48%
Pressure :	1010 hPa	Test Voltage :	DC 50V
Test Mode :	Mode 2 (5.8G ac20 CH165 - 25dBi Antenna)		

Polar (H/V)	Frequency	Meter Reading	Factor	Emission Level	Limits	Margin	Remark
	(MHz)	(dBuV)	(dB)	(dBuV/m)	(dBuV/m)	(dB)	
V	31.1798	4.15	18.16	22.31	40.00	-17.69	QP
V	35.1278	5.06	15.51	20.57	40.00	-19.43	QP
V	40.7014	6.02	12.68	18.70	40.00	-21.30	QP
V	118.1862	5.34	12.18	17.52	43.50	-25.98	QP
V	268.4853	4.75	15.24	19.99	46.00	-26.01	QP
V	590.9737	6.54	22.39	28.93	46.00	-17.07	QP

Remark:

Emission Level = Meter Reading + Factor, Margin= Emission Level - Limit

All modes have been tested, just the 802.11ac20 CH165 MIMO worst mode has been recorded in the report.

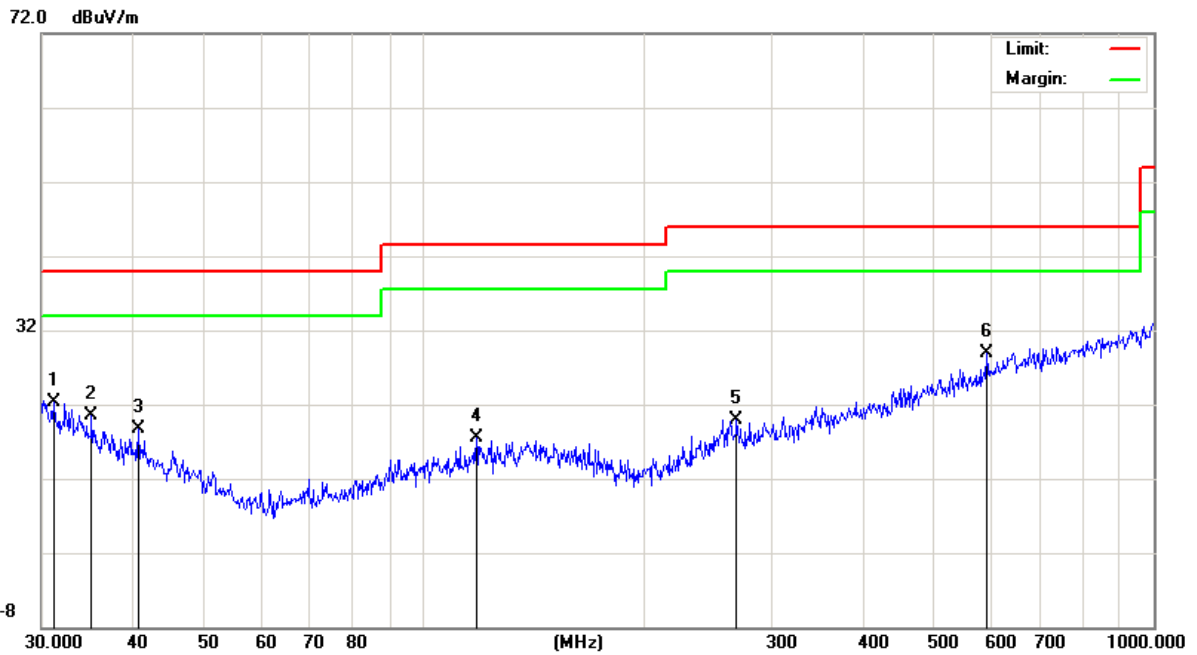

Polar (H/V)	Frequency	Meter Reading	Factor	Emission Level	Limits	Margin	Remark
	(MHz)	(dBuV)	(dB)	(dBuV/m)	(dBuV/m)	(dB)	
H	30.7454	5.17	18.63	23.80	40.00	-16.20	QP
H	33.6802	5.89	16.39	22.28	40.00	-17.72	QP
H	139.8508	5.90	13.20	19.10	43.50	-24.40	QP
H	268.4853	5.98	15.24	21.22	46.00	-24.78	QP
H	416.1791	6.43	18.37	24.80	46.00	-21.20	QP
H	675.2078	7.67	23.72	31.39	46.00	-14.61	QP

Remark:

Emission Level = Meter Reading + Factor, Margin= Emission Level - Limit

All modes have been tested, just the 802.11ac20 CH165 MIMO worst mode has been recorded in the report.

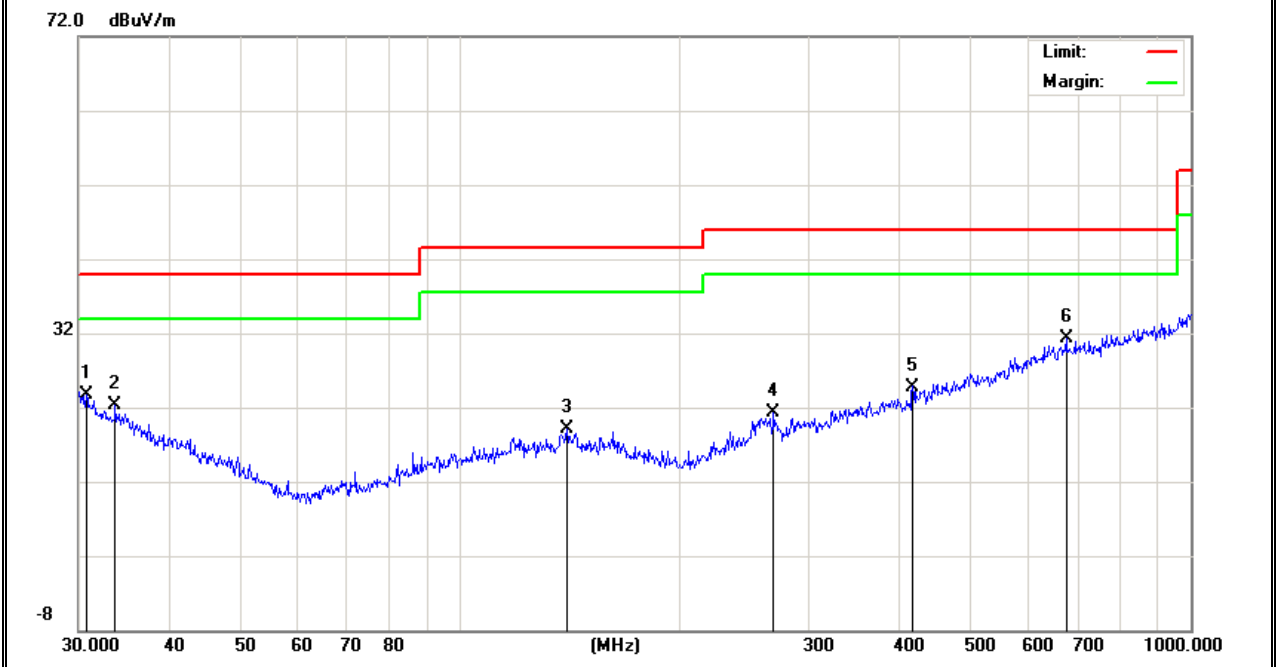

3.2.8 TEST RESULTS (1GHZ-18GHZ)

EUT :	Point to Point Wireless Device	Model Name. :	B5x
Temperature :	20 °C	Relative Humidity :	48%
Pressure :	1010 hPa	Test Voltage :	DC 50V
Test Mode :	Mode 2/3/4 (5.2G - 8dBi Antenna - outdoor AP)		

Polar	Frequency	Meter Reading	Cable loss	Antenna Factor	Preamp Factor	Emission Level	Limits	Margin	Detector Type
(H/V)	(MHz)	(dBuV)	(dB)	dB/m	(dB)	(dBuV/m)	(dBuV/m)	(dB)	
Low Channel (5180 MHz)-Above 1G									
Vertical	3015	54.11	5.94	35.4	44	51.45	68.2	-16.75	Pk
Vertical	10360	60.69	8.46	39.75	44.5	64.40	68.2	-3.80	Pk
Vertical	15540	60.56	10.12	38.8	44.1	65.38	74	-8.62	Pk
Vertical	15540	37.63	10.12	38.8	42.7	43.85	54	-10.15	AV
Horizontal	2981	52.44	5.94	35.18	44	49.56	68.2	-18.64	Pk
Horizontal	10360	62.37	8.46	38.71	44.5	65.04	68.2	-3.16	Pk
Horizontal	15540	54.29	10.12	38.38	44.1	58.69	74	-15.31	Pk
Horizontal	15540	39.21	10.12	38.38	44.1	43.61	54	-10.39	AV
middle Channel (5200 MHz)-Above 1G									
Vertical	3561	55.70	6.48	36.35	44.05	54.48	68.2	-13.72	Pk
Vertical	10400	63.15	8.47	37.88	44.51	64.99	68.2	-3.21	Pk
Vertical	15600	54.34	10.12	38.8	44.1	59.16	74	-14.84	Pk
Vertical	15600	36.04	10.12	38.8	42.7	42.26	54	-11.74	AV
Horizontal	3363	56.70	6.48	36.37	44.05	55.50	68.2	-12.70	Pk
Horizontal	10400	61.38	8.47	38.64	44.5	63.99	68.2	-4.21	Pk
Horizontal	15600	55.06	10.12	38.38	44.1	59.46	74	-14.54	Pk
Horizontal	15600	39.83	10.12	38.38	44.1	44.23	54	-9.77	AV

High Channel (5240 MHz)-Above 1G									
Vertical	3926	60.00	7.1	37.24	43.5	60.84	74	-13.16	Pk
Vertical	3926	44.59	7.1	37.24	43.5	45.43	54	-8.57	AV
Vertical	10480	62.79	8.46	37.68	44.5	64.43	68.2	-3.77	Pk
Vertical	15720	54.91	10.12	38.8	44.1	59.73	74	-14.27	Pk
Vertical	15720	34.74	10.12	38.8	42.7	40.96	54	-13.04	AV
Horizontal	3885	61.89	7.1	37.24	43.5	62.73	74	-11.27	Pk
Horizontal	3885	40.04	7.1	37.24	43.5	40.88	54	-13.12	AV
Horizontal	10480	61.11	8.46	38.57	44.5	63.64	68.2	-4.56	Pk
Horizontal	15720	56.97	10.12	38.38	44.1	61.37	74	-12.63	Pk
Horizontal	15720	38.80	10.12	38.38	44.1	43.20	54	-10.80	AV

Note: "802.11ac20 MIMO" mode is the worst mode.

The amplitude of spurious emissions that are attenuated by more than 20dB below the permissible value has no need to be reported.

Emission level (dBuV/m) = 20 log Emission level (uV/m).

Corrected Reading: Antenna Factor + Cable Loss + Read Level - Preamp Factor = Level.

All modes have been tested, just the 802.11ac20 MIMO worst mode has been recorded in the report.

EUT :	Point to Point Wireless Device	Model Name. :	B5x
Temperature :	20 °C	Relative Humidity :	48%
Pressure :	1010 hPa	Test Voltage :	DC 50V
Test Mode :	Mode 2/3/4 (5.2G - 25dBi Antenna - outdoor AP)		

Polar	Frequency	Meter Reading	Cable loss	Antenna Factor	Preamp Factor	Emission Level	Limits	Margin	Detector Type
(H/V)	(MHz)	(dBuV)	(dB)	dB/m	(dB)	(dBuV/m)	(dBuV/m)	(dB)	
Low Channel (5180 MHz)-Above 1G									
Vertical	3015	55.41	5.94	35.4	44	52.75	68.2	-15.45	Pk
Vertical	10360	59.74	8.46	39.75	44.5	63.45	68.2	-4.75	Pk
Vertical	15540	56.40	10.12	38.8	44.1	61.22	74	-12.78	Pk
Vertical	15540	38.78	10.12	38.8	42.7	45.00	54	-9.00	AV
Horizontal	2981	56.72	5.94	35.18	44	53.84	68.2	-14.36	Pk
Horizontal	10360	61.83	8.46	38.71	44.5	64.50	68.2	-3.70	Pk
Horizontal	15540	54.06	10.12	38.38	44.1	58.46	74	-15.54	Pk
Horizontal	15540	35.88	10.12	38.38	44.1	40.28	54	-13.72	AV
middle Channel (5200 MHz)-Above 1G									
Vertical	3561	52.63	6.48	36.35	44.05	51.41	68.2	-16.79	Pk
Vertical	10400	62.75	8.47	37.88	44.51	64.59	68.2	-3.61	Pk
Vertical	15600	56.39	10.12	38.8	44.1	61.21	74	-12.79	Pk
Vertical	15600	36.86	10.12	38.8	42.7	43.08	54	-10.92	AV
Horizontal	3363	54.38	6.48	36.37	44.05	53.18	68.2	-15.02	Pk
Horizontal	10400	61.60	8.47	38.64	44.5	64.21	68.2	-3.99	Pk
Horizontal	15600	55.25	10.12	38.38	44.1	59.65	74	-14.35	Pk
Horizontal	15600	40.98	10.12	38.38	44.1	45.38	54	-8.62	AV

High Channel (5240 MHz)-Above 1G									
Vertical	3926	58.03	7.1	37.24	43.5	58.87	74	-15.13	Pk
Vertical	3926	40.39	7.1	37.24	43.5	41.23	54	-12.77	AV
Vertical	10480	61.12	8.46	37.68	44.5	62.76	68.2	-5.44	Pk
Vertical	15720	56.96	10.12	38.8	44.1	61.78	74	-12.22	Pk
Vertical	15720	33.70	10.12	38.8	42.7	39.92	54	-14.08	AV
Horizontal	3885	62.54	7.1	37.24	43.5	63.38	74	-10.62	Pk
Horizontal	3885	38.71	7.1	37.24	43.5	39.55	54	-14.45	AV
Horizontal	10480	61.62	8.46	38.57	44.5	64.15	68.2	-4.05	Pk
Horizontal	15720	61.26	10.12	38.38	44.1	65.66	74	-8.34	Pk
Horizontal	15720	40.23	10.12	38.38	44.1	44.63	54	-9.37	AV

Note: "802.11ac20 MIMO" mode is the worst mode.

The amplitude of spurious emissions that are attenuated by more than 20dB below the permissible value has no need to be reported.

Emission level (dBuV/m) = 20 log Emission level (uV/m).

Corrected Reading: Antenna Factor + Cable Loss + Read Level - Preamp Factor = Level.

All modes have been tested, just the 802.11ac20 MIMO worst mode has been recorded in the report.

EUT :	Point to Point Wireless Device	Model Name. :	B5x
Temperature :	20 °C	Relative Humidity :	48%
Pressure :	1010 hPa	Test Voltage :	DC 50V
Test Mode :	Mode 2/3/4 (5.2G - 8dBi Antenna - point-to-point)		

Polar	Frequency	Meter Reading	Cable loss	Antenna Factor	Preamp Factor	Emission Level	Limits	Margin	Detector Type
(H/V)	(MHz)	(dBuV)	(dB)	dB/m	(dB)	(dBuV/m)	(dBuV/m)	(dB)	
Low Channel (5180 MHz)-Above 1G									
Vertical	3015	52.94	5.94	35.4	44	50.28	68.2	-17.92	Pk
Vertical	10360	60.57	8.46	39.75	44.5	64.28	68.2	-3.92	Pk
Vertical	15540	59.26	10.12	38.8	44.1	64.08	74	-9.92	Pk
Vertical	15540	40.53	10.12	38.8	42.7	46.75	54	-7.25	AV
Horizontal	2981	56.69	5.94	35.18	44	53.81	68.2	-14.39	Pk
Horizontal	10360	61.57	8.46	38.71	44.5	64.24	68.2	-3.96	Pk
Horizontal	15540	53.10	10.12	38.38	44.1	57.50	74	-16.50	Pk
Horizontal	15540	37.85	10.12	38.38	44.1	42.25	54	-11.75	AV
middle Channel (5200 MHz)-Above 1G									
Vertical	3561	52.81	6.48	36.35	44.05	51.59	68.2	-16.61	Pk
Vertical	10400	62.65	8.47	37.88	44.51	64.49	68.2	-3.71	Pk
Vertical	15600	55.04	10.12	38.8	44.1	59.86	74	-14.14	Pk
Vertical	15600	38.24	10.12	38.8	42.7	44.46	54	-9.54	AV
Horizontal	3363	52.32	6.48	36.37	44.05	51.12	68.2	-17.08	Pk
Horizontal	10400	61.52	8.47	38.64	44.5	64.13	68.2	-4.07	Pk
Horizontal	15600	54.54	10.12	38.38	44.1	58.94	74	-15.06	Pk
Horizontal	15600	40.19	10.12	38.38	44.1	44.59	54	-9.41	AV

High Channel (5240 MHz)-Above 1G									
Vertical	3926	61.39	7.1	37.24	43.5	62.23	74	-11.77	Pk
Vertical	3926	40.35	7.1	37.24	43.5	41.19	54	-12.81	AV
Vertical	10480	63.54	8.46	37.68	44.5	65.18	68.2	-3.02	Pk
Vertical	15720	58.59	10.12	38.8	44.1	63.41	74	-10.59	Pk
Vertical	15720	34.98	10.12	38.8	42.7	41.20	54	-12.80	AV
Horizontal	3885	61.29	7.1	37.24	43.5	62.13	74	-11.87	Pk
Horizontal	3885	41.20	7.1	37.24	43.5	42.04	54	-11.96	AV
Horizontal	10480	62.24	8.46	38.57	44.5	64.77	68.2	-3.43	Pk
Horizontal	15720	59.53	10.12	38.38	44.1	63.93	74	-10.07	Pk
Horizontal	15720	38.87	10.12	38.38	44.1	43.27	54	-10.73	AV

Note: "802.11ac20 MIMO" mode is the worst mode.

The amplitude of spurious emissions that are attenuated by more than 20dB below the permissible value has no need to be reported.

Emission level (dBuV/m) = 20 log Emission level (uV/m).

Corrected Reading: Antenna Factor + Cable Loss + Read Level - Preamp Factor = Level.

All modes have been tested, just the 802.11ac20 MIMO worst mode has been recorded in the report.

EUT :	Point to Point Wireless Device	Model Name. :	B5x
Temperature :	20 °C	Relative Humidity :	48%
Pressure :	1010 hPa	Test Voltage :	DC 50V
Test Mode :	Mode 2/3/4 (5.2G - 25dBi Antenna - point-to-point)		

Polar	Frequency	Meter Reading	Cable loss	Antenna Factor	Preamp Factor	Emission Level	Limits	Margin	Detector Type
(H/V)	(MHz)	(dBuV)	(dB)	dB/m	(dB)	(dBuV/m)	(dBuV/m)	(dB)	
Low Channel (5180 MHz)-Above 1G									
Vertical	3015	55.59	5.94	35.4	44	52.93	68.2	-15.27	Pk
Vertical	10360	60.95	8.46	39.75	44.5	64.66	68.2	-3.54	Pk
Vertical	15540	56.81	10.12	38.8	44.1	61.63	74	-12.37	Pk
Vertical	15540	37.03	10.12	38.8	42.7	43.25	54	-10.75	AV
Horizontal	2981	54.49	5.94	35.18	44	51.61	68.2	-16.59	Pk
Horizontal	10360	61.87	8.46	38.71	44.5	64.54	68.2	-3.66	Pk
Horizontal	15540	54.45	10.12	38.38	44.1	58.85	74	-15.15	Pk
Horizontal	15540	39.18	10.12	38.38	44.1	43.58	54	-10.42	AV
middle Channel (5200 MHz)-Above 1G									
Vertical	3561	56.85	6.48	36.35	44.05	55.63	68.2	-12.57	Pk
Vertical	10400	62.69	8.47	37.88	44.51	64.53	68.2	-3.67	Pk
Vertical	15600	57.89	10.12	38.8	44.1	62.71	74	-11.29	Pk
Vertical	15600	36.55	10.12	38.8	42.7	42.77	54	-11.23	AV
Horizontal	3363	55.85	6.48	36.37	44.05	54.65	68.2	-13.55	Pk
Horizontal	10400	61.58	8.47	38.64	44.5	64.19	68.2	-4.01	Pk
Horizontal	15600	58.48	10.12	38.38	44.1	62.88	74	-11.12	Pk
Horizontal	15600	40.96	10.12	38.38	44.1	45.36	54	-8.64	AV

High Channel (5240 MHz)-Above 1G									
Vertical	3926	60.57	7.1	37.24	43.5	61.41	74	-12.59	Pk
Vertical	3926	41.70	7.1	37.24	43.5	42.54	54	-11.46	AV
Vertical	10480	61.78	8.46	37.68	44.5	63.42	68.2	-4.78	Pk
Vertical	15720	56.91	10.12	38.8	44.1	61.73	74	-12.27	Pk
Vertical	15720	35.91	10.12	38.8	42.7	42.13	54	-11.87	AV
Horizontal	3885	60.37	7.1	37.24	43.5	61.21	74	-12.79	Pk
Horizontal	3885	40.36	7.1	37.24	43.5	41.20	54	-12.80	AV
Horizontal	10480	61.49	8.46	38.57	44.5	64.02	68.2	-4.18	Pk
Horizontal	15720	56.92	10.12	38.38	44.1	61.32	74	-12.68	Pk
Horizontal	15720	39.65	10.12	38.38	44.1	44.05	54	-9.95	AV

Note: "802.11ac20 MIMO" mode is the worst mode.

The amplitude of spurious emissions that are attenuated by more than 20dB below the permissible value has no need to be reported.

Emission level (dBuV/m) = 20 log Emission level (uV/m).

Corrected Reading: Antenna Factor + Cable Loss + Read Level - Preamp Factor = Level.

All modes have been tested, just the 802.11ac20 MIMO worst mode has been recorded in the report.

EUT :	Point to Point Wireless Device	Model Name. :	B5x
Temperature :	20 °C	Relative Humidity :	48%
Pressure :	1010 hPa	Test Voltage :	DC 50V
Test Mode :	Mode 2/3/4 (5.3G - 8dBi Antenna)		

Polar	Frequency	Meter Reading	Cable loss	Antenna Factor	Preamp Factor	Emission Level	Limits	Margin	Detector Type
(H/V)	(MHz)	(dBuV)	(dB)	dB/m	(dB)	(dBuV/m)	(dBuV/m)	(dB)	
Low Channel (5260 MHz)-Above 1G									
Vertical	3015	53.08	5.94	35.4	44	50.42	68.2	-17.78	Pk
Vertical	10520	59.54	8.46	39.75	44.5	63.25	68.2	-4.95	Pk
Vertical	15780	56.49	10.12	38.8	44.1	61.31	74	-12.69	Pk
Vertical	15780	33.96	10.12	38.8	42.7	40.18	54	-13.82	AV
Horizontal	2981	55.41	5.94	35.18	44	52.53	68.2	-15.67	Pk
Horizontal	10520	60.55	8.46	38.71	44.5	63.22	68.2	-4.98	Pk
Horizontal	15780	55.31	10.12	38.38	44.1	59.71	74	-14.29	Pk
Horizontal	15780	35.85	10.12	38.38	44.1	40.25	54	-13.75	AV
middle Channel (5280 MHz)-Above 1G									
Vertical	3561	54.73	6.48	36.35	44.05	53.51	68.2	-14.69	Pk
Vertical	10560	63.19	8.47	37.88	44.51	65.03	68.2	-3.17	Pk
Vertical	15840	56.66	10.12	38.8	44.1	61.48	74	-12.52	Pk
Vertical	15840	35.29	10.12	38.8	42.7	41.51	54	-12.49	AV
Horizontal	3363	56.42	6.48	36.37	44.05	55.22	68.2	-12.98	Pk
Horizontal	10560	61.01	8.47	38.64	44.5	63.62	68.2	-4.58	Pk
Horizontal	15840	58.69	10.12	38.38	44.1	63.09	74	-10.91	Pk
Horizontal	15840	38.82	10.12	38.38	44.1	43.22	54	-10.78	AV

High Channel (5320 MHz)-Above 1G									
Vertical	3926	60.11	7.1	37.24	43.5	60.95	74	-13.05	Pk
Vertical	3926	41.56	7.1	37.24	43.5	42.40	54	-11.60	AV
Vertical	10640	62.84	8.46	37.68	44.5	64.48	68.2	-3.72	Pk
Vertical	15960	57.17	10.12	38.8	44.1	61.99	74	-12.01	Pk
Vertical	15960	36.02	10.12	38.8	42.7	42.24	54	-11.76	AV
Horizontal	3885	62.05	7.1	37.24	43.5	62.89	74	-11.11	Pk
Horizontal	3885	41.73	7.1	37.24	43.5	42.57	54	-11.43	AV
Horizontal	10640	62.26	8.46	38.57	44.5	64.79	68.2	-3.41	Pk
Horizontal	15960	57.89	10.12	38.38	44.1	62.29	74	-11.71	Pk
Horizontal	15960	37.52	10.12	38.38	44.1	41.92	54	-12.08	AV

Note: "802.11ac20 MIMO" mode is the worst mode.

The amplitude of spurious emissions that are attenuated by more than 20dB below the permissible value has no need to be reported.

Emission level (dBuV/m) = 20 log Emission level (uV/m).

Corrected Reading: Antenna Factor + Cable Loss + Read Level - Preamp Factor = Level.

All modes have been tested, just the 802.11ac20 MIMO worst mode has been recorded in the report.

EUT :	Point to Point Wireless Device	Model Name. :	B5x
Temperature :	20 °C	Relative Humidity :	48%
Pressure :	1010 hPa	Test Voltage :	DC 50V
Test Mode :	Mode 2/3/4 (5.3G - 25dBi Antenna)		

Polar	Frequency	Meter Reading	Cable loss	Antenna Factor	Preamp Factor	Emission Level	Limits	Margin	Detector Type
(H/V)	(MHz)	(dBuV)	(dB)	dB/m	(dB)	(dBuV/m)	(dBuV/m)	(dB)	
Low Channel (5260 MHz)-Above 1G									
Vertical	3015	56.22	5.94	35.4	44	53.56	68.2	-14.64	Pk
Vertical	10520	61.47	8.46	39.75	44.5	65.18	68.2	-3.02	Pk
Vertical	15780	57.38	10.12	38.8	44.1	62.20	74	-11.80	Pk
Vertical	15780	39.77	10.12	38.8	42.7	45.99	54	-8.01	AV
Horizontal	2981	54.83	5.94	35.18	44	51.95	68.2	-16.25	Pk
Horizontal	10520	61.25	8.46	38.71	44.5	63.92	68.2	-4.28	Pk
Horizontal	15780	52.49	10.12	38.38	44.1	56.89	74	-17.11	Pk
Horizontal	15780	37.70	10.12	38.38	44.1	42.10	54	-11.90	AV
middle Channel (5280 MHz)-Above 1G									
Vertical	3561	53.07	6.48	36.35	44.05	51.85	68.2	-16.35	Pk
Vertical	10560	62.65	8.47	37.88	44.51	64.49	68.2	-3.71	Pk
Vertical	15840	57.59	10.12	38.8	44.1	62.41	74	-11.59	Pk
Vertical	15840	37.82	10.12	38.8	42.7	44.04	54	-9.96	AV
Horizontal	3363	53.68	6.48	36.37	44.05	52.48	68.2	-15.72	Pk
Horizontal	10560	62.50	8.47	38.64	44.5	65.11	68.2	-3.09	Pk
Horizontal	15840	56.15	10.12	38.38	44.1	60.55	74	-13.45	Pk
Horizontal	15840	41.23	10.12	38.38	44.1	45.63	54	-8.37	AV

High Channel (5320 MHz)-Above 1G									
Vertical	3926	60.38	7.1	37.24	43.5	61.22	74	-12.78	Pk
Vertical	3926	41.59	7.1	37.24	43.5	42.43	54	-11.57	AV
Vertical	10640	63.04	8.46	37.68	44.5	64.68	68.2	-3.52	Pk
Vertical	15960	54.78	10.12	38.8	44.1	59.60	74	-14.40	Pk
Vertical	15960	36.28	10.12	38.8	42.7	42.50	54	-11.50	AV
Horizontal	3885	63.01	7.1	37.24	43.5	63.85	74	-10.15	Pk
Horizontal	3885	38.31	7.1	37.24	43.5	39.15	54	-14.85	AV
Horizontal	10640	62.03	8.46	38.57	44.5	64.56	68.2	-3.64	Pk
Horizontal	15960	57.38	10.12	38.38	44.1	61.78	74	-12.22	Pk
Horizontal	15960	36.92	10.12	38.38	44.1	41.32	54	-12.68	AV

Note: "802.11ac20 MIMO" mode is the worst mode.

The amplitude of spurious emissions that are attenuated by more than 20dB below the permissible value has no need to be reported.

Emission level (dBuV/m) = 20 log Emission level (uV/m).

Corrected Reading: Antenna Factor + Cable Loss + Read Level - Preamp Factor = Level.

All modes have been tested, just the 802.11ac20 MIMO worst mode has been recorded in the report.

EUT :	Point to Point Wireless Device	Model Name. :	B5x
Temperature :	20 °C	Relative Humidity :	48%
Pressure :	1010 hPa	Test Voltage :	DC 50V
Test Mode :	Mode 2/3/4 (5.6G - 8dBi Antenna)		

Polar	Frequency	Meter Reading	Cable loss	Antenna Factor	Preamp Factor	Emission Level	Limits	Margin	Detector Type
(H/V)	(MHz)	(dBuV)	(dB)	dB/m	(dB)	(dBuV/m)	(dBuV/m)	(dB)	
Low Channel (5500 MHz)-Above 1G									
Vertical	3015	52.36	5.94	35.4	44	49.70	68.2	-18.50	Pk
Vertical	11000	55.74	8.46	39.75	44.5	59.45	74	-14.55	Pk
Vertical	11000	35.64	8.46	39.75	44.5	39.35	54	-14.65	AV
Vertical	16500	60.41	10.12	38.8	44.1	65.23	68.2	-2.97	Pk
Horizontal	2981	57.02	5.94	35.18	44	54.14	68.2	-14.06	Pk
Horizontal	11000	59.87	8.46	38.71	44.5	62.54	74	-11.46	Pk
Horizontal	11000	43.34	8.46	38.71	44.5	46.01	54	-7.99	AV
Horizontal	16500	59.51	10.12	38.38	44.1	63.91	68.2	-4.29	Pk
middle Channel (5600 MHz)-Above 1G									
Vertical	3561	55.70	6.48	36.35	44.05	54.48	68.2	-13.72	Pk
Vertical	11200	56.19	8.47	37.88	44.51	58.03	74	-15.97	Pk
Vertical	11200	34.90	8.47	37.88	44.51	36.74	54	-17.26	AV
Vertical	16800	59.39	10.12	38.8	44.1	64.21	68.2	-3.99	Pk
Horizontal	3363	56.98	6.48	36.37	44.05	55.78	68.2	-12.42	Pk
Horizontal	11200	50.29	8.47	38.64	44.5	52.90	74	-21.10	Pk
Horizontal	11200	28.66	8.47	38.64	44.5	31.27	54	-22.73	AV
Horizontal	16800	60.43	10.12	38.38	44.1	64.83	68.2	-3.37	Pk

High Channel (5700 MHz)-Above 1G									
Vertical	3926	59.34	7.1	37.24	43.5	60.18	74	-13.82	Pk
Vertical	3926	40.73	7.1	37.24	43.5	41.57	54	-12.43	AV
Vertical	11400	57.19	8.46	37.68	44.5	58.83	74	-15.17	Pk
Vertical	11400	39.22	8.46	37.68	44.5	40.86	54	-13.14	AV
Vertical	17100	59.60	10.12	38.8	44.1	64.42	68.2	-3.78	Pk
Horizontal	3885	61.20	7.1	37.24	43.5	62.04	74	-11.96	Pk
Horizontal	3885	39.83	7.1	37.24	43.5	40.67	54	-13.33	AV
Horizontal	11400	52.28	8.46	38.57	44.5	54.81	74	-19.19	Pk
Horizontal	11400	38.58	8.46	38.57	44.5	41.11	54	-12.89	AV
Horizontal	17100	59.31	10.12	38.38	44.1	63.71	68.2	-4.49	Pk

Note: "802.11ac20 MIMO" mode is the worst mode.

The amplitude of spurious emissions that are attenuated by more than 20dB below the permissible value has no need to be reported.

Emission level (dBuV/m) = 20 log Emission level (uV/m).

Corrected Reading: Antenna Factor + Cable Loss + Read Level - Preamp Factor = Level.

All modes have been tested, just the 802.11ac20 MIMO worst mode has been recorded in the report.

EUT :	Point to Point Wireless Device	Model Name. :	B5x
Temperature :	20 °C	Relative Humidity :	48%
Pressure :	1010 hPa	Test Voltage :	DC 50V
Test Mode :	Mode 2/3/4 (5.6G - 25dBi Antenna)		

Polar	Frequency	Meter Reading	Cable loss	Antenna Factor	Preamp Factor	Emission Level	Limits	Margin	Detector Type
(H/V)	(MHz)	(dBuV)	(dB)	dB/m	(dB)	(dBuV/m)	(dBuV/m)	(dB)	
Low Channel (5500 MHz)-Above 1G									
Vertical	3015	50.95	5.94	35.4	44	48.29	68.2	-19.91	Pk
Vertical	11000	51.84	8.46	39.75	44.5	55.55	74	-18.45	Pk
Vertical	11000	32.23	8.46	39.75	44.5	35.94	54	-18.06	AV
Vertical	16500	59.37	10.12	38.8	44.1	64.19	68.2	-4.01	Pk
Horizontal	2981	59.07	5.94	35.18	44	56.19	68.2	-12.01	Pk
Horizontal	11000	56.42	8.46	38.71	44.5	59.09	74	-14.91	Pk
Horizontal	11000	41.76	8.46	38.71	44.5	44.43	54	-9.57	AV
Horizontal	16500	58.89	10.12	38.38	44.1	63.29	68.2	-4.91	Pk
middle Channel (5600 MHz)-Above 1G									
Vertical	3561	51.86	6.48	36.35	44.05	50.64	68.2	-17.56	Pk
Vertical	11200	59.42	8.47	37.88	44.51	61.26	74	-12.74	Pk
Vertical	11200	40.52	8.47	37.88	44.51	42.36	54	-11.64	AV
Vertical	16800	59.03	10.12	38.8	44.1	63.85	68.2	-4.35	Pk
Horizontal	3363	52.85	6.48	36.37	44.05	51.65	68.2	-16.55	Pk
Horizontal	11200	54.11	8.47	38.64	44.5	56.72	74	-17.28	Pk
Horizontal	11200	38.87	8.47	38.64	44.5	41.48	54	-12.52	AV
Horizontal	16800	60.11	10.12	38.38	44.1	64.51	68.2	-3.69	Pk

High Channel (5700 MHz)-Above 1G									
Vertical	3926	56.96	7.1	37.24	43.5	57.80	74	-16.20	Pk
Vertical	3926	39.96	7.1	37.24	43.5	40.80	54	-13.20	AV
Vertical	11400	58.99	8.46	37.68	44.5	60.63	74	-13.37	Pk
Vertical	11400	42.69	8.46	37.68	44.5	44.33	54	-9.67	AV
Vertical	17100	59.83	10.12	38.8	44.1	64.65	68.2	-3.55	Pk
Horizontal	3885	60.29	7.1	37.24	43.5	61.13	74	-12.87	Pk
Horizontal	3885	41.14	7.1	37.24	43.5	41.98	54	-12.02	AV
Horizontal	11400	59.65	8.46	38.57	44.5	62.18	74	-11.82	Pk
Horizontal	11400	42.54	8.46	38.57	44.5	45.07	54	-8.93	AV
Horizontal	17100	60.67	10.12	38.38	44.1	65.07	68.2	-3.13	Pk

Note: "802.11ac20 MIMO" mode is the worst mode.

The amplitude of spurious emissions that are attenuated by more than 20dB below the permissible value has no need to be reported.

Emission level (dBuV/m) = 20 log Emission level (uV/m).

Corrected Reading: Antenna Factor + Cable Loss + Read Level - Preamp Factor = Level.

All modes have been tested, just the 802.11ac20 MIMO worst mode has been recorded in the report.

EUT :	Point to Point Wireless Device	Model Name. :	B5x
Temperature :	20 °C	Relative Humidity :	48%
Pressure :	1010 hPa	Test Voltage :	DC 50V
Test Mode :	Mode 2/3/4 (5.8G - 8dBi Antenna)		

Polar	Frequency	Meter Reading	Cable loss	Antenna Factor	Preamp Factor	Emission Level	Limits	Margin	Detector Type
(H/V)	(MHz)	(dBuV)	(dB)	dB/m	(dB)	(dBuV/m)	(dBuV/m)	(dB)	
Low Channel (5745 MHz)-Above 1G									
Vertical	2806	62.80	5.94	35.40	44.00	60.14	74.00	-13.86	Pk
Vertical	2806	42.40	5.94	35.40	44.00	39.74	54.00	-14.26	AV
Vertical	11490	59.34	8.46	39.75	44.50	63.05	74.00	-10.95	Pk
Vertical	11490	43.28	8.46	39.75	44.50	46.99	54.00	-7.01	AV
Vertical	17235	60.55	10.12	38.80	44.10	65.37	68.20	-2.83	Pk
Horizontal	2911	56.60	5.94	35.18	44.00	53.72	68.20	-14.48	Pk
Horizontal	11490	57.98	8.46	38.71	44.50	60.65	74.00	-13.35	Pk
Horizontal	11490	39.96	8.46	38.71	44.50	42.63	54.00	-11.37	AV
Horizontal	17235	59.67	10.12	38.38	44.10	64.07	68.20	-4.13	Pk
middle Channel (5785 MHz)-Above 1G									
Vertical	3763	59.59	6.48	36.35	44.05	58.37	74.00	-15.63	Pk
Vertical	3763	40.48	6.48	36.35	44.05	39.26	54.00	-14.74	AV
Vertical	11570	62.27	8.47	37.88	44.51	64.11	74.00	-9.89	Pk
Vertical	11570	43.38	8.47	37.88	44.51	45.22	54.00	-8.78	AV
Vertical	17355	60.06	10.12	38.8	44.10	64.88	68.20	-3.32	Pk
Horizontal	3561	50.91	6.48	36.37	44.05	49.71	68.20	-18.49	Pk
Horizontal	11570	55.92	8.47	38.64	44.50	58.53	74.00	-15.47	Pk
Horizontal	11570	41.62	8.47	38.64	44.50	44.23	54.00	-9.77	AV
Horizontal	17355	60.39	10.12	38.38	44.10	64.79	68.20	-3.41	Pk

High Channel (5825 MHz)-Above 1G									
Vertical	3907	56.31	7.10	37.24	43.50	57.15	74.00	-16.85	Pk
Vertical	3907	41.84	7.10	37.24	43.50	42.68	54.00	-11.32	AV
Vertical	11650	58.67	8.46	37.68	44.50	60.31	74.00	-13.69	Pk
Vertical	11650	40.36	8.46	37.68	44.50	42.00	54.00	-12.00	AV
Vertical	17475	59.54	10.12	38.8	44.10	64.36	68.20	-3.84	Pk
Horizontal	3912	59.30	7.10	37.24	43.50	60.14	74.00	-13.86	Pk
Horizontal	3912	38.73	7.10	37.24	43.50	39.57	54.00	-14.43	AV
Horizontal	11650	60.97	8.46	38.57	44.50	63.50	74.00	-10.50	Pk
Horizontal	11650	39.87	8.46	38.57	44.50	42.40	54.00	-11.60	AV
Horizontal	17475	59.17	10.12	38.38	44.10	63.57	68.20	-4.63	Pk

Note: "802.11ac20 MIMO" mode is the worst mode.

The amplitude of spurious emissions that are attenuated by more than 20dB below the permissible value has no need to be reported.

Emission level (dBuV/m) = 20 log Emission level (uV/m).

Corrected Reading: Antenna Factor + Cable Loss + Read Level - Preamp Factor = Level.

All modes have been tested, just the 802.11ac20 MIMO worst mode has been recorded in the report.

EUT :	Point to Point Wireless Device	Model Name. :	B5x
Temperature :	20 °C	Relative Humidity :	48%
Pressure :	1010 hPa	Test Voltage :	DC 50V
Test Mode :	Mode 2/3/4 (5.8G - 25dBi Antenna)		

Polar	Frequency	Meter Reading	Cable loss	Antenna Factor	Preamp Factor	Emission Level	Limits	Margin	Detector Type
(H/V)	(MHz)	(dBuV)	(dB)	dB/m	(dB)	(dBuV/m)	(dBuV/m)	(dB)	
Low Channel (5745 MHz)-Above 1G									
Vertical	2806	61.34	5.94	35.40	44.00	58.68	74.00	-15.32	Pk
Vertical	2806	44.21	5.94	35.40	44.00	41.55	54.00	-12.45	AV
Vertical	11490	61.16	8.46	39.75	44.50	64.87	74.00	-9.13	Pk
Vertical	11490	42.64	8.46	39.75	44.50	46.35	54.00	-7.65	AV
Vertical	17235	59.69	10.12	38.80	44.10	64.51	68.20	-3.69	Pk
Horizontal	2911	54.69	5.94	35.18	44.00	51.81	68.20	-16.39	Pk
Horizontal	11490	62.42	8.46	38.71	44.50	65.09	74.00	-8.91	Pk
Horizontal	11490	38.66	8.46	38.71	44.50	41.33	54.00	-12.67	AV
Horizontal	17235	60.74	10.12	38.38	44.10	65.14	68.20	-3.06	Pk
middle Channel (5785 MHz)-Above 1G									
Vertical	3763	61.42	6.48	36.35	44.05	60.20	74.00	-13.80	Pk
Vertical	3763	41.21	6.48	36.35	44.05	39.99	54.00	-14.01	AV
Vertical	11570	61.74	8.47	37.88	44.51	63.58	74.00	-10.42	Pk
Vertical	11570	44.46	8.47	37.88	44.51	46.30	54.00	-7.70	AV
Vertical	17355	60.77	10.12	38.8	44.10	65.59	68.20	-2.61	Pk
Horizontal	3561	53.25	6.48	36.37	44.05	52.05	68.20	-16.15	Pk
Horizontal	11570	56.38	8.47	38.64	44.50	58.99	74.00	-15.01	Pk
Horizontal	11570	41.95	8.47	38.64	44.50	44.56	54.00	-9.44	AV
Horizontal	17355	59.63	10.12	38.38	44.10	64.03	68.20	-4.17	Pk

High Channel (5825 MHz)-Above 1G									
Vertical	3907	60.15	7.10	37.24	43.50	60.99	74.00	-13.01	Pk
Vertical	3907	41.47	7.10	37.24	43.50	42.31	54.00	-11.69	AV
Vertical	11650	60.27	8.46	37.68	44.50	61.91	74.00	-12.09	Pk
Vertical	11650	39.12	8.46	37.68	44.50	40.76	54.00	-13.24	AV
Vertical	17475	59.04	10.12	38.8	44.10	63.86	68.20	-4.34	Pk
Horizontal	3912	59.82	7.10	37.24	43.50	60.66	74.00	-13.34	Pk
Horizontal	3912	38.14	7.10	37.24	43.50	38.98	54.00	-15.02	AV
Horizontal	11650	59.72	8.46	38.57	44.50	62.25	74.00	-11.75	Pk
Horizontal	11650	41.72	8.46	38.57	44.50	44.25	54.00	-9.75	AV
Horizontal	17475	60.40	10.12	38.38	44.10	64.80	68.20	-3.40	Pk

Note: "802.11ac20 MIMO" mode is the worst mode.

The amplitude of spurious emissions that are attenuated by more than 20dB below the permissible value has no need to be reported.

Emission level (dBuV/m) = 20 log Emission level (uV/m).

Corrected Reading: Antenna Factor + Cable Loss + Read Level - Preamp Factor = Level.

All modes have been tested, just the 802.11ac20 MIMO worst mode has been recorded in the report.

3.2.9 TEST RESULTS (18GHZ-40GHZ)

EUT :	Point to Point Wireless Device	Model Name. :	B5x
Temperature :	20 °C	Relative Humidity :	48%
Pressure :	1010 hPa	Test Voltage :	DC 50V
Test Mode :	Mode 2/3/4 (5.2G - 8dBi Antenna - outdoor AP)		

All modes have been tested, just the 802.11ac20 MIMO worst mode has been recorded in the report.

Low Channel (5180 MHz)-Above 1G
Horizontal

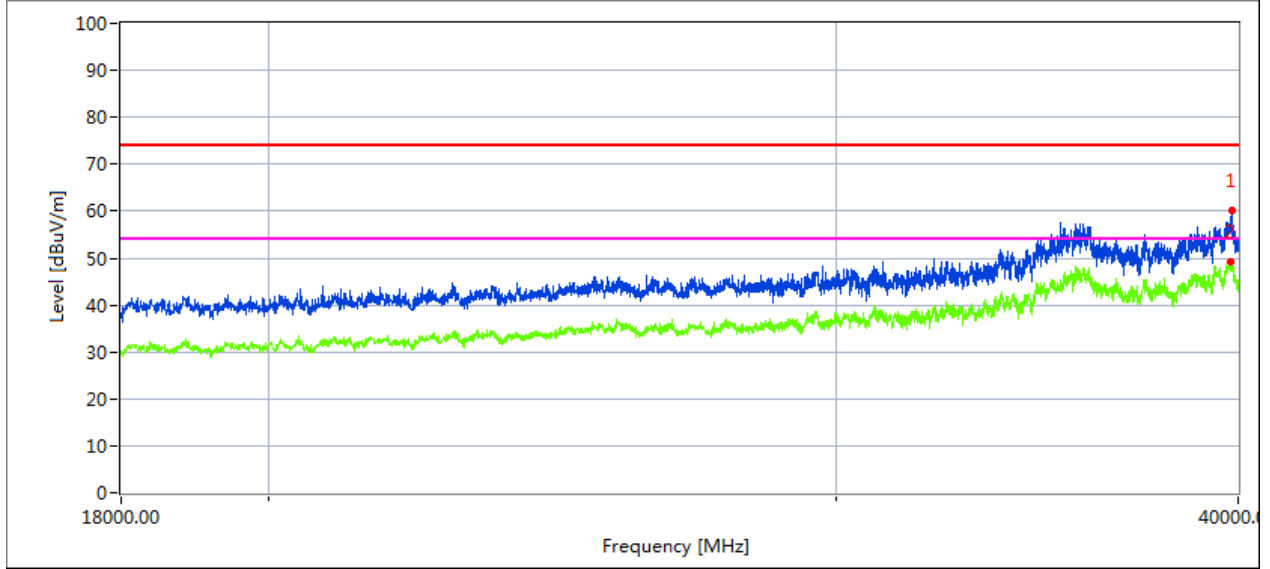

Measurement Result:

Frequency MHz	Meter Reading dBuV	Cable loss dB	Antenna Factor dB/m	Preamp Factor dB	Emission Level dBuV/m	Limits dBuV/m	Margin dB	Detector Type
39782.649	37.97	20.09	44.07	43.48	58.65	68.20	9.55	Peak

Vertical

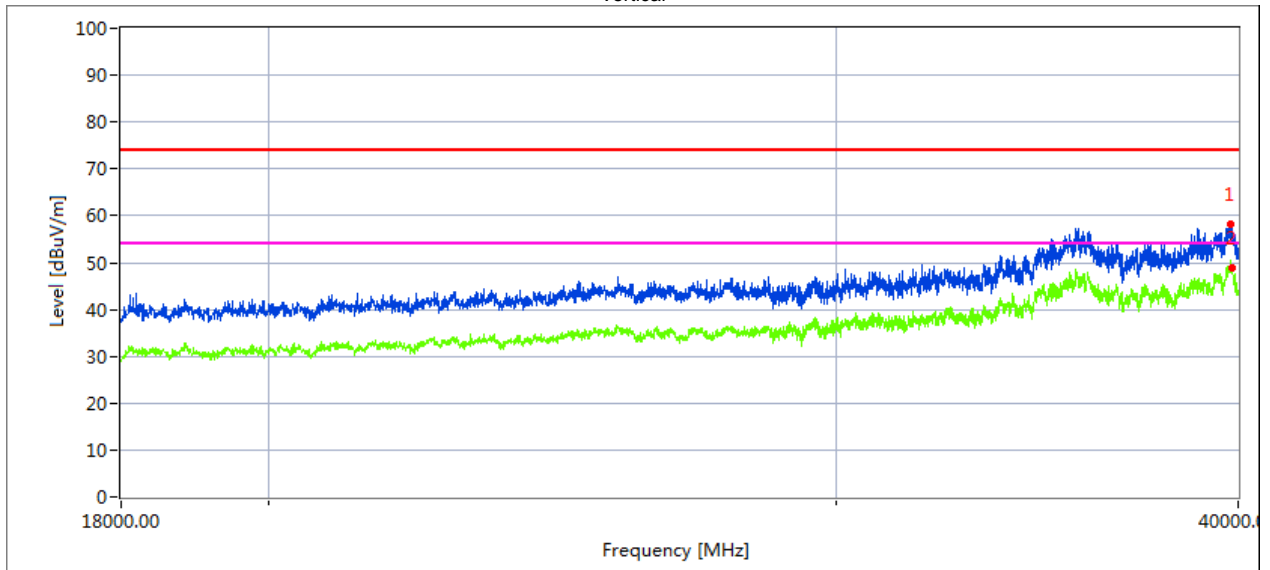

Measurement Result:

Frequency MHz	Meter Reading dBuV	Cable loss dB	Antenna Factor dB/m	Preamp Factor dB	Emission Level dBuV/m	Limits dBuV/m	Margin dB	Detector Type
39798.845	41.03	19.11	42.73	44.61	58.26	68.20	9.94	Peak

High Channel (5240 MHz)-Above 1G

Horizontal

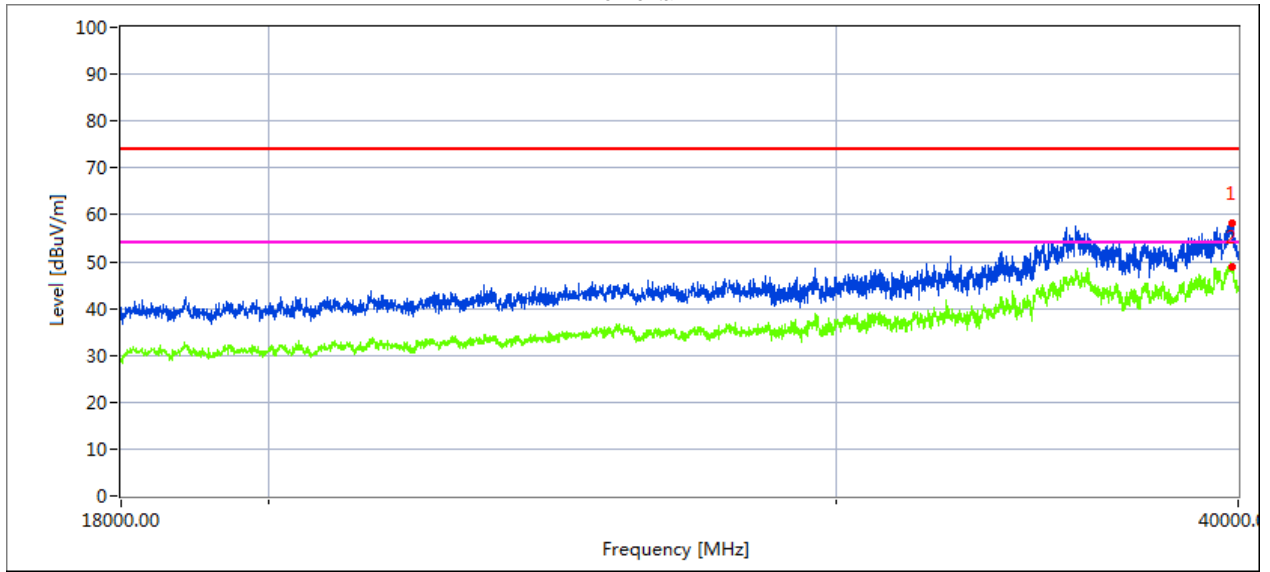

Measurement Result:

Frequency MHz	Meter Reading dBuV	Cable loss dB	Antenna Factor dB/m	Preamp Factor dB	Emission Level dBuV/m	Limits dBuV/m	Margin dB	Detector Type
39799.384	38.44	20.09	44.07	43.48	59.12	68.20	9.08	Peak

Vertical

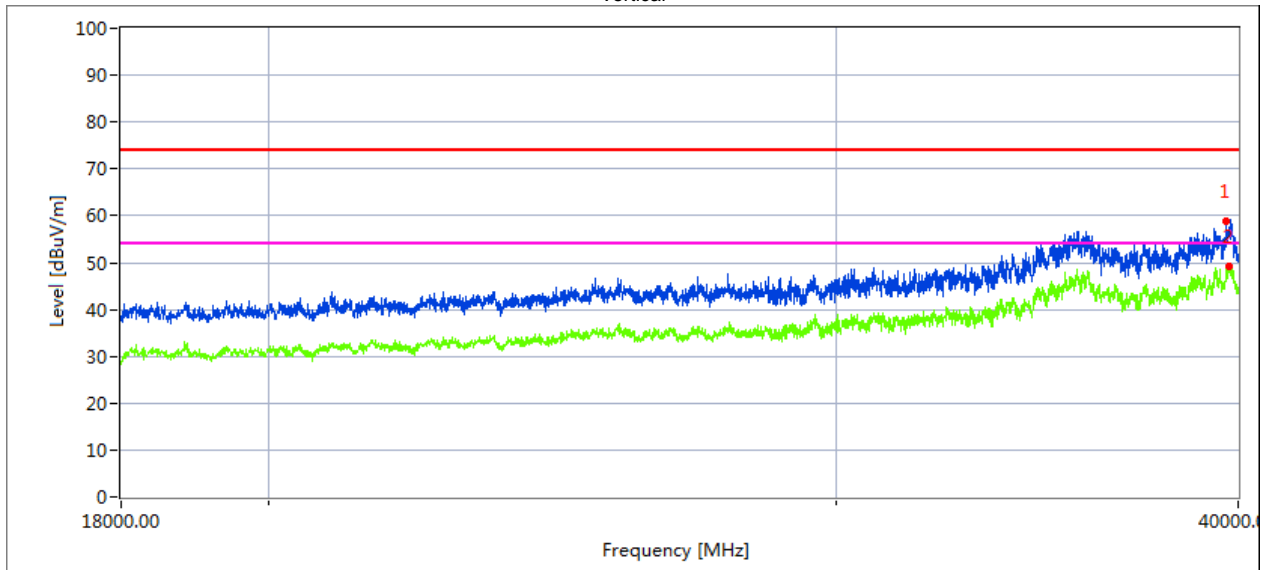

Measurement Result:

Frequency MHz	Meter Reading dBuV	Cable loss dB	Antenna Factor dB/m	Preamp Factor dB	Emission Level dBuV/m	Limits dBuV/m	Margin dB	Detector Type
39672.067	38.40	20.09	44.07	43.48	59.08	68.20	9.12	Peak

EUT :	Point to Point Wireless Device	Model Name. :	B5x
Temperature :	20 °C	Relative Humidity :	48%
Pressure :	1010 hPa	Test Voltage :	DC 50V
Test Mode :	Mode 2/3/4 (5.2G - 25dBi Antenna - outdoor AP)		

All modes have been tested, just the 802.11ac20 MIMO worst mode has been recorded in the report.

Low Channel (5180 MHz)-Above 1G
Horizontal

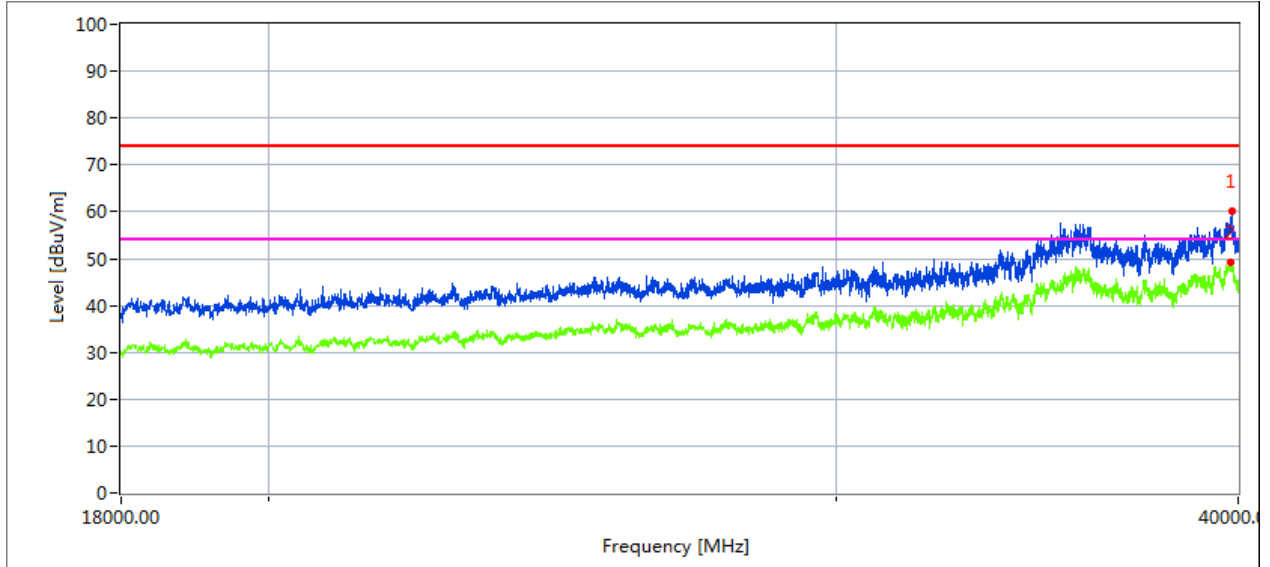

Measurement Result:

Frequency MHz	Meter Reading dBuV	Cable loss dB	Antenna Factor dB/m	Preamp Factor dB	Emission Level dBuV/m	Limits dBuV/m	Margin dB	Detector Type
39782.618	38.47	20.09	44.07	43.48	59.15	68.20	9.05	Peak

Vertical

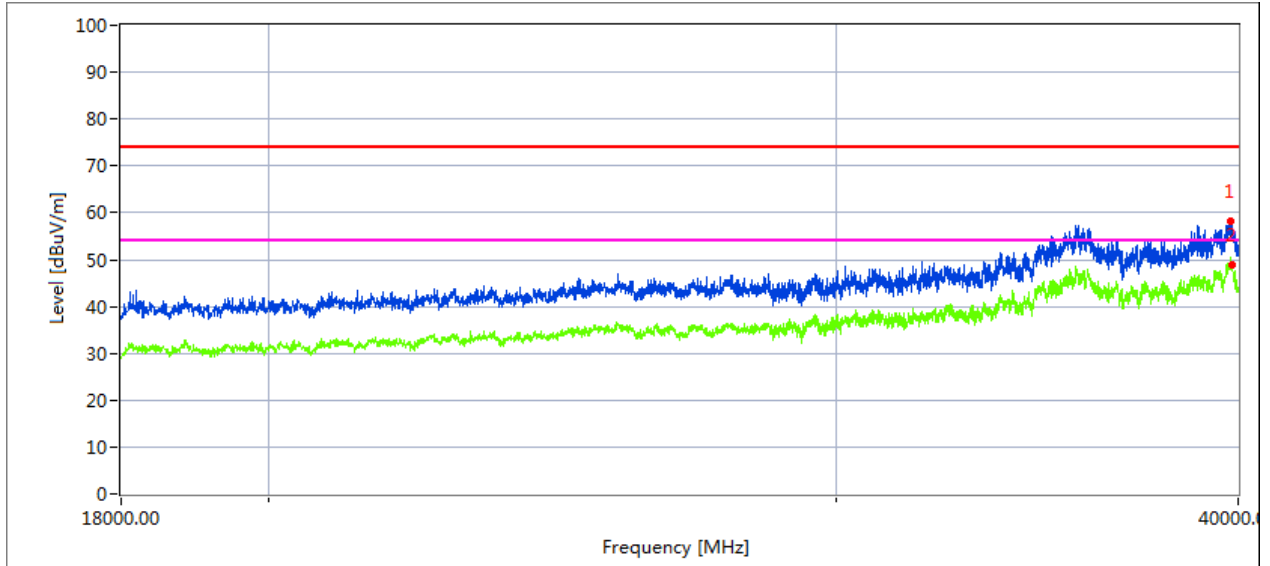

Measurement Result:

Frequency MHz	Meter Reading dBuV	Cable loss dB	Antenna Factor dB/m	Preamp Factor dB	Emission Level dBuV/m	Limits dBuV/m	Margin dB	Detector Type
39798.918	40.76	19.11	42.73	44.61	57.99	68.20	10.21	Peak

High Channel (5240 MHz)-Above 1G

Horizontal

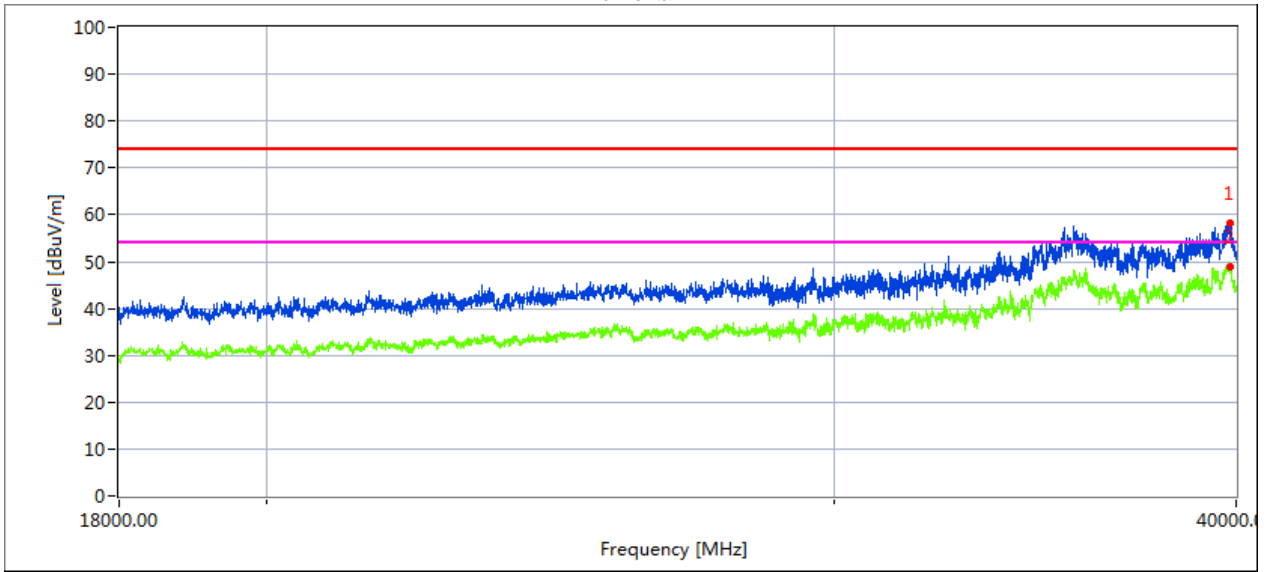

Measurement Result:

Frequency MHz	Meter Reading dBuV	Cable loss dB	Antenna Factor dB/m	Preamp Factor dB	Emission Level dBuV/m	Limits dBuV/m	Margin dB	Detector Type
39799.439	37.77	20.09	44.07	43.48	58.45	68.20	9.75	Peak

Vertical

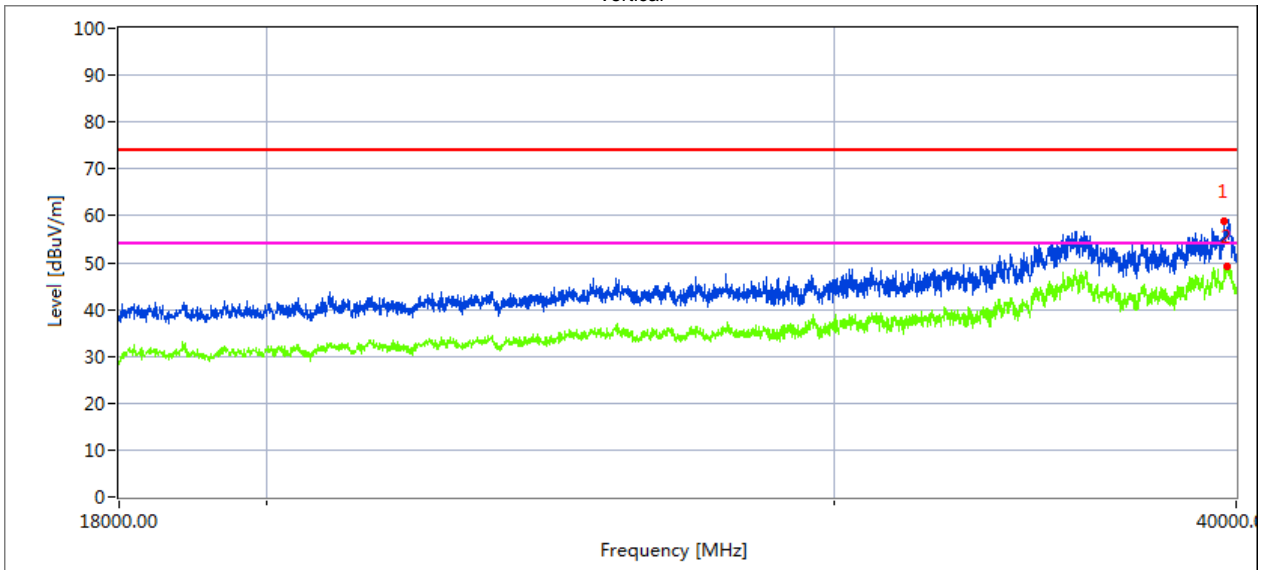

Measurement Result:

Frequency MHz	Meter Reading dBuV	Cable loss dB	Antenna Factor dB/m	Preamp Factor dB	Emission Level dBuV/m	Limits dBuV/m	Margin dB	Detector Type
39672.069	38.53	20.09	44.07	43.48	59.21	68.20	8.99	Peak

EUT :	Point to Point Wireless Device	Model Name. :	B5x
Temperature :	20 °C	Relative Humidity :	48%
Pressure :	1010 hPa	Test Voltage :	DC 50V
Test Mode :	Mode 2/3/4 (5.2G - 8dBi Antenna - point-to-point)		

All modes have been tested, just the 802.11ac20 MIMO worst mode has been recorded in the report.

Low Channel (5180 MHz)-Above 1G
Horizontal

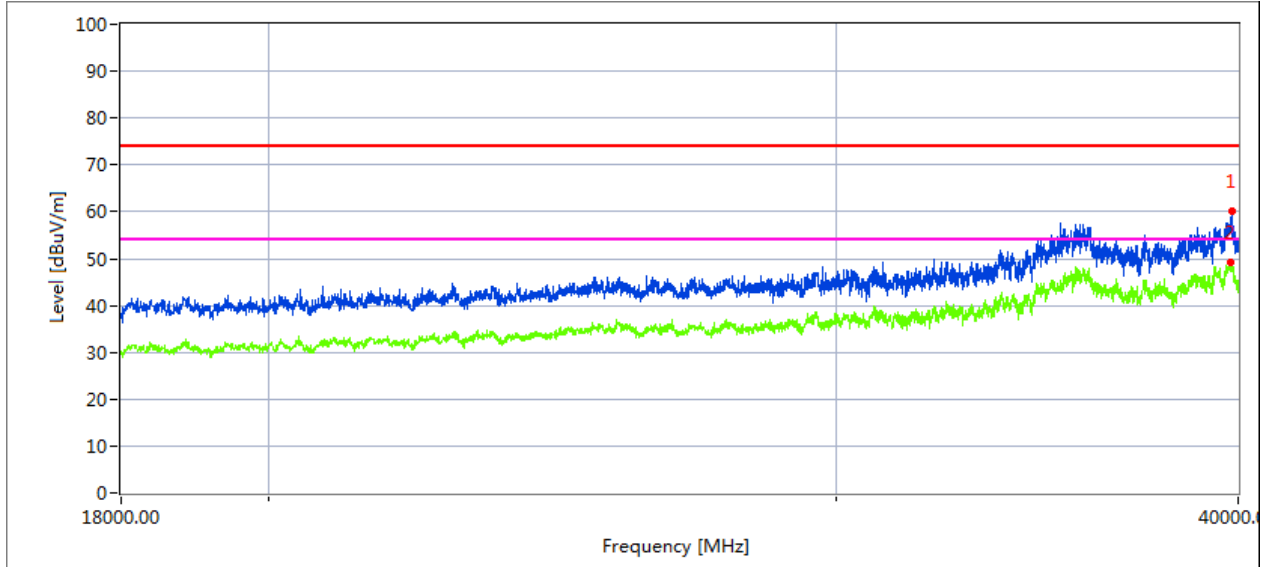

Measurement Result:

Frequency MHz	Meter Reading dBuV	Cable loss dB	Antenna Factor dB/m	Preamp Factor dB	Emission Level dBuV/m	Limits dBuV/m	Margin dB	Detector Type
39782.802	37.65	20.09	44.07	43.48	58.33	68.20	9.87	Peak

Vertical

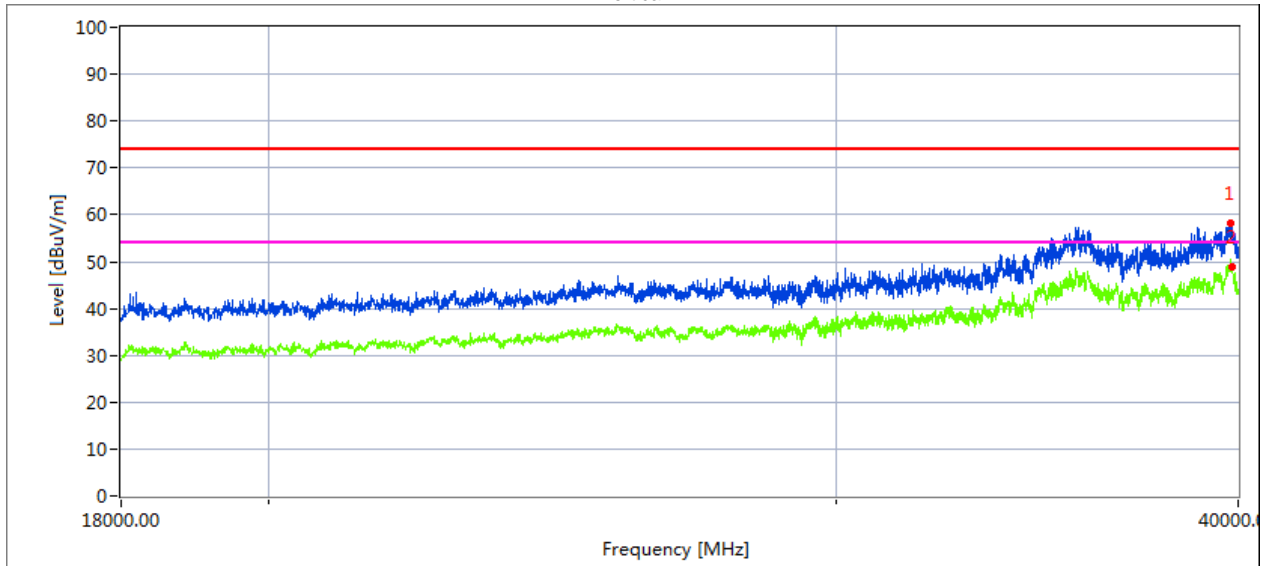

Measurement Result:

Frequency MHz	Meter Reading dBuV	Cable loss dB	Antenna Factor dB/m	Preamp Factor dB	Emission Level dBuV/m	Limits dBuV/m	Margin dB	Detector Type
39798.863	41.31	19.11	42.73	44.61	58.54	68.20	9.66	Peak

High Channel (5240 MHz)-Above 1G

Horizontal

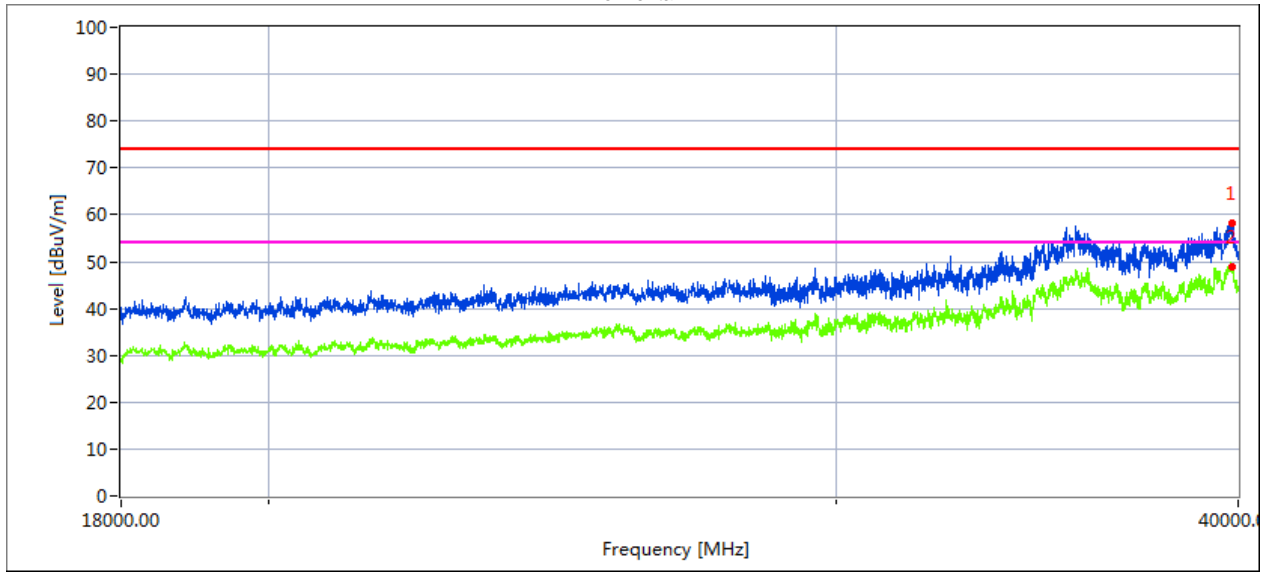

Measurement Result:

Frequency MHz	Meter Reading dBuV	Cable loss dB	Antenna Factor dB/m	Preamp Factor dB	Emission Level dBuV/m	Limits dBuV/m	Margin dB	Detector Type
39799.195	38.33	20.09	44.07	43.48	59.01	68.20	9.19	Peak

Vertical

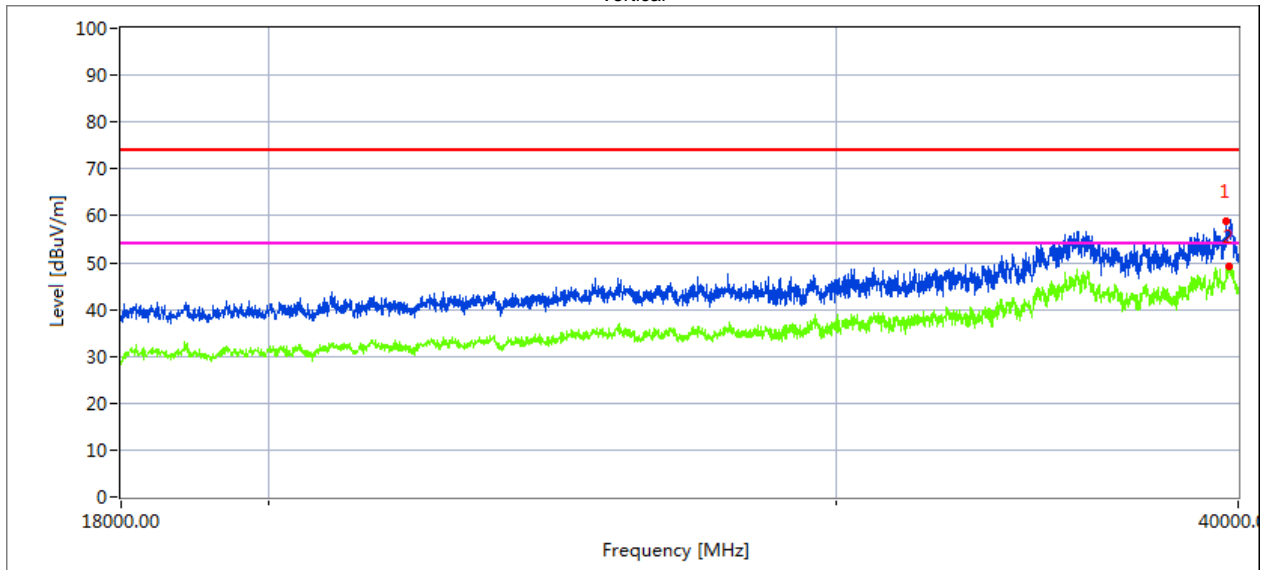

Measurement Result:

Frequency MHz	Meter Reading dBuV	Cable loss dB	Antenna Factor dB/m	Preamp Factor dB	Emission Level dBuV/m	Limits dBuV/m	Margin dB	Detector Type
39672.313	39.01	20.09	44.07	43.48	59.69	68.20	8.51	Peak

EUT :	Point to Point Wireless Device	Model Name. :	B5x
Temperature :	20 °C	Relative Humidity :	48%
Pressure :	1010 hPa	Test Voltage :	DC 50V
Test Mode :	Mode 2/3/4 (5.2G - 25dBi Antenna - point-to-point)		

All modes have been tested, just the 802.11ac20 MIMO worst mode has been recorded in the report.

Low Channel (5180 MHz)-Above 1G
Horizontal

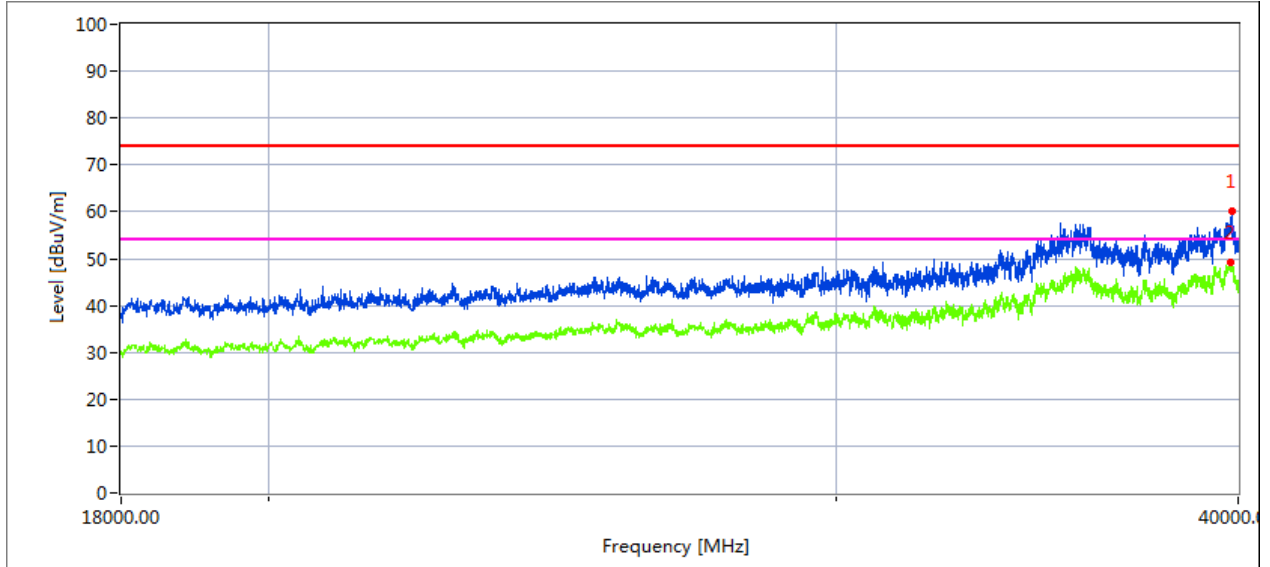

Measurement Result:

Frequency MHz	Meter Reading dBuV	Cable loss dB	Antenna Factor dB/m	Preamp Factor dB	Emission Level dBuV/m	Limits dBuV/m	Margin dB	Detector Type
39782.711	38.21	20.09	44.07	43.48	58.89	68.20	9.31	Peak

Vertical

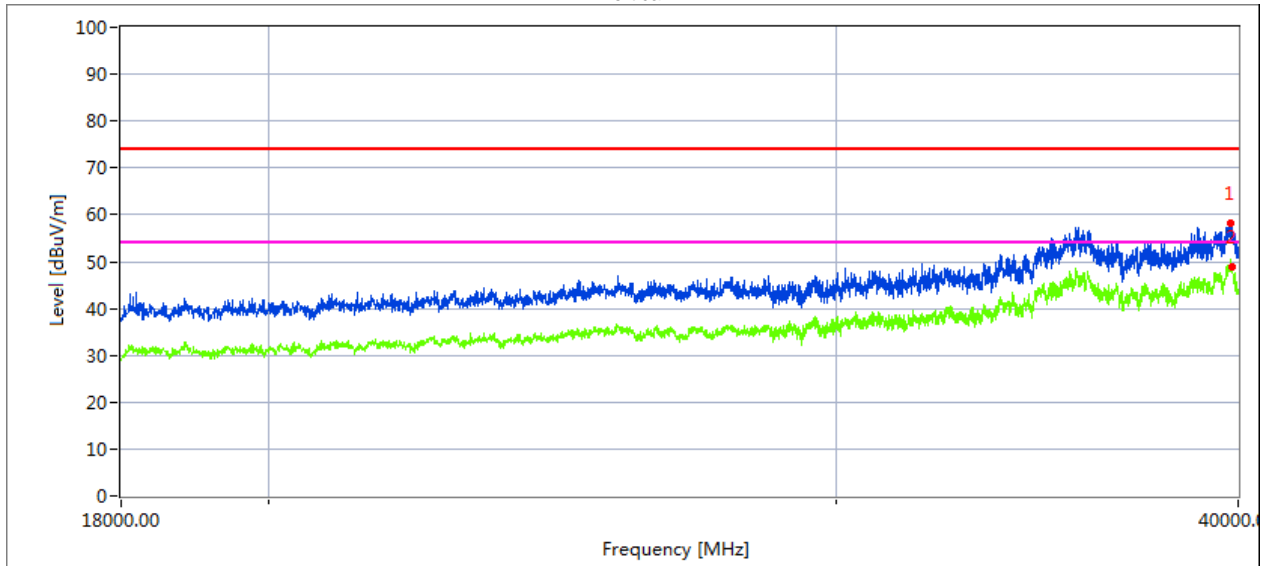

Measurement Result:

Frequency MHz	Meter Reading dBuV	Cable loss dB	Antenna Factor dB/m	Preamp Factor dB	Emission Level dBuV/m	Limits dBuV/m	Margin dB	Detector Type
39798.671	41.00	19.11	42.73	44.61	58.23	68.20	9.97	Peak

High Channel (5240 MHz)-Above 1G

Horizontal

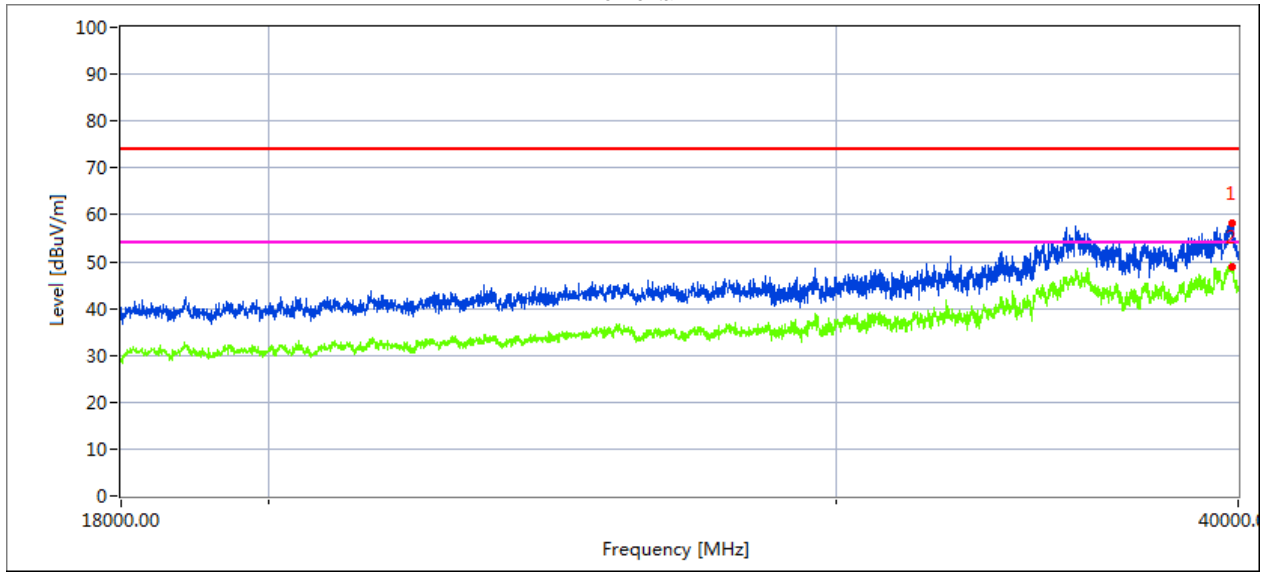

Measurement Result:

Frequency MHz	Meter Reading dBuV	Cable loss dB	Antenna Factor dB/m	Preamp Factor dB	Emission Level dBuV/m	Limits dBuV/m	Margin dB	Detector Type
39799.275	38.23	20.09	44.07	43.48	58.91	68.20	9.29	Peak

Vertical

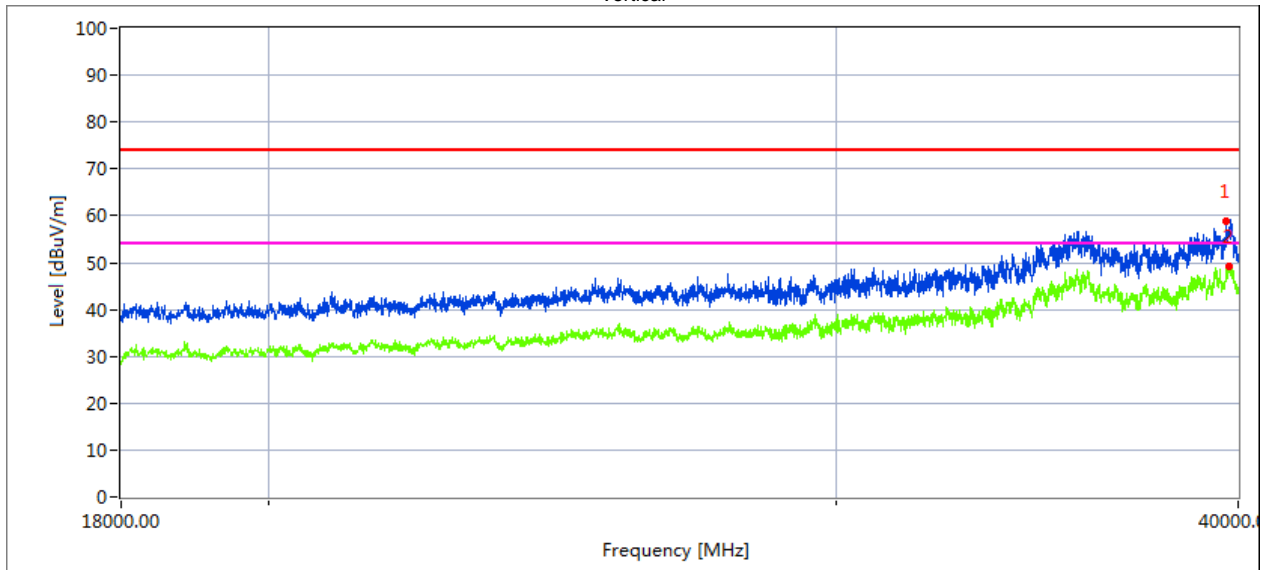

Measurement Result:

Frequency MHz	Meter Reading dBuV	Cable loss dB	Antenna Factor dB/m	Preamp Factor dB	Emission Level dBuV/m	Limits dBuV/m	Margin dB	Detector Type
39672.025	38.94	20.09	44.07	43.48	59.62	68.20	8.58	Peak

EUT :	Point to Point Wireless Device	Model Name. :	B5x
Temperature :	20 °C	Relative Humidity :	48%
Pressure :	1010 hPa	Test Voltage :	DC 50V
Test Mode :	Mode 2/3/4 (5.3G - 8dBi Antenna)		

All modes have been tested, just the 802.11ac20 MIMO worst mode has been recorded in the report.

Low Channel (5260 MHz)-Above 1G
Horizontal

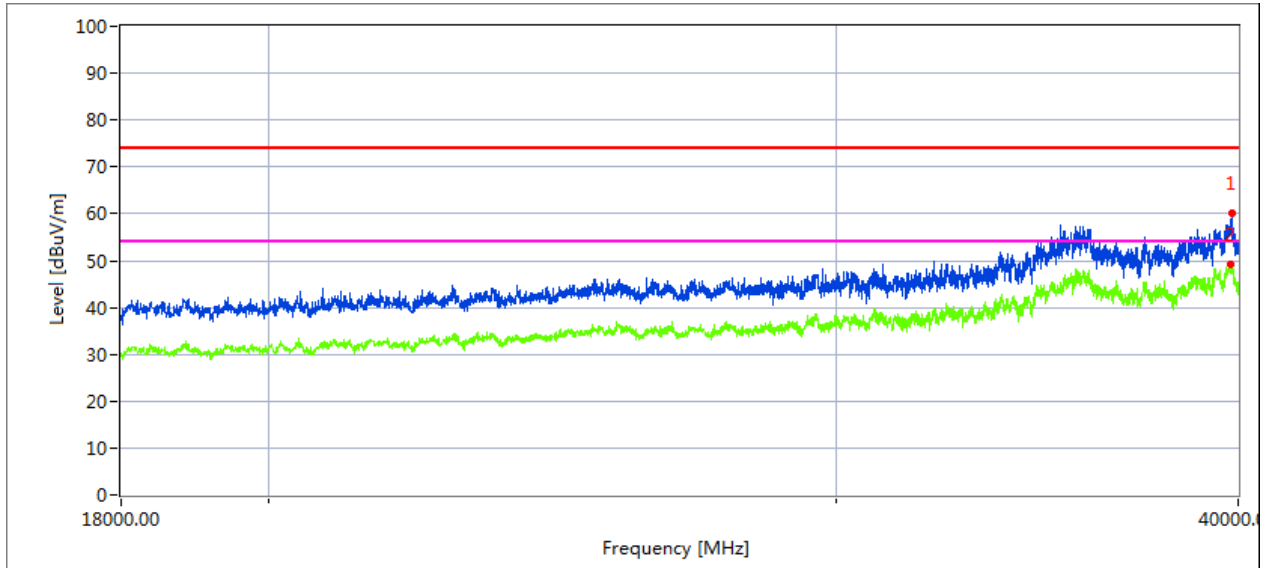

Measurement Result:

Frequency MHz	Meter Reading dBuV	Cable loss dB	Antenna Factor dB/m	Preamp Factor dB	Emission Level dBuV/m	Limits dBuV/m	Margin dB	Detector Type
39782.593	37.99	20.09	44.07	43.48	58.67	68.20	9.53	Peak

Vertical

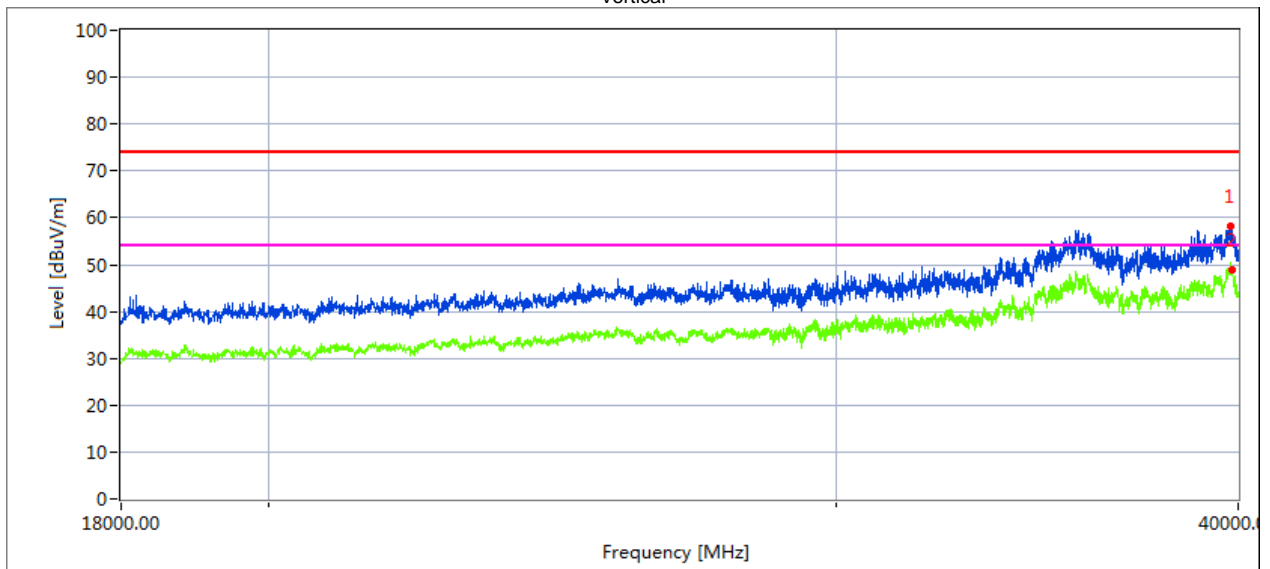

Measurement Result:

Frequency MHz	Meter Reading dBuV	Cable loss dB	Antenna Factor dB/m	Preamp Factor dB	Emission Level dBuV/m	Limits dBuV/m	Margin dB	Detector Type
39798.706	40.76	19.11	42.73	44.61	57.99	68.20	10.21	Peak

High Channel (5320 MHz)-Above 1G

Horizontal

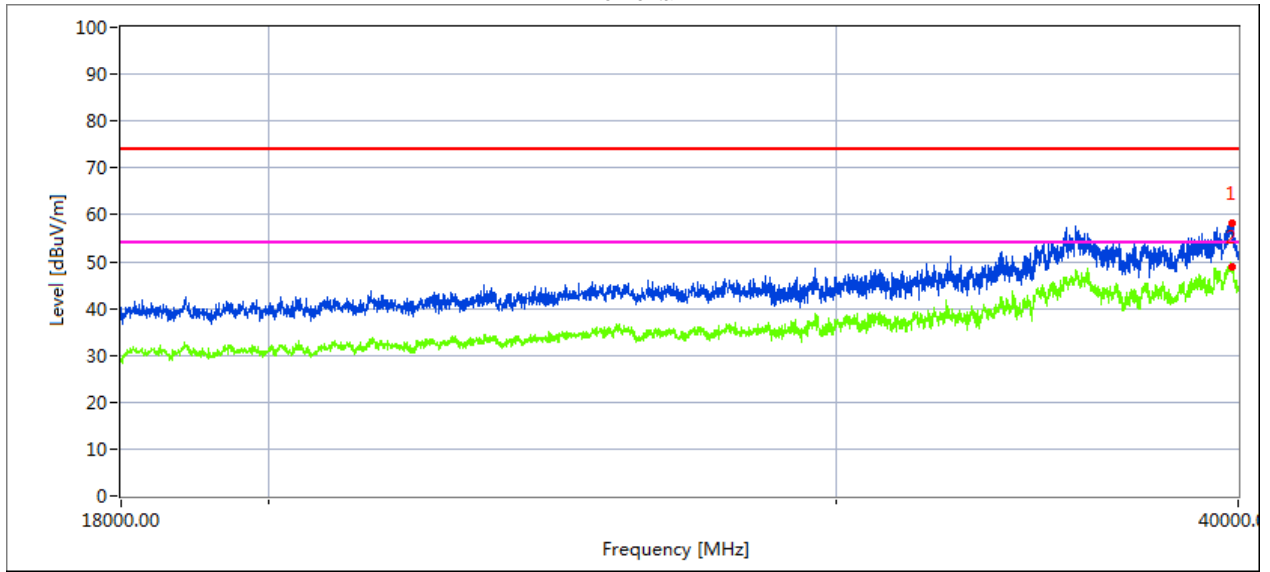

Measurement Result:

Frequency MHz	Meter Reading dBuV	Cable loss dB	Antenna Factor dB/m	Preamp Factor dB	Emission Level dBuV/m	Limits dBuV/m	Margin dB	Detector Type
39799.153	38.29	20.09	44.07	43.48	58.97	68.20	9.23	Peak

Vertical

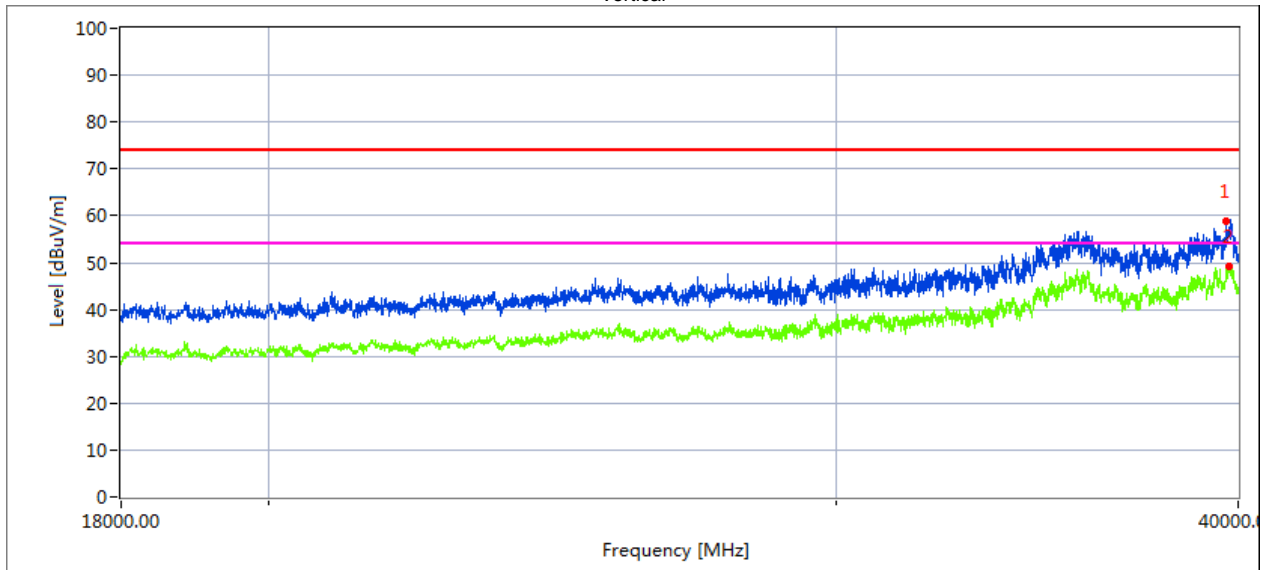

Measurement Result:

Frequency MHz	Meter Reading dBuV	Cable loss dB	Antenna Factor dB/m	Preamp Factor dB	Emission Level dBuV/m	Limits dBuV/m	Margin dB	Detector Type
39672.163	38.74	20.09	44.07	43.48	59.42	68.20	8.78	Peak

EUT :	Point to Point Wireless Device	Model Name. :	B5x
Temperature :	20 °C	Relative Humidity :	48%
Pressure :	1010 hPa	Test Voltage :	DC 50V
Test Mode :	Mode 2/3/4 (5.3G - 25dBi Antenna)		

All modes have been tested, just the 802.11ac20 MIMO worst mode has been recorded in the report.

Low Channel (5260 MHz)-Above 1G
Horizontal

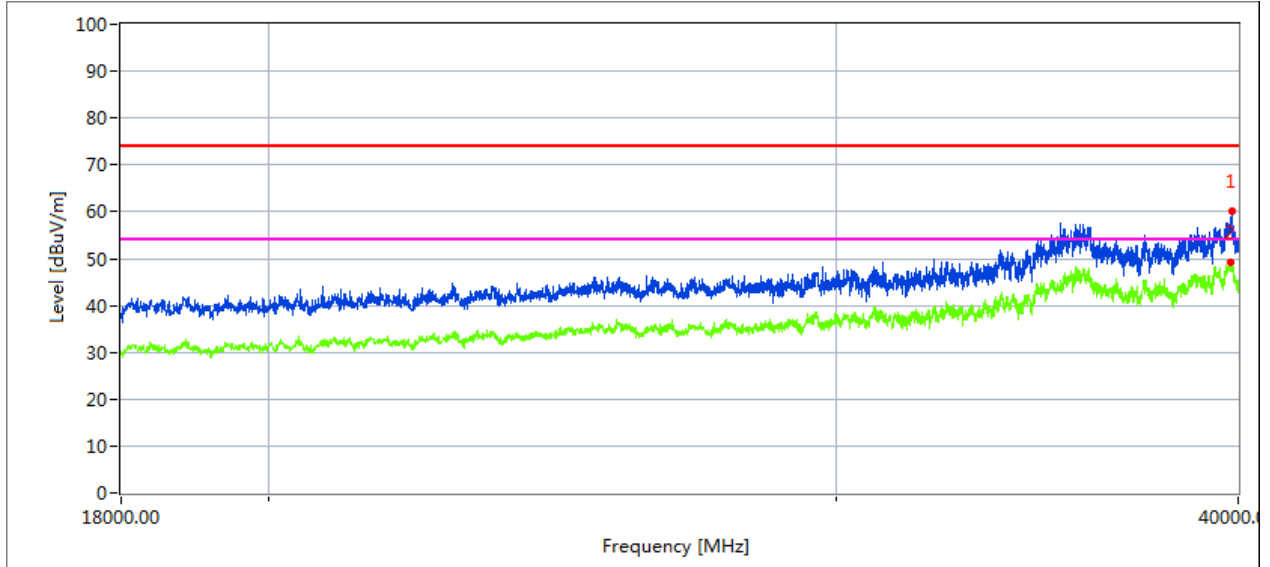

Measurement Result:

Frequency MHz	Meter Reading dBuV	Cable loss dB	Antenna Factor dB/m	Preamp Factor dB	Emission Level dBuV/m	Limits dBuV/m	Margin dB	Detector Type
39782.623	37.53	20.09	44.07	43.48	58.21	68.20	9.99	Peak

Vertical

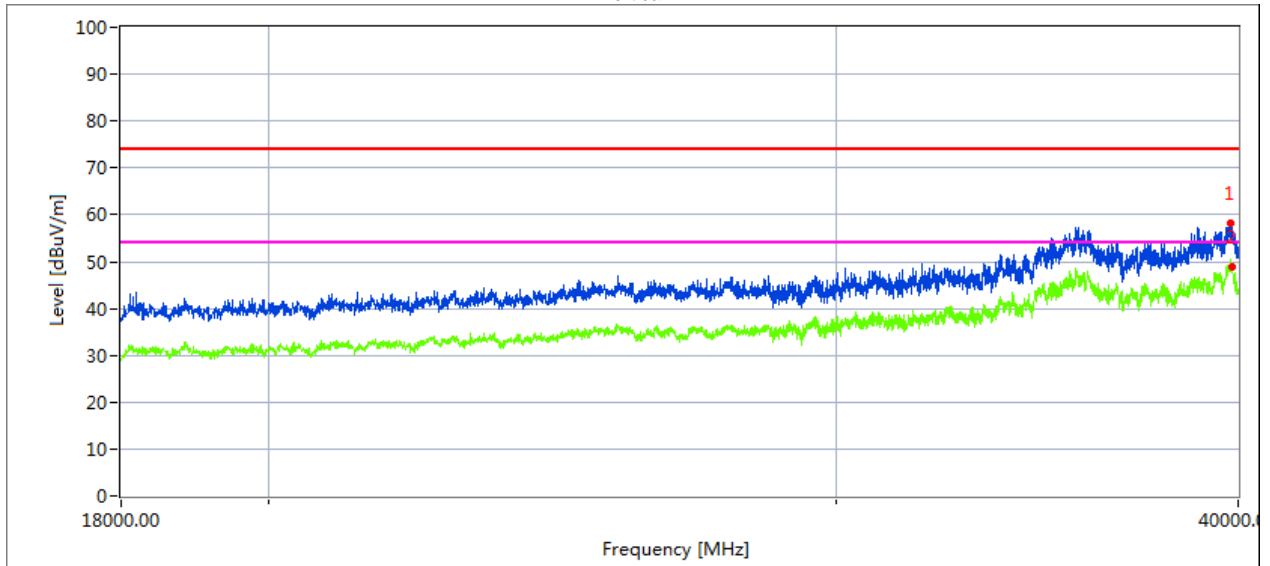

Measurement Result:

Frequency MHz	Meter Reading dBuV	Cable loss dB	Antenna Factor dB/m	Preamp Factor dB	Emission Level dBuV/m	Limits dBuV/m	Margin dB	Detector Type
39798.621	41.22	19.11	42.73	44.61	58.45	68.20	9.75	Peak

High Channel (5320 MHz)-Above 1G

Horizontal

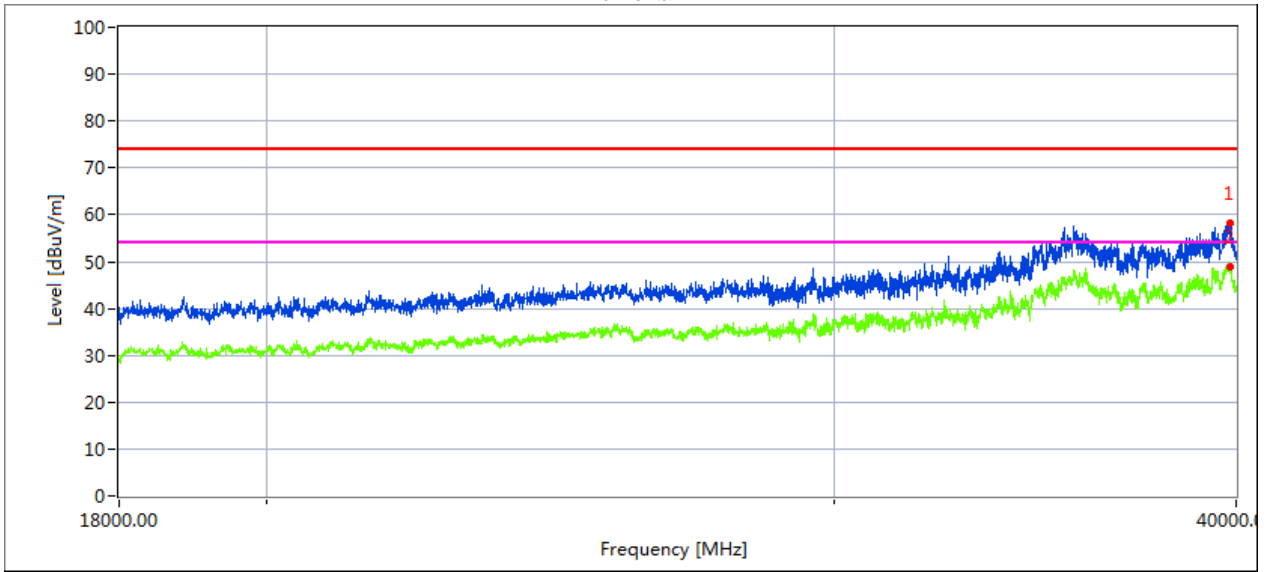

Measurement Result:

Frequency MHz	Meter Reading dBuV	Cable loss dB	Antenna Factor dB/m	Preamp Factor dB	Emission Level dBuV/m	Limits dBuV/m	Margin dB	Detector Type
39799.325	38.08	20.09	44.07	43.48	58.76	68.20	9.44	Peak

Vertical

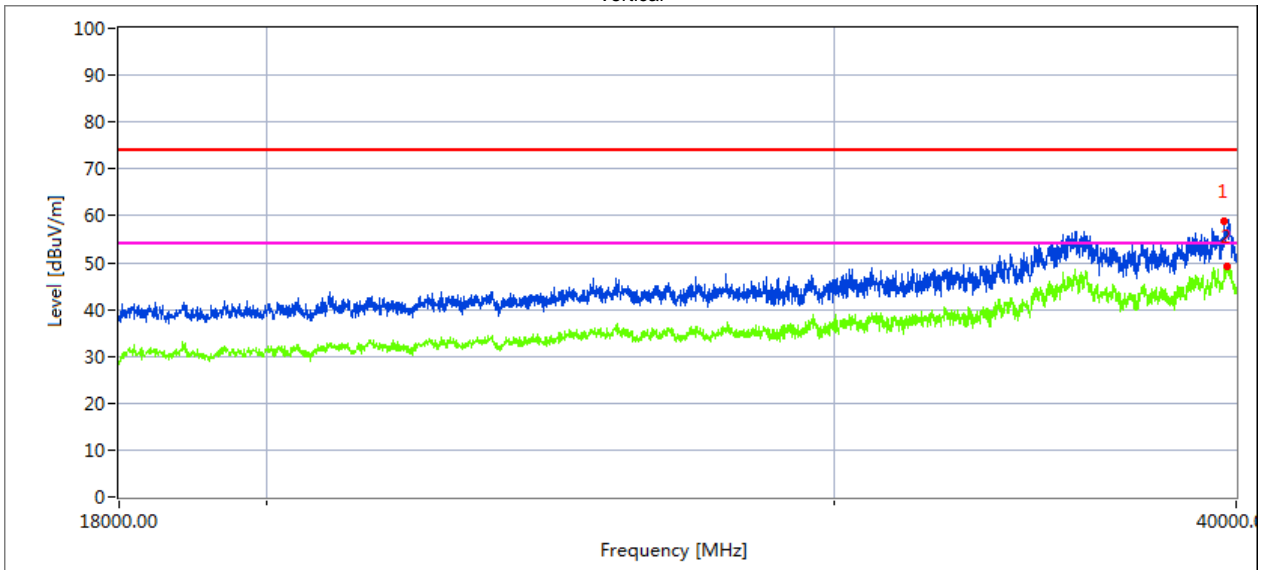

Measurement Result:

Frequency MHz	Meter Reading dBuV	Cable loss dB	Antenna Factor dB/m	Preamp Factor dB	Emission Level dBuV/m	Limits dBuV/m	Margin dB	Detector Type
39672.141	38.73	20.09	44.07	43.48	59.41	68.20	8.79	Peak

EUT :	Point to Point Wireless Device	Model Name. :	B5x
Temperature :	20 °C	Relative Humidity :	48%
Pressure :	1010 hPa	Test Voltage :	DC 50V
Test Mode :	Mode 2/3/4 (5.6G - 8dBi Antenna)		

All modes have been tested, just the 802.11ac20 MIMO worst mode has been recorded in the report.

Low Channel (5500 MHz)-Above 1G
Horizontal

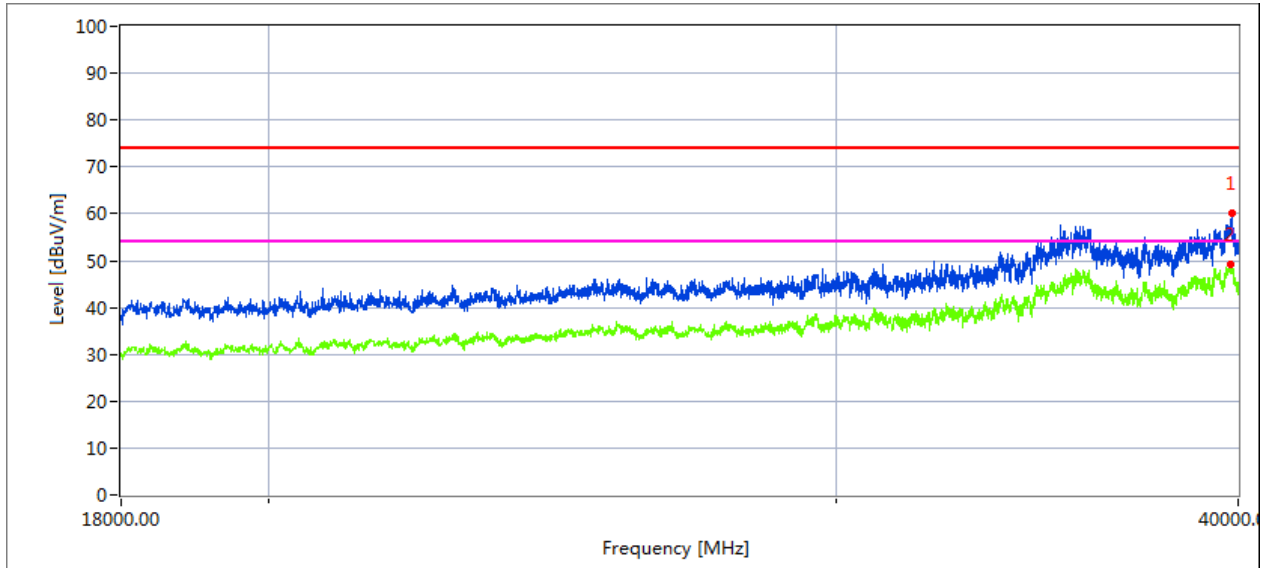

Measurement Result:

Frequency MHz	Meter Reading dBuV	Cable loss dB	Antenna Factor dB/m	Preamp Factor dB	Emission Level dBuV/m	Limits dBuV/m	Margin dB	Detector Type
39782.642	37.92	20.09	44.07	43.48	58.60	68.20	9.60	Peak

Vertical

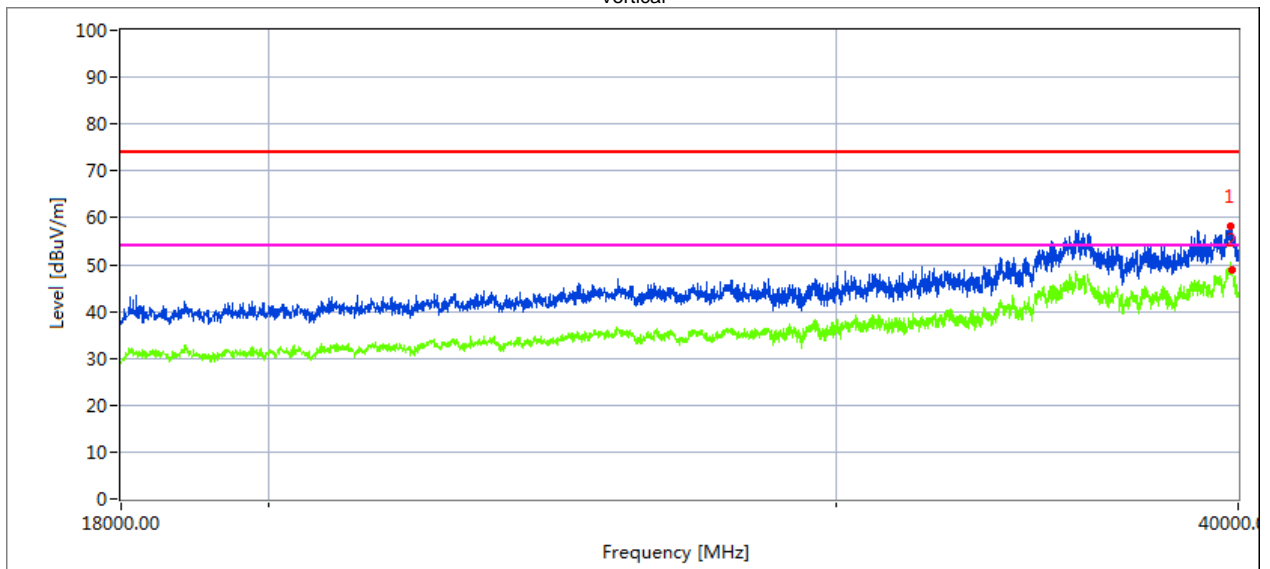

Measurement Result:

Frequency MHz	Meter Reading dBuV	Cable loss dB	Antenna Factor dB/m	Preamp Factor dB	Emission Level dBuV/m	Limits dBuV/m	Margin dB	Detector Type
39798.698	40.93	19.11	42.73	44.61	58.16	68.20	10.04	Peak

High Channel (5700 MHz)-Above 1G

Horizontal

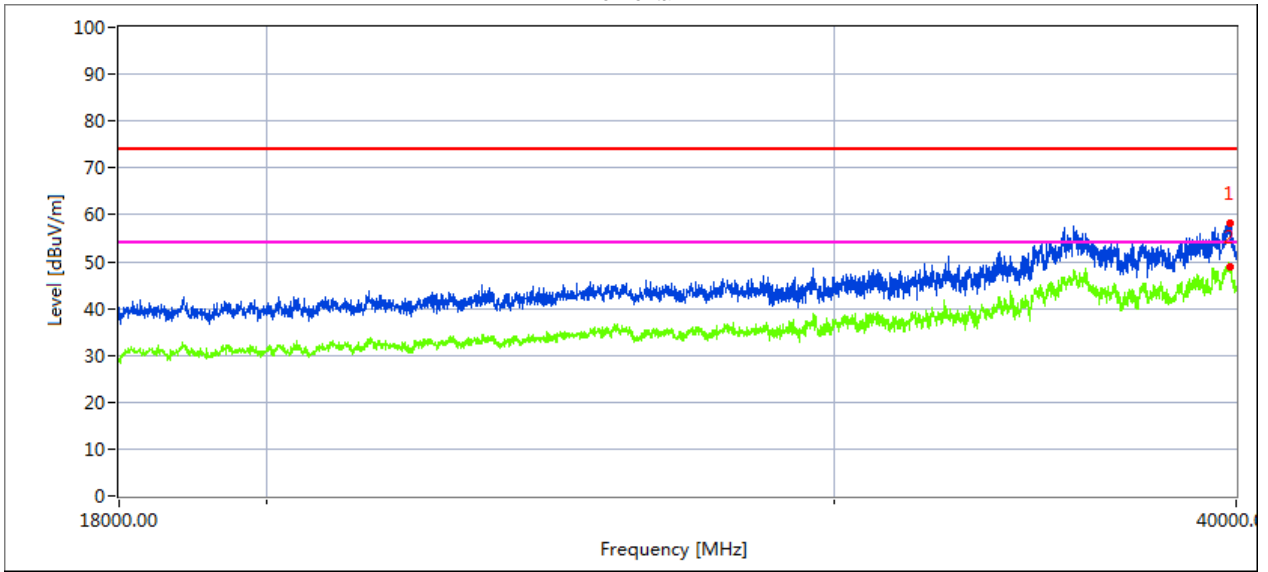

Measurement Result:

Frequency MHz	Meter Reading dBuV	Cable loss dB	Antenna Factor dB/m	Preamp Factor dB	Emission Level dBuV/m	Limits dBuV/m	Margin dB	Detector Type
39799.385	37.83	20.09	44.07	43.48	58.51	68.20	9.69	Peak

Vertical

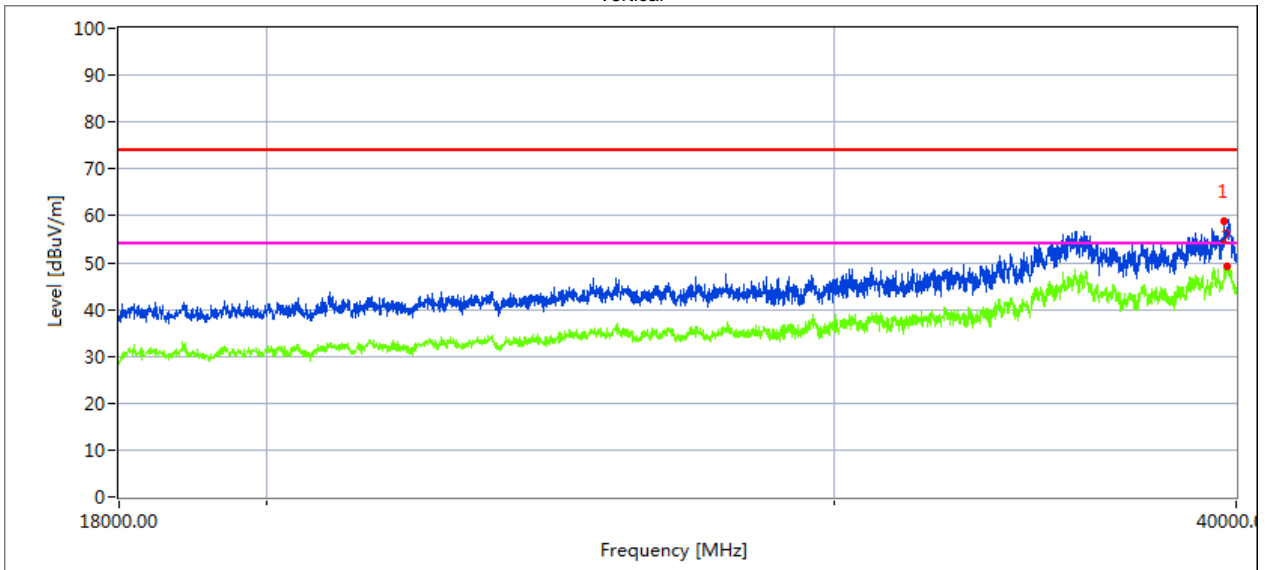

Measurement Result:

Frequency MHz	Meter Reading dBuV	Cable loss dB	Antenna Factor dB/m	Preamp Factor dB	Emission Level dBuV/m	Limits dBuV/m	Margin dB	Detector Type
39672.336	38.31	20.09	44.07	43.48	58.99	68.20	9.21	Peak

EUT :	Point to Point Wireless Device	Model Name. :	B5x
Temperature :	20 °C	Relative Humidity :	48%
Pressure :	1010 hPa	Test Voltage :	DC 50V
Test Mode :	Mode 2/3/4 (5.6G - 25dBi Antenna)		

All modes have been tested, just the 802.11ac20 MIMO worst mode has been recorded in the report.

Low Channel (5500 MHz)-Above 1G
Horizontal

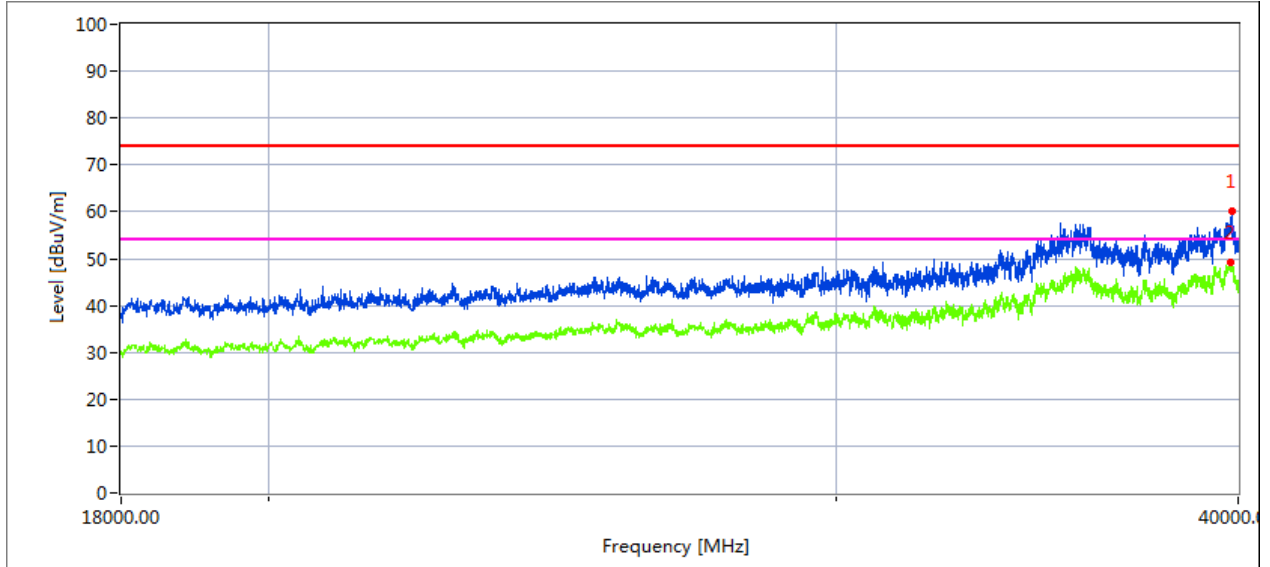

Measurement Result:

Frequency MHz	Meter Reading dBuV	Cable loss dB	Antenna Factor dB/m	Preamp Factor dB	Emission Level dBuV/m	Limits dBuV/m	Margin dB	Detector Type
39782.813	37.68	20.09	44.07	43.48	58.36	68.20	9.84	Peak

Vertical

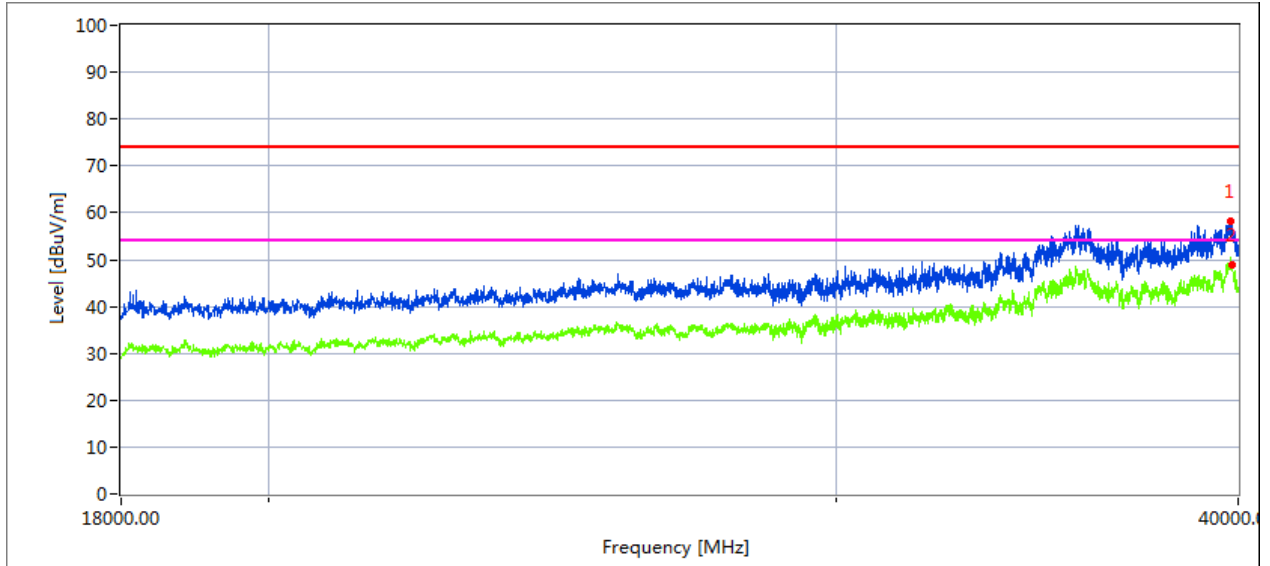

Measurement Result:

Frequency MHz	Meter Reading dBuV	Cable loss dB	Antenna Factor dB/m	Preamp Factor dB	Emission Level dBuV/m	Limits dBuV/m	Margin dB	Detector Type
39798.730	40.74	19.11	42.73	44.61	57.97	68.20	10.23	Peak

High Channel (5700 MHz)-Above 1G

Horizontal

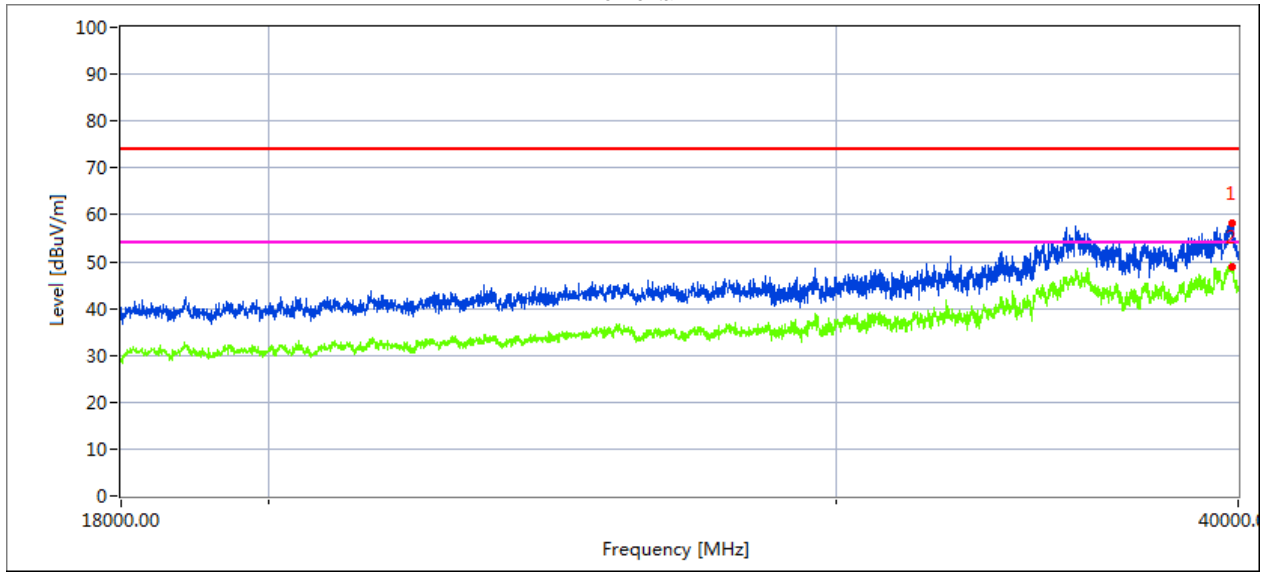

Measurement Result:

Frequency MHz	Meter Reading dBuV	Cable loss dB	Antenna Factor dB/m	Preamp Factor dB	Emission Level dBuV/m	Limits dBuV/m	Margin dB	Detector Type
39799.363	38.18	20.09	44.07	43.48	58.86	68.20	9.34	Peak

Vertical

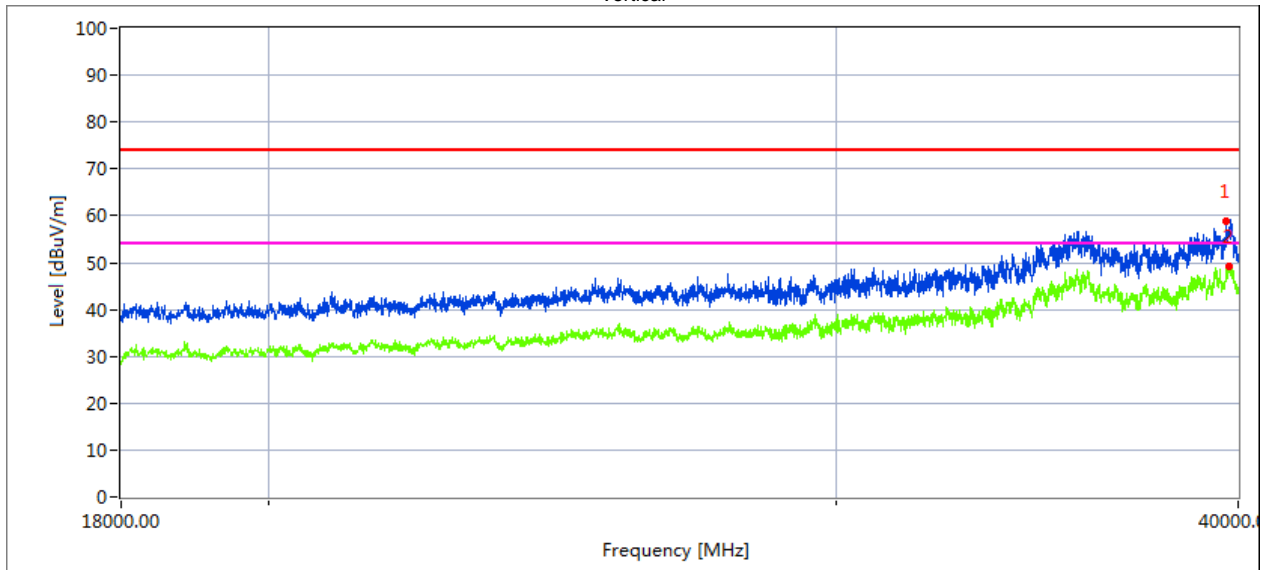

Measurement Result:

Frequency MHz	Meter Reading dBuV	Cable loss dB	Antenna Factor dB/m	Preamp Factor dB	Emission Level dBuV/m	Limits dBuV/m	Margin dB	Detector Type
39672.126	38.46	20.09	44.07	43.48	59.14	68.20	9.06	Peak

EUT :	Point to Point Wireless Device	Model Name. :	B5x
Temperature :	20 °C	Relative Humidity :	48%
Pressure :	1010 hPa	Test Voltage :	DC 50V
Test Mode :	Mode 2/3/4 (5.8G - 8dBi Antenna)		

All modes have been tested, just the 802.11ac20 MIMO worst mode has been recorded in the report.

Low Channel (5745 MHz)-Above 1G

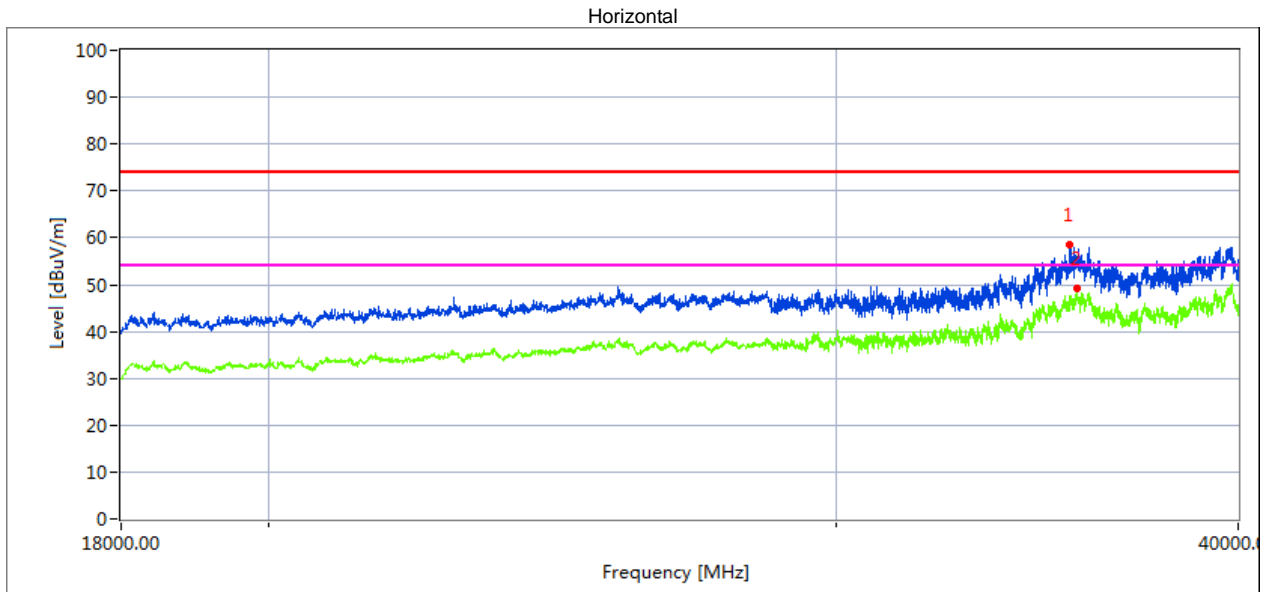

Measurement Result:

Frequency MHz	Meter Reading dBuV	Cable loss dB	Antenna Factor dB/m	Preamp Factor dB	Emission Level dBuV/m	Limits dBuV/m	Margin dB	Detector Type
35459.339	38.38	20.09	44.16	43.48	59.15	68.20	9.05	Peak

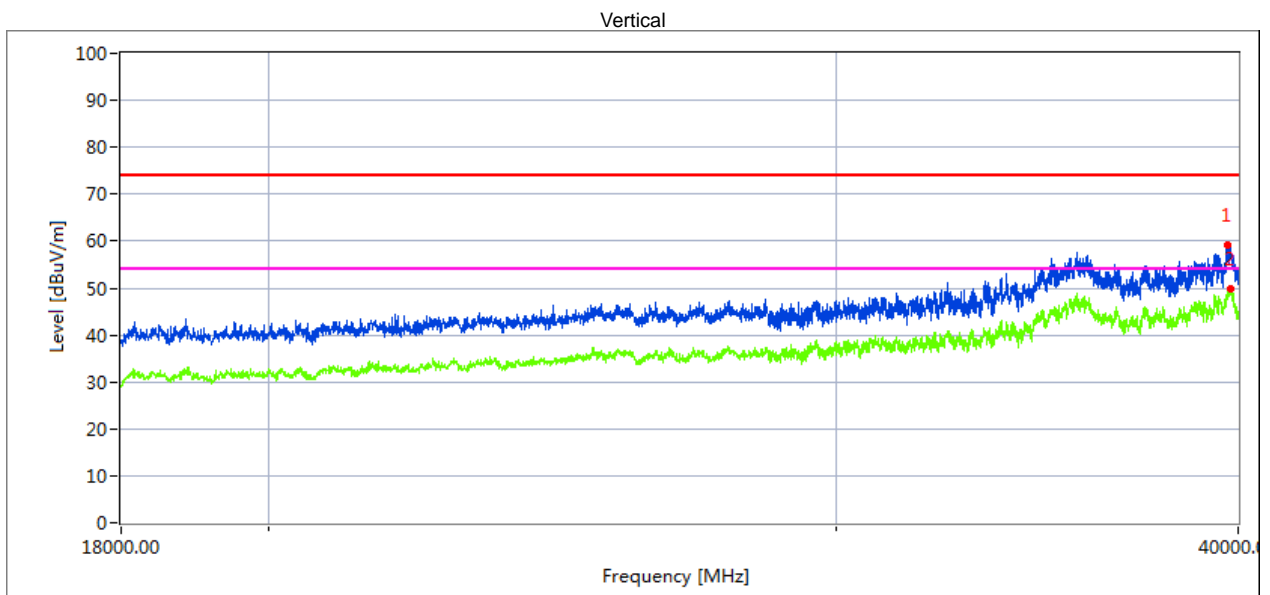

Measurement Result:

Frequency MHz	Meter Reading dBuV	Cable loss dB	Antenna Factor dB/m	Preamp Factor dB	Emission Level dBuV/m	Limits dBuV/m	Margin dB	Detector Type
39716.247	38.24	20.06	44.07	43.21	59.16	68.20	9.04	Peak

High Channel (5825 MHz)-Above 1G

Horizontal

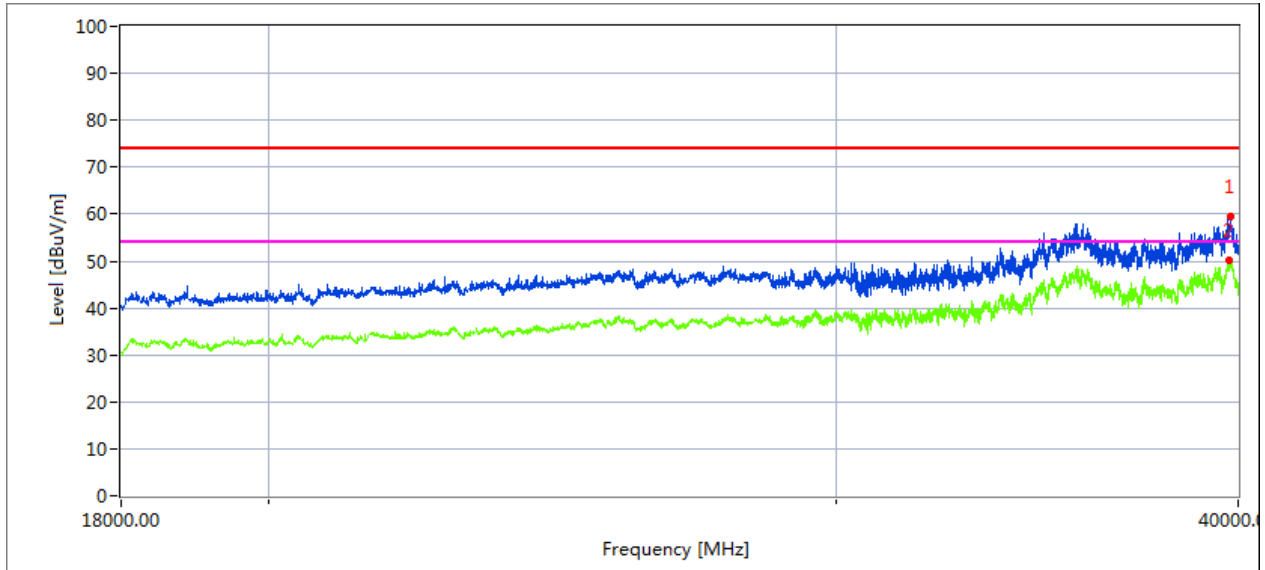

Measurement Result:

Frequency MHz	Meter Reading dBuV	Cable loss dB	Antenna Factor dB/m	Preamp Factor dB	Emission Level dBuV/m	Limits dBuV/m	Margin dB	Detector Type
39765.228	41.11	19.11	42.63	43.48	59.37	68.20	8.83	Peak

Vertical

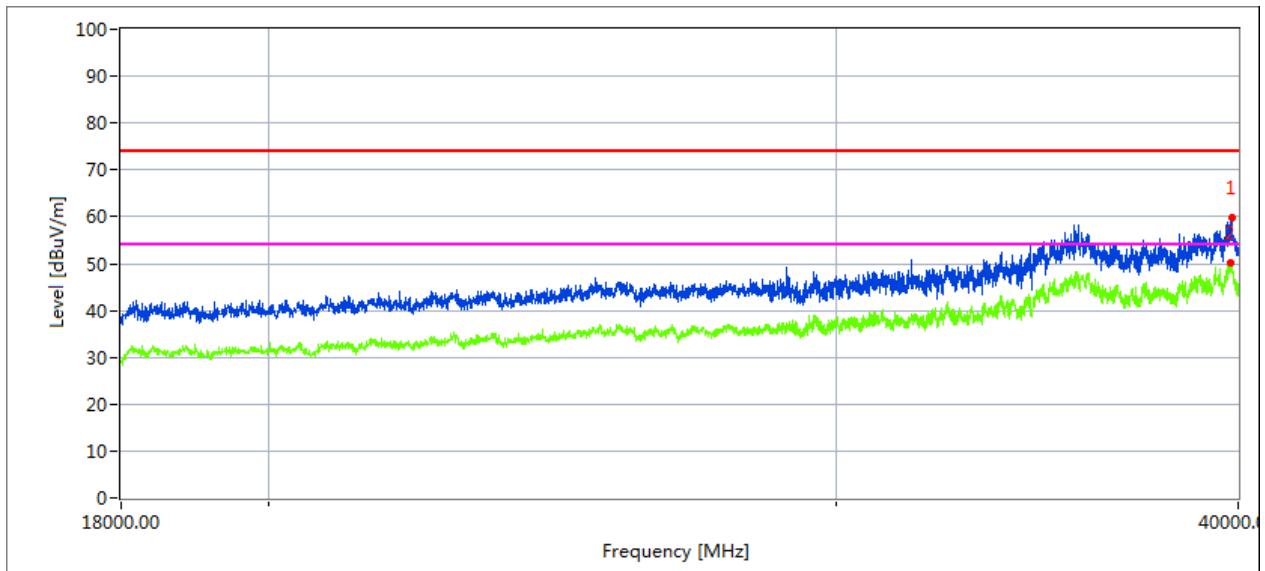

Measurement Result:

Frequency MHz	Meter Reading dBuV	Cable loss dB	Antenna Factor dB/m	Preamp Factor dB	Emission Level dBuV/m	Limits dBuV/m	Margin dB	Detector Type
39815.331	38.70	20.10	44.10	43.22	59.68	68.20	8.52	Peak

EUT :	Point to Point Wireless Device	Model Name. :	B5x
Temperature :	20 °C	Relative Humidity :	48%
Pressure :	1010 hPa	Test Voltage :	DC 50V
Test Mode :	Mode 2/3/4 (5.8G - 25dBi Antenna)		

All modes have been tested, just the 802.11ac20 MIMO worst mode has been recorded in the report.

Low Channel (5745 MHz)-Above 1G

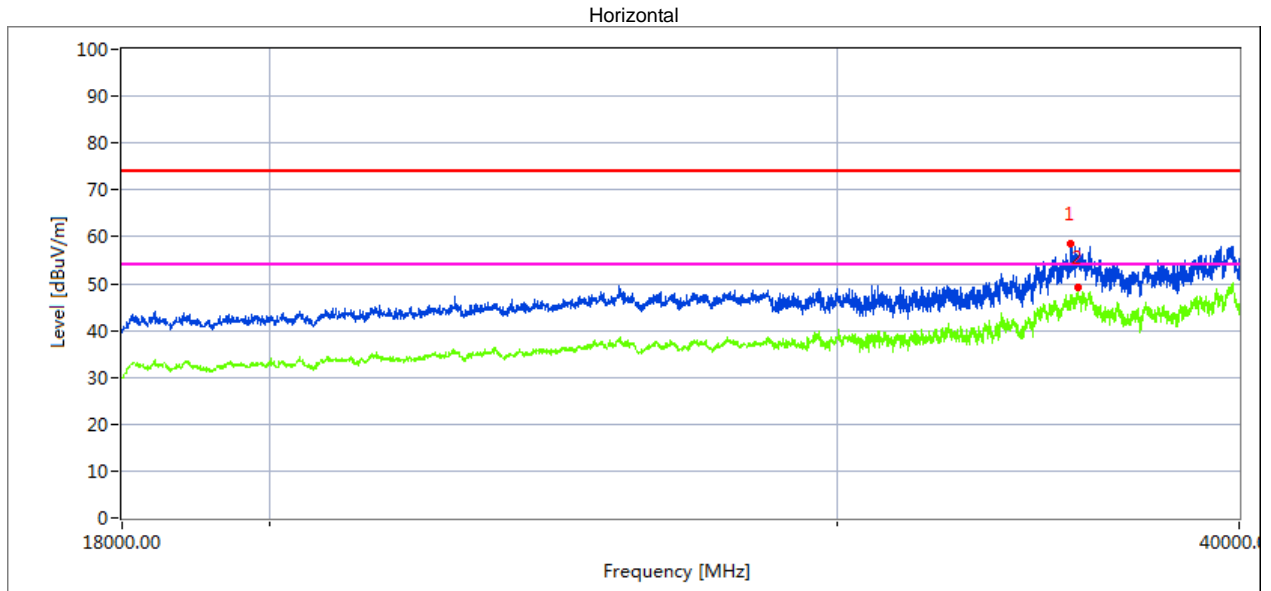

Measurement Result:

Frequency MHz	Meter Reading dBuV	Cable loss dB	Antenna Factor dB/m	Preamp Factor dB	Emission Level dBuV/m	Limits dBuV/m	Margin dB	Detector Type
35459.209	38.80	20.09	44.16	43.48	59.57	68.20	8.63	Peak

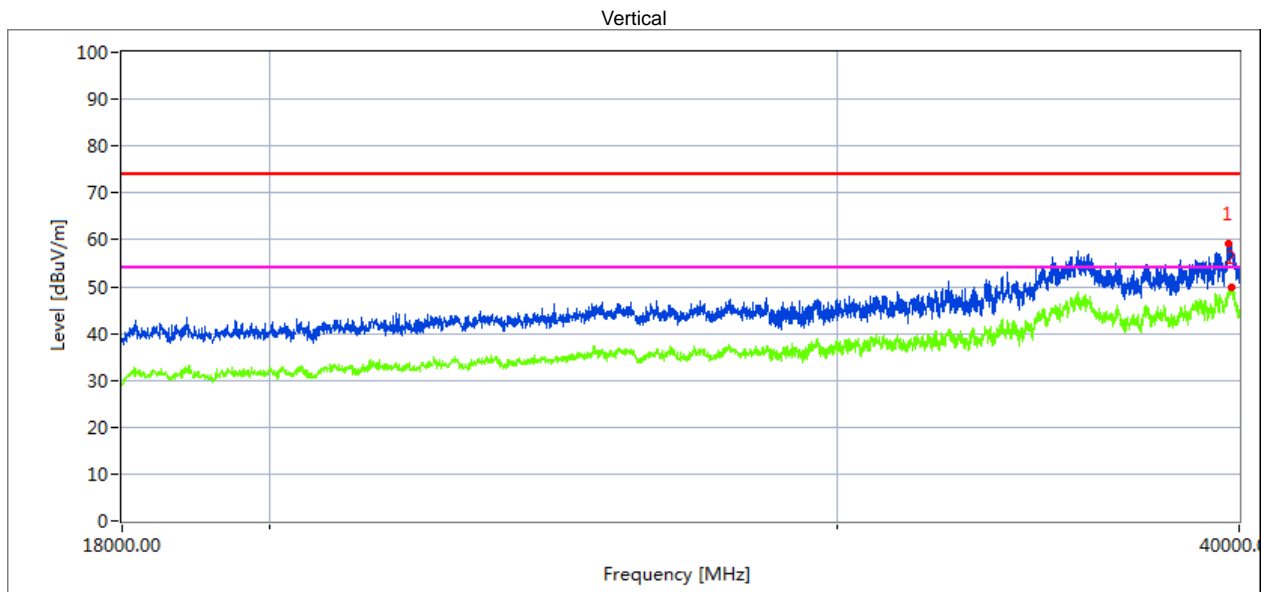

Measurement Result:

Frequency MHz	Meter Reading dBuV	Cable loss dB	Antenna Factor dB/m	Preamp Factor dB	Emission Level dBuV/m	Limits dBuV/m	Margin dB	Detector Type
39716.258	37.60	20.06	44.07	43.21	58.52	68.20	9.68	Peak

High Channel (5825 MHz)-Above 1G

Horizontal

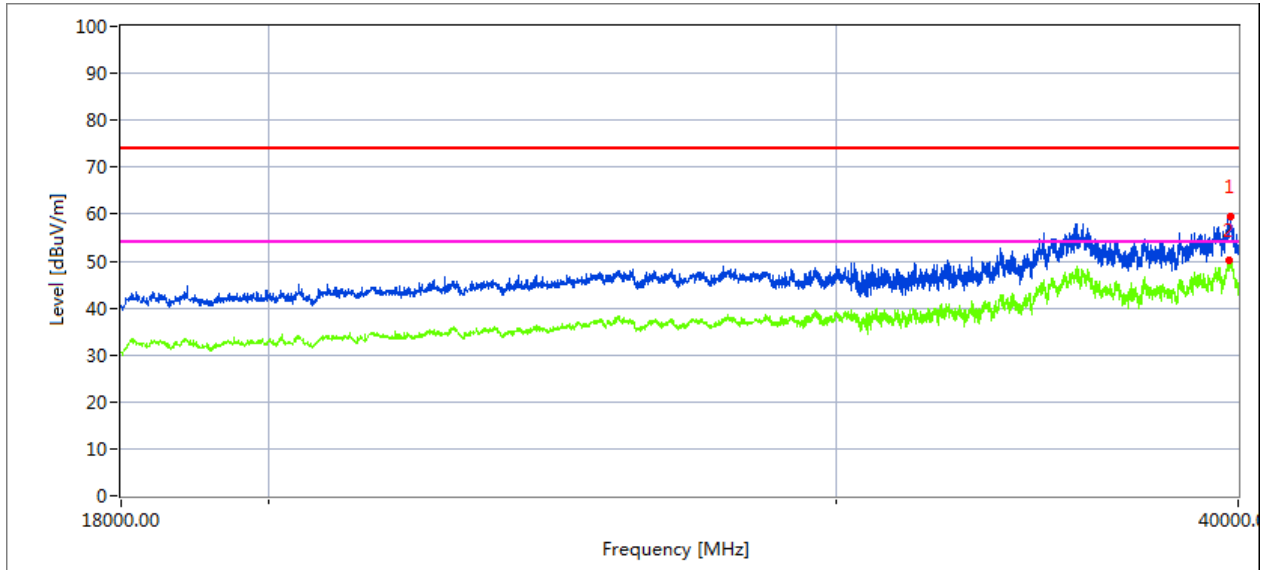

Measurement Result:

Frequency MHz	Meter Reading dBuV	Cable loss dB	Antenna Factor dB/m	Preamp Factor dB	Emission Level dBuV/m	Limits dBuV/m	Margin dB	Detector Type
39765.275	40.93	19.11	42.63	43.48	59.19	68.20	9.01	Peak

Vertical

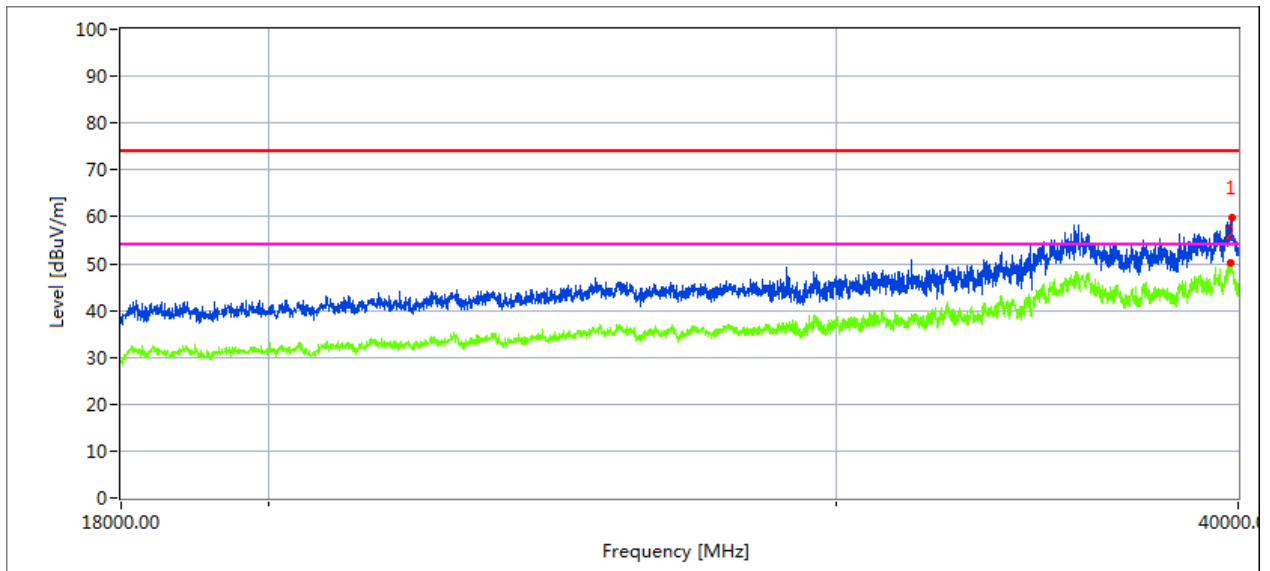

Measurement Result:

Frequency MHz	Meter Reading dBuV	Cable loss dB	Antenna Factor dB/m	Preamp Factor dB	Emission Level dBuV/m	Limits dBuV/m	Margin dB	Detector Type
39815.403	38.64	20.10	44.10	43.22	59.62	68.20	8.58	Peak

3.2.10 SPURIOUS EMISSION IN RESTRICTED BAND 4.5GHZ~5.150 GHZ& 5.350GHZ~5460GHZ

EUT :	Point to Point Wireless Device	Model Name. :	B5x
Temperature :	20 °C	Relative Humidity :	48%
Pressure :	1010 hPa	Test Voltage :	DC 50V
Test Mode :	Mode 2/3/4 (5.2G - 8dBi Antenna - outdoor AP)		

All modes have been tested, just the 802.11ac20 CH36 MIMO mode is the worst mode has been recorded in the report.

Frequency (MHz)	Meter Reading (dBμV)	Cable Loss (dB)	Antenna Factor dB/m	Preamp Factor (dB)	Emission Level (dBμV/m)	Limits (dBμV/m)	Margin (dB)	Detector Type	Comment
5.2G WIFI-802.11ac20 MIMO Mode									
4500	62.98	5.20	35.60	44.20	59.58	74	-14.42	Pk	Horizontal
4500	45.40	5.20	35.60	44.20	42.00	54	-12.00	AV	Horizontal
4500	61.57	5.20	35.60	44.20	58.17	74	-15.83	Pk	Vertical
4500	39.35	5.20	35.60	44.20	35.95	54	-18.05	AV	Vertical
5150	56.44	5.36	35.66	44.22	53.24	74	-20.76	Pk	Horizontal
5150	35.94	5.36	35.66	44.22	32.74	54	-21.26	AV	Horizontal
5150	59.42	5.36	35.66	44.22	56.22	74	-17.78	Pk	Vertical
5150	39.05	5.36	35.66	44.22	35.85	54	-18.15	AV	Vertical
5350	57.47	5.68	35.68	44.22	54.61	74	-19.39	Pk	Horizontal
5350	39.93	5.68	35.68	44.22	37.07	54	-16.93	AV	Horizontal
5350	52.68	5.68	35.68	44.22	49.82	74	-24.18	Pk	Vertical
5350	39.45	5.68	35.68	44.22	36.59	54	-17.41	AV	Vertical

Note: (1) Emission Level= Antenna Factor + Cable Loss + Read Level - Preamp Factor

(2) "802.11ac20 CH36 MIMO " mode is the worst mode. When PK value is lower than the Average value limit, average don't record.

EUT :	Point to Point Wireless Device	Model Name. :	B5x
Temperature :	20 °C	Relative Humidity :	48%
Pressure :	1010 hPa	Test Voltage :	DC 50V
Test Mode :	Mode 2/3/4 (5.2G - 25dBi Antenna - outdoor AP)		

All modes have been tested, just the 802.11ac20 CH36 MIMO mode is the worst mode has been recorded in the report.

Frequency (MHz)	Meter Reading (dBμV)	Cable Loss (dB)	Antenna Factor dB/m	Preamp Factor (dB)	Emission Level (dBμV/m)	Limits (dBμV/m)	Margin (dB)	Detector Type	Comment
5.2G WIFI-802.11ac20 MIMO Mode									
4500	59.75	5.20	35.60	44.20	56.35	74	-17.65	Pk	Horizontal
4500	46.18	5.20	35.60	44.20	42.78	54	-11.22	AV	Horizontal
4500	59.91	5.20	35.60	44.20	56.51	74	-17.49	Pk	Vertical
4500	42.21	5.20	35.60	44.20	38.81	54	-15.19	AV	Vertical
5150	55.65	5.36	35.66	44.22	52.45	74	-21.55	Pk	Horizontal
5150	38.24	5.36	35.66	44.22	35.04	54	-18.96	AV	Horizontal
5150	63.05	5.36	35.66	44.22	59.85	74	-14.15	Pk	Vertical
5150	41.96	5.36	35.66	44.22	38.76	54	-15.24	AV	Vertical
5350	57.92	5.68	35.68	44.22	55.06	74	-18.94	Pk	Horizontal
5350	38.05	5.68	35.68	44.22	35.19	54	-18.81	AV	Horizontal
5350	52.44	5.68	35.68	44.22	49.58	74	-24.42	Pk	Vertical
5350	37.84	5.68	35.68	44.22	34.98	54	-19.02	AV	Vertical

Note: (1) Emission Level= Antenna Factor + Cable Loss + Read Level - Preamp Factor

(2) "802.11ac20 CH36 MIMO " mode is the worst mode. When PK value is lower than the Average value limit, average don't record.

EUT :	Point to Point Wireless Device	Model Name. :	B5x
Temperature :	20 °C	Relative Humidity :	48%
Pressure :	1010 hPa	Test Voltage :	DC 50V
Test Mode :	Mode 2/3/4 (5.2G - 8dBi Antenna - point-to-point)		

All modes have been tested, just the 802.11ac20 CH36 MIMO mode is the worst mode has been recorded in the report.

Frequency (MHz)	Meter Reading (dBμV)	Cable Loss (dB)	Antenna Factor dB/m	Preamp Factor (dB)	Emission Level (dBμV/m)	Limits (dBμV/m)	Margin (dB)	Detector Type	Comment
5.2G WIFI-802.11ac20 MIMO Mode									
4500	61.42	5.20	35.60	44.20	58.02	74	-15.98	Pk	Horizontal
4500	43.78	5.20	35.60	44.20	40.38	54	-13.62	AV	Horizontal
4500	59.85	5.20	35.60	44.20	56.45	74	-17.55	Pk	Vertical
4500	43.08	5.20	35.60	44.20	39.68	54	-14.32	AV	Vertical
5150	55.75	5.36	35.66	44.22	52.55	74	-21.45	Pk	Horizontal
5150	39.54	5.36	35.66	44.22	36.34	54	-17.66	AV	Horizontal
5150	61.40	5.36	35.66	44.22	58.20	74	-15.80	Pk	Vertical
5150	40.72	5.36	35.66	44.22	37.52	54	-16.48	AV	Vertical
5350	55.36	5.68	35.68	44.22	52.50	74	-21.50	Pk	Horizontal
5350	38.58	5.68	35.68	44.22	35.72	54	-18.28	AV	Horizontal
5350	53.71	5.68	35.68	44.22	50.85	74	-23.15	Pk	Vertical
5350	39.89	5.68	35.68	44.22	37.03	54	-16.97	AV	Vertical

Note: (1) Emission Level= Antenna Factor + Cable Loss + Read Level - Preamp Factor

(2) "802.11ac20 CH36 MIMO " mode is the worst mode. When PK value is lower than the Average value limit, average don't record.

EUT :	Point to Point Wireless Device	Model Name. :	B5x
Temperature :	20 °C	Relative Humidity :	48%
Pressure :	1010 hPa	Test Voltage :	DC 50V
Test Mode :	Mode 2/3/4 (5.2G - 25dBi Antenna - point-to-point)		

All modes have been tested, just the 802.11ac20 CH36 MIMO mode is the worst mode has been recorded in the report.

Frequency (MHz)	Meter Reading (dBμV)	Cable Loss (dB)	Antenna Factor dB/m	Preamp Factor (dB)	Emission Level (dBμV/m)	Limits (dBμV/m)	Margin (dB)	Detector Type	Comment
5.2G WIFI-802.11ac20 MIMO Mode									
4500	59.47	5.20	35.60	44.20	56.07	74	-17.93	Pk	Horizontal
4500	45.29	5.20	35.60	44.20	41.89	54	-12.11	AV	Horizontal
4500	59.36	5.20	35.60	44.20	55.96	74	-18.04	Pk	Vertical
4500	41.87	5.20	35.60	44.20	38.47	54	-15.53	AV	Vertical
5150	58.77	5.36	35.66	44.22	55.57	74	-18.43	Pk	Horizontal
5150	36.11	5.36	35.66	44.22	32.91	54	-21.09	AV	Horizontal
5150	60.61	5.36	35.66	44.22	57.41	74	-16.59	Pk	Vertical
5150	42.09	5.36	35.66	44.22	38.89	54	-15.11	AV	Vertical
5350	55.24	5.68	35.68	44.22	52.38	74	-21.62	Pk	Horizontal
5350	37.48	5.68	35.68	44.22	34.62	54	-19.38	AV	Horizontal
5350	54.94	5.68	35.68	44.22	52.08	74	-21.92	Pk	Vertical
5350	36.78	5.68	35.68	44.22	33.92	54	-20.08	AV	Vertical

Note: (1) Emission Level= Antenna Factor + Cable Loss + Read Level - Preamp Factor

(2) "802.11ac20 CH36 MIMO " mode is the worst mode. When PK value is lower than the Average value limit, average don't record.

EUT :	Point to Point Wireless Device	Model Name. :	B5x
Temperature :	20 °C	Relative Humidity :	48%
Pressure :	1010 hPa	Test Voltage :	DC 50V
Test Mode :	Mode 2/3/4 (5.3G - 8dBi Antenna)		

All modes have been tested, just the 802.11ac20 CH64 MIMO mode is the worst mode has been recorded in the report.

Frequency	Meter Reading	Cable Loss	Antenna Factor	Preamp Factor	Emission Level	Limits	Margin	Detector	Comment
(MHz)	(dBμV)	(dB)	dB/m	(dB)	(dBμV/m)	(dBμV/m)	(dB)	Type	
5.3G WIFI-802.11ac20 MIMO Mode									
5350	54.68	5.68	35.68	44.22	51.82	74	-22.18	Pk	Horizontal
5350	37.09	5.68	35.68	44.22	34.23	54	-19.77	AV	Horizontal
5350	56.07	5.68	35.68	44.22	53.21	74	-20.79	Pk	Vertical
5350	40.50	5.68	35.68	44.22	37.64	54	-16.36	AV	Vertical

Note: (1) Emission Level= Antenna Factor + Cable Loss + Read Level - Preamp Factor

(2) "802.11ac20 CH64 MIMO " mode is the worst mode. When PK value is lower than the Average value limit, average don't record.

EUT :	Point to Point Wireless Device	Model Name. :	B5x
Temperature :	20 °C	Relative Humidity :	48%
Pressure :	1010 hPa	Test Voltage :	DC 50V
Test Mode :	Mode 2/3/4 (5.3G - 25dBi Antenna)		

All modes have been tested, just the 802.11ac20 CH64 MIMO mode is the worst mode has been recorded in the report.

Frequency	Meter Reading	Cable Loss	Antenna Factor	Preamp Factor	Emission Level	Limits	Margin	Detector	Comment
(MHz)	(dBμV)	(dB)	dB/m	(dB)	(dBμV/m)	(dBμV/m)	(dB)	Type	
5.3G WIFI-802.11ac20 MIMO Mode									
5350	58.86	5.68	35.68	44.22	56.00	74	-18.00	Pk	Horizontal
5350	38.74	5.68	35.68	44.22	35.88	54	-18.12	AV	Horizontal
5350	52.76	5.68	35.68	44.22	49.90	74	-24.10	Pk	Vertical
5350	39.38	5.68	35.68	44.22	36.52	54	-17.48	AV	Vertical

Note: (1) Emission Level= Antenna Factor + Cable Loss + Read Level - Preamp Factor

(2) "802.11ac20 CH64 MIMO " mode is the worst mode. When PK value is lower than the Average value limit, average don't record.

EUT :	Point to Point Wireless Device	Model Name. :	B5x
Temperature :	20 °C	Relative Humidity :	48%
Pressure :	1010 hPa	Test Voltage :	DC 50V
Test Mode :	Mode 2/3/4 (5.6G - 8dBi Antenna)		

All modes have been tested, just the 802.11ac20 CH100 MIMO mode is the worst mode has been recorded in the report.

Frequency	Meter Reading	Cable Loss	Antenna Factor	Preamp Factor	Emission Level	Limits	Margin	Detector	Comment
(MHz)	(dBμV)	(dB)	dB/m	(dB)	(dBμV/m)	(dBμV/m)	(dB)	Type	
5.6G WIFI-802.11ac20 MIMO Mode									
5460	57.35	5.68	35.68	44.22	54.49	74	-19.51	Pk	Horizontal
5460	37.86	5.68	35.68	44.22	35.00	54	-19.00	AV	Horizontal
5460	55.62	5.68	35.68	44.22	52.76	74	-21.24	Pk	Vertical
5460	38.13	5.68	35.68	44.22	35.27	54	-18.73	AV	Vertical

Note: (1) Emission Level= Antenna Factor + Cable Loss + Read Level - Preamp Factor

(2) "802.11ac20 CH100 MIMO " mode is the worst mode. When PK value is lower than the Average value limit, average don't record.

EUT :	Point to Point Wireless Device	Model Name. :	B5x
Temperature :	20 °C	Relative Humidity :	48%
Pressure :	1010 hPa	Test Voltage :	DC 50V
Test Mode :	Mode 2/3/4 (5.6G - 25dBi Antenna)		

All modes have been tested, just the 802.11ac20 CH100 MIMO mode is the worst mode has been recorded in the report.

Frequency (MHz)	Meter Reading (dBμV)	Cable Loss (dB)	Antenna Factor dB/m	Preamp Factor (dB)	Emission Level (dBμV/m)	Limits (dBμV/m)	Margin (dB)	Detector Type	Comment
5.6G WIFI-802.11ac20 MIMO Mode									
5460	58.56	5.68	35.68	44.22	55.70	74	-18.30	Pk	Horizontal
5460	37.69	5.68	35.68	44.22	34.83	54	-19.17	AV	Horizontal
5460	53.06	5.68	35.68	44.22	50.20	74	-23.80	Pk	Vertical
5460	40.15	5.68	35.68	44.22	37.29	54	-16.71	AV	Vertical

Note: (1) Emission Level= Antenna Factor + Cable Loss + Read Level - Preamp Factor

(2) "802.11ac20 CH100 MIMO " mode is the worst mode. When PK value is lower than the Average value limit, average don't record.

3.3 POWER SPECTRAL DENSITY TEST

3.3.1 APPLIED PROCEDURES / LIMIT

According to FCC §15.407(a)

For the band 5.15-5.25 GHz,

- (i) For an outdoor access point operating in the band 5.15-5.25 GHz, the maximum power spectral density shall not exceed 17 dBm in any 1 megahertz band. If transmitting antennas of directional gain greater than 6 dBi are used, both the maximum conducted output power and the maximum power spectral density shall be reduced by the amount in dB that the directional gain of the antenna exceeds 6 dBi. The maximum e.i.r.p. at any elevation angle above 30 degrees as measured from the horizon must not exceed 125 mW (21 dBm).
- (ii) For an indoor access point operating in the band 5.15-5.25 GHz, the maximum power spectral density shall not exceed 17 dBm in any 1 megahertz band. If transmitting antennas of directional gain greater than 6 dBi are used, both the maximum conducted output power and the maximum power spectral density shall be reduced by the amount in dB that the directional gain of the antenna exceeds 6 dBi.
- (iii) For fixed point-to-point access points operating in the band 5.15-5.25 GHz, the maximum power spectral density shall not exceed 17 dBm in any 1 megahertz band. Fixed point-to-point U-NII devices may employ antennas with directional gain up to 23 dBi without any corresponding reduction in the maximum conducted output power or maximum power spectral density. For fixed point-to-point transmitters that employ a directional antenna gain greater than 23 dBi, a 1 dB reduction in maximum conducted output power and maximum power spectral density is required for each 1 dB of antenna gain in excess of 23 dBi. Fixed, point-to-point operations exclude the use of point-to-multipoint systems, omnidirectional applications, and multiple collocated transmitters transmitting the same information. The operator of the U-NII device, or if the equipment is professionally installed, the installer, is responsible for ensuring that systems employing high gain directional antennas are used exclusively for fixed, point-to-point operations.
- (iv) For client devices in the 5.15-5.25 GHz band, the maximum power spectral density shall not exceed 11 dBm in any 1 megahertz band. If transmitting antennas of directional gain greater than 6 dBi are used, both the maximum conducted output power and the maximum power spectral density shall be reduced by the amount in dB that the directional gain of the antenna exceeds 6 dBi.

For the 5.25-5.35 GHz and 5.47-5.725 GHz bands

The maximum conducted output power over the frequency bands of operation shall not exceed the lesser of 250 mW or $11 \text{ dBm} + 10 \log B$, where B is the 26 dB emission bandwidth in megahertz. In addition, the maximum power spectral density shall not exceed 11 dBm in any 1 megahertz band. If transmitting antennas of directional gain greater than 6 dBi are used, both the maximum conducted output power and the maximum power spectral density shall be reduced by the amount in dB that the directional gain of the antenna exceeds 6 dBi.

For the band 5.725-5.85 GHz

(3) For the band 5.725-5.85 GHz, the maximum power spectral density shall not exceed 30 dBm in any 500-kHz band. If transmitting antennas of directional gain greater than 6 dBi are used, both the maximum conducted output power and the maximum power spectral density shall be reduced by the amount in dB that the directional gain of the antenna exceeds 6 dBi.

3.3.2 TEST PROCEDURE

For devices operating in the bands 5.15-5.25 GHz, 5.25-5.35 GHz, and 5.47-5.725 GHz, the above procedures make use of 1 MHz RBW to satisfy directly the 1 MHz reference bandwidth specified in § 15.407(a)(5). For devices operating in the band 5.725-5.85 GHz, the rules specify a measurement bandwidth of 500 kHz. Many spectrum analyzers do not have 500 kHz RBW, thus a narrower RBW may need to be used. The rules permit the use of a RBWs less than 1 MHz, or 500 kHz, “provided that the measured power is integrated over the full reference bandwidth” to show the total power over the specified measurement bandwidth (i.e., 1 MHz, or 500 kHz). If measurements are performed using a reduced resolution bandwidth (< 1 MHz, or < 500 kHz) and integrated over 1 MHz, or 500 KHz bandwidth, the following adjustments to the procedures apply:

- a) Set $RBW \geq 1/T$, where T is defined in section II.B.I.a).
- b) Set $VBW \geq 3 RBW$.
- c) If measurement bandwidth of Maximum PSD is specified in 500 kHz, add $10\log(500\text{kHz}/RBW)$ to the measured result, whereas $RBW (< 500 \text{ KHz})$ is the reduced resolution bandwidth of the spectrum analyzer set during measurement.
- d) If measurement bandwidth of Maximum PSD is specified in 1 MHz, add $10\log(1\text{MHz}/RBW)$ to the measured result, whereas $RBW (< 1 \text{ MHz})$ is the reduced resolution bandwidth of spectrum analyzer set during measurement.
- e) Care must be taken to ensure that the measurements are performed during a period of continuous transmission or are corrected upward for duty cycle.

Note: As a practical matter, it is recommended to use reduced RBW of 100 KHz for the sections 5.c) and 5.d) above, since $RBW=100 \text{ KHz}$ is available on nearly all spectrum analyzers.

3.3.3 DEVIATION FROM STANDARD

No deviation.

3.3.4 TEST SETUP



3.3.5 EUT OPERATION CONDITIONS

The EUT tested system was configured as the statements of 2.1 Unless otherwise a special operating condition is specified in the follows during the testing.

3.3.6 TEST RESULTS

EUT :	Point to Point Wireless Device	Model Name. :	B5x
Temperature :	25 °C	Relative Humidity :	56%
Pressure :	1015 hPa	Test Voltage :	DC 50V
Test Mode :	Mode 2/3/4		

Refer to section 2.2 of this report:

8dBi Antenna

For 5.2G band outdoor AP, 802.11ac has MIMO mode. Directional gain=11.01 dBi
 11.01 dBi > 6.0 dBi, so power spectral density limit=17-(11.01-6)=11.99dBm / 1MHz;
 For 5.2G band point-to-point, 802.11ac has MIMO mode. Directional gain=11.01 dBi
 11.01 dBi < 23.0 dBi, so power spectral density limit=17dBm / 1MHz;
 For 5.3G band, 802.11ac has MIMO mode. Directional gain=11.01 dBi
 11.01 dBi > 6.0 dBi, so power spectral density limit=11-(11.01-6)=5.99dBm / 1MHz;
 For 5.6G band, 802.11ac has MIMO mode. Directional gain=11.01 dBi
 11.01 dBi > 6.0 dBi, so power spectral density limit=11-(11.01-6)=5.99dBm / 1MHz;
 For 5.8G band, 802.11ac has MIMO mode. Directional gain=11.01 dBi
 11.01 dBi > 6.0 dBi, so power spectral density limit=30-(11.01-6)=24.99dBm / 500kHz;

25dBi Antenna

For 5.2G band outdoor AP, 802.11ac has MIMO mode. Directional gain=28.01 dBi
 28.01 dBi > 6.0 dBi, so power spectral density limit=17-(28.01-6)=-5.01dBm / 1MHz;
 For 5.2G band point-to-point, 802.11ac has MIMO mode. Directional gain=28.01 dBi
 28.01 dBi > 23.0 dBi, so power spectral density limit=17-(28.01-23)=11.99dBm / 1MHz;
 For 5.3G band, 802.11ac has MIMO mode. Directional gain=28.01 dBi
 28.01 dBi > 6.0 dBi, so power spectral density limit=11-(28.01-6)=-11.01dBm / 1MHz;
 For 5.6G band, 802.11ac has MIMO mode. Directional gain=28.01 dBi
 28.01 dBi > 6.0 dBi, so power spectral density limit=11-(28.01-6)=-11.01dBm / 1MHz;
 For 5.8G band, 802.11ac has MIMO mode. Directional gain=28.01 dBi
 28.01 dBi > 6.0 dBi, so power spectral density limit=30-(28.01-6)=7.99dBm / 500kHz;

Test data reference attachment.

3.4 26DB & 99% EMISSION BANDWIDTH

3.4.1 APPLIED PROCEDURES / LIMIT

The maximum power spectral density is measured as a conducted emission by direct connection of a calibrated test instrument to the equipment under test. If the device cannot be connected directly, alternative techniques acceptable to the Commission may be used. Measurements in the 5.725-5.85 GHz band are made over a reference bandwidth of 500 kHz or the 26 dB emission bandwidth of the device, whichever is less. Measurements in the 5.15-5.25 GHz, 5.25-5.35 GHz, and the 5.47-5.725 GHz bands are made over a bandwidth of 1 MHz or the 26 dB emission bandwidth of the device, whichever is less. A narrower resolution bandwidth can be used, provided that the measured power is integrated over the full reference bandwidth.

3.4.2 TEST PROCEDURE

- a) Set RBW = approximately 1% of the emission bandwidth.
- b) Set the VBW > RBW.
- c) Detector = Peak.
- d) Trace mode = max hold.
- e) Measure the maximum width of the emission that is 26 dB down from the maximum of the emission. Compare this with the RBW setting of the analyzer. Readjust RBW and repeat measurement as needed until the RBW/EBW ratio is approximately 1%.

The following procedure shall be used for measuring (99 %) power bandwidth:

1. Set center frequency to the nominal EUT channel center frequency.
2. Set span = 1.5 times to 5.0 times the OBW.
3. Set RBW = 1 % to 5 % of the OBW
4. Set VBW $\geq 3 \cdot$ RBW
5. Video averaging is not permitted. Where practical, a sample detection and single sweep mode shall be used. Otherwise, peak detection and max hold mode (until the trace stabilizes) shall be used.
6. Use the 99 % power bandwidth function of the instrument (if available).
7. If the instrument does not have a 99 % power bandwidth function, the trace data points are recovered and directly summed in power units. The recovered amplitude data points, beginning at the lowest frequency, are placed in a running sum until 0.5 % of the total is reached; that frequency is recorded as the lower frequency. The process is repeated until 99.5 % of the total is reached; that frequency is recorded as the upper frequency. The 99% occupied bandwidth is the difference between these two frequencies.

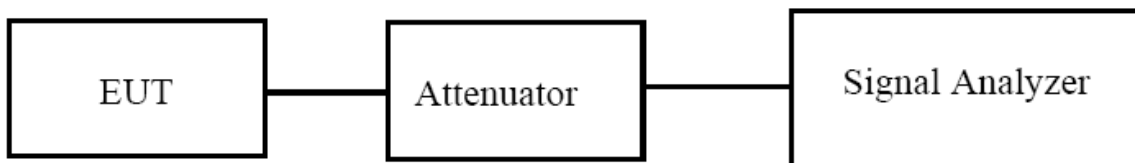

3.4.3 EUT OPERATION CONDITIONS

The EUT tested system was configured as the statements of 2.4 Unless otherwise a special operating condition is specified in the follows during the testing.

3.4.4 TEST RESULTS

EUT :	Point to Point Wireless Device	Model Name. :	B5x
Temperature :	25 °C	Relative Humidity :	56%
Pressure :	1012 hPa	Test Voltage :	DC 50V
Test Mode :	Mode 2/3/4		

Test data reference attachment.

3.5 MINIMUM 6 DB BANDWIDTH

3.5.1 APPLIED PROCEDURES / LIMIT

According to FCC §15.407(e)

(e) Within the 5.725-5.85 GHz band, the minimum 6 dB bandwidth of U-NII devices shall be at least 500 kHz.

3.5.2 TEST PROCEDURE

Section 15.407(e) specifies the minimum 6 dB emission bandwidth of at least 500 KHz for the band 5.715-5.85 GHz. The following procedure shall be used for measuring this bandwidth:

- a) Set RBW = 100 kHz.
- b) Set the video bandwidth (VBW) $\geq 3 \times$ RBW.
- c) Detector = Peak.
- d) Trace mode = max hold.
- e) Sweep = auto couple.
- f) Allow the trace to stabilize.
- g) Measure the maximum width of the emission that is constrained by the frequencies associated with the two outermost amplitude points (upper and lower frequencies) that are attenuated by 6 dB relative to the maximum level measured in the fundamental emission.

3.5.3 DEVIATION FROM STANDARD

No deviation.

3.5.4 TEST SETUP

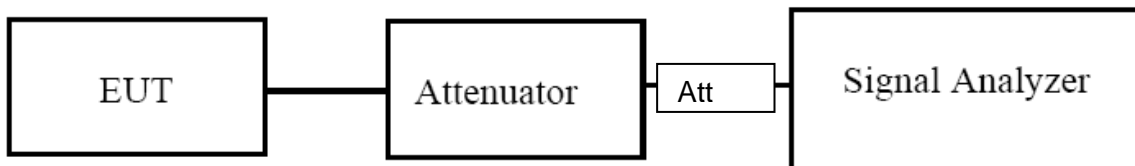

3.5.5 EUT OPERATION CONDITIONS

The EUT tested system was configured as the statements of 2.4 Unless otherwise a special operating condition is specified in the follows during the testing.

3.5.6 TEST RESULTS

EUT :	Point to Point Wireless Device	Model Name. :	B5x
Temperature :	25 °C	Relative Humidity :	60%
Pressure :	1012 hPa	Test Voltage :	DC 50V
Test Mode :	Mode 2/3/4 (5.8G)		

Test data reference attachment.

3.6 MAXIMUM CONDUCTED OUTPUT POWER

3.6.1 APPLIED PROCEDURES / LIMIT

According to FCC §15.407a)

The maximum conducted output power should not exceed:

For the band 5.15-5.25 GHz,

- (i) For an outdoor access point operating in the band 5.15-5.25 GHz, the maximum power spectral density shall not exceed 17 dBm in any 1 megahertz band. If transmitting antennas of directional gain greater than 6 dBi are used, both the maximum conducted output power and the maximum power spectral density shall be reduced by the amount in dB that the directional gain of the antenna exceeds 6 dBi. The maximum e.i.r.p. at any elevation angle above 30 degrees as measured from the horizon must not exceed 125 mW (21 dBm).
- (ii) For an indoor access point operating in the band 5.15-5.25 GHz, the maximum power spectral density shall not exceed 17 dBm in any 1 megahertz band. If transmitting antennas of directional gain greater than 6 dBi are used, both the maximum conducted output power and the maximum power spectral density shall be reduced by the amount in dB that the directional gain of the antenna exceeds 6 dBi.
- (iii) For fixed point-to-point access points operating in the band 5.15-5.25 GHz, the maximum power spectral density shall not exceed 17 dBm in any 1 megahertz band. Fixed point-to-point U-NII devices may employ antennas with directional gain up to 23 dBi without any corresponding reduction in the maximum conducted output power or maximum power spectral density. For fixed point-to-point transmitters that employ a directional antenna gain greater than 23 dBi, a 1 dB reduction in maximum conducted output power and maximum power spectral density is required for each 1 dB of antenna gain in excess of 23 dBi. Fixed, point-to-point operations exclude the use of point-to-multipoint systems, omnidirectional applications, and multiple collocated transmitters transmitting the same information. The operator of the U-NII device, or if the equipment is professionally installed, the installer, is responsible for ensuring that systems employing high gain directional antennas are used exclusively for fixed, point-to-point operations.
- (iv) For client devices in the 5.15-5.25 GHz band, the maximum power spectral density shall not exceed 11 dBm in any 1 megahertz band. If transmitting antennas of directional gain greater than 6 dBi are used, both the maximum conducted output power and the maximum power spectral density shall be reduced by the amount in dB that the directional gain of the antenna exceeds 6 dBi.

For the 5.25-5.35 GHz and 5.47-5.725 GHz bands

The maximum conducted output power over the frequency bands of operation shall not exceed the lesser of 250 mW or $11 \text{ dBm} + 10 \log B$, where B is the 26 dB emission bandwidth in megahertz. In addition, the maximum power spectral density shall not exceed 11 dBm in any 1 megahertz band. If transmitting antennas of directional gain greater than 6 dBi are used, both the maximum conducted output power and the maximum power spectral density shall be reduced by the amount in dB that the directional gain of the antenna exceeds 6 dBi.

For the band 5.725-5.85 GHz

(3) For the band 5.725-5.85 GHz, the maximum power spectral density shall not exceed 30 dBm in any 500-kHz band. If transmitting antennas of directional gain greater than 6 dBi are used, both the maximum conducted output power and the maximum power spectral density shall be reduced by the amount in dB that the directional gain of the antenna exceeds 6 dBi.

3.6.2 TEST PROCEDURE

- Maximum conducted output power may be measured using a spectrum analyzer/EMI receiver or an RF power meter.

1. Device Configuration

If possible, configure or modify the operation of the EUT so that it transmits continuously at its maximum power control level (see section II.B.).

a) The intent is to test at 100 percent duty cycle; however a small reduction in duty cycle (to no lower than 98 percent) is permitted if required by the EUT for amplitude control purposes. Manufacturers are expected to provide software to the test lab to permit such continuous operation.

b) If continuous transmission (or at least 98 percent duty cycle) cannot be achieved due to hardware limitations (e.g., overheating), the EUT shall be operated at its maximum power control level with the transmit duration as long as possible and the duty cycle as high as possible.

2. Measurement using a Spectrum Analyzer or EMI Receiver (SA)

Measurement of maximum conducted output power using a spectrum analyzer requires integrating the spectrum across a frequency span that encompasses, at a minimum, either the EBW or the 99-percent occupied bandwidth of the signal.¹ However, the EBW must be used to determine bandwidth dependent limits on maximum conducted output power in accordance with § 15.407(a).

a) The test method shall be selected as follows: (i) Method SA-1 or SA-1 Alternative (averaging with the EUT transmitting at full power throughout each sweep) shall be applied if either of the following conditions can be satisfied:

- The EUT transmits continuously (or with a duty cycle ≥ 98 percent).
- Sweep triggering or gating can be implemented in a way that the device transmits at the maximum power control level throughout the duration of each of the instrument sweeps to be averaged. This condition can generally be achieved by triggering the instrument's sweep if the duration of the sweep (with the analyzer configured as in Method SA-1, below) is equal to or shorter than the duration T of each transmission from the EUT and if those transmissions exhibit full power throughout their durations.

(ii) Method SA-2 or SA-2 Alternative (averaging across on and off times of the EUT transmissions, followed by duty cycle correction) shall be applied if the conditions of (i) cannot be achieved and the transmissions exhibit a constant duty cycle during the measurement duration. Duty cycle will be considered to be constant if variations are less than ± 2 percent.

(iii) Method SA-3 (RMS detection with max hold) or SA-3 Alternative (reduced VBW with max hold) shall be applied if the conditions of (i) and (ii) cannot be achieved.

b) Method SA-1 (trace averaging with the EUT transmitting at full power throughout each sweep): (i) Set span to encompass the entire emission bandwidth (EBW) (or, alternatively, the entire 99% occupied bandwidth) of the signal.

(ii) Set RBW = 1 MHz.

(iii) Set VBW ≥ 3 MHz.

(iv) Number of points in sweep ≥ 2 Span / RBW. (This ensures that bin-to-bin spacing is \leq RBW/2, so that narrowband signals are not lost between frequency bins.)

(v) Sweep time = auto.

(vi) Detector = RMS (i.e., power averaging), if available. Otherwise, use sample detector mode.

(vii) If transmit duty cycle < 98 percent, use a video trigger with the trigger level set to enable triggering only on full power pulses. Transmitter must operate at maximum power control level for the entire duration of every sweep. If the EUT transmits continuously (i.e., with no off intervals) or at duty cycle ≥ 98 percent, and if each transmission is entirely at the maximum power control level, then the trigger shall be set to "free run".

(viii) Trace average at least 100 traces in power averaging (i.e., RMS) mode.

(ix) Compute power by integrating the spectrum across the EBW (or, alternatively, the entire 99% occupied bandwidth) of the signal using the instrument's band power measurement function with band limits set equal to the EBW (or occupied bandwidth) band edges. If the instrument does not have a band power function, sum the spectrum

3.6.3 DEVIATION FROM STANDARD

No deviation.

3.6.4 TEST SETUP

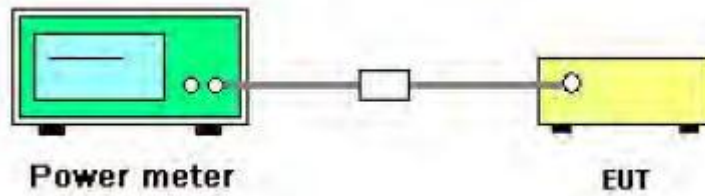

3.6.5 EUT OPERATION CONDITIONS

The EUT tested system was configured as the statements of 2.4 Unless otherwise a special operating condition is specified in the follows during the testing.

3.6.6 TEST RESULTS

EUT :	Point to Point Wireless Device	Model Name. :	B5x
Temperature :	25 °C	Relative Humidity :	60%
Pressure :	1012 hPa	Test Voltage :	DC 50V
Test Mode :	Mode 2/3/4		

Refer to section 2.2 of this report:
8dBi Antenna

For 5.2G band outdoor AP, 802.11ac has MIMO mode. Directional gain=8dBi
8dBi > 6.0dBi, so power limit=30-(8-6)=28dBm;
For 5.2G band point-to-point, 802.11ac has MIMO mode. Directional gain=8dBi
8dBi < 23.0dBi, so power limit=30dBm;
For 5.3G band, 802.11ac has MIMO mode. Directional gain=8dBi
8dBi > 6.0dBi, so power limit=(the lesser of 250 mW or 11 dBm + 10 log B, where B is the 26 dB emission bandwidth in megahertz.)-(8-6);
For 5.6G band, 802.11ac has MIMO mode. Directional gain=8dBi
8dBi > 6.0dBi, so power limit=(the lesser of 250 mW or 11 dBm + 10 log B, where B is the 26 dB emission bandwidth in megahertz.)-(8-6);
For 5.8G band, 802.11ac has MIMO mode. Directional gain=8dBi
8dBi > 6.0dBi, so power limit=30-(8-6)=28dBm;

25dBi Antenna

For 5.2G band outdoor AP, 802.11ac has MIMO mode. Directional gain=25dBi
25dBi > 6.0dBi, so power limit=30-(25-6)=11dBm;
For 5.2G band point-to-point, 802.11ac has MIMO mode. Directional gain=25dBi
25dBi > 23.0dBi, so power limit=30-(25-23)=28dBm;
For 5.3G band, 802.11ac has MIMO mode. Directional gain=25dBi
25dBi > 6.0dBi, so power limit=(the lesser of 250 mW or 11 dBm + 10 log B, where B is the 26 dB emission bandwidth in megahertz.)-(25-6);
For 5.6G band, 802.11ac has MIMO mode. Directional gain=25dBi
25dBi > 6.0dBi, so power limit=(the lesser of 250 mW or 11 dBm + 10 log B, where B is the 26 dB emission bandwidth in megahertz.)-(25-6);
For 5.8G band, 802.11ac has MIMO mode. Directional gain=25dBi
25dBi > 6.0dBi, so power limit=30-(25-6)=11dBm;

Test data reference attachment.

3.6.7 MASTER MODE ELEVATION ANGLE ABOVE 30 DEGREES MAXIMUM E.I.R.P. EVALUATION:

The maximum e.i.r.p. at any elevation angle above 30 degrees as measured from the horizon must not exceed 125 mW (21 dBm).

For 8dBi antenna, the antenna gain at any elevation above 30 degrees (measured at 5.2 GHz) is less than or equal to 5.6dBi.

Frequency (MHz)	Conducted Average Power (dBm)			EIRP (dBm)	Limit (dBm)
	ANT 1	ANT 2	Total		
802.11ac40					
5230	12.53	9.829	14.396	19.996	21

For 25dBi antenna, the antenna gain at any elevation above 30 degrees (measured at 5.2 GHz) is less than or equal to 1.3dBi.

Frequency (MHz)	Conducted Average Power (dBm)			EIRP (dBm)	Limit (dBm)
	ANT 1	ANT 2	Total		
802.11ac20					
5200	-7.351	-7.631	-4.478	-3.178	21

3.7 OUT OF BAND EMISSIONS

3.7.1 APPLICABLE STANDARD

According to FCC §15.407(b)

Undesirable emission limits. Except as shown in paragraph (b)(7) of this section, the maximum emissions outside of the frequency bands of operation shall be attenuated in accordance with the following limits:

(1) For transmitters operating in the 5.15-5.25 GHz band: All emissions outside of the 5.15-5.35 GHz band shall not exceed an e.i.r.p. of -27 dBm/MHz.

(2) For transmitters operating in the 5.25-5.35 GHz band: All emissions outside of the 5.15-5.35 GHz band shall not exceed an e.i.r.p. of -27 dBm/MHz.

(3) For transmitters operating in the 5.47-5.725 GHz band: All emissions outside of the 5.47-5.725 GHz band shall not exceed an e.i.r.p. of -27 dBm/MHz.

(4) For transmitters operating in the 5.725-5.85 GHz band: All emissions shall be limited to a level of -27 dBm/MHz at 75 MHz or more above or below the band edge increasing linearly to 10 dBm/MHz at 25 MHz above or below the band edge, and from 25 MHz above or below the band edge increasing linearly to a level of 15.6 dBm/MHz at 5 MHz above or below the band edge, and from 5 MHz above or below the band edge increasing linearly to a level of 27 dBm/MHz at the band edge.

3.7.2 TEST PROCEDURE

1. Check the calibration of the measuring instrument using either an internal calibrator or a known signal from an external generator.
2. Position the EUT without connection to measurement instrument. Turn on the EUT and connect its antenna terminal to measurement instrument via a low loss cable. Then set it to any one measured frequency within its operating range, and make sure the instrument is operated in its linear range.
3. Set RBW of spectrum analyzer to 1 MHz with a convenient frequency span.
4. Measure the highest amplitude appearing on spectral display and set it as a reference level. Plot the graph with marking the highest point and edge frequency.
5. Repeat above procedures until all measured frequencies were complete.

3.7.3 DEVIATION FROM STANDARD

No deviation.

3.7.4 TEST SETUP

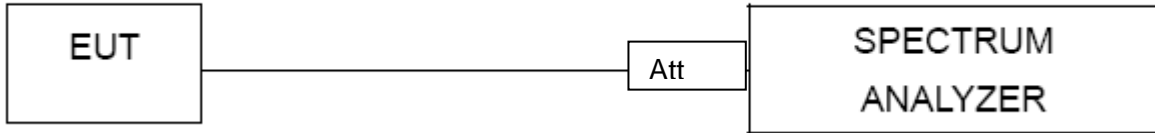

3.7.5 EUT OPERATION CONDITIONS

The EUT tested system was configured as the statements of 2.4 Unless otherwise a special operating condition is specified in the follows during the testing.

3.7.6 TEST RESULTS

EUT :	Point to Point Wireless Device	Model Name. :	B5x
Temperature :	25 °C	Relative Humidity :	56%
Pressure :	1012 hPa	Test Voltage :	DC 50V

Test data reference attachment.

3.8 SPURIOUS RF CONDUCTED EMISSIONS

3.8.1 CONFORMANCE LIMIT

According to FCC §15.407b

3.8.2 MEASURING INSTRUMENTS

The Measuring equipment is listed in the section 6.3 of this test report.

3.8.3 TEST SETUP

Please refer to Section 6.1 of this test report.

3.8.4 TEST PROCEDURE

The Spurious RF conducted emissions compliance of RF radiated emission should be measured by following the guidance in ANSI C63.10-2013 with respect to maximizing the emission by rotating the EUT, measuring the emission while the EUT is situated in three orthogonal planes (if appropriate), adjusting the measurement antenna height and polarization etc. Set RBW=1000kHz and VBW= 3000KHz to measure the peak field strength , and measure frequency range from 30MHz to 40GHz.

3.8.5 TEST RESULTS

Remark: The measurement frequency range is from 30MHz to the 10th harmonic of the fundamental frequency. The lowest, middle and highest channels are tested to verify the spurious emissions and bandedge measurement data.

Test data reference attachment.

3.9 FREQUENCY STABILITY

Section 15.407(g) specifies that U-NII devices are required to ensure frequency stability. It is required that that the emissions are maintained within the band of operation under all conditions of normal operation as specified in the user's manual. The grantee is responsible for ensuring that the EUT meets Section 15.407(g) requirements; however, the applications for equipment certification are not required to include test reports with explicit demonstration of compliance.

4. ANTENNA REQUIREMENT

4.1 STANDARD REQUIREMENT

15.203 requirement: For intentional device, according to 15.203: an intentional radiator shall be designed to ensure that no antenna other than that furnished by the responsible party shall be used with the device.

4.2 EUT ANTENNA

The EUT have a permanent attached Integral(Panel) antenna, and additional flexible external (Screw on) cassegrain antenna options. It comply with the standard requirement.

5. DYNAMIC FREQUENCY SELECTION(DFS)

Test results reference to the DFS test report.

END OF REPORT