





FCC PART 15.407
 ISED RSS-247, ISSUE 2, FEBRUARY 2017
 DYNAMIC FREQUENCY SELECTION
 TEST REPORT

For

Mimosa Networks, Inc.

469 El Camino Real, Suite 100,
 Santa Clara, CA 95050, USA

FCC ID: 2ABZJ-100-00085
IC: 11823A-10000085

Report Type: Original Report	Product Type: Point to Point Wireless Device
Prepared By: Chin Ming Lui Test Engineer	
Report Number: R18062717-DFS	
Report Date: 2018-10-18	
Reviewed By: Xiao Lin RF Engineer	
Bay Area Compliance Laboratories Corporation (BACL) 1274 Anvilwood Avenue, Sunnyvale, CA 94089, USA Tel: 1 (408) 732-9162 Fax: 1 (408) 732-9164	

Note: This test report is prepared for the customer shown above and for the device described herein. It may not be duplicated or used in part without prior written consent from Bay Area Compliance Laboratories Corp. This report **must not** be used by the customer to claim product certification, approval, or endorsement by A2LA* or any agency of the Federal Government.

* This report may contain data that are not covered by the A2LA accreditation and are marked with an asterisk "*" encl

TABLE OF CONTENTS

1	GENERAL DESCRIPTION.....	4
1.1	PRODUCT DESCRIPTION FOR EQUIPMENT UNDER TEST (EUT).....	4
1.2	OBJECTIVE.....	4
1.3	RELATED SUBMITTAL(S)/GRANT(S).....	4
1.4	TEST METHODOLOGY.....	4
1.5	MEASUREMENT UNCERTAINTY.....	5
1.6	TEST FACILITY REGISTRATIONS.....	5
1.7	TEST FACILITY ACCREDITATIONS.....	5
2	EUT TEST CONFIGURATION.....	8
2.1	JUSTIFICATION.....	8
2.2	EUT EXERCISE SOFTWARE.....	8
2.3	EQUIPMENT MODIFICATIONS.....	9
2.4	LOCAL SUPPORT EQUIPMENT.....	9
2.5	SUPPORT EQUIPMENT.....	9
2.6	INTERFACE PORTS AND CABLES.....	10
3	SUMMARY OF TEST RESULTS.....	11
4	APPLICABLE STANDARDS.....	12
4.1	DFS REQUIREMENT.....	12
4.2	DFS MEASUREMENT SYSTEM.....	15
4.3	SYSTEM BLOCK DIAGRAM.....	15
4.4	CONDUCTED METHOD.....	15
4.5	RADIATED METHOD.....	17
4.6	TEST PROCEDURE.....	17
5	TEST RESULTS.....	18
5.1	DESCRIPTION OF EUT.....	18
5.2	ANTENNA DESCRIPTION.....	18
5.3	TEST EQUIPMENT LIST AND DETAILS.....	18
5.4	RADAR WAVEFORM CALIBRATION.....	19
5.5	TEST ENVIRONMENTAL CONDITIONS.....	19
6	CHANNEL AVAILABILITY CHECK TIME (CAC).....	40
6.1	TEST PROCEDURE.....	40
7	CHANNEL MOVE TIME AND CHANNEL CLOSING TRANSMISSION TIME.....	45
7.1	TEST PROCEDURE.....	45
7.2	TEST RESULTS.....	45
8	NON-OCCUPANCY PERIOD.....	52
8.1	TEST PROCEDURE.....	52
8.2	TEST RESULTS.....	52
9	RADAR DETECTION BANDWIDTH & RADAR DETECTION PERFORMANCE CHECK.....	55
9.1	DETECTION BANDWIDTH.....	55
9.2	RADAR DETECTION PERFORMANCE CHECK.....	63
10	ANNEX A (NORMATIVE) - U-NII-2A RADAR PARAMETER DATA SHEET FOR MASTER MODE	70
11	ANNEX B (NORMATIVE) - U-NII-2C RADAR PARAMETER DATA SHEET FOR MASTER MODE	71
12	ANNEX C (NORMATIVE) - U-NII-2A RADAR PARAMETER DATA SHEET FOR CLIENT MODE	72
13	ANNEX D (NORMATIVE) - U-NII-2C RADAR PARAMETER DATA SHEET FOR CLIENT MODE	73
14	ANNEX E (NORMATIVE) - DFS TEST SETUP PHOTO.....	74
15	ANNEX F (NORMATIVE) - A2LA ELECTRICAL TESTING CERTIFICATE.....	75

DOCUMENT REVISION HISTORY

Revision Number	Report Number	Description of Revision	Date of Revision
0	R18062717-DFS	Original Report	2018-10-18

1 General Description

1.1 Product Description for Equipment under Test (EUT)

This test and measurement report was prepared on behalf of *Mimosa Networks*, and their product model: *C5x*, FCC ID: 2ABZJ-100-00085, IC: 11823A-10000085 or the “EUT” as referred to in this report. The product is a point to point/point to multipoint wireless device.

1.2 Objective

This report is prepared on behalf of *Mimosa Networks* in accordance with FCC CFR47 §15.407 (h) & RSS 247 §6.3 and KDB: 905462 D02 UNII DFS Compliance Procedures New Rules v02.

The objective is to determine compliance with FCC rules for DFS Detection Threshold, Channel Availability Check Time, Uniform Spreading U-NII Detection Bandwidth, Channel Closing Transmission Time, and Channel Move time in Master Mode.

1.3 Related Submittal(s)/Grant(s)

None.

1.4 Test Methodology

FCC CFR 47 Part2, Part15.407 (h)

RSS 247 §6.3

KDB: 905462 D02 UNII DFS Compliance Procedures New Rules v02.

COMPLIANCE MEASUREMENT PROCEDURES FOR UNLICENSED-NATIONAL INFORMATION INFRASTRUCTURE DEVICES OPERATING IN THE 5250-5350 MHz AND 5470-5725 MHz BANDS INCORPORATING DYNAMIC FREQUENCY SELECTION

1.5 Measurement Uncertainty

All measurements involve certain levels of uncertainties, especially in the field of EMC. The factors contributing to uncertainties are spectrum analyzer, cable loss, antenna factor calibration, antenna directivity, antenna factor variation with height, antenna phase center variation, antenna factor frequency interpolation, measurement distance variation, site imperfections, mismatch (average), and system repeatability.

Parameter	Measurement uncertainty
Occupied Channel Bandwidth	±5 %
RF output power, conducted	±0.57 dB
Power Spectral Density, conducted	±1.48dB
Unwanted Emissions, conducted	±1.57dB
All emissions, radiated	±4.0 dB
AC power line Conducted Emission	±2.0 dB
Temperature	±2 ° C
Humidity	±5 %
DC and low frequency voltages	±1.0 %
Time	±2 %
Duty Cycle	±3 %

1.6 Test Facility Registrations

BACL's test facilities that are used to perform Radiated and Conducted Emissions tests are currently recognized by the Federal Communications Commission as Accredited with NIST Designation Number US1129.

BACL's test facilities that are used to perform Radiated and Conducted Emissions tests are currently registered with Industry Canada under Registration Numbers: 3062A-1, 3062A-2, and 3062A-3.

BACL is a Chinese Taipei Bureau of Standards Metrology and Inspection (BSMI) validated Conformity Assessment Body (CAB), under Annex B, Phase I Procedures of the APEC Mutual Recognition Arrangement (MRA). BACL's BSMI Lab Code Number is: SL2-IN-E-1002R

BACL's test facilities that are used to perform AC Line Conducted Emissions, Telecommunications Line Conducted Emissions, Radiated Emissions from 30 MHz to 1 GHz, and Radiated Emissions from 1 GHz to 6 GHz are currently recognized as Accredited in accordance with the Voluntary Control Council for Interference [VCCI] Article 15 procedures under Registration Number A-0027.

1.7 Test Facility Accreditations

Bay Area Compliance Laboratories Corp. (BACL) is:

A- An independent, 3rd-Party, Commercial Test Laboratory accredited to ISO/IEC 17025:2005 by A2LA (Test Laboratory Accreditation Certificate Number 3279.02), in the fields of: Electromagnetic Compatibility and Telecommunications. Unless noted by an Asterisk (*) in the Compliance Matrix (See Section 3 of this Test Report), BACL's ISO/IEC 17025:2005 Scope of Accreditation includes all of the Test Method Standards and/or the Product Family Standards detailed in this Test Report.

BACL's ISO/IEC 17025:2005 Scope of Accreditation includes a comprehensive suite of EMC Emissions, EMC Immunity, Radio, RF Exposure, Safety and wireline Telecommunications test methods applicable to a wide range of product categories. These product categories include Central Office Telecommunications Equipment [including NEBS - Network Equipment Building Systems], Unlicensed and Licensed Wireless and RF devices, Information Technology Equipment (ITE); Telecommunications Terminal Equipment (TTE); Medical Electrical Equipment; Industrial, Scientific and Medical Test Equipment; Professional Audio and Video Equipment;

Industrial and Scientific Instruments and Laboratory Apparatus; Cable Distribution Systems, and Energy Efficient Lighting.

B- A Product Certification Body accredited to ISO/IEC 17065:2012 by A2LA (Product Certification Body Accreditation Certificate Number 3279.03) to certify

- For the USA (Federal Communications Commission):
 - 1- All Unlicensed radio frequency devices within FCC Scopes A1, A2, A3, and A4;
 - 2- All Licensed radio frequency devices within FCC Scopes B1, B2, B3, and B4;
 - 3- All Telephone Terminal Equipment within FCC Scope C.
- For the Canada (Industry Canada):
 - 1 All Scope 1-Licence-Exempt Radio Frequency Devices;
 - 2 All Scope 2-Licensed Personal Mobile Radio Services;
 - 3 All Scope 3-Licensed General Mobile & Fixed Radio Services;
 - 4 All Scope 4-Licensed Maritime & Aviation Radio Services;
 - 5 All Scope 5-Licensed Fixed Microwave Radio Services
 - 6 All Broadcasting Technical Standards (BETS) in the Category I Equipment Standards List.
- For Singapore (Info-Communications Development Authority (IDA)):
 - 1 All Line Terminal Equipment: All Technical Specifications for Line Terminal Equipment – Table 1 of IDA MRA Recognition Scheme: 2011, Annex 2
 2. All Radio-Communication Equipment: All Technical Specifications for Radio-Communication Equipment – Table 2 of IDA MRA Recognition Scheme: 2011, Annex 2
- For the Hong Kong Special Administrative Region:
 - 1 All Radio Equipment, per KHCA 10XX-series Specifications;
 - 2 All GMDSS Marine Radio Equipment, per HKCA 12XX-series Specifications;
 - 3 All Fixed Network Equipment, per HKCA 20XX-series Specifications.
- For Japan:
 - 1 MIC Telecommunication Business Law (Terminal Equipment):
 - All Scope A1 - Terminal Equipment for the Purpose of Calls;
 - All Scope A2 - Other Terminal Equipment
 - 2 Radio Law (Radio Equipment):
 - All Scope B1 - Specified Radio Equipment specified in Article 38-2-2, paragraph 1, item 1 of the Radio Law
 - All Scope B2 - Specified Radio Equipment specified in Article 38-2-2, paragraph 1, item 2 of the Radio Law
 - All Scope B3 - Specified Radio Equipment specified in Article 38-2-2, paragraph 1, item 3 of the Radio Law

C- A Product Certification Body accredited to ISO/IEC 17065:2012 by A2LA (Product Certification Body Accreditation Certificate Number 3279.01) to certify Products to USA's Environmental Protection Agency (EPA) ENERGY STAR Product Specifications for:

- 1 Electronics and Office Equipment:
 - for Telephony (ver. 3.0)
 - for Audio/Video (ver. 3.0)
 - for Battery Charging Systems (ver. 1.1)
 - for Set-top Boxes & Cable Boxes (ver. 4.1)
 - for Televisions (ver. 6.1)
 - for Computers (ver. 6.0)
 - for Displays (ver. 6.0)
 - for Imaging Equipment (ver. 2.0)
 - for Computer Servers (ver. 2.0)
- 2 Commercial Food Service Equipment
 - for Commercial Dishwashers (ver. 2.0)
 - for Commercial Ice Machines (ver. 2.0)

- for Commercial Ovens (ver. 2.1)
- for Commercial Refrigerators and Freezers
- 3 Lighting Products
 - For Decorative Light Strings (ver. 1.5)
 - For Luminaires (including sub-components) and Lamps (ver. 1.2)
 - For Compact Fluorescent Lamps (CFLs) (ver. 4.3)
 - For Integral LED Lamps (ver. 1.4)
- 4 Heating, Ventilation, and AC Products
 - for Residential Ceiling Fans (ver. 3.0)
 - for Residential Ventilating Fans (ver. 3.2)
- 5 Other
 - For Water Coolers (ver. 3.0)

D- A NIST Designated Phase-I and Phase-II Conformity Assessment Body (CAB) for the following economies and regulatory authorities under the terms of the stated MRAs/Treaties:

- Australia: ACMA (Australian Communication and Media Authority) – APEC Tel MRA -Phase I;
 - Canada: (Innovation, Science and Economic development Canada - ISEDC) Foreign Certification Body – FCB – APEC Tel MRA -Phase I & Phase II;
 - Chinese Taipei (Republic of China – Taiwan):
 - o BSMI (Bureau of Standards, Metrology and Inspection) APEC Tel MRA -Phase I;
 - o NCC (National Communications Commission) APEC Tel MRA -Phase I;
 - European Union:
 - o EMC Directive 2014/30/EU US-EU EMC & Telecom MRA CAB (NB)
 - o Radio Equipment (RE) Directive 2014/53/EU US-EU EMC & Telecom MRA CAB (NB)
 - o Low Voltage Directive (LVD) 2014/35/EU
 - Hong Kong Special Administrative Region: (Office of the Telecommunications Authority – OFTA) APEC Tel MRA -Phase I & Phase II
 - Israel – US-Israel MRA Phase I
 - Republic of Korea (Ministry of Communications - Radio Research Laboratory) APEC Tel MRA -Phase I
 - Singapore: (Infocomm Media Development Authority - IMDA) APEC Tel MRA -Phase I & Phase II;
 - Japan: VCCI - Voluntary Control Council for Interference US-Japan Telecom Treaty VCCI Side Letter-
 - USA:
 - o ENERGY STAR Recognized Test Laboratory – US EPA
 - o Telecommunications Certification Body (TCB) – US FCC;
 - o Nationally Recognized Test Laboratory (NRTL) – US OSHA
- Vietnam: APEC Tel MRA -Phase I;

2 EUT Test Configuration

2.1 Justification

The EUT was configured for testing according to FCC CFR47 §15.407 (h) & RSS 247 §6.3, and KDB: 905462 D02 UNII DFS Compliance Procedures New Rules v02.

2.2 EUT Exercise Software

The custom DFS SW was provided by Mimosa Networks, and was verified by *Chinming Liu* to comply with the standard requirements being tested against.

EUT supports point-to-multipoint client mode and fixed point-to-point Master mode. The EUT supports 5 MHz channel spacing. Please refer to the following table for the test channel selection and corresponding power setting.

8 dBi Antenna:

Modulation	Band	Channel	Frequency (MHz)	Power Setting
802.11ac20 mode	U-NII-2A	Low	5260	18
		Middle	5280	18
		High	5310	18
	U-NII-2C	Low	5510	18
		Middle	5590	16
		High	5695	16
802.11ac40 mode	U-NII-2A	Low	5270	18
		Middle	5285	18
		High	5300	18
	U-NII-2C	Low	5520	17
		Middle	5580	15
		High	5685	15
802.11ac80 mode	U-NII-2C	Low	5540	17
		Middle	5560	15
		High	5665	15

25 dBi Antenna:

Modulation	Band	Channel	Frequency (MHz)	Power Setting
802.11ac20 mode	U-NII-2A	Low	5260	-6
		Middle	5280	-6
		High	5310	-6
	U-NII-2C	Low	5510	-6
		Middle	5590	-6
		High	5695	-6
802.11ac40 mode	U-NII-2A	Low	5270	-6
		Middle	5285	-6
		High	5300	-6
	U-NII-2C	Low	5520	-6
		Middle	5580	-6
		High	5685	-6
802.11ac80 mode	U-NII-2C	Low	5540	-6
		Middle	5560	-6
		High	5665	-6

Note: EUT does not support any channels fall into 5600-5650MHz band in Canada.

2.3 Equipment Modifications

N/A

2.4 Local Support Equipment

Manufacturer	Description	Model
Dell	Laptop	Latitude E6410

2.5 Support Equipment

Manufacturer	Description	Model
Lenovo	Laptop	P50s
Mimosa Networks	POE injector	G0566-500-120

2.6 Interface Ports and Cables

Cable Description	Length (m)	To	From
Cat5e	~5	EUT	POE Injector
Cat5e	~5	POE Injector	Laptop

3 Summary of Test Results

The following result table represents the list of measurements required under the FCC CFR47 §15.407 (h) & RSS 247 §6.3, and KDB: 905462 D02 UNII DFS Compliance Procedures New Rules v02.

Items	Description of Test (Master)	Results
Detection Bandwidth	UNII Detection Bandwidth	Compliant
Performance Requirements Check	Initial Channel Availability Check Time (CAC)	Compliant
	Radar Burst at the Beginning of the CAC	Compliant
	Radar Burst at the End of the CAC	Compliant
In-Service Monitoring	Channel Move Time	Compliant
	Channel Closing Transmission Time	Compliant
	Non-Occupancy Period	Compliant
Radar Detection	Statistical Performance Check	Compliant

Items	Description of Test (Client with Radar Detection)	Results
Detection Bandwidth	UNII Detection Bandwidth	Compliant
Performance Requirements Check	Initial Channel Availability Check Time (CAC)	NR
	Radar Burst at the Beginning of the CAC	NR
	Radar Burst at the End of the CAC	NR
In-Service Monitoring	Channel Move Time	Compliant
	Channel Closing Transmission Time	Compliant
	Non-Occupancy Period	Compliant
Radar Detection	Statistical Performance Check	Compliant

Note: worst case 8 dBi antenna condition was tested.

NR: not required.

4 Applicable Standards

4.1 DFS Requirement

FCC CFR47 §15.407 (h) & RSS 247 §6.3, and KDB: 905462 D02 UNII DFS Compliance Procedures New Rules v02.

Table 1: Applicability of DFS requirements prior to use of a channel

Requirement	Operational Mode		
	Master	Client (Without radar detection)	Client (With radar detection)
Non-Occupancy Period	Yes	Not Required	Yes
DFS Detection Threshold	Yes	Not Required	Yes
Channel Availability Check Time	Yes	Not Required	Not Required
U-NII Detection Bandwidth	Yes	Not Required	Yes

Table 2: Applicability of DFS requirements during normal operation

Requirement	Operational Mode	
	Master Device or Client with Radar Detection	Client Without Radar Detection
DFS Detection Threshold	Yes	Not Required
Channel Closing Transmission Time	Yes	Yes
Channel Move Time	Yes	Yes
U-NII Detection Bandwidth	Yes	Not Required

Additional requirements for devices with multiple bandwidth modes	Master Device or Client with Radar Detection	Client Without Radar Detection
U-NII Detection Bandwidth and Statistical Performance Check	All BW modes must be tested	Not required
Channel Move Time and Channel Closing Transmission Time	Test using widest BW mode available	Test using the widest BW mode available for the link
All other tests	Any single BW mode	Not required

Note: Frequencies selected for statistical performance check (Section 7.8.4) should include several frequencies within the radar detection bandwidth and frequencies near the edge of the radar detection bandwidth. For 802.11 devices it is suggested to select frequencies in each of the bonded 20 MHz channels and the channel center frequency.

Table 3: Interference Threshold for Master and Client with Radar Detection

Maximum Transmit Power	Value (See Notes 1, 2 and 3)
EIRP \geq 200 milliwatt	-64 dBm
EIRP $<$ 200 milliwatt and power spectral density $<$ 10dBm/MHz	-62 dBm
EIRP $<$ 200 milliwatt that do not meet the power spectral density requirement	-64 dBm

Note 1: This is the level at the input of the receiver assuming a 0 dBi receive antenna.
Note 2: Throughout these test procedures an additional 1 dB has been added to the amplitude of the test transmission waveforms to account for variations in measurement equipment. This will ensure that the test signal is at or above the detection threshold level to trigger a DFS response.
Note 3: EIRP is based on the highest antenna gain. For MIMO devices refer to KDB Publication 662911 D01.

Table 4: DFS Response Requirement Values

Parameter	Value
Non-occupancy period	Minimum 30 minutes
Channel Availability Check Time	60 seconds
Channel Move Time	10 seconds <i>See Note 1.</i>
Channel Closing Transmission Time	200 milliseconds + an aggregate of 60 milliseconds over remaining 10 second period. <i>See Notes 1 and 2.</i>
U-NII Detection Bandwidth	Minimum 100% of the UNII 99% transmission power bandwidth. <i>See Note 3.</i>

Note 1: Channel Move Time and the Channel Closing Transmission Time should be performed with Radar Type 0. The measurement timing begins at the end of the Radar Type 0 burst.

Note 2: The Channel Closing Transmission Time is comprised of 200 milliseconds starting at the beginning of the Channel Move Time plus any additional intermittent control signals required to facilitate a Channel move (an aggregate of 60 milliseconds) during the remainder of the 10 second period. The aggregate duration of control signals will not count quiet periods in between transmissions.

Note 3: During the U-NII Detection Bandwidth detection test, radar type 0 should be used. For each frequency step the minimum percentage of detection is 90 percent. Measurements are performed with no data traffic.

Table 5: Short Pulse Radar Test Waveforms

Radar Type	Pulse Width (Microseconds)	PRI (Microseconds)	Pulses	Minimum Percentage of Successful Detection	Minimum Number of Trials
0	1	1428	18	See Note 1	See Note 1
1	1	Test A: 15 unique PRI values randomly selected from the list of 23 PRI values in Table 5a Test B: 15 unique PRI values randomly selected within the range of 518-3066 μ sec, with a minimum increment of 1 μ sec, excluding PRI values selected in Test A	$\text{Roundup} \left\{ \begin{array}{l} \left(\frac{1}{360} \right) \\ \left(\frac{19 \cdot 10^6}{\text{PRI}_{\mu\text{sec}}} \right) \end{array} \right.$	60%	30
2	1-5	150-230	23-29	60%	30
3	6-10	200-500	16-18	60%	30
4	11-20	200-500	12-16	60%	30
Aggregate (Radar Types 1-4)				80%	120
Note 1: Short Pulse Radar Type 0 should be used for the detection bandwidth test, channel move time, and channel closing time tests.					

Table 6: Long Pulse Radar Test Signal

Radar Type	Bursts	Chirp Width (MHz)	PRI (usec)	Number of Pulses per Burst	Number of Bursts	Minimum Percentage of Successful Detection	Minimum Number of Trials
5	50-100	5-20	1000-2000	1-3	8-20	80%	30

Table 7: Frequency Hopping Radar Test Signal

Radar Type	Pulse Width (usec)	PRI (usec)	Pulses per Hop	Hopping Rate (kHz)	Hopping Sequence Length (msec)	Minimum Percentage of Successful Detection	Minimum Number of Trials
6	1	333	9	0.333	300	70%	30

4.2 DFS Measurement System

BACL DFS measurement system consists of two subsystems: (1) The radar signal generating subsystem and (2) the traffic monitoring subsystem.

4.3 System Block Diagram

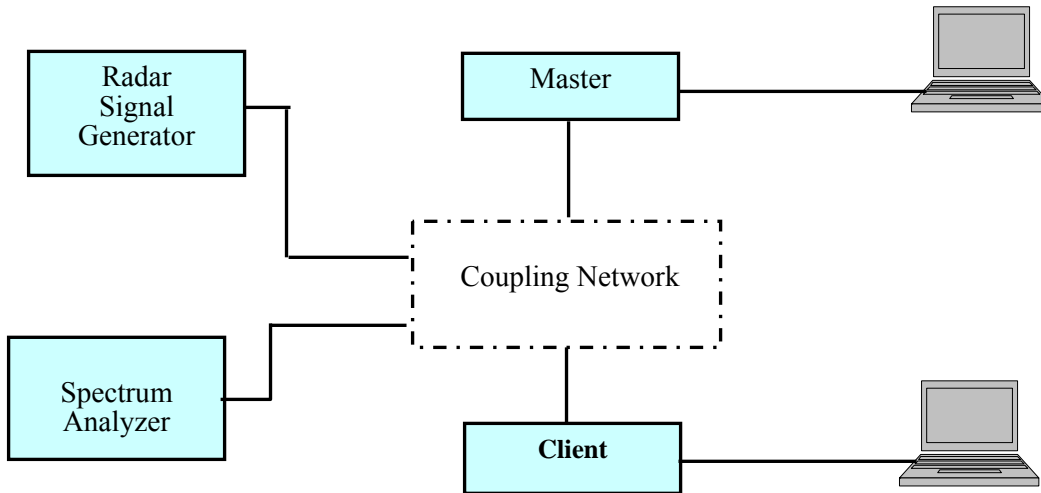

4.4 Conducted Method

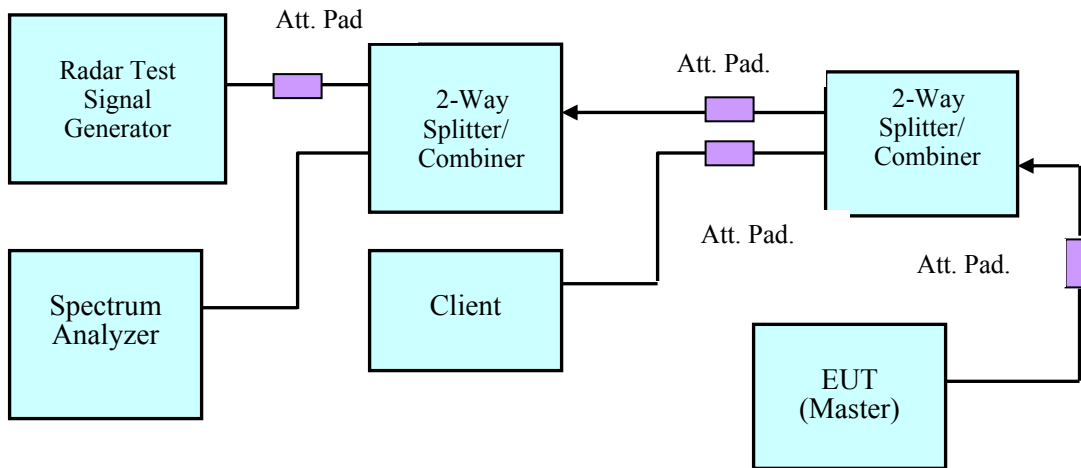

Setup for Master with injection at the Master

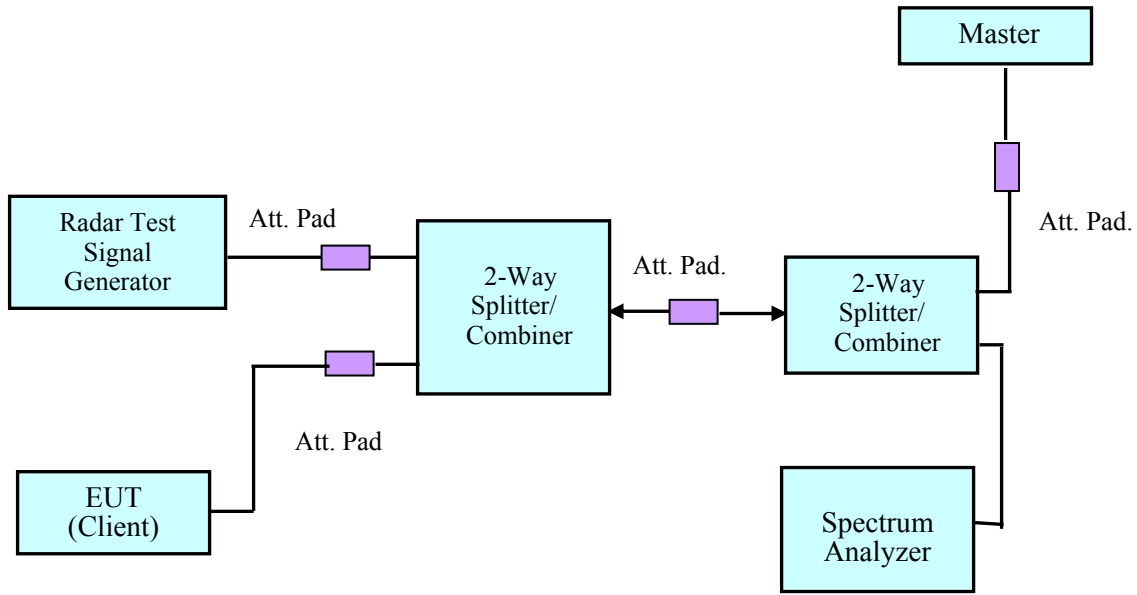

Setup for Client with injection at the Master

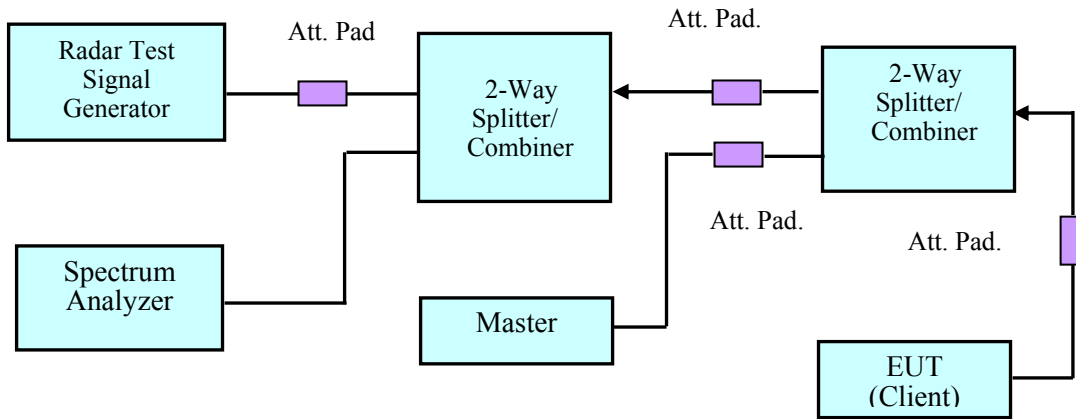

Setup for Client with injection at the Client

4.5 Radiated Method

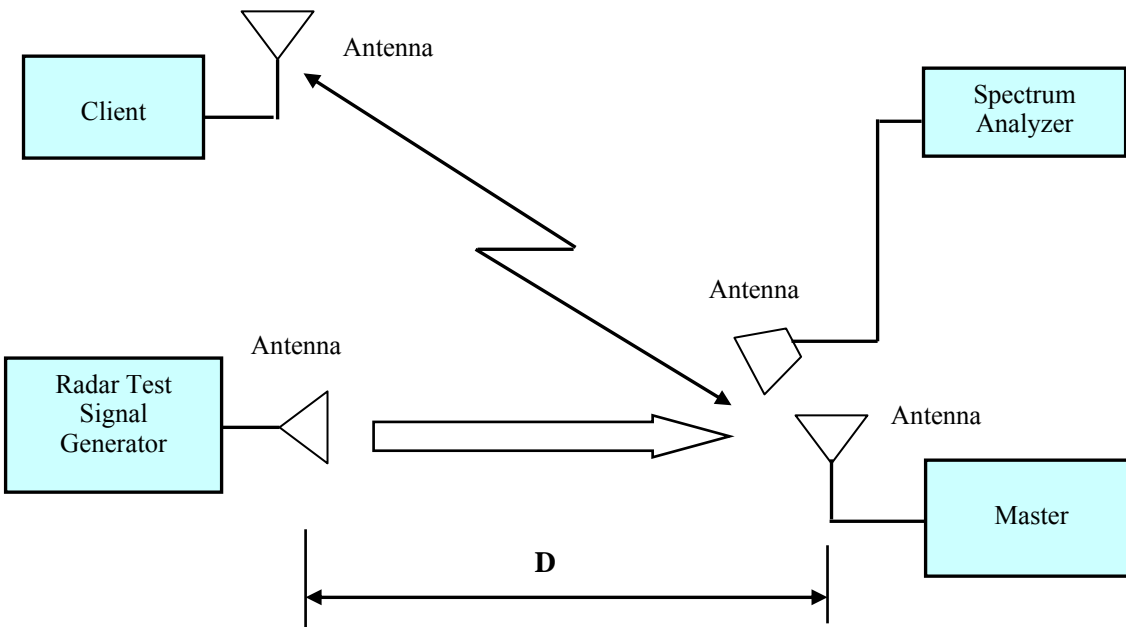

4.6 Test Procedure

A spectrum analyzer is used as a monitor that verifies the EUT's status, which includes the Channel Closing Transmission Time and the Channel Move Time. The Spectrum analyzer is used to monitor the equipment under test (EUT) does not transmit on the same channel during the Non-Occupied Period after the radar detection. It is also used to monitor EUT transmissions during the Channel Availability Check Time.

5 Test Results

5.1 Description of EUT

The EUT operates in 5230-5350 MHz and 5470-5725 MHz range in Master and Client with radar detection Mode.

The rated output power of EUT is > 23 dBm (EIRP), Therefore the required interference threshold level is -64 dBm, the required radiated threshold at antenna port is -64 dBm.

The calibrated radiated DFS detection threshold level is set to -64 dBm.

WLAN traffic was generated by using Iperf. The EUT can be configured to Master mode or Client Mode by using Mimosa UI.

5.2 Antenna Description

Frequency Range (MHz)	External/Internal/Integral	Maximum Antenna Gain (dBi)	Antenna Tpye/Pattern
4900 - 5900	Integral	8	Panel
4900 - 5900	External (Screw on)	25	Cassegrain

5.3 Test Equipment List and Details

Manufacturer	Equipment Description	Model	S/N	Calibration Date	Calibration Interval
National Instruments	NI PXI-1042 8-Slot chassis	PXI-1042	V08X01EE1	N/A	N/A
National Instruments	Arbitrary Waveform Generator	PXI-5421	N/A	N/A	N/A
National Instruments	RF Upconverter	PXI-5610	N/A	N/A	N/A
ASCOR	Upconverter	AS-7206	N/A	N/A	N/A
Agilent	Analyzer, Spectrum	E4446A	MY48250238	2018-05-18	1 year
A. H. Systems	Antenna Horn	SAS-200/571	261	2017-05-16	2 years
EMCO	Antenna Horn	3115	9511-4627	2018-03-28	2 years
Mini-Circuits	Splitter/Combiner	2FSC-2-10G	0349	N/A	N/A
Narda	Splitter/Combiner	4326B-2	03514	N/A	N/A
Midwest	Attenuator	290-30	N/A	N/A	N/A
Mini-Circuits	Attenuator	BW-S30W2	N/A	N/A	N/A

Statement of Traceability: **BACL Corp.** attests that all calibrations have been performed per the A2LA requirements, traceable to the NIST.

5.4 Radar Waveform Calibration

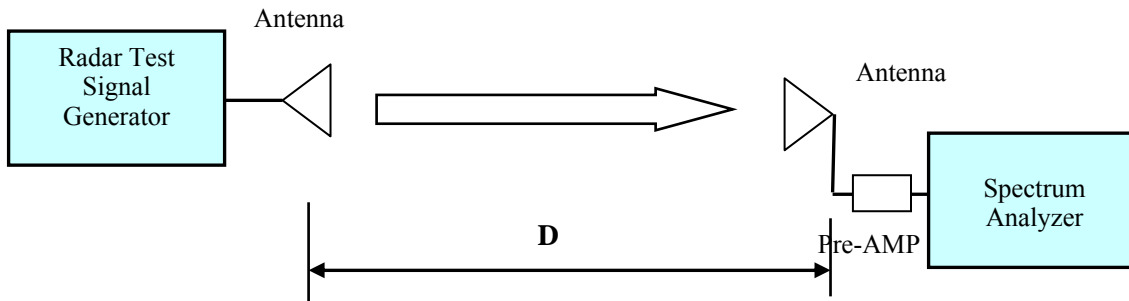

Radiated Calibration Setup Block Diagram

5.5 Test Environmental Conditions

Temperature:	22° C
Relative Humidity:	45 %
ATM Pressure:	102.1 kPa

Testing was performed by Chin Ming Lui from 2018-07-26 to 2018-07-31 at the DFS site.

Plots of Radar Waveforms

20 MHz BW, 5260 MHz

Radar Type 0

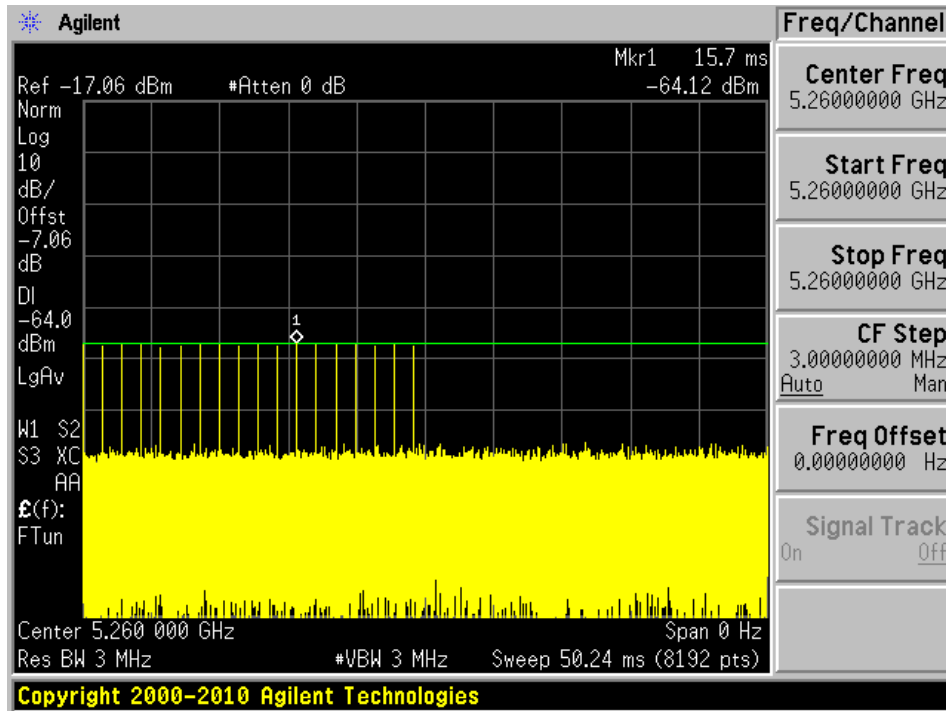

Radar Type 1A

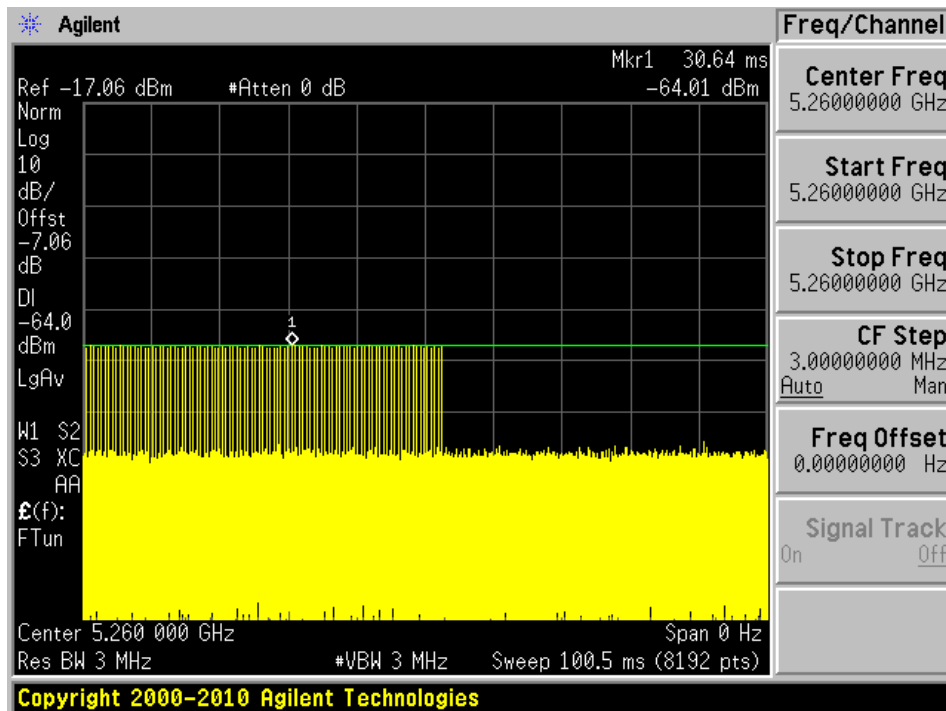

Radar Type 1B

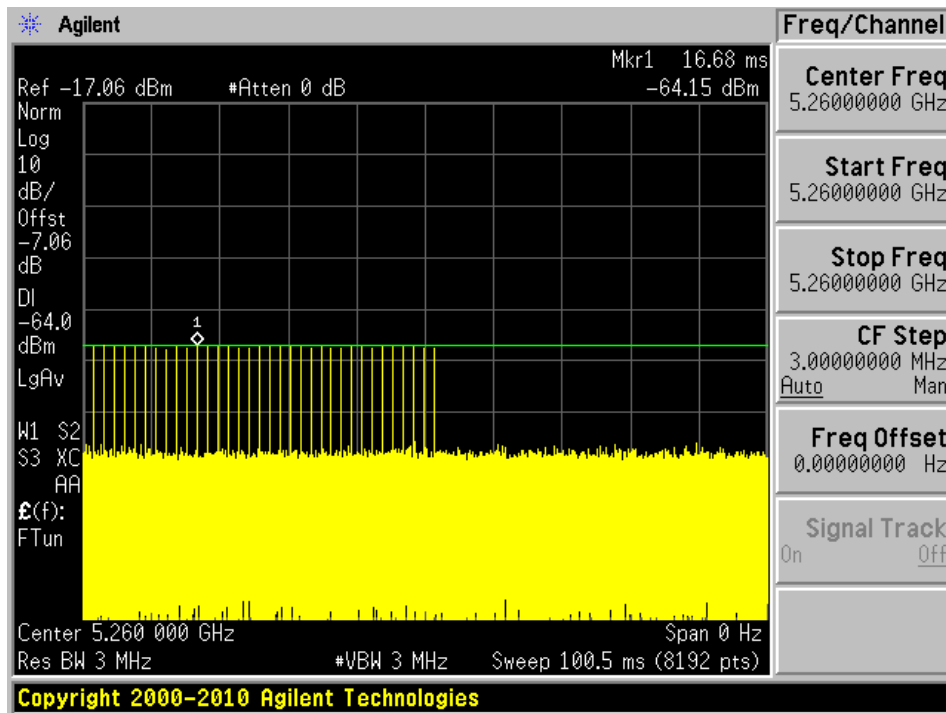

Radar Type 2

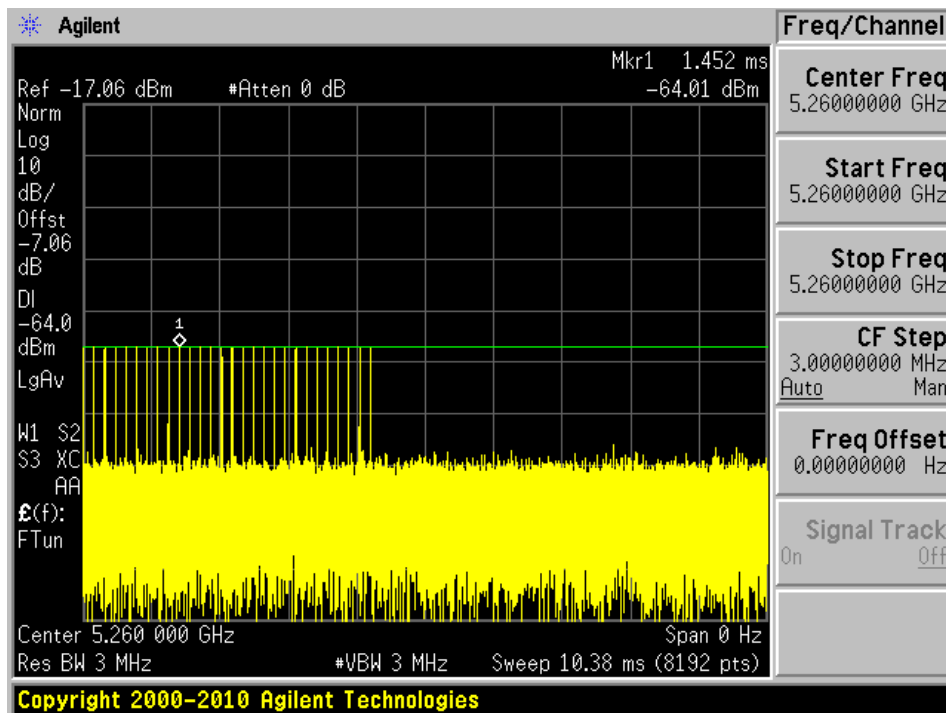

Radar Type 3

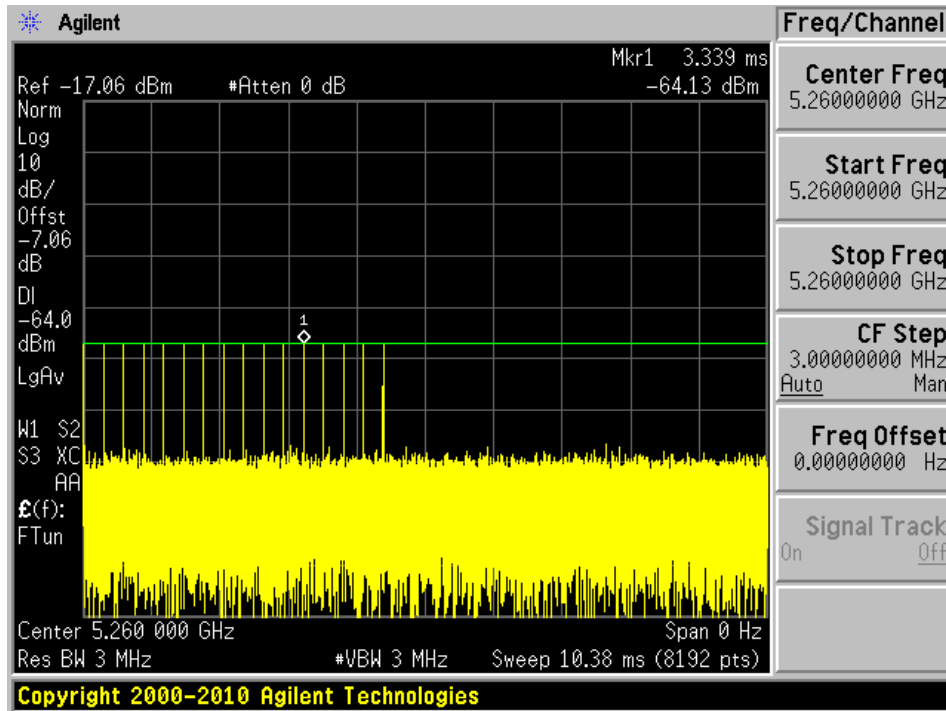

Radar Type 4

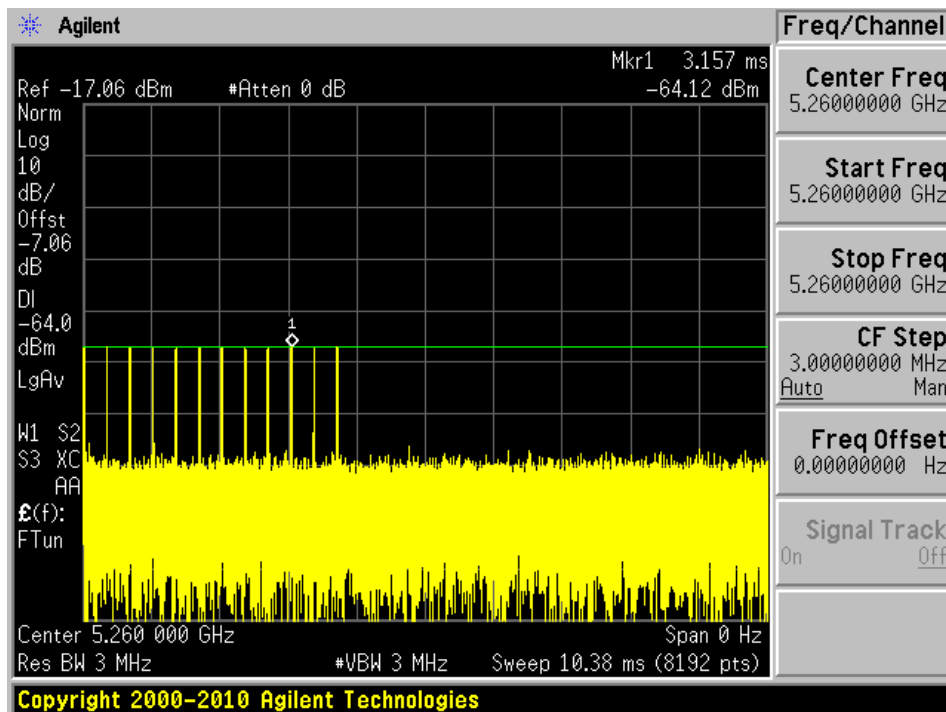

Radar Type 5

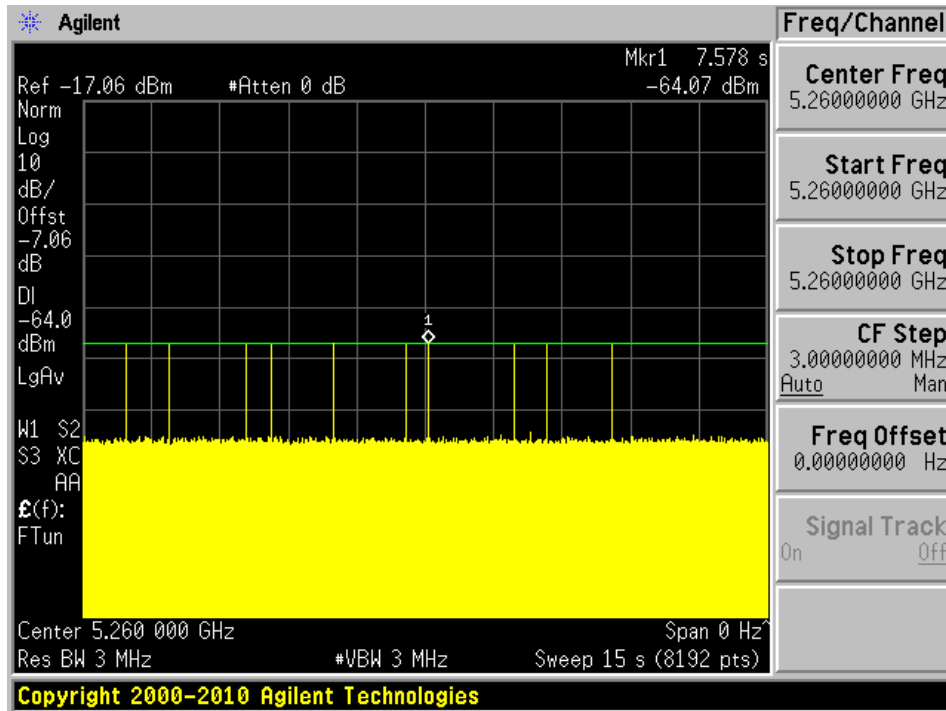

Radar Type 6

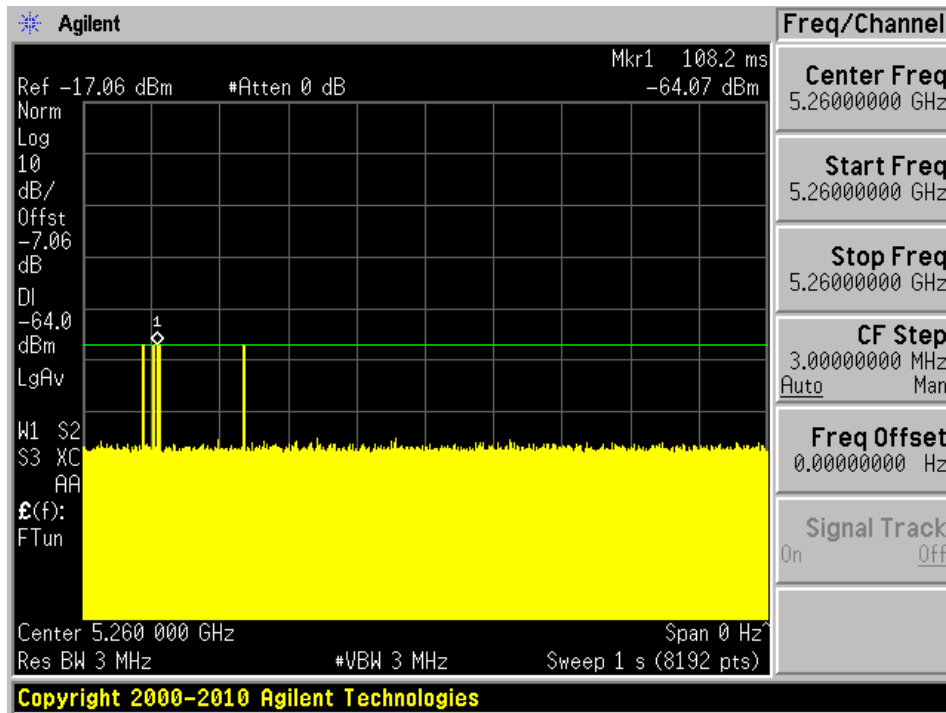

40 MHz BW, 5270 MHz

Radar Type 0

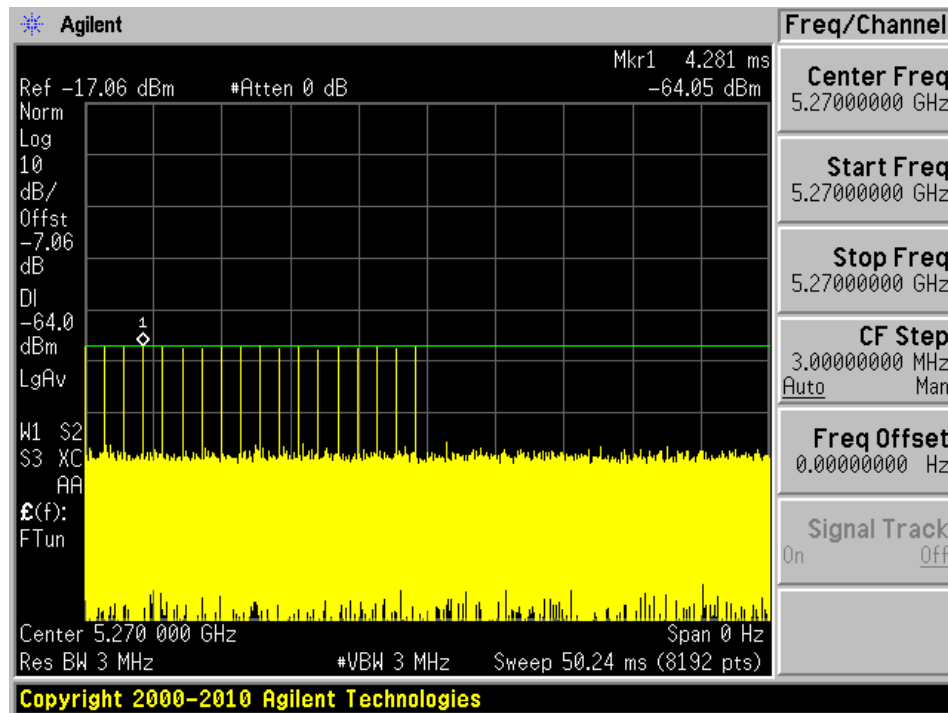

Radar Type 1A

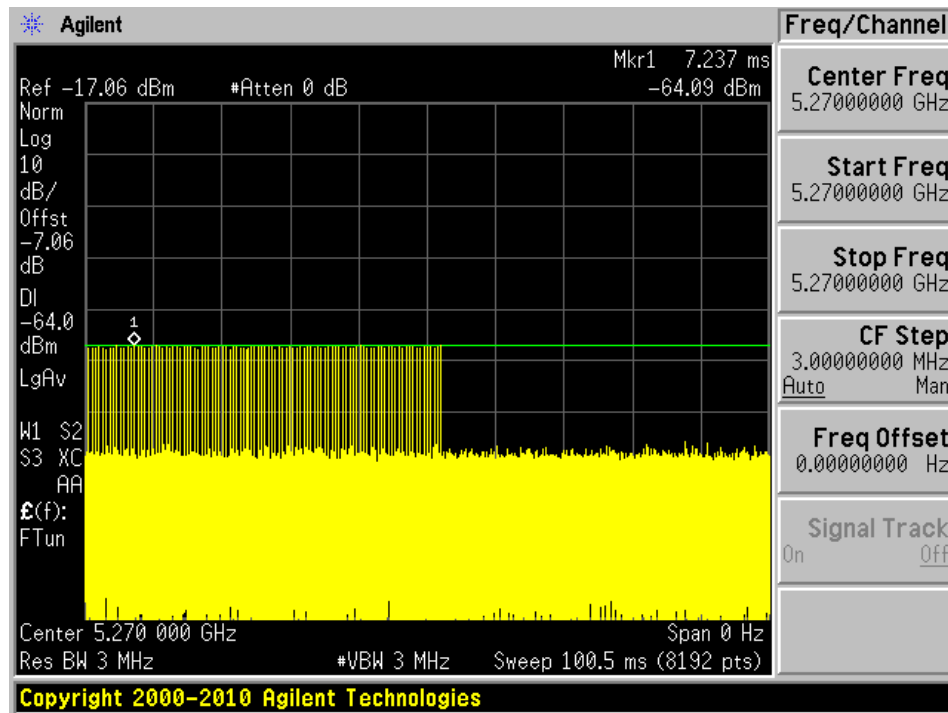

Radar Type 1B

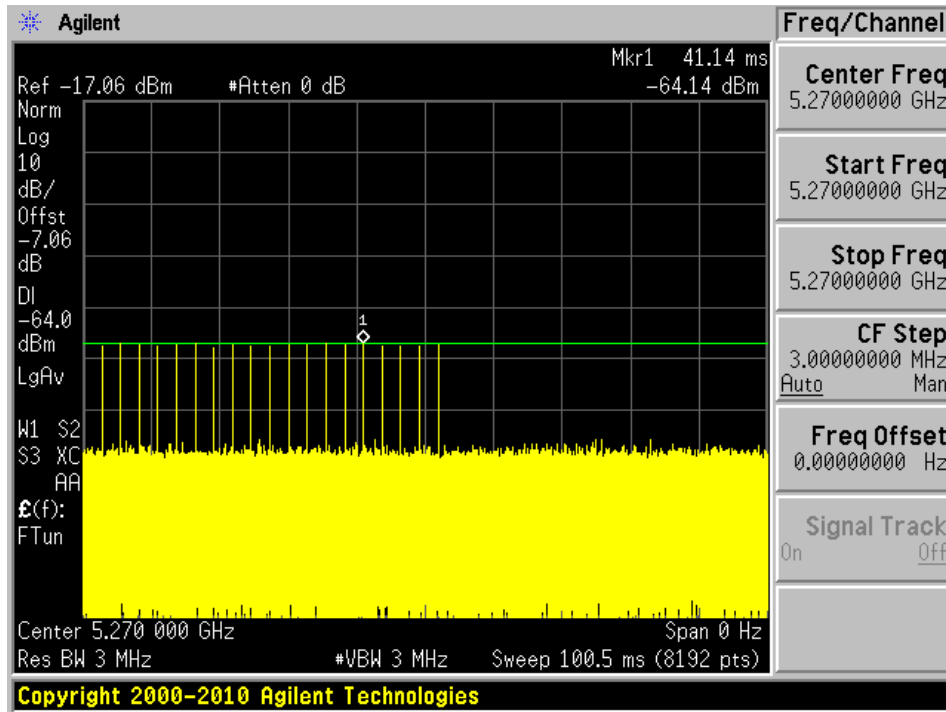

Radar Type 2

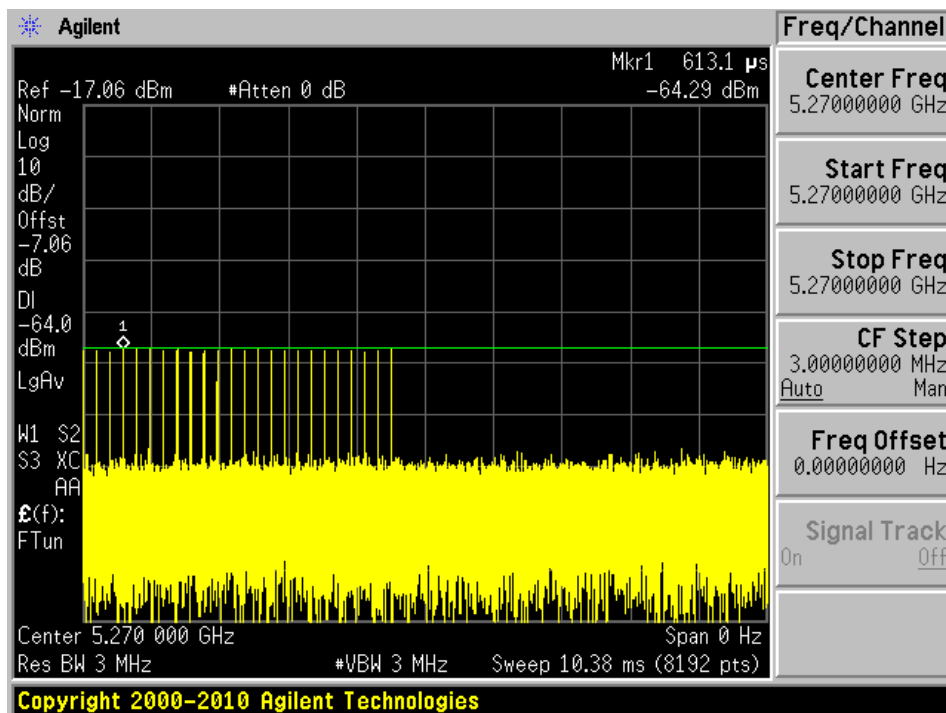

Radar Type 3

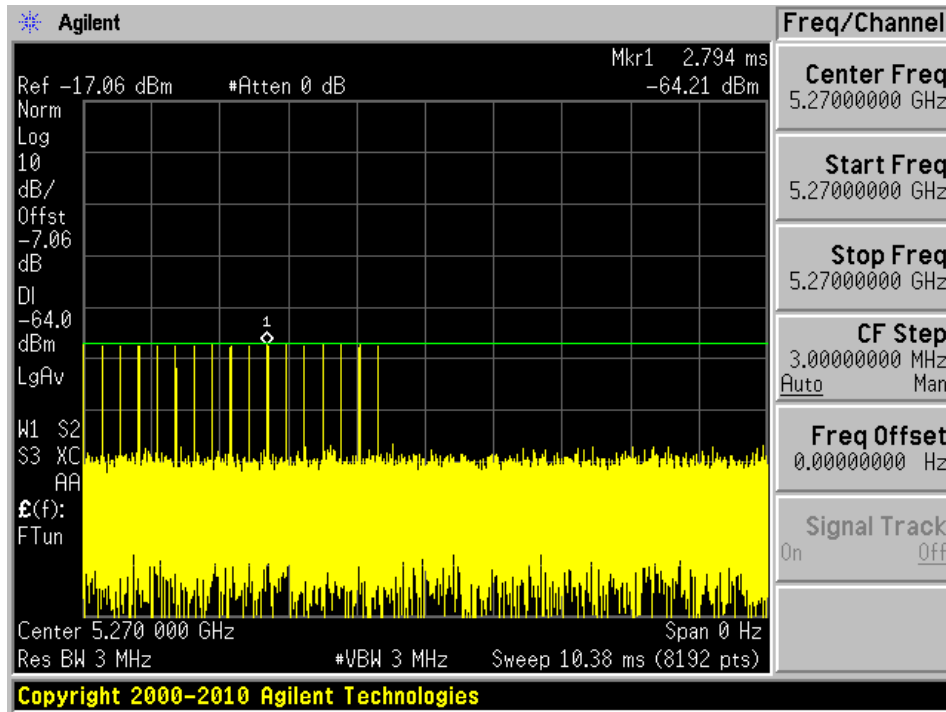

Radar Type 4

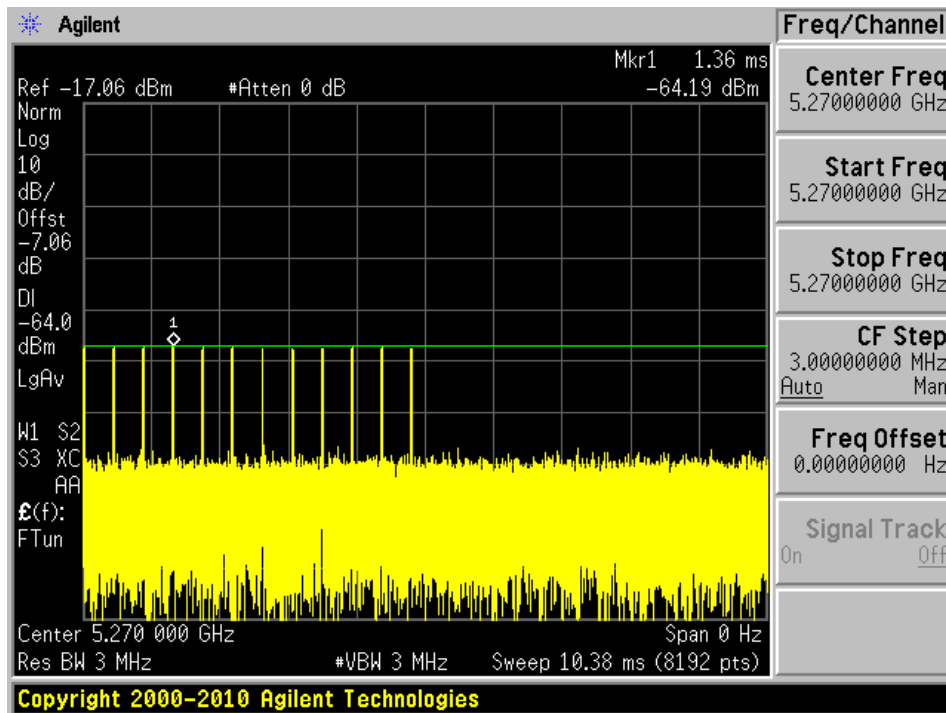

Radar Type 5

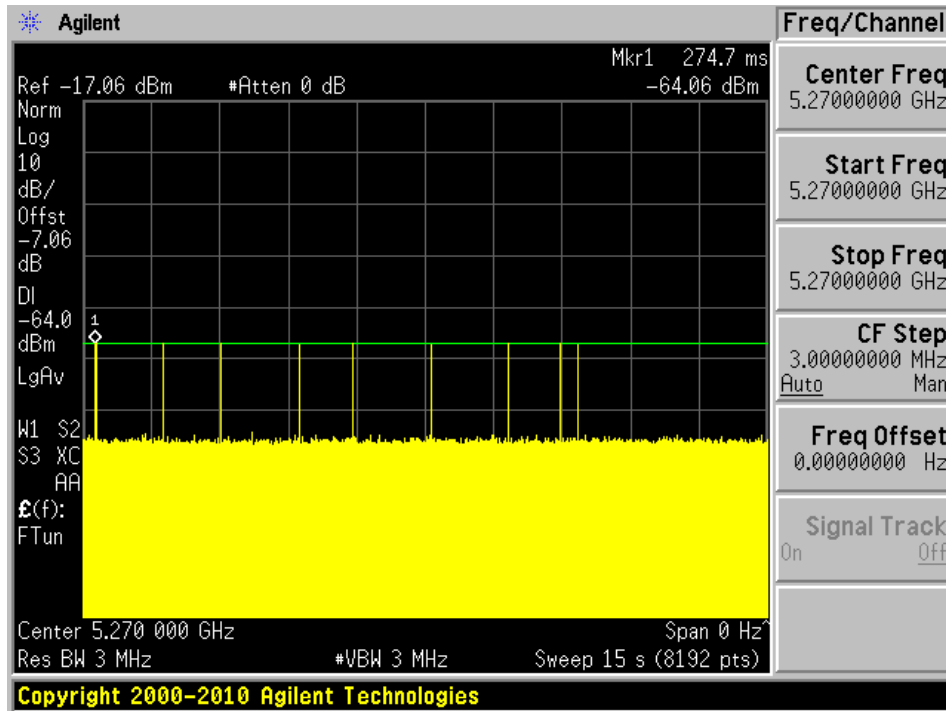

Radar Type 6

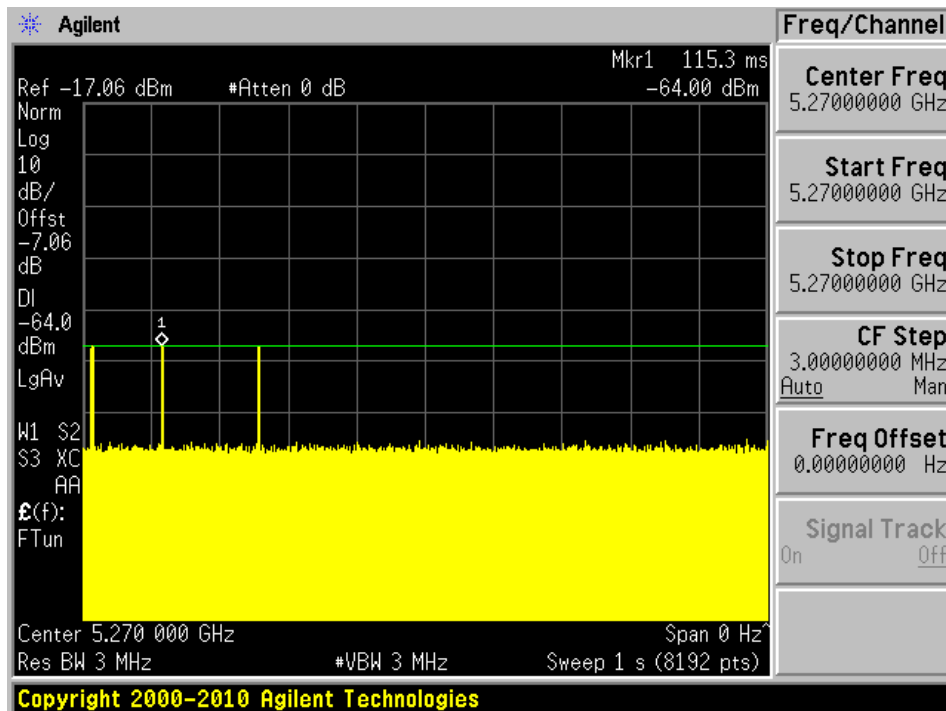

20 MHz BW, 5510 MHz

Radar Type 0

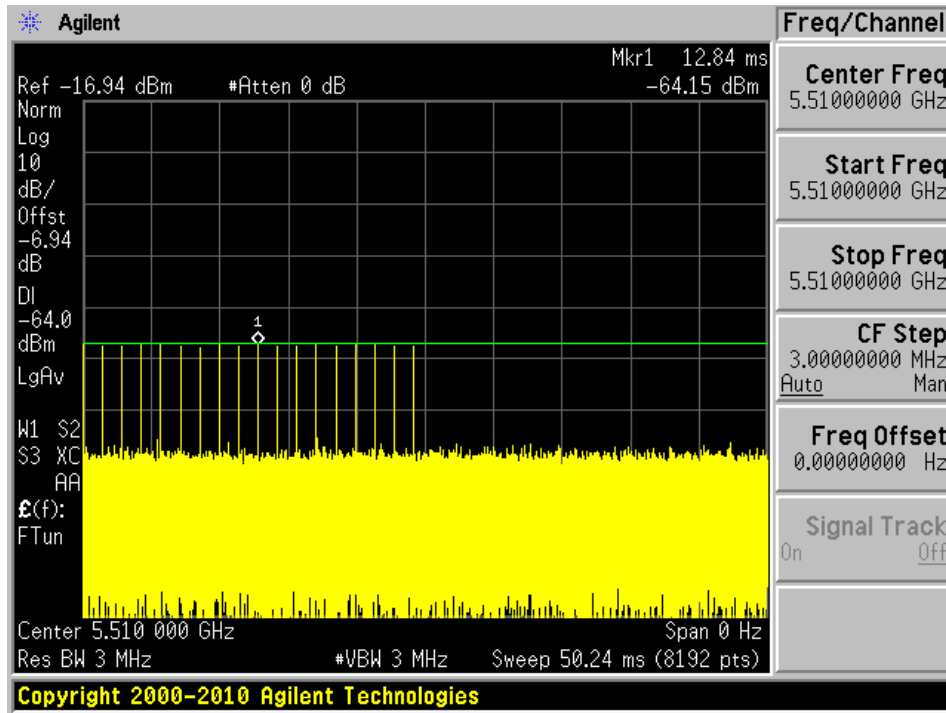

Radar Type 1A

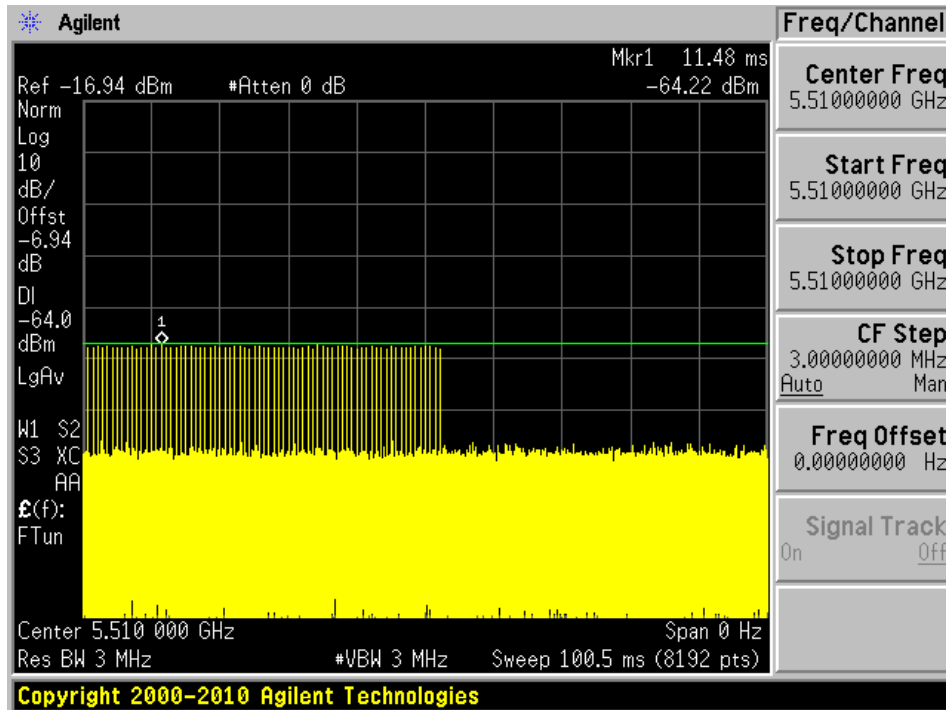

Radar Type 1B

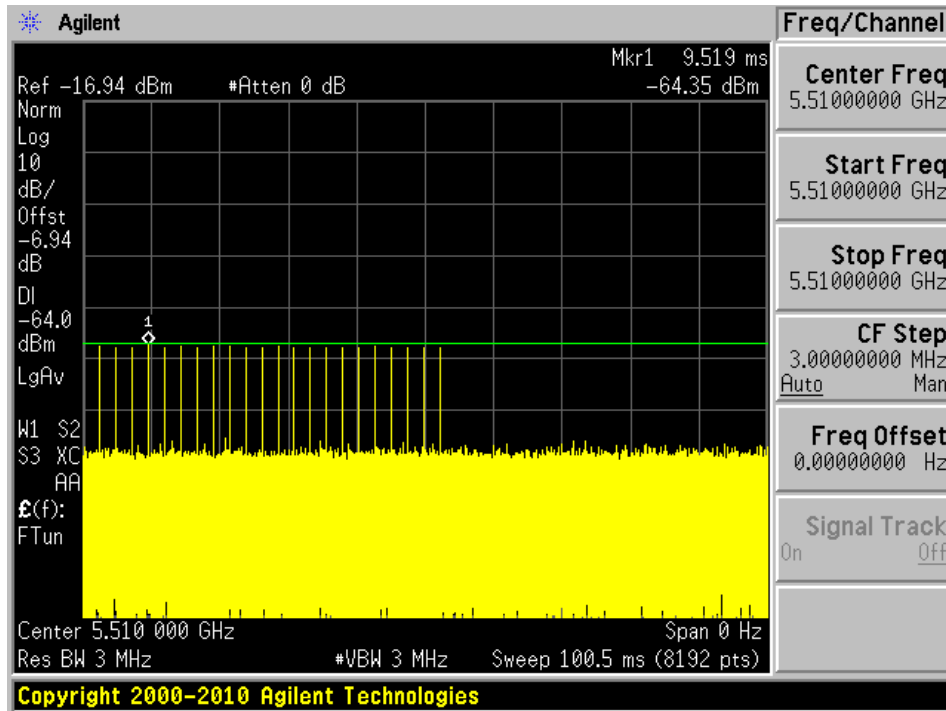

Radar Type 2

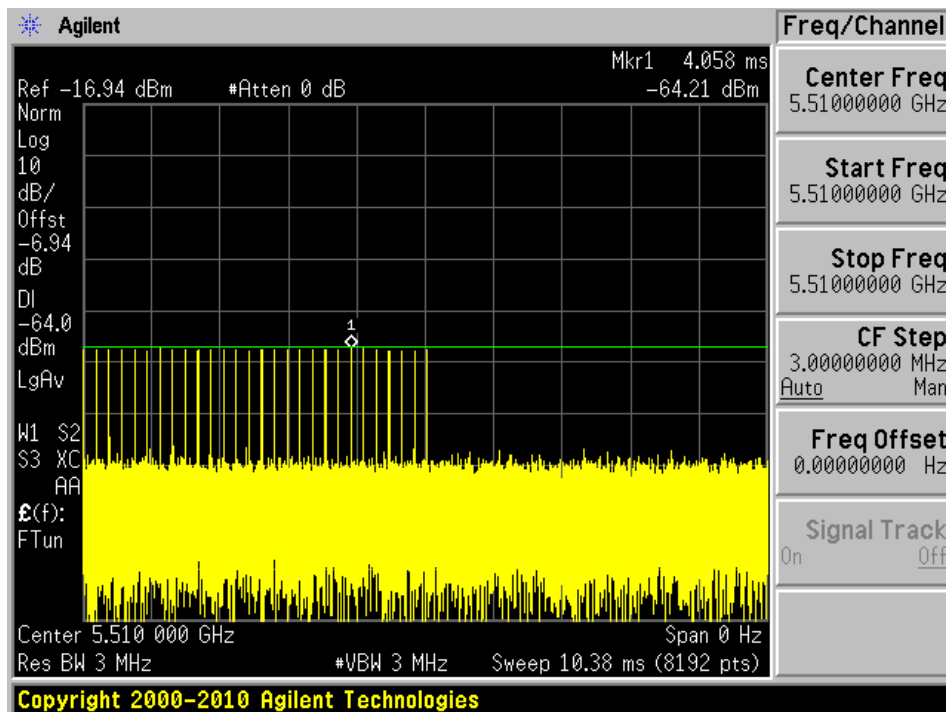

Radar Type 3

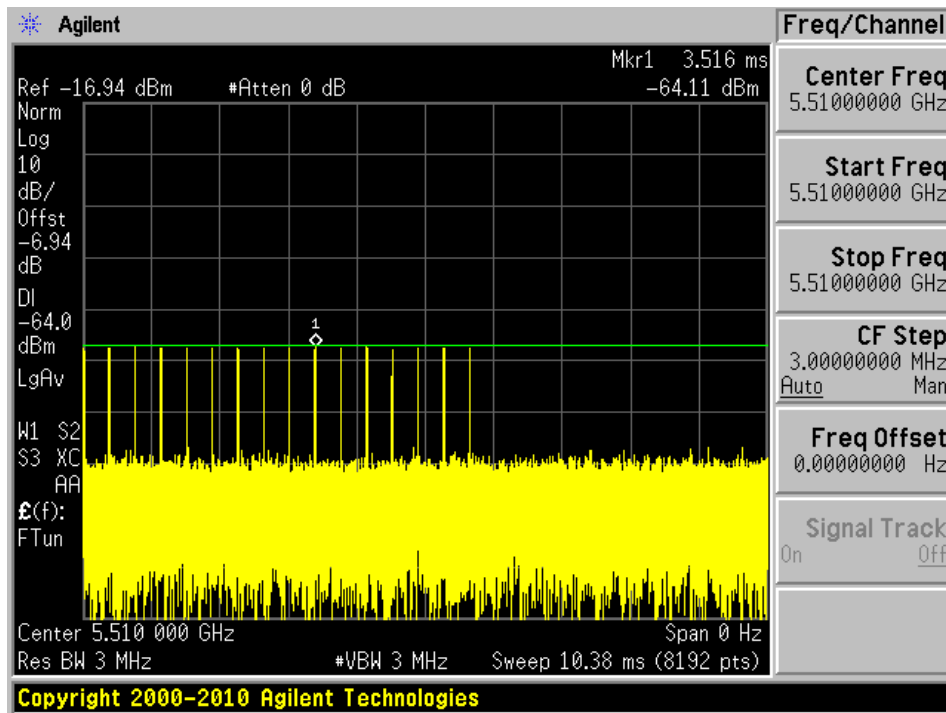

Radar Type 4

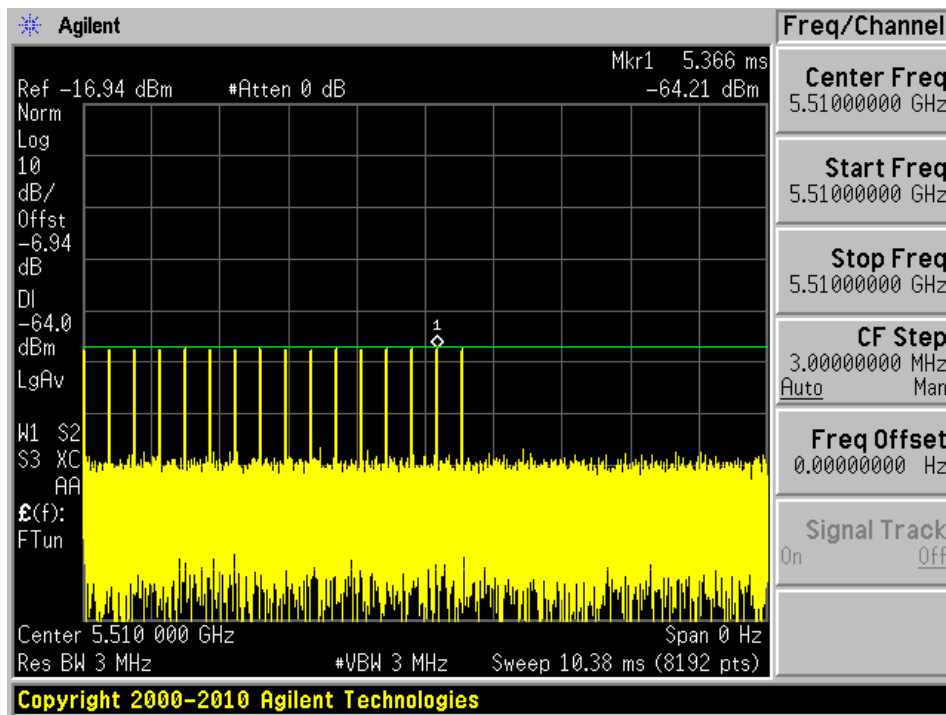

Radar Type 5

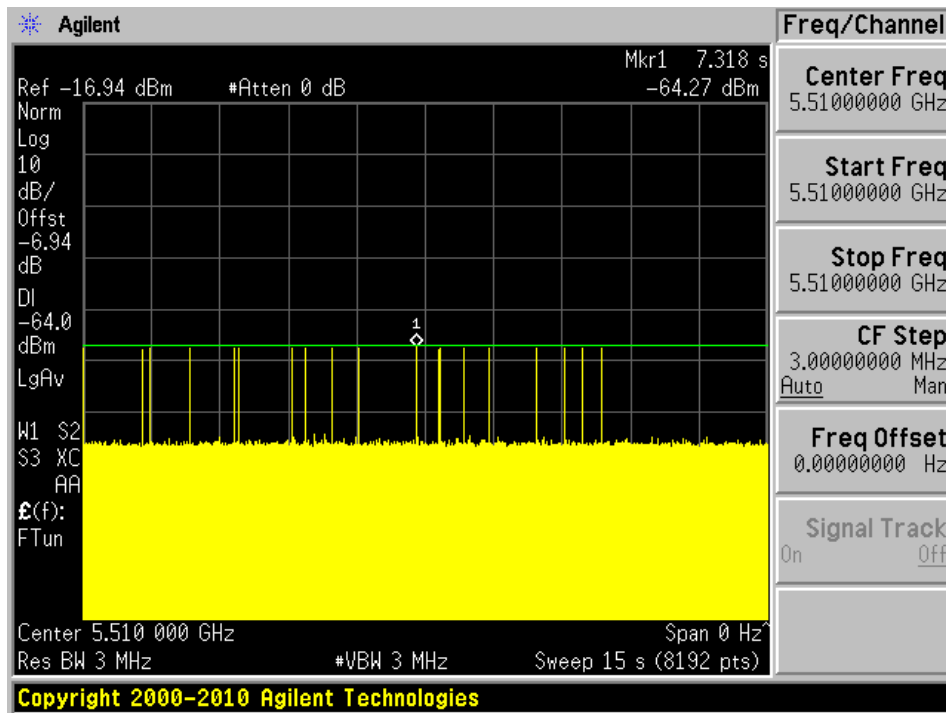

Radar Type 6

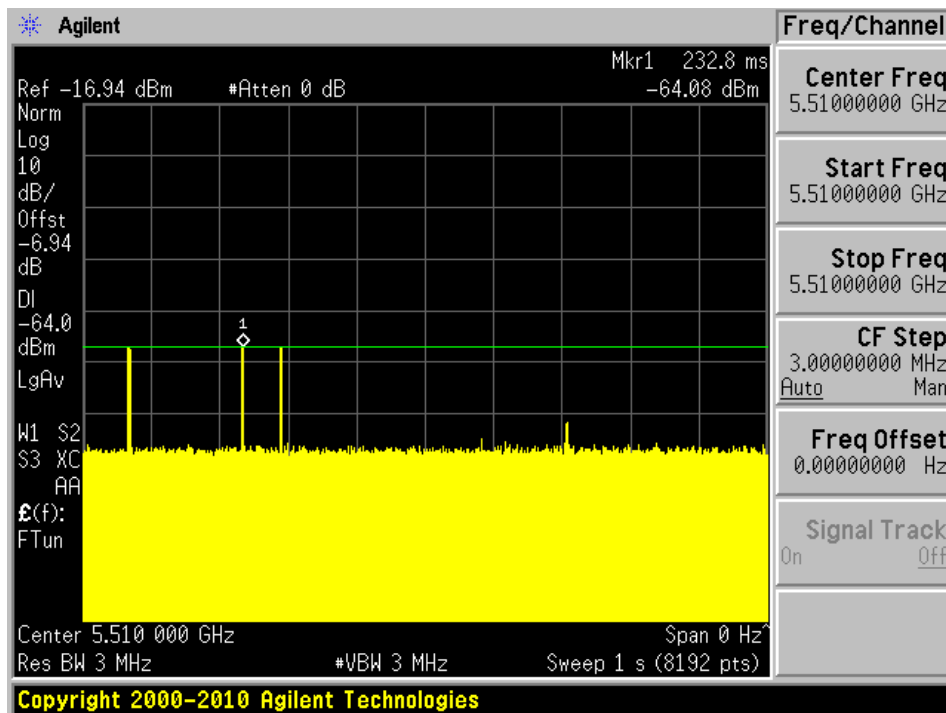

40 MHz BW, 5520 MHz

Radar Type 0

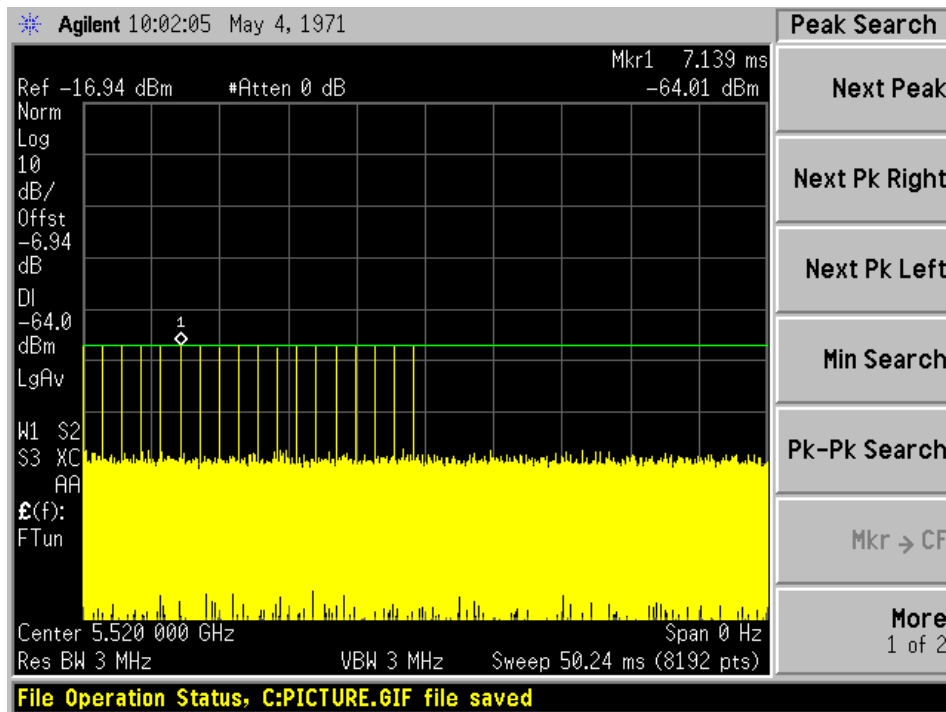

Radar Type 1A

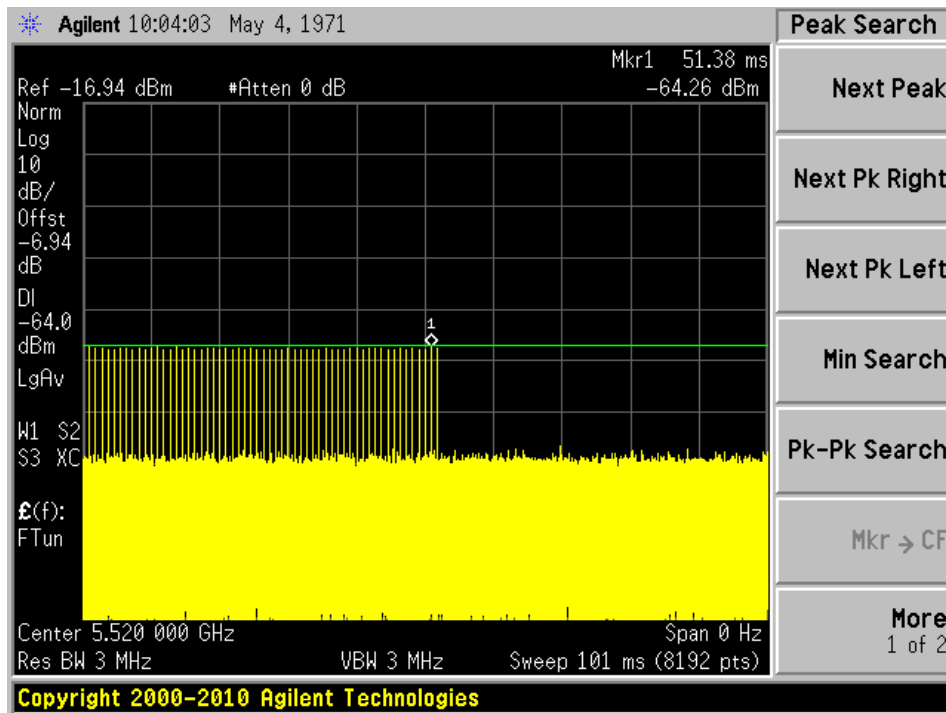

Radar Type 1B

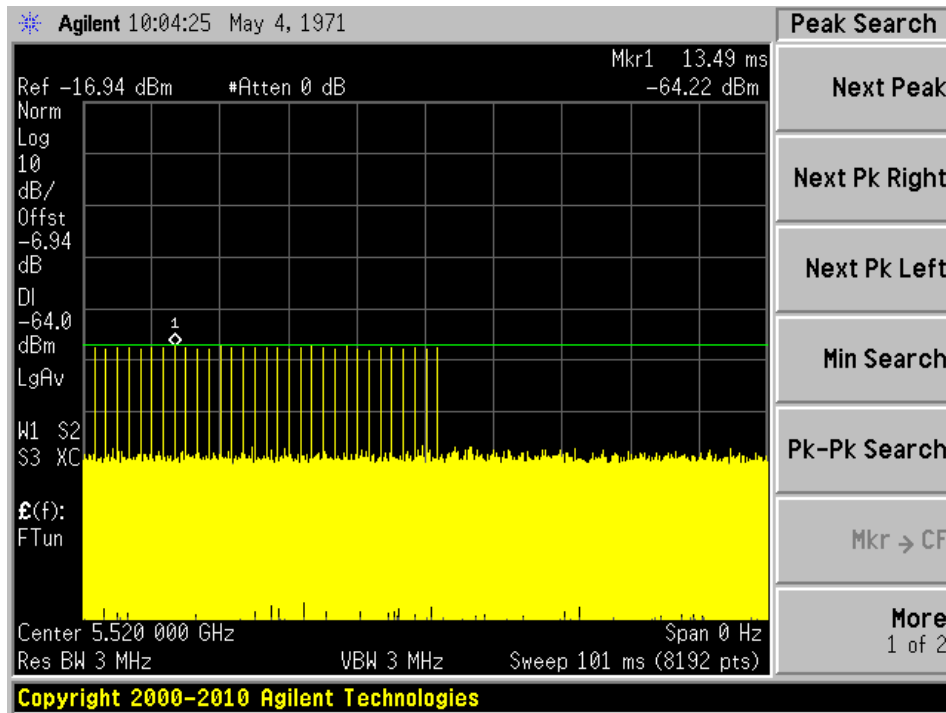

Radar Type 2

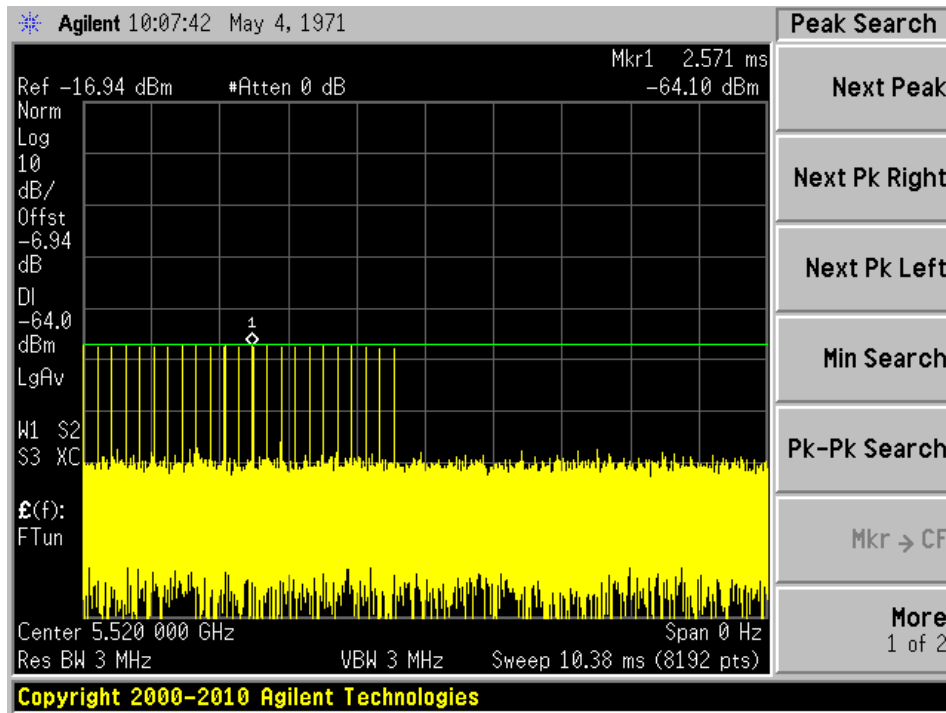

Radar Type 3

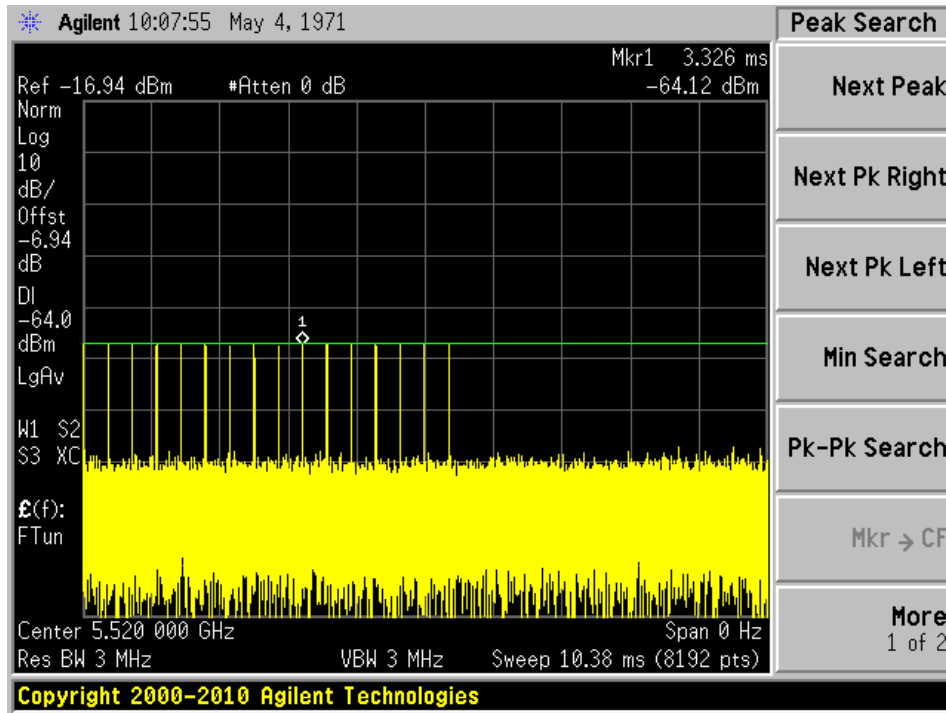

Radar Type 4

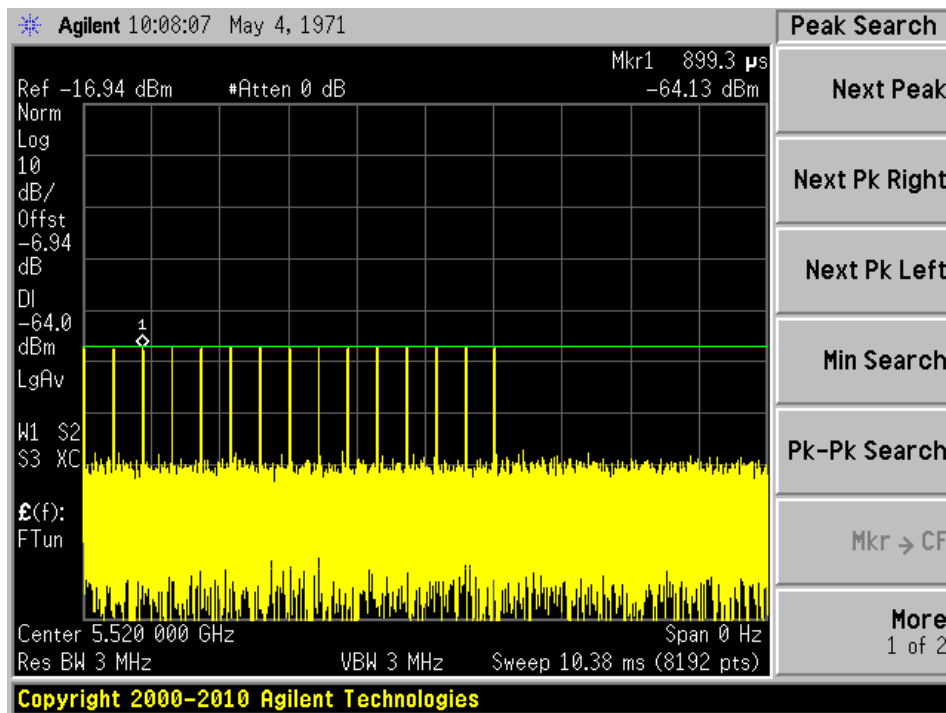

Radar Type 5

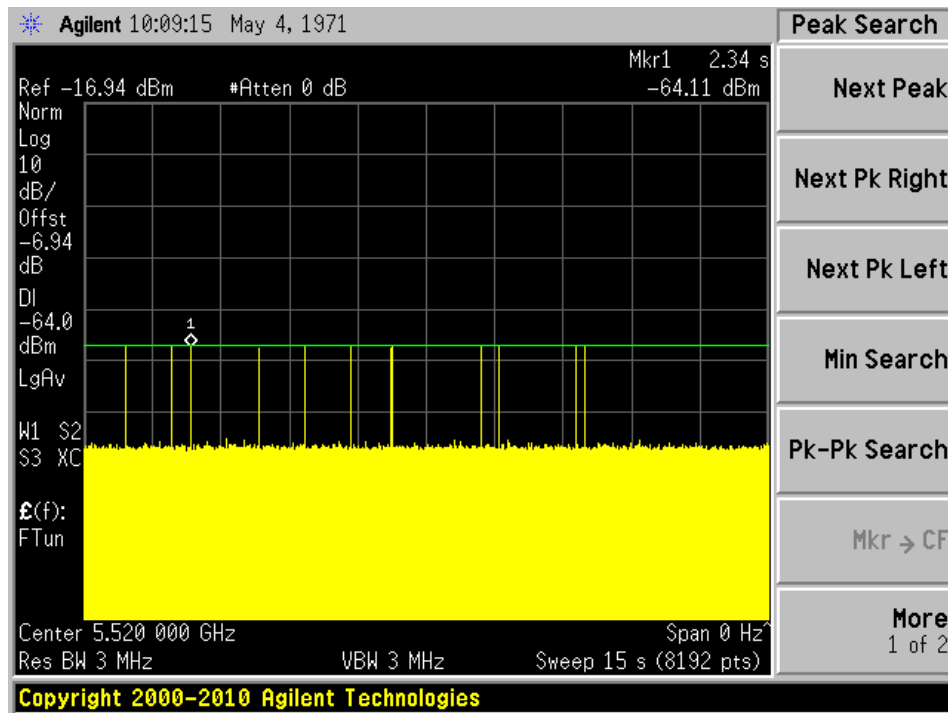

Radar Type 6

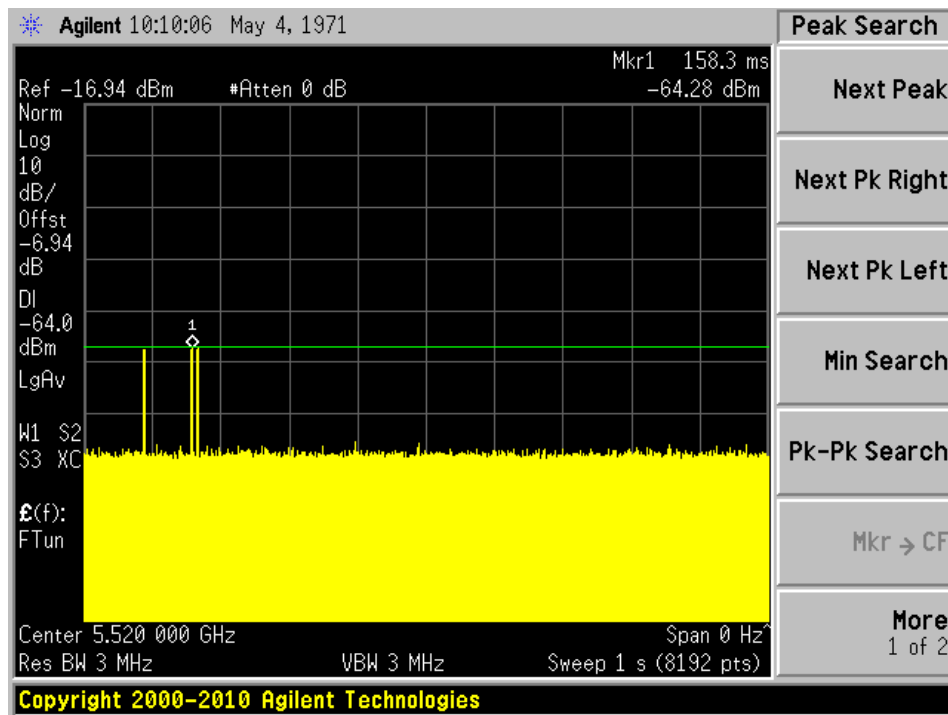

80 MHz BW, 5540 MHz

Radar Type 0

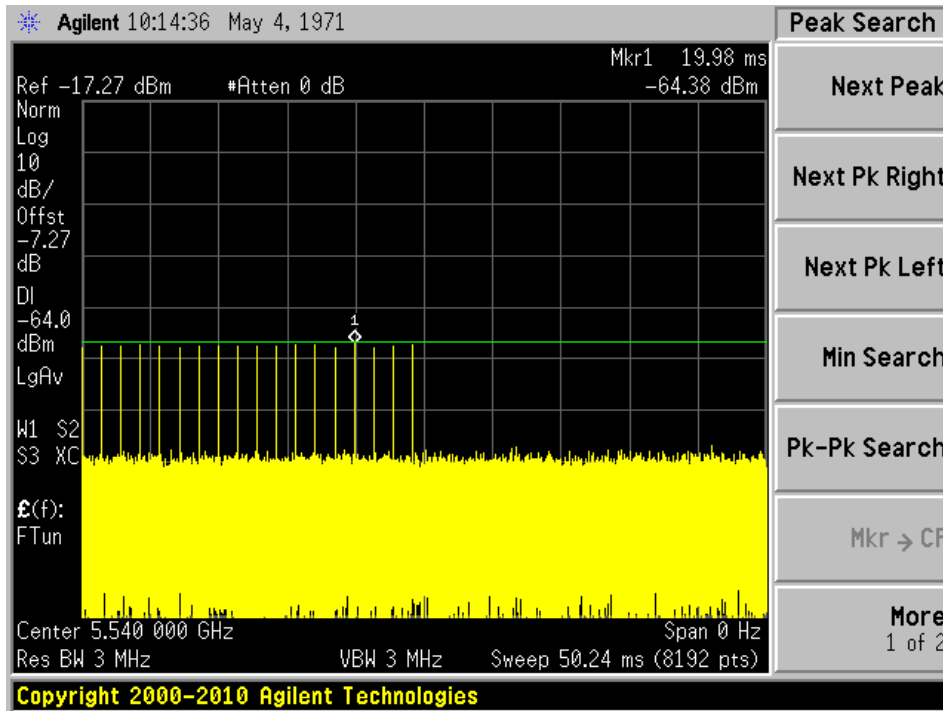

Radar Type 1A

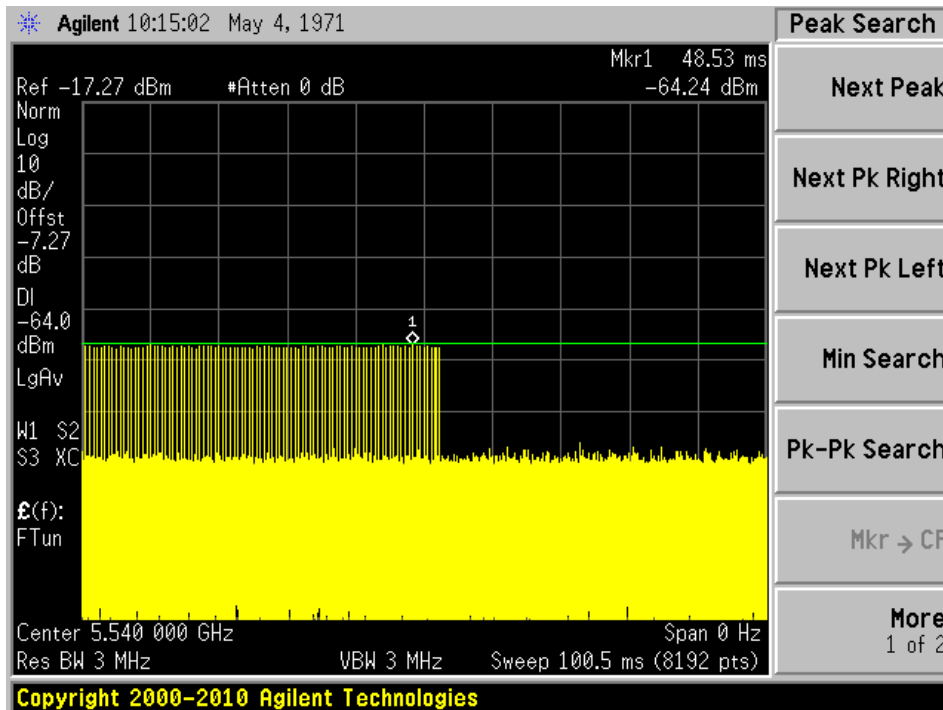

Radar Type 1B

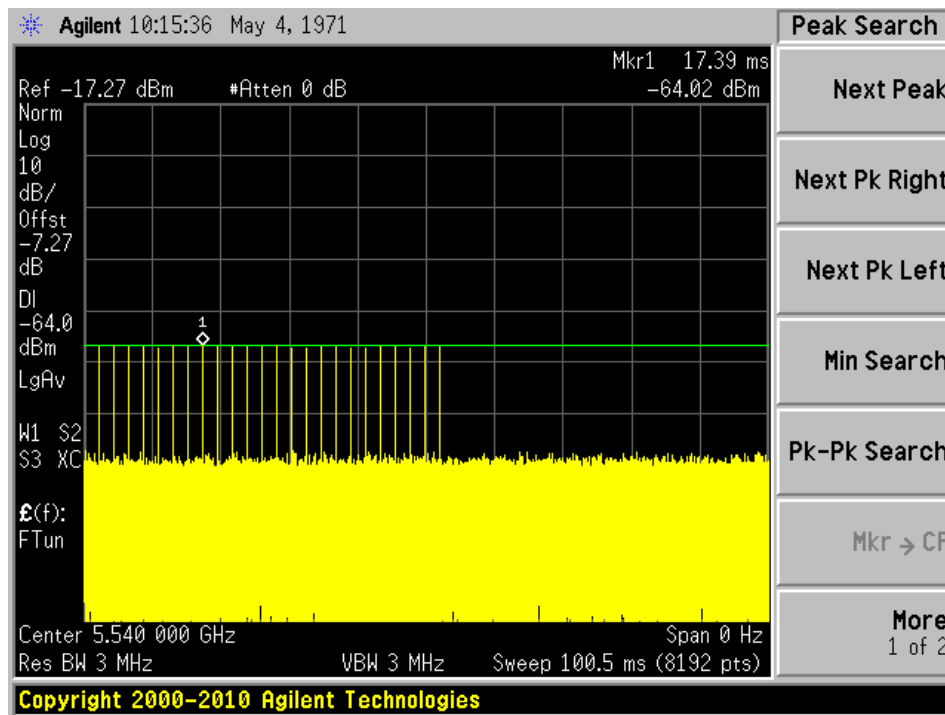

Radar Type 2

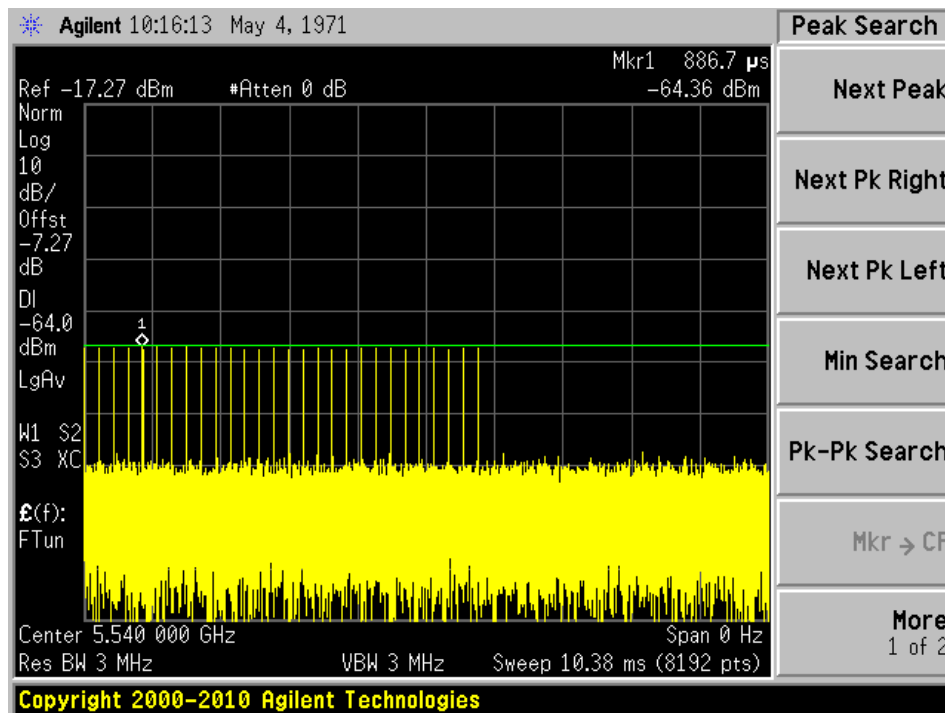

Radar Type 3

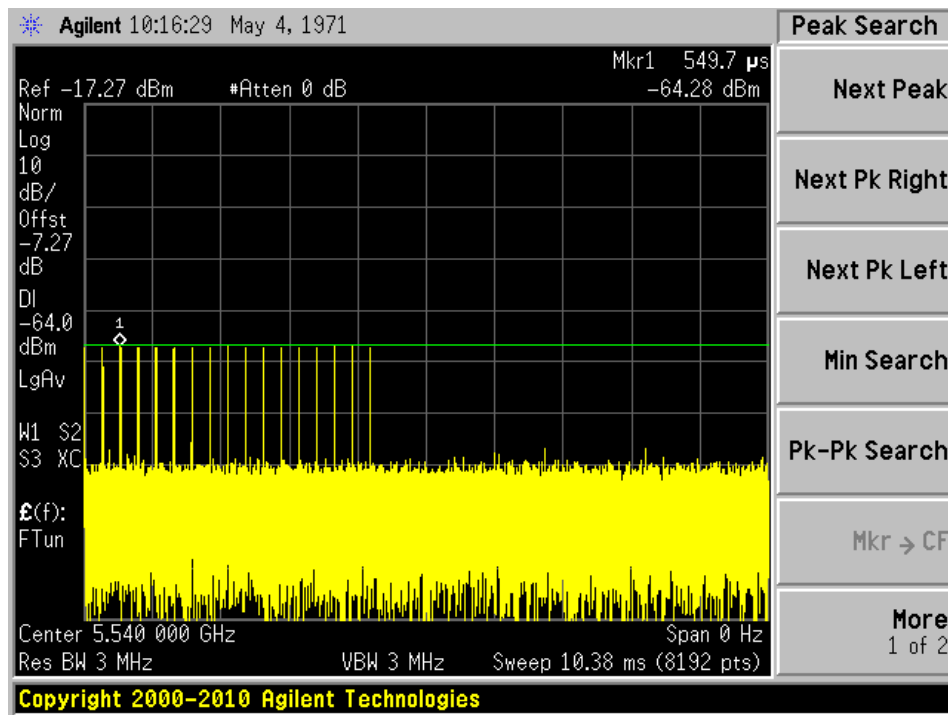

Radar Type 4

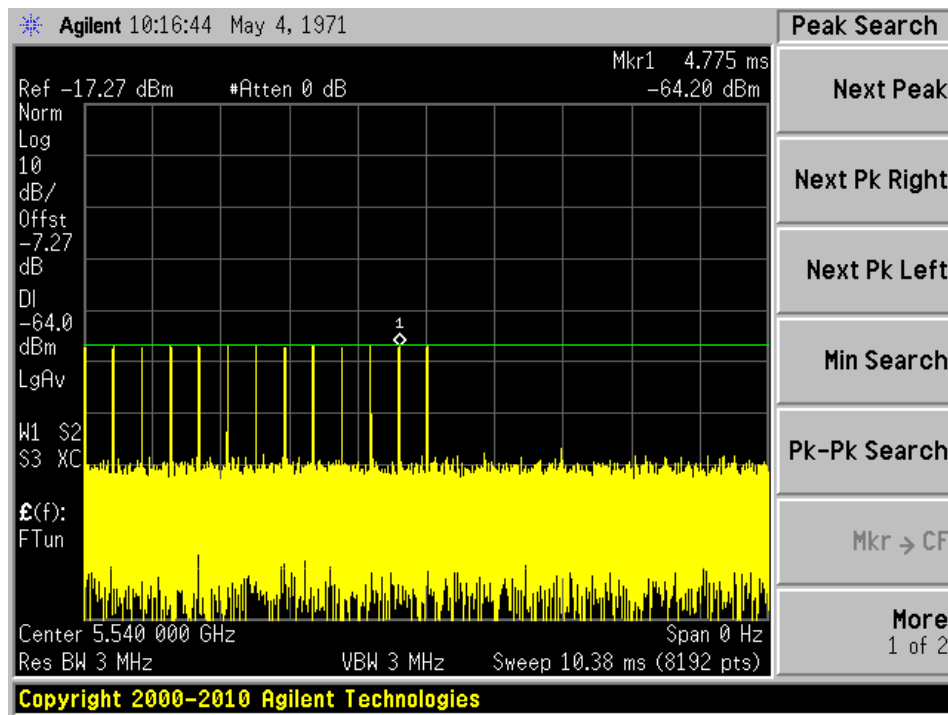

Radar Type 5

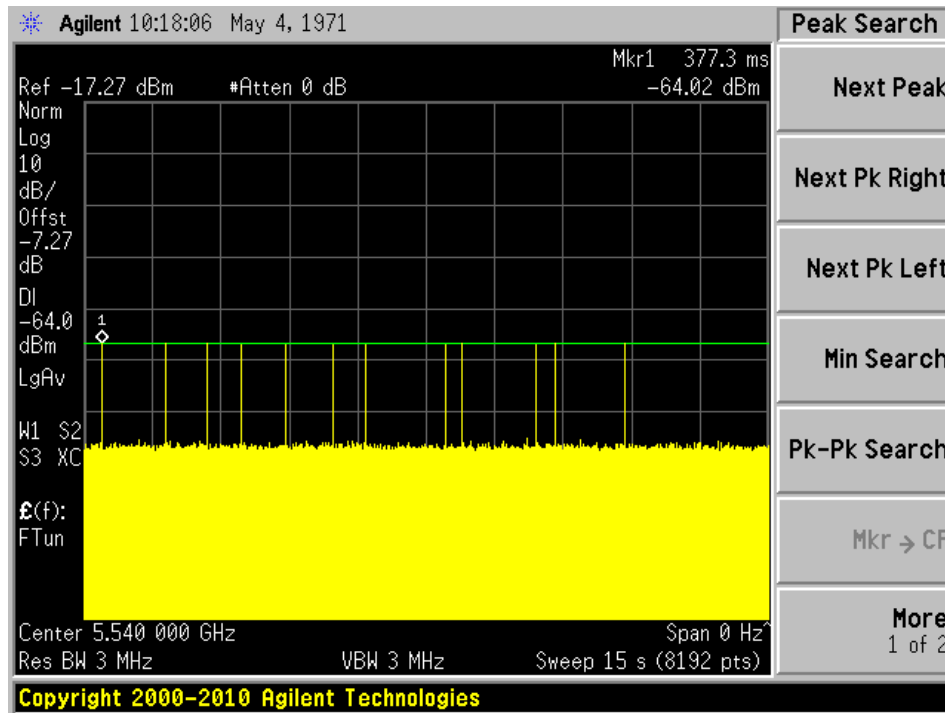

Radar Type 6

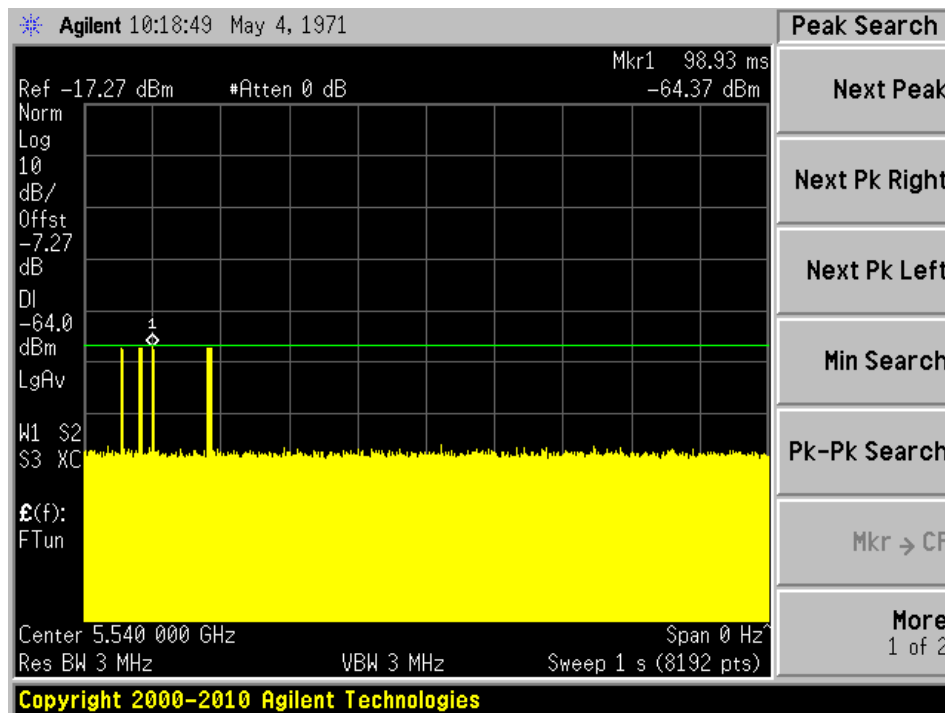

6 Channel Availability Check Time (CAC)

6.1 Test Procedure

- 1) Measure the initial power-up time of EUT.
- 2) With link established on channel, apply a radar signal within 0~6 seconds after the initial power-up period; monitor the transmissions on channel from the spectrum analyzer.
- 3) Reboot EUT, with a link established on channel, apply a radar signal within 54~60 seconds after the initial power-up period, and monitor the transmission on channel from the spectrum analyzer.

Results:

CAC Total Time: 60 Seconds

Timing of Radar Burst	Spectrum Analyzer Display	Result
No Radar Triggered	Transmission begin after power-up cycle 60 seconds CAC	Pass
Within 6 seconds of the CAC starting	No transmission	Pass
Within the last 6 seconds of the CAC	No transmission	Pass

Note: The CAC test is with the Radar type 0.

Plot of Radar signal applied at the end of 6 seconds of CAC

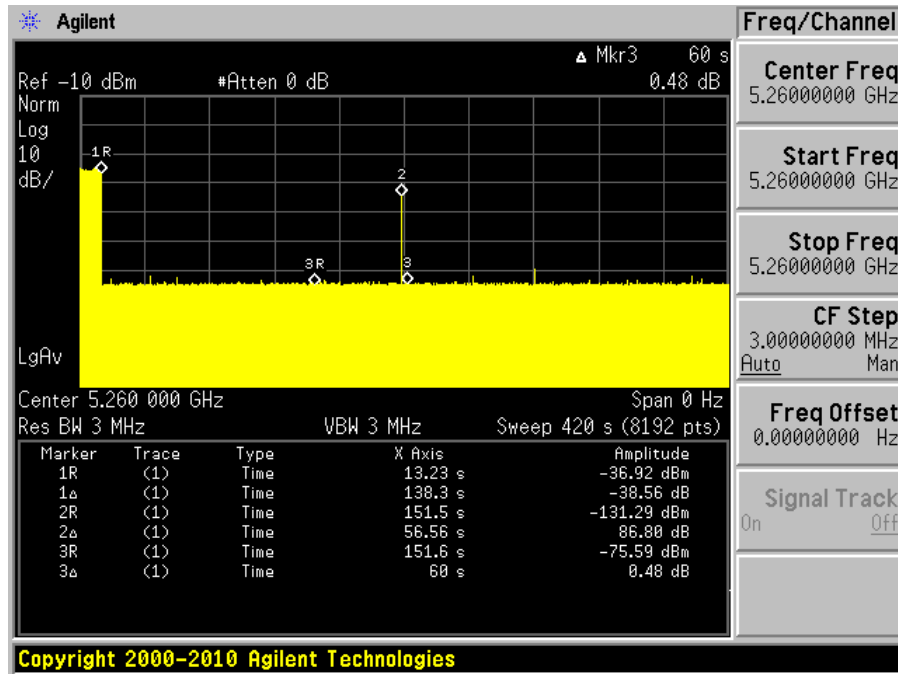

No transmissions found after radar signal applied.

5510 MHz

Plot of Power up Cycle (137.9 s)

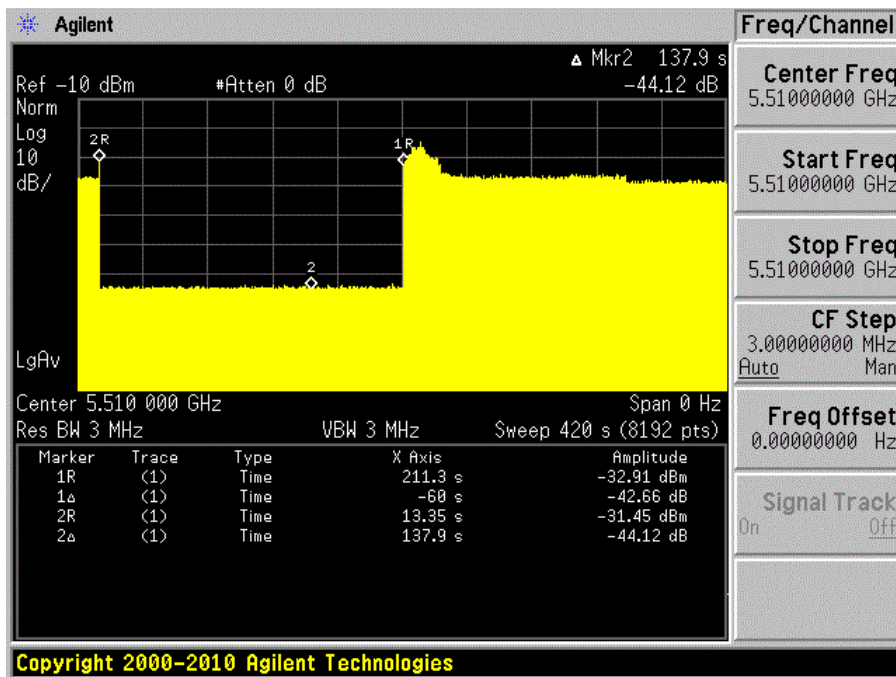

Plot of Radar signal applied within 6 seconds of start of CAC

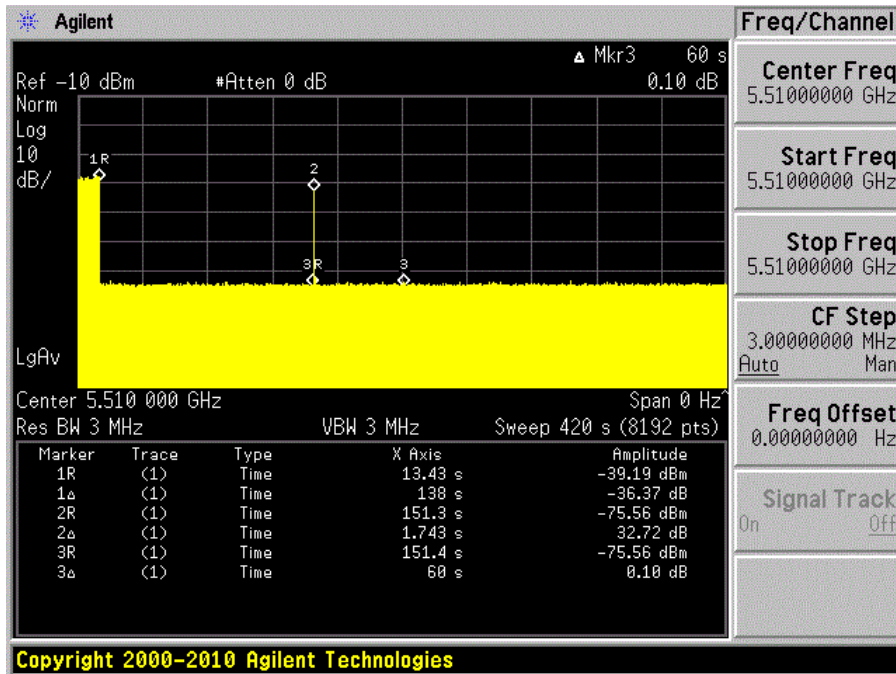

No transmissions found after radar signal applied.

Plot of Radar signal applied at the end of 6 seconds of CAC

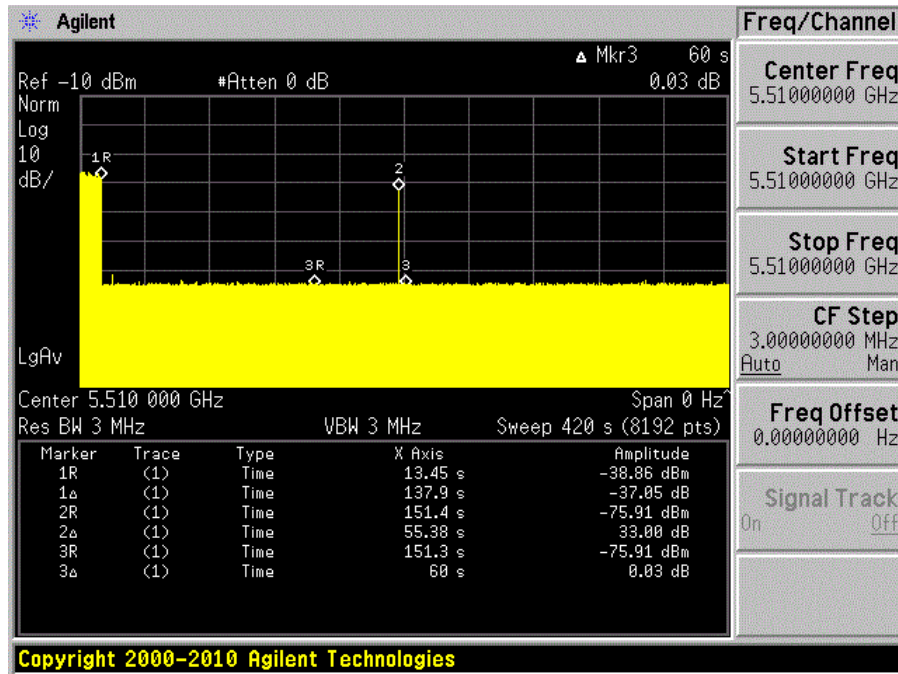

No transmissions found after radar signal applied.

7 Channel Move Time and Channel Closing Transmission Time

7.1 Test Procedure

BACL use type 0 radar signal to test the channel move time and channel closing transmission time.

The aggregate channel closing transmission time is calculated as follows:

Aggregate Transmission Time = N * Dwell Time

N is the number of spectrum analyzer bins showing a device transmission

Dwell Time is the dwell time per bin (i.e. Dwell Time = S/B, S is the sweep time and B is the number of bin, i.e. 8192)

7.2 Test Results

Frequency (MHz)	Bandwidth (MHz)	Radar Type	Results
5270	40	Type 0	Compliant
5540	80	Type 0	Compliant

Please refer to the following tables and plots.

Master Mode:

5270 MHz, Bandwidth 40 MHz

Type 0 radar channel move time and channel closing transmission time result:

Channel closing transmitting time (ms)	Limit (ms)	Result
105+12.21	200+60	Pass

Channel move time (s)	Limit (s)	Result
< 10	10	Pass

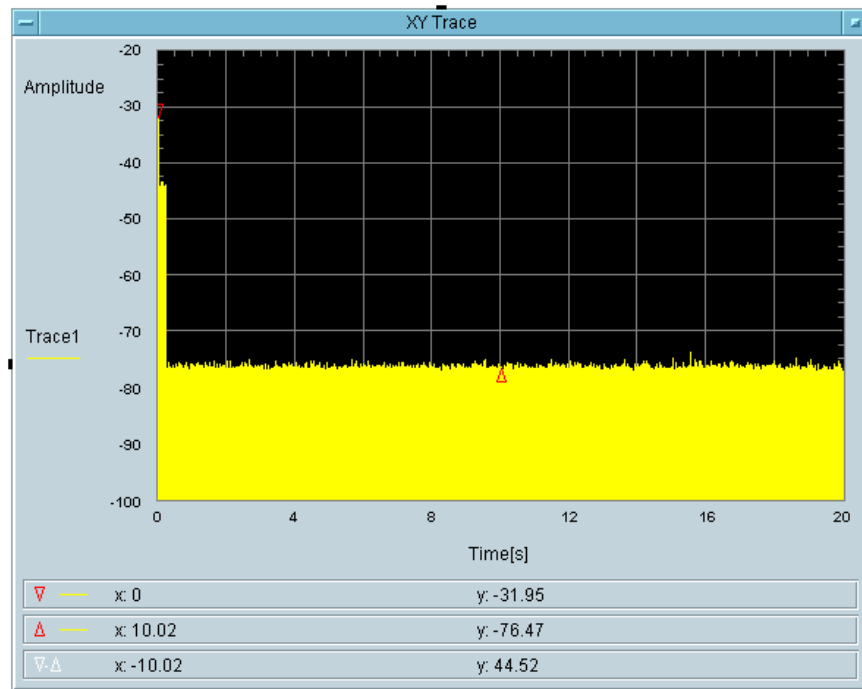

Total On Time [s]
0.105

Total On Time After Delay [s]
12.21m

5540 MHz, Bandwidth 80 MHz

Type 0 radar channel move time and channel closing transmission time result:

Channel closing transmitting time (ms)	Limit (ms)	Result
65.92+0	200+60	Pass

Channel move time (s)	Limit (s)	Result
< 10	10	Pass

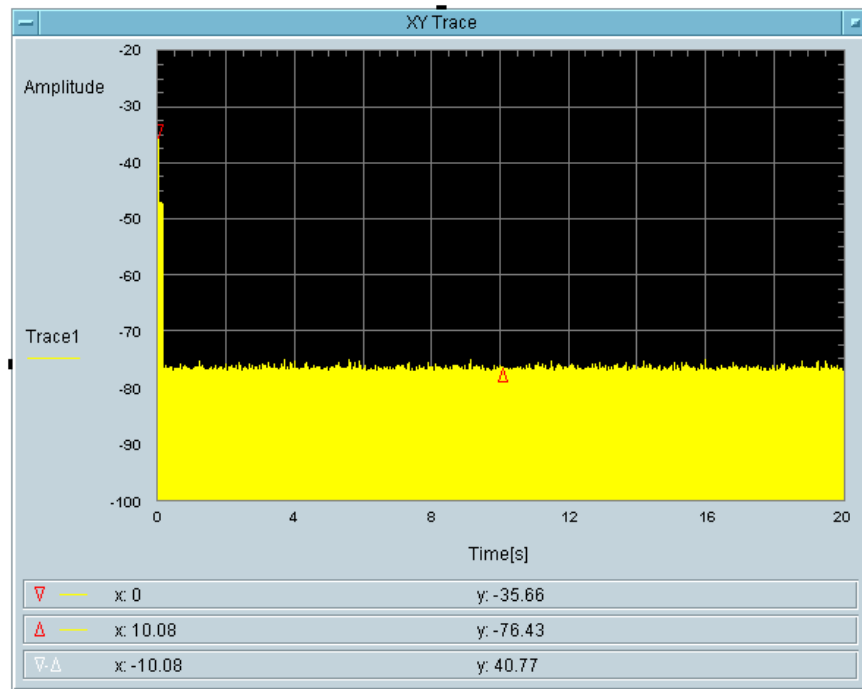

Total On Time [s]
65.92m

Client Mode:

5270 MHz, Bandwidth 40 MHz

Type 0 radar channel move time and channel closing transmission time result:

Channel closing transmitting time (ms)	Limit (ms)	Result
85.45+0	200+60	Pass

Channel move time (s)	Limit (s)	Result
< 10	10	Pass

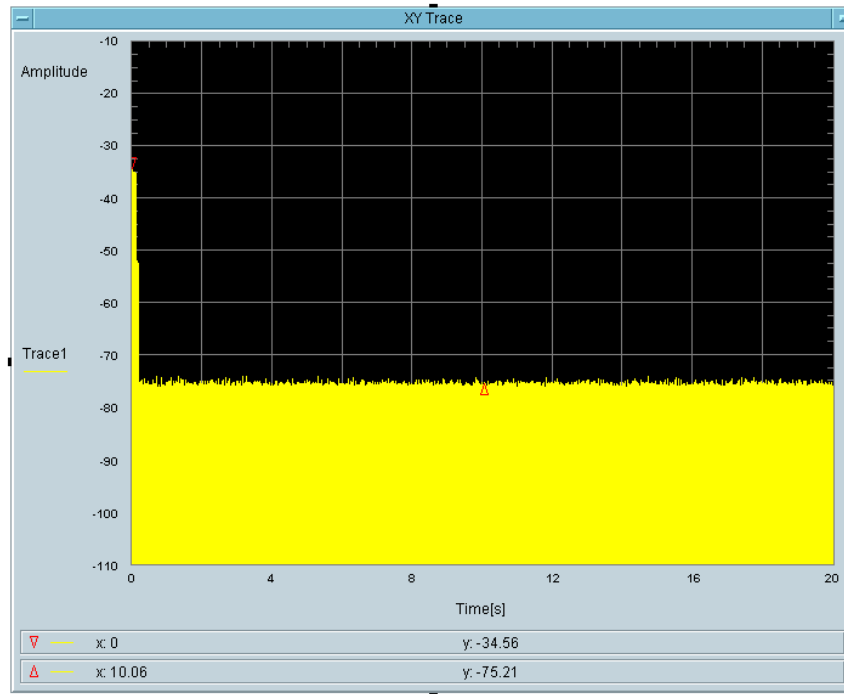

Total On Time [s]
85.45m

5270 MHz, Bandwidth 40 MHz

Type 5 radar channel move time and channel closing transmission time result:

Channel closing transmitting time (ms)	Limit (ms)	Result
66.56+0	200+60	Pass

Channel move time (s)	Limit (s)	Result
< 10	10	Pass

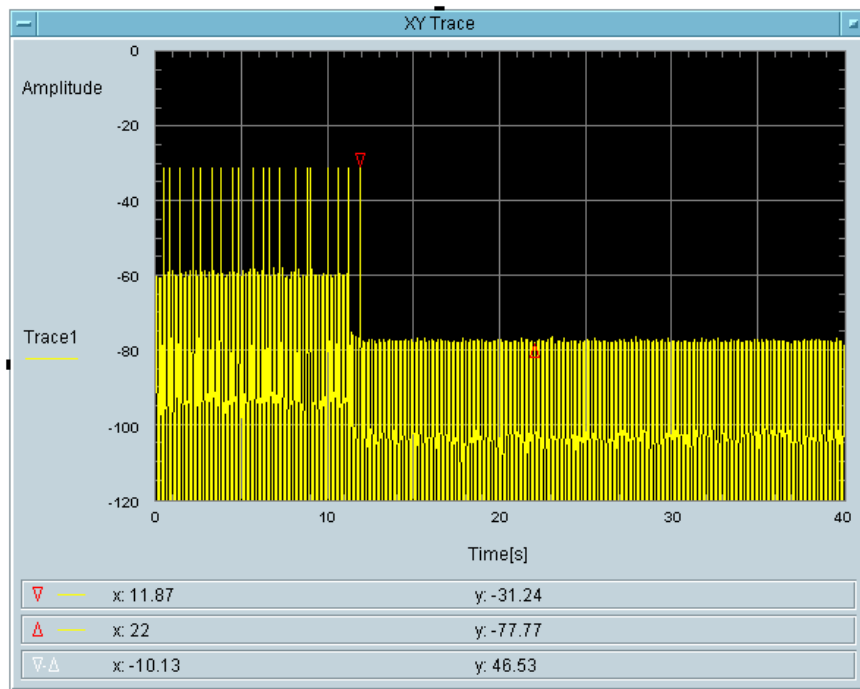

Total On Time [s]
66.56m

5540 MHz, Bandwidth 80 MHz

Type 0 radar channel move time and channel closing transmission time result:

Channel closing transmitting time (ms)	Limit (ms)	Result
66.56+0	200+60	Pass

Channel move time (s)	Limit (s)	Result
< 10	10	Pass

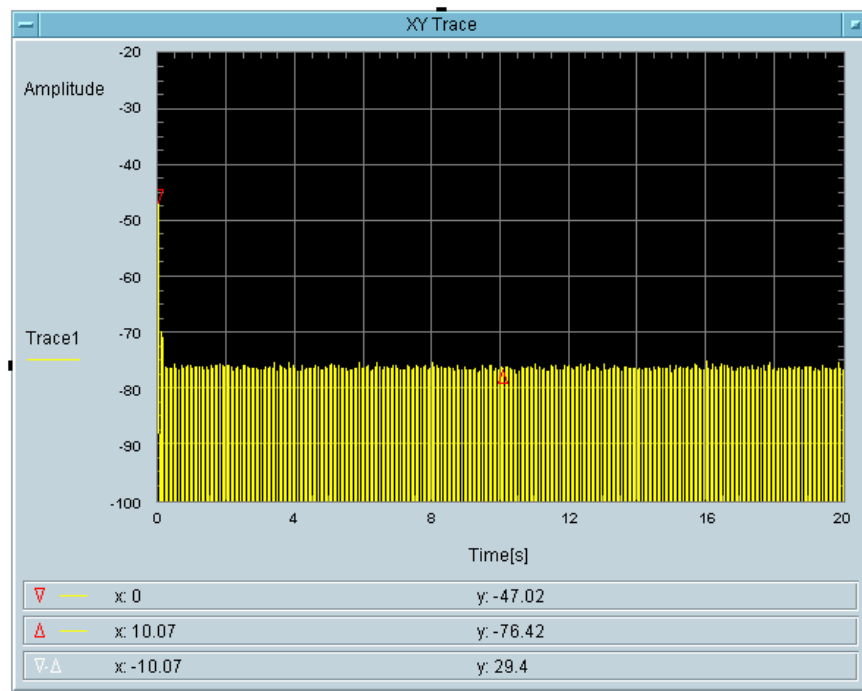

Total On Time [s]
66.56m

5540 MHz, Bandwidth 80 MHz

Type 5 radar channel move time and channel closing transmission time result:

Channel closing transmitting time (ms)	Limit (ms)	Result
66.56+0	200+60	Pass

Channel move time (s)	Limit (s)	Result
< 10	10	Pass

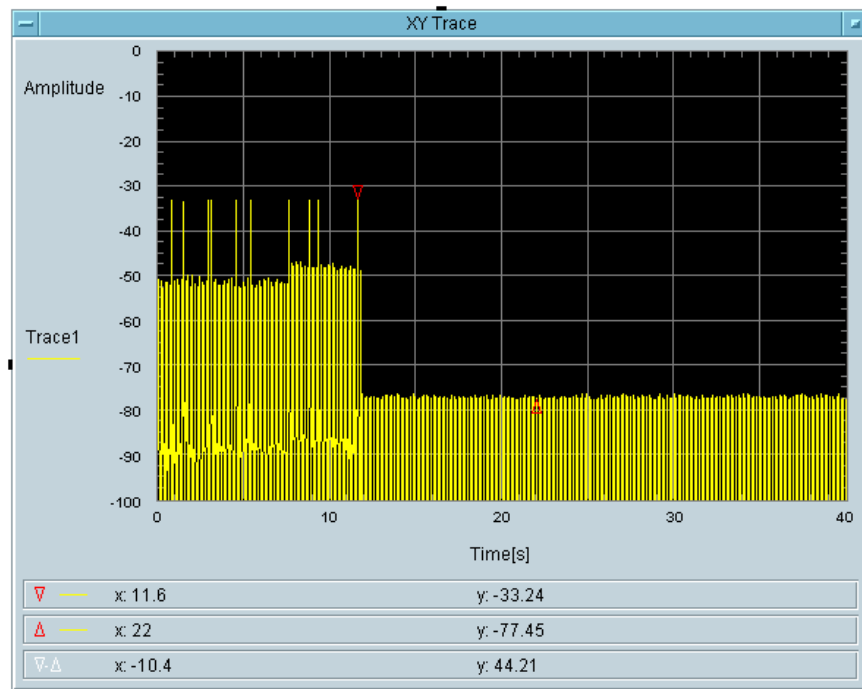

Total On Time [s]
66.56m

8 Non-Occupancy Period

8.1 Test Procedure

Measure the EUT for more than 30 minutes following the channel close/move time to verify that the EUT does not resume any transmissions on this channel. Provide one plot to demonstrate no transmission on the channel for the non-occupancy period (30 minutes observation time)

8.2 Test Results

Frequency (MHz)	Bandwidth (MHz)	Spectrum Analyzer Display
5260	20	No transmission within 30 minutes
5510	20	No transmission within 30 minutes

Please refer to the following plots.

Master Mode:

5260 MHz, Bandwidth 20 MHz

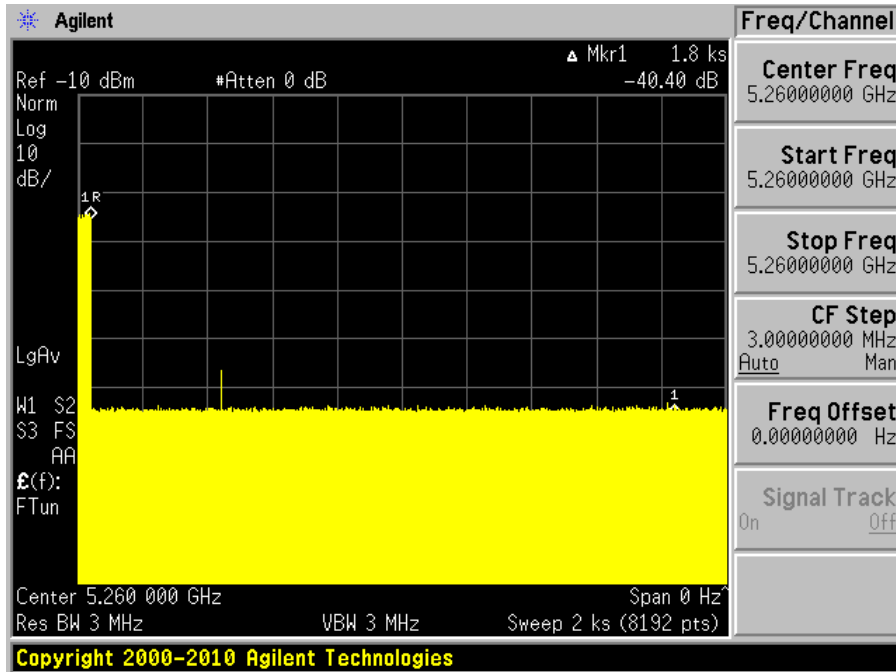

5510 MHz, Bandwidth 20 MHz

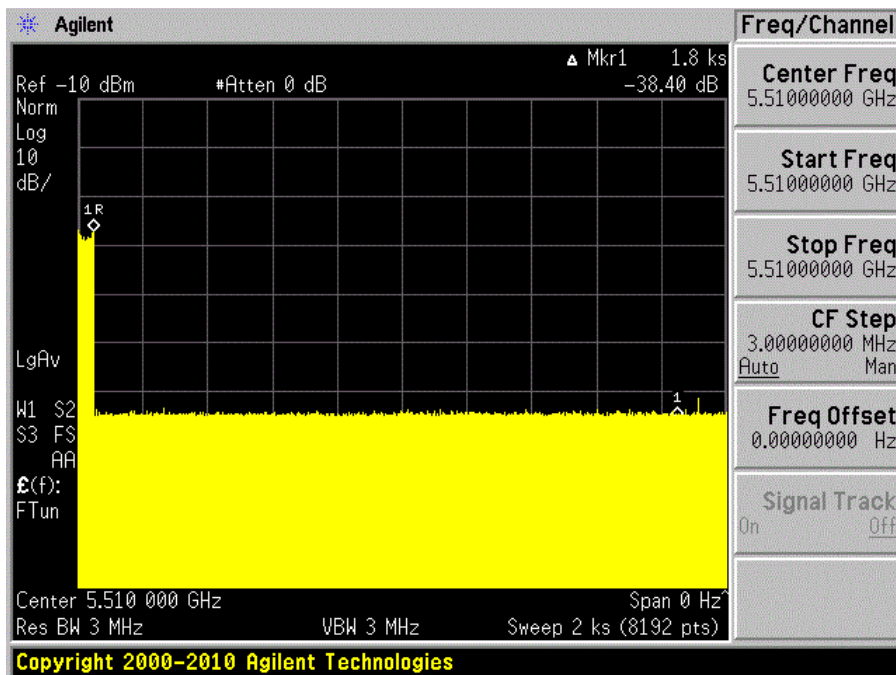

Client Mode:

5260 MHz, Bandwidth 20 MHz

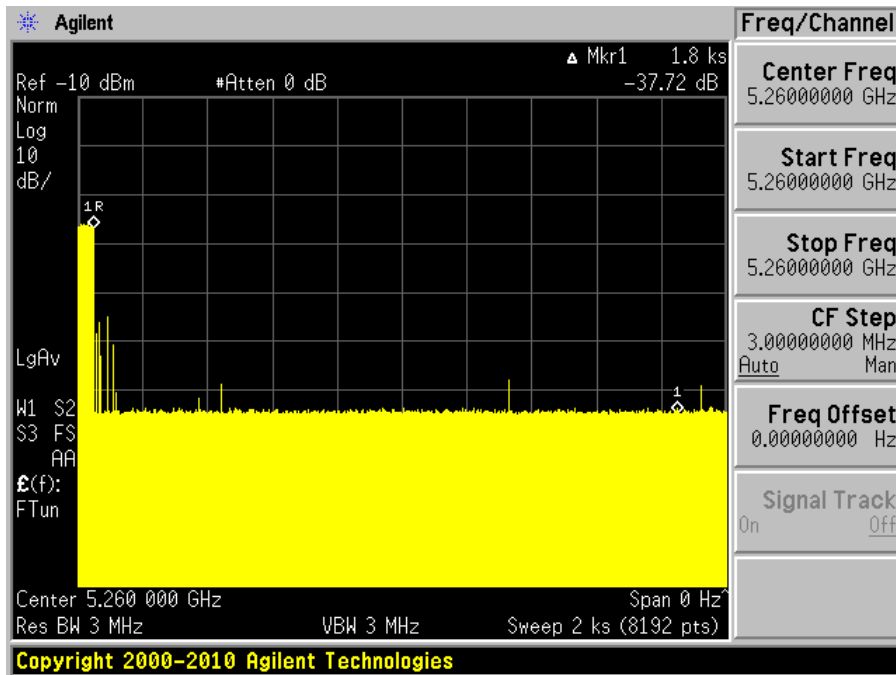

5510 MHz, Bandwidth 20 MHz

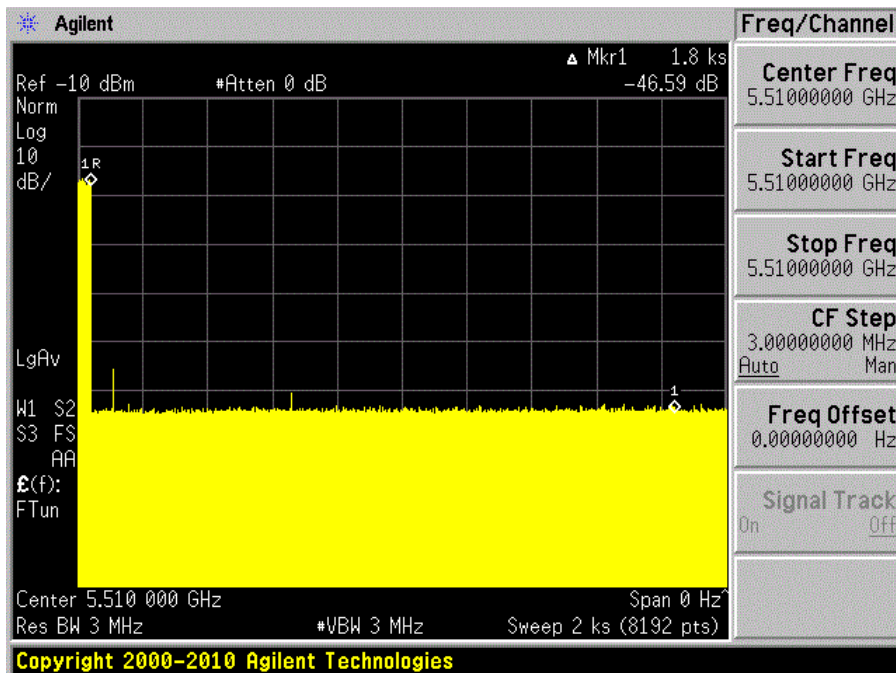

9 Radar Detection Bandwidth & Radar Detection Performance Check

9.1 Detection Bandwidth

Procedure:

Performed with any one of the short pulse radar waveforms type 0

Starting at the center frequency of the UUT operating Channel, increase the radar frequency in 5 MHz steps, repeating the above test sequence, until the detection rate falls below the U-NII Detection Bandwidth criterion specified in Table 4. Repeat this measurement in 1MHz steps at frequencies 5 MHz below where the detection rate begins to fall. Record the highest frequency (denote as FH) at which detection is greater than or equal to the U-NII Detection Bandwidth criterion. Recording the detection rate at frequencies above FH is not required to demonstrate compliance.

Starting at the center frequency of the UUT operating Channel, decrease the radar frequency in 5 MHz steps, repeating the above test sequence, until the detection rate falls below the U-NII Detection Bandwidth criterion specified in Table 4. Repeat this measurement in 1MHz steps at frequencies 5 MHz above where the detection rate begins to fall. Record the lowest frequency (denote as FL) at which detection is greater than or equal to the U-NII Detection Bandwidth criterion. Recording the detection rate at frequencies below FL is not required to demonstrate compliance.

The U-NII Detection Bandwidth is calculated as follows: $\text{U-NII Detection Bandwidth} = \text{FH} - \text{FL}$

Test Results**Master Mode:**

Frequency (MHz)	F _L (MHz)	F _H (MHz)	Detection Bandwidth (MHz)	Minimum Limit	Result
5260	5250	5270	20	100%	Compliance
5270	5250	5290	40	100%	Compliance
5510	5490	5510	20	100%	Compliance
5520	5490	5530	40	100%	Compliance
5540	5490	5570	80	100%	Compliance

Client Mode:

Frequency (MHz)	F _L (MHz)	F _H (MHz)	Detection Bandwidth (MHz)	Minimum Limit	Result
5260	5250	5270	20	100%	Compliance
5270	5250	5290	40	100%	Compliance
5510	5490	5510	20	100%	Compliance
5520	5490	5530	40	100%	Compliance
5540	5490	5570	80	100%	Compliance

Please refer to the following tables.

Master Mode:**Results of Detection Bandwidth:**

EUT Frequency = 5260 MHz											
DFS Detection Trials (1 = Detected, 0 = No Detected)											
Radar Frequency (MHz)	1	2	3	4	5	6	7	8	9	10	Detection Rate (%)
5247	0	0	0	0	0	0	0	0	0	0	0 %
5250(F_L)	1	1	1	1	1	1	1	1	1	1	100 %
5255	1	1	1	1	1	1	1	1	1	1	100 %
5260(F _c)	1	1	1	1	1	1	1	1	1	1	100 %
5265	1	1	1	1	1	1	1	1	1	1	100 %
5270(F_H)	1	1	1	1	1	1	1	1	1	1	100 %
5273	0	0	0	0	0	0	0	0	0	0	0 %
Detection Bandwidth = F_H - F_L=5270-5250=20 MHz											
EUT 99% OBW = 18 MHz; 18 x 100% = 18 MHz						Result:		Pass			

EUT Frequency = 5510 MHz											
DFS Detection Trials (1 = Detected, 0 = No Detected)											
Radar Frequency (MHz)	1	2	3	4	5	6	7	8	9	10	Detection Rate (%)
5498	0	0	0	0	0	0	0	0	0	0	0 %
5500(F_L)	1	1	1	1	1	1	1	1	1	1	100 %
5105	1	1	1	1	1	1	1	1	1	1	100 %
5510(F _c)	1	1	1	1	1	1	1	1	1	1	100 %
5515	1	1	1	1	1	1	1	1	1	1	100 %
5520 (F_H)	1	1	1	1	1	1	1	1	1	1	100 %
5521	0	0	0	0	0	0	0	0	0	0	0 %
Detection Bandwidth = F_H - F_L=5510-5490=20 MHz											
EUT 99% OBW = 18 MHz; 18 x 100% = 18 MHz						Result:		Pass			

Results of Detection Bandwidth:

EUT Frequency = 5270 MHz											
DFS Detection Trials (1 = Detected, 0 = No Detected)											
Radar Frequency (MHz)	1	2	3	4	5	6	7	8	9	10	Detection Rate (%)
5246	0	0	0	0	0	0	0	0	0	0	0 %
5250(F_L)	1	1	1	1	1	1	1	1	1	1	100 %
5255	1	1	1	1	1	1	1	1	1	1	100 %
5260	1	1	1	1	1	1	1	1	1	1	100 %
5265	1	1	1	1	1	1	1	1	1	1	100 %
5270(F _C)	1	1	1	1	1	1	1	1	1	1	100 %
5275	1	1	1	1	1	1	1	1	1	1	100 %
5280	1	1	1	1	1	1	1	1	1	1	100 %
5285	1	1	1	1	1	1	1	1	1	1	100 %
5290(F_H)	1	1	1	1	1	1	1	1	1	1	100 %
5294	0	0	0	0	0	0	0	0	0	0	0 %
Detection Bandwidth = F_H - F_L=5290-5250=40 MHz											
EUT 99% OBW = 37 MHz; 37 x 100% = 37 MHz						Result:		Pass			

EUT Frequency = 5520 MHz											
DFS Detection Trials (1 = Detected, 0 = No Detected)											
Radar Frequency (MHz)	1	2	3	4	5	6	7	8	9	10	Detection Rate (%)
5497	0	0	0	0	0	0	0	0	0	0	0 %
5500(F_L)	1	1	1	1	1	1	1	1	1	1	100 %
5505	1	1	1	1	1	1	1	1	1	1	100 %
5510	1	1	1	1	1	1	1	1	1	1	100 %
5515	1	1	1	1	1	1	1	1	1	1	100 %
5520(F _C)	1	1	1	1	1	1	1	1	1	1	100 %
5525	1	1	1	1	1	1	1	1	1	1	100 %
5530	1	1	1	1	1	1	1	1	1	1	100 %
5535	1	1	1	1	1	1	1	1	1	1	100 %
5540(F_H)	1	1	1	1	1	1	1	1	1	1	100 %
5543	0	0	0	0	0	0	0	0	0	0	0 %
Detection Bandwidth = F_H - F_L=5540-5500=40 MHz											
EUT 99% OBW = 37 MHz; 37 x 100% = 37 MHz						Result:		Pass			

Results of Detection Bandwidth:

EUT Frequency = 5540 MHz											
DFS Detection Trials (1 = Detected, 0 = No Detected)											
Radar Frequency (MHz)	1	2	3	4	5	6	7	8	9	10	Detection Rate (%)
5496	0	0	0	0	0	0	0	0	0	0	0 %
5500(F_L)	1	1	1	1	1	1	1	1	1	1	100 %
5505	1	1	1	1	1	1	1	1	1	1	100 %
5510	1	1	1	1	1	1	1	1	1	1	100 %
5515	1	1	1	1	1	1	1	1	1	1	100 %
5520	1	1	1	1	1	1	1	1	1	1	100 %
5525	1	1	1	1	1	1	1	1	1	1	100 %
5530	1	1	1	1	1	1	1	1	1	1	100 %
5535	1	1	1	1	1	1	1	1	1	1	100 %
5540(F _C)	1	1	1	1	1	1	1	1	1	1	100 %
5545	1	1	1	1	1	1	1	1	1	1	100 %
5550	1	1	1	1	1	1	1	1	1	1	100 %
5555	1	1	1	1	1	1	1	1	1	1	100 %
5560	1	1	1	1	1	1	1	1	1	1	100 %
5565	1	1	1	1	1	1	1	1	1	1	100 %
5570	1	1	1	1	1	1	1	1	1	1	100 %
5575	1	1	1	1	1	1	1	1	1	1	100 %
5580(F_H)	1	1	1	1	1	1	1	1	1	1	100 %
5583	0	0	0	0	0	0	0	0	0	0	0 %
Detection Bandwidth = F_H - F_L=5580-5500=80 MHz											
EUT 99% OBW = 76 MHz; 76 x 100% = 76 MHz						Result:		Pass			

Client Mode:**Results of Detection Bandwidth:**

EUT Frequency = 5260 MHz											
DFS Detection Trials (1 = Detected, 0 = No Detected)											
Radar Frequency (MHz)	1	2	3	4	5	6	7	8	9	10	Detection Rate (%)
5247	0	0	0	0	0	0	0	0	0	0	0 %
5250(F_L)	1	1	1	1	1	1	1	1	1	1	100 %
5255	1	1	1	1	1	1	1	1	1	1	100 %
5260(F _c)	1	1	1	1	1	1	1	1	1	1	100 %
5265	1	1	1	1	1	1	1	1	1	1	100 %
5270(F_H)	1	1	1	1	1	1	1	1	1	1	100 %
5273	0	0	0	0	0	0	0	0	0	0	0 %
Detection Bandwidth = F_H - F_L=5270-5250=20 MHz											
EUT 99% OBW = 18 MHz; 18 x 100% = 18 MHz						Result:		Pass			

EUT Frequency = 5510 MHz											
DFS Detection Trials (1 = Detected, 0 = No Detected)											
Radar Frequency (MHz)	1	2	3	4	5	6	7	8	9	10	Detection Rate (%)
5498	0	0	0	0	0	0	0	0	0	0	0 %
5500(F_L)	1	1	1	1	1	1	1	1	1	1	100 %
5105	1	1	1	1	1	1	1	1	1	1	100 %
5510(F _c)	1	1	1	1	1	1	1	1	1	1	100 %
5515	1	1	1	1	1	1	1	1	1	1	100 %
5520 (F_H)	1	1	1	1	1	1	1	1	1	1	100 %
5522	0	0	0	0	0	0	0	0	0	0	0 %
Detection Bandwidth = F_H - F_L=5520-5500=20 MHz											
EUT 99% OBW = 18 MHz; 18 x 100% = 18 MHz						Result:		Pass			

Results of Detection Bandwidth:

EUT Frequency = 5270 MHz											
DFS Detection Trials (1 = Detected, 0 = No Detected)											
Radar Frequency (MHz)	1	2	3	4	5	6	7	8	9	10	Detection Rate (%)
5246	1	0	0	1	0	1	0	0	1	0	40 %
5250(F_L)	1	1	1	1	1	1	1	1	1	1	100 %
5255	1	1	1	1	1	1	1	1	1	1	100 %
5260	1	1	1	1	1	1	1	1	1	1	100 %
5265	1	1	1	1	1	1	1	1	1	1	100 %
5270(F _C)	1	1	1	1	1	1	1	1	1	1	100 %
5275	1	1	1	1	1	1	1	1	1	1	100 %
5280	1	1	1	1	1	1	1	1	1	1	100 %
5285	1	1	1	1	1	1	1	1	1	1	100 %
5290(F_H)	1	1	1	1	1	1	1	1	1	1	100 %
5294	0	0	0	0	0	0	0	0	0	0	0 %
Detection Bandwidth = F_H - F_L=5290-5250=40 MHz											
EUT 99% OBW = 37 MHz; 37 x 100% = 37 MHz Result: Pass											

EUT Frequency = 5520 MHz											
DFS Detection Trials (1 = Detected, 0 = No Detected)											
Radar Frequency (MHz)	1	2	3	4	5	6	7	8	9	10	Detection Rate (%)
5497	0	0	0	0	0	0	0	0	0	0	0 %
5500(F_L)	1	1	1	1	1	1	1	1	1	1	100 %
5505	1	1	1	1	1	1	1	1	1	1	100 %
5510	1	1	1	1	1	1	1	1	1	1	100 %
5515	1	1	1	1	1	1	1	1	1	1	100 %
5520(F _C)	1	1	1	1	1	1	1	1	1	1	100 %
5525	1	1	1	1	1	1	1	1	1	1	100 %
5530	1	1	1	1	1	1	1	1	1	1	100 %
5535	1	1	1	1	1	1	1	1	1	1	100 %
5540(F_H)	1	1	1	1	1	1	1	1	1	1	100 %
5543	0	0	0	0	0	0	0	0	0	0	0 %
Detection Bandwidth = F_H - F_L=5540-5500=40 MHz											
EUT 99% OBW = 37 MHz; 37 x 100% = 37 MHz Result: Pass											

Results of Detection Bandwidth:

EUT Frequency = 5540 MHz											
DFS Detection Trials (1 = Detected, 0 = No Detected)											
Radar Frequency (MHz)	1	2	3	4	5	6	7	8	9	10	Detection Rate (%)
5496	0	0	0	0	0	0	0	0	0	0	0 %
5500(F_L)	1	1	1	1	1	1	1	1	1	1	100 %
5505	1	1	1	1	1	1	1	1	1	1	100 %
5510	1	1	1	1	1	1	1	1	1	1	100 %
5515	1	1	1	1	1	1	1	1	1	1	100 %
5520	1	1	1	1	1	1	1	1	1	1	100 %
5525	1	1	1	1	1	1	1	1	1	1	100 %
5530	1	1	1	1	1	1	1	1	1	1	100 %
5535	1	1	1	1	1	1	1	1	1	1	100 %
5540(F _C)	1	1	1	1	1	1	1	1	1	1	100 %
5545	1	1	1	1	1	1	1	1	1	1	100 %
5550	1	1	1	1	1	1	1	1	1	1	100 %
5555	1	1	1	1	1	1	1	1	1	1	100 %
5560	1	1	1	1	1	1	1	1	1	1	100 %
5565	1	1	1	1	1	1	1	1	1	1	100 %
5570	1	1	1	1	1	1	1	1	1	1	100 %
5575	1	1	1	1	1	1	1	1	1	1	100 %
5580(F_H)	1	1	1	1	1	1	1	1	1	1	100 %
5584	0	0	0	0	0	0	0	0	0	0	0 %
Detection Bandwidth = F_H - F_L=5580-5500=80 MHz											
EUT 99% OBW = 76 MHz; 76 x 100% = 76 MHz						Result:		Pass			

9.2 Radar Detection Performance Check

Procedure:

Stream MPEG file from master to slave

Generate radar waveform

Record whether or not the waveform was detected

At least 30 trials are applied for each radar type

For radar types with randomized parameters, each trial uses a unique waveform

Perform with each of the radar types 1-6

Confirm that the detection rate for each radar type meets the minimum requirement

Type 1A&1B, 2, 3, 4: 60% each

Type 5: 80%

Type 6: 70%

Confirm that the mean of the rates for radar types 1 through 4 meets the requirement of 80%

$$\text{Detection Ratio} = \frac{\text{Total Waveform Detections}}{\text{Total Waveform Trials}} \times 100$$

Test Results:

Please refer to the following summary table.

Master Mode:**5260 MHz, 20 MHz Bandwidth**

Radar Signal Type	Waveform/Trial Number	Detection (%)	Limit (%)	Pass/Fail
Type 1A/1B	30	100 %	60%	Pass
Type 2	30	100 %	60%	Pass
Type 3	30	100 %	60%	Pass
Type 4	30	100 %	60%	Pass
Aggregate (Type1 to 4)	120	100 %	80%	Pass
Type 5	30	96.67 %	80%	Pass
Type 6	30	100 %	70%	Pass

Please refer to Section A.1 of Annex A for the radar parameter data sheet.

5270 MHz, 40 MHz Bandwidth

Radar Signal Type	Waveform/Trial Number	Detection (%)	Limit (%)	Pass/Fail
Type 1A/1B	30	100 %	60%	Pass
Type 2	30	100 %	60%	Pass
Type 3	30	100 %	60%	Pass
Type 4	30	100 %	60%	Pass
Aggregate (Type1 to 4)	120	100 %	80%	Pass
Type 5	30	100 %	80%	Pass
Type 6	30	100 %	70%	Pass

Please refer to Section A.2 of Annex A for the radar parameter data sheet.

5510 MHz, 20 MHz Bandwidth

Radar Signal Type	Waveform/Trial Number	Detection (%)	Limit (%)	Pass/Fail
Type 1A/1B	30	93.3%	60%	Pass
Type 2	30	93.3%	60%	Pass
Type 3	30	86.7%	60%	Pass
Type 4	30	76.7%	60%	Pass
Aggregate (Type1 to 4)	120	87.5%	80%	Pass
Type 5	30	86.7%	80%	Pass
Type 6	30	86.7%	70%	Pass

Please refer to Section B.1 of Annex B for the radar parameter data sheet.

5520 MHz, 40 MHz Bandwidth

Radar Signal Type	Waveform/Trial Number	Detection (%)	Limit (%)	Pass/Fail
Type 1A/1B	30	100%	60%	Pass
Type 2	30	100%	60%	Pass
Type 3	30	100%	60%	Pass
Type 4	30	90%	60%	Pass
Aggregate (Type1 to 4)	120	97.5%	80%	Pass
Type 5	30	86.7%	80%	Pass
Type 6	30	100%	70%	Pass

Please refer to Section B.2 of Annex B for the radar parameter data sheet.

5540 MHz, 80 MHz Bandwidth

Radar Signal Type	Waveform/Trial Number	Detection (%)	Limit (%)	Pass/Fail
Type 1A/1B	30	100 %	60%	Pass
Type 2	30	96.7 %	60%	Pass
Type 3	30	100 %	60%	Pass
Type 4	30	100 %	60%	Pass
Aggregate (Type1 to 4)	120	99.2 %	80%	Pass
Type 5	30	96.7 %	80%	Pass
Type 6	30	100 %	70%	Pass

Please refer to Section B.3 of Annex B for the radar parameter data sheet.

Client Mode:**5260 MHz, 20 MHz Bandwidth**

Radar Signal Type	Waveform/Trial Number	Detection (%)	Limit (%)	Pass/Fail
Type 1A/1B	30	100 %	60%	Pass
Type 2	30	100 %	60%	Pass
Type 3	30	100 %	60%	Pass
Type 4	30	100 %	60%	Pass
Aggregate (Type1 to 4)	120	100 %	80%	Pass
Type 5	30	100 %	80%	Pass
Type 6	30	100 %	70%	Pass

Please refer to Section C.1 of Annex C for the radar parameter data sheet.

5270 MHz, 40 MHz Bandwidth

Radar Signal Type	Waveform/Trial Number	Detection (%)	Limit (%)	Pass/Fail
Type 1A/1B	30	100 %	60%	Pass
Type 2	30	100 %	60%	Pass
Type 3	30	100 %	60%	Pass
Type 4	30	100 %	60%	Pass
Aggregate (Type1 to 4)	120	100 %	80%	Pass
Type 5	30	100 %	80%	Pass
Type 6	30	100 %	70%	Pass

Please refer to Section C.2 of Annex C for the radar parameter data sheet.

5510 MHz, 20 MHz Bandwidth

Radar Signal Type	Waveform/Trial Number	Detection (%)	Limit (%)	Pass/Fail
Type 1A/1B	30	100%	60%	Pass
Type 2	30	100%	60%	Pass
Type 3	30	83.3%	60%	Pass
Type 4	30	86.7%	60%	Pass
Aggregate (Type 1 to 4)	120	92.5%	80%	Pass
Type 5	30	86.7%	80%	Pass
Type 6	30	90%	70%	Pass

Please refer to Section D.1 of Annex D for the radar parameter data sheet.

5520 MHz, 40 MHz Bandwidth

Radar Signal Type	Waveform/Trial Number	Detection (%)	Limit (%)	Pass/Fail
Type 1A/1B	30	96.7%	60%	Pass
Type 2	30	100%	60%	Pass
Type 3	30	86.7%	60%	Pass
Type 4	30	83.3%	60%	Pass
Aggregate (Type1 to 4)	120	91.7%	80%	Pass
Type 5	30	83.3%	80%	Pass
Type 6	30	100%	70%	Pass

Please refer to Section D.2 of Annex D for the radar parameter data sheet.

5540 MHz, 80 MHz Bandwidth

Radar Signal Type	Waveform/Trial Number	Detection (%)	Limit (%)	Pass/Fail
Type 1A/1B	30	100 %	60%	Pass
Type 2	30	90 %	60%	Pass
Type 3	30	93.3 %	60%	Pass
Type 4	30	76.7 %	60%	Pass
Aggregate (Type1 to 4)	120	90 %	80%	Pass
Type 5	30	90 %	80%	Pass
Type 6	30	100 %	70%	Pass

Please refer to Section D.3 of Annex D for the radar parameter data sheet.

10 Annex A (Normative) - U-NII-2A Radar Parameter Data Sheet for Master Mode

Please refer to separated file for this annex.

11 Annex B (Normative) - U-NII-2C Radar Parameter Data Sheet for Master Mode

Please refer to separated file for this annex.

12 Annex C (Normative) - U-NII-2A Radar Parameter Data Sheet for Client Mode

Please refer to separated file for this annex.

13 Annex D (Normative) - U-NII-2C Radar Parameter Data Sheet for Client Mode

Please refer to separated file for this annex.

14 Annex E (Normative) - DFS Test Setup Photo

Please refer to Exhibit A for this annex.

15 Annex F (Normative) - A2LA Electrical Testing Certificate



Accredited Laboratory

A2LA has accredited

BAY AREA COMPLIANCE LABORATORIES CORP.

Sunnyvale, CA

for technical competence in the field of

Electrical Testing

This laboratory is accredited in accordance with the recognized International Standard ISO/IEC 17025:2005 General requirements for the competence of testing and calibration laboratories. This laboratory also meets A2LA R222 - Specific Requirements EPA ENERGY STAR Accreditation Program. This accreditation demonstrates technical competence for a defined scope and the operation of a laboratory quality management system (refer to joint ISO-ILAC-IAF Communiqué dated April 2017).



Presented this 2nd day of October 2018.

President and CEO
For the Accreditation Council
Certificate Number 3297.02
Valid to September 30, 2020

For the tests to which this accreditation applies, please refer to the laboratory's Electrical Scope of Accreditation.

--- END OF REPORT ---

Annex A – U-NII-2A Radar Parameter Data Sheet for Master Mode

A.1 20 MHz Bandwidth @ 5260 MHz

Table-1A/1B Radar Type 1A/1B Statistical Performance

Trial #	Fc (MHz)	Pulse/Burst	Pulse Width (μS)	PRI (μs)	Detection (1:yes; 0:no)
1	5260	63	1	838	1
2	5260	76	1	698	1
3	5260	67	1	798	1
4	5260	65	1	818	1
5	5260	58	1	918	1
6	5260	81	1	658	1
7	5260	68	1	778	1
8	5260	59	1	898	1
9	5260	62	1	858	1
10	5260	99	1	538	1
11	5260	72	1	738	1
12	5260	95	1	558	1
13	5260	92	1	578	1
14	5260	78	1	678	1
15	5260	86	1	618	1
16	5260	20	1	2769	1
17	5260	38	1	1421	1
18	5260	29	1	1858	1
19	5260	41	1	1292	1
20	5260	55	1	967	1
21	5260	38	1	1415	1
22	5260	27	1	2002	1
23	5260	26	1	2103	1
24	5260	19	1	2778	1
25	5260	91	1	580	1
26	5260	38	1	1390	1
27	5260	36	1	1473	1
28	5260	28	1	1939	1
29	5260	21	1	2519	1
30	5260	61	1	868	1
Detection Percentage: 100 % (>60%)					

Table-2 Radar Type 2 Statistical Performance

Trial #	Fc (MHz)	Pulse/Burst	Pulse Width (μ S)	PRI (μ s)	Detection (1:yes; 0:no)
1	5260	23	3	178	1
2	5260	29	5	183	1
3	5260	25	5	164	1
4	5260	24	2.2	172	1
5	5260	25	4.7	158	1
6	5260	26	4.7	214	1
7	5260	25	4.8	155	1
8	5260	28	4.2	168	1
9	5260	28	4	193	1
10	5260	26	3.2	212	1
11	5260	24	3.2	164	1
12	5260	26	2.8	152	1
13	5260	25	3.5	166	1
14	5260	23	2	225	1
15	5260	27	4.9	158	1
16	5260	28	1.1	199	1
17	5260	29	2.4	202	1
18	5260	27	3.7	218	1
19	5260	29	2.8	193	1
20	5260	27	4.3	208	1
21	5260	23	1.3	159	1
22	5260	28	2.3	173	1
23	5260	25	2.2	189	1
24	5260	23	3.7	220	1
25	5260	25	3.8	181	1
26	5260	24	4.9	221	1
27	5260	28	1	169	1
28	5260	28	2.7	153	1
29	5260	23	1.1	162	1
30	5260	26	2.9	222	1
Detection Percentage: 100 % (>60%)					

Table-3 Radar Type 3 Statistical Performance

Trial #	Fc (MHz)	Pulse/Burst	Pulse Width (μS)	PRI (μs)	Detection (1:yes; 0:no)
1	5260	18	9.6	432	1
2	5260	16	9.8	279	1
3	5260	18	7.9	442	1
4	5260	17	9.2	201	1
5	5260	17	8.9	294	1
6	5260	18	7.8	204	1
7	5260	18	6.5	314	1
8	5260	17	7.7	448	1
9	5260	16	6.9	322	1
10	5260	16	7	477	1
11	5260	18	8.7	243	1
12	5260	17	9.6	232	1
13	5260	16	6.3	344	1
14	5260	18	7.8	289	1
15	5260	17	7.7	354	1
16	5260	16	9.7	474	1
17	5260	16	6.3	276	1
18	5260	18	7.1	216	1
19	5260	17	6.1	207	1
20	5260	16	9.7	237	1
21	5260	17	6.8	467	1
22	5260	18	8.1	358	1
23	5260	16	6.5	262	1
24	5260	16	7.1	314	1
25	5260	17	7.2	398	1
26	5260	18	10	259	1
27	5260	17	8.1	214	1
28	5260	18	7.1	334	1
29	5260	18	6.3	285	1
30	5260	16	7	357	1
Detection Percentage: 100 % (>60%)					

Table-4 Radar Type 4 Statistical Performance

Trial #	Fc (MHz)	Pulse/Burst	Pulse Width (μS)	PRI (μs)	Detection (1:yes; 0:no)
1	5260	16	11.8	208	1
2	5260	13	17.7	389	1
3	5260	13	20	445	1
4	5260	15	16	457	1
5	5260	14	13.2	288	1
6	5260	13	15.3	218	1
7	5260	12	14.1	349	1
8	5260	13	12.1	473	1
9	5260	16	16.1	335	1
10	5260	14	15.1	370	1
11	5260	16	15.1	322	1
12	5260	14	11.7	404	1
13	5260	16	13.7	410	1
14	5260	16	17.3	372	1
15	5260	13	19.7	275	1
16	5260	14	14.8	474	1
17	5260	16	13.8	229	1
18	5260	16	19.3	295	1
19	5260	12	20	291	1
20	5260	12	19.6	355	1
21	5260	12	19.8	228	1
22	5260	15	19	316	1
23	5260	14	15.1	204	1
24	5260	16	16.4	468	1
25	5260	14	15.3	347	1
26	5260	16	13.8	368	1
27	5260	12	15.7	423	1
28	5260	14	11.2	427	1
29	5260	14	14.3	420	1
30	5260	16	12.9	477	1
Detection Percentage: 100 % (>60%)					

Table-5 Radar Type 5 Statistical Performance

Trial #	Fc (MHz)	Detection (1:yes; 0:no)
1	5260	1
2	5260	1
3	5260	1
4	5260	1
5	5260	1
6	5260	1
7	5260	1
8	5260	1
9	5260	1
10	5260	1
11	5252.8	1
12	5255.6	1
13	5255.6	1
14	5257.2	0
15	5256.0	1
16	5254.4	1
17	5255.2	1
18	5256.8	1
19	5252.4	1
20	5255.6	1
21	5267.2	1
22	5267.2	1
23	5264.8	1
24	5262.4	1
25	5262.8	1
26	5265.2	1
27	5263.6	1
28	5265.6	1
29	5264.0	1
30	5263.6	1
Detection Percentage: 96.67 % (>80%)		

Bin5 Statistics 1

Trial #	Pulse	Chirp (MHz)	Pulse Width (µS)	Pulse 1-2 spacing (µS)	Pulse 2-3 spacing (µS)	Pulse Start(S)	Detection (1:yes; 0:no)
0	2	11	76.7	1694		0.670417	1
1	2	11	56.9	1370		0.92341	
2	2	11	57.2	1486		2.114671	
3	2	11	74.4	1074		3.246407	
4	1	11	98.9			4.60795	
5	1	11	83.6			5.481555	
6	2	11	56.8	1403		6.094969	
7	3	11	68.9	1107	1567	7.057553	
8	3	11	63.7	1953	1790	7.742334	
9	2	11	89.7	1251		8.71974	
10	2	11	60.3	1212		9.89806	
11	2	11	56.7	1674		10.882315	
12	1	11	66.5			11.707565	

Bin5 Statistics 2

Trial #	Pulse	Chirp (MHz)	Pulse Width (µS)	Pulse 1-2 spacing (µS)	Pulse 2-3 spacing (µS)	Pulse Start(S)	Detection (1:yes; 0:no)
0	2	13	69.4	1562		0.006044	1
1	3	13	79.9	1335	1692	1.187846	
2	1	13	86.4			1.437202	
3	2	13	76.9	1195		2.138707	
4	2	13	54	1782		3.107531	
5	2	13	69.4	1374		4.077012	
6	3	13	55.3	1599	1825	4.466568	
7	2	13	94.5	1943		5.592926	
8	2	13	57.8	1507		5.833411	
9	1	13	89.3			6.730665	
10	2	13	72.7	1608		7.44581	
11	2	13	82.9	1160		8.267306	
12	2	13	72.8	1633		8.620386	
13	1	13	78			9.846438	
14	2	13	87.3	1291		10.442656	
15	3	13	57.6	1614	1618	11.10682	
16	3	13	65.5	1279	1816	11.952562	

Bin5 Statistics 3

Trial #	Pulse	Chirp (MHz)	Pulse Width (µS)	Pulse 1-2 spacing (uS)	Pulse 2-3 spacing (uS)	Pulse Start(S)	Detection (1:yes; 0:no)
0	2	5	64.5	1011		0.144838	1
1	2	5	86.6	1030		1.59023	
2	3	5	75.9	1760	1716	1.845562	
3	3	5	93.1	1944	1610	2.804413	
4	2	5	79.6	1678		3.944489	
5	1	5	94.7			4.976289	
6	1	5	57			5.688241	
7	2	5	71.8	1481		6.582284	
8	2	5	62.9	1593		7.605535	
9	3	5	52.1	1636	1819	8.205747	
10	1	5	80.6			8.741697	
11	1	5	92.5			10.070179	
12	2	5	83	1175		10.340007	
13	2	5	88.7	1292		11.259883	

Bin5 Statistics 4

Trial #	Pulse	Chirp (MHz)	Pulse Width (µS)	Pulse 1-2 spacing (uS)	Pulse 2-3 spacing (uS)	Pulse Start(S)	Detection (1:yes; 0:no)
0	3	10	63.5	1204	1397	1.112689	1
1	3	10	67.1	1461	1192	1.831219	
2	3	10	65.6	1051	1862	2.88786	
3	2	10	78.6	1371		4.438596	
4	2	10	90.6	1177		4.875467	
5	1	10	70.9			6.375474	
6	3	10	56	1132	1295	7.224809	
7	3	10	85.7	1792	1871	8.701555	
8	1	10	58.6			10.733454	
9	3	10	63.9	1063	1667	10.941267	

Bin5 Statistics 5

Trial #	Pulse	Chirp (MHz)	Pulse Width (µS)	Pulse 1-2 spacing (uS)	Pulse 2-3 spacing (uS)	Pulse Start(S)	Detection (1:yes; 0:no)
0	1	11	68.5			0.740095	1
1	2	11	78	1289		1.412368	
2	3	11	75.7	1282	1511	2.528548	
3	2	11	71.1	1208		3.334502	
4	3	11	88.4	1966	1909	3.572483	
5	1	11	59.2			5.03199	
6	1	11	82.1			5.37465	
7	1	11	92.8			6.537765	
8	1	11	56.4			7.404116	
9	3	11	73.5	1183	1465	8.025816	
10	3	11	72.5	1263	1093	8.696954	
11	1	11	63.6			9.546754	
12	1	11	52.4			10.766278	
13	3	11	74.9	1199	1729	11.153421	

Bin5 Statistics 6

Trial #	Pulse	Chirp (MHz)	Pulse Width (µS)	Pulse 1-2 spacing (uS)	Pulse 2-3 spacing (uS)	Pulse Start(S)	Detection (1:yes; 0:no)
0	2	12	100	1067		0.387926	1
1	2	12	66.1	1939		1.482175	
2	2	12	87.8	1257		3.157626	
3	3	12	87.8	1993	1130	4.212867	
4	2	12	56.9	1703		4.812978	
5	2	12	59.5	1168		6.011429	
6	2	12	90	1042		8.086215	
7	3	12	89	1338	1516	8.843921	
8	2	12	69.6	1582		9.850811	
9	2	12	66.9	1756		11.774033	

Bin5 Statistics 7

Trial #	Pulse	Chirp (MHz)	Pulse Width (µS)	Pulse 1-2 spacing (uS)	Pulse 2-3 spacing (uS)	Pulse Start(S)	Detection (1:yes; 0:no)
0	1	11	77.9			0.780943	1
1	3	11	51.9	1312	1426	0.942897	
2	3	11	90.8	1908	1474	2.093467	
3	2	11	60.7	1336		3.035779	
4	2	11	94	1216		3.586621	
5	2	11	88.7	1565		4.628677	
6	2	11	65.2	1737		5.220959	
7	1	11	77			5.62814	
8	3	11	74.9	1368	1619	7.108962	
9	2	11	84.3	1726		7.542181	
10	3	11	67.3	1228	1697	8.614226	
11	2	11	96.7	1151		9.127687	
12	3	11	96.8	1741	1957	10.163417	
13	2	11	92.5	1036		10.657508	
14	2	11	81	1914		11.738858	

Bin5 Statistics 8

Trial #	Pulse	Chirp (MHz)	Pulse Width (µS)	Pulse 1-2 spacing (uS)	Pulse 2-3 spacing (uS)	Pulse Start(S)	Detection (1:yes; 0:no)
0	2	10	89	1693		0.706178	0
1	2	10	94.8	1644		1.474642	
2	2	10	96.7	1177		3.068268	
3	1	10	95.2			4.079353	
4	2	10	61.2	1118		5.797739	
5	2	10	56.5	1729		7.50994	
6	1	10	59.2			8.89374	
7	3	10	96.6	1761	1299	10.480192	
8	3	10	55.2	1814	1109	10.881915	

Bin5 Statistics 9

Trial #	Pulse	Chirp (MHz)	Pulse Width (µS)	Pulse 1-2 spacing (µS)	Pulse 2-3 spacing (µS)	Pulse Start(S)	Detection (1:yes; 0:no)
0	1	11	58.2			0.30164	1
1	2	11	97.5	1988		1.068341	
2	2	11	92	1211		1.742119	
3	2	11	95.6	1300		2.739653	
4	3	11	69.8	1402	1248	3.641805	
5	1	11	85.9			4.200108	
6	1	11	70			4.955734	
7	1	11	70.6			5.642514	
8	1	11	90.1			6.196522	
9	2	11	53.4	1021		6.849893	
10	2	11	64.8	1074		7.824009	
11	2	11	99.7	1787		8.575779	
12	2	11	68.1	1534		9.64917	
13	3	11	97.9	1831	1871	10.447348	
14	1	11	57.8			10.701564	
15	3	11	76.5	1900	1022	11.957257	

Bin5 Statistics 10

Trial #	Pulse	Chirp (MHz)	Pulse Width (µS)	Pulse 1-2 spacing (µS)	Pulse 2-3 spacing (µS)	Pulse Start(S)	Detection (1:yes; 0:no)
0	2	8	59.8	1863		0.664771	1
1	2	8	53.2	1482		1.260002	
2	1	8	79.6			2.465733	
3	3	8	79	1111	1965	3.625469	
4	3	8	81.3	1359	1863	4.444549	
5	1	8	92.3			5.439019	
6	3	8	55	1597	1261	6.409402	
7	2	8	74.7	1088		7.33456	
8	2	8	56.7	1755		8.390719	
9	2	8	68.1	1522		9.478717	
10	2	8	58.9	1923		10.596881	
11	3	8	90.2	1007	1436	11.44482	

Bin5 Statistics 11

Trial #	Pulse	Chirp (MHz)	Pulse Width (µS)	Pulse 1-2 spacing (uS)	Pulse 2-3 spacing (uS)	Pulse Start(S)	Detection (1:yes; 0:no)
0	2	7	53.2	1054		0.297434	1
1	2	7	52.9	1197		1.285035	
2	1	7	83.4			1.979325	
3	2	7	55.6	1775		2.496411	
4	3	7	61.6	1693	1994	3.356346	
5	2	7	65.3	1785		4.051339	
6	2	7	86.9	1526		4.722232	
7	3	7	77.3	1553	1495	5.157456	
8	3	7	69.5	1985	1749	6.285785	
9	1	7	60.7			6.796392	
10	3	7	94.6	1052	1500	7.131229	
11	3	7	87.2	1715	1087	8.452038	
12	2	7	70.6	1636		8.971031	
13	3	7	56.5	1141	1246	9.477118	
14	2	7	98.9	1008		10.38813	
15	2	7	82.7	1311		10.678681	
16	1	7	75.7			11.542171	

Bin5 Statistics 12

Trial #	Pulse	Chirp (MHz)	Pulse Width (µS)	Pulse 1-2 spacing (uS)	Pulse 2-3 spacing (uS)	Pulse Start(S)	Detection (1:yes; 0:no)
0	2	14	57.4	1943		0.356096	1
1	1	14	54.8			1.853415	
2	2	14	69.5	1048		3.349092	
3	3	14	66.3	1263	1480	4.13986	
4	2	14	63.2	1626		5.749257	
5	1	14	86.3			7.480644	
6	2	14	89.2	1279		8.478076	
7	3	14	87.3	1294	1696	9.609428	
8	2	14	59.1	1532		11.324185	

Bin5 Statistics 13

Trial #	Pulse	Chirp (MHz)	Pulse Width (µS)	Pulse 1-2 spacing (uS)	Pulse 2-3 spacing (uS)	Pulse Start(S)	Detection (1:yes; 0:no)
0	2	14	63.4	1105		0.099301	1
1	3	14	73.5	1730	1369	0.911379	
2	3	14	72.8	1667	1578	1.775948	
3	2	14	83.5	1805		3.280973	
4	2	14	67.6	1448		3.757812	
5	2	14	65.9	1238		4.84877	
6	1	14	90			5.51855	
7	1	14	67.1			6.08217	
8	1	14	99.2			7.227765	
9	3	14	72.7	1060	1367	8.404211	
10	2	14	59.3	1672		8.699726	
11	3	14	59.5	1384	1486	9.932548	
12	1	14	53.4			10.511679	
13	3	14	66.7	1068	1827	11.153325	

Bin5 Statistics 14

Trial #	Pulse	Chirp (MHz)	Pulse Width (µS)	Pulse 1-2 spacing (uS)	Pulse 2-3 spacing (uS)	Pulse Start(S)	Detection (1:yes; 0:no)
0	2	18	82.2	1641		0.495699	1
1	3	18	71.5	1036	1786	1.587321	
2	2	18	88.7	1811		2.330671	
3	2	18	91.7	1242		2.879688	
4	3	18	81.8	1508	1050	3.558283	
5	2	18	51	1386		4.453988	
6	3	18	94.8	1595	1057	5.605434	
7	1	18	83.7			6.677677	
8	2	18	63.8	1087		7.142532	
9	2	18	70.6	1583		8.006854	
10	1	18	75.9			8.619015	
11	3	18	60.6	1750	1163	10.161802	
12	3	18	68.7	1489	1129	11.009511	
13	1	18	83.4			11.858439	

Bin5 Statistics 15

Trial #	Pulse	Chirp (MHz)	Pulse Width (µS)	Pulse 1-2 spacing (uS)	Pulse 2-3 spacing (uS)	Pulse Start(S)	Detection (1:yes; 0:no)
0	1	15	62.2			0.309228	1
1	3	15	98.4	1389	1891	2.217482	
2	1	15	60.6			3.722962	
3	3	15	83.1	1825	1820	4.092678	
4	2	15	98.6	1693		6.206447	
5	2	15	55.4	1515		7.47614	
6	2	15	73.8	1471		8.561227	
7	2	15	88.3	1569		10.412768	
8	2	15	54.1	1895		11.972105	

Bin5 Statistics 16

Trial #	Pulse	Chirp (MHz)	Pulse Width (µS)	Pulse 1-2 spacing (uS)	Pulse 2-3 spacing (uS)	Pulse Start(S)	Detection (1:yes; 0:no)
0	1	11	77.8			1.014673	1
1	3	11	85.6	1754	1283	1.928869	
2	2	11	59.7	1947		2.454243	
3	1	11	77.6			3.53694	
4	1	11	97.3			4.983125	
5	2	11	64	1180		5.962572	
6	1	11	74.1			7.058142	
7	2	11	79.8	1995		7.882788	
8	2	11	77.2	1130		8.748997	
9	3	11	72.1	1646	1760	10.237892	
10	2	11	88.7	1757		11.132688	

Bin5 Statistics 17

Trial #	Pulse	Chirp (MHz)	Pulse Width (µS)	Pulse 1-2 spacing (µS)	Pulse 2-3 spacing (µS)	Pulse Start(S)	Detection (1:yes; 0:no)
0	1	13	71			0.706878	1
1	2	13	50.8	1090		0.981156	
2	2	13	62.1	1304		1.6873	
3	2	13	88.5	1863		2.402434	
4	1	13	85.9			3.237063	
5	2	13	74	1194		4.794071	
6	3	13	63.2	1350	1709	5.265845	
7	1	13	59.4			6.346829	
8	1	13	83.8			7.112219	
9	2	13	64	1282		7.631421	
10	1	13	80.4			8.758155	
11	3	13	64.5	1261	1680	9.540093	
12	2	13	56.1	1257		10.364088	
13	3	13	93	1640	1538	10.744395	
14	1	13	56.8			11.476398	

Bin5 Statistics 18

Trial #	Pulse	Chirp (MHz)	Pulse Width (µS)	Pulse 1-2 spacing (µS)	Pulse 2-3 spacing (µS)	Pulse Start(S)	Detection (1:yes; 0:no)
0	2	17	90.6	1036		0.82838	1
1	2	17	86.8	1956		1.765095	
2	3	17	53	1563	1758	2.930993	
3	3	17	80.5	1854	1183	3.561747	
4	2	17	87.9	1496		4.875201	
5	1	17	70.2			5.924246	
6	2	17	55.7	1876		7.328426	
7	1	17	87.5			8.083589	
8	3	17	84	1173	1137	9.503836	
9	2	17	69.1	1036		10.003754	
10	2	17	96.3	1448		11.233237	

Bin5 Statistics 19

Trial #	Pulse	Chirp (MHz)	Pulse Width (µS)	Pulse 1-2 spacing (µS)	Pulse 2-3 spacing (µS)	Pulse Start(S)	Detection (1:yes; 0:no)
0	1	6	57.4			0.261638	1
1	2	6	70.3	1644		0.889472	
2	3	6	86.3	1023	1882	1.623889	
3	1	6	68.8			2.13706	
4	2	6	60.4	1938		2.4297	
5	2	6	52.4	1746		3.415001	
6	1	6	59.3			4.074114	
7	2	6	59.2	1010		4.413325	
8	3	6	77.2	1253	1782	4.932392	
9	3	6	51.8	1499	1500	5.816135	
10	1	6	66.4			6.036066	
11	2	6	65.7	1469		7.045272	
12	2	6	82.6	1830		7.695431	
13	2	6	51.5	1336		8.254525	
14	2	6	82.3	1297		8.812483	
15	2	6	57.5	1026		9.018055	
16	2	6	58.4	1075		9.710748	
17	2	6	98.3	1885		10.245716	
18	2	6	94.3	1230		11.326526	
19	2	6	82.7	1912		11.48363	

Bin5 Statistics 20

Trial #	Pulse	Chirp (MHz)	Pulse Width (µS)	Pulse 1-2 spacing (µS)	Pulse 2-3 spacing (µS)	Pulse Start(S)	Detection (1:yes; 0:no)
0	3	14	81.5	1488	1512	0.264883	1
1	3	14	67	1957	1164	1.496993	
2	1	14	69.6			1.924575	
3	1	14	88.7			2.957904	
4	2	14	83.3	1142		3.521058	
5	2	14	78	1717		4.203044	
6	3	14	84.2	1413	1074	5.51329	
7	2	14	55.9	1098		5.925445	
8	1	14	86.2			6.580491	
9	3	14	91.1	1395	1304	7.96168	
10	2	14	88.3	1642		8.718688	
11	2	14	61.4	1063		9.514003	
12	3	14	97.3	1645	1574	9.667774	
13	1	14	91.3			10.481837	
14	1	14	57.7			11.656178	

Bin5 Statistics 21

Trial #	Pulse	Chirp (MHz)	Pulse Width (µS)	Pulse 1-2 spacing (µS)	Pulse 2-3 spacing (µS)	Pulse Start(S)	Detection (1:yes; 0:no)
0	2	7	78.9	1208		1.2293	1
1	2	7	52.1	1162		1.950768	
2	2	7	69.7	1004		4.202094	
3	2	7	73.4	1664		5.00154	
4	2	7	57.9	1623		7.205131	
5	3	7	92.5	1331	1710	8.113861	
6	2	7	77.4	1821		9.674204	
7	2	7	85.7	1636		11.555745	

Bin5 Statistics 22

Trial #	Pulse	Chirp (MHz)	Pulse Width (µS)	Pulse 1-2 spacing (µS)	Pulse 2-3 spacing (µS)	Pulse Start(S)	Detection (1:yes; 0:no)
0	3	7	72.8	1323	1436	0.296817	1
1	2	7	54.5	1404		1.446971	
2	2	7	89.8	1666		1.849442	
3	1	7	82.7			3.04544	
4	3	7	58.7	1085	1876	3.574477	
5	2	7	95.6	1536		4.494242	
6	2	7	67.9	1133		5.430447	
7	2	7	59	1926		6.241341	
8	2	7	97	1638		7.405279	
9	2	7	71.5	1921		8.338225	
10	2	7	91	1158		9.365916	
11	1	7	90.3			10.11234	
12	1	7	52.7			10.505792	
13	1	7	55.9			11.499557	

Bin5 Statistics 23

Trial #	Pulse	Chirp (MHz)	Pulse Width (uS)	Pulse 1-2 spacing (uS)	Pulse 2-3 spacing (uS)	Pulse Start(S)	Detection (1:yes; 0:no)
0	1	13	71.2			0.21121	1
1	1	13	91.7			1.342618	
2	2	13	87	1776		1.568724	
3	2	13	50.9	1482		2.728875	
4	2	13	52.1	1589		3.112298	
5	2	13	92.7	1083		4.073683	
6	1	13	99.6			4.392016	
7	3	13	62.8	1189	1556	5.411713	
8	1	13	51.5			6.032117	
9	2	13	93.7	1610		6.572915	
10	2	13	80	1841		7.078533	
11	2	13	76.5	1185		8.275618	
12	2	13	53.4	1798		9.00179	
13	1	13	92.8			9.191619	
14	2	13	58.4	1338		10.571828	
15	3	13	53.3	1895	1806	10.654159	
16	1	13	56.6			11.364436	

Bin5 Statistics 24

Trial #	Pulse	Chirp (MHz)	Pulse Width (uS)	Pulse 1-2 spacing (uS)	Pulse 2-3 spacing (uS)	Pulse Start(S)	Detection (1:yes; 0:no)
0	3	19	65.7	1337	1544	0.638072	1
1	3	19	74.6	1818	1202	1.645606	
2	2	19	71.3	1050		2.096548	
3	2	19	78.1	1917		3.47161	
4	2	19	94.4	1496		4.322316	
5	1	19	73.6			5.604408	
6	3	19	84.9	1888	1579	6.582838	
7	3	19	77.7	1849	1627	7.506374	
8	1	19	97.9			8.176387	
9	1	19	95.1			9.383576	
10	1	19	87.2			10.732094	
11	3	19	59.3	1498	1116	11.08326	

Bin5 Statistics 25

Trial #	Pulse	Chirp (MHz)	Pulse Width (µS)	Pulse 1-2 spacing (uS)	Pulse 2-3 spacing (uS)	Pulse Start(S)	Detection (1:yes; 0:no)
0	1	18	68.9			0.472747	1
1	2	18	52.6	1426		1.118521	
2	2	18	93	1903		1.564986	
3	1	18	86.7			1.921588	
4	2	18	52	1023		2.917931	
5	1	18	66.4			3.211402	
6	3	18	74.9	1288	1848	4.258643	
7	3	18	69.2	1557	1823	4.445467	
8	2	18	77.4	1369		5.62336	
9	3	18	64.4	1841	1283	6.203182	
10	2	18	53.6	1048		6.473048	
11	1	18	56.3			7.199057	
12	3	18	87.8	1399	1820	7.835462	
13	1	18	53.9			8.763168	
14	2	18	90.8	1485		8.85678	
15	2	18	65.3	1399		9.790256	
16	2	18	72.9	1757		10.462707	
17	2	18	64.1	1503		10.803983	
18	3	18	88.4	1927	1801	11.811166	

Bin5 Statistics 26

Trial #	Pulse	Chirp (MHz)	Pulse Width (µS)	Pulse 1-2 spacing (µS)	Pulse 2-3 spacing (µS)	Pulse Start(S)	Detection (1:yes; 0:no)
0	2	12	55.7	1421		0.281911	1
1	2	12	74.9	1190		0.904838	
2	2	12	68.9	1965		1.519312	
3	2	12	61.9	1366		1.904641	
4	2	12	55.6	1810		2.931631	
5	2	12	93.2	1437		3.635484	
6	2	12	57.3	1027		4.104953	
7	2	12	74.6	1411		4.916909	
8	2	12	72.9	1595		5.556213	
9	2	12	97.4	1707		6.014626	
10	3	12	60.1	1235	1343	6.454476	
11	2	12	99.7	1939		7.548098	
12	2	12	52.5	1429		7.621158	
13	3	12	66.5	1116	1914	8.605635	
14	2	12	98	1674		8.998768	
15	2	12	90.5	1468		9.930134	
16	1	12	89.2			10.229852	
17	3	12	86.9	1275	1522	11.110883	
18	1	12	81.4			11.555793	

Bin5 Statistics 27

Trial #	Pulse	Chirp (MHz)	Pulse Width (µS)	Pulse 1-2 spacing (µS)	Pulse 2-3 spacing (µS)	Pulse Start(S)	Detection (1:yes; 0:no)
0	2	16	74	1355		0.132532	1
1	2	16	58.3	1349		1.341641	
2	2	16	68.6	1906		2.593601	
3	2	16	50.3	1599		3.721244	
4	2	16	91.6	1181		4.68104	
5	3	16	68.4	1817	1620	5.779279	
6	2	16	62.7	1864		6.509368	
7	2	16	72.5	1408		7.307311	
8	1	16	75.8			8.064826	
9	2	16	53.2	1873		9.512111	
10	1	16	84.5			10.303375	
11	2	16	60.5	1287		11.581126	

Bin5 Statistics 28

Trial #	Pulse	Chirp (MHz)	Pulse Width (µS)	Pulse 1-2 spacing (uS)	Pulse 2-3 spacing (uS)	Pulse Start(S)	Detection (1:yes; 0:no)
0	2	11	61.7	1603		0.306113	1
1	3	11	75.2	1226	1625	0.949764	
2	2	11	80.7	1160		2.042919	
3	3	11	95.2	1319	1806	2.726284	
4	1	11	89.8			4.048032	
5	2	11	99.1	1412		4.36025	
6	1	11	91.9			5.933217	
7	3	11	75.4	1085	1429	6.200762	
8	2	11	58.8	1497		7.604818	
9	2	11	68.1	1882		8.286379	
10	3	11	73.5	1608	1130	9.262583	
11	3	11	64.1	1723	1716	9.563168	
12	2	11	80.6	1449		10.695991	
13	1	11	95.2			11.604193	

Bin5 Statistics 29

Trial #	Pulse	Chirp (MHz)	Pulse Width (µS)	Pulse 1-2 spacing (uS)	Pulse 2-3 spacing (uS)	Pulse Start(S)	Detection (1:yes; 0:no)
0	3	15	89.8	1317	1830	0.121769	1
1	3	15	87.2	1380	1149	1.609217	
2	2	15	64.8	1010		3.331353	
3	3	15	63.3	1748	1213	4.952867	
4	1	15	58.2			5.807532	
5	2	15	71	1509		7.160255	
6	2	15	67.2	1119		9.266138	
7	2	15	50.7	1500		9.833832	
8	2	15	90	1445		10.914848	

Bin5 Statistics 30

Trial #	Pulse	Chirp (MHz)	Pulse Width (µS)	Pulse 1-2 spacing (µS)	Pulse 2-3 spacing (µS)	Pulse Start(S)	Detection (1:yes; 0:no)
0	3	16	81.3	1311	1767	0.145438	1
1	1	16	78.5			1.144795	
2	2	16	57.4	1851		1.423621	
3	2	16	75.4	1176		2.364372	
4	2	16	99.4	1899		2.921999	
5	1	16	93.8			3.496807	
6	1	16	57.1			4.590579	
7	2	16	56.7	1636		4.689787	
8	2	16	65	1013		5.760108	
9	3	16	59.2	1840	1042	6.492053	
10	2	16	50.8	1719		7.27779	
11	2	16	96.6	1266		7.79965	
12	1	16	51.2			8.215256	
13	1	16	60			9.313728	
14	1	16	65			9.95041	
15	1	16	59.2			10.606307	
16	3	16	83.5	1321	1131	10.723477	
17	1	16	59.8			11.443311	

Table-6 Radar Type 6 Statistical Performance

Trial #	Fc (MHz)	Pulse /Burst	Pulse Width (µS)	PRI (µs)	Detection (1:yes; 0:no)	Hopping Sequence
1	5260	9	1	333	1	5273.0, 5590.0, 5321.0, 5604.0, 5389.0, 5414.0, 5510.0, 5382.0, 5437.0, 5555.0, 5557.0, 5390.0, 5527.0, 5334.0, 5260.0, 5477.0, 5422.0, 5348.0, 5501.0, 5605.0, 5498.0, 5682.0, 5697.0, 5622.0, 5659.0, 5564.0, 5546.0, 5580.0, 5317.0, 5685.0, 5593.0, 5267.0, 5413.0, 5599.0, 5324.0, 5597.0, 5300.0, 5369.0, 5303.0, 5291.0, 5476.0, 5397.0, 5714.0, 5288.0, 5531.0, 5625.0, 5539.0, 5575.0, 5286.0, 5428.0, 5570.0, 5626.0, 5635.0, 5610.0, 5642.0, 5709.0, 5287.0, 5339.0, 5295.0, 5671.0, 5594.0, 5401.0, 5628.0, 5315.0, 5567.0, 5383.0, 5691.0, 5490.0, 5471.0, 5472.0, 5665.0, 5507.0, 5438.0, 5559.0, 5343.0, 5376.0, 5358.0, 5356.0, 5252.0, 5723.0, 5653.0, 5652.0, 5562.0, 5491.0, 5342.0, 5509.0, 5460.0, 5354.0, 5639.0, 5595.0, 5338.0, 5425.0, 5276.0, 5621.0, 5353.0, 5377.0, 5703.0, 5574.0, 5453.0, 5585.0 (number of hits: 3)
2	5260	9	1	333	1	5642.0, 5650.0, 5486.0, 5338.0, 5303.0, 5675.0, 5490.0, 5402.0, 5703.0, 5378.0, 5432.0, 5275.0, 5597.0, 5312.0, 5527.0, 5427.0, 5657.0, 5342.0, 5418.0, 5540.0, 5271.0, 5545.0, 5329.0, 5682.0, 5323.0, 5457.0, 5345.0, 5293.0, 5470.0, 5253.0, 5549.0, 5712.0, 5564.0, 5577.0, 5654.0, 5494.0, 5366.0, 5535.0, 5599.0, 5720.0, 5290.0, 5518.0, 5683.0, 5493.0, 5267.0, 5434.0, 5592.0, 5723.0, 5680.0, 5688.0, 5500.0, 5307.0, 5272.0, 5522.0, 5570.0, 5533.0, 5302.0, 5559.0, 5692.0, 5614.0, 5625.0, 5268.0, 5544.0, 5392.0, 5396.0, 5623.0, 5691.0, 5468.0, 5689.0, 5629.0, 5491.0, 5665.0, 5460.0, 5451.0, 5537.0, 5666.0, 5356.0, 5371.0, 5515.0, 5309.0, 5647.0, 5407.0, 5707.0, 5446.0, 5705.0, 5634.0, 5580.0, 5280.0, 5337.0, 5440.0, 5441.0, 5448.0, 5663.0, 5438.0, 5509.0, 5496.0, 5602.0, 5696.0, 5671.0, 5455.0 (number of hits: 3)
3	5260	9	1	333	1	5290.0, 5434.0, 5599.0, 5355.0, 5679.0, 5661.0, 5441.0, 5276.0, 5352.0, 5669.0, 5558.0, 5705.0, 5533.0, 5670.0, 5615.0, 5443.0, 5723.0, 5522.0, 5698.0, 5508.0, 5681.0, 5526.0, 5333.0, 5470.0, 5340.0, 5553.0, 5324.0, 5582.0, 5366.0, 5493.0, 5648.0, 5261.0, 5405.0, 5674.0, 5660.0, 5577.0, 5527.0, 5323.0, 5649.0, 5673.0, 5647.0, 5383.0, 5277.0, 5555.0, 5630.0, 5468.0, 5621.0, 5515.0, 5358.0, 5694.0, 5629.0, 5447.0, 5371.0, 5370.0, 5410.0, 5480.0, 5671.0, 5556.0, 5568.0, 5521.0, 5528.0, 5659.0, 5668.0, 5575.0, 5552.0, 5259.0, 5704.0, 5465.0, 5519.0, 5337.0,

						5643.0, 5424.0, 5572.0, 5658.0, 5286.0, 5676.0, 5313.0, 5399.0, 5328.0, 5504.0, 5387.0, 5460.0, 5496.0, 5344.0, 5506.0, 5608.0, 5349.0, 5682.0, 5699.0, 5652.0, 5537.0, 5546.0, 5397.0, 5318.0, 5332.0, 5331.0, 5425.0, 5613.0, 5287.0, 5691.0 (number of hits: 2)
4	5260	9	1	333	1	5399.0, 5642.0, 5328.0, 5581.0, 5385.0, 5352.0, 5439.0, 5569.0, 5565.0, 5550.0, 5469.0, 5427.0, 5471.0, 5269.0, 5317.0, 5723.0, 5522.0, 5407.0, 5561.0, 5545.0, 5693.0, 5667.0, 5466.0, 5509.0, 5553.0, 5583.0, 5571.0, 5619.0, 5538.0, 5262.0, 5641.0, 5578.0, 5700.0, 5542.0, 5444.0, 5461.0, 5613.0, 5423.0, 5353.0, 5649.0, 5666.0, 5257.0, 5507.0, 5259.0, 5689.0, 5336.0, 5595.0, 5584.0, 5397.0, 5668.0, 5493.0, 5417.0, 5505.0, 5628.0, 5546.0, 5382.0, 5483.0, 5344.0, 5271.0, 5422.0, 5534.0, 5355.0, 5655.0, 5381.0, 5574.0, 5575.0, 5600.0, 5489.0, 5430.0, 5263.0, 5494.0, 5376.0, 5697.0, 5648.0, 5676.0, 5594.0, 5283.0, 5645.0, 5670.0, 5698.0, 5330.0, 5503.0, 5661.0, 5424.0, 5531.0, 5620.0, 5580.0, 5460.0, 5434.0, 5682.0, 5634.0, 5665.0, 5421.0, 5275.0, 5554.0, 5307.0, 5664.0, 5588.0, 5405.0, 5472.0 (number of hits: 5)
5	5260	9	1	333	1	5295.0, 5643.0, 5273.0, 5392.0, 5511.0, 5660.0, 5547.0, 5446.0, 5644.0, 5370.0, 5449.0, 5620.0, 5650.0, 5637.0, 5709.0, 5326.0, 5397.0, 5666.0, 5671.0, 5536.0, 5550.0, 5576.0, 5445.0, 5716.0, 5401.0, 5253.0, 5641.0, 5554.0, 5420.0, 5559.0, 5691.0, 5404.0, 5490.0, 5533.0, 5313.0, 5534.0, 5517.0, 5698.0, 5278.0, 5680.0, 5357.0, 5673.0, 5479.0, 5560.0, 5367.0, 5595.0, 5712.0, 5724.0, 5300.0, 5327.0, 5631.0, 5339.0, 5678.0, 5425.0, 5436.0, 5395.0, 5417.0, 5669.0, 5592.0, 5423.0, 5598.0, 5686.0, 5345.0, 5258.0, 5289.0, 5589.0, 5688.0, 5710.0, 5717.0, 5694.0, 5373.0, 5531.0, 5282.0, 5647.0, 5411.0, 5655.0, 5622.0, 5297.0, 5529.0, 5654.0, 5564.0, 5590.0, 5551.0, 5612.0, 5501.0, 5596.0, 5334.0, 5521.0, 5330.0, 5489.0, 5376.0, 5314.0, 5625.0, 5416.0, 5723.0, 5271.0, 5627.0, 5610.0, 5354.0, 5388.0 (number of hits: 2)
6	5260	9	1	333	1	5711.0, 5608.0, 5449.0, 5482.0, 5487.0, 5453.0, 5518.0, 5397.0, 5532.0, 5605.0, 5257.0, 5401.0, 5251.0, 5319.0, 5684.0, 5291.0, 5595.0, 5357.0, 5313.0, 5253.0, 5302.0, 5585.0, 5658.0, 5413.0, 5424.0, 5359.0, 5716.0, 5377.0, 5615.0, 5422.0, 5665.0, 5523.0, 5356.0, 5276.0, 5394.0, 5632.0, 5656.0, 5570.0, 5340.0, 5418.0, 5669.0, 5303.0, 5700.0, 5643.0, 5464.0, 5338.0, 5693.0, 5600.0, 5531.0, 5541.0, 5274.0, 5536.0, 5344.0, 5525.0, 5602.0, 5271.0, 5635.0, 5299.0, 5580.0, 5573.0,

						5270.0, 5513.0, 5620.0, 5561.0, 5442.0, 5579.0, 5486.0, 5277.0, 5517.0, 5262.0, 5490.0, 5430.0, 5469.0, 5297.0, 5350.0, 5519.0, 5582.0, 5671.0, 5446.0, 5610.0, 5260.0, 5489.0, 5252.0, 5404.0, 5687.0, 5466.0, 5447.0, 5346.0, 5559.0, 5310.0, 5254.0, 5565.0, 5719.0, 5662.0, 5659.0, 5617.0, 5514.0, 5329.0, 5720.0, 5462.0 (number of hits: 7)
7	5260	9	1	333	1	5318.0, 5432.0, 5389.0, 5663.0, 5254.0, 5576.0, 5255.0, 5545.0, 5658.0, 5603.0, 5464.0, 5356.0, 5664.0, 5306.0, 5548.0, 5352.0, 5610.0, 5419.0, 5638.0, 5618.0, 5359.0, 5312.0, 5490.0, 5418.0, 5500.0, 5414.0, 5512.0, 5551.0, 5465.0, 5661.0, 5313.0, 5594.0, 5629.0, 5514.0, 5392.0, 5341.0, 5329.0, 5468.0, 5360.0, 5338.0, 5260.0, 5693.0, 5379.0, 5533.0, 5394.0, 5365.0, 5701.0, 5559.0, 5291.0, 5697.0, 5486.0, 5390.0, 5473.0, 5503.0, 5565.0, 5560.0, 5461.0, 5596.0, 5580.0, 5335.0, 5303.0, 5710.0, 5518.0, 5470.0, 5641.0, 5645.0, 5584.0, 5522.0, 5474.0, 5591.0, 5398.0, 5521.0, 5601.0, 5635.0, 5519.0, 5570.0, 5446.0, 5531.0, 5646.0, 5517.0, 5677.0, 5655.0, 5462.0, 5685.0, 5532.0, 5544.0, 5593.0, 5351.0, 5342.0, 5707.0, 5667.0, 5538.0, 5587.0, 5424.0, 5483.0, 5624.0, 5564.0, 5497.0, 5550.0, 5415.0 (number of hits: 3)
8	5260	9	1	333	1	5645.0, 5615.0, 5517.0, 5695.0, 5674.0, 5366.0, 5526.0, 5705.0, 5391.0, 5295.0, 5593.0, 5701.0, 5605.0, 5463.0, 5715.0, 5339.0, 5445.0, 5336.0, 5586.0, 5447.0, 5307.0, 5470.0, 5431.0, 5460.0, 5712.0, 5536.0, 5437.0, 5697.0, 5369.0, 5608.0, 5270.0, 5563.0, 5265.0, 5365.0, 5255.0, 5287.0, 5260.0, 5685.0, 5452.0, 5708.0, 5675.0, 5527.0, 5509.0, 5292.0, 5264.0, 5587.0, 5654.0, 5588.0, 5661.0, 5501.0, 5529.0, 5454.0, 5503.0, 5347.0, 5634.0, 5473.0, 5584.0, 5367.0, 5306.0, 5678.0, 5531.0, 5710.0, 5479.0, 5310.0, 5332.0, 5433.0, 5578.0, 5535.0, 5261.0, 5505.0, 5372.0, 5289.0, 5322.0, 5434.0, 5585.0, 5376.0, 5623.0, 5716.0, 5691.0, 5518.0, 5553.0, 5274.0, 5554.0, 5300.0, 5499.0, 5412.0, 5642.0, 5498.0, 5406.0, 5429.0, 5484.0, 5494.0, 5524.0, 5504.0, 5410.0, 5449.0, 5659.0, 5389.0, 5438.0, 5490.0 (number of hits: 5)
9	5260	9	1	333	1	5454.0, 5597.0, 5542.0, 5334.0, 5614.0, 5425.0, 5434.0, 5569.0, 5398.0, 5326.0, 5561.0, 5263.0, 5319.0, 5516.0, 5292.0, 5571.0, 5596.0, 5499.0, 5622.0, 5517.0, 5566.0, 5580.0, 5330.0, 5658.0, 5673.0, 5349.0, 5556.0, 5535.0, 5518.0, 5444.0, 5295.0, 5662.0, 5474.0, 5456.0, 5671.0, 5447.0, 5479.0, 5450.0, 5446.0, 5576.0, 5340.0, 5544.0, 5355.0, 5339.0, 5365.0, 5476.0, 5493.0, 5552.0, 5623.0, 5298.0,

						5524.0, 5262.0, 5590.0, 5418.0, 5690.0, 5478.0, 5619.0, 5652.0, 5426.0, 5343.0, 5350.0, 5501.0, 5410.0, 5309.0, 5463.0, 5573.0, 5300.0, 5394.0, 5274.0, 5468.0, 5540.0, 5588.0, 5570.0, 5457.0, 5579.0, 5429.0, 5711.0, 5437.0, 5595.0, 5293.0, 5356.0, 5600.0, 5567.0, 5321.0, 5338.0, 5554.0, 5592.0, 5527.0, 5589.0, 5428.0, 5568.0, 5685.0, 5495.0, 5467.0, 5436.0, 5698.0, 5392.0, 5406.0, 5282.0, 5279.0 (number of hits: 2)
10	5260	9	1	333	1	5287.0, 5712.0, 5566.0, 5593.0, 5534.0, 5351.0, 5343.0, 5640.0, 5326.0, 5432.0, 5611.0, 5532.0, 5575.0, 5459.0, 5269.0, 5420.0, 5705.0, 5496.0, 5374.0, 5686.0, 5568.0, 5547.0, 5716.0, 5468.0, 5505.0, 5393.0, 5437.0, 5286.0, 5702.0, 5646.0, 5436.0, 5258.0, 5644.0, 5290.0, 5637.0, 5256.0, 5633.0, 5677.0, 5516.0, 5639.0, 5615.0, 5345.0, 5603.0, 5456.0, 5282.0, 5430.0, 5555.0, 5521.0, 5293.0, 5531.0, 5700.0, 5397.0, 5666.0, 5292.0, 5489.0, 5331.0, 5648.0, 5517.0, 5452.0, 5675.0, 5612.0, 5387.0, 5261.0, 5711.0, 5475.0, 5447.0, 5348.0, 5527.0, 5312.0, 5464.0, 5337.0, 5514.0, 5632.0, 5546.0, 5412.0, 5626.0, 5655.0, 5296.0, 5410.0, 5295.0, 5322.0, 5367.0, 5706.0, 5308.0, 5486.0, 5357.0, 5281.0, 5353.0, 5526.0, 5268.0, 5304.0, 5355.0, 5257.0, 5595.0, 5549.0, 5717.0, 5457.0, 5466.0, 5510.0, 5485.0 (number of hits: 6)
11	5250	9	1	333	1	5705.0, 5593.0, 5671.0, 5463.0, 5257.0, 5452.0, 5495.0, 5261.0, 5687.0, 5655.0, 5614.0, 5366.0, 5332.0, 5709.0, 5530.0, 5271.0, 5601.0, 5457.0, 5622.0, 5280.0, 5688.0, 5317.0, 5462.0, 5259.0, 5573.0, 5360.0, 5552.0, 5464.0, 5673.0, 5297.0, 5503.0, 5343.0, 5349.0, 5621.0, 5674.0, 5703.0, 5454.0, 5564.0, 5365.0, 5278.0, 5647.0, 5314.0, 5675.0, 5678.0, 5418.0, 5384.0, 5456.0, 5690.0, 5632.0, 5679.0, 5541.0, 5408.0, 5393.0, 5412.0, 5620.0, 5681.0, 5715.0, 5355.0, 5639.0, 5268.0, 5308.0, 5460.0, 5628.0, 5389.0, 5569.0, 5342.0, 5598.0, 5487.0, 5358.0, 5372.0, 5313.0, 5708.0, 5254.0, 5266.0, 5361.0, 5658.0, 5306.0, 5380.0, 5584.0, 5565.0, 5298.0, 5484.0, 5702.0, 5330.0, 5722.0, 5277.0, 5494.0, 5507.0, 5617.0, 5553.0, 5698.0, 5483.0, 5476.0, 5294.0, 5385.0, 5449.0, 5576.0, 5660.0, 5284.0, 5574.0 (number of hits: 3)
12	5250	9	1	333	1	5705.0, 5542.0, 5675.0, 5547.0, 5348.0, 5503.0, 5629.0, 5662.0, 5345.0, 5508.0, 5691.0, 5531.0, 5714.0, 5427.0, 5658.0, 5405.0, 5493.0, 5630.0, 5641.0, 5588.0, 5434.0, 5517.0, 5509.0, 5642.0, 5522.0, 5253.0, 5282.0, 5448.0, 5507.0, 5556.0, 5706.0, 5412.0, 5539.0, 5432.0, 5320.0, 5585.0, 5343.0, 5550.0, 5269.0, 5358.0,

						5477.0, 5557.0, 5445.0, 5667.0, 5251.0, 5334.0, 5523.0, 5449.0, 5592.0, 5695.0, 5384.0, 5465.0, 5257.0, 5255.0, 5349.0, 5403.0, 5697.0, 5263.0, 5331.0, 5347.0, 5467.0, 5339.0, 5369.0, 5306.0, 5616.0, 5274.0, 5315.0, 5419.0, 5620.0, 5446.0, 5398.0, 5283.0, 5636.0, 5703.0, 5692.0, 5495.0, 5581.0, 5579.0, 5416.0, 5690.0, 5535.0, 5527.0, 5500.0, 5551.0, 5699.0, 5440.0, 5513.0, 5672.0, 5548.0, 5601.0, 5584.0, 5462.0, 5670.0, 5460.0, 5559.0, 5415.0, 5689.0, 5625.0, 5425.0, 5328.0 (number of hits: 4)
13	5250	9	1	333	1	5384.0, 5575.0, 5293.0, 5447.0, 5653.0, 5489.0, 5252.0, 5461.0, 5594.0, 5408.0, 5493.0, 5549.0, 5660.0, 5686.0, 5492.0, 5598.0, 5257.0, 5336.0, 5451.0, 5652.0, 5456.0, 5418.0, 5365.0, 5437.0, 5416.0, 5707.0, 5603.0, 5600.0, 5312.0, 5310.0, 5274.0, 5314.0, 5695.0, 5255.0, 5691.0, 5656.0, 5509.0, 5272.0, 5398.0, 5434.0, 5480.0, 5569.0, 5581.0, 5579.0, 5265.0, 5487.0, 5525.0, 5302.0, 5554.0, 5268.0, 5413.0, 5488.0, 5533.0, 5475.0, 5279.0, 5563.0, 5390.0, 5276.0, 5690.0, 5515.0, 5322.0, 5713.0, 5471.0, 5510.0, 5315.0, 5412.0, 5602.0, 5546.0, 5403.0, 5349.0, 5595.0, 5375.0, 5698.0, 5417.0, 5428.0, 5678.0, 5659.0, 5266.0, 5677.0, 5277.0, 5639.0, 5425.0, 5467.0, 5284.0, 5301.0, 5326.0, 5298.0, 5648.0, 5530.0, 5658.0, 5624.0, 5439.0, 5557.0, 5414.0, 5321.0, 5540.0, 5560.0, 5386.0, 5689.0, 5359.0 (number of hits: 3)
14	5250	9	1	333	1	5434.0, 5496.0, 5260.0, 5256.0, 5349.0, 5387.0, 5710.0, 5456.0, 5403.0, 5389.0, 5622.0, 5682.0, 5594.0, 5626.0, 5614.0, 5715.0, 5324.0, 5329.0, 5579.0, 5361.0, 5298.0, 5334.0, 5590.0, 5335.0, 5333.0, 5609.0, 5601.0, 5505.0, 5490.0, 5578.0, 5445.0, 5563.0, 5613.0, 5382.0, 5275.0, 5531.0, 5450.0, 5589.0, 5534.0, 5621.0, 5536.0, 5681.0, 5459.0, 5522.0, 5411.0, 5561.0, 5436.0, 5255.0, 5440.0, 5454.0, 5352.0, 5566.0, 5696.0, 5562.0, 5580.0, 5285.0, 5573.0, 5516.0, 5476.0, 5367.0, 5339.0, 5623.0, 5441.0, 5337.0, 5261.0, 5521.0, 5492.0, 5525.0, 5497.0, 5344.0, 5353.0, 5328.0, 5455.0, 5672.0, 5320.0, 5368.0, 5663.0, 5306.0, 5677.0, 5286.0, 5524.0, 5264.0, 5251.0, 5535.0, 5494.0, 5716.0, 5282.0, 5485.0, 5336.0, 5453.0, 5597.0, 5360.0, 5471.0, 5658.0, 5304.0, 5647.0, 5537.0, 5723.0, 5655.0, 5591.0 (number of hits: 3)
15	5250	9	1	333	1	5505.0, 5400.0, 5669.0, 5547.0, 5707.0, 5430.0, 5523.0, 5598.0, 5679.0, 5594.0, 5353.0, 5377.0, 5381.0, 5638.0, 5537.0, 5455.0, 5325.0, 5342.0, 5561.0, 5678.0, 5375.0, 5504.0, 5656.0, 5462.0, 5495.0, 5304.0, 5608.0, 5465.0, 5491.0, 5445.0,

						5508.0, 5340.0, 5360.0, 5694.0, 5632.0, 5358.0, 5401.0, 5604.0, 5390.0, 5496.0, 5333.0, 5489.0, 5416.0, 5251.0, 5431.0, 5645.0, 5637.0, 5615.0, 5311.0, 5700.0, 5581.0, 5254.0, 5475.0, 5334.0, 5708.0, 5574.0, 5539.0, 5281.0, 5520.0, 5454.0, 5392.0, 5532.0, 5654.0, 5365.0, 5666.0, 5280.0, 5470.0, 5402.0, 5526.0, 5626.0, 5336.0, 5460.0, 5410.0, 5257.0, 5298.0, 5668.0, 5421.0, 5510.0, 5705.0, 5555.0, 5449.0, 5479.0, 5492.0, 5501.0, 5711.0, 5467.0, 5573.0, 5332.0, 5652.0, 5657.0, 5352.0, 5675.0, 5258.0, 5288.0, 5435.0, 5530.0, 5589.0, 5506.0, 5411.0, 5450.0 (number of hits: 4)
16	5250	9	1	333	1	5584.0, 5683.0, 5450.0, 5605.0, 5573.0, 5424.0, 5648.0, 5419.0, 5280.0, 5333.0, 5542.0, 5511.0, 5642.0, 5493.0, 5388.0, 5459.0, 5658.0, 5273.0, 5304.0, 5387.0, 5362.0, 5669.0, 5457.0, 5448.0, 5311.0, 5451.0, 5404.0, 5612.0, 5292.0, 5601.0, 5533.0, 5555.0, 5441.0, 5360.0, 5650.0, 5667.0, 5488.0, 5513.0, 5559.0, 5349.0, 5503.0, 5720.0, 5390.0, 5260.0, 5405.0, 5553.0, 5426.0, 5672.0, 5723.0, 5520.0, 5543.0, 5525.0, 5274.0, 5380.0, 5440.0, 5329.0, 5340.0, 5444.0, 5689.0, 5558.0, 5381.0, 5572.0, 5400.0, 5413.0, 5606.0, 5264.0, 5494.0, 5569.0, 5303.0, 5712.0, 5703.0, 5437.0, 5458.0, 5361.0, 5332.0, 5347.0, 5430.0, 5272.0, 5300.0, 5428.0, 5655.0, 5312.0, 5344.0, 5717.0, 5675.0, 5255.0, 5278.0, 5498.0, 5305.0, 5259.0, 5600.0, 5467.0, 5626.0, 5564.0, 5630.0, 5261.0, 5567.0, 5713.0, 5705.0, 5423.0 (number of hits: 2)
17	5250	9	1	333	1	5525.0, 5575.0, 5709.0, 5441.0, 5672.0, 5651.0, 5572.0, 5411.0, 5645.0, 5351.0, 5649.0, 5343.0, 5254.0, 5264.0, 5718.0, 5323.0, 5474.0, 5287.0, 5576.0, 5453.0, 5546.0, 5534.0, 5717.0, 5326.0, 5466.0, 5458.0, 5507.0, 5556.0, 5547.0, 5469.0, 5361.0, 5406.0, 5354.0, 5498.0, 5284.0, 5552.0, 5456.0, 5635.0, 5444.0, 5594.0, 5408.0, 5345.0, 5317.0, 5298.0, 5685.0, 5715.0, 5515.0, 5663.0, 5591.0, 5340.0, 5253.0, 5687.0, 5720.0, 5558.0, 5320.0, 5579.0, 5526.0, 5689.0, 5405.0, 5310.0, 5655.0, 5574.0, 5504.0, 5281.0, 5537.0, 5657.0, 5599.0, 5321.0, 5646.0, 5471.0, 5612.0, 5299.0, 5251.0, 5350.0, 5443.0, 5590.0, 5472.0, 5376.0, 5348.0, 5600.0, 5626.0, 5431.0, 5653.0, 5587.0, 5721.0, 5413.0, 5675.0, 5391.0, 5402.0, 5688.0, 5668.0, 5541.0, 5438.0, 5416.0, 5324.0, 5421.0, 5315.0, 5493.0, 5488.0, 5422.0 (number of hits: 3)
18	5250	9	1	333	1	5508.0, 5629.0, 5709.0, 5437.0, 5380.0, 5588.0, 5570.0, 5316.0, 5476.0, 5526.0, 5657.0, 5273.0, 5519.0, 5434.0, 5624.0, 5435.0, 5451.0, 5683.0, 5680.0, 5371.0,

						5369.0, 5723.0, 5258.0, 5650.0, 5665.0, 5522.0, 5720.0, 5630.0, 5711.0, 5617.0, 5483.0, 5357.0, 5267.0, 5674.0, 5593.0, 5480.0, 5279.0, 5307.0, 5272.0, 5682.0, 5662.0, 5666.0, 5571.0, 5575.0, 5381.0, 5385.0, 5253.0, 5556.0, 5291.0, 5430.0, 5669.0, 5590.0, 5254.0, 5600.0, 5546.0, 5415.0, 5558.0, 5712.0, 5339.0, 5456.0, 5459.0, 5394.0, 5717.0, 5564.0, 5303.0, 5478.0, 5439.0, 5652.0, 5494.0, 5521.0, 5467.0, 5261.0, 5344.0, 5514.0, 5472.0, 5639.0, 5540.0, 5393.0, 5597.0, 5355.0, 5474.0, 5260.0, 5582.0, 5581.0, 5638.0, 5578.0, 5497.0, 5436.0, 5343.0, 5457.0, 5420.0, 5460.0, 5462.0, 5320.0, 5547.0, 5493.0, 5634.0, 5427.0, 5586.0, 5416.0 (number of hits: 3)
19	5250	9	1	333	1	5595.0, 5532.0, 5414.0, 5264.0, 5278.0, 5482.0, 5303.0, 5466.0, 5570.0, 5267.0, 5283.0, 5372.0, 5533.0, 5502.0, 5368.0, 5478.0, 5572.0, 5282.0, 5371.0, 5571.0, 5410.0, 5293.0, 5445.0, 5501.0, 5314.0, 5370.0, 5722.0, 5458.0, 5671.0, 5617.0, 5703.0, 5447.0, 5318.0, 5678.0, 5329.0, 5362.0, 5261.0, 5673.0, 5411.0, 5696.0, 5633.0, 5334.0, 5335.0, 5562.0, 5369.0, 5542.0, 5419.0, 5443.0, 5452.0, 5672.0, 5504.0, 5313.0, 5625.0, 5537.0, 5706.0, 5456.0, 5576.0, 5606.0, 5511.0, 5674.0, 5263.0, 5647.0, 5333.0, 5470.0, 5602.0, 5384.0, 5356.0, 5358.0, 5548.0, 5641.0, 5426.0, 5684.0, 5536.0, 5558.0, 5266.0, 5529.0, 5455.0, 5611.0, 5407.0, 5550.0, 5549.0, 5291.0, 5316.0, 5692.0, 5388.0, 5409.0, 5512.0, 5367.0, 5296.0, 5716.0, 5483.0, 5315.0, 5321.0, 5676.0, 5583.0, 5701.0, 5280.0, 5515.0, 5406.0, 5259.0 (number of hits: 1)
20	5250	9	1	333	1	5329.0, 5693.0, 5416.0, 5559.0, 5404.0, 5305.0, 5413.0, 5689.0, 5540.0, 5364.0, 5386.0, 5465.0, 5598.0, 5699.0, 5595.0, 5524.0, 5315.0, 5316.0, 5506.0, 5303.0, 5672.0, 5718.0, 5705.0, 5289.0, 5466.0, 5560.0, 5720.0, 5293.0, 5377.0, 5587.0, 5556.0, 5632.0, 5521.0, 5567.0, 5414.0, 5692.0, 5295.0, 5658.0, 5550.0, 5420.0, 5648.0, 5548.0, 5666.0, 5488.0, 5518.0, 5714.0, 5312.0, 5511.0, 5497.0, 5444.0, 5317.0, 5522.0, 5680.0, 5660.0, 5538.0, 5526.0, 5395.0, 5625.0, 5467.0, 5345.0, 5258.0, 5254.0, 5429.0, 5482.0, 5297.0, 5516.0, 5588.0, 5571.0, 5282.0, 5388.0, 5597.0, 5552.0, 5277.0, 5308.0, 5711.0, 5549.0, 5331.0, 5275.0, 5402.0, 5367.0, 5371.0, 5396.0, 5605.0, 5376.0, 5449.0, 5406.0, 5645.0, 5419.0, 5565.0, 5349.0, 5284.0, 5500.0, 5584.0, 5512.0, 5580.0, 5719.0, 5649.0, 5602.0, 5503.0, 5462.0 (number of hits: 2)
21	5270	9	1	333	1	5693.0, 5679.0, 5255.0, 5327.0, 5275.0, 5302.0, 5290.0, 5502.0, 5292.0, 5526.0,

						5588.0, 5506.0, 5648.0, 5695.0, 5592.0, 5565.0, 5431.0, 5683.0, 5491.0, 5598.0, 5564.0, 5297.0, 5578.0, 5514.0, 5544.0, 5516.0, 5584.0, 5632.0, 5720.0, 5478.0, 5370.0, 5314.0, 5424.0, 5610.0, 5480.0, 5315.0, 5281.0, 5675.0, 5373.0, 5513.0, 5392.0, 5541.0, 5515.0, 5645.0, 5643.0, 5658.0, 5668.0, 5409.0, 5342.0, 5321.0, 5676.0, 5586.0, 5389.0, 5600.0, 5613.0, 5519.0, 5497.0, 5298.0, 5316.0, 5418.0, 5511.0, 5473.0, 5338.0, 5303.0, 5393.0, 5628.0, 5477.0, 5459.0, 5375.0, 5719.0, 5286.0, 5672.0, 5299.0, 5404.0, 5716.0, 5449.0, 5561.0, 5529.0, 5362.0, 5270.0, 5707.0, 5420.0, 5456.0, 5351.0, 5452.0, 5718.0, 5386.0, 5546.0, 5414.0, 5625.0, 5606.0, 5350.0, 5583.0, 5638.0, 5458.0, 5400.0, 5425.0, 5260.0, 5479.0, 5349.0 (number of hits: 3)
22	5270	9	1	333	1	5465.0, 5364.0, 5606.0, 5344.0, 5481.0, 5559.0, 5627.0, 5537.0, 5534.0, 5282.0, 5601.0, 5366.0, 5275.0, 5420.0, 5478.0, 5506.0, 5386.0, 5528.0, 5710.0, 5575.0, 5603.0, 5605.0, 5285.0, 5544.0, 5572.0, 5668.0, 5680.0, 5532.0, 5600.0, 5471.0, 5374.0, 5464.0, 5526.0, 5547.0, 5724.0, 5660.0, 5387.0, 5411.0, 5524.0, 5580.0, 5513.0, 5643.0, 5683.0, 5378.0, 5419.0, 5548.0, 5697.0, 5685.0, 5424.0, 5461.0, 5491.0, 5382.0, 5469.0, 5451.0, 5343.0, 5625.0, 5608.0, 5681.0, 5502.0, 5400.0, 5368.0, 5480.0, 5358.0, 5540.0, 5489.0, 5292.0, 5495.0, 5543.0, 5445.0, 5392.0, 5399.0, 5557.0, 5669.0, 5474.0, 5353.0, 5389.0, 5691.0, 5496.0, 5700.0, 5393.0, 5571.0, 5574.0, 5383.0, 5589.0, 5308.0, 5510.0, 5418.0, 5522.0, 5290.0, 5578.0, 5459.0, 5598.0, 5473.0, 5594.0, 5347.0, 5258.0, 5406.0, 5609.0, 5276.0, 5626.0 (number of hits: 2)
23	5270	9	1	333	1	5482.0, 5445.0, 5501.0, 5302.0, 5687.0, 5340.0, 5405.0, 5554.0, 5509.0, 5657.0, 5438.0, 5587.0, 5461.0, 5418.0, 5456.0, 5493.0, 5259.0, 5324.0, 5267.0, 5693.0, 5368.0, 5415.0, 5534.0, 5603.0, 5591.0, 5304.0, 5390.0, 5346.0, 5310.0, 5478.0, 5604.0, 5466.0, 5444.0, 5413.0, 5396.0, 5380.0, 5647.0, 5354.0, 5592.0, 5626.0, 5256.0, 5665.0, 5605.0, 5463.0, 5414.0, 5379.0, 5723.0, 5313.0, 5450.0, 5522.0, 5408.0, 5629.0, 5319.0, 5510.0, 5264.0, 5366.0, 5499.0, 5316.0, 5341.0, 5565.0, 5690.0, 5597.0, 5555.0, 5449.0, 5688.0, 5721.0, 5658.0, 5377.0, 5621.0, 5253.0, 5656.0, 5423.0, 5269.0, 5595.0, 5355.0, 5419.0, 5705.0, 5526.0, 5381.0, 5454.0, 5683.0, 5643.0, 5337.0, 5689.0, 5472.0, 5533.0, 5585.0, 5671.0, 5680.0, 5443.0, 5290.0, 5507.0, 5724.0, 5359.0, 5514.0, 5343.0, 5276.0, 5617.0, 5674.0, 5696.0 (number of hits: 4)

24	5270	9	1	333	1	5330.0, 5320.0, 5543.0, 5647.0, 5651.0, 5510.0, 5461.0, 5556.0, 5511.0, 5517.0, 5641.0, 5580.0, 5313.0, 5281.0, 5673.0, 5585.0, 5377.0, 5721.0, 5459.0, 5269.0, 5331.0, 5414.0, 5423.0, 5352.0, 5264.0, 5666.0, 5282.0, 5348.0, 5551.0, 5526.0, 5579.0, 5675.0, 5432.0, 5503.0, 5550.0, 5421.0, 5357.0, 5504.0, 5547.0, 5536.0, 5468.0, 5480.0, 5528.0, 5680.0, 5396.0, 5686.0, 5350.0, 5516.0, 5457.0, 5534.0, 5262.0, 5722.0, 5632.0, 5704.0, 5437.0, 5681.0, 5694.0, 5649.0, 5560.0, 5392.0, 5445.0, 5640.0, 5594.0, 5279.0, 5363.0, 5612.0, 5523.0, 5329.0, 5316.0, 5251.0, 5429.0, 5578.0, 5300.0, 5676.0, 5481.0, 5664.0, 5278.0, 5595.0, 5576.0, 5587.0, 5342.0, 5455.0, 5529.0, 5620.0, 5695.0, 5351.0, 5508.0, 5622.0, 5679.0, 5270.0, 5533.0, 5520.0, 5280.0, 5609.0, 5294.0, 5255.0, 5507.0, 5404.0, 5385.0, 5394.0 (number of hits: 6)
25	5270	9	1	333	1	5717.0, 5710.0, 5676.0, 5350.0, 5473.0, 5301.0, 5453.0, 5634.0, 5370.0, 5650.0, 5267.0, 5420.0, 5467.0, 5369.0, 5357.0, 5551.0, 5649.0, 5638.0, 5644.0, 5502.0, 5654.0, 5359.0, 5291.0, 5308.0, 5713.0, 5355.0, 5416.0, 5537.0, 5360.0, 5611.0, 5313.0, 5388.0, 5684.0, 5485.0, 5310.0, 5383.0, 5440.0, 5635.0, 5498.0, 5371.0, 5547.0, 5362.0, 5545.0, 5669.0, 5570.0, 5407.0, 5482.0, 5322.0, 5633.0, 5720.0, 5260.0, 5386.0, 5525.0, 5435.0, 5276.0, 5662.0, 5285.0, 5540.0, 5722.0, 5600.0, 5542.0, 5563.0, 5682.0, 5558.0, 5506.0, 5564.0, 5677.0, 5295.0, 5395.0, 5712.0, 5302.0, 5544.0, 5376.0, 5438.0, 5332.0, 5560.0, 5470.0, 5521.0, 5252.0, 5365.0, 5460.0, 5465.0, 5406.0, 5497.0, 5606.0, 5531.0, 5280.0, 5399.0, 5593.0, 5487.0, 5458.0, 5692.0, 5471.0, 5508.0, 5418.0, 5254.0, 5367.0, 5707.0, 5539.0, 5459.0 (number of hits: 3)
26	5270	9	1	333	1	5509.0, 5479.0, 5551.0, 5440.0, 5443.0, 5607.0, 5314.0, 5431.0, 5321.0, 5676.0, 5515.0, 5371.0, 5524.0, 5370.0, 5448.0, 5372.0, 5543.0, 5324.0, 5552.0, 5463.0, 5353.0, 5303.0, 5635.0, 5504.0, 5698.0, 5664.0, 5270.0, 5256.0, 5307.0, 5382.0, 5654.0, 5289.0, 5505.0, 5558.0, 5554.0, 5267.0, 5612.0, 5436.0, 5285.0, 5535.0, 5413.0, 5565.0, 5387.0, 5579.0, 5365.0, 5541.0, 5388.0, 5251.0, 5275.0, 5430.0, 5450.0, 5674.0, 5287.0, 5428.0, 5514.0, 5522.0, 5441.0, 5596.0, 5523.0, 5707.0, 5693.0, 5675.0, 5574.0, 5346.0, 5634.0, 5559.0, 5655.0, 5614.0, 5692.0, 5531.0, 5716.0, 5342.0, 5454.0, 5572.0, 5706.0, 5363.0, 5580.0, 5714.0, 5499.0, 5597.0, 5705.0, 5296.0, 5486.0, 5553.0, 5685.0, 5521.0, 5633.0, 5399.0, 5568.0, 5459.0, 5389.0, 5313.0, 5645.0, 5381.0, 5452.0,

						5294.0, 5444.0, 5293.0, 5556.0, 5368.0 (number of hits: 3)
27	5270	9	1	333	1	5257.0, 5291.0, 5428.0, 5661.0, 5634.0, 5551.0, 5648.0, 5430.0, 5480.0, 5681.0, 5607.0, 5277.0, 5423.0, 5478.0, 5399.0, 5611.0, 5351.0, 5329.0, 5482.0, 5334.0, 5536.0, 5576.0, 5604.0, 5402.0, 5289.0, 5446.0, 5476.0, 5475.0, 5270.0, 5409.0, 5691.0, 5343.0, 5366.0, 5331.0, 5411.0, 5267.0, 5258.0, 5447.0, 5690.0, 5606.0, 5555.0, 5483.0, 5330.0, 5419.0, 5424.0, 5413.0, 5342.0, 5664.0, 5528.0, 5531.0, 5683.0, 5637.0, 5558.0, 5445.0, 5564.0, 5314.0, 5595.0, 5668.0, 5716.0, 5417.0, 5272.0, 5308.0, 5448.0, 5685.0, 5362.0, 5349.0, 5489.0, 5702.0, 5679.0, 5656.0, 5292.0, 5686.0, 5632.0, 5303.0, 5644.0, 5601.0, 5381.0, 5358.0, 5704.0, 5505.0, 5515.0, 5474.0, 5254.0, 5658.0, 5352.0, 5339.0, 5594.0, 5666.0, 5579.0, 5327.0, 5372.0, 5450.0, 5575.0, 5296.0, 5557.0, 5287.0, 5678.0, 5574.0, 5562.0, 5640.0 (number of hits: 4)
28	5270	9	1	333	1	5605.0, 5379.0, 5274.0, 5565.0, 5264.0, 5723.0, 5717.0, 5465.0, 5583.0, 5412.0, 5487.0, 5446.0, 5437.0, 5606.0, 5620.0, 5561.0, 5374.0, 5372.0, 5393.0, 5452.0, 5575.0, 5557.0, 5601.0, 5607.0, 5391.0, 5451.0, 5659.0, 5257.0, 5454.0, 5617.0, 5648.0, 5401.0, 5700.0, 5438.0, 5423.0, 5549.0, 5632.0, 5508.0, 5309.0, 5695.0, 5533.0, 5647.0, 5697.0, 5512.0, 5258.0, 5624.0, 5650.0, 5676.0, 5287.0, 5480.0, 5696.0, 5721.0, 5509.0, 5714.0, 5680.0, 5431.0, 5651.0, 5608.0, 5383.0, 5627.0, 5328.0, 5394.0, 5286.0, 5536.0, 5626.0, 5297.0, 5704.0, 5603.0, 5310.0, 5544.0, 5388.0, 5511.0, 5335.0, 5472.0, 5501.0, 5639.0, 5311.0, 5459.0, 5467.0, 5318.0, 5580.0, 5679.0, 5411.0, 5645.0, 5591.0, 5636.0, 5353.0, 5656.0, 5674.0, 5266.0, 5283.0, 5722.0, 5357.0, 5705.0, 5710.0, 5368.0, 5373.0, 5596.0, 5503.0, 5356.0 (number of hits: 3)
29	5270	9	1	333	1	5546.0, 5615.0, 5263.0, 5310.0, 5422.0, 5600.0, 5623.0, 5266.0, 5294.0, 5449.0, 5671.0, 5254.0, 5657.0, 5356.0, 5602.0, 5679.0, 5252.0, 5562.0, 5660.0, 5634.0, 5676.0, 5542.0, 5402.0, 5455.0, 5556.0, 5675.0, 5392.0, 5704.0, 5665.0, 5397.0, 5368.0, 5454.0, 5526.0, 5315.0, 5654.0, 5603.0, 5620.0, 5474.0, 5488.0, 5693.0, 5696.0, 5574.0, 5359.0, 5351.0, 5582.0, 5420.0, 5297.0, 5471.0, 5631.0, 5536.0, 5281.0, 5271.0, 5722.0, 5590.0, 5588.0, 5601.0, 5336.0, 5630.0, 5720.0, 5706.0, 5257.0, 5661.0, 5442.0, 5386.0, 5476.0, 5463.0, 5565.0, 5335.0, 5431.0, 5295.0, 5622.0, 5405.0, 5334.0, 5576.0, 5342.0, 5364.0, 5483.0, 5489.0, 5540.0, 5353.0, 5604.0, 5291.0, 5521.0, 5419.0, 5702.0,

						5425.0, 5427.0, 5410.0, 5302.0, 5596.0, 5515.0, 5299.0, 5564.0, 5513.0, 5710.0, 5585.0, 5275.0, 5418.0, 5712.0, 5572.0 (number of hits: 4)
30	5270	9	1	333	1	5624.0, 5349.0, 5569.0, 5663.0, 5568.0, 5484.0, 5513.0, 5396.0, 5263.0, 5588.0, 5681.0, 5635.0, 5480.0, 5604.0, 5405.0, 5340.0, 5593.0, 5270.0, 5442.0, 5525.0, 5344.0, 5584.0, 5467.0, 5272.0, 5265.0, 5307.0, 5656.0, 5535.0, 5554.0, 5336.0, 5251.0, 5564.0, 5508.0, 5455.0, 5548.0, 5557.0, 5291.0, 5302.0, 5555.0, 5411.0, 5267.0, 5391.0, 5347.0, 5446.0, 5370.0, 5512.0, 5616.0, 5595.0, 5529.0, 5552.0, 5528.0, 5403.0, 5606.0, 5614.0, 5704.0, 5693.0, 5659.0, 5492.0, 5308.0, 5524.0, 5556.0, 5558.0, 5505.0, 5717.0, 5545.0, 5497.0, 5509.0, 5531.0, 5433.0, 5279.0, 5479.0, 5261.0, 5372.0, 5481.0, 5421.0, 5674.0, 5332.0, 5320.0, 5392.0, 5625.0, 5453.0, 5451.0, 5586.0, 5582.0, 5491.0, 5298.0, 5269.0, 5253.0, 5543.0, 5315.0, 5669.0, 5282.0, 5430.0, 5379.0, 5273.0, 5281.0, 5515.0, 5477.0, 5400.0, 5538.0 (number of hits: 9)

A.2 40 MHz Bandwidth @ 5270 MHz

Table-1A/1B Radar Type 1A/1B Statistical Performance

Trial #	Fc (MHz)	Pulse/Burst	Pulse Width (μS)	PRI (μs)	Detection (1:yes; 0:no)
1	5270	95	1	558	1
2	5270	57	1	938	1
3	5270	68	1	778	1
4	5270	63	1	838	1
5	5270	102	1	518	1
6	5270	74	1	718	1
7	5270	58	1	918	1
8	5270	67	1	798	1
9	5270	61	1	878	1
10	5270	76	1	698	1
11	5270	92	1	578	1
12	5270	59	1	898	1
13	5270	86	1	618	1
14	5270	81	1	658	1
15	5270	83	1	638	1
16	5270	32	1	1684	1
17	5270	27	1	1965	1
18	5270	50	1	1070	1
19	5270	27	1	2019	1
20	5270	33	1	1645	1
21	5270	40	1	1345	1
22	5270	24	1	2204	1
23	5270	30	1	1777	1
24	5270	20	1	2755	1
25	5270	41	1	1313	1
26	5270	40	1	1353	1
27	5270	23	1	2396	1
28	5270	60	1	888	1
29	5270	35	1	1523	1
30	5270	20	1	2682	1
Detection Percentage: 100 % (>60%)					

Table-2 Radar Type 2 Statistical Performance

Trial #	Fc (MHz)	Pulse/Burst	Pulse Width (μS)	PRI (μs)	Detection (1:yes; 0:no)
1	5270	25	3.1	178	1
2	5270	23	1.3	224	1
3	5270	29	4	202	1
4	5270	26	3.6	172	1
5	5270	25	3	156	1
6	5270	29	4.6	222	1
7	5270	26	3.5	158	1
8	5270	24	5	216	1
9	5270	24	1.1	150	1
10	5270	24	4.6	229	1
11	5270	23	4.9	156	1
12	5270	24	1	150	1
13	5270	25	4.1	186	1
14	5270	23	3	189	1
15	5270	29	5	221	1
16	5270	28	1.8	218	1
17	5270	23	4.8	216	1
18	5270	25	3.1	207	1
19	5270	23	4.8	187	1
20	5270	27	3.3	183	1
21	5270	23	2.9	174	1
22	5270	27	4.5	178	1
23	5270	26	2.2	203	1
24	5270	25	4.6	157	1
25	5270	28	4.2	195	1
26	5270	27	2.5	230	1
27	5270	28	2.8	156	1
28	5270	25	2.8	160	1
29	5270	27	4.6	184	1
30	5270	23	2.4	171	1
Detection Percentage: 100 % (>60%)					

Table-3 Radar Type 3 Statistical Performance

Trial #	Fc (MHz)	Pulse/Burst	Pulse Width (μS)	PRI (μs)	Detection (1:yes; 0:no)
1	5270	17	9.3	396	1
2	5270	18	6.8	442	1
3	5270	18	8.2	482	1
4	5270	17	7.6	333	1
5	5270	16	9.6	460	1
6	5270	17	6.1	205	1
7	5270	18	6.8	429	1
8	5270	18	7.1	450	1
9	5270	17	7.7	293	1
10	5270	16	8.1	208	1
11	5270	18	9.5	444	1
12	5270	16	7	358	1
13	5270	17	7	411	1
14	5270	16	8.8	214	1
15	5270	18	9.7	402	1
16	5270	18	8.2	393	1
17	5270	18	8.2	271	1
18	5270	18	7.2	371	1
19	5270	16	6.5	438	1
20	5270	16	7.5	289	1
21	5270	16	6.8	385	1
22	5270	18	7.6	250	1
23	5270	17	6.5	275	1
24	5270	16	8.5	236	1
25	5270	18	8.9	487	1
26	5270	16	8.7	446	1
27	5270	17	7	339	1
28	5270	18	7.5	239	1
29	5270	16	9.5	285	1
30	5270	16	9.6	285	1
Detection Percentage: 100 % (>60%)					

Table-4 Radar Type 4 Statistical Performance

Trial #	Fc (MHz)	Pulse/Burst	Pulse Width (μS)	PRI (μs)	Detection (1:yes; 0:no)
1	5270	12	13.3	312	1
2	5270	15	16.2	373	1
3	5270	15	13.6	261	1
4	5270	15	17.2	253	1
5	5270	16	18.8	489	1
6	5270	12	11.6	373	1
7	5270	13	16.2	240	1
8	5270	14	13.5	324	1
9	5270	12	13	332	1
10	5270	12	14.4	261	1
11	5270	13	19.4	428	1
12	5270	16	19.5	357	1
13	5270	14	19.9	243	1
14	5270	16	11.3	458	1
15	5270	14	19.9	231	1
16	5270	13	13.5	232	1
17	5270	15	15.5	487	1
18	5270	12	13.1	381	1
19	5270	13	14.6	253	1
20	5270	12	15	292	1
21	5270	14	20	346	1
22	5270	16	14.4	330	1
23	5270	15	15	423	1
24	5270	15	15.5	276	1
25	5270	13	19.9	346	1
26	5270	16	15.1	229	1
27	5270	14	12.9	277	1
28	5270	16	18.3	291	1
29	5270	16	14.1	260	1
30	5270	15	15.8	238	1
Detection Percentage: 100 % (>60%)					

Table-5 Radar Type 5 Statistical Performance

Trial #	Fc (MHz)	Detection (1:yes; 0:no)
1	5270	1
2	5270	1
3	5270	1
4	5270	1
5	5270	1
6	5270	1
7	5270	1
8	5270	1
9	5270	1
10	5270	1
11	5257.2	1
12	5252.0	1
13	5253.2	1
14	5254.4	1
15	5255.6	1
16	5256.8	1
17	5252.4	1
18	5252.4	1
19	5252.4	1
20	5257.6	1
21	5283.6	1
22	5282.4	1
23	5286.0	1
24	5286.4	1
25	5286.4	1
26	5286.4	1
27	5284.8	1
28	5285.6	1
29	5284.4	1
30	5288.0	1
Detection Percentage: 100 % (>80%)		

Bin5 Statistics 1

Trial #	Pulse	Chirp (MHz)	Pulse Width (µS)	Pulse 1-2 spacing (µS)	Pulse 2-3 spacing (µS)	Pulse Start(S)	Detection (1:yes; 0:no)
0	1	6	86.2			0.533785	1
1	2	6	83.6	1012		1.323187	
2	2	6	99.9	1979		2.295182	
3	3	6	94.8	1442	1484	3.16514	
4	1	6	75.2			3.776712	
5	3	6	69	1621	1553	4.357818	
6	2	6	78.4	1271		5.374355	
7	2	6	81.1	1412		6.044288	
8	2	6	58.4	1653		7.519998	
9	2	6	59.2	1241		8.199609	
10	2	6	82.9	1470		8.95914	
11	2	6	80.1	1546		9.433304	
12	2	6	91.9	1267		10.812345	
13	2	6	77	1013		11.751177	

Bin5 Statistics 2

Trial #	Pulse	Chirp (MHz)	Pulse Width (µS)	Pulse 1-2 spacing (µS)	Pulse 2-3 spacing (µS)	Pulse Start(S)	Detection (1:yes; 0:no)
0	1	15	75.5			0.470736	1
1	2	15	64.3	1232		1.561642	
2	3	15	67.8	1247	1886	2.230777	
3	3	15	83.3	1535	1696	2.84937	
4	2	15	73.2	1682		4.471618	
5	3	15	71.8	1969	1644	5.176605	
6	3	15	79.3	1230	1302	6.179957	
7	3	15	83.3	1151	1066	6.896034	
8	3	15	66.7	1115	1814	7.864498	
9	3	15	90.5	1416	1957	8.577677	
10	2	15	56.8	1053		9.663171	
11	2	15	64.2	1447		10.301535	
12	2	15	69.5	1601		11.214791	

Bin5 Statistics 3

Trial #	Pulse	Chirp (MHz)	Pulse Width (µS)	Pulse 1-2 spacing (uS)	Pulse 2-3 spacing (uS)	Pulse Start(S)	Detection (1:yes; 0:no)
0	1	9	63.4			0.674975	1
1	3	9	87.2	1397	1263	2.02784	
2	2	9	64.1	1820		2.909956	
3	3	9	72.8	1002	1620	5.229881	
4	2	9	98.5	1720		6.475735	
5	2	9	50.9	1413		7.366846	
6	3	9	77.6	1435	1428	9.172801	
7	2	9	60.8	1307		9.732429	
8	3	9	98.6	1374	1015	11.225404	

Bin5 Statistics 4

Trial #	Pulse	Chirp (MHz)	Pulse Width (µS)	Pulse 1-2 spacing (uS)	Pulse 2-3 spacing (uS)	Pulse Start(S)	Detection (1:yes; 0:no)
0	2	12	74.5	1072		0.378654	1
1	2	12	53.9	1449		0.700966	
2	1	12	61.7			1.698385	
3	2	12	95.6	1240		2.069264	
4	2	12	70.4	1481		2.666815	
5	2	12	92	1034		3.125154	
6	3	12	89.3	1550	1954	4.061954	
7	3	12	53.2	1213	1602	4.716608	
8	2	12	62	1137		5.166408	
9	1	12	76.7			5.645056	
10	3	12	72.6	1522	1376	6.189961	
11	2	12	88.6	1448		6.939332	
12	1	12	57.8			7.746627	
13	2	12	77.2	1246		8.311951	
14	2	12	82.2	1573		8.816969	
15	3	12	92	1576	1862	9.084975	
16	1	12	67.8			9.942015	
17	2	12	86.9	1153		10.311671	
18	1	12	54.5			11.04284	
19	1	12	92.1			11.958237	

Bin5 Statistics 5

Trial #	Pulse	Chirp (MHz)	Pulse Width (µS)	Pulse 1-2 spacing (uS)	Pulse 2-3 spacing (uS)	Pulse Start(S)	Detection (1:yes; 0:no)
0	2	6	75.4	1905		0.095828	1
1	2	6	50.1	1097		0.878461	
2	3	6	57.8	1878	1550	1.999149	
3	2	6	92.1	1541		2.632874	
4	2	6	63.7	1039		3.388627	
5	1	6	85.2			3.832973	
6	2	6	90.7	1583		4.539266	
7	1	6	88.2			5.232128	
8	3	6	95.1	1435	1012	5.993963	
9	1	6	70.9			6.490872	
10	3	6	63.1	1918	1438	7.389172	
11	2	6	52	1908		7.82883	
12	1	6	72.9			8.500719	
13	2	6	99.6	1574		9.697394	
14	3	6	71.8	1954	1456	10.129213	
15	3	6	91.2	1377	1179	11.199362	
16	1	6	78.9			11.654487	

Bin5 Statistics 6

Trial #	Pulse	Chirp (MHz)	Pulse Width (µS)	Pulse 1-2 spacing (uS)	Pulse 2-3 spacing (uS)	Pulse Start(S)	Detection (1:yes; 0:no)
0	2	9	90	1804		0.149383	1
1	2	9	51.2	1695		1.682207	
2	2	9	73.3	1430		2.756417	
3	1	9	74.3			4.174014	
4	2	9	52	1582		6.384567	
5	2	9	65.4	1913		6.717726	
6	3	9	67.9	1062	1361	9.09113	
7	2	9	86.8	1476		9.396657	
8	2	9	59	1579		11.030433	

Bin5 Statistics 7

Trial #	Pulse	Chirp (MHz)	Pulse Width (µS)	Pulse 1-2 spacing (uS)	Pulse 2-3 spacing (uS)	Pulse Start(S)	Detection (1:yes; 0:no)
0	3	10	59.7	1120	1918	0.2646	1
1	2	10	71.4	1251		1.592663	
2	2	10	86.9	1808		2.46493	
3	3	10	92.4	1302	1442	4.197491	
4	2	10	74.2	1266		5.114438	
5	3	10	78.6	1441	1085	7.170604	
6	1	10	54.1			7.807928	
7	2	10	76.5	1265		8.864687	
8	3	10	83.8	1032	1464	9.900596	
9	2	10	61.6	1969		11.187654	

Bin5 Statistics 8

Trial #	Pulse	Chirp (MHz)	Pulse Width (µS)	Pulse 1-2 spacing (uS)	Pulse 2-3 spacing (uS)	Pulse Start(S)	Detection (1:yes; 0:no)
0	3	11	56.5	1195	1170	0.294498	1
1	1	11	59.7			1.860146	
2	2	11	57.3	1739		4.460334	
3	2	11	67.5	1483		5.659657	
4	1	11	60.9			6.125606	
5	2	11	57.3	1780		7.607927	
6	2	11	77.6	1192		9.07488	
7	2	11	65.1	1370		11.231345	

Bin5 Statistics 9

Trial #	Pulse	Chirp (MHz)	Pulse Width (µS)	Pulse 1-2 spacing (uS)	Pulse 2-3 spacing (uS)	Pulse Start(S)	Detection (1:yes; 0:no)
0	2	12	64.3	1197		0.493296	1
1	3	12	66.8	1026	1652	1.164212	
2	1	12	54			2.224408	
3	2	12	81.6	1958		2.568178	
4	2	12	93	1277		3.233387	
5	2	12	98.3	1600		3.935342	
6	1	12	65.4			4.697928	
7	2	12	57.6	1054		5.910488	
8	1	12	81.6			6.33128	
9	2	12	61.5	1429		7.106063	
10	1	12	69.6			7.995029	
11	2	12	87.9	1800		8.704356	
12	2	12	65.6	1395		9.380567	
13	2	12	82.3	1507		9.851933	
14	2	12	94.7	1737		10.744096	
15	2	12	89.4	1089		11.401625	

Bin5 Statistics 10

Trial #	Pulse	Chirp (MHz)	Pulse Width (µS)	Pulse 1-2 spacing (uS)	Pulse 2-3 spacing (uS)	Pulse Start(S)	Detection (1:yes; 0:no)
0	2	12	64	1472		0.169233	1
1	3	12	92.7	1110	1520	0.966072	
2	3	12	63.3	1295	1375	2.013329	
3	3	12	90.4	1205	1058	3.128077	
4	2	12	96.9	1310		3.742241	
5	3	12	65.2	1147	1061	4.173902	
6	3	12	79	1427	1409	5.131313	
7	2	12	69.8	1937		5.874256	
8	2	12	90.6	1906		6.958716	
9	2	12	92.9	1756		7.326868	
10	2	12	79.6	1570		8.723046	
11	3	12	82.3	1649	1350	9.581244	
12	2	12	60.1	1474		10.108404	
13	2	12	77.5	1308		11.153132	
14	2	12	66.9	1154		11.607825	

Bin5 Statistics 11

Trial #	Pulse	Chirp (MHz)	Pulse Width (μS)	Pulse 1-2 spacing (uS)	Pulse 2-3 spacing (uS)	Pulse Start(S)	Detection (1:yes; 0:no)
0	3	18	98.1	1622	1474	0.606936	1
1	2	18	56.9	1692		1.153023	
2	2	18	50.6	1953		1.434964	
3	3	18	69.9	1381	1219	2.362971	
4	2	18	51.2	1984		2.887281	
5	3	18	63.8	1040	1078	3.640551	
6	3	18	75	1635	1685	3.934743	
7	1	18	95.8			4.984353	
8	2	18	74.1	1555		5.155053	
9	1	18	59.4			6.312669	
10	3	18	57.2	1332	1965	6.687622	
11	1	18	98			7.114785	
12	1	18	86.4			7.642471	
13	3	18	93.3	1320	1909	8.49543	
14	2	18	91.6	1229		9.370831	
15	3	18	76.3	1070	1431	10.042844	
16	2	18	81.6	1989		10.470784	
17	1	18	67.3			11.185375	
18	2	18	79.8	1033		11.595498	

Bin5 Statistics 12

Trial #	Pulse	Chirp (MHz)	Pulse Width (µS)	Pulse 1-2 spacing (µS)	Pulse 2-3 spacing (µS)	Pulse Start(S)	Detection (1:yes; 0:no)
0	2	5	99	1640		0.360646	1
1	1	5	96.1			1.214361	
2	1	5	79.8			1.68341	
3	3	5	77	1269	1722	2.357313	
4	2	5	72.1	1462		2.99759	
5	2	5	86.8	1666		3.763417	
6	2	5	85.6	1225		4.393913	
7	2	5	80.3	1597		4.531302	
8	1	5	90.8			5.655068	
9	1	5	52.8			5.698115	
10	2	5	63.4	1299		6.867477	
11	1	5	66.6			7.220053	
12	2	5	91.7	1402		7.866972	
13	3	5	87	1528	1865	8.516555	
14	1	5	72.1			9.064658	
15	2	5	94.2	1549		9.513692	
16	2	5	75	1398		10.208626	
17	3	5	68.9	1195	1805	11.34298	
18	2	5	72.9	1739		11.565349	

Bin5 Statistics 13

Trial #	Pulse	Chirp (MHz)	Pulse Width (µS)	Pulse 1-2 spacing (µS)	Pulse 2-3 spacing (µS)	Pulse Start(S)	Detection (1:yes; 0:no)
0	1	8	69.4			0.041757	1
1	2	8	78	1637		1.258956	
2	2	8	89.4	1507		3.219445	
3	2	8	98.2	1583		3.982546	
4	1	8	91.8			5.364511	
5	1	8	67			6.037234	
6	1	8	65			7.335945	
7	1	8	84.5			8.23606	
8	1	8	98.6			8.823222	
9	2	8	94.2	1762		10.741989	
10	3	8	70.6	1180	1251	11.007906	

Bin5 Statistics 14

Trial #	Pulse	Chirp (MHz)	Pulse Width (µS)	Pulse 1-2 spacing (uS)	Pulse 2-3 spacing (uS)	Pulse Start(S)	Detection (1:yes; 0:no)
0	3	11	65.2	1386	1446	1.201406	1
1	1	11	83.3			2.040368	
2	3	11	81.9	1135	1837	3.897924	
3	2	11	65.8	1749		5.885711	
4	2	11	88.3	1163		6.758666	
5	1	11	59.9			8.573934	
6	2	11	87.9	1798		10.040602	
7	2	11	68.1	1574		11.655279	

Bin5 Statistics 15

Trial #	Pulse	Chirp (MHz)	Pulse Width (µS)	Pulse 1-2 spacing (uS)	Pulse 2-3 spacing (uS)	Pulse Start(S)	Detection (1:yes; 0:no)
0	1	14	89.8			0.765176	1
1	3	14	94.9	1336	1200	1.142282	
2	3	14	59.6	1562	1138	2.017105	
3	1	14	77.8			2.432098	
4	2	14	91.6	1334		3.219551	
5	2	14	91.1	1853		4.085112	
6	3	14	91.7	1227	1891	5.409582	
7	1	14	62.7			6.140816	
8	2	14	97.4	1351		6.440937	
9	1	14	61			7.256749	
10	2	14	98.7	1182		8.123614	
11	2	14	72.4	1159		9.372633	
12	2	14	86.7	1405		10.314851	
13	2	14	99.5	1368		10.790242	
14	2	14	95.6	1464		11.504042	

Bin5 Statistics 16

Trial #	Pulse	Chirp (MHz)	Pulse Width (µS)	Pulse 1-2 spacing (µS)	Pulse 2-3 spacing (µS)	Pulse Start(S)	Detection (1:yes; 0:no)
0	2	17	64	1240		0.672266	1
1	2	17	58.4	1013		1.782247	
2	2	17	65	1119		2.344287	
3	3	17	98.5	1704	1146	3.961226	
4	2	17	70.8	1177		4.620716	
5	2	17	59.1	1191		6.279779	
6	3	17	71.1	1828	1035	6.598651	
7	3	17	85	1977	1824	8.313251	
8	3	17	91.3	1169	1490	9.264273	
9	2	17	97.1	1679		10.297017	
10	2	17	85.4	1372		11.599956	

Bin5 Statistics 17

Trial #	Pulse	Chirp (MHz)	Pulse Width (µS)	Pulse 1-2 spacing (µS)	Pulse 2-3 spacing (µS)	Pulse Start(S)	Detection (1:yes; 0:no)
0	2	6	76.3	1200		0.128364	1
1	1	6	64.9			1.193749	
2	2	6	82.5	1139		1.956842	
3	2	6	90.2	1913		2.564547	
4	1	6	89.5			3.504052	
5	2	6	77.8	1525		3.783651	
6	2	6	91.8	1619		4.991189	
7	3	6	67.6	1944	1261	5.724915	
8	1	6	83			6.694135	
9	2	6	75.7	1704		6.86781	
10	3	6	99.1	1131	1897	7.852145	
11	1	6	99.2			8.320301	
12	3	6	66.7	1606	1294	9.705437	
13	3	6	85.1	1440	1712	9.958425	
14	3	6	97.4	1938	1883	11.203436	
15	2	6	58.9	1317		11.363994	

Bin5 Statistics 18

Trial #	Pulse	Chirp (MHz)	Pulse Width (µS)	Pulse 1-2 spacing (uS)	Pulse 2-3 spacing (uS)	Pulse Start(S)	Detection (1:yes; 0:no)
0	2	6	56.8	1678		0.557	1
1	2	6	99.2	1482		1.233713	
2	2	6	96.2	1307		1.788933	
3	1	6	72.9			2.056956	
4	2	6	91.1	1814		2.973221	
5	3	6	78.4	1581	1105	3.930248	
6	3	6	62.8	1457	1113	4.43033	
7	3	6	55.9	1635	1738	4.713308	
8	2	6	85.5	1728		5.455887	
9	2	6	67.3	1946		6.212364	
10	2	6	55.4	1804		6.919003	
11	2	6	89.3	1652		7.675061	
12	2	6	82.3	1718		8.635274	
13	3	6	89.1	1722	1978	8.694704	
14	1	6	64.1			9.772721	
15	2	6	51.7	1249		10.502201	
16	1	6	91			10.71662	
17	2	6	67.6	1966		11.966746	

Bin5 Statistics 19

Trial #	Pulse	Chirp (MHz)	Pulse Width (µS)	Pulse 1-2 spacing (uS)	Pulse 2-3 spacing (uS)	Pulse Start(S)	Detection (1:yes; 0:no)
0	2	6	87.2	1825		0.456157	1
1	3	6	50.7	1551	1322	0.965835	
2	1	6	64			1.548044	
3	1	6	95.4			2.601529	
4	3	6	66.4	1961	1574	3.713854	
5	1	6	75.6			4.164602	
6	2	6	95.9	1962		4.827609	
7	2	6	83.2	1803		5.26973	
8	2	6	98.3	1310		6.183928	
9	2	6	90.8	1177		7.02353	
10	3	6	88.4	1692	1926	7.764192	
11	2	6	92	1204		8.619373	
12	3	6	79.4	1972	1981	9.442285	
13	1	6	71.9			9.830074	
14	2	6	90.9	1469		10.804459	
15	3	6	62	1550	1141	11.783833	

Bin5 Statistics 20

Trial #	Pulse	Chirp (MHz)	Pulse Width (µS)	Pulse 1-2 spacing (uS)	Pulse 2-3 spacing (uS)	Pulse Start(S)	Detection (1:yes; 0:no)
0	1	19	89.9			0.507925	1
1	2	19	93.1	1513		1.552446	
2	2	19	73.4	1698		2.483444	
3	2	19	96.8	1161		4.309106	
4	1	19	62.2			5.770826	
5	2	19	83.7	1160		7.17395	
6	1	19	71.5			7.32234	
7	1	19	82			8.935822	
8	2	19	75.1	1113		10.669392	
9	2	19	75.9	1413		10.808412	

Bin5 Statistics 21

Trial #	Pulse	Chirp (MHz)	Pulse Width (µS)	Pulse 1-2 spacing (uS)	Pulse 2-3 spacing (uS)	Pulse Start(S)	Detection (1:yes; 0:no)
0	2	16	85.4	1009		0.696436	1
1	3	16	96.8	1937	1679	1.623258	
2	2	16	99.8	1798		3.887627	
3	2	16	52.5	1623		4.859441	
4	3	16	75.3	1985	1669	5.54346	
5	2	16	79.9	1322		7.861806	
6	2	16	54.4	1754		8.513596	
7	1	16	98			10.353609	
8	1	16	99.1			11.238837	

Bin5 Statistics 22

Trial #	Pulse	Chirp (MHz)	Pulse Width (µS)	Pulse 1-2 spacing (uS)	Pulse 2-3 spacing (uS)	Pulse Start(S)	Detection (1:yes; 0:no)
0	1	19	59.8			0.67883	1
1	2	19	88.4	1954		1.66319	
2	2	19	51.3	1214		3.201924	
3	1	19	91.6			4.449914	
4	1	19	78.3			4.886962	
5	3	19	55.3	1629	1783	6.154981	
6	2	19	69.5	1906		7.914865	
7	2	19	98.4	1835		9.332962	
8	3	19	83.1	1666	1201	9.749896	
9	2	19	71.6	1729		11.200039	

Bin5 Statistics 23

Trial #	Pulse	Chirp (MHz)	Pulse Width (µS)	Pulse 1-2 spacing (µS)	Pulse 2-3 spacing (µS)	Pulse Start(S)	Detection (1:yes; 0:no)
0	1	10	66.9			0.541441	1
1	3	10	67.6	1005	1854	1.2814	
2	3	10	62.1	1674	1114	1.516015	
3	3	10	70.9	1277	1337	2.619472	
4	2	10	59.6	1518		2.993427	
5	2	10	78.6	1848		4.141568	
6	1	10	65			4.299209	
7	3	10	92.6	1760	1113	5.001314	
8	1	10	85.2			5.734762	
9	2	10	99.5	1575		6.445272	
10	2	10	63.1	1536		7.671108	
11	2	10	92.3	1623		8.425531	
12	1	10	54.8			9.084938	
13	2	10	52.5	1609		9.438762	
14	2	10	66.2	1699		9.930522	
15	2	10	83.5	1567		10.648511	
16	1	10	73.9			11.775749	

Bin5 Statistics 24

Trial #	Pulse	Chirp (MHz)	Pulse Width (µS)	Pulse 1-2 spacing (µS)	Pulse 2-3 spacing (µS)	Pulse Start(S)	Detection (1:yes; 0:no)
0	1	9	58.6			0.038454	1
1	2	9	86.1	1961		0.880842	
2	1	9	50.8			1.82794	
3	2	9	87.7	1999		2.201513	
4	1	9	75.8			3.160111	
5	2	9	72.7	1320		3.494227	
6	2	9	62.7	1152		4.547585	
7	3	9	62.3	1564	1690	5.001738	
8	2	9	88.9	1807		5.337511	
9	1	9	91.1			6.644026	
10	2	9	65.1	1891		6.8058	
11	3	9	52.2	1846	1534	7.566884	
12	3	9	96.3	1258	1001	8.200621	
13	2	9	92.3	1952		9.112318	
14	2	9	98.6	1906		9.656059	
15	2	9	82	1263		10.345642	
16	1	9	77.4			11.14162	
17	2	9	99.2	1931		11.947281	

Bin5 Statistics 25

Trial #	Pulse	Chirp (MHz)	Pulse Width (µS)	Pulse 1-2 spacing (µS)	Pulse 2-3 spacing (µS)	Pulse Start(S)	Detection (1:yes; 0:no)
0	3	9	89	1445	1187	0.543871	1
1	2	9	77.4	1041		1.098198	
2	2	9	66.2	1279		1.800916	
3	2	9	70.3	1277		2.741121	
4	2	9	58.9	1544		3.069885	
5	2	9	72	1595		4.128797	
6	2	9	75.3	1065		4.735522	
7	2	9	96.2	1186		5.156124	
8	1	9	77.8			6.213324	
9	1	9	57.4			6.727288	
10	1	9	89			7.18453	
11	3	9	87.8	1445	1840	8.376645	
12	2	9	63.6	1084		8.744511	
13	1	9	71.2			9.31221	
14	3	9	54.8	1330	1692	10.261112	
15	2	9	74.6	1501		11.126579	
16	1	9	97.8			11.993592	

Bin5 Statistics 26

Trial #	Pulse	Chirp (MHz)	Pulse Width (µS)	Pulse 1-2 spacing (µS)	Pulse 2-3 spacing (µS)	Pulse Start(S)	Detection (1:yes; 0:no)
0	1	14	64.5			0.094955	1
1	3	14	61.6	1226	1550	1.215104	
2	1	14	56.3			1.695795	
3	3	14	94.4	1485	1644	2.641987	
4	1	14	79.6			3.522617	
5	2	14	72.7	1900		3.976375	
6	3	14	80	1337	1488	4.922155	
7	2	14	75.1	1011		5.197728	
8	3	14	74.8	1056	1904	5.992768	
9	3	14	55.2	1756	1289	7.001342	
10	2	14	81.8	1394		7.528595	
11	3	14	68.1	1576	1470	8.447348	
12	2	14	84.2	1653		9.019091	
13	2	14	96.5	1776		9.873272	
14	3	14	79.4	1338	1542	9.954779	
15	3	14	84.4	1470	1675	10.737263	
16	1	14	62.5			11.507294	

Bin5 Statistics 27

Trial #	Pulse	Chirp (MHz)	Pulse Width (uS)	Pulse 1-2 spacing (uS)	Pulse 2-3 spacing (uS)	Pulse Start(S)	Detection (1:yes; 0:no)
0	2	13	53.5	1105		0.510795	1
1	3	13	65.7	1541	1022	1.863916	
2	3	13	95.2	1478	1743	4.072529	
3	3	13	74	1205	1658	4.850028	
4	2	13	60.5	1035		7.224229	
5	1	13	50.9			8.132615	
6	3	13	74.3	1079	1186	9.759628	
7	2	13	91.9	1028		10.9987	

Bin5 Statistics 28

Trial #	Pulse	Chirp (MHz)	Pulse Width (uS)	Pulse 1-2 spacing (uS)	Pulse 2-3 spacing (uS)	Pulse Start(S)	Detection (1:yes; 0:no)
0	2	11	99.2	1683		0.339801	1
1	3	11	70.4	1961	1494	1.422015	
2	1	11	74.6			2.126777	
3	2	11	95.8	1263		2.351218	
4	1	11	86.6			3.227744	
5	2	11	75.3	1576		4.079951	
6	1	11	55.5			4.679384	
7	1	11	84.6			5.724856	
8	3	11	57.4	1562	1149	6.247916	
9	2	11	99.2	1031		7.456887	
10	3	11	73	1896	1626	7.764838	
11	3	11	72.8	1295	1361	8.970783	
12	3	11	95	1243	1882	9.384932	
13	3	11	81.1	1265	1651	10.362597	
14	2	11	80.4	1329		10.99623	
15	2	11	57.4	1037		11.454342	

Bin5 Statistics 29

Trial #	Pulse	Chirp (MHz)	Pulse Width (µS)	Pulse 1-2 spacing (µS)	Pulse 2-3 spacing (µS)	Pulse Start(S)	Detection (1:yes; 0:no)
0	1	14	78.7			0.553787	1
1	2	14	73.9	1905		1.777642	
2	1	14	70.1			2.363303	
3	2	14	55.2	1061		3.816385	
4	2	14	52.3	1740		4.463867	
5	3	14	87.6	1154	1161	5.244174	
6	1	14	52			6.527394	
7	3	14	62.3	1499	1527	7.111105	
8	1	14	87			8.977569	
9	2	14	98.8	1809		9.166271	
10	1	14	79.9			10.507865	
11	2	14	56.6	1799		11.954214	

Bin5 Statistics 30

Trial #	Pulse	Chirp (MHz)	Pulse Width (µS)	Pulse 1-2 spacing (µS)	Pulse 2-3 spacing (µS)	Pulse Start(S)	Detection (1:yes; 0:no)
0	1	5	51.7			0.232259	1
1	2	5	74.1	1708		1.321152	
2	1	5	52			3.205748	
3	2	5	67.5	1082		4.725264	
4	3	5	78.5	1886	1984	4.904604	
5	1	5	57.8			6.354809	
6	2	5	55.8	1965		7.227263	
7	3	5	85.5	1467	1358	8.433223	
8	2	5	91.1	1334		9.887434	
9	2	5	69	1549		11.738814	

Table-6 Radar Type 6 Statistical Performance

Trial #	Fc (MHz)	Pulse /Burst	Pulse Width (µS)	PRI (µs)	Detection (1:yes; 0:no)	Hopping Sequence
1	5270	9	1	333	1	5356.0, 5373.0, 5575.0, 5499.0, 5548.0, 5534.0, 5331.0, 5546.0, 5490.0, 5335.0, 5293.0, 5285.0, 5636.0, 5407.0, 5304.0, 5383.0, 5668.0, 5266.0, 5541.0, 5584.0, 5519.0, 5420.0, 5718.0, 5594.0, 5574.0, 5517.0, 5362.0, 5332.0, 5394.0, 5390.0, 5319.0, 5472.0, 5369.0, 5348.0, 5526.0, 5397.0, 5416.0, 5269.0, 5624.0, 5272.0, 5436.0, 5587.0, 5368.0, 5604.0, 5402.0, 5592.0, 5301.0, 5376.0, 5435.0, 5495.0, 5633.0, 5676.0, 5508.0, 5667.0, 5537.0, 5338.0, 5696.0, 5330.0, 5531.0, 5391.0, 5512.0, 5487.0, 5347.0, 5431.0, 5349.0, 5697.0, 5434.0, 5670.0, 5528.0, 5303.0, 5530.0, 5305.0, 5328.0, 5251.0, 5706.0, 5581.0, 5283.0, 5538.0, 5396.0, 5601.0, 5350.0, 5453.0, 5341.0, 5258.0, 5398.0, 5378.0, 5387.0, 5611.0, 5440.0, 5256.0, 5539.0, 5380.0, 5711.0, 5327.0, 5586.0, 5631.0, 5260.0, 5280.0, 5489.0, 5588.0 (number of hits: 10)
2	5270	9	1	333	1	5589.0, 5307.0, 5514.0, 5317.0, 5407.0, 5653.0, 5570.0, 5418.0, 5680.0, 5668.0, 5399.0, 5432.0, 5375.0, 5606.0, 5721.0, 5369.0, 5715.0, 5698.0, 5319.0, 5449.0, 5569.0, 5305.0, 5271.0, 5420.0, 5701.0, 5691.0, 5361.0, 5340.0, 5575.0, 5315.0, 5383.0, 5696.0, 5713.0, 5456.0, 5256.0, 5488.0, 5649.0, 5264.0, 5348.0, 5654.0, 5260.0, 5463.0, 5523.0, 5689.0, 5336.0, 5461.0, 5326.0, 5671.0, 5427.0, 5355.0, 5633.0, 5651.0, 5301.0, 5526.0, 5270.0, 5489.0, 5472.0, 5611.0, 5486.0, 5294.0, 5511.0, 5261.0, 5617.0, 5273.0, 5350.0, 5508.0, 5683.0, 5298.0, 5258.0, 5634.0, 5405.0, 5359.0, 5393.0, 5267.0, 5693.0, 5699.0, 5568.0, 5484.0, 5559.0, 5443.0, 5345.0, 5410.0, 5491.0, 5487.0, 5705.0, 5681.0, 5289.0, 5655.0, 5706.0, 5363.0, 5635.0, 5601.0, 5391.0, 5682.0, 5471.0, 5304.0, 5621.0, 5608.0, 5502.0, 5620.0 (number of hits: 10)
3	5270	9	1	333	1	5630.0, 5660.0, 5252.0, 5280.0, 5532.0, 5522.0, 5648.0, 5659.0, 5470.0, 5541.0, 5556.0, 5513.0, 5717.0, 5386.0, 5433.0, 5408.0, 5429.0, 5294.0, 5679.0, 5521.0, 5663.0, 5524.0, 5383.0, 5589.0, 5334.0, 5570.0, 5677.0, 5395.0, 5451.0, 5710.0, 5573.0, 5443.0, 5333.0, 5704.0, 5687.0, 5621.0, 5674.0, 5432.0, 5314.0, 5304.0, 5518.0, 5412.0, 5302.0, 5490.0, 5437.0, 5611.0, 5606.0, 5384.0, 5289.0, 5345.0, 5359.0, 5695.0, 5707.0, 5323.0, 5376.0, 5583.0, 5364.0, 5647.0, 5683.0, 5523.0, 5331.0, 5426.0, 5368.0, 5675.0, 5431.0, 5339.0, 5525.0, 5445.0, 5654.0, 5271.0,

						5347.0, 5310.0, 5346.0, 5416.0, 5327.0, 5533.0, 5392.0, 5360.0, 5565.0, 5676.0, 5635.0, 5504.0, 5602.0, 5693.0, 5397.0, 5566.0, 5407.0, 5439.0, 5664.0, 5286.0, 5629.0, 5326.0, 5722.0, 5385.0, 5258.0, 5322.0, 5572.0, 5510.0, 5643.0, 5387.0 (number of hits: 6)
4	5270	9	1	333	1	5677.0, 5698.0, 5508.0, 5383.0, 5584.0, 5420.0, 5627.0, 5531.0, 5427.0, 5498.0, 5311.0, 5354.0, 5419.0, 5701.0, 5412.0, 5706.0, 5645.0, 5675.0, 5289.0, 5464.0, 5614.0, 5554.0, 5548.0, 5550.0, 5308.0, 5612.0, 5255.0, 5524.0, 5490.0, 5344.0, 5334.0, 5720.0, 5661.0, 5416.0, 5356.0, 5327.0, 5639.0, 5377.0, 5555.0, 5276.0, 5616.0, 5407.0, 5414.0, 5424.0, 5457.0, 5551.0, 5373.0, 5651.0, 5545.0, 5418.0, 5313.0, 5451.0, 5516.0, 5559.0, 5397.0, 5507.0, 5338.0, 5592.0, 5520.0, 5405.0, 5649.0, 5435.0, 5363.0, 5697.0, 5694.0, 5483.0, 5595.0, 5688.0, 5604.0, 5540.0, 5571.0, 5453.0, 5361.0, 5426.0, 5588.0, 5260.0, 5353.0, 5396.0, 5672.0, 5669.0, 5560.0, 5402.0, 5261.0, 5488.0, 5254.0, 5307.0, 5475.0, 5582.0, 5659.0, 5681.0, 5593.0, 5472.0, 5366.0, 5658.0, 5613.0, 5575.0, 5687.0, 5349.0, 5288.0, 5388.0 (number of hits: 7)
5	5270	9	1	333	1	5384.0, 5499.0, 5541.0, 5483.0, 5436.0, 5648.0, 5553.0, 5351.0, 5348.0, 5417.0, 5284.0, 5298.0, 5518.0, 5334.0, 5636.0, 5357.0, 5547.0, 5509.0, 5292.0, 5336.0, 5599.0, 5346.0, 5618.0, 5482.0, 5577.0, 5673.0, 5606.0, 5645.0, 5574.0, 5513.0, 5706.0, 5644.0, 5283.0, 5338.0, 5634.0, 5312.0, 5322.0, 5305.0, 5252.0, 5392.0, 5411.0, 5445.0, 5477.0, 5641.0, 5662.0, 5439.0, 5451.0, 5578.0, 5653.0, 5362.0, 5505.0, 5687.0, 5403.0, 5562.0, 5339.0, 5516.0, 5367.0, 5485.0, 5474.0, 5416.0, 5594.0, 5598.0, 5342.0, 5313.0, 5373.0, 5639.0, 5455.0, 5407.0, 5333.0, 5501.0, 5379.0, 5415.0, 5514.0, 5704.0, 5658.0, 5290.0, 5613.0, 5631.0, 5256.0, 5701.0, 5512.0, 5389.0, 5430.0, 5677.0, 5712.0, 5466.0, 5289.0, 5461.0, 5365.0, 5378.0, 5307.0, 5628.0, 5588.0, 5294.0, 5370.0, 5295.0, 5538.0, 5453.0, 5714.0, 5678.0 (number of hits: 5)
6	5270	9	1	333	1	5708.0, 5283.0, 5466.0, 5667.0, 5685.0, 5696.0, 5599.0, 5286.0, 5439.0, 5378.0, 5307.0, 5433.0, 5387.0, 5349.0, 5556.0, 5577.0, 5376.0, 5543.0, 5422.0, 5639.0, 5391.0, 5258.0, 5580.0, 5313.0, 5310.0, 5692.0, 5420.0, 5544.0, 5488.0, 5315.0, 5298.0, 5507.0, 5397.0, 5542.0, 5579.0, 5445.0, 5443.0, 5329.0, 5656.0, 5619.0, 5588.0, 5679.0, 5373.0, 5534.0, 5442.0, 5519.0, 5659.0, 5284.0, 5411.0, 5546.0, 5476.0, 5721.0, 5301.0, 5617.0, 5352.0, 5680.0, 5552.0, 5371.0, 5535.0, 5309.0

						5653.0, 5545.0, 5424.0, 5332.0, 5562.0, 5328.0, 5596.0, 5618.0, 5698.0, 5493.0, 5500.0, 5447.0, 5314.0, 5681.0, 5295.0, 5496.0, 5455.0, 5528.0, 5625.0, 5270.0, 5553.0, 5499.0, 5690.0, 5701.0, 5487.0, 5645.0, 5567.0, 5555.0, 5481.0, 5382.0, 5584.0, 5431.0, 5440.0, 5489.0, 5320.0, 5572.0, 5524.0, 5614.0, 5686.0, 5636.0 (number of hits: 5)
7	5270	9	1	333	1	5350.0, 5647.0, 5678.0, 5513.0, 5272.0, 5515.0, 5254.0, 5306.0, 5603.0, 5446.0, 5458.0, 5283.0, 5453.0, 5632.0, 5345.0, 5576.0, 5586.0, 5358.0, 5328.0, 5419.0, 5362.0, 5636.0, 5484.0, 5610.0, 5681.0, 5367.0, 5550.0, 5312.0, 5716.0, 5388.0, 5656.0, 5493.0, 5465.0, 5546.0, 5685.0, 5308.0, 5612.0, 5664.0, 5641.0, 5315.0, 5595.0, 5709.0, 5459.0, 5569.0, 5544.0, 5276.0, 5338.0, 5343.0, 5253.0, 5329.0, 5443.0, 5294.0, 5471.0, 5311.0, 5364.0, 5322.0, 5326.0, 5437.0, 5631.0, 5705.0, 5436.0, 5331.0, 5423.0, 5485.0, 5304.0, 5440.0, 5487.0, 5297.0, 5554.0, 5660.0, 5717.0, 5497.0, 5473.0, 5468.0, 5613.0, 5508.0, 5464.0, 5413.0, 5527.0, 5289.0, 5596.0, 5470.0, 5299.0, 5330.0, 5500.0, 5265.0, 5262.0, 5674.0, 5457.0, 5510.0, 5533.0, 5670.0, 5521.0, 5372.0, 5438.0, 5366.0, 5598.0, 5628.0, 5361.0, 5679.0 (number of hits: 8)
8	5270	9	1	333	1	5332.0, 5635.0, 5605.0, 5263.0, 5345.0, 5465.0, 5362.0, 5428.0, 5709.0, 5313.0, 5590.0, 5646.0, 5298.0, 5303.0, 5633.0, 5556.0, 5268.0, 5275.0, 5544.0, 5526.0, 5378.0, 5433.0, 5502.0, 5410.0, 5660.0, 5277.0, 5418.0, 5653.0, 5546.0, 5251.0, 5483.0, 5588.0, 5451.0, 5624.0, 5696.0, 5434.0, 5358.0, 5503.0, 5657.0, 5381.0, 5700.0, 5584.0, 5445.0, 5497.0, 5636.0, 5348.0, 5284.0, 5423.0, 5403.0, 5280.0, 5494.0, 5294.0, 5308.0, 5570.0, 5472.0, 5721.0, 5719.0, 5661.0, 5698.0, 5484.0, 5496.0, 5523.0, 5594.0, 5587.0, 5390.0, 5401.0, 5415.0, 5479.0, 5631.0, 5477.0, 5670.0, 5424.0, 5307.0, 5573.0, 5382.0, 5400.0, 5576.0, 5600.0, 5563.0, 5543.0, 5713.0, 5514.0, 5416.0, 5420.0, 5550.0, 5427.0, 5632.0, 5677.0, 5610.0, 5527.0, 5411.0, 5530.0, 5486.0, 5438.0, 5566.0, 5290.0, 5372.0, 5555.0, 5252.0, 5457.0 (number of hits: 8)
9	5270	9	1	333	1	5511.0, 5445.0, 5373.0, 5573.0, 5629.0, 5494.0, 5463.0, 5335.0, 5404.0, 5267.0, 5272.0, 5339.0, 5584.0, 5530.0, 5503.0, 5655.0, 5290.0, 5646.0, 5640.0, 5583.0, 5293.0, 5497.0, 5327.0, 5391.0, 5581.0, 5632.0, 5722.0, 5653.0, 5428.0, 5319.0, 5707.0, 5475.0, 5666.0, 5374.0, 5700.0, 5447.0, 5299.0, 5621.0, 5671.0, 5590.0, 5543.0, 5460.0, 5454.0, 5504.0, 5252.0, 5627.0, 5474.0, 5338.0, 5585.0, 5565.0,

						5304.0, 5453.0, 5547.0, 5673.0, 5641.0, 5617.0, 5682.0, 5436.0, 5468.0, 5572.0, 5324.0, 5257.0, 5635.0, 5605.0, 5712.0, 5412.0, 5287.0, 5355.0, 5587.0, 5487.0, 5519.0, 5542.0, 5443.0, 5371.0, 5523.0, 5593.0, 5642.0, 5631.0, 5532.0, 5260.0, 5597.0, 5423.0, 5714.0, 5562.0, 5491.0, 5359.0, 5492.0, 5416.0, 5282.0, 5507.0, 5389.0, 5283.0, 5702.0, 5706.0, 5410.0, 5637.0, 5328.0, 5550.0, 5300.0, 5560.0 (number of hits: 8)
10	5270	9	1	333	1	5580.0, 5581.0, 5604.0, 5419.0, 5445.0, 5613.0, 5692.0, 5355.0, 5584.0, 5369.0, 5566.0, 5689.0, 5640.0, 5558.0, 5631.0, 5413.0, 5716.0, 5538.0, 5522.0, 5557.0, 5661.0, 5430.0, 5423.0, 5676.0, 5524.0, 5588.0, 5502.0, 5533.0, 5669.0, 5489.0, 5252.0, 5647.0, 5707.0, 5619.0, 5547.0, 5455.0, 5570.0, 5269.0, 5263.0, 5312.0, 5421.0, 5270.0, 5376.0, 5359.0, 5347.0, 5507.0, 5305.0, 5560.0, 5690.0, 5700.0, 5344.0, 5609.0, 5457.0, 5659.0, 5548.0, 5608.0, 5543.0, 5490.0, 5665.0, 5348.0, 5418.0, 5280.0, 5679.0, 5279.0, 5284.0, 5643.0, 5601.0, 5364.0, 5652.0, 5372.0, 5330.0, 5633.0, 5277.0, 5254.0, 5554.0, 5444.0, 5710.0, 5292.0, 5693.0, 5294.0, 5594.0, 5397.0, 5695.0, 5500.0, 5446.0, 5612.0, 5674.0, 5386.0, 5282.0, 5427.0, 5563.0, 5341.0, 5473.0, 5293.0, 5606.0, 5681.0, 5585.0, 5398.0, 5678.0, 5345.0 (number of hits: 10)
11	5270	9	1	333	1	5494.0, 5563.0, 5514.0, 5426.0, 5627.0, 5415.0, 5682.0, 5686.0, 5409.0, 5709.0, 5565.0, 5672.0, 5509.0, 5264.0, 5392.0, 5702.0, 5492.0, 5624.0, 5339.0, 5576.0, 5313.0, 5408.0, 5288.0, 5441.0, 5681.0, 5347.0, 5370.0, 5420.0, 5300.0, 5448.0, 5407.0, 5493.0, 5484.0, 5265.0, 5321.0, 5475.0, 5327.0, 5589.0, 5695.0, 5629.0, 5315.0, 5466.0, 5724.0, 5706.0, 5323.0, 5395.0, 5649.0, 5663.0, 5386.0, 5465.0, 5278.0, 5593.0, 5697.0, 5418.0, 5499.0, 5479.0, 5381.0, 5716.0, 5612.0, 5470.0, 5306.0, 5337.0, 5566.0, 5467.0, 5447.0, 5721.0, 5477.0, 5511.0, 5516.0, 5279.0, 5462.0, 5364.0, 5331.0, 5548.0, 5671.0, 5355.0, 5444.0, 5292.0, 5577.0, 5712.0, 5519.0, 5354.0, 5626.0, 5562.0, 5483.0, 5574.0, 5579.0, 5711.0, 5390.0, 5344.0, 5556.0, 5362.0, 5480.0, 5417.0, 5350.0, 5458.0, 5555.0, 5383.0, 5273.0, 5604.0 (number of hits: 2)
12	5270	9	1	333	1	5480.0, 5481.0, 5574.0, 5569.0, 5567.0, 5722.0, 5460.0, 5317.0, 5336.0, 5721.0, 5502.0, 5289.0, 5578.0, 5694.0, 5382.0, 5679.0, 5612.0, 5470.0, 5636.0, 5476.0, 5405.0, 5591.0, 5683.0, 5275.0, 5259.0, 5320.0, 5448.0, 5393.0, 5332.0, 5627.0, 5651.0, 5579.0, 5671.0, 5424.0, 5548.0, 5674.0, 5290.0, 5349.0, 5451.0, 5461.0,

						5556.0, 5697.0, 5262.0, 5430.0, 5663.0, 5644.0, 5496.0, 5533.0, 5659.0, 5459.0, 5527.0, 5387.0, 5335.0, 5538.0, 5641.0, 5623.0, 5306.0, 5457.0, 5618.0, 5571.0, 5455.0, 5655.0, 5447.0, 5515.0, 5511.0, 5680.0, 5355.0, 5376.0, 5396.0, 5589.0, 5707.0, 5323.0, 5486.0, 5283.0, 5508.0, 5315.0, 5632.0, 5521.0, 5272.0, 5348.0, 5365.0, 5479.0, 5345.0, 5507.0, 5310.0, 5357.0, 5373.0, 5446.0, 5667.0, 5530.0, 5369.0, 5276.0, 5516.0, 5277.0, 5584.0, 5590.0, 5523.0, 5518.0, 5279.0, 5489.0 (number of hits: 2)
13	5270	9	1	333	1	5652.0, 5328.0, 5644.0, 5723.0, 5620.0, 5666.0, 5446.0, 5561.0, 5311.0, 5622.0, 5350.0, 5716.0, 5498.0, 5410.0, 5365.0, 5493.0, 5318.0, 5522.0, 5653.0, 5541.0, 5651.0, 5386.0, 5302.0, 5252.0, 5554.0, 5514.0, 5342.0, 5526.0, 5700.0, 5684.0, 5553.0, 5348.0, 5562.0, 5424.0, 5650.0, 5439.0, 5551.0, 5506.0, 5565.0, 5265.0, 5436.0, 5552.0, 5488.0, 5489.0, 5657.0, 5707.0, 5582.0, 5432.0, 5364.0, 5533.0, 5638.0, 5664.0, 5587.0, 5673.0, 5713.0, 5462.0, 5556.0, 5291.0, 5419.0, 5502.0, 5359.0, 5273.0, 5612.0, 5598.0, 5297.0, 5456.0, 5524.0, 5406.0, 5629.0, 5599.0, 5702.0, 5294.0, 5433.0, 5617.0, 5287.0, 5689.0, 5606.0, 5368.0, 5542.0, 5634.0, 5343.0, 5611.0, 5566.0, 5519.0, 5573.0, 5476.0, 5315.0, 5710.0, 5403.0, 5570.0, 5399.0, 5630.0, 5472.0, 5396.0, 5628.0, 5437.0, 5284.0, 5592.0, 5418.0, 5615.0 (number of hits: 2)
14	5270	9	1	333	1	5456.0, 5719.0, 5253.0, 5281.0, 5466.0, 5581.0, 5277.0, 5525.0, 5364.0, 5652.0, 5329.0, 5458.0, 5503.0, 5702.0, 5676.0, 5269.0, 5353.0, 5641.0, 5453.0, 5263.0, 5665.0, 5520.0, 5449.0, 5488.0, 5625.0, 5417.0, 5557.0, 5470.0, 5568.0, 5552.0, 5559.0, 5362.0, 5307.0, 5573.0, 5264.0, 5672.0, 5629.0, 5558.0, 5373.0, 5457.0, 5571.0, 5596.0, 5507.0, 5693.0, 5342.0, 5451.0, 5377.0, 5279.0, 5459.0, 5660.0, 5268.0, 5670.0, 5323.0, 5423.0, 5547.0, 5371.0, 5655.0, 5657.0, 5674.0, 5700.0, 5287.0, 5260.0, 5408.0, 5600.0, 5437.0, 5490.0, 5685.0, 5614.0, 5363.0, 5499.0, 5619.0, 5327.0, 5275.0, 5713.0, 5316.0, 5401.0, 5723.0, 5295.0, 5606.0, 5529.0, 5271.0, 5605.0, 5611.0, 5396.0, 5374.0, 5594.0, 5550.0, 5697.0, 5551.0, 5409.0, 5398.0, 5436.0, 5524.0, 5597.0, 5404.0, 5282.0, 5311.0, 5395.0, 5483.0, 5369.0 (number of hits: 6)
15	5270	9	1	333	1	5575.0, 5556.0, 5436.0, 5540.0, 5474.0, 5324.0, 5651.0, 5654.0, 5592.0, 5319.0, 5494.0, 5689.0, 5423.0, 5701.0, 5517.0, 5255.0, 5377.0, 5563.0, 5573.0, 5263.0, 5537.0, 5706.0, 5276.0, 5695.0, 5297.0, 5350.0, 5484.0, 5386.0, 5582.0, 5574.0,

						5387.0, 5480.0, 5305.0, 5560.0, 5627.0, 5661.0, 5388.0, 5363.0, 5476.0, 5302.0, 5415.0, 5550.0, 5720.0, 5446.0, 5346.0, 5294.0, 5333.0, 5361.0, 5483.0, 5409.0, 5293.0, 5568.0, 5587.0, 5322.0, 5470.0, 5325.0, 5335.0, 5369.0, 5640.0, 5713.0, 5447.0, 5340.0, 5303.0, 5300.0, 5649.0, 5585.0, 5469.0, 5296.0, 5667.0, 5626.0, 5520.0, 5655.0, 5593.0, 5523.0, 5547.0, 5473.0, 5644.0, 5408.0, 5612.0, 5404.0, 5723.0, 5683.0, 5663.0, 5516.0, 5608.0, 5553.0, 5552.0, 5403.0, 5581.0, 5536.0, 5507.0, 5330.0, 5439.0, 5576.0, 5545.0, 5595.0, 5315.0, 5359.0, 5374.0, 5619.0 (number of hits: 2)
16	5270	9	1	333	1	5329.0, 5664.0, 5309.0, 5384.0, 5568.0, 5700.0, 5530.0, 5505.0, 5623.0, 5604.0, 5313.0, 5324.0, 5433.0, 5286.0, 5414.0, 5684.0, 5282.0, 5342.0, 5383.0, 5706.0, 5460.0, 5480.0, 5601.0, 5372.0, 5364.0, 5477.0, 5644.0, 5447.0, 5314.0, 5695.0, 5654.0, 5305.0, 5715.0, 5288.0, 5332.0, 5317.0, 5307.0, 5278.0, 5548.0, 5586.0, 5382.0, 5304.0, 5269.0, 5600.0, 5369.0, 5443.0, 5541.0, 5712.0, 5720.0, 5412.0, 5689.0, 5694.0, 5501.0, 5407.0, 5638.0, 5503.0, 5680.0, 5476.0, 5713.0, 5421.0, 5573.0, 5360.0, 5431.0, 5259.0, 5419.0, 5532.0, 5598.0, 5499.0, 5392.0, 5328.0, 5442.0, 5703.0, 5261.0, 5254.0, 5643.0, 5411.0, 5379.0, 5553.0, 5457.0, 5296.0, 5557.0, 5510.0, 5648.0, 5613.0, 5543.0, 5612.0, 5492.0, 5343.0, 5441.0, 5518.0, 5255.0, 5427.0, 5632.0, 5529.0, 5469.0, 5490.0, 5470.0, 5451.0, 5389.0, 5630.0 (number of hits: 5)
17	5270	9	1	333	1	5503.0, 5394.0, 5521.0, 5253.0, 5400.0, 5425.0, 5506.0, 5604.0, 5393.0, 5417.0, 5683.0, 5498.0, 5512.0, 5465.0, 5495.0, 5677.0, 5613.0, 5279.0, 5583.0, 5549.0, 5398.0, 5490.0, 5383.0, 5584.0, 5698.0, 5494.0, 5283.0, 5359.0, 5300.0, 5718.0, 5701.0, 5260.0, 5252.0, 5413.0, 5422.0, 5484.0, 5510.0, 5477.0, 5488.0, 5655.0, 5632.0, 5590.0, 5474.0, 5562.0, 5296.0, 5717.0, 5645.0, 5266.0, 5631.0, 5581.0, 5544.0, 5367.0, 5664.0, 5319.0, 5323.0, 5714.0, 5623.0, 5593.0, 5332.0, 5692.0, 5656.0, 5700.0, 5442.0, 5318.0, 5415.0, 5486.0, 5373.0, 5353.0, 5321.0, 5348.0, 5436.0, 5435.0, 5445.0, 5628.0, 5265.0, 5722.0, 5457.0, 5662.0, 5704.0, 5307.0, 5476.0, 5273.0, 5388.0, 5482.0, 5588.0, 5365.0, 5643.0, 5696.0, 5493.0, 5304.0, 5663.0, 5565.0, 5624.0, 5287.0, 5500.0, 5456.0, 5608.0, 5556.0, 5487.0, 5371.0 (number of hits: 5)
18	5270	9	1	333	1	5641.0, 5499.0, 5324.0, 5646.0, 5556.0, 5643.0, 5480.0, 5509.0, 5445.0, 5283.0, 5561.0, 5654.0, 5443.0, 5479.0, 5274.0, 5455.0, 5523.0, 5295.0, 5444.0, 5368.0,

						5433.0, 5464.0, 5378.0, 5550.0, 5621.0, 5688.0, 5626.0, 5612.0, 5264.0, 5301.0, 5590.0, 5425.0, 5554.0, 5530.0, 5505.0, 5279.0, 5396.0, 5592.0, 5251.0, 5255.0, 5387.0, 5526.0, 5651.0, 5555.0, 5379.0, 5709.0, 5342.0, 5655.0, 5563.0, 5362.0, 5660.0, 5711.0, 5268.0, 5325.0, 5319.0, 5656.0, 5321.0, 5441.0, 5676.0, 5304.0, 5297.0, 5408.0, 5684.0, 5453.0, 5622.0, 5579.0, 5496.0, 5589.0, 5432.0, 5557.0, 5381.0, 5659.0, 5470.0, 5559.0, 5449.0, 5287.0, 5535.0, 5539.0, 5600.0, 5636.0, 5524.0, 5669.0, 5613.0, 5634.0, 5603.0, 5478.0, 5549.0, 5586.0, 5678.0, 5435.0, 5411.0, 5694.0, 5296.0, 5358.0, 5633.0, 5662.0, 5519.0, 5256.0, 5664.0, 5620.0 (number of hits: 5)
19	5270	9	1	333	1	5385.0, 5632.0, 5285.0, 5706.0, 5601.0, 5271.0, 5366.0, 5682.0, 5415.0, 5292.0, 5374.0, 5560.0, 5392.0, 5496.0, 5375.0, 5502.0, 5613.0, 5456.0, 5508.0, 5543.0, 5269.0, 5445.0, 5351.0, 5470.0, 5717.0, 5664.0, 5525.0, 5722.0, 5699.0, 5623.0, 5300.0, 5559.0, 5646.0, 5422.0, 5641.0, 5631.0, 5293.0, 5296.0, 5698.0, 5642.0, 5318.0, 5511.0, 5497.0, 5595.0, 5393.0, 5649.0, 5447.0, 5367.0, 5683.0, 5443.0, 5563.0, 5349.0, 5504.0, 5602.0, 5459.0, 5666.0, 5629.0, 5337.0, 5323.0, 5542.0, 5535.0, 5412.0, 5493.0, 5298.0, 5295.0, 5430.0, 5554.0, 5457.0, 5519.0, 5262.0, 5590.0, 5273.0, 5541.0, 5406.0, 5597.0, 5486.0, 5471.0, 5721.0, 5290.0, 5344.0, 5578.0, 5263.0, 5436.0, 5667.0, 5635.0, 5512.0, 5673.0, 5483.0, 5672.0, 5270.0, 5352.0, 5437.0, 5607.0, 5584.0, 5645.0, 5418.0, 5609.0, 5253.0, 5665.0, 5694.0 (number of hits: 4)
20	5270	9	1	333	1	5290.0, 5468.0, 5510.0, 5284.0, 5276.0, 5382.0, 5423.0, 5460.0, 5331.0, 5296.0, 5432.0, 5701.0, 5712.0, 5615.0, 5362.0, 5436.0, 5671.0, 5594.0, 5424.0, 5417.0, 5535.0, 5437.0, 5352.0, 5548.0, 5550.0, 5308.0, 5325.0, 5514.0, 5711.0, 5509.0, 5522.0, 5628.0, 5255.0, 5527.0, 5611.0, 5673.0, 5338.0, 5687.0, 5556.0, 5580.0, 5456.0, 5418.0, 5685.0, 5586.0, 5705.0, 5710.0, 5663.0, 5270.0, 5438.0, 5707.0, 5307.0, 5348.0, 5367.0, 5356.0, 5323.0, 5560.0, 5596.0, 5427.0, 5645.0, 5483.0, 5579.0, 5617.0, 5721.0, 5648.0, 5490.0, 5713.0, 5455.0, 5415.0, 5320.0, 5647.0, 5379.0, 5396.0, 5504.0, 5655.0, 5279.0, 5632.0, 5414.0, 5668.0, 5702.0, 5651.0, 5358.0, 5590.0, 5397.0, 5604.0, 5467.0, 5627.0, 5475.0, 5271.0, 5345.0, 5469.0, 5342.0, 5558.0, 5718.0, 5600.0, 5677.0, 5410.0, 5440.0, 5698.0, 5489.0, 5575.0 (number of hits: 1)
21	5270	9	1	333	1	5598.0, 5346.0, 5391.0, 5272.0, 5612.0, 5673.0, 5556.0, 5467.0, 5696.0, 5623.0,

						5364.0, 5327.0, 5333.0, 5435.0, 5334.0, 5508.0, 5310.0, 5309.0, 5554.0, 5355.0, 5469.0, 5374.0, 5288.0, 5539.0, 5699.0, 5269.0, 5530.0, 5407.0, 5681.0, 5427.0, 5665.0, 5300.0, 5363.0, 5703.0, 5366.0, 5616.0, 5627.0, 5408.0, 5472.0, 5666.0, 5440.0, 5405.0, 5357.0, 5541.0, 5399.0, 5713.0, 5684.0, 5347.0, 5389.0, 5441.0, 5719.0, 5253.0, 5482.0, 5342.0, 5292.0, 5378.0, 5294.0, 5436.0, 5661.0, 5631.0, 5686.0, 5318.0, 5370.0, 5431.0, 5504.0, 5683.0, 5505.0, 5561.0, 5502.0, 5365.0, 5298.0, 5352.0, 5377.0, 5457.0, 5337.0, 5587.0, 5720.0, 5451.0, 5362.0, 5311.0, 5323.0, 5516.0, 5723.0, 5695.0, 5396.0, 5697.0, 5677.0, 5341.0, 5371.0, 5456.0, 5626.0, 5492.0, 5463.0, 5414.0, 5353.0, 5282.0, 5372.0, 5640.0, 5488.0, 5400.0 (number of hits: 8)
22	5270	9	1	333	1	5311.0, 5492.0, 5291.0, 5632.0, 5327.0, 5523.0, 5324.0, 5344.0, 5399.0, 5615.0, 5668.0, 5269.0, 5720.0, 5413.0, 5424.0, 5345.0, 5515.0, 5312.0, 5648.0, 5273.0, 5722.0, 5543.0, 5596.0, 5448.0, 5710.0, 5402.0, 5265.0, 5587.0, 5409.0, 5446.0, 5347.0, 5690.0, 5253.0, 5703.0, 5602.0, 5287.0, 5466.0, 5450.0, 5697.0, 5375.0, 5350.0, 5393.0, 5586.0, 5689.0, 5328.0, 5487.0, 5695.0, 5271.0, 5588.0, 5366.0, 5301.0, 5411.0, 5412.0, 5700.0, 5275.0, 5432.0, 5431.0, 5593.0, 5313.0, 5547.0, 5550.0, 5716.0, 5514.0, 5583.0, 5592.0, 5507.0, 5426.0, 5386.0, 5481.0, 5511.0, 5320.0, 5251.0, 5553.0, 5449.0, 5378.0, 5419.0, 5574.0, 5563.0, 5651.0, 5280.0, 5467.0, 5362.0, 5505.0, 5331.0, 5499.0, 5405.0, 5458.0, 5385.0, 5560.0, 5566.0, 5557.0, 5513.0, 5398.0, 5323.0, 5363.0, 5263.0, 5268.0, 5582.0, 5368.0, 5712.0 (number of hits: 7)
23	5270	9	1	333	1	5498.0, 5291.0, 5391.0, 5491.0, 5403.0, 5282.0, 5714.0, 5374.0, 5324.0, 5457.0, 5681.0, 5677.0, 5333.0, 5468.0, 5436.0, 5394.0, 5361.0, 5595.0, 5329.0, 5428.0, 5623.0, 5419.0, 5530.0, 5510.0, 5284.0, 5497.0, 5518.0, 5610.0, 5441.0, 5617.0, 5556.0, 5343.0, 5519.0, 5668.0, 5698.0, 5382.0, 5540.0, 5651.0, 5566.0, 5422.0, 5474.0, 5569.0, 5596.0, 5650.0, 5465.0, 5648.0, 5480.0, 5418.0, 5637.0, 5467.0, 5347.0, 5632.0, 5654.0, 5533.0, 5605.0, 5301.0, 5647.0, 5612.0, 5505.0, 5424.0, 5719.0, 5397.0, 5579.0, 5260.0, 5532.0, 5550.0, 5388.0, 5630.0, 5328.0, 5704.0, 5450.0, 5670.0, 5421.0, 5693.0, 5608.0, 5449.0, 5407.0, 5307.0, 5463.0, 5665.0, 5278.0, 5606.0, 5490.0, 5542.0, 5642.0, 5318.0, 5507.0, 5312.0, 5567.0, 5354.0, 5538.0, 5631.0, 5611.0, 5386.0, 5723.0, 5493.0, 5553.0, 5494.0, 5292.0, 5662.0 (number of hits: 7)

24	5270	9	1	333	1	5375.0, 5372.0, 5629.0, 5389.0, 5638.0, 5478.0, 5336.0, 5484.0, 5316.0, 5500.0, 5337.0, 5332.0, 5378.0, 5632.0, 5311.0, 5415.0, 5522.0, 5466.0, 5641.0, 5428.0, 5548.0, 5673.0, 5421.0, 5388.0, 5264.0, 5475.0, 5426.0, 5403.0, 5584.0, 5252.0, 5590.0, 5468.0, 5497.0, 5578.0, 5371.0, 5319.0, 5644.0, 5430.0, 5447.0, 5294.0, 5298.0, 5452.0, 5439.0, 5529.0, 5364.0, 5592.0, 5531.0, 5381.0, 5407.0, 5505.0, 5623.0, 5379.0, 5401.0, 5417.0, 5481.0, 5526.0, 5495.0, 5257.0, 5536.0, 5718.0, 5541.0, 5556.0, 5425.0, 5560.0, 5465.0, 5659.0, 5682.0, 5557.0, 5660.0, 5279.0, 5587.0, 5410.0, 5278.0, 5442.0, 5250.0, 5511.0, 5347.0, 5462.0, 5400.0, 5502.0, 5419.0, 5640.0, 5406.0, 5586.0, 5380.0, 5305.0, 5620.0, 5704.0, 5686.0, 5413.0, 5333.0, 5528.0, 5684.0, 5585.0, 5624.0, 5599.0, 5282.0, 5550.0, 5283.0, 5310.0 (number of hits: 7)
25	5270	9	1	333	1	5394.0, 5339.0, 5455.0, 5624.0, 5606.0, 5605.0, 5293.0, 5555.0, 5441.0, 5640.0, 5490.0, 5294.0, 5558.0, 5699.0, 5602.0, 5327.0, 5549.0, 5702.0, 5350.0, 5588.0, 5265.0, 5596.0, 5607.0, 5271.0, 5599.0, 5694.0, 5453.0, 5689.0, 5447.0, 5450.0, 5482.0, 5707.0, 5716.0, 5712.0, 5386.0, 5539.0, 5276.0, 5693.0, 5298.0, 5504.0, 5593.0, 5576.0, 5449.0, 5511.0, 5589.0, 5559.0, 5512.0, 5376.0, 5609.0, 5600.0, 5412.0, 5630.0, 5315.0, 5362.0, 5629.0, 5385.0, 5499.0, 5509.0, 5536.0, 5391.0, 5432.0, 5364.0, 5485.0, 5657.0, 5413.0, 5326.0, 5348.0, 5595.0, 5642.0, 5574.0, 5667.0, 5598.0, 5475.0, 5443.0, 5319.0, 5562.0, 5334.0, 5723.0, 5306.0, 5269.0, 5251.0, 5283.0, 5252.0, 5314.0, 5354.0, 5700.0, 5353.0, 5292.0, 5274.0, 5543.0, 5515.0, 5545.0, 5560.0, 5417.0, 5437.0, 5611.0, 5374.0, 5341.0, 5692.0, 5534.0 (number of hits: 9)
26	5270	9	1	333	1	5345.0, 5354.0, 5494.0, 5283.0, 5503.0, 5694.0, 5361.0, 5318.0, 5408.0, 5686.0, 5306.0, 5279.0, 5695.0, 5499.0, 5621.0, 5294.0, 5720.0, 5702.0, 5677.0, 5360.0, 5324.0, 5654.0, 5532.0, 5261.0, 5560.0, 5462.0, 5396.0, 5339.0, 5611.0, 5459.0, 5700.0, 5657.0, 5646.0, 5407.0, 5480.0, 5674.0, 5297.0, 5724.0, 5315.0, 5446.0, 5512.0, 5367.0, 5292.0, 5423.0, 5529.0, 5589.0, 5516.0, 5420.0, 5431.0, 5599.0, 5595.0, 5372.0, 5406.0, 5558.0, 5414.0, 5442.0, 5358.0, 5519.0, 5620.0, 5454.0, 5663.0, 5644.0, 5466.0, 5521.0, 5253.0, 5630.0, 5267.0, 5552.0, 5344.0, 5586.0, 5721.0, 5455.0, 5285.0, 5389.0, 5378.0, 5679.0, 5678.0, 5722.0, 5440.0, 5534.0, 5258.0, 5673.0, 5669.0, 5391.0, 5684.0, 5689.0, 5484.0, 5433.0, 5580.0, 5410.0, 5437.0, 5291.0, 5633.0, 5271.0, 5351.0,

						5537.0, 5333.0, 5649.0, 5653.0, 5278.0 (number of hits: 10)
27	5270	9	1	333	1	5378.0, 5393.0, 5639.0, 5500.0, 5480.0, 5476.0, 5282.0, 5340.0, 5426.0, 5283.0, 5643.0, 5678.0, 5431.0, 5369.0, 5322.0, 5251.0, 5671.0, 5640.0, 5297.0, 5608.0, 5633.0, 5483.0, 5576.0, 5505.0, 5521.0, 5360.0, 5591.0, 5284.0, 5691.0, 5398.0, 5645.0, 5693.0, 5515.0, 5654.0, 5482.0, 5587.0, 5652.0, 5452.0, 5286.0, 5488.0, 5404.0, 5612.0, 5334.0, 5357.0, 5602.0, 5309.0, 5427.0, 5267.0, 5498.0, 5539.0, 5596.0, 5624.0, 5366.0, 5397.0, 5532.0, 5548.0, 5435.0, 5512.0, 5324.0, 5510.0, 5410.0, 5479.0, 5280.0, 5445.0, 5279.0, 5628.0, 5433.0, 5466.0, 5583.0, 5675.0, 5342.0, 5319.0, 5490.0, 5254.0, 5474.0, 5261.0, 5455.0, 5496.0, 5606.0, 5551.0, 5471.0, 5262.0, 5650.0, 5365.0, 5443.0, 5273.0, 5467.0, 5560.0, 5666.0, 5305.0, 5432.0, 5578.0, 5567.0, 5724.0, 5304.0, 5338.0, 5713.0, 5296.0, 5444.0, 5416.0 (number of hits: 12)
28	5270	9	1	333	1	5480.0, 5280.0, 5364.0, 5652.0, 5483.0, 5702.0, 5432.0, 5517.0, 5428.0, 5573.0, 5713.0, 5695.0, 5435.0, 5467.0, 5670.0, 5516.0, 5337.0, 5686.0, 5384.0, 5707.0, 5290.0, 5383.0, 5501.0, 5303.0, 5265.0, 5399.0, 5387.0, 5351.0, 5385.0, 5509.0, 5641.0, 5631.0, 5458.0, 5688.0, 5507.0, 5273.0, 5367.0, 5515.0, 5348.0, 5639.0, 5388.0, 5580.0, 5360.0, 5634.0, 5463.0, 5630.0, 5530.0, 5257.0, 5633.0, 5304.0, 5542.0, 5722.0, 5275.0, 5270.0, 5272.0, 5704.0, 5448.0, 5376.0, 5696.0, 5709.0, 5417.0, 5668.0, 5301.0, 5525.0, 5576.0, 5664.0, 5555.0, 5401.0, 5437.0, 5356.0, 5506.0, 5600.0, 5406.0, 5687.0, 5544.0, 5481.0, 5602.0, 5492.0, 5587.0, 5667.0, 5500.0, 5438.0, 5409.0, 5413.0, 5346.0, 5368.0, 5398.0, 5422.0, 5429.0, 5391.0, 5410.0, 5656.0, 5478.0, 5701.0, 5635.0, 5466.0, 5486.0, 5479.0, 5345.0, 5653.0 (number of hits: 9)
29	5270	9	1	333	1	5587.0, 5534.0, 5569.0, 5348.0, 5455.0, 5458.0, 5260.0, 5453.0, 5483.0, 5543.0, 5693.0, 5267.0, 5639.0, 5498.0, 5385.0, 5310.0, 5353.0, 5559.0, 5482.0, 5291.0, 5319.0, 5422.0, 5358.0, 5551.0, 5342.0, 5419.0, 5449.0, 5463.0, 5692.0, 5350.0, 5535.0, 5525.0, 5566.0, 5610.0, 5418.0, 5686.0, 5554.0, 5321.0, 5477.0, 5372.0, 5441.0, 5287.0, 5633.0, 5502.0, 5371.0, 5333.0, 5724.0, 5514.0, 5334.0, 5573.0, 5447.0, 5616.0, 5584.0, 5504.0, 5580.0, 5634.0, 5510.0, 5518.0, 5258.0, 5677.0, 5253.0, 5556.0, 5423.0, 5666.0, 5279.0, 5289.0, 5591.0, 5670.0, 5588.0, 5507.0, 5671.0, 5277.0, 5271.0, 5690.0, 5568.0, 5433.0, 5446.0, 5259.0, 5549.0, 5295.0, 5547.0, 5715.0, 5717.0, 5632.0, 5459.0

						5516.0, 5687.0, 5442.0, 5305.0, 5590.0, 5722.0, 5620.0, 5493.0, 5548.0, 5339.0, 5399.0, 5296.0, 5672.0, 5506.0, 5346.0 (number of hits: 9)
30	5270	9	1	333	1	5251.0, 5395.0, 5511.0, 5274.0, 5393.0, 5586.0, 5663.0, 5563.0, 5441.0, 5554.0, 5381.0, 5318.0, 5625.0, 5367.0, 5385.0, 5500.0, 5448.0, 5613.0, 5292.0, 5376.0, 5604.0, 5495.0, 5294.0, 5304.0, 5645.0, 5311.0, 5298.0, 5591.0, 5535.0, 5668.0, 5400.0, 5477.0, 5509.0, 5548.0, 5641.0, 5424.0, 5582.0, 5336.0, 5278.0, 5438.0, 5420.0, 5281.0, 5350.0, 5513.0, 5683.0, 5705.0, 5339.0, 5295.0, 5605.0, 5533.0, 5637.0, 5482.0, 5631.0, 5708.0, 5595.0, 5577.0, 5701.0, 5280.0, 5581.0, 5660.0, 5519.0, 5459.0, 5479.0, 5379.0, 5626.0, 5268.0, 5667.0, 5518.0, 5640.0, 5359.0, 5672.0, 5512.0, 5592.0, 5458.0, 5412.0, 5316.0, 5301.0, 5352.0, 5457.0, 5461.0, 5475.0, 5356.0, 5327.0, 5408.0, 5285.0, 5425.0, 5652.0, 5594.0, 5310.0, 5266.0, 5264.0, 5492.0, 5346.0, 5465.0, 5437.0, 5508.0, 5496.0, 5643.0, 5343.0, 5538.0 (number of hits: 11)

Annex B – U-NII-2C Radar Parameter Data Sheet for Master Mode

B.1 20 MHz Bandwidth @ 5510 MHz

Table-1A/1B Radar Type 1A/1B Statistical Performance

Trial #	Fc (MHz)	Pulse/Burst	Pulse Width (μS)	PRI (μs)	Detection (1:yes; 0:no)
1	5510	58	1	918	1
2	5510	76	1	698	1
3	5510	68	1	778	1
4	5510	95	1	558	1
5	5510	57	1	938	1
6	5510	59	1	898	1
7	5510	67	1	798	1
8	5510	63	1	838	1
9	5510	74	1	718	1
10	5510	99	1	538	1
11	5510	81	1	658	1
12	5510	102	1	518	1
13	5510	62	1	858	1
14	5510	86	1	618	1
15	5510	78	1	678	1
16	5510	37	1	1430	1
17	5510	50	1	1062	1
18	5510	36	1	1480	1
19	5510	32	1	1677	1
20	5510	74	1	717	1
21	5510	22	1	2415	1
22	5510	29	1	1855	1
23	5510	20	1	2697	1
24	5510	18	1	2996	1
25	5510	18	1	2946	0
26	5510	62	1	862	1
27	5510	26	1	2075	1
28	5510	34	1	1582	1
29	5510	40	1	1346	1
30	5510	18	1	3005	0
Detection Percentage: 93.3 % (>60%)					

Table-2 Radar Type 2 Statistical Performance

Trial #	Fc (MHz)	Pulse/Burst	Pulse Width (μ S)	PRI (μ s)	Detection (1:yes; 0:no)
1	5510	26	3.8	217	1
2	5510	28	5	216	1
3	5510	25	4.7	189	0
4	5510	23	4.8	172	1
5	5510	26	2.2	201	1
6	5510	28	1.1	158	1
7	5510	24	3	227	1
8	5510	25	3.9	208	1
9	5510	29	5	174	1
10	5510	26	1.6	191	1
11	5510	26	1	166	1
12	5510	23	1	173	1
13	5510	28	3.2	190	1
14	5510	23	4.7	154	1
15	5510	23	1.6	189	1
16	5510	23	5	183	1
17	5510	26	1.3	173	1
18	5510	26	3.1	199	1
19	5510	24	5	219	1
20	5510	24	4.9	155	1
21	5510	26	2.9	184	0
22	5510	28	3.6	164	1
23	5510	25	2	182	1
24	5510	29	1.5	203	1
25	5510	27	1.3	166	1
26	5510	25	1.6	189	1
27	5510	28	2	226	1
28	5510	28	2.5	182	1
29	5510	25	4.2	152	1
30	5510	29	3.8	206	1
Detection Percentage: 93.3 % (>60%)					

Table-3 Radar Type 3 Statistical Performance

Trial #	Fc (MHz)	Pulse/Burst	Pulse Width (μS)	PRI (μs)	Detection (1:yes; 0:no)
1	5510	16	7.7	389	1
2	5510	17	8.4	412	1
3	5510	16	6	361	1
4	5510	18	7.2	493	1
5	5510	17	8.4	313	1
6	5510	17	9.8	483	1
7	5510	18	8.8	340	1
8	5510	16	6.7	255	0
9	5510	18	7.4	222	0
10	5510	18	6.4	396	1
11	5510	18	8.7	456	1
12	5510	17	9	486	1
13	5510	17	9.9	349	1
14	5510	16	7.1	324	0
15	5510	17	9.2	212	1
16	5510	16	6	239	1
17	5510	18	10	229	1
18	5510	18	6.3	403	1
19	5510	17	7.5	318	1
20	5510	18	6.8	325	1
21	5510	18	9.4	425	1
22	5510	16	7.5	339	0
23	5510	18	8.4	202	1
24	5510	16	6.5	261	1
25	5510	17	9.5	349	1
26	5510	17	8	500	1
27	5510	18	6.8	395	1
28	5510	17	8.3	397	1
29	5510	16	7.9	403	1
30	5510	18	8.3	424	1
Detection Percentage: 86.7 % (>60%)					

Table-4 Radar Type 4 Statistical Performance

Trial #	Fc (MHz)	Pulse/Burst	Pulse Width (μS)	PRI (μs)	Detection (1:yes; 0:no)
1	5510	16	16.3	217	1
2	5510	12	13.3	222	0
3	5510	14	14.1	449	1
4	5510	15	18.8	210	1
5	5510	14	17.8	372	1
6	5510	14	12.8	431	0
7	5510	13	17.4	317	1
8	5510	12	17.4	493	0
9	5510	13	14.1	395	1
10	5510	15	20	260	1
11	5510	16	11.9	363	0
12	5510	16	14.3	264	1
13	5510	15	19.1	343	1
14	5510	12	17.8	280	1
15	5510	16	14.7	236	1
16	5510	13	11.3	267	1
17	5510	15	19.9	256	1
18	5510	16	14.8	216	1
19	5510	12	18.3	277	1
20	5510	12	19.9	490	1
21	5510	12	15.5	271	1
22	5510	12	14.7	262	1
23	5510	14	16.6	467	1
24	5510	16	15.3	298	1
25	5510	16	11.8	237	0
26	5510	14	17.1	343	0
27	5510	13	15.1	223	0
28	5510	14	11.5	471	1
29	5510	15	11.3	270	1
30	5510	16	11.4	292	1
Detection Percentage: 76.7 % (>60%)					

Table-5 Radar Type 5 Statistical Performance

Trial #	Fc (MHz)	Detection (1:yes; 0:no)
1	5510	1
2	5510	1
3	5510	1
4	5510	1
5	5510	1
6	5510	0
7	5510	1
8	5510	1
9	5510	1
10	5510	0
11	5503.8	1
12	5508.6	1
13	5505.8	1
14	5506.6	0
15	5508.2	1
16	5503.4	1
17	5507.0	1
18	5503.8	1
19	5507.4	1
20	5506.6	1
21	5512.6	1
22	5517.0	1
23	5513.0	1
24	5515.0	1
25	5511.8	0
26	5511.8	1
27	5516.2	1
28	5512.2	1
29	5511.8	1
30	5517.0	1
Detection Percentage: 86.7 % (>80%)		

Bin5 Statistics 1

Trial #	Pulse	Chirp (MHz)	Pulse Width (μS)	Pulse 1-2 spacing (uS)	Pulse 2-3 spacing (uS)	Pulse Start(S)	Detection (1:yes; 0:no)
0	2	10	56.5	1136		0.512141	1
1	2	10	59.2	1333		0.621139	
2	2	10	69.8	1422		1.230742	
3	3	10	94.3	1466	1808	2.197619	
4	2	10	85.3	1221		2.459094	
5	1	10	68.3			3.233999	
6	1	10	54.4			4.012648	
7	3	10	94.2	1385	1481	4.478193	
8	3	10	83.4	1054	1119	4.845529	
9	1	10	94.2			5.505675	
10	2	10	71.3	1213		6.281906	
11	1	10	99			6.639982	
12	2	10	70.2	1593		7.245345	
13	2	10	75.4	1991		7.851755	
14	2	10	86.6	1673		8.627908	
15	1	10	72.2			9.1845	
16	2	10	81.3	1035		9.820141	
17	2	10	63.7	1210		10.727218	
18	2	10	63.2	1656		11.032853	
19	1	10	88.6			11.616447	

Bin5 Statistics 2

Trial #	Pulse	Chirp (MHz)	Pulse Width (µS)	Pulse 1-2 spacing (uS)	Pulse 2-3 spacing (uS)	Pulse Start(S)	Detection (1:yes; 0:no)
0	3	6	90.4	1246	1088	0.367199	1
1	2	6	69.2	1177		0.765508	
2	2	6	87.2	1535		1.521205	
3	2	6	59.2	1395		2.468503	
4	2	6	55.2	1687		2.979193	
5	3	6	75.7	1125	1690	3.406025	
6	1	6	51			3.799846	
7	2	6	69.1	1491		4.980479	
8	2	6	86.1	1984		5.194061	
9	2	6	71	1809		5.895089	
10	3	6	72.5	1484	1022	6.621925	
11	3	6	82	1252	1531	7.115246	
12	1	6	75.3			7.667151	
13	1	6	63.2			8.628332	
14	1	6	58			9.022612	
15	2	6	86.6	1143		9.877761	
16	3	6	88.7	1439	1852	10.65437	
17	2	6	68.3	1310		11.04702	
18	3	6	77.4	1896	1183	11.858976	

Bin5 Statistics 3

Trial #	Pulse	Chirp (MHz)	Pulse Width (µS)	Pulse 1-2 spacing (uS)	Pulse 2-3 spacing (uS)	Pulse Start(S)	Detection (1:yes; 0:no)
0	1	10	82.4			0.438231	1
1	2	10	67.5	1803		1.635693	
2	1	10	95			1.800361	
3	2	10	78.8	1724		3.354694	
4	1	10	79.2			3.908157	
5	3	10	55.6	1253	1777	4.519886	
6	1	10	81.5			5.311429	
7	2	10	73.2	1603		6.672113	
8	2	10	61.3	1804		7.40914	
9	2	10	58.9	1351		7.730201	
10	2	10	64.8	1312		9.203821	
11	2	10	76.8	1242		9.627887	
12	1	10	85			11.13854	
13	2	10	84.6	1975		11.738281	

Bin5 Statistics 4

Trial #	Pulse	Chirp (MHz)	Pulse Width (µS)	Pulse 1-2 spacing (uS)	Pulse 2-3 spacing (uS)	Pulse Start(S)	Detection (1:yes; 0:no)
0	2	10	76.3	1882		0.840168	1
1	1	10	64.1			1.296133	
2	1	10	84.7			3.264945	
3	2	10	93.7	1329		3.504625	
4	3	10	55.5	1633	1370	4.914819	
5	2	10	97.1	1362		5.638129	
6	2	10	58.1	1109		6.759382	
7	1	10	76.4			7.715369	
8	2	10	70	1445		9.17413	
9	1	10	69.7			10.197322	
10	3	10	67.7	1065	1597	11.744583	

Bin5 Statistics 5

Trial #	Pulse	Chirp (MHz)	Pulse Width (µS)	Pulse 1-2 spacing (uS)	Pulse 2-3 spacing (uS)	Pulse Start(S)	Detection (1:yes; 0:no)
0	2	11	62.2	1138		0.430227	1
1	2	11	92	1083		1.144556	
2	2	11	80.4	1523		1.987076	
3	3	11	78.6	1624	1668	2.796413	
4	2	11	82.9	1137		3.520289	
5	1	11	60.2			3.814121	
6	1	11	54			4.938036	
7	2	11	73.8	1958		5.359169	
8	2	11	86	1292		6.131997	
9	2	11	98.4	1599		6.998529	
10	3	11	67.3	1489	1189	7.76392	
11	2	11	92	1295		8.858886	
12	2	11	51.2	1704		9.044432	
13	1	11	77.8			10.05054	
14	2	11	95.2	1908		11.118692	
15	1	11	96.2			11.357113	

Bin5 Statistics 6

Trial #	Pulse	Chirp (MHz)	Pulse Width (µS)	Pulse 1-2 spacing (uS)	Pulse 2-3 spacing (uS)	Pulse Start(S)	Detection (1:yes; 0:no)
0	1	5	92.8			0.493388	0
1	3	5	72.7	1704	1188	1.345014	
2	1	5	69.6			1.817029	
3	2	5	82.6	1615		3.29969	
4	3	5	57	1585	1463	4.174342	
5	2	5	97.7	1377		4.636352	
6	1	5	64.8			5.618155	
7	2	5	98.8	1221		6.181472	
8	2	5	79.5	1165		6.890226	
9	1	5	96.3			8.355192	
10	2	5	67.1	1203		8.834722	
11	1	5	52.2			10.093732	
12	1	5	58.8			10.856645	
13	2	5	64.6	1293		11.817389	

Bin5 Statistics 7

Trial #	Pulse	Chirp (MHz)	Pulse Width (µS)	Pulse 1-2 spacing (uS)	Pulse 2-3 spacing (uS)	Pulse Start(S)	Detection (1:yes; 0:no)
0	2	10	86.6	1009		0.322369	1
1	3	10	76.1	1321	1286	1.513747	
2	3	10	72.9	1164	1032	2.443083	
3	2	10	76.6	1428		3.005177	
4	3	10	56.4	1980	1860	4.415847	
5	2	10	94.1	1884		5.226937	
6	2	10	64.3	1813		5.918219	
7	3	10	85.8	1590	1191	6.919095	
8	2	10	90.4	1646		7.438634	
9	2	10	82	1785		8.835907	
10	3	10	52	1717	1109	9.473138	
11	1	10	93.9			10.75034	
12	3	10	81.2	1359	1120	11.276326	

Bin5 Statistics 8

Trial #	Pulse	Chirp (MHz)	Pulse Width (µS)	Pulse 1-2 spacing (uS)	Pulse 2-3 spacing (uS)	Pulse Start(S)	Detection (1:yes; 0:no)
0	2	10	96.4	1768		0.650347	1
1	3	10	58.6	1611	1654	1.291368	
2	2	10	61.6	1299		1.754979	
3	3	10	83.7	1841	1159	2.13697	
4	3	10	69	1132	1092	3.044112	
5	2	10	50.6	1304		3.748295	
6	2	10	65.4	1560		4.627278	
7	2	10	85.4	1646		4.964707	
8	2	10	94.1	1747		5.553068	
9	3	10	85.5	1483	1810	6.071233	
10	2	10	63.6	1232		6.700002	
11	2	10	92.6	1172		7.600689	
12	2	10	53.3	1628		8.463069	
13	2	10	52.2	1166		8.881808	
14	3	10	71.1	1430	1005	9.542023	
15	3	10	69.5	1960	1950	10.445163	
16	2	10	85.4	1393		10.949744	
17	1	10	84.7			11.3569	

Bin5 Statistics 9

Trial #	Pulse	Chirp (MHz)	Pulse Width (µS)	Pulse 1-2 spacing (uS)	Pulse 2-3 spacing (uS)	Pulse Start(S)	Detection (1:yes; 0:no)
0	1	6	75.5			0.543889	1
1	3	6	72.2	1011	1913	1.227121	
2	1	6	93.1			2.056425	
3	2	6	57.1	1997		2.750125	
4	2	6	53	1610		2.890944	
5	2	6	69.1	1328		3.666747	
6	3	6	90.4	1817	1314	4.491664	
7	2	6	99.7	1790		5.200052	
8	2	6	78.8	1447		6.068857	
9	3	6	69.7	1170	1395	6.444744	
10	2	6	95.2	1961		7.495502	
11	2	6	81.7	1464		8.07484	
12	2	6	82.2	1154		8.545955	
13	2	6	79.5	1442		9.195896	
14	3	6	77	1230	1430	10.428855	
15	2	6	72	1325		10.618246	
16	2	6	63.9	1511		11.607353	

Bin5 Statistics 10

Trial #	Pulse	Chirp (MHz)	Pulse Width (µS)	Pulse 1-2 spacing (uS)	Pulse 2-3 spacing (uS)	Pulse Start(S)	Detection (1:yes; 0:no)
0	1	8	55.5			0.151737	0
1	2	8	58.8	1239		1.306267	
2	3	8	72.6	1837	1320	2.299446	
3	1	8	91.4			3.222636	
4	2	8	80.1	1245		4.071572	
5	1	8	61.8			4.361053	
6	2	8	86.3	1364		5.447408	
7	1	8	62.6			6.288754	
8	1	8	95.6			6.934593	
9	2	8	66.2	1481		7.821349	
10	2	8	94.4	1854		8.967442	
11	3	8	75.7	1189	1390	9.805293	
12	3	8	60.7	1924	1404	10.381874	
13	3	8	59.6	1807	1775	11.811516	

Bin5 Statistics 11

Trial #	Pulse	Chirp (MHz)	Pulse Width (µS)	Pulse 1-2 spacing (uS)	Pulse 2-3 spacing (uS)	Pulse Start(S)	Detection (1:yes; 0:no)
0	3	7	90.9	1681	1672	0.624896	1
1	2	7	60.7	1983		1.162517	
2	1	7	82			1.582261	
3	1	7	56.9			2.369762	
4	2	7	54.7	1718		2.693978	
5	1	7	65.9			3.990931	
6	1	7	69.6			4.395174	
7	1	7	99.9			5.010027	
8	2	7	67	1803		5.737976	
9	1	7	64.8			6.51272	
10	2	7	72.4	1304		6.868413	
11	1	7	56.7			7.748934	
12	2	7	56.7	1882		8.007192	
13	3	7	58.1	1942	1912	9.230299	
14	1	7	99.4			9.804995	
15	1	7	97.9			10.192627	
16	2	7	66.8	1360		11.135407	
17	3	7	76.1	1805	1161	11.871822	

Bin5 Statistics 12

Trial #	Pulse	Chirp (MHz)	Pulse Width (µS)	Pulse 1-2 spacing (uS)	Pulse 2-3 spacing (uS)	Pulse Start(S)	Detection (1:yes; 0:no)
0	1	19	56.2			0.343672	1
1	2	19	62.5	1571		1.068883	
2	3	19	86.8	1500	1241	2.038492	
3	2	19	76.2	1704		2.995539	
4	1	19	73.3			4.319556	
5	1	19	63.4			5.245038	
6	1	19	98.5			5.548626	
7	2	19	50.3	1228		6.917426	
8	3	19	83.6	1683	1298	7.971723	
9	1	19	94.2			9.096639	
10	2	19	73.2	1113		10.104501	
11	2	19	80.6	1746		10.962862	
12	3	19	78.6	1762	1953	11.419779	

Bin5 Statistics 13

Trial #	Pulse	Chirp (MHz)	Pulse Width (µS)	Pulse 1-2 spacing (uS)	Pulse 2-3 spacing (uS)	Pulse Start(S)	Detection (1:yes; 0:no)
0	1	12	90.2			0.189872	1
1	1	12	99.7			1.377578	
2	3	12	73.1	1257	1806	2.185894	
3	2	12	67.6	1713		3.137395	
4	1	12	89.9			3.373843	
5	2	12	71.2	1303		4.547562	
6	2	12	78.8	1651		5.383066	
7	3	12	51.1	1625	1023	5.72056	
8	2	12	67.9	1342		7.085762	
9	1	12	60.9			7.608016	
10	2	12	79.2	1611		8.502638	
11	2	12	89.2	1302		9.139071	
12	2	12	76.3	1436		9.66048	
13	3	12	82.4	1609	1834	10.542227	
14	2	12	83.6	1659		11.695149	

Bin5 Statistics 14

Trial #	Pulse	Chirp (MHz)	Pulse Width (µS)	Pulse 1-2 spacing (uS)	Pulse 2-3 spacing (uS)	Pulse Start(S)	Detection (1:yes; 0:no)
0	3	14	54.6	1824	1144	0.259455	0
1	2	14	97.2	1406		1.538292	
2	2	14	58.8	1103		4.074073	
3	2	14	97.9	1216		5.850015	
4	2	14	57.1	1115		6.958957	
5	1	14	78.8			8.770798	
6	1	14	56.4			10.076081	
7	2	14	96.4	1216		11.210363	

Bin5 Statistics 15

Trial #	Pulse	Chirp (MHz)	Pulse Width (µS)	Pulse 1-2 spacing (µS)	Pulse 2-3 spacing (µS)	Pulse Start(S)	Detection (1:yes; 0:no)
0	2	18	100	1280		0.182842	1
1	1	18	98.8			1.437134	
2	3	18	61.1	1924	1601	2.674275	
3	2	18	71.8	1357		3.912772	
4	2	18	79.2	1489		5.438464	
5	1	18	92			5.50674	
6	2	18	59	1912		7.40191	
7	3	18	83.4	1868	1189	7.849096	
8	3	18	60.1	1448	1321	9.627421	
9	2	18	57.4	1070		10.198632	
10	2	18	69.3	1751		11.328286	

Bin5 Statistics 16

Trial #	Pulse	Chirp (MHz)	Pulse Width (µS)	Pulse 1-2 spacing (µS)	Pulse 2-3 spacing (µS)	Pulse Start(S)	Detection (1:yes; 0:no)
0	2	6	97.7	1202		0.706366	1
1	2	6	75.2	1084		1.328235	
2	2	6	76.6	1082		1.617376	
3	3	6	79.6	1629	1998	2.548024	
4	2	6	81.5	1001		3.107216	
5	2	6	68.1	1069		4.462344	
6	2	6	61.3	1139		4.70004	
7	2	6	73.7	1769		5.673403	
8	2	6	85.3	1655		6.171599	
9	3	6	76.5	1416	1511	7.098035	
10	2	6	76.8	1851		8.189507	
11	1	6	81.5			8.400125	
12	1	6	53.8			9.430078	
13	2	6	93.8	1117		9.862683	
14	3	6	61.5	1801	1543	10.620374	
15	2	6	56.8	1146		11.597292	

Bin5 Statistics 17

Trial #	Pulse	Chirp (MHz)	Pulse Width (µS)	Pulse 1-2 spacing (uS)	Pulse 2-3 spacing (uS)	Pulse Start(S)	Detection (1:yes; 0:no)
0	2	15	96.3	1319		0.993808	1
1	1	15	99.6			2.026889	
2	1	15	53.4			2.211271	
3	1	15	55.4			4.211921	
4	1	15	95.8			4.587721	
5	3	15	94	1823	1768	6.325757	
6	2	15	98.4	1654		7.224733	
7	1	15	70.3			7.759778	
8	3	15	73.7	1172	1960	9.476064	
9	2	15	79.4	1888		9.828202	
10	2	15	75.5	1958		11.892753	

Bin5 Statistics 18

Trial #	Pulse	Chirp (MHz)	Pulse Width (µS)	Pulse 1-2 spacing (uS)	Pulse 2-3 spacing (uS)	Pulse Start(S)	Detection (1:yes; 0:no)
0	1	7	51.1			0.445576	1
1	3	7	69.4	1926	1048	1.384377	
2	3	7	90.7	1343	1445	1.703413	
3	3	7	97.1	1941	1217	2.689068	
4	3	7	93.7	1206	1303	3.373102	
5	3	7	99.8	1057	1003	4.222959	
6	2	7	79.5	1389		4.778305	
7	1	7	80.9			5.254133	
8	1	7	54.9			5.929541	
9	3	7	52.4	1758	1736	6.957892	
10	2	7	79.6	1644		7.194265	
11	2	7	90.9	1056		8.308229	
12	3	7	78.9	1894	1819	8.735848	
13	1	7	92.6			9.533429	
14	3	7	52.4	1807	1910	10.349257	
15	2	7	71	1121		10.819862	
16	1	7	86			11.329706	

Bin5 Statistics 19

Trial #	Pulse	Chirp (MHz)	Pulse Width (μS)	Pulse 1-2 spacing (uS)	Pulse 2-3 spacing (uS)	Pulse Start(S)	Detection (1:yes; 0:no)
0	2	16	82.4	1080		0.483957	1
1	3	16	83.1	1594	1943	1.229073	
2	3	16	94.9	1297	1923	1.729208	
3	1	16	89.2			2.088007	
4	1	16	57.8			2.944242	
5	1	16	75.5			3.819768	
6	3	16	63	1698	1926	4.23743	
7	1	16	93.8			4.793259	
8	2	16	59.8	1768		5.766952	
9	3	16	76.6	1538	1047	6.400709	
10	2	16	56	1690		6.960702	
11	2	16	99	1061		7.689529	
12	2	16	93	1758		8.433909	
13	2	16	62.2	1156		9.163932	
14	2	16	93	1600		9.751589	
15	3	16	63	1443	1544	10.537309	
16	2	16	81.6	1642		10.705985	
17	2	16	63	1749		11.697214	

Bin5 Statistics 20

Trial #	Pulse	Chirp (MHz)	Pulse Width (µS)	Pulse 1-2 spacing (uS)	Pulse 2-3 spacing (uS)	Pulse Start(S)	Detection (1:yes; 0:no)
0	2	14	64.7	1220		0.187941	1
1	2	14	75.9	1768		1.032403	
2	3	14	64.5	1414	1424	1.939416	
3	1	14	71			2.084424	
4	1	14	70.2			3.136002	
5	3	14	69.1	1386	1078	3.967921	
6	2	14	54.3	1396		4.157927	
7	2	14	59.3	1112		5.223139	
8	1	14	87.6			5.832689	
9	2	14	52.6	1416		6.30989	
10	1	14	70.5			7.015243	
11	3	14	76.7	1215	1994	7.982896	
12	2	14	74.3	1619		8.641003	
13	1	14	65			8.912746	
14	2	14	76.3	1990		9.536726	
15	2	14	87.9	1780		10.136346	
16	2	14	97.8	1821		10.874154	
17	2	14	89.5	1474		11.759774	

Bin5 Statistics 21

Trial #	Pulse	Chirp (MHz)	Pulse Width (µS)	Pulse 1-2 spacing (uS)	Pulse 2-3 spacing (uS)	Pulse Start(S)	Detection (1:yes; 0:no)
0	2	16	68.7	1333		0.419746	1
1	3	16	91.7	1633	1952	0.798666	
2	2	16	62.1	1644		1.765542	
3	3	16	74	1532	1061	2.372875	
4	3	16	60.9	1052	1229	3.138058	
5	2	16	74.5	1408		3.484255	
6	2	16	73.8	1794		4.122026	
7	1	16	52.1			4.996458	
8	3	16	86.8	1775	1854	5.34467	
9	3	16	79.5	1093	1804	6.24911	
10	2	16	70.8	1193		7.327609	
11	2	16	87	1085		7.575197	
12	3	16	95.9	1174	1774	8.333978	
13	2	16	82.4	1116		9.283183	
14	3	16	79.9	1585	1527	9.916278	
15	3	16	89.7	1838	1263	10.019329	
16	1	16	69.2			11.249682	
17	2	16	92.7	1519		11.847301	

Bin5 Statistics 22

Trial #	Pulse	Chirp (MHz)	Pulse Width (µS)	Pulse 1-2 spacing (uS)	Pulse 2-3 spacing (uS)	Pulse Start(S)	Detection (1:yes; 0:no)
0	3	5	92.4	1629	1121	0.886238	1
1	1	5	50.5			1.579552	
2	3	5	56.2	1973	1170	2.727435	
3	2	5	53.5	1520		3.804556	
4	3	5	52	1586	1660	4.163465	
5	3	5	58	1973	1860	5.600175	
6	1	5	84.9			6.872131	
7	3	5	79.8	1462	1079	7.848496	
8	2	5	95.4	1254		8.644467	
9	2	5	66.4	1223		9.39519	
10	1	5	71.3			10.052442	
11	2	5	61.9	1976		11.648812	

Bin5 Statistics 23

Trial #	Pulse	Chirp (MHz)	Pulse Width (µS)	Pulse 1-2 spacing (uS)	Pulse 2-3 spacing (uS)	Pulse Start(S)	Detection (1:yes; 0:no)
0	1	15	85.6			0.473887	1
1	2	15	79.6	1869		1.306091	
2	3	15	59.2	1285	1936	2.868606	
3	2	15	64.5	1131		3.503852	
4	3	15	99.8	1110	1812	4.665853	
5	3	15	76.1	1461	1701	5.678296	
6	2	15	85.6	1911		6.854327	
7	2	15	99.3	1185		7.655667	
8	2	15	81.8	1875		9.479424	
9	2	15	74.8	1919		10.404889	
10	1	15	58.6			11.060437	

Bin5 Statistics 24

Trial #	Pulse	Chirp (MHz)	Pulse Width (µS)	Pulse 1-2 spacing (uS)	Pulse 2-3 spacing (uS)	Pulse Start(S)	Detection (1:yes; 0:no)
0	2	10	94.1	1158		0.223229	1
1	2	10	89.1	1626		1.059312	
2	2	10	65.1	1589		1.708949	
3	2	10	69.5	1228		2.585921	
4	2	10	71.8	1821		3.446071	
5	3	10	94	1053	1108	4.236109	
6	3	10	58.8	1150	1630	4.938354	
7	3	10	83.6	1077	1510	5.465634	
8	2	10	55	1885		6.564585	
9	2	10	71.2	1033		7.391885	
10	3	10	76.9	1482	1854	8.152824	
11	1	10	90.8			8.262113	
12	2	10	58.8	1474		9.48899	
13	3	10	81.7	1544	1330	10.144061	
14	1	10	54.8			10.904627	
15	1	10	62.4			11.867709	

Bin5 Statistics 25

Trial #	Pulse	Chirp (MHz)	Pulse Width (µS)	Pulse 1-2 spacing (uS)	Pulse 2-3 spacing (uS)	Pulse Start(S)	Detection (1:yes; 0:no)
0	3	18	60.3	1848	1355	0.358879	0
1	3	18	68	1425	1282	1.44887	
2	2	18	87.3	1335		2.276877	
3	2	18	80.8	1332		3.139163	
4	2	18	74.8	1051		3.690321	
5	3	18	69.2	1033	1485	4.975427	
6	3	18	70.9	1150	1370	5.906768	
7	2	18	61.2	1684		6.186028	
8	1	18	98.6			7.211405	
9	3	18	72	1930	1314	8.085059	
10	2	18	67.4	1762		8.587942	
11	2	18	58.9	1062		9.60143	
12	2	18	56.1	1726		11.104548	
13	1	18	78.6			11.552696	

Bin5 Statistics 26

Trial #	Pulse	Chirp (MHz)	Pulse Width (µS)	Pulse 1-2 spacing (uS)	Pulse 2-3 spacing (uS)	Pulse Start(S)	Detection (1:yes; 0:no)
0	3	18	61.5	1340	1674	0.792128	1
1	3	18	84.7	1284	1088	1.672892	
2	2	18	82.6	1399		2.652667	
3	2	18	53.4	1614		3.706603	
4	3	18	80.5	1141	1259	4.015081	
5	3	18	52.9	1905	1884	5.083011	
6	2	18	75.3	1257		6.033832	
7	1	18	98.9			7.969904	
8	3	18	98.8	1731	1083	8.813057	
9	1	18	58.8			9.91502	
10	1	18	84.2			10.547186	
11	1	18	94			11.499623	

Bin5 Statistics 27

Trial #	Pulse	Chirp (MHz)	Pulse Width (µS)	Pulse 1-2 spacing (uS)	Pulse 2-3 spacing (uS)	Pulse Start(S)	Detection (1:yes; 0:no)
0	1	7	62.3			0.249383	1
1	2	7	76.6	1703		2.024418	
2	2	7	88.9	1201		3.795173	
3	3	7	79.8	1124	1553	4.35405	
4	3	7	99.2	1978	1192	5.36701	
5	2	7	51.8	1058		7.48707	
6	1	7	93			9.317262	
7	1	7	85.3			10.164708	
8	2	7	95.3	1484		11.024862	

Bin5 Statistics 28

Trial #	Pulse	Chirp (MHz)	Pulse Width (µS)	Pulse 1-2 spacing (uS)	Pulse 2-3 spacing (uS)	Pulse Start(S)	Detection (1:yes; 0:no)
0	1	17	66.5			1.08357	1
1	1	17	75.3			2.014358	
2	3	17	99.3	1403	1273	2.836054	
3	2	17	82.7	1564		4.495081	
4	2	17	88.3	1523		5.888028	
5	1	17	96.9			7.944075	
6	3	17	73.6	1238	1528	9.172751	
7	3	17	99.8	1064	1212	9.594757	
8	2	17	77.8	1980		11.826161	

Bin5 Statistics 29

Trial #	Pulse	Chirp (MHz)	Pulse Width (µS)	Pulse 1-2 spacing (uS)	Pulse 2-3 spacing (uS)	Pulse Start(S)	Detection (1:yes; 0:no)
0	1	18	65.6			0.175686	1
1	2	18	65.3	1804		0.857128	
2	1	18	64.8			1.801407	
3	2	18	74.6	1546		2.388774	
4	3	18	67.5	1333	1707	2.6149	
5	2	18	65.7	1868		3.530214	
6	3	18	70.5	1675	1693	4.216246	
7	3	18	82.9	1583	1461	4.954668	
8	1	18	60.5			5.512326	
9	2	18	93.7	1315		6.233992	
10	1	18	66.8			6.732356	
11	1	18	89.2			7.274328	
12	1	18	60.6			7.864741	
13	2	18	94.1	1677		8.788899	
14	2	18	60	1394		8.894014	
15	3	18	55	1526	1888	9.923111	
16	1	18	58.9			10.442955	
17	2	18	89	1318		10.793765	
18	2	18	92.7	1323		11.863869	

Bin5 Statistics 30

Trial #	Pulse	Chirp (MHz)	Pulse Width (µS)	Pulse 1-2 spacing (uS)	Pulse 2-3 spacing (uS)	Pulse Start(S)	Detection (1:yes; 0:no)
0	2	5	63.6	1075		0.62654	1
1	2	5	96.2	1594		2.404147	
2	3	5	84	1760	1356	3.232072	
3	2	5	95.5	1049		5.194514	
4	1	5	60.5			7.331744	
5	2	5	53.4	1647		8.972378	
6	1	5	97.9			9.112164	
7	3	5	52.2	1858	1279	11.160087	

Table-6 Radar Type 6 Statistical Performance

Trial #	Fc (MHz)	Pulse /Burst	Pulse Width (μS)	PRI (μs)	Detection (1:yes; 0:no)	Hopping Sequence
1	5510	9	1	333	1	5413.0, 5652.0, 5250.0, 5311.0, 5285.0, 5614.0, 5372.0, 5451.0, 5270.0, 5676.0, 5642.0, 5461.0, 5620.0, 5562.0, 5419.0, 5628.0, 5715.0, 5561.0, 5467.0, 5493.0, 5606.0, 5696.0, 5584.0, 5477.0, 5708.0, 5638.0, 5415.0, 5258.0, 5635.0, 5400.0, 5722.0, 5690.0, 5275.0, 5639.0, 5338.0, 5298.0, 5282.0, 5669.0, 5408.0, 5307.0, 5589.0, 5441.0, 5284.0, 5615.0, 5495.0, 5721.0, 5444.0, 5278.0, 5404.0, 5435.0, 5254.0, 5272.0, 5252.0, 5711.0, 5344.0, 5563.0, 5503.0, 5375.0, 5403.0, 5518.0, 5431.0, 5603.0, 5684.0, 5341.0, 5549.0, 5361.0, 5384.0, 5396.0, 5314.0, 5647.0, 5658.0, 5515.0, 5499.0, 5353.0, 5500.0, 5347.0, 5592.0, 5617.0, 5390.0, 5325.0, 5522.0, 5306.0, 5600.0, 5513.0, 5364.0, 5590.0, 5313.0, 5537.0, 5622.0, 5293.0, 5351.0, 5259.0, 5333.0, 5469.0, 5343.0, 5430.0, 5256.0, 5531.0, 5429.0, 5497.0 (number of hits: 4)
2	5510	9	1	333	1	5590.0, 5414.0, 5659.0, 5253.0, 5646.0, 5707.0, 5308.0, 5261.0, 5292.0, 5539.0, 5618.0, 5363.0, 5296.0, 5654.0, 5276.0, 5518.0, 5528.0, 5349.0, 5317.0, 5622.0, 5264.0, 5273.0, 5483.0, 5672.0, 5467.0, 5481.0, 5265.0, 5340.0, 5479.0, 5471.0, 5571.0, 5491.0, 5616.0, 5448.0, 5272.0, 5711.0, 5405.0, 5451.0, 5598.0, 5369.0, 5437.0, 5551.0, 5594.0, 5254.0, 5368.0, 5287.0, 5372.0, 5620.0, 5476.0, 5702.0, 5496.0, 5415.0, 5323.0, 5596.0, 5573.0, 5345.0, 5465.0, 5316.0, 5562.0, 5683.0, 5267.0, 5297.0, 5294.0, 5498.0, 5423.0, 5521.0, 5677.0, 5696.0, 5624.0, 5378.0, 5519.0, 5314.0, 5642.0, 5713.0, 5268.0, 5458.0, 5477.0, 5279.0, 5602.0, 5671.0, 5578.0, 5720.0, 5394.0, 5310.0, 5603.0, 5427.0, 5617.0, 5600.0, 5326.0, 5274.0, 5453.0, 5425.0, 5543.0, 5547.0, 5560.0, 5375.0, 5355.0, 5411.0, 5504.0, 5380.0 (number of hits: 2)
3	5510	9	1	333	1	5422.0, 5378.0, 5701.0, 5310.0, 5347.0, 5256.0, 5482.0, 5570.0, 5669.0, 5281.0, 5317.0, 5436.0, 5618.0, 5332.0, 5253.0, 5402.0, 5407.0, 5553.0, 5298.0, 5392.0, 5561.0, 5681.0, 5403.0, 5525.0, 5677.0, 5435.0, 5604.0, 5533.0, 5380.0, 5292.0, 5646.0, 5389.0, 5384.0, 5306.0, 5723.0, 5601.0, 5682.0, 5684.0, 5575.0, 5522.0, 5437.0, 5506.0, 5632.0, 5541.0, 5534.0, 5451.0, 5377.0, 5464.0, 5372.0, 5529.0, 5505.0, 5296.0, 5473.0, 5517.0, 5445.0, 5600.0, 5648.0, 5638.0, 5692.0, 5429.0, 5408.0, 5653.0, 5432.0, 5399.0, 5400.0

						5584.0, 5699.0, 5355.0, 5454.0, 5340.0, 5550.0, 5484.0, 5680.0, 5455.0, 5428.0, 5284.0, 5299.0, 5320.0, 5656.0, 5258.0, 5712.0, 5700.0, 5465.0, 5493.0, 5366.0, 5511.0, 5415.0, 5443.0, 5329.0, 5480.0, 5667.0, 5609.0, 5477.0, 5496.0, 5670.0, 5635.0, 5503.0, 5319.0, 5538.0, 5717.0 (number of hits: 5)
4	5510	9	1	333	1	5409.0, 5442.0, 5275.0, 5446.0, 5419.0, 5468.0, 5297.0, 5480.0, 5308.0, 5465.0, 5322.0, 5482.0, 5299.0, 5466.0, 5315.0, 5341.0, 5473.0, 5551.0, 5563.0, 5293.0, 5343.0, 5349.0, 5441.0, 5331.0, 5316.0, 5381.0, 5718.0, 5715.0, 5646.0, 5567.0, 5272.0, 5535.0, 5622.0, 5655.0, 5525.0, 5549.0, 5682.0, 5400.0, 5609.0, 5569.0, 5672.0, 5448.0, 5366.0, 5404.0, 5580.0, 5399.0, 5570.0, 5524.0, 5256.0, 5344.0, 5395.0, 5394.0, 5714.0, 5658.0, 5523.0, 5700.0, 5597.0, 5515.0, 5251.0, 5643.0, 5320.0, 5340.0, 5639.0, 5261.0, 5295.0, 5362.0, 5385.0, 5369.0, 5294.0, 5571.0, 5526.0, 5413.0, 5500.0, 5574.0, 5460.0, 5472.0, 5300.0, 5499.0, 5561.0, 5377.0, 5271.0, 5608.0, 5717.0, 5305.0, 5555.0, 5457.0, 5696.0, 5612.0, 5632.0, 5359.0, 5578.0, 5554.0, 5453.0, 5707.0, 5619.0, 5602.0, 5368.0, 5704.0, 5720.0, 5333.0 (number of hits: 1)
5	5510	9	1	333	1	5319.0, 5616.0, 5330.0, 5356.0, 5427.0, 5404.0, 5338.0, 5337.0, 5345.0, 5704.0, 5307.0, 5619.0, 5416.0, 5491.0, 5670.0, 5381.0, 5589.0, 5276.0, 5643.0, 5429.0, 5256.0, 5622.0, 5442.0, 5485.0, 5379.0, 5468.0, 5555.0, 5691.0, 5557.0, 5526.0, 5501.0, 5706.0, 5314.0, 5693.0, 5522.0, 5699.0, 5344.0, 5351.0, 5297.0, 5577.0, 5301.0, 5285.0, 5284.0, 5696.0, 5388.0, 5594.0, 5554.0, 5722.0, 5545.0, 5593.0, 5264.0, 5257.0, 5715.0, 5296.0, 5717.0, 5438.0, 5524.0, 5437.0, 5606.0, 5439.0, 5623.0, 5320.0, 5293.0, 5533.0, 5720.0, 5336.0, 5568.0, 5649.0, 5321.0, 5698.0, 5477.0, 5694.0, 5363.0, 5303.0, 5654.0, 5547.0, 5392.0, 5488.0, 5701.0, 5494.0, 5710.0, 5402.0, 5418.0, 5711.0, 5662.0, 5412.0, 5707.0, 5642.0, 5389.0, 5410.0, 5440.0, 5610.0, 5573.0, 5368.0, 5687.0, 5447.0, 5689.0, 5591.0, 5419.0, 5380.0 (number of hits: 1)
6	5510	9	1	333	1	5365.0, 5263.0, 5299.0, 5363.0, 5321.0, 5314.0, 5684.0, 5598.0, 5585.0, 5304.0, 5517.0, 5295.0, 5305.0, 5493.0, 5362.0, 5396.0, 5544.0, 5514.0, 5607.0, 5710.0, 5621.0, 5444.0, 5507.0, 5441.0, 5560.0, 5274.0, 5634.0, 5595.0, 5367.0, 5315.0, 5422.0, 5591.0, 5260.0, 5370.0, 5714.0, 5541.0, 5253.0, 5605.0, 5600.0, 5627.0, 5338.0, 5554.0, 5461.0, 5306.0, 5677.0, 5524.0, 5535.0, 5669.0, 5336.0, 5403.0, 5563.0, 5313.0, 5375.0, 5386.0, 5620.0

						5675.0, 5413.0, 5471.0, 5644.0, 5488.0, 5400.0, 5347.0, 5307.0, 5251.0, 5565.0, 5679.0, 5553.0, 5287.0, 5701.0, 5414.0, 5392.0, 5559.0, 5328.0, 5609.0, 5470.0, 5502.0, 5527.0, 5511.0, 5599.0, 5467.0, 5651.0, 5323.0, 5378.0, 5648.0, 5412.0, 5641.0, 5570.0, 5576.0, 5708.0, 5628.0, 5681.0, 5670.0, 5298.0, 5668.0, 5278.0, 5349.0, 5312.0, 5612.0, 5358.0, 5611.0 (number of hits: 5)
7	5510	9	1	333	1	5392.0, 5272.0, 5508.0, 5274.0, 5448.0, 5699.0, 5657.0, 5643.0, 5445.0, 5292.0, 5374.0, 5453.0, 5368.0, 5420.0, 5266.0, 5280.0, 5684.0, 5356.0, 5423.0, 5454.0, 5296.0, 5370.0, 5523.0, 5712.0, 5654.0, 5575.0, 5525.0, 5434.0, 5295.0, 5433.0, 5285.0, 5607.0, 5405.0, 5371.0, 5536.0, 5337.0, 5561.0, 5457.0, 5373.0, 5613.0, 5400.0, 5352.0, 5600.0, 5318.0, 5447.0, 5487.0, 5403.0, 5310.0, 5474.0, 5366.0, 5437.0, 5692.0, 5377.0, 5507.0, 5350.0, 5409.0, 5706.0, 5564.0, 5634.0, 5278.0, 5490.0, 5335.0, 5509.0, 5593.0, 5271.0, 5273.0, 5642.0, 5303.0, 5619.0, 5622.0, 5547.0, 5476.0, 5567.0, 5494.0, 5721.0, 5626.0, 5595.0, 5332.0, 5294.0, 5422.0, 5485.0, 5470.0, 5493.0, 5452.0, 5369.0, 5580.0, 5428.0, 5686.0, 5410.0, 5705.0, 5697.0, 5553.0, 5449.0, 5355.0, 5401.0, 5413.0, 5463.0, 5637.0, 5519.0, 5549.0 (number of hits: 3)
8	5510	9	1	333	1	5539.0, 5452.0, 5526.0, 5488.0, 5636.0, 5588.0, 5322.0, 5711.0, 5336.0, 5678.0, 5323.0, 5441.0, 5250.0, 5506.0, 5553.0, 5312.0, 5613.0, 5335.0, 5555.0, 5538.0, 5642.0, 5332.0, 5668.0, 5417.0, 5439.0, 5360.0, 5283.0, 5560.0, 5659.0, 5426.0, 5638.0, 5321.0, 5451.0, 5327.0, 5710.0, 5387.0, 5525.0, 5663.0, 5314.0, 5471.0, 5382.0, 5670.0, 5547.0, 5480.0, 5609.0, 5256.0, 5274.0, 5388.0, 5376.0, 5578.0, 5344.0, 5394.0, 5422.0, 5509.0, 5342.0, 5315.0, 5266.0, 5435.0, 5614.0, 5264.0, 5677.0, 5647.0, 5641.0, 5540.0, 5447.0, 5397.0, 5499.0, 5273.0, 5307.0, 5561.0, 5535.0, 5404.0, 5620.0, 5651.0, 5595.0, 5599.0, 5320.0, 5326.0, 5297.0, 5285.0, 5361.0, 5477.0, 5429.0, 5433.0, 5570.0, 5657.0, 5594.0, 5606.0, 5622.0, 5284.0, 5586.0, 5545.0, 5402.0, 5345.0, 5690.0, 5644.0, 5700.0, 5340.0, 5377.0, 5270.0 (number of hits: 2)
9	5510	9	1	333	0	
10	5510	9	1	333	1	5302.0, 5531.0, 5486.0, 5419.0, 5661.0, 5588.0, 5404.0, 5590.0, 5426.0, 5258.0, 5330.0, 5368.0, 5378.0, 5616.0, 5585.0, 5680.0, 5351.0, 5381.0, 5360.0, 5398.0, 5387.0, 5682.0, 5473.0, 5371.0, 5632.0, 5265.0, 5664.0, 5695.0, 5333.0, 5349.0, 5294.0, 5676.0, 5655.0, 5500.0, 5554.0, 5653.0, 5383.0, 5502.0, 5552.0, 5480.0,

						5665.0, 5280.0, 5483.0, 5654.0, 5583.0, 5619.0, 5657.0, 5624.0, 5321.0, 5601.0, 5704.0, 5506.0, 5307.0, 5475.0, 5530.0, 5318.0, 5298.0, 5608.0, 5319.0, 5284.0, 5363.0, 5618.0, 5570.0, 5544.0, 5698.0, 5512.0, 5697.0, 5614.0, 5408.0, 5464.0, 5558.0, 5366.0, 5649.0, 5584.0, 5490.0, 5517.0, 5645.0, 5574.0, 5678.0, 5322.0, 5317.0, 5693.0, 5435.0, 5327.0, 5442.0, 5609.0, 5388.0, 5702.0, 5592.0, 5640.0, 5689.0, 5510.0, 5550.0, 5534.0, 5422.0, 5617.0, 5384.0, 5425.0, 5571.0, 5539.0 (number of hits: 5)
11	5501	9	1	333	1	5269.0, 5375.0, 5552.0, 5290.0, 5647.0, 5598.0, 5282.0, 5276.0, 5571.0, 5503.0, 5385.0, 5599.0, 5669.0, 5366.0, 5260.0, 5428.0, 5456.0, 5658.0, 5268.0, 5648.0, 5634.0, 5604.0, 5518.0, 5549.0, 5374.0, 5488.0, 5466.0, 5685.0, 5596.0, 5580.0, 5367.0, 5626.0, 5431.0, 5663.0, 5500.0, 5331.0, 5305.0, 5457.0, 5298.0, 5569.0, 5697.0, 5480.0, 5572.0, 5530.0, 5478.0, 5418.0, 5359.0, 5719.0, 5508.0, 5343.0, 5631.0, 5356.0, 5358.0, 5467.0, 5526.0, 5525.0, 5292.0, 5253.0, 5640.0, 5535.0, 5561.0, 5280.0, 5527.0, 5306.0, 5464.0, 5449.0, 5424.0, 5582.0, 5436.0, 5542.0, 5591.0, 5540.0, 5504.0, 5583.0, 5608.0, 5368.0, 5573.0, 5643.0, 5676.0, 5612.0, 5410.0, 5338.0, 5373.0, 5289.0, 5360.0, 5317.0, 5700.0, 5558.0, 5384.0, 5440.0, 5304.0, 5533.0, 5671.0, 5673.0, 5524.0, 5322.0, 5515.0, 5537.0, 5432.0, 5586.0 (number of hits: 4)
12	5501	9	1	333	1	5466.0, 5302.0, 5270.0, 5508.0, 5366.0, 5479.0, 5529.0, 5646.0, 5604.0, 5257.0, 5718.0, 5397.0, 5679.0, 5596.0, 5345.0, 5458.0, 5369.0, 5546.0, 5574.0, 5271.0, 5411.0, 5615.0, 5626.0, 5316.0, 5364.0, 5663.0, 5363.0, 5590.0, 5545.0, 5649.0, 5330.0, 5250.0, 5489.0, 5568.0, 5511.0, 5341.0, 5708.0, 5623.0, 5594.0, 5514.0, 5658.0, 5682.0, 5430.0, 5415.0, 5473.0, 5601.0, 5539.0, 5619.0, 5459.0, 5637.0, 5685.0, 5566.0, 5263.0, 5587.0, 5424.0, 5417.0, 5381.0, 5630.0, 5705.0, 5311.0, 5509.0, 5252.0, 5292.0, 5308.0, 5701.0, 5560.0, 5712.0, 5500.0, 5518.0, 5582.0, 5694.0, 5483.0, 5288.0, 5445.0, 5416.0, 5662.0, 5674.0, 5668.0, 5377.0, 5375.0, 5457.0, 5526.0, 5723.0, 5464.0, 5490.0, 5702.0, 5486.0, 5386.0, 5348.0, 5287.0, 5556.0, 5690.0, 5382.0, 5538.0, 5532.0, 5628.0, 5353.0, 5261.0, 5498.0, 5692.0 (number of hits: 4)
13	5501	9	1	333	1	5281.0, 5554.0, 5325.0, 5549.0, 5335.0, 5463.0, 5266.0, 5689.0, 5496.0, 5546.0, 5723.0, 5487.0, 5388.0, 5510.0, 5626.0, 5608.0, 5702.0, 5283.0, 5613.0, 5460.0, 5674.0, 5286.0, 5722.0, 5534.0, 5507.0, 5378.0, 5538.0, 5317.0, 5398.0, 5337.0

						5451.0, 5590.0, 5406.0, 5677.0, 5637.0, 5352.0, 5503.0, 5287.0, 5401.0, 5361.0, 5582.0, 5474.0, 5524.0, 5670.0, 5498.0, 5506.0, 5667.0, 5470.0, 5297.0, 5502.0, 5628.0, 5618.0, 5322.0, 5368.0, 5579.0, 5678.0, 5654.0, 5316.0, 5699.0, 5359.0, 5612.0, 5485.0, 5555.0, 5641.0, 5433.0, 5416.0, 5698.0, 5273.0, 5580.0, 5279.0, 5289.0, 5302.0, 5403.0, 5456.0, 5404.0, 5478.0, 5425.0, 5382.0, 5617.0, 5439.0, 5483.0, 5333.0, 5256.0, 5556.0, 5263.0, 5683.0, 5296.0, 5441.0, 5353.0, 5523.0, 5706.0, 5386.0, 5423.0, 5658.0, 5285.0, 5703.0, 5417.0, 5414.0, 5614.0, 5391.0 (number of hits: 6)
14	5501	9	1	333	1	5542.0, 5336.0, 5463.0, 5330.0, 5680.0, 5621.0, 5493.0, 5523.0, 5658.0, 5345.0, 5675.0, 5661.0, 5708.0, 5686.0, 5376.0, 5527.0, 5291.0, 5252.0, 5630.0, 5439.0, 5575.0, 5448.0, 5697.0, 5604.0, 5459.0, 5591.0, 5492.0, 5300.0, 5683.0, 5465.0, 5271.0, 5716.0, 5470.0, 5299.0, 5437.0, 5500.0, 5596.0, 5623.0, 5333.0, 5577.0, 5261.0, 5274.0, 5572.0, 5344.0, 5340.0, 5551.0, 5302.0, 5526.0, 5370.0, 5332.0, 5514.0, 5438.0, 5564.0, 5372.0, 5693.0, 5674.0, 5581.0, 5457.0, 5536.0, 5687.0, 5704.0, 5403.0, 5495.0, 5417.0, 5537.0, 5464.0, 5267.0, 5384.0, 5334.0, 5366.0, 5694.0, 5656.0, 5721.0, 5453.0, 5454.0, 5486.0, 5491.0, 5341.0, 5499.0, 5560.0, 5619.0, 5461.0, 5251.0, 5606.0, 5406.0, 5317.0, 5410.0, 5531.0, 5532.0, 5571.0, 5699.0, 5409.0, 5389.0, 5490.0, 5379.0, 5466.0, 5320.0, 5429.0, 5719.0, 5285.0 (number of hits: 5)
15	5501	9	1	333	1	5318.0, 5570.0, 5376.0, 5512.0, 5700.0, 5309.0, 5307.0, 5652.0, 5406.0, 5340.0, 5723.0, 5493.0, 5389.0, 5528.0, 5644.0, 5534.0, 5465.0, 5481.0, 5618.0, 5560.0, 5383.0, 5687.0, 5352.0, 5621.0, 5351.0, 5266.0, 5403.0, 5395.0, 5405.0, 5255.0, 5460.0, 5401.0, 5515.0, 5447.0, 5356.0, 5539.0, 5530.0, 5522.0, 5476.0, 5681.0, 5653.0, 5670.0, 5593.0, 5708.0, 5466.0, 5281.0, 5568.0, 5418.0, 5537.0, 5597.0, 5380.0, 5275.0, 5720.0, 5438.0, 5264.0, 5628.0, 5683.0, 5324.0, 5620.0, 5277.0, 5342.0, 5331.0, 5321.0, 5617.0, 5442.0, 5270.0, 5367.0, 5394.0, 5298.0, 5589.0, 5370.0, 5288.0, 5398.0, 5520.0, 5262.0, 5592.0, 5657.0, 5689.0, 5639.0, 5596.0, 5531.0, 5709.0, 5386.0, 5538.0, 5509.0, 5399.0, 5495.0, 5358.0, 5332.0, 5586.0, 5521.0, 5508.0, 5409.0, 5603.0, 5544.0, 5355.0, 5635.0, 5655.0, 5545.0, 5672.0 (number of hits: 4)
16	5501	9	1	333	0	
17	5501	9	1	333	1	5461.0, 5447.0, 5380.0, 5544.0, 5317.0, 5589.0, 5575.0, 5715.0, 5681.0, 5503.0, 5637.0, 5300.0, 5647.0, 5293.0, 5712.0,

						5716.0, 5372.0, 5287.0, 5428.0, 5631.0, 5671.0, 5508.0, 5529.0, 5483.0, 5538.0, 5328.0, 5365.0, 5270.0, 5427.0, 5321.0, 5369.0, 5668.0, 5341.0, 5360.0, 5621.0, 5306.0, 5497.0, 5595.0, 5524.0, 5368.0, 5658.0, 5486.0, 5697.0, 5550.0, 5654.0, 5457.0, 5412.0, 5505.0, 5555.0, 5683.0, 5342.0, 5329.0, 5352.0, 5280.0, 5324.0, 5574.0, 5477.0, 5678.0, 5502.0, 5640.0, 5308.0, 5433.0, 5686.0, 5370.0, 5401.0, 5254.0, 5282.0, 5295.0, 5272.0, 5601.0, 5577.0, 5664.0, 5404.0, 5343.0, 5619.0, 5331.0, 5364.0, 5395.0, 5334.0, 5581.0, 5333.0, 5376.0, 5549.0, 5467.0, 5614.0, 5628.0, 5679.0, 5610.0, 5617.0, 5537.0, 5650.0, 5438.0, 5694.0, 5451.0, 5265.0, 5339.0, 5382.0, 5511.0, 5522.0, 5298.0 (number of hits: 5)
18	5501	9	1	333	0	0
19	5501	9	1	333	1	5685.0, 5715.0, 5314.0, 5410.0, 5700.0, 5546.0, 5472.0, 5707.0, 5471.0, 5336.0, 5572.0, 5418.0, 5379.0, 5466.0, 5389.0, 5305.0, 5264.0, 5638.0, 5392.0, 5530.0, 5574.0, 5720.0, 5474.0, 5393.0, 5456.0, 5455.0, 5642.0, 5509.0, 5447.0, 5521.0, 5331.0, 5437.0, 5670.0, 5278.0, 5489.0, 5563.0, 5289.0, 5617.0, 5500.0, 5261.0, 5492.0, 5482.0, 5317.0, 5569.0, 5622.0, 5583.0, 5450.0, 5403.0, 5452.0, 5481.0, 5645.0, 5485.0, 5361.0, 5512.0, 5365.0, 5414.0, 5677.0, 5609.0, 5286.0, 5515.0, 5346.0, 5646.0, 5584.0, 5585.0, 5335.0, 5356.0, 5604.0, 5633.0, 5591.0, 5411.0, 5575.0, 5538.0, 5422.0, 5279.0, 5562.0, 5251.0, 5717.0, 5606.0, 5573.0, 5281.0, 5429.0, 5275.0, 5250.0, 5424.0, 5558.0, 5373.0, 5486.0, 5684.0, 5592.0, 5316.0, 5577.0, 5338.0, 5371.0, 5653.0, 5345.0, 5394.0, 5334.0, 5615.0, 5699.0, 5673.0 (number of hits: 3)
20	5501	9	1	333	1	5659.0, 5366.0, 5313.0, 5466.0, 5530.0, 5656.0, 5496.0, 5337.0, 5560.0, 5302.0, 5631.0, 5680.0, 5556.0, 5276.0, 5583.0, 5480.0, 5289.0, 5443.0, 5527.0, 5523.0, 5376.0, 5458.0, 5495.0, 5385.0, 5348.0, 5510.0, 5637.0, 5626.0, 5598.0, 5455.0, 5433.0, 5634.0, 5380.0, 5341.0, 5382.0, 5312.0, 5578.0, 5327.0, 5507.0, 5277.0, 5610.0, 5253.0, 5497.0, 5258.0, 5307.0, 5567.0, 5347.0, 5716.0, 5278.0, 5652.0, 5492.0, 5603.0, 5282.0, 5619.0, 5407.0, 5441.0, 5374.0, 5577.0, 5386.0, 5558.0, 5333.0, 5676.0, 5322.0, 5707.0, 5550.0, 5435.0, 5562.0, 5283.0, 5629.0, 5520.0, 5612.0, 5623.0, 5646.0, 5343.0, 5534.0, 5294.0, 5486.0, 5698.0, 5291.0, 5568.0, 5614.0, 5502.0, 5607.0, 5514.0, 5413.0, 5370.0, 5509.0, 5524.0, 5381.0, 5346.0, 5304.0, 5669.0, 5367.0, 5408.0, 5714.0, 5356.0, 5362.0, 5412.0, 5536.0, 5559.0 (number of hits: 7)

21	5519	9	1	333	1	5372.0, 5547.0, 5685.0, 5375.0, 5364.0, 5501.0, 5476.0, 5628.0, 5416.0, 5699.0, 5332.0, 5589.0, 5477.0, 5555.0, 5641.0, 5390.0, 5709.0, 5465.0, 5428.0, 5546.0, 5644.0, 5397.0, 5408.0, 5286.0, 5446.0, 5337.0, 5595.0, 5302.0, 5252.0, 5554.0, 5631.0, 5267.0, 5317.0, 5553.0, 5312.0, 5351.0, 5622.0, 5346.0, 5646.0, 5262.0, 5441.0, 5657.0, 5502.0, 5409.0, 5422.0, 5473.0, 5706.0, 5424.0, 5350.0, 5334.0, 5572.0, 5340.0, 5316.0, 5630.0, 5519.0, 5678.0, 5419.0, 5674.0, 5510.0, 5537.0, 5529.0, 5394.0, 5392.0, 5711.0, 5575.0, 5494.0, 5410.0, 5540.0, 5329.0, 5557.0, 5368.0, 5610.0, 5583.0, 5361.0, 5581.0, 5357.0, 5276.0, 5635.0, 5695.0, 5560.0, 5717.0, 5460.0, 5349.0, 5556.0, 5627.0, 5427.0, 5400.0, 5379.0, 5310.0, 5345.0, 5287.0, 5260.0, 5431.0, 5618.0, 5452.0, 5254.0, 5670.0, 5668.0, 5669.0, 5569.0 (number of hits: 2)
22	5519	9	1	333	0	
23	5519	9	1	333	1	5688.0, 5565.0, 5646.0, 5436.0, 5666.0, 5701.0, 5329.0, 5621.0, 5321.0, 5644.0, 5593.0, 5712.0, 5606.0, 5574.0, 5501.0, 5300.0, 5410.0, 5334.0, 5402.0, 5458.0, 5271.0, 5607.0, 5433.0, 5547.0, 5503.0, 5472.0, 5288.0, 5663.0, 5608.0, 5378.0, 5579.0, 5254.0, 5657.0, 5280.0, 5302.0, 5389.0, 5430.0, 5361.0, 5457.0, 5399.0, 5313.0, 5466.0, 5370.0, 5376.0, 5486.0, 5473.0, 5514.0, 5417.0, 5450.0, 5631.0, 5266.0, 5578.0, 5303.0, 5586.0, 5619.0, 5325.0, 5585.0, 5616.0, 5517.0, 5557.0, 5683.0, 5432.0, 5408.0, 5395.0, 5287.0, 5698.0, 5491.0, 5265.0, 5661.0, 5476.0, 5529.0, 5464.0, 5462.0, 5350.0, 5519.0, 5624.0, 5520.0, 5563.0, 5677.0, 5674.0, 5550.0, 5368.0, 5535.0, 5490.0, 5353.0, 5281.0, 5297.0, 5467.0, 5629.0, 5711.0, 5494.0, 5386.0, 5272.0, 5312.0, 5513.0, 5404.0, 5538.0, 5652.0, 5308.0, 5393.0 (number of hits: 5)
24	5519	9	1	333	1	5662.0, 5287.0, 5334.0, 5697.0, 5635.0, 5511.0, 5480.0, 5253.0, 5428.0, 5495.0, 5533.0, 5336.0, 5425.0, 5414.0, 5472.0, 5694.0, 5416.0, 5441.0, 5521.0, 5294.0, 5474.0, 5704.0, 5544.0, 5275.0, 5289.0, 5335.0, 5714.0, 5709.0, 5649.0, 5498.0, 5520.0, 5421.0, 5718.0, 5698.0, 5637.0, 5545.0, 5650.0, 5278.0, 5722.0, 5515.0, 5442.0, 5346.0, 5330.0, 5665.0, 5529.0, 5349.0, 5496.0, 5567.0, 5679.0, 5299.0, 5691.0, 5420.0, 5485.0, 5492.0, 5337.0, 5512.0, 5266.0, 5461.0, 5270.0, 5401.0, 5663.0, 5347.0, 5711.0, 5674.0, 5384.0, 5437.0, 5610.0, 5415.0, 5712.0, 5482.0, 5558.0, 5393.0, 5290.0, 5633.0, 5306.0, 5395.0, 5321.0, 5274.0, 5312.0, 5696.0, 5549.0, 5719.0, 5706.0, 5373.0, 5612.0, 5353.0, 5593.0, 5684.0, 5259.0, 5708.0

						5557.0, 5673.0, 5403.0, 5350.0, 5530.0, 5620.0, 5652.0, 5323.0, 5258.0, 5451.0 (number of hits: 5)
25	5519	9	1	333	1	5677.0, 5699.0, 5350.0, 5378.0, 5710.0, 5679.0, 5425.0, 5482.0, 5256.0, 5571.0, 5681.0, 5483.0, 5608.0, 5505.0, 5697.0, 5558.0, 5722.0, 5692.0, 5266.0, 5395.0, 5404.0, 5641.0, 5353.0, 5716.0, 5262.0, 5593.0, 5720.0, 5468.0, 5480.0, 5723.0, 5317.0, 5344.0, 5701.0, 5398.0, 5338.0, 5320.0, 5685.0, 5326.0, 5308.0, 5526.0, 5682.0, 5437.0, 5531.0, 5592.0, 5490.0, 5372.0, 5487.0, 5671.0, 5588.0, 5331.0, 5459.0, 5603.0, 5292.0, 5657.0, 5354.0, 5454.0, 5566.0, 5300.0, 5386.0, 5598.0, 5653.0, 5340.0, 5535.0, 5676.0, 5687.0, 5601.0, 5379.0, 5293.0, 5280.0, 5408.0, 5528.0, 5626.0, 5305.0, 5360.0, 5560.0, 5706.0, 5589.0, 5272.0, 5427.0, 5451.0, 5362.0, 5548.0, 5547.0, 5403.0, 5469.0, 5463.0, 5313.0, 5503.0, 5352.0, 5334.0, 5512.0, 5443.0, 5282.0, 5413.0, 5391.0, 5388.0, 5361.0, 5556.0, 5285.0, 5496.0 (number of hits: 2)
26	5519	9	1	333	1	5472.0, 5252.0, 5448.0, 5444.0, 5478.0, 5544.0, 5396.0, 5486.0, 5668.0, 5372.0, 5411.0, 5272.0, 5466.0, 5718.0, 5707.0, 5528.0, 5362.0, 5523.0, 5376.0, 5649.0, 5432.0, 5555.0, 5706.0, 5431.0, 5410.0, 5337.0, 5562.0, 5576.0, 5536.0, 5684.0, 5454.0, 5316.0, 5457.0, 5403.0, 5597.0, 5709.0, 5632.0, 5607.0, 5646.0, 5479.0, 5719.0, 5600.0, 5366.0, 5613.0, 5558.0, 5674.0, 5292.0, 5627.0, 5584.0, 5654.0, 5298.0, 5315.0, 5591.0, 5605.0, 5350.0, 5421.0, 5342.0, 5368.0, 5355.0, 5615.0, 5395.0, 5673.0, 5606.0, 5527.0, 5521.0, 5637.0, 5581.0, 5320.0, 5439.0, 5675.0, 5455.0, 5280.0, 5507.0, 5588.0, 5652.0, 5550.0, 5691.0, 5386.0, 5687.0, 5515.0, 5392.0, 5551.0, 5462.0, 5611.0, 5695.0, 5594.0, 5618.0, 5385.0, 5393.0, 5340.0, 5408.0, 5658.0, 5402.0, 5700.0, 5621.0, 5608.0, 5356.0, 5560.0, 5610.0, 5297.0 (number of hits: 4)
27	5519	9	1	333	1	5720.0, 5722.0, 5506.0, 5362.0, 5353.0, 5395.0, 5691.0, 5432.0, 5675.0, 5318.0, 5336.0, 5427.0, 5259.0, 5450.0, 5468.0, 5488.0, 5374.0, 5574.0, 5715.0, 5445.0, 5337.0, 5495.0, 5575.0, 5384.0, 5329.0, 5351.0, 5684.0, 5440.0, 5314.0, 5476.0, 5702.0, 5485.0, 5670.0, 5550.0, 5358.0, 5585.0, 5372.0, 5368.0, 5479.0, 5633.0, 5377.0, 5393.0, 5322.0, 5601.0, 5502.0, 5597.0, 5455.0, 5498.0, 5338.0, 5332.0, 5470.0, 5628.0, 5463.0, 5316.0, 5521.0, 5654.0, 5429.0, 5293.0, 5420.0, 5662.0, 5397.0, 5378.0, 5642.0, 5564.0, 5667.0, 5524.0, 5695.0, 5328.0, 5345.0, 5656.0, 5706.0, 5356.0, 5669.0, 5457.0, 5705.0, 5556.0, 5497.0, 5648.0, 5275.0, 5484.0,

						5542.0, 5614.0, 5290.0, 5673.0, 5553.0, 5554.0, 5296.0, 5481.0, 5652.0, 5270.0, 5406.0, 5366.0, 5262.0, 5385.0, 5298.0, 5534.0, 5364.0, 5344.0, 5660.0, 5677.0 (number of hits: 2)
28	5519	9	1	333	1	5597.0, 5434.0, 5344.0, 5633.0, 5384.0, 5367.0, 5482.0, 5259.0, 5424.0, 5503.0, 5397.0, 5352.0, 5364.0, 5455.0, 5320.0, 5705.0, 5336.0, 5311.0, 5451.0, 5392.0, 5500.0, 5572.0, 5680.0, 5546.0, 5291.0, 5357.0, 5437.0, 5315.0, 5676.0, 5661.0, 5586.0, 5585.0, 5540.0, 5722.0, 5628.0, 5636.0, 5398.0, 5614.0, 5416.0, 5436.0, 5354.0, 5303.0, 5709.0, 5683.0, 5321.0, 5329.0, 5480.0, 5550.0, 5316.0, 5293.0, 5290.0, 5647.0, 5393.0, 5405.0, 5528.0, 5372.0, 5425.0, 5640.0, 5565.0, 5613.0, 5254.0, 5476.0, 5353.0, 5401.0, 5495.0, 5523.0, 5453.0, 5530.0, 5461.0, 5584.0, 5280.0, 5626.0, 5622.0, 5325.0, 5543.0, 5386.0, 5612.0, 5371.0, 5652.0, 5713.0, 5559.0, 5591.0, 5644.0, 5668.0, 5524.0, 5697.0, 5464.0, 5388.0, 5407.0, 5510.0, 5429.0, 5538.0, 5460.0, 5282.0, 5383.0, 5471.0, 5694.0, 5369.0, 5459.0, 5365.0 (number of hits: 3)
29	5519	9	1	333	1	5528.0, 5607.0, 5428.0, 5454.0, 5403.0, 5455.0, 5332.0, 5623.0, 5588.0, 5524.0, 5695.0, 5296.0, 5708.0, 5431.0, 5448.0, 5556.0, 5487.0, 5357.0, 5554.0, 5508.0, 5572.0, 5682.0, 5298.0, 5331.0, 5254.0, 5289.0, 5411.0, 5646.0, 5650.0, 5427.0, 5511.0, 5717.0, 5618.0, 5362.0, 5323.0, 5500.0, 5586.0, 5349.0, 5523.0, 5694.0, 5555.0, 5698.0, 5335.0, 5719.0, 5615.0, 5495.0, 5490.0, 5603.0, 5307.0, 5721.0, 5585.0, 5327.0, 5504.0, 5668.0, 5517.0, 5313.0, 5675.0, 5584.0, 5493.0, 5458.0, 5345.0, 5631.0, 5367.0, 5541.0, 5506.0, 5269.0, 5579.0, 5446.0, 5385.0, 5672.0, 5608.0, 5592.0, 5438.0, 5353.0, 5688.0, 5328.0, 5496.0, 5258.0, 5514.0, 5292.0, 5492.0, 5559.0, 5518.0, 5501.0, 5685.0, 5346.0, 5510.0, 5252.0, 5400.0, 5319.0, 5435.0, 5360.0, 5535.0, 5527.0, 5489.0, 5266.0, 5342.0, 5478.0, 5545.0, 5462.0 (number of hits: 8)
30	5519	9	1	333	1	5462.0, 5381.0, 5446.0, 5501.0, 5406.0, 5452.0, 5295.0, 5349.0, 5718.0, 5606.0, 5691.0, 5700.0, 5531.0, 5576.0, 5667.0, 5594.0, 5360.0, 5694.0, 5526.0, 5346.0, 5458.0, 5379.0, 5389.0, 5609.0, 5307.0, 5336.0, 5703.0, 5313.0, 5527.0, 5652.0, 5630.0, 5443.0, 5341.0, 5424.0, 5603.0, 5513.0, 5541.0, 5554.0, 5485.0, 5611.0, 5563.0, 5350.0, 5548.0, 5640.0, 5259.0, 5712.0, 5685.0, 5532.0, 5408.0, 5591.0, 5493.0, 5477.0, 5621.0, 5298.0, 5487.0, 5355.0, 5271.0, 5661.0, 5308.0, 5656.0, 5468.0, 5333.0, 5483.0, 5547.0, 5486.0, 5413.0, 5688.0, 5403.0, 5529.0, 5723.0,

						5421.0, 5491.0, 5602.0, 5420.0, 5623.0, 5279.0, 5601.0, 5552.0, 5254.0, 5345.0, 5310.0, 5343.0, 5555.0, 5361.0, 5352.0, 5698.0, 5318.0, 5407.0, 5478.0, 5520.0, 5441.0, 5280.0, 5328.0, 5704.0, 5306.0, 5660.0, 5303.0, 5321.0, 5676.0, 5284.0 (number of hits: 4)
--	--	--	--	--	--	--

B.2 40 MHz Bandwidth @ 5520 MHz

Table-1A/1B Radar Type 1A/1B Statistical Performance

Trial #	Fc (MHz)	Pulse/Burst	Pulse Width (μS)	PRI (μs)	Detection (1:yes; 0:no)
1	5520	86	1	618	1
2	5520	58	1	918	1
3	5520	95	1	558	1
4	5520	92	1	578	1
5	5520	59	1	898	1
6	5520	62	1	858	1
7	5520	76	1	698	1
8	5520	61	1	878	1
9	5520	57	1	938	1
10	5520	70	1	758	1
11	5520	99	1	538	1
12	5520	74	1	718	1
13	5520	83	1	638	1
14	5520	89	1	598	1
15	5520	102	1	518	1
16	5520	27	1	1972	1
17	5520	29	1	1855	1
18	5520	27	1	2009	1
19	5520	21	1	2575	1
20	5520	31	1	1738	1
21	5520	22	1	2454	1
22	5520	22	1	2404	1
23	5520	53	1	997	1
24	5520	23	1	2314	1
25	5520	57	1	942	1
26	5520	21	1	2630	1
27	5520	22	1	2496	1
28	5520	39	1	1387	1
29	5520	26	1	2030	1
30	5520	20	1	2752	1
Detection Percentage: 100 % (>60%)					

Table-2 Radar Type 2 Statistical Performance

Trial #	Fc (MHz)	Pulse/Burst	Pulse Width (μS)	PRI (μs)	Detection (1:yes; 0:no)
1	5520	26	1.1	222	1
2	5520	29	4.5	189	1
3	5520	27	4.6	229	1
4	5520	24	5	222	1
5	5520	26	4.7	150	1
6	5520	24	1.1	185	1
7	5520	27	1.1	228	1
8	5520	23	2	207	1
9	5520	27	4.7	152	1
10	5520	27	4.3	205	1
11	5520	27	3.5	172	1
12	5520	27	4	174	1
13	5520	25	2.3	164	1
14	5520	25	3	183	1
15	5520	24	3.5	171	1
16	5520	27	2.9	210	1
17	5520	29	1.3	154	1
18	5520	29	4.3	219	1
19	5520	29	1.7	210	1
20	5520	23	1.9	219	1
21	5520	29	3	167	1
22	5520	26	2.6	215	1
23	5520	28	1.7	166	1
24	5520	26	3.9	190	1
25	5520	28	4.7	158	1
26	5520	24	3.2	215	1
27	5520	25	5	204	1
28	5520	27	1.8	217	1
29	5520	29	2.6	163	1
30	5520	25	1.3	156	1
Detection Percentage: 100 % (>60%)					

Table-3 Radar Type 3 Statistical Performance

Trial #	Fc (MHz)	Pulse/Burst	Pulse Width (μ S)	PRI (μ s)	Detection (1:yes; 0:no)
1	5520	16	6.3	420	1
2	5520	17	9.4	376	1
3	5520	16	6.4	480	1
4	5520	16	9.8	475	1
5	5520	16	9.1	368	1
6	5520	16	8.3	412	1
7	5520	16	6.8	499	1
8	5520	17	9.4	401	1
9	5520	17	9.2	321	1
10	5520	16	9	228	1
11	5520	16	8.6	202	1
12	5520	17	6.3	409	1
13	5520	17	8.1	383	1
14	5520	17	6.2	359	1
15	5520	16	9.4	214	1
16	5520	17	9.6	383	1
17	5520	16	8.5	442	1
18	5520	16	8.5	392	1
19	5520	16	8.9	362	1
20	5520	18	8	239	1
21	5520	17	9.6	334	1
22	5520	18	8.5	426	1
23	5520	18	6.6	425	1
24	5520	17	6.9	471	1
25	5520	16	6.2	252	1
26	5520	18	7.3	302	1
27	5520	16	9.4	415	1
28	5520	16	9.4	301	1
29	5520	17	8.6	257	1
30	5520	17	8.5	349	1
Detection Percentage: 100 % (>60%)					

Table-4 Radar Type 4 Statistical Performance

Trial #	Fc (MHz)	Pulse/Burst	Pulse Width (μS)	PRI (μs)	Detection (1:yes; 0:no)
1	5520	16	15.5	421	1
2	5520	15	11.6	311	1
3	5520	16	17.7	432	1
4	5520	15	17.1	398	1
5	5520	13	14.8	490	1
6	5520	13	16.3	493	1
7	5520	14	14.4	419	1
8	5520	13	16.6	282	1
9	5520	13	16.2	400	1
10	5520	13	17	255	1
11	5520	13	15.4	320	1
12	5520	15	19.8	416	1
13	5520	14	12.6	411	1
14	5520	14	11.5	468	0
15	5520	15	11.8	474	1
16	5520	14	16.8	478	1
17	5520	12	19.4	246	1
18	5520	15	19.3	247	1
19	5520	13	17.9	406	1
20	5520	16	18.4	275	0
21	5520	13	13.2	212	1
22	5520	14	15.4	213	1
23	5520	16	13.7	345	1
24	5520	15	15.5	340	1
25	5520	14	12.7	448	0
26	5520	12	13.7	205	1
27	5520	16	16.3	314	1
28	5520	13	16.8	443	1
29	5520	15	18.5	483	1
30	5520	15	14.1	383	1
Detection Percentage: 90 % (>60%)					

Table-5 Radar Type 5 Statistical Performance

Trial #	Fc (MHz)	Detection (1:yes; 0:no)
1	5520	1
2	5520	1
3	5520	0
4	5520	1
5	5520	1
6	5520	1
7	5520	1
8	5520	1
9	5520	0
10	5520	1
11	5507.1	1
12	5505.5	0
13	5508.3	1
14	5503.9	1
15	5508.7	1
16	5506.7	1
17	5509.1	1
18	5507.1	1
19	5505.9	1
20	5505.5	1
21	5531.7	1
22	5531.7	1
23	5536.5	0
24	5532.1	1
25	5531.3	1
26	5536.1	1
27	5531.7	1
28	5533.7	1
29	5535.7	1
30	5535.7	1
Detection Percentage: 86.7 % (>80%)		

Bin5 Statistics 1

Trial #	Pulse	Chirp (MHz)	Pulse Width (µS)	Pulse 1-2 spacing (uS)	Pulse 2-3 spacing (uS)	Pulse Start(S)	Detection (1:yes; 0:no)
0	2	10	58.7	1548		0.258392	1
1	1	10	73			0.96573	
2	1	10	76.2			1.321159	
3	2	10	81.1	1372		1.97067	
4	3	10	78.4	1733	1102	2.772672	
5	1	10	59.7			3.693418	
6	2	10	85.5	1983		3.808041	
7	2	10	98.3	1413		4.834221	
8	1	10	68.4			5.060638	
9	3	10	80.9	1371	1458	5.735636	
10	1	10	69.2			6.44504	
11	1	10	98.5			7.571251	
12	1	10	96.9			8.118726	
13	2	10	50.1	1222		8.772221	
14	2	10	92.5	1308		9.177829	
15	3	10	86.8	1333	1424	10.096813	
16	1	10	82.7			10.130864	
17	2	10	85.7	1175		11.129635	
18	1	10	84			11.460962	

Bin5 Statistics 2

Trial #	Pulse	Chirp (MHz)	Pulse Width (µS)	Pulse 1-2 spacing (uS)	Pulse 2-3 spacing (uS)	Pulse Start(S)	Detection (1:yes; 0:no)
0	3	10	58.7	1419	1372	0.95069	1
1	3	10	50.2	1923	1656	1.452443	
2	1	10	51.5			3.106694	
3	2	10	73.4	1628		4.373292	
4	3	10	73.7	1718	1395	6.621689	
5	2	10	92.6	1703		7.30859	
6	2	10	58	1793		8.646745	
7	2	10	57.9	1207		9.963448	
8	2	10	94.9	1308		11.342732	

Bin5 Statistics 3

Trial #	Pulse	Chirp (MHz)	Pulse Width (µS)	Pulse 1-2 spacing (uS)	Pulse 2-3 spacing (uS)	Pulse Start(S)	Detection (1:yes; 0:no)
0	2	8	66.3	1541		0.892661	0
1	3	8	73	1102	1038	1.763891	
2	3	8	93.7	1407	1267	2.559942	
3	2	8	96.9	1742		3.660953	
4	2	8	83.6	1944		5.342138	
5	2	8	52.8	1584		5.462537	
6	3	8	97.4	1349	1663	6.695377	
7	2	8	85.6	1684		8.110448	
8	3	8	93	1216	1463	9.205559	
9	1	8	65.5			9.923373	
10	1	8	85.2			10.954934	

Bin5 Statistics 4

Trial #	Pulse	Chirp (MHz)	Pulse Width (µS)	Pulse 1-2 spacing (uS)	Pulse 2-3 spacing (uS)	Pulse Start(S)	Detection (1:yes; 0:no)
0	3	9	81.4	1035	1078	0.734341	1
1	1	9	54.6			1.449013	
2	2	9	64.7	1339		2.174312	
3	3	9	72	1507	1738	2.978393	
4	2	9	71.5	1068		4.032641	
5	2	9	60.9	1914		5.203457	
6	3	9	91.3	1211	1035	5.665188	
7	2	9	86.8	1549		6.756035	
8	2	9	83.7	1564		7.818787	
9	2	9	87.2	1679		8.54204	
10	3	9	75.6	1065	1079	9.979279	
11	1	9	51.1			10.270802	
12	2	9	86.4	1608		11.466112	

Bin5 Statistics 5

Trial #	Pulse	Chirp (MHz)	Pulse Width (µS)	Pulse 1-2 spacing (uS)	Pulse 2-3 spacing (uS)	Pulse Start(S)	Detection (1:yes; 0:no)
0	2	10	66.1	1086		0.238928	1
1	3	10	52	1796	1284	1.211632	
2	1	10	59.2			1.447766	
3	2	10	84.4	1028		1.978984	
4	1	10	71.3			3.021232	
5	1	10	82.9			3.588064	
6	3	10	56.3	1107	1128	4.252418	
7	2	10	55.1	1031		5.042821	
8	1	10	70.3			5.543434	
9	2	10	83.9	1469		6.200197	
10	2	10	85.8	1565		6.749054	
11	1	10	51.5			7.010117	
12	3	10	80.4	1988	1915	8.008051	
13	2	10	91	1943		8.324707	
14	2	10	87.9	1678		9.014721	
15	3	10	67.2	1037	1431	9.516588	
16	2	10	67	1299		10.501129	
17	2	10	86.3	1473		11.225471	
18	3	10	58.1	1863	1751	11.913045	

Bin5 Statistics 6

Trial #	Pulse	Chirp (MHz)	Pulse Width (µS)	Pulse 1-2 spacing (uS)	Pulse 2-3 spacing (uS)	Pulse Start(S)	Detection (1:yes; 0:no)
0	2	10	72.2	1561		0.752002	1
1	3	10	96.3	1077	1668	1.780764	
2	3	10	71	1048	1619	2.762139	
3	3	10	92.5	1503	2000	2.869372	
4	1	10	85.5			4.219351	
5	1	10	84.5			4.621333	
6	2	10	68.6	1793		5.815008	
7	3	10	68.6	1969	1890	6.806809	
8	2	10	83.2	1869		7.436759	
9	1	10	81.1			8.556234	
10	1	10	88.5			9.922825	
11	1	10	98.7			10.947035	
12	2	10	84.9	1479		11.78412	

Bin5 Statistics 7

Trial #	Pulse	Chirp (MHz)	Pulse Width (µS)	Pulse 1-2 spacing (uS)	Pulse 2-3 spacing (uS)	Pulse Start(S)	Detection (1:yes; 0:no)
0	3	12	51	1737	1976	0.339947	1
1	2	12	67.2	1083		1.134244	
2	3	12	95.8	1674	1267	2.857379	
3	1	12	79			4.314004	
4	1	12	63.7			4.469713	
5	1	12	77			5.666212	
6	1	12	93.6			7.566115	
7	3	12	60.8	1790	1715	8.717624	
8	2	12	57.5	1004		8.835198	
9	2	12	80.6	1862		10.883282	
10	2	12	53.5	1880		11.349734	

Bin5 Statistics 8

Trial #	Pulse	Chirp (MHz)	Pulse Width (µS)	Pulse 1-2 spacing (uS)	Pulse 2-3 spacing (uS)	Pulse Start(S)	Detection (1:yes; 0:no)
0	2	5	74.2	1180		0.180669	1
1	2	5	86.4	1463		0.837988	
2	1	5	54			1.774264	
3	2	5	66.9	1232		2.925194	
4	3	5	78.4	1432	1861	3.672422	
5	3	5	77.8	1848	1976	4.315682	
6	2	5	97.7	1895		5.306068	
7	1	5	93.8			6.24968	
8	2	5	74.5	1340		6.85197	
9	2	5	62.3	1784		7.610665	
10	2	5	96.8	1864		8.453118	
11	2	5	66.1	1699		9.386861	
12	1	5	67			10.024973	
13	2	5	64.6	1554		11.11419	
14	2	5	94.5	1196		11.504014	

Bin5 Statistics 9

Trial #	Pulse	Chirp (MHz)	Pulse Width (µS)	Pulse 1-2 spacing (uS)	Pulse 2-3 spacing (uS)	Pulse Start(S)	Detection (1:yes; 0:no)
0	2	6	78.1	1291		0.544205	0
1	1	6	69.2			0.968941	
2	2	6	53.9	1589		1.882571	
3	1	6	82.3			2.658375	
4	2	6	89.6	1595		3.036656	
5	3	6	52.7	1533	1587	3.527007	
6	2	6	60.3	1239		4.540904	
7	2	6	76.1	1106		4.873118	
8	1	6	83.7			5.460633	
9	3	6	90.4	1927	1110	6.183569	
10	2	6	69.1	1999		7.316941	
11	1	6	92.1			7.56998	
12	1	6	95.4			8.573077	
13	3	6	84.8	1328	1279	9.120427	
14	1	6	75.8			9.348515	
15	2	6	60.7	1563		10.475892	
16	3	6	88.1	1754	1872	10.718809	
17	2	6	94.7	1768		11.828591	

Bin5 Statistics 10

Trial #	Pulse	Chirp (MHz)	Pulse Width (µS)	Pulse 1-2 spacing (uS)	Pulse 2-3 spacing (uS)	Pulse Start(S)	Detection (1:yes; 0:no)
0	1	8	56.8			0.138333	1
1	2	8	87.1	1859		1.283441	
2	2	8	94.9	1454		1.985032	
3	2	8	69.6	1817		2.687159	
4	2	8	65.3	1682		3.737446	
5	2	8	81.1	1948		4.362939	
6	1	8	70.2			4.532362	
7	3	8	60.7	1759	1517	5.657697	
8	2	8	71.7	1147		6.136643	
9	2	8	72.8	1254		7.256042	
10	1	8	59.2			8.166441	
11	2	8	75.9	1996		8.962574	
12	3	8	92.5	1716	1887	9.159429	
13	2	8	53.3	1560		9.855617	
14	2	8	73.7	1285		10.815527	
15	3	8	79.7	1956	1151	11.27232	

Bin5 Statistics 11

Trial #	Pulse	Chirp (MHz)	Pulse Width (µS)	Pulse 1-2 spacing (uS)	Pulse 2-3 spacing (uS)	Pulse Start(S)	Detection (1:yes; 0:no)
0	2	14	61.5	1932		0.522054	1
1	1	14	78.1			1.203463	
2	1	14	78.4			1.912506	
3	2	14	65.9	1993		2.676152	
4	2	14	91.9	1296		3.658526	
5	3	14	82.6	1833	1269	4.334377	
6	2	14	50	1049		4.970265	
7	3	14	59.1	1796	1192	5.312092	
8	2	14	99.1	1460		6.099204	
9	3	14	94.4	1355	1795	7.091558	
10	2	14	94.8	1195		8.236853	
11	1	14	80			8.318075	
12	2	14	96.1	1617		9.743753	
13	2	14	79.3	1002		9.922672	
14	3	14	63.4	1497	1633	10.593223	
15	1	14	50.6			11.71952	

Bin5 Statistics 12

Trial #	Pulse	Chirp (MHz)	Pulse Width (µS)	Pulse 1-2 spacing (uS)	Pulse 2-3 spacing (uS)	Pulse Start(S)	Detection (1:yes; 0:no)
0	2	10	83.5	1403		0.501672	0
1	2	10	81.9	1830		1.447805	
2	2	10	83.8	1982		2.842234	
3	2	10	59.3	1262		4.205424	
4	2	10	58.4	1159		5.386523	
5	2	10	78.5	1590		6.589142	
6	2	10	76.5	1110		7.83713	
7	3	10	97.6	1406	1850	9.378793	
8	1	10	97.7			10.108492	
9	1	10	91.1			11.454854	

Bin5 Statistics 13

Trial #	Pulse	Chirp (MHz)	Pulse Width (µS)	Pulse 1-2 spacing (uS)	Pulse 2-3 spacing (uS)	Pulse Start(S)	Detection (1:yes; 0:no)
0	2	17	57.9	1916		0.278757	1
1	2	17	64.6	1899		1.521329	
2	3	17	58.5	1805	1072	2.170176	
3	3	17	52	1267	1492	3.01564	
4	2	17	73.4	1647		4.97014	
5	2	17	72.9	1039		5.856958	
6	2	17	86.9	1162		6.878913	
7	2	17	88	1310		7.525655	
8	3	17	72.2	1527	1510	8.036334	
9	2	17	68.6	1000		9.291266	
10	1	17	94.7			10.249094	
11	1	17	77.9			11.215689	

Bin5 Statistics 14

Trial #	Pulse	Chirp (MHz)	Pulse Width (µS)	Pulse 1-2 spacing (uS)	Pulse 2-3 spacing (uS)	Pulse Start(S)	Detection (1:yes; 0:no)
0	2	6	96.7	1051		0.430588	1
1	3	6	67.1	1843	1784	1.115053	
2	2	6	62.9	1332		2.224504	
3	1	6	50.6			3.222733	
4	2	6	50.9	1859		4.228018	
5	2	6	89.9	1256		4.957429	
6	1	6	67.2			5.925948	
7	2	6	86.3	1188		6.300935	
8	3	6	95	1675	1903	6.966059	
9	1	6	94.5			7.867074	
10	2	6	77.9	1280		8.6138	
11	2	6	90	1061		10.199446	
12	1	6	52.1			10.871199	
13	3	6	73.8	1536	1480	11.656534	

Bin5 Statistics 15

Trial #	Pulse	Chirp (MHz)	Pulse Width (µS)	Pulse 1-2 spacing (uS)	Pulse 2-3 spacing (uS)	Pulse Start(S)	Detection (1:yes; 0:no)
0	1	18	54			0.464118	1
1	2	18	67.4	1923		0.878262	
2	1	18	75.1			1.398484	
3	3	18	91.8	1407	1290	1.991307	
4	1	18	84.9			3.015548	
5	1	18	72			3.460851	
6	1	18	92.6			4.176499	
7	2	18	51.8	1160		4.780909	
8	3	18	80.2	1346	1514	5.455926	
9	1	18	89			5.914961	
10	2	18	90.6	1281		6.553393	
11	3	18	61.5	1012	1751	7.101948	
12	2	18	77.4	1315		7.925408	
13	3	18	69.7	1638	1030	8.660746	
14	3	18	95.2	1872	1378	9.19674	
15	1	18	85.1			9.634639	
16	3	18	72.6	1849	1422	10.354824	
17	2	18	65.3	1350		10.96624	
18	2	18	58	1269		11.389552	

Bin5 Statistics 16

Trial #	Pulse	Chirp (MHz)	Pulse Width (µS)	Pulse 1-2 spacing (uS)	Pulse 2-3 spacing (uS)	Pulse Start(S)	Detection (1:yes; 0:no)
0	2	13	69.7	1713		0.137854	1
1	2	13	54.4	1649		0.807978	
2	3	13	83.6	1077	1904	1.852379	
3	2	13	59.9	1106		2.268347	
4	3	13	60.7	1402	1276	3.027656	
5	2	13	77.5	1831		3.693854	
6	2	13	66.5	1499		4.34833	
7	2	13	50	1023		4.851465	
8	2	13	70.4	1029		5.135018	
9	3	13	55	1356	1974	6.185489	
10	3	13	58.6	1243	1861	6.879629	
11	1	13	52.7			7.211873	
12	3	13	78.8	1241	1210	8.157885	
13	2	13	53.6	1800		8.509098	
14	2	13	63.6	1630		8.923025	
15	2	13	56.6	1466		9.809423	
16	1	13	93.6			10.431275	
17	1	13	78.7			11.195839	
18	1	13	57			11.401587	

Bin5 Statistics 17

Trial #	Pulse	Chirp (MHz)	Pulse Width (µS)	Pulse 1-2 spacing (uS)	Pulse 2-3 spacing (uS)	Pulse Start(S)	Detection (1:yes; 0:no)
0	2	19	55.2	1140		0.810191	1
1	3	19	65.2	1954	1546	1.513445	
2	3	19	64	1401	1954	1.779205	
3	1	19	62.6			2.84014	
4	2	19	69.5	1013		4.273387	
5	2	19	74.2	1232		4.71077	
6	2	19	85.1	1884		5.781108	
7	1	19	58.3			6.091816	
8	1	19	63.3			7.141346	
9	2	19	57.1	1086		8.077496	
10	2	19	61.2	1046		9.162011	
11	2	19	87.6	1572		9.805745	
12	1	19	86.4			11.026593	
13	2	19	50	1467		11.650153	

Bin5 Statistics 18

Trial #	Pulse	Chirp (MHz)	Pulse Width (µS)	Pulse 1-2 spacing (uS)	Pulse 2-3 spacing (uS)	Pulse Start(S)	Detection (1:yes; 0:no)
0	2	14	72	1395		0.0139	1
1	2	14	51.9	1749		1.428728	
2	1	14	98.5			2.820068	
3	1	14	81.5			3.859221	
4	3	14	82.9	1356	1874	4.699078	
5	3	14	62.7	1601	1722	5.191692	
6	1	14	96.3			6.879229	
7	3	14	66.3	1272	1455	7.496102	
8	3	14	63.1	1888	1248	8.754437	
9	2	14	99.9	1739		9.238672	
10	2	14	95.7	1688		10.143466	
11	1	14	79.4			11.004345	

Bin5 Statistics 19

Trial #	Pulse	Chirp (MHz)	Pulse Width (µS)	Pulse 1-2 spacing (uS)	Pulse 2-3 spacing (uS)	Pulse Start(S)	Detection (1:yes; 0:no)
0	1	11	94.8			0.374356	1
1	3	11	53.7	1449	1553	1.372418	
2	2	11	58	1381		2.014734	
3	2	11	78.1	1724		3.363983	
4	3	11	80.2	1125	1628	4.180675	
5	3	11	90.1	1214	1535	5.335926	
6	2	11	66	1840		5.921411	
7	1	11	96.4			7.297416	
8	1	11	59.5			7.695792	
9	2	11	62	1019		8.783679	
10	2	11	92.6	1774		9.567222	
11	2	11	64.6	1453		11.059256	
12	1	11	94.6			11.378099	

Bin5 Statistics 20

Trial #	Pulse	Chirp (MHz)	Pulse Width (µS)	Pulse 1-2 spacing (uS)	Pulse 2-3 spacing (uS)	Pulse Start(S)	Detection (1:yes; 0:no)
0	3	10	71	1835	1127	0.201699	1
1	3	10	81.7	1327	1327	1.415197	
2	2	10	64.1	1594		2.102237	
3	2	10	87.9	1726		3.617567	
4	2	10	75.9	1670		4.360898	
5	2	10	77.2	1044		5.106418	
6	3	10	84.9	1273	1486	5.699679	
7	1	10	65.6			7.349294	
8	2	10	98.8	1210		7.52918	
9	1	10	70.9			9.036487	
10	2	10	76	1355		10.103138	
11	2	10	87.5	1934		10.795142	
12	3	10	77.2	1026	1481	11.086014	

Bin5 Statistics 21

Trial #	Pulse	Chirp (MHz)	Pulse Width (µS)	Pulse 1-2 spacing (uS)	Pulse 2-3 spacing (uS)	Pulse Start(S)	Detection (1:yes; 0:no)
0	1	17	74.5			0.738894	1
1	1	17	81.5			1.607843	
2	3	17	92.8	1104	1578	2.496456	
3	1	17	93			3.385098	
4	3	17	88.6	1620	1094	4.415258	
5	3	17	93.5	1988	1402	5.235431	
6	2	17	81.8	1470		6.899642	
7	2	17	76.5	1417		7.45049	
8	1	17	51.1			8.770943	
9	1	17	93.4			9.335558	
10	3	17	74.4	1786	1982	10.594462	
11	2	17	52.4	1560		11.611108	

Bin5 Statistics 22

Trial #	Pulse	Chirp (MHz)	Pulse Width (µS)	Pulse 1-2 spacing (uS)	Pulse 2-3 spacing (uS)	Pulse Start(S)	Detection (1:yes; 0:no)
0	1	17	78.1			0.42612	1
1	1	17	60			1.271436	
2	2	17	85.4	1651		1.873826	
3	1	17	97.9			2.490078	
4	2	17	83	1924		3.309917	
5	2	17	92.3	1566		3.516882	
6	2	17	59.4	1237		4.408403	
7	2	17	81.4	1247		5.046446	
8	1	17	71.1			5.903418	
9	2	17	86.6	1832		6.468556	
10	2	17	79.7	1688		7.250734	
11	1	17	61.1			7.737284	
12	1	17	56.2			8.018021	
13	2	17	64.8	1544		9.299788	
14	2	17	81.7	1384		9.619828	
15	3	17	59.7	1677	1406	10.003681	
16	3	17	95.9	1940	1082	11.073597	
17	1	17	64.9			11.365467	

Bin5 Statistics 23

Trial #	Pulse	Chirp (MHz)	Pulse Width (µS)	Pulse 1-2 spacing (uS)	Pulse 2-3 spacing (uS)	Pulse Start(S)	Detection (1:yes; 0:no)
0	3	5	53.7	1512	1084	0.25454	0
1	2	5	89.9	1760		1.412924	
2	3	5	83.8	1016	1876	2.530647	
3	1	5	66.7			3.648212	
4	3	5	97.6	1155	1294	5.091691	
5	2	5	54.3	1988		6.102927	
6	1	5	61			7.156995	
7	2	5	91.6	1619		8.262192	
8	2	5	75.7	1950		9.09212	
9	1	5	87.3			10.86832	
10	2	5	65.7	1111		11.366641	

Bin5 Statistics 24

Trial #	Pulse	Chirp (MHz)	Pulse Width (µS)	Pulse 1-2 spacing (uS)	Pulse 2-3 spacing (uS)	Pulse Start(S)	Detection (1:yes; 0:no)
0	3	16	65.3	1338	1738	0.487142	1
1	2	16	94.2	1947		1.81959	
2	1	16	66			2.396338	
3	2	16	68.6	1115		3.353322	
4	2	16	77.9	1780		4.018385	
5	2	16	54.8	1619		4.723275	
6	2	16	94.8	1396		5.945654	
7	1	16	70.5			6.753689	
8	3	16	66.7	1966	1767	7.647257	
9	3	16	63	1127	1824	9.162663	
10	3	16	87.8	1206	1730	9.900349	
11	2	16	95.8	1989		10.422872	
12	3	16	88.3	1723	1335	11.38037	

Bin5 Statistics 25

Trial #	Pulse	Chirp (MHz)	Pulse Width (µS)	Pulse 1-2 spacing (uS)	Pulse 2-3 spacing (uS)	Pulse Start(S)	Detection (1:yes; 0:no)
0	3	18	79.1	1047	1277	0.395217	1
1	3	18	57.4	1380	1280	1.805163	
2	1	18	93.3			2.088884	
3	1	18	66.8			3.291223	
4	2	18	93.3	1241		4.437655	
5	2	18	87.3	1378		4.852091	
6	2	18	92.6	1828		6.303823	
7	2	18	69.5	1402		7.217593	
8	3	18	74.8	1679	1422	8.253818	
9	1	18	68.4			9.044407	
10	2	18	81.8	1518		9.559299	
11	2	18	50.3	1098		10.80124	
12	2	18	98.6	1075		11.738519	

Bin5 Statistics 26

Trial #	Pulse	Chirp (MHz)	Pulse Width (µS)	Pulse 1-2 spacing (uS)	Pulse 2-3 spacing (uS)	Pulse Start(S)	Detection (1:yes; 0:no)
0	2	6	71.8	1524		0.199441	1
1	3	6	82.9	1553	1173	0.949848	
2	2	6	65.1	1684		1.529797	
3	2	6	76.1	1661		2.661516	
4	2	6	51.8	1482		3.029604	
5	2	6	62.6	1316		4.050262	
6	2	6	91.5	1273		4.804239	
7	1	6	66.9			5.133008	
8	2	6	89	1086		5.944117	
9	3	6	69.7	1231	1418	6.584085	
10	1	6	98			7.197027	
11	1	6	98.8			8.392228	
12	3	6	51.8	1695	1640	8.815522	
13	2	6	85.2	1412		9.467905	
14	2	6	57.4	1757		10.536276	
15	2	6	97.3	1131		10.753897	
16	3	6	56.8	1136	1065	11.584342	

Bin5 Statistics 27

Trial #	Pulse	Chirp (MHz)	Pulse Width (µS)	Pulse 1-2 spacing (uS)	Pulse 2-3 spacing (uS)	Pulse Start(S)	Detection (1:yes; 0:no)
0	2	17	70.8	1275		0.978383	1
1	2	17	68.4	1851		2.123116	
2	1	17	63.6			2.588054	
3	2	17	98.8	1340		4.014579	
4	1	17	70.7			5.739753	
5	2	17	60.9	1821		7.013548	
6	2	17	55.6	1777		7.795388	
7	1	17	76.9			8.982213	
8	3	17	61	1142	1831	10.433306	
9	3	17	65.3	1285	1257	11.939093	

Bin5 Statistics 28

Trial #	Pulse	Chirp (MHz)	Pulse Width (µS)	Pulse 1-2 spacing (µS)	Pulse 2-3 spacing (µS)	Pulse Start(S)	Detection (1:yes; 0:no)
0	3	12	74.8	1081	1993	0.321547	1
1	2	12	61.8	1941		1.143814	
2	2	12	61.2	1845		1.650557	
3	2	12	77	1204		2.20359	
4	2	12	94	1770		3.477853	
5	1	12	79.6			3.95366	
6	3	12	59.2	1909	1032	4.540555	
7	1	12	97.9			5.153126	
8	3	12	74.2	1518	1669	5.705759	
9	2	12	57.7	1317		6.768065	
10	2	12	83.5	1316		7.696762	
11	2	12	88.4	1611		7.798235	
12	2	12	76.3	1411		8.886555	
13	1	12	74.2			9.755798	
14	2	12	59.2	1227		10.019041	
15	2	12	79.1	1651		10.970798	
16	3	12	94	1313	1134	11.372962	

Bin5 Statistics 29

Trial #	Pulse	Chirp (MHz)	Pulse Width (µS)	Pulse 1-2 spacing (µS)	Pulse 2-3 spacing (µS)	Pulse Start(S)	Detection (1:yes; 0:no)
0	3	7	61.1	1043	1092	0.898912	1
1	2	7	76.5	1867		1.303346	
2	3	7	79.1	1439	1239	1.906673	
3	2	7	64.3	1271		2.795055	
4	2	7	52.2	1379		4.156731	
5	3	7	98.7	1408	1308	5.386532	
6	2	7	51.2	1336		6.103557	
7	2	7	68.5	1340		6.733541	
8	2	7	79	1761		7.752171	
9	1	7	68.1			9.096366	
10	3	7	61.8	1317	1909	9.900984	
11	3	7	86.1	1641	1314	10.464858	
12	1	7	69			11.465741	

Bin5 Statistics 30

Trial #	Pulse	Chirp (MHz)	Pulse Width (µS)	Pulse 1-2 spacing (uS)	Pulse 2-3 spacing (uS)	Pulse Start(S)	Detection (1:yes; 0:no)
0	2	7	70.3	1101		0.218322	1
1	1	7	70.8			1.58116	
2	2	7	94.4	1466		2.924621	
3	2	7	74	1033		4.212448	
4	1	7	67			4.470482	
5	1	7	96.9			6.419077	
6	1	7	51.5			6.977839	
7	3	7	92.3	1251	1205	7.76472	
8	1	7	57.9			9.388103	
9	2	7	57.2	1825		10.482499	
10	2	7	65.8	1778		11.17525	

Table-6 Radar Type 6 Statistical Performance

Trial #	Fc (MHz)	Pulse /Burst	Pulse Width (μS)	PRI (μs)	Detection (1:yes; 0:no)	Hopping Sequence
1	5520	9	1	333	1	5594.0, 5389.0, 5672.0, 5411.0, 5449.0, 5556.0, 5362.0, 5610.0, 5485.0, 5462.0, 5496.0, 5437.0, 5545.0, 5535.0, 5684.0, 5583.0, 5695.0, 5572.0, 5444.0, 5650.0, 5418.0, 5325.0, 5700.0, 5647.0, 5319.0, 5629.0, 5402.0, 5463.0, 5341.0, 5534.0, 5292.0, 5438.0, 5375.0, 5264.0, 5416.0, 5560.0, 5667.0, 5364.0, 5675.0, 5658.0, 5563.0, 5278.0, 5263.0, 5634.0, 5440.0, 5415.0, 5367.0, 5307.0, 5333.0, 5558.0, 5441.0, 5541.0, 5494.0, 5384.0, 5523.0, 5439.0, 5313.0, 5600.0, 5569.0, 5447.0, 5422.0, 5419.0, 5718.0, 5434.0, 5304.0, 5518.0, 5442.0, 5519.0, 5443.0, 5306.0, 5709.0, 5711.0, 5409.0, 5421.0, 5455.0, 5338.0, 5374.0, 5417.0, 5289.0, 5340.0, 5527.0, 5723.0, 5370.0, 5557.0, 5632.0, 5254.0, 5559.0, 5433.0, 5383.0, 5555.0, 5257.0, 5401.0, 5670.0, 5696.0, 5548.0, 5611.0, 5651.0, 5507.0, 5343.0, 5483.0 (number of hits: 7)
2	5520	9	1	333	1	5331.0, 5664.0, 5717.0, 5705.0, 5251.0, 5358.0, 5592.0, 5526.0, 5281.0, 5692.0, 5580.0, 5693.0, 5363.0, 5672.0, 5405.0, 5380.0, 5548.0, 5454.0, 5447.0, 5716.0, 5559.0, 5288.0, 5350.0, 5521.0, 5455.0, 5342.0, 5564.0, 5388.0, 5645.0, 5423.0, 5547.0, 5372.0, 5381.0, 5562.0, 5507.0, 5591.0, 5520.0, 5445.0, 5642.0, 5584.0, 5588.0, 5410.0, 5295.0, 5586.0, 5324.0, 5689.0, 5518.0, 5311.0, 5648.0, 5328.0, 5506.0, 5535.0, 5357.0, 5641.0, 5291.0, 5345.0, 5617.0, 5394.0, 5276.0, 5532.0, 5490.0, 5722.0, 5269.0, 5589.0, 5695.0, 5413.0, 5284.0, 5449.0, 5553.0, 5436.0, 5300.0, 5270.0, 5581.0, 5354.0, 5677.0, 5441.0, 5419.0, 5282.0, 5550.0, 5310.0, 5433.0, 5483.0, 5338.0, 5569.0, 5561.0, 5590.0, 5615.0, 5315.0, 5503.0, 5472.0, 5523.0, 5624.0, 5488.0, 5431.0, 5498.0, 5487.0, 5373.0, 5626.0, 5341.0, 5508.0 (number of hits: 11)
3	5520	9	1	333	1	5690.0, 5463.0, 5289.0, 5691.0, 5603.0, 5440.0, 5331.0, 5684.0, 5508.0, 5290.0, 5615.0, 5568.0, 5475.0, 5438.0, 5411.0, 5674.0, 5627.0, 5649.0, 5547.0, 5367.0, 5562.0, 5530.0, 5381.0, 5672.0, 5717.0, 5453.0, 5647.0, 5307.0, 5671.0, 5701.0, 5507.0, 5314.0, 5535.0, 5300.0, 5581.0, 5681.0, 5515.0, 5304.0, 5427.0, 5634.0, 5655.0, 5630.0, 5336.0, 5378.0, 5405.0, 5322.0, 5467.0, 5341.0, 5404.0, 5348.0, 5541.0, 5525.0, 5449.0, 5536.0, 5642.0, 5704.0, 5260.0, 5489.0, 5340.0, 5412.0, 5469.0, 5560.0, 5261.0, 5298.0, 5332.0, 5713.0, 5419.0, 5645.0, 5557.0, 5517.0,

						5258.0, 5646.0, 5664.0, 5550.0, 5359.0, 5605.0, 5595.0, 5524.0, 5492.0, 5629.0, 5585.0, 5319.0, 5413.0, 5607.0, 5310.0, 5326.0, 5565.0, 5251.0, 5620.0, 5644.0, 5370.0, 5476.0, 5698.0, 5494.0, 5571.0, 5697.0, 5462.0, 5506.0, 5262.0, 5418.0 (number of hits: 10)
4	5520	9	1	333	1	5409.0, 5454.0, 5373.0, 5466.0, 5634.0, 5527.0, 5512.0, 5456.0, 5295.0, 5588.0, 5572.0, 5522.0, 5379.0, 5413.0, 5577.0, 5476.0, 5443.0, 5681.0, 5667.0, 5621.0, 5506.0, 5346.0, 5566.0, 5366.0, 5623.0, 5441.0, 5396.0, 5436.0, 5324.0, 5477.0, 5652.0, 5303.0, 5287.0, 5377.0, 5611.0, 5680.0, 5709.0, 5624.0, 5389.0, 5398.0, 5533.0, 5604.0, 5310.0, 5262.0, 5508.0, 5311.0, 5697.0, 5587.0, 5663.0, 5252.0, 5288.0, 5583.0, 5586.0, 5616.0, 5713.0, 5704.0, 5664.0, 5424.0, 5364.0, 5411.0, 5596.0, 5509.0, 5632.0, 5642.0, 5653.0, 5676.0, 5622.0, 5541.0, 5630.0, 5671.0, 5547.0, 5412.0, 5255.0, 5286.0, 5661.0, 5503.0, 5531.0, 5710.0, 5578.0, 5284.0, 5609.0, 5674.0, 5342.0, 5325.0, 5721.0, 5365.0, 5500.0, 5519.0, 5567.0, 5579.0, 5285.0, 5666.0, 5493.0, 5513.0, 5281.0, 5429.0, 5636.0, 5549.0, 5576.0, 5448.0 (number of hits: 11)
5	5520	9	1	333	1	5470.0, 5654.0, 5299.0, 5440.0, 5553.0, 5688.0, 5383.0, 5368.0, 5611.0, 5530.0, 5255.0, 5630.0, 5313.0, 5605.0, 5306.0, 5415.0, 5657.0, 5338.0, 5715.0, 5407.0, 5394.0, 5366.0, 5561.0, 5502.0, 5331.0, 5545.0, 5319.0, 5686.0, 5615.0, 5651.0, 5542.0, 5656.0, 5562.0, 5682.0, 5596.0, 5524.0, 5441.0, 5292.0, 5379.0, 5311.0, 5269.0, 5381.0, 5451.0, 5635.0, 5559.0, 5392.0, 5534.0, 5708.0, 5627.0, 5362.0, 5272.0, 5432.0, 5574.0, 5546.0, 5632.0, 5558.0, 5433.0, 5399.0, 5555.0, 5481.0, 5575.0, 5652.0, 5342.0, 5449.0, 5348.0, 5386.0, 5641.0, 5324.0, 5378.0, 5675.0, 5455.0, 5347.0, 5419.0, 5506.0, 5462.0, 5401.0, 5380.0, 5260.0, 5648.0, 5288.0, 5695.0, 5323.0, 5487.0, 5550.0, 5620.0, 5284.0, 5655.0, 5474.0, 5408.0, 5673.0, 5405.0, 5661.0, 5543.0, 5301.0, 5677.0, 5527.0, 5317.0, 5483.0, 5698.0, 5696.0 (number of hits: 6)
6	5520	9	1	333	1	5453.0, 5516.0, 5666.0, 5614.0, 5345.0, 5623.0, 5496.0, 5531.0, 5429.0, 5426.0, 5719.0, 5279.0, 5679.0, 5670.0, 5296.0, 5442.0, 5302.0, 5419.0, 5457.0, 5650.0, 5448.0, 5330.0, 5477.0, 5272.0, 5490.0, 5267.0, 5707.0, 5687.0, 5349.0, 5721.0, 5541.0, 5355.0, 5255.0, 5381.0, 5421.0, 5434.0, 5473.0, 5626.0, 5711.0, 5589.0, 5478.0, 5722.0, 5316.0, 5526.0, 5350.0, 5327.0, 5408.0, 5409.0, 5492.0, 5532.0, 5542.0, 5378.0, 5568.0, 5683.0, 5665.0, 5667.0, 5346.0, 5370.0, 5602.0, 5582.0,

						5265.0, 5373.0, 5307.0, 5404.0, 5427.0, 5664.0, 5293.0, 5366.0, 5636.0, 5592.0, 5417.0, 5288.0, 5519.0, 5326.0, 5368.0, 5451.0, 5305.0, 5661.0, 5583.0, 5399.0, 5566.0, 5580.0, 5464.0, 5470.0, 5462.0, 5560.0, 5607.0, 5625.0, 5428.0, 5318.0, 5341.0, 5686.0, 5396.0, 5261.0, 5604.0, 5458.0, 5529.0, 5269.0, 5528.0, 5252.0 (number of hits: 7)
7	5520	9	1	333	1	5680.0, 5421.0, 5594.0, 5720.0, 5526.0, 5640.0, 5492.0, 5252.0, 5525.0, 5489.0, 5563.0, 5711.0, 5710.0, 5614.0, 5662.0, 5344.0, 5675.0, 5377.0, 5595.0, 5499.0, 5277.0, 5422.0, 5333.0, 5637.0, 5440.0, 5601.0, 5349.0, 5448.0, 5301.0, 5355.0, 5453.0, 5531.0, 5521.0, 5379.0, 5351.0, 5290.0, 5665.0, 5581.0, 5633.0, 5585.0, 5360.0, 5545.0, 5500.0, 5551.0, 5523.0, 5649.0, 5537.0, 5271.0, 5410.0, 5325.0, 5384.0, 5352.0, 5532.0, 5310.0, 5437.0, 5367.0, 5613.0, 5697.0, 5651.0, 5452.0, 5604.0, 5643.0, 5267.0, 5611.0, 5536.0, 5493.0, 5449.0, 5451.0, 5414.0, 5365.0, 5608.0, 5663.0, 5254.0, 5461.0, 5396.0, 5316.0, 5426.0, 5358.0, 5273.0, 5269.0, 5382.0, 5602.0, 5391.0, 5350.0, 5587.0, 5510.0, 5327.0, 5634.0, 5262.0, 5257.0, 5562.0, 5616.0, 5578.0, 5568.0, 5479.0, 5299.0, 5413.0, 5386.0, 5375.0, 5439.0 (number of hits: 9)
8	5520	9	1	333	1	5717.0, 5301.0, 5482.0, 5605.0, 5456.0, 5430.0, 5638.0, 5436.0, 5443.0, 5435.0, 5252.0, 5530.0, 5610.0, 5283.0, 5596.0, 5300.0, 5260.0, 5365.0, 5354.0, 5457.0, 5381.0, 5621.0, 5337.0, 5585.0, 5446.0, 5575.0, 5277.0, 5434.0, 5259.0, 5307.0, 5429.0, 5405.0, 5480.0, 5496.0, 5342.0, 5503.0, 5589.0, 5344.0, 5692.0, 5498.0, 5687.0, 5425.0, 5325.0, 5631.0, 5311.0, 5648.0, 5312.0, 5402.0, 5451.0, 5308.0, 5392.0, 5510.0, 5321.0, 5636.0, 5607.0, 5600.0, 5691.0, 5580.0, 5720.0, 5556.0, 5289.0, 5672.0, 5561.0, 5549.0, 5597.0, 5574.0, 5564.0, 5500.0, 5515.0, 5293.0, 5592.0, 5523.0, 5335.0, 5254.0, 5318.0, 5619.0, 5632.0, 5253.0, 5285.0, 5414.0, 5543.0, 5525.0, 5433.0, 5708.0, 5351.0, 5323.0, 5422.0, 5362.0, 5671.0, 5591.0, 5524.0, 5419.0, 5573.0, 5366.0, 5440.0, 5438.0, 5464.0, 5382.0, 5704.0, 5437.0 (number of hits: 7)
9	5520	9	1	333	1	5298.0, 5306.0, 5540.0, 5598.0, 5383.0, 5455.0, 5667.0, 5330.0, 5397.0, 5396.0, 5553.0, 5610.0, 5337.0, 5348.0, 5503.0, 5531.0, 5567.0, 5336.0, 5304.0, 5279.0, 5425.0, 5671.0, 5508.0, 5639.0, 5668.0, 5258.0, 5700.0, 5268.0, 5302.0, 5498.0, 5711.0, 5631.0, 5468.0, 5597.0, 5516.0, 5694.0, 5539.0, 5580.0, 5589.0, 5257.0, 5409.0, 5548.0, 5395.0, 5373.0, 5470.0, 5421.0, 5333.0, 5632.0, 5265.0, 5392.0,

						5415.0, 5284.0, 5295.0, 5615.0, 5713.0, 5400.0, 5484.0, 5693.0, 5259.0, 5554.0, 5574.0, 5577.0, 5708.0, 5341.0, 5643.0, 5369.0, 5714.0, 5255.0, 5524.0, 5572.0, 5350.0, 5381.0, 5433.0, 5538.0, 5588.0, 5528.0, 5633.0, 5375.0, 5638.0, 5495.0, 5310.0, 5275.0, 5522.0, 5582.0, 5356.0, 5262.0, 5497.0, 5388.0, 5650.0, 5394.0, 5346.0, 5256.0, 5314.0, 5698.0, 5297.0, 5517.0, 5303.0, 5379.0, 5477.0, 5377.0 (number of hits: 8)
10	5520	9	1	333	1	5682.0, 5355.0, 5539.0, 5555.0, 5264.0, 5261.0, 5492.0, 5684.0, 5524.0, 5331.0, 5389.0, 5375.0, 5384.0, 5663.0, 5307.0, 5628.0, 5583.0, 5519.0, 5714.0, 5354.0, 5674.0, 5624.0, 5486.0, 5589.0, 5407.0, 5545.0, 5514.0, 5462.0, 5602.0, 5448.0, 5280.0, 5563.0, 5675.0, 5703.0, 5329.0, 5452.0, 5687.0, 5556.0, 5442.0, 5631.0, 5540.0, 5574.0, 5564.0, 5317.0, 5359.0, 5643.0, 5560.0, 5609.0, 5324.0, 5426.0, 5621.0, 5650.0, 5723.0, 5512.0, 5489.0, 5580.0, 5409.0, 5259.0, 5604.0, 5485.0, 5521.0, 5368.0, 5367.0, 5629.0, 5651.0, 5458.0, 5268.0, 5348.0, 5644.0, 5611.0, 5678.0, 5698.0, 5603.0, 5429.0, 5379.0, 5425.0, 5601.0, 5279.0, 5435.0, 5287.0, 5298.0, 5533.0, 5633.0, 5372.0, 5277.0, 5640.0, 5285.0, 5376.0, 5290.0, 5617.0, 5525.0, 5715.0, 5333.0, 5400.0, 5412.0, 5342.0, 5366.0, 5270.0, 5625.0, 5536.0 (number of hits: 8)
11	5501.5	9	1	333	1	5477.0, 5379.0, 5289.0, 5283.0, 5546.0, 5296.0, 5264.0, 5680.0, 5485.0, 5612.0, 5324.0, 5535.0, 5410.0, 5359.0, 5607.0, 5439.0, 5708.0, 5641.0, 5305.0, 5595.0, 5452.0, 5589.0, 5371.0, 5419.0, 5631.0, 5482.0, 5267.0, 5475.0, 5647.0, 5675.0, 5646.0, 5585.0, 5635.0, 5367.0, 5505.0, 5470.0, 5281.0, 5431.0, 5676.0, 5703.0, 5368.0, 5285.0, 5496.0, 5663.0, 5254.0, 5611.0, 5571.0, 5604.0, 5541.0, 5654.0, 5445.0, 5529.0, 5307.0, 5572.0, 5411.0, 5394.0, 5696.0, 5369.0, 5634.0, 5348.0, 5717.0, 5683.0, 5423.0, 5499.0, 5279.0, 5542.0, 5425.0, 5458.0, 5268.0, 5454.0, 5539.0, 5600.0, 5705.0, 5325.0, 5620.0, 5323.0, 5594.0, 5501.0, 5614.0, 5256.0, 5301.0, 5590.0, 5561.0, 5280.0, 5530.0, 5432.0, 5562.0, 5327.0, 5661.0, 5467.0, 5435.0, 5406.0, 5679.0, 5337.0, 5349.0, 5408.0, 5533.0, 5447.0, 5490.0, 5577.0 (number of hits: 6)
12	5501.5	9	1	333	1	5569.0, 5479.0, 5504.0, 5621.0, 5375.0, 5296.0, 5603.0, 5604.0, 5448.0, 5265.0, 5685.0, 5404.0, 5427.0, 5258.0, 5566.0, 5368.0, 5356.0, 5553.0, 5379.0, 5721.0, 5409.0, 5554.0, 5360.0, 5300.0, 5261.0, 5718.0, 5490.0, 5715.0, 5297.0, 5660.0, 5658.0, 5568.0, 5438.0, 5271.0, 5665.0, 5317.0, 5575.0, 5420.0, 5627.0, 5288.0,

						5405.0, 5638.0, 5451.0, 5644.0, 5609.0, 5397.0, 5455.0, 5374.0, 5337.0, 5645.0, 5269.0, 5649.0, 5475.0, 5283.0, 5570.0, 5700.0, 5639.0, 5675.0, 5277.0, 5636.0, 5308.0, 5384.0, 5275.0, 5561.0, 5335.0, 5501.0, 5328.0, 5263.0, 5419.0, 5497.0, 5417.0, 5702.0, 5324.0, 5624.0, 5659.0, 5395.0, 5524.0, 5460.0, 5354.0, 5406.0, 5537.0, 5608.0, 5618.0, 5292.0, 5556.0, 5414.0, 5348.0, 5706.0, 5712.0, 5585.0, 5683.0, 5293.0, 5525.0, 5591.0, 5707.0, 5339.0, 5669.0, 5286.0, 5398.0, 5595.0 (number of hits: 4)
13	5501.5	9	1	333	1	5465.0, 5387.0, 5282.0, 5555.0, 5723.0, 5415.0, 5452.0, 5600.0, 5418.0, 5284.0, 5476.0, 5275.0, 5483.0, 5352.0, 5314.0, 5690.0, 5448.0, 5353.0, 5261.0, 5405.0, 5436.0, 5308.0, 5390.0, 5311.0, 5601.0, 5578.0, 5513.0, 5697.0, 5421.0, 5306.0, 5319.0, 5270.0, 5654.0, 5332.0, 5634.0, 5266.0, 5631.0, 5506.0, 5557.0, 5464.0, 5571.0, 5458.0, 5528.0, 5507.0, 5539.0, 5585.0, 5269.0, 5679.0, 5724.0, 5708.0, 5666.0, 5450.0, 5406.0, 5313.0, 5424.0, 5523.0, 5383.0, 5429.0, 5490.0, 5411.0, 5473.0, 5440.0, 5672.0, 5315.0, 5444.0, 5295.0, 5289.0, 5683.0, 5341.0, 5591.0, 5461.0, 5287.0, 5272.0, 5482.0, 5425.0, 5304.0, 5346.0, 5318.0, 5527.0, 5267.0, 5375.0, 5489.0, 5718.0, 5351.0, 5669.0, 5547.0, 5622.0, 5434.0, 5545.0, 5560.0, 5656.0, 5633.0, 5367.0, 5334.0, 5651.0, 5475.0, 5607.0, 5569.0, 5628.0, 5467.0 (number of hits: 6)
14	5501.5	9	1	333	1	5465.0, 5473.0, 5518.0, 5422.0, 5380.0, 5493.0, 5685.0, 5301.0, 5584.0, 5572.0, 5348.0, 5315.0, 5698.0, 5656.0, 5274.0, 5514.0, 5442.0, 5667.0, 5660.0, 5544.0, 5329.0, 5395.0, 5636.0, 5497.0, 5662.0, 5578.0, 5320.0, 5331.0, 5450.0, 5680.0, 5603.0, 5336.0, 5293.0, 5619.0, 5633.0, 5353.0, 5707.0, 5290.0, 5541.0, 5377.0, 5438.0, 5501.0, 5669.0, 5318.0, 5713.0, 5401.0, 5558.0, 5433.0, 5390.0, 5645.0, 5652.0, 5545.0, 5386.0, 5419.0, 5561.0, 5542.0, 5346.0, 5342.0, 5355.0, 5272.0, 5529.0, 5370.0, 5627.0, 5723.0, 5622.0, 5258.0, 5496.0, 5605.0, 5604.0, 5683.0, 5719.0, 5640.0, 5303.0, 5617.0, 5283.0, 5406.0, 5416.0, 5577.0, 5590.0, 5278.0, 5429.0, 5271.0, 5548.0, 5498.0, 5500.0, 5659.0, 5456.0, 5505.0, 5486.0, 5524.0, 5705.0, 5624.0, 5305.0, 5323.0, 5286.0, 5279.0, 5626.0, 5515.0, 5316.0, 5325.0 (number of hits: 11)
15	5501.5	9	1	333	1	5471.0, 5417.0, 5313.0, 5659.0, 5442.0, 5443.0, 5300.0, 5273.0, 5378.0, 5284.0, 5295.0, 5664.0, 5255.0, 5303.0, 5291.0, 5272.0, 5679.0, 5510.0, 5339.0, 5256.0, 5713.0, 5314.0, 5603.0, 5434.0, 5393.0, 5461.0, 5353.0, 5592.0, 5394.0, 5524.0,

						5317.0, 5491.0, 5364.0, 5369.0, 5678.0, 5654.0, 5384.0, 5293.0, 5709.0, 5438.0, 5479.0, 5410.0, 5287.0, 5299.0, 5385.0, 5628.0, 5691.0, 5426.0, 5266.0, 5264.0, 5281.0, 5652.0, 5259.0, 5379.0, 5308.0, 5594.0, 5470.0, 5334.0, 5627.0, 5574.0, 5474.0, 5362.0, 5382.0, 5407.0, 5439.0, 5522.0, 5641.0, 5598.0, 5412.0, 5538.0, 5546.0, 5667.0, 5666.0, 5274.0, 5285.0, 5497.0, 5386.0, 5478.0, 5683.0, 5360.0, 5578.0, 5409.0, 5715.0, 5591.0, 5463.0, 5324.0, 5340.0, 5309.0, 5488.0, 5703.0, 5350.0, 5446.0, 5435.0, 5468.0, 5645.0, 5596.0, 5437.0, 5469.0, 5521.0, 5427.0 (number of hits: 4)
16	5501.5	9	1	333	1	5301.0, 5498.0, 5515.0, 5604.0, 5706.0, 5440.0, 5624.0, 5492.0, 5401.0, 5412.0, 5469.0, 5592.0, 5630.0, 5605.0, 5644.0, 5692.0, 5713.0, 5250.0, 5398.0, 5300.0, 5411.0, 5445.0, 5501.0, 5269.0, 5560.0, 5527.0, 5306.0, 5394.0, 5389.0, 5331.0, 5564.0, 5279.0, 5336.0, 5509.0, 5657.0, 5257.0, 5552.0, 5651.0, 5286.0, 5670.0, 5616.0, 5646.0, 5641.0, 5502.0, 5593.0, 5648.0, 5544.0, 5325.0, 5577.0, 5270.0, 5718.0, 5432.0, 5687.0, 5673.0, 5521.0, 5264.0, 5629.0, 5317.0, 5417.0, 5554.0, 5660.0, 5483.0, 5679.0, 5314.0, 5723.0, 5291.0, 5654.0, 5600.0, 5297.0, 5462.0, 5598.0, 5557.0, 5418.0, 5465.0, 5441.0, 5700.0, 5497.0, 5470.0, 5475.0, 5714.0, 5449.0, 5569.0, 5518.0, 5399.0, 5658.0, 5640.0, 5426.0, 5324.0, 5316.0, 5262.0, 5376.0, 5617.0, 5410.0, 5298.0, 5350.0, 5427.0, 5542.0, 5655.0, 5547.0, 5474.0 (number of hits: 9)
17	5501.5	9	1	333	1	5519.0, 5472.0, 5272.0, 5607.0, 5594.0, 5498.0, 5428.0, 5646.0, 5622.0, 5679.0, 5503.0, 5697.0, 5639.0, 5704.0, 5403.0, 5456.0, 5540.0, 5532.0, 5597.0, 5682.0, 5493.0, 5390.0, 5270.0, 5716.0, 5283.0, 5523.0, 5361.0, 5392.0, 5253.0, 5267.0, 5571.0, 5352.0, 5379.0, 5318.0, 5254.0, 5393.0, 5720.0, 5543.0, 5312.0, 5262.0, 5443.0, 5671.0, 5269.0, 5496.0, 5661.0, 5299.0, 5505.0, 5522.0, 5610.0, 5320.0, 5438.0, 5666.0, 5369.0, 5520.0, 5567.0, 5494.0, 5404.0, 5280.0, 5691.0, 5378.0, 5303.0, 5683.0, 5598.0, 5573.0, 5308.0, 5385.0, 5363.0, 5370.0, 5631.0, 5251.0, 5314.0, 5448.0, 5481.0, 5351.0, 5596.0, 5643.0, 5401.0, 5651.0, 5556.0, 5473.0, 5603.0, 5287.0, 5580.0, 5674.0, 5467.0, 5677.0, 5687.0, 5394.0, 5268.0, 5585.0, 5324.0, 5602.0, 5259.0, 5696.0, 5476.0, 5709.0, 5310.0, 5291.0, 5511.0, 5460.0 (number of hits: 8)
18	5501.5	9	1	333	1	5417.0, 5611.0, 5542.0, 5635.0, 5463.0, 5452.0, 5385.0, 5585.0, 5323.0, 5671.0, 5332.0, 5516.0, 5253.0, 5641.0, 5601.0, 5591.0, 5502.0, 5388.0, 5619.0, 5283.0,

						5715.0, 5558.0, 5524.0, 5648.0, 5445.0, 5401.0, 5289.0, 5649.0, 5475.0, 5666.0, 5413.0, 5379.0, 5381.0, 5470.0, 5318.0, 5392.0, 5437.0, 5439.0, 5521.0, 5599.0, 5577.0, 5338.0, 5575.0, 5352.0, 5418.0, 5514.0, 5689.0, 5365.0, 5723.0, 5647.0, 5697.0, 5513.0, 5396.0, 5639.0, 5312.0, 5355.0, 5650.0, 5485.0, 5655.0, 5708.0, 5268.0, 5569.0, 5620.0, 5520.0, 5685.0, 5609.0, 5541.0, 5474.0, 5604.0, 5566.0, 5479.0, 5598.0, 5447.0, 5399.0, 5428.0, 5287.0, 5661.0, 5307.0, 5573.0, 5305.0, 5531.0, 5512.0, 5436.0, 5607.0, 5455.0, 5337.0, 5457.0, 5623.0, 5596.0, 5387.0, 5375.0, 5298.0, 5716.0, 5662.0, 5660.0, 5488.0, 5669.0, 5313.0, 5545.0, 5721.0 (number of hits: 7)
19	5501.5	9	1	333	1	5385.0, 5566.0, 5460.0, 5535.0, 5353.0, 5636.0, 5588.0, 5542.0, 5692.0, 5690.0, 5583.0, 5269.0, 5371.0, 5271.0, 5577.0, 5532.0, 5571.0, 5309.0, 5377.0, 5392.0, 5386.0, 5419.0, 5504.0, 5624.0, 5578.0, 5326.0, 5346.0, 5366.0, 5278.0, 5464.0, 5368.0, 5670.0, 5327.0, 5615.0, 5332.0, 5458.0, 5311.0, 5563.0, 5635.0, 5294.0, 5639.0, 5272.0, 5632.0, 5354.0, 5303.0, 5527.0, 5552.0, 5312.0, 5676.0, 5718.0, 5495.0, 5455.0, 5315.0, 5466.0, 5461.0, 5641.0, 5510.0, 5569.0, 5491.0, 5403.0, 5516.0, 5694.0, 5481.0, 5529.0, 5381.0, 5689.0, 5282.0, 5637.0, 5562.0, 5443.0, 5631.0, 5306.0, 5683.0, 5264.0, 5482.0, 5329.0, 5275.0, 5613.0, 5705.0, 5530.0, 5633.0, 5449.0, 5270.0, 5393.0, 5601.0, 5457.0, 5560.0, 5638.0, 5257.0, 5347.0, 5452.0, 5433.0, 5623.0, 5716.0, 5693.0, 5506.0, 5714.0, 5620.0, 5515.0, 5517.0 (number of hits: 8)
20	5501.5	9	1	333	1	5640.0, 5634.0, 5568.0, 5418.0, 5262.0, 5515.0, 5309.0, 5358.0, 5334.0, 5696.0, 5554.0, 5653.0, 5384.0, 5519.0, 5449.0, 5601.0, 5267.0, 5457.0, 5290.0, 5598.0, 5543.0, 5617.0, 5273.0, 5533.0, 5284.0, 5427.0, 5268.0, 5417.0, 5331.0, 5621.0, 5623.0, 5704.0, 5707.0, 5436.0, 5433.0, 5392.0, 5551.0, 5398.0, 5391.0, 5408.0, 5705.0, 5479.0, 5686.0, 5279.0, 5697.0, 5337.0, 5518.0, 5620.0, 5434.0, 5454.0, 5410.0, 5315.0, 5654.0, 5431.0, 5607.0, 5579.0, 5716.0, 5380.0, 5661.0, 5382.0, 5545.0, 5375.0, 5709.0, 5363.0, 5335.0, 5722.0, 5477.0, 5296.0, 5606.0, 5468.0, 5702.0, 5403.0, 5646.0, 5504.0, 5511.0, 5411.0, 5293.0, 5409.0, 5402.0, 5379.0, 5455.0, 5557.0, 5528.0, 5636.0, 5292.0, 5299.0, 5711.0, 5294.0, 5572.0, 5719.0, 5527.0, 5318.0, 5401.0, 5507.0, 5645.0, 5677.0, 5302.0, 5259.0, 5276.0, 5396.0 (number of hits: 6)
21	5538.5	9	1	333	1	5623.0, 5712.0, 5715.0, 5497.0, 5505.0, 5390.0, 5550.0, 5285.0, 5601.0, 5452.0,

						5503.0, 5652.0, 5397.0, 5469.0, 5526.0, 5311.0, 5544.0, 5515.0, 5486.0, 5665.0, 5713.0, 5464.0, 5297.0, 5403.0, 5286.0, 5546.0, 5319.0, 5280.0, 5450.0, 5686.0, 5673.0, 5664.0, 5610.0, 5564.0, 5351.0, 5595.0, 5346.0, 5704.0, 5521.0, 5312.0, 5560.0, 5381.0, 5576.0, 5492.0, 5300.0, 5635.0, 5289.0, 5491.0, 5463.0, 5617.0, 5602.0, 5587.0, 5680.0, 5600.0, 5691.0, 5541.0, 5321.0, 5267.0, 5401.0, 5394.0, 5481.0, 5447.0, 5276.0, 5488.0, 5358.0, 5490.0, 5391.0, 5523.0, 5456.0, 5584.0, 5437.0, 5603.0, 5476.0, 5427.0, 5667.0, 5631.0, 5327.0, 5540.0, 5411.0, 5684.0, 5626.0, 5559.0, 5696.0, 5309.0, 5596.0, 5436.0, 5303.0, 5364.0, 5305.0, 5506.0, 5593.0, 5520.0, 5692.0, 5292.0, 5482.0, 5258.0, 5323.0, 5609.0, 5648.0, 5679.0 (number of hits: 9)
22	5538.5	9	1	333	1	5328.0, 5517.0, 5483.0, 5600.0, 5550.0, 5370.0, 5313.0, 5644.0, 5294.0, 5427.0, 5504.0, 5591.0, 5342.0, 5708.0, 5488.0, 5552.0, 5655.0, 5348.0, 5408.0, 5330.0, 5721.0, 5322.0, 5597.0, 5463.0, 5622.0, 5259.0, 5499.0, 5341.0, 5296.0, 5300.0, 5510.0, 5533.0, 5551.0, 5608.0, 5689.0, 5538.0, 5633.0, 5433.0, 5638.0, 5381.0, 5596.0, 5521.0, 5682.0, 5634.0, 5458.0, 5396.0, 5651.0, 5487.0, 5422.0, 5378.0, 5291.0, 5628.0, 5675.0, 5614.0, 5669.0, 5374.0, 5375.0, 5451.0, 5661.0, 5701.0, 5570.0, 5545.0, 5636.0, 5429.0, 5647.0, 5258.0, 5665.0, 5498.0, 5264.0, 5502.0, 5284.0, 5491.0, 5497.0, 5349.0, 5578.0, 5664.0, 5671.0, 5612.0, 5432.0, 5412.0, 5606.0, 5694.0, 5280.0, 5619.0, 5331.0, 5484.0, 5267.0, 5363.0, 5251.0, 5544.0, 5547.0, 5366.0, 5573.0, 5355.0, 5548.0, 5387.0, 5539.0, 5710.0, 5712.0, 5260.0 (number of hits: 11)
23	5538.5	9	1	333	1	5427.0, 5285.0, 5589.0, 5386.0, 5626.0, 5439.0, 5329.0, 5627.0, 5546.0, 5619.0, 5375.0, 5567.0, 5415.0, 5265.0, 5489.0, 5611.0, 5353.0, 5687.0, 5658.0, 5652.0, 5500.0, 5261.0, 5278.0, 5461.0, 5544.0, 5395.0, 5324.0, 5604.0, 5307.0, 5504.0, 5487.0, 5464.0, 5631.0, 5280.0, 5685.0, 5526.0, 5633.0, 5717.0, 5530.0, 5451.0, 5722.0, 5357.0, 5505.0, 5583.0, 5514.0, 5272.0, 5653.0, 5467.0, 5384.0, 5632.0, 5309.0, 5260.0, 5401.0, 5320.0, 5562.0, 5563.0, 5527.0, 5428.0, 5310.0, 5426.0, 5535.0, 5429.0, 5445.0, 5525.0, 5312.0, 5377.0, 5576.0, 5564.0, 5255.0, 5343.0, 5507.0, 5536.0, 5537.0, 5677.0, 5431.0, 5517.0, 5606.0, 5281.0, 5556.0, 5716.0, 5254.0, 5368.0, 5695.0, 5625.0, 5323.0, 5614.0, 5698.0, 5361.0, 5434.0, 5673.0, 5408.0, 5433.0, 5469.0, 5364.0, 5435.0, 5273.0, 5446.0, 5497.0, 5441.0, 5359.0 (number of hits: 10)

24	5538.5	9	1	333	1	<p>5638.0, 5311.0, 5567.0, 5481.0, 5456.0, 5327.0, 5650.0, 5558.0, 5376.0, 5723.0, 5566.0, 5642.0, 5353.0, 5514.0, 5533.0, 5688.0, 5387.0, 5655.0, 5538.0, 5659.0, 5474.0, 5630.0, 5381.0, 5390.0, 5600.0, 5385.0, 5701.0, 5571.0, 5395.0, 5658.0, 5370.0, 5460.0, 5617.0, 5674.0, 5699.0, 5320.0, 5423.0, 5712.0, 5463.0, 5260.0, 5669.0, 5539.0, 5691.0, 5668.0, 5336.0, 5666.0, 5358.0, 5288.0, 5362.0, 5543.0, 5508.0, 5561.0, 5548.0, 5496.0, 5719.0, 5662.0, 5432.0, 5382.0, 5487.0, 5348.0, 5687.0, 5479.0, 5488.0, 5251.0, 5597.0, 5303.0, 5563.0, 5300.0, 5555.0, 5594.0, 5257.0, 5599.0, 5486.0, 5444.0, 5342.0, 5522.0, 5457.0, 5312.0, 5627.0, 5667.0, 5400.0, 5596.0, 5640.0, 5603.0, 5678.0, 5702.0, 5302.0, 5499.0, 5476.0, 5368.0, 5636.0, 5717.0, 5651.0, 5256.0, 5536.0, 5532.0, 5282.0, 5472.0, 5616.0, 5383.0 (number of hits: 9)</p>
25	5538.5	9	1	333	1	<p>5448.0, 5592.0, 5560.0, 5629.0, 5624.0, 5622.0, 5267.0, 5513.0, 5322.0, 5296.0, 5524.0, 5594.0, 5679.0, 5254.0, 5499.0, 5266.0, 5330.0, 5428.0, 5657.0, 5508.0, 5438.0, 5435.0, 5497.0, 5607.0, 5483.0, 5662.0, 5549.0, 5676.0, 5430.0, 5471.0, 5646.0, 5665.0, 5491.0, 5711.0, 5625.0, 5555.0, 5307.0, 5644.0, 5470.0, 5370.0, 5399.0, 5590.0, 5384.0, 5419.0, 5529.0, 5319.0, 5347.0, 5684.0, 5673.0, 5417.0, 5352.0, 5310.0, 5341.0, 5718.0, 5585.0, 5272.0, 5587.0, 5518.0, 5316.0, 5376.0, 5656.0, 5405.0, 5288.0, 5541.0, 5373.0, 5344.0, 5517.0, 5623.0, 5258.0, 5360.0, 5462.0, 5633.0, 5433.0, 5616.0, 5621.0, 5653.0, 5279.0, 5458.0, 5477.0, 5601.0, 5275.0, 5696.0, 5393.0, 5630.0, 5565.0, 5516.0, 5597.0, 5457.0, 5698.0, 5520.0, 5394.0, 5484.0, 5447.0, 5371.0, 5700.0, 5313.0, 5569.0, 5320.0, 5381.0, 5337.0 (number of hits: 6)</p>
26	5538.5	9	1	333	1	<p>5700.0, 5342.0, 5595.0, 5299.0, 5511.0, 5558.0, 5484.0, 5411.0, 5452.0, 5414.0, 5561.0, 5702.0, 5364.0, 5528.0, 5258.0, 5279.0, 5353.0, 5254.0, 5519.0, 5708.0, 5366.0, 5367.0, 5343.0, 5295.0, 5466.0, 5435.0, 5571.0, 5680.0, 5317.0, 5456.0, 5409.0, 5330.0, 5280.0, 5523.0, 5297.0, 5271.0, 5314.0, 5529.0, 5315.0, 5415.0, 5626.0, 5450.0, 5610.0, 5344.0, 5449.0, 5540.0, 5274.0, 5460.0, 5532.0, 5267.0, 5574.0, 5383.0, 5638.0, 5518.0, 5605.0, 5372.0, 5253.0, 5454.0, 5671.0, 5399.0, 5361.0, 5338.0, 5600.0, 5612.0, 5667.0, 5604.0, 5543.0, 5422.0, 5410.0, 5608.0, 5373.0, 5293.0, 5611.0, 5602.0, 5506.0, 5436.0, 5640.0, 5323.0, 5405.0, 5476.0, 5687.0, 5396.0, 5694.0, 5666.0, 5290.0, 5654.0, 5490.0, 5357.0, 5488.0, 5521.0, 5395.0, 5585.0, 5485.0, 5339.0, 5614.0,</p>

						5432.0, 5376.0, 5402.0, 5420.0, 5698.0 (number of hits: 7)
27	5538.5	9	1	333	1	5510.0, 5390.0, 5393.0, 5492.0, 5367.0, 5673.0, 5321.0, 5521.0, 5637.0, 5383.0, 5335.0, 5400.0, 5547.0, 5531.0, 5458.0, 5355.0, 5584.0, 5503.0, 5330.0, 5252.0, 5513.0, 5431.0, 5286.0, 5477.0, 5577.0, 5364.0, 5482.0, 5589.0, 5582.0, 5316.0, 5396.0, 5578.0, 5572.0, 5614.0, 5553.0, 5427.0, 5291.0, 5262.0, 5499.0, 5306.0, 5449.0, 5371.0, 5535.0, 5533.0, 5645.0, 5560.0, 5467.0, 5399.0, 5479.0, 5267.0, 5373.0, 5375.0, 5570.0, 5528.0, 5366.0, 5511.0, 5706.0, 5649.0, 5308.0, 5450.0, 5469.0, 5516.0, 5564.0, 5457.0, 5721.0, 5690.0, 5574.0, 5508.0, 5676.0, 5678.0, 5606.0, 5410.0, 5550.0, 5697.0, 5626.0, 5285.0, 5447.0, 5357.0, 5677.0, 5675.0, 5313.0, 5270.0, 5299.0, 5424.0, 5519.0, 5385.0, 5546.0, 5633.0, 5555.0, 5635.0, 5435.0, 5389.0, 5279.0, 5556.0, 5459.0, 5273.0, 5525.0, 5506.0, 5554.0, 5339.0 (number of hits: 13)
28	5538.5	9	1	333	1	5298.0, 5510.0, 5716.0, 5307.0, 5571.0, 5270.0, 5349.0, 5329.0, 5250.0, 5651.0, 5288.0, 5295.0, 5504.0, 5296.0, 5380.0, 5340.0, 5320.0, 5538.0, 5300.0, 5327.0, 5597.0, 5586.0, 5398.0, 5593.0, 5507.0, 5492.0, 5357.0, 5281.0, 5325.0, 5680.0, 5275.0, 5523.0, 5343.0, 5439.0, 5441.0, 5405.0, 5631.0, 5681.0, 5445.0, 5560.0, 5528.0, 5537.0, 5348.0, 5460.0, 5722.0, 5572.0, 5514.0, 5318.0, 5324.0, 5534.0, 5702.0, 5434.0, 5477.0, 5503.0, 5351.0, 5413.0, 5663.0, 5264.0, 5468.0, 5432.0, 5565.0, 5670.0, 5271.0, 5713.0, 5292.0, 5342.0, 5427.0, 5685.0, 5359.0, 5313.0, 5261.0, 5695.0, 5634.0, 5652.0, 5415.0, 5658.0, 5444.0, 5599.0, 5369.0, 5464.0, 5525.0, 5596.0, 5567.0, 5517.0, 5548.0, 5671.0, 5627.0, 5397.0, 5700.0, 5459.0, 5519.0, 5371.0, 5355.0, 5579.0, 5474.0, 5705.0, 5446.0, 5419.0, 5704.0, 5536.0 (number of hits: 8)
29	5538.5	9	1	333	1	5480.0, 5495.0, 5542.0, 5253.0, 5402.0, 5587.0, 5592.0, 5426.0, 5300.0, 5643.0, 5335.0, 5645.0, 5496.0, 5482.0, 5393.0, 5344.0, 5505.0, 5292.0, 5514.0, 5395.0, 5378.0, 5547.0, 5467.0, 5303.0, 5440.0, 5334.0, 5566.0, 5358.0, 5377.0, 5443.0, 5521.0, 5493.0, 5701.0, 5359.0, 5338.0, 5428.0, 5367.0, 5673.0, 5631.0, 5665.0, 5333.0, 5361.0, 5651.0, 5307.0, 5683.0, 5705.0, 5326.0, 5295.0, 5286.0, 5418.0, 5630.0, 5590.0, 5674.0, 5368.0, 5600.0, 5355.0, 5507.0, 5486.0, 5356.0, 5376.0, 5441.0, 5519.0, 5606.0, 5397.0, 5420.0, 5398.0, 5491.0, 5625.0, 5321.0, 5720.0, 5304.0, 5349.0, 5710.0, 5699.0, 5254.0, 5681.0, 5648.0, 5296.0, 5548.0, 5489.0, 5298.0, 5362.0, 5524.0, 5374.0, 5262.0,

						5624.0, 5291.0, 5250.0, 5518.0, 5392.0, 5466.0, 5531.0, 5259.0, 5483.0, 5716.0, 5633.0, 5258.0, 5688.0, 5626.0, 5327.0 (number of hits: 6)
30	5538.5	9	1	333	1	5615.0, 5657.0, 5521.0, 5584.0, 5413.0, 5603.0, 5317.0, 5336.0, 5444.0, 5561.0, 5387.0, 5348.0, 5703.0, 5341.0, 5470.0, 5376.0, 5271.0, 5303.0, 5358.0, 5722.0, 5366.0, 5662.0, 5628.0, 5353.0, 5687.0, 5289.0, 5469.0, 5441.0, 5313.0, 5691.0, 5538.0, 5367.0, 5320.0, 5692.0, 5302.0, 5693.0, 5290.0, 5462.0, 5591.0, 5558.0, 5655.0, 5567.0, 5578.0, 5639.0, 5611.0, 5349.0, 5613.0, 5430.0, 5670.0, 5265.0, 5451.0, 5563.0, 5593.0, 5549.0, 5592.0, 5649.0, 5390.0, 5431.0, 5481.0, 5676.0, 5412.0, 5256.0, 5347.0, 5343.0, 5254.0, 5553.0, 5442.0, 5426.0, 5583.0, 5371.0, 5255.0, 5466.0, 5401.0, 5297.0, 5279.0, 5272.0, 5600.0, 5331.0, 5384.0, 5643.0, 5566.0, 5269.0, 5425.0, 5630.0, 5503.0, 5460.0, 5601.0, 5300.0, 5556.0, 5579.0, 5281.0, 5486.0, 5526.0, 5612.0, 5685.0, 5378.0, 5508.0, 5625.0, 5493.0, 5385.0 (number of hits: 6)

B.3 80 MHz Bandwidth @ 5540 MHz

Table-1A/1B Radar Type 1A/1B Statistical Performance

Trial #	Fc (MHz)	Pulse/Burst	Pulse Width (μS)	PRI (μs)	Detection (1:yes; 0:no)
1	5540	63	1	838	1
2	5540	61	1	878	1
3	5540	78	1	678	1
4	5540	86	1	618	1
5	5540	62	1	858	1
6	5540	83	1	638	1
7	5540	81	1	658	1
8	5540	57	1	938	1
9	5540	68	1	778	1
10	5540	58	1	918	1
11	5540	74	1	718	1
12	5540	92	1	578	1
13	5540	76	1	698	1
14	5540	65	1	818	1
15	5540	102	1	518	1
16	5540	54	1	994	1
17	5540	69	1	774	1
18	5540	29	1	1867	1
19	5540	23	1	2323	1
20	5540	24	1	2200	1
21	5540	61	1	875	1
22	5540	19	1	2874	1
23	5540	20	1	2677	1
24	5540	20	1	2739	1
25	5540	23	1	2343	1
26	5540	21	1	2518	1
27	5540	48	1	1120	1
28	5540	21	1	2520	1
29	5540	20	1	2702	1
30	5540	35	1	1527	1
Detection Percentage: 100 % (>60%)					

Table-2 Radar Type 2 Statistical Performance

Trial #	Fc (MHz)	Pulse/Burst	Pulse Width (μ S)	PRI (μ s)	Detection (1:yes; 0:no)
1	5540	28	3.2	151	1
2	5540	24	3.9	150	1
3	5540	27	2.9	199	1
4	5540	26	2.5	176	1
5	5540	27	3.7	155	1
6	5540	24	3.1	173	1
7	5540	25	2.2	214	1
8	5540	26	3.9	195	1
9	5540	28	1	212	1
10	5540	27	2.2	167	1
11	5540	28	4.4	182	1
12	5540	27	1.9	201	1
13	5540	29	5	197	1
14	5540	26	3.6	174	1
15	5540	29	1.5	180	1
16	5540	29	5	203	1
17	5540	27	3.6	161	1
18	5540	24	4.8	165	1
19	5540	29	4.7	155	1
20	5540	26	3.9	162	0
21	5540	24	1.4	180	1
22	5540	24	1.4	164	1
23	5540	29	2.2	215	1
24	5540	29	3.8	227	1
25	5540	23	3.1	214	1
26	5540	23	3.8	181	1
27	5540	27	3.6	206	1
28	5540	28	2.3	202	1
29	5540	27	1.6	226	1
30	5540	25	4.7	177	1
Detection Percentage: 96.7 % (>60%)					

Table-3 Radar Type 3 Statistical Performance

Trial #	Fc (MHz)	Pulse/Burst	Pulse Width (μS)	PRI (μs)	Detection (1:yes; 0:no)
1	5540	16	7.6	260	1
2	5540	16	7.9	452	1
3	5540	17	8.3	486	1
4	5540	18	8.3	481	1
5	5540	18	8.7	436	1
6	5540	18	6.6	383	1
7	5540	16	6.2	304	1
8	5540	17	7.4	484	1
9	5540	17	7.5	263	1
10	5540	16	9.1	306	1
11	5540	16	7.5	292	1
12	5540	17	8.1	415	1
13	5540	17	9.8	357	1
14	5540	16	9.4	494	1
15	5540	17	7.7	414	1
16	5540	18	8.2	407	1
17	5540	17	6.2	379	1
18	5540	18	9.1	274	1
19	5540	16	8.1	278	1
20	5540	16	9.3	218	1
21	5540	18	10	295	1
22	5540	16	7.5	302	1
23	5540	16	6.3	390	1
24	5540	16	6.3	398	1
25	5540	18	6.7	290	1
26	5540	16	7.6	274	1
27	5540	17	7.3	441	1
28	5540	16	8.4	417	1
29	5540	17	6.4	450	1
30	5540	18	9.5	483	1
Detection Percentage: 100 % (>60%)					

Table-4 Radar Type 4 Statistical Performance

Trial #	Fc (MHz)	Pulse/Burst	Pulse Width (μS)	PRI (μs)	Detection (1:yes; 0:no)
1	5540	16	19.6	344	1
2	5540	12	18.6	291	1
3	5540	12	11.6	212	1
4	5540	15	11.7	214	1
5	5540	14	17.5	464	1
6	5540	15	19.6	236	1
7	5540	15	17.6	407	1
8	5540	14	18.3	430	1
9	5540	15	13.7	202	1
10	5540	15	17.2	322	1
11	5540	14	17.8	200	1
12	5540	14	11.9	375	1
13	5540	14	13.6	466	1
14	5540	14	18	372	1
15	5540	12	17	464	1
16	5540	12	12.7	322	1
17	5540	13	19.7	355	1
18	5540	16	12.6	392	1
19	5540	12	19.2	404	1
20	5540	14	15.7	271	1
21	5540	12	13.8	482	1
22	5540	15	19.3	404	1
23	5540	16	13.7	235	1
24	5540	15	11.9	422	1
25	5540	13	18.7	481	1
26	5540	14	19.9	366	1
27	5540	16	11	477	1
28	5540	14	14	375	1
29	5540	13	12.8	269	1
30	5540	12	14	246	1
Detection Percentage: 100 % (>60%)					

Table-5 Radar Type 5 Statistical Performance

Trial #	Fc (MHz)	Detection (1:yes; 0:no)
1	5540	1
2	5540	1
3	5540	1
4	5540	0
5	5540	1
6	5540	1
7	5540	1
8	5540	1
9	5540	1
10	5540	1
11	5504.4	1
12	5509.2	1
13	5508.8	1
14	5506.0	1
15	5508.4	1
16	5508.4	1
17	5505.2	1
18	5508.4	1
19	5507.6	1
20	5506.8	1
21	5572.0	1
22	5575.2	1
23	5571.2	1
24	5575.2	1
25	5573.2	1
26	5576.0	1
27	5575.6	1
28	5572.0	1
29	5574.4	1
30	5574.4	1
Detection Percentage: 96.7 % (>80%)		

Bin5 Statistics 1

Trial #	Pulse	Chirp (MHz)	Pulse Width (µS)	Pulse 1-2 spacing (µS)	Pulse 2-3 spacing (µS)	Pulse Start(S)	Detection (1:yes; 0:no)
0	3	8	57.3	1077	1432	0.386826	1
1	1	8	67.1			1.192966	
2	2	8	73.4	1602		1.774383	
3	2	8	62.6	1707		2.462265	
4	3	8	51.5	1868	1879	3.312669	
5	3	8	73.7	1607	1158	4.134083	
6	2	8	52.6	1705		4.527203	
7	1	8	73.7			5.9417	
8	2	8	93.1	1854		6.259684	
9	3	8	96.3	1229	1428	7.057596	
10	1	8	86.8			7.874311	
11	3	8	97.1	1895	1457	8.789818	
12	2	8	97.8	1339		9.071969	
13	1	8	88.8			10.07231	
14	1	8	95.8			11.013258	
15	2	8	72.3	1974		11.648751	

Bin5 Statistics 2

Trial #	Pulse	Chirp (MHz)	Pulse Width (µS)	Pulse 1-2 spacing (µS)	Pulse 2-3 spacing (µS)	Pulse Start(S)	Detection (1:yes; 0:no)
0	2	14	79.4	1363		0.950847	1
1	3	14	57.1	1170	1883	2.382858	
2	3	14	86	1955	1556	3.240964	
3	2	14	86.3	1718		4.271147	
4	3	14	51.2	1756	1204	5.822876	
5	1	14	99.3			6.494589	
6	3	14	81.1	1863	1282	8.137431	
7	2	14	64.6	1622		9.560904	
8	2	14	53.1	1794		10.78209	
9	2	14	73.6	1374		11.20312	

Bin5 Statistics 3

Trial #	Pulse	Chirp (MHz)	Pulse Width (µS)	Pulse 1-2 spacing (uS)	Pulse 2-3 spacing (uS)	Pulse Start(S)	Detection (1:yes; 0:no)
0	2	13	52.7	1142		0.039522	1
1	3	13	56.3	1618	1941	1.260952	
2	1	13	63.8			2.230233	
3	1	13	96.2			3.162813	
4	3	13	92	1622	1535	3.990327	
5	2	13	65.8	1918		5.102471	
6	2	13	64.5	1723		6.298559	
7	2	13	96.3	1493		6.757679	
8	1	13	69.7			7.77906	
9	2	13	97.5	1574		9.015554	
10	3	13	63.3	1584	1949	9.88407	
11	1	13	61.9			10.760673	
12	3	13	84	1016	1994	11.437772	

Bin5 Statistics 4

Trial #	Pulse	Chirp (MHz)	Pulse Width (µS)	Pulse 1-2 spacing (uS)	Pulse 2-3 spacing (uS)	Pulse Start(S)	Detection (1:yes; 0:no)
0	2	11	68.2	1204		0.650364	0
1	3	11	73.7	1427	1954	1.566286	
2	2	11	57.7	1333		2.663199	
3	1	11	69.8			3.579767	
4	1	11	86.9			4.556656	
5	1	11	69.5			6.434339	
6	2	11	70.8	1723		7.578788	
7	2	11	72.9	1026		7.74427	
8	3	11	67.3	1013	1916	9.462424	
9	2	11	89.8	1084		10.602747	
10	2	11	63.4	1780		10.961302	

Bin5 Statistics 5

Trial #	Pulse	Chirp (MHz)	Pulse Width (µS)	Pulse 1-2 spacing (uS)	Pulse 2-3 spacing (uS)	Pulse Start(S)	Detection (1:yes; 0:no)
0	1	7	86.1			0.020678	1
1	1	7	94.9			1.749483	
2	2	7	77.9	1983		2.948564	
3	2	7	64.9	1247		4.031472	
4	2	7	83.2	1879		5.081135	
5	2	7	82.1	1464		5.893081	
6	2	7	82.9	1831		7.618105	
7	1	7	88.3			7.759547	
8	1	7	79			9.183444	
9	3	7	68.9	1402	1684	10.550143	
10	2	7	82.1	1498		11.2466	

Bin5 Statistics 6

Trial #	Pulse	Chirp (MHz)	Pulse Width (µS)	Pulse 1-2 spacing (uS)	Pulse 2-3 spacing (uS)	Pulse Start(S)	Detection (1:yes; 0:no)
0	3	16	91.8	1322	1916	0.352282	1
1	2	16	93.9	1966		2.301316	
2	2	16	75.1	1599		3.196684	
3	1	16	69			4.591121	
4	2	16	79	1445		5.329795	
5	2	16	58.8	1733		6.44134	
6	3	16	84.6	1359	1302	7.593976	
7	2	16	74.9	1794		8.776021	
8	1	16	85.9			10.023337	
9	1	16	79.4			11.673968	

Bin5 Statistics 7

Trial #	Pulse	Chirp (MHz)	Pulse Width (µS)	Pulse 1-2 spacing (uS)	Pulse 2-3 spacing (uS)	Pulse Start(S)	Detection (1:yes; 0:no)
0	2	11	85.4	1156		0.437733	1
1	2	11	57.2	1450		1.083878	
2	3	11	76.6	1578	1389	2.212813	
3	2	11	96.5	1464		2.295769	
4	1	11	53.9			3.070252	
5	3	11	56.2	1692	1403	4.148383	
6	2	11	91.3	1910		5.044108	
7	3	11	57.5	1085	1759	5.699419	
8	2	11	67.7	1435		6.435201	
9	1	11	69.3			7.25003	
10	1	11	96			8.118328	
11	2	11	50.2	1992		8.853578	
12	2	11	53.4	1769		9.24811	
13	2	11	92.3	1175		10.10753	
14	2	11	83.1	1636		10.905964	
15	2	11	73	1701		11.868442	

Bin5 Statistics 8

Trial #	Pulse	Chirp (MHz)	Pulse Width (µS)	Pulse 1-2 spacing (uS)	Pulse 2-3 spacing (uS)	Pulse Start(S)	Detection (1:yes; 0:no)
0	2	8	94.4	1759		0.130681	1
1	1	8	60.5			1.407115	
2	2	8	61.9	1590		2.081468	
3	2	8	60.7	1705		3.578575	
4	3	8	77.2	1398	1244	4.613953	
5	2	8	95.4	1013		5.972334	
6	2	8	74	1750		6.487016	
7	3	8	55.8	1496	1707	7.687092	
8	2	8	88	1791		8.240783	
9	3	8	85.7	1699	1462	9.28574	
10	2	8	57.2	1014		10.189875	
11	1	8	91.9			11.814849	

Bin5 Statistics 9

Trial #	Pulse	Chirp (MHz)	Pulse Width (μS)	Pulse 1-2 spacing (uS)	Pulse 2-3 spacing (uS)	Pulse Start(S)	Detection (1:yes; 0:no)
0	1	5	92.6			1.187177	1
1	1	5	56.8			1.259607	
2	2	5	76.9	1125		2.942539	
3	3	5	88	1061	1870	4.538676	
4	2	5	74.6	1025		4.933515	
5	3	5	77.6	1666	1024	6.715204	
6	2	5	94.5	1476		7.274805	
7	2	5	71.3	1909		8.680515	
8	1	5	89.9			9.776532	
9	3	5	75.7	1413	1441	11.274234	

Bin5 Statistics 10

Trial #	Pulse	Chirp (MHz)	Pulse Width (μS)	Pulse 1-2 spacing (uS)	Pulse 2-3 spacing (uS)	Pulse Start(S)	Detection (1:yes; 0:no)
0	2	15	97.5	1675		0.746076	1
1	2	15	81.5	1175		2.013614	
2	2	15	87.9	1548		3.088277	
3	2	15	85	1991		3.461929	
4	2	15	93.6	1449		4.874735	
5	1	15	84.3			5.589563	
6	2	15	81.7	1057		6.934499	
7	1	15	71.7			8.406751	
8	2	15	67.6	1068		8.914027	
9	3	15	95.6	1476	1424	10.672567	
10	3	15	98.7	1861	1167	11.633626	

Bin5 Statistics 11

Trial #	Pulse	Chirp (MHz)	Pulse Width (µS)	Pulse 1-2 spacing (uS)	Pulse 2-3 spacing (uS)	Pulse Start(S)	Detection (1:yes; 0:no)
0	2	6	56.9	1800		0.869393	1
1	1	6	74.6			1.256183	
2	3	6	80.8	1596	1452	2.478636	
3	2	6	96.6	1296		3.487565	
4	2	6	95.6	1240		3.934287	
5	1	6	87.2			5.437285	
6	2	6	78.1	1505		6.197696	
7	3	6	63.4	1390	1793	7.375439	
8	3	6	73.9	1216	1916	7.841107	
9	1	6	55.8			8.868424	
10	3	6	52.8	1721	1667	9.446635	
11	1	6	79.1			10.352268	
12	2	6	55.8	1323		11.732012	

Bin5 Statistics 12

Trial #	Pulse	Chirp (MHz)	Pulse Width (µS)	Pulse 1-2 spacing (uS)	Pulse 2-3 spacing (uS)	Pulse Start(S)	Detection (1:yes; 0:no)
0	2	18	68.3	1617		0.859725	1
1	2	18	87.9	1313		2.101064	
2	3	18	50.6	1829	1605	3.589136	
3	3	18	87.9	1382	1275	5.04646	
4	1	18	96.8			6.09745	
5	2	18	98.2	1779		7.552408	
6	1	18	98.2			8.739858	
7	2	18	73.5	1532		10.594386	
8	2	18	99.1	1045		10.872109	

Bin5 Statistics 13

Trial #	Pulse	Chirp (MHz)	Pulse Width (µS)	Pulse 1-2 spacing (uS)	Pulse 2-3 spacing (uS)	Pulse Start(S)	Detection (1:yes; 0:no)
0	2	17	60.3	1566		0.013381	1
1	3	17	96.2	1277	1111	1.094539	
2	2	17	75.4	1318		1.632143	
3	2	17	74.3	1974		2.72996	
4	2	17	63.1	1157		3.284765	
5	3	17	66.2	1640	1935	3.707629	
6	2	17	83.7	1381		4.430716	
7	2	17	53.6	1316		5.479024	
8	3	17	91.5	1535	1792	6.03725	
9	2	17	83.8	1041		6.494161	
10	2	17	83.2	1030		7.215439	
11	1	17	65.6			7.836274	
12	3	17	64.8	1581	1833	8.62853	
13	1	17	82.7			9.861864	
14	1	17	63.9			10.146369	
15	2	17	98.3	1534		10.89732	
16	3	17	86.4	1985	1249	11.465475	

Bin5 Statistics 14

Trial #	Pulse	Chirp (MHz)	Pulse Width (µS)	Pulse 1-2 spacing (uS)	Pulse 2-3 spacing (uS)	Pulse Start(S)	Detection (1:yes; 0:no)
0	3	10	55.8	1119	1443	0.075139	1
1	1	10	53.6			1.168569	
2	2	10	65.8	1691		2.467412	
3	1	10	66.8			2.762163	
4	2	10	95.2	1768		3.65797	
5	3	10	65.2	1519	1223	4.400492	
6	3	10	66.8	1944	1547	5.787078	
7	3	10	80.2	1301	1778	6.241278	
8	2	10	83.4	1502		7.036	
9	1	10	62.6			8.226985	
10	3	10	91.9	1926	1680	9.239641	
11	2	10	97.5	1402		9.560665	
12	2	10	71.4	1381		10.706812	
13	2	10	71.4	1715		11.706328	
0	3	10	55.8	1119	1443	0.075139	

Bin5 Statistics 15

Trial #	Pulse	Chirp (MHz)	Pulse Width (µS)	Pulse 1-2 spacing (uS)	Pulse 2-3 spacing (uS)	Pulse Start(S)	Detection (1:yes; 0:no)
0	2	16	59.6	1507		0.226026	1
1	3	16	53.6	1552	1296	0.927675	
2	3	16	58.2	1026	1610	2.058342	
3	2	16	74.8	1976		2.33455	
4	2	16	68.3	1146		3.191729	
5	1	16	78.5			4.175956	
6	3	16	78.3	1222	1885	4.62526	
7	1	16	89.9			5.437766	
8	1	16	94.1			5.934631	
9	1	16	59.8			6.759703	
10	2	16	75.9	1201		7.174798	
11	1	16	85.4			8.215774	
12	3	16	54.1	1806	1019	9.06745	
13	2	16	80.1	1306		9.868392	
14	2	16	72.7	1081		10.017824	
15	2	16	90.1	1330		11.162984	
16	2	16	91.6	1390		11.333936	

Bin5 Statistics 16

Trial #	Pulse	Chirp (MHz)	Pulse Width (µS)	Pulse 1-2 spacing (uS)	Pulse 2-3 spacing (uS)	Pulse Start(S)	Detection (1:yes; 0:no)
0	1	16	72.4			0.188462	1
1	1	16	55			1.564664	
2	3	16	58.5	1530	1103	2.156747	
3	2	16	75.2	1729		3.412222	
4	2	16	93.6	1819		4.112352	
5	2	16	99.8	1577		5.145591	
6	3	16	87	1481	1136	5.976093	
7	1	16	73.8			6.662791	
8	1	16	68.4			8.188645	
9	2	16	98.8	1060		8.939828	
10	3	16	64.1	1629	1905	9.467629	
11	3	16	81.9	1101	1703	11.02513	
12	2	16	66.3	1835		11.115781	

Bin5 Statistics 17

Trial #	Pulse	Chirp (MHz)	Pulse Width (µS)	Pulse 1-2 spacing (uS)	Pulse 2-3 spacing (uS)	Pulse Start(S)	Detection (1:yes; 0:no)
0	2	8	95.5	1527		0.765763	1
1	2	8	83.2	1617		1.254916	
2	3	8	73.1	1797	1695	2.547143	
3	1	8	58.3			3.016725	
4	2	8	85.7	1516		3.951744	
5	2	8	89.3	1844		4.568052	
6	3	8	61.7	1189	1844	5.352131	
7	2	8	87.5	1195		6.09128	
8	2	8	90.4	1203		6.9863	
9	3	8	84.2	1219	1938	8.517591	
10	2	8	73.7	1770		8.941528	
11	3	8	94.7	1864	1479	9.486074	
12	3	8	68.3	1551	1530	10.505277	
13	2	8	51	1840		11.642197	

Bin5 Statistics 18

Trial #	Pulse	Chirp (MHz)	Pulse Width (µS)	Pulse 1-2 spacing (uS)	Pulse 2-3 spacing (uS)	Pulse Start(S)	Detection (1:yes; 0:no)
0	1	16	88.1			0.377871	1
1	2	16	73	1242		0.852259	
2	1	16	89.4			1.541397	
3	3	16	51.9	1463	1817	2.359871	
4	2	16	60.2	1459		3.012245	
5	3	16	63.9	1634	1742	3.627575	
6	2	16	68.6	1594		4.377903	
7	2	16	89.1	1890		4.844067	
8	3	16	95.4	1935	1143	5.993598	
9	2	16	69	1521		6.619414	
10	3	16	69.1	1628	1573	7.233835	
11	2	16	80.8	1505		7.987498	
12	2	16	85.2	1719		8.354598	
13	3	16	64.9	1328	1182	8.77892	
14	3	16	80.2	1634	1322	9.44262	
15	2	16	86.7	1815		10.374126	
16	3	16	64	1286	1849	11.048517	
17	2	16	94.2	1346		11.632461	

Bin5 Statistics 19

Trial #	Pulse	Chirp (MHz)	Pulse Width (µS)	Pulse 1-2 spacing (µS)	Pulse 2-3 spacing (µS)	Pulse Start(S)	Detection (1:yes; 0:no)
0	2	14	99.7	1948		0.19328	1
1	2	14	77.4	1847		1.101129	
2	2	14	54.8	1931		1.650479	
3	2	14	91.6	1516		2.66702	
4	2	14	71.3	1251		3.062293	
5	1	14	57.1			4.378091	
6	2	14	80.1	1618		4.901517	
7	2	14	54.7	1939		5.678847	
8	3	14	73.7	1163	1532	6.042115	
9	2	14	75.2	1658		6.783662	
10	2	14	59	1248		7.806741	
11	2	14	94.9	1023		8.370302	
12	2	14	92.5	1131		9.0789	
13	2	14	53.9	1584		10.339399	
14	1	14	75.7			10.693967	
15	3	14	56.3	1824	1698	11.448507	

Bin5 Statistics 20

Trial #	Pulse	Chirp (MHz)	Pulse Width (µS)	Pulse 1-2 spacing (µS)	Pulse 2-3 spacing (µS)	Pulse Start(S)	Detection (1:yes; 0:no)
0	2	12	70	1387		0.515405	1
1	2	12	88.5	1183		1.379041	
2	3	12	57.1	1521	1600	2.283925	
3	1	12	55.2			3.452453	
4	1	12	95.6			4.341095	
5	1	12	59.4			5.365726	
6	2	12	93	1822		6.4417	
7	1	12	90.2			7.003445	
8	1	12	81.4			7.447043	
9	2	12	67.6	1098		8.596606	
10	2	12	64	1369		10.123016	
11	3	12	99.9	1354	1502	10.192761	
12	2	12	66.7	1984		11.22131	

Bin5 Statistics 21

Trial #	Pulse	Chirp (MHz)	Pulse Width (µS)	Pulse 1-2 spacing (uS)	Pulse 2-3 spacing (uS)	Pulse Start(S)	Detection (1:yes; 0:no)
0	3	15	93.8	1717	1472	0.638091	1
1	1	15	65.4			1.719723	
2	3	15	99.5	1552	1689	2.459367	
3	2	15	69.1	1733		4.586116	
4	2	15	94.5	1611		5.821548	
5	1	15	90.5			6.921051	
6	3	15	72.6	1185	1097	7.685978	
7	2	15	58.9	1245		8.58108	
8	2	15	51.1	1653		9.774098	
9	2	15	72.4	1874		11.042627	

Bin5 Statistics 22

Trial #	Pulse	Chirp (MHz)	Pulse Width (µS)	Pulse 1-2 spacing (uS)	Pulse 2-3 spacing (uS)	Pulse Start(S)	Detection (1:yes; 0:no)
0	2	7	67.3	1812		0.339185	1
1	2	7	54.2	1065		0.700239	
2	2	7	63.8	1073		1.843633	
3	1	7	87.5			2.359283	
4	2	7	62.9	1214		2.881552	
5	3	7	91.2	1294	1953	3.631356	
6	2	7	98.5	1402		4.444415	
7	3	7	94.4	1239	1297	5.159398	
8	2	7	84	1225		5.403251	
9	1	7	62.8			6.274931	
10	3	7	61.3	1415	1557	6.976722	
11	2	7	52.8	1163		7.66473	
12	1	7	51.5			8.281769	
13	1	7	79.3			8.959573	
14	1	7	54			9.357326	
15	2	7	61.3	1677		10.520012	
16	2	7	90.3	1852		10.862934	
17	2	7	55.7	1385		11.983641	

Bin5 Statistics 23

Trial #	Pulse	Chirp (MHz)	Pulse Width (µS)	Pulse 1-2 spacing (uS)	Pulse 2-3 spacing (uS)	Pulse Start(S)	Detection (1:yes; 0:no)
0	3	17	61.6	1257	1671	0.338723	1
1	2	17	90.1	1376		1.428132	
2	1	17	78.5			1.692548	
3	2	17	92.1	1521		2.612429	
4	3	17	88	1440	1209	3.35645	
5	2	17	97.8	1378		4.247646	
6	3	17	67.6	1388	1240	4.655406	
7	3	17	55.3	1310	1868	5.891573	
8	2	17	78.3	1741		6.463183	
9	2	17	85.6	1917		7.351469	
10	2	17	70	1945		7.847271	
11	1	17	52.4			8.846288	
12	1	17	54.9			9.270518	
13	2	17	77.6	1048		10.421671	
14	2	17	77.2	1887		10.878717	
15	2	17	99	1282		11.44305	

Bin5 Statistics 24

Trial #	Pulse	Chirp (MHz)	Pulse Width (µS)	Pulse 1-2 spacing (uS)	Pulse 2-3 spacing (uS)	Pulse Start(S)	Detection (1:yes; 0:no)
0	2	7	87	1461		0.277992	1
1	3	7	66.9	1494	1092	1.06586	
2	3	7	91	1869	1142	2.171455	
3	1	7	59.7			2.73017	
4	2	7	63.3	1348		3.768755	
5	3	7	88.8	1989	1865	4.9065	
6	2	7	98.9	1380		5.311461	
7	3	7	60.5	1696	1718	6.786286	
8	3	7	97.4	1920	1366	7.224447	
9	2	7	99.9	1076		7.71776	
10	3	7	63.4	1662	1830	8.731407	
11	2	7	65.1	1232		9.696062	
12	2	7	78.9	1084		10.589516	
13	1	7	84.5			11.830714	

Bin5 Statistics 25

Trial #	Pulse	Chirp (MHz)	Pulse Width (µS)	Pulse 1-2 spacing (uS)	Pulse 2-3 spacing (uS)	Pulse Start(S)	Detection (1:yes; 0:no)
0	3	12	85	1824	1551	0.660495	1
1	3	12	95.8	1687	1337	1.824326	
2	2	12	95.3	1075		2.014931	
3	1	12	85.1			3.427069	
4	2	12	81.3	1780		3.963103	
5	2	12	53.3	1042		4.6833	
6	3	12	60.7	1324	1782	5.962385	
7	2	12	73.5	1805		7.267173	
8	2	12	89.7	1697		7.490497	
9	1	12	54.4			9.108933	
10	2	12	72.4	1297		9.979861	
11	2	12	65.6	1149		10.473208	
12	1	12	92.4			11.32003	

Bin5 Statistics 26

Trial #	Pulse	Chirp (MHz)	Pulse Width (µS)	Pulse 1-2 spacing (uS)	Pulse 2-3 spacing (uS)	Pulse Start(S)	Detection (1:yes; 0:no)
0	2	5	73.4	1520		0.581173	1
1	2	5	51	1639		1.088615	
2	1	5	72.6			2.290864	
3	1	5	69.7			2.628176	
4	3	5	97	1660	1637	3.938863	
5	2	5	78.8	1563		4.093835	
6	2	5	74.8	1805		5.243407	
7	2	5	52	1600		6.243306	
8	3	5	73	1938	1860	6.647663	
9	3	5	71	1805	1747	7.461372	
10	1	5	54.4			8.639708	
11	3	5	74	1264	1953	9.423978	
12	3	5	50.7	1126	1333	9.609443	
13	2	5	64.2	1058		10.651171	
14	2	5	94.9	1486		11.410505	

Bin5 Statistics 27

Trial #	Pulse	Chirp (MHz)	Pulse Width (µS)	Pulse 1-2 spacing (uS)	Pulse 2-3 spacing (uS)	Pulse Start(S)	Detection (1:yes; 0:no)
0	3	6	57.4	1303	1942	0.213887	1
1	2	6	68	1903		1.313167	
2	3	6	63	1493	1002	1.933052	
3	3	6	87.1	1475	1354	3.100067	
4	2	6	86.8	1955		3.833721	
5	2	6	77.4	1133		4.204532	
6	2	6	91	1102		5.473945	
7	2	6	75.9	1993		6.334379	
8	3	6	76.3	1026	1285	6.556211	
9	3	6	79.5	1870	1290	7.629469	
10	2	6	93.1	1662		8.464252	
11	3	6	95.5	1998	1862	9.11645	
12	2	6	69	1371		9.981479	
13	2	6	91.4	1616		10.454264	
14	3	6	74.7	1757	1299	11.572955	

Bin5 Statistics 28

Trial #	Pulse	Chirp (MHz)	Pulse Width (µS)	Pulse 1-2 spacing (uS)	Pulse 2-3 spacing (uS)	Pulse Start(S)	Detection (1:yes; 0:no)
0	2	15	91.3	1577		0.478599	1
1	1	15	86.6			0.994655	
2	2	15	97.2	1737		1.511675	
3	2	15	86.6	1920		2.544727	
4	2	15	91.2	1889		3.117706	
5	3	15	69.4	1739	1139	4.310122	
6	2	15	52.2	1306		4.989514	
7	2	15	62.6	1000		5.824466	
8	3	15	55.3	1165	1605	6.46266	
9	2	15	86.8	1974		7.465344	
10	2	15	81.3	1202		7.754039	
11	2	15	57	1534		8.540105	
12	2	15	61.2	1446		9.159456	
13	2	15	88.1	1348		10.284984	
14	2	15	96.7	1968		10.608613	
15	2	15	82.8	1370		11.570627	

Bin5 Statistics 29

Trial #	Pulse	Chirp (MHz)	Pulse Width (µS)	Pulse 1-2 spacing (uS)	Pulse 2-3 spacing (uS)	Pulse Start(S)	Detection (1:yes; 0:no)
0	1	9	58			0.110723	1
1	2	9	92.5	1876		1.607728	
2	2	9	79.9	1686		3.219529	
3	2	9	92.9	1101		3.614598	
4	3	9	55.5	1712	1305	4.98403	
5	3	9	73.5	1595	1662	6.147767	
6	1	9	66.5			7.175428	
7	2	9	84.3	1373		8.505169	
8	2	9	91.4	1640		9.044793	
9	1	9	60.2			10.041318	
10	2	9	95.9	1273		11.393764	

Bin5 Statistics 30

Trial #	Pulse	Chirp (MHz)	Pulse Width (µS)	Pulse 1-2 spacing (uS)	Pulse 2-3 spacing (uS)	Pulse Start(S)	Detection (1:yes; 0:no)
0	3	9	54.3	1751	1094	0.164245	1
1	3	9	96.9	1805	1397	0.817024	
2	2	9	84.1	1323		2.179088	
3	3	9	96.6	1045	1213	2.985991	
4	1	9	75.6			3.611422	
5	2	9	92.5	1358		4.057174	
6	2	9	73	1239		4.890678	
7	1	9	92.4			5.67628	
8	2	9	93.5	1109		6.409091	
9	2	9	90.8	1336		7.45514	
10	2	9	51.8	1753		7.505368	
11	3	9	63.6	1801	1083	8.981287	
12	2	9	60.6	1007		9.532713	
13	3	9	75.5	1159	1173	10.298033	
14	1	9	53.3			11.083716	
15	3	9	94.3	1781	1220	11.435756	

Table-6 Radar Type 6 Statistical Performance

Trial #	Fc (MHz)	Pulse /Burst	Pulse Width (μS)	PRI (μs)	Detection (1:yes; 0:no)	Hopping Sequence
1	5540	9	1	333	1	5316.0, 5381.0, 5663.0, 5504.0, 5667.0, 5688.0, 5282.0, 5288.0, 5593.0, 5514.0, 5253.0, 5385.0, 5582.0, 5641.0, 5711.0, 5555.0, 5628.0, 5340.0, 5500.0, 5522.0, 5596.0, 5471.0, 5649.0, 5470.0, 5301.0, 5405.0, 5416.0, 5413.0, 5374.0, 5559.0, 5722.0, 5360.0, 5573.0, 5630.0, 5511.0, 5541.0, 5353.0, 5262.0, 5497.0, 5271.0, 5263.0, 5693.0, 5586.0, 5356.0, 5331.0, 5477.0, 5272.0, 5672.0, 5597.0, 5261.0, 5408.0, 5702.0, 5300.0, 5592.0, 5634.0, 5369.0, 5367.0, 5681.0, 5291.0, 5390.0, 5329.0, 5457.0, 5258.0, 5279.0, 5712.0, 5328.0, 5724.0, 5426.0, 5644.0, 5656.0, 5250.0, 5298.0, 5391.0, 5280.0, 5503.0, 5283.0, 5700.0, 5255.0, 5478.0, 5601.0, 5467.0, 5320.0, 5563.0, 5612.0, 5378.0, 5415.0, 5549.0, 5437.0, 5348.0, 5260.0, 5627.0, 5574.0, 5458.0, 5619.0, 5440.0, 5640.0, 5682.0, 5557.0, 5639.0, 5528.0 (number of hits: 14)
2	5540	9	1	333	1	5382.0, 5353.0, 5504.0, 5498.0, 5478.0, 5346.0, 5557.0, 5354.0, 5417.0, 5684.0, 5680.0, 5381.0, 5480.0, 5492.0, 5632.0, 5511.0, 5294.0, 5558.0, 5572.0, 5424.0, 5524.0, 5305.0, 5304.0, 5574.0, 5532.0, 5471.0, 5610.0, 5443.0, 5290.0, 5660.0, 5482.0, 5699.0, 5257.0, 5351.0, 5600.0, 5419.0, 5430.0, 5591.0, 5287.0, 5302.0, 5586.0, 5373.0, 5475.0, 5633.0, 5465.0, 5484.0, 5254.0, 5718.0, 5635.0, 5561.0, 5719.0, 5320.0, 5568.0, 5527.0, 5334.0, 5683.0, 5451.0, 5711.0, 5337.0, 5427.0, 5714.0, 5462.0, 5298.0, 5692.0, 5608.0, 5507.0, 5426.0, 5533.0, 5363.0, 5348.0, 5412.0, 5647.0, 5595.0, 5717.0, 5606.0, 5495.0, 5306.0, 5526.0, 5277.0, 5499.0, 5421.0, 5700.0, 5685.0, 5698.0, 5668.0, 5642.0, 5359.0, 5689.0, 5539.0, 5697.0, 5624.0, 5614.0, 5672.0, 5599.0, 5643.0, 5292.0, 5686.0, 5467.0, 5566.0, 5349.0 (number of hits: 16)
3	5540	9	1	333	1	5506.0, 5425.0, 5446.0, 5462.0, 5305.0, 5293.0, 5679.0, 5718.0, 5412.0, 5540.0, 5698.0, 5263.0, 5394.0, 5376.0, 5255.0, 5533.0, 5440.0, 5280.0, 5367.0, 5296.0, 5495.0, 5402.0, 5536.0, 5323.0, 5530.0, 5645.0, 5566.0, 5429.0, 5346.0, 5668.0, 5434.0, 5416.0, 5351.0, 5692.0, 5490.0, 5606.0, 5531.0, 5503.0, 5553.0, 5403.0, 5377.0, 5653.0, 5544.0, 5271.0, 5688.0, 5361.0, 5393.0, 5538.0, 5615.0, 5649.0, 5693.0, 5463.0, 5427.0, 5365.0, 5715.0, 5685.0, 5286.0, 5337.0, 5616.0, 5724.0, 5349.0, 5297.0, 5401.0, 5467.0, 5570.0,

						5638.0, 5675.0, 5640.0, 5478.0, 5673.0, 5624.0, 5500.0, 5287.0, 5596.0, 5264.0, 5489.0, 5366.0, 5455.0, 5643.0, 5674.0, 5314.0, 5284.0, 5654.0, 5473.0, 5319.0, 5625.0, 5483.0, 5256.0, 5619.0, 5565.0, 5562.0, 5618.0, 5391.0, 5312.0, 5537.0, 5341.0, 5324.0, 5343.0, 5294.0, 5441.0 (number of hits: 15)
4	5540	9	1	333	1	5560.0, 5673.0, 5376.0, 5649.0, 5691.0, 5590.0, 5265.0, 5589.0, 5372.0, 5389.0, 5353.0, 5646.0, 5577.0, 5252.0, 5505.0, 5290.0, 5384.0, 5476.0, 5395.0, 5687.0, 5623.0, 5352.0, 5586.0, 5430.0, 5315.0, 5383.0, 5342.0, 5652.0, 5707.0, 5711.0, 5563.0, 5332.0, 5457.0, 5453.0, 5546.0, 5686.0, 5486.0, 5598.0, 5723.0, 5414.0, 5506.0, 5489.0, 5689.0, 5280.0, 5344.0, 5534.0, 5377.0, 5536.0, 5697.0, 5355.0, 5633.0, 5555.0, 5516.0, 5562.0, 5669.0, 5533.0, 5627.0, 5375.0, 5655.0, 5601.0, 5661.0, 5635.0, 5394.0, 5685.0, 5431.0, 5275.0, 5396.0, 5572.0, 5703.0, 5724.0, 5324.0, 5467.0, 5369.0, 5370.0, 5271.0, 5295.0, 5306.0, 5582.0, 5581.0, 5254.0, 5400.0, 5477.0, 5337.0, 5529.0, 5578.0, 5692.0, 5571.0, 5267.0, 5490.0, 5644.0, 5464.0, 5483.0, 5259.0, 5307.0, 5346.0, 5293.0, 5524.0, 5426.0, 5310.0, 5680.0 (number of hits: 16)
5	5540	9	1	333	1	5544.0, 5545.0, 5281.0, 5563.0, 5252.0, 5707.0, 5630.0, 5332.0, 5594.0, 5284.0, 5336.0, 5610.0, 5532.0, 5681.0, 5325.0, 5413.0, 5475.0, 5657.0, 5458.0, 5482.0, 5398.0, 5314.0, 5347.0, 5617.0, 5420.0, 5412.0, 5287.0, 5527.0, 5699.0, 5358.0, 5586.0, 5568.0, 5651.0, 5646.0, 5543.0, 5293.0, 5583.0, 5269.0, 5619.0, 5369.0, 5441.0, 5530.0, 5505.0, 5555.0, 5442.0, 5352.0, 5560.0, 5591.0, 5334.0, 5290.0, 5541.0, 5483.0, 5271.0, 5366.0, 5645.0, 5310.0, 5306.0, 5490.0, 5598.0, 5538.0, 5328.0, 5321.0, 5491.0, 5689.0, 5488.0, 5394.0, 5516.0, 5682.0, 5276.0, 5584.0, 5261.0, 5663.0, 5577.0, 5410.0, 5582.0, 5440.0, 5512.0, 5519.0, 5400.0, 5375.0, 5537.0, 5343.0, 5695.0, 5465.0, 5266.0, 5668.0, 5406.0, 5606.0, 5363.0, 5708.0, 5397.0, 5507.0, 5498.0, 5480.0, 5253.0, 5330.0, 5250.0, 5472.0, 5298.0, 5331.0 (number of hits: 19)
6	5540	9	1	333	1	5336.0, 5466.0, 5722.0, 5432.0, 5657.0, 5435.0, 5690.0, 5643.0, 5626.0, 5638.0, 5470.0, 5706.0, 5442.0, 5469.0, 5322.0, 5608.0, 5415.0, 5306.0, 5675.0, 5471.0, 5507.0, 5538.0, 5578.0, 5463.0, 5476.0, 5333.0, 5555.0, 5449.0, 5584.0, 5574.0, 5285.0, 5550.0, 5605.0, 5318.0, 5300.0, 5457.0, 5564.0, 5331.0, 5716.0, 5350.0, 5569.0, 5541.0, 5255.0, 5702.0, 5637.0, 5607.0, 5598.0, 5712.0, 5376.0, 5649.0, 5383.0, 5590.0, 5498.0, 5652.0, 5388.0

						5351.0, 5634.0, 5672.0, 5349.0, 5326.0, 5625.0, 5615.0, 5260.0, 5387.0, 5599.0, 5327.0, 5365.0, 5661.0, 5384.0, 5324.0, 5394.0, 5451.0, 5335.0, 5280.0, 5377.0, 5456.0, 5467.0, 5259.0, 5623.0, 5400.0, 5651.0, 5431.0, 5682.0, 5646.0, 5597.0, 5678.0, 5404.0, 5421.0, 5619.0, 5724.0, 5459.0, 5544.0, 5292.0, 5659.0, 5640.0, 5374.0, 5612.0, 5566.0, 5594.0, 5474.0 (number of hits: 10)
7	5540	9	1	333	1	5479.0, 5566.0, 5695.0, 5698.0, 5438.0, 5261.0, 5722.0, 5578.0, 5681.0, 5598.0, 5672.0, 5582.0, 5471.0, 5407.0, 5477.0, 5679.0, 5294.0, 5399.0, 5570.0, 5315.0, 5611.0, 5436.0, 5457.0, 5498.0, 5653.0, 5642.0, 5622.0, 5707.0, 5654.0, 5652.0, 5560.0, 5506.0, 5453.0, 5703.0, 5666.0, 5478.0, 5482.0, 5403.0, 5424.0, 5443.0, 5432.0, 5377.0, 5409.0, 5374.0, 5295.0, 5360.0, 5337.0, 5568.0, 5371.0, 5268.0, 5476.0, 5575.0, 5592.0, 5309.0, 5584.0, 5511.0, 5500.0, 5581.0, 5591.0, 5299.0, 5456.0, 5359.0, 5670.0, 5657.0, 5673.0, 5556.0, 5321.0, 5626.0, 5375.0, 5288.0, 5318.0, 5410.0, 5507.0, 5254.0, 5640.0, 5656.0, 5380.0, 5351.0, 5378.0, 5469.0, 5356.0, 5614.0, 5317.0, 5311.0, 5589.0, 5662.0, 5435.0, 5718.0, 5366.0, 5330.0, 5631.0, 5280.0, 5576.0, 5617.0, 5523.0, 5636.0, 5503.0, 5674.0, 5464.0, 5605.0 (number of hits: 12)
8	5540	9	1	333	1	5642.0, 5720.0, 5501.0, 5455.0, 5445.0, 5335.0, 5611.0, 5285.0, 5655.0, 5320.0, 5288.0, 5665.0, 5379.0, 5473.0, 5497.0, 5620.0, 5294.0, 5409.0, 5584.0, 5381.0, 5300.0, 5716.0, 5324.0, 5326.0, 5296.0, 5669.0, 5553.0, 5351.0, 5334.0, 5708.0, 5690.0, 5661.0, 5416.0, 5384.0, 5329.0, 5415.0, 5677.0, 5522.0, 5426.0, 5464.0, 5424.0, 5636.0, 5460.0, 5348.0, 5430.0, 5342.0, 5332.0, 5318.0, 5546.0, 5357.0, 5374.0, 5290.0, 5571.0, 5518.0, 5372.0, 5713.0, 5316.0, 5592.0, 5278.0, 5672.0, 5470.0, 5340.0, 5622.0, 5484.0, 5723.0, 5407.0, 5475.0, 5663.0, 5425.0, 5315.0, 5306.0, 5693.0, 5578.0, 5421.0, 5395.0, 5634.0, 5341.0, 5557.0, 5517.0, 5558.0, 5422.0, 5668.0, 5343.0, 5476.0, 5435.0, 5323.0, 5608.0, 5513.0, 5607.0, 5717.0, 5336.0, 5673.0, 5540.0, 5386.0, 5691.0, 5284.0, 5577.0, 5495.0, 5492.0, 5462.0 (number of hits: 11)
9	5540	9	1	333	1	5488.0, 5601.0, 5620.0, 5557.0, 5717.0, 5521.0, 5480.0, 5418.0, 5331.0, 5565.0, 5673.0, 5285.0, 5385.0, 5553.0, 5664.0, 5646.0, 5406.0, 5496.0, 5373.0, 5469.0, 5575.0, 5306.0, 5472.0, 5720.0, 5475.0, 5351.0, 5660.0, 5350.0, 5596.0, 5680.0, 5372.0, 5271.0, 5459.0, 5603.0, 5649.0, 5495.0, 5500.0, 5334.0, 5524.0, 5329.0, 5445.0, 5516.0, 5685.0, 5410.0, 5422.0,

						5278.0, 5622.0, 5255.0, 5573.0, 5714.0, 5389.0, 5721.0, 5473.0, 5312.0, 5371.0, 5489.0, 5376.0, 5342.0, 5525.0, 5269.0, 5421.0, 5465.0, 5434.0, 5566.0, 5633.0, 5574.0, 5535.0, 5558.0, 5554.0, 5697.0, 5665.0, 5651.0, 5631.0, 5644.0, 5657.0, 5388.0, 5594.0, 5624.0, 5457.0, 5281.0, 5724.0, 5552.0, 5531.0, 5592.0, 5669.0, 5303.0, 5567.0, 5559.0, 5254.0, 5512.0, 5436.0, 5666.0, 5602.0, 5626.0, 5466.0, 5250.0, 5584.0, 5270.0, 5555.0, 5381.0 (number of hits: 20)
10	5540	9	1	333	1	5530.0, 5672.0, 5358.0, 5305.0, 5611.0, 5704.0, 5641.0, 5616.0, 5574.0, 5629.0, 5600.0, 5416.0, 5644.0, 5608.0, 5331.0, 5724.0, 5584.0, 5501.0, 5573.0, 5307.0, 5687.0, 5343.0, 5540.0, 5296.0, 5633.0, 5304.0, 5299.0, 5511.0, 5549.0, 5318.0, 5493.0, 5558.0, 5592.0, 5632.0, 5601.0, 5395.0, 5693.0, 5349.0, 5507.0, 5283.0, 5692.0, 5427.0, 5291.0, 5405.0, 5392.0, 5575.0, 5673.0, 5595.0, 5543.0, 5568.0, 5591.0, 5676.0, 5597.0, 5329.0, 5435.0, 5683.0, 5357.0, 5293.0, 5323.0, 5428.0, 5436.0, 5471.0, 5535.0, 5431.0, 5490.0, 5586.0, 5412.0, 5671.0, 5553.0, 5265.0, 5452.0, 5321.0, 5697.0, 5647.0, 5579.0, 5607.0, 5437.0, 5309.0, 5684.0, 5545.0, 5719.0, 5582.0, 5635.0, 5383.0, 5284.0, 5566.0, 5554.0, 5419.0, 5402.0, 5567.0, 5552.0, 5686.0, 5272.0, 5626.0, 5339.0, 5379.0, 5690.0, 5614.0, 5662.0, 5261.0 (number of hits: 18)
11	5502	9	1	333	1	5400.0, 5448.0, 5565.0, 5706.0, 5621.0, 5539.0, 5614.0, 5663.0, 5540.0, 5514.0, 5639.0, 5561.0, 5474.0, 5473.0, 5471.0, 5290.0, 5686.0, 5602.0, 5254.0, 5472.0, 5407.0, 5688.0, 5653.0, 5417.0, 5698.0, 5437.0, 5523.0, 5307.0, 5397.0, 5404.0, 5434.0, 5682.0, 5571.0, 5557.0, 5406.0, 5644.0, 5538.0, 5610.0, 5310.0, 5446.0, 5265.0, 5564.0, 5463.0, 5574.0, 5416.0, 5701.0, 5720.0, 5660.0, 5683.0, 5482.0, 5549.0, 5418.0, 5489.0, 5705.0, 5536.0, 5296.0, 5402.0, 5367.0, 5704.0, 5413.0, 5673.0, 5439.0, 5280.0, 5681.0, 5313.0, 5649.0, 5598.0, 5722.0, 5577.0, 5719.0, 5352.0, 5676.0, 5641.0, 5377.0, 5390.0, 5675.0, 5395.0, 5624.0, 5496.0, 5279.0, 5566.0, 5470.0, 5691.0, 5504.0, 5648.0, 5284.0, 5599.0, 5286.0, 5399.0, 5318.0, 5334.0, 5317.0, 5582.0, 5453.0, 5609.0, 5595.0, 5358.0, 5344.0, 5349.0, 5633.0 (number of hits: 14)
12	5502	9	1	333	1	5595.0, 5331.0, 5496.0, 5300.0, 5337.0, 5623.0, 5360.0, 5377.0, 5517.0, 5719.0, 5454.0, 5452.0, 5630.0, 5650.0, 5435.0, 5560.0, 5713.0, 5592.0, 5340.0, 5516.0, 5700.0, 5426.0, 5254.0, 5717.0, 5607.0, 5544.0, 5273.0, 5575.0, 5609.0, 5296.0, 5320.0, 5628.0, 5701.0, 5380.0, 5668.0,

						5299.0, 5482.0, 5545.0, 5309.0, 5345.0, 5680.0, 5565.0, 5376.0, 5291.0, 5259.0, 5285.0, 5614.0, 5464.0, 5479.0, 5458.0, 5394.0, 5409.0, 5576.0, 5521.0, 5610.0, 5563.0, 5621.0, 5432.0, 5569.0, 5706.0, 5659.0, 5702.0, 5327.0, 5284.0, 5617.0, 5392.0, 5305.0, 5465.0, 5415.0, 5353.0, 5350.0, 5472.0, 5531.0, 5355.0, 5498.0, 5371.0, 5252.0, 5676.0, 5378.0, 5598.0, 5338.0, 5266.0, 5492.0, 5363.0, 5485.0, 5258.0, 5374.0, 5336.0, 5715.0, 5685.0, 5459.0, 5262.0, 5274.0, 5716.0, 5554.0, 5487.0, 5666.0, 5632.0, 5512.0, 5549.0 (number of hits: 15)
13	5502	9	1	333	1	5314.0, 5670.0, 5633.0, 5334.0, 5494.0, 5680.0, 5580.0, 5650.0, 5473.0, 5610.0, 5577.0, 5583.0, 5405.0, 5547.0, 5581.0, 5627.0, 5471.0, 5628.0, 5282.0, 5326.0, 5336.0, 5683.0, 5346.0, 5519.0, 5342.0, 5606.0, 5343.0, 5327.0, 5301.0, 5582.0, 5641.0, 5340.0, 5325.0, 5401.0, 5604.0, 5699.0, 5441.0, 5686.0, 5512.0, 5638.0, 5475.0, 5528.0, 5255.0, 5698.0, 5281.0, 5649.0, 5548.0, 5260.0, 5701.0, 5298.0, 5691.0, 5639.0, 5620.0, 5312.0, 5291.0, 5250.0, 5559.0, 5434.0, 5617.0, 5305.0, 5395.0, 5317.0, 5521.0, 5631.0, 5502.0, 5295.0, 5353.0, 5424.0, 5443.0, 5287.0, 5603.0, 5707.0, 5447.0, 5412.0, 5532.0, 5504.0, 5387.0, 5675.0, 5574.0, 5697.0, 5630.0, 5613.0, 5578.0, 5480.0, 5439.0, 5415.0, 5486.0, 5550.0, 5562.0, 5426.0, 5515.0, 5646.0, 5263.0, 5643.0, 5489.0, 5421.0, 5615.0, 5546.0, 5472.0, 5350.0 (number of hits: 16)
14	5502	9	1	333	1	5689.0, 5644.0, 5634.0, 5560.0, 5324.0, 5372.0, 5356.0, 5529.0, 5613.0, 5433.0, 5346.0, 5698.0, 5471.0, 5625.0, 5515.0, 5376.0, 5652.0, 5315.0, 5699.0, 5499.0, 5690.0, 5516.0, 5458.0, 5466.0, 5659.0, 5338.0, 5614.0, 5682.0, 5635.0, 5392.0, 5658.0, 5310.0, 5258.0, 5298.0, 5362.0, 5561.0, 5481.0, 5715.0, 5593.0, 5714.0, 5600.0, 5706.0, 5411.0, 5302.0, 5304.0, 5271.0, 5368.0, 5309.0, 5264.0, 5577.0, 5578.0, 5687.0, 5475.0, 5717.0, 5282.0, 5386.0, 5594.0, 5528.0, 5429.0, 5393.0, 5447.0, 5539.0, 5671.0, 5274.0, 5567.0, 5330.0, 5407.0, 5504.0, 5519.0, 5444.0, 5308.0, 5722.0, 5527.0, 5667.0, 5657.0, 5502.0, 5505.0, 5630.0, 5518.0, 5297.0, 5454.0, 5465.0, 5576.0, 5610.0, 5285.0, 5398.0, 5336.0, 5413.0, 5705.0, 5673.0, 5420.0, 5574.0, 5591.0, 5286.0, 5497.0, 5344.0, 5606.0, 5653.0, 5408.0, 5534.0 (number of hits: 19)
15	5502	9	1	333	1	5268.0, 5434.0, 5357.0, 5527.0, 5431.0, 5498.0, 5679.0, 5579.0, 5694.0, 5254.0, 5475.0, 5566.0, 5678.0, 5508.0, 5706.0, 5256.0, 5491.0, 5292.0, 5403.0, 5510.0, 5384.0, 5668.0, 5570.0, 5391.0, 5634.0,

						5417.0, 5296.0, 5649.0, 5324.0, 5459.0, 5662.0, 5723.0, 5710.0, 5515.0, 5499.0, 5623.0, 5625.0, 5688.0, 5362.0, 5613.0, 5411.0, 5413.0, 5562.0, 5469.0, 5265.0, 5282.0, 5325.0, 5478.0, 5461.0, 5560.0, 5395.0, 5457.0, 5685.0, 5581.0, 5450.0, 5408.0, 5573.0, 5506.0, 5618.0, 5651.0, 5271.0, 5645.0, 5470.0, 5638.0, 5540.0, 5502.0, 5383.0, 5479.0, 5564.0, 5596.0, 5463.0, 5500.0, 5419.0, 5661.0, 5276.0, 5286.0, 5412.0, 5334.0, 5473.0, 5636.0, 5399.0, 5251.0, 5481.0, 5708.0, 5715.0, 5433.0, 5353.0, 5580.0, 5392.0, 5563.0, 5303.0, 5553.0, 5538.0, 5537.0, 5398.0, 5657.0, 5547.0, 5284.0, 5281.0, 5608.0 (number of hits: 19)
16	5502	9	1	333	1	5534.0, 5575.0, 5486.0, 5364.0, 5445.0, 5256.0, 5446.0, 5498.0, 5472.0, 5491.0, 5363.0, 5510.0, 5301.0, 5423.0, 5455.0, 5288.0, 5293.0, 5703.0, 5502.0, 5551.0, 5344.0, 5481.0, 5558.0, 5688.0, 5680.0, 5479.0, 5283.0, 5716.0, 5379.0, 5289.0, 5537.0, 5383.0, 5407.0, 5700.0, 5405.0, 5579.0, 5471.0, 5321.0, 5265.0, 5583.0, 5659.0, 5719.0, 5529.0, 5322.0, 5587.0, 5592.0, 5422.0, 5711.0, 5393.0, 5629.0, 5538.0, 5517.0, 5273.0, 5682.0, 5607.0, 5695.0, 5518.0, 5262.0, 5654.0, 5625.0, 5277.0, 5285.0, 5463.0, 5483.0, 5391.0, 5552.0, 5507.0, 5709.0, 5356.0, 5535.0, 5280.0, 5447.0, 5553.0, 5523.0, 5720.0, 5606.0, 5528.0, 5522.0, 5282.0, 5541.0, 5270.0, 5424.0, 5624.0, 5444.0, 5386.0, 5609.0, 5712.0, 5348.0, 5404.0, 5582.0, 5252.0, 5574.0, 5326.0, 5266.0, 5305.0, 5302.0, 5323.0, 5519.0, 5603.0, 5559.0 (number of hits: 22)
17	5502	9	1	333	1	5532.0, 5591.0, 5403.0, 5296.0, 5419.0, 5590.0, 5292.0, 5319.0, 5520.0, 5682.0, 5486.0, 5256.0, 5505.0, 5378.0, 5710.0, 5698.0, 5713.0, 5615.0, 5396.0, 5450.0, 5689.0, 5431.0, 5514.0, 5377.0, 5366.0, 5318.0, 5257.0, 5460.0, 5530.0, 5414.0, 5495.0, 5446.0, 5433.0, 5617.0, 5304.0, 5452.0, 5285.0, 5288.0, 5372.0, 5573.0, 5380.0, 5568.0, 5518.0, 5291.0, 5325.0, 5550.0, 5343.0, 5496.0, 5648.0, 5647.0, 5661.0, 5310.0, 5536.0, 5330.0, 5651.0, 5354.0, 5470.0, 5358.0, 5493.0, 5566.0, 5611.0, 5560.0, 5715.0, 5588.0, 5502.0, 5265.0, 5699.0, 5653.0, 5663.0, 5527.0, 5644.0, 5367.0, 5662.0, 5574.0, 5540.0, 5507.0, 5497.0, 5461.0, 5363.0, 5669.0, 5392.0, 5519.0, 5336.0, 5299.0, 5332.0, 5466.0, 5276.0, 5608.0, 5487.0, 5516.0, 5437.0, 5381.0, 5578.0, 5692.0, 5506.0, 5273.0, 5675.0, 5270.0, 5555.0, 5711.0 (number of hits: 21)
18	5502	9	1	333	1	5489.0, 5520.0, 5634.0, 5290.0, 5453.0, 5584.0, 5514.0, 5679.0, 5530.0, 5624.0, 5531.0, 5305.0, 5518.0, 5595.0, 5329.0,

						5277.0, 5293.0, 5610.0, 5430.0, 5513.0, 5661.0, 5601.0, 5615.0, 5682.0, 5347.0, 5522.0, 5251.0, 5628.0, 5606.0, 5525.0, 5583.0, 5268.0, 5540.0, 5314.0, 5557.0, 5468.0, 5344.0, 5511.0, 5570.0, 5313.0, 5434.0, 5264.0, 5706.0, 5496.0, 5486.0, 5384.0, 5350.0, 5414.0, 5470.0, 5351.0, 5348.0, 5637.0, 5446.0, 5563.0, 5603.0, 5369.0, 5299.0, 5618.0, 5286.0, 5404.0, 5566.0, 5316.0, 5512.0, 5417.0, 5260.0, 5276.0, 5399.0, 5340.0, 5479.0, 5502.0, 5256.0, 5711.0, 5349.0, 5456.0, 5533.0, 5255.0, 5270.0, 5510.0, 5356.0, 5398.0, 5431.0, 5478.0, 5474.0, 5689.0, 5669.0, 5378.0, 5664.0, 5591.0, 5371.0, 5589.0, 5504.0, 5640.0, 5542.0, 5631.0, 5300.0, 5306.0, 5724.0, 5660.0, 5524.0, 5558.0 (number of hits: 23)
19	5502	9	1	333	1	5685.0, 5607.0, 5407.0, 5500.0, 5386.0, 5653.0, 5585.0, 5700.0, 5299.0, 5298.0, 5487.0, 5644.0, 5307.0, 5548.0, 5597.0, 5633.0, 5402.0, 5582.0, 5393.0, 5704.0, 5560.0, 5575.0, 5364.0, 5376.0, 5601.0, 5555.0, 5674.0, 5397.0, 5399.0, 5421.0, 5510.0, 5640.0, 5724.0, 5420.0, 5284.0, 5302.0, 5594.0, 5327.0, 5286.0, 5441.0, 5447.0, 5612.0, 5502.0, 5605.0, 5404.0, 5514.0, 5581.0, 5591.0, 5574.0, 5460.0, 5490.0, 5333.0, 5374.0, 5274.0, 5554.0, 5697.0, 5620.0, 5454.0, 5488.0, 5371.0, 5362.0, 5281.0, 5295.0, 5563.0, 5701.0, 5368.0, 5423.0, 5486.0, 5324.0, 5705.0, 5513.0, 5518.0, 5315.0, 5439.0, 5408.0, 5473.0, 5405.0, 5339.0, 5562.0, 5570.0, 5568.0, 5695.0, 5616.0, 5499.0, 5702.0, 5656.0, 5590.0, 5721.0, 5662.0, 5276.0, 5262.0, 5436.0, 5630.0, 5410.0, 5638.0, 5533.0, 5690.0, 5715.0, 5305.0, 5451.0 (number of hits: 13)
20	5502	9	1	333	1	5590.0, 5671.0, 5672.0, 5323.0, 5619.0, 5425.0, 5336.0, 5626.0, 5306.0, 5389.0, 5285.0, 5520.0, 5522.0, 5264.0, 5576.0, 5277.0, 5331.0, 5644.0, 5440.0, 5569.0, 5338.0, 5347.0, 5527.0, 5447.0, 5361.0, 5332.0, 5436.0, 5488.0, 5634.0, 5464.0, 5451.0, 5482.0, 5450.0, 5566.0, 5269.0, 5556.0, 5385.0, 5297.0, 5623.0, 5356.0, 5308.0, 5673.0, 5410.0, 5551.0, 5570.0, 5529.0, 5428.0, 5298.0, 5554.0, 5310.0, 5636.0, 5406.0, 5467.0, 5608.0, 5723.0, 5259.0, 5449.0, 5642.0, 5311.0, 5446.0, 5305.0, 5291.0, 5299.0, 5514.0, 5715.0, 5316.0, 5696.0, 5587.0, 5341.0, 5474.0, 5286.0, 5567.0, 5360.0, 5379.0, 5499.0, 5649.0, 5711.0, 5611.0, 5443.0, 5318.0, 5584.0, 5490.0, 5346.0, 5272.0, 5293.0, 5407.0, 5281.0, 5572.0, 5498.0, 5362.0, 5534.0, 5639.0, 5386.0, 5674.0, 5515.0, 5481.0, 5525.0, 5465.0, 5602.0, 5679.0 (number of hits: 18)
21	5578	9	1	333	1	5540.0, 5470.0, 5496.0, 5411.0, 5535.0,

						5359.0, 5612.0, 5529.0, 5570.0, 5617.0, 5344.0, 5536.0, 5401.0, 5358.0, 5480.0, 5523.0, 5386.0, 5640.0, 5298.0, 5365.0, 5666.0, 5325.0, 5413.0, 5697.0, 5528.0, 5320.0, 5554.0, 5682.0, 5399.0, 5271.0, 5268.0, 5419.0, 5311.0, 5695.0, 5628.0, 5658.0, 5279.0, 5274.0, 5539.0, 5327.0, 5573.0, 5276.0, 5336.0, 5525.0, 5395.0, 5722.0, 5356.0, 5622.0, 5545.0, 5441.0, 5292.0, 5461.0, 5683.0, 5670.0, 5694.0, 5575.0, 5439.0, 5423.0, 5437.0, 5454.0, 5309.0, 5578.0, 5333.0, 5260.0, 5323.0, 5712.0, 5421.0, 5370.0, 5625.0, 5285.0, 5610.0, 5307.0, 5277.0, 5420.0, 5319.0, 5700.0, 5684.0, 5524.0, 5388.0, 5569.0, 5579.0, 5329.0, 5482.0, 5585.0, 5316.0, 5663.0, 5507.0, 5614.0, 5332.0, 5580.0, 5645.0, 5638.0, 5627.0, 5592.0, 5689.0, 5588.0, 5373.0, 5596.0, 5434.0, 5442.0 (number of hits: 17)
22	5578	9	1	333	1	5508.0, 5705.0, 5723.0, 5333.0, 5354.0, 5667.0, 5580.0, 5550.0, 5325.0, 5340.0, 5261.0, 5608.0, 5569.0, 5283.0, 5672.0, 5351.0, 5514.0, 5414.0, 5412.0, 5494.0, 5464.0, 5461.0, 5716.0, 5497.0, 5338.0, 5590.0, 5331.0, 5680.0, 5630.0, 5578.0, 5409.0, 5366.0, 5724.0, 5598.0, 5568.0, 5401.0, 5560.0, 5380.0, 5391.0, 5394.0, 5498.0, 5477.0, 5301.0, 5703.0, 5423.0, 5545.0, 5420.0, 5402.0, 5350.0, 5443.0, 5273.0, 5698.0, 5505.0, 5389.0, 5670.0, 5252.0, 5657.0, 5346.0, 5596.0, 5552.0, 5619.0, 5377.0, 5678.0, 5668.0, 5610.0, 5525.0, 5613.0, 5365.0, 5364.0, 5444.0, 5695.0, 5362.0, 5438.0, 5422.0, 5555.0, 5310.0, 5603.0, 5304.0, 5556.0, 5697.0, 5543.0, 5267.0, 5592.0, 5339.0, 5637.0, 5679.0, 5321.0, 5490.0, 5710.0, 5717.0, 5432.0, 5392.0, 5706.0, 5544.0, 5553.0, 5455.0, 5607.0, 5311.0, 5295.0, 5363.0 (number of hits: 22)
23	5578	9	1	333	1	5269.0, 5664.0, 5646.0, 5450.0, 5528.0, 5296.0, 5337.0, 5437.0, 5576.0, 5303.0, 5697.0, 5312.0, 5535.0, 5336.0, 5642.0, 5632.0, 5550.0, 5402.0, 5700.0, 5712.0, 5671.0, 5583.0, 5255.0, 5300.0, 5563.0, 5465.0, 5662.0, 5371.0, 5704.0, 5400.0, 5301.0, 5606.0, 5355.0, 5644.0, 5272.0, 5373.0, 5489.0, 5554.0, 5268.0, 5396.0, 5421.0, 5434.0, 5306.0, 5698.0, 5305.0, 5451.0, 5356.0, 5618.0, 5419.0, 5483.0, 5587.0, 5455.0, 5298.0, 5448.0, 5482.0, 5499.0, 5524.0, 5372.0, 5343.0, 5307.0, 5669.0, 5413.0, 5364.0, 5543.0, 5260.0, 5321.0, 5423.0, 5496.0, 5481.0, 5568.0, 5720.0, 5715.0, 5703.0, 5359.0, 5345.0, 5416.0, 5709.0, 5637.0, 5494.0, 5280.0, 5707.0, 5681.0, 5285.0, 5311.0, 5623.0, 5318.0, 5633.0, 5401.0, 5397.0, 5546.0, 5354.0, 5540.0, 5675.0, 5486.0, 5472.0, 5619.0, 5262.0, 5420.0, 5645.0, 5654.0

						(number of hits: 11)
24	5578	9	1	333	1	5444.0, 5407.0, 5566.0, 5473.0, 5385.0, 5423.0, 5541.0, 5321.0, 5578.0, 5699.0, 5678.0, 5552.0, 5490.0, 5478.0, 5399.0, 5603.0, 5397.0, 5485.0, 5645.0, 5276.0, 5361.0, 5488.0, 5294.0, 5337.0, 5513.0, 5364.0, 5403.0, 5501.0, 5510.0, 5615.0, 5644.0, 5512.0, 5419.0, 5254.0, 5384.0, 5300.0, 5286.0, 5447.0, 5719.0, 5538.0, 5311.0, 5504.0, 5690.0, 5309.0, 5526.0, 5554.0, 5617.0, 5665.0, 5426.0, 5530.0, 5684.0, 5400.0, 5332.0, 5318.0, 5688.0, 5548.0, 5668.0, 5698.0, 5599.0, 5472.0, 5390.0, 5259.0, 5266.0, 5709.0, 5379.0, 5291.0, 5680.0, 5586.0, 5442.0, 5674.0, 5395.0, 5297.0, 5451.0, 5477.0, 5413.0, 5681.0, 5440.0, 5572.0, 5561.0, 5532.0, 5486.0, 5557.0, 5517.0, 5647.0, 5519.0, 5539.0, 5431.0, 5507.0, 5661.0, 5298.0, 5387.0, 5580.0, 5460.0, 5448.0, 5481.0, 5410.0, 5467.0, 5250.0, 5339.0, 5270.0
						(number of hits: 14)
25	5578	9	1	333	1	5273.0, 5375.0, 5541.0, 5618.0, 5609.0, 5379.0, 5283.0, 5409.0, 5665.0, 5518.0, 5589.0, 5666.0, 5520.0, 5536.0, 5514.0, 5649.0, 5442.0, 5417.0, 5582.0, 5305.0, 5268.0, 5703.0, 5716.0, 5279.0, 5292.0, 5505.0, 5485.0, 5630.0, 5463.0, 5702.0, 5497.0, 5258.0, 5501.0, 5586.0, 5288.0, 5636.0, 5696.0, 5267.0, 5555.0, 5548.0, 5331.0, 5695.0, 5615.0, 5315.0, 5488.0, 5301.0, 5617.0, 5264.0, 5476.0, 5457.0, 5269.0, 5462.0, 5531.0, 5681.0, 5491.0, 5378.0, 5471.0, 5419.0, 5468.0, 5720.0, 5653.0, 5706.0, 5260.0, 5270.0, 5332.0, 5337.0, 5659.0, 5715.0, 5358.0, 5280.0, 5724.0, 5343.0, 5581.0, 5403.0, 5282.0, 5484.0, 5692.0, 5390.0, 5443.0, 5338.0, 5431.0, 5399.0, 5608.0, 5607.0, 5323.0, 5473.0, 5503.0, 5464.0, 5575.0, 5454.0, 5652.0, 5511.0, 5656.0, 5310.0, 5406.0, 5452.0, 5597.0, 5451.0, 5631.0, 5717.0
						(number of hits: 13)
26	5578	9	1	333	1	5578.0, 5401.0, 5651.0, 5462.0, 5615.0, 5432.0, 5652.0, 5632.0, 5686.0, 5513.0, 5356.0, 5322.0, 5608.0, 5479.0, 5553.0, 5263.0, 5680.0, 5673.0, 5504.0, 5551.0, 5671.0, 5364.0, 5419.0, 5707.0, 5581.0, 5458.0, 5547.0, 5544.0, 5594.0, 5489.0, 5690.0, 5438.0, 5488.0, 5319.0, 5665.0, 5534.0, 5611.0, 5375.0, 5320.0, 5645.0, 5682.0, 5718.0, 5486.0, 5285.0, 5376.0, 5603.0, 5503.0, 5687.0, 5678.0, 5316.0, 5298.0, 5571.0, 5532.0, 5457.0, 5634.0, 5326.0, 5394.0, 5506.0, 5712.0, 5646.0, 5528.0, 5655.0, 5714.0, 5370.0, 5491.0, 5703.0, 5341.0, 5385.0, 5464.0, 5721.0, 5602.0, 5449.0, 5554.0, 5368.0, 5330.0, 5286.0, 5495.0, 5684.0, 5288.0, 5386.0, 5568.0, 5431.0, 5543.0, 5395.0, 5674.0, 5274.0, 5425.0, 5392.0, 5402.0, 5328.0

						5702.0, 5639.0, 5312.0, 5708.0, 5332.0, 5546.0, 5621.0, 5610.0, 5345.0, 5539.0 (number of hits: 18)
27	5578	9	1	333	1	5509.0, 5653.0, 5662.0, 5674.0, 5307.0, 5464.0, 5526.0, 5358.0, 5554.0, 5482.0, 5297.0, 5529.0, 5306.0, 5512.0, 5665.0, 5348.0, 5494.0, 5578.0, 5405.0, 5619.0, 5456.0, 5579.0, 5486.0, 5360.0, 5720.0, 5532.0, 5564.0, 5314.0, 5261.0, 5479.0, 5309.0, 5270.0, 5713.0, 5303.0, 5601.0, 5638.0, 5645.0, 5702.0, 5710.0, 5561.0, 5711.0, 5355.0, 5489.0, 5475.0, 5718.0, 5378.0, 5567.0, 5647.0, 5621.0, 5293.0, 5379.0, 5487.0, 5345.0, 5689.0, 5359.0, 5430.0, 5545.0, 5633.0, 5397.0, 5604.0, 5496.0, 5447.0, 5393.0, 5704.0, 5483.0, 5376.0, 5692.0, 5573.0, 5418.0, 5670.0, 5381.0, 5654.0, 5459.0, 5478.0, 5537.0, 5511.0, 5370.0, 5371.0, 5448.0, 5695.0, 5560.0, 5295.0, 5549.0, 5288.0, 5616.0, 5316.0, 5349.0, 5576.0, 5707.0, 5274.0, 5652.0, 5365.0, 5335.0, 5450.0, 5356.0, 5546.0, 5679.0, 5502.0, 5278.0, 5677.0 (number of hits: 14)
28	5578	9	1	333	1	5314.0, 5275.0, 5272.0, 5285.0, 5564.0, 5306.0, 5264.0, 5580.0, 5398.0, 5390.0, 5295.0, 5457.0, 5441.0, 5367.0, 5304.0, 5405.0, 5422.0, 5512.0, 5682.0, 5496.0, 5464.0, 5703.0, 5722.0, 5297.0, 5697.0, 5619.0, 5432.0, 5511.0, 5591.0, 5589.0, 5646.0, 5395.0, 5408.0, 5328.0, 5261.0, 5556.0, 5535.0, 5537.0, 5381.0, 5504.0, 5576.0, 5299.0, 5575.0, 5662.0, 5596.0, 5542.0, 5643.0, 5509.0, 5533.0, 5516.0, 5711.0, 5252.0, 5411.0, 5318.0, 5283.0, 5312.0, 5333.0, 5568.0, 5708.0, 5637.0, 5476.0, 5583.0, 5529.0, 5532.0, 5584.0, 5379.0, 5433.0, 5669.0, 5645.0, 5466.0, 5419.0, 5650.0, 5298.0, 5668.0, 5554.0, 5518.0, 5638.0, 5447.0, 5573.0, 5597.0, 5599.0, 5586.0, 5287.0, 5714.0, 5326.0, 5385.0, 5501.0, 5620.0, 5629.0, 5667.0, 5527.0, 5355.0, 5420.0, 5661.0, 5311.0, 5651.0, 5393.0, 5442.0, 5498.0, 5523.0 (number of hits: 17)
29	5578	9	1	333	1	5602.0, 5485.0, 5518.0, 5680.0, 5561.0, 5546.0, 5295.0, 5638.0, 5533.0, 5539.0, 5698.0, 5525.0, 5487.0, 5453.0, 5346.0, 5499.0, 5323.0, 5664.0, 5351.0, 5529.0, 5590.0, 5364.0, 5339.0, 5495.0, 5477.0, 5717.0, 5670.0, 5401.0, 5290.0, 5530.0, 5343.0, 5286.0, 5689.0, 5606.0, 5450.0, 5391.0, 5332.0, 5262.0, 5413.0, 5653.0, 5369.0, 5635.0, 5270.0, 5721.0, 5322.0, 5478.0, 5544.0, 5688.0, 5593.0, 5660.0, 5516.0, 5609.0, 5299.0, 5501.0, 5554.0, 5390.0, 5272.0, 5552.0, 5614.0, 5581.0, 5528.0, 5504.0, 5568.0, 5562.0, 5627.0, 5356.0, 5702.0, 5566.0, 5409.0, 5371.0, 5621.0, 5292.0, 5578.0, 5711.0, 5334.0, 5278.0, 5574.0, 5687.0, 5671.0, 5713.0,

						5472.0, 5668.0, 5471.0, 5582.0, 5646.0, 5484.0, 5514.0, 5421.0, 5311.0, 5576.0, 5623.0, 5296.0, 5649.0, 5331.0, 5306.0, 5667.0, 5387.0, 5684.0, 5494.0, 5534.0 (number of hits: 19)
30	5578	9	1	333	1	5722.0, 5474.0, 5697.0, 5645.0, 5505.0, 5322.0, 5438.0, 5454.0, 5653.0, 5352.0, 5372.0, 5559.0, 5537.0, 5593.0, 5636.0, 5624.0, 5509.0, 5375.0, 5489.0, 5617.0, 5536.0, 5672.0, 5283.0, 5324.0, 5410.0, 5496.0, 5586.0, 5723.0, 5684.0, 5500.0, 5423.0, 5387.0, 5619.0, 5629.0, 5640.0, 5363.0, 5370.0, 5398.0, 5479.0, 5330.0, 5477.0, 5279.0, 5289.0, 5522.0, 5634.0, 5455.0, 5683.0, 5648.0, 5691.0, 5482.0, 5678.0, 5281.0, 5463.0, 5348.0, 5389.0, 5720.0, 5654.0, 5604.0, 5259.0, 5575.0, 5524.0, 5674.0, 5316.0, 5570.0, 5284.0, 5616.0, 5622.0, 5280.0, 5261.0, 5558.0, 5628.0, 5374.0, 5364.0, 5493.0, 5585.0, 5655.0, 5288.0, 5630.0, 5664.0, 5535.0, 5517.0, 5503.0, 5306.0, 5666.0, 5574.0, 5338.0, 5449.0, 5689.0, 5551.0, 5339.0, 5544.0, 5620.0, 5692.0, 5444.0, 5707.0, 5565.0, 5426.0, 5326.0, 5405.0, 5318.0 (number of hits: 12)

Annex C – U-NII-2A Radar Parameter Data Sheet for Client Mode

C.1 20 MHz Bandwidth @ 5260 MHz

Table-1A/1B Radar Type 1A/1B Statistical Performance

Trial #	Fc (MHz)	Pulse/Burst	Pulse Width (μS)	PRI (μs)	Detection (1:yes; 0:no)
1	5260	67	1	798	1
2	5260	61	1	878	1
3	5260	81	1	658	1
4	5260	86	1	618	1
5	5260	58	1	918	1
6	5260	99	1	538	1
7	5260	76	1	698	1
8	5260	92	1	578	1
9	5260	70	1	758	1
10	5260	63	1	838	1
11	5260	72	1	738	1
12	5260	59	1	898	1
13	5260	89	1	598	1
14	5260	83	1	638	1
15	5260	65	1	818	1
16	5260	25	1	2174	1
17	5260	26	1	2040	1
18	5260	21	1	2526	1
19	5260	20	1	2752	1
20	5260	24	1	2288	1
21	5260	19	1	2910	1
22	5260	30	1	1810	1
23	5260	81	1	652	1
24	5260	40	1	1341	1
25	5260	85	1	622	1
26	5260	25	1	2127	1
27	5260	90	1	591	1
28	5260	63	1	839	1
29	5260	54	1	980	1
30	5260	22	1	2441	1
Detection Percentage: 100 % (>60%)					

Table-2 Radar Type 2 Statistical Performance

Trial #	Fc (MHz)	Pulse/Burst	Pulse Width (μS)	PRI (μs)	Detection (1:yes; 0:no)
1	5260	26	2.7	227	1
2	5260	28	2.6	220	1
3	5260	29	2.6	209	1
4	5260	24	4.5	226	1
5	5260	29	1.6	190	1
6	5260	25	2	193	1
7	5260	24	3.3	178	1
8	5260	29	4.9	160	1
9	5260	27	4.1	197	1
10	5260	26	1.1	229	1
11	5260	28	3.5	178	1
12	5260	23	2.7	205	1
13	5260	24	1.3	150	1
14	5260	24	4.5	217	1
15	5260	28	4.1	173	1
16	5260	24	4.5	199	1
17	5260	25	3.2	179	1
18	5260	25	2.1	224	1
19	5260	29	1.2	175	1
20	5260	27	3.4	159	1
21	5260	26	2.3	191	1
22	5260	26	2.8	186	1
23	5260	25	3	161	1
24	5260	26	3.1	164	1
25	5260	27	1	169	1
26	5260	27	3.9	163	1
27	5260	27	2.2	206	1
28	5260	27	3.8	176	1
29	5260	27	3.7	225	1
30	5260	24	3.6	161	1
Detection Percentage: 100 % (>60%)					

Table-3 Radar Type 3 Statistical Performance

Trial #	Fc (MHz)	Pulse/Burst	Pulse Width (μ S)	PRI (μ s)	Detection (1:yes; 0:no)
1	5260	18	8.5	394	1
2	5260	17	8.9	371	1
3	5260	18	9.4	217	1
4	5260	16	8.7	456	1
5	5260	18	6.9	267	1
6	5260	17	9.5	223	1
7	5260	16	9.8	471	1
8	5260	16	10	274	1
9	5260	17	6.7	238	1
10	5260	16	9.6	275	1
11	5260	16	6.2	490	1
12	5260	16	9.5	227	1
13	5260	16	7.8	421	1
14	5260	17	8	487	1
15	5260	17	9.9	311	1
16	5260	18	7.5	254	1
17	5260	17	6	434	1
18	5260	16	7.2	282	1
19	5260	16	8.4	373	1
20	5260	16	6.5	473	1
21	5260	16	6	281	1
22	5260	18	6.4	498	1
23	5260	16	8.5	490	1
24	5260	16	8.2	374	1
25	5260	17	8.6	348	1
26	5260	17	9.6	495	1
27	5260	18	7.3	483	1
28	5260	18	8.4	477	1
29	5260	18	9	318	1
30	5260	17	6	234	1
Detection Percentage: 100 % (>60%)					

Table-4 Radar Type 4 Statistical Performance

Trial #	Fc (MHz)	Pulse/Burst	Pulse Width (μS)	PRI (μs)	Detection (1:yes; 0:no)
1	5260	14	14.9	387	1
2	5260	13	18.2	239	1
3	5260	13	14.8	290	1
4	5260	12	12.1	411	1
5	5260	16	15.2	264	1
6	5260	13	11.2	488	1
7	5260	13	18.7	384	1
8	5260	15	12.6	251	1
9	5260	16	11	240	1
10	5260	16	14.6	441	1
11	5260	14	19.6	365	1
12	5260	13	17.6	422	1
13	5260	15	17.5	305	1
14	5260	14	19.9	305	1
15	5260	13	12.8	314	1
16	5260	15	14.2	324	1
17	5260	16	16.8	275	1
18	5260	13	11.5	489	1
19	5260	16	19	429	1
20	5260	15	14.8	272	1
21	5260	16	14.3	243	1
22	5260	14	15.3	274	1
23	5260	13	18.3	491	1
24	5260	16	16.1	290	1
25	5260	14	18.9	469	1
26	5260	13	13.2	411	1
27	5260	14	19.3	427	1
28	5260	16	11.7	316	1
29	5260	13	19.9	318	1
30	5260	15	19.8	220	1
Detection Percentage: 100 % (>60%)					

Table-5 Radar Type 5 Statistical Performance

Trial #	Fc (MHz)	Detection (1:yes; 0:no)
1	5260	1
2	5260	1
3	5260	1
4	5260	1
5	5260	1
6	5260	1
7	5260	1
8	5260	1
9	5260	1
10	5260	1
11	5256.0	1
12	5253.2	1
13	5256.4	1
14	5254.0	1
15	5257.6	1
16	5254.0	1
17	5253.6	1
18	5254.8	1
19	5255.6	1
20	5254.4	1
21	5266.4	1
22	5265.6	1
23	5264.8	1
24	5266.4	1
25	5262.0	1
26	5264.0	1
27	5266.0	1
28	5266.4	1
29	5265.2	1
30	5262.4	1
Detection Percentage: 100 % (>80%)		

Bin5 Statistics 1

Trial #	Pulse	Chirp (MHz)	Pulse Width (µS)	Pulse 1-2 spacing (uS)	Pulse 2-3 spacing (uS)	Pulse Start(S)	Detection (1:yes; 0:no)
0	3	13	69.5	1332	1362	0.124695	1
1	1	13	53.5			2.135427	
2	2	13	55.7	1960		3.495571	
3	3	13	75.5	1568	1901	4.911461	
4	1	13	82.3			6.45927	
5	1	13	77.5			6.798643	
6	3	13	57	1007	1745	8.862569	
7	1	13	89.2			9.49126	
8	3	13	56	1771	1317	11.981212	

Bin5 Statistics 2

Trial #	Pulse	Chirp (MHz)	Pulse Width (µS)	Pulse 1-2 spacing (uS)	Pulse 2-3 spacing (uS)	Pulse Start(S)	Detection (1:yes; 0:no)
0	2	9	56.9	1505		0.584131	1
1	3	9	74.8	1942	1283	0.720603	
2	2	9	67.1	1792		1.374645	
3	1	9	80.8			2.450755	
4	1	9	93.5			2.63747	
5	1	9	57			3.19206	
6	1	9	80.7			3.906002	
7	1	9	93.8			4.661155	
8	3	9	77.2	1764	1748	5.31674	
9	2	9	96.5	1468		6.061254	
10	2	9	75	1866		6.47678	
11	2	9	86.8	1767		7.31411	
12	2	9	78.2	1207		8.100544	
13	1	9	86.3			8.836684	
14	1	9	81.7			9.311281	
15	1	9	67.9			9.988242	
16	3	9	65.3	1285	1440	10.256343	
17	3	9	52.2	1109	1351	10.840287	
18	1	9	74			11.956032	

Bin5 Statistics 3

Trial #	Pulse	Chirp (MHz)	Pulse Width (µS)	Pulse 1-2 spacing (uS)	Pulse 2-3 spacing (uS)	Pulse Start(S)	Detection (1:yes; 0:no)
0	1	6	72.2			0.574475	1
1	2	6	60.2	1519		1.164777	
2	1	6	52			1.820011	
3	2	6	95.9	1495		2.185091	
4	2	6	92	1320		2.687745	
5	2	6	84	1340		3.759234	
6	2	6	88.4	1377		4.460201	
7	1	6	75.8			5.230506	
8	3	6	94.1	1580	1185	5.818298	
9	1	6	52.3			6.447752	
10	3	6	76.3	1143	1804	7.046109	
11	3	6	54.7	1471	1788	7.791071	
12	2	6	65.4	1069		8.271272	
13	3	6	99.6	1931	1766	9.214619	
14	3	6	55.6	1083	1733	9.442674	
15	1	6	73.3			10.021341	
16	2	6	89.2	1400		11.266078	
17	3	6	53.4	1237	1818	11.434231	

Bin5 Statistics 4

Trial #	Pulse	Chirp (MHz)	Pulse Width (µS)	Pulse 1-2 spacing (uS)	Pulse 2-3 spacing (uS)	Pulse Start(S)	Detection (1:yes; 0:no)
0	1	6	88.2			0.152892	1
1	1	6	72.8			1.246556	
2	3	6	69	1634	1994	2.54858	
3	2	6	75.2	1998		3.143766	
4	2	6	91.8	1707		3.794871	
5	1	6	61.4			5.044983	
6	1	6	51.9			5.768387	
7	2	6	91.1	1032		6.903148	
8	2	6	60.1	1652		7.683742	
9	2	6	88.9	1600		8.965729	
10	3	6	60.5	1639	1889	9.58905	
11	3	6	62.8	1905	1831	10.862193	
12	2	6	87.8	1907		11.478614	

Bin5 Statistics 5

Trial #	Pulse	Chirp (MHz)	Pulse Width (µS)	Pulse 1-2 spacing (µS)	Pulse 2-3 spacing (µS)	Pulse Start(S)	Detection (1:yes; 0:no)
0	3	10	72.5	1112	1163	0.275687	1
1	2	10	80.1	1036		1.129993	
2	3	10	72.9	1583	1049	1.596241	
3	2	10	83.3	1464		2.190147	
4	3	10	84.1	1924	1527	2.960398	
5	2	10	78.7	1590		3.307845	
6	1	10	58.3			3.665576	
7	2	10	71.7	1591		4.395128	
8	1	10	93.7			4.982992	
9	2	10	97.5	1297		5.691056	
10	1	10	57.5			6.198422	
11	2	10	94.4	1003		7.175748	
12	2	10	50.1	1957		7.279627	
13	1	10	60.3			8.146707	
14	2	10	69.2	1596		8.828872	
15	3	10	93.5	1997	1821	9.103207	
16	3	10	84.6	1605	1158	9.774537	
17	2	10	55.3	1541		10.601559	
18	2	10	85.4	1648		10.874031	
19	2	10	78.1	1471		11.748494	

Bin5 Statistics 6

Trial #	Pulse	Chirp (MHz)	Pulse Width (µS)	Pulse 1-2 spacing (uS)	Pulse 2-3 spacing (uS)	Pulse Start(S)	Detection (1:yes; 0:no)
0	3	7	72.8	1705	1377	0.507471	1
1	1	7	66.2			1.122477	
2	2	7	70.4	1040		1.417123	
3	1	7	55			2.658172	
4	2	7	54.5	1922		2.89277	
5	1	7	78.5			3.600484	
6	1	7	95.4			4.590543	
7	1	7	67.5			5.125445	
8	1	7	55.3			6.10932	
9	2	7	84.6	1426		6.359555	
10	1	7	83.4			7.241498	
11	1	7	93.3			8.207621	
12	2	7	97.2	1671		8.690928	
13	2	7	61.6	1623		9.588738	
14	2	7	94.9	1531		10.120167	
15	1	7	52.4			10.978815	
16	2	7	78.6	1120		11.927052	

Bin5 Statistics 7

Trial #	Pulse	Chirp (MHz)	Pulse Width (µS)	Pulse 1-2 spacing (uS)	Pulse 2-3 spacing (uS)	Pulse Start(S)	Detection (1:yes; 0:no)
0	1	12	83.1			0.593945	1
1	1	12	91.7			0.925898	
2	2	12	79.2	1533		2.132521	
3	1	12	63.8			2.908534	
4	1	12	78.1			3.654011	
5	3	12	85.8	1013	1843	4.010377	
6	3	12	51.7	1933	1686	4.971616	
7	2	12	55.5	1679		6.042392	
8	2	12	99.4	1626		6.782925	
9	1	12	62.3			7.795243	
10	3	12	76	1539	1672	8.543555	
11	2	12	77.8	1223		9.497044	
12	2	12	85.6	1585		9.764338	
13	1	12	51.2			10.670427	
14	3	12	75.3	1055	1281	11.863125	

Bin5 Statistics 8

Trial #	Pulse	Chirp (MHz)	Pulse Width (µS)	Pulse 1-2 spacing (uS)	Pulse 2-3 spacing (uS)	Pulse Start(S)	Detection (1:yes; 0:no)
0	3	16	85.9	1624	1983	0.62176	1
1	1	16	94.7			1.086528	
2	1	16	65.2			1.593274	
3	2	16	53.2	1039		2.208979	
4	2	16	69.4	1818		3.061046	
5	2	16	80	1197		3.185023	
6	2	16	90.5	1291		4.030503	
7	2	16	86.7	1293		4.457977	
8	2	16	90.1	1992		5.475422	
9	1	16	71.3			5.973447	
10	2	16	75.7	1309		6.884896	
11	2	16	67.2	1618		7.05309	
12	3	16	74.9	1870	1208	7.935976	
13	1	16	61.2			8.603597	
14	1	16	65.8			8.927386	
15	2	16	73.5	1819		10.023121	
16	1	16	90.3			10.381146	
17	1	16	90.9			10.980934	
18	3	16	51.5	1980	1223	11.418515	

Bin5 Statistics 9

Trial #	Pulse	Chirp (MHz)	Pulse Width (µS)	Pulse 1-2 spacing (uS)	Pulse 2-3 spacing (uS)	Pulse Start(S)	Detection (1:yes; 0:no)
0	2	15	64	1946		0.760092	1
1	3	15	67.8	1323	1751	1.749382	
2	2	15	95.9	1427		2.60862	
3	2	15	98.6	1998		2.886248	
4	3	15	58.7	1063	1187	4.548693	
5	3	15	68.6	1718	1643	5.522683	
6	1	15	83.7			5.706023	
7	3	15	55.8	1289	1064	7.367809	
8	2	15	75.2	1079		7.469588	
9	1	15	94.9			8.879535	
10	3	15	54	1021	1773	9.84488	
11	1	15	78.4			10.507762	
12	2	15	79.5	1476		11.640427	

Bin5 Statistics 10

Trial #	Pulse	Chirp (MHz)	Pulse Width (µS)	Pulse 1-2 spacing (uS)	Pulse 2-3 spacing (uS)	Pulse Start(S)	Detection (1:yes; 0:no)
0	2	9	80.7	1104		0.327535	1
1	2	9	91.7	1070		1.714171	
2	2	9	52.3	1452		1.982358	
3	2	9	64.4	1432		3.048411	
4	1	9	83			4.248128	
5	2	9	78.3	1066		4.85788	
6	1	9	65.1			6.091944	
7	2	9	60.8	1681		6.764442	
8	1	9	58.4			7.697681	
9	1	9	76.8			8.466948	
10	1	9	81			9.474394	
11	1	9	84			10.925294	
12	2	9	79.2	1268		11.771615	

Bin5 Statistics 11

Trial #	Pulse	Chirp (MHz)	Pulse Width (µS)	Pulse 1-2 spacing (uS)	Pulse 2-3 spacing (uS)	Pulse Start(S)	Detection (1:yes; 0:no)
0	3	15	70.9	1870	1188	0.966424	1
1	1	15	58.3			1.252899	
2	2	15	86.6	1990		2.511332	
3	3	15	94.1	1991	1519	3.425224	
4	2	15	90.2	1412		4.456613	
5	1	15	93.1			5.685114	
6	1	15	54.7			6.741594	
7	2	15	85	1020		8.146791	
8	1	15	73.7			9.343938	
9	2	15	85.8	1991		10.788659	
10	2	15	60.9	1313		11.053804	

Bin5 Statistics 12

Trial #	Pulse	Chirp (MHz)	Pulse Width (µS)	Pulse 1-2 spacing (µS)	Pulse 2-3 spacing (µS)	Pulse Start(S)	Detection (1:yes; 0:no)
0	2	8	67.2	1656		0.101552	1
1	2	8	86.5	1324		1.082718	
2	1	8	85.9			2.034947	
3	3	8	62	1113	1369	2.161331	
4	2	8	53.8	1482		3.250986	
5	1	8	68.6			3.802644	
6	1	8	94.7			4.55689	
7	2	8	70	1536		5.160285	
8	1	8	85.2			5.67395	
9	2	8	81.3	1873		6.773732	
10	2	8	93.4	1938		7.395378	
11	2	8	97.1	1842		8.37949	
12	2	8	92.5	1070		8.677064	
13	2	8	80.7	1968		9.830714	
14	2	8	76.2	1313		10.25244	
15	3	8	97.2	1936	1899	11.156846	
16	1	8	58.3			11.554356	

Bin5 Statistics 13

Trial #	Pulse	Chirp (MHz)	Pulse Width (µS)	Pulse 1-2 spacing (µS)	Pulse 2-3 spacing (µS)	Pulse Start(S)	Detection (1:yes; 0:no)
0	2	16	80.4	1998		0.521828	1
1	2	16	78.3	1405		0.802621	
2	1	16	53.4			2.366407	
3	2	16	70.8	1148		3.107132	
4	2	16	95.2	1344		3.746977	
5	3	16	64.3	1464	1235	4.496184	
6	2	16	81.8	1774		5.018116	
7	2	16	82.6	1883		6.25382	
8	3	16	75.1	1286	1936	6.811245	
9	3	16	56.9	1377	1694	7.738752	
10	3	16	86.3	1028	1841	8.784425	
11	2	16	63.3	1543		8.926394	
12	2	16	55.5	1929		10.237068	
13	2	16	63.2	1408		10.516546	
14	3	16	60.8	1412	1098	11.959594	

Bin5 Statistics 14

Trial #	Pulse	Chirp (MHz)	Pulse Width (µS)	Pulse 1-2 spacing (µS)	Pulse 2-3 spacing (µS)	Pulse Start(S)	Detection (1:yes; 0:no)
0	1	10	54.6			0.889476	1
1	2	10	94	1311		2.115882	
2	2	10	52.2	1415		2.755524	
3	3	10	72.6	1960	1716	3.835612	
4	2	10	68.8	1993		4.858993	
5	1	10	50.6			6.286457	
6	3	10	67.2	1693	1920	7.461414	
7	3	10	60	1928	1060	7.934547	
8	1	10	91.5			9.594587	
9	3	10	50.2	1803	1078	10.039451	
10	2	10	91.8	1584		10.952182	

Bin5 Statistics 15

Trial #	Pulse	Chirp (MHz)	Pulse Width (µS)	Pulse 1-2 spacing (µS)	Pulse 2-3 spacing (µS)	Pulse Start(S)	Detection (1:yes; 0:no)
0	3	19	85	1196	1789	0.711361	1
1	2	19	58	1871		1.551611	
2	2	19	54.5	1481		2.348216	
3	2	19	93.9	1795		3.336713	
4	1	19	90.1			4.034588	
5	1	19	55.2			5.875415	
6	1	19	59.8			6.143225	
7	2	19	84.8	1611		7.994378	
8	3	19	77.7	1188	1028	8.206338	
9	2	19	73.4	1851		9.434709	
10	2	19	88.7	1857		10.727255	
11	2	19	96.9	1035		11.124929	

Bin5 Statistics 16

Trial #	Pulse	Chirp (MHz)	Pulse Width (µS)	Pulse 1-2 spacing (uS)	Pulse 2-3 spacing (uS)	Pulse Start(S)	Detection (1:yes; 0:no)
0	3	10	51.4	1310	1765	0.425991	1
1	2	10	59.1	1879		1.032976	
2	3	10	58.8	1596	1130	2.297849	
3	2	10	58.2	1402		2.536521	
4	1	10	98.9			3.556455	
5	2	10	58.2	1797		4.05029	
6	1	10	79.1			5.235316	
7	1	10	75			5.876316	
8	2	10	98.1	1907		6.529288	
9	2	10	93.2	1918		7.204133	
10	1	10	68.3			8.021962	
11	2	10	59.2	1240		9.284455	
12	2	10	52.2	1680		10.259682	
13	2	10	68.4	1170		11.174902	
14	3	10	99.1	1635	1720	11.914	

Bin5 Statistics 17

Trial #	Pulse	Chirp (MHz)	Pulse Width (µS)	Pulse 1-2 spacing (uS)	Pulse 2-3 spacing (uS)	Pulse Start(S)	Detection (1:yes; 0:no)
0	3	9	87.3	1903	1624	0.648307	1
1	3	9	58.4	1733	1505	2.478975	
2	2	9	53.4	1413		3.047467	
3	2	9	65.7	1353		4.490464	
4	3	9	70.4	1472	1965	6.387953	
5	3	9	95.2	1237	1373	7.49609	
6	2	9	79.8	1883		8.880875	
7	2	9	79.8	1155		9.507671	
8	2	9	95.9	1702		10.894886	

Bin5 Statistics 18

Trial #	Pulse	Chirp (MHz)	Pulse Width (µS)	Pulse 1-2 spacing (uS)	Pulse 2-3 spacing (uS)	Pulse Start(S)	Detection (1:yes; 0:no)
0	2	12	83.3	1908		0.184024	1
1	3	12	97.7	1559	1055	0.951258	
2	1	12	97.2			1.636888	
3	2	12	50.8	1402		2.294537	
4	3	12	98.9	1175	1838	3.643641	
5	2	12	78.9	1489		4.105208	
6	3	12	50.6	1215	1863	4.835182	
7	2	12	64.5	1284		5.705766	
8	2	12	97.7	1535		6.455754	
9	3	12	58.3	1706	1675	6.987637	
10	1	12	81.7			7.874863	
11	2	12	80.4	1563		8.720853	
12	1	12	56.7			9.478709	
13	2	12	73.1	1760		10.285366	
14	2	12	69.8	1051		11.118346	
15	1	12	98.8			11.307274	

Bin5 Statistics 19

Trial #	Pulse	Chirp (MHz)	Pulse Width (µS)	Pulse 1-2 spacing (uS)	Pulse 2-3 spacing (uS)	Pulse Start(S)	Detection (1:yes; 0:no)
0	2	14	62.5	1223		0.138841	1
1	3	14	69.3	1016	1400	0.900862	
2	3	14	62.8	1585	1933	1.543329	
3	1	14	60			2.143698	
4	3	14	94.5	1945	1025	2.710226	
5	1	14	82.8			3.75184	
6	2	14	59.1	1863		4.25534	
7	2	14	56.4	1516		4.699996	
8	1	14	54.6			5.080316	
9	3	14	82.3	1744	1561	6.224694	
10	1	14	94.1			6.574961	
11	2	14	73.9	1490		7.451275	
12	3	14	62.4	1552	1281	7.965035	
13	3	14	53.7	1263	1018	8.284794	
14	1	14	89.9			9.171008	
15	1	14	90.9			9.624948	
16	3	14	88.9	1029	1345	10.250455	
17	2	14	97.2	1366		10.942735	
18	3	14	89.9	1599	1822	11.843413	

Bin5 Statistics 20

Trial #	Pulse	Chirp (MHz)	Pulse Width (µS)	Pulse 1-2 spacing (uS)	Pulse 2-3 spacing (uS)	Pulse Start(S)	Detection (1:yes; 0:no)
0	3	11	88.1	1366	1008	0.567724	1
1	2	11	93.1	1308		1.489049	
2	1	11	89.8			2.142623	
3	3	11	81.6	1367	1067	2.458698	
4	3	11	80.9	1771	1765	3.272631	
5	3	11	72.9	1224	1020	4.334703	
6	2	11	51.9	1333		5.328408	
7	3	11	85.8	1816	1560	5.620142	
8	1	11	93.1			6.579183	
9	3	11	88.4	1472	1996	7.558584	
10	3	11	54.9	1574	1389	8.543388	
11	3	11	84.1	1427	1895	9.085304	
12	2	11	66.2	1934		9.644124	
13	1	11	83.8			10.683457	
14	2	11	61.7	1362		11.371666	

Bin5 Statistics 21

Trial #	Pulse	Chirp (MHz)	Pulse Width (µS)	Pulse 1-2 spacing (uS)	Pulse 2-3 spacing (uS)	Pulse Start(S)	Detection (1:yes; 0:no)
0	2	9	95.5	1403		0.141725	1
1	2	9	62	1215		1.160683	
2	3	9	67.7	1604	1497	1.528729	
3	2	9	100	1178		2.437931	
4	1	9	54.7			3.270006	
5	1	9	82.3			3.785723	
6	3	9	94.9	1692	1784	4.352957	
7	3	9	66.4	1517	1462	5.070758	
8	3	9	85.9	1158	1314	5.40212	
9	2	9	87.4	1610		6.117179	
10	2	9	74.6	1177		6.792842	
11	2	9	85.5	1833		7.407626	
12	2	9	98.5	1120		8.074252	
13	3	9	61.7	1299	1994	9.228215	
14	3	9	74.9	1097	1354	9.91581	
15	3	9	88.1	1664	1895	10.353318	
16	3	9	57.8	1743	1926	10.933538	
17	2	9	90.8	1111		11.651035	

Bin5 Statistics 22

Trial #	Pulse	Chirp (MHz)	Pulse Width (µS)	Pulse 1-2 spacing (uS)	Pulse 2-3 spacing (uS)	Pulse Start(S)	Detection (1:yes; 0:no)
0	2	11	83.6	1458		0.740815	1
1	2	11	70.8	1545		1.290883	
2	1	11	79.6			2.139459	
3	3	11	88.7	1424	1301	2.807909	
4	2	11	50.2	1487		3.464953	
5	2	11	73.2	1407		4.167397	
6	2	11	72.7	1669		5.249774	
7	2	11	96.8	1055		6.310313	
8	1	11	62			7.135542	
9	3	11	84.2	1610	1468	7.939803	
10	2	11	52.3	1698		8.470568	
11	2	11	86.1	1349		9.384476	
12	2	11	72.9	1568		9.73652	
13	1	11	68.5			11.025674	
14	1	11	69.5			11.301907	

Bin5 Statistics 23

Trial #	Pulse	Chirp (MHz)	Pulse Width (µS)	Pulse 1-2 spacing (uS)	Pulse 2-3 spacing (uS)	Pulse Start(S)	Detection (1:yes; 0:no)
0	2	13	96.7	1310		0.585473	1
1	1	13	52.6			1.854073	
2	1	13	54.3			2.822174	
3	1	13	91.7			3.164331	
4	2	13	77.6	1860		4.38253	
5	2	13	85.1	1234		5.434594	
6	2	13	98.1	1646		6.503923	
7	3	13	93.8	1176	1945	7.074705	
8	3	13	88.9	1479	1576	8.737932	
9	1	13	90			9.760575	
10	1	13	77.8			10.088021	
11	1	13	54.8			11.557122	

Bin5 Statistics 24

Trial #	Pulse	Chirp (MHz)	Pulse Width (µS)	Pulse 1-2 spacing (uS)	Pulse 2-3 spacing (uS)	Pulse Start(S)	Detection (1:yes; 0:no)
0	1	9	62.5			0.50987	1
1	1	9	84.2			1.673726	
2	2	9	61.3	1174		3.1863	
3	3	9	56	1568	1509	5.094695	
4	1	9	82.2			6.323645	
5	3	9	86.2	1561	1251	7.516661	
6	2	9	60.5	1914		8.881663	
7	3	9	54.5	1925	1187	10.3898	
8	2	9	60	1476		10.77729	

Bin5 Statistics 25

Trial #	Pulse	Chirp (MHz)	Pulse Width (µS)	Pulse 1-2 spacing (uS)	Pulse 2-3 spacing (uS)	Pulse Start(S)	Detection (1:yes; 0:no)
0	2	20	87.3	1369		0.074292	1
1	2	20	67.2	1510		1.751804	
2	1	20	53.3			2.579139	
3	1	20	89.1			3.075229	
4	2	20	83	1879		4.697879	
5	3	20	68	1403	1886	5.741315	
6	1	20	87			6.240833	
7	2	20	53.2	1692		7.946594	
8	1	20	50.4			8.157358	
9	2	20	50.9	1441		9.262555	
10	2	20	61.4	1504		10.474324	
11	3	20	84.2	1704	1388	11.969826	

Bin5 Statistics 26

Trial #	Pulse	Chirp (MHz)	Pulse Width (µS)	Pulse 1-2 spacing (µS)	Pulse 2-3 spacing (µS)	Pulse Start(S)	Detection (1:yes; 0:no)
0	2	15	61.5	1718		0.035609	1
1	3	15	95.7	1403	1078	1.282664	
2	3	15	78.2	1990	1686	3.167075	
3	2	15	81.6	1394		3.920246	
4	1	15	54.7			4.729704	
5	3	15	83.4	1988	1391	5.952412	
6	2	15	54.3	1548		6.794355	
7	1	15	77			7.643732	
8	3	15	89.4	1276	1923	9.597109	
9	2	15	62.6	1179		10.379393	
10	2	15	54.4	1292		11.025835	

Bin5 Statistics 27

Trial #	Pulse	Chirp (MHz)	Pulse Width (µS)	Pulse 1-2 spacing (µS)	Pulse 2-3 spacing (µS)	Pulse Start(S)	Detection (1:yes; 0:no)
0	2	10	77.3	1359		0.068703	1
1	1	10	92.3			0.698124	
2	1	10	84.2			1.397377	
3	3	10	98.6	1163	1603	2.015673	
4	2	10	54.2	1644		3.076028	
5	1	10	83.8			3.250347	
6	1	10	68			3.898392	
7	3	10	66.1	1868	1464	4.450528	
8	2	10	64	1327		5.083021	
9	2	10	88.6	1733		6.229556	
10	2	10	80.3	1668		6.892651	
11	1	10	83.9			7.507713	
12	3	10	99.7	1580	1930	8.022397	
13	2	10	79.9	1484		8.367996	
14	2	10	67.5	1903		9.441279	
15	3	10	87.9	1421	1451	9.702425	
16	2	10	59.8	1478		10.151101	
17	2	10	86.1	1780		11.211897	
18	2	10	67.9	1958		11.430396	

Bin5 Statistics 28

Trial #	Pulse	Chirp (MHz)	Pulse Width (µS)	Pulse 1-2 spacing (uS)	Pulse 2-3 spacing (uS)	Pulse Start(S)	Detection (1:yes; 0:no)
0	2	9	73.5	1367		0.448385	1
1	1	9	88.5			1.399316	
2	2	9	69.6	1585		1.962518	
3	2	9	91.9	1520		2.202069	
4	1	9	64.7			3.246092	
5	1	9	84.6			4.022996	
6	3	9	93.3	1335	1545	4.635531	
7	1	9	76.7			5.377991	
8	2	9	97.4	1854		6.223766	
9	1	9	70.7			6.916343	
10	2	9	71.7	1239		7.713618	
11	2	9	54.3	1754		7.950572	
12	2	9	67	1729		8.608733	
13	3	9	96.5	1087	1188	9.846229	
14	2	9	70.7	1583		10.413941	
15	2	9	76.1	1159		11.06701	
16	3	9	53.4	1733	1708	11.734375	

Bin5 Statistics 29

Trial #	Pulse	Chirp (MHz)	Pulse Width (µS)	Pulse 1-2 spacing (uS)	Pulse 2-3 spacing (uS)	Pulse Start(S)	Detection (1:yes; 0:no)
0	1	12	74.2			0.60329	1
1	1	12	56.5			2.16977	
2	3	12	66	1887	1358	4.257252	
3	3	12	74	1205	1731	4.694028	
4	2	12	91.2	1370		7.127785	
5	2	12	74.1	1039		8.896017	
6	3	12	97.2	1638	1095	9.597611	
7	2	12	51.7	1749		11.256297	

Bin5 Statistics 30

Trial #	Pulse	Chirp (MHz)	Pulse Width (µS)	Pulse 1-2 spacing (uS)	Pulse 2-3 spacing (uS)	Pulse Start(S)	Detection (1:yes; 0:no)
0	1	19	56.7			0.183668	1
1	2	19	68.8	1148		1.592443	
2	3	19	73.4	1060	1969	2.737085	
3	1	19	69			3.89518	
4	1	19	70.9			4.063349	
5	2	19	86.2	1877		5.796947	
6	3	19	97.1	1438	1083	6.230598	
7	1	19	82.1			7.586443	
8	2	19	81.4	1634		8.509071	
9	1	19	74.9			9.157385	
10	3	19	90.6	1838	1829	10.468664	
11	2	19	51.2	1650		11.57028	

Table-6 Radar Type 6 Statistical Performance

Trial #	Fc (MHz)	Pulse /Burst	Pulse Width (µS)	PRI (µs)	Detection (1:yes; 0:no)	Hopping Sequence
1	5260	9	1	333	1	5686.0, 5403.0, 5257.0, 5500.0, 5388.0, 5523.0, 5541.0, 5444.0, 5474.0, 5431.0, 5330.0, 5350.0, 5358.0, 5536.0, 5679.0, 5661.0, 5462.0, 5430.0, 5569.0, 5599.0, 5628.0, 5711.0, 5322.0, 5571.0, 5492.0, 5555.0, 5596.0, 5328.0, 5506.0, 5392.0, 5533.0, 5348.0, 5513.0, 5621.0, 5343.0, 5307.0, 5636.0, 5424.0, 5485.0, 5657.0, 5648.0, 5331.0, 5609.0, 5505.0, 5567.0, 5316.0, 5539.0, 5637.0, 5401.0, 5535.0, 5278.0, 5675.0, 5287.0, 5360.0, 5253.0, 5529.0, 5493.0, 5370.0, 5566.0, 5277.0, 5346.0, 5582.0, 5354.0, 5324.0, 5623.0, 5562.0, 5700.0, 5684.0, 5329.0, 5588.0, 5563.0, 5402.0, 5349.0, 5323.0, 5559.0, 5385.0, 5545.0, 5656.0, 5475.0, 5649.0, 5405.0, 5465.0, 5568.0, 5435.0, 5374.0, 5327.0, 5456.0, 5722.0, 5587.0, 5717.0, 5422.0, 5688.0, 5502.0, 5593.0, 5602.0, 5412.0, 5670.0, 5260.0, 5557.0, 5662.0 (number of hits: 3)
2	5260	9	1	333	1	5506.0, 5628.0, 5639.0, 5413.0, 5470.0, 5264.0, 5459.0, 5669.0, 5383.0, 5539.0, 5319.0, 5310.0, 5573.0, 5668.0, 5401.0, 5646.0, 5718.0, 5476.0, 5353.0, 5564.0, 5655.0, 5453.0, 5706.0, 5716.0, 5489.0, 5337.0, 5644.0, 5409.0, 5419.0, 5402.0, 5503.0, 5697.0, 5561.0, 5462.0, 5712.0, 5551.0, 5474.0, 5520.0, 5491.0, 5703.0, 5510.0, 5477.0, 5617.0, 5350.0, 5418.0, 5621.0, 5373.0, 5515.0, 5473.0, 5717.0, 5251.0, 5391.0, 5679.0, 5527.0, 5595.0, 5271.0, 5670.0, 5579.0, 5578.0, 5541.0, 5554.0, 5436.0, 5582.0, 5475.0, 5486.0, 5567.0, 5586.0, 5696.0, 5660.0, 5490.0, 5685.0, 5496.0, 5721.0, 5517.0, 5592.0, 5343.0, 5290.0, 5698.0, 5428.0, 5487.0, 5449.0, 5682.0, 5305.0, 5719.0, 5397.0, 5640.0, 5707.0, 5365.0, 5497.0, 5581.0, 5313.0, 5693.0, 5602.0, 5565.0, 5493.0, 5645.0, 5457.0, 5433.0, 5508.0, 5691.0 (number of hits: 2)
3	5260	9	1	333	1	5321.0, 5697.0, 5645.0, 5577.0, 5635.0, 5290.0, 5295.0, 5357.0, 5464.0, 5390.0, 5693.0, 5527.0, 5681.0, 5418.0, 5513.0, 5642.0, 5526.0, 5712.0, 5624.0, 5339.0, 5375.0, 5556.0, 5265.0, 5460.0, 5607.0, 5552.0, 5428.0, 5555.0, 5320.0, 5501.0, 5312.0, 5557.0, 5533.0, 5463.0, 5512.0, 5524.0, 5470.0, 5450.0, 5258.0, 5440.0, 5598.0, 5343.0, 5496.0, 5432.0, 5351.0, 5250.0, 5366.0, 5484.0, 5383.0, 5340.0, 5458.0, 5344.0, 5604.0, 5605.0, 5273.0, 5586.0, 5262.0, 5574.0, 5447.0, 5417.0, 5465.0, 5711.0, 5388.0, 5691.0, 5277.0, 5478.0, 5293.0, 5713.0, 5393.0, 5583.0,

						5308.0, 5599.0, 5411.0, 5349.0, 5536.0, 5346.0, 5296.0, 5664.0, 5347.0, 5567.0, 5372.0, 5301.0, 5667.0, 5698.0, 5434.0, 5515.0, 5288.0, 5254.0, 5600.0, 5451.0, 5721.0, 5329.0, 5685.0, 5352.0, 5575.0, 5421.0, 5639.0, 5570.0, 5498.0, 5616.0 (number of hits: 5)
4	5260	9	1	333	1	5511.0, 5555.0, 5341.0, 5268.0, 5385.0, 5408.0, 5391.0, 5607.0, 5291.0, 5429.0, 5656.0, 5454.0, 5531.0, 5300.0, 5528.0, 5394.0, 5588.0, 5515.0, 5464.0, 5673.0, 5383.0, 5468.0, 5490.0, 5438.0, 5355.0, 5322.0, 5711.0, 5487.0, 5703.0, 5559.0, 5315.0, 5389.0, 5543.0, 5672.0, 5261.0, 5601.0, 5281.0, 5546.0, 5333.0, 5562.0, 5364.0, 5695.0, 5561.0, 5469.0, 5625.0, 5381.0, 5553.0, 5351.0, 5374.0, 5365.0, 5331.0, 5589.0, 5642.0, 5307.0, 5297.0, 5306.0, 5316.0, 5274.0, 5493.0, 5671.0, 5574.0, 5677.0, 5651.0, 5506.0, 5691.0, 5367.0, 5592.0, 5665.0, 5583.0, 5548.0, 5350.0, 5533.0, 5337.0, 5318.0, 5443.0, 5416.0, 5714.0, 5424.0, 5720.0, 5538.0, 5310.0, 5295.0, 5722.0, 5371.0, 5702.0, 5579.0, 5444.0, 5659.0, 5535.0, 5632.0, 5721.0, 5626.0, 5399.0, 5707.0, 5449.0, 5600.0, 5384.0, 5402.0, 5426.0, 5311.0 (number of hits: 2)
5	5260	9	1	333	1	5636.0, 5494.0, 5359.0, 5332.0, 5296.0, 5595.0, 5522.0, 5390.0, 5540.0, 5309.0, 5388.0, 5634.0, 5340.0, 5251.0, 5575.0, 5542.0, 5482.0, 5631.0, 5710.0, 5581.0, 5518.0, 5545.0, 5656.0, 5717.0, 5490.0, 5369.0, 5645.0, 5644.0, 5569.0, 5452.0, 5685.0, 5321.0, 5679.0, 5426.0, 5615.0, 5548.0, 5434.0, 5319.0, 5639.0, 5316.0, 5462.0, 5449.0, 5429.0, 5541.0, 5378.0, 5391.0, 5414.0, 5721.0, 5527.0, 5427.0, 5536.0, 5588.0, 5413.0, 5532.0, 5389.0, 5330.0, 5573.0, 5507.0, 5285.0, 5709.0, 5714.0, 5282.0, 5669.0, 5374.0, 5368.0, 5475.0, 5267.0, 5600.0, 5659.0, 5383.0, 5349.0, 5533.0, 5384.0, 5398.0, 5262.0, 5622.0, 5517.0, 5395.0, 5649.0, 5323.0, 5534.0, 5440.0, 5428.0, 5720.0, 5612.0, 5713.0, 5652.0, 5364.0, 5502.0, 5715.0, 5444.0, 5253.0, 5370.0, 5620.0, 5535.0, 5470.0, 5354.0, 5646.0, 5611.0, 5483.0 (number of hits: 4)
6	5260	9	1	333	1	5356.0, 5425.0, 5398.0, 5383.0, 5517.0, 5431.0, 5510.0, 5452.0, 5590.0, 5449.0, 5464.0, 5703.0, 5569.0, 5503.0, 5293.0, 5702.0, 5592.0, 5494.0, 5450.0, 5273.0, 5469.0, 5710.0, 5259.0, 5490.0, 5566.0, 5352.0, 5475.0, 5518.0, 5322.0, 5306.0, 5609.0, 5364.0, 5667.0, 5387.0, 5394.0, 5457.0, 5474.0, 5460.0, 5668.0, 5666.0, 5689.0, 5324.0, 5373.0, 5506.0, 5385.0, 5658.0, 5363.0, 5307.0, 5359.0, 5255.0, 5316.0, 5561.0, 5472.0, 5523.0, 5633.0, 5501.0, 5402.0, 5438.0, 5545.0, 5705.0

						5578.0, 5636.0, 5642.0, 5639.0, 5583.0, 5467.0, 5369.0, 5654.0, 5338.0, 5722.0, 5289.0, 5696.0, 5698.0, 5267.0, 5399.0, 5522.0, 5632.0, 5623.0, 5709.0, 5677.0, 5508.0, 5582.0, 5309.0, 5571.0, 5645.0, 5591.0, 5417.0, 5520.0, 5274.0, 5573.0, 5521.0, 5663.0, 5343.0, 5649.0, 5371.0, 5251.0, 5331.0, 5271.0, 5557.0, 5459.0 (number of hits: 4)
7	5260	9	1	333	1	5580.0, 5436.0, 5609.0, 5292.0, 5695.0, 5313.0, 5704.0, 5349.0, 5333.0, 5257.0, 5447.0, 5633.0, 5513.0, 5255.0, 5635.0, 5526.0, 5441.0, 5437.0, 5653.0, 5298.0, 5469.0, 5448.0, 5344.0, 5412.0, 5378.0, 5545.0, 5618.0, 5519.0, 5350.0, 5603.0, 5271.0, 5521.0, 5398.0, 5525.0, 5289.0, 5455.0, 5651.0, 5300.0, 5406.0, 5496.0, 5564.0, 5318.0, 5256.0, 5361.0, 5512.0, 5341.0, 5334.0, 5393.0, 5282.0, 5615.0, 5582.0, 5489.0, 5502.0, 5467.0, 5310.0, 5498.0, 5439.0, 5346.0, 5691.0, 5605.0, 5311.0, 5656.0, 5431.0, 5721.0, 5457.0, 5433.0, 5259.0, 5473.0, 5667.0, 5669.0, 5544.0, 5541.0, 5293.0, 5675.0, 5377.0, 5622.0, 5589.0, 5260.0, 5340.0, 5432.0, 5601.0, 5592.0, 5505.0, 5616.0, 5403.0, 5374.0, 5546.0, 5619.0, 5655.0, 5294.0, 5290.0, 5380.0, 5557.0, 5640.0, 5302.0, 5476.0, 5518.0, 5499.0, 5479.0, 5367.0 (number of hits: 5)
8	5260	9	1	333	1	5300.0, 5520.0, 5512.0, 5409.0, 5557.0, 5510.0, 5592.0, 5606.0, 5506.0, 5677.0, 5443.0, 5385.0, 5336.0, 5518.0, 5386.0, 5389.0, 5265.0, 5362.0, 5485.0, 5519.0, 5498.0, 5623.0, 5630.0, 5279.0, 5328.0, 5297.0, 5264.0, 5552.0, 5342.0, 5651.0, 5426.0, 5528.0, 5618.0, 5388.0, 5626.0, 5572.0, 5270.0, 5662.0, 5555.0, 5720.0, 5349.0, 5640.0, 5694.0, 5549.0, 5258.0, 5282.0, 5494.0, 5379.0, 5627.0, 5296.0, 5718.0, 5414.0, 5324.0, 5570.0, 5582.0, 5515.0, 5488.0, 5440.0, 5504.0, 5517.0, 5298.0, 5322.0, 5638.0, 5477.0, 5556.0, 5334.0, 5441.0, 5289.0, 5563.0, 5452.0, 5543.0, 5503.0, 5704.0, 5407.0, 5375.0, 5533.0, 5326.0, 5550.0, 5668.0, 5299.0, 5260.0, 5554.0, 5305.0, 5406.0, 5383.0, 5320.0, 5392.0, 5587.0, 5341.0, 5373.0, 5367.0, 5368.0, 5536.0, 5605.0, 5716.0, 5621.0, 5661.0, 5310.0, 5350.0, 5551.0 (number of hits: 4)
9	5260	9	1	333	1	5654.0, 5660.0, 5470.0, 5624.0, 5280.0, 5447.0, 5331.0, 5314.0, 5460.0, 5449.0, 5591.0, 5515.0, 5597.0, 5678.0, 5403.0, 5562.0, 5695.0, 5573.0, 5711.0, 5381.0, 5533.0, 5593.0, 5511.0, 5542.0, 5406.0, 5520.0, 5395.0, 5723.0, 5397.0, 5567.0, 5335.0, 5633.0, 5527.0, 5688.0, 5469.0, 5483.0, 5352.0, 5274.0, 5305.0, 5702.0, 5630.0, 5371.0, 5373.0, 5647.0, 5639.0, 5536.0, 5370.0, 5354.0, 5691.0, 5569.0

						5489.0, 5554.0, 5671.0, 5257.0, 5497.0, 5713.0, 5518.0, 5347.0, 5389.0, 5357.0, 5556.0, 5694.0, 5706.0, 5272.0, 5431.0, 5668.0, 5361.0, 5482.0, 5304.0, 5358.0, 5278.0, 5722.0, 5590.0, 5374.0, 5455.0, 5635.0, 5296.0, 5644.0, 5420.0, 5355.0, 5714.0, 5441.0, 5632.0, 5499.0, 5289.0, 5485.0, 5595.0, 5538.0, 5547.0, 5396.0, 5682.0, 5712.0, 5710.0, 5353.0, 5719.0, 5572.0, 5535.0, 5408.0, 5513.0, 5464.0 (number of hits: 1)
10	5260	9	1	333	1	5403.0, 5551.0, 5297.0, 5271.0, 5402.0, 5646.0, 5602.0, 5587.0, 5365.0, 5634.0, 5462.0, 5666.0, 5520.0, 5701.0, 5554.0, 5400.0, 5386.0, 5491.0, 5590.0, 5498.0, 5661.0, 5492.0, 5417.0, 5629.0, 5549.0, 5517.0, 5395.0, 5376.0, 5582.0, 5659.0, 5655.0, 5622.0, 5273.0, 5457.0, 5311.0, 5577.0, 5490.0, 5704.0, 5334.0, 5702.0, 5436.0, 5410.0, 5580.0, 5478.0, 5599.0, 5299.0, 5481.0, 5352.0, 5254.0, 5620.0, 5494.0, 5605.0, 5618.0, 5441.0, 5565.0, 5699.0, 5383.0, 5323.0, 5431.0, 5499.0, 5405.0, 5696.0, 5272.0, 5422.0, 5523.0, 5480.0, 5679.0, 5596.0, 5567.0, 5536.0, 5339.0, 5718.0, 5390.0, 5465.0, 5692.0, 5324.0, 5527.0, 5316.0, 5408.0, 5306.0, 5558.0, 5420.0, 5256.0, 5371.0, 5595.0, 5619.0, 5535.0, 5576.0, 5541.0, 5458.0, 5380.0, 5471.0, 5688.0, 5330.0, 5550.0, 5276.0, 5703.0, 5258.0, 5673.0, 5603.0 (number of hits: 3)
11	5250	9	1	333	1	5336.0, 5628.0, 5661.0, 5491.0, 5561.0, 5475.0, 5468.0, 5295.0, 5581.0, 5400.0, 5415.0, 5567.0, 5635.0, 5658.0, 5670.0, 5268.0, 5611.0, 5431.0, 5320.0, 5502.0, 5655.0, 5348.0, 5532.0, 5624.0, 5292.0, 5252.0, 5704.0, 5615.0, 5499.0, 5550.0, 5574.0, 5665.0, 5299.0, 5623.0, 5402.0, 5390.0, 5373.0, 5293.0, 5421.0, 5524.0, 5516.0, 5343.0, 5583.0, 5695.0, 5723.0, 5398.0, 5264.0, 5683.0, 5326.0, 5328.0, 5576.0, 5378.0, 5622.0, 5621.0, 5365.0, 5482.0, 5472.0, 5542.0, 5406.0, 5610.0, 5416.0, 5692.0, 5533.0, 5509.0, 5374.0, 5321.0, 5301.0, 5287.0, 5560.0, 5558.0, 5461.0, 5686.0, 5600.0, 5522.0, 5463.0, 5465.0, 5375.0, 5358.0, 5458.0, 5396.0, 5289.0, 5608.0, 5529.0, 5584.0, 5275.0, 5346.0, 5435.0, 5256.0, 5510.0, 5719.0, 5352.0, 5566.0, 5518.0, 5309.0, 5512.0, 5391.0, 5568.0, 5361.0, 5606.0, 5428.0 (number of hits: 2)
12	5250	9	1	333	1	5358.0, 5433.0, 5479.0, 5664.0, 5458.0, 5334.0, 5464.0, 5506.0, 5696.0, 5255.0, 5276.0, 5426.0, 5712.0, 5704.0, 5636.0, 5564.0, 5460.0, 5254.0, 5708.0, 5278.0, 5293.0, 5257.0, 5440.0, 5674.0, 5442.0, 5380.0, 5620.0, 5393.0, 5608.0, 5616.0, 5262.0, 5352.0, 5549.0, 5332.0, 5634.0, 5382.0, 5615.0, 5602.0, 5487.0, 5505.0,

						5670.0, 5480.0, 5709.0, 5272.0, 5385.0, 5619.0, 5720.0, 5530.0, 5304.0, 5292.0, 5441.0, 5377.0, 5471.0, 5399.0, 5295.0, 5401.0, 5648.0, 5533.0, 5467.0, 5560.0, 5545.0, 5285.0, 5360.0, 5711.0, 5287.0, 5493.0, 5378.0, 5721.0, 5605.0, 5526.0, 5369.0, 5376.0, 5313.0, 5386.0, 5584.0, 5322.0, 5672.0, 5656.0, 5296.0, 5478.0, 5264.0, 5392.0, 5309.0, 5542.0, 5388.0, 5306.0, 5502.0, 5627.0, 5387.0, 5421.0, 5288.0, 5361.0, 5576.0, 5398.0, 5453.0, 5559.0, 5593.0, 5569.0, 5350.0, 5705.0 (number of hits: 3)
13	5250	9	1	333	1	5383.0, 5265.0, 5318.0, 5322.0, 5616.0, 5482.0, 5404.0, 5658.0, 5537.0, 5255.0, 5473.0, 5511.0, 5594.0, 5546.0, 5515.0, 5363.0, 5704.0, 5433.0, 5675.0, 5458.0, 5501.0, 5449.0, 5513.0, 5401.0, 5437.0, 5402.0, 5664.0, 5443.0, 5626.0, 5254.0, 5671.0, 5427.0, 5597.0, 5559.0, 5284.0, 5620.0, 5420.0, 5261.0, 5642.0, 5721.0, 5460.0, 5316.0, 5555.0, 5298.0, 5376.0, 5276.0, 5264.0, 5536.0, 5373.0, 5299.0, 5689.0, 5273.0, 5418.0, 5311.0, 5518.0, 5312.0, 5516.0, 5456.0, 5372.0, 5521.0, 5467.0, 5585.0, 5609.0, 5659.0, 5391.0, 5388.0, 5574.0, 5533.0, 5519.0, 5601.0, 5568.0, 5693.0, 5599.0, 5257.0, 5323.0, 5700.0, 5572.0, 5457.0, 5459.0, 5577.0, 5280.0, 5663.0, 5382.0, 5685.0, 5679.0, 5505.0, 5379.0, 5313.0, 5335.0, 5535.0, 5508.0, 5539.0, 5351.0, 5282.0, 5369.0, 5353.0, 5308.0, 5541.0, 5490.0, 5584.0 (number of hits: 3)
14	5250	9	1	333	1	5346.0, 5669.0, 5534.0, 5449.0, 5580.0, 5445.0, 5429.0, 5383.0, 5705.0, 5502.0, 5694.0, 5331.0, 5544.0, 5637.0, 5394.0, 5498.0, 5540.0, 5433.0, 5323.0, 5602.0, 5608.0, 5629.0, 5613.0, 5255.0, 5614.0, 5350.0, 5633.0, 5481.0, 5643.0, 5329.0, 5679.0, 5639.0, 5676.0, 5610.0, 5590.0, 5693.0, 5300.0, 5615.0, 5312.0, 5647.0, 5464.0, 5529.0, 5365.0, 5677.0, 5631.0, 5630.0, 5307.0, 5356.0, 5421.0, 5339.0, 5314.0, 5277.0, 5617.0, 5318.0, 5418.0, 5370.0, 5374.0, 5337.0, 5376.0, 5330.0, 5571.0, 5413.0, 5373.0, 5468.0, 5474.0, 5603.0, 5645.0, 5521.0, 5463.0, 5578.0, 5649.0, 5712.0, 5259.0, 5470.0, 5671.0, 5267.0, 5293.0, 5525.0, 5469.0, 5442.0, 5612.0, 5509.0, 5562.0, 5573.0, 5482.0, 5403.0, 5597.0, 5335.0, 5570.0, 5278.0, 5345.0, 5324.0, 5706.0, 5271.0, 5401.0, 5696.0, 5334.0, 5686.0, 5443.0, 5703.0 (number of hits: 2)
15	5250	9	1	333	1	5582.0, 5320.0, 5308.0, 5653.0, 5568.0, 5289.0, 5261.0, 5253.0, 5704.0, 5682.0, 5610.0, 5437.0, 5581.0, 5717.0, 5708.0, 5645.0, 5542.0, 5552.0, 5260.0, 5371.0, 5324.0, 5536.0, 5439.0, 5321.0, 5278.0, 5543.0, 5602.0, 5474.0, 5596.0, 5266.0,

						5444.0, 5547.0, 5518.0, 5400.0, 5515.0, 5443.0, 5575.0, 5657.0, 5408.0, 5712.0, 5561.0, 5422.0, 5617.0, 5429.0, 5642.0, 5265.0, 5344.0, 5577.0, 5401.0, 5271.0, 5571.0, 5643.0, 5461.0, 5675.0, 5441.0, 5294.0, 5315.0, 5390.0, 5678.0, 5436.0, 5567.0, 5649.0, 5425.0, 5619.0, 5350.0, 5660.0, 5679.0, 5336.0, 5509.0, 5375.0, 5716.0, 5707.0, 5331.0, 5694.0, 5597.0, 5540.0, 5347.0, 5525.0, 5317.0, 5709.0, 5537.0, 5352.0, 5555.0, 5668.0, 5295.0, 5396.0, 5459.0, 5438.0, 5293.0, 5523.0, 5520.0, 5671.0, 5325.0, 5687.0, 5456.0, 5427.0, 5637.0, 5413.0, 5393.0, 5407.0 (number of hits: 1)
16	5250	9	1	333	1	5330.0, 5567.0, 5292.0, 5635.0, 5366.0, 5410.0, 5277.0, 5699.0, 5492.0, 5365.0, 5274.0, 5468.0, 5539.0, 5368.0, 5413.0, 5446.0, 5623.0, 5412.0, 5593.0, 5459.0, 5437.0, 5254.0, 5543.0, 5560.0, 5655.0, 5473.0, 5537.0, 5317.0, 5334.0, 5547.0, 5344.0, 5558.0, 5659.0, 5673.0, 5307.0, 5647.0, 5315.0, 5608.0, 5666.0, 5427.0, 5309.0, 5293.0, 5375.0, 5615.0, 5723.0, 5273.0, 5581.0, 5682.0, 5311.0, 5361.0, 5387.0, 5324.0, 5614.0, 5396.0, 5698.0, 5626.0, 5590.0, 5476.0, 5428.0, 5404.0, 5488.0, 5528.0, 5517.0, 5500.0, 5463.0, 5298.0, 5674.0, 5362.0, 5320.0, 5392.0, 5258.0, 5355.0, 5620.0, 5565.0, 5376.0, 5253.0, 5650.0, 5291.0, 5523.0, 5679.0, 5263.0, 5641.0, 5264.0, 5451.0, 5513.0, 5495.0, 5455.0, 5336.0, 5445.0, 5325.0, 5370.0, 5458.0, 5542.0, 5267.0, 5462.0, 5597.0, 5270.0, 5297.0, 5544.0, 5680.0 (number of hits: 3)
17	5250	9	1	333	1	5712.0, 5521.0, 5414.0, 5485.0, 5669.0, 5488.0, 5464.0, 5252.0, 5589.0, 5527.0, 5342.0, 5555.0, 5705.0, 5328.0, 5400.0, 5634.0, 5270.0, 5621.0, 5494.0, 5696.0, 5505.0, 5566.0, 5255.0, 5682.0, 5590.0, 5508.0, 5463.0, 5587.0, 5708.0, 5648.0, 5293.0, 5394.0, 5352.0, 5405.0, 5633.0, 5676.0, 5698.0, 5287.0, 5481.0, 5489.0, 5613.0, 5624.0, 5278.0, 5256.0, 5683.0, 5465.0, 5286.0, 5435.0, 5639.0, 5569.0, 5605.0, 5609.0, 5416.0, 5298.0, 5276.0, 5290.0, 5355.0, 5291.0, 5603.0, 5343.0, 5690.0, 5660.0, 5576.0, 5480.0, 5680.0, 5406.0, 5580.0, 5399.0, 5409.0, 5266.0, 5647.0, 5629.0, 5322.0, 5333.0, 5514.0, 5578.0, 5612.0, 5536.0, 5415.0, 5429.0, 5512.0, 5478.0, 5561.0, 5499.0, 5380.0, 5354.0, 5345.0, 5695.0, 5284.0, 5344.0, 5351.0, 5471.0, 5371.0, 5431.0, 5452.0, 5684.0, 5448.0, 5643.0, 5390.0, 5306.0 (number of hits: 3)
18	5250	9	1	333	1	5445.0, 5584.0, 5613.0, 5688.0, 5337.0, 5477.0, 5273.0, 5590.0, 5719.0, 5630.0, 5577.0, 5461.0, 5691.0, 5694.0, 5651.0, 5253.0, 5454.0, 5310.0, 5341.0, 5581.0,

						5667.0, 5697.0, 5720.0, 5392.0, 5563.0, 5612.0, 5470.0, 5580.0, 5507.0, 5496.0, 5576.0, 5293.0, 5510.0, 5672.0, 5377.0, 5609.0, 5283.0, 5432.0, 5426.0, 5430.0, 5261.0, 5637.0, 5662.0, 5332.0, 5527.0, 5575.0, 5565.0, 5417.0, 5457.0, 5508.0, 5288.0, 5365.0, 5629.0, 5271.0, 5579.0, 5668.0, 5267.0, 5425.0, 5617.0, 5648.0, 5262.0, 5478.0, 5625.0, 5311.0, 5537.0, 5619.0, 5718.0, 5555.0, 5351.0, 5499.0, 5643.0, 5490.0, 5289.0, 5307.0, 5322.0, 5428.0, 5559.0, 5484.0, 5647.0, 5291.0, 5342.0, 5723.0, 5316.0, 5669.0, 5272.0, 5681.0, 5280.0, 5517.0, 5515.0, 5269.0, 5604.0, 5502.0, 5265.0, 5671.0, 5597.0, 5437.0, 5449.0, 5412.0, 5700.0, 5493.0 (number of hits: 1)
19	5250	9	1	333	1	5429.0, 5602.0, 5684.0, 5287.0, 5670.0, 5399.0, 5506.0, 5515.0, 5382.0, 5595.0, 5352.0, 5511.0, 5640.0, 5551.0, 5600.0, 5662.0, 5614.0, 5691.0, 5557.0, 5281.0, 5272.0, 5436.0, 5424.0, 5369.0, 5400.0, 5556.0, 5689.0, 5397.0, 5347.0, 5503.0, 5537.0, 5366.0, 5722.0, 5289.0, 5357.0, 5522.0, 5667.0, 5526.0, 5293.0, 5464.0, 5371.0, 5714.0, 5368.0, 5482.0, 5675.0, 5678.0, 5543.0, 5672.0, 5660.0, 5474.0, 5283.0, 5554.0, 5280.0, 5331.0, 5441.0, 5582.0, 5694.0, 5323.0, 5575.0, 5702.0, 5562.0, 5261.0, 5315.0, 5413.0, 5518.0, 5613.0, 5384.0, 5346.0, 5456.0, 5253.0, 5686.0, 5431.0, 5629.0, 5479.0, 5325.0, 5571.0, 5466.0, 5450.0, 5295.0, 5271.0, 5711.0, 5682.0, 5327.0, 5673.0, 5633.0, 5652.0, 5420.0, 5692.0, 5547.0, 5402.0, 5641.0, 5679.0, 5601.0, 5292.0, 5421.0, 5524.0, 5615.0, 5671.0, 5471.0, 5605.0 (number of hits: 1)
20	5250	9	1	333	1	5688.0, 5397.0, 5679.0, 5391.0, 5624.0, 5615.0, 5390.0, 5485.0, 5454.0, 5364.0, 5467.0, 5665.0, 5332.0, 5438.0, 5571.0, 5430.0, 5422.0, 5589.0, 5363.0, 5702.0, 5720.0, 5341.0, 5646.0, 5276.0, 5568.0, 5692.0, 5557.0, 5651.0, 5414.0, 5350.0, 5312.0, 5515.0, 5270.0, 5666.0, 5619.0, 5699.0, 5658.0, 5398.0, 5337.0, 5315.0, 5376.0, 5698.0, 5491.0, 5429.0, 5265.0, 5396.0, 5297.0, 5278.0, 5329.0, 5616.0, 5684.0, 5259.0, 5604.0, 5400.0, 5513.0, 5647.0, 5301.0, 5637.0, 5520.0, 5579.0, 5310.0, 5466.0, 5406.0, 5419.0, 5492.0, 5656.0, 5711.0, 5546.0, 5674.0, 5576.0, 5449.0, 5256.0, 5402.0, 5408.0, 5526.0, 5528.0, 5421.0, 5368.0, 5517.0, 5331.0, 5590.0, 5280.0, 5721.0, 5370.0, 5556.0, 5439.0, 5319.0, 5494.0, 5446.0, 5461.0, 5565.0, 5490.0, 5262.0, 5362.0, 5471.0, 5578.0, 5644.0, 5340.0, 5496.0, 5678.0 (number of hits: 2)
21	5270	9	1	333	1	5386.0, 5351.0, 5700.0, 5518.0, 5665.0, 5263.0, 5484.0, 5360.0, 5509.0, 5475.0,

						<p>5277.0, 5373.0, 5368.0, 5513.0, 5389.0, 5258.0, 5300.0, 5508.0, 5621.0, 5678.0, 5420.0, 5577.0, 5315.0, 5712.0, 5347.0, 5424.0, 5381.0, 5565.0, 5600.0, 5531.0, 5445.0, 5356.0, 5279.0, 5562.0, 5367.0, 5504.0, 5344.0, 5310.0, 5511.0, 5394.0, 5627.0, 5542.0, 5406.0, 5470.0, 5718.0, 5455.0, 5303.0, 5253.0, 5606.0, 5682.0, 5342.0, 5301.0, 5528.0, 5275.0, 5693.0, 5613.0, 5252.0, 5423.0, 5696.0, 5529.0, 5716.0, 5653.0, 5334.0, 5254.0, 5408.0, 5499.0, 5573.0, 5467.0, 5466.0, 5314.0, 5668.0, 5644.0, 5293.0, 5370.0, 5635.0, 5328.0, 5454.0, 5332.0, 5548.0, 5434.0, 5327.0, 5541.0, 5625.0, 5574.0, 5691.0, 5609.0, 5491.0, 5383.0, 5703.0, 5430.0, 5672.0, 5309.0, 5271.0, 5492.0, 5614.0, 5464.0, 5640.0, 5409.0, 5523.0, 5343.0</p> <p>(number of hits: 5)</p>
22	5270	9	1	333	1	<p>5610.0, 5533.0, 5411.0, 5304.0, 5279.0, 5451.0, 5358.0, 5263.0, 5332.0, 5334.0, 5508.0, 5461.0, 5631.0, 5360.0, 5581.0, 5485.0, 5292.0, 5606.0, 5453.0, 5605.0, 5447.0, 5560.0, 5683.0, 5719.0, 5652.0, 5472.0, 5662.0, 5669.0, 5401.0, 5498.0, 5537.0, 5361.0, 5325.0, 5262.0, 5337.0, 5346.0, 5489.0, 5424.0, 5541.0, 5308.0, 5612.0, 5641.0, 5561.0, 5398.0, 5604.0, 5422.0, 5355.0, 5392.0, 5328.0, 5532.0, 5720.0, 5350.0, 5549.0, 5520.0, 5643.0, 5467.0, 5491.0, 5500.0, 5283.0, 5375.0, 5659.0, 5421.0, 5425.0, 5644.0, 5409.0, 5670.0, 5501.0, 5524.0, 5275.0, 5542.0, 5637.0, 5323.0, 5568.0, 5442.0, 5599.0, 5634.0, 5515.0, 5627.0, 5393.0, 5525.0, 5253.0, 5608.0, 5412.0, 5630.0, 5426.0, 5271.0, 5269.0, 5432.0, 5607.0, 5691.0, 5682.0, 5402.0, 5465.0, 5278.0, 5505.0, 5277.0, 5406.0, 5540.0, 5477.0, 5673.0</p> <p>(number of hits: 8)</p>
23	5270	9	1	333	1	<p>5499.0, 5487.0, 5269.0, 5583.0, 5321.0, 5295.0, 5597.0, 5392.0, 5332.0, 5314.0, 5613.0, 5341.0, 5411.0, 5296.0, 5359.0, 5477.0, 5285.0, 5485.0, 5323.0, 5723.0, 5528.0, 5302.0, 5567.0, 5514.0, 5517.0, 5665.0, 5469.0, 5556.0, 5550.0, 5405.0, 5351.0, 5696.0, 5617.0, 5521.0, 5548.0, 5325.0, 5651.0, 5564.0, 5335.0, 5620.0, 5386.0, 5304.0, 5541.0, 5672.0, 5524.0, 5576.0, 5361.0, 5538.0, 5401.0, 5493.0, 5623.0, 5676.0, 5702.0, 5712.0, 5701.0, 5455.0, 5531.0, 5274.0, 5671.0, 5337.0, 5338.0, 5551.0, 5434.0, 5502.0, 5719.0, 5394.0, 5398.0, 5639.0, 5467.0, 5675.0, 5562.0, 5406.0, 5435.0, 5505.0, 5459.0, 5512.0, 5500.0, 5540.0, 5315.0, 5316.0, 5277.0, 5612.0, 5716.0, 5720.0, 5369.0, 5271.0, 5692.0, 5490.0, 5533.0, 5372.0, 5526.0, 5311.0, 5513.0, 5640.0, 5284.0, 5317.0, 5373.0, 5276.0, 5421.0, 5355.0</p> <p>(number of hits: 5)</p>

24	5270	9	1	333	1	<p>5570.0, 5584.0, 5668.0, 5281.0, 5624.0, 5341.0, 5606.0, 5623.0, 5412.0, 5427.0, 5686.0, 5479.0, 5262.0, 5432.0, 5666.0, 5653.0, 5253.0, 5590.0, 5610.0, 5436.0, 5274.0, 5701.0, 5721.0, 5433.0, 5561.0, 5713.0, 5530.0, 5393.0, 5506.0, 5524.0, 5719.0, 5416.0, 5516.0, 5482.0, 5297.0, 5511.0, 5415.0, 5426.0, 5292.0, 5434.0, 5381.0, 5291.0, 5683.0, 5335.0, 5609.0, 5542.0, 5695.0, 5439.0, 5317.0, 5699.0, 5639.0, 5682.0, 5594.0, 5306.0, 5563.0, 5312.0, 5649.0, 5296.0, 5413.0, 5545.0, 5703.0, 5508.0, 5264.0, 5582.0, 5660.0, 5693.0, 5447.0, 5273.0, 5608.0, 5613.0, 5437.0, 5342.0, 5417.0, 5513.0, 5616.0, 5651.0, 5724.0, 5633.0, 5395.0, 5468.0, 5533.0, 5652.0, 5629.0, 5389.0, 5483.0, 5675.0, 5368.0, 5517.0, 5458.0, 5667.0, 5605.0, 5399.0, 5392.0, 5382.0, 5272.0, 5408.0, 5551.0, 5720.0, 5597.0, 5579.0 (number of hits: 5)</p>
25	5270	9	1	333	1	<p>5646.0, 5619.0, 5251.0, 5354.0, 5313.0, 5252.0, 5352.0, 5364.0, 5444.0, 5254.0, 5344.0, 5439.0, 5478.0, 5361.0, 5259.0, 5657.0, 5379.0, 5522.0, 5479.0, 5620.0, 5677.0, 5589.0, 5329.0, 5458.0, 5676.0, 5406.0, 5399.0, 5581.0, 5351.0, 5287.0, 5530.0, 5409.0, 5500.0, 5553.0, 5447.0, 5670.0, 5708.0, 5711.0, 5720.0, 5680.0, 5311.0, 5495.0, 5429.0, 5682.0, 5642.0, 5396.0, 5336.0, 5562.0, 5645.0, 5668.0, 5257.0, 5378.0, 5350.0, 5309.0, 5372.0, 5296.0, 5486.0, 5310.0, 5510.0, 5658.0, 5358.0, 5638.0, 5454.0, 5501.0, 5700.0, 5393.0, 5457.0, 5341.0, 5712.0, 5597.0, 5523.0, 5472.0, 5491.0, 5701.0, 5282.0, 5678.0, 5609.0, 5513.0, 5584.0, 5342.0, 5521.0, 5493.0, 5369.0, 5626.0, 5686.0, 5639.0, 5357.0, 5723.0, 5579.0, 5665.0, 5290.0, 5376.0, 5561.0, 5502.0, 5571.0, 5384.0, 5328.0, 5572.0, 5487.0, 5278.0 (number of hits: 1)</p>
26	5270	9	1	333	1	<p>5490.0, 5351.0, 5712.0, 5632.0, 5416.0, 5431.0, 5559.0, 5336.0, 5576.0, 5532.0, 5704.0, 5277.0, 5273.0, 5675.0, 5261.0, 5400.0, 5693.0, 5592.0, 5444.0, 5713.0, 5617.0, 5528.0, 5492.0, 5463.0, 5543.0, 5410.0, 5388.0, 5680.0, 5527.0, 5339.0, 5325.0, 5608.0, 5385.0, 5283.0, 5467.0, 5428.0, 5306.0, 5552.0, 5518.0, 5614.0, 5619.0, 5697.0, 5692.0, 5621.0, 5474.0, 5625.0, 5525.0, 5488.0, 5406.0, 5358.0, 5561.0, 5439.0, 5553.0, 5301.0, 5664.0, 5462.0, 5601.0, 5346.0, 5454.0, 5668.0, 5430.0, 5662.0, 5571.0, 5702.0, 5622.0, 5331.0, 5588.0, 5485.0, 5661.0, 5468.0, 5284.0, 5721.0, 5398.0, 5529.0, 5363.0, 5647.0, 5694.0, 5638.0, 5579.0, 5291.0, 5560.0, 5479.0, 5399.0, 5364.0, 5420.0, 5672.0, 5458.0, 5403.0, 5564.0, 5583.0, 5422.0, 5508.0, 5723.0, 5472.0, 5676.0,</p>

						5426.0, 5341.0, 5510.0, 5453.0, 5496.0 (number of hits: 3)
27	5270	9	1	333	1	5515.0, 5708.0, 5305.0, 5315.0, 5632.0, 5308.0, 5568.0, 5367.0, 5534.0, 5403.0, 5337.0, 5346.0, 5609.0, 5702.0, 5522.0, 5303.0, 5707.0, 5598.0, 5399.0, 5514.0, 5447.0, 5436.0, 5278.0, 5493.0, 5289.0, 5412.0, 5358.0, 5503.0, 5585.0, 5595.0, 5701.0, 5330.0, 5342.0, 5694.0, 5323.0, 5602.0, 5393.0, 5592.0, 5675.0, 5461.0, 5661.0, 5709.0, 5374.0, 5638.0, 5364.0, 5366.0, 5679.0, 5671.0, 5405.0, 5454.0, 5391.0, 5626.0, 5691.0, 5631.0, 5491.0, 5653.0, 5280.0, 5375.0, 5462.0, 5250.0, 5381.0, 5318.0, 5382.0, 5516.0, 5285.0, 5667.0, 5480.0, 5290.0, 5264.0, 5613.0, 5635.0, 5711.0, 5525.0, 5481.0, 5575.0, 5710.0, 5641.0, 5717.0, 5578.0, 5416.0, 5676.0, 5549.0, 5686.0, 5365.0, 5643.0, 5530.0, 5398.0, 5321.0, 5453.0, 5577.0, 5724.0, 5599.0, 5604.0, 5329.0, 5559.0, 5376.0, 5443.0, 5339.0, 5442.0, 5311.0 (number of hits: 2)
28	5270	9	1	333	1	5611.0, 5476.0, 5347.0, 5544.0, 5332.0, 5553.0, 5669.0, 5285.0, 5689.0, 5279.0, 5385.0, 5456.0, 5407.0, 5701.0, 5660.0, 5636.0, 5255.0, 5373.0, 5380.0, 5710.0, 5538.0, 5698.0, 5586.0, 5265.0, 5464.0, 5271.0, 5720.0, 5260.0, 5329.0, 5391.0, 5495.0, 5254.0, 5606.0, 5620.0, 5565.0, 5408.0, 5634.0, 5693.0, 5305.0, 5461.0, 5549.0, 5662.0, 5599.0, 5351.0, 5490.0, 5531.0, 5338.0, 5349.0, 5270.0, 5442.0, 5657.0, 5666.0, 5613.0, 5532.0, 5437.0, 5418.0, 5514.0, 5481.0, 5643.0, 5321.0, 5529.0, 5410.0, 5411.0, 5444.0, 5324.0, 5440.0, 5537.0, 5415.0, 5269.0, 5716.0, 5319.0, 5469.0, 5262.0, 5687.0, 5597.0, 5376.0, 5458.0, 5491.0, 5699.0, 5406.0, 5467.0, 5625.0, 5454.0, 5585.0, 5267.0, 5308.0, 5397.0, 5503.0, 5256.0, 5653.0, 5682.0, 5545.0, 5631.0, 5302.0, 5665.0, 5595.0, 5508.0, 5471.0, 5341.0, 5542.0 (number of hits: 8)
29	5270	9	1	333	1	5491.0, 5702.0, 5435.0, 5680.0, 5302.0, 5526.0, 5405.0, 5449.0, 5533.0, 5305.0, 5493.0, 5265.0, 5492.0, 5584.0, 5388.0, 5677.0, 5341.0, 5600.0, 5325.0, 5668.0, 5438.0, 5420.0, 5488.0, 5474.0, 5354.0, 5564.0, 5657.0, 5536.0, 5464.0, 5494.0, 5549.0, 5698.0, 5568.0, 5275.0, 5626.0, 5352.0, 5635.0, 5251.0, 5427.0, 5681.0, 5288.0, 5650.0, 5349.0, 5468.0, 5524.0, 5428.0, 5543.0, 5532.0, 5379.0, 5348.0, 5256.0, 5309.0, 5378.0, 5517.0, 5715.0, 5688.0, 5594.0, 5563.0, 5611.0, 5654.0, 5342.0, 5541.0, 5291.0, 5307.0, 5588.0, 5590.0, 5649.0, 5344.0, 5551.0, 5304.0, 5458.0, 5575.0, 5712.0, 5284.0, 5425.0, 5558.0, 5527.0, 5393.0, 5709.0, 5287.0, 5296.0, 5334.0, 5685.0, 5369.0, 5270.0,

						5396.0, 5360.0, 5585.0, 5406.0, 5408.0, 5487.0, 5723.0, 5328.0, 5631.0, 5315.0, 5268.0, 5370.0, 5386.0, 5687.0, 5314.0 (number of hits: 4)
30	5270	9	1	333	1	5414.0, 5385.0, 5261.0, 5531.0, 5689.0, 5331.0, 5538.0, 5710.0, 5411.0, 5297.0, 5310.0, 5306.0, 5286.0, 5473.0, 5450.0, 5397.0, 5665.0, 5679.0, 5394.0, 5367.0, 5600.0, 5445.0, 5343.0, 5644.0, 5723.0, 5587.0, 5292.0, 5408.0, 5479.0, 5475.0, 5566.0, 5602.0, 5264.0, 5464.0, 5374.0, 5329.0, 5550.0, 5513.0, 5578.0, 5609.0, 5296.0, 5716.0, 5472.0, 5486.0, 5272.0, 5577.0, 5380.0, 5377.0, 5635.0, 5502.0, 5514.0, 5423.0, 5270.0, 5569.0, 5615.0, 5673.0, 5470.0, 5642.0, 5400.0, 5677.0, 5359.0, 5652.0, 5417.0, 5308.0, 5542.0, 5682.0, 5326.0, 5567.0, 5378.0, 5580.0, 5688.0, 5454.0, 5383.0, 5432.0, 5271.0, 5525.0, 5467.0, 5340.0, 5518.0, 5494.0, 5403.0, 5412.0, 5623.0, 5366.0, 5643.0, 5258.0, 5507.0, 5462.0, 5693.0, 5599.0, 5663.0, 5666.0, 5533.0, 5596.0, 5484.0, 5458.0, 5656.0, 5606.0, 5324.0, 5621.0 (number of hits: 5)

C.2 40 MHz Bandwidth @ 5270 MHz

Table-1A/1B Radar Type 1A/1B Statistical Performance

Trial #	Fc (MHz)	Pulse/Burst	Pulse Width (μS)	PRI (μs)	Detection (1:yes; 0:no)
1	5270	92	1	578	1
2	5270	72	1	738	1
3	5270	58	1	918	1
4	5270	83	1	638	1
5	5270	86	1	618	1
6	5270	99	1	538	1
7	5270	70	1	758	1
8	5270	78	1	678	1
9	5270	63	1	838	1
10	5270	74	1	718	1
11	5270	89	1	598	1
12	5270	76	1	698	1
13	5270	62	1	858	1
14	5270	67	1	798	1
15	5270	57	1	938	1
16	5270	29	1	1862	1
17	5270	84	1	631	1
18	5270	87	1	607	1
19	5270	50	1	1059	1
20	5270	18	1	3025	1
21	5270	73	1	724	1
22	5270	20	1	2651	1
23	5270	18	1	2939	1
24	5270	19	1	2796	1
25	5270	65	1	815	1
26	5270	58	1	922	1
27	5270	90	1	587	1
28	5270	20	1	2773	1
29	5270	18	1	2943	1
30	5270	24	1	2264	1
Detection Percentage: 100 % (>60%)					

Table-2 Radar Type 2 Statistical Performance

Trial #	Fc (MHz)	Pulse/Burst	Pulse Width (μ S)	PRI (μ s)	Detection (1:yes; 0:no)
1	5270	28	4.8	175	1
2	5270	23	1.8	216	1
3	5270	25	3.2	170	1
4	5270	23	3.5	194	1
5	5270	29	3	194	1
6	5270	28	1.6	212	1
7	5270	24	1.8	187	1
8	5270	26	2.4	158	1
9	5270	24	3.3	210	1
10	5270	26	4	172	1
11	5270	23	2.5	219	1
12	5270	23	3.6	179	1
13	5270	24	1.8	211	1
14	5270	28	5	162	1
15	5270	28	4	154	1
16	5270	23	1.5	165	1
17	5270	29	4	202	1
18	5270	26	4.7	212	1
19	5270	26	3.1	216	1
20	5270	26	2.6	225	1
21	5270	29	2	188	1
22	5270	29	2	225	1
23	5270	23	5	193	1
24	5270	28	1.8	220	1
25	5270	26	2.4	183	1
26	5270	25	4.5	202	1
27	5270	25	4.7	152	1
28	5270	24	1.2	183	1
29	5270	25	1.8	222	1
30	5270	24	3.4	160	1
Detection Percentage: 100 % (>60%)					

Table-3 Radar Type 3 Statistical Performance

Trial #	Fc (MHz)	Pulse/Burst	Pulse Width (μ S)	PRI (μ s)	Detection (1:yes; 0:no)
1	5270	17	8.3	445	1
2	5270	17	6.1	201	1
3	5270	18	6.7	310	1
4	5270	18	9.7	429	1
5	5270	18	7.3	427	1
6	5270	17	9.4	355	1
7	5270	16	8.5	281	1
8	5270	16	9.6	439	1
9	5270	18	7.1	256	1
10	5270	16	6.5	494	1
11	5270	16	7.4	438	1
12	5270	18	8.6	458	1
13	5270	18	6.3	273	1
14	5270	17	9.1	433	1
15	5270	17	8.5	464	1
16	5270	16	8.7	375	1
17	5270	18	6.5	313	1
18	5270	18	8.6	318	1
19	5270	18	9.8	398	1
20	5270	16	9.4	341	1
21	5270	17	7.4	288	1
22	5270	18	6.8	473	1
23	5270	18	6.5	335	1
24	5270	16	6.9	242	1
25	5270	18	8.6	393	1
26	5270	18	6.8	261	1
27	5270	18	8.3	280	1
28	5270	18	6.9	379	1
29	5270	18	7.6	374	1
30	5270	18	9.5	455	1
Detection Percentage: 100 % (>60%)					

Table-4 Radar Type 4 Statistical Performance

Trial #	Fc (MHz)	Pulse/Burst	Pulse Width (μS)	PRI (μs)	Detection (1:yes; 0:no)
1	5270	16	15	317	1
2	5270	15	15.9	473	1
3	5270	14	14	220	1
4	5270	12	12	455	1
5	5270	16	12.3	430	1
6	5270	12	13.8	469	1
7	5270	15	19.4	227	1
8	5270	15	14.4	299	1
9	5270	15	17	378	1
10	5270	12	13.1	232	1
11	5270	12	17.7	273	1
12	5270	14	15.7	484	1
13	5270	13	14.8	232	1
14	5270	14	13.2	337	1
15	5270	15	14.3	461	1
16	5270	13	11.2	264	1
17	5270	14	14.9	471	1
18	5270	12	18.3	254	1
19	5270	13	11.2	397	1
20	5270	13	17.6	426	1
21	5270	13	11.7	223	1
22	5270	15	13.3	215	1
23	5270	15	14	485	1
24	5270	14	14.7	287	1
25	5270	16	12.8	364	1
26	5270	12	19.5	409	1
27	5270	12	15.3	459	1
28	5270	13	17.6	383	1
29	5270	14	15.7	408	1
30	5270	16	18	455	1
Detection Percentage: 100 % (>60%)					

Table-5 Radar Type 5 Statistical Performance

Trial #	Fc (MHz)	Detection (1:yes; 0:no)
1	5270	1
2	5270	1
3	5270	1
4	5270	1
5	5270	1
6	5270	1
7	5270	1
8	5270	1
9	5270	1
10	5270	1
11	5256.8	1
12	5257.6	1
13	5257.6	1
14	5254.0	1
15	5252.8	1
16	5254.4	1
17	5255.6	1
18	5255.6	1
19	5256.8	1
20	5257.2	1
21	5288.0	1
22	5282.8	1
23	5285.6	1
24	5287.2	1
25	5287.2	1
26	5284.8	1
27	5283.2	1
28	5284.8	1
29	5287.2	1
30	5286.4	1
Detection Percentage: 100 % (>80%)		

Bin5 Statistics 1

Trial #	Pulse	Chirp (MHz)	Pulse Width (µS)	Pulse 1-2 spacing (uS)	Pulse 2-3 spacing (uS)	Pulse Start(S)	Detection (1:yes; 0:no)
0	2	9	68.1	1680		0.503391	1
1	2	9	83.1	1198		1.538656	
2	2	9	71.4	1564		2.127449	
3	2	9	63.1	1222		3.149343	
4	2	9	70.4	1735		3.516702	
5	2	9	53.9	1679		4.426889	
6	2	9	77.8	1326		5.42642	
7	2	9	86.3	1904		6.477506	
8	3	9	97.9	1328	1416	7.623845	
9	3	9	50.9	1209	1444	8.036951	
10	1	9	64.6			8.744658	
11	1	9	63.6			9.604235	
12	2	9	83.9	1504		10.58813	
13	2	9	64.7	2000		11.725901	

Bin5 Statistics 2

Trial #	Pulse	Chirp (MHz)	Pulse Width (µS)	Pulse 1-2 spacing (uS)	Pulse 2-3 spacing (uS)	Pulse Start(S)	Detection (1:yes; 0:no)
0	1	11	59.9			0.166903	1
1	2	11	63.3	1997		1.34211	
2	2	11	80.5	1258		3.180515	
3	1	11	58.4			3.689886	
4	3	11	94.5	1413	1944	5.248142	
5	2	11	65.2	1322		6.411826	
6	2	11	54.7	1722		6.674617	
7	1	11	65.4			8.092499	
8	2	11	83.4	1557		9.085177	
9	1	11	58.8			10.278168	
10	1	11	99			11.131036	

Bin5 Statistics 3

Trial #	Pulse	Chirp (MHz)	Pulse Width (µS)	Pulse 1-2 spacing (uS)	Pulse 2-3 spacing (uS)	Pulse Start(S)	Detection (1:yes; 0:no)
0	3	13	77.9	1711	1571	0.169538	1
1	2	13	67.7	1906		1.120553	
2	3	13	86.7	1375	1671	1.855053	
3	2	13	75.8	1192		2.038819	
4	3	13	64.8	1567	1144	3.188456	
5	2	13	65.8	1658		3.702895	
6	1	13	70.4			4.632067	
7	1	13	77.4			4.998213	
8	2	13	54.3	1982		5.822193	
9	1	13	85.6			6.172118	
10	1	13	94.5			7.178572	
11	2	13	56	1720		7.622336	
12	1	13	67.2			8.26765	
13	2	13	81.3	1303		8.811911	
14	2	13	87.5	1012		9.597358	
15	2	13	88.9	1133		10.446876	
16	2	13	83.7	1171		11.075481	
17	1	13	76.3			11.910496	

Bin5 Statistics 4

Trial #	Pulse	Chirp (MHz)	Pulse Width (µS)	Pulse 1-2 spacing (uS)	Pulse 2-3 spacing (uS)	Pulse Start(S)	Detection (1:yes; 0:no)
0	1	5	56.3			0.613383	1
1	1	5	67.2			1.816761	
2	2	5	93	1166		2.443073	
3	2	5	99.3	1953		3.274104	
4	2	5	70.9	1845		4.265995	
5	3	5	65	1304	1796	5.311814	
6	2	5	94.6	1551		6.875646	
7	1	5	78.3			7.906091	
8	3	5	62.6	1123	1774	8.058074	
9	3	5	73.8	1595	1591	9.673907	
10	1	5	76.6			10.285737	
11	2	5	59	1984		11.436433	

Bin5 Statistics 5

Trial #	Pulse	Chirp (MHz)	Pulse Width (µS)	Pulse 1-2 spacing (uS)	Pulse 2-3 spacing (uS)	Pulse Start(S)	Detection (1:yes; 0:no)
0	2	8	58.1	1991		0.324804	1
1	2	8	98.1	1421		1.392376	
2	1	8	91			2.462893	
3	2	8	90	1627		3.655517	
4	3	8	93.2	1420	1868	4.100666	
5	2	8	52.2	1440		4.711671	
6	2	8	51.4	1594		6.280043	
7	2	8	76.4	1760		6.699256	
8	3	8	82.9	1893	1237	7.421012	
9	3	8	69.4	1104	1672	8.75473	
10	1	8	64.1			9.789853	
11	2	8	86.4	1339		10.75428	
12	1	8	77.5			11.428196	

Bin5 Statistics 6

Trial #	Pulse	Chirp (MHz)	Pulse Width (µS)	Pulse 1-2 spacing (uS)	Pulse 2-3 spacing (uS)	Pulse Start(S)	Detection (1:yes; 0:no)
0	2	9	89.6	1014		0.799928	1
1	1	9	91.3			1.958512	
2	2	9	99.8	1788		3.301104	
3	2	9	75.9	1933		4.627192	
4	2	9	72.7	1327		5.641769	
5	2	9	65.1	1984		7.004928	
6	2	9	84.5	1629		8.253933	
7	2	9	57.9	1909		9.406295	
8	2	9	66.4	1267		10.514105	
9	1	9	94.7			11.496571	

Bin5 Statistics 7

Trial #	Pulse	Chirp (MHz)	Pulse Width (µS)	Pulse 1-2 spacing (uS)	Pulse 2-3 spacing (uS)	Pulse Start(S)	Detection (1:yes; 0:no)
0	3	7	81.5	1873	1162	0.1989	1
1	2	7	70.7	1405		1.082321	
2	3	7	59.1	1669	1898	2.051194	
3	2	7	86	1066		2.813795	
4	1	7	68.4			3.779912	
5	2	7	53.7	1188		4.395128	
6	3	7	66.9	1556	1220	4.955742	
7	2	7	97.9	1049		6.014447	
8	1	7	78.3			6.826245	
9	3	7	75.6	1080	1550	7.633715	
10	3	7	74.3	1290	1318	8.196512	
11	1	7	63.6			9.585358	
12	2	7	98.5	1457		10.384124	
13	1	7	68.4			10.881792	
14	3	7	90.6	1035	1903	11.335254	

Bin5 Statistics 8

Trial #	Pulse	Chirp (MHz)	Pulse Width (µS)	Pulse 1-2 spacing (uS)	Pulse 2-3 spacing (uS)	Pulse Start(S)	Detection (1:yes; 0:no)
0	2	5	90.7	1855		0.20541	1
1	2	5	91.1	1736		1.65789	
2	2	5	53.9	1617		3.05214	
3	3	5	81.6	1660	1072	4.777979	
4	3	5	74.7	1328	1387	6.241434	
5	3	5	67.6	1493	1439	7.247688	
6	2	5	51.8	1188		9.25094	
7	2	5	74.4	1704		9.808921	
8	3	5	53.6	1782	1850	11.687535	

Bin5 Statistics 9

Trial #	Pulse	Chirp (MHz)	Pulse Width (µS)	Pulse 1-2 spacing (uS)	Pulse 2-3 spacing (uS)	Pulse Start(S)	Detection (1:yes; 0:no)
0	3	13	93.8	1456	1340	1.008473	1
1	2	13	53.9	1484		1.683642	
2	1	13	61.3			2.305208	
3	3	13	92.5	1927	1238	3.990665	
4	3	13	72.4	1044	1235	4.904923	
5	2	13	60.2	1627		6.109282	
6	2	13	88.4	1631		7.172347	
7	3	13	81.4	1187	1707	8.311078	
8	1	13	90.7			8.913366	
9	2	13	85	1387		10.100502	
10	2	13	97.9	1248		11.081665	

Bin5 Statistics 10

Trial #	Pulse	Chirp (MHz)	Pulse Width (µS)	Pulse 1-2 spacing (uS)	Pulse 2-3 spacing (uS)	Pulse Start(S)	Detection (1:yes; 0:no)
0	2	11	81.2	1669		0.114218	1
1	3	11	55.2	1332	1116	1.166518	
2	2	11	58.6	1678		1.770197	
3	3	11	91.9	1255	1575	2.047338	
4	2	11	80.4	1890		2.430645	
5	2	11	63.8	1236		3.346931	
6	3	11	57.2	1182	1244	3.657616	
7	2	11	62.9	1166		4.781054	
8	1	11	65.1			5.184562	
9	3	11	79.1	1804	1294	5.573473	
10	3	11	56	1130	1476	6.097541	
11	2	11	85	1930		7.055877	
12	3	11	62	1922	1203	7.393846	
13	1	11	70.5			8.283634	
14	3	11	95.2	1325	1850	8.42565	
15	2	11	75.4	1617		9.540646	
16	2	11	88.6	1484		9.869559	
17	3	11	75.7	1593	1439	10.583176	
18	2	11	87.8	1668		10.81356	
19	3	11	91	1282	1849	11.741677	

Bin5 Statistics 11

Trial #	Pulse	Chirp (MHz)	Pulse Width (µS)	Pulse 1-2 spacing (uS)	Pulse 2-3 spacing (uS)	Pulse Start(S)	Detection (1:yes; 0:no)
0	1	17	58.8			0.32061	1
1	1	17	81.3			2.084741	
2	1	17	78.5			3.519609	
3	2	17	70.4	1462		5.407323	
4	1	17	73.1			6.78177	
5	2	17	55.7	1441		8.564096	
6	2	17	85.8	1061		10.102293	
7	2	17	94.6	1015		10.838666	

Bin5 Statistics 12

Trial #	Pulse	Chirp (MHz)	Pulse Width (µS)	Pulse 1-2 spacing (uS)	Pulse 2-3 spacing (uS)	Pulse Start(S)	Detection (1:yes; 0:no)
0	2	19	78.8	1204		0.444289	1
1	2	19	58.8	1678		1.123063	
2	1	19	83			3.183442	
3	2	19	86	1332		4.323543	
4	3	19	82.9	1455	1662	4.674274	
5	2	19	94.8	1459		5.88955	
6	2	19	92.9	1566		6.837713	
7	1	19	87.4			8.49018	
8	2	19	96.5	1462		9.458773	
9	2	19	52.2	1700		10.101575	
10	3	19	73.4	1838	1228	11.07788	

Bin5 Statistics 13

Trial #	Pulse	Chirp (MHz)	Pulse Width (µS)	Pulse 1-2 spacing (uS)	Pulse 2-3 spacing (uS)	Pulse Start(S)	Detection (1:yes; 0:no)
0	3	19	92.7	1718	1629	0.221704	1
1	3	19	72.2	1406	1530	0.690099	
2	3	19	99.7	1666	1277	1.459575	
3	2	19	58.3	1328		2.492039	
4	1	19	61.6			2.680621	
5	2	19	62	1040		3.93778	
6	2	19	71.9	1482		4.480331	
7	2	19	58.6	1315		5.022669	
8	2	19	81.1	1401		5.69392	
9	1	19	54.7			6.197383	
10	1	19	82.7			7.040203	
11	2	19	85	1078		7.494855	
12	2	19	84.6	1689		8.213544	
13	3	19	65.5	1599	1201	9.098085	
14	1	19	87.5			9.693456	
15	2	19	61.9	1773		10.379264	
16	2	19	58.4	1404		11.000298	
17	3	19	52.4	1346	1502	11.911221	

Bin5 Statistics 14

Trial #	Pulse	Chirp (MHz)	Pulse Width (µS)	Pulse 1-2 spacing (uS)	Pulse 2-3 spacing (uS)	Pulse Start(S)	Detection (1:yes; 0:no)
0	2	10	96	1443		0.095055	1
1	2	10	82.1	1048		1.40567	
2	2	10	65.5	1648		2.717669	
3	1	10	57.1			3.827866	
4	3	10	71.5	1302	1033	4.927288	
5	3	10	77.9	1842	1468	5.638448	
6	2	10	92.3	1085		7.036326	
7	1	10	84.9			8.32542	
8	3	10	96	1199	1088	9.471017	
9	3	10	85.8	1630	1163	10.643891	
10	3	10	63.6	1530	1838	11.881646	

Bin5 Statistics 15

Trial #	Pulse	Chirp (MHz)	Pulse Width (µS)	Pulse 1-2 spacing (uS)	Pulse 2-3 spacing (uS)	Pulse Start(S)	Detection (1:yes; 0:no)
0	1	7	84.3			0.588917	1
1	3	7	68.7	1369	1408	0.766521	
2	2	7	80.2	1466		1.530814	
3	2	7	56	1986		2.054756	
4	2	7	50.1	1162		3.078143	
5	2	7	53.1	1805		3.506182	
6	1	7	58.6			4.620635	
7	2	7	85.2	1817		5.105298	
8	2	7	73.3	1184		5.761425	
9	2	7	70	1160		6.032778	
10	2	7	65.4	1975		7.057654	
11	2	7	91.5	1264		7.603652	
12	2	7	74.3	1072		8.343406	
13	1	7	75.7			9.272659	
14	2	7	51	1036		9.958723	
15	3	7	66.5	1976	1445	10.645011	
16	3	7	77.2	1104	1176	11.066088	
17	3	7	93	1221	1460	11.868239	

Bin5 Statistics 16

Trial #	Pulse	Chirp (MHz)	Pulse Width (µS)	Pulse 1-2 spacing (uS)	Pulse 2-3 spacing (uS)	Pulse Start(S)	Detection (1:yes; 0:no)
0	2	11	76.2	1448		0.19137	1
1	2	11	87.6	1909		2.515671	
2	1	11	66			3.411359	
3	2	11	54.3	1651		4.22528	
4	2	11	79.2	1279		5.584057	
5	1	11	67.6			6.834444	
6	2	11	53	1678		8.750072	
7	2	11	52.4	1705		10.208939	
8	2	11	64.6	1360		11.949417	

Bin5 Statistics 17

Trial #	Pulse	Chirp (MHz)	Pulse Width (µS)	Pulse 1-2 spacing (uS)	Pulse 2-3 spacing (uS)	Pulse Start(S)	Detection (1:yes; 0:no)
0	2	14	86.1	1644		0.405215	1
1	2	14	85.9	1464		1.10521	
2	3	14	59.9	1857	1033	2.731388	
3	1	14	69.7			3.017903	
4	1	14	51.7			4.54922	
5	2	14	92.4	1866		5.298466	
6	2	14	79.8	1524		5.70823	
7	2	14	51.6	1290		7.18012	
8	2	14	61.3	1347		7.768496	
9	1	14	87			8.355446	
10	2	14	93.8	1516		9.270045	
11	3	14	94.1	1850	1299	10.471782	
12	1	14	76			11.369912	

Bin5 Statistics 18

Trial #	Pulse	Chirp (MHz)	Pulse Width (µS)	Pulse 1-2 spacing (uS)	Pulse 2-3 spacing (uS)	Pulse Start(S)	Detection (1:yes; 0:no)
0	2	14	94.8	1562		0.84989	1
1	2	14	68.5	1835		1.419077	
2	2	14	60.4	1095		2.793841	
3	2	14	79.1	1228		3.002404	
4	2	14	79.1	1124		4.013533	
5	3	14	84.1	1186	1899	5.985233	
6	2	14	100	1929		6.248047	
7	2	14	70	1709		7.898487	
8	3	14	63.6	1363	1260	8.428336	
9	1	14	92.3			9.898605	
10	1	14	50.4			10.730594	
11	3	14	51.1	1073	1688	11.743566	

Bin5 Statistics 19

Trial #	Pulse	Chirp (MHz)	Pulse Width (µS)	Pulse 1-2 spacing (uS)	Pulse 2-3 spacing (uS)	Pulse Start(S)	Detection (1:yes; 0:no)
0	3	17	82.9	1349	1370	0.451466	1
1	2	17	88.3	1460		1.410953	
2	3	17	78.1	1110	1986	1.962451	
3	3	17	71.8	1757	1858	2.501373	
4	1	17	56			3.443773	
5	3	17	51	1682	1893	4.331797	
6	2	17	59.1	1582		4.769829	
7	1	17	53.9			5.736558	
8	3	17	87.9	1955	1096	6.49978	
9	3	17	88.6	1817	1581	7.445325	
10	2	17	74.3	1877		7.657758	
11	3	17	56.4	1634	1367	8.988303	
12	2	17	96.9	1519		9.058396	
13	3	17	82.4	1366	1415	9.944154	
14	2	17	55.1	1705		10.831089	
15	2	17	84.3	1311		11.691391	

Bin5 Statistics 20

Trial #	Pulse	Chirp (MHz)	Pulse Width (µS)	Pulse 1-2 spacing (uS)	Pulse 2-3 spacing (uS)	Pulse Start(S)	Detection (1:yes; 0:no)
0	2	18	97.7	1430		0.235654	1
1	1	18	90.5			0.8155	
2	2	18	76.1	1502		1.596109	
3	1	18	93.1			2.229375	
4	1	18	90.3			2.633395	
5	3	18	99.5	1344	1982	3.424394	
6	1	18	62.8			4.04222	
7	2	18	95.9	1042		4.654467	
8	1	18	72.7			5.053602	
9	2	18	66.7	1139		5.705693	
10	2	18	79.7	1126		6.798026	
11	1	18	96.9			7.529494	
12	2	18	73.9	1605		7.582441	
13	2	18	59.6	1888		8.724698	
14	2	18	63.8	1032		8.990046	
15	3	18	80.1	1443	1541	9.665076	
16	1	18	81.3			10.521783	
17	3	18	75.4	1701	1033	10.869719	
18	3	18	58.4	1832	1123	11.754209	

Bin5 Statistics 21

Trial #	Pulse	Chirp (MHz)	Pulse Width (µS)	Pulse 1-2 spacing (uS)	Pulse 2-3 spacing (uS)	Pulse Start(S)	Detection (1:yes; 0:no)
0	2	5	81.7	1186		0.869324	1
1	2	5	59.8	1461		1.015883	
2	1	5	80			1.916974	
3	3	5	69.5	1263	1298	3.076271	
4	2	5	71.6	1694		3.822147	
5	1	5	57.7			5.112292	
6	3	5	74.2	1883	1752	5.985875	
7	2	5	50.4	1218		6.608413	
8	3	5	63	1760	1088	8.247268	
9	1	5	94.2			8.926408	
10	1	5	59.1			9.700475	
11	2	5	74	1015		10.850968	
12	1	5	88.7			11.340336	

Bin5 Statistics 22

Trial #	Pulse	Chirp (MHz)	Pulse Width (µS)	Pulse 1-2 spacing (uS)	Pulse 2-3 spacing (uS)	Pulse Start(S)	Detection (1:yes; 0:no)
0	2	18	53.8	1200		0.475037	1
1	2	18	58.9	1173		1.862203	
2	3	18	82.1	1698	1284	3.217976	
3	3	18	59.1	1998	1546	3.566719	
4	2	18	63.1	1067		5.383108	
5	2	18	67.9	1042		6.016199	
6	2	18	92.1	1715		7.074174	
7	1	18	55.2			8.147466	
8	2	18	61.8	1237		9.640823	
9	3	18	72.3	1319	1886	10.493147	
10	3	18	51.6	1230	1288	11.099948	

Bin5 Statistics 23

Trial #	Pulse	Chirp (MHz)	Pulse Width (µS)	Pulse 1-2 spacing (uS)	Pulse 2-3 spacing (uS)	Pulse Start(S)	Detection (1:yes; 0:no)
0	1	11	93.9			0.100807	1
1	3	11	69.7	1460	1025	1.199879	
2	1	11	52			1.740294	
3	2	11	78.2	1394		2.390405	
4	3	11	98.8	1911	1608	2.809661	
5	3	11	59.4	1085	1938	3.961095	
6	1	11	81.1			4.407091	
7	2	11	87.9	1878		4.937913	
8	2	11	59.2	1738		5.499177	
9	2	11	71.8	1276		6.62793	
10	2	11	80.3	1895		7.311242	
11	3	11	77.9	1356	1611	7.88331	
12	2	11	70.1	1314		8.276059	
13	3	11	65.9	1913	1711	8.719314	
14	2	11	81.1	1906		9.609539	
15	3	11	73.5	1466	1883	10.177875	
16	2	11	82.3	1086		11.172532	
17	2	11	85	1397		11.518118	

Bin5 Statistics 24

Trial #	Pulse	Chirp (MHz)	Pulse Width (µS)	Pulse 1-2 spacing (uS)	Pulse 2-3 spacing (uS)	Pulse Start(S)	Detection (1:yes; 0:no)
0	1	7	50.2			0.658888	1
1	2	7	85.6	1151		1.510174	
2	1	7	92.4			2.21694	
3	1	7	69.3			3.353077	
4	2	7	77.7	1855		4.832482	
5	1	7	52			5.919936	
6	3	7	53.6	1764	1458	7.475638	
7	2	7	76.4	1170		7.830673	
8	2	7	59.1	1524		9.663963	
9	2	7	94.6	1107		9.934804	
10	2	7	87.9	1534		11.298521	

Bin5 Statistics 25

Trial #	Pulse	Chirp (MHz)	Pulse Width (µS)	Pulse 1-2 spacing (uS)	Pulse 2-3 spacing (uS)	Pulse Start(S)	Detection (1:yes; 0:no)
0	2	7	76.5	1911		0.654103	1
1	1	7	53			0.723086	
2	1	7	65.7			1.867902	
3	1	7	66.8			2.051972	
4	2	7	63	1011		3.111246	
5	2	7	86.4	1026		3.702975	
6	2	7	81.5	1275		4.409372	
7	1	7	69.7			5.128408	
8	3	7	76.4	1306	1867	5.515172	
9	2	7	70.2	1253		6.37687	
10	2	7	94.6	1508		7.101036	
11	2	7	64.6	1038		7.605957	
12	1	7	56.7			8.237172	
13	2	7	95.6	1038		8.919003	
14	3	7	50.8	1469	1942	9.703678	
15	2	7	89.2	1271		10.540726	
16	3	7	58.9	1055	1973	11.146985	
17	1	7	99.9			11.552363	

Bin5 Statistics 26

Trial #	Pulse	Chirp (MHz)	Pulse Width (µS)	Pulse 1-2 spacing (uS)	Pulse 2-3 spacing (uS)	Pulse Start(S)	Detection (1:yes; 0:no)
0	2	13	57	1620		0.534707	1
1	2	13	97.3	1408		1.113658	
2	1	13	98.6			1.691874	
3	1	13	79			2.41853	
4	2	13	53.2	1053		2.856986	
5	1	13	74.4			3.64855	
6	1	13	73.1			4.830091	
7	3	13	68.1	1687	1147	5.348367	
8	3	13	64.9	1520	1812	6.145534	
9	3	13	96.9	1622	1371	6.481794	
10	2	13	94.4	1318		7.145123	
11	3	13	92.5	1124	1938	8.230907	
12	2	13	80.3	1179		8.67466	
13	1	13	91.7			9.860616	
14	3	13	82.7	1123	1960	10.42873	
15	3	13	73.1	1716	1246	11.066613	
16	3	13	50.4	1490	1591	11.934288	

Bin5 Statistics 27

Trial #	Pulse	Chirp (MHz)	Pulse Width (µS)	Pulse 1-2 spacing (uS)	Pulse 2-3 spacing (uS)	Pulse Start(S)	Detection (1:yes; 0:no)
0	2	17	58.3	1290		0.114667	1
1	3	17	69.7	1668	1896	2.699558	
2	2	17	61.8	1671		4.401104	
3	1	17	76.3			5.100814	
4	3	17	76.1	1175	1003	6.868335	
5	1	17	95			8.075786	
6	2	17	91.5	1688		9.790387	
7	2	17	73.5	1952		11.378952	

Bin5 Statistics 28

Trial #	Pulse	Chirp (MHz)	Pulse Width (µS)	Pulse 1-2 spacing (uS)	Pulse 2-3 spacing (uS)	Pulse Start(S)	Detection (1:yes; 0:no)
0	3	13	87.4	1577	1087	0.559422	1
1	2	13	70.4	1782		2.002165	
2	1	13	88.2			2.351372	
3	2	13	65.7	1819		4.238843	
4	2	13	54.5	1504		4.780438	
5	2	13	86.6	1729		5.47202	
6	3	13	66.1	1579	1421	6.97599	
7	3	13	52	1845	1787	8.161827	
8	3	13	72.6	1589	1599	9.319616	
9	1	13	58.2			10.126362	
10	1	13	81.9			11.399279	

Bin5 Statistics 29

Trial #	Pulse	Chirp (MHz)	Pulse Width (µS)	Pulse 1-2 spacing (uS)	Pulse 2-3 spacing (uS)	Pulse Start(S)	Detection (1:yes; 0:no)
0	2	7	78.3	1346		0.313465	1
1	2	7	54	1485		1.063128	
2	1	7	63.4			1.869059	
3	2	7	84.6	1047		3.049342	
4	2	7	91.6	1917		3.561535	
5	2	7	75.5	1823		4.964172	
6	2	7	57.7	1208		5.761238	
7	2	7	88.7	1587		6.3168	
8	1	7	54.3			7.050861	
9	2	7	63.6	1443		8.304038	
10	3	7	95	1877	1939	8.713713	
11	1	7	80.8			9.448758	
12	2	7	67.3	1332		10.652926	
13	1	7	78.5			11.746141	

Bin5 Statistics 30

Trial #	Pulse	Chirp (MHz)	Pulse Width (µS)	Pulse 1-2 spacing (uS)	Pulse 2-3 spacing (uS)	Pulse Start(S)	Detection (1:yes; 0:no)
0	3	9	85.5	1698	1804	0.083199	1
1	2	9	74.3	1277		1.245934	
2	2	9	64.7	1910		1.842377	
3	2	9	60.8	1338		2.115757	
4	2	9	77.1	1010		2.536323	
5	2	9	74.8	1158		3.634663	
6	3	9	78.3	1453	1157	4.007184	
7	3	9	88.7	1199	1334	4.871929	
8	2	9	52.8	1229		5.457895	
9	2	9	99.7	1816		6.100662	
10	2	9	76.5	1425		6.884658	
11	2	9	59.9	1114		6.97156	
12	2	9	51	1393		7.881245	
13	2	9	81.1	1488		8.360586	
14	3	9	84.1	1140	1676	8.985584	
15	3	9	83	1087	1867	10.009585	
16	2	9	84.5	1944		10.357939	
17	2	9	82.2	1320		10.78469	
18	3	9	67.6	1375	1508	11.792114	

Table-6 Radar Type 6 Statistical Performance

Trial #	Fc (MHz)	Pulse /Burst	Pulse Width (µS)	PRI (µs)	Detection (1:yes; 0:no)	Hopping Sequence
1	5270	9	1	333	1	5486.0, 5310.0, 5274.0, 5254.0, 5572.0, 5278.0, 5279.0, 5516.0, 5355.0, 5346.0, 5482.0, 5289.0, 5523.0, 5379.0, 5457.0, 5694.0, 5421.0, 5649.0, 5576.0, 5464.0, 5471.0, 5674.0, 5571.0, 5710.0, 5336.0, 5315.0, 5479.0, 5385.0, 5477.0, 5329.0, 5388.0, 5460.0, 5695.0, 5305.0, 5512.0, 5618.0, 5397.0, 5474.0, 5347.0, 5670.0, 5705.0, 5409.0, 5723.0, 5251.0, 5554.0, 5481.0, 5434.0, 5301.0, 5320.0, 5563.0, 5318.0, 5424.0, 5614.0, 5609.0, 5304.0, 5602.0, 5323.0, 5619.0, 5381.0, 5500.0, 5605.0, 5256.0, 5520.0, 5721.0, 5588.0, 5393.0, 5255.0, 5562.0, 5317.0, 5684.0, 5340.0, 5343.0, 5529.0, 5361.0, 5384.0, 5364.0, 5325.0, 5344.0, 5370.0, 5664.0, 5447.0, 5253.0, 5334.0, 5396.0, 5652.0, 5470.0, 5371.0, 5498.0, 5631.0, 5483.0, 5534.0, 5442.0, 5440.0, 5704.0, 5398.0, 5319.0, 5258.0, 5260.0, 5579.0, 5505.0 (number of hits: 11)
2	5270	9	1	333	1	5354.0, 5520.0, 5460.0, 5689.0, 5702.0, 5439.0, 5573.0, 5275.0, 5364.0, 5349.0, 5654.0, 5511.0, 5382.0, 5467.0, 5499.0, 5671.0, 5444.0, 5682.0, 5568.0, 5550.0, 5253.0, 5665.0, 5524.0, 5705.0, 5541.0, 5330.0, 5410.0, 5429.0, 5322.0, 5692.0, 5296.0, 5601.0, 5566.0, 5255.0, 5563.0, 5663.0, 5564.0, 5669.0, 5483.0, 5503.0, 5450.0, 5423.0, 5496.0, 5547.0, 5639.0, 5584.0, 5537.0, 5498.0, 5622.0, 5311.0, 5615.0, 5331.0, 5276.0, 5542.0, 5268.0, 5522.0, 5508.0, 5434.0, 5427.0, 5254.0, 5512.0, 5474.0, 5535.0, 5263.0, 5618.0, 5341.0, 5581.0, 5696.0, 5586.0, 5381.0, 5291.0, 5551.0, 5577.0, 5290.0, 5458.0, 5433.0, 5701.0, 5531.0, 5488.0, 5374.0, 5530.0, 5553.0, 5375.0, 5614.0, 5491.0, 5327.0, 5623.0, 5620.0, 5612.0, 5684.0, 5329.0, 5310.0, 5493.0, 5592.0, 5629.0, 5494.0, 5326.0, 5321.0, 5456.0, 5596.0 (number of hits: 7)
3	5270	9	1	333	1	5721.0, 5618.0, 5339.0, 5540.0, 5536.0, 5295.0, 5502.0, 5360.0, 5585.0, 5706.0, 5363.0, 5635.0, 5522.0, 5601.0, 5722.0, 5661.0, 5311.0, 5657.0, 5283.0, 5541.0, 5469.0, 5381.0, 5511.0, 5278.0, 5503.0, 5617.0, 5696.0, 5626.0, 5367.0, 5336.0, 5583.0, 5483.0, 5566.0, 5644.0, 5286.0, 5419.0, 5393.0, 5252.0, 5327.0, 5477.0, 5374.0, 5261.0, 5377.0, 5428.0, 5253.0, 5525.0, 5291.0, 5612.0, 5560.0, 5318.0, 5330.0, 5642.0, 5356.0, 5580.0, 5500.0, 5281.0, 5543.0, 5556.0, 5660.0, 5639.0, 5674.0, 5251.0, 5686.0, 5695.0, 5274.0, 5620.0, 5345.0, 5328.0, 5444.0, 5491.0,

						5645.0, 5309.0, 5710.0, 5516.0, 5277.0, 5405.0, 5646.0, 5322.0, 5476.0, 5272.0, 5410.0, 5523.0, 5285.0, 5325.0, 5604.0, 5454.0, 5269.0, 5509.0, 5507.0, 5263.0, 5718.0, 5358.0, 5513.0, 5651.0, 5514.0, 5680.0, 5418.0, 5323.0, 5577.0, 5402.0 (number of hits: 14)
4	5270	9	1	333	1	5377.0, 5521.0, 5446.0, 5408.0, 5372.0, 5322.0, 5443.0, 5525.0, 5319.0, 5610.0, 5686.0, 5679.0, 5467.0, 5608.0, 5343.0, 5524.0, 5717.0, 5268.0, 5308.0, 5294.0, 5353.0, 5283.0, 5532.0, 5355.0, 5566.0, 5591.0, 5606.0, 5291.0, 5332.0, 5700.0, 5561.0, 5436.0, 5293.0, 5504.0, 5345.0, 5638.0, 5567.0, 5654.0, 5407.0, 5422.0, 5682.0, 5657.0, 5405.0, 5503.0, 5344.0, 5342.0, 5511.0, 5290.0, 5549.0, 5646.0, 5303.0, 5352.0, 5390.0, 5393.0, 5596.0, 5668.0, 5449.0, 5664.0, 5643.0, 5557.0, 5270.0, 5696.0, 5515.0, 5280.0, 5568.0, 5359.0, 5471.0, 5615.0, 5663.0, 5438.0, 5466.0, 5554.0, 5306.0, 5612.0, 5578.0, 5672.0, 5364.0, 5671.0, 5305.0, 5684.0, 5362.0, 5274.0, 5617.0, 5605.0, 5464.0, 5480.0, 5498.0, 5718.0, 5673.0, 5623.0, 5313.0, 5655.0, 5451.0, 5386.0, 5399.0, 5275.0, 5347.0, 5582.0, 5418.0, 5548.0 (number of hits: 6)
5	5270	9	1	333	1	5297.0, 5497.0, 5257.0, 5607.0, 5676.0, 5429.0, 5653.0, 5476.0, 5474.0, 5397.0, 5378.0, 5708.0, 5327.0, 5592.0, 5448.0, 5256.0, 5259.0, 5266.0, 5469.0, 5424.0, 5515.0, 5538.0, 5309.0, 5425.0, 5267.0, 5430.0, 5404.0, 5661.0, 5718.0, 5348.0, 5529.0, 5260.0, 5558.0, 5678.0, 5463.0, 5347.0, 5550.0, 5495.0, 5487.0, 5273.0, 5555.0, 5587.0, 5622.0, 5418.0, 5468.0, 5680.0, 5697.0, 5383.0, 5480.0, 5374.0, 5700.0, 5471.0, 5417.0, 5477.0, 5330.0, 5388.0, 5336.0, 5372.0, 5722.0, 5255.0, 5638.0, 5433.0, 5656.0, 5342.0, 5472.0, 5333.0, 5709.0, 5419.0, 5305.0, 5461.0, 5328.0, 5534.0, 5639.0, 5672.0, 5314.0, 5688.0, 5599.0, 5320.0, 5633.0, 5283.0, 5684.0, 5692.0, 5539.0, 5373.0, 5531.0, 5606.0, 5574.0, 5516.0, 5528.0, 5325.0, 5518.0, 5649.0, 5643.0, 5590.0, 5646.0, 5449.0, 5386.0, 5581.0, 5719.0, 5462.0 (number of hits: 9)
6	5270	9	1	333	1	5400.0, 5371.0, 5532.0, 5580.0, 5445.0, 5413.0, 5341.0, 5720.0, 5381.0, 5495.0, 5565.0, 5327.0, 5269.0, 5723.0, 5318.0, 5602.0, 5304.0, 5377.0, 5405.0, 5404.0, 5395.0, 5308.0, 5419.0, 5389.0, 5656.0, 5475.0, 5676.0, 5271.0, 5303.0, 5514.0, 5548.0, 5432.0, 5503.0, 5460.0, 5598.0, 5563.0, 5597.0, 5345.0, 5280.0, 5672.0, 5627.0, 5516.0, 5689.0, 5543.0, 5717.0, 5382.0, 5607.0, 5623.0, 5625.0, 5365.0, 5334.0, 5251.0, 5295.0, 5652.0, 5639.0, 5619.0, 5641.0, 5659.0, 5330.0, 5575.0,

						5601.0, 5675.0, 5669.0, 5584.0, 5468.0, 5564.0, 5490.0, 5558.0, 5498.0, 5705.0, 5378.0, 5631.0, 5521.0, 5420.0, 5528.0, 5436.0, 5658.0, 5673.0, 5713.0, 5666.0, 5346.0, 5259.0, 5589.0, 5612.0, 5549.0, 5328.0, 5679.0, 5645.0, 5469.0, 5628.0, 5529.0, 5681.0, 5482.0, 5454.0, 5385.0, 5527.0, 5316.0, 5296.0, 5398.0, 5605.0 (number of hits: 5)
7	5270	9	1	333	1	5610.0, 5423.0, 5443.0, 5350.0, 5432.0, 5299.0, 5337.0, 5366.0, 5646.0, 5507.0, 5503.0, 5442.0, 5465.0, 5592.0, 5453.0, 5519.0, 5316.0, 5506.0, 5368.0, 5335.0, 5642.0, 5341.0, 5557.0, 5458.0, 5280.0, 5532.0, 5700.0, 5719.0, 5650.0, 5723.0, 5365.0, 5581.0, 5446.0, 5491.0, 5520.0, 5682.0, 5620.0, 5570.0, 5685.0, 5300.0, 5591.0, 5355.0, 5343.0, 5713.0, 5298.0, 5304.0, 5674.0, 5272.0, 5677.0, 5327.0, 5572.0, 5314.0, 5698.0, 5720.0, 5606.0, 5409.0, 5317.0, 5648.0, 5510.0, 5422.0, 5474.0, 5601.0, 5301.0, 5661.0, 5308.0, 5563.0, 5357.0, 5690.0, 5467.0, 5338.0, 5421.0, 5701.0, 5614.0, 5374.0, 5561.0, 5379.0, 5267.0, 5396.0, 5603.0, 5647.0, 5504.0, 5460.0, 5488.0, 5329.0, 5344.0, 5436.0, 5616.0, 5411.0, 5678.0, 5667.0, 5516.0, 5264.0, 5345.0, 5602.0, 5269.0, 5567.0, 5522.0, 5331.0, 5534.0, 5513.0 (number of hits: 5)
8	5270	9	1	333	1	5255.0, 5604.0, 5360.0, 5417.0, 5429.0, 5593.0, 5568.0, 5639.0, 5711.0, 5629.0, 5517.0, 5526.0, 5583.0, 5705.0, 5637.0, 5569.0, 5310.0, 5274.0, 5652.0, 5654.0, 5696.0, 5487.0, 5675.0, 5525.0, 5690.0, 5721.0, 5655.0, 5315.0, 5616.0, 5395.0, 5633.0, 5488.0, 5506.0, 5680.0, 5553.0, 5716.0, 5609.0, 5714.0, 5618.0, 5638.0, 5715.0, 5722.0, 5443.0, 5335.0, 5685.0, 5493.0, 5346.0, 5645.0, 5391.0, 5533.0, 5382.0, 5576.0, 5325.0, 5342.0, 5551.0, 5666.0, 5686.0, 5542.0, 5597.0, 5656.0, 5455.0, 5374.0, 5336.0, 5411.0, 5422.0, 5332.0, 5676.0, 5577.0, 5509.0, 5713.0, 5653.0, 5636.0, 5370.0, 5723.0, 5489.0, 5513.0, 5534.0, 5650.0, 5378.0, 5423.0, 5607.0, 5470.0, 5330.0, 5321.0, 5270.0, 5311.0, 5565.0, 5657.0, 5260.0, 5447.0, 5497.0, 5365.0, 5284.0, 5615.0, 5689.0, 5541.0, 5704.0, 5328.0, 5648.0, 5326.0 (number of hits: 5)
9	5270	9	1	333	1	5399.0, 5661.0, 5690.0, 5474.0, 5615.0, 5337.0, 5402.0, 5599.0, 5316.0, 5370.0, 5616.0, 5287.0, 5315.0, 5293.0, 5269.0, 5618.0, 5297.0, 5607.0, 5314.0, 5257.0, 5368.0, 5397.0, 5524.0, 5515.0, 5568.0, 5556.0, 5494.0, 5652.0, 5358.0, 5255.0, 5554.0, 5518.0, 5386.0, 5526.0, 5338.0, 5696.0, 5465.0, 5643.0, 5715.0, 5455.0, 5575.0, 5369.0, 5563.0, 5644.0, 5509.0, 5701.0, 5606.0, 5697.0, 5387.0, 5295.0

						5317.0, 5457.0, 5639.0, 5342.0, 5657.0, 5273.0, 5447.0, 5463.0, 5418.0, 5473.0, 5550.0, 5580.0, 5502.0, 5469.0, 5384.0, 5662.0, 5513.0, 5500.0, 5329.0, 5432.0, 5544.0, 5322.0, 5678.0, 5493.0, 5549.0, 5347.0, 5596.0, 5256.0, 5635.0, 5400.0, 5414.0, 5510.0, 5722.0, 5504.0, 5718.0, 5307.0, 5429.0, 5623.0, 5637.0, 5682.0, 5536.0, 5401.0, 5498.0, 5392.0, 5605.0, 5304.0, 5658.0, 5446.0, 5483.0, 5382.0 (number of hits: 6)
10	5270	9	1	333	1	5304.0, 5319.0, 5723.0, 5502.0, 5563.0, 5600.0, 5531.0, 5673.0, 5343.0, 5699.0, 5649.0, 5650.0, 5561.0, 5644.0, 5419.0, 5342.0, 5433.0, 5478.0, 5428.0, 5261.0, 5310.0, 5715.0, 5708.0, 5452.0, 5439.0, 5455.0, 5383.0, 5665.0, 5257.0, 5492.0, 5382.0, 5457.0, 5398.0, 5465.0, 5491.0, 5294.0, 5265.0, 5357.0, 5658.0, 5607.0, 5599.0, 5326.0, 5295.0, 5632.0, 5620.0, 5722.0, 5610.0, 5260.0, 5474.0, 5252.0, 5473.0, 5333.0, 5300.0, 5572.0, 5306.0, 5479.0, 5533.0, 5603.0, 5381.0, 5707.0, 5338.0, 5580.0, 5345.0, 5615.0, 5611.0, 5505.0, 5420.0, 5336.0, 5621.0, 5537.0, 5477.0, 5351.0, 5692.0, 5717.0, 5344.0, 5627.0, 5592.0, 5651.0, 5323.0, 5576.0, 5388.0, 5269.0, 5678.0, 5551.0, 5574.0, 5521.0, 5285.0, 5511.0, 5432.0, 5597.0, 5569.0, 5389.0, 5429.0, 5447.0, 5275.0, 5365.0, 5377.0, 5411.0, 5312.0, 5475.0 (number of hits: 8)
11	5250	9	1	333	1	5520.0, 5608.0, 5472.0, 5618.0, 5527.0, 5334.0, 5621.0, 5351.0, 5455.0, 5721.0, 5468.0, 5607.0, 5531.0, 5636.0, 5298.0, 5663.0, 5464.0, 5318.0, 5319.0, 5711.0, 5559.0, 5637.0, 5659.0, 5503.0, 5465.0, 5404.0, 5342.0, 5339.0, 5350.0, 5291.0, 5670.0, 5305.0, 5475.0, 5715.0, 5405.0, 5365.0, 5458.0, 5270.0, 5501.0, 5446.0, 5691.0, 5504.0, 5289.0, 5352.0, 5252.0, 5470.0, 5373.0, 5391.0, 5412.0, 5482.0, 5435.0, 5650.0, 5301.0, 5353.0, 5456.0, 5471.0, 5406.0, 5258.0, 5491.0, 5493.0, 5476.0, 5648.0, 5656.0, 5695.0, 5283.0, 5267.0, 5611.0, 5703.0, 5263.0, 5381.0, 5502.0, 5295.0, 5631.0, 5597.0, 5622.0, 5303.0, 5279.0, 5589.0, 5370.0, 5639.0, 5282.0, 5265.0, 5683.0, 5356.0, 5509.0, 5419.0, 5718.0, 5654.0, 5549.0, 5553.0, 5254.0, 5463.0, 5609.0, 5545.0, 5712.0, 5562.0, 5682.0, 5453.0, 5275.0, 5480.0 (number of hits: 6)
12	5250	9	1	333	1	5433.0, 5691.0, 5578.0, 5296.0, 5268.0, 5551.0, 5342.0, 5643.0, 5388.0, 5297.0, 5328.0, 5510.0, 5685.0, 5647.0, 5298.0, 5721.0, 5633.0, 5288.0, 5502.0, 5635.0, 5396.0, 5495.0, 5528.0, 5381.0, 5444.0, 5711.0, 5392.0, 5490.0, 5337.0, 5384.0, 5521.0, 5611.0, 5382.0, 5524.0, 5461.0, 5405.0, 5638.0, 5654.0, 5572.0, 5423.0

						5374.0, 5493.0, 5541.0, 5432.0, 5463.0, 5581.0, 5690.0, 5713.0, 5554.0, 5592.0, 5275.0, 5259.0, 5343.0, 5363.0, 5486.0, 5336.0, 5285.0, 5670.0, 5586.0, 5514.0, 5464.0, 5605.0, 5642.0, 5580.0, 5602.0, 5302.0, 5255.0, 5359.0, 5577.0, 5570.0, 5344.0, 5311.0, 5482.0, 5284.0, 5500.0, 5492.0, 5596.0, 5671.0, 5702.0, 5682.0, 5558.0, 5316.0, 5614.0, 5289.0, 5699.0, 5641.0, 5307.0, 5693.0, 5389.0, 5529.0, 5608.0, 5345.0, 5471.0, 5294.0, 5404.0, 5313.0, 5299.0, 5282.0, 5430.0, 5488.0 (number of hits: 3)
13	5250	9	1	333	1	5495.0, 5515.0, 5554.0, 5321.0, 5481.0, 5520.0, 5553.0, 5432.0, 5557.0, 5490.0, 5691.0, 5290.0, 5328.0, 5556.0, 5400.0, 5439.0, 5579.0, 5724.0, 5673.0, 5413.0, 5426.0, 5263.0, 5680.0, 5463.0, 5582.0, 5635.0, 5532.0, 5485.0, 5342.0, 5343.0, 5716.0, 5715.0, 5683.0, 5456.0, 5573.0, 5374.0, 5271.0, 5437.0, 5457.0, 5622.0, 5425.0, 5389.0, 5356.0, 5580.0, 5510.0, 5428.0, 5516.0, 5310.0, 5376.0, 5514.0, 5468.0, 5403.0, 5419.0, 5312.0, 5378.0, 5477.0, 5295.0, 5615.0, 5668.0, 5416.0, 5636.0, 5639.0, 5708.0, 5420.0, 5722.0, 5517.0, 5473.0, 5684.0, 5588.0, 5305.0, 5503.0, 5309.0, 5704.0, 5534.0, 5652.0, 5449.0, 5406.0, 5408.0, 5252.0, 5528.0, 5714.0, 5721.0, 5383.0, 5571.0, 5524.0, 5607.0, 5486.0, 5578.0, 5695.0, 5264.0, 5469.0, 5572.0, 5667.0, 5422.0, 5332.0, 5409.0, 5398.0, 5421.0, 5467.0, 5511.0 (number of hits: 3)
14	5250	9	1	333	1	5374.0, 5634.0, 5485.0, 5652.0, 5637.0, 5718.0, 5455.0, 5255.0, 5375.0, 5632.0, 5314.0, 5331.0, 5510.0, 5423.0, 5477.0, 5675.0, 5295.0, 5573.0, 5372.0, 5679.0, 5536.0, 5615.0, 5348.0, 5706.0, 5639.0, 5695.0, 5269.0, 5606.0, 5651.0, 5633.0, 5550.0, 5476.0, 5449.0, 5712.0, 5384.0, 5521.0, 5432.0, 5523.0, 5336.0, 5338.0, 5624.0, 5667.0, 5324.0, 5563.0, 5318.0, 5386.0, 5686.0, 5280.0, 5694.0, 5322.0, 5444.0, 5539.0, 5266.0, 5392.0, 5621.0, 5524.0, 5412.0, 5581.0, 5709.0, 5499.0, 5714.0, 5533.0, 5566.0, 5450.0, 5290.0, 5409.0, 5555.0, 5373.0, 5359.0, 5399.0, 5487.0, 5595.0, 5497.0, 5440.0, 5605.0, 5720.0, 5302.0, 5430.0, 5538.0, 5427.0, 5647.0, 5685.0, 5250.0, 5626.0, 5358.0, 5467.0, 5496.0, 5371.0, 5655.0, 5654.0, 5273.0, 5716.0, 5383.0, 5708.0, 5260.0, 5410.0, 5607.0, 5312.0, 5333.0, 5562.0 (number of hits: 5)
15	5250	9	1	333	1	5505.0, 5401.0, 5509.0, 5266.0, 5672.0, 5556.0, 5296.0, 5468.0, 5545.0, 5702.0, 5382.0, 5688.0, 5656.0, 5331.0, 5689.0, 5559.0, 5393.0, 5541.0, 5708.0, 5637.0, 5290.0, 5516.0, 5622.0, 5565.0, 5512.0, 5683.0, 5723.0, 5527.0, 5589.0, 5292.0,

						5486.0, 5564.0, 5650.0, 5575.0, 5710.0, 5521.0, 5720.0, 5352.0, 5648.0, 5579.0, 5349.0, 5439.0, 5599.0, 5602.0, 5498.0, 5295.0, 5342.0, 5276.0, 5490.0, 5440.0, 5348.0, 5317.0, 5326.0, 5477.0, 5615.0, 5453.0, 5572.0, 5692.0, 5323.0, 5400.0, 5548.0, 5255.0, 5340.0, 5536.0, 5251.0, 5367.0, 5456.0, 5411.0, 5644.0, 5369.0, 5714.0, 5330.0, 5282.0, 5253.0, 5561.0, 5721.0, 5410.0, 5256.0, 5607.0, 5566.0, 5421.0, 5322.0, 5647.0, 5497.0, 5460.0, 5264.0, 5414.0, 5329.0, 5412.0, 5654.0, 5464.0, 5427.0, 5379.0, 5345.0, 5438.0, 5334.0, 5417.0, 5366.0, 5661.0, 5335.0 (number of hits: 6)
16	5250	9	1	333	1	5275.0, 5357.0, 5457.0, 5678.0, 5535.0, 5545.0, 5655.0, 5496.0, 5583.0, 5564.0, 5307.0, 5360.0, 5684.0, 5300.0, 5372.0, 5686.0, 5588.0, 5408.0, 5555.0, 5425.0, 5594.0, 5675.0, 5488.0, 5591.0, 5596.0, 5418.0, 5475.0, 5628.0, 5501.0, 5662.0, 5721.0, 5677.0, 5622.0, 5364.0, 5462.0, 5589.0, 5467.0, 5473.0, 5650.0, 5266.0, 5569.0, 5598.0, 5575.0, 5548.0, 5379.0, 5497.0, 5601.0, 5315.0, 5325.0, 5386.0, 5681.0, 5313.0, 5534.0, 5469.0, 5424.0, 5463.0, 5334.0, 5311.0, 5312.0, 5528.0, 5374.0, 5557.0, 5414.0, 5580.0, 5722.0, 5479.0, 5459.0, 5621.0, 5712.0, 5453.0, 5498.0, 5576.0, 5474.0, 5402.0, 5651.0, 5278.0, 5260.0, 5431.0, 5577.0, 5281.0, 5258.0, 5368.0, 5423.0, 5359.0, 5356.0, 5603.0, 5709.0, 5437.0, 5299.0, 5251.0, 5579.0, 5361.0, 5415.0, 5449.0, 5430.0, 5259.0, 5554.0, 5705.0, 5478.0, 5724.0 (number of hits: 5)
17	5250	9	1	333	1	5521.0, 5382.0, 5611.0, 5683.0, 5707.0, 5428.0, 5657.0, 5624.0, 5620.0, 5279.0, 5577.0, 5557.0, 5711.0, 5356.0, 5388.0, 5601.0, 5289.0, 5556.0, 5385.0, 5451.0, 5322.0, 5370.0, 5718.0, 5301.0, 5453.0, 5462.0, 5265.0, 5339.0, 5541.0, 5626.0, 5267.0, 5686.0, 5614.0, 5590.0, 5634.0, 5698.0, 5363.0, 5285.0, 5323.0, 5437.0, 5580.0, 5335.0, 5261.0, 5341.0, 5635.0, 5485.0, 5715.0, 5321.0, 5540.0, 5337.0, 5252.0, 5421.0, 5504.0, 5587.0, 5703.0, 5644.0, 5471.0, 5445.0, 5523.0, 5617.0, 5393.0, 5551.0, 5695.0, 5501.0, 5269.0, 5474.0, 5673.0, 5463.0, 5704.0, 5255.0, 5376.0, 5581.0, 5310.0, 5414.0, 5494.0, 5584.0, 5300.0, 5475.0, 5645.0, 5483.0, 5442.0, 5366.0, 5537.0, 5364.0, 5714.0, 5420.0, 5630.0, 5621.0, 5605.0, 5377.0, 5525.0, 5390.0, 5528.0, 5344.0, 5465.0, 5358.0, 5710.0, 5529.0, 5484.0, 5256.0 (number of hits: 7)
18	5250	9	1	333	1	5579.0, 5424.0, 5595.0, 5513.0, 5369.0, 5580.0, 5286.0, 5309.0, 5544.0, 5258.0, 5320.0, 5484.0, 5591.0, 5521.0, 5542.0, 5515.0, 5288.0, 5592.0, 5675.0, 5438.0,

						5573.0, 5389.0, 5377.0, 5720.0, 5583.0, 5552.0, 5713.0, 5402.0, 5490.0, 5305.0, 5700.0, 5613.0, 5701.0, 5418.0, 5692.0, 5671.0, 5664.0, 5356.0, 5316.0, 5569.0, 5443.0, 5593.0, 5633.0, 5290.0, 5400.0, 5501.0, 5385.0, 5649.0, 5351.0, 5704.0, 5267.0, 5282.0, 5639.0, 5430.0, 5604.0, 5615.0, 5557.0, 5446.0, 5529.0, 5480.0, 5495.0, 5414.0, 5403.0, 5295.0, 5531.0, 5376.0, 5311.0, 5410.0, 5451.0, 5299.0, 5670.0, 5494.0, 5723.0, 5263.0, 5520.0, 5354.0, 5275.0, 5359.0, 5655.0, 5616.0, 5518.0, 5470.0, 5676.0, 5404.0, 5452.0, 5601.0, 5417.0, 5461.0, 5273.0, 5661.0, 5349.0, 5293.0, 5597.0, 5423.0, 5609.0, 5618.0, 5563.0, 5537.0, 5289.0, 5523.0 (number of hits: 3)
19	5250	9	1	333	1	5385.0, 5276.0, 5558.0, 5270.0, 5337.0, 5555.0, 5454.0, 5508.0, 5377.0, 5703.0, 5561.0, 5482.0, 5333.0, 5491.0, 5322.0, 5329.0, 5284.0, 5347.0, 5666.0, 5716.0, 5586.0, 5631.0, 5466.0, 5296.0, 5272.0, 5328.0, 5415.0, 5417.0, 5397.0, 5412.0, 5283.0, 5475.0, 5717.0, 5311.0, 5485.0, 5505.0, 5565.0, 5278.0, 5262.0, 5307.0, 5439.0, 5434.0, 5455.0, 5344.0, 5521.0, 5313.0, 5265.0, 5695.0, 5293.0, 5710.0, 5460.0, 5584.0, 5353.0, 5303.0, 5427.0, 5447.0, 5481.0, 5723.0, 5256.0, 5523.0, 5416.0, 5355.0, 5494.0, 5638.0, 5568.0, 5288.0, 5490.0, 5630.0, 5254.0, 5694.0, 5553.0, 5488.0, 5345.0, 5597.0, 5601.0, 5374.0, 5453.0, 5383.0, 5570.0, 5261.0, 5386.0, 5302.0, 5452.0, 5609.0, 5424.0, 5691.0, 5469.0, 5693.0, 5646.0, 5551.0, 5279.0, 5446.0, 5492.0, 5655.0, 5471.0, 5560.0, 5268.0, 5611.0, 5451.0, 5461.0 (number of hits: 6)
20	5250	9	1	333	1	5692.0, 5419.0, 5583.0, 5593.0, 5536.0, 5364.0, 5262.0, 5600.0, 5703.0, 5512.0, 5270.0, 5647.0, 5382.0, 5444.0, 5363.0, 5534.0, 5265.0, 5575.0, 5367.0, 5426.0, 5552.0, 5633.0, 5258.0, 5660.0, 5273.0, 5623.0, 5524.0, 5466.0, 5619.0, 5350.0, 5458.0, 5667.0, 5548.0, 5370.0, 5539.0, 5538.0, 5395.0, 5448.0, 5620.0, 5261.0, 5457.0, 5581.0, 5283.0, 5615.0, 5255.0, 5253.0, 5454.0, 5459.0, 5250.0, 5483.0, 5626.0, 5506.0, 5649.0, 5289.0, 5371.0, 5630.0, 5564.0, 5384.0, 5465.0, 5412.0, 5526.0, 5545.0, 5646.0, 5393.0, 5528.0, 5365.0, 5518.0, 5435.0, 5666.0, 5608.0, 5423.0, 5341.0, 5404.0, 5680.0, 5315.0, 5696.0, 5471.0, 5305.0, 5580.0, 5641.0, 5390.0, 5496.0, 5556.0, 5562.0, 5477.0, 5687.0, 5251.0, 5715.0, 5530.0, 5577.0, 5379.0, 5461.0, 5629.0, 5565.0, 5342.0, 5522.0, 5398.0, 5360.0, 5601.0, 5336.0 (number of hits: 8)
21	5290	9	1	333	1	5503.0, 5494.0, 5450.0, 5462.0, 5383.0, 5510.0, 5418.0, 5671.0, 5474.0, 5670.0,

						5336.0, 5509.0, 5620.0, 5545.0, 5480.0, 5674.0, 5384.0, 5441.0, 5491.0, 5428.0, 5680.0, 5355.0, 5590.0, 5293.0, 5640.0, 5289.0, 5575.0, 5274.0, 5534.0, 5282.0, 5430.0, 5273.0, 5261.0, 5411.0, 5266.0, 5455.0, 5435.0, 5301.0, 5425.0, 5446.0, 5382.0, 5573.0, 5588.0, 5338.0, 5394.0, 5433.0, 5572.0, 5424.0, 5599.0, 5364.0, 5257.0, 5285.0, 5644.0, 5326.0, 5486.0, 5707.0, 5525.0, 5567.0, 5629.0, 5344.0, 5250.0, 5605.0, 5646.0, 5708.0, 5416.0, 5361.0, 5309.0, 5360.0, 5473.0, 5329.0, 5683.0, 5460.0, 5267.0, 5625.0, 5654.0, 5688.0, 5456.0, 5589.0, 5714.0, 5260.0, 5582.0, 5716.0, 5517.0, 5393.0, 5662.0, 5412.0, 5408.0, 5610.0, 5665.0, 5531.0, 5568.0, 5297.0, 5405.0, 5587.0, 5302.0, 5506.0, 5427.0, 5331.0, 5449.0, 5657.0 (number of hits: 10)
22	5290	9	1	333	1	5360.0, 5610.0, 5575.0, 5422.0, 5417.0, 5487.0, 5630.0, 5533.0, 5327.0, 5416.0, 5318.0, 5345.0, 5663.0, 5489.0, 5705.0, 5507.0, 5471.0, 5355.0, 5681.0, 5499.0, 5656.0, 5649.0, 5506.0, 5426.0, 5508.0, 5512.0, 5362.0, 5684.0, 5324.0, 5450.0, 5382.0, 5576.0, 5532.0, 5257.0, 5366.0, 5319.0, 5404.0, 5680.0, 5570.0, 5409.0, 5600.0, 5540.0, 5479.0, 5654.0, 5622.0, 5625.0, 5692.0, 5633.0, 5523.0, 5670.0, 5368.0, 5556.0, 5470.0, 5390.0, 5448.0, 5559.0, 5311.0, 5617.0, 5458.0, 5554.0, 5644.0, 5592.0, 5614.0, 5407.0, 5571.0, 5542.0, 5640.0, 5391.0, 5477.0, 5560.0, 5352.0, 5301.0, 5718.0, 5525.0, 5462.0, 5526.0, 5695.0, 5435.0, 5474.0, 5664.0, 5708.0, 5252.0, 5259.0, 5423.0, 5702.0, 5424.0, 5716.0, 5564.0, 5520.0, 5303.0, 5335.0, 5578.0, 5563.0, 5284.0, 5329.0, 5691.0, 5452.0, 5721.0, 5293.0, 5451.0 (number of hits: 4)
23	5290	9	1	333	1	5354.0, 5575.0, 5674.0, 5592.0, 5689.0, 5687.0, 5252.0, 5251.0, 5593.0, 5604.0, 5452.0, 5572.0, 5257.0, 5684.0, 5402.0, 5353.0, 5394.0, 5477.0, 5618.0, 5531.0, 5488.0, 5581.0, 5694.0, 5334.0, 5568.0, 5456.0, 5335.0, 5440.0, 5672.0, 5465.0, 5485.0, 5297.0, 5445.0, 5384.0, 5254.0, 5641.0, 5364.0, 5606.0, 5619.0, 5605.0, 5654.0, 5432.0, 5471.0, 5530.0, 5459.0, 5517.0, 5392.0, 5333.0, 5620.0, 5448.0, 5658.0, 5559.0, 5645.0, 5417.0, 5443.0, 5341.0, 5506.0, 5264.0, 5318.0, 5671.0, 5380.0, 5554.0, 5409.0, 5414.0, 5342.0, 5596.0, 5690.0, 5601.0, 5476.0, 5329.0, 5360.0, 5667.0, 5284.0, 5454.0, 5404.0, 5548.0, 5582.0, 5608.0, 5663.0, 5496.0, 5549.0, 5679.0, 5491.0, 5320.0, 5271.0, 5370.0, 5371.0, 5704.0, 5652.0, 5701.0, 5681.0, 5567.0, 5631.0, 5430.0, 5272.0, 5327.0, 5399.0, 5429.0, 5678.0, 5369.0 (number of hits: 4)

24	5290	9	1	333	1	<p>5597.0, 5368.0, 5556.0, 5398.0, 5624.0, 5372.0, 5683.0, 5582.0, 5593.0, 5476.0, 5432.0, 5385.0, 5651.0, 5671.0, 5577.0, 5608.0, 5636.0, 5715.0, 5370.0, 5638.0, 5274.0, 5661.0, 5534.0, 5645.0, 5503.0, 5673.0, 5374.0, 5397.0, 5520.0, 5450.0, 5477.0, 5505.0, 5354.0, 5550.0, 5589.0, 5440.0, 5498.0, 5586.0, 5571.0, 5714.0, 5314.0, 5283.0, 5256.0, 5340.0, 5646.0, 5402.0, 5421.0, 5394.0, 5285.0, 5552.0, 5614.0, 5688.0, 5393.0, 5502.0, 5399.0, 5478.0, 5406.0, 5718.0, 5632.0, 5692.0, 5414.0, 5560.0, 5423.0, 5270.0, 5613.0, 5438.0, 5486.0, 5276.0, 5497.0, 5255.0, 5263.0, 5517.0, 5653.0, 5291.0, 5584.0, 5513.0, 5250.0, 5667.0, 5604.0, 5518.0, 5346.0, 5381.0, 5356.0, 5558.0, 5344.0, 5656.0, 5678.0, 5456.0, 5694.0, 5591.0, 5506.0, 5474.0, 5635.0, 5491.0, 5342.0, 5253.0, 5617.0, 5415.0, 5706.0, 5460.0 (number of hits: 6)</p>
25	5290	9	1	333	1	<p>5441.0, 5254.0, 5693.0, 5559.0, 5578.0, 5442.0, 5419.0, 5722.0, 5484.0, 5606.0, 5377.0, 5279.0, 5494.0, 5549.0, 5572.0, 5417.0, 5458.0, 5315.0, 5259.0, 5714.0, 5320.0, 5631.0, 5346.0, 5585.0, 5293.0, 5512.0, 5298.0, 5697.0, 5453.0, 5504.0, 5643.0, 5434.0, 5466.0, 5540.0, 5277.0, 5272.0, 5448.0, 5262.0, 5658.0, 5646.0, 5604.0, 5382.0, 5343.0, 5567.0, 5457.0, 5286.0, 5297.0, 5570.0, 5520.0, 5712.0, 5478.0, 5563.0, 5352.0, 5465.0, 5710.0, 5544.0, 5661.0, 5375.0, 5477.0, 5401.0, 5415.0, 5688.0, 5432.0, 5367.0, 5701.0, 5304.0, 5295.0, 5455.0, 5571.0, 5345.0, 5600.0, 5495.0, 5568.0, 5282.0, 5607.0, 5641.0, 5575.0, 5537.0, 5720.0, 5547.0, 5273.0, 5487.0, 5460.0, 5581.0, 5694.0, 5301.0, 5519.0, 5561.0, 5653.0, 5554.0, 5668.0, 5318.0, 5587.0, 5656.0, 5670.0, 5403.0, 5652.0, 5589.0, 5356.0, 5528.0 (number of hits: 12)</p>
26	5290	9	1	333	1	<p>5302.0, 5564.0, 5471.0, 5626.0, 5585.0, 5589.0, 5377.0, 5674.0, 5454.0, 5618.0, 5340.0, 5663.0, 5441.0, 5335.0, 5317.0, 5258.0, 5364.0, 5584.0, 5304.0, 5652.0, 5645.0, 5667.0, 5403.0, 5315.0, 5501.0, 5522.0, 5525.0, 5308.0, 5367.0, 5264.0, 5300.0, 5711.0, 5569.0, 5648.0, 5550.0, 5432.0, 5296.0, 5715.0, 5400.0, 5477.0, 5382.0, 5413.0, 5531.0, 5655.0, 5460.0, 5599.0, 5404.0, 5259.0, 5430.0, 5469.0, 5260.0, 5295.0, 5721.0, 5439.0, 5468.0, 5301.0, 5251.0, 5440.0, 5662.0, 5601.0, 5465.0, 5397.0, 5350.0, 5285.0, 5512.0, 5344.0, 5399.0, 5355.0, 5526.0, 5446.0, 5398.0, 5383.0, 5252.0, 5699.0, 5701.0, 5619.0, 5269.0, 5280.0, 5359.0, 5408.0, 5307.0, 5696.0, 5418.0, 5642.0, 5288.0, 5515.0, 5456.0, 5299.0, 5375.0, 5349.0, 5566.0, 5388.0, 5633.0, 5672.0, 5596.0</p>

						5692.0, 5263.0, 5291.0, 5273.0, 5664.0 (number of hits: 14)
27	5290	9	1	333	1	5530.0, 5539.0, 5698.0, 5639.0, 5260.0, 5627.0, 5614.0, 5688.0, 5640.0, 5454.0, 5641.0, 5540.0, 5474.0, 5550.0, 5357.0, 5348.0, 5441.0, 5295.0, 5663.0, 5673.0, 5444.0, 5379.0, 5657.0, 5500.0, 5392.0, 5615.0, 5587.0, 5291.0, 5311.0, 5595.0, 5372.0, 5677.0, 5329.0, 5374.0, 5559.0, 5416.0, 5340.0, 5354.0, 5456.0, 5646.0, 5450.0, 5409.0, 5334.0, 5496.0, 5358.0, 5376.0, 5335.0, 5423.0, 5626.0, 5620.0, 5633.0, 5604.0, 5689.0, 5507.0, 5352.0, 5603.0, 5448.0, 5384.0, 5459.0, 5426.0, 5427.0, 5278.0, 5327.0, 5339.0, 5266.0, 5462.0, 5685.0, 5561.0, 5304.0, 5298.0, 5356.0, 5576.0, 5258.0, 5415.0, 5588.0, 5630.0, 5472.0, 5715.0, 5473.0, 5435.0, 5373.0, 5252.0, 5328.0, 5674.0, 5254.0, 5586.0, 5276.0, 5310.0, 5452.0, 5558.0, 5482.0, 5664.0, 5553.0, 5695.0, 5655.0, 5719.0, 5446.0, 5284.0, 5253.0, 5531.0 (number of hits: 7)
28	5290	9	1	333	1	5467.0, 5394.0, 5332.0, 5688.0, 5514.0, 5479.0, 5450.0, 5396.0, 5677.0, 5355.0, 5536.0, 5456.0, 5587.0, 5263.0, 5378.0, 5614.0, 5306.0, 5484.0, 5367.0, 5425.0, 5391.0, 5542.0, 5504.0, 5620.0, 5269.0, 5253.0, 5707.0, 5705.0, 5698.0, 5704.0, 5474.0, 5279.0, 5503.0, 5609.0, 5657.0, 5550.0, 5650.0, 5276.0, 5711.0, 5632.0, 5346.0, 5299.0, 5319.0, 5288.0, 5665.0, 5518.0, 5291.0, 5610.0, 5324.0, 5282.0, 5451.0, 5538.0, 5645.0, 5490.0, 5612.0, 5611.0, 5360.0, 5608.0, 5361.0, 5651.0, 5308.0, 5462.0, 5250.0, 5569.0, 5595.0, 5579.0, 5257.0, 5457.0, 5326.0, 5671.0, 5515.0, 5526.0, 5652.0, 5491.0, 5427.0, 5256.0, 5622.0, 5723.0, 5588.0, 5336.0, 5415.0, 5674.0, 5511.0, 5623.0, 5562.0, 5439.0, 5325.0, 5495.0, 5296.0, 5505.0, 5497.0, 5695.0, 5687.0, 5575.0, 5434.0, 5423.0, 5410.0, 5352.0, 5397.0, 5637.0 (number of hits: 9)
29	5290	9	1	333	1	5320.0, 5529.0, 5632.0, 5592.0, 5531.0, 5717.0, 5419.0, 5292.0, 5404.0, 5530.0, 5343.0, 5512.0, 5467.0, 5464.0, 5598.0, 5649.0, 5601.0, 5412.0, 5684.0, 5386.0, 5715.0, 5311.0, 5642.0, 5698.0, 5435.0, 5280.0, 5480.0, 5665.0, 5657.0, 5500.0, 5640.0, 5460.0, 5668.0, 5509.0, 5645.0, 5284.0, 5629.0, 5631.0, 5626.0, 5574.0, 5605.0, 5450.0, 5650.0, 5663.0, 5304.0, 5427.0, 5532.0, 5540.0, 5452.0, 5429.0, 5327.0, 5407.0, 5387.0, 5273.0, 5308.0, 5475.0, 5421.0, 5577.0, 5338.0, 5691.0, 5434.0, 5376.0, 5594.0, 5702.0, 5613.0, 5611.0, 5470.0, 5551.0, 5633.0, 5371.0, 5285.0, 5491.0, 5326.0, 5444.0, 5511.0, 5513.0, 5306.0, 5627.0, 5271.0, 5489.0, 5602.0, 5707.0, 5688.0, 5564.0, 5599.0,

						5630.0, 5537.0, 5515.0, 5440.0, 5356.0, 5502.0, 5548.0, 5706.0, 5269.0, 5694.0, 5587.0, 5487.0, 5495.0, 5443.0, 5289.0 (number of hits: 10)
30	5290	9	1	333	1	5497.0, 5352.0, 5487.0, 5671.0, 5269.0, 5606.0, 5369.0, 5378.0, 5263.0, 5343.0, 5534.0, 5346.0, 5668.0, 5277.0, 5283.0, 5370.0, 5417.0, 5327.0, 5550.0, 5404.0, 5716.0, 5448.0, 5282.0, 5422.0, 5498.0, 5554.0, 5426.0, 5619.0, 5258.0, 5338.0, 5591.0, 5469.0, 5652.0, 5511.0, 5485.0, 5411.0, 5468.0, 5630.0, 5363.0, 5477.0, 5600.0, 5409.0, 5684.0, 5596.0, 5639.0, 5264.0, 5674.0, 5509.0, 5334.0, 5345.0, 5533.0, 5257.0, 5252.0, 5425.0, 5438.0, 5515.0, 5718.0, 5386.0, 5445.0, 5359.0, 5510.0, 5310.0, 5360.0, 5597.0, 5279.0, 5433.0, 5301.0, 5628.0, 5355.0, 5394.0, 5358.0, 5612.0, 5293.0, 5353.0, 5672.0, 5400.0, 5483.0, 5280.0, 5315.0, 5462.0, 5319.0, 5402.0, 5250.0, 5273.0, 5516.0, 5309.0, 5551.0, 5458.0, 5451.0, 5603.0, 5270.0, 5700.0, 5559.0, 5332.0, 5690.0, 5663.0, 5380.0, 5541.0, 5645.0, 5364.0 (number of hits: 10)

Annex D – U-NII-2C Radar Parameter Data Sheet for Client Mode

D.1 20 MHz Bandwidth @ 5510 MHz

Table-1A/1B Radar Type 1A/1B Statistical Performance

Trial #	Fc (MHz)	Pulse/Burst	Pulse Width (µS)	PRI (µs)	Detection (1:yes; 0:no)
1	5510	102	1	518	1
2	5510	70	1	758	1
3	5510	76	1	698	1
4	5510	62	1	858	1
5	5510	89	1	598	1
6	5510	78	1	678	1
7	5510	81	1	658	1
8	5510	92	1	578	1
9	5510	18	1	3066	1
10	5510	72	1	738	1
11	5510	61	1	878	1
12	5510	67	1	798	1
13	5510	74	1	718	1
14	5510	63	1	838	1
15	5510	58	1	918	1
16	5510	39	1	1385	1
17	5510	45	1	1194	1
18	5510	36	1	1484	1
19	5510	25	1	2183	1
20	5510	23	1	2316	1
21	5510	35	1	1509	1
22	5510	43	1	1232	1
23	5510	46	1	1155	1
24	5510	21	1	2519	1
25	5510	25	1	2144	1
26	5510	37	1	1441	1
27	5510	36	1	1479	1
28	5510	26	1	2108	1
29	5510	29	1	1820	1
30	5510	33	1	1623	1
Detection Percentage: 100 % (>60%)					

Table-2 Radar Type 2 Statistical Performance

Trial #	Fc (MHz)	Pulse/Burst	Pulse Width (μ S)	PRI (μ s)	Detection (1:yes; 0:no)
1	5510	24	1.4	199	1
2	5510	26	1.8	219	1
3	5510	28	3.9	210	1
4	5510	23	3.9	222	1
5	5510	27	3	170	1
6	5510	23	2.2	225	1
7	5510	27	1.6	211	1
8	5510	25	3.1	203	1
9	5510	26	4.5	182	1
10	5510	29	3.7	174	1
11	5510	28	2	155	1
12	5510	24	4.1	204	1
13	5510	28	3	179	1
14	5510	28	2.6	169	1
15	5510	23	1.7	178	1
16	5510	24	1.8	193	1
17	5510	26	1.1	178	1
18	5510	28	1.9	225	1
19	5510	26	1.9	164	1
20	5510	27	2.5	162	1
21	5510	25	2.7	159	1
22	5510	23	3.7	215	1
23	5510	25	1.8	189	1
24	5510	27	5	226	1
25	5510	23	1.9	178	1
26	5510	26	2.2	155	1
27	5510	25	4.2	196	1
28	5510	26	3.7	183	1
29	5510	27	3.7	165	1
30	5510	26	2.3	156	1
Detection Percentage: 100 % (>60%)					

Table-3 Radar Type 3 Statistical Performance

Trial #	Fc (MHz)	Pulse/Burst	Pulse Width (μ S)	PRI (μ s)	Detection (1:yes; 0:no)
1	5510	18	8.9	358	1
2	5510	16	8.6	232	1
3	5510	18	8.7	471	1
4	5510	17	7.8	315	1
5	5510	18	7.7	370	1
6	5510	16	8.4	213	0
7	5510	18	8.9	265	1
8	5510	16	10	452	1
9	5510	16	6.7	220	1
10	5510	18	7	411	1
11	5510	18	7.7	317	1
12	5510	16	7.8	221	1
13	5510	18	6.5	290	1
14	5510	18	7	389	1
15	5510	16	9.5	219	0
16	5510	16	10	207	0
17	5510	18	9.1	273	1
18	5510	18	6.4	313	1
19	5510	17	8	272	1
20	5510	17	9.6	238	1
21	5510	16	6.7	245	1
22	5510	17	6.9	293	0
23	5510	18	8.3	495	1
24	5510	16	8	220	0
25	5510	17	7.4	261	1
26	5510	16	9.8	486	1
27	5510	17	9.7	483	1
28	5510	18	9.7	451	1
29	5510	17	8.6	270	1
30	5510	18	8	444	1
Detection Percentage: 83.3 % (>60%)					

Table-4 Radar Type 4 Statistical Performance

Trial #	Fc (MHz)	Pulse/Burst	Pulse Width (μS)	PRI (μs)	Detection (1:yes; 0:no)
1	5510	16	17.4	484	1
2	5510	12	14.8	401	0
3	5510	16	13.9	434	1
4	5510	14	12	343	1
5	5510	16	17.6	244	1
6	5510	12	17.9	486	1
7	5510	12	17.3	271	1
8	5510	13	16.8	253	1
9	5510	14	18.3	401	1
10	5510	12	13.1	265	1
11	5510	15	15	450	1
12	5510	15	13.6	244	1
13	5510	12	13	413	0
14	5510	16	19.2	391	1
15	5510	13	15.2	406	1
16	5510	16	18.3	440	1
17	5510	13	12.8	424	1
18	5510	14	13.1	262	1
19	5510	14	11.5	335	0
20	5510	16	19.4	340	1
21	5510	16	17	425	1
22	5510	16	15.4	386	1
23	5510	14	16.7	294	1
24	5510	12	19.7	417	1
25	5510	16	16.1	247	1
26	5510	13	19.1	317	0
27	5510	16	14.7	392	1
28	5510	16	16.2	212	1
29	5510	14	16.2	316	1
30	5510	14	15.4	371	1
Detection Percentage: 86.7 % (>60%)					

Table-5 Radar Type 5 Statistical Performance

Trial #	Fc (MHz)	Detection (1:yes; 0:no)
1	5510	1
2	5510	1
3	5510	0
4	5510	1
5	5510	1
6	5510	1
7	5510	1
8	5510	1
9	5510	1
10	5510	1
11	5503.8	1
12	5503.4	1
13	5508.6	0
14	5503.8	1
15	5507.4	1
16	5505.8	1
17	5507.0	1
18	5506.6	1
19	5504.6	1
20	5506.6	0
21	5514.2	1
22	5513.4	1
23	5515.4	1
24	5517.0	1
25	5513.4	1
26	5514.6	0
27	5511.8	1
28	5516.6	1
29	5514.6	1
30	5515.4	1
Detection Percentage: 86.7 % (>80%)		

Bin5 Statistics 1

Trial #	Pulse	Chirp (MHz)	Pulse Width (μS)	Pulse 1-2 spacing (uS)	Pulse 2-3 spacing (uS)	Pulse Start(S)	Detection (1:yes; 0:no)
0	2	13	62.7	1111		0.65098	1
1	2	13	54.7	1677		0.916469	
2	2	13	72	1764		1.894465	
3	2	13	91.1	1060		2.260585	
4	1	13	76			3.318355	
5	2	13	98.7	1184		3.577389	
6	3	13	83.3	1742	1952	4.853846	
7	1	13	79.7			5.016823	
8	3	13	75.5	1433	1480	6.043563	
9	2	13	60.6	1360		6.496544	
10	1	13	54.9			7.283487	
11	2	13	97.4	1741		8.220552	
12	2	13	94.3	1550		8.703035	
13	2	13	89.4	1552		9.532026	
14	2	13	91.9	1030		10.443283	
15	3	13	66.1	1729	1739	10.962692	
16	2	13	51.7	1631		11.74676	

Bin5 Statistics 2

Trial #	Pulse	Chirp (MHz)	Pulse Width (µS)	Pulse 1-2 spacing (uS)	Pulse 2-3 spacing (uS)	Pulse Start(S)	Detection (1:yes; 0:no)
0	3	8	82.9	1366	1331	0.480641	1
1	3	8	73.8	1374	1609	0.648279	
2	1	8	74.3			1.455683	
3	3	8	87.7	1958	1976	2.037762	
4	2	8	77.5	1777		3.148676	
5	2	8	99.2	1205		3.453932	
6	2	8	52.7	1863		4.227754	
7	3	8	73.8	1454	1018	4.75059	
8	2	8	80.4	1037		5.598196	
9	2	8	71.2	1598		5.811453	
10	2	8	83.3	1979		6.321533	
11	2	8	69.2	1593		7.054503	
12	3	8	65.8	1121	1939	7.719729	
13	2	8	62.6	1481		8.266185	
14	3	8	67.9	1259	1089	9.439562	
15	2	8	90	1814		9.630334	
16	3	8	84.3	1426	1905	10.325554	
17	3	8	60.4	1935	1322	10.745141	
18	1	8	96			11.380072	

Bin5 Statistics 3

Trial #	Pulse	Chirp (MHz)	Pulse Width (µS)	Pulse 1-2 spacing (uS)	Pulse 2-3 spacing (uS)	Pulse Start(S)	Detection (1:yes; 0:no)
0	2	13	73.5	1213		0.712838	0
1	2	13	96.4	1319		1.348376	
2	3	13	74.8	1240	1974	2.974661	
3	3	13	53.9	1141	1518	4.767611	
4	2	13	53	1497		5.590607	
5	2	13	68.1	1647		6.301731	
6	1	13	95.2			8.312291	
7	1	13	53.1			9.228813	
8	2	13	50.5	1457		10.63042	
9	2	13	59.3	1650		10.945262	

Bin5 Statistics 4

Trial #	Pulse	Chirp (MHz)	Pulse Width (µS)	Pulse 1-2 spacing (uS)	Pulse 2-3 spacing (uS)	Pulse Start(S)	Detection (1:yes; 0:no)
0	2	7	66.5	1173		0.458866	1
1	3	7	85.1	1772	1431	1.081224	
2	2	7	93.2	1581		2.554775	
3	2	7	99.5	1525		3.296825	
4	3	7	53.6	1924	1266	4.094287	
5	3	7	85.8	1260	1976	4.82276	
6	1	7	50.6			5.390705	
7	3	7	50.2	1692	1413	6.7714	
8	1	7	60.1			6.906543	
9	3	7	74.6	1669	1272	7.726206	
10	2	7	89	1014		8.901477	
11	3	7	78.1	1932	1282	9.54373	
12	3	7	98.2	1752	1677	10.961772	
13	3	7	68.7	1005	1059	11.217932	

Bin5 Statistics 5

Trial #	Pulse	Chirp (MHz)	Pulse Width (µS)	Pulse 1-2 spacing (uS)	Pulse 2-3 spacing (uS)	Pulse Start(S)	Detection (1:yes; 0:no)
0	1	6	81.5			0.683424	1
1	2	6	56.5	1011		1.252605	
2	2	6	50.6	1224		2.128869	
3	2	6	61.5	1385		2.654257	
4	1	6	97.6			3.827168	
5	3	6	94.3	1780	1260	4.174583	
6	3	6	79.3	1714	1181	5.403061	
7	3	6	69.9	1838	1570	5.761629	
8	2	6	76.1	1902		6.800274	
9	1	6	91.8			7.929474	
10	3	6	89.1	1098	1449	8.245191	
11	1	6	84.2			9.08227	
12	3	6	65.5	1021	1314	9.788943	
13	3	6	69.7	1161	1328	10.60984	
14	2	6	70.9	1576		11.781463	

Bin5 Statistics 6

Trial #	Pulse	Chirp (MHz)	Pulse Width (µS)	Pulse 1-2 spacing (uS)	Pulse 2-3 spacing (uS)	Pulse Start(S)	Detection (1:yes; 0:no)
0	2	8	74.3	1458		0.594243	1
1	2	8	53.9	1444		1.108466	
2	3	8	74.7	1232	1048	1.643237	
3	3	8	60.3	1566	1633	2.058419	
4	2	8	76	1590		2.701616	
5	2	8	100	1543		3.591438	
6	2	8	77.1	1775		3.824697	
7	3	8	83.4	1093	1871	4.603027	
8	1	8	65.2			5.415578	
9	3	8	60	1843	1569	6.209625	
10	2	8	67.7	1789		6.417712	
11	3	8	94.4	1013	1533	7.517693	
12	1	8	75.3			7.980364	
13	3	8	87.1	1279	1290	8.791813	
14	1	8	62.2			9.115432	
15	2	8	63.9	1723		9.678812	
16	3	8	79.7	1498	1981	10.673764	
17	3	8	71.8	1952	1877	10.897862	
18	3	8	99.6	1150	1030	11.692058	

Bin5 Statistics 7

Trial #	Pulse	Chirp (MHz)	Pulse Width (µS)	Pulse 1-2 spacing (uS)	Pulse 2-3 spacing (uS)	Pulse Start(S)	Detection (1:yes; 0:no)
0	1	7	84.4			0.443449	1
1	2	7	65.6	1872		1.008416	
2	3	7	51.3	1045	1275	2.218439	
3	1	7	96.7			2.957904	
4	3	7	76.4	1721	1324	3.826863	
5	3	7	65.8	1905	1892	4.66838	
6	2	7	65.1	1175		5.016241	
7	1	7	88.5			5.901913	
8	2	7	88.9	1647		6.464473	
9	3	7	83.9	1219	1462	7.880989	
10	1	7	98.2			8.088857	
11	2	7	53.8	1836		9.575865	
12	2	7	79.7	1764		10.195887	
13	2	7	70.9	1480		10.769349	
14	2	7	61.8	1872		11.288926	

Bin5 Statistics 8

Trial #	Pulse	Chirp (MHz)	Pulse Width (µS)	Pulse 1-2 spacing (uS)	Pulse 2-3 spacing (uS)	Pulse Start(S)	Detection (1:yes; 0:no)
0	1	8	75.8			0.031264	1
1	2	8	85	1740		1.348495	
2	1	8	83.3			1.740844	
3	1	8	90.2			2.694911	
4	3	8	77.2	1488	1646	3.294561	
5	1	8	81.4			3.803513	
6	1	8	55.9			4.622596	
7	2	8	59.5	1913		5.297525	
8	1	8	82.7			6.114326	
9	2	8	86.5	1584		6.727299	
10	2	8	82.7	1855		7.720782	
11	1	8	52			7.831767	
12	1	8	63.1			8.937987	
13	1	8	93.7			9.740436	
14	3	8	62.3	1946	1144	10.068381	
15	3	8	69.4	1219	1729	11.183572	
16	2	8	89.4	1968		11.902492	

Bin5 Statistics 9

Trial #	Pulse	Chirp (MHz)	Pulse Width (µS)	Pulse 1-2 spacing (uS)	Pulse 2-3 spacing (uS)	Pulse Start(S)	Detection (1:yes; 0:no)
0	2	10	70.6	1569		0.023719	1
1	2	10	60.7	1039		1.114585	
2	3	10	94.2	1563	1519	1.444077	
3	1	10	80.2			2.364478	
4	3	10	61.7	1258	1443	3.132694	
5	2	10	73.9	1011		3.72744	
6	1	10	65.2			3.806651	
7	1	10	52.9			4.610793	
8	3	10	56.9	1293	1010	5.282301	
9	1	10	98.5			5.707379	
10	3	10	92.7	1901	1783	6.463826	
11	2	10	66.8	1700		7.32147	
12	2	10	90.3	1973		7.588044	
13	2	10	60.5	1565		8.560862	
14	2	10	93.4	1838		9.022984	
15	1	10	98			9.684631	
16	3	10	69.2	1606	1862	10.663882	
17	2	10	94.6	1774		10.753555	
18	2	10	77.5	1559		11.542152	

Bin5 Statistics 10

Trial #	Pulse	Chirp (MHz)	Pulse Width (µS)	Pulse 1-2 spacing (uS)	Pulse 2-3 spacing (uS)	Pulse Start(S)	Detection (1:yes; 0:no)
0	2	12	99.4	1427		0.530627	1
1	1	12	74.3			1.106603	
2	2	12	78.1	1847		2.840161	
3	1	12	59.6			3.180264	
4	2	12	74.8	1817		4.972861	
5	1	12	94.5			5.633078	
6	1	12	68.2			6.456087	
7	1	12	59.3			7.386951	
8	3	12	92.6	1948	1257	8.126454	
9	3	12	62.9	1490	1010	9.871684	
10	1	12	55.2			10.789819	
11	2	12	59.1	1871		11.261955	

Bin5 Statistics 11

Trial #	Pulse	Chirp (MHz)	Pulse Width (µS)	Pulse 1-2 spacing (uS)	Pulse 2-3 spacing (uS)	Pulse Start(S)	Detection (1:yes; 0:no)
0	3	7	64.2	1230	1889	0.266043	1
1	1	7	84.6			1.164996	
2	1	7	50.4			1.79168	
3	3	7	63.4	1473	1558	2.352725	
4	3	7	62.9	1758	1040	2.7075	
5	2	7	85	1009		3.332759	
6	2	7	58.6	1660		4.107769	
7	1	7	84.7			4.8224	
8	2	7	55.8	1980		5.163034	
9	2	7	85.3	1324		5.729025	
10	2	7	99.2	1493		6.411672	
11	3	7	71.4	1350	1964	7.201679	
12	2	7	86.6	1473		7.861674	
13	2	7	81.1	1316		8.692376	
14	2	7	50.3	1781		9.366123	
15	3	7	71.8	1387	1723	9.54196	
16	2	7	62.2	1737		10.214487	
17	2	7	60	1629		10.959702	
18	2	7	65.5	1454		11.988899	

Bin5 Statistics 12

Trial #	Pulse	Chirp (MHz)	Pulse Width (µS)	Pulse 1-2 spacing (uS)	Pulse 2-3 spacing (uS)	Pulse Start(S)	Detection (1:yes; 0:no)
0	3	6	64.5	1871	1512	0.841042	1
1	3	6	69.8	1837	1324	1.633276	
2	3	6	76	1032	1605	2.68141	
3	1	6	72.6			3.295339	
4	3	6	74.5	1021	1756	4.377429	
5	2	6	95.5	1898		5.224464	
6	1	6	50.1			6.000697	
7	2	6	66	1172		7.292661	
8	1	6	60.5			7.985882	
9	2	6	62.4	1528		8.88457	
10	1	6	73.7			9.436485	
11	2	6	72.3	1833		10.425526	
12	1	6	84.6			11.280982	

Bin5 Statistics 13

Trial #	Pulse	Chirp (MHz)	Pulse Width (µS)	Pulse 1-2 spacing (uS)	Pulse 2-3 spacing (uS)	Pulse Start(S)	Detection (1:yes; 0:no)
0	2	19	90.4	1361		0.020864	0
1	2	19	75.7	1747		1.046791	
2	1	19	69.1			1.861266	
3	2	19	77.6	1322		2.701851	
4	1	19	51.4			3.503858	
5	3	19	50.6	1601	1837	3.720925	
6	1	19	64.2			4.473649	
7	2	19	53.5	1867		5.354654	
8	3	19	50.7	1358	1641	6.217283	
9	2	19	50.8	1622		6.732896	
10	2	19	72.7	1543		7.508848	
11	3	19	52.7	1103	1664	7.817895	
12	2	19	75.6	1263		9.077578	
13	2	19	76.5	1252		9.442157	
14	2	19	63.3	1638		9.964517	
15	3	19	51.6	1932	1447	10.801736	
16	2	19	62.9	1447		11.552833	

Bin5 Statistics 14

Trial #	Pulse	Chirp (MHz)	Pulse Width (µS)	Pulse 1-2 spacing (uS)	Pulse 2-3 spacing (uS)	Pulse Start(S)	Detection (1:yes; 0:no)
0	2	7	80.3	1074		0.343759	1
1	2	7	58	1500		1.610366	
2	3	7	53.3	1032	1902	3.133893	
3	2	7	96.4	1714		3.963913	
4	2	7	68.8	1186		4.959569	
5	2	7	81.9	1818		6.132247	
6	2	7	62.9	1875		6.768503	
7	3	7	62.3	1771	1764	8.432144	
8	3	7	60.7	1366	1475	9.364533	
9	1	7	70			10.097649	
10	1	7	74.5			11.10957	

Bin5 Statistics 15

Trial #	Pulse	Chirp (MHz)	Pulse Width (µS)	Pulse 1-2 spacing (uS)	Pulse 2-3 spacing (uS)	Pulse Start(S)	Detection (1:yes; 0:no)
0	2	16	99.1	1408		0.093481	1
1	2	16	72.4	1233		0.668455	
2	2	16	88.6	1666		1.823122	
3	2	16	96.5	1412		2.087384	
4	3	16	72.5	1411	1369	3.084035	
5	3	16	72.6	1378	1779	3.725789	
6	3	16	96.5	1100	1565	4.559938	
7	1	16	82.2			4.942622	
8	1	16	58.1			5.847506	
9	2	16	64.3	1820		6.47628	
10	2	16	52.6	1049		7.245823	
11	2	16	54.6	1317		7.892723	
12	1	16	82			8.294882	
13	2	16	96.4	1133		8.8783	
14	3	16	81.1	1515	1006	9.834935	
15	3	16	63.8	1777	1407	10.098841	
16	2	16	74.8	1372		10.70081	
17	3	16	54.1	1833	1251	11.820299	

Bin5 Statistics 16

Trial #	Pulse	Chirp (MHz)	Pulse Width (µS)	Pulse 1-2 spacing (uS)	Pulse 2-3 spacing (uS)	Pulse Start(S)	Detection (1:yes; 0:no)
0	2	12	71.7	1759		0.301162	1
1	2	12	91.5	1616		1.575563	
2	3	12	61.6	1418	1939	2.216092	
3	3	12	71.1	1702	1658	3.289487	
4	2	12	55.5	1063		4.502489	
5	3	12	93.6	1076	1485	5.922366	
6	2	12	72.9	1065		6.520581	
7	3	12	71.5	1781	1123	7.627964	
8	1	12	52.3			8.678461	
9	1	12	95.5			9.105176	
10	1	12	73.6			10.671997	
11	1	12	65.3			11.341073	

Bin5 Statistics 17

Trial #	Pulse	Chirp (MHz)	Pulse Width (µS)	Pulse 1-2 spacing (uS)	Pulse 2-3 spacing (uS)	Pulse Start(S)	Detection (1:yes; 0:no)
0	1	15	76			0.272118	1
1	2	15	79.1	1268		0.957977	
2	3	15	91.5	1071	1447	1.691223	
3	2	15	88.8	1164		2.358102	
4	3	15	66	1365	1036	2.580164	
5	1	15	62.3			3.684562	
6	2	15	89.7	1823		3.928364	
7	2	15	51.8	1838		4.722717	
8	2	15	68.2	1193		5.346611	
9	2	15	90.4	1208		6.035116	
10	2	15	94.2	1013		6.338629	
11	3	15	82.5	1393	1226	7.315613	
12	2	15	91.3	1177		7.607114	
13	2	15	87.2	1623		8.388878	
14	2	15	77.5	1651		9.432901	
15	3	15	71.4	1892	1434	9.602856	
16	2	15	98.5	1186		10.638524	
17	2	15	78.6	1817		10.781766	
18	3	15	52.3	1486	1999	11.411348	

Bin5 Statistics 18

Trial #	Pulse	Chirp (MHz)	Pulse Width (μS)	Pulse 1-2 spacing (uS)	Pulse 2-3 spacing (uS)	Pulse Start(S)	Detection (1:yes; 0:no)
0	3	14	77	1598	1872	0.481946	1
1	2	14	88	1524		0.64913	
2	1	14	68.5			1.22345	
3	2	14	79.6	1909		1.942623	
4	2	14	71.2	1863		2.741614	
5	2	14	54.3	1985		3.376768	
6	1	14	54.7			4.007412	
7	2	14	55	1051		4.498885	
8	1	14	64.7			5.018927	
9	2	14	61.1	1008		5.869197	
10	2	14	76.2	1234		6.161349	
11	3	14	69.7	1882	1968	6.934944	
12	2	14	81.5	1086		7.219424	
13	2	14	61.2	1357		8.188075	
14	2	14	83.6	1211		8.748324	
15	2	14	60.9	1345		9.071274	
16	1	14	86.7			9.760299	
17	1	14	70.1			10.620983	
18	2	14	69.9	1122		11.290546	
19	2	14	67.9	1703		11.578027	

Bin5 Statistics 19

Trial #	Pulse	Chirp (MHz)	Pulse Width (µS)	Pulse 1-2 spacing (uS)	Pulse 2-3 spacing (uS)	Pulse Start(S)	Detection (1:yes; 0:no)
0	3	9	93	1523	1303	0.47108	1
1	1	9	88.3			1.054089	
2	1	9	58			1.306595	
3	3	9	92.1	1584	1091	2.43583	
4	3	9	62.7	1757	1670	3.074505	
5	1	9	73.4			3.623631	
6	1	9	89.2			4.162263	
7	2	9	92.9	1995		4.604316	
8	2	9	56.9	1234		5.120936	
9	2	9	76.7	1185		6.181859	
10	3	9	89.3	1561	1348	6.774831	
11	2	9	73.6	1353		7.443088	
12	3	9	81.9	1213	1744	7.912488	
13	2	9	96.6	1229		8.418038	
14	3	9	87.1	1618	1547	8.987131	
15	2	9	69.8	1335		9.632785	
16	2	9	64	1413		10.679946	
17	2	9	57.2	1585		10.986584	
18	3	9	95.2	1127	1404	11.97656	

Bin5 Statistics 20

Trial #	Pulse	Chirp (MHz)	Pulse Width (µS)	Pulse 1-2 spacing (uS)	Pulse 2-3 spacing (uS)	Pulse Start(S)	Detection (1:yes; 0:no)
0	3	14	61.9	1457	1832	0.055446	0
1	1	14	54.3			1.542343	
2	1	14	97.8			2.958059	
3	1	14	50.7			4.608534	
4	2	14	73.5	1195		5.315239	
5	2	14	92.2	1618		6.260793	
6	1	14	63.8			8.388859	
7	2	14	78.6	1935		9.43185	
8	3	14	63.3	1200	1231	10.321658	
9	1	14	50.6			11.262423	

Bin5 Statistics 21

Trial #	Pulse	Chirp (MHz)	Pulse Width (µS)	Pulse 1-2 spacing (uS)	Pulse 2-3 spacing (uS)	Pulse Start(S)	Detection (1:yes; 0:no)
0	2	12	98.1	1366		0.299877	1
1	1	12	82.9			1.04961	
2	2	12	94.5	1764		1.279776	
3	3	12	50.8	1992	1137	2.356701	
4	1	12	58			2.669216	
5	3	12	52.6	1188	1312	3.626647	
6	3	12	61.4	1305	1119	4.144905	
7	1	12	95.5			5.035929	
8	2	12	90.5	1762		5.454565	
9	2	12	62.1	1900		5.913166	
10	2	12	90.3	1435		6.9271	
11	2	12	84.7	1142		7.518045	
12	2	12	78.6	1885		7.605984	
13	3	12	51.3	1426	1003	8.312045	
14	3	12	82.1	1932	1858	9.278237	
15	1	12	63			10.024348	
16	3	12	96.8	1328	1157	10.543885	
17	1	12	58.1			11.227611	
18	2	12	58.4	1434		11.57859	

Bin5 Statistics 22

Trial #	Pulse	Chirp (MHz)	Pulse Width (µS)	Pulse 1-2 spacing (uS)	Pulse 2-3 spacing (uS)	Pulse Start(S)	Detection (1:yes; 0:no)
0	2	14	87	1412		0.793081	1
1	3	14	59.4	1607	1381	1.642474	
2	2	14	99.4	1588		2.009047	
3	2	14	91	1870		3.156104	
4	2	14	80.7	1768		4.269127	
5	2	14	85.4	1833		4.371809	
6	2	14	50.2	1169		5.252287	
7	3	14	76.1	1635	1080	6.736172	
8	3	14	98.2	1779	1521	7.667495	
9	3	14	50.5	1602	1398	8.085349	
10	2	14	61.4	1264		8.81623	
11	2	14	93.4	1495		10.028857	
12	1	14	53.3			10.660319	
13	1	14	85.2			11.762476	

Bin5 Statistics 23

Trial #	Pulse	Chirp (MHz)	Pulse Width (µS)	Pulse 1-2 spacing (µS)	Pulse 2-3 spacing (µS)	Pulse Start(S)	Detection (1:yes; 0:no)
0	3	9	80.7	1709	1421	0.732071	1
1	1	9	70.7			1.353338	
2	3	9	63.1	1715	1824	2.451602	
3	1	9	60.1			3.389093	
4	2	9	60.5	1088		4.094439	
5	2	9	79.9	1839		5.351121	
6	3	9	90	1013	1334	6.194814	
7	2	9	53.1	1456		7.291657	
8	2	9	72.9	1934		8.151397	
9	3	9	61.9	1221	1065	9.778391	
10	3	9	67.6	1629	1434	10.944812	
11	2	9	67.3	1036		11.980704	

Bin5 Statistics 24

Trial #	Pulse	Chirp (MHz)	Pulse Width (µS)	Pulse 1-2 spacing (µS)	Pulse 2-3 spacing (µS)	Pulse Start(S)	Detection (1:yes; 0:no)
0	1	5	93.2			0.037754	1
1	3	5	85.9	1256	1481	1.43063	
2	2	5	71.6	1865		1.836636	
3	3	5	94.7	1674	1881	2.528626	
4	1	5	88			3.74577	
5	3	5	63	1029	1207	4.060062	
6	2	5	90.5	1481		5.207465	
7	1	5	85.4			5.355646	
8	2	5	67	1746		6.518073	
9	2	5	55.5	1366		7.361684	
10	2	5	77.1	1715		7.567878	
11	1	5	59.8			8.828573	
12	2	5	75	1281		9.305224	
13	3	5	81.2	1702	1126	10.133762	
14	2	5	57	1640		11.237134	
15	2	5	62.6	1836		11.671189	

Bin5 Statistics 25

Trial #	Pulse	Chirp (MHz)	Pulse Width (µS)	Pulse 1-2 spacing (uS)	Pulse 2-3 spacing (uS)	Pulse Start(S)	Detection (1:yes; 0:no)
0	3	14	80.1	1722	1026	0.134606	1
1	3	14	94.4	1124	1215	0.967882	
2	2	14	84.9	1153		2.078933	
3	3	14	68.5	1354	1269	2.249306	
4	3	14	83.3	1881	1325	2.870822	
5	1	14	60.3			3.842821	
6	2	14	92	1199		4.849454	
7	3	14	85.4	1292	1766	5.257886	
8	1	14	98.8			5.98494	
9	1	14	54.8			6.858189	
10	2	14	78.1	1557		7.755528	
11	2	14	58.1	1272		8.018534	
12	3	14	59.5	1314	1839	8.633245	
13	1	14	57.4			9.796385	
14	2	14	54	1101		10.451438	
15	2	14	60.1	1345		11.143929	
16	1	14	50.7			11.354475	

Bin5 Statistics 26

Trial #	Pulse	Chirp (MHz)	Pulse Width (µS)	Pulse 1-2 spacing (uS)	Pulse 2-3 spacing (uS)	Pulse Start(S)	Detection (1:yes; 0:no)
0	1	11	87.9			0.301512	0
1	1	11	85.2			1.078885	
2	3	11	97.2	1971	1677	2.308683	
3	2	11	59.4	1084		3.213103	
4	2	11	99.2	1771		4.068283	
5	3	11	57.7	1196	1600	5.733876	
6	2	11	50.5	1708		6.745143	
7	2	11	65.8	1639		7.183999	
8	2	11	98	1055		8.001668	
9	2	11	98.6	1853		9.087606	
10	3	11	81.3	1181	1519	10.347879	
11	1	11	90.6			11.227341	

Bin5 Statistics 27

Trial #	Pulse	Chirp (MHz)	Pulse Width (µS)	Pulse 1-2 spacing (uS)	Pulse 2-3 spacing (uS)	Pulse Start(S)	Detection (1:yes; 0:no)
0	2	18	54	1796		0.235793	1
1	2	18	60	1947		1.210416	
2	1	18	65.7			1.862583	
3	2	18	90.1	1486		3.16287	
4	2	18	70.4	1634		3.489126	
5	2	18	92.1	1320		4.640799	
6	2	18	79.2	1470		5.398073	
7	2	18	96.8	1874		6.040492	
8	2	18	52.8	1165		7.259979	
9	2	18	65.9	1714		8.305052	
10	2	18	62.2	1243		9.348178	
11	3	18	96.5	1878	1122	9.607018	
12	2	18	90	1174		10.702242	
13	1	18	59.7			11.164015	

Bin5 Statistics 28

Trial #	Pulse	Chirp (MHz)	Pulse Width (µS)	Pulse 1-2 spacing (uS)	Pulse 2-3 spacing (uS)	Pulse Start(S)	Detection (1:yes; 0:no)
0	2	6	92	1287		0.025989	1
1	1	6	60.1			0.858633	
2	2	6	50	1987		1.778508	
3	3	6	63.5	1657	1784	2.1843	
4	2	6	98.6	1431		3.066085	
5	2	6	92.8	1104		3.191056	
6	2	6	70.8	1003		4.161781	
7	1	6	71.2			4.963303	
8	2	6	63.9	1764		5.270015	
9	3	6	81.1	1832	1812	6.208407	
10	2	6	63	1826		6.512221	
11	2	6	89.2	1630		7.494767	
12	2	6	56.9	1056		8.067069	
13	2	6	74.5	1946		8.403079	
14	2	6	51.3	1521		8.930737	
15	2	6	53.3	1050		9.910574	
16	2	6	63.2	1578		10.471994	
17	2	6	60.3	1088		10.875961	
18	3	6	94	1572	1468	11.799545	

Bin5 Statistics 29

Trial #	Pulse	Chirp (MHz)	Pulse Width (µS)	Pulse 1-2 spacing (uS)	Pulse 2-3 spacing (uS)	Pulse Start(S)	Detection (1:yes; 0:no)
0	1	11	51.1			0.147424	1
1	3	11	81.7	1398	1906	1.123434	
2	1	11	81			1.424119	
3	2	11	57.4	1941		2.381992	
4	2	11	97.2	1322		3.282269	
5	2	11	82.2	1933		4.165601	
6	2	11	68	1502		4.430543	
7	1	11	50.7			5.607371	
8	3	11	56.4	1419	1172	5.789303	
9	2	11	62.3	1224		6.930119	
10	3	11	63.3	1146	1835	7.698934	
11	2	11	65.5	1853		7.796109	
12	2	11	75.7	1792		8.999591	
13	2	11	67	1486		9.538605	
14	2	11	61.8	1131		10.293899	
15	3	11	50.3	1668	1812	10.900406	
16	3	11	92	1560	1085	11.338357	

Bin5 Statistics 30

Trial #	Pulse	Chirp (MHz)	Pulse Width (µS)	Pulse 1-2 spacing (uS)	Pulse 2-3 spacing (uS)	Pulse Start(S)	Detection (1:yes; 0:no)
0	2	9	59	1594		0.15696	1
1	3	9	78.2	1478	1589	1.23155	
2	1	9	71.1			2.69915	
3	1	9	52.1			3.259206	
4	2	9	62.1	1936		4.579114	
5	1	9	81.4			5.221003	
6	1	9	92.3			5.541415	
7	2	9	58	1199		6.588622	
8	1	9	93.5			7.948407	
9	1	9	77.4			9.107206	
10	2	9	70.4	1708		10.140703	
11	1	9	91.8			10.507391	
12	2	9	81	1670		11.079931	

Table-6 Radar Type 6 Statistical Performance

Trial #	Fc (MHz)	Pulse /Burst	Pulse Width (µS)	PRI (µs)	Detection (1:yes; 0:no)	Hopping Sequence
1	5510	9	1	333	1	5508.0, 5390.0, 5391.0, 5486.0, 5269.0, 5499.0, 5625.0, 5412.0, 5491.0, 5638.0, 5709.0, 5394.0, 5307.0, 5703.0, 5597.0, 5257.0, 5402.0, 5560.0, 5479.0, 5379.0, 5602.0, 5254.0, 5485.0, 5440.0, 5417.0, 5559.0, 5325.0, 5467.0, 5535.0, 5716.0, 5644.0, 5674.0, 5352.0, 5711.0, 5689.0, 5371.0, 5642.0, 5672.0, 5626.0, 5452.0, 5387.0, 5529.0, 5421.0, 5621.0, 5643.0, 5579.0, 5287.0, 5669.0, 5372.0, 5300.0, 5389.0, 5578.0, 5554.0, 5457.0, 5481.0, 5290.0, 5722.0, 5489.0, 5677.0, 5277.0, 5331.0, 5717.0, 5373.0, 5571.0, 5350.0, 5446.0, 5692.0, 5456.0, 5515.0, 5275.0, 5332.0, 5473.0, 5671.0, 5561.0, 5360.0, 5542.0, 5381.0, 5582.0, 5471.0, 5494.0, 5346.0, 5651.0, 5444.0, 5658.0, 5568.0, 5306.0, 5341.0, 5539.0, 5556.0, 5443.0, 5720.0, 5357.0, 5512.0, 5356.0, 5646.0, 5309.0, 5291.0, 5605.0, 5647.0, 5285.0 (number of hits: 3)
2	5510	9	1	333	1	5497.0, 5556.0, 5636.0, 5629.0, 5699.0, 5715.0, 5397.0, 5717.0, 5591.0, 5714.0, 5442.0, 5711.0, 5337.0, 5620.0, 5411.0, 5618.0, 5343.0, 5368.0, 5493.0, 5685.0, 5414.0, 5361.0, 5468.0, 5537.0, 5384.0, 5529.0, 5593.0, 5387.0, 5371.0, 5452.0, 5706.0, 5507.0, 5321.0, 5545.0, 5680.0, 5724.0, 5575.0, 5492.0, 5310.0, 5453.0, 5377.0, 5644.0, 5522.0, 5677.0, 5311.0, 5295.0, 5330.0, 5595.0, 5524.0, 5513.0, 5394.0, 5319.0, 5615.0, 5266.0, 5658.0, 5643.0, 5360.0, 5708.0, 5632.0, 5679.0, 5419.0, 5388.0, 5506.0, 5576.0, 5305.0, 5444.0, 5587.0, 5651.0, 5504.0, 5317.0, 5614.0, 5422.0, 5517.0, 5514.0, 5718.0, 5272.0, 5672.0, 5322.0, 5344.0, 5519.0, 5584.0, 5496.0, 5287.0, 5553.0, 5691.0, 5445.0, 5423.0, 5263.0, 5518.0, 5251.0, 5458.0, 5308.0, 5401.0, 5712.0, 5283.0, 5688.0, 5323.0, 5583.0, 5353.0, 5275.0 (number of hits: 7)
3	5510	9	1	333	1	5604.0, 5357.0, 5254.0, 5577.0, 5458.0, 5486.0, 5552.0, 5418.0, 5374.0, 5623.0, 5339.0, 5715.0, 5669.0, 5717.0, 5514.0, 5497.0, 5345.0, 5672.0, 5536.0, 5280.0, 5471.0, 5266.0, 5286.0, 5614.0, 5417.0, 5565.0, 5314.0, 5268.0, 5303.0, 5587.0, 5472.0, 5600.0, 5592.0, 5579.0, 5441.0, 5498.0, 5613.0, 5555.0, 5707.0, 5292.0, 5444.0, 5415.0, 5530.0, 5301.0, 5689.0, 5309.0, 5272.0, 5650.0, 5474.0, 5546.0, 5630.0, 5400.0, 5463.0, 5636.0, 5657.0, 5389.0, 5697.0, 5460.0, 5327.0, 5359.0, 5256.0, 5676.0, 5335.0, 5602.0, 5255.0

						5521.0, 5523.0, 5702.0, 5326.0, 5548.0, 5562.0, 5260.0, 5354.0, 5352.0, 5557.0, 5549.0, 5259.0, 5473.0, 5447.0, 5340.0, 5489.0, 5426.0, 5461.0, 5421.0, 5457.0, 5528.0, 5440.0, 5712.0, 5386.0, 5673.0, 5619.0, 5469.0, 5703.0, 5535.0, 5637.0, 5519.0, 5363.0, 5714.0, 5505.0, 5654.0 (number of hits: 2)
4	5510	9	1	333	1	5484.0, 5680.0, 5614.0, 5572.0, 5289.0, 5633.0, 5555.0, 5448.0, 5616.0, 5493.0, 5518.0, 5512.0, 5722.0, 5563.0, 5341.0, 5323.0, 5684.0, 5482.0, 5278.0, 5662.0, 5691.0, 5519.0, 5709.0, 5499.0, 5480.0, 5510.0, 5496.0, 5603.0, 5376.0, 5548.0, 5375.0, 5714.0, 5584.0, 5592.0, 5615.0, 5436.0, 5658.0, 5414.0, 5550.0, 5294.0, 5507.0, 5686.0, 5517.0, 5373.0, 5351.0, 5562.0, 5346.0, 5677.0, 5604.0, 5284.0, 5538.0, 5526.0, 5371.0, 5274.0, 5546.0, 5463.0, 5716.0, 5596.0, 5679.0, 5296.0, 5634.0, 5520.0, 5445.0, 5587.0, 5516.0, 5404.0, 5397.0, 5355.0, 5534.0, 5656.0, 5348.0, 5663.0, 5608.0, 5702.0, 5275.0, 5494.0, 5696.0, 5645.0, 5372.0, 5339.0, 5366.0, 5612.0, 5475.0, 5443.0, 5335.0, 5638.0, 5485.0, 5710.0, 5450.0, 5337.0, 5464.0, 5383.0, 5626.0, 5429.0, 5500.0, 5590.0, 5704.0, 5566.0, 5625.0, 5653.0 (number of hits: 6)
5	5510	9	1	333	1	5295.0, 5368.0, 5464.0, 5253.0, 5407.0, 5680.0, 5583.0, 5545.0, 5342.0, 5370.0, 5272.0, 5477.0, 5624.0, 5668.0, 5702.0, 5659.0, 5373.0, 5706.0, 5542.0, 5532.0, 5316.0, 5320.0, 5694.0, 5512.0, 5458.0, 5263.0, 5658.0, 5427.0, 5481.0, 5332.0, 5600.0, 5629.0, 5661.0, 5637.0, 5501.0, 5645.0, 5601.0, 5625.0, 5646.0, 5335.0, 5336.0, 5660.0, 5446.0, 5574.0, 5522.0, 5286.0, 5662.0, 5716.0, 5509.0, 5655.0, 5256.0, 5419.0, 5697.0, 5420.0, 5676.0, 5445.0, 5607.0, 5314.0, 5615.0, 5500.0, 5345.0, 5325.0, 5537.0, 5567.0, 5527.0, 5465.0, 5436.0, 5606.0, 5514.0, 5413.0, 5334.0, 5699.0, 5305.0, 5497.0, 5454.0, 5301.0, 5267.0, 5398.0, 5580.0, 5552.0, 5618.0, 5673.0, 5417.0, 5392.0, 5258.0, 5528.0, 5686.0, 5723.0, 5649.0, 5695.0, 5715.0, 5483.0, 5609.0, 5402.0, 5667.0, 5666.0, 5322.0, 5496.0, 5386.0, 5277.0 (number of hits: 4)
6	5510	9	1	333	1	5606.0, 5656.0, 5449.0, 5329.0, 5433.0, 5460.0, 5427.0, 5315.0, 5605.0, 5593.0, 5662.0, 5357.0, 5340.0, 5477.0, 5336.0, 5437.0, 5411.0, 5450.0, 5342.0, 5716.0, 5654.0, 5300.0, 5325.0, 5275.0, 5310.0, 5258.0, 5303.0, 5463.0, 5492.0, 5499.0, 5516.0, 5494.0, 5429.0, 5706.0, 5534.0, 5651.0, 5623.0, 5718.0, 5644.0, 5581.0, 5586.0, 5475.0, 5257.0, 5560.0, 5319.0, 5320.0, 5664.0, 5376.0, 5359.0, 5702.0, 5373.0, 5633.0, 5557.0, 5497.0, 5620.0,

						5714.0, 5641.0, 5401.0, 5326.0, 5616.0, 5405.0, 5472.0, 5305.0, 5410.0, 5596.0, 5459.0, 5569.0, 5531.0, 5585.0, 5594.0, 5392.0, 5561.0, 5488.0, 5337.0, 5720.0, 5610.0, 5524.0, 5428.0, 5578.0, 5316.0, 5554.0, 5270.0, 5684.0, 5564.0, 5384.0, 5689.0, 5678.0, 5575.0, 5533.0, 5468.0, 5299.0, 5298.0, 5535.0, 5659.0, 5471.0, 5486.0, 5327.0, 5386.0, 5722.0, 5308.0 (number of hits: 1)
7	5510	9	1	333	1	5694.0, 5567.0, 5370.0, 5421.0, 5302.0, 5645.0, 5360.0, 5648.0, 5410.0, 5289.0, 5544.0, 5511.0, 5506.0, 5290.0, 5257.0, 5624.0, 5665.0, 5314.0, 5680.0, 5711.0, 5450.0, 5620.0, 5479.0, 5439.0, 5466.0, 5309.0, 5521.0, 5347.0, 5408.0, 5569.0, 5560.0, 5428.0, 5619.0, 5483.0, 5504.0, 5342.0, 5510.0, 5545.0, 5400.0, 5590.0, 5442.0, 5448.0, 5578.0, 5685.0, 5380.0, 5296.0, 5512.0, 5626.0, 5577.0, 5705.0, 5496.0, 5459.0, 5331.0, 5538.0, 5691.0, 5268.0, 5261.0, 5499.0, 5437.0, 5301.0, 5362.0, 5299.0, 5536.0, 5526.0, 5376.0, 5719.0, 5280.0, 5701.0, 5717.0, 5608.0, 5489.0, 5430.0, 5720.0, 5652.0, 5251.0, 5622.0, 5572.0, 5422.0, 5530.0, 5513.0, 5326.0, 5311.0, 5547.0, 5690.0, 5539.0, 5365.0, 5396.0, 5464.0, 5334.0, 5472.0, 5412.0, 5288.0, 5349.0, 5441.0, 5707.0, 5718.0, 5604.0, 5423.0, 5565.0, 5697.0 (number of hits: 6)
8	5510	9	1	333	1	5453.0, 5556.0, 5463.0, 5717.0, 5581.0, 5517.0, 5519.0, 5496.0, 5502.0, 5701.0, 5311.0, 5607.0, 5378.0, 5533.0, 5398.0, 5289.0, 5330.0, 5685.0, 5445.0, 5365.0, 5400.0, 5493.0, 5645.0, 5549.0, 5592.0, 5462.0, 5381.0, 5510.0, 5301.0, 5414.0, 5545.0, 5610.0, 5310.0, 5671.0, 5263.0, 5713.0, 5418.0, 5706.0, 5559.0, 5627.0, 5456.0, 5595.0, 5546.0, 5640.0, 5329.0, 5681.0, 5380.0, 5596.0, 5608.0, 5554.0, 5575.0, 5643.0, 5367.0, 5339.0, 5396.0, 5540.0, 5394.0, 5691.0, 5287.0, 5370.0, 5719.0, 5626.0, 5623.0, 5479.0, 5601.0, 5612.0, 5570.0, 5317.0, 5692.0, 5486.0, 5359.0, 5489.0, 5273.0, 5255.0, 5402.0, 5689.0, 5714.0, 5506.0, 5420.0, 5662.0, 5633.0, 5469.0, 5542.0, 5324.0, 5294.0, 5523.0, 5276.0, 5386.0, 5374.0, 5318.0, 5589.0, 5373.0, 5331.0, 5555.0, 5618.0, 5586.0, 5674.0, 5698.0, 5650.0, 5584.0 (number of hits: 4)
9	5510	9	1	333	1	5476.0, 5621.0, 5403.0, 5691.0, 5318.0, 5563.0, 5504.0, 5409.0, 5421.0, 5371.0, 5684.0, 5490.0, 5251.0, 5579.0, 5447.0, 5384.0, 5416.0, 5422.0, 5594.0, 5588.0, 5328.0, 5327.0, 5486.0, 5616.0, 5344.0, 5511.0, 5582.0, 5580.0, 5585.0, 5438.0, 5649.0, 5516.0, 5339.0, 5443.0, 5529.0, 5629.0, 5667.0, 5387.0, 5359.0, 5523.0, 5720.0, 5572.0, 5673.0, 5448.0, 5349.0,

						5435.0, 5633.0, 5456.0, 5441.0, 5460.0, 5279.0, 5363.0, 5315.0, 5348.0, 5397.0, 5659.0, 5661.0, 5498.0, 5467.0, 5335.0, 5544.0, 5340.0, 5701.0, 5715.0, 5561.0, 5450.0, 5612.0, 5560.0, 5358.0, 5488.0, 5255.0, 5613.0, 5324.0, 5557.0, 5444.0, 5670.0, 5697.0, 5280.0, 5436.0, 5558.0, 5410.0, 5346.0, 5584.0, 5298.0, 5309.0, 5586.0, 5593.0, 5723.0, 5300.0, 5259.0, 5417.0, 5520.0, 5604.0, 5554.0, 5717.0, 5709.0, 5272.0, 5452.0, 5683.0, 5693.0 (number of hits: 3)
10	5510	9	1	333	0	
11	5501	9	1	333	1	5463.0, 5338.0, 5400.0, 5679.0, 5436.0, 5526.0, 5605.0, 5723.0, 5422.0, 5681.0, 5583.0, 5491.0, 5691.0, 5495.0, 5343.0, 5414.0, 5252.0, 5499.0, 5623.0, 5665.0, 5254.0, 5709.0, 5604.0, 5333.0, 5468.0, 5643.0, 5342.0, 5497.0, 5372.0, 5369.0, 5626.0, 5581.0, 5715.0, 5310.0, 5429.0, 5717.0, 5682.0, 5706.0, 5600.0, 5250.0, 5585.0, 5281.0, 5410.0, 5671.0, 5453.0, 5451.0, 5632.0, 5303.0, 5660.0, 5446.0, 5527.0, 5661.0, 5478.0, 5260.0, 5674.0, 5464.0, 5631.0, 5699.0, 5570.0, 5306.0, 5409.0, 5557.0, 5554.0, 5556.0, 5297.0, 5513.0, 5546.0, 5518.0, 5472.0, 5371.0, 5678.0, 5284.0, 5449.0, 5286.0, 5426.0, 5304.0, 5269.0, 5298.0, 5404.0, 5270.0, 5624.0, 5423.0, 5612.0, 5573.0, 5347.0, 5701.0, 5636.0, 5524.0, 5607.0, 5340.0, 5395.0, 5418.0, 5687.0, 5273.0, 5610.0, 5673.0, 5658.0, 5360.0, 5316.0, 5277.0 (number of hits: 3)
12	5501	9	1	333	0	
13	5501	9	1	333	1	5548.0, 5464.0, 5619.0, 5418.0, 5364.0, 5685.0, 5350.0, 5499.0, 5639.0, 5575.0, 5568.0, 5410.0, 5655.0, 5269.0, 5377.0, 5372.0, 5629.0, 5524.0, 5289.0, 5600.0, 5452.0, 5536.0, 5689.0, 5541.0, 5458.0, 5698.0, 5407.0, 5486.0, 5668.0, 5261.0, 5601.0, 5341.0, 5505.0, 5258.0, 5609.0, 5268.0, 5383.0, 5470.0, 5475.0, 5714.0, 5703.0, 5592.0, 5596.0, 5275.0, 5395.0, 5496.0, 5481.0, 5434.0, 5485.0, 5255.0, 5428.0, 5436.0, 5252.0, 5447.0, 5549.0, 5544.0, 5719.0, 5558.0, 5579.0, 5312.0, 5640.0, 5699.0, 5690.0, 5259.0, 5307.0, 5401.0, 5276.0, 5659.0, 5466.0, 5527.0, 5274.0, 5396.0, 5508.0, 5487.0, 5611.0, 5525.0, 5648.0, 5465.0, 5284.0, 5520.0, 5570.0, 5376.0, 5613.0, 5326.0, 5324.0, 5557.0, 5717.0, 5494.0, 5637.0, 5715.0, 5346.0, 5314.0, 5531.0, 5664.0, 5442.0, 5490.0, 5605.0, 5456.0, 5707.0, 5632.0 (number of hits: 5)
14	5501	9	1	333	1	5417.0, 5280.0, 5703.0, 5602.0, 5644.0, 5325.0, 5346.0, 5574.0, 5415.0, 5372.0, 5290.0, 5459.0, 5503.0, 5358.0, 5467.0, 5359.0, 5618.0, 5669.0, 5446.0, 5510.0, 5297.0, 5526.0, 5554.0, 5708.0, 5444.0,

						5451.0, 5523.0, 5716.0, 5578.0, 5254.0, 5603.0, 5430.0, 5651.0, 5311.0, 5353.0, 5269.0, 5304.0, 5544.0, 5281.0, 5589.0, 5455.0, 5375.0, 5303.0, 5400.0, 5409.0, 5585.0, 5633.0, 5477.0, 5482.0, 5380.0, 5273.0, 5354.0, 5469.0, 5479.0, 5676.0, 5495.0, 5341.0, 5681.0, 5718.0, 5699.0, 5568.0, 5424.0, 5625.0, 5710.0, 5577.0, 5712.0, 5694.0, 5283.0, 5591.0, 5715.0, 5695.0, 5407.0, 5520.0, 5443.0, 5355.0, 5665.0, 5253.0, 5314.0, 5534.0, 5624.0, 5250.0, 5289.0, 5556.0, 5714.0, 5537.0, 5384.0, 5472.0, 5433.0, 5600.0, 5440.0, 5370.0, 5682.0, 5406.0, 5535.0, 5579.0, 5405.0, 5504.0, 5368.0, 5607.0, 5438.0 (number of hits: 3)
15	5501	9	1	333	1	5349.0, 5336.0, 5317.0, 5346.0, 5472.0, 5659.0, 5719.0, 5402.0, 5395.0, 5588.0, 5665.0, 5648.0, 5683.0, 5562.0, 5331.0, 5676.0, 5253.0, 5463.0, 5299.0, 5471.0, 5577.0, 5709.0, 5465.0, 5717.0, 5506.0, 5295.0, 5476.0, 5265.0, 5520.0, 5644.0, 5278.0, 5404.0, 5437.0, 5656.0, 5376.0, 5290.0, 5267.0, 5455.0, 5523.0, 5519.0, 5369.0, 5595.0, 5381.0, 5597.0, 5407.0, 5435.0, 5396.0, 5504.0, 5550.0, 5457.0, 5559.0, 5511.0, 5272.0, 5291.0, 5681.0, 5412.0, 5628.0, 5345.0, 5549.0, 5264.0, 5516.0, 5700.0, 5643.0, 5650.0, 5679.0, 5654.0, 5689.0, 5564.0, 5283.0, 5590.0, 5488.0, 5410.0, 5531.0, 5419.0, 5507.0, 5636.0, 5671.0, 5698.0, 5292.0, 5355.0, 5704.0, 5618.0, 5261.0, 5660.0, 5508.0, 5300.0, 5541.0, 5333.0, 5256.0, 5366.0, 5566.0, 5426.0, 5537.0, 5548.0, 5573.0, 5555.0, 5582.0, 5357.0, 5321.0, 5325.0 (number of hits: 4)
16	5501	9	1	333	1	5460.0, 5473.0, 5351.0, 5335.0, 5324.0, 5571.0, 5646.0, 5450.0, 5254.0, 5617.0, 5527.0, 5638.0, 5715.0, 5386.0, 5445.0, 5430.0, 5706.0, 5713.0, 5403.0, 5609.0, 5469.0, 5474.0, 5452.0, 5536.0, 5360.0, 5665.0, 5516.0, 5337.0, 5663.0, 5423.0, 5256.0, 5359.0, 5614.0, 5566.0, 5653.0, 5259.0, 5648.0, 5476.0, 5569.0, 5397.0, 5442.0, 5600.0, 5267.0, 5277.0, 5336.0, 5273.0, 5265.0, 5631.0, 5371.0, 5449.0, 5596.0, 5425.0, 5694.0, 5714.0, 5696.0, 5384.0, 5327.0, 5413.0, 5408.0, 5679.0, 5532.0, 5309.0, 5424.0, 5271.0, 5406.0, 5264.0, 5463.0, 5611.0, 5446.0, 5669.0, 5554.0, 5508.0, 5475.0, 5418.0, 5375.0, 5381.0, 5704.0, 5255.0, 5528.0, 5573.0, 5599.0, 5629.0, 5650.0, 5538.0, 5325.0, 5552.0, 5312.0, 5576.0, 5477.0, 5320.0, 5703.0, 5717.0, 5681.0, 5404.0, 5633.0, 5519.0, 5417.0, 5503.0, 5388.0, 5578.0 (number of hits: 2)
17	5501	9	1	333	1	5623.0, 5579.0, 5568.0, 5480.0, 5399.0, 5486.0, 5679.0, 5673.0, 5682.0, 5711.0, 5588.0, 5424.0, 5374.0, 5525.0, 5462.0,

						5278.0, 5431.0, 5670.0, 5718.0, 5487.0, 5361.0, 5638.0, 5485.0, 5329.0, 5724.0, 5592.0, 5370.0, 5499.0, 5714.0, 5365.0, 5527.0, 5354.0, 5332.0, 5619.0, 5393.0, 5468.0, 5720.0, 5472.0, 5446.0, 5254.0, 5565.0, 5345.0, 5586.0, 5324.0, 5369.0, 5402.0, 5657.0, 5269.0, 5386.0, 5407.0, 5355.0, 5498.0, 5523.0, 5272.0, 5559.0, 5553.0, 5362.0, 5316.0, 5635.0, 5662.0, 5465.0, 5577.0, 5500.0, 5491.0, 5453.0, 5639.0, 5603.0, 5652.0, 5571.0, 5621.0, 5276.0, 5495.0, 5366.0, 5408.0, 5625.0, 5654.0, 5509.0, 5381.0, 5460.0, 5333.0, 5702.0, 5597.0, 5456.0, 5371.0, 5649.0, 5561.0, 5471.0, 5511.0, 5615.0, 5298.0, 5349.0, 5311.0, 5287.0, 5543.0, 5669.0, 5628.0, 5443.0, 5422.0, 5302.0, 5550.0 (number of hits: 5)
18	5501	9	1	333	0	
19	5501	9	1	333	1	5424.0, 5609.0, 5624.0, 5432.0, 5622.0, 5711.0, 5426.0, 5420.0, 5679.0, 5507.0, 5523.0, 5585.0, 5365.0, 5587.0, 5648.0, 5361.0, 5606.0, 5601.0, 5554.0, 5619.0, 5693.0, 5417.0, 5517.0, 5404.0, 5352.0, 5559.0, 5511.0, 5708.0, 5723.0, 5434.0, 5522.0, 5499.0, 5304.0, 5328.0, 5670.0, 5521.0, 5530.0, 5478.0, 5256.0, 5555.0, 5506.0, 5501.0, 5302.0, 5695.0, 5660.0, 5334.0, 5259.0, 5539.0, 5297.0, 5390.0, 5255.0, 5494.0, 5515.0, 5310.0, 5314.0, 5610.0, 5500.0, 5476.0, 5491.0, 5557.0, 5384.0, 5581.0, 5661.0, 5448.0, 5447.0, 5360.0, 5672.0, 5320.0, 5273.0, 5528.0, 5276.0, 5464.0, 5406.0, 5398.0, 5551.0, 5350.0, 5707.0, 5680.0, 5341.0, 5724.0, 5552.0, 5709.0, 5413.0, 5312.0, 5615.0, 5482.0, 5422.0, 5618.0, 5503.0, 5668.0, 5540.0, 5586.0, 5516.0, 5602.0, 5705.0, 5396.0, 5443.0, 5367.0, 5251.0, 5475.0 (number of hits: 7)
20	5501	9	1	333	1	5473.0, 5262.0, 5556.0, 5562.0, 5681.0, 5580.0, 5485.0, 5355.0, 5288.0, 5574.0, 5383.0, 5327.0, 5626.0, 5356.0, 5325.0, 5458.0, 5462.0, 5641.0, 5545.0, 5285.0, 5603.0, 5578.0, 5718.0, 5492.0, 5253.0, 5397.0, 5384.0, 5366.0, 5455.0, 5533.0, 5512.0, 5256.0, 5451.0, 5434.0, 5369.0, 5622.0, 5623.0, 5716.0, 5476.0, 5421.0, 5449.0, 5326.0, 5459.0, 5251.0, 5520.0, 5712.0, 5427.0, 5588.0, 5413.0, 5385.0, 5343.0, 5627.0, 5341.0, 5391.0, 5334.0, 5676.0, 5542.0, 5526.0, 5696.0, 5599.0, 5446.0, 5504.0, 5584.0, 5279.0, 5260.0, 5628.0, 5523.0, 5525.0, 5489.0, 5272.0, 5618.0, 5516.0, 5548.0, 5589.0, 5291.0, 5633.0, 5274.0, 5714.0, 5323.0, 5662.0, 5635.0, 5664.0, 5535.0, 5594.0, 5638.0, 5277.0, 5332.0, 5652.0, 5553.0, 5312.0, 5313.0, 5632.0, 5563.0, 5441.0, 5456.0, 5295.0, 5519.0, 5437.0, 5447.0, 5538.0 (number of hits: 2)

21	5519	9	1	333	1	<p>5363.0, 5521.0, 5263.0, 5579.0, 5513.0, 5490.0, 5520.0, 5677.0, 5426.0, 5672.0, 5701.0, 5387.0, 5514.0, 5428.0, 5636.0, 5512.0, 5400.0, 5618.0, 5697.0, 5398.0, 5444.0, 5461.0, 5284.0, 5437.0, 5256.0, 5699.0, 5706.0, 5559.0, 5721.0, 5603.0, 5389.0, 5673.0, 5491.0, 5462.0, 5655.0, 5268.0, 5465.0, 5313.0, 5707.0, 5306.0, 5434.0, 5442.0, 5272.0, 5441.0, 5278.0, 5517.0, 5335.0, 5628.0, 5506.0, 5317.0, 5607.0, 5616.0, 5602.0, 5473.0, 5378.0, 5497.0, 5334.0, 5674.0, 5623.0, 5544.0, 5277.0, 5690.0, 5375.0, 5539.0, 5283.0, 5597.0, 5631.0, 5269.0, 5487.0, 5700.0, 5633.0, 5573.0, 5314.0, 5295.0, 5463.0, 5688.0, 5455.0, 5339.0, 5553.0, 5509.0, 5315.0, 5564.0, 5660.0, 5644.0, 5668.0, 5489.0, 5322.0, 5464.0, 5515.0, 5670.0, 5714.0, 5301.0, 5305.0, 5325.0, 5486.0, 5438.0, 5372.0, 5529.0, 5518.0, 5620.0 (number of hits: 8)</p>
22	5519	9	1	333	1	<p>5690.0, 5487.0, 5629.0, 5263.0, 5315.0, 5426.0, 5358.0, 5355.0, 5307.0, 5500.0, 5571.0, 5644.0, 5512.0, 5562.0, 5659.0, 5448.0, 5555.0, 5513.0, 5604.0, 5624.0, 5459.0, 5337.0, 5606.0, 5460.0, 5375.0, 5455.0, 5407.0, 5304.0, 5352.0, 5316.0, 5514.0, 5280.0, 5385.0, 5400.0, 5700.0, 5405.0, 5415.0, 5686.0, 5568.0, 5576.0, 5591.0, 5558.0, 5675.0, 5640.0, 5697.0, 5651.0, 5301.0, 5291.0, 5359.0, 5648.0, 5372.0, 5434.0, 5722.0, 5279.0, 5477.0, 5583.0, 5373.0, 5401.0, 5478.0, 5311.0, 5360.0, 5724.0, 5341.0, 5542.0, 5660.0, 5326.0, 5585.0, 5267.0, 5533.0, 5354.0, 5465.0, 5321.0, 5677.0, 5666.0, 5516.0, 5650.0, 5282.0, 5433.0, 5338.0, 5441.0, 5653.0, 5498.0, 5306.0, 5572.0, 5451.0, 5625.0, 5593.0, 5428.0, 5620.0, 5595.0, 5351.0, 5345.0, 5504.0, 5369.0, 5566.0, 5334.0, 5692.0, 5361.0, 5250.0, 5482.0 (number of hits: 4)</p>
23	5519	9	1	333	1	<p>5255.0, 5504.0, 5452.0, 5606.0, 5639.0, 5402.0, 5601.0, 5345.0, 5300.0, 5614.0, 5468.0, 5405.0, 5382.0, 5348.0, 5333.0, 5523.0, 5295.0, 5698.0, 5594.0, 5505.0, 5380.0, 5330.0, 5542.0, 5709.0, 5254.0, 5268.0, 5538.0, 5391.0, 5572.0, 5436.0, 5482.0, 5585.0, 5679.0, 5261.0, 5540.0, 5627.0, 5447.0, 5558.0, 5619.0, 5323.0, 5685.0, 5250.0, 5544.0, 5690.0, 5475.0, 5281.0, 5501.0, 5607.0, 5374.0, 5686.0, 5697.0, 5598.0, 5378.0, 5581.0, 5722.0, 5712.0, 5454.0, 5448.0, 5533.0, 5579.0, 5641.0, 5711.0, 5635.0, 5721.0, 5440.0, 5266.0, 5370.0, 5570.0, 5630.0, 5400.0, 5569.0, 5527.0, 5545.0, 5621.0, 5264.0, 5562.0, 5305.0, 5410.0, 5421.0, 5703.0, 5665.0, 5573.0, 5336.0, 5669.0, 5653.0, 5480.0, 5269.0, 5277.0, 5668.0, 5707.0, 5687.0, 5316.0, 5708.0, 5710.0, 5532.0,</p>

						5474.0, 5695.0, 5320.0, 5344.0, 5596.0 (number of hits: 2)
24	5519	9	1	333	1	5540.0, 5285.0, 5417.0, 5670.0, 5647.0, 5519.0, 5612.0, 5527.0, 5452.0, 5465.0, 5470.0, 5684.0, 5531.0, 5549.0, 5533.0, 5565.0, 5288.0, 5421.0, 5440.0, 5694.0, 5631.0, 5629.0, 5260.0, 5411.0, 5712.0, 5630.0, 5386.0, 5406.0, 5512.0, 5413.0, 5646.0, 5590.0, 5387.0, 5599.0, 5294.0, 5366.0, 5449.0, 5299.0, 5514.0, 5438.0, 5632.0, 5637.0, 5443.0, 5262.0, 5586.0, 5473.0, 5361.0, 5551.0, 5546.0, 5513.0, 5297.0, 5313.0, 5267.0, 5350.0, 5561.0, 5448.0, 5666.0, 5488.0, 5265.0, 5595.0, 5662.0, 5651.0, 5426.0, 5504.0, 5354.0, 5496.0, 5714.0, 5532.0, 5283.0, 5389.0, 5536.0, 5279.0, 5380.0, 5545.0, 5602.0, 5484.0, 5253.0, 5624.0, 5657.0, 5610.0, 5619.0, 5654.0, 5650.0, 5371.0, 5343.0, 5419.0, 5349.0, 5323.0, 5705.0, 5497.0, 5535.0, 5644.0, 5564.0, 5408.0, 5304.0, 5321.0, 5645.0, 5429.0, 5395.0, 5575.0 (number of hits: 5)
25	5519	9	1	333	1	5254.0, 5490.0, 5711.0, 5489.0, 5327.0, 5702.0, 5589.0, 5587.0, 5313.0, 5323.0, 5502.0, 5271.0, 5319.0, 5274.0, 5471.0, 5487.0, 5619.0, 5442.0, 5541.0, 5398.0, 5382.0, 5662.0, 5367.0, 5690.0, 5363.0, 5326.0, 5497.0, 5623.0, 5555.0, 5279.0, 5665.0, 5421.0, 5314.0, 5296.0, 5354.0, 5345.0, 5542.0, 5454.0, 5521.0, 5283.0, 5397.0, 5523.0, 5481.0, 5646.0, 5522.0, 5389.0, 5507.0, 5392.0, 5331.0, 5267.0, 5529.0, 5609.0, 5341.0, 5462.0, 5452.0, 5494.0, 5710.0, 5499.0, 5405.0, 5655.0, 5415.0, 5304.0, 5703.0, 5380.0, 5516.0, 5534.0, 5565.0, 5400.0, 5445.0, 5644.0, 5617.0, 5620.0, 5307.0, 5692.0, 5396.0, 5298.0, 5724.0, 5630.0, 5575.0, 5306.0, 5458.0, 5722.0, 5688.0, 5699.0, 5374.0, 5346.0, 5628.0, 5357.0, 5386.0, 5394.0, 5393.0, 5501.0, 5704.0, 5641.0, 5333.0, 5322.0, 5550.0, 5570.0, 5635.0, 5636.0 (number of hits: 4)
26	5519	9	1	333	1	5288.0, 5723.0, 5297.0, 5476.0, 5368.0, 5411.0, 5289.0, 5586.0, 5424.0, 5333.0, 5566.0, 5370.0, 5693.0, 5307.0, 5408.0, 5375.0, 5345.0, 5716.0, 5526.0, 5711.0, 5528.0, 5466.0, 5585.0, 5416.0, 5632.0, 5661.0, 5277.0, 5499.0, 5607.0, 5602.0, 5640.0, 5269.0, 5418.0, 5294.0, 5315.0, 5360.0, 5611.0, 5577.0, 5457.0, 5561.0, 5471.0, 5669.0, 5595.0, 5477.0, 5459.0, 5599.0, 5568.0, 5329.0, 5665.0, 5378.0, 5553.0, 5431.0, 5677.0, 5666.0, 5287.0, 5560.0, 5404.0, 5433.0, 5422.0, 5703.0, 5339.0, 5550.0, 5535.0, 5479.0, 5251.0, 5341.0, 5567.0, 5653.0, 5712.0, 5650.0, 5635.0, 5385.0, 5511.0, 5442.0, 5622.0, 5563.0, 5272.0, 5421.0, 5487.0, 5399.0, 5559.0, 5606.0, 5536.0, 5458.0, 5253.0,

						5429.0, 5629.0, 5267.0, 5397.0, 5273.0, 5680.0, 5533.0, 5308.0, 5460.0, 5451.0, 5455.0, 5290.0, 5497.0, 5412.0, 5430.0 (number of hits: 2)
27	5519	9	1	333	1	5382.0, 5357.0, 5271.0, 5275.0, 5463.0, 5565.0, 5462.0, 5524.0, 5339.0, 5436.0, 5276.0, 5295.0, 5470.0, 5387.0, 5260.0, 5559.0, 5658.0, 5375.0, 5688.0, 5333.0, 5567.0, 5575.0, 5634.0, 5398.0, 5701.0, 5366.0, 5353.0, 5668.0, 5329.0, 5689.0, 5297.0, 5528.0, 5386.0, 5639.0, 5606.0, 5285.0, 5705.0, 5599.0, 5457.0, 5310.0, 5277.0, 5369.0, 5629.0, 5687.0, 5596.0, 5715.0, 5410.0, 5396.0, 5327.0, 5513.0, 5637.0, 5269.0, 5376.0, 5699.0, 5686.0, 5491.0, 5311.0, 5564.0, 5612.0, 5532.0, 5706.0, 5485.0, 5542.0, 5430.0, 5399.0, 5664.0, 5520.0, 5622.0, 5328.0, 5521.0, 5591.0, 5655.0, 5358.0, 5273.0, 5674.0, 5633.0, 5434.0, 5573.0, 5692.0, 5391.0, 5516.0, 5624.0, 5282.0, 5557.0, 5408.0, 5482.0, 5307.0, 5458.0, 5628.0, 5380.0, 5289.0, 5717.0, 5302.0, 5254.0, 5685.0, 5253.0, 5652.0, 5546.0, 5334.0, 5653.0 (number of hits: 5)
28	5519	9	1	333	1	5667.0, 5643.0, 5283.0, 5644.0, 5618.0, 5546.0, 5590.0, 5398.0, 5457.0, 5403.0, 5605.0, 5721.0, 5691.0, 5582.0, 5432.0, 5666.0, 5333.0, 5460.0, 5524.0, 5661.0, 5677.0, 5420.0, 5501.0, 5305.0, 5535.0, 5499.0, 5656.0, 5338.0, 5410.0, 5617.0, 5592.0, 5478.0, 5529.0, 5493.0, 5550.0, 5393.0, 5596.0, 5510.0, 5404.0, 5653.0, 5428.0, 5549.0, 5450.0, 5606.0, 5678.0, 5408.0, 5672.0, 5645.0, 5435.0, 5453.0, 5439.0, 5709.0, 5659.0, 5540.0, 5650.0, 5587.0, 5289.0, 5336.0, 5589.0, 5301.0, 5485.0, 5494.0, 5424.0, 5689.0, 5579.0, 5347.0, 5527.0, 5697.0, 5337.0, 5348.0, 5506.0, 5416.0, 5433.0, 5327.0, 5434.0, 5561.0, 5429.0, 5473.0, 5438.0, 5299.0, 5468.0, 5467.0, 5633.0, 5559.0, 5472.0, 5296.0, 5533.0, 5541.0, 5459.0, 5325.0, 5342.0, 5407.0, 5268.0, 5451.0, 5345.0, 5684.0, 5716.0, 5308.0, 5376.0, 5278.0 (number of hits: 3)
29	5519	9	1	333	1	5680.0, 5577.0, 5609.0, 5294.0, 5442.0, 5494.0, 5283.0, 5531.0, 5298.0, 5631.0, 5571.0, 5600.0, 5653.0, 5343.0, 5309.0, 5464.0, 5543.0, 5688.0, 5420.0, 5523.0, 5564.0, 5338.0, 5424.0, 5480.0, 5683.0, 5468.0, 5493.0, 5705.0, 5423.0, 5568.0, 5379.0, 5460.0, 5385.0, 5507.0, 5713.0, 5432.0, 5617.0, 5502.0, 5575.0, 5548.0, 5279.0, 5501.0, 5510.0, 5615.0, 5430.0, 5690.0, 5499.0, 5679.0, 5261.0, 5409.0, 5270.0, 5638.0, 5299.0, 5311.0, 5457.0, 5563.0, 5252.0, 5415.0, 5622.0, 5508.0, 5651.0, 5355.0, 5454.0, 5476.0, 5383.0, 5550.0, 5429.0, 5511.0, 5625.0, 5703.0, 5416.0, 5562.0, 5700.0, 5483.0, 5565.0,

						5307.0, 5439.0, 5384.0, 5356.0, 5335.0, 5425.0, 5436.0, 5696.0, 5528.0, 5539.0, 5652.0, 5544.0, 5458.0, 5647.0, 5662.0, 5352.0, 5254.0, 5419.0, 5401.0, 5715.0, 5492.0, 5273.0, 5572.0, 5300.0, 5366.0 (number of hits: 3)
30	5519	9	1	333	1	5720.0, 5464.0, 5645.0, 5380.0, 5309.0, 5718.0, 5649.0, 5705.0, 5461.0, 5625.0, 5533.0, 5398.0, 5722.0, 5290.0, 5277.0, 5537.0, 5662.0, 5598.0, 5329.0, 5681.0, 5259.0, 5478.0, 5565.0, 5656.0, 5579.0, 5677.0, 5330.0, 5717.0, 5688.0, 5715.0, 5547.0, 5702.0, 5621.0, 5305.0, 5587.0, 5459.0, 5668.0, 5591.0, 5414.0, 5623.0, 5470.0, 5687.0, 5630.0, 5566.0, 5571.0, 5335.0, 5616.0, 5467.0, 5507.0, 5724.0, 5340.0, 5574.0, 5525.0, 5314.0, 5548.0, 5365.0, 5260.0, 5711.0, 5449.0, 5543.0, 5588.0, 5584.0, 5367.0, 5422.0, 5678.0, 5409.0, 5648.0, 5635.0, 5613.0, 5448.0, 5637.0, 5269.0, 5333.0, 5660.0, 5634.0, 5493.0, 5369.0, 5358.0, 5489.0, 5585.0, 5376.0, 5385.0, 5647.0, 5692.0, 5568.0, 5680.0, 5364.0, 5392.0, 5536.0, 5683.0, 5597.0, 5583.0, 5495.0, 5442.0, 5370.0, 5679.0, 5279.0, 5388.0, 5494.0, 5610.0 (number of hits: 1)

D.2 40 MHz Bandwidth @ 5520 MHz

Table-1A/1B Radar Type 1A/1B Statistical Performance

Trial #	Fc (MHz)	Pulse/Burst	Pulse Width (μS)	PRI (μs)	Detection (1:yes; 0:no)
1	5520	57	1	938	1
2	5520	70	1	758	1
3	5520	95	1	558	1
4	5520	78	1	678	1
5	5520	63	1	838	1
6	5520	62	1	858	1
7	5520	76	1	698	1
8	5520	99	1	538	1
9	5520	58	1	918	1
10	5520	72	1	738	1
11	5520	67	1	798	1
12	5520	86	1	618	1
13	5520	83	1	638	1
14	5520	61	1	878	1
15	5520	89	1	598	1
16	5520	36	1	1506	1
17	5520	75	1	713	1
18	5520	24	1	2242	1
19	5520	26	1	2051	1
20	5520	51	1	1051	1
21	5520	19	1	2898	1
22	5520	19	1	2819	0
23	5520	32	1	1677	1
24	5520	26	1	2047	1
25	5520	88	1	601	1
26	5520	22	1	2475	1
27	5520	99	1	534	1
28	5520	32	1	1700	1
29	5520	25	1	2141	1
30	5520	43	1	1233	1
Detection Percentage: 96.7 % (>60%)					

Table-2 Radar Type 2 Statistical Performance

Trial #	Fc (MHz)	Pulse/Burst	Pulse Width (μ S)	PRI (μ s)	Detection (1:yes; 0:no)
1	5520	28	3.7	168	1
2	5520	28	3.3	213	1
3	5520	28	2.4	150	1
4	5520	27	1.8	200	1
5	5520	25	1.2	191	1
6	5520	24	3.4	204	1
7	5520	26	2.4	188	1
8	5520	23	2.5	203	1
9	5520	25	4.5	230	1
10	5520	27	2.2	160	1
11	5520	28	1.4	217	1
12	5520	23	2.6	153	1
13	5520	26	3.3	229	1
14	5520	28	2.5	201	1
15	5520	24	2.5	170	1
16	5520	25	2.3	182	1
17	5520	23	2.4	150	1
18	5520	27	2.7	197	1
19	5520	26	1.3	166	1
20	5520	26	3.9	173	1
21	5520	25	2.3	208	1
22	5520	24	1.3	198	1
23	5520	28	1.8	171	1
24	5520	28	1.7	196	1
25	5520	29	3.6	220	1
26	5520	27	1.3	171	1
27	5520	28	1.8	184	1
28	5520	24	2.2	196	1
29	5520	24	3.5	224	1
30	5520	25	2.2	225	1
Detection Percentage: 100 % (>60%)					

Table-3 Radar Type 3 Statistical Performance

Trial #	Fc (MHz)	Pulse/Burst	Pulse Width (μ S)	PRI (μ s)	Detection (1:yes; 0:no)
1	5520	17	9.8	283	1
2	5520	17	7	269	1
3	5520	16	8.7	256	0
4	5520	18	8.6	205	0
5	5520	18	8.7	411	1
6	5520	17	7.8	347	0
7	5520	17	9.6	388	1
8	5520	17	7	447	1
9	5520	16	6.6	238	1
10	5520	18	7.9	361	1
11	5520	17	6.1	396	1
12	5520	16	8.5	487	1
13	5520	18	8	376	1
14	5520	16	9.5	285	1
15	5520	18	8.1	243	1
16	5520	18	7.2	426	1
17	5520	17	6.5	295	1
18	5520	17	8.2	270	1
19	5520	16	6.4	298	0
20	5520	18	6.1	367	1
21	5520	16	7.5	413	1
22	5520	18	8.5	435	1
23	5520	18	7.2	344	1
24	5520	17	7.6	384	1
25	5520	17	8.2	303	1
26	5520	18	8.4	367	1
27	5520	17	8	229	1
28	5520	16	8.3	207	1
29	5520	16	7.3	407	1
30	5520	18	6.3	318	1
Detection Percentage: 86.7 % (>60%)					

Table-4 Radar Type 4 Statistical Performance

Trial #	Fc (MHz)	Pulse/Burst	Pulse Width (μS)	PRI (μs)	Detection (1:yes; 0:no)
1	5520	12	15	401	0
2	5520	12	19	218	1
3	5520	16	12.9	355	1
4	5520	16	18	453	1
5	5520	13	19.2	394	1
6	5520	16	12.5	398	1
7	5520	12	17.3	401	1
8	5520	16	13.2	290	1
9	5520	14	15.1	403	1
10	5520	13	15.4	473	1
11	5520	15	12	372	1
12	5520	14	11.4	281	1
13	5520	12	18.1	337	1
14	5520	14	13.6	350	0
15	5520	13	19.3	293	1
16	5520	16	13.3	405	1
17	5520	15	12.6	232	1
18	5520	12	14.7	267	0
19	5520	13	17.6	201	0
20	5520	12	16.6	367	0
21	5520	13	16.7	220	1
22	5520	14	13.5	284	1
23	5520	15	18.8	363	1
24	5520	16	18.2	365	1
25	5520	13	13.1	333	1
26	5520	12	11	358	1
27	5520	16	19	436	1
28	5520	14	15	406	1
29	5520	15	14.2	212	1
30	5520	16	18.4	454	1
Detection Percentage: 83.3 % (>60%)					

Table-5 Radar Type 5 Statistical Performance

Trial #	Fc (MHz)	Detection (1:yes; 0:no)
1	5520	1
2	5520	1
3	5520	1
4	5520	1
5	5520	1
6	5520	1
7	5520	1
8	5520	1
9	5520	1
10	5520	0
11	5506.3	1
12	5507.9	1
13	5509.1	1
14	5508.7	1
15	5509.5	0
16	5506.7	1
17	5507.5	0
18	5503.9	1
19	5507.9	1
20	5508.3	1
21	5530.9	1
22	5533.3	0
23	5536.5	1
24	5533.7	1
25	5531.3	1
26	5533.3	1
27	5530.9	1
28	5536.1	0
29	5536.5	1
30	5532.1	1
Detection Percentage: 83.3 % (>80%)		

Bin5 Statistics 1

Trial #	Pulse	Chirp (MHz)	Pulse Width (µS)	Pulse 1-2 spacing (uS)	Pulse 2-3 spacing (uS)	Pulse Start(S)	Detection (1:yes; 0:no)
0	1	7	55.8			0.340583	1
1	2	7	64.3	1793		1.504366	
2	2	7	72	1462		1.825132	
3	1	7	92.7			2.943819	
4	2	7	75	1238		3.582095	
5	2	7	62.2	1083		4.309245	
6	3	7	96	1735	1806	5.886454	
7	1	7	52.6			6.069779	
8	1	7	53.9			7.690586	
9	2	7	57.5	1332		7.850955	
10	1	7	93.8			8.710498	
11	2	7	80.6	1004		9.865619	
12	1	7	52.6			10.359031	
13	3	7	82.1	1939	1752	11.638799	

Bin5 Statistics 2

Trial #	Pulse	Chirp (MHz)	Pulse Width (µS)	Pulse 1-2 spacing (uS)	Pulse 2-3 spacing (uS)	Pulse Start(S)	Detection (1:yes; 0:no)
0	2	13	70.1	1835		0.465692	1
1	1	13	74.7			1.747183	
2	3	13	56.9	1188	1349	2.709033	
3	2	13	66.5	1916		3.638139	
4	3	13	76.5	1538	1842	4.264833	
5	2	13	76.9	1752		5.181158	
6	3	13	86	1846	1360	6.051486	
7	1	13	71.7			7.309026	
8	2	13	68.5	1583		8.933174	
9	2	13	71.5	1371		9.852109	
10	2	13	93.7	1935		10.778099	
11	2	13	70.2	1163		11.235478	

Bin5 Statistics 3

Trial #	Pulse	Chirp (MHz)	Pulse Width (µS)	Pulse 1-2 spacing (uS)	Pulse 2-3 spacing (uS)	Pulse Start(S)	Detection (1:yes; 0:no)
0	2	6	80	1080		0.322382	1
1	3	6	98.8	1305	1759	1.323966	
2	1	6	92.8			1.833653	
3	3	6	98.8	1733	1548	2.413737	
4	1	6	53.1			2.899156	
5	1	6	82.3			4.105035	
6	2	6	79.7	1011		4.768878	
7	3	6	96.2	1931	1915	5.099821	
8	1	6	72.1			5.850245	
9	2	6	70.5	1660		6.604284	
10	2	6	81.7	1263		7.461866	
11	2	6	85.8	1790		7.884679	
12	3	6	57.7	1572	1728	8.53622	
13	2	6	84	1656		9.818252	
14	2	6	56.5	1359		10.275737	
15	2	6	79.3	1176		10.978934	
16	2	6	65.7	1197		11.369629	

Bin5 Statistics 4

Trial #	Pulse	Chirp (MHz)	Pulse Width (µS)	Pulse 1-2 spacing (uS)	Pulse 2-3 spacing (uS)	Pulse Start(S)	Detection (1:yes; 0:no)
0	2	14	91	1239		0.334973	1
1	2	14	73	1957		1.192657	
2	3	14	68.9	1204	1552	1.338947	
3	3	14	88.7	1852	1694	1.979405	
4	3	14	92.1	1450	1124	2.788532	
5	2	14	58.2	1531		3.339711	
6	1	14	80.3			3.66857	
7	1	14	78.4			4.583598	
8	2	14	93.2	1928		4.828917	
9	1	14	69.4			5.977665	
10	2	14	96.8	1079		6.426966	
11	3	14	92.6	1614	1767	7.097474	
12	1	14	85.6			7.682833	
13	2	14	88.7	1499		8.366524	
14	3	14	75.6	1749	1733	8.612058	
15	3	14	51	1062	1728	9.052902	
16	1	14	87.4			9.897692	
17	3	14	61.7	1458	1858	10.200255	
18	1	14	85			10.85959	
19	3	14	96.4	1963	1732	11.866525	

Bin5 Statistics 5

Trial #	Pulse	Chirp (MHz)	Pulse Width (µS)	Pulse 1-2 spacing (uS)	Pulse 2-3 spacing (uS)	Pulse Start(S)	Detection (1:yes; 0:no)
0	1	7	86.1			0.447923	1
1	2	7	88.3	1098		1.108416	
2	2	7	78.8	1904		1.677742	
3	3	7	56.7	1873	1555	2.494115	
4	2	7	73.7	1694		3.047613	
5	3	7	85.7	1842	1753	3.943325	
6	2	7	87	1758		4.302938	
7	3	7	60.2	1332	1069	4.846387	
8	2	7	88.4	1818		5.506997	
9	2	7	78.6	1539		6.521247	
10	2	7	69.3	1123		6.682243	
11	1	7	91			7.684825	
12	1	7	97.7			8.614227	
13	1	7	73.4			8.886631	
14	2	7	80.4	1105		9.500904	
15	3	7	52.4	1177	1171	10.475161	
16	2	7	91.1	1859		10.831353	
17	3	7	64.8	1115	1458	11.50484	

Bin5 Statistics 6

Trial #	Pulse	Chirp (MHz)	Pulse Width (µS)	Pulse 1-2 spacing (uS)	Pulse 2-3 spacing (uS)	Pulse Start(S)	Detection (1:yes; 0:no)
0	2	7	61.8	1966		0.453004	1
1	2	7	67.3	1736		1.172732	
2	2	7	59.3	1112		1.81192	
3	2	7	91.5	1797		3.209012	
4	2	7	74.6	1294		3.675395	
5	1	7	52.5			4.428243	
6	2	7	55.2	1599		5.425892	
7	2	7	52.5	1349		6.557959	
8	2	7	56.4	1823		7.099969	
9	2	7	68	1758		8.371364	
10	1	7	60.6			8.918508	
11	2	7	91.9	1392		10.267296	
12	2	7	71	1136		10.446405	
13	2	7	79.7	1452		11.794078	

Bin5 Statistics 7

Trial #	Pulse	Chirp (MHz)	Pulse Width (µS)	Pulse 1-2 spacing (uS)	Pulse 2-3 spacing (uS)	Pulse Start(S)	Detection (1:yes; 0:no)
0	2	10	71.6	1101		0.312596	1
1	1	10	74.5			1.440278	
2	2	10	58.1	1016		2.390987	
3	3	10	54.6	1676	1543	2.621659	
4	3	10	79.8	1729	1024	3.658752	
5	2	10	83.8	1696		4.143663	
6	3	10	79.8	1232	1318	4.875304	
7	2	10	54.2	1231		6.322904	
8	2	10	50.7	1341		7.092231	
9	3	10	54.4	1087	1059	7.753993	
10	2	10	87.6	1512		8.037238	
11	2	10	95.5	1962		9.593071	
12	1	10	88.8			9.72725	
13	2	10	77.3	1729		10.477865	
14	2	10	77.1	1360		11.58347	

Bin5 Statistics 8

Trial #	Pulse	Chirp (MHz)	Pulse Width (µS)	Pulse 1-2 spacing (uS)	Pulse 2-3 spacing (uS)	Pulse Start(S)	Detection (1:yes; 0:no)
0	3	14	80.3	1019	1398	0.235009	1
1	2	14	66.6	1324		1.19196	
2	2	14	68.3	1888		2.401137	
3	2	14	91.5	1722		3.319987	
4	2	14	71	1290		3.855961	
5	2	14	67.5	1116		4.700984	
6	1	14	63.8			5.795531	
7	1	14	90.8			6.443466	
8	1	14	61.3			7.038122	
9	2	14	75.2	1577		8.539688	
10	3	14	56.8	1047	1659	9.060488	
11	1	14	92.3			10.229867	
12	3	14	52	1721	1041	10.630955	
13	1	14	81.1			11.564258	

Bin5 Statistics 9

Trial #	Pulse	Chirp (MHz)	Pulse Width (µS)	Pulse 1-2 spacing (uS)	Pulse 2-3 spacing (uS)	Pulse Start(S)	Detection (1:yes; 0:no)
0	1	14	85.3			0.401515	1
1	2	14	87.3	1718		0.719798	
2	1	14	87.8			1.795361	
3	2	14	99.6	1124		2.043582	
4	3	14	68.2	1694	1129	2.958282	
5	1	14	67.5			3.412714	
6	3	14	87.8	1142	1343	4.65046	
7	1	14	51.1			4.773326	
8	1	14	62.5			5.781654	
9	2	14	56.3	1434		6.262482	
10	3	14	91.2	1797	1158	7.033452	
11	2	14	98	1354		7.941232	
12	1	14	54.5			8.389861	
13	2	14	60.6	1324		8.862121	
14	1	14	63			9.449062	
15	2	14	71.7	1128		10.347531	
16	3	14	61.2	1360	1143	11.135581	
17	1	14	95.1			11.47231	

Bin5 Statistics 10

Trial #	Pulse	Chirp (MHz)	Pulse Width (µS)	Pulse 1-2 spacing (uS)	Pulse 2-3 spacing (uS)	Pulse Start(S)	Detection (1:yes; 0:no)
0	1	16	89.3			0.565495	0
1	2	16	90.8	1199		0.892983	
2	1	16	77.6			1.869053	
3	1	16	93.8			2.153928	
4	1	16	51			2.64026	
5	2	16	65.6	1807		3.424089	
6	2	16	69	1388		3.82406	
7	3	16	89.5	1746	1194	4.427679	
8	3	16	62.3	1909	1493	5.168012	
9	2	16	73.4	1155		5.727549	
10	2	16	59.8	1195		6.668399	
11	1	16	99.2			7.140884	
12	1	16	50.9			7.724473	
13	2	16	76.6	1294		8.755892	
14	2	16	95	1357		9.086047	
15	1	16	81.1			10.059007	
16	3	16	56.5	1726	1477	10.186215	
17	2	16	81.4	1374		11.299893	
18	3	16	83.4	1522	1394	11.718623	

Bin5 Statistics 11

Trial #	Pulse	Chirp (MHz)	Pulse Width (µS)	Pulse 1-2 spacing (uS)	Pulse 2-3 spacing (uS)	Pulse Start(S)	Detection (1:yes; 0:no)
0	1	12	75.2			0.226483	1
1	1	12	75.9			1.447513	
2	2	12	84.7	1802		2.626824	
3	2	12	83.4	1367		3.298036	
4	3	12	51.2	1075	1743	4.218169	
5	3	12	78.2	1728	1439	5.467245	
6	2	12	99.2	1003		6.760197	
7	2	12	57.3	1601		7.756655	
8	2	12	69.1	1799		8.36246	
9	2	12	94.2	1765		9.811523	
10	3	12	92	1878	1448	10.806037	
11	2	12	53.2	1330		11.611689	

Bin5 Statistics 12

Trial #	Pulse	Chirp (MHz)	Pulse Width (µS)	Pulse 1-2 spacing (uS)	Pulse 2-3 spacing (uS)	Pulse Start(S)	Detection (1:yes; 0:no)
0	3	16	99.9	1673	1213	1.468419	1
1	2	16	98.4	1532		1.523768	
2	2	16	55.7	1267		4.156527	
3	2	16	78.7	1391		5.752555	
4	3	16	77.3	1943	1242	7.000698	
5	2	16	65.7	1685		7.896347	
6	2	16	76.9	1554		9.685589	
7	1	16	90.8			11.592698	

Bin5 Statistics 13

Trial #	Pulse	Chirp (MHz)	Pulse Width (µS)	Pulse 1-2 spacing (uS)	Pulse 2-3 spacing (uS)	Pulse Start(S)	Detection (1:yes; 0:no)
0	2	19	63.6	1572		0.127035	1
1	1	19	68.6			1.076277	
2	1	19	66.3			2.115018	
3	3	19	65.8	1754	1825	2.172612	
4	2	19	60	1032		3.099647	
5	1	19	64.8			3.647842	
6	1	19	74.9			4.538816	
7	2	19	93	1613		5.262814	
8	2	19	59.3	1260		6.330222	
9	1	19	56.4			6.611817	
10	2	19	73.4	1855		7.166737	
11	1	19	53.4			8.140446	
12	1	19	53.6			8.521833	
13	2	19	79.7	1942		9.349141	
14	3	19	74.7	1830	1675	10.36918	
15	2	19	60.6	1350		10.791891	
16	2	19	52.3	1009		11.711169	

Bin5 Statistics 14

Trial #	Pulse	Chirp (MHz)	Pulse Width (µS)	Pulse 1-2 spacing (uS)	Pulse 2-3 spacing (uS)	Pulse Start(S)	Detection (1:yes; 0:no)
0	1	18	77.2			0.462652	1
1	2	18	76	1864		1.32661	
2	3	18	68.4	1986	1135	1.71873	
3	2	18	51.5	1138		2.540684	
4	2	18	72.9	1139		3.473642	
5	2	18	63.2	1719		3.662546	
6	2	18	63.9	1046		4.410455	
7	1	18	60.7			5.011705	
8	3	18	50.4	1919	1154	5.990167	
9	1	18	79.2			6.928735	
10	2	18	75.1	1596		7.234218	
11	3	18	98.1	1679	1599	8.276196	
12	2	18	81.3	1760		9.128271	
13	1	18	59.4			9.528819	
14	1	18	80.1			10.332586	
15	2	18	77.9	1621		10.79731	
16	3	18	91.7	1820	1831	11.872429	

Bin5 Statistics 15

Trial #	Pulse	Chirp (MHz)	Pulse Width (µS)	Pulse 1-2 spacing (uS)	Pulse 2-3 spacing (uS)	Pulse Start(S)	Detection (1:yes; 0:no)
0	1	20	98.6			0.798138	0
1	3	20	79.1	1513	1198	2.075451	
2	1	20	72.4			3.281585	
3	2	20	99.6	1184		4.176713	
4	1	20	81.6			6.207343	
5	2	20	92.6	1823		7.231711	
6	1	20	91.2			8.988357	
7	1	20	58.6			10.548277	
8	2	20	69.9	1331		10.720041	

Bin5 Statistics 16

Trial #	Pulse	Chirp (MHz)	Pulse Width (µS)	Pulse 1-2 spacing (uS)	Pulse 2-3 spacing (uS)	Pulse Start(S)	Detection (1:yes; 0:no)
0	2	13	53.1	1902		0.609211	1
1	1	13	72.8			1.801085	
2	2	13	83	1744		2.195951	
3	1	13	89.8			3.676579	
4	2	13	86	1549		4.361412	
5	2	13	70.2	1001		4.809278	
6	2	13	87.6	1099		6.37142	
7	2	13	68.4	1331		6.563417	
8	1	13	92.2			7.551168	
9	2	13	87.9	1852		8.796693	
10	3	13	91.4	1612	1654	9.339499	
11	2	13	63.3	1545		10.821439	
12	3	13	58	1343	1067	11.19283	

Bin5 Statistics 17

Trial #	Pulse	Chirp (MHz)	Pulse Width (µS)	Pulse 1-2 spacing (uS)	Pulse 2-3 spacing (uS)	Pulse Start(S)	Detection (1:yes; 0:no)
0	3	15	53	1907	1311	0.036065	1
1	2	15	83.2	1615		1.614032	
2	2	15	92.2	1396		2.882846	
3	3	15	93.5	1566	1299	5.237246	
4	1	15	62.7			5.936475	
5	3	15	94.4	1006	1625	6.751262	
6	1	15	70.6			8.671316	
7	3	15	54.4	1556	1243	10.431701	
8	2	15	64.8	1647		11.217064	

Bin5 Statistics 18

Trial #	Pulse	Chirp (MHz)	Pulse Width (μS)	Pulse 1-2 spacing (uS)	Pulse 2-3 spacing (uS)	Pulse Start(S)	Detection (1:yes; 0:no)
0	3	6	54.8	1798	1925	0.37618	1
1	3	6	67.2	1590	1910	1.188776	
2	2	6	84.4	1430		1.373187	
3	2	6	50.6	1485		1.827383	
4	1	6	68.8			2.968788	
5	1	6	82.4			3.072214	
6	3	6	51.1	1876	1248	3.868069	
7	2	6	98.3	1528		4.364257	
8	2	6	55.3	1906		4.995146	
9	2	6	90	1074		5.578691	
10	1	6	93.4			6.19937	
11	2	6	58.9	1384		7.022543	
12	3	6	56.6	1048	1035	7.327742	
13	2	6	71.6	1494		8.112758	
14	2	6	51.1	1607		8.446753	
15	2	6	83.3	1773		9.013107	
16	3	6	70.1	1364	1201	10.190575	
17	1	6	79.5			10.52847	
18	2	6	65.5	1765		11.29122	
19	2	6	76.3	1140		11.865798	

Bin5 Statistics 19

Trial #	Pulse	Chirp (MHz)	Pulse Width (µS)	Pulse 1-2 spacing (uS)	Pulse 2-3 spacing (uS)	Pulse Start(S)	Detection (1:yes; 0:no)
0	1	16	52.3			0.363292	1
1	2	16	50.9	1015		0.759435	
2	1	16	83.1			1.928803	
3	2	16	83.5	1963		2.559229	
4	1	16	73.8			2.757632	
5	2	16	76.6	1385		3.597111	
6	1	16	81.7			4.169985	
7	2	16	58.4	1623		5.259338	
8	2	16	88.2	1517		5.338039	
9	3	16	99.2	1960	1181	6.396869	
10	2	16	94.4	1954		6.759438	
11	1	16	82.9			7.499337	
12	2	16	55.3	1269		8.267914	
13	1	16	73.8			9.228695	
14	2	16	89.3	1809		9.700167	
15	3	16	76.9	1241	1621	10.213242	
16	2	16	80.2	1646		10.993348	
17	3	16	79.5	1467	1140	11.863135	

Bin5 Statistics 20

Trial #	Pulse	Chirp (MHz)	Pulse Width (µS)	Pulse 1-2 spacing (uS)	Pulse 2-3 spacing (uS)	Pulse Start(S)	Detection (1:yes; 0:no)
0	2	17	73	1138		0.315592	1
1	3	17	59.1	1596	1126	0.827971	
2	3	17	98.6	1335	1872	1.6823	
3	2	17	69.5	1408		2.073336	
4	3	17	78.8	1405	1750	2.796846	
5	2	17	71.9	1184		3.204943	
6	1	17	67.9			4.341987	
7	2	17	86.6	1025		4.441258	
8	1	17	87.6			5.073372	
9	2	17	83.1	1490		5.849405	
10	1	17	71.8			6.653738	
11	3	17	91	1037	1955	7.152194	
12	2	17	60.6	1588		7.592307	
13	1	17	80.4			8.520761	
14	2	17	84.4	1893		9.341619	
15	1	17	83.2			9.814078	
16	3	17	55.4	1871	1119	10.643958	
17	2	17	72.8	1546		10.994213	
18	3	17	65.1	1464	1676	11.716016	

Bin5 Statistics 21

Trial #	Pulse	Chirp (MHz)	Pulse Width (µS)	Pulse 1-2 spacing (uS)	Pulse 2-3 spacing (uS)	Pulse Start(S)	Detection (1:yes; 0:no)
0	3	19	70.1	1051	1303	0.462291	1
1	2	19	93.4	1628		1.337576	
2	2	19	62	1013		2.472554	
3	2	19	91	1701		3.086358	
4	3	19	67	1327	1119	3.970811	
5	1	19	56.6			5.027245	
6	1	19	95.3			5.586497	
7	3	19	57.2	1240	1521	7.073713	
8	1	19	73.3			7.614524	
9	1	19	91.7			9.067135	
10	1	19	81.9			9.343419	
11	2	19	96.6	1401		10.596636	
12	1	19	86.3			11.751456	

Bin5 Statistics 22

Trial #	Pulse	Chirp (MHz)	Pulse Width (µS)	Pulse 1-2 spacing (uS)	Pulse 2-3 spacing (uS)	Pulse Start(S)	Detection (1:yes; 0:no)
0	1	13	98.1			0.781663	0
1	2	13	55.5	1382		1.760466	
2	2	13	78.9	1432		2.079609	
3	1	13	85.8			3.505725	
4	2	13	56.6	1223		4.152833	
5	1	13	55.2			5.1162	
6	2	13	79.5	1806		5.958229	
7	2	13	79.1	1490		7.055465	
8	1	13	66.2			8.215538	
9	2	13	80.8	1782		8.731975	
10	3	13	59	1750	1356	9.525256	
11	1	13	86.7			10.277077	
12	2	13	66.6	1386		11.584524	

Bin5 Statistics 23

Trial #	Pulse	Chirp (MHz)	Pulse Width (µS)	Pulse 1-2 spacing (uS)	Pulse 2-3 spacing (uS)	Pulse Start(S)	Detection (1:yes; 0:no)
0	3	5	93.4	1794	1710	0.609272	1
1	3	5	64.5	1263	1216	1.30094	
2	3	5	81.3	1369	1080	1.610046	
3	2	5	72.4	1632		2.120349	
4	3	5	78.4	1254	1713	2.96278	
5	2	5	86.9	1543		3.72	
6	2	5	80.5	1168		4.571353	
7	1	5	79.2			5.187623	
8	1	5	75.2			5.737077	
9	2	5	78.1	1697		6.019783	
10	2	5	93.4	1176		6.960846	
11	2	5	57.3	1139		7.872796	
12	3	5	78.4	1016	1364	8.03165	
13	2	5	51.2	1694		8.90341	
14	3	5	74.2	1004	1604	9.457932	
15	1	5	59.9			10.189515	
16	1	5	50.4			10.871213	
17	3	5	52.8	1523	1727	11.600144	

Bin5 Statistics 24

Trial #	Pulse	Chirp (MHz)	Pulse Width (µS)	Pulse 1-2 spacing (uS)	Pulse 2-3 spacing (uS)	Pulse Start(S)	Detection (1:yes; 0:no)
0	2	12	79.2	1480		0.069756	1
1	2	12	75.4	1031		1.477392	
2	2	12	74.8	1580		2.711848	
3	3	12	71.3	1901	1830	3.392306	
4	3	12	52	1596	1450	4.14511	
5	2	12	60	1370		4.712659	
6	2	12	72.7	1586		5.966209	
7	1	12	65.6			6.935429	
8	3	12	97.9	1521	1493	8.17027	
9	1	12	68.3			9.225829	
10	3	12	59.3	1374	1732	9.778725	
11	2	12	82.1	1201		10.397525	
12	2	12	54.6	1712		11.107457	

Bin5 Statistics 25

Trial #	Pulse	Chirp (MHz)	Pulse Width (µS)	Pulse 1-2 spacing (uS)	Pulse 2-3 spacing (uS)	Pulse Start(S)	Detection (1:yes; 0:no)
0	1	18	99.2			0.854262	1
1	2	18	91.6	1478		1.173763	
2	2	18	51.1	1896		2.798815	
3	3	18	87.2	1937	1950	4.288309	
4	2	18	59.3	1847		4.630881	
5	2	18	71.2	1181		6.283186	
6	2	18	68	1594		6.932249	
7	1	18	94.4			8.432601	
8	3	18	85.3	1149	1269	9.38577	
9	3	18	83.5	1101	1025	10.05458	
10	3	18	96	1798	1901	11.296457	

Bin5 Statistics 26

Trial #	Pulse	Chirp (MHz)	Pulse Width (µS)	Pulse 1-2 spacing (uS)	Pulse 2-3 spacing (uS)	Pulse Start(S)	Detection (1:yes; 0:no)
0	2	13	75.8	1875		0.004594	1
1	1	13	74.6			1.658733	
2	1	13	92.8			2.319539	
3	2	13	82.6	1824		3.252686	
4	3	13	81	1310	1902	4.405017	
5	2	13	61.6	1200		5.219116	
6	2	13	64.3	1522		6.893866	
7	1	13	60.8			7.356302	
8	2	13	95.8	1615		8.585578	
9	2	13	87.7	1761		9.886869	
10	1	13	87.1			10.716335	
11	2	13	64.7	1723		11.513857	

Bin5 Statistics 27

Trial #	Pulse	Chirp (MHz)	Pulse Width (µS)	Pulse 1-2 spacing (uS)	Pulse 2-3 spacing (uS)	Pulse Start(S)	Detection (1:yes; 0:no)
0	3	19	55	1538	1724	0.221818	1
1	3	19	93.6	1960	1766	1.06765	
2	2	19	64.2	1639		2.016076	
3	2	19	75.1	1543		3.163754	
4	1	19	53.7			3.251091	
5	1	19	67.2			4.633298	
6	2	19	75.9	1933		5.42725	
7	2	19	70	1399		6.193804	
8	2	19	73.9	1169		6.64008	
9	3	19	56.3	1907	1705	7.799493	
10	2	19	96.3	1617		8.125438	
11	3	19	85.4	1312	1471	9.354153	
12	2	19	63.4	1109		10.370604	
13	2	19	77.4	1581		11.084719	
14	1	19	96.1			11.44446	

Bin5 Statistics 28

Trial #	Pulse	Chirp (MHz)	Pulse Width (µS)	Pulse 1-2 spacing (uS)	Pulse 2-3 spacing (uS)	Pulse Start(S)	Detection (1:yes; 0:no)
0	2	6	96.4	1867		0.035596	0
1	2	6	78	1203		1.527694	
2	3	6	93	1295	1747	2.252039	
3	1	6	62.2			2.863433	
4	2	6	93.4	1619		3.257397	
5	2	6	53	1637		4.693605	
6	1	6	84.7			5.585922	
7	2	6	50.7	1808		5.944464	
8	2	6	52.8	1922		7.107697	
9	3	6	96.4	1566	1875	7.571293	
10	3	6	54.9	1130	1540	8.000033	
11	2	6	67.9	1323		9.571898	
12	3	6	59.6	1832	1736	9.640355	
13	2	6	55.1	1725		11.028253	
14	1	6	71.6			11.789089	

Bin5 Statistics 29

Trial #	Pulse	Chirp (MHz)	Pulse Width (µS)	Pulse 1-2 spacing (uS)	Pulse 2-3 spacing (uS)	Pulse Start(S)	Detection (1:yes; 0:no)
0	2	5	84	1843		0.115723	1
1	2	5	52.7	1620		1.4414	
2	2	5	73.6	1320		2.217681	
3	2	5	87.1	1649		3.470648	
4	3	5	86	1559	1378	4.32879	
5	2	5	57.7	1861		4.75115	
6	2	5	81.8	1342		5.554635	
7	3	5	91.3	1397	1205	7.127964	
8	2	5	79.2	1594		7.796198	
9	2	5	75.4	1628		8.336018	
10	2	5	64.7	1095		9.904105	
11	2	5	72.4	1116		10.743179	
12	1	5	85.9			11.780151	

Bin5 Statistics 30

Trial #	Pulse	Chirp (MHz)	Pulse Width (µS)	Pulse 1-2 spacing (uS)	Pulse 2-3 spacing (uS)	Pulse Start(S)	Detection (1:yes; 0:no)
0	2	16	56.2	1623		0.45788	1
1	2	16	68.8	1508		1.328306	
2	3	16	89.4	1580	1330	3.262509	
3	1	16	51.8			3.866373	
4	1	16	91.7			4.850626	
5	3	16	91.4	1603	1020	6.572972	
6	2	16	62.6	1071		7.972797	
7	1	16	62.1			8.66562	
8	3	16	99.7	1542	1992	10.057882	
9	3	16	60	1932	1703	11.236102	

Table-6 Radar Type 6 Statistical Performance

Trial #	Fc (MHz)	Pulse /Burst	Pulse Width (µS)	PRI (µs)	Detection (1:yes; 0:no)	Hopping Sequence
1	5520	9	1	333	1	5555.0, 5530.0, 5333.0, 5434.0, 5253.0, 5505.0, 5641.0, 5648.0, 5643.0, 5264.0, 5298.0, 5280.0, 5665.0, 5409.0, 5339.0, 5590.0, 5523.0, 5357.0, 5565.0, 5326.0, 5340.0, 5518.0, 5372.0, 5317.0, 5676.0, 5524.0, 5390.0, 5455.0, 5374.0, 5305.0, 5600.0, 5433.0, 5457.0, 5495.0, 5328.0, 5342.0, 5514.0, 5680.0, 5394.0, 5260.0, 5567.0, 5712.0, 5482.0, 5358.0, 5689.0, 5623.0, 5709.0, 5538.0, 5445.0, 5308.0, 5398.0, 5563.0, 5367.0, 5421.0, 5535.0, 5699.0, 5313.0, 5446.0, 5418.0, 5697.0, 5558.0, 5573.0, 5383.0, 5542.0, 5362.0, 5450.0, 5422.0, 5644.0, 5288.0, 5587.0, 5620.0, 5638.0, 5645.0, 5267.0, 5438.0, 5379.0, 5312.0, 5425.0, 5597.0, 5444.0, 5621.0, 5432.0, 5520.0, 5388.0, 5544.0, 5647.0, 5255.0, 5309.0, 5681.0, 5349.0, 5423.0, 5494.0, 5556.0, 5634.0, 5572.0, 5655.0, 5443.0, 5490.0, 5543.0, 5512.0 (number of hits: 9)
2	5520	9	1	333	1	5422.0, 5668.0, 5563.0, 5483.0, 5633.0, 5465.0, 5577.0, 5689.0, 5490.0, 5517.0, 5473.0, 5376.0, 5359.0, 5547.0, 5317.0, 5584.0, 5604.0, 5589.0, 5497.0, 5307.0, 5314.0, 5323.0, 5551.0, 5693.0, 5627.0, 5570.0, 5676.0, 5370.0, 5549.0, 5286.0, 5655.0, 5455.0, 5310.0, 5700.0, 5347.0, 5529.0, 5367.0, 5356.0, 5675.0, 5557.0, 5499.0, 5591.0, 5458.0, 5541.0, 5528.0, 5466.0, 5342.0, 5362.0, 5275.0, 5461.0, 5467.0, 5524.0, 5489.0, 5562.0, 5619.0, 5505.0, 5260.0, 5287.0, 5586.0, 5334.0, 5683.0, 5534.0, 5555.0, 5454.0, 5523.0, 5674.0, 5546.0, 5560.0, 5433.0, 5385.0, 5508.0, 5299.0, 5417.0, 5329.0, 5390.0, 5612.0, 5395.0, 5426.0, 5327.0, 5623.0, 5599.0, 5696.0, 5420.0, 5457.0, 5553.0, 5468.0, 5503.0, 5573.0, 5501.0, 5611.0, 5435.0, 5532.0, 5548.0, 5535.0, 5318.0, 5578.0, 5516.0, 5364.0, 5521.0, 5704.0 (number of hits: 13)
3	5520	9	1	333	1	5428.0, 5539.0, 5291.0, 5413.0, 5614.0, 5576.0, 5296.0, 5673.0, 5265.0, 5632.0, 5630.0, 5660.0, 5456.0, 5303.0, 5708.0, 5435.0, 5446.0, 5650.0, 5345.0, 5422.0, 5544.0, 5654.0, 5272.0, 5365.0, 5388.0, 5279.0, 5707.0, 5594.0, 5560.0, 5374.0, 5325.0, 5646.0, 5648.0, 5362.0, 5387.0, 5309.0, 5599.0, 5443.0, 5354.0, 5315.0, 5276.0, 5657.0, 5469.0, 5425.0, 5655.0, 5343.0, 5484.0, 5548.0, 5381.0, 5483.0, 5698.0, 5607.0, 5393.0, 5625.0, 5686.0, 5617.0, 5347.0, 5676.0, 5581.0, 5423.0, 5644.0, 5680.0, 5418.0, 5501.0, 5640.0

						5701.0, 5583.0, 5638.0, 5564.0, 5408.0, 5281.0, 5554.0, 5674.0, 5406.0, 5588.0, 5367.0, 5481.0, 5515.0, 5390.0, 5328.0, 5570.0, 5490.0, 5375.0, 5283.0, 5316.0, 5561.0, 5398.0, 5587.0, 5314.0, 5412.0, 5311.0, 5717.0, 5506.0, 5716.0, 5540.0, 5497.0, 5392.0, 5448.0, 5678.0, 5468.0 (number of hits: 2)
4	5520	9	1	333	1	5521.0, 5307.0, 5545.0, 5387.0, 5532.0, 5622.0, 5388.0, 5654.0, 5477.0, 5507.0, 5675.0, 5334.0, 5506.0, 5591.0, 5374.0, 5370.0, 5359.0, 5412.0, 5495.0, 5268.0, 5278.0, 5723.0, 5424.0, 5287.0, 5587.0, 5602.0, 5321.0, 5453.0, 5277.0, 5539.0, 5597.0, 5400.0, 5306.0, 5515.0, 5592.0, 5438.0, 5350.0, 5493.0, 5721.0, 5694.0, 5368.0, 5271.0, 5393.0, 5502.0, 5340.0, 5408.0, 5498.0, 5362.0, 5352.0, 5512.0, 5445.0, 5464.0, 5611.0, 5661.0, 5642.0, 5397.0, 5404.0, 5286.0, 5551.0, 5695.0, 5481.0, 5323.0, 5363.0, 5476.0, 5690.0, 5485.0, 5326.0, 5330.0, 5664.0, 5294.0, 5590.0, 5398.0, 5314.0, 5516.0, 5335.0, 5556.0, 5256.0, 5504.0, 5462.0, 5463.0, 5650.0, 5718.0, 5613.0, 5669.0, 5391.0, 5659.0, 5435.0, 5280.0, 5655.0, 5674.0, 5478.0, 5673.0, 5640.0, 5628.0, 5263.0, 5451.0, 5631.0, 5583.0, 5720.0, 5630.0 (number of hits: 9)
5	5520	9	1	333	1	5394.0, 5307.0, 5578.0, 5386.0, 5646.0, 5300.0, 5573.0, 5722.0, 5423.0, 5290.0, 5524.0, 5687.0, 5327.0, 5513.0, 5662.0, 5600.0, 5588.0, 5392.0, 5547.0, 5374.0, 5338.0, 5355.0, 5306.0, 5317.0, 5499.0, 5459.0, 5658.0, 5560.0, 5546.0, 5552.0, 5664.0, 5411.0, 5677.0, 5365.0, 5519.0, 5550.0, 5330.0, 5610.0, 5480.0, 5539.0, 5643.0, 5485.0, 5276.0, 5342.0, 5329.0, 5529.0, 5535.0, 5303.0, 5271.0, 5606.0, 5665.0, 5331.0, 5633.0, 5482.0, 5431.0, 5358.0, 5666.0, 5366.0, 5697.0, 5333.0, 5301.0, 5399.0, 5595.0, 5654.0, 5397.0, 5489.0, 5707.0, 5660.0, 5627.0, 5326.0, 5692.0, 5564.0, 5570.0, 5400.0, 5347.0, 5274.0, 5466.0, 5409.0, 5596.0, 5684.0, 5291.0, 5700.0, 5486.0, 5498.0, 5675.0, 5488.0, 5413.0, 5267.0, 5454.0, 5563.0, 5593.0, 5467.0, 5583.0, 5405.0, 5379.0, 5492.0, 5468.0, 5414.0, 5708.0, 5575.0 (number of hits: 5)
6	5520	9	1	333	1	5663.0, 5317.0, 5624.0, 5268.0, 5637.0, 5671.0, 5565.0, 5672.0, 5410.0, 5257.0, 5282.0, 5516.0, 5584.0, 5717.0, 5469.0, 5517.0, 5420.0, 5646.0, 5448.0, 5596.0, 5366.0, 5593.0, 5609.0, 5500.0, 5619.0, 5640.0, 5698.0, 5681.0, 5501.0, 5470.0, 5284.0, 5552.0, 5561.0, 5302.0, 5648.0, 5505.0, 5545.0, 5589.0, 5334.0, 5579.0, 5641.0, 5512.0, 5388.0, 5518.0, 5521.0, 5340.0, 5253.0, 5301.0, 5278.0, 5612.0, 5664.0, 5421.0, 5465.0, 5354.0, 5556.0

						5720.0, 5676.0, 5479.0, 5265.0, 5661.0, 5415.0, 5332.0, 5452.0, 5445.0, 5323.0, 5480.0, 5547.0, 5614.0, 5409.0, 5305.0, 5496.0, 5631.0, 5269.0, 5459.0, 5696.0, 5454.0, 5478.0, 5262.0, 5567.0, 5289.0, 5706.0, 5644.0, 5306.0, 5562.0, 5497.0, 5600.0, 5554.0, 5680.0, 5591.0, 5336.0, 5360.0, 5473.0, 5362.0, 5294.0, 5287.0, 5254.0, 5687.0, 5542.0, 5395.0, 5582.0 (number of hits: 6)
7	5520	9	1	333	1	5681.0, 5594.0, 5708.0, 5582.0, 5303.0, 5665.0, 5687.0, 5502.0, 5442.0, 5562.0, 5700.0, 5604.0, 5576.0, 5718.0, 5346.0, 5553.0, 5586.0, 5318.0, 5342.0, 5448.0, 5548.0, 5720.0, 5524.0, 5467.0, 5690.0, 5441.0, 5462.0, 5265.0, 5404.0, 5466.0, 5683.0, 5573.0, 5355.0, 5619.0, 5667.0, 5622.0, 5493.0, 5286.0, 5565.0, 5709.0, 5644.0, 5284.0, 5469.0, 5450.0, 5405.0, 5419.0, 5397.0, 5684.0, 5500.0, 5546.0, 5699.0, 5430.0, 5476.0, 5388.0, 5474.0, 5514.0, 5483.0, 5359.0, 5335.0, 5602.0, 5588.0, 5257.0, 5327.0, 5600.0, 5496.0, 5401.0, 5316.0, 5618.0, 5311.0, 5566.0, 5291.0, 5706.0, 5605.0, 5424.0, 5529.0, 5549.0, 5523.0, 5475.0, 5591.0, 5468.0, 5590.0, 5393.0, 5620.0, 5654.0, 5438.0, 5580.0, 5293.0, 5584.0, 5686.0, 5299.0, 5557.0, 5320.0, 5592.0, 5270.0, 5403.0, 5641.0, 5333.0, 5368.0, 5642.0, 5617.0 (number of hits: 5)
8	5520	9	1	333	1	5653.0, 5352.0, 5490.0, 5320.0, 5335.0, 5719.0, 5570.0, 5407.0, 5617.0, 5519.0, 5651.0, 5691.0, 5564.0, 5254.0, 5546.0, 5455.0, 5284.0, 5701.0, 5581.0, 5475.0, 5718.0, 5516.0, 5468.0, 5521.0, 5447.0, 5508.0, 5590.0, 5421.0, 5714.0, 5483.0, 5417.0, 5481.0, 5524.0, 5579.0, 5285.0, 5648.0, 5545.0, 5454.0, 5451.0, 5695.0, 5665.0, 5391.0, 5456.0, 5526.0, 5662.0, 5621.0, 5690.0, 5624.0, 5446.0, 5409.0, 5416.0, 5289.0, 5501.0, 5403.0, 5384.0, 5567.0, 5260.0, 5488.0, 5280.0, 5612.0, 5426.0, 5359.0, 5361.0, 5399.0, 5392.0, 5499.0, 5669.0, 5709.0, 5292.0, 5267.0, 5540.0, 5532.0, 5647.0, 5367.0, 5547.0, 5354.0, 5608.0, 5353.0, 5491.0, 5520.0, 5704.0, 5522.0, 5566.0, 5412.0, 5276.0, 5327.0, 5418.0, 5670.0, 5580.0, 5713.0, 5324.0, 5544.0, 5694.0, 5371.0, 5459.0, 5346.0, 5434.0, 5282.0, 5270.0, 5432.0 (number of hits: 9)
9	5520	9	1	333	1	5674.0, 5713.0, 5461.0, 5456.0, 5374.0, 5278.0, 5434.0, 5510.0, 5715.0, 5531.0, 5593.0, 5489.0, 5566.0, 5702.0, 5320.0, 5670.0, 5657.0, 5680.0, 5346.0, 5399.0, 5293.0, 5618.0, 5341.0, 5722.0, 5450.0, 5356.0, 5641.0, 5498.0, 5481.0, 5337.0, 5659.0, 5567.0, 5643.0, 5638.0, 5398.0, 5448.0, 5482.0, 5521.0, 5710.0, 5655.0, 5582.0, 5703.0, 5700.0, 5585.0, 5322.0

						5405.0, 5438.0, 5596.0, 5471.0, 5387.0, 5606.0, 5516.0, 5368.0, 5429.0, 5328.0, 5263.0, 5707.0, 5682.0, 5629.0, 5552.0, 5711.0, 5583.0, 5468.0, 5714.0, 5283.0, 5608.0, 5649.0, 5612.0, 5430.0, 5351.0, 5454.0, 5563.0, 5379.0, 5662.0, 5514.0, 5470.0, 5570.0, 5550.0, 5431.0, 5260.0, 5386.0, 5603.0, 5321.0, 5554.0, 5488.0, 5442.0, 5667.0, 5381.0, 5394.0, 5297.0, 5251.0, 5491.0, 5699.0, 5435.0, 5373.0, 5273.0, 5412.0, 5541.0, 5466.0, 5634.0 (number of hits: 5)
10	5520	9	1	333	1	5417.0, 5462.0, 5601.0, 5655.0, 5711.0, 5422.0, 5369.0, 5650.0, 5528.0, 5615.0, 5636.0, 5439.0, 5302.0, 5378.0, 5338.0, 5715.0, 5330.0, 5596.0, 5677.0, 5700.0, 5282.0, 5497.0, 5394.0, 5705.0, 5402.0, 5538.0, 5714.0, 5536.0, 5432.0, 5307.0, 5446.0, 5610.0, 5305.0, 5325.0, 5617.0, 5495.0, 5510.0, 5440.0, 5602.0, 5546.0, 5433.0, 5448.0, 5288.0, 5435.0, 5500.0, 5264.0, 5682.0, 5561.0, 5685.0, 5675.0, 5301.0, 5298.0, 5376.0, 5616.0, 5375.0, 5679.0, 5479.0, 5628.0, 5331.0, 5593.0, 5289.0, 5651.0, 5477.0, 5568.0, 5712.0, 5374.0, 5383.0, 5501.0, 5670.0, 5562.0, 5450.0, 5545.0, 5442.0, 5350.0, 5419.0, 5527.0, 5342.0, 5300.0, 5512.0, 5321.0, 5473.0, 5276.0, 5268.0, 5345.0, 5631.0, 5595.0, 5348.0, 5362.0, 5535.0, 5505.0, 5657.0, 5290.0, 5566.0, 5296.0, 5360.0, 5640.0, 5513.0, 5671.0, 5406.0, 5471.0 (number of hits: 8)
11	5501.5	9	1	333	1	5698.0, 5684.0, 5467.0, 5670.0, 5259.0, 5597.0, 5289.0, 5692.0, 5389.0, 5295.0, 5568.0, 5477.0, 5513.0, 5604.0, 5284.0, 5337.0, 5368.0, 5254.0, 5469.0, 5524.0, 5332.0, 5700.0, 5526.0, 5618.0, 5659.0, 5250.0, 5402.0, 5474.0, 5664.0, 5391.0, 5635.0, 5313.0, 5463.0, 5433.0, 5493.0, 5701.0, 5417.0, 5542.0, 5441.0, 5649.0, 5554.0, 5414.0, 5572.0, 5328.0, 5488.0, 5596.0, 5709.0, 5510.0, 5418.0, 5341.0, 5636.0, 5547.0, 5707.0, 5286.0, 5297.0, 5641.0, 5311.0, 5615.0, 5426.0, 5494.0, 5570.0, 5404.0, 5703.0, 5335.0, 5639.0, 5623.0, 5432.0, 5427.0, 5466.0, 5551.0, 5435.0, 5710.0, 5415.0, 5690.0, 5399.0, 5421.0, 5364.0, 5316.0, 5461.0, 5257.0, 5443.0, 5569.0, 5591.0, 5366.0, 5588.0, 5706.0, 5688.0, 5496.0, 5579.0, 5447.0, 5658.0, 5683.0, 5451.0, 5351.0, 5651.0, 5464.0, 5312.0, 5575.0, 5356.0, 5353.0 (number of hits: 6)
12	5501.5	9	1	333	1	5418.0, 5476.0, 5304.0, 5558.0, 5482.0, 5537.0, 5390.0, 5622.0, 5684.0, 5340.0, 5693.0, 5391.0, 5701.0, 5656.0, 5369.0, 5710.0, 5333.0, 5345.0, 5315.0, 5273.0, 5631.0, 5723.0, 5720.0, 5466.0, 5608.0, 5661.0, 5506.0, 5599.0, 5360.0, 5285.0, 5351.0, 5570.0, 5334.0, 5365.0, 5263.0,

						5454.0, 5361.0, 5605.0, 5538.0, 5386.0, 5410.0, 5685.0, 5676.0, 5302.0, 5427.0, 5669.0, 5317.0, 5531.0, 5699.0, 5347.0, 5276.0, 5597.0, 5393.0, 5485.0, 5443.0, 5624.0, 5674.0, 5670.0, 5519.0, 5402.0, 5404.0, 5671.0, 5709.0, 5407.0, 5387.0, 5496.0, 5291.0, 5696.0, 5704.0, 5703.0, 5536.0, 5394.0, 5690.0, 5312.0, 5417.0, 5548.0, 5672.0, 5626.0, 5450.0, 5567.0, 5321.0, 5423.0, 5459.0, 5403.0, 5553.0, 5521.0, 5310.0, 5325.0, 5364.0, 5287.0, 5352.0, 5677.0, 5269.0, 5662.0, 5532.0, 5409.0, 5374.0, 5435.0, 5518.0, 5575.0 (number of hits: 5)
13	5501.5	9	1	333	1	5579.0, 5491.0, 5707.0, 5718.0, 5369.0, 5390.0, 5511.0, 5684.0, 5382.0, 5314.0, 5412.0, 5678.0, 5493.0, 5633.0, 5661.0, 5503.0, 5320.0, 5711.0, 5355.0, 5531.0, 5260.0, 5601.0, 5609.0, 5343.0, 5632.0, 5524.0, 5347.0, 5452.0, 5623.0, 5376.0, 5455.0, 5330.0, 5446.0, 5586.0, 5256.0, 5498.0, 5557.0, 5515.0, 5573.0, 5307.0, 5567.0, 5667.0, 5510.0, 5690.0, 5605.0, 5344.0, 5371.0, 5715.0, 5461.0, 5262.0, 5529.0, 5490.0, 5270.0, 5526.0, 5576.0, 5272.0, 5566.0, 5505.0, 5535.0, 5583.0, 5462.0, 5377.0, 5544.0, 5485.0, 5588.0, 5488.0, 5325.0, 5713.0, 5590.0, 5391.0, 5407.0, 5614.0, 5527.0, 5277.0, 5331.0, 5474.0, 5618.0, 5394.0, 5444.0, 5285.0, 5584.0, 5624.0, 5541.0, 5294.0, 5339.0, 5669.0, 5585.0, 5473.0, 5400.0, 5274.0, 5304.0, 5572.0, 5654.0, 5558.0, 5418.0, 5253.0, 5356.0, 5403.0, 5379.0, 5685.0 (number of hits: 11)
14	5501.5	9	1	333	1	5674.0, 5669.0, 5568.0, 5401.0, 5655.0, 5526.0, 5403.0, 5672.0, 5460.0, 5722.0, 5719.0, 5715.0, 5274.0, 5304.0, 5582.0, 5417.0, 5549.0, 5412.0, 5506.0, 5279.0, 5289.0, 5490.0, 5706.0, 5349.0, 5343.0, 5561.0, 5424.0, 5264.0, 5705.0, 5528.0, 5653.0, 5358.0, 5578.0, 5612.0, 5375.0, 5517.0, 5671.0, 5459.0, 5303.0, 5590.0, 5603.0, 5313.0, 5592.0, 5463.0, 5406.0, 5423.0, 5704.0, 5462.0, 5475.0, 5319.0, 5658.0, 5491.0, 5436.0, 5361.0, 5456.0, 5483.0, 5621.0, 5617.0, 5421.0, 5680.0, 5326.0, 5433.0, 5598.0, 5329.0, 5357.0, 5273.0, 5295.0, 5275.0, 5271.0, 5366.0, 5290.0, 5465.0, 5695.0, 5356.0, 5270.0, 5712.0, 5267.0, 5638.0, 5367.0, 5605.0, 5602.0, 5681.0, 5604.0, 5593.0, 5563.0, 5388.0, 5607.0, 5283.0, 5625.0, 5510.0, 5574.0, 5569.0, 5721.0, 5548.0, 5337.0, 5482.0, 5647.0, 5461.0, 5581.0, 5723.0 (number of hits: 6)
15	5501.5	9	1	333	1	5610.0, 5714.0, 5361.0, 5617.0, 5536.0, 5537.0, 5281.0, 5419.0, 5527.0, 5404.0, 5535.0, 5638.0, 5531.0, 5267.0, 5589.0, 5606.0, 5340.0, 5392.0, 5294.0, 5719.0, 5434.0, 5461.0, 5414.0, 5590.0, 5662.0,

						5407.0, 5391.0, 5275.0, 5616.0, 5471.0, 5300.0, 5332.0, 5293.0, 5432.0, 5491.0, 5336.0, 5423.0, 5398.0, 5313.0, 5258.0, 5576.0, 5583.0, 5314.0, 5453.0, 5687.0, 5564.0, 5592.0, 5561.0, 5650.0, 5357.0, 5403.0, 5570.0, 5648.0, 5569.0, 5694.0, 5642.0, 5260.0, 5683.0, 5658.0, 5429.0, 5511.0, 5312.0, 5466.0, 5321.0, 5711.0, 5284.0, 5256.0, 5693.0, 5497.0, 5273.0, 5417.0, 5716.0, 5279.0, 5433.0, 5556.0, 5329.0, 5420.0, 5558.0, 5295.0, 5637.0, 5557.0, 5484.0, 5460.0, 5328.0, 5372.0, 5387.0, 5437.0, 5645.0, 5695.0, 5393.0, 5615.0, 5301.0, 5600.0, 5406.0, 5587.0, 5562.0, 5448.0, 5472.0, 5555.0, 5700.0 (number of hits: 4)
16	5501.5	9	1	333	1	5617.0, 5452.0, 5481.0, 5635.0, 5618.0, 5546.0, 5526.0, 5529.0, 5673.0, 5446.0, 5515.0, 5389.0, 5465.0, 5286.0, 5540.0, 5535.0, 5324.0, 5314.0, 5309.0, 5649.0, 5271.0, 5403.0, 5412.0, 5302.0, 5311.0, 5281.0, 5334.0, 5399.0, 5679.0, 5466.0, 5432.0, 5460.0, 5682.0, 5676.0, 5586.0, 5687.0, 5444.0, 5614.0, 5584.0, 5420.0, 5516.0, 5581.0, 5611.0, 5645.0, 5426.0, 5494.0, 5510.0, 5266.0, 5520.0, 5685.0, 5563.0, 5538.0, 5377.0, 5479.0, 5634.0, 5424.0, 5547.0, 5722.0, 5257.0, 5347.0, 5509.0, 5522.0, 5671.0, 5485.0, 5490.0, 5317.0, 5704.0, 5338.0, 5672.0, 5445.0, 5382.0, 5684.0, 5296.0, 5325.0, 5688.0, 5428.0, 5393.0, 5493.0, 5708.0, 5373.0, 5698.0, 5472.0, 5383.0, 5443.0, 5332.0, 5667.0, 5585.0, 5294.0, 5625.0, 5447.0, 5330.0, 5312.0, 5505.0, 5464.0, 5328.0, 5258.0, 5537.0, 5285.0, 5272.0, 5577.0 (number of hits: 9)
17	5501.5	9	1	333	1	5577.0, 5571.0, 5332.0, 5508.0, 5596.0, 5456.0, 5406.0, 5622.0, 5312.0, 5492.0, 5670.0, 5545.0, 5654.0, 5664.0, 5616.0, 5541.0, 5617.0, 5643.0, 5636.0, 5379.0, 5682.0, 5721.0, 5286.0, 5409.0, 5684.0, 5490.0, 5546.0, 5718.0, 5639.0, 5257.0, 5511.0, 5522.0, 5481.0, 5268.0, 5554.0, 5503.0, 5328.0, 5555.0, 5687.0, 5299.0, 5339.0, 5451.0, 5680.0, 5488.0, 5327.0, 5383.0, 5593.0, 5520.0, 5420.0, 5672.0, 5297.0, 5575.0, 5547.0, 5529.0, 5293.0, 5691.0, 5685.0, 5253.0, 5649.0, 5449.0, 5432.0, 5587.0, 5709.0, 5290.0, 5479.0, 5651.0, 5367.0, 5713.0, 5518.0, 5683.0, 5314.0, 5538.0, 5629.0, 5415.0, 5535.0, 5657.0, 5525.0, 5568.0, 5595.0, 5665.0, 5679.0, 5491.0, 5267.0, 5502.0, 5717.0, 5565.0, 5352.0, 5625.0, 5382.0, 5283.0, 5424.0, 5720.0, 5557.0, 5411.0, 5607.0, 5653.0, 5705.0, 5455.0, 5495.0, 5602.0 (number of hits: 10)
18	5501.5	9	1	333	1	5599.0, 5346.0, 5386.0, 5673.0, 5329.0, 5512.0, 5398.0, 5310.0, 5288.0, 5648.0, 5612.0, 5316.0, 5475.0, 5483.0, 5559.0,

						5497.0, 5457.0, 5627.0, 5440.0, 5583.0, 5494.0, 5686.0, 5607.0, 5365.0, 5676.0, 5663.0, 5649.0, 5573.0, 5548.0, 5531.0, 5358.0, 5490.0, 5399.0, 5373.0, 5436.0, 5452.0, 5370.0, 5691.0, 5722.0, 5587.0, 5617.0, 5296.0, 5661.0, 5286.0, 5258.0, 5328.0, 5577.0, 5636.0, 5542.0, 5716.0, 5492.0, 5600.0, 5473.0, 5518.0, 5389.0, 5564.0, 5459.0, 5401.0, 5645.0, 5629.0, 5449.0, 5379.0, 5667.0, 5375.0, 5352.0, 5606.0, 5424.0, 5634.0, 5640.0, 5444.0, 5715.0, 5319.0, 5369.0, 5534.0, 5560.0, 5683.0, 5535.0, 5570.0, 5467.0, 5363.0, 5354.0, 5625.0, 5680.0, 5597.0, 5638.0, 5260.0, 5397.0, 5344.0, 5620.0, 5303.0, 5544.0, 5624.0, 5299.0, 5489.0, 5584.0, 5703.0, 5277.0, 5654.0, 5679.0, 5425.0 (number of hits: 8)
19	5538.5	9	1	333	1	5721.0, 5662.0, 5571.0, 5625.0, 5453.0, 5719.0, 5581.0, 5422.0, 5715.0, 5427.0, 5685.0, 5554.0, 5679.0, 5342.0, 5653.0, 5627.0, 5692.0, 5531.0, 5445.0, 5324.0, 5551.0, 5272.0, 5667.0, 5292.0, 5383.0, 5678.0, 5431.0, 5485.0, 5416.0, 5546.0, 5314.0, 5390.0, 5647.0, 5402.0, 5408.0, 5253.0, 5354.0, 5283.0, 5496.0, 5437.0, 5722.0, 5539.0, 5327.0, 5338.0, 5439.0, 5708.0, 5293.0, 5613.0, 5541.0, 5341.0, 5289.0, 5701.0, 5397.0, 5547.0, 5518.0, 5380.0, 5618.0, 5563.0, 5304.0, 5405.0, 5266.0, 5552.0, 5346.0, 5642.0, 5461.0, 5352.0, 5499.0, 5608.0, 5355.0, 5489.0, 5463.0, 5597.0, 5454.0, 5609.0, 5633.0, 5645.0, 5279.0, 5584.0, 5252.0, 5621.0, 5274.0, 5375.0, 5508.0, 5548.0, 5273.0, 5265.0, 5634.0, 5643.0, 5680.0, 5686.0, 5446.0, 5476.0, 5558.0, 5655.0, 5261.0, 5619.0, 5334.0, 5350.0, 5534.0, 5661.0 (number of hits: 10)
20	5538.5	9	1	333	1	5372.0, 5651.0, 5385.0, 5665.0, 5400.0, 5517.0, 5494.0, 5363.0, 5683.0, 5612.0, 5677.0, 5659.0, 5464.0, 5629.0, 5303.0, 5290.0, 5440.0, 5365.0, 5528.0, 5402.0, 5429.0, 5258.0, 5254.0, 5671.0, 5463.0, 5312.0, 5617.0, 5564.0, 5269.0, 5509.0, 5603.0, 5553.0, 5384.0, 5522.0, 5535.0, 5631.0, 5514.0, 5293.0, 5561.0, 5420.0, 5307.0, 5587.0, 5614.0, 5458.0, 5342.0, 5310.0, 5397.0, 5459.0, 5585.0, 5592.0, 5341.0, 5723.0, 5451.0, 5645.0, 5704.0, 5510.0, 5573.0, 5481.0, 5698.0, 5546.0, 5316.0, 5568.0, 5664.0, 5484.0, 5261.0, 5448.0, 5488.0, 5270.0, 5428.0, 5686.0, 5519.0, 5278.0, 5572.0, 5421.0, 5571.0, 5321.0, 5613.0, 5324.0, 5720.0, 5396.0, 5623.0, 5287.0, 5611.0, 5343.0, 5404.0, 5721.0, 5663.0, 5304.0, 5622.0, 5306.0, 5584.0, 5482.0, 5570.0, 5653.0, 5652.0, 5289.0, 5416.0, 5344.0, 5493.0, 5655.0 (number of hits: 5)
21	5538.5	9	1	333	1	5665.0, 5267.0, 5416.0, 5263.0, 5627.0,

						5512.0, 5483.0, 5364.0, 5623.0, 5701.0, 5555.0, 5460.0, 5666.0, 5591.0, 5278.0, 5345.0, 5607.0, 5495.0, 5433.0, 5585.0, 5541.0, 5314.0, 5558.0, 5487.0, 5389.0, 5279.0, 5285.0, 5711.0, 5343.0, 5551.0, 5476.0, 5534.0, 5266.0, 5644.0, 5573.0, 5440.0, 5450.0, 5599.0, 5492.0, 5557.0, 5414.0, 5408.0, 5300.0, 5636.0, 5692.0, 5275.0, 5309.0, 5722.0, 5693.0, 5445.0, 5708.0, 5626.0, 5413.0, 5455.0, 5697.0, 5301.0, 5676.0, 5559.0, 5611.0, 5481.0, 5293.0, 5527.0, 5467.0, 5594.0, 5412.0, 5503.0, 5317.0, 5631.0, 5465.0, 5506.0, 5421.0, 5312.0, 5533.0, 5672.0, 5280.0, 5324.0, 5399.0, 5370.0, 5269.0, 5575.0, 5468.0, 5494.0, 5463.0, 5593.0, 5673.0, 5427.0, 5391.0, 5663.0, 5396.0, 5576.0, 5721.0, 5320.0, 5716.0, 5398.0, 5265.0, 5252.0, 5442.0, 5380.0, 5437.0, 5406.0 (number of hits: 6)
22	5538.5	9	1	333	1	5346.0, 5377.0, 5526.0, 5336.0, 5329.0, 5440.0, 5444.0, 5688.0, 5419.0, 5573.0, 5480.0, 5523.0, 5360.0, 5672.0, 5673.0, 5602.0, 5534.0, 5479.0, 5716.0, 5477.0, 5284.0, 5509.0, 5468.0, 5461.0, 5323.0, 5540.0, 5565.0, 5275.0, 5486.0, 5362.0, 5547.0, 5625.0, 5361.0, 5718.0, 5514.0, 5532.0, 5279.0, 5455.0, 5365.0, 5417.0, 5618.0, 5650.0, 5564.0, 5615.0, 5568.0, 5638.0, 5277.0, 5463.0, 5412.0, 5413.0, 5324.0, 5357.0, 5394.0, 5411.0, 5724.0, 5465.0, 5406.0, 5600.0, 5556.0, 5553.0, 5674.0, 5252.0, 5446.0, 5576.0, 5575.0, 5483.0, 5481.0, 5392.0, 5447.0, 5694.0, 5665.0, 5313.0, 5307.0, 5464.0, 5651.0, 5544.0, 5271.0, 5691.0, 5369.0, 5476.0, 5485.0, 5402.0, 5654.0, 5521.0, 5364.0, 5299.0, 5345.0, 5395.0, 5707.0, 5645.0, 5596.0, 5318.0, 5536.0, 5381.0, 5579.0, 5513.0, 5384.0, 5590.0, 5569.0, 5368.0 (number of hits: 11)
23	5538.5	9	1	333	1	5448.0, 5661.0, 5642.0, 5688.0, 5334.0, 5387.0, 5497.0, 5450.0, 5269.0, 5322.0, 5550.0, 5391.0, 5604.0, 5426.0, 5719.0, 5698.0, 5414.0, 5660.0, 5535.0, 5283.0, 5683.0, 5709.0, 5273.0, 5611.0, 5330.0, 5304.0, 5630.0, 5663.0, 5437.0, 5385.0, 5678.0, 5325.0, 5691.0, 5706.0, 5649.0, 5446.0, 5355.0, 5342.0, 5530.0, 5328.0, 5431.0, 5300.0, 5382.0, 5405.0, 5376.0, 5533.0, 5699.0, 5532.0, 5694.0, 5340.0, 5713.0, 5324.0, 5289.0, 5607.0, 5458.0, 5466.0, 5438.0, 5659.0, 5656.0, 5561.0, 5447.0, 5641.0, 5707.0, 5407.0, 5538.0, 5700.0, 5292.0, 5378.0, 5494.0, 5634.0, 5291.0, 5505.0, 5315.0, 5526.0, 5653.0, 5410.0, 5363.0, 5528.0, 5513.0, 5711.0, 5720.0, 5390.0, 5465.0, 5625.0, 5491.0, 5262.0, 5624.0, 5296.0, 5594.0, 5367.0, 5597.0, 5703.0, 5281.0, 5693.0, 5646.0, 5359.0, 5272.0, 5665.0, 5612.0, 5404.0

						(number of hits: 8)
24	5538.5	9	1	333	1	5669.0, 5328.0, 5649.0, 5681.0, 5668.0, 5356.0, 5395.0, 5635.0, 5549.0, 5539.0, 5430.0, 5442.0, 5612.0, 5343.0, 5273.0, 5474.0, 5460.0, 5371.0, 5585.0, 5294.0, 5427.0, 5346.0, 5473.0, 5580.0, 5509.0, 5375.0, 5389.0, 5272.0, 5544.0, 5522.0, 5269.0, 5674.0, 5443.0, 5564.0, 5641.0, 5299.0, 5520.0, 5263.0, 5453.0, 5665.0, 5313.0, 5634.0, 5696.0, 5646.0, 5366.0, 5327.0, 5675.0, 5526.0, 5693.0, 5499.0, 5588.0, 5604.0, 5699.0, 5413.0, 5303.0, 5456.0, 5622.0, 5339.0, 5292.0, 5507.0, 5377.0, 5423.0, 5267.0, 5606.0, 5439.0, 5633.0, 5252.0, 5373.0, 5400.0, 5479.0, 5512.0, 5254.0, 5342.0, 5514.0, 5448.0, 5503.0, 5685.0, 5719.0, 5277.0, 5624.0, 5662.0, 5532.0, 5702.0, 5722.0, 5428.0, 5584.0, 5418.0, 5661.0, 5459.0, 5542.0, 5381.0, 5432.0, 5322.0, 5689.0, 5266.0, 5411.0, 5504.0, 5637.0, 5543.0, 5581.0
						(number of hits: 9)
25	5538.5	9	1	333	1	5661.0, 5576.0, 5698.0, 5327.0, 5527.0, 5530.0, 5318.0, 5350.0, 5593.0, 5258.0, 5672.0, 5266.0, 5369.0, 5462.0, 5539.0, 5596.0, 5549.0, 5494.0, 5653.0, 5470.0, 5448.0, 5401.0, 5447.0, 5307.0, 5489.0, 5251.0, 5699.0, 5344.0, 5377.0, 5677.0, 5487.0, 5472.0, 5337.0, 5526.0, 5296.0, 5315.0, 5294.0, 5433.0, 5358.0, 5429.0, 5651.0, 5268.0, 5564.0, 5411.0, 5334.0, 5404.0, 5355.0, 5562.0, 5523.0, 5629.0, 5582.0, 5537.0, 5604.0, 5459.0, 5398.0, 5555.0, 5508.0, 5370.0, 5357.0, 5634.0, 5704.0, 5607.0, 5665.0, 5393.0, 5467.0, 5347.0, 5293.0, 5679.0, 5567.0, 5276.0, 5551.0, 5635.0, 5540.0, 5626.0, 5356.0, 5502.0, 5714.0, 5584.0, 5568.0, 5648.0, 5351.0, 5492.0, 5589.0, 5550.0, 5320.0, 5621.0, 5723.0, 5454.0, 5617.0, 5594.0, 5673.0, 5624.0, 5501.0, 5254.0, 5279.0, 5397.0, 5720.0, 5636.0, 5311.0, 5443.0
						(number of hits: 11)
26	5538.5	9	1	333	1	5296.0, 5469.0, 5331.0, 5288.0, 5550.0, 5602.0, 5434.0, 5328.0, 5429.0, 5712.0, 5450.0, 5487.0, 5343.0, 5289.0, 5659.0, 5284.0, 5355.0, 5382.0, 5367.0, 5707.0, 5555.0, 5321.0, 5445.0, 5409.0, 5710.0, 5326.0, 5316.0, 5625.0, 5607.0, 5438.0, 5417.0, 5661.0, 5333.0, 5455.0, 5407.0, 5573.0, 5308.0, 5708.0, 5533.0, 5290.0, 5268.0, 5365.0, 5454.0, 5559.0, 5616.0, 5523.0, 5394.0, 5294.0, 5458.0, 5405.0, 5657.0, 5457.0, 5596.0, 5588.0, 5624.0, 5384.0, 5524.0, 5428.0, 5678.0, 5510.0, 5257.0, 5479.0, 5660.0, 5541.0, 5437.0, 5692.0, 5385.0, 5667.0, 5480.0, 5515.0, 5593.0, 5398.0, 5629.0, 5274.0, 5610.0, 5567.0, 5681.0, 5370.0, 5693.0, 5690.0, 5687.0, 5399.0, 5675.0, 5630.0, 5556.0, 5337.0, 5537.0, 5340.0, 5571.0, 5436.0

						5627.0, 5379.0, 5614.0, 5283.0, 5492.0, 5501.0, 5497.0, 5353.0, 5695.0, 5604.0 (number of hits: 8)
27	5538.5	9	1	333	1	5485.0, 5313.0, 5257.0, 5628.0, 5442.0, 5668.0, 5278.0, 5494.0, 5427.0, 5282.0, 5301.0, 5585.0, 5365.0, 5618.0, 5327.0, 5409.0, 5708.0, 5400.0, 5696.0, 5680.0, 5704.0, 5565.0, 5428.0, 5362.0, 5677.0, 5349.0, 5312.0, 5611.0, 5549.0, 5470.0, 5507.0, 5685.0, 5644.0, 5383.0, 5490.0, 5265.0, 5375.0, 5295.0, 5614.0, 5721.0, 5655.0, 5617.0, 5434.0, 5508.0, 5404.0, 5369.0, 5666.0, 5538.0, 5660.0, 5553.0, 5540.0, 5321.0, 5563.0, 5302.0, 5525.0, 5340.0, 5558.0, 5251.0, 5279.0, 5592.0, 5482.0, 5407.0, 5393.0, 5277.0, 5646.0, 5414.0, 5367.0, 5528.0, 5304.0, 5626.0, 5562.0, 5296.0, 5531.0, 5345.0, 5707.0, 5604.0, 5577.0, 5650.0, 5276.0, 5267.0, 5497.0, 5322.0, 5450.0, 5261.0, 5693.0, 5514.0, 5374.0, 5395.0, 5299.0, 5371.0, 5689.0, 5608.0, 5712.0, 5610.0, 5632.0, 5625.0, 5377.0, 5705.0, 5260.0, 5455.0 (number of hits: 7)
28	5538.5	9	1	333	1	5349.0, 5631.0, 5555.0, 5270.0, 5565.0, 5339.0, 5450.0, 5703.0, 5656.0, 5291.0, 5470.0, 5294.0, 5511.0, 5299.0, 5363.0, 5273.0, 5679.0, 5522.0, 5264.0, 5387.0, 5606.0, 5582.0, 5394.0, 5340.0, 5260.0, 5324.0, 5657.0, 5712.0, 5430.0, 5468.0, 5578.0, 5524.0, 5352.0, 5571.0, 5285.0, 5255.0, 5655.0, 5496.0, 5389.0, 5455.0, 5514.0, 5421.0, 5446.0, 5357.0, 5516.0, 5458.0, 5674.0, 5592.0, 5508.0, 5317.0, 5614.0, 5350.0, 5701.0, 5403.0, 5405.0, 5472.0, 5494.0, 5573.0, 5644.0, 5695.0, 5384.0, 5254.0, 5251.0, 5626.0, 5663.0, 5552.0, 5379.0, 5415.0, 5667.0, 5419.0, 5528.0, 5696.0, 5408.0, 5338.0, 5561.0, 5557.0, 5346.0, 5404.0, 5428.0, 5484.0, 5460.0, 5619.0, 5579.0, 5282.0, 5373.0, 5581.0, 5545.0, 5518.0, 5692.0, 5541.0, 5330.0, 5653.0, 5272.0, 5448.0, 5365.0, 5548.0, 5637.0, 5471.0, 5432.0, 5438.0 (number of hits: 8)
29	5538.5	9	1	333	1	5506.0, 5582.0, 5616.0, 5449.0, 5567.0, 5544.0, 5365.0, 5708.0, 5481.0, 5322.0, 5627.0, 5522.0, 5583.0, 5514.0, 5713.0, 5629.0, 5316.0, 5580.0, 5351.0, 5702.0, 5662.0, 5461.0, 5651.0, 5695.0, 5409.0, 5388.0, 5715.0, 5707.0, 5644.0, 5668.0, 5452.0, 5266.0, 5404.0, 5502.0, 5472.0, 5312.0, 5556.0, 5510.0, 5435.0, 5690.0, 5590.0, 5251.0, 5487.0, 5493.0, 5387.0, 5710.0, 5427.0, 5561.0, 5442.0, 5420.0, 5433.0, 5454.0, 5552.0, 5623.0, 5526.0, 5473.0, 5671.0, 5319.0, 5447.0, 5642.0, 5340.0, 5542.0, 5359.0, 5437.0, 5380.0, 5645.0, 5457.0, 5492.0, 5269.0, 5656.0, 5654.0, 5615.0, 5523.0, 5572.0, 5509.0, 5267.0, 5321.0, 5539.0, 5490.0, 5268.0,

						5419.0, 5476.0, 5260.0, 5265.0, 5686.0, 5255.0, 5280.0, 5256.0, 5540.0, 5336.0, 5589.0, 5396.0, 5309.0, 5488.0, 5576.0, 5286.0, 5603.0, 5471.0, 5485.0, 5368.0 (number of hits: 9)
30	5538.5	9	1	333	1	5370.0, 5298.0, 5449.0, 5350.0, 5501.0, 5550.0, 5494.0, 5436.0, 5593.0, 5424.0, 5532.0, 5723.0, 5651.0, 5310.0, 5305.0, 5491.0, 5649.0, 5599.0, 5693.0, 5342.0, 5464.0, 5355.0, 5584.0, 5565.0, 5401.0, 5278.0, 5450.0, 5328.0, 5495.0, 5320.0, 5425.0, 5559.0, 5402.0, 5682.0, 5598.0, 5685.0, 5374.0, 5272.0, 5590.0, 5375.0, 5675.0, 5371.0, 5534.0, 5621.0, 5380.0, 5717.0, 5346.0, 5439.0, 5637.0, 5720.0, 5262.0, 5701.0, 5648.0, 5662.0, 5554.0, 5493.0, 5671.0, 5390.0, 5517.0, 5468.0, 5642.0, 5639.0, 5497.0, 5256.0, 5347.0, 5459.0, 5602.0, 5530.0, 5652.0, 5471.0, 5504.0, 5396.0, 5676.0, 5555.0, 5632.0, 5719.0, 5579.0, 5558.0, 5585.0, 5353.0, 5448.0, 5423.0, 5331.0, 5309.0, 5619.0, 5604.0, 5606.0, 5567.0, 5460.0, 5395.0, 5432.0, 5654.0, 5658.0, 5626.0, 5457.0, 5266.0, 5483.0, 5479.0, 5445.0, 5409.0 (number of hits: 6)

D.3 80 MHz Bandwidth @ 5540 MHz

Table-1A/1B Radar Type 1A/1B Statistical Performance

Trial #	Fc (MHz)	Pulse/Burst	Pulse Width (μS)	PRI (μs)	Detection (1:yes; 0:no)
1	5540	62	1	858	1
2	5540	63	1	838	1
3	5540	58	1	918	1
4	5540	57	1	938	1
5	5540	86	1	618	1
6	5540	70	1	758	1
7	5540	89	1	598	1
8	5540	99	1	538	1
9	5540	92	1	578	1
10	5540	65	1	818	1
11	5540	59	1	898	1
12	5540	76	1	698	1
13	5540	67	1	798	1
14	5540	78	1	678	1
15	5540	83	1	638	1
16	5540	32	1	1671	1
17	5540	65	1	820	1
18	5540	18	1	2952	1
19	5540	40	1	1347	1
20	5540	48	1	1102	1
21	5540	98	1	541	1
22	5540	64	1	832	1
23	5540	95	1	561	1
24	5540	33	1	1644	1
25	5540	45	1	1182	1
26	5540	28	1	1915	1
27	5540	60	1	894	1
28	5540	28	1	1899	1
29	5540	21	1	2637	1
30	5540	28	1	1949	1
Detection Percentage: 100 % (>60%)					

Table-2 Radar Type 2 Statistical Performance

Trial #	Fc (MHz)	Pulse/Burst	Pulse Width (μ S)	PRI (μ s)	Detection (1:yes; 0:no)
1	5540	24	5	193	1
2	5540	23	3.9	152	1
3	5540	24	1.9	227	1
4	5540	28	3.5	151	0
5	5540	29	4.9	172	1
6	5540	29	1	230	1
7	5540	24	4.6	204	0
8	5540	26	4.2	223	1
9	5540	29	3.9	211	1
10	5540	26	3.7	214	1
11	5540	26	1.3	160	1
12	5540	26	3.5	168	1
13	5540	29	4.9	179	1
14	5540	29	1.6	187	1
15	5540	24	4.1	214	1
16	5540	26	2.6	191	1
17	5540	25	2.5	167	1
18	5540	23	4.3	210	1
19	5540	28	1.4	162	1
20	5540	26	3.6	209	1
21	5540	28	4.7	187	1
22	5540	27	4.6	212	1
23	5540	23	2.2	190	1
24	5540	25	2.5	219	1
25	5540	26	1.1	202	1
26	5540	24	1.7	203	1
27	5540	23	4.9	166	1
28	5540	24	4	159	0
29	5540	29	1.3	195	1
30	5540	24	2.5	207	1
Detection Percentage: 90 % (>60%)					

Table-3 Radar Type 3 Statistical Performance

Trial #	Fc (MHz)	Pulse/Burst	Pulse Width (μ S)	PRI (μ s)	Detection (1:yes; 0:no)
1	5540	16	9.1	365	1
2	5540	17	6.9	482	1
3	5540	18	8.1	430	1
4	5540	18	7.1	251	1
5	5540	18	6	471	1
6	5540	18	6.9	485	1
7	5540	18	7.8	407	1
8	5540	18	9.5	463	1
9	5540	17	7.8	225	1
10	5540	17	8.2	490	1
11	5540	16	9.7	371	1
12	5540	18	7.9	228	1
13	5540	18	8.4	462	1
14	5540	18	9.5	372	1
15	5540	17	9.9	401	1
16	5540	18	9.9	430	1
17	5540	18	6.5	281	1
18	5540	16	8.6	347	1
19	5540	17	9.6	215	1
20	5540	16	6.3	489	1
21	5540	18	7.6	319	1
22	5540	18	10	202	0
23	5540	16	7	414	1
24	5540	18	9.8	350	1
25	5540	16	7.4	328	1
26	5540	17	9.6	365	1
27	5540	16	10	358	0
28	5540	17	8.6	482	1
29	5540	18	9.7	441	1
30	5540	18	6	240	1
Detection Percentage: 93.3 % (>60%)					

Table-4 Radar Type 4 Statistical Performance

Trial #	Fc (MHz)	Pulse/Burst	Pulse Width (μ S)	PRI (μ s)	Detection (1:yes; 0:no)
1	5540	12	12	356	1
2	5540	14	17.9	340	1
3	5540	14	13.1	265	1
4	5540	12	13	391	1
5	5540	14	19.1	289	1
6	5540	16	11.6	219	1
7	5540	12	13.9	402	0
8	5540	16	11.8	346	1
9	5540	16	15.5	442	0
10	5540	16	13.5	416	1
11	5540	16	16.3	352	1
12	5540	14	13.3	362	1
13	5540	16	13.7	427	1
14	5540	14	12	396	1
15	5540	13	13.4	249	0
16	5540	13	16.5	463	0
17	5540	15	17.3	259	1
18	5540	13	11.1	437	1
19	5540	15	16.1	271	1
20	5540	15	14.4	424	1
21	5540	16	12.9	433	1
22	5540	12	14.8	217	1
23	5540	13	15.7	299	1
24	5540	14	15.7	305	0
25	5540	14	12	488	1
26	5540	13	12.1	301	0
27	5540	16	13.5	206	1
28	5540	12	13.8	431	1
29	5540	15	19.8	449	0
30	5540	15	15.1	313	1
Detection Percentage: 76.7 % (>60%)					

Table-5 Radar Type 5 Statistical Performance

Trial #	Fc (MHz)	Detection (1:yes; 0:no)
1	5540	1
2	5540	1
3	5540	1
4	5540	1
5	5540	1
6	5540	1
7	5540	1
8	5540	0
9	5540	1
10	5540	1
11	5506.4	1
12	5506.8	1
13	5504.8	1
14	5509.2	0
15	5509.6	1
16	5506.0	1
17	5504.0	1
18	5505.6	1
19	5508.8	1
20	5508.8	1
21	5574.4	1
22	5574.8	1
23	5574.0	1
24	5573.6	0
25	5572.8	1
26	5574.8	1
27	5570.8	1
28	5574.0	1
29	5570.4	1
30	5573.6	1
Detection Percentage: 90 % (>80%)		

Bin5 Statistics 1

Trial #	Pulse	Chirp (MHz)	Pulse Width (µS)	Pulse 1-2 spacing (uS)	Pulse 2-3 spacing (uS)	Pulse Start(S)	Detection (1:yes; 0:no)
0	1	13	74.7			0.033611	1
1	1	13	94.6			1.289618	
2	3	13	84.7	1794	1985	1.756214	
3	1	13	77.4			2.205186	
4	2	13	59.5	1558		3.22518	
5	2	13	86.3	1414		3.644154	
6	3	13	52.1	1893	1401	4.563755	
7	3	13	59	1969	1639	5.068404	
8	3	13	88.6	1121	1600	5.883014	
9	2	13	92.9	1956		6.454257	
10	2	13	59.2	1991		7.720155	
11	2	13	59.1	1859		8.426202	
12	3	13	96	1722	1418	9.06668	
13	1	13	97.3			9.449626	
14	2	13	74.7	1682		10.471249	
15	2	13	68.3	1249		10.658724	
16	3	13	82.8	1077	1793	11.593208	

Bin5 Statistics 2

Trial #	Pulse	Chirp (MHz)	Pulse Width (µS)	Pulse 1-2 spacing (uS)	Pulse 2-3 spacing (uS)	Pulse Start(S)	Detection (1:yes; 0:no)
0	3	7	87.2	1101	1846	0.31063	1
1	3	7	63.7	1890	1658	1.058141	
2	2	7	63.9	1562		2.752234	
3	2	7	61.6	1342		3.308769	
4	2	7	75.6	1942		4.007417	
5	2	7	93.9	1283		5.003662	
6	3	7	74.7	1371	1411	6.088743	
7	3	7	90	1783	1541	7.755669	
8	3	7	70	1717	1195	8.105165	
9	2	7	63.8	1746		9.046899	
10	3	7	88.4	1629	1495	10.529307	
11	3	7	64.7	1026	1710	11.491579	

Bin5 Statistics 3

Trial #	Pulse	Chirp (MHz)	Pulse Width (µS)	Pulse 1-2 spacing (µS)	Pulse 2-3 spacing (µS)	Pulse Start(S)	Detection (1:yes; 0:no)
0	3	8	76.7	1927	1956	0.755301	1
1	2	8	93.3	1516		0.908753	
2	2	8	81.4	1181		2.495049	
3	2	8	83.4	1752		3.393215	
4	2	8	71.1	1079		4.149884	
5	3	8	68.4	1260	1868	4.854324	
6	2	8	98.8	1099		5.888581	
7	2	8	72.4	1855		6.392754	
8	3	8	96	1222	1603	6.93525	
9	2	8	71.9	1610		8.014326	
10	1	8	61			9.20416	
11	1	8	94.8			9.936918	
12	2	8	85.6	1318		10.681912	
13	2	8	83.1	1182		11.613273	

Bin5 Statistics 4

Trial #	Pulse	Chirp (MHz)	Pulse Width (µS)	Pulse 1-2 spacing (µS)	Pulse 2-3 spacing (µS)	Pulse Start(S)	Detection (1:yes; 0:no)
0	2	15	57.3	1463		0.460451	1
1	2	15	59.8	1823		1.165472	
2	1	15	80.2			1.248231	
3	1	15	94.2			1.984388	
4	2	15	60.2	1489		2.761357	
5	2	15	70.2	1078		3.20448	
6	2	15	80	1372		3.67065	
7	1	15	55.9			4.772192	
8	2	15	85.1	1440		4.853006	
9	2	15	73.8	1739		5.690444	
10	1	15	79.5			6.1109	
11	1	15	87.5			6.966742	
12	3	15	59.4	1711	1125	7.782051	
13	2	15	82.8	1657		8.222301	
14	1	15	53.3			8.736021	
15	2	15	71.6	1216		9.492363	
16	1	15	91.2			9.688344	
17	1	15	63.5			10.608368	
18	1	15	96.4			10.978237	
19	2	15	59.5	1359		11.844301	

Bin5 Statistics 5

Trial #	Pulse	Chirp (MHz)	Pulse Width (µS)	Pulse 1-2 spacing (uS)	Pulse 2-3 spacing (uS)	Pulse Start(S)	Detection (1:yes; 0:no)
0	3	14	51.7	1819	1261	0.086603	1
1	2	14	99.4	1231		1.937912	
2	1	14	79.3			3.063393	
3	3	14	79.2	1132	1920	4.265023	
4	2	14	83.1	1607		5.156154	
5	3	14	64.7	1056	1473	5.991554	
6	2	14	99.2	1206		6.968936	
7	2	14	79.4	1055		8.379506	
8	2	14	59.9	1257		9.132284	
9	3	14	68.1	1970	1242	9.978322	
10	1	14	62.4			11.754571	

Bin5 Statistics 6

Trial #	Pulse	Chirp (MHz)	Pulse Width (µS)	Pulse 1-2 spacing (uS)	Pulse 2-3 spacing (uS)	Pulse Start(S)	Detection (1:yes; 0:no)
0	1	9	79			0.995823	1
1	1	9	90.7			1.668635	
2	3	9	83.7	1111	1217	2.9856	
3	3	9	68.6	1887	1213	4.366851	
4	1	9	67.1			5.017962	
5	2	9	90.7	1002		6.085416	
6	3	9	90.6	1063	1505	7.805086	
7	3	9	73	1741	1855	9.412565	
8	3	9	75.9	1928	1895	10.214425	
9	3	9	92.5	1078	1551	11.10399	

Bin5 Statistics 7

Trial #	Pulse	Chirp (MHz)	Pulse Width (µS)	Pulse 1-2 spacing (uS)	Pulse 2-3 spacing (uS)	Pulse Start(S)	Detection (1:yes; 0:no)
0	2	14	90.9	1814		0.514446	1
1	2	14	89.7	1547		0.718375	
2	3	14	81.9	1148	1190	1.414747	
3	2	14	62.5	1505		2.064987	
4	1	14	76.5			2.881339	
5	2	14	79.7	1565		3.024814	
6	2	14	99.7	1662		3.730778	
7	1	14	64.5			4.286029	
8	3	14	64.2	1597	1918	5.048621	
9	2	14	68.4	1275		5.800813	
10	1	14	62.9			6.267756	
11	3	14	79.4	1704	1682	6.763074	
12	3	14	59.9	1761	1353	7.263614	
13	1	14	62.4			8.30712	
14	2	14	75.7	1207		8.803309	
15	3	14	92.8	1772	1546	9.126076	
16	1	14	55.8			9.891139	
17	3	14	90.1	1855	1775	10.595166	
18	3	14	56.2	1861	1318	10.839097	
19	3	14	61.6	1018	1274	11.902506	

Bin5 Statistics 8

Trial #	Pulse	Chirp (MHz)	Pulse Width (µS)	Pulse 1-2 spacing (uS)	Pulse 2-3 spacing (uS)	Pulse Start(S)	Detection (1:yes; 0:no)
0	3	11	94	1985	1777	0.275047	0
1	2	11	53.6	1104		1.372306	
2	3	11	57.8	1542	1236	2.92068	
3	2	11	57	1743		3.164739	
4	2	11	62.4	1307		4.961525	
5	1	11	83.3			5.757994	
6	2	11	51.1	1976		6.726855	
7	2	11	61.6	1860		7.732256	
8	2	11	87.6	1075		8.188654	
9	2	11	91.1	1488		9.138771	
10	3	11	59.8	1398	1380	10.755562	
11	3	11	54.1	1868	1108	11.938946	

Bin5 Statistics 9

Trial #	Pulse	Chirp (MHz)	Pulse Width (µS)	Pulse 1-2 spacing (uS)	Pulse 2-3 spacing (uS)	Pulse Start(S)	Detection (1:yes; 0:no)
0	2	7	93.3	1682		0.292228	1
1	2	7	89.1	1333		1.003315	
2	2	7	90.6	1567		1.968266	
3	2	7	98.9	1128		2.525837	
4	2	7	79.6	1205		3.161904	
5	3	7	77.6	1583	1431	4.203746	
6	3	7	90.2	1090	1067	4.646445	
7	1	7	61.8			5.075717	
8	1	7	87.2			6.313033	
9	2	7	95.4	1661		6.397462	
10	2	7	69	1719		7.425822	
11	3	7	62.9	1252	1223	8.023337	
12	2	7	82.7	1474		9.019843	
13	2	7	92.4	1769		9.574724	
14	2	7	78.8	1372		10.398916	
15	1	7	64.4			11.254094	
16	2	7	70.9	1517		11.445764	

Bin5 Statistics 10

Trial #	Pulse	Chirp (MHz)	Pulse Width (µS)	Pulse 1-2 spacing (uS)	Pulse 2-3 spacing (uS)	Pulse Start(S)	Detection (1:yes; 0:no)
0	3	8	52.7	1040	1509	0.317373	1
1	2	8	86.5	1118		0.909549	
2	2	8	68.6	1880		1.463552	
3	1	8	94.1			2.082164	
4	2	8	94.5	1845		3.286905	
5	3	8	82.7	1847	1806	3.758607	
6	2	8	80.8	1114		4.465727	
7	1	8	92.8			4.934703	
8	2	8	75.2	1022		5.60025	
9	1	8	54.4			6.219064	
10	2	8	90.3	1421		7.044441	
11	1	8	54			7.574936	
12	2	8	51.4	1681		8.233619	
13	2	8	95.9	1086		8.801061	
14	1	8	100			9.533919	
15	3	8	92.1	1363	1082	10.248952	
16	1	8	83.7			10.94447	
17	2	8	95.6	1518		11.619657	

Bin5 Statistics 11

Trial #	Pulse	Chirp (MHz)	Pulse Width (µS)	Pulse 1-2 spacing (uS)	Pulse 2-3 spacing (uS)	Pulse Start(S)	Detection (1:yes; 0:no)
0	2	11	75.8	1010		0.277153	1
1	1	11	56.8			1.216543	
2	2	11	75.7	1103		2.271341	
3	1	11	61.7			2.800579	
4	2	11	70.2	1117		3.91438	
5	3	11	89.3	1004	1104	5.093981	
6	1	11	73.3			5.297259	
7	3	11	77	1007	1008	6.19235	
8	2	11	95.1	1857		7.06884	
9	1	11	75.9			8.355497	
10	2	11	91.6	1787		9.08435	
11	3	11	90.3	1927	1465	9.84293	
12	1	11	66.7			10.757238	
13	2	11	72.7	1545		11.427786	

Bin5 Statistics 12

Trial #	Pulse	Chirp (MHz)	Pulse Width (µS)	Pulse 1-2 spacing (µS)	Pulse 2-3 spacing (µS)	Pulse Start(S)	Detection (1:yes; 0:no)
0	2	12	83	1339		0.54102	1
1	2	12	97.2	1116		0.844988	
2	2	12	77	1389		1.444811	
3	3	12	51.6	1946	1977	2.150117	
4	2	12	69	1281		3.119628	
5	3	12	65.6	1033	1502	3.91342	
6	2	12	64.3	1937		4.92086	
7	1	12	72.4			5.642916	
8	2	12	69.3	1006		5.866424	
9	1	12	99.8			6.693033	
10	3	12	84.2	1282	1901	7.706238	
11	3	12	92.4	1586	1931	8.411721	
12	1	12	61			8.661202	
13	1	12	73.4			9.190438	
14	3	12	81.5	1954	1692	10.249685	
15	2	12	62.1	1260		11.147496	
16	3	12	77.8	1474	1839	11.30035	

Bin5 Statistics 13

Trial #	Pulse	Chirp (MHz)	Pulse Width (µS)	Pulse 1-2 spacing (µS)	Pulse 2-3 spacing (µS)	Pulse Start(S)	Detection (1:yes; 0:no)
0	2	7	73.6	1820		0.017709	1
1	2	7	93	1633		0.981016	
2	1	7	93.8			1.873799	
3	2	7	76.4	1927		3.095676	
4	3	7	61.9	1324	1220	3.783163	
5	1	7	54.7			4.840968	
6	2	7	81.6	1257		5.364274	
7	2	7	61.5	1014		6.095486	
8	3	7	83.1	1019	1209	7.152709	
9	1	7	68.2			8.076028	
10	2	7	60.2	1399		9.404219	
11	2	7	54.1	1238		9.458592	
12	2	7	80.9	1572		10.778692	
13	1	7	86.9			11.452295	

Bin5 Statistics 14

Trial #	Pulse	Chirp (MHz)	Pulse Width (µS)	Pulse 1-2 spacing (uS)	Pulse 2-3 spacing (uS)	Pulse Start(S)	Detection (1:yes; 0:no)
0	2	18	69.6	1371		0.952264	0
1	2	18	52.4	1571		1.896645	
2	2	18	51.6	1439		3.287794	
3	3	18	82.2	1111	1854	4.063964	
4	2	18	85.3	1516		5.957821	
5	3	18	96.8	1465	1062	6.920174	
6	1	18	51.8			8.853165	
7	2	18	55	1287		9.845482	
8	2	18	59.5	1255		11.602294	

Bin5 Statistics 15

Trial #	Pulse	Chirp (MHz)	Pulse Width (µS)	Pulse 1-2 spacing (uS)	Pulse 2-3 spacing (uS)	Pulse Start(S)	Detection (1:yes; 0:no)
0	2	19	53	1047		0.725958	1
1	2	19	73.1	1100		1.862299	
2	2	19	57.8	1243		2.88342	
3	2	19	65.5	1506		3.630379	
4	1	19	79.5			4.241278	
5	2	19	98.4	1955		5.675543	
6	2	19	56	1738		6.272916	
7	1	19	83.5			7.391649	
8	3	19	51.3	1343	1125	8.607	
9	1	19	91.8			9.869019	
10	2	19	70.3	1053		10.8908	
11	1	19	63.1			11.491466	

Bin5 Statistics 16

Trial #	Pulse	Chirp (MHz)	Pulse Width (µS)	Pulse 1-2 spacing (uS)	Pulse 2-3 spacing (uS)	Pulse Start(S)	Detection (1:yes; 0:no)
0	2	10	57.7	1859		0.105883	1
1	3	10	79.3	1550	1747	1.554108	
2	2	10	55.9	1432		2.230805	
3	2	10	77.4	1101		2.799177	
4	1	10	78.2			3.66585	
5	2	10	50.3	1888		4.475226	
6	1	10	91.3			5.562455	
7	1	10	62.8			6.140374	
8	1	10	58.7			7.094446	
9	3	10	50.7	1198	1498	7.45339	
10	1	10	66.4			8.388364	
11	1	10	79.1			9.143358	
12	2	10	93.2	1448		10.392498	
13	2	10	62.3	1736		11.093045	
14	2	10	69.1	1260		11.680748	

Bin5 Statistics 17

Trial #	Pulse	Chirp (MHz)	Pulse Width (µS)	Pulse 1-2 spacing (uS)	Pulse 2-3 spacing (uS)	Pulse Start(S)	Detection (1:yes; 0:no)
0	2	5	67.8	1212		0.211935	1
1	3	5	99.8	1937	1042	1.43998	
2	1	5	89.6			2.053831	
3	3	5	53.1	1276	1163	3.459406	
4	1	5	71.6			4.521794	
5	3	5	51.2	1697	1031	4.687876	
6	2	5	54	1979		6.114126	
7	2	5	80.4	1599		6.869185	
8	3	5	91.6	1675	1180	8.29307	
9	2	5	84.4	1573		9.132893	
10	2	5	67.6	1441		9.891221	
11	2	5	50.6	1779		10.929348	
12	1	5	96.5			11.174151	

Bin5 Statistics 18

Trial #	Pulse	Chirp (MHz)	Pulse Width (µS)	Pulse 1-2 spacing (uS)	Pulse 2-3 spacing (uS)	Pulse Start(S)	Detection (1:yes; 0:no)
0	2	9	66.8	1504		0.774279	1
1	1	9	74.7			0.985479	
2	1	9	93.9			2.525598	
3	1	9	79.4			3.271338	
4	2	9	98.9	1902		4.296237	
5	1	9	79.4			4.928501	
6	2	9	75.1	1206		5.841504	
7	1	9	78.3			7.151079	
8	1	9	75.3			7.502968	
9	3	9	63.5	1726	1830	8.362799	
10	1	9	76			9.947451	
11	2	9	81.2	1038		10.652955	
12	2	9	76.1	1580		11.121842	

Bin5 Statistics 19

Trial #	Pulse	Chirp (MHz)	Pulse Width (µS)	Pulse 1-2 spacing (uS)	Pulse 2-3 spacing (uS)	Pulse Start(S)	Detection (1:yes; 0:no)
0	2	17	65.1	1426		0.611452	1
1	2	17	58.2	1599		1.153647	
2	2	17	83.8	1274		2.497307	
3	3	17	94.6	1769	1297	3.37733	
4	2	17	70.2	1191		4.063129	
5	2	17	63	1428		5.209359	
6	1	17	97.3			6.97638	
7	2	17	84.8	1723		7.677234	
8	3	17	77.4	1344	1182	8.055668	
9	2	17	55.8	1534		9.360563	
0	2	17	65.1	1426		0.611452	
1	2	17	58.2	1599		1.153647	

Bin5 Statistics 20

Trial #	Pulse	Chirp (MHz)	Pulse Width (µS)	Pulse 1-2 spacing (uS)	Pulse 2-3 spacing (uS)	Pulse Start(S)	Detection (1:yes; 0:no)
0	2	17	54.9	1480		0.713227	1
1	2	17	96.5	1533		1.02772	
2	2	17	54.8	1571		1.678903	
3	2	17	74.7	1636		3.024116	
4	3	17	85.9	1926	1415	3.687311	
5	3	17	62.9	1512	1516	4.235415	
6	3	17	66.6	1568	1493	5.007605	
7	2	17	53.8	1398		5.689988	
8	2	17	60.7	1411		6.816699	
9	3	17	76.9	1414	1699	7.791478	
10	2	17	98.5	1488		8.40694	
11	1	17	65			9.152273	
12	2	17	98.5	1560		9.993978	
13	2	17	80	1149		10.704854	
14	3	17	60.1	1591	1192	11.503133	

Bin5 Statistics 21

Trial #	Pulse	Chirp (MHz)	Pulse Width (µS)	Pulse 1-2 spacing (uS)	Pulse 2-3 spacing (uS)	Pulse Start(S)	Detection (1:yes; 0:no)
0	1	9	55.8			0.596687	1
1	3	9	62.5	1930	1746	1.095331	
2	3	9	92.7	1304	1436	1.901871	
3	1	9	80.7			2.309373	
4	1	9	90.8			3.307404	
5	1	9	62.1			3.562124	
6	2	9	78.1	1511		4.805359	
7	1	9	59.4			5.304074	
8	1	9	55.5			6.347831	
9	2	9	73.1	1254		6.610577	
10	2	9	53.3	1284		7.204777	
11	2	9	51.5	1511		8.308118	
12	3	9	92.8	1755	1210	8.629188	
13	1	9	57.3			9.322716	
14	1	9	84.2			10.115219	
15	3	9	59.4	1117	1013	10.792466	
16	2	9	84.6	1141		11.96447	

Bin5 Statistics 22

Trial #	Pulse	Chirp (MHz)	Pulse Width (µS)	Pulse 1-2 spacing (uS)	Pulse 2-3 spacing (uS)	Pulse Start(S)	Detection (1:yes; 0:no)
0	2	8	53.4	1914		0.530327	1
1	2	8	84.9	1191		1.769314	
2	2	8	95.1	1376		2.739115	
3	2	8	50.4	1630		3.698737	
4	2	8	90.4	1443		4.993626	
5	2	8	97.4	1606		6.996615	
6	1	8	63.4			7.707462	
7	2	8	96.1	1367		8.972106	
8	2	8	76.1	1707		10.113815	
9	2	8	83.6	1278		11.184034	

Bin5 Statistics 23

Trial #	Pulse	Chirp (MHz)	Pulse Width (µS)	Pulse 1-2 spacing (uS)	Pulse 2-3 spacing (uS)	Pulse Start(S)	Detection (1:yes; 0:no)
0	3	10	55.1	1030	1087	0.00684	1
1	1	10	64.2			1.111538	
2	2	10	63.3	1728		1.764313	
3	1	10	75			2.249214	
4	3	10	74.8	1772	1469	2.625493	
5	2	10	88.6	1460		3.400889	
6	1	10	63.3			4.037948	
7	3	10	96.4	1022	1735	4.459404	
8	2	10	69.5	1177		4.986453	
9	2	10	75.4	1508		5.762582	
10	2	10	68.4	1584		6.481557	
11	2	10	93.9	1393		6.828941	
12	2	10	68.4	1288		7.661752	
13	1	10	60.5			7.987773	
14	3	10	83	1584	1528	8.635126	
15	3	10	76.3	1105	1485	9.286344	
16	2	10	79.8	1255		10.090189	
17	3	10	66.8	1263	1294	10.397644	
18	2	10	53	1080		11.302843	
19	2	10	84	1031		11.473584	

Bin5 Statistics 24

Trial #	Pulse	Chirp (MHz)	Pulse Width (µS)	Pulse 1-2 spacing (uS)	Pulse 2-3 spacing (uS)	Pulse Start(S)	Detection (1:yes; 0:no)
0	1	11	68.8			0.388742	0
1	2	11	97.8	1833		1.623534	
2	2	11	56.5	1098		2.054714	
3	1	11	80.4			3.475625	
4	2	11	95.7	1712		4.391147	
5	2	11	70.5	1977		5.523523	
6	3	11	93.8	1481	1872	5.611743	
7	2	11	74.4	1073		6.983723	
8	3	11	99.1	1334	1956	7.53219	
9	2	11	54.4	1476		9.132909	
10	2	11	87.9	1444		9.489548	
11	3	11	86.4	1855	1227	10.237888	
12	2	11	68.2	1138		11.917691	

Bin5 Statistics 25

Trial #	Pulse	Chirp (MHz)	Pulse Width (µS)	Pulse 1-2 spacing (uS)	Pulse 2-3 spacing (uS)	Pulse Start(S)	Detection (1:yes; 0:no)
0	3	13	64.7	1633	1915	0.063233	1
1	2	13	88.9	1026		1.582212	
2	2	13	79.7	1408		2.275856	
3	1	13	69			3.182499	
4	1	13	78.8			4.20911	
5	2	13	86.4	1694		4.372917	
6	2	13	85.5	1024		5.272226	
7	1	13	51.8			6.65585	
8	2	13	99.7	1385		7.470597	
9	2	13	51	1110		7.844483	
10	1	13	75.7			8.985024	
11	2	13	95.7	1229		9.625065	
12	1	13	54.3			10.911757	
13	2	13	52.8	1907		11.613896	

Bin5 Statistics 26

Trial #	Pulse	Chirp (MHz)	Pulse Width (µS)	Pulse 1-2 spacing (uS)	Pulse 2-3 spacing (uS)	Pulse Start(S)	Detection (1:yes; 0:no)
0	2	8	81	1222		0.869611	1
1	1	8	95.3			2.888412	
2	2	8	71.2	1320		3.417032	
3	1	8	97.5			4.809672	
4	3	8	84.3	1205	1456	6.861962	
5	2	8	69.9	1391		8.862139	
6	1	8	68			9.313765	
7	2	8	69.2	1544		11.069215	

Bin5 Statistics 27

Trial #	Pulse	Chirp (MHz)	Pulse Width (µS)	Pulse 1-2 spacing (uS)	Pulse 2-3 spacing (uS)	Pulse Start(S)	Detection (1:yes; 0:no)
0	2	18	89.4	1212		0.932261	1
1	3	18	98.1	1799	1012	1.263203	
2	2	18	57	1792		2.39629	
3	2	18	95.6	1455		4.219171	
4	2	18	50.9	1739		4.572941	
5	2	18	63.7	1998		6.066261	
6	2	18	96.2	1730		6.924869	
7	2	18	97	1789		8.567536	
8	1	18	74.2			8.963501	
9	1	18	74.6			10.194328	
10	2	18	83.3	1076		11.051348	

Bin5 Statistics 28

Trial #	Pulse	Chirp (MHz)	Pulse Width (µS)	Pulse 1-2 spacing (uS)	Pulse 2-3 spacing (uS)	Pulse Start(S)	Detection (1:yes; 0:no)
0	2	10	54.4	1757		0.225266	1
1	2	10	65.2	1353		1.440805	
2	1	10	77.8			2.155789	
3	2	10	74	1495		2.421127	
4	2	10	78.1	1303		3.199236	
5	1	10	95.6			3.964467	
6	3	10	91.4	1014	1145	4.592571	
7	2	10	56.2	1271		5.821162	
8	2	10	82.7	1467		6.443877	
9	2	10	82.2	1918		6.897265	
10	2	10	79.8	1879		7.633587	
11	1	10	82.7			8.891437	
12	3	10	79.8	1570	1653	9.089326	
13	2	10	52.4	1340		9.819509	
14	3	10	52.5	1314	1004	10.704145	
15	3	10	54.9	1049	1364	11.965899	

Bin5 Statistics 29

Trial #	Pulse	Chirp (MHz)	Pulse Width (µS)	Pulse 1-2 spacing (uS)	Pulse 2-3 spacing (uS)	Pulse Start(S)	Detection (1:yes; 0:no)
0	2	19	97	1422		0.542482	1
1	3	19	57.1	1007	1373	1.461531	
2	3	19	88.9	1480	1690	2.462183	
3	1	19	50.5			3.663106	
4	1	19	61.5			4.17187	
5	2	19	51.5	1021		5.680421	
6	1	19	79.1			6.313322	
7	2	19	85.1	1858		7.519018	
8	3	19	57.2	1571	1294	8.983967	
9	1	19	83.8			9.684256	
10	1	19	73.2			10.875094	
11	1	19	55.4			11.243819	

Bin5 Statistics 30

Trial #	Pulse	Chirp (MHz)	Pulse Width (µS)	Pulse 1-2 spacing (uS)	Pulse 2-3 spacing (uS)	Pulse Start(S)	Detection (1:yes; 0:no)
0	1	11	58.8			0.991802	1
1	1	11	75.1			1.804574	
2	2	11	99.1	1569		2.703292	
3	2	11	93.7	1318		3.727634	
4	2	11	93.8	1079		4.913954	
5	2	11	98.9	1202		5.59279	
6	2	11	88.9	1040		6.739744	
7	1	11	93.6			7.130811	
8	2	11	62.5	1159		8.188619	
9	2	11	94.7	1961		9.753799	
10	1	11	93.4			10.41478	
11	1	11	79.8			11.748677	

Table-6 Radar Type 6 Statistical Performance

Trial #	Fc (MHz)	Pulse /Burst	Pulse Width (µS)	PRI (µs)	Detection (1:yes; 0:no)	Hopping Sequence
1	5540	9	1	333	1	5333.0, 5456.0, 5620.0, 5532.0, 5394.0, 5701.0, 5332.0, 5510.0, 5664.0, 5386.0, 5626.0, 5291.0, 5707.0, 5710.0, 5580.0, 5547.0, 5275.0, 5468.0, 5494.0, 5650.0, 5271.0, 5393.0, 5632.0, 5518.0, 5474.0, 5413.0, 5495.0, 5695.0, 5546.0, 5634.0, 5602.0, 5421.0, 5295.0, 5599.0, 5412.0, 5563.0, 5382.0, 5277.0, 5466.0, 5613.0, 5362.0, 5418.0, 5636.0, 5326.0, 5488.0, 5678.0, 5700.0, 5662.0, 5699.0, 5279.0, 5422.0, 5335.0, 5640.0, 5585.0, 5523.0, 5721.0, 5385.0, 5504.0, 5706.0, 5475.0, 5419.0, 5324.0, 5539.0, 5538.0, 5684.0, 5545.0, 5529.0, 5575.0, 5405.0, 5605.0, 5319.0, 5427.0, 5273.0, 5704.0, 5282.0, 5688.0, 5459.0, 5272.0, 5668.0, 5430.0, 5649.0, 5592.0, 5377.0, 5590.0, 5594.0, 5323.0, 5612.0, 5623.0, 5283.0, 5352.0, 5696.0, 5639.0, 5630.0, 5593.0, 5691.0, 5581.0, 5656.0, 5705.0, 5549.0, 5672.0 (number of hits: 14)
2	5540	9	1	333	1	5400.0, 5670.0, 5654.0, 5667.0, 5625.0, 5634.0, 5426.0, 5618.0, 5626.0, 5280.0, 5701.0, 5556.0, 5530.0, 5623.0, 5329.0, 5674.0, 5302.0, 5665.0, 5273.0, 5350.0, 5413.0, 5417.0, 5456.0, 5548.0, 5605.0, 5534.0, 5295.0, 5542.0, 5598.0, 5599.0, 5601.0, 5337.0, 5555.0, 5715.0, 5257.0, 5702.0, 5714.0, 5298.0, 5620.0, 5414.0, 5481.0, 5669.0, 5686.0, 5384.0, 5296.0, 5375.0, 5359.0, 5668.0, 5276.0, 5512.0, 5345.0, 5659.0, 5647.0, 5494.0, 5397.0, 5341.0, 5393.0, 5570.0, 5290.0, 5265.0, 5405.0, 5479.0, 5662.0, 5502.0, 5560.0, 5566.0, 5507.0, 5533.0, 5391.0, 5272.0, 5377.0, 5344.0, 5267.0, 5614.0, 5446.0, 5612.0, 5707.0, 5252.0, 5437.0, 5561.0, 5666.0, 5594.0, 5688.0, 5367.0, 5682.0, 5648.0, 5318.0, 5474.0, 5706.0, 5629.0, 5658.0, 5376.0, 5399.0, 5259.0, 5368.0, 5402.0, 5458.0, 5319.0, 5529.0, 5394.0 (number of hits: 15)
3	5540	9	1	333	1	5612.0, 5621.0, 5443.0, 5720.0, 5681.0, 5657.0, 5398.0, 5315.0, 5523.0, 5563.0, 5722.0, 5654.0, 5536.0, 5716.0, 5538.0, 5591.0, 5383.0, 5427.0, 5386.0, 5358.0, 5272.0, 5565.0, 5723.0, 5412.0, 5636.0, 5527.0, 5395.0, 5273.0, 5302.0, 5380.0, 5258.0, 5362.0, 5338.0, 5384.0, 5389.0, 5558.0, 5659.0, 5377.0, 5573.0, 5452.0, 5454.0, 5388.0, 5606.0, 5279.0, 5614.0, 5666.0, 5289.0, 5658.0, 5406.0, 5285.0, 5490.0, 5615.0, 5583.0, 5264.0, 5509.0, 5309.0, 5622.0, 5283.0, 5325.0, 5461.0, 5577.0, 5464.0, 5508.0, 5699.0, 5278.0,

						5415.0, 5270.0, 5453.0, 5369.0, 5702.0, 5554.0, 5332.0, 5381.0, 5301.0, 5432.0, 5463.0, 5442.0, 5629.0, 5379.0, 5588.0, 5682.0, 5498.0, 5416.0, 5651.0, 5396.0, 5268.0, 5579.0, 5310.0, 5378.0, 5673.0, 5696.0, 5488.0, 5350.0, 5328.0, 5698.0, 5630.0, 5679.0, 5291.0, 5262.0, 5284.0 (number of hits: 12)
4	5540	9	1	333	1	5580.0, 5610.0, 5508.0, 5506.0, 5279.0, 5494.0, 5607.0, 5367.0, 5514.0, 5362.0, 5353.0, 5414.0, 5688.0, 5458.0, 5602.0, 5695.0, 5542.0, 5426.0, 5294.0, 5384.0, 5405.0, 5622.0, 5648.0, 5400.0, 5701.0, 5451.0, 5300.0, 5637.0, 5382.0, 5647.0, 5467.0, 5360.0, 5646.0, 5306.0, 5423.0, 5721.0, 5357.0, 5446.0, 5659.0, 5343.0, 5683.0, 5621.0, 5355.0, 5329.0, 5455.0, 5699.0, 5387.0, 5280.0, 5450.0, 5257.0, 5575.0, 5564.0, 5660.0, 5261.0, 5656.0, 5606.0, 5611.0, 5380.0, 5347.0, 5543.0, 5568.0, 5497.0, 5313.0, 5614.0, 5591.0, 5345.0, 5574.0, 5634.0, 5682.0, 5643.0, 5465.0, 5516.0, 5437.0, 5715.0, 5454.0, 5670.0, 5312.0, 5557.0, 5567.0, 5626.0, 5500.0, 5322.0, 5372.0, 5377.0, 5649.0, 5636.0, 5403.0, 5577.0, 5434.0, 5612.0, 5310.0, 5586.0, 5411.0, 5571.0, 5679.0, 5674.0, 5704.0, 5289.0, 5275.0, 5430.0 (number of hits: 14)
5	5540	9	1	333	1	5508.0, 5318.0, 5503.0, 5685.0, 5478.0, 5544.0, 5385.0, 5448.0, 5624.0, 5292.0, 5391.0, 5543.0, 5454.0, 5466.0, 5599.0, 5411.0, 5670.0, 5631.0, 5367.0, 5531.0, 5372.0, 5429.0, 5652.0, 5498.0, 5691.0, 5480.0, 5428.0, 5432.0, 5708.0, 5611.0, 5655.0, 5608.0, 5445.0, 5633.0, 5704.0, 5697.0, 5395.0, 5422.0, 5653.0, 5326.0, 5397.0, 5618.0, 5307.0, 5690.0, 5425.0, 5513.0, 5324.0, 5630.0, 5276.0, 5636.0, 5551.0, 5568.0, 5569.0, 5345.0, 5609.0, 5632.0, 5647.0, 5650.0, 5694.0, 5481.0, 5540.0, 5528.0, 5366.0, 5451.0, 5440.0, 5586.0, 5384.0, 5348.0, 5707.0, 5444.0, 5613.0, 5252.0, 5460.0, 5511.0, 5369.0, 5510.0, 5404.0, 5538.0, 5258.0, 5474.0, 5332.0, 5398.0, 5339.0, 5277.0, 5417.0, 5542.0, 5679.0, 5442.0, 5286.0, 5635.0, 5564.0, 5662.0, 5457.0, 5336.0, 5677.0, 5361.0, 5656.0, 5675.0, 5356.0, 5370.0 (number of hits: 16)
6	5540	9	1	333	1	5311.0, 5306.0, 5639.0, 5354.0, 5318.0, 5618.0, 5412.0, 5697.0, 5328.0, 5425.0, 5588.0, 5591.0, 5594.0, 5666.0, 5620.0, 5634.0, 5274.0, 5698.0, 5564.0, 5490.0, 5548.0, 5657.0, 5457.0, 5435.0, 5518.0, 5471.0, 5581.0, 5264.0, 5713.0, 5600.0, 5576.0, 5681.0, 5391.0, 5679.0, 5307.0, 5301.0, 5536.0, 5633.0, 5252.0, 5257.0, 5254.0, 5368.0, 5426.0, 5277.0, 5448.0, 5529.0, 5392.0, 5699.0, 5586.0, 5532.0, 5293.0, 5280.0, 5353.0, 5443.0, 5361.0,

						5438.0, 5446.0, 5470.0, 5434.0, 5557.0, 5642.0, 5616.0, 5345.0, 5286.0, 5539.0, 5660.0, 5414.0, 5377.0, 5310.0, 5654.0, 5327.0, 5440.0, 5495.0, 5467.0, 5366.0, 5491.0, 5331.0, 5630.0, 5513.0, 5623.0, 5526.0, 5615.0, 5341.0, 5670.0, 5662.0, 5506.0, 5408.0, 5624.0, 5504.0, 5460.0, 5612.0, 5550.0, 5431.0, 5385.0, 5272.0, 5574.0, 5589.0, 5684.0, 5559.0, 5295.0 (number of hits: 16)
7	5540	9	1	333	1	5705.0, 5381.0, 5490.0, 5580.0, 5590.0, 5481.0, 5602.0, 5672.0, 5468.0, 5680.0, 5343.0, 5699.0, 5684.0, 5254.0, 5499.0, 5322.0, 5538.0, 5319.0, 5640.0, 5569.0, 5505.0, 5673.0, 5399.0, 5720.0, 5348.0, 5401.0, 5304.0, 5445.0, 5545.0, 5661.0, 5364.0, 5472.0, 5471.0, 5585.0, 5579.0, 5571.0, 5704.0, 5288.0, 5379.0, 5609.0, 5639.0, 5428.0, 5311.0, 5637.0, 5715.0, 5622.0, 5434.0, 5456.0, 5516.0, 5407.0, 5627.0, 5470.0, 5562.0, 5292.0, 5484.0, 5700.0, 5273.0, 5441.0, 5557.0, 5572.0, 5474.0, 5721.0, 5451.0, 5465.0, 5694.0, 5713.0, 5663.0, 5708.0, 5594.0, 5693.0, 5405.0, 5317.0, 5426.0, 5592.0, 5400.0, 5396.0, 5315.0, 5462.0, 5438.0, 5361.0, 5497.0, 5711.0, 5439.0, 5318.0, 5503.0, 5324.0, 5652.0, 5305.0, 5553.0, 5356.0, 5568.0, 5613.0, 5587.0, 5320.0, 5447.0, 5376.0, 5352.0, 5384.0, 5525.0, 5339.0 (number of hits: 13)
8	5540	9	1	333	1	5710.0, 5723.0, 5477.0, 5413.0, 5597.0, 5384.0, 5591.0, 5281.0, 5580.0, 5722.0, 5254.0, 5556.0, 5307.0, 5684.0, 5463.0, 5696.0, 5579.0, 5462.0, 5318.0, 5594.0, 5299.0, 5276.0, 5554.0, 5564.0, 5679.0, 5669.0, 5621.0, 5568.0, 5500.0, 5515.0, 5645.0, 5583.0, 5537.0, 5607.0, 5343.0, 5524.0, 5720.0, 5300.0, 5689.0, 5473.0, 5365.0, 5707.0, 5654.0, 5589.0, 5519.0, 5553.0, 5466.0, 5415.0, 5308.0, 5457.0, 5575.0, 5665.0, 5538.0, 5397.0, 5376.0, 5614.0, 5501.0, 5694.0, 5569.0, 5513.0, 5468.0, 5690.0, 5615.0, 5438.0, 5673.0, 5525.0, 5683.0, 5670.0, 5620.0, 5656.0, 5688.0, 5699.0, 5590.0, 5363.0, 5563.0, 5350.0, 5443.0, 5709.0, 5493.0, 5675.0, 5411.0, 5328.0, 5512.0, 5511.0, 5352.0, 5311.0, 5329.0, 5637.0, 5436.0, 5253.0, 5347.0, 5437.0, 5367.0, 5429.0, 5660.0, 5359.0, 5320.0, 5573.0, 5541.0, 5492.0 (number of hits: 19)
9	5540	9	1	333	1	5671.0, 5431.0, 5472.0, 5674.0, 5513.0, 5693.0, 5362.0, 5337.0, 5386.0, 5461.0, 5443.0, 5669.0, 5361.0, 5505.0, 5394.0, 5266.0, 5578.0, 5325.0, 5318.0, 5489.0, 5276.0, 5424.0, 5677.0, 5527.0, 5271.0, 5609.0, 5539.0, 5294.0, 5709.0, 5516.0, 5573.0, 5451.0, 5354.0, 5252.0, 5711.0, 5449.0, 5452.0, 5678.0, 5441.0, 5720.0, 5597.0, 5371.0, 5425.0, 5690.0, 5688.0,

						5389.0, 5306.0, 5619.0, 5556.0, 5629.0, 5340.0, 5486.0, 5384.0, 5497.0, 5375.0, 5365.0, 5721.0, 5525.0, 5651.0, 5392.0, 5323.0, 5622.0, 5614.0, 5312.0, 5623.0, 5689.0, 5268.0, 5326.0, 5467.0, 5304.0, 5333.0, 5459.0, 5336.0, 5257.0, 5256.0, 5439.0, 5648.0, 5686.0, 5583.0, 5706.0, 5636.0, 5261.0, 5404.0, 5438.0, 5260.0, 5704.0, 5470.0, 5499.0, 5335.0, 5554.0, 5503.0, 5396.0, 5605.0, 5683.0, 5477.0, 5710.0, 5273.0, 5543.0, 5691.0, 5581.0 (number of hits: 11)
10	5540	9	1	333	1	5646.0, 5498.0, 5533.0, 5457.0, 5326.0, 5419.0, 5289.0, 5369.0, 5418.0, 5540.0, 5720.0, 5269.0, 5494.0, 5374.0, 5677.0, 5313.0, 5330.0, 5556.0, 5621.0, 5673.0, 5586.0, 5384.0, 5252.0, 5606.0, 5607.0, 5287.0, 5610.0, 5618.0, 5309.0, 5376.0, 5703.0, 5532.0, 5605.0, 5690.0, 5351.0, 5707.0, 5277.0, 5292.0, 5493.0, 5387.0, 5318.0, 5657.0, 5438.0, 5680.0, 5333.0, 5525.0, 5505.0, 5458.0, 5538.0, 5593.0, 5700.0, 5517.0, 5475.0, 5530.0, 5364.0, 5357.0, 5455.0, 5570.0, 5710.0, 5620.0, 5302.0, 5713.0, 5487.0, 5366.0, 5711.0, 5702.0, 5692.0, 5425.0, 5263.0, 5526.0, 5414.0, 5676.0, 5534.0, 5316.0, 5650.0, 5667.0, 5670.0, 5694.0, 5439.0, 5543.0, 5327.0, 5596.0, 5557.0, 5286.0, 5314.0, 5472.0, 5545.0, 5580.0, 5421.0, 5629.0, 5473.0, 5481.0, 5377.0, 5527.0, 5635.0, 5687.0, 5669.0, 5259.0, 5462.0, 5705.0 (number of hits: 16)
11	5502	9	1	333	1	5715.0, 5656.0, 5616.0, 5498.0, 5553.0, 5429.0, 5328.0, 5541.0, 5456.0, 5397.0, 5341.0, 5546.0, 5438.0, 5260.0, 5621.0, 5602.0, 5265.0, 5642.0, 5641.0, 5484.0, 5502.0, 5629.0, 5351.0, 5671.0, 5590.0, 5481.0, 5462.0, 5610.0, 5723.0, 5439.0, 5717.0, 5292.0, 5605.0, 5276.0, 5449.0, 5688.0, 5659.0, 5478.0, 5565.0, 5298.0, 5405.0, 5358.0, 5663.0, 5581.0, 5530.0, 5418.0, 5516.0, 5701.0, 5556.0, 5654.0, 5453.0, 5295.0, 5305.0, 5417.0, 5344.0, 5587.0, 5419.0, 5709.0, 5591.0, 5299.0, 5713.0, 5601.0, 5409.0, 5716.0, 5321.0, 5574.0, 5469.0, 5411.0, 5573.0, 5458.0, 5398.0, 5518.0, 5523.0, 5485.0, 5280.0, 5510.0, 5560.0, 5564.0, 5589.0, 5421.0, 5474.0, 5490.0, 5538.0, 5347.0, 5520.0, 5673.0, 5684.0, 5548.0, 5376.0, 5400.0, 5628.0, 5377.0, 5447.0, 5428.0, 5261.0, 5699.0, 5683.0, 5430.0, 5633.0, 5383.0 (number of hits: 16)
12	5502	9	1	333	1	5364.0, 5598.0, 5353.0, 5305.0, 5426.0, 5478.0, 5534.0, 5552.0, 5601.0, 5495.0, 5466.0, 5316.0, 5706.0, 5396.0, 5518.0, 5499.0, 5257.0, 5687.0, 5463.0, 5514.0, 5569.0, 5317.0, 5556.0, 5382.0, 5686.0, 5652.0, 5274.0, 5304.0, 5679.0, 5709.0, 5694.0, 5560.0, 5287.0, 5669.0, 5497.0,

						5278.0, 5640.0, 5292.0, 5283.0, 5337.0, 5370.0, 5492.0, 5476.0, 5578.0, 5543.0, 5501.0, 5390.0, 5306.0, 5285.0, 5342.0, 5389.0, 5670.0, 5621.0, 5667.0, 5422.0, 5267.0, 5263.0, 5609.0, 5557.0, 5700.0, 5315.0, 5462.0, 5573.0, 5602.0, 5698.0, 5254.0, 5566.0, 5583.0, 5504.0, 5548.0, 5270.0, 5367.0, 5692.0, 5688.0, 5265.0, 5648.0, 5567.0, 5643.0, 5701.0, 5666.0, 5515.0, 5555.0, 5580.0, 5428.0, 5553.0, 5357.0, 5722.0, 5630.0, 5264.0, 5659.0, 5288.0, 5695.0, 5347.0, 5320.0, 5586.0, 5479.0, 5407.0, 5520.0, 5381.0, 5336.0 (number of hits: 15)
13	5502	9	1	333	1	5513.0, 5298.0, 5451.0, 5639.0, 5584.0, 5350.0, 5404.0, 5541.0, 5719.0, 5611.0, 5709.0, 5270.0, 5284.0, 5419.0, 5519.0, 5588.0, 5630.0, 5658.0, 5511.0, 5285.0, 5501.0, 5405.0, 5597.0, 5418.0, 5454.0, 5446.0, 5654.0, 5369.0, 5535.0, 5612.0, 5672.0, 5265.0, 5390.0, 5394.0, 5467.0, 5604.0, 5429.0, 5309.0, 5540.0, 5696.0, 5340.0, 5283.0, 5266.0, 5435.0, 5275.0, 5395.0, 5276.0, 5256.0, 5567.0, 5516.0, 5559.0, 5622.0, 5312.0, 5508.0, 5461.0, 5524.0, 5566.0, 5579.0, 5667.0, 5462.0, 5273.0, 5411.0, 5623.0, 5488.0, 5590.0, 5287.0, 5413.0, 5687.0, 5363.0, 5560.0, 5357.0, 5458.0, 5457.0, 5325.0, 5614.0, 5576.0, 5558.0, 5277.0, 5448.0, 5557.0, 5643.0, 5459.0, 5591.0, 5258.0, 5263.0, 5714.0, 5550.0, 5480.0, 5439.0, 5695.0, 5434.0, 5327.0, 5474.0, 5336.0, 5569.0, 5504.0, 5533.0, 5644.0, 5525.0, 5503.0 (number of hits: 16)
14	5502	9	1	333	1	5701.0, 5558.0, 5600.0, 5360.0, 5460.0, 5613.0, 5337.0, 5527.0, 5719.0, 5610.0, 5662.0, 5494.0, 5679.0, 5408.0, 5661.0, 5712.0, 5263.0, 5424.0, 5687.0, 5305.0, 5425.0, 5603.0, 5668.0, 5380.0, 5472.0, 5579.0, 5370.0, 5420.0, 5342.0, 5435.0, 5254.0, 5546.0, 5390.0, 5457.0, 5448.0, 5488.0, 5403.0, 5690.0, 5434.0, 5410.0, 5638.0, 5431.0, 5651.0, 5315.0, 5585.0, 5517.0, 5441.0, 5634.0, 5255.0, 5346.0, 5426.0, 5624.0, 5665.0, 5381.0, 5322.0, 5334.0, 5324.0, 5711.0, 5291.0, 5669.0, 5252.0, 5429.0, 5588.0, 5479.0, 5541.0, 5549.0, 5450.0, 5297.0, 5475.0, 5303.0, 5401.0, 5681.0, 5409.0, 5341.0, 5618.0, 5486.0, 5331.0, 5491.0, 5593.0, 5301.0, 5686.0, 5330.0, 5649.0, 5389.0, 5271.0, 5376.0, 5463.0, 5571.0, 5625.0, 5412.0, 5388.0, 5632.0, 5392.0, 5442.0, 5566.0, 5586.0, 5371.0, 5495.0, 5584.0, 5296.0 (number of hits: 10)
15	5502	9	1	333	1	5647.0, 5691.0, 5721.0, 5457.0, 5386.0, 5257.0, 5336.0, 5406.0, 5498.0, 5472.0, 5251.0, 5688.0, 5575.0, 5508.0, 5720.0, 5512.0, 5675.0, 5367.0, 5376.0, 5528.0, 5600.0, 5697.0, 5379.0, 5260.0, 5699.0,

						5397.0, 5479.0, 5409.0, 5523.0, 5263.0, 5423.0, 5521.0, 5614.0, 5454.0, 5627.0, 5509.0, 5707.0, 5396.0, 5444.0, 5398.0, 5492.0, 5303.0, 5427.0, 5356.0, 5604.0, 5648.0, 5399.0, 5280.0, 5582.0, 5452.0, 5453.0, 5711.0, 5712.0, 5692.0, 5460.0, 5477.0, 5609.0, 5511.0, 5319.0, 5309.0, 5710.0, 5355.0, 5259.0, 5652.0, 5271.0, 5489.0, 5533.0, 5664.0, 5587.0, 5507.0, 5586.0, 5459.0, 5456.0, 5325.0, 5643.0, 5473.0, 5324.0, 5525.0, 5693.0, 5418.0, 5542.0, 5349.0, 5476.0, 5560.0, 5462.0, 5504.0, 5320.0, 5657.0, 5500.0, 5653.0, 5670.0, 5631.0, 5277.0, 5438.0, 5553.0, 5505.0, 5641.0, 5433.0, 5464.0, 5405.0 (number of hits: 22)
16	5502	9	1	333	1	5449.0, 5511.0, 5293.0, 5429.0, 5438.0, 5600.0, 5366.0, 5519.0, 5478.0, 5516.0, 5265.0, 5710.0, 5558.0, 5506.0, 5627.0, 5414.0, 5619.0, 5332.0, 5464.0, 5264.0, 5722.0, 5347.0, 5555.0, 5426.0, 5326.0, 5459.0, 5370.0, 5440.0, 5604.0, 5336.0, 5446.0, 5500.0, 5625.0, 5688.0, 5479.0, 5680.0, 5329.0, 5285.0, 5696.0, 5540.0, 5475.0, 5307.0, 5357.0, 5454.0, 5348.0, 5638.0, 5677.0, 5514.0, 5421.0, 5267.0, 5379.0, 5322.0, 5407.0, 5358.0, 5597.0, 5721.0, 5562.0, 5531.0, 5593.0, 5251.0, 5280.0, 5467.0, 5518.0, 5699.0, 5425.0, 5255.0, 5569.0, 5698.0, 5353.0, 5473.0, 5471.0, 5605.0, 5515.0, 5349.0, 5572.0, 5431.0, 5669.0, 5443.0, 5416.0, 5568.0, 5303.0, 5253.0, 5652.0, 5325.0, 5720.0, 5501.0, 5413.0, 5611.0, 5404.0, 5400.0, 5714.0, 5396.0, 5492.0, 5579.0, 5442.0, 5639.0, 5707.0, 5324.0, 5281.0, 5659.0 (number of hits: 18)
17	5502	9	1	333	1	5546.0, 5553.0, 5564.0, 5657.0, 5335.0, 5571.0, 5614.0, 5360.0, 5363.0, 5425.0, 5455.0, 5258.0, 5495.0, 5415.0, 5522.0, 5543.0, 5589.0, 5582.0, 5405.0, 5667.0, 5619.0, 5369.0, 5477.0, 5711.0, 5539.0, 5421.0, 5678.0, 5273.0, 5376.0, 5426.0, 5584.0, 5331.0, 5705.0, 5381.0, 5641.0, 5668.0, 5461.0, 5297.0, 5519.0, 5432.0, 5265.0, 5650.0, 5254.0, 5633.0, 5697.0, 5523.0, 5351.0, 5583.0, 5525.0, 5444.0, 5526.0, 5312.0, 5479.0, 5473.0, 5255.0, 5527.0, 5515.0, 5649.0, 5325.0, 5359.0, 5567.0, 5626.0, 5487.0, 5506.0, 5307.0, 5380.0, 5483.0, 5456.0, 5288.0, 5622.0, 5464.0, 5413.0, 5724.0, 5269.0, 5480.0, 5272.0, 5252.0, 5430.0, 5556.0, 5494.0, 5290.0, 5652.0, 5403.0, 5345.0, 5278.0, 5588.0, 5600.0, 5535.0, 5440.0, 5282.0, 5509.0, 5695.0, 5531.0, 5305.0, 5370.0, 5623.0, 5545.0, 5707.0, 5548.0, 5257.0 (number of hits: 21)
18	5502	9	1	333	1	5701.0, 5462.0, 5369.0, 5561.0, 5361.0, 5680.0, 5687.0, 5496.0, 5490.0, 5642.0, 5360.0, 5407.0, 5509.0, 5548.0, 5356.0,

						5563.0, 5661.0, 5562.0, 5587.0, 5706.0, 5344.0, 5559.0, 5530.0, 5695.0, 5545.0, 5416.0, 5325.0, 5311.0, 5374.0, 5471.0, 5411.0, 5600.0, 5590.0, 5365.0, 5478.0, 5383.0, 5503.0, 5450.0, 5516.0, 5419.0, 5615.0, 5643.0, 5631.0, 5316.0, 5504.0, 5406.0, 5652.0, 5354.0, 5305.0, 5303.0, 5389.0, 5711.0, 5675.0, 5589.0, 5295.0, 5619.0, 5410.0, 5570.0, 5373.0, 5370.0, 5473.0, 5696.0, 5401.0, 5427.0, 5290.0, 5519.0, 5283.0, 5402.0, 5398.0, 5417.0, 5434.0, 5622.0, 5277.0, 5710.0, 5313.0, 5336.0, 5535.0, 5304.0, 5281.0, 5480.0, 5708.0, 5624.0, 5539.0, 5458.0, 5718.0, 5364.0, 5512.0, 5280.0, 5697.0, 5395.0, 5717.0, 5550.0, 5594.0, 5583.0, 5659.0, 5334.0, 5491.0, 5441.0, 5610.0, 5428.0 (number of hits: 16)
19	5502	9	1	333	1	5297.0, 5547.0, 5589.0, 5572.0, 5432.0, 5436.0, 5540.0, 5620.0, 5337.0, 5427.0, 5641.0, 5578.0, 5577.0, 5379.0, 5472.0, 5505.0, 5368.0, 5467.0, 5668.0, 5696.0, 5254.0, 5685.0, 5504.0, 5585.0, 5378.0, 5680.0, 5437.0, 5426.0, 5369.0, 5392.0, 5330.0, 5273.0, 5673.0, 5592.0, 5476.0, 5559.0, 5461.0, 5563.0, 5718.0, 5554.0, 5425.0, 5285.0, 5338.0, 5613.0, 5527.0, 5381.0, 5677.0, 5535.0, 5400.0, 5704.0, 5480.0, 5340.0, 5478.0, 5260.0, 5336.0, 5598.0, 5576.0, 5513.0, 5647.0, 5458.0, 5450.0, 5453.0, 5517.0, 5341.0, 5410.0, 5506.0, 5610.0, 5595.0, 5664.0, 5317.0, 5390.0, 5287.0, 5702.0, 5693.0, 5496.0, 5562.0, 5507.0, 5536.0, 5417.0, 5280.0, 5377.0, 5304.0, 5270.0, 5299.0, 5546.0, 5324.0, 5451.0, 5650.0, 5619.0, 5360.0, 5355.0, 5510.0, 5479.0, 5416.0, 5528.0, 5587.0, 5362.0, 5648.0, 5638.0, 5305.0 (number of hits: 18)
20	5502	9	1	333	1	5528.0, 5632.0, 5561.0, 5471.0, 5622.0, 5292.0, 5626.0, 5678.0, 5486.0, 5323.0, 5721.0, 5542.0, 5653.0, 5372.0, 5715.0, 5334.0, 5592.0, 5424.0, 5695.0, 5704.0, 5566.0, 5573.0, 5645.0, 5470.0, 5331.0, 5341.0, 5380.0, 5705.0, 5476.0, 5407.0, 5477.0, 5450.0, 5355.0, 5463.0, 5296.0, 5505.0, 5537.0, 5670.0, 5661.0, 5662.0, 5710.0, 5445.0, 5689.0, 5587.0, 5426.0, 5423.0, 5274.0, 5458.0, 5633.0, 5688.0, 5571.0, 5337.0, 5499.0, 5608.0, 5624.0, 5395.0, 5519.0, 5614.0, 5594.0, 5414.0, 5439.0, 5411.0, 5553.0, 5398.0, 5610.0, 5393.0, 5696.0, 5360.0, 5422.0, 5711.0, 5256.0, 5498.0, 5270.0, 5366.0, 5643.0, 5615.0, 5619.0, 5316.0, 5415.0, 5444.0, 5251.0, 5683.0, 5431.0, 5617.0, 5404.0, 5707.0, 5687.0, 5351.0, 5628.0, 5457.0, 5375.0, 5654.0, 5706.0, 5271.0, 5684.0, 5317.0, 5384.0, 5279.0, 5665.0, 5676.0 (number of hits: 11)
21	5578	9	1	333	1	5698.0, 5490.0, 5649.0, 5312.0, 5340.0,

						5556.0, 5584.0, 5526.0, 5424.0, 5386.0, 5455.0, 5489.0, 5633.0, 5517.0, 5499.0, 5550.0, 5719.0, 5583.0, 5414.0, 5561.0, 5654.0, 5453.0, 5441.0, 5379.0, 5429.0, 5547.0, 5257.0, 5672.0, 5334.0, 5475.0, 5642.0, 5339.0, 5643.0, 5553.0, 5647.0, 5332.0, 5440.0, 5693.0, 5251.0, 5284.0, 5532.0, 5448.0, 5317.0, 5458.0, 5533.0, 5494.0, 5270.0, 5514.0, 5488.0, 5403.0, 5681.0, 5718.0, 5390.0, 5363.0, 5255.0, 5683.0, 5586.0, 5705.0, 5457.0, 5597.0, 5419.0, 5632.0, 5511.0, 5397.0, 5723.0, 5323.0, 5423.0, 5668.0, 5682.0, 5326.0, 5717.0, 5447.0, 5595.0, 5459.0, 5275.0, 5476.0, 5299.0, 5590.0, 5569.0, 5558.0, 5474.0, 5437.0, 5430.0, 5625.0, 5656.0, 5531.0, 5610.0, 5451.0, 5620.0, 5636.0, 5535.0, 5505.0, 5400.0, 5449.0, 5716.0, 5704.0, 5676.0, 5288.0, 5659.0, 5612.0 (number of hits: 15)
22	5578	9	1	333	1	5344.0, 5380.0, 5390.0, 5652.0, 5630.0, 5407.0, 5259.0, 5301.0, 5394.0, 5645.0, 5634.0, 5357.0, 5650.0, 5653.0, 5501.0, 5485.0, 5387.0, 5469.0, 5423.0, 5284.0, 5465.0, 5563.0, 5331.0, 5518.0, 5418.0, 5698.0, 5312.0, 5680.0, 5442.0, 5659.0, 5700.0, 5591.0, 5504.0, 5596.0, 5602.0, 5452.0, 5649.0, 5353.0, 5430.0, 5642.0, 5480.0, 5505.0, 5623.0, 5375.0, 5683.0, 5569.0, 5278.0, 5581.0, 5564.0, 5638.0, 5386.0, 5405.0, 5626.0, 5559.0, 5446.0, 5710.0, 5292.0, 5622.0, 5615.0, 5695.0, 5425.0, 5671.0, 5536.0, 5696.0, 5315.0, 5330.0, 5436.0, 5328.0, 5300.0, 5393.0, 5377.0, 5440.0, 5289.0, 5429.0, 5372.0, 5690.0, 5658.0, 5271.0, 5444.0, 5420.0, 5402.0, 5348.0, 5437.0, 5506.0, 5275.0, 5336.0, 5443.0, 5620.0, 5556.0, 5332.0, 5404.0, 5482.0, 5665.0, 5451.0, 5346.0, 5618.0, 5379.0, 5686.0, 5713.0, 5666.0 (number of hits: 10)
23	5578	9	1	333	1	5308.0, 5375.0, 5555.0, 5621.0, 5513.0, 5577.0, 5291.0, 5342.0, 5666.0, 5531.0, 5592.0, 5641.0, 5642.0, 5489.0, 5261.0, 5283.0, 5411.0, 5305.0, 5688.0, 5673.0, 5391.0, 5644.0, 5548.0, 5609.0, 5358.0, 5686.0, 5515.0, 5389.0, 5491.0, 5262.0, 5360.0, 5387.0, 5607.0, 5419.0, 5503.0, 5610.0, 5519.0, 5527.0, 5582.0, 5575.0, 5693.0, 5269.0, 5252.0, 5537.0, 5307.0, 5485.0, 5330.0, 5454.0, 5694.0, 5267.0, 5546.0, 5346.0, 5382.0, 5426.0, 5438.0, 5697.0, 5300.0, 5365.0, 5655.0, 5583.0, 5717.0, 5631.0, 5393.0, 5618.0, 5578.0, 5492.0, 5638.0, 5671.0, 5572.0, 5345.0, 5709.0, 5512.0, 5625.0, 5406.0, 5594.0, 5507.0, 5597.0, 5528.0, 5713.0, 5544.0, 5277.0, 5567.0, 5691.0, 5383.0, 5353.0, 5381.0, 5506.0, 5656.0, 5712.0, 5299.0, 5397.0, 5398.0, 5595.0, 5327.0, 5701.0, 5396.0, 5526.0, 5532.0, 5373.0, 5312.0

						(number of hits: 18)
24	5578	9	1	333	1	5648.0, 5713.0, 5309.0, 5469.0, 5684.0, 5277.0, 5569.0, 5500.0, 5635.0, 5701.0, 5624.0, 5463.0, 5280.0, 5389.0, 5411.0, 5298.0, 5330.0, 5425.0, 5600.0, 5514.0, 5307.0, 5527.0, 5664.0, 5448.0, 5618.0, 5338.0, 5442.0, 5653.0, 5300.0, 5520.0, 5566.0, 5455.0, 5325.0, 5285.0, 5437.0, 5690.0, 5719.0, 5485.0, 5341.0, 5489.0, 5549.0, 5541.0, 5536.0, 5540.0, 5614.0, 5666.0, 5380.0, 5544.0, 5522.0, 5629.0, 5465.0, 5403.0, 5535.0, 5697.0, 5292.0, 5420.0, 5634.0, 5402.0, 5573.0, 5350.0, 5580.0, 5313.0, 5297.0, 5655.0, 5324.0, 5337.0, 5593.0, 5477.0, 5615.0, 5264.0, 5491.0, 5616.0, 5675.0, 5462.0, 5289.0, 5373.0, 5406.0, 5377.0, 5599.0, 5646.0, 5704.0, 5335.0, 5283.0, 5578.0, 5340.0, 5471.0, 5591.0, 5268.0, 5368.0, 5360.0, 5254.0, 5434.0, 5612.0, 5602.0, 5694.0, 5383.0, 5304.0, 5619.0, 5475.0, 5509.0
						(number of hits: 17)
25	5578	9	1	333	1	5279.0, 5684.0, 5403.0, 5383.0, 5447.0, 5265.0, 5253.0, 5553.0, 5696.0, 5535.0, 5300.0, 5487.0, 5289.0, 5267.0, 5661.0, 5464.0, 5559.0, 5513.0, 5699.0, 5339.0, 5378.0, 5349.0, 5375.0, 5316.0, 5611.0, 5346.0, 5338.0, 5674.0, 5484.0, 5609.0, 5489.0, 5432.0, 5500.0, 5277.0, 5589.0, 5703.0, 5274.0, 5698.0, 5361.0, 5598.0, 5368.0, 5433.0, 5379.0, 5479.0, 5426.0, 5441.0, 5539.0, 5689.0, 5648.0, 5437.0, 5353.0, 5312.0, 5650.0, 5538.0, 5626.0, 5583.0, 5453.0, 5636.0, 5336.0, 5560.0, 5377.0, 5299.0, 5608.0, 5573.0, 5552.0, 5421.0, 5549.0, 5442.0, 5311.0, 5491.0, 5670.0, 5619.0, 5292.0, 5296.0, 5347.0, 5709.0, 5569.0, 5537.0, 5374.0, 5651.0, 5503.0, 5325.0, 5582.0, 5658.0, 5410.0, 5393.0, 5574.0, 5334.0, 5254.0, 5570.0, 5276.0, 5700.0, 5388.0, 5667.0, 5434.0, 5348.0, 5659.0, 5256.0, 5621.0, 5536.0
						(number of hits: 16)
26	5578	9	1	333	1	5366.0, 5428.0, 5563.0, 5614.0, 5697.0, 5722.0, 5449.0, 5507.0, 5524.0, 5461.0, 5617.0, 5363.0, 5277.0, 5274.0, 5665.0, 5550.0, 5429.0, 5346.0, 5709.0, 5652.0, 5503.0, 5338.0, 5715.0, 5316.0, 5437.0, 5471.0, 5668.0, 5509.0, 5571.0, 5300.0, 5420.0, 5412.0, 5603.0, 5537.0, 5358.0, 5716.0, 5266.0, 5581.0, 5374.0, 5373.0, 5458.0, 5400.0, 5649.0, 5281.0, 5568.0, 5626.0, 5304.0, 5586.0, 5302.0, 5457.0, 5661.0, 5361.0, 5411.0, 5478.0, 5409.0, 5404.0, 5530.0, 5684.0, 5592.0, 5467.0, 5280.0, 5604.0, 5386.0, 5600.0, 5630.0, 5529.0, 5584.0, 5590.0, 5711.0, 5570.0, 5502.0, 5444.0, 5577.0, 5637.0, 5669.0, 5678.0, 5443.0, 5413.0, 5672.0, 5680.0, 5351.0, 5615.0, 5703.0, 5511.0, 5468.0, 5441.0, 5681.0, 5610.0, 5653.0, 5395.0

						5489.0, 5453.0, 5339.0, 5666.0, 5714.0, 5393.0, 5692.0, 5561.0, 5422.0, 5462.0 (number of hits: 18)
27	5578	9	1	333	1	5599.0, 5317.0, 5579.0, 5482.0, 5357.0, 5635.0, 5511.0, 5464.0, 5397.0, 5436.0, 5605.0, 5368.0, 5674.0, 5652.0, 5349.0, 5264.0, 5308.0, 5687.0, 5429.0, 5476.0, 5580.0, 5688.0, 5486.0, 5353.0, 5334.0, 5329.0, 5321.0, 5695.0, 5717.0, 5509.0, 5433.0, 5270.0, 5355.0, 5395.0, 5686.0, 5648.0, 5488.0, 5369.0, 5289.0, 5376.0, 5705.0, 5489.0, 5350.0, 5337.0, 5556.0, 5690.0, 5371.0, 5664.0, 5689.0, 5659.0, 5576.0, 5693.0, 5551.0, 5704.0, 5719.0, 5590.0, 5458.0, 5356.0, 5325.0, 5498.0, 5468.0, 5552.0, 5550.0, 5666.0, 5678.0, 5566.0, 5453.0, 5583.0, 5596.0, 5681.0, 5665.0, 5565.0, 5431.0, 5586.0, 5634.0, 5394.0, 5530.0, 5569.0, 5555.0, 5668.0, 5494.0, 5592.0, 5502.0, 5340.0, 5595.0, 5391.0, 5722.0, 5614.0, 5478.0, 5702.0, 5544.0, 5603.0, 5292.0, 5484.0, 5646.0, 5346.0, 5282.0, 5721.0, 5402.0, 5571.0 (number of hits: 23)
28	5578	9	1	333	1	5624.0, 5441.0, 5632.0, 5694.0, 5537.0, 5482.0, 5506.0, 5520.0, 5321.0, 5668.0, 5319.0, 5285.0, 5257.0, 5265.0, 5619.0, 5648.0, 5467.0, 5579.0, 5581.0, 5656.0, 5402.0, 5338.0, 5562.0, 5424.0, 5399.0, 5312.0, 5519.0, 5314.0, 5413.0, 5500.0, 5596.0, 5621.0, 5371.0, 5472.0, 5254.0, 5528.0, 5679.0, 5271.0, 5396.0, 5460.0, 5267.0, 5508.0, 5326.0, 5286.0, 5293.0, 5420.0, 5352.0, 5529.0, 5348.0, 5685.0, 5644.0, 5322.0, 5645.0, 5718.0, 5585.0, 5594.0, 5661.0, 5377.0, 5408.0, 5380.0, 5383.0, 5316.0, 5516.0, 5723.0, 5669.0, 5421.0, 5273.0, 5393.0, 5303.0, 5618.0, 5570.0, 5329.0, 5590.0, 5266.0, 5463.0, 5431.0, 5453.0, 5560.0, 5440.0, 5276.0, 5690.0, 5617.0, 5306.0, 5369.0, 5687.0, 5323.0, 5429.0, 5391.0, 5295.0, 5642.0, 5532.0, 5620.0, 5274.0, 5649.0, 5280.0, 5546.0, 5700.0, 5704.0, 5493.0, 5575.0 (number of hits: 11)
29	5578	9	1	333	1	5594.0, 5417.0, 5709.0, 5315.0, 5252.0, 5368.0, 5431.0, 5352.0, 5612.0, 5575.0, 5448.0, 5605.0, 5635.0, 5686.0, 5690.0, 5283.0, 5433.0, 5529.0, 5542.0, 5685.0, 5514.0, 5644.0, 5273.0, 5446.0, 5350.0, 5389.0, 5561.0, 5646.0, 5343.0, 5598.0, 5388.0, 5406.0, 5289.0, 5312.0, 5331.0, 5356.0, 5449.0, 5292.0, 5390.0, 5357.0, 5490.0, 5545.0, 5703.0, 5491.0, 5531.0, 5666.0, 5617.0, 5626.0, 5663.0, 5516.0, 5571.0, 5452.0, 5569.0, 5379.0, 5704.0, 5369.0, 5546.0, 5337.0, 5664.0, 5719.0, 5285.0, 5471.0, 5410.0, 5476.0, 5466.0, 5504.0, 5536.0, 5407.0, 5710.0, 5424.0, 5298.0, 5425.0, 5511.0, 5329.0, 5392.0, 5596.0, 5394.0, 5464.0, 5637.0, 5662.0,

						5619.0, 5694.0, 5383.0, 5278.0, 5673.0, 5366.0, 5589.0, 5677.0, 5310.0, 5555.0, 5522.0, 5457.0, 5393.0, 5339.0, 5513.0, 5462.0, 5538.0, 5327.0, 5344.0, 5576.0 (number of hits: 15)
30	5578	9	1	333	1	5400.0, 5357.0, 5680.0, 5572.0, 5535.0, 5473.0, 5458.0, 5412.0, 5403.0, 5553.0, 5289.0, 5634.0, 5721.0, 5325.0, 5302.0, 5415.0, 5288.0, 5269.0, 5612.0, 5324.0, 5348.0, 5429.0, 5332.0, 5628.0, 5441.0, 5260.0, 5255.0, 5297.0, 5580.0, 5392.0, 5310.0, 5431.0, 5312.0, 5413.0, 5490.0, 5631.0, 5567.0, 5393.0, 5684.0, 5593.0, 5659.0, 5665.0, 5326.0, 5356.0, 5691.0, 5439.0, 5443.0, 5508.0, 5545.0, 5468.0, 5504.0, 5410.0, 5421.0, 5405.0, 5515.0, 5483.0, 5632.0, 5303.0, 5375.0, 5611.0, 5333.0, 5397.0, 5575.0, 5254.0, 5388.0, 5321.0, 5557.0, 5425.0, 5456.0, 5547.0, 5530.0, 5539.0, 5699.0, 5424.0, 5417.0, 5432.0, 5650.0, 5658.0, 5323.0, 5568.0, 5454.0, 5464.0, 5689.0, 5640.0, 5305.0, 5334.0, 5625.0, 5487.0, 5686.0, 5358.0, 5597.0, 5382.0, 5550.0, 5618.0, 5314.0, 5520.0, 5498.0, 5702.0, 5371.0, 5446.0 (number of hits: 14)