

Test of: Mimosa Networks A5c, A5-14, A5-18

To: FCC 47 CFR Part 90, Subpart Y; IC RSS-111

Test Report Serial No.: MIMO09-U10 Rev A



TEST REPORT

FROM



Test of Mimosa Networks A5c, A5-14, A5-18

To FCC 47 CFR Part 90, Subpart Y; IC RSS-111

Test Report Serial No.: MIMO09-U10 Rev A

This report supersedes NONE

Manufacturer: Mimosa Networks, Inc.
469 El Camino Real, Suite 100
Santa Clara California 95050
USA

Product Function: 5 GHz Wireless Module

Copy No: pdf **Issue Date:** 2nd August 2016

This Test Report is Issued Under the Authority of:

MiCOM Labs, Inc.
575 Boulder Court
Pleasanton California 94566
USA
Phone: +1 (925) 462-0304
Fax: +1 (925) 462-0306
www.micomlabs.com



MiCOM Labs is an ISO 17025 Accredited Testing Laboratory



Title: Mimosa Networks A5c, A5-14, A5-18
To: FCC 47 CFR Part 90, Subpart Y; IC RSS-111
Serial #: MIMO09-U10 Rev A
Issue Date: 2nd August 2016
Page: 3 of 105

This page has been left intentionally blank

This test report may be reproduced in full only. The document may only be updated by MiCOM Labs personnel. Any changes will be noted in the Document History section of the report.



TABLE OF CONTENTS

ACCREDITATION, LISTINGS & RECOGNITION	5
TESTING ACCREDITATION	5
RECOGNITION.....	6
PRODUCT CERTIFICATION	7
1. TEST RESULT CERTIFICATE.....	9
2. REFERENCES AND MEASUREMENT UNCERTAINTY	10
2.1. Normative References	10
2.2. Test and Uncertainty Procedures.....	11
3. PRODUCT DETAILS AND TEST CONFIGURATIONS.....	12
3.1. Technical Details.....	12
3.2. Scope of Test Program	13
1.1. Equipment Model(s) and Serial Number(s).....	16
1.2. Antenna Details.....	16
4. TEST SUMMARY	17
5. TEST EQUIPMENT CONFIGURATION(S).....	18
5.1. Conducted Test Set-Up.....	18
5.2. Radiated Emission Test Set-Up	20
5.3. ac Wireline Emission Test Set-up.....	22
6. TEST RESULTS	24
6.1. Device Characteristics	24
6.1.1. <i>Occupied Bandwidth and Emission Mask</i>	24
6.1.2. <i>Output Power</i>	39
6.1.3. <i>Peak Power Spectral Density (PPSD)</i>	44
6.1.4. <i>Maximum Permissible Exposure</i>	58
6.1.5. <i>Frequency Stability; Temperature Variations, and Voltage Variations</i> ..	59
6.1.6. <i>Spurious Emissions at Antenna Terminals - Transmitter</i>	77
6.1.7. <i>Radiated Spurious Emissions</i>	91
6.1.8. <i>Digital Emissions (0.03 – 1 GHz)</i>	96
6.1.9. <i>Receiver Radiated Spurious Emissions (above 1 GHz)</i>	98

This test report may be reproduced in full only. The document may only be updated by MiCOM Labs personnel. All changes will be noted in the Document History section of the report.

ACCREDITATION, LISTINGS & RECOGNITION

TESTING ACCREDITATION

MiCOM Labs, Inc. is an accredited Electrical testing laboratory per the international standard ISO/IEC 17025:2005. The company is accredited by the American Association for Laboratory Accreditation (A2LA) www.a2la.org test laboratory number 2381.01. MiCOM Labs test schedule is available at the following URL; <http://www.a2la.org/scopepdf/2381-01.pdf>



Accredited Laboratory

A2LA has accredited

MICOM LABS

Pleasanton, CA

for technical competence in the field of

Electrical Testing

This laboratory is accredited in accordance with the recognized International Standard ISO/IEC 17025:2005 General requirements for the competence of testing and calibration laboratories. This accreditation demonstrates technical competence for a defined scope and the operation of a laboratory quality management system (refer to joint ISO-ILAC-IAF Communiqué dated 8 January 2009).



Presented this 4th day of February 2016.

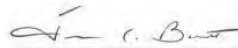

Senior Director of Quality & Communications
For the Accreditation Council
Certificate Number 2381.01
Valid to November 30, 2017

For the tests or types of tests to which this accreditation applies, please refer to the laboratory's Electrical Scope of Accreditation.

This test report may be reproduced in full only. The document may only be updated by MiCOM Labs personnel. All changes will be noted in the Document History section of the report.



RECOGNITION

MiCOM Labs, Inc has widely recognized Electrical testing capabilities. Our international recognition includes Conformity Assessment Body designation by APEC MRA** countries. Our test reports are widely accepted for global type approvals.

Country	Recognition Body	Status	Phase	Identification No.
USA	Federal Communications Commission (FCC)	TCB	-	US0159 Listing #: 102167
Canada	Industry Canada (IC)	FCB	APEC MRA 2	US0159 Listing #: 4143A-2
Japan	MIC (Ministry of Internal Affairs and Communication)	CAB	APEC MRA 2	RCB 210
	VCCI	--	--	A-0012
Europe	European Commission	NB	EU MRA	NB 2280
Australia	Australian Communications and Media Authority (ACMA)	CAB	APEC MRA 1	US0159
Hong Kong	Office of the Telecommunication Authority (OFTA)	CAB	APEC MRA 1	
Korea	Ministry of Information and Communication Radio Research Laboratory (RRL)	CAB	APEC MRA 1	
Singapore	Infocomm Development Authority (IDA)	CAB	APEC MRA 1	
Taiwan	National Communications Commission (NCC) Bureau of Standards, Metrology and Inspection (BSMI)	CAB	APEC MRA 1	
Vietnam	Ministry of Communication (MIC)	CAB	APEC MRA 1	

**APEC MRA – Asia Pacific Economic Community Mutual Recognition Agreement.

Is a recognition agreement under which test lab is accredited to regulatory standards of the APEC member countries.

Phase I - recognition for product testing

Phase II – recognition for both product testing and certification

N/A – Not Applicable

**EU MRA – European Union Mutual Recognition Agreement.

Is a recognition agreement under which test lab is accredited to regulatory standards of the EU member countries.

**NB – Notified Body

This test report may be reproduced in full only. The document may only be updated by MiCOM Labs personnel. All changes will be noted in the Document History section of the report.

PRODUCT CERTIFICATION

MiCOM Labs, Inc. is an accredited Product Certification Body per the international standard ISO/IEC 17065:2012. The company is accredited by the American Association for Laboratory Accreditation (A2LA) www.a2la.org test laboratory number 2381.02. MiCOM Labs test schedule is available at the following URL; <http://www.a2la.org/scopepdf/2381-02.pdf>



Accredited Product Certification Body

A2LA has accredited

MICOM LABS

Pleasanton, CA

This product certification body is accredited in accordance with the recognized International Standard ISO/IEC 17065:2012 *Requirements for bodies certifying products, processes and services*. This accreditation demonstrates technical competence for a defined scope and the operation of a management system.



Presented this 4th day of February 2016.



Senior Director of Quality & Communications
For the Accreditation Council
Certificate Number 2381.02
Valid to November 30, 2017

For the product certification schemes to which this accreditation applies, please refer to the organization's Product Certification Scope of Accreditation.

United States of America – Telecommunication Certification Body (TCB)
Industry Canada – Certification Body, CAB Identifier – US0159
Europe – Notified Body (NB), NB Identifier - 2280
Japan – Recognized Certification Body (RCB), RCB Identifier - 210

This test report may be reproduced in full only. The document may only be updated by MiCOM Labs personnel. All changes will be noted in the Document History section of the report.



Title: Mimosa Networks A5c, A5-14, A5-18
To: FCC 47 CFR Part 90, Subpart Y; IC RSS-111
Serial #: MIMO09-U10 Rev A
Issue Date: 2nd August 2016
Page: 8 of 105

DOCUMENT HISTORY

Document History		
Revision	Date	Comments
Draft	11 th July 2016	
Rev A	2 nd August 2016	Initial Release

This test report may be reproduced in full only. The document may only be updated by MiCOM Labs personnel. All changes will be noted in the Document History section of the report.



Title: Mimosa Networks A5c, A5-14, A5-18
To: FCC 47 CFR Part 90, Subpart Y; IC RSS-111
Serial #: MIMO09-U10 Rev A
Issue Date: 2nd August 2016
Page: 9 of 105

1. TEST RESULT CERTIFICATE

Manufacturer: Mimosa Networks, Inc. 469 El Camino Real, Suite 100 Santa Clara California 95050 USA	Tested By: MiCOM Labs, Inc. 575 Boulder Court Pleasanton California, 94566, USA
EUT: RF Module operating in the 4.9 – 5.8 GHz bands.	Telephone: +1 925 462 0304
Model: A5c, A5-14, A5-18	Fax: +1 925 462 0306
S/N's: 2118161852	
Test Date(s): 5th to 6th July 2016	Website: www.micomlabs.com

STANDARD(S)	TEST RESULTS
FCC 47 CFR Part 90, Subpart Y; IC RSS-111	EQUIPMENT COMPLIES

MiCOM Labs, Inc. tested the equipment mentioned in accordance with the requirements set forth in the above standards. Test results indicate that the equipment tested is capable of demonstrating compliance with the requirements as documented within this report.

Notes:

1. This document reports conditions under which testing was conducted and the results of testing performed.
2. Details of test methods used have been recorded and kept on file by the laboratory.
3. Test results apply only to the item(s) tested.

Approved & Released for MiCOM Labs, Inc. by:



Graeme Grieve
Quality Manager MiCOM Labs,

Gordon Hurst
President & CEO MiCOM Labs, Inc.

This test report may be reproduced in full only. The document may only be updated by MiCOM Labs personnel. All changes will be noted in the Document History section of the report.

2. REFERENCES AND MEASUREMENT UNCERTAINTY

2.1. Normative References

REF.	PUBLICATION	YEAR	TITLE
(i)	FCC 47 CFR Part 90	2015	Code of Federal Regulations
(ii)	RSS-111 Issue 5	Sept 2014	Broadband Public Safety Equipment Operating in the Band 4940-4990 MHz
(iii)	ANSI C63.4	2014	American National Standards for Methods of Measurement of Radio-Noise Emissions from Low-Voltage Electrical and Electronic Equipment in the Range of 9 kHz to 40 GHz
(iv)	CISPR 22/ EN 55022	2008 / 2010	Limits and Methods of Measurements of Radio Disturbance Characteristics of Information Technology Equipment
(v)	M 3003	Edition 3 Nov.2012	Expression of Uncertainty and Confidence in Measurements
(vi)	LAB34	Edition 1 Aug 2002	The expression of uncertainty in EMC Testing
(vii)	ETSI TR 100 028	2001-12	Parts 1 and 2 Electromagnetic compatibility and Radio Spectrum Matters (ERM); Uncertainties in the measurement of mobile radio equipment characteristics
(viii)	A2LA	Feb 2016	Reference to A2LA Accreditation Status – A2LA Advertising Policy



Title: Mimosa Networks A5c, A5-14, A5-18
To: FCC 47 CFR Part 90, Subpart Y; IC RSS-111
Serial #: MIMO09-U10 Rev A
Issue Date: 2nd August 2016
Page: 11 of 105

2.2. Test and Uncertainty Procedures

Conducted and radiated emission measurements were conducted in accordance with American National Standards Institute ANSI C63.4, listed in the Normative References section of this report.

Measurement uncertainties stated are based on a standard uncertainty multiplied by a coverage factor $k = 2$, providing a level of confidence of approximately 95 % in accordance with UKAS document M 3003 listed in the Normative References section of this report.

This test report may be reproduced in full only. The document may only be updated by MiCOM Labs personnel. All changes will be noted in the Document History section of the report.



Title: Mimosa Networks A5c, A5-14, A5-18
To: FCC 47 CFR Part 90, Subpart Y; IC RSS-111
Serial #: MIMO09-U10 Rev A
Issue Date: 2nd August 2016
Page: 12 of 105

3. PRODUCT DETAILS AND TEST CONFIGURATIONS

3.1. Technical Details

Details	Description
Purpose:	Test of Mimosa Networks, Inc. A5c to FCC Part 90 SubPart Y and IC RSS-111 regulations
Applicant:	Mimosa Networks, Inc. 469 El Camino Real, Suite 100 Santa Clara California 95050, USA
Manufacturer:	As applicant
Laboratory performing the tests:	MiCOM Labs, Inc. 575 Boulder Court Pleasanton, California 94566 USA
Test report reference number:	MIMO09-U10 Rev A
Date EUT received:	14 th July 2015
Standard(s) applied:	FCC 47 CFR Part 90 Subpart Y and IC RSS-111
Dates of test (from - to):	5th to 6th July 2016
No of Units Tested:	One
Type of Equipment:	5 GHz Wireless Module 2x2 Spatial Multiplexing MIMO configuration
Manufacturers Trade Name:	Wireless Module
Model(s):	A5c, A5-14, A5-18
Location for use:	Indoor and Outdoor
Declared Frequency Range(s):	4,940 – 4,990 MHz
Hardware Rev	D
Software Rev	2.0
EUT Modes of Operation:	20 MHz
Type of Modulation:	OFDM
Declared Nominal Average Output Power:	20 MHz: +20.0 dBm
Transmit/Receive Operation:	Time Division Duplex
System Beam Forming:	no beam-forming capability
Rated Input Voltage and Current:	POE 48 Vdc 1 A
Operating Temperature Range:	Declared Range -40°C to +55°C
ITU Emission Designator:	20 MHz 20M0W7W
Equipment Dimensions:	A5-14: (H) 12.6 in x (L) 5.6 in A5-18: (H) 25.3 in x (L) 5.6 in A5c: (H) 11.75 in x (L) 3.2 in x (W) 6.0 in
Weight:	A5-14: 4 lbs A5-18: 8 lbs A5c: 3.5 lbs
Primary function of equipment:	RF module for transmitting and receiving data

This test report may be reproduced in full only. The document may only be updated by MiCOM Labs personnel. All changes will be noted in the Document History section of the report.

3.2. Scope of Test Program

Mimosa Networks, INC A5c RF Testing

The scope of the test program was to test the Mimosa Networks HSU-E, HSU-R 5 GHz wireless module configurations in the frequency range 4,940 to 4,990 MHz for compliance against FCC 47 CFR Part 90 Subpart Y and Industry Canada RSS-111 specifications.

Mimosa Networks A5-14



This test report may be reproduced in full only. The document may only be updated by MiCOM Labs personnel. All changes will be noted in the Document History section of the report.

Mimosa Networks A5-18



This test report may be reproduced in full only. The document may only be updated by MiCOM Labs personnel. All changes will be noted in the Document History section of the report.

Mimosa Networks A5c



This test report may be reproduced in full only. The document may only be updated by MiCOM Labs personnel. All changes will be noted in the Document History section of the report.



3.3. Equipment Model(s) and Serial Number(s)

Type	Description	Manufacturer	Model	Serial No.	Delivery Date
EUT	Access Point	Mimosa Networks	A5c	2115237991	17 th June 2016
EUT	Access Point	Mimosa Networks	A5-14	2112696984	17 th June 2016
EUT	Access Point	Mimosa Networks	A5-18	2119591877	17 th June 2016

3.4. Antenna Details

*802.11a Operational Mode (legacy) does not have beam forming gains

Type	Manufacturer	Model	Family	Gain (dBi)	BF Gain	Dir BW	X-Pol	Frequency Band (MHz)
external	KP Performance	KPPA-5GHZHV4P65-17 (X4)	Sector Antenna	17.5	-	360	Y	5250 – 5350
external	KP Performance	KPPA-5GHZHV4P65-17 (X4)	Sector Antenna	18.0	-	360	Y	5470 – 5725
integral	Mimosa	Not Provided	Circular Polarized Panel	5.0	-	360	Y	5250 – 5350 5470 – 5725
integral	Mimosa	Not Provided	Circular Polarized Panel	8.0	-	360	Y	5250 – 5350 5470 – 5725

BF Gain - Beamforming Gain
Dir BW - Directional BeamWidth
X-Pol - Cross Polarization



4. TEST SUMMARY

List of Measurements

The following table represents the list of measurements required under the **FCC CFR47 Part 90, Subpart Y (except Section 5.1.4)** and **Industry Canada RSS-111; Industry Canada RSS-Gen.**

Section(s)	Test Items	Description	Condition	Result	Test Report Section
2.1049; 90.210(m) 5.3 4.6	26 dB Occupied BW & Emission Mask	Emission mask and bandwidth measurement(s)	Conducted	Complies	6.1.1
2.1046; 90.1215 (a) 5.3 4.8	Peak Output Power	Modulated Output Power	Conducted	Complies	6.1.2
2.1046; 90.1215 (a) 4.2	Peak Power Spectral Density	Maximum Spectral Density	Conducted	Complies	6.1.3
Subpart C 90.1217 5.6	Maximum Permissible Exposure	Exposure to radio frequency energy levels	Radiated	Complies	6.1.4
2.1055(a)(1); 90.213 5.2 4.7	Frequency Stability	Includes temperature and voltage variations	Conducted	Complies	6.1.5
2.1051; 90.210(m) 5.4 4.9	Conducted Spurious Emissions at Antenna Port	Emissions from the antenna port 30 MHz – 40 GHz	Conducted	Complies	6.1.6
2.1053; 90.210(m) 5.3 4.9	Radiated Spurious Emissions	Spurious emissions 30 MHz – 40 GHz	Radiated	Complies	6.1.7
15.205 15.209	Digital Emissions	0.03 – 1 GHz	Radiated	Complies	6.1.8
4.10 6	Radiated Receiver Emissions	Spurious emissions 30 MHz – 18 GHz	Radiated	Complies	6.1.9

Note 1: Test results reported in this document relate only to the items tested

Note 2: The required tests demonstrated compliance as per client declaration of test configuration, monitoring methodology and associated pass/fail criteria

Note 3: Section 3.7 Equipment Modifications highlights the equipment modifications that were required to bring the product into compliance with the above test matrix

This test report may be reproduced in full only. The document may only be updated by MiCOM Labs personnel. All changes will be noted in the Document History section of the report.

5. TEST EQUIPMENT CONFIGURATION(S)

5.1. Conducted Test Set-Up

Conducted RF Emission Test Set-up(s).

The following tests were performed using the conducted test set-up shown in the diagram below.

1. Occupied Bandwidth and Emission Mask
2. Peak Output Power
3. Peak Power Spectral Density
4. Frequency Stability
5. Spurious Emissions at Antenna Terminals - Transmitter

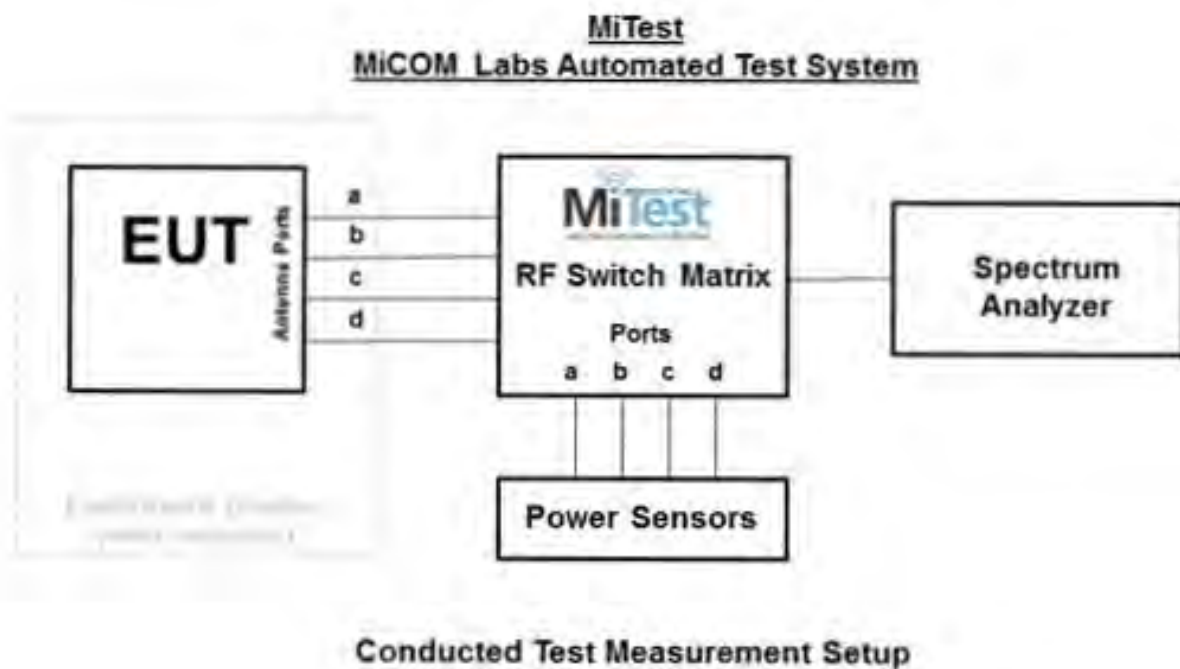

A full system calibration was performed on the test station and any resulting system losses (or gains) were taken into account in the production of all final measurement data.



Title: Mimosa Networks A5c, A5-14, A5-18
To: FCC 47 CFR Part 90, Subpart Y; IC RSS-111
Serial #: MIMO09-U10 Rev A
Issue Date: 2nd August 2016
Page: 19 of 105

Asset#	Description	Manufacturer	Model#	Serial#	Calibration Due Date
158	Barometer/Thermometer	Control Company	4196	E2846	01 Dec 2016
249	Resistance Thermometer	Thermotronics	GR2105-02	9340 #2	23 Oct 2016
287	Rohde & Schwarz 40 GHz Receiver	Rhode & Schwarz	ESIB40	100201	27 Aug 2016
361	Desktop for RF#1, Labview Software installed	Dell	Vostro 220	WS RF#1	Not Required
378	Rohde & Schwarz 40 GHz Receiver with Generator	Rhode & Schwarz	ESIB40	100107/040	04 Aug 2016
380	4x4 RF Switch Box	MiCOM Labs	MiTest RF Switch Box	MIC001	06 Dec 2016
390	USB Power Head 50MHz - 24GHz -60 to +20dBm	Agilent	U2002A	MY50000103	17 Oct 2016
398	Test Software	MiCOM	MiTest ATS	Version 3.0.0.16	Not Required
405	DC Power Supply 0-60V	Agilent	6654A	MY4001826	Cal when used
408	USB to GPIB interface	National Instruments	GPIB-USB HS	14C0DE9	Not Required
436	USB Wideband Power Sensor	Boonton	55006	8731	31 Jul 2016
437	USB Wideband Power Sensor	Boonton	55006	8759	31 Jul 2016
445	PoE Injector	D-Link	DPE-101GL	QTAH1E2000625	Not Required
461	Spectrum Analyzer	Agilent	E4440A	MY46185537	13 Aug 2016
75	Environmental Chamber	Thermatron	SE-300-2-2	27946	24 Nov 2016
RF#1 GPIB#1	GPIB cable to Power Supply	HP	GPIB	None	Not Required
RF#1 SMA SA #452	Precision SMA Male RG-402 Spectrun Analyzer	Fairview Microwave	Precision SMA Male RG 402 coax	None	06 Dec 2016
RF#1 SMA#1	EUT to Mitest box port 1	Flexco	SMA Cable port1	None	06 Dec 2016
RF#1 SMA#2	EUT to Mitest box port 2	Flexco	SMA Cable port2	None	06 Dec 2016
RF#1 SMA#3	EUT to Mitest box port 3	Flexco	SMA Cable port3	None	06 Dec 2016
RF#1 SMA#4	EUT to Mitest box port 4	Flexco	SMA Cable port4	None	06 Dec 2016
RF#1 USB#1	USB Cable to Mitest Box	Dynex	USB Cable	None	Not Required

This test report may be reproduced in full only. The document may only be updated by MiCOM Labs personnel. All changes will be noted in the Document History section of the report.

5.2. Radiated Emission Test Set-Up

The following tests were performed using the conducted test set-up shown in the diagram below.

1. Radiated Spurious Emissions
2. Radiated Digital Emissions (0.03 – 1 GHz)
3. Receiver Spurious Emissions

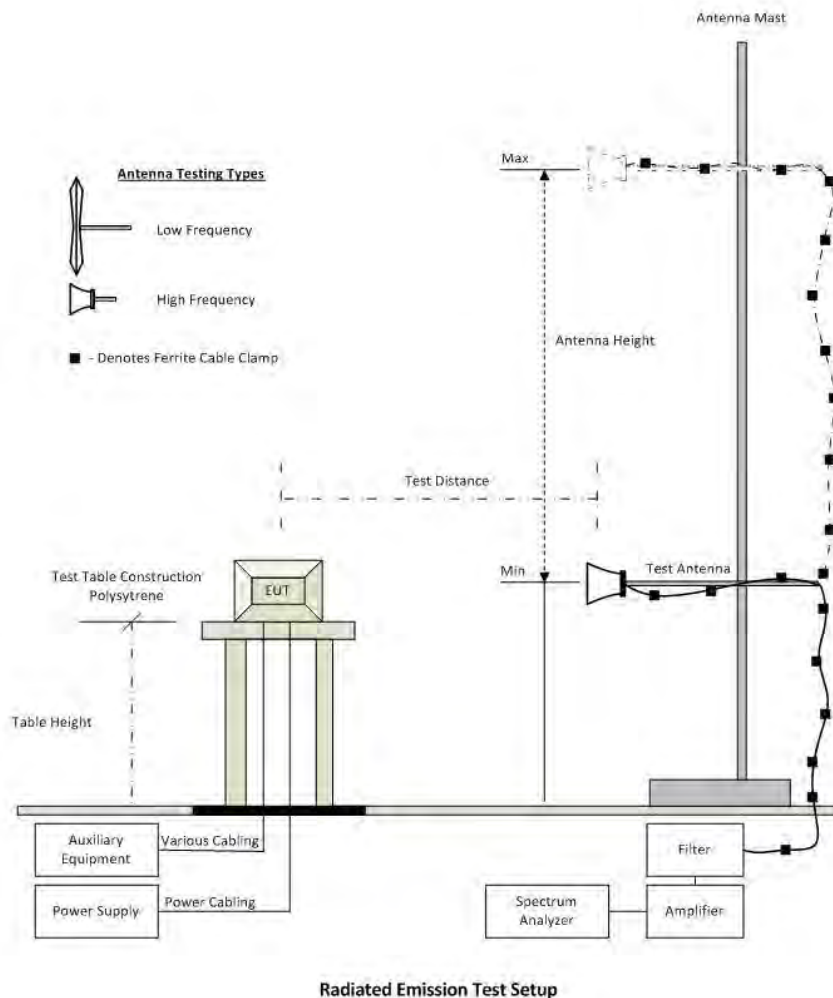

A full system calibration was performed on the test station and any resulting system losses (or gains) were taken into account in the production of all final measurement data.



Title: Mimosa Networks A5c, A5-14, A5-18
To: FCC 47 CFR Part 90, Subpart Y; IC RSS-111
Serial #: MIMO09-U10 Rev A
Issue Date: 2nd August 2016
Page: 21 of 105

Asset#	Description	Manufacturer	Model#	Serial#	Calibration Due Date
158	Barometer/Thermometer	Control Company	4196	E2846	01 Dec 2016
170	Video System Controller for Semi Anechoic Chamber	Panasonic	WV-CY101	04R08507	Not Required
287	Rohde & Schwarz 40 GHz Receiver	Rhode & Schwarz	ESIB40	100201	27 Aug 2016
338	Sunol 30 to 3000 MHz Antenna	Sunol	JB3	A052907	15 Aug 2016
396	2.4 GHz Notch Filter	Microtronics	BRM50701	001	18 Aug 2016
397	Amp 10 - 2500MHz	MiCOM Labs	Amp 10 - 2500 MHz	NA	9 June 2017
399	ETS 1-18 GHz Horn Antenna	ETS	3117	00154575	10 Oct 2016
406	Amplifier for Radiated Emissions	MiCOM Labs	40dB 1 to 18GHz Amp	0406	9 June 2017
410	Desktop Computer	Dell	Inspiron 620	WS38	Not Required
411	Mast/Turntable Controller	Sunol Sciences	SC98V	060199-1D	Not Required
412	USB to GPIB Interface	National Instruments	GPIB-USB HS	11B8DC2	Not Required
413	Mast Controller	Sunol Science	TWR95-4	030801-3	Not Required
415	Turntable Controller	Sunol Sciences	Turntable Controller	None	Not Required
447	Rad Emissions Test Software	MiCOM	Rad Emissions Test Software Version 1.0.73	447	Not Required
462	Schwarzbeck cable from Antenna to Amplifier.	Schwarzbeck	AK 9513	462	31 May 2017
463	Schwarzbeck cable from Amplifier to Bulkhead.	Schwarzbeck	AK 9513	463	31 May 2017
464	Schwarzbeck cable from Bulkhead to Receiver	Schwarzbeck	AK 9513	464	31 May 2017
465	Low Pass Filter DC-1000 MHz	Mini-Circuits	NLP-1200+	VUU01901402	2 June 2017
480	Cable - Bulkhead to Amp	SRC Haverhill	157-157-3050360	480	2 June 2017
481	Cable - Bulkhead to Receiver	SRC Haverhill	151-151-3050787	481	2 June 2017
482	Cable - Amp to Antenna	SRC Haverhill	157-157-3051574	482	2 June 2017

This test report may be reproduced in full only. The document may only be updated by MiCOM Labs personnel. All changes will be noted in the Document History section of the report.

5.3. ac Wireline Emission Test Set-up

The following tests were performed using the conducted test set-up shown in the diagram below.

1. ac Wireline Conducted Emissions

Test Measurement Set up

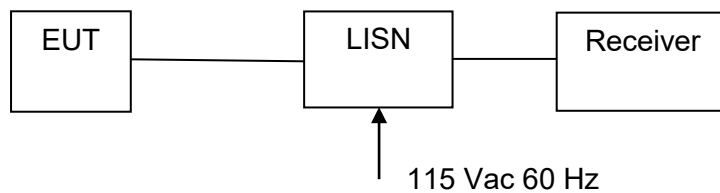

Measurement set up for AC Wireline Conducted Emissions Test

A full system calibration was performed on the test station and any resulting system losses (or gains) were taken into account in the production of all final measurement data.



Title: Mimosa Networks A5c, A5-14, A5-18
To: FCC 47 CFR Part 90, Subpart Y; IC RSS-111
Serial #: MIMO09-U10 Rev A
Issue Date: 2nd August 2016
Page: 23 of 105

Traceability of Test Equipment Utilized for ac Wireline Emission Testing

Asset#	Description	Manufacturer	Model#	Serial#	Calibration Due Date
158	Barometer/Thermometer	Control Company	4196	E2846	01 Dec 2016
184	Pulse Limiter	Rhode & Schwarz	ESH3Z2	357.8810.52	27 Oct 2016
190	LISN (two-line V-network)	Rhode & Schwarz	ESH3Z5	836679/006	29 Oct 2016
193	Receiver 20 Hz to 7 GHz	Rhode & Schwarz	ESI 7	838496/007	17 July 2016
287	Rohde & Schwarz 40 GHz Receiver	Rhode & Schwarz	ESIB40	100201	27 Aug 2016
307	BNC-CABLE	Megaphase	1689 1GVT4	15F50B002	27 Oct 2016
316	Dell desktop computer workstation with Vasona	Dell	Desktop	WS04	Not Required
372	AC Variable PS	California Instruments	1251P	L06951	Cal when used
378	Rohde & Schwarz 40 GHz Receiver with Generator	Rhode & Schwarz	ESIB40	100107/040	04 Aug 2016
388	LISN (3 Phase) 9kHz - 30MHz	Rohde & Schwarz	ESH2-Z5	892107/022	30 Oct 2016
ADAPT SMA#1	SMA Cable	Megaphase	SMA Cable #1	None	Cal when used

This test report may be reproduced in full only. The document may only be updated by MiCOM Labs personnel. All changes will be noted in the Document History section of the report.



Title: Mimosa Networks A5c, A5-14, A5-18
To: FCC 47 CFR Part 90, Subpart Y; IC RSS-111
Serial #: MIMO09-U10 Rev A
Issue Date: 2nd August 2016
Page: 24 of 105

6. TEST RESULTS

6.1. Device Characteristics

6.1.1. Occupied Bandwidth and Emission Mask

FCC 47 CFR Part 90, Subpart Y; 2.1049; §90.210(m)

Test Procedure

The transmitter terminal of EUT was connected to the input of the spectrum analyzer set to measure the 26 dB occupied bandwidth and emission mask for the radio. The system highest power setting was selected with modulation ON and duty cycle set for 100% i.e. continuous operation at all times.

For emission masks the zero dB reference is measured relative to the highest average power of the fundamental emission measured across the designated channel bandwidth using a resolution bandwidth of at least one percent of the occupied bandwidth of the fundamental emission and a video bandwidth of 30 kHz.

Ambient conditions.

Temperature: 19 to 26 °C Relative humidity: 31 to 57 % Pressure: 999 to 1009 mbar

This test report may be reproduced in full only. The document may only be updated by MiCOM Labs personnel. All changes will be noted in the Document History section of the report.



Port B
26 dB Bandwidth 20 MHz Channel Freq 4950 MHz

Delta 1 [T1] RBW 200 kHz RF Att 10 dB
Ref Lvl 0.57 dB VBW 30 kHz
19.5 dBm 21.88376754 MHz SWT 10 s Unit dBm

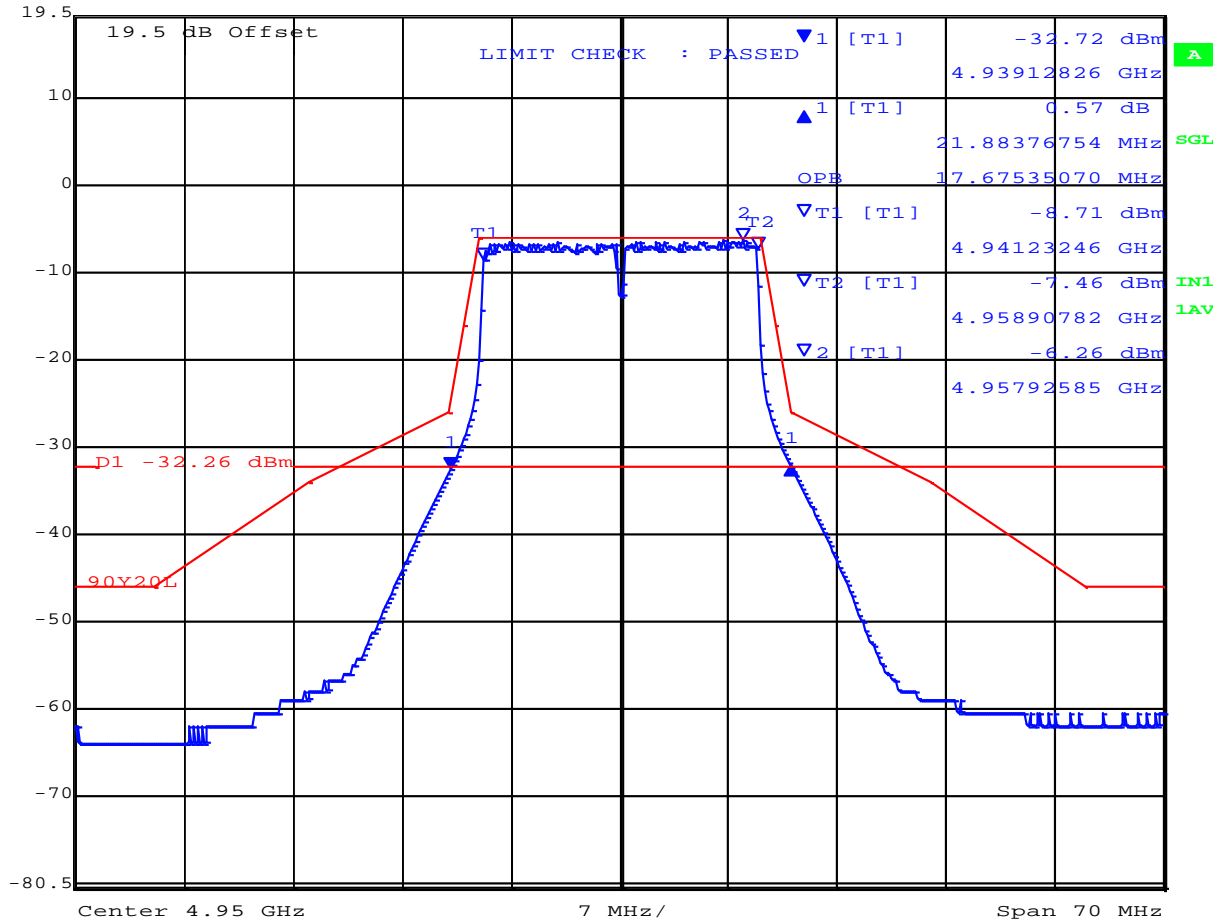

Date: 5.JUL.2016 10:23:04

This test report may be reproduced in full only. The document may only be updated by MiCOM Labs personnel. All changes will be noted in the Document History section of the report.



Port C
26 dB Bandwidth 20 MHz Channel Freq 4950 MHz

Delta 1 [T1] RBW 200 kHz RF Att 10 dB
Ref Lvl 19.5 dBm -0.49 dB VBW 30 kHz
22.02404810 MHz SWT 10 s Unit dBm

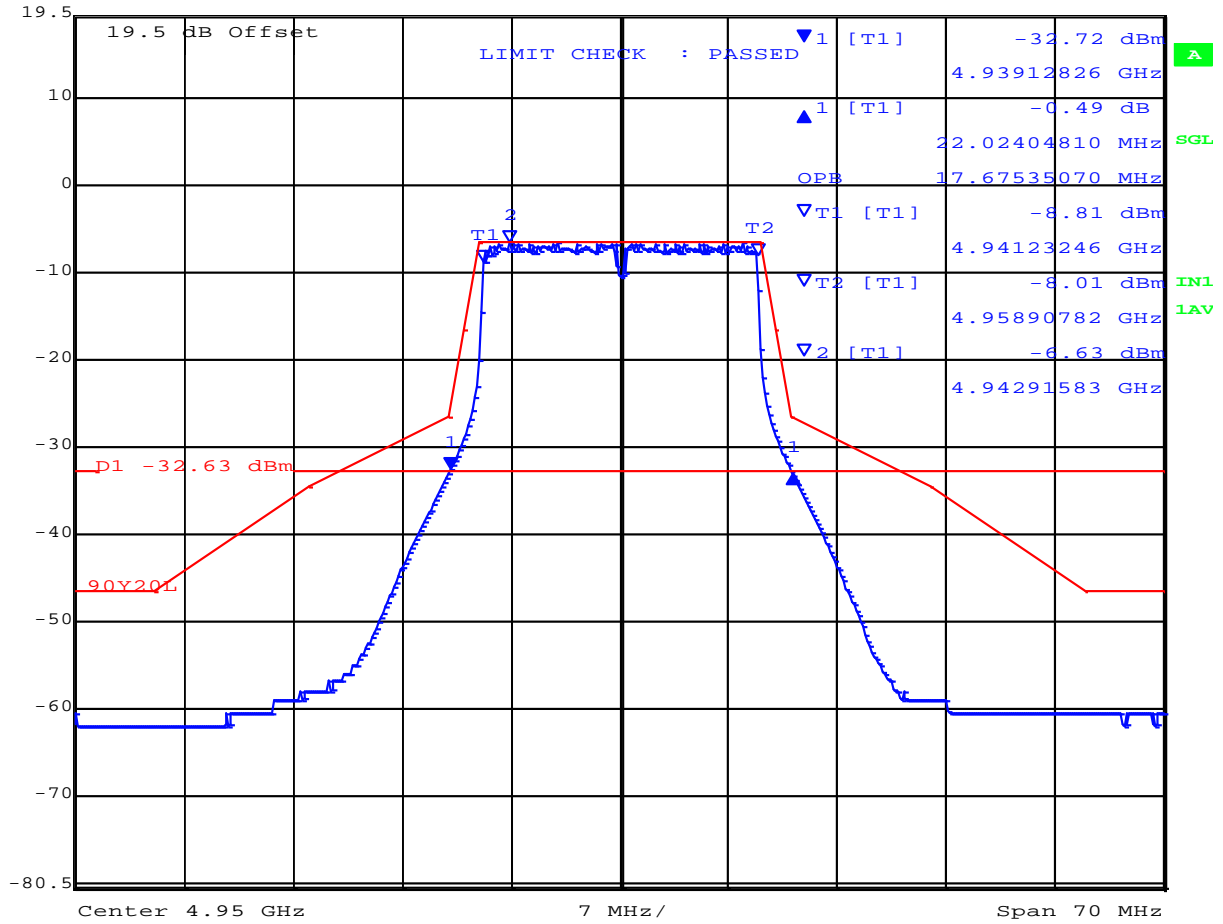

Date: 5.JUL.2016 10:25:16

This test report may be reproduced in full only. The document may only be updated by MiCOM Labs personnel. All changes will be noted in the Document History section of the report.



Port D
26 dB Bandwidth 20 MHz Channel Freq 4950 MHz



Delta 1 [T1] RBW 200 kHz RF Att 10 dB
Ref Lvl -0.16 dB VBW 30 kHz
19.5 dBm 22.02404810 MHz SWT 10 s Unit dBm

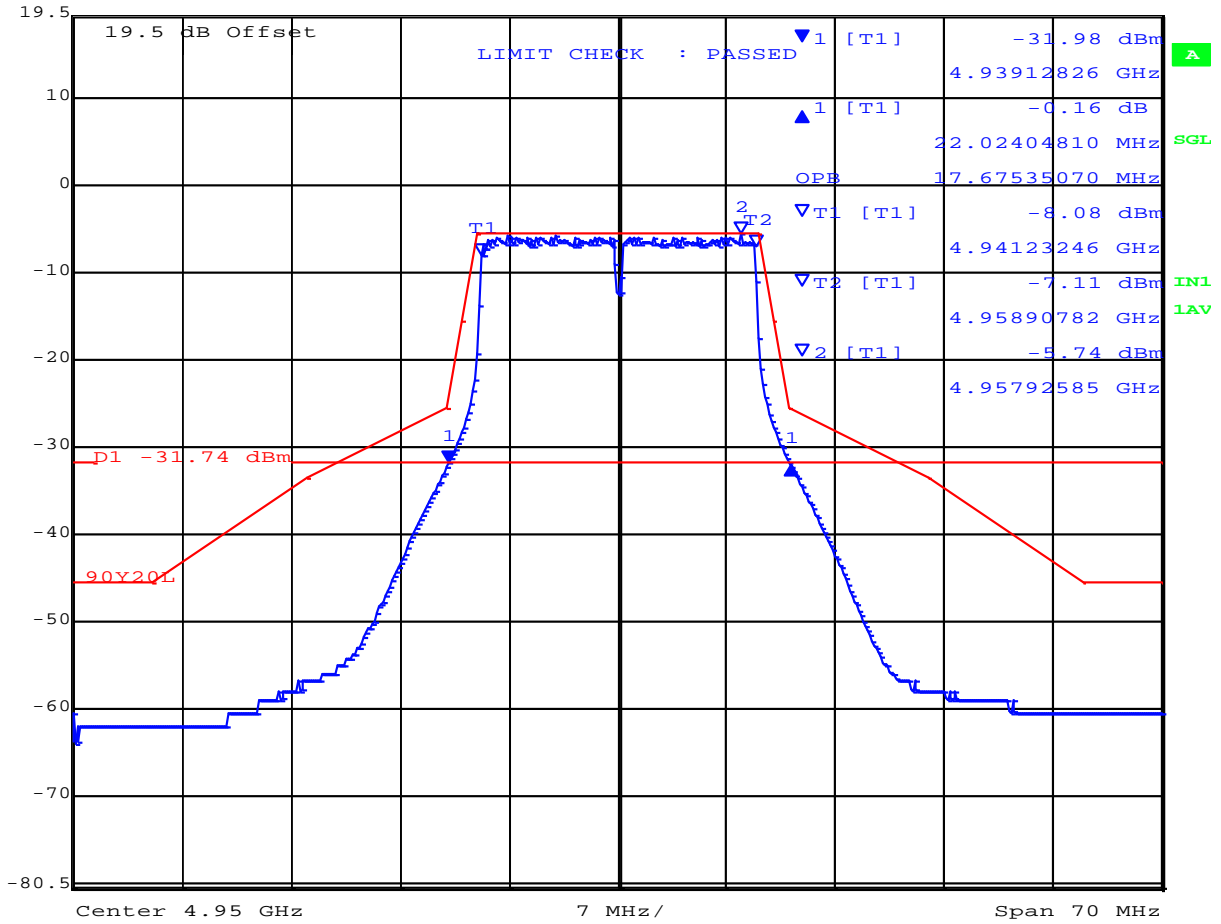

Date: 5.JUL.2016 10:28:31

This test report may be reproduced in full only. The document may only be updated by MiCOM Labs personnel. All changes will be noted in the Document History section of the report.



Port A
26 dB Bandwidth 20 MHz Channel Freq 4965 MHz

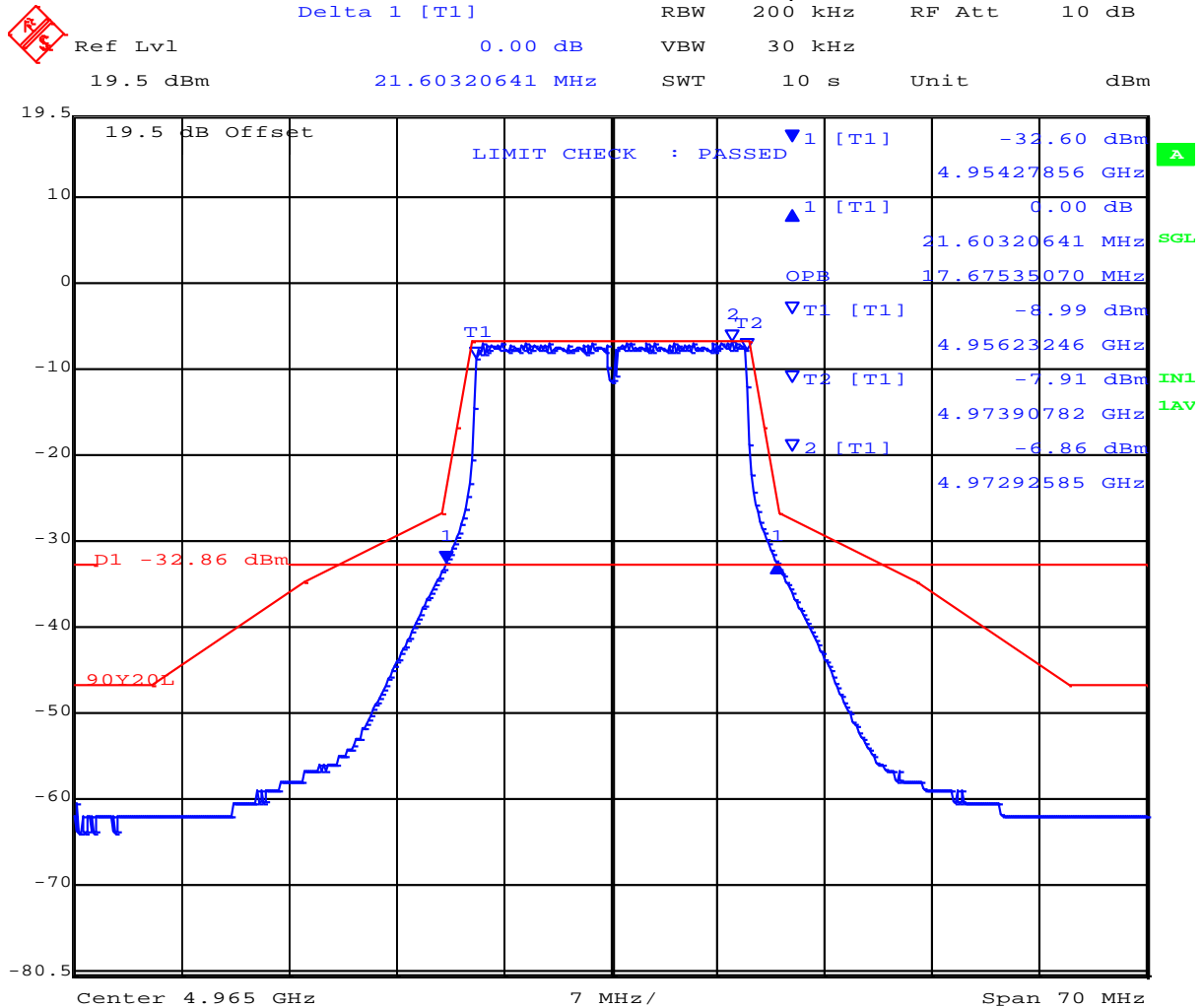

Date: 5.JUL.2016 10:33:41

This test report may be reproduced in full only. The document may only be updated by MiCOM Labs personnel. All changes will be noted in the Document History section of the report.



Port B
26 dB Bandwidth 20 MHz Channel Freq 4965 MHz

Delta 1 [T1] RBW 200 kHz RF Att 10 dB
Ref Lvl 19.5 dBm Delta 1 [T1] 0.17 dB VBW 30 kHz
21.74348697 MHz SWT 10 s Unit dBm

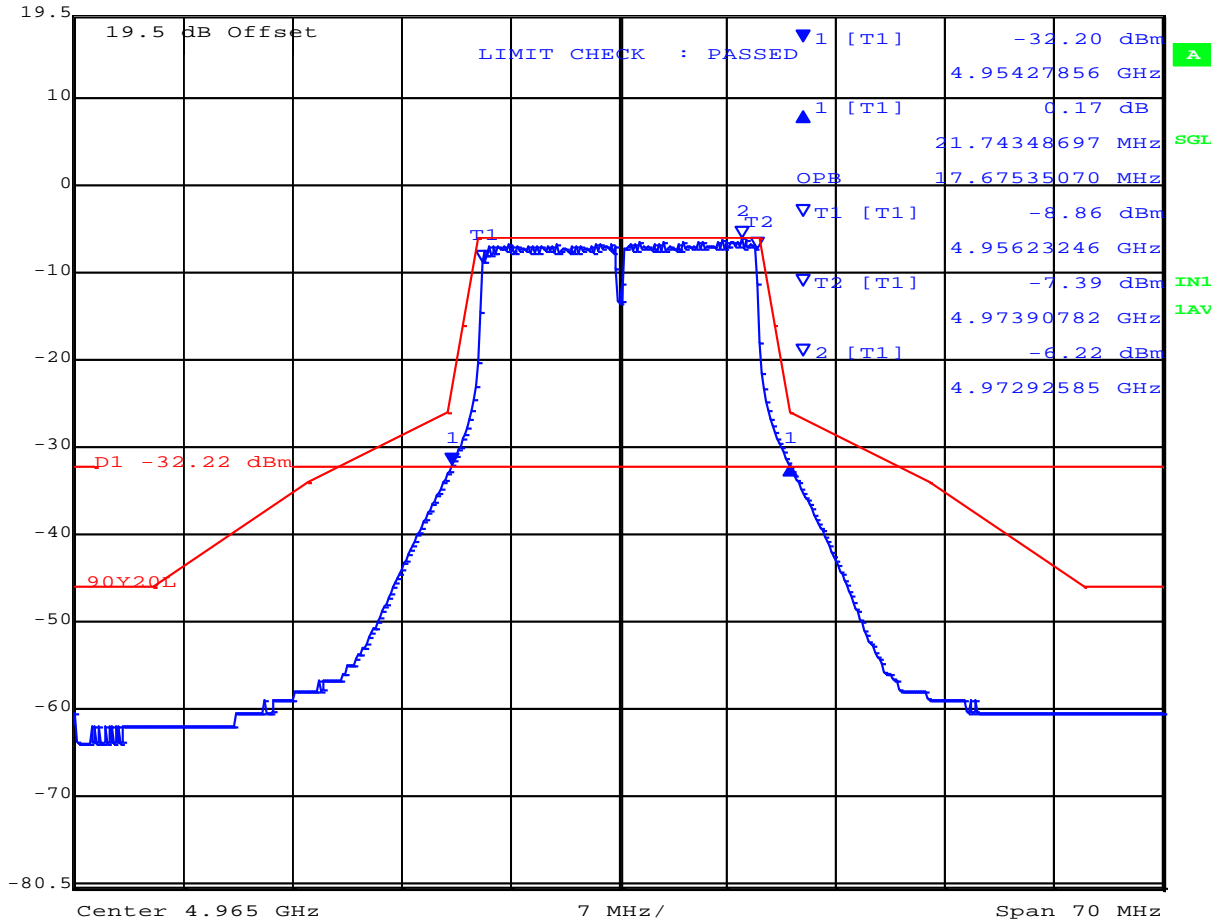

Date: 5.JUL.2016 10:36:15

This test report may be reproduced in full only. The document may only be updated by MiCOM Labs personnel. All changes will be noted in the Document History section of the report.



Port C
26 dB Bandwidth 20 MHz Channel Freq 4965 MHz

Delta 1 [T1] RBW 200 kHz RF Att 10 dB
Ref Lvl 19.5 dBm -0.06 dB VBW 30 kHz
22.16432866 MHz SWT 10 s Unit dBm

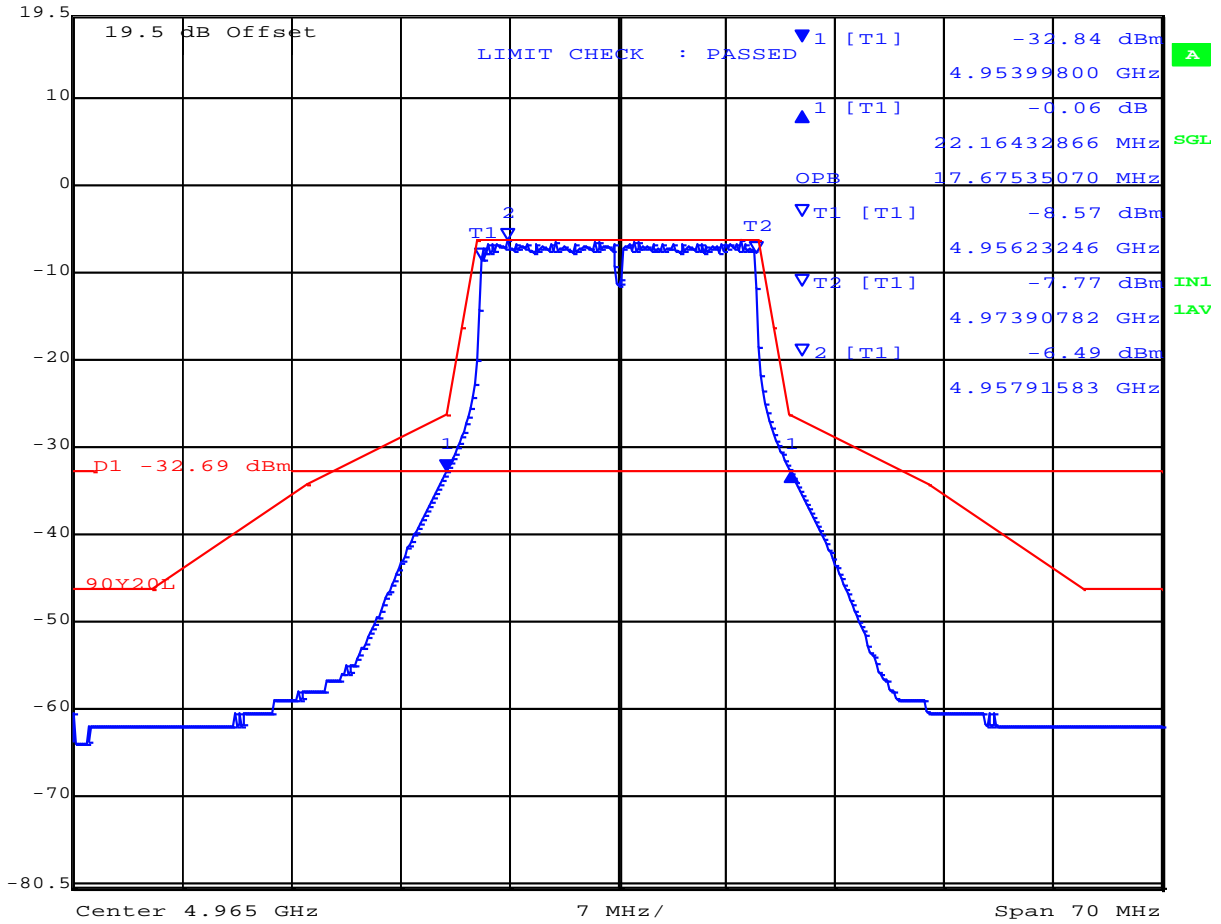

Date: 5.JUL.2016 10:43:15

This test report may be reproduced in full only. The document may only be updated by MiCOM Labs personnel. All changes will be noted in the Document History section of the report.



Port D
26 dB Bandwidth 20 MHz Channel Freq 4965 MHz

Delta 1 [T1] RBW 200 kHz RF Att 10 dB
Ref Lvl 0.30 dB VBW 30 kHz
19.5 dBm 21.74348697 MHz SWT 10 s Unit dBm

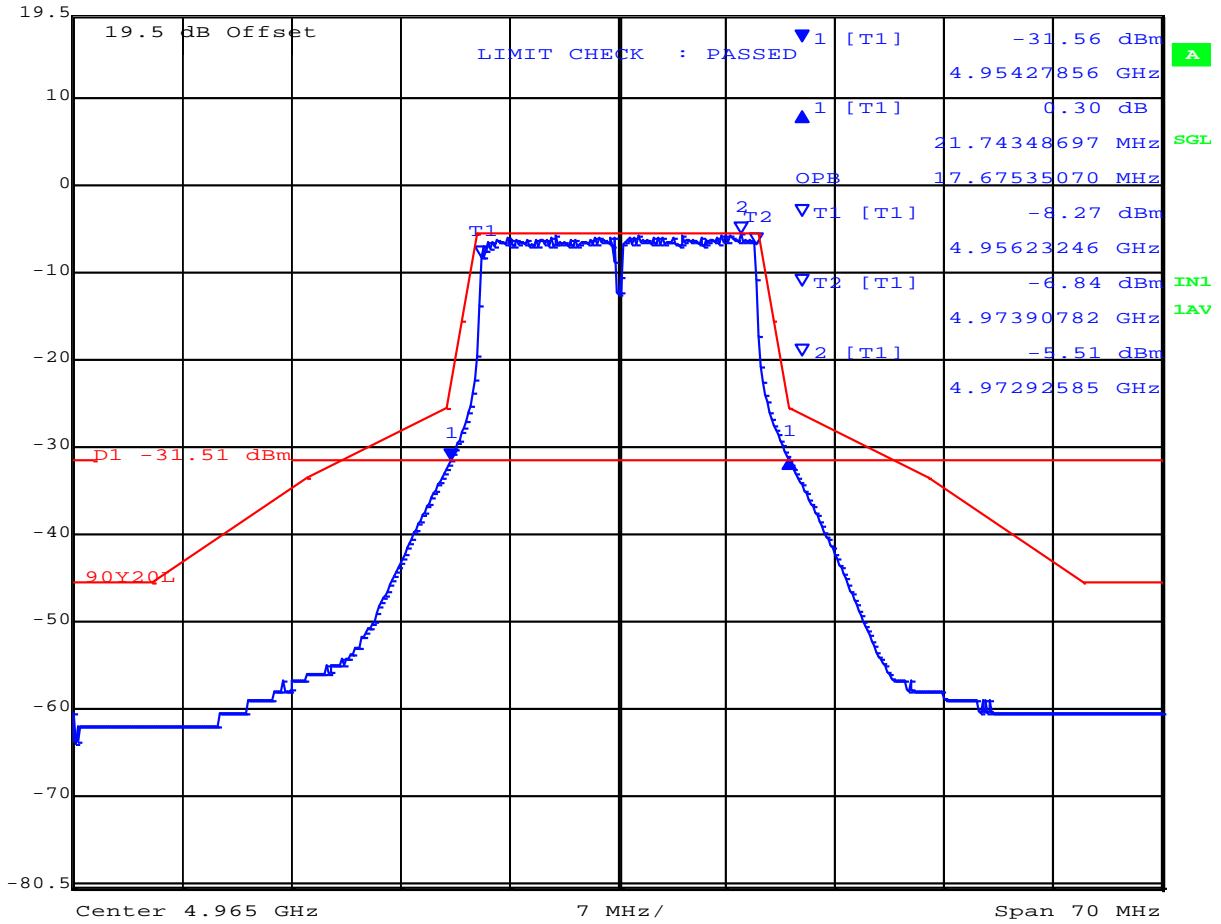

Date: 5.JUL.2016 10:44:55

This test report may be reproduced in full only. The document may only be updated by MiCOM Labs personnel. All changes will be noted in the Document History section of the report.



Port A
26 dB Bandwidth 20 MHz Channel Freq 4980 MHz



Delta 1 [T1] RBW 200 kHz RF Att 10 dB
Ref Lvl 0.60 dB VBW 30 kHz
19.5 dBm 21.74348697 MHz SWT 10 s Unit dBm

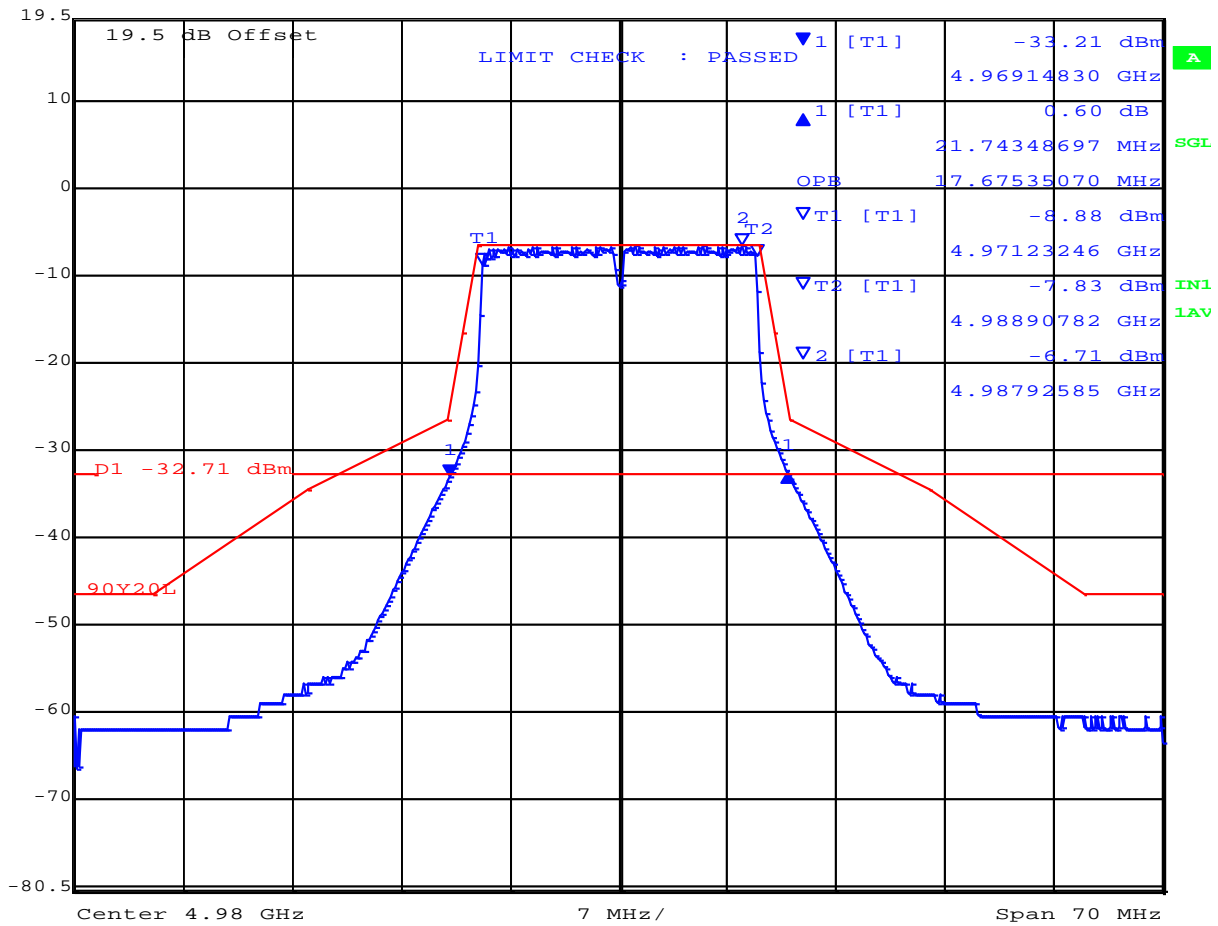

Date: 5.JUL.2016 10:58:45

This test report may be reproduced in full only. The document may only be updated by MiCOM Labs personnel. All changes will be noted in the Document History section of the report.



Port B
26 dB Bandwidth 20 MHz Channel Freq 4980 MHz



Delta 1 [T1] RBW 200 kHz RF Att 10 dB
Ref Lvl 0.58 dB VBW 30 kHz
19.5 dBm 21.88376754 MHz SWT 10 s Unit dBm

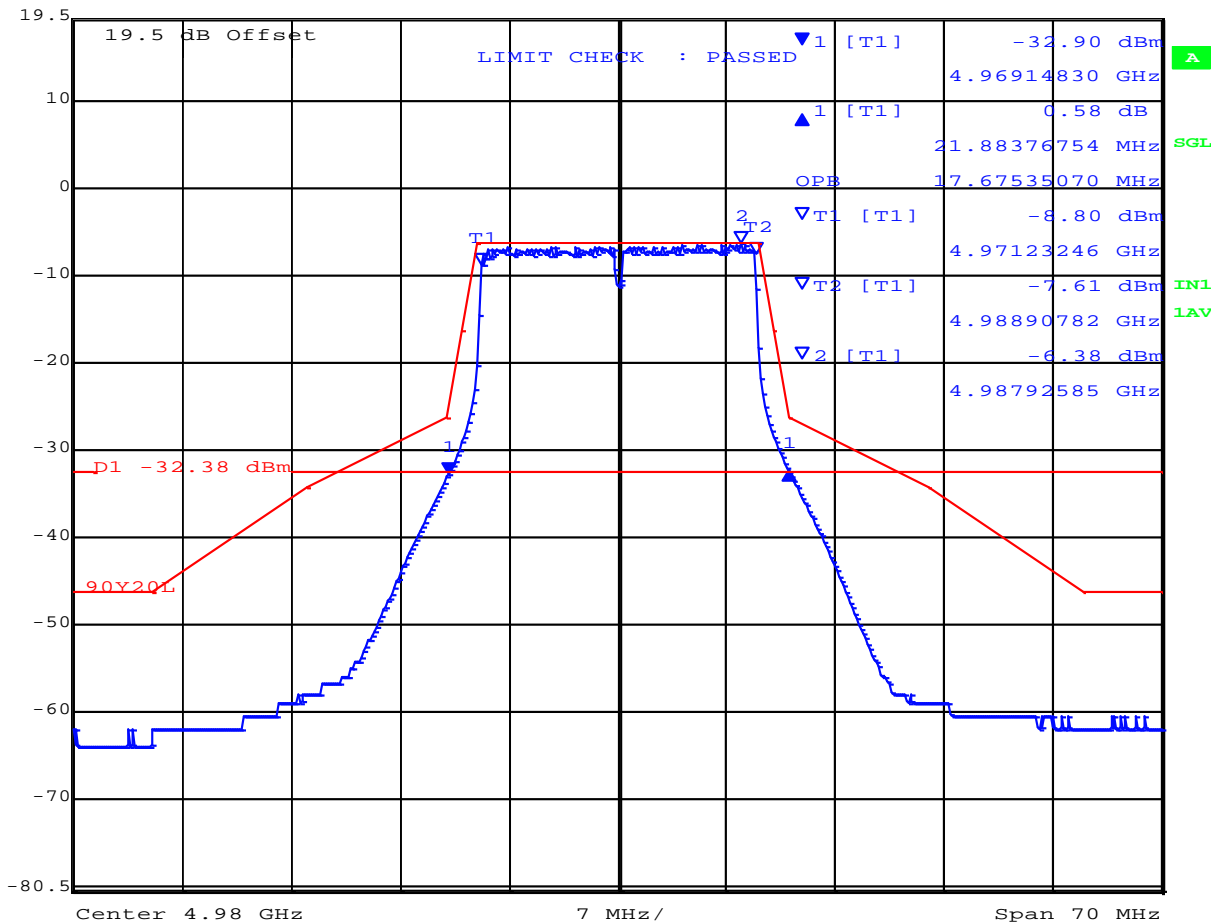

Date: 5.JUL.2016 10:56:27

This test report may be reproduced in full only. The document may only be updated by MiCOM Labs personnel. All changes will be noted in the Document History section of the report.



Port C
 26 dB Bandwidth 20 MHz Channel Freq 4980 MHz



Delta 1 [T1] RBW 200 kHz RF Att 20 dB
 Ref Lvl -0.17 dB VBW 30 kHz
 19.5 dBm 22.16432866 MHz SWT 10 s Unit dBm

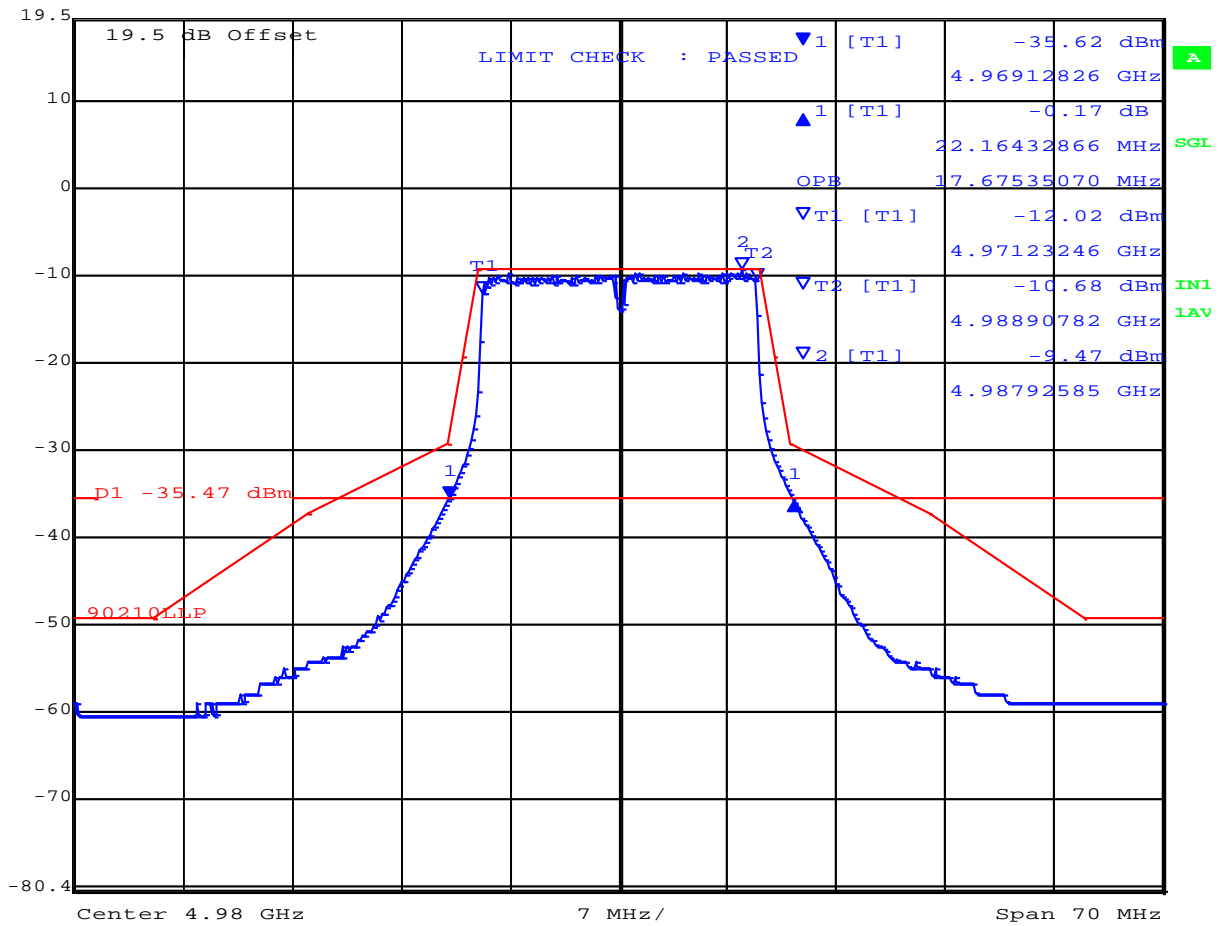

Date: 11.JUL.2016 10:53:53

This test report may be reproduced in full only. The document may only be updated by MiCOM Labs personnel. All changes will be noted in the Document History section of the report.



Port D
26 dB Bandwidth 20 MHz Channel Freq 4980 MHz



Delta 1 [T1] RBW 200 kHz RF Att 10 dB
Ref Lvl 0.48 dB VBW 30 kHz
19.5 dBm 21.88376754 MHz SWT 10 s Unit dBm

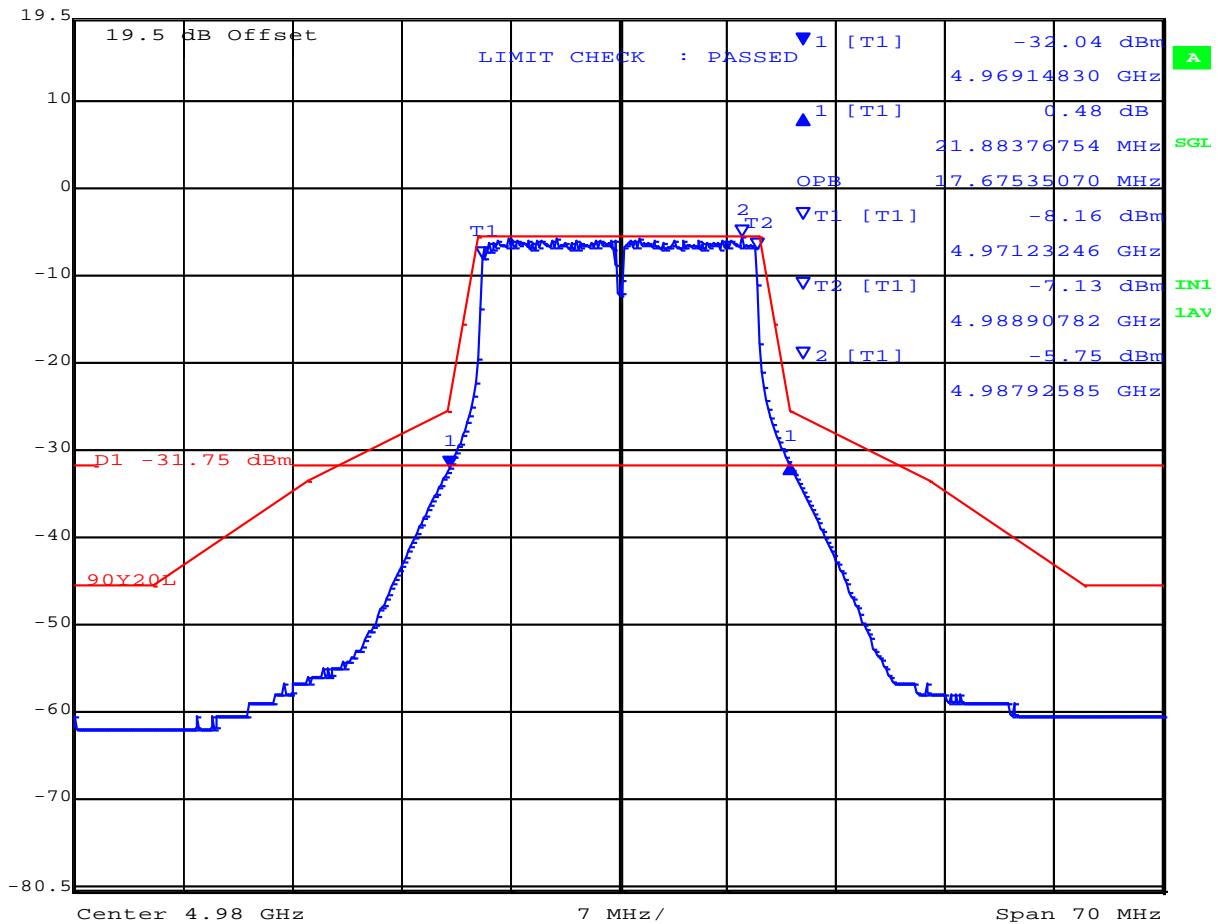

Date: 5.JUL.2016 10:51:05

This test report may be reproduced in full only. The document may only be updated by MiCOM Labs personnel. All changes will be noted in the Document History section of the report.



Specification Limits
FCC Part §90.210

Limits for Authorized Bandwidth

Frequency Band (MHz) and Related Documents	Spectrum Masks with Audio Filter	Without Audio Filter
4950 – 4990 MHz	L or M	L or M

Reference to the emission masks are provided below

Limits Emission Masks
90.210(L)

Emission Mask L. For low power transmitters (20 dBm or less) operating in the 4940-4990 MHz frequency band, the power spectral density of the emissions must be attenuated below the output power of the transmitter as follows:

- (1) On any frequency removed from the assigned frequency between 0-45% of the authorized bandwidth (BW): 0 dB.
- (2) On any frequency removed from the assigned frequency between 45-50% of the authorized bandwidth: $219 \log (\% \text{ of } (BW)/45)$ dB.
- (3) On any frequency removed from the assigned frequency between 50-55% of the authorized bandwidth: $10 + 242 \log (\% \text{ of } (BW)/50)$ dB.
- (4) On any frequency removed from the assigned frequency between 55-100% of the authorized bandwidth: $20 + 31 \log (\% \text{ of } (BW)/55)$ dB attenuation.
- (5) On any frequency removed from the assigned frequency between 100-150% of the authorized bandwidth: $28 + 68 \log (\% \text{ of } (BW)/100)$ dB attenuation.
- (6) On any frequency removed from the assigned frequency above 150% of the authorized bandwidth: 40 dB.
- (7) The zero dB reference is measured relative to the highest average power of the fundamental emission measured across the designated channel bandwidth using a resolution bandwidth of at least one percent of the occupied bandwidth of the fundamental emission and a video bandwidth of 30 kHz. The power spectral density is the power measured within the resolution bandwidth of the measurement device divided by the resolution bandwidth of the measurement device. Emission levels are also based on the use of measurement instrumentation employing a resolution bandwidth of at least one percent of the occupied bandwidth.



Limits Emission Masks (continued)

90.210(M),

(m) *Emission Mask M.* For high power transmitters (greater than 20 dBm) operating in the 4940-4990 MHz frequency band, the power spectral density of the emissions must be attenuated below the output power of the transmitter as follows:

(1) On any frequency removed from the assigned frequency between 0-45% of the authorized bandwidth (BW): 0 dB.

(2) On any frequency removed from the assigned frequency between 45-50% of the authorized bandwidth: $56.8 \log (\% \text{ of } (BW)/45)$ dB.

(3) On any frequency removed from the assigned frequency between 50-55% of the authorized bandwidth: $26 + 14.5 \log (\% \text{ of } BW/50)$ dB.

(4) On any frequency removed from the assigned frequency between 55-100% of the authorized bandwidth: $32 + 3.1 \log (\% \text{ of } (BW)/55)$ dB.

(5) On any frequency removed from the assigned frequency between 100-150% of the authorized bandwidth: $40 + 5.7 \log (\% \text{ of } (BW)/100)$ dB.

(6) On any frequency removed from the assigned frequency between above 150% of the authorized bandwidth: 50 dB or $55 + 10 \log (P)$ dB, whichever is the lesser attenuation.

(7) The zero dB reference is measured relative to the highest average power of the fundamental emission measured across the designated channel bandwidth using a resolution bandwidth of at least one percent of the occupied bandwidth of the fundamental emission and a video bandwidth of 30 kHz. The power spectral density is the power measured within the resolution bandwidth of the measurement device divided by the resolution bandwidth of the measurement device. Emission levels are also based on the use of measurement instrumentation employing a resolution bandwidth of at least one percent of the occupied bandwidth.

NOTE TO PARAGRAPH (m): Low power devices may as an option, comply with paragraph (m).

Laboratory Measurement Uncertainty for Power Measurements

Measurement uncertainty	± 1.33 dB
-------------------------	---------------

Traceability

Method
Measurements were made per work instruction WI-03 'Measurement of RF Spectrum Mask'



Title: Mimosa Networks A5c, A5-14, A5-18
To: FCC 47 CFR Part 90, Subpart Y; IC RSS-111
Serial #: MIMO09-U10 Rev A
Issue Date: 2nd August 2016
Page: 39 of 105

6.1.2. Output Power

FCC 47 CFR Part 90, Subpart Y; §90.1215

Test Procedure

Average power measurements were measured with the use of an average power head. Peak power measurements were recorded via the spectrum analyzer. The system highest power setting was selected with modulation ON. Should the device implement a duty cycle then this is added to the measured power as a Duty Cycle Correction Factor (DCCF).

This test report may be reproduced in full only. The document may only be updated by MiCOM Labs personnel. All changes will be noted in the Document History section of the report.



TABLE OF RESULTS – 20 MHz Bandwidth Modulated Carrier

20 MHz Duty Cycle Correction factor 99%

Center Frequency (MHz)	Peak Transmitter Power (+dBm)				Total Power + DCCF (dBm)
	Port A	Port B	Port C	Port D	Calculated
4950	12.07	12.50	12.43	13.21	18.83
4965	11.98	12.30	12.41	13.19	18.75
4980	13.18	12.41	12.35	12.32	18.83

DCCF – Duty Cycle Correction Factor



Specification Limits

FCC Part §90.1215

Power limits.

The transmitting power of stations operating in the 4940-4990 MHz band must not exceed the maximum limits in this section.

(a)(1) The maximum conducted output power should not exceed:

Channel Bandwidth (MHz)	Low Transmitter Power (dBm)	High Transmitter Power (dBm)
1	7	20
5	14	27
10	17	30
15	18.8	31.8
20	20	33

(2) High power devices are also limited to a peak power spectral density of 21 dBm per one MHz. High power devices using channel bandwidths other than those listed above are permitted; however, they are limited to peak power spectral density of 21 dBm/MHz. If transmitting antennas of directional gain greater than 9 dBi are used, both the maximum conducted output power and the peak power spectral density should be reduced by the amount in decibels that the directional gain of the antenna exceeds 9 dBi. However, high power point-to-point and point-to-multipoint operations (both fixed and temporary-fixed rapid deployment) may employ transmitting antennas with directional gain up to 26 dBi without any corresponding reduction in the maximum conducted output power or spectral density. Corresponding reduction in the maximum conducted output power and peak power spectral density should be the amount in decibels that the directional gain of the antenna exceeds 26 dBi.

(b) Low power devices are also limited to a peak power spectral density of 8 dBm per one MHz. Low power devices using channel bandwidths other than those listed above are permitted; however, they are limited to a peak power spectral density of 8 dBm/MHz. If transmitting antennas of directional gain greater than 9 dBi are used, both the maximum conducted output power and the peak power spectral density should be reduced by the amount in decibels that the directional gain of the antenna exceeds 9 dBi.

(c) The maximum conducted output power is measured as a conducted emission over any interval of continuous transmission using instrumentation calibrated in terms of an RMS-equivalent voltage. If the device cannot be connected directly, alternative techniques acceptable to the Commission may be used. The measurement results shall be properly adjusted for any instrument limitations, such as detector response times, limited resolution bandwidth capability when compared to the emission bandwidth, sensitivity, etc., so as to obtain a true maximum conducted output power measurement conforming to the definitions in this paragraph for the emission in question.

(d) The peak power spectral density is measured as conducted emission by direct connection of a calibrated test instrument to the equipment under test. If the device cannot be connected



Title: Mimosa Networks A5c, A5-14, A5-18
To: FCC 47 CFR Part 90, Subpart Y; IC RSS-111
Serial #: MIMO09-U10 Rev A
Issue Date: 2nd August 2016
Page: 42 of 105

directly, alternative techniques acceptable to the Commission may be used. Measurements are made over a bandwidth of one MHz or the 26 dB emission bandwidth of the device, whichever is less. A resolution bandwidth less than the measurement bandwidth can be used, provided that the measured power is integrated to show total power over the measurement bandwidth. If the resolution bandwidth is approximately equal to the measurement bandwidth, and much less than the emission bandwidth of the equipment under test, the measured results shall be corrected to account for any difference between the resolution bandwidth of the test instrument and its actual noise bandwidth.

(e) The ratio of the peak excursion of the modulation envelope (measured using a peak hold function) to the maximum conducted output power shall not exceed 13 dB across any 1 MHz bandwidth or the emission bandwidth whichever is less.

This test report may be reproduced in full only. The document may only be updated by MiCOM Labs personnel. All changes will be noted in the Document History section of the report.



Title: Mimosa Networks A5c, A5-14, A5-18
To: FCC 47 CFR Part 90, Subpart Y; IC RSS-111
Serial #: MIMO09-U10 Rev A
Issue Date: 2nd August 2016
Page: 43 of 105

Laboratory Measurement Uncertainty for Power Measurement

Measurement uncertainty	± 1.33 dB
-------------------------	---------------

Traceability

Method
Measurements were made per work instruction WI-03 'Measurement of RF Output Power'

This test report may be reproduced in full only. The document may only be updated by MiCOM Labs personnel. All changes will be noted in the Document History section of the report.



Title: Mimosa Networks A5c, A5-14, A5-18
To: FCC 47 CFR Part 90, Subpart Y; IC RSS-111
Serial #: MIMO09-U10 Rev A
Issue Date: 2nd August 2016
Page: 44 of 105

6.1.3. Peak Power Spectral Density (PPSD)

FCC 47 CFR Part 90, Subpart Y; §90.1215

Test Procedure

The test methodology used for this measurement was determined to provide the highest possible PPSD readings.

Peak power spectral density measurements were performed via the spectrum analyzer and plots were recorded. Modulation was ON and the system duty cycle was set for 100% i.e. continuous operation at all times. The system highest power setting was selected with modulation ON and duty cycle set for 100% i.e. continuous operation at all times.

This test report may be reproduced in full only. The document may only be updated by MiCOM Labs personnel. All changes will be noted in the Document History section of the report.



TABLE OF RESULTS – 20 MHz Peak Power Spectral Density(s)

Center Frequency (MHz)	Peak Power Spectral Density (dBm/MHz)				
	Port A	Port B	Port C	Port D	Total
4950	-1.07	-0.30	-0.58	-0.06	8.79
4965	-1.20	-0.30	-0.50	-0.00	8.80
4980	-0.75	-0.57	-0.85	-0.12	8.76

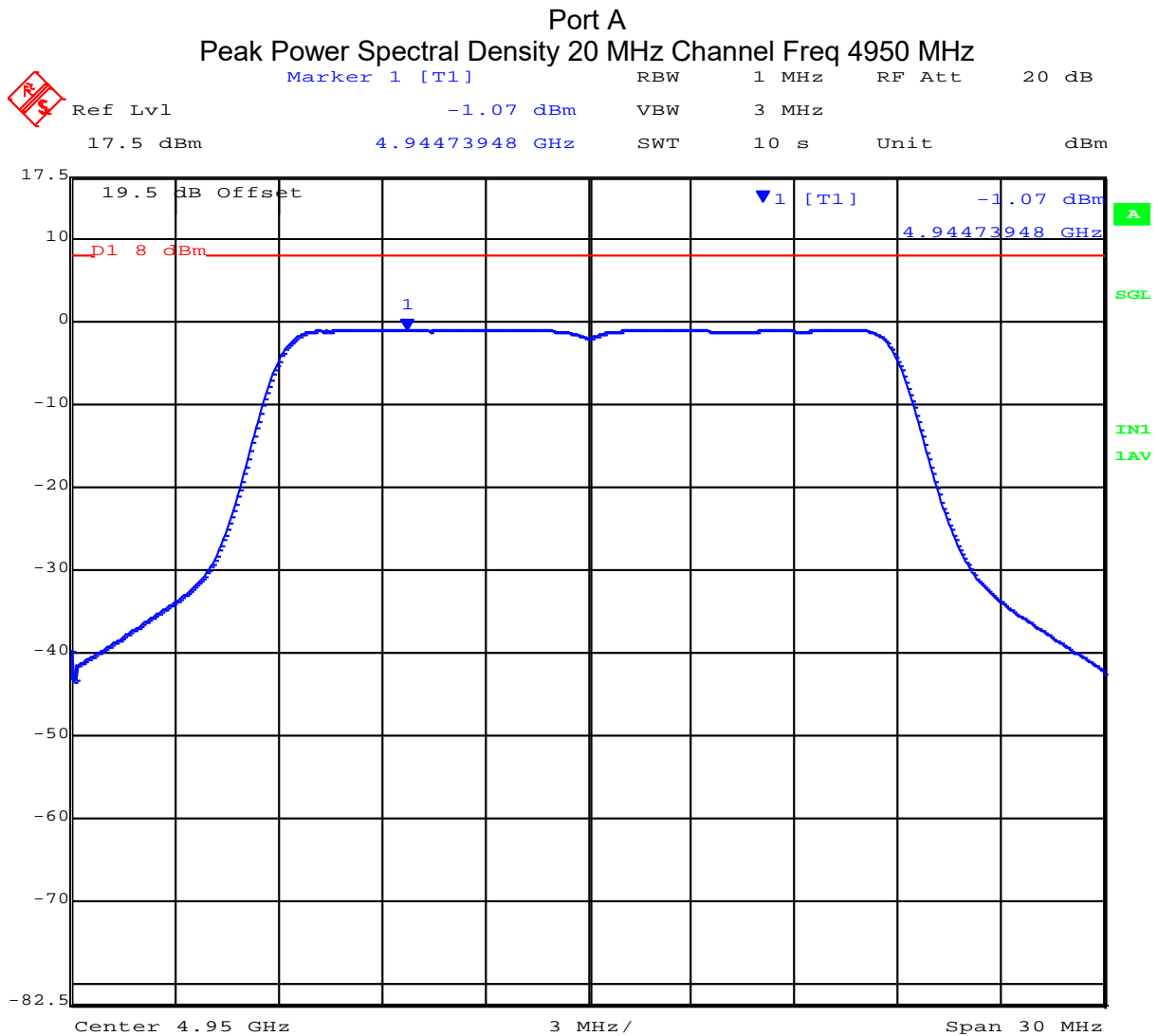

Date: 5.JUL.2016 11:21:24

This test report may be reproduced in full only. The document may only be updated by MiCOM Labs personnel. All changes will be noted in the Document History section of the report.



Port B
Peak Power Spectral Density 20 MHz Channel Freq 4950 MHz

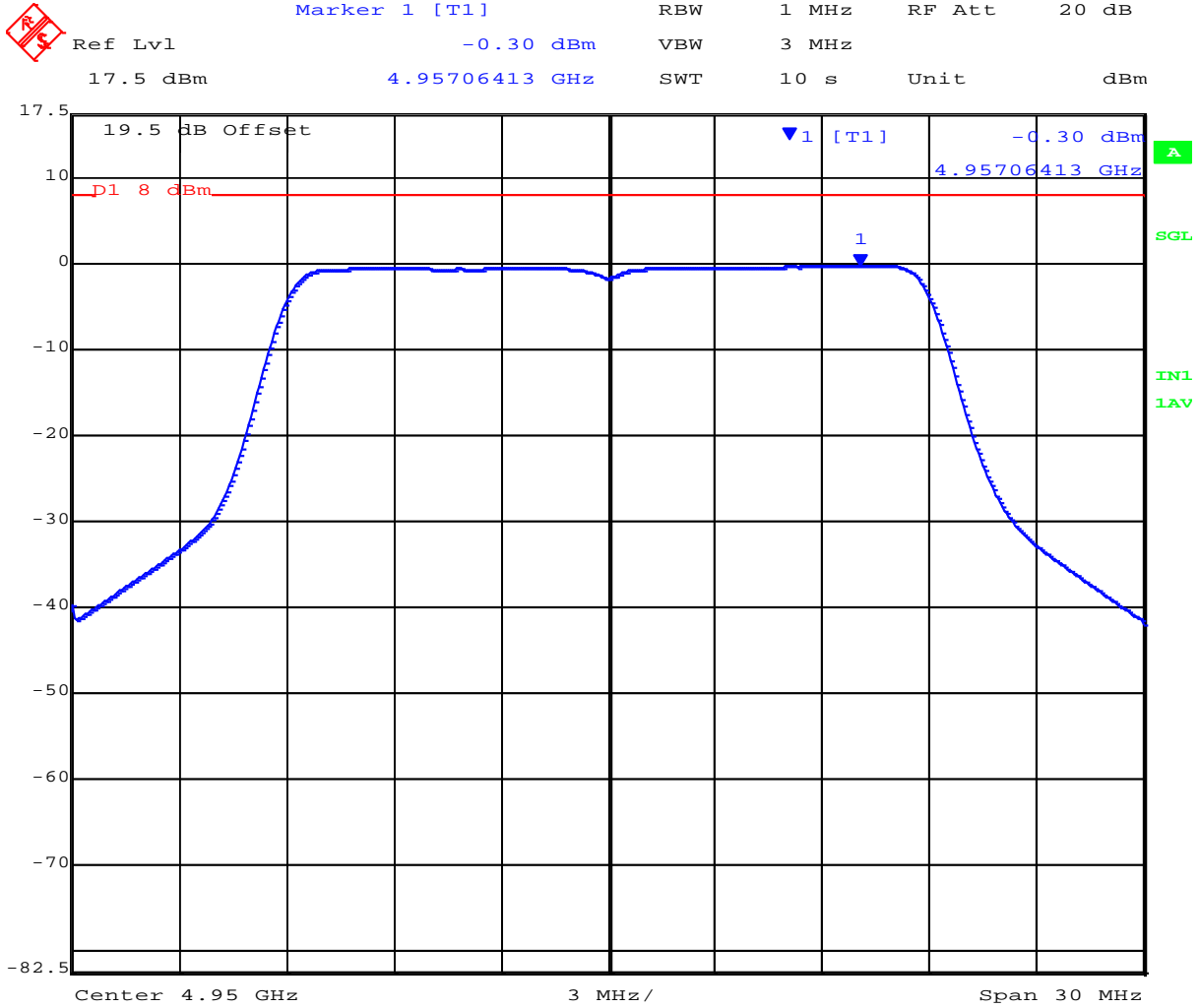

Date: 5.JUL.2016 11:22:25

This test report may be reproduced in full only. The document may only be updated by MiCOM Labs personnel. All changes will be noted in the Document History section of the report.



Port C
Peak Power Spectral Density 20 MHz Channel Freq 4950 MHz

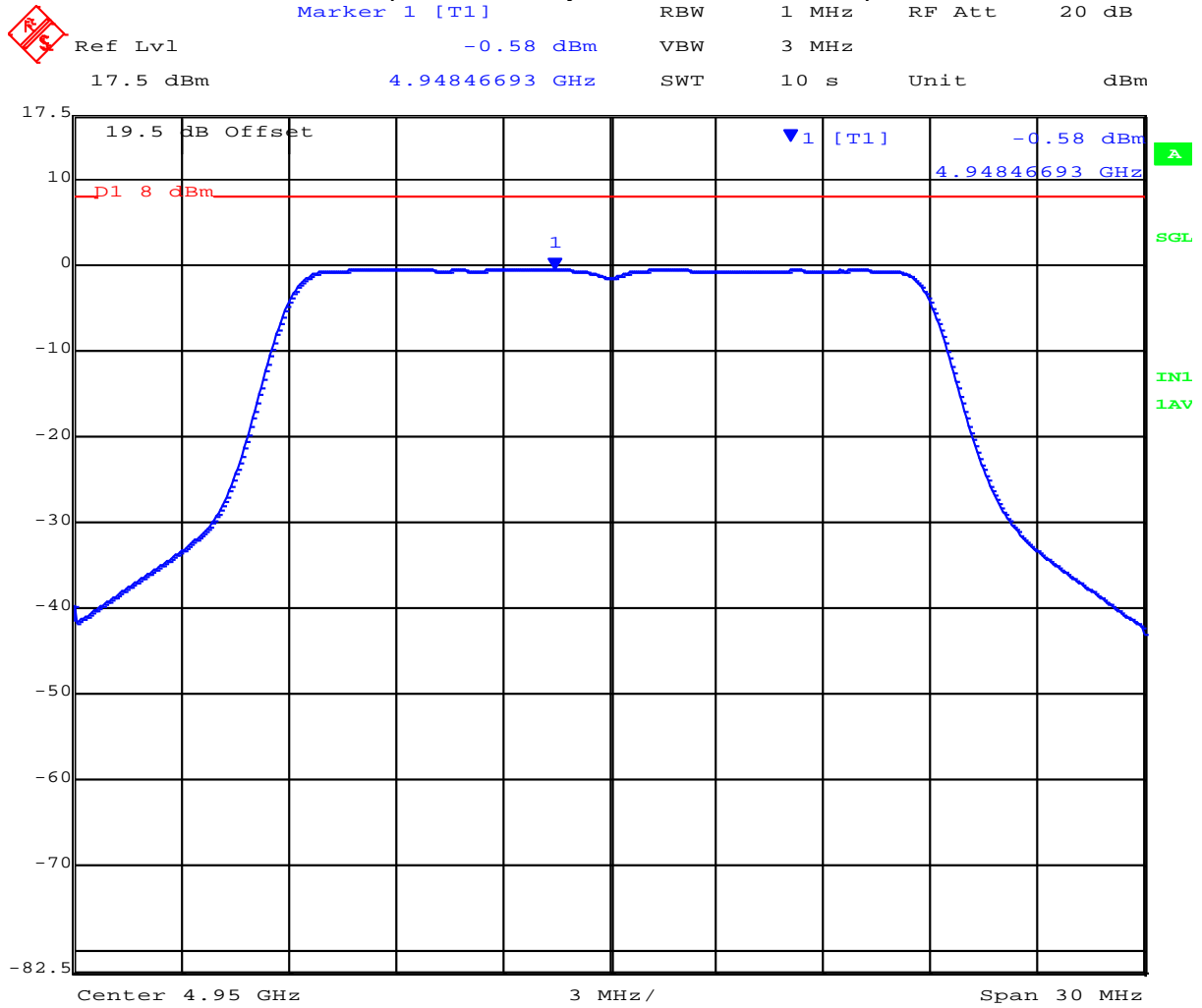

Date: 5.JUL.2016 11:23:05

This test report may be reproduced in full only. The document may only be updated by MiCOM Labs personnel. All changes will be noted in the Document History section of the report.



Port D
Peak Power Spectral Density 20 MHz Channel Freq 4950 MHz

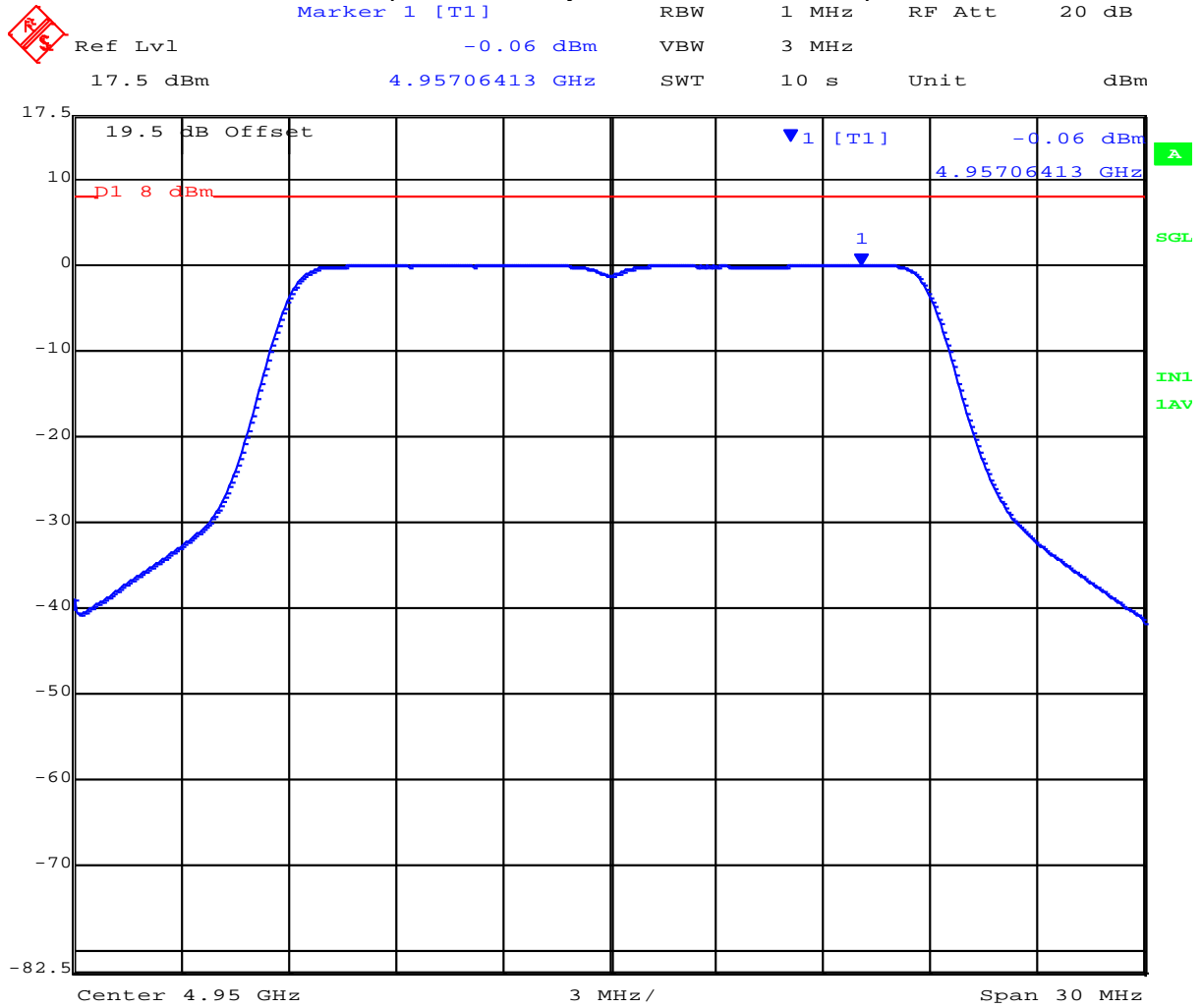

Date: 5.JUL.2016 11:23:46

This test report may be reproduced in full only. The document may only be updated by MiCOM Labs personnel. All changes will be noted in the Document History section of the report.



Port A
Peak Power Spectral Density 20 MHz Channel Freq 4965 MHz

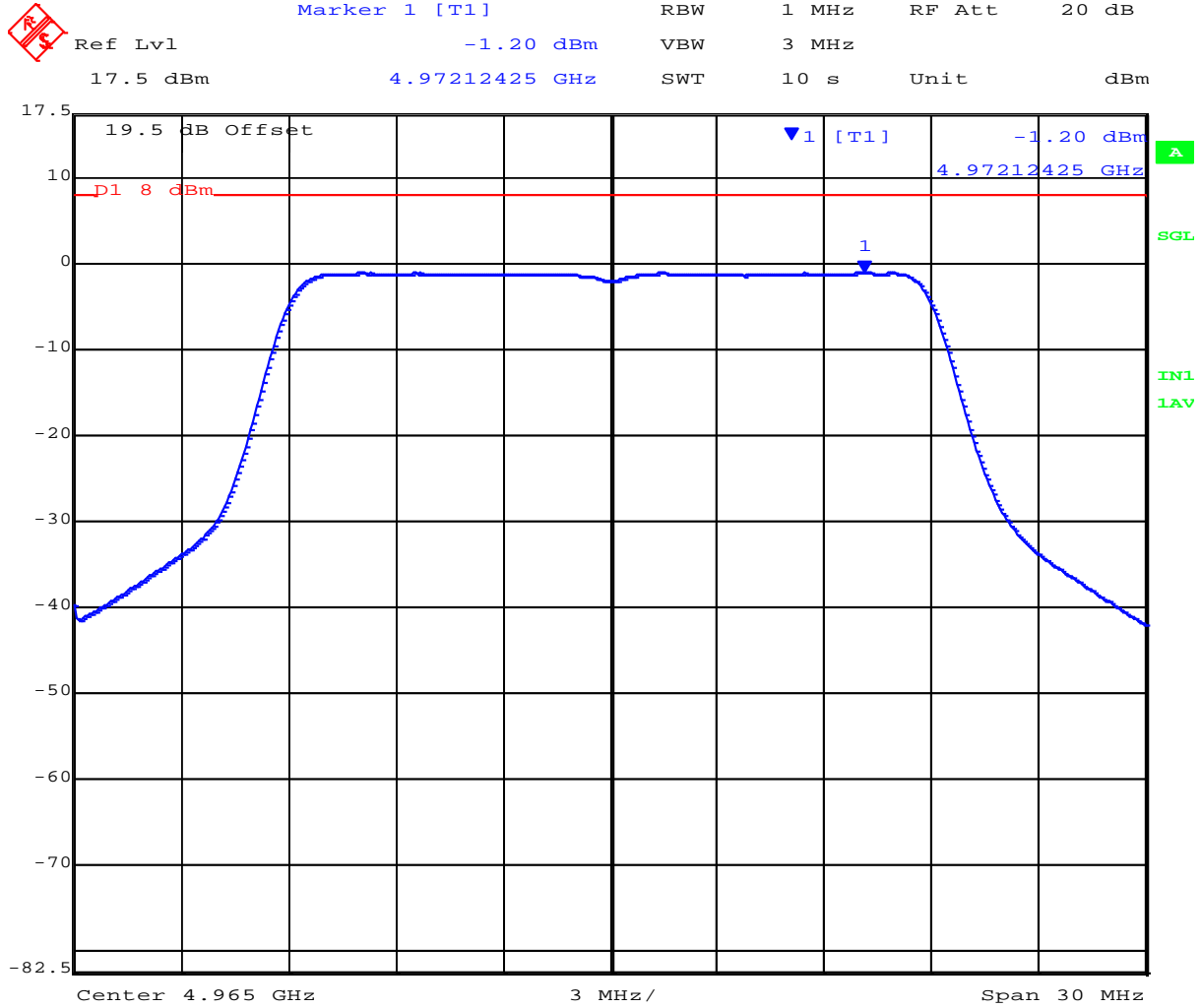

Date: 5.JUL.2016 11:20:12

This test report may be reproduced in full only. The document may only be updated by MiCOM Labs personnel. All changes will be noted in the Document History section of the report.



Port B
Peak Power Spectral Density 20 MHz Channel Freq 4965 MHz

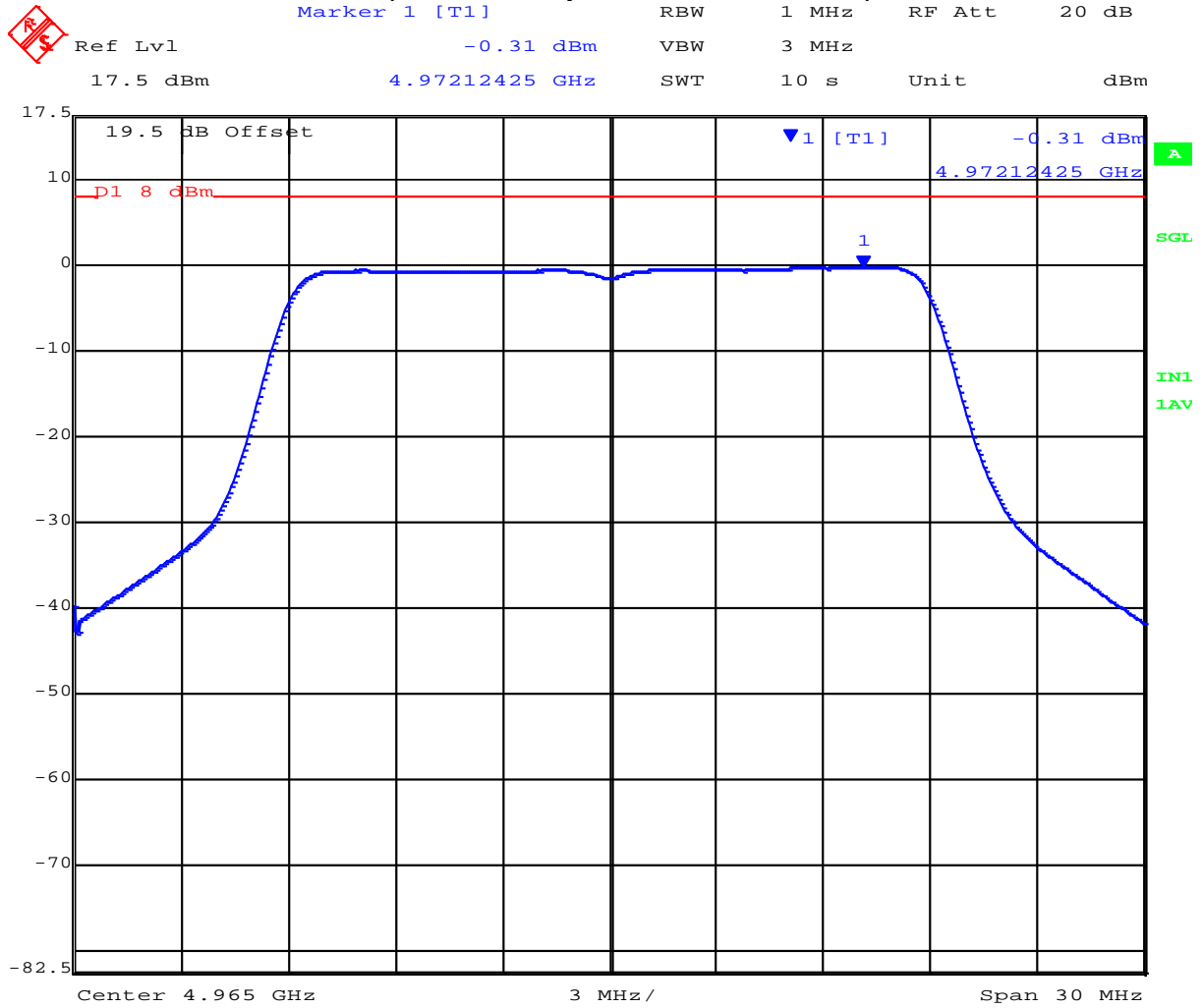

Date: 5.JUL.2016 11:19:11

This test report may be reproduced in full only. The document may only be updated by MiCOM Labs personnel. All changes will be noted in the Document History section of the report.



Port C
Peak Power Spectral Density 20 MHz Channel Freq 4965 MHz

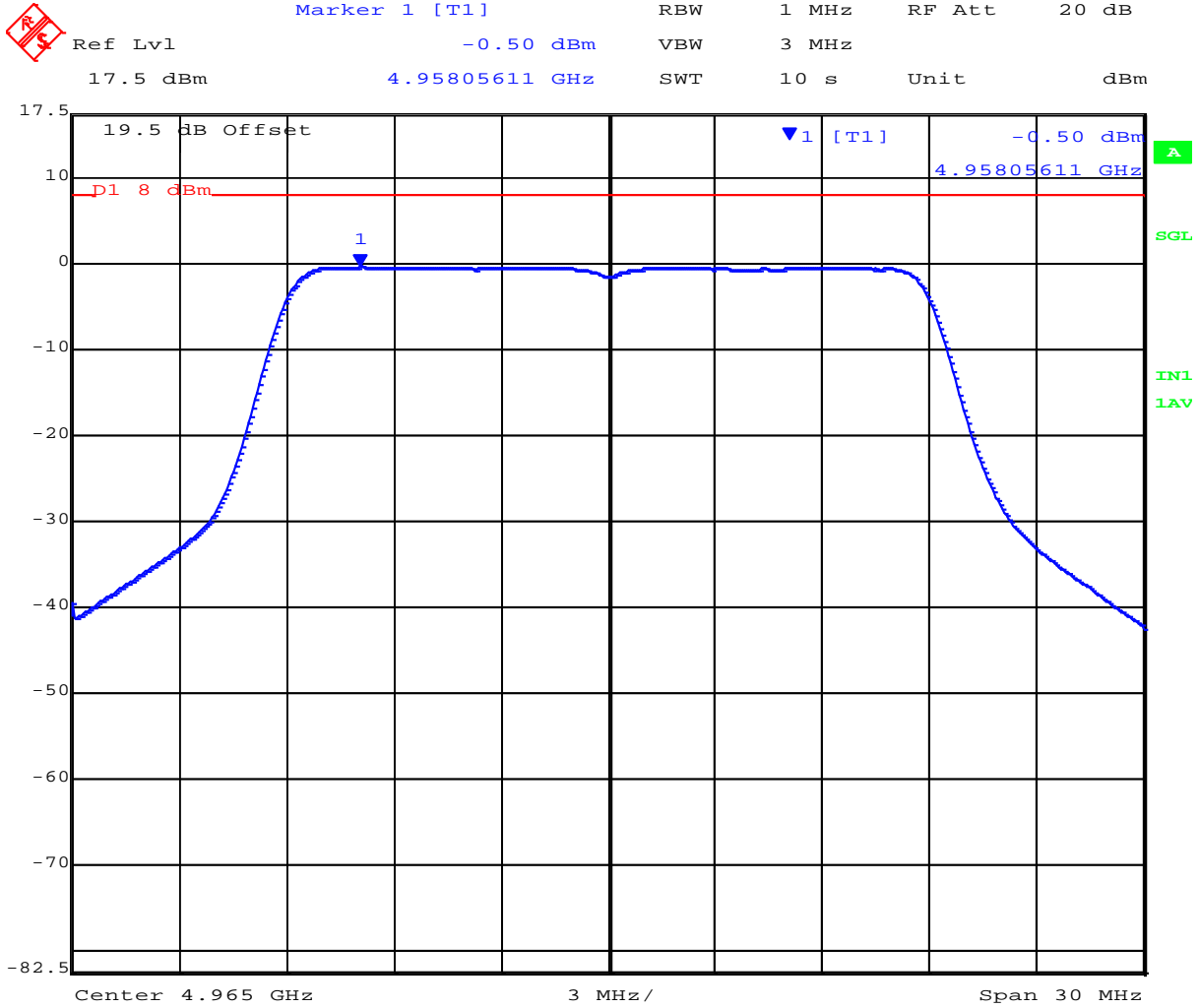

Date: 5.JUL.2016 11:18:18

This test report may be reproduced in full only. The document may only be updated by MiCOM Labs personnel. All changes will be noted in the Document History section of the report.



Port D
Peak Power Spectral Density 20 MHz Channel Freq 4965 MHz

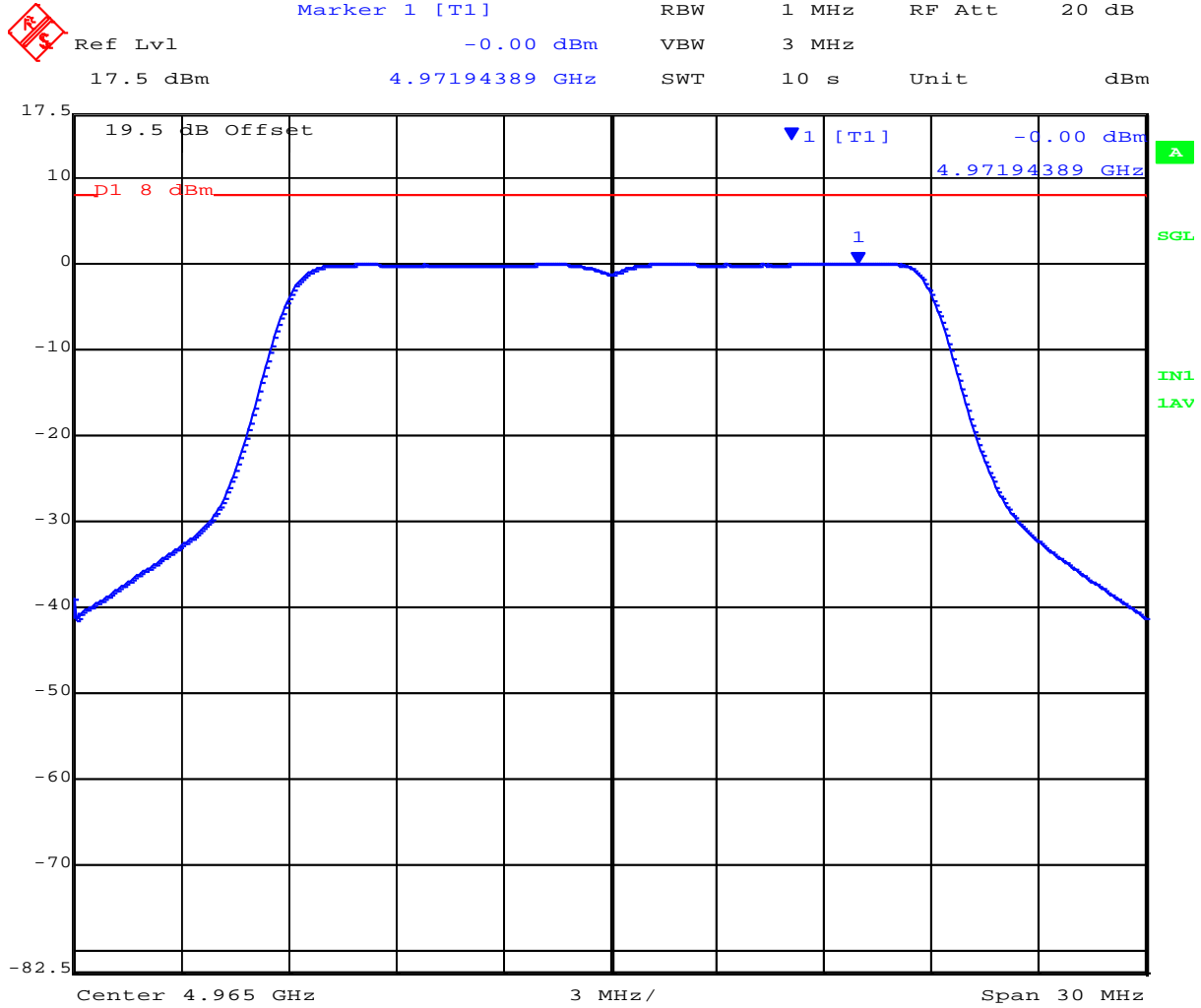

Date: 5.JUL.2016 11:16:59

This test report may be reproduced in full only. The document may only be updated by MiCOM Labs personnel. All changes will be noted in the Document History section of the report.



Port A
Peak Power Spectral Density 20 MHz Channel Freq 4980 MHz

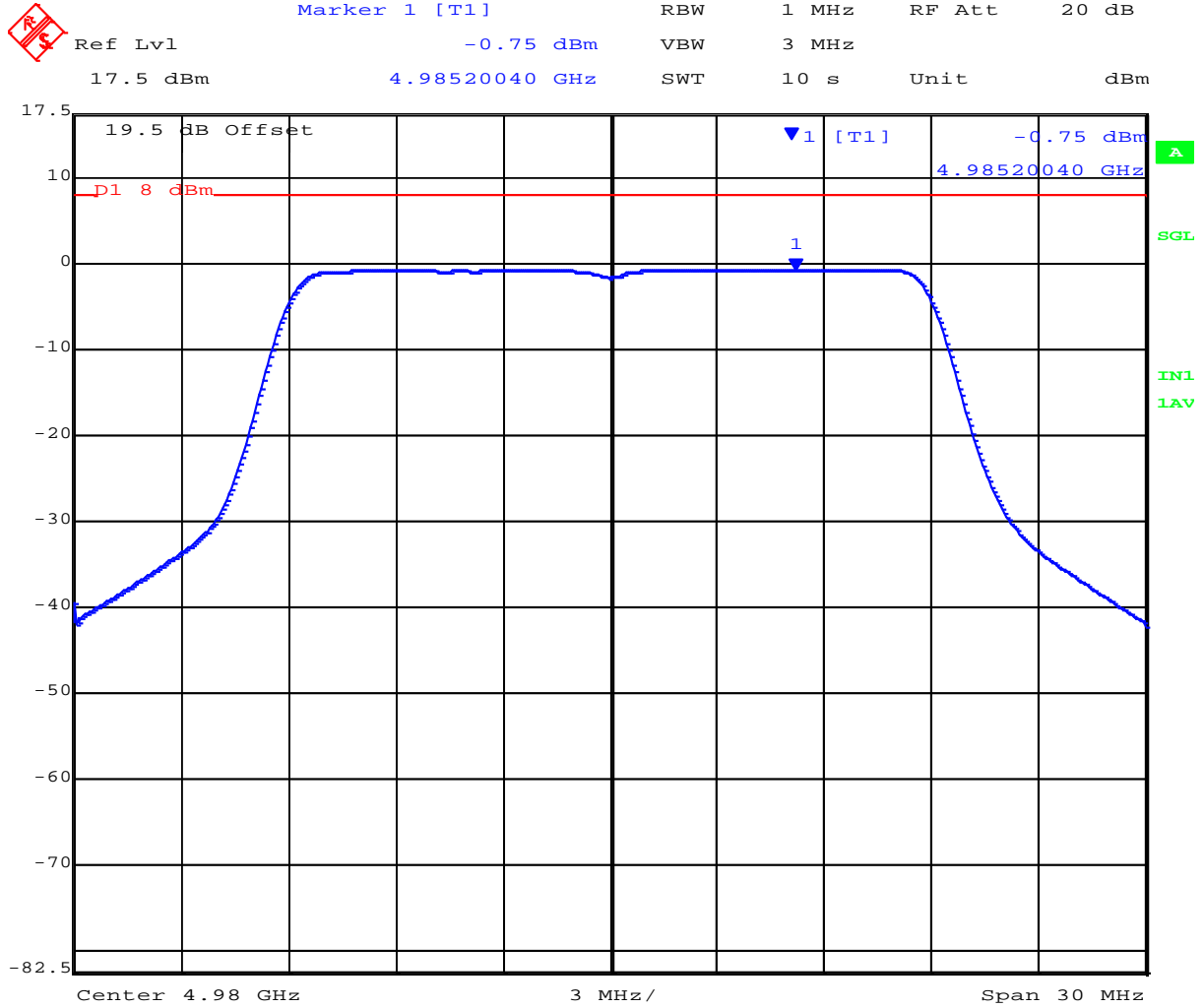

Date: 5.JUL.2016 11:12:16

This test report may be reproduced in full only. The document may only be updated by MiCOM Labs personnel. All changes will be noted in the Document History section of the report.



Port B
Peak Power Spectral Density 20 MHz Channel Freq 4980 MHz

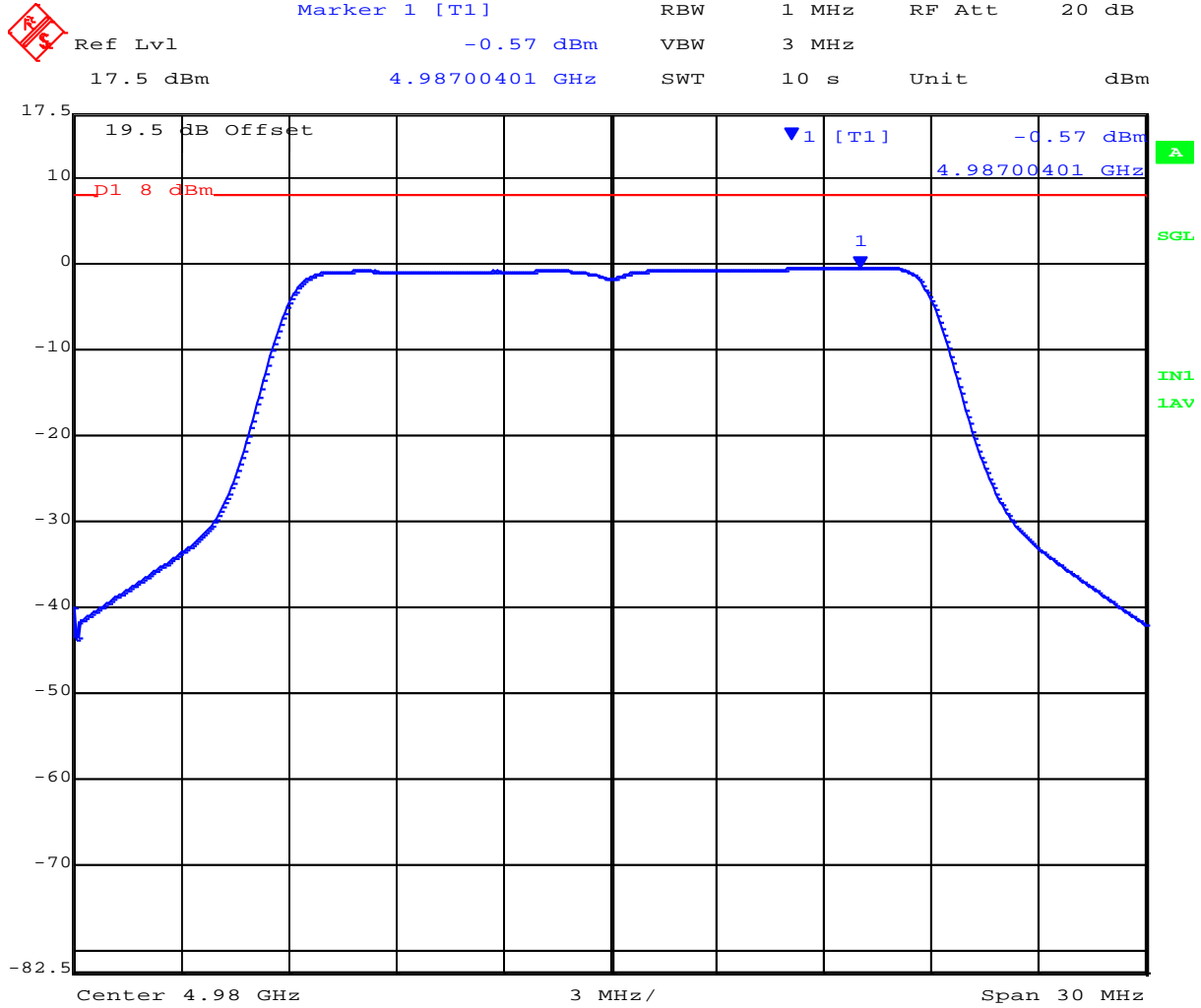

Date: 5.JUL.2016 11:13:10

This test report may be reproduced in full only. The document may only be updated by MiCOM Labs personnel. All changes will be noted in the Document History section of the report.



Port C
Peak Power Spectral Density 20 MHz Channel Freq 4980 MHz

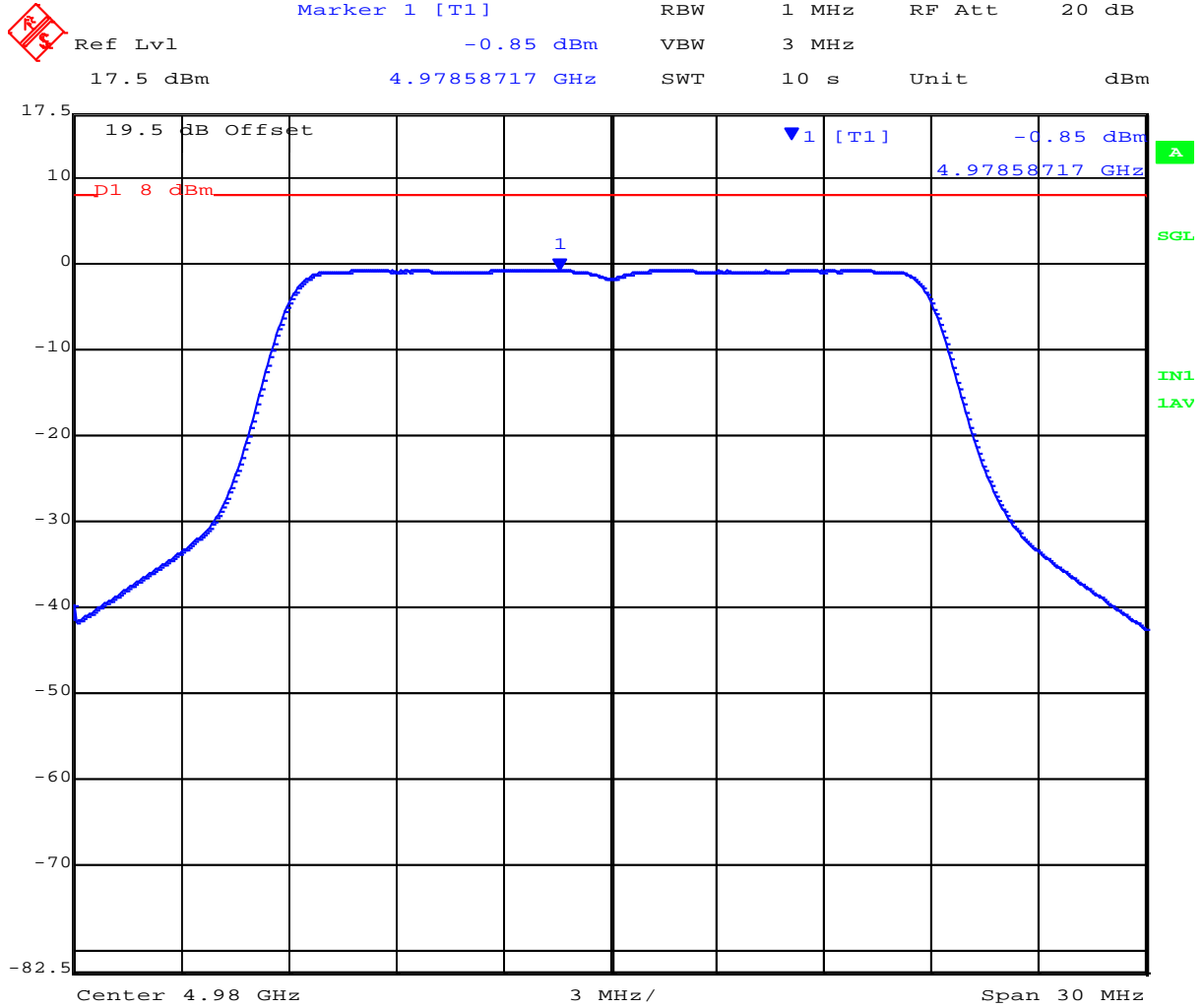

Date: 5.JUL.2016 11:14:03

This test report may be reproduced in full only. The document may only be updated by MiCOM Labs personnel. All changes will be noted in the Document History section of the report.



Port D
Peak Power Spectral Density 20 MHz Channel Freq 4980 MHz

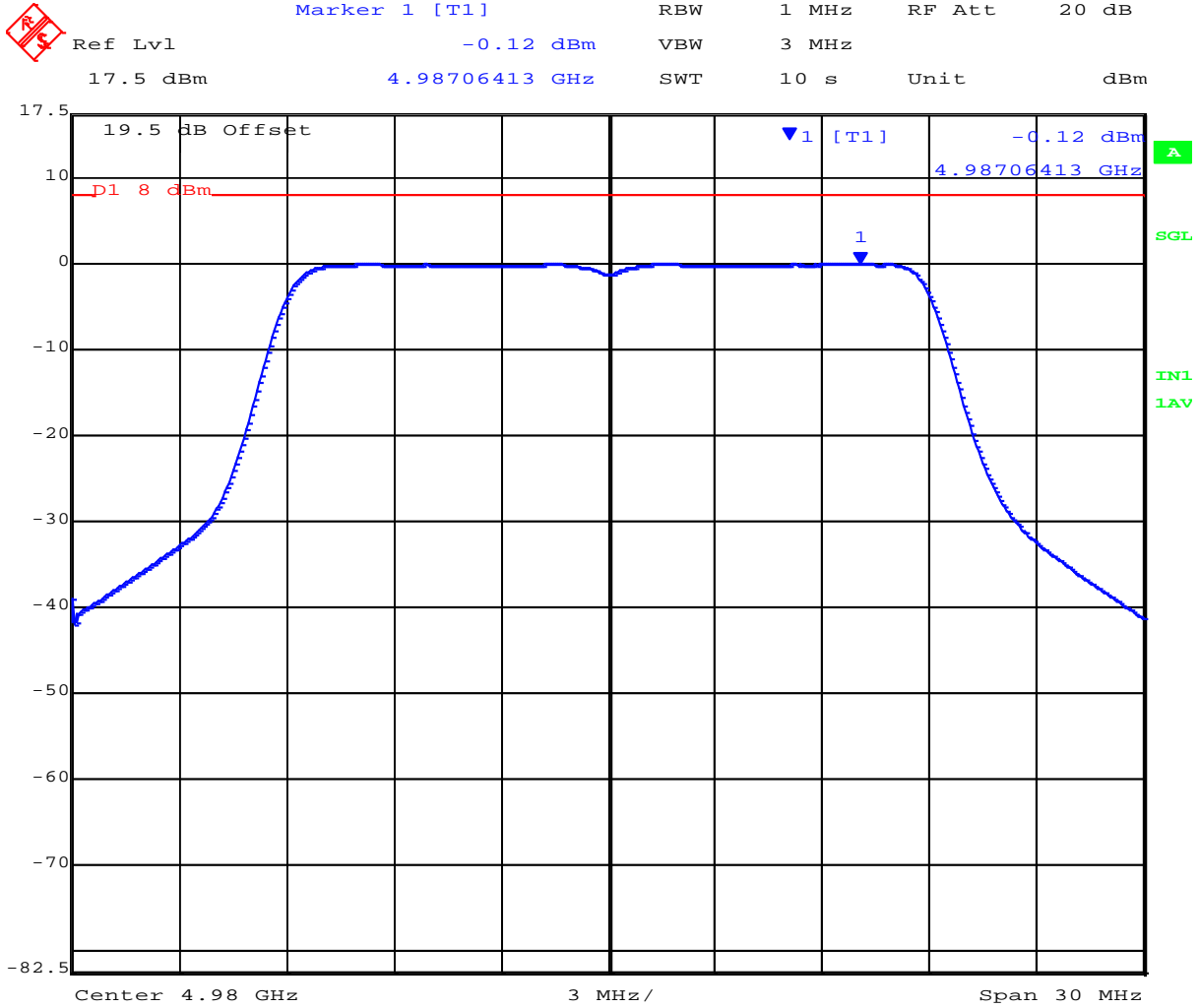

Date: 5.JUL.2016 11:15:03

This test report may be reproduced in full only. The document may only be updated by MiCOM Labs personnel. All changes will be noted in the Document History section of the report.



Title: Mimosa Networks A5c, A5-14, A5-18
To: FCC 47 CFR Part 90, Subpart Y; IC RSS-111
Serial #: MIMO09-U10 Rev A
Issue Date: 2nd August 2016
Page: 57 of 105

Specification Limits
FCC Part §90.1215

Refer to the Power Limits Specification in Section 6.1.2 of this report.

Laboratory Measurement Uncertainty for Power Measurement

Measurement uncertainty	± 1.33 dB
-------------------------	---------------

Traceability

Method
Measurements were made per work instruction WI-03 'Measurement of RF Output Power'

This test report may be reproduced in full only. The document may only be updated by MiCOM Labs personnel. All changes will be noted in the Document History section of the report.



6.1.4. Maximum Permissible Exposure
FCC, Part 90 Subpart C §90.1217
Industry Canada RSS-Gen §5.6

Calculations for Maximum Permissible Exposure Levels

$$\text{Power Density} = P_d \text{ (mW/cm}^2\text{)} = \text{EIRP}/(4\pi d^2)$$

$$\text{EIRP} = P * G$$

P = Peak output power (mW)

G = Antenna numeric gain (numeric)

d = Separation distance (cm)

$$\text{Numeric Gain} = 10 ^ (G \text{ (dBi)}/10)$$

Because the EUT belongs to the General Population/Uncontrolled Exposure the limit of power density is 1.0 mW/cm²

Note: for mobile or fixed location transmitters the minimum separation distance is 20cm, even if calculations indicate the MPE distance to be less.

Specification

Maximum Permissible Exposure Limits

§90.1217

Licenses and manufacturers are subject to the radiofrequency radiation exposure requirements specified in §§ 1.1307(b), 2.1091 and 2.1093 of this chapter, as appropriate. Applications for equipment authorization of mobile or portable devices operating under this section must contain a statement confirming compliance with these requirements for both fundamental emissions and unwanted emissions. Technical information showing the basis for this statement must be submitted to the Commission upon request.

FCC §1.1310 Limit = 1mW / cm² from 1.310 Table 1

RSS-Gen §5.6 Category I and Category II equipment shall comply with the applicable requirements of RSS-102.

Laboratory Measurement Uncertainty for Power Measurements

Measurement uncertainty

±1.33dB



Title: Mimosa Networks A5c, A5-14, A5-18
To: FCC 47 CFR Part 90, Subpart Y; IC RSS-111
Serial #: MIMO09-U10 Rev A
Issue Date: 2nd August 2016
Page: 59 of 105

6.1.5. Frequency Stability; Temperature Variations, and Voltage Variations

FCC 47 CFR Part 90, Subpart Y; §90.213

Test Procedure

The transmitter output was connected to a spectrum analyzer and the frequency stability was measured in either modulated or unmodulated state. Frequency stability was measured through the extremes of temperature on the selected channel only. Prior to a taking a frequency / temperature measurement the device is powered off and the temperature changed. The device is left to stabilize at the new temperature for 15 mins then switched on before any measurement is taken.

This test report may be reproduced in full only. The document may only be updated by MiCOM Labs personnel. All changes will be noted in the Document History section of the report.



Ambient conditions.

Temperature: 19 to 26 °C Relative humidity: 31 to 57 % Pressure: 999 to 1009 mbar

TABLE OF RESULTS Frequency Stability:

Voltage (dc)	Temperature	Measured Frequency (Hz)	Delta (kHz)	Drift (ppm)
		Channel 4965 MHz		
24	55	4964938350	-61.65	-12.4169
	45	4964939850	-60.15	-12.1148
	35	4964939960	-60.04	-12.0926
	25	4964940470	-59.53	-11.9899
	20	4964940084	-59.916	-12.0677
	10	4964941300	-58.7	-11.8228
	0	4964941260	-58.74	-11.8308
	-10	4964941330	-58.67	-11.8167
	-20	4964940450	-59.55	-11.994
	-30	4964939560	-60.44	-12.1732
	-40	4964937780	-62.22	-12.5317

Modulated carrier breakthrough was used to measure frequency stability.



Frequency Stability 4965 MHz 48 Vdc +55°C



Ref Lvl	Marker 1 [T1]	RBW	20 Hz	RF Att	10 dB
19.5 dBm	-4.75 dBm	VBW	20 Hz		
	4.96493835 GHz	SWT	15 s	Unit	dBm

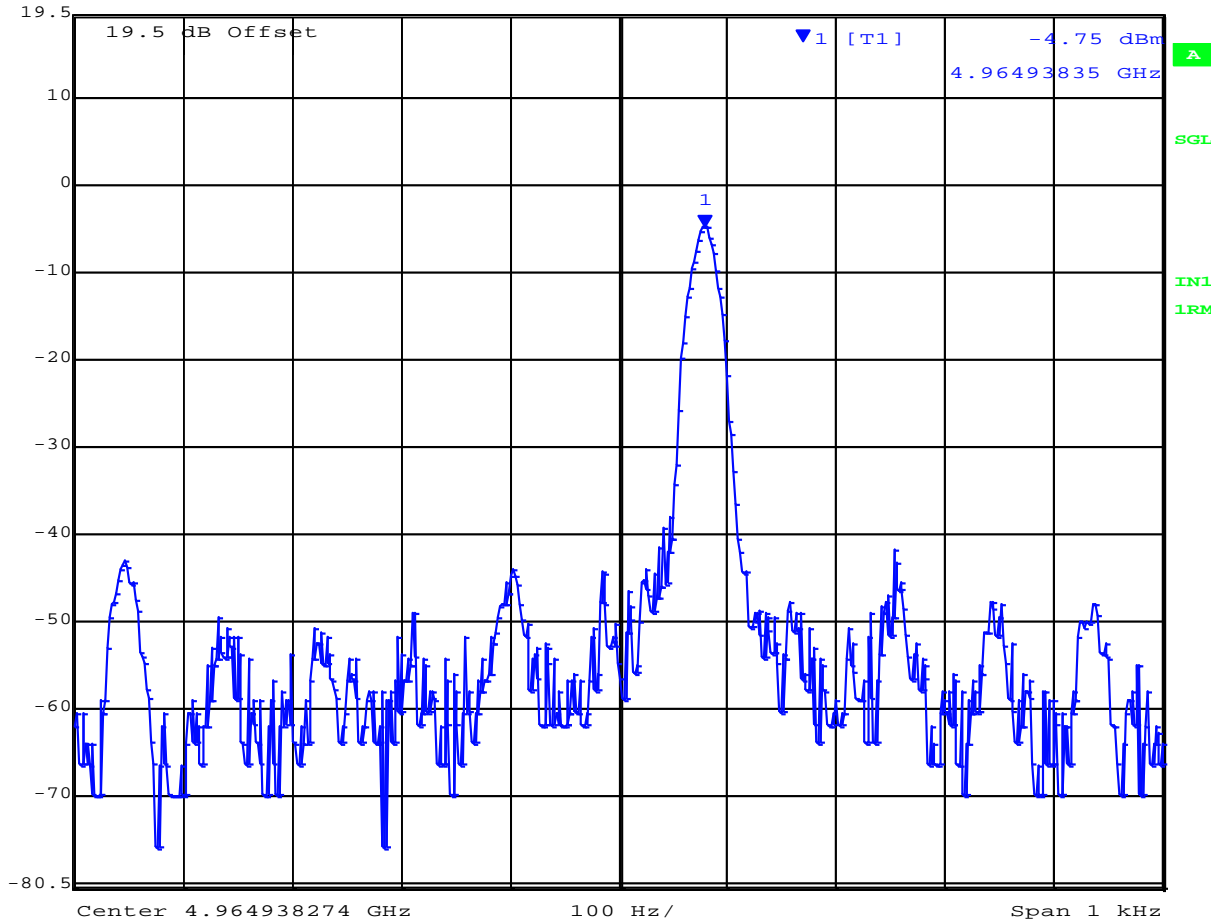

Date: 5.JUL.2016 15:57:34

This test report may be reproduced in full only. The document may only be updated by MiCOM Labs personnel. All changes will be noted in the Document History section of the report.



Frequency Stability 4965 MHz 48 Vdc+45°C



Ref Lvl	19.5 dBm	Marker 1 [T1]	-7.60 dBm	RBW	20 Hz	RF Att	10 dB
			4.96493985 GHz	VBW	20 Hz		
				SWT	15 s	Unit	dBm

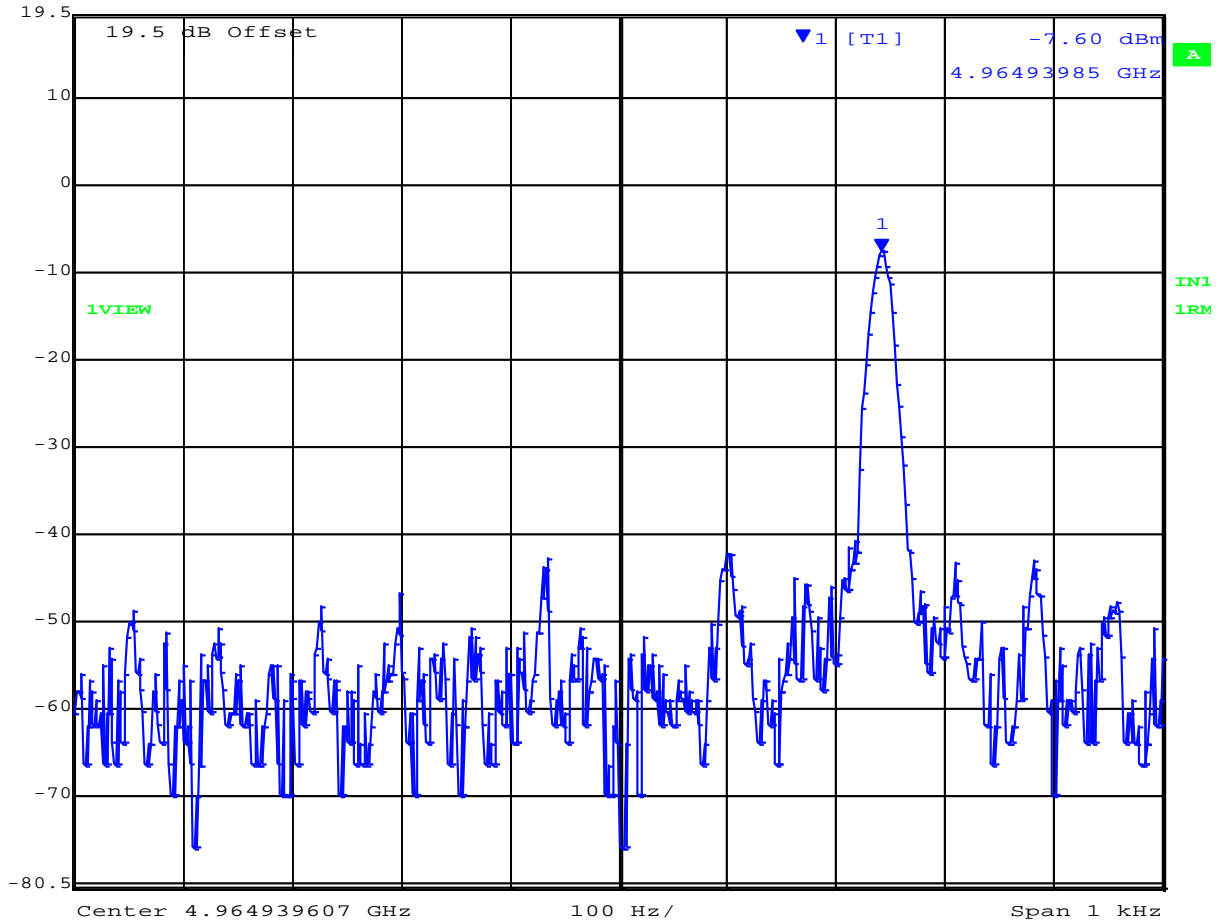

Date: 5.JUL.2016 15:49:00

This test report may be reproduced in full only. The document may only be updated by MiCOM Labs personnel. All changes will be noted in the Document History section of the report.



Frequency Stability 4965 MHz 48 Vdc+35°C

	Ref Lvl	Marker 1 [T1]	RBW	20 Hz	RF Att	10 dB
	19.5 dBm	-8.98 dBm	VBW	20 Hz		
		4.96493996 GHz	SWT	15 s	Unit	dBm

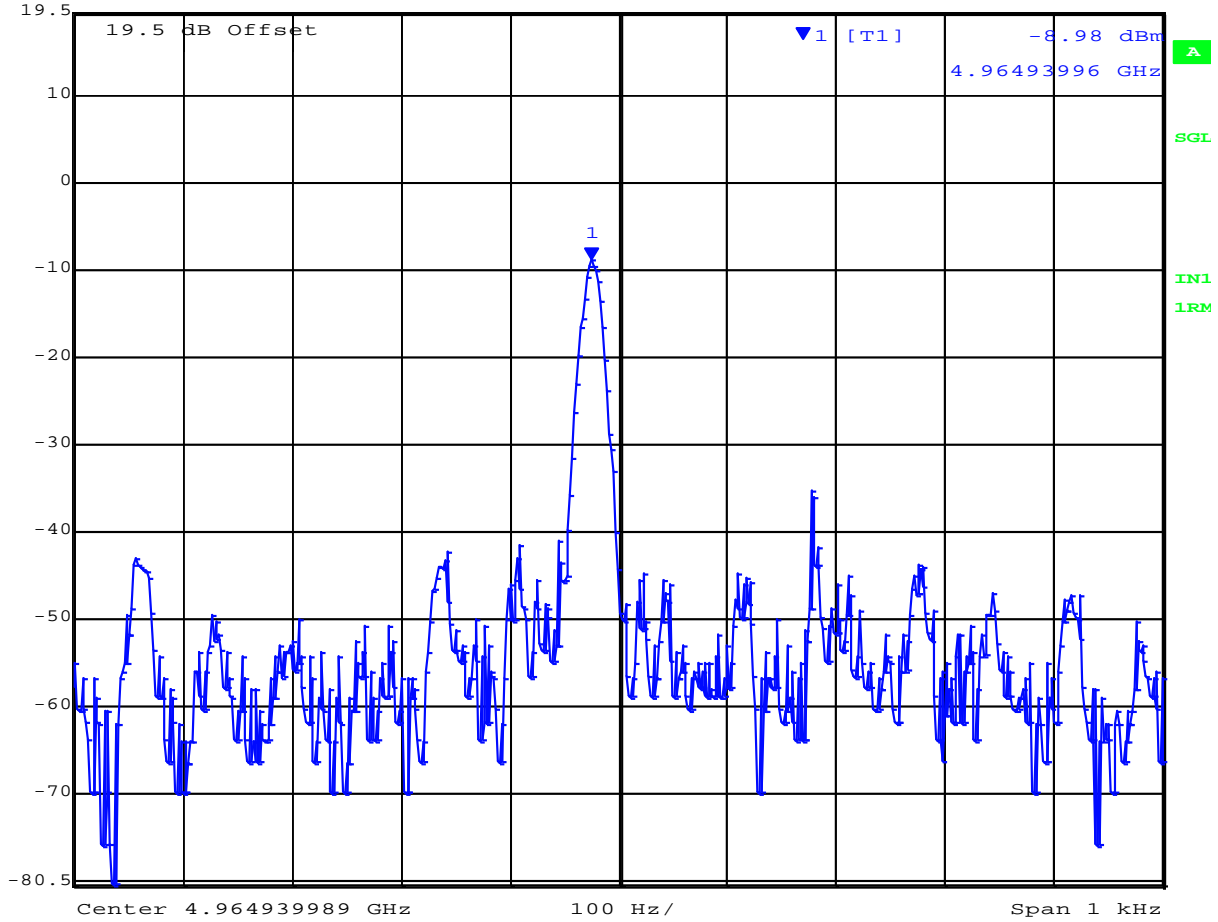

Date: 5.JUL.2016 15:47:07

This test report may be reproduced in full only. The document may only be updated by MiCOM Labs personnel. All changes will be noted in the Document History section of the report.



Frequency Stability 4965 MHz 48 Vdc+25°C



Marker 1 [T1] RBW 20 Hz RF Att 10 dB
Ref Lvl -11.10 dBm VBW 20 Hz
19.5 dBm 4.96494047 GHz SWT 15 s Unit dBm

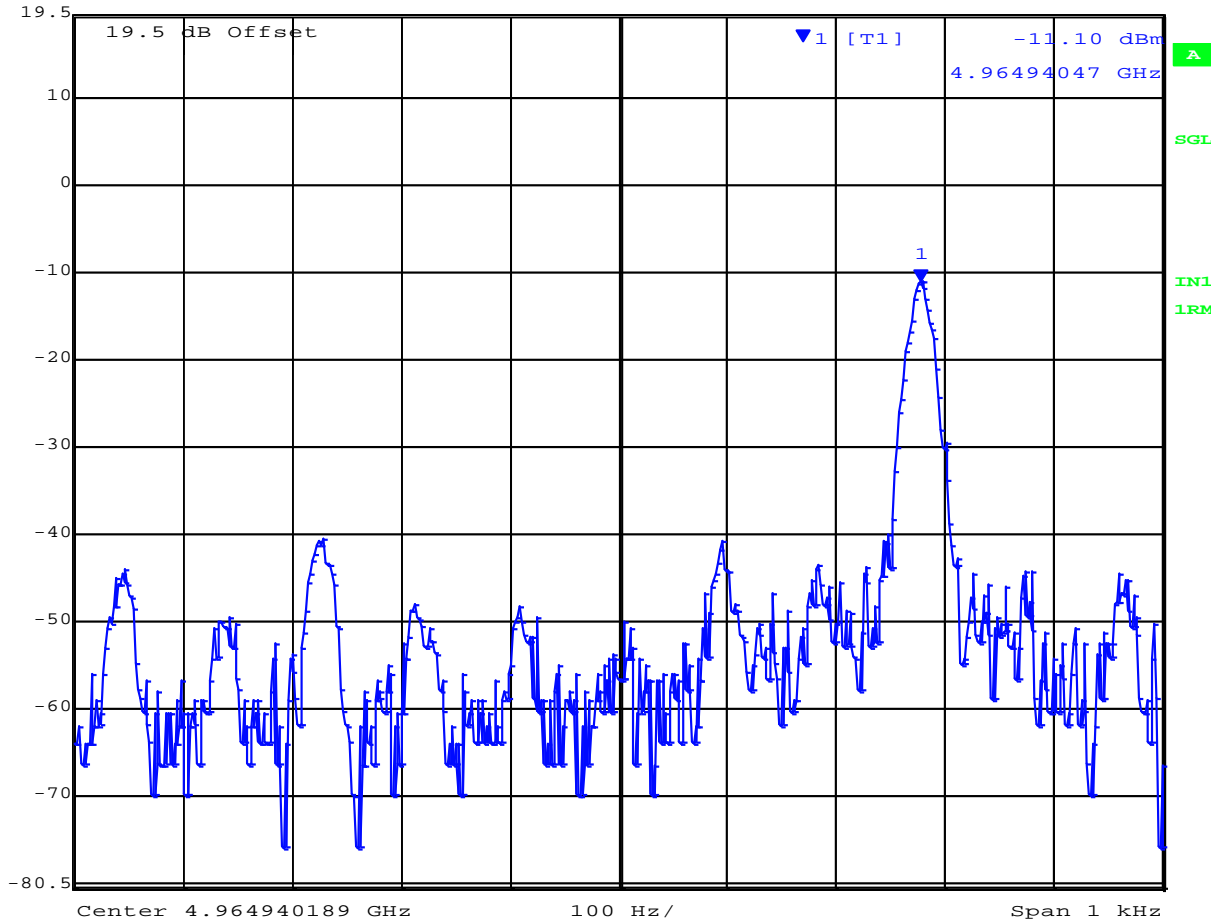

Date: 5.JUL.2016 15:38:53

This test report may be reproduced in full only. The document may only be updated by MiCOM Labs personnel. All changes will be noted in the Document History section of the report.



Frequency Stability 4965 MHz 48 Vdc+20°C



Marker 1 [T1] RBW 20 Hz RF Att 10 dB
Ref Lvl -10.41 dBm VBW 20 Hz
19.5 dBm 4.96494008 GHz SWT 15 s Unit dBm

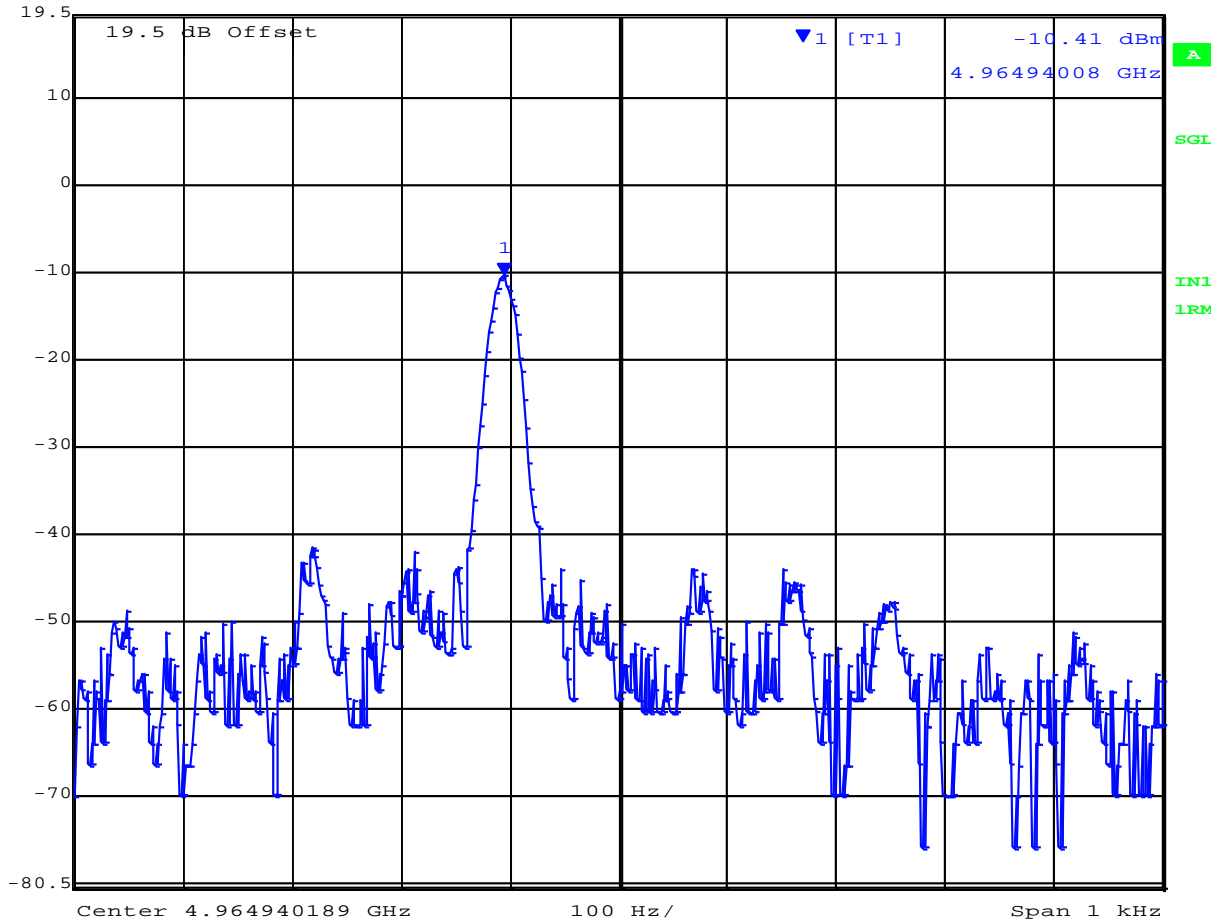

Date: 5.JUL.2016 15:33:58

This test report may be reproduced in full only. The document may only be updated by MiCOM Labs personnel. All changes will be noted in the Document History section of the report.



Frequency Stability 4965 MHz 48 Vdc+10°C



Marker 1 [T1] RBW 20 Hz RF Att 10 dB
Ref Lvl -21.45 dBm VBW 20 Hz
19.5 dBm 4.96494130 GHz SWT 15 s Unit dBm

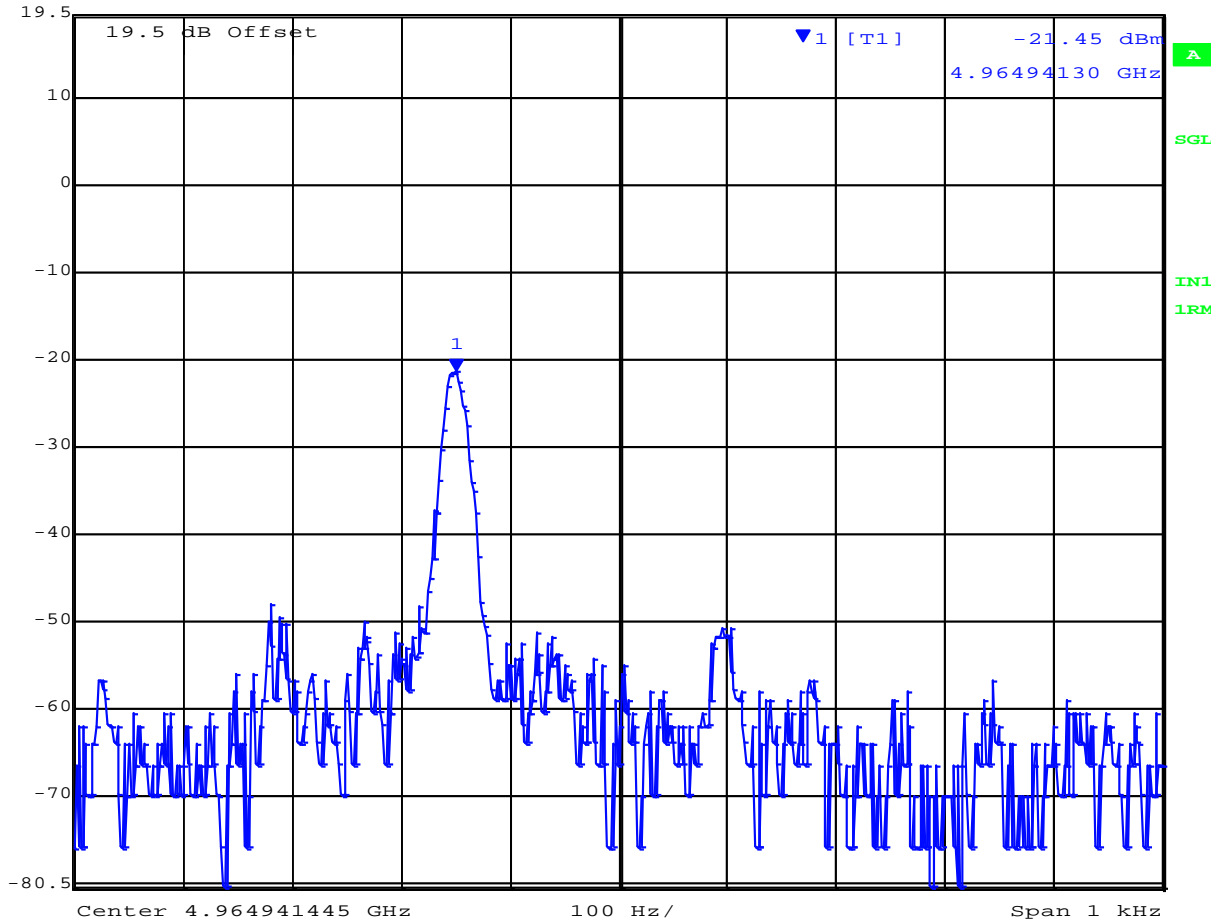

Date: 5.JUL.2016 15:16:43

This test report may be reproduced in full only. The document may only be updated by MiCOM Labs personnel. All changes will be noted in the Document History section of the report.



Frequency Stability 4965 MHz 48 Vdc+0°C



Ref Lvl	19.5 dBm	Marker 1 [T1]	-16.37 dBm	RBW	20 Hz	RF Att	10 dB
			4.96494126 GHz	VBW	20 Hz		
				SWT	15 s	Unit	dBm

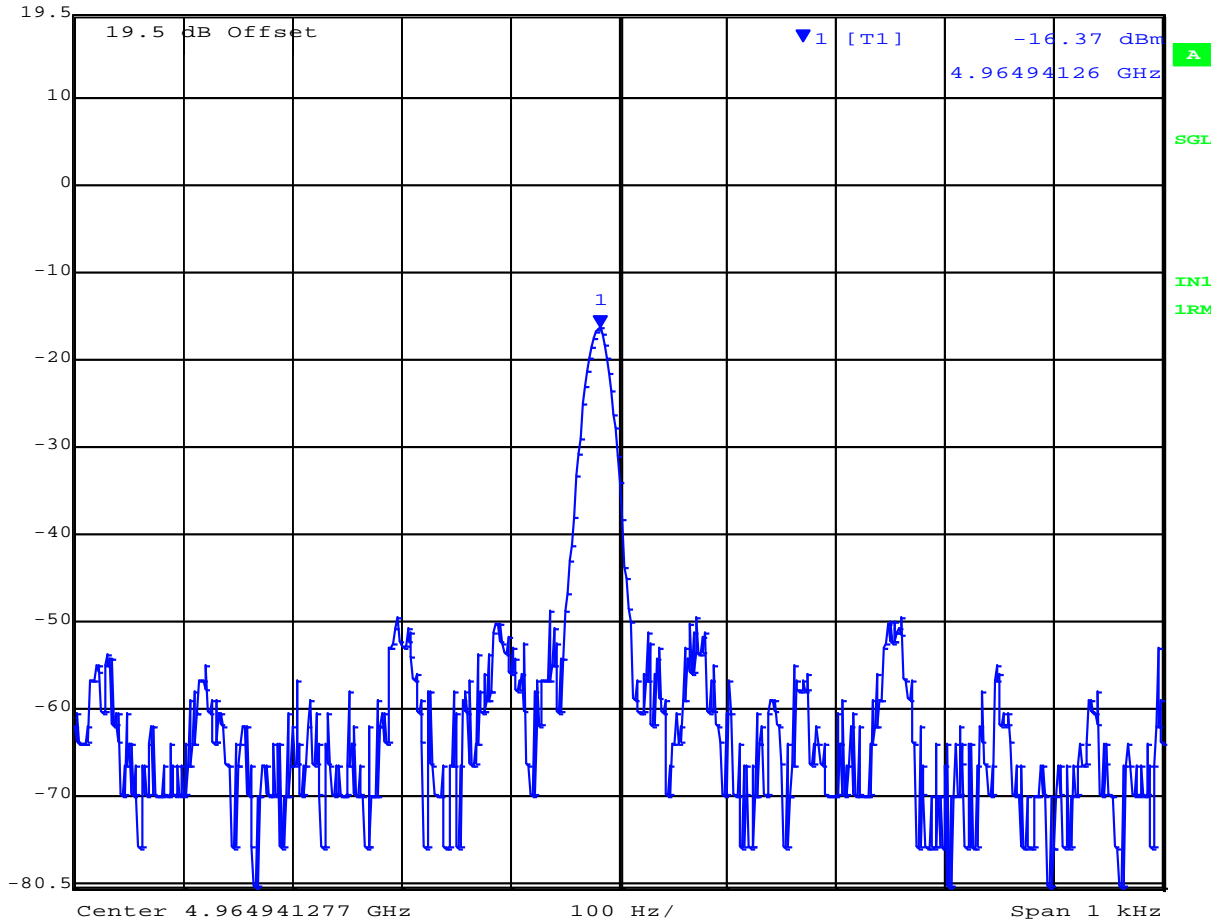

Date: 5.JUL.2016 15:09:27

This test report may be reproduced in full only. The document may only be updated by MiCOM Labs personnel. All changes will be noted in the Document History section of the report.



Frequency Stability 4965 MHz 48 Vdc-10°C



Ref Lvl	19.5 dBm	Marker 1 [T1]	-14.51 dBm	RBW	20 Hz	RF Att	10 dB
			4.96494113 GHz	VBW	20 Hz	Unit	dBm
				SWT	15 s		

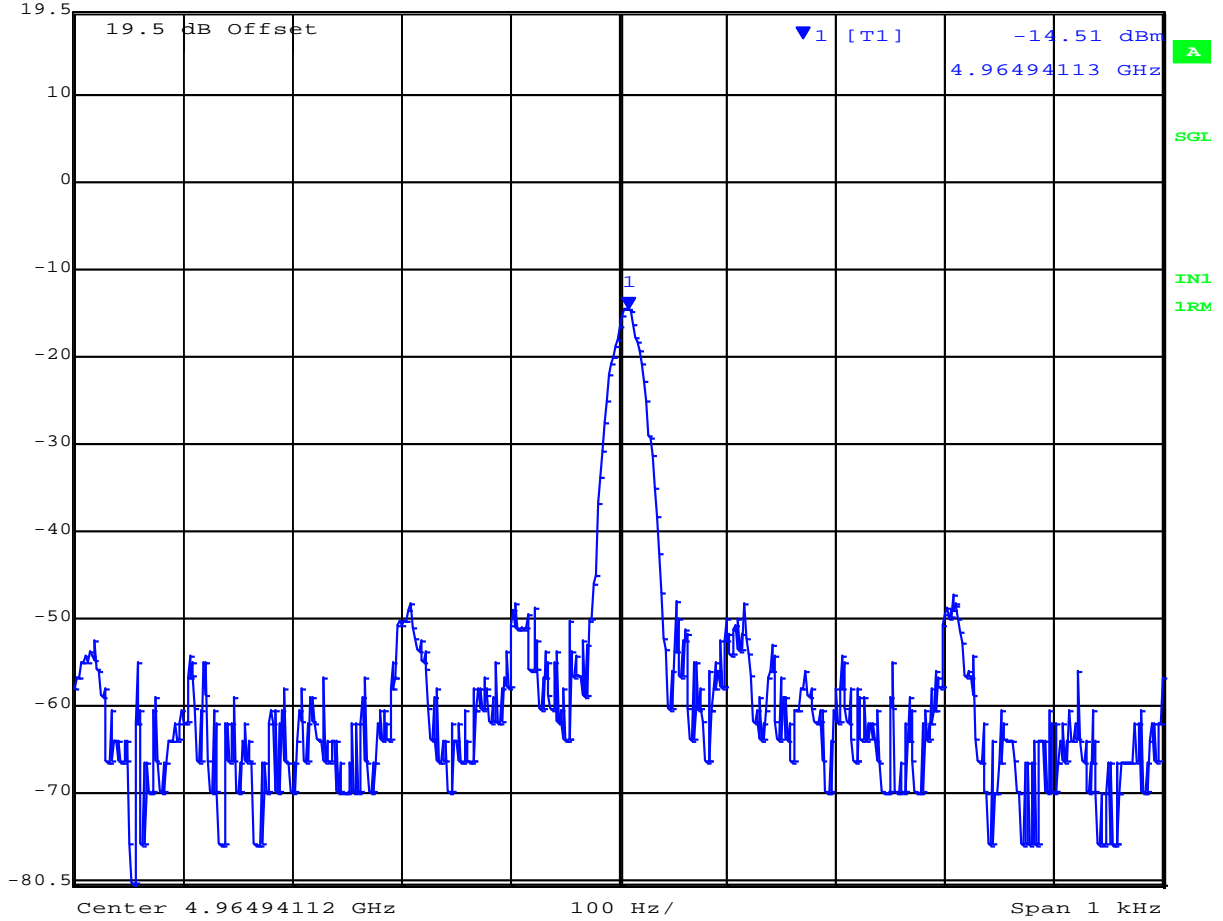

Date: 5.JUL.2016 15:01:23

This test report may be reproduced in full only. The document may only be updated by MiCOM Labs personnel. All changes will be noted in the Document History section of the report.



Frequency Stability 4965 MHz 48 Vdc-20°C



Marker 1 [T1] RBW 20 Hz RF Att 10 dB
Ref Lvl -11.84 dBm VBW 20 Hz
19.5 dBm 4.96494045 GHz SWT 15 s Unit dBm

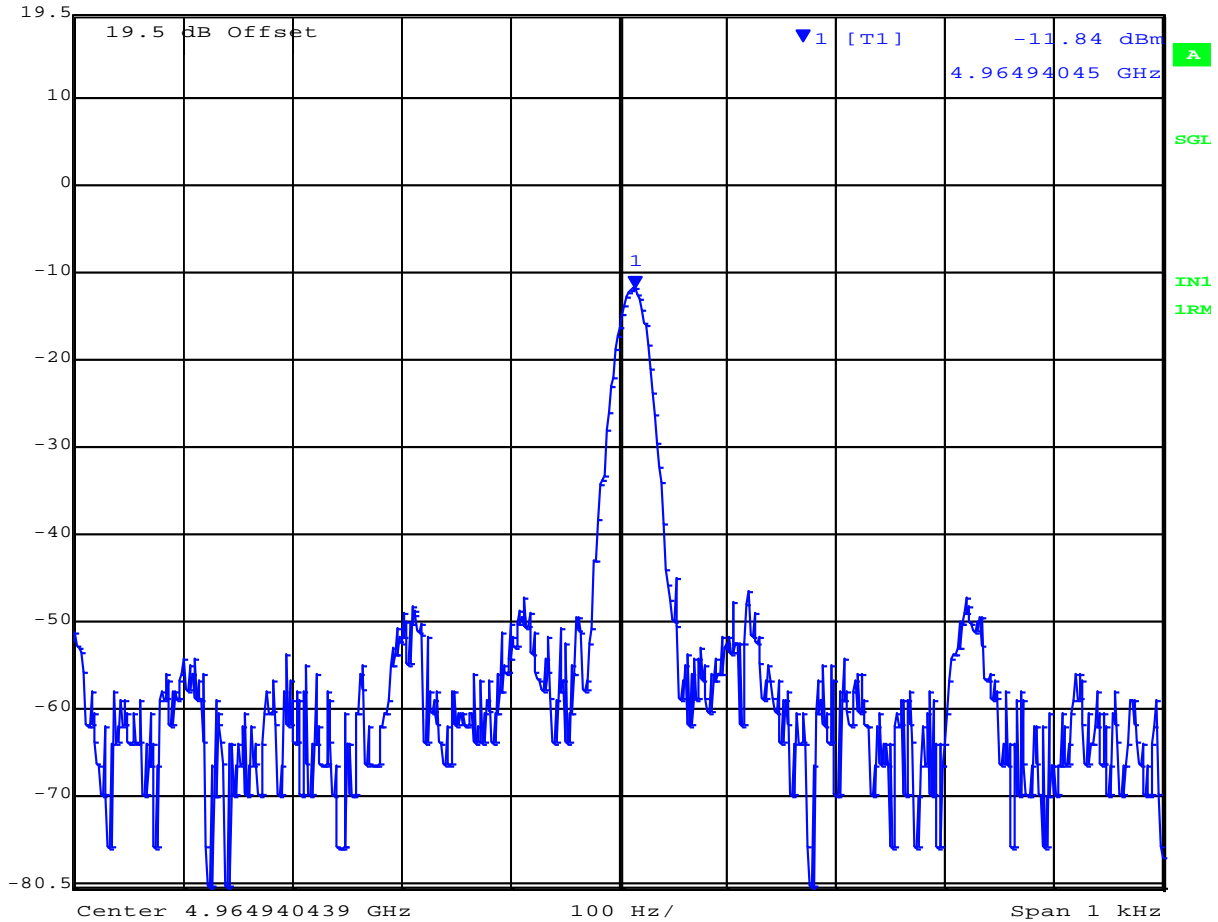

Date: 5.JUL.2016 14:46:04

This test report may be reproduced in full only. The document may only be updated by MiCOM Labs personnel. All changes will be noted in the Document History section of the report.



Frequency Stability 4965 MHz 48 Vdc-30°C

 Marker 1 [T1] RBW 20 Hz RF Att 10 dB
Ref Lvl -9.30 dBm VBW 20 Hz
19.5 dBm 4.96493956 GHz SWT 15 s Unit dBm

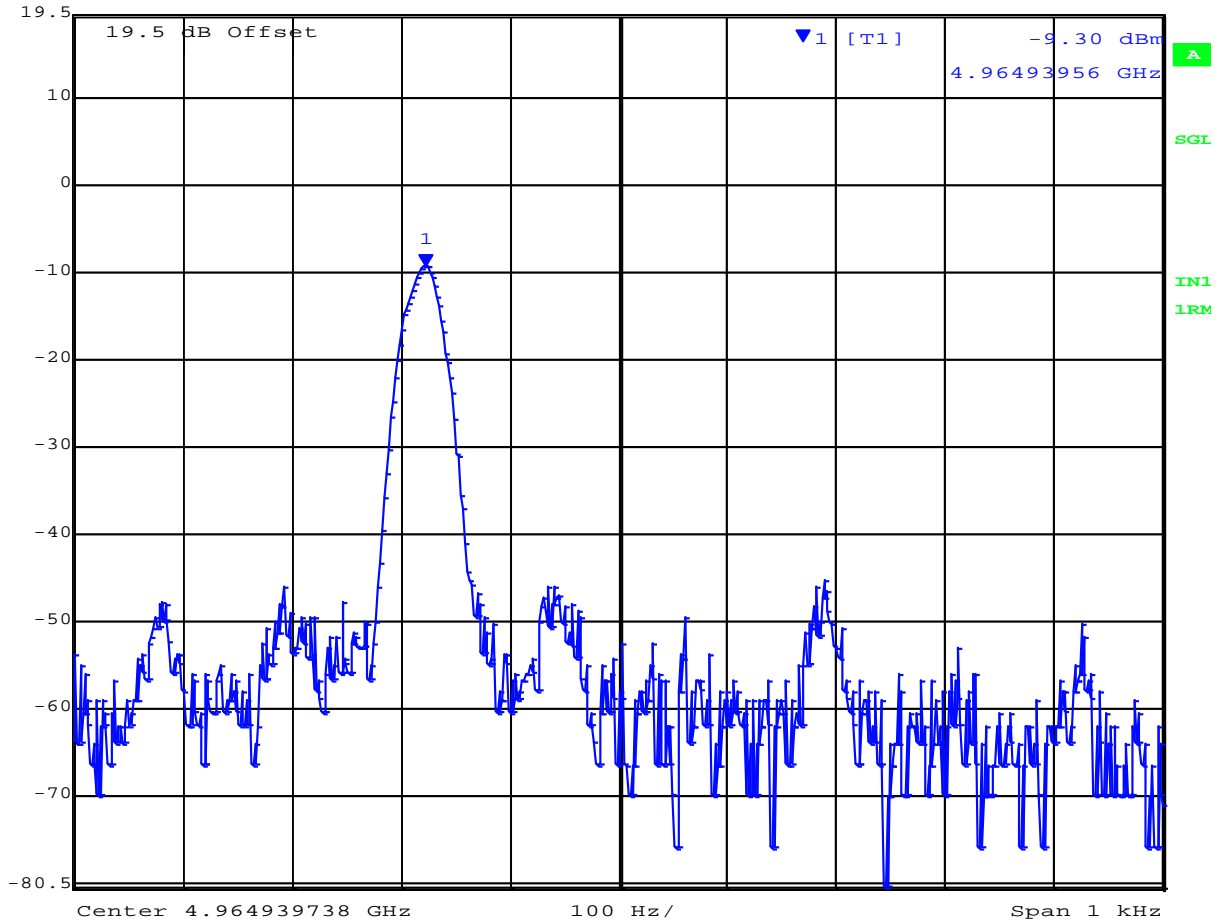

Date: 5.JUL.2016 14:23:08

This test report may be reproduced in full only. The document may only be updated by MiCOM Labs personnel. All changes will be noted in the Document History section of the report.



Title: Mimosa Networks A5c, A5-14, A5-18
To: FCC 47 CFR Part 90, Subpart Y; IC RSS-111
Serial #: MIMO09-U10 Rev A
Issue Date: 2nd August 2016
Page: 71 of 105

Frequency Stability 4965 MHz 48 Vdc-40°C

 Ref Lvl 19.5 dBm
Marker 1 [T1] 4.96493778 GHz
RBW 20 Hz
RF Att 10 dB
VBW 20 Hz
SWT 15 s
Unit dBm

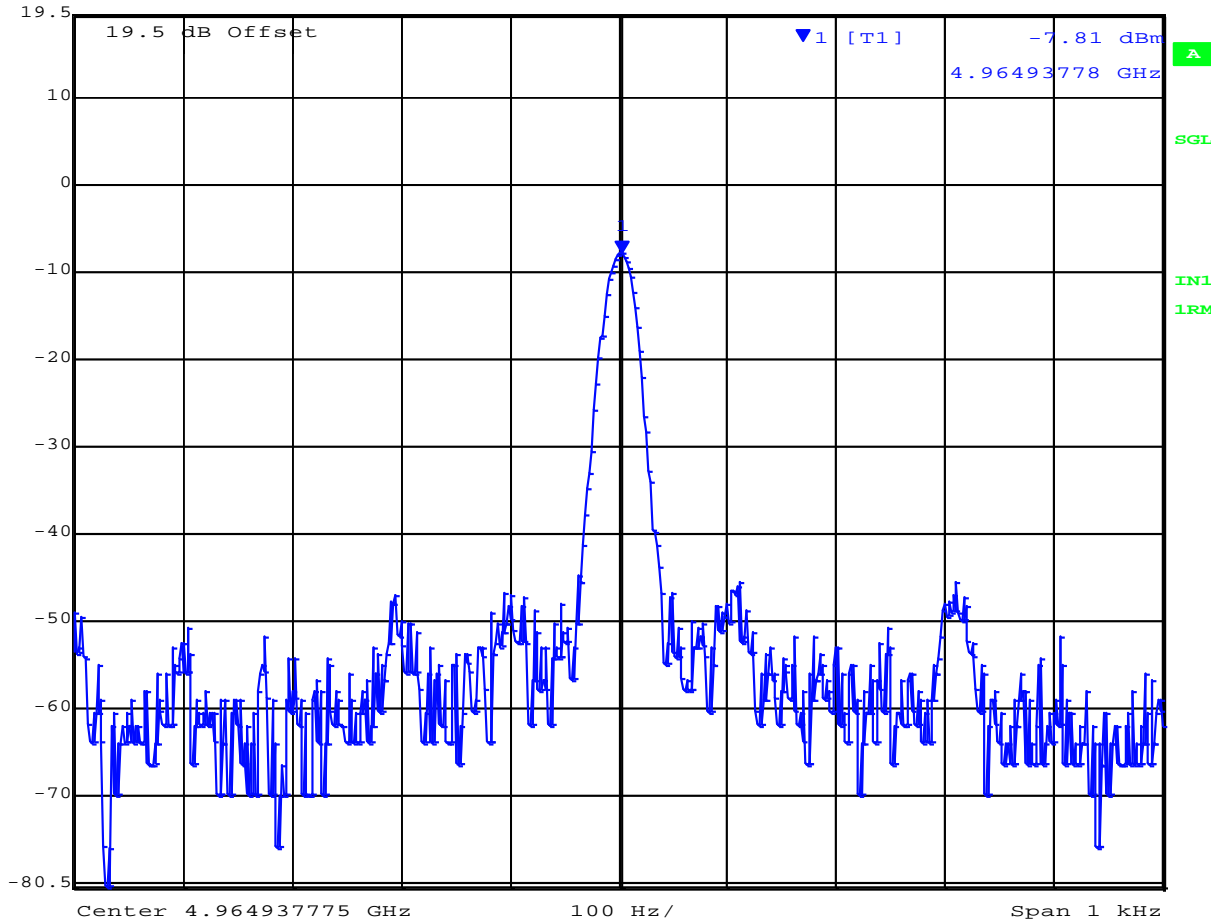

Date: 5.JUL.2016 14:09:50

This test report may be reproduced in full only. The document may only be updated by MiCOM Labs personnel. All changes will be noted in the Document History section of the report.



TABLE OF RESULTS Frequency Stability;-

Voltage Variations at Ambient

Temperature	Voltage (VDC)	FREQUENCY Delta (kHz)	Drift
		Channel 4965 MHz	ppm
Ambient	+41	4964940350	-59.65
	+60	4964940410	-59.59

This test report may be reproduced in full only. The document may only be updated by MiCOM Labs personnel. All changes will be noted in the Document History section of the report.



Frequency Stability 4965 MHz 21.6 Vdc +25°C



Marker 1 [T1] RBW 20 Hz RF Att 10 dB
Ref Lvl -10.82 dBm VBW 20 Hz
19.5 dBm 4.96494035 GHz SWT 15 s Unit dBm

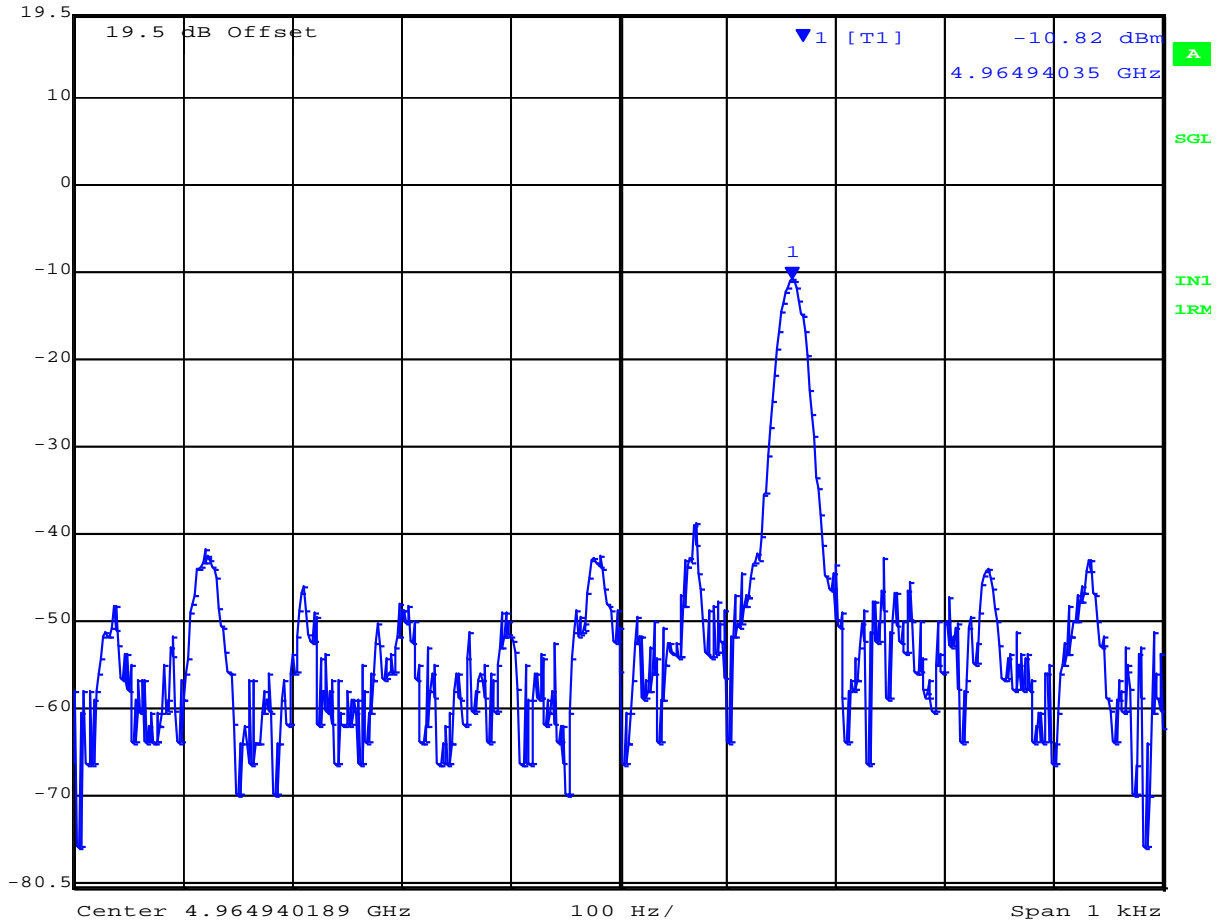

Date: 5.JUL.2016 15:35:26

This test report may be reproduced in full only. The document may only be updated by MiCOM Labs personnel. All changes will be noted in the Document History section of the report.



Frequency Stability 4965 MHz 60 Vdc +25°C



Ref Lvl	19.5 dBm	Marker 1 [T1]	-9.88 dBm	RBW	20 Hz	RF Att	10 dB
			4.96494041 GHz	VBW	20 Hz	Unit	dBm
				SWT	15 s		

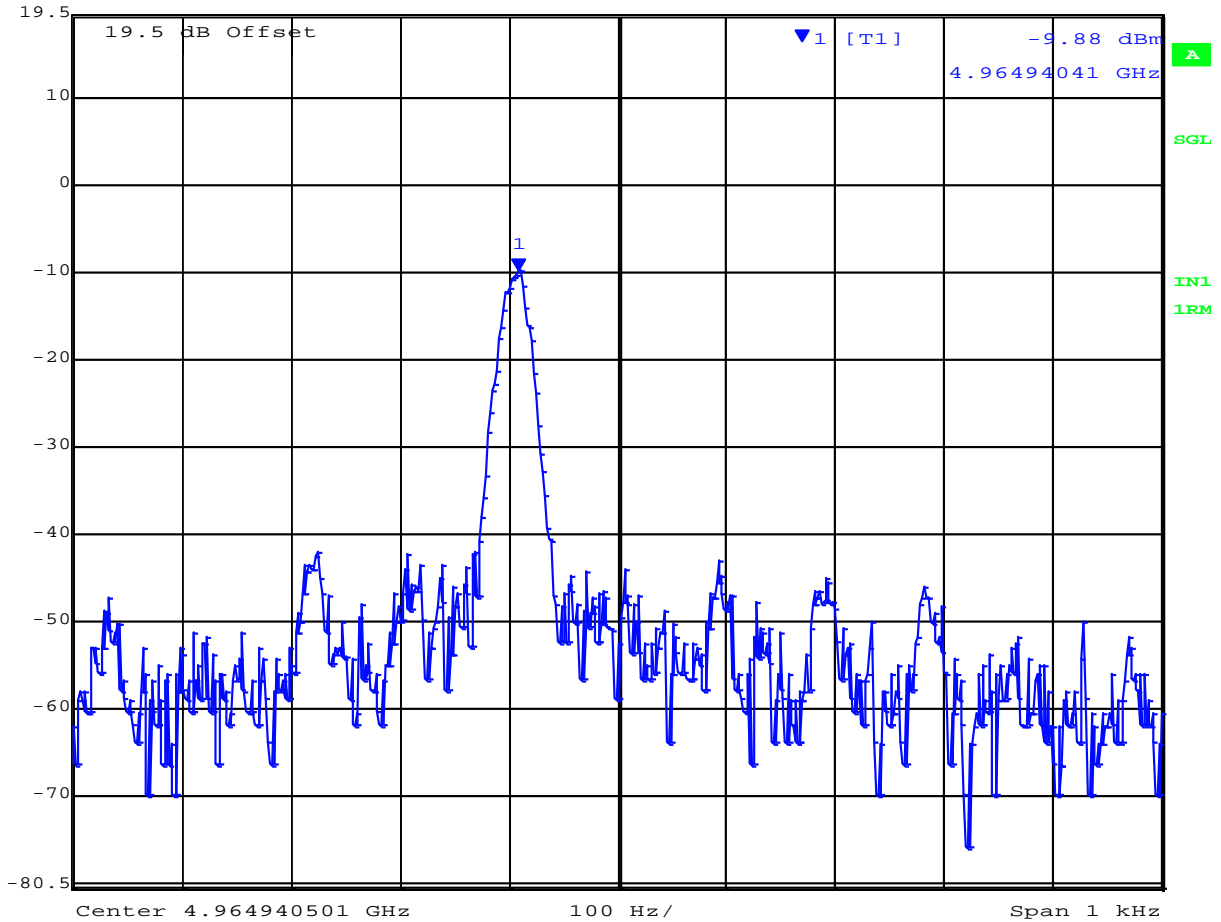

Date: 5.JUL.2016 15:40:25

This test report may be reproduced in full only. The document may only be updated by MiCOM Labs personnel. All changes will be noted in the Document History section of the report.



Specification Limits – Frequency stability

FCC Part §90.213

(a) Unless noted elsewhere, transmitters used in the services governed by this part must have a minimum frequency stability as specified in the following table.

Minimum Frequency Stability

[Parts per million (ppm)]

Frequency range (MHz)	Fixed and base stations	Mobile stations	
		Over 2 watts output power	2 watts or less output power
Below 25	^{1,2,3} 100	100	200
25-50	20	20	50
72-76	5		50
150-174	^{5,11} 5	⁶ 5	^{4,6} 50
216-220	1.0		1.0
220-222 ¹²	0.1	1.5	1.5
421-512	^{7,11,14} 2.5	⁸ 5	⁸ 5
806-809	¹⁴ 1.0	1.5	1.5
809-824	¹⁴ 1.5	2.5	2.5
851-854	1.0	1.5	1.5
854-869	1.5	2.5	2.5
896-901	¹⁴ 0.1	1.5	1.5
902-928	2.5	2.5	2.5
902-928 ¹³	2.5	2.5	2.5
929-930	1.5		
935-940	0.1	1.5	1.5
1427-1435	⁹ 300	300	300
Above 2450 ¹⁰			

¹⁰ Except for DSRCS equipment in the 5850-5925 MHz band, frequency stability is to be specified in the station authorization. Frequency stability for DSRCS equipment in the 5850-5925 MHz band is specified in subpart M of this part.

Manufacturers Specification for Frequency Stability

As no apparent frequency stability limits were provided the manufacturer's specification was used ± 20 ppm.



Title: Mimosa Networks A5c, A5-14, A5-18
To: FCC 47 CFR Part 90, Subpart Y; IC RSS-111
Serial #: MIMO09-U10 Rev A
Issue Date: 2nd August 2016
Page: 76 of 105

Laboratory Measurement Uncertainty for Frequency Stability

Measurement uncertainty	± 0.866 ppm
-------------------------	-----------------

Traceability

Method	Test Equipment Used
Measurements were made per work instruction WI-02 'Frequency Measurement'	0070, 0116, 0158, 0193, 0252, 0313, 0314.

This test report may be reproduced in full only. The document may only be updated by MiCOM Labs personnel. All changes will be noted in the Document History section of the report.



Title: Mimosa Networks A5c, A5-14, A5-18
To: FCC 47 CFR Part 90, Subpart Y; IC RSS-111
Serial #: MIMO09-U10 Rev A
Issue Date: 2nd August 2016
Page: 77 of 105

6.1.6. Spurious Emissions at Antenna Terminals - Transmitter

FCC 47 CFR Part 90, Subpart Y; §90.210(m)

Test Procedure

Transmitter conducted spurious emissions were measured for each bandwidth. Measurement were made while EUT was operating in a modulated transmit mode of operation, at the appropriate center frequency, 100% duty cycle and maximum power at all times. Conducted spurious emissions were measured to 40 GHz.

Conducted spurious emissions' testing was performed only in the configuration with the highest spectral density.

From FCC Part 90.210 (m)

On any frequency removed from the assigned frequency between above 150 % of the authorized bandwidth: 50 dB or $55 + 10 \log (P)$ dB, (P in Watts) whichever is the lesser attenuation.

This test report may be reproduced in full only. The document may only be updated by MiCOM Labs personnel. All changes will be noted in the Document History section of the report.



TABLE OF RESULTS – 20 MHz Bandwidth

PORT A Limit: -25 dBm

Channel (MHz)	Frequency (MHz)			Emission Amplitude (dBm)	Margin (dB)
	Start (MHz)	Stop (MHz)	Freq of Maximum Emission (MHz)		
4945	30	40,000	39843.6	-29.46	-4.46
4965	30	40,000	39843.6	-29.52	-4.52
4980	30	40,000	39843.6	-29.08	-4.08

Port A

Conducted Emissions 20 MHz Channel Freq 4945 MHz

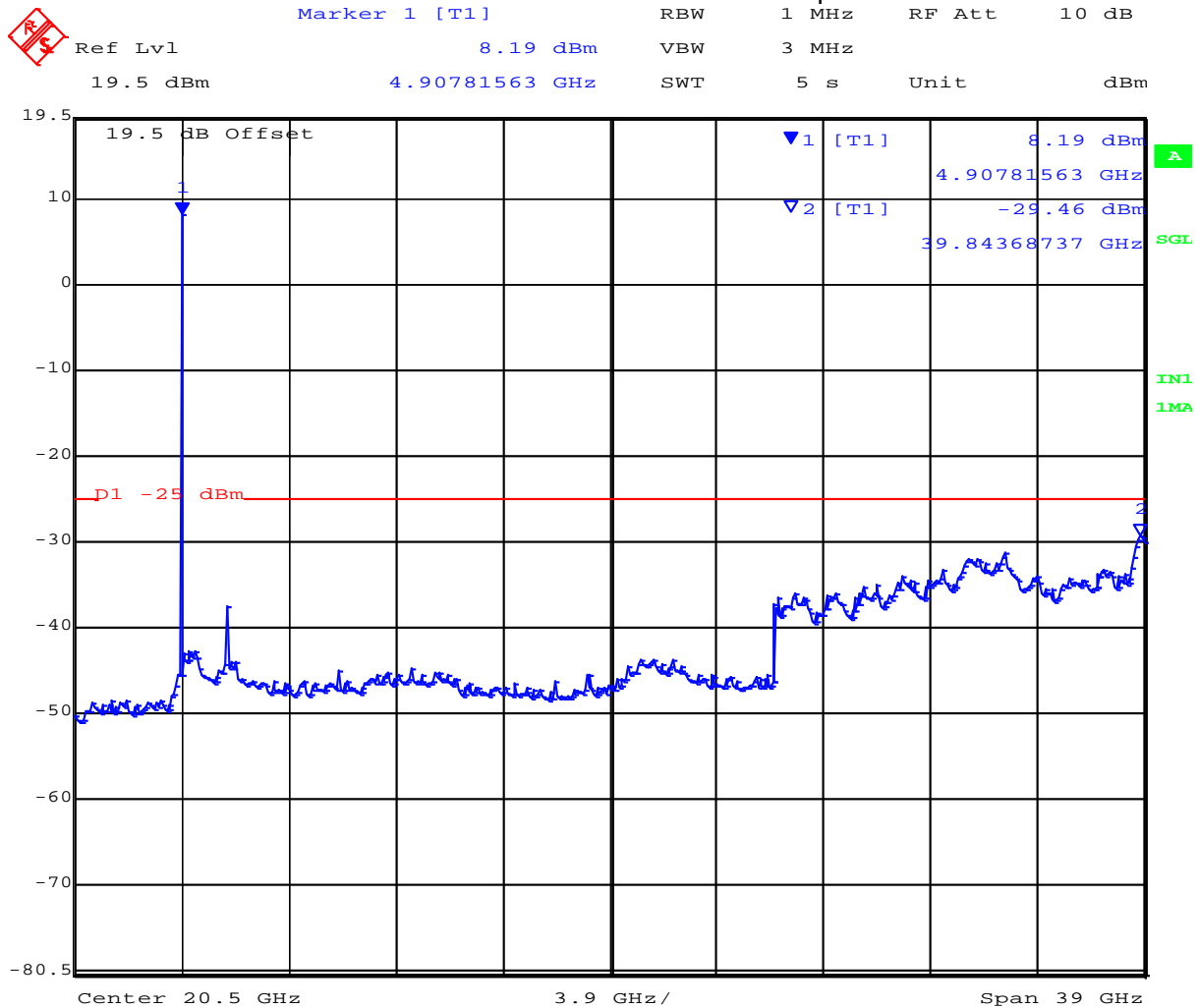

Date: 5.JUL.2016 11:34:50

This test report may be reproduced in full only. The document may only be updated by MiCOM Labs personnel. All changes will be noted in the Document History section of the report.



Port A
Conducted Emissions 20 MHz Channel Freq 4965 MHz

Marker 1 [T1] RBW 1 MHz RF Att 10 dB
Ref Lvl 19.5 dBm 8.03 dBm VBW 3 MHz
4.90781563 GHz SWT 5 s Unit dBm

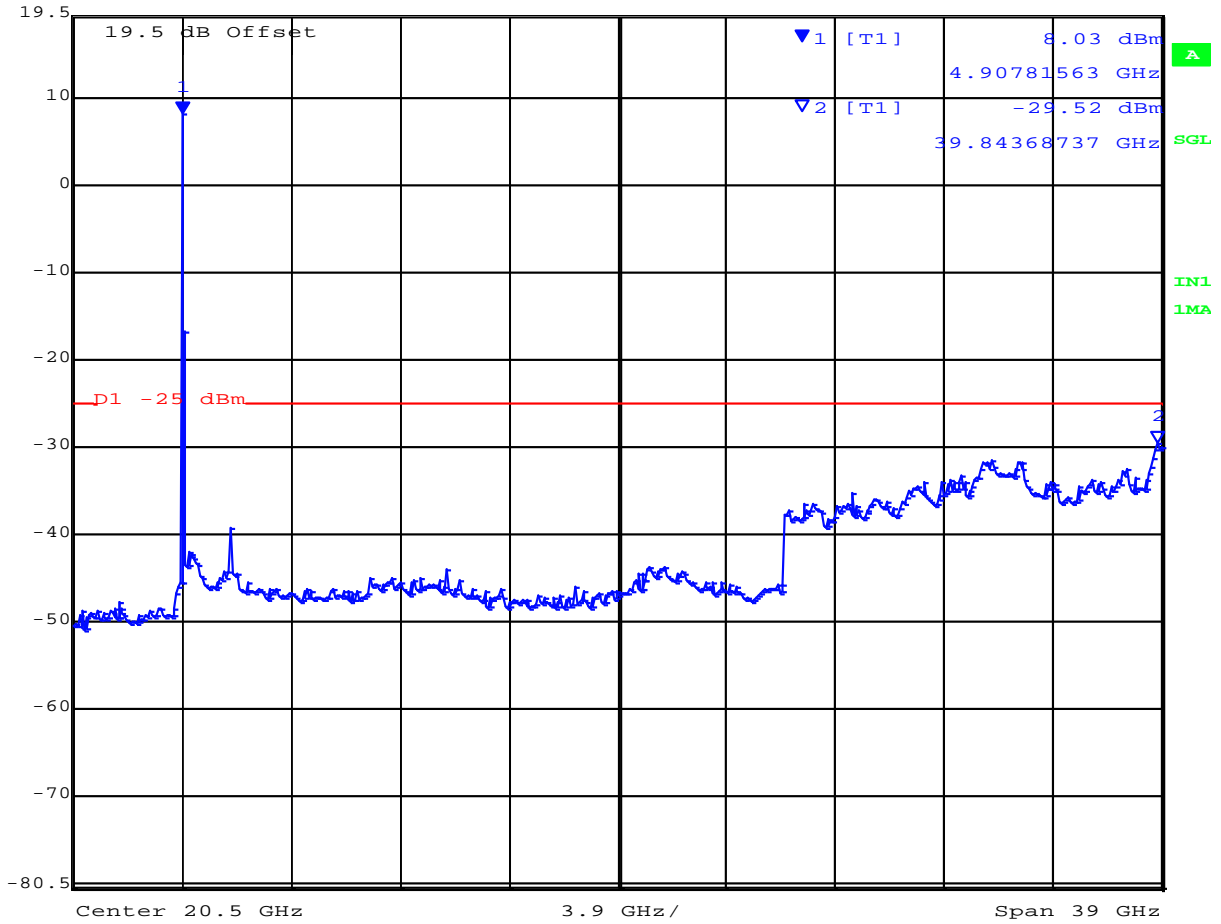

Date: 5.JUL.2016 11:35:58

This test report may be reproduced in full only. The document may only be updated by MiCOM Labs personnel. All changes will be noted in the Document History section of the report.



Port A
Conducted Emissions 20 MHz Channel Freq 4980 MHz

Marker 1 [T1] RBW 1 MHz RF Att 10 dB
Ref Lvl 19.5 dBm 8.03 dBm VBW 3 MHz
4.98597194 GHz SWT 5 s Unit dBm

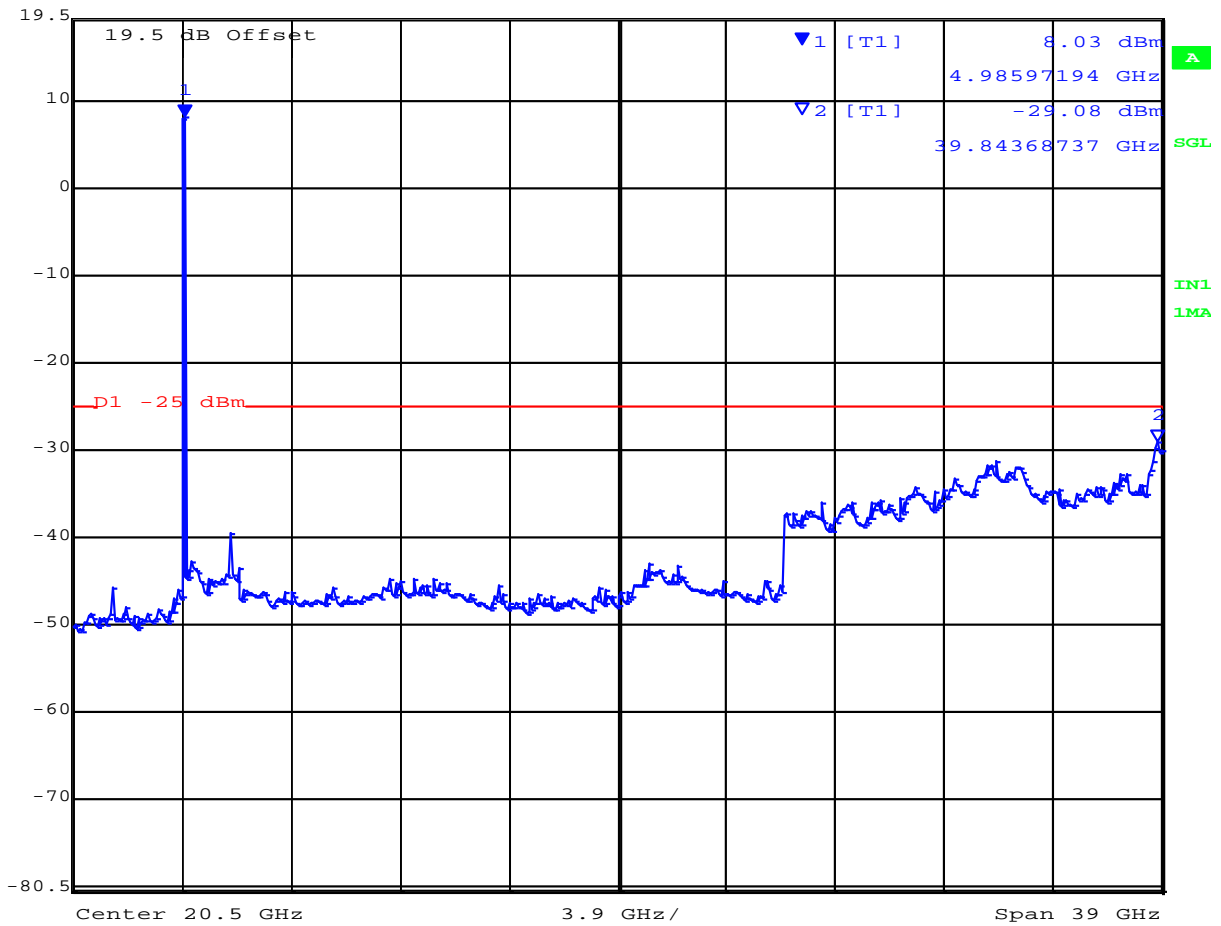

Date: 5 JUL 2016 11:59:59

This test report may be reproduced in full only. The document may only be updated by MiCOM Labs personnel. All changes will be noted in the Document History section of the report.



PORT B Limit: -25 dBm

Channel (MHz)	Frequency (MHz)		Freq of Maximum Emission (MHz)	Emission Amplitude (dBm)	Margin (dB)
	Start (MHz)	Stop (MHz)			
4945	30	40,000	39843.6	-27.89	-2.89
4965	30	40,000	39921.8	-29.22	-4.22
4980	30	40,000	39765.5	-30.27	-5.27

Port B
 Conducted Emissions 20 MHz Channel Freq 4945 MHz

 Marker 1 [T1] RBW 1 MHz RF Att 10 dB
 Ref Lvl 8.75 dBm VBW 3 MHz
 19.5 dBm 4.90781563 GHz SWT 5 s Unit dBm

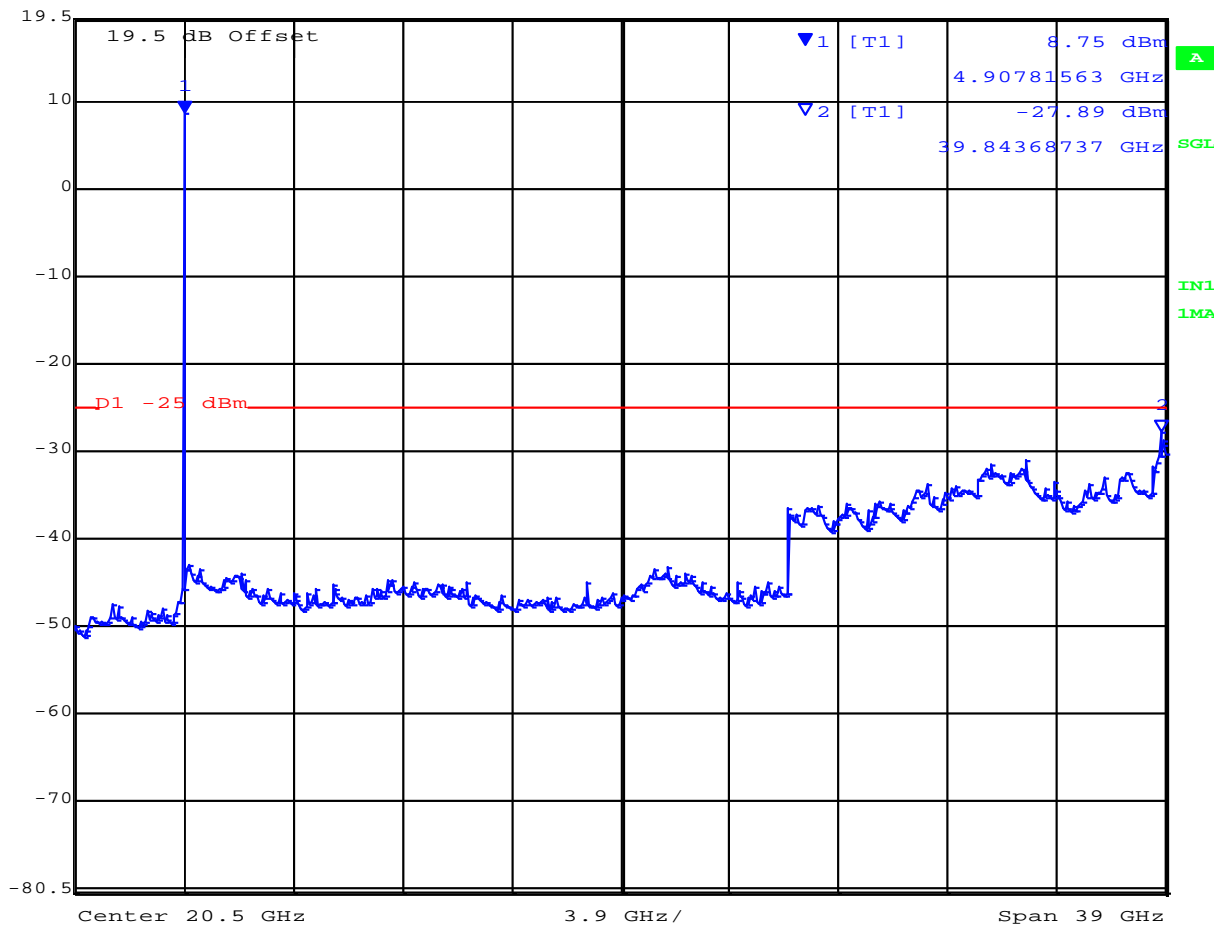

Date: 5.JUL.2016 11:34:01

This test report may be reproduced in full only. The document may only be updated by MiCOM Labs personnel. All changes will be noted in the Document History section of the report.



Port B
Conducted Emissions 20 MHz Channel Freq 4965 MHz

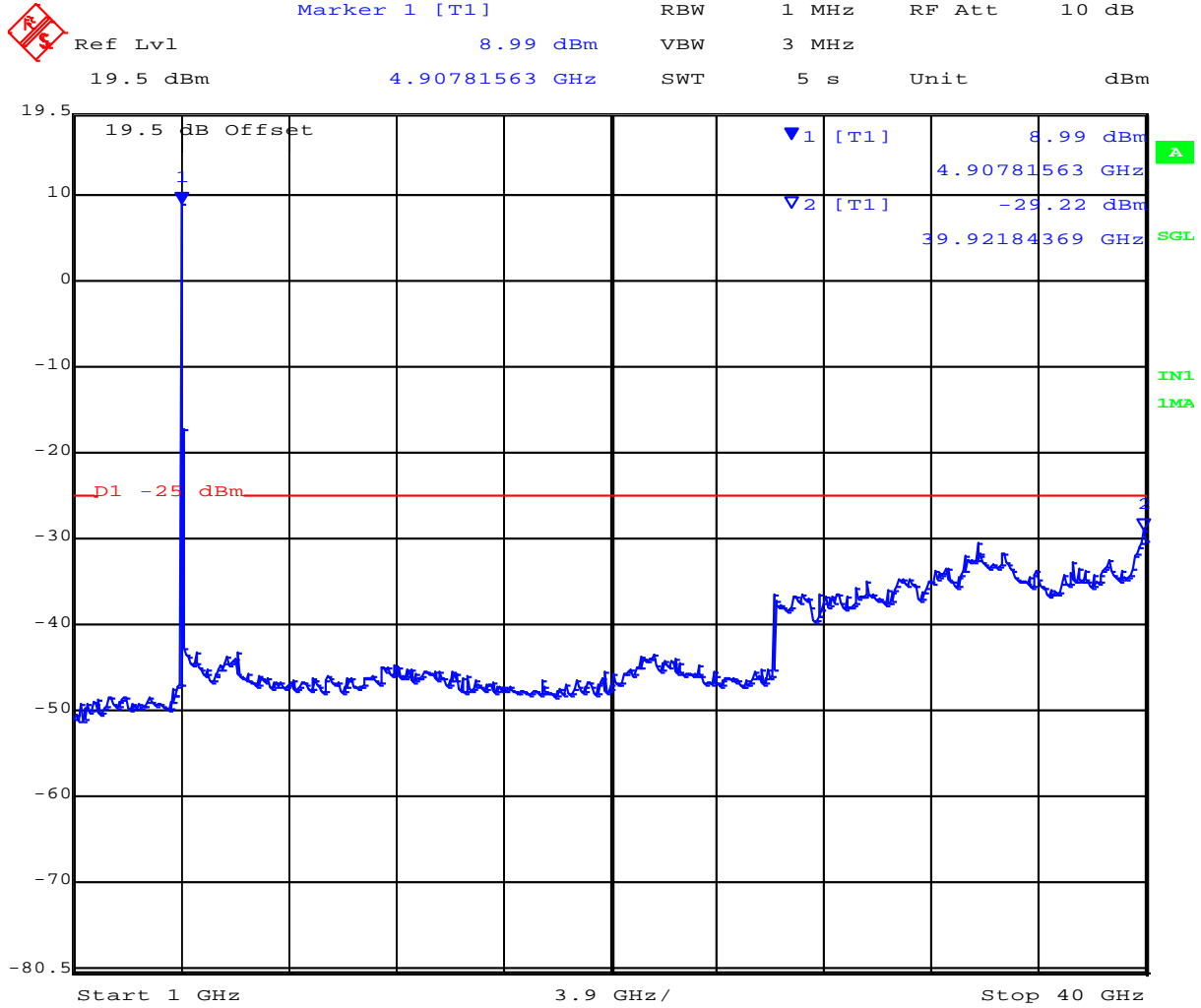

Date: 5.JUL.2016 11:37:10

This test report may be reproduced in full only. The document may only be updated by MiCOM Labs personnel. All changes will be noted in the Document History section of the report.



Port B
Conducted Emissions 20 MHz Channel Freq 4980 MHz



Marker 1 [T1] RBW 1 MHz RF Att 10 dB
Ref Lvl 19.5 dBm 8.09 dBm VBW 3 MHz
4.90781563 GHz SWT 5 s Unit dBm

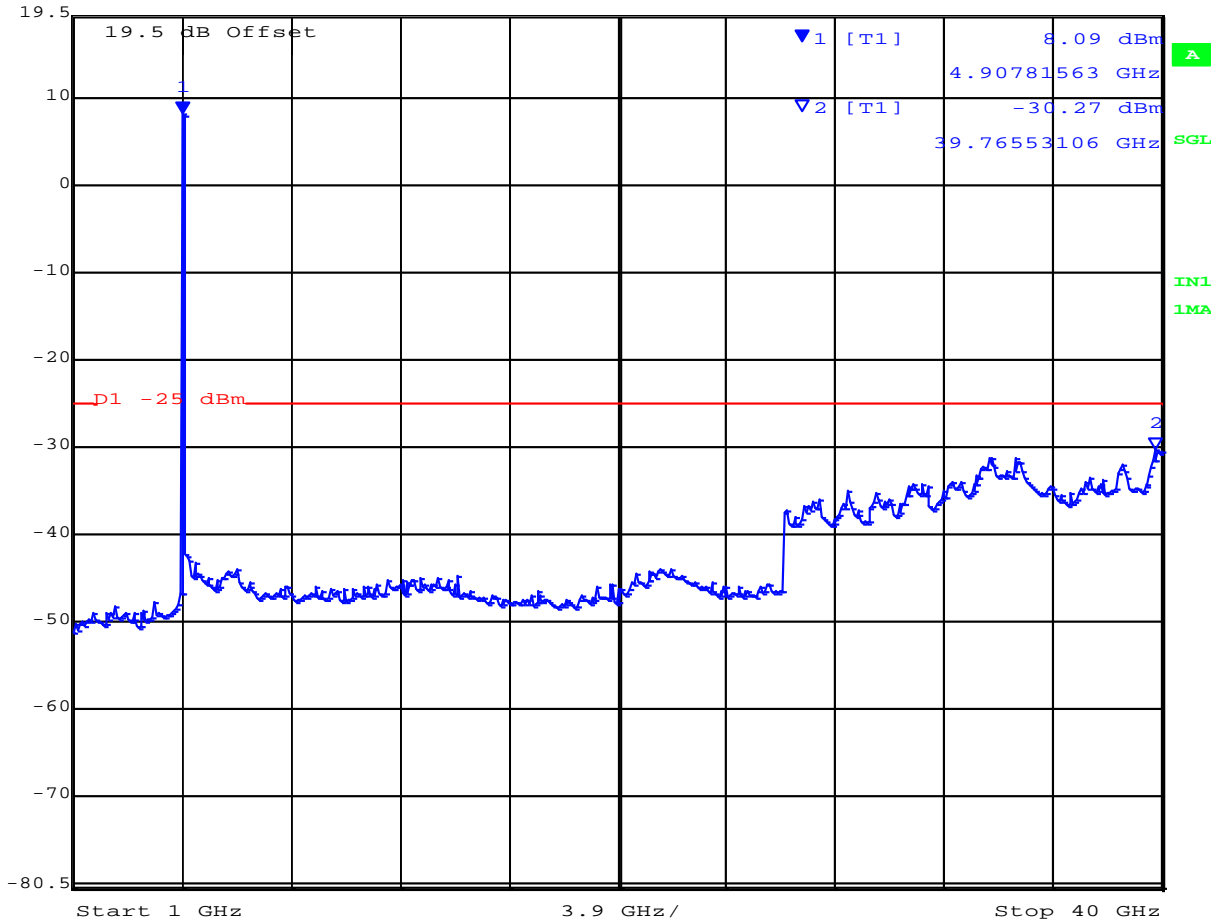

Date: 5.JUL.2016 11:59:18

This test report may be reproduced in full only. The document may only be updated by MiCOM Labs personnel. All changes will be noted in the Document History section of the report.



PORT C Limit: -25 dBm

Channel (MHz)	Frequency (MHz)		Emission Amplitude (dBm)	Margin (dB)
	Start (MHz)	Stop (MHz)		
4945	30	40,000	-28.98	-3.98
4965	30	40,000	-29.82	-4.82
4980	30	40,000	-29.95	-4.95

Port C
Conducted Emissions 20 MHz Channel Freq 4945 MHz

 Marker 1 [T1] RBW 1 MHz RF Att 10 dB
 Ref Lvl 10.72 dBm VBW 3 MHz
 19.5 dBm 4.90781563 GHz SWT 5 s Unit dBm

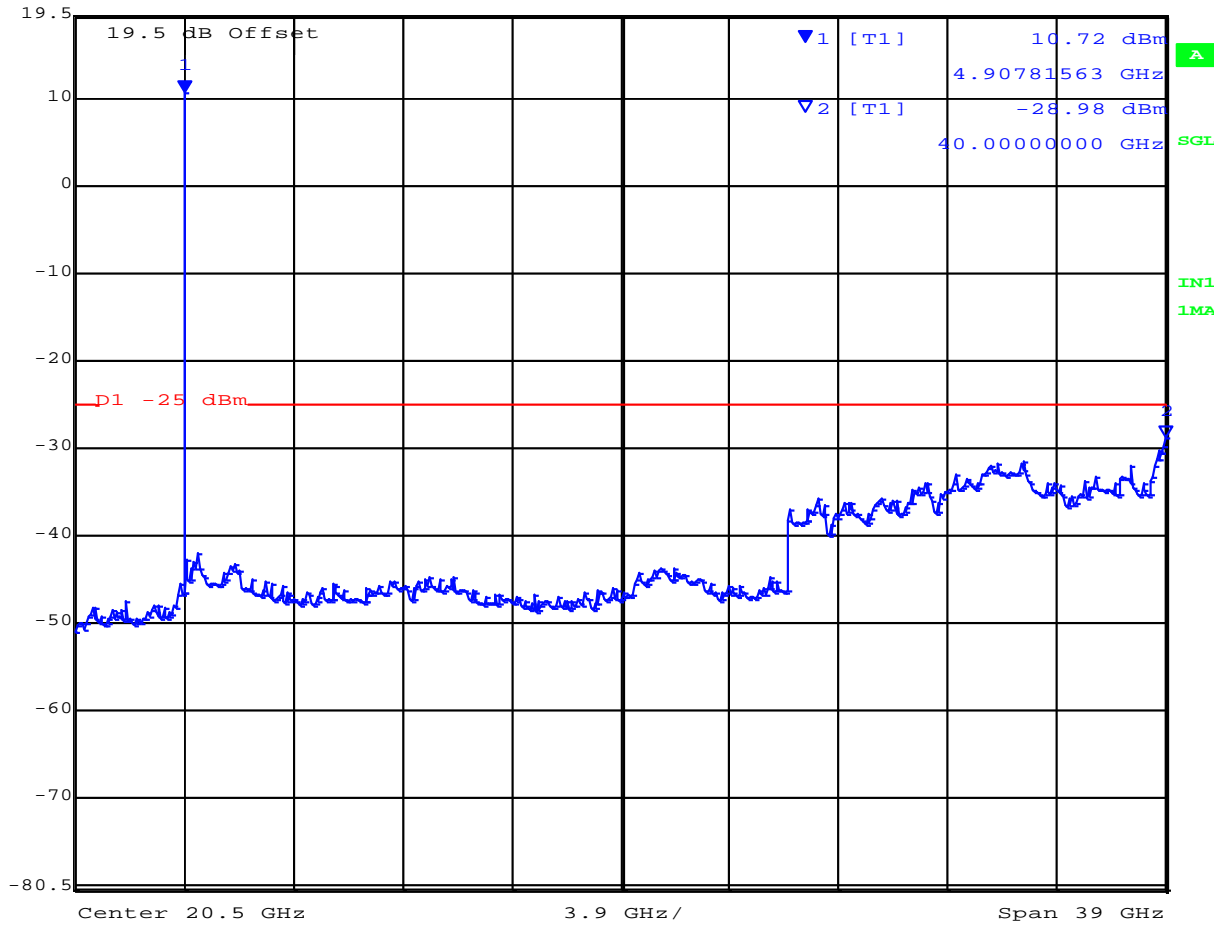

Date: 5.JUL.2016 11:30:21

This test report may be reproduced in full only. The document may only be updated by MiCOM Labs personnel. All changes will be noted in the Document History section of the report.



Port C
Conducted Emissions 20 MHz Channel Freq 4965 MHz

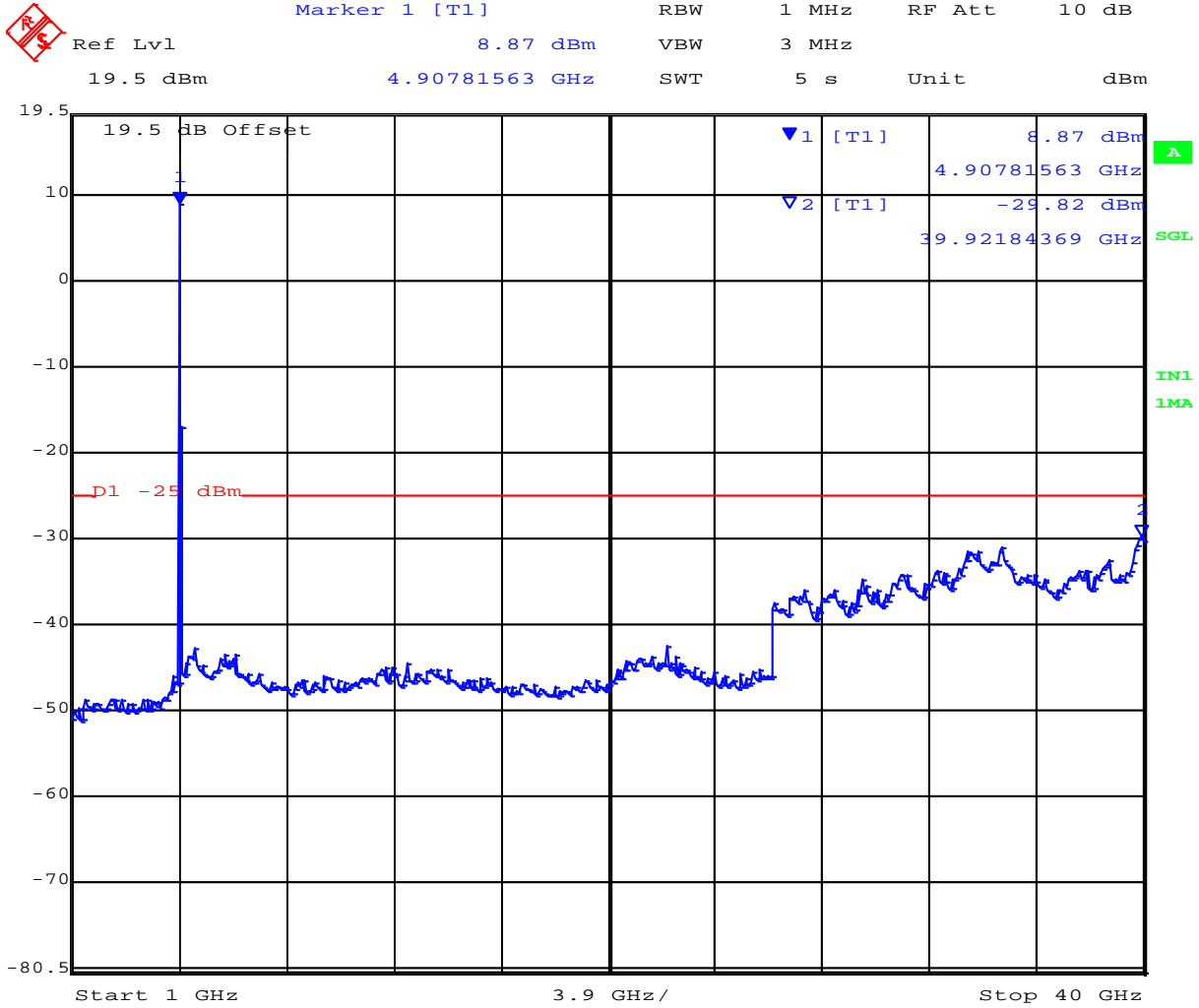

Date: 5.JUL.2016 11:37:50

This test report may be reproduced in full only. The document may only be updated by MiCOM Labs personnel. All changes will be noted in the Document History section of the report.



Port C
Conducted Emissions 20 MHz Channel Freq 4980 MHz

 Marker 1 [T1] RBW 1 MHz RF Att 10 dB
Ref Lvl 19.5 dBm 8.30 dBm VBW 3 MHz
19.5 dBm 4.98597194 GHz SWT 5 s Unit dBm

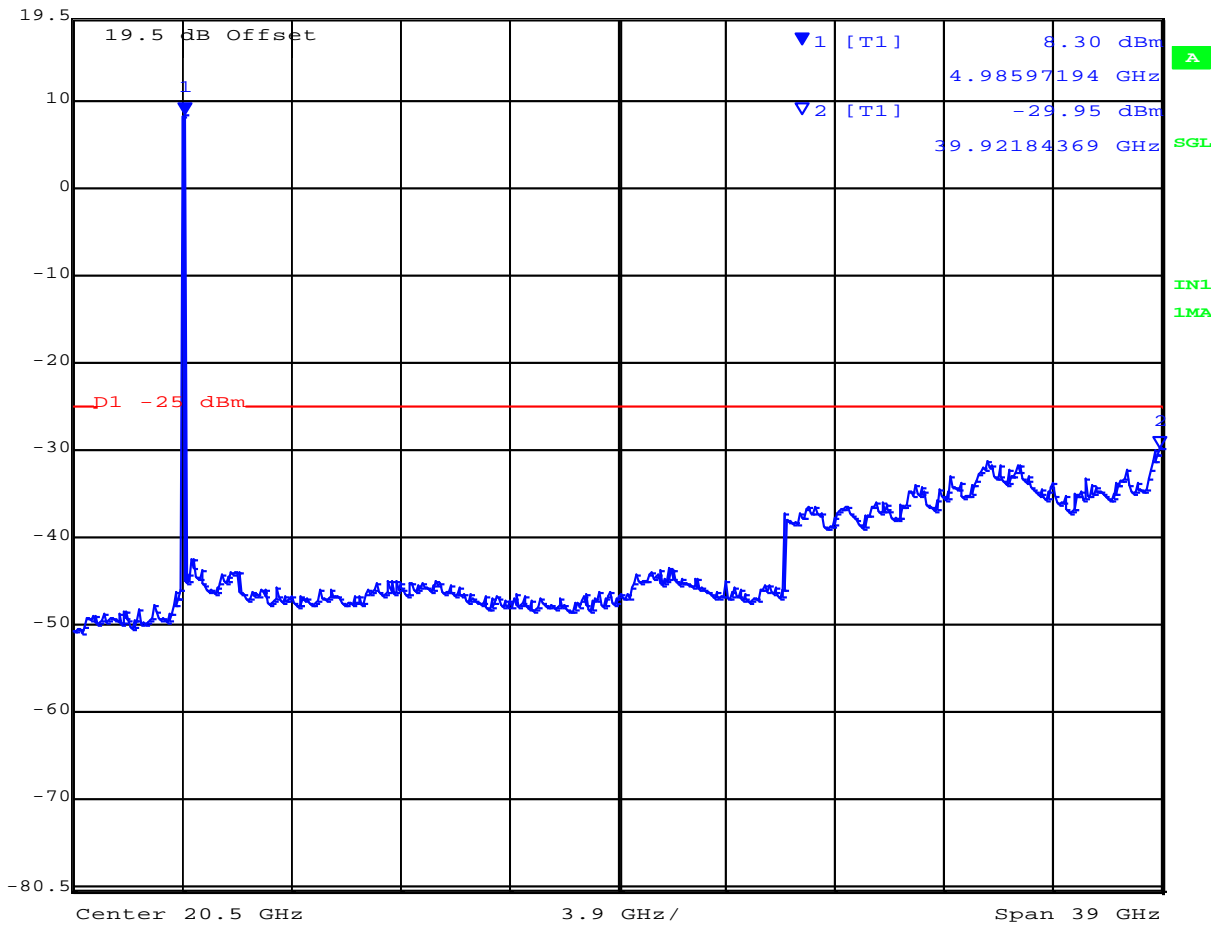

Date: 5.JUL.2016 11:58:37

This test report may be reproduced in full only. The document may only be updated by MiCOM Labs personnel. All changes will be noted in the Document History section of the report.



PORT D Limit: -25 dBm

Channel (MHz)	Frequency (MHz)			Emission Amplitude (dBm)	Margin (dB)
	Start (MHz)	Stop (MHz)	Freq of Maximum Emission (MHz)		
4945	30	40,000	39765.5	-30.28	-5.28
4965	30	40,000	40000.0	-29.41	-4.41
4980	30	40,000	39843.6	-29.94	-4.94

Port D
Conducted Emissions 20 MHz Channel Freq 4945 MHz

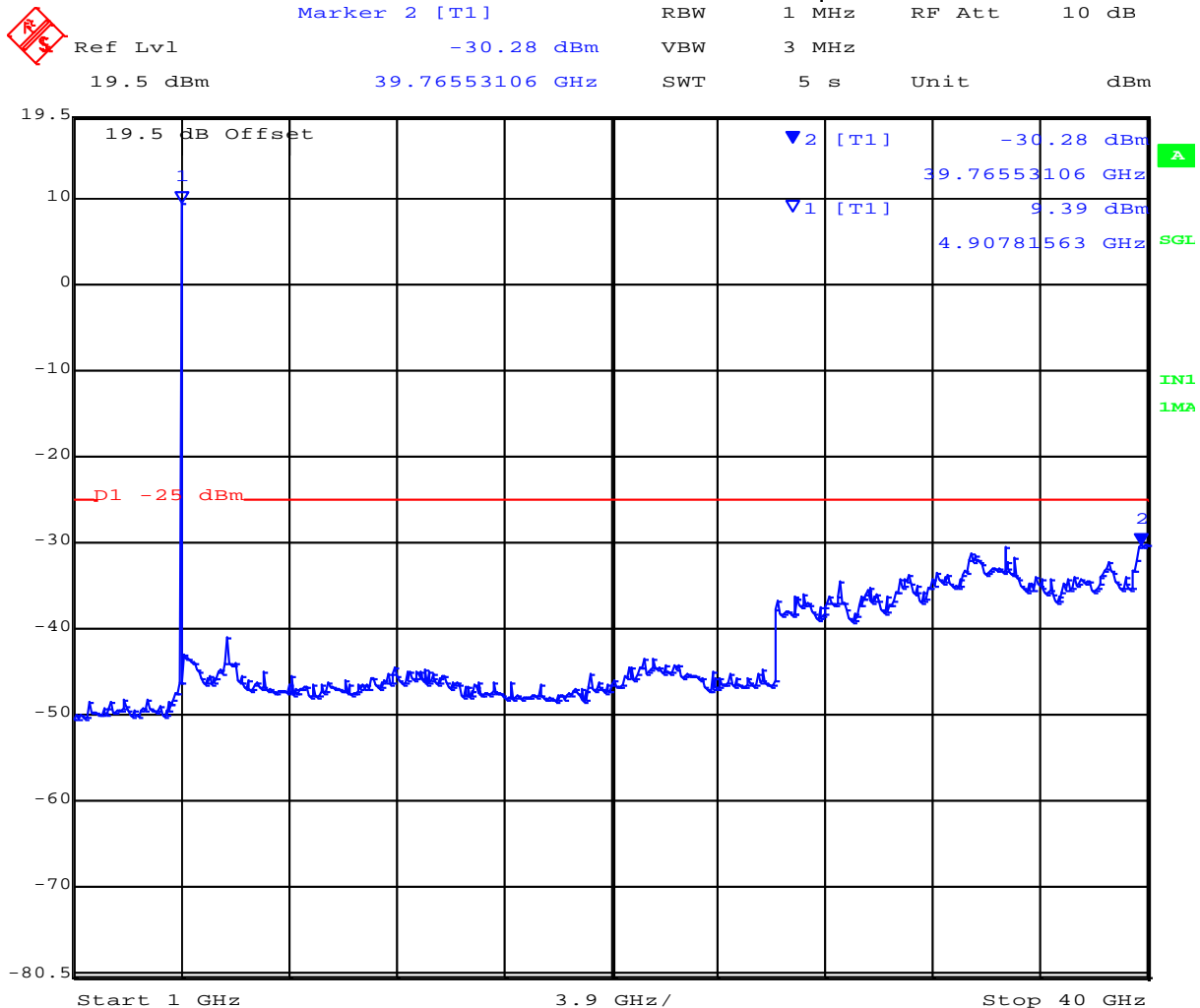

Date: 5.JUL.2016 11:28:36

This test report may be reproduced in full only. The document may only be updated by MiCOM Labs personnel. All changes will be noted in the Document History section of the report.



Port D
Conducted Emissions 20 MHz Channel Freq 4965 MHz

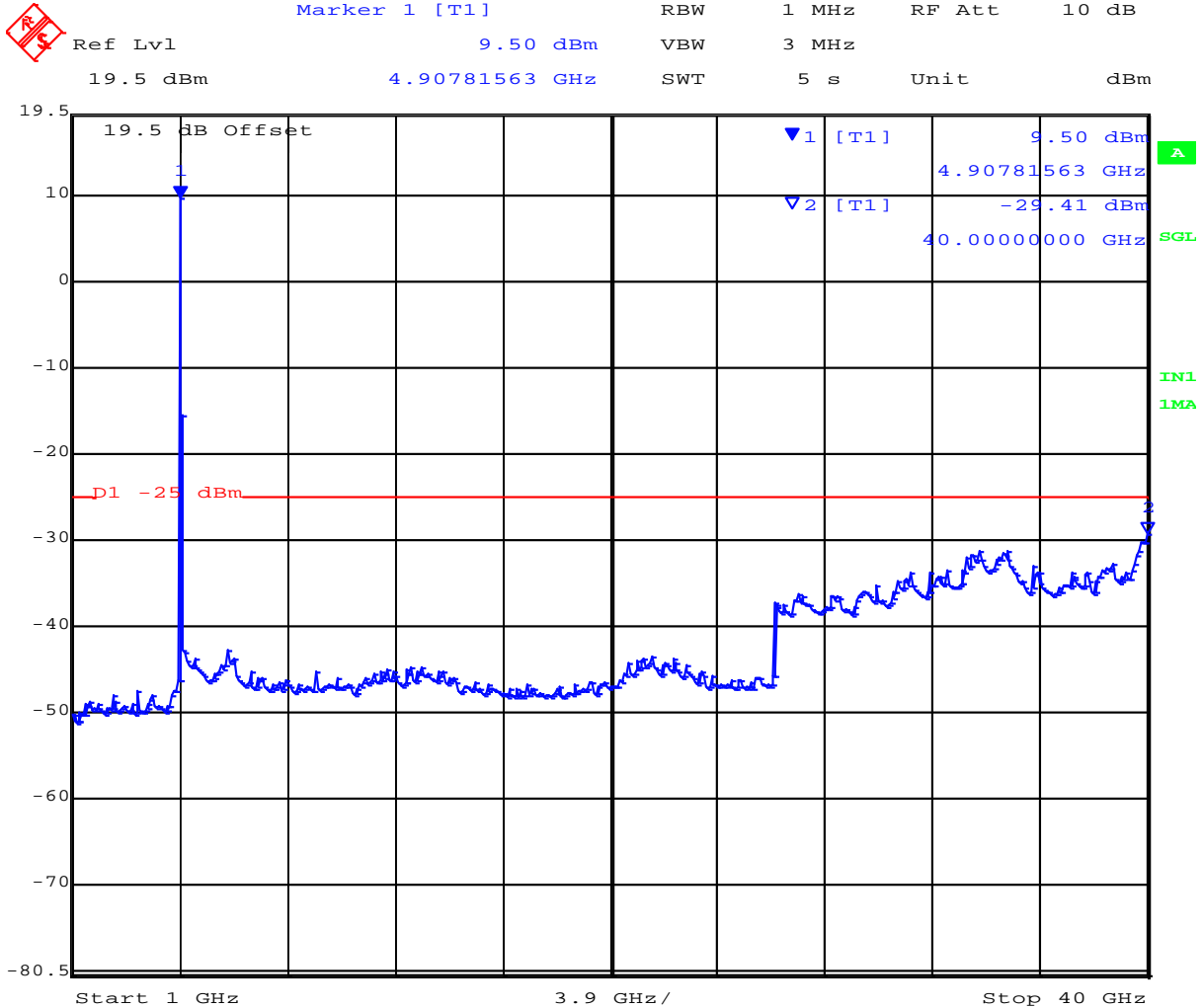

Date: 5.JUL.2016 11:38:31

This test report may be reproduced in full only. The document may only be updated by MiCOM Labs personnel. All changes will be noted in the Document History section of the report.



Port D
Conducted Emissions 20 MHz Channel Freq 4980 MHz

Marker 1 [T1] RBW 1 MHz RF Att 10 dB
Ref Lvl 9.33 dBm VBW 3 MHz
19.5 dBm 4.90781563 GHz SWT 5 s Unit dBm

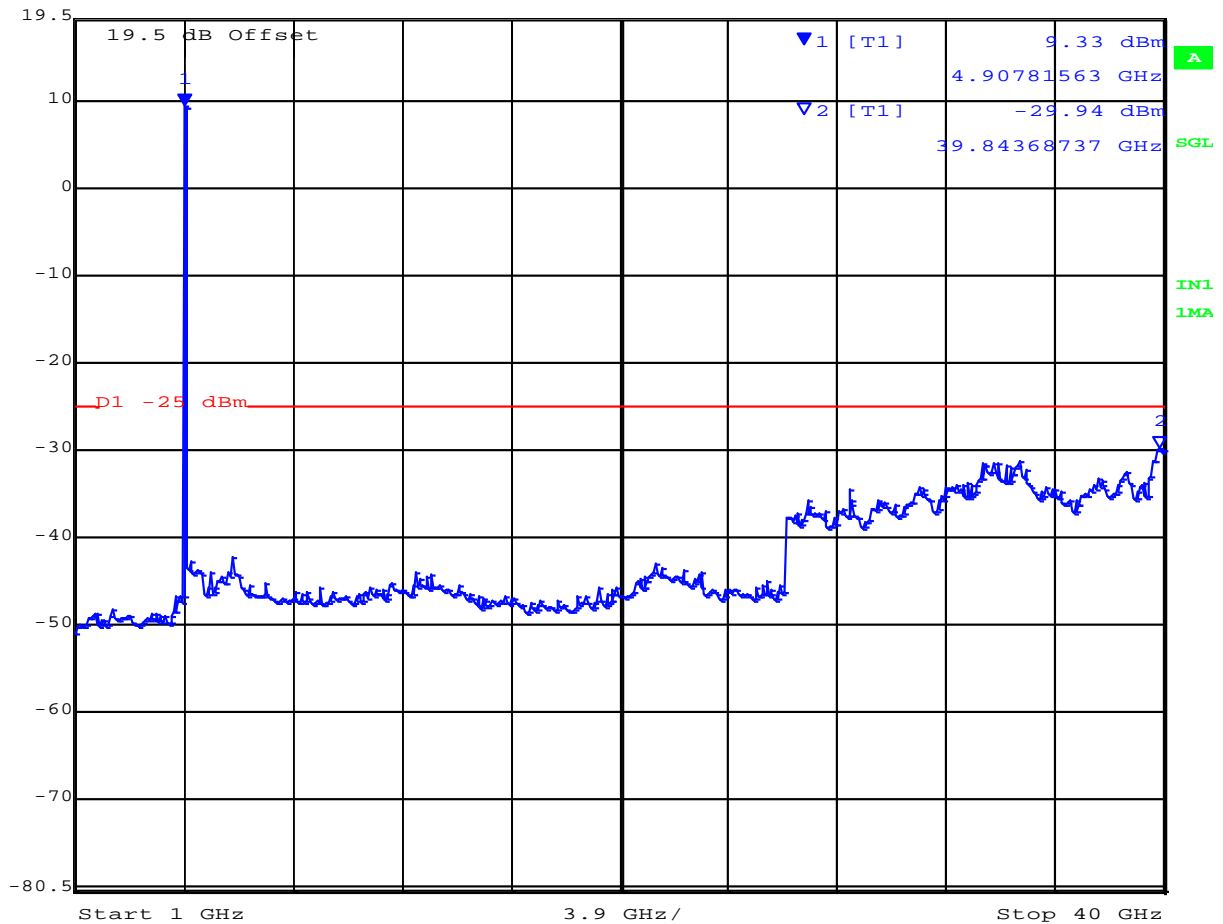

Date: 5.JUL.2016 11:43:26

This test report may be reproduced in full only. The document may only be updated by MiCOM Labs personnel. All changes will be noted in the Document History section of the report.



Title: Mimosa Networks A5c, A5-14, A5-18
To: FCC 47 CFR Part 90, Subpart Y; IC RSS-111
Serial #: MIMO09-U10 Rev A
Issue Date: 2nd August 2016
Page: 90 of 105

Specification Limits

Conducted Spurious Emission at Antenna Terminals – Transmitter Limits **FCC Part §90.210**

Emission Mask (m)

(6) On any frequency removed from the assigned frequency above 150% of the authorized bandwidth: 50 dB or $55 + 10 \cdot \log(P)$ dB, whichever is the lesser attenuation.
--

Laboratory Measurement Uncertainty for Conducted Spurious Emissions

Measurement uncertainty	± 2.37 dB
-------------------------	---------------

Traceability

Method

Measurements were made per work instruction WI-05 'Measurement of Spurious Emissions'
--

This test report may be reproduced in full only. The document may only be updated by MiCOM Labs personnel. All changes will be noted in the Document History section of the report.



6.1.7. Radiated Spurious Emissions

FCC 47 CFR Part 90, §90.210(m)

Test Procedure

Measurements were made while EUT was operating in a modulated transmit mode of operation, at the appropriate center frequency, 100% duty cycle and maximum power at all times. Radiated spurious emissions were measured to 40 GHz. Substitution was performed on any emissions observed. The antenna port was attenuated with 50 dB attenuation plus a 50 Ω terminator.

The measurement equipment was set to measure in peak hold mode. The emissions were measured in the anechoic chamber at a 3-meter distance on every azimuth in both horizontal and vertical polarities. The emissions are recorded and maximized as a function of azimuth by rotation through 360° with a spectrum analyzer in peak hold mode.

The highest emissions relative to the limit are listed for each frequency spanned.

Measurements below 1 GHz utilized 100 KHz RBW, measurements above 1 GHz were performed using a minimum RBW of 1 MHz.

From FCC Part 90.210 (m)

On any frequency removed from the assigned frequency between above 150 % of the authorized bandwidth: 50 dB or $55 + 10 \log (P)$ dB, whichever is the lesser attenuation.

Radiated emissions' testing was performed only in the configuration with the highest spectral density.

Attenuation

$55 + 10 \log (P)$ dB for 10 MHz bandwidth = 49.1 dB attenuation (P is in Watts)

Therefore maximum attenuation for any channel spacing is = 49.1 dB

10 MHz bandwidth limit: $+24.1 - 49.1 = -25$ dBm (82 dBuV)

Emission measurements were performed to the 10th harmonic of the transmitter. No emissions were found.



RADIATED SPURIOUS - RESTRICTED BAND EMISSIONS

Variant: 20 MHz, Test Freq: 4950.00 MHz, Antenna: Term Ports, Power Setting: 15, Duty Cycle (%): 99

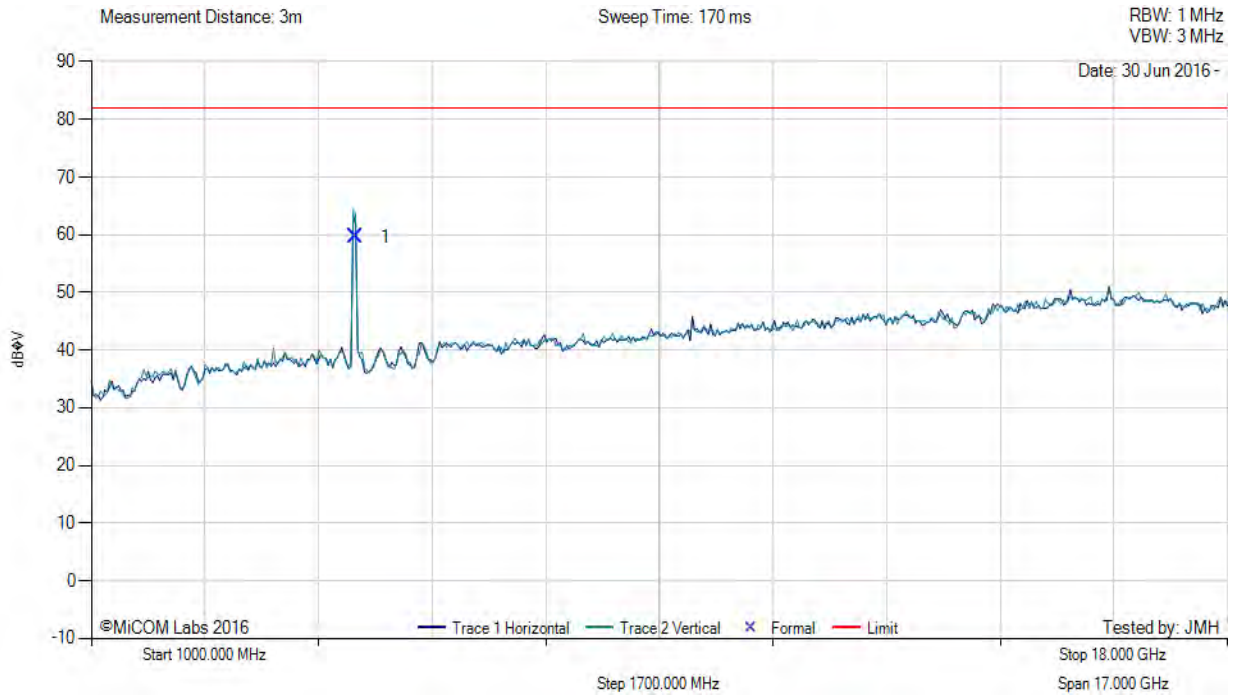

Num	Frequency MHz	Raw dBµV	Cable Loss	AF dB	Level dBµV/m	Measurement Type	Pol	Hgt cm	Azt Deg	Limit dBµV/m	Margin dB	Pass /Fail
1	4951.54	67.57	3.55	-11.47	59.65	Fundamental	Horizontal	200	1	--	--	

Test Notes: EUT A5c SN: 2118161852 on 150cm table, powered by Mimosa POE PS 502-00002. Ports Term with 50 ohms

The emission breaking the limit line is the transmitter fundamental.

dBm to dBuV Conversion: $dBuV = dBm + 107$.

This test report may be reproduced in full only. The document may only be updated by MiCOM Labs personnel. All changes will be noted in the Document History section of the report.



RADIATED SPURIOUS - RESTRICTED BAND EMISSIONS

Variant: 20 MHz, Test Freq: 4965.00 MHz, Antenna: Term Ports, Power Setting: 15, Duty Cycle (%): 99

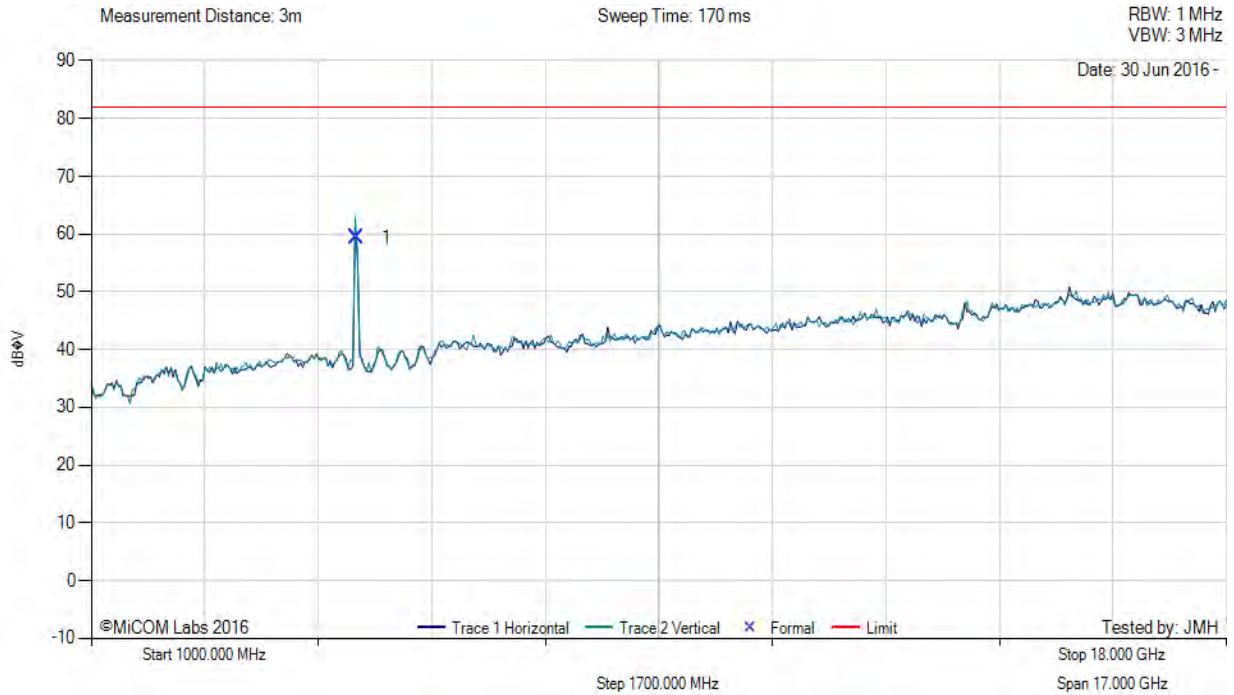

Num	Frequency MHz	Raw dBμV	Cable Loss	AF dB	Level dBμV/m	Measurement Type	Pol	Hgt cm	Azt Deg	Limit dBμV/m	Margin dB	Pass /Fail
1	4969.82	67.35	3.60	-11.51	59.44	Fundamental	Vertical	100	1	--	--	

Test Notes: EUT A5c SN: 2118161852 on 150cm table, powered by Mimosa POE PS 502-00002. Ports Term with 50 ohms

The emission breaking the limit line is the transmitter fundamental.

dBm to dBuV Conversion: $\text{dBuV} = \text{dBm} + 107$.

This test report may be reproduced in full only. The document may only be updated by MiCOM Labs personnel. All changes will be noted in the Document History section of the report.



RADIATED SPURIOUS - RESTRICTED BAND EMISSIONS

Variant: 20 MHz, Test Freq: 4980.00 MHz, Power Setting: 15, Duty Cycle (%): 99

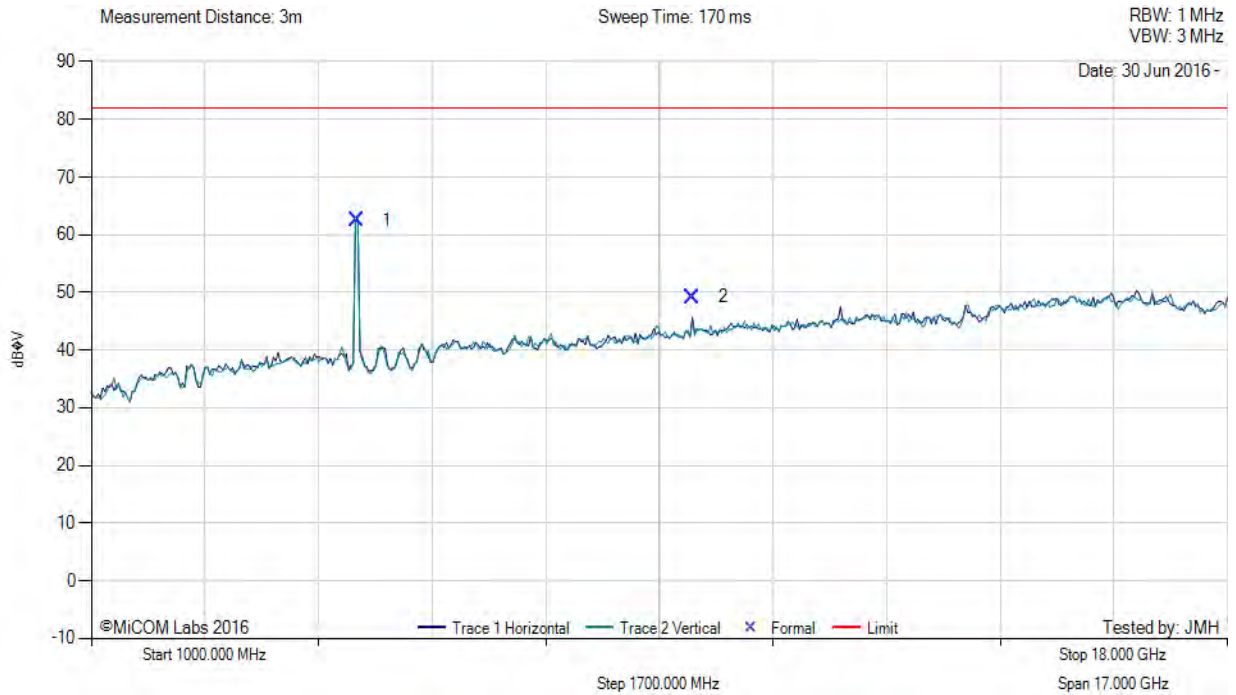

Num	Frequency MHz	Raw dBµV	Cable Loss	AF dB	Level dBµV/m	Measurement Type	Pol	Hgt cm	Azt Deg	Limit dBµV/m	Margin dB	Pass /Fail
1	4978.72	70.40	3.62	-11.52	62.50	Fundamental	Vertical	151	1	--	--	
2	9999.72	49.05	5.32	-5.17	49.20	Peak (NRB)	Horizontal	151	1	--	--	Pass

Test Notes: EUT A5c SN: 2118161852 on 150cm table, powered by Mimosa POE PS 502-00002. Ports Term with 50 ohms

The emission breaking the limit line is the transmitter fundamental.

dBm to dBuV Conversion: $dBuV = dBm + 107$.

This test report may be reproduced in full only. The document may only be updated by MiCOM Labs personnel. All changes will be noted in the Document History section of the report.



Title: Mimosa Networks A5c, A5-14, A5-18
To: FCC 47 CFR Part 90, Subpart Y; IC RSS-111
Serial #: MIMO09-U10 Rev A
Issue Date: 2nd August 2016
Page: 95 of 105

Radiated Spurious Emission Limits;

Transmitter Limits FCC Part §90.210 (m)

Emission Mask M

(6) On any frequency removed from the assigned frequency above 150% of the authorized bandwidth: 50 dB or $55 + 10 \log(P)$ dB, whichever is the lesser attenuation.
--

Laboratory Measurement Uncertainty for Radiated Emissions

Measurement uncertainty

+5.6/ -4.5 dB

Traceability

Method

Measurements were made per work instruction WI-03 'Measurement of Radiated Emissions'

This test report may be reproduced in full only. The document may only be updated by MiCOM Labs personnel. All changes will be noted in the Document History section of the report.



6.1.8. Digital Emissions (0.03 – 1 GHz)

FCC, Part 15 Subpart C §15.205/ §15.209

Test Procedure

Testing 30M-1 GHz was performed in a 3-meter anechoic chamber using a CISPR compliant receiver. Preliminary radiated emissions were measured on every azimuth and with the receiving antenna in both horizontal and vertical polarizations. To further maximize emissions the receive antenna was varied between 1 and 4 meters. The emissions are recorded with receiver in peak hold mode. Emissions closest to the limits are measured in the quasi-peak mode with the tuned receiver using a bandwidth of 120 kHz. Only the highest emissions relative to the limit are listed. The anechoic chamber test set-up is identified in Section 6 Test Set-Up Photographs.

Field Strength Calculation

The field strength is calculated by adding the Antenna Factor and Cable Loss, and subtracting Amplifier Gain from the measured reading. In this test facility, the Antenna Factor, Cable Loss, and Amplifier Gains are loaded into the Rohde & Schwarz Receiver and the corrected field strength can be read directly on the receiver.

$$FS = R + AF + CORR$$

where:

FS = Field Strength

R = Measured Receiver Input Amplitude

AF = Antenna Factor

CORR = Correction Factor = CL – AG + NFL

CL = Cable Loss

AG = Amplifier Gain

For example:

Given a Receiver input reading of 51.5dB μ V; Antenna Factor of 8.5dB; Cable Loss of 1.3dB; Falloff Factor of 0dB, an Amplifier Gain of 26dB and Notch Filter Loss of 1dB. The Field Strength of the measured emission is:

$$FS = 51.5 + 8.5 + 1.3 - 26.0 + 1 = 36.3\text{dB}\mu\text{V/m}$$

Conversion between dB μ V/m (or dB μ V) and μ V/m (or μ V) are done as:

$$\text{Level (dB}\mu\text{V/m)} = 20 * \text{Log (level (\mu\text{V/m}))}$$

$$40 \text{ dB}\mu\text{V/m} = 100\mu\text{V/m}$$



RADIATED SPURIOUS - RESTRICTED BAND EMISSIONS

Variant: 20 MHz, Test Freq: 4965.00 MHz, Antenna: 50 ohm Term, Power Setting: 15, Duty Cycle (%): 99

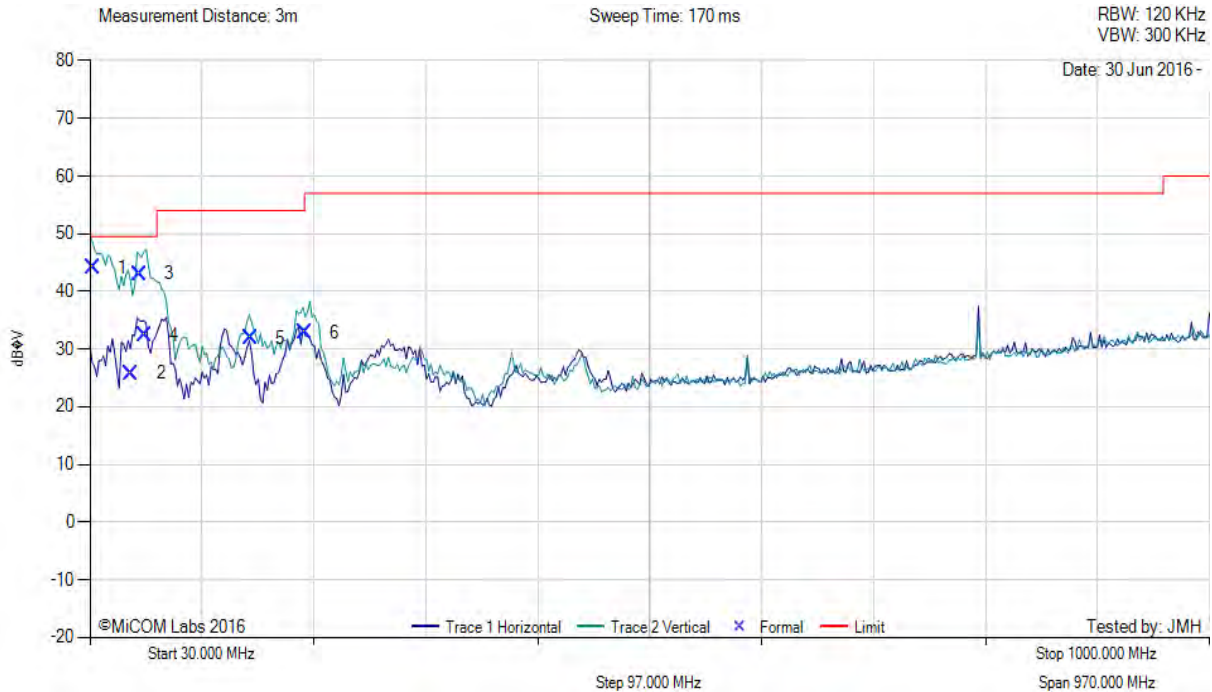

Num	Frequency MHz	Raw dBµV	Cable Loss	AF dB	Level dBµV/m	Measurement Type	Pol	Hgt cm	Azt Deg	Limit dBµV/m	Margin dB	Pass /Fail
1	32.57	52.70	3.44	-12.09	44.05	MaxQP	Vertical	101	331	49.5	-5.5	Pass
2	65.96	45.62	3.68	-23.51	25.79	MaxQP	Horizontal	308	18	49.5	-23.7	Pass
3	72.87	62.40	3.73	-23.08	43.05	MaxQP	Vertical	100	43	49.5	-6.5	Pass
4	77.15	51.88	3.76	-23.26	32.38	MaxQP	Horizontal	235	250	49.5	-17.1	Pass
5	169.17	46.96	4.21	-19.28	31.89	MaxQP	Vertical	102	316	54.0	-22.1	Pass
6	215.89	48.35	4.40	-19.92	32.83	MaxQP	Vertical	204	126	54.0	-21.2	Pass

Test Notes: EUT A5c SN: 2118161852 on 150cm table powered by Mimosa POE PS 502-00002. Ports Term with 50 ohms

This test report may be reproduced in full only. The document may only be updated by MiCOM Labs personnel. All changes will be noted in the Document History section of the report.

6.1.9. Receiver Radiated Spurious Emissions (above 1 GHz)

Industry Canada RSS-Gen §4.10, §6

Test Procedure

Radiated emissions above 1 GHz are measured in the anechoic chamber at a 3-meter distance on every azimuth in both horizontal and vertical polarities. The emissions are recorded and maximized as a function of azimuth by rotation through 360° with a spectrum analyzer in peak hold mode. Depending on the frequency band spanned a notch filter and waveguide filter was used to remove the fundamental frequency. The highest emissions relative to the limit are listed for each frequency spanned.

All measurements on any frequency or frequencies over 1 MHz are based on the use of measurement instrumentation employing an average detector function. All measurements above 1 GHz were performed using a minimum resolution bandwidth of 1 MHz.

All Sectors of the EUT were tested simultaneously

Test Measurement Set up

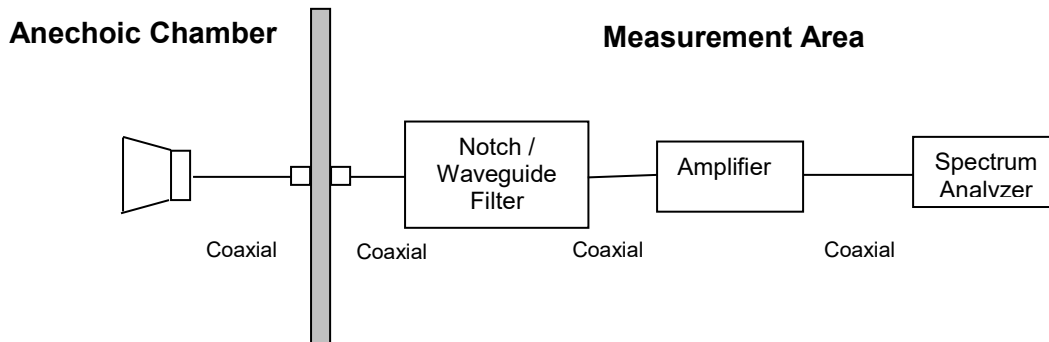

Measurement set up for Radiated Emission Test

Field Strength Calculation

The field strength is calculated by adding the Antenna Factor and Cable Loss, and subtracting Amplifier Gain from the measured reading. All factors are included in the reported data.

$$FS = R + AF + CORR - FO$$

where: FS = Field Strength
R = Measured Spectrum analyzer Input Amplitude
AF = Antenna Factor
CORR = Correction Factor = CL – AG + NFL
CL = Cable Loss
AG = Amplifier Gain
FO = Distance Falloff Factor
NFL = Notch Filter Loss or Waveguide Loss



Title: Mimosa Networks A5c, A5-14, A5-18
To: FCC 47 CFR Part 90, Subpart Y; IC RSS-111
Serial #: MIMO09-U10 Rev A
Issue Date: 2nd August 2016
Page: 99 of 105

For example:

Given receiver input reading of 51.5 dB μ V; Antenna Factor of 8.5 dB; Cable Loss of 1.3 dB; Falloff Factor of 0 dB, an Amplifier Gain of 26 dB and Notch Filter Loss of 1 dB. The Field Strength of the measured emission is:

$$FS = 51.5 + 8.5 + 1.3 - 26.0 + 1 = 36.3 \text{ dB}\mu\text{V/m}$$

Conversion between dB μ V/m (or dB μ V) and μ V/m (or μ V) are done as:

$$\text{Level (dB}\mu\text{V/m)} = 20 * \text{Log (level (\mu\text{V/m}))}$$

$$40 \text{ dB}\mu\text{V/m} = 100 \mu\text{V/m}$$

$$48 \text{ dB}\mu\text{V/m} = 250 \mu\text{V/m}$$

This test report may be reproduced in full only. The document may only be updated by MiCOM Labs personnel. All changes will be noted in the Document History section of the report.



Specification

Radiated Receiver Spurious Emissions

RSS-Gen §4.10 the search for spurious emissions shall be from the lowest frequency internally generated or used in the receiver (e.g.. local oscillator, intermediate or carrier frequency), or 30 MHz, whichever is higher, to at least 3 times the highest tunable or local oscillator frequency, whichever is higher, without exceeding 40 GHz.

For emissions below 1000 MHz, measurements shall be performed using a CISPR quasi-peak detector and the related measurement bandwidth. As an alternative to CISPR quasi-peak measurement, compliance with the emission limit can be demonstrated using measuring equipment employing a peak detector function properly adjusted for factors such as pulse desensitization as required, with an equal or greater measurement bandwidth relative to the applicable CISPR quasi-peak bandwidth.

Above 1000 MHz, measurements shall be performed using an average detector with a minimum resolution bandwidth of 1 MHz.

RSS-Gen §6 Receiver Spurious Radiated Limits

Spurious emissions from receivers shall not exceed the radiated limits shown in the table below:

RSS-Gen Spurious Emissions Limits

Frequency (MHz)	Field Strength ($\mu\text{V/m}$)	Field Strength ($\text{dB}\mu\text{V/m}$)	Measurement Distance (meters)
30-88	100	40.0	3
88-216	150	43.5	3
216-960	200	46.0	3
Above 960	500	54.0	3

Traceability:

Test Equipment Used

0088, 0158, 0134, 0304, 0311, 0315, 0310, 0312



Receiver Radiated Spurious Emissions above 1 GHz



RECEIVER SPURIOUS - RESTRICTED BAND EMISSIONS

Variation: 20 MHz, Test Freq: 4965.00 MHz, Power Setting: NA, Duty Cycle (%): 99

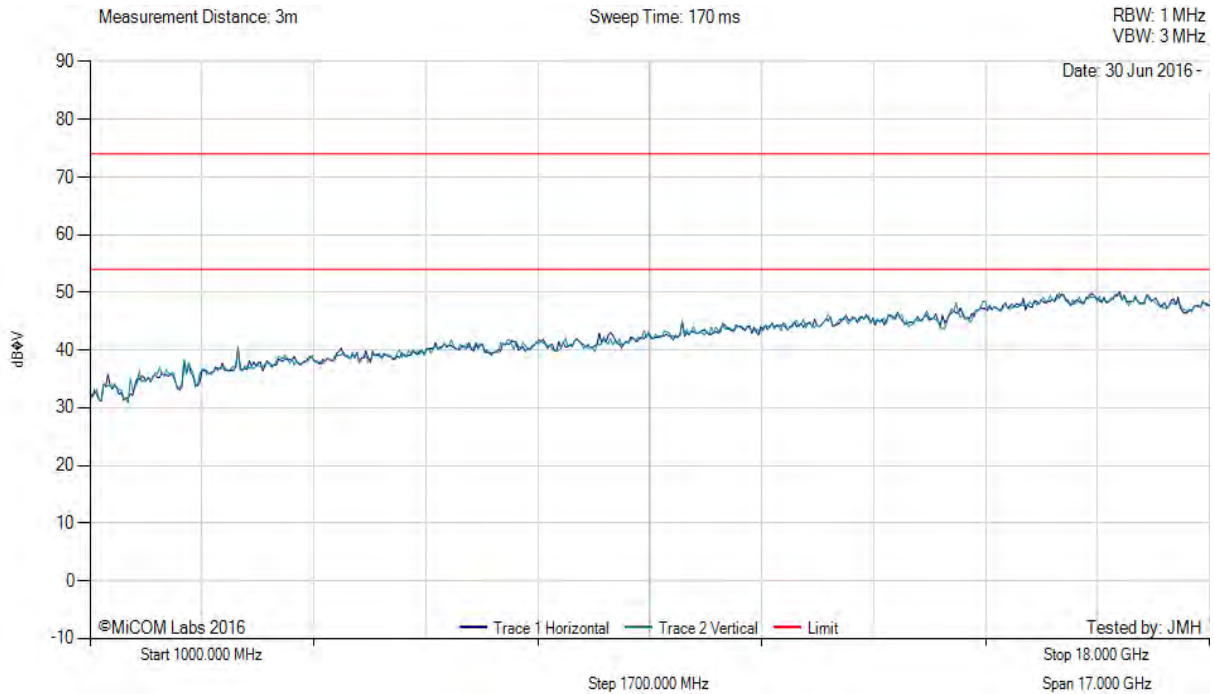

There are no emissions found within 6dB of the limit line.

Test Notes: EUT A5c SN: 2118161852 on 150cm table powered by Mimosa POE PS 502-00002. Ports Term with 50 ohms

This test report may be reproduced in full only. The document may only be updated by MiCOM Labs personnel. All changes will be noted in the Document History section of the report.



Title: Mimosa Networks A5c, A5-14, A5-18
To: FCC 47 CFR Part 90, Subpart Y; IC RSS-111
Serial #: MIMO09-U10 Rev A
Issue Date: 2nd August 2016
Page: 102 of 105

6.1.10. AC Wireline Emissions

FCC, Part 15 Subpart C §15.207

Test Procedure

The EUT is configured in accordance with ANSI C63.4. The conducted emissions are measured in a shielded room with a spectrum analyzer in peak hold in the first instance. Emissions closest to the limit are measured in the quasi-peak mode (QP) with the tuned receiver using a bandwidth of 9 kHz. The emissions are maximized further by cable manipulation. The highest emissions relative to the limit are listed.

This test report may be reproduced in full only. The document may only be updated by MiCOM Labs personnel. All changes will be noted in the Document History section of the report.



Measurement Results for ac Wireline Conducted Emissions (150 kHz – 30 MHz)

Model Number	A5c, S/N: SN114870292	Engineer	OC
Variant	AC Wireline 120VAC, 60Hz	Temp (°C)	20
Freq. Range	30 – 1000 MHz	Rel. Hum.(%)	41
Power Setting	NA	Press. (mBars)	1002
Antenna	N/A		
Test Notes 1	PoE powered: Manu.: Mimosa Networks, Model: P42900690A1		
Test Notes 2	Class A Limits		



Variant: AC Line

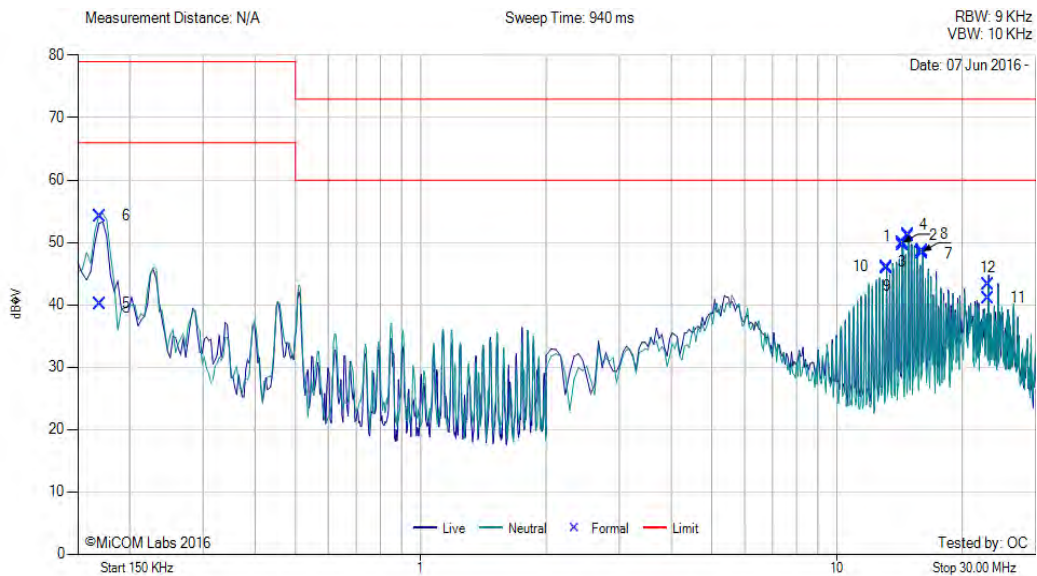

Num	Frequency MHz	Raw dBµV	Cable Loss	Factor dB	Total Correction dBµV	Corrected Value dBµV	Measurement Type	Line	Limit dBµV	Margin dB	Pass /Fail
1	14.856	39.94	0.51	10.50	11.01	50.95	Max Avg	Live	60.0	-9.1	Pass
2	14.856	40.22	0.51	10.50	11.01	51.23	Max Qp	Live	73.0	-21.8	Pass
3	14.369	38.65	0.49	10.48	10.97	49.62	Max Avg	Live	60.0	-10.4	Pass
4	14.369	39.00	0.49	10.48	10.97	49.97	Max Qp	Live	73.0	-23.0	Pass
5	0.170	30.20	0.05	9.92	9.97	40.17	Max Avg	Neutral	66.0	-25.8	Pass
6	0.170	44.23	0.05	9.92	9.97	54.20	Max Qp	Neutral	79.0	-24.8	Pass
7	16.074	37.13	0.55	10.54	11.09	48.22	Max Avg	Live	60.0	-11.8	Pass
8	16.074	37.48	0.55	10.54	11.09	48.57	Max Qp	Live	73.0	-24.4	Pass
9	13.153	34.88	0.47	10.42	10.89	45.77	Max Avg	Neutral	60.0	-14.2	Pass
10	13.153	35.17	0.47	10.42	10.89	46.06	Max Qp	Neutral	73.0	-26.9	Pass
11	23.130	29.59	0.64	10.85	11.49	41.08	Max Avg	Live	60.0	-18.9	Pass
12	23.130	31.75	0.64	10.85	11.49	43.24	Max Qp	Live	73.0	-29.8	Pass

Test Notes: 120V 60Hz. Model: A5c, S/N: SN114870292. PoE configuration, S/N: P42900690A1. EUT set to ping laptop continuously.

This test report may be reproduced in full only. The document may only be updated by MiCOM Labs personnel. All changes will be noted in the Document History section of the report.



Specification

Limits

§15.207 (a) Except as shown in paragraphs (b) and (c) of this section, for an intentional radiator that is designed to be connected to the public utility (AC) power line, the radio frequency voltage that is conducted back onto the AC power line on any frequency or frequencies within the band 150 kHz to 30 MHz shall not exceed the limits in the following table, as measured using a 50 $\mu\Omega$ line impedance stabilization network (LISN), see §15.207 (a) matrix below. Compliance with the provisions of this paragraph shall be based on the measurement of the radio frequency voltage between each power line and ground at the power terminal.

§15.207 (a) Limit Matrix

The lower limit applies at the boundary between frequency ranges

Frequency of Emission (MHz)	Conducted Limit (dB μ V)	
	Quasi-peak	Average
0.15-0.5	66 to 56*	56 to 46*
0.5-5	56	46
5-30	60	50

* Decreases with the logarithm of the frequency

Laboratory Measurement Uncertainty for Conducted Emissions

Measurement uncertainty	± 2.64 dB
-------------------------	---------------



575 Boulder Court
Pleasanton, California 94566, USA
Tel: 1.925.462.0304
Fax: 1.925.462.0306
www.micomlabs.com