

**FCC 47 CFR PART 15 SUBPART C &  
INDUSTRY CANADA RSS-247**

**TEST REPORT**

**For**

**2.4 GHz Wi-Fi PoE Gateway**

**Model: G2**

**Trade Name: MIMOSA NETWORKS**

*Issued to*

**Mimosa Networks, Inc.  
469 EL CAMINO REAL, SUITE 100, SANTA CLARA, CA 95050 USA**

*Issued by*

**Compliance Certification Services Inc.  
No.11, Wugong 6th Rd., Wugu Dist.,  
New Taipei City 24891, Taiwan. (R.O.C.)  
<http://www.ccsrf.com>  
[service@ccsrf.com](mailto:service@ccsrf.com)**

**Issued Date: January 19, 2016**



---

**Note:** This report shall not be reproduced except in full, without the written approval of Compliance Certification Services Inc. This document may be altered or revised by Compliance Certification Services Inc. personnel only, and shall be noted in the revision section of the document.

### Revision History

Rev.	Issue Date	Revisions	Effect Page	Revised By
00	January 19, 2016	Initial Issue	ALL	Doris Chu
01	April 20, 2016	Rev. (01)	ALL	Doris Chu

Rev. (01):

1. Modify IC UPN Number.

2. Modify setting to 1.5MHz on P.82.

3. Added FCC Rules Part 15.203 on Page 4, 5, 6.

4. Added product HW / SW version and radio HW / SW version on page 5.

5. Added test firmware and RF power setting on page 8.

## TABLE OF CONTENTS

<b>1. TEST RESULT CERTIFICATION .....</b>	<b>4</b>
<b>2. EUT DESCRIPTION.....</b>	<b>5</b>
<b>3. TEST METHODOLOGY.....</b>	<b>6</b>
3.1 EUT CONFIGURATION .....	6
3.2 EUT EXERCISE .....	6
3.3 GENERAL TEST PROCEDURES.....	6
3.4 FCC PART 15.205 RESTRICTED BANDS OF OPERATIONS .....	7
3.5 DESCRIPTION OF TEST MODES.....	8
<b>4. INSTRUMENT CALIBRATION .....</b>	<b>10</b>
4.1 MEASURING INSTRUMENT CALIBRATION .....	10
4.2 MEASUREMENT EQUIPMENT USED .....	10
4.3 MEASUREMENT UNCERTAINTY .....	11
<b>5. FACILITIES AND ACCREDITATIONS .....</b>	<b>12</b>
5.1 FACILITIES .....	12
5.2 EQUIPMENT .....	12
5.3 LABORATORY ACCREDITATIONS AND LISTING.....	12
5.4 TABLE OF ACCREDITATIONS AND LISTINGS.....	13
<b>6. SETUP OF EQUIPMENT UNDER TEST .....</b>	<b>14</b>
6.1 SETUP CONFIGURATION OF EUT .....	14
6.2 SUPPORT EQUIPMENT.....	14
<b>7. FCC PART 15.247 REQUIREMENTS &amp; RSS-247 REQUIREMENTS.....</b>	<b>15</b>
7.1 99% BANDWIDTH .....	15
7.2 6DB BANDWIDTH.....	34
7.3 PEAK POWER .....	53
7.4 AVERAGE POWER .....	55
7.5 BAND EDGES MEASUREMENT .....	57
7.6 PEAK POWER SPECTRAL DENSITY .....	83
7.7 RADIATED EMISSIONS .....	101
7.8 POWERLINE CONDUCTED EMISSIONS.....	143
<b>APPENDIX II PHOTOGRAPHS OF TEST SETUP .....</b>	<b>146</b>

## 1. TEST RESULT CERTIFICATION

**Applicant:** Mimosa Networks, Inc.  
469 EL CAMINO REAL, SUITE 100, SANTA CLARA, CA  
95050 USA

**Manufacturer:** Lite-On Network Communication (Dongguan) Limited  
30#Keji Rd., Yin Hu Industrial Area, Qingxi Town, DongGuan  
City, Guangdong, China

**Equipment Under Test:** 2.4 GHz Wi-Fi PoE Gateway

**Model Number:** G2

**Trade Name:** MIMOSA NETWORKS

**Date of Test:** January 8 ~ 13, 2016

APPLICABLE STANDARDS	
STANDARD	TEST RESULT
FCC 47 CFR Part 15 Subpart C Industry Canada RSS-247 Issue 1	No non-compliance noted

### We hereby certify that:

The above equipment was tested by Compliance Certification Services Inc. The test data, data evaluation, test procedures, and equipment configurations shown in this report were made in accordance with the procedures given in ANSI C63.10: 2013 for IC, ANSI C63.10: 2009 for FCC and the energy emitted by the sample EUT tested as described in this report is in compliance with the requirements of FCC Rules Part 15.203, 15.207, 15.209, 15.247 and Industry Canada RSS-247.

The test results of this report relate only to the tested sample EUT identified in this report.

Approved by:

Reviewed by:





---

Miller Lee  
Manager  
Compliance Certification Services Inc.

---

Angel Cheng  
Section Manager  
Compliance Certification Services Inc.

## 2. EUT DESCRIPTION

<b>Product</b>	2.4 GHz Wi-Fi PoE Gateway			
<b>Model Number</b>	G2			
<b>Trade Name</b>	MIMOSA NETWORKS			
<b>Model Discrepancy</b>	N/A			
<b>Received Date</b>	January 5, 2016			
<b>Power supply</b>	Power from adapter I/P: 100-240Vac, 0.6A, 50-60Hz O/P: 48Vdc, 210mA			
<b>Frequency Range</b>	2412 ~ 2462 MHz			
<b>Transmit Power</b>	<b>Mode</b>	<b>Frequency Range</b>	<b>Output Power (dBm)</b>	<b>Output Power (W)</b>
	IEEE 802.11b	2412 - 2462	26.69	0.4667
	IEEE 802.11g	2412 - 2462	27.12	0.5152
	IEEE 802.11n HT 20 MHz	2412 - 2462	27.09	0.5117
	IEEE 802.11n HT 40 MHz	2422 - 2452	25.78	0.3784
<b>Modulation Technique</b>	IEEE 802.11b mode: DSSS (1, 2, 5.5 and 11 Mbps) IEEE 802.11g mode: OFDM (6, 9, 12, 18, 24, 36, 48 and 54 Mbps) IEEE 802.11n HT 20 MHz mode: OFDM (6.5, 7.2, 13, 14.4, 14.44, 19.5, 21.7, 26, 28.89, 28.9, 39, 43.3, 43.33 52, 57.78, 57.8, 58.5, 65.0, 72.2, 78, 86.67, 104, 115.56, 117, 130, 144.44 Mbps) IEEE 802.11n HT 40 MHz mode: OFDM (13.5, 15, 27, 30, 40.5, 45, 54, 60, 81, 90, 108, 120, 121.5, 135, 150, 162, 180, 216, 240, 243, 270, 300 Mbps)			
<b>Number of Channels</b>	IEEE 802.11b/g mode: 11 Channels IEEE 802.11n HT 20 MHz mode: 11 Channels IEEE 802.11n HT 40 MHz mode: 7 Channels			
<b>Antenna Specification</b>	LITE-ON / WR300-Mi Peak / PCB Antenna Antenna 1: 2.0 dBi Antenna 2: 2.4 dBi			
<b>Product SW version</b>	v0.1.1			
<b>Product HW version</b>	A			
<b>Radio SW version</b>	v0.1.1			
<b>Radio HW version</b>	V1.0			

**Remark:**

1. The sample selected for test was engineering sample that approximated to production product and was provided by manufacturer.
2. This submittal(s) (test report) is intended for FCC ID: **2ABZJ-100-00033** & IC: **11823A-10000033** filing to comply with FCC Part 15C, Section 15.203, 15.207, 15.209 and IC RSS-247 & RSS-GEN.

### **3. TEST METHODOLOGY**

The tests documented in this report were performed in accordance with ANSI C63.10: 2009 and FCC CFR 47 Part 15.203, 15.207, 15.209, 15.247, KDB558074.

The tests documented in this report were performed in accordance with IC RSS-247, IC RSS-Gen and ANSI C63.10:2013.

This submittal(s) (test report) is intended for IC Certification with Industry Canada RSS-247.

#### **3.1 EUT CONFIGURATION**

The EUT configuration for testing is installed on RF field strength measurement to meet the Commissions requirement and operating in a manner that intends to maximize its emission characteristics in a continuous normal application.

#### **3.2 EUT EXERCISE**

The EUT was operated in the engineering mode to fix the TX frequency that was for the purpose of the measurements.

According to its specifications, the EUT must comply with the requirements of the Section 15.207, 15.209 and 15.247 under the FCC Rules Part 15 Subpart C.

The tests documented in this report were performed in accordance with IC RSS-247, IC RSS-Gen, IC RSS-102, and ANSI C63.10: 2013.

#### **3.3 GENERAL TEST PROCEDURES**

##### **Conducted Emissions**

According to the requirements in ANSI C63.10: 2013 for IC, ANSI C63.10: 2009 for FCC Conducted emissions from the EUT measured in the frequency range between 0.15 MHz and 30MHz using CISPR Quasi-peak and average detector modes.

##### **Radiated Emissions**

The EUT is placed on a turn table, which is 1.5 m above ground plane. The turntable shall rotate 360 degrees to determine the position of maximum emission level. EUT is set 3m away from the receiving antenna, which varied from 1m to 4m to find out the highest emission. And also, each emission was to be maximized by changing the polarization of receiving antenna both horizontal and vertical. In order to find out the maximum emissions, exploratory radiated emission measurements were made according to the requirements in ANSI C63.10: 2013 for IC, ANSI C63.10: 2009 for FCC.

### 3.4 FCC PART 15.205 RESTRICTED BANDS OF OPERATIONS

(a) Except as shown in paragraph (d) of this section, only spurious emissions are permitted in any of the frequency bands listed below:

MHz	MHz	MHz	GHz
0.090 - 0.110	16.42 - 16.423	399.9 - 410	4.5 - 5.15
<sup>1</sup> 0.495 - 0.505	16.69475 - 16.69525	608 - 614	5.35 - 5.46
2.1735 - 2.1905	16.80425 - 16.80475	960 - 1240	7.25 - 7.75
4.125 - 4.128	25.5 - 25.67	1300 - 1427	8.025 - 8.5
4.17725 - 4.17775	37.5 - 38.25	1435 - 1626.5	9.0 - 9.2
4.20725 - 4.20775	73 - 74.6	1645.5 - 1646.5	9.3 - 9.5
6.215 - 6.218	74.8 - 75.2	1660 - 1710	10.6 - 12.7
6.26775 - 6.26825	108 - 121.94	1718.8 - 1722.2	13.25 - 13.4
6.31175 - 6.31225	123 - 138	2200 - 2300	14.47 - 14.5
8.291 - 8.294	149.9 - 150.05	2310 - 2390	15.35 - 16.2
8.362 - 8.366	156.52475 -	2483.5 - 2500	17.7 - 21.4
8.37625 - 8.38675	156.52525	2655 - 2900	22.01 - 23.12
8.41425 - 8.41475	156.7 - 156.9	3260 - 3267	23.6 - 24.0
12.29 - 12.293	162.0125 - 167.17	3332 - 3339	31.2 - 31.8
12.51975 - 12.52025	167.72 - 173.2	3345.8 - 3358	36.43 - 36.5
12.57675 - 12.57725	240 - 285	3600 - 4400	( <sup>2</sup> )
13.36 - 13.41	322 - 335.4		

<sup>1</sup> Until February 1, 1999, this restricted band shall be 0.490-0.510 MHz.

<sup>2</sup> Above 38.6

(b) Except as provided in paragraphs (d) and (e), the field strength of emissions appearing within these frequency bands shall not exceed the limits shown in Section 15.209. At frequencies equal to or less than 1000 MHz, compliance with the limits in Section 15.209 shall be demonstrated using measurement instrumentation employing a CISPR quasi-peak detector. Above 1000 MHz, compliance with the emission limits in Section 15.209 shall be demonstrated based on the average value of the measured emissions. The provisions in Section 15.35 apply to these measurements.

### 3.5 DESCRIPTION OF TEST MODES

The EUT (model: G2) had been tested under operating condition.

The EUT is a 2x2 configuration spatial MIMO (2Tx & 2Rx) without beam forming function that operate in double TX chains and double RX chains. The 2x2 configuration is implemented with two outside TX & RX chains (Chain 0 and 1).

Software used to control the EUT for staying in continuous transmitting and receiving mode was programmed.

After verification, all tests carried out are with the worst-case test modes as shown below except radiated spurious emission below 1GHz and power line conducted emissions below 30MHz, which worst case was in normal link mode and receiving radiated spurious emission above 1GHz, which worst case was in CH Mid mode only.

**IEEE 802.11b mode:**

Channel Low (2412MHz), Channel Mid (2437MHz) and Channel High (2462MHz) with 1Mbps data rate were chosen for full testing.

**IEEE 802.11g mode:**

Channel Low (2412MHz), Channel Mid (2437MHz) and Channel High (2462MHz) with 6Mbps data rate were chosen for full testing.

**IEEE 802.11n HT 20 MHz mode:**

Channel Low (2412MHz), Channel Mid (2437MHz) and Channel High (2462MHz) with 6.5Mbps data rate were chosen for full testing.

**IEEE 802.11n HT 40 MHz mode:**

Channel Low (2422MHz), Channel Mid (2437MHz) and Channel High (2452MHz) with 13.5Mbps data rate were chosen for full testing.

The field strength of spurious emission was measured in the following position: EUT stand-up position (Z axis), lie-down position (X, Y axis). The worst emission was found in lie-down position (Y axis) and the worst case was recorded.

### 3.6 THE WORST CASE POWER SETTING PARAMETER

Test Software Version	Doc Command						
Modulation Mode	N <sub>TX</sub>	Test Frequency (MHz)					
		BW: 20MHz			BW: 40MHz		
		2412	2437	2462	2422	2437	2452
11b	2	9	20	7	-	-	-
11g	2	-4	15	-7	-	-	-
HT20	錯誤!找不到參照來	-6	13	-7	-	-	-



	源。						
HT40	錯誤! 找不到參照來源。	-	-	-	-12	-2	-13

## 4. INSTRUMENT CALIBRATION

### 4.1 MEASURING INSTRUMENT CALIBRATION

The measuring equipment, which was utilized in performing the tests documented herein, has been calibrated in accordance with the manufacturer's recommendations for utilizing calibration equipment, which is traceable to recognized national standards.

### 4.2 MEASUREMENT EQUIPMENT USED

#### Equipment Used for Emissions Measurement

*Remark: Each piece of equipment is scheduled for calibration once a year and Loop Antenna is scheduled for calibration once three years.*

Conducted Emissions Test Site				
Name of Equipment	Manufacturer	Model	Serial Number	Calibration Due
Spectrum Analyzer	Agilent	E4446A	US42510252	12/07/2016
Thermostatic/Humidity Chamber	TAICHY	MHG-150LF	930619	10/07/2016
AC Power Source	EXTECH	6205	1140845	N.C.R
DC Power Supply	ABM	8301HD	D011531	N.C.R
Power Meter	Anritsu	ML2495A	1012009	07/07/2016
Power Sensor	Anritsu	MA2411A	0917072	07/07/2016
Spectrum Analyzer	ROHDE&SCHWARZ	FSV40	101073	07/19/2016

Wugu 966 Chamber A				
Name of Equipment	Manufacturer	Model	Serial Number	Calibration Due
Spectrum Analyzer	Agilent	E4446A	US42510268	01/25/2016
EMI Test Receiver	R&S	ESCI	100064	06/03/2016
Bilog Antenna	Sunol Sciences	JB3	A030105	08/05/2016
Horn Antenna	EMCO	3117	00055165	01/26/2016
Horn Antenna	EMCO	3116	26370	12/24/2016
Turn Table	CCS	CC-T-1F	N/A	N.C.R
Antenna Tower	CCS	CC-A-1F	N/A	N.C.R
Controller	CCS	CC-C-1F	N/A	N.C.R
Pre-Amplifier	MITEQ	1652-3000	1490939	08/09/2016
Pre-Amplifier	EMC	EMC 012635	980151	06/04/2016
Pre-Amplifier	MITEQ	AMF-6F-260400-40-8P	985646	12/24/2016
Coaxial Cable	Huber+Suhner	102	29212/2	12/24/2016
Coaxial Cable	Huber+Suhner	102	29406/2	12/24/2016
Test S/W	EZ-EMC (CCS-3A1RE)			

Conducted Emission room # B				
Name of Equipment	Manufacturer	Model	Serial Number	Calibration Due
EMI Test Receiver	R&S	ESCI	101073	09/08/2016
LISN	R&S	ENV216	101054	06/06/2016
LISN	SCHWARZBECK	NSLK 8127	8127-541	11/22/2016
Capacitive Voltage Probe	FCC	F-CVP-1	100185	03/12/2016
Test S/W	CCS-3A1-CE			

### 4.3 MEASUREMENT UNCERTAINTY

PARAMETER	UNCERTAINTY
Powerline Conducted Emission	+/- 1.2575
3M Semi Anechoic Chamber / 30M~200M	+/- 4.0138
3M Semi Anechoic Chamber / 200M~1000M	+/- 3.9483
3M Semi Anechoic Chamber / 1G~8G	+/- 2.5975
3M Semi Anechoic Chamber / 8G~18G	+/- 2.6112
3M Semi Anechoic Chamber / 18G~26G	+/- 2.7389
3M Semi Anechoic Chamber / 26G~40G	+/- 2.9683

**Remark:** This uncertainty represents an expanded uncertainty expressed at approximately the 95% confidence level using a coverage factor of  $k=2$ .

## 5. FACILITIES AND ACCREDITATIONS

### 5.1 FACILITIES

All measurement facilities used to collect the measurement data are located at

- No.199, Chungsen Road, Hsintien City, Taipei Hsien, Taiwan, R.O.C.  
Tel: 886-2-2217-0894 / Fax: 886-2-2217-1029
- No.11, Wugong 6th Rd., Wugu Dist., New Taipei City 24891, Taiwan. (R.O.C.)  
Tel: 886-2-2299-9720 / Fax: 886-2-2298-4045
- No.81-1, Lane 210, Bade 2nd Rd., Lujhu Township, Taoyuan County 33841, TAIWAN, R.O.C.  
Tel: 886-3-324-0332 / Fax: 886-3-324-5235

The sites are constructed in conformance with the requirements of ANSI C63.7, ANSI C63.10: 2013 for IC, ANSI C63.10: 2009 for FCC and CISPR Publication 22.

### 5.2 EQUIPMENT

Radiated emissions are measured with one or more of the following types of linearly polarized antennas: tuned dipole, biconical, log periodic, bi-log, ridged waveguide, horn and/or Loop. Spectrum analyzers with pre-selectors and quasi-peak detectors are used to perform radiated measurements.

Conducted emissions are measured with Line Impedance Stabilization Networks and EMI Test Receivers.



Calibrated wideband preamplifiers, coaxial cables, and coaxial attenuators are also used for making measurements.

All receiving equipment conforms to CISPR Publication 16-1, "Radio Interference Measuring Apparatus and Measurement Methods."

### 5.3 LABORATORY ACCREDITATIONS AND LISTING

The test facilities used to perform radiated and conducted emissions tests are accredited by American Association for Laboratory Accreditation Program for the specific scope accreditation under Lab Code: 0824-01 to perform Electromagnetic Interference tests according to FCC Part 15 and CISPR 22 requirements. In addition, the test facilities are listed with Industry Canada, Certification and Engineering Bureau, IC 2324G-1 for 3M Semi Anechoic Chamber A, 2324G-2 for 3M Semi Anechoic Chamber B.

### 5.4 TABLE OF ACCREDITATIONS AND LISTINGS

Country	Agency	Scope of Accreditation	Logo
USA	FCC	3M Semi Anechoic Chamber (FCC MRA: TW1039) to perform FCC Part 15 measurements	 FCC MRA: TW1039
Taiwan	TAF	LP0002, RTTE01, FCC Method-47 CFR Part 15 Subpart C, D, E, RSS-210, RSS-310 IDA TS SRD, AS/NZS 4268, AS/NZS 4771, TS 12.1 & 12.2, ETSI EN 300 440-1, ETSI EN 300 440-2, ETSI EN 300 328, ETSI EN 300 220-1, ETSI EN 300 220-2, ETSI EN 301 893, ETSI EN 301 489-1/3/7/17 FCC OET Bulletin 65 + Supplement C, EN 50360, EN 50361, EN 50371, RSS 102, EN 50383, EN 50385, EN 50392, IEC 62209, CNS 14958-1, CNS 14959 FCC Method -47 CFR Part 15 Subpart B IEC / EN 61000-3-2, IEC / EN 61000-3-3, IEC / EN 61000-4-2/3/4/5/6/8/11	
Canada	Industry Canada	3M Semi Anechoic Chamber (IC 2324G-1 / IC 2324G-2) to perform	 IC 2324G-1 IC 2324G-2

\* No part of this report may be used to claim or imply product endorsement by A2LA or any agency of the US Government.

## 6. SETUP OF EQUIPMENT UNDER TEST

### 6.1 SETUP CONFIGURATION OF EUT

See test photographs attached in Appendix II for the actual connections between EUT and support equipment.

### 6.2 SUPPORT EQUIPMENT

No	Equipment	Brand	Model	Series No.	FCC ID	Data Cable	Power Cord
	N/A						

**Remark:**

- 1. All the equipment/cables were placed in the worst-case configuration to maximize the emission during the test.*
- 2. Grounding was established in accordance with the manufacturer's requirements and conditions for the intended use.*

## 7. FCC PART 15.247 REQUIREMENTS & RSS-247 REQUIREMENTS

### 7.1 99% BANDWIDTH

#### Test Configuration

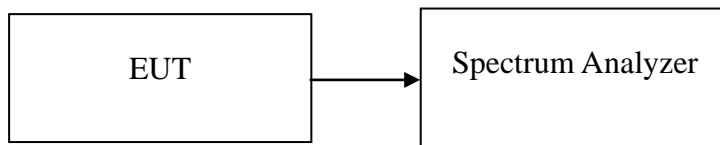

#### TEST PROCEDURE

The resolution bandwidth shall be set to as close to 1% of the selected span as is possible without being below 1%. The video bandwidth shall be set to 3 times the resolution bandwidth. Video averaging is not permitted. Where practical, a sampling detector shall be used since a peak or, peak hold.

**Test Data**

**IEEE 802.11b mode / Chain 0**

Channel	Frequency (MHz)	99% Bandwidth (MHz)
Low	2412	13.0288
Mid	2437	17.3076
High	2462	12.8365

**IEEE 802.11b mode / Chain 1**

Channel	Frequency (MHz)	99% Bandwidth (MHz)
Low	2412	13.4615
Mid	2437	16.1057
High	2462	13.0769

**IEEE 802.11g mode / Chain 0**

Channel	Frequency (MHz)	99% Bandwidth (MHz)
Low	2412	17.1153
Mid	2437	23.4615
High	2462	17.1634

**IEEE 802.11g mode / Chain 1**

Channel	Frequency (MHz)	99% Bandwidth (MHz)
Low	2412	17.0673
Mid	2437	24.4711
High	2462	17.2115

**IEEE 802.11n HT 20 MHz mode / Chain 0**

Channel	Frequency (MHz)	99% Bandwidth (MHz)
Low	2412	17.7884
Mid	2437	24.3750
High	2462	17.7884

**IEEE 802.11n HT 20 MHz mode / Chain 1**

Channel	Frequency (MHz)	99% Bandwidth (MHz)
Low	2412	17.7403
Mid	2437	23.5096
High	2462	17.7884



**IEEE 802.11n HT 40 MHz mode / Chain 0**

Channel	Frequency (MHz)	99% Bandwidth (MHz)
Low	2422	37.1794
Mid	2437	37.6923
High	2452	37.1794

**IEEE 802.11n HT 40 MHz mode / Chain 1**

Channel	Frequency (MHz)	99% Bandwidth (MHz)
Low	2422	37.1794
Mid	2437	37.4358
High	2452	37.0512

**Test Plot**

**IEEE 802.11b mode / Chain 0  
99% Bandwidth (CH Low)**

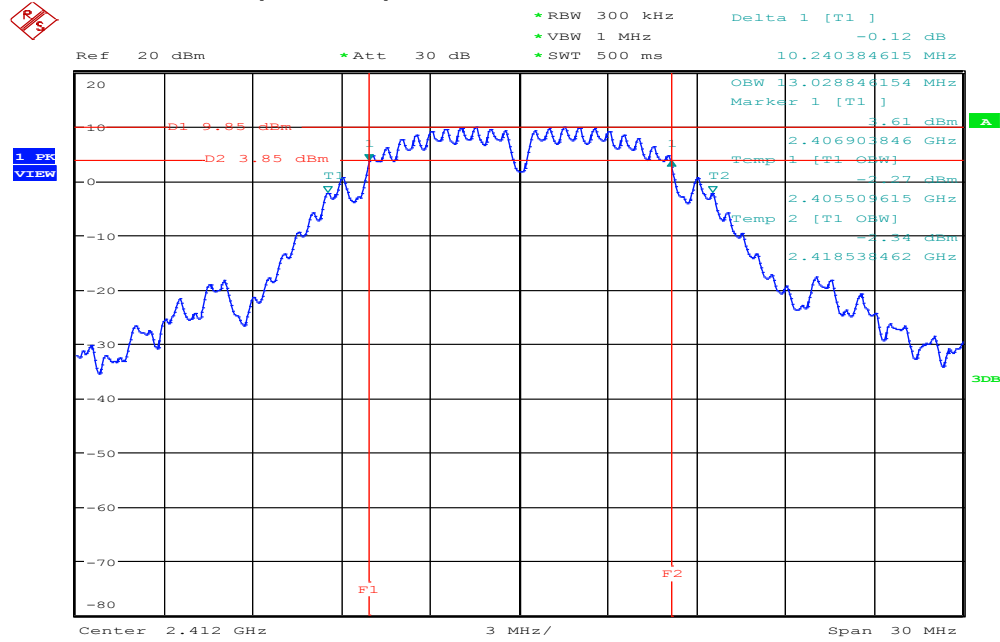

Date: 8.JAN.2016 17:19:19

**99% Bandwidth (CH Mid)**

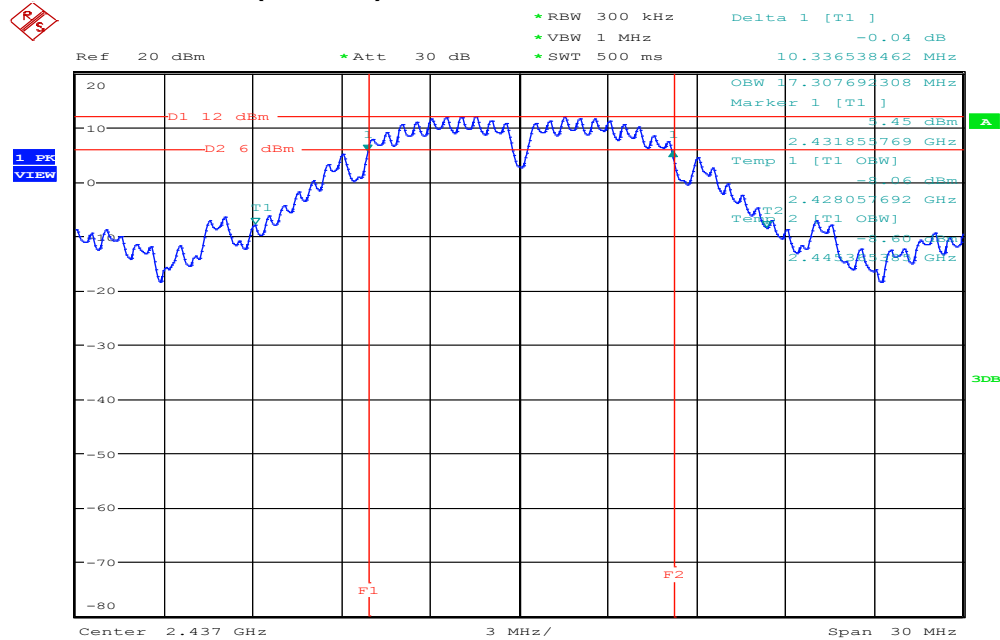

Date: 8.JAN.2016 17:39:31



**IEEE 802.11b mode / Chain 1  
99% Bandwidth (CH Low)**

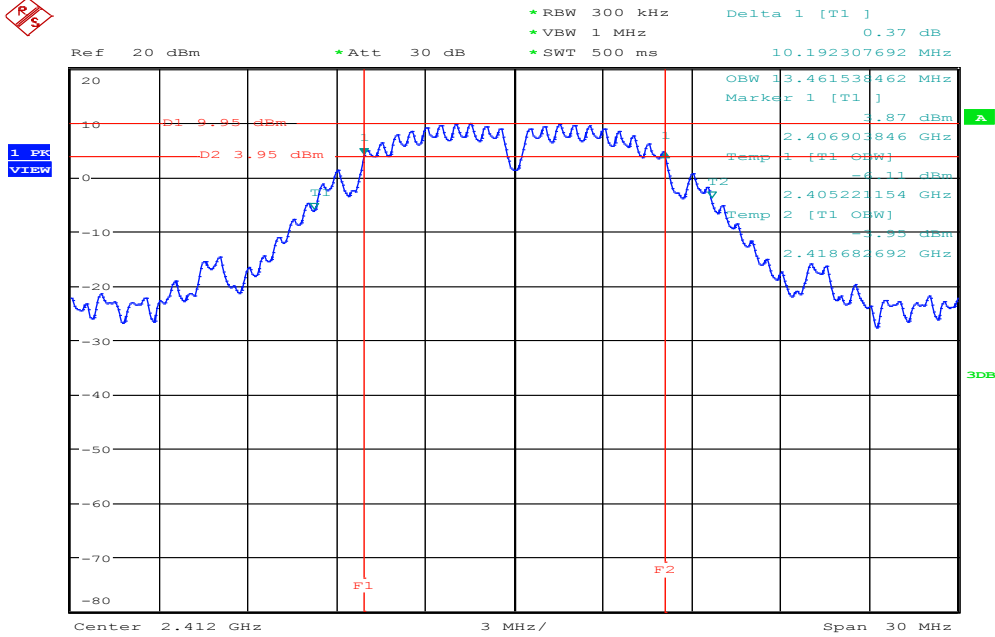

Date: 8.JAN.2016 17:15:22

**99% Bandwidth (CH Mid)**

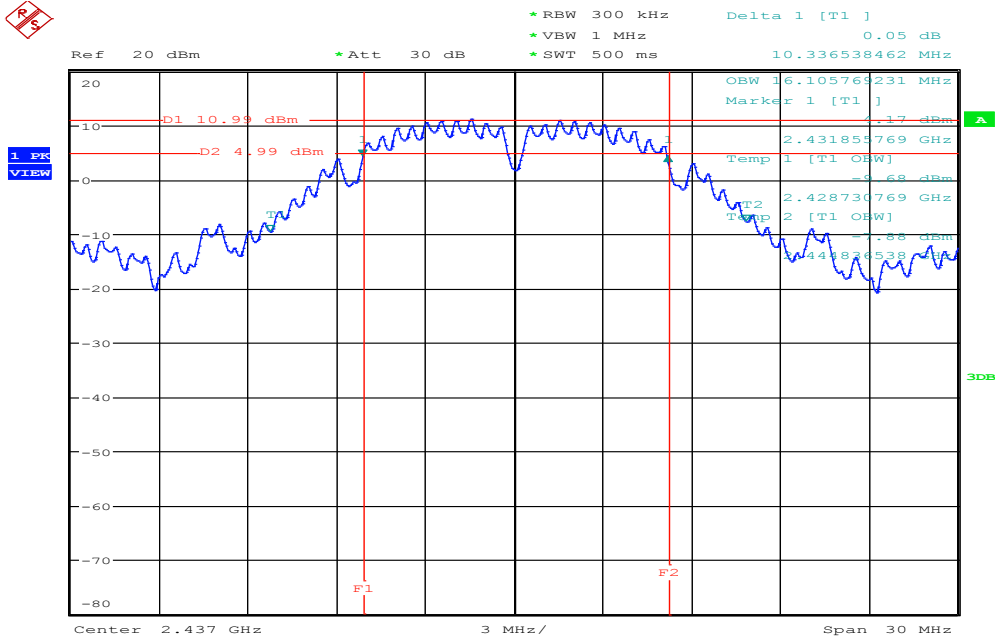

Date: 8.JAN.2016 17:37:38

### 99% Bandwidth (CH High)

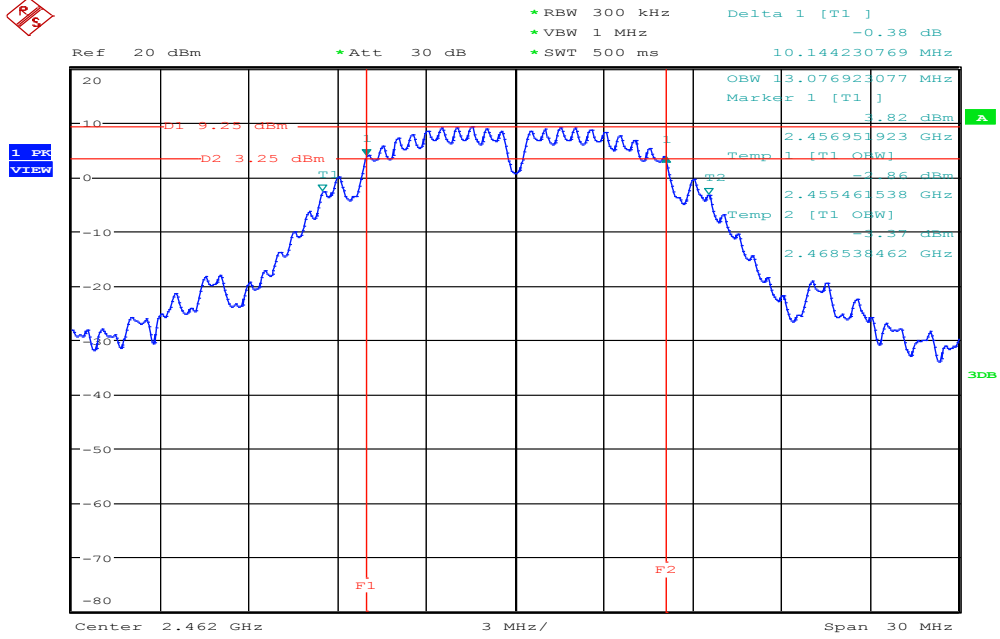

Date: 8.JAN.2016 17:45:28

IEEE 802.11g mode / Chain 0  
99% Bandwidth (CH Low)

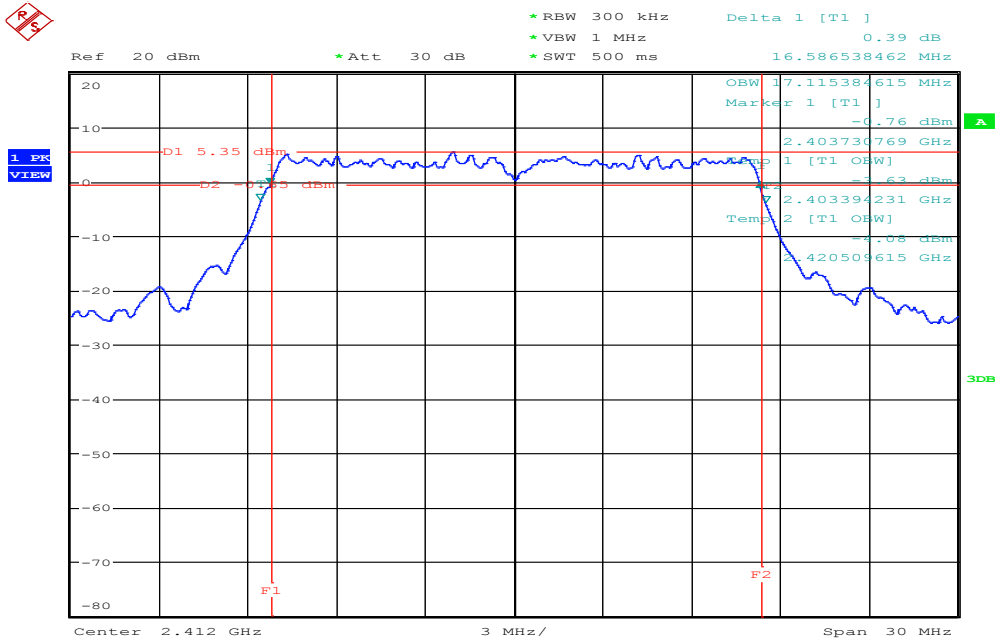

Date: 8.JAN.2016 17:49:52

99% Bandwidth (CH Mid)

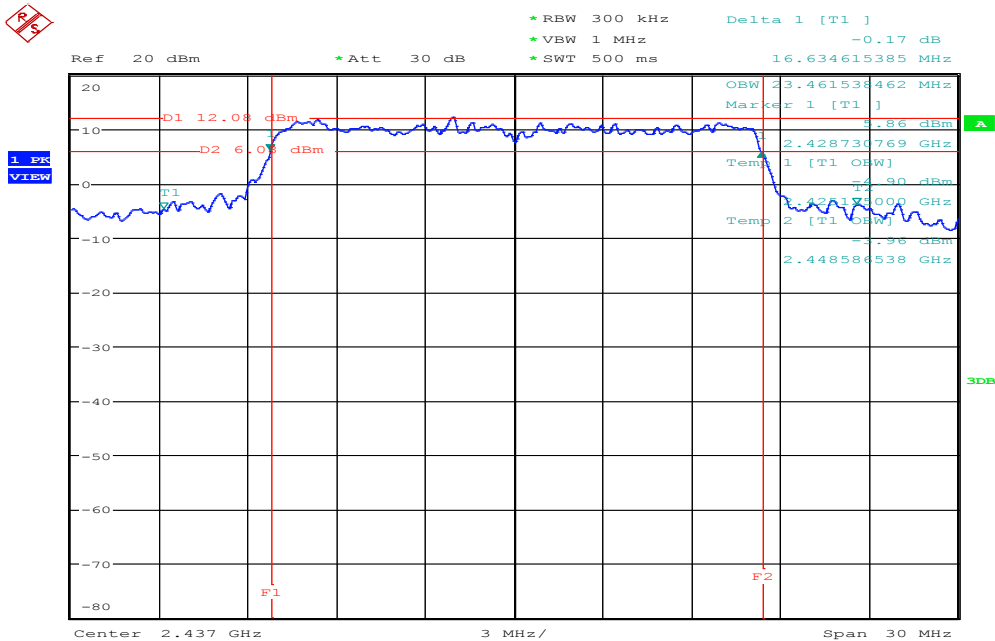

Date: 8.JAN.2016 20:26:57

### 99% Bandwidth (CH High)

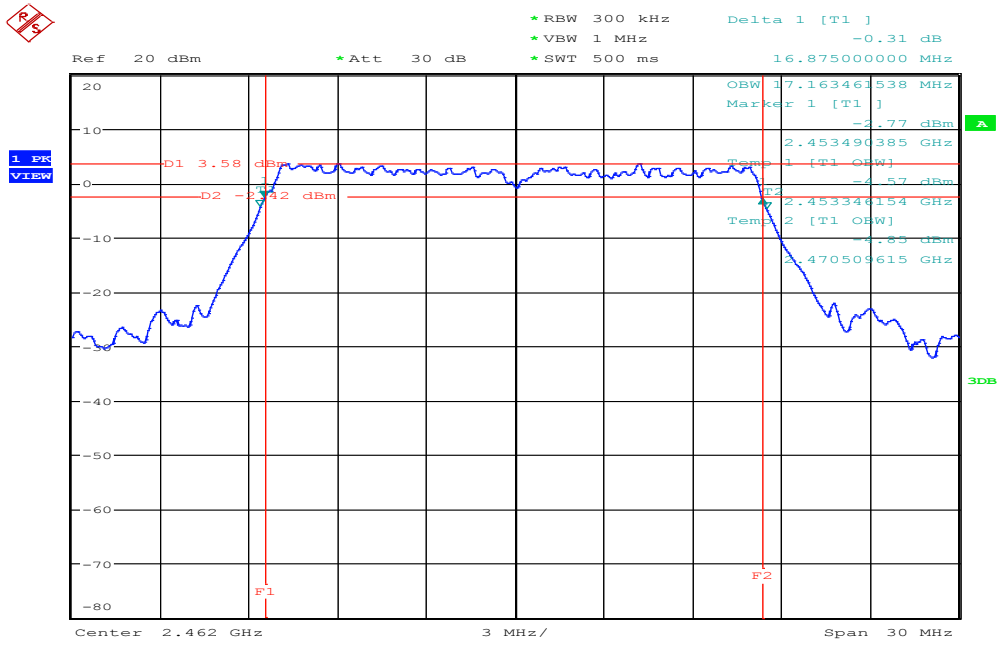

Date: 8.JAN.2016 17:59:59





### 99% Bandwidth (CH High)

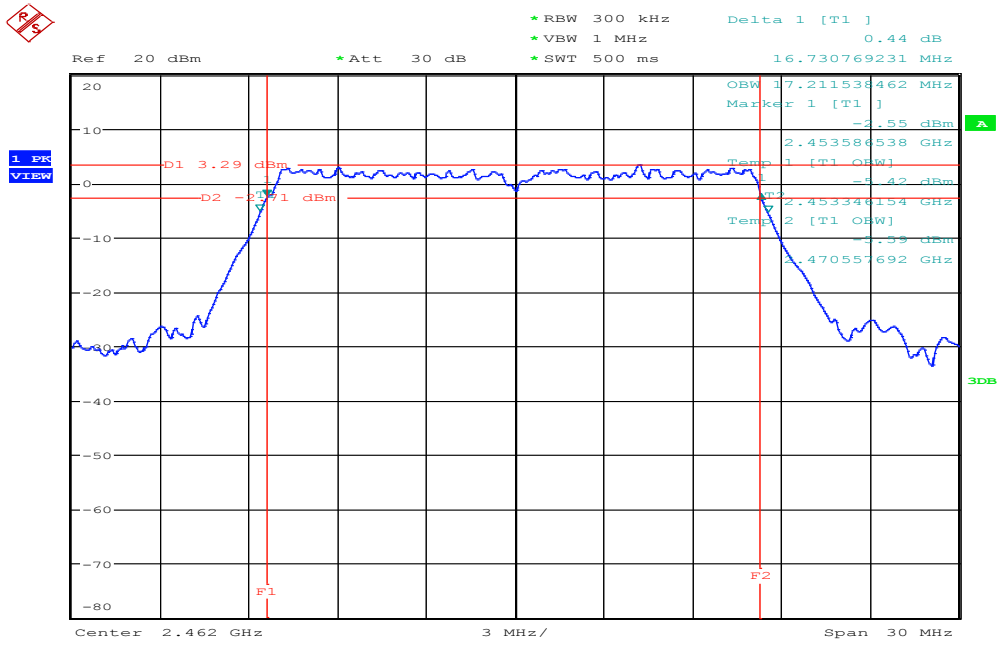

Date: 8.JAN.2016 17:58:19

IEEE 802.11n HT 20 MHz mode / Chain 0

99% Bandwidth (CH Low)

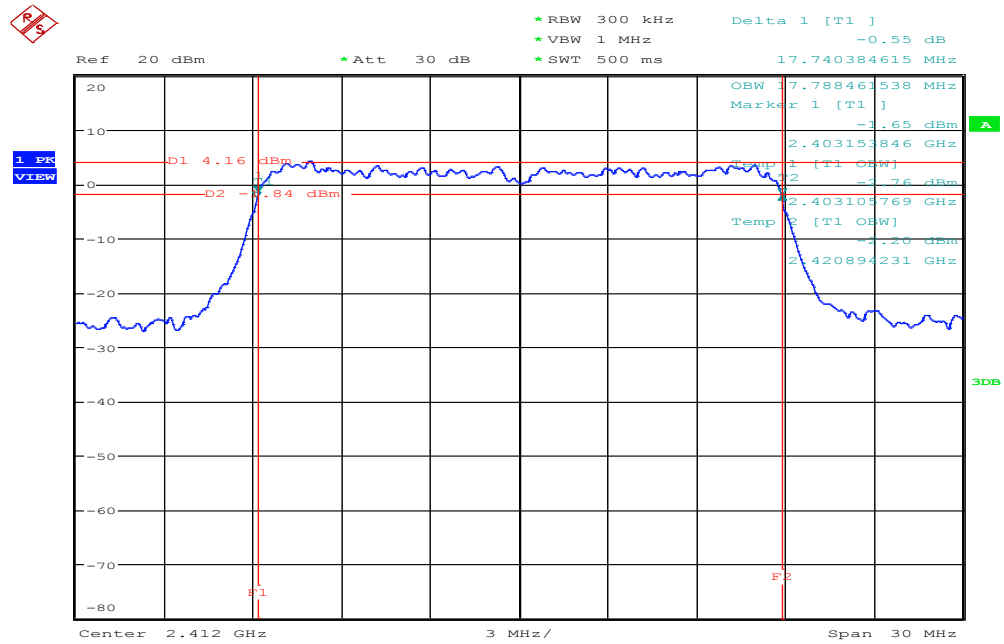

Date: 8.JAN.2016 18:09:25

99% Bandwidth (CH Mid)

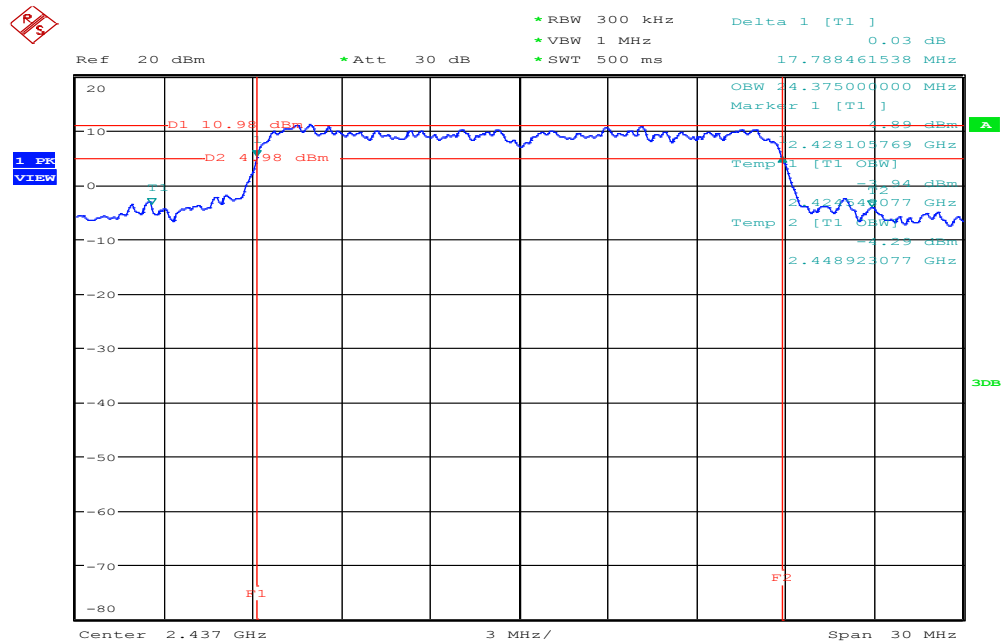

Date: 8.JAN.2016 20:22:45



**IEEE 802.11n HT 20 MHz mode / Chain 1**

**99% Bandwidth (CH Low)**

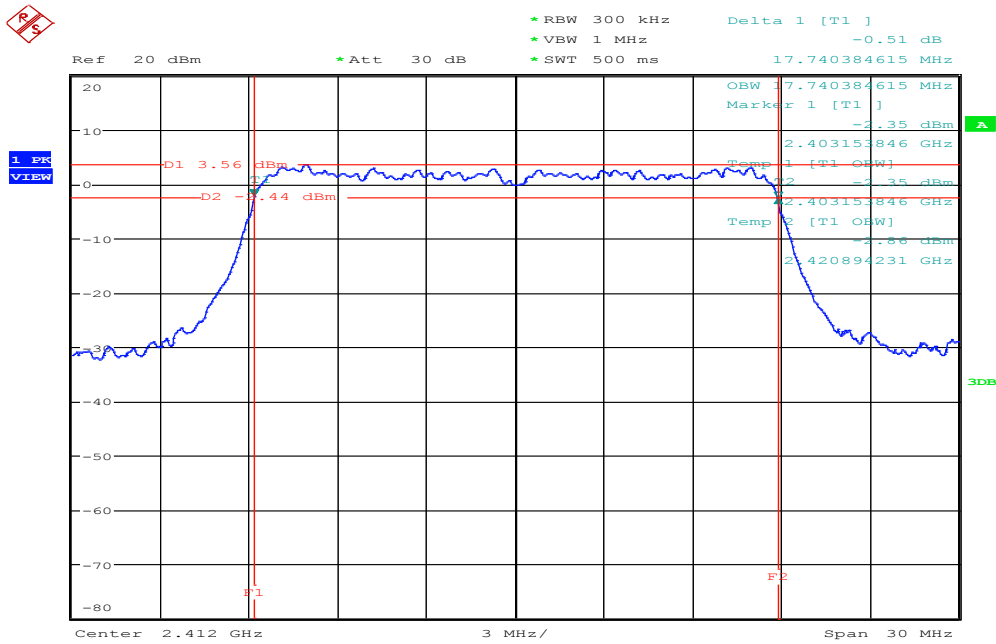

Date: 8.JAN.2016 18:11:40

**99% Bandwidth (CH Mid)**

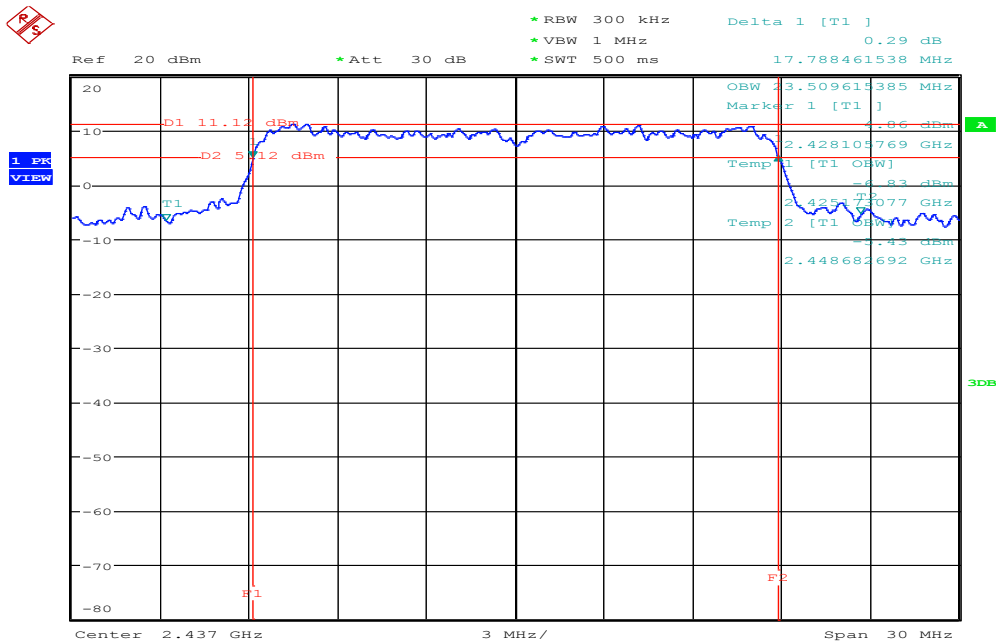

Date: 8.JAN.2016 20:24:21

### 99% Bandwidth (CH High)

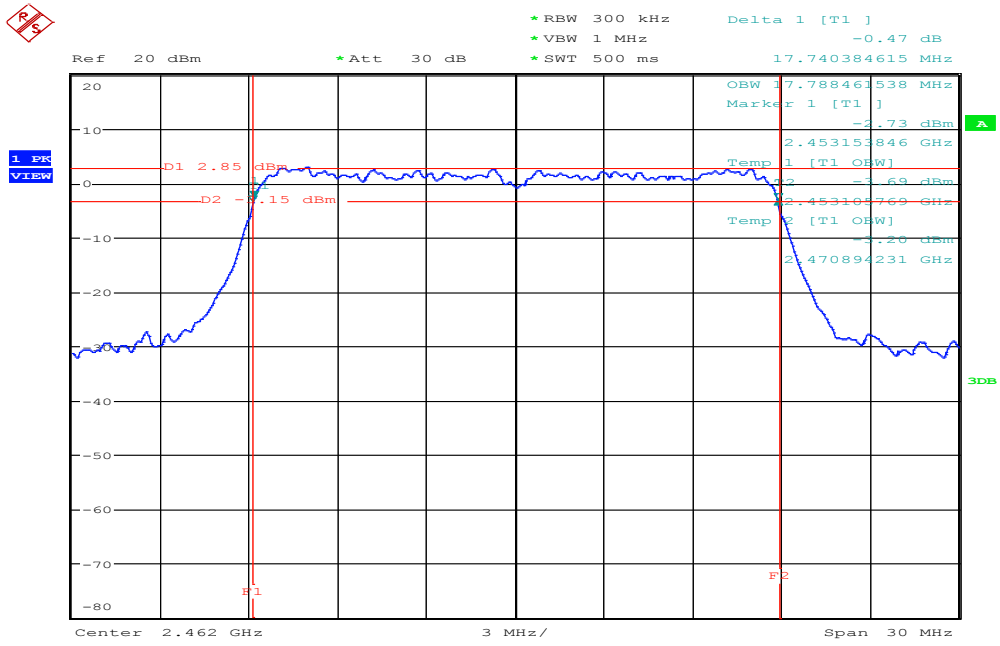

Date: 8.JAN.2016 18:16:01

**IEEE 802.11n HT 40 MHz mode / Chain 0**

**99% Bandwidth (CH Low)**

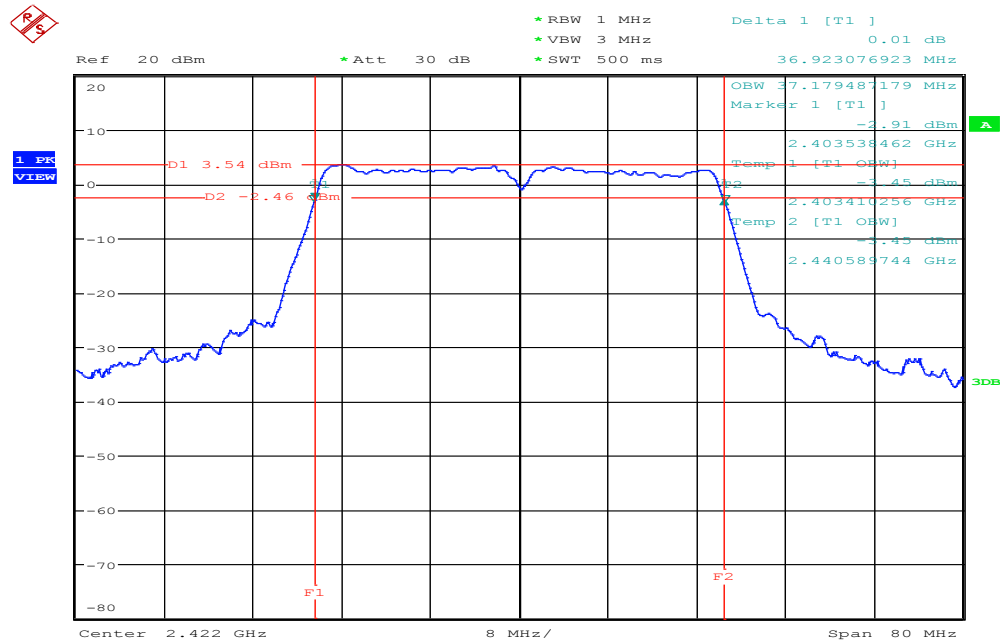

Date: 8.JAN.2016 19:49:54

**99% Bandwidth (CH Mid)**

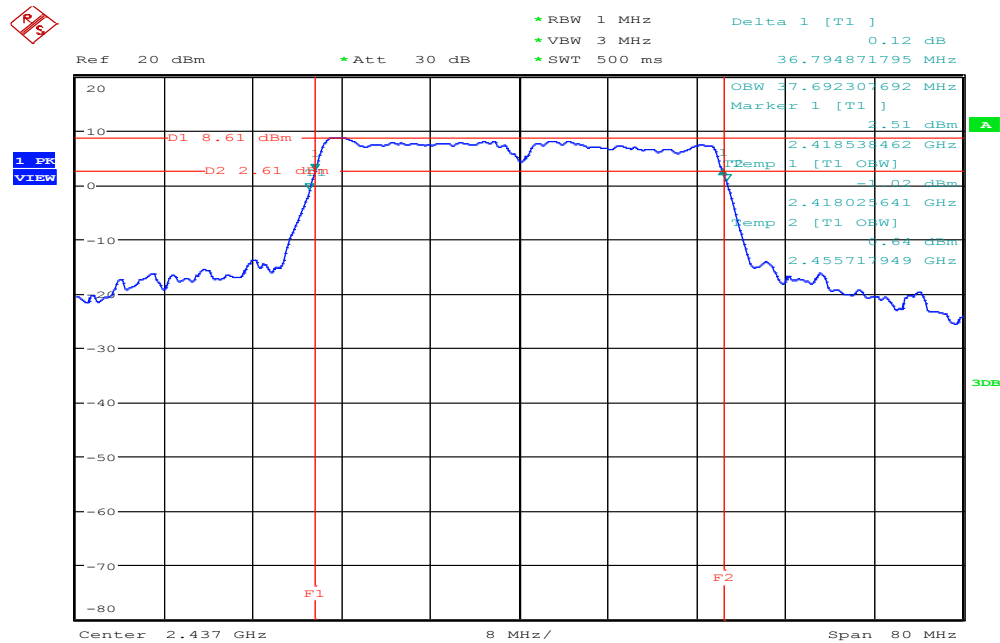

Date: 8.JAN.2016 19:46:16

### 99% Bandwidth (CH High)

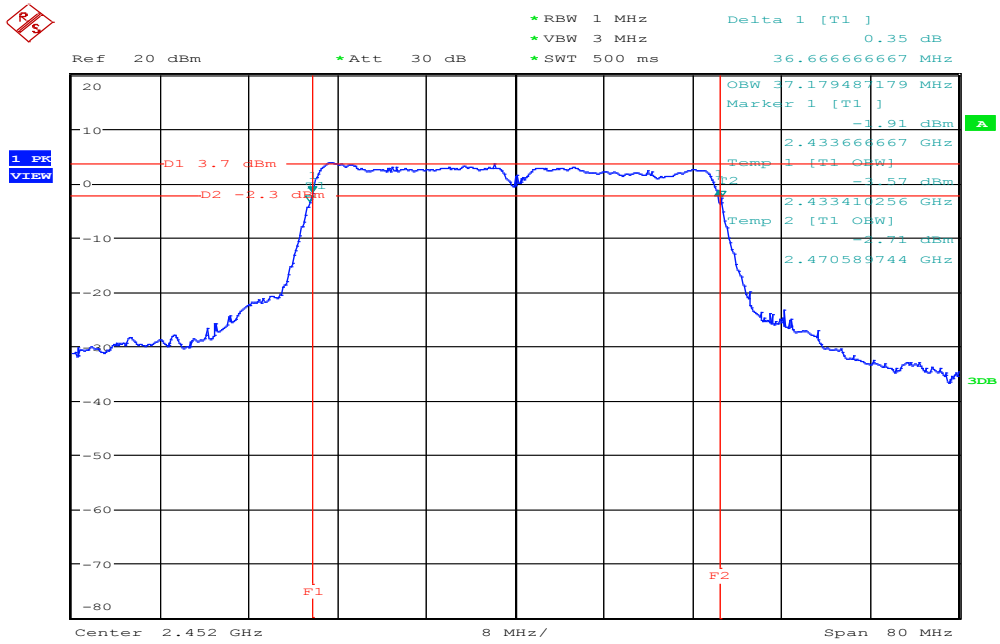

Date: 8.JAN.2016 20:01:22

**IEEE 802.11n HT 40 MHz mode / Chain 1**

**99% Bandwidth (CH Low)**

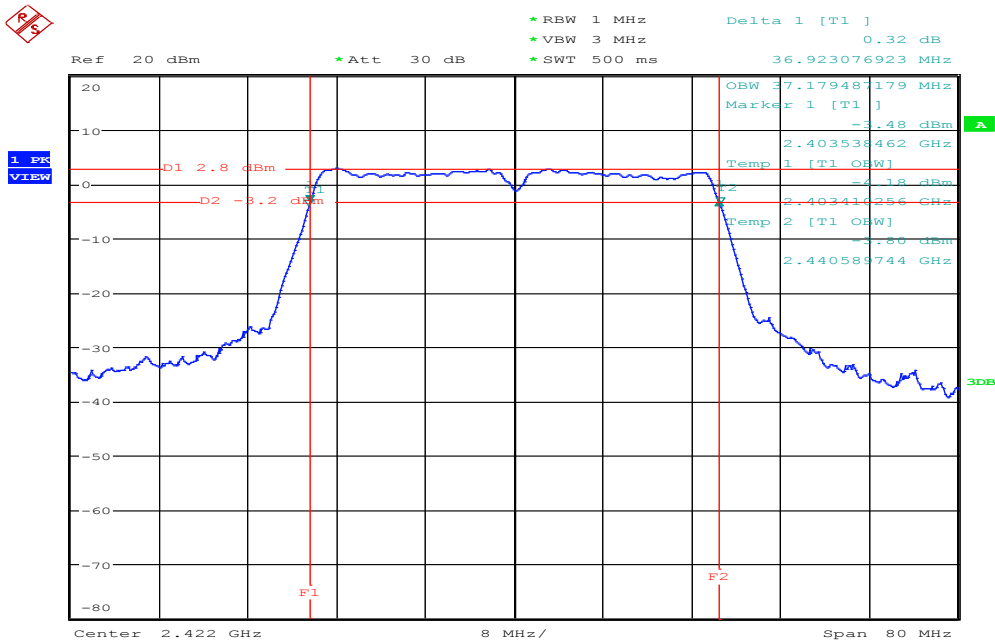

Date: 8.JAN.2016 19:52:15

**99% Bandwidth (CH Mid)**

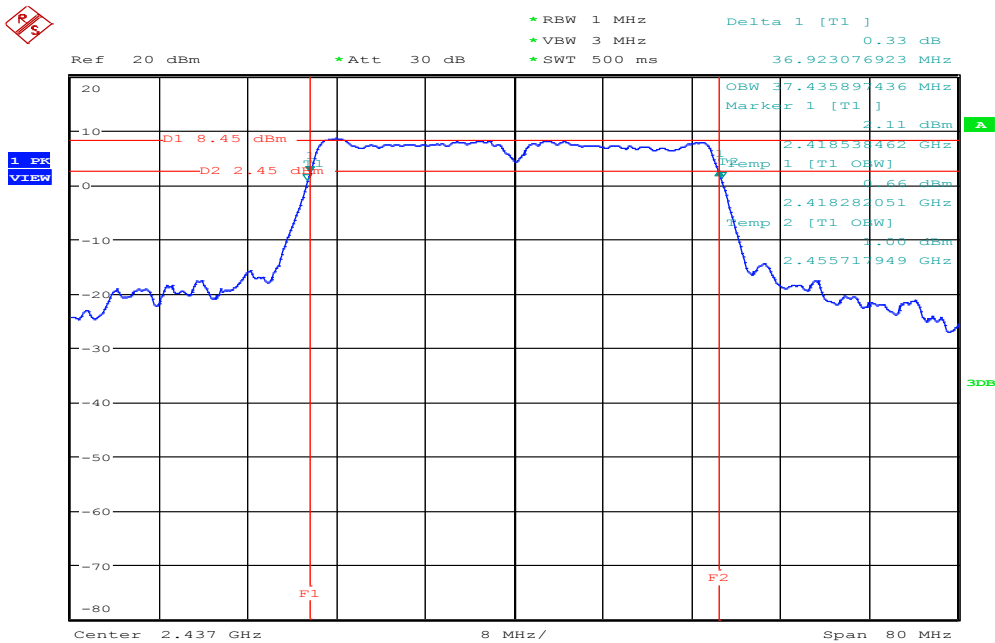

Date: 8.JAN.2016 19:44:40



### 99% Bandwidth (CH High)

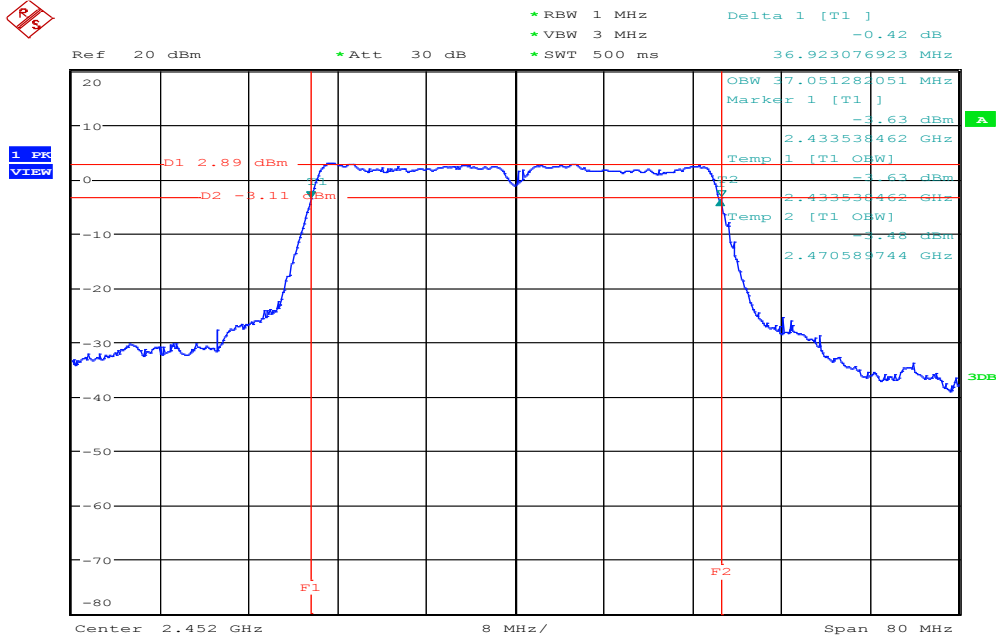

Date: 8.JAN.2016 19:56:15

## 7.2 6DB BANDWIDTH

### LIMIT

According to §15.247(a)(2) & RSS-247, systems using digital modulation techniques may operate in the 902 - 928 MHz, 2400 - 2483.5 MHz, and 5725 - 5850 MHz bands. The minimum 6dB bandwidth shall be at least 500 kHz.

### Test Configuration

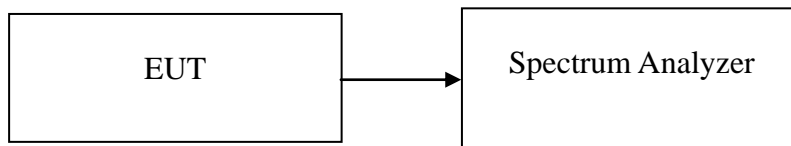

### TEST PROCEDURE

1. Place the EUT on the table and set it in the transmitting mode.
2. Remove the antenna from the EUT and then connect a low loss RF cable from the antenna port to the spectrum analyzer.
3. Set the spectrum analyzer as RBW = 100 kHz, VBW= 300kHz, Span = 50 MHz, Sweep = auto.
4. Mark the peak frequency and –6dB (upper and lower) frequency.
5. Repeat until all the rest channels are investigated.

### TEST RESULTS

*No non-compliance noted*

**Test Data**

**IEEE 802.11b mode / Chain 0**

Channel	Frequency (MHz)	6dB Bandwidth (MHz)	Limit (kHz)	Result
Low	2412	10.0961	>500	PASS
Mid	2437	10.2403		PASS
High	2462	10.0480		PASS

**IEEE 802.11b mode / Chain 1**

Channel	Frequency (MHz)	6dB Bandwidth (MHz)	Limit (kHz)	Result
Low	2412	10.0961	>500	PASS
Mid	2437	10.1442		PASS
High	2462	10.0961		PASS

**IEEE 802.11g mode / Chain 0**

Channel	Frequency (MHz)	6dB Bandwidth (MHz)	Limit (kHz)	Result
Low	2412	16.6346	>500	PASS
Mid	2437	16.5384		PASS
High	2462	16.6346		PASS

**IEEE 802.11g mode / Chain 1**

Channel	Frequency (MHz)	6dB Bandwidth (MHz)	Limit (kHz)	Result
Low	2412	16.6346	>500	PASS
Mid	2437	16.6346		PASS
High	2462	16.6346		PASS

**IEEE 802.11n HT 20 MHz mode / Chain 0**

Channel	Frequency (MHz)	6dB Bandwidth (MHz)	Limit (kHz)	Result
Low	2412	17.7884	>500	PASS
Mid	2437	17.7884		PASS
High	2462	17.7884		PASS

**IEEE 802.11n HT 20 MHz mode / Chain 1**

Channel	Frequency (MHz)	6dB Bandwidth (MHz)	Limit (kHz)	Result
Low	2412	17.7884	>500	PASS
Mid	2437	17.7884		PASS
High	2462	17.7403		PASS

**IEEE 802.11n HT 40 MHz mode / Chain 0**

Channel	Frequency (MHz)	6dB Bandwidth (MHz)	Limit (kHz)	Result
Low	2422	36.6666	>500	PASS
Mid	2437	36.6666		PASS
High	2452	36.6666		PASS

**IEEE 802.11n HT 40 MHz mode / Chain 1**

Channel	Frequency (MHz)	6dB Bandwidth (MHz)	Limit (kHz)	Result
Low	2422	36.6666	>500	PASS
Mid	2437	36.6666		PASS
High	2452	36.6666		PASS

**Test Plot**

**IEEE 802.11b mode / Chain 0**

**6dB Bandwidth (CH Low)**

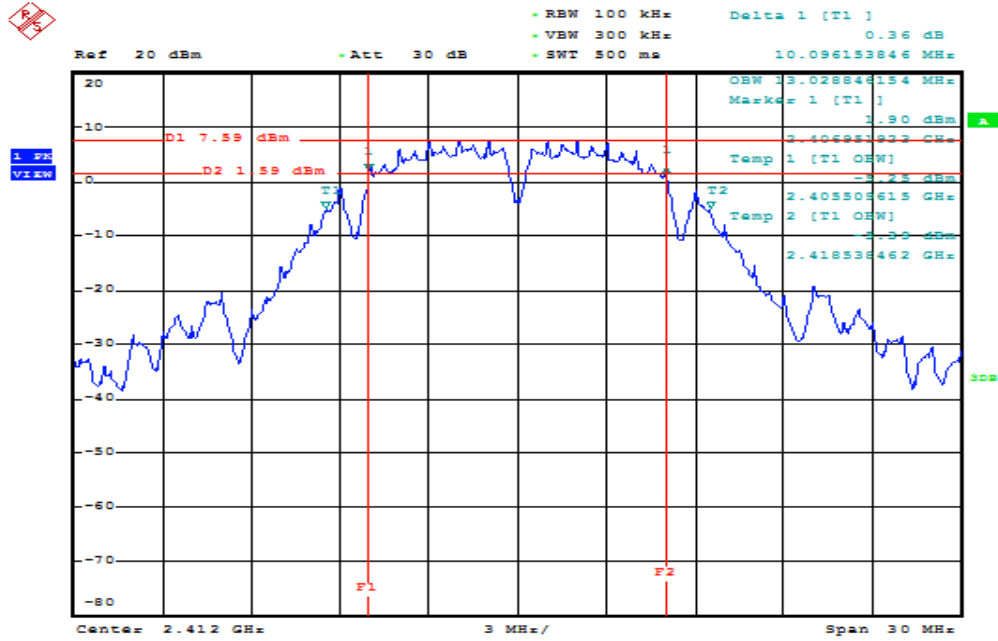

Date: 8.JAN.2016 11:26:10

**6dB Bandwidth (CH Mid)**

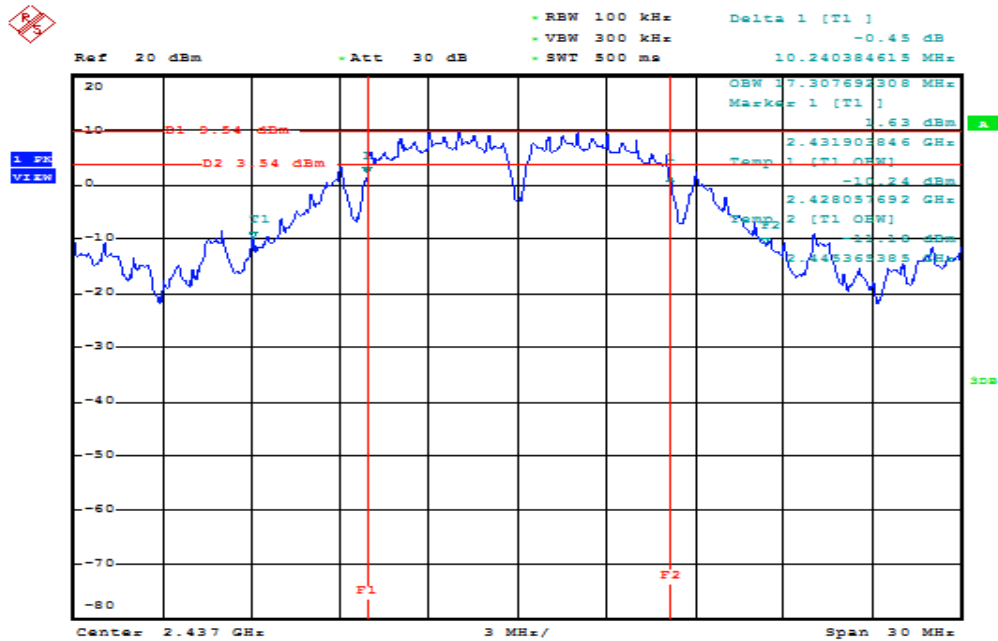

Date: 8.JAN.2016 13:11:46

### 6dB Bandwidth (CH High)

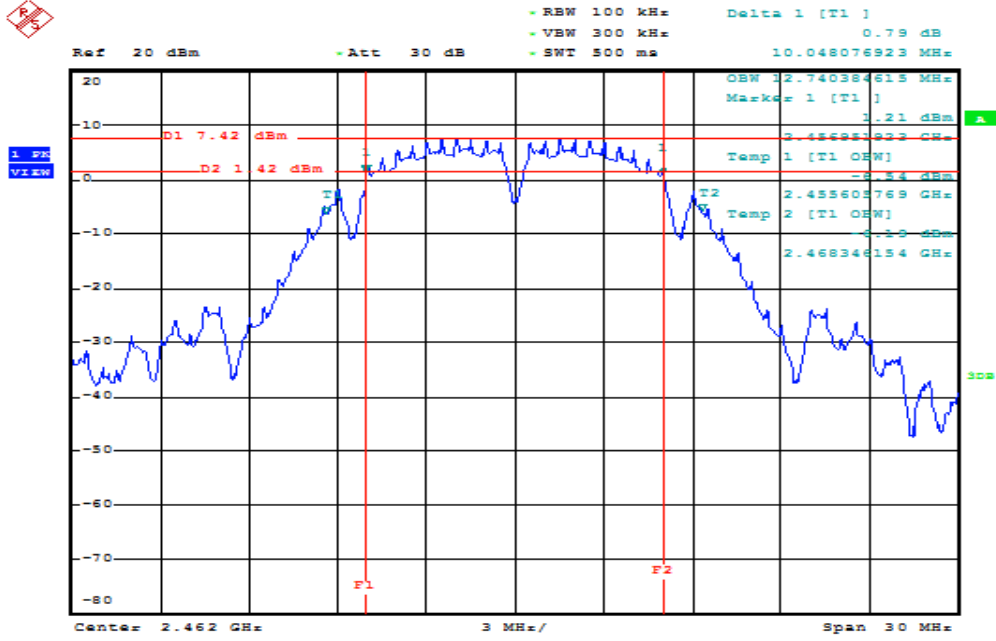

Date: 8.JAN.2016 13:28:59

IEEE 802.11b mode / Chain 1

6dB Bandwidth (CH Low)

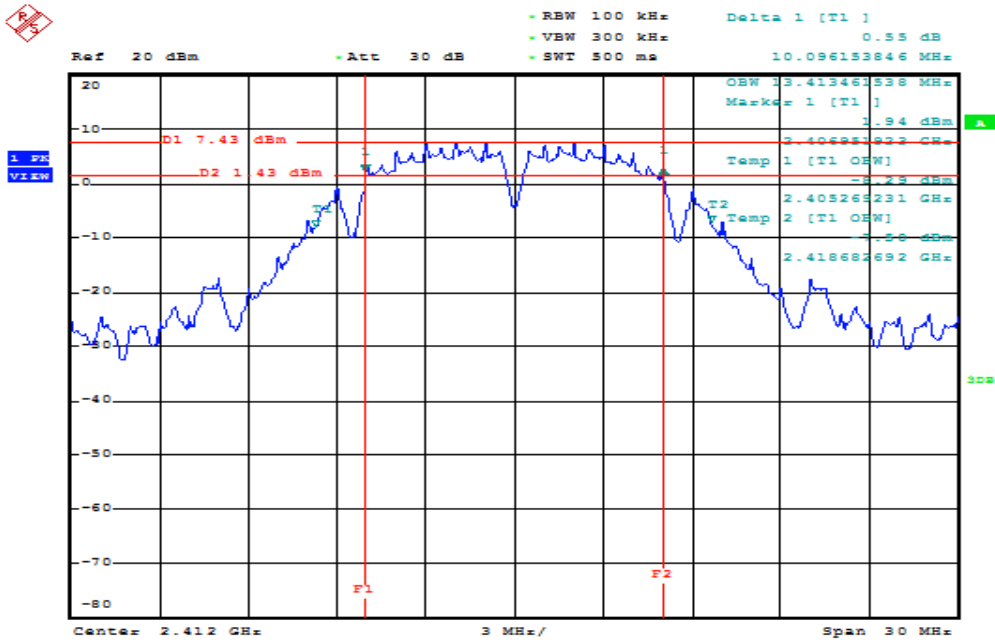

Date: 8.JAN.2016 12:02:00

6dB Bandwidth (CH Mid)

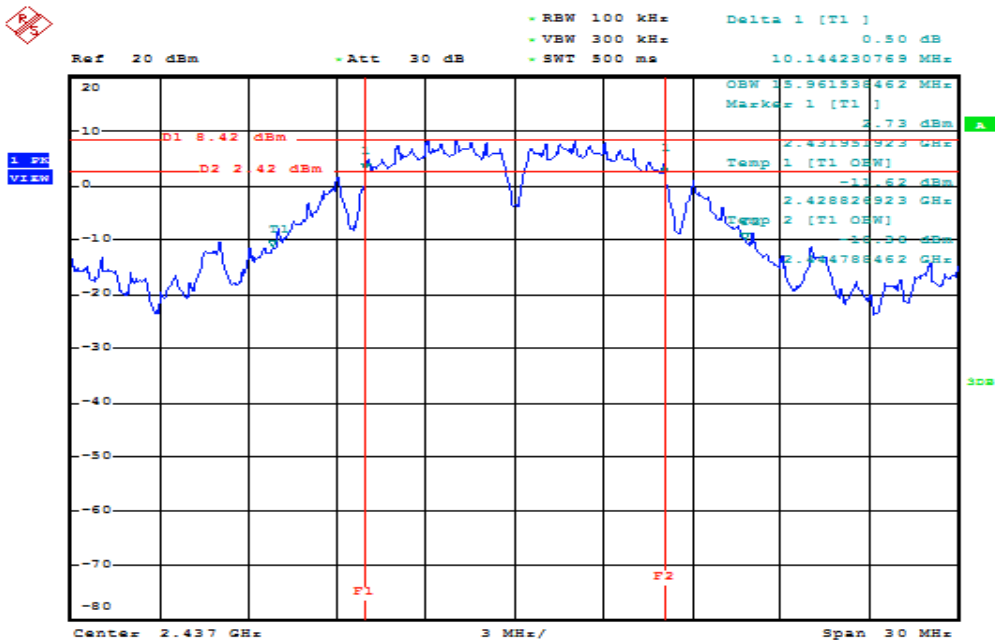

Date: 8.JAN.2016 13:17:57

### 6dB Bandwidth (CH High)

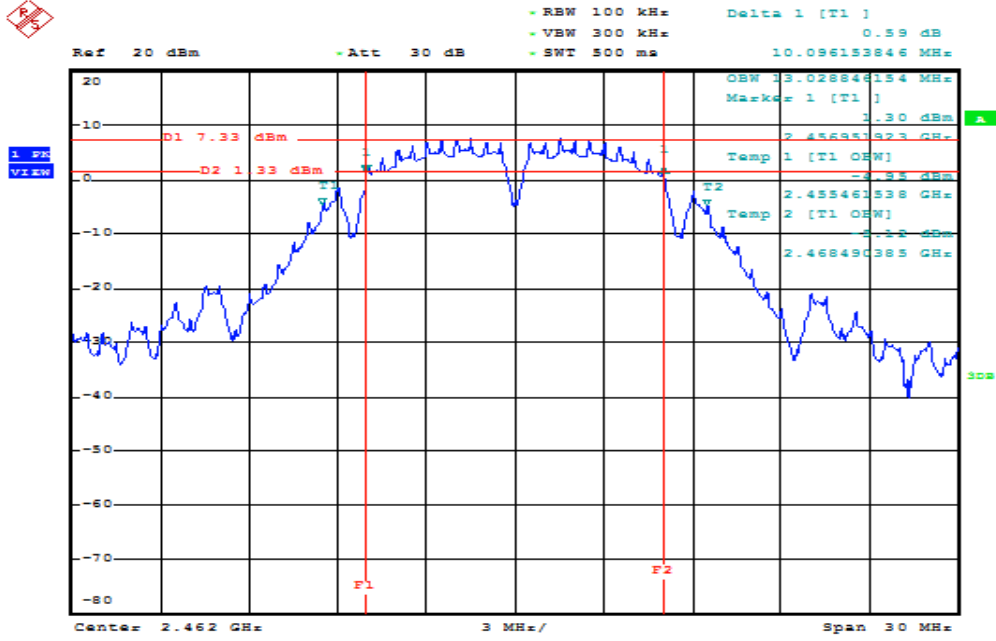

Date: 8.JAN.2016 13:22:54



IEEE 802.11g mode / Chain 0

6dB Bandwidth (CH Low)

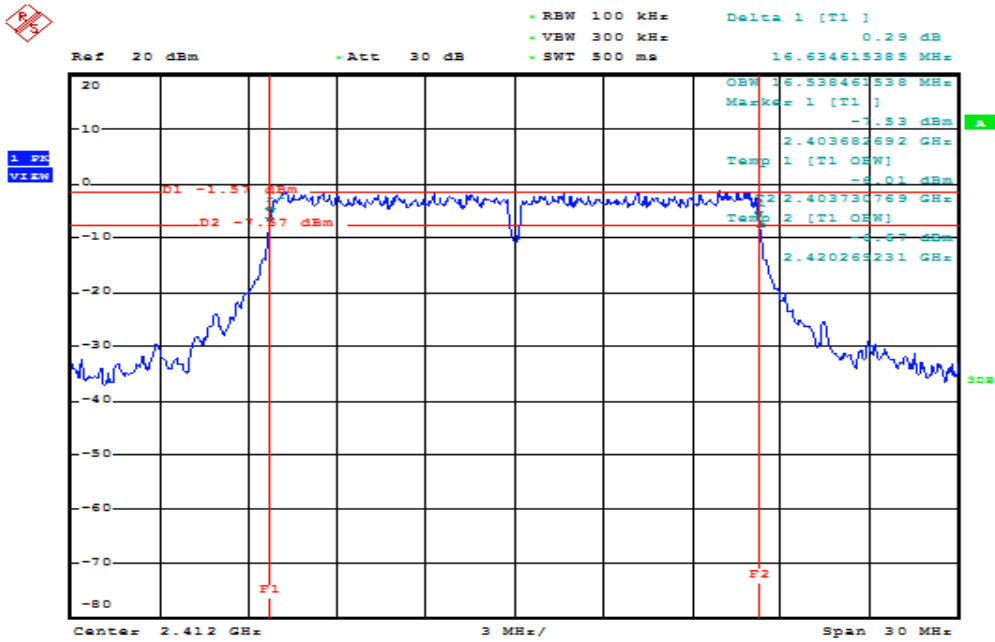

Date: 8.JAN.2016 13:35:44

6dB Bandwidth (CH Mid)

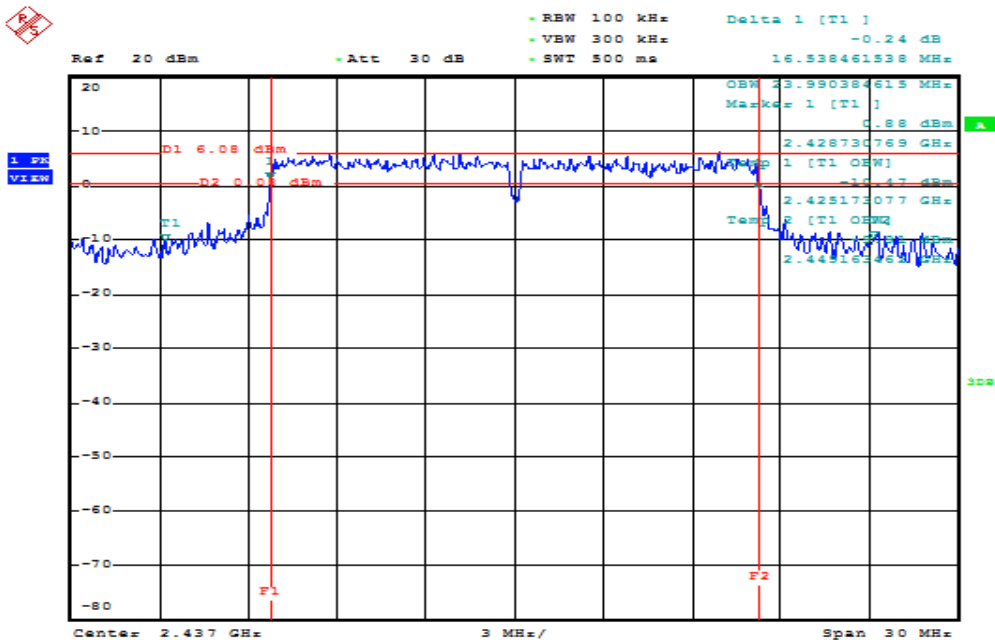

Date: 8.JAN.2016 13:58:26

### 6dB Bandwidth (CH High)

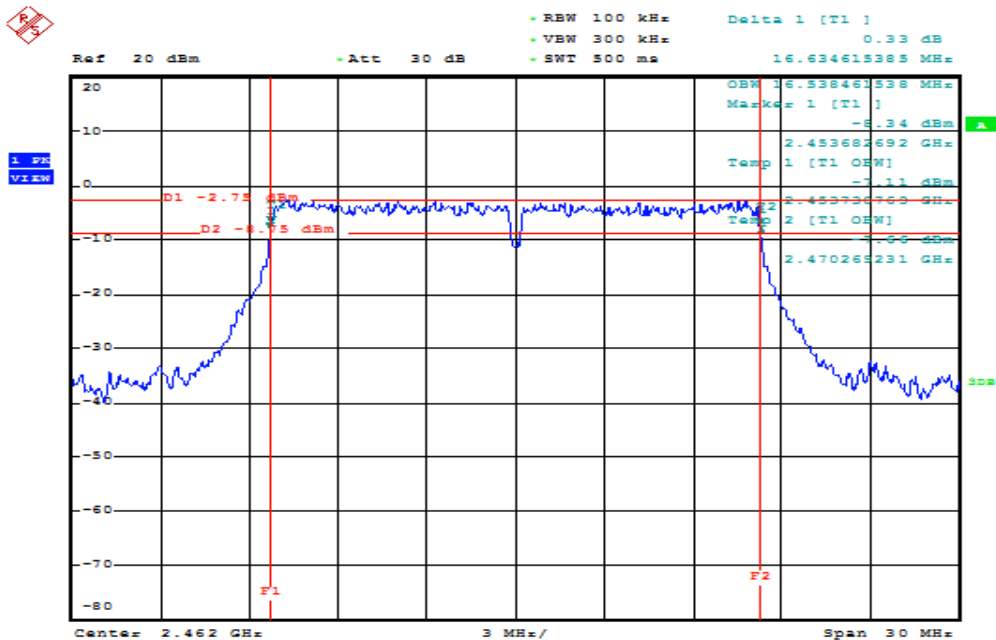

Date: 8.JAN.2016 14:03:31

IEEE 802.11g mode / Chain 1

6dB Bandwidth (CH Low)

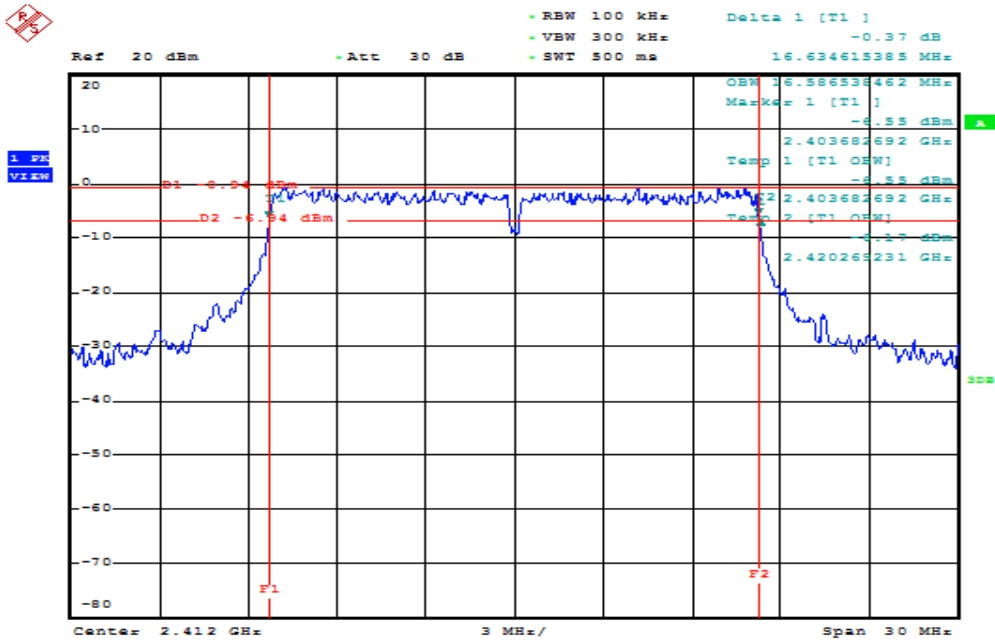

Date: 8.JAN.2016 13:40:23

6dB Bandwidth (CH Mid)

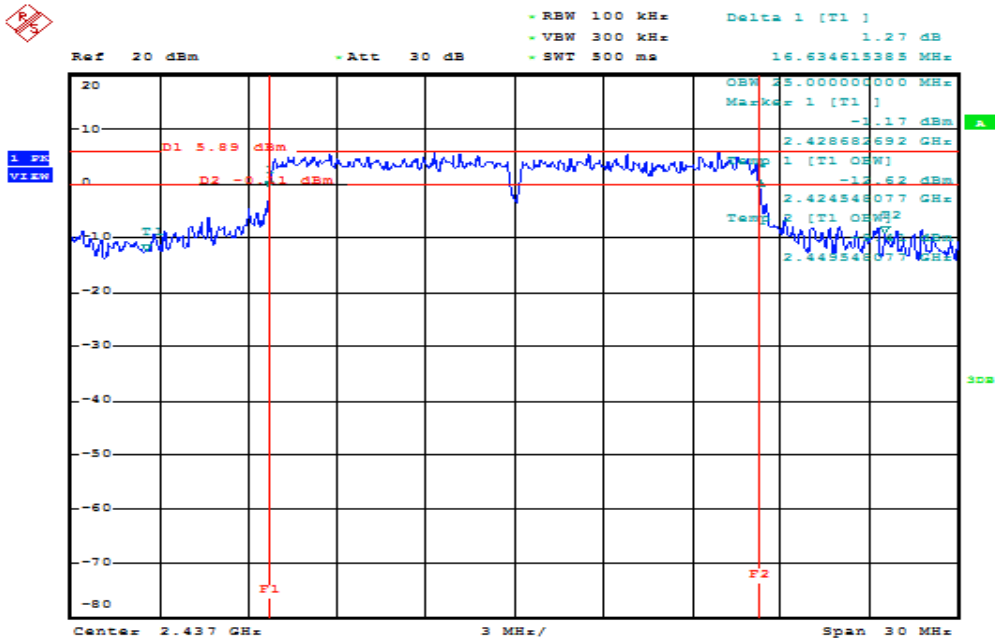

Date: 8.JAN.2016 13:56:40

### 6dB Bandwidth (CH High)

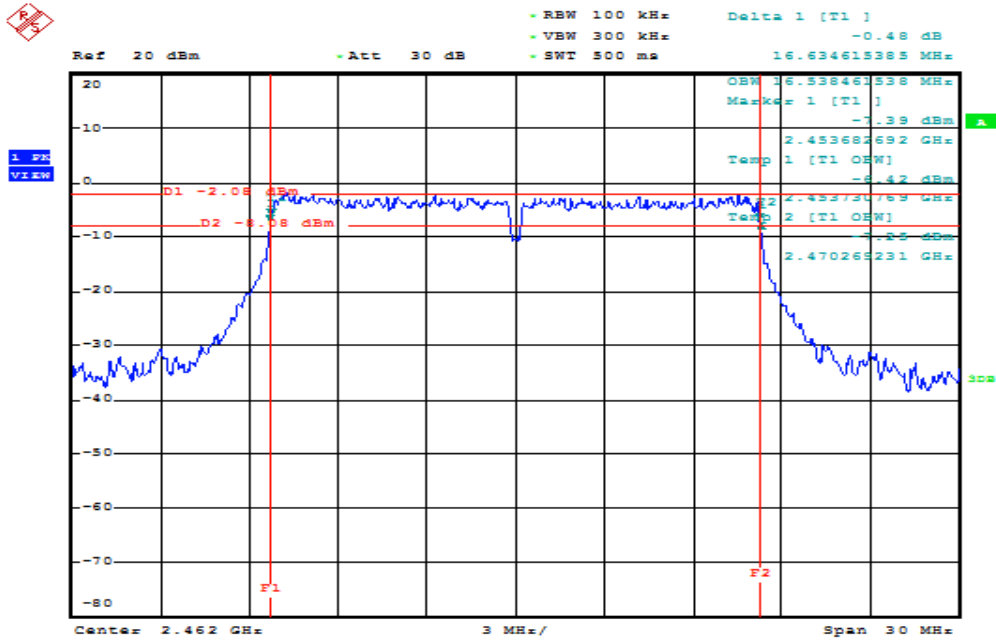

Date: 8.JAN.2016 14:09:53

**IEEE 802.11n HT 20 MHz mode / Chain 0**

**6dB Bandwidth (CH Low)**

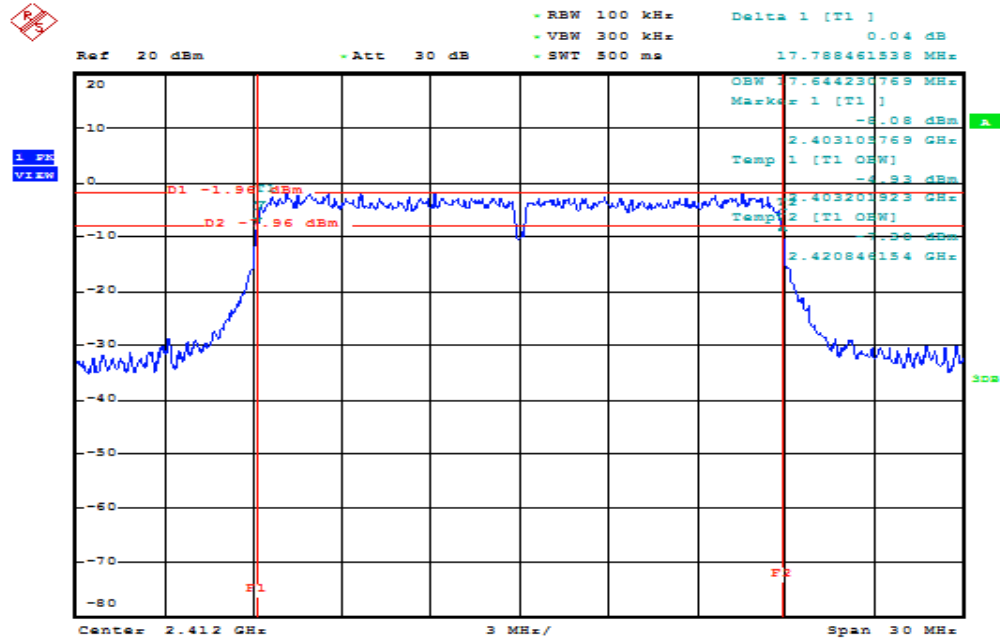

Date: 8.JAN.2016 14:15:06

**6dB Bandwidth (CH Mid)**

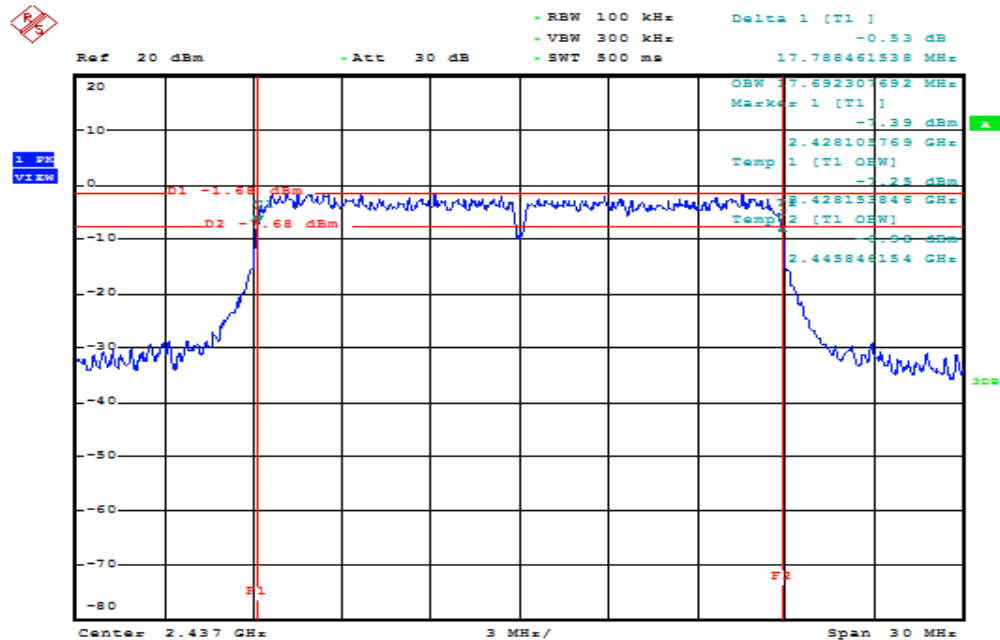

Date: 8.JAN.2016 14:24:07

### 6dB Bandwidth (CH High)

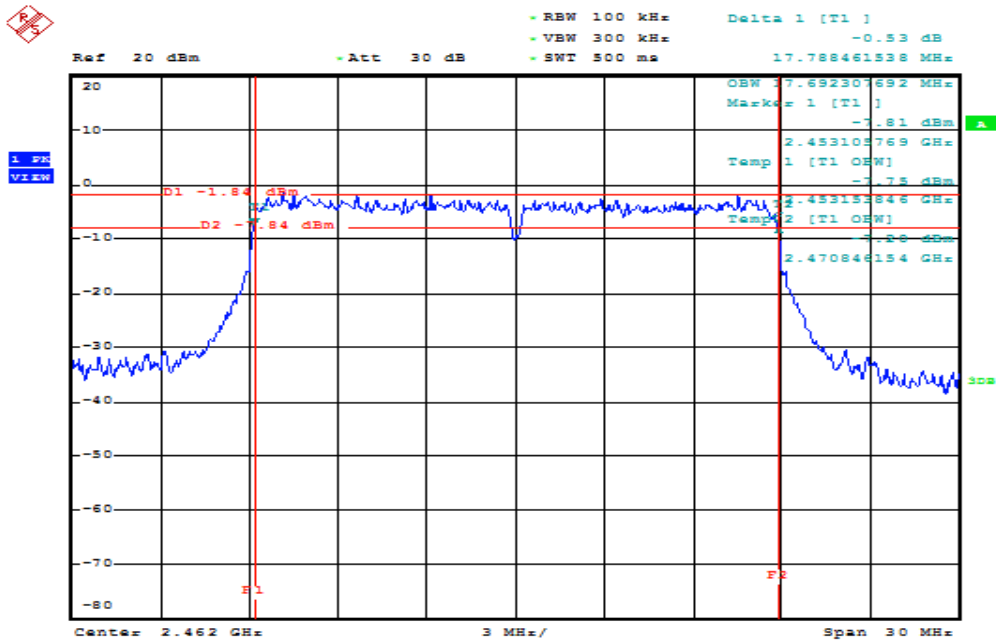

Date: 8.JAN.2016 14:27:26

### IEEE 802.11n HT 20 MHz mode / Chain 1

#### 6dB Bandwidth (CH Low)

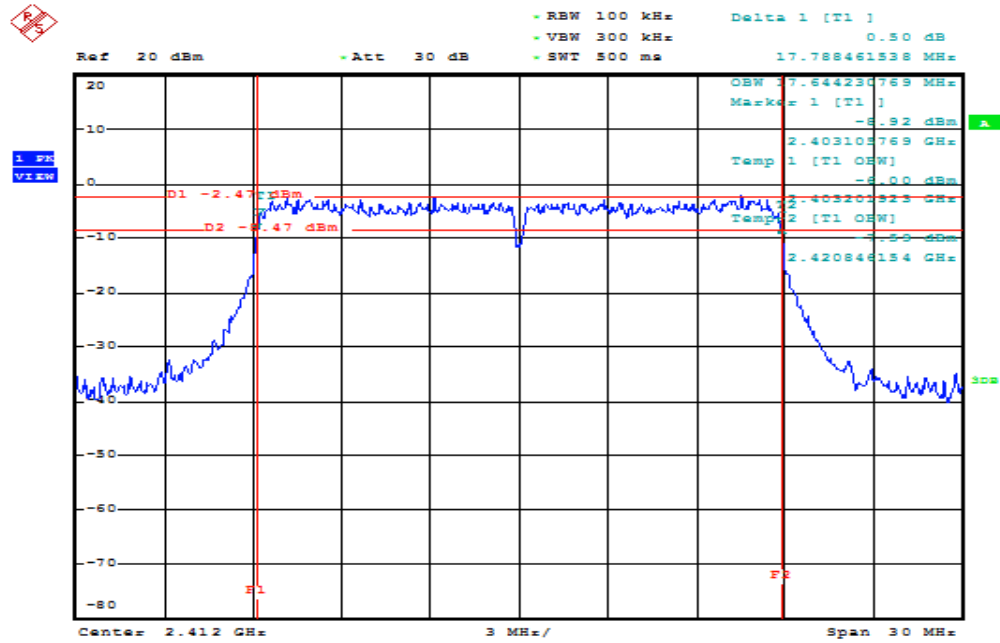

Date: 8.JAN.2016 14:17:17

#### 6dB Bandwidth (CH Mid)

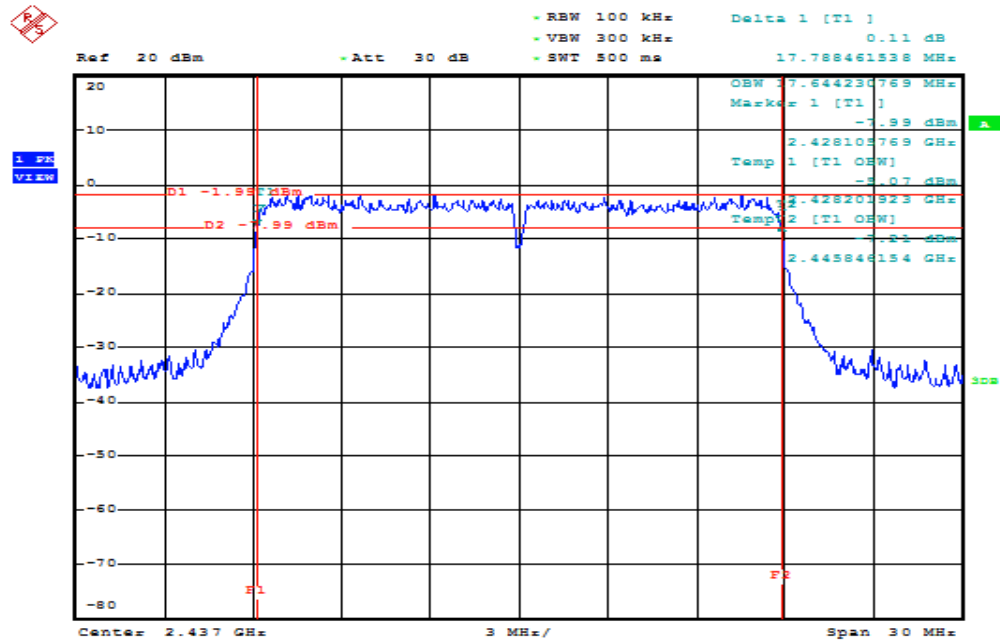

Date: 8.JAN.2016 14:21:45

### 6dB Bandwidth (CH High)

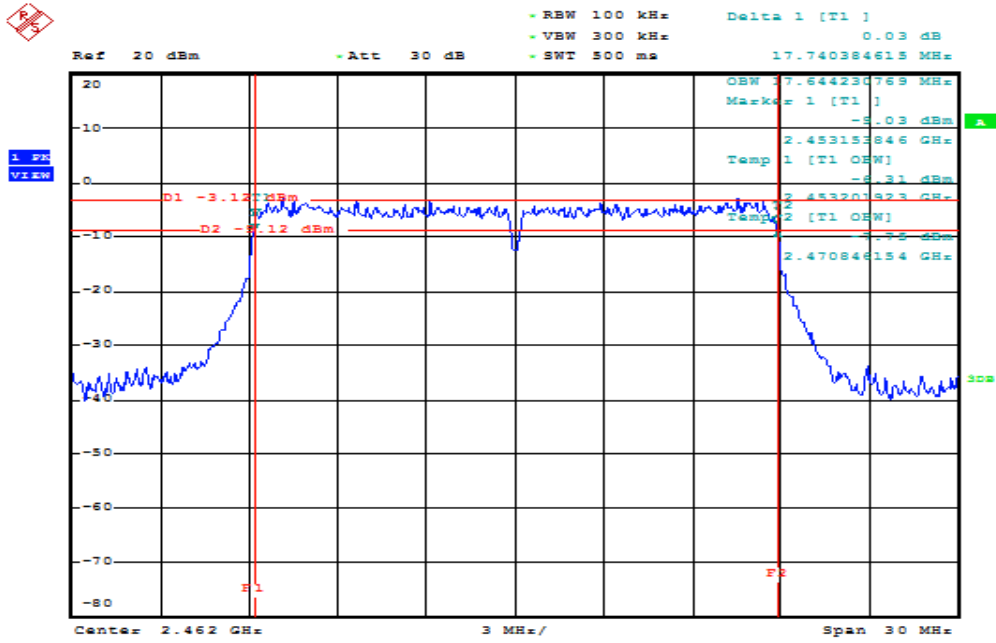

Date: 8.JAN.2016 14:33:53



IEEE 802.11n HT 40 MHz mode / Chain 0

6dB Bandwidth (CH Low)

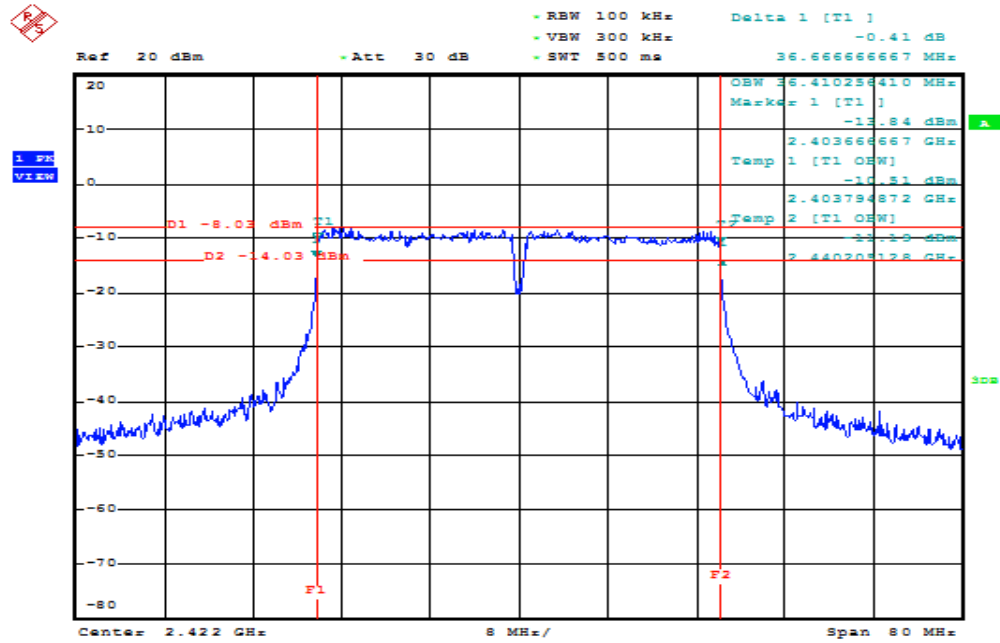

Date: 8.JAN.2016 14:44:36

6dB Bandwidth (CH Mid)

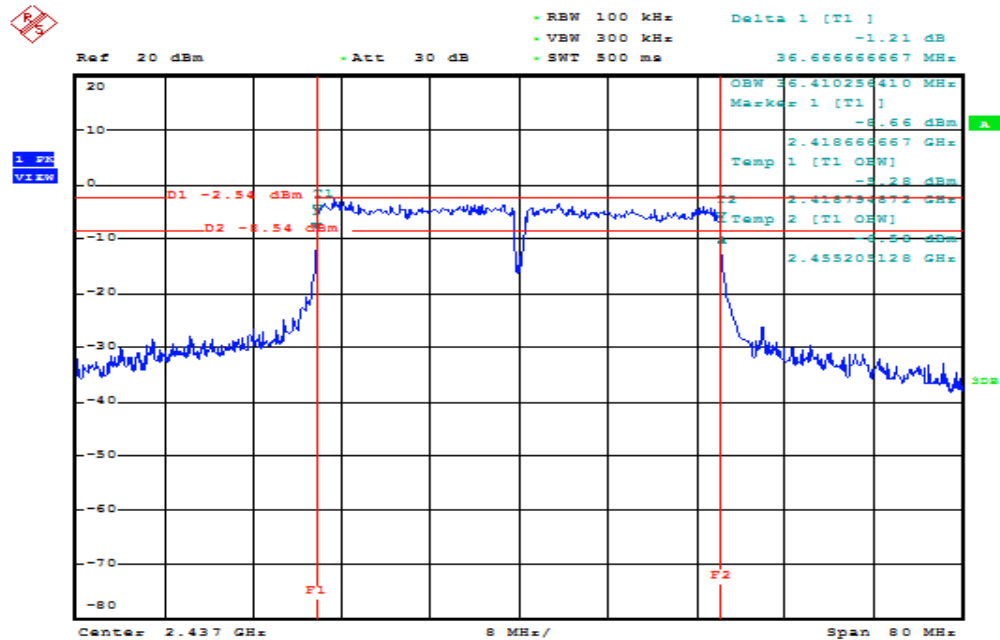

Date: 8.JAN.2016 14:53:02

### 6dB Bandwidth (CH High)

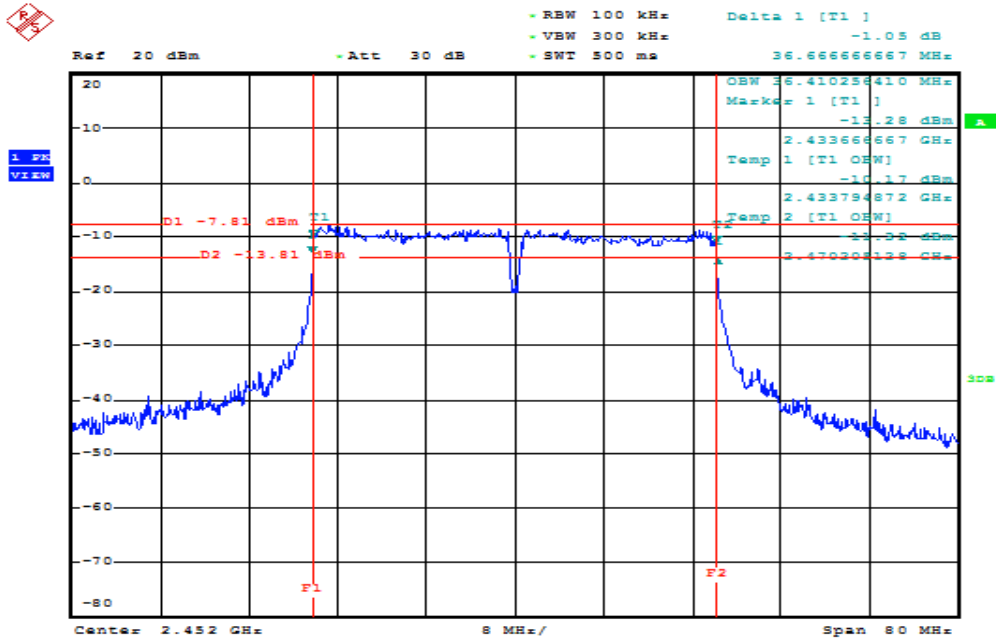

Date: 8.JAN.2016 14:55:46

### IEEE 802.11n HT 40 MHz mode / Chain 1 6dB Bandwidth (CH Low)

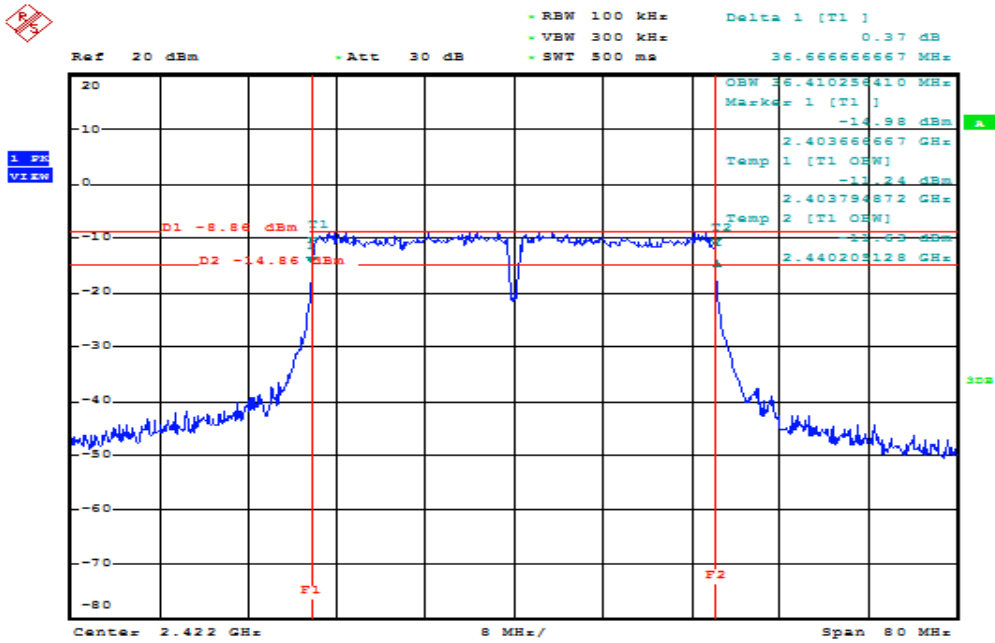

Date: 8.JAN.2016 14:47:21

### 6dB Bandwidth (CH Mid)

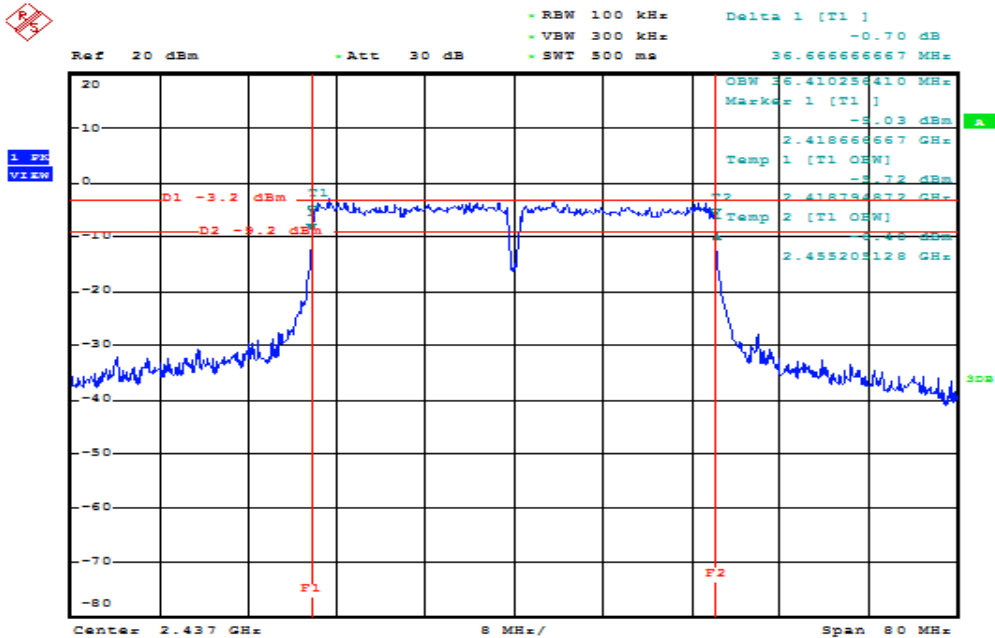

Date: 8.JAN.2016 14:50:43

### 6dB Bandwidth (CH High)

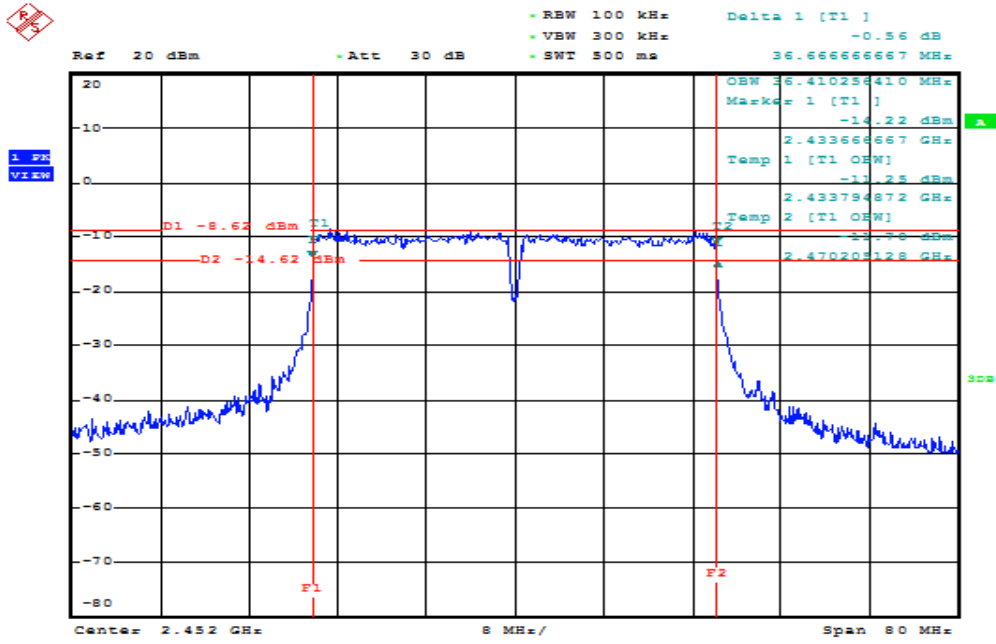

Date: 8.JAN.2016 14:58:35

## 7.3 PEAK POWER

### LIMIT

The maximum peak output power of the intentional radiator shall not exceed the following:

1. According to §15.247(b)(3), for systems using digital modulation in the bands of 902-928 MHz, 2400-2483.5 MHz, and 5725-5850 MHz: 1 Watt.
2. According to §15.247(b)(4), the conducted output power limit specified in paragraph (b) of this section is based on the use of antennas with directional gains that do not exceed 6 dBi. Except as shown in paragraph (c) of this section, if transmitting antennas of directional gain greater than 6 dBi are used, the conducted output power from the intentional radiator shall be reduced below the stated values in paragraphs (b)(1), (b)(2), and (b)(3) of this section, as appropriate, by the amount in dB that the directional gain of the antenna exceeds 6 dBi.
3. According to RSS-247, for systems employing digital modulation techniques operating in the bands 902-928 MHz, 2400-2483.5 MHz and 5725-5850 MHz, the maximum peak conducted output power shall not exceed 1 W.

### Test Configuration

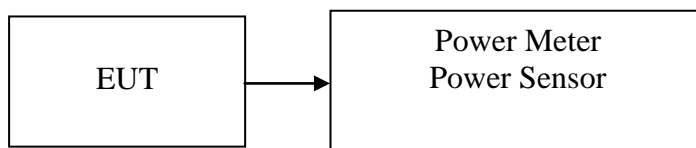

### TEST PROCEDURE

The transmitter output is connected to the Power Meter. The Power Meter is set to the peak power detection.

### TEST RESULTS

*No non-compliance noted*

**Test Data**

**IEEE 802.11b mode**

Channel	Frequency (MHz)	Chain 0 Output Power (dBm)	Chain 1 Output Power (dBm)	Total Output Power (dBm)	Output Power (W)	Limit (dBm)	Result
Low	2412	22.71	22.78	25.76	0.3767	30	PASS
Mid	2437	23.54	23.82	<b>*26.69</b>	0.4667		PASS
High	2462	22.39	22.05	25.23	0.3334		PASS

**IEEE 802.11g mode**

Channel	Frequency (MHz)	Chain 0 Output Power (dBm)	Chain 1 Output Power (dBm)	Total Output Power (dBm)	Output Power (W)	Limit (dBm)	Result
Low	2412	22.45	22.47	25.47	0.3524	30	PASS
Mid	2437	24.09	24.12	<b>*27.12</b>	0.5152		PASS
High	2462	21.34	21.82	24.60	0.2884		PASS

**IEEE 802.11n HT 20 MHz mode**

Channel	Frequency (MHz)	Chain 0 Output Power (dBm)	Chain 1 Output Power (dBm)	Total Output Power (dBm)	Output Power (W)	Limit (dBm)	Result
Low	2412	21.18	21.27	24.24	0.2655	30	PASS
Mid	2437	24.12	24.04	<b>*27.09</b>	0.5117		PASS
High	2462	21.17	21.57	24.38	0.2742		PASS

**IEEE 802.11n HT 40 MHz mode**

Channel	Frequency (MHz)	Chain 0 Output Power (dBm)	Chain 1 Output Power (dBm)	Total Output Power (dBm)	Output Power (W)	Limit (dBm)	Result
Low	2422	18.66	18.91	21.80	0.1514	30	PASS
Mid	2437	22.72	22.82	<b>*25.78</b>	0.3784		PASS
High	2452	18.91	18.68	21.81	0.1517		PASS

**Remark:**

1. Total Output Power (w) = Chain 0 (10^(Output Power /10)/1000)+ Chain 1 (10^(Output Power /10)/1000)

## 7.4 AVERAGE POWER

### LIMIT

None; for reporting purposes only.

### Test Configuration

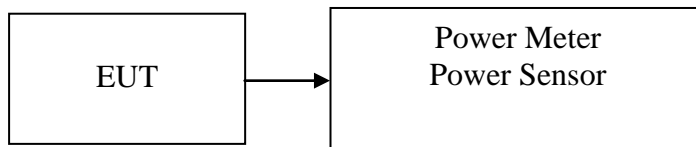

### TEST PROCEDURE

The transmitter output is connected to the Power Meter. The Power Meter is set to the peak power detection.

### TEST RESULTS

*No non-compliance noted*

**Test Data**

**Test mode: IEEE 802.11b mode**

Channel	Frequency (MHz)	Chain 0 Output Power (dBm)	Chain 1 Output Power (dBm)	Total Output Power (dBm)	Output Power (W)
Low	2412	20.09	20.01	23.06	0.2023
Mid	2437	21.96	22.49	25.24	0.3342
High	2462	19.97	19.41	22.71	0.1866

**Test mode: IEEE 802.11g mode**

Channel	Frequency (MHz)	Chain 0 Output Power (dBm)	Chain 1 Output Power (dBm)	Total Output Power (dBm)	Output Power (W)
Low	2412	13.85	14.38	17.13	0.0516
Mid	2437	21.44	21.35	24.41	0.2761
High	2462	13.18	14.19	16.72	0.0470

**Test mode: IEEE 802.11n HT 20 MHz mode**

Channel	Frequency (MHz)	Chain 0 Output Power (dBm)	Chain 1 Output Power (dBm)	Total Output Power (dBm)	Output Power (W)
Low	2412	13.09	12.84	15.98	0.0396
Mid	2437	21.02	20.97	24.01	0.2518
High	2462	13.13	14.14	16.67	0.0465

**Test mode: IEEE 802.11n HT 40 MHz mode**

Channel	Frequency (MHz)	Chain 0 Output Power (dBm)	Chain 1 Output Power (dBm)	Total Output Power (dBm)	Output Power (W)
Low	2422	9.45	9.78	12.63	0.0183
Mid	2437	15.31	15.33	18.33	0.0681
High	2452	9.85	10.47	13.18	0.0208

**Remark:** Total Output Power (w) = Chain 0 (10^(Output Power /10)/1000) + Chain 1 (10^(Output Power /10)/1000)



## 7.5 BAND EDGES MEASUREMENT

### LIMIT

According to §15.247(d) & RSS-247, in any 100 kHz bandwidth outside the frequency bands in which the spread spectrum intentional radiator is operating, the radio frequency power that is produced by the intentional radiator shall be at least 20 dB below that in the 100 kHz bandwidth within the band that contains the highest level of the desired power, based on either an RF conducted or a radiated measurement, provided the transmitter demonstrates compliance with the peak conducted power limits. In addition, radiated emissions which fall in the restricted bands, as defined in §15.205(a), must also comply with the radiated emission limits specified in 15.209(a) (see Section 15.205(c)).

### Test Configuration

#### For Radiated

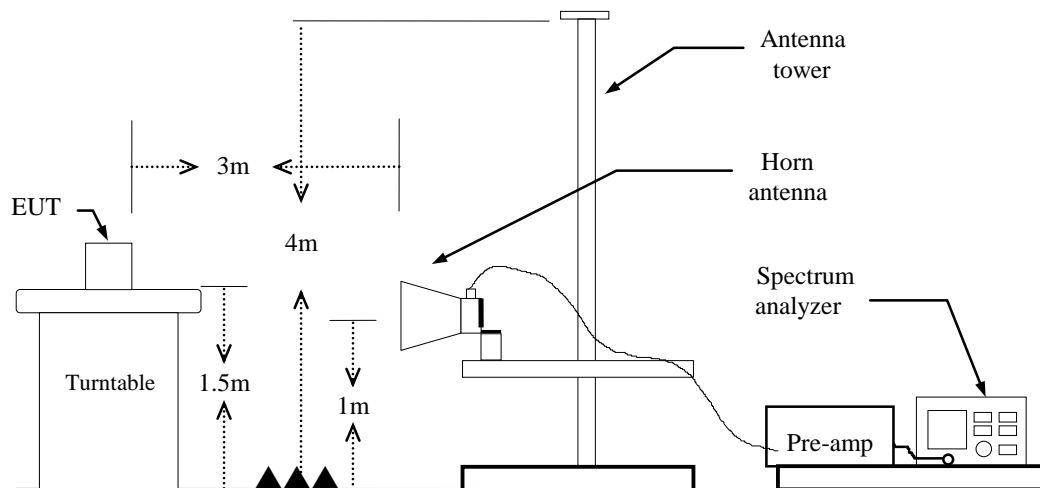

#### For Conducted

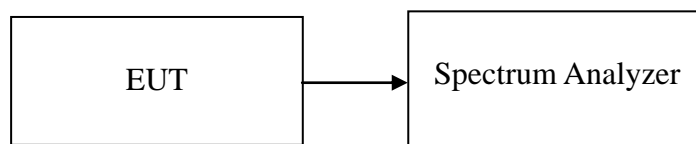

## **TEST PROCEDURE**

### **For Radiated**

1. The EUT is placed on a turntable, which is 1.5m above the ground plane.
2. The turntable shall be rotated for 360 degrees to determine the position of maximum emission level.
3. EUT is set 3m away from the receiving antenna, which is varied from 1m to 4m to find out the highest emission.
4. Set the spectrum analyzer in the following setting in order to capture the lower and upper band-edges of the emission:
  - (a) PEAK: RBW=1MHz / VBW=3MHz / Sweep=AUTO
  - (b) AVERAGE: RBW=1MHz,  
if duty cycle  $\geq 98\%$ , VBW=10Hz.  
if duty cycle  $< 98\%$  VBW=1/T.  
**IEEE 802.11b mode:**  $\geq 98\%$ , VBW=10Hz  
**IEEE 802.11g mode:**  $\geq 98\%$ , VBW=10Hz  
**IEEE 802.11n HT 20 MHz mode:**  $\geq 98\%$ , VBW=10Hz  
**IEEE 802.11n HT 40 MHz mode:**  $\geq 98\%$ , VBW=10Hz
5. Repeat the procedures until all the PEAK and AVERAGE versus POLARIZATION are measured.
6. Result = Spectrum Reading + cable loss(spectrum to Amp) - Amp Gain + Cable loss(Amp to receive Ant)+ Receive Ant

### **For Conducted**

Conducted RF measurements of the transmitter output were made to confirm that the EUT antenna port conducted emissions meet the specified limit and to identify any spurious signals that require further investigation or measurements on the radiated emissions site.

The transmitter output is connected to the spectrum analyzer. The resolution bandwidth is set to 100 kHz. The video bandwidth is set to 300 kHz.

## **TEST RESULTS**

Refer to attach spectrum analyzer data chart.

**Band Edges (IEEE 802.11b mode / CH Low)**

**Polarity: Vertical**

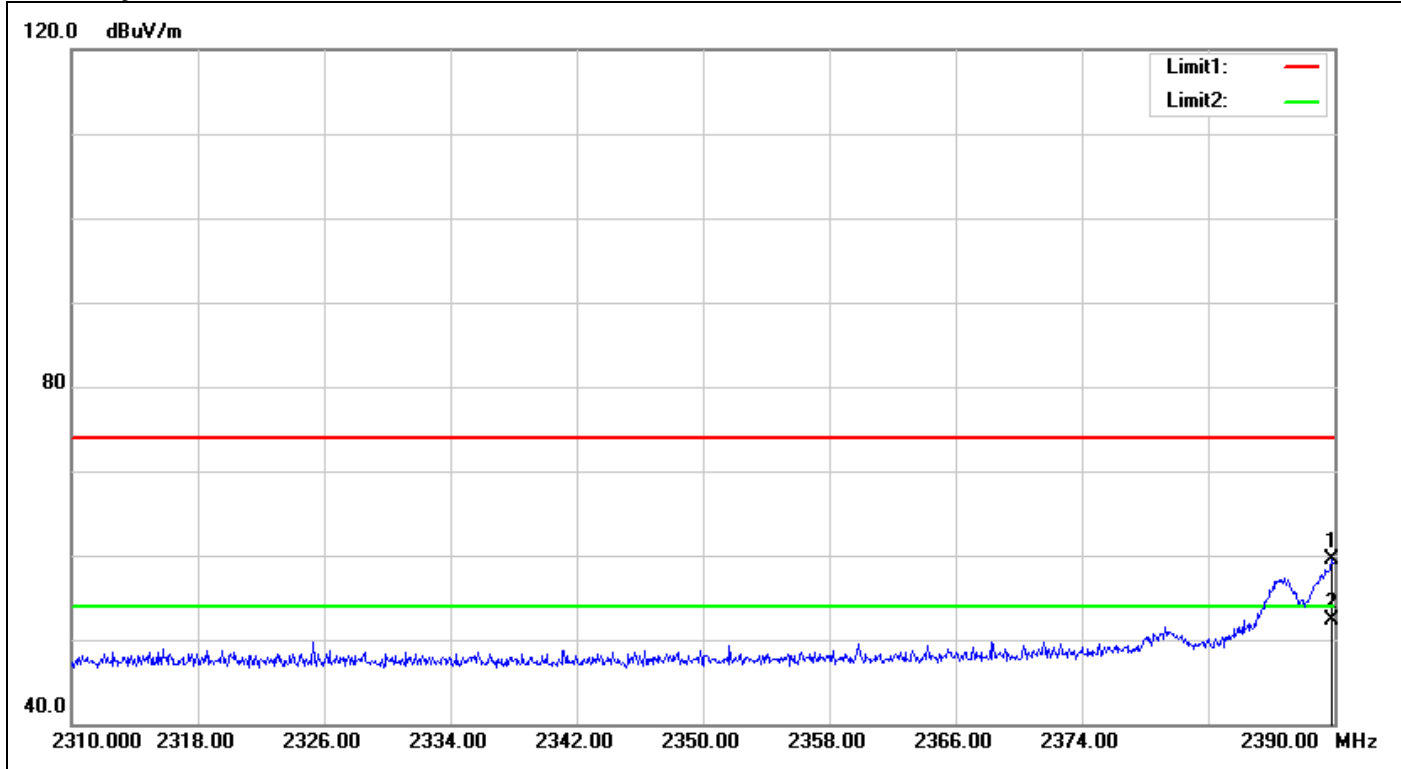

No.	Frequency (MHz)	Reading (dBuV)	Correct Factor(dB/m)	Result (dBuV/m)	Limit (dBuV/m)	Margin (dB)	Height (cm)	Degree (°)	Remark
1	2389.840	61.98	-2.49	59.49	74.00	-14.51	150	44	peak
2	2389.840	54.86	-2.49	52.37	54.00	-1.63	150	44	AVG

**Polarity: Horizontal**

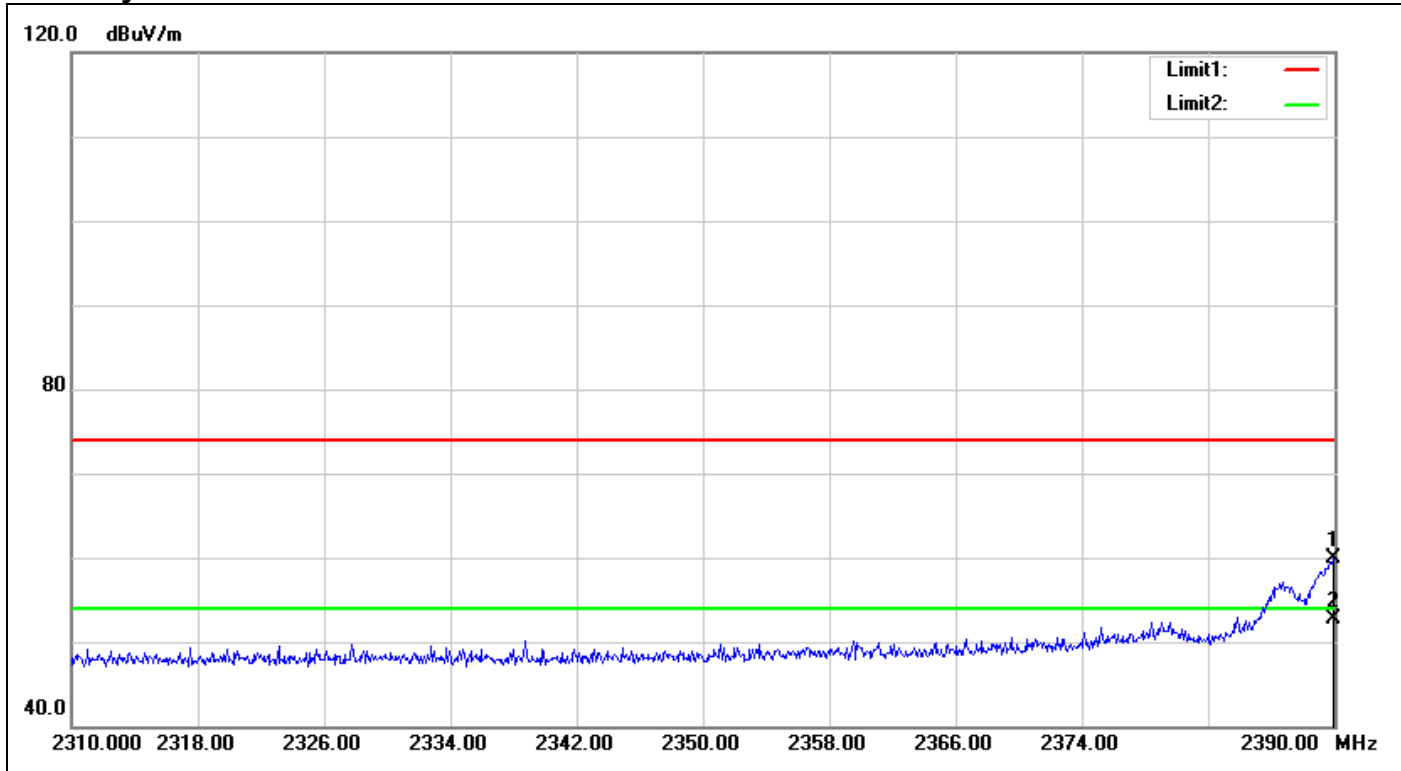

No.	Frequency (MHz)	Reading (dBuV)	Correct Factor(dB/m)	Result (dBuV/m)	Limit (dBuV/m)	Margin (dB)	Height (cm)	Degree (°)	Remark
1	2389.920	62.45	-2.49	59.96	74.00	-14.04	150	44	peak
2	2389.920	55.28	-2.49	52.79	54.00	-1.21	150	44	AVG

**Band Edges (IEEE 802.11b mode / CH High)**

**Polarity: Vertical**

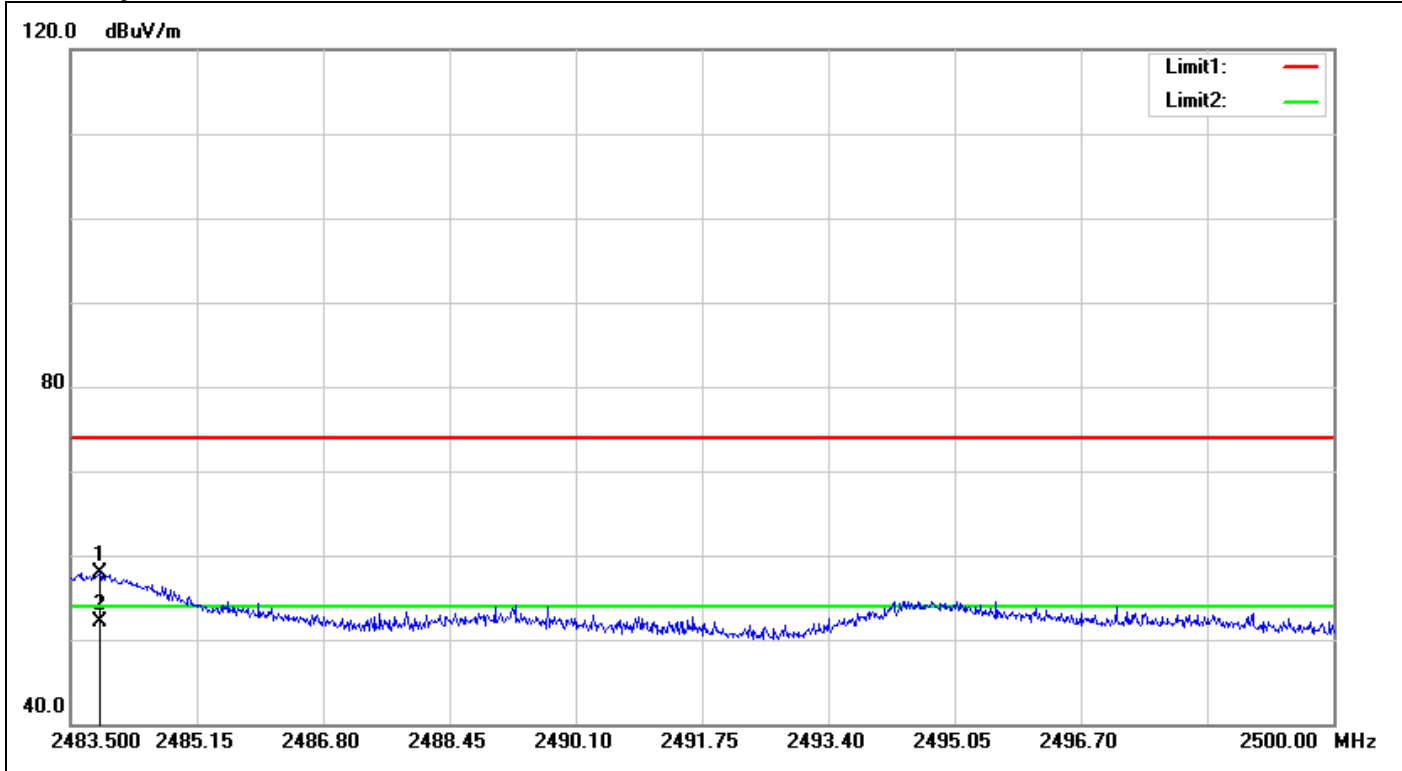

No.	Frequency (MHz)	Reading (dBuV)	Correct Factor(dB/m)	Result (dBuV/m)	Limit (dBuV/m)	Margin (dB)	Height (cm)	Degree (°)	Remark
1	2483.880	59.95	-1.99	57.96	74.00	-16.04	150	157	peak
2	2483.880	54.00	-1.99	52.01	54.00	-1.99	150	157	AVG

**Polarity: Horizontal**

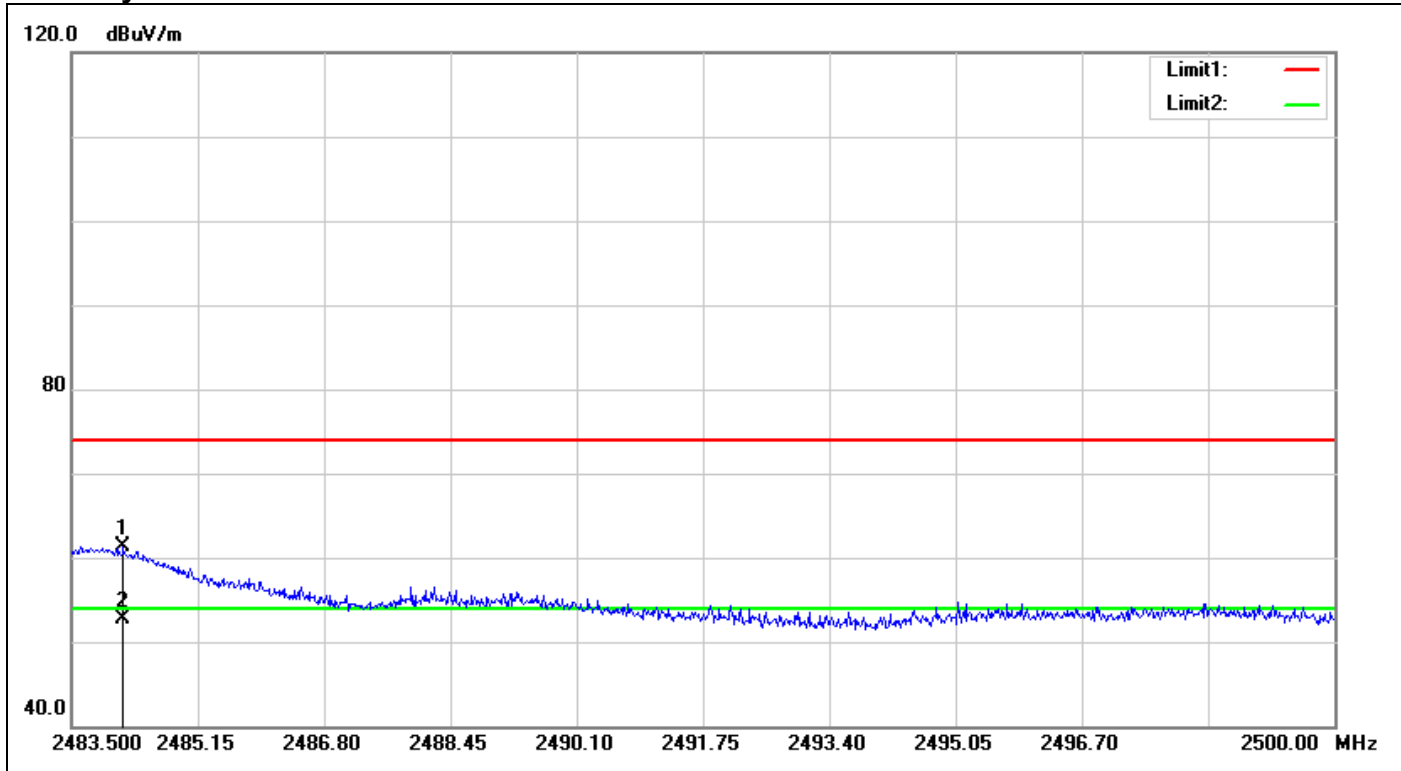

No.	Frequency (MHz)	Reading (dBuV)	Correct Factor(dB/m)	Result (dBuV/m)	Limit (dBuV/m)	Margin (dB)	Height (cm)	Degree (°)	Remark
1	2484.177	63.38	-1.99	61.39	74.00	-12.61	150	261	peak
2	2484.177	54.71	-1.99	52.72	54.00	-1.28	150	261	AVG

**Band Edges (IEEE 802.11g mode / CH Low)**

**Polarity: Vertical**

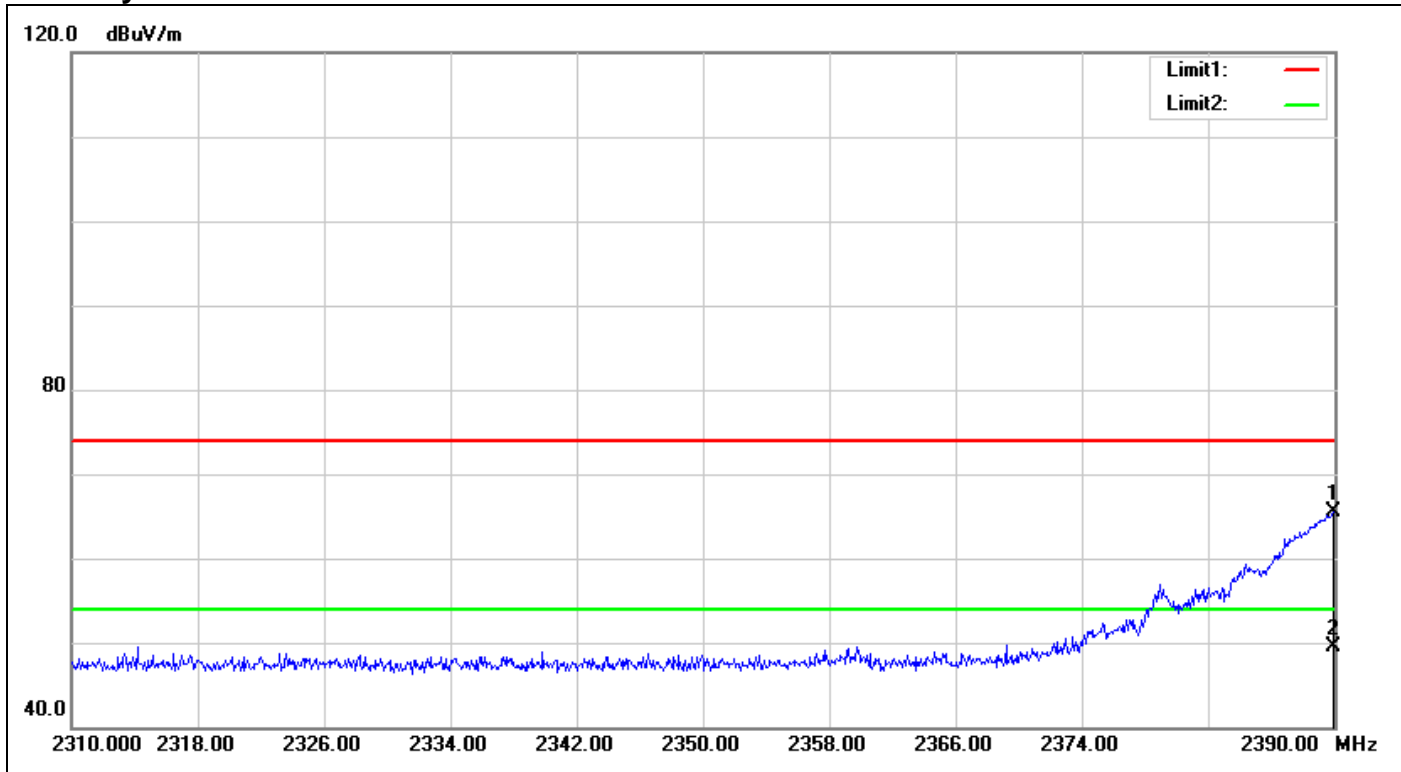

No.	Frequency (MHz)	Reading (dBuV)	Correct Factor(dB/m)	Result (dBuV/m)	Limit (dBuV/m)	Margin (dB)	Height (cm)	Degree (°)	Remark
1	2389.920	68.03	-2.49	65.54	74.00	-8.46	150	23	peak
2	2389.920	51.95	-2.49	49.46	54.00	-4.54	150	23	AVG

**Polarity: Horizontal**

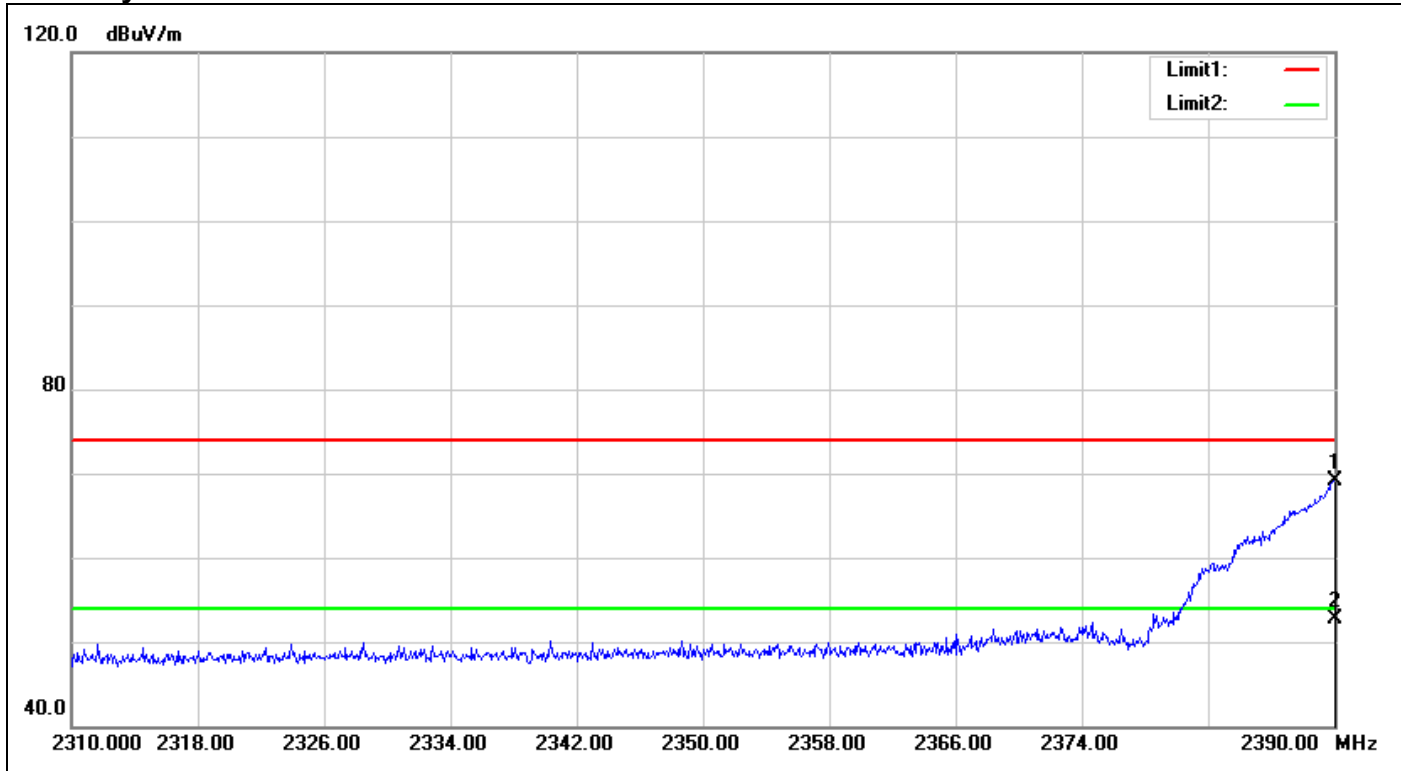

No.	Frequency (MHz)	Reading (dBuV)	Correct Factor(dB/m)	Result (dBuV/m)	Limit (dBuV/m)	Margin (dB)	Height (cm)	Degree (°)	Remark
1	2390.000	71.67	-2.49	69.18	74.00	-4.82	150	189	peak
2	2390.000	55.23	-2.49	52.74	54.00	-1.26	150	189	AVG



**Band Edges (IEEE 802.11g mode / CH High)**

**Polarity: Vertical**

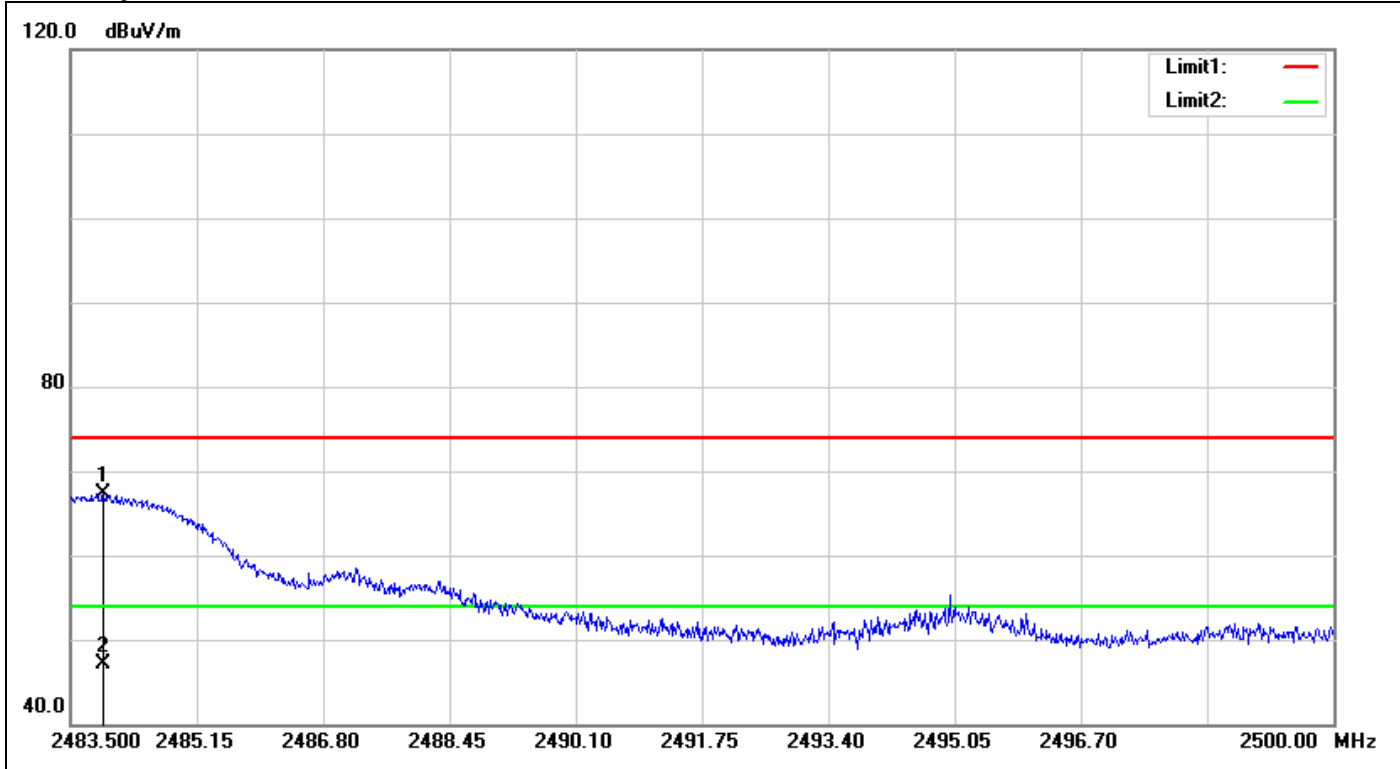

No.	Frequency (MHz)	Reading (dBuV)	Correct Factor(dB/m)	Result (dBuV/m)	Limit (dBuV/m)	Margin (dB)	Height (cm)	Degree (°)	Remark
1	2483.929	69.25	-1.99	67.26	74.00	-6.74	150	313	peak
2	2483.929	49.15	-1.99	47.16	54.00	-6.84	150	313	AVG

**Polarity: Horizontal**

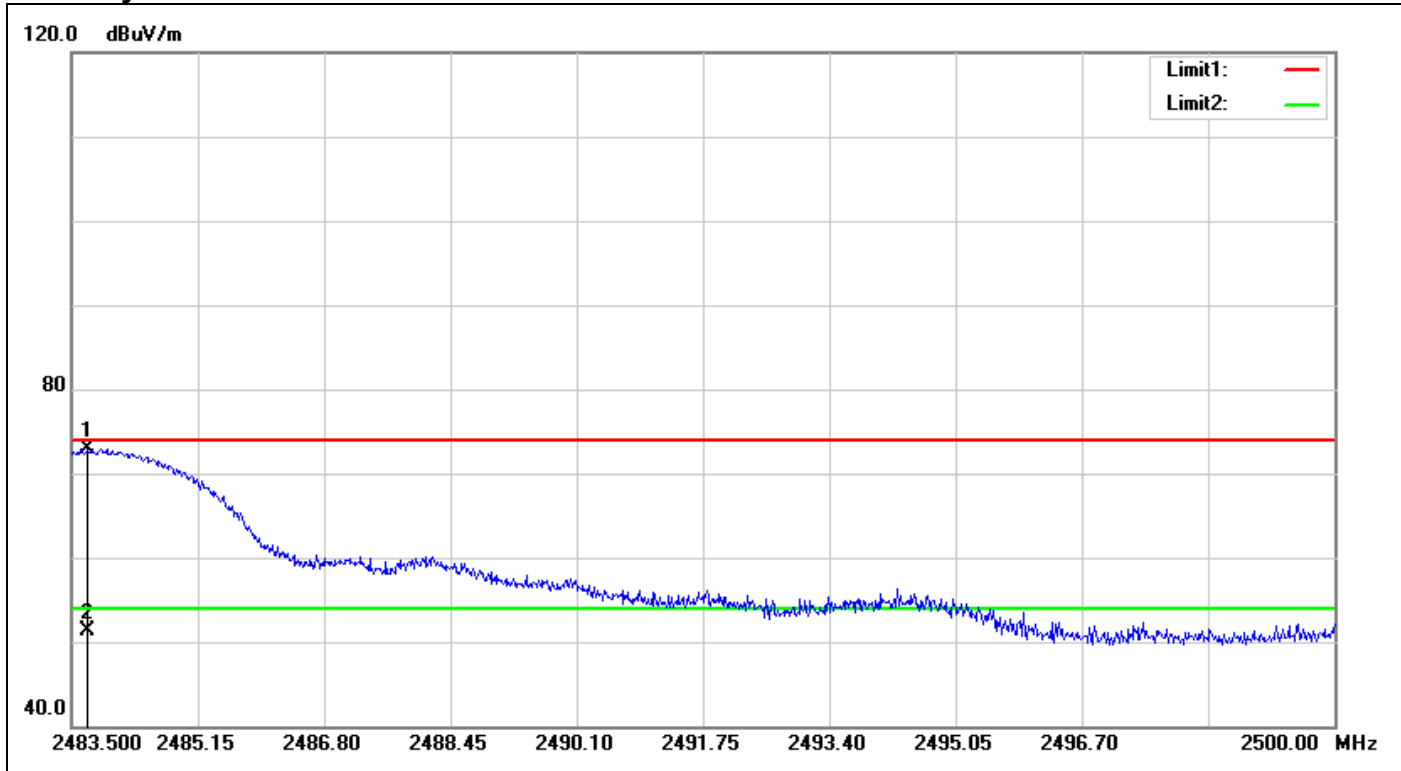

No.	Frequency (MHz)	Reading (dBuV)	Correct Factor(dB/m)	Result (dBuV/m)	Limit (dBuV/m)	Margin (dB)	Height (cm)	Degree (°)	Remark
1	2483.715	74.90	-1.99	72.91	74.00	-1.09	150	116	peak
2	2483.715	53.22	-1.99	51.23	54.00	-2.77	150	116	AVG

**Band Edges (IEEE 802.11n HT 20 MHz mode / CH Low)**

**Polarity: Vertical**

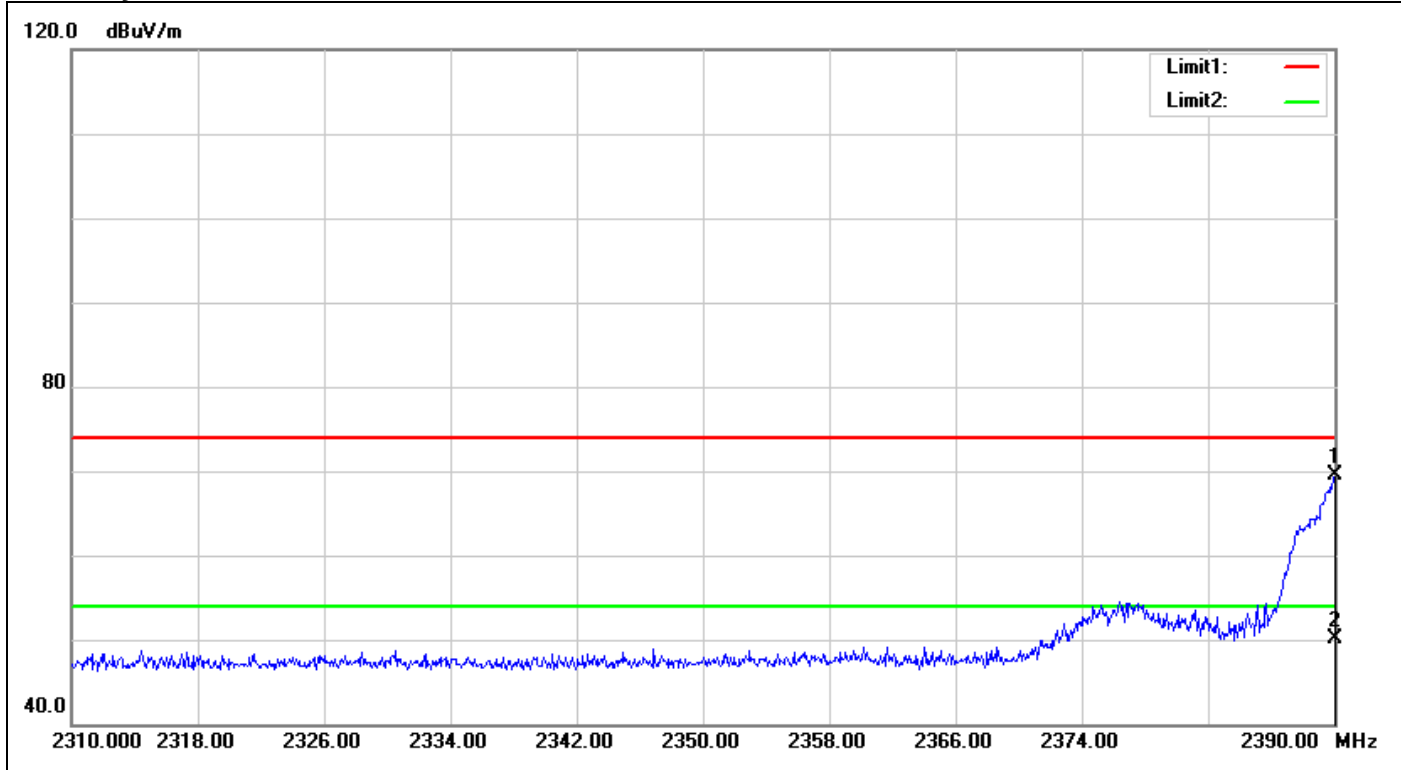

No.	Frequency (MHz)	Reading (dBuV)	Correct Factor(dB/m)	Result (dBuV/m)	Limit (dBuV/m)	Margin (dB)	Height (cm)	Degree (°)	Remark
1	2390.000	72.01	-2.49	69.52	74.00	-4.48	150	359	peak
2	2390.000	52.56	-2.49	50.07	54.00	-3.93	150	359	AVG

**Polarity: Horizontal**

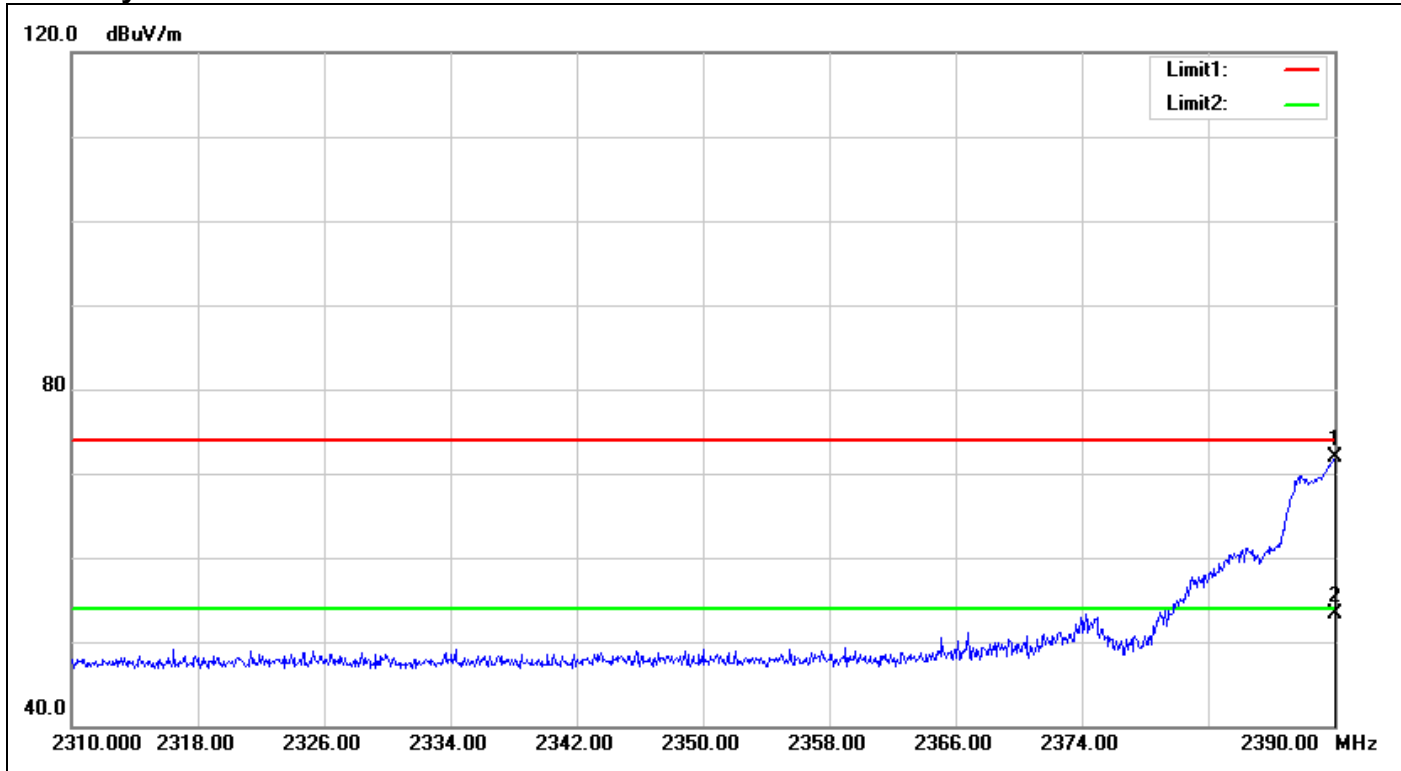

No.	Frequency (MHz)	Reading (dBuV)	Correct Factor(dB/m)	Result (dBuV/m)	Limit (dBuV/m)	Margin (dB)	Height (cm)	Degree (°)	Remark
1	2390.000	74.43	-2.49	71.94	74.00	-2.06	150	359	peak
2	2390.000	55.71	-2.49	53.22	54.00	-0.78	150	359	AVG

**Band Edges (IEEE 802.11n HT 20 MHz mode / CH High)**

**Polarity: Vertical**

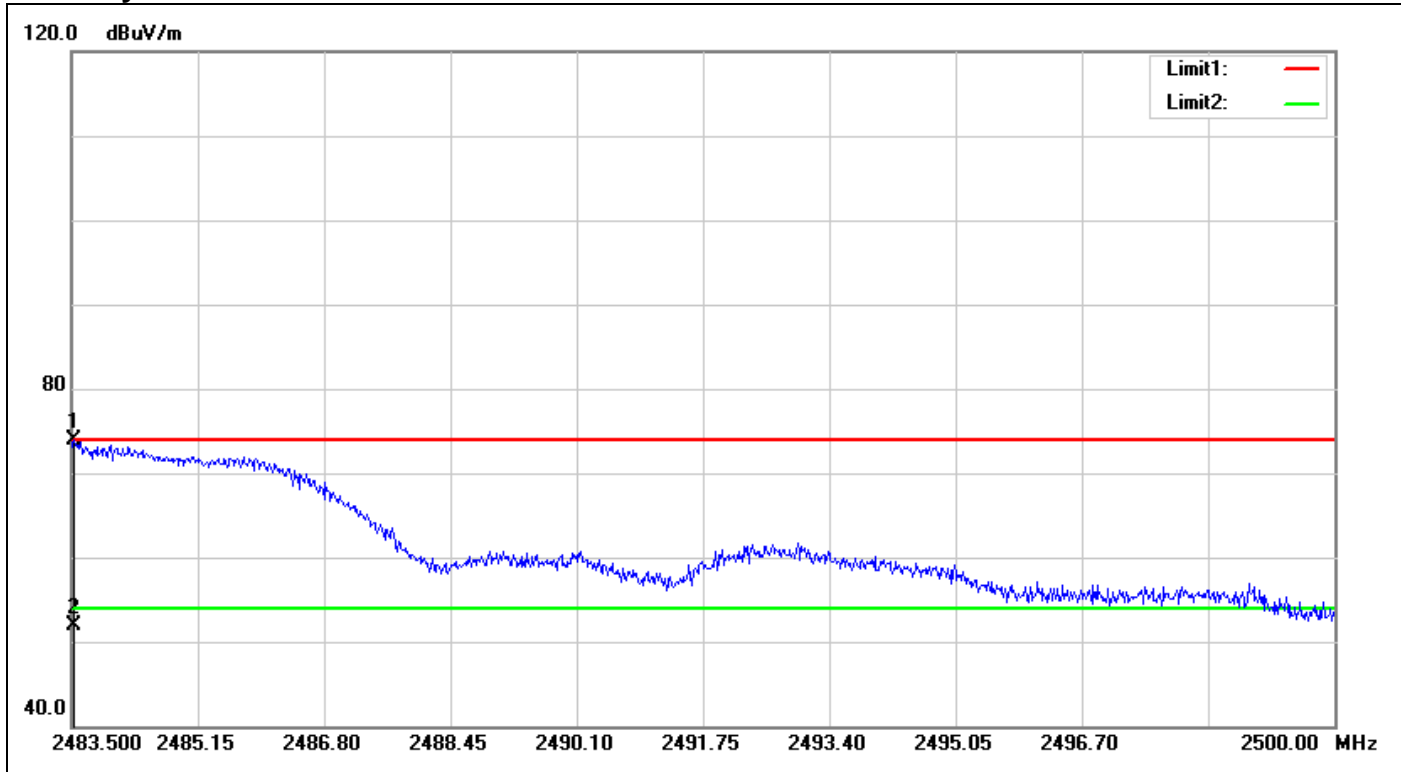

No.	Frequency (MHz)	Reading (dBuV)	Correct Factor(dB/m)	Result (dBuV/m)	Limit (dBuV/m)	Margin (dB)	Height (cm)	Degree (°)	Remark
1	2483.533	75.88	-1.99	73.89	74.00	-0.11	150	10	peak
2	2483.533	53.97	-1.99	51.98	54.00	-2.02	150	10	AVG

**Polarity: Horizontal**

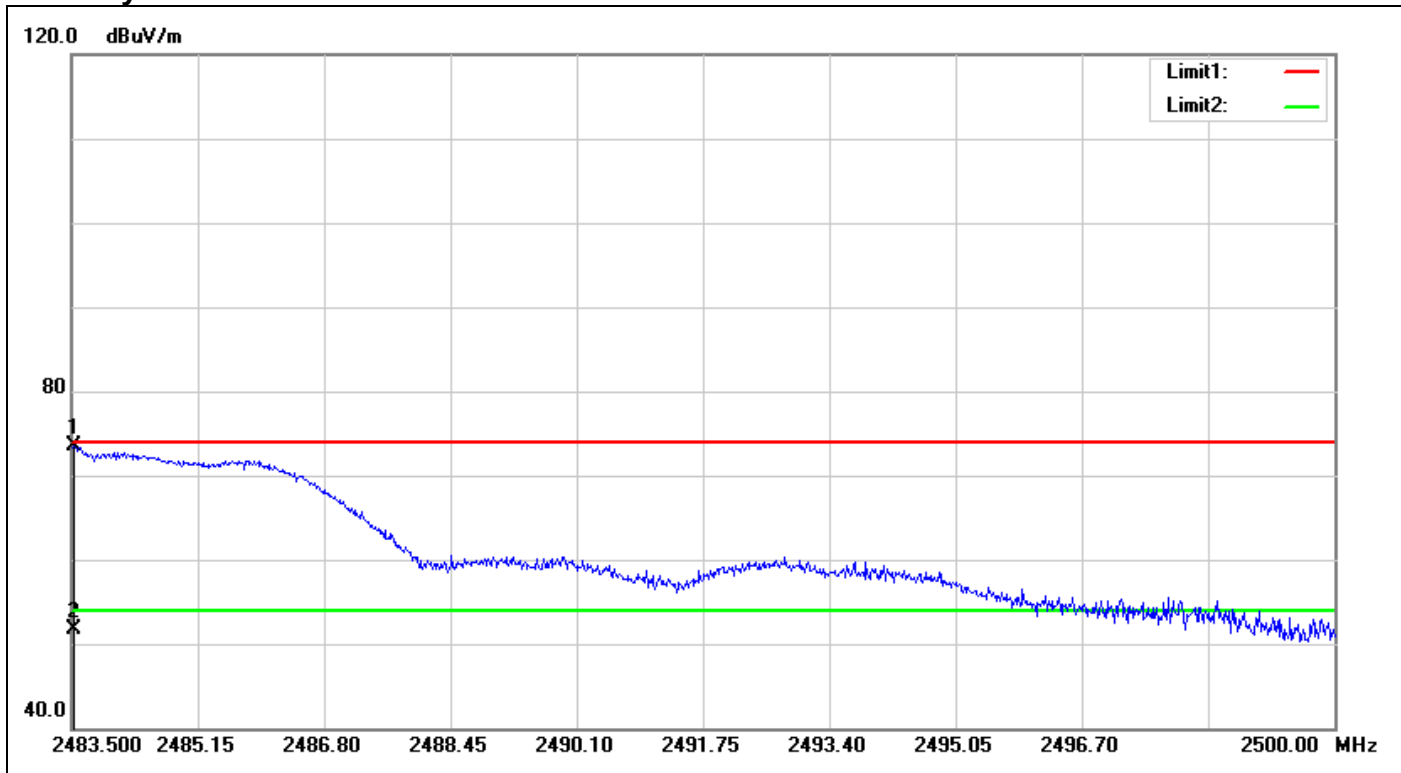

No.	Frequency (MHz)	Reading (dBuV)	Correct Factor(dB/m)	Result (dBuV/m)	Limit (dBuV/m)	Margin (dB)	Height (cm)	Degree (°)	Remark
1	2483.533	75.45	-1.99	73.46	74.00	-0.54	150	10	peak
2	2483.533	53.59	-1.99	51.60	54.00	-2.40	150	10	AVG

**Band Edges (IEEE 802.11n HT 40 MHz mode / CH Low)**

**Polarity: Vertical**

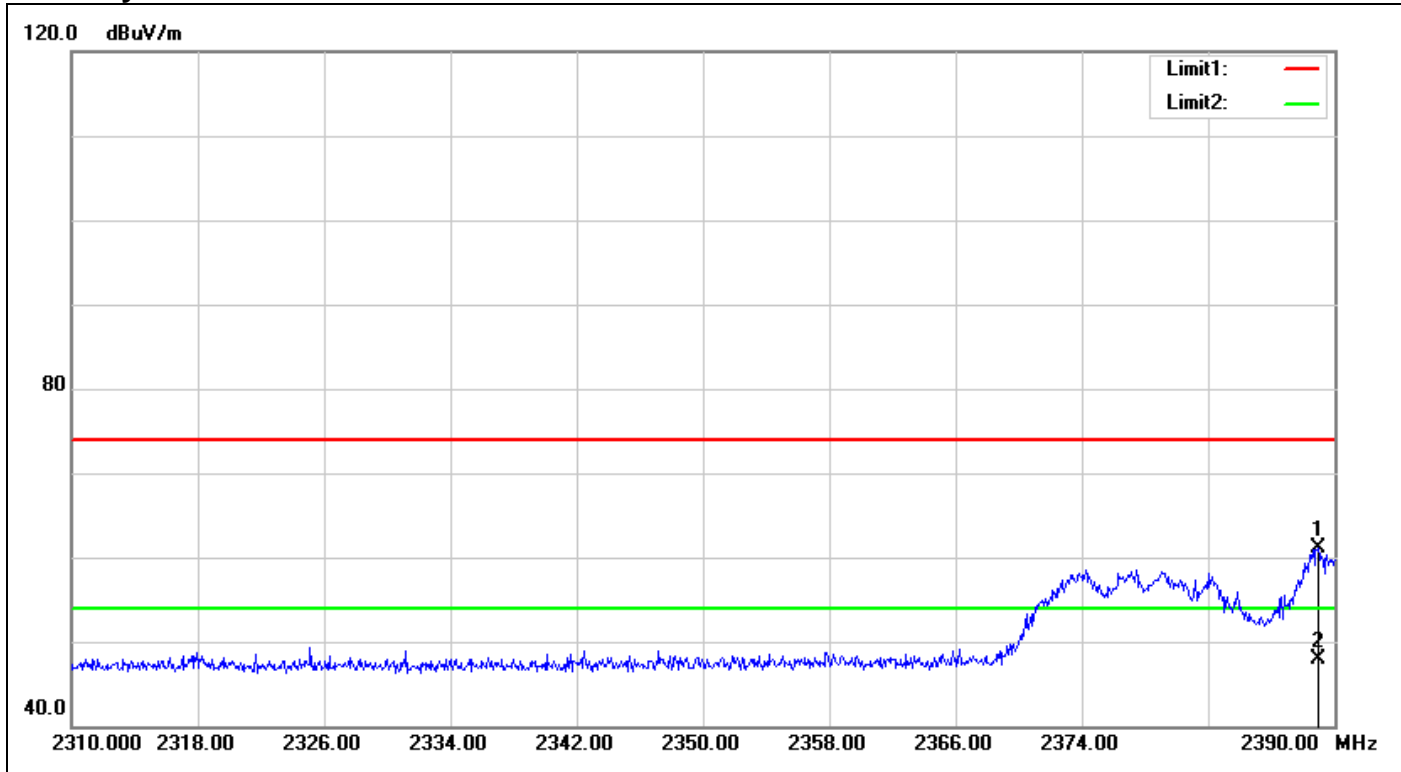

No.	Frequency (MHz)	Reading (dBuV)	Correct Factor(dB/m)	Result (dBuV/m)	Limit (dBuV/m)	Margin (dB)	Height (cm)	Degree (°)	Remark
1	2388.960	63.63	-2.50	61.13	74.00	-12.87	150	290	peak
2	2388.960	50.41	-2.50	47.91	54.00	-6.09	150	290	AVG

**Polarity: Horizontal**

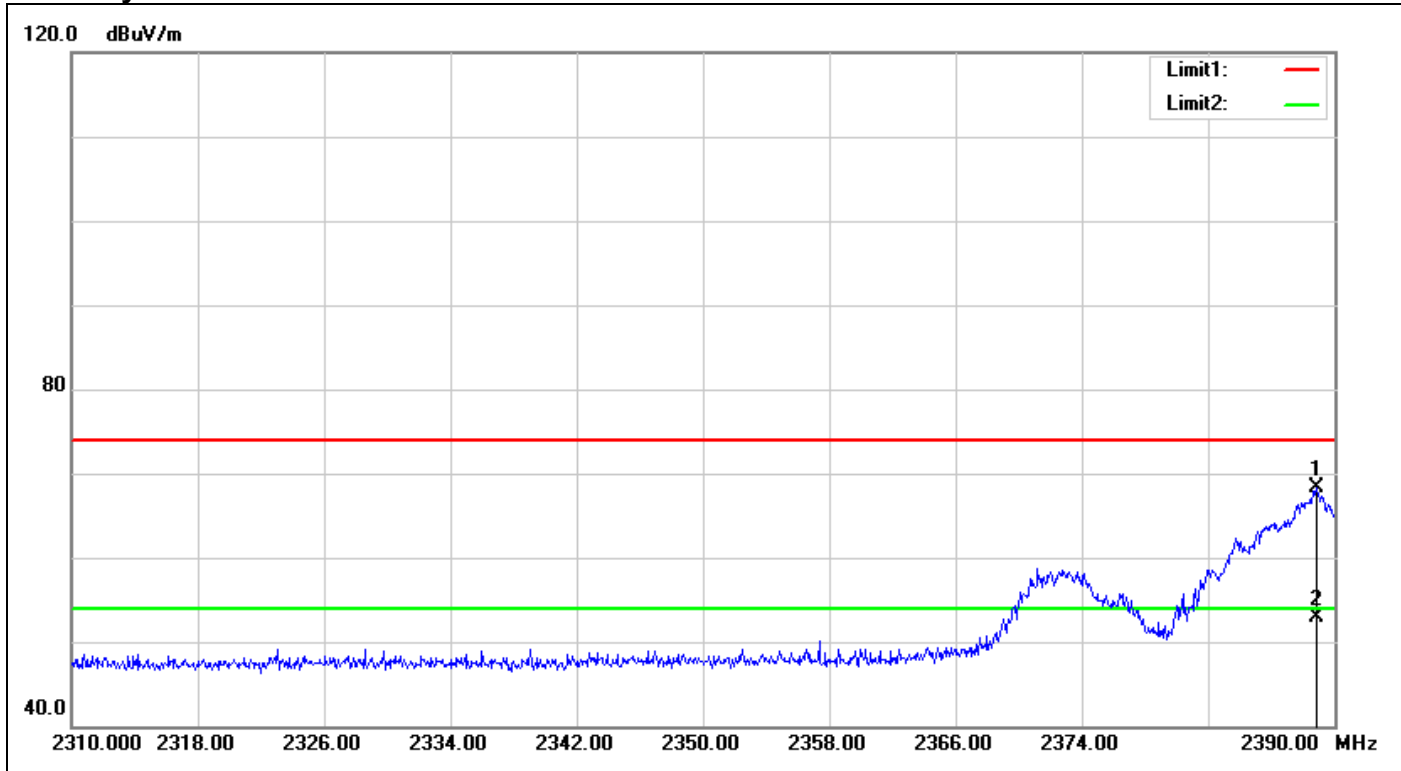

No.	Frequency (MHz)	Reading (dBuV)	Correct Factor(dB/m)	Result (dBuV/m)	Limit (dBuV/m)	Margin (dB)	Height (cm)	Degree (°)	Remark
1	2388.880	70.74	-2.50	68.24	74.00	-5.76	150	2	peak
2	2388.880	55.40	-2.50	52.90	54.00	-1.10	150	2	AVG



**Band Edges (IEEE 802.11n HT 40 MHz mode / CH High)**

**Polarity: Vertical**

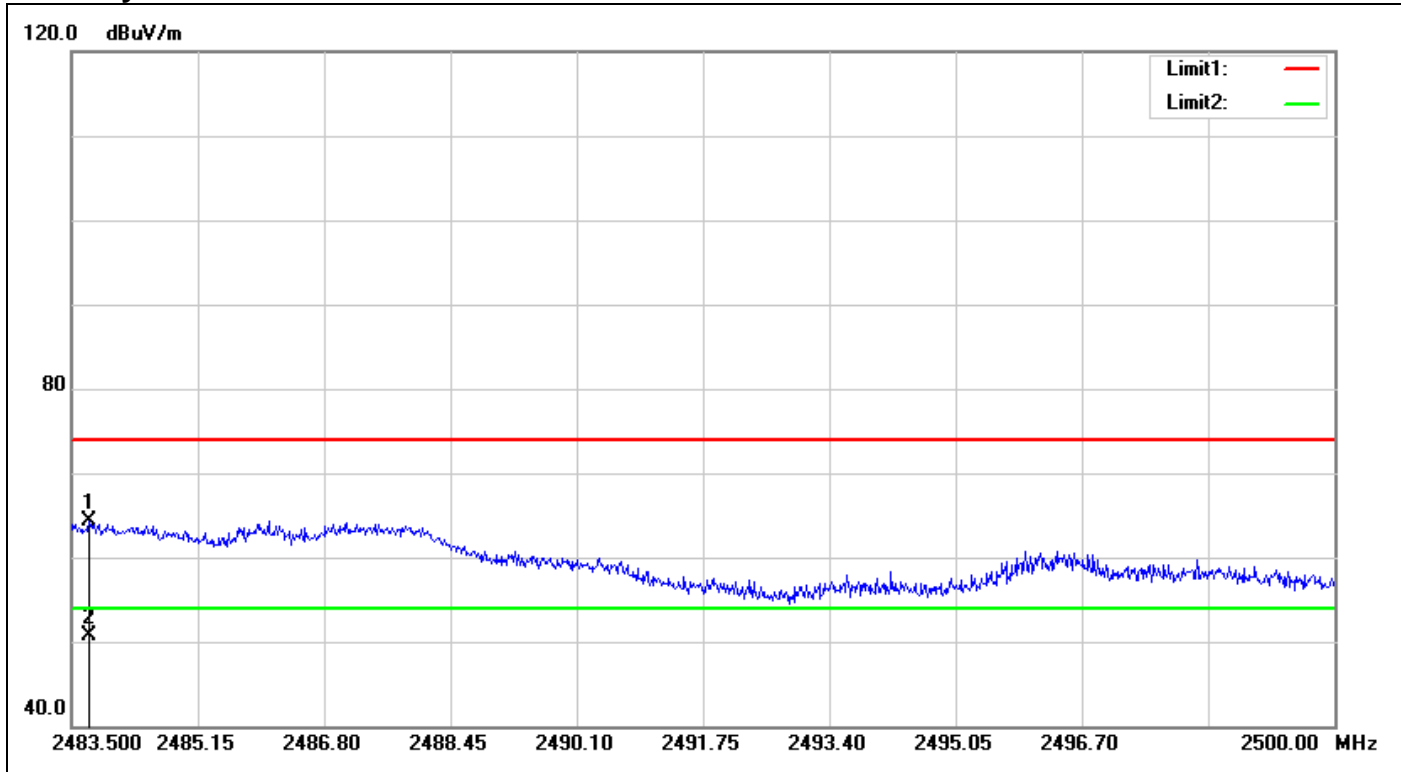

No.	Frequency (MHz)	Reading (dBuV)	Correct Factor(dB/m)	Result (dBuV/m)	Limit (dBuV/m)	Margin (dB)	Height (cm)	Degree (°)	Remark
1	2483.731	66.33	-1.99	64.34	74.00	-9.66	150	359	peak
2	2483.731	52.63	-1.99	50.64	54.00	-3.36	150	359	AVG

**Polarity: Horizontal**

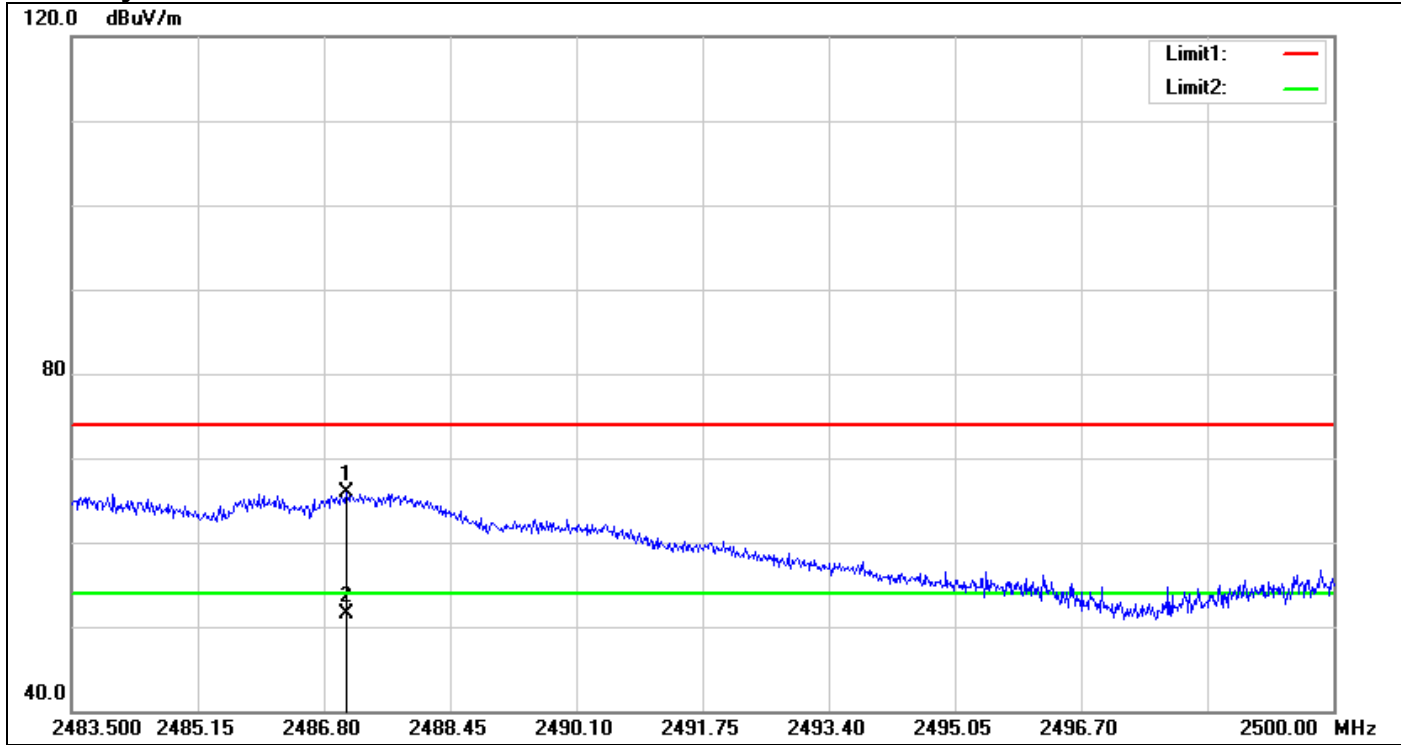

No.	Frequency (MHz)	Reading (dBuV)	Correct Factor(dB/m)	Result (dBuV/m)	Limit (dBuV/m)	Margin (dB)	Height (cm)	Degree (°)	Remark
1	2487.097	67.79	-1.96	65.83	74.00	-8.17	150	334	peak
2	2487.097	53.39	-1.96	51.43	54.00	-2.57	150	334	AVG

**Test Plot**  
**Conducted Band Edges (IEEE 802.11b mode / CH Low)**

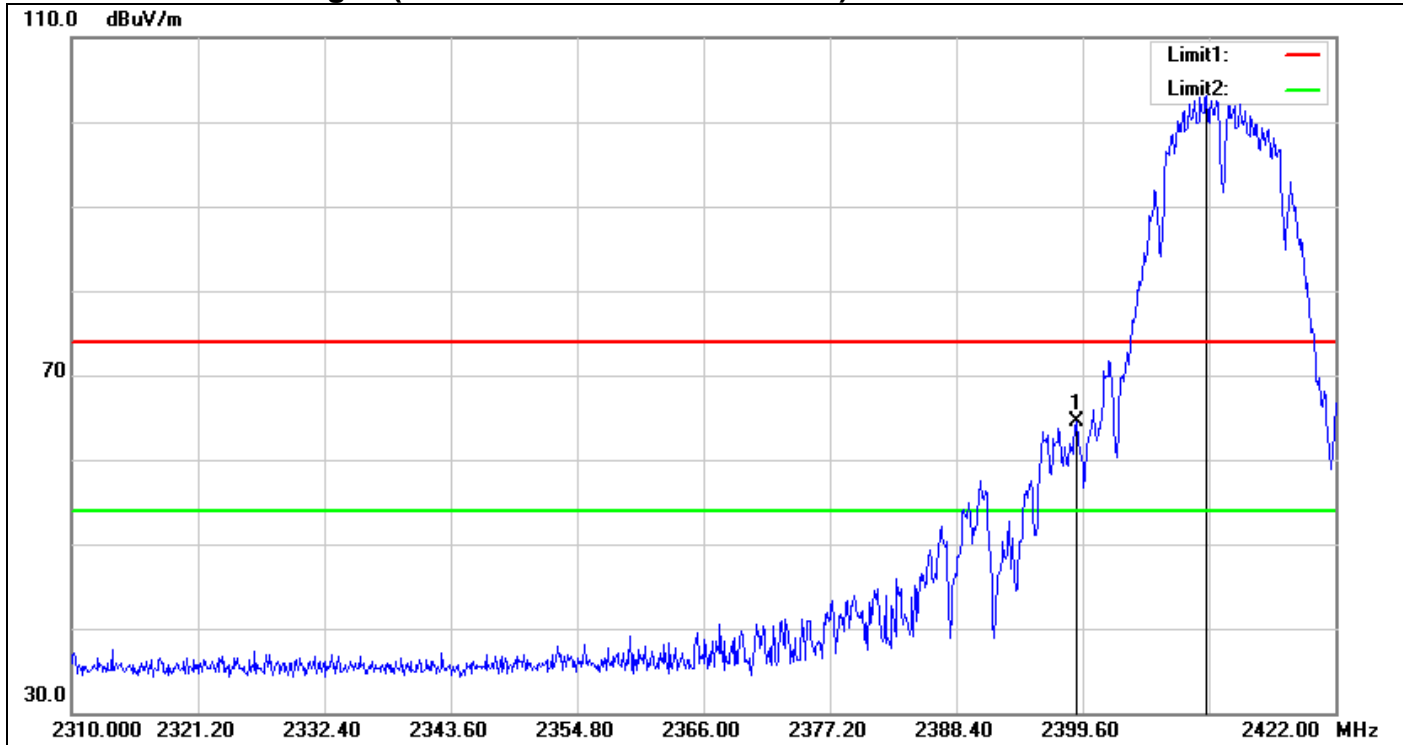

No.	Frequency (MHz)	Reading (dBuV)	Correct Factor(dB/m)	Result (dBuV/m)	Limit (dBuV/m)	Margin (dB)	Height (cm)	Degree (°)	Remark
1	2399.040	67.00	-2.42	64.58	74.00	-9.42	150	8	peak
2	2410.576	105.47	-2.43	103.04	74.00	29.04	150	17	peak

**Conducted Band Edges (IEEE 802.11b mode / CH High)**

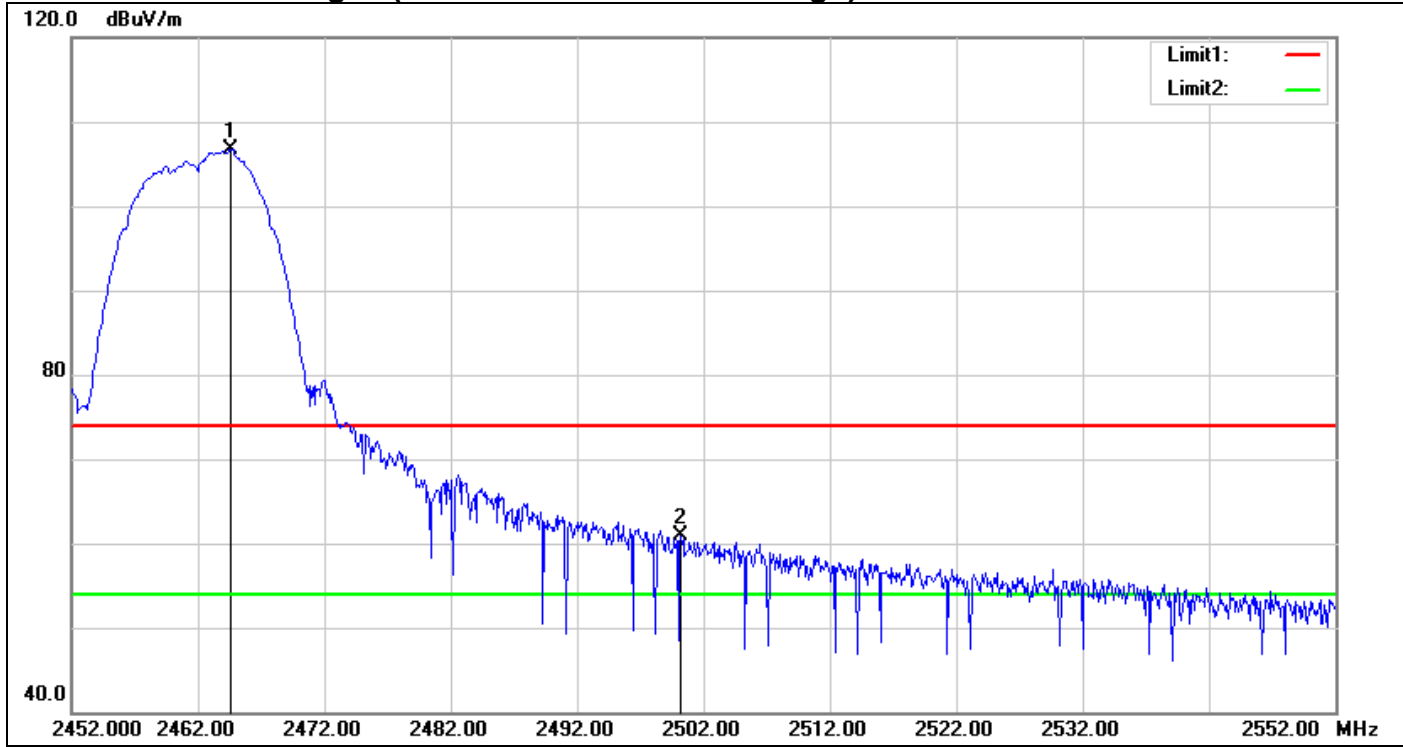

No.	Frequency (MHz)	Reading (dBuV)	Correct Factor(dB/m)	Result (dBuV/m)	Limit (dBuV/m)	Margin (dB)	Height (cm)	Degree (°)	Remark
1	2464.600	108.89	-2.09	106.80	74.00	32.80	150	290	peak
2	2500.200	62.78	-1.86	60.92	74.00	-13.08	150	351	peak

**Conducted Band Edges (IEEE 802.11g mode / CH Low)**

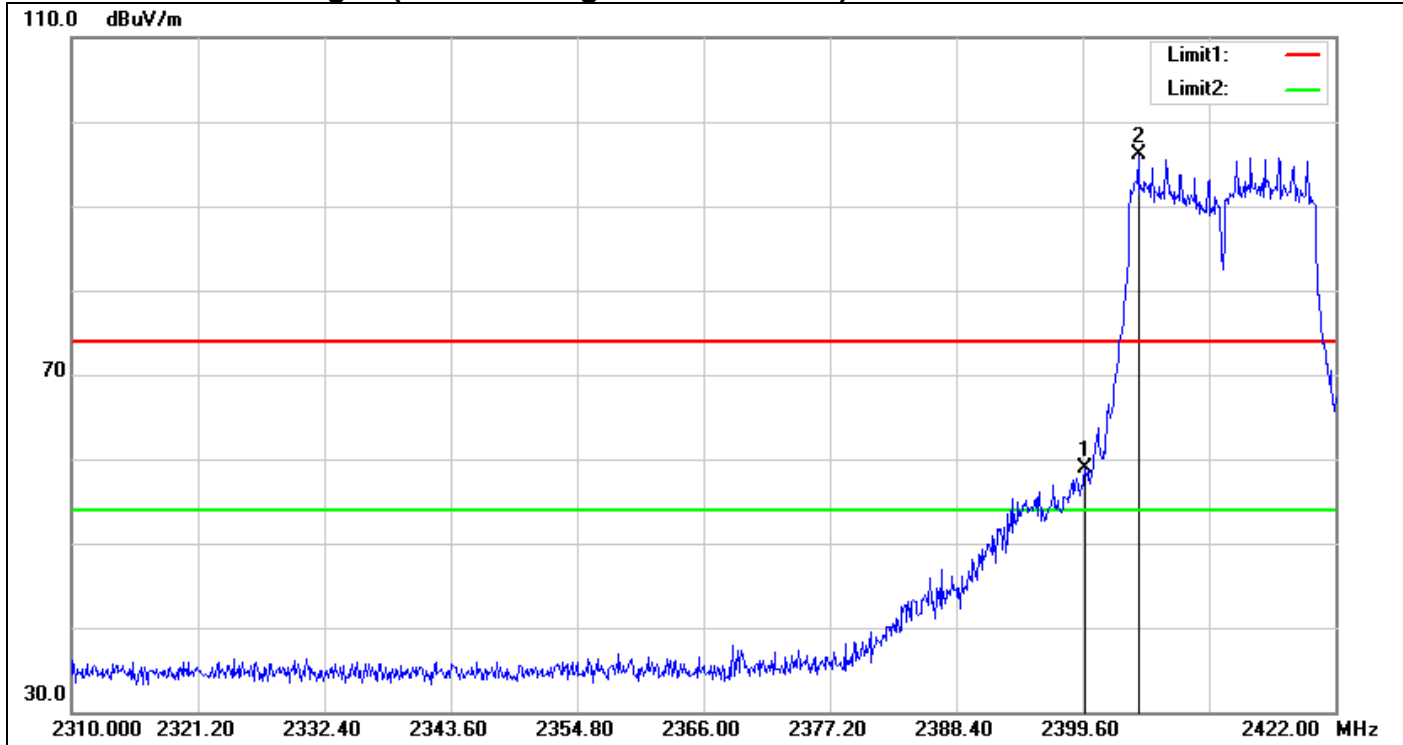

No.	Frequency (MHz)	Reading (dBuV)	Correct Factor(dB/m)	Result (dBuV/m)	Limit (dBuV/m)	Margin (dB)	Height (cm)	Degree (°)	Remark
1	2399.824	61.26	-2.41	58.85	74.00	-15.15	150	325	peak
2	2404.528	98.52	-2.42	96.10	74.00	22.10	150	14	peak

**Conducted Band Edges (IEEE 802.11g mode / CH High)**



No.	Frequency (MHz)	Reading (dBuV)	Correct Factor(dB/m)	Result (dBuV/m)	Limit (dBuV/m)	Margin (dB)	Height (cm)	Degree (°)	Remark
1	2469.500	100.67	-2.07	98.60	74.00	24.60	150	290	peak
2	2504.500	42.25	-1.85	40.40	74.00	-33.60	150	296	peak

**Conducted Band Edges (IEEE 802.11n HT 20 MHz mode / CH Low)**

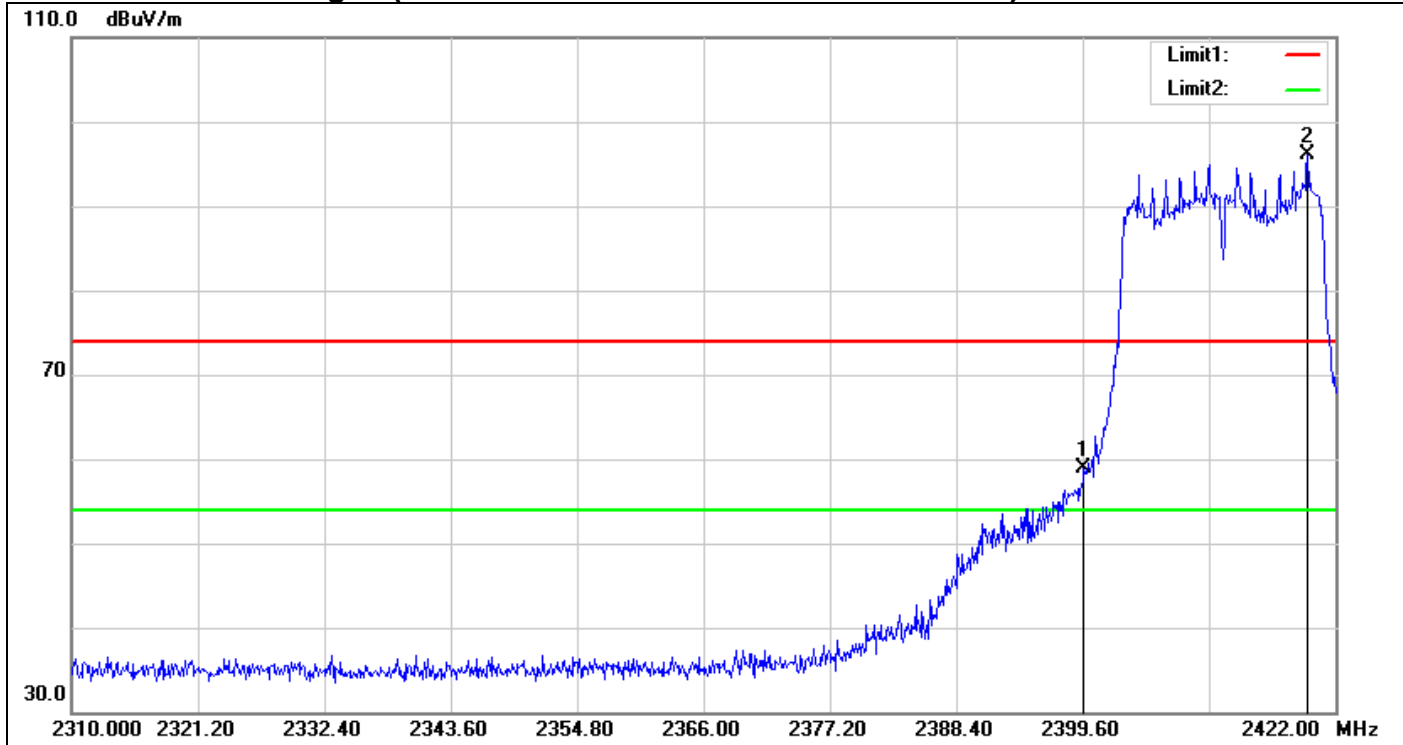

No.	Frequency (MHz)	Reading (dBuV)	Correct Factor(dB/m)	Result (dBuV/m)	Limit (dBuV/m)	Margin (dB)	Height (cm)	Degree (°)	Remark
1	2399.712	61.24	-2.41	58.83	74.00	-15.17	150	346	peak
2	2419.536	98.50	-2.36	96.14	74.00	22.14	150	10	peak

**Conducted Band Edges (IEEE 802.11n HT 20 MHz mode / CH High)**

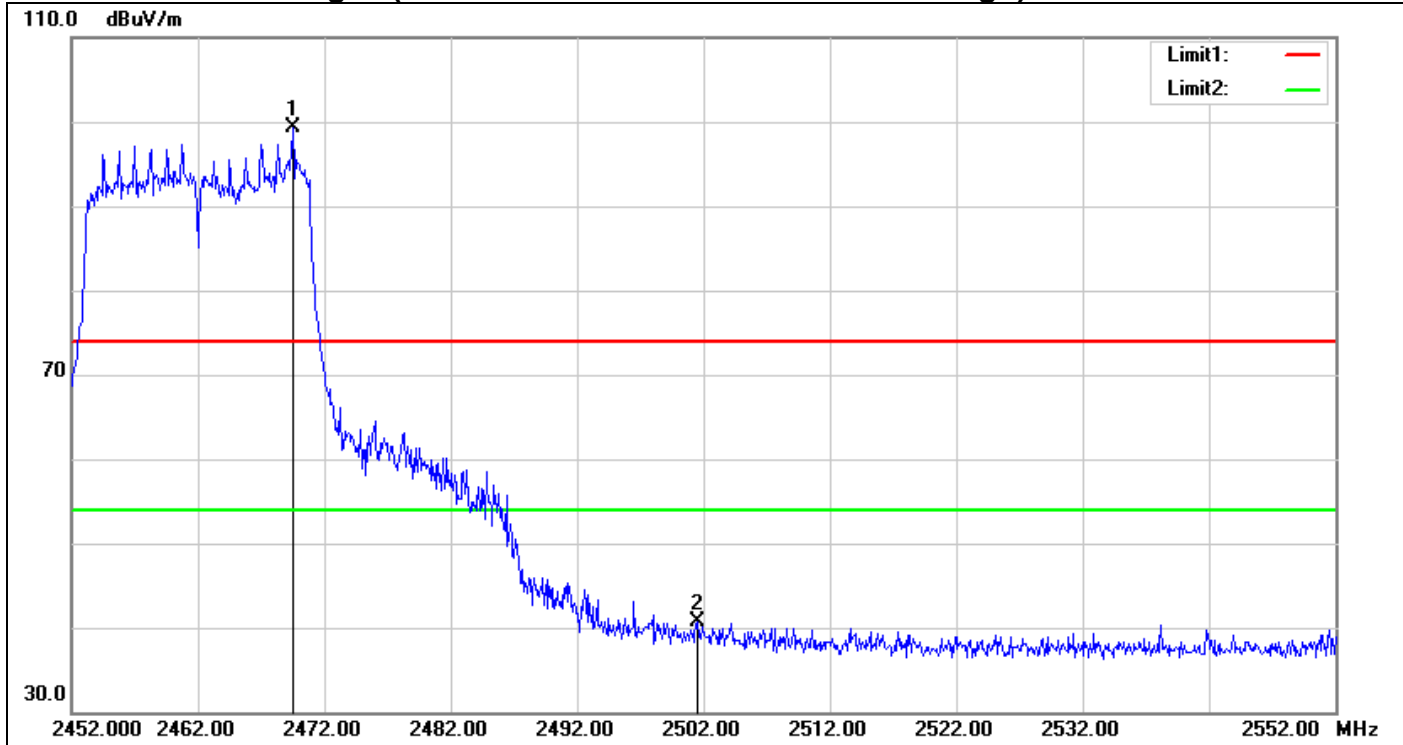

No.	Frequency (MHz)	Reading (dBuV)	Correct Factor(dB/m)	Result (dBuV/m)	Limit (dBuV/m)	Margin (dB)	Height (cm)	Degree (°)	Remark
1	2469.500	101.28	-2.07	99.21	74.00	25.21	150	291	peak
2	2501.500	42.53	-1.86	40.67	74.00	-33.33	150	273	peak



**Conducted Band Edges (IEEE 802.11n HT 40 MHz mode / CH Low)**

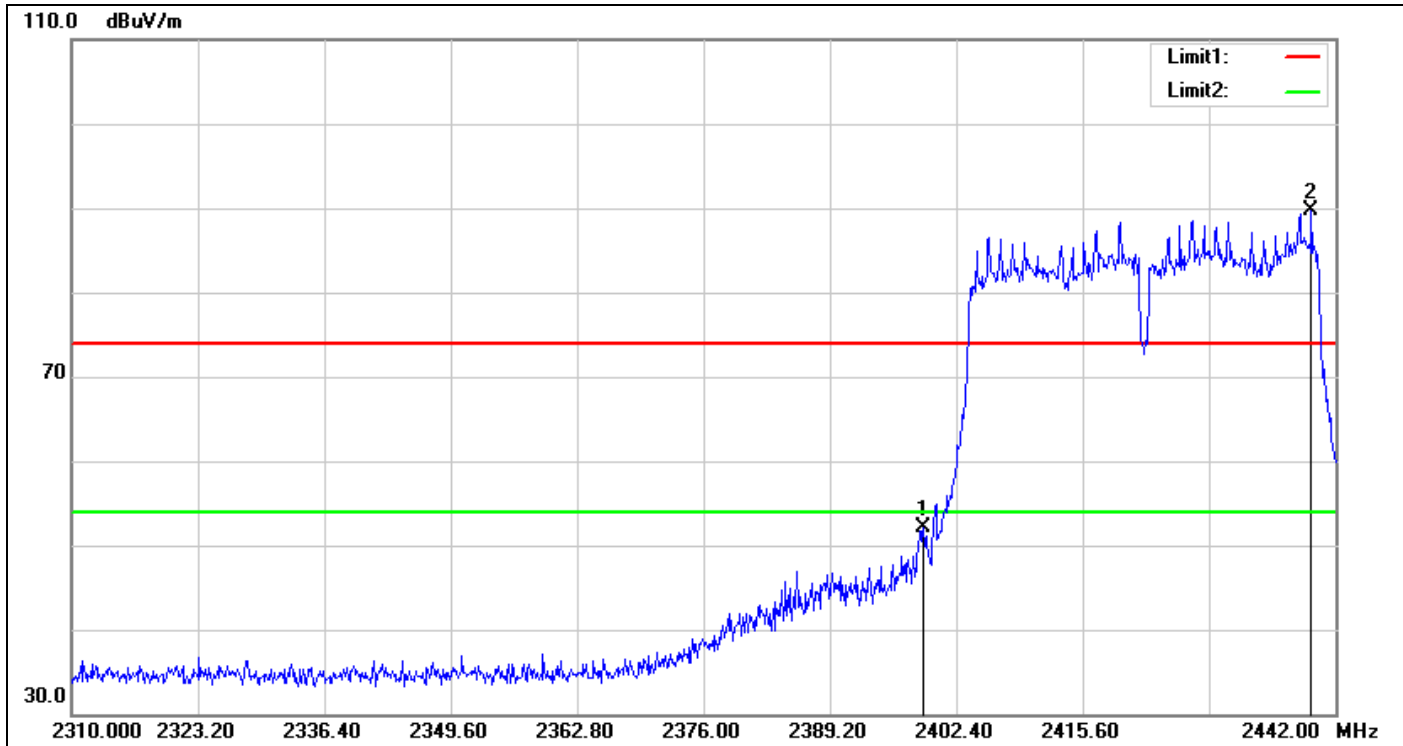

No.	Frequency (MHz)	Reading (dBuV)	Correct Factor(dB/m)	Result (dBuV/m)	Limit (dBuV/m)	Margin (dB)	Height (cm)	Degree (°)	Remark
1	2398.968	54.44	-2.42	52.02	74.00	-21.98	150	120	peak
2	2439.492	92.00	-2.22	89.78	74.00	15.78	150	17	peak

**Conducted Band Edges (IEEE 802.11n HT 40 MHz mode / CH High)**

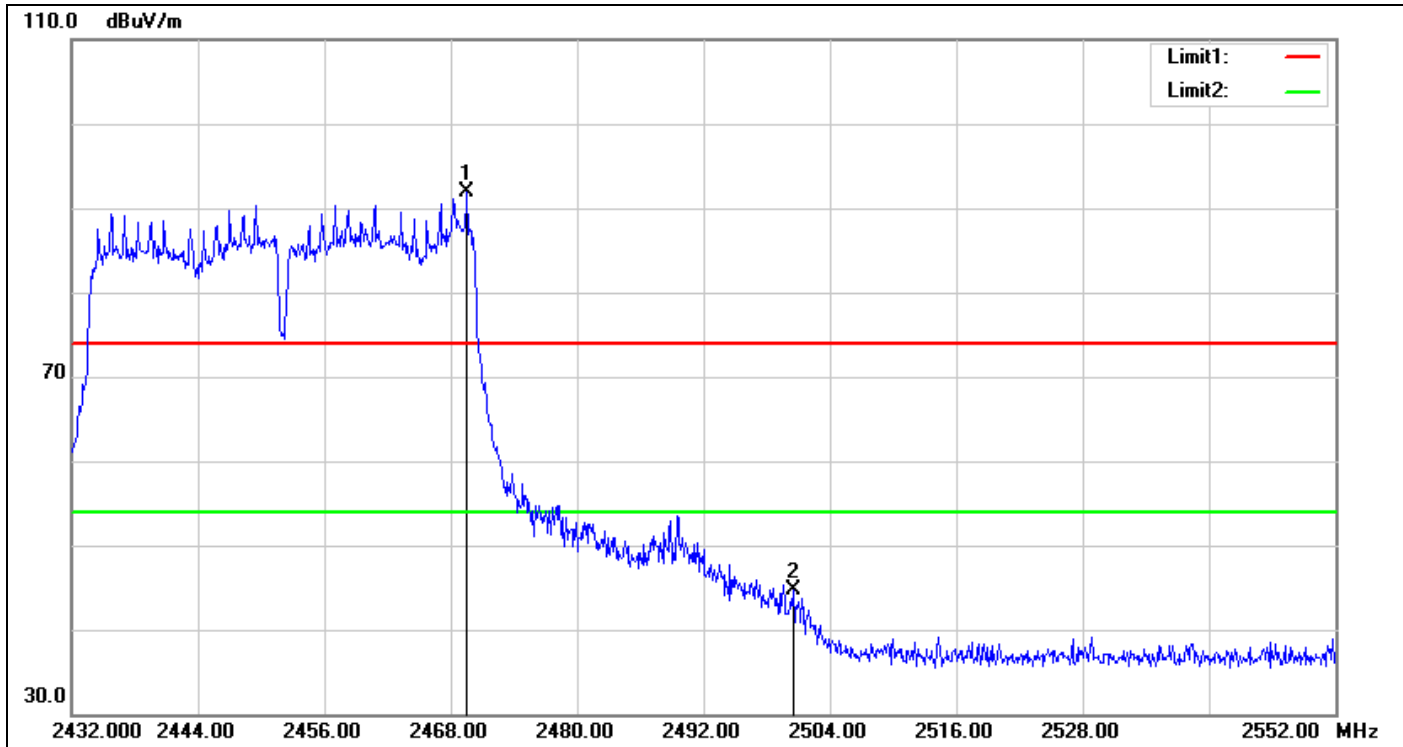

No.	Frequency (MHz)	Reading (dBuV)	Correct Factor(dB/m)	Result (dBuV/m)	Limit (dBuV/m)	Margin (dB)	Height (cm)	Degree (°)	Remark
1	2469.560	93.88	-2.07	91.81	74.00	17.81	150	293	peak
2	2500.520	46.53	-1.86	44.67	74.00	-29.33	150	358	peak

## 7.6 PEAK POWER SPECTRAL DENSITY

### LIMIT

1. According to §15.247(e) & RSS-247, for digitally modulated systems, the power spectral density conducted from the intentional radiator to the antenna shall not be greater than 8 dBm in any 3 kHz band during any time interval of continuous transmission.
2. According to §15.247(f) & RSS-247, the digital modulation operation of the hybrid system, with the frequency hopping turned off, shall comply with the power density requirements of paragraph (d) of this section.

### Test Configuration

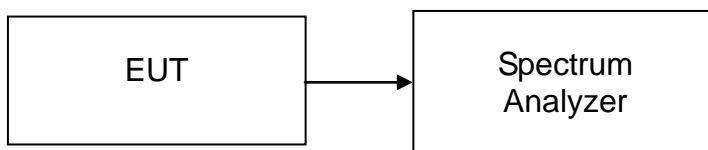

### TEST PROCEDURE

1. Place the EUT on the table and set it in transmitting mode. Remove the antenna from the EUT and then connect a low loss RF cable from the antenna port to the spectrum analyzer.
2. Set the spectrum analyzer as RBW = 3 kHz, VBW = 30 kHz, Span = 1.5MHz, Sweep time = 100 s
3. Record the max reading.
4. Repeat the above procedure until the measurements for all frequencies are completed.

### TEST RESULTS

*No non-compliance noted*

**Test Data**

**IEEE 802.11b mode**

Channel	Frequency (MHz)	Chain 0 PPSD (dBm)	Chain 1 PPSD (dBm)	PPSD (dBm)	Limit (dBm)	Result
Low	2412	-10.56	-10.71	-7.62	8.00	PASS
Mid	2437	-8.42	-9.30	-5.83		PASS
High	2462	-11.44	-11.03	-8.22		PASS

**IEEE 802.11g mode**

Channel	Frequency (MHz)	Chain 0 PPSD (dBm)	Chain 1 PPSD (dBm)	PPSD (dBm)	Limit (dBm)	Result
Low	2412	-14.00	-14.94	-11.43	8.00	PASS
Mid	2437	-8.66	-8.03	-5.32		PASS
High	2462	-15.25	-16.18	-12.68		PASS

**IEEE 802.11n HT 20 MHz mode**

Channel	Frequency (MHz)	Chain 0 PPSD (dBm)	Chain 1 PPSD (dBm)	PPSD (dBm)	Limit (dBm)	Result
Low	2412	-15.13	-14.59	-11.84	8.00	PASS
Mid	2437	-7.43	-7.70	-4.55		PASS
High	2462	-15.76	-15.21	-12.47		PASS

**IEEE 802.11n HT 40 MHz mode**

Channel	Frequency (MHz)	Chain 0 PPSD (dBm)	Chain 1 PPSD (dBm)	PPSD (dBm)	Limit (dBm)	Result
Low	2422	-21.39	-20.35	-17.83	8.00	PASS
Mid	2437	-14.70	-15.23	-11.95		PASS
High	2452	-22.18	-20.23	-18.09		PASS

**Remark:**

1. Total PPSD (dBm) =  $10 \cdot \text{LOG}(10^{\text{Chain 0 PPSD} / 10} + 10^{\text{Chain 1 PPSD} / 10})$

**Test Plot**

**IEEE 802.11b mode / Chain 0**

**PPSD (CH Low)**

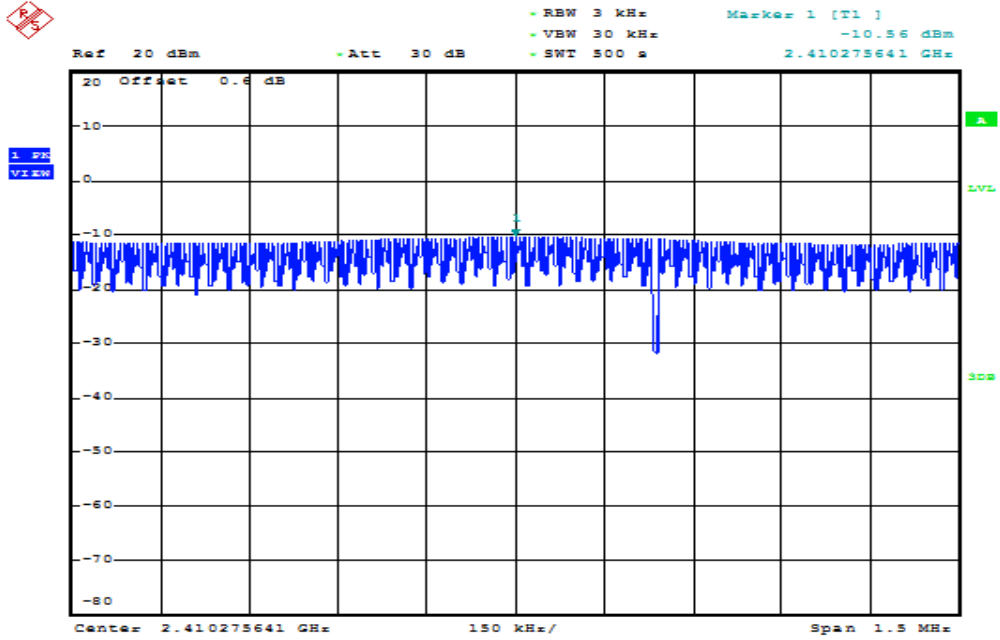

Date: 8.JAN.2016 15:39:32

**PPSD (CH Mid)**

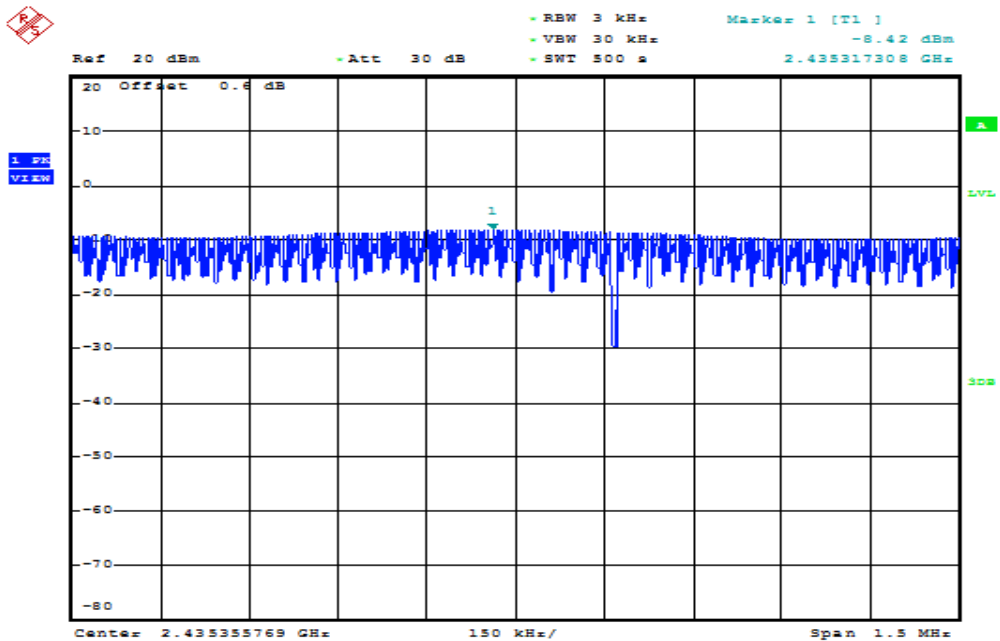

Date: 8.JAN.2016 15:45:51

### PPSD (CH High)

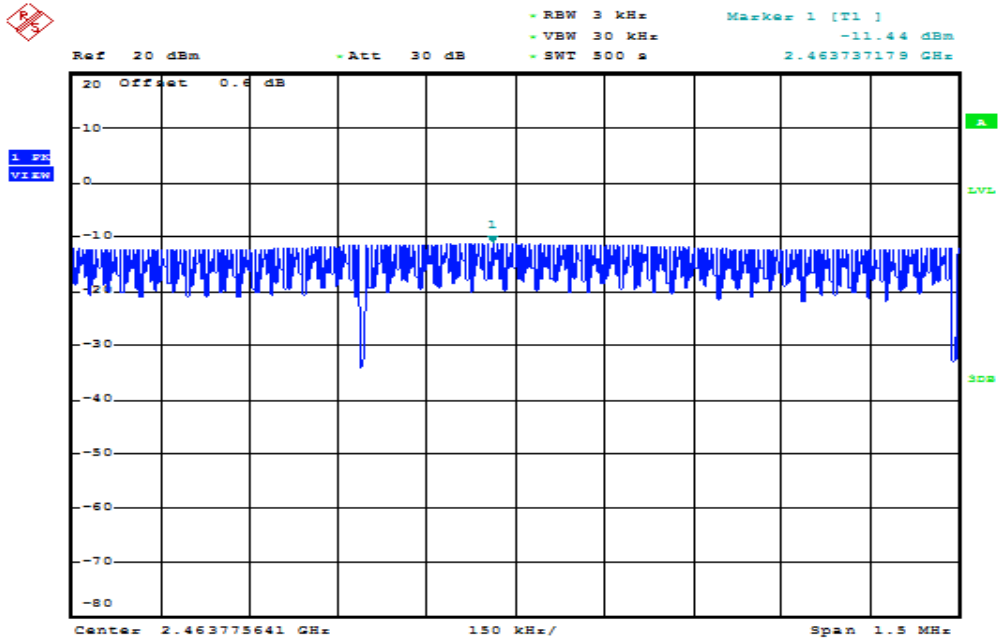

Date: 8.JAN.2016 15:48:07

### IEEE 802.11b mode / Chain 1

### PPSD (CH Low)

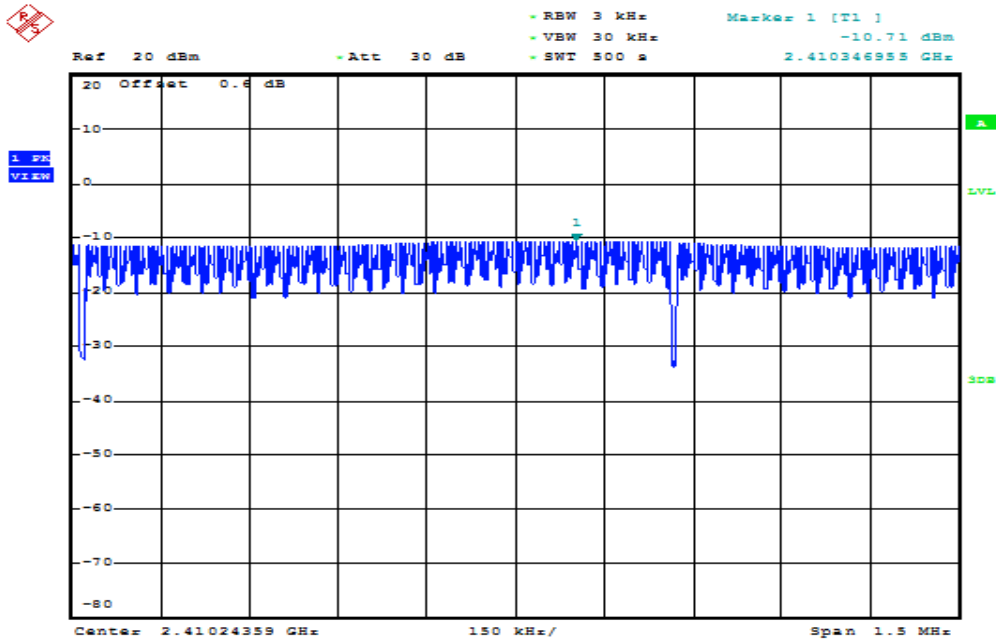

Date: 8.JAN.2016 15:41:29

### PPSD (CH Mid)

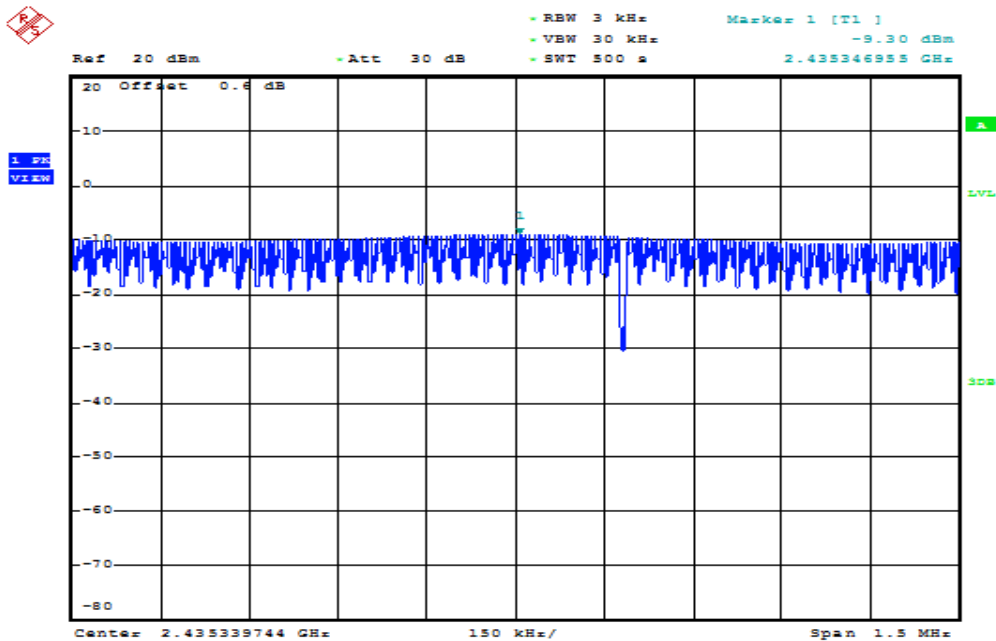

Date: 8.JAN.2016 15:44:48

### PPSD (CH High)

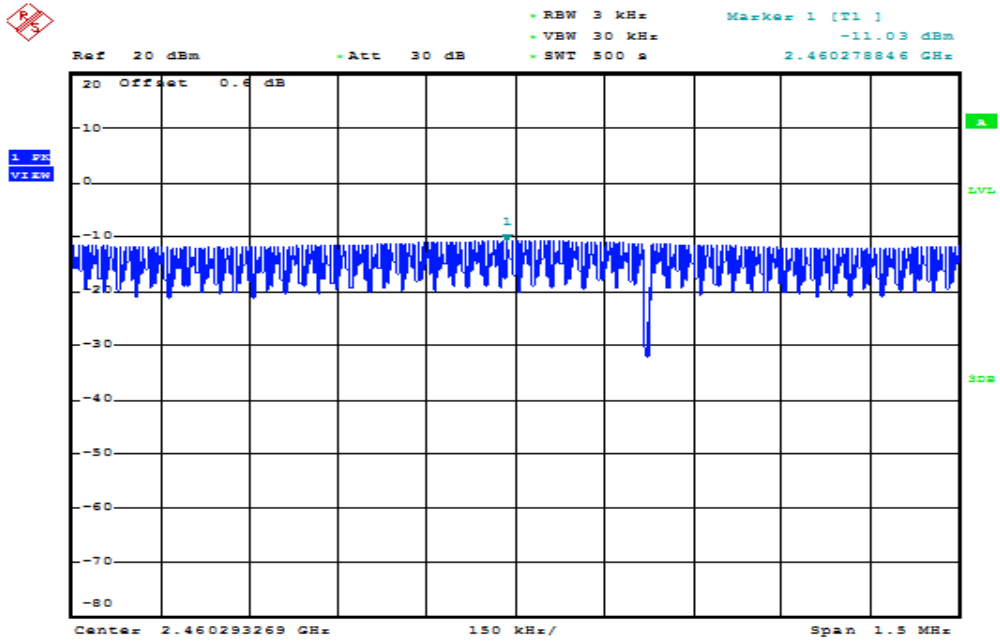

Date: 8.JAN.2016 15:49:21



### IEEE 802.11g mode / Chain 0

### PPSD (CH Low)

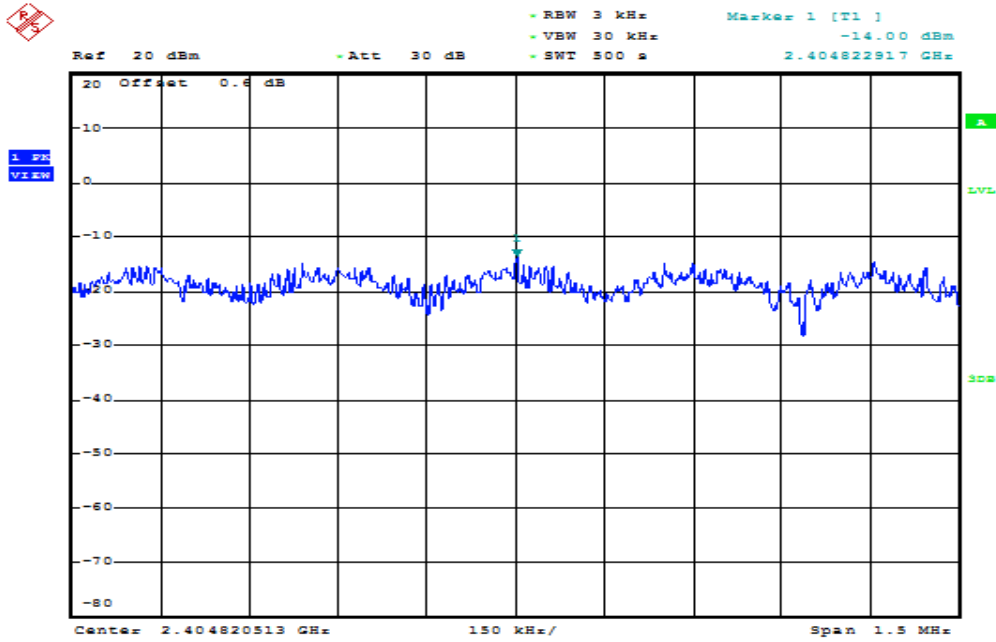

Date: 8.JAN.2016 15:59:12

### PPSD (CH Mid)

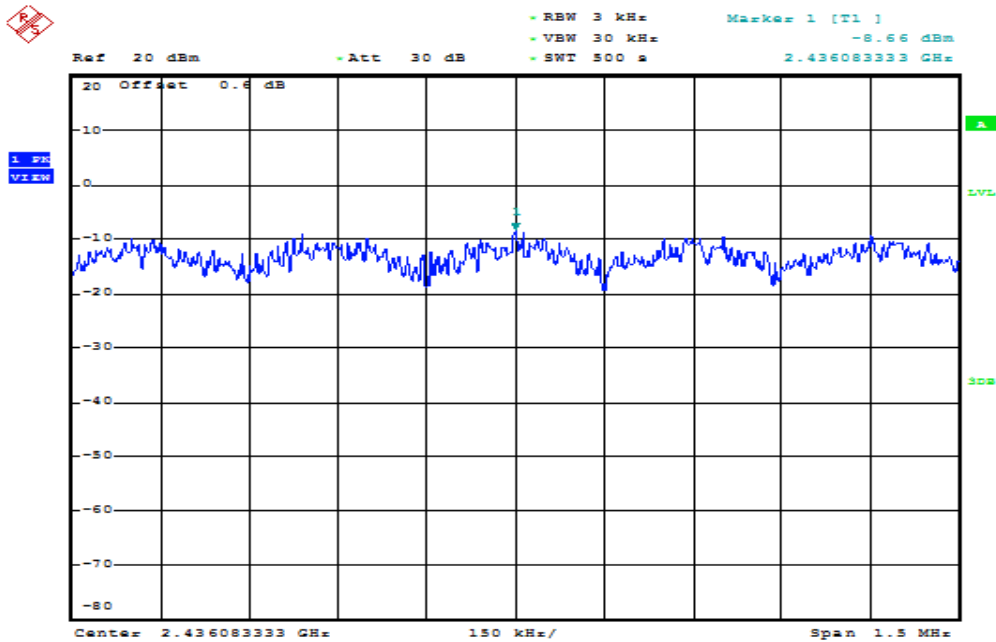

Date: 8.JAN.2016 16:05:11

### PPSD (CH High)

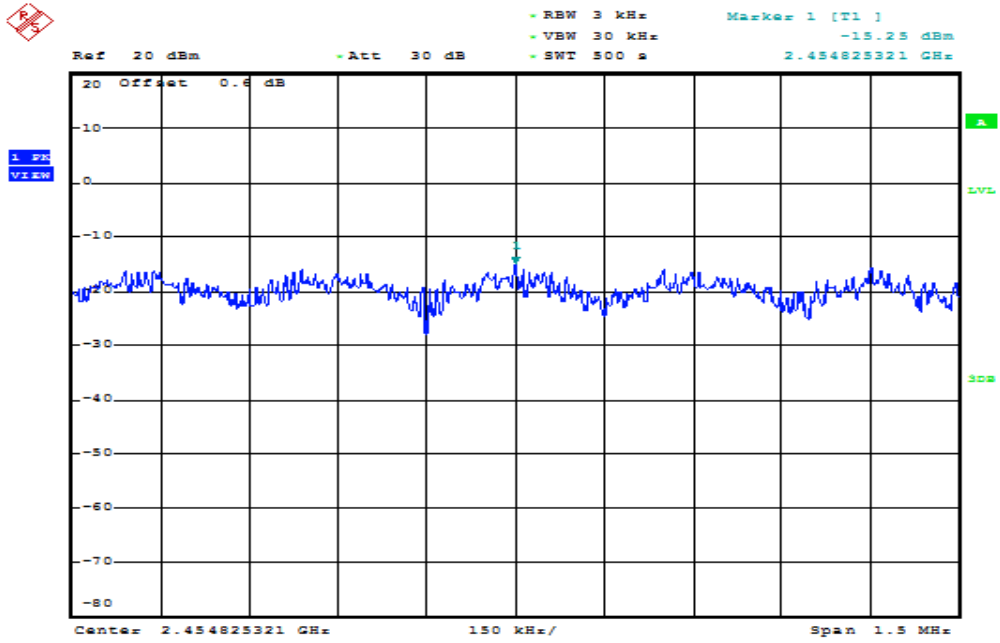

Date: 8.JAN.2016 16:06:54

### IEEE 802.11g mode / Chain 1

### PPSD (CH Low)

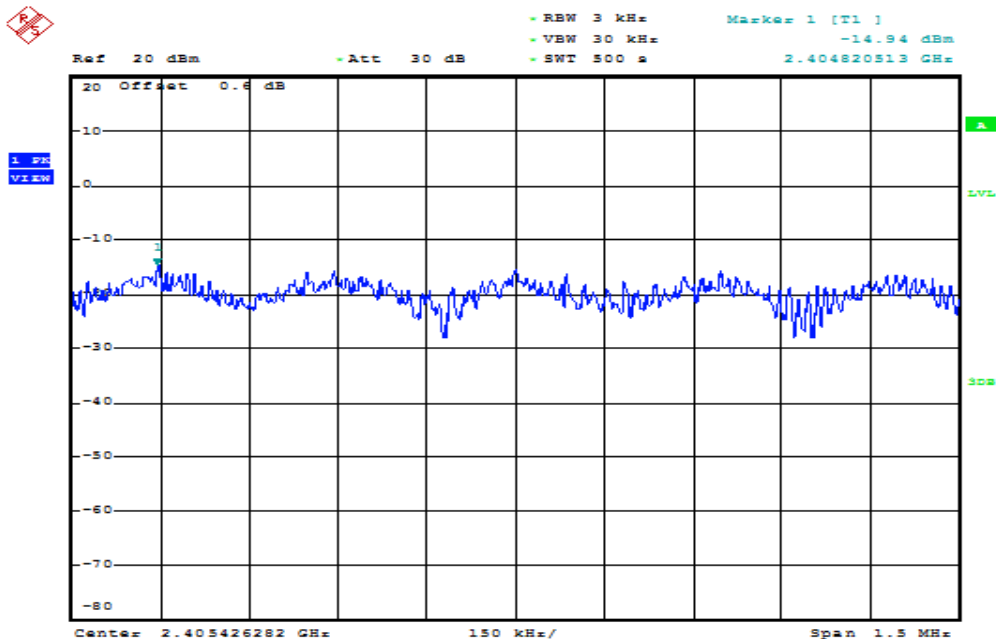

Date: 8.JAN.2016 16:01:28

### PPSD (CH Mid)

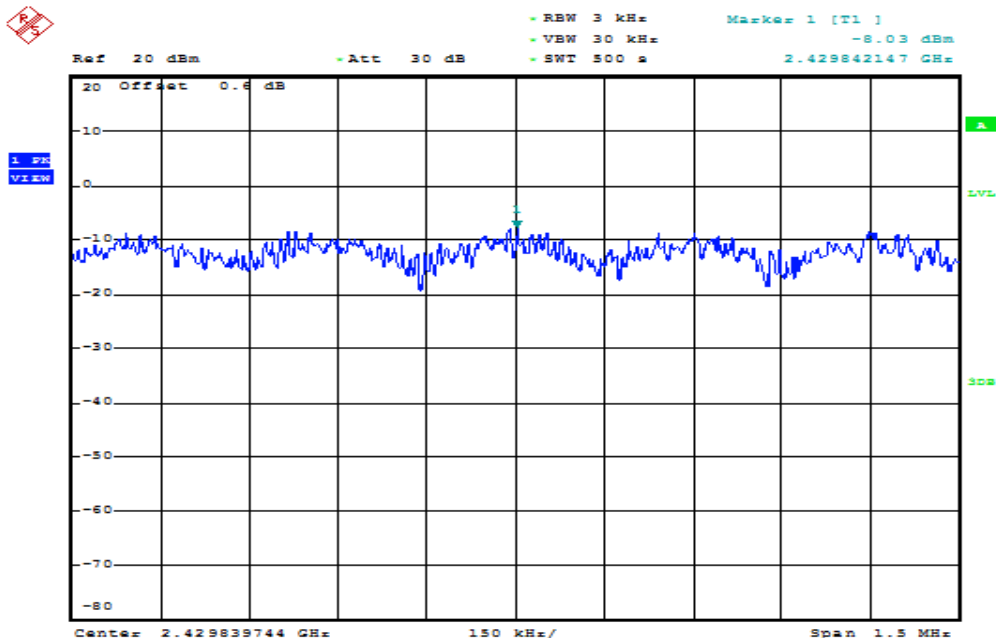

Date: 8.JAN.2016 16:03:13

### PPSD (CH High)

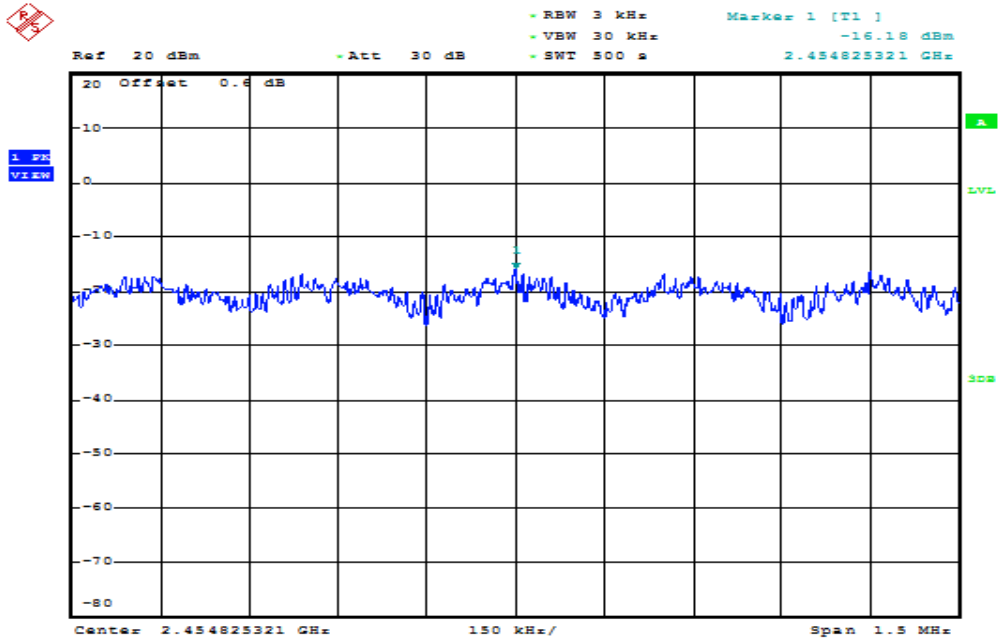

Date: 8.JAN.2016 16:08:23

### IEEE 802.11n HT 20 MHz mode / Chain 0

### PPSD (CH Low)

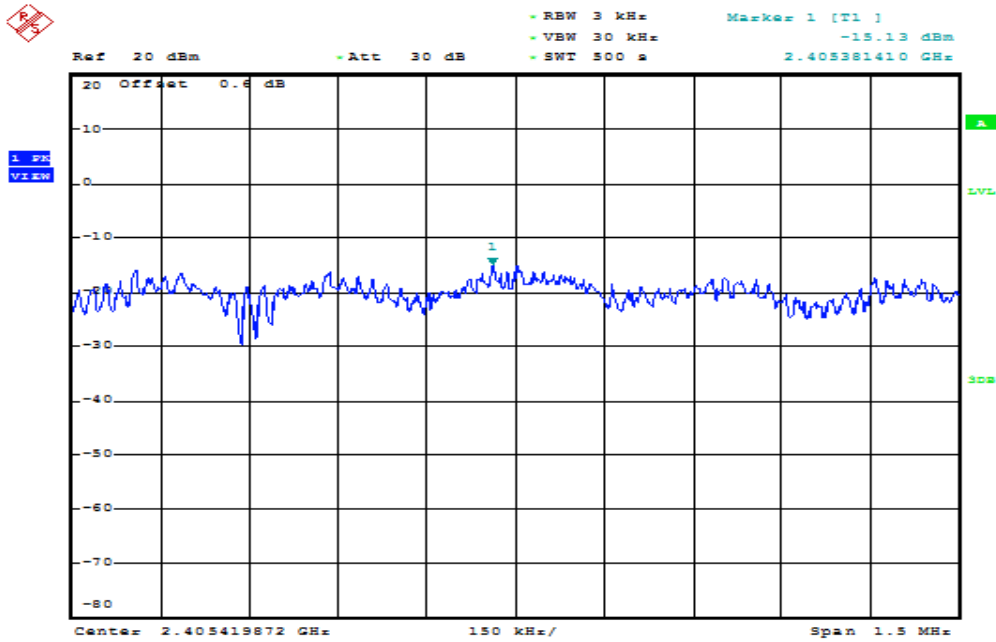

Date: 8.JAN.2016 16:11:12

### PPSD (CH Mid)

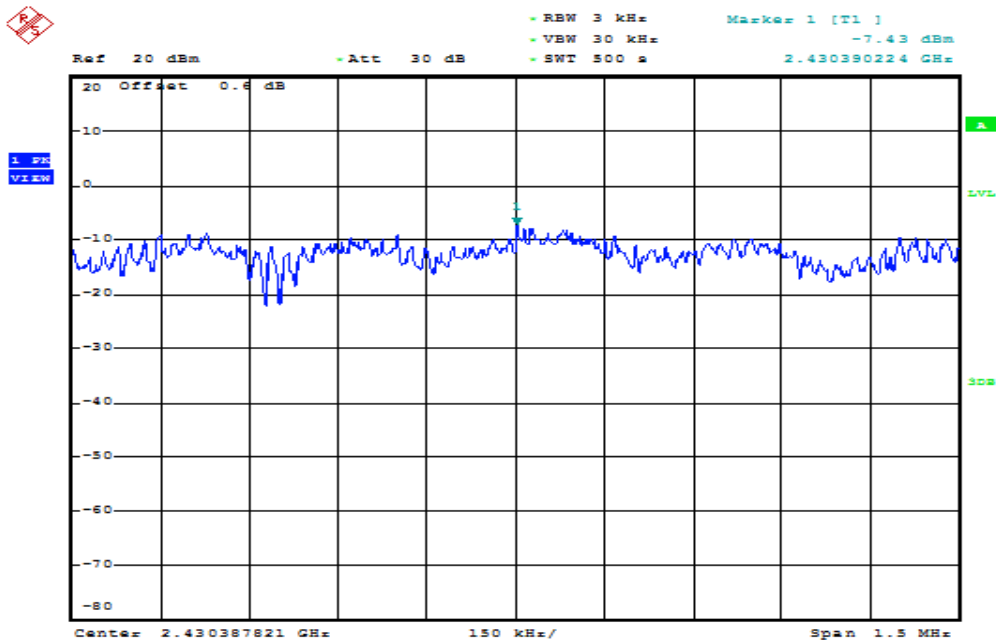

Date: 8.JAN.2016 16:19:13

### PPSD (CH High)

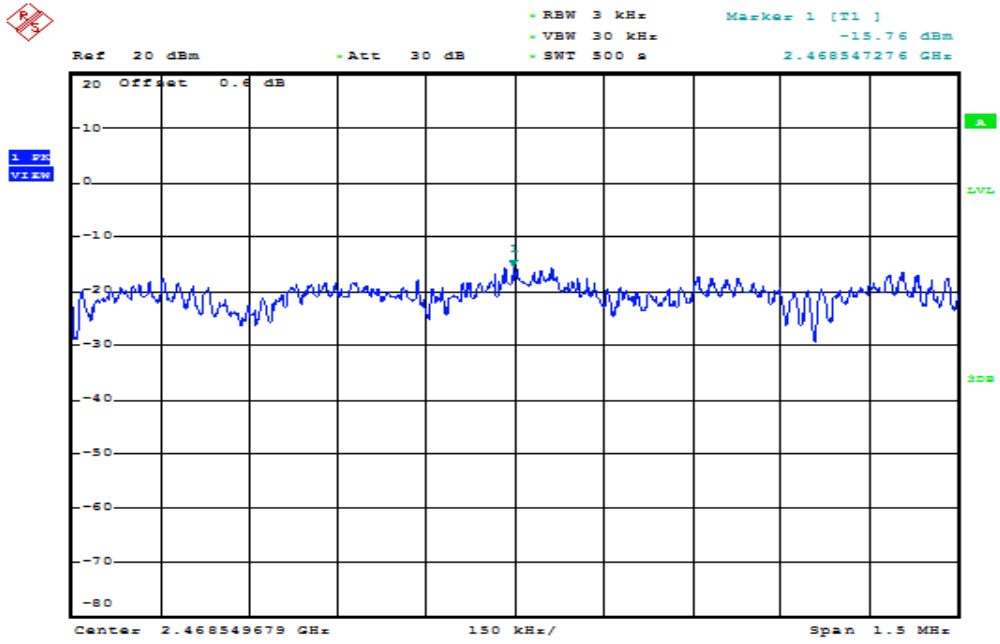

Date: 8.JAN.2016 16:27:05

### IEEE 802.11n HT 20 MHz mode / Chain 1

#### PPSD (CH Low)

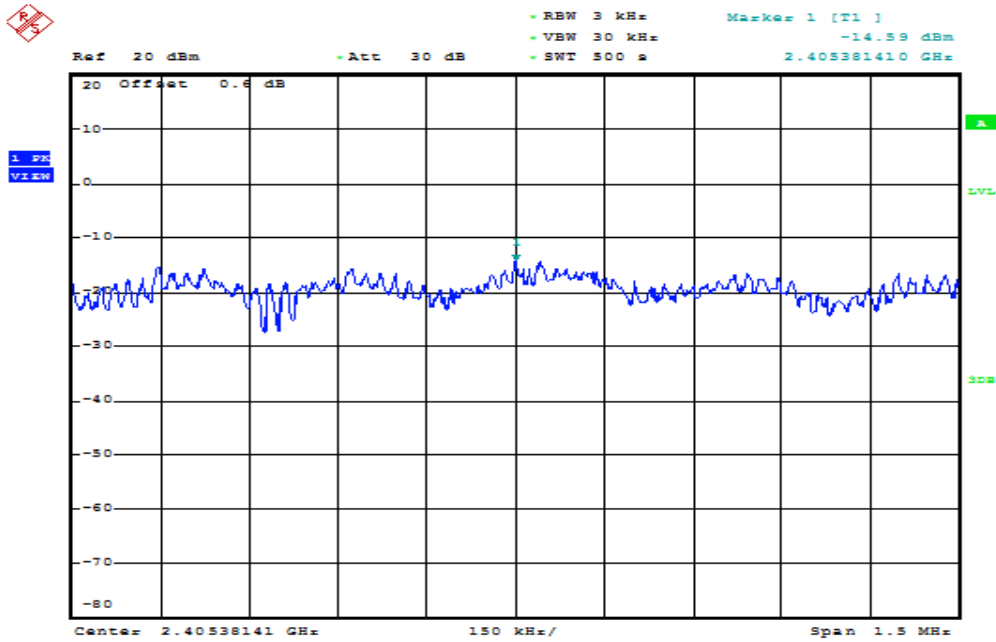

Date: 8.JAN.2016 16:13:48

#### PPSD (CH Mid)

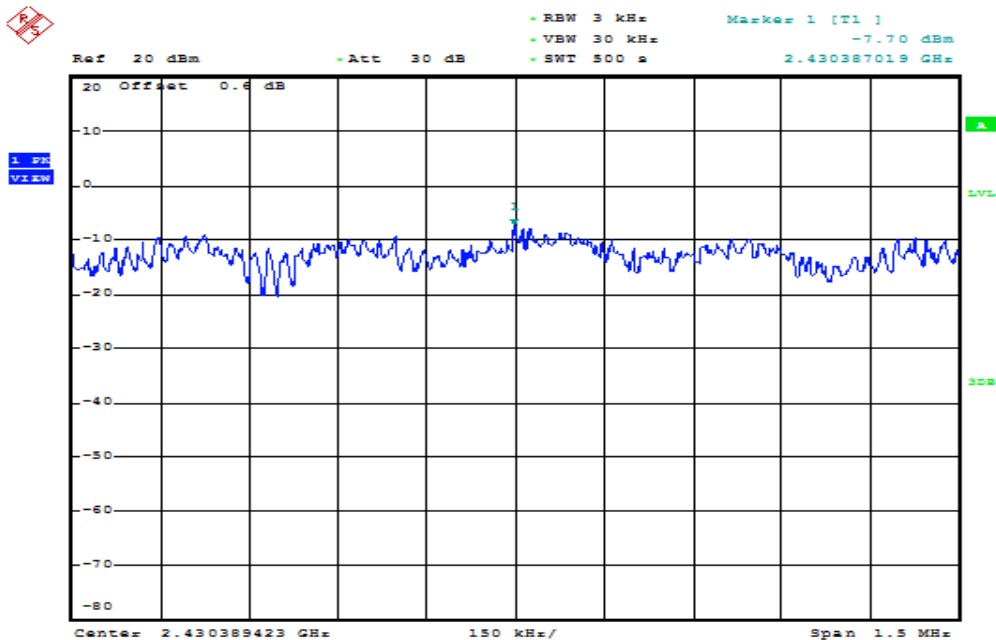

Date: 8.JAN.2016 16:17:13

### PPSD (CH High)

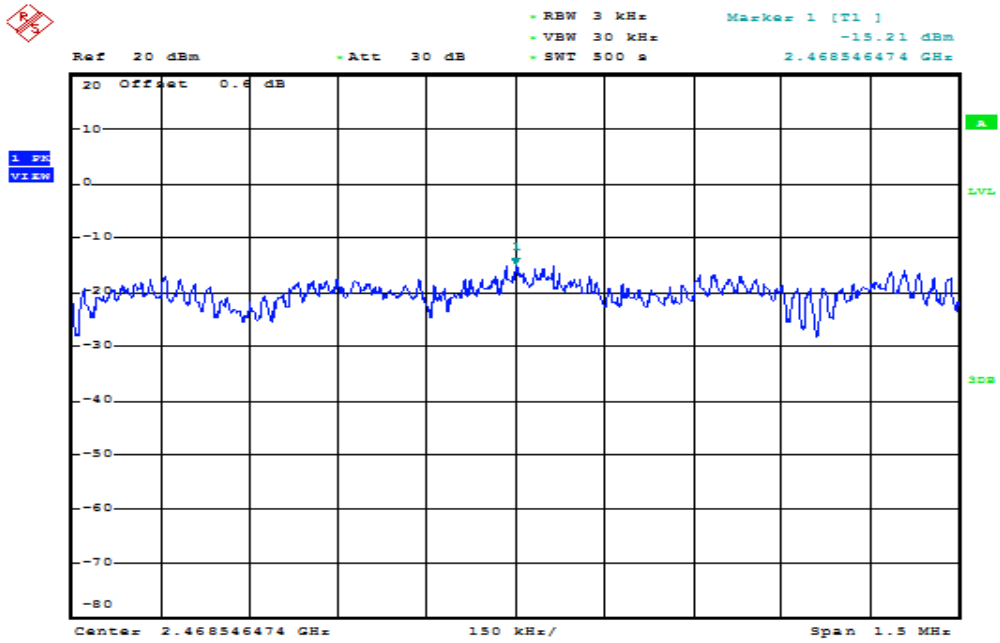

Date: 8.JAN.2016 16:28:32



### IEEE 802.11n HT 40 MHz mode / Chain 0

### PPSD (CH Low)

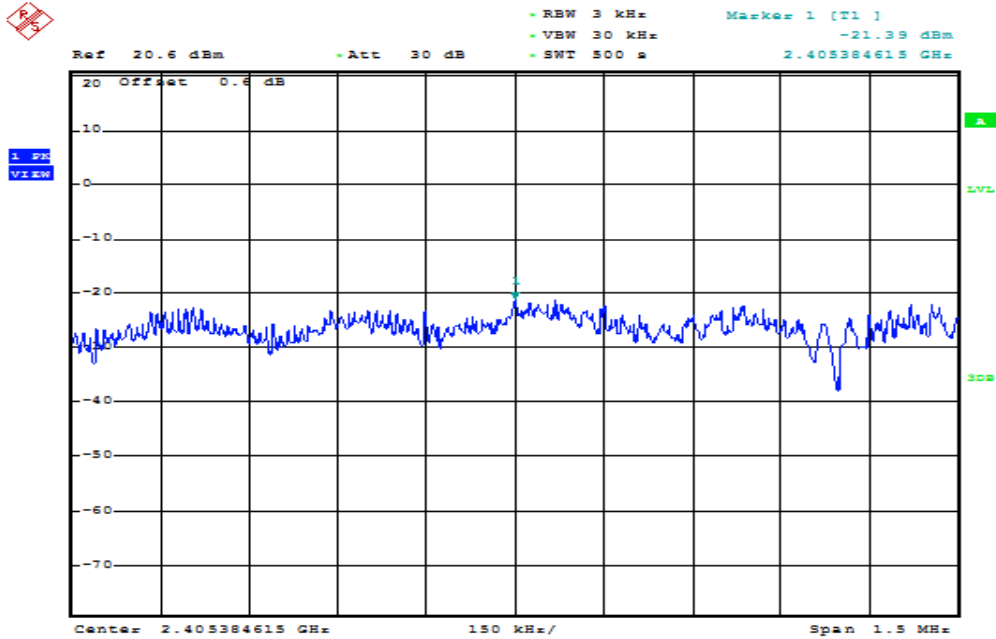

Date: 8.JAN.2016 15:26:35

### PPSD (CH Mid)

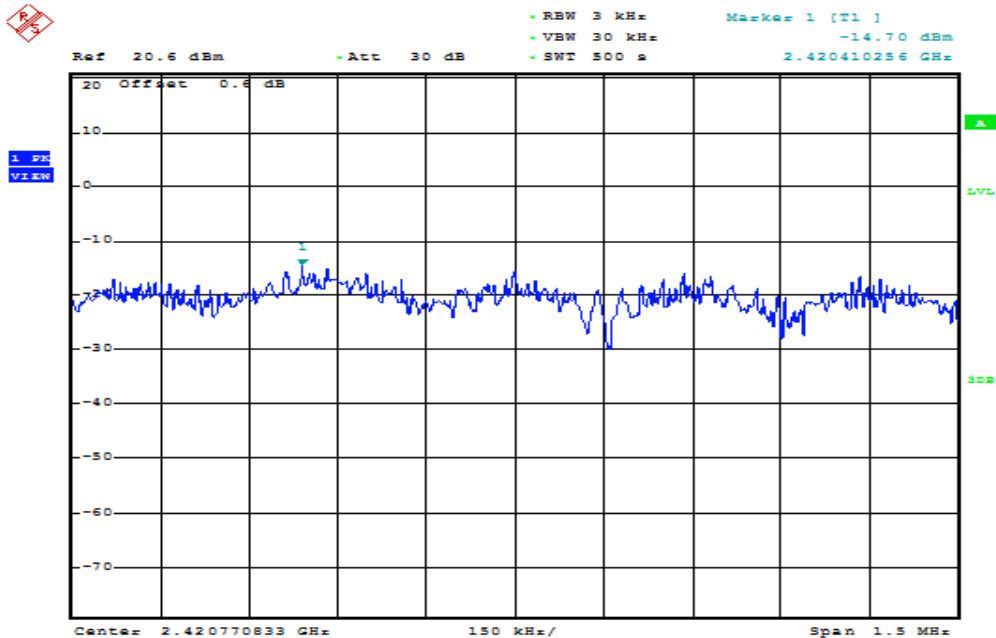

Date: 8.JAN.2016 15:21:14

### PPSD (CH High)

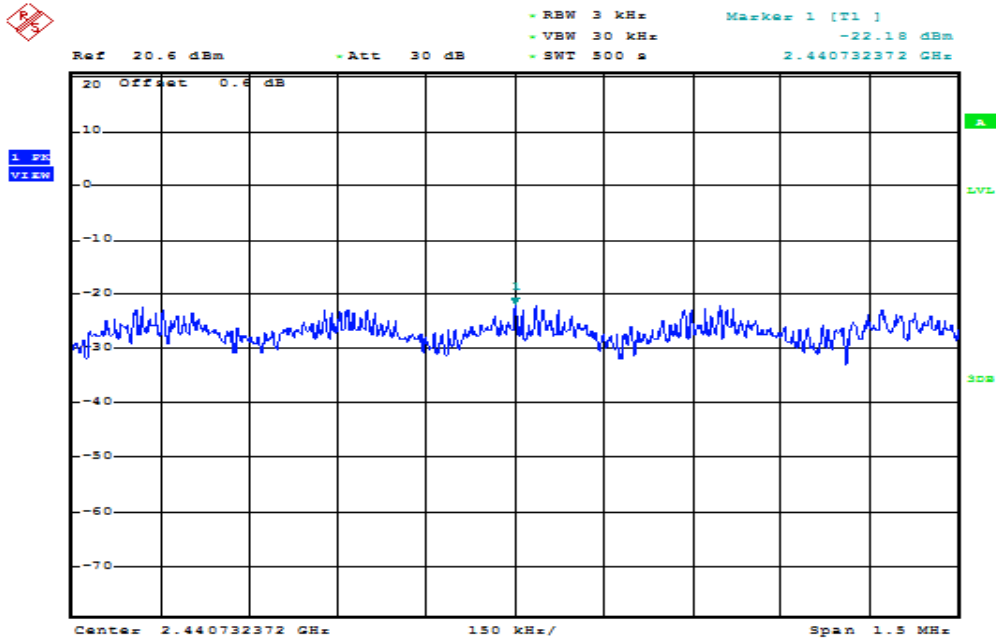

Date: 8.JAN.2016 15:14:00

### IEEE 802.11n HT 40 MHz mode / Chain 1

### PPSD (CH Low)

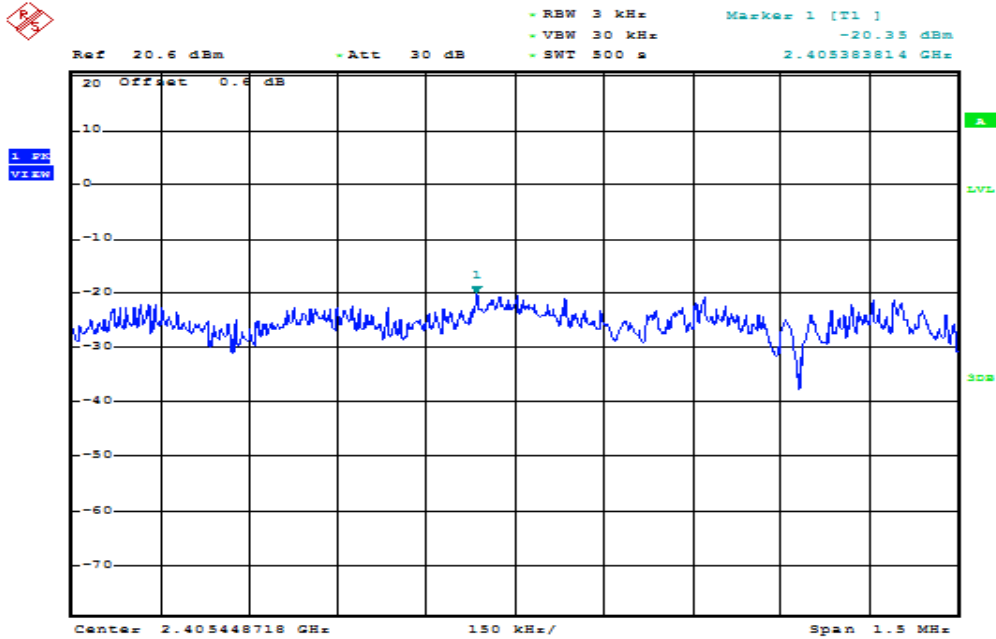

Date: 8.JAN.2016 15:30:00

### PPSD (CH Mid)

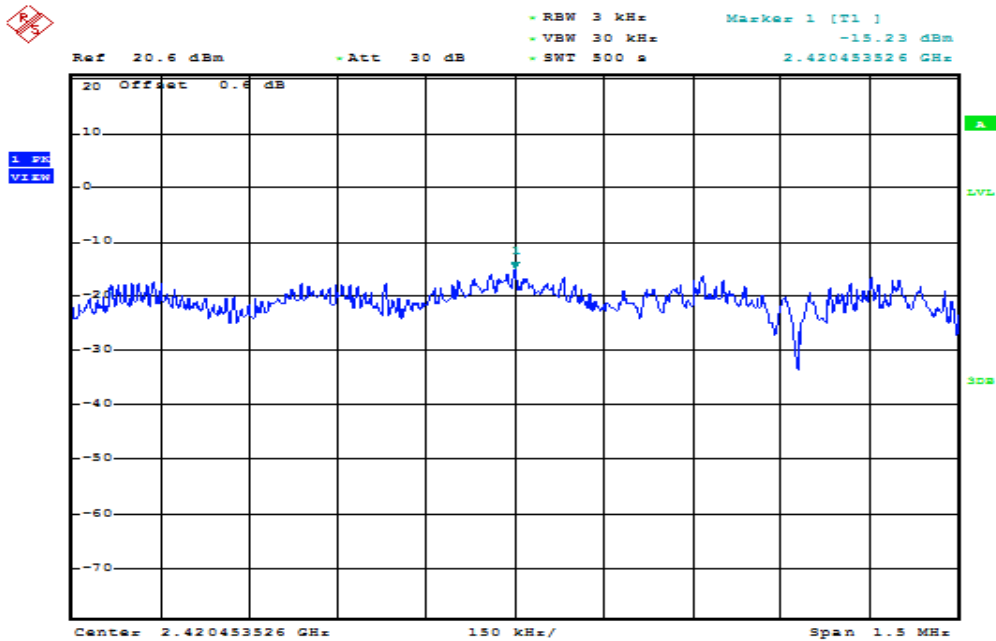

Date: 8.JAN.2016 15:37:20

### PPSD (CH High)

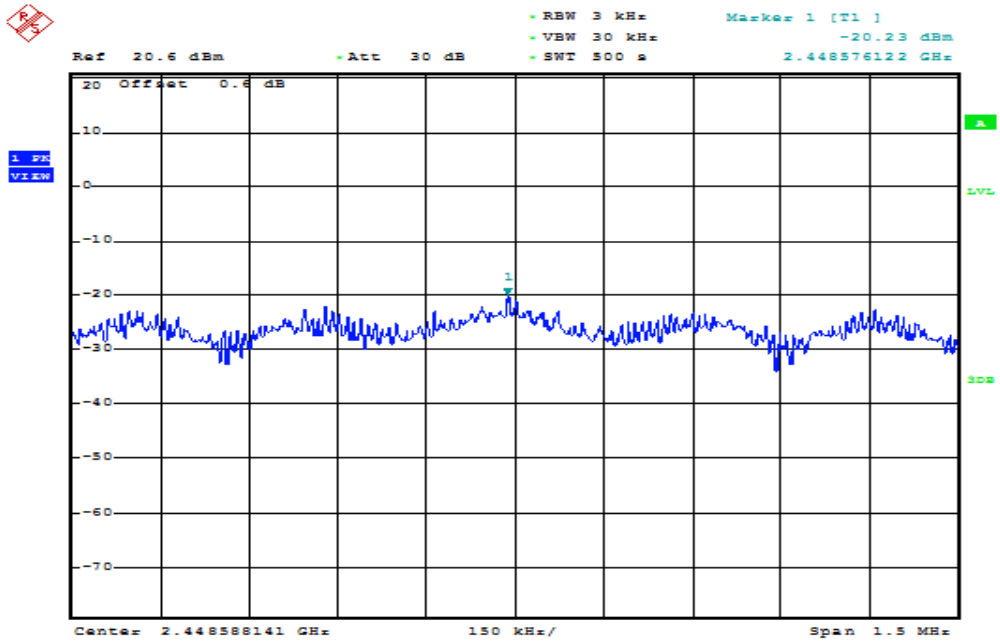

Date: 8.JAN.2016 15:02:01

## 7.7 RADIATED EMISSIONS

### LIMIT

All spurious emissions shall comply with the limits of §15.209(a) and RSS-Gen Table 2 & Table 5.

#### **RSS-Gen Table 2 & Table 5: General Field Strength Limits for Transmitters and Receivers at Frequencies Above 30 MHz** <sup>(Note)</sup>

Frequency (MHz)	Field Strength microvolts/m at 3 metres (watts, e.i.r.p.)	
	Transmitters	Receivers
30-88	100 (3 nW)	100 (3 nW)
88-216	150 (6.8 nW)	150 (6.8 nW)
216-960	200 (12 nW)	200 (12 nW)
Above 960	500 (75 nW)	500 (75 nW)

**Note:** \*Measurements for compliance with limits in the above table may be performed at distances other than 3 metres, in accordance with Section 7.2.7.

Transmitting devices are not permitted in Table 1 bands or, unless stated otherwise, in TV bands (54-72 MHz, 76-88 MHz, 174-216 MHz, 470-608 MHz and 614-806 MHz).

#### **RSS-Gen Table 6: General Field Strength Limits for Transmitters at Frequencies Below 30 MHz (Transmit)**

Frequency	Field Strength (microvolts/m)	Magnetic H-Field (microamperes/m)	Measurement Distance (metres)
9-490 kHz	2,400/F (F in kHz)	2,400/377F (F in kHz)	3000
490-1,705 kHz	24,000/F (F in kHz)	24,000/377F (F in kHz)	30
1.705-30 MHz	30	N/A	30

**Note:** The emission limits for the bands 9-90 kHz and 110-490 kHz are based on measurements employing an average detector.

**Test Configuration**

**9kHz ~ 30MHz**

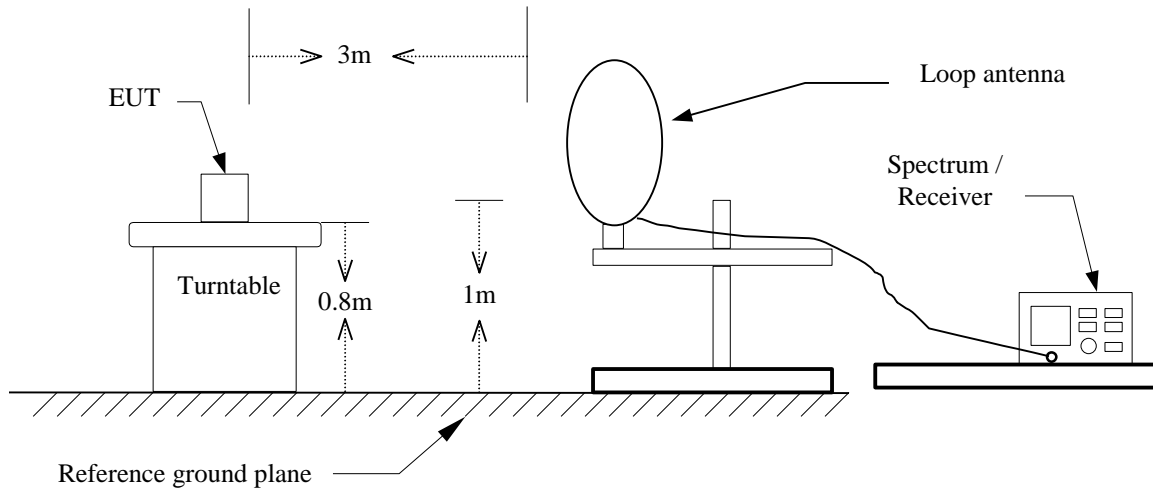

**30MHz ~ 1GHz**

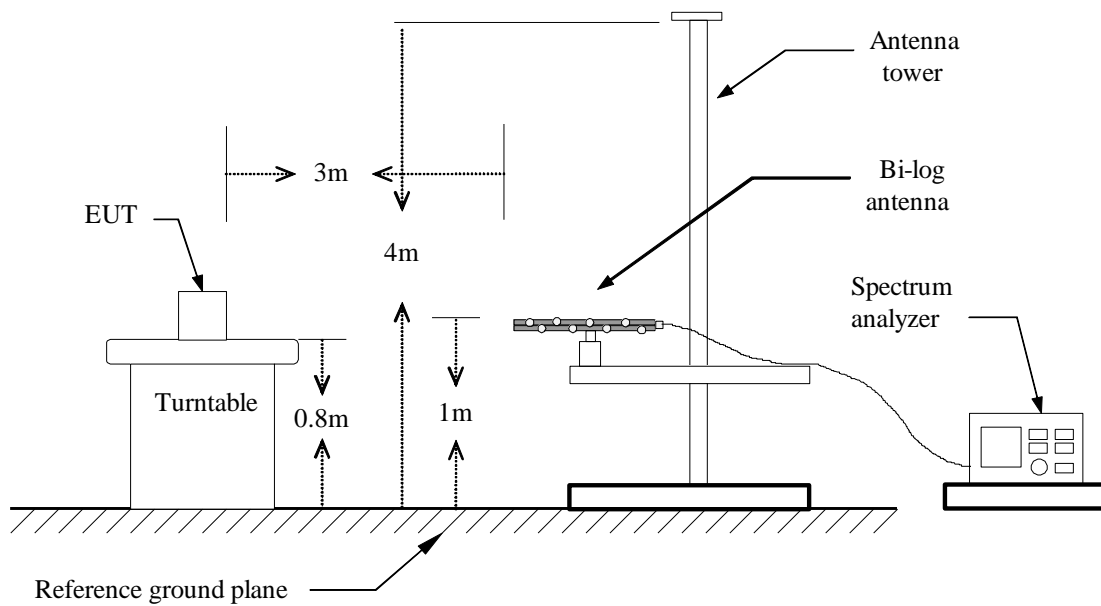

**Above 1 GHz**

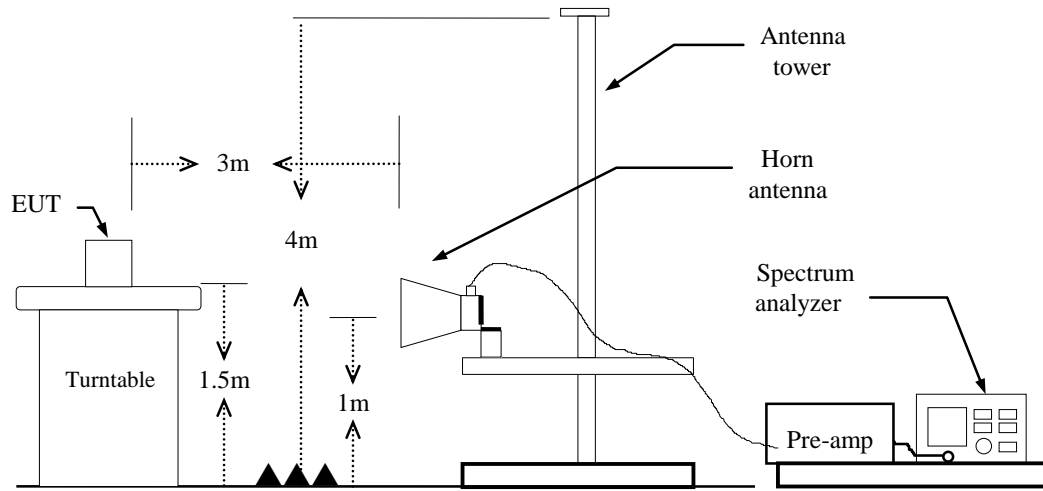

## **TEST PROCEDURE**

1. The EUT is placed on a turntable, Above 1 GHz is 1.5m high and below 1 GHz is 0.8m high above ground plane.
2. The turntable shall be rotated for 360 degrees to determine the position of maximum emission level.
3. EUT is set 3m away from the receiving antenna, which is varied from 1m to 4m to find out the highest emissions.
4. Maximum procedure was performed on the six highest emissions to ensure EUT compliance.
5. And also, each emission was to be maximized by changing the polarization of receiving antenna both horizontal and vertical.
6. Set the spectrum analyzer in the following setting as:

Below 1GHz:

RBW=100kHz / VBW=300kHz / Sweep=AUTO

Above 1GHz:

(a) PEAK: RBW=1MHz / VBW=3MHz / Sweep=AUTO

(b) AVERAGE: RBW=1MHz,

if duty cycle  $\geq$  98%, VBW=10Hz.

if duty cycle < 98% VBW=1/T.

**IEEE 802.11b mode:**  $\geq$  98%, VBW=10Hz

**IEEE 802.11g mode:**  $\geq$  98%, VBW=10Hz

**IEEE 802.11n HT 20 MHz mode:**  $\geq$  98%, VBW=10Hz

**IEEE 802.11n HT 40 MHz mode:**  $\geq$  98%, VBW=10Hz

7. Repeat above procedures until the measurements for all frequencies are complete.
8. Result = Spectrum Reading + cable loss(spectrum to Amp) - Amp Gain + Cable loss(Amp to receive Ant)+ Receive Ant

**Note:** We checked every harmonics frequencies from Fundamental frequencies with reduced VBW, and we mark a point to prove pass or not if we find any emission. For this case, there are no emissions hidden in the noise floor.



**Below 1GHz**

**Operation Mode:** Normal Link

**Test Date:** January 13, 2016

**Temperature:** 27°C

**Tested by:** Jason Lu

**Humidity:** 53% RH

**Polarity:** Ver.

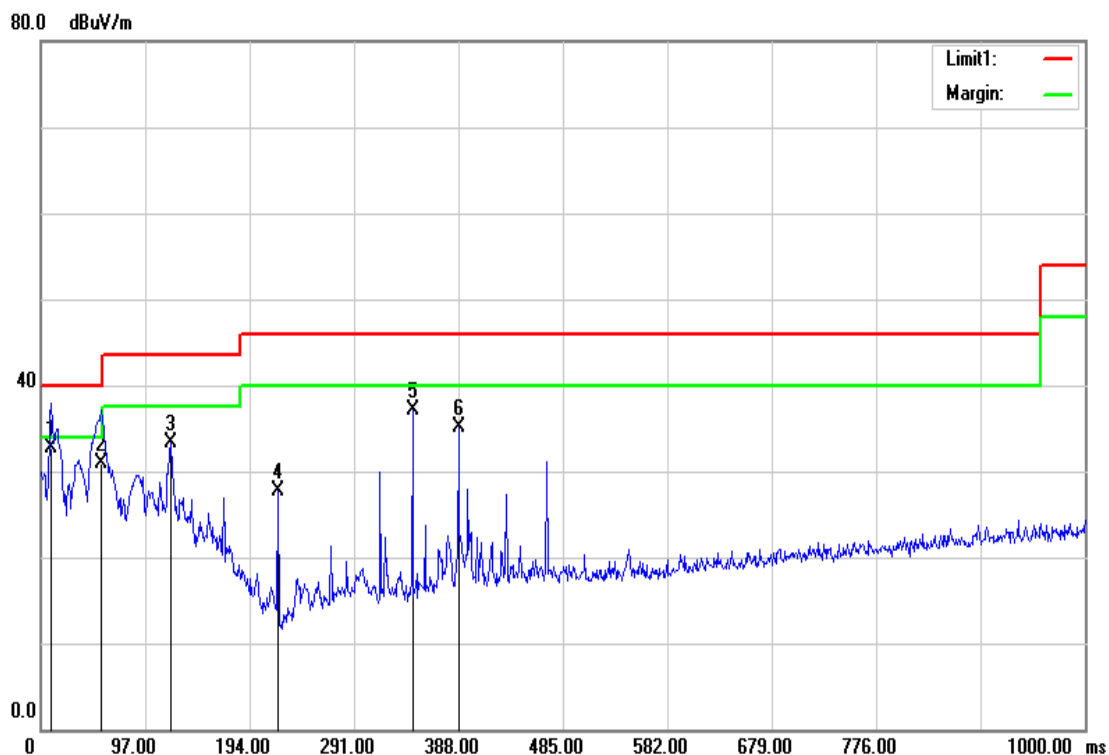

Frequency (MHz)	Reading (dBuV)	Correction Factor (dB/m)	Result (dBuV/m)	Limit (dBuV/m)	Margin (dB)	Remark	Ant. Pol. (H/V)
39.7000	47.78	-15.12	32.66	40.00	-7.34	QP	V
86.2600	52.32	-21.41	30.91	40.00	-9.09	QP	V
150.2800	49.47	-16.08	33.39	43.50	-10.11	peak	V
250.1900	43.98	-16.27	27.71	46.00	-18.29	peak	V
375.3200	49.35	-12.29	37.06	46.00	-8.94	peak	V
418.0000	46.35	-11.16	35.19	46.00	-10.81	peak	V

**Remark:**

1. Measuring frequencies from 30 MHz to the 1GHz.
2. Radiated emissions measured in frequency range from 30 MHz to 1000MHz were made with an instrument using peak/quasi-peak detector mode.
3. Quasi-peak test would be performed if the peak result were greater than the quasi-peak limit or as required by the applicant.
4. Measurements above show only up to 6 maximum emissions noted, or would be lesser, with " N/A " remark, if no specific emissions from the EUT are recorded (ie: margin>20dB from the applicable limit) and considered that's already beyond the background noise floor.
5. Margin (dB) = Result (dBuV/m) – Limit (dBuV/m).

**Operation Mode:** Normal Link

**Test Date:** January 13, 2016

**Temperature:** 27°C

**Tested by:** Jason Lu

**Humidity:** 53% RH

**Polarity:** Hor.

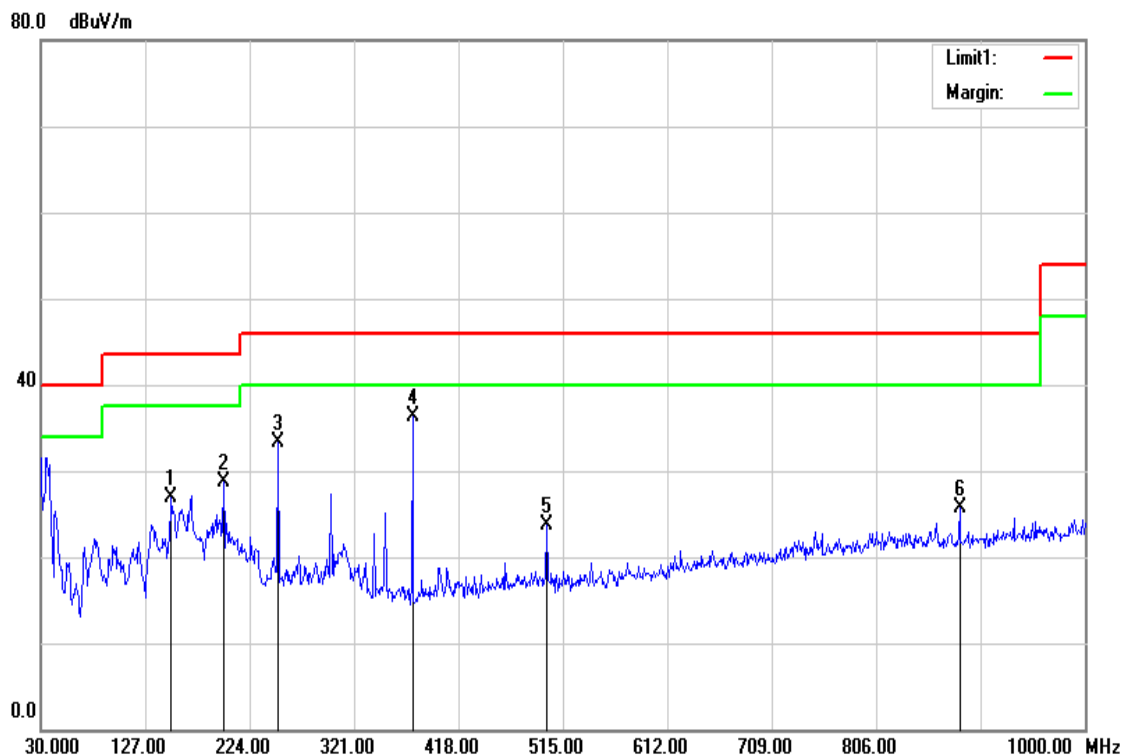

Frequency (MHz)	Reading (dBuV)	Correction Factor (dB/m)	Result (dBuV/m)	Limit (dBuV/m)	Margin (dB)	Remark	Ant. Pol. (H/V)
151.2500	42.95	-16.11	26.84	43.50	-16.66	peak	H
199.7500	44.19	-15.57	28.62	43.50	-14.88	peak	H
250.1900	49.51	-16.27	33.24	46.00	-12.76	peak	H
375.3200	48.52	-12.29	36.23	46.00	-9.77	peak	H
500.4500	33.01	-9.23	23.78	46.00	-22.22	peak	H
883.6000	29.08	-3.38	25.70	46.00	-20.30	peak	H

**Remark:**

1. Measuring frequencies from 30 MHz to the 1GHz.
2. Radiated emissions measured in frequency range from 30 MHz to 1000MHz were made with an instrument using peak/quasi-peak detector mode.
3. Quasi-peak test would be performed if the peak result were greater than the quasi-peak limit or as required by the applicant.
4. Measurements above show only up to 6 maximum emissions noted, or would be lesser, with " N/A " remark, if no specific emissions from the EUT are recorded (ie: margin>20dB from the applicable limit) and considered that's already beyond the background noise floor.
5. Margin (dB) = Result (dBuV/m) – Limit (dBuV/m).

**Above 1 GHz**

**TX / IEEE 802.11b / CH Low**

**Polarity: Vertical**

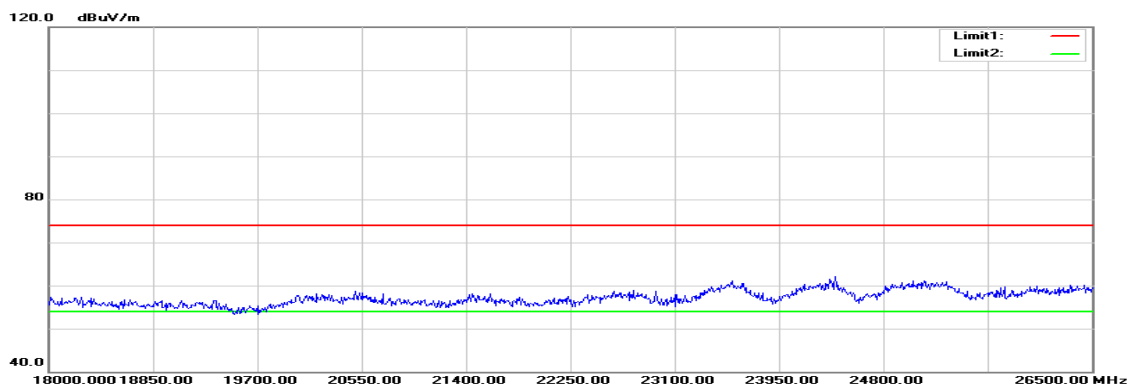
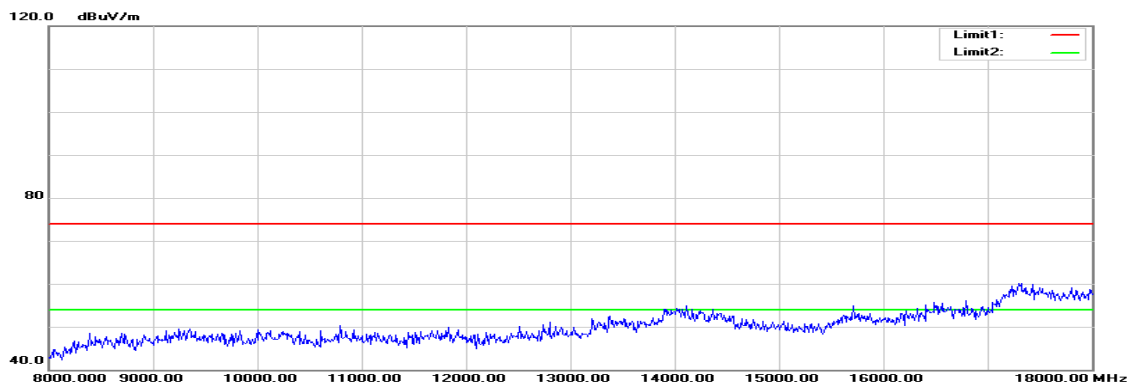
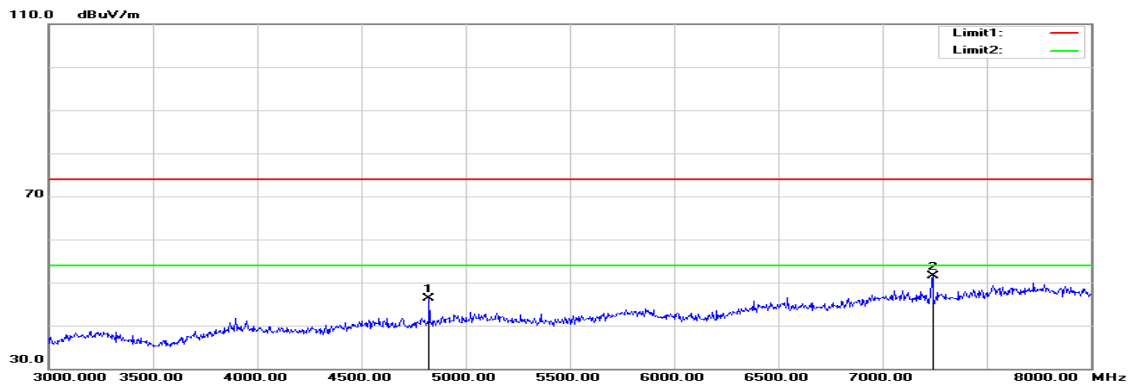
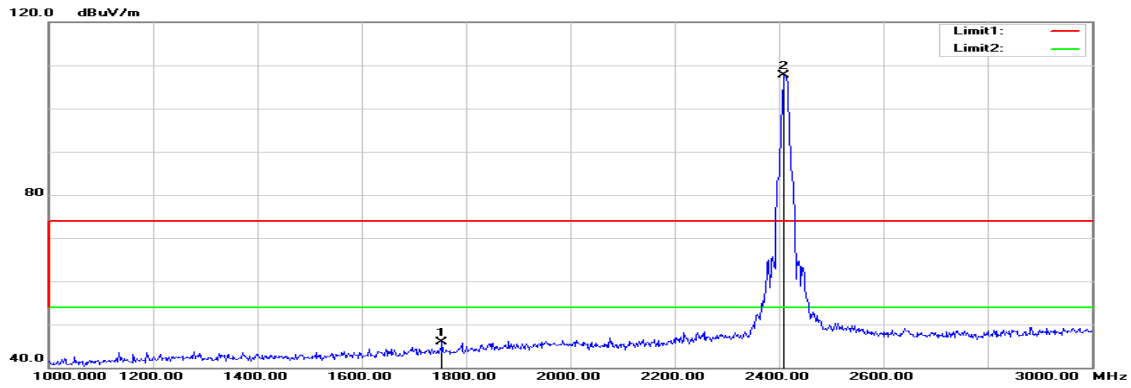

Polarity: Horizontal

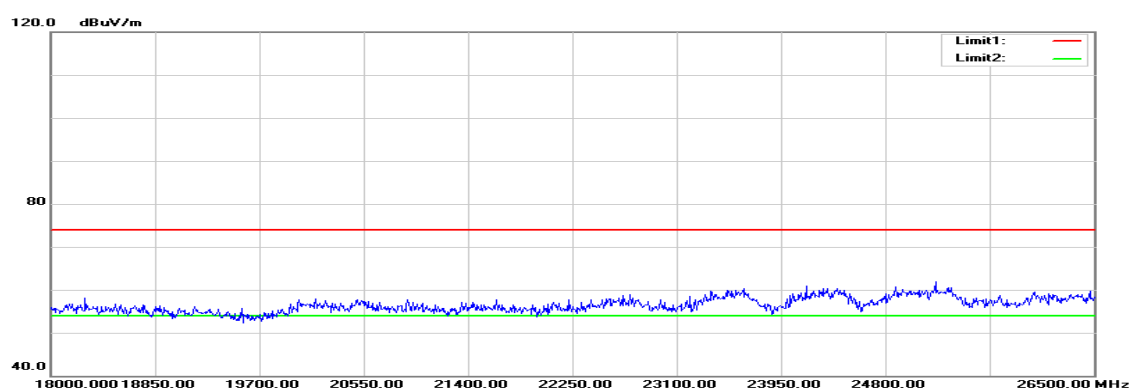
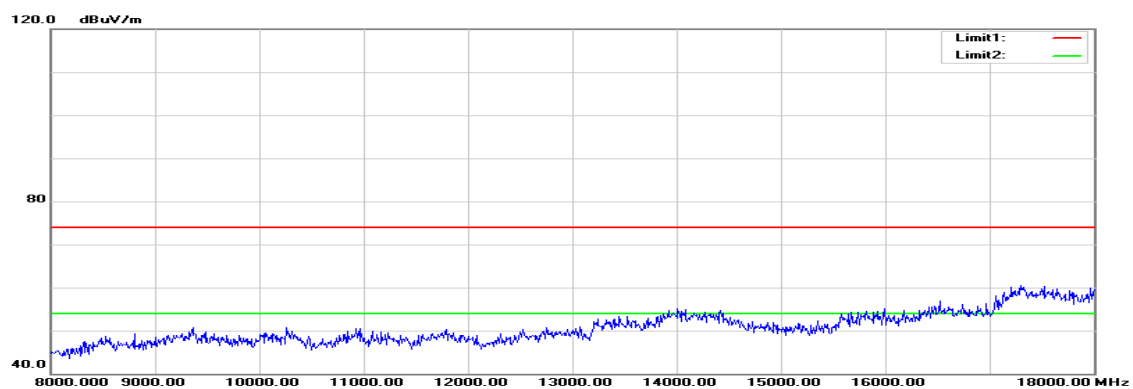
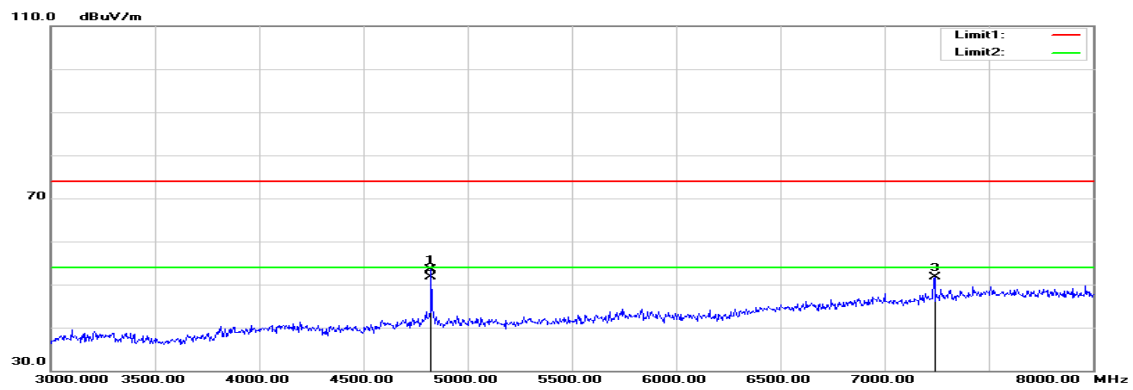
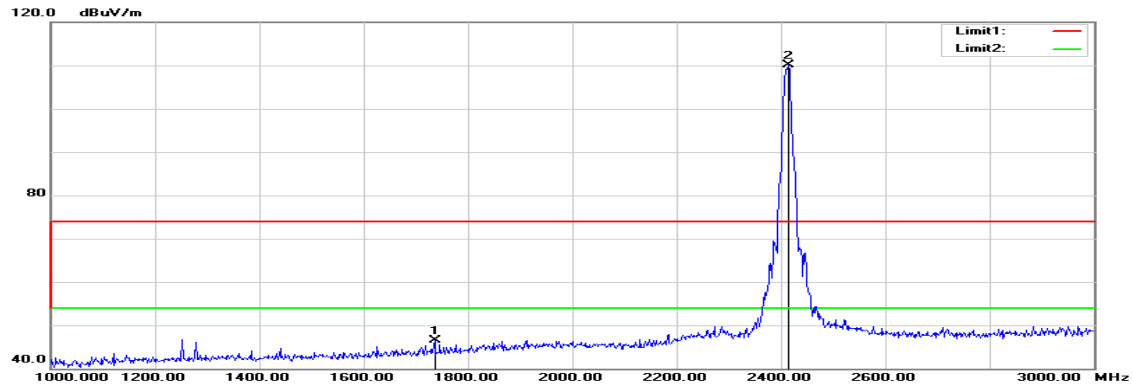

**Above 1 GHz**

**Operation Mode:** TX / IEEE 802.11b / CH Low

**Test Date:** January 13, 2016

**Temperature:** 27°C

**Tested by:** Jason Lu

**Humidity:** 53% RH

**Polarity:** Ver. / Hor.

Frequency (MHz)	Reading (dBuV)	Correction Factor (dB/m)	Result (dBuV/m)	Limit (dBuV/m)	Margin (dB)	Remark	Ant. Pol. (H/V)
1754.000	50.69	-4.87	45.82	74.00	-28.18	peak	V
4825.000	41.27	5.10	46.37	74.00	-27.63	peak	V
7240.000	38.87	12.72	51.59	74.00	-22.41	peak	V
N/A							
1736.000	51.55	-4.97	46.58	74.00	-27.42	peak	H
4825.000	48.37	5.10	53.47	74.00	-20.53	peak	H
4825.000	46.59	5.10	51.69	54.00	-2.31	AVG	H
7240.000	39.03	12.72	51.75	74.00	-22.25	peak	H
N/A							

**Remark:**

1. *Measuring frequencies from 1 GHz to the 10th harmonic of highest fundamental frequency.*
2. *Radiated emissions measured in frequency above 1000MHz were made with an instrument using peak/average detector mode.*
3. *Average test would be performed if the peak result were greater than the average limit or as required by the applicant.*
4. *Data of measurement within this frequency range shown " --- " in the table above means the reading of emissions are attenuated more than 20dB below the permissible limits or the field strength is too small to be measured.*
5. *Measurements above show only up to 6 maximum emissions noted, or would be lesser, with " N/A " remark, if no specific emissions from the EUT are recorded (ie: margin>20dB from the applicable limit) and considered that's already beyond the background noise floor.*
6. *Margin (dB) = Remark result (dBuV/m) – Average limit (dBuV/m).*

**TX / IEEE 802.11b / CH Mid**

**Polarity: Vertical**

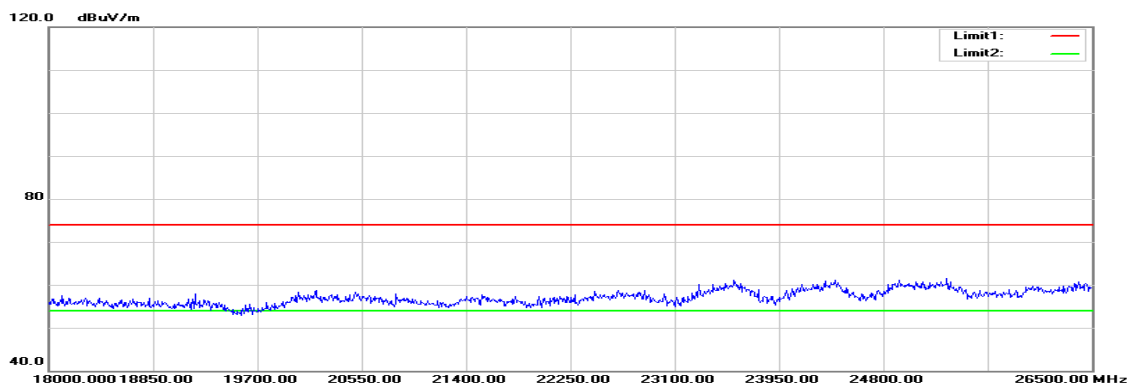
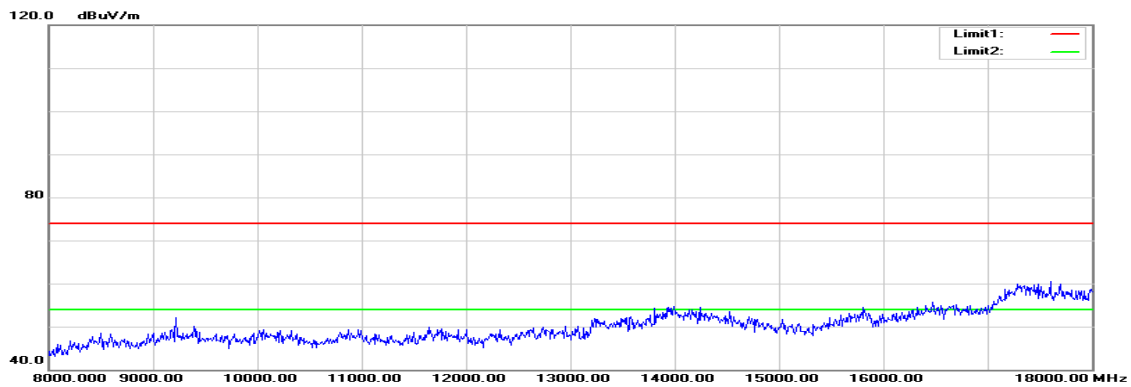
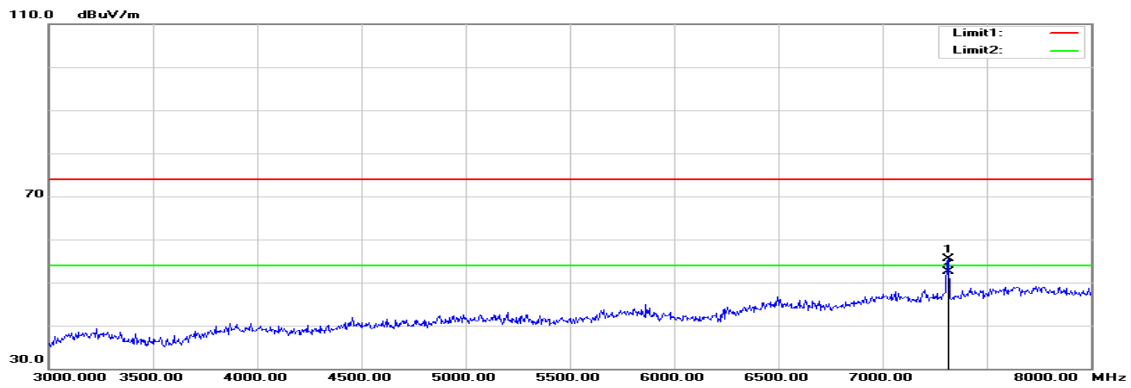
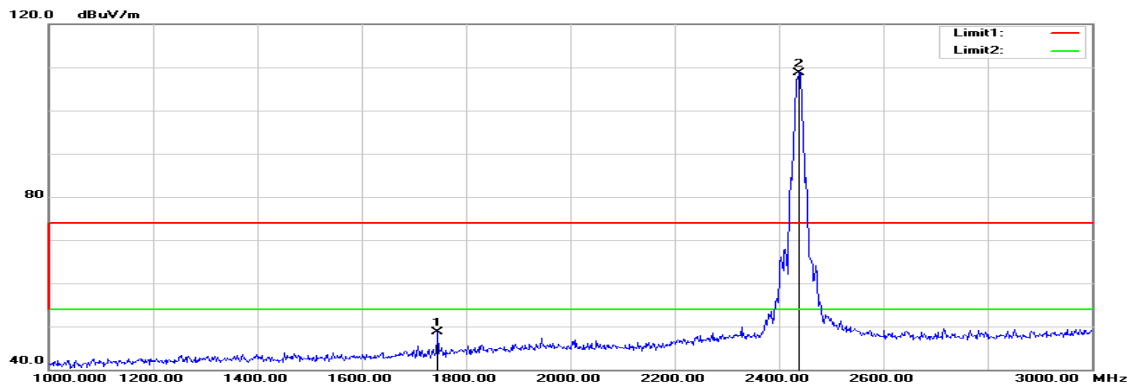

Polarity: Horizontal

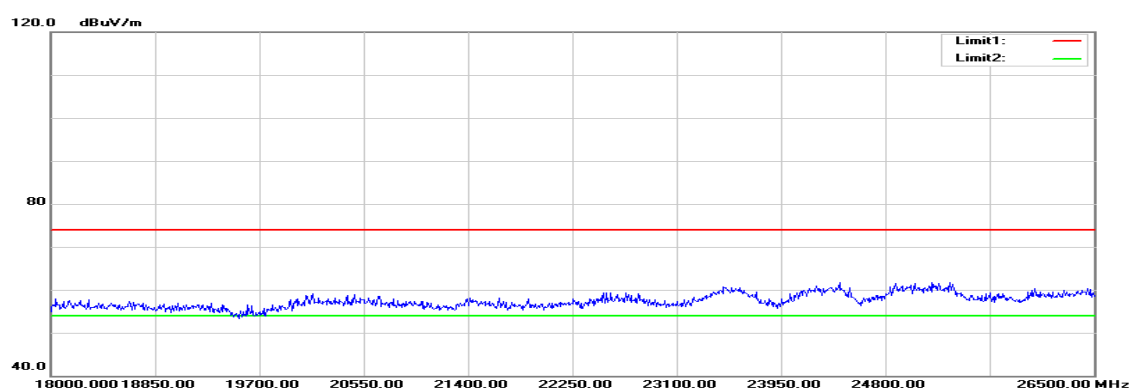
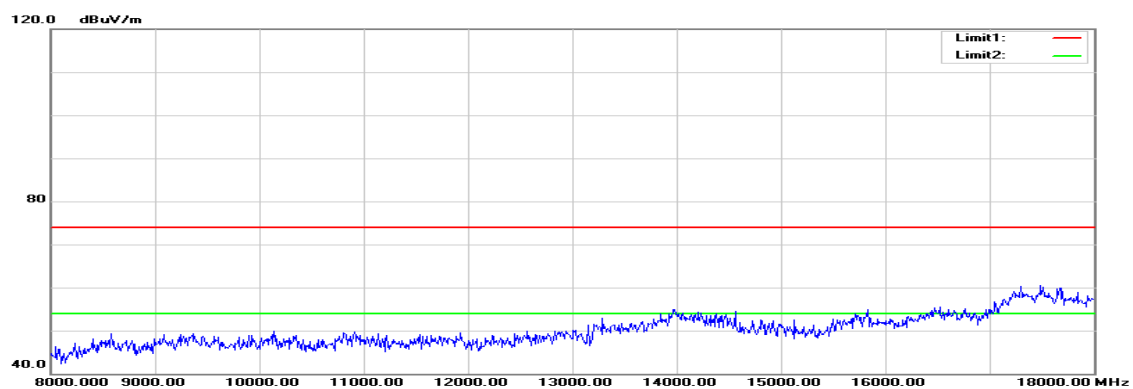
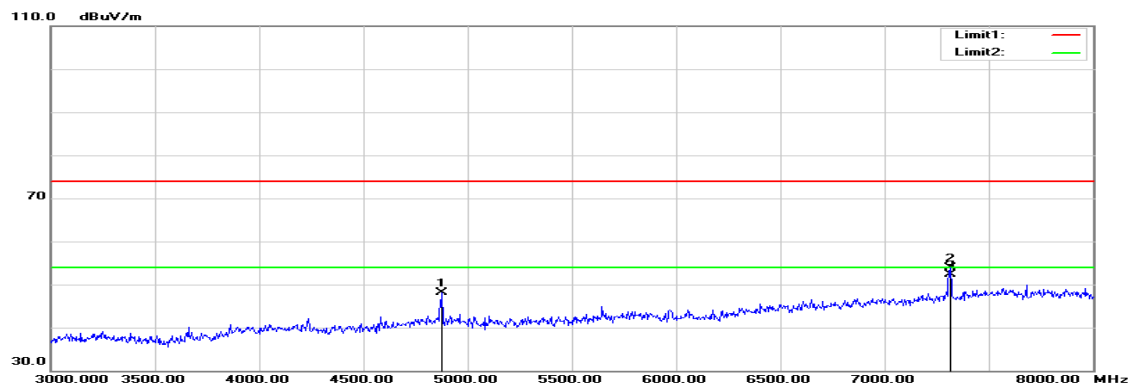
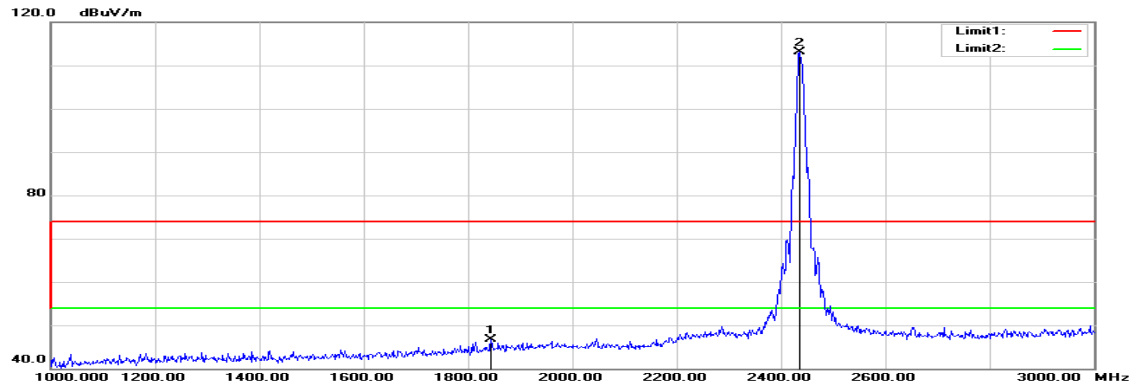

**Operation Mode:** TX / IEEE 802.11b / CH Mid

**Test Date:** January 13, 2016

**Temperature:** 27°C

**Tested by:** Jason Lu

**Humidity:** 53% RH

**Polarity:** Ver. / Hor.

Frequency (MHz)	Reading (dBuV)	Correction Factor (dB/m)	Result (dBuV/m)	Limit (dBuV/m)	Margin (dB)	Remark	Ant. Pol. (H/V)
1746.000	53.64	-4.92	48.72	74.00	-25.28	peak	V
7315.000	42.56	12.95	55.51	74.00	-18.49	peak	V
7315.000	39.54	12.95	52.49	54.00	-1.51	AVG	V
N/A							
1844.000	51.02	-4.41	46.61	74.00	-27.39	peak	H
4875.000	42.77	5.24	48.01	74.00	-25.99	peak	H
7315.000	40.97	12.95	53.92	74.00	-20.08	peak	H
7315.000	39.45	12.95	52.40	54.00	-1.60	AVG	H
N/A							

**Remark:**

1. Measuring frequencies from 1 GHz to the 10th harmonic of highest fundamental frequency.
2. Radiated emissions measured in frequency above 1000MHz were made with an instrument using peak/average detector mode.
3. Average test would be performed if the peak result were greater than the average limit or as required by the applicant.
4. Data of measurement within this frequency range shown " --- " in the table above means the reading of emissions are attenuated more than 20dB below the permissible limits or the field strength is too small to be measured.
5. Measurements above show only up to 6 maximum emissions noted, or would be lesser, with " N/A " remark, if no specific emissions from the EUT are recorded (ie: margin>20dB from the applicable limit) and considered that's already beyond the background noise floor.
6. Margin (dB) = Remark result (dBuV/m) – Average limit (dBuV/m).



**TX / IEEE 802.11b / CH High**

**Polarity: Vertical**

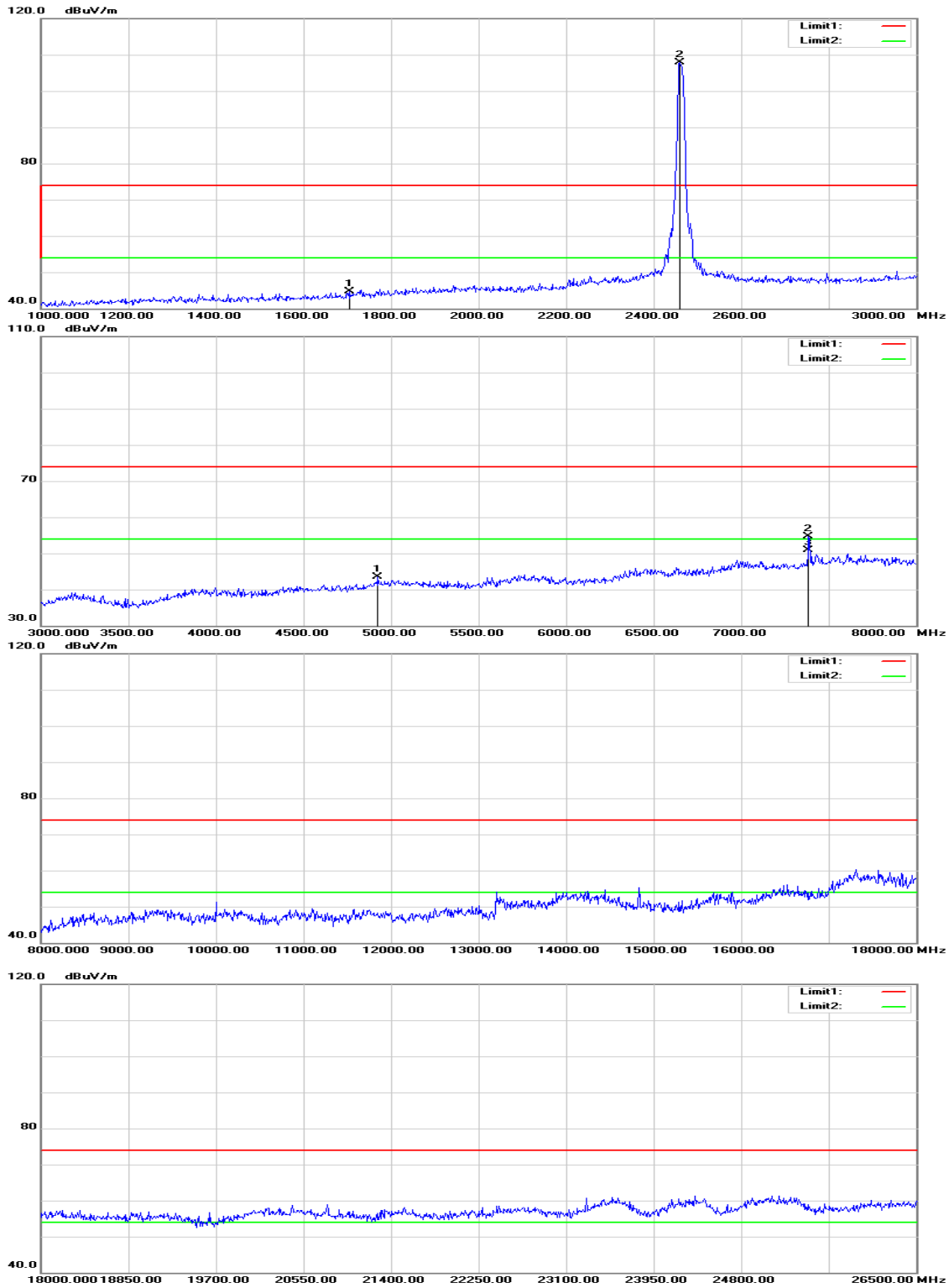

Polarity: Horizontal

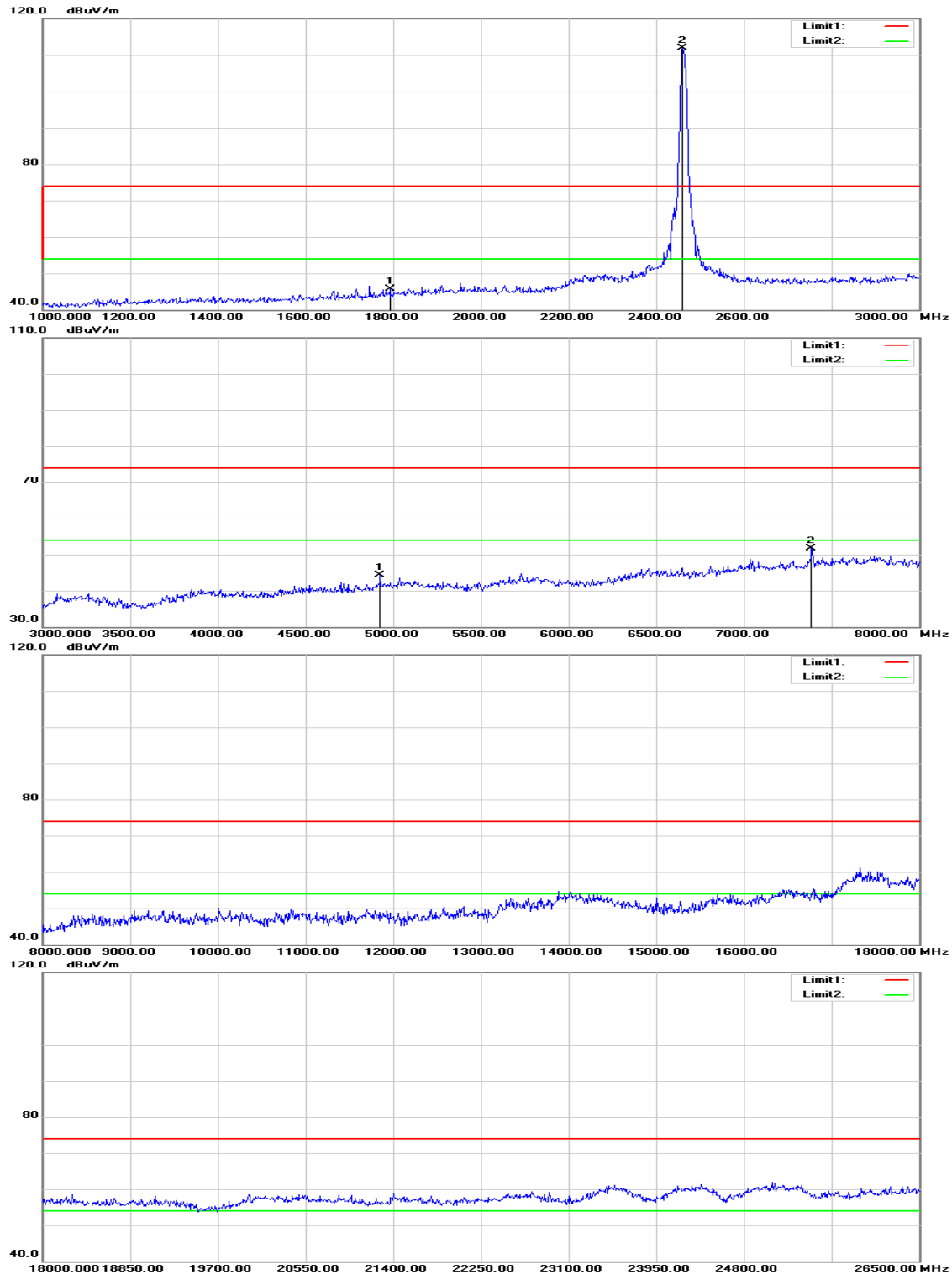

**Operation Mode:** TX / IEEE 802.11b / CH High

**Test Date:** January 13, 2016

**Temperature:** 27°C

**Tested by:** Jason Lu

**Humidity:** 53% RH

**Polarity:** Ver. / Hor.

Frequency (MHz)	Reading (dBuV)	Correction Factor (dB/m)	Result (dBuV/m)	Limit (dBuV/m)	Margin (dB)	Remark	Ant. Pol. (H/V)
1704.000	49.84	-5.13	44.71	74.00	-29.29	peak	V
4925.000	38.14	5.37	43.51	74.00	-30.49	peak	V
7385.000	41.51	13.16	54.67	74.00	-19.33	peak	V
7385.000	37.73	13.16	50.89	54.00	-3.11	AVG	V
N/A							
1792.000	50.37	-4.68	45.69	74.00	-28.31	peak	H
4925.000	38.93	5.37	44.30	74.00	-29.70	peak	H
7385.000	38.52	13.16	51.68	74.00	-22.32	peak	H
N/A							

**Remark:**

1. *Measuring frequencies from 1 GHz to the 10th harmonic of highest fundamental frequency.*
2. *Radiated emissions measured in frequency above 1000MHz were made with an instrument using peak/average detector mode.*
3. *Average test would be performed if the peak result were greater than the average limit or as required by the applicant.*
4. *Data of measurement within this frequency range shown " --- " in the table above means the reading of emissions are attenuated more than 20dB below the permissible limits or the field strength is too small to be measured.*
5. *Measurements above show only up to 6 maximum emissions noted, or would be lesser, with " N/A " remark, if no specific emissions from the EUT are recorded (ie: margin>20dB from the applicable limit) and considered that's already beyond the background noise floor.*
6. *Margin (dB) = Remark result (dBuV/m) – Average limit (dBuV/m).*

**TX / IEEE 802.11g / CH Low**

**Polarity: Vertical**

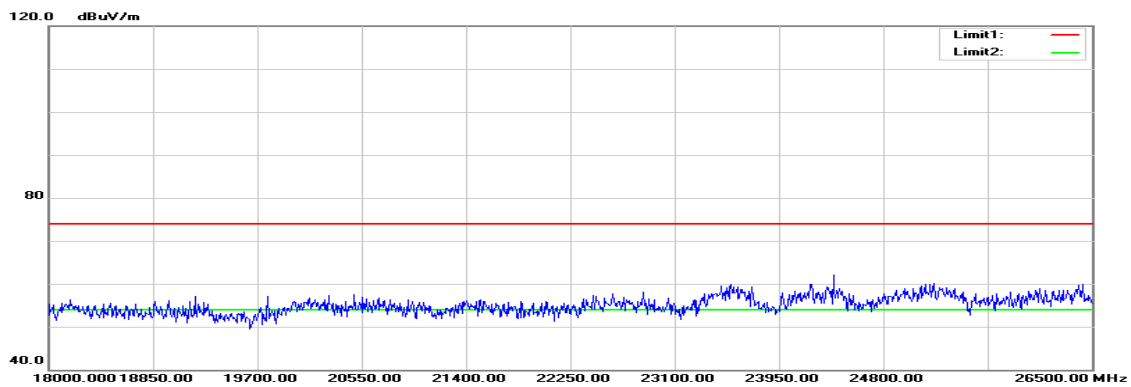
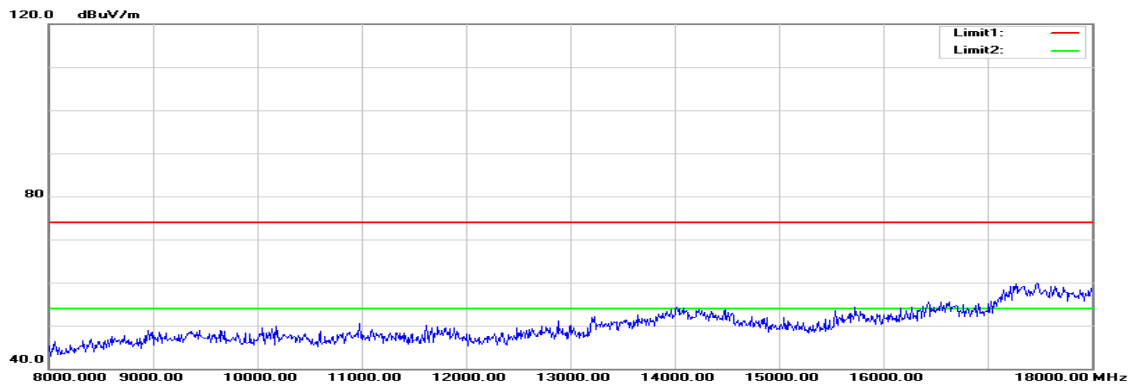
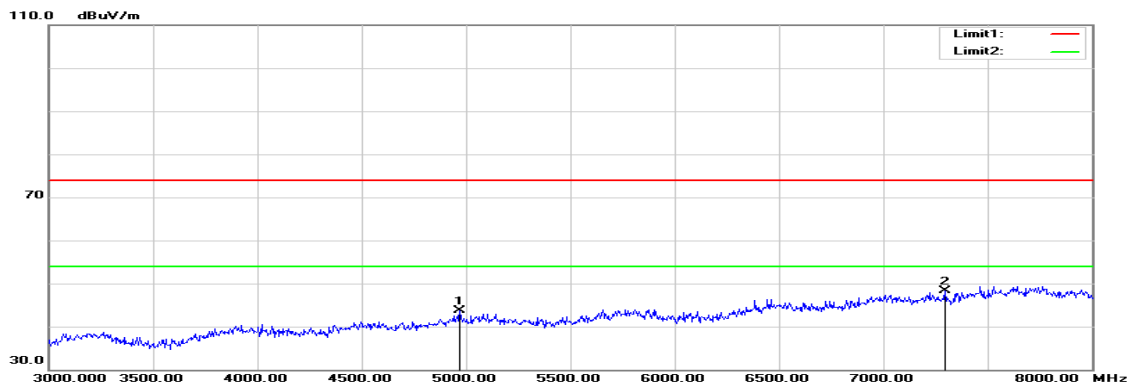
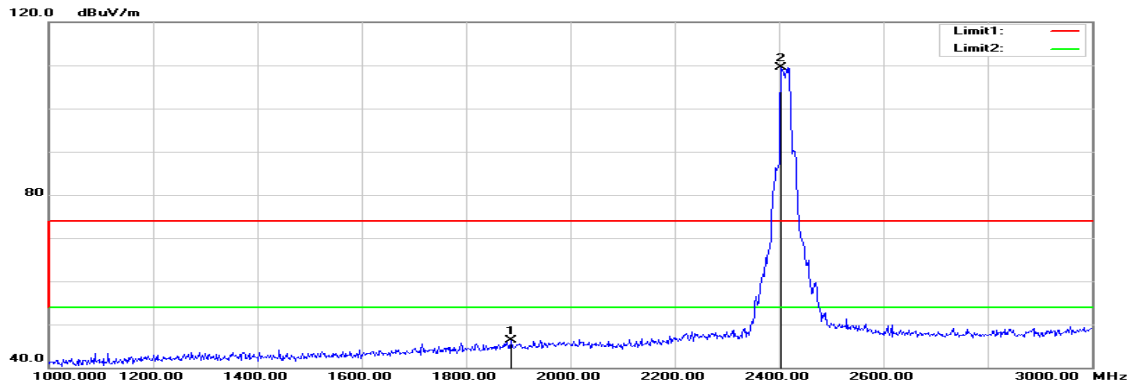

Polarity: Horizontal

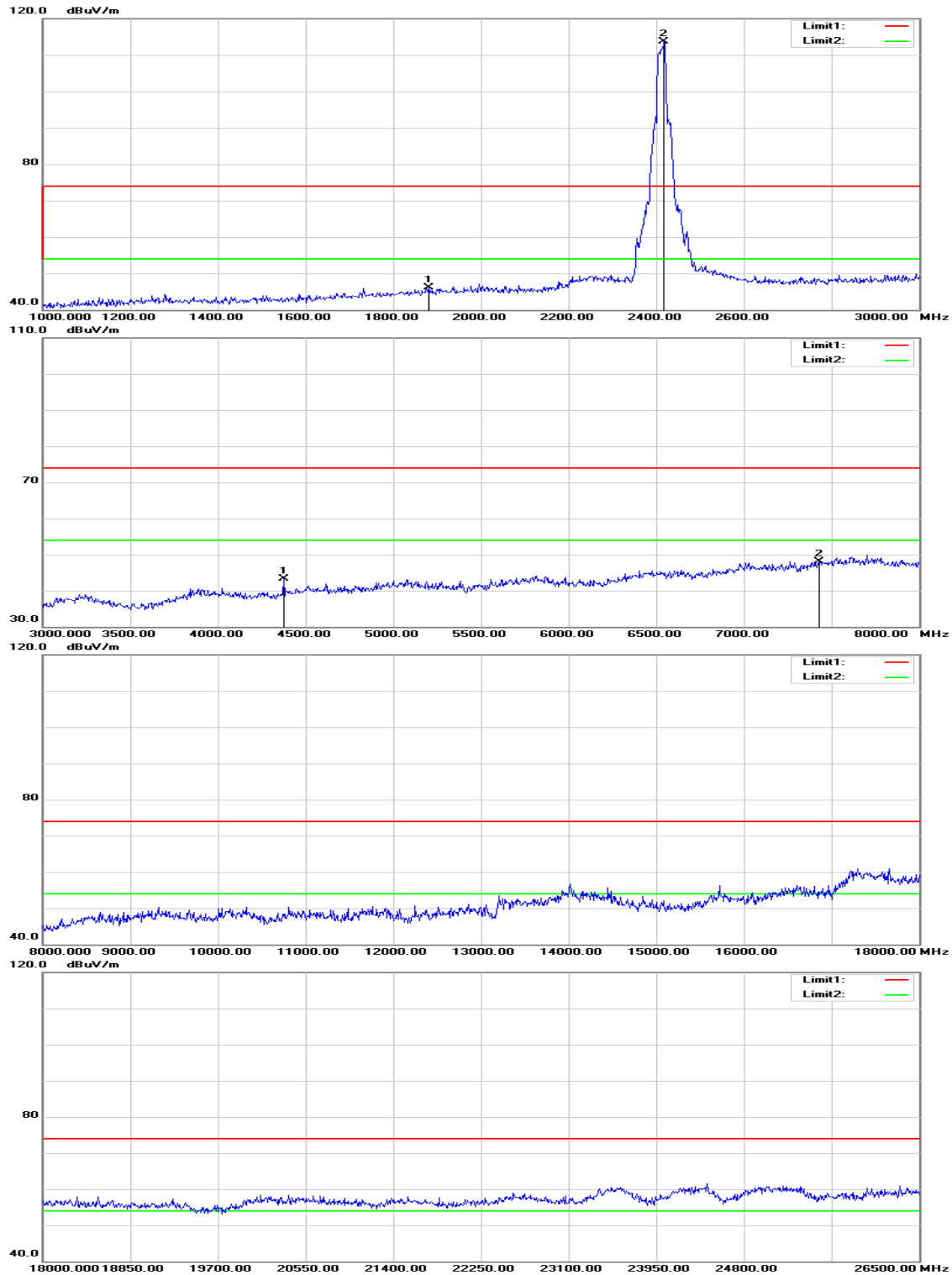

**Operation Mode:** TX / IEEE 802.11g / CH Low

**Test Date:** January 13, 2016

**Temperature:** 27°C

**Tested by:** Jason Lu

**Humidity:** 53% RH

**Polarity:** Ver. / Hor.

Frequency (MHz)	Reading (dBuV)	Correction Factor (dB/m)	Result (dBuV/m)	Limit (dBuV/m)	Margin (dB)	Remark	Ant. Pol. (H/V)
1886.000	50.44	-4.19	46.25	74.00	-27.75	peak	V
4970.000	38.14	5.49	43.63	74.00	-30.37	peak	V
7295.000	35.33	12.89	48.22	74.00	-25.78	peak	V
N/A							
1882.000	50.27	-4.21	46.06	74.00	-27.94	peak	H
4375.000	39.40	3.81	43.21	74.00	-30.79	peak	H
7430.000	34.88	13.30	48.18	74.00	-25.82	peak	H
N/A							

**Remark:**

1. *Measuring frequencies from 1 GHz to the 10th harmonic of highest fundamental frequency.*
2. *Radiated emissions measured in frequency above 1000MHz were made with an instrument using peak/average detector mode.*
3. *Average test would be performed if the peak result were greater than the average limit or as required by the applicant.*
4. *Data of measurement within this frequency range shown “ --- ” in the table above means the reading of emissions are attenuated more than 20dB below the permissible limits or the field strength is too small to be measured.*
5. *Measurements above show only up to 6 maximum emissions noted, or would be lesser, with “ N/A ” remark, if no specific emissions from the EUT are recorded (ie: margin>20dB from the applicable limit) and considered that's already beyond the background noise floor.*
6. *Margin (dB) = Remark result (dBuV/m) – Average limit (dBuV/m).*

**TX / IEEE 802.11g / CH Mid**

**Polarity: Vertical**

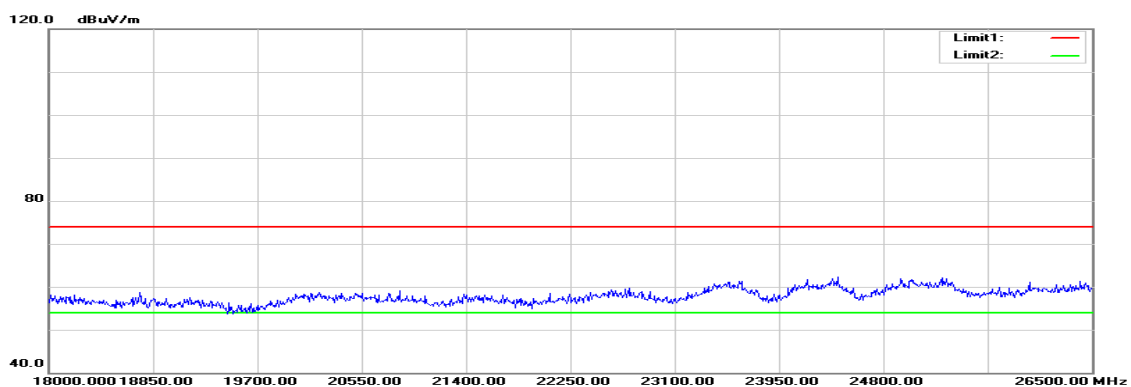
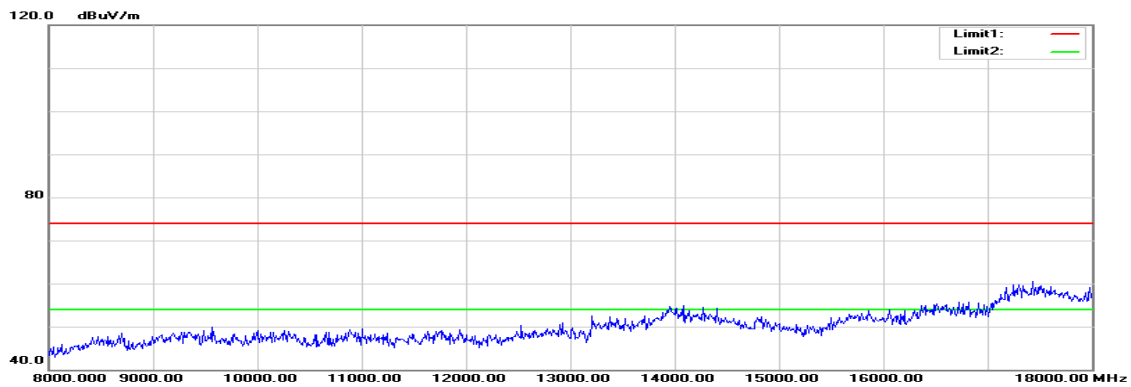
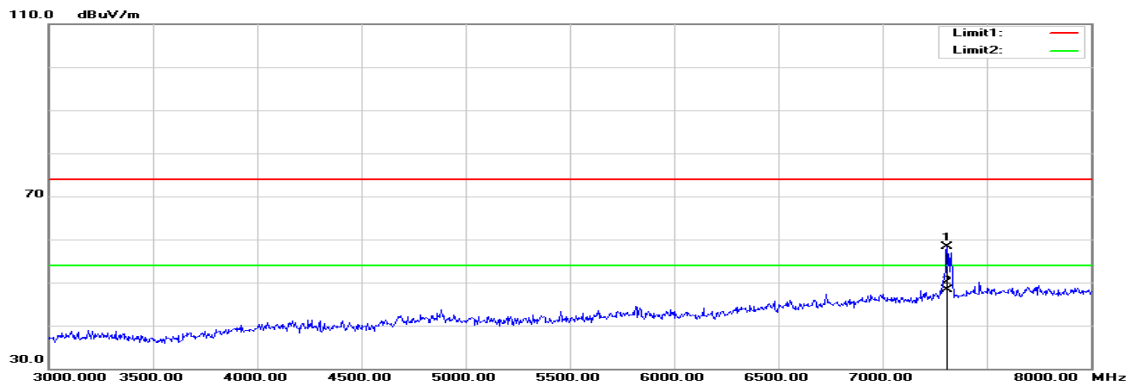
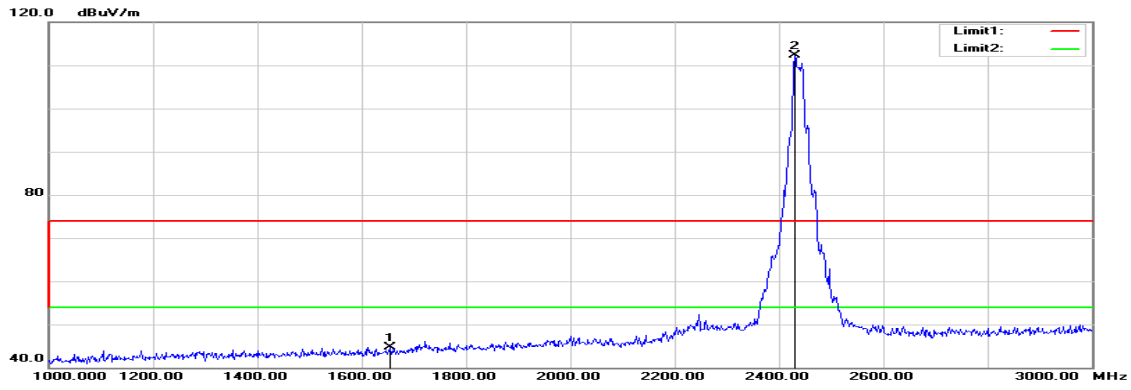

Polarity: Horizontal

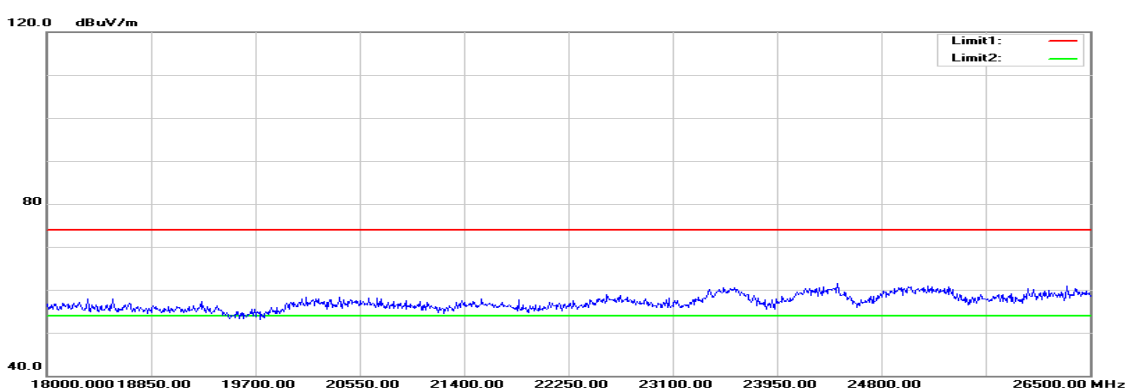
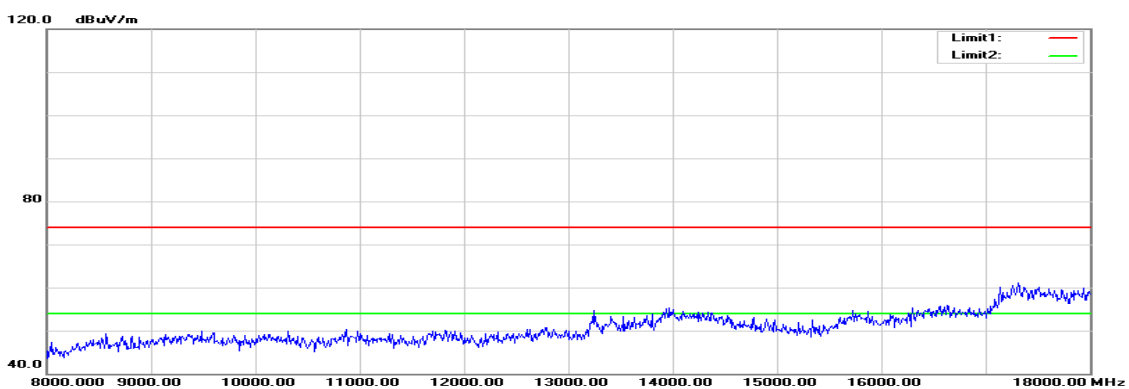
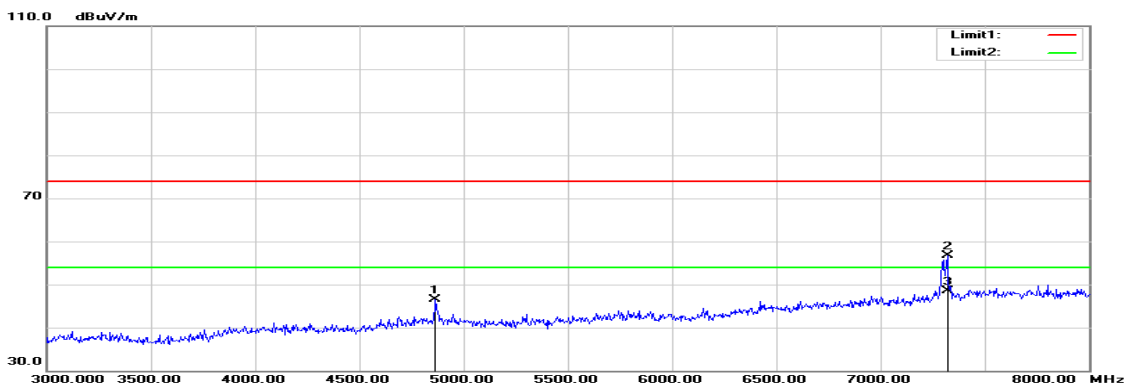
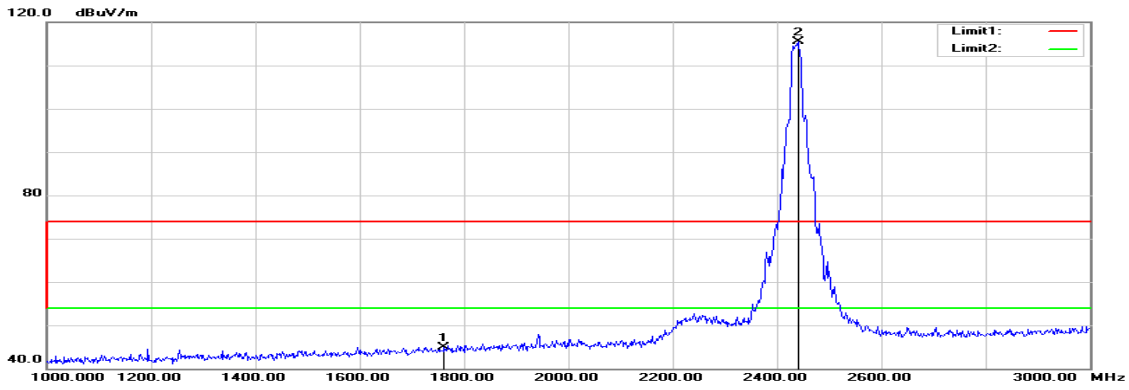



**Operation Mode:** TX / IEEE 802.11g / CH Mid

**Test Date:** January 13, 2016

**Temperature:** 27°C

**Tested by:** Jason Lu

**Humidity:** 53% RH

**Polarity:** Ver. / Hor.

Frequency (MHz)	Reading (dBuV)	Correction Factor (dB/m)	Result (dBuV/m)	Limit (dBuV/m)	Margin (dB)	Remark	Ant. Pol. (H/V)
1654.000	50.06	-5.39	44.67	74.00	-29.33	peak	V
7310.000	45.35	12.94	58.29	74.00	-15.71	peak	V
7310.000	35.39	12.94	48.33	54.00	-5.67	AVG	V
N/A							
1762.000	49.72	-4.83	44.89	74.00	-29.11	peak	H
4865.000	41.30	5.21	46.51	74.00	-27.49	peak	H
7320.000	43.66	12.97	56.63	74.00	-17.37	peak	H
7320.000	35.54	12.97	48.51	54.00	-5.49	AVG	H
N/A							

**Remark:**

1. Measuring frequencies from 1 GHz to the 10th harmonic of highest fundamental frequency.
2. Radiated emissions measured in frequency above 1000MHz were made with an instrument using peak/average detector mode.
3. Average test would be performed if the peak result were greater than the average limit or as required by the applicant.
4. Data of measurement within this frequency range shown " --- " in the table above means the reading of emissions are attenuated more than 20dB below the permissible limits or the field strength is too small to be measured.
5. Measurements above show only up to 6 maximum emissions noted, or would be lesser, with " N/A " remark, if no specific emissions from the EUT are recorded (ie: margin>20dB from the applicable limit) and considered that's already beyond the background noise floor.
6. Margin (dB) = Remark result (dBuV/m) – Average limit (dBuV/m).

**TX / IEEE 802.11g / CH High**

**Polarity: Vertical**

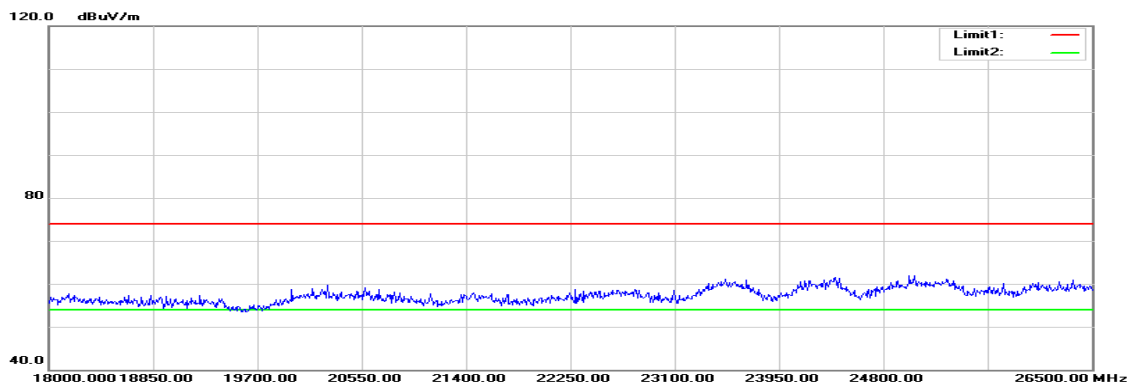
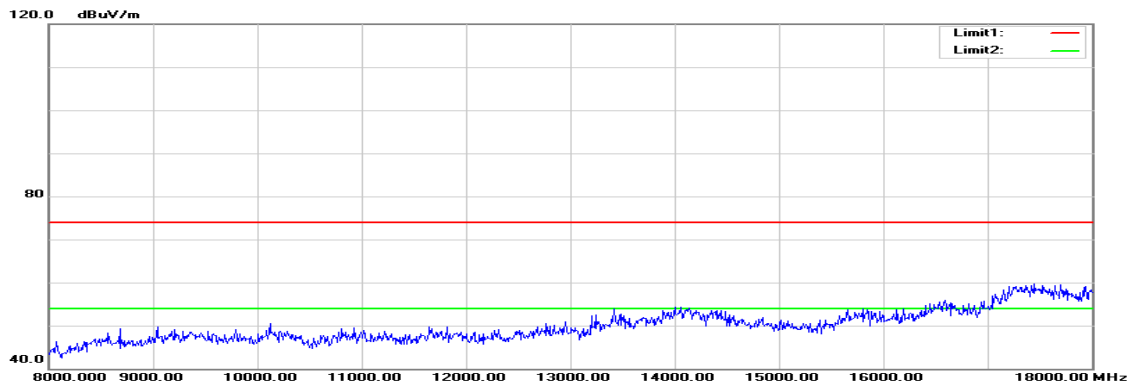
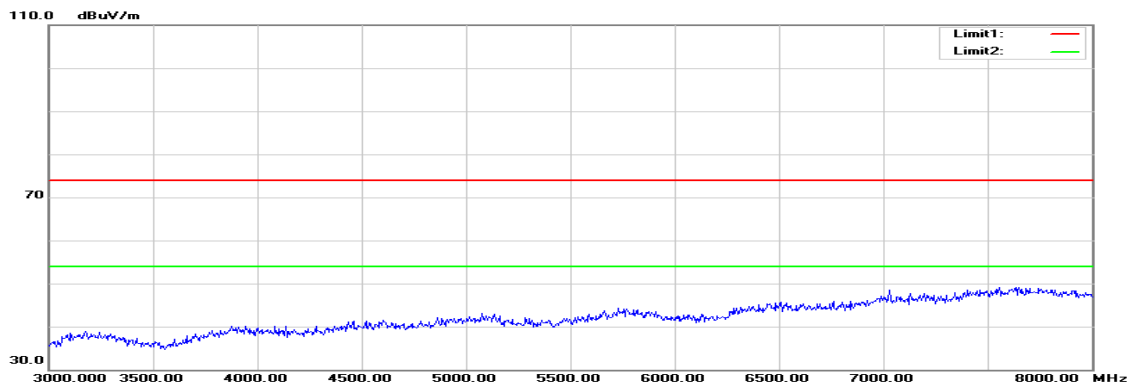
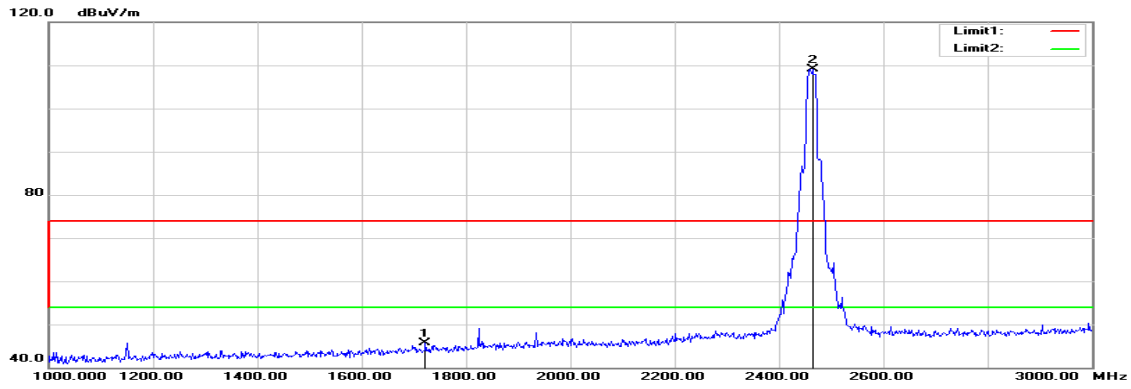

Polarity: Horizontal

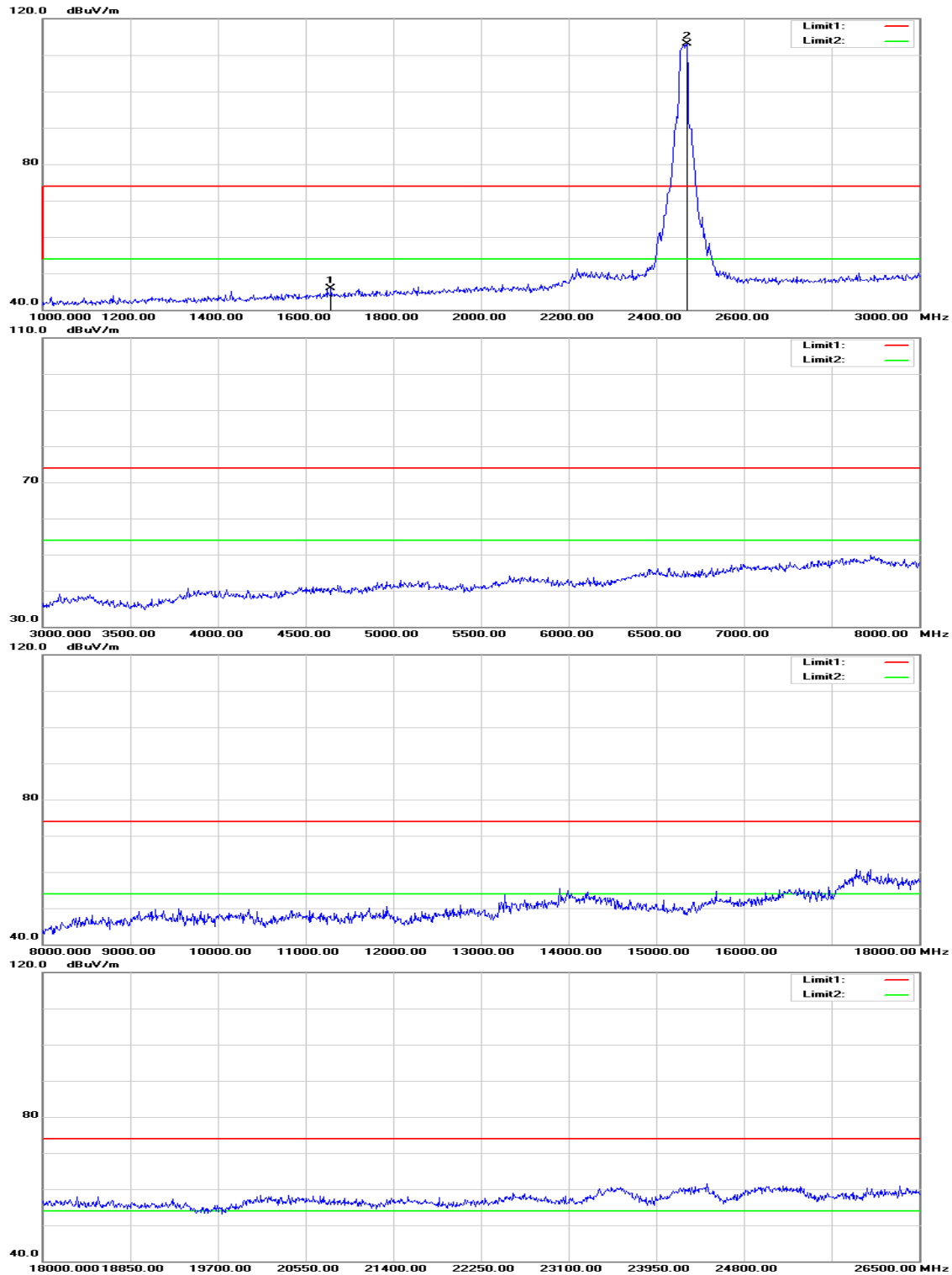

**Operation Mode:** TX / IEEE 802.11g / CH High

**Test Date:** January 13, 2016

**Temperature:** 27°C

**Tested by:** Jason Lu

**Humidity:** 53% RH

**Polarity:** Ver. / Hor.

Frequency (MHz)	Reading (dBuV)	Correction Factor (dB/m)	Result (dBuV/m)	Limit (dBuV/m)	Margin (dB)	Remark	Ant. Pol. (H/V)
1722.000	50.80	-5.04	45.76	74.00	-28.24	peak	V
N/A							
1658.000	51.18	-5.37	45.81	74.00	-28.19	peak	H
N/A							

**Remark:**

1. Measuring frequencies from 1 GHz to the 10th harmonic of highest fundamental frequency.
2. Radiated emissions measured in frequency above 1000MHz were made with an instrument using peak/average detector mode.
3. Average test would be performed if the peak result were greater than the average limit or as required by the applicant.
4. Data of measurement within this frequency range shown " --- " in the table above means the reading of emissions are attenuated more than 20dB below the permissible limits or the field strength is too small to be measured.
5. Measurements above show only up to 6 maximum emissions noted, or would be lesser, with " N/A " remark, if no specific emissions from the EUT are recorded (ie: margin>20dB from the applicable limit) and considered that's already beyond the background noise floor.
6. Margin (dB) = Remark result (dBuV/m) – Average limit (dBuV/m).

**TX / IEEE 802.11n HT 20 MHz mode / CH Low**

**Polarity: Vertical**

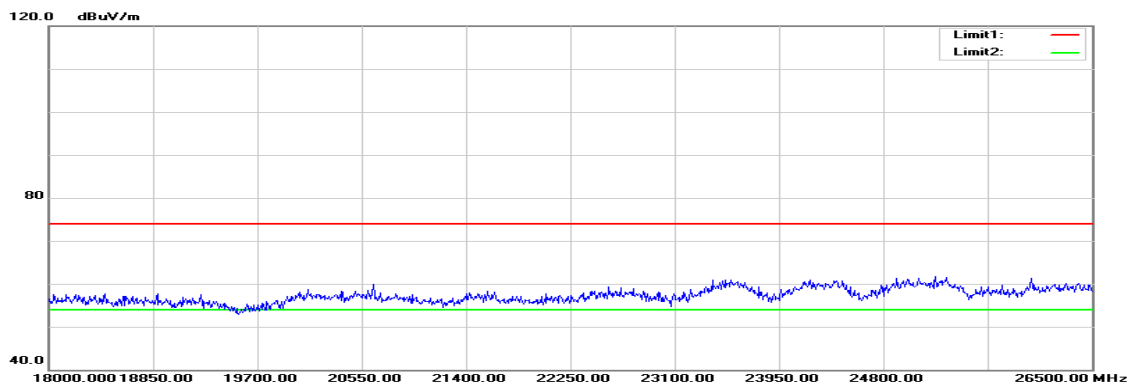
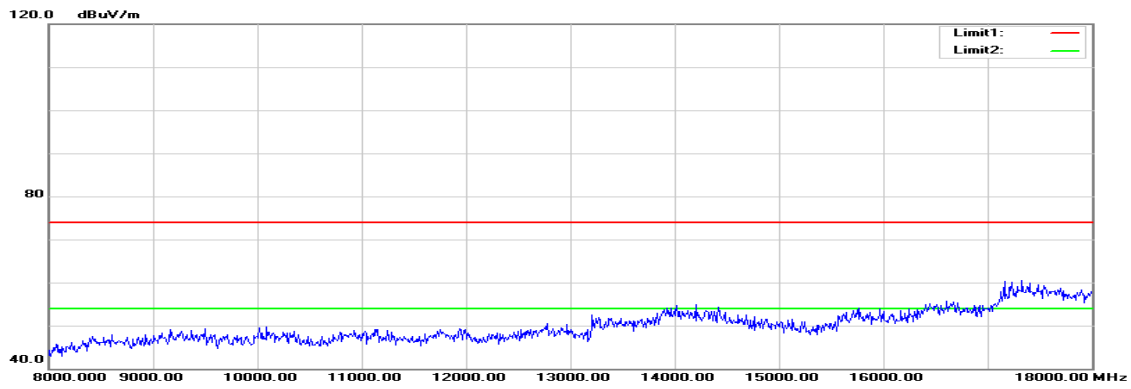
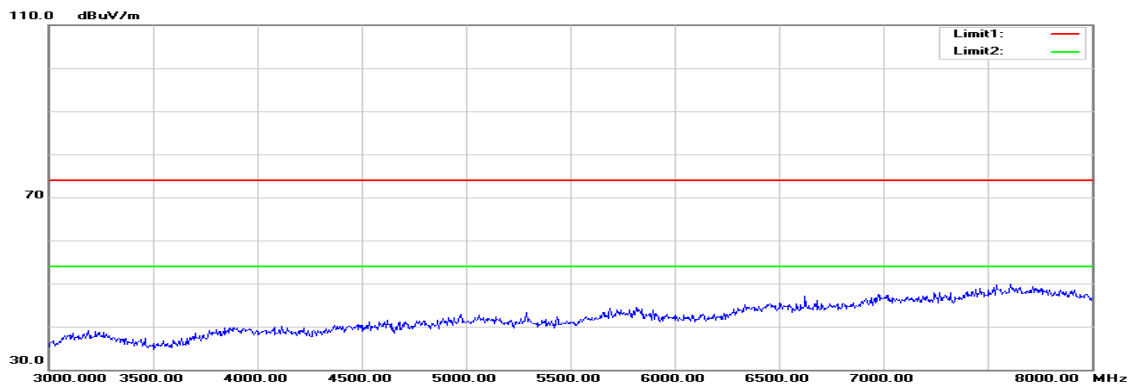
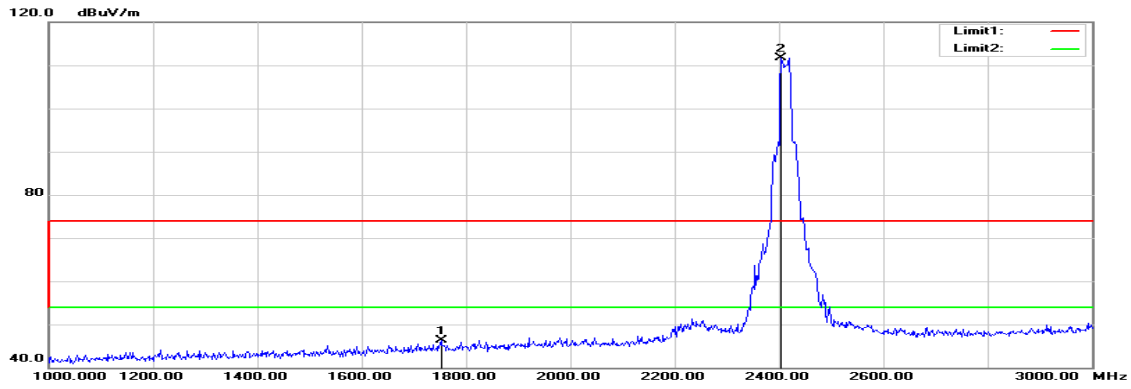

Polarity: Horizontal

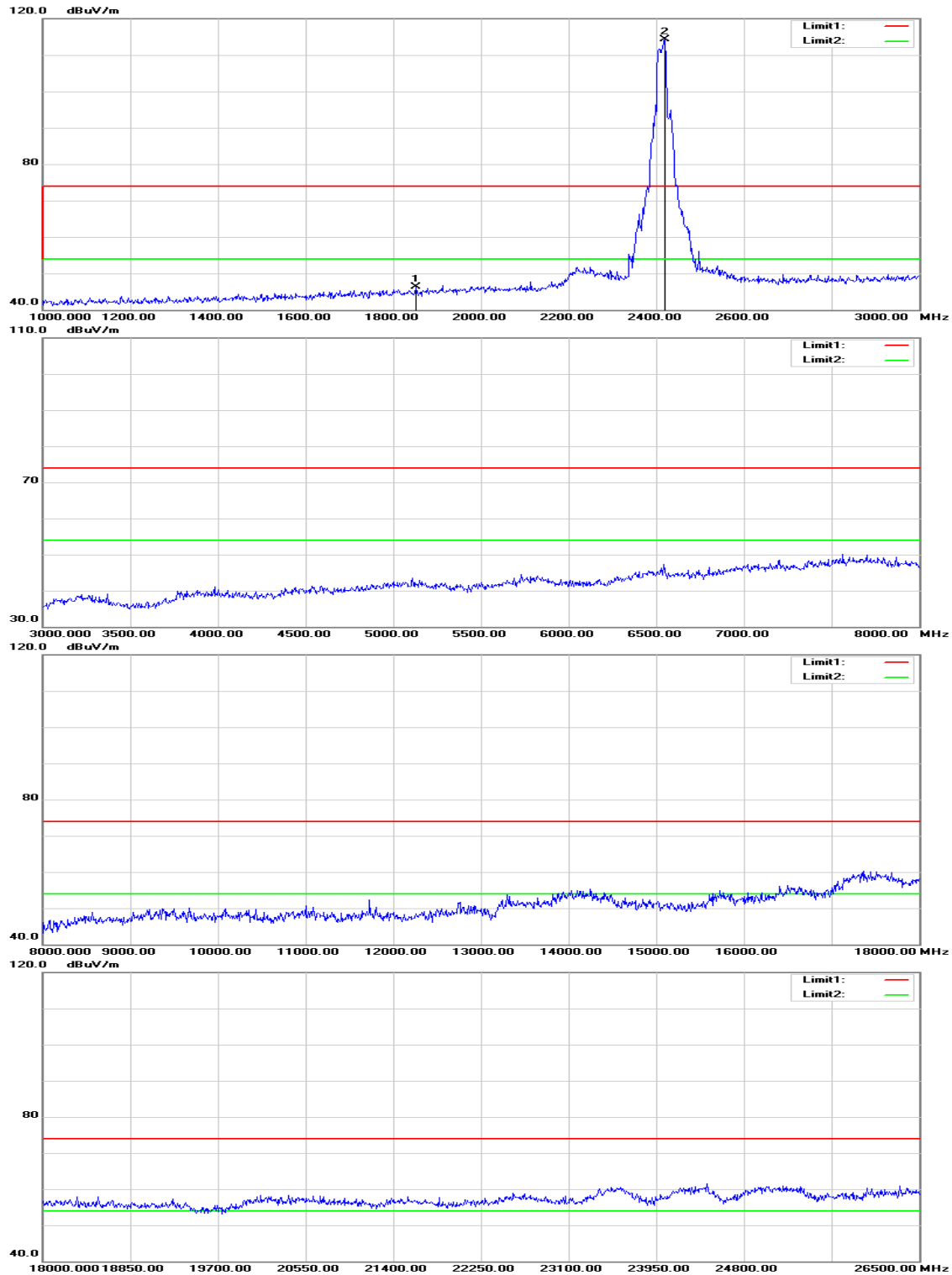

**Operation Mode:** TX / IEEE 802.11n HT 20 MHz mode / CH Low **Test Date:** January 13, 2016

**Temperature:** 27°C

**Tested by:** Jason Lu

**Humidity:** 53% RH

**Polarity:** Ver. / Hor.

Frequency (MHz)	Reading (dBuV)	Correction Factor (dB/m)	Result (dBuV/m)	Limit (dBuV/m)	Margin (dB)	Remark	Ant. Pol. (H/V)
1752.000	51.14	-4.88	46.26	74.00	-27.74	peak	V
N/A							
1852.000	50.63	-4.37	46.26	74.00	-27.74	peak	H
N/A							

**Remark:**

1. Measuring frequencies from 1 GHz to the 10th harmonic of highest fundamental frequency.
2. Radiated emissions measured in frequency above 1000MHz were made with an instrument using peak/average detector mode.
3. Average test would be performed if the peak result were greater than the average limit or as required by the applicant.
4. Data of measurement within this frequency range shown " --- " in the table above means the reading of emissions are attenuated more than 20dB below the permissible limits or the field strength is too small to be measured.
5. Measurements above show only up to 6 maximum emissions noted, or would be lesser, with " N/A " remark, if no specific emissions from the EUT are recorded (ie: margin>20dB from the applicable limit) and considered that's already beyond the background noise floor.
6. Margin (dB) = Remark result (dBuV/m) – Average limit (dBuV/m).

**TX / IEEE 802.11n HT 20 MHz mode / CH Mid**

**Polarity: Vertical**

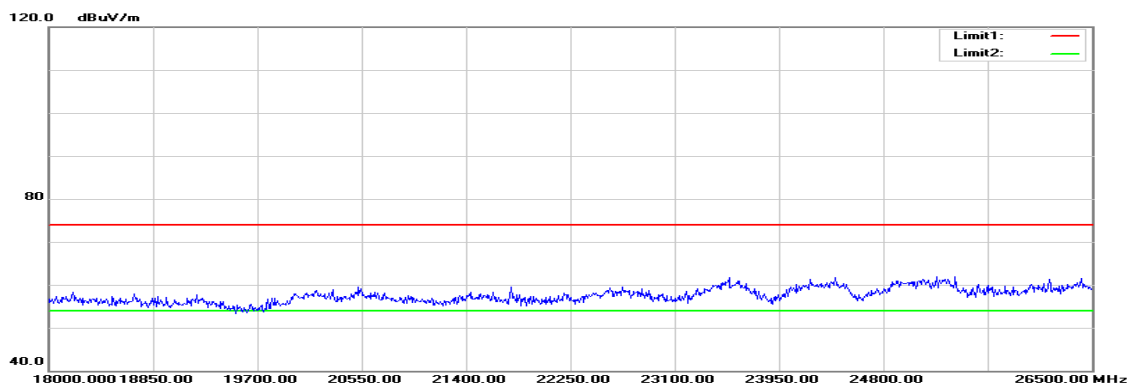
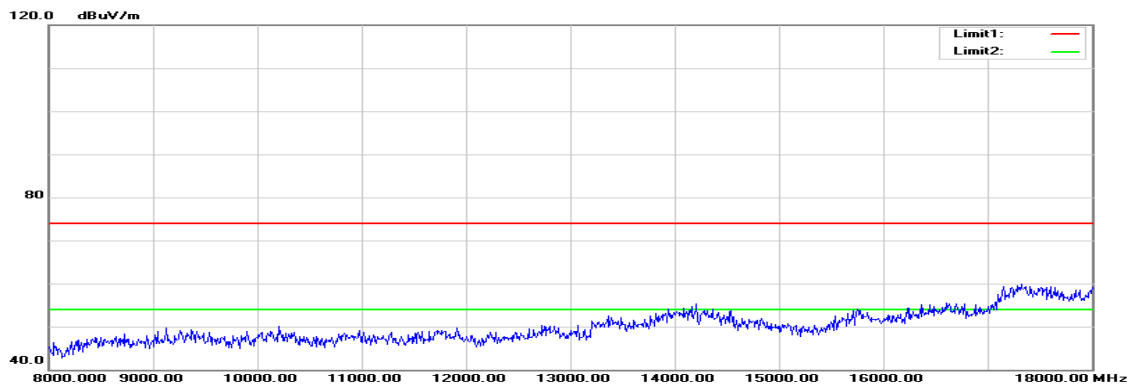
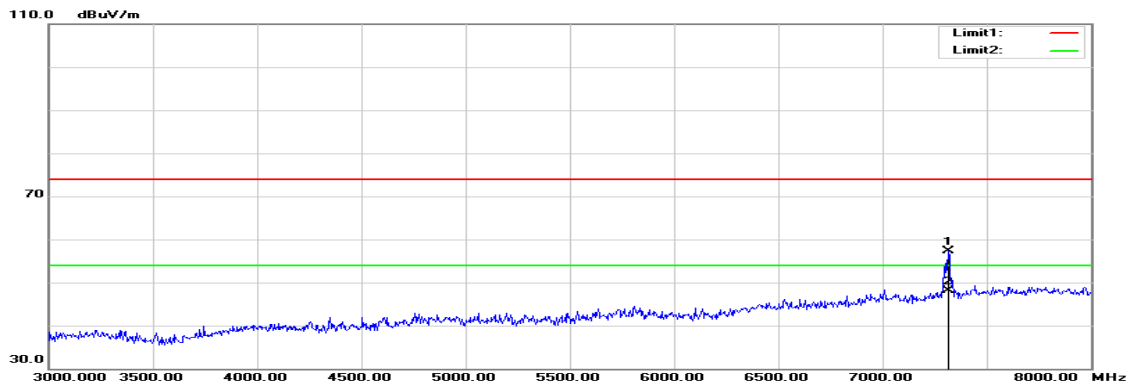
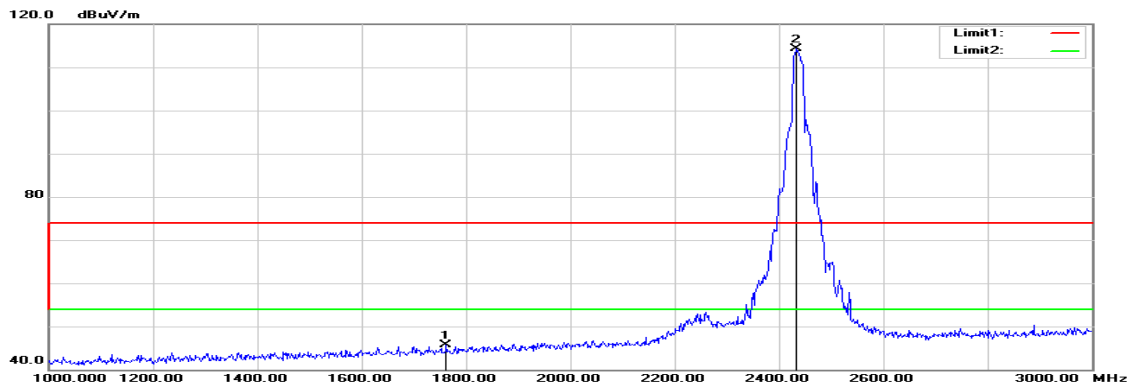



Polarity: Horizontal

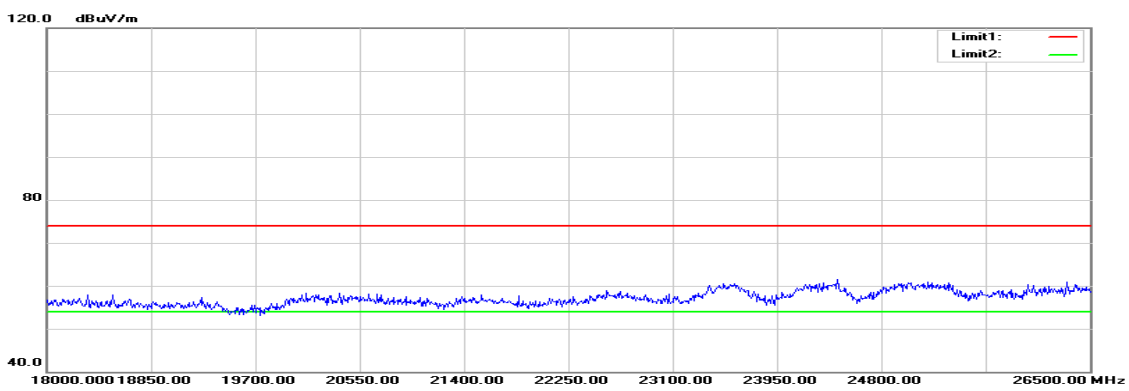
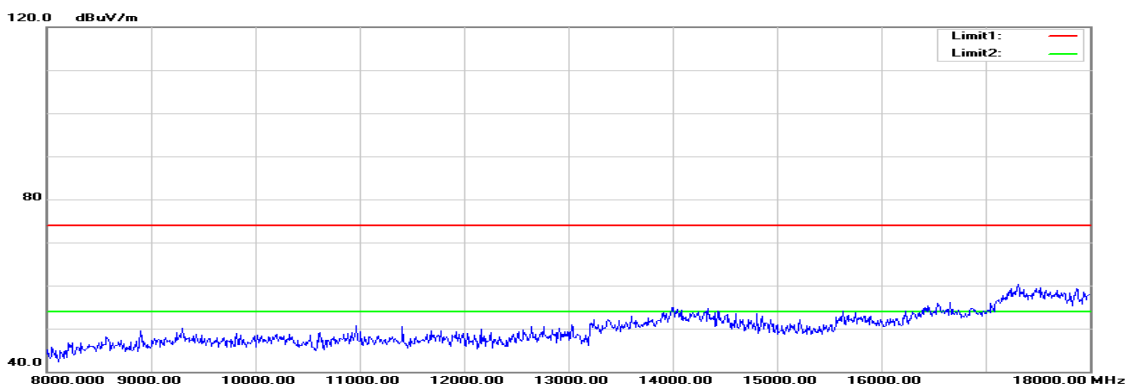
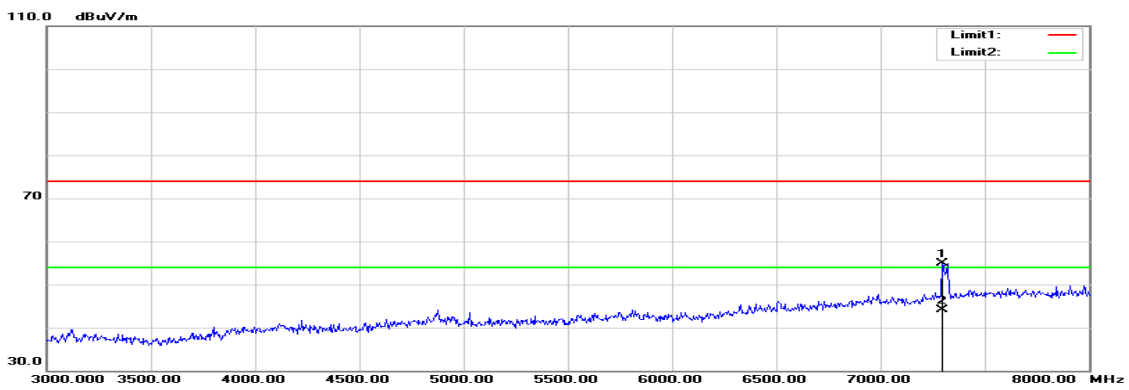
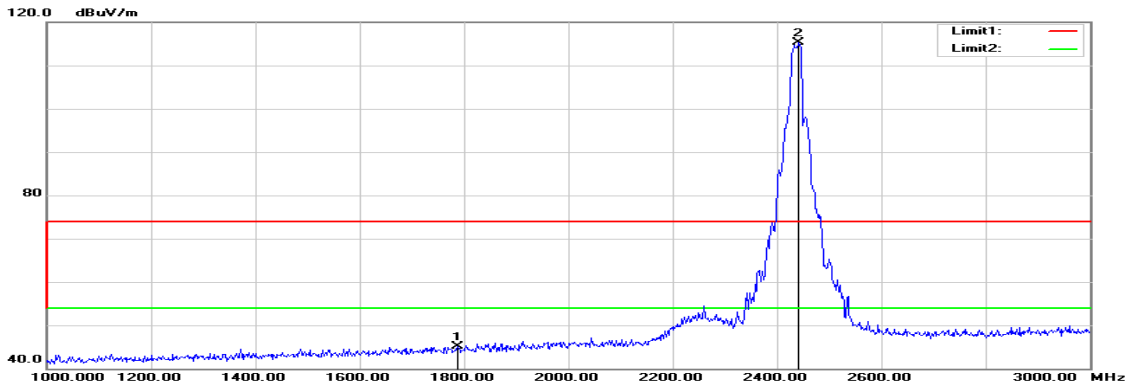

**Operation Mode:** TX / IEEE 802.11n HT 20 MHz mode / CH Mid**Test Date:** January 13, 2016

**Temperature:** 27°C

**Tested by:** Jason Lu

**Humidity:** 53% RH

**Polarity:** Ver. / Hor.

Frequency (MHz)	Reading (dBuV)	Correction Factor (dB/m)	Result (dBuV/m)	Limit (dBuV/m)	Margin (dB)	Remark	Ant. Pol. (H/V)
1762.000	50.54	-4.83	45.71	74.00	-28.29	peak	V
7315.000	44.35	12.95	57.30	74.00	-16.70	peak	V
7315.000	35.06	12.95	48.01	54.00	-5.99	AVG	V
N/A							
1788.000	49.84	-4.70	45.14	74.00	-28.86	peak	H
7295.000	42.06	12.89	54.95	74.00	-19.05	peak	H
7295.000	31.29	12.89	44.18	54.00	-9.82	AVG	H
N/A							

**Remark:**

1. *Measuring frequencies from 1 GHz to the 10th harmonic of highest fundamental frequency.*
2. *Radiated emissions measured in frequency above 1000MHz were made with an instrument using peak/average detector mode.*
3. *Average test would be performed if the peak result were greater than the average limit or as required by the applicant.*
4. *Data of measurement within this frequency range shown " --- " in the table above means the reading of emissions are attenuated more than 20dB below the permissible limits or the field strength is too small to be measured.*
5. *Measurements above show only up to 6 maximum emissions noted, or would be lesser, with " N/A " remark, if no specific emissions from the EUT are recorded (ie: margin>20dB from the applicable limit) and considered that's already beyond the background noise floor.*
6. *Margin (dB) = Remark result (dBuV/m) – Average limit (dBuV/m).*

**TX / IEEE 802.11n HT 20 MHz mode / CH High**

**Polarity: Vertical**

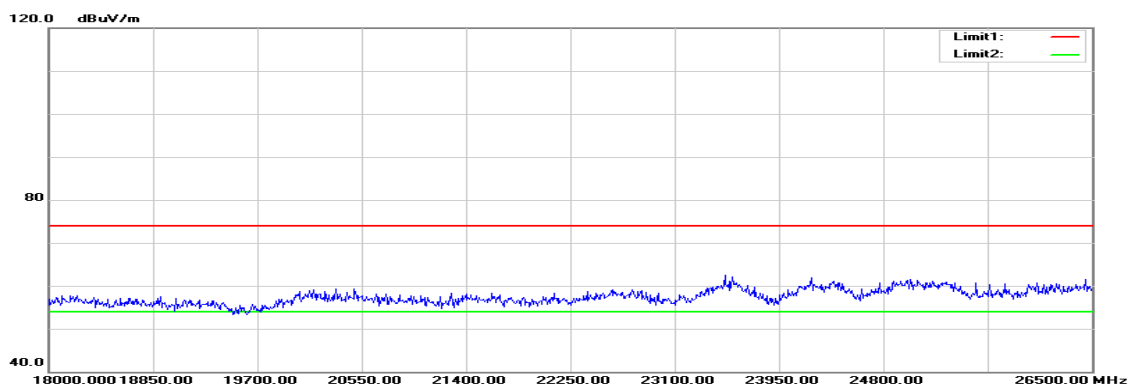
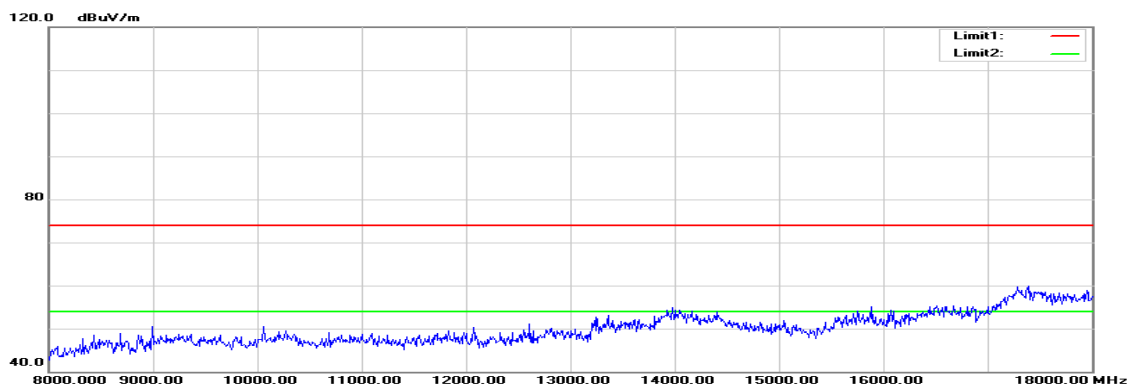
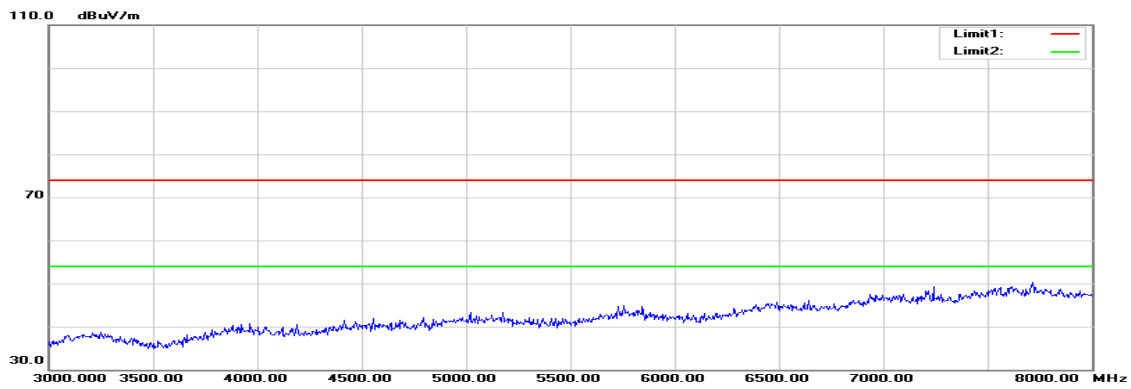
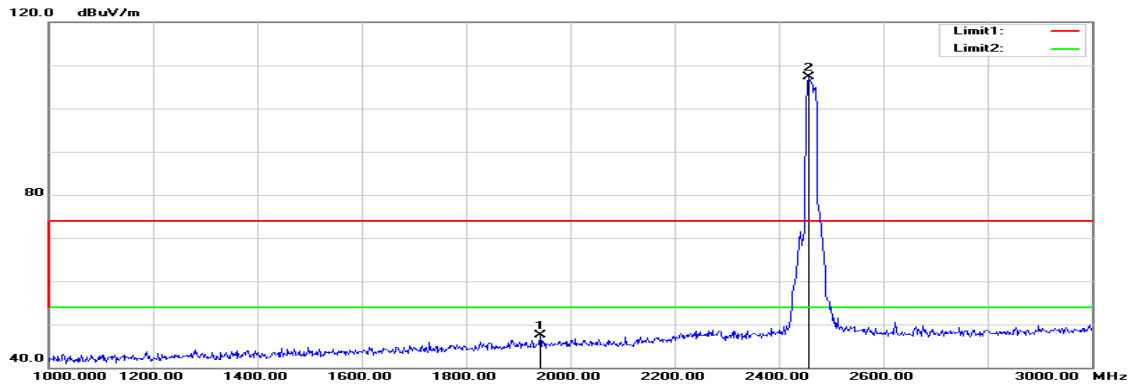

Polarity: Horizontal

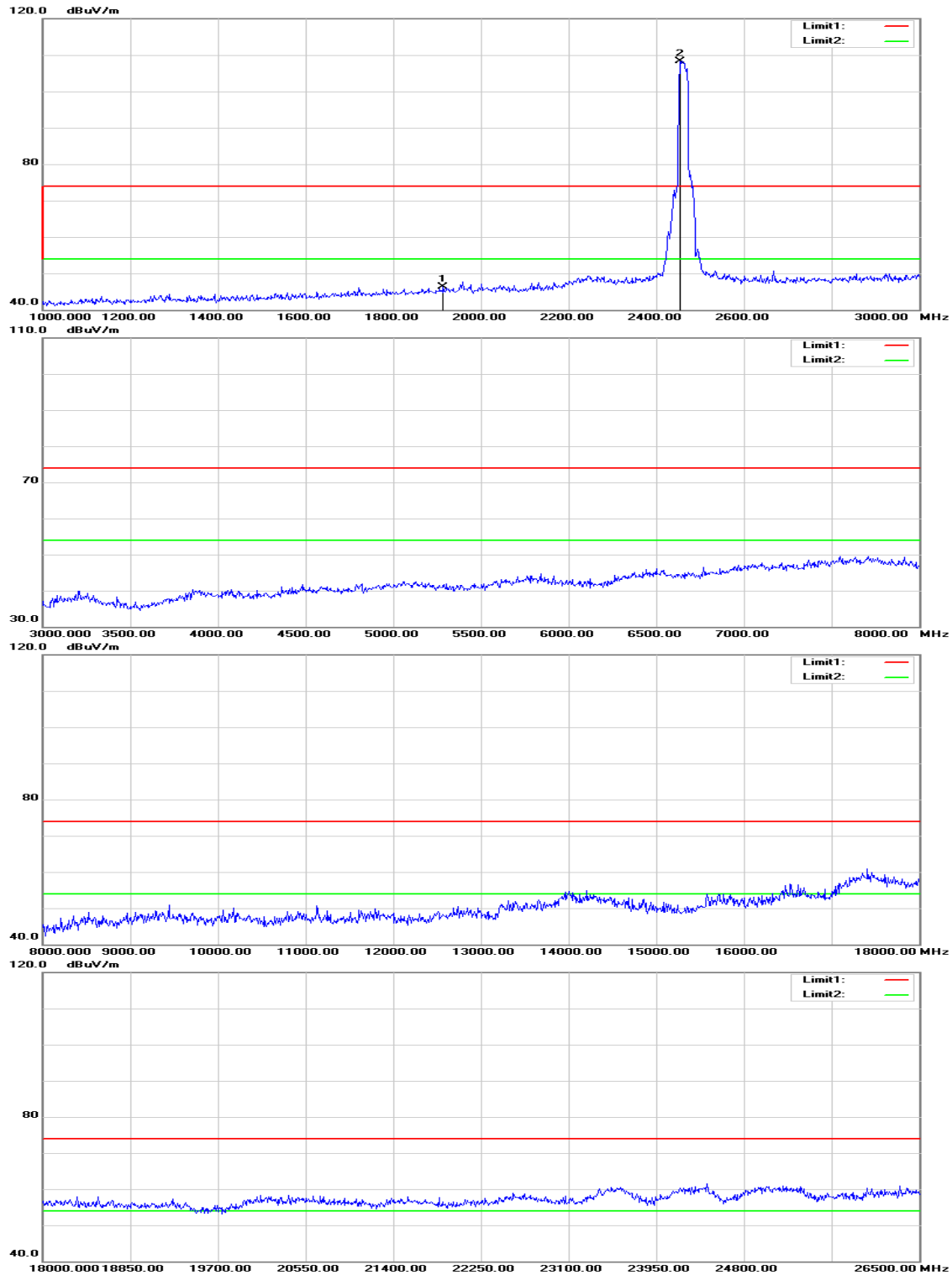

**Operation Mode:** TX / IEEE 802.11n HT 20 MHz mode / CH High  
**Temperature:** 27°C  
**Humidity:** 53% RH

**Test Date:** January 13, 2016  
**Tested by:** Jason Lu  
**Polarity:** Ver. / Hor.

Frequency (MHz)	Reading (dBuV)	Correction Factor (dB/m)	Result (dBuV/m)	Limit (dBuV/m)	Margin (dB)	Remark	Ant. Pol. (H/V)
1942.000	51.34	-3.90	47.44	74.00	-26.56	peak	V
N/A							
1914.000	50.34	-4.05	46.29	74.00	-27.71	peak	H
N/A							

**Remark:**

1. Measuring frequencies from 1 GHz to the 10th harmonic of highest fundamental frequency.
2. Radiated emissions measured in frequency above 1000MHz were made with an instrument using peak/average detector mode.
3. Average test would be performed if the peak result were greater than the average limit or as required by the applicant.
4. Data of measurement within this frequency range shown “ --- ” in the table above means the reading of emissions are attenuated more than 20dB below the permissible limits or the field strength is too small to be measured.
5. Measurements above show only up to 6 maximum emissions noted, or would be lesser, with “ N/A ” remark, if no specific emissions from the EUT are recorded (ie: margin>20dB from the applicable limit) and considered that's already beyond the background noise floor.
6. Margin (dB) = Remark result (dBuV/m) – Average limit (dBuV/m).

**TX / IEEE 802.11n HT 40 MHz mode / CH Low**

**Polarity: Vertical**

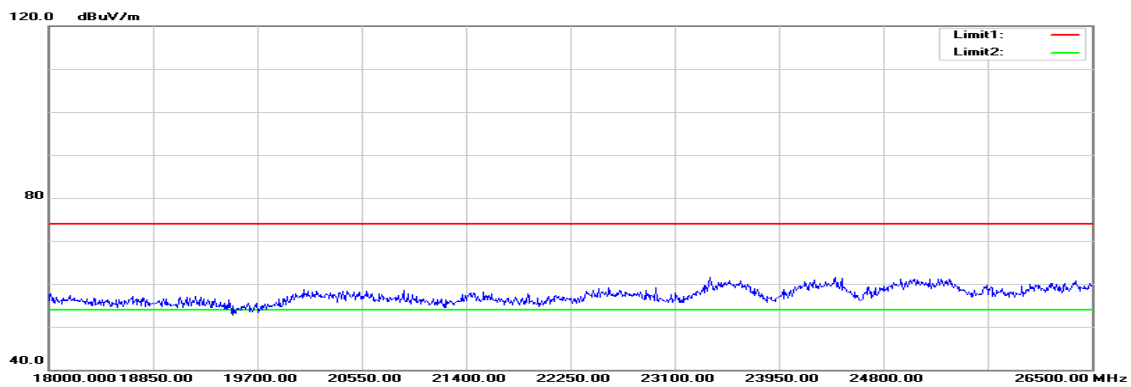
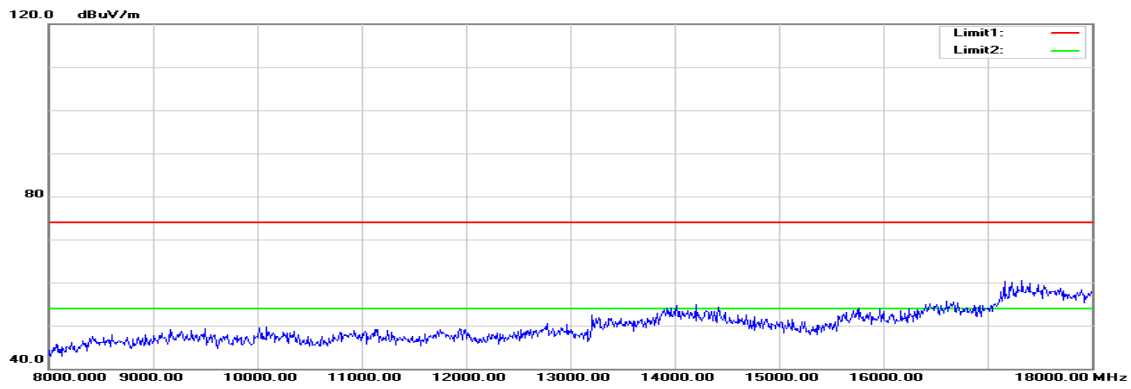
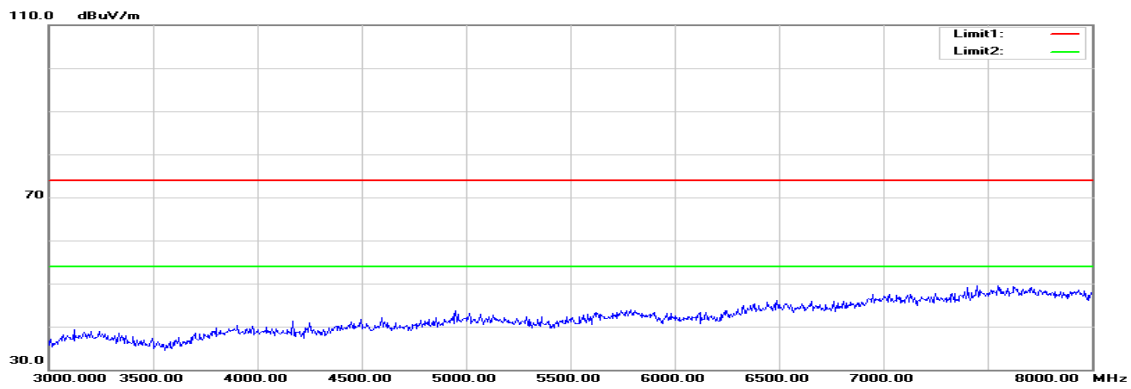
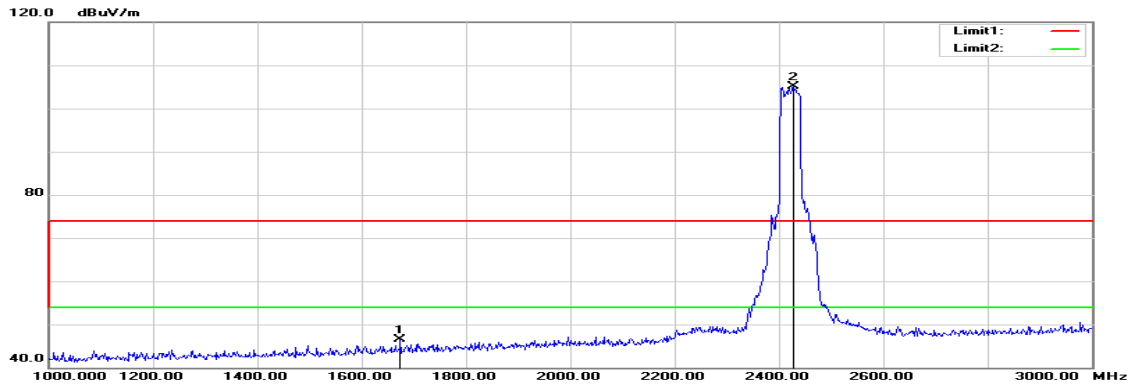

Polarity: Horizontal

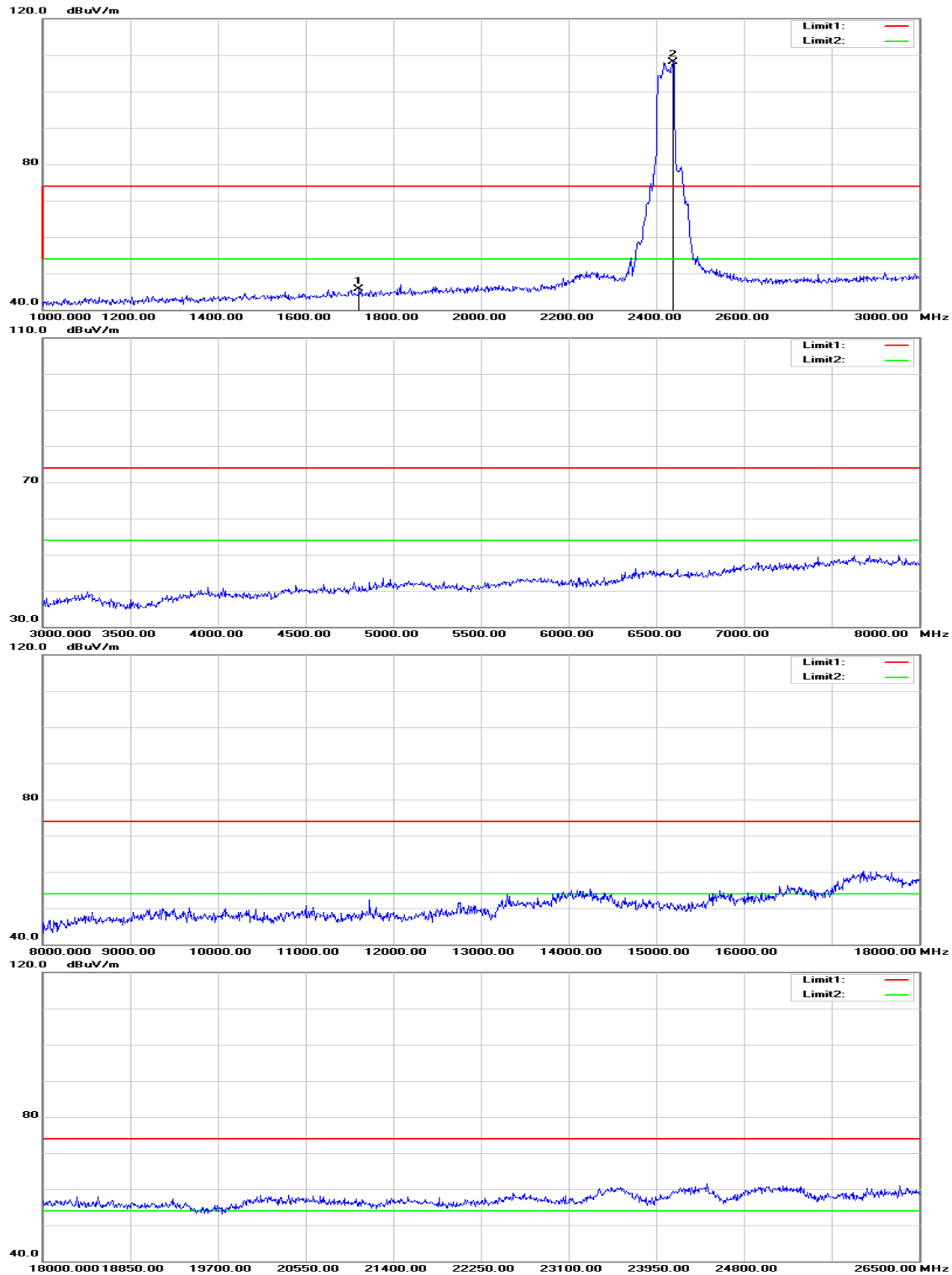

**Operation Mode:** TX / IEEE 802.11n HT 40 MHz mode  
/ CH Low

**Test Date:** January 13, 2016

**Temperature:** 27°C

**Tested by:** Jason Lu

**Humidity:** 53% RH

**Polarity:** Ver. / Hor.

Frequency (MHz)	Reading (dBuV)	Correction Factor (dB/m)	Result (dBuV/m)	Limit (dBuV/m)	Margin (dB)	Remark	Ant. Pol. (H/V)
1674.000	51.82	-5.29	46.53	74.00	-27.47	peak	V
N/A							
1722.000	50.64	-5.04	45.60	74.00	-28.40	peak	H
N/A							

**Remark:**

1. Measuring frequencies from 1 GHz to the 10th harmonic of highest fundamental frequency.
2. Radiated emissions measured in frequency above 1000MHz were made with an instrument using peak/average detector mode.
3. Average test would be performed if the peak result were greater than the average limit or as required by the applicant.
4. Data of measurement within this frequency range shown “ --- ” in the table above means the reading of emissions are attenuated more than 20dB below the permissible limits or the field strength is too small to be measured.
5. Measurements above show only up to 6 maximum emissions noted, or would be lesser, with “ N/A ” remark, if no specific emissions from the EUT are recorded (ie: margin>20dB from the applicable limit) and considered that's already beyond the background noise floor.
6. Margin (dB) = Remark result (dBuV/m) – Average limit (dBuV/m).



**TX / IEEE 802.11n HT 40 MHz mode / CH Mid**

**Polarity: Vertical**

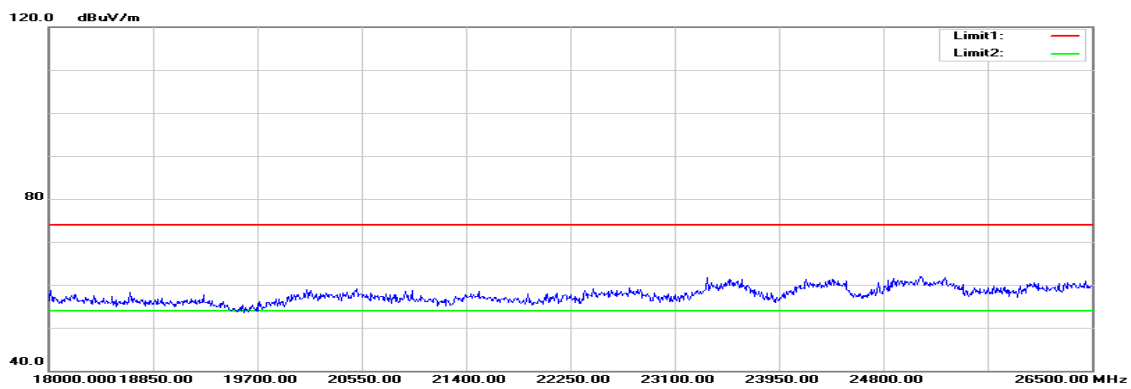
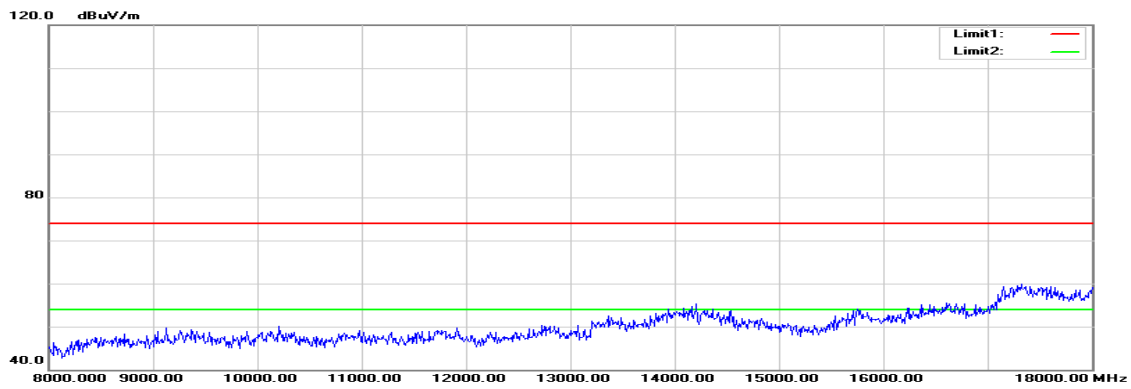
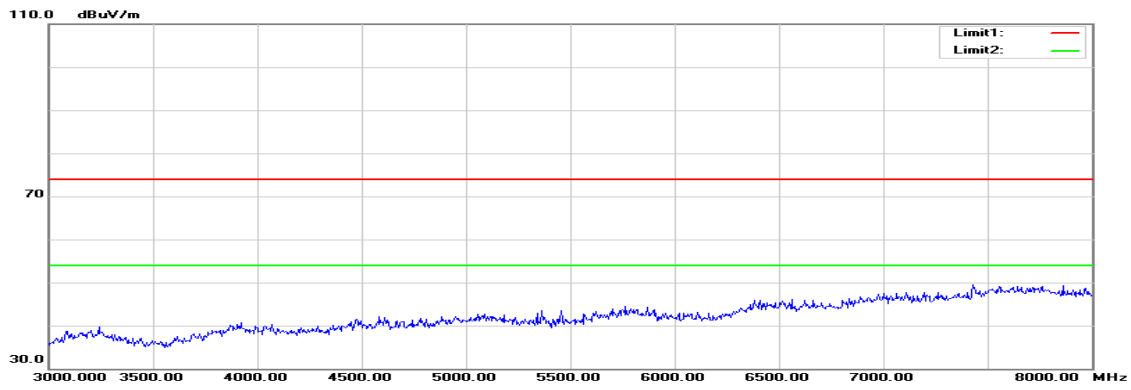
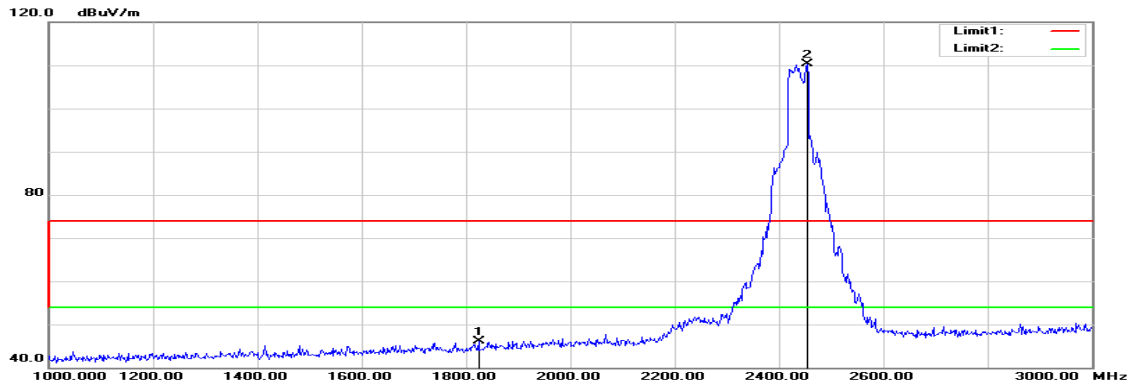

Polarity: Horizontal

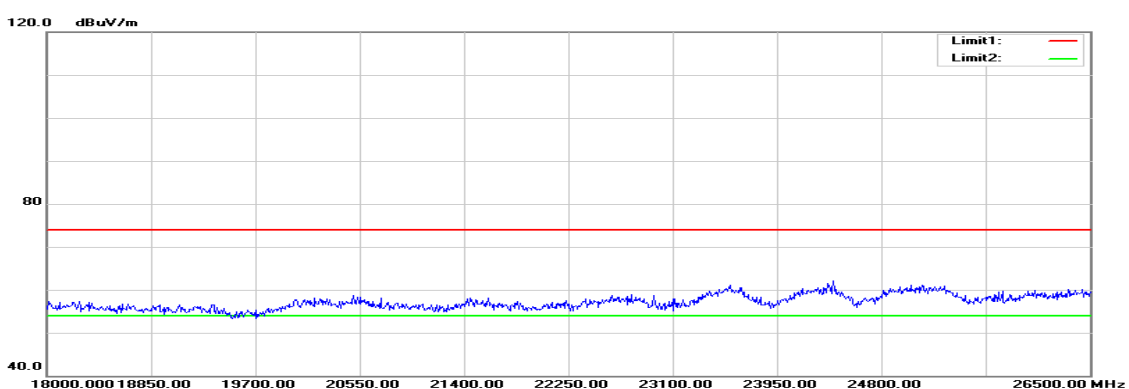
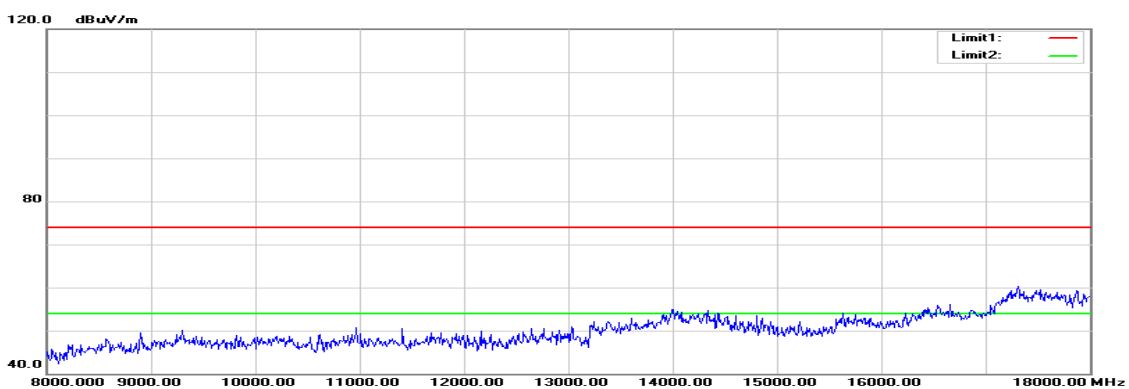
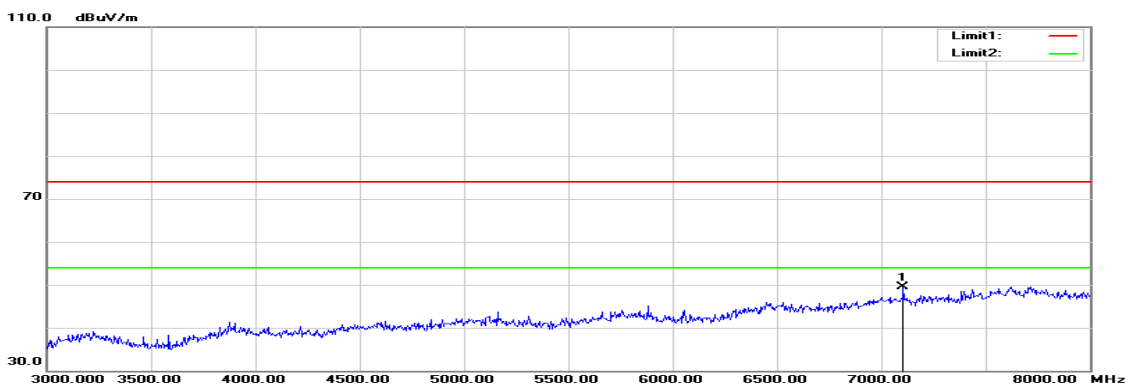
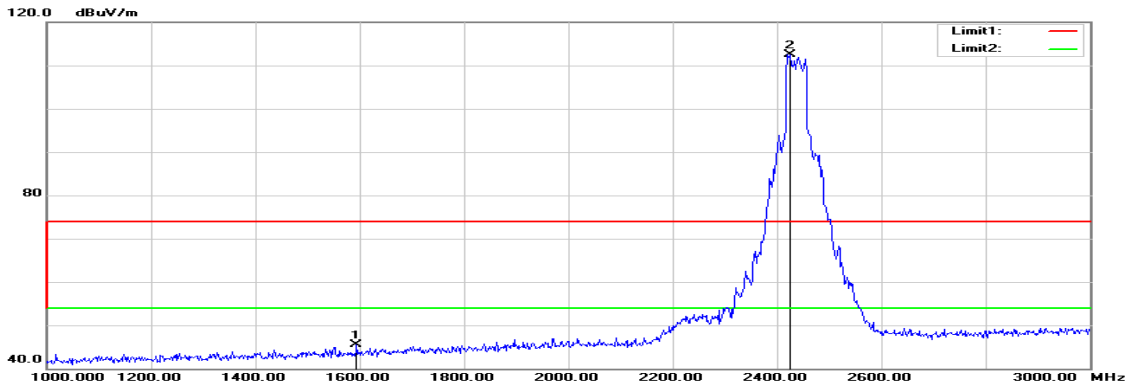

**Operation Mode:** TX / IEEE 802.11n HT 40 MHz mode  
/ CH Mid

**Test Date:** January 13, 2016

**Temperature:** 27°C

**Tested by:** Jason Lu

**Humidity:** 53% RH

**Polarity:** Ver. / Hor.

Frequency (MHz)	Reading (dBuV)	Correction Factor (dB/m)	Result (dBuV/m)	Limit (dBuV/m)	Margin (dB)	Remark	Ant. Pol. (H/V)
1824.000	50.56	-4.51	46.05	74.00	-27.95	peak	V
N/A							
1594.000	51.16	-5.70	45.46	74.00	-28.54	peak	H
7105.000	37.18	12.32	49.50	74.00	-24.50	peak	H
N/A							

**Remark:**

1. Measuring frequencies from 1 GHz to the 10th harmonic of highest fundamental frequency.
2. Radiated emissions measured in frequency above 1000MHz were made with an instrument using peak/average detector mode.
3. Average test would be performed if the peak result were greater than the average limit or as required by the applicant.
4. Data of measurement within this frequency range shown “ --- ” in the table above means the reading of emissions are attenuated more than 20dB below the permissible limits or the field strength is too small to be measured.
5. Measurements above show only up to 6 maximum emissions noted, or would be lesser, with “ N/A ” remark, if no specific emissions from the EUT are recorded (ie: margin>20dB from the applicable limit) and considered that's already beyond the background noise floor.
6. Margin (dB) = Remark result (dBuV/m) – Average limit (dBuV/m).

**TX / IEEE 802.11n HT 40 MHz mode / CH High**

**Polarity: Vertical**

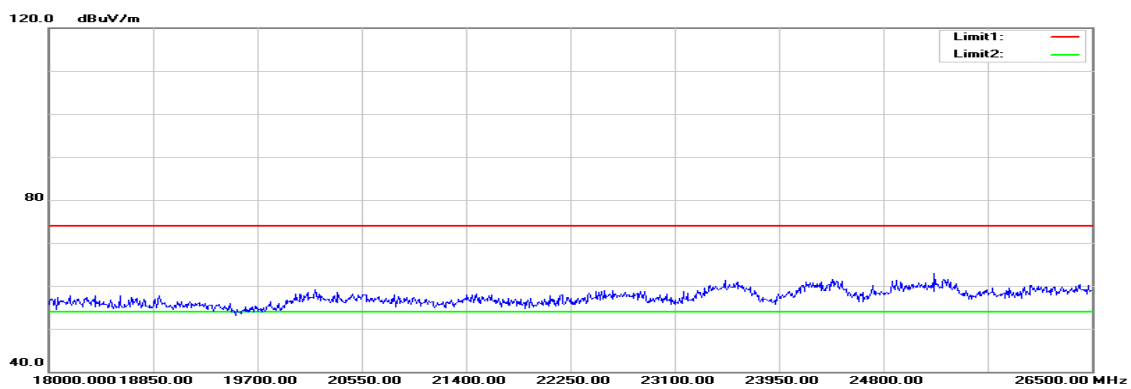
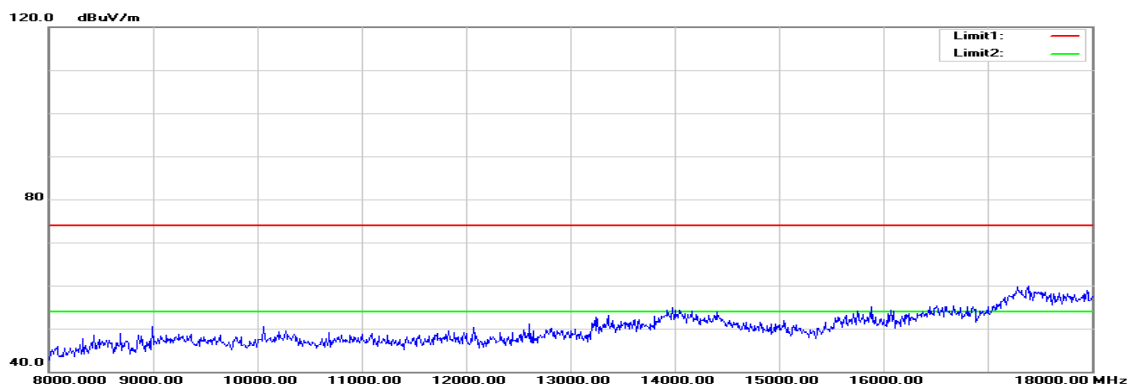
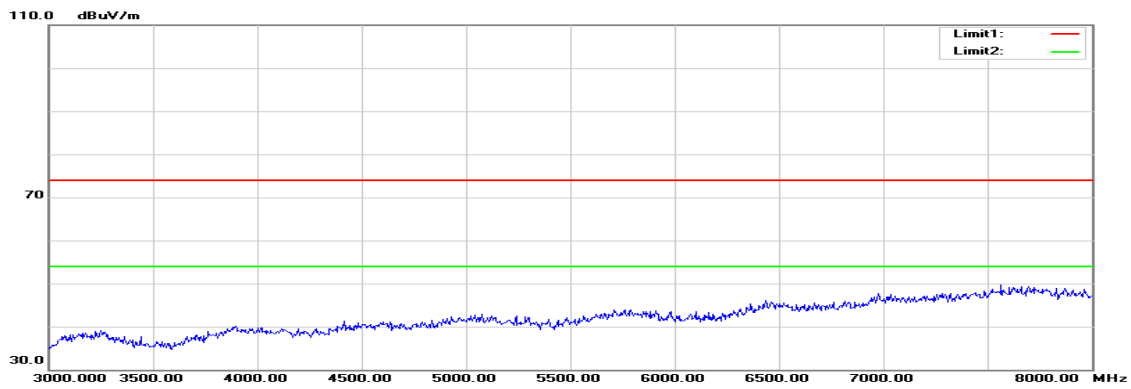
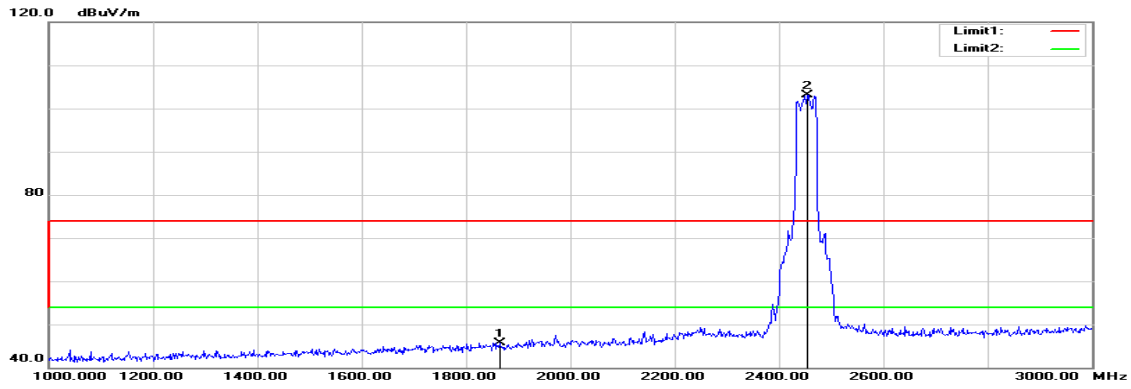

Polarity: Horizontal

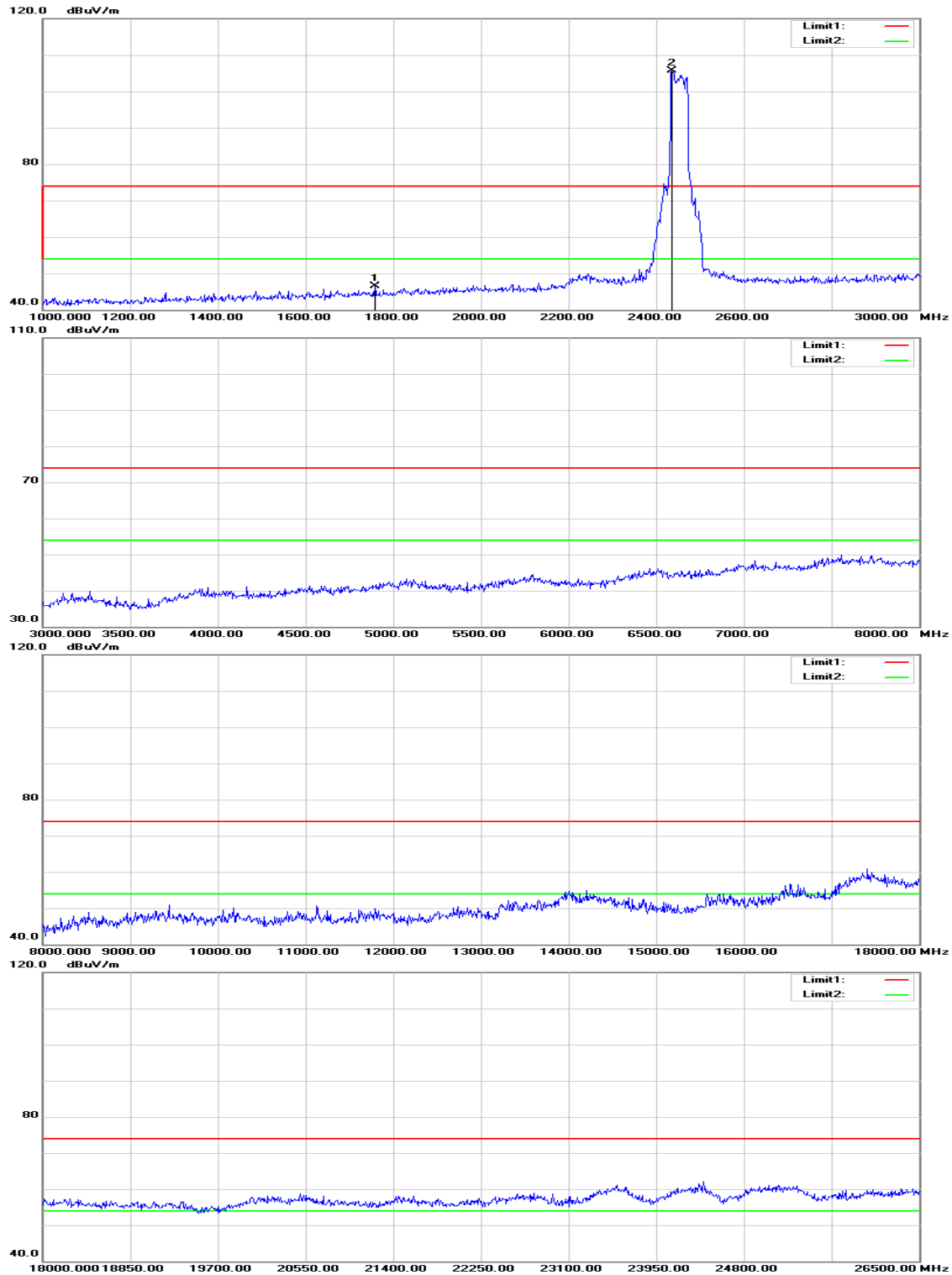

**Operation Mode:** TX / IEEE 802.11n HT 40 MHz mode  
/ CH High

**Test Date:** January 13, 2016

**Temperature:** 27°C

**Tested by:** Jason Lu

**Humidity:** 53% RH

**Polarity:** Ver. / Hor.

Frequency (MHz)	Reading (dBuV)	Correction Factor (dB/m)	Result (dBuV/m)	Limit (dBuV/m)	Margin (dB)	Remark	Ant. Pol. (H/V)
1864.000	50.07	-4.30	45.77	74.00	-28.23	peak	V
N/A							
1758.000	51.37	-4.85	46.52	74.00	-27.48	peak	H
N/A							

**Remark:**

1. Measuring frequencies from 1 GHz to the 10th harmonic of highest fundamental frequency.
2. Radiated emissions measured in frequency above 1000MHz were made with an instrument using peak/average detector mode.
3. Average test would be performed if the peak result were greater than the average limit or as required by the applicant.
4. Data of measurement within this frequency range shown “ --- ” in the table above means the reading of emissions are attenuated more than 20dB below the permissible limits or the field strength is too small to be measured.
5. Measurements above show only up to 6 maximum emissions noted, or would be lesser, with “ N/A ” remark, if no specific emissions from the EUT are recorded (ie: margin>20dB from the applicable limit) and considered that's already beyond the background noise floor.
6. Margin (dB) = Remark result (dBuV/m) – Average limit (dBuV/m).

## 7.8 POWERLINE CONDUCTED EMISSIONS

### LIMIT

According to §15.207(a) & RSS-Gen §7.2.4, except as shown in paragraphs (b) and (c) of this section, for an intentional radiator that is designed to be connected to the public utility (AC) power line, the radio frequency voltage that is conducted back onto the AC power line on any frequency or frequencies within the band 150 kHz to 30 MHz shall not exceed the limits in the following table, as measured using a 50  $\mu$ H/50 ohms line impedance stabilization network (LISN). Compliance with the provisions of this paragraph shall be based on the measurement of the radio frequency voltage between each power line and ground at the power terminal. The lower limit applies at the boundary between the frequency ranges.

Frequency Range (MHz)	Limits (dB $\mu$ V)	
	Quasi-peak	Average
0.15 to 0.50	66 to 56*	56 to 46*
0.50 to 5	56	46
5 to 30	60	50

\* Decreases with the logarithm of the frequency.

### Test Configuration

See test photographs attached in Appendix II for the actual connections between EUT and support equipment.

### TEST PROCEDURE

1. The EUT was placed on a table, which is 0.8m above ground plane.
2. Maximum procedure was performed on the six highest emissions to ensure EUT compliance.
3. Repeat above procedures until all frequency measured were complete.

**TEST RESULTS**

The initial step in collecting conducted data is a spectrum analyzer peak scan of the measurement range. Significant peaks are then marked as shown on the following data page, and these signals are then quasi-peaked.

**Test Data**

**Operation Mode:** Normal Link                      **Test Date:** January 11, 2016  
**Temperature:** 24°C                                      **Tested by:** Dennis Li  
**Humidity:** 50% RH

Freq. (MHz)	QP Reading (dBuV)	AV Reading (dBuV)	Corr. factor (dB/m)	QP Result (dBuV/m)	AV Result (dBuV/m)	QP Limit (dBuV)	AV Limit (dBuV)	QP Margin (dB)	AV Margin (dB)	Note
0.1500	36.14	18.98	9.69	45.83	28.67	66.00	56.00	-20.17	-27.33	L1
0.1700	35.19	24.09	9.69	44.88	33.78	64.96	54.96	-20.08	-21.18	L1
0.1860	33.47	21.18	9.68	43.15	30.86	64.21	54.21	-21.06	-23.35	L1
0.1940	32.14	20.57	9.68	41.82	30.25	63.86	53.86	-22.04	-23.61	L1
0.2340	28.93	11.52	9.68	38.61	21.20	62.31	52.31	-23.70	-31.11	L1
0.5380	17.87	11.20	9.88	27.75	21.08	56.00	46.00	-28.25	-24.92	L1
0.1500	35.95	19.33	9.64	45.59	28.97	65.99	56.00	-20.40	-27.03	L2
0.1580	35.89	21.35	9.64	45.53	30.99	65.56	55.57	-20.03	-24.58	L2
0.2060	31.80	13.73	9.64	41.44	23.37	63.36	53.37	-21.92	-30.00	L2
0.2180	30.24	15.21	9.64	39.88	24.85	62.89	52.89	-23.01	-28.04	L2
0.3100	23.18	10.72	9.65	32.83	20.37	59.97	49.97	-27.14	-29.60	L2
1.0020	18.14	13.41	10.48	28.62	23.89	56.00	46.00	-27.38	-22.11	L2

**Remark:**

1. Measuring frequencies from 0.15 MHz to 30MHz.
2. The emissions measured in frequency range from 0.15 MHz to 30MHz were made with an instrument using Quasi-peak detector and average detector.
3. The IF bandwidth of SPA between 0.15MHz and 30MHz was 10 kHz; the IF bandwidth of Test Receiver between 0.15MHz and 30MHz was 9 kHz;
4. L1 = Line One (Live Line) / L2 = Line Two (Neutral Line)



**Test Plots**

**Conducted emissions (Line 1)**

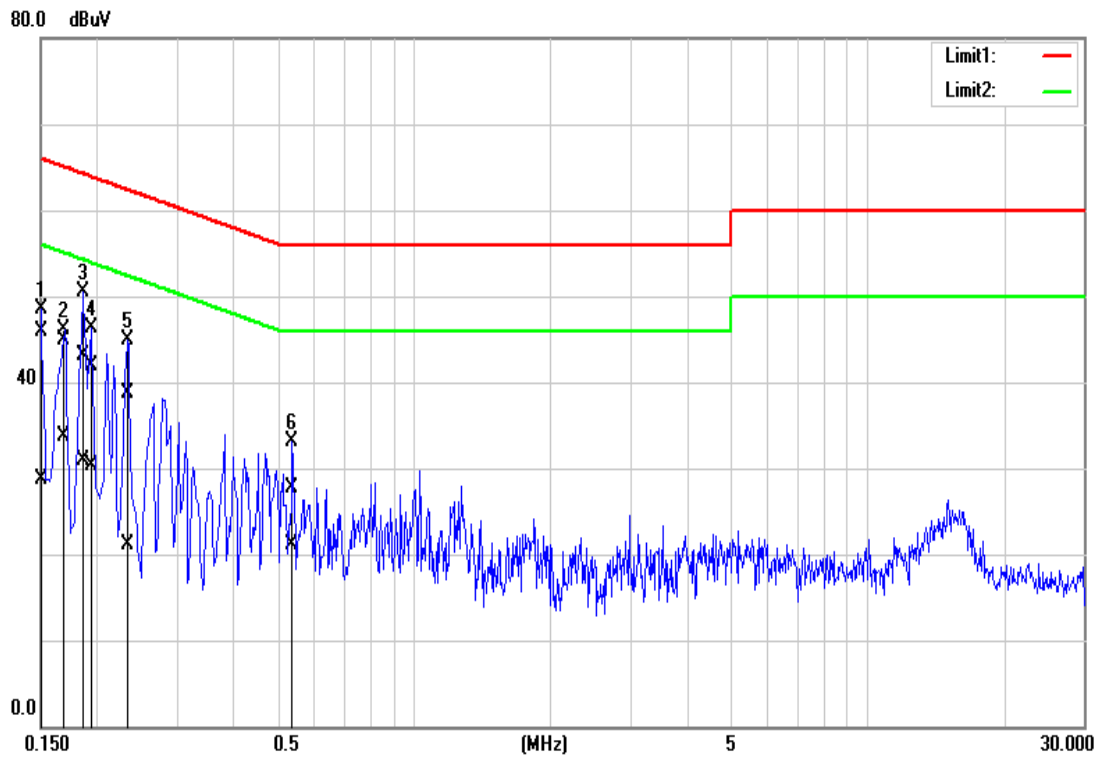

**Conducted emissions (Line 2)**

