





FCC PART 15.407
TEST AND MEASUREMENT REPORT

For

Mimosa Networks

300 Orchard City Dr., Suite 100,
Campbell, CA 95008, USA

FCC ID: 2ABZJ-100-00014

Report Type: CIIPC Report	Product Type: Point-to-Point Device
Prepared By	Cipher Chu 
Report Number	R1404042-407 W53 W56
Report Date	2014-09-08
Reviewed By	Bo Li  Test Engineer
	Bay Area Compliance Laboratories Corp. 1274 Anvilwood Avenue, Sunnyvale, CA 94089, USA Tel: (408) 732-9162 Fax: (408) 732-9164

Note: This test report is prepared for the customer shown above and for the device described herein. It may not be duplicated or used in part without prior written consent from Bay Area Compliance Laboratories Corp. This report **must not** be used by the customer to claim product certification, approval, or endorsement by A2LA* or any agency of the Federal Government.

* This report may contain data that are not covered by the A2LA accreditation and are marked with an asterisk "*" (b)(3)

TABLE OF CONTENTS

1	GENERAL DESCRIPTION.....	6
1.1	PRODUCT DESCRIPTION FOR EQUIPMENT UNDER TEST (EUT).....	6
1.2	MECHANICAL DESCRIPTION OF EUT.....	6
1.3	OBJECTIVE.....	6
1.4	RELATED SUBMITTAL(S)/GRANT(S).....	6
1.5	TEST METHODOLOGY.....	6
1.6	MEASUREMENT UNCERTAINTY.....	6
1.7	TEST FACILITY.....	7
2	EUT TEST CONFIGURATION.....	8
2.1	JUSTIFICATION.....	8
2.2	EUT EXERCISE SOFTWARE.....	8
2.3	EQUIPMENT MODIFICATIONS.....	8
2.4	SPECIAL ACCESSORIES.....	8
2.5	LOCAL SUPPORT EQUIPMENT.....	8
2.6	INTERFACE PORTS AND CABLING.....	8
2.7	POWER SUPPLY AND LINE FILTERS.....	8
2.8	EUT INTERNAL CONFIGURATIONS.....	9
3	SUMMARY OF TEST RESULTS.....	10
4	FCC §15.407(F) & §2.1091 - RF EXPOSURE.....	11
4.1	APPLICABLE STANDARD.....	11
4.2	MPE PREDICTION.....	11
4.3	MPE RESULTS.....	11
5	FCC §15.203 – ANTENNA REQUIREMENTS.....	13
5.1	APPLICABLE STANDARD.....	13
5.2	ANTENNA LIST.....	13
6	FCC §15.207 - AC POWER LINE CONDUCTED EMISSIONS.....	14
6.1	APPLICABLE STANDARDS.....	14
6.2	TEST SETUP.....	14
6.3	TEST PROCEDURE.....	14
6.4	TEST SETUP BLOCK DIAGRAM.....	15
6.5	CORRECTED AMPLITUDE & MARGIN CALCULATION.....	15
6.6	TEST EQUIPMENT LIST AND DETAILS.....	16
6.7	TEST ENVIRONMENTAL CONDITIONS.....	16
6.8	SUMMARY OF TEST RESULTS.....	16
6.9	CONDUCTED EMISSIONS TEST PLOTS AND DATA.....	17
7	FCC §15.209 & §15.407(B) - SPURIOUS RADIATED EMISSIONS AND OUT OF BAND EMISSIONS.....	19
7.1	APPLICABLE STANDARD.....	19
7.2	TEST SETUP.....	20
7.3	TEST PROCEDURE.....	20
7.4	CORRECTED AMPLITUDE & MARGIN CALCULATION.....	21
7.5	TEST EQUIPMENT LIST AND DETAILS.....	21
7.6	TEST ENVIRONMENTAL CONDITIONS.....	21
7.7	SUMMARY OF TEST RESULTS.....	22
7.8	RADIATED EMISSIONS TEST DATA.....	23

8	FCC §15.407(A) & §15.407(E) – EMISSION BANDWIDTH.....	49
8.1	APPLICABLE STANDARD.....	49
8.2	MEASUREMENT PROCEDURE.....	49
8.3	TEST EQUIPMENT LIST AND DETAILS.....	49
8.4	TEST ENVIRONMENTAL CONDITIONS.....	49
8.5	TEST RESULTS.....	49
9	FCC §15.407(A)(1) & §15.407 (A)(3) - OUTPUT POWER.....	86
9.1	APPLICABLE STANDARDS.....	86
9.2	MEASUREMENT PROCEDURE.....	86
9.3	TEST EQUIPMENT LIST AND DETAILS.....	86
9.4	TEST ENVIRONMENTAL CONDITIONS.....	87
9.5	TEST RESULTS.....	87
10	FCC §15.407(B) - OUT OF BAND EMISSIONS.....	91
10.1	APPLICABLE STANDARD.....	91
10.2	MEASUREMENT PROCEDURE.....	91
10.3	TEST EQUIPMENT LIST AND DETAILS.....	91
10.4	TEST ENVIRONMENTAL CONDITIONS.....	91
10.5	TEST RESULTS.....	92
11	FCC §15.407(A)(1) & (A)(3)- POWER SPECTRAL DENSITY.....	116
11.1	APPLICABLE STANDARD.....	116
11.2	MEASUREMENT PROCEDURE.....	116
11.3	TEST EQUIPMENT LIST AND DETAILS.....	116
11.4	TEST ENVIRONMENTAL CONDITIONS.....	117
11.5	TEST RESULTS.....	117
12	FCC §15.407(B) - SPURIOUS EMISSIONS AT ANTENNA TERMINALS.....	153
12.1	APPLICABLE STANDARD.....	153
12.2	MEASUREMENT PROCEDURE.....	153
12.3	TEST EQUIPMENT LIST AND DETAILS.....	153
12.4	TEST ENVIRONMENTAL CONDITIONS.....	153
12.5	TEST RESULTS.....	153
13	EXHIBIT A – FCC EQUIPMENT LABELLING REQUIREMENTS.....	218
13.1	FCC ID LABEL REQUIREMENTS.....	218
13.2	FCC ID LABEL CONTENTS AND LOCATION.....	219
14	EXHIBIT B - EUT SETUP PHOTOGRAPHS.....	220
14.1	RADIATED EMISSION - BELOW 1 GHz FRONT VIEW (25 dBi ANTENNA).....	220
14.2	RADIATED EMISSION - BELOW 1 GHz REAR VIEW (25 dBi ANTENNA).....	220
14.3	RADIATED EMISSION - ABOVE 1 GHz FRONT VIEW (25 dBi ANTENNA).....	221
14.4	RADIATED EMISSION - ABOVE 1 GHz REAR VIEW (25 dBi ANTENNA).....	221
14.5	RADIATED EMISSION - BELOW 1 GHz FRONT VIEW (0 dBi ANTENNA).....	222
14.6	RADIATED EMISSION - BELOW 1 GHz REAR VIEW (0 dBi ANTENNA).....	222
14.7	RADIATED EMISSION - ABOVE 1 GHz FRONT VIEW (0 dBi ANTENNA).....	223
14.8	RADIATED EMISSION - ABOVE 1 GHz REAR VIEW (0 dBi ANTENNA).....	223
14.9	AC LINE CONDUCTED EMISSIONS - FRONT VIEW.....	224
14.10	AC LINE CONDUCTED EMISSIONS - SIDE VIEW.....	224
15	EXHIBIT C – EUT PHOTOGRAPHS.....	225
15.1	EUT – TOP VIEW.....	225
15.2	EUT – BOTTOM VIEW.....	225
15.3	EUT – SIDE VIEW.....	226
15.4	EUT – POE TOP VIEW.....	226
15.5	EUT– OPEN CASE TOP VIEW.....	227

15.6	EUT – MAIN PCB BOARD TOP VIEW	227
15.7	EUT – MAIN PCB BOARD BACK VIEW	228
15.8	EUT – MAIN PCB BOARD BACK VIEW WITHOUT SHIELDING	228
15.9	EUT – LTE VIEW	229
15.10	ANTENNA VIEW – 1 (0 DBI ANTENNA).....	229
15.11	ANTENNA VIEW – 2 (25 DBI ANTENNA).....	230

DOCUMENT REVISION HISTORY

Revision Number	Report Number	Description of Revision	Date of Revision
0	R1404042-407 W53 W56	CIIPC Initial Report	2014-09-08

1 General Description

1.1 Product Description for Equipment under Test (EUT)

This test and measurement report was prepared on behalf of *Mimosa Networks*, and their product model: *B5c*, *FCC ID: 2ABZJ-100-00014*, which will henceforth be referred to as the “EUT” (Equipment under Test) in this report. The EUT is a point-to-point device operates in 5 GHz bands.

1.2 Mechanical Description of EUT

The EUT measures approximately 17.3 cm (L) x 17.3 cm (W) x 7.3 cm (H) and weighs 3.2 kg.

The test data gathered are from typical production sample, serial number: 13461M0028 assigned by manufacturer.

1.3 Objective

This report is prepared on behalf of *Mimosa Networks* in accordance with FCC CFR47 §15.407

The objective is to determine compliance with FCC rules for Antenna Requirments, AC Line Conducted Emissions, Occupied Bandwidth, Maximum Peak Output Power, Power Spectral Density, Radiated and Conducted Spurious Emissions, and Band Edge.

1.4 Related Submittal(s)/Grant(s)

N/A

1.5 Test Methodology

All measurements contained in this report were conducted in accordance with ANSI C63.4-2009, American National Standard for Methods of Measurement of Radio-Noise Emissions from Low-Voltage Electrical and Electronic Equipment in the range of 9 kHz to 40 GHz and FCC KDB 789033 D02 General UNII Test Procedures v01: Guidelines for Compliance Testing of Unlicensed National Information Infrastructure (U-NII) Devices Part 15, Subpart E

1.6 Measurement Uncertainty

All measurements involve certain levels of uncertainties, especially in the field of EMC. The factors contributing to uncertainties are spectrum analyzer, cable loss, antenna factor calibration, antenna directivity, antenna factor variation with height, antenna phase center variation, antenna factor frequency interpolation, measurement distance variation, site imperfections, mismatch (average), and system repeatability.

Based on CISPR16-4-2: 2011, The Treatment of Uncertainty in EMC Measurements, the values ranging from ± 2.0 dB for Conducted Emissions tests and ± 4.0 dB for Radiated Emissions tests are the most accurate estimates pertaining to uncertainty of EMC measurements at BACL Corp.

All radiated and conducted emissions measurement was performed at Bay Area Compliance Laboratory, Corp. The radiated testing was performed at an antenna-to-EUT distance of 3 meters.

1.7 Test Facility

Bay area compliance Laboratories Corp. (BACL) is:

1- An independent Commercial Test Laboratory accredited to **ISO 17025: 2005** by **A2LA**, in the fields of: Electromagnetic Compatibility & Telecommunications covering Emissions, Immunity, Radio, RF Exposure, Safety and Telecom. This includes NEBS (Network Equipment Building System), Wireless RF, Telecommunications Terminal Equipment (TTE); Network Equipment; Information Technology Equipment (ITE); Medical Electrical Equipment; Industrial, Commercial, and Medical Test Equipment; Professional Audio and Video Equipment; Electronic (Digital) Products; Industrial and Scientific Instruments; Cabled Distribution Systems and Energy Efficiency Lighting.

2- An ENERGY STAR Recognized Laboratory, for the LM80 Testing, a wide variety of Luminaires and Computers.

3- A NIST Designated Phase-I and Phase-II CAB including: ACMA (Australian Communication and Media Authority), BSMI (Bureau of Standards, Metrology and Inspection of Taiwan), IDA (Infocomm Development Authority of Singapore), IC(Industry Canada), Korea (Ministry of Communications Radio Research Laboratory), NCC (Formerly DGT; Directorate General of Telecommunication of Chinese Taipei) OFTA (Office of the Telecommunications Authority of Hong Kong), Vietnam, VCCI - Voluntary Control Council for Interference of Japan and a designated EU CAB (Conformity Assessment Body) (Notified Body) for the EMC and R&TTE Directives.

4- A Product Certification Body accredited to **ISO Guide 65: 1996** by **A2LA** to certify:

1- Unlicensed, Licensed radio frequency devices and Telephone Terminal Equipment for the FCC. Scope A1, A2, A3, A4, B1, B2, B3, B4 & C.

2. Radio Standards Specifications (RSS) in the Category I Equipment Standards List and All Broadcasting Technical Standards (BETS) in Category I Equipment Standards List for Industry Canada.

3. Radio Communication Equipment for Singapore.

4. Radio Equipment Specifications, GMDSS Marine Radio Equipment Specifications, and Fixed Network Equipment Specifications for Hong Kong.

5. Japan MIC Telecommunication Business Law (A1, A2) and Radio Law (B1, B2 and B3).

6. Audio/Video, Battery Charging Systems, Computers, Displays, Enterprise Servers, Imaging Equipment, Set-Top Boxes, Telephony, Televisions, Ceiling Fans, CFLs (Including GU24s), Decorative Light Strings, Integral LED Lamps, Luminaires, Residential Ventilating Fans.

The test site used by BACL Corp. to collect radiated and conducted emissions measurement data is located at its facility in Sunnyvale, California, USA.

The test site at BACL Corp. has been fully described in reports submitted to the Federal Communication Commission (FCC) and Voluntary Control Council for Interference (VCCI). The details of these reports have been found to be in compliance with the requirements of Section 2.948 of the FCC Rules on February 11 and December 10, 1997, and Article 8 of the VCCI regulations on December 25, 1997. The test site also complies with the test methods and procedures set forth in CISPR 22:2008 §10.4 for measurements below 1 GHz and §10.6 for measurements above 1 GHz as well as ANSI C63.4-2009, ANSI C63.4-2009, TIA/EIA-603 & CISPR 24:2010.

The Federal Communications Commission and Voluntary Control Council for Interference have the reports on file and they are listed under FCC registration number: 90464 and VCCI Registration No.: A-0027. The test site has been approved by the FCC and VCCI for public use and is listed in the FCC Public Access Link (PAL) database.

Additionally, BACL Corp. is an American Association for Laboratory Accreditation (A2LA) accredited laboratory (Lab Code 3297-02). The current scope of accreditations can be found at

<http://www.a2la.org/scopepdf/3297-02.pdf?CFID=1132286&CFTOKEN=e42a3240dac3f6ba-6DE17DCB-1851-9E57-477422F667031258&jsessionid=8430d44f1f47cf2996124343c704b367816b>

2 EUT Test Configuration

2.1 Justification

The EUT was configured for testing according to ANSI C63.4-2009 and FCC KDB 789033 D02 General UNII Test Procedures v01

The EUT was tested in a testing mode to represent worst-case results during the final qualification test.

The worst-case data rates are determined to be as follows for each mode based upon investigation by measuring the average power, peak power and PPSD across all data rates bandwidths, and modulations.

2.2 EUT Exercise Software

The test utility used version was 00.10.00-5 was provided by Mimosa Networks., and was verified Cipher Chu to comply with the standard requirements being tested against.

2.3 Equipment Modifications

No modifications were made to the EUT.

2.4 Special Accessories

There were no special accessories were required, included, or intended for use with EUT during these tests.

2.5 Local Support Equipment

Manufacturers	Description	Models	Serial Number
Lenovo	Laptop	T530	PK-0XD9H

2.6 Interface Ports and Cabling

Cable Description	Length (M)	From	To
RF Cable	<1.0	PSA	EUT

2.7 Power Supply and Line Filters

Manufacturer	Description	Model Number	Serial Number
Fortune Power	AC/DC Adaptor of POE	GRT 480125A	130669328

2.8 EUT Internal Configurations

Manufacturers	Descriptions	Models	Serial Numbers
Mimosa Networks	Main PCB Board	B5c	1346101000017

3 Summary of Test Results

FCC Rules	Description of Test	Result
§15.407(f), §2.1091	RF Exposure	Calculation
§15.203	Antenna Requirement	Compliant
§15.207	AC Power Line Conducted Emissions	Compliant
§15.209(a), §15.407(b)	Spurious Emissions	Compliant
§15.407(a)	Emission Bandwidth	Compliant
§15.407(a)(1)(iii) §15.407 (a)(3)	Output Power	Compliant
§2.1051, §15.407(b)	Undesirable Emissions	Compliant
§15.407(a)(1)(iii) §15.407(a)(3)	Power Spectral Density	Compliant
§15.407(h)	DFS	Note*

Note: Please refer to R1404042-DFS report

4 FCC §15.407(f) & §2.1091 - RF Exposure

4.1 Applicable Standard

According to FCC §15.407(f) and §1.1307(b)(1), systems operating under the provisions of this section shall be operated in a manner that ensures that the public is not exposed to radio frequency energy level in excess of the Commission's guidelines.

Limits for General Population/Uncontrolled Exposure

Frequency Range (MHz)	Electric Field Strength (V/m)	Magnetic Field Strength (A/m)	Power Density (mW/cm ²)	Averaging Time (minutes)
Limits for General Population/Uncontrolled Exposure				
0.3-1.34	614	1.63	* (100)	30
1.34-30	824/f	2.19/f	* (180/f ²)	30
30-300	27.5	0.073	0.2	30
300-1500	/	/	f/1500	30
1500-100,000	/	/	1.0	30

f = frequency in MHz

* = Plane-wave equivalent power density

4.2 MPE Prediction

$$S = PG/4\pi R^2$$

Where: S = power density

P = power input to antenna

G = power gain of the antenna in the direction of interest relative to an isotropic radiator

R = distance to the center of radiation of the antenna

4.3 MPE Results

25 dBi Antenna:

5.3 GHz Band

<u>Maximum peak output power at antenna input terminal (dBm):</u>	<u>4.89</u>
<u>Maximum peak output power at antenna input terminal (mW):</u>	<u>3.083</u>
<u>Prediction distance (cm):</u>	<u>20</u>
<u>Prediction frequency (MHz):</u>	<u>5320</u>
<u>Maximum Antenna Gain, typical (dBi):</u>	<u>25</u>
<u>Maximum Antenna Gain (numeric):</u>	<u>316.227</u>
<u>Power density of prediction frequency at 20.0 cm (mW/cm²):</u>	<u>0.1939</u>
<u>Power density of prediction frequency at 20.0 cm (W/m²):</u>	<u>1.9396</u>
<u>MPE limit for uncontrolled exposure at prediction frequency (mW/cm²):</u>	<u>1.0</u>
<u>MPE limit for uncontrolled exposure at prediction frequency (W/m²):</u>	<u>10</u>

5.6 GHz Band

<u>Maximum peak output power at antenna input terminal (dBm):</u>	<u>4.88</u>
<u>Maximum peak output power at antenna input terminal (mW):</u>	<u>3.076</u>
<u>Prediction distance (cm):</u>	<u>20</u>
<u>Prediction frequency (MHz):</u>	<u>5500</u>
<u>Maximum Antenna Gain, typical (dBi):</u>	<u>25</u>
<u>Maximum Antenna Gain (numeric):</u>	<u>316.227</u>
<u>Power density of prediction frequency at 20.0 cm (mW/cm²):</u>	<u>0.1935</u>
<u>Power density of prediction frequency at 20.0 cm (W/m²):</u>	<u>1.9352</u>
<u>MPE limit for uncontrolled exposure at prediction frequency (mW/cm²):</u>	<u>1.0</u>
<u>MPE limit for uncontrolled exposure at prediction frequency (W/m²):</u>	<u>10</u>

0 dBi Antenna:**5.3 GHz Band**

<u>Maximum peak output power at antenna input terminal (dBm):</u>	<u>23.54</u>
<u>Maximum peak output power at antenna input terminal (mW):</u>	<u>225.94</u>
<u>Prediction distance (cm):</u>	<u>20</u>
<u>Prediction frequency (MHz):</u>	<u>5260</u>
<u>Maximum Antenna Gain, typical (dBi):</u>	<u>0</u>
<u>Maximum Antenna Gain (numeric):</u>	<u>1</u>
<u>Power density of prediction frequency at 20 cm (mW/cm²):</u>	<u>0.045</u>
<u>MPE limit for uncontrolled exposure at prediction frequency (mW/cm²):</u>	<u>1</u>

5.6 GHz Band

<u>Maximum peak output power at antenna input terminal (dBm):</u>	<u>23.34</u>
<u>Maximum peak output power at antenna input terminal (mW):</u>	<u>215.77</u>
<u>Prediction distance (cm):</u>	<u>20</u>
<u>Prediction frequency (MHz):</u>	<u>5700</u>
<u>Maximum Antenna Gain, typical (dBi):</u>	<u>0</u>
<u>Maximum Antenna Gain (numeric):</u>	<u>1</u>
<u>Power density of prediction frequency at 20 cm (mW/cm²):</u>	<u>0.043</u>
<u>MPE limit for uncontrolled exposure at prediction frequency (mW/cm²):</u>	<u>1</u>

The device meets FCC MPE requirement for uncontrolled exposure environment at 20 cm distance.

5 FCC §15.203 – Antenna Requirements

5.1 Applicable Standard

According to FCC §15.203, an intentional radiator shall be designed to ensure that no antenna other than that furnished by the responsible party shall be used with the device. The use of a permanently attached antenna or of an antenna that uses a unique coupling to the intentional radiator shall be considered sufficient to comply with the provisions of this Section. The manufacturer may design the unit so that a broken antenna can be replaced by the user, but the use of a standard antenna jack or electrical connector is prohibited.

And according to FCC §15.407 (a)(1) and (2), If transmitting antennas of directional gain greater than 6 dBi are used, both the maximum conducted output power and the maximum power spectral density shall be reduced by the amount in dB that the directional gain of the antenna exceeds 6 dBi.

And according to FCC §15.407 (a)(1) (iii) For fixed point-to-point access points operating in the band 5.15-5.25 GHz, the maximum conducted output power over the frequency band of operation shall not exceed 1 W. Fixed point-to-point U-NII devices may employ antennas with directional gain up to 23 dBi without any corresponding reduction in the maximum conducted output power or maximum power spectral density. For fixed point-to-point transmitters that employ a directional antenna gain greater than 23 dBi, a 1 dB reduction in maximum conducted output power and maximum power spectral density is required for each 1 dB of antenna gain in excess of 23 dBi. Fixed, point-to-point operations exclude the use of point-to-multipoint systems, omnidirectional applications, and multiple collocated transmitters transmitting the same information. The operator of the U-NII device, or if the equipment is professionally installed, the installer, is responsible for ensuring that systems employing high gain directional antennas are used exclusively for fixed, point-to-point operations.

And according to FCC §15.407 (a)(3) , However, fixed point-to-point U-NII devices operating in this band may employ transmitting antennas with directional gain greater than 6 dBi without any corresponding reduction in transmitter conducted power. Fixed, point-to-point operations exclude the use of point-to-multipoint systems, omnidirectional applications, and multiple collocated transmitters transmitting the same information. The operator of the U-NII device, or if the equipment is professionally installed, the installer, is responsible for ensuring that systems employing high gain directional antennas are used exclusively for fixed, point-to-point operations.

5.2 Antenna List

P/NO	Antenna Gain (dBi)
Center Fed Reflector/Pencil Beam	0
Center Fed Reflector/Pencil Beam	25

Note: This product shall be professional installation. The client provided the installation instruction to meet the FCC §15.203 requirement.

6 FCC §15.207 - AC Power Line Conducted Emissions

6.1 Applicable Standards

As per FCC §15.207 Conducted limits:

For an intentional radiator that is designed to be connected to the public utility (AC) power line, the radio frequency voltage that is conducted back onto the AC power line on any frequency or frequencies within the band 150 kHz to 30 MHz shall not exceed the limits in the following table, as measured using a 50 μ H/50 ohms line impedance stabilization network (LISN). Compliance with the provisions of this paragraph shall be based on the measurement of the radio frequency voltage between each power line and ground at the power terminal. The lower limit applies at the boundary between the frequencies ranges.

Frequency of Emission (MHz)	Conducted Limit (dBuV)	
	Quasi-Peak	Average
0.15-0.5	66 to 56 *	56 to 46 *
0.5-5	56	46
5-30	60	50

**Decreases with the logarithm of the frequency.*

6.2 Test Setup

The measurement was performed at shield room, using the setup per ANSI C63.4-2009 measurement procedure. The specification used was FCC §15.207 limits.

External I/O cables were draped along the edge of the test table and bundle when necessary.

The AC/DC power adapter of the EUT was connected with LISN-1 which provided 120 V/60 Hz AC power.

6.3 Test Procedure

During the conducted emissions test, the power cord of the EUT host system was connected to the mains outlet of the LISN-1.

Maximizing procedure was performed on the six (6) highest emissions of the EUT.

All data was recorded in the peak detection mode, quasi-peak and average. Quasi-Peak readings are distinguished with a "QP." Average readings are distinguished with an "Ave".

6.4 Test Setup Block Diagram

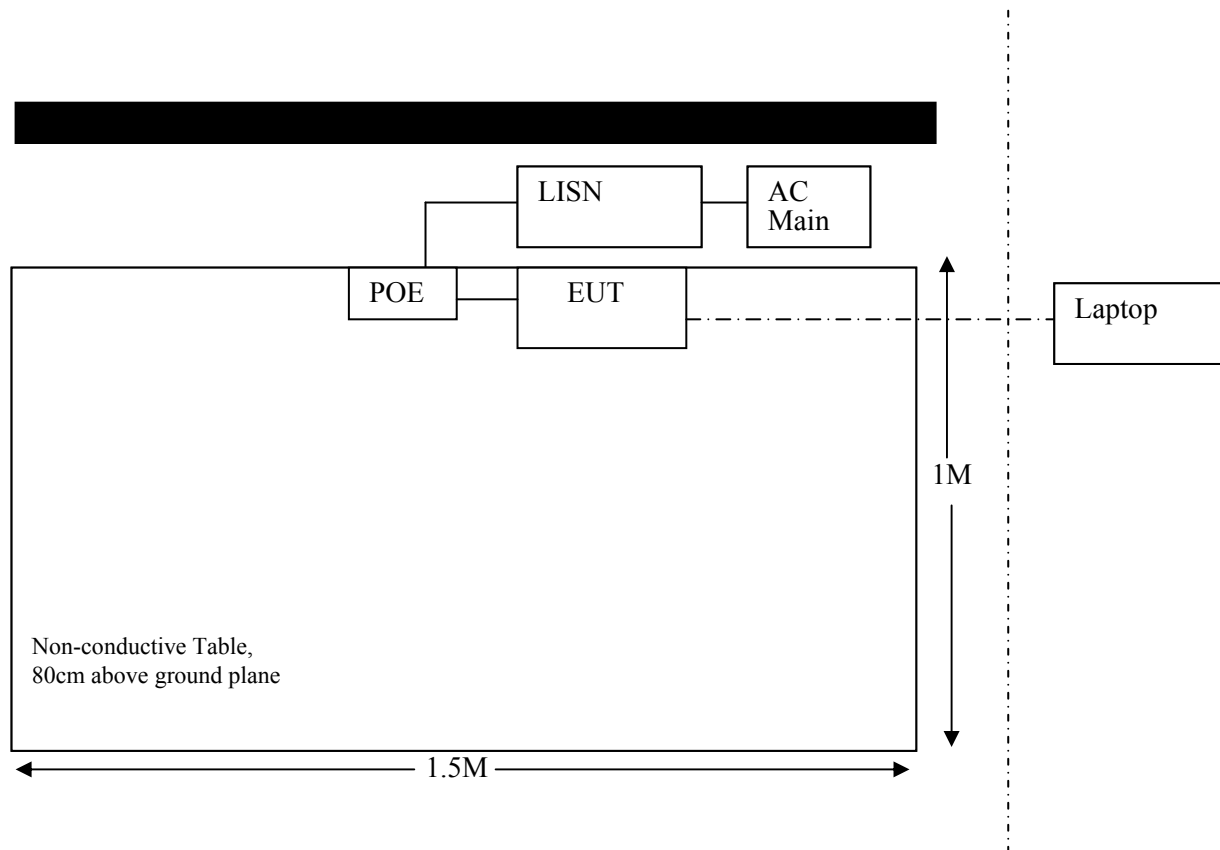

6.5 Corrected Amplitude & Margin Calculation

The Corrected Amplitude (CA) is calculated by adding the Cable Loss (CL), the Attenuator Factor (Atten) to indicated Amplitude (Ai) reading. The basic equation is as follows:

$$CA = A_i + CL + \text{Atten}$$

For example, a corrected amplitude of 46.2 dBuV = Indicated Reading (32.5 dBuV) + Cable Loss (3.7 dB) + Attenuator (10 dB)

The “**Margin**” column of the following data tables indicates the degree of compliance within the applicable limit. For example, a margin of -7 dB means the emission is 7 dB below the maximum limit. The equation for margin calculation is as follows:

$$\text{Margin} = \text{Corrected Amplitude} - \text{Limit}$$

6.6 Test Equipment List and Details

Manufacturer	Description	Model No.	Serial No.	Calibration Date	Calibration Interval
Rohde & Schwarz	EMI Test Receiver	ESCI 1166.5950K03	100337	2013-09-28	1 year
Solar Electronics	LISN	9252-R-24-BNC	511205	2014-06-25	1 year
TTE	Filter, High Pass	H962-150k-50-21378	K7133	2014-01-30	1 year

Statement of Traceability: *BACL Corp.* attests that all calibrations have been performed per the A2LA requirements, traceable to the NIST.

6.7 Test Environmental Conditions

Temperature:	20-22° C
Relative Humidity:	51-53 %
ATM Pressure:	101-101.1 kPa

The testing was performed by Cipher Chu on 2014-03-06 to 2014-03-14 and 2014-08-09 to 2014-08-21 at 10m chamber 1.

6.8 Summary of Test Results

According to the recorded data in following table, the EUT complied with the FCC standard's conducted emissions limits, with the margin reading of:

Connection: Connected to 120 V/60 Hz, AC			
Margin (dB)	Frequency (MHz)	Conductor Mode (Line/Neutral)	Range (MHz)
-1.76	4.602941	Neutral	0.15-30

6.9 Conducted Emissions Test Plots and Data

120 V, 60 Hz – Line

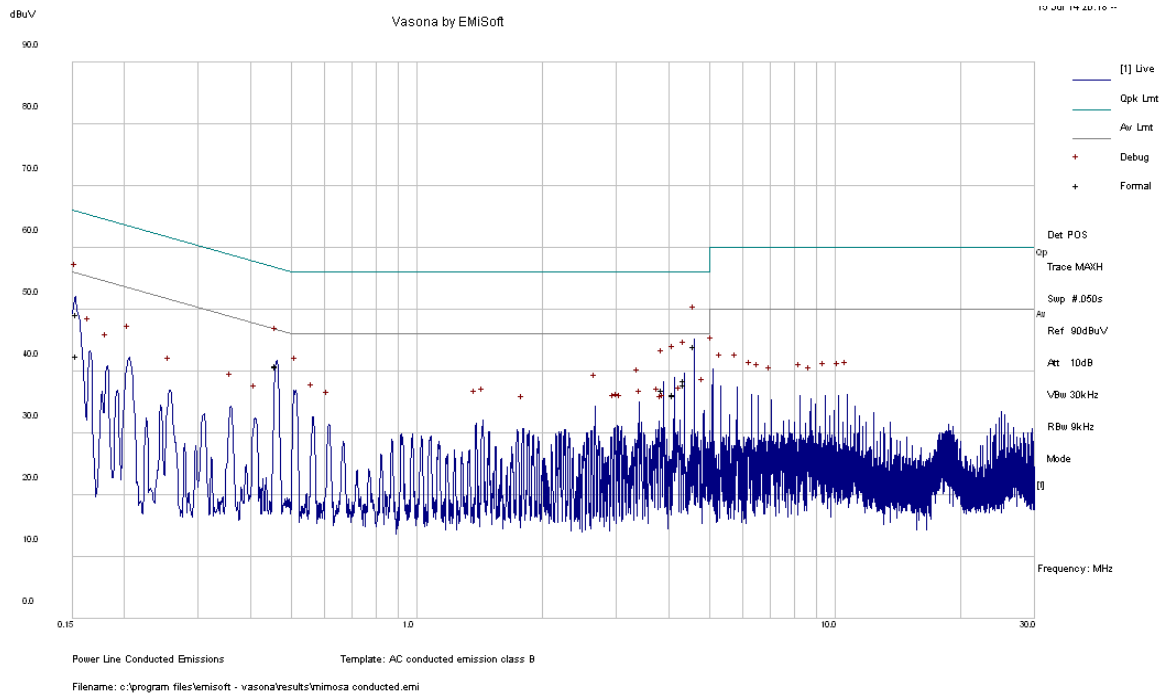

Frequency (MHz)	Corrected Amplitude (dBµV)	Conductor (Line/Neutral)	Limit (dBµV)	Margin (dB)	Detector (QP/Ave.)
4.603229	44.14	Line	56	-11.86	QP
0.153699	49.3	Line	65.8	-16.5	QP
0.462288	40.91	Line	56.65	-15.74	QP
4.361672	38.55	Line	56	-17.45	QP
4.120808	36.16	Line	56	-19.84	QP
3.876734	37.05	Line	56	-18.95	QP

Frequency (MHz)	Corrected Amplitude (dBµV)	Conductor (Line/Neutral)	Limit (dBµV)	Margin (dB)	Detector (QP/Ave.)
4.603229	44.1	Line	46	-1.9	Ave.
0.153699	42.47	Line	55.8	-13.33	Ave.
0.462288	40.86	Line	46.65	-5.79	Ave.
4.361672	37.79	Line	46	-8.21	Ave.
4.120808	36.27	Line	46	-9.73	Ave.
3.876734	37.03	Line	46	-8.97	Ave.

120 V, 60 Hz – Neutral

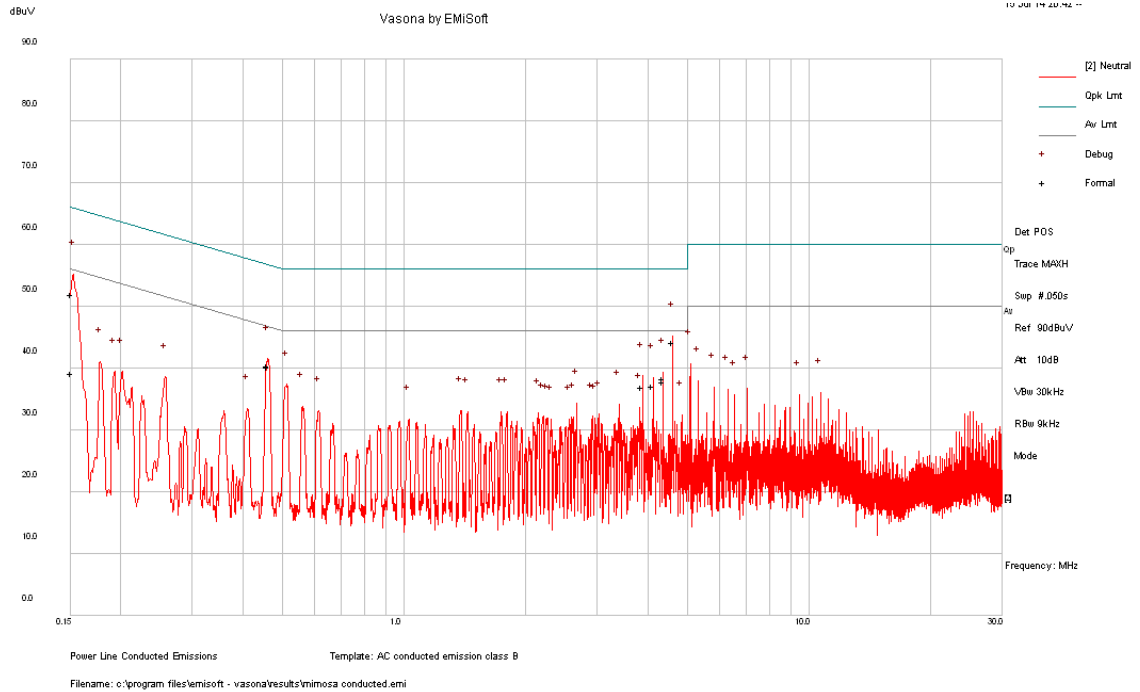

Frequency (MHz)	Corrected Amplitude (dBµV)	Conductor (Line/Neutral)	Limit (dBµV)	Margin (dB)	Detector (QP/Ave.)
0.151341	51.94	Neutral	65.93	-13.98	QP
4.602941	44.27	Neutral	56	-11.73	QP
0.462237	40.51	Neutral	56.65	-16.15	QP
4.361102	38.41	Neutral	56	-17.59	QP
3.877033	37.04	Neutral	56	-18.96	QP
4.119182	37.22	Neutral	56	-18.78	QP

Frequency (MHz)	Corrected Amplitude (dBµV)	Conductor (Line/Neutral)	Limit (dBµV)	Margin (dB)	Detector (QP/Ave.)
0.151341	39.28	Neutral	55.93	-16.64	Ave.
4.602941	44.24	Neutral	46	-1.76	Ave.
0.462237	40.31	Neutral	46.65	-6.34	Ave.
4.361102	37.81	Neutral	46	-8.19	Ave.
3.877033	36.95	Neutral	46	-9.05	Ave.
4.119182	37.2	Neutral	46	-8.8	Ave.

7 FCC §15.209 & §15.407(b) - Spurious Radiated Emissions And Out of Band Emissions

7.1 Applicable Standard

According to FCC §15.407(b)

For transmitters operating in the 5.15-5.25 GHz band: All emissions outside of the 5.15-5.35 GHz band shall not exceed an e.i.r.p. of -27 dBm/MHz.

For transmitters operating in the 5.25-5.35 GHz band: All emissions outside of the 5.15-5.35 GHz band shall not exceed an e.i.r.p. of -27 dBm/MHz.

For transmitters operating in the 5.47-5.725 GHz band: All emissions outside of the 5.47-5.725 GHz band shall not exceed an e.i.r.p. of -27 dBm/MHz.

For transmitters operating in the 5.725-5.85 GHz band: All emissions within the frequency range from the band edge to 10 MHz above or below the band edge shall not exceed an e.i.r.p. of -17 dBm/MHz; for frequencies 10 MHz or greater above or below the band edge, emissions shall not exceed an e.i.r.p. of -27 dBm/MHz.

As per FCC §15.35(d): Unless otherwise specified, on any frequency or frequencies above 1000 MHz, the radiated emission limits are based on the use of measurement instrumentation employing an average detector function. Unless otherwise specified, measurements above 1000 MHz shall be performed using a minimum resolution bandwidth of 1 MHz.

As per FCC §15.209(a) and RSS-210: Except as provided elsewhere in this Subpart, the emissions from an intentional radiator shall not exceed the field strength levels specified in the following table

Frequency (MHz)	Field Strength (micro volts/meter)	Measurement Distance (meters)
0.009 - 0.490	2400/F(kHz)	300
0.490 - 1.705	24000/F(kHz)	30
1.705 - 30.0	30	30
30 - 88	100**	3
88 - 216	150**	3
216 - 960	200**	3
Above 960	500	3

** Except as provided in paragraph (g), fundamental emissions from intentional radiators operating under this Section shall not be located in the frequency bands 54-72 MHz, 76-88 MHz, 174-216 MHz or 470-806 MHz. However, operation within these frequency bands is permitted under other sections of this Part, e.g., Sections 15.231 and 15.241.

As Per FCC §15.205(a) except as show in paragraph (d) of this section, only spurious emissions are permitted in any of the frequency bands listed below:

MHz	MHz	MHz	GHz
0.090 – 0.110	16.42 – 16.423	960 – 1240	4.5 – 5.15
0.495 – 0.505	16.69475 – 16.69525	1300 – 1427	5.35 – 5.46
2.1735 – 2.1905	25.5 – 25.67	1435 – 1626.5	7.25 – 7.75
4.125 – 4.128	37.5 – 38.25	1645.5 – 1646.5	8.025 – 8.5
4.17725 – 4.17775	73 – 74.6	1660 – 1710	9.0 – 9.2
4.20725 – 4.20775	74.8 – 75.2	1718.8 – 1722.2	9.3 – 9.5
6.215 – 6.218	108 – 121.94	2200 – 2300	10.6 – 12.7
6.26775 – 6.26825	123 – 138	2310 – 2390	13.25 – 13.4
6.31175 – 6.31225	149.9 – 150.05	2483.5 – 2500	14.47 – 14.5
8.291 – 8.294	156.52475 – 156.52525	2690 – 2900	15.35 – 16.2
8.362 – 8.366	156.7 – 156.9	3260 – 3267	17.7 – 21.4
8.37625 – 8.38675	162.0125 – 167.17	3.332 – 3.339	22.01 – 23.12
8.41425 – 8.41475	167.72 – 173.2	3.3458 – 3.358	23.6 – 24.0
12.29 – 12.293	240 – 285	3.600 – 4.400	31.2 – 31.8
12.51975 – 12.52025	322 – 335.4		36.43 – 36.5
12.57675 – 12.57725	399.9 – 410		Above 38.6
13.36 – 13.41	608 – 614		

7.2 Test Setup

The radiated emissions tests were performed in the 10-meter Chamber, using the setup in accordance with ANSI C63.4-2009. The specification used was the FCC 15 Subpart E limits.

The spacing between the peripherals was 10 centimeters.

External I/O cables were draped along the edge of the test table and bundle when necessary.

7.3 Test Procedure

The measurements are base on FCC KDB 789033 D02 General UNII Test Procedures v01: Guidelines for Compliance Testing of Unlicensed National Information Infrastructure (U-NII) Devices Part 15, Subpart E Section H: Unwanted emissions measurement as well as ANSI C63.4: 2009 as described below:

For the radiated emissions test, the EUT host, and all support equipment power cords was connected to the AC floor outlet.

Maximizing procedure was performed on the highest emissions to ensure that the EUT complied with all installation combinations.

The EUT is set 10 meter away from the testing antenna, which is varied from 1-4 meter, and the EUT is placed on a turntable, which is 0.8 meter above ground plane, the table shall be rotated for 360 degrees to find out the highest emission. The receiving antenna should be changed the polarization both of horizontal and vertical.

The spectrum analyzer or receiver is set as:

Below 1000 MHz:

$$\text{RBW} = 100 \text{ kHz/VBW} = 300 \text{ kHz/Sweep} = \text{Auto}$$

Above 1000 MHz:

- (1) Peak: RBW = 1MHz/VBW = 1MHz/Sweep = Auto
- (2) Average: RBW = 1MHz/VBW = 10Hz/Sweep = Auto

7.4 Corrected Amplitude & Margin Calculation

The Corrected Amplitude (CA) is calculated by adding the Antenna Factor (AF), the Cable Loss (CL), the Attenuator Factor (Atten) and subtracting the Amplifier Gain (Ga) to indicated Amplitude (Ai) reading. The basic equation is as follows:

$$CA = Ai + AF + CL + Atten - Ga$$

For example, a corrected amplitude of 40.3 dBuV/m = Indicated Reading (32.5 dBuV) + Antenna Factor (+23.5dB) + Cable Loss (3.7 dB) + Attenuator (10 dB) - Amplifier Gain (29.4 dB)

The “**Margin**” column of the following data tables indicates the degree of compliance within the applicable limit. For example, a margin of -7 dB means the emission is 7 dB below the maximum limit. The equation for margin calculation is as follows:

$$\text{Margin} = \text{Corrected Amplitude} - \text{Limit}$$

7.5 Test Equipment List and Details

Manufacturer	Description	Model No.	Serial No.	Calibration Date	Calibration Interval
Agilent	Analyzer, Spectrum	E4440A	MY44303352	2013-10-16	1 year
EMCO	Antenna, Horn	3115	9511-4627	2013-10-17	1 year
Mini-Circuits	Pre-amplifier	ZVA-183-S	570400946	2014-05-09	1 year
Hewlett Packard	Pre-amplifier	8449B	3147A00400	2014-03-10	1 year
Rohde & Schwarz	EMI Test Receiver	ESCI 1166.5950K03	100337	2013-09-28	1 year
Sunol Sciences	Antenna, Biconi-Log	JB3	A020106-2	2013-08-12	1 year
HP	Pre-amplifier	8447D	2944A06639	2013-06-09	1 year
Sunol Science	System Controller	SC99V	122303-1	N/R	N/R

Statement of Traceability: BACL attests that all calibrations have been performed per the A2LA requirements, traceable to NIST.

7.6 Test Environmental Conditions

Temperature:	20-23° C
Relative Humidity:	51-59 %
ATM Pressure:	101.1-101.8 kPa

The testing was performed by Cipher Chu on 2014-03-06 to 2014-03-14 and 2014-08-09 to 2014-08-21 at 10m Camber 1.

7.7 Summary of Test Results

According to the data hereinafter, the EUT complied with the FCC Title 47, Part 15.407 standard's radiated emissions limits, and had the worst margin of:

25 dBi Antenna:

30-1000 MHz:

Mode: Transmitting			
Margin (dB)	Frequency (MHz)	Polarization (Horizontal/Vertical)	Mode, Channel
-6.03	58.874	Vertical	20 MHz Bandwidth, Low

1-40 GHz:

Mode: Transmitting			
Margin (dB)	Frequency (MHz)	Polarization (Horizontal/Vertical)	Mode, Channel
-0.525	5290	Vertical	80 MHz Bandwidth

0 dBi Antenna:

30-1000 MHz:

Mode: Transmitting			
Margin (dB)	Frequency (MHz)	Polarization (Horizontal/Vertical)	Mode, Channel
-1.62	125.0038	Vertical	20 MHz bandwidth , Low

1-40 GHz:

Mode: Transmitting			
Margin (dB)	Frequency (MHz)	Polarization (Horizontal/Vertical)	Mode, Channel
-0.485	5350	Vertical	80 MHz bandwidth , High

Please refer to the following table and plots for specific test result details.

7.8 Radiated Emissions Test Data

1) 30 MHz–1 GHz, Quasi-Peak Measurements

Note: for all the emissions from 30 MHzHz to 1 GHz, they all below -27 dBm EIRP limit.

25 dBi Antenna:

Frequency (MHz)	Corrected Amplitude (dB μ V/m)	Antenna Height (cm)	Antenna Polarity (H/V)	Turntable Azimuth (degrees)	Limit (dB μ V/m)	Margin (dB)
212.5425	36.83	130	V	197	43.5	-6.67
58.874	33.97	128	V	281	40	-6.03
43.16275	31.09	98	V	263	40	-8.91
226.458	33.08	172	V	181	46	-12.92
455.9815	36.6	102	V	212	46	-9.40
431.978	37.12	101	V	360	46	-8.88
996.0975	26.93	262	V	166	54	-27.07

0 dBi Antenna:

Frequency (MHz)	Corrected Amplitude (dB μ V/m)	Antenna Height (cm)	Antenna Polarity (H/V)	Turntable Azimuth (degrees)	Limit (dB μ V/m)	Margin (dB)
125.0038	41.88	142	V	112	43.5	-1.62
622.7872	40.63	123	H	218	46	-5.37
71.97675	32.81	107	V	268	40	-7.19
501.0506	40.32	149	H	120	46	-5.86

Note: Only digital emissions present from 30 MHzHz to 1GHz, therefore only the middle channel was tested.

2) 1–40 GHz, Measured at 3 meters

25 dBi Antenna:

5.3 GHz Band

20 MHz Bandwidth

Frequency (MHz)	S.A. Reading (dBµV)	Turntable Azimuth (degrees)	Test Antenna			Cable Loss (dB)	Pre-Amp. (dB)	Cord. Reading (dBµV/m)	FCC		Comments
			Height (cm)	Polarity (H/V)	Factor (dB/m)				Limit (dBµV/m)	Margin (dB)	
Low Channel 5260 MHz, measured at 3 meters											
5260	109.51	0	135	V	33.835	4.56	0	147.905	-	-	Peak/ Fund
5260	109.75	0	120	H	33.835	4.56	0	148.145	-	-	Peak/ Fund
5260	96.59	0	135	V	33.835	4.56	0	134.985	-	-	Ave/ Fund
5260	98.49	0	120	H	33.835	4.56	0	136.885	-	-	Ave/ Fund
10520	34.27	0	100	V	38.214	6.2	27.7	50.984	74	-23.016	Peak
10520	33.14	0	100	H	38.214	6.2	27.7	49.854	74	-24.146	Peak
10520	19.01	0	100	V	38.214	6.2	27.7	35.724	54	-18.276	Ave
10520	18.3	0	100	H	38.214	6.2	27.7	35.014	54	-18.986	Ave
15780	32.72	0	100	V	37.943	8.31	27.58	51.393	74	-22.607	Peak
15780	32.9	0	100	H	37.943	8.31	27.58	51.573	74	-22.427	Peak
15780	18.63	0	100	V	37.943	8.31	27.58	37.303	54	-16.697	Ave
15780	18.66	0	100	H	37.943	8.31	27.58	37.333	54	-16.667	Ave
21040	32.37	0	100	V	49.67	9.74	27.06	64.72	74	-9.28	Peak
21040	31.73	0	100	H	49.67	9.74	27.06	64.08	74	-9.92	Peak
21040	18.33	0	100	V	49.67	9.74	27.06	50.68	54	-3.32	Ave
21040	18.26	0	100	H	49.67	9.74	27.06	50.61	54	-3.39	Ave
Middle Channel 5295 MHz, measured at 3 meters											
5295	109.53	0	135	V	33.835	4.56	0	147.925	-	-	Peak/ Fund
5295	109.64	0	120	H	33.835	4.56	0	148.035	-	-	Peak/ Fund
5295	97.52	0	135	V	33.835	4.56	0	135.915	-	-	Ave/ Fund
5295	98.17	0	120	H	33.835	4.56	0	136.565	-	-	Ave/ Fund
10590	32.82	0	100	V	38.214	6.2	27.7	49.534	74	-24.466	Peak
10590	32.84	0	100	H	38.214	6.2	27.7	49.554	74	-24.446	Peak
10590	18.32	0	100	V	38.214	6.2	27.7	35.034	54	-18.966	Ave
10590	18.22	0	100	H	38.214	6.2	27.7	34.934	54	-19.066	Ave
15885	33.3	0	100	V	37.943	8.31	27.58	51.973	74	-22.027	Peak
15885	33.23	0	100	H	37.943	8.31	27.58	51.903	74	-22.097	Peak
15885	19.03	0	100	V	37.943	8.31	27.58	37.703	54	-16.297	Ave
15885	19.13	0	100	H	37.943	8.31	27.58	37.803	54	-16.197	Ave
21180	32.94	0	100	V	49.67	9.74	27.06	65.29	74	-8.71	Peak
21180	33.09	0	100	H	49.67	9.74	27.06	65.44	74	-8.56	Peak
21180	18.89	0	100	V	49.67	9.74	27.06	51.24	54	-2.76	Ave
21180	18.92	0	100	H	49.67	9.74	27.06	51.27	54	-2.73	Ave

Frequency (MHz)	S.A. Reading (dBµV)	Turntable Azimuth (degrees)	Test Antenna			Cable Loss (dB)	Pre-Amp. (dB)	Cord. Reading (dBµV/m)	FCC		Comments
			Height (cm)	Polarity (H/V)	Factor (dB/m)				Limit (dBµV/m)	Margin (dB)	
High Channel 5320 MHz, measured at 3 meters											
5320	109.3	0	135	V	33.835	4.56	0	147.695	-	-	Peak/ Fund
5320	108.96	0	120	H	33.835	4.56	0	147.355	-	-	Peak/ Fund
5320	96.75	0	135	V	33.835	4.56	0	135.145	-	-	Ave/ Fund
5320	97.59	0	120	H	33.835	4.56	0	135.985	-	-	Ave/ Fund
10640	32.81	0	100	V	38.214	6.2	27.7	49.524	74	-24.476	Peak
10640	31.91	0	100	H	38.214	6.2	27.7	48.624	74	-25.376	Peak
10640	18.15	0	100	V	38.214	6.2	27.7	34.864	54	-19.136	Ave
10640	18.12	0	100	H	38.214	6.2	27.7	34.834	54	-19.166	Ave
15960	33.04	0	100	V	37.943	8.31	27.58	51.713	74	-22.287	Peak
15960	33.09	0	100	H	37.943	8.31	27.58	51.763	74	-22.237	Peak
15960	18.68	0	100	V	37.943	8.31	27.58	37.353	54	-16.647	Ave
15960	18.72	0	100	H	37.943	8.31	27.58	37.393	54	-16.607	Ave
21280	32.29	0	100	V	49.67	9.74	27.06	64.64	74	-9.36	Peak
21280	32.91	0	100	H	49.67	9.74	27.06	65.26	74	-8.74	Peak
21280	18.19	0	100	V	49.67	9.74	27.06	50.54	54	-3.46	Ave
21280	18.22	0	100	H	49.67	9.74	27.06	50.57	54	-3.43	Ave

40 MHz Bandwidth

Frequency (MHz)	S.A. Reading (dBµV)	Turntable Azimuth (degrees)	Test Antenna			Cable Loss (dB)	Pre-Amp. (dB)	Cord. Reading (dBµV/m)	FCC		Comments
			Height (cm)	Polarity (H/V)	Factor (dB/m)				Limit (dBµV/m)	Margin (dB)	
Low Channel 5270 MHz, measured at 3 meters											
5270	106.05	0	135	V	33.835	4.56	0	144.445	-	-	Peak/ Fund
5270	106.08	0	120	H	33.835	4.56	0	144.475	-	-	Peak/ Fund
5270	94.12	0	135	V	33.835	4.56	0	132.515	-	-	Ave/ Fund
5270	95.09	0	120	H	33.835	4.56	0	133.485	-	-	Ave/ Fund
10540	32.85	0	100	V	38.214	6.2	27.7	49.564	74	-24.436	Peak
10540	32.47	0	100	H	38.214	6.2	27.7	49.184	74	-24.816	Peak
10540	18.73	0	100	V	38.214	6.2	27.7	35.444	54	-18.556	Ave
10540	18.41	0	100	H	38.214	6.2	27.7	35.124	54	-18.876	Ave
15810	33.96	0	100	V	37.943	8.31	27.58	52.633	74	-21.367	Peak
15810	32.72	0	100	H	37.943	8.31	27.58	51.393	74	-22.607	Peak
15810	18.96	0	100	V	37.943	8.31	27.58	37.633	54	-16.367	Ave
15810	18.87	0	100	H	37.943	8.31	27.58	37.543	54	-16.457	Ave
21080	32.54	0	100	V	49.67	9.74	27.06	64.89	74	-9.11	Peak
21080	33.56	0	100	H	49.67	9.74	27.06	65.91	74	-8.09	Peak
21080	18.38	0	100	V	49.67	9.74	27.06	50.73	54	-3.27	Ave
21080	18.31	0	100	H	49.67	9.74	27.06	50.66	54	-3.34	Ave
Middle Channel 5290 MHz, measured at 3 meters											
5290	106.05	0	135	V	33.835	4.56	0	144.445	-	-	Peak/ Fund
5290	106.37	0	120	H	33.835	4.56	0	144.765	-	-	Peak/ Fund
5290	94.02	0	135	V	33.835	4.56	0	132.415	-	-	Ave/ Fund
5290	95.13	0	120	H	33.835	4.56	0	133.525	-	-	Ave/ Fund
10580	33.98	0	100	V	38.214	6.2	27.7	50.694	74	-23.306	Peak
10580	32.52	0	100	H	38.214	6.2	27.7	49.234	74	-24.766	Peak
10580	17.66	0	100	V	38.214	6.2	27.7	34.374	54	-19.626	Ave
10580	17.88	0	100	H	38.214	6.2	27.7	34.594	54	-19.406	Ave
15870	32.46	0	100	V	37.943	8.31	27.58	51.133	74	-22.867	Peak
15870	32.81	0	100	H	37.943	8.31	27.58	51.483	74	-22.517	Peak
15870	18.37	0	100	V	37.943	8.31	27.58	37.043	54	-16.957	Ave
15870	18.72	0	100	H	37.943	8.31	27.58	37.393	54	-16.607	Ave
21160	33.39	0	100	V	49.67	9.74	27.06	65.74	74	-8.26	Peak
21160	32.91	0	100	H	49.67	9.74	27.06	65.26	74	-8.74	Peak
21160	18.52	0	100	V	49.67	9.74	27.06	50.87	54	-3.13	Ave
21160	18.55	0	100	H	49.67	9.74	27.06	50.9	54	-3.1	Ave

Frequency (MHz)	S.A. Reading (dBμV)	Turntable Azimuth (degrees)	Test Antenna			Cable Loss (dB)	Pre-Amp. (dB)	Cord. Reading (dBμV/m)	FCC		Comments
			Height (cm)	Polarity (H/V)	Factor (dB/m)				Limit (dBμV/m)	Margin (dB)	
High Channel 5310 MHz, measured at 3 meters											
5310	105.32	0	135	V	33.835	4.56	0	143.715	-	-	Peak/ Fund
5310	106.21	0	120	H	33.835	4.56	0	144.605	-	-	Peak/ Fund
5310	93.86	0	135	V	33.835	4.56	0	132.255	-	-	Ave/ Fund
5310	95.14	0	120	H	33.835	4.56	0	133.535	-	-	Ave/ Fund
10620	32.82	0	100	V	38.214	6.2	27.7	49.534	74	-24.466	Peak
10620	32.21	0	100	H	38.214	6.2	27.7	48.924	74	-25.076	Peak
10620	17.71	0	100	V	38.214	6.2	27.7	34.424	54	-19.576	Ave
10620	17.65	0	100	H	38.214	6.2	27.7	34.364	54	-19.636	Ave
15930	32.86	0	100	V	37.943	8.31	27.58	51.533	74	-22.467	Peak
15930	33.49	0	100	H	37.943	8.31	27.58	52.163	74	-21.837	Peak
15930	18.87	0	100	V	37.943	8.31	27.58	37.543	54	-16.457	Ave
15930	18.69	0	100	H	37.943	8.31	27.58	37.363	54	-16.637	Ave
21240	32.53	0	100	V	49.67	9.74	27.06	64.88	74	-9.12	Peak
21240	32.25	0	100	H	49.67	9.74	27.06	64.6	74	-9.4	Peak
21240	18.35	0	100	V	49.67	9.74	27.06	50.7	54	-3.3	Ave
21240	18.27	0	100	H	49.67	9.74	27.06	50.62	54	-3.38	Ave

80 MHz Bandwidth

Frequency (MHz)	S.A. Reading (dBμV)	Turntable Azimuth (degrees)	Test Antenna			Cable Loss (dB)	Pre-Amp. (dB)	Cord. Reading (dBμV/m)	FCC		Comments
			Height (cm)	Polarity (H/V)	Factor (dB/m)				Limit (dBμV/m)	Margin (dB)	
Channel 5290 MHz, measured at 3 meters											
5290	103.37	0	135	V	33.835	4.56	0	141.765	-	-	Peak/ Fund
5290	104.68	0	120	H	33.835	4.56	0	143.075	-	-	Peak/ Fund
5290	89.65	0	135	V	33.835	4.56	0	128.045	-	-	Ave/ Fund
5290	91.56	0	120	H	33.835	4.56	0	129.955	-	-	Ave/ Fund
10580	32.49	0	100	V	38.214	6.2	27.7	49.204	74	-24.796	Peak
10580	32.15	0	100	H	38.214	6.2	27.7	48.864	74	-25.136	Peak
10580	18.55	0	100	V	38.214	6.2	27.7	35.264	54	-18.736	Ave
10580	18.47	0	100	H	38.214	6.2	27.7	35.184	54	-18.816	Ave
15870	33.92	0	100	V	37.943	8.31	27.58	52.593	74	-21.407	Peak
15870	32.99	0	100	H	37.943	8.31	27.58	51.663	74	-22.337	Peak
15870	19.19	0	100	V	37.943	8.31	27.58	37.863	54	-16.137	Ave
15870	19.21	0	100	H	37.943	8.31	27.58	37.883	54	-16.117	Ave
21160	32.93	0	100	V	49.67	9.74	27.06	65.28	74	-8.72	Peak
21160	32.57	0	100	H	49.67	9.74	27.06	64.92	74	-9.08	Peak
21160	19.02	0	100	V	49.67	9.74	27.06	51.37	54	-2.63	Ave
21160	18.89	0	100	H	49.67	9.74	27.06	51.24	54	-2.76	Ave

5.6 GHz Band**20 MHz Bandwidth**

Frequency (MHz)	S.A. Reading (dBµV)	Turntable Azimuth (degrees)	Test Antenna			Cable Loss (dB)	Pre-Amp. (dB)	Cord. Reading (dBµV/m)	FCC		Comments
			Height (cm)	Polarity (H/V)	Factor (dB/m)				Limit (dBµV/m)	Margin (dB)	
Low Channel 5500 MHz, measured at 3 meters											
5500	109.81	0	135	V	33.977	4.59	0	148.377	-	-	Peak/ Fund
5500	108.02	0	120	H	33.977	4.59	0	146.587	-	-	Peak/ Fund
5500	97.36	0	135	V	33.977	4.59	0	135.927	-	-	Ave/ Fund
5500	96.66	0	120	H	33.977	4.59	0	135.227	-	-	Ave/ Fund
11000	32.17	0	100	V	38.827	6.2	27.7	49.497	74	-24.503	Peak
11000	32.37	0	100	H	38.827	6.2	27.7	49.697	74	-24.303	Peak
11000	17.79	0	100	V	38.827	6.2	27.7	35.117	54	-18.883	Ave
11000	17.96	0	100	H	38.827	6.2	27.7	35.287	54	-18.713	Ave
16500	32.19	0	100	V	43.239	8.31	27.58	56.159	74	-17.841	Peak
16500	32.26	0	100	H	43.239	8.31	27.58	56.229	74	-17.771	Peak
16500	18.32	0	100	V	43.239	8.31	27.58	42.289	54	-11.711	Ave
16500	18.13	0	100	H	43.239	8.31	27.58	42.099	54	-11.901	Ave
22000	32.11	0	100	V	49.854	9.74	27.06	64.644	74	-9.356	Peak
22000	33.12	0	100	H	49.854	9.74	27.06	65.654	74	-8.346	Peak
22000	17.93	0	100	V	49.854	9.74	27.06	50.464	54	-3.536	Ave
22000	18.18	0	100	H	49.854	9.74	27.06	50.714	54	-3.286	Ave
Middle Channel 5590 MHz, measured at 3 meters											
5590	108.92	0	135	V	33.977	4.59	0	147.487	-	-	Peak/ Fund
5590	106.48	0	120	H	33.977	4.59	0	145.047	-	-	Peak/ Fund
5590	96.48	0	135	V	33.977	4.59	0	135.047	-	-	Ave/ Fund
5590	95.09	0	120	H	33.977	4.59	0	133.657	-	-	Ave/ Fund
11180	31.77	0	100	V	38.827	6.2	27.7	49.097	74	-24.903	Peak
11180	32.08	0	100	H	38.827	6.2	27.7	49.407	74	-24.593	Peak
11180	17.39	0	100	V	38.827	6.2	27.7	34.717	54	-19.283	Ave
11180	17.59	0	100	H	38.827	6.2	27.7	34.917	54	-19.083	Ave
16770	32.84	0	100	V	43.239	8.31	27.58	56.809	74	-17.191	Peak
16770	32.18	0	100	H	43.239	8.31	27.58	56.149	74	-17.851	Peak
16770	18.25	0	100	V	43.239	8.31	27.58	42.219	54	-11.781	Ave
16770	18.28	0	100	H	43.239	8.31	27.58	42.249	54	-11.751	Ave
22360	31.91	0	100	V	49.854	9.74	27.06	64.444	74	-9.556	Peak
22360	31.38	0	100	H	49.854	9.74	27.06	63.914	74	-10.086	Peak
22360	17.74	0	100	V	49.854	9.74	27.06	50.274	54	-3.726	Ave
22360	17.62	0	100	H	49.854	9.74	27.06	50.154	54	-3.846	Ave

Frequency (MHz)	S.A. Reading (dBμV)	Turntable Azimuth (degrees)	Test Antenna			Cable Loss (dB)	Pre-Amp. (dB)	Cord. Reading (dBμV/m)	FCC		Comments
			Height (cm)	Polarity (H/V)	Factor (dB/m)				Limit (dBμV/m)	Margin (dB)	
High Channel 5700 MHz, measured at 3 meters											
5700	109.04	0	135	V	33.977	4.59	0	147.607	-	-	Peak/ Fund
5700	108.73	0	120	H	33.977	4.59	0	147.297	-	-	Peak/ Fund
5700	96.5	0	135	V	33.977	4.59	0	135.067	-	-	Ave/ Fund
5700	96.76	0	120	H	33.977	4.59	0	135.327	-	-	Ave/ Fund
11400	31.72	0	100	V	38.827	6.2	27.7	49.047	74	-24.953	Peak
11400	31.43	0	100	H	38.827	6.2	27.7	48.757	74	-25.243	Peak
11400	17.31	0	100	V	38.827	6.2	27.7	34.637	54	-19.363	Ave
11400	17.41	0	100	H	38.827	6.2	27.7	34.737	54	-19.263	Ave
17100	31.79	0	100	V	43.239	8.31	27.58	55.759	74	-18.241	Peak
17100	32.52	0	100	H	43.239	8.31	27.58	56.489	74	-17.511	Peak
17100	17.98	0	100	V	43.239	8.31	27.58	41.949	54	-12.051	Ave
17100	17.91	0	100	H	43.239	8.31	27.58	41.879	54	-12.121	Ave
22800	32.94	0	100	V	49.854	9.74	27.06	65.474	74	-8.526	Peak
22800	31.35	0	100	H	49.854	9.74	27.06	63.884	74	-10.116	Peak
22800	17.75	0	100	V	49.854	9.74	27.06	50.284	54	-3.716	Ave
22800	17.73	0	100	H	49.854	9.74	27.06	50.264	54	-3.736	Ave

40 MHz Bandwidth

Frequency (MHz)	S.A. Reading (dBµV)	Turntable Azimuth (degrees)	Test Antenna			Cable Loss (dB)	Pre-Amp. (dB)	Cord. Reading (dBµV/m)	FCC		Comments
			Height (cm)	Polarity (H/V)	Factor (dB/m)				Limit (dBµV/m)	Margin (dB)	
Low Channel 5510 MHz, measured at 3 meters											
5510	106.76	0	135	V	33.977	4.59	0	145.327	-	-	Peak/ Fund
5510	104.85	0	120	H	33.977	4.59	0	143.417	-	-	Peak/ Fund
5510	94.45	0	135	V	33.977	4.59	0	133.017	-	-	Ave/ Fund
5510	93.35	0	120	H	33.977	4.59	0	131.917	-	-	Ave/ Fund
11020	31.27	0	100	V	38.827	6.2	27.7	48.597	74	-25.403	Peak
11020	31.68	0	100	H	38.827	6.2	27.7	49.007	74	-24.993	Peak
11020	18	0	100	V	38.827	6.2	27.7	35.327	54	-18.673	Ave
11020	18.13	0	100	H	38.827	6.2	27.7	35.457	54	-18.543	Ave
16530	32.42	0	100	V	43.239	8.31	27.58	56.389	74	-17.611	Peak
16530	31.75	0	100	H	43.239	8.31	27.58	55.719	74	-18.281	Peak
16530	18.93	0	100	V	43.239	8.31	27.58	42.899	54	-11.101	Ave
16530	18.88	0	100	H	43.239	8.31	27.58	42.849	54	-11.151	Ave
22040	31.75	0	100	V	49.854	9.74	27.06	64.284	74	-9.716	Peak
22040	32.18	0	100	H	49.854	9.74	27.06	64.714	74	-9.286	Peak
22040	18.64	0	100	V	49.854	9.74	27.06	51.174	54	-2.826	Ave
22040	18.62	0	100	H	49.854	9.74	27.06	51.154	54	-2.846	Ave
Middle Channel 5555 MHz, measured at 3 meters											
5555	106.22	0	135	V	33.977	4.59	0	144.787	-	-	Peak/ Fund
5555	104.8	0	120	H	33.977	4.59	0	143.367	-	-	Peak/ Fund
5555	94.05	0	135	V	33.977	4.59	0	132.617	-	-	Ave/ Fund
5555	93.33	0	120	H	33.977	4.59	0	131.897	-	-	Ave/ Fund
11110	32.07	0	100	V	38.827	6.2	27.7	49.397	74	-24.603	Peak
11110	32.54	0	100	H	38.827	6.2	27.7	49.867	74	-24.133	Peak
11110	18.41	0	100	V	38.827	6.2	27.7	35.737	54	-18.263	Ave
11110	18.67	0	100	H	38.827	6.2	27.7	35.997	54	-18.003	Ave
16665	32.35	0	100	V	43.239	8.31	27.58	56.319	74	-17.681	Peak
16665	31.86	0	100	H	43.239	8.31	27.58	55.829	74	-18.171	Peak
16665	18.7	0	100	V	43.239	8.31	27.58	42.669	54	-11.331	Ave
16665	18.15	0	100	H	43.239	8.31	27.58	42.119	54	-11.881	Ave
22220	32.22	0	100	V	49.854	9.74	27.06	64.754	74	-9.246	Peak
22220	32.57	0	100	H	49.854	9.74	27.06	65.104	74	-8.896	Peak
22220	18.36	0	100	V	49.854	9.74	27.06	50.894	54	-3.106	Ave
22220	18.39	0	100	H	49.854	9.74	27.06	50.924	54	-3.076	Ave

Frequency (MHz)	S.A. Reading (dB μ V)	Turntable Azimuth (degrees)	Test Antenna			Cable Loss (dB)	Pre-Amp. (dB)	Cord. Reading (dB μ V/m)	FCC		Comments
			Height (cm)	Polarity (H/V)	Factor (dB/m)				Limit (dB μ V/m)	Margin (dB)	
High Channel 5690 MHz, measured at 3 meters											
5690	105.56	0	135	V	33.977	4.59	0	144.127	-	-	Peak/ Fund
5690	104.95	0	120	H	33.977	4.59	0	143.517	-	-	Peak/ Fund
5690	93.82	0	135	V	33.977	4.59	0	132.387	-	-	Ave/ Fund
5690	93.52	0	120	H	33.977	4.59	0	132.087	-	-	Ave/ Fund
11380	33.23	0	100	V	38.827	6.2	27.7	50.557	74	-23.443	Peak
11380	31.82	0	100	H	38.827	6.2	27.7	49.147	74	-24.853	Peak
11380	17.67	0	100	V	38.827	6.2	27.7	34.997	54	-19.003	Ave
11380	17.8	0	100	H	38.827	6.2	27.7	35.127	54	-18.873	Ave
17070	32.51	0	100	V	43.239	8.31	27.58	56.479	74	-17.521	Peak
17070	31.92	0	100	H	43.239	8.31	27.58	55.889	74	-18.111	Peak
17070	17.99	0	100	V	43.239	8.31	27.58	41.959	54	-12.041	Ave
17070	17.83	0	100	H	43.239	8.31	27.58	41.799	54	-12.201	Ave
22760	31.74	0	100	V	49.854	9.74	27.06	64.274	74	-9.726	Peak
22760	32.19	0	100	H	49.854	9.74	27.06	64.724	74	-9.276	Peak
22760	17.36	0	100	V	49.854	9.74	27.06	49.894	54	-4.106	Ave
22760	17.71	0	100	H	49.854	9.74	27.06	50.244	54	-3.756	Ave

80 MHz Bandwidth

Frequency (MHz)	S.A. Reading (dBμV)	Turntable Azimuth (degrees)	Test Antenna			Cable Loss (dB)	Pre-Amp. (dB)	Cord. Reading (dBμV/m)	FCC		Comments
			Height (cm)	Polarity (H/V)	Factor (dB/m)				Limit (dBμV/m)	Margin (dB)	
Low Channel 5530 MHz, measured at 3 meters											
5530	103.82	0	135	V	33.977	4.59	0	142.387	-	-	Peak/ Fund
5530	102.67	0	120	H	33.977	4.59	0	141.237	-	-	Peak/ Fund
5530	89.63	0	135	V	33.977	4.59	0	128.197	-	-	Ave/ Fund
5530	89.6	0	120	H	33.977	4.59	0	128.167	-	-	Ave/ Fund
11060	32.54	0	100	V	38.827	6.2	27.7	49.867	74	-24.133	Peak
11060	31.92	0	100	H	38.827	6.2	27.7	49.247	74	-24.753	Peak
11060	18.39	0	100	V	38.827	6.2	27.7	35.717	54	-18.283	Ave
11060	18.43	0	100	H	38.827	6.2	27.7	35.757	54	-18.243	Ave
16590	32.66	0	100	V	43.239	8.31	27.58	56.629	74	-17.371	Peak
16590	31.76	0	100	H	43.239	8.31	27.58	55.729	74	-18.271	Peak
16590	18.68	0	100	V	43.239	8.31	27.58	42.649	54	-11.351	Ave
16590	18.51	0	100	H	43.239	8.31	27.58	42.479	54	-11.521	Ave
22120	32.53	0	100	V	49.854	9.74	27.06	65.064	74	-8.936	Peak
22120	32.32	0	100	H	49.854	9.74	27.06	64.854	74	-9.146	Peak
22120	18.77	0	100	V	49.854	9.74	27.06	51.304	54	-2.696	Ave
22120	18.68	0	100	H	49.854	9.74	27.06	51.214	54	-2.786	Ave
Middle Channel 5545 MHz, measured at 3 meters											
5545	104.58	0	135	V	33.977	4.59	0	143.147	-	-	Peak/ Fund
5545	103.09	0	120	H	33.977	4.59	0	141.657	-	-	Peak/ Fund
5545	88.94	0	135	V	33.977	4.59	0	127.507	-	-	Ave/ Fund
5545	89.37	0	120	H	33.977	4.59	0	127.937	-	-	Ave/ Fund
11090	32.38	0	100	V	38.827	6.2	27.7	49.707	74	-24.293	Peak
11090	32.68	0	100	H	38.827	6.2	27.7	50.007	74	-23.993	Peak
11090	18.16	0	100	V	38.827	6.2	27.7	35.487	54	-18.513	Ave
11090	17.79	0	100	H	38.827	6.2	27.7	35.117	54	-18.883	Ave
16635	32.91	0	100	V	43.239	8.31	27.58	56.879	74	-17.121	Peak
16635	32.26	0	100	H	43.239	8.31	27.58	56.229	74	-17.771	Peak
16635	18.83	0	100	V	43.239	8.31	27.58	42.799	54	-11.201	Ave
16635	18.65	0	100	H	43.239	8.31	27.58	42.619	54	-11.381	Ave
22180	33.02	0	100	V	49.854	9.74	27.06	65.554	74	-8.446	Peak
22180	31.98	0	100	H	49.854	9.74	27.06	64.514	74	-9.486	Peak
22180	18.96	0	100	V	49.854	9.74	27.06	51.494	54	-2.506	Ave
22180	18.67	0	100	H	49.854	9.74	27.06	51.204	54	-2.796	Ave

Frequency (MHz)	S.A. Reading (dB μ V)	Turntable Azimuth (degrees)	Test Antenna			Cable Loss (dB)	Pre-Amp. (dB)	Cord. Reading (dB μ V/m)	FCC		Comments
			Height (cm)	Polarity (H/V)	Factor (dB/m)				Limit (dB μ V/m)	Margin (dB)	
High Channel 5560 MHz, measured at 3 meters											
5560	104.34	0	135	V	33.977	4.59	0	142.907	-	-	Peak/ Fund
5560	103.29	0	120	H	33.977	4.59	0	141.857	-	-	Peak/ Fund
5560	89.84	0	135	V	33.977	4.59	0	128.407	-	-	Ave/ Fund
5560	89.38	0	120	H	33.977	4.59	0	127.947	-	-	Ave/ Fund
11120	32.02	0	100	V	38.827	6.2	27.7	49.347	74	-24.653	Peak
11120	31.52	0	100	H	38.827	6.2	27.7	48.847	74	-25.153	Peak
11120	18.52	0	100	V	38.827	6.2	27.7	35.847	54	-18.153	Ave
11120	19.16	0	100	H	38.827	6.2	27.7	36.487	54	-17.513	Ave
16680	32.45	0	100	V	43.239	8.31	27.58	56.419	74	-17.581	Peak
16680	32.44	0	100	H	43.239	8.31	27.58	56.409	74	-17.591	Peak
16680	18.63	0	100	V	43.239	8.31	27.58	42.599	54	-11.401	Ave
16680	18.65	0	100	H	43.239	8.31	27.58	42.619	54	-11.381	Ave
22240	31.71	0	100	V	49.854	9.74	27.06	64.244	74	-9.756	Peak
22240	32.64	0	100	H	49.854	9.74	27.06	65.174	74	-8.826	Peak
22240	18.74	0	100	V	49.854	9.74	27.06	51.274	54	-2.726	Ave
22240	18.67	0	100	H	49.854	9.74	27.06	51.204	54	-2.796	Ave

0 dBi Antenna:**5.3 GHz Band:****20 MHz Bandwidth**

Frequency (MHz)	S.A. Reading (dBµV)	Turntable Azimuth (degrees)	Test Antenna			Cable Loss (dB)	Pre-Amp. (dB)	Cord. Reading (dBµV/m)	FCC		Comments
			Height (cm)	Polarity (H/V)	Factor (dB/m)				Limit (dBµV/m)	Margin (dB)	
Low Channel 5260 MHz, measured at 3 meters											
5260	64.44	0	135	V	33.922	3.47	0	101.832	-	-	Peak/Fund
5260	64.68	0	120	H	33.922	3.47	0	102.072	-	-	Peak/Fund
5260	51.52	0	135	V	33.922	3.47	0	88.912	-	-	Ave/Fund
5260	53.42	0	120	H	33.922	3.47	0	90.812	-	-	Ave/Fund
10520	28.35	0	100	V	38.845	6.2	36.5	36.895	74	-37.105	Peak
10520	28.55	0	100	H	38.845	6.2	36.5	37.095	74	-36.905	Peak
10520	13.97	0	100	V	38.845	6.2	36.5	22.515	54	-31.485	Ave
10520	14.14	0	100	H	38.845	6.2	36.5	22.685	54	-31.315	Ave
15780	28.37	0	100	V	42.941	8.31	36.7	42.921	74	-31.079	Peak
15780	28.44	0	100	H	42.941	8.31	36.7	42.991	74	-31.009	Peak
15780	14.5	0	100	V	42.941	8.31	36.7	29.051	54	-24.949	Ave
15780	14.31	0	100	H	42.941	8.31	36.7	28.861	54	-25.139	Ave
21040	28.29	0	100	V	49.67	9.74	36.9	50.8	74	-23.2	Peak
21040	29.3	0	100	H	49.67	9.74	36.9	51.81	74	-22.19	Peak
21040	14.11	0	100	V	49.67	9.74	36.9	36.62	54	-17.38	Ave
21040	14.36	0	100	H	49.67	9.74	36.9	36.87	54	-17.13	Ave
Middle Channel 5295 MHz, measured at 3 meters											
5295	64.46	0	135	V	33.922	3.47	0	101.852	-	-	Peak/Fund
5295	64.57	0	120	H	33.922	3.47	0	101.962	-	-	Peak/Fund
5295	52.45	0	135	V	33.922	3.47	0	89.842	-	-	Ave/Fund
5295	53.1	0	120	H	33.922	3.47	0	90.492	-	-	Ave/Fund
10590	28.39	0	100	V	38.845	6.2	36.5	36.935	74	-37.065	Peak
10590	28.59	0	100	H	38.845	6.2	36.5	37.135	74	-36.865	Peak
10590	14.01	0	100	V	38.845	6.2	36.5	22.555	54	-31.445	Ave
10590	14.18	0	100	H	38.845	6.2	36.5	22.725	54	-31.275	Ave
15885	28.41	0	100	V	42.941	8.31	36.7	42.961	74	-31.039	Peak
15885	28.48	0	100	H	42.941	8.31	36.7	43.031	74	-30.969	Peak
15885	14.54	0	100	V	42.941	8.31	36.7	29.091	54	-24.909	Ave
15885	14.35	0	100	H	42.941	8.31	36.7	28.901	54	-25.099	Ave
21180	28.33	0	100	V	49.67	9.74	36.9	50.84	74	-23.16	Peak
21180	29.34	0	100	H	49.67	9.74	36.9	51.85	74	-22.15	Peak
21180	14.15	0	100	V	49.67	9.74	36.9	36.66	54	-17.34	Ave
21180	14.4	0	100	H	49.67	9.74	36.9	36.91	54	-17.09	Ave

Frequency (MHz)	S.A. Reading (dBµV)	Turntable Azimuth (degrees)	Test Antenna			Cable Loss (dB)	Pre-Amp. (dB)	Cord. Reading (dBµV/m)	FCC		Comments
			Height (cm)	Polarity (H/V)	Factor (dB/m)				Limit (dBµV/m)	Margin (dB)	
High Channel 5320 MHz, measured at 3 meters											
5320	64.23	0	135	V	33.922	3.47	0	101.622	-	-	Peak/Fund
5320	63.89	0	120	H	33.922	3.47	0	101.282	-	-	Peak/Fund
5320	51.68	0	135	V	33.922	3.47	0	89.072	-	-	Ave/Fund
5320	52.52	0	120	H	33.922	3.47	0	89.912	-	-	Ave/Fund
10640	28.52	0	100	V	38.845	6.2	36.5	37.065	74	-36.935	Peak
10640	28.72	0	100	H	38.845	6.2	36.5	37.265	74	-36.735	Peak
10640	14.14	0	100	V	38.845	6.2	36.5	22.685	54	-31.315	Ave
10640	14.31	0	100	H	38.845	6.2	36.5	22.855	54	-31.145	Ave
15960	28.54	0	100	V	42.941	8.31	36.7	43.091	74	-30.909	Peak
15960	28.61	0	100	H	42.941	8.31	36.7	43.161	74	-30.839	Peak
15960	14.67	0	100	V	42.941	8.31	36.7	29.221	54	-24.779	Ave
15960	14.48	0	100	H	42.941	8.31	36.7	29.031	54	-24.969	Ave
21280	28.46	0	100	V	49.67	9.74	36.9	50.97	74	-23.03	Peak
21280	29.47	0	100	H	49.67	9.74	36.9	51.98	74	-22.02	Peak
21280	14.28	0	100	V	49.67	9.74	36.9	36.79	54	-17.21	Ave
21280	14.53	0	100	H	49.67	9.74	36.9	37.04	54	-16.96	Ave

40 MHz Bandwidth

Frequency (MHz)	S.A. Reading (dBµV)	Turntable Azimuth (degrees)	Test Antenna			Cable Loss (dB)	Pre-Amp. (dB)	Cord. Reading (dBµV/m)	FCC		Comments
			Height (cm)	Polarity (H/V)	Factor (dB/m)				Limit (dBµV/m)	Margin (dB)	
Low Channel 5270 MHz, measured at 3 meters											
5270	60.98	0	135	V	33.922	3.47	0	98.372	-	-	Peak/Fund
5270	61.01	0	120	H	33.922	3.47	0	98.402	-	-	Peak/Fund
5270	49.05	0	135	V	33.922	3.47	0	86.442	-	-	Ave/Fund
5270	50.02	0	120	H	33.922	3.47	0	87.412	-	-	Ave/Fund
10540	28.28	0	100	V	38.845	6.2	36.5	36.825	74	-37.175	Peak
10540	28.48	0	100	H	38.845	6.2	36.5	37.025	74	-36.975	Peak
10540	13.9	0	100	V	38.845	6.2	36.5	22.445	54	-31.555	Ave
10540	14.07	0	100	H	38.845	6.2	36.5	22.615	54	-31.385	Ave
15810	28.3	0	100	V	42.941	8.31	36.7	42.851	74	-31.149	Peak
15810	28.37	0	100	H	42.941	8.31	36.7	42.921	74	-31.079	Peak
15810	14.43	0	100	V	42.941	8.31	36.7	28.981	54	-25.019	Ave
15810	14.24	0	100	H	42.941	8.31	36.7	28.791	54	-25.209	Ave
21080	28.22	0	100	V	49.67	9.74	36.9	50.73	74	-23.27	Peak
21080	29.23	0	100	H	49.67	9.74	36.9	51.74	74	-22.26	Peak
21080	14.04	0	100	V	49.67	9.74	36.9	36.55	54	-17.45	Ave
21080	14.29	0	100	H	49.67	9.74	36.9	36.8	54	-17.2	Ave
Middle Channel 5290 MHz, measured at 3 meters											
5290	60.98	0	135	V	33.922	3.47	0	98.372	-	-	Peak/Fund
5290	61.3	0	120	H	33.922	3.47	0	98.692	-	-	Peak/Fund
5290	48.95	0	135	V	33.922	3.47	0	86.342	-	-	Ave/Fund
5290	50.06	0	120	H	33.922	3.47	0	87.452	-	-	Ave/Fund
10580	28.48	0	100	V	38.845	6.2	36.5	37.025	74	-36.975	Peak
10580	28.68	0	100	H	38.845	6.2	36.5	37.225	74	-36.775	Peak
10580	14.1	0	100	V	38.845	6.2	36.5	22.645	54	-31.355	Ave
10580	14.27	0	100	H	38.845	6.2	36.5	22.815	54	-31.185	Ave
15870	28.5	0	100	V	42.941	8.31	36.7	43.051	74	-30.949	Peak
15870	28.57	0	100	H	42.941	8.31	36.7	43.121	74	-30.879	Peak
15870	14.63	0	100	V	42.941	8.31	36.7	29.181	54	-24.819	Ave
15870	14.44	0	100	H	42.941	8.31	36.7	28.991	54	-25.009	Ave
21160	28.42	0	100	V	49.67	9.74	36.9	50.93	74	-23.07	Peak
21160	29.43	0	100	H	49.67	9.74	36.9	51.94	74	-22.06	Peak
21160	14.24	0	100	V	49.67	9.74	36.9	36.75	54	-17.25	Ave
21160	14.49	0	100	H	49.67	9.74	36.9	37	54	-17	Ave

Frequency (MHz)	S.A. Reading (dB μ V)	Turntable Azimuth (degrees)	Test Antenna			Cable Loss (dB)	Pre-Amp. (dB)	Cord. Reading (dB μ V/m)	FCC		Comments
			Height (cm)	Polarity (H/V)	Factor (dB/m)				Limit (dB μ V/m)	Margin (dB)	
High Channel 5310 MHz, measured at 3 meters											
5310	60.25	0	135	V	33.922	3.47	0	97.642	-	-	Peak/Fund
5310	61.14	0	120	H	33.922	3.47	0	98.532	-	-	Peak/Fund
5310	48.79	0	135	V	33.922	3.47	0	86.182	-	-	Ave/Fund
5310	50.07	0	120	H	33.922	3.47	0	87.462	-	-	Ave/Fund
10620	28.73	0	100	V	38.845	6.2	36.5	37.275	74	-36.725	Peak
10620	28.93	0	100	H	38.845	6.2	36.5	37.475	74	-36.525	Peak
10620	14.35	0	100	V	38.845	6.2	36.5	22.895	54	-31.105	Ave
10620	14.52	0	100	H	38.845	6.2	36.5	23.065	54	-30.935	Ave
15930	28.75	0	100	V	42.941	8.31	36.7	43.301	74	-30.699	Peak
15930	28.82	0	100	H	42.941	8.31	36.7	43.371	74	-30.629	Peak
15930	14.88	0	100	V	42.941	8.31	36.7	29.431	54	-24.569	Ave
15930	14.69	0	100	H	42.941	8.31	36.7	29.241	54	-24.759	Ave
21240	28.67	0	100	V	49.67	9.74	36.9	51.18	74	-22.82	Peak
21240	29.68	0	100	H	49.67	9.74	36.9	52.19	74	-21.81	Peak
21240	14.49	0	100	V	49.67	9.74	36.9	37	54	-17	Ave
21240	14.74	0	100	H	49.67	9.74	36.9	37.25	54	-16.75	Ave

80 MHz Bandwidth

Frequency (MHz)	S.A. Reading (dB μ V)	Turntable Azimuth (degrees)	Test Antenna			Cable Loss (dB)	Pre-Amp. (dB)	Cord. Reading (dB μ V/m)	FCC		Comments
			Height (cm)	Polarity (H/V)	Factor (dB/m)				Limit (dB μ V/m)	Margin (dB)	
Channel 5290 MHz, measured at 3 meters											
5290	58.3	0	135	V	33.922	3.47	0	95.692	-	-	Peak/Fund
5290	59.61	0	120	H	33.922	3.47	0	97.002	-	-	Peak/Fund
5290	44.58	0	135	V	33.922	3.47	0	81.972	-	-	Ave/Fund
5290	46.49	0	120	H	33.922	3.47	0	83.882	-	-	Ave/Fund
10580	28.56	0	100	V	38.845	6.2	36.5	37.105	74	-36.895	Peak
10580	28.76	0	100	H	38.845	6.2	36.5	37.305	74	-36.695	Peak
10580	14.18	0	100	V	38.845	6.2	36.5	22.725	54	-31.275	Ave
10580	14.35	0	100	H	38.845	6.2	36.5	22.895	54	-31.105	Ave
15870	28.58	0	100	V	42.941	8.31	36.7	43.131	74	-30.869	Peak
15870	28.65	0	100	H	42.941	8.31	36.7	43.201	74	-30.799	Peak
15870	14.71	0	100	V	42.941	8.31	36.7	29.261	54	-24.739	Ave
15870	14.52	0	100	H	42.941	8.31	36.7	29.071	54	-24.929	Ave
21160	28.5	0	100	V	49.67	9.74	36.9	51.01	74	-22.99	Peak
21160	29.51	0	100	H	49.67	9.74	36.9	52.02	74	-21.98	Peak
21160	14.32	0	100	V	49.67	9.74	36.9	36.83	54	-17.17	Ave
21160	14.57	0	100	H	49.67	9.74	36.9	37.08	54	-16.92	Ave

5.6 GHz Band:**20 MHz Bandwidth**

Frequency (MHz)	S.A. Reading (dBμV)	Turntable Azimuth (degrees)	Test Antenna			Cable Loss (dB)	Pre-Amp. (dB)	Cord. Reading (dBμV/m)	FCC		Comments
			Height (cm)	Polarity (H/V)	Factor (dB/m)				Limit (dBμV/m)	Margin (dB)	
Low Channel 5500 MHz, measured at 3 meters											
5500	64.74	0	135	V	33.922	3.47	0	102.132	-	-	Peak/Fund
5500	62.95	0	120	H	33.922	3.47	0	100.342	-	-	Peak/Fund
5500	52.29	0	135	V	33.922	3.47	0	89.682	-	-	Ave/Fund
5500	51.59	0	120	H	33.922	3.47	0	88.982	-	-	Ave/Fund
11000	29.21	0	100	V	38.845	6.2	36.5	37.755	74	-36.245	Peak
11000	29.41	0	100	H	38.845	6.2	36.5	37.955	74	-36.045	Peak
11000	14.83	0	100	V	38.845	6.2	36.5	23.375	54	-30.625	Ave
11000	15	0	100	H	38.845	6.2	36.5	23.545	54	-30.455	Ave
16500	29.23	0	100	V	42.941	8.31	36.7	43.781	74	-30.219	Peak
16500	29.3	0	100	H	42.941	8.31	36.7	43.851	74	-30.149	Peak
16500	15.36	0	100	V	42.941	8.31	36.7	29.911	54	-24.089	Ave
16500	15.17	0	100	H	42.941	8.31	36.7	29.721	54	-24.279	Ave
22000	29.15	0	100	V	49.67	9.74	36.9	51.66	74	-22.34	Peak
22000	30.16	0	100	H	49.67	9.74	36.9	52.67	74	-21.33	Peak
22000	14.97	0	100	V	49.67	9.74	36.9	37.48	54	-16.52	Ave
22000	15.22	0	100	H	49.67	9.74	36.9	37.73	54	-16.27	Ave
Middle Channel 5590 MHz, measured at 3 meters											
5590	63.85	0	135	V	33.922	3.47	0	101.242	-	-	Peak/Fund
5590	61.41	0	120	H	33.922	3.47	0	98.802	-	-	Peak/Fund
5590	51.41	0	135	V	33.922	3.47	0	88.802	-	-	Ave/Fund
5590	50.02	0	120	H	33.922	3.47	0	87.412	-	-	Ave/Fund
11180	32.27	0	100	V	38.845	6.2	36.5	40.815	74	-33.185	Peak
11180	32.31	0	100	H	38.845	6.2	36.5	40.855	74	-33.145	Peak
11180	15.16	0	100	V	38.845	6.2	36.5	23.705	54	-30.295	Ave
11180	15.34	0	100	H	38.845	6.2	36.5	23.885	54	-30.115	Ave
16770	28.75	0	100	V	42.941	8.31	36.7	43.301	74	-30.699	Peak
16770	28.08	0	100	H	42.941	8.31	36.7	42.631	74	-31.369	Peak
16770	14.39	0	100	V	42.941	8.31	36.7	28.941	54	-25.059	Ave
16770	14.34	0	100	H	42.941	8.31	36.7	28.891	54	-25.109	Ave
22360	28.14	0	100	V	49.67	9.74	36.9	50.65	74	-23.35	Peak
22360	28.1	0	100	H	49.67	9.74	36.9	50.61	74	-23.39	Peak
22360	14.54	0	100	V	49.67	9.74	36.9	37.05	54	-16.95	Ave
22360	14.6	0	100	H	49.67	9.74	36.9	37.11	54	-16.89	Ave

Frequency (MHz)	S.A. Reading (dB μ V)	Turntable Azimuth (degrees)	Test Antenna			Cable Loss (dB)	Pre-Amp. (dB)	Cord. Reading (dB μ V/m)	FCC		Comments
			Height (cm)	Polarity (H/V)	Factor (dB/m)				Limit (dB μ V/m)	Margin (dB)	
High Channel 5700 MHz, measured at 3 meters											
5700	63.97	0	135	V	33.922	3.47	0	101.362	-	-	Peak/Fund
5700	63.66	0	120	H	33.922	3.47	0	101.052	-	-	Peak/Fund
5700	51.43	0	135	V	33.922	3.47	0	88.822	-	-	Ave/Fund
5700	51.69	0	120	H	33.922	3.47	0	89.082	-	-	Ave/Fund
11400	30.14	0	100	V	38.845	6.2	36.5	38.685	74	-35.315	Peak
11400	29.85	0	100	H	38.845	6.2	36.5	38.395	74	-35.605	Peak
11400	15.73	0	100	V	38.845	6.2	36.5	24.275	54	-29.725	Ave
11400	15.83	0	100	H	38.845	6.2	36.5	24.375	54	-29.625	Ave
17100	30.21	0	100	V	42.941	8.31	36.7	44.761	74	-29.239	Peak
17100	30.94	0	100	H	42.941	8.31	36.7	45.491	74	-28.509	Peak
17100	16.4	0	100	V	42.941	8.31	36.7	30.951	54	-23.049	Ave
17100	16.33	0	100	H	42.941	8.31	36.7	30.881	54	-23.119	Ave
22800	31.36	0	100	V	49.67	9.74	36.9	53.87	74	-20.13	Peak
22800	29.77	0	100	H	49.67	9.74	36.9	52.28	74	-21.72	Peak
22800	16.17	0	100	V	49.67	9.74	36.9	38.68	54	-15.32	Ave
22800	16.15	0	100	H	49.67	9.74	36.9	38.66	54	-15.34	Ave

40 MHz Bandwidth

Frequency (MHz)	S.A. Reading (dBµV)	Turntable Azimuth (degrees)	Test Antenna			Cable Loss (dB)	Pre-Amp. (dB)	Cord. Reading (dBµV/m)	FCC		Comments
			Height (cm)	Polarity (H/V)	Factor (dB/m)				Limit (dBµV/m)	Margin (dB)	
Low Channel 5510 MHz, measured at 3 meters											
5510	61.69	0	135	V	33.922	3.47	0	99.082	-	-	Peak/Fund
5510	59.78	0	120	H	33.922	3.47	0	97.172	-	-	Peak/Fund
5510	49.38	0	135	V	33.922	3.47	0	86.772	-	-	Ave/Fund
5510	48.28	0	120	H	33.922	3.47	0	85.672	-	-	Ave/Fund
11020	29.21	0	100	V	38.845	6.2	36.5	37.755	74	-36.245	Peak
11020	29.41	0	100	H	38.845	6.2	36.5	37.955	74	-36.045	Peak
11020	14.83	0	100	V	38.845	6.2	36.5	23.375	54	-30.625	Ave
11020	15	0	100	H	38.845	6.2	36.5	23.545	54	-30.455	Ave
16530	29.23	0	100	V	42.941	8.31	36.7	43.781	74	-30.219	Peak
16530	29.3	0	100	H	42.941	8.31	36.7	43.851	74	-30.149	Peak
16530	15.36	0	100	V	42.941	8.31	36.7	29.911	54	-24.089	Ave
16530	15.17	0	100	H	42.941	8.31	36.7	29.721	54	-24.279	Ave
22040	29.15	0	100	V	49.67	9.74	36.9	51.66	74	-22.34	Peak
22040	30.16	0	100	H	49.67	9.74	36.9	52.67	74	-21.33	Peak
22040	14.97	0	100	V	49.67	9.74	36.9	37.48	54	-16.52	Ave
22040	15.22	0	100	H	49.67	9.74	36.9	37.73	54	-16.27	Ave
Middle Channel 5555 MHz, measured at 3 meters											
5555	61.15	0	135	V	33.922	3.47	0	98.542	-	-	Peak/Fund
5555	59.73	0	120	H	33.922	3.47	0	97.122	-	-	Peak/Fund
5555	48.98	0	135	V	33.922	3.47	0	86.372	-	-	Ave/Fund
5555	48.26	0	120	H	33.922	3.47	0	85.652	-	-	Ave/Fund
11110	33	0	100	V	38.845	6.2	36.5	41.545	74	-32.455	Peak
11110	33.04	0	100	H	38.845	6.2	36.5	41.585	74	-32.415	Peak
11110	15.89	0	100	V	38.845	6.2	36.5	24.435	54	-29.565	Ave
11110	16.07	0	100	H	38.845	6.2	36.5	24.615	54	-29.385	Ave
16665	29.48	0	100	V	42.941	8.31	36.7	44.031	74	-29.969	Peak
16665	28.81	0	100	H	42.941	8.31	36.7	43.361	74	-30.639	Peak
16665	15.12	0	100	V	42.941	8.31	36.7	29.671	54	-24.329	Ave
16665	15.07	0	100	H	42.941	8.31	36.7	29.621	54	-24.379	Ave
22220	28.87	0	100	V	49.67	9.74	36.9	51.38	74	-22.62	Peak
22220	28.83	0	100	H	49.67	9.74	36.9	51.34	74	-22.66	Peak
22220	15.27	0	100	V	49.67	9.74	36.9	37.78	54	-16.22	Ave
22220	15.33	0	100	H	49.67	9.74	36.9	37.84	54	-16.16	Ave

Frequency (MHz)	S.A. Reading (dBμV)	Turntable Azimuth (degrees)	Test Antenna			Cable Loss (dB)	Pre-Amp. (dB)	Cord. Reading (dBμV/m)	FCC		Comments
			Height (cm)	Polarity (H/V)	Factor (dB/m)				Limit (dBμV/m)	Margin (dB)	
High Channel 5690 MHz, measured at 3 meters											
5690	60.49	0	135	V	33.922	3.47	0	97.882	-	-	Peak/Fund
5690	59.88	0	120	H	33.922	3.47	0	97.272	-	-	Peak/Fund
5690	48.75	0	135	V	33.922	3.47	0	86.142	-	-	Ave/Fund
5690	48.45	0	120	H	33.922	3.47	0	85.842	-	-	Ave/Fund
11380	30.14	0	100	V	38.845	6.2	36.5	38.685	74	-35.315	Peak
11380	29.85	0	100	H	38.845	6.2	36.5	38.395	74	-35.605	Peak
11380	15.73	0	100	V	38.845	6.2	36.5	24.275	54	-29.725	Ave
11380	15.83	0	100	H	38.845	6.2	36.5	24.375	54	-29.625	Ave
17070	30.21	0	100	V	42.941	8.31	36.7	44.761	74	-29.239	Peak
17070	30.94	0	100	H	42.941	8.31	36.7	45.491	74	-28.509	Peak
17070	16.4	0	100	V	42.941	8.31	36.7	30.951	54	-23.049	Ave
17070	16.33	0	100	H	42.941	8.31	36.7	30.881	54	-23.119	Ave
22760	31.36	0	100	V	49.67	9.74	36.9	53.87	74	-20.13	Peak
22760	29.77	0	100	H	49.67	9.74	36.9	52.28	74	-21.72	Peak
22760	16.17	0	100	V	49.67	9.74	36.9	38.68	54	-15.32	Ave
22760	16.15	0	100	H	49.67	9.74	36.9	38.66	54	-15.34	Ave

80 MHz Bandwidth

Frequency (MHz)	S.A. Reading (dBµV)	Turntable Azimuth (degrees)	Test Antenna			Cable Loss (dB)	Pre-Amp. (dB)	Cord. Reading (dBµV/m)	FCC		Comments
			Height (cm)	Polarity (H/V)	Factor (dB/m)				Limit (dBµV/m)	Margin (dB)	
Low Channel 5530 MHz, measured at 3 meters											
5530	58.75	0	135	V	33.922	3.47	0	96.142	-	-	Peak/Fund
5530	57.6	0	120	H	33.922	3.47	0	94.992	-	-	Peak/Fund
5530	44.56	0	135	V	33.922	3.47	0	81.952	-	-	Ave/Fund
5530	44.53	0	120	H	33.922	3.47	0	81.922	-	-	Ave/Fund
11060	29.21	0	100	V	38.845	6.2	36.5	37.755	74	-36.245	Peak
11060	29.41	0	100	H	38.845	6.2	36.5	37.955	74	-36.045	Peak
11060	14.83	0	100	V	38.845	6.2	36.5	23.375	54	-30.625	Ave
11060	15	0	100	H	38.845	6.2	36.5	23.545	54	-30.455	Ave
16590	29.23	0	100	V	42.941	8.31	36.7	43.781	74	-30.219	Peak
16590	29.3	0	100	H	42.941	8.31	36.7	43.851	74	-30.149	Peak
16590	15.36	0	100	V	42.941	8.31	36.7	29.911	54	-24.089	Ave
16590	15.17	0	100	H	42.941	8.31	36.7	29.721	54	-24.279	Ave
22120	29.15	0	100	V	49.67	9.74	36.9	51.66	74	-22.34	Peak
22120	30.16	0	100	H	49.67	9.74	36.9	52.67	74	-21.33	Peak
22120	14.97	0	100	V	49.67	9.74	36.9	37.48	54	-16.52	Ave
22120	15.22	0	100	H	49.67	9.74	36.9	37.73	54	-16.27	Ave
Middle Channel 5545 MHz, measured at 3 meters											
5545	59.51	0	135	V	33.922	3.47	0	96.902	-	-	Peak/Fund
5545	58.02	0	120	H	33.922	3.47	0	95.412	-	-	Peak/Fund
5545	43.87	0	135	V	33.922	3.47	0	81.262	-	-	Ave/Fund
5545	44.3	0	120	H	33.922	3.47	0	81.692	-	-	Ave/Fund
11090	30.14	0	100	V	38.845	6.2	36.5	38.685	74	-35.315	Peak
11090	29.85	0	100	H	38.845	6.2	36.5	38.395	74	-35.605	Peak
11090	15.73	0	100	V	38.845	6.2	36.5	24.275	54	-29.725	Ave
11090	15.83	0	100	H	38.845	6.2	36.5	24.375	54	-29.625	Ave
16635	30.21	0	100	V	42.941	8.31	36.7	44.761	74	-29.239	Peak
16635	30.94	0	100	H	42.941	8.31	36.7	45.491	74	-28.509	Peak
16635	16.4	0	100	V	42.941	8.31	36.7	30.951	54	-23.049	Ave
16635	16.33	0	100	H	42.941	8.31	36.7	30.881	54	-23.119	Ave
22180	31.36	0	100	V	49.67	9.74	36.9	53.87	74	-20.13	Peak
22180	29.77	0	100	H	49.67	9.74	36.9	52.28	74	-21.72	Peak
22180	16.17	0	100	V	49.67	9.74	36.9	38.68	54	-15.32	Ave
22180	16.15	0	100	H	49.67	9.74	36.9	38.66	54	-15.34	Ave

Frequency (MHz)	S.A. Reading (dB μ V)	Turntable Azimuth (degrees)	Test Antenna			Cable Loss (dB)	Pre-Amp. (dB)	Cord. Reading (dB μ V/m)	FCC		Comments
			Height (cm)	Polarity (H/V)	Factor (dB/m)				Limit (dB μ V/m)	Margin (dB)	
High Channel 5560 MHz, measured at 3 meters											
5560	59.27	0	135	V	33.922	3.47	0	96.662	-	-	Peak/Fund
5560	58.22	0	120	H	33.922	3.47	0	95.612	-	-	Peak/Fund
5560	44.77	0	135	V	33.922	3.47	0	82.162	-	-	Ave/Fund
5560	44.31	0	120	H	33.922	3.47	0	81.702	-	-	Ave/Fund
11120	30.2	0	100	V	38.845	6.2	36.5	38.745	74	-35.255	Peak
11120	29.91	0	100	H	38.845	6.2	36.5	38.455	74	-35.545	Peak
11120	15.79	0	100	V	38.845	6.2	36.5	24.335	54	-29.665	Ave
11120	15.89	0	100	H	38.845	6.2	36.5	24.435	54	-29.565	Ave
16680	30.27	0	100	V	42.941	8.31	36.7	44.821	74	-29.179	Peak
16680	31	0	100	H	42.941	8.31	36.7	45.551	74	-28.449	Peak
16680	16.46	0	100	V	42.941	8.31	36.7	31.011	54	-22.989	Ave
16680	16.39	0	100	H	42.941	8.31	36.7	30.941	54	-23.059	Ave
22240	31.42	0	100	V	49.67	9.74	36.9	53.93	74	-20.07	Peak
22240	29.83	0	100	H	49.67	9.74	36.9	52.34	74	-21.66	Peak
22240	16.23	0	100	V	49.67	9.74	36.9	38.74	54	-15.26	Ave
22240	16.21	0	100	H	49.67	9.74	36.9	38.72	54	-15.28	Ave

3) Restricted Band Edge, Measured at 3 meters**25 dBi Antenna:****5.3 GHz Band****20 MHz Bandwidth**

Frequency (MHz)	S.A. Reading (dB μ V)	Turntable Azimuth (degrees)	Test Antenna			Cable Loss (dB)	Pre-Amp. (dB)	Cord. Reading (dB μ V/m)	FCC		Comments
			Height (cm)	Polarity (H/V)	Factor (dB/m)				Limit (dB μ V/m)	Margin (dB)	
Low Channel 5260 MHz, measured at 3 meters											
4500	26.21	0	135	V	33.835	4.56	0	64.605	74	-9.395	Peak
4500	24.07	0	120	H	33.835	4.56	0	62.465	74	-11.535	Peak
4500	12.62	0	135	V	33.835	4.56	0	51.015	54	-2.985	Ave
4500	10.55	0	120	H	33.835	4.56	0	48.945	54	-5.055	Ave
High Channel 5320 MHz, measured at 3 meters											
5350	31.66	0	135	V	33.835	4.56	0	70.055	74	-3.945	Peak
5350	29.73	0	120	H	33.835	4.56	0	68.125	74	-5.875	Peak
5350	14.58	0	135	V	33.835	4.56	0	52.975	54	-1.025	Ave
5350	14.09	0	120	H	33.835	4.56	0	52.485	54	-1.515	Ave

40 MHz Bandwidth

Frequency (MHz)	S.A. Reading (dB μ V)	Turntable Azimuth (degrees)	Test Antenna			Cable Loss (dB)	Pre-Amp. (dB)	Cord. Reading (dB μ V/m)	FCC		Comments
			Height (cm)	Polarity (H/V)	Factor (dB/m)				Limit (dB μ V/m)	Margin (dB)	
Low Channel 5270 MHz, measured at 3 meters											
4500	26.3	0	135	V	33.835	4.56	0	64.695	74	-9.305	Peak
4500	23.66	0	120	H	33.835	4.56	0	62.055	74	-11.945	Peak
4500	12.38	0	135	V	33.835	4.56	0	50.775	54	-3.225	Ave
4500	11.7	0	120	H	33.835	4.56	0	50.095	54	-3.905	Ave
High Channel 5310 MHz, measured at 3 meters											
5350	31.71	0	135	V	33.835	4.56	0	70.105	74	-3.895	Peak
5350	31.35	0	120	H	33.835	4.56	0	69.745	74	-4.255	Peak
5350	14.94	0	135	V	33.835	4.56	0	53.335	54	-0.665	Ave
5350	13.73	0	120	H	33.835	4.56	0	52.125	54	-1.875	Ave

80 MHz Bandwidth

Frequency (MHz)	S.A. Reading (dB μ V)	Turntable Azimuth (degrees)	Test Antenna			Cable Loss (dB)	Pre-Amp. (dB)	Cord. Reading (dB μ V/m)	FCC		Comments
			Height (cm)	Polarity (H/V)	Factor (dB/m)				Limit (dB μ V/m)	Margin (dB)	
Channel 5290 MHz, measured at 3 meters											
4500	25.95	0	135	V	33.835	4.56	0	64.345	74	-9.655	Peak
4500	24.42	0	120	H	33.835	4.56	0	62.815	74	-11.185	Peak
4500	12.09	0	135	V	33.835	4.56	0	50.485	54	-3.515	Ave
4500	11.18	0	120	H	33.835	4.56	0	49.575	54	-4.425	Ave
Channel 5290 MHz, measured at 3 meters											
5350	31.12	0	135	V	33.835	4.56	0	69.515	74	-4.485	Peak
5350	32.15	0	120	H	33.835	4.56	0	70.545	74	-3.455	Peak
5350	15.08	0	135	V	33.835	4.56	0	53.475	54	-0.525	Ave
5350	14.81	0	120	H	33.835	4.56	0	53.205	54	-0.795	Ave

5.6 GHz Band**20 MHz Bandwidth**

Frequency (MHz)	S.A. Reading (dB μ V)	Turntable Azimuth (degrees)	Test Antenna			Cable Loss (dB)	Pre-Amp. (dB)	Cord. Reading (dB μ V/m)	FCC		Comments
			Height (cm)	Polarity (H/V)	Factor (dB/m)				Limit (dB μ V/m)	Margin (dB)	
Low Channel 5745 MHz, measured at 3 meters											
5350	24.74	0	135	V	33.977	4.59	0	63.307	74	-10.693	Peak
5350	24.16	0	120	H	33.977	4.59	0	62.727	74	-11.273	Peak
5350	10.48	0	135	V	33.977	4.59	0	49.047	54	-4.953	Ave
5350	10.52	0	120	H	33.977	4.59	0	49.087	54	-4.913	Ave

40 MHz Bandwidth

Frequency (MHz)	S.A. Reading (dB μ V)	Turntable Azimuth (degrees)	Test Antenna			Cable Loss (dB)	Pre-Amp. (dB)	Cord. Reading (dB μ V/m)	FCC		Comments
			Height (cm)	Polarity (H/V)	Factor (dB/m)				Limit (dB μ V/m)	Margin (dB)	
Low Channel 5745 MHz, measured at 3 meters											
5350	24.19	0	135	V	33.977	4.59	0	62.757	74	-11.243	Peak
5350	24.44	0	120	H	33.977	4.59	0	63.007	74	-10.993	Peak
5350	11.15	0	135	V	33.977	4.59	0	49.717	54	-4.283	Ave
5350	11.36	0	120	H	33.977	4.59	0	49.927	54	-4.073	Ave

80 MHz Bandwidth

Frequency (MHz)	S.A. Reading (dB μ V)	Turntable Azimuth (degrees)	Test Antenna			Cable Loss (dB)	Pre-Amp. (dB)	Cord. Reading (dB μ V/m)	FCC		Comments
			Height (cm)	Polarity (H/V)	Factor (dB/m)				Limit (dB μ V/m)	Margin (dB)	
Low Channel 5745 MHz, measured at 3 meters											
5350	24.51	0	135	V	33.977	4.59	0	63.077	74	-10.923	Peak
5350	23.64	0	120	H	33.977	4.59	0	62.207	74	-11.793	Peak
5350	10.71	0	135	V	33.977	4.59	0	49.277	54	-4.723	Ave
5350	10.87	0	120	H	33.977	4.59	0	49.437	54	-4.563	Ave

0 dBi Antenna:**5.3 GHz Band****20 MHz bandwidth**

Frequency (MHz)	S.A. Reading (dB μ V)	Turntable Azimuth (degrees)	Test Antenna			Cable Loss (dB)	Pre-Amp. (dB)	Cord. Reading (dB μ V/m)	FCC		Comments
			Height (cm)	Polarity (H/V)	Factor (dB/m)				Limit (dB μ V/m)	Margin (dB)	
Low Channel 5260 MHz, measured at 3 meters											
4500	27.34	0	135	V	33.835	3.47	0	64.645	74	-9.355	Peak
4500	25.2	0	120	H	33.835	3.47	0	62.505	74	-11.495	Peak
4500	13.75	0	135	V	33.835	3.47	0	51.055	54	-2.945	Ave
4500	11.68	0	120	H	33.835	3.47	0	48.985	54	-5.015	Ave
High Channel 5320 MHz, measured at 3 meters											
5350	32.79	0	135	V	33.835	3.47	0	70.095	74	-3.905	Peak
5350	30.86	0	120	H	33.835	3.47	0	68.165	74	-5.835	Peak
5350	15.71	0	135	V	33.835	3.47	0	53.015	54	-0.985	Ave
5350	15.22	0	120	H	33.835	3.47	0	52.525	54	-1.475	Ave

40 MHz bandwidth

Frequency (MHz)	S.A. Reading (dB μ V)	Turntable Azimuth (degrees)	Test Antenna			Cable Loss (dB)	Pre-Amp. (dB)	Cord. Reading (dB μ V/m)	FCC		Comments
			Height (cm)	Polarity (H/V)	Factor (dB/m)				Limit (dB μ V/m)	Margin (dB)	
Low Channel 5270 MHz, measured at 3 meters											
4500	27.43	0	135	V	33.835	3.47	0	64.735	74	-9.265	Peak
4500	24.79	0	120	H	33.835	3.47	0	62.095	74	-11.905	Peak
4500	13.51	0	135	V	33.835	3.47	0	50.815	54	-3.185	Ave
4500	12.83	0	120	H	33.835	3.47	0	50.135	54	-3.865	Ave
High Channel 5310 MHz, measured at 3 meters											
5350	32.84	0	135	V	33.835	3.47	0	70.145	74	-3.855	Peak
5350	32.48	0	120	H	33.835	3.47	0	69.785	74	-4.215	Peak
5350	16.07	0	135	V	33.835	3.47	0	53.375	54	-0.625	Ave
5350	14.86	0	120	H	33.835	3.47	0	52.165	54	-1.835	Ave

80 MHz bandwidth

Frequency (MHz)	S.A. Reading (dBμV)	Turntable Azimuth (degrees)	Test Antenna			Cable Loss (dB)	Pre-Amp. (dB)	Cord. Reading (dBμV/m)	FCC		Comments
			Height (cm)	Polarity (H/V)	Factor (dB/m)				Limit (dBμV/m)	Margin (dB)	
Channel 5195 MHz, measured at 3 meters											
4500	27.08	0	135	V	33.835	3.47	0	64.385	74	-9.615	Peak
4500	25.55	0	120	H	33.835	3.47	0	62.855	74	-11.145	Peak
4500	13.22	0	135	V	33.835	3.47	0	50.525	54	-3.475	Ave
4500	12.31	0	120	H	33.835	3.47	0	49.615	54	-4.385	Ave
Channel 5210 MHz, measured at 3 meters											
5350	32.25	0	135	V	33.835	3.47	0	69.555	74	-4.445	Peak
5350	33.28	0	120	H	33.835	3.47	0	70.585	74	-3.415	Peak
5350	16.21	0	135	V	33.835	3.47	0	53.515	54	-0.485	Ave
5350	15.94	0	120	H	33.835	3.47	0	53.245	54	-0.755	Ave

5.6 GHz Band**20 MHz bandwidth**

Frequency (MHz)	S.A. Reading (dBμV)	Turntable Azimuth (degrees)	Test Antenna			Cable Loss (dB)	Pre-Amp. (dB)	Cord. Reading (dBμV/m)	FCC		Comments
			Height (cm)	Polarity (H/V)	Factor (dB/m)				Limit (dBμV/m)	Margin (dB)	
Low Channel measured at 3 meters											
5350	25.87	0	135	V	33.835	3.47	0	63.175	74	-10.825	Peak
5350	25.29	0	120	H	33.835	3.47	0	62.595	74	-11.405	Peak
5350	11.61	0	135	V	33.835	3.47	0	48.915	54	-5.085	Ave
5350	11.65	0	120	H	33.835	3.47	0	48.955	54	-5.045	Ave

40 MHz bandwidth

Frequency (MHz)	S.A. Reading (dBμV)	Turntable Azimuth (degrees)	Test Antenna			Cable Loss (dB)	Pre-Amp. (dB)	Cord. Reading (dBμV/m)	FCC		Comments
			Height (cm)	Polarity (H/V)	Factor (dB/m)				Limit (dBμV/m)	Margin (dB)	
Low Channel measured at 3 meters											
5350	25.32	0	135	V	33.835	3.47	0	62.625	74	-11.375	Peak
5350	25.57	0	120	H	33.835	3.47	0	62.875	74	-11.125	Peak
5350	12.28	0	135	V	33.835	3.47	0	49.585	54	-4.415	Ave
5350	12.49	0	120	H	33.835	3.47	0	49.795	54	-4.205	Ave

80 MHz bandwidth

Frequency (MHz)	S.A. Reading (dBμV)	Turntable Azimuth (degrees)	Test Antenna			Cable Loss (dB)	Pre-Amp. (dB)	Cord. Reading (dBμV/m)	FCC		Comments
			Height (cm)	Polarity (H/V)	Factor (dB/m)				Limit (dBμV/m)	Margin (dB)	
Low Channel measured at 3 meters											
5350	25.64	0	135	V	33.835	3.47	0	62.945	74	-11.055	Peak
5350	24.77	0	120	H	33.835	3.47	0	62.075	74	-11.925	Peak
5350	11.84	0	135	V	33.835	3.47	0	49.145	54	-4.855	Ave
5350	12.01	0	120	H	33.835	3.47	0	49.315	54	-4.685	Ave

8 FCC §15.407(a) & §15.407(e) – Emission Bandwidth

8.1 Applicable Standard

FCC §15.407(a) and FCC §15.407(e)

8.2 Measurement Procedure

The measurements are base on FCC KDB 789033 D02 General UNII Test Procedures v01: Guidelines for Compliance Testing of Unlicensed National Information Infrastructure (U-NII) Devices section C: Emission bandwidth and section D: 99 Percent Occupied Bandwidth

8.3 Test Equipment List and Details

Manufacturer	Description	Model No.	Serial No.	Calibration Date	Calibration Interval
Agilent	Spectrum Analyzer	E4446A	US44300386	2013-09-29	1 year

Statement of Traceability: BACL Corp. attests that all calibrations have been performed according to A2LA requirements, traceable to the NIST.

8.4 Test Environmental Conditions

Temperature:	22-23° C
Relative Humidity:	43-53 %
ATM Pressure:	101-101.3 kPa

The testing was performed by Cipher Chu on 2014-04-04 to 2014-04-07 and 2014-08-09 to 2014-08-21 at the RF Site.

8.5 Test Results

Please refer to the following tables and plots

Note: (1) Chain1 and Chain 4 is Vertical, and Chain 2 and Chain 3 is Horizontal
 (2) C1, C2, C3 and C4 stands for TX Chain1, Chain2, Chain3 and Chain4.

25 dBi Antenna:**5.3 GHz Band**

Antenna Port	Channel	Frequency (MHz)	99% Emission Bandwidth (MHz)
20 MHz Bandwidth			
C1	Low	5260	18.2166
	Middle	5295	18.1762
	High	5320	18.1892
C2	Low	5260	18.0997
	Middle	5295	18.1042
	High	5320	18.1113
C3	Low	5260	18.0170
	Middle	5295	18.0065
	High	5320	18.0328
C4	Low	5260	17.9642
	Middle	5295	17.9233
	High	5320	17.9264
40 MHz Bandwidth			
C1	Low	5270	36.3431
	Middle	5290	36.3032
	High	5310	36.3786
C2	Low	5270	36.3262
	Middle	5290	36.3025
	High	5310	36.2567
C3	Low	5270	36.2886
	Middle	5290	36.2550
	High	5310	36.2234
C4	Low	5270	36.2555
	Middle	5290	36.2312
	High	5310	36.2343
80 MHz Bandwidth			
C1		5290	75.3719
C2		5290	75.2296
C3		5290	75.3033
C4		5290	75.3379

5.6 GHz Band

Antenna Port	Channel	Frequency (MHz)	99% Emission Bandwidth (MHz)
20 MHz Bandwidth			
C1	Low	5500	18.1953
	Middle	5590	18.1537
	High	5700	18.1665
C2	Low	5500	18.0639
	Middle	5590	18.0230
	High	5700	18.1344
C3	Low	5500	17.9591
	Middle	5590	18.0516
	High	5700	18.0571
C4	Low	5500	17.9569
	Middle	5590	17.9804
	High	5700	17.9548
40 MHz Bandwidth			
C1	Low	5510	36.3534
	Middle	5555	36.3486
	High	5690	36.3917
C2	Low	5510	36.3055
	Middle	5555	36.2912
	High	5690	36.2758
C3	Low	5510	36.3085
	Middle	5555	36.2802
	High	5690	36.3027
C4	Low	5510	36.2567
	Middle	5555	36.2659
	High	5690	36.2405
80 MHz Bandwidth			
C1	Low	5530	75.4508
	Middle	5545	75.3264
	High	5560	75.4700
C2	Low	5530	75.1163
	Middle	5545	75.0646
	High	5560	75.1635
C3	Low	5530	75.3913
	Middle	5545	75.2796
	High	5560	75.3806
C4	Low	5530	75.4241
	Middle	5545	75.4404
	High	5560	75.4948

0 dBi Antenna:**5.3 GHz Band**

TX Chain	Channel	Frequency (MHz)	99% Emission Bandwidth (MHz)
20 MHz bandwidth			
C1	Low	5260	18.1257
	Middle	5295	17.991
	High	5320	18.1082
C2	Low	5260	18.0327
	Middle	5295	18.1019
	High	5320	17.9132
C3	Low	5260	18.1717
	Middle	5295	17.9534
	High	5320	18.0503
C4	Low	5260	18.0339
	Middle	5295	18.1453
	High	5320	17.9591
40 MHz bandwidth			
C1	Low	5270	36.5297
	Middle	5290	36.9605
	High	5310	36.4483
C2	Low	5270	36.284
	Middle	5290	37.0397
	High	5310	36.3841
C3	Low	5270	36.3667
	Middle	5290	36.9129
	High	5310	36.4989
C4	Low	5270	36.5788
	Middle	5290	36.6069
	High	5310	36.4288
80 MHz bandwidth			
C1	-	5290	75.567
C2	-	5290	75.5998
C3	-	5290	75.5725
C4	-	5290	75.5153

5.6 GHz Band

Antenna Port	Channel	Frequency (MHz)	99% Emission Bandwidth (MHz)
20 MHz Bandwidth			
C1	Low	5500	17.954
	Middle	5590	17.9358
	High	5700	17.966
C2	Low	5500	17.9423
	Middle	5590	17.8575
	High	5700	17.9203
C3	Low	5500	17.9246
	Middle	5590	17.9269
	High	5700	17.9292
C4	Low	5500	17.9547
	Middle	5590	17.9201
	High	5700	17.9544
40 MHz Bandwidth			
C1	Low	5510	36.34
	Middle	5555	36.4114
	High	5690	36.347
C2	Low	5510	36.4682
	Middle	5555	36.4177
	High	5690	36.3558
C3	Low	5510	36.3592
	Middle	5555	36.2172
	High	5690	36.3284
C4	Low	5510	36.4488
	Middle	5555	36.3276
	High	5690	36.2791
80 MHz Bandwidth			
C1	Low	5530	75.6297
	Middle	5545	75.6056
	High	5560	75.5044
C2	Low	5530	75.6772
	Middle	5545	75.4359
	High	5560	75.5405
C3	Low	5530	75.5048
	Middle	5545	75.6202
	High	5560	75.4285
C4	Low	5530	75.5143
	Middle	5545	75.5888
	High	5560	100.759

25 dBi Antenna:

5.3 GHz Band

20 MHz Bandwidth, Low Channel, 5260 MHz

C1

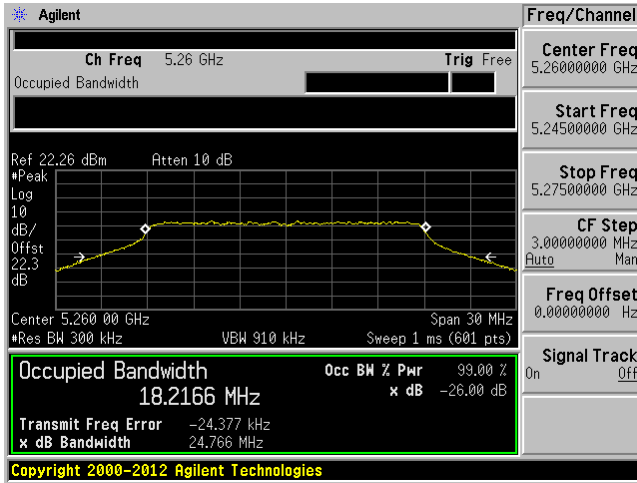

C2

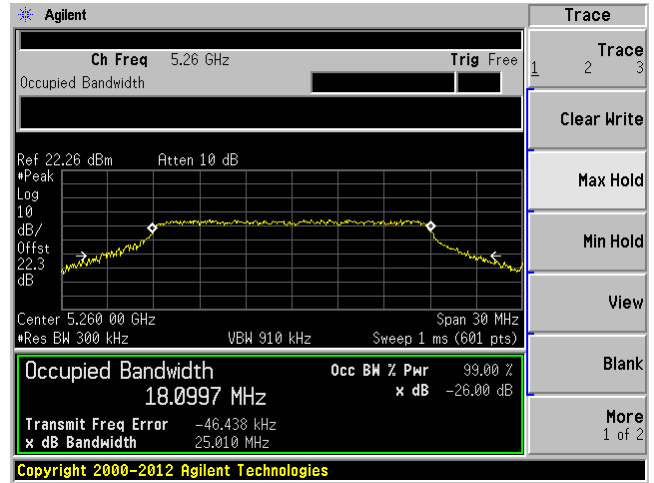

C3

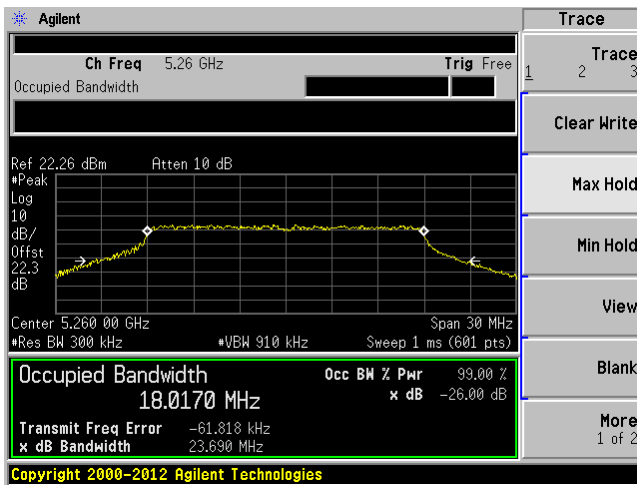

C4

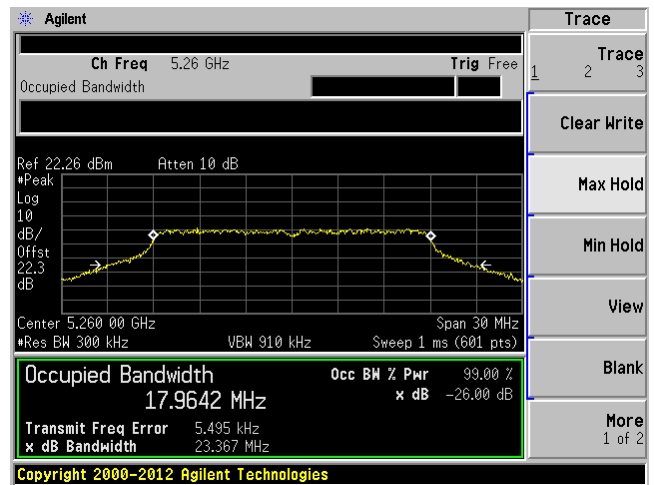

20 MHz Bandwidth, Middle Channel, 5295 MHz

C1

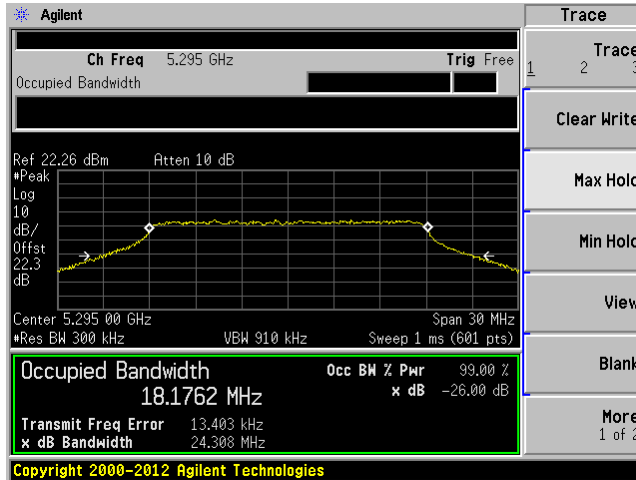

C2

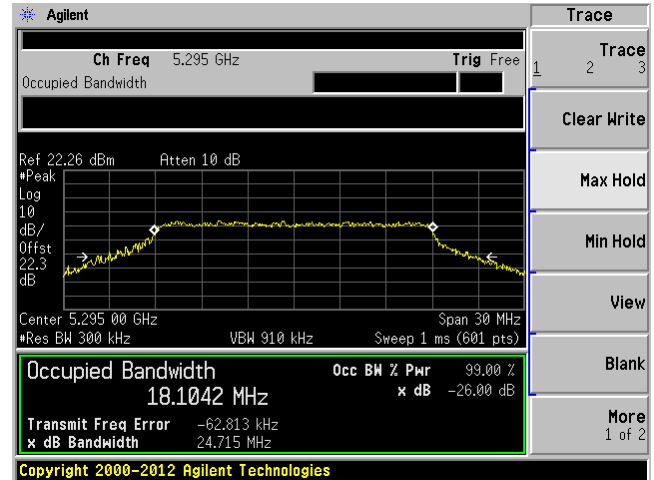

C3

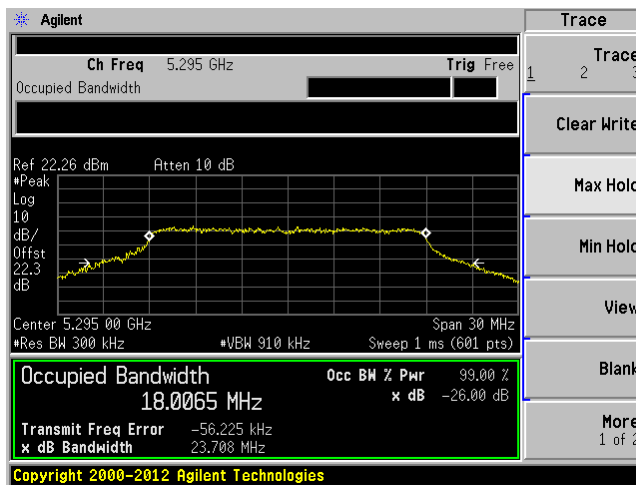

C4

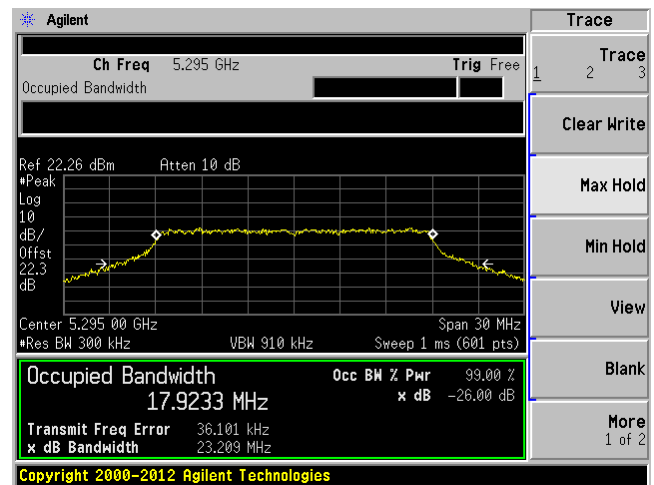

20 MHz Bandwidth, High Channel, 5320 MHz

C1

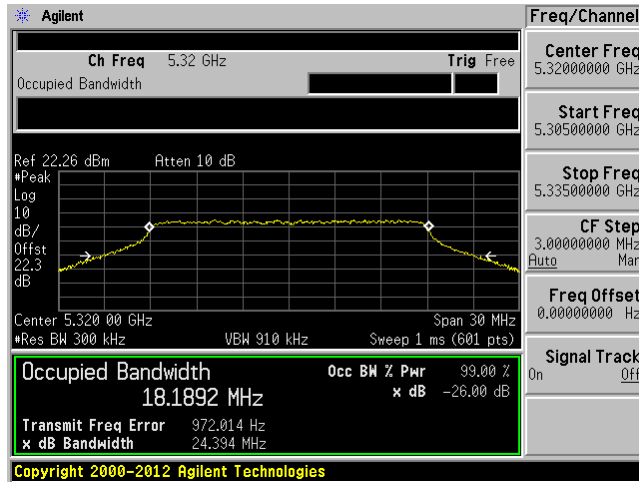

C2

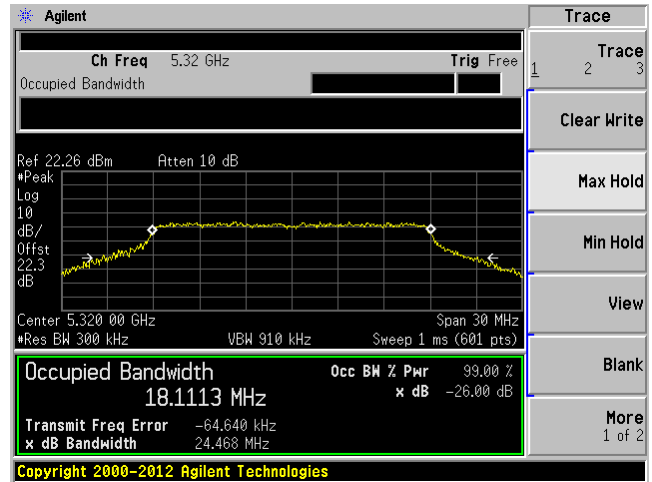

C3

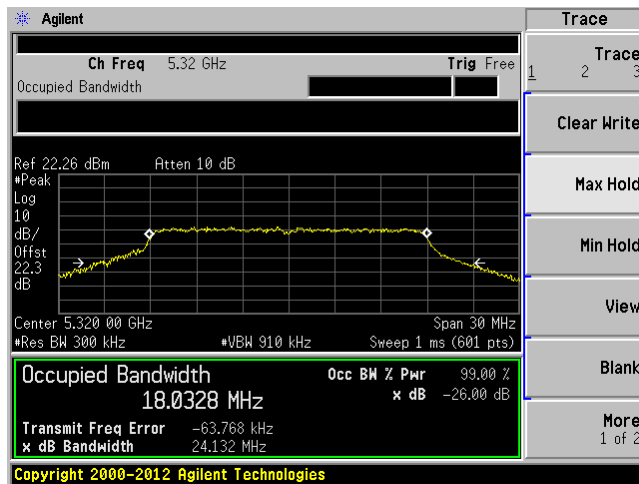

C4

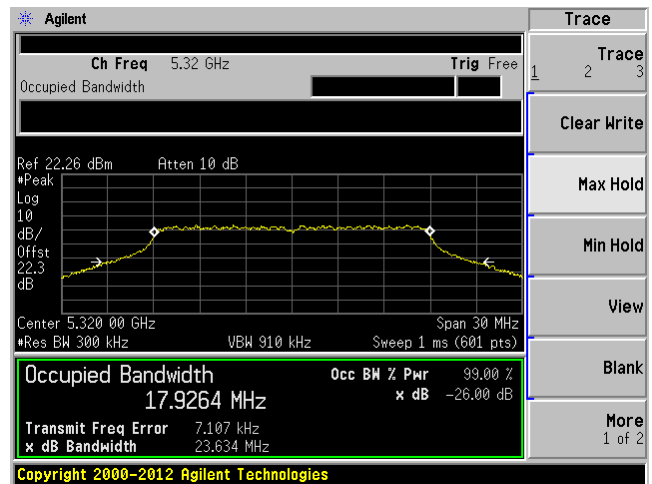

40 MHz Bandwidth, Low Channel, 5270 MHz

C1

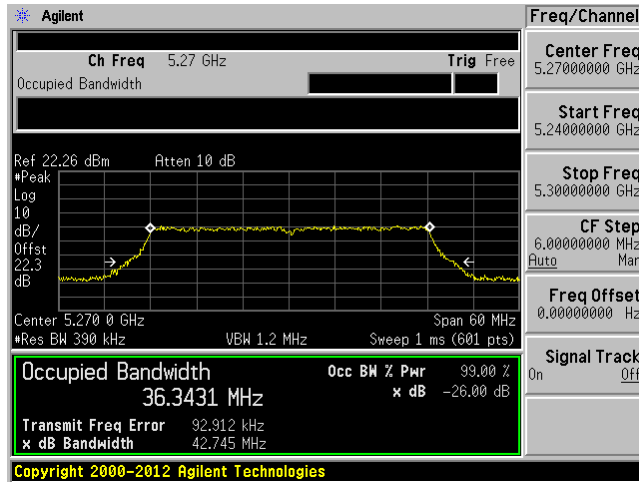

C2

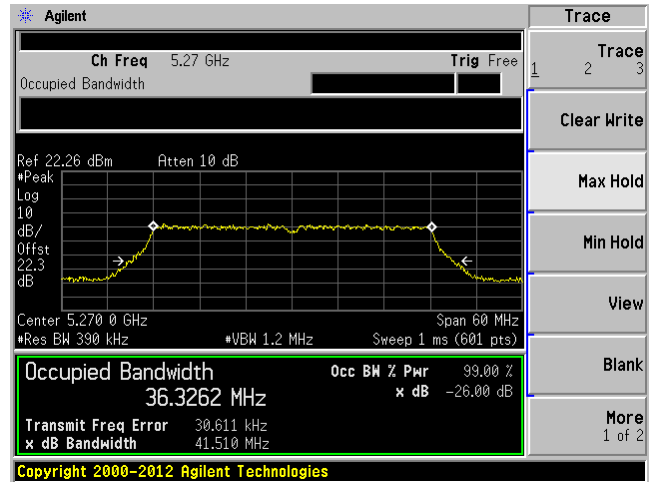

C3

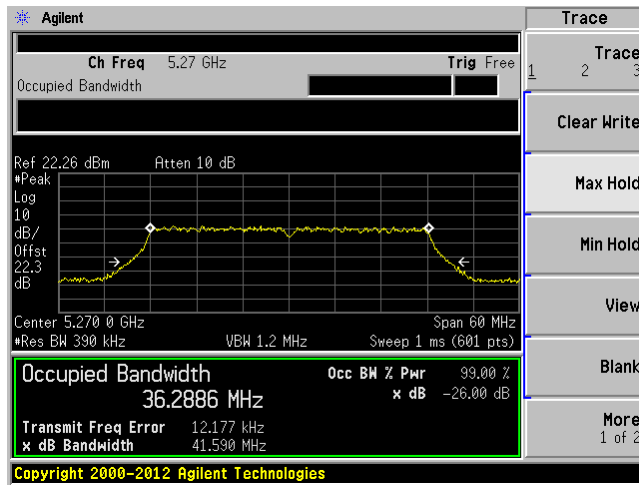

C4

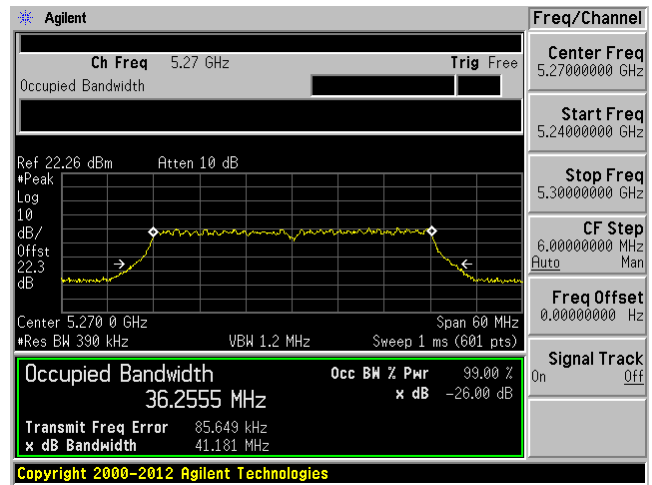

40 MHz Bandwidth, Middle Channel, 5290 MHz

C1

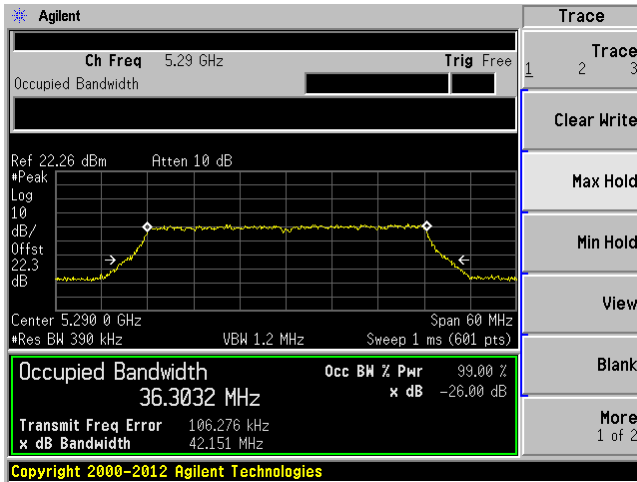

C2

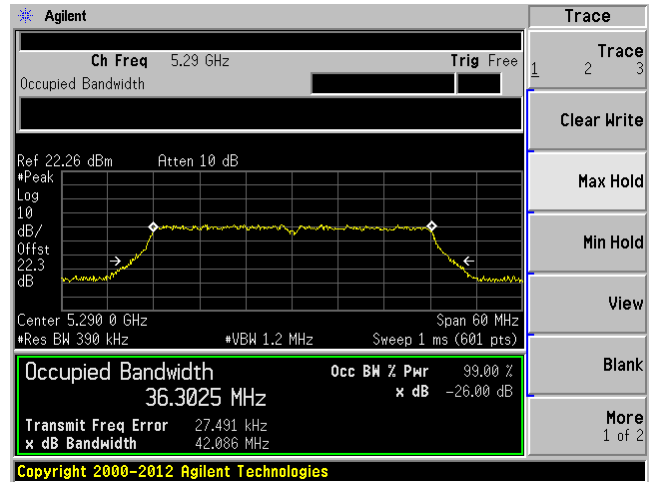

C3

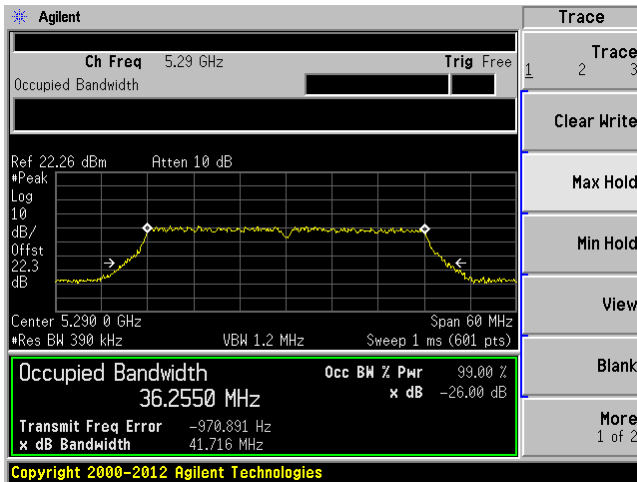

C4

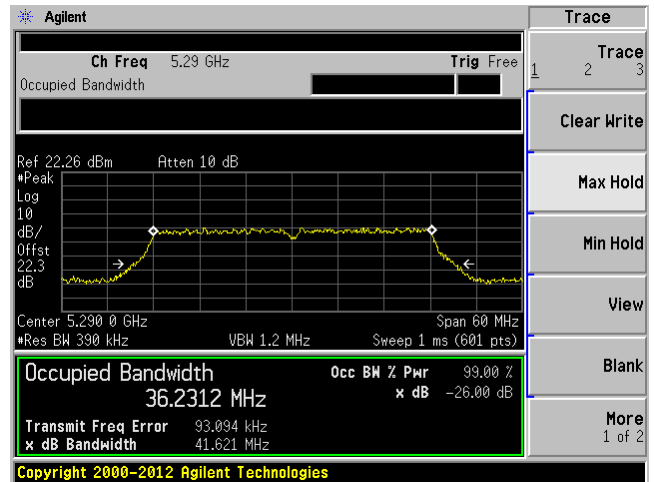

40 MHz Bandwidth, High Channel, 5310 MHz

C1

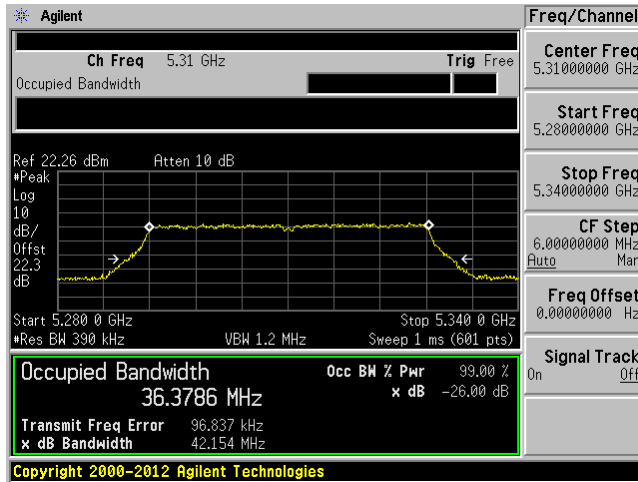

C2

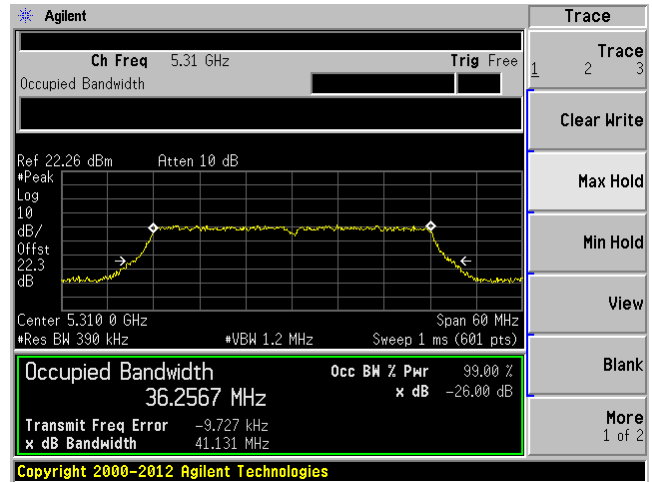

C3

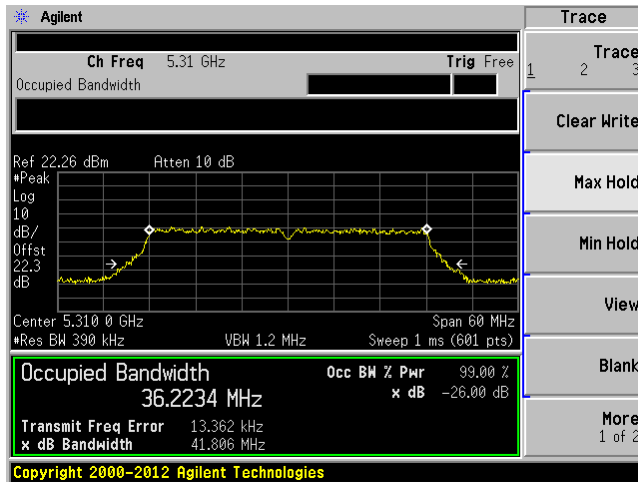

C4

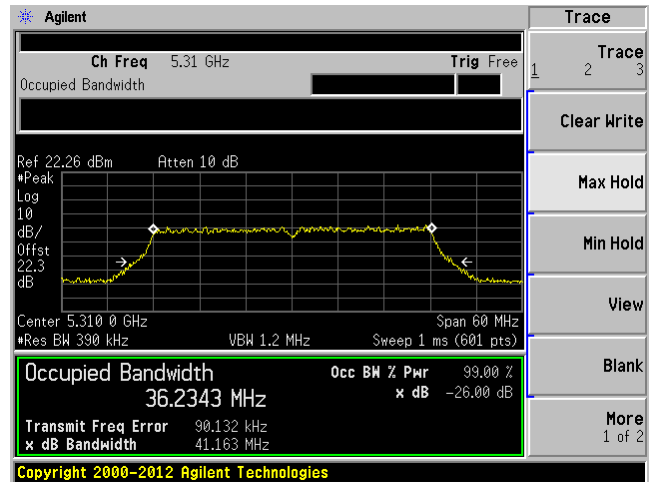

80 MHz Bandwidth, Channel, 5290 MHz

C1

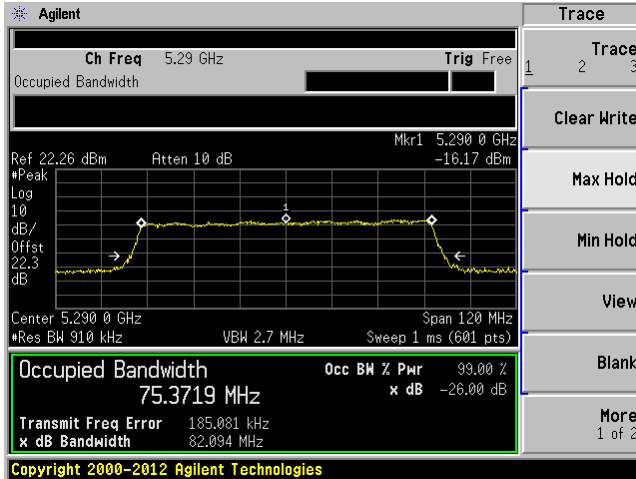

C2

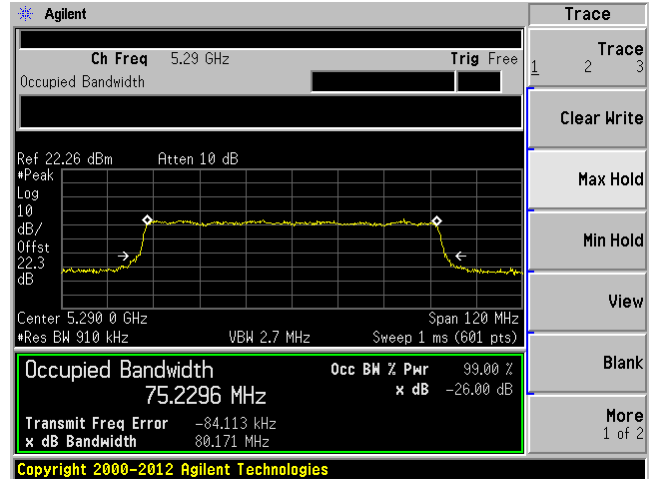

C3

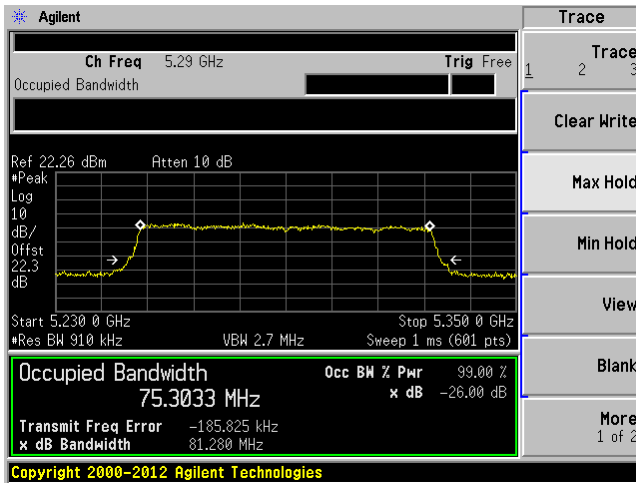

C4

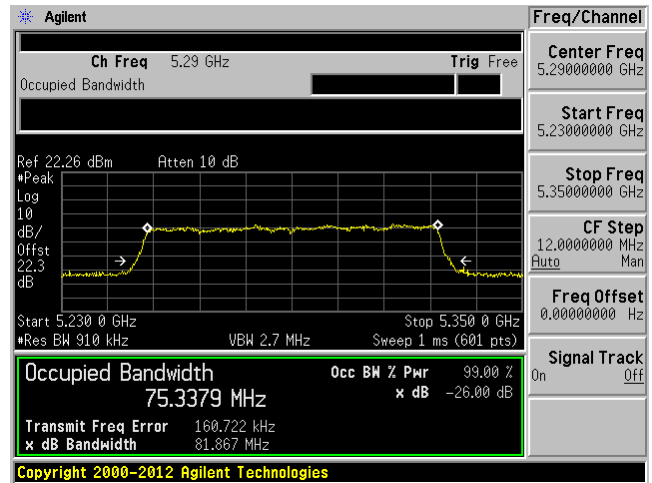

5.6 GHz Band

20 MHz Bandwidth, Low Channel, 5500 MHz

C1

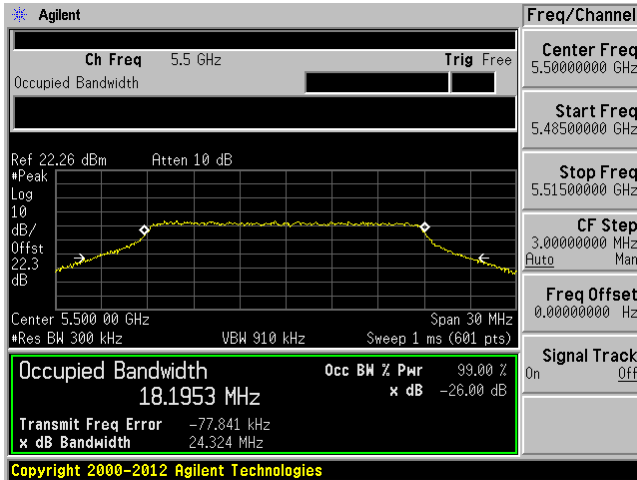

C2

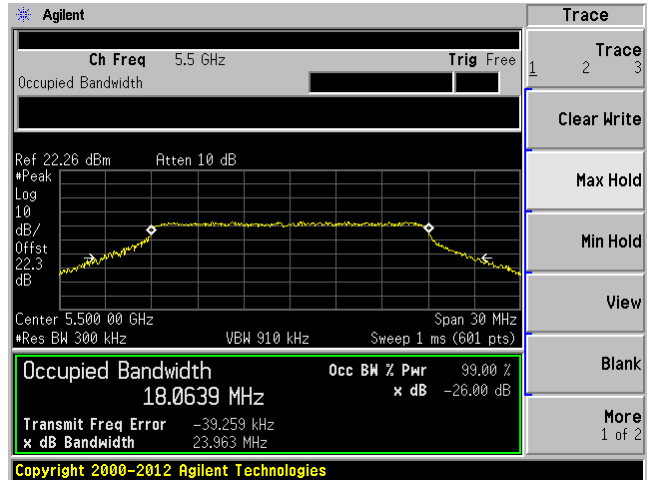

C3

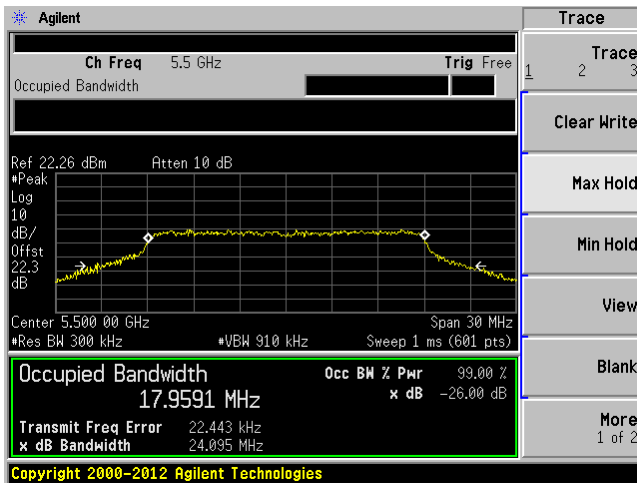

C4

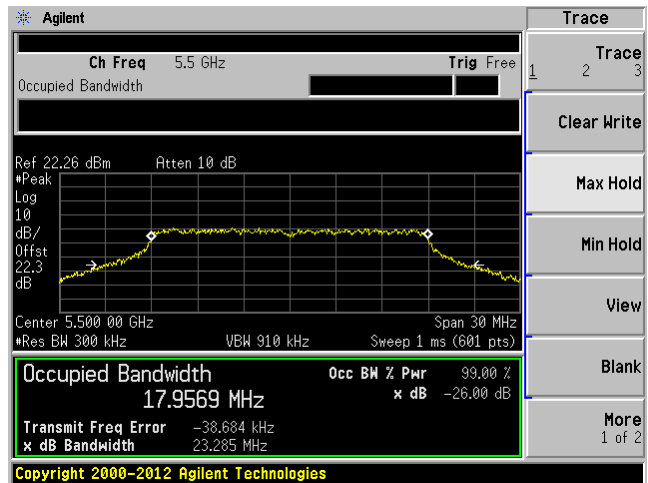

20 MHz Bandwidth, Middle Channel, 5590 MHz

C1

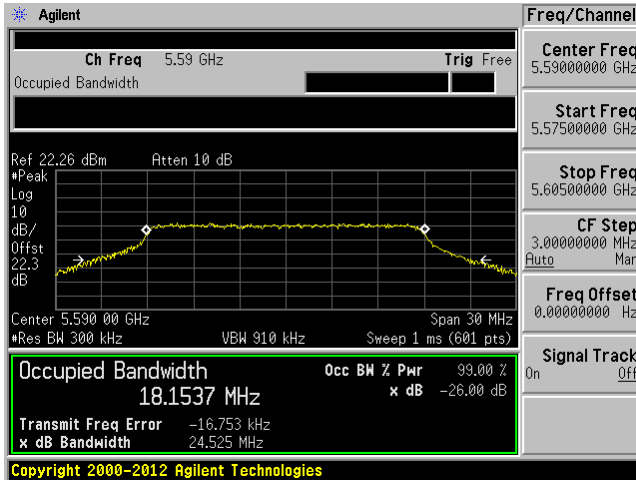

C2

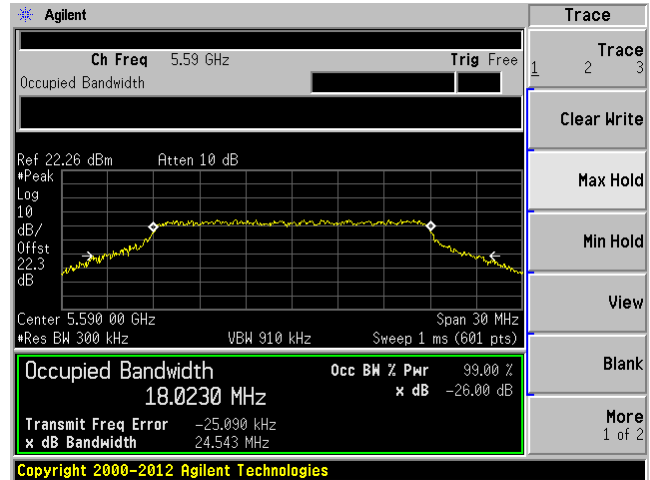

C3

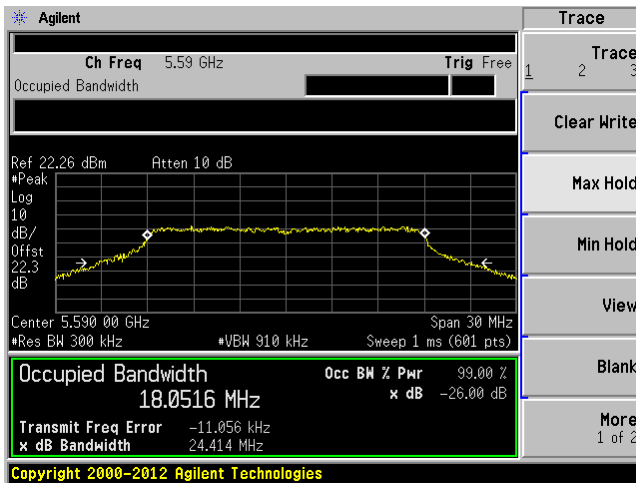

C4

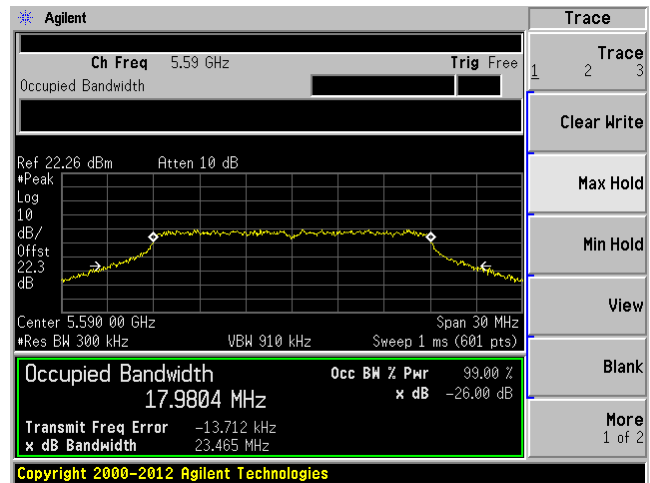

20 MHz Bandwidth, High Channel, 5700 MHz

C1

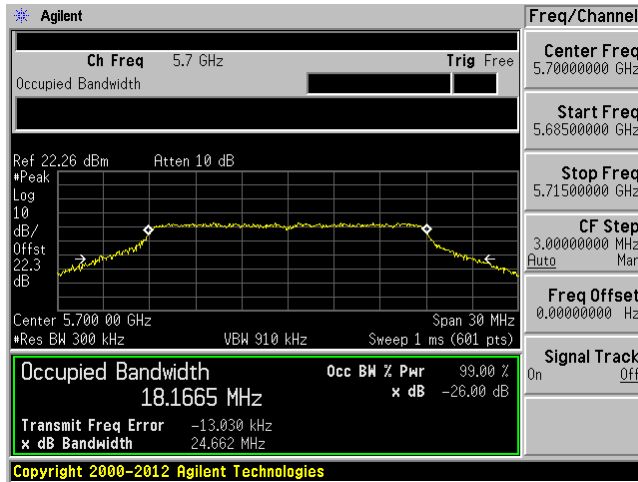

C2

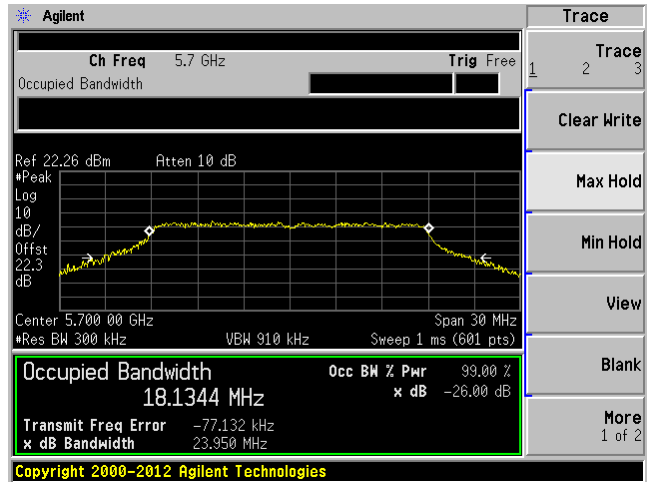

C3

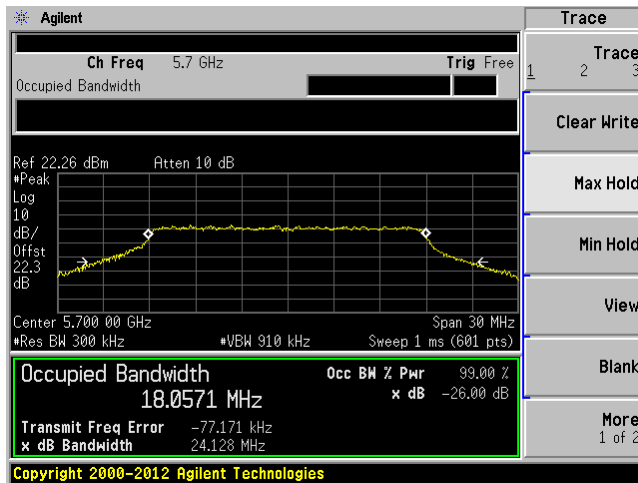

C4

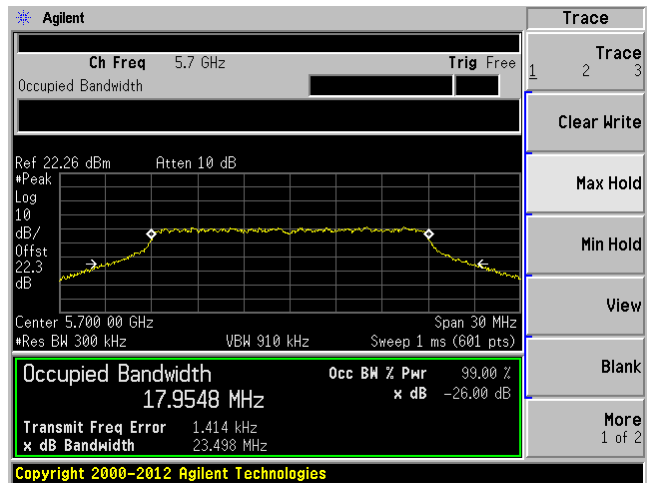

40 MHz Bandwidth, Low Channel, 5510 MHz

C1

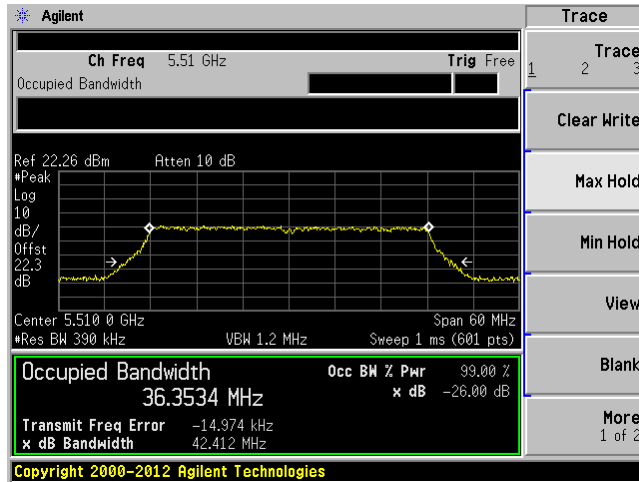

C2

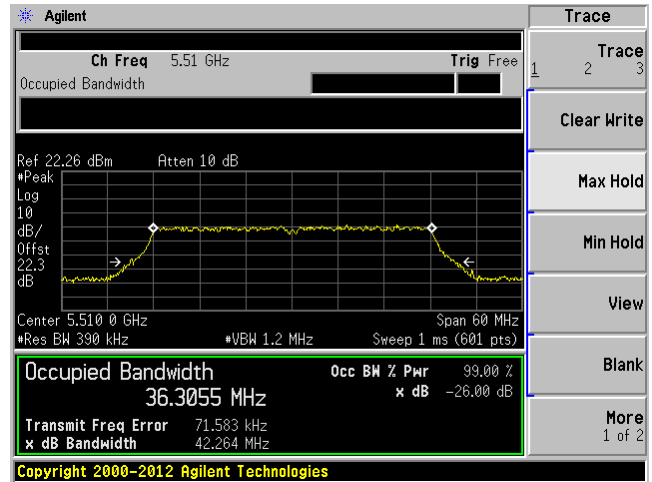

C3

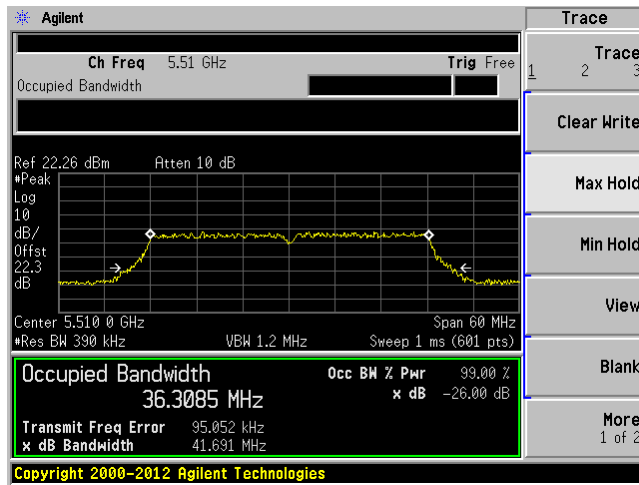

C4

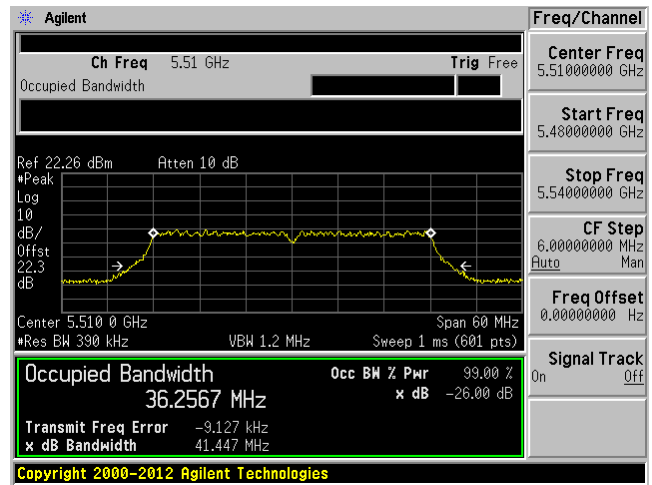

40 MHz Bandwidth, Middle Channel, 5555 MHz

C1

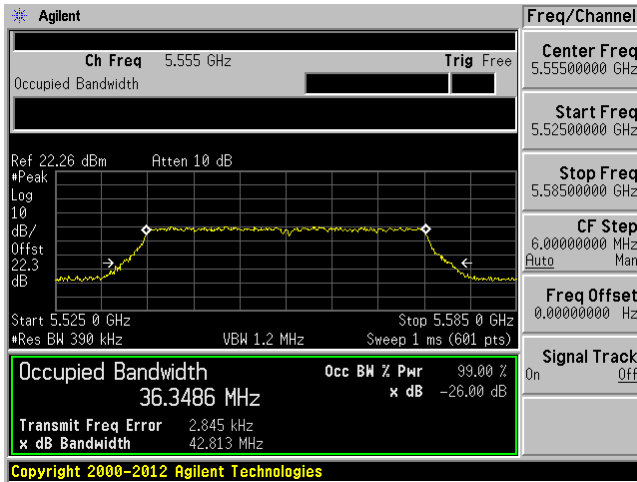

C2

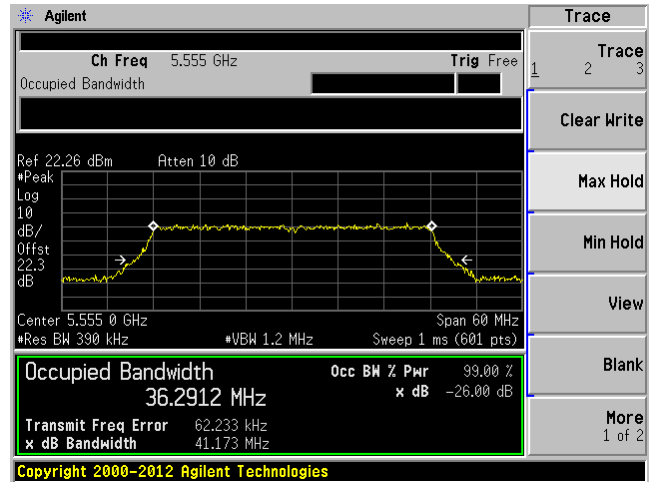

C3

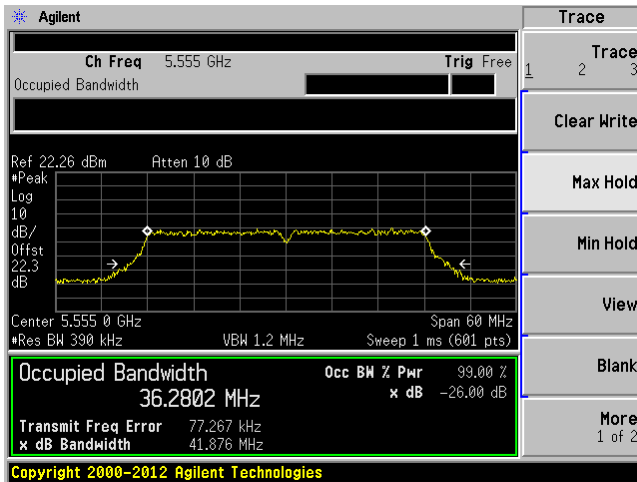

C4

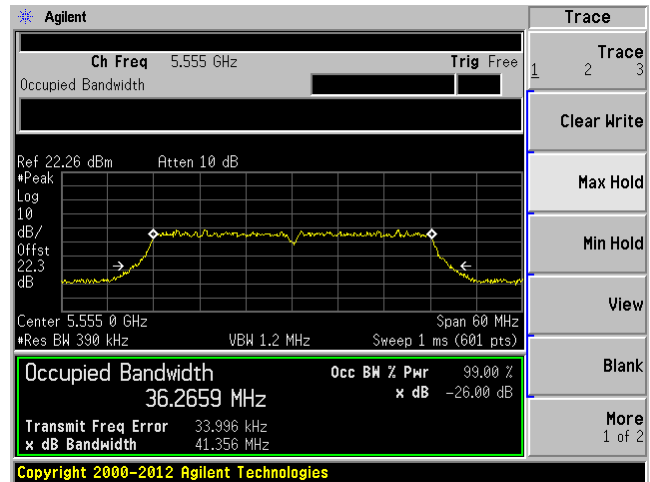

40 MHz Bandwidth, High Channel, 5690 MHz

C1

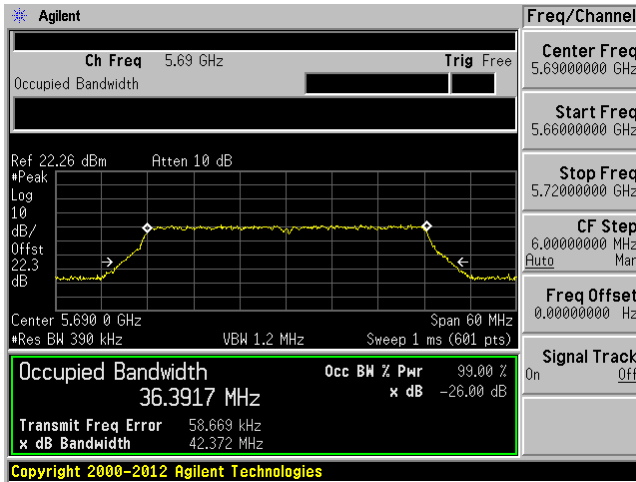

C2

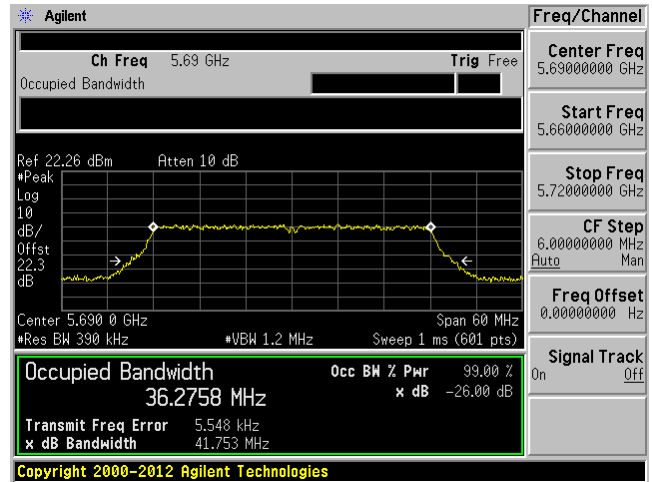

C3

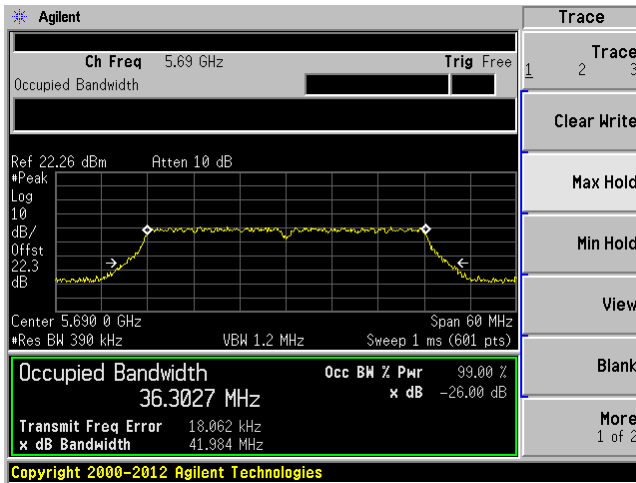

C4

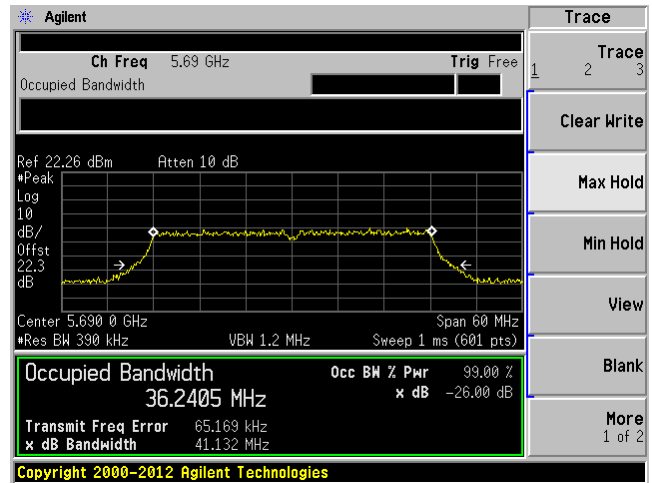

80 MHz Bandwidth, Low Channel, 5530 MHz

C1

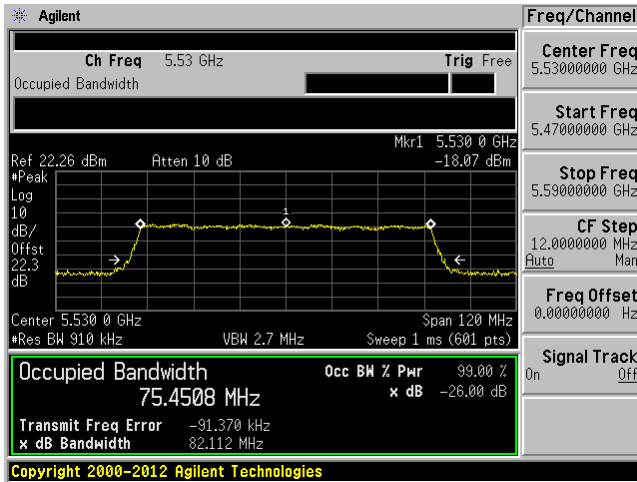

C2

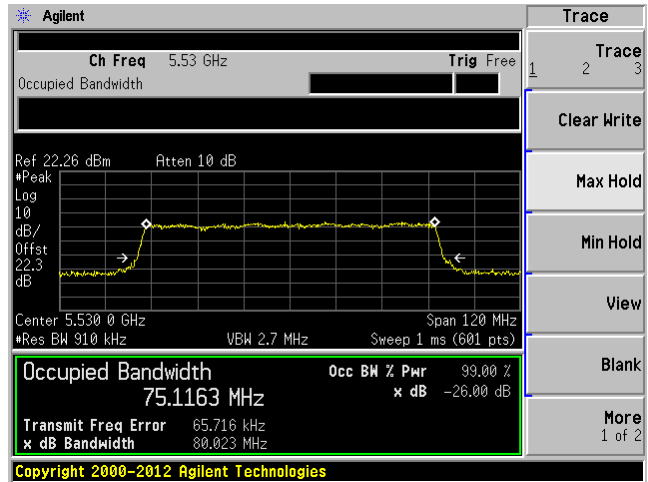

C3

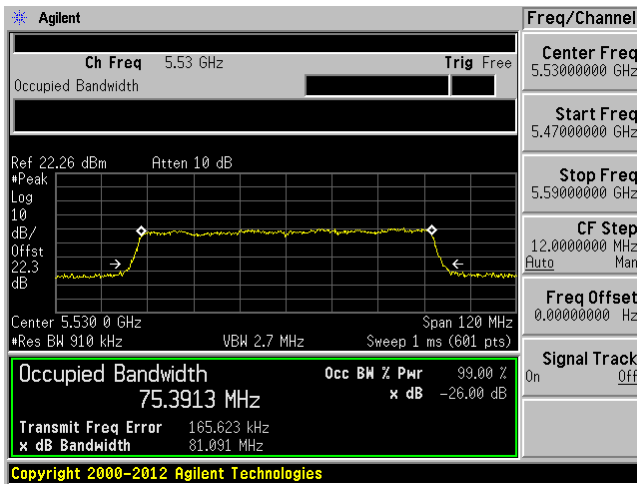

C4

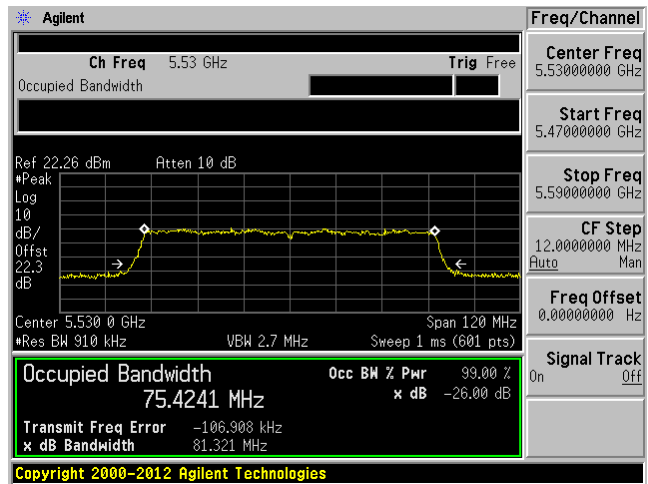

80 MHz Bandwidth, Middle Channel, 5545 MHz

C1

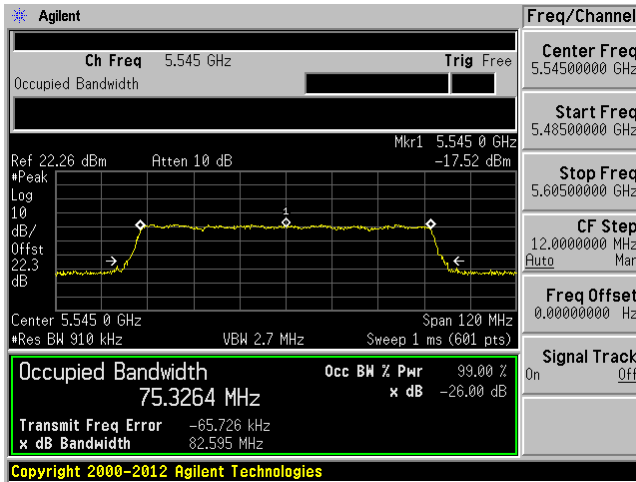

C2

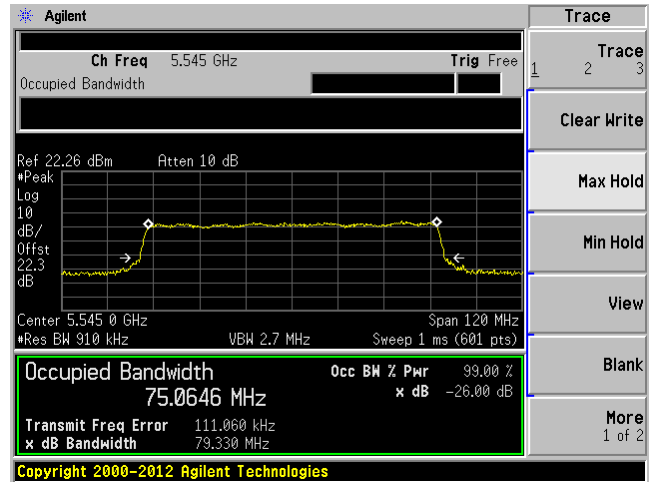

C3

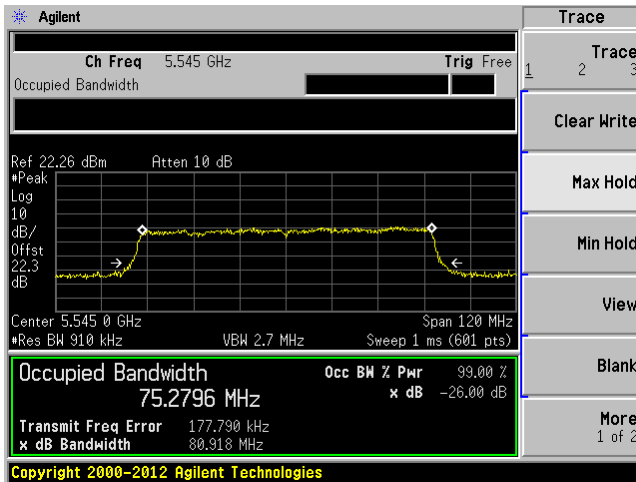

C4

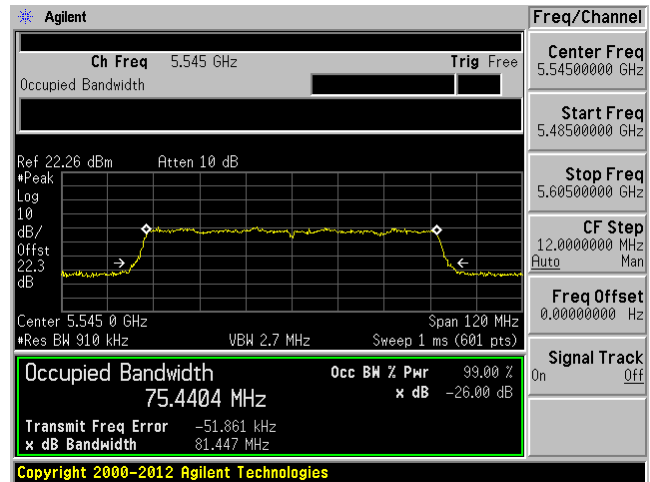

80 MHz Bandwidth, High Channel, 5560 MHz

C1

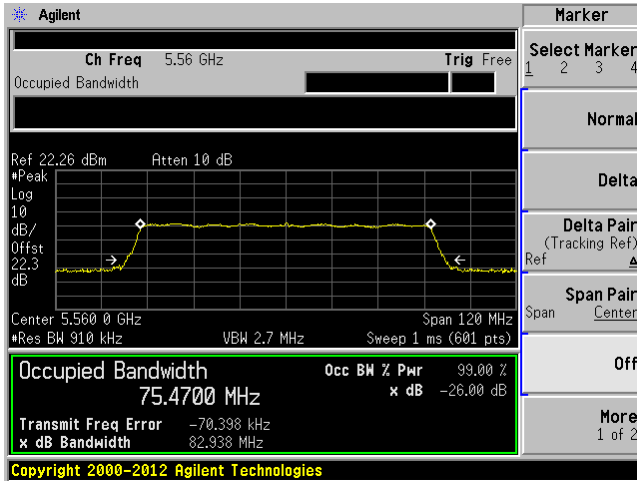

C2

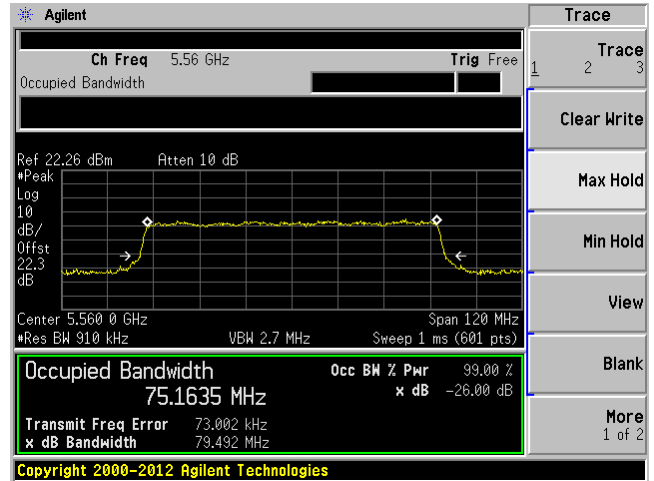

C3

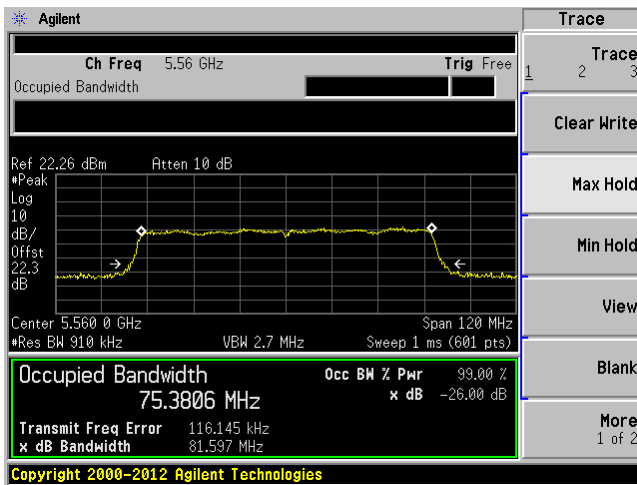

C4

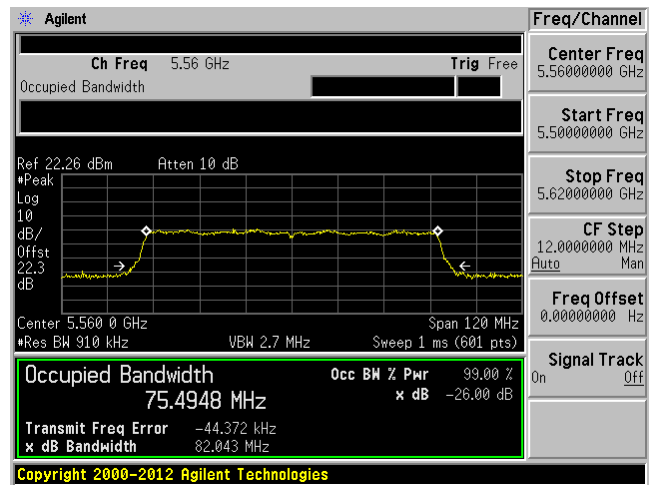

0 dBi Antenna:

5.3 GHz Band:

20 MHz bandwidth, Low Channel, 5260 MHz

C1

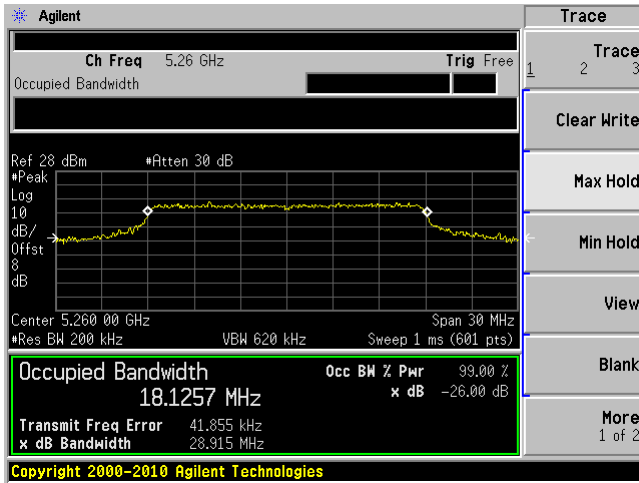

C2

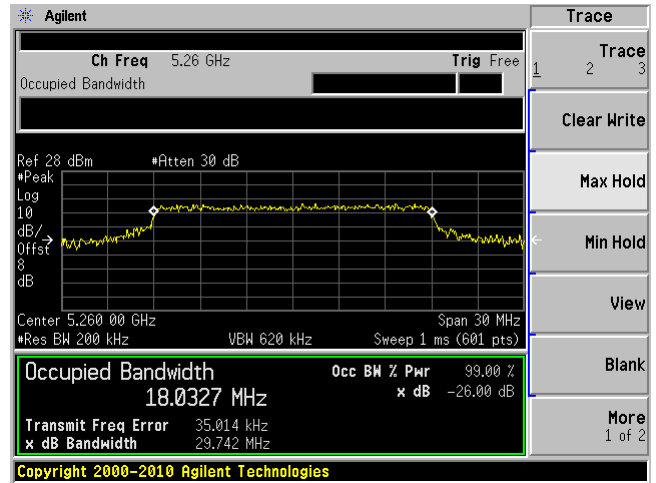

C3

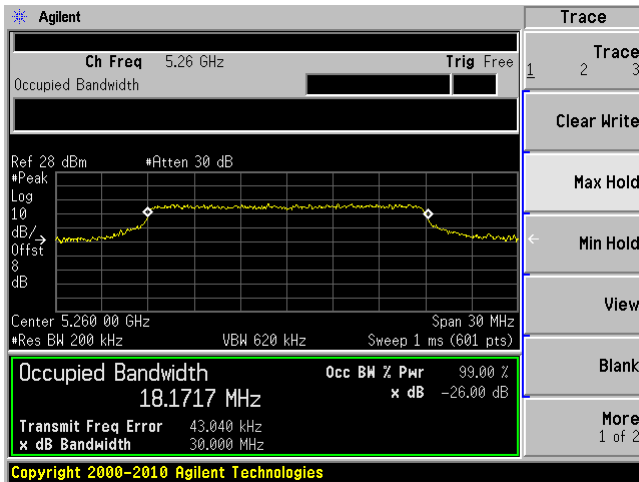

C4

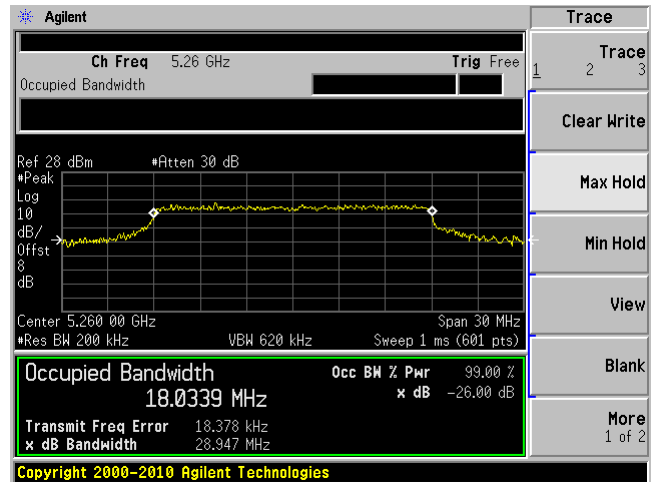

20 MHz bandwidth, Middle Channel, 5295 MHz

C1

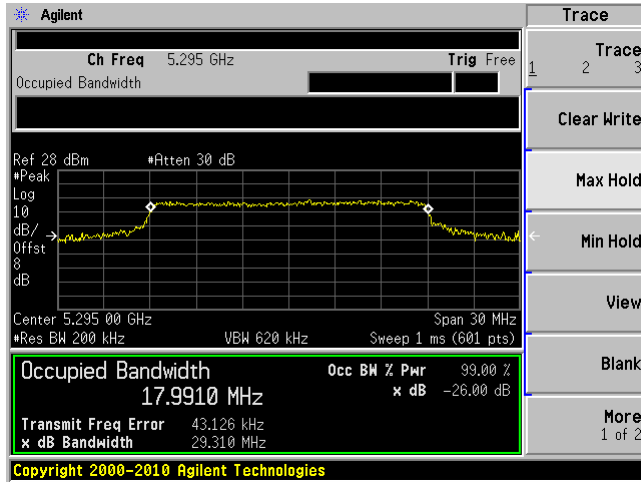

C2

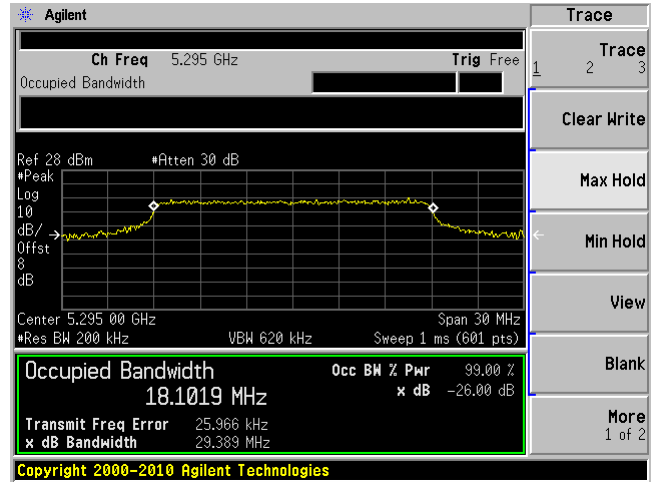

C3

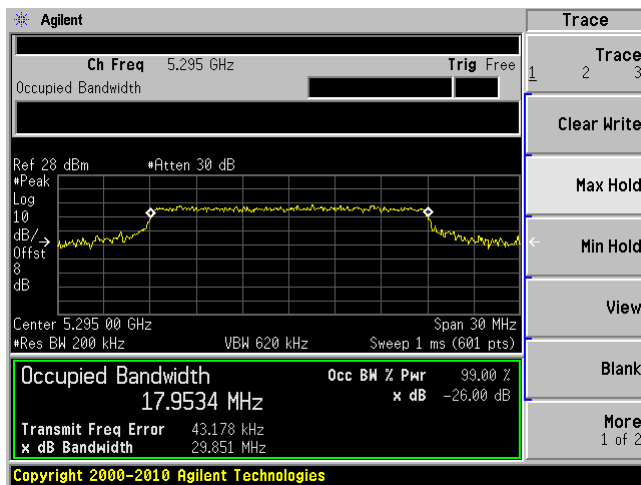

C4

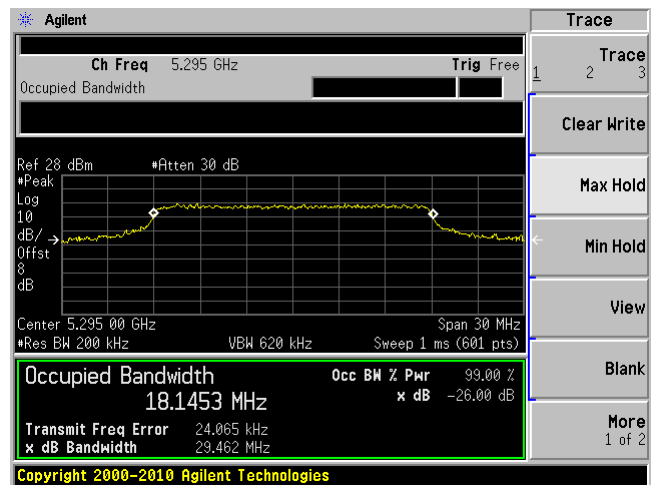

20 MHz bandwidth, High Channel, 5320 MHz

C1

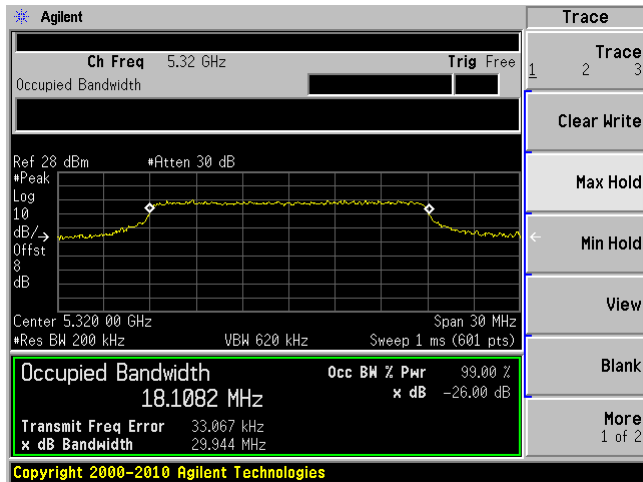

C2

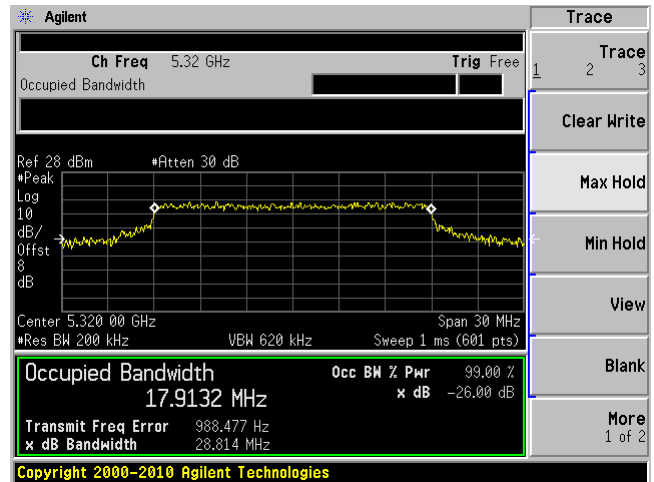

C3

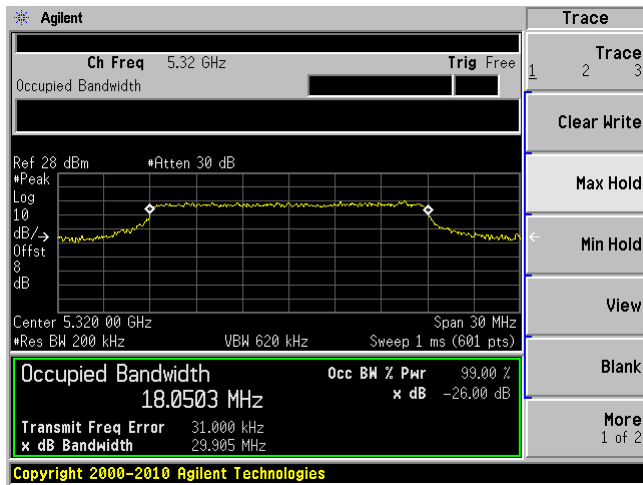

C4

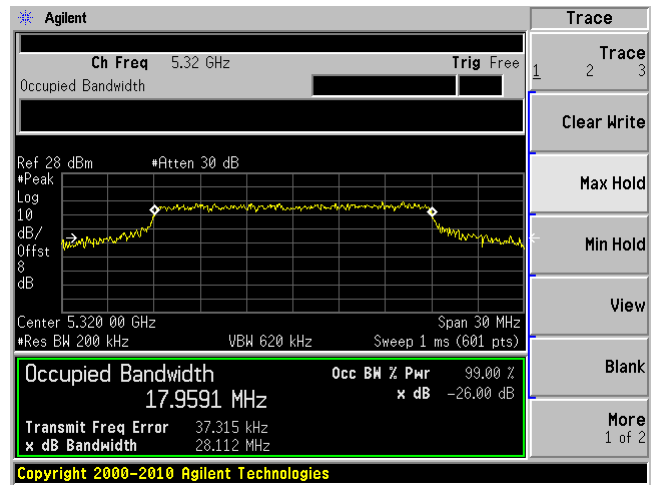

40 MHz bandwidth, Low Channel, 5270 MHz

C1

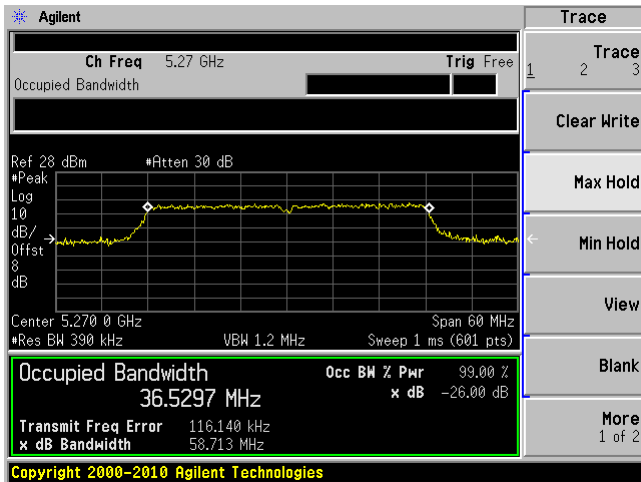

C2

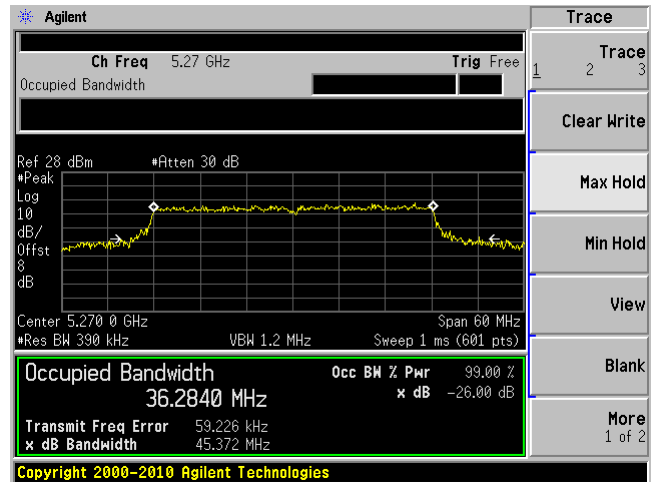

C3

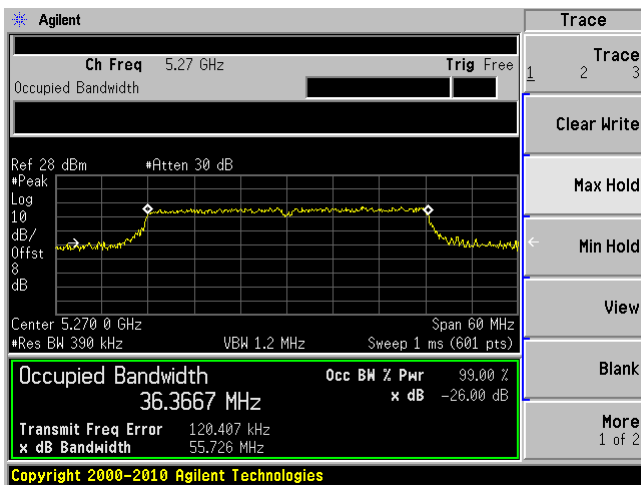

C4

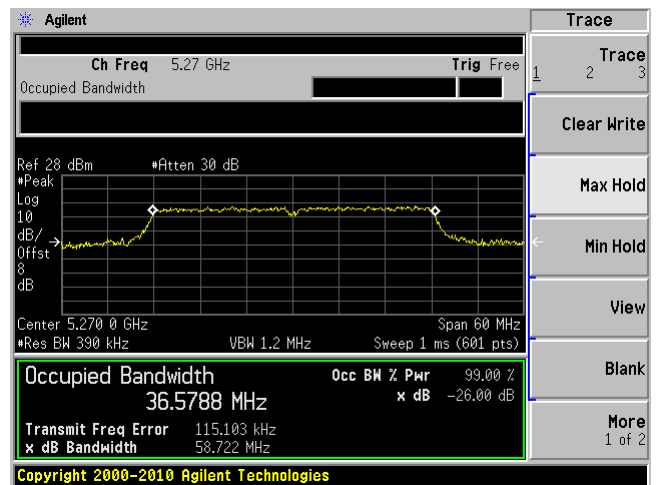

40 MHz bandwidth, Middle Channel, 5290 MHz

C1

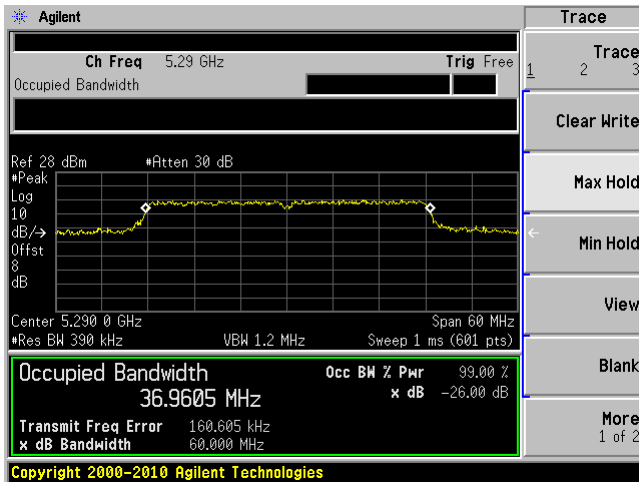

C2

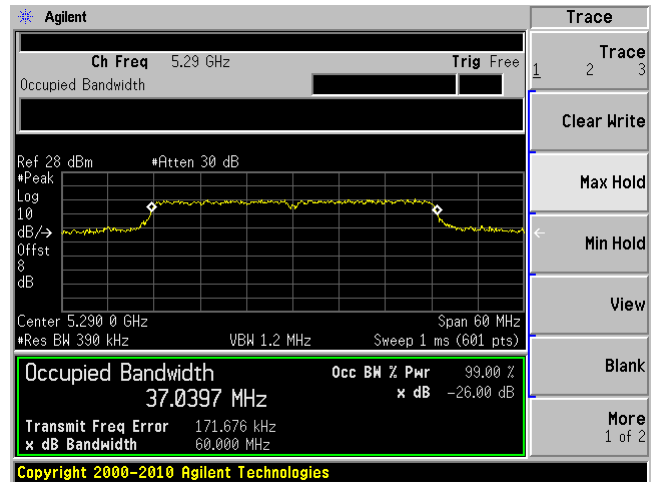

C3

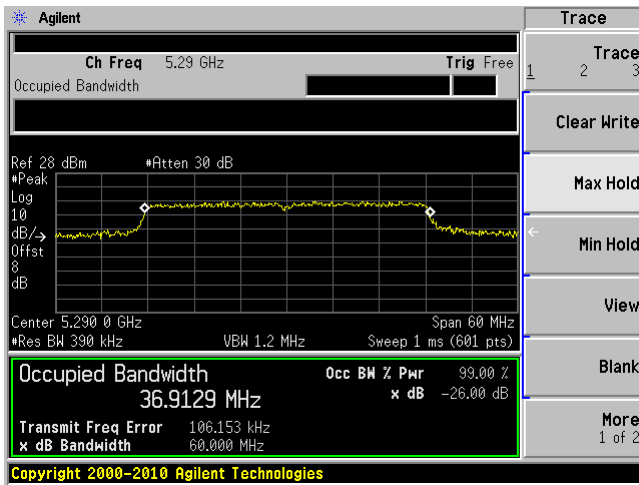

C4

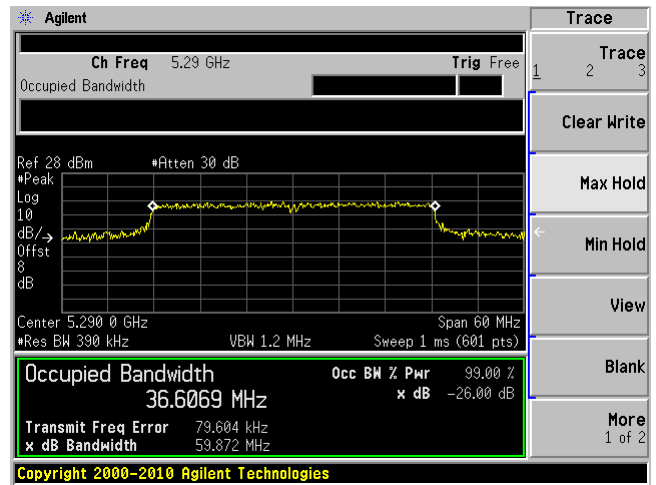

40 MHz bandwidth, High Channel, 5310 MHz

C1

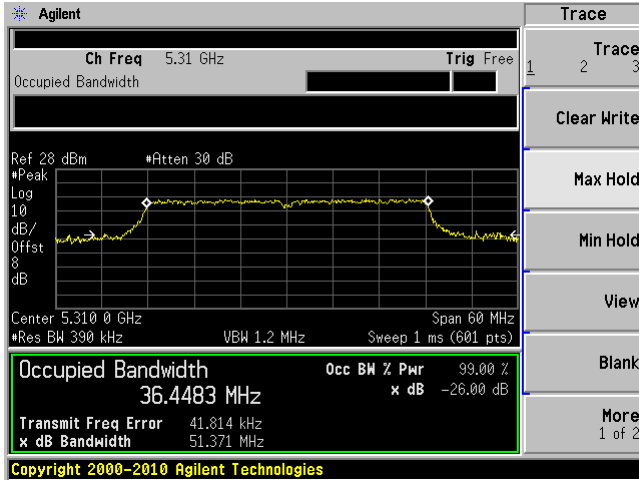

C2

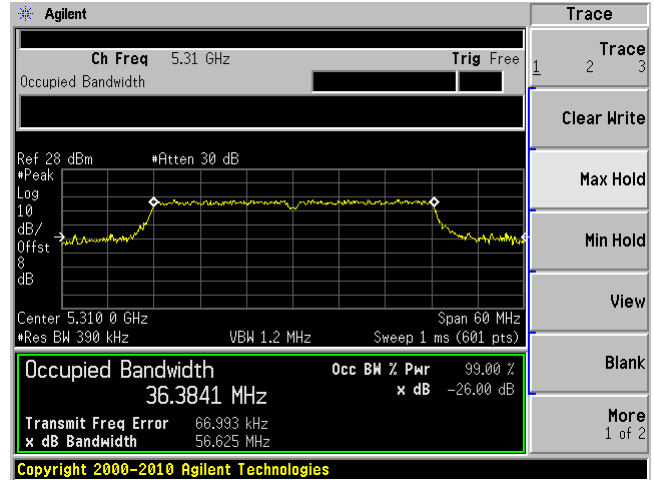

C3

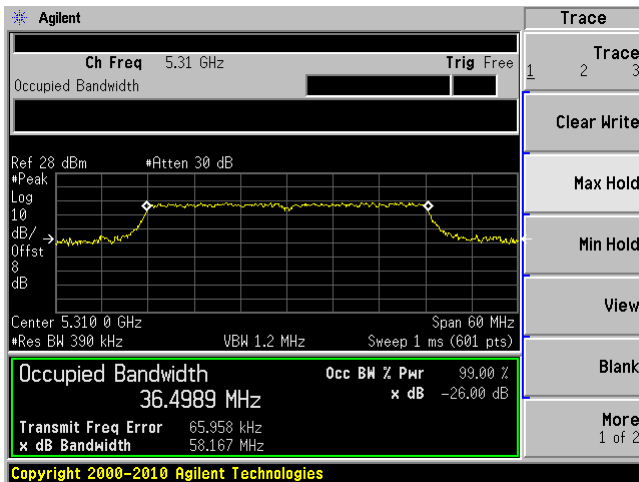

C4

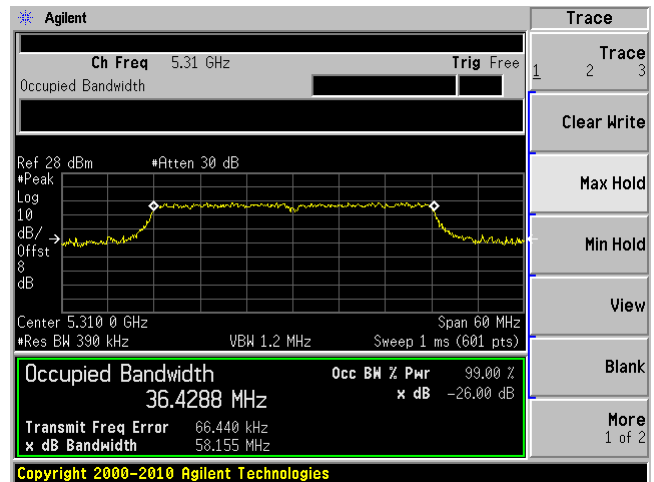

80 MHz bandwidth, 5290 MHz

C1

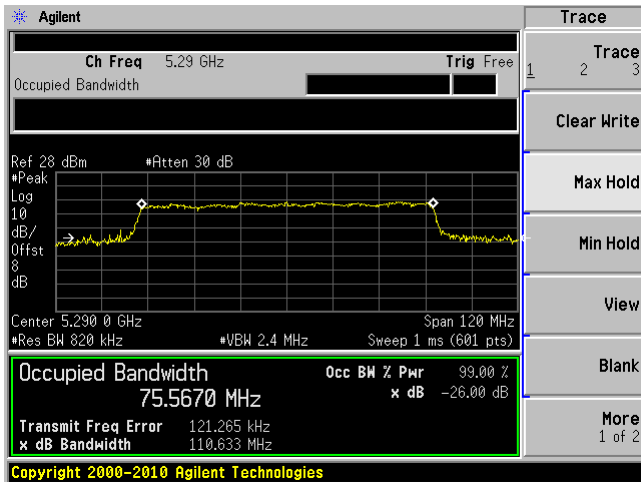

C2

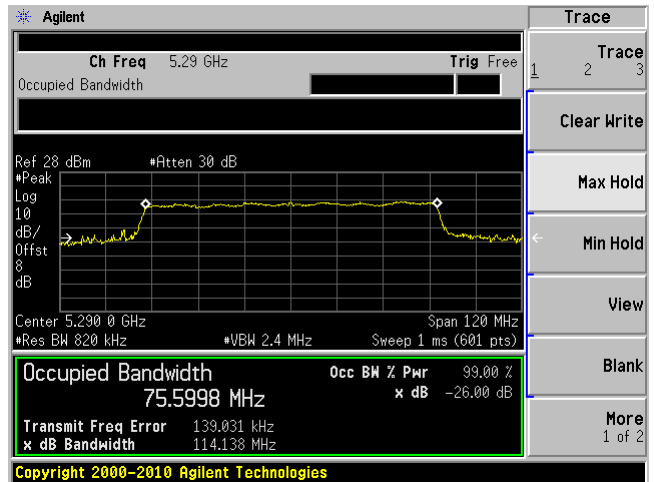

C3

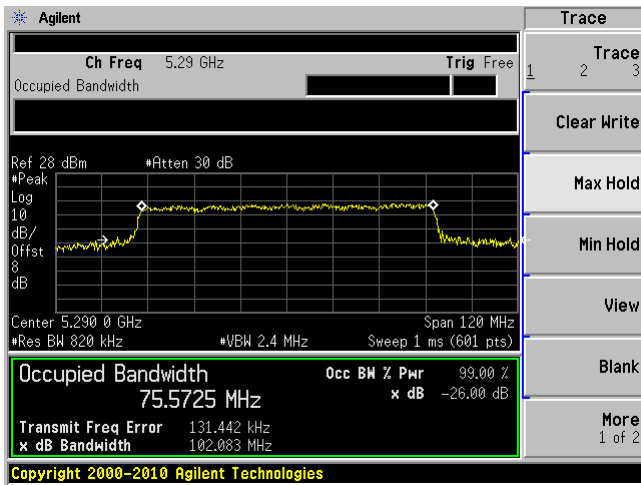

C4

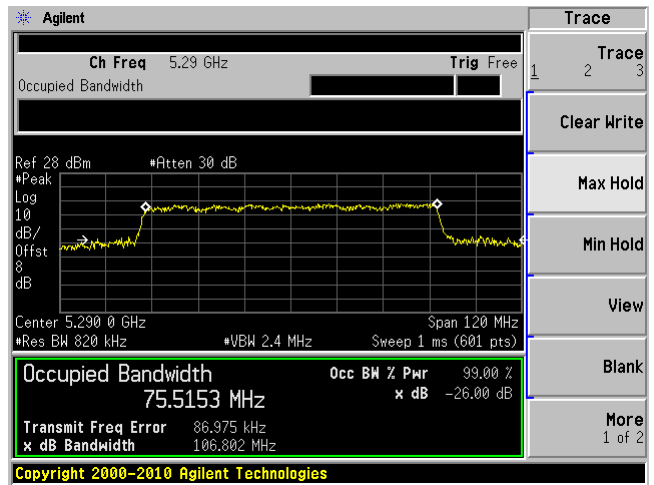

5.6 GHz Band:

20 MHz bandwidth, Low Channel, 5500 MHz

C1

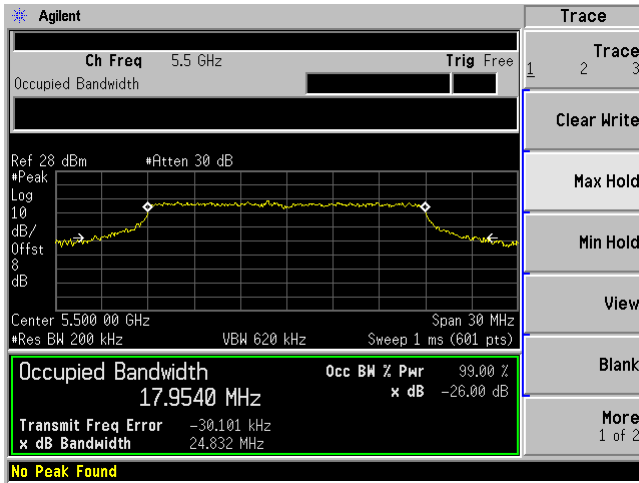

C2

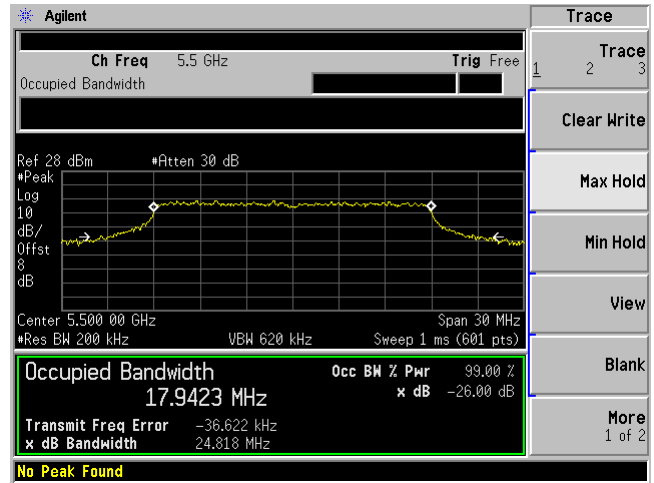

C3

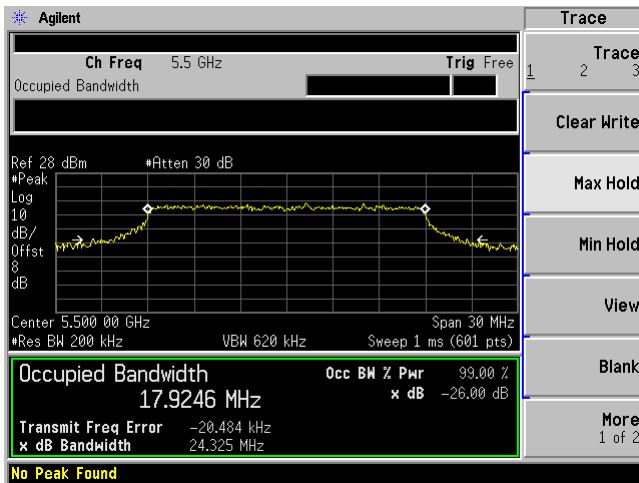

C4

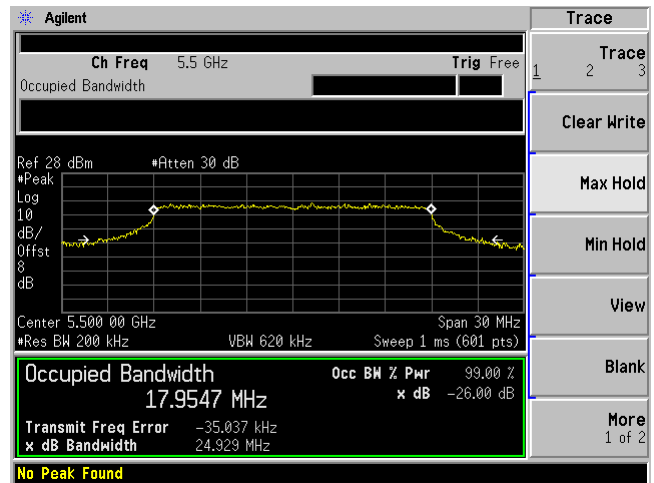

20 MHz bandwidth, Middle Channel, 5590 MHz

C1

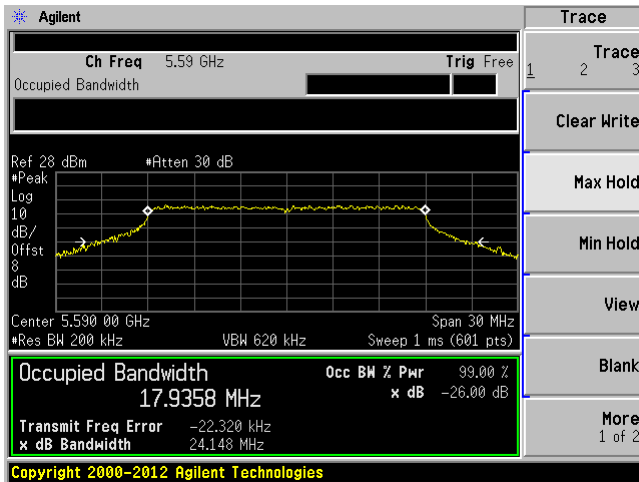

C2

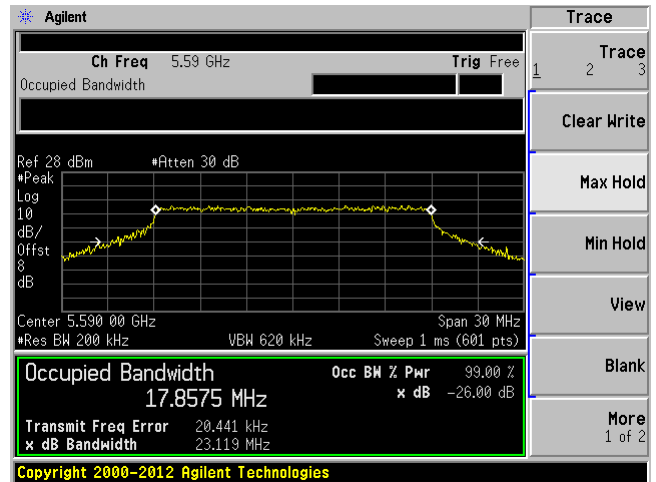

C3

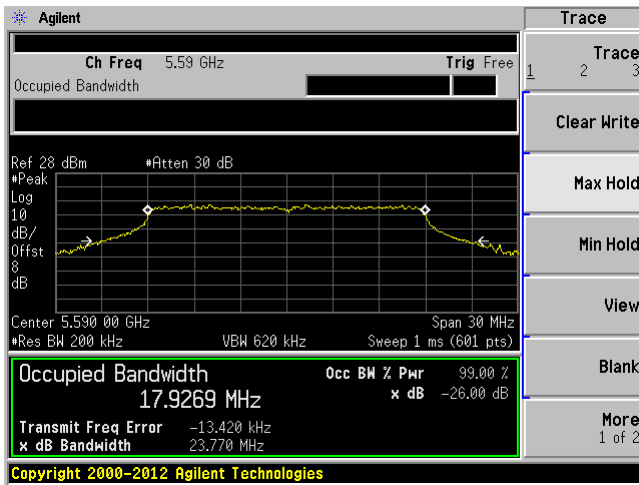

C4

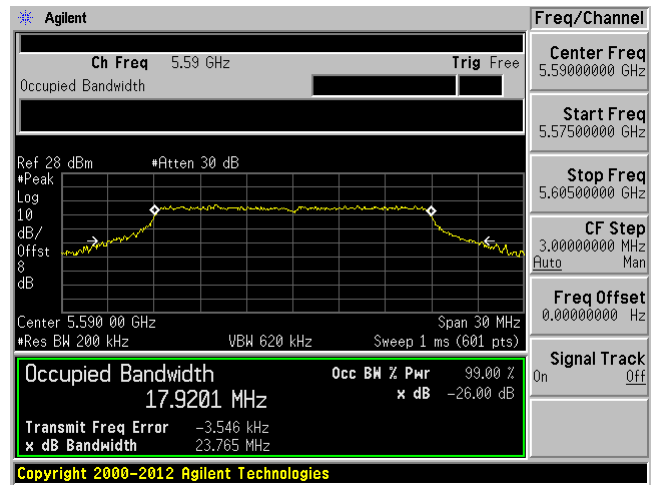

20 MHz bandwidth, High Channel, 5700 MHz

C1

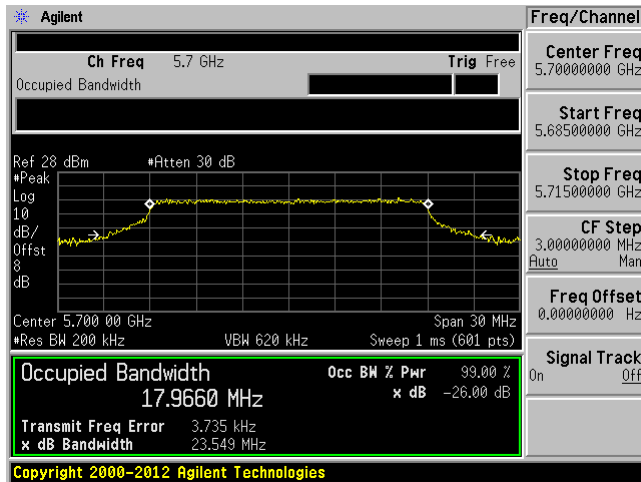

C2

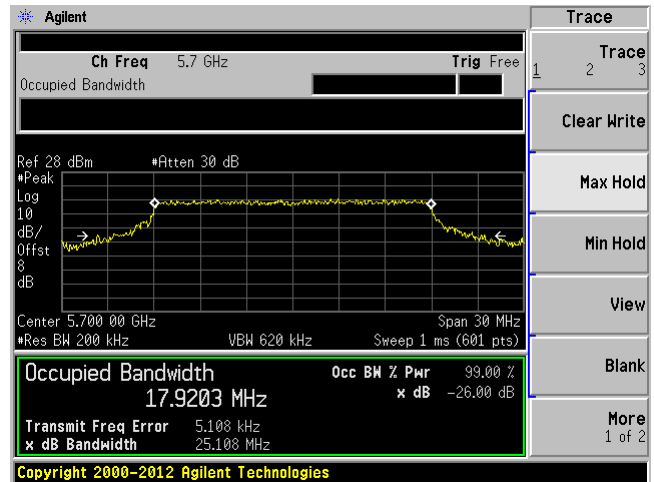

C3

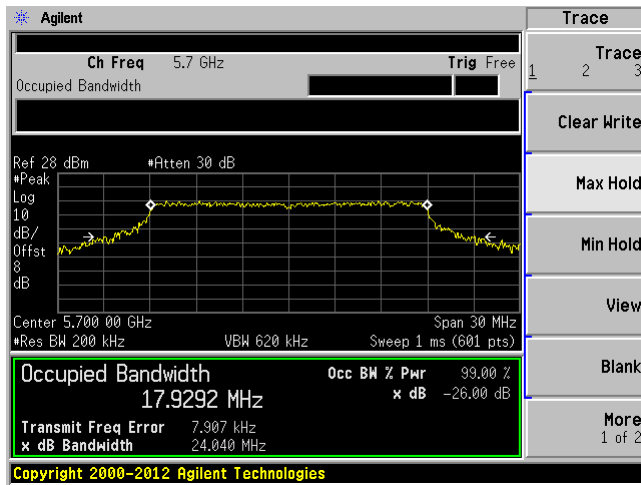

C4

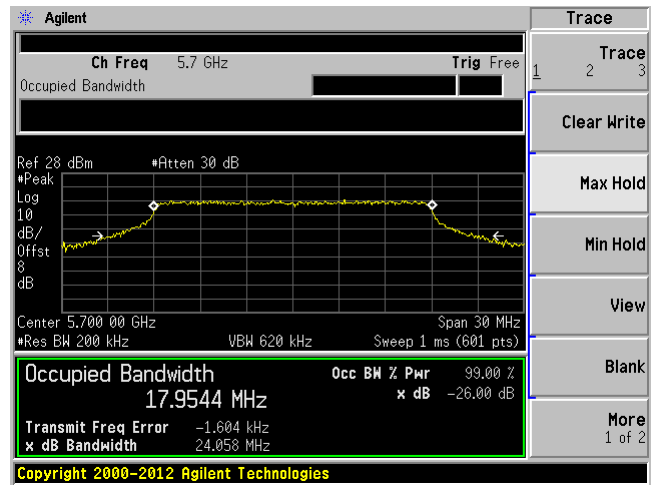

40 MHz bandwidth, Low Channel, 5510 MHz

C1

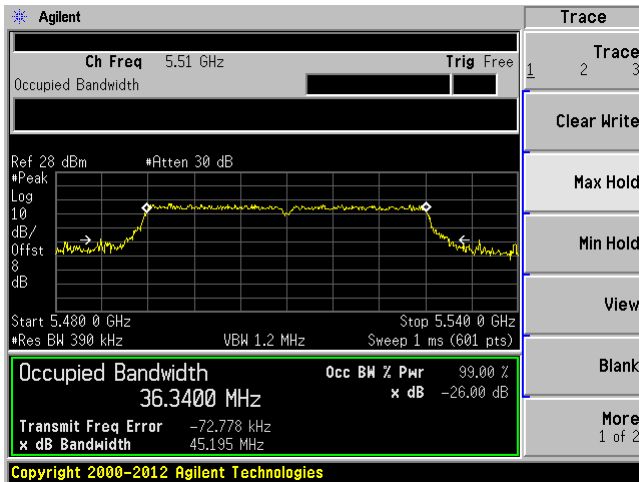

C2

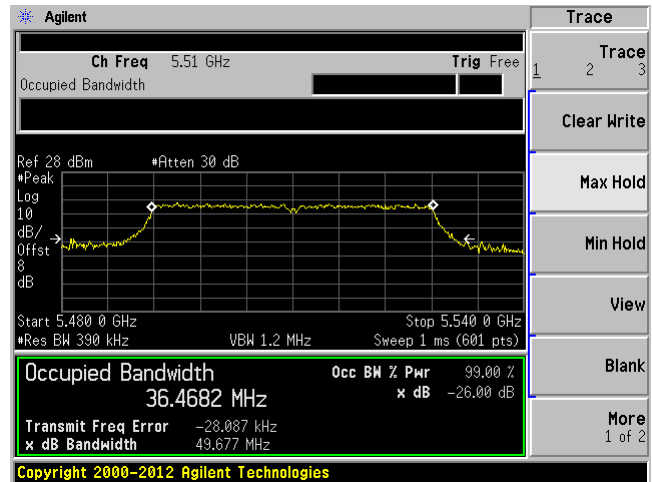

C3

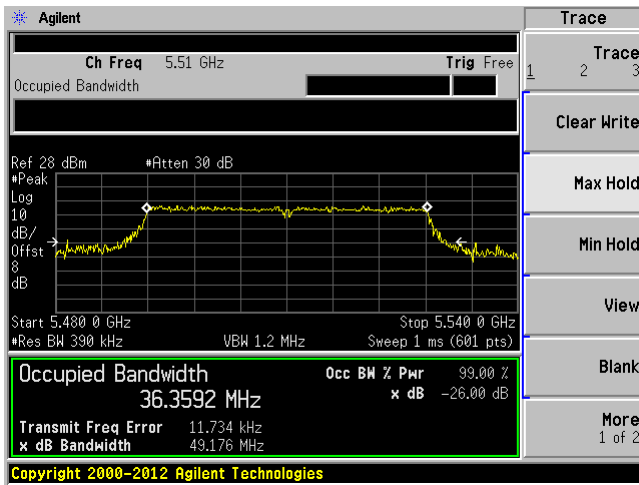

C4

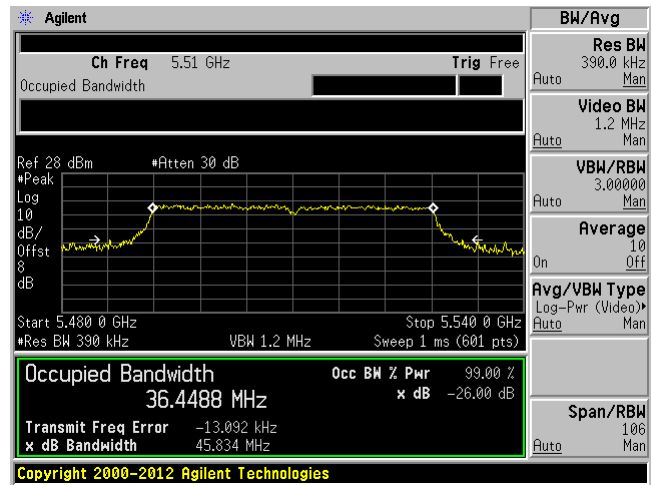

40 MHz bandwidth, Middle Channel, 5555 MHz

C1

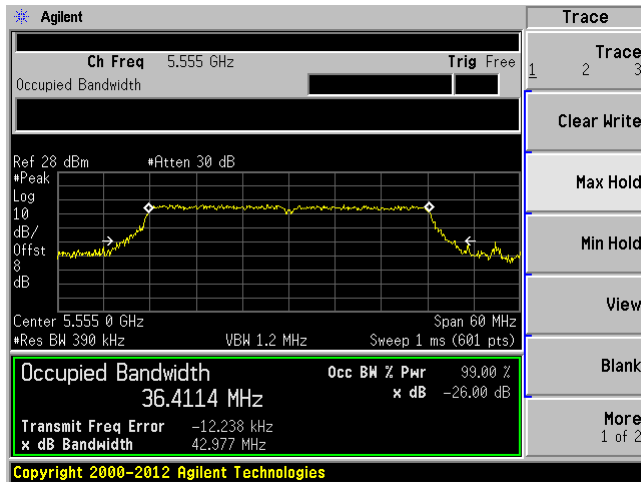

C2

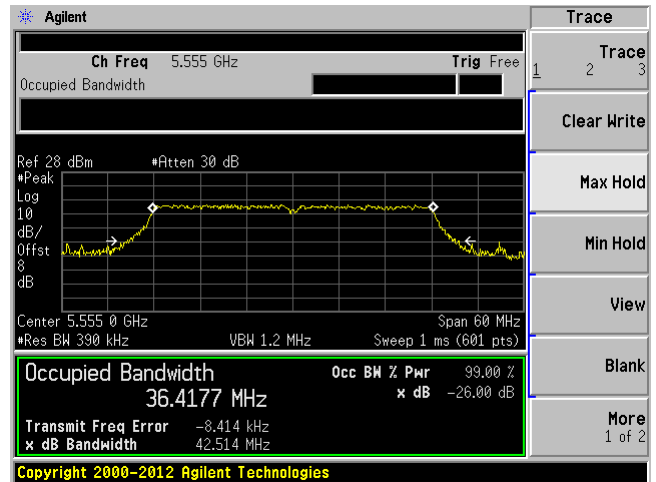

C3

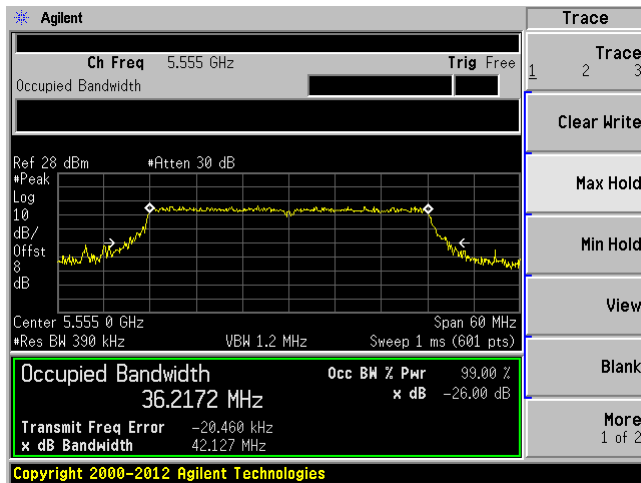

C4

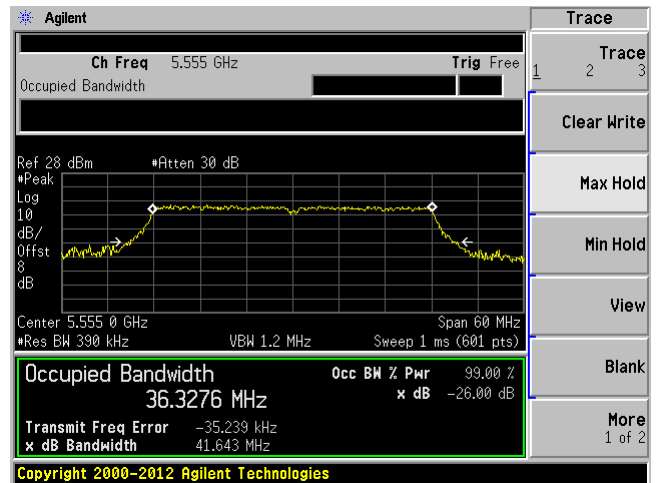

40 MHz bandwidth, High Channel, 5690 MHz

C1

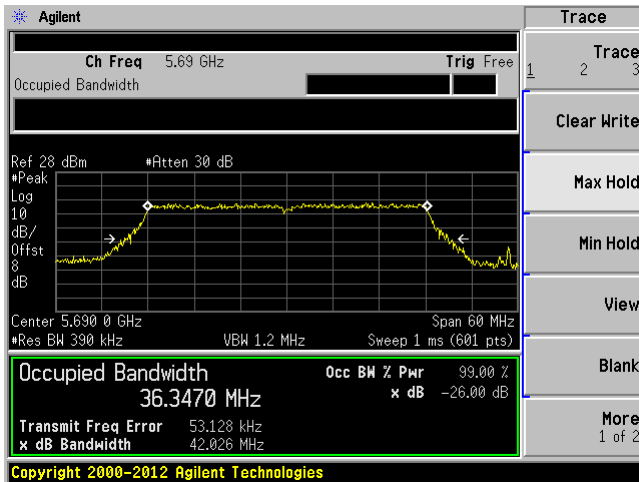

C2

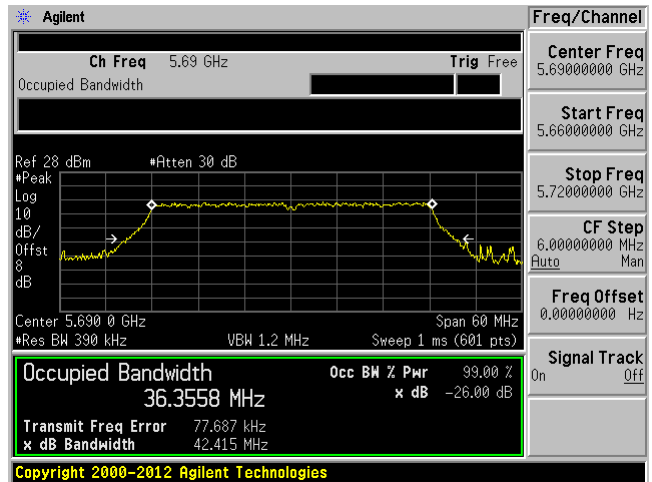

C3

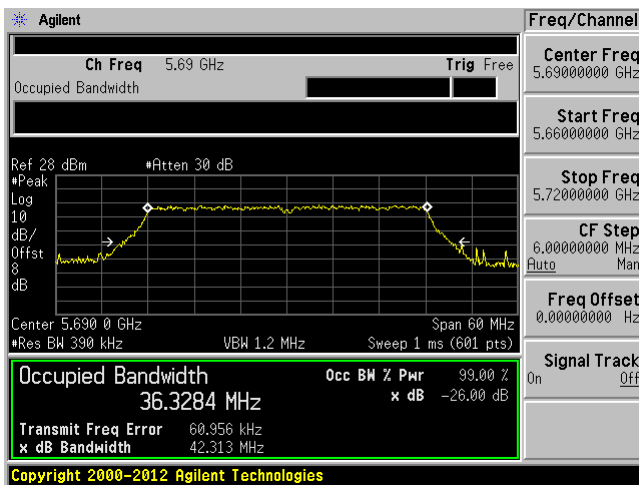

C4

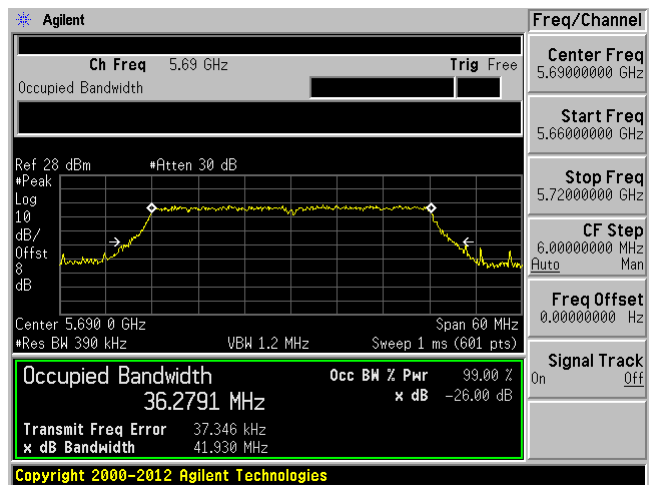

80 MHz bandwidth, Low Channel, 5530 MHz

C1

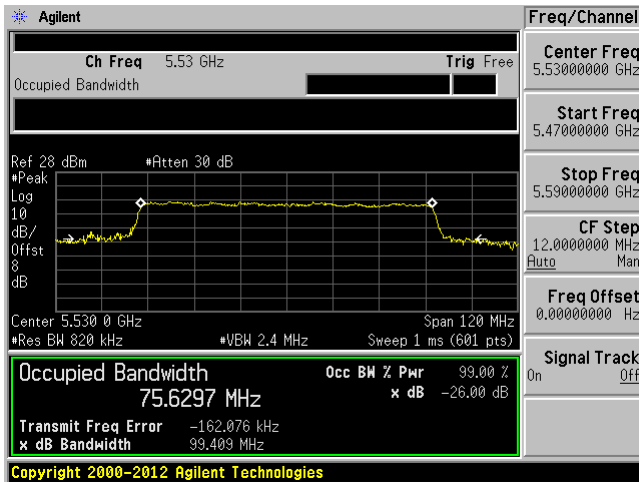

C2

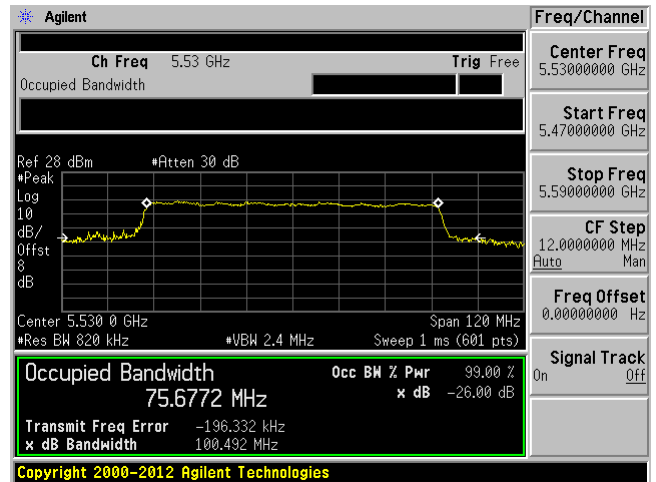

C3

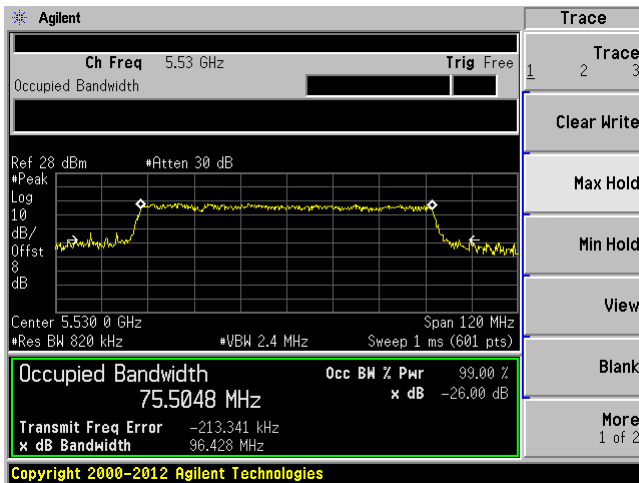

C4

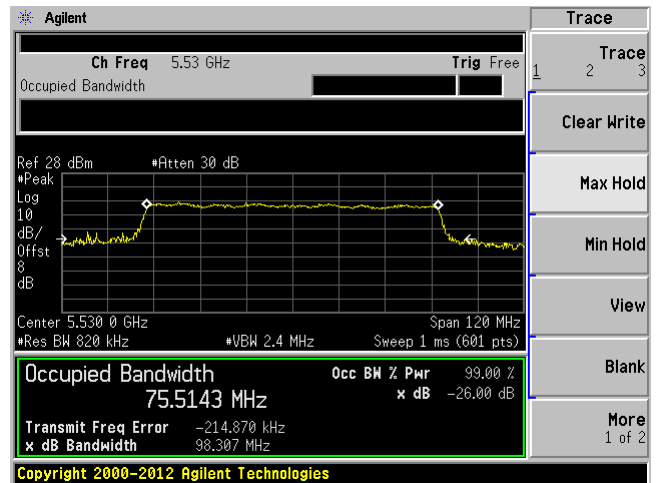

80 MHz bandwidth, Middle Channel, 5545 MHz

C1

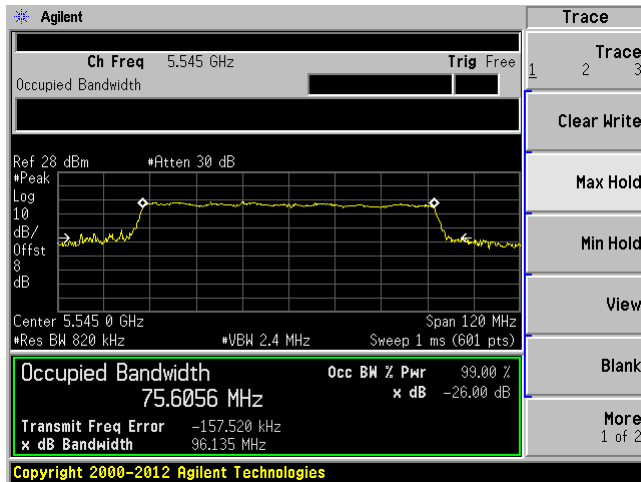

C2

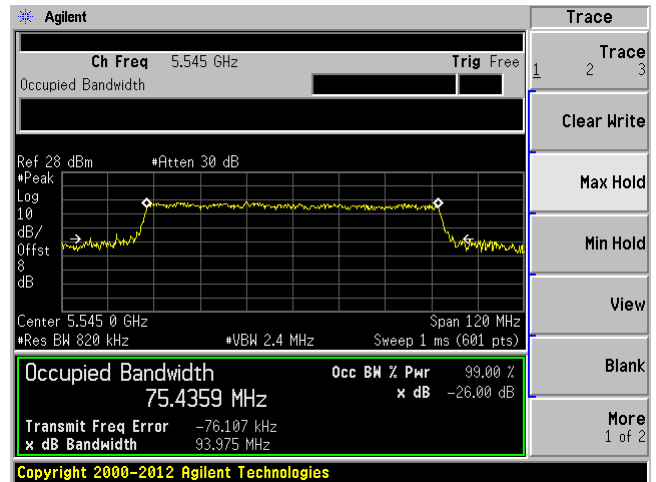

C3

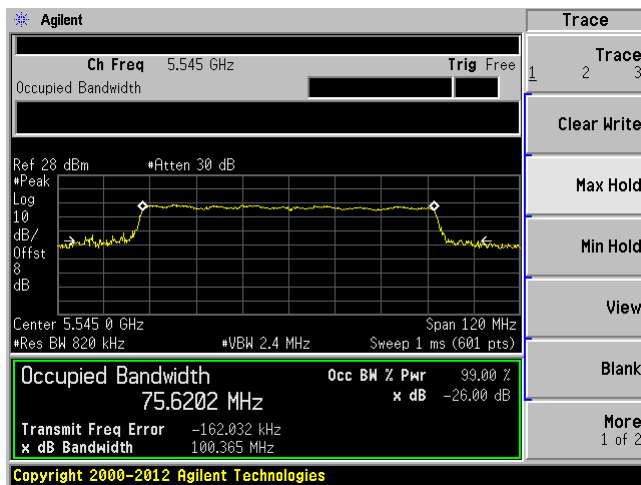

C4

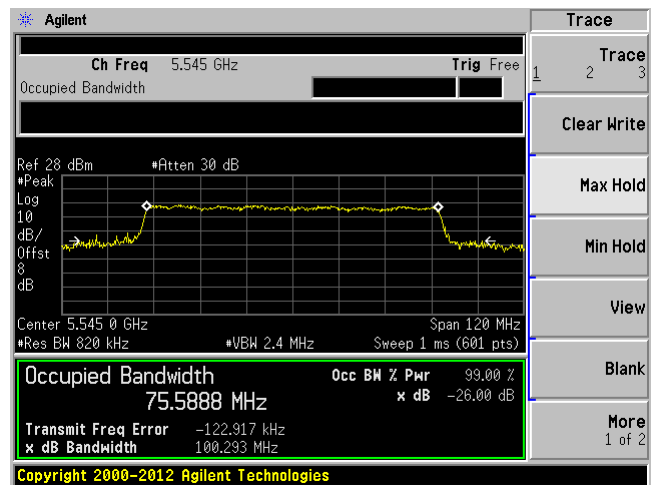

80 MHz bandwidth, High Channel, 5560 MHz

C1

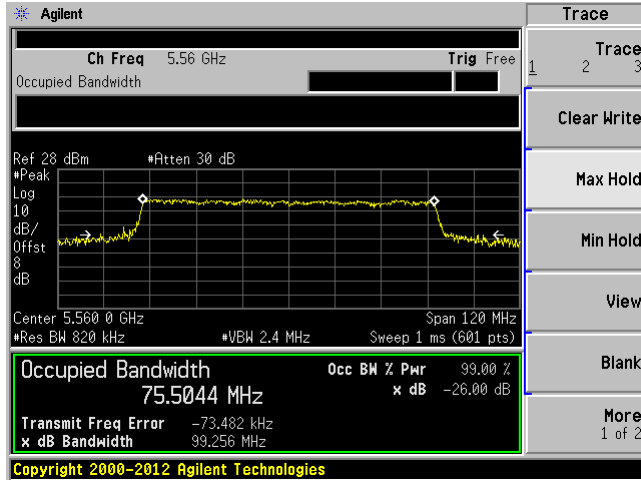

C2

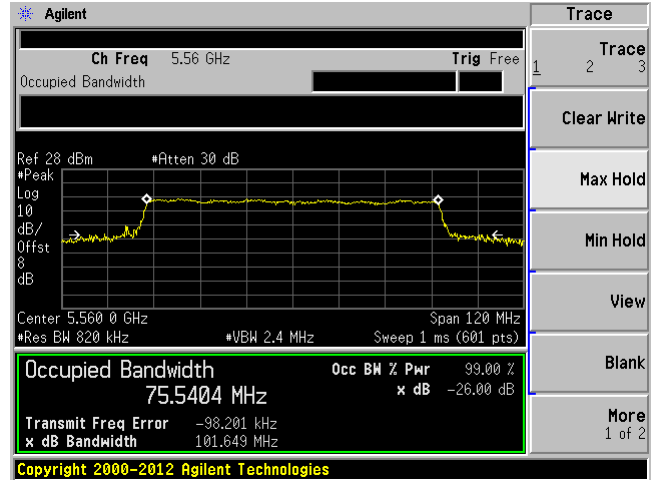

C3

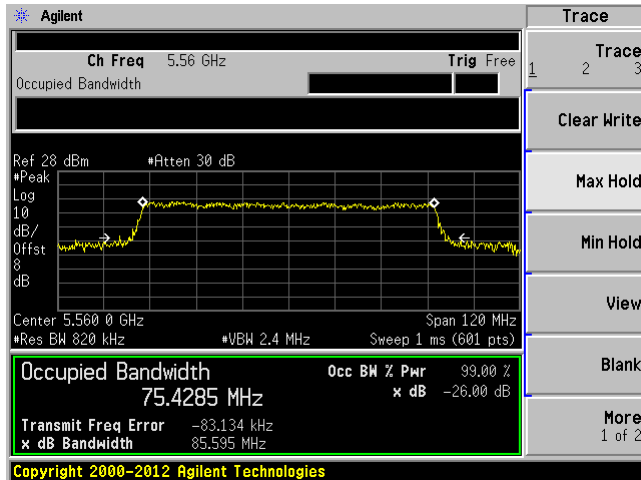

C4

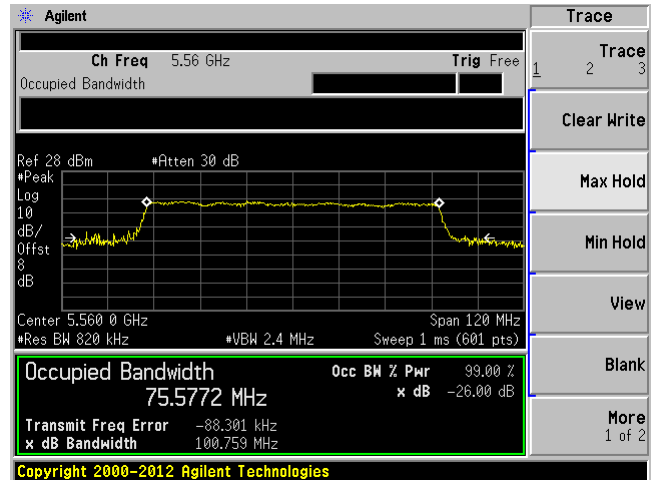

9 FCC §15.407(a)(1) & §15.407 (a)(3) - Output Power

9.1 Applicable Standards

According to FCC §15.407(a)(1)

For fixed point-to-point access points operating in the band 5.15-5.25 GHz, the maximum conducted output power over the frequency band of operation shall not exceed 1 W. Fixed point-to-point U-NII devices may employ antennas with directional gain up to 23 dBi without any corresponding reduction in the maximum conducted output power or maximum power spectral density. For fixed point-to-point transmitters that employ a directional antenna gain greater than 23 dBi, a 1 dB reduction in maximum conducted output power and maximum power spectral density is required for each 1 dB of antenna gain in excess of 23 dBi. Fixed, point-to-point operations exclude the use of point-to-multipoint systems, omnidirectional applications, and multiple collocated transmitters transmitting the same information. The operator of the U-NII device, or if the equipment is professionally installed, the installer, is responsible for ensuring that systems employing high gain directional antennas are used exclusively for fixed, point-to-point operations.

For the 5.25–5.35 GHz and 5.47–5.725 GHz bands, the maximum conducted output power over the frequency bands of operation shall not exceed the lesser of 250 mW or $11 \text{ dBm} + 10 \log B$, where B is the 26 dB Emission Bandwidth in megahertz. In addition, the peak power spectral density shall not exceed 11 dBm in any 1 megahertz band. If transmitting antennas of directional gain greater than 6 dBi are used, both the maximum conducted output power and the peak power spectral density shall be reduced by the amount in dB that the directional gain of the antenna exceeds 6 dBi.

According to FCC §15.407(a)(3)

For the band 5.725-5.85 GHz, the maximum conducted output power over the frequency band of operation shall not exceed 1 W. In addition, the maximum power spectral density shall not exceed 30 dBm in any 500-kHz band. If transmitting antennas of directional gain greater than 6 dBi are used, both the maximum conducted output power and the maximum power spectral density shall be reduced by the amount in dB that the directional gain of the antenna exceeds 6 dBi. However, fixed point-to-point U-NII devices operating in this band may employ transmitting antennas with directional gain greater than 6 dBi without any corresponding reduction in transmitter conducted power. Fixed, point-to-point operations exclude the use of point-to-multipoint systems, omnidirectional applications, and multiple collocated transmitters transmitting the same information. The operator of the U-NII device, or if the equipment is professionally installed, the installer, is responsible for ensuring that systems employing high gain directional antennas are used exclusively for fixed, point-to-point operations.

9.2 Measurement Procedure

The measurements are based on FCC KDB 789033 D02 General UNII Test Procedures v01: Guidelines for Compliance Testing of Unlicensed National Information Infrastructure (U-NII) Devices section E: Maximum conducted output power

9.3 Test Equipment List and Details

Manufacturer	Description	Model No.	Serial No.	Calibration Date	Calibration Interval
Agilent	Spectrum Analyzer	E4446A	US44300386	2013-09-29	1 year

Statement of Traceability: *BACL Corp.* attests that all calibrations have been performed according to A2LA requirements, traceable to the NIST.

9.4 Test Environmental Conditions

Temperature:	21-23° C
Relative Humidity:	43-48 %
ATM Pressure:	101.1-101.3 kPa

The testing was performed by Cipher Chu on 2014-04-04 to 2014-04-07 and 2014-08-09 to 2014-08-21 at the RF Site

9.5 Test Results

Note: Chain 1 and Chain 4 is Vertical, and Chain 2 and Chain 3 is Horizontal

Note: C1, C2, C3 and C4 stands for Chain 1, Chain 2, Chain 3 and Chain 4.

25 dBi Antenna:

5.3 GHz Band

20 MHz Bandwidth

Channel	Frequency (MHz)	Conducted Output Power C1/C2 (dBm)	Conducted Output Power C3/C4 (dBm)	Total Power C1,C2 (dBm)	Total Power C3,C4 (dBm)	Limit (dBm)
Low	5260	1.68/1.52	1.47/1.74	4.61	4.62	5
Middle	5295	1.58/1.74	1.59/1.70	4.67	4.66	5
High	5320	1.48/1.51	1.89/1.86	4.55	4.89	5

40 MHz Bandwidth

Channel	Frequency (MHz)	Conducted Output Power C1/C2 (dBm)	Conducted Output Power C3/C4 (dBm)	Total Power C1,C2 (dBm)	Total Power C3,C4 (dBm)	Limit (dBm)
Low	5270	1.33/1.77	1.59/1.46	4.57	4.54	5
Middle	5290	1.63/1.79	1.40/1.64	4.72	4.53	5
High	5310	1.71/1.44	1.63/1.62	4.59	4.64	5

80 MHz Bandwidth

Channel	Frequency (MHz)	Conducted Output Power C1/C2 (dBm)	Conducted Output Power C3/C4 (dBm)	Total Power C1,C2 (dBm)	Total Power C3,C4 (dBm)	Limit (dBm)
High	5290	1.14/1.85	1.44/1.41	4.52	4.44	5

Note: Antenna gain of EUT is 25 dBi which is over 19 dB of 6 dBi allowed by FCC Part 15.407 (a)(2), a 1 dB reduction in maximum conducted output power and maximum power spectral density is required for each 1 dB of antenna gain in excess of 6 dBi

5.6 GHz Band

20 MHz Bandwidth

Channel	Frequency (MHz)	Conducted Output Power C1/C2 (dBm)	Conducted Output Power C3/C4 (dBm)	Total Power C1,C2 (dBm)	Total Power C3,C4 (dBm)	Limit (dBm)
Low	5500	1.56/1.54	1.88/1.85	4.56	4.88	5
Middle	5590	1.69/1.42	1.39/1.60	4.57	4.51	5
High	5700	1.46/1.51	1.59/1.63	4.50	4.62	5

40 MHz Bandwidth

Channel	Frequency (MHz)	Conducted Output Power C1/C2 (dBm)	Conducted Output Power C3/C4 (dBm)	Total Power C1,C2 (dBm)	Total Power C3,C4 (dBm)	Limit (dBm)
Low	5510	1.21/1.64	1.77/1.55	4.44	4.67	5
Middle	5555	1.80/1.83	1.49/1.86	4.83	4.69	5
High	5690	1.30/1.88	1.52/1.47	4.61	4.51	5

80 MHz Bandwidth

Channel	Frequency (MHz)	Conducted Output Power C1/C2 (dBm)	Conducted Output Power C3/C4 (dBm)	Total Power C1,C2 (dBm)	Total Power C3,C4 (dBm)	Limit (dBm)
Low	5530	1.67/1.34	1.68/1.51	4.52	4.61	5
Middle	5545	1.52/1.68	1.70/1.31	4.61	4.52	5
High	5560	1.37/1.49	1.53/1.78	4.44	4.67	5

Note: Antenna gain of EUT is 25 dBi which is over 19 dB of 6 dBi allowed by FCC Part 15.407 (a)(2), a 1 dB reduction in maximum conducted output power and maximum power spectral density is required for each 1 dB of antenna gain in excess of 6 dBi

0 dBi Antenna:**5.3 GHz Band**

20 MHz bandwidth

Channel	Frequency (MHz)	Conducted Power C1 (dBm)	Conducted Power C2 (dBm)	Conducted Power C3 (dBm)	Conducted Power C4 (dBm)	Total Power C1,C2 (dBm)	Total Power C3,C4 (dBm)	Limit (dBm)
Low	5260	16.9	20.46	21.72	18.87	22.05	23.54	24
Middle	5295	17.2	20.26	20.96	18.47	22.00	22.90	24
High	5320	16.08	17.08	17.76	16.31	19.62	20.11	24

40 MHz bandwidth

Channel	Frequency (MHz)	Conducted Power C1 (dBm)	Conducted Power C2 (dBm)	Conducted Power C3 (dBm)	Conducted Power C4 (dBm)	Total Power C1,C2 (dBm)	Total Power C3,C4 (dBm)	Limit (dBm)
Low	5270	16.84	21.4	20.66	18.81	22.70	22.84	24
Middle	5290	17.14	20.2	20.9	18.04	21.94	22.71	24
High	5310	16.03	17.02	17.7	16.25	19.56	20.05	24

80 MHz bandwidth

Channel	Frequency (MHz)	Conducted Power C1 (dBm)	Conducted Power C2 (dBm)	Conducted Power C3 (dBm)	Conducted Power C4 (dBm)	Total Power C1,C2 (dBm)	Total Power C3,C4 (dBm)	Limit (dBm)
-	5290	16.69	16.94	17.11	16.17	19.83	19.68	24

5.6 GHz Band

20 MHz bandwidth

Channel	Frequency (MHz)	Conducted Power C1 (dBm)	Conducted Power C2 (dBm)	Conducted Power C3 (dBm)	Conducted Power C4 (dBm)	Total Power C1,C2 (dBm)	Total Power C3,C4 (dBm)	Limit (dBm)
Low	5500	17.09	20.65	20.91	19.06	22.24	23.09	24
Middle	5590	17.39	20.45	21.13	18.54	22.19	23.04	24
High	5700	18.02	22.27	21.03	19.5	23.66	23.34	24

40 MHz bandwidth

Channel	Frequency (MHz)	Conducted Power C1 (dBm)	Conducted Power C2 (dBm)	Conducted Power C3 (dBm)	Conducted Power C4 (dBm)	Total Power C1,C2 (dBm)	Total Power C3,C4 (dBm)	Limit (dBm)
Low	5510	17.03	20.59	19.28	18.33	22.18	21.84	24
Middle	5555	17.33	20.39	21.09	18.6	22.13	23.03	24
High	5690	17.96	22.21	20.89	18.44	23.60	22.85	24

80 MHz bandwidth

Channel	Frequency (MHz)	Conducted Power C1 (dBm)	Conducted Power C2 (dBm)	Conducted Power C3 (dBm)	Conducted Power C4 (dBm)	Total Power C1,C2 (dBm)	Total Power C3,C4 (dBm)	Limit (dBm)
Low	5530	16.95	20.51	20.77	17.92	22.10	22.59	24
Middle	5545	17.25	20.31	20.01	17.52	22.05	21.95	24
High	5560	17.88	21.13	18.81	18.36	22.81	21.60	24

10 FCC §15.407(b) - Out of Band Emissions

10.1 Applicable Standard

According to FCC §15.407(b)

For transmitters operating in the 5.15-5.25 GHz band: All emissions outside of the 5.15-5.35 GHz band shall not exceed an e.i.r.p. of -27 dBm/MHz.

For transmitters operating in the 5.25-5.35 GHz band: All emissions outside of the 5.15-5.35 GHz band shall not exceed an e.i.r.p. of -27 dBm/MHz.

For transmitters operating in the 5.47-5.725 GHz band: All emissions outside of the 5.47-5.725 GHz band shall not exceed an e.i.r.p. of -27 dBm/MHz.

For transmitters operating in the 5.725-5.85 GHz band: All emissions within the frequency range from the band edge to 10 MHz above or below the band edge shall not exceed an e.i.r.p. of -17 dBm/MHz; for frequencies 10 MHz or greater above or below the band edge, emissions shall not exceed an e.i.r.p. of -27 dBm/MHz.

10.2 Measurement Procedure

The measurements are based on FCC KDB 789033 D02 General UNII Test Procedures v01: Guidelines for Compliance Testing of Unlicensed National Information Infrastructure (U-NII) Devices section H: Unwanted emissions measurement

10.3 Test Equipment List and Details

Manufacturer	Description	Model No.	Serial No.	Calibration Date	Calibration Interval
Agilent	Spectrum Analyzer	E4446A	US44300386	2013-09-29	1 year

Statement of Traceability: BACL Corp. attests that all calibrations have been performed according to A2LA requirements, traceable to the NIST.

10.4 Test Environmental Conditions

Temperature:	22 - 24° C
Relative Humidity:	45 - 51 %
ATM Pressure:	101 - 101.1 kPa

The testing was performed by Cipher Chu on 2014-04-04 to 2014-04-07 and 2014-08-09 to 2014-08-21 at the RF Site

Note: The antenna gain already adds on the offset.

Note: Chain 1 and Chain 4 is Vertical, and Chain 2 and Chain 3 is Horizontal

Note: C1, C2, C3 and C4 stands for Chain 1, Chain 2, Chain 3 and Chain 4.

10.5 Test Results

Please refer to following pages for plots of band edge.

25 dBi Antenna:

5.3 GHz Band

20 MHz Bandwidth, Low Channel, 5260 MHz

C1

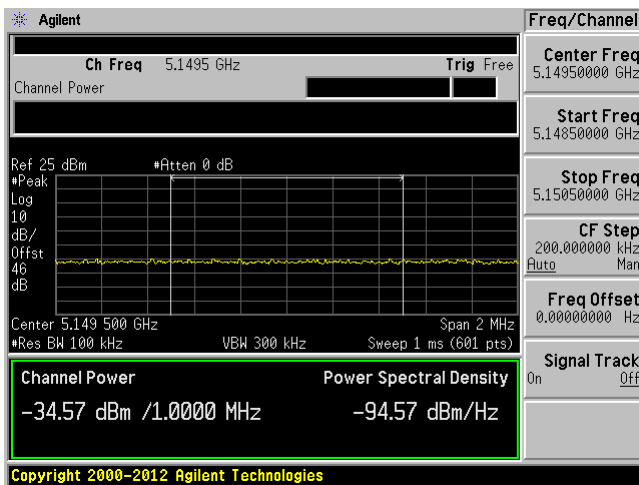

C2

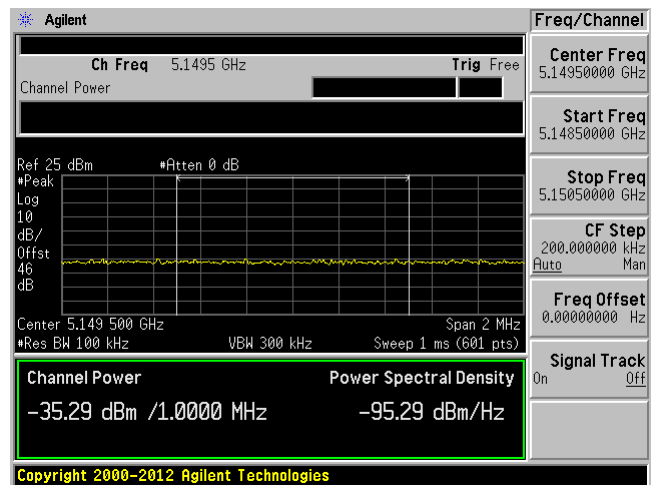

C3

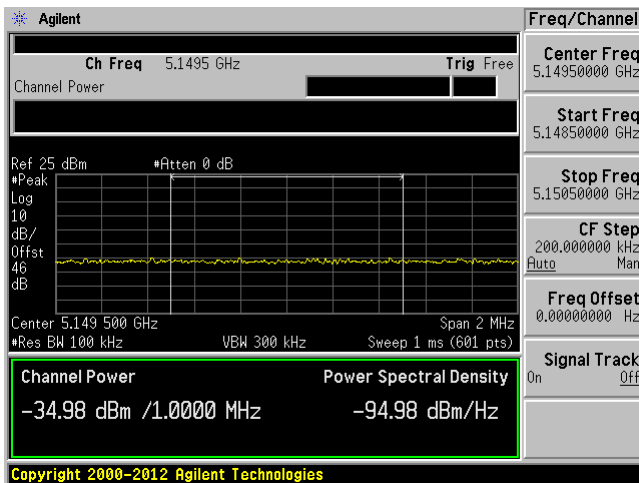

C4

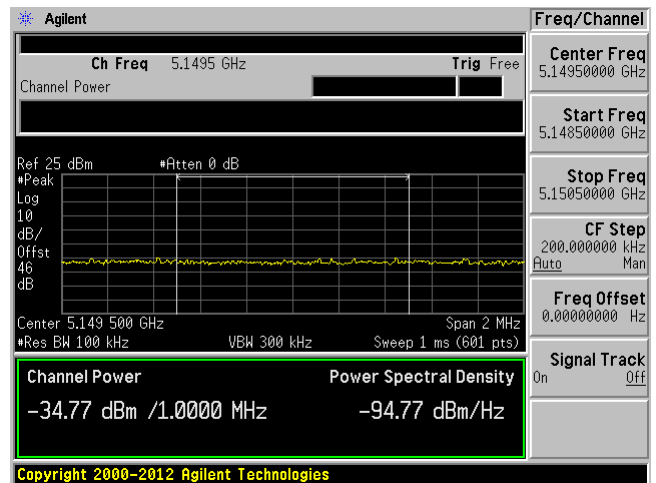

20 MHz Bandwidth, High Channel, 5320 MHz

C1

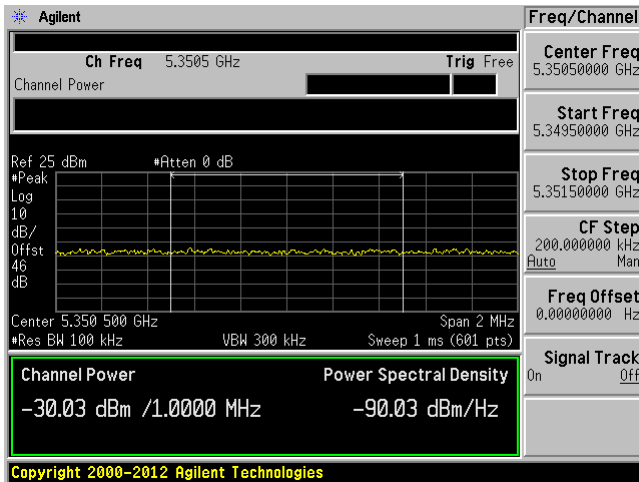

C2

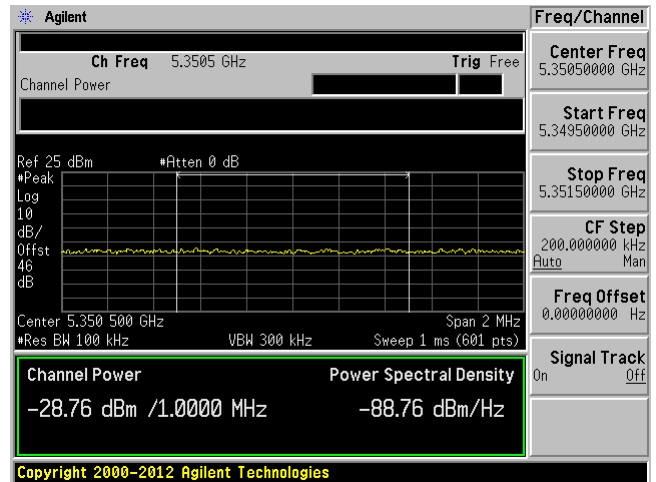

C3

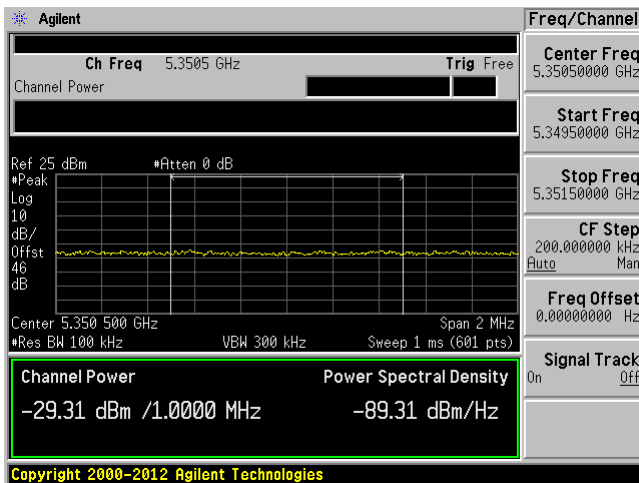

C4

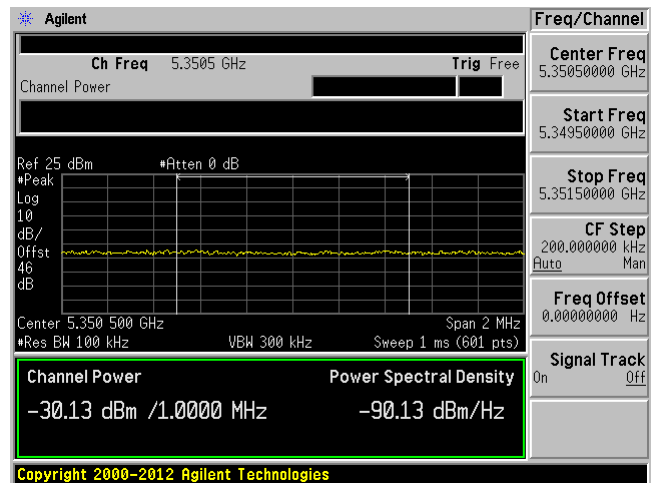

40 MHz Bandwidth, Low Channel, 5270 MHz

C1

C2

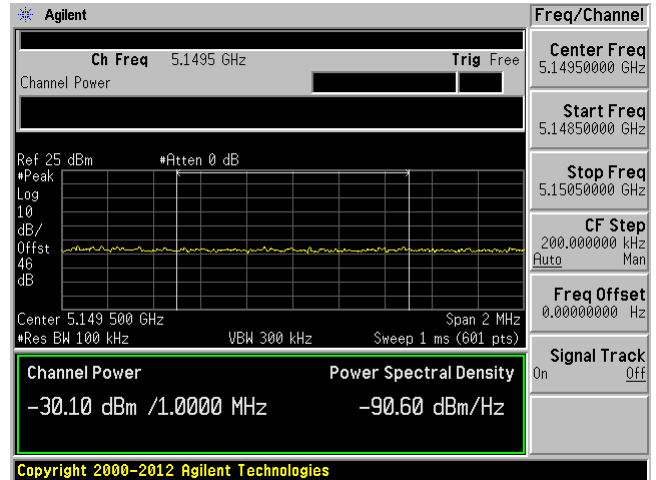
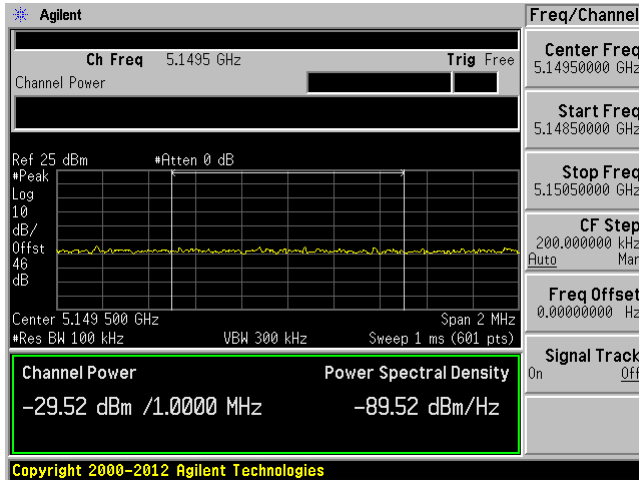

C3

C4

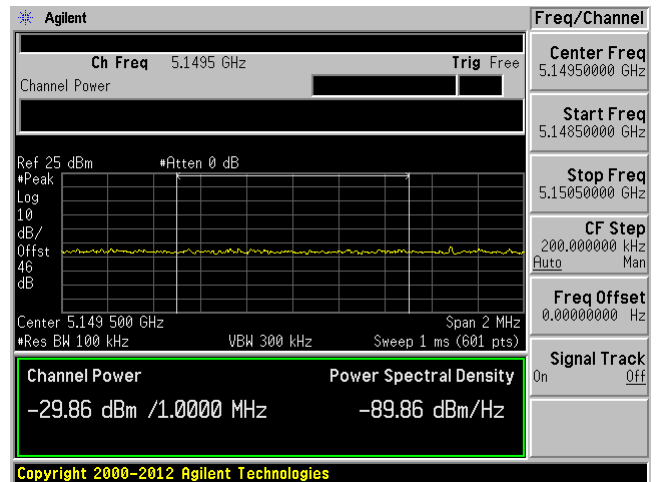
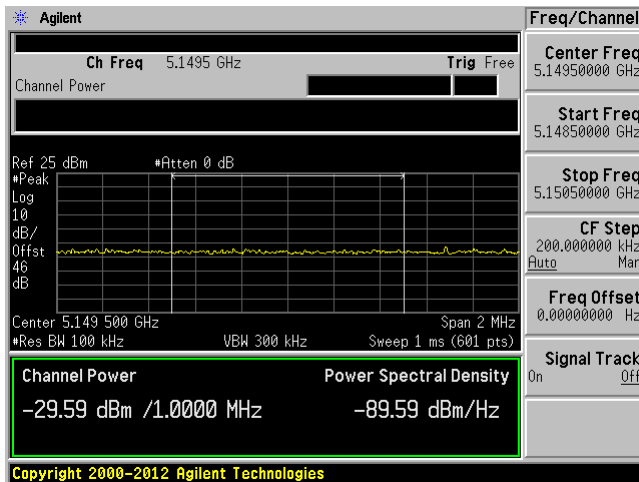

40 MHz Bandwidth, High Channel, 5310 MHz

C1

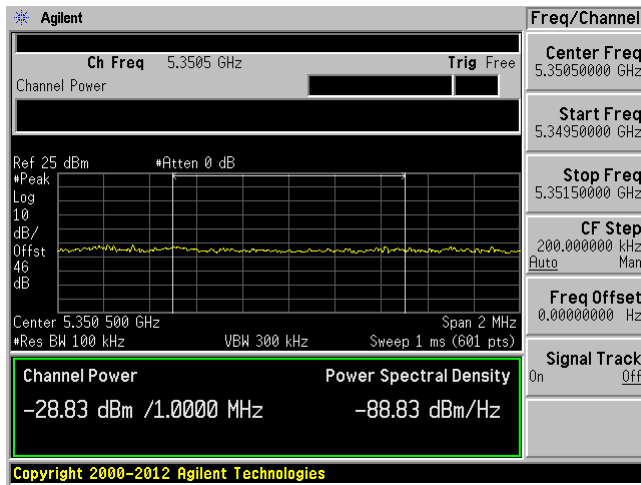

C2

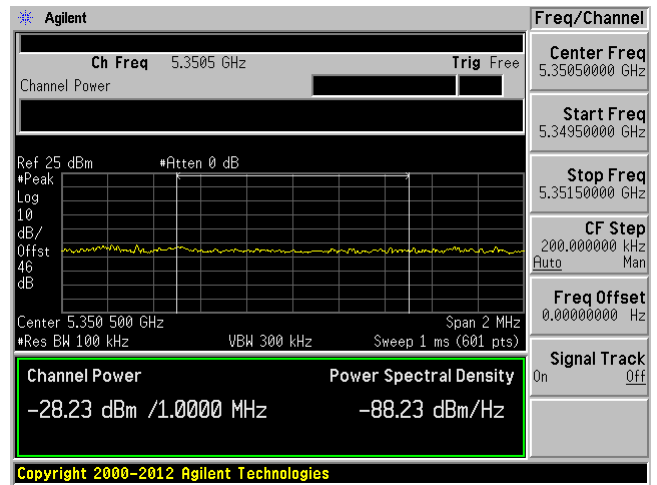

C3

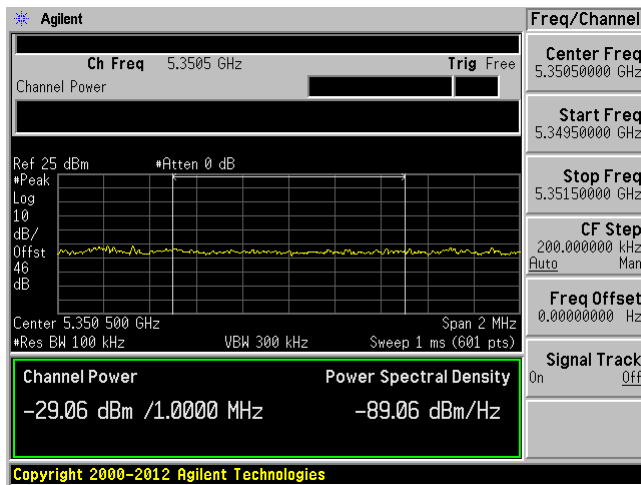

C4

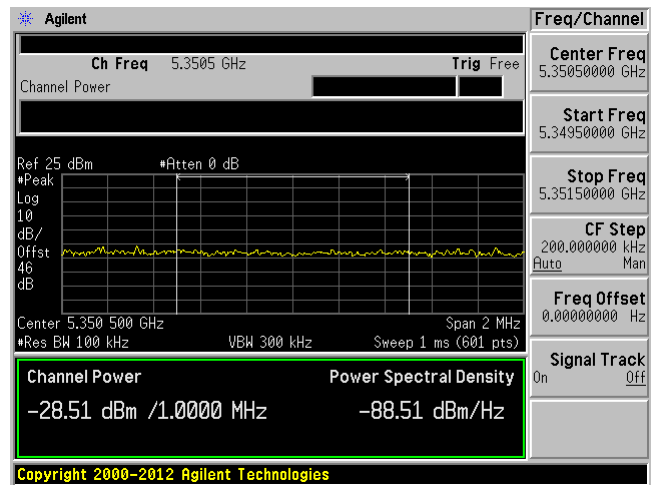

80 MHz Bandwidth, Low Channel, 5290 MHz

C1

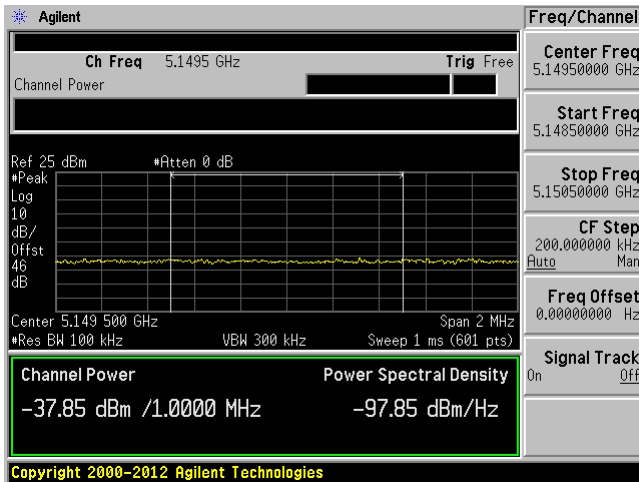

C2

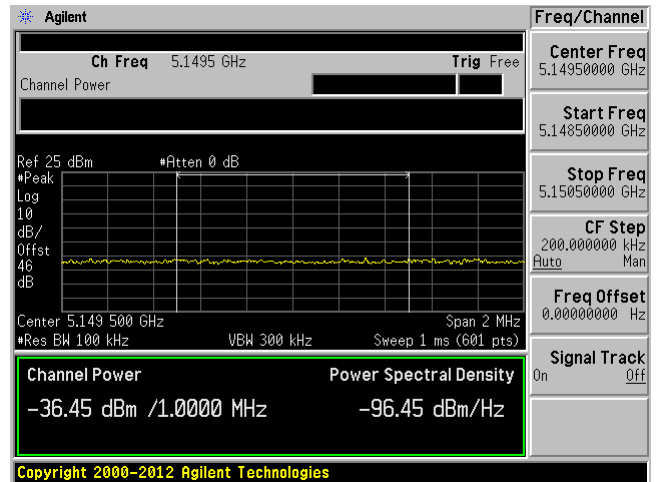

C3

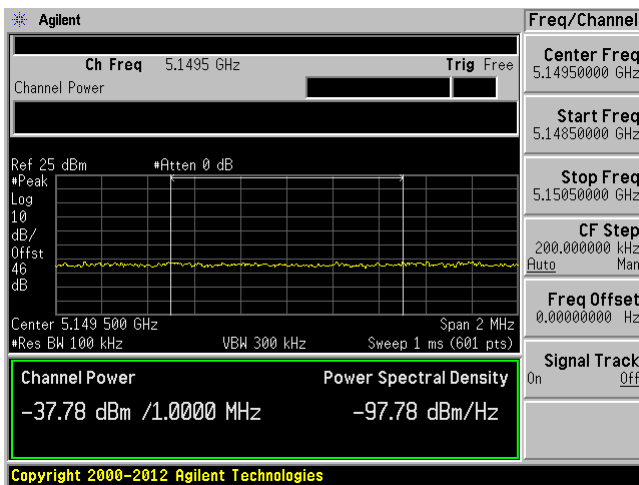

C4

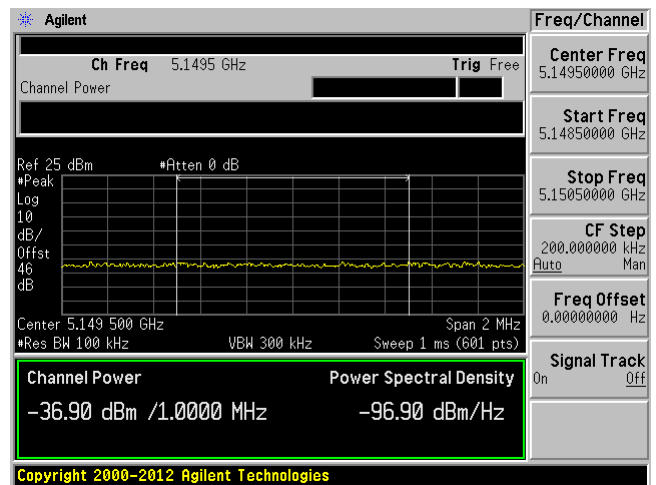

80 MHz Bandwidth, High Channel, 5290 MHz

C1

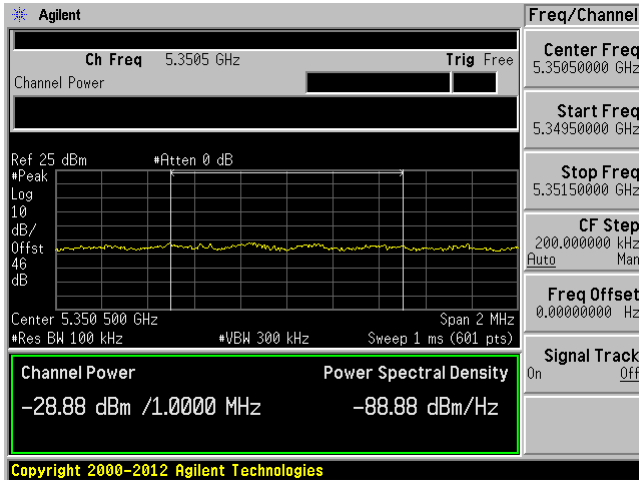

C2

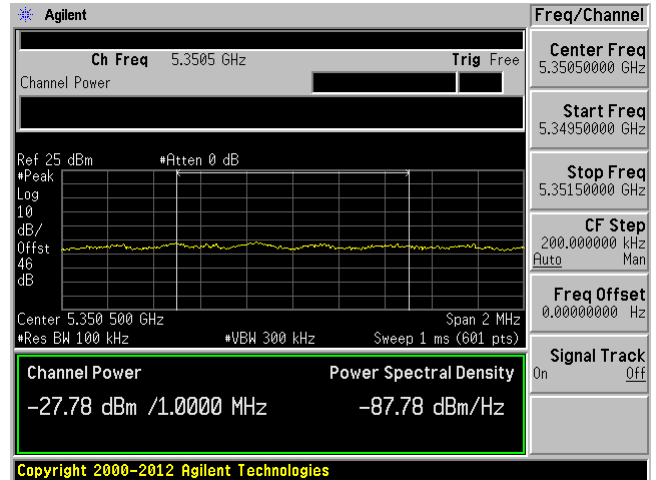

C3

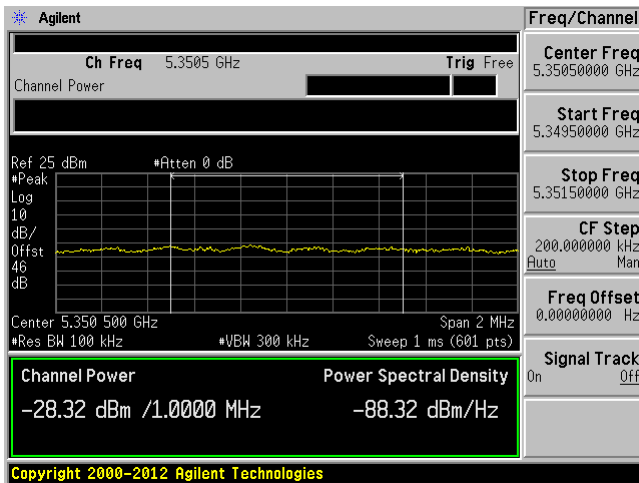

C4

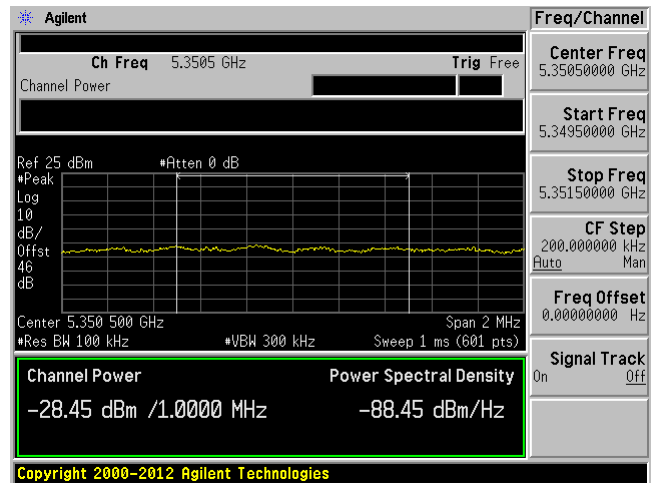

5.6 GHz Band

20 MHz Bandwidth, Low Channel, 5500 MHz

C1

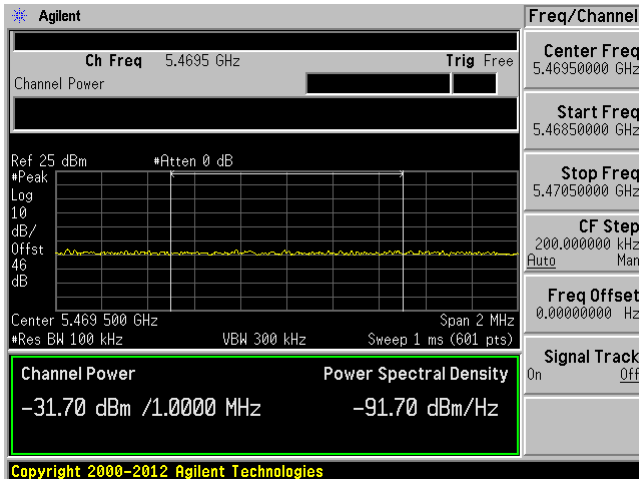

C2

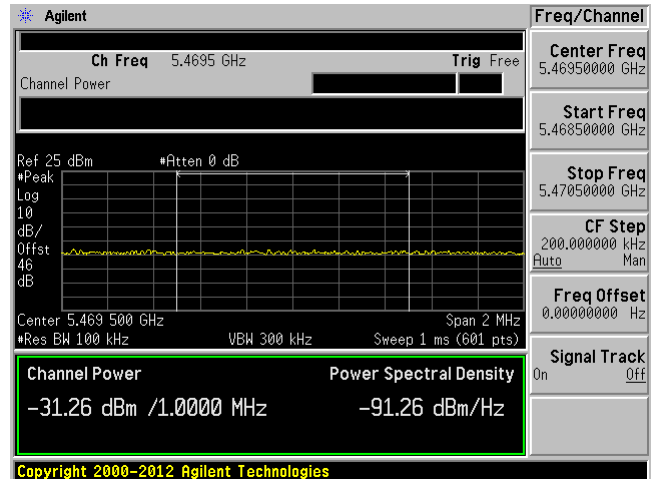

C3

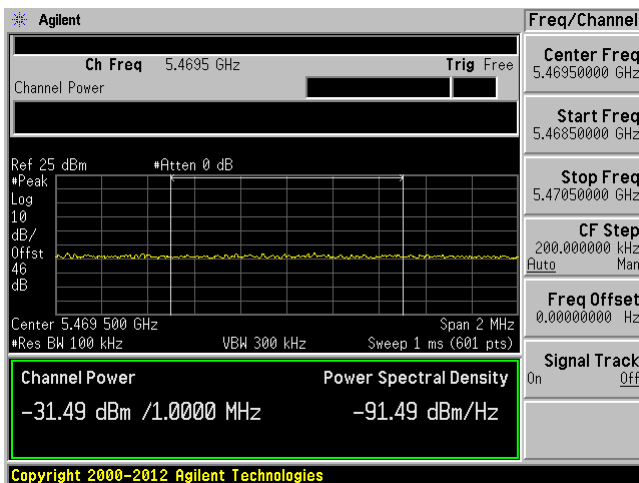

C4

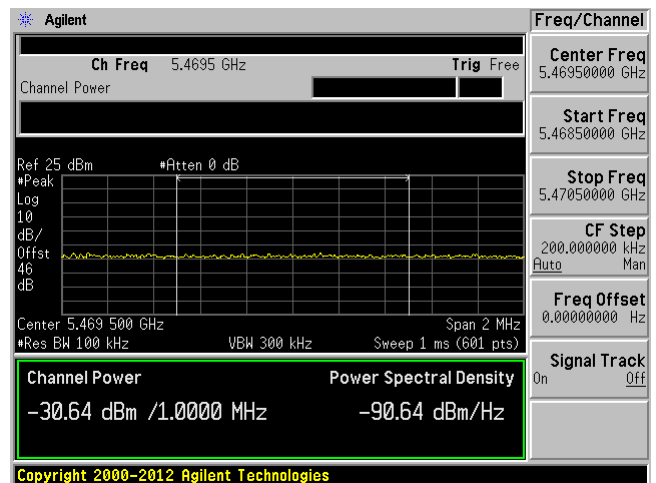

20 MHz Bandwidth, High Channel, 5700 MHz

C1

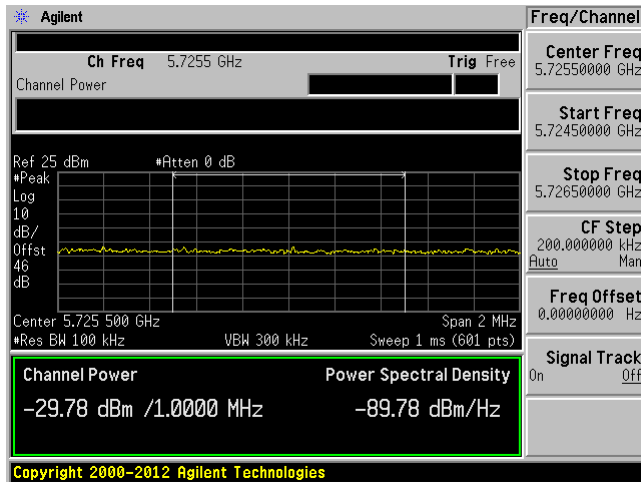

C2

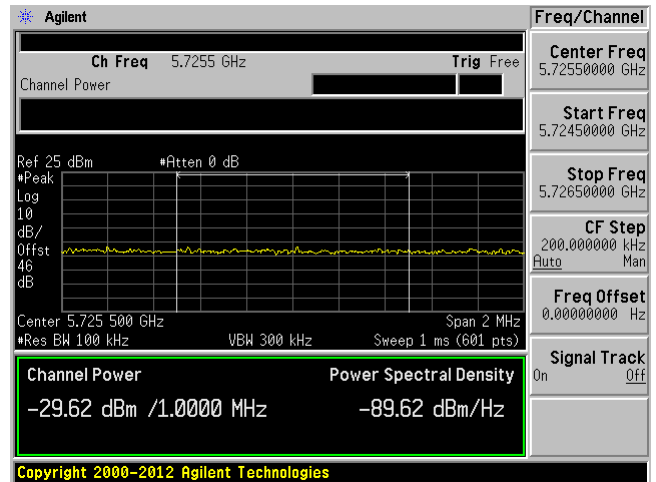

C3

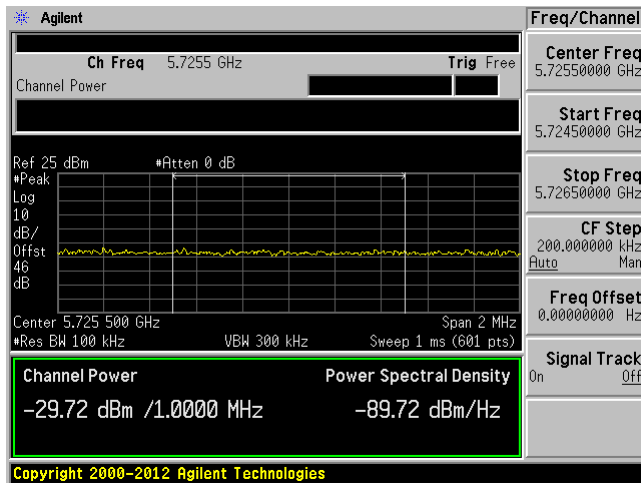

C4

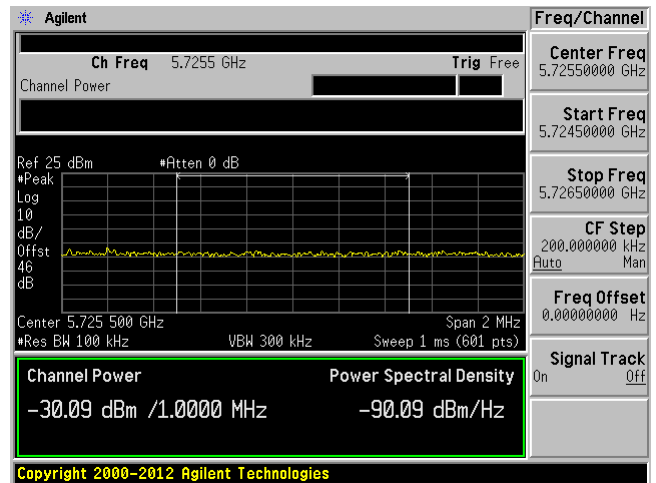

40 MHz Bandwidth, Low Channel, 5510 MHz

C1

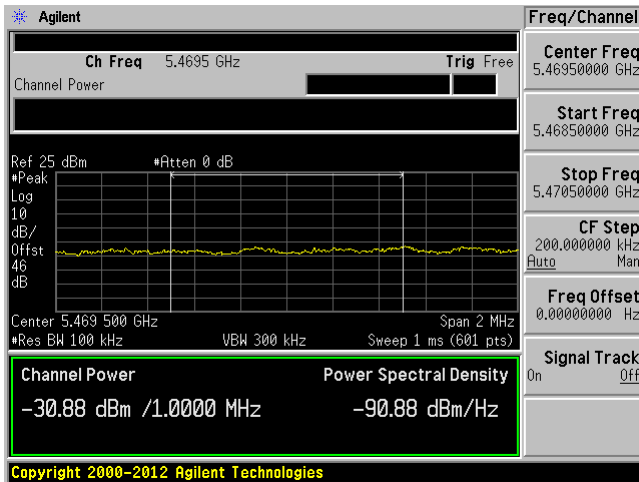

C2

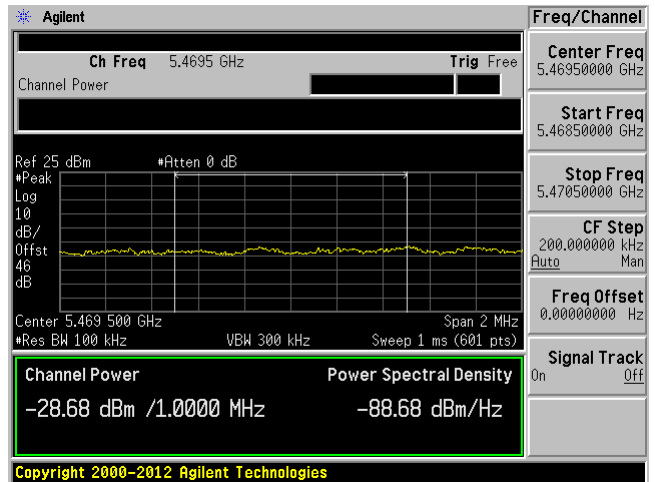

C3

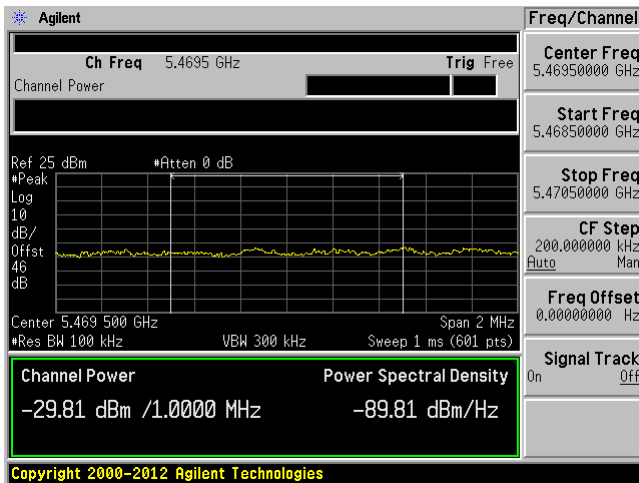

C4

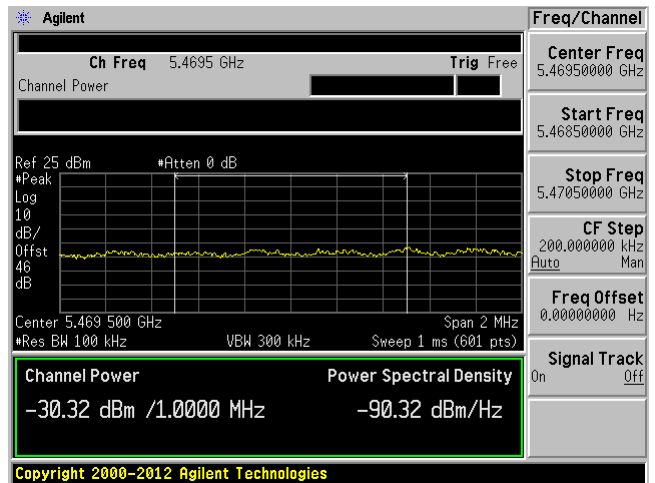

40 MHz Bandwidth, High Channel, 5690 MHz

C1

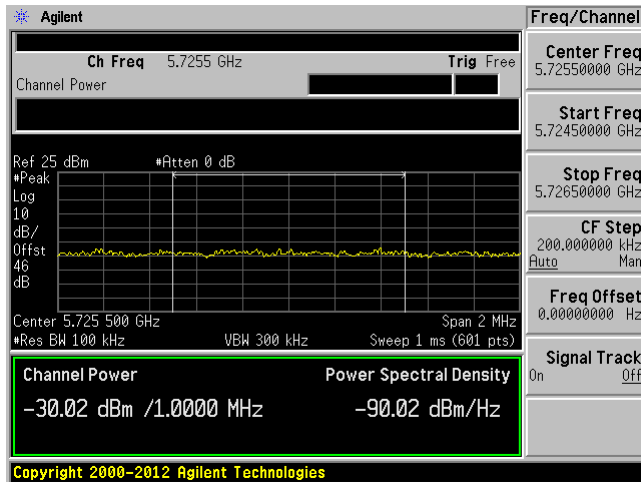

C2

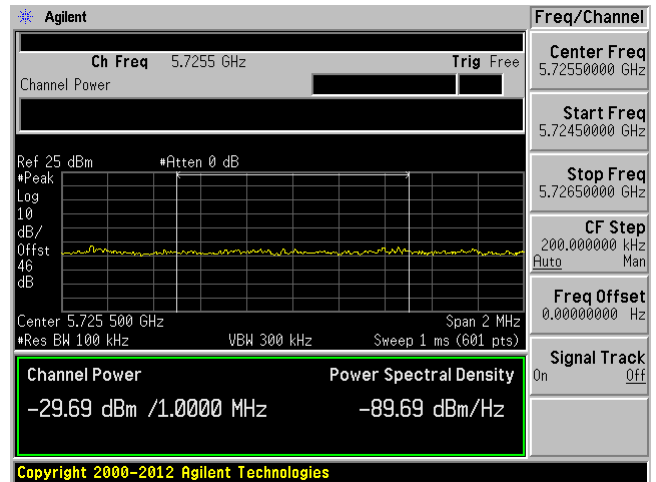

C3

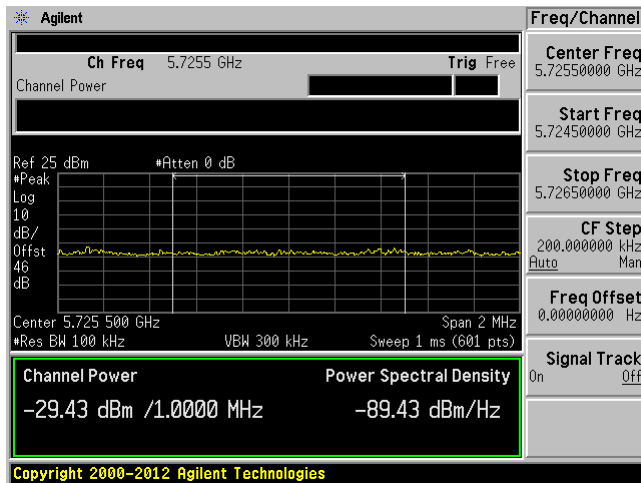

C4

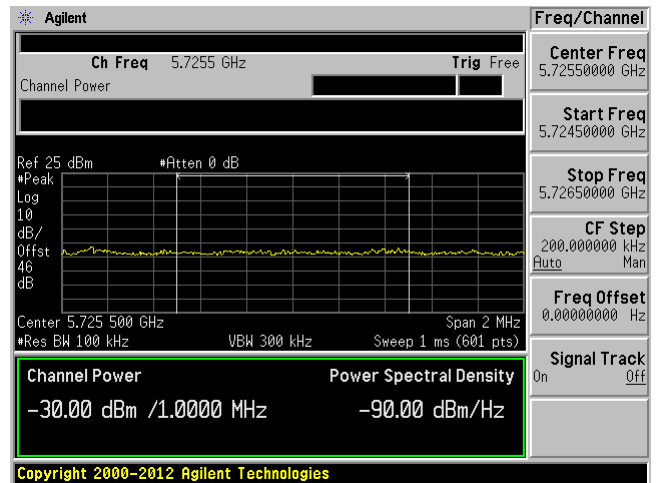

80 MHz Bandwidth, Low Channel, 5530 MHz

C1

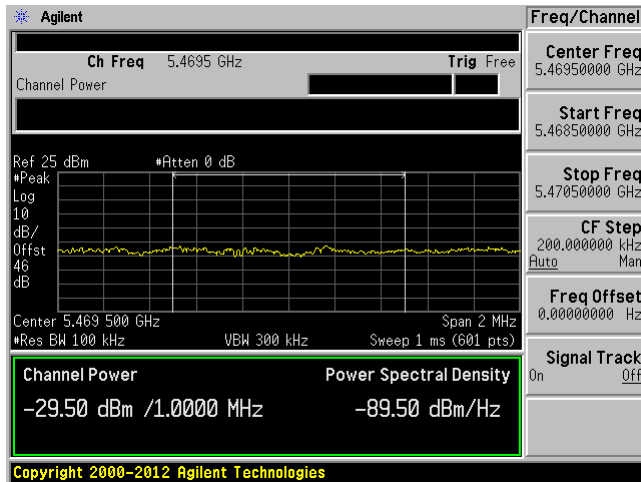

C2

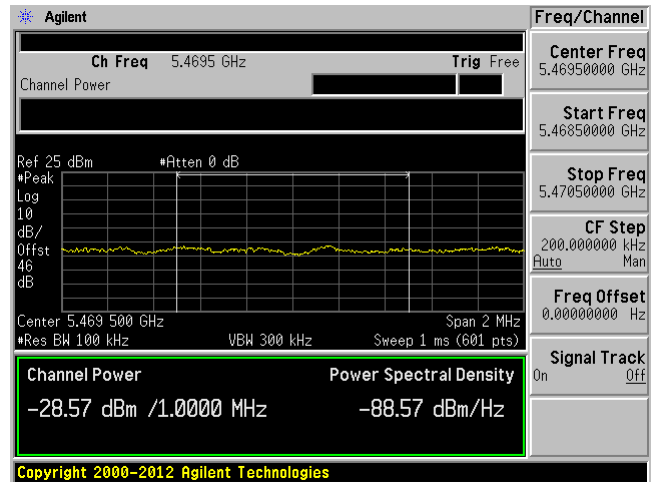

C3

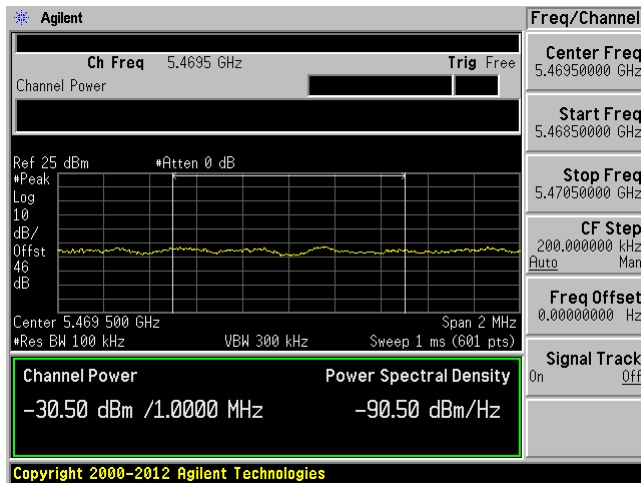

C4

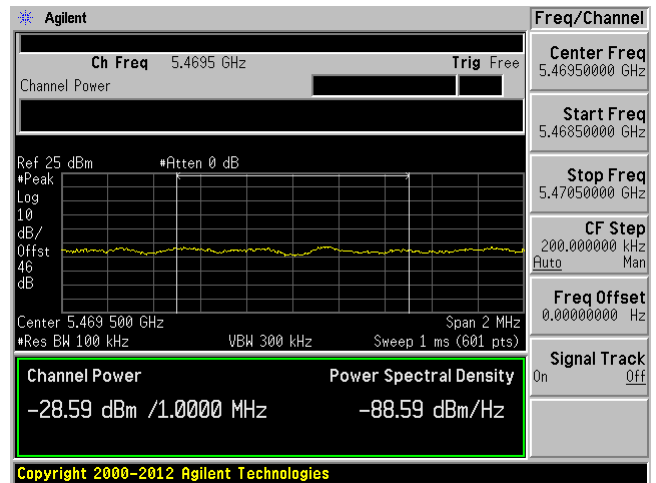

80 MHz Bandwidth, High Channel, 5560 MHz

C1

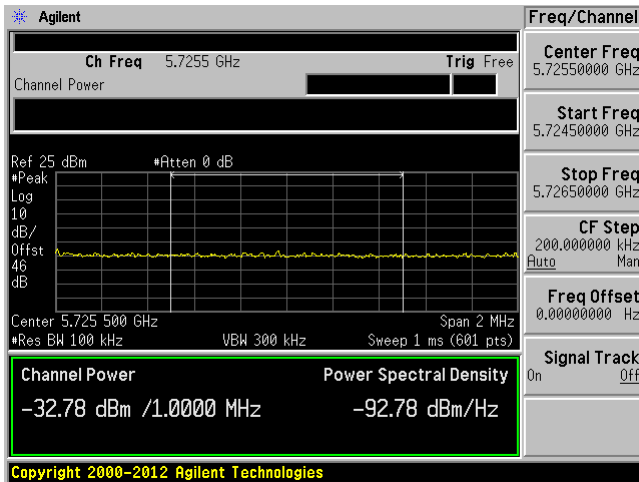

C2

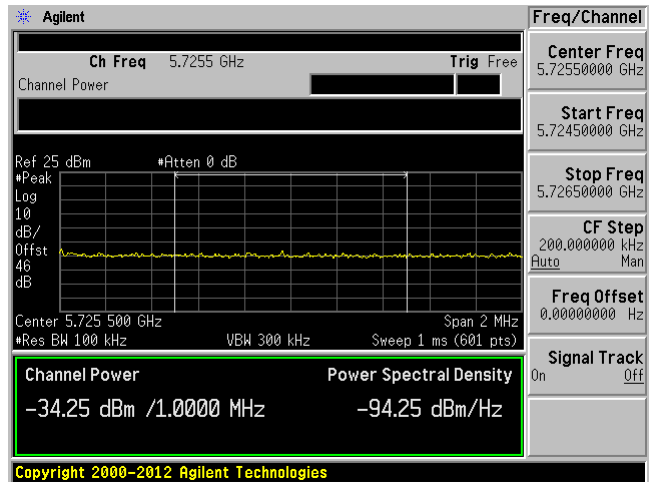

C3

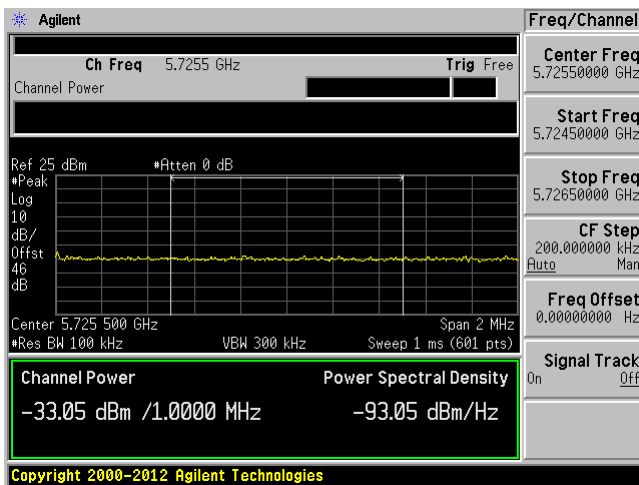

C4

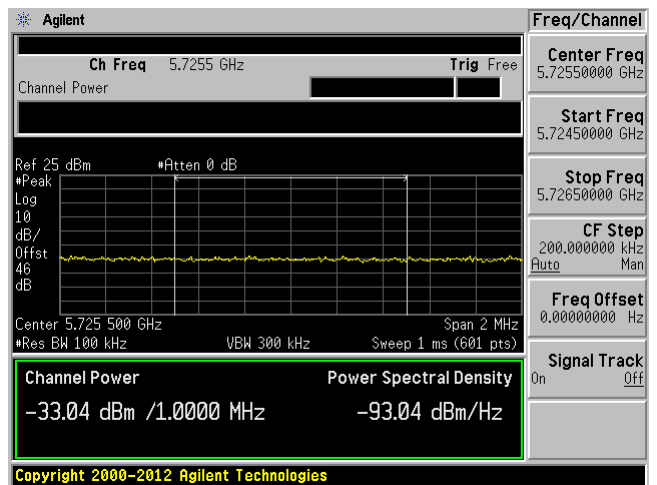

0 dBi Antenna:

5.3 GHz Band:

20 MHz bandwidth, Low Channel, 5260 MHz

C1

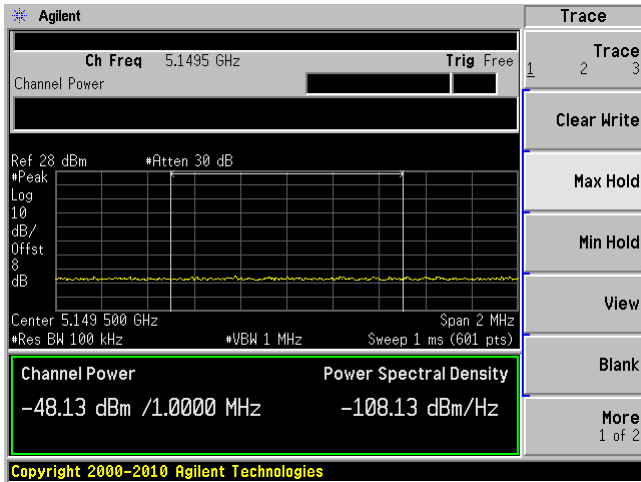

C2

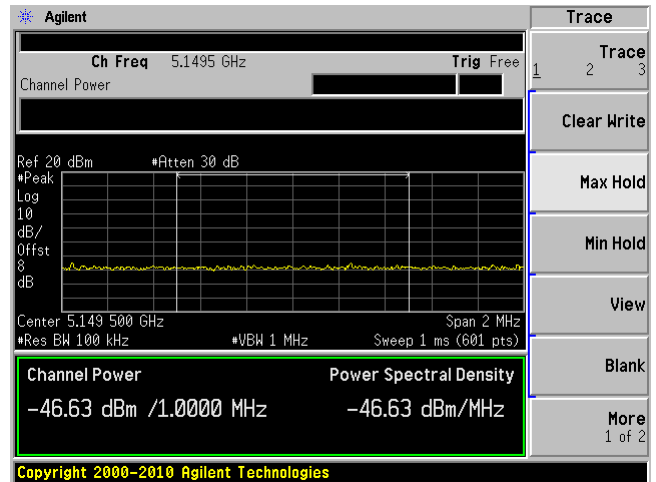

C3

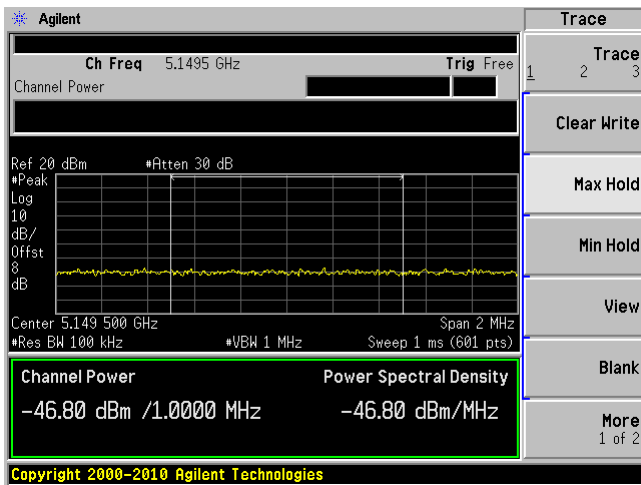

C4

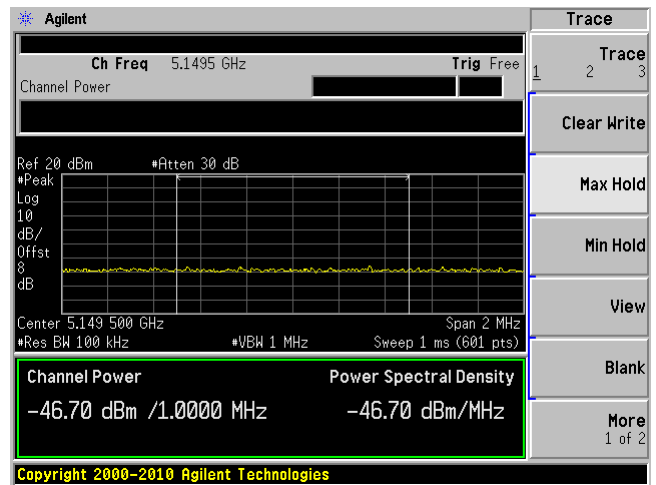

20 MHz bandwidth, High Channel, 5320 MHz

C1

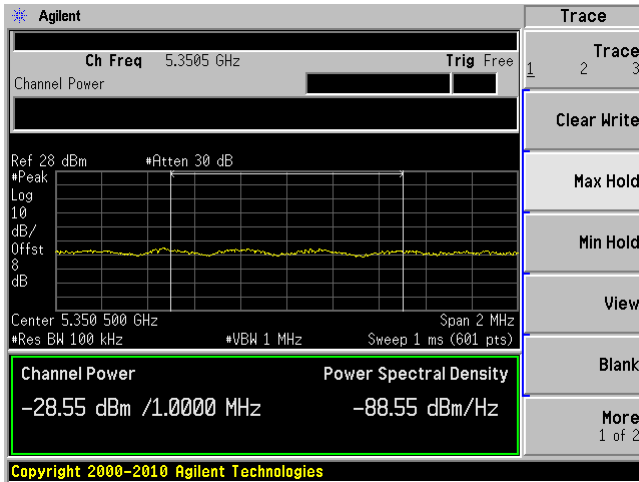

C2

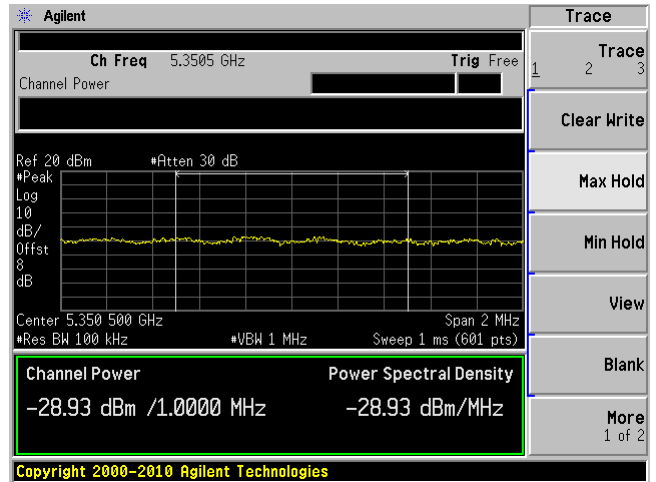

C3

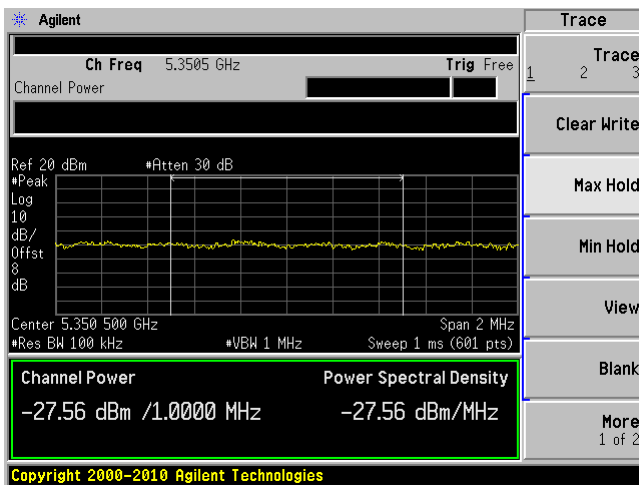

C4

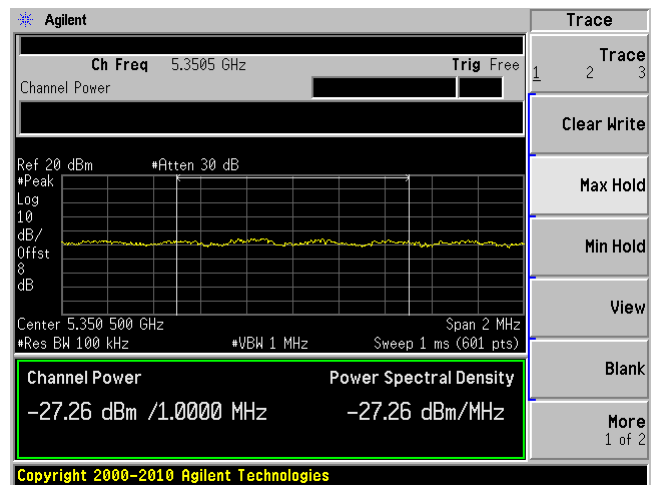

40 MHz bandwidth, Low Channel, 5270 MHz

C1

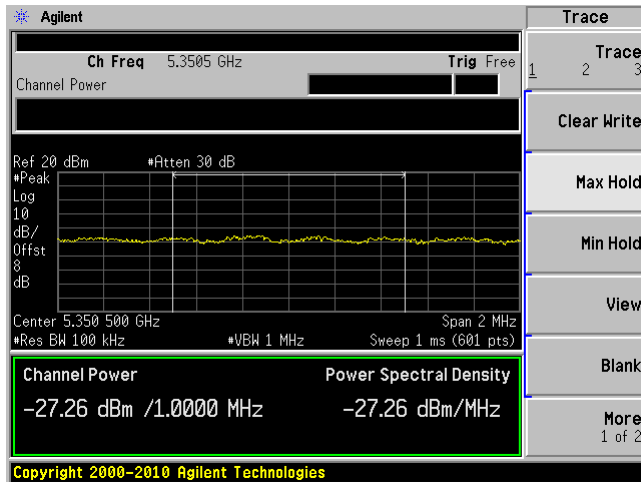

C2

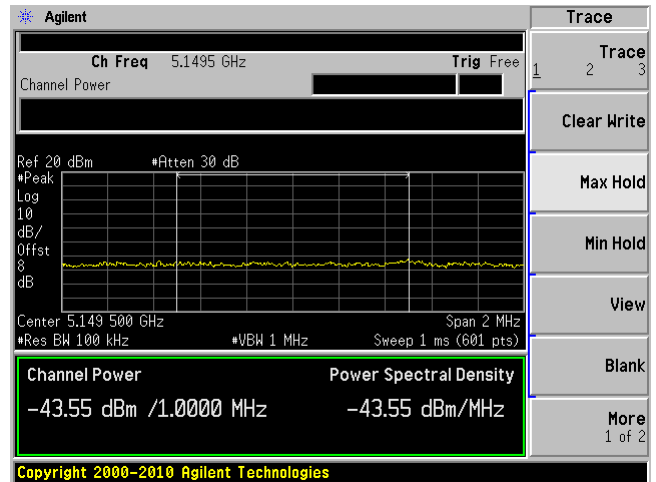

C3

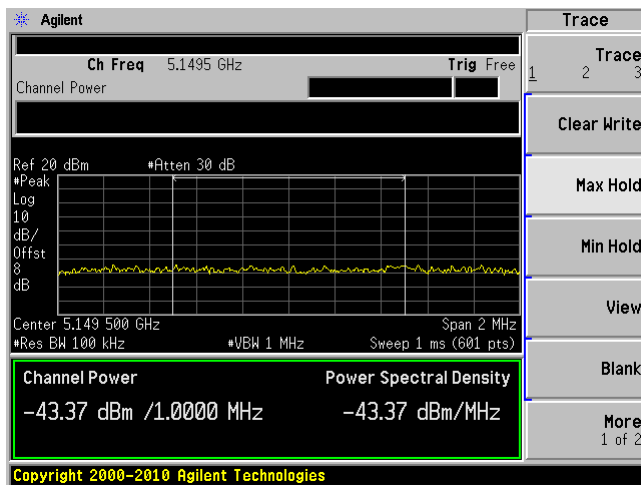

C4

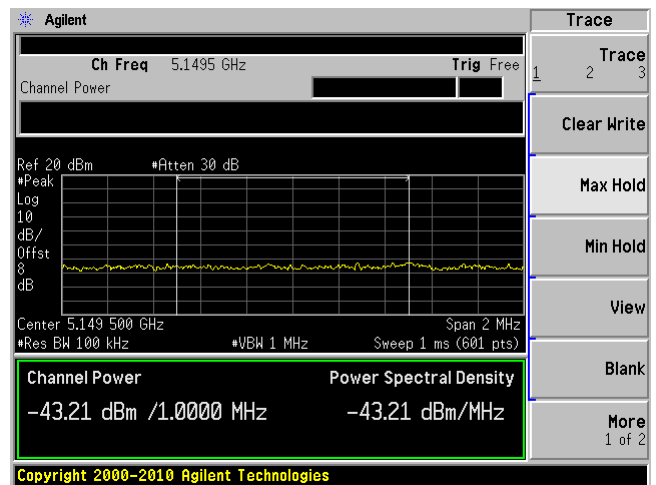

40 MHz bandwidth, High Channel, 5310 MHz

C1

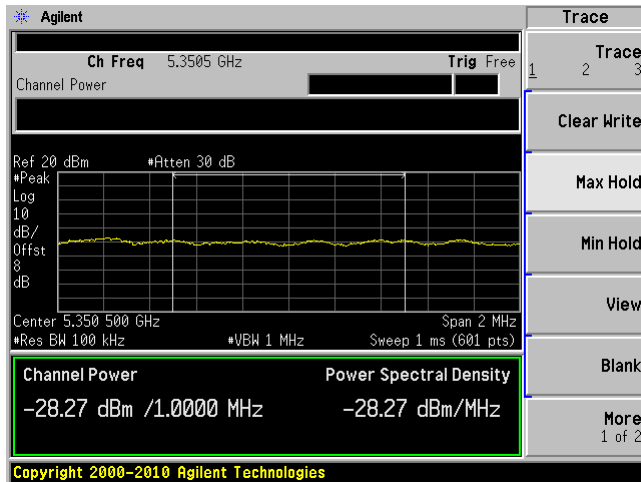

C2

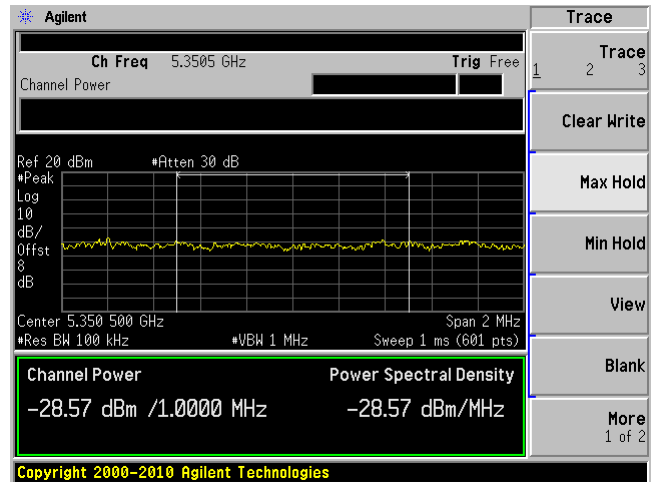

C3

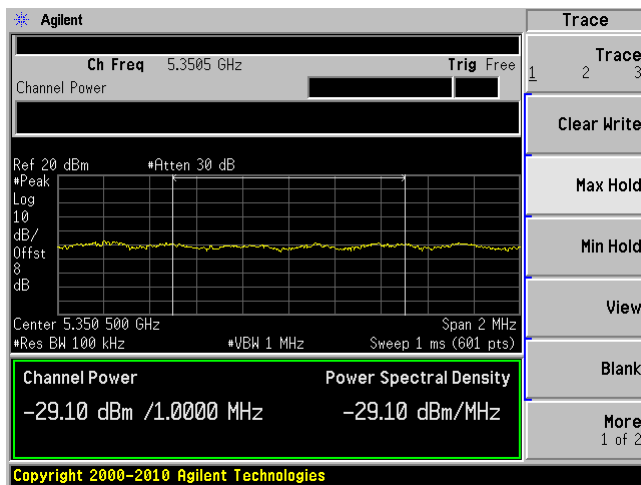

C4

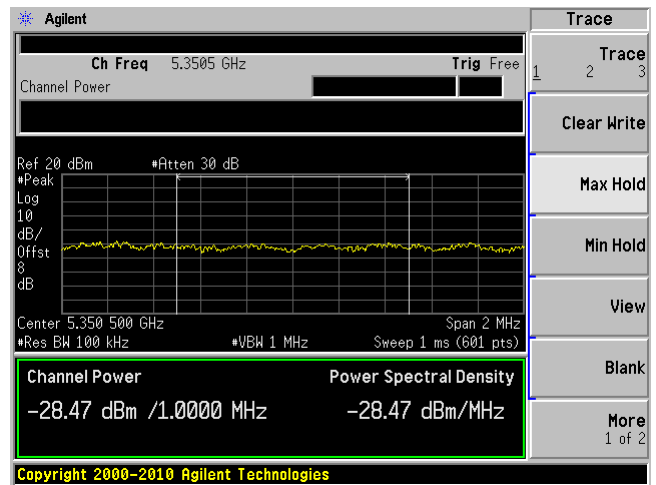

80 MHz bandwidth, Low Channel, 5290 MHz

C1

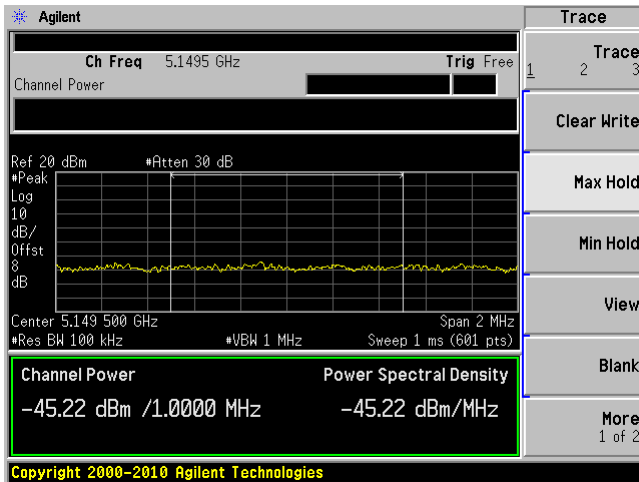

C2

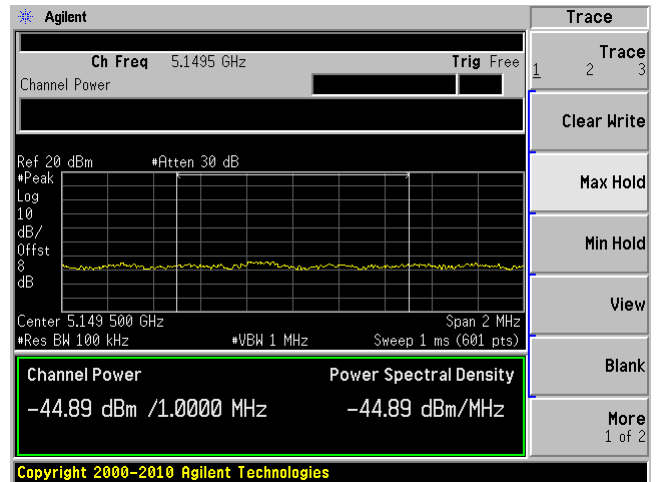

C3

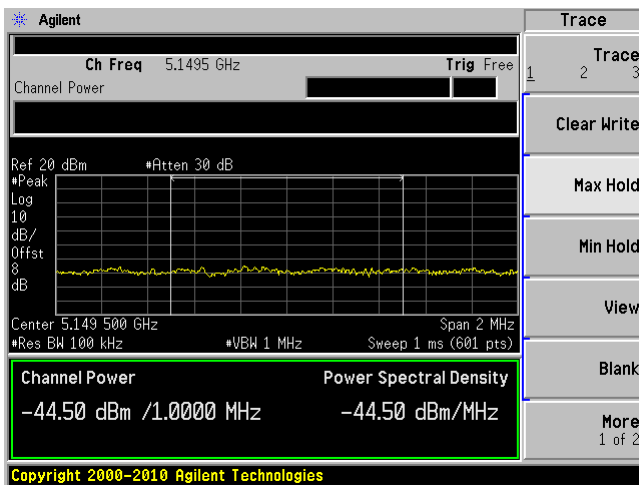

C4

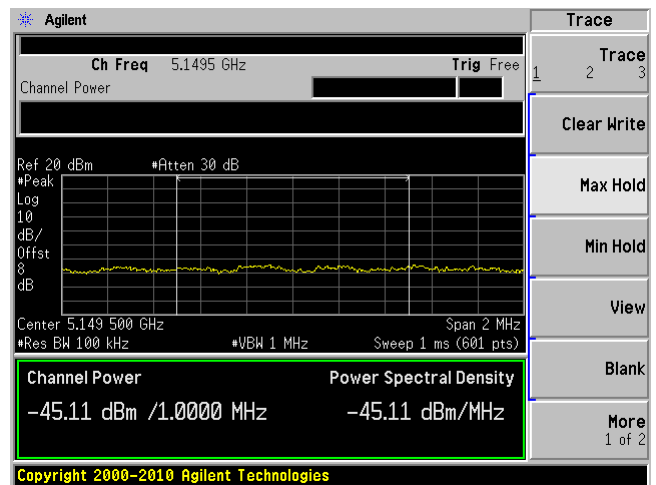

80 MHz bandwidth, High Channel, 5290 MHz

C1

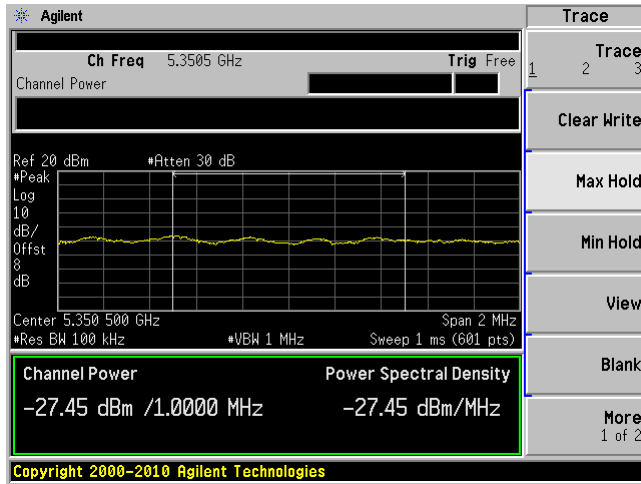

C2

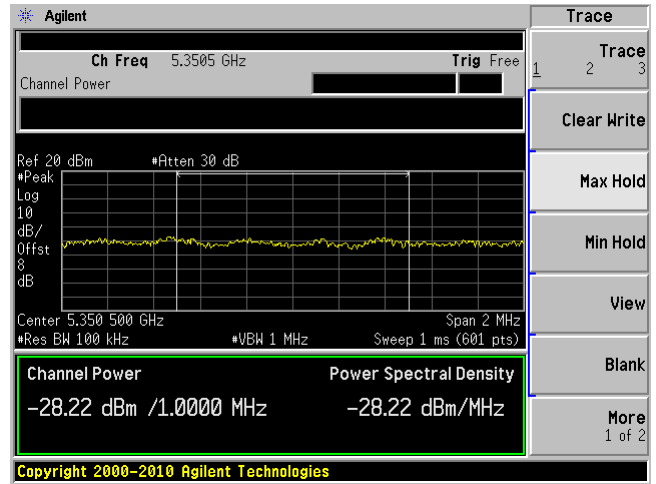

C3

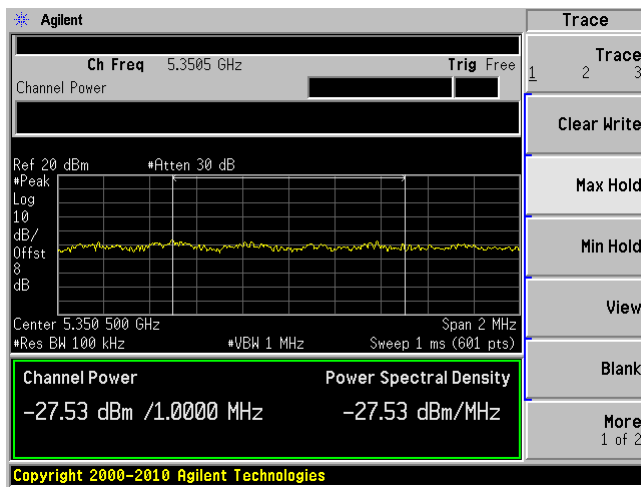

C4

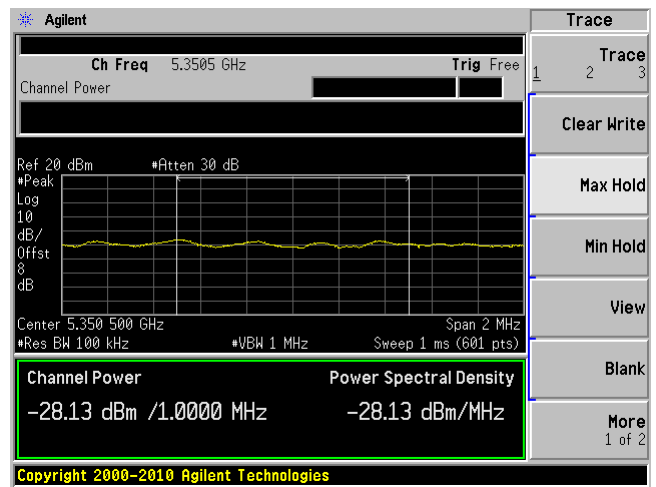

5.6 GHz Band:

20 MHz bandwidth, Low Channel, 5500 MHz

C1

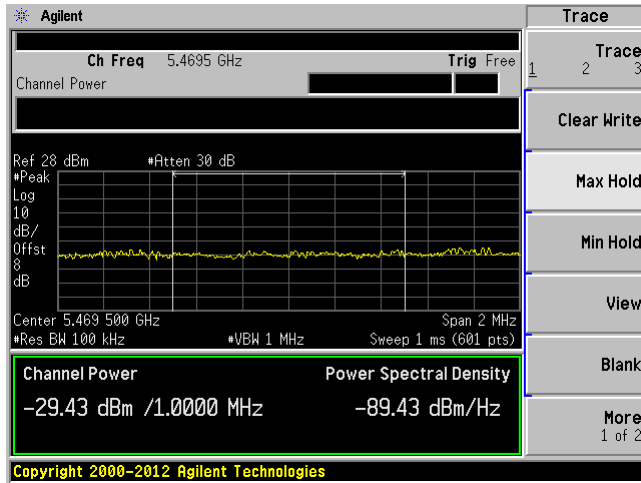

C2

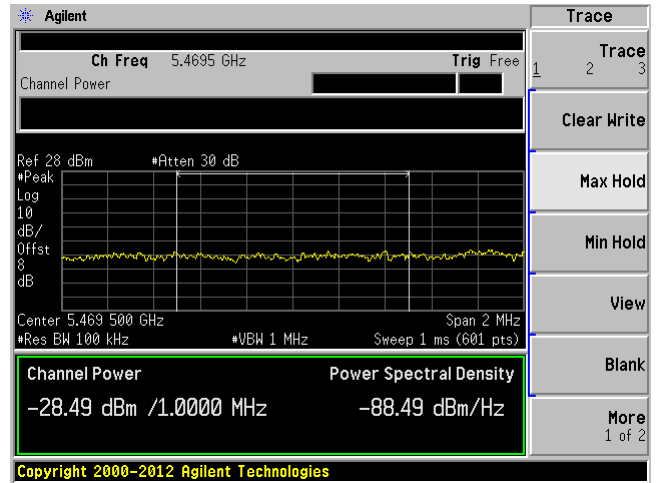

C3

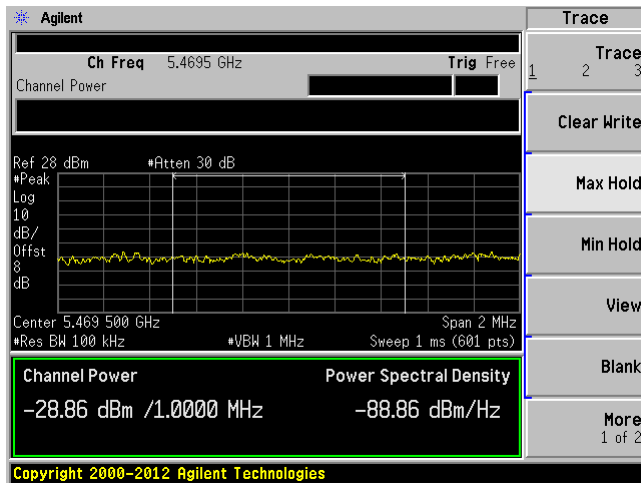

C4

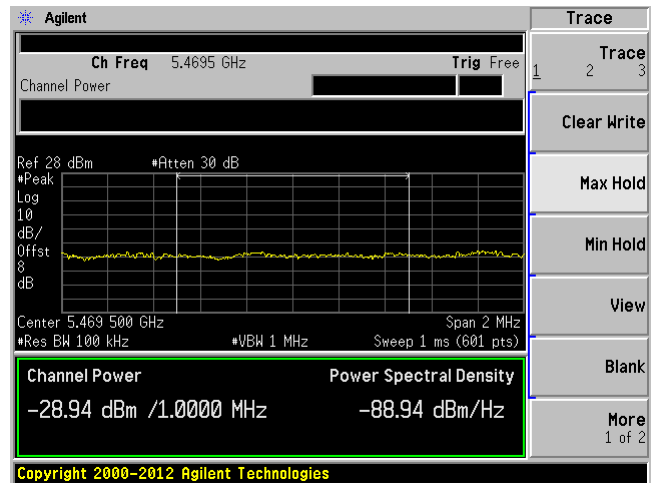

20 MHz bandwidth, High Channel, 5700 MHz

C1

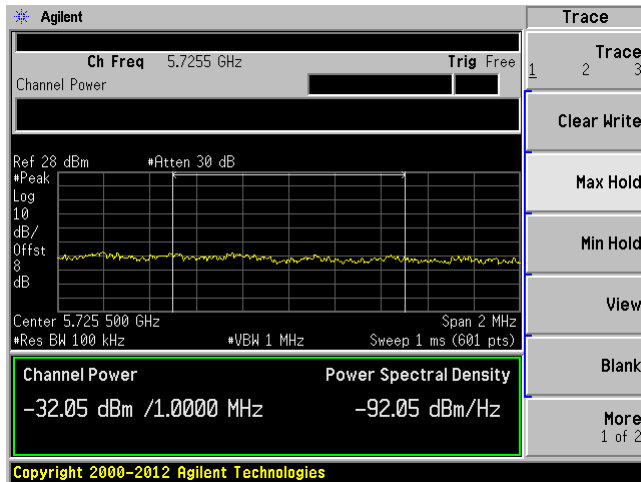

C2

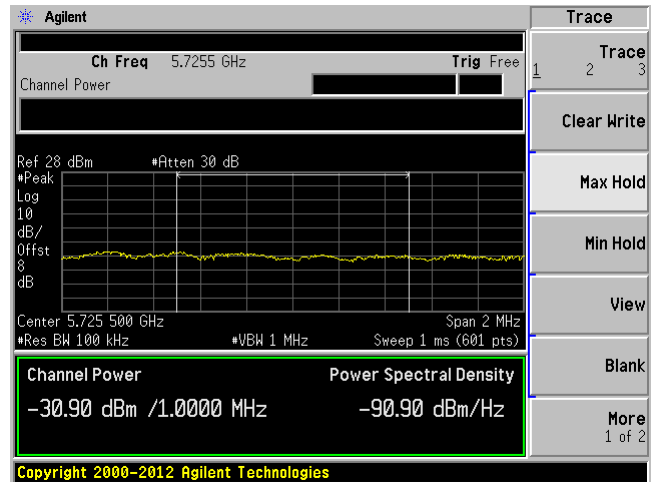

C3

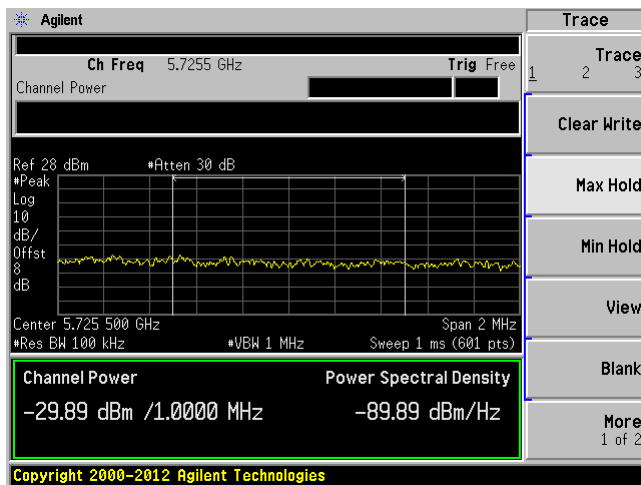

C4

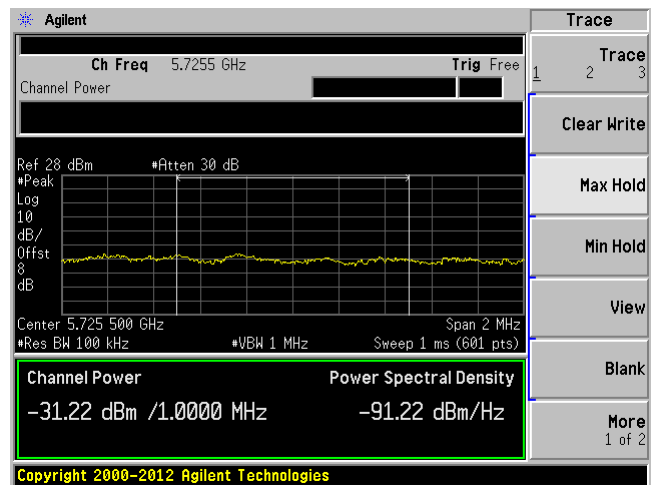

40 MHz bandwidth, Low Channel, 5510 MHz

C1

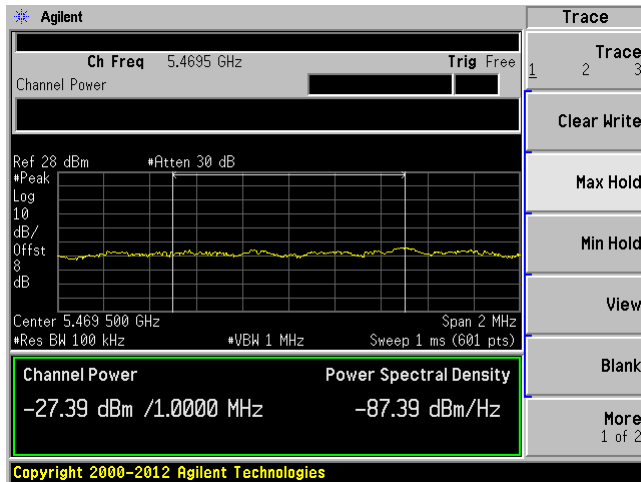

C2

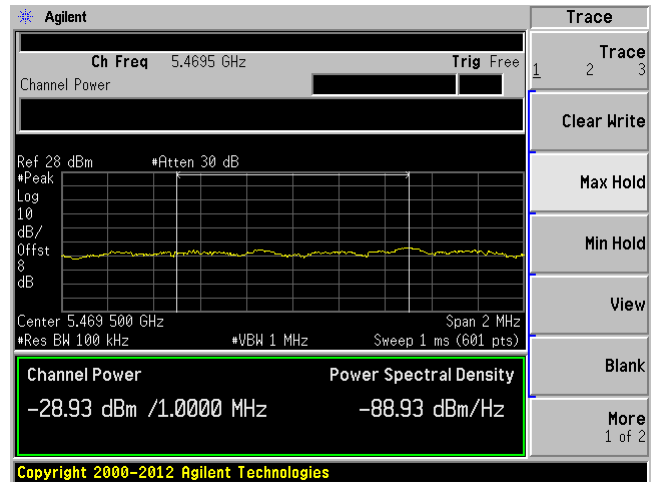

C3

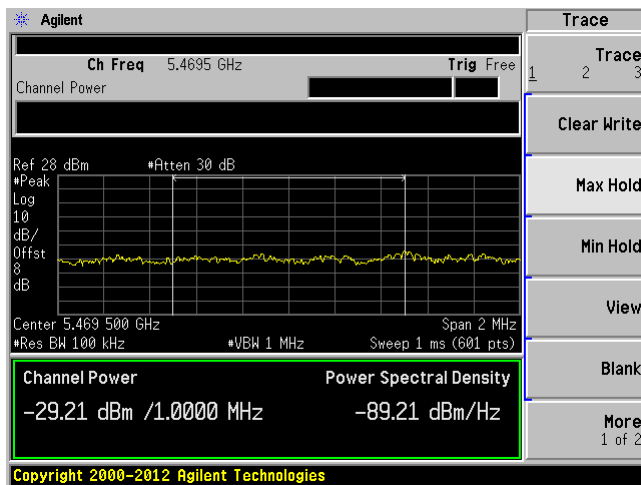

C4

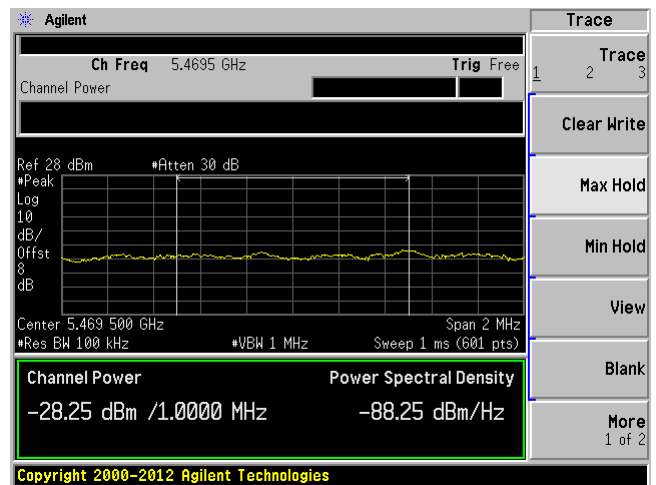

40 MHz bandwidth, High Channel, 5690 MHz

C1

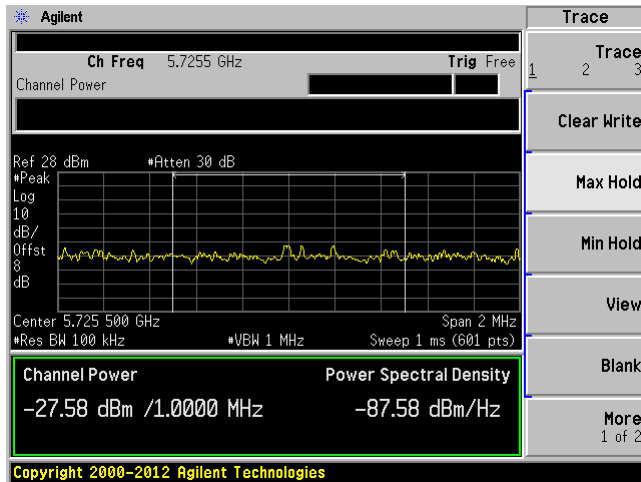

C2

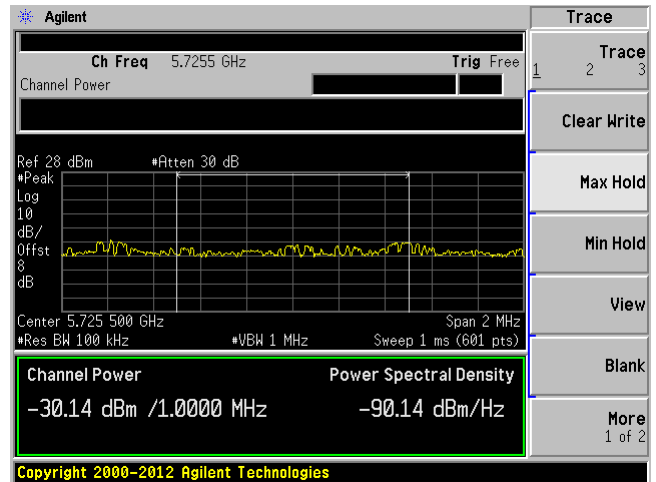

C3

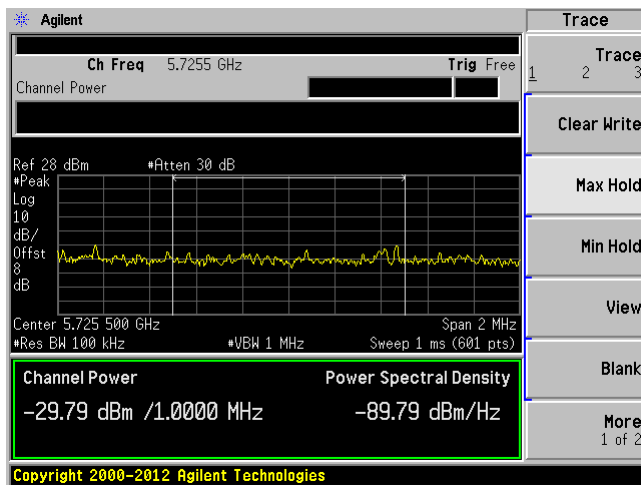

C4

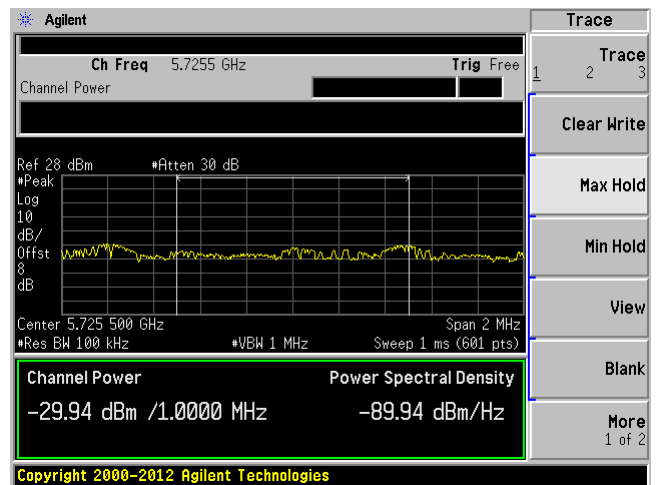

80 MHz bandwidth, Low Channel, 5530 MHz

C1

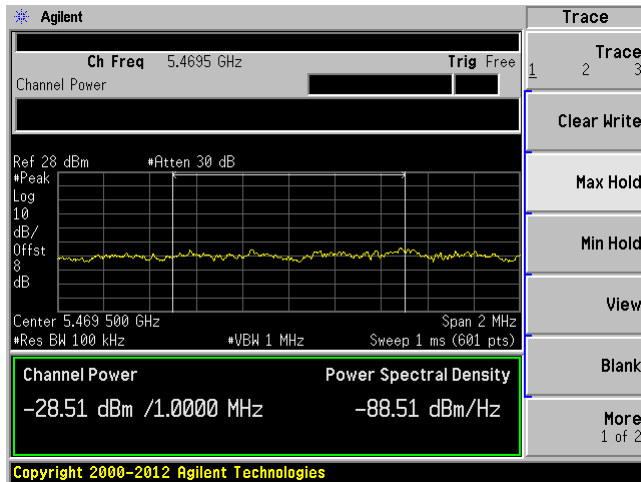

C2

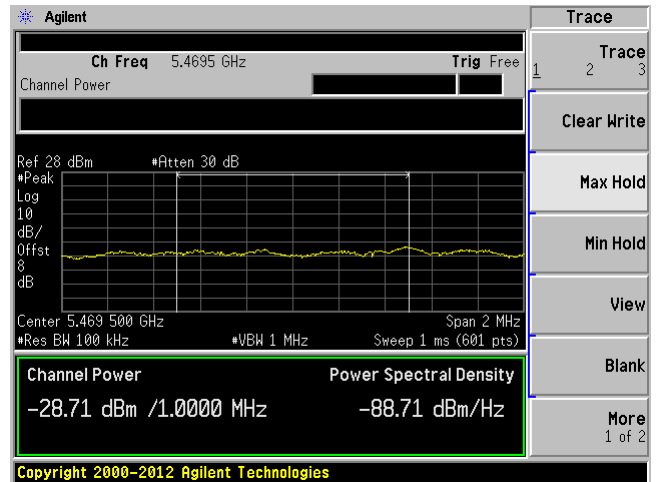

C3

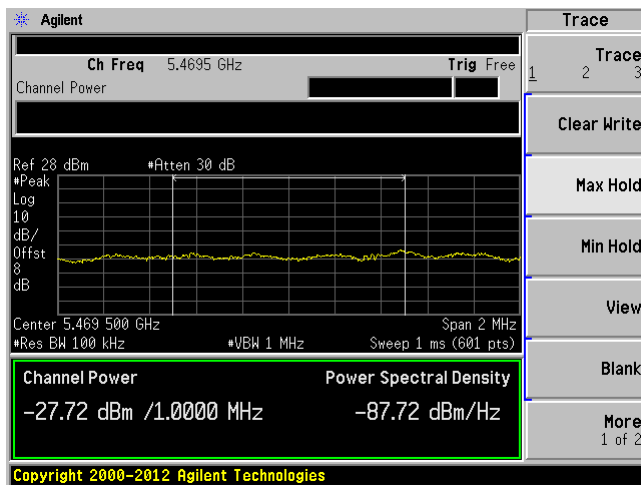

C4

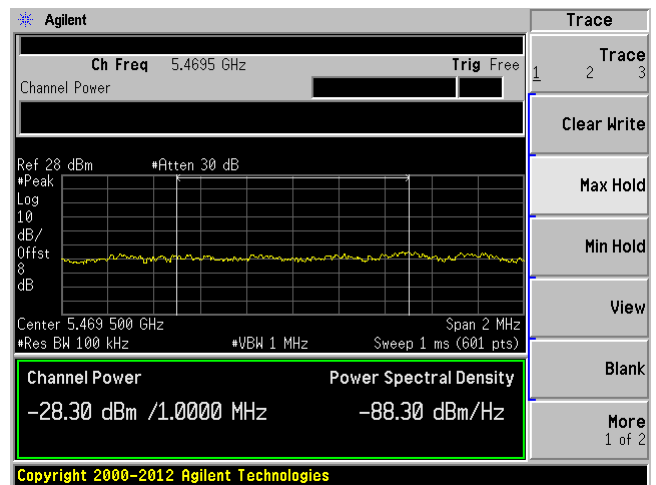

80 MHz bandwidth, High Channel, 5560 MHz

C1

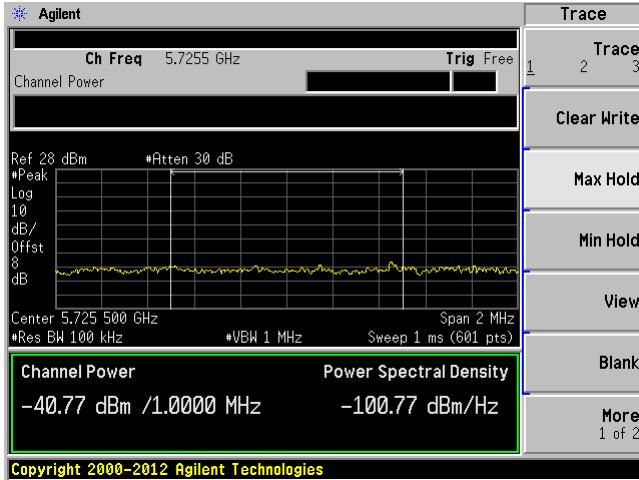

C2

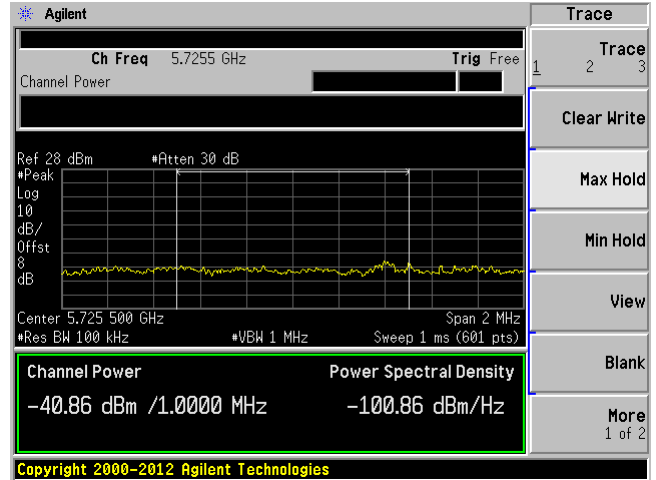

C3

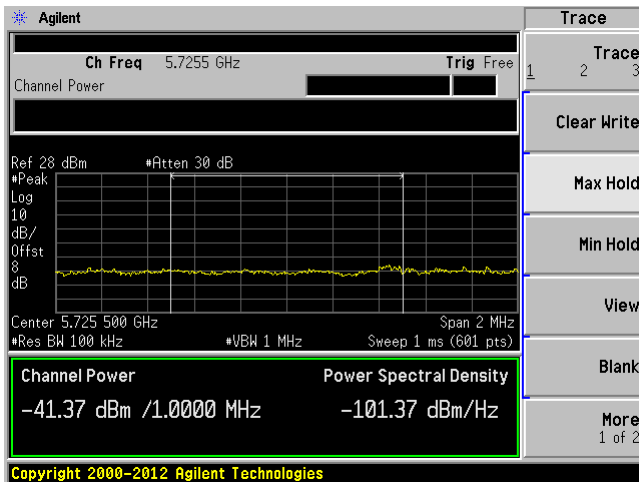

C4

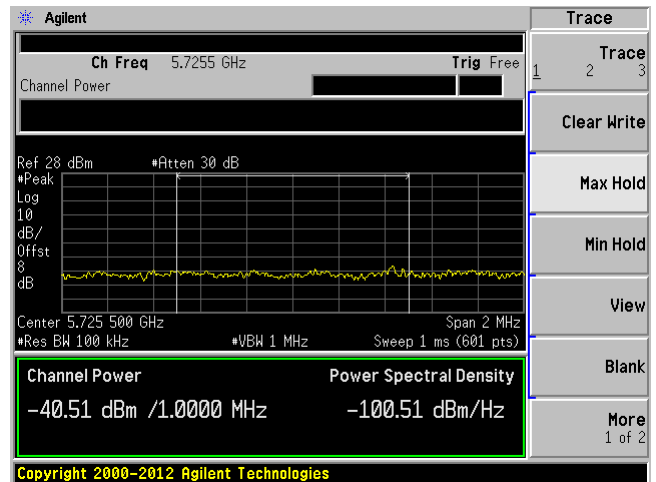

11 FCC §15.407(a)(1) & (a)(3)- Power Spectral Density

11.1 Applicable Standard

According to FCC §15.407(a)(1)

For the band 5.15–5.25 GHz, the maximum conducted output power over the frequency band of operation shall not exceed the lesser of 50 mW or 4 dBm + 10 log B, where B is the 26-dB emission bandwidth in MHz. In addition, the peak power spectral density shall not exceed 4 dBm in any 1-MHz band. If transmitting antennas of directional gain greater than 6 dBi are used, both the maximum conducted output power and the peak power spectral density shall be reduced by the amount in dB that the directional gain of the antenna exceeds 6 dBi.

For the 5.25–5.35 GHz and 5.47–5.725 GHz bands, the maximum conducted output power over the frequency bands of operation shall not exceed the lesser of 250 mW or 11 dBm + 10 log B, where B is the 226 dB Emission Bandwidth in megahertz. In addition, the peak power spectral density shall not exceed 11 dBm in any 1 megahertz band. If transmitting antennas of directional gain greater than 6 dBi are used, both the maximum conducted output power and the peak power spectral density shall be reduced by the amount in dB that the directional gain of the antenna exceeds 6 dBi.

According to FCC §15.407(a)(3)

For the band 5.725-5.85 GHz, the maximum conducted output power over the frequency band of operation shall not exceed 1 W. In addition, the maximum power spectral density shall not exceed 30 dBm in any 500-kHz band. If transmitting antennas of directional gain greater than 6 dBi are used, both the maximum conducted output power and the maximum power spectral density shall be reduced by the amount in dB that the directional gain of the antenna exceeds 6 dBi. However, fixed point-to-point U-NII devices operating in this band may employ transmitting antennas with directional gain greater than 6 dBi without any corresponding reduction in transmitter conducted power. Fixed, point-to-point operations exclude the use of point-to-multipoint systems, omnidirectional applications, and multiple collocated transmitters transmitting the same information. The operator of the U-NII device, or if the equipment is professionally installed, the installer, is responsible for ensuring that systems employing high gain directional antennas are used exclusively for fixed, point-to-point operations.

11.2 Measurement Procedure

The measurements are base on FCC KDB 789033 D02 General UNII Test Procedures v01: Guidelines for Compliance Testing of Unlicensed National Information Infrastructure (U-NII) Devices section F:
Peak power spectral density (PPSD)

11.3 Test Equipment List and Details

Manufacturer	Description	Model No.	Serial No.	Calibration Date	Calibration Interval
Agilent	Spectrum Analyzer	E4446A	US44300386	2013-09-29	1 year

Statement of Traceability: *BACL Corp.* attests that all calibrations have been performed according to A2LA requirements, traceable to the NIST.

11.4 Test Environmental Conditions

Temperature:	21-23° C
Relative Humidity:	43-48 %
ATM Pressure:	101-101.3 kPa

The testing was performed by Cipher Chu on 2014-04-04 to 2014-04-07 and 2014-08-09 to 2014-08-21 at the RF Site

11.5 Test Results

Note: Chain 1 and Chain 4 is Vertical, and Chain 2 and Chain 3 is Horizontal

Note: C1, C2, C3 and C4 stands for Chain1, Chain 2, Chain 3 and Chain 4.

25 dBi Antenna:

5.3 GHz Band

20 MHz Bandwidth

Channel	Frequency (MHz)	Conducted PSD C1/C2 (dBm)	Conducted PSD C3/C4 (dBm)	Total PSD C1,C2 (dBm)	Total PSD C3,C4 (dBm)	Limit (dBm)
Low	5260	-11.21/-12.23	-11.74/-11.96	-11.82	-13.81	-8
Middle	5295	-11.77/-11.57	-11.86/-11.90	6.42	7.49	-8
High	5320	-12.15/-12.13	-12.71/-11.54	2.37	2.37	-8

40 MHz Bandwidth

Channel	Frequency (MHz)	Conducted PSD C1/C2 (dBm)	Conducted PSD C3/C4 (dBm)	Total PSD C1,C2 (dBm)	Total PSD C3,C4 (dBm)	Limit (dBm)
Low	5270	-12.30/-11.86	-12.90/-11.91	-9.06	-9.37	-8
Middle	5290	-13.38/-12.05	-11.88/-12.41	-9.65	-9.13	-8
High	5310	-12.88/-11.96	-11.54/-13.04	-9.39	-9.22	-8

80 MHz Bandwidth

Channel	Frequency (MHz)	Conducted PSD C1/C2 (dBm)	Conducted PSD C3/C4 (dBm)	Total PSD C1,C2 (dBm)	Total PSD C3,C4 (dBm)	Limit (dBm)
	5290	-11.72/-12.01	-13.21/-11.50	-8.85	-9.26	-8

Note: Antenna gain of EUT is 25 dBi which is over 2 dB of 6 dBi allowed by FCC Part 15.407 (a)(2), a 1 dB reduction in maximum conducted output power and maximum power spectral density is required for each 1 dB of antenna gain in excess of 6 dBi

5.6 GHz Band

20 MHz Bandwidth

Channel	Frequency (MHz)	Conducted PSD C1/C2 (dBm)	Conducted PSD C3/C4 (dBm)	Total PSD C1,C2 (dBm)	Total PSD C3,C4 (dBm)	Limit (dBm)
Low	5500	-11.66/-11.52	-12.92/-12.56	-8.58	-9.73	-8
Middle	5590	-11.95/-11.98	-11.29/-12.53	-8.95	-8.86	-8
High	5700	-11.42/-11.77	-11.72/-12.29	-8.58	-8.99	-8

40 MHz Bandwidth

Channel	Frequency (MHz)	Conducted PSD C1/C2 (dBm)	Conducted PSD C3/C4 (dBm)	Total PSD C1,C2 (dBm)	Total PSD C3,C4 (dBm)	Limit (dBm)
Low	5510	-13.07/-12.37	-12.92/-12.05	-9.70	-9.45	-8
Middle	5555	-11.61/-12.36	-12.40/-12.59	-8.96	-9.48	-8
High	5690	-11.71/-11.94	-13.67/-13.32	-8.81	-10.48	-8

80 MHz Bandwidth

Channel	Frequency (MHz)	Conducted PSD C1/C2 (dBm)	Conducted PSD C3/C4 (dBm)	Total PSD C1,C2 (dBm)	Total PSD C3,C4 (dBm)	Limit (dBm)
Low	5530	-11.27/-12.35	-12.18/-12.97	-8.77	-9.55	-8
Middle	5545	-12.12/-12.89	-11.91/-11.89	-9.48	-8.89	-8
High	5560	-11.67/-11.56	-11.92/-11.73	-8.60	-8.81	-8

Note: Antenna gain of EUT is 25 dBi which is over 2 dB of 6 dBi allowed by FCC Part 15.407 (a)(2), a 1 dB reduction in maximum conducted output power and maximum power spectral density is required for each 1 dB of antenna gain in excess of 6 dBi

0 dBi Antenna:**5.3 GHz Band:**

20 MHz bandwidth

Channel	Frequency (MHz)	Conducted PSD C1/C2 (dBm)	Conducted PSD C3/C4 (dBm)	Total PSD C1,C2 (dBm)	Total PSD C3,C4 (dBm)	Limit (dBm)
Low	5260	5.59/5.07	5.213/5.673	8.35	8.46	11
Middle	5295	6.209/6.498	5.709/6.756	9.37	9.27	11
High	5320	5.047/5.056	4.978/5.083	8.06	8.04	11

40 MHz bandwidth

Channel	Frequency (MHz)	Conducted PSD C1/C2 (dBm)	Conducted PSD C3/C4 (dBm)	Total PSD C1,C2 (dBm)	Total PSD C3,C4 (dBm)	Limit (dBm)
Low	5270	3.043/3.178	3.064/2.616	6.12	5.86	11
Middle	5290	2.373/2.439	2.106/2.726	5.42	5.44	11
High	5310	2.943/2.442	1.851/2.0405	5.71	4.96	11

80 MHz bandwidth

Channel	Frequency (MHz)	Conducted PSD C1/C2 (dBm)	Conducted PSD C3/C4 (dBm)	Total PSD C1,C2 (dBm)	Total PSD C3,C4 (dBm)	Limit (dBm)
High	5290	2.212/2.13	2.009/2.569	5.18	5.31	11

5.6 GHz Band:

20 MHz bandwidth

Channel	Frequency (MHz)	Conducted PSD C1/C2 (dBm)	Conducted PSD C3/C4 (dBm)	Total PSD C1,C2 (dBm)	Total PSD C3,C4 (dBm)	Limit (dBm)
Low	5500	4.995/4.769	4.235/4.109	7.89	7.18	11
Middle	5590	5.582/5.208	5.905/6.153	8.41	9.04	11
High	5700	5.688/4.804	4.432/4.196	8.28	7.33	11

40 MHz bandwidth

Channel	Frequency (MHz)	Conducted PSD C1/C2 (dBm)	Conducted PSD C3/C4 (dBm)	Total PSD C1,C2 (dBm)	Total PSD C3,C4 (dBm)	Limit (dBm)
Low	5510	4.828/3.907	5.028/5.307	7.40	8.18	11
Middle	5555	5.564/5.053	4.716/4.402	8.33	7.57	11
High	5690	5.792/6.125	6.233/6.811	8.97	9.54	11

80 MHz bandwidth

Channel	Frequency (MHz)	Conducted PSD C1/C2 (dBm)	Conducted PSD C3/C4 (dBm)	Total PSD C1,C2 (dBm)	Total PSD C3,C4 (dBm)	Limit (dBm)
Low	5530	3.111/2.681	3.053/2.834	5.91	5.96	11
Middle	5545	2.895/2.304	3.087/3.368	5.62	6.24	11
High	5560	1.387/1.112	2.393/2.266	4.26	5.34	11

Please refer to the following plots.

25 dBi Antenna:

5.3 GHz Band

20 MHz Bandwidth, Low Channel, 5260 MHz

C1

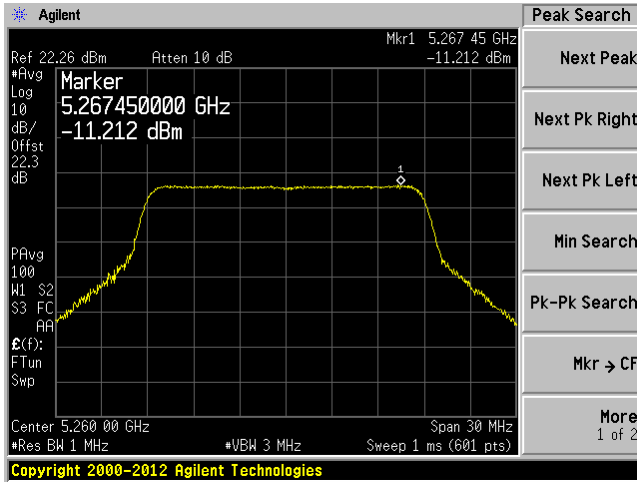

C2

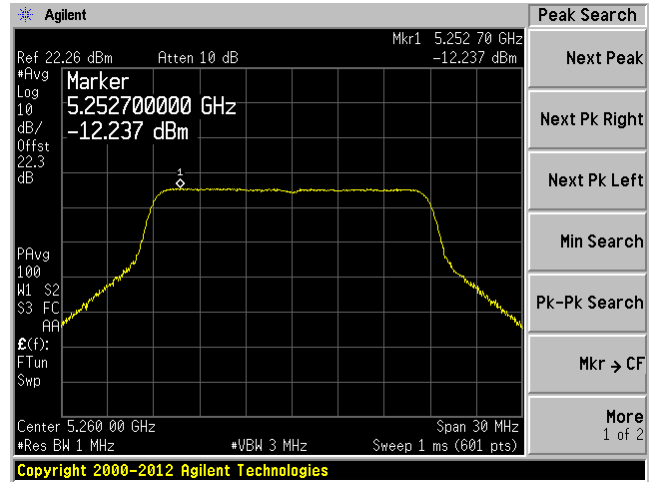

C3

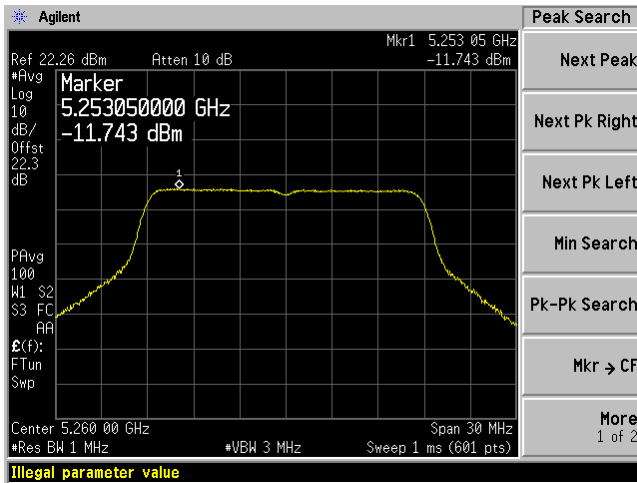

C4

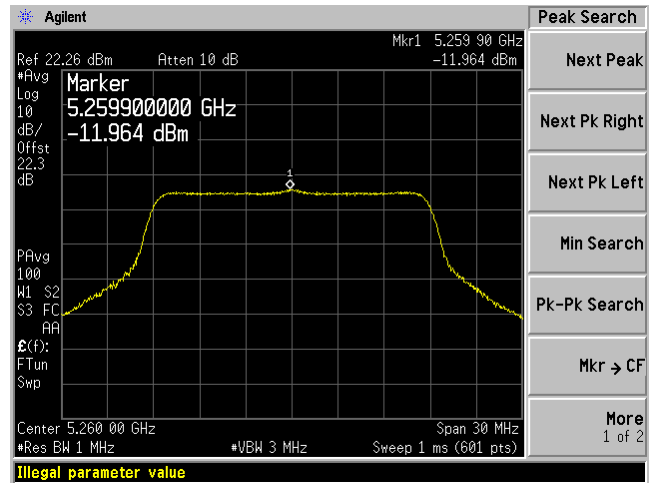

20 MHz Bandwidth, Middle Channel, 5295 MHz

C1

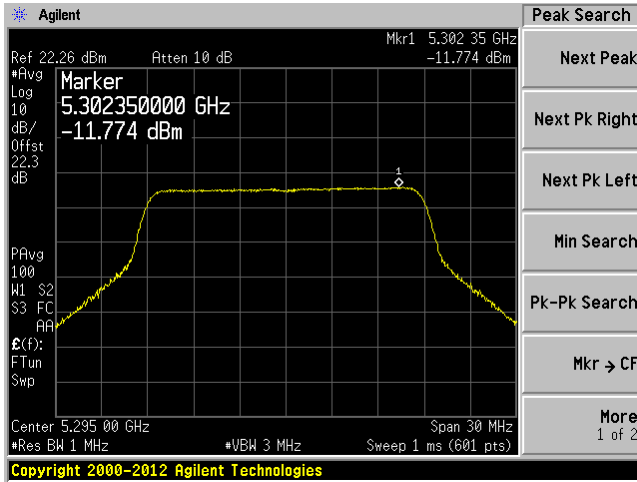

C2

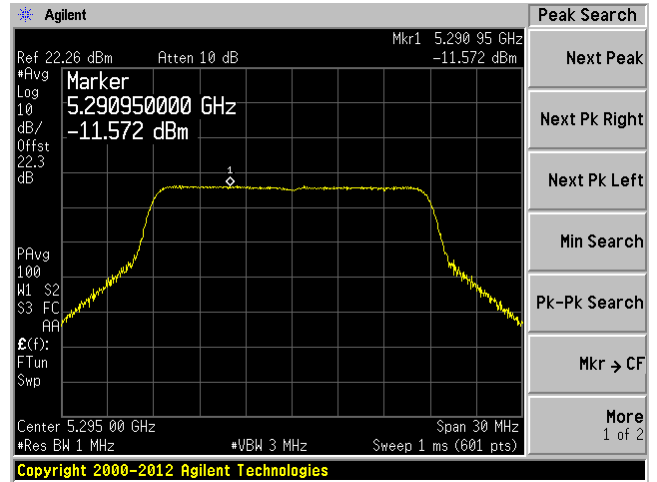

C3

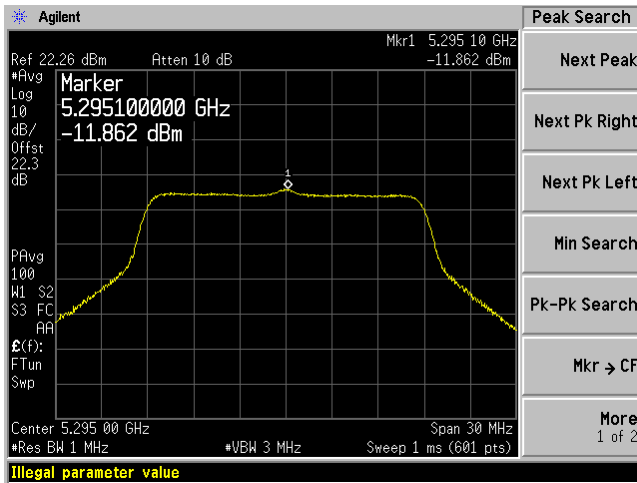

C4

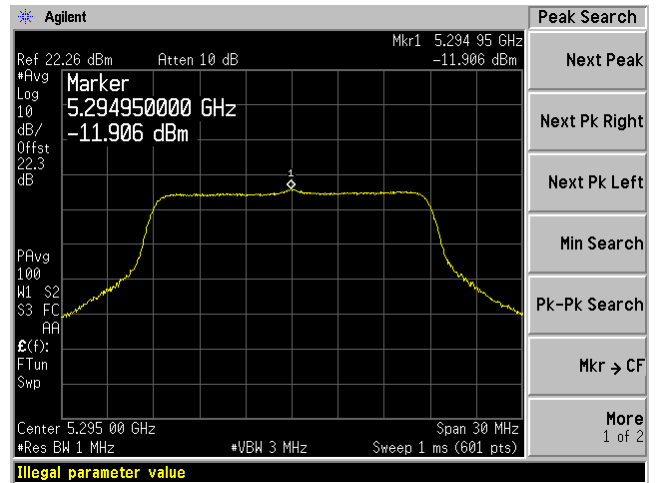

20 MHz Bandwidth, High Channel, 5320 MHz

C1

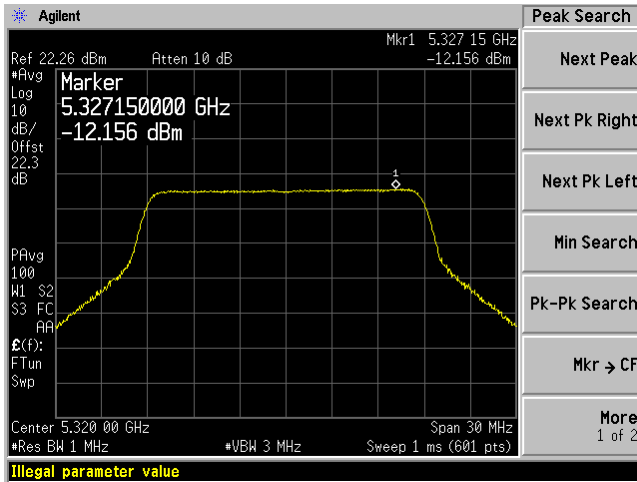

C2

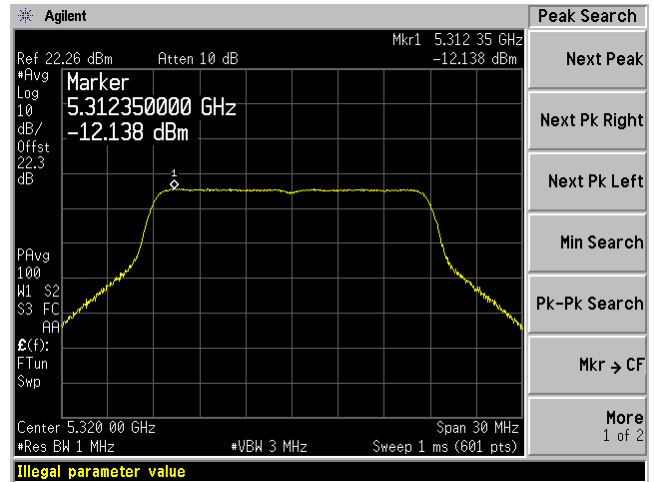

C3

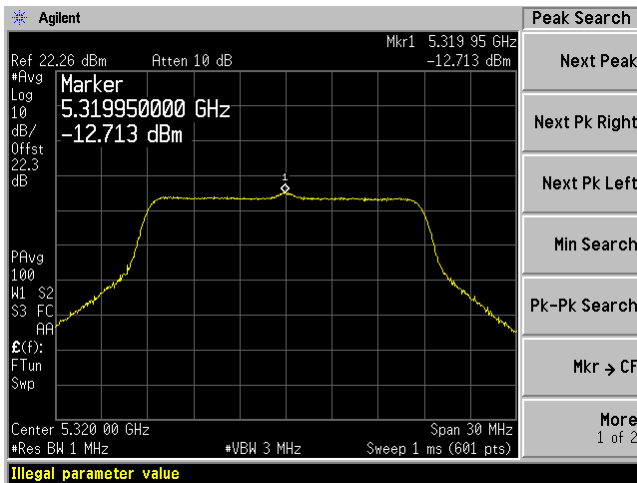

C4

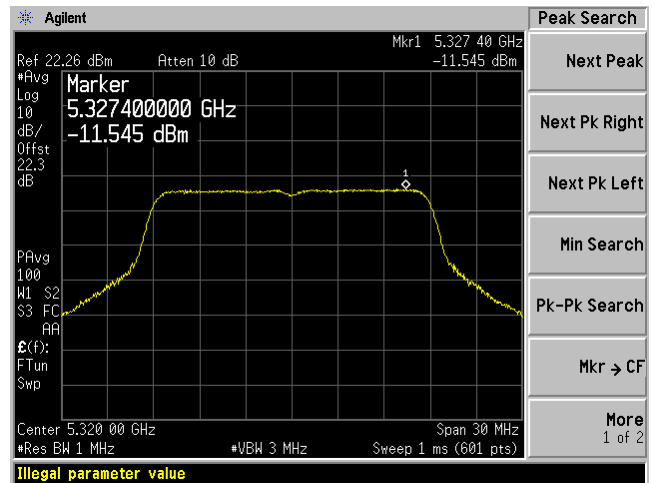

40 MHz Bandwidth, Low Channel, 5270 MHz

C1

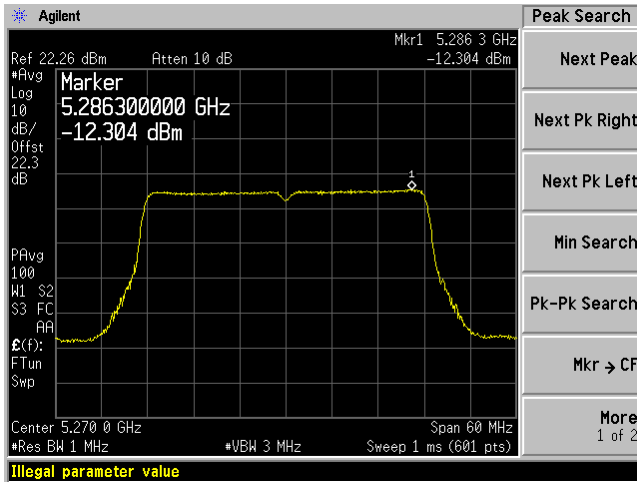

C2

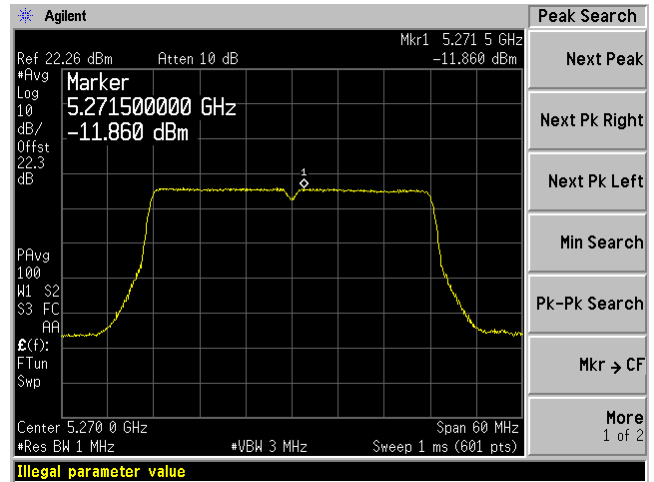

C3

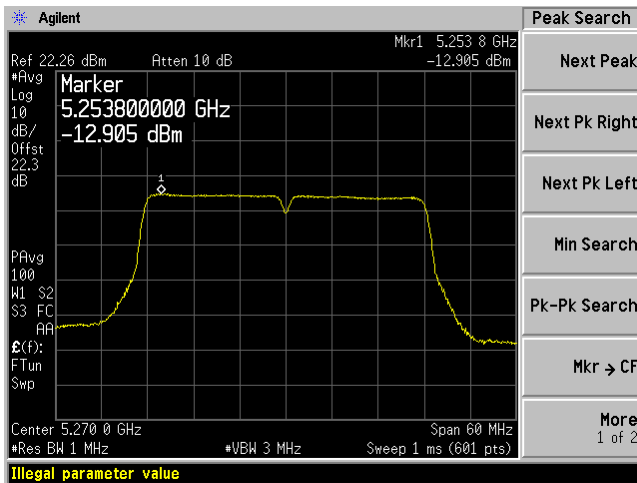

C4

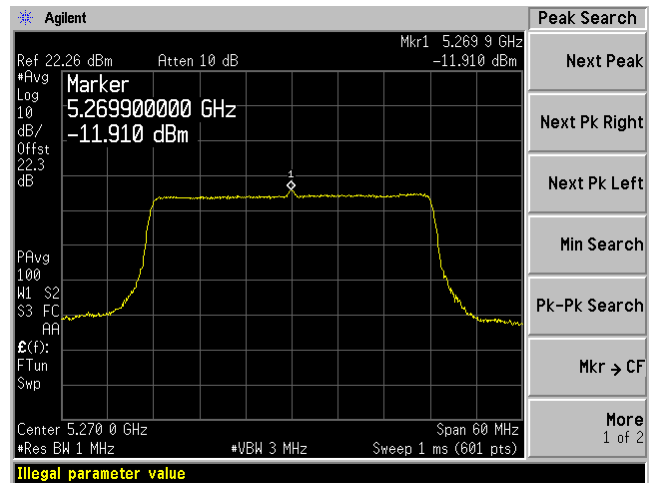

40 MHz Bandwidth, Middle Channel, 5290 MHz

C1

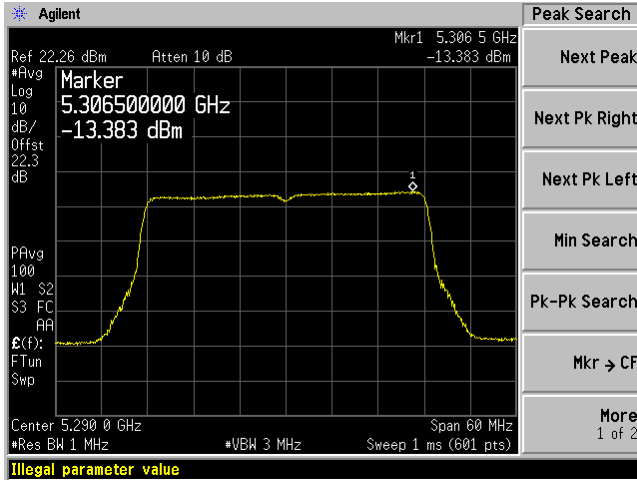

C2

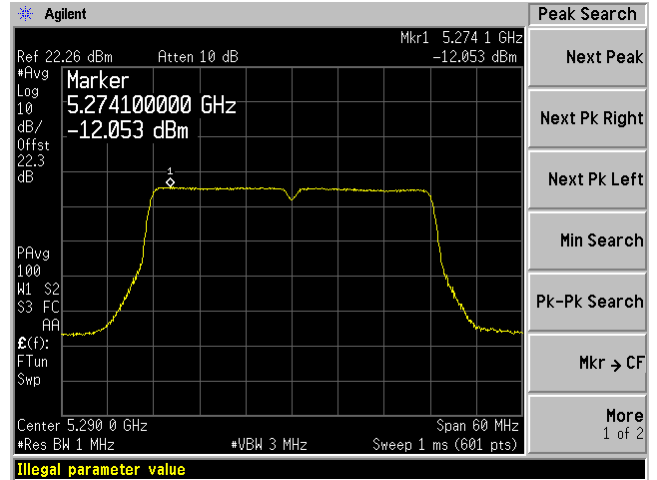

C3

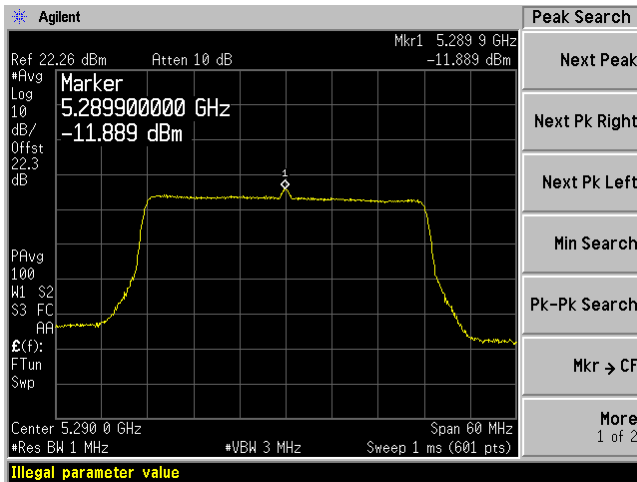

C4

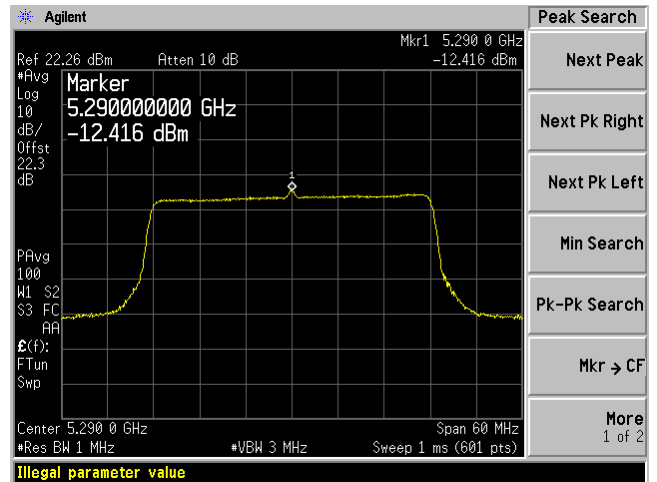

40 MHz Bandwidth, High Channel, 5310 MHz

C1

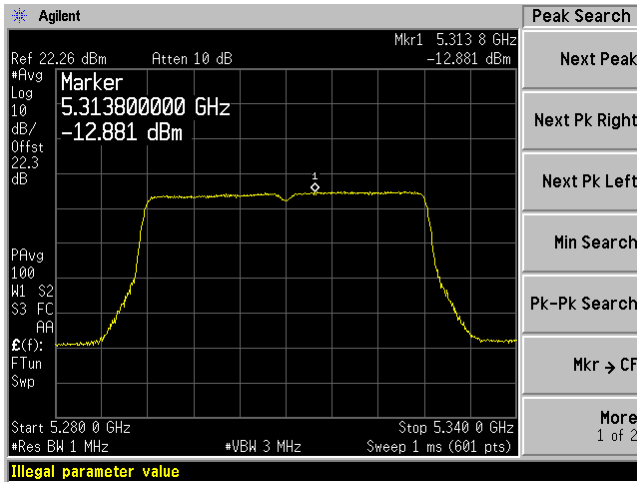

C2

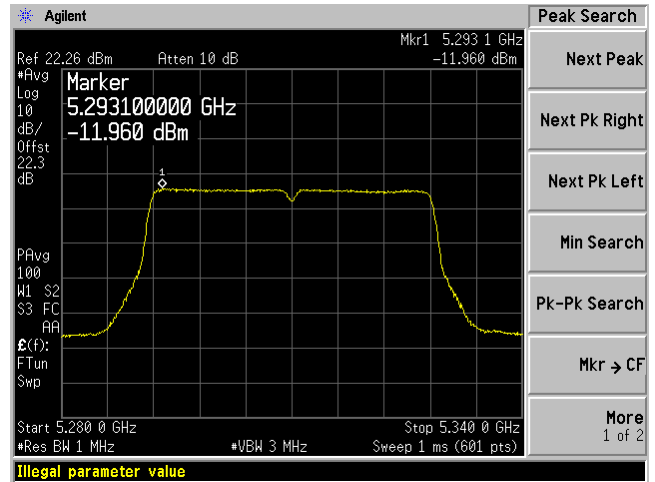

C3

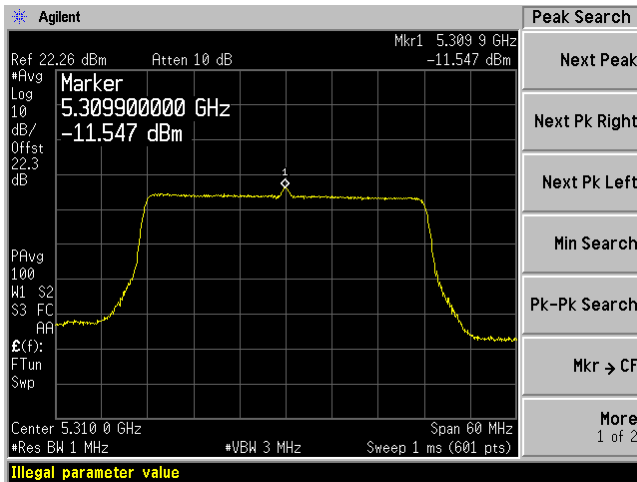

C4

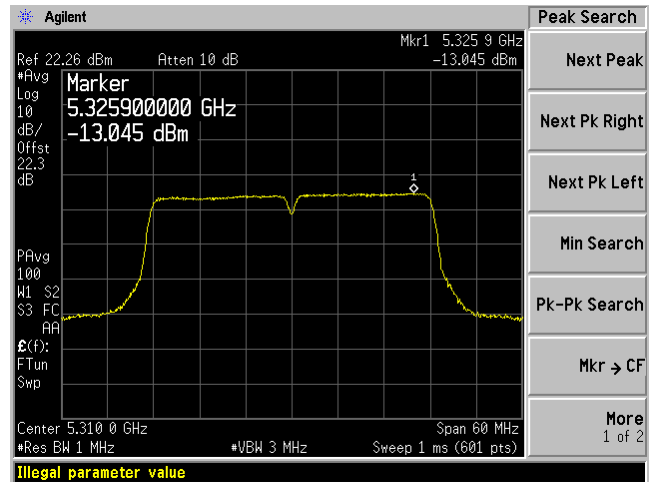

80 MHz Bandwidth, Channel, 5290 MHz

C1

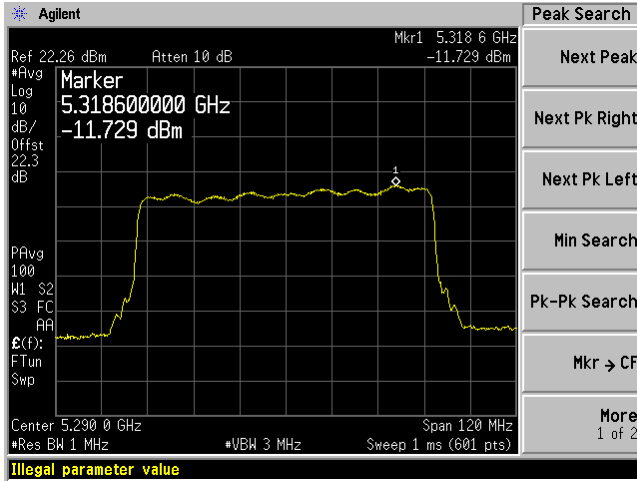

C2

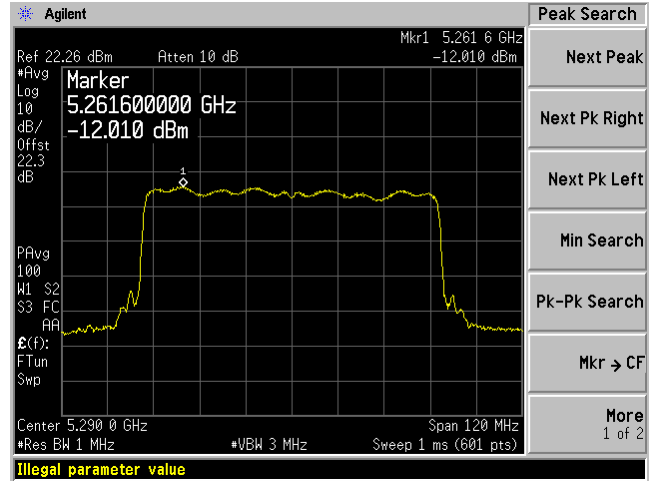

C3

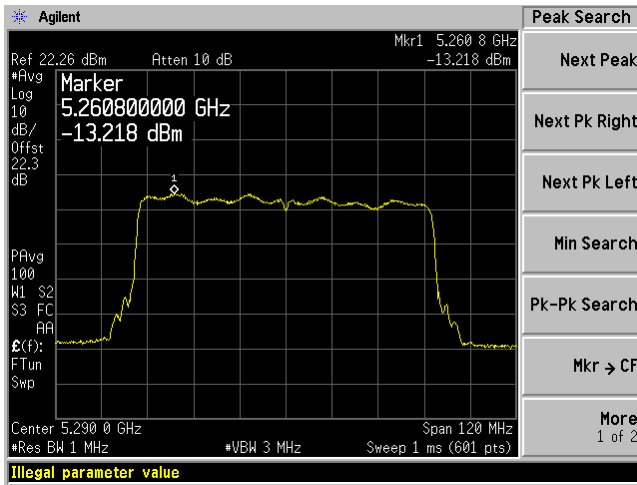

C4

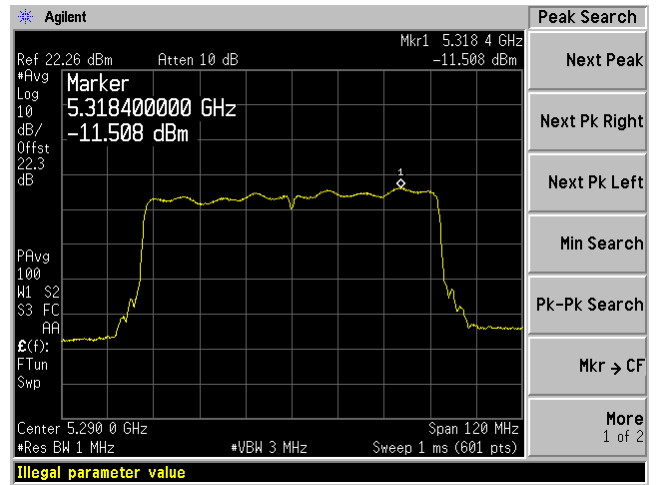

5.6 GHz Band

20 MHz Bandwidth, Low Channel, 5500 MHz

C1

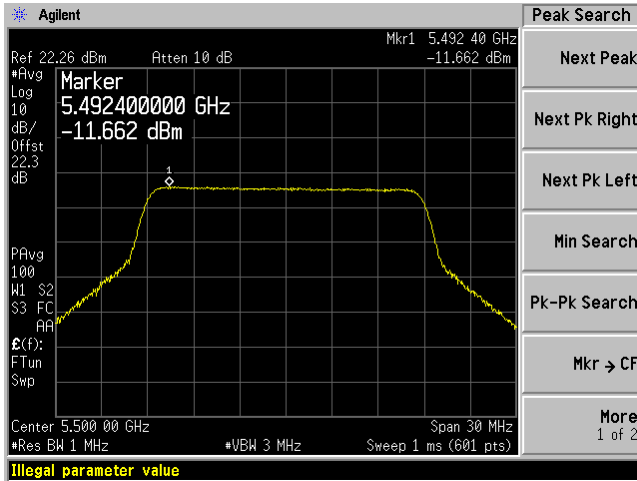

C2

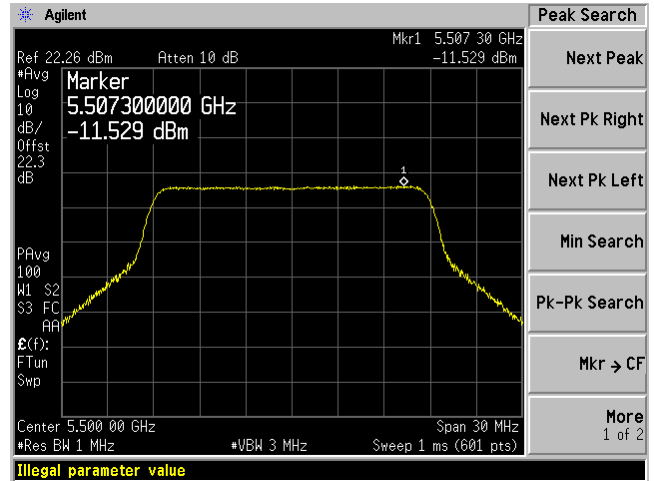

C3

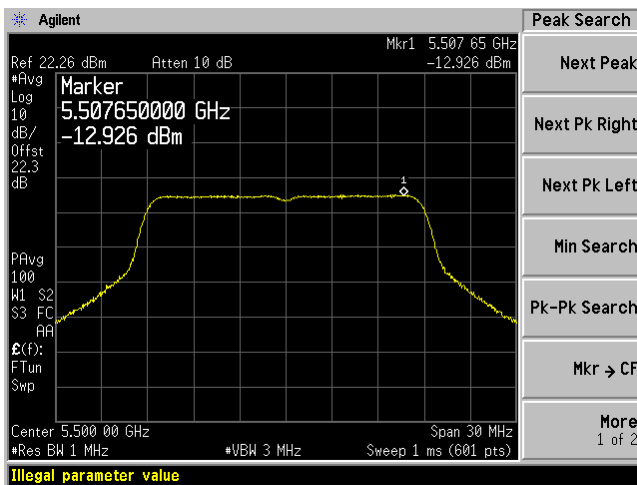

C4

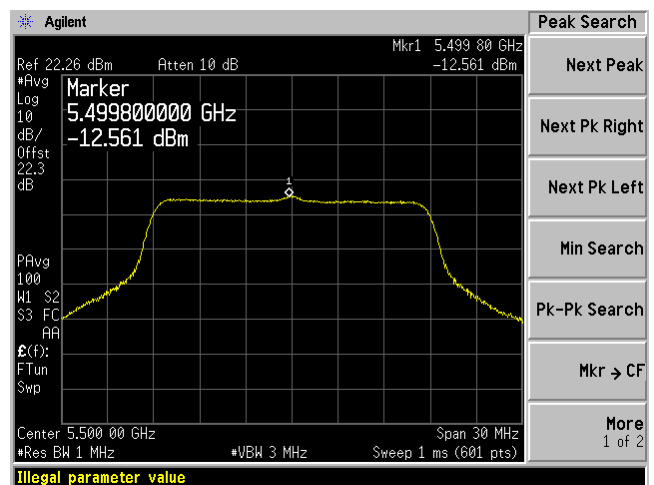

20 MHz Bandwidth, Middle Channel, 5590 MHz

C1

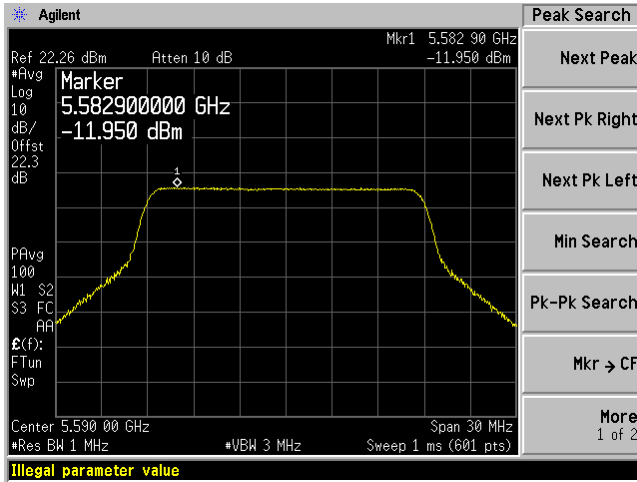

C2

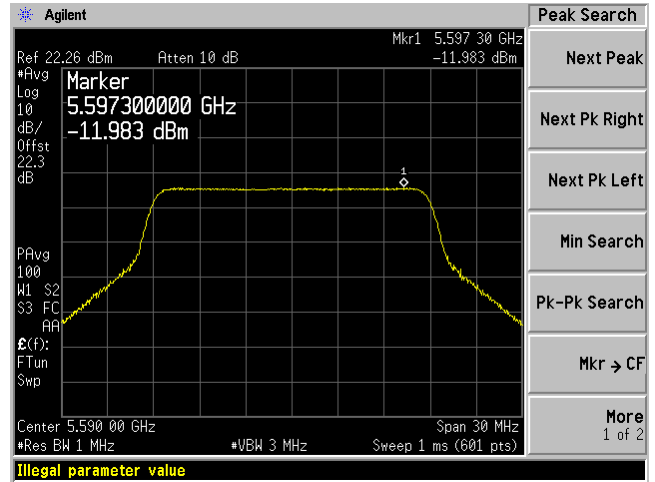

C3

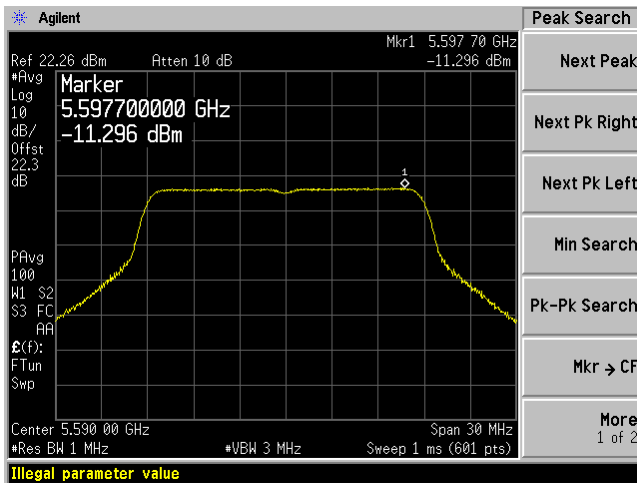

C4

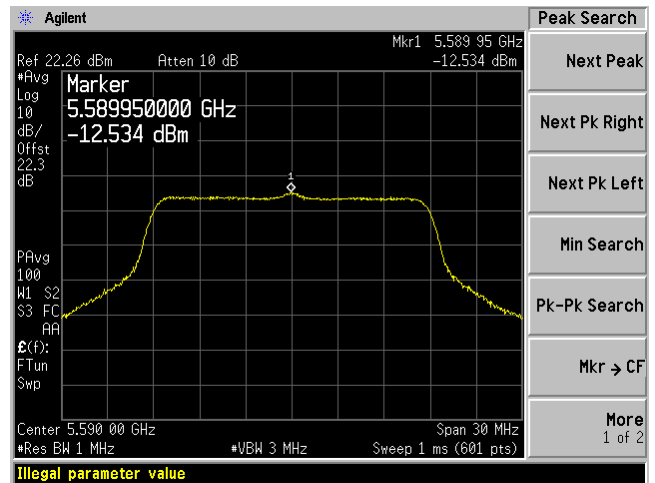

20 MHz Bandwidth, High Channel, 5700 MHz

C1

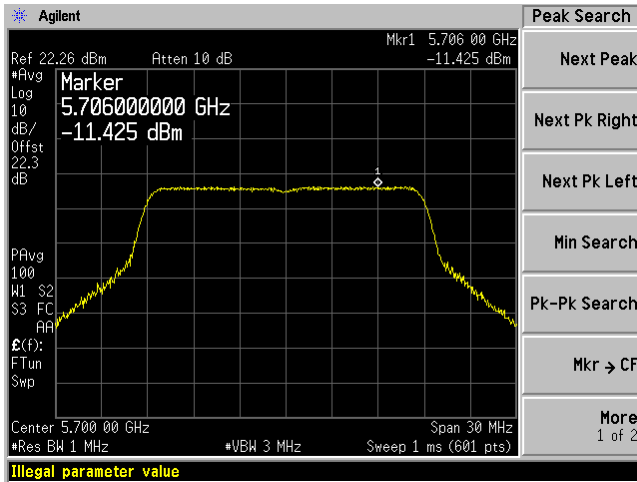

C2

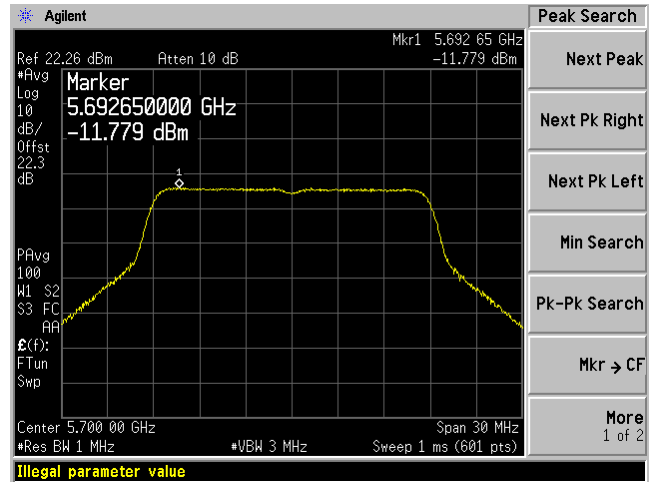

C3

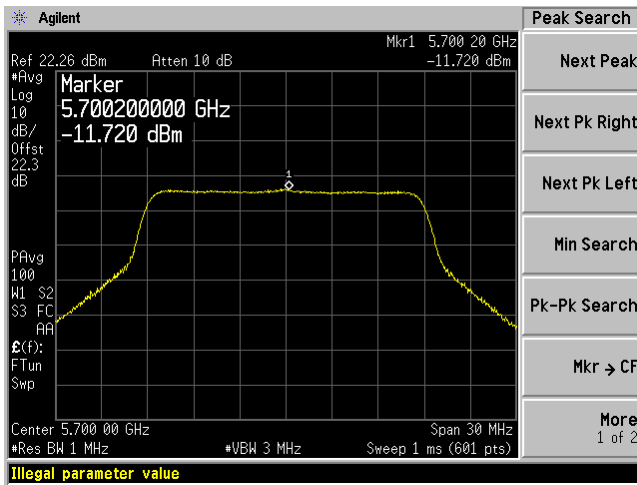

C4

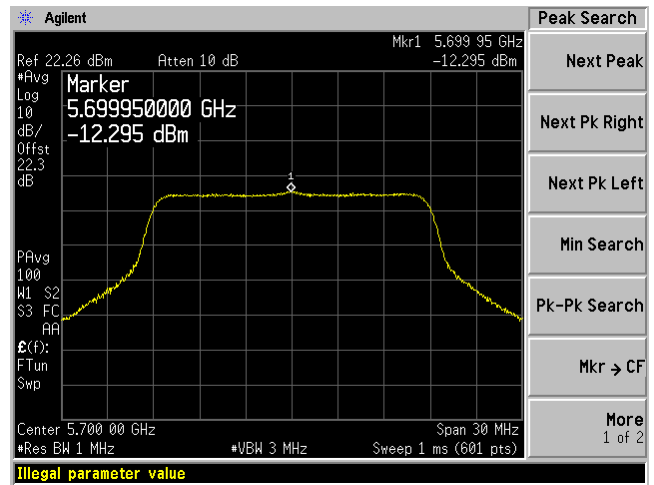

40 MHz Bandwidth, Low Channel, 5510 MHz

C1

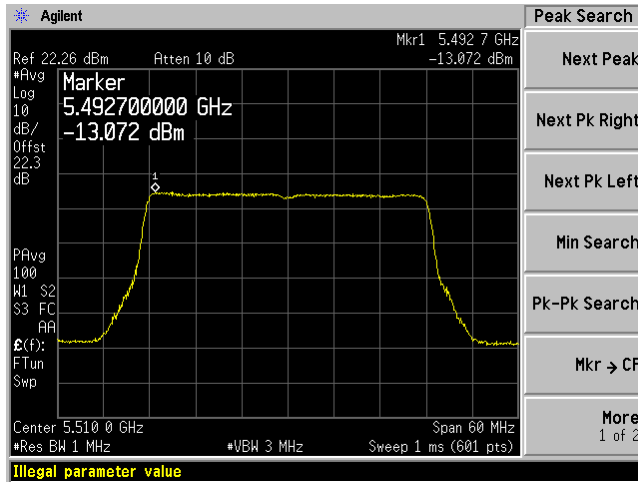

C2

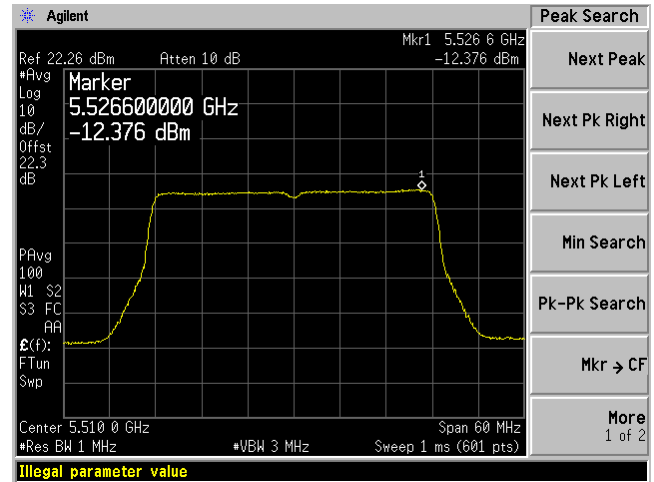

C3

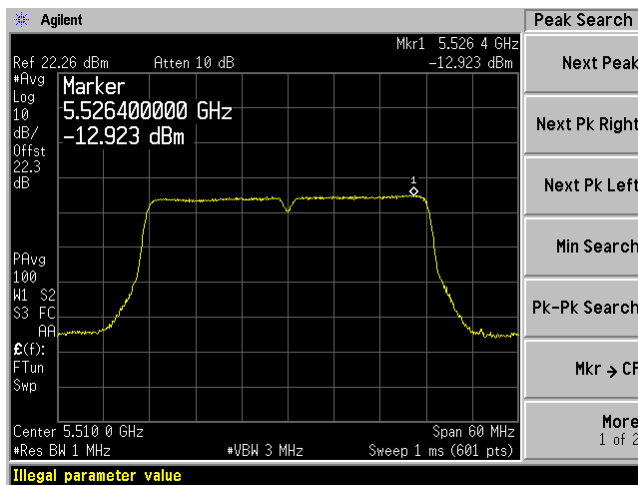

C4

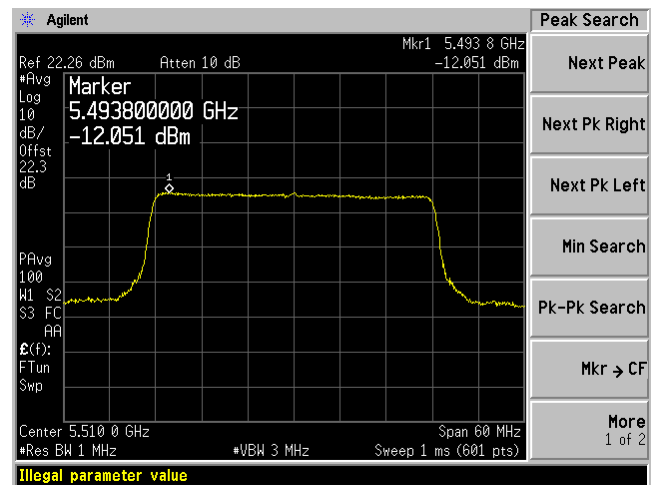

40 MHz Bandwidth, Middle Channel, 5555 MHz

C1

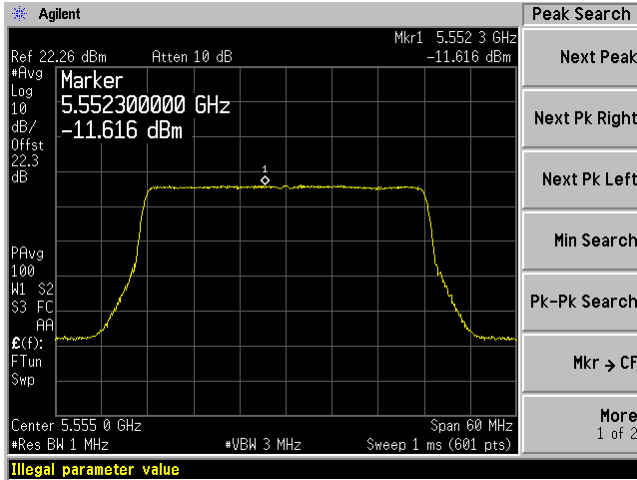

C2

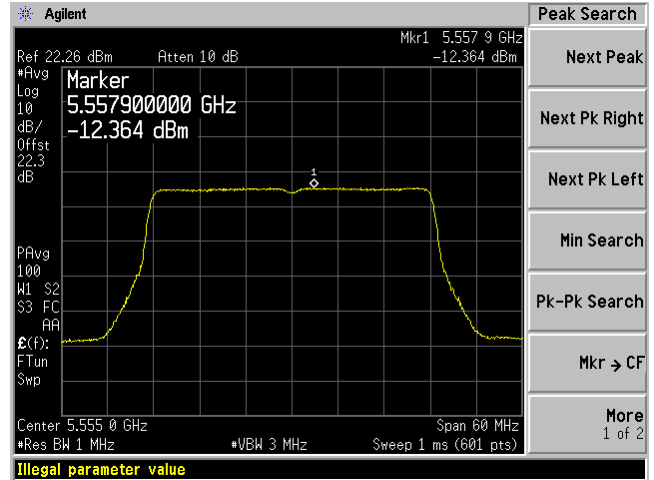

C3

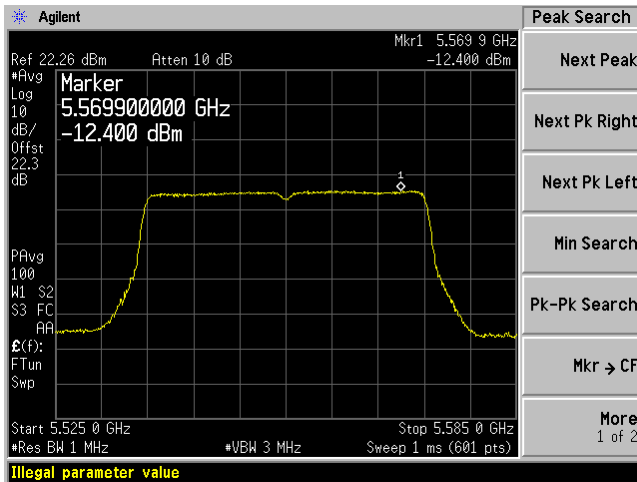

C4

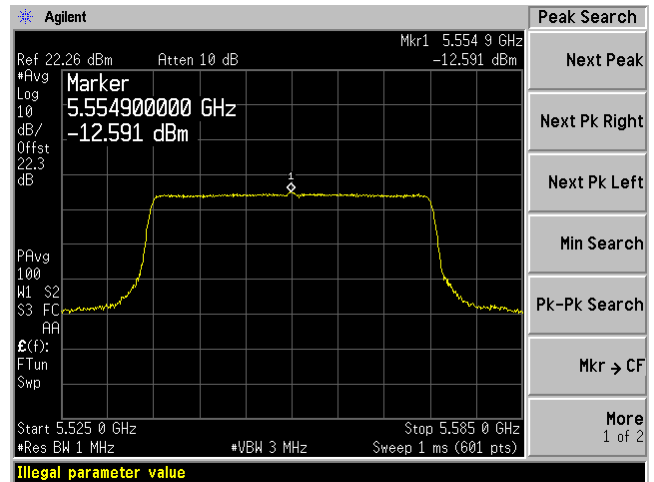

40 MHz Bandwidth, High Channel, 5690 MHz

C1

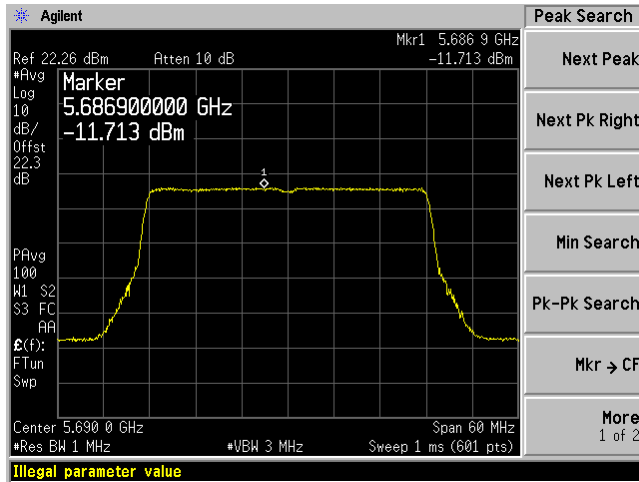

C2

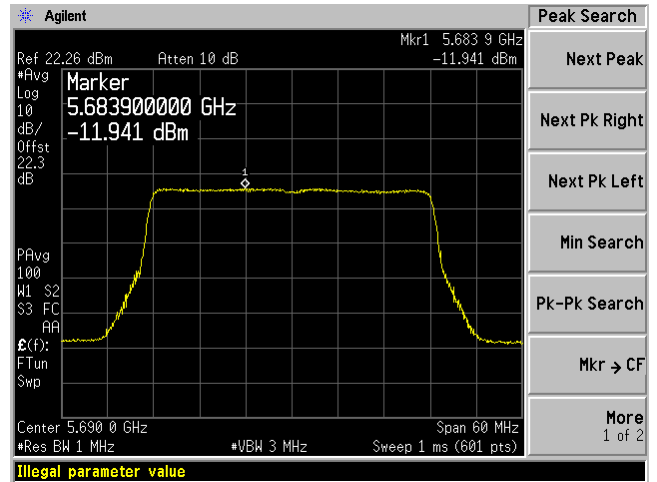

C3

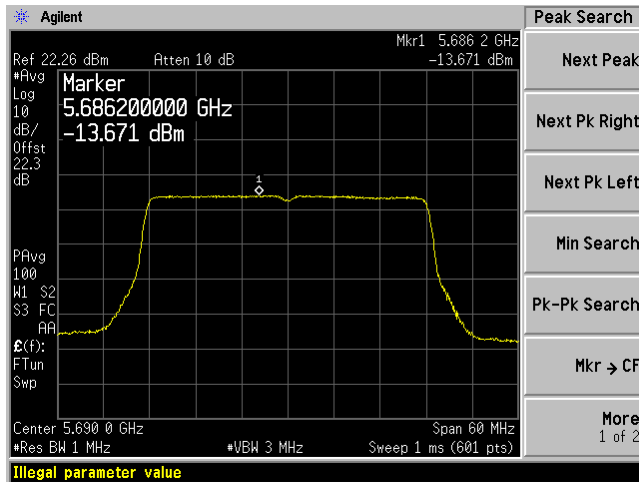

C4

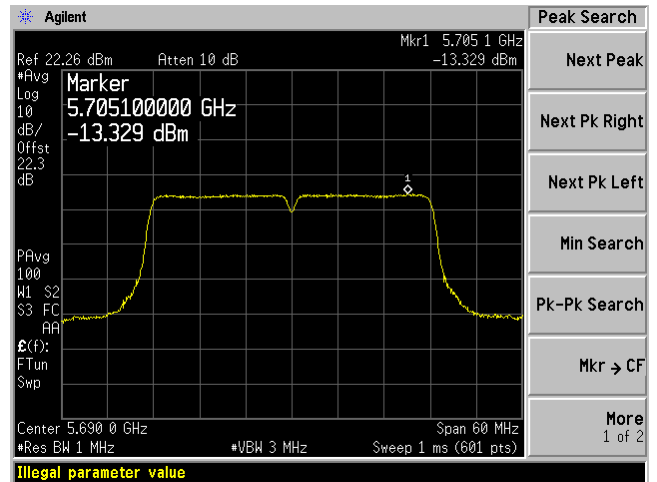

80 MHz Bandwidth, Low Channel, 5530 MHz

C1

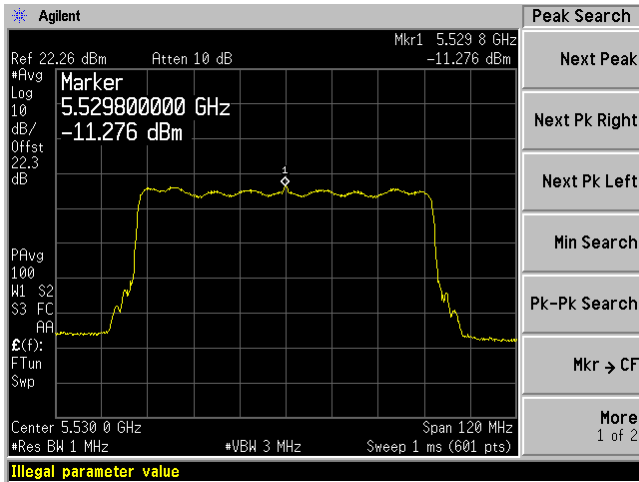

C2

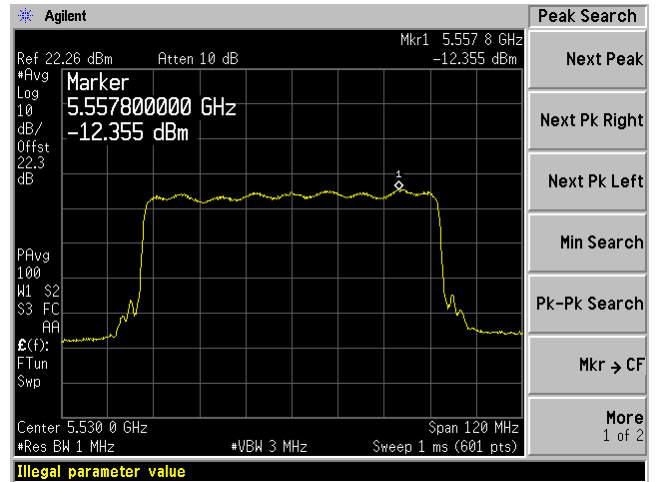

C3

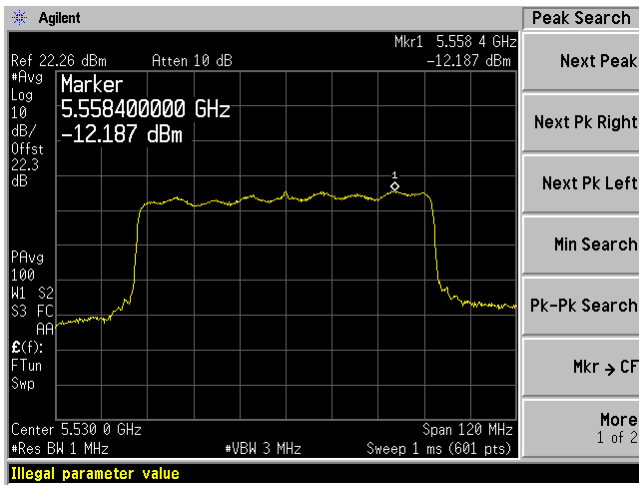

C4

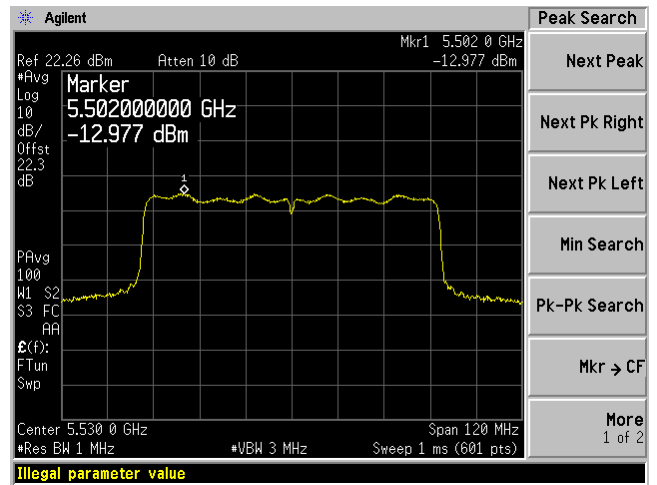

80 MHz Bandwidth, Middle Channel, 5545 MHz

C1

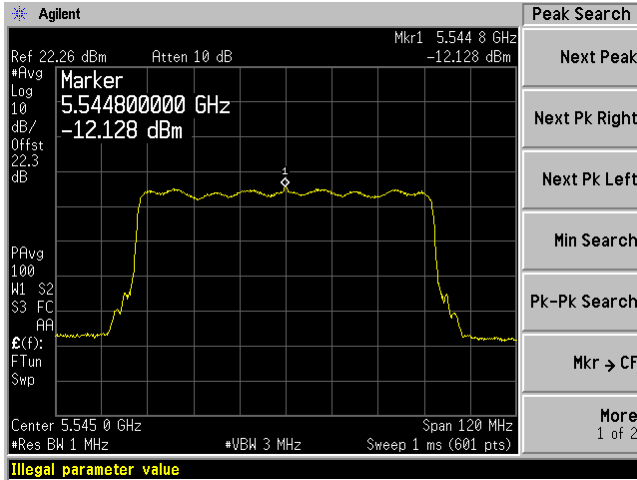

C2

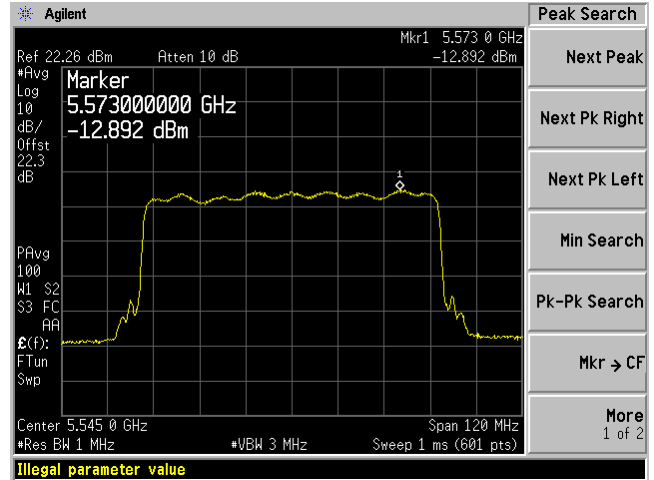

C3

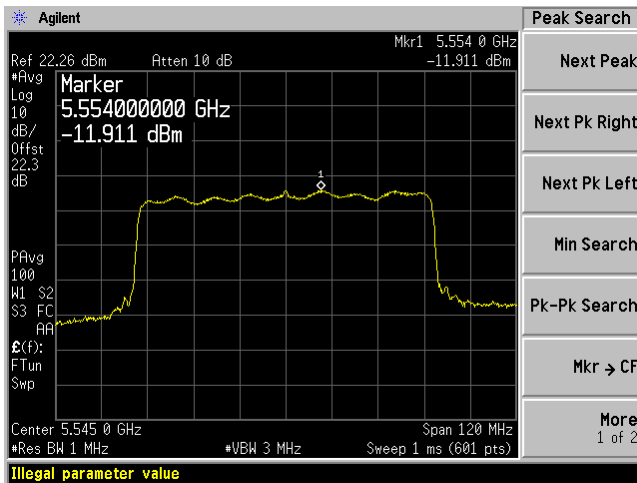

C4

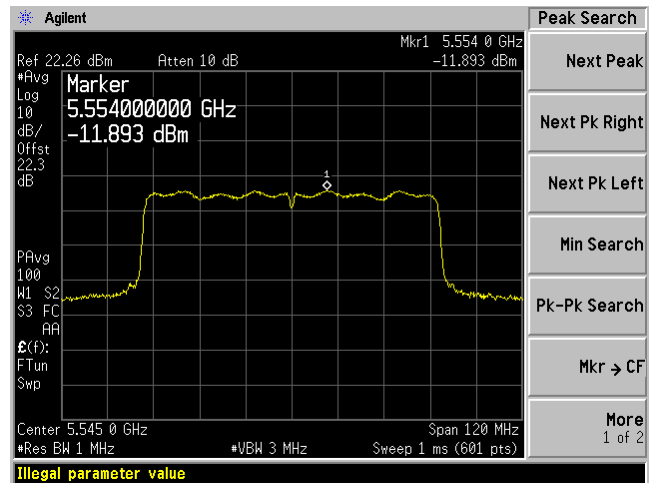

80 MHz Bandwidth, High Channel, 5560 MHz

C1

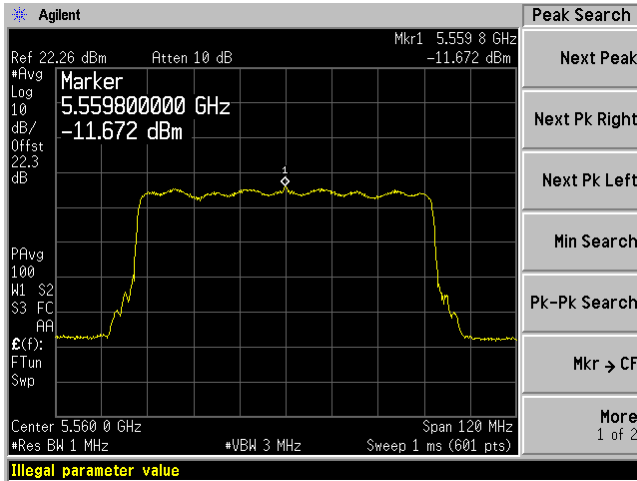

C2

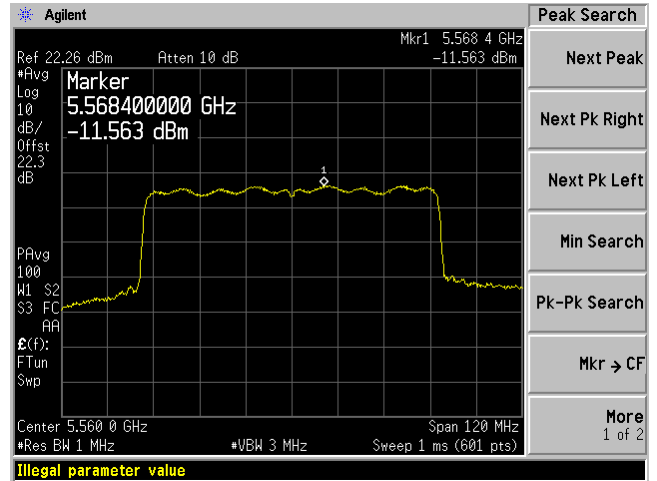

C3

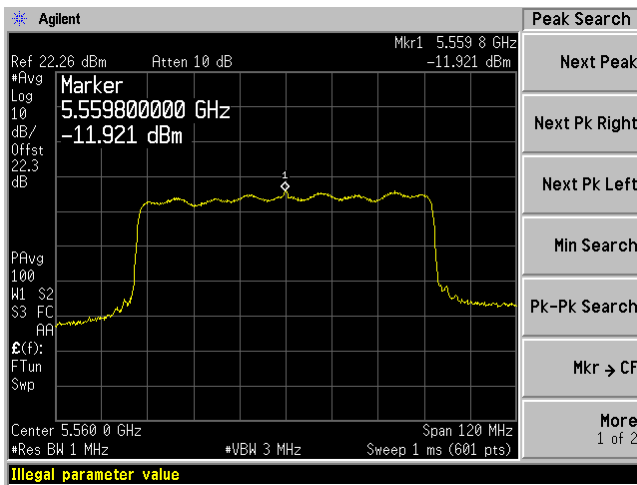

C4

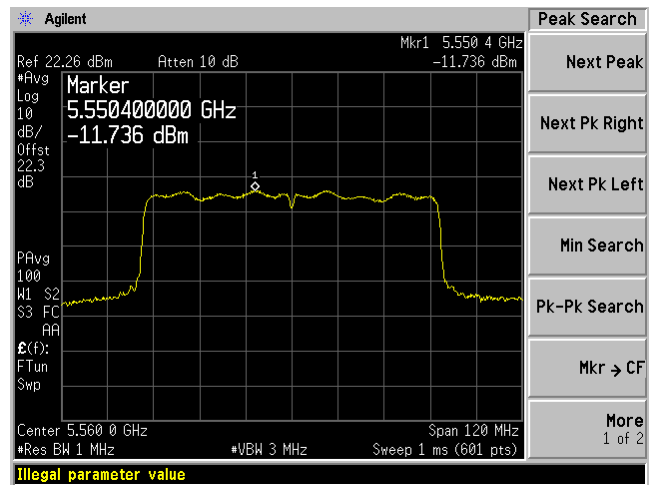

0 dBi Antenna:

5.3 GHz Band:

20 MHz bandwidth, Low Channel, 5260 MHz

C1

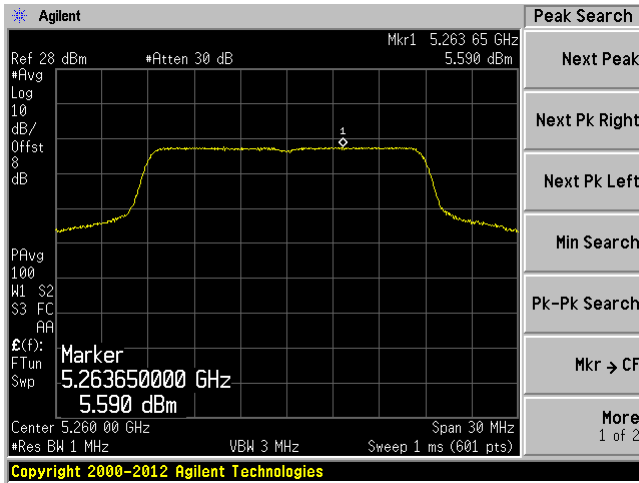

C2

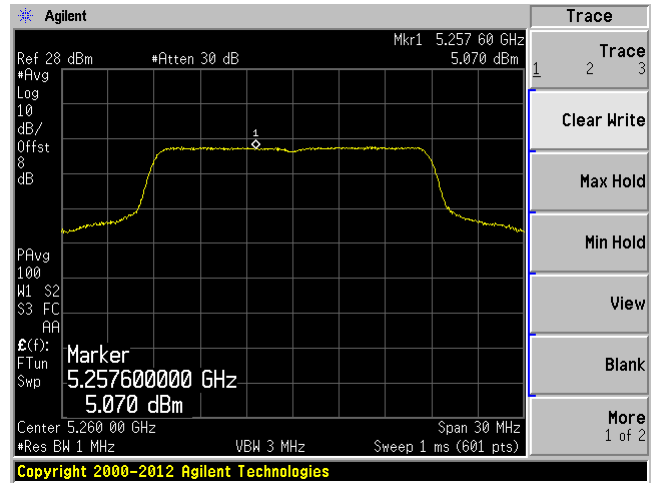

C3

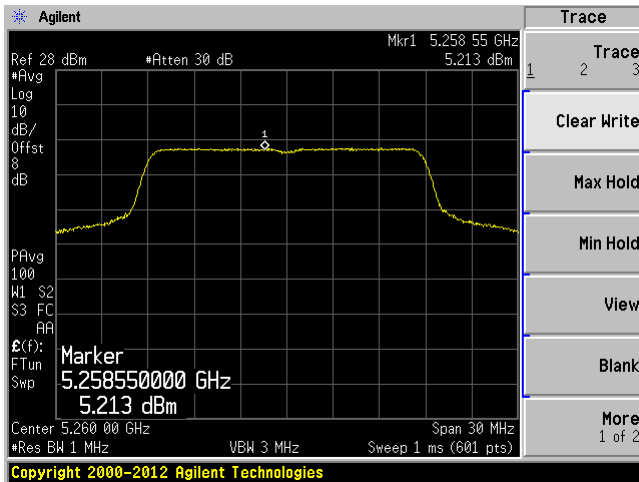

C4

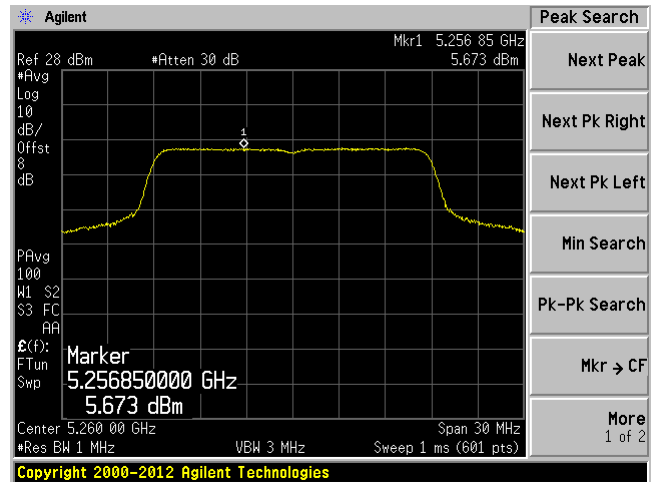

20 MHz bandwidth, Middle Channel, 5295 MHz

C1

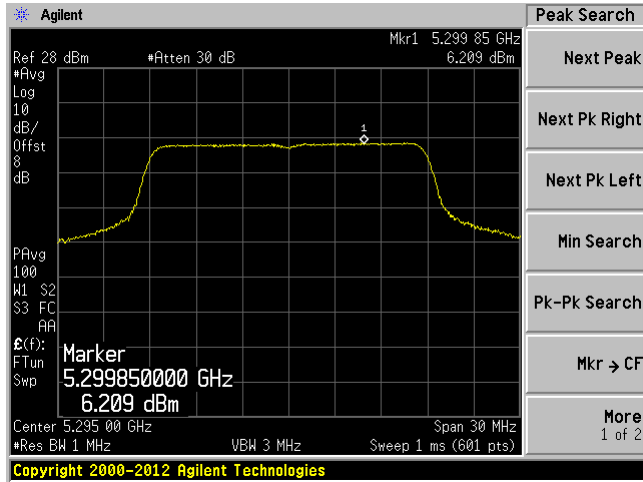

C2

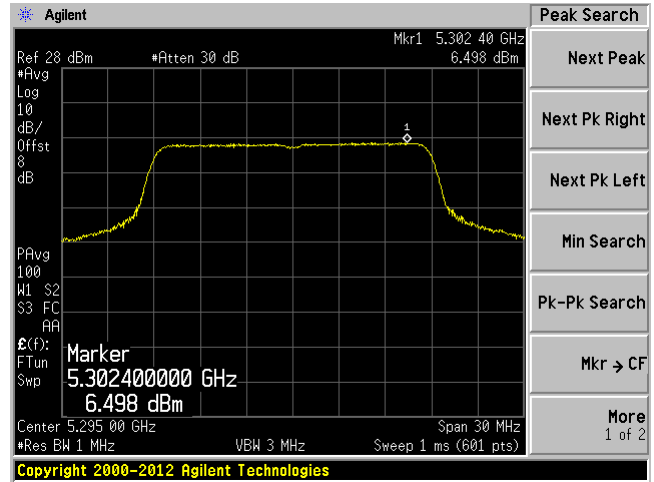

C3

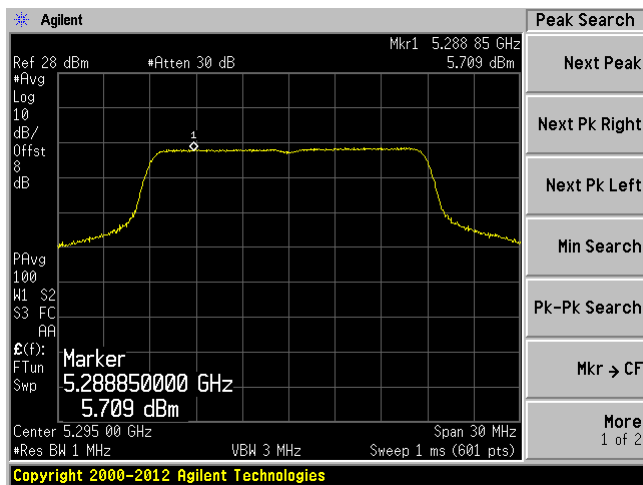

C4

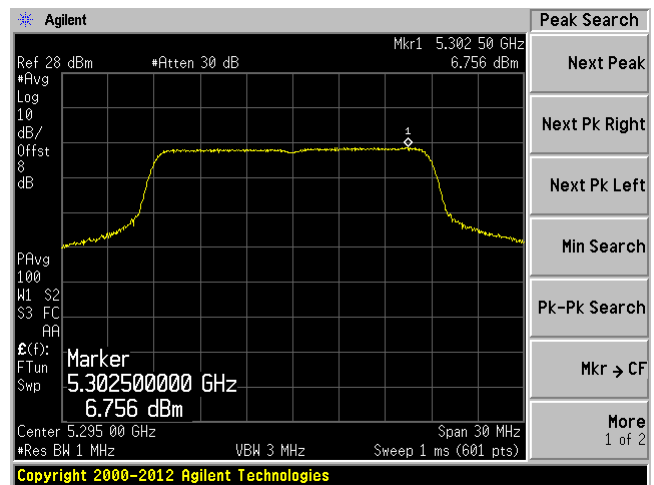

20 MHz bandwidth, High Channel, 5320 MHz

C1

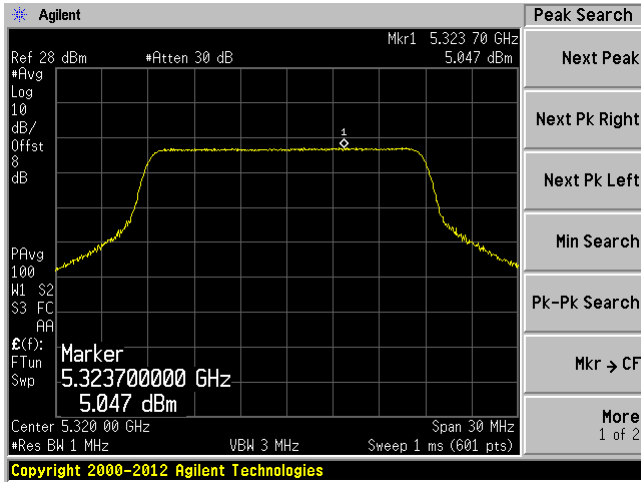

C2

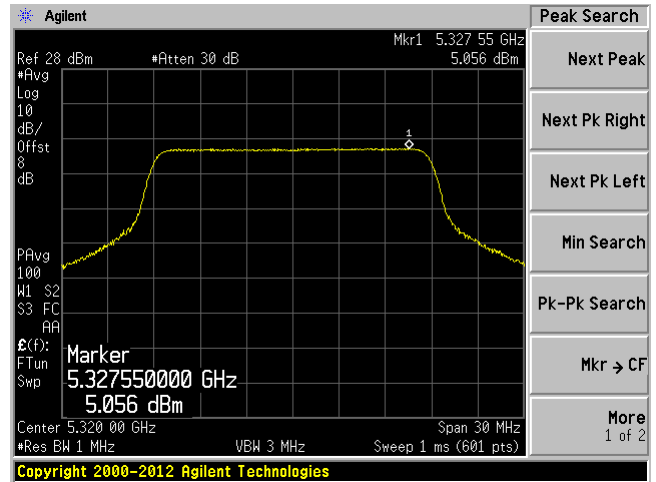

C3

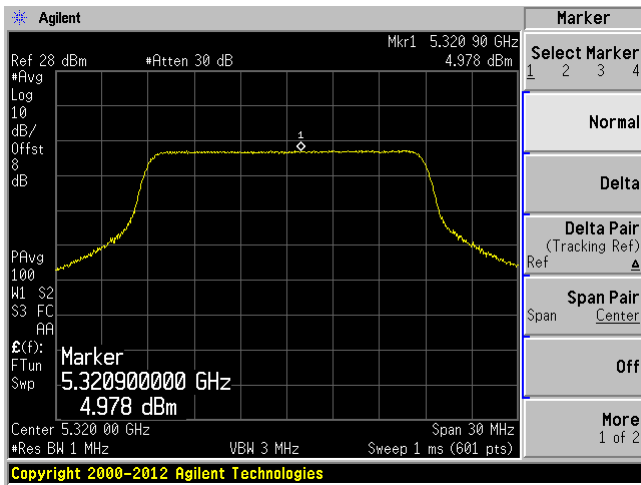

C4

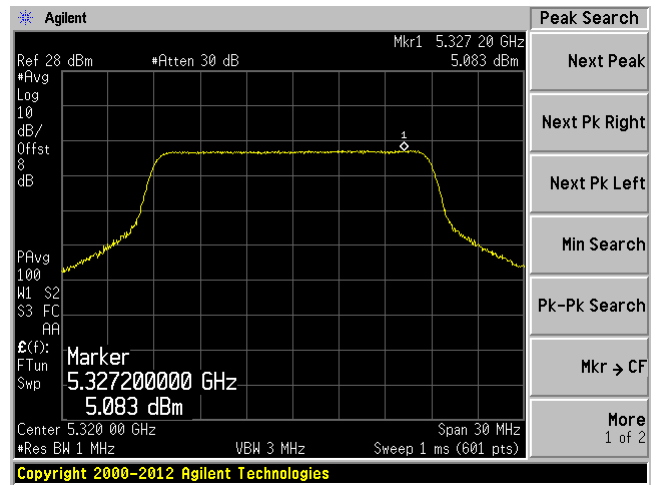

40 MHz bandwidth, Low Channel, 5270 MHz

C1

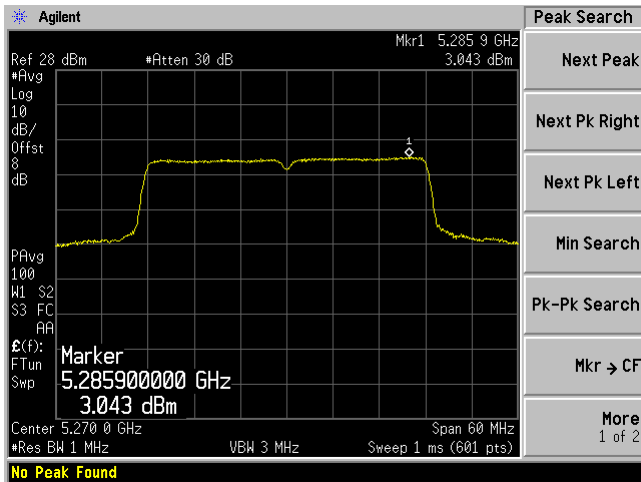

C2

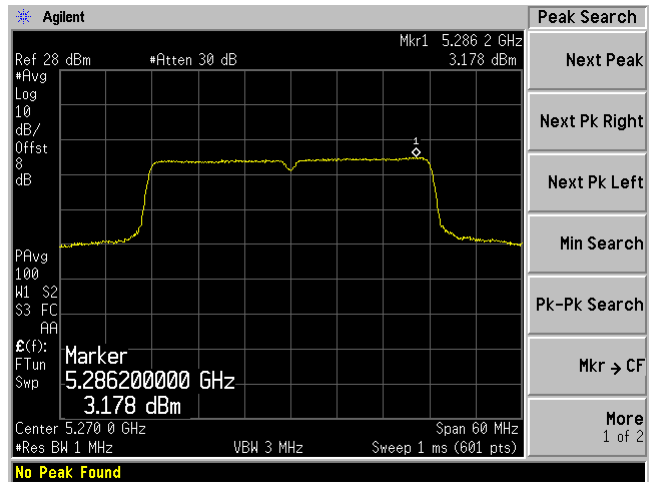

C3

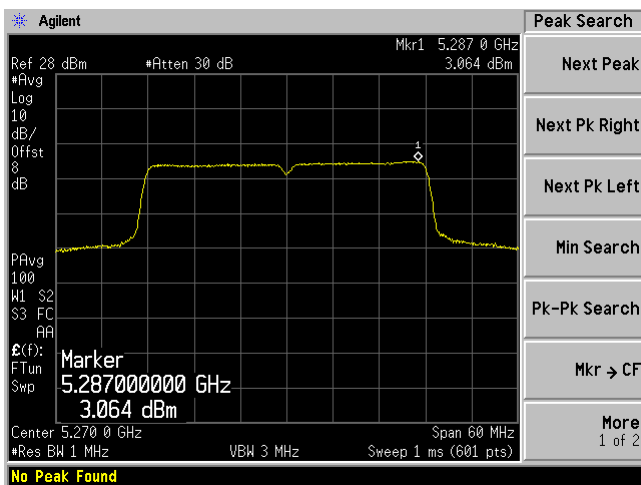

C4

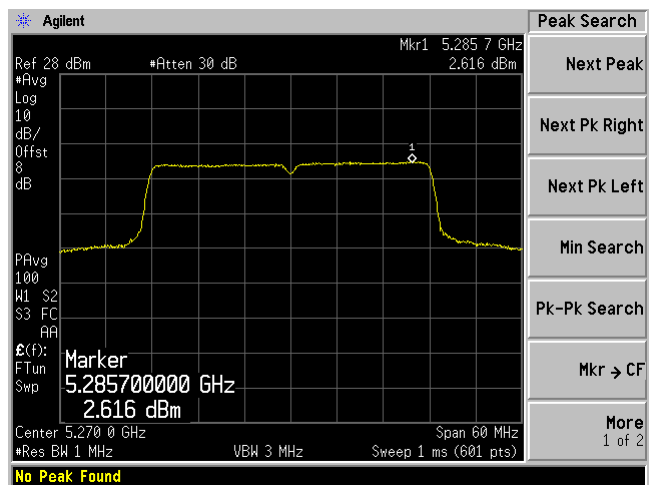

40 MHz bandwidth, Middle Channel, 5290 MHz

C1

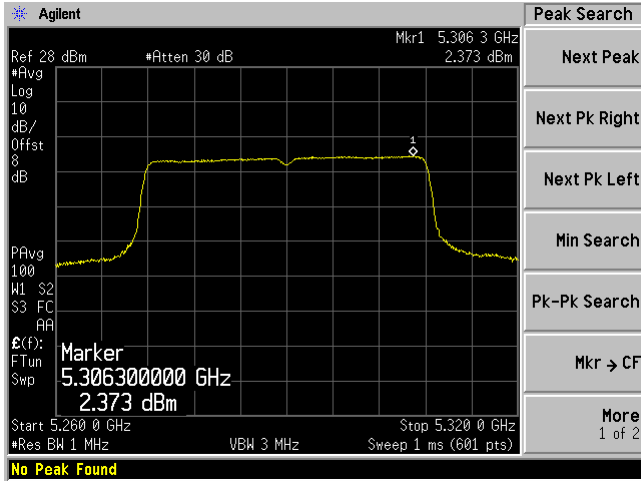

C2

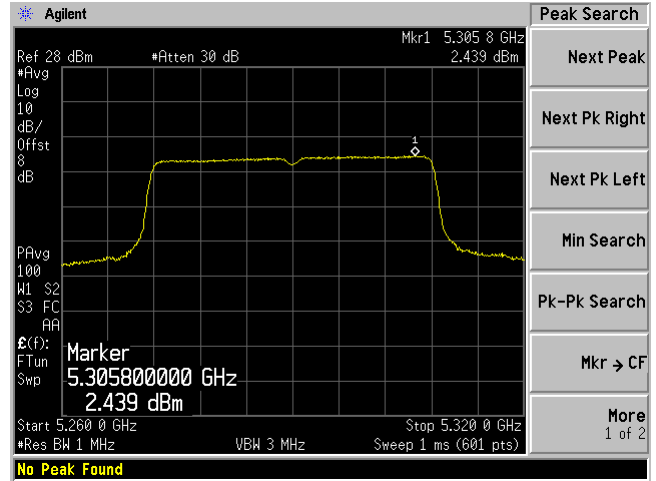

C3

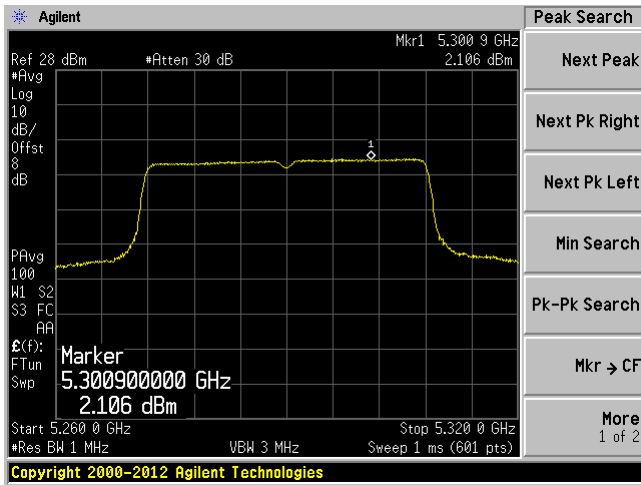

C4

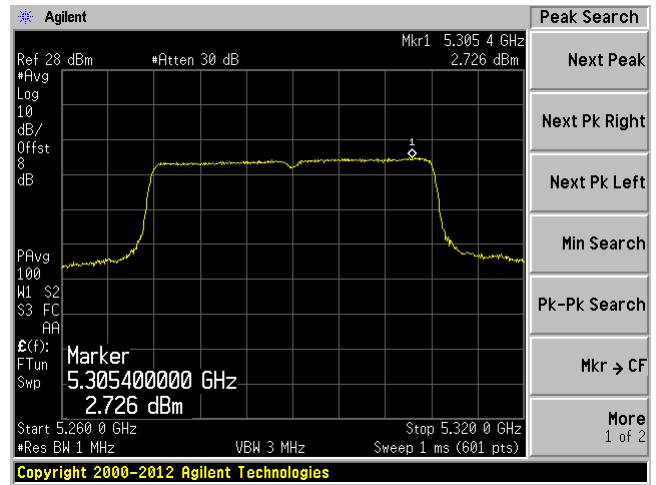

40 MHz bandwidth, High Channel, 5310 MHz

C1

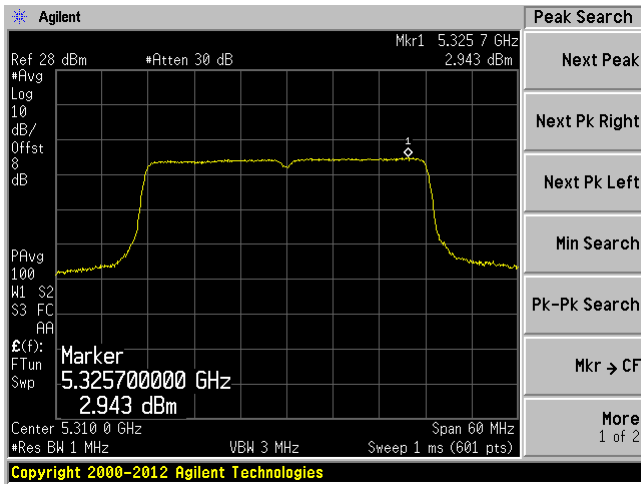

C2

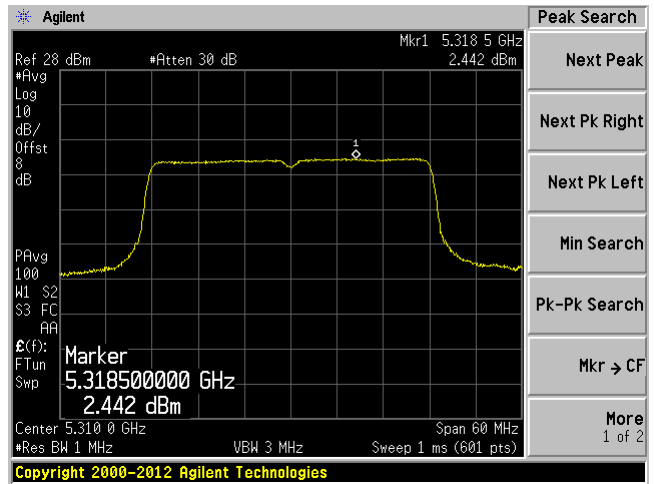

C3

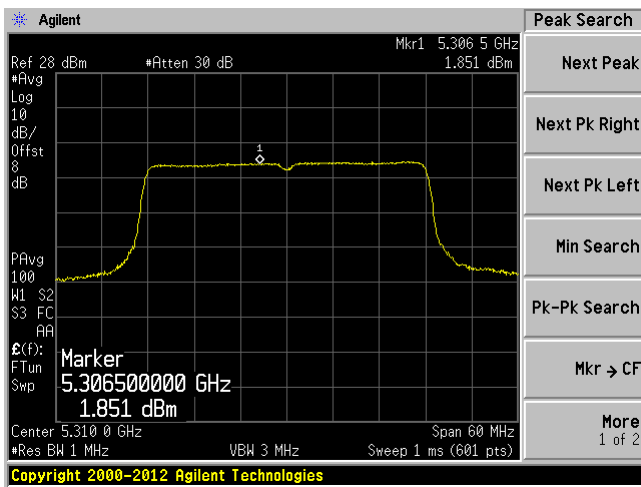

C4

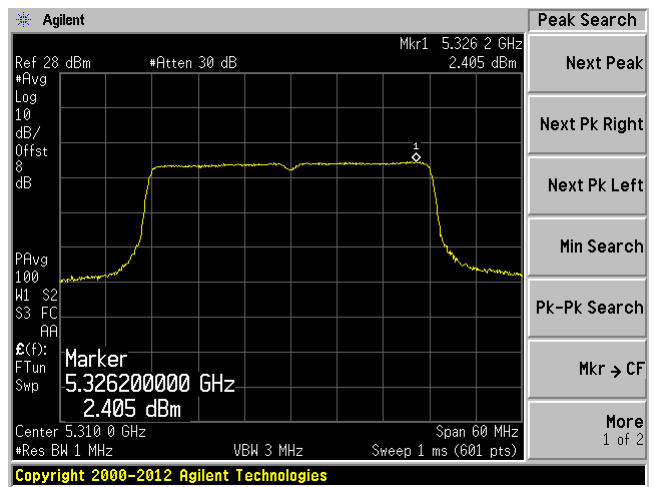

80 MHz bandwidth, 5290 MHz

C1

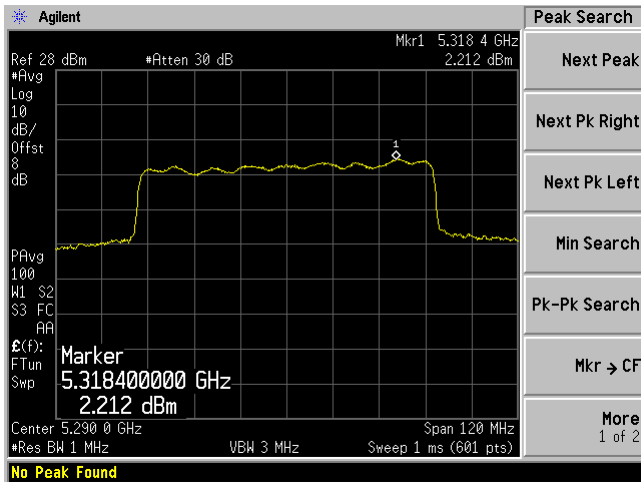

C2

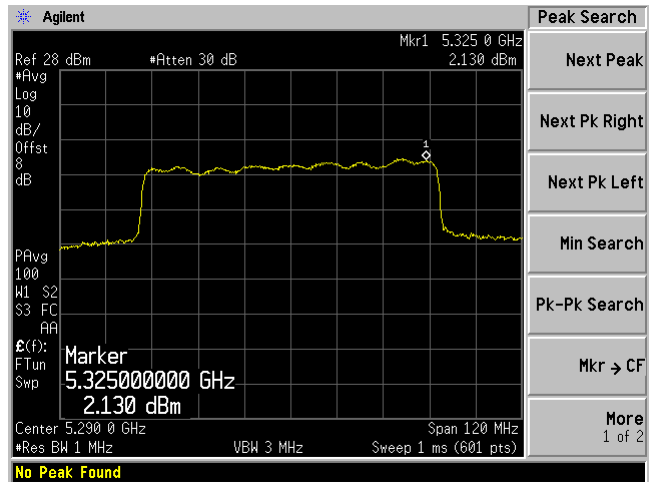

C3

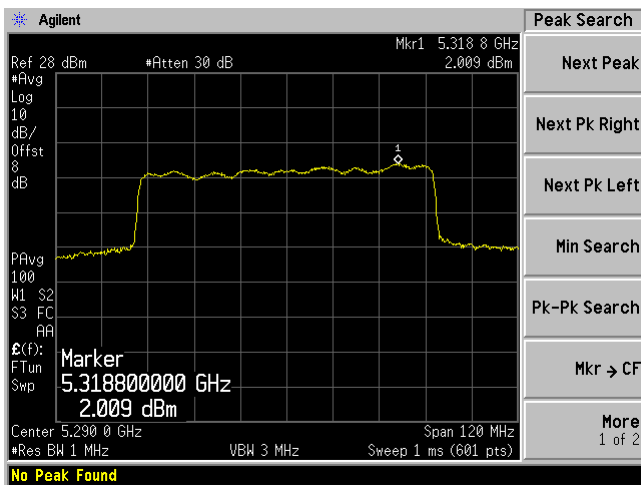

C4

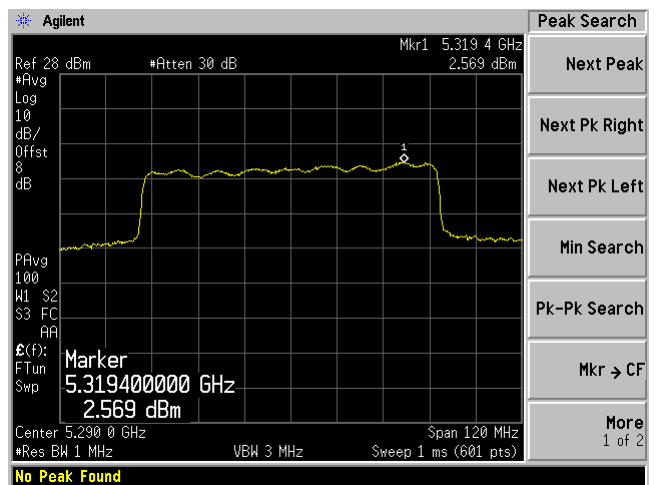

5.6 GHz Band:

20 MHz bandwidth, Low Channel, 5500 MHz

C1

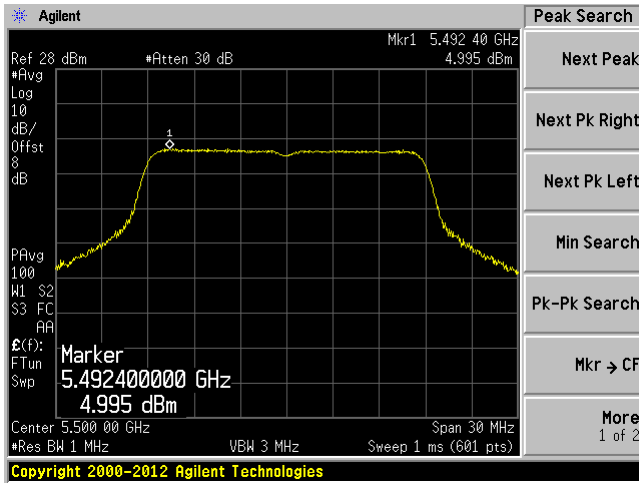

C2

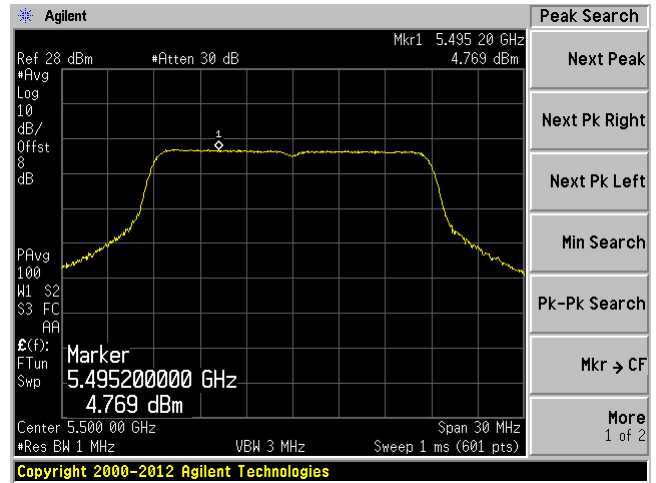

C3

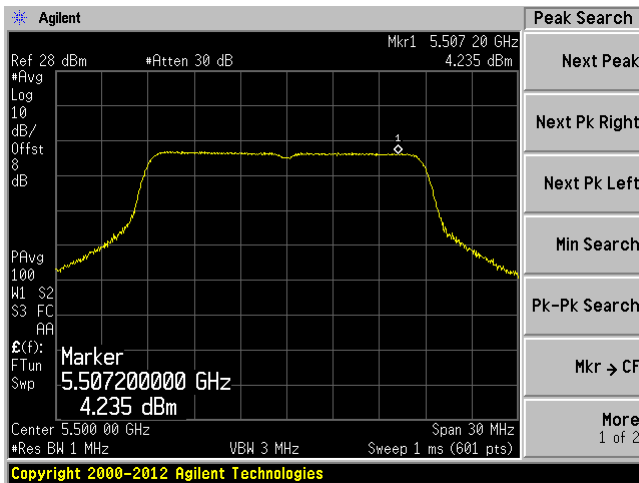

C4

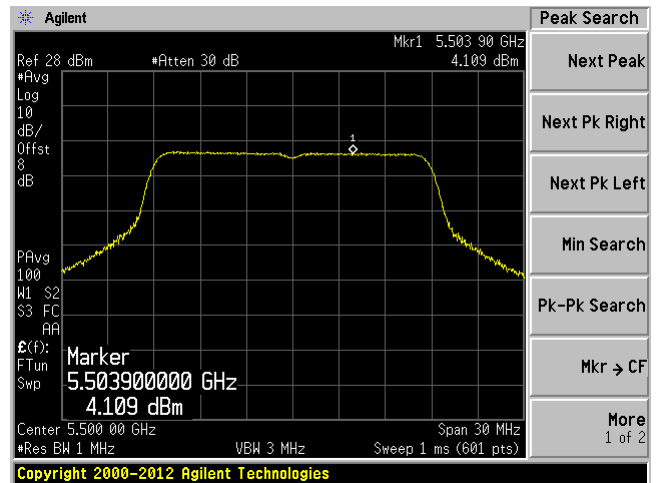

20 MHz bandwidth, Middle Channel, 5590 MHz

C1

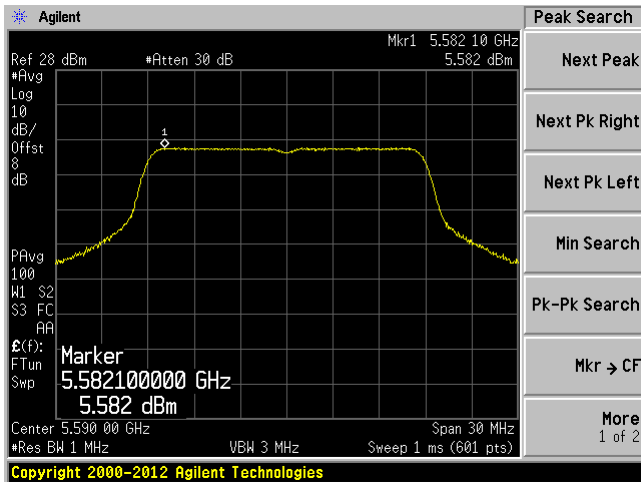

C2

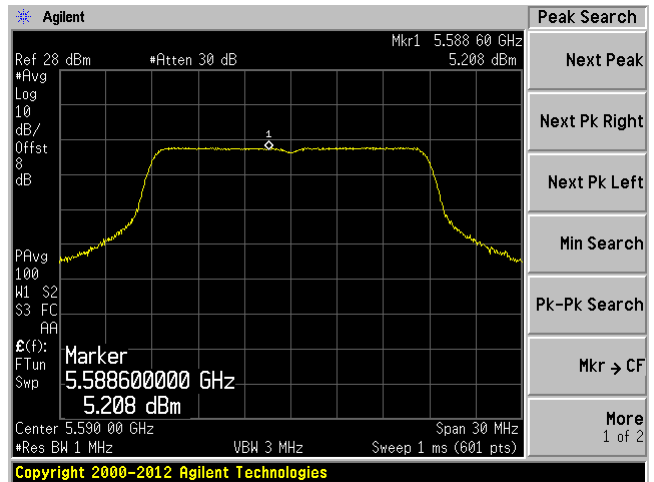

C3

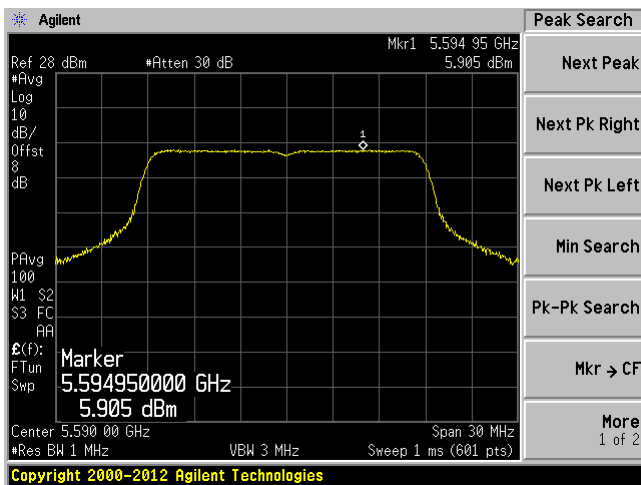

C4

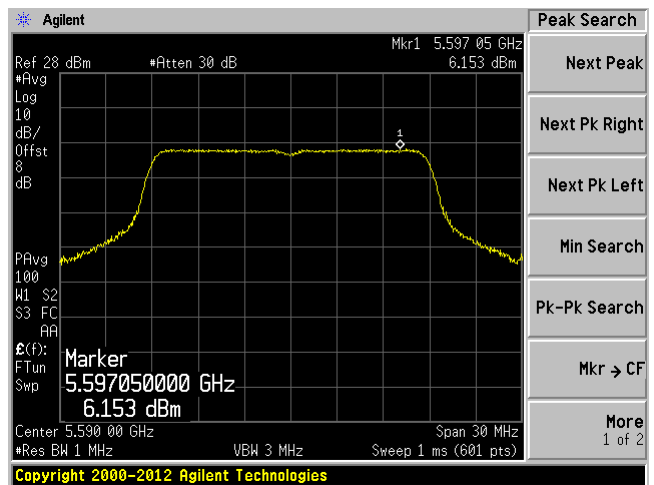

20 MHz bandwidth, High Channel, 5700 MHz

C1

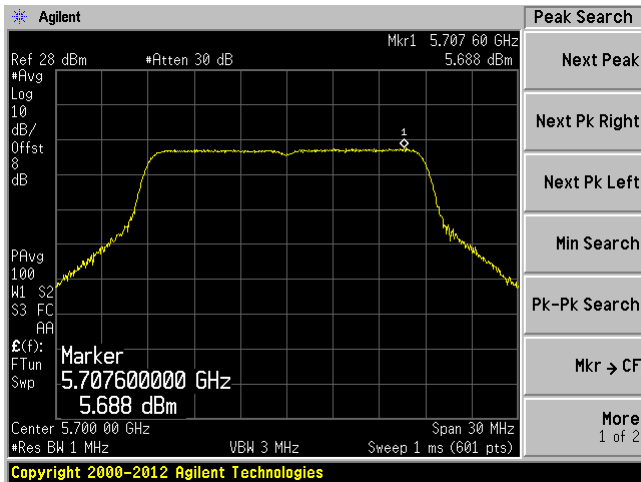

C2

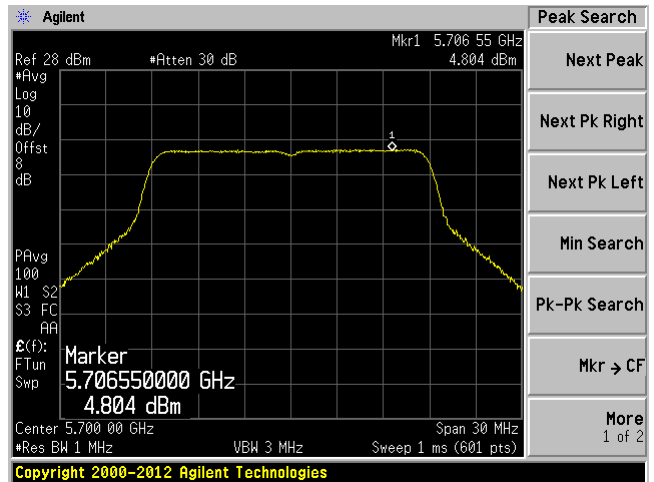

C3

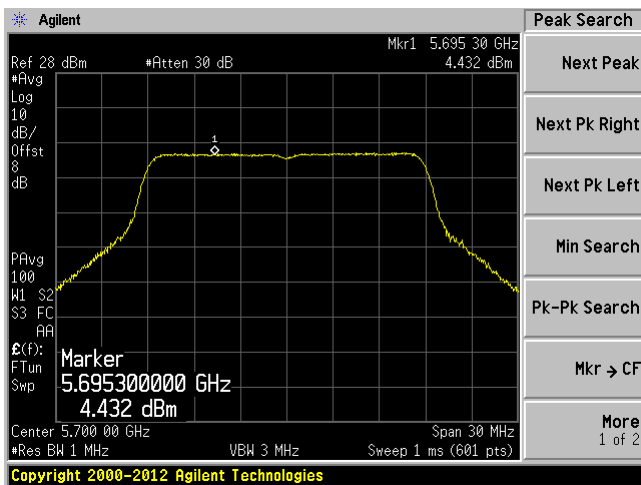

C4

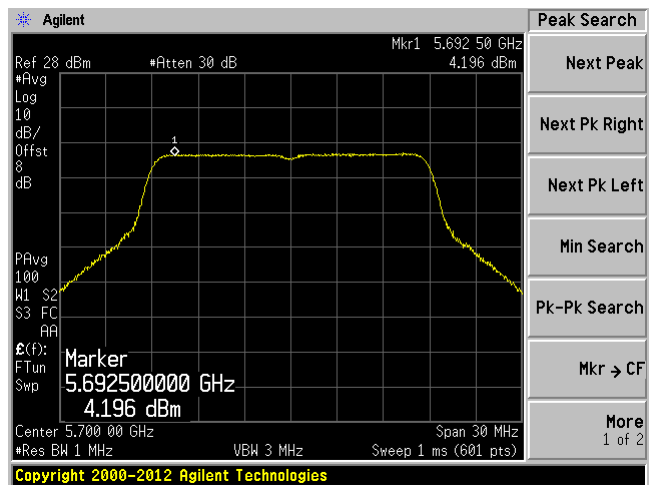

40 MHz bandwidth, Low Channel, 5510 MHz

C1

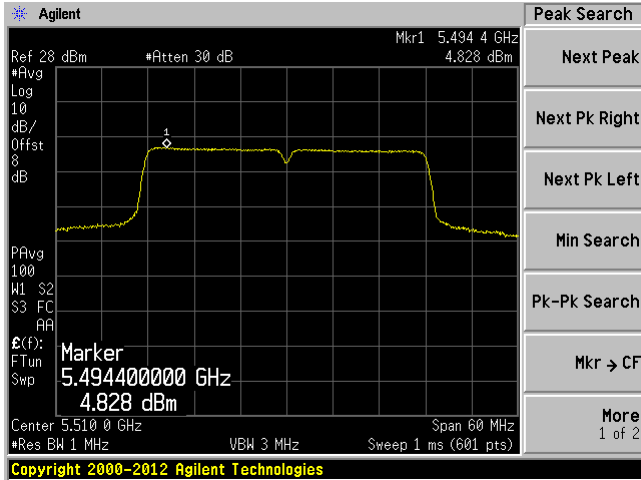

C2

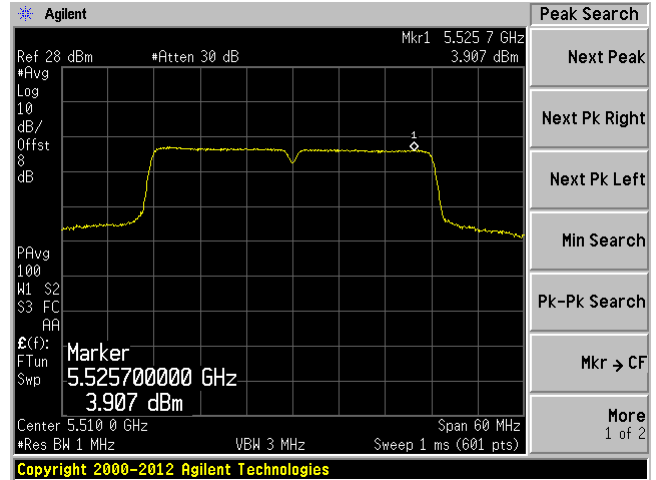

C3

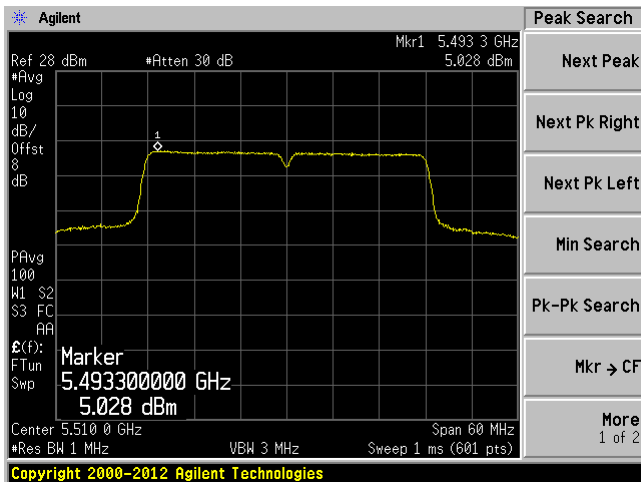

C4

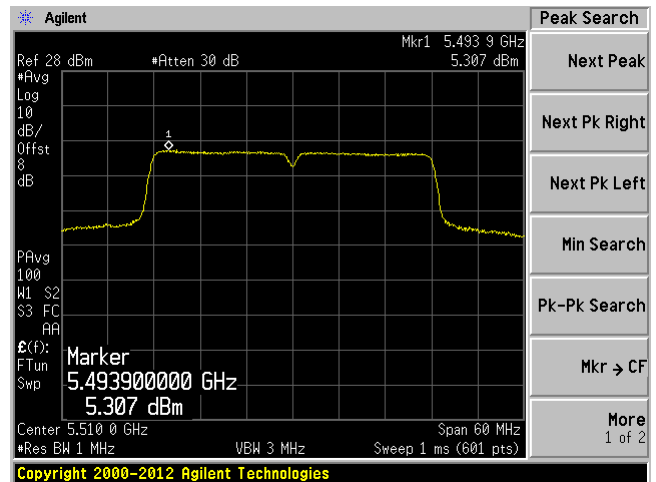

40 MHz bandwidth, Middle Channel, 5555 MHz

C1

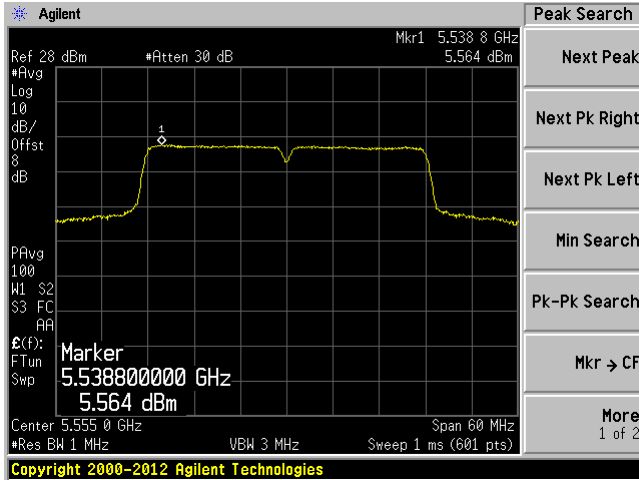

C2

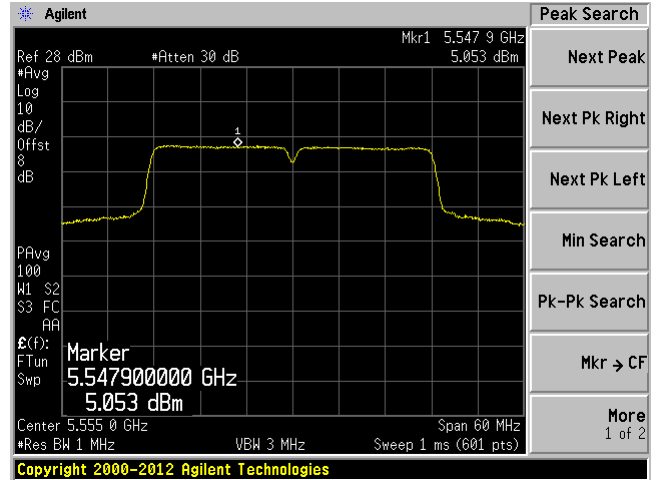

C3

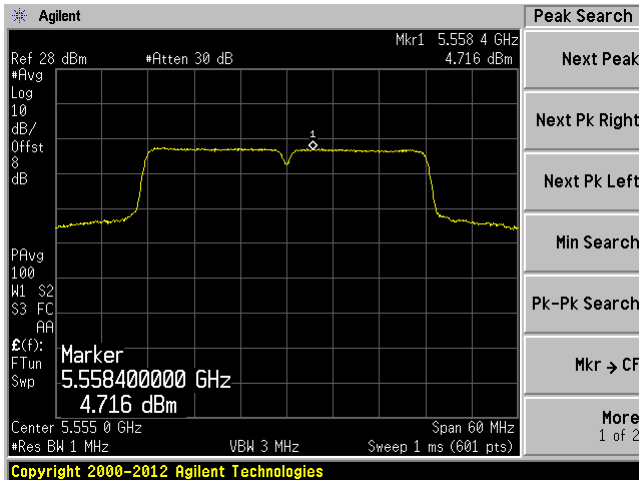

C4

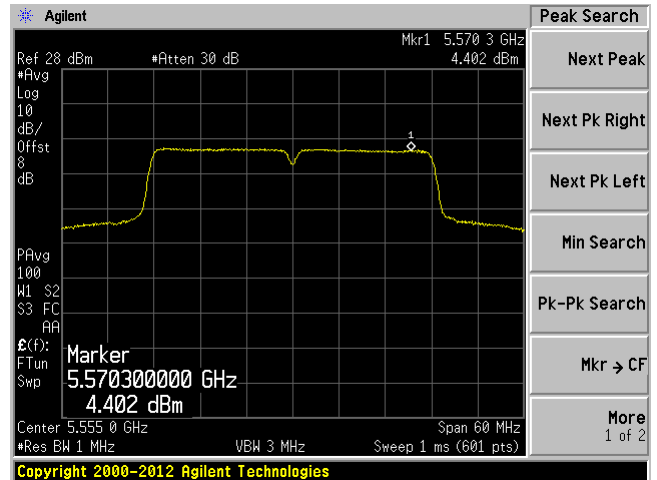

40 MHz bandwidth, High Channel, 5690 MHz

C1

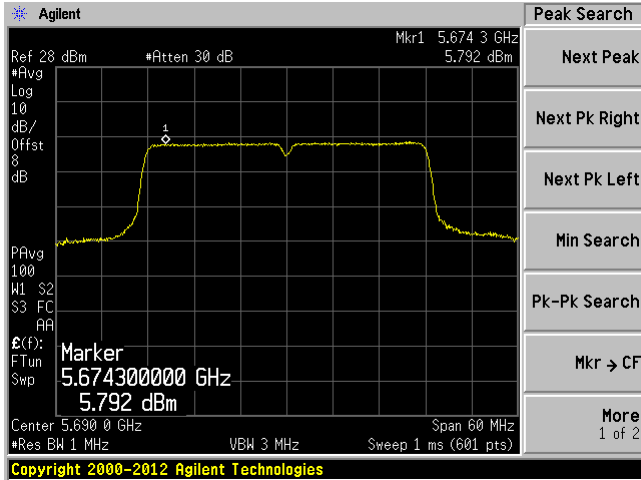

C2

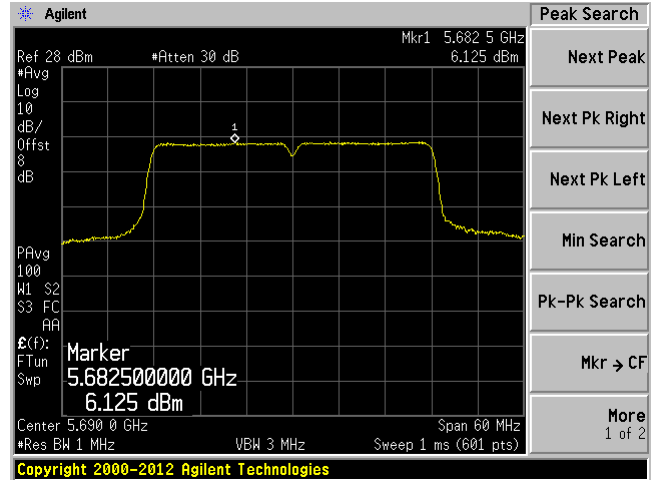

C3

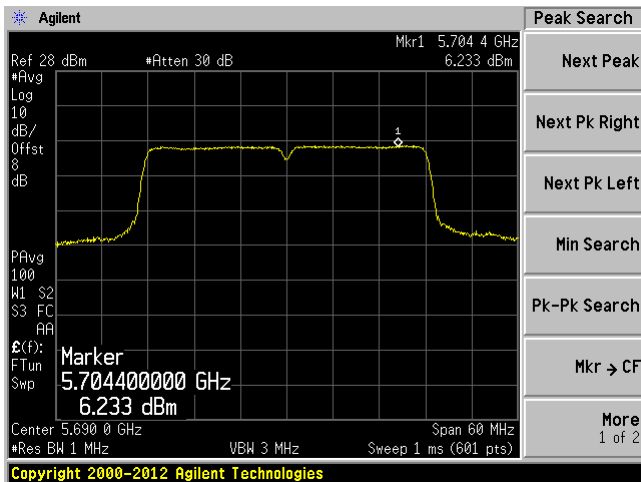

C4

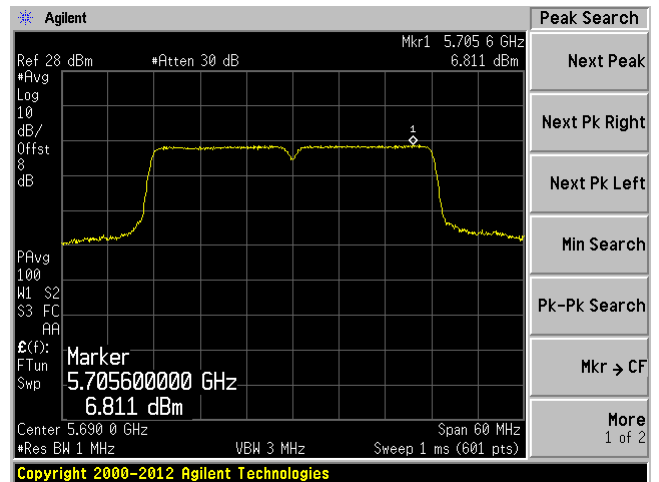

80 MHz bandwidth, Low Channel, 5530 MHz

C1

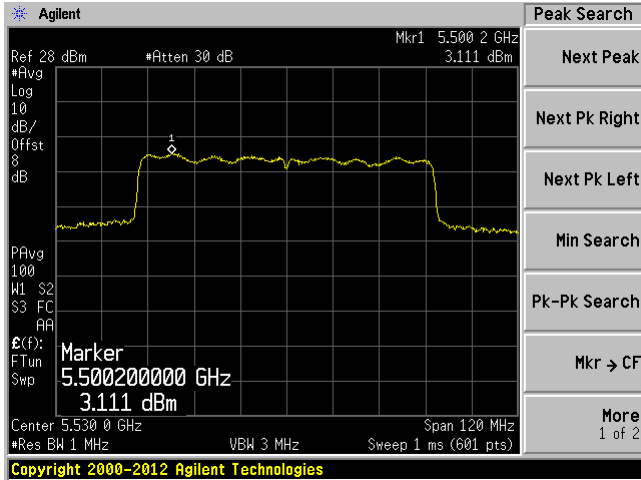

C2

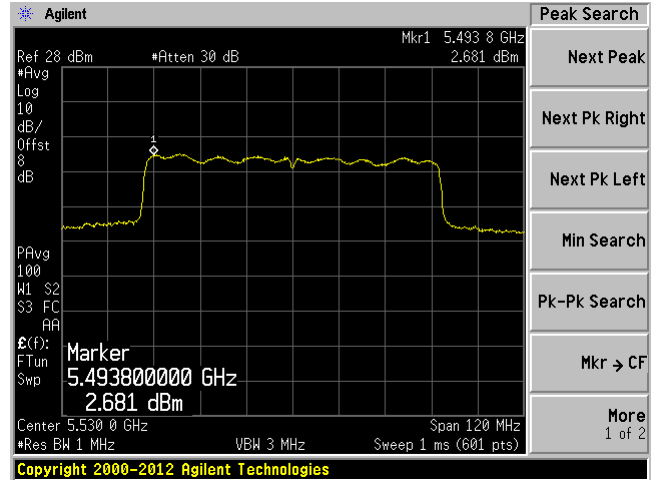

C3

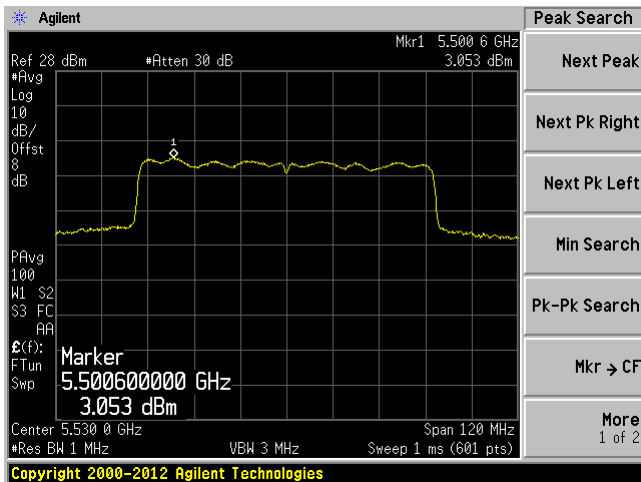

C4

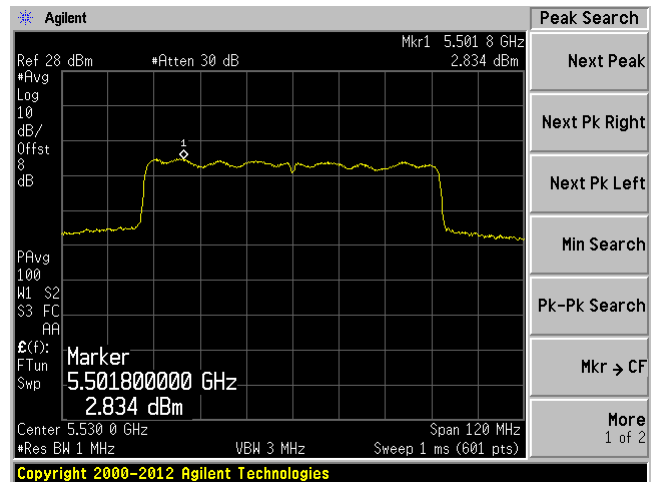

80 MHz bandwidth, Middle Channel, 5545 MHz

C1

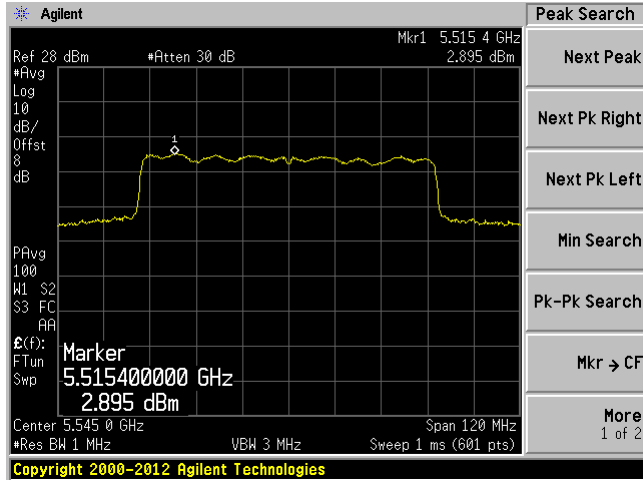

C2

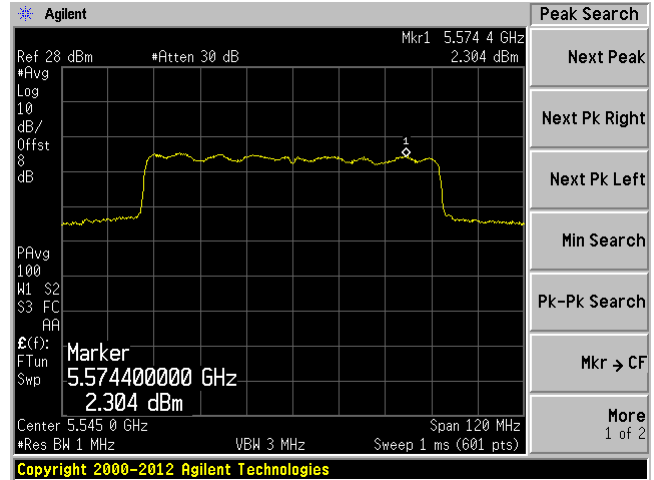

C3

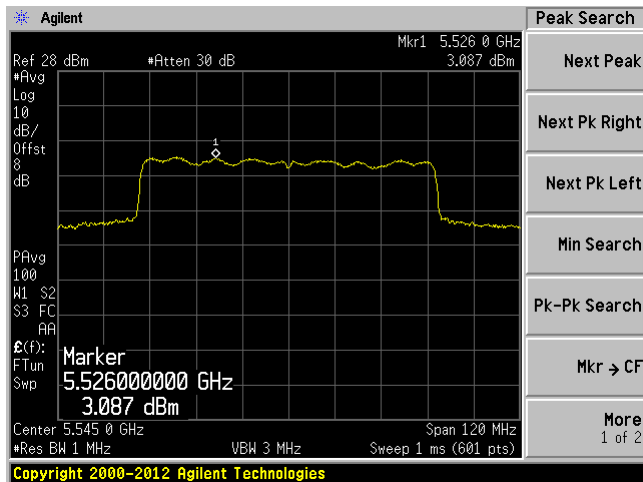

C4

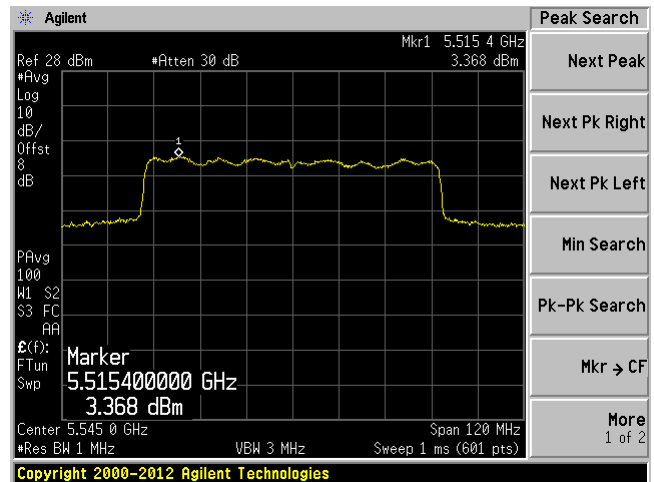

80 MHz bandwidth, High Channel, 5560 MHz

C1

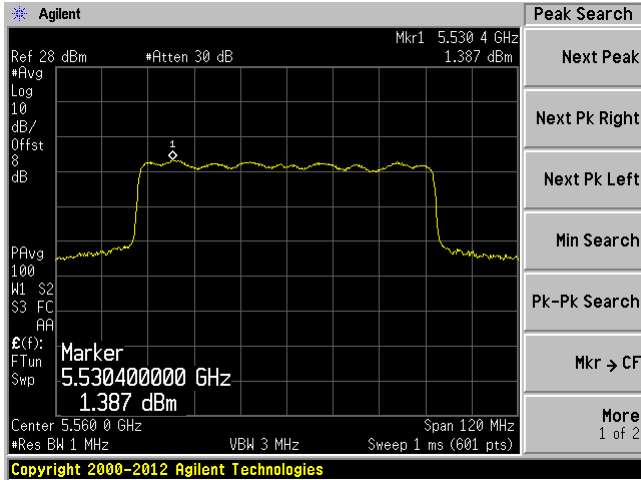

C2

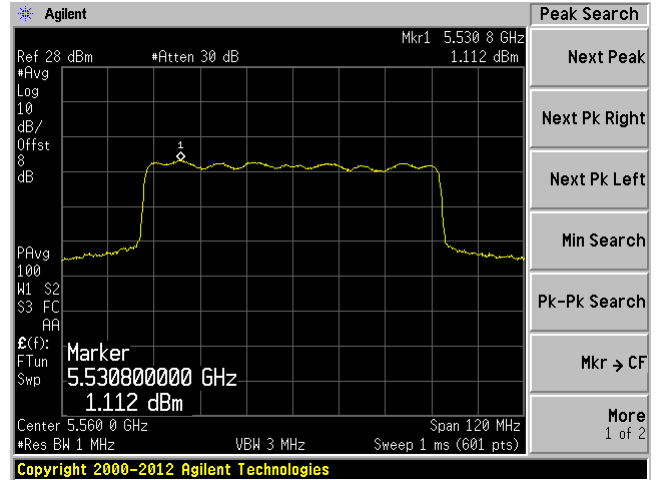

C3

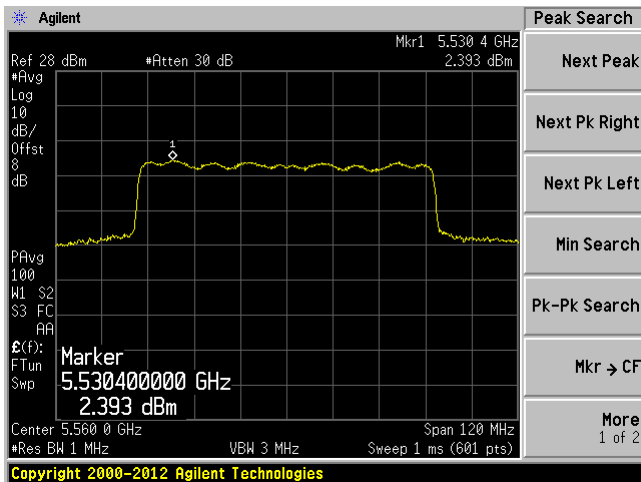

C4

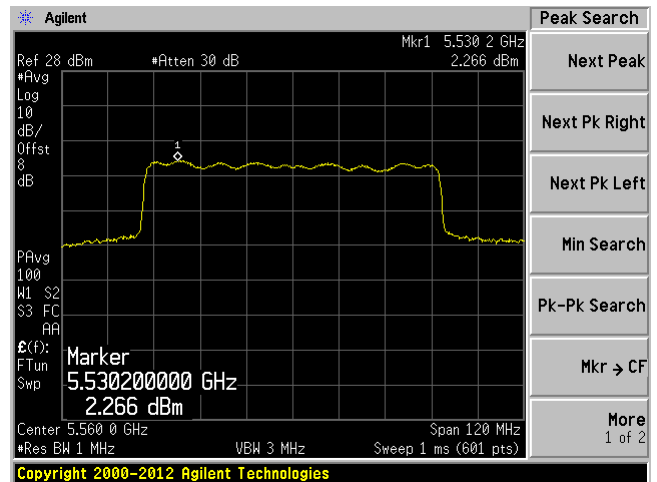

12 FCC §15.407(b) - Spurious Emissions at Antenna Terminals

12.1 Applicable Standard

According to FCC §15.407(b)

For transmitters operating in the 5.15-5.25 GHz band: All emissions outside of the 5.15-5.35 GHz band shall not exceed an e.i.r.p. of -27 dBm/MHz.

For transmitters operating in the 5.25-5.35 GHz band: All emissions outside of the 5.15-5.35 GHz band shall not exceed an e.i.r.p. of -27 dBm/MHz.

For transmitters operating in the 5.47-5.725 GHz band: All emissions outside of the 5.47-5.725 GHz band shall not exceed an e.i.r.p. of -27 dBm/MHz.

For transmitters operating in the 5.725-5.85 GHz band: All emissions within the frequency range from the band edge to 10 MHz above or below the band edge shall not exceed an e.i.r.p. of -17 dBm/MHz; for frequencies 10 MHz or greater above or below the band edge, emissions shall not exceed an e.i.r.p. of -27 dBm/MHz.

12.2 Measurement Procedure

The measurements are base on FCC KDB 789033 D02 General UNII Test Procedures v01: Guidelines for Compliance Testing of Unlicensed National Information Infrastructure (U-NII) Devices section H: Unwanted emissions measurement

12.3 Test Equipment List and Details

Manufacturer	Description	Model No.	Serial No.	Calibration Date	Calibration Interval
Agilent	Spectrum Analyzer	E4446A	US44300386	2013-09-29	1 year

Statement of Traceability: BACL Corp. attests that all calibrations have been performed per the A2LA requirements, traceable to the NIST.

12.4 Test Environmental Conditions

Temperature:	22-24° C
Relative Humidity:	42-45 %
ATM Pressure:	101-102 kPa

The testing was performed by Cipher Chu on 2014-04-04 to 2014-04-07 and 2014-08-09 to 2014-08-21 at the RF Site

12.5 Test Results

Please refer to following plots of spurious emissions.

Note: Chain 1 and Chain 4 is Vertical, and Chain 2 and Chain 3 is Horizontal

Note: C1, C2, C3 and C4 stands for Chain1, Chain 2, Chain 3 and Chain 4.

25 dBi Antenna:

5.3 GHz Band

20 MHz Bandwidth, Low Channel, 5260 MHz

C1 30 MHz-6 GHz

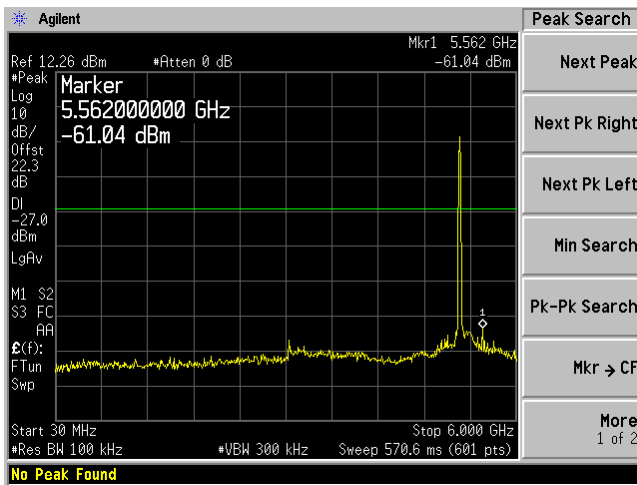

C1 6 GHz-40 GHz

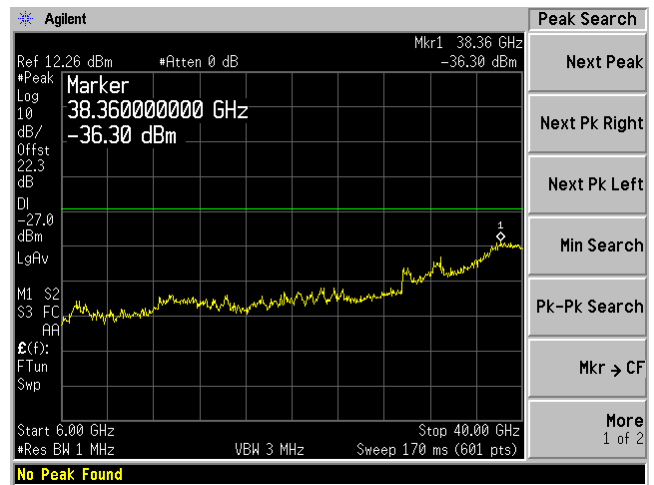

C2 30 MHz-6 GHz

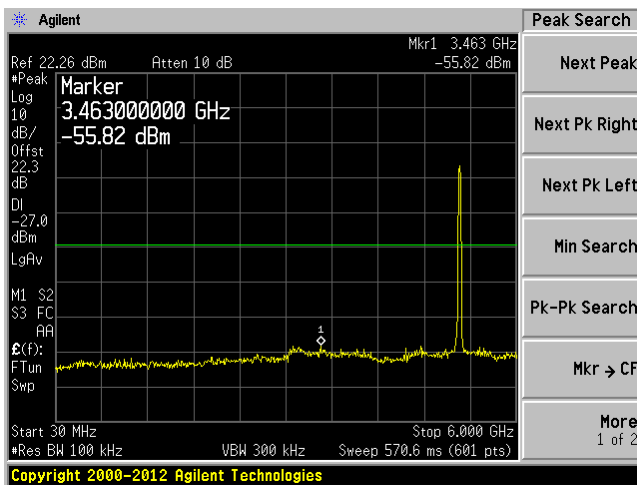

C2 6 GHz-40 GHz

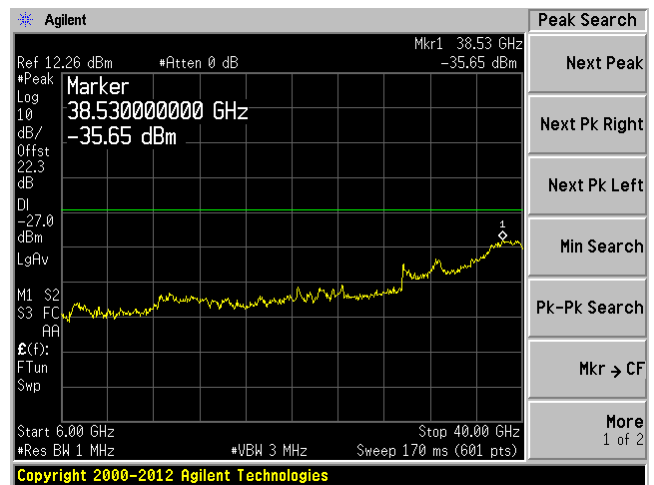

C3 30 MHz-6 GHz

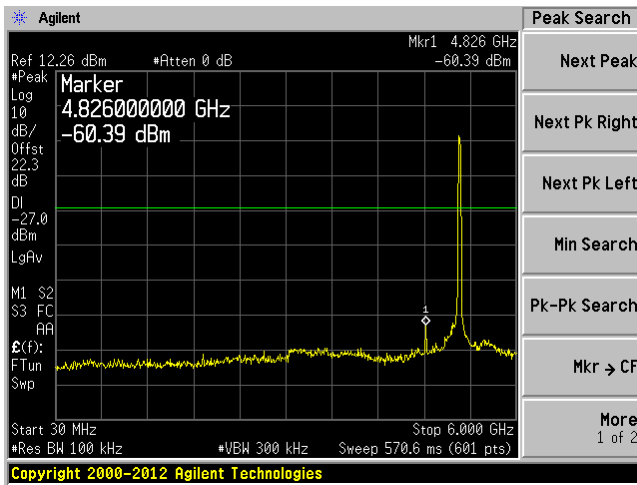

C3 6 GHz-40 GHz

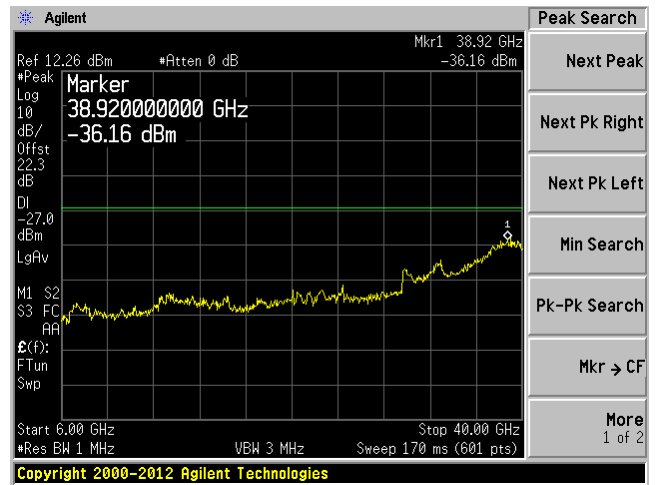

C4 30 MHz-6 GHz

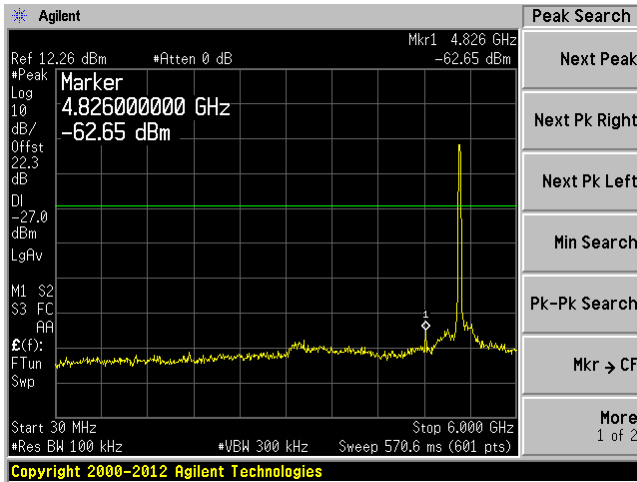

C4 6 GHz-40 GHz

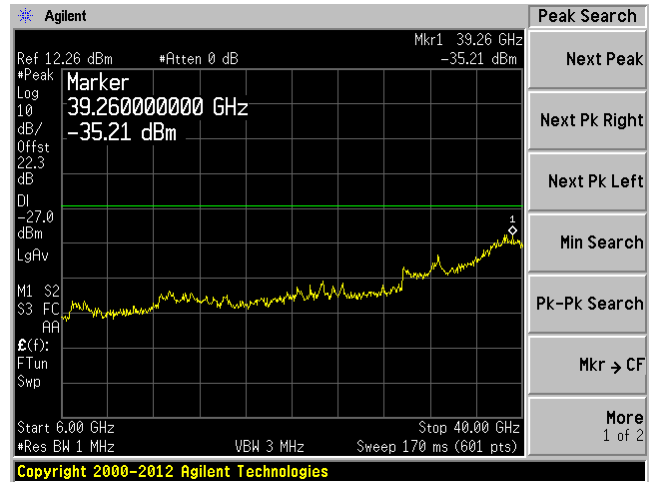

20 MHz Bandwidth, Middle Channel, 5295 MHz

C1 30 MHz-6 GHz

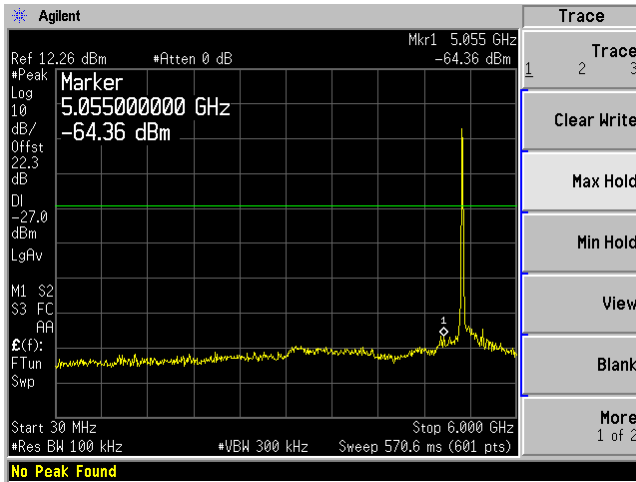

C1 6 GHz-40 GHz

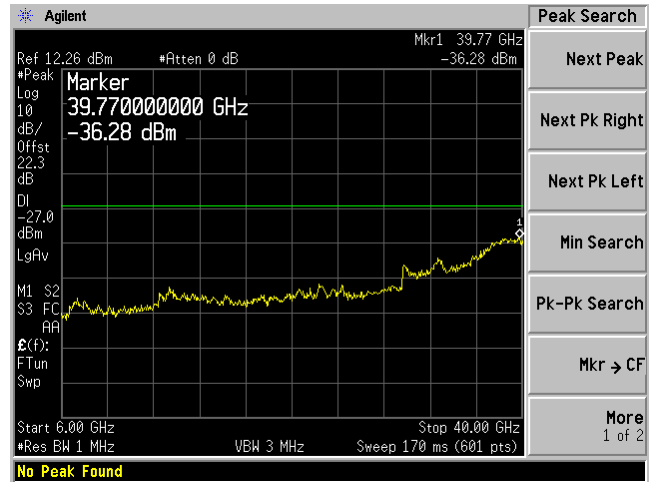

C2 30 MHz-6 GHz

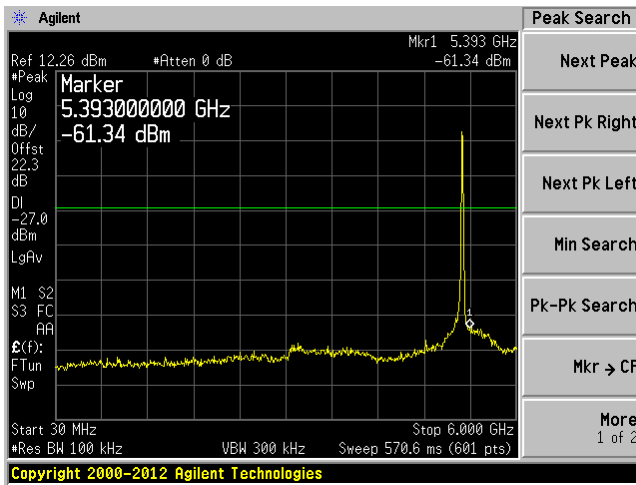

C2 6 GHz-40 GHz

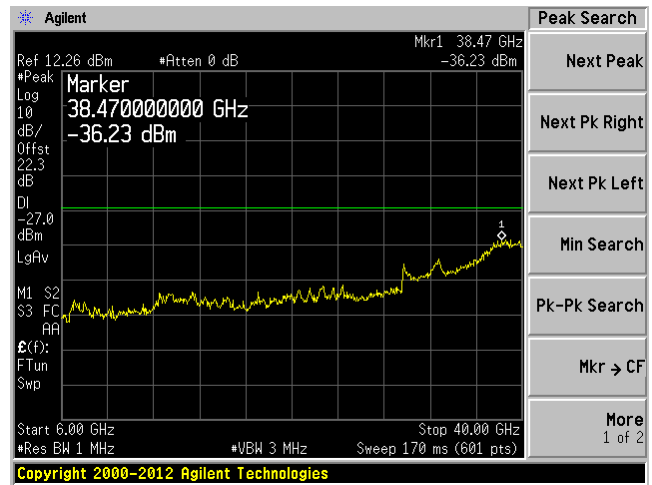

C3 30 MHz-6 GHz

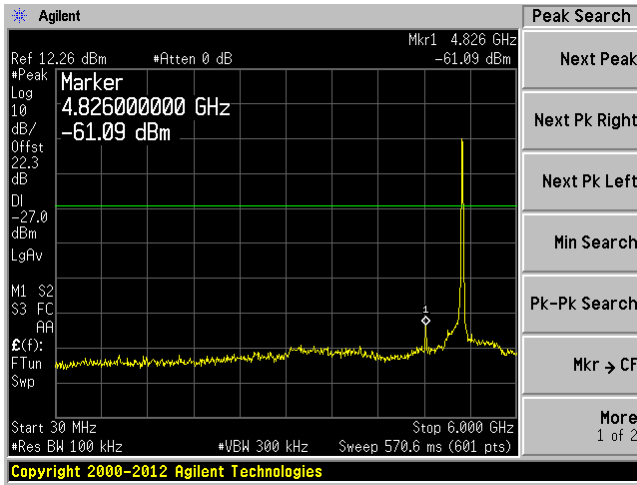

C3 6 GHz-40 GHz

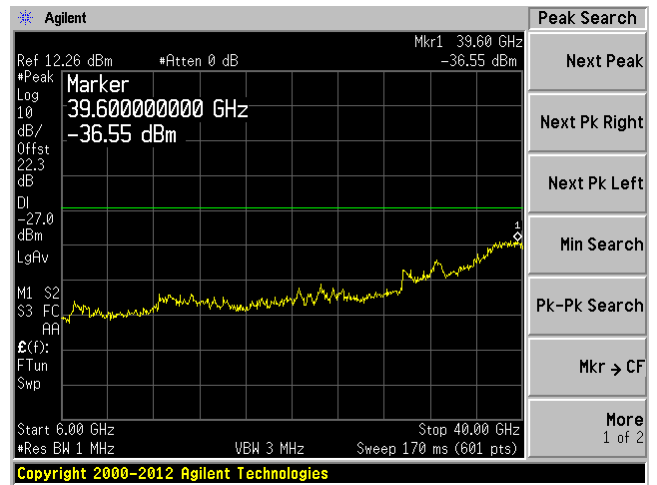

C4 30 MHz-6 GHz

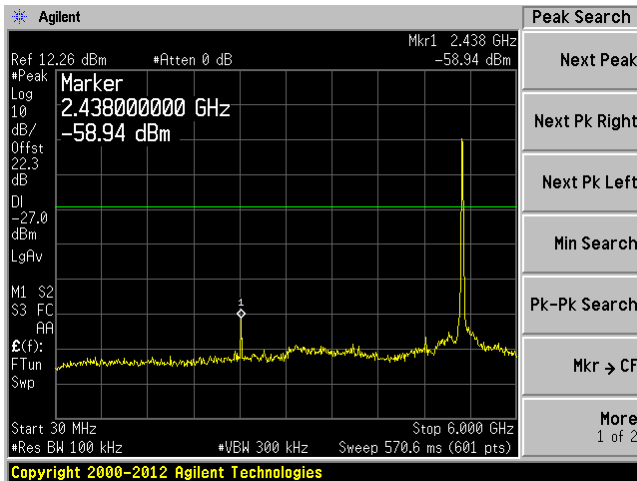

C4 6 GHz-40 GHz

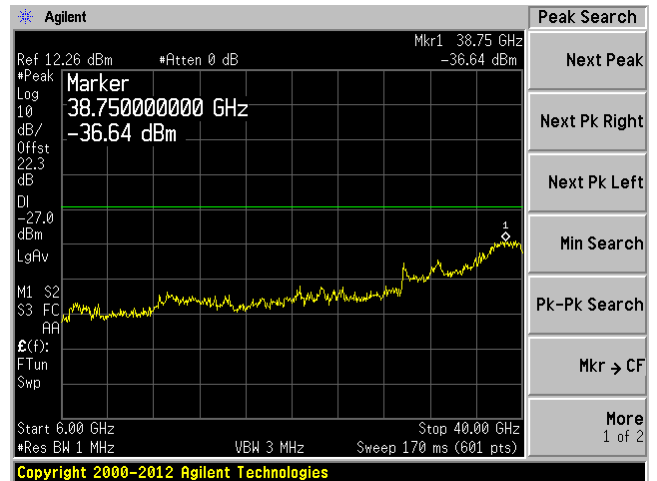

20 MHz Bandwidth, High Channel, 5320 MHz

C1 30 MHz-6 GHz

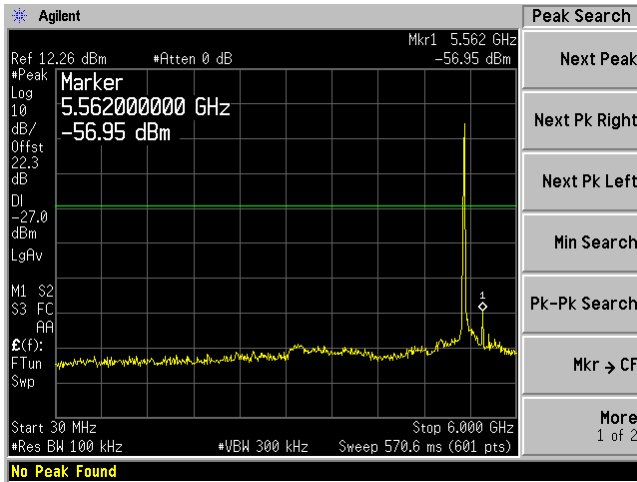

C1 6 GHz-40 GHz



C2 30 MHz-6 GHz

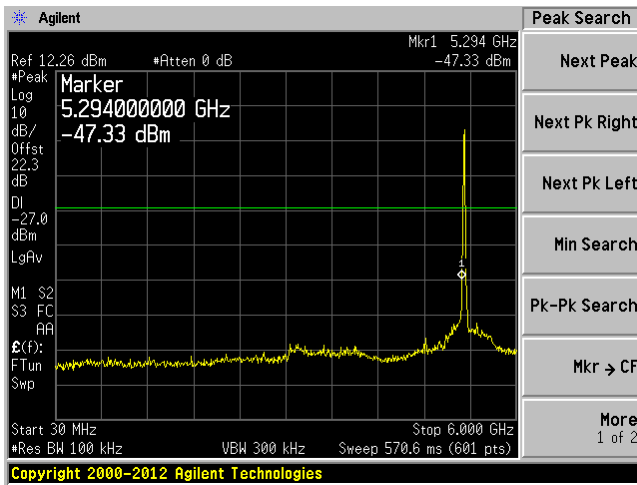

C2 6 GHz-40 GHz

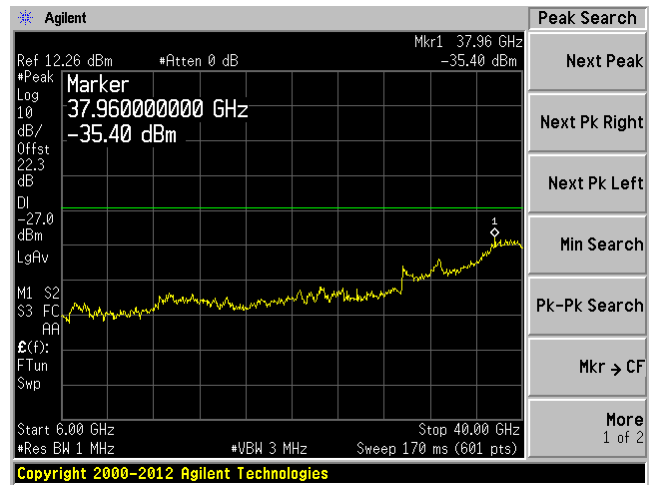

C3 30 MHz-6 GHz

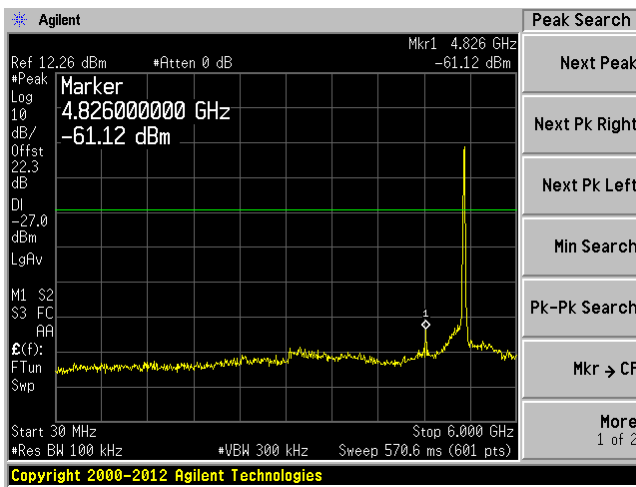

C3 6 GHz-40 GHz

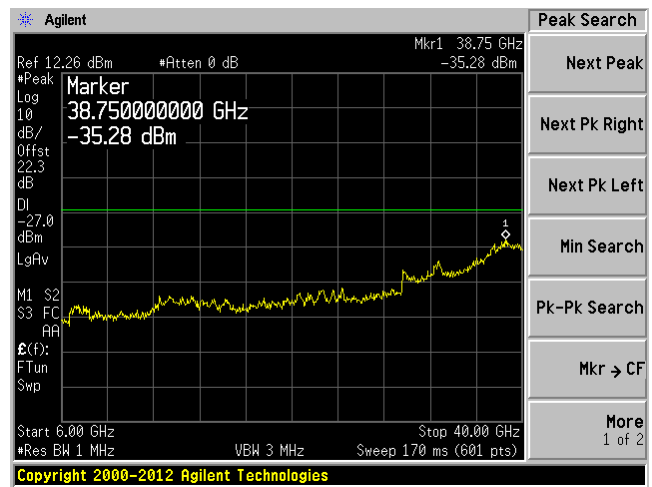

C4 30 MHz-6 GHz

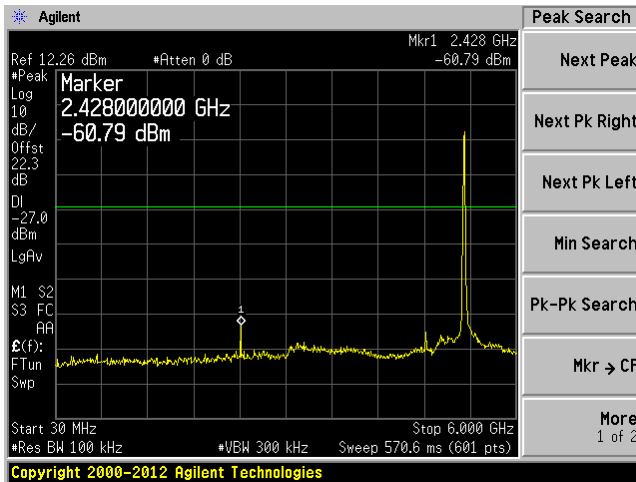

C4 6 GHz-40 GHz

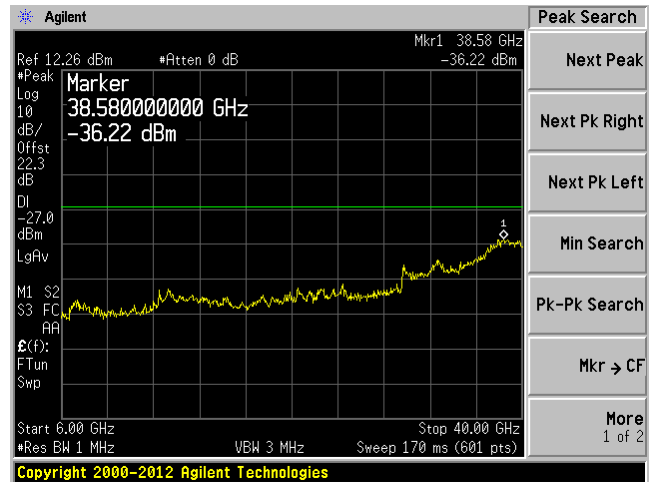

40 MHz Bandwidth, Low Channel, 5270 MHz

C1 30 MHz-6 GHz

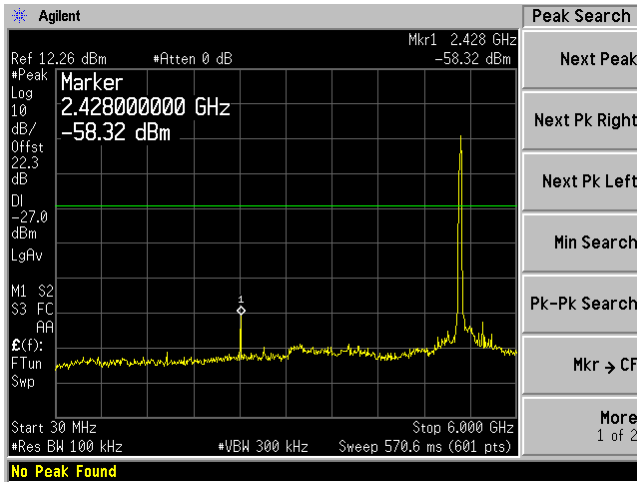

C1 6 GHz-40 GHz



C2 30 MHz-6 GHz

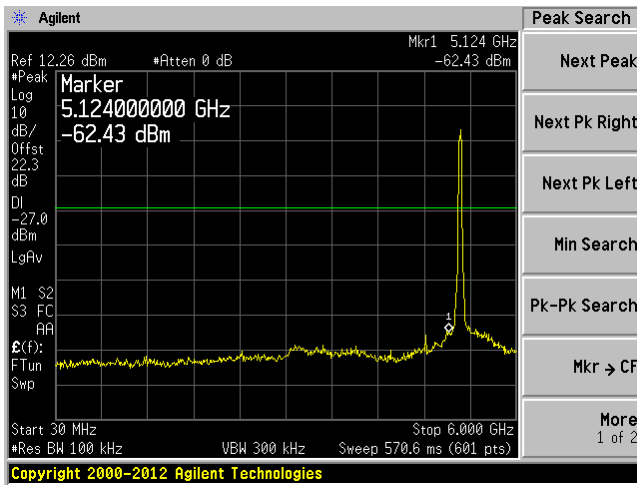

C2 6 GHz-40 GHz

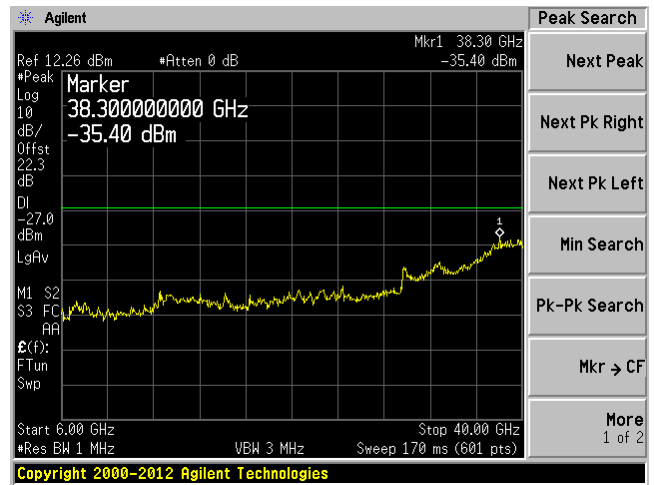

C3 30 MHz-6 GHz

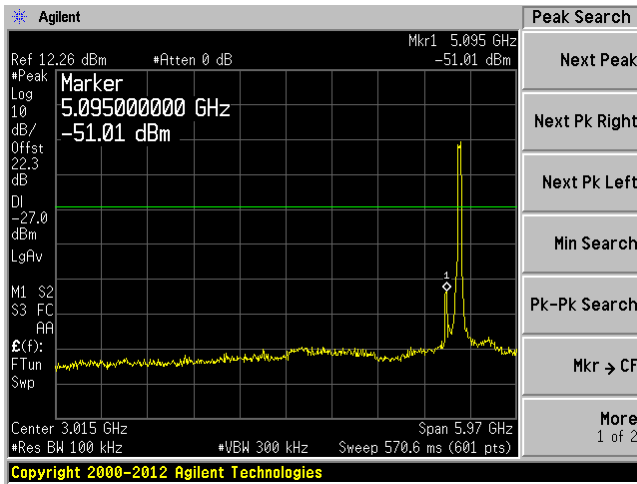

C3 6 GHz-40 GHz

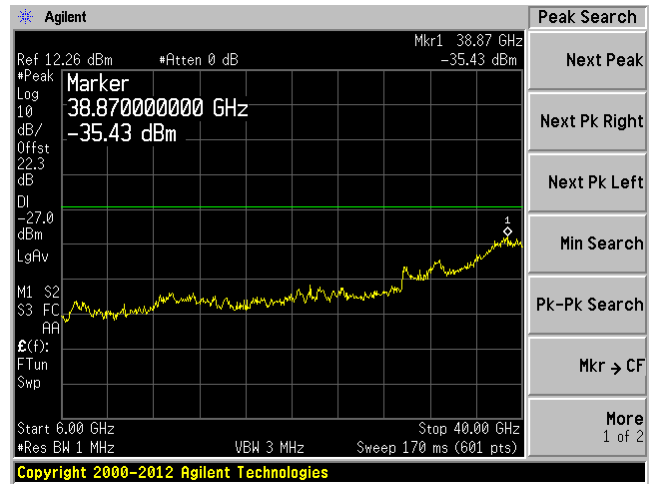

C4 30 MHz-6 GHz

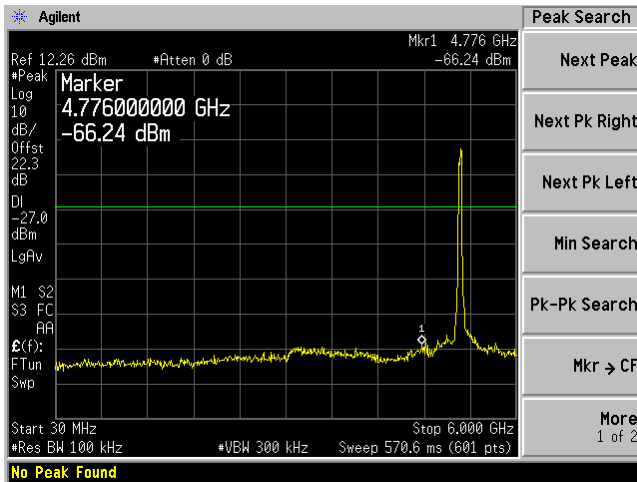

C4 6 GHz-40 GHz

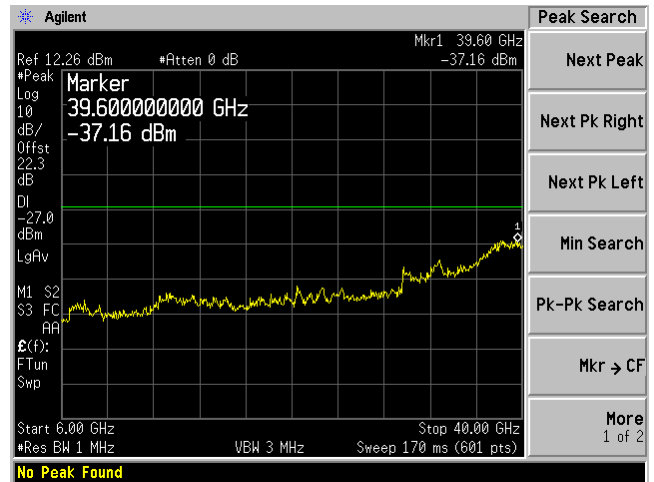

40 MHz Bandwidth, Middle Channel, 5290 MHz

C1 30 MHz-6 GHz

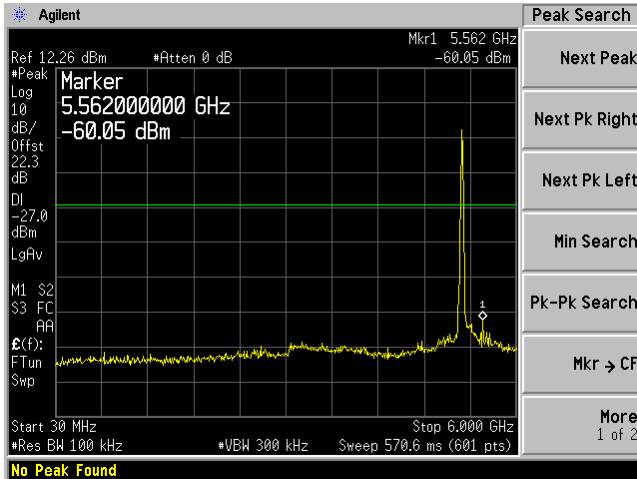

C1 6 GHz-40 GHz

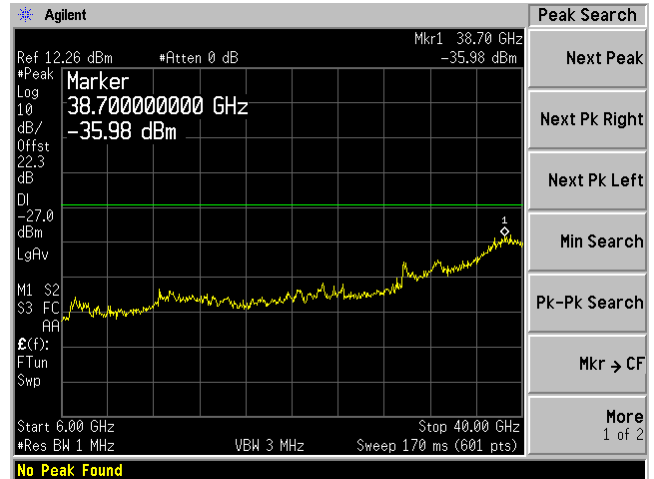

C2 30 MHz-6 GHz

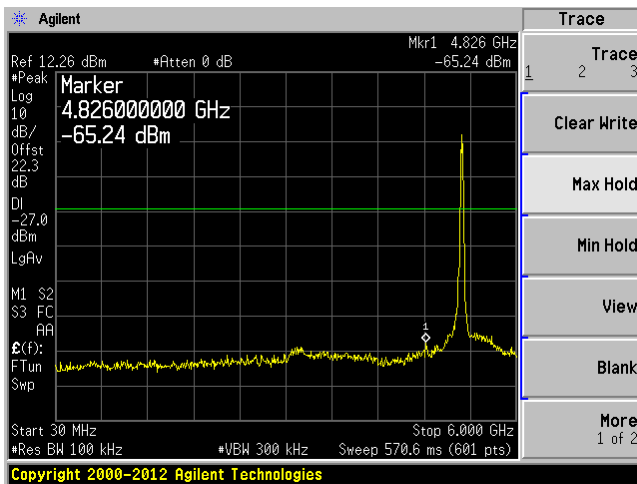

C2 6 GHz-40 GHz

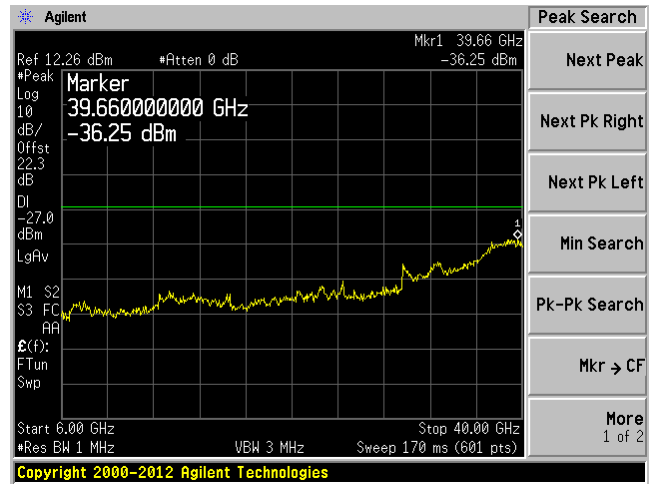

C3 30 MHz-6 GHz

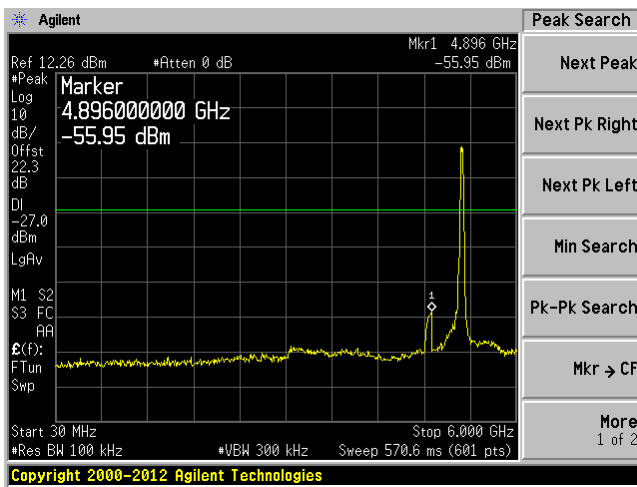

C3 6 GHz-40 GHz

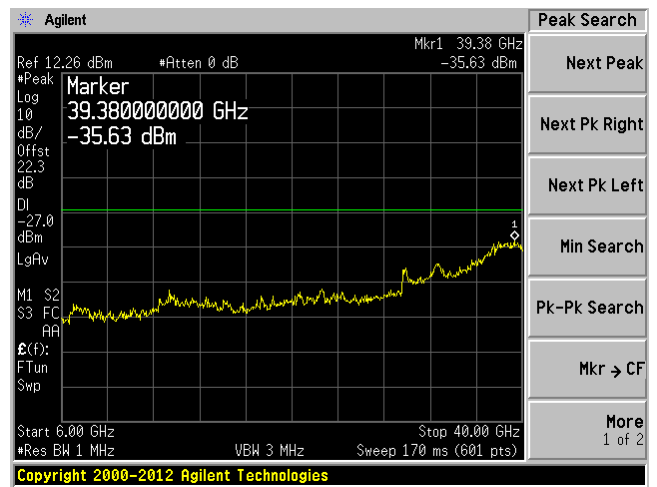

C4 30 MHz-6 GHz

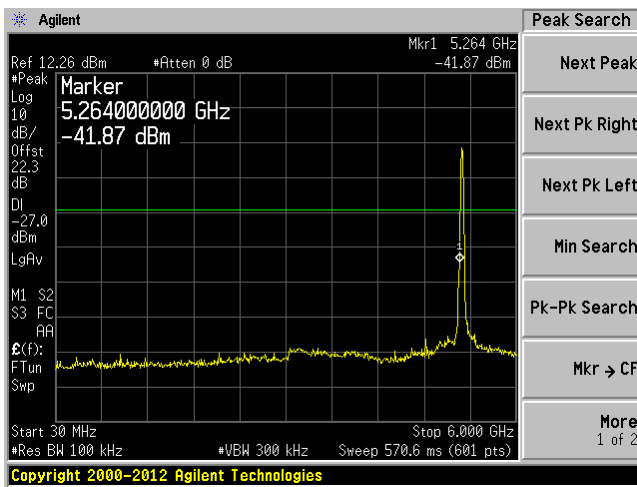

C4 6 GHz-40 GHz

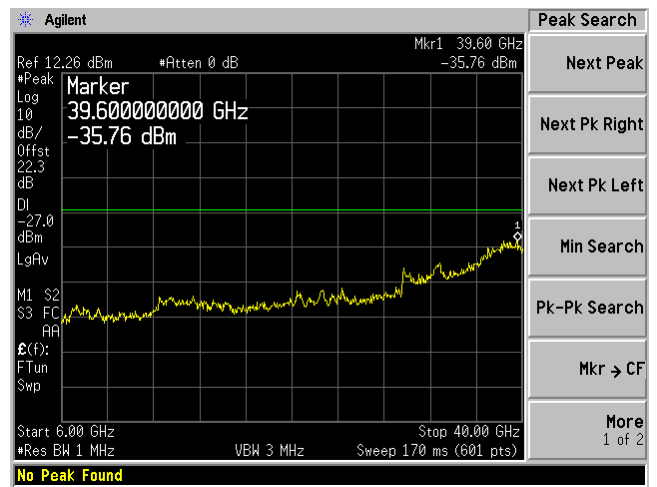

40 MHz Bandwidth, High Channel, 5310 MHz

C1 30 MHz-6 GHz

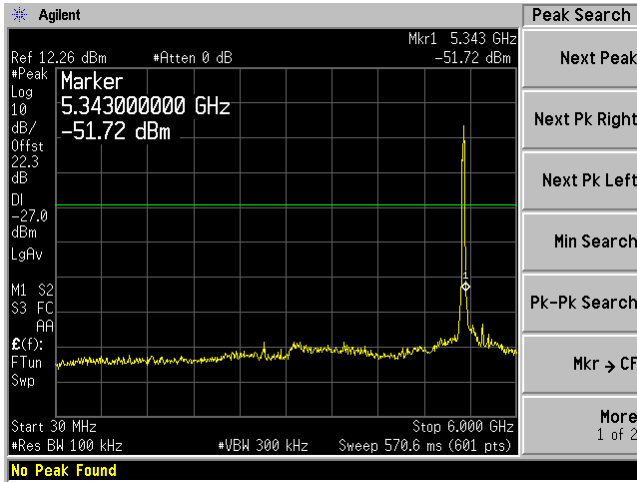

C1 6 GHz-40 GHz

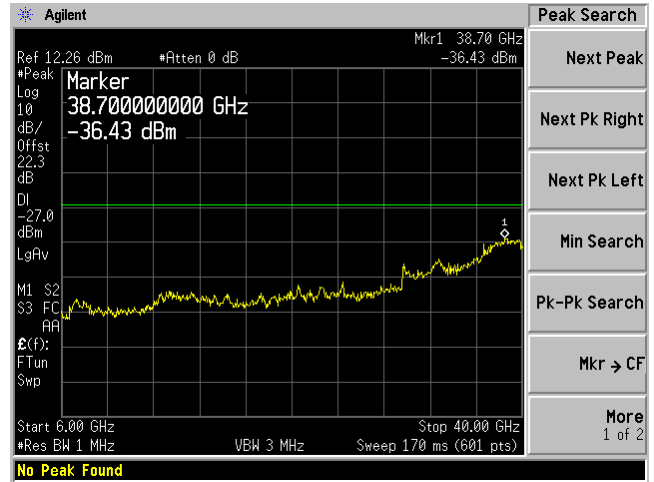

C2 30 MHz-6 GHz

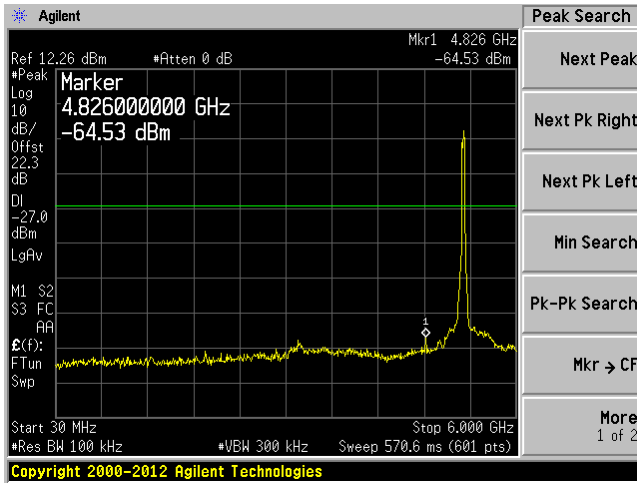

C2 6 GHz-40 GHz

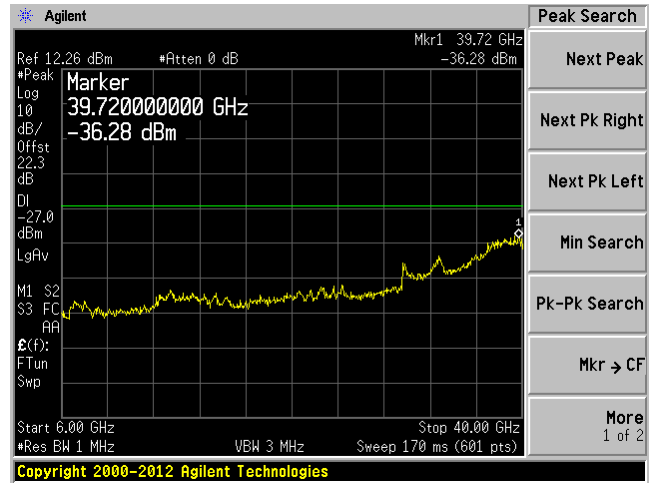

C3 30 MHz-6 GHz

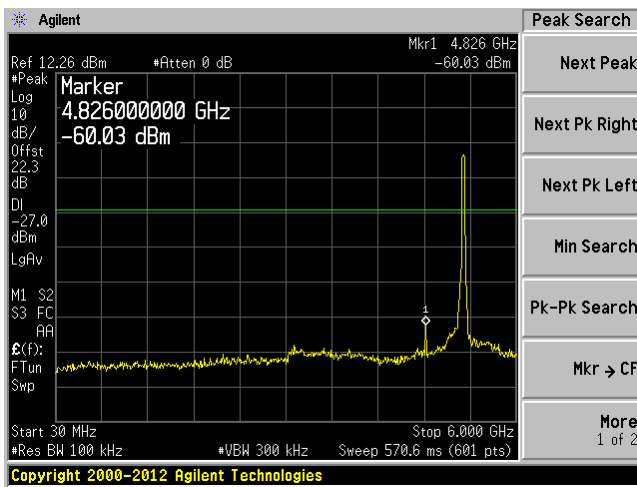

C3 6 GHz-40 GHz

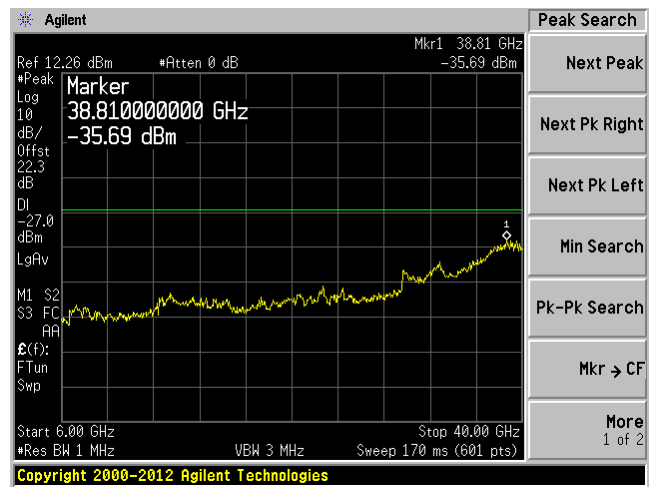

C4 30 MHz-6 GHz

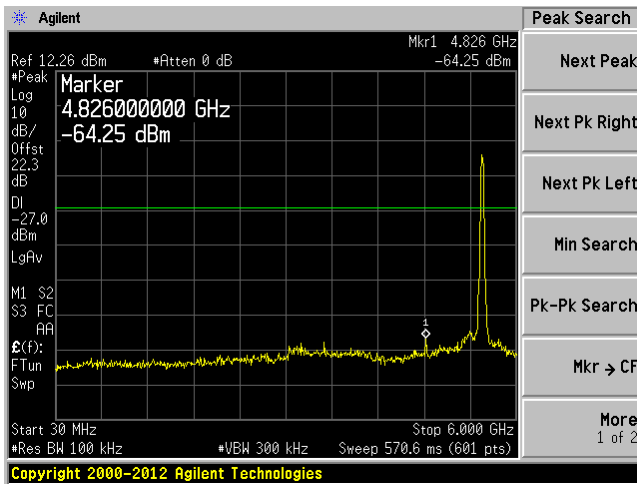

C4 6 GHz-40 GHz

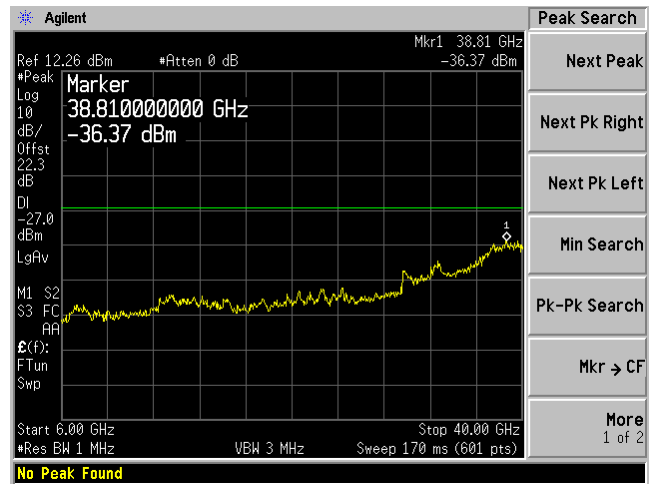

80 MHz Bandwidth, Channel, 5290 MHz

C1 30 MHz-6 GHz

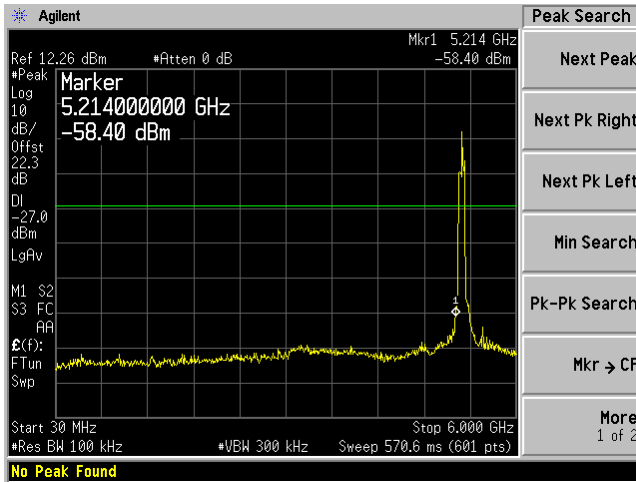

C1 6 GHz-40 GHz

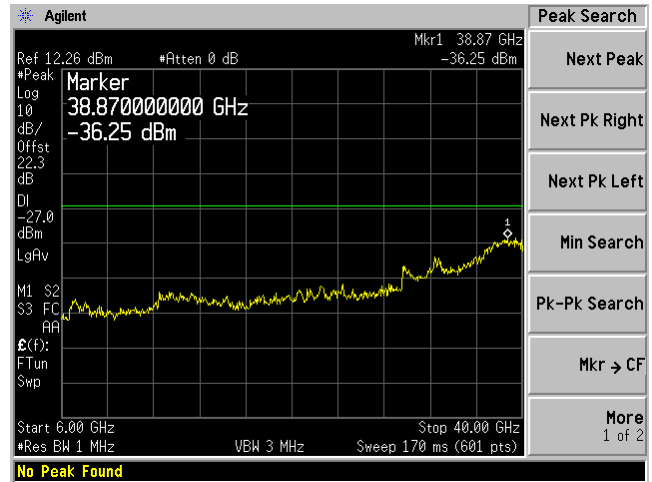

C2 30 MHz-6 GHz

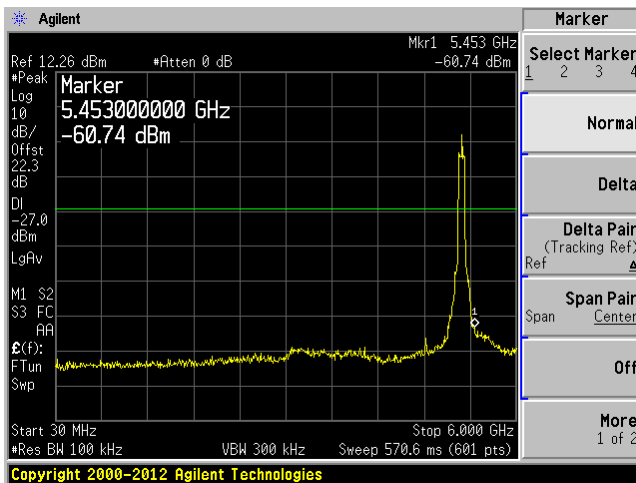

C2 6 GHz-40 GHz

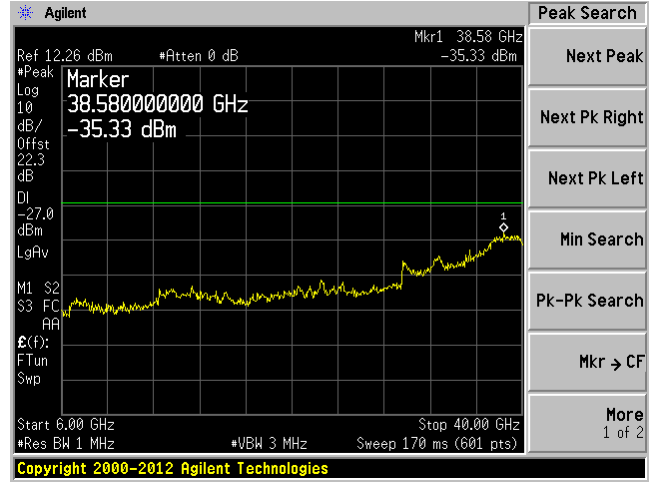

C3 30 MHz-6 GHz

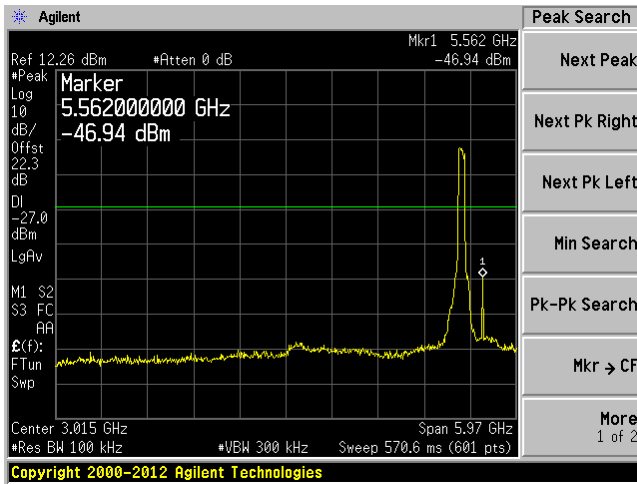

C3 6 GHz-40 GHz

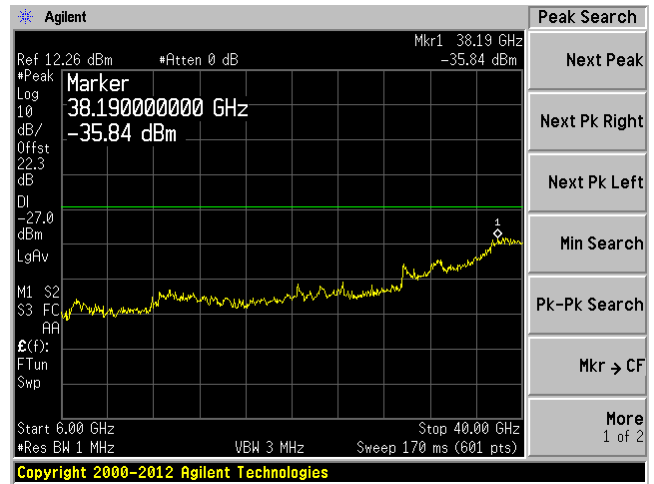

C4 30 MHz-6 GHz

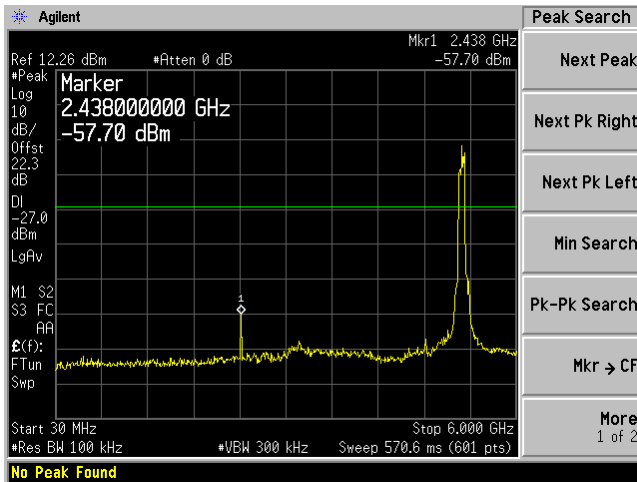

C4 6 GHz-40 GHz

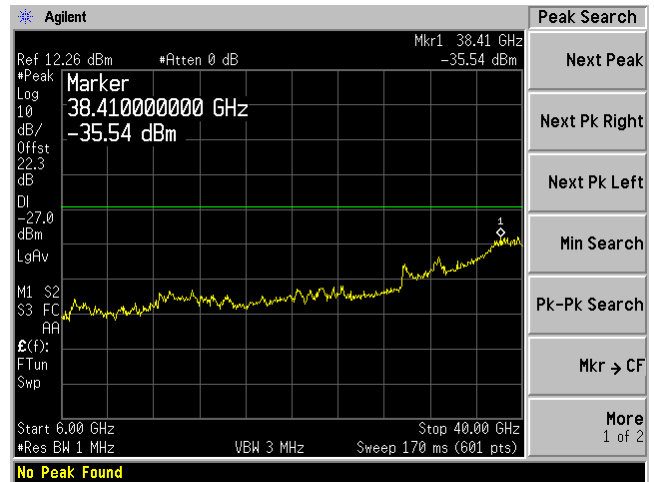

5.6 GHz Band

20 MHz Bandwidth, Low Channel, 5500 MHz

C1 30 MHz-6 GHz

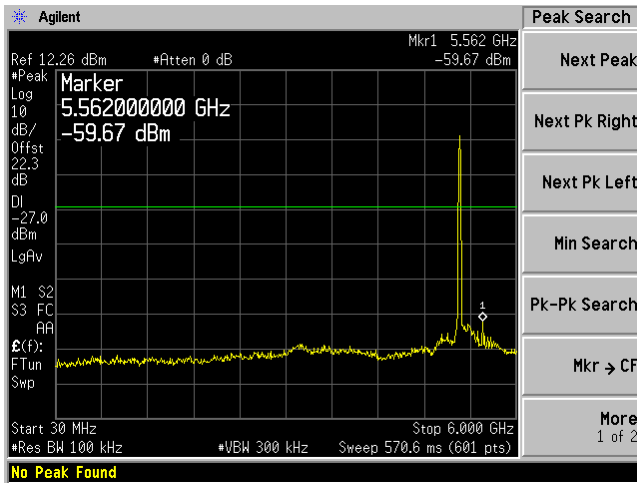

C1 6 GHz-40 GHz

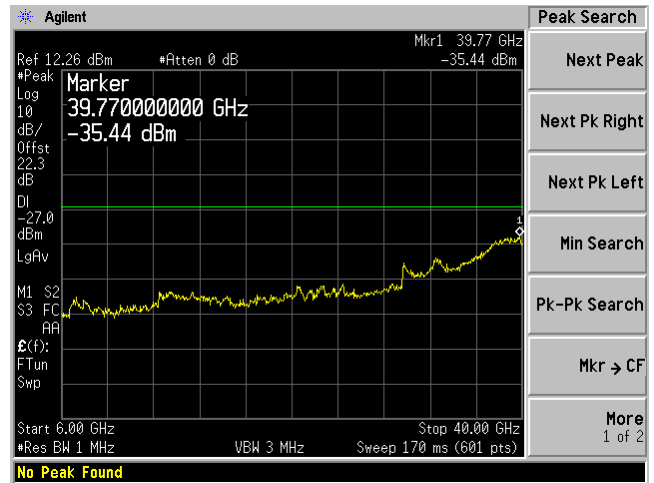

C2 30 MHz-6 GHz

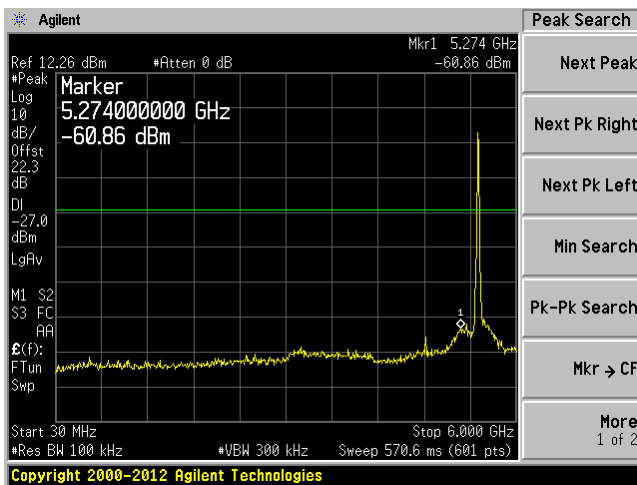

C2 6 GHz-40 GHz

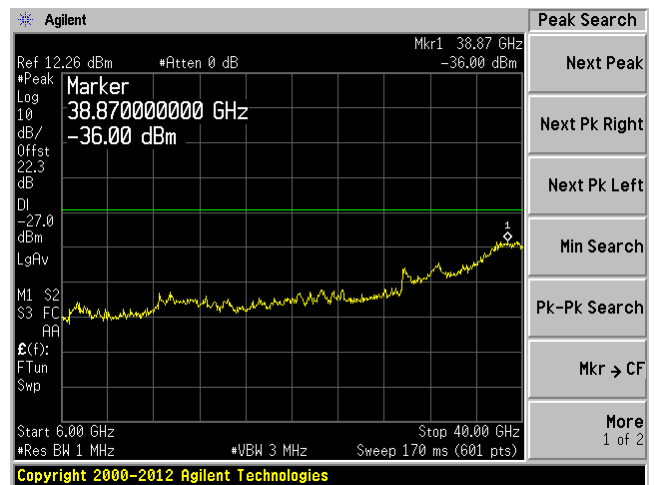

C3 30 MHz-6 GHz

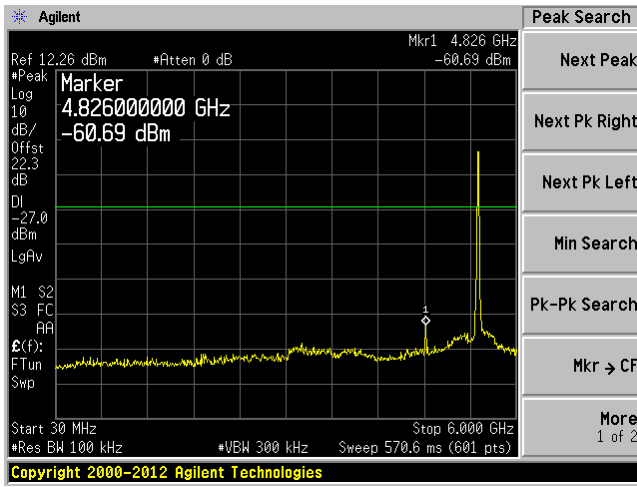

C3 6 GHz-40 GHz

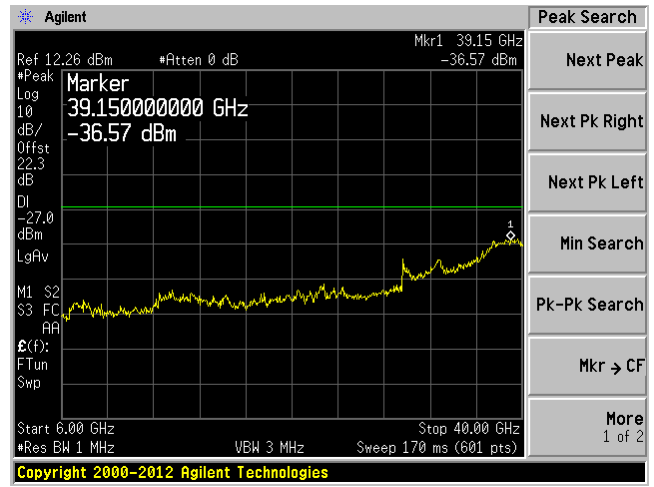

C4 30 MHz-6 GHz

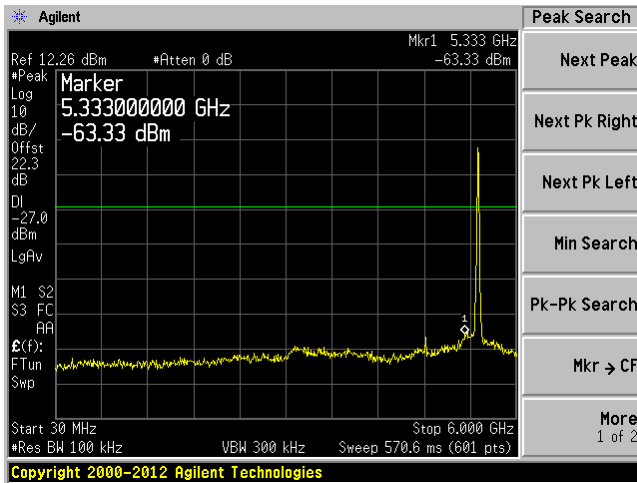

C4 6 GHz-40 GHz

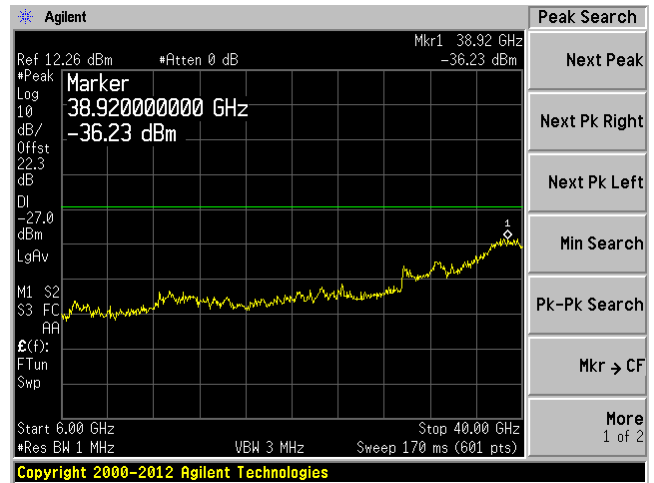

20 MHz Bandwidth, Middle Channel, 5590 MHz

C1 30 MHz-6 GHz

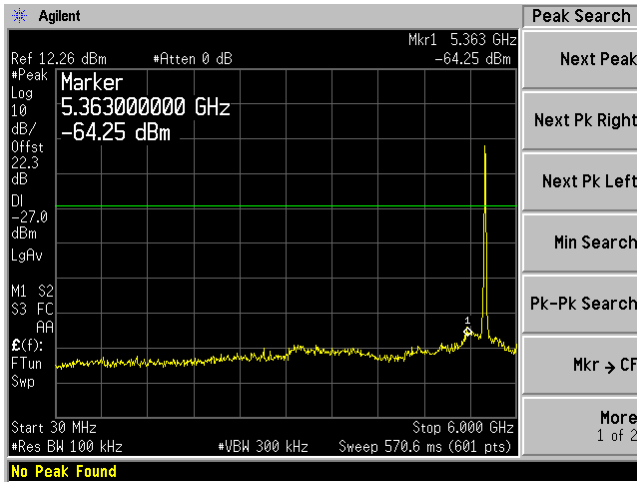

C1 6 GHz-40 GHz

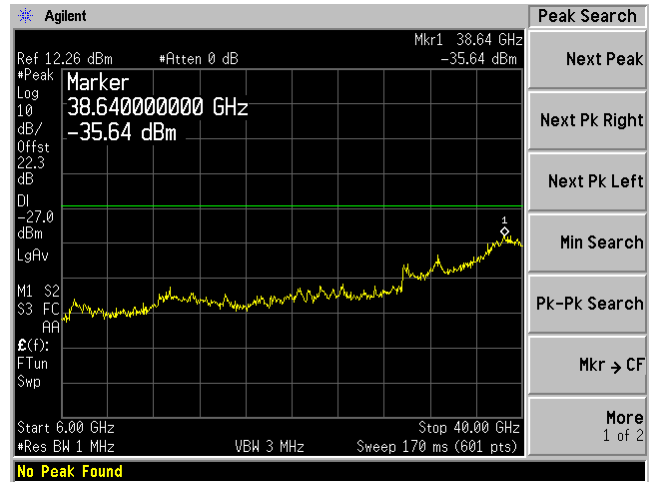

C2 30 MHz-6 GHz

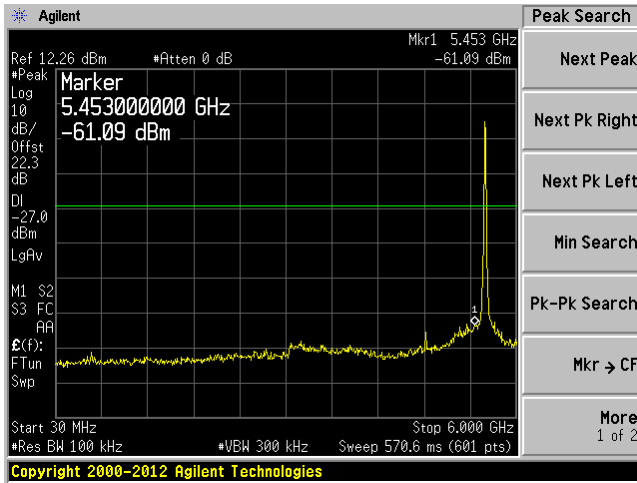

C2 6 GHz-40 GHz

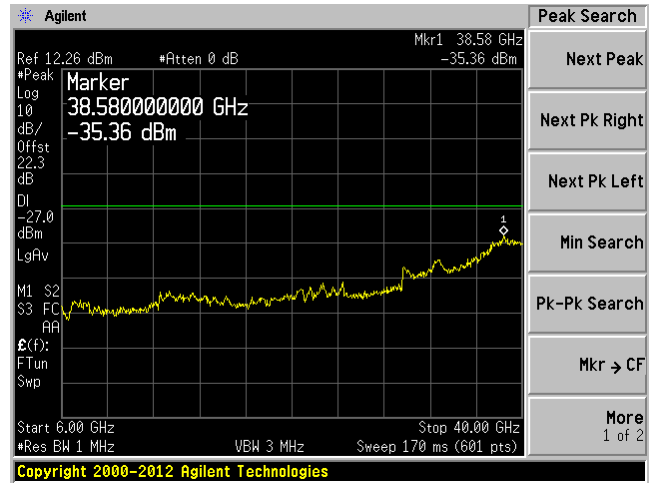

C3 30 MHz-6 GHz

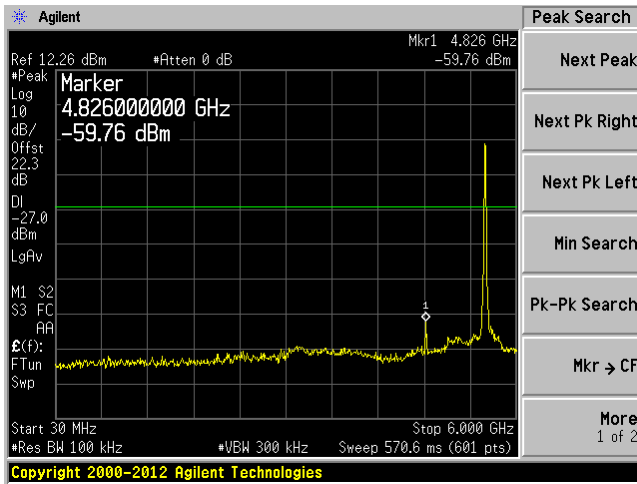

C3 6 GHz-40 GHz

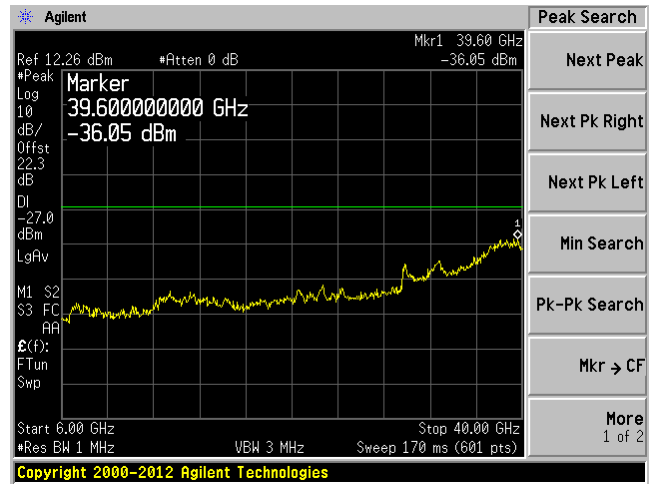

C4 30 MHz-6 GHz

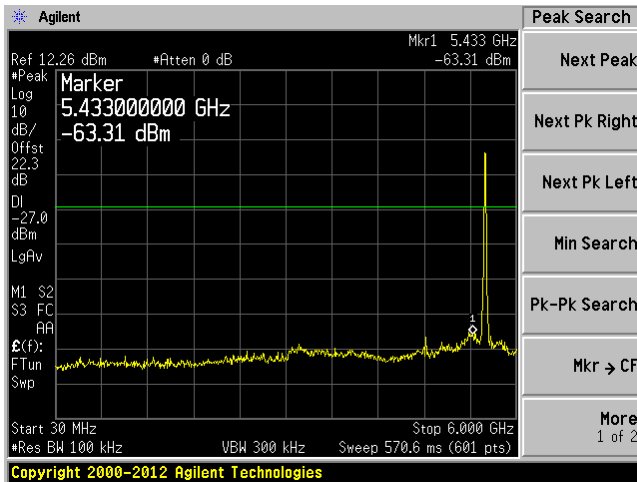

C4 6 GHz-40 GHz

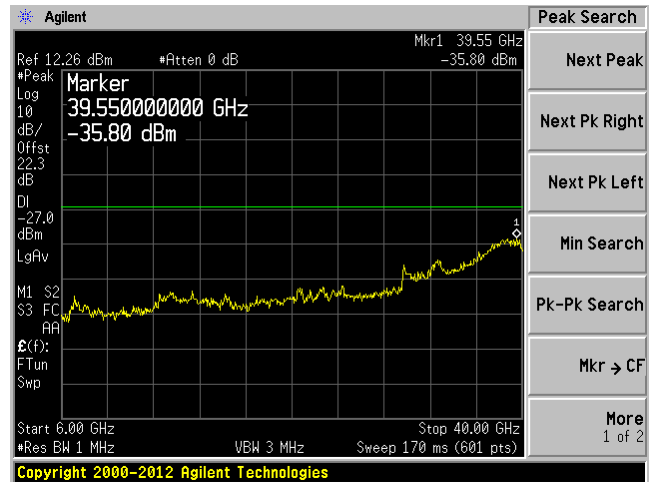

20 MHz Bandwidth, High Channel, 5700 MHz

C1 30 MHz-6 GHz

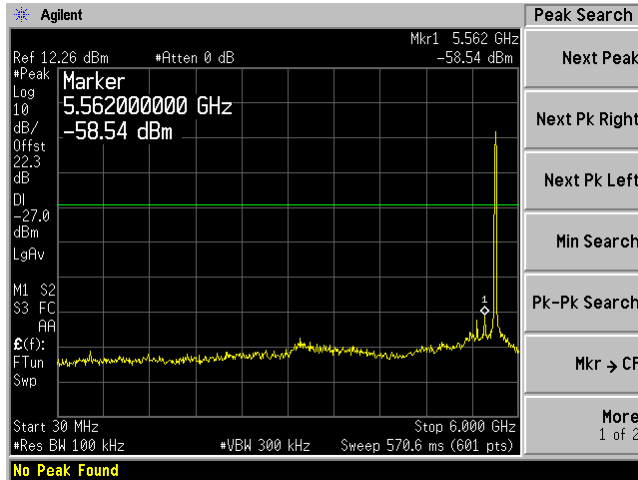

C1 6 GHz-40 GHz

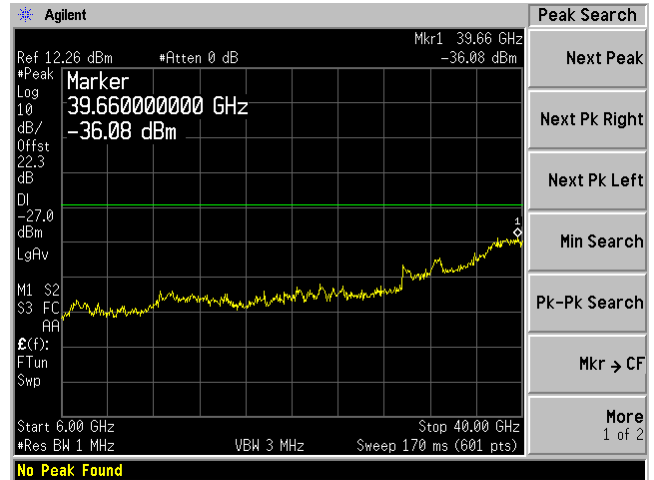

C2 30 MHz-6 GHz

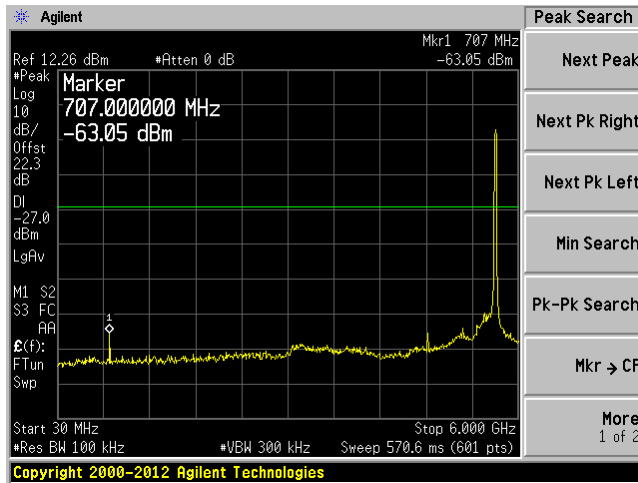

C2 6 GHz-40 GHz

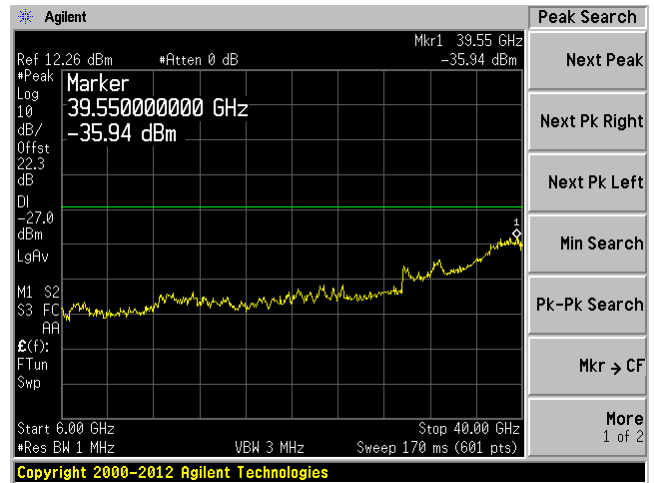

C3 30 MHz-6 GHz

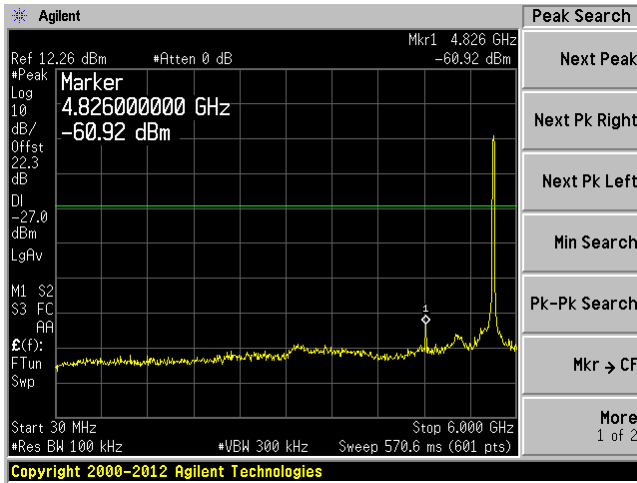

C3 6 GHz-40 GHz

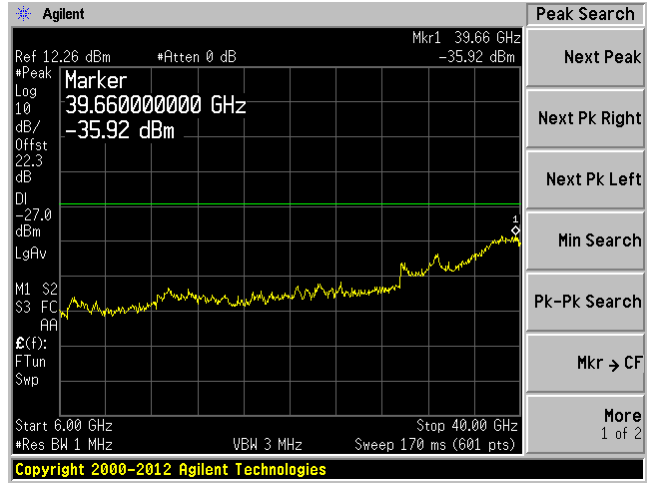

C4 30 MHz-6 GHz

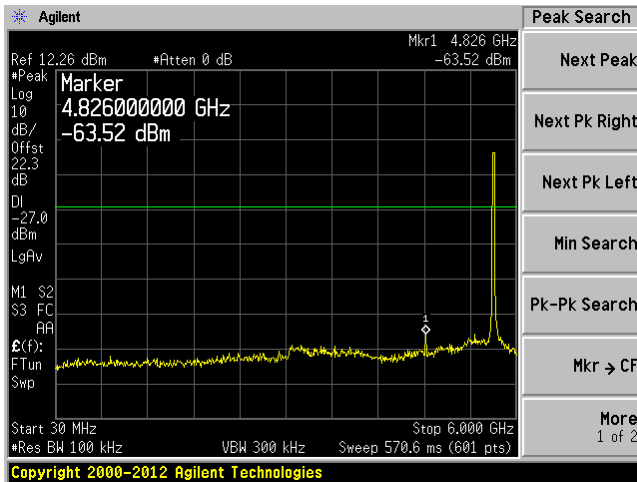

C4 6 GHz-40 GHz

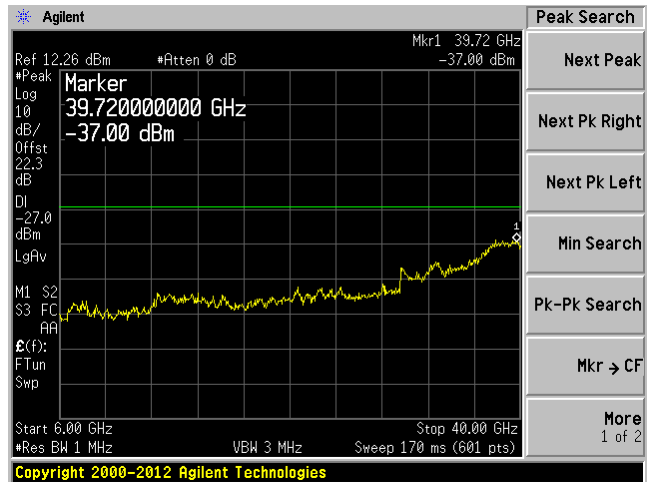

40 MHz Bandwidth, Low Channel, 5510 MHz

C1 30 MHz-6 GHz

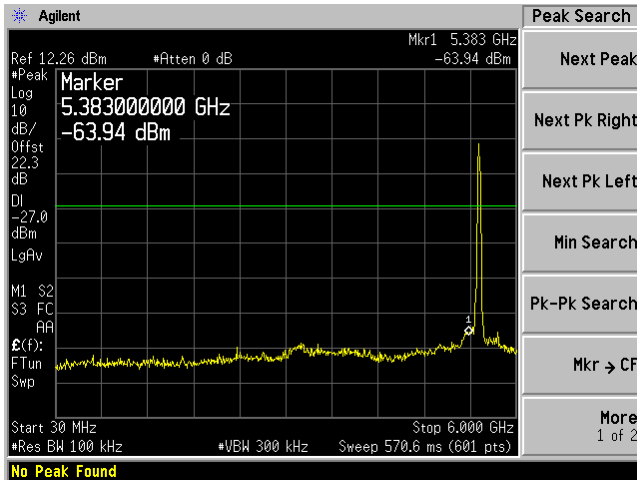

C1 6 GHz-40 GHz

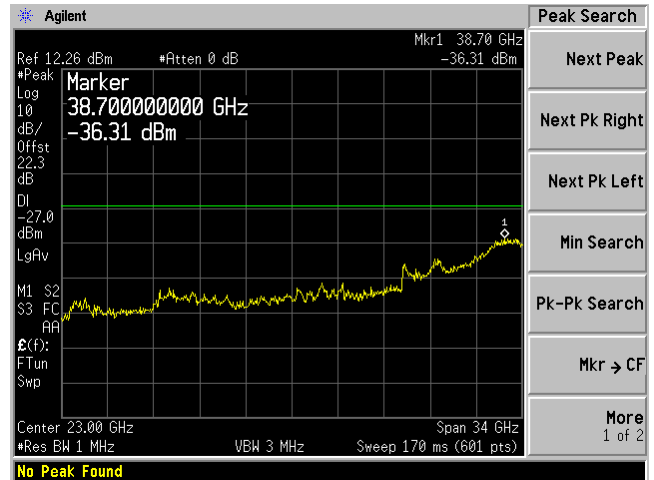

C2 30 MHz-6 GHz

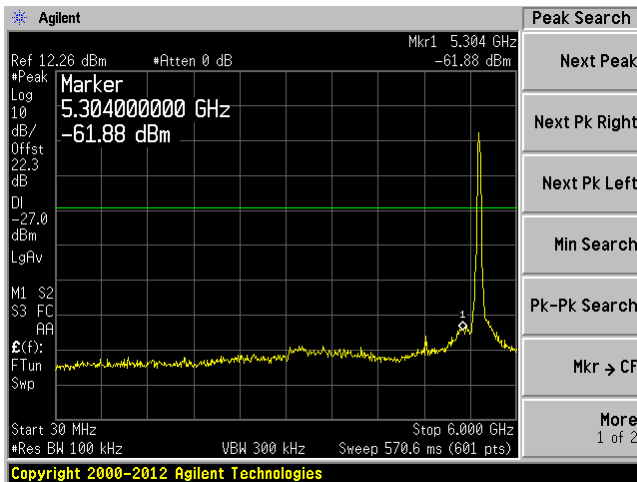

C2 6 GHz-40 GHz

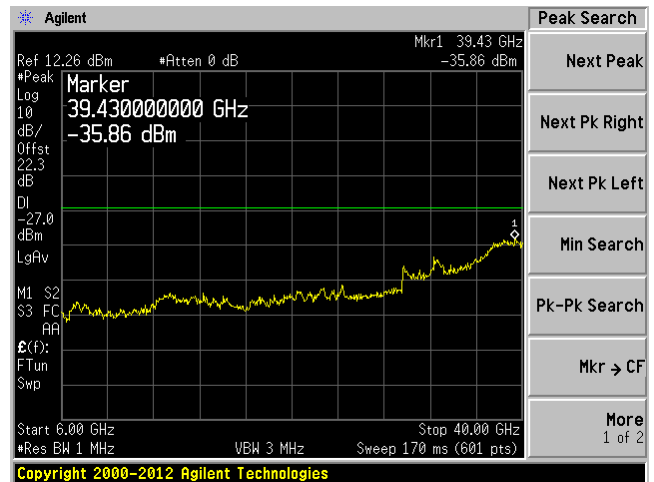

C3 30 MHz-6 GHz

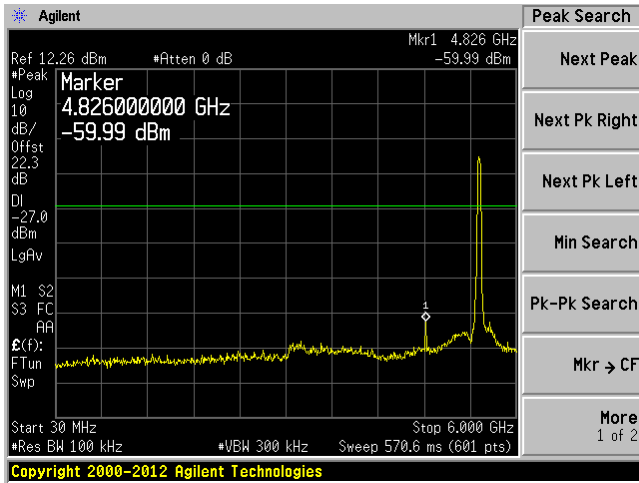

C3 6 GHz-40 GHz

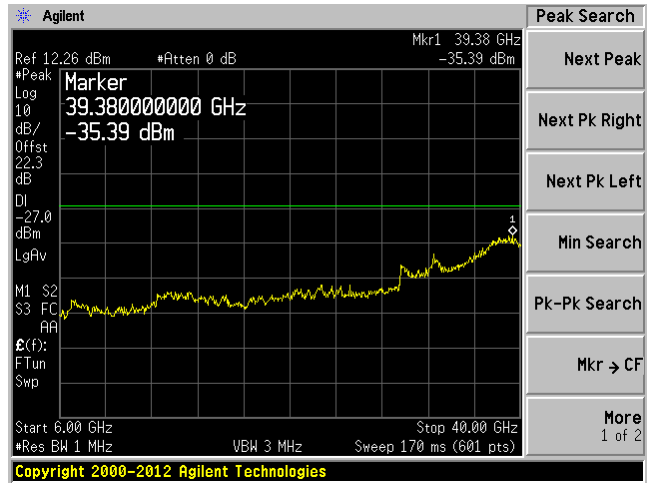

C4 30 MHz-6 GHz

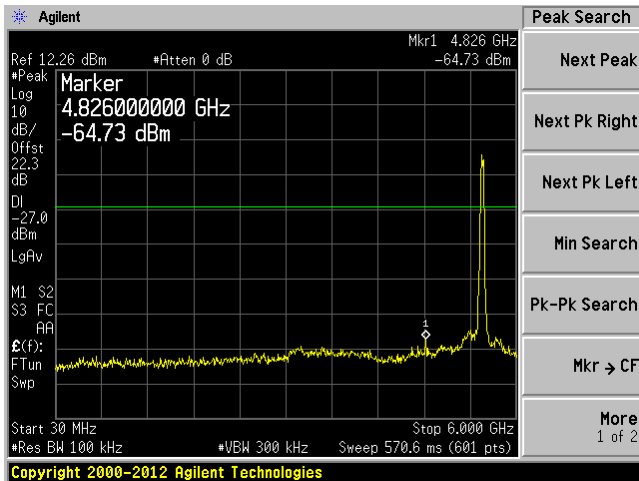

C4 6 GHz-40 GHz

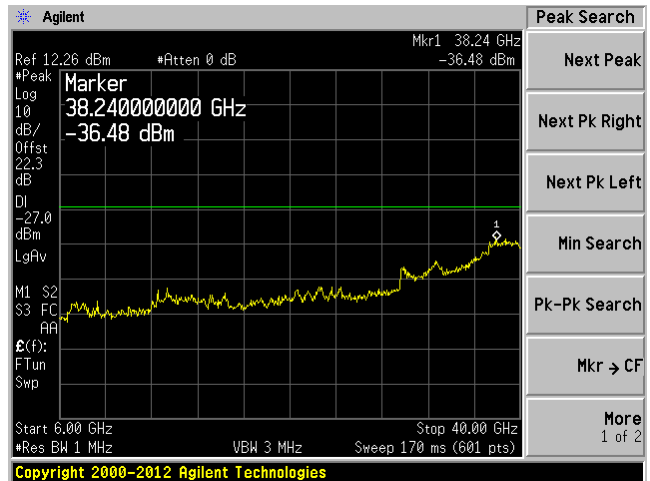

40 MHz Bandwidth, Middle Channel, 5555 MHz

C1 30 MHz-6 GHz

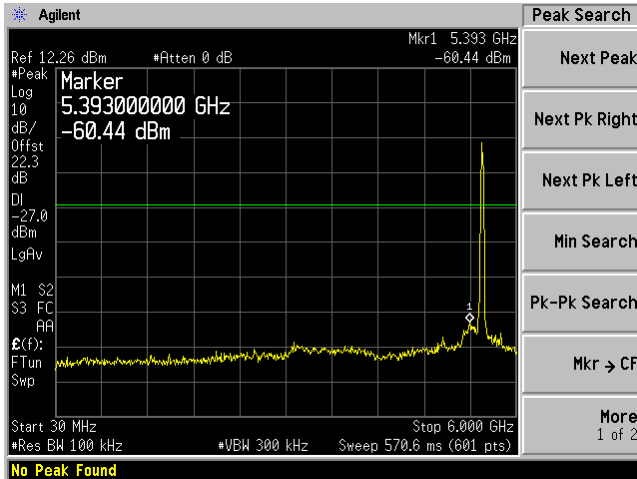

C1 6 GHz-40 GHz

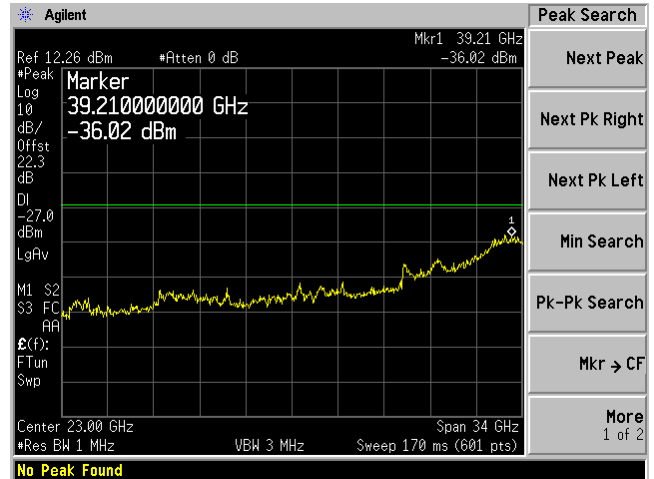

C2 30 MHz-6 GHz

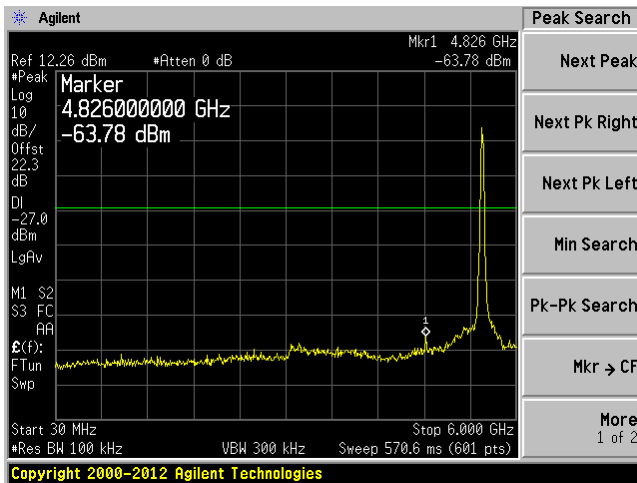

C2 6 GHz-40 GHz

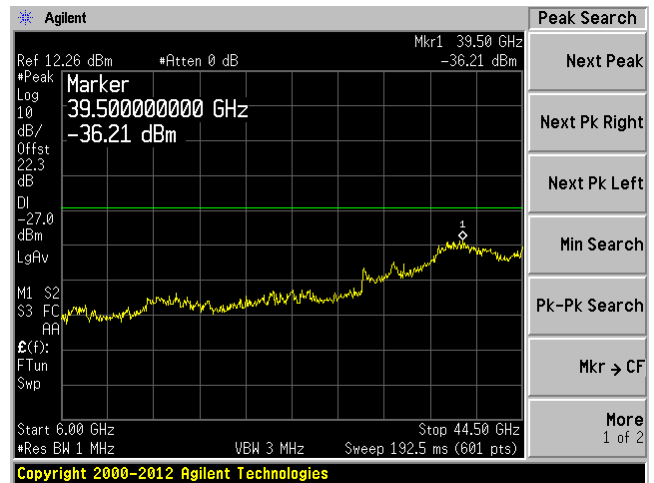

C3 30 MHz-6 GHz

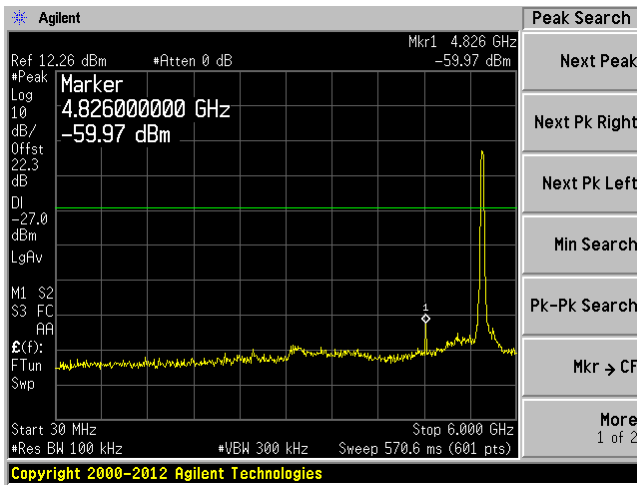

C3 6 GHz-40 GHz

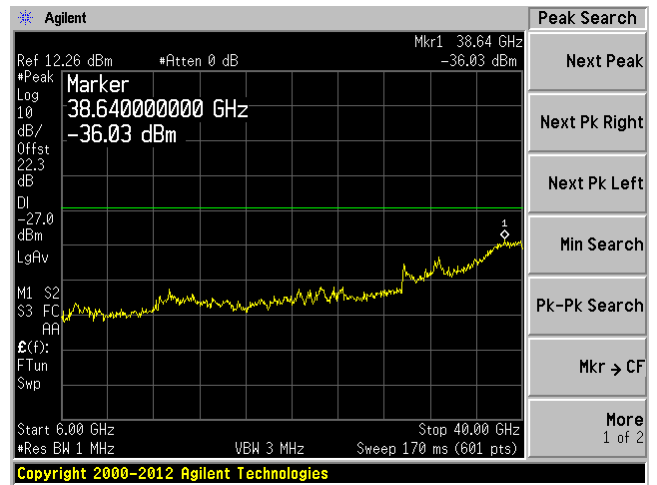

C4 30 MHz-6 GHz

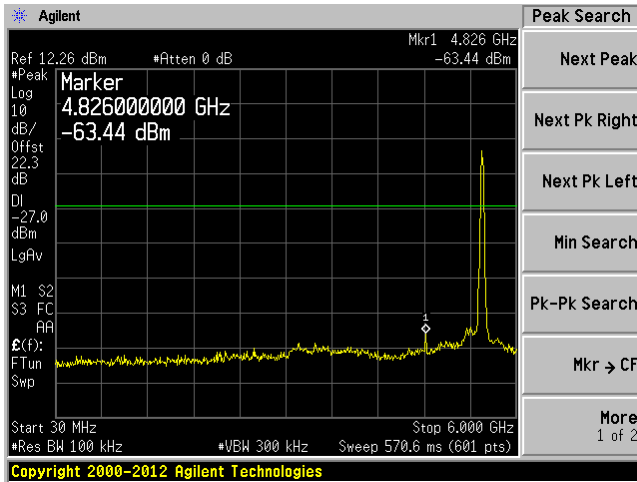

C4 6 GHz-40 GHz

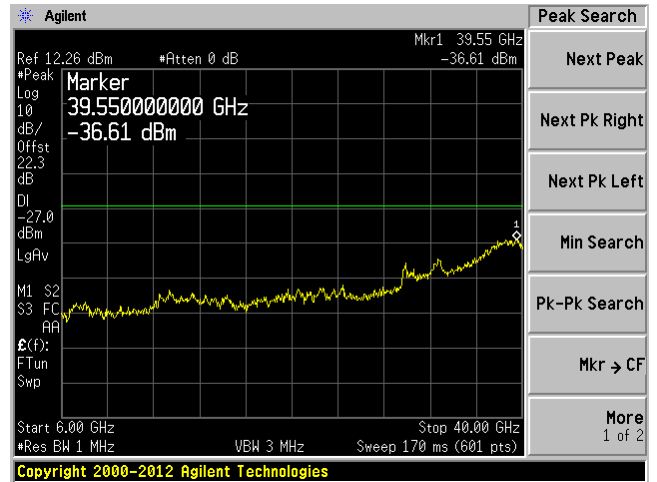

40 MHz Bandwidth, High Channel, 5690 MHz

C1 30 MHz-6 GHz

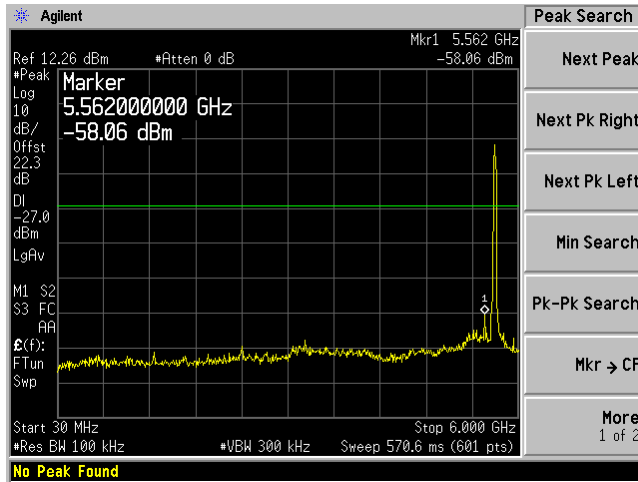

C1 6 GHz-40 GHz

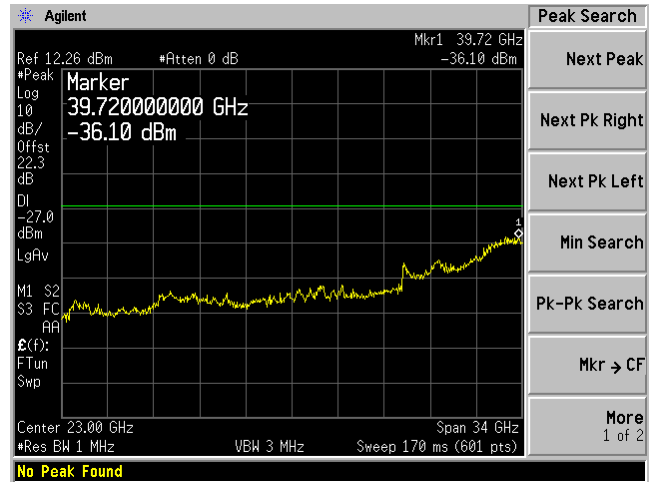

C2 30 MHz-6 GHz

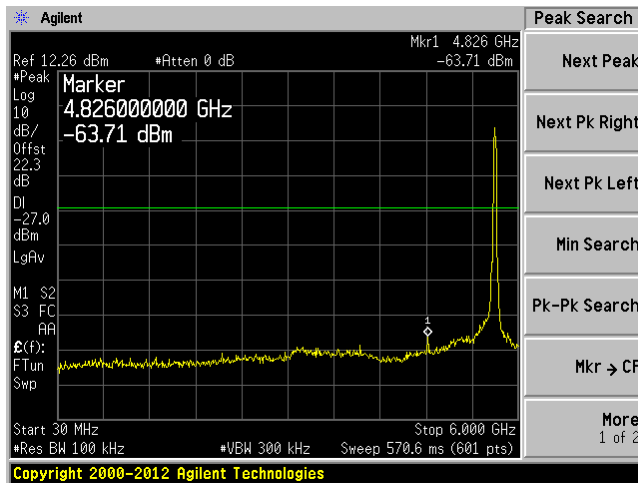

C2 6 GHz-40 GHz

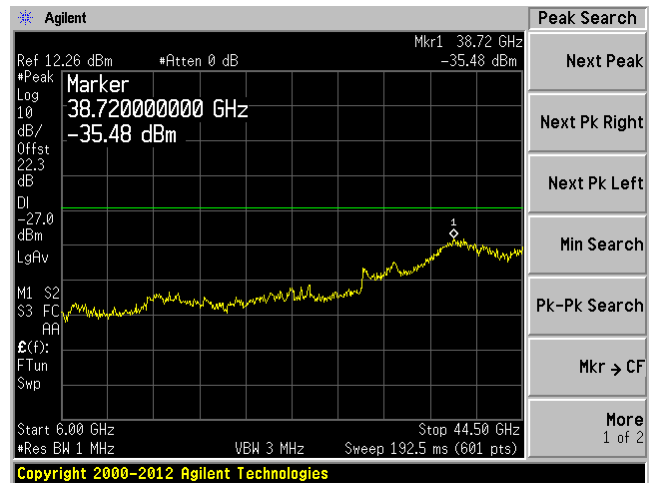

C3 30 MHz-6 GHz

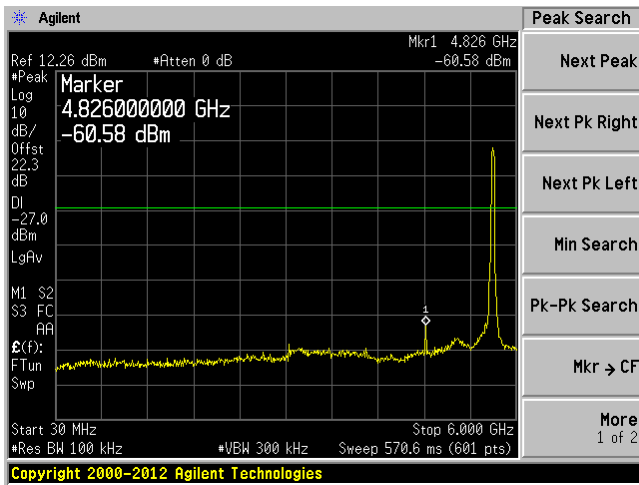

C3 6 GHz-40 GHz

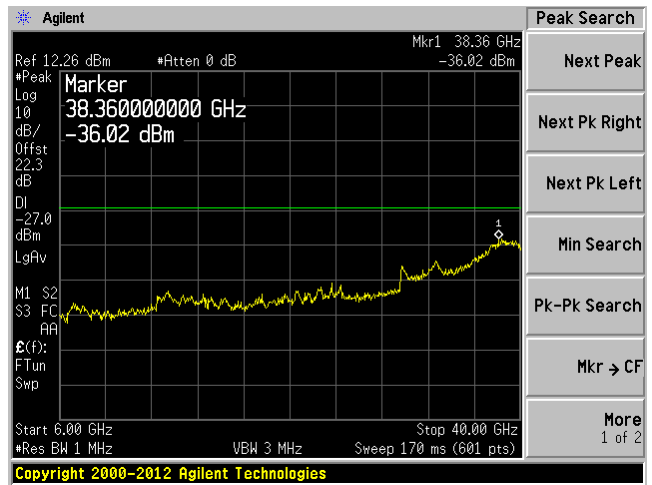

C4 30 MHz-6 GHz

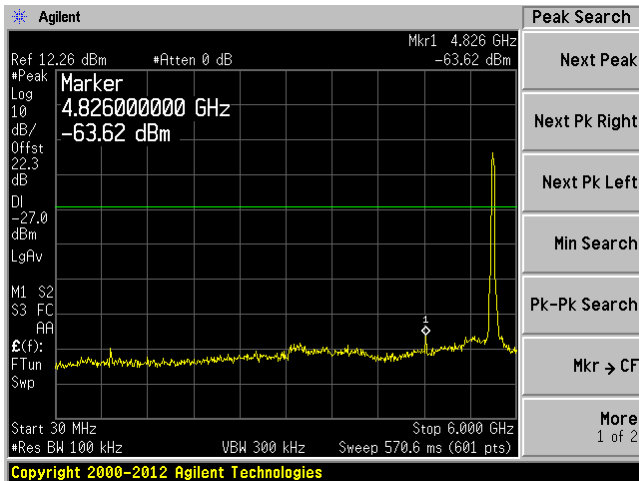

C4 6 GHz-40 GHz

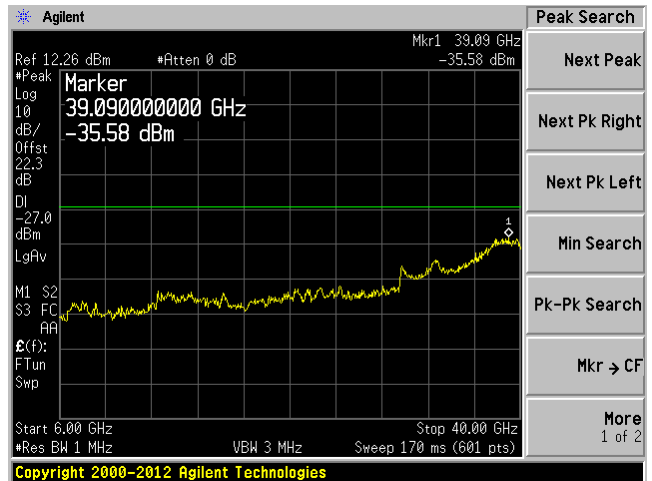

80 MHz Bandwidth, Low Channel, 5530 MHz

C1 30 MHz-6 GHz

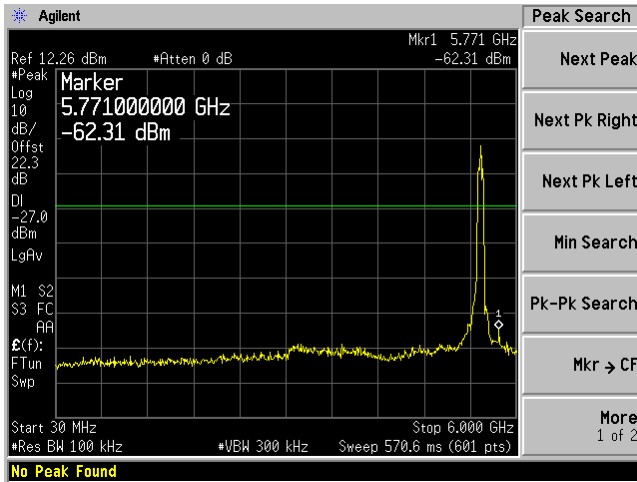

C1 6 GHz-40 GHz

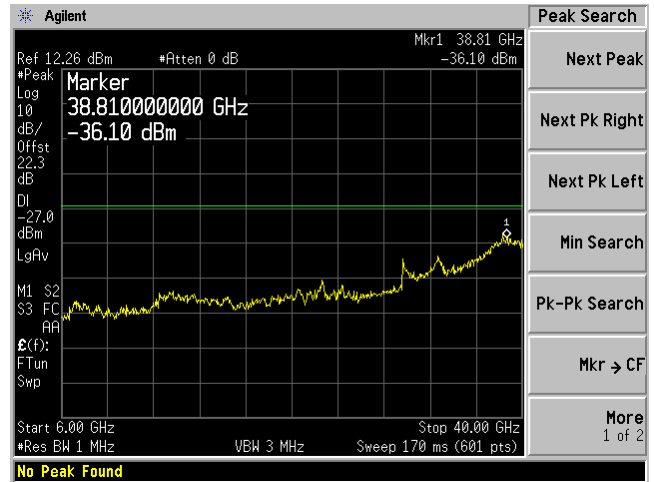

C2 30 MHz-6 GHz

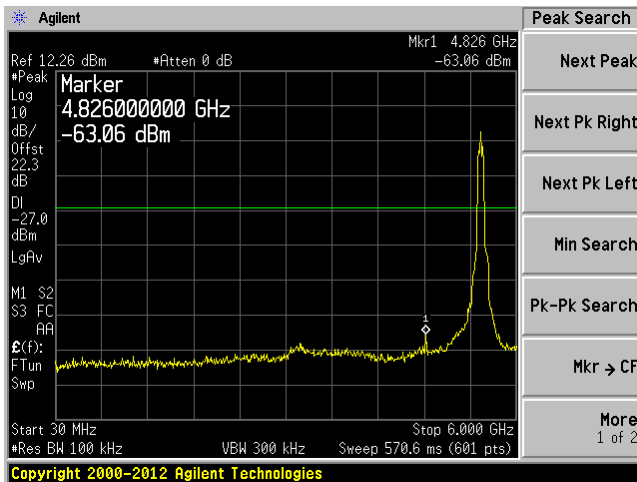

C2 6 GHz-40 GHz



C3 30 MHz-6 GHz

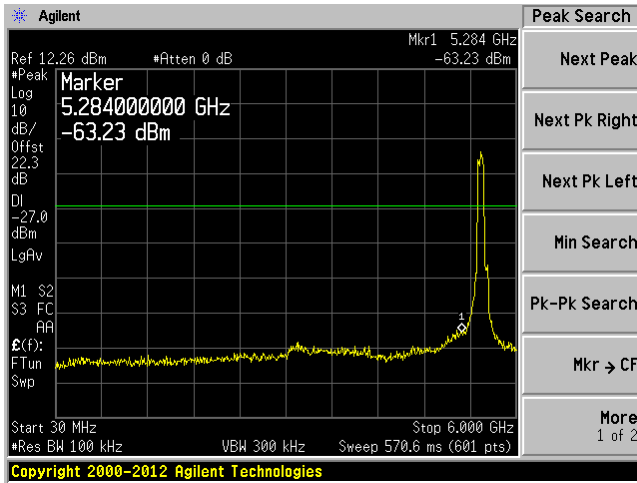

C3 6 GHz-40 GHz

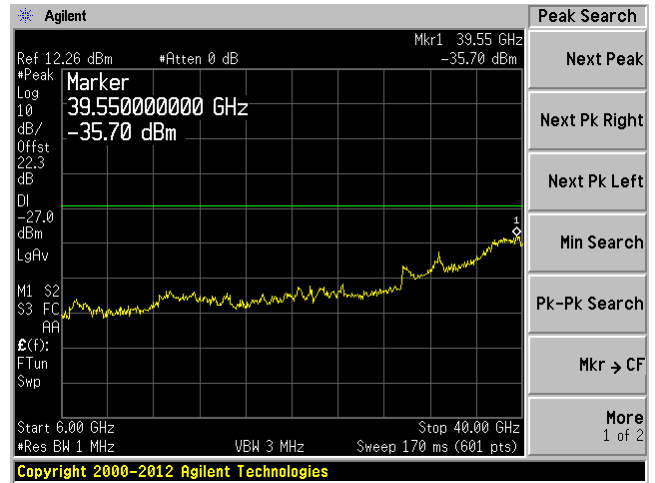

C4 30 MHz-6 GHz

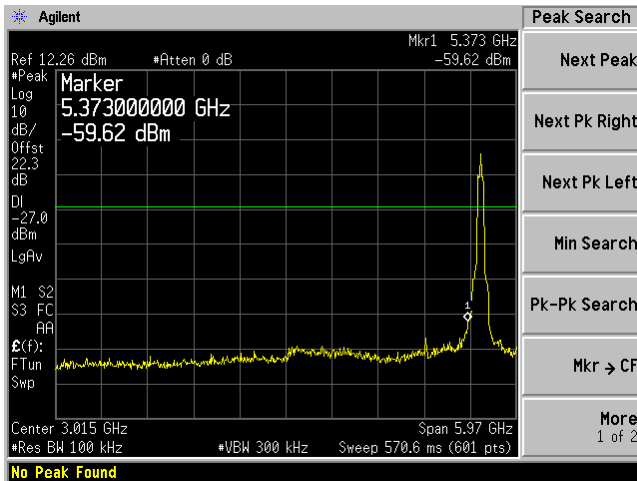

C4 6 GHz-40 GHz

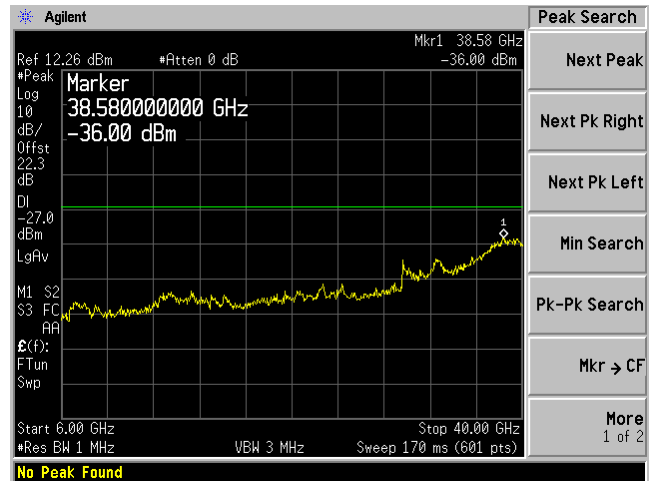

80 MHz Bandwidth, Middle Channel, 5545 MHz

C1 30 MHz-6 GHz

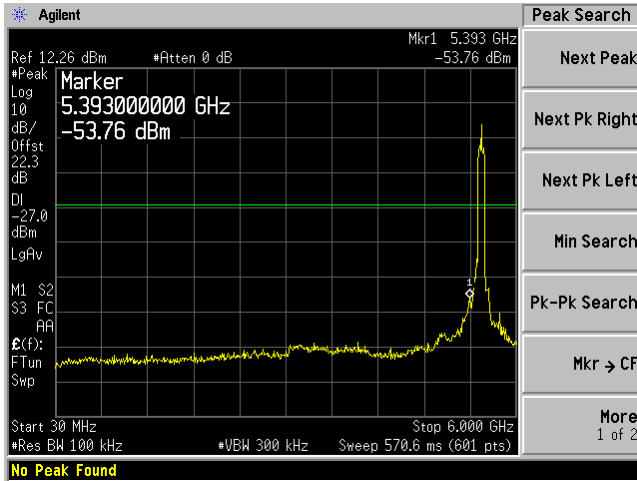

C1 6 GHz-40 GHz

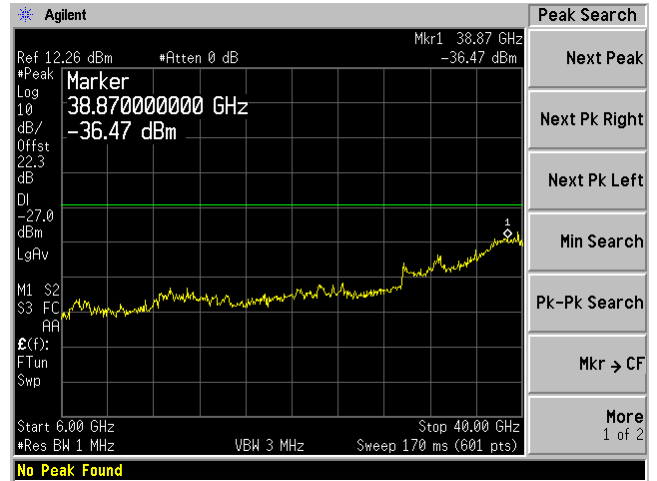

C2 30 MHz-6 GHz

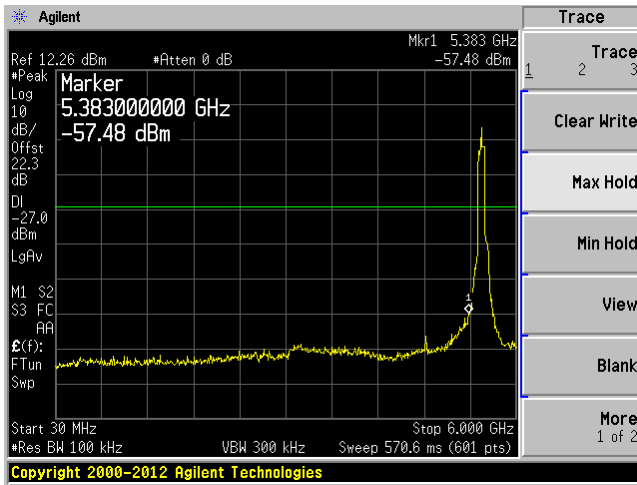

C2 6 GHz-40 GHz

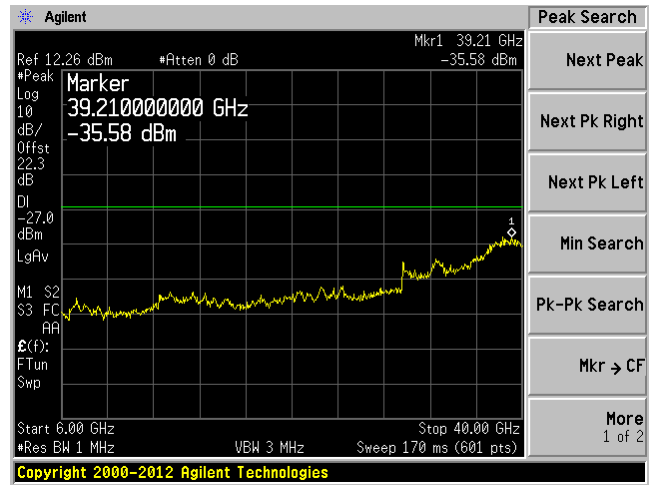

C3 30 MHz-6 GHz

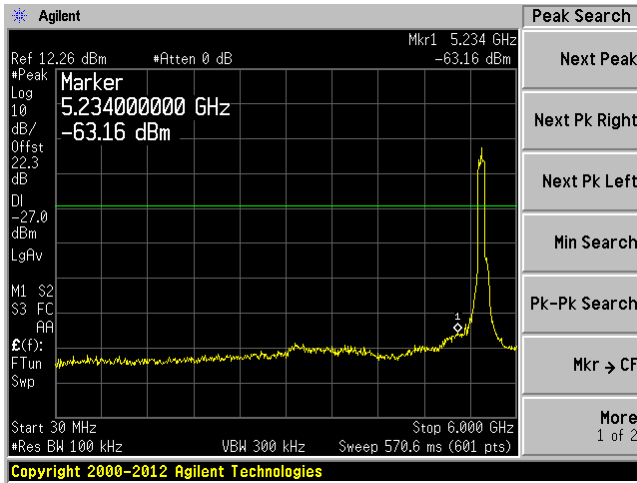

C3 6 GHz-40 GHz

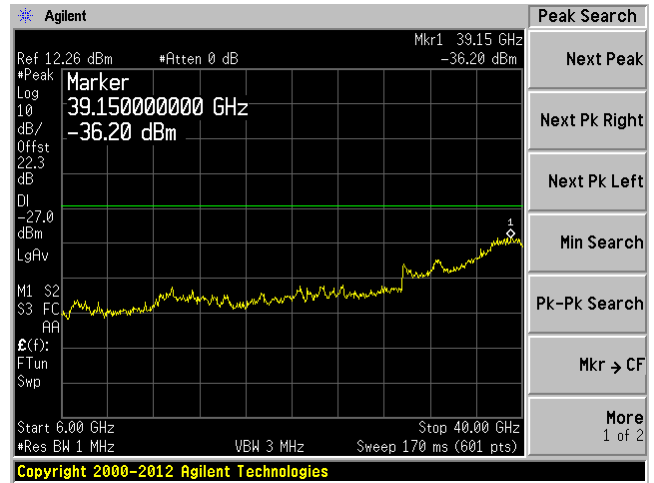

C4 30 MHz-6 GHz

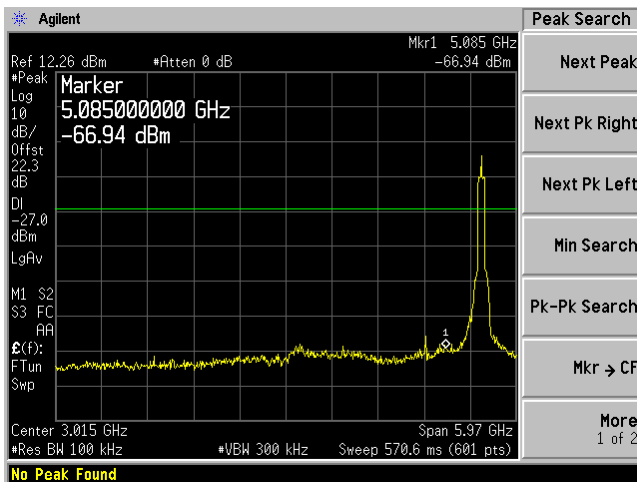

C4 6 GHz-40 GHz

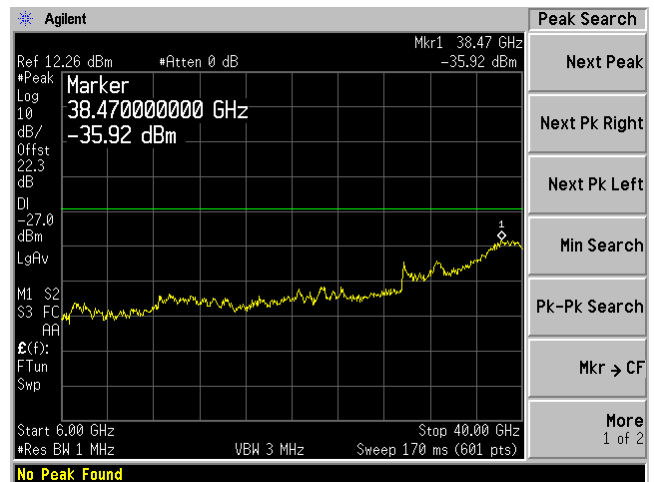

80 MHz Bandwidth, High Channel, 5560 MHz

C1 30 MHz-6 GHz

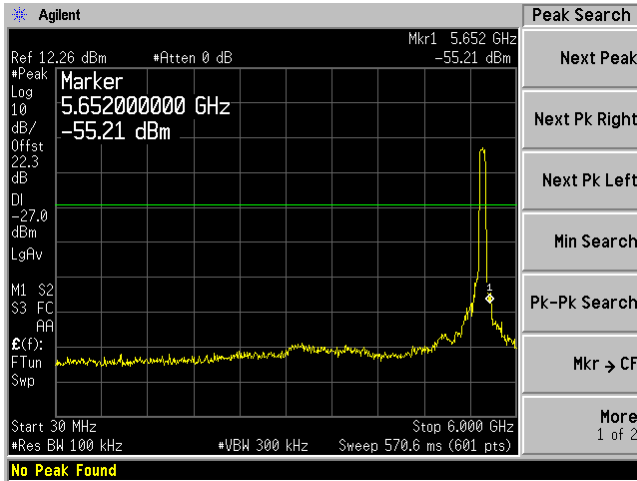

C1 6 GHz-40 GHz

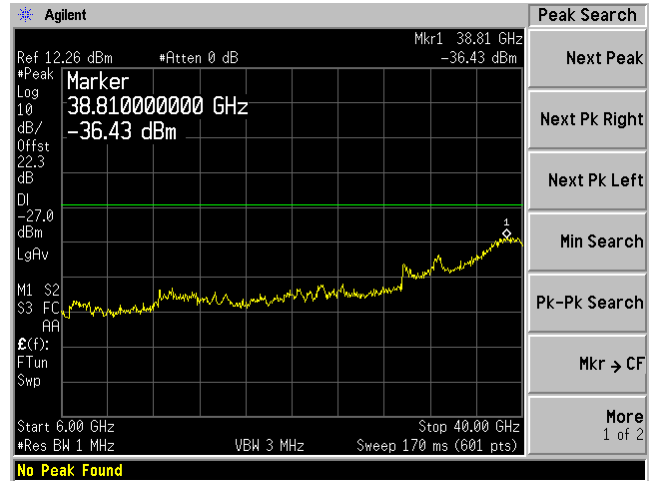

C2 30 MHz-6 GHz

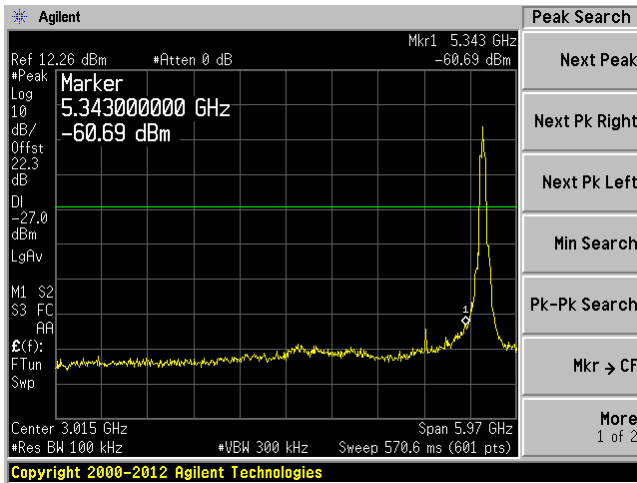

C2 6 GHz-40 GHz

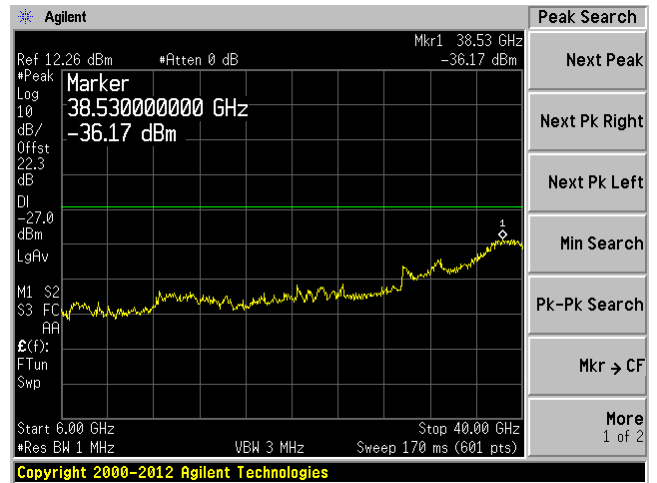

C3 30 MHz-6 GHz

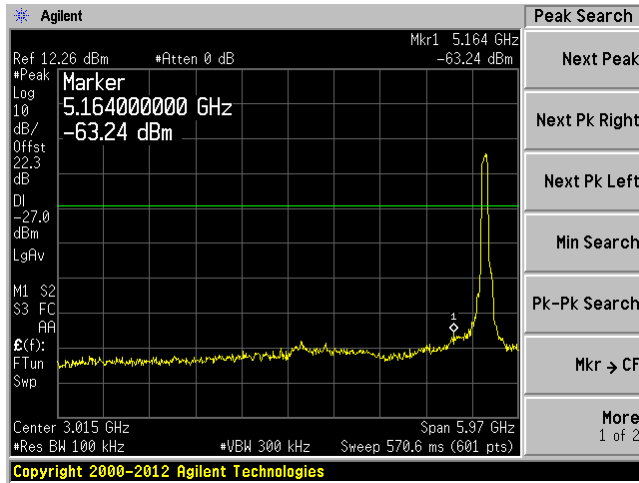

C3 6 GHz-40 GHz

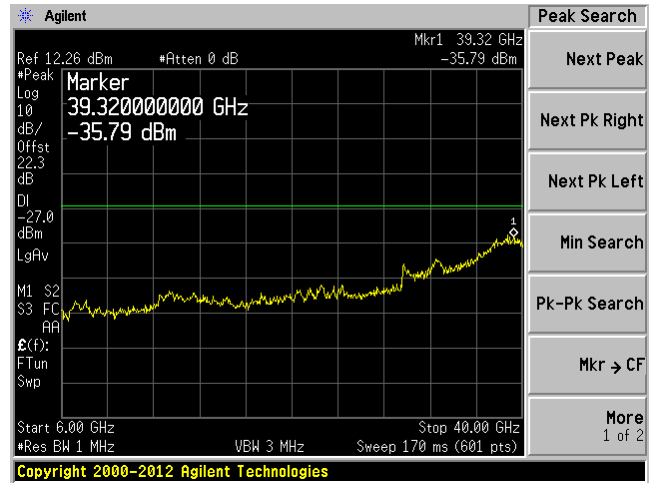

C4 30 MHz-6 GHz

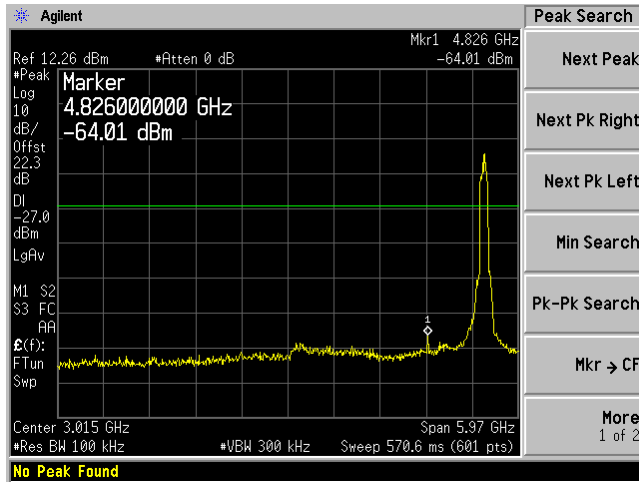

C4 6 GHz-40 GHz



0 dBi Antenna:

5.3 GHz Band:

20 MHz bandwidth, Low Channel, 5260 MHz

C1 30 MHz-6 GHz

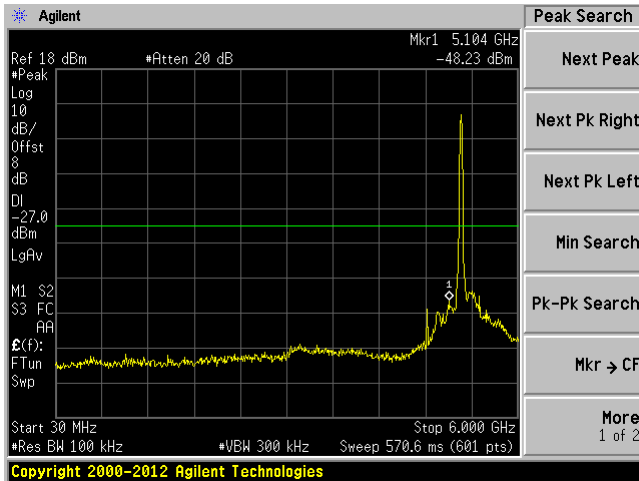

C1 6 GHz-40 GHz

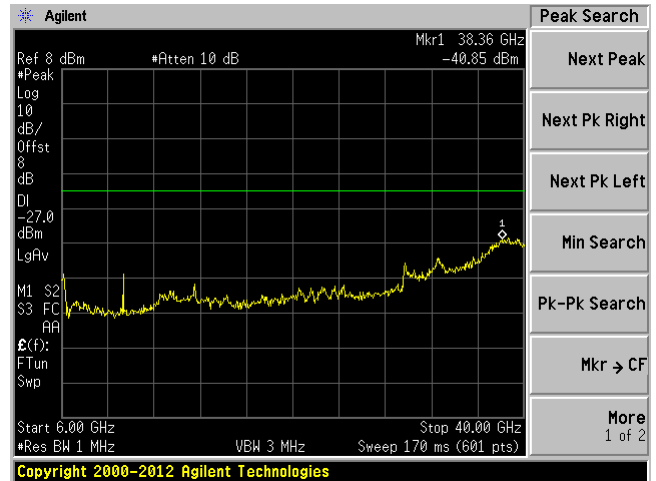

C2 30 MHz-6 GHz

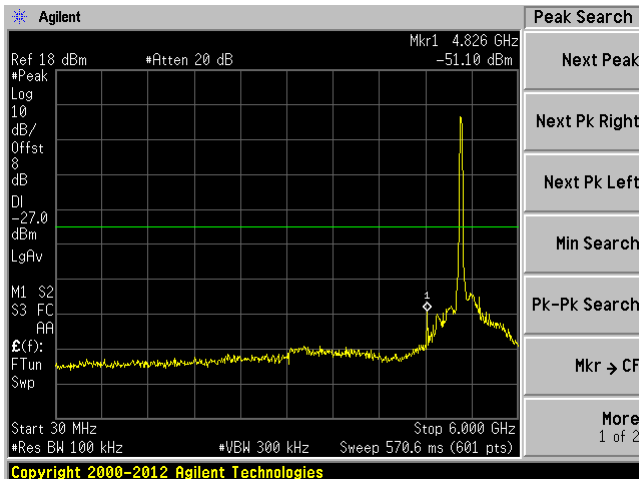

C2 6 GHz-40 GHz

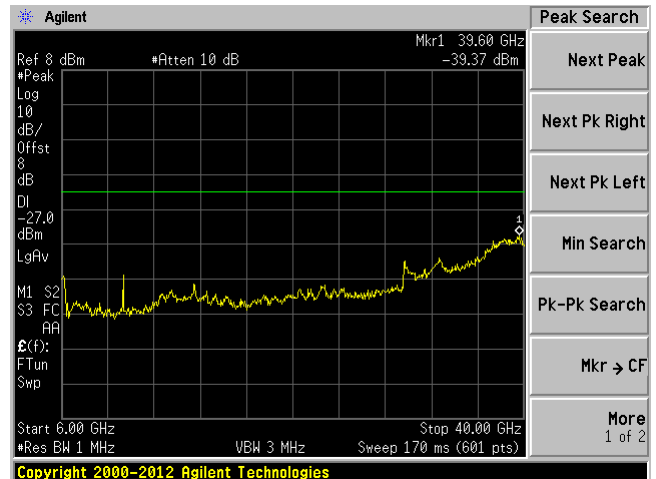

C3 30 MHz-6 GHz

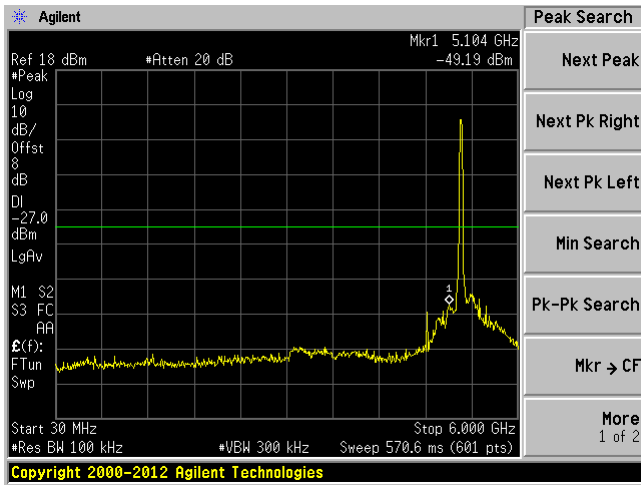

C3 6 GHz-40 GHz

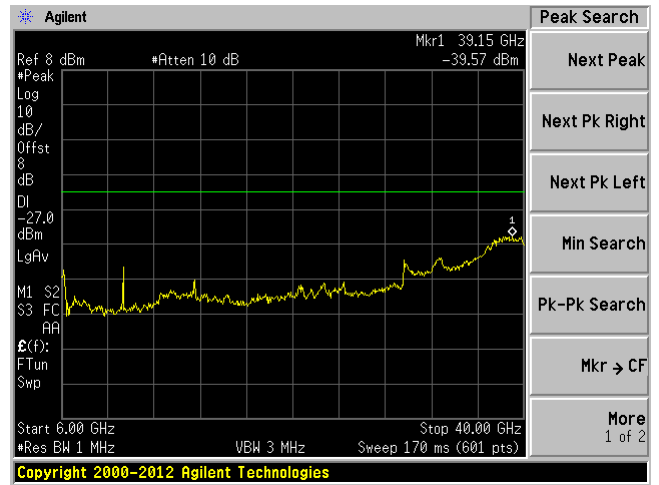

C4 30 MHz-6 GHz

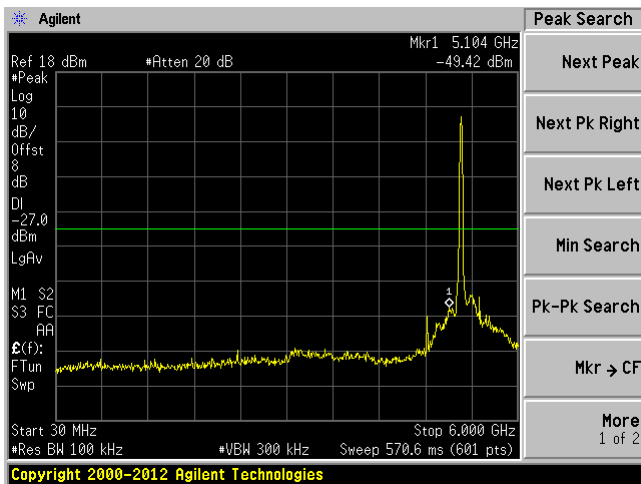

C4 6 GHz-40 GHz

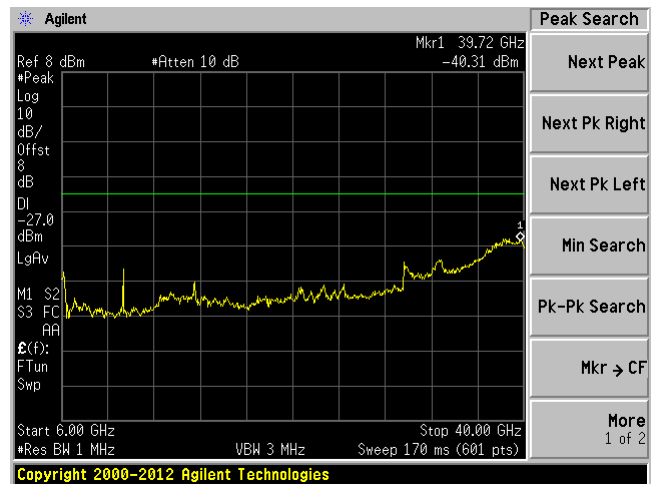

20 MHz bandwidth, Middle Channel, 5295 MHz

C1 30 MHz-6 GHz

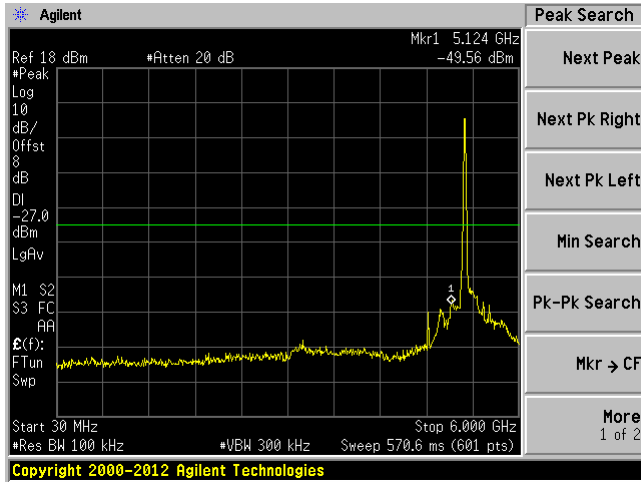

C1 6 GHz-40 GHz

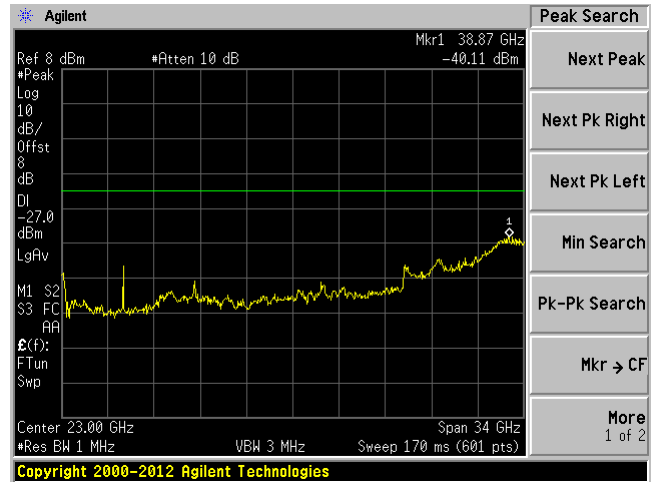

C2 30 MHz-6 GHz

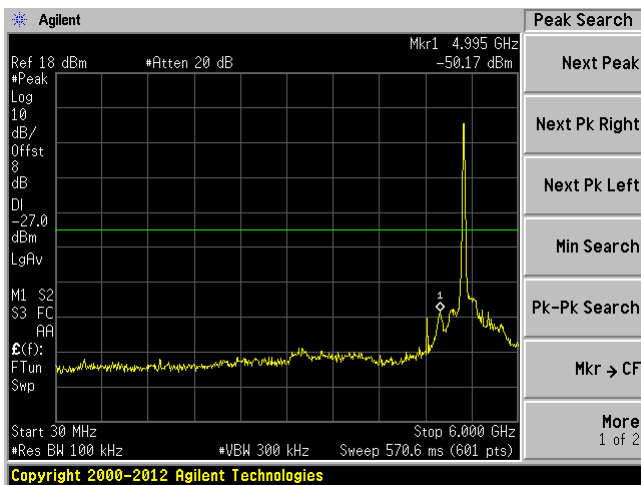

C2 6 GHz-40 GHz

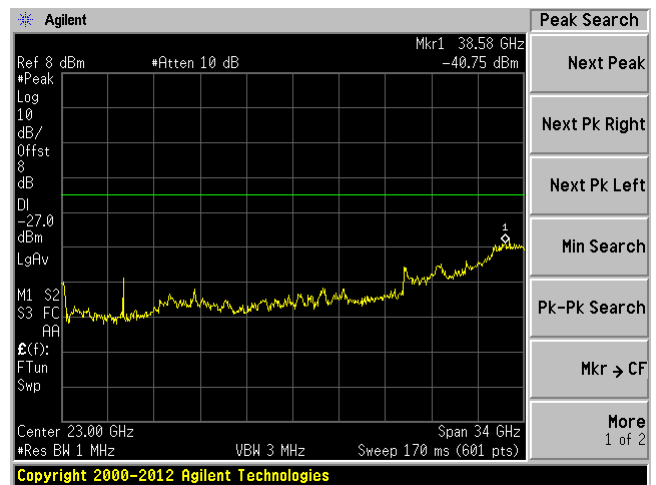

C3 30 MHz-6 GHz

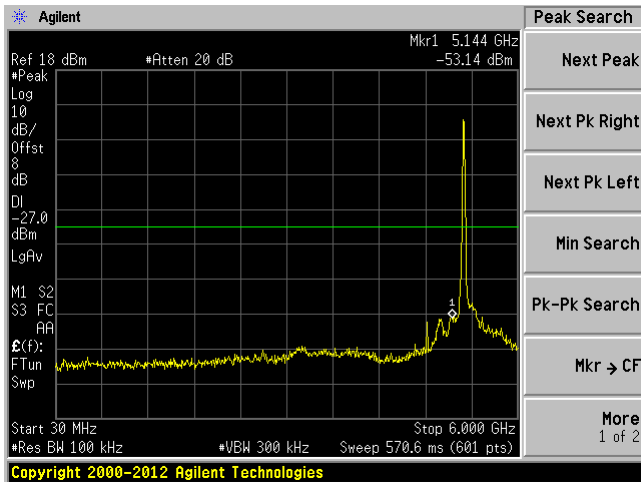

C3 6 GHz-40 GHz

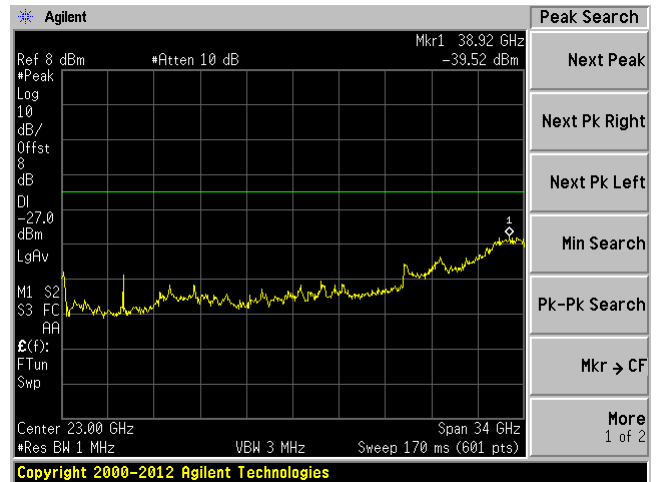

C4 30 MHz-6 GHz

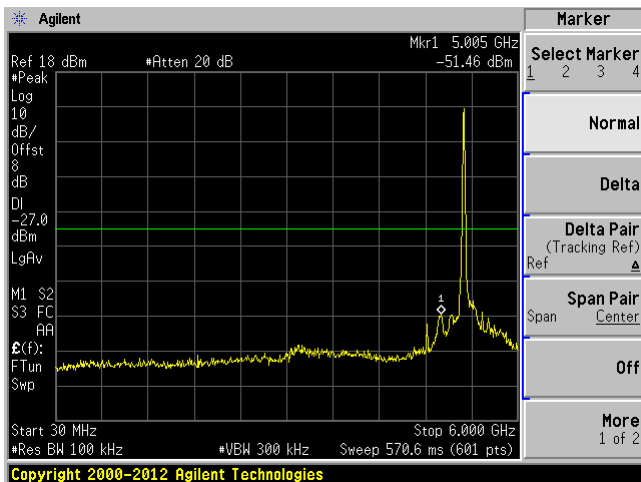

C4 6 GHz-40 GHz

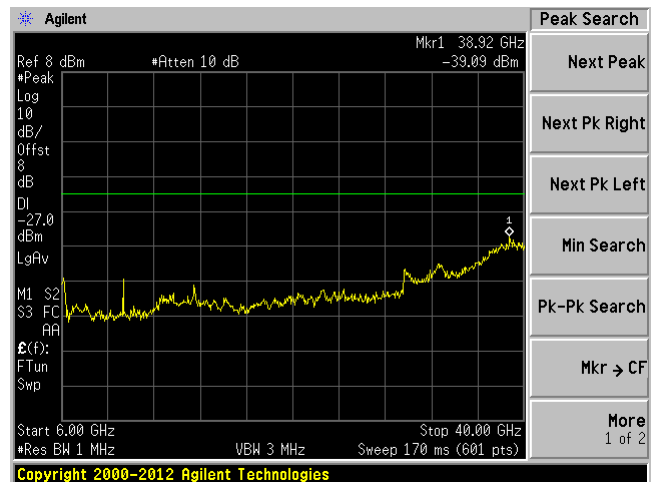

20 MHz bandwidth, High Channel, 5320 MHz

C1 30 MHz-6 GHz

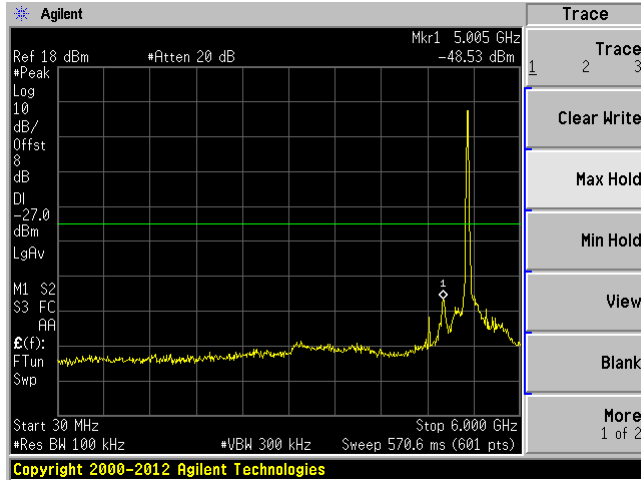

C1 6 GHz-40 GHz

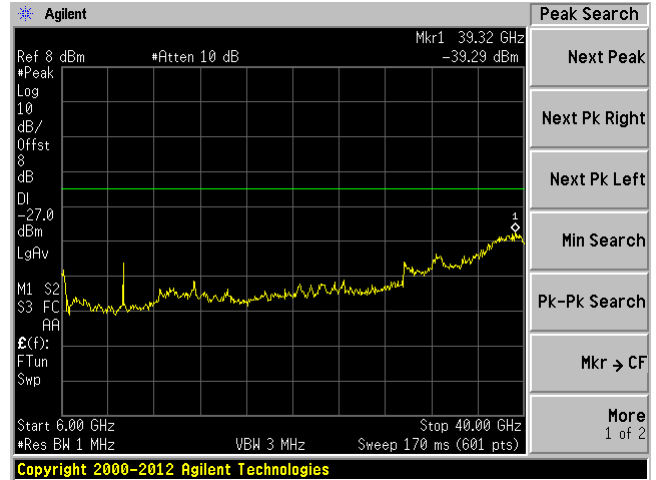

C2 30 MHz-6 GHz

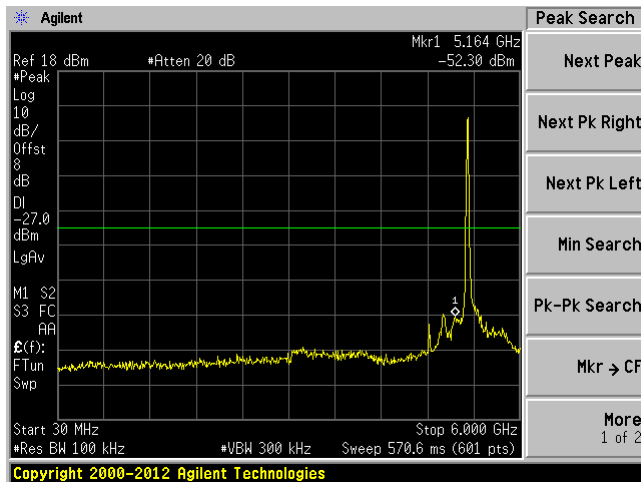

C2 6 GHz-40 GHz

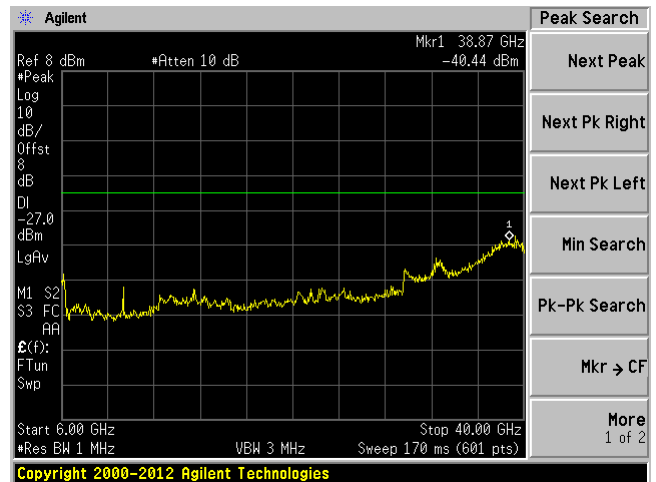

C3 30 MHz-6 GHz

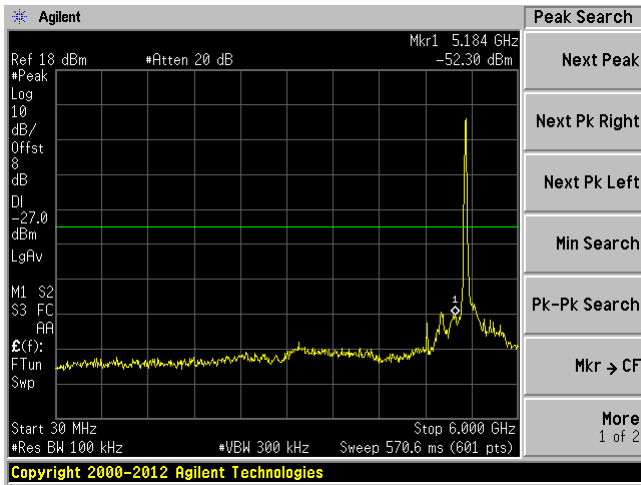

C3 6 GHz-40 GHz

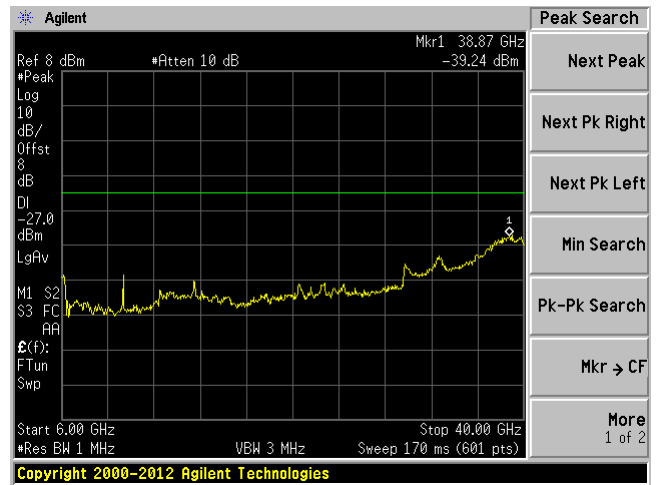

C4 30 MHz-6 GHz

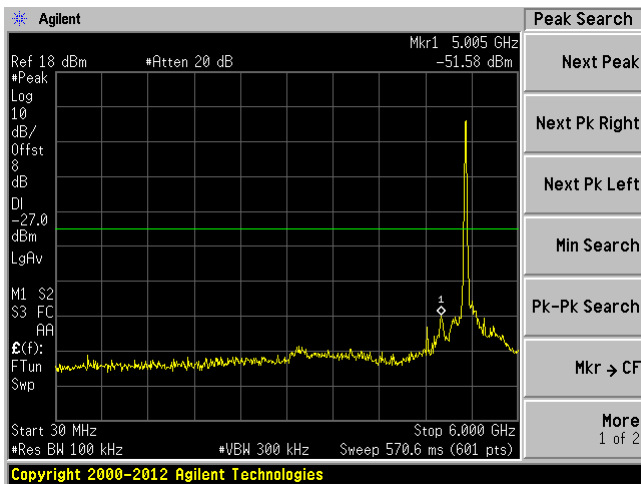

C4 6 GHz-40 GHz

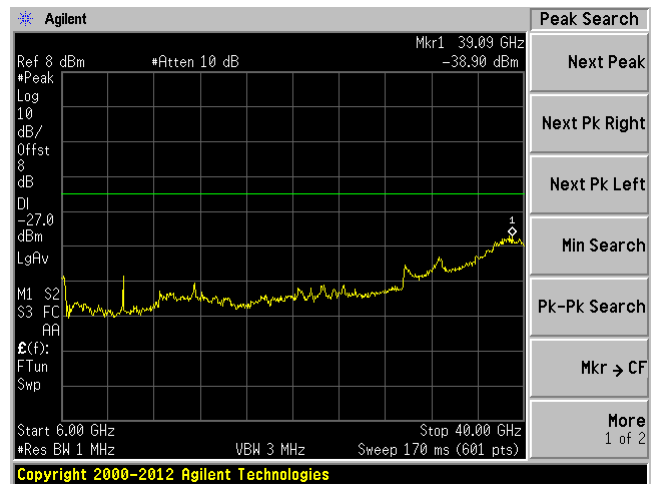

40 MHz bandwidth, Low Channel, 5270 MHz

C1 30 MHz-6 GHz

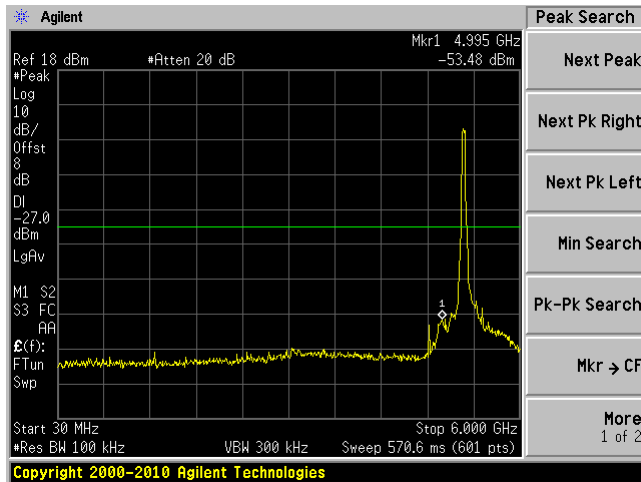

C1 6 GHz-40 GHz

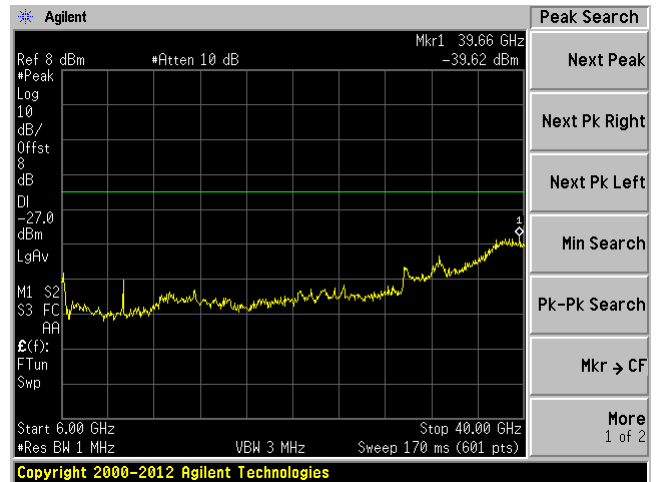

C2 30 MHz-6 GHz

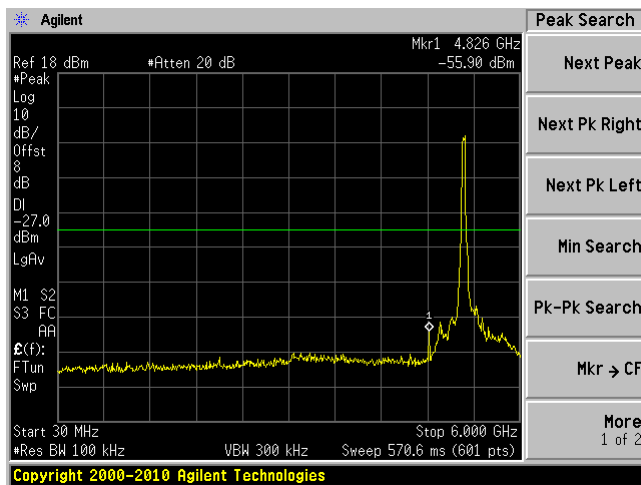

C2 6 GHz-40 GHz

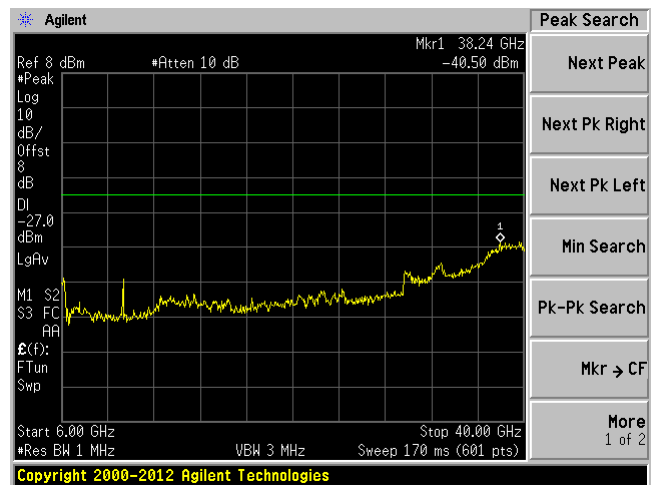

C3 30 MHz-6 GHz

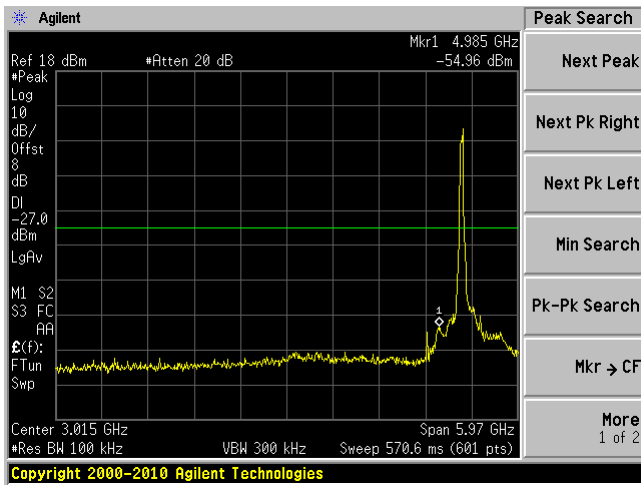

C3 6 GHz-40 GHz

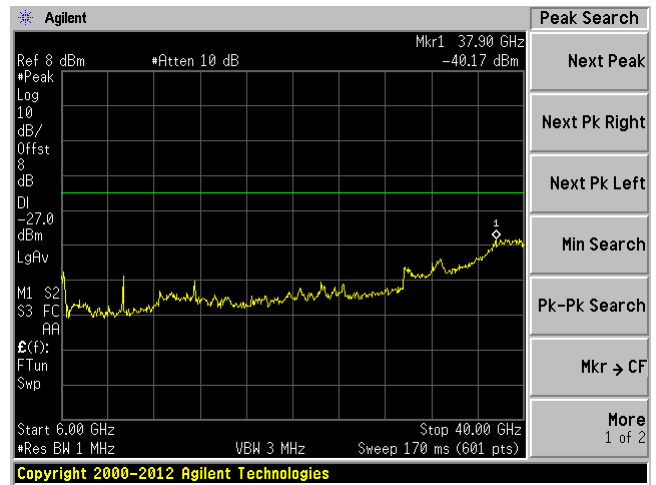

C4 30 MHz-6 GHz

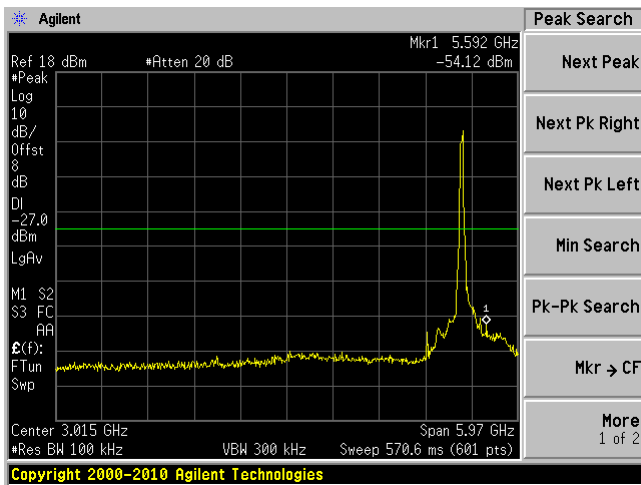

C4 6 GHz-40 GHz

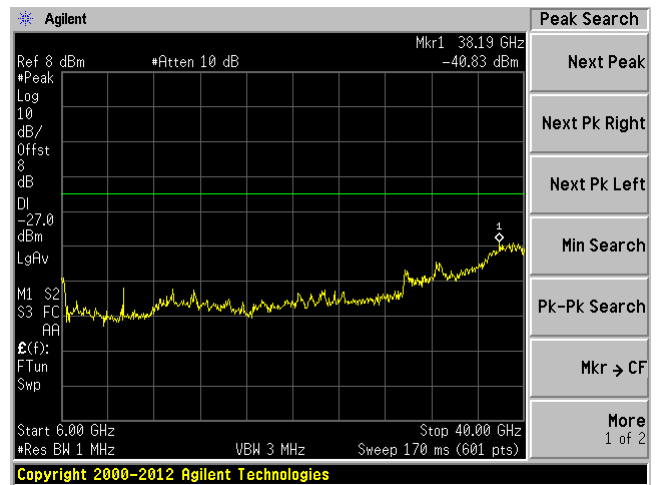

40 MHz bandwidth, Middle Channel, 5290 MHz

C1 30 MHz-6 GHz

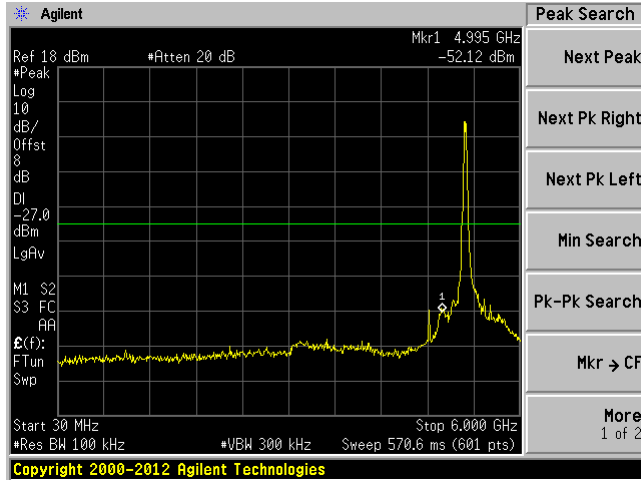

C1 6 GHz-40 GHz

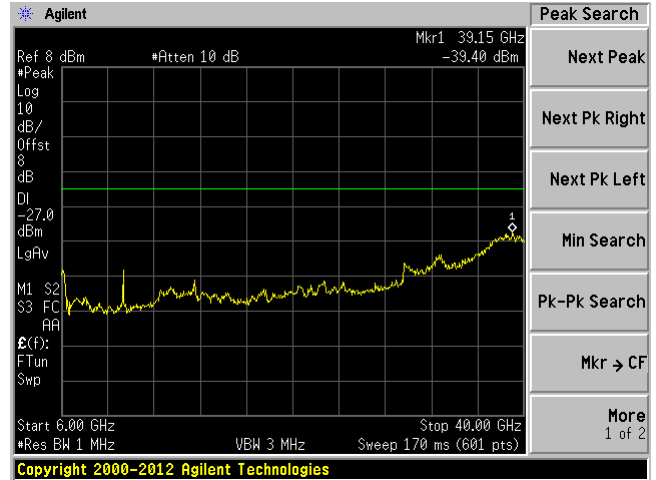

C2 30 MHz-6 GHz

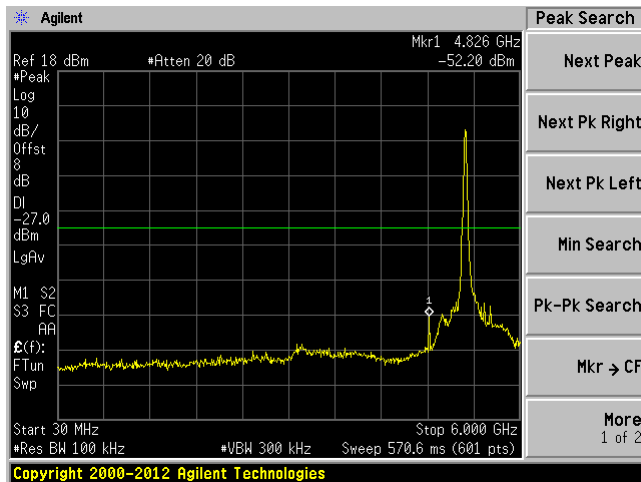

C2 6 GHz-40 GHz

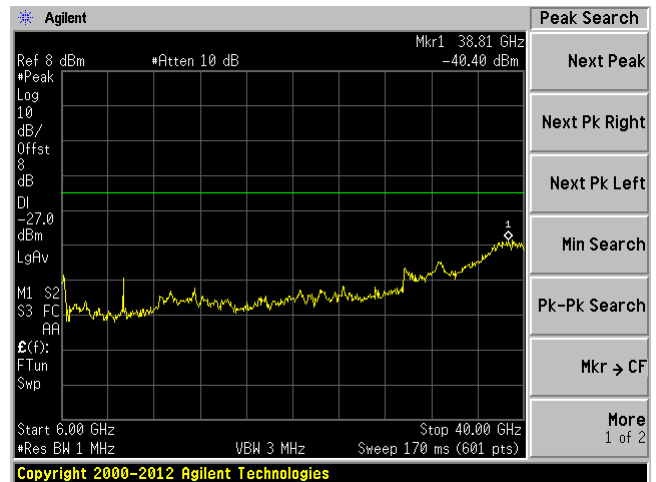

C3 30 MHz-6 GHz

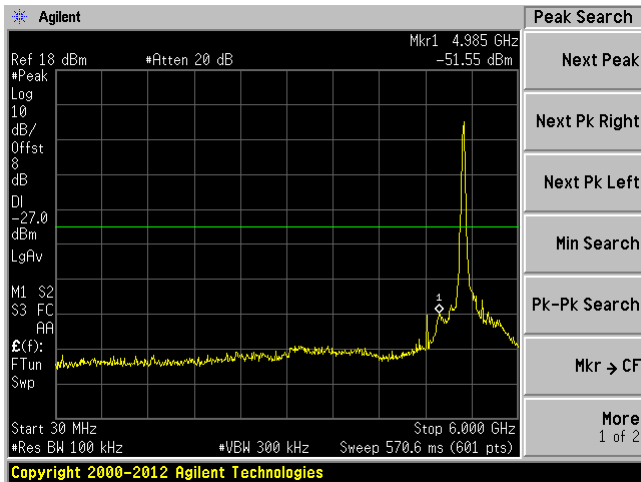

C3 6 GHz-40 GHz

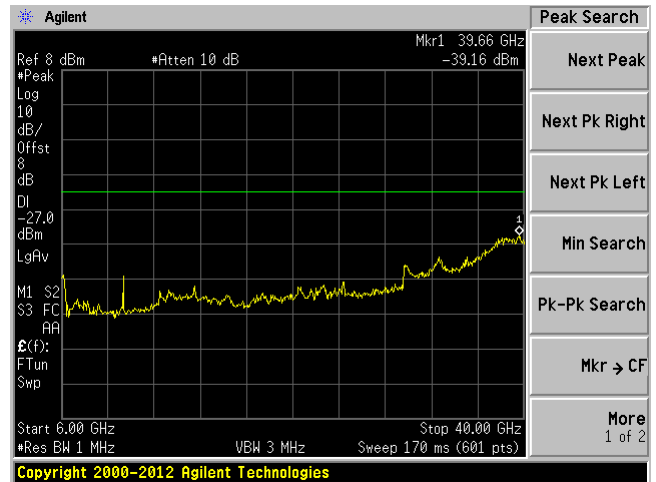

C4 30 MHz-6 GHz

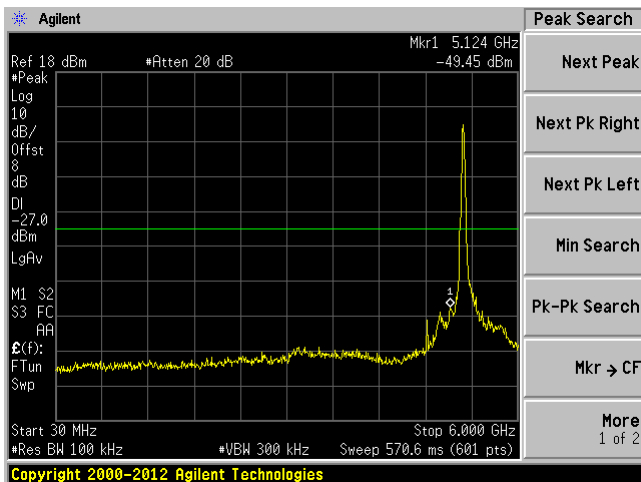

C4 6 GHz-40 GHz

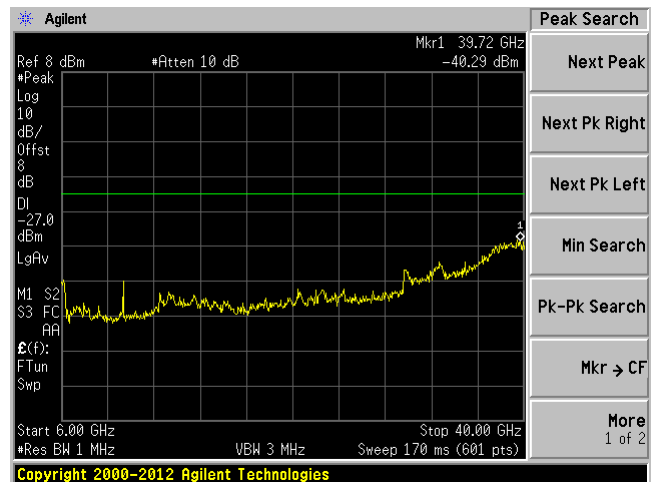

40 MHz bandwidth, High Channel, 5310 MHz

C1 30 MHz-6 GHz

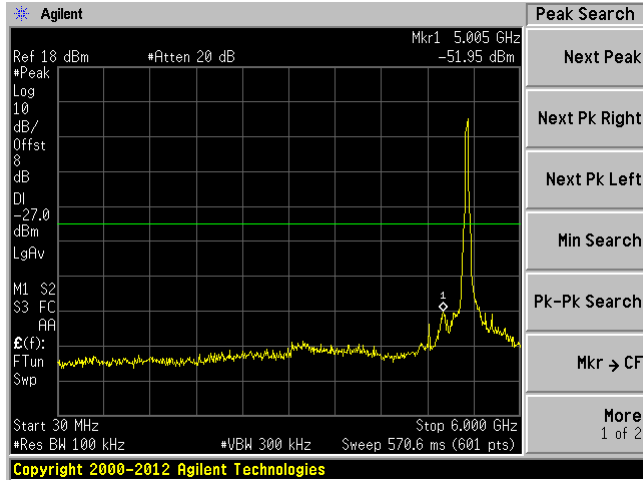

C1 6 GHz-40 GHz

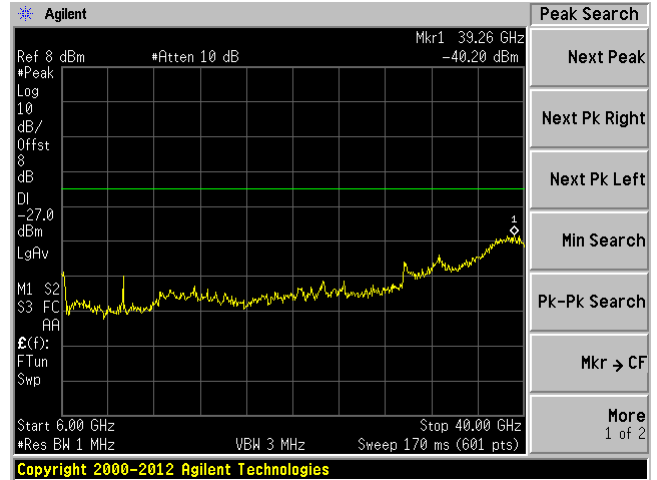

C2 30 MHz-6 GHz

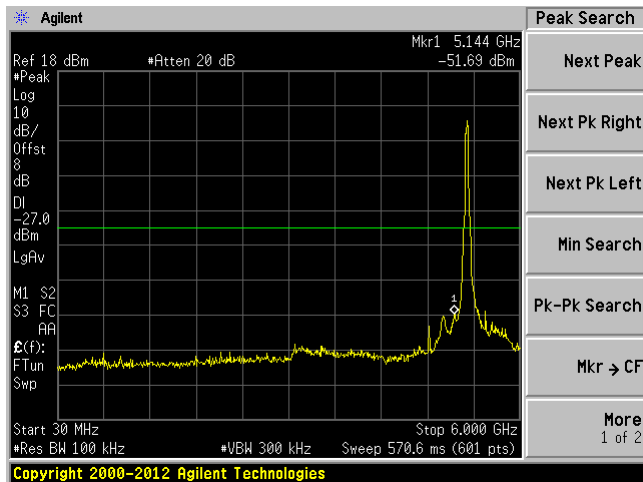

C2 6 GHz-40 GHz

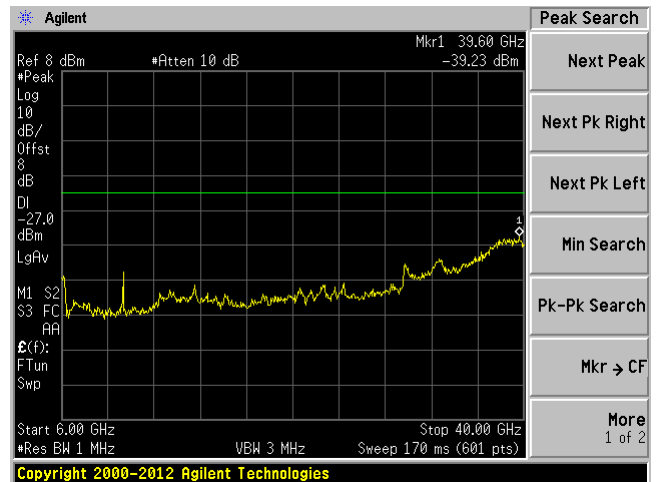

C3 30 MHz-6 GHz

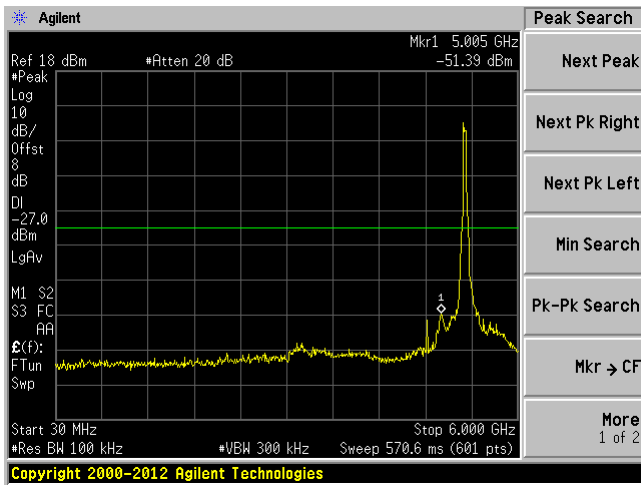

C3 6 GHz-40 GHz

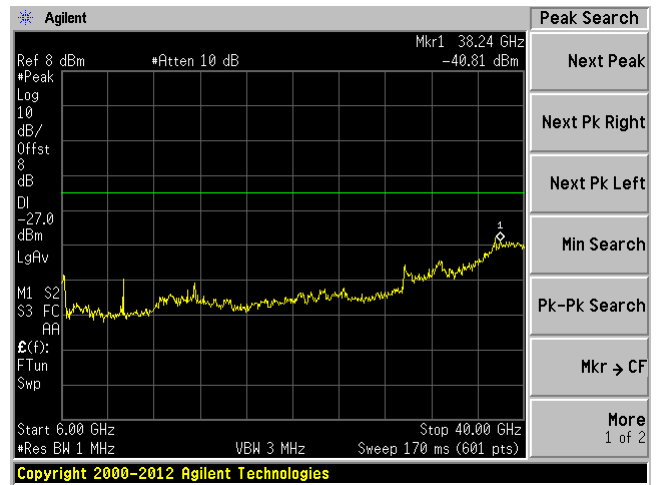

C4 30 MHz-6 GHz

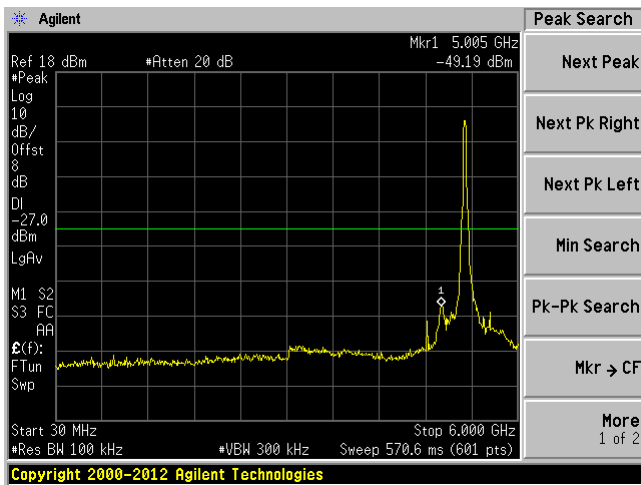

C4 6 GHz-40 GHz

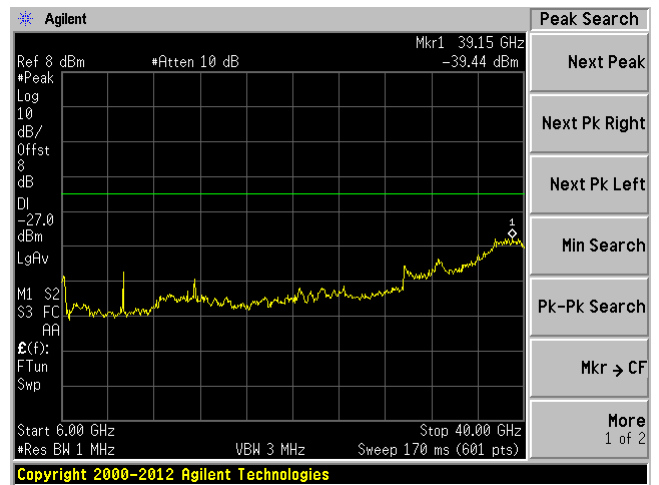

80 MHz bandwidth, 5290 MHz

C1 30 MHz-6 GHz

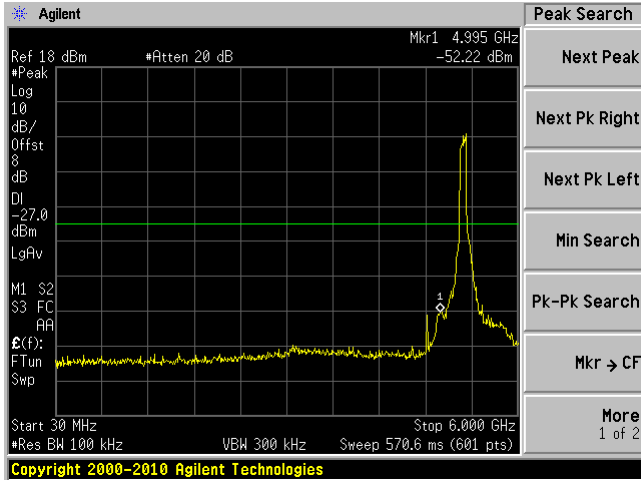

C1 6 GHz-40 GHz

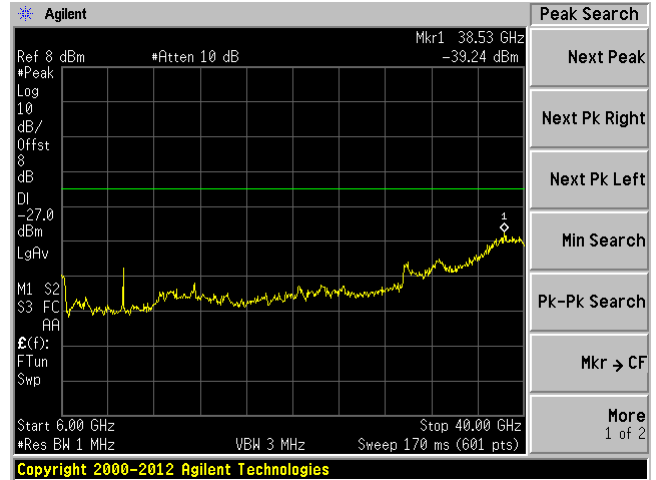

C2 30 MHz-6 GHz

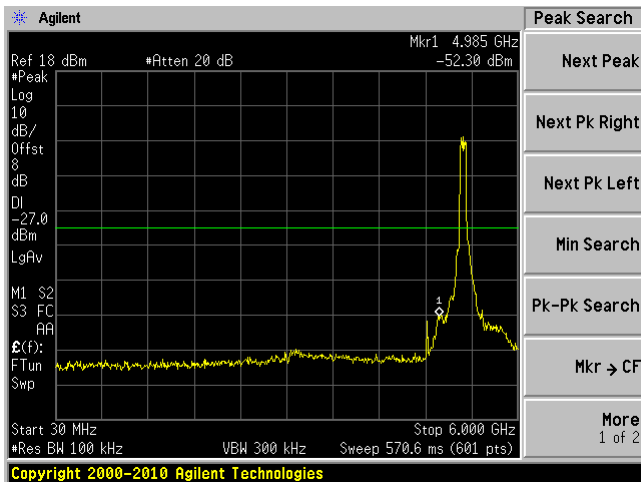

C2 6 GHz-40 GHz

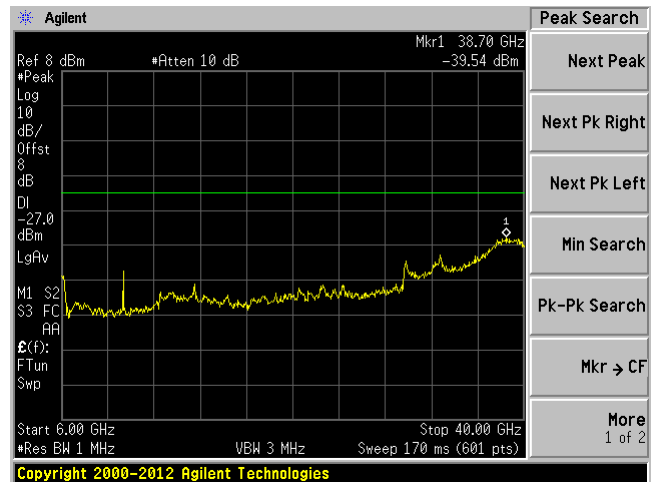

C3 30 MHz-6 GHz

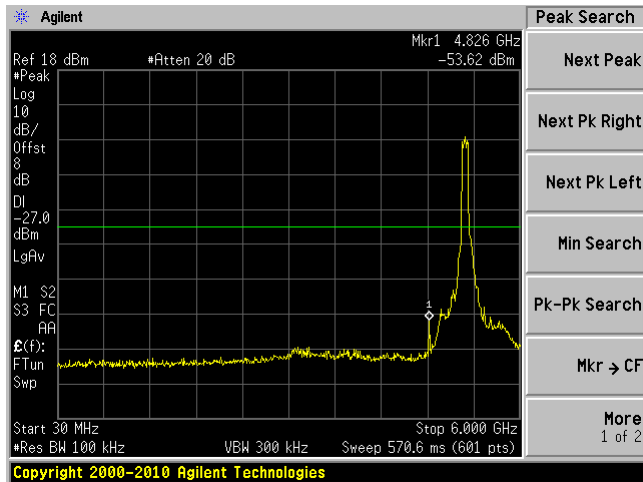

C3 6 GHz-40 GHz

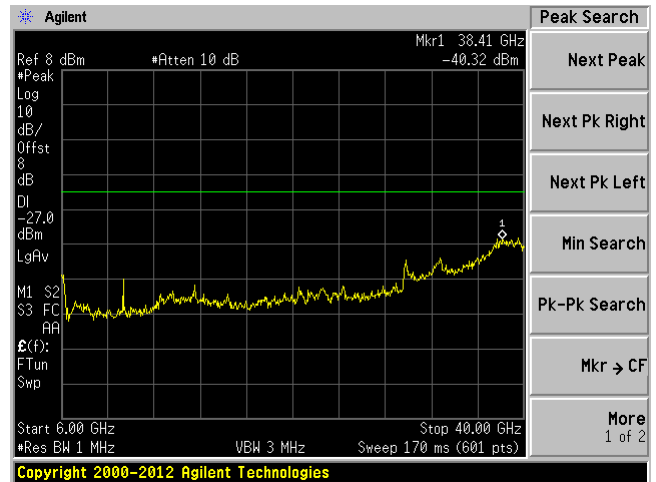

C4 30 MHz-6 GHz

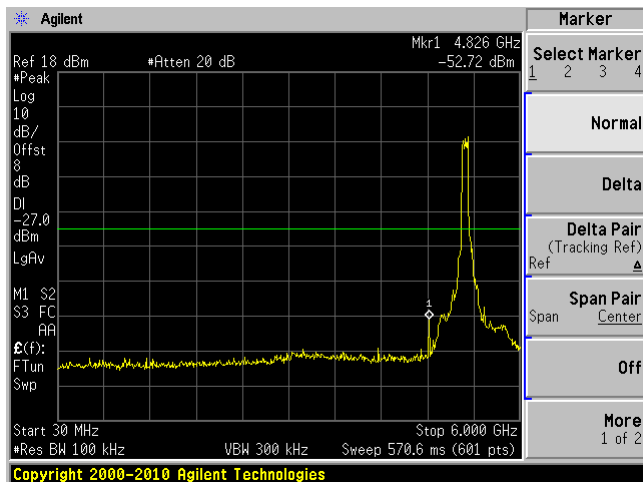

C4 6 GHz-40 GHz

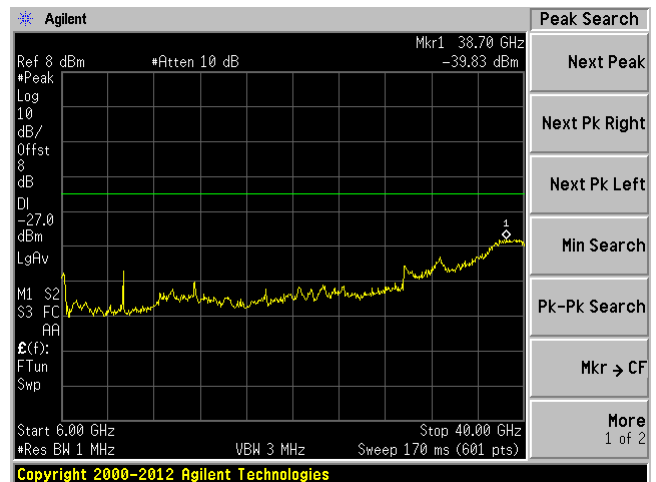

5.6 GHz Band:

20 MHz bandwidth, Low Channel, 5500 MHz

C1 30 MHz-6 GHz

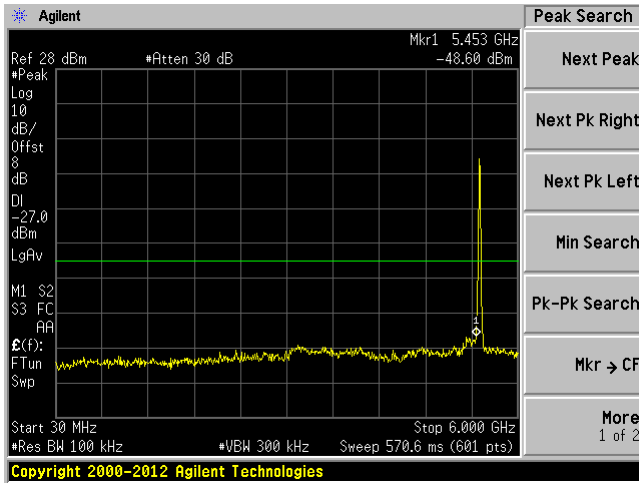

C1 6 GHz-40 GHz

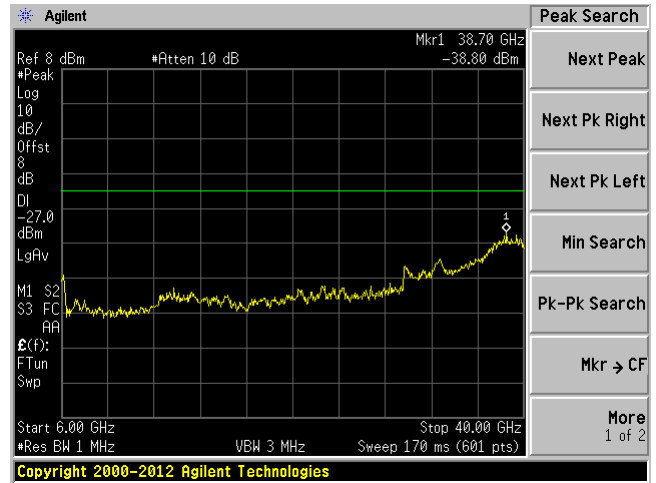

C2 30 MHz-6 GHz

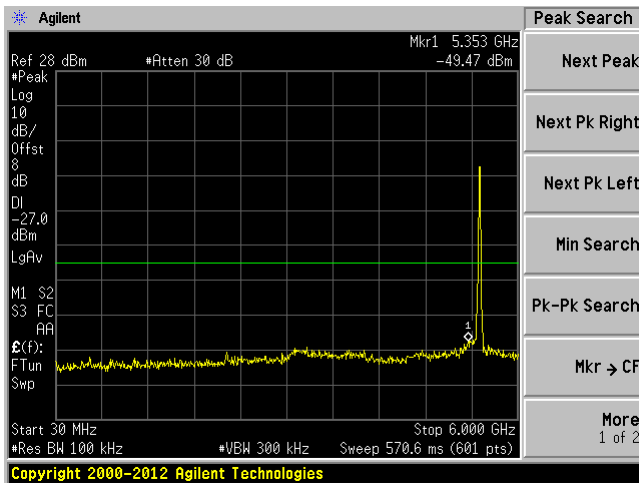

C2 6 GHz-40 GHz

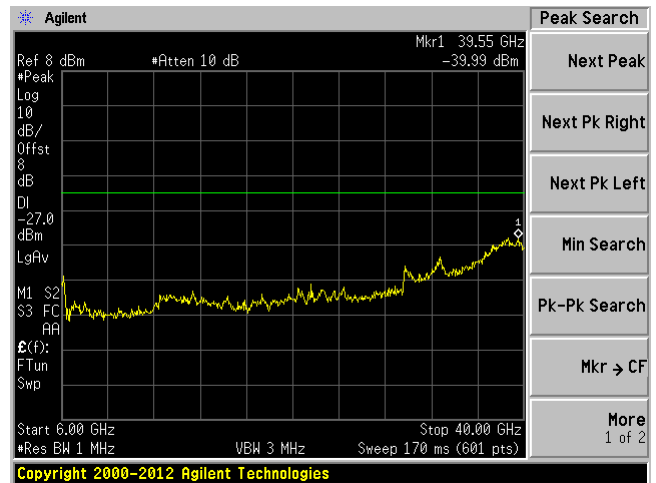

C3 30 MHz-6 GHz

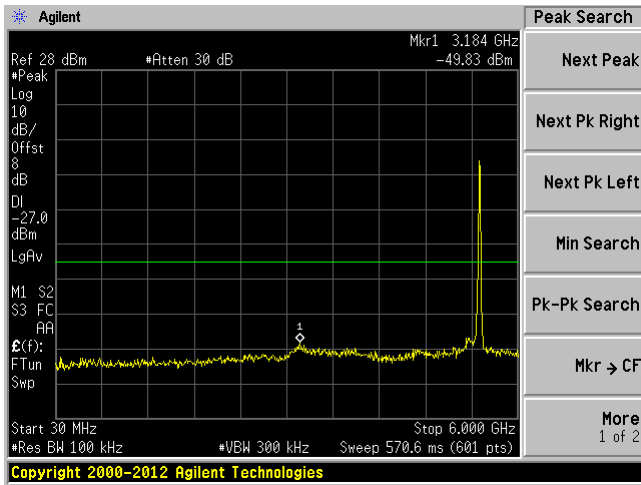

C3 6 GHz-40 GHz

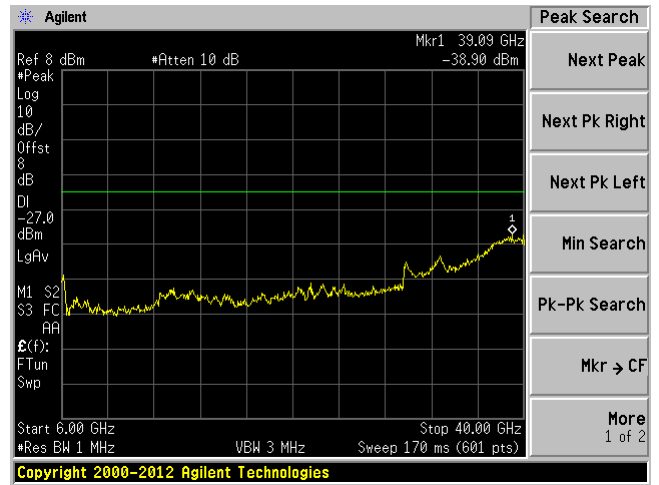

C4 30 MHz-6 GHz

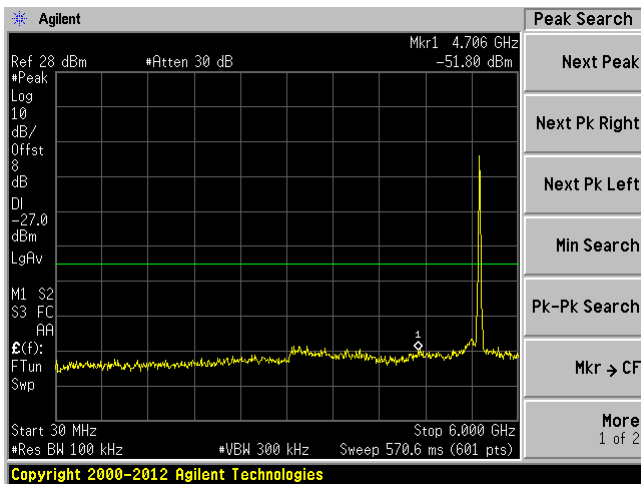

C4 6 GHz-40 GHz

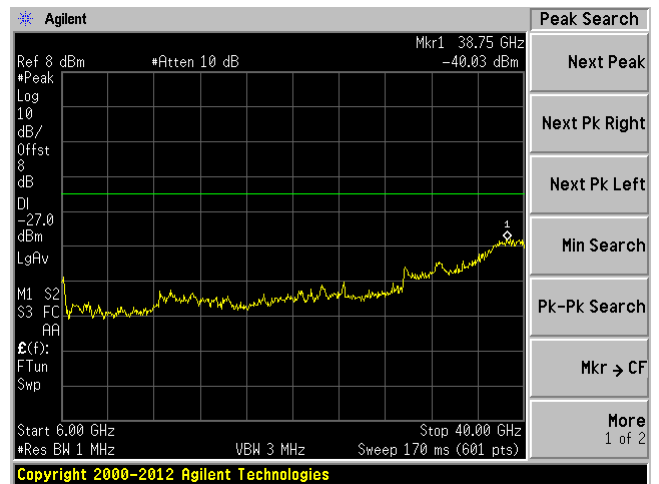

20 MHz bandwidth, Middle Channel, 5590 MHz

C1 30 MHz-6 GHz

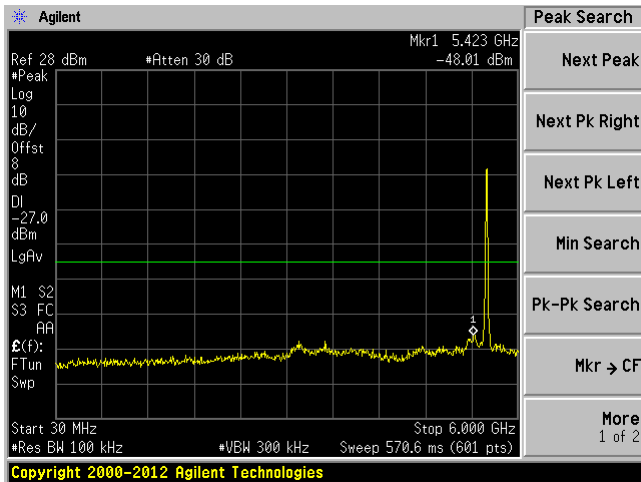

C1 6 GHz-40 GHz

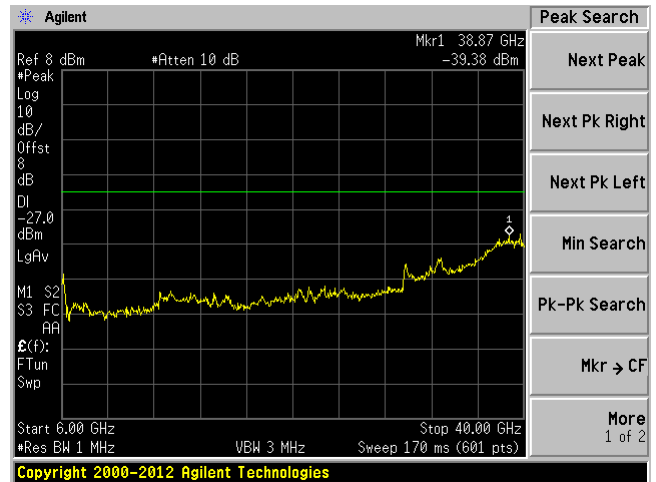

C2 30 MHz-6 GHz

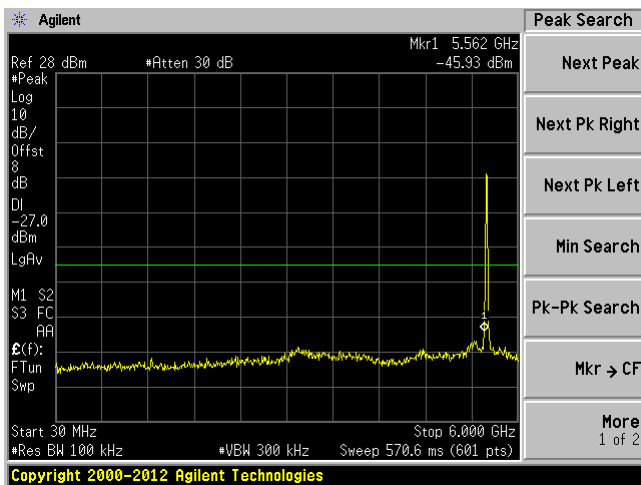

C2 6 GHz-40 GHz

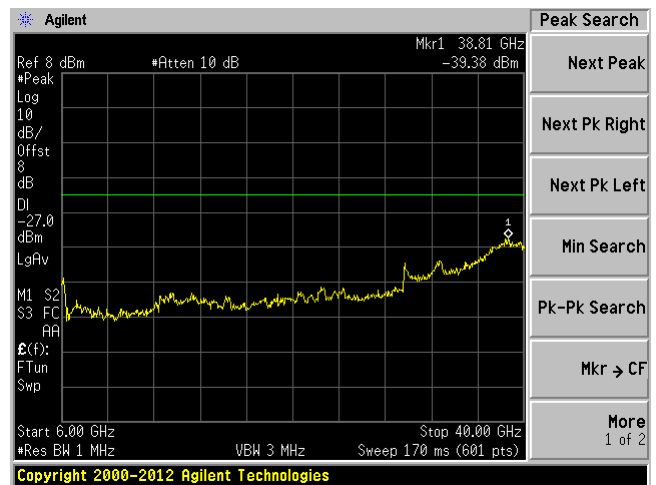

C3 30 MHz-6 GHz

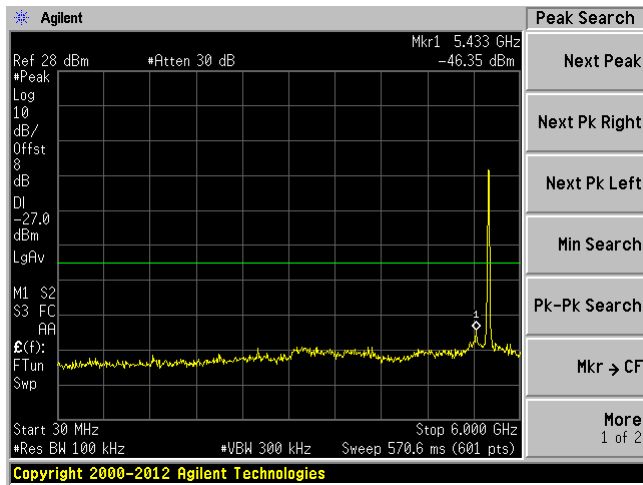

C3 6 GHz-40 GHz

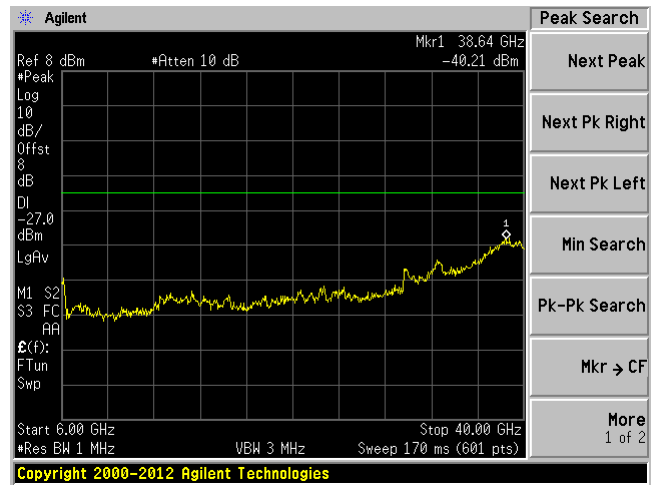

C4 30 MHz-6 GHz

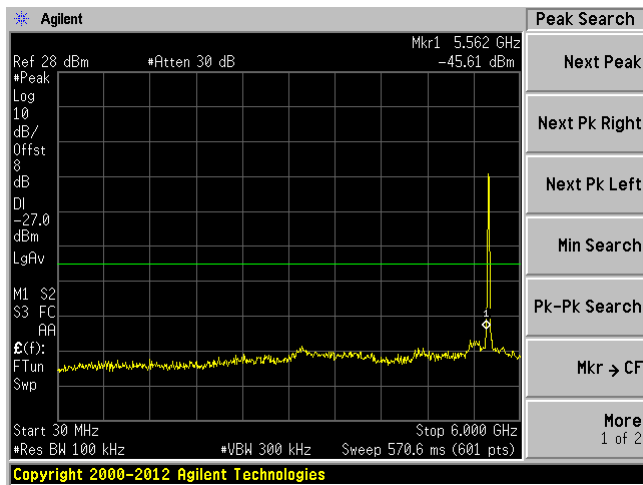

C4 6 GHz-40 GHz

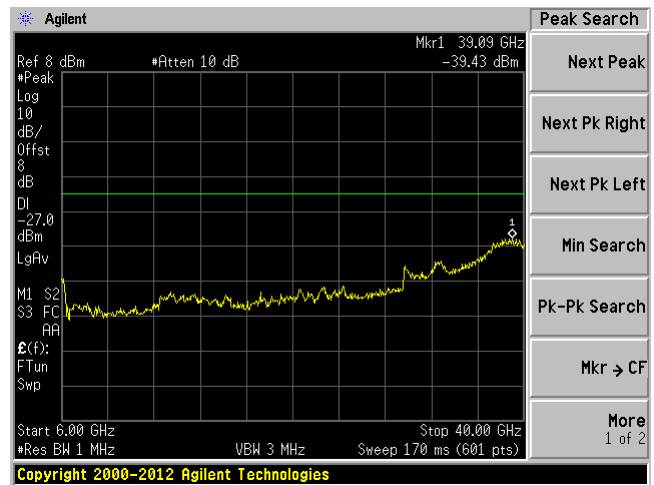

20 MHz bandwidth, High Channel, 5700 MHz

C1 30 MHz-6 GHz

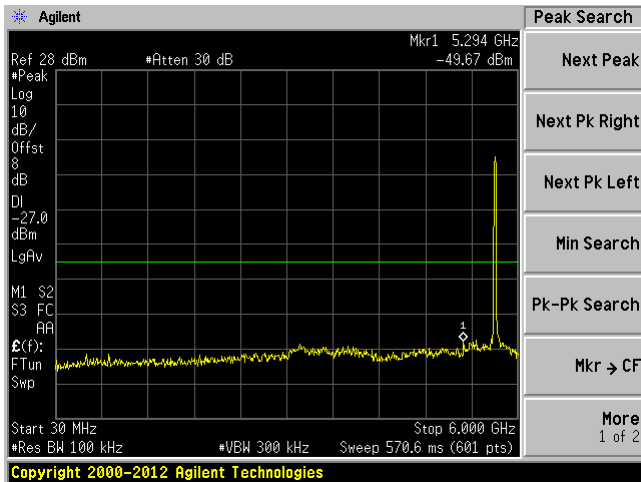

C1 6 GHz-40 GHz

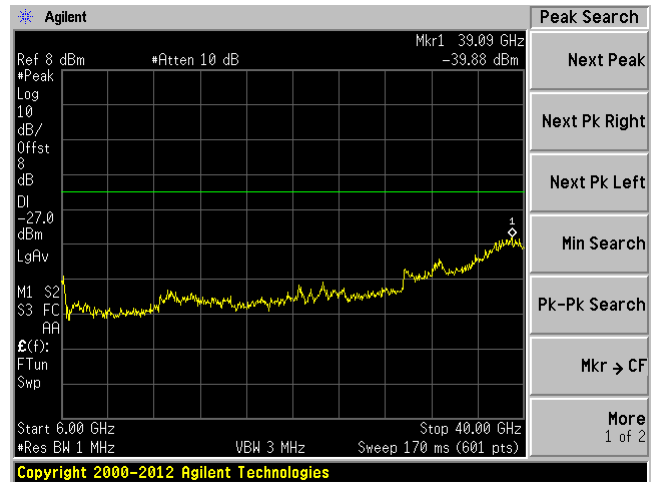

C2 30 MHz-6 GHz

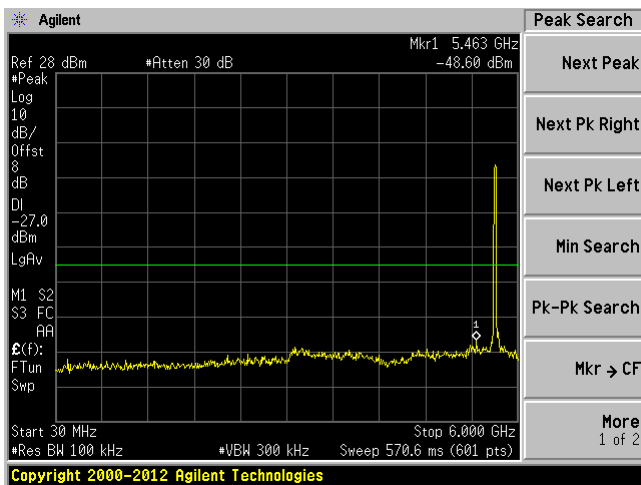

C2 6 GHz-40 GHz

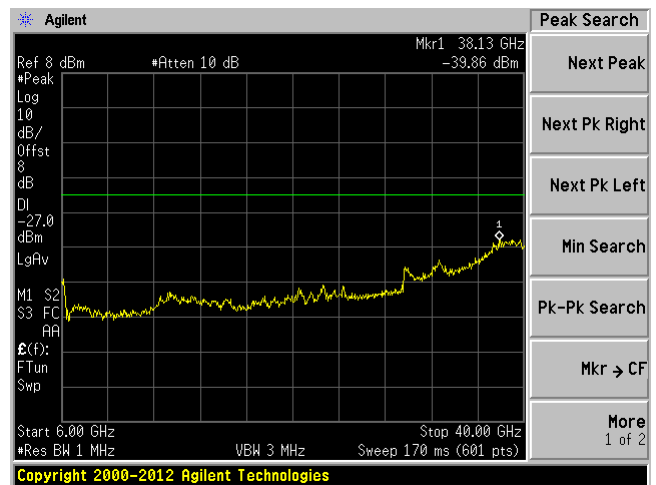

C3 30 MHz-6 GHz

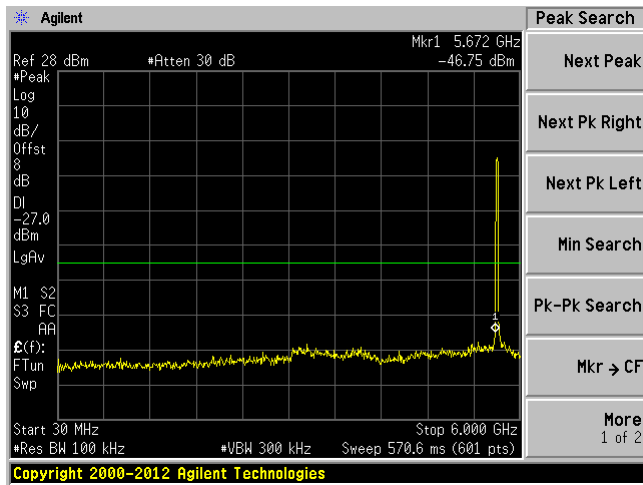

C3 6 GHz-40 GHz

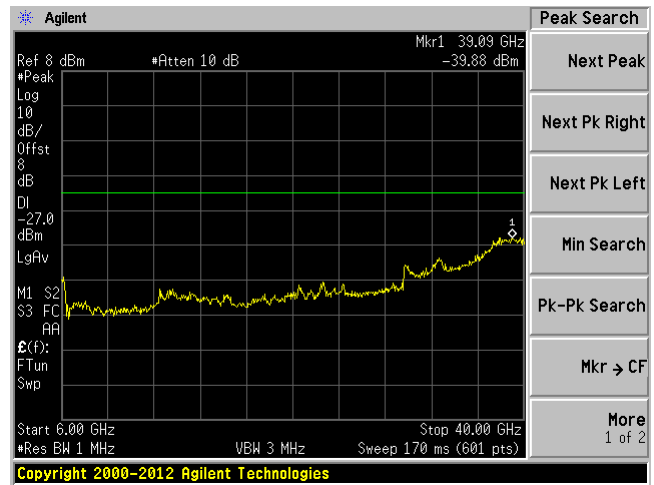

C4 30 MHz-6 GHz

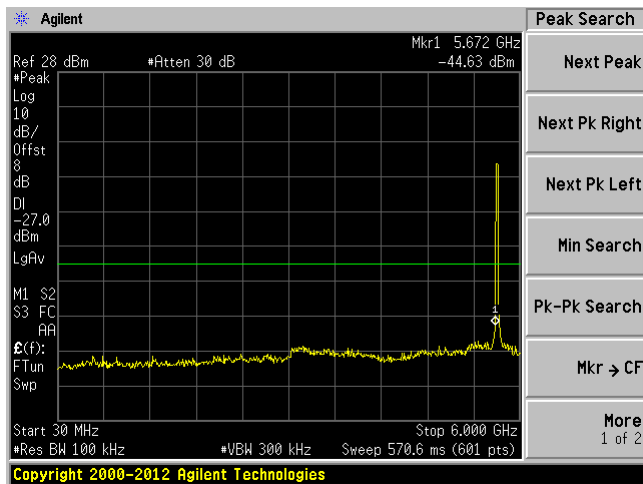

C4 6 GHz-40 GHz

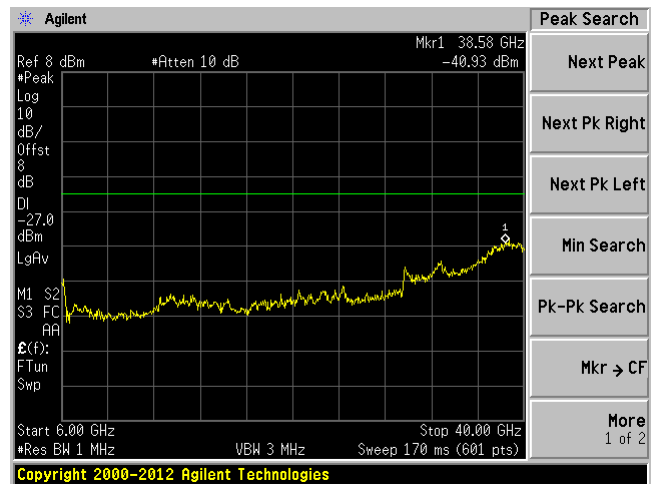

40 MHz bandwidth, Low Channel, 5510 MHz

C1 30 MHz-6 GHz

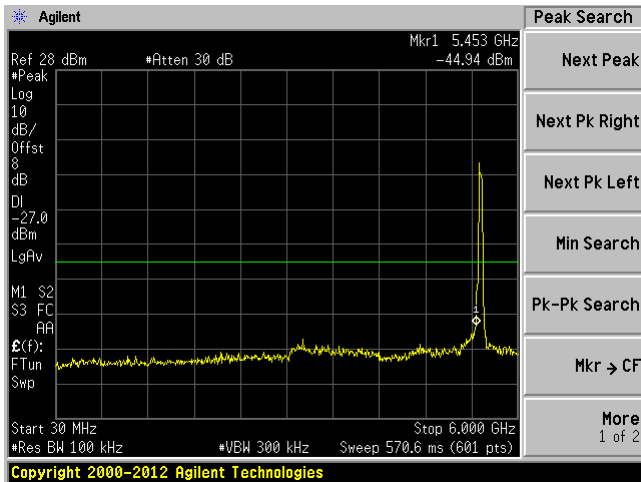

C1 6 GHz-40 GHz

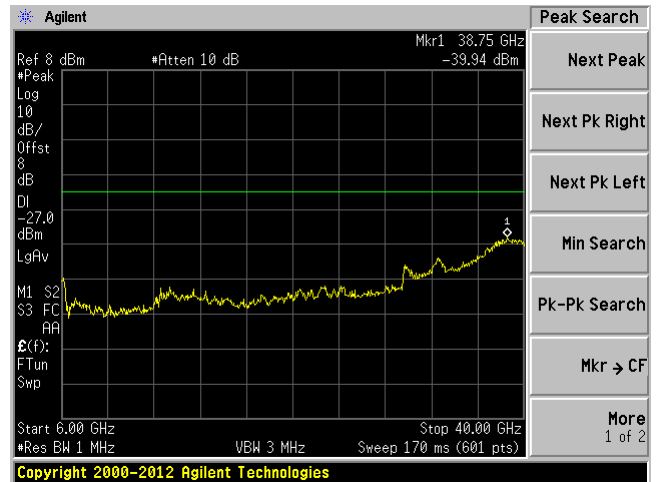

C2 30 MHz-6 GHz

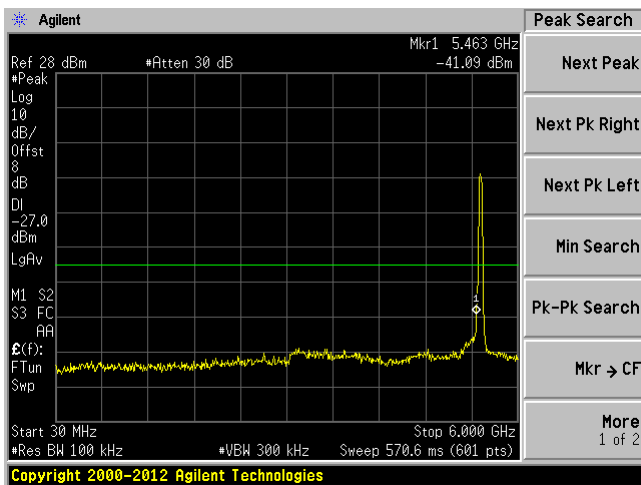

C2 6 GHz-40 GHz

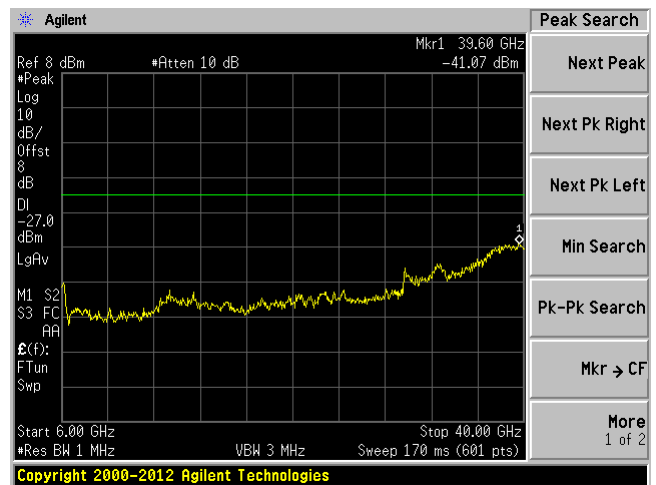

C3 30 MHz-6 GHz

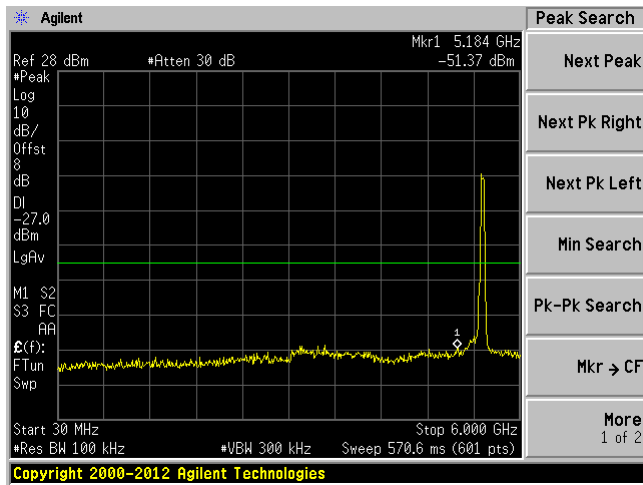

C3 6 GHz-40 GHz

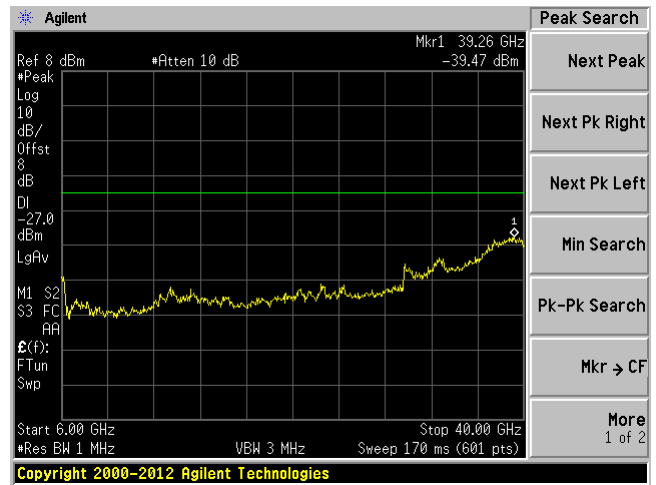

C4 30 MHz-6 GHz

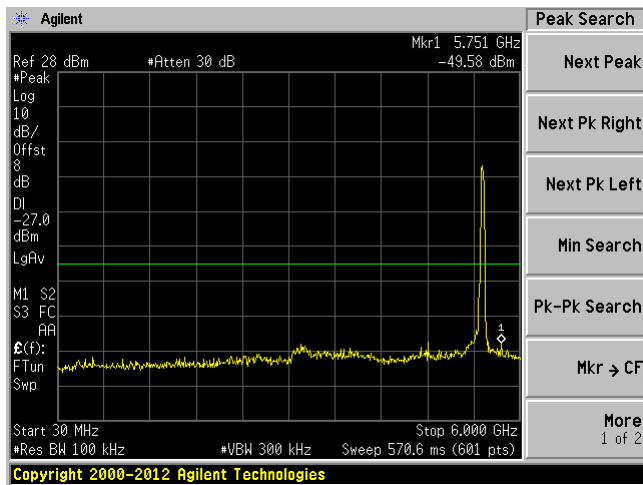

C4 6 GHz-40 GHz

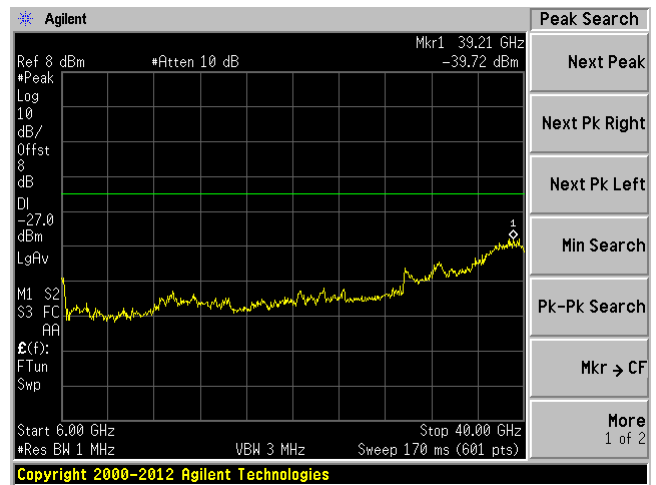

40 MHz bandwidth, Middle Channel, 5555 MHz

C1 30 MHz-6 GHz

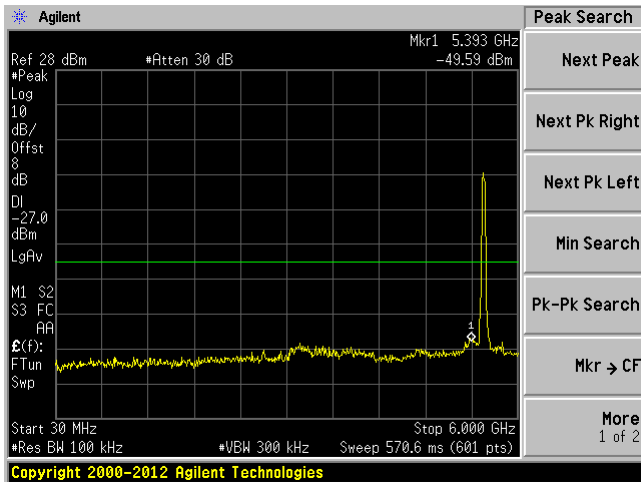

C1 6 GHz-40 GHz

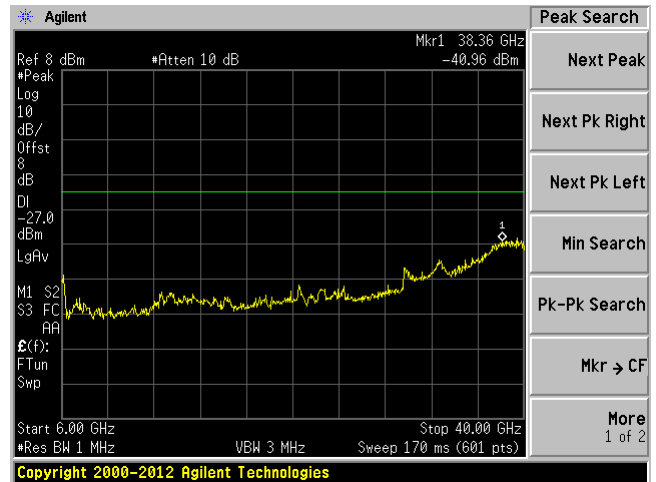

C2 30 MHz-6 GHz

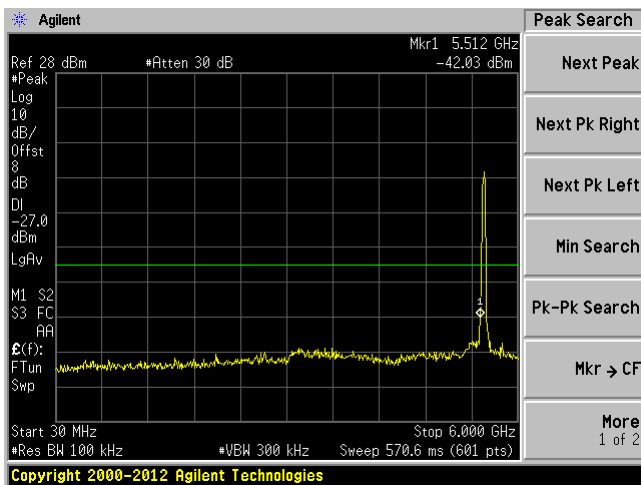

C2 6 GHz-40 GHz

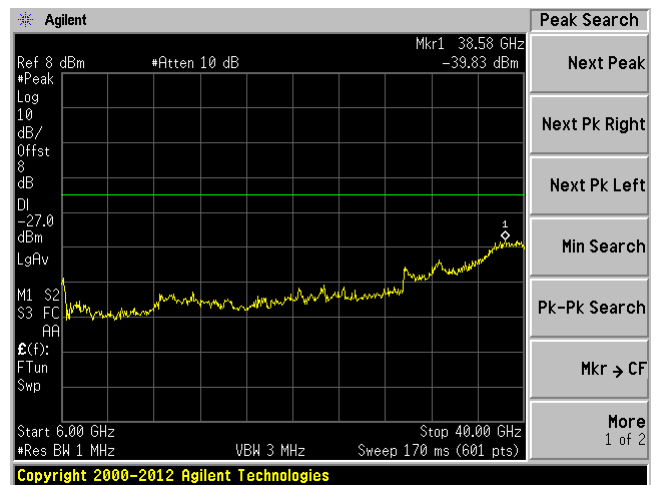

C3 30 MHz-6 GHz

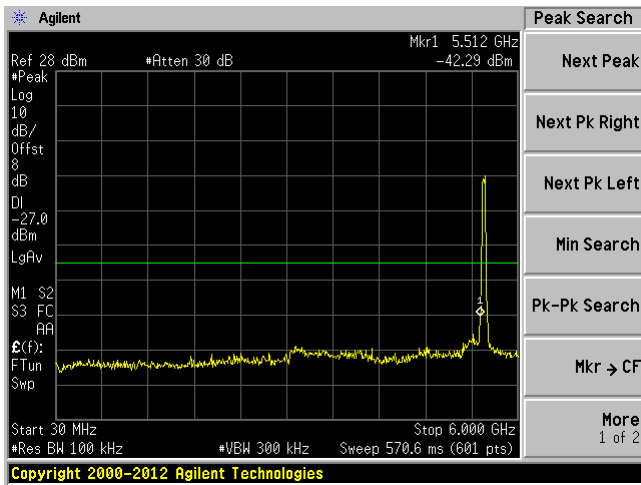

C3 6 GHz-40 GHz

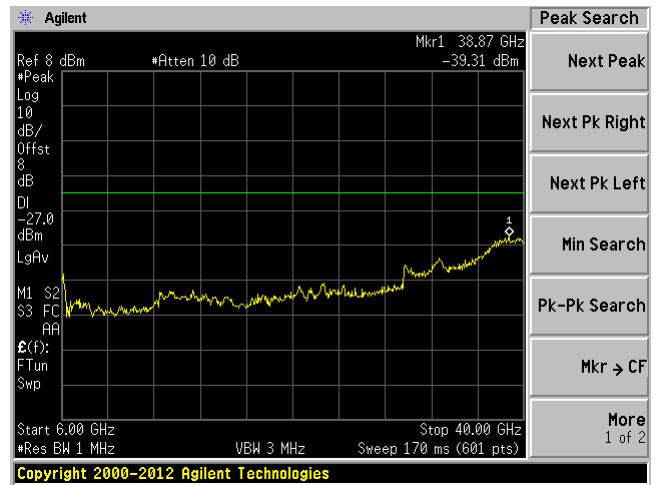

C4 30 MHz-6 GHz

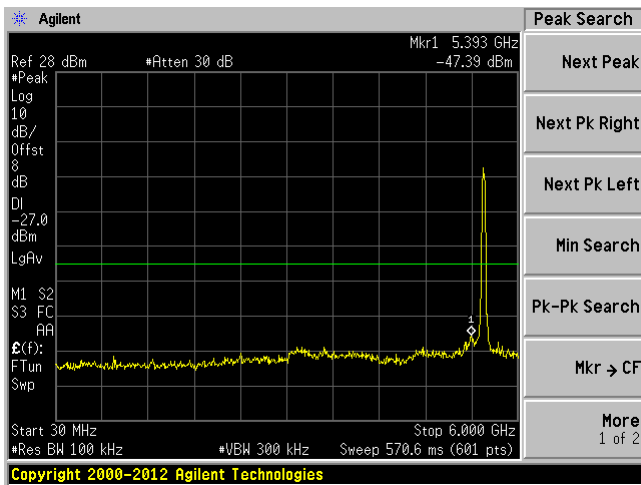

C4 6 GHz-40 GHz

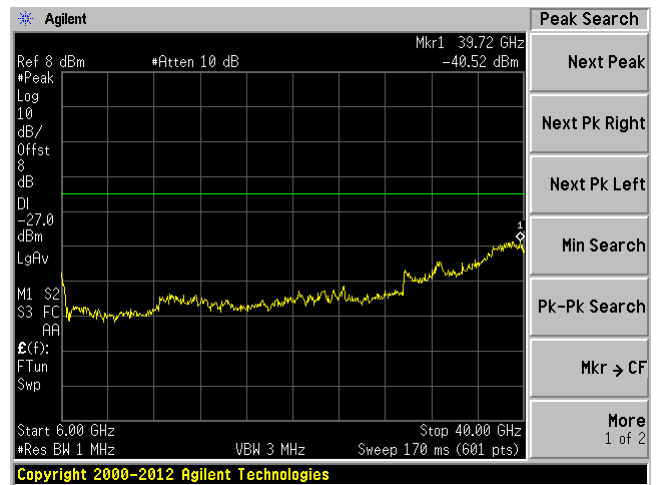

40 MHz bandwidth, High Channel, 5690 MHz

C1 30 MHz-6 GHz

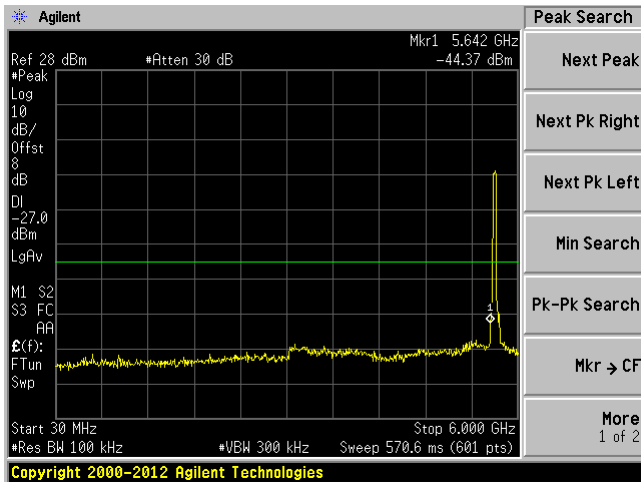

C1 6 GHz-40 GHz

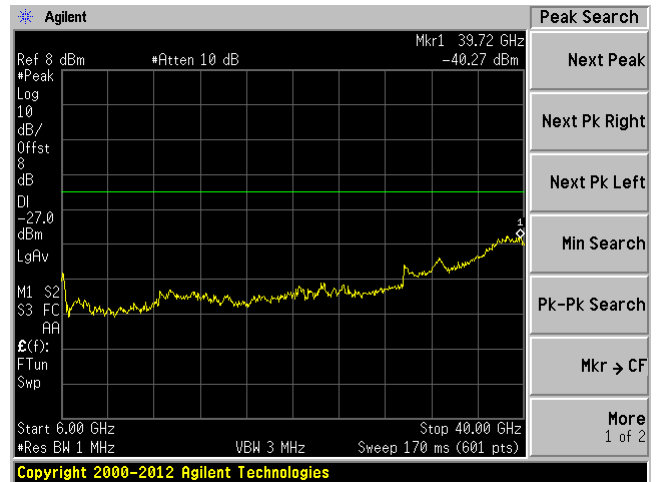

C2 30 MHz-6 GHz

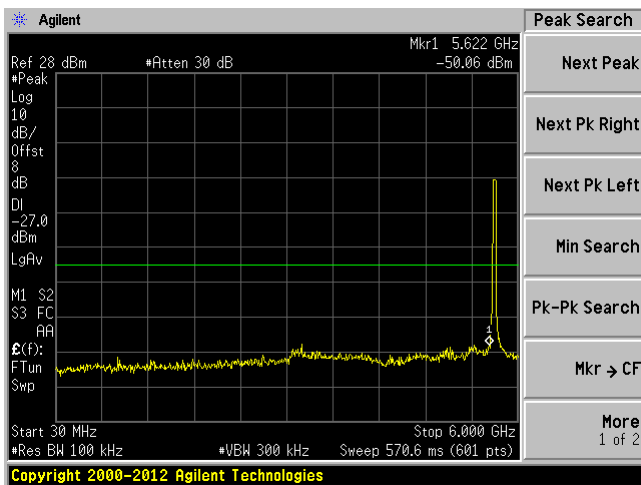

C2 6 GHz-40 GHz

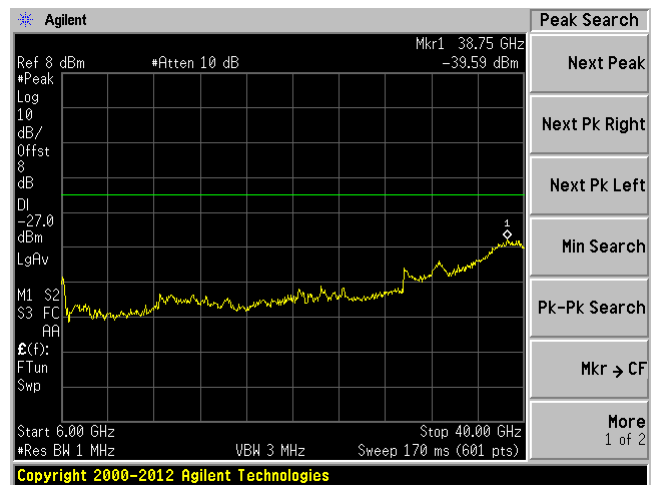

C3 30 MHz-6 GHz

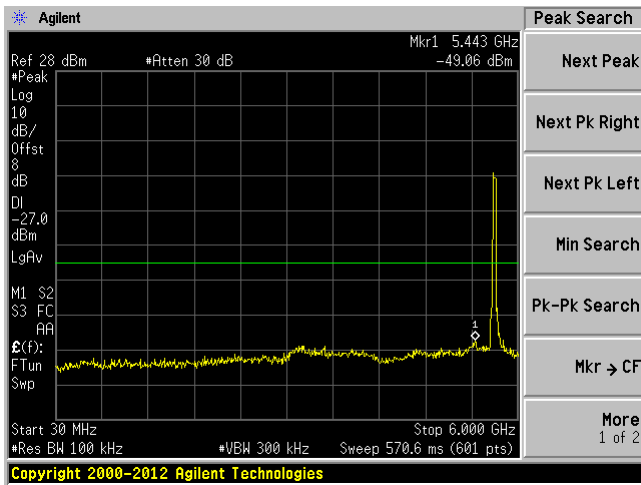

C3 6 GHz-40 GHz

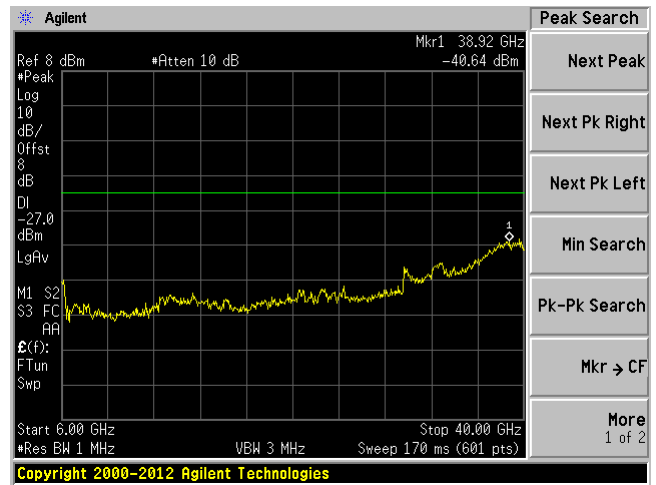

C4 30 MHz-6 GHz

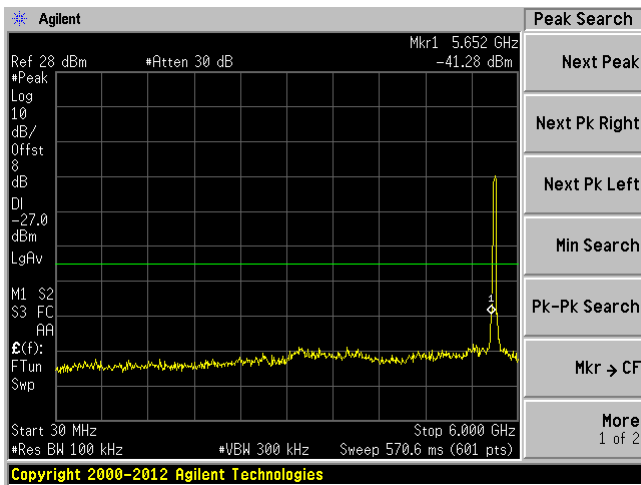

C4 6 GHz-40 GHz

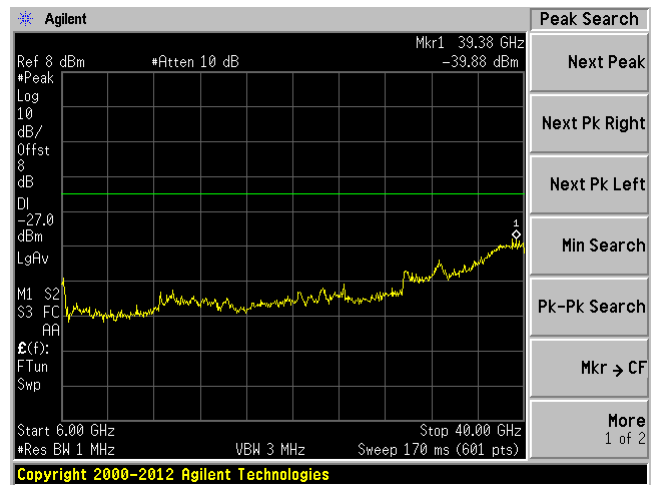

80 MHz bandwidth, Low Channel, 5530 MHz

C1 30 MHz-6 GHz

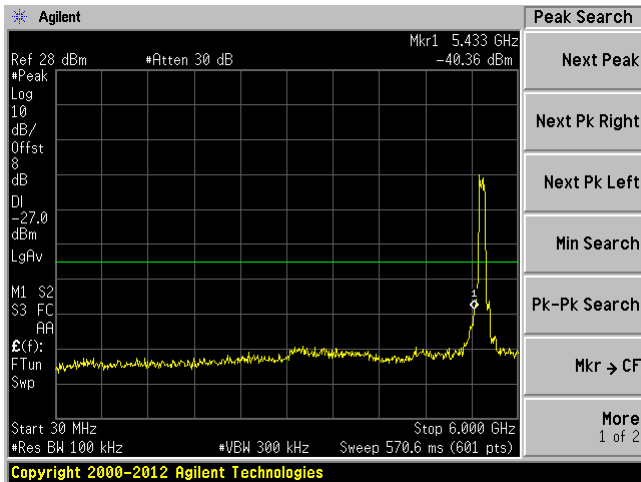

C1 6 GHz-40 GHz

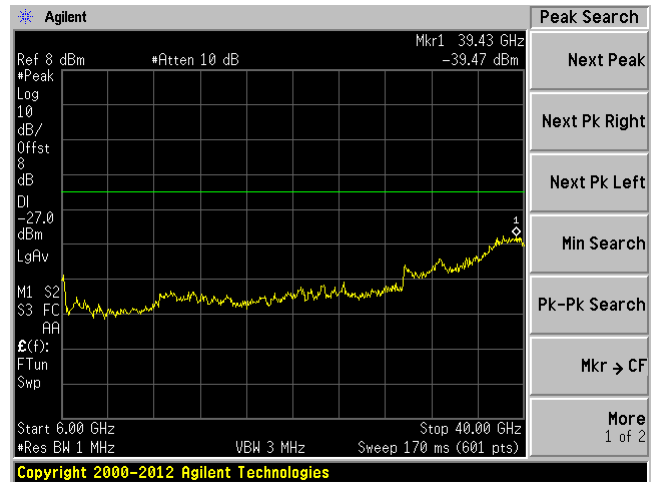

C2 30 MHz-6 GHz

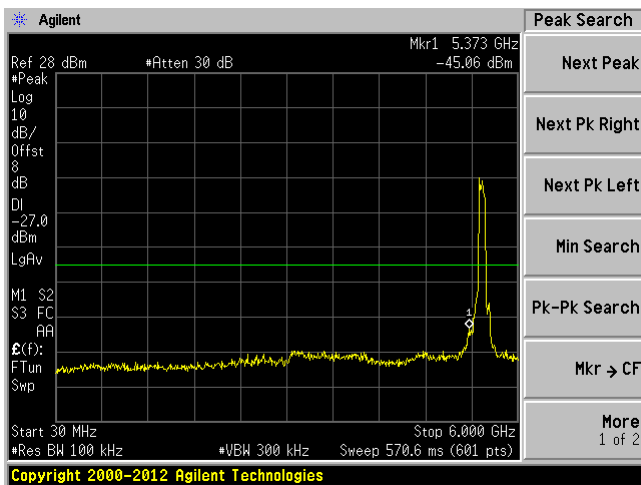

C2 6 GHz-40 GHz

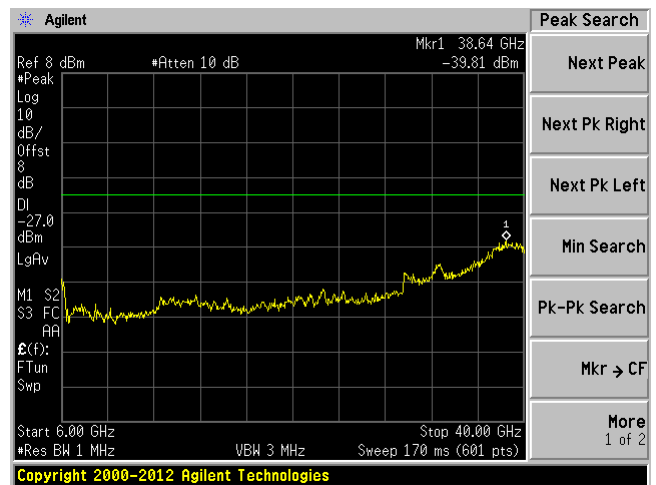

C3 30 MHz-6 GHz

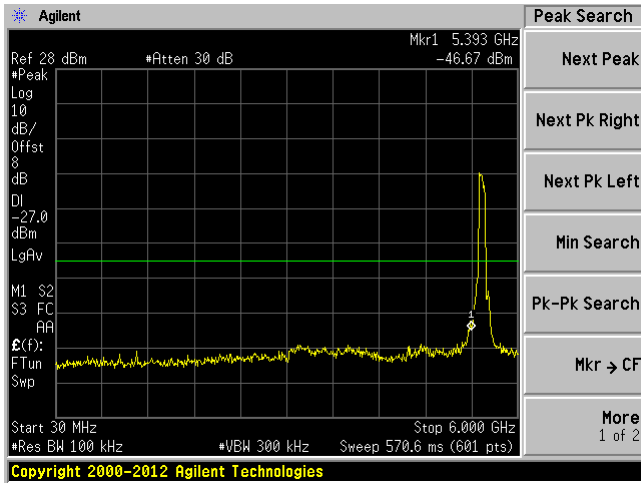

C3 6 GHz-40 GHz

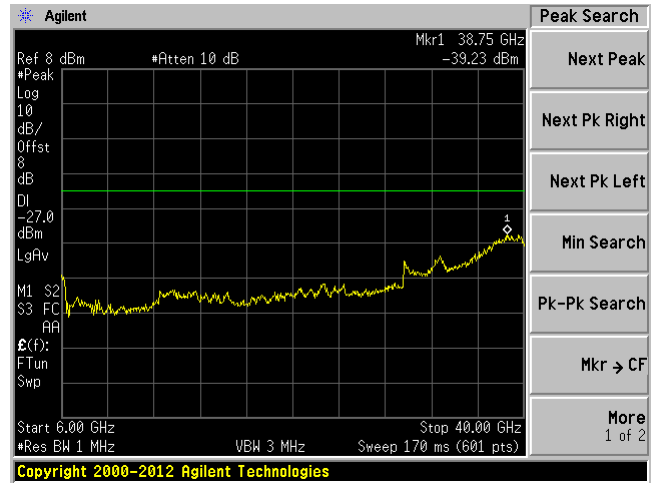

C4 30 MHz-6 GHz

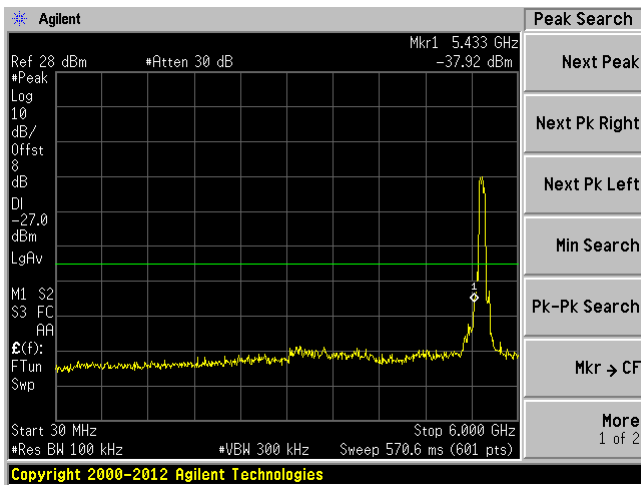

C4 6 GHz-40 GHz

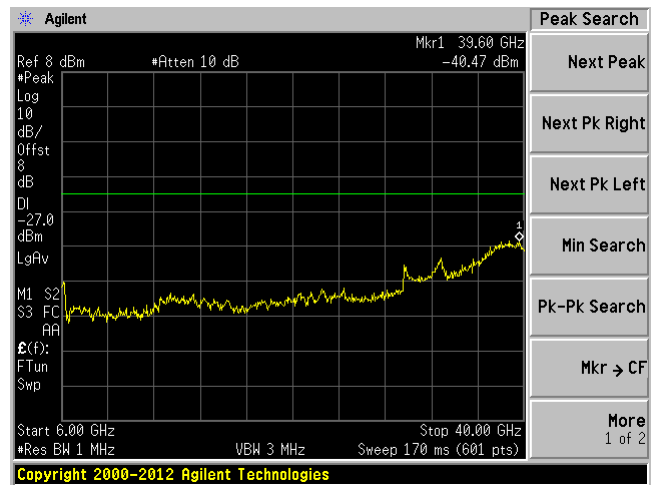

80 MHz bandwidth, Middle Channel, 5545 MHz

C1 30 MHz-6 GHz

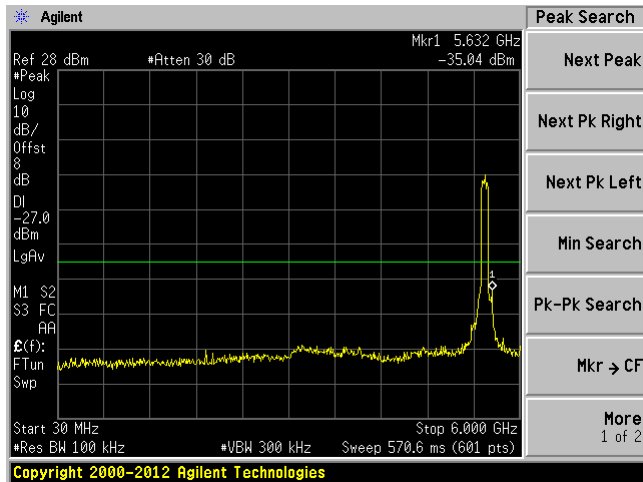

C1 6 GHz-40 GHz

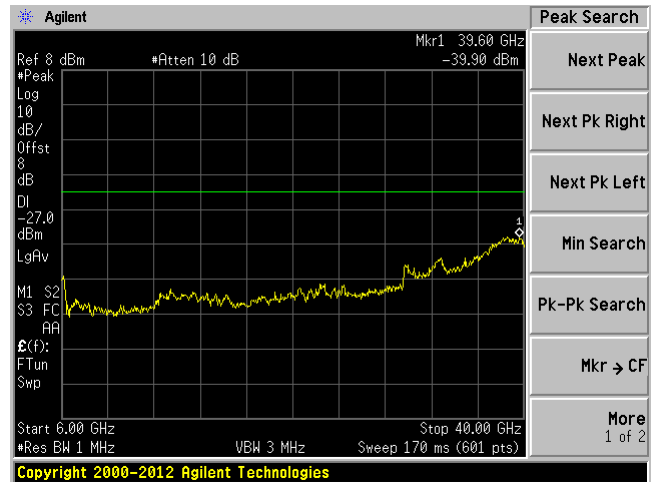

C2 30 MHz-6 GHz

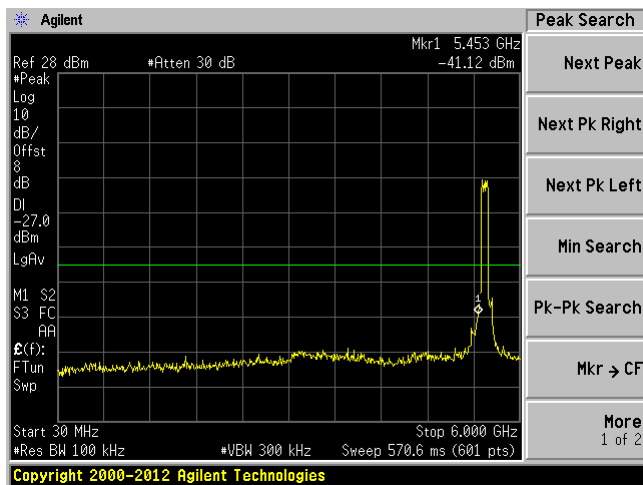

C2 6 GHz-40 GHz

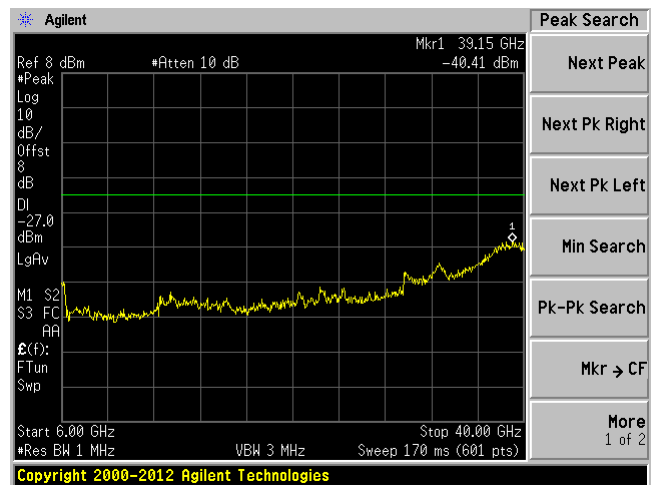

C3 30 MHz-6 GHz

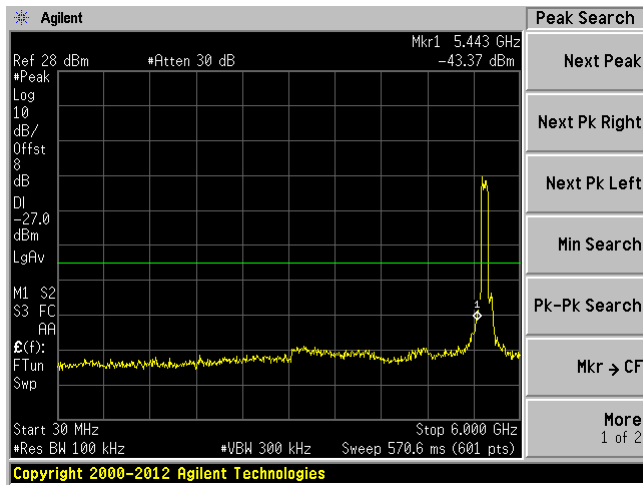

C3 6 GHz-40 GHz

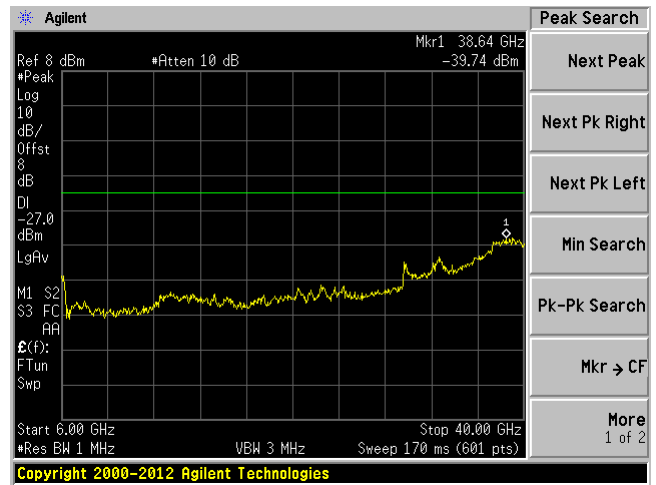

C4 30 MHz-6 GHz

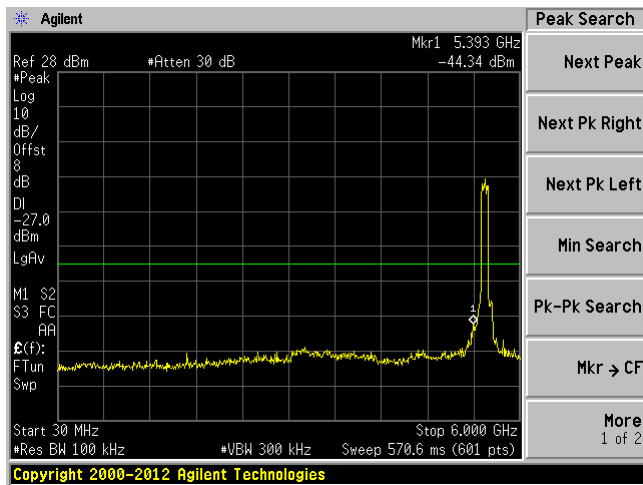

C4 6 GHz-40 GHz

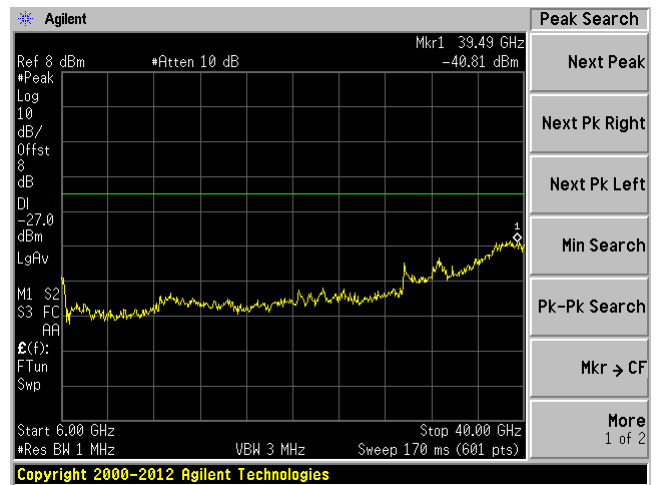

80 MHz bandwidth, High Channel, 5560 MHz

C1 30 MHz-6 GHz

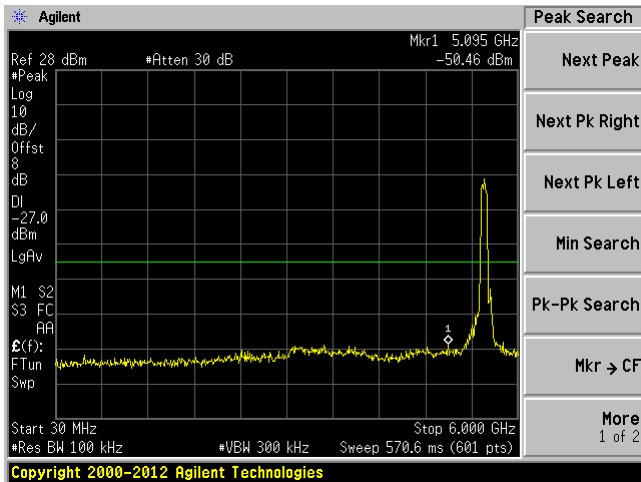

C1 6 GHz-40 GHz

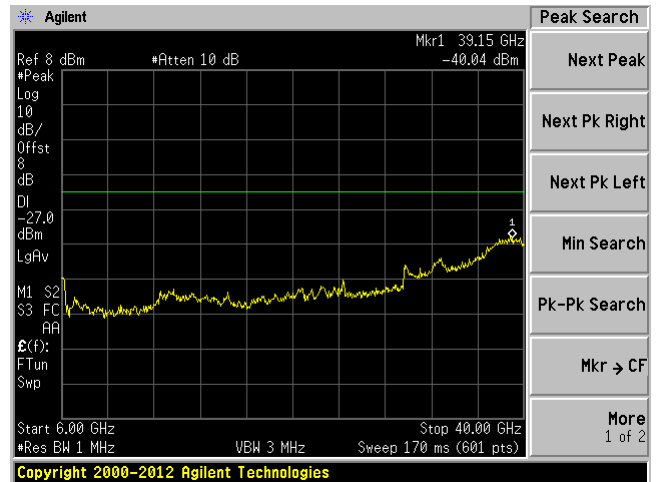

C2 30 MHz-6 GHz

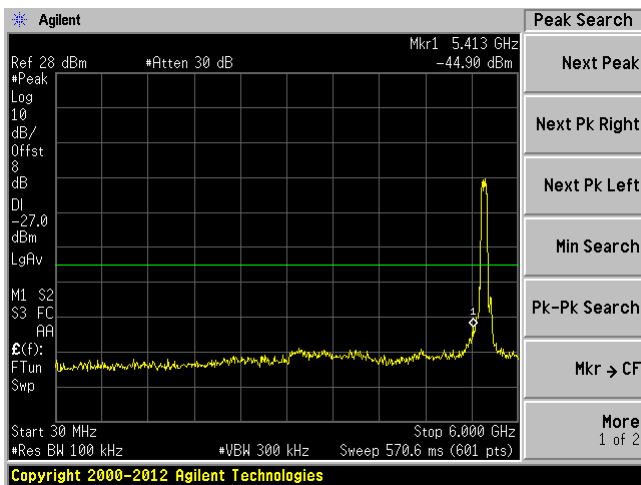

C2 6 GHz-40 GHz

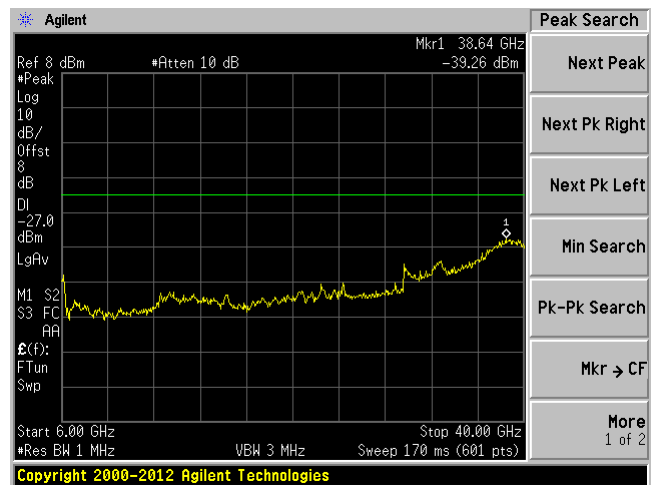

C3 30 MHz-6 GHz

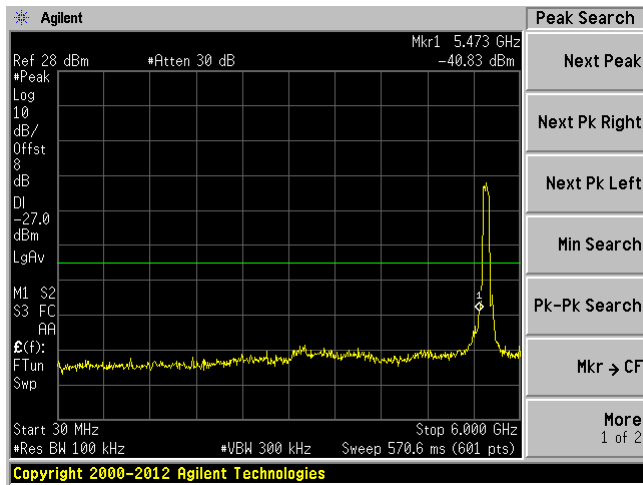

C3 6 GHz-40 GHz

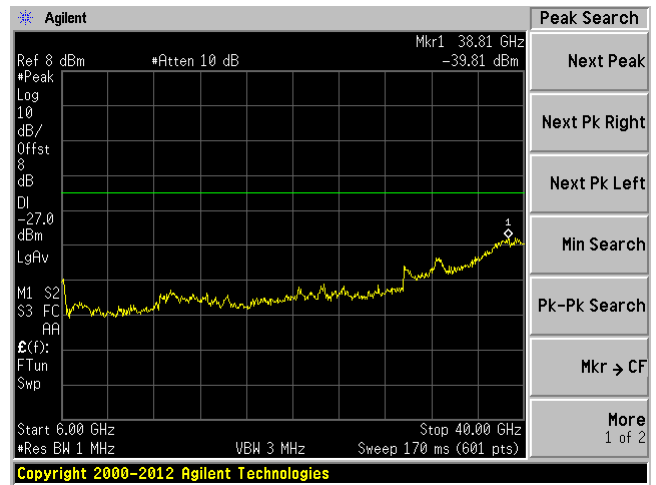

C4 30 MHz-6 GHz

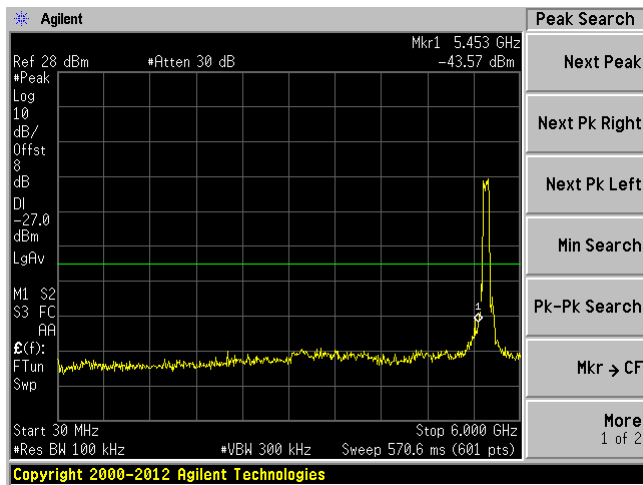

C4 6 GHz-40 GHz

