



FCC PART 15.407
DYNAMIC FREQUENCY SELECTION
TEST AND MEASUREMENT REPORT

For

Mimosa Networks

300 Orchard City Dr., Suite 100, Campbell, CA 95008, USA

FCC ID: 2ABZJ-100-00014

Report Type: Original Report	Equipment Type: Point-to-Point Device
Prepared By: Chen Ge	<i>Chen Ge</i>
Report Number: R1404042-DFS	
Report Date: 2014-10-27	
Reviewed By: Bo Li Test Engineer	<i>Bo Li</i>
Bay Area Compliance Laboratories Corporation (BACL) 1274 Anvilwood Avenue, Sunnyvale, CA 94089, USA Tel: (408) 732-9162 Fax: (408) 732-9164	

Note: This test report is prepared for the customer shown above and for the device described herein. It may not be duplicated or used in part without prior written consent from Bay Area Compliance Laboratories Corp. This report **must not** be used by the customer to claim product certification, approval, or endorsement by A2LA* or any agency of the Federal Government.

* This report may contain data that are not covered by the A2LA accreditation and are marked with an asterisk "*" (b)(7)

TABLE OF CONTENTS

1	GENERAL DESCRIPTION.....	5
1.1	PRODUCT DESCRIPTION FOR EQUIPMENT UNDER TEST (EUT).....	5
1.2	MECHANICAL DESCRIPTION OF EUT.....	5
1.3	OBJECTIVE.....	5
1.4	RELATED SUBMITTAL(S)/GRANT(S).....	5
1.5	TEST METHODOLOGY.....	5
1.6	TEST FACILITY.....	6
2	EUT TEST CONFIGURATION.....	8
2.1	JUSTIFICATION.....	8
2.2	EUT EXERCISE SOFTWARE.....	8
2.3	EQUIPMENT MODIFICATIONS.....	8
2.4	LOCAL SUPPORT EQUIPMENT.....	8
2.5	INTERFACE PORTS AND CABLING.....	8
2.6	POWER SUPPLY AND LINE FILTERS.....	8
2.7	EUT INTERNAL CONFIGURATIONS.....	8
3	SUMMARY OF TEST RESULTS.....	9
4	APPLICABLE STANDARDS.....	10
4.1	DFS REQUIREMENT.....	10
4.2	DFS MEASUREMENT SYSTEM.....	13
4.3	SYSTEM BLOCK DIAGRAM.....	13
4.4	CONDUCTED METHOD.....	14
4.5	RADIATED METHOD.....	15
4.6	TEST PROCEDURE.....	15
5	TEST RESULTS.....	16
5.1	DESCRIPTION OF EUT.....	16
5.2	TEST EQUIPMENT LIST AND DETAILS.....	17
5.3	RADAR WAVEFORM CALIBRATION.....	17
5.4	TEST ENVIRONMENTAL CONDITIONS.....	17
6	CHANNEL AVAILABILITY CHECK TIME (CAC).....	26
6.1	TEST PROCEDURE.....	26
7	CHANNEL MOVE TIME AND CHANNEL CLOSING TRANSMISSION TIME.....	39
7.1	TEST PROCEDURE.....	39
7.2	TEST RESULTS.....	39
8	NON-OCCUPANCY PERIOD.....	52
8.1	TEST PROCEDURE.....	52
8.2	TEST RESULTS.....	52
9	RADAR DETECTION BANDWIDTH & RADAR DETECTION PERFORMANCE CHECK.....	55
9.1	DETECTION BANDWIDTH.....	55
9.2	RADAR DETECTION PERFORMANCE CHECK.....	60
10	EXHIBIT A – TEST SETUP PHOTOGRAPHS.....	191
10.1	DFS TEST SETUP VIEW.....	191
11	EXHIBIT B – EUT PHOTOGRAPHS.....	192
11.1	EUT – TOP VIEW.....	192

11.2	EUT – BOTTOM VIEW	192
11.3	EUT – SIDE VIEW	193
11.4	0 dBi ANTENNA VIEW	193
11.5	25 dBi ANTENNA VIEW	194
11.6	EUT – POE TOP VIEW	194

DOCUMENT REVISION HISTORY

Revision Number	Report Number	Description of Revision	Date of Revision
0	R1404042-DFS	Original Report	2014-09-08
1	R1404042-DFS	Removed Internal Photos	2014-10-27

1 General Description

1.1 Product Description for Equipment under Test (EUT)

This test and measurement report was prepared on behalf of *Mimosa Networks*, and their product model: *B5c*, *FCC ID: 2ABZJ-100-00014*, which will henceforth be referred to as the “EUT” (Equipment under Test) in this report. The EUT is a point-to-point device operates in 5 GHz bands.

1.2 Mechanical Description of EUT

The EUT measures approximately 17.3 cm (L) x 17.3 cm (W) x 7.3 cm (H) and weighs 3.2 kg.

The test data gathered are from typical production sample, serial number: 13461M0028 assigned by manufacturer.

1.3 Objective

This report is prepared on behalf of *Mimosa Networks* in accordance with FCC CFR47 §15.407 (h), and KDB: 905462 D02 UNII DFS Compliance Procedures New Rules v01r01

The objective is to determine compliance with FCC rules for DFS Detection Threshold, Channel Availability Check Time, Uniform Spreading U-NII Detection Bandwidth, Channel Closing Transmission Time, and Channel Move time in Master Mode.

1.4 Related Submittal(s)/Grant(s)

N/A

1.5 Test Methodology

FCC CFR 47 Part2, Part15.407 (h)

KDB: 905462 D02 UNII DFS Compliance Procedures New Rules v01r01

COMPLIANCE MEASUREMENT PROCEDURES FOR UNLICENSED-NATIONAL
INFORMATION INFRASTRUCTURE DEVICES OPERATING IN THE 5250-5350 MHz
AND 5470-5725 MHz BANDS INCORPORATING DYNAMIC FREQUENCY
SELECTION

1.6 Test Facility

Bay Area Compliance Laboratories Corp. (BACL) is:

1- An independent Commercial Test Laboratory accredited to **ISO 17025: 2005** by **A2LA**, in the fields of: Electromagnetic Compatibility & Telecommunications covering Emissions, Immunity, Radio, RF Exposure, Safety and Telecom. This includes NEBS (Network Equipment Building System), Wireless RF, Telecommunications Terminal Equipment (TTE); Network Equipment; Information Technology Equipment (ITE); Medical Electrical Equipment; Industrial, Commercial, and Medical Test Equipment; Professional Audio and Video Equipment; Electronic (Digital) Products; Industrial and Scientific Instruments; Cabled Distribution Systems and Energy Efficiency Lighting.

2- An ENERGY STAR Recognized Laboratory, for the LM80 Testing, a wide variety of Luminaires and Computers.

3- A NIST Designated Phase-I and Phase-II CAB including: ACMA (Australian Communication and Media Authority), BSMI (Bureau of Standards, Metrology and Inspection of Taiwan), IDA (Infocomm Development Authority of Singapore), IC (Industry Canada), Korea (Ministry of Communications Radio Research Laboratory), NCC (Formerly DGT; Directorate General of Telecommunication of Chinese Taipei) OFTA (Office of the Telecommunications Authority of Hong Kong), Vietnam, VCCI - Voluntary Control Council for Interference of Japan and a designated EU CAB (Conformity Assessment Body) (Notified Body) for the EMC and R&TTE Directives.

4 - A Product Certification Body accredited to **ISO Guide 65: 1996** by **A2LA** to certify:

1- Unlicensed, Licensed radio frequency devices and Telephone Terminal Equipment for the FCC. Scope A1, A2, A3, A4, B1, B2, B3, B4 & C.

2. Radio Standards Specifications (RSS) in the Category I Equipment Standards List and All Broadcasting Technical Standards (BETS) in Category I Equipment Standards List for Industry Canada.

3. Radio Communication Equipment for Singapore.

4. Radio Equipment Specifications, GMDSS Marine Radio Equipment Specifications, and Fixed Network Equipment Specifications for Hong Kong.

5. Japan MIC Telecommunication Business Law (A1, A2) and Radio Law (B1, B2 and B3).

6. Audio/Video, Battery Charging Systems, Computers, Displays, Enterprise Servers, Imaging Equipment, Set-Top Boxes, Telephony, Televisions, Ceiling Fans, CFLs (including GU24s), Decorative Light Strings, Integral LED Lamps, Luminaires, Residential Ventilating Fans.

The test site used by BACL Corp. to collect radiated and conducted emissions measurement data is located at its facility in Sunnyvale, California, USA.

The test site at BACL Corp. has been fully described in reports submitted to the Federal Communication Commission (FCC) and Voluntary Control Council for Interference (VCCI). The details of these reports have been found to be in compliance with the requirements of Section 2.948 of the FCC Rules on February 11 and December 10, 1997, and Article 8 of the VCCI regulations on December 25, 1997. The test site also complies with the test methods and procedures set forth in CISPR 22:2008 §10.4 for measurements below 1 GHz and §10.6 for measurements above 1 GHz, as well as ANSI C63.4-2009, ANSI C63.4-2009, TIA/EIA-603 & CISPR 24: 2010.

The Federal Communications Commission and Voluntary Control Council for Interference have the reports on file and they are listed under FCC registration number: 90464 and VCCI Registration No.: A-0027. The test site has been approved by the FCC and VCCI for public use and is listed in the FCC Public Access Link (PAL) database.

Additionally, BACL Corp. is an American Association for Laboratory Accreditation (A2LA) accredited laboratory (Lab Code 3297-02). The current scope of accreditations can be found at

<http://www.a2la.org/scopepdf/3297-02.pdf?CFID=1132286&CFTOKEN=e42a3240dac3f6ba-6DE17DCB-1851-9E57-477422F667031258&jsessionid=8430d44f1f47cf2996124343c704b367816b>

2 EUT TEST CONFIGURATION

2.1 Justification

The EUT was configured for testing according to FCC Part 15.407(H), and KDB: 905462 D02 UNII DFS Compliance Procedures New Rules v01r01

2.2 EUT Exercise Software

The test utility used version was 00.10.00-5 was provided by *Mimosa Networks.*, and was verified *Chen Ge* to comply with the standard requirements being tested against.

2.3 Equipment Modifications

N/A

2.4 Local Support Equipment

Manufacturers	Description	Models	Serial Number
Lenovo	Laptop	T530	PK-0XD9H

2.5 Interface Ports and Cabling

Cable Description	Length (M)	From	To
RF Cable	<1.0	PSA	EUT

2.6 Power Supply and Line Filters

Manufacturer	Description	Model Number	Serial Number
Fortune Power	AC/DC Adaptor of POE	GRT 480125A	130669328

2.7 EUT Internal Configurations

Manufacturers	Descriptions	Models	Serial Numbers
Mimosa Networks	Main PCB Board	B5	1346101000017

3 Summary of Test Results

The following result table represents the list of measurements required under the CFR47 §47 Part15.407 (h), and KDB: 905462 D02 UNII DFS Compliance Procedures New Rules v01r01

Items	Description of Test	Results
Detection Bandwidth	UNII Detection Bandwidth	Compliant
Performance Requirements Check	Initial Channel Availability Check Time (CAC)	Compliant
	Radar Burst at the Beginning of the CAC	Compliant
	Radar Burst at the End of the CAC	Compliant
In-Service Monitoring	Channel Move Time	Compliant
	Channel Closing Transmission Time	Compliant
	Non-Occupancy Period	Compliant
Radar Detection	Statistical Performance Check	Compliant

4 Applicable Standards

4.1 DFS Requirement

FCC CFR47 §15.407 (h), and KDB: 905462 D02 UNII DFS Compliance Procedures New Rules v01r01

Table 1: Applicability of DFS requirements prior to use of a channel

Requirement	Operational Mode		
	Master	Client (Without radar detection)	Client (With radar detection)
Non-Occupancy Period	Yes	Not Required	Yes
DFS Detection Threshold	Yes	Not Required	Yes
Channel Availability Check Time	Yes	Not Required	Not Required
U-NII Detection Bandwidth	Yes	Not Required	Yes

Table 2: Applicability of DFS requirements during normal operation

Requirement	Operational Mode	
	Master Device or Client with Radar Detection	Client Without Radar Detection
DFS Detection Threshold	Yes	Not Required
Channel Closing Transmission Time	Yes	Yes
Channel Move Time	Yes	Yes
U-NII Detection Bandwidth	Yes	Not Required

Additional requirements for devices with multiple bandwidth modes	Master Device or Client with Radar Detection	Client Without Radar Detection
U-NII Detection Bandwidth and Statistical Performance Check	All BW modes must be tested	Not required
Channel Move Time and Channel Closing Transmission Time	Test using widest BW mode available	Test using the widest BW mode available for the link
All other tests	Any single BW mode	Not required
Note: Frequencies selected for statistical performance check (Section 7.8.4) should include several frequencies within the radar detection bandwidth and frequencies near the edge of the radar detection bandwidth. For 802.11 devices it is suggested to select frequencies in each of the bonded 20 MHz channels and the channel center frequency.		

Table 3: Interference Threshold values, Master or Client incorporating In-Service Monitoring

Maximum Transmit Power	Value (See Notes 1, 2 and 3)
EIRP \geq 200 milliwatt	-64 dBm
EIRP < 200 milliwatt and power spectral density < 10dBm/MHz	-62 dBm
EIRP < 200 milliwatt that do not meet the power spectral density requirement	-64 dBm

Note 1: This is the level at the input of the receiver assuming a 0 dBi receive antenna.
Note 2: Throughout these test procedures an additional 1 dB has been added to the amplitude of the test transmission waveforms to account for variations in measurement equipment. This will ensure that the test signal is at or above the detection threshold level to trigger a DFS response.
Note 3: EIRP is based on the highest antenna gain. For MIMO devices refer to KDB Publication 662911 D01.

Table 4: DFS Response Requirement Values

Parameter	Value
Non-occupancy period	Minimum 30 minutes
Channel Availability Check Time	60 seconds
Channel Move Time	10 seconds See Note 1.
Channel Closing Transmission Time	200 milliseconds + an aggregate of 60 milliseconds over remaining 10 second period. See Notes 1 and 2.
U-NII Detection Bandwidth	Minimum 100% of the UNII 99% transmission power bandwidth. See Note 3.

Note 1: The instant that the *Channel Move Time* and the *Channel Closing Transmission Time* begins is as follows:

- For the Short Pulse Radar Test Signals this instant is the end of the *Burst*.
- For the Frequency Hopping radar Test Signal, this instant is the end of the last radar *Burst* generated.
- For the Long Pulse Radar Test Signal this instant is the end of the 12 second period defining the *Radar Waveform*.

Note 2: The *Channel Closing Transmission Time* is comprised of 200 milliseconds starting at the beginning of the *Channel Move Time* plus any additional intermittent control signals required to facilitate a *Channel* move (an aggregate of 60 milliseconds) during the remainder of the 10 second period. The aggregate duration of control signals will not count quiet periods in between transmissions.

Note 3: During the *U-NII Detection Bandwidth* detection test, radar type 0 is used and for each frequency step the minimum percentage of detection is 90 percent. Measurements are performed with no data traffic.

Table 5: Short Pulse Radar Test Waveforms

Radar Type	Pulse Width (Microseconds)	PRI (Microseconds)	Pulses	Minimum Percentage of Successful Detection	Minimum Number of Trials
0	1	1428	18	See Note 1	See Note 1
1	1	Test A: 15 unique PRI values randomly selected from the list of 23 PRI values in Table 5a Test B: 15 unique PRI values randomly selected within the range of 518-3066 μ sec, with a minimum increment of 1 μ sec, excluding PRI values selected in Test A	$\text{Roundup} \left(\frac{\left(\frac{1}{360} \right) \cdot \left(\frac{19 \cdot 10^6}{\text{PRI}_{\mu\text{sec}}} \right)}{1} \right)$	60%	30
2	1-5	150-230	23-29	60%	30
3	6-10	200-500	16-18	60%	30
4	11-20	200-500	12-16	60%	30
Aggregate (Radar Types 1-4)				80%	120
Note 1: Short Pulse Radar Type 0 should be used for the detection bandwidth test, channel move time, and channel closing time tests.					

Table 6: Long Pulse Radar Test Signal

Radar Type	Bursts	Chirp Width (MHz)	PRI (usec)	Number of Pulses per Burst	Number of Bursts	Minimum Percentage of Successful Detection	Minimum Number of Trials
5	50-100	5-20	1000-2000	1-3	8-20	80%	30

Table 7: Frequency Hopping Radar Test Signal

Radar Type	Pulse Width (usec)	PRI (usec)	Pulses per Hop	Hopping Rate (kHz)	Hopping Sequence Length (msec)	Minimum Percentage of Successful Detection	Minimum Number of Trials
6	1	333	9	0.333	300	70%	30

4.2 DFS Measurement System

BACL DFS measurement system consists of two subsystems: (1) The radar signal generating subsystem and (2) the traffic monitoring subsystem.

4.3 System Block Diagram

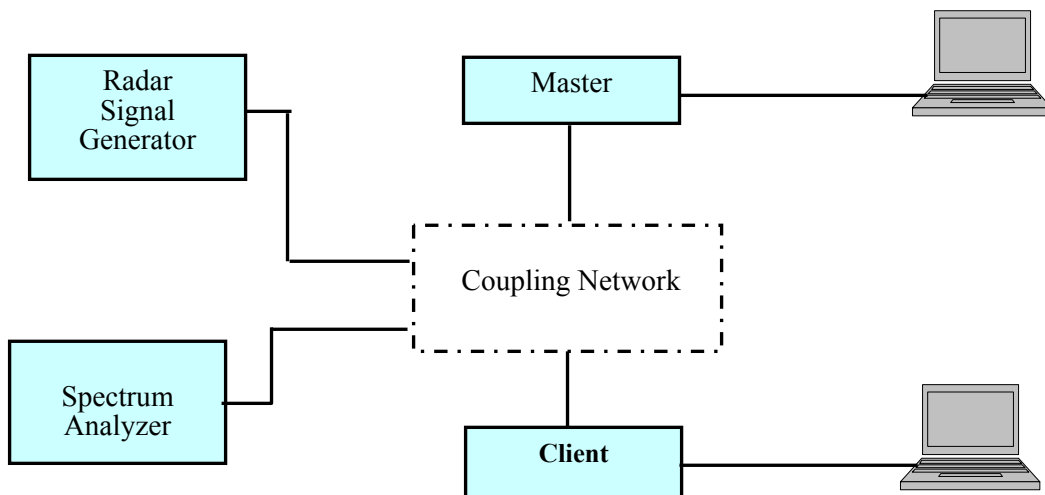

4.4 Conducted Method

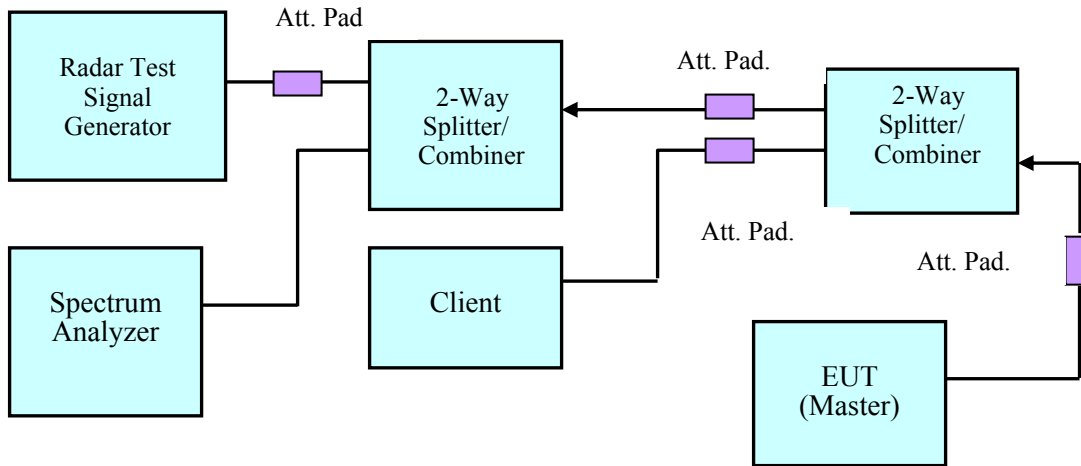

Setup for Master with injection at the Master

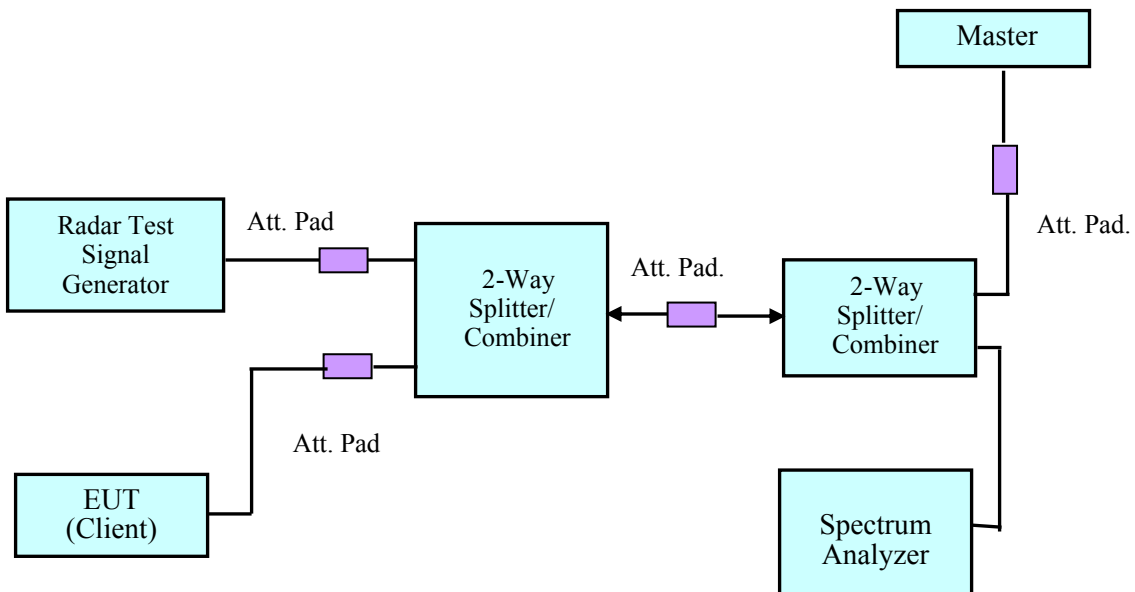

Setup for Client with injection at the Master

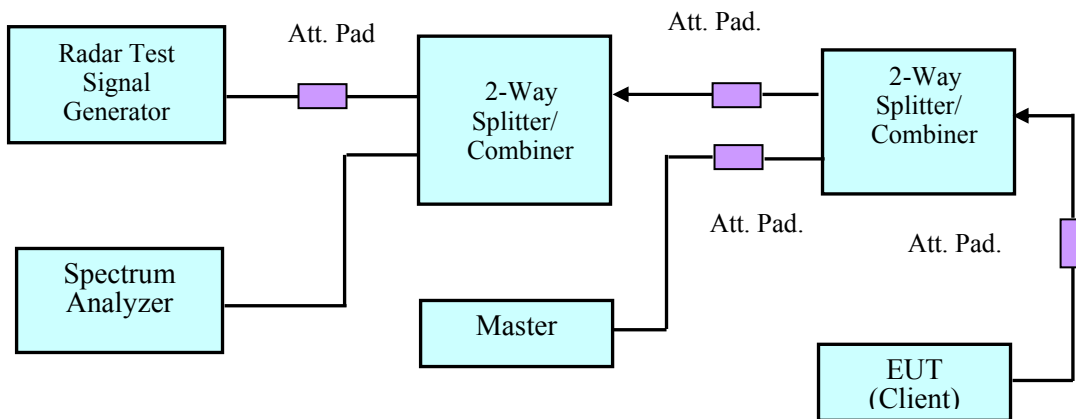

Setup for Client with injection at the Client

4.5 Radiated Method

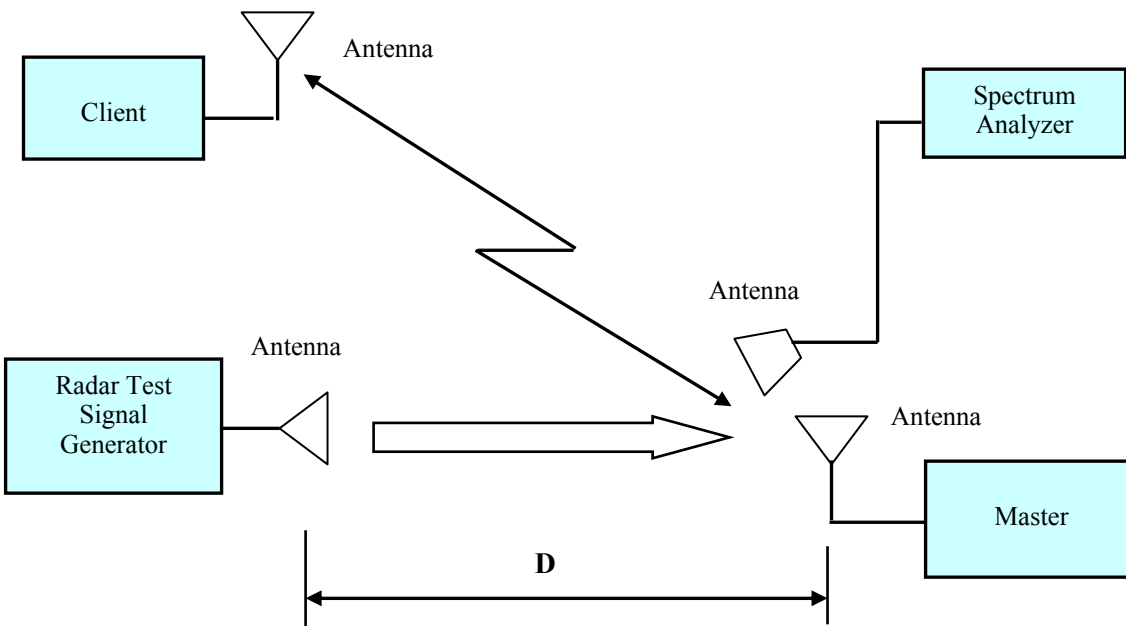

4.6 Test Procedure

A spectrum analyzer is used as a monitor that verifies the EUT's status, which includes the Channel Closing Transmission Time and the Channel Move Time. The Spectrum analyzer is used to monitor the equipment under test (EUT) does not transmit on the same channel during the Non-Occupied Period after the radar detection. It is also used to monitor EUT transmissions during the Channel Availability Check Time.

5 Test Results

5.1 Description of EUT

The EUT operates in 5230-5350 MHz and 5470-5725 MHz range in Master Mode.

0 dBi antenna:

The maximum e.i.r.p of EUT in 5230-5350 MHz 23.54 dBm > 23 dBm (EIRP)

The maximum e.i.r.p of EUT in 5470-5725 MHz 23.34 dBm > 23 dBm (EIRP)

25 dBi antenna:

The maximum e.i.r.p of EUT in 5230-5350 MHz 29.89 dBm > 23 dBm (EIRP)

The maximum e.i.r.p of EUT in 5470-5725 MHz 29.88 dBm > 23 dBm (EIRP)

Therefore the required interference threshold level is -64 dBm, the required radiated threshold at antenna port is -64 dBm.

The calibrated radiated DFS detection threshold level is set to -64 dBm.

WLAN traffic is generated by streaming the video file TestFile.mpg, this file is used by IP and Frame based systems for loading the test channel during the In-service compliance testing of the U-NII device. The file is streamed from the Access Point to the Client in full motion video mode using the media player with the V2.61 Codec package. The BW of the EUT is 20 MHz, 40 MHz and 80 MHz.

The EUT was tested with the 0 dBi gain antenna.

The EUT will not work in 5600-5650 MHz band.

Antenna List:

P/NO	Antenna Gain (dBi)
Center Fed Reflector/Pencil Beam	0
Center Fed Reflector/Pencil Beam	25

5.2 Test Equipment List and Details

Manufacturer	Equipment Description	Model	S/N	Calibration Date
National Instruments	NI PXI-1042 8-Slot chassis	PXI-1042	V08X01EE1	N/A
National Instruments	Arbitrary Waveform Generator	PXI-5421	N/A	N/A
National Instruments	RF Upconverter	PXI-5610	N/A	N/A
ASCOR	Upconverter	AS-7206	N/A	N/A
Agilent	Spectrum Analyzer	E4440A	MY44303352	2013-10-16
A.R.A.	Antenna Horn	DRG-118/A	1132	2014-01-29
EMCO	Antenna Horn	3115	9511-4627	2013-10-17
Mini-Circuits	Splitter/Combiner	2FSC-2-10G	0349	N/A
Narda	Splitter/Combiner	4326B-2	03514	N/A
Midwest	Attenuator	290-30	N/A	N/A
Mini-Circuits	Attenuator	BW-S30W2	N/A	N/A

Statement of Traceability: **BACL Corp.** attests that all calibrations have been performed per the A2LA requirements, traceable to the NIST.

5.3 Radar Waveform Calibration

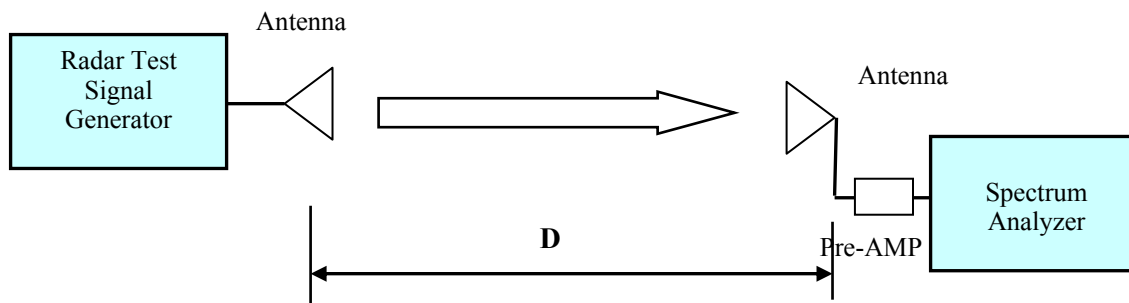

Radiated Calibration Setup Block Diagram

5.4 Test Environmental Conditions

Temperature:	21-23 °C
Relative Humidity:	33-36 %
ATM Pressure:	101-102 kPa

Testing performed by Chen Ge on 2014-08-21 to 2014-08-22 at DFS testing site.

Plots of Radar Waveforms

5280 MHz

Radar Type 0

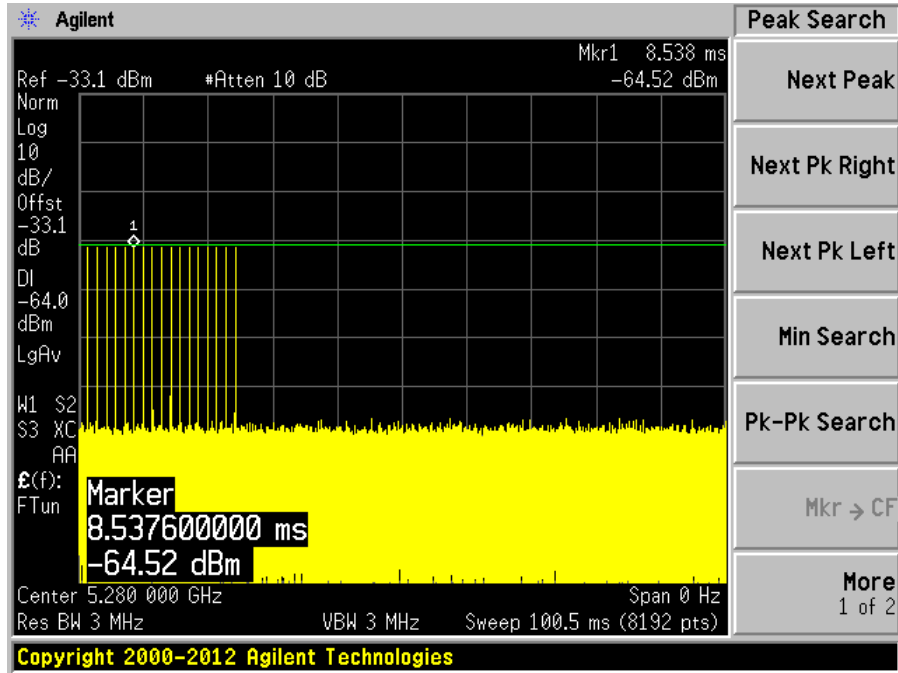

Radar Type 1A

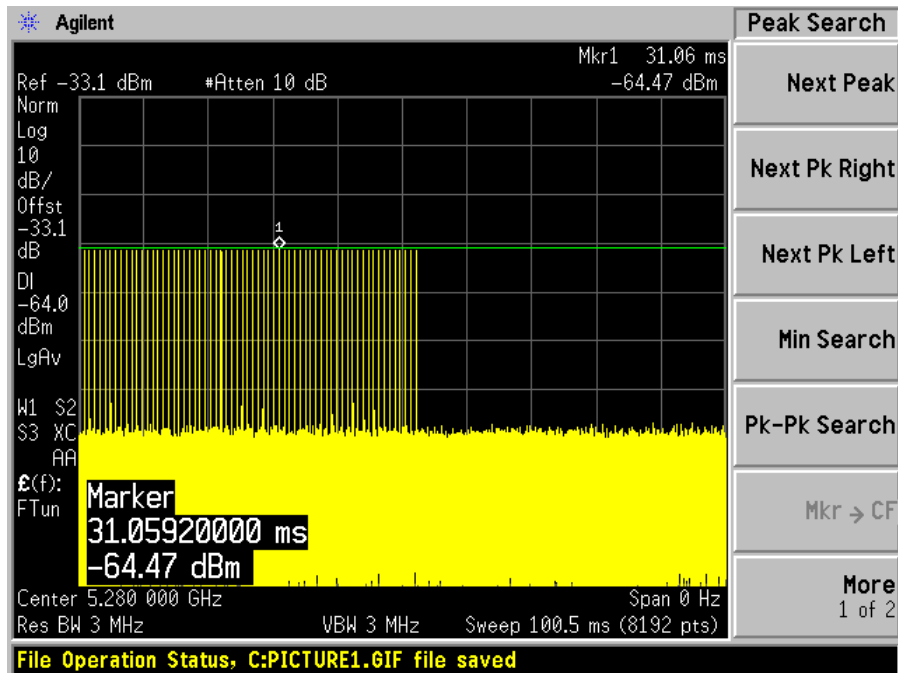

Radar Type 1B

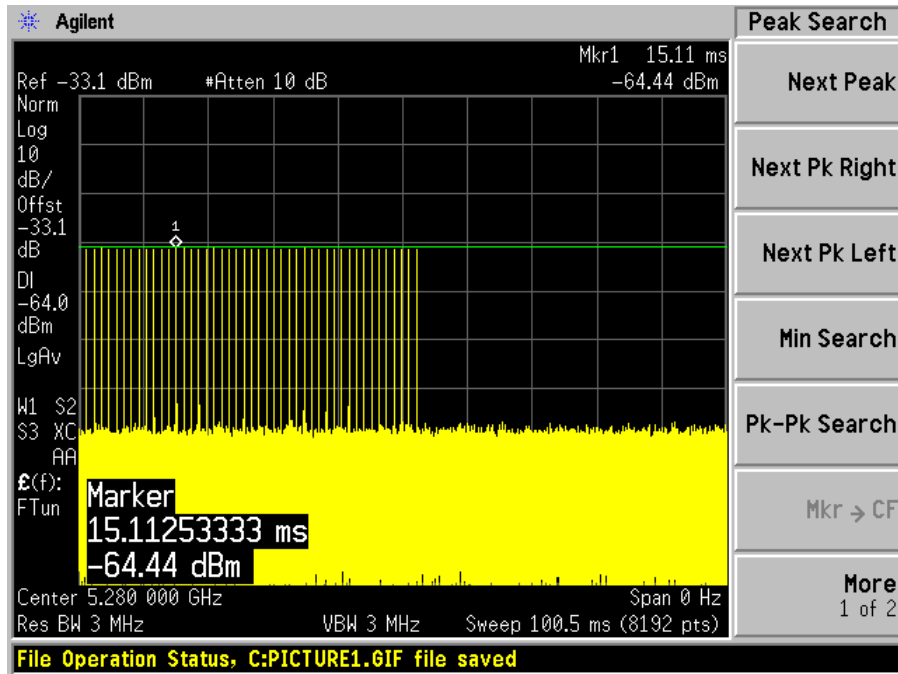

Radar Type 2

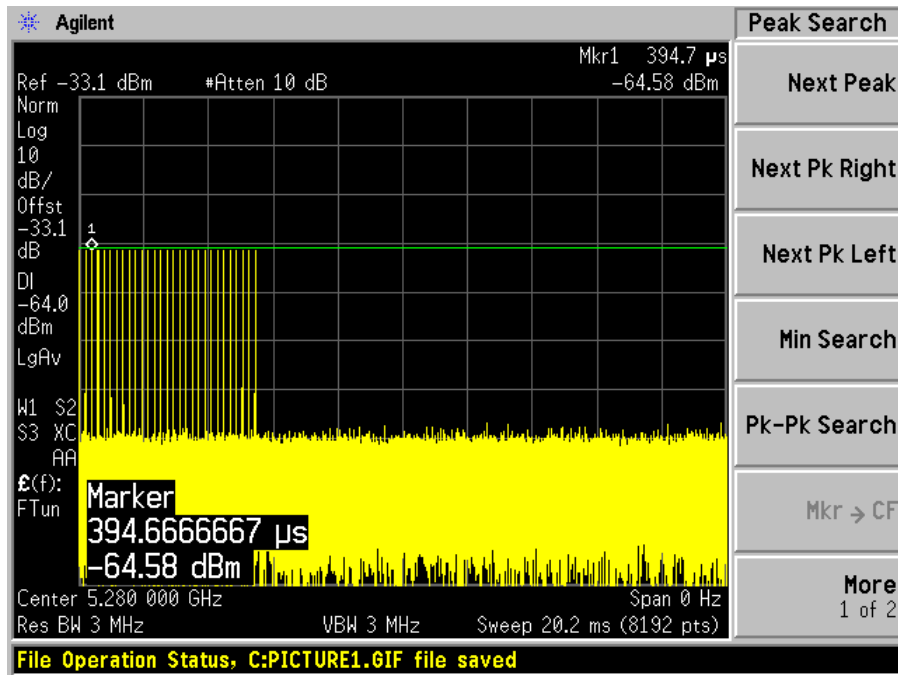

Radar Type 3

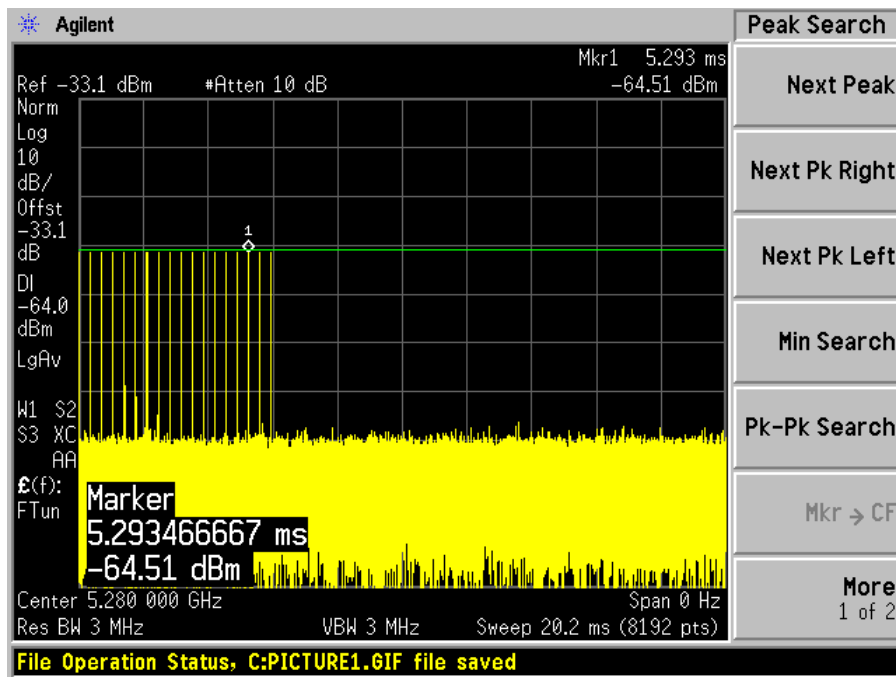

Radar Type 4

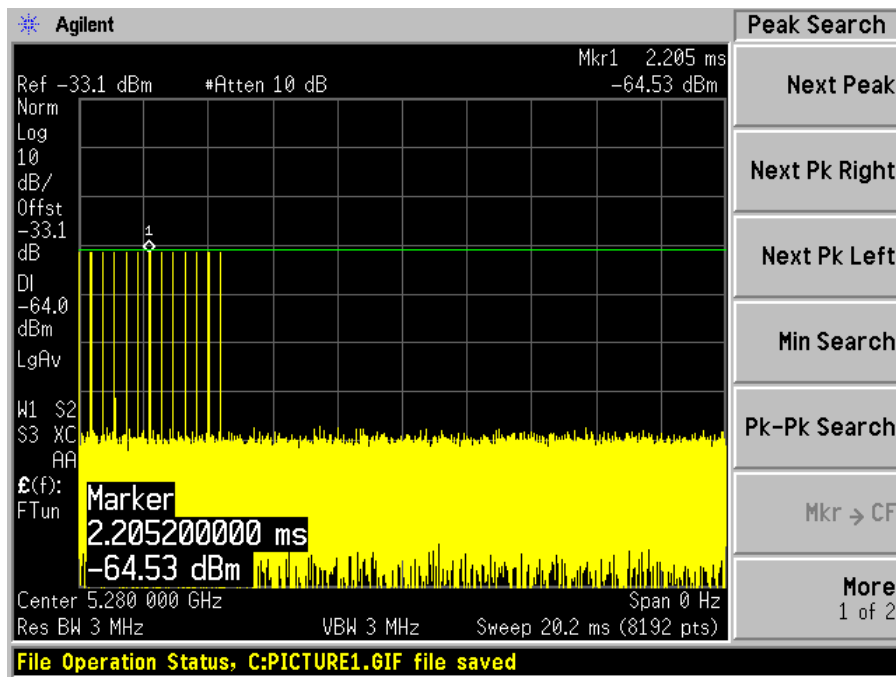

Radar Type 5

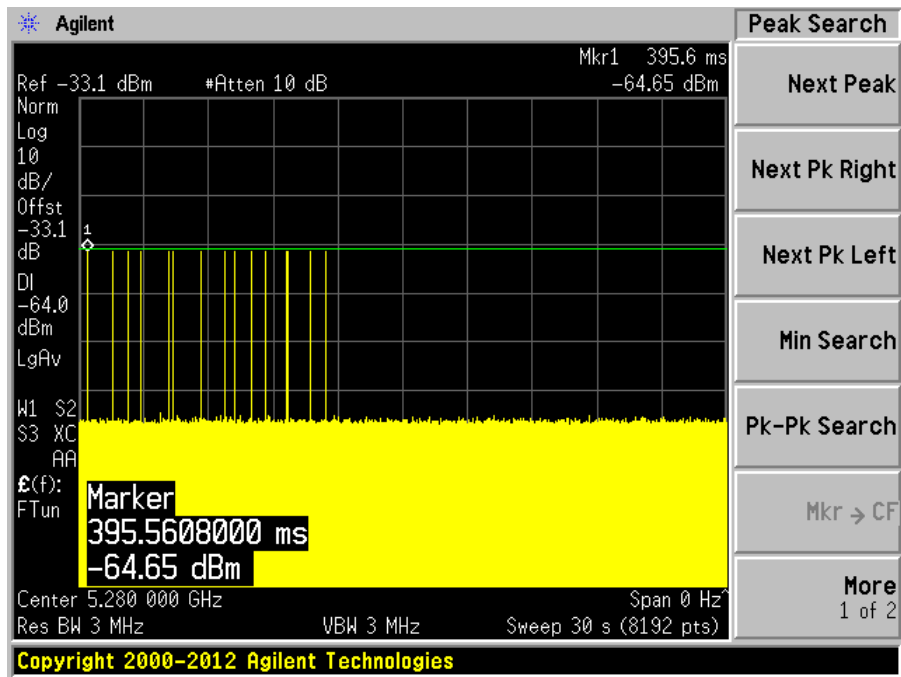

Radar Type 6

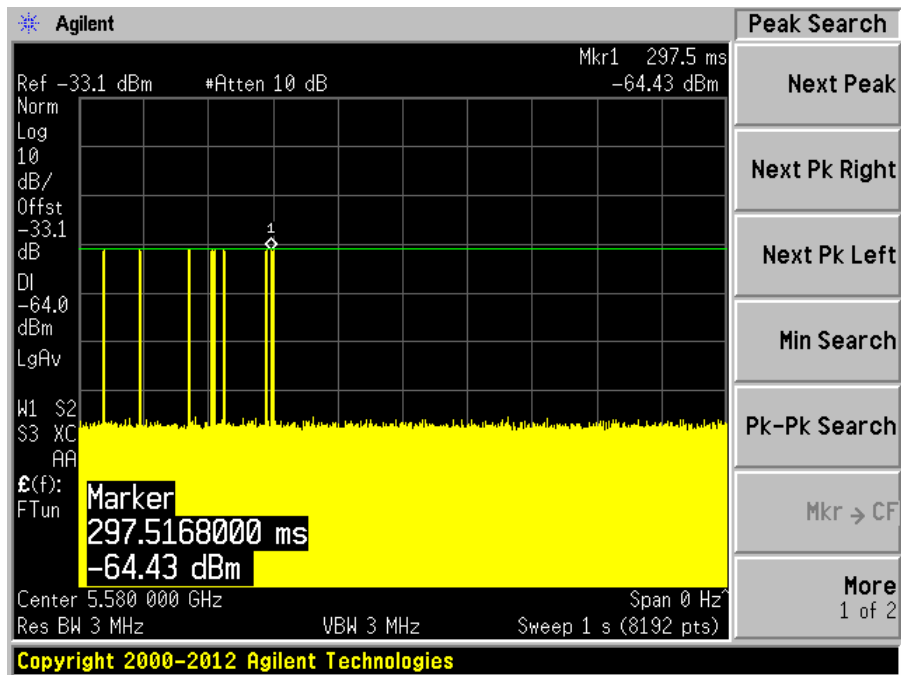

5580 MHz

Radar Type 0

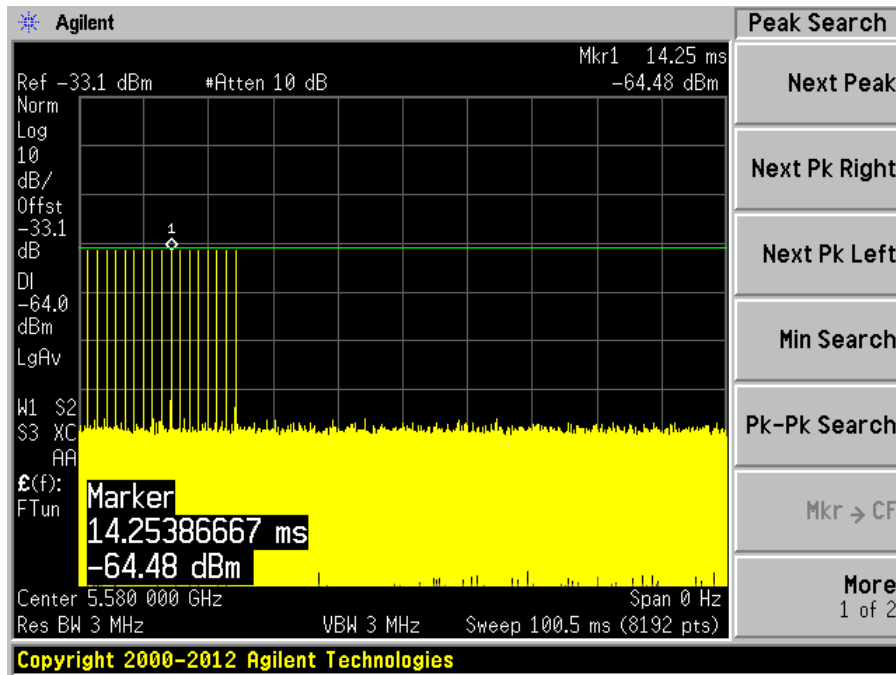

Radar Type 1A

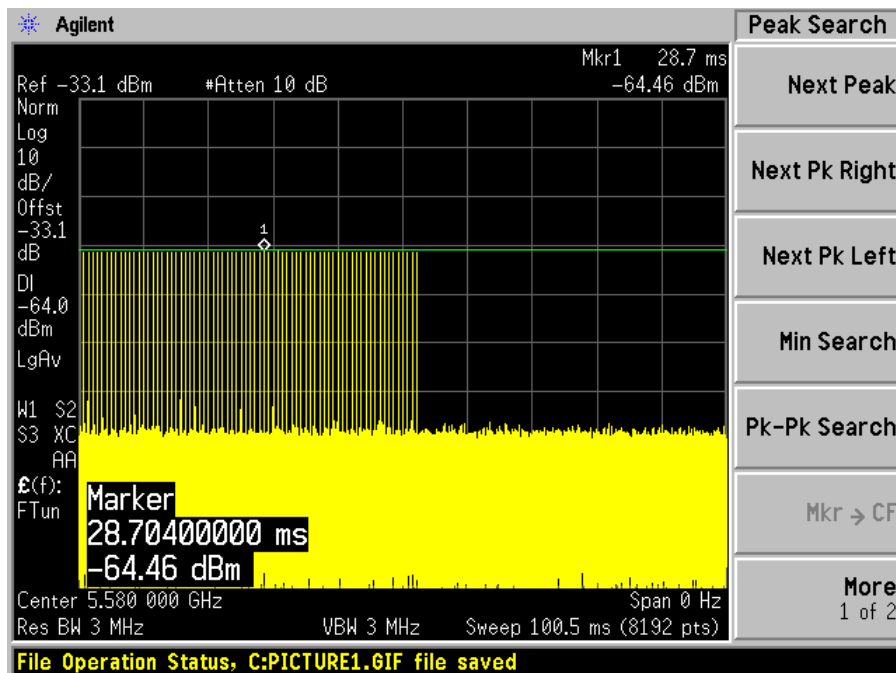

Radar Type 1B

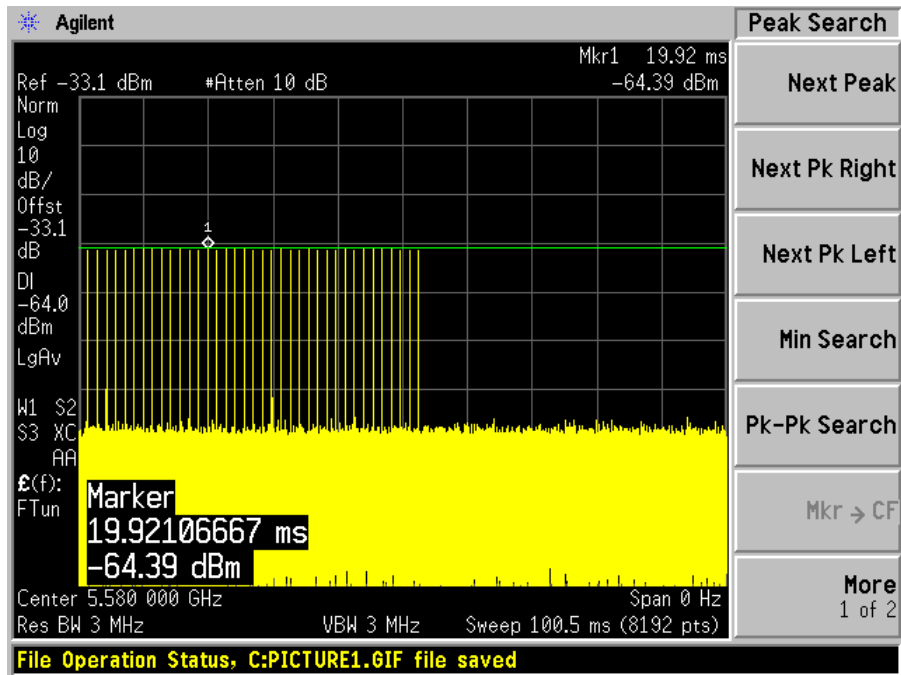

Radar Type 2

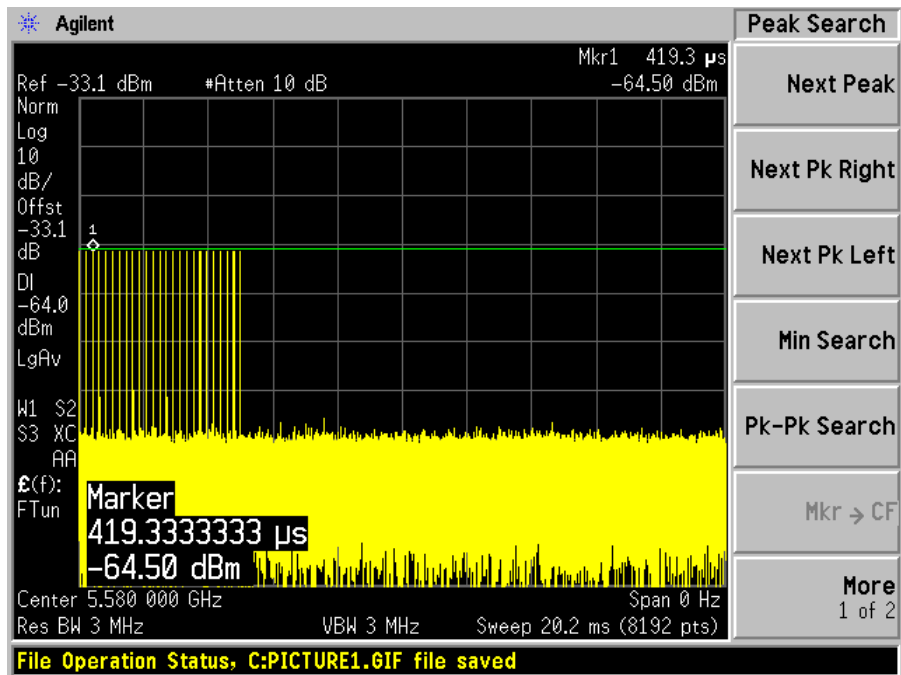

Radar Type 3

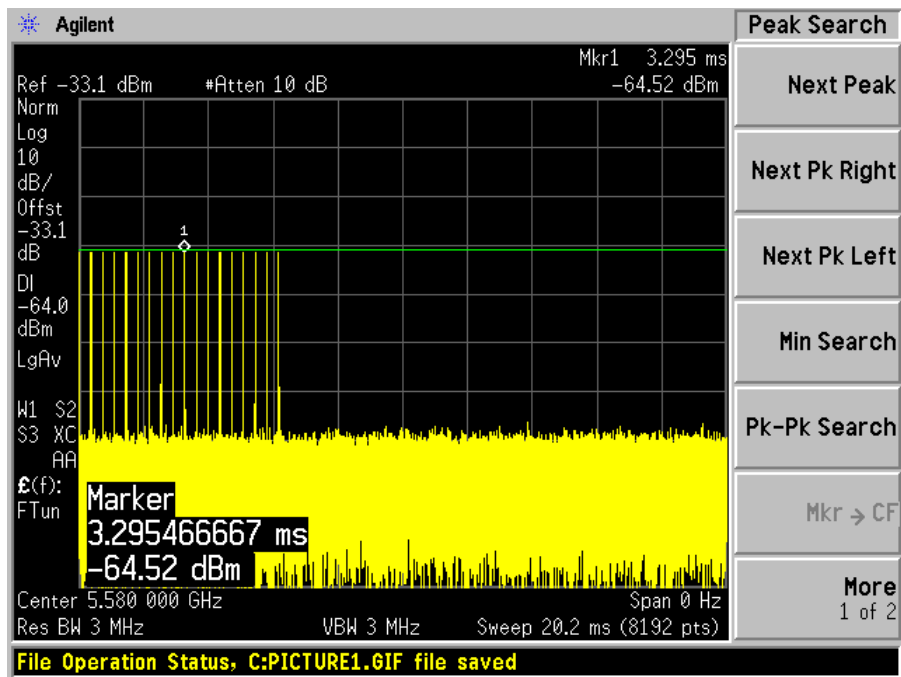

Radar Type 4

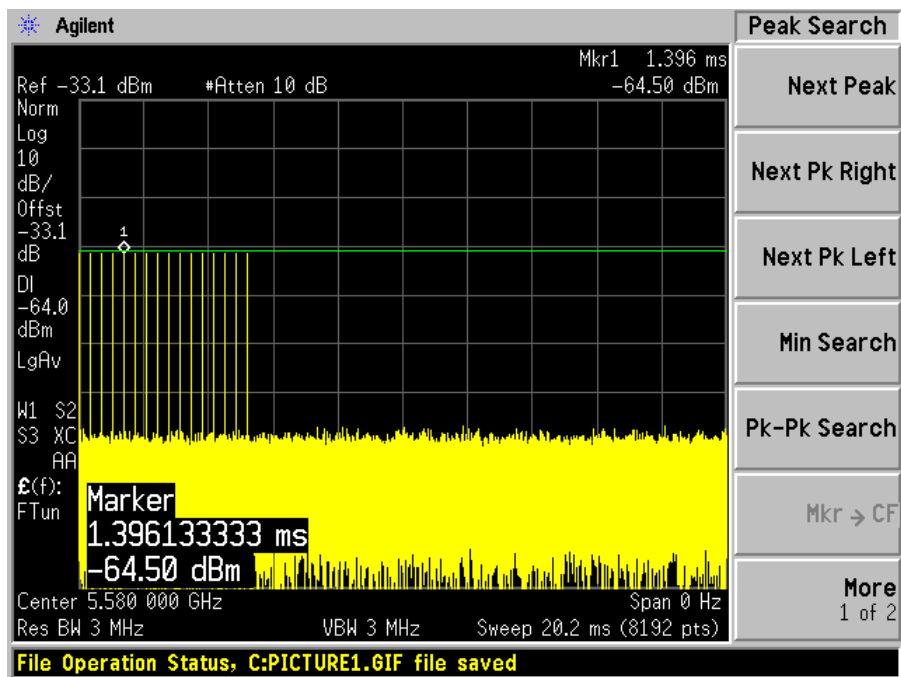

Radar Type 5

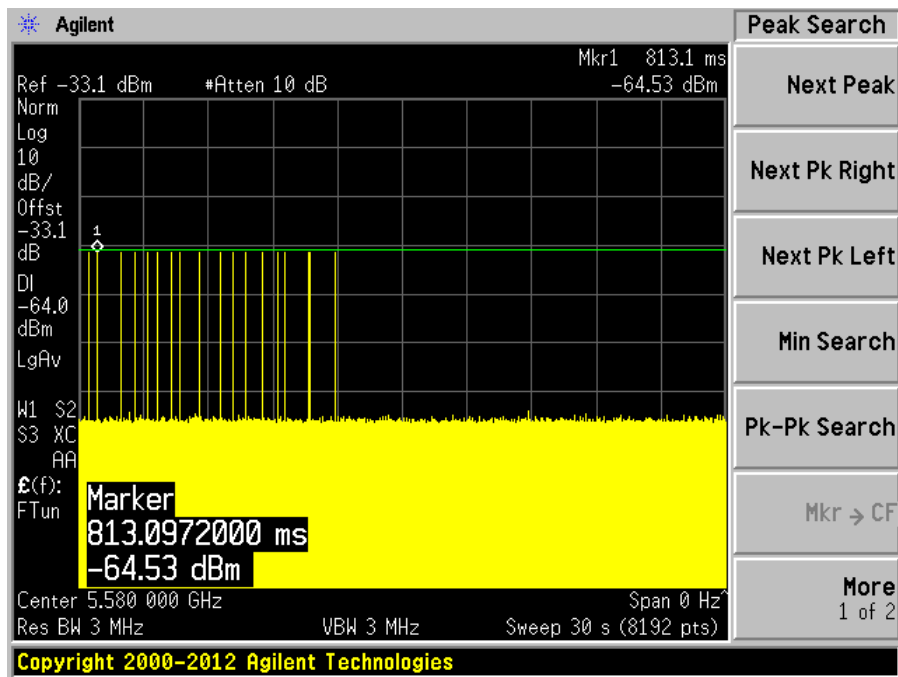

Radar Type 6

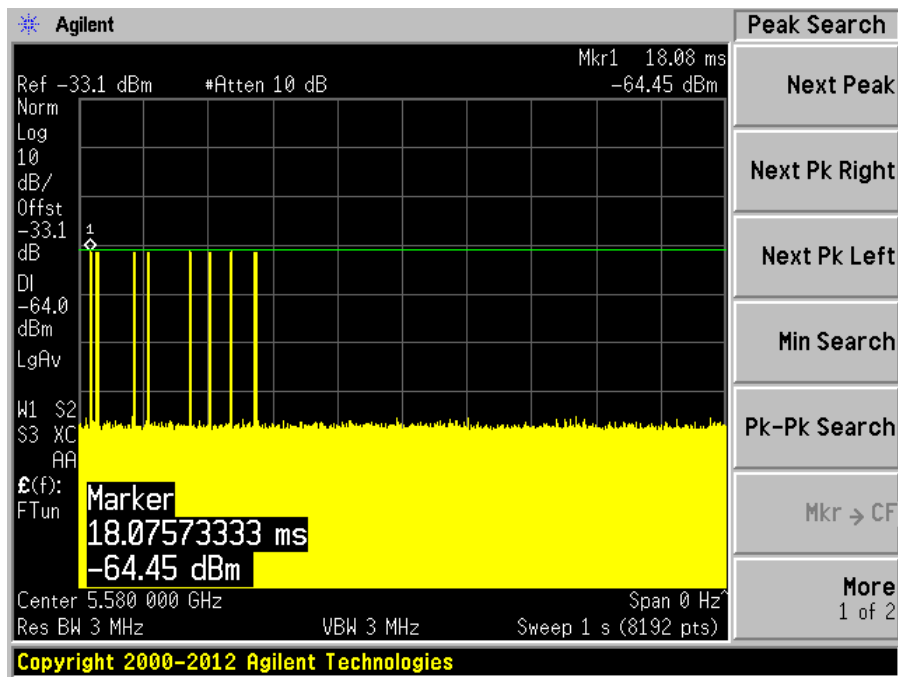

6 Channel Availability Check Time (CAC)

6.1 Test Procedure

- 1) Measure the initial power-up time of EUT.
- 2) With link established on channel, apply a radar signal within 0~6 seconds after the initial power-up period; monitor the transmissions on channel from the spectrum analyzer.
- 3) Reboot EUT, with a link established on channel, apply a radar signal within 54~60 seconds after the initial power-up period, and monitor the transmission on channel from the spectrum analyzer.

EUT Initial power-up Cycle Time

5270 MHz and 5550 MHz Bandwidth 40 MHz

EUT initial Power-up cycle (Second)
43

5290 MHz and 5530 MHz Bandwidth 80 MHz

EUT initial Power-up cycle (Second)
43

Results:

Timing of Radar Burst	Spectrum Analyzer Display
No Radar Triggered	Transmission begin after power-up cycle +60 seconds CAC
Within 2 seconds of the CAC starting	No transmission
Within the last 2 seconds of the CAC	No transmission

Please refer to the following plots.

5270 MHz, Bandwidth 40 MHz

Plot of without Radar signal applied

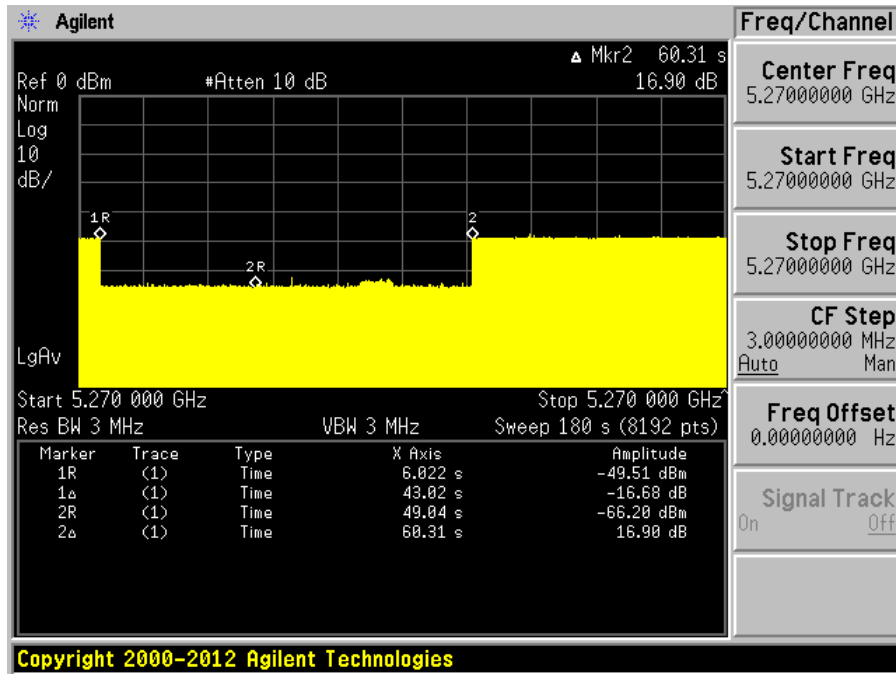

Note: The power-up cycle is 43 seconds.

Plot of Radar signal applied within 2 seconds of start of CAC

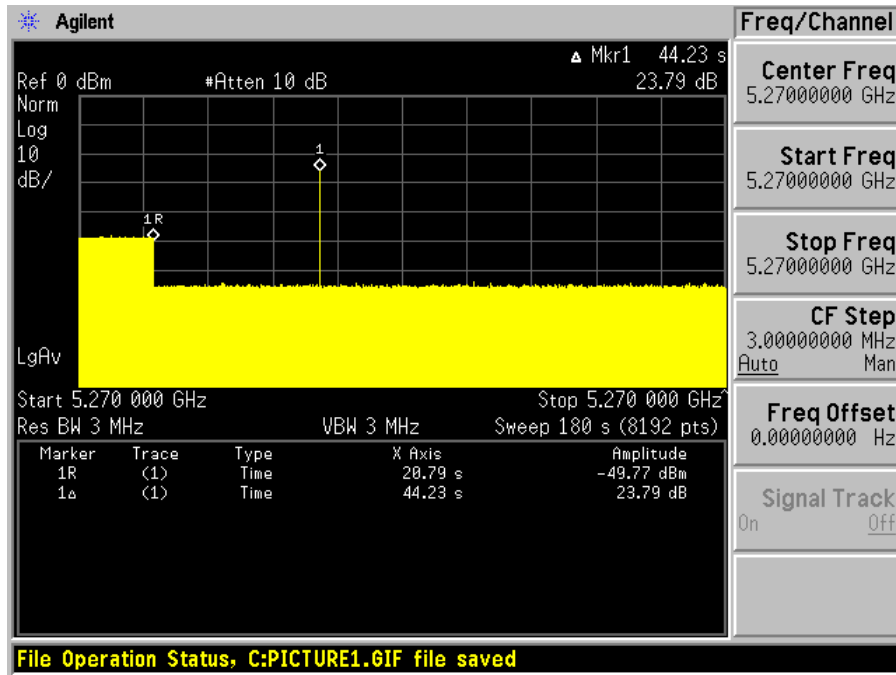

No transmissions found after radar signal applied.

Plot of Radar signal applied at the end of 2 seconds of CAC

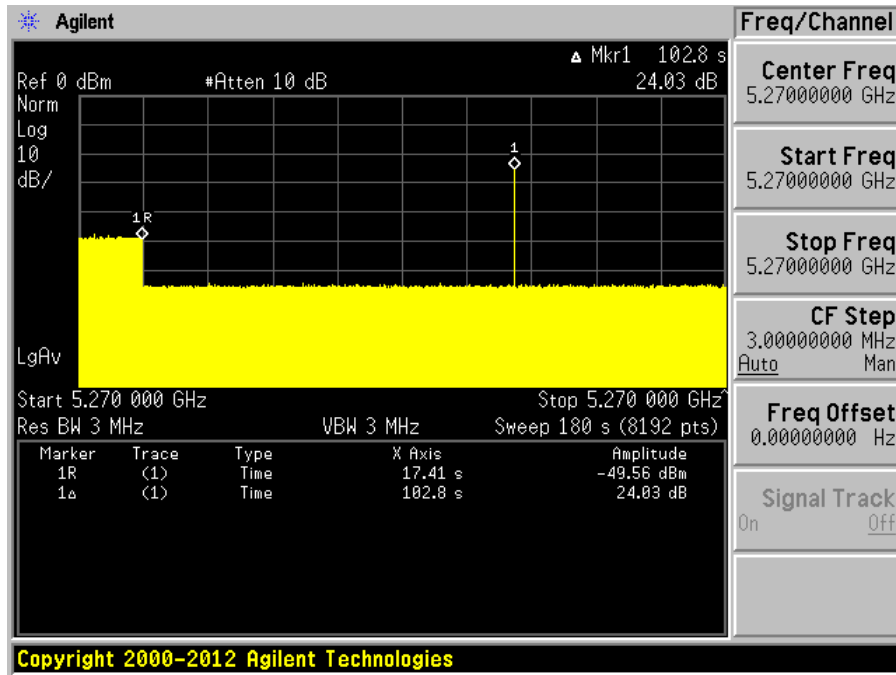

No transmissions found after radar signal applied.

5550 MHz, Bandwidth 40 MHz

Plot of without Radar signal applied

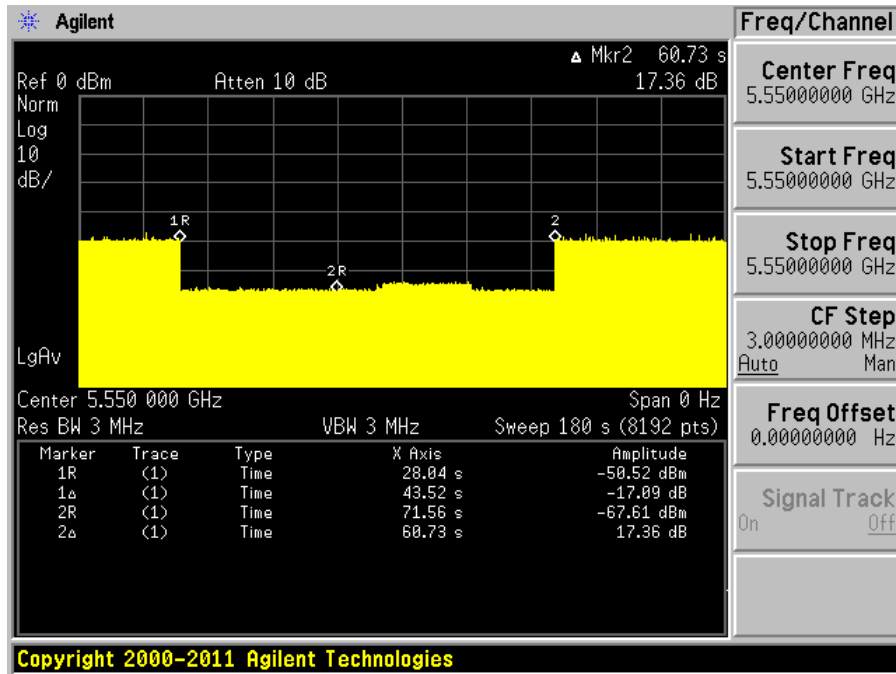

Note: The power-up cycle is 43 seconds.

Plot of Radar signal applied within 2 seconds of start of CAC

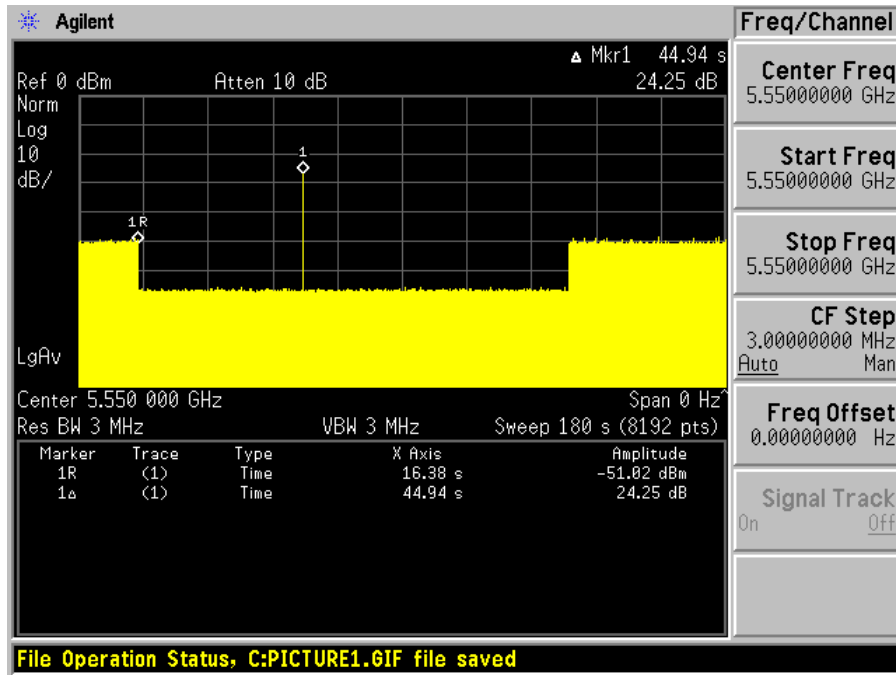

No transmissions found after radar signal applied.

Plot of Radar signal applied at the end of 2 seconds of CAC

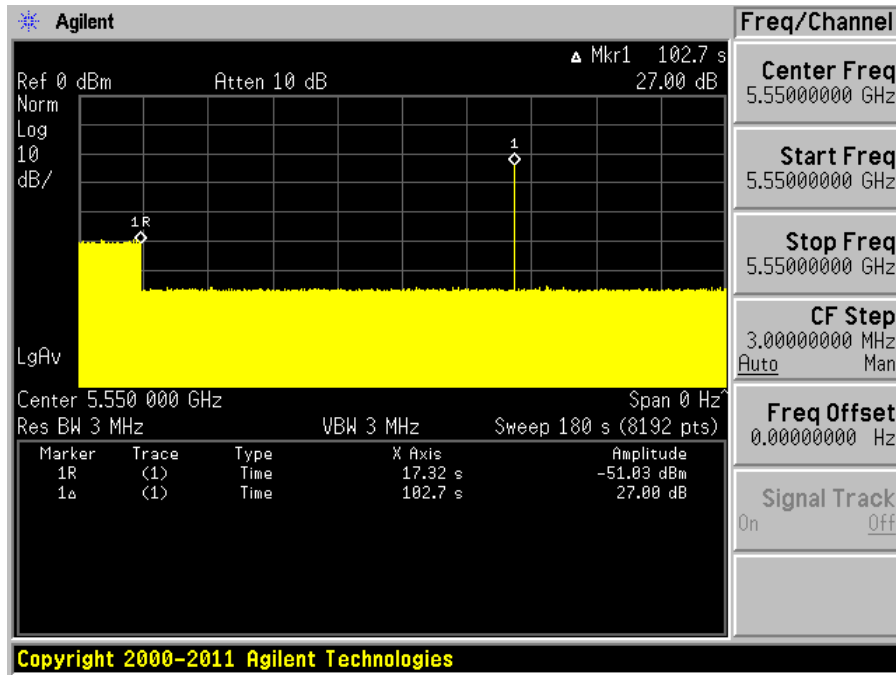

No transmissions found after radar signal applied.

5290 MHz, Bandwidth 80 MHz

Plot of without Radar signal applied

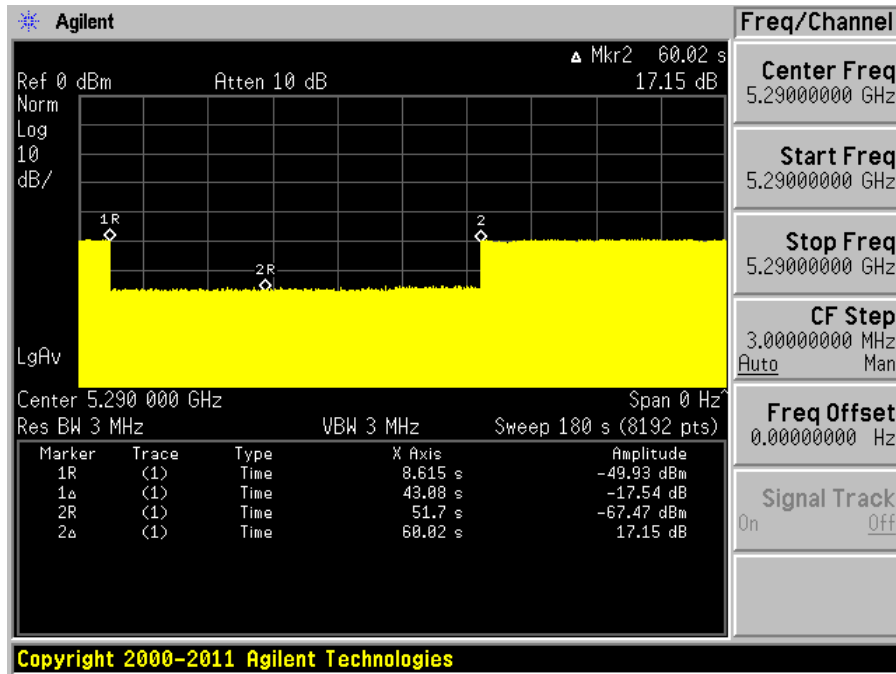

Note: The power-up cycle is 43 seconds.

Plot of Radar signal applied within 2 seconds of start of CAC

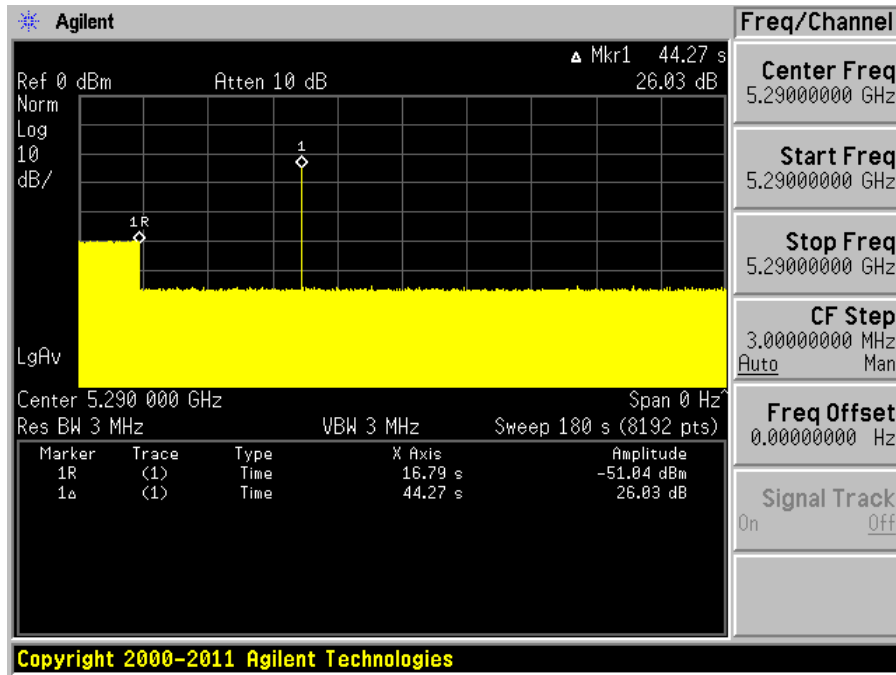

No transmissions found after radar signal applied.

Plot of Radar signal applied at the end of 2 seconds of CAC

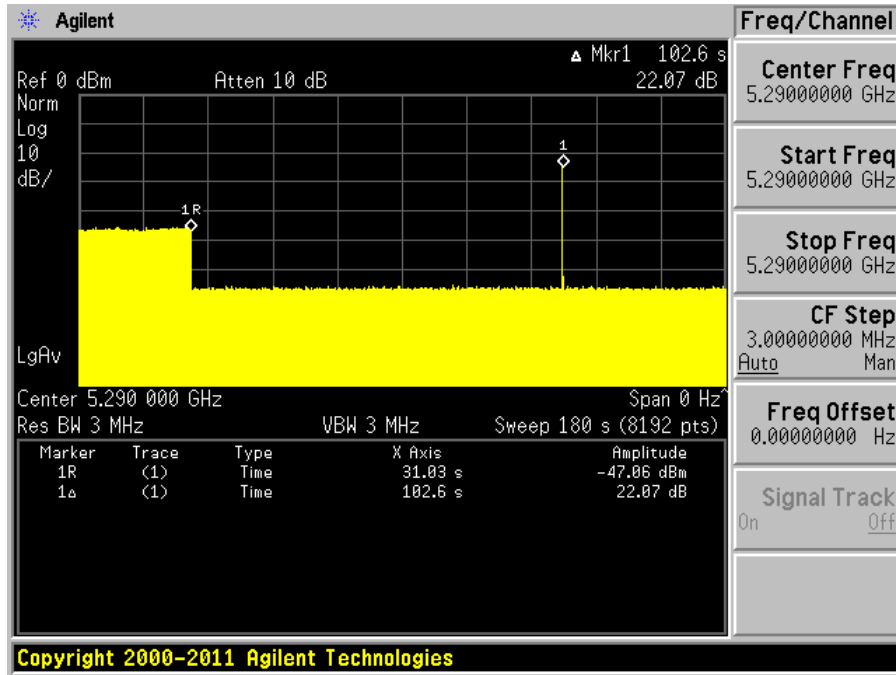

No transmissions found after radar signal applied.

5530 MHz, Bandwidth 80 MHz

Plot of without Radar signal applied

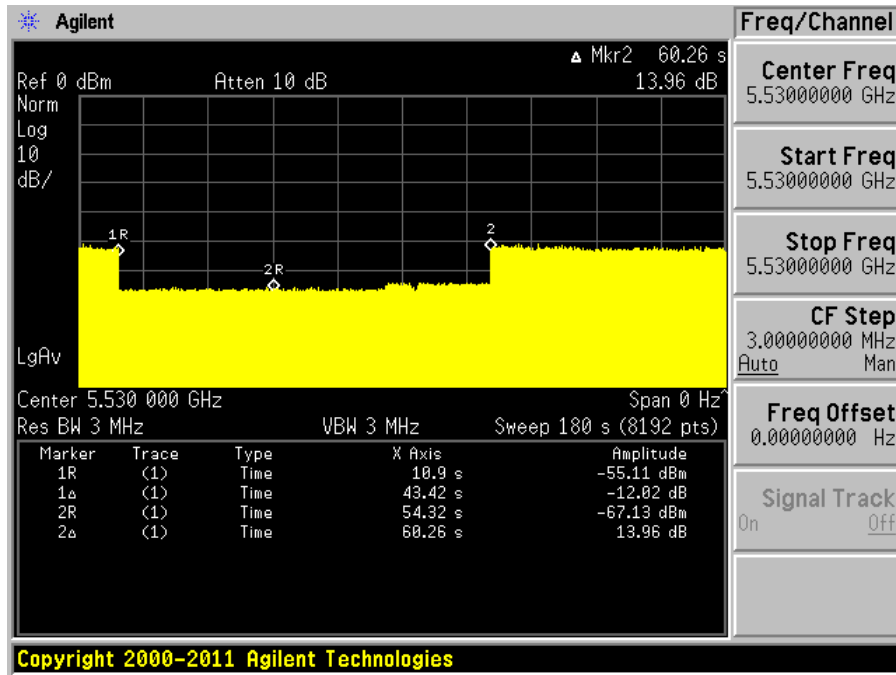

Note: The power-up cycle is 43 seconds.

Plot of Radar signal applied within 2 seconds of start of CAC

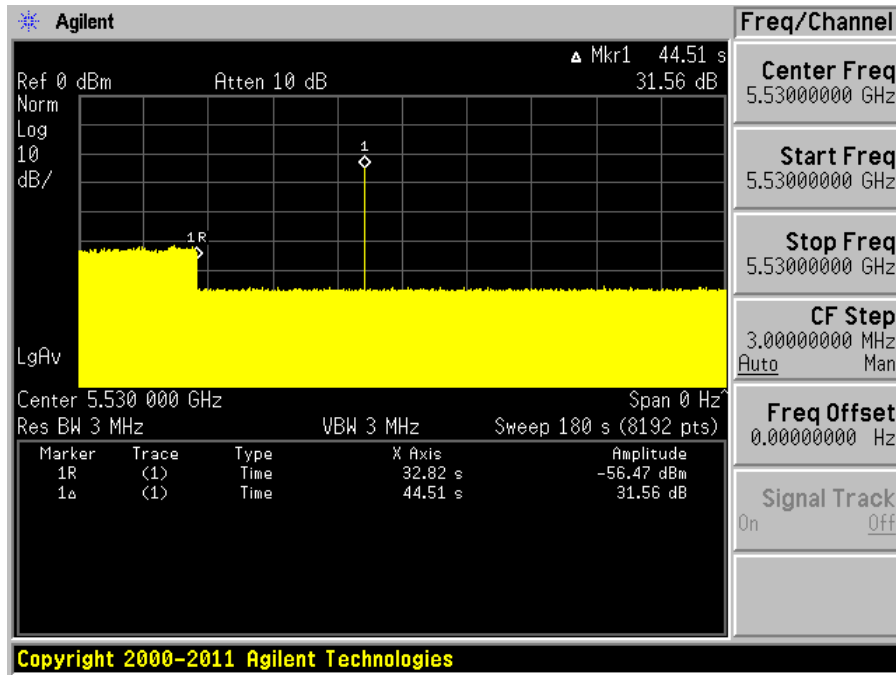

No transmissions found after radar signal applied.

Plot of Radar signal applied at the end of 2 seconds of CAC

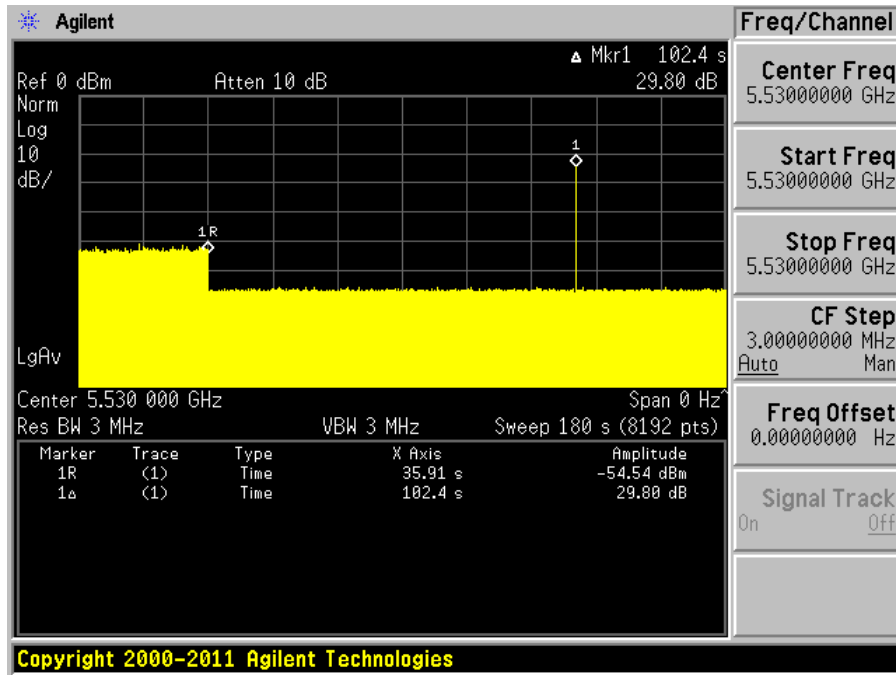

No transmissions found after radar signal applied.

7 Channel Move Time and Channel Closing Transmission Time

7.1 Test Procedure

Perform one of the type 0 to type 4 short pulse radar waveform, BACL use type 0 radar signal, repeat using a long pulse radar type5 waveform.

The aggregate channel closing transmission time is calculated as follows:

Aggregate Transmission Time = N * Dwell Time

N is the number of spectrum analyzer bins showing a device transmission

Dwell Time is the dwell time per bin (i.e. Dwell Time = S/B, S is the sweep time and B is the number of bin, i.e. 8192)

7.2 Test Results

Frequency (MHz)	Bandwidth (MHz)	Radar Type	Results
5270	40	Type 0	Compliant
		Type 5	Compliant
5550	40	Type 0	Compliant
		Type 5	Compliant
5290	80	Type 0	Compliant
		Type 5	Compliant
5530	80	Type 0	Compliant
		Type 5	Compliant

Please refer to the following tables and plots.

5270 MHz Bandwidth 40 MHz

Type 0 radar channel move time result:

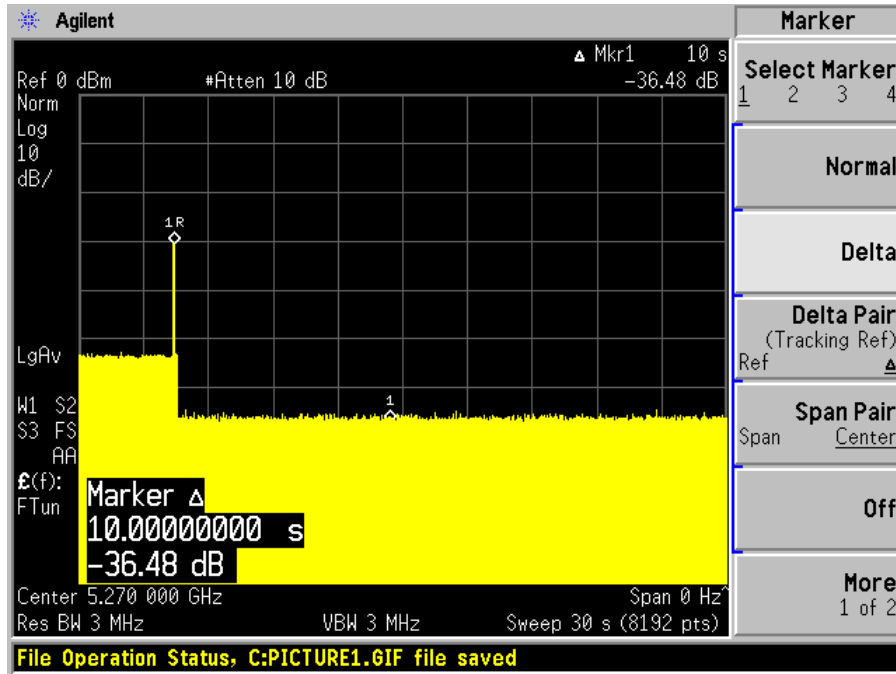

Type 0 radar channel closing transmission time result:

Frequency (MHz)	Radar Type	Channel Closing Transmission Time				Channel Move Time	
		Test	Limit	Aggregate Transmission Time	Limit	Test	Limit
5270	0	3.662 ms	200 ms	0 ms	60 ms	< 10 s	10 s

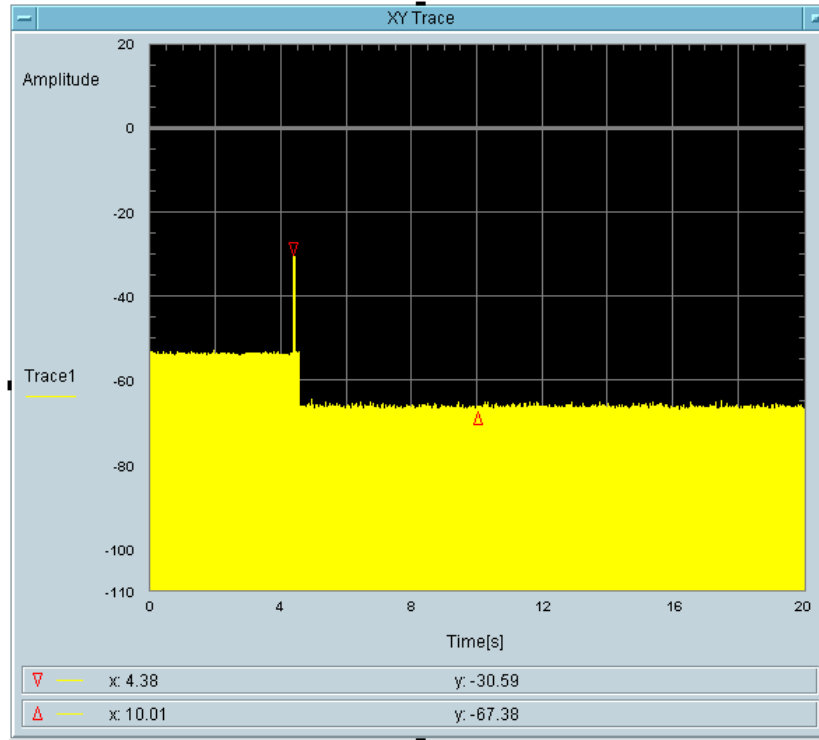

Total On Time [s]
3.662m

Type 5 radar channel move time result:

The traffic ceases at the end of the radar waveform, therefore it also ceases at 10 seconds after the end of the radar waveform.

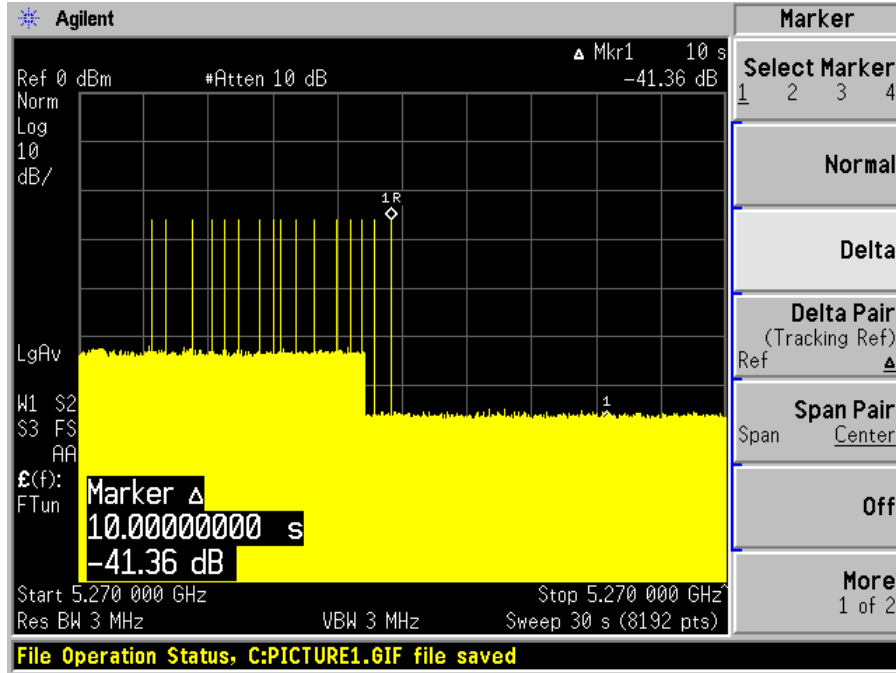

5550 MHz, Bandwidth 40 MHz

Type 0 radar channel move time result:

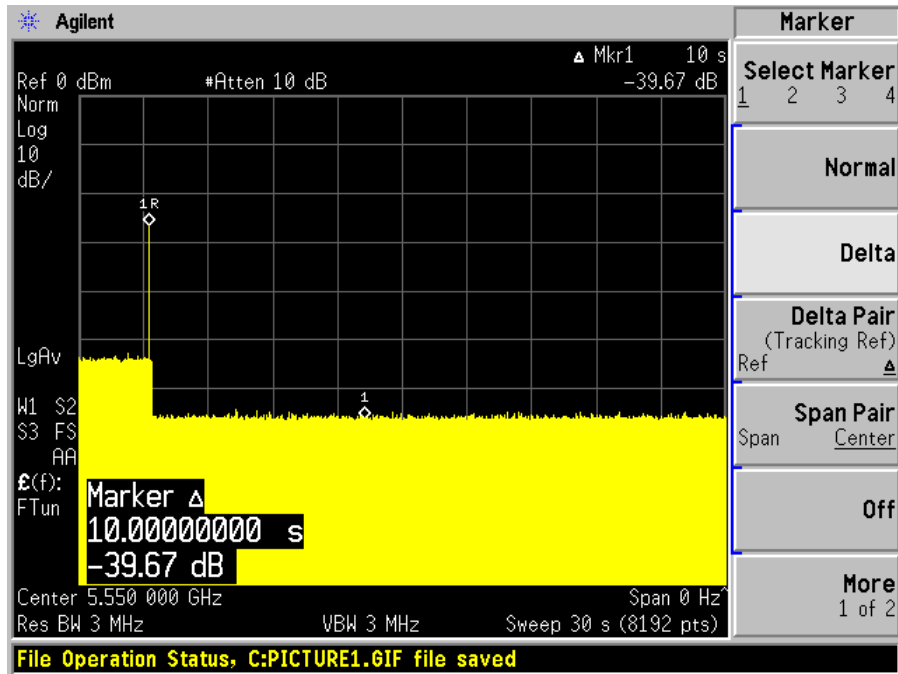

Type 0 radar channel closing transmission time result:

Frequency (MHz)	Radar Type	Channel Closing Transmission Time				Channel Move Time	
		Test	Limit	Aggregate Transmission Time	Limit	Test	Limit
5550	0	3.662 ms	200 ms	0 ms	60 ms	< 10 s	10 s

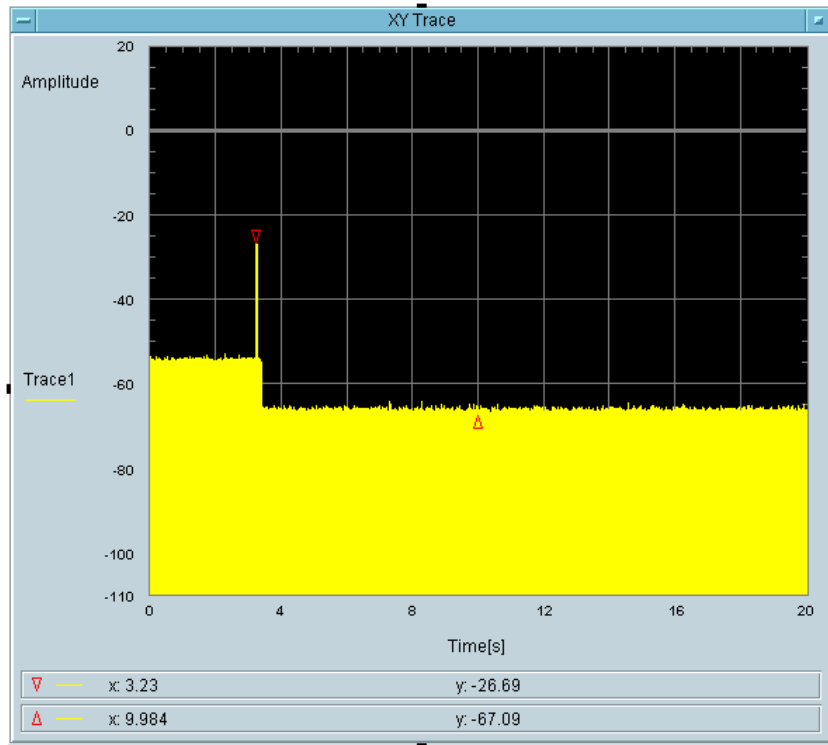

Total On Time [s]
3.662m

Type 5 radar channel move time result:

The traffic ceases at the end of the radar waveform, therefore it also ceases at 10 seconds after the end of the radar waveform.

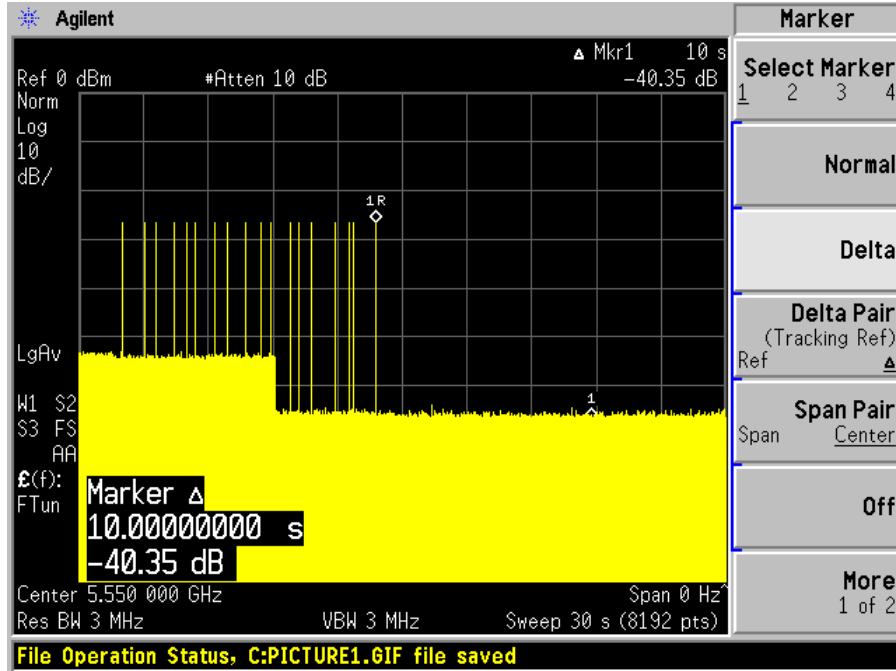

5290 MHz, Bandwidth 80 MHz

Type 0 radar channel move time result:

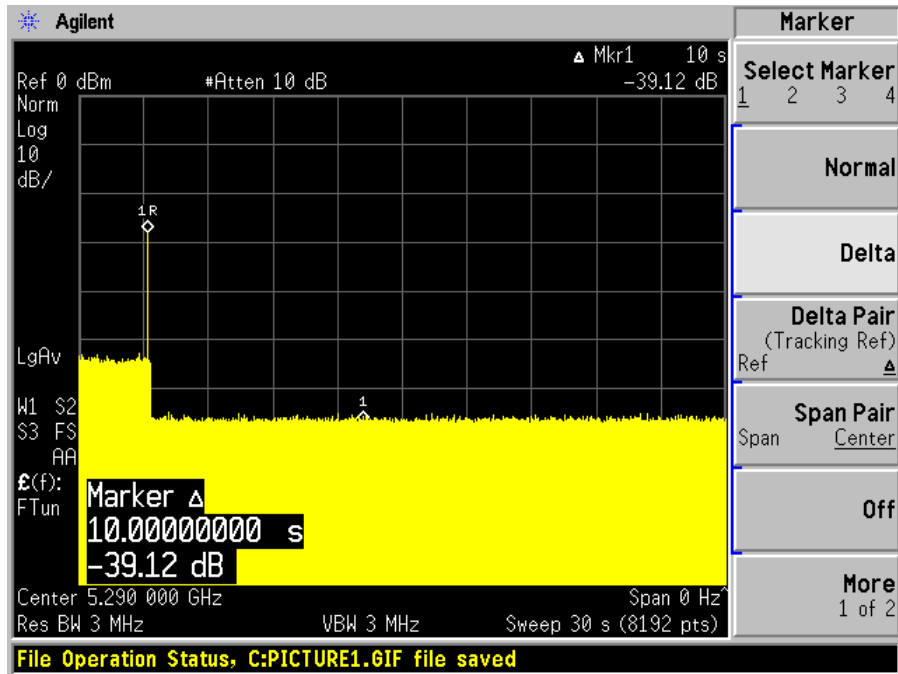

Type 0 radar channel closing transmission time result:

Frequency (MHz)	Radar Type	Channel Closing Transmission Time				Channel Move Time	
		Test	Limit	Aggregate Transmission Time	Limit	Test	Limit
5290	0	3.662 ms	200 ms	0 ms	60 ms	< 10 s	10 s

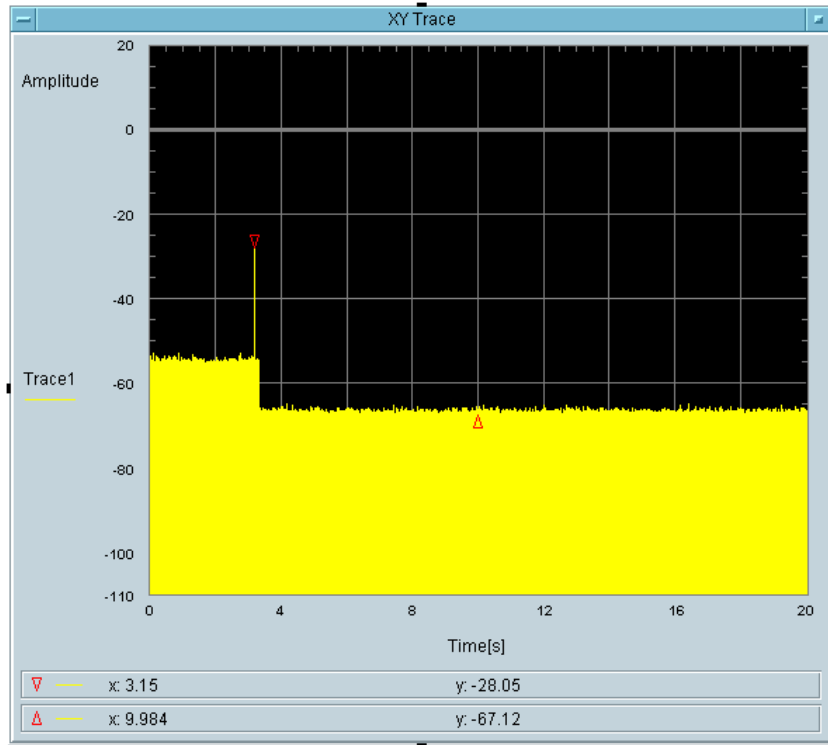

Total On Time [s]
3.662m

Type 5 radar channel move time result:

The traffic ceases at the end of the radar waveform, therefore it also ceases at 10 seconds after the end of the radar waveform.

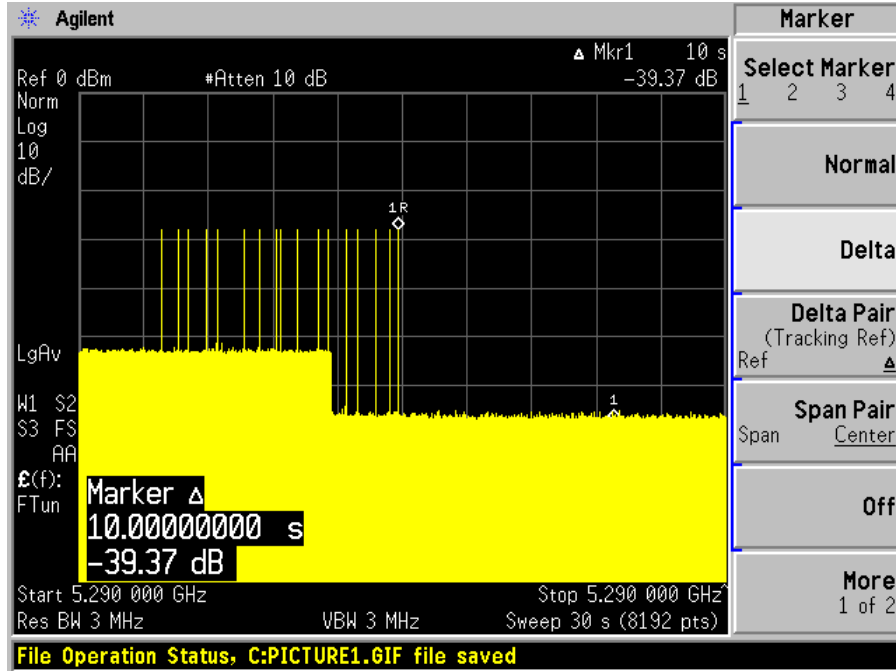

5530 MHz, Bandwidth 80 MHz

Type 0 radar channel move time result:

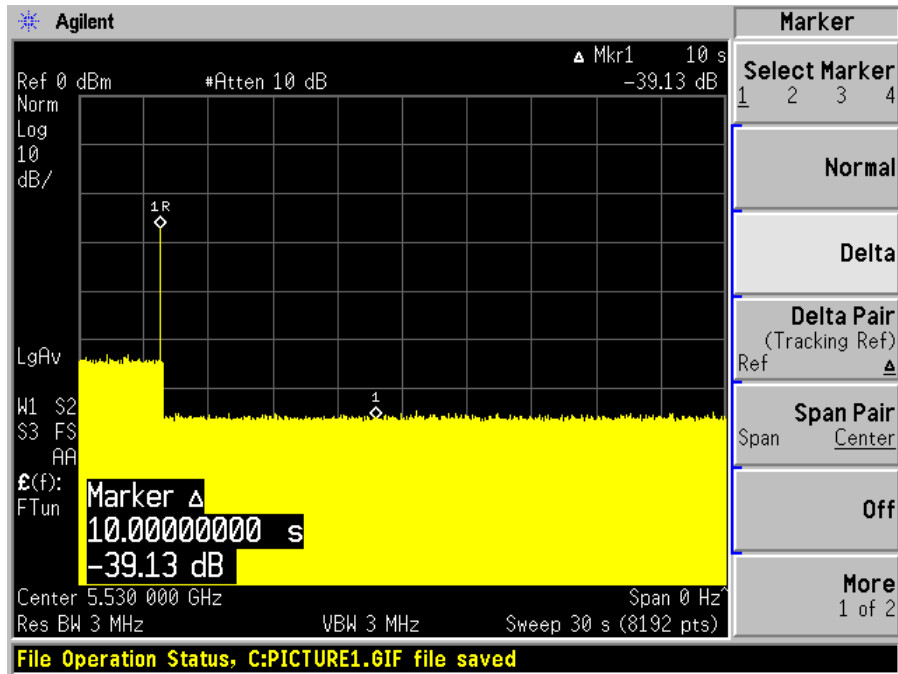

Type 0 radar channel closing transmission time result:

Frequency (MHz)	Radar Type	Channel Closing Transmission Time				Channel Move Time	
		Test	Limit	Aggregate Transmission Time	Limit	Test	Limit
5530	0	3.662 ms	200 ms	0 ms	60 ms	< 10 s	10 s

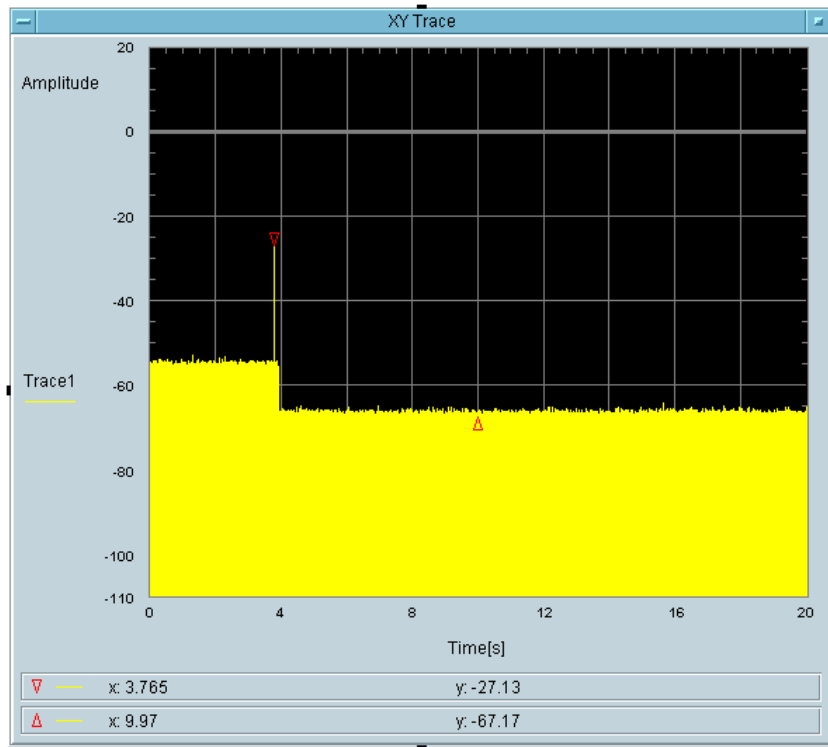

Total On Time [s]
3.662m

Type 5 radar channel move time result:

The traffic ceases at the end of the radar waveform, therefore it also ceases at 10 seconds after the end of the radar waveform.

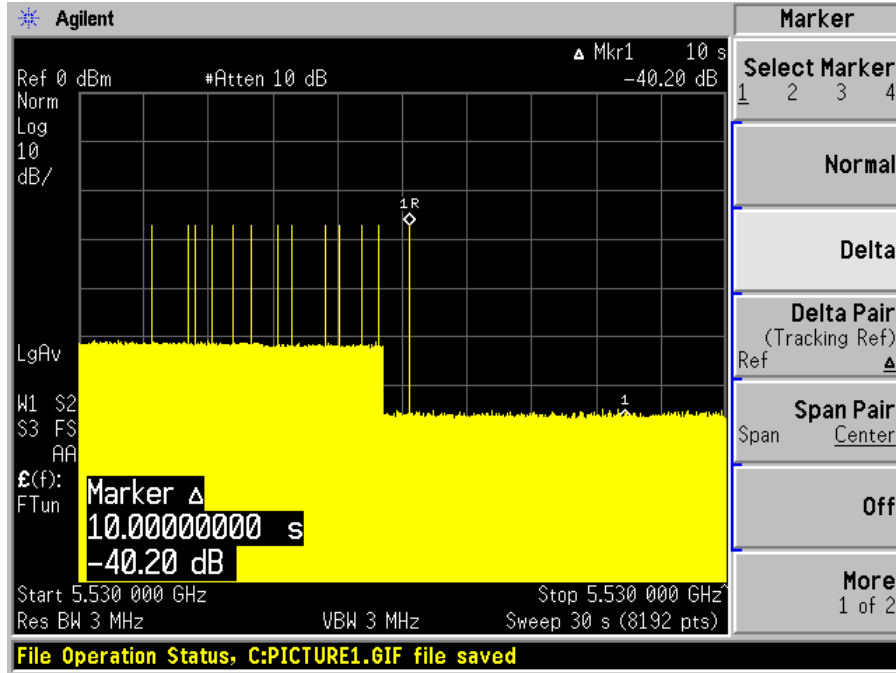

8 Non-Occupancy Period

8.1 Test Procedure

Measure the EUT for more than 30 minutes following the channel close/move time to verify that the EUT does not resume any transmissions on this channel. Provide one plot to demonstrate no transmission on the channel for the non-occupancy period (30 minutes observation time)

8.2 Test Results

Frequency (MHz)	Bandwidth (MHz)	Spectrum Analyzer Display
5270	40	No transmission within 30 minutes
5550	40	No transmission within 30 minutes
5290	80	No transmission within 30 minutes
5530	80	No transmission within 30 minutes

Please refer to the following plots.

5270 MHz, Bandwidth 40 MHz

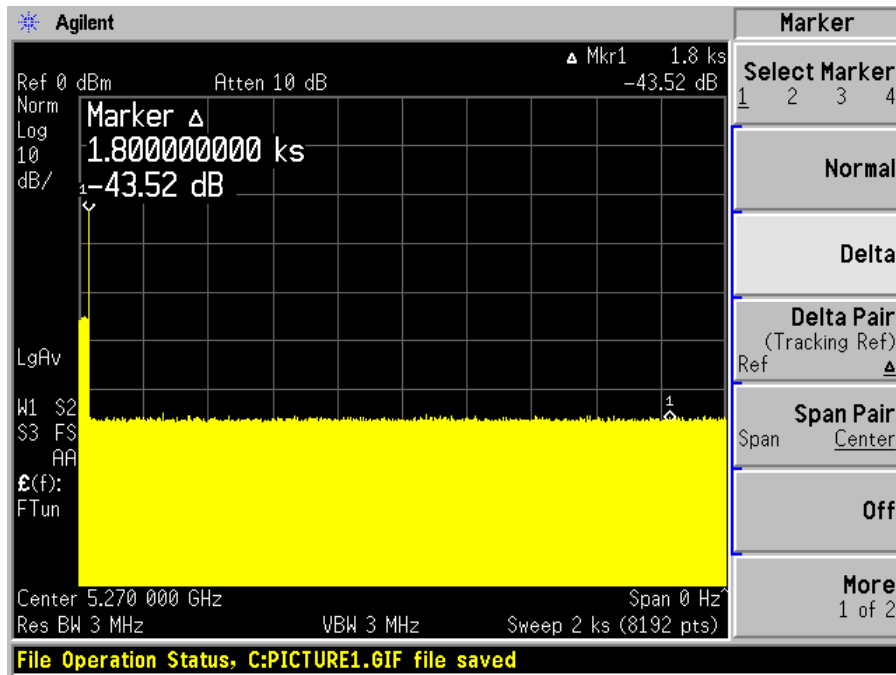

5550 MHz, Bandwidth 40 MHz

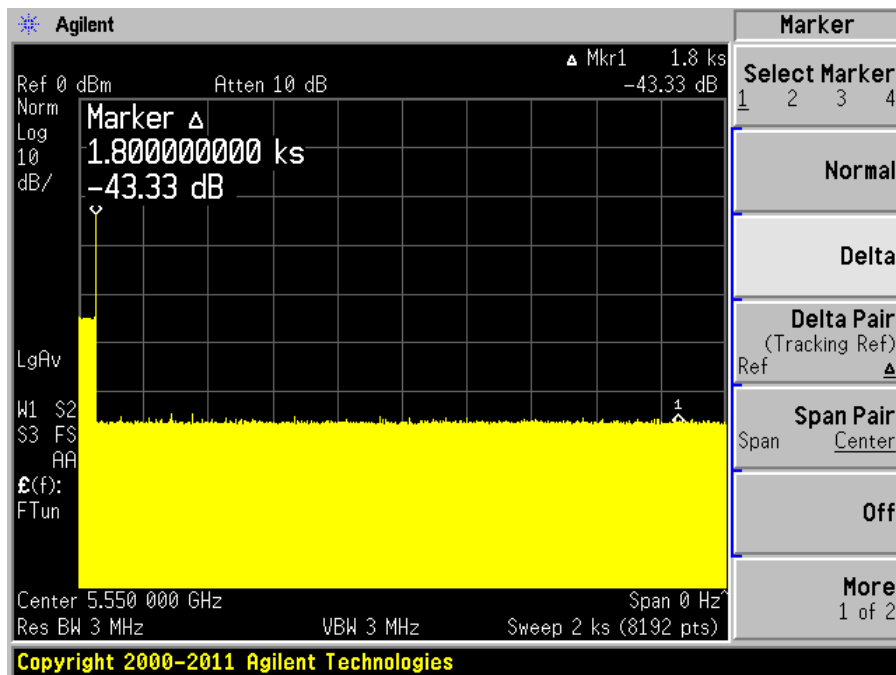

5290 MHz, Bandwidth 80 MHz

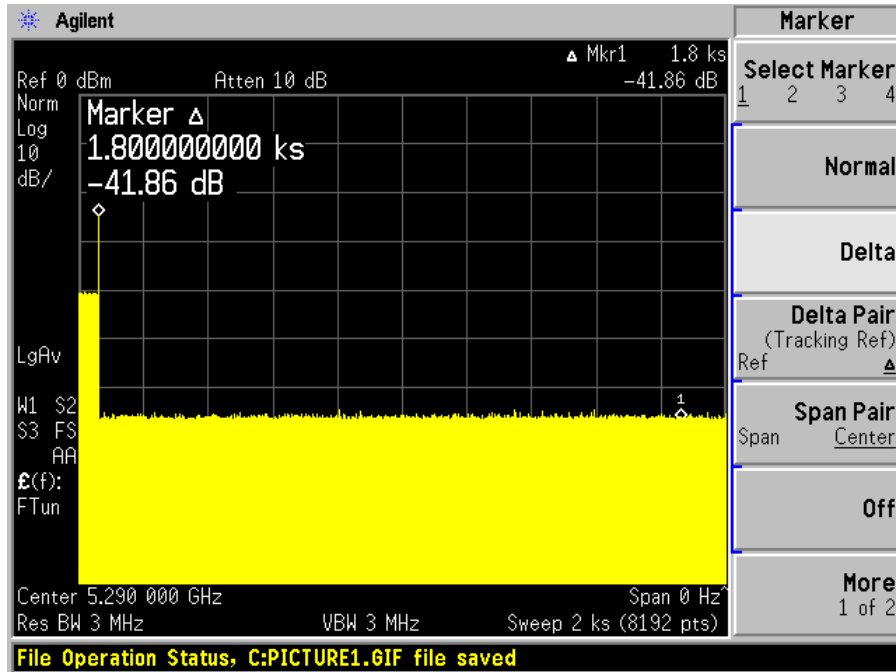

5530 MHz, Bandwidth 80 MHz

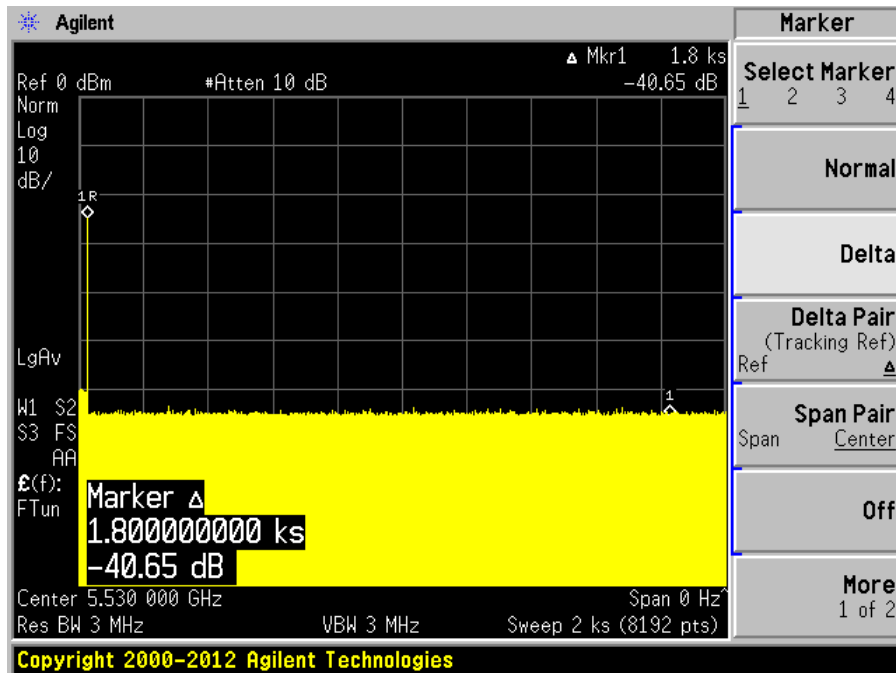

9 Radar Detection Bandwidth & Radar Detection Performance Check

9.1 Detection Bandwidth

Procedure:

Performed with any one of the short pulse radar waveforms (type 1A, 1B, 2, 3 or 4)

Start with radar generator frequency set to the center of the channel (F_c)

Perform at least 10 trials and confirm at least 90% detected

Increment radar generator frequency by 5 MHz and repeat

Perform at least 10 trials and confirm at least 90% detected

Continue incrementing the radar frequency until detection rate falls below 90%

Starting at $F_c - 5$ MHz, Repeat this measurement in 1MHz steps at frequencies 5 MHz below where the detection rate begins to fall.

F_L is the lowest frequency at which detection was 100% or better

F_H is the highest frequency at which detection was 100% or better

UNII Detection Bandwidth = $F_H - F_L$

Test Results

Frequency (MHz)	F_L (MHz)	F_H (MHz)	Detection Bandwidth (MHz)	Minimum Limit	Result
5270	5249	5291	42	100%	Compliance
5550	5429	5571	42	100%	Compliance
5290	5249	5330	81	100%	Compliance
5530	5489	5570	81	100%	Compliance

Please refer to the following tables and plots.

Results of Detection Bandwidth:

EUT Frequency = 5270 MHz											
DFS Detection Trials (1 = Detected, Blank = No Detected)											
Radar Frequency (MHz)	1	2	3	4	5	6	7	8	9	10	Detection Rate (%)
5248	0	0	0	0	0	0	0	0	0	0	0 %
5249(F_L)	1	1	1	1	1	1	1	1	1	1	100 %
5250	1	1	1	1	1	1	1	1	1	1	100 %
5255	1	1	1	1	1	1	1	1	1	1	100 %
5260	1	1	1	1	1	1	1	1	1	1	100 %
5265	1	1	1	1	1	1	1	1	1	1	100 %
5270(F _c)	1	1	1	1	1	1	1	1	1	1	100 %
5275	1	1	1	1	1	1	1	1	1	1	100 %
5280	1	1	1	1	1	1	1	1	1	1	100 %
5285	1	1	1	1	1	1	1	1	1	1	100 %
5290	1	1	1	1	1	1	1	1	1	1	100 %
5291(F_H)	1	1	1	1	1	1	1	1	1	1	100 %
5292	0	0	0	0	0	0	0	0	0	0	0 %
Detection Bandwidth = F_H - F_L=5291-5249=42 MHz											
EUT 99% OBW = 36.5297 MHz; 36.5297 x 100% = 36.5297 MHz										Result: Pass	

EUT Frequency = 5550 MHz											
DFS Detection Trials (1 = Detected, Blank = No Detected)											
Radar Frequency (MHz)	1	2	3	4	5	6	7	8	9	10	Detection Rate (%)
5428	0	0	0	0	0	0	0	0	0	0	0 %
5429(F_L)	1	1	1	1	1	1	1	1	1	1	100 %
5530	1	1	1	1	1	1	1	1	1	1	100 %
5535	1	1	1	1	1	1	1	1	1	1	100 %
5540	1	1	1	1	1	1	1	1	1	1	100 %
5545	1	1	1	1	1	1	1	1	1	1	100 %
5550(F _c)	1	1	1	1	1	1	1	1	1	1	100 %
5555	1	1	1	1	1	1	1	1	1	1	100 %
5560	1	1	1	1	1	1	1	1	1	1	100 %
5565	1	1	1	1	1	1	1	1	1	1	100 %
5570	1	1	1	1	1	1	1	1	1	1	100 %
5571(F_H)	1	1	1	1	1	1	1	1	1	1	100 %
5572	0	0	0	0	0	0	0	0	0	0	0 %
Detection Bandwidth = F_H - F_L = 5571 - 5429 = 42 MHz											
EUT 99% OBW = 36.4682 MHz; 36.4680 x 100% = 36.4682 MHz								Result:		Pass	

EUT Frequency = 5290 MHz											
DFS Detection Trials (1 = Detected, Blank = No Detected)											
Radar Frequency (MHz)	1	2	3	4	5	6	7	8	9	10	Detection Rate (%)
5248	0	0	0	0	0	0	0	0	0	0	0 %
5249(F_L)	1	1	1	1	1	1	1	1	1	1	100 %
5250	1	1	1	1	1	1	1	1	1	1	100 %
5255	1	1	1	1	1	1	1	1	1	1	100 %
5260	1	1	1	1	1	1	1	1	1	1	100 %
5265	1	1	1	1	1	1	1	1	1	1	100 %
5270	1	1	1	1	1	1	1	1	1	1	100 %
5275	1	1	1	1	1	1	1	1	1	1	100 %
5280	1	1	1	1	1	1	1	1	1	1	100 %
5285	1	1	1	1	1	1	1	1	1	1	100 %
5290(F _c)	1	1	1	1	1	1	1	1	1	1	100 %
5295	1	1	1	1	1	1	1	1	1	1	100 %
5300	1	1	1	1	1	1	1	1	1	1	100 %
5305	1	1	1	1	1	1	1	1	1	1	100 %
5310	1	1	1	1	1	1	1	1	1	1	100 %
5315	1	1	1	1	1	1	1	1	1	1	100 %
5320	1	1	1	1	1	1	1	1	1	1	100 %
5325	1	1	1	1	1	1	1	1	1	1	100 %
5330(F_H)	1	1	1	1	1	1	1	1	1	1	100 %
5331	0	0	0	0	0	0	0	0	0	0	0 %
Detection Bandwidth = F _H – F _L = 5330-5249=81 MHz											
EUT 99% OBW = 75.6297 MHz; 75.6297 x 100% = 75.6297 MHz										Result: Pass	

EUT Frequency = 5530 MHz											
DFS Detection Trials (1 = Detected, Blank = No Detected)											
Radar Frequency (MHz)	1	2	3	4	5	6	7	8	9	10	Detection Rate (%)
5488	0	0	0	0	0	0	0	0	0	0	0 %
5489(F_L)	1	1	1	1	1	1	1	1	1	1	100 %
5490	1	1	1	1	1	1	1	1	1	1	100 %
5495	1	1	1	1	1	1	1	1	1	1	100 %
5500	1	1	1	1	1	1	1	1	1	1	100 %
5505	1	1	1	1	1	1	1	1	1	1	100 %
5510	1	1	1	1	1	1	1	1	1	1	100 %
5515	1	1	1	1	1	1	1	1	1	1	100 %
5520	1	1	1	1	1	1	1	1	1	1	100 %
5525	1	1	1	1	1	1	1	1	1	1	100 %
5530 (F _c)	1	1	1	1	1	1	1	1	1	1	100 %
5535	1	1	1	1	1	1	1	1	1	1	100 %
5540	1	1	1	1	1	1	1	1	1	1	100 %
5545	1	1	1	1	1	1	1	1	1	1	100 %
5550	1	1	1	1	1	1	1	1	1	1	100 %
5555	1	1	1	1	1	1	1	1	1	1	100 %
5560	1	1	1	1	1	1	1	1	1	1	100 %
5565	1	1	1	1	1	1	1	1	1	1	100 %
5570(F_H)	1	1	1	1	1	1	1	1	1	1	100 %
5571	0	0	0	0	0	0	0	0	0	0	0 %
Detection Bandwidth = F _H – F _L =5570–5489=81 MHz											
EUT 99% OBW =75.4587 MHz; 75.4587 x 100% = 75.4587 MHz Result: Pass											

9.2 Radar Detection Performance Check

Procedure:

Stream MPEG file from master to slave

Generate radar waveform

Record whether or not the waveform was detected

At least 30 trials are applied for each radar type

For radar types with randomized parameters, each trial uses a unique waveform

Perform with each of the radar types 1-6

Confirm that the detection rate for each radar type meets the minimum requirement

Type 1A&1B, 2, 3, 4: 60% each

Type 5: 80%

Type 6: 70%

Confirm that the mean of the rates for radar types 1 through 4 meets the requirement of 80%

$$\text{Detection Ratio} = \frac{\text{Total Waveform Detections}}{\text{Total Waveform Trials}} \times 100$$

Test Results:

5270 MHz, 40 MHz Bandwidth

Radar Signal Type	Waveform/Trial Number	Detection (%)	Limit (%)	Pass/Fail
Type 1A/1B	30	100 %	60%	Pass
Type 2	30	100 %	60%	Pass
Type 3	30	100 %	60%	Pass
Type 4	30	100 %	60%	Pass
Aggregate (Type1 to 4)	120	100 %	80%	Pass
Type 5	30	100 %	80%	Pass
Type 6	30	100 %	70%	Pass

Please refer to the following statistical tables:

5270 MHz, 40 MHz Bandwidth

Table-1A/1B Radar Type 1A/1B Statistical Performance

Trial #	Fc (MHz)	Pulse/Burst	Pulse Width (μS)	PRI (μs)	Detection (1:yes; 0:no)
1	5270	63	1	838	1
2	5270	62	1	858	1
3	5270	65	1	818	1
4	5270	67	1	798	1
5	5270	57	1	938	1
6	5270	74	1	718	1
7	5270	81	1	658	1
8	5270	83	1	638	1
9	5270	72	1	738	1
10	5270	95	1	558	1
11	5270	86	1	618	1
12	5270	58	1	918	1
13	5270	99	1	538	1
14	5270	18	1	3066	1
15	5270	70	1	758	1
16	5270	27	1	2017	1
17	5270	19	1	2929	1
18	5270	63	1	848	1
19	5270	21	1	2557	1
20	5270	26	1	2054	1
21	5270	81	1	657	1
22	5270	70	1	762	1
23	5270	38	1	1390	1
24	5270	36	1	1488	1
25	5270	55	1	964	1
26	5270	21	1	2624	1
27	5270	69	1	771	1
28	5270	33	1	1647	1
29	5270	80	1	667	1
30	5270	65	1	822	1
Detection Percentage: 100 % (>60%)					

Table-2 Radar Type 2 Statistical Performance

Trial #	Fc (MHz)	Pulse/Burst	Pulse Width (μS)	PRI (μs)	Detection (1:yes; 0:no)
1	5270	25	1.1	165	1
2	5270	29	1	220	1
3	5270	23	4.5	185	1
4	5270	28	4.9	227	1
5	5270	23	4.2	193	1
6	5270	27	1.8	170	1
7	5270	27	3.4	194	1
8	5270	28	4.4	194	1
9	5270	24	3.6	179	1
10	5270	27	4.5	204	1
11	5270	27	3.4	214	1
12	5270	24	4.7	229	1
13	5270	25	4	219	1
14	5270	23	5	197	1
15	5270	29	5	173	1
16	5270	23	2.7	158	1
17	5270	27	4.6	192	1
18	5270	27	4.5	182	1
19	5270	27	4.3	197	1
20	5270	28	4.5	180	1
21	5270	28	2.3	191	1
22	5270	23	2.4	219	1
23	5270	24	1.1	193	1
24	5270	26	1.9	177	1
25	5270	29	1.4	193	1
26	5270	23	3.8	192	1
27	5270	23	4.4	223	1
28	5270	23	1.9	206	1
29	5270	24	2.6	211	1
30	5270	26	1.9	211	1
Detection Percentage: 100 % (>60%)					

Table-3 Radar Type 3 Statistical Performance

Trial #	Fc (MHz)	Pulse/Burst	Pulse Width (μS)	PRI (μs)	Detection (1:yes; 0:no)
1	5270	18	7.7	471	1
2	5270	17	9.3	350	1
3	5270	18	9	200	1
4	5270	18	6.3	310	1
5	5270	16	9.4	319	1
6	5270	18	6.1	322	1
7	5270	18	9	326	1
8	5270	16	8.3	206	1
9	5270	17	8.1	256	1
10	5270	18	9.7	244	1
11	5270	18	6.9	253	1
12	5270	18	9.4	332	1
13	5270	16	9.9	390	1
14	5270	16	6.8	221	1
15	5270	16	7	321	1
16	5270	16	9.9	232	1
17	5270	17	7.3	343	1
18	5270	16	8.6	272	1
19	5270	16	7.5	449	1
20	5270	18	9.8	418	1
21	5270	16	7.7	348	1
22	5270	16	6.1	238	1
23	5270	18	9.8	454	1
24	5270	17	7.8	477	1
25	5270	17	6.8	481	1
26	5270	17	10	404	1
27	5270	16	7.2	464	1
28	5270	18	9.2	313	1
29	5270	17	7.7	327	1
30	5270	18	9.7	376	1
Detection Percentage: 100 % (>60%)					

Table-4 Radar Type 4 Statistical Performance

Trial #	Fc (MHz)	Pulse/Burst	Pulse Width (μS)	PRI (μs)	Detection (1:yes; 0:no)
1	5270	12	13	416	1
2	5270	14	17.6	324	1
3	5270	12	15.5	372	1
4	5270	12	13	409	1
5	5270	15	12.3	216	1
6	5270	14	18.6	285	1
7	5270	16	18.7	457	1
8	5270	14	17.5	209	1
9	5270	16	19.5	304	1
10	5270	16	15.6	282	1
11	5270	14	17	493	1
12	5270	13	12	308	1
13	5270	14	11.2	291	1
14	5270	13	15.7	288	1
15	5270	12	18.3	326	1
16	5270	16	11	322	1
17	5270	12	14.8	311	1
18	5270	14	17	393	1
19	5270	16	16.2	438	1
20	5270	16	15.5	310	1
21	5270	15	19.9	391	1
22	5270	14	18.5	475	1
23	5270	13	18.1	449	1
24	5270	15	15.9	266	1
25	5270	16	14.3	437	1
26	5270	12	15.9	374	1
27	5270	14	19.7	480	1
28	5270	14	17.4	500	1
29	5270	15	17.8	279	1
30	5270	13	14.8	251	1
Detection Percentage: 100 % (>60%)					

Table-5 Radar Type 5 Statistical Performance

Bin5 Statistics 1

Trial #	Pulse	Chirp (MHz)	Pulse Width (µS)	Pulse 1-2 spacing (uS)	Pulse 2-3 spacing (uS)	Pulse Start(S)	Detection (1:yes; 0:no)
0	2	18	69.3	1825		0.641457	1
1	1	20	65.8			0.673221	
2	1	11	85.5			1.397641	
3	3	12	53.4	1724	1096	2.299973	
4	3	13	84.3	1695	1786	2.836497	
5	2	6	91.7	1746		3.884453	
6	3	9	90.9	1126	1500	4.260873	
7	2	19	73.2	1767		4.678096	
8	3	6	75.5	1409	1395	5.521104	
9	3	13	91.9	1921	1495	6.354614	
10	2	15	98.1	1408		6.849383	
11	3	8	93.6	1070	1922	7.705407	
12	3	13	56	1366	1211	8.0068	
13	2	10	73.7	1384		8.941332	
14	2	15	76.7	1972		9.591004	
15	2	7	74	1124		10.50453	
16	1	15	61.2			11.28477	
17	1	14	99			11.73884	

Bin5 Statistics 2

Trial #	Pulse	Chirp (MHz)	Pulse Width (µS)	Pulse 1-2 spacing (uS)	Pulse 2-3 spacing (uS)	Pulse Start(S)	Detection (1:yes; 0:no)
0	2	12	92.1	1041		0.645005	1
1	1	18	88.5			1.524082	
2	3	20	50.5	1882	1646	2.455432	
3	2	15	96.4	1333		2.970242	
4	2	14	54.5	1404		3.848759	
5	3	9	80.7	1764	1379	4.933232	
6	3	7	88.8	1728	1449	6.328779	
7	1	6	78.2			6.64185	
8	1	9	64.7			7.88392	
9	1	9	90.7			8.71962	
10	2	12	54.3	1740		9.428305	
11	1	13	50.8			10.96983	
12	2	12	82.3	1177		11.27301	

Bin5 Statistics 3

Trial #	Pulse	Chirp (MHz)	Pulse Width (µS)	Pulse 1-2 spacing (µS)	Pulse 2-3 spacing (µS)	Pulse Start(S)	Detection (1:yes; 0:no)
0	2	19	55.4	1767		0.722817	1
1	2	14	73.4	1178		1.100496	
2	2	5	57.9	1730		1.755054	
3	2	16	76.7	1050		3.141218	
4	2	6	52.3	1060		3.485246	
5	2	13	83.3	1078		4.619155	
6	1	11	77.2			5.99028	
7	3	11	67.8	1585	1302	6.46237	
8	3	8	72.2	1144	1708	7.514388	
9	1	6	92			7.834784	
10	1	8	65.4			8.9792	
11	2	10	69.5	1060		9.712312	
12	3	7	69	1508	1672	10.93235	
13	1	13	80.5			11.58959	

Bin5 Statistics 4

Trial #	Pulse	Chirp (MHz)	Pulse Width (µS)	Pulse 1-2 spacing (µS)	Pulse 2-3 spacing (µS)	Pulse Start(S)	Detection (1:yes; 0:no)
0	3	13	94	1333	1469	0.072412	1
1	2	7	81	1082		0.970407	
2	2	8	89.3	1668		1.388093	
3	3	15	63	1029	1308	2.161744	
4	2	17	62.4	1526		2.76675	
5	2	16	96	1252		3.496772	
6	3	5	55.5	1734	1962	4.596878	
7	2	14	97.9	1170		4.985571	
8	2	7	88.5	1206		5.884257	
9	1	9	94.2			6.064754	
10	1	15	95.1			7.106662	
11	1	18	80.8			7.930217	
12	2	5	98.1	1772		8.45195	
13	2	8	85.4	1674		9.280489	
14	3	19	93.7	1113	1985	9.462251	
15	2	6	72.2	1373		10.61509	
16	2	5	51.8	1408		11.16572	
17	1	19	51.7			11.39535	

Bin5 Statistics 5

Trial #	Pulse	Chirp (MHz)	Pulse Width (µS)	Pulse 1-2 spacing (µS)	Pulse 2-3 spacing (µS)	Pulse Start(S)	Detection (1:yes; 0:no)
0	3	12	86.7	1343	1013	0.231033	1
1	2	16	88.8	1560		1.219823	
2	2	19	92.2	1061		1.859401	
3	1	13	65.1			2.339215	
4	1	6	73.8			2.946443	
5	3	15	97.1	1927	1461	4.058571	
6	2	6	51.8	1815		4.236445	
7	2	19	96.2	1699		5.233221	
8	2	9	79.6	1187		6.010966	
9	2	10	56.6	1364		6.819526	
10	2	10	92.3	1314		7.494403	
11	3	10	59.1	1299	1529	8.074676	
12	3	15	79.6	1435	1809	9.131519	
13	2	9	61.8	1182		9.56551	
14	2	19	95.1	1261		10.50185	
15	3	10	59.2	1603	1413	11.28342	
16	3	11	97	1053	1598	11.40818	

Bin5 Statistics 6

Trial #	Pulse	Chirp (MHz)	Pulse Width (µS)	Pulse 1-2 spacing (µS)	Pulse 2-3 spacing (µS)	Pulse Start(S)	Detection (1:yes; 0:no)
0	2	18	59.5	1721		0.335753	1
1	1	12	90.8			1.694712	
2	1	12	88.5			2.430281	
3	2	15	70.9	1043		3.023667	
4	3	16	61.4	1609	1686	4.123876	
5	2	15	54.2	1418		5.200088	
6	2	13	68.9	1869		6.80093	
7	1	18	71.5			7.065108	
8	2	5	72.6	1662		8.192787	
9	3	6	72.1	1610	1597	9.498708	
10	2	12	63	1271		10.18095	
11	2	8	93.8	1135		11.40431	

Bin5 Statistics 7

Trial #	Pulse	Chirp (MHz)	Pulse Width (µS)	Pulse 1-2 spacing (uS)	Pulse 2-3 spacing (uS)	Pulse Start(S)	Detection (1:yes; 0:no)
0	3	18	80.8	1525	1292	0.833113	1
1	2	6	57.5	1919		2.150808	
2	2	11	84.1	1361		2.335588	
3	3	15	51.9	1041	1239	3.576473	
4	2	17	65	1728		4.87139	
5	3	6	81.5	1571	1171	6.164697	
6	1	6	50.4			7.388879	
7	2	14	99.6	1546		7.925623	
8	2	13	89.8	1155		9.78765	
9	1	14	76.4			10.23696	
10	2	19	96	1535		11.08375	

Bin5 Statistics 8

Trial #	Pulse	Chirp (MHz)	Pulse Width (µS)	Pulse 1-2 spacing (uS)	Pulse 2-3 spacing (uS)	Pulse Start(S)	Detection (1:yes; 0:no)
0	3	15	60.9	1376	1277	0.329747	1
1	3	14	72.8	1230	1097	1.334612	
2	2	19	87.9	1442		2.385649	
3	3	18	86.7	1824	1234	3.621486	
4	3	17	99.7	1270	1389	4.264158	
5	1	14	72.1			5.666556	
6	3	19	89.3	1142	1824	6.969091	
7	1	11	59.8			7.122297	
8	1	19	65.3			8.601031	
9	2	6	83	1930		9.600005	
10	1	12	62.2			10.6646	
11	2	12	100	1748		11.28749	

Bin5 Statistics 9

Trial #	Pulse	Chirp (MHz)	Pulse Width (µS)	Pulse 1-2 spacing (µS)	Pulse 2-3 spacing (µS)	Pulse Start(S)	Detection (1:yes; 0:no)
0	2	13	71.9	1774		0.500031	1
1	2	16	98.7	1775		1.188756	
2	2	11	65.1	1808		1.699798	
3	3	19	73.3	1996	1183	2.365945	
4	2	13	83.5	1029		3.541963	
5	2	16	82.3	1372		3.789346	
6	2	12	68.1	1836		4.696045	
7	1	10	83.8			5.80187	
8	3	5	72.3	1946	1014	6.323578	
9	2	12	69.5	1728		7.105994	
10	2	7	92.1	1166		7.690358	
11	2	20	60.5	1206		8.386373	
12	2	9	68	1216		9.455478	
13	2	9	59.9	1315		10.16334	
14	2	17	59.6	1160		10.87527	
15	1	19	90.7			11.96383	

Bin5 Statistics 10

Trial #	Pulse	Chirp (MHz)	Pulse Width (µS)	Pulse 1-2 spacing (µS)	Pulse 2-3 spacing (µS)	Pulse Start(S)	Detection (1:yes; 0:no)
0	3	6	63.7	1821	1104	0.701178	1
1	3	18	81.3	1688	1221	1.630923	
2	1	15	51.3			2.083227	
3	2	6	82.9	1661		2.859576	
4	2	5	62.2	1286		4.243942	
5	1	19	52.9			4.437171	
6	3	15	58.9	1418	1493	5.161317	
7	1	11	98			6.464277	
8	2	14	72.8	1546		6.951948	
9	2	17	65.7	1535		8.504867	
10	2	16	75.3	1825		8.763378	
11	2	12	60.6	1649		10.03172	
12	3	14	96.5	1064	1878	10.53906	
13	1	12	52.9			11.51595	

Bin5 Statistics 11

Trial #	Pulse	Chirp (MHz)	Pulse Width (µS)	Pulse 1-2 spacing (uS)	Pulse 2-3 spacing (uS)	Pulse Start(S)	Detection (1:yes; 0:no)
0	2	9	98.4	1222		0.682085	1
1	1	11	63.5			1.207342	
2	2	9	79.3	1307		2.094669	
3	2	17	76	1442		2.81286	
4	2	16	89.8	1081		3.251744	
5	2	9	66.1	1137		3.785142	
6	3	17	82.2	1925	1484	4.854955	
7	1	15	65.8			5.295817	
8	2	18	90	1423		5.987299	
9	2	15	75.1	1166		6.635387	
10	2	12	79.8	1373		7.726216	
11	2	19	59.3	1480		8.462295	
12	2	11	57.5	1624		9.10084	
13	3	11	94.1	1415	1806	9.44005	
14	2	19	59.1	1051		10.2868	
15	2	14	86.9	1275		10.84304	
16	2	19	93.3	1927		11.50967	

Bin5 Statistics 12

Trial #	Pulse	Chirp (MHz)	Pulse Width (µS)	Pulse 1-2 spacing (uS)	Pulse 2-3 spacing (uS)	Pulse Start(S)	Detection (1:yes; 0:no)
0	1	12	80.2			0.504955	1
1	1	13	95.5			1.400054	
2	3	12	64.9	1927	1506	2.37624	
3	2	8	96.8	1601		3.309292	
4	2	12	73.6	1096		4.178229	
5	2	12	82.5	1480		4.558353	
6	3	6	75.4	1483	1781	5.371873	
7	3	5	64.9	1018	1961	6.765557	
8	2	7	64.4	1215		7.001954	
9	2	12	85.3	1748		8.542305	
10	3	9	56.1	1518	1403	8.79006	
11	3	13	79.6	1736	1168	9.48614	
12	1	13	56.4			10.90501	
13	1	12	53			11.19641	

Bin5 Statistics 13

Trial #	Pulse	Chirp (MHz)	Pulse Width (µS)	Pulse 1-2 spacing (µS)	Pulse 2-3 spacing (µS)	Pulse Start(S)	Detection (1:yes; 0:no)
0	1	17	58.4			0.56721	1
1	3	8	94.1	1591	1232	1.319278	
2	1	11	73			1.685188	
3	2	16	98.5	1779		2.022354	
4	2	8	56.4	1521		3.024205	
5	3	19	66.2	1125	1240	3.850077	
6	3	5	84.5	1090	1846	4.181328	
7	2	9	96.2	1925		5.171747	
8	2	14	55.9	1161		5.690416	
9	2	9	62	1116		6.550461	
10	2	8	80.9	1593		6.90045	
11	2	19	53.7	1547		7.974147	
12	2	10	96.8	1975		8.498714	
13	1	14	100			8.875751	
14	3	15	61.2	1669	1902	9.574382	
15	2	7	84.7	1677		10.38726	
16	2	8	76.1	1422		10.95602	
17	3	12	98.5	1311	1623	11.54089	

Bin5 Statistics 14

Trial #	Pulse	Chirp (MHz)	Pulse Width (µS)	Pulse 1-2 spacing (µS)	Pulse 2-3 spacing (µS)	Pulse Start(S)	Detection (1:yes; 0:no)
0	3	16	99.3	1907	1573	0.400635	0
1	1	19	92.1			1.909258	
2	1	10	59.9			2.083608	
3	3	5	84.5	1914	1597	3.144455	
4	2	13	82.7	1379		4.287395	
5	2	12	83.9	1231		5.830293	
6	1	9	71.4			6.899635	
7	3	13	75.1	1315	1779	7.264912	
8	2	20	95.7	1995		8.638958	
9	2	12	67.8	1757		9.891277	
10	2	19	74.4	1243		10.35278	
11	3	11	79.7	1669	1547	11.45298	

Bin5 Statistics 15

Trial #	Pulse	Chirp (MHz)	Pulse Width (µS)	Pulse 1-2 spacing (µS)	Pulse 2-3 spacing (µS)	Pulse Start(S)	Detection (1:yes; 0:no)
0	2	18	83.9	1554		0.718696	1
1	2	7	80.7	1301		1.294244	
2	2	6	50.5	1338		2.911639	
3	2	18	70.3	1822		4.119966	
4	3	13	86	1804	1065	4.797184	
5	2	19	98.6	1276		6.213607	
6	3	11	54	1571	1469	7.563129	
7	2	16	96.8	1034		8.529816	
8	3	16	72.3	1368	1993	9.538117	
9	3	18	74.9	1621	1201	10.645198	
10	2	18	56.6	1559		11.583963	

Bin5 Statistics 16

Trial #	Pulse	Chirp (MHz)	Pulse Width (µS)	Pulse 1-2 spacing (µS)	Pulse 2-3 spacing (µS)	Pulse Start(S)	Detection (1:yes; 0:no)
0	3	19	68	1054	1426	0.591554	1
1	1	8	76.4			1.673104	
2	3	13	51.7	1823	1178	2.201828	
3	2	6	64.8	1645		3.944624	
4	2	6	94.6	1280		4.715371	
5	3	19	58.1	1502	1049	5.74827	
6	1	19	92.3			6.230631	
7	1	15	94.7			7.979358	
8	2	12	99.4	1433		8.84652	
9	2	20	94.6	1349		9.549839	
10	1	6	70.6			10.161721	
11	2	7	78.1	1595		11.56011	

Bin5 Statistics 17

Trial #	Pulse	Chirp (MHz)	Pulse Width (µS)	Pulse 1-2 spacing (µS)	Pulse 2-3 spacing (µS)	Pulse Start(S)	Detection (1:yes; 0:no)
0	2	19	92.2	1885		0.120111	1
1	2	12	94.6	1054		0.831845	
2	2	6	92.9	1982		1.802427	
3	2	6	50.7	1179		2.770807	
4	2	9	75.8	1111		3.176428	
5	2	18	88.4	1810		4.071861	
6	2	13	67.2	1683		4.780064	
7	3	13	58.1	1129	1198	5.695741	
8	2	5	91	1810		6.05944	
9	2	7	58	1595		6.907508	
10	2	19	85.2	1026		7.529897	
11	2	17	60	1444		8.569534	
12	2	10	84.5	1830		9.690465	
13	2	6	57.1	1327		10.011201	
14	2	8	88.2	1490		11.051905	
15	2	12	69.9	1704		11.736678	

Bin5 Statistics 18

Trial #	Pulse	Chirp (MHz)	Pulse Width (µS)	Pulse 1-2 spacing (uS)	Pulse 2-3 spacing (uS)	Pulse Start(S)	Detection (1:yes; 0:no)
0	2	14	59.7	1218		0.396092	1
1	2	8	89.6	1728		0.709075	
2	2	17	56.5	1974		1.578064	
3	1	16	69.8			2.328183	
4	3	6	82.4	1437	1502	2.737672	
5	2	19	62.9	1450		3.918441	
6	3	6	67.1	1350	1635	4.048986	
7	1	10	86.9			5.118619	
8	2	16	84.8	1603		5.344727	
9	2	9	58.5	1835		6.501177	
10	3	17	97.3	1019	1955	6.967778	
11	2	16	80.9	1460		7.854949	
12	2	9	95.6	1885		8.648777	
13	1	12	69.7			8.84042	
14	3	5	94.1	1381	1443	9.405142	
15	3	17	60.2	1922	1104	10.471076	
16	1	14	77.8			10.990576	
17	3	8	63.4	1474	1811	11.45206	

Bin5 Statistics 19

Trial #	Pulse	Chirp (MHz)	Pulse Width (µS)	Pulse 1-2 spacing (uS)	Pulse 2-3 spacing (uS)	Pulse Start(S)	Detection (1:yes; 0:no)
0	3	6	88.6	1006	1287	0.046681	1
1	2	11	80.2	1316		2.00524	
2	2	5	68.5	1687		3.058206	
3	1	6	58.4			4.157471	
4	2	14	70.1	1613		5.116283	
5	2	14	75.9	1926		5.580207	
6	2	5	65.2	1352		7.272175	
7	3	18	70.8	1315	1756	8.563198	
8	2	19	65.7	1509		8.902047	
9	3	8	79.4	1428	1805	10.631196	
10	2	14	72.6	1483		10.981701	

Bin5 Statistics 20

Trial #	Pulse	Chirp (MHz)	Pulse Width (µS)	Pulse 1-2 spacing (uS)	Pulse 2-3 spacing (uS)	Pulse Start(S)	Detection (1:yes; 0:no)
0	2	17	75.8	1788		0.727866	1
1	2	16	66.3	1364		1.494254	
2	1	13	52.2			2.027853	
3	3	18	56.1	1026	1339	3.528265	
4	2	14	80.3	1625		4.049766	
5	1	8	67.6			5.252335	
6	3	18	66.6	1376	1174	6.083843	
7	1	17	56.8			6.819451	
8	1	15	88.7			8.272068	
9	1	12	63.8			8.959606	
10	1	12	73.4			9.523496	
11	2	9	96.4	1955		10.875979	
12	2	10	100	1763		11.161724	

Bin5 Statistics 21

Trial #	Pulse	Chirp (MHz)	Pulse Width (µS)	Pulse 1-2 spacing (uS)	Pulse 2-3 spacing (uS)	Pulse Start(S)	Detection (1:yes; 0:no)
0	3	10	63	1553	1794	0.039126	1
1	2	16	87.1	1451		1.098953	
2	2	11	69.1	1412		1.567673	
3	1	15	75			2.637138	
4	2	9	85.2	1680		3.056134	
5	1	16	87.3			4.26616	
6	2	14	57.3	1476		5.086968	
7	2	10	55.5	1744		5.635045	
8	1	11	95.5			6.576143	
9	2	17	74.7	1237		7.391084	
10	1	11	94.8			7.924706	
11	3	18	77.1	1051	1323	8.607352	
12	1	13	91.7			9.589824	
13	3	11	53.2	1263	1886	10.463182	
14	3	17	50.8	1247	1254	10.81675	
15	2	6	87.2	1756		11.669875	

Bin5 Statistics 22

Trial #	Pulse	Chirp (MHz)	Pulse Width (µS)	Pulse 1-2 spacing (µS)	Pulse 2-3 spacing (µS)	Pulse Start(S)	Detection (1:yes; 0:no)
0	2	6	76.5	1524		0.454204	1
1	2	7	50.7	1956		0.738159	
2	1	16	95.5			1.873036	
3	2	15	67.6	1747		2.015719	
4	2	11	56.2	1378		3.122586	
5	3	17	68.8	1712	1918	3.305251	
6	1	20	94.7			3.991467	
7	2	7	65	1575		4.436646	
8	2	17	63.6	1142		5.480487	
9	1	8	58.6			6.013446	
10	3	14	58.6	1693	1516	6.549555	
11	3	16	67.9	1090	1744	7.334511	
12	2	9	75.3	1147		7.668284	
13	2	15	97.3	1518		8.552222	
14	2	10	89.7	1046		8.864412	
15	2	12	70.8	1245		9.957023	
16	2	8	63.3	1340		10.560283	
17	2	5	82.1	1354		11.297235	
18	2	14	87	1697		11.71353	

Bin5 Statistics 23

Trial #	Pulse	Chirp (MHz)	Pulse Width (µS)	Pulse 1-2 spacing (µS)	Pulse 2-3 spacing (µS)	Pulse Start(S)	Detection (1:yes; 0:no)
0	3	17	90	1697	1746	0.181666	0
1	2	17	67.7	1914		1.123369	
2	3	10	61.4	1542	1475	1.999766	
3	1	12	91.3			3.000023	
4	1	20	50.4			3.729719	
5	3	19	51.9	1172	1342	4.761004	
6	2	8	90.5	1984		4.865218	
7	2	17	56.2	1031		6.014297	
8	3	9	62.4	1029	1717	6.982927	
9	1	14	74.6			7.461169	
10	2	12	98.7	1573		8.353578	
11	1	10	66.3			9.099945	
12	2	11	63.2	1375		9.968835	
13	2	5	89.5	1690		10.98573	
14	3	20	95.2	1075	1173	11.27578	

Bin5 Statistics 24

Trial #	Pulse	Chirp (MHz)	Pulse Width (µS)	Pulse 1-2 spacing (uS)	Pulse 2-3 spacing (uS)	Pulse Start(S)	Detection (1:yes; 0:no)
0	2	6	89.8	1520		0.109735	1
1	2	20	56	1227		1.874777	
2	2	15	55	1270		2.710996	
3	2	16	86.4	1416		3.051689	
4	1	17	71			4.001403	
5	1	18	62.7			5.642549	
6	3	6	57.9	1756	1380	6.735476	
7	1	20	95.1			7.238173	
8	2	7	77.5	1482		8.433512	
9	2	19	69.9	1093		9.777674	
10	3	20	71.1	1570	1903	10.43843	
11	2	19	54.8	1941		11.87972	

Bin5 Statistics 25

Trial #	Pulse	Chirp (MHz)	Pulse Width (µS)	Pulse 1-2 spacing (uS)	Pulse 2-3 spacing (uS)	Pulse Start(S)	Detection (1:yes; 0:no)
0	2	8	53.8	1759		0.752259	1
1	2	8	70.4	1027		1.981717	
2	2	5	56.1	1412		2.775191	
3	2	16	62.9	1547		4.705794	
4	3	5	99.6	1590	1671	5.660925	
5	2	13	56.6	1448		7.804223	
6	2	8	53.4	1668		8.656508	
7	2	6	88.6	1932		9.564367	
8	2	6	58.6	1567		11.5935	

Bin5 Statistics 26

Trial #	Pulse	Chirp (MHz)	Pulse Width (µS)	Pulse 1-2 spacing (uS)	Pulse 2-3 spacing (uS)	Pulse Start(S)	Detection (1:yes; 0:no)
0	3	12	79.1	1375	1108	0.84305	1
1	1	16	65.7			1.470164	
2	1	12	89.7			2.41404	
3	2	16	78.7	1890		3.396022	
4	1	11	61.3			5.368584	
5	1	9	78.4			5.63391	
6	2	8	63.7	1117		7.000084	
7	2	17	87.2	1941		8.299692	
8	3	14	71.5	1686	1910	9.264421	
9	2	16	59.6	1237		10.852133	
10	2	7	62.5	1477		11.124095	

Bin5 Statistics 27

Trial #	Pulse	Chirp (MHz)	Pulse Width (µS)	Pulse 1-2 spacing (uS)	Pulse 2-3 spacing (uS)	Pulse Start(S)	Detection (1:yes; 0:no)
0	3	7	78.5	1227	1429	0.898539	1
1	2	8	53.2	1875		2.192383	
2	3	6	69	1418	1647	2.482668	
3	2	18	56.1	1819		4.5901	
4	2	13	79.9	1149		5.700786	
5	1	15	60.3			7.154518	
6	3	11	70.5	1196	1930	7.733009	
7	2	19	52.1	1620		9.159663	
8	2	20	58.5	1196		10.537827	
9	2	13	53.5	1731		10.901798	

Bin5 Statistics 28

Trial #	Pulse	Chirp (MHz)	Pulse Width (µS)	Pulse 1-2 spacing (uS)	Pulse 2-3 spacing (uS)	Pulse Start(S)	Detection (1:yes; 0:no)
0	2	7	79	1795		0.383592	1
1	2	8	50.4	1195		1.714485	
2	2	6	90	1622		2.517586	
3	2	15	98.4	1726		4.283731	
4	1	12	80.5			5.33766	
5	1	13	64.9			5.935067	
6	3	9	65.9	1517	1221	6.672393	
7	3	7	67.7	1469	1689	8.380036	
8	3	9	62.1	1018	1918	9.211958	
9	2	12	52	1547		10.015429	
10	2	19	66.8	1552		11.90685	

Bin5 Statistics 29

Trial #	Pulse	Chirp (MHz)	Pulse Width (µS)	Pulse 1-2 spacing (uS)	Pulse 2-3 spacing (uS)	Pulse Start(S)	Detection (1:yes; 0:no)
0	3	14	69.6	1268	1968	0.538548	1
1	2	19	86	1174		1.032971	
2	3	15	83.5	1225	1766	2.343373	
3	3	20	80.6	1640	1190	3.110275	
4	1	11	73.1			4.138065	
5	1	8	60.4			5.466691	
6	2	9	79.3	1813		6.566842	
7	2	7	92.6	1719		7.042328	
8	1	9	76.2			8.778831	
9	3	6	59.8	1105	1805	9.054574	
10	1	7	58.2			10.913744	
11	2	12	78.3	1037		11.859019	

Bin5 Statistics 30

Trial #	Pulse	Chirp (MHz)	Pulse Width (µS)	Pulse 1-2 spacing (µS)	Pulse 2-3 spacing (µS)	Pulse Start(S)	Detection (1:yes; 0:no)
0	1	15	87.8			0.026541	1
1	1	11	96.5			1.045482	
2	3	11	63.6	1690	1553	1.861366	
3	3	13	87.1	1845	1514	2.933725	
4	2	10	76.7	1373		3.24639	
5	3	6	98.2	1368	1269	4.486489	
6	2	9	97.4	1610		5.36281	
7	3	14	61	1714	1521	6.174353	
8	2	13	95.5	1024		6.481358	
9	3	11	67.9	1379	1247	7.852888	
10	3	12	97.2	1024	1332	8.544809	
11	2	7	71.2	1110		9.492827	
12	3	13	71.7	1268	1781	9.904623	
13	1	12	74.5			10.759644	
14	2	15	62.9	1509		11.775151	

Table-6 Radar Type 6 Statistical Performance

Trial #	Fc (MHz)	Pulse /Burst	Pulse Width (µS)	PRI (µs)	Detection (1:yes; 0:no)	Hopping Sequence
1	5270	9	1	333	1	5627.0, 5302.0, 5498.0, 5700.0, 5348.0, 5698.0, 5569.0, 5280.0, 5597.0, 5596.0, 5328.0, 5342.0, 5255.0, 5547.0, 5446.0, 5581.0, 5660.0, 5518.0, 5722.0, 5315.0, 5638.0, 5288.0, 5527.0, 5579.0, 5590.0, 5526.0, 5525.0, 5530.0, 5391.0, 5407.0, 5508.0, 5278.0, 5588.0, 5528.0, 5259.0, 5607.0, 5332.0, 5680.0, 5366.0, 5619.0, 5529.0, 5258.0, 5612.0, 5344.0, 5578.0, 5360.0, 5543.0, 5713.0, 5499.0, 5609.0, 5379.0, 5655.0, 5472.0, 5614.0, 5403.0, 5511.0, 5701.0, 5401.0, 5316.0, 5349.0, 5553.0, 5712.0, 5260.0, 5421.0, 5548.0, 5513.0, 5371.0, 5631.0, 5707.0, 5447.0, 5662.0, 5479.0, 5642.0, 5424.0, 5672.0, 5251.0, 5367.0, 5641.0, 5502.0, 5469.0, 5317.0, 5353.0, 5504.0, 5297.0, 5515.0, 5651.0, 5668.0, 5312.0, 5695.0, 5263.0, 5557.0, 5303.0, 5572.0, 5531.0, 5346.0, 5710.0, 5383.0, 5423.0, 5358.0, 5390.0 (number of hits: 9)
2	5270	9	1	333	1	5418.0, 5575.0, 5515.0, 5291.0, 5664.0, 5508.0, 5268.0, 5278.0, 5280.0, 5411.0, 5613.0, 5501.0, 5296.0, 5522.0, 5585.0, 5290.0, 5269.0, 5595.0, 5353.0, 5255.0, 5511.0, 5345.0, 5500.0, 5295.0, 5352.0, 5524.0, 5398.0, 5553.0, 5485.0, 5578.0, 5479.0, 5302.0, 5388.0, 5373.0, 5323.0, 5570.0, 5663.0, 5419.0, 5371.0, 5333.0, 5428.0, 5482.0, 5723.0, 5640.0, 5610.0, 5448.0, 5401.0, 5486.0, 5322.0, 5631.0, 5252.0, 5432.0, 5653.0, 5326.0, 5529.0, 5532.0, 5445.0, 5520.0, 5314.0, 5641.0, 5649.0, 5572.0, 5451.0, 5344.0, 5337.0, 5387.0, 5488.0, 5693.0, 5698.0, 5679.0, 5396.0, 5315.0, 5472.0, 5658.0, 5439.0, 5684.0, 5593.0, 5435.0, 5455.0, 5484.0, 5622.0, 5713.0, 5374.0, 5580.0, 5551.0, 5718.0, 5390.0, 5579.0, 5655.0, 5703.0, 5685.0, 5483.0, 5628.0, 5571.0, 5465.0, 5452.0, 5279.0, 5431.0, 5310.0, 5581.0 (number of hits: 7)
3	5270	9	1	333	1	5300.0, 5563.0, 5407.0, 5497.0, 5498.0, 5590.0, 5310.0, 5321.0, 5609.0, 5416.0, 5545.0, 5666.0, 5526.0, 5544.0, 5586.0, 5709.0, 5317.0, 5717.0, 5655.0, 5510.0, 5375.0, 5645.0, 5591.0, 5462.0, 5403.0, 5347.0, 5326.0, 5636.0, 5625.0, 5644.0, 5635.0, 5559.0, 5577.0, 5274.0, 5540.0, 5550.0, 5420.0, 5512.0, 5339.0, 5277.0, 5461.0, 5552.0, 5373.0, 5530.0, 5662.0, 5492.0, 5257.0, 5582.0, 5425.0, 5575.0, 5513.0, 5432.0, 5404.0, 5383.0, 5446.0,

						5364.0, 5437.0, 5387.0, 5311.0, 5324.0, 5541.0, 5298.0, 5539.0, 5459.0, 5612.0, 5676.0, 5561.0, 5417.0, 5360.0, 5388.0, 5579.0, 5305.0, 5398.0, 5564.0, 5626.0, 5331.0, 5643.0, 5572.0, 5536.0, 5443.0, 5456.0, 5477.0, 5428.0, 5410.0, 5508.0, 5657.0, 5587.0, 5549.0, 5336.0, 5519.0, 5271.0, 5314.0, 5705.0, 5251.0, 5619.0, 5668.0, 5723.0, 5714.0, 5419.0, 5299.0 (number of hits: 5)
4	5270	9	1	333	1	5309.0, 5677.0, 5608.0, 5603.0, 5577.0, 5549.0, 5518.0, 5682.0, 5283.0, 5558.0, 5297.0, 5619.0, 5389.0, 5698.0, 5367.0, 5520.0, 5422.0, 5286.0, 5308.0, 5394.0, 5385.0, 5277.0, 5450.0, 5449.0, 5338.0, 5723.0, 5296.0, 5464.0, 5458.0, 5383.0, 5578.0, 5322.0, 5491.0, 5648.0, 5352.0, 5709.0, 5484.0, 5508.0, 5631.0, 5712.0, 5553.0, 5714.0, 5478.0, 5350.0, 5614.0, 5652.0, 5312.0, 5633.0, 5481.0, 5582.0, 5690.0, 5515.0, 5493.0, 5358.0, 5721.0, 5703.0, 5423.0, 5426.0, 5357.0, 5494.0, 5388.0, 5519.0, 5584.0, 5452.0, 5288.0, 5568.0, 5510.0, 5371.0, 5687.0, 5693.0, 5538.0, 5567.0, 5466.0, 5327.0, 5663.0, 5611.0, 5335.0, 5275.0, 5446.0, 5502.0, 5707.0, 5621.0, 5716.0, 5498.0, 5521.0, 5333.0, 5472.0, 5483.0, 5499.0, 5300.0, 5724.0, 5649.0, 5315.0, 5597.0, 5439.0, 5398.0, 5671.0, 5573.0, 5507.0, 5319.0 (number of hits: 5)
5	5270	9	1	333	1	5658.0, 5283.0, 5720.0, 5355.0, 5308.0, 5625.0, 5539.0, 5619.0, 5689.0, 5411.0, 5343.0, 5644.0, 5330.0, 5295.0, 5558.0, 5327.0, 5328.0, 5692.0, 5613.0, 5653.0, 5394.0, 5560.0, 5656.0, 5265.0, 5509.0, 5480.0, 5420.0, 5648.0, 5710.0, 5446.0, 5715.0, 5555.0, 5573.0, 5465.0, 5376.0, 5590.0, 5567.0, 5278.0, 5632.0, 5304.0, 5354.0, 5594.0, 5319.0, 5615.0, 5294.0, 5296.0, 5679.0, 5407.0, 5415.0, 5374.0, 5259.0, 5325.0, 5459.0, 5486.0, 5581.0, 5401.0, 5528.0, 5549.0, 5530.0, 5707.0, 5535.0, 5706.0, 5676.0, 5388.0, 5699.0, 5300.0, 5601.0, 5642.0, 5576.0, 5347.0, 5680.0, 5711.0, 5271.0, 5572.0, 5462.0, 5266.0, 5722.0, 5463.0, 5331.0, 5443.0, 5301.0, 5511.0, 5673.0, 5649.0, 5630.0, 5634.0, 5382.0, 5290.0, 5559.0, 5704.0, 5310.0, 5419.0, 5499.0, 5318.0, 5718.0, 5563.0, 5423.0, 5543.0, 5553.0, 5578.0 (number of hits: 6)
6	5270	9	1	333	1	5503.0, 5520.0, 5403.0, 5677.0, 5625.0, 5705.0, 5440.0, 5418.0, 5660.0, 5419.0, 5719.0, 5320.0, 5617.0, 5701.0, 5648.0, 5465.0, 5264.0, 5720.0, 5311.0, 5445.0, 5441.0, 5463.0, 5682.0, 5708.0, 5565.0, 5447.0, 5478.0, 5316.0, 5346.0, 5608.0, 5661.0, 5479.0, 5480.0, 5295.0, 5681.0,

						5654.0, 5337.0, 5622.0, 5378.0, 5547.0, 5375.0, 5715.0, 5401.0, 5438.0, 5380.0, 5590.0, 5524.0, 5329.0, 5531.0, 5621.0, 5256.0, 5304.0, 5325.0, 5573.0, 5281.0, 5396.0, 5280.0, 5384.0, 5454.0, 5713.0, 5690.0, 5702.0, 5634.0, 5355.0, 5268.0, 5711.0, 5655.0, 5413.0, 5296.0, 5414.0, 5530.0, 5433.0, 5269.0, 5623.0, 5642.0, 5469.0, 5331.0, 5618.0, 5476.0, 5593.0, 5581.0, 5512.0, 5344.0, 5546.0, 5645.0, 5688.0, 5535.0, 5308.0, 5405.0, 5619.0, 5451.0, 5517.0, 5461.0, 5487.0, 5286.0, 5693.0, 5588.0, 5641.0, 5458.0, 5400.0 (number of hits: 7)
7	5270	9	1	333	1	5704.0, 5722.0, 5700.0, 5606.0, 5437.0, 5455.0, 5494.0, 5549.0, 5406.0, 5656.0, 5660.0, 5283.0, 5686.0, 5338.0, 5475.0, 5414.0, 5714.0, 5559.0, 5315.0, 5387.0, 5646.0, 5697.0, 5395.0, 5439.0, 5599.0, 5546.0, 5293.0, 5541.0, 5286.0, 5576.0, 5303.0, 5548.0, 5509.0, 5694.0, 5691.0, 5419.0, 5589.0, 5654.0, 5401.0, 5270.0, 5325.0, 5544.0, 5309.0, 5677.0, 5538.0, 5520.0, 5355.0, 5448.0, 5591.0, 5584.0, 5542.0, 5626.0, 5605.0, 5258.0, 5638.0, 5427.0, 5313.0, 5333.0, 5662.0, 5365.0, 5630.0, 5555.0, 5616.0, 5643.0, 5405.0, 5664.0, 5574.0, 5345.0, 5367.0, 5403.0, 5409.0, 5680.0, 5724.0, 5670.0, 5491.0, 5391.0, 5707.0, 5463.0, 5435.0, 5302.0, 5348.0, 5321.0, 5422.0, 5699.0, 5474.0, 5357.0, 5580.0, 5311.0, 5486.0, 5259.0, 5275.0, 5362.0, 5508.0, 5526.0, 5531.0, 5545.0, 5330.0, 5467.0, 5417.0, 5622.0 (number of hits: 6)
8	5270	9	1	333	1	5369.0, 5273.0, 5293.0, 5351.0, 5449.0, 5524.0, 5625.0, 5587.0, 5403.0, 5315.0, 5674.0, 5309.0, 5297.0, 5364.0, 5532.0, 5513.0, 5491.0, 5254.0, 5318.0, 5611.0, 5679.0, 5609.0, 5283.0, 5688.0, 5560.0, 5696.0, 5422.0, 5716.0, 5664.0, 5334.0, 5599.0, 5632.0, 5481.0, 5450.0, 5291.0, 5561.0, 5548.0, 5574.0, 5594.0, 5493.0, 5392.0, 5627.0, 5289.0, 5498.0, 5706.0, 5668.0, 5270.0, 5394.0, 5349.0, 5614.0, 5451.0, 5528.0, 5404.0, 5305.0, 5319.0, 5356.0, 5424.0, 5534.0, 5581.0, 5432.0, 5378.0, 5660.0, 5606.0, 5564.0, 5384.0, 5558.0, 5373.0, 5427.0, 5540.0, 5590.0, 5689.0, 5666.0, 5649.0, 5490.0, 5431.0, 5553.0, 5559.0, 5487.0, 5595.0, 5567.0, 5409.0, 5377.0, 5275.0, 5712.0, 5286.0, 5592.0, 5659.0, 5571.0, 5442.0, 5697.0, 5631.0, 5321.0, 5669.0, 5531.0, 5342.0, 5454.0, 5536.0, 5467.0, 5402.0, 5370.0 (number of hits: 7)
9	5270	9	1	333	1	5475.0, 5684.0, 5607.0, 5419.0, 5259.0, 5255.0, 5596.0, 5372.0, 5277.0, 5496.0, 5434.0, 5458.0, 5546.0, 5421.0, 5718.0,

						5666.0, 5521.0, 5262.0, 5704.0, 5280.0, 5432.0, 5701.0, 5577.0, 5392.0, 5461.0, 5293.0, 5403.0, 5312.0, 5611.0, 5486.0, 5678.0, 5310.0, 5299.0, 5655.0, 5266.0, 5692.0, 5637.0, 5589.0, 5688.0, 5320.0, 5435.0, 5657.0, 5720.0, 5540.0, 5268.0, 5721.0, 5450.0, 5430.0, 5522.0, 5378.0, 5516.0, 5330.0, 5652.0, 5384.0, 5353.0, 5618.0, 5350.0, 5480.0, 5442.0, 5568.0, 5529.0, 5273.0, 5404.0, 5509.0, 5275.0, 5610.0, 5398.0, 5634.0, 5363.0, 5565.0, 5662.0, 5697.0, 5520.0, 5556.0, 5445.0, 5680.0, 5282.0, 5417.0, 5649.0, 5682.0, 5615.0, 5627.0, 5400.0, 5295.0, 5477.0, 5402.0, 5575.0, 5547.0, 5562.0, 5252.0, 5375.0, 5298.0, 5427.0, 5279.0, 5523.0, 5658.0, 5503.0, 5625.0, 5439.0, 5390.0 (number of hits: 12)
10	5270	9	1	333	1	5574.0, 5486.0, 5447.0, 5360.0, 5309.0, 5295.0, 5611.0, 5568.0, 5646.0, 5440.0, 5586.0, 5418.0, 5503.0, 5482.0, 5475.0, 5498.0, 5367.0, 5644.0, 5550.0, 5460.0, 5504.0, 5608.0, 5682.0, 5354.0, 5392.0, 5348.0, 5654.0, 5421.0, 5288.0, 5716.0, 5703.0, 5545.0, 5628.0, 5708.0, 5342.0, 5325.0, 5711.0, 5491.0, 5662.0, 5526.0, 5712.0, 5253.0, 5601.0, 5596.0, 5336.0, 5700.0, 5613.0, 5321.0, 5685.0, 5277.0, 5285.0, 5598.0, 5508.0, 5624.0, 5468.0, 5580.0, 5415.0, 5462.0, 5570.0, 5605.0, 5294.0, 5356.0, 5497.0, 5251.0, 5558.0, 5510.0, 5512.0, 5420.0, 5287.0, 5578.0, 5386.0, 5322.0, 5328.0, 5337.0, 5404.0, 5668.0, 5516.0, 5349.0, 5268.0, 5640.0, 5402.0, 5298.0, 5648.0, 5582.0, 5589.0, 5394.0, 5688.0, 5587.0, 5463.0, 5478.0, 5417.0, 5266.0, 5657.0, 5320.0, 5720.0, 5527.0, 5599.0, 5366.0, 5565.0, 5466.0 (number of hits: 8)
11	5270	9	1	333	1	5494.0, 5410.0, 5446.0, 5251.0, 5543.0, 5260.0, 5449.0, 5680.0, 5279.0, 5252.0, 5395.0, 5579.0, 5353.0, 5482.0, 5602.0, 5429.0, 5474.0, 5450.0, 5468.0, 5413.0, 5537.0, 5556.0, 5369.0, 5322.0, 5599.0, 5687.0, 5259.0, 5611.0, 5528.0, 5431.0, 5527.0, 5412.0, 5654.0, 5315.0, 5280.0, 5283.0, 5524.0, 5583.0, 5452.0, 5418.0, 5381.0, 5269.0, 5433.0, 5630.0, 5666.0, 5553.0, 5526.0, 5476.0, 5586.0, 5705.0, 5367.0, 5660.0, 5377.0, 5696.0, 5313.0, 5716.0, 5701.0, 5443.0, 5427.0, 5688.0, 5349.0, 5507.0, 5379.0, 5345.0, 5448.0, 5392.0, 5522.0, 5422.0, 5329.0, 5298.0, 5473.0, 5541.0, 5256.0, 5263.0, 5275.0, 5685.0, 5488.0, 5538.0, 5632.0, 5338.0, 5513.0, 5435.0, 5442.0, 5387.0, 5712.0, 5709.0, 5690.0, 5485.0, 5357.0, 5314.0, 5299.0, 5560.0, 5291.0, 5402.0, 5582.0, 5295.0, 5633.0, 5535.0, 5674.0, 5375.0

						(number of hits: 11)
12	5270	9	1	333	1	5395.0, 5585.0, 5487.0, 5511.0, 5381.0, 5546.0, 5418.0, 5337.0, 5509.0, 5340.0, 5435.0, 5628.0, 5516.0, 5454.0, 5527.0, 5550.0, 5281.0, 5291.0, 5344.0, 5456.0, 5563.0, 5676.0, 5410.0, 5572.0, 5560.0, 5420.0, 5649.0, 5687.0, 5662.0, 5343.0, 5428.0, 5651.0, 5341.0, 5297.0, 5468.0, 5690.0, 5439.0, 5692.0, 5256.0, 5659.0, 5273.0, 5640.0, 5536.0, 5478.0, 5661.0, 5721.0, 5307.0, 5708.0, 5715.0, 5414.0, 5258.0, 5504.0, 5549.0, 5338.0, 5597.0, 5472.0, 5548.0, 5432.0, 5566.0, 5322.0, 5679.0, 5287.0, 5537.0, 5278.0, 5373.0, 5407.0, 5470.0, 5419.0, 5530.0, 5522.0, 5717.0, 5496.0, 5593.0, 5457.0, 5535.0, 5275.0, 5654.0, 5388.0, 5497.0, 5426.0, 5465.0, 5670.0, 5366.0, 5714.0, 5451.0, 5553.0, 5412.0, 5318.0, 5326.0, 5313.0, 5320.0, 5334.0, 5646.0, 5342.0, 5594.0, 5577.0, 5453.0, 5677.0, 5443.0, 5355.0
						(number of hits: 7)
13	5270	9	1	333	1	5382.0, 5394.0, 5546.0, 5562.0, 5511.0, 5328.0, 5293.0, 5501.0, 5337.0, 5359.0, 5498.0, 5289.0, 5459.0, 5548.0, 5647.0, 5275.0, 5524.0, 5475.0, 5462.0, 5503.0, 5480.0, 5388.0, 5423.0, 5651.0, 5302.0, 5630.0, 5482.0, 5644.0, 5368.0, 5722.0, 5633.0, 5290.0, 5409.0, 5518.0, 5535.0, 5380.0, 5600.0, 5631.0, 5666.0, 5338.0, 5426.0, 5383.0, 5712.0, 5589.0, 5403.0, 5471.0, 5628.0, 5443.0, 5721.0, 5432.0, 5273.0, 5528.0, 5349.0, 5588.0, 5542.0, 5291.0, 5552.0, 5616.0, 5663.0, 5452.0, 5322.0, 5400.0, 5422.0, 5602.0, 5506.0, 5568.0, 5428.0, 5441.0, 5266.0, 5583.0, 5515.0, 5253.0, 5572.0, 5268.0, 5701.0, 5711.0, 5376.0, 5276.0, 5668.0, 5378.0, 5558.0, 5597.0, 5261.0, 5612.0, 5505.0, 5622.0, 5371.0, 5477.0, 5267.0, 5629.0, 5672.0, 5367.0, 5639.0, 5465.0, 5468.0, 5405.0, 5420.0, 5532.0, 5314.0, 5333.0
						(number of hits: 9)
14	5270	9	1	333	1	5710.0, 5260.0, 5713.0, 5525.0, 5398.0, 5688.0, 5715.0, 5502.0, 5544.0, 5642.0, 5264.0, 5283.0, 5385.0, 5371.0, 5369.0, 5426.0, 5711.0, 5662.0, 5367.0, 5485.0, 5574.0, 5605.0, 5344.0, 5463.0, 5541.0, 5682.0, 5252.0, 5588.0, 5395.0, 5669.0, 5517.0, 5338.0, 5393.0, 5296.0, 5512.0, 5625.0, 5276.0, 5356.0, 5382.0, 5661.0, 5291.0, 5437.0, 5351.0, 5585.0, 5405.0, 5343.0, 5559.0, 5614.0, 5383.0, 5434.0, 5522.0, 5332.0, 5379.0, 5446.0, 5697.0, 5562.0, 5465.0, 5700.0, 5534.0, 5624.0, 5611.0, 5597.0, 5655.0, 5363.0, 5701.0, 5643.0, 5565.0, 5411.0, 5298.0, 5475.0, 5366.0, 5330.0, 5408.0, 5407.0, 5491.0, 5286.0, 5657.0, 5615.0, 5354.0, 5439.0,

						5603.0, 5600.0, 5384.0, 5569.0, 5481.0, 5436.0, 5546.0, 5352.0, 5564.0, 5335.0, 5490.0, 5590.0, 5623.0, 5520.0, 5418.0, 5399.0, 5524.0, 5442.0, 5651.0, 5409.0 (number of hits: 6)
15	5270	9	1	333	1	5607.0, 5605.0, 5544.0, 5365.0, 5279.0, 5518.0, 5552.0, 5362.0, 5371.0, 5550.0, 5339.0, 5486.0, 5441.0, 5584.0, 5406.0, 5340.0, 5657.0, 5255.0, 5716.0, 5419.0, 5291.0, 5644.0, 5499.0, 5642.0, 5712.0, 5452.0, 5388.0, 5689.0, 5479.0, 5305.0, 5325.0, 5323.0, 5718.0, 5252.0, 5491.0, 5267.0, 5380.0, 5545.0, 5624.0, 5302.0, 5310.0, 5533.0, 5363.0, 5586.0, 5285.0, 5466.0, 5666.0, 5608.0, 5482.0, 5532.0, 5306.0, 5691.0, 5478.0, 5588.0, 5327.0, 5286.0, 5355.0, 5398.0, 5598.0, 5564.0, 5609.0, 5281.0, 5629.0, 5511.0, 5569.0, 5556.0, 5625.0, 5410.0, 5259.0, 5492.0, 5263.0, 5622.0, 5453.0, 5264.0, 5501.0, 5300.0, 5328.0, 5451.0, 5413.0, 5422.0, 5685.0, 5513.0, 5699.0, 5256.0, 5519.0, 5411.0, 5626.0, 5577.0, 5266.0, 5289.0, 5420.0, 5368.0, 5271.0, 5562.0, 5270.0, 5397.0, 5250.0, 5616.0, 5566.0, 5498.0 (number of hits: 16)
16	5270	9	1	333	1	5624.0, 5522.0, 5333.0, 5460.0, 5443.0, 5468.0, 5312.0, 5501.0, 5698.0, 5610.0, 5715.0, 5629.0, 5372.0, 5295.0, 5255.0, 5444.0, 5310.0, 5375.0, 5669.0, 5595.0, 5671.0, 5296.0, 5420.0, 5282.0, 5576.0, 5545.0, 5294.0, 5570.0, 5425.0, 5408.0, 5474.0, 5483.0, 5421.0, 5366.0, 5719.0, 5388.0, 5560.0, 5268.0, 5571.0, 5406.0, 5404.0, 5503.0, 5461.0, 5512.0, 5343.0, 5368.0, 5306.0, 5300.0, 5579.0, 5655.0, 5696.0, 5434.0, 5666.0, 5290.0, 5320.0, 5520.0, 5313.0, 5516.0, 5277.0, 5500.0, 5256.0, 5603.0, 5496.0, 5694.0, 5436.0, 5292.0, 5677.0, 5682.0, 5288.0, 5555.0, 5403.0, 5386.0, 5338.0, 5596.0, 5514.0, 5683.0, 5482.0, 5637.0, 5479.0, 5413.0, 5264.0, 5678.0, 5521.0, 5332.0, 5397.0, 5341.0, 5598.0, 5278.0, 5317.0, 5591.0, 5525.0, 5493.0, 5673.0, 5391.0, 5401.0, 5502.0, 5464.0, 5284.0, 5342.0, 5266.0 (number of hits: 10)
17	5270	9	1	333	1	5618.0, 5571.0, 5560.0, 5443.0, 5658.0, 5483.0, 5323.0, 5698.0, 5306.0, 5383.0, 5623.0, 5542.0, 5308.0, 5303.0, 5514.0, 5393.0, 5606.0, 5364.0, 5715.0, 5261.0, 5671.0, 5378.0, 5318.0, 5440.0, 5504.0, 5281.0, 5265.0, 5426.0, 5384.0, 5529.0, 5637.0, 5707.0, 5563.0, 5657.0, 5307.0, 5278.0, 5668.0, 5595.0, 5336.0, 5339.0, 5496.0, 5269.0, 5499.0, 5419.0, 5413.0, 5358.0, 5712.0, 5569.0, 5259.0, 5385.0, 5624.0, 5266.0, 5617.0, 5611.0, 5469.0, 5386.0, 5368.0, 5582.0, 5550.0, 5603.0,

						5549.0, 5427.0, 5552.0, 5356.0, 5612.0, 5597.0, 5428.0, 5520.0, 5488.0, 5305.0, 5518.0, 5654.0, 5255.0, 5699.0, 5377.0, 5583.0, 5408.0, 5381.0, 5436.0, 5329.0, 5544.0, 5533.0, 5260.0, 5374.0, 5519.0, 5486.0, 5456.0, 5299.0, 5404.0, 5527.0, 5350.0, 5328.0, 5497.0, 5295.0, 5484.0, 5410.0, 5587.0, 5292.0, 5414.0, 5405.0 (number of hits: 9)
18	5270	9	1	333	1	5356.0, 5254.0, 5524.0, 5590.0, 5464.0, 5544.0, 5267.0, 5348.0, 5296.0, 5326.0, 5593.0, 5410.0, 5493.0, 5527.0, 5423.0, 5323.0, 5541.0, 5554.0, 5547.0, 5681.0, 5680.0, 5698.0, 5608.0, 5372.0, 5629.0, 5313.0, 5417.0, 5600.0, 5564.0, 5643.0, 5340.0, 5540.0, 5647.0, 5673.0, 5412.0, 5635.0, 5276.0, 5656.0, 5352.0, 5532.0, 5336.0, 5482.0, 5366.0, 5558.0, 5573.0, 5592.0, 5325.0, 5671.0, 5492.0, 5476.0, 5289.0, 5328.0, 5388.0, 5290.0, 5529.0, 5577.0, 5685.0, 5636.0, 5260.0, 5667.0, 5434.0, 5512.0, 5507.0, 5655.0, 5475.0, 5449.0, 5462.0, 5463.0, 5705.0, 5508.0, 5574.0, 5631.0, 5480.0, 5376.0, 5474.0, 5571.0, 5648.0, 5259.0, 5368.0, 5612.0, 5641.0, 5691.0, 5701.0, 5668.0, 5489.0, 5499.0, 5616.0, 5591.0, 5633.0, 5555.0, 5605.0, 5495.0, 5384.0, 5252.0, 5516.0, 5552.0, 5610.0, 5420.0, 5335.0, 5688.0 (number of hits: 7)
19	5270	9	1	333	1	5385.0, 5441.0, 5724.0, 5356.0, 5522.0, 5638.0, 5567.0, 5677.0, 5644.0, 5393.0, 5649.0, 5492.0, 5425.0, 5368.0, 5685.0, 5496.0, 5269.0, 5376.0, 5600.0, 5599.0, 5583.0, 5304.0, 5433.0, 5533.0, 5669.0, 5666.0, 5418.0, 5494.0, 5327.0, 5373.0, 5464.0, 5281.0, 5265.0, 5361.0, 5617.0, 5290.0, 5509.0, 5570.0, 5610.0, 5523.0, 5562.0, 5520.0, 5397.0, 5514.0, 5408.0, 5316.0, 5384.0, 5676.0, 5709.0, 5267.0, 5508.0, 5519.0, 5311.0, 5355.0, 5421.0, 5394.0, 5298.0, 5473.0, 5480.0, 5572.0, 5608.0, 5574.0, 5366.0, 5422.0, 5646.0, 5392.0, 5325.0, 5698.0, 5565.0, 5426.0, 5379.0, 5612.0, 5713.0, 5423.0, 5453.0, 5502.0, 5641.0, 5516.0, 5661.0, 5352.0, 5682.0, 5274.0, 5549.0, 5551.0, 5536.0, 5399.0, 5292.0, 5524.0, 5590.0, 5546.0, 5691.0, 5645.0, 5526.0, 5318.0, 5260.0, 5671.0, 5643.0, 5307.0, 5697.0, 5458.0 (number of hits: 6)
20	5270	9	1	333	1	5551.0, 5337.0, 5723.0, 5258.0, 5280.0, 5602.0, 5568.0, 5614.0, 5528.0, 5660.0, 5678.0, 5718.0, 5561.0, 5586.0, 5622.0, 5458.0, 5695.0, 5451.0, 5685.0, 5580.0, 5677.0, 5468.0, 5719.0, 5334.0, 5495.0, 5557.0, 5480.0, 5342.0, 5563.0, 5658.0, 5294.0, 5276.0, 5655.0, 5283.0, 5465.0, 5310.0, 5675.0, 5413.0, 5282.0, 5629.0,

						5317.0, 5523.0, 5395.0, 5411.0, 5682.0, 5702.0, 5341.0, 5511.0, 5257.0, 5708.0, 5414.0, 5668.0, 5367.0, 5431.0, 5709.0, 5508.0, 5486.0, 5408.0, 5644.0, 5698.0, 5262.0, 5679.0, 5415.0, 5597.0, 5459.0, 5447.0, 5443.0, 5713.0, 5572.0, 5304.0, 5556.0, 5344.0, 5717.0, 5715.0, 5314.0, 5461.0, 5515.0, 5543.0, 5291.0, 5502.0, 5613.0, 5645.0, 5593.0, 5273.0, 5544.0, 5482.0, 5630.0, 5403.0, 5670.0, 5652.0, 5402.0, 5281.0, 5309.0, 5396.0, 5493.0, 5293.0, 5491.0, 5587.0, 5538.0, 5684.0 (number of hits: 9)
21	5270	9	1	333	1	5424.0, 5255.0, 5648.0, 5707.0, 5451.0, 5312.0, 5550.0, 5481.0, 5521.0, 5635.0, 5452.0, 5513.0, 5434.0, 5303.0, 5710.0, 5592.0, 5435.0, 5692.0, 5467.0, 5456.0, 5272.0, 5433.0, 5399.0, 5368.0, 5310.0, 5690.0, 5566.0, 5462.0, 5695.0, 5639.0, 5505.0, 5251.0, 5280.0, 5348.0, 5324.0, 5645.0, 5409.0, 5329.0, 5625.0, 5618.0, 5483.0, 5347.0, 5554.0, 5500.0, 5380.0, 5539.0, 5577.0, 5342.0, 5340.0, 5295.0, 5400.0, 5288.0, 5596.0, 5282.0, 5374.0, 5417.0, 5326.0, 5543.0, 5422.0, 5437.0, 5652.0, 5401.0, 5258.0, 5644.0, 5254.0, 5620.0, 5365.0, 5599.0, 5492.0, 5556.0, 5261.0, 5665.0, 5677.0, 5472.0, 5638.0, 5484.0, 5305.0, 5593.0, 5297.0, 5708.0, 5307.0, 5333.0, 5425.0, 5660.0, 5475.0, 5527.0, 5379.0, 5334.0, 5292.0, 5443.0, 5724.0, 5301.0, 5524.0, 5696.0, 5376.0, 5535.0, 5316.0, 5564.0, 5607.0, 5575.0 (number of hits: 9)
22	5270	9	1	333	1	5693.0, 5495.0, 5582.0, 5484.0, 5682.0, 5395.0, 5456.0, 5319.0, 5335.0, 5703.0, 5389.0, 5641.0, 5524.0, 5538.0, 5385.0, 5705.0, 5562.0, 5572.0, 5676.0, 5564.0, 5479.0, 5343.0, 5400.0, 5269.0, 5609.0, 5352.0, 5326.0, 5390.0, 5430.0, 5379.0, 5355.0, 5468.0, 5380.0, 5452.0, 5603.0, 5568.0, 5629.0, 5263.0, 5650.0, 5284.0, 5278.0, 5646.0, 5344.0, 5718.0, 5722.0, 5250.0, 5271.0, 5574.0, 5450.0, 5519.0, 5616.0, 5329.0, 5515.0, 5398.0, 5575.0, 5290.0, 5525.0, 5599.0, 5363.0, 5626.0, 5633.0, 5545.0, 5387.0, 5558.0, 5485.0, 5535.0, 5449.0, 5511.0, 5607.0, 5684.0, 5707.0, 5416.0, 5658.0, 5283.0, 5349.0, 5579.0, 5362.0, 5642.0, 5541.0, 5315.0, 5618.0, 5631.0, 5605.0, 5700.0, 5587.0, 5645.0, 5279.0, 5717.0, 5376.0, 5374.0, 5654.0, 5331.0, 5467.0, 5493.0, 5296.0, 5298.0, 5573.0, 5408.0, 5276.0, 5673.0 (number of hits: 9)
23	5270	9	1	333	1	5431.0, 5269.0, 5638.0, 5458.0, 5627.0, 5646.0, 5401.0, 5536.0, 5296.0, 5436.0, 5546.0, 5702.0, 5691.0, 5282.0, 5706.0, 5432.0, 5332.0, 5285.0, 5351.0, 5652.0,

						5337.0, 5649.0, 5695.0, 5288.0, 5509.0, 5425.0, 5599.0, 5446.0, 5712.0, 5355.0, 5714.0, 5462.0, 5382.0, 5357.0, 5704.0, 5528.0, 5617.0, 5271.0, 5683.0, 5356.0, 5669.0, 5578.0, 5304.0, 5659.0, 5404.0, 5333.0, 5675.0, 5575.0, 5500.0, 5300.0, 5276.0, 5542.0, 5713.0, 5434.0, 5415.0, 5644.0, 5445.0, 5279.0, 5524.0, 5547.0, 5293.0, 5368.0, 5641.0, 5270.0, 5413.0, 5511.0, 5467.0, 5610.0, 5281.0, 5667.0, 5582.0, 5359.0, 5305.0, 5620.0, 5515.0, 5375.0, 5503.0, 5294.0, 5400.0, 5529.0, 5690.0, 5253.0, 5523.0, 5552.0, 5639.0, 5342.0, 5369.0, 5537.0, 5379.0, 5373.0, 5633.0, 5266.0, 5559.0, 5723.0, 5374.0, 5647.0, 5674.0, 5521.0, 5533.0, 5484.0 (number of hits: 11)
24	5270	9	1	333	1	5610.0, 5652.0, 5450.0, 5462.0, 5277.0, 5645.0, 5498.0, 5423.0, 5719.0, 5369.0, 5547.0, 5499.0, 5626.0, 5349.0, 5317.0, 5475.0, 5496.0, 5668.0, 5466.0, 5385.0, 5609.0, 5665.0, 5376.0, 5658.0, 5399.0, 5409.0, 5580.0, 5325.0, 5284.0, 5606.0, 5579.0, 5357.0, 5256.0, 5258.0, 5382.0, 5561.0, 5670.0, 5692.0, 5333.0, 5384.0, 5521.0, 5380.0, 5454.0, 5548.0, 5261.0, 5410.0, 5451.0, 5396.0, 5604.0, 5263.0, 5717.0, 5584.0, 5280.0, 5269.0, 5320.0, 5420.0, 5568.0, 5585.0, 5386.0, 5595.0, 5394.0, 5611.0, 5474.0, 5678.0, 5632.0, 5434.0, 5274.0, 5621.0, 5480.0, 5566.0, 5391.0, 5350.0, 5332.0, 5693.0, 5290.0, 5721.0, 5518.0, 5564.0, 5588.0, 5485.0, 5605.0, 5443.0, 5613.0, 5494.0, 5338.0, 5251.0, 5559.0, 5437.0, 5330.0, 5389.0, 5253.0, 5655.0, 5536.0, 5636.0, 5519.0, 5659.0, 5448.0, 5510.0, 5676.0, 5722.0 (number of hits: 11)
25	5270	9	1	333	1	5410.0, 5302.0, 5296.0, 5364.0, 5276.0, 5631.0, 5333.0, 5442.0, 5517.0, 5453.0, 5482.0, 5401.0, 5531.0, 5699.0, 5686.0, 5601.0, 5307.0, 5306.0, 5472.0, 5564.0, 5475.0, 5407.0, 5611.0, 5694.0, 5653.0, 5721.0, 5473.0, 5574.0, 5529.0, 5303.0, 5643.0, 5429.0, 5607.0, 5280.0, 5624.0, 5561.0, 5388.0, 5619.0, 5567.0, 5543.0, 5283.0, 5417.0, 5373.0, 5452.0, 5515.0, 5532.0, 5501.0, 5588.0, 5598.0, 5325.0, 5547.0, 5599.0, 5459.0, 5266.0, 5465.0, 5361.0, 5384.0, 5464.0, 5441.0, 5382.0, 5363.0, 5380.0, 5633.0, 5566.0, 5507.0, 5295.0, 5548.0, 5510.0, 5522.0, 5533.0, 5594.0, 5565.0, 5458.0, 5674.0, 5439.0, 5637.0, 5648.0, 5462.0, 5354.0, 5425.0, 5477.0, 5403.0, 5622.0, 5486.0, 5356.0, 5639.0, 5705.0, 5595.0, 5343.0, 5284.0, 5415.0, 5347.0, 5559.0, 5321.0, 5326.0, 5600.0, 5355.0, 5537.0, 5689.0, 5357.0 (number of hits: 5)

26	5270	9	1	333	1	<p>5659.0, 5380.0, 5596.0, 5722.0, 5410.0, 5471.0, 5267.0, 5631.0, 5566.0, 5408.0, 5551.0, 5687.0, 5707.0, 5346.0, 5302.0, 5539.0, 5611.0, 5296.0, 5417.0, 5475.0, 5441.0, 5709.0, 5492.0, 5638.0, 5452.0, 5537.0, 5402.0, 5383.0, 5459.0, 5367.0, 5653.0, 5310.0, 5608.0, 5293.0, 5251.0, 5420.0, 5718.0, 5313.0, 5348.0, 5617.0, 5371.0, 5373.0, 5250.0, 5599.0, 5398.0, 5668.0, 5381.0, 5531.0, 5580.0, 5623.0, 5612.0, 5445.0, 5672.0, 5614.0, 5517.0, 5700.0, 5316.0, 5481.0, 5387.0, 5327.0, 5663.0, 5434.0, 5582.0, 5693.0, 5399.0, 5558.0, 5706.0, 5569.0, 5622.0, 5377.0, 5450.0, 5618.0, 5557.0, 5643.0, 5259.0, 5257.0, 5490.0, 5512.0, 5703.0, 5541.0, 5272.0, 5484.0, 5268.0, 5283.0, 5476.0, 5717.0, 5389.0, 5354.0, 5554.0, 5549.0, 5610.0, 5324.0, 5547.0, 5477.0, 5368.0, 5339.0, 5496.0, 5350.0, 5543.0, 5500.0 (number of hits: 8)</p>
27	5270	9	1	333	1	<p>5676.0, 5271.0, 5515.0, 5300.0, 5678.0, 5420.0, 5517.0, 5700.0, 5310.0, 5431.0, 5329.0, 5361.0, 5353.0, 5388.0, 5615.0, 5588.0, 5253.0, 5566.0, 5468.0, 5424.0, 5437.0, 5719.0, 5624.0, 5440.0, 5258.0, 5495.0, 5341.0, 5699.0, 5471.0, 5580.0, 5516.0, 5280.0, 5691.0, 5387.0, 5503.0, 5645.0, 5433.0, 5308.0, 5423.0, 5632.0, 5576.0, 5266.0, 5560.0, 5375.0, 5555.0, 5325.0, 5372.0, 5294.0, 5665.0, 5414.0, 5477.0, 5350.0, 5275.0, 5490.0, 5578.0, 5641.0, 5304.0, 5339.0, 5612.0, 5278.0, 5526.0, 5705.0, 5302.0, 5679.0, 5525.0, 5627.0, 5616.0, 5472.0, 5540.0, 5663.0, 5697.0, 5618.0, 5605.0, 5452.0, 5259.0, 5577.0, 5257.0, 5656.0, 5611.0, 5384.0, 5457.0, 5559.0, 5592.0, 5654.0, 5698.0, 5637.0, 5573.0, 5323.0, 5326.0, 5370.0, 5322.0, 5670.0, 5373.0, 5393.0, 5432.0, 5340.0, 5439.0, 5482.0, 5344.0, 5297.0 (number of hits: 9)</p>
28	5270	9	1	333	1	<p>5539.0, 5352.0, 5623.0, 5555.0, 5573.0, 5253.0, 5597.0, 5460.0, 5391.0, 5666.0, 5292.0, 5701.0, 5655.0, 5317.0, 5308.0, 5294.0, 5584.0, 5282.0, 5532.0, 5373.0, 5450.0, 5429.0, 5468.0, 5436.0, 5266.0, 5398.0, 5275.0, 5669.0, 5313.0, 5470.0, 5393.0, 5397.0, 5263.0, 5605.0, 5602.0, 5390.0, 5714.0, 5719.0, 5668.0, 5600.0, 5689.0, 5572.0, 5716.0, 5693.0, 5361.0, 5405.0, 5594.0, 5507.0, 5563.0, 5706.0, 5715.0, 5524.0, 5343.0, 5261.0, 5426.0, 5723.0, 5386.0, 5531.0, 5500.0, 5408.0, 5565.0, 5610.0, 5519.0, 5506.0, 5527.0, 5548.0, 5707.0, 5603.0, 5632.0, 5419.0, 5559.0, 5400.0, 5629.0, 5369.0, 5412.0, 5662.0, 5529.0, 5350.0, 5535.0, 5533.0, 5464.0, 5311.0, 5522.0, 5525.0, 5489.0</p>

						5433.0, 5301.0, 5339.0, 5608.0, 5511.0, 5344.0, 5463.0, 5642.0, 5324.0, 5551.0, 5385.0, 5691.0, 5556.0, 5586.0, 5364.0 (number of hits: 6)
29	5270	9	1	333	1	5336.0, 5386.0, 5392.0, 5364.0, 5429.0, 5454.0, 5330.0, 5499.0, 5337.0, 5653.0, 5582.0, 5721.0, 5673.0, 5569.0, 5583.0, 5447.0, 5394.0, 5618.0, 5562.0, 5414.0, 5412.0, 5432.0, 5624.0, 5530.0, 5559.0, 5313.0, 5693.0, 5478.0, 5655.0, 5374.0, 5541.0, 5430.0, 5283.0, 5418.0, 5325.0, 5712.0, 5254.0, 5257.0, 5537.0, 5665.0, 5433.0, 5688.0, 5563.0, 5527.0, 5567.0, 5377.0, 5398.0, 5687.0, 5590.0, 5484.0, 5441.0, 5326.0, 5604.0, 5356.0, 5543.0, 5426.0, 5560.0, 5383.0, 5420.0, 5456.0, 5611.0, 5321.0, 5358.0, 5641.0, 5575.0, 5503.0, 5360.0, 5577.0, 5438.0, 5417.0, 5483.0, 5597.0, 5708.0, 5632.0, 5405.0, 5506.0, 5453.0, 5332.0, 5357.0, 5711.0, 5389.0, 5638.0, 5255.0, 5464.0, 5689.0, 5473.0, 5700.0, 5613.0, 5463.0, 5669.0, 5539.0, 5526.0, 5675.0, 5413.0, 5512.0, 5351.0, 5345.0, 5319.0, 5631.0, 5600.0 (number of hits: 4)
30	5270	9	1	333	1	5712.0, 5492.0, 5622.0, 5439.0, 5338.0, 5547.0, 5454.0, 5381.0, 5263.0, 5309.0, 5680.0, 5294.0, 5618.0, 5685.0, 5593.0, 5335.0, 5352.0, 5310.0, 5635.0, 5578.0, 5414.0, 5436.0, 5323.0, 5665.0, 5478.0, 5545.0, 5251.0, 5379.0, 5657.0, 5502.0, 5398.0, 5689.0, 5440.0, 5650.0, 5293.0, 5637.0, 5591.0, 5470.0, 5675.0, 5368.0, 5314.0, 5270.0, 5626.0, 5312.0, 5499.0, 5525.0, 5694.0, 5324.0, 5486.0, 5580.0, 5565.0, 5404.0, 5503.0, 5495.0, 5271.0, 5511.0, 5624.0, 5541.0, 5359.0, 5608.0, 5663.0, 5586.0, 5633.0, 5701.0, 5707.0, 5307.0, 5313.0, 5375.0, 5705.0, 5260.0, 5275.0, 5673.0, 5365.0, 5401.0, 5272.0, 5308.0, 5336.0, 5267.0, 5349.0, 5549.0, 5634.0, 5276.0, 5714.0, 5354.0, 5498.0, 5619.0, 5279.0, 5362.0, 5715.0, 5554.0, 5627.0, 5713.0, 5448.0, 5318.0, 5611.0, 5649.0, 5462.0, 5363.0, 5397.0, 5452.0 (number of hits: 10)

5550 MHz, 40 MHz Bandwidth

Radar Signal Type	Waveform/Trial Number	Detection (%)	Limit (%)	Pass/Fail
Type 1A/1B	30	100 %	60%	Pass
Type 2	30	100 %	60%	Pass
Type 3	30	100 %	60%	Pass
Type 4	30	100 %	60%	Pass
Aggregate (Type1 to 4)	120	100 %	80%	Pass
Type 5	30	100 %	80%	Pass
Type 6	30	100 %	70%	Pass

Please refer to the following statistical tables:

Table-1 Radar Type 1A/1B Statistical Performance

Trial #	Fc (MHz)	Pulse/Burst	Pulse Width (μS)	PRI (μs)	Detection (1:yes; 0:no)
1	5550	72	1	738	1
2	5550	70	1	758	1
3	5550	76	1	698	1
4	5550	67	1	798	1
5	5550	68	1	778	1
6	5550	92	1	578	1
7	5550	86	1	618	1
8	5550	81	1	658	1
9	5550	61	1	878	1
10	5550	74	1	718	1
11	5550	78	1	678	1
12	5550	63	1	838	1
13	5550	57	1	938	1
14	5550	58	1	918	1
15	5550	89	1	598	1
16	5550	49	1	1083	1
17	5550	53	1	1012	1
18	5550	56	1	952	1
19	5550	34	1	1592	1
20	5550	29	1	1882	1
21	5550	66	1	806	1
22	5550	41	1	1317	1
23	5550	27	1	2011	1
24	5550	35	1	1518	1
25	5550	64	1	832	1
26	5550	42	1	1278	1
27	5550	32	1	1699	1
28	5550	30	1	1780	1
29	5550	19	1	2914	1
30	5550	85	1	623	1
Detection Percentage: 100 % (>60%)					

Table-2 Radar Type 2 Statistical Performance

Trial #	Fc (MHz)	Pulse/Burst	Pulse Width (μS)	PRI (μs)	Detection (1:yes; 0:no)
1	5550	27	4.9	173	1
2	5550	24	1.8	172	1
3	5550	24	1.4	177	1
4	5550	25	4.5	170	1
5	5550	24	4	175	1
6	5550	23	5	204	1
7	5550	25	1.7	205	1
8	5550	25	1.3	156	1
9	5550	26	4.9	192	1
10	5550	24	2.9	201	1
11	5550	26	3.1	158	1
12	5550	23	2.4	192	1
13	5550	23	3.6	194	1
14	5550	27	1.6	156	1
15	5550	26	4.5	160	1
16	5550	26	3	188	1
17	5550	24	3.3	216	1
18	5550	23	2.4	161	1
19	5550	26	5	168	1
20	5550	29	4.1	187	1
21	5550	23	3.6	188	1
22	5550	24	1.8	178	1
23	5550	24	2.4	156	1
24	5550	27	3.8	221	1
25	5550	25	2.5	192	1
26	5550	25	3.3	213	1
27	5550	27	5	204	1
28	5550	27	4.9	188	1
29	5550	28	1.9	168	1
30	5550	29	3.1	157	1
Detection Percentage: 100 % (>60%)					

Table-3 Radar Type 3 Statistical Performance

Trial #	Fc (MHz)	Pulse/Burst	Pulse Width (μS)	PRI (μs)	Detection (1:yes; 0:no)
1	5550	17	7.3	361	1
2	5550	18	7.4	249	1
3	5550	18	8	226	1
4	5550	16	8.5	238	1
5	5550	17	7.9	286	1
6	5550	17	6	441	1
7	5550	17	7.4	346	1
8	5550	16	9.1	312	1
9	5550	17	8.3	373	1
10	5550	18	6.5	406	1
11	5550	18	6.9	454	1
12	5550	16	6.9	245	1
13	5550	16	9.4	424	1
14	5550	18	7.7	234	1
15	5550	18	8.2	454	1
16	5550	18	8.4	418	1
17	5550	16	9.3	207	1
18	5550	17	6.4	340	1
19	5550	16	9.7	413	1
20	5550	18	6.3	223	1
21	5550	18	8.6	383	1
22	5550	18	6.2	345	1
23	5550	16	7.3	237	1
24	5550	17	8.3	398	1
25	5550	16	8.6	253	1
26	5550	18	8.6	313	1
27	5550	16	7.9	268	1
28	5550	16	6.2	209	1
29	5550	17	8.7	226	1
30	5550	16	6.2	220	1
Detection Percentage: 100 % (>60%)					

Table-4 Radar Type 4 Statistical Performance

Trial #	Fc (MHz)	Pulse/Burst	Pulse Width (μS)	PRI (μs)	Detection (1:yes; 0:no)
1	5550	16	11.9	372	1
2	5550	12	11.6	284	1
3	5550	12	12.3	289	1
4	5550	15	14.1	402	1
5	5550	16	12.3	334	1
6	5550	12	17	380	1
7	5550	12	12.1	312	1
8	5550	13	11.7	287	1
9	5550	14	14.1	200	1
10	5550	15	16.1	448	1
11	5550	14	13.3	485	1
12	5550	13	19.9	251	1
13	5550	14	16.8	335	1
14	5550	16	17.9	410	1
15	5550	14	17.9	212	1
16	5550	15	19.2	476	1
17	5550	16	11.5	369	1
18	5550	14	13.8	462	1
19	5550	13	19.1	437	1
20	5550	13	13.8	425	1
21	5550	13	16.9	390	1
22	5550	13	18.3	456	1
23	5550	14	18.5	342	1
24	5550	16	18.7	248	1
25	5550	12	13.5	424	1
26	5550	16	11.8	498	1
27	5550	12	17.7	391	1
28	5550	15	17.4	457	1
29	5550	16	12.7	200	1
30	5550	16	12.2	395	1
Detection Percentage: 100 % (>60%)					

Table-5 Radar Type 5 Statistical Performance

Bin5 Statistics 1

Trial #	Pulse	Chirp (MHz)	Pulse Width (µS)	Pulse 1-2 spacing (µS)	Pulse 2-3 spacing (µS)	Pulse Start(S)	Detection (1:yes; 0:no)
0	2	10	93.8	1074		0.237467	1
1	2	16	77	1682		1.167234	
2	2	18	68.2	1351		1.280311	
3	1	6	97.4			2.301338	
4	2	11	52.9	1366		2.56743	
5	2	14	58.4	1694		3.552397	
6	3	9	97.4	1159	1608	3.988912	
7	2	15	72.2	1101		4.852472	
8	1	12	71.9			5.237454	
9	2	19	86.3	1682		6.012752	
10	2	13	97.5	1888		6.875055	
11	2	10	78.7	1852		7.261782	
12	2	9	50.7	1173		7.96153	
13	2	19	65.4	1723		8.273484	
14	1	6	91.7			9.18912	
15	2	9	55.1	1022		9.946964	
16	1	16	90.6			10.625679	
17	2	8	65.9	1667		10.931592	
18	3	16	99.6	1635	1893	11.458569	

Bin5 Statistics 2

Trial #	Pulse	Chirp (MHz)	Pulse Width (µS)	Pulse 1-2 spacing (uS)	Pulse 2-3 spacing (uS)	Pulse Start(S)	Detection (1:yes; 0:no)
0	1	13	99.7			0.457842	1
1	3	12	54.8	1463	1526	1.805566	
2	2	8	90.7	1314		2.522136	
3	3	19	80.8	1914	1362	3.342917	
4	1	9	62.9			4.224533	
5	2	17	62.3	1520		4.685596	
6	1	8	91.2			6.114721	
7	2	15	57.5	1214		6.747643	
8	2	18	89.7	1018		7.92926	
9	2	17	55.3	1581		8.566611	
10	3	17	99	1760	1213	9.812547	
11	2	12	61.3	1916		10.669243	
12	3	10	65.6	1290	1745	11.135457	

Bin5 Statistics 3

Trial #	Pulse	Chirp (MHz)	Pulse Width (µS)	Pulse 1-2 spacing (uS)	Pulse 2-3 spacing (uS)	Pulse Start(S)	Detection (1:yes; 0:no)
0	2	8	64.1	1111		0.165478	1
1	3	19	50.7	1872	1889	0.777596	
2	2	5	58	1879		1.946971	
3	2	9	94.8	1927		2.119374	
4	3	13	96.6	1419	1145	3.077259	
5	2	14	74.1	1816		3.945192	
6	2	6	73	1681		4.258545	
7	3	14	82.9	1845	1136	5.107979	
8	1	13	92.6			5.781086	
9	2	20	68.8	1556		6.519675	
10	1	7	66.9			6.878001	
11	3	18	66.8	1258	1509	7.482406	
12	2	19	50.2	1135		8.050778	
13	2	7	96.9	1899		9.274337	
14	2	20	82.7	1669		9.335864	
15	2	6	72.5	1707		10.250863	
16	2	15	77.4	1603		11.076319	
17	3	18	68.8	1317	1582	11.973325	

Bin5 Statistics 4

Trial #	Pulse	Chirp (MHz)	Pulse Width (µS)	Pulse 1-2 spacing (µS)	Pulse 2-3 spacing (µS)	Pulse Start(S)	Detection (1:yes; 0:no)
0	2	15	54	1958		0.336767	1
1	2	14	63.5	1341		0.780473	
2	3	16	51.4	1964	1679	1.528215	
3	2	14	73.2	1555		2.28871	
4	2	12	96.5	1929		2.446423	
5	2	17	59.2	1617		3.389011	
6	2	20	97.9	1183		3.880452	
7	2	14	71.7	1196		4.251645	
8	2	12	70.4	1982		4.897576	
9	2	5	80.4	1762		5.827273	
10	2	14	81.4	1896		6.164654	
11	3	17	71.8	1812	1810	6.704849	
12	2	16	65.6	1754		7.739886	
13	2	8	99.1	1883		8.250644	
14	2	16	71.4	1497		8.846534	
15	2	9	52.7	1204		9.117683	
16	2	15	66.2	1726		9.773167	
17	2	11	84.3	1574		10.20256	
18	2	13	55.8	1514		11.042549	
19	2	9	53.9	1056		11.49716	

Bin5 Statistics 5

Trial #	Pulse	Chirp (MHz)	Pulse Width (µS)	Pulse 1-2 spacing (µS)	Pulse 2-3 spacing (µS)	Pulse Start(S)	Detection (1:yes; 0:no)
0	2	16	79.3	1269		0.804027	1
1	3	13	70.6	1556	1725	0.976867	
2	1	18	78.6			1.921271	
3	2	15	64.9	1253		3.590106	
4	2	8	82.7	1989		3.887587	
5	2	8	98.8	1296		5.336825	
6	2	13	81.9	1442		5.628593	
7	3	16	92	1562	1873	6.657001	
8	1	19	87.5			7.874058	
9	3	17	77.1	1502	1617	9.182057	
10	3	6	64.8	1966	1968	9.641529	
11	3	16	94.8	1041	1198	10.78745	
12	2	17	56.7	1434		11.823398	

Bin5 Statistics 6

Trial #	Pulse	Chirp (MHz)	Pulse Width (µS)	Pulse 1-2 spacing (uS)	Pulse 2-3 spacing (uS)	Pulse Start(S)	Detection (1:yes; 0:no)
0	2	11	76.5	1790		0.595125	1
1	2	16	56.8	1702		2.460677	
2	2	15	55.1	1781		3.304306	
3	2	9	98.1	1256		4.966316	
4	1	11	78.2			5.581363	
5	2	6	76.8	1520		7.096764	
6	2	16	58.2	1485		8.60774	
7	2	10	73.7	1893		10.213594	
8	3	15	83.2	1941	1734	11.833962	

Bin5 Statistics 7

Trial #	Pulse	Chirp (MHz)	Pulse Width (µS)	Pulse 1-2 spacing (uS)	Pulse 2-3 spacing (uS)	Pulse Start(S)	Detection (1:yes; 0:no)
0	1	10	87.1			0.274884	1
1	2	7	91.2	1649		1.101242	
2	3	8	64.5	1173	1555	1.981827	
3	3	13	79.9	1487	1115	2.497498	
4	2	13	96.5	1045		3.221301	
5	2	14	51.6	1659		3.389143	
6	1	6	67			4.604181	
7	2	10	76.3	1152		4.992503	
8	1	5	81.7			5.962707	
9	1	16	95.9			6.451212	
10	1	13	63.1			6.746495	
11	2	13	87	1819		7.701308	
12	1	10	83.3			8.007186	
13	2	13	52.7	1163		8.881047	
14	1	12	53			9.469037	
15	1	13	86.3			10.660166	
16	2	12	68.7	1247		10.826772	
17	2	5	88.4	1454		11.591779	

Bin5 Statistics 8

Trial #	Pulse	Chirp (MHz)	Pulse Width (µS)	Pulse 1-2 spacing (uS)	Pulse 2-3 spacing (uS)	Pulse Start(S)	Detection (1:yes; 0:no)
0	2	6	72.7	1147		0.468734	1
1	2	9	81.1	1600		1.136572	
2	1	16	63.3			2.341725	
3	3	9	65.4	1362	1218	2.94246	
4	1	9	67.4			3.740538	
5	2	6	71.5	1062		4.289217	
6	2	19	65	1320		5.517585	
7	2	18	72.9	1971		5.666393	
8	1	9	63.8			6.516937	
9	2	17	68.2	1074		7.57812	
10	2	10	55.9	1429		8.382518	
11	2	15	66.9	1698		8.960249	
12	1	10	57			10.199809	
13	3	10	96.1	1462	1029	10.645223	
14	3	12	93.4	1676	1175	11.947169	

Bin5 Statistics 9

Trial #	Pulse	Chirp (MHz)	Pulse Width (µS)	Pulse 1-2 spacing (µS)	Pulse 2-3 spacing (µS)	Pulse Start(S)	Detection (1:yes; 0:no)
0	2	12	65	1176		0.096567	1
1	1	17	67.3			0.61576	
2	3	15	78.8	1812	1421	1.209712	
3	2	11	82.8	1209		1.847457	
4	1	11	95			2.504194	
5	3	14	89.8	1364	1909	3.543536	
6	2	8	50.9	1973		4.163656	
7	2	13	74.6	1994		4.521958	
8	3	19	70.7	1592	1588	5.113521	
9	3	18	68.7	1792	1953	5.508244	
10	2	11	54.3	1277		6.357109	
11	2	6	60.1	1137		6.65616	
12	1	14	55.9			7.248858	
13	3	13	58.7	1900	1839	8.214003	
14	2	14	86.6	1127		8.416791	
15	2	8	68.3	1345		9.158622	
16	1	14	97.9			9.789189	
17	2	14	70.5	1367		10.642943	
18	3	14	63.3	1222	1139	10.821692	
19	3	15	80.2	1563	1119	11.845048	

Bin5 Statistics 10

Trial #	Pulse	Chirp (MHz)	Pulse Width (µS)	Pulse 1-2 spacing (µS)	Pulse 2-3 spacing (µS)	Pulse Start(S)	Detection (1:yes; 0:no)
0	3	18	55	1277	1118	1.049961	1
1	3	17	91.7	1543	1292	2.562989	
2	1	10	84.8			3.321913	
3	1	7	92			4.685238	
4	2	18	66.5	1808		6.489179	
5	2	13	65.1	1539		7.888631	
6	1	15	63.3			9.807107	
7	1	12	98.7			11.968985	

Bin5 Statistics 11

Trial #	Pulse	Chirp (MHz)	Pulse Width (µS)	Pulse 1-2 spacing (µS)	Pulse 2-3 spacing (µS)	Pulse Start(S)	Detection (1:yes; 0:no)
0	2	11	98.4	1520		0.476381	1
1	2	7	71.1	1101		1.53103	
2	3	16	93.5	1739	1369	2.033941	
3	2	17	82.5	1917		3.007325	
4	2	14	64.4	1292		4.15379	
5	1	7	54.9			5.021275	
6	2	14	96.8	1154		5.862749	
7	2	19	50.5	1776		6.066339	
8	1	11	88.2			7.123909	
9	2	9	51.1	1156		8.312842	
10	2	8	68.2	1289		9.121138	
11	3	7	84.9	1209	1793	9.969399	
12	2	10	74.8	1153		11.043877	
13	2	7	60.6	1534		11.980207	

Bin5 Statistics 12

Trial #	Pulse	Chirp (MHz)	Pulse Width (µS)	Pulse 1-2 spacing (µS)	Pulse 2-3 spacing (µS)	Pulse Start(S)	Detection (1:yes; 0:no)
0	3	19	71.6	1437	1909	0.779524	1
1	1	6	75.4			1.062501	
2	2	18	59.2	1061		2.012212	
3	2	16	60.5	1914		3.003592	
4	2	12	73.4	1353		4.869765	
5	3	12	83.4	1839	1564	5.699228	
6	3	9	88.8	1257	1043	6.233184	
7	3	14	73.7	1851	1385	7.215913	
8	2	16	98.2	1896		8.365808	
9	2	20	98.9	1734		9.091352	
10	1	5	82.7			10.754671	
11	2	9	92	1882		11.421021	

Bin5 Statistics 13

Trial #	Pulse	Chirp (MHz)	Pulse Width (µS)	Pulse 1-2 spacing (uS)	Pulse 2-3 spacing (uS)	Pulse Start(S)	Detection (1:yes; 0:no)
0	3	18	67.7	1369	1019	0.556994	1
1	1	11	85.7			1.116253	
2	1	14	62.6			1.758926	
3	2	16	95.2	1333		2.282677	
4	1	5	82.9			3.164232	
5	3	9	89	1953	1043	3.914514	
6	3	17	96.6	1187	1661	4.556393	
7	2	11	54	1517		4.794758	
8	2	12	76.2	1691		5.832134	
9	3	12	63.1	1372	1458	6.563297	
10	2	20	60.6	1902		7.09703	
11	2	18	50.7	1702		7.720127	
12	1	19	67.7			8.425736	
13	1	10	79.5			8.965055	
14	3	17	77.8	1673	1088	9.648247	
15	2	20	83.4	1274		10.187974	
16	3	14	69.2	1142	1584	10.96703	
17	3	10	88.8	1218	1985	11.781948	

Bin5 Statistics 14

Trial #	Pulse	Chirp (MHz)	Pulse Width (µS)	Pulse 1-2 spacing (uS)	Pulse 2-3 spacing (uS)	Pulse Start(S)	Detection (1:yes; 0:no)
0	2	6	56.7	1488		0.213062	1
1	3	12	74.9	1178	1085	1.129624	
2	1	19	86.9			2.471475	
3	1	18	93.8			3.166532	
4	2	11	65.3	1138		4.743509	
5	2	12	70.3	1643		5.791112	
6	1	15	77.8			6.246244	
7	2	12	77.7	1664		7.266528	
8	2	16	84.5	1023		8.784321	
9	2	9	73	1518		9.596083	
10	2	19	71.4	1895		10.728955	
11	2	15	87.1	1032		11.785219	

Bin5 Statistics 15

Trial #	Pulse	Chirp (MHz)	Pulse Width (µS)	Pulse 1-2 spacing (uS)	Pulse 2-3 spacing (uS)	Pulse Start(S)	Detection (1:yes; 0:no)
0	2	18	77.9	1388		0.682874	1
1	3	13	88.3	1725	1961	1.00411	
2	1	8	79.2			2.277981	
3	1	5	71			3.028265	
4	2	6	67.3	1848		3.308917	
5	2	12	57.2	1535		4.204833	
6	3	13	66.4	1845	1949	5.088899	
7	2	18	62.1	1987		6.310758	
8	3	13	62.8	1132	1051	6.8506	
9	2	10	95.2	1437		7.868866	
10	2	19	53.3	1998		8.503332	
11	2	6	54.5	1848		9.219993	
12	2	11	66.8	1310		9.923199	
13	2	15	50.5	1958		10.960711	
14	1	6	75.8			11.232107	

Bin5 Statistics 16

Trial #	Pulse	Chirp (MHz)	Pulse Width (µS)	Pulse 1-2 spacing (uS)	Pulse 2-3 spacing (uS)	Pulse Start(S)	Detection (1:yes; 0:no)
0	2	10	99.4	1118		0.76706	1
1	1	19	69.6			1.294028	
2	3	7	93.6	1384	1126	3.041664	
3	3	20	61.4	1679	1868	4.73834	
4	1	12	69.7			5.13243	
5	3	6	94.3	1756	1870	7.128011	
6	1	18	87.3			8.128186	
7	1	10	83.8			9.088983	
8	2	5	72.2	1477		10.054112	
9	1	19	65.6			11.588803	

Bin5 Statistics 17

Trial #	Pulse	Chirp (MHz)	Pulse Width (µS)	Pulse 1-2 spacing (uS)	Pulse 2-3 spacing (uS)	Pulse Start(S)	Detection (1:yes; 0:no)
0	3	13	60.5	1359	1267	0.275293	1
1	2	11	58	1532		1.182046	
2	1	6	50.5			2.025896	
3	1	11	55.6			2.872149	
4	2	17	97.3	1369		3.960292	
5	3	11	70.3	1600	1661	4.456601	
6	1	20	81.6			5.297649	
7	2	14	99.4	1215		5.875052	
8	2	16	63.7	1069		6.740252	
9	2	6	91.8	1368		7.243431	
10	2	12	76.3	1340		8.630625	
11	1	6	51			8.83333	
12	1	7	64.4			10.358601	
13	1	5	74.7			10.791743	
14	2	14	56.8	1310		11.419082	

Bin5 Statistics 18

Trial #	Pulse	Chirp (MHz)	Pulse Width (µS)	Pulse 1-2 spacing (uS)	Pulse 2-3 spacing (uS)	Pulse Start(S)	Detection (1:yes; 0:no)
0	2	20	81.9	1457		0.495291	1
1	1	9	76.4			1.748118	
2	2	6	90.1	1632		2.192074	
3	2	11	58.5	1064		3.570118	
4	2	18	50.2	1135		5.040055	
5	2	10	70.8	1569		6.137864	
6	3	18	94.8	1468	1202	6.854476	
7	3	12	67.7	1531	1368	7.923235	
8	2	14	51.1	1373		9.098565	
9	1	10	57.7			10.283784	
10	1	10	86.9			11.682245	

Bin5 Statistics 19

Trial #	Pulse	Chirp (MHz)	Pulse Width (µS)	Pulse 1-2 spacing (uS)	Pulse 2-3 spacing (uS)	Pulse Start(S)	Detection (1:yes; 0:no)
0	1	16	70.9			1.289552	1
1	1	16	79.8			2.729401	
2	1	10	68.5			4.460828	
3	1	11	55.8			5.931828	
4	1	16	77.9			6.714958	
5	2	9	62.3	1165		8.802101	
6	2	9	75.2	1579		9.689179	
7	1	6	60.3			10.772968	

Bin5 Statistics 20

Trial #	Pulse	Chirp (MHz)	Pulse Width (µS)	Pulse 1-2 spacing (uS)	Pulse 2-3 spacing (uS)	Pulse Start(S)	Detection (1:yes; 0:no)
0	2	7	89.1	1986		0.902147	1
1	1	5	94.6			2.453147	
2	3	6	88.5	1978	1493	4.225996	
3	2	15	93.1	1407		4.861884	
4	2	12	63.5	1070		6.401066	
5	1	8	82.9			8.167809	
6	3	14	83.5	1233	1640	10.040743	
7	3	12	64.8	1319	1448	11.843995	

Bin5 Statistics 21

Trial #	Pulse	Chirp (MHz)	Pulse Width (µS)	Pulse 1-2 spacing (µS)	Pulse 2-3 spacing (µS)	Pulse Start(S)	Detection (1:yes; 0:no)
0	1	7	89.7			0.474594	1
1	2	7	53.6	1140		1.236155	
2	2	17	79.7	1559		2.375489	
3	3	8	87.1	1022	1287	2.547729	
4	2	18	90.6	1474		3.282232	
5	3	7	61.8	1973	1998	4.738775	
6	2	13	84.8	1532		5.183184	
7	2	17	96.7	1332		5.865261	
8	2	5	66.8	1739		6.904503	
9	1	10	67.4			7.739199	
10	2	14	64.4	1237		8.756915	
11	2	10	60.1	1620		9.498064	
12	1	15	97.1			9.96441	
13	1	15	96.2			10.489473	
14	1	20	62.8			11.979551	

Bin5 Statistics 22

Trial #	Pulse	Chirp (MHz)	Pulse Width (µS)	Pulse 1-2 spacing (µS)	Pulse 2-3 spacing (µS)	Pulse Start(S)	Detection (1:yes; 0:no)
0	2	14	81.5	1877		1.303235	1
1	1	14	61.6			1.373222	
2	2	13	90.1	1389		2.722898	
3	2	11	83.1	1488		4.538366	
4	2	12	60.2	1719		6.075524	
5	2	14	77.3	1075		7.375835	
6	2	7	65.1	1484		8.545862	
7	3	14	73.4	1534	1711	9.740739	
8	2	5	83.5	1317		11.887459	

Bin5 Statistics 23

Trial #	Pulse	Chirp (MHz)	Pulse Width (µS)	Pulse 1-2 spacing (uS)	Pulse 2-3 spacing (uS)	Pulse Start(S)	Detection (1:yes; 0:no)
0	1	9	67.6			0.857731	1
1	2	16	93.9	1672		1.176209	
2	1	16	63.3			2.973918	
3	2	20	52	1015		3.565012	
4	2	11	59.7	1975		4.02925	
5	2	7	66.6	1380		5.533337	
6	2	10	92.9	1909		6.159269	
7	2	10	72.5	1439		7.87465	
8	2	11	57.9	1531		8.784479	
9	2	9	55.8	1579		9.199069	
10	2	14	71.9	1410		10.312799	
11	2	5	95.3	1607		11.251925	

Bin5 Statistics 24

Trial #	Pulse	Chirp (MHz)	Pulse Width (µS)	Pulse 1-2 spacing (uS)	Pulse 2-3 spacing (uS)	Pulse Start(S)	Detection (1:yes; 0:no)
0	3	14	62.2	1225	1710	0.434004	1
1	2	14	83.5	1706		0.752007	
2	1	18	88.2			1.383063	
3	2	9	78.6	1635		2.113257	
4	2	19	89.5	1516		2.613942	
5	2	16	93.6	1884		3.190374	
6	2	11	55.8	1110		3.800799	
7	1	10	77.1			4.408407	
8	3	11	80.3	1394	1805	5.342925	
9	1	8	58.1			5.855852	
10	2	18	69.2	1555		6.377127	
11	3	9	96.4	1156	1081	7.056761	
12	3	13	59.9	1167	1375	7.265104	
13	1	9	80.4			7.904603	
14	1	15	90.1			8.850315	
15	2	11	73.7	1990		9.351937	
16	2	15	59	1799		9.811448	
17	2	18	65.9	1408		10.784878	
18	2	16	79.3	1520		10.850141	
19	2	18	60.7	1274		11.673213	

Bin5 Statistics 25

Trial #	Pulse	Chirp (MHz)	Pulse Width (µS)	Pulse 1-2 spacing (uS)	Pulse 2-3 spacing (uS)	Pulse Start(S)	Detection (1:yes; 0:no)
0	1	13	93.6			0.480924	1
1	3	6	86.3	1385	1349	1.534898	
2	1	15	60.9			1.871798	
3	2	7	93	1571		3.07412	
4	1	16	87.1			3.513404	
5	2	13	62.8	1538		4.099102	
6	1	14	74.7			5.049724	
7	2	17	62.3	1401		5.969339	
8	2	10	59.6	1867		6.936977	
9	2	20	96.7	1990		7.280102	
10	3	12	51.4	1786	1874	8.186203	
11	2	11	93.9	1241		9.459744	
12	2	17	60.3	1977		9.800042	
13	3	16	88.8	1043	1874	10.409435	
14	1	13	94.1			11.95058	

Bin5 Statistics 26

Trial #	Pulse	Chirp (MHz)	Pulse Width (µS)	Pulse 1-2 spacing (µS)	Pulse 2-3 spacing (µS)	Pulse Start(S)	Detection (1:yes; 0:no)
0	2	20	61.4	1432		0.366299	1
1	2	13	94.5	1096		1.091291	
2	3	19	59.7	1145	1806	1.696251	
3	2	19	69.4	1482		2.102528	
4	2	8	71.6	1278		2.979022	
5	3	9	55.9	1633	1299	3.395137	
6	2	12	87.1	1168		3.780889	
7	3	14	72.7	1806	1283	4.350669	
8	2	6	91.1	1780		5.077928	
9	3	7	87.9	1771	1711	5.603442	
10	1	7	56.5			6.443946	
11	1	11	78.1			6.698168	
12	1	10	54.8			7.490544	
13	2	9	87.1	1943		8.302088	
14	2	8	95.8	1884		8.90772	
15	2	8	75.9	1058		9.490469	
16	2	8	61.3	1309		9.835958	
17	2	15	93.3	1495		10.678883	
18	2	19	53	1783		10.848511	
19	2	19	92.7	1679		11.900681	

Bin5 Statistics 27

Trial #	Pulse	Chirp (MHz)	Pulse Width (µS)	Pulse 1-2 spacing (µS)	Pulse 2-3 spacing (µS)	Pulse Start(S)	Detection (1:yes; 0:no)
0	2	5	65.7	1192		0.05178	1
1	1	20	86.6			1.544907	
2	2	14	95.8	1536		2.158906	
3	1	18	95.8			3.14831	
4	3	8	81.2	1491	1706	3.404437	
5	2	9	51.5	1603		4.094444	
6	2	11	81.1	1889		5.226783	
7	1	16	74.7			5.838891	
8	2	8	55.6	1746		6.932694	
9	1	8	59.4			7.405992	
10	2	13	88.2	1795		8.6905	
11	2	6	90.6	1829		9.492609	
12	3	7	51.5	1246	1320	9.957264	
13	1	7	65.7			10.906178	
14	2	7	50.1	1602		11.514076	

Bin5 Statistics 28

Trial #	Pulse	Chirp (MHz)	Pulse Width (µS)	Pulse 1-2 spacing (µS)	Pulse 2-3 spacing (µS)	Pulse Start(S)	Detection (1:yes; 0:no)
0	2	18	72.4	1783		0.006379	1
1	2	15	58.9	1495		1.658308	
2	2	6	77.4	1020		2.053842	
3	1	10	69.2			2.797227	
4	2	7	97.5	1327		3.941507	
5	3	8	92.3	1474	1473	5.071667	
6	1	18	92.6			5.499227	
7	3	17	80.8	1250	1352	6.754796	
8	1	18	50			7.672649	
9	2	10	72.7	1204		7.8862	
10	2	6	72.1	1691		8.988937	
11	2	17	98.3	1325		9.979728	
12	2	11	94	1091		11.095414	
13	3	19	56.8	1350	1495	11.294677	

Bin5 Statistics 29

Trial #	Pulse	Chirp (MHz)	Pulse Width (µS)	Pulse 1-2 spacing (uS)	Pulse 2-3 spacing (uS)	Pulse Start(S)	Detection (1:yes; 0:no)
0	3	8	65.9	1541	1102	0.425057	1
1	1	12	62.4			0.846991	
2	1	15	73.7			1.666907	
3	3	20	90.2	1633	1141	2.96898	
4	1	11	83.5			3.319808	
5	2	7	83.6	1039		4.768596	
6	1	15	88.9			5.521317	
7	2	15	82.2	1848		6.184612	
8	2	14	97.5	1887		6.861379	
9	2	14	70.5	1342		7.548024	
10	2	18	100	1045		8.434773	
11	3	13	50.9	1635	1735	9.347507	
12	2	12	56.5	1766		10.056863	
13	2	12	90.3	1386		10.773549	
14	2	18	62.8	1962		11.905099	

Bin5 Statistics 30

Trial #	Pulse	Chirp (MHz)	Pulse Width (µS)	Pulse 1-2 spacing (uS)	Pulse 2-3 spacing (uS)	Pulse Start(S)	Detection (1:yes; 0:no)
0	2	16	80.3	1583		0.406429	1
1	1	12	92.9			1.342152	
2	2	17	80.2	1635		2.283996	
3	1	9	50.7			3.143782	
4	2	19	53.8	1550		4.247872	
5	3	18	98.4	1013	1811	4.929375	
6	2	20	84.2	1827		5.302176	
7	2	9	66.3	1989		6.441505	
8	3	10	51.5	1573	1150	6.904464	
9	3	16	57.4	1668	1527	7.715592	
10	2	13	75.1	1419		9.028513	
11	2	9	75.8	1016		10.191872	
12	1	17	70.1			11.04946	
13	1	13	60.6			11.581886	

Table-6 Radar Type 6 Statistical Performance

Trial #	Fc (MHz)	Pulse /Burst	Pulse Width (µS)	PRI (µs)	Detection (1:yes; 0:no)	Hopping Sequence
1	5550	9	1	333	1	5397.0, 5275.0, 5303.0, 5378.0, 5615.0, 5582.0, 5322.0, 5577.0, 5250.0, 5641.0, 5338.0, 5269.0, 5528.0, 5466.0, 5404.0, 5305.0, 5613.0, 5701.0, 5434.0, 5376.0, 5340.0, 5676.0, 5588.0, 5527.0, 5635.0, 5265.0, 5568.0, 5488.0, 5692.0, 5558.0, 5374.0, 5520.0, 5367.0, 5601.0, 5610.0, 5410.0, 5626.0, 5501.0, 5277.0, 5325.0, 5491.0, 5622.0, 5457.0, 5256.0, 5543.0, 5538.0, 5492.0, 5400.0, 5612.0, 5365.0, 5597.0, 5594.0, 5721.0, 5349.0, 5566.0, 5522.0, 5262.0, 5608.0, 5680.0, 5465.0, 5548.0, 5356.0, 5411.0, 5458.0, 5354.0, 5317.0, 5276.0, 5499.0, 5689.0, 5620.0, 5562.0, 5631.0, 5606.0, 5515.0, 5671.0, 5372.0, 5423.0, 5691.0, 5723.0, 5383.0, 5421.0, 5503.0, 5506.0, 5481.0, 5489.0, 5259.0, 5681.0, 5408.0, 5715.0, 5642.0, 5549.0, 5652.0, 5633.0, 5313.0, 5300.0, 5654.0, 5555.0, 5550.0, 5260.0, 5456.0 (number of hits: 10)
2	5550	9	1	333	1	5423.0, 5309.0, 5333.0, 5408.0, 5307.0, 5705.0, 5391.0, 5392.0, 5714.0, 5260.0, 5300.0, 5349.0, 5486.0, 5639.0, 5539.0, 5440.0, 5426.0, 5435.0, 5361.0, 5549.0, 5334.0, 5580.0, 5427.0, 5644.0, 5393.0, 5339.0, 5330.0, 5620.0, 5315.0, 5664.0, 5648.0, 5695.0, 5370.0, 5283.0, 5674.0, 5642.0, 5449.0, 5321.0, 5593.0, 5390.0, 5293.0, 5379.0, 5452.0, 5473.0, 5669.0, 5621.0, 5567.0, 5332.0, 5605.0, 5505.0, 5400.0, 5488.0, 5362.0, 5411.0, 5292.0, 5359.0, 5261.0, 5360.0, 5631.0, 5348.0, 5554.0, 5436.0, 5470.0, 5484.0, 5378.0, 5716.0, 5422.0, 5476.0, 5398.0, 5278.0, 5477.0, 5661.0, 5456.0, 5720.0, 5632.0, 5640.0, 5368.0, 5277.0, 5508.0, 5312.0, 5325.0, 5299.0, 5453.0, 5428.0, 5289.0, 5270.0, 5267.0, 5445.0, 5345.0, 5619.0, 5600.0, 5358.0, 5311.0, 5495.0, 5681.0, 5572.0, 5568.0, 5271.0, 5529.0, 5546.0 (number of hits: 9)
3	5550	9	1	333	1	5309.0, 5286.0, 5485.0, 5677.0, 5251.0, 5467.0, 5275.0, 5267.0, 5713.0, 5403.0, 5264.0, 5429.0, 5606.0, 5594.0, 5635.0, 5550.0, 5564.0, 5427.0, 5583.0, 5318.0, 5566.0, 5328.0, 5598.0, 5414.0, 5723.0, 5441.0, 5317.0, 5346.0, 5411.0, 5661.0, 5670.0, 5326.0, 5614.0, 5378.0, 5570.0, 5642.0, 5426.0, 5250.0, 5430.0, 5293.0, 5500.0, 5439.0, 5266.0, 5699.0, 5454.0, 5354.0, 5560.0, 5330.0, 5461.0, 5433.0, 5308.0, 5368.0, 5620.0, 5432.0, 5646.0, 5471.0, 5669.0, 5484.0, 5401.0, 5255.0

						5579.0, 5304.0, 5537.0, 5676.0, 5442.0, 5684.0, 5636.0, 5451.0, 5687.0, 5514.0, 5386.0, 5337.0, 5539.0, 5392.0, 5457.0, 5290.0, 5508.0, 5379.0, 5549.0, 5415.0, 5681.0, 5576.0, 5616.0, 5610.0, 5630.0, 5445.0, 5473.0, 5453.0, 5518.0, 5569.0, 5522.0, 5253.0, 5455.0, 5314.0, 5507.0, 5481.0, 5425.0, 5353.0, 5482.0, 5351.0 (number of hits: 9)
4	5550	9	1	333	1	5271.0, 5360.0, 5586.0, 5724.0, 5513.0, 5392.0, 5326.0, 5280.0, 5507.0, 5287.0, 5385.0, 5643.0, 5261.0, 5421.0, 5309.0, 5654.0, 5481.0, 5316.0, 5275.0, 5590.0, 5575.0, 5542.0, 5604.0, 5552.0, 5679.0, 5476.0, 5535.0, 5510.0, 5380.0, 5373.0, 5427.0, 5498.0, 5413.0, 5713.0, 5606.0, 5315.0, 5617.0, 5382.0, 5439.0, 5268.0, 5717.0, 5589.0, 5587.0, 5387.0, 5381.0, 5330.0, 5459.0, 5529.0, 5520.0, 5574.0, 5323.0, 5584.0, 5711.0, 5338.0, 5660.0, 5489.0, 5611.0, 5642.0, 5479.0, 5274.0, 5263.0, 5519.0, 5563.0, 5474.0, 5301.0, 5378.0, 5352.0, 5499.0, 5670.0, 5570.0, 5565.0, 5666.0, 5723.0, 5337.0, 5359.0, 5376.0, 5638.0, 5651.0, 5472.0, 5480.0, 5390.0, 5508.0, 5671.0, 5496.0, 5624.0, 5453.0, 5332.0, 5458.0, 5426.0, 5255.0, 5452.0, 5714.0, 5361.0, 5484.0, 5356.0, 5524.0, 5339.0, 5451.0, 5528.0, 5551.0 (number of hits: 9)
5	5550	9	1	333	1	5473.0, 5325.0, 5413.0, 5502.0, 5556.0, 5302.0, 5481.0, 5351.0, 5593.0, 5381.0, 5561.0, 5602.0, 5634.0, 5718.0, 5499.0, 5357.0, 5491.0, 5349.0, 5486.0, 5525.0, 5592.0, 5583.0, 5361.0, 5416.0, 5642.0, 5471.0, 5399.0, 5681.0, 5659.0, 5319.0, 5337.0, 5251.0, 5629.0, 5256.0, 5539.0, 5657.0, 5617.0, 5298.0, 5443.0, 5268.0, 5309.0, 5687.0, 5415.0, 5329.0, 5277.0, 5640.0, 5646.0, 5594.0, 5380.0, 5408.0, 5554.0, 5588.0, 5633.0, 5616.0, 5692.0, 5520.0, 5669.0, 5710.0, 5638.0, 5377.0, 5356.0, 5431.0, 5323.0, 5534.0, 5544.0, 5717.0, 5562.0, 5290.0, 5711.0, 5360.0, 5387.0, 5442.0, 5371.0, 5274.0, 5613.0, 5303.0, 5297.0, 5435.0, 5698.0, 5345.0, 5715.0, 5306.0, 5407.0, 5604.0, 5516.0, 5462.0, 5685.0, 5630.0, 5577.0, 5531.0, 5419.0, 5569.0, 5608.0, 5521.0, 5625.0, 5694.0, 5641.0, 5463.0, 5445.0, 5568.0 (number of hits: 5)
6	5550	9	1	333	1	5574.0, 5652.0, 5260.0, 5542.0, 5644.0, 5679.0, 5422.0, 5415.0, 5274.0, 5591.0, 5719.0, 5384.0, 5392.0, 5551.0, 5303.0, 5387.0, 5370.0, 5322.0, 5701.0, 5704.0, 5541.0, 5449.0, 5607.0, 5407.0, 5271.0, 5426.0, 5287.0, 5378.0, 5361.0, 5508.0, 5673.0, 5380.0, 5693.0, 5623.0, 5313.0, 5633.0, 5334.0, 5413.0, 5266.0, 5697.0,

						5653.0, 5610.0, 5329.0, 5568.0, 5570.0, 5582.0, 5331.0, 5412.0, 5605.0, 5510.0, 5390.0, 5528.0, 5270.0, 5547.0, 5264.0, 5639.0, 5613.0, 5311.0, 5473.0, 5662.0, 5479.0, 5550.0, 5448.0, 5616.0, 5403.0, 5427.0, 5537.0, 5583.0, 5394.0, 5360.0, 5281.0, 5577.0, 5699.0, 5505.0, 5488.0, 5513.0, 5655.0, 5706.0, 5308.0, 5503.0, 5365.0, 5420.0, 5340.0, 5333.0, 5455.0, 5462.0, 5383.0, 5504.0, 5482.0, 5292.0, 5686.0, 5300.0, 5600.0, 5659.0, 5687.0, 5578.0, 5694.0, 5373.0, 5509.0, 5625.0 (number of hits: 8)
7	5550	9	1	333	1	5657.0, 5494.0, 5431.0, 5665.0, 5477.0, 5525.0, 5309.0, 5265.0, 5433.0, 5550.0, 5263.0, 5516.0, 5501.0, 5584.0, 5499.0, 5507.0, 5327.0, 5276.0, 5590.0, 5595.0, 5391.0, 5397.0, 5419.0, 5689.0, 5534.0, 5267.0, 5286.0, 5310.0, 5542.0, 5519.0, 5522.0, 5636.0, 5398.0, 5567.0, 5284.0, 5457.0, 5654.0, 5349.0, 5254.0, 5642.0, 5599.0, 5369.0, 5521.0, 5306.0, 5384.0, 5589.0, 5285.0, 5408.0, 5315.0, 5343.0, 5558.0, 5454.0, 5462.0, 5683.0, 5396.0, 5619.0, 5312.0, 5577.0, 5289.0, 5404.0, 5655.0, 5450.0, 5456.0, 5252.0, 5575.0, 5625.0, 5380.0, 5461.0, 5275.0, 5372.0, 5368.0, 5566.0, 5288.0, 5311.0, 5643.0, 5458.0, 5365.0, 5307.0, 5333.0, 5715.0, 5424.0, 5541.0, 5382.0, 5383.0, 5353.0, 5686.0, 5626.0, 5490.0, 5346.0, 5437.0, 5710.0, 5295.0, 5261.0, 5298.0, 5301.0, 5720.0, 5551.0, 5621.0, 5485.0, 5592.0 (number of hits: 13)
8	5550	9	1	333	1	5508.0, 5632.0, 5354.0, 5628.0, 5302.0, 5263.0, 5675.0, 5546.0, 5545.0, 5599.0, 5412.0, 5586.0, 5375.0, 5446.0, 5502.0, 5534.0, 5647.0, 5626.0, 5470.0, 5601.0, 5640.0, 5328.0, 5315.0, 5326.0, 5343.0, 5633.0, 5643.0, 5459.0, 5619.0, 5493.0, 5587.0, 5334.0, 5490.0, 5388.0, 5667.0, 5448.0, 5299.0, 5341.0, 5414.0, 5438.0, 5542.0, 5418.0, 5382.0, 5577.0, 5324.0, 5717.0, 5595.0, 5598.0, 5597.0, 5391.0, 5310.0, 5651.0, 5350.0, 5401.0, 5714.0, 5682.0, 5348.0, 5320.0, 5325.0, 5271.0, 5477.0, 5336.0, 5708.0, 5692.0, 5303.0, 5330.0, 5600.0, 5612.0, 5270.0, 5358.0, 5293.0, 5425.0, 5719.0, 5605.0, 5333.0, 5292.0, 5327.0, 5496.0, 5489.0, 5607.0, 5345.0, 5369.0, 5361.0, 5504.0, 5585.0, 5629.0, 5447.0, 5712.0, 5634.0, 5309.0, 5615.0, 5570.0, 5642.0, 5264.0, 5298.0, 5567.0, 5513.0, 5581.0, 5637.0, 5617.0 (number of hits: 4)
9	5550	9	1	333	1	5639.0, 5495.0, 5448.0, 5387.0, 5542.0, 5569.0, 5409.0, 5472.0, 5384.0, 5497.0, 5321.0, 5625.0, 5286.0, 5365.0, 5604.0, 5430.0, 5671.0, 5631.0, 5513.0, 5599.0,

						5435.0, 5333.0, 5506.0, 5462.0, 5700.0, 5416.0, 5683.0, 5443.0, 5490.0, 5356.0, 5469.0, 5256.0, 5564.0, 5421.0, 5494.0, 5682.0, 5627.0, 5307.0, 5706.0, 5349.0, 5667.0, 5640.0, 5565.0, 5392.0, 5545.0, 5363.0, 5588.0, 5287.0, 5378.0, 5620.0, 5482.0, 5560.0, 5401.0, 5452.0, 5330.0, 5508.0, 5346.0, 5352.0, 5719.0, 5636.0, 5624.0, 5668.0, 5591.0, 5550.0, 5308.0, 5396.0, 5431.0, 5651.0, 5708.0, 5360.0, 5512.0, 5687.0, 5521.0, 5691.0, 5578.0, 5538.0, 5288.0, 5476.0, 5644.0, 5312.0, 5318.0, 5656.0, 5263.0, 5595.0, 5419.0, 5648.0, 5562.0, 5407.0, 5395.0, 5460.0, 5566.0, 5638.0, 5386.0, 5618.0, 5474.0, 5293.0, 5310.0, 5576.0, 5518.0, 5573.0 (number of hits: 5)
10	5550	9	1	333	1	5591.0, 5417.0, 5673.0, 5579.0, 5331.0, 5476.0, 5711.0, 5462.0, 5307.0, 5404.0, 5721.0, 5410.0, 5529.0, 5448.0, 5520.0, 5406.0, 5344.0, 5323.0, 5378.0, 5719.0, 5629.0, 5304.0, 5503.0, 5386.0, 5626.0, 5649.0, 5621.0, 5381.0, 5425.0, 5322.0, 5606.0, 5399.0, 5532.0, 5657.0, 5342.0, 5510.0, 5358.0, 5590.0, 5602.0, 5596.0, 5312.0, 5412.0, 5531.0, 5290.0, 5660.0, 5326.0, 5537.0, 5564.0, 5316.0, 5708.0, 5383.0, 5549.0, 5662.0, 5652.0, 5540.0, 5396.0, 5592.0, 5264.0, 5697.0, 5330.0, 5522.0, 5584.0, 5335.0, 5687.0, 5302.0, 5421.0, 5418.0, 5501.0, 5523.0, 5513.0, 5467.0, 5600.0, 5403.0, 5521.0, 5611.0, 5270.0, 5320.0, 5483.0, 5336.0, 5297.0, 5435.0, 5650.0, 5337.0, 5538.0, 5298.0, 5565.0, 5546.0, 5578.0, 5637.0, 5533.0, 5688.0, 5494.0, 5359.0, 5315.0, 5250.0, 5345.0, 5655.0, 5461.0, 5534.0, 5497.0 (number of hits: 3)
11	5550	9	1	333	1	5508.0, 5477.0, 5452.0, 5529.0, 5309.0, 5448.0, 5266.0, 5466.0, 5364.0, 5345.0, 5608.0, 5697.0, 5610.0, 5256.0, 5445.0, 5358.0, 5323.0, 5640.0, 5522.0, 5713.0, 5347.0, 5431.0, 5349.0, 5614.0, 5346.0, 5482.0, 5532.0, 5513.0, 5701.0, 5672.0, 5644.0, 5293.0, 5334.0, 5621.0, 5292.0, 5564.0, 5273.0, 5534.0, 5587.0, 5360.0, 5503.0, 5437.0, 5514.0, 5576.0, 5267.0, 5604.0, 5261.0, 5284.0, 5575.0, 5622.0, 5485.0, 5455.0, 5339.0, 5417.0, 5305.0, 5289.0, 5404.0, 5403.0, 5617.0, 5523.0, 5557.0, 5304.0, 5569.0, 5692.0, 5469.0, 5679.0, 5422.0, 5598.0, 5651.0, 5550.0, 5332.0, 5459.0, 5427.0, 5472.0, 5415.0, 5668.0, 5583.0, 5419.0, 5676.0, 5475.0, 5454.0, 5340.0, 5274.0, 5335.0, 5507.0, 5342.0, 5327.0, 5568.0, 5535.0, 5413.0, 5662.0, 5319.0, 5648.0, 5720.0, 5308.0, 5505.0, 5368.0, 5606.0, 5545.0, 5703.0 (number of hits: 8)

12	5550	9	1	333	1	<p>5364.0, 5508.0, 5636.0, 5366.0, 5388.0, 5306.0, 5595.0, 5564.0, 5631.0, 5617.0, 5548.0, 5373.0, 5426.0, 5348.0, 5644.0, 5594.0, 5587.0, 5430.0, 5263.0, 5649.0, 5251.0, 5513.0, 5566.0, 5331.0, 5277.0, 5562.0, 5539.0, 5691.0, 5350.0, 5451.0, 5657.0, 5716.0, 5509.0, 5322.0, 5677.0, 5540.0, 5470.0, 5633.0, 5612.0, 5606.0, 5695.0, 5655.0, 5272.0, 5347.0, 5432.0, 5261.0, 5429.0, 5459.0, 5607.0, 5332.0, 5488.0, 5352.0, 5598.0, 5302.0, 5565.0, 5543.0, 5353.0, 5292.0, 5370.0, 5255.0, 5635.0, 5264.0, 5523.0, 5601.0, 5397.0, 5669.0, 5689.0, 5648.0, 5652.0, 5386.0, 5599.0, 5658.0, 5492.0, 5551.0, 5392.0, 5628.0, 5557.0, 5611.0, 5530.0, 5514.0, 5596.0, 5280.0, 5665.0, 5401.0, 5256.0, 5570.0, 5569.0, 5384.0, 5698.0, 5273.0, 5572.0, 5411.0, 5270.0, 5454.0, 5685.0, 5307.0, 5654.0, 5424.0, 5259.0, 5337.0 (number of hits: 12)</p>
13	5550	9	1	333	1	<p>5587.0, 5269.0, 5503.0, 5707.0, 5257.0, 5298.0, 5410.0, 5611.0, 5651.0, 5661.0, 5655.0, 5600.0, 5305.0, 5477.0, 5722.0, 5557.0, 5405.0, 5281.0, 5336.0, 5262.0, 5515.0, 5577.0, 5690.0, 5401.0, 5699.0, 5499.0, 5256.0, 5334.0, 5375.0, 5293.0, 5297.0, 5555.0, 5335.0, 5327.0, 5462.0, 5453.0, 5390.0, 5342.0, 5545.0, 5670.0, 5301.0, 5486.0, 5265.0, 5272.0, 5697.0, 5581.0, 5683.0, 5705.0, 5664.0, 5475.0, 5404.0, 5445.0, 5558.0, 5713.0, 5280.0, 5331.0, 5637.0, 5465.0, 5553.0, 5286.0, 5260.0, 5425.0, 5423.0, 5438.0, 5399.0, 5625.0, 5275.0, 5448.0, 5403.0, 5368.0, 5360.0, 5656.0, 5255.0, 5413.0, 5504.0, 5612.0, 5647.0, 5674.0, 5546.0, 5309.0, 5532.0, 5668.0, 5615.0, 5427.0, 5542.0, 5675.0, 5320.0, 5313.0, 5671.0, 5646.0, 5517.0, 5442.0, 5254.0, 5382.0, 5464.0, 5349.0, 5303.0, 5663.0, 5454.0, 5601.0 (number of hits: 13)</p>
14	5550	9	1	333	1	<p>5699.0, 5642.0, 5442.0, 5365.0, 5348.0, 5525.0, 5281.0, 5689.0, 5356.0, 5408.0, 5318.0, 5315.0, 5264.0, 5266.0, 5620.0, 5389.0, 5569.0, 5287.0, 5273.0, 5632.0, 5706.0, 5286.0, 5703.0, 5511.0, 5395.0, 5346.0, 5692.0, 5529.0, 5504.0, 5321.0, 5450.0, 5585.0, 5623.0, 5543.0, 5677.0, 5478.0, 5541.0, 5342.0, 5711.0, 5320.0, 5271.0, 5653.0, 5386.0, 5368.0, 5308.0, 5379.0, 5440.0, 5586.0, 5479.0, 5652.0, 5351.0, 5647.0, 5297.0, 5495.0, 5381.0, 5252.0, 5418.0, 5437.0, 5607.0, 5392.0, 5444.0, 5376.0, 5617.0, 5499.0, 5341.0, 5423.0, 5354.0, 5526.0, 5562.0, 5693.0, 5370.0, 5282.0, 5721.0, 5540.0, 5280.0, 5646.0, 5257.0, 5700.0, 5559.0, 5467.0, 5422.0, 5716.0, 5656.0, 5438.0, 5322.0,</p>

						5326.0, 5554.0, 5385.0, 5644.0, 5487.0, 5305.0, 5654.0, 5476.0, 5456.0, 5695.0, 5337.0, 5472.0, 5592.0, 5588.0, 5507.0 (number of hits: 11)
15	5550	9	1	333	1	5363.0, 5544.0, 5400.0, 5258.0, 5547.0, 5299.0, 5313.0, 5555.0, 5433.0, 5361.0, 5463.0, 5455.0, 5409.0, 5445.0, 5321.0, 5689.0, 5472.0, 5352.0, 5539.0, 5251.0, 5320.0, 5683.0, 5596.0, 5700.0, 5617.0, 5303.0, 5369.0, 5388.0, 5653.0, 5685.0, 5523.0, 5312.0, 5415.0, 5590.0, 5502.0, 5515.0, 5362.0, 5405.0, 5721.0, 5428.0, 5297.0, 5533.0, 5575.0, 5364.0, 5452.0, 5654.0, 5552.0, 5254.0, 5491.0, 5637.0, 5660.0, 5536.0, 5546.0, 5594.0, 5444.0, 5514.0, 5301.0, 5483.0, 5639.0, 5257.0, 5317.0, 5576.0, 5275.0, 5581.0, 5294.0, 5372.0, 5311.0, 5327.0, 5557.0, 5414.0, 5605.0, 5379.0, 5382.0, 5601.0, 5358.0, 5253.0, 5632.0, 5336.0, 5437.0, 5269.0, 5606.0, 5468.0, 5384.0, 5500.0, 5461.0, 5580.0, 5664.0, 5597.0, 5609.0, 5624.0, 5330.0, 5360.0, 5399.0, 5431.0, 5591.0, 5338.0, 5559.0, 5565.0, 5291.0, 5416.0 (number of hits: 7)
16	5550	9	1	333	1	5563.0, 5347.0, 5255.0, 5339.0, 5513.0, 5283.0, 5372.0, 5316.0, 5306.0, 5506.0, 5607.0, 5368.0, 5365.0, 5606.0, 5551.0, 5403.0, 5336.0, 5651.0, 5310.0, 5458.0, 5313.0, 5459.0, 5406.0, 5623.0, 5254.0, 5382.0, 5602.0, 5448.0, 5350.0, 5420.0, 5346.0, 5691.0, 5277.0, 5330.0, 5354.0, 5510.0, 5528.0, 5419.0, 5444.0, 5331.0, 5300.0, 5514.0, 5378.0, 5552.0, 5540.0, 5720.0, 5361.0, 5309.0, 5610.0, 5630.0, 5559.0, 5656.0, 5341.0, 5543.0, 5391.0, 5636.0, 5430.0, 5688.0, 5410.0, 5660.0, 5594.0, 5405.0, 5697.0, 5505.0, 5465.0, 5433.0, 5445.0, 5325.0, 5318.0, 5638.0, 5439.0, 5650.0, 5509.0, 5567.0, 5482.0, 5693.0, 5463.0, 5542.0, 5694.0, 5475.0, 5572.0, 5634.0, 5522.0, 5702.0, 5588.0, 5370.0, 5500.0, 5600.0, 5295.0, 5250.0, 5507.0, 5259.0, 5659.0, 5383.0, 5503.0, 5498.0, 5257.0, 5343.0, 5687.0, 5289.0 (number of hits: 8)
17	5550	9	1	333	1	5399.0, 5316.0, 5393.0, 5588.0, 5694.0, 5391.0, 5340.0, 5443.0, 5647.0, 5309.0, 5717.0, 5410.0, 5636.0, 5501.0, 5528.0, 5477.0, 5396.0, 5459.0, 5275.0, 5383.0, 5455.0, 5698.0, 5271.0, 5600.0, 5283.0, 5472.0, 5533.0, 5603.0, 5301.0, 5327.0, 5339.0, 5494.0, 5474.0, 5518.0, 5447.0, 5304.0, 5374.0, 5372.0, 5649.0, 5369.0, 5582.0, 5422.0, 5311.0, 5537.0, 5711.0, 5464.0, 5653.0, 5604.0, 5545.0, 5530.0, 5291.0, 5288.0, 5276.0, 5458.0, 5405.0, 5452.0, 5277.0, 5454.0, 5398.0, 5485.0, 5506.0, 5511.0, 5547.0, 5257.0, 5356.0

						5471.0, 5497.0, 5416.0, 5397.0, 5431.0, 5569.0, 5693.0, 5527.0, 5390.0, 5671.0, 5282.0, 5492.0, 5375.0, 5437.0, 5548.0, 5704.0, 5370.0, 5611.0, 5560.0, 5298.0, 5696.0, 5712.0, 5321.0, 5423.0, 5428.0, 5544.0, 5294.0, 5703.0, 5482.0, 5425.0, 5299.0, 5708.0, 5427.0, 5302.0, 5621.0 (number of hits: 8)
18	5550	9	1	333	1	5324.0, 5333.0, 5408.0, 5719.0, 5565.0, 5646.0, 5390.0, 5482.0, 5437.0, 5393.0, 5443.0, 5293.0, 5625.0, 5286.0, 5370.0, 5343.0, 5561.0, 5474.0, 5374.0, 5371.0, 5273.0, 5276.0, 5659.0, 5282.0, 5477.0, 5362.0, 5640.0, 5714.0, 5360.0, 5703.0, 5345.0, 5261.0, 5307.0, 5401.0, 5605.0, 5663.0, 5713.0, 5355.0, 5323.0, 5334.0, 5696.0, 5462.0, 5426.0, 5564.0, 5253.0, 5466.0, 5317.0, 5622.0, 5412.0, 5428.0, 5341.0, 5492.0, 5550.0, 5686.0, 5431.0, 5536.0, 5314.0, 5295.0, 5313.0, 5257.0, 5364.0, 5523.0, 5570.0, 5501.0, 5446.0, 5452.0, 5604.0, 5514.0, 5285.0, 5335.0, 5528.0, 5296.0, 5289.0, 5594.0, 5627.0, 5435.0, 5392.0, 5353.0, 5254.0, 5710.0, 5399.0, 5535.0, 5664.0, 5451.0, 5266.0, 5638.0, 5338.0, 5460.0, 5404.0, 5308.0, 5385.0, 5654.0, 5546.0, 5526.0, 5673.0, 5612.0, 5438.0, 5607.0, 5339.0, 5358.0 (number of hits: 11)
19	5550	9	1	333	1	5570.0, 5433.0, 5545.0, 5602.0, 5563.0, 5377.0, 5485.0, 5409.0, 5282.0, 5542.0, 5613.0, 5320.0, 5308.0, 5511.0, 5293.0, 5619.0, 5467.0, 5615.0, 5516.0, 5693.0, 5530.0, 5471.0, 5584.0, 5285.0, 5473.0, 5669.0, 5689.0, 5548.0, 5616.0, 5398.0, 5437.0, 5267.0, 5583.0, 5569.0, 5482.0, 5522.0, 5343.0, 5429.0, 5360.0, 5337.0, 5626.0, 5438.0, 5502.0, 5252.0, 5558.0, 5251.0, 5657.0, 5434.0, 5258.0, 5311.0, 5365.0, 5633.0, 5369.0, 5430.0, 5508.0, 5283.0, 5594.0, 5256.0, 5368.0, 5509.0, 5397.0, 5452.0, 5572.0, 5353.0, 5601.0, 5451.0, 5448.0, 5480.0, 5341.0, 5262.0, 5608.0, 5650.0, 5418.0, 5422.0, 5376.0, 5716.0, 5646.0, 5692.0, 5454.0, 5375.0, 5599.0, 5390.0, 5461.0, 5351.0, 5413.0, 5621.0, 5489.0, 5295.0, 5673.0, 5366.0, 5634.0, 5274.0, 5678.0, 5637.0, 5500.0, 5304.0, 5486.0, 5300.0, 5301.0, 5604.0 (number of hits: 10)
20	5550	9	1	333	1	5298.0, 5535.0, 5558.0, 5464.0, 5448.0, 5289.0, 5474.0, 5706.0, 5545.0, 5544.0, 5423.0, 5532.0, 5282.0, 5538.0, 5661.0, 5340.0, 5270.0, 5318.0, 5686.0, 5497.0, 5454.0, 5699.0, 5339.0, 5608.0, 5276.0, 5610.0, 5385.0, 5285.0, 5314.0, 5658.0, 5625.0, 5444.0, 5642.0, 5505.0, 5481.0, 5360.0, 5542.0, 5381.0, 5480.0, 5326.0, 5586.0, 5515.0, 5284.0, 5439.0, 5429.0

						5577.0, 5415.0, 5251.0, 5594.0, 5595.0, 5702.0, 5524.0, 5649.0, 5297.0, 5599.0, 5266.0, 5501.0, 5717.0, 5359.0, 5300.0, 5662.0, 5678.0, 5288.0, 5443.0, 5618.0, 5531.0, 5308.0, 5445.0, 5508.0, 5574.0, 5682.0, 5697.0, 5602.0, 5316.0, 5683.0, 5720.0, 5327.0, 5344.0, 5640.0, 5589.0, 5534.0, 5620.0, 5412.0, 5479.0, 5597.0, 5465.0, 5523.0, 5695.0, 5679.0, 5486.0, 5441.0, 5622.0, 5660.0, 5592.0, 5483.0, 5280.0, 5446.0, 5562.0, 5253.0, 5490.0 (number of hits: 11)
21	5550	9	1	333	1	5333.0, 5257.0, 5507.0, 5602.0, 5565.0, 5377.0, 5663.0, 5560.0, 5577.0, 5559.0, 5286.0, 5400.0, 5331.0, 5589.0, 5657.0, 5552.0, 5352.0, 5614.0, 5456.0, 5514.0, 5520.0, 5429.0, 5563.0, 5341.0, 5453.0, 5641.0, 5713.0, 5632.0, 5302.0, 5523.0, 5371.0, 5401.0, 5444.0, 5395.0, 5393.0, 5510.0, 5505.0, 5541.0, 5549.0, 5707.0, 5568.0, 5342.0, 5585.0, 5328.0, 5671.0, 5385.0, 5387.0, 5474.0, 5412.0, 5613.0, 5332.0, 5299.0, 5485.0, 5667.0, 5583.0, 5260.0, 5308.0, 5367.0, 5693.0, 5278.0, 5284.0, 5527.0, 5261.0, 5375.0, 5683.0, 5545.0, 5486.0, 5634.0, 5327.0, 5323.0, 5348.0, 5404.0, 5403.0, 5326.0, 5471.0, 5676.0, 5280.0, 5715.0, 5392.0, 5539.0, 5652.0, 5677.0, 5706.0, 5553.0, 5622.0, 5465.0, 5464.0, 5498.0, 5571.0, 5269.0, 5458.0, 5441.0, 5570.0, 5718.0, 5368.0, 5654.0, 5383.0, 5664.0, 5468.0, 5372.0 (number of hits: 8)
22	5550	9	1	333	1	5528.0, 5458.0, 5694.0, 5254.0, 5550.0, 5283.0, 5462.0, 5628.0, 5648.0, 5654.0, 5349.0, 5598.0, 5319.0, 5308.0, 5690.0, 5439.0, 5704.0, 5655.0, 5703.0, 5343.0, 5268.0, 5560.0, 5584.0, 5524.0, 5360.0, 5707.0, 5590.0, 5413.0, 5645.0, 5586.0, 5455.0, 5469.0, 5436.0, 5673.0, 5251.0, 5392.0, 5522.0, 5401.0, 5280.0, 5665.0, 5290.0, 5356.0, 5507.0, 5399.0, 5255.0, 5719.0, 5388.0, 5461.0, 5386.0, 5326.0, 5723.0, 5642.0, 5674.0, 5592.0, 5641.0, 5577.0, 5583.0, 5614.0, 5380.0, 5681.0, 5533.0, 5376.0, 5559.0, 5371.0, 5264.0, 5713.0, 5442.0, 5363.0, 5597.0, 5373.0, 5457.0, 5647.0, 5505.0, 5389.0, 5639.0, 5384.0, 5567.0, 5608.0, 5668.0, 5593.0, 5627.0, 5282.0, 5685.0, 5387.0, 5490.0, 5697.0, 5574.0, 5294.0, 5475.0, 5624.0, 5303.0, 5700.0, 5341.0, 5396.0, 5364.0, 5716.0, 5298.0, 5427.0, 5596.0, 5724.0 (number of hits: 8)
23	5550	9	1	333	1	5415.0, 5696.0, 5325.0, 5654.0, 5477.0, 5644.0, 5575.0, 5520.0, 5315.0, 5533.0, 5684.0, 5387.0, 5538.0, 5548.0, 5331.0, 5367.0, 5534.0, 5271.0, 5282.0, 5448.0, 5404.0, 5432.0, 5377.0, 5705.0, 5379.0

						5445.0, 5421.0, 5409.0, 5650.0, 5355.0, 5682.0, 5590.0, 5467.0, 5594.0, 5718.0, 5553.0, 5633.0, 5554.0, 5352.0, 5665.0, 5709.0, 5348.0, 5381.0, 5627.0, 5510.0, 5479.0, 5349.0, 5547.0, 5398.0, 5541.0, 5550.0, 5468.0, 5268.0, 5285.0, 5264.0, 5433.0, 5471.0, 5643.0, 5710.0, 5254.0, 5338.0, 5559.0, 5343.0, 5645.0, 5288.0, 5693.0, 5635.0, 5646.0, 5400.0, 5567.0, 5388.0, 5326.0, 5420.0, 5618.0, 5418.0, 5378.0, 5686.0, 5300.0, 5578.0, 5429.0, 5493.0, 5605.0, 5599.0, 5427.0, 5566.0, 5668.0, 5364.0, 5335.0, 5431.0, 5536.0, 5584.0, 5336.0, 5466.0, 5397.0, 5294.0, 5350.0, 5298.0, 5485.0, 5563.0, 5410.0 (number of hits: 7)
24	5550	9	1	333	1	5321.0, 5621.0, 5414.0, 5555.0, 5393.0, 5588.0, 5670.0, 5653.0, 5499.0, 5452.0, 5683.0, 5278.0, 5628.0, 5618.0, 5593.0, 5612.0, 5477.0, 5311.0, 5677.0, 5270.0, 5660.0, 5694.0, 5261.0, 5460.0, 5557.0, 5724.0, 5434.0, 5456.0, 5409.0, 5708.0, 5599.0, 5313.0, 5707.0, 5515.0, 5440.0, 5463.0, 5483.0, 5277.0, 5259.0, 5437.0, 5281.0, 5266.0, 5380.0, 5305.0, 5260.0, 5602.0, 5711.0, 5344.0, 5490.0, 5596.0, 5319.0, 5505.0, 5601.0, 5561.0, 5258.0, 5309.0, 5361.0, 5296.0, 5438.0, 5589.0, 5611.0, 5498.0, 5605.0, 5424.0, 5289.0, 5428.0, 5697.0, 5308.0, 5717.0, 5563.0, 5413.0, 5364.0, 5288.0, 5722.0, 5453.0, 5673.0, 5334.0, 5713.0, 5352.0, 5345.0, 5699.0, 5491.0, 5389.0, 5719.0, 5316.0, 5318.0, 5357.0, 5291.0, 5253.0, 5632.0, 5468.0, 5464.0, 5310.0, 5485.0, 5624.0, 5359.0, 5375.0, 5374.0, 5394.0, 5689.0 (number of hits: 12)
25	5550	9	1	333	1	5622.0, 5722.0, 5664.0, 5332.0, 5449.0, 5334.0, 5488.0, 5328.0, 5661.0, 5723.0, 5267.0, 5659.0, 5720.0, 5337.0, 5655.0, 5362.0, 5445.0, 5419.0, 5620.0, 5576.0, 5527.0, 5643.0, 5398.0, 5395.0, 5587.0, 5610.0, 5268.0, 5688.0, 5579.0, 5709.0, 5325.0, 5475.0, 5558.0, 5554.0, 5456.0, 5313.0, 5338.0, 5412.0, 5706.0, 5272.0, 5717.0, 5372.0, 5712.0, 5428.0, 5482.0, 5630.0, 5403.0, 5259.0, 5715.0, 5453.0, 5673.0, 5649.0, 5336.0, 5559.0, 5300.0, 5413.0, 5575.0, 5676.0, 5375.0, 5349.0, 5390.0, 5301.0, 5572.0, 5309.0, 5286.0, 5569.0, 5392.0, 5380.0, 5626.0, 5424.0, 5373.0, 5605.0, 5632.0, 5665.0, 5429.0, 5589.0, 5522.0, 5321.0, 5396.0, 5686.0, 5596.0, 5551.0, 5719.0, 5479.0, 5422.0, 5416.0, 5535.0, 5550.0, 5402.0, 5504.0, 5344.0, 5658.0, 5721.0, 5672.0, 5420.0, 5303.0, 5358.0, 5548.0, 5310.0, 5264.0 (number of hits: 6)
26	5550	9	1	333	1	5480.0, 5642.0, 5608.0, 5358.0, 5426.0,

						5463.0, 5364.0, 5464.0, 5253.0, 5305.0, 5596.0, 5679.0, 5399.0, 5272.0, 5598.0, 5602.0, 5255.0, 5469.0, 5605.0, 5314.0, 5647.0, 5513.0, 5623.0, 5303.0, 5650.0, 5258.0, 5338.0, 5672.0, 5715.0, 5440.0, 5317.0, 5484.0, 5474.0, 5499.0, 5456.0, 5406.0, 5276.0, 5475.0, 5443.0, 5670.0, 5375.0, 5341.0, 5599.0, 5331.0, 5604.0, 5683.0, 5439.0, 5347.0, 5548.0, 5277.0, 5528.0, 5629.0, 5723.0, 5680.0, 5376.0, 5624.0, 5330.0, 5390.0, 5479.0, 5363.0, 5662.0, 5400.0, 5616.0, 5304.0, 5643.0, 5617.0, 5576.0, 5483.0, 5282.0, 5688.0, 5356.0, 5592.0, 5573.0, 5256.0, 5316.0, 5615.0, 5505.0, 5429.0, 5709.0, 5675.0, 5292.0, 5417.0, 5661.0, 5408.0, 5549.0, 5633.0, 5628.0, 5313.0, 5559.0, 5423.0, 5663.0, 5626.0, 5478.0, 5378.0, 5519.0, 5645.0, 5546.0, 5380.0, 5377.0, 5274.0 (number of hits: 9)
27	5550	9	1	333	1	5578.0, 5344.0, 5584.0, 5345.0, 5383.0, 5286.0, 5655.0, 5310.0, 5591.0, 5429.0, 5585.0, 5455.0, 5491.0, 5407.0, 5463.0, 5707.0, 5639.0, 5299.0, 5711.0, 5439.0, 5433.0, 5255.0, 5582.0, 5702.0, 5371.0, 5475.0, 5272.0, 5333.0, 5401.0, 5712.0, 5669.0, 5703.0, 5594.0, 5576.0, 5395.0, 5601.0, 5532.0, 5289.0, 5534.0, 5275.0, 5424.0, 5700.0, 5277.0, 5426.0, 5368.0, 5387.0, 5486.0, 5438.0, 5361.0, 5583.0, 5488.0, 5590.0, 5370.0, 5694.0, 5374.0, 5281.0, 5646.0, 5645.0, 5308.0, 5430.0, 5683.0, 5575.0, 5267.0, 5457.0, 5339.0, 5437.0, 5449.0, 5454.0, 5380.0, 5282.0, 5435.0, 5603.0, 5364.0, 5571.0, 5326.0, 5667.0, 5261.0, 5413.0, 5440.0, 5572.0, 5529.0, 5353.0, 5715.0, 5442.0, 5417.0, 5356.0, 5624.0, 5653.0, 5545.0, 5592.0, 5485.0, 5478.0, 5699.0, 5398.0, 5618.0, 5394.0, 5264.0, 5631.0, 5431.0, 5635.0 (number of hits: 11)
28	5550	9	1	333	1	5463.0, 5427.0, 5692.0, 5529.0, 5381.0, 5594.0, 5575.0, 5284.0, 5626.0, 5634.0, 5438.0, 5655.0, 5713.0, 5662.0, 5477.0, 5255.0, 5451.0, 5341.0, 5345.0, 5570.0, 5257.0, 5423.0, 5656.0, 5625.0, 5680.0, 5507.0, 5410.0, 5348.0, 5511.0, 5452.0, 5643.0, 5548.0, 5408.0, 5469.0, 5523.0, 5462.0, 5608.0, 5354.0, 5506.0, 5474.0, 5661.0, 5281.0, 5321.0, 5674.0, 5467.0, 5251.0, 5683.0, 5250.0, 5613.0, 5554.0, 5501.0, 5579.0, 5390.0, 5309.0, 5253.0, 5403.0, 5372.0, 5618.0, 5606.0, 5388.0, 5327.0, 5588.0, 5314.0, 5395.0, 5417.0, 5624.0, 5602.0, 5615.0, 5699.0, 5706.0, 5335.0, 5446.0, 5600.0, 5333.0, 5472.0, 5288.0, 5604.0, 5436.0, 5552.0, 5532.0, 5525.0, 5306.0, 5280.0, 5642.0, 5368.0, 5419.0, 5515.0, 5531.0, 5444.0, 5279.0

						5710.0, 5268.0, 5550.0, 5499.0, 5628.0, 5540.0, 5577.0, 5509.0, 5714.0, 5612.0 (number of hits: 11)
29	5550	9	1	333	1	5534.0, 5643.0, 5407.0, 5538.0, 5387.0, 5577.0, 5620.0, 5466.0, 5699.0, 5694.0, 5483.0, 5654.0, 5651.0, 5723.0, 5497.0, 5642.0, 5314.0, 5565.0, 5482.0, 5266.0, 5703.0, 5666.0, 5647.0, 5420.0, 5663.0, 5665.0, 5474.0, 5453.0, 5548.0, 5346.0, 5652.0, 5322.0, 5563.0, 5404.0, 5557.0, 5507.0, 5486.0, 5394.0, 5674.0, 5473.0, 5436.0, 5709.0, 5602.0, 5337.0, 5562.0, 5636.0, 5426.0, 5488.0, 5612.0, 5597.0, 5343.0, 5592.0, 5264.0, 5716.0, 5352.0, 5353.0, 5347.0, 5282.0, 5512.0, 5564.0, 5685.0, 5373.0, 5515.0, 5521.0, 5281.0, 5315.0, 5511.0, 5700.0, 5697.0, 5596.0, 5706.0, 5491.0, 5335.0, 5467.0, 5480.0, 5481.0, 5431.0, 5299.0, 5348.0, 5418.0, 5374.0, 5445.0, 5301.0, 5398.0, 5586.0, 5613.0, 5623.0, 5702.0, 5595.0, 5341.0, 5390.0, 5574.0, 5278.0, 5370.0, 5568.0, 5535.0, 5550.0, 5283.0, 5547.0, 5385.0 (number of hits: 6)
30	5550	9	1	333	1	5651.0, 5330.0, 5321.0, 5623.0, 5448.0, 5471.0, 5292.0, 5419.0, 5277.0, 5300.0, 5656.0, 5392.0, 5541.0, 5579.0, 5377.0, 5456.0, 5601.0, 5432.0, 5310.0, 5505.0, 5414.0, 5595.0, 5510.0, 5634.0, 5258.0, 5312.0, 5669.0, 5575.0, 5463.0, 5290.0, 5627.0, 5494.0, 5635.0, 5515.0, 5467.0, 5701.0, 5501.0, 5550.0, 5354.0, 5582.0, 5458.0, 5647.0, 5372.0, 5612.0, 5714.0, 5559.0, 5342.0, 5404.0, 5329.0, 5287.0, 5385.0, 5344.0, 5426.0, 5286.0, 5319.0, 5325.0, 5533.0, 5469.0, 5653.0, 5479.0, 5299.0, 5700.0, 5536.0, 5314.0, 5596.0, 5417.0, 5672.0, 5429.0, 5553.0, 5454.0, 5613.0, 5297.0, 5439.0, 5302.0, 5397.0, 5415.0, 5278.0, 5508.0, 5422.0, 5657.0, 5355.0, 5328.0, 5707.0, 5435.0, 5455.0, 5250.0, 5347.0, 5498.0, 5382.0, 5546.0, 5585.0, 5490.0, 5594.0, 5514.0, 5540.0, 5560.0, 5593.0, 5695.0, 5571.0, 5285.0 (number of hits: 7)

5290 MHz, 80 MHz Bandwidth

Radar Signal Type	Waveform/Trial Number	Detection (%)	Limit (%)	Pass/Fail
Type 1A/1B	30	100 %	60%	Pass
Type 2	30	100 %	60%	Pass
Type 3	30	100 %	60%	Pass
Type 4	30	100 %	60%	Pass
Aggregate (Type1 to 4)	120	100 %	80%	Pass
Type 5	30	100 %	80%	Pass
Type 6	30	100 %	70%	Pass

Please refer to the following statistical tables:

Table-1 Radar Type 1A/1B Statistical Performance

Trial #	Fc (MHz)	Pulse/Burst	Pulse Width (μS)	PRI (μs)	Detection (1:yes; 0:no)
1	5290	83	1	638	1
2	5290	18	1	3066	1
3	5290	70	1	758	1
4	5290	74	1	718	1
5	5290	59	1	898	1
6	5290	62	1	858	1
7	5290	102	1	518	1
8	5290	81	1	658	1
9	5290	67	1	798	1
10	5290	76	1	698	1
11	5290	86	1	618	1
12	5290	72	1	738	1
13	5290	95	1	558	1
14	5290	58	1	918	1
15	5290	61	1	878	1
16	5290	96	1	551	1
17	5290	93	1	568	1
18	5290	39	1	1387	1
19	5290	31	1	1716	
20	5290	38	1	1405	1
21	5290	21	1	2544	1
22	5290	86	1	614	1
23	5290	44	1	1207	1
24	5290	79	1	669	1
25	5290	19	1	2824	1
26	5290	39	1	1360	1
27	5290	70	1	755	1
28	5290	47	1	1133	1
29	5290	21	1	2571	1
30	5290	26	1	2073	1
Detection Percentage: 100 % (>60%)					

Table-2 Radar Type 2 Statistical Performance

Trial #	Fc (MHz)	Pulse/Burst	Pulse Width (μS)	PRI (μs)	Detection (1:yes; 0:no)
1	5290	29	2.5	218	1
2	5290	24	2.5	200	1
3	5290	25	4.4	156	1
4	5290	29	2.6	216	1
5	5290	24	4.8	185	1
6	5290	27	3	152	1
7	5290	28	1.8	200	1
8	5290	27	4.6	206	1
9	5290	28	1.8	166	1
10	5290	29	2.4	230	1
11	5290	24	2.6	152	1
12	5290	27	4.9	209	1
13	5290	29	4.7	209	1
14	5290	29	1.2	164	1
15	5290	29	3.2	205	1
16	5290	23	1.4	182	1
17	5290	27	2.7	221	1
18	5290	26	1.4	199	1
19	5290	29	4.9	155	1
20	5290	24	3.5	221	1
21	5290	29	2.7	155	1
22	5290	27	2.4	155	1
23	5290	25	4.4	216	1
24	5290	26	4	200	1
25	5290	24	4.5	217	1
26	5290	25	1.3	192	1
27	5290	23	2.2	186	1
28	5290	27	2.9	179	1
29	5290	27	2.9	203	1
30	5290	26	4.4	196	1
Detection Percentage: 100% (>60%)					

Table-3 Radar Type 3 Statistical Performance

Trial #	Fc (MHz)	Pulse/Burst	Pulse Width (μS)	PRI (μs)	Detection (1:yes; 0:no)
1	5290	16	7	224	1
2	5290	17	7	371	1
3	5290	17	8.5	320	1
4	5290	18	8.5	396	1
5	5290	17	8.1	485	1
6	5290	16	7.7	234	1
7	5290	18	7.1	376	1
8	5290	17	7.7	445	1
9	5290	18	7	486	1
10	5290	18	8.6	325	1
11	5290	17	8.8	458	1
12	5290	17	8.8	469	1
13	5290	17	9.1	403	1
14	5290	16	9.5	364	1
15	5290	17	9.1	295	1
16	5290	18	9	411	1
17	5290	16	10	492	1
18	5290	16	8	465	1
19	5290	16	9.2	317	1
20	5290	16	7.5	443	1
21	5290	16	9.7	321	1
22	5290	17	8.6	345	1
23	5290	18	8.3	471	1
24	5290	17	9.3	472	1
25	5290	16	9.1	363	1
26	5290	17	9.7	357	1
27	5290	18	7.8	227	1
28	5290	17	9.9	317	1
29	5290	17	6.9	330	1
30	5290	18	7.4	251	1
Detection Percentage: 100 % (>60%)					

Table-4 Radar Type 4 Statistical Performance

Trial #	Fc (MHz)	Pulse/Burst	Pulse Width (μS)	PRI (μs)	Detection (1:yes; 0:no)
1	5290	15	18.8	275	1
2	5290	16	13.3	297	1
3	5290	16	11.4	471	1
4	5290	13	15.8	427	1
5	5290	16	12.7	268	1
6	5290	16	18.3	208	1
7	5290	13	13	380	1
8	5290	12	18.6	210	1
9	5290	13	17.4	419	1
10	5290	12	15.5	332	1
11	5290	16	19.6	446	1
12	5290	15	14.5	424	1
13	5290	12	19.4	441	1
14	5290	15	16.3	269	1
15	5290	15	11.2	498	1
16	5290	13	14	443	1
17	5290	15	16.4	424	1
18	5290	15	13.9	441	1
19	5290	15	19.3	414	1
20	5290	16	19.4	500	1
21	5290	15	14.2	484	1
22	5290	13	18	355	1
23	5290	16	17.3	262	1
24	5290	14	19	229	1
25	5290	13	17.2	206	1
26	5290	14	12.3	369	1
27	5290	14	15.6	311	1
28	5290	13	12.3	294	1
29	5290	16	16.5	393	1
30	5290	15	11.4	387	1
Detection Percentage: 100 % (>60%)					

Table-5 Radar Type 5 Statistical Performance

Bin5 Statistics 1

Trial #	Pulse	Chirp (MHz)	Pulse Width (μS)	Pulse 1-2 spacing (uS)	Pulse 2-3 spacing (uS)	Pulse Start(S)	Detection (1:yes; 0:no)
0	1	16	98.9			0.215763	1
1	1	12	69.4			1.15478	
2	2	8	67.4	1722		1.46616	
3	2	9	91.1	1661		1.960491	
4	2	16	61.6	1944		2.90282	
5	2	6	57.5	1235		3.709668	
6	3	11	86.8	1245	1436	3.86139	
7	3	11	64.7	1377	1880	4.949265	
8	2	17	84.6	1417		5.236975	
9	2	8	61	1873		6.226736	
10	2	15	89.7	1783		6.681542	
11	2	17	60.3	1489		7.426708	
12	1	11	88.8			7.835059	
13	1	16	73.5			8.270164	
14	3	8	62.2	1685	1277	9.265195	
15	3	5	80.6	1952	1607	10.001703	
16	1	12	75.6			10.363623	
17	1	6	81.7			11.306532	
18	1	5	62.4			11.815449	

Bin5 Statistics 2

Trial #	Pulse	Chirp (MHz)	Pulse Width (µS)	Pulse 1-2 spacing (µS)	Pulse 2-3 spacing (µS)	Pulse Start(S)	Detection (1:yes; 0:no)
0	1	19	93.2			0.562623	1
1	1	17	61.4			1.534597	
2	3	17	98.5	1026	1626	2.356959	
3	1	9	77.1			2.706387	
4	2	20	92.4	1915		3.552059	
5	3	6	69.9	1087	1322	4.181677	
6	3	15	68.1	1118	1960	5.010205	
7	2	17	51.4	1100		5.796739	
8	1	15	58.7			6.744231	
9	2	10	51.3	1646		7.51995	
10	2	10	50.8	1930		8.060739	
11	1	19	96.8			9.527572	
12	3	15	90.2	1843	1206	9.847235	
13	1	5	98.9			11.097459	
14	2	12	98.9	1780		11.384349	

Bin5 Statistics 3

Trial #	Pulse	Chirp (MHz)	Pulse Width (µS)	Pulse 1-2 spacing (µS)	Pulse 2-3 spacing (µS)	Pulse Start(S)	Detection (1:yes; 0:no)
0	2	17	82.6	1338		0.352454	1
1	1	10	80.6			0.996612	
2	3	17	83	1546	1976	2.07986	
3	2	8	69	1820		2.981393	
4	1	12	91.7			3.531076	
5	2	6	93.2	1404		4.35342	
6	2	10	50.7	1321		4.802785	
7	2	7	54.2	1177		6.295574	
8	1	15	91.5			7.109846	
9	2	18	97.5	1579		7.699166	
10	3	6	95.3	1983	1559	8.124749	
11	1	15	72.5			8.910874	
12	2	17	54.7	1840		10.151545	
13	1	9	53.4			11.155038	
14	3	11	77.5	1001	1883	11.207078	

Bin5 Statistics 4

Trial #	Pulse	Chirp (MHz)	Pulse Width (µS)	Pulse 1-2 spacing (µS)	Pulse 2-3 spacing (µS)	Pulse Start(S)	Detection (1:yes; 0:no)
i	2	5	91.1	1723		0.518542	1
1	1	18	60.9			0.99978	
2	2	7	70.2	1033		1.859668	
3	3	20	73.4	1420	1891	2.323204	
4	3	18	83.5	1730	1996	3.012766	
5	3	13	83.1	1106	1646	4.4157	
6	2	18	94.8	1055		5.173875	
7	2	10	79.7	1906		5.35294	
8	1	9	73.8			6.185405	
9	3	14	87.3	1824	1128	7.14294	
10	2	8	67.1	1230		7.566528	
11	3	18	88.2	1783	1365	8.515608	
12	2	7	98.4	1724		9.045069	
13	3	14	68.6	1534	1777	9.917739	
14	1	9	70.5			11.172449	
15	2	13	57.8	1277		11.52385	

Bin5 Statistics 5

Trial #	Pulse	Chirp (MHz)	Pulse Width (µS)	Pulse 1-2 spacing (µS)	Pulse 2-3 spacing (µS)	Pulse Start(S)	Detection (1:yes; 0:no)
0	2	6	91.7	1735		0.335489	1
1	2	20	67.6	1600		0.777505	
2	2	7	80.9	1210		1.519666	
3	1	10	99.1			2.134512	
4	3	9	62.9	1530	1013	3.096624	
5	3	8	89.4	1785	1751	3.984704	
6	2	15	87.8	1352		4.39954	
7	2	19	99.2	1751		4.932728	
8	3	16	51.4	1939	1105	5.641382	
9	1	13	65.3			6.115597	
10	2	8	76.8	1501		6.817356	
11	2	6	58.7	1728		7.800601	
12	2	19	63.8	1459		8.581496	
13	3	8	69.6	1479	1186	8.733802	
14	3	13	85.6	1775	1297	9.547431	
15	3	20	67.7	1570	1223	10.032005	
16	3	6	88.5	1916	1921	11.027528	
17	2	8	81.8	1047		11.851843	

Bin5 Statistics 6

Trial #	Pulse	Chirp (MHz)	Pulse Width (µS)	Pulse 1-2 spacing (µS)	Pulse 2-3 spacing (µS)	Pulse Start(S)	Detection (1:yes; 0:no)
0	2	15	74.4	1291		0.702917	1
1	3	15	78.7	1890	1791	1.133289	
2	1	8	69.9			2.210693	
3	2	15	68.2	1403		2.656378	
4	2	17	72.6	1434		3.230312	
5	2	11	88.1	1239		4.180591	
6	3	9	76.8	1084	1025	5.016029	
7	3	11	77.1	1276	1679	5.388	
8	3	12	97.4	1293	1088	6.057341	
9	2	18	54.1	1517		7.086035	
10	2	9	80.8	1682		7.575701	
11	1	9	78.5			8.439873	
12	2	10	99.5	1075		9.170231	
13	3	13	58.3	1887	1025	10.423865	
14	2	17	67	1123		10.936923	
15	2	10	69.8	1230		11.946299	

Bin5 Statistics 7

Trial #	Pulse	Chirp (MHz)	Pulse Width (µS)	Pulse 1-2 spacing (µS)	Pulse 2-3 spacing (µS)	Pulse Start(S)	Detection (1:yes; 0:no)
0	2	11	64.8	1011		0.279701	1
1	2	17	57	1654		1.161761	
2	2	12	51.5	1568		2.476257	
3	1	13	93.6			3.465615	
4	2	16	62.7	1070		4.65904	
5	2	14	98.3	1086		5.63823	
6	2	20	80.6	1306		6.801739	
7	2	18	56.7	1119		7.877703	
8	3	16	63.7	1016	1189	8.510069	
9	2	18	50.1	1083		9.985655	
10	2	8	64.6	1536		10.385721	
11	2	12	51.5	1275		11.08831	

Bin5 Statistics 8

Trial #	Pulse	Chirp (MHz)	Pulse Width (µS)	Pulse 1-2 spacing (uS)	Pulse 2-3 spacing (uS)	Pulse Start(S)	Detection (1:yes; 0:no)
0	1	11	93.4			0.163033	1
1	2	16	69.1	1929		0.952783	
2	3	18	50.4	1120	1131	2.098011	
3	3	18	67.1	1124	1599	2.366684	
4	2	9	71	1133		3.327663	
5	3	19	96.1	1120	1146	3.542294	
6	2	17	77.8	1776		4.712096	
7	3	18	76	1095	1164	5.604891	
8	2	11	71.7	1601		5.723392	
9	3	15	54.1	1267	1318	6.457351	
10	1	10	95			7.079365	
11	3	20	90.1	1185	1607	8.111561	
12	1	15	85.1			8.656251	
13	3	6	61.4	1954	1108	9.383754	
14	1	17	64.5			10.135863	
15	3	9	56.6	1293	1246	10.729112	
16	2	18	77.1	1307		11.370257	

Bin5 Statistics 9

Trial #	Pulse	Chirp (MHz)	Pulse Width (µS)	Pulse 1-2 spacing (uS)	Pulse 2-3 spacing (uS)	Pulse Start(S)	Detection (1:yes; 0:no)
0	2	5	74.3	1944		0.891598	1
1	2	11	80.2	1578		1.173864	
2	3	6	53.2	1699	1331	2.340361	
3	2	8	58	1098		3.810679	
4	2	18	94.9	1197		4.045054	
5	2	17	79.3	1968		5.33546	
6	3	5	60.7	1130	1565	6.239681	
7	2	15	75.7	1567		7.414667	
8	2	19	70.6	1057		8.871681	
9	3	7	92.1	1209	1004	9.336929	
10	2	14	86.2	1819		10.609561	
11	2	16	99.2	1576		11.348661	

Bin5 Statistics 10

Trial #	Pulse	Chirp (MHz)	Pulse Width (µS)	Pulse 1-2 spacing (uS)	Pulse 2-3 spacing (uS)	Pulse Start(S)	Detection (1:yes; 0:no)
0	1	10	54			0.226321	1
1	3	12	86.3	1160	1968	1.082588	
2	2	19	81.6	1115		1.81158	
3	3	7	55.2	1300	1864	2.39778	
4	2	20	87.8	1920		3.116684	
5	1	6	60.1			3.53678	
6	2	8	87.6	1695		3.867494	
7	2	11	73.3	1985		4.625871	
8	3	10	87.1	1587	1405	5.644249	
9	2	10	90.5	1089		6.276497	
10	1	19	53.9			6.610128	
11	2	15	97.8	1775		7.1718	
12	1	7	58.1			8.068433	
13	3	19	78.1	1046	1467	8.751873	
14	1	19	90.7			9.21763	
15	2	9	91.3	1919		9.767184	
16	3	7	54.9	1574	1506	10.267899	
17	2	10	80.9	1736		10.800774	
18	3	11	64.1	1972	1770	11.979517	

Bin5 Statistics 11

Trial #	Pulse	Chirp (MHz)	Pulse Width (µS)	Pulse 1-2 spacing (uS)	Pulse 2-3 spacing (uS)	Pulse Start(S)	Detection (1:yes; 0:no)
0	2	20	79.9	1955		0.398485	1
1	2	5	77.2	1950		1.992325	
2	2	5	97.4	1890		2.862004	
3	1	10	59.9			3.540066	
4	3	15	84.9	1824	1613	4.384732	
5	3	8	81.1	1262	1122	5.674161	
6	1	10	82.8			6.877165	
7	1	17	82			7.173311	
8	3	19	86.5	1164	1369	8.488704	
9	3	19	91.9	1886	1141	9.741433	
10	1	6	99.6			10.278232	
11	1	16	60.6			11.336986	

Bin5 Statistics 12

Trial #	Pulse	Chirp (MHz)	Pulse Width (µS)	Pulse 1-2 spacing (uS)	Pulse 2-3 spacing (uS)	Pulse Start(S)	Detection (1:yes; 0:no)
0	2	6	87.7	1748		0.565937	1
1	2	6	86.6	1261		1.472806	
2	3	16	68	1559	1260	2.263427	
3	2	20	71.5	1573		3.199497	
4	1	11	58.3			4.145976	
5	2	14	66.3	1030		5.144701	
6	2	16	56.8	1977		5.932732	
7	2	15	91.1	1746		7.322212	
8	1	19	69			7.99847	
9	3	13	75.7	1840	1232	8.637068	
10	3	12	85	1994	1153	10.027812	
11	3	11	94	1003	1279	10.401529	
12	1	9	75.8			11.713901	
0	2	6	87.7	1748		0.565937	

Bin5 Statistics 13

Trial #	Pulse	Chirp (MHz)	Pulse Width (µS)	Pulse 1-2 spacing (uS)	Pulse 2-3 spacing (uS)	Pulse Start(S)	Detection (1:yes; 0:no)
0	2	16	97.8	1893		1.069735	1
1	2	6	58.6	1061		1.322981	
2	3	10	86	1904	1654	3.146364	
3	3	9	52.7	1338	1208	4.215962	
4	3	18	86	1487	1106	4.909444	
5	3	13	88.7	1060	1747	6.794505	
6	2	10	76	1683		7.852978	
7	2	6	72.3	1105		8.78921	
8	3	17	66.1	1543	1987	10.659359	
9	2	8	65.7	1955		11.408731	

Bin5 Statistics 14

Trial #	Pulse	Chirp (MHz)	Pulse Width (µS)	Pulse 1-2 spacing (uS)	Pulse 2-3 spacing (uS)	Pulse Start(S)	Detection (1:yes; 0:no)
0	3	15	93	1712	1741	0.111328	1
1	3	12	87.3	1737	1529	1.098904	
2	1	11	77.4			1.89804	
3	1	10	84.2			2.924968	
4	2	9	58.6	1323		3.495553	
5	2	10	66.8	1230		4.313152	
6	2	9	85.6	1641		5.187104	
7	1	6	70.1			5.857298	
8	3	18	62.1	1761	1008	6.910741	
9	3	10	90.1	1680	1974	7.609978	
10	2	12	55.8	1993		8.477932	
11	2	18	80.7	1740		8.855057	
12	2	9	71.9	1565		9.805378	
13	2	16	94.2	1217		11.144002	
14	1	7	85.3			11.700187	

Bin5 Statistics 15

Trial #	Pulse	Chirp (MHz)	Pulse Width (µS)	Pulse 1-2 spacing (uS)	Pulse 2-3 spacing (uS)	Pulse Start(S)	Detection (1:yes; 0:no)
0	2	5	66.4	1888		0.862635	1
1	3	8	68.8	1061	1292	1.89915	
2	2	15	90.6	1474		3.159409	
3	3	16	61.2	1269	1279	4.864432	
4	1	18	63.8			6.319573	
5	2	10	84.2	1099		8.993813	
6	1	20	86.7			9.546883	
7	3	7	74.1	1222	1916	10.66015	

Bin5 Statistics 16

Trial #	Pulse	Chirp (MHz)	Pulse Width (µS)	Pulse 1-2 spacing (uS)	Pulse 2-3 spacing (uS)	Pulse Start(S)	Detection (1:yes; 0:no)
0	1	7	53.5			0.26163	1
1	3	15	75.1	1346	1559	1.325359	
2	2	14	89.9	1860		1.734585	
3	3	19	76.7	1971	1333	3.18081	
4	1	8	54.9			3.484937	
5	2	12	77.5	1021		4.036767	
6	2	11	91.7	1800		5.347488	
7	2	15	80	1162		6.014386	
8	3	16	61.9	1641	1730	7.128979	
9	2	6	60	1059		7.664479	
10	3	7	96.6	1082	1161	8.089463	
11	3	19	92.1	1088	1786	8.934769	
12	1	18	52.9			10.366348	
13	3	11	98	1101	1764	10.409559	
14	1	14	97.3			11.845497	

Bin5 Statistics 17

Trial #	Pulse	Chirp (MHz)	Pulse Width (µS)	Pulse 1-2 spacing (uS)	Pulse 2-3 spacing (uS)	Pulse Start(S)	Detection (1:yes; 0:no)
0	2	8	85.9	1117		0.413173	1
1	2	17	59.9	1196		2.388782	
2	2	5	85.1	1942		4.015485	
3	2	17	97.5	1572		5.143914	
4	3	20	69.3	1582	1299	6.518601	
5	3	16	55.4	1760	1510	7.743172	
6	3	6	52.2	1414	1626	9.380802	
7	2	8	90.8	1956		10.838961	

Bin5 Statistics 18

Trial #	Pulse	Chirp (MHz)	Pulse Width (µS)	Pulse 1-2 spacing (uS)	Pulse 2-3 spacing (uS)	Pulse Start(S)	Detection (1:yes; 0:no)
0	2	14	100	1619		0.619248	1
1	2	11	96.8	1871		1.235841	
2	1	7	98.8			1.703323	
3	2	9	98.2	1857		3.155657	
4	3	16	68.3	1875	1599	3.582758	
5	3	12	55.3	1817	1837	4.436561	
6	1	7	76.7			4.987148	
7	1	14	95.3			5.659266	
8	2	13	64.3	1954		6.567959	
9	3	11	80.9	1393	1308	7.304484	
10	2	14	99.6	1054		8.57554	
11	3	18	68.6	1331	1567	8.957716	
12	1	17	83.3			10.317271	
13	1	14	87.9			10.761439	
14	1	6	54.4			11.56911	

Bin5 Statistics 19

Trial #	Pulse	Chirp (MHz)	Pulse Width (µS)	Pulse 1-2 spacing (uS)	Pulse 2-3 spacing (uS)	Pulse Start(S)	Detection (1:yes; 0:no)
0	2	5	66	1086		1.027276	1
1	2	18	55.3	1302		1.704113	
2	1	8	95.8			2.905768	
3	2	15	79.3	1128		4.159926	
4	3	10	94.8	1404	1580	4.832603	
5	3	11	69.5	1058	1318	6.041765	
6	2	18	55.5	1401		7.161703	
7	2	17	85.5	1036		8.158887	
8	2	11	91.2	1347		9.661561	
9	2	14	89	1310		10.135314	
10	3	10	81.5	1008	1405	11.534932	

Bin5 Statistics 20

Trial #	Pulse	Chirp (MHz)	Pulse Width (µS)	Pulse 1-2 spacing (µS)	Pulse 2-3 spacing (µS)	Pulse Start(S)	Detection (1:yes; 0:no)
0	1	17	77.6			0.247554	1
1	2	14	69	1078		1.122097	
2	3	19	71.4	1812	1404	1.418535	
3	2	11	79.8	1281		2.679771	
4	3	10	84.7	1417	1563	3.362002	
5	2	7	61	1531		3.619362	
6	1	8	89.3			4.395562	
7	3	7	64	1687	1774	5.162764	
8	1	11	82.9			5.935332	
9	1	10	68.8			6.52325	
10	1	19	72.7			7.513435	
11	3	9	76.7	1604	1589	7.771203	
12	2	6	65.3	1360		8.697479	
13	2	18	56.3	1624		9.570749	
14	2	7	84.6	1410		10.356664	
15	1	6	59.7			10.883787	
16	2	16	76.6	1769		11.502457	

Bin5 Statistics 21

Trial #	Pulse	Chirp (MHz)	Pulse Width (µS)	Pulse 1-2 spacing (µS)	Pulse 2-3 spacing (µS)	Pulse Start(S)	Detection (1:yes; 0:no)
0	2	13	81.6	1757		0.106587	1
1	3	12	80.9	1192	1303	1.543387	
2	2	13	91.5	1813		1.75792	
3	2	15	97.5	1720		3.398805	
4	3	7	77.2	1068	1167	3.530125	
5	1	19	87.3			4.379879	
6	3	20	83.2	1340	1950	5.671395	
7	2	12	70.1	1004		6.35843	
8	1	13	62.6			6.893637	
9	2	12	59.2	1769		7.996357	
10	2	13	63.4	1407		8.753408	
11	2	10	86.3	1499		9.523653	
12	2	8	99.2	1192		11.111641	
13	1	17	73.2			11.407704	

Bin5 Statistics 22

Trial #	Pulse	Chirp (MHz)	Pulse Width (µS)	Pulse 1-2 spacing (uS)	Pulse 2-3 spacing (uS)	Pulse Start(S)	Detection (1:yes; 0:no)
0	3	14	74.4	1954	1230	1.032379	1
1	2	5	55.1	1653		2.106069	
2	2	15	80.2	1198		3.024764	
3	2	10	59.1	1562		4.647418	
4	2	18	72	1478		7.453961	
5	2	7	55.3	1522		8.288072	
6	2	10	62.3	1315		9.141027	
7	2	11	55.6	1449		11.535972	

Bin5 Statistics 23

Trial #	Pulse	Chirp (MHz)	Pulse Width (µS)	Pulse 1-2 spacing (uS)	Pulse 2-3 spacing (uS)	Pulse Start(S)	Detection (1:yes; 0:no)
0	3	15	84.5	1748	1228	0.275615	1
1	2	5	87.8	1908		2.413665	
2	2	9	74	1896		2.794211	
3	3	13	62.9	1741	1319	5.310938	
4	2	5	98	1070		6.533958	
5	1	18	62.3			6.97159	
6	1	6	82.6			8.334154	
7	1	6	56.2			9.957382	
8	3	18	68.4	1627	1221	11.54211	

Bin5 Statistics 24

Trial #	Pulse	Chirp (MHz)	Pulse Width (µS)	Pulse 1-2 spacing (uS)	Pulse 2-3 spacing (uS)	Pulse Start(S)	Detection (1:yes; 0:no)
0	1	20	92.1			0.457905	1
1	1	8	79.5			1.460642	
2	1	9	52.8			2.019962	
3	1	19	52.8			2.370641	
4	3	9	82.9	1792	1960	3.38294	
5	2	13	86.7	1861		3.930709	
6	2	14	69.5	1346		5.135172	
7	2	5	60.5	1858		5.453923	
8	1	5	60.5			6.005875	
9	2	6	95.2	1186		7.318678	
10	3	15	53.1	1842	1260	7.972214	
11	2	15	97.6	1883		8.43657	
12	2	12	77.7	1398		9.296158	
13	1	9	87.1			10.242026	
14	2	17	86	1142		10.745884	
15	2	20	95.8	1487		11.871684	

Bin5 Statistics 25

Trial #	Pulse	Chirp (MHz)	Pulse Width (µS)	Pulse 1-2 spacing (uS)	Pulse 2-3 spacing (uS)	Pulse Start(S)	Detection (1:yes; 0:no)
0	3	14	83	1574	1462	0.097665	1
1	2	9	71.7	1507		0.899716	
2	1	7	77.1			1.683704	
3	2	19	62.5	1612		1.968696	
4	2	19	60.4	1144		3.056974	
5	1	19	70.4			3.487842	
6	1	5	69.6			4.253999	
7	1	7	71.1			4.924466	
8	3	18	92.4	1407	1595	5.335845	
9	1	7	88.9			6.041376	
10	1	8	56.3			6.420881	
11	1	16	93.6			7.473116	
12	1	12	91.1			7.860552	
13	1	16	57			8.272246	
14	2	15	60.2	1372		9.39725	
15	2	15	80.8	1012		10.080066	
16	3	14	63.1	1926	1446	10.506605	
17	1	9	81.3			10.82578	
18	2	17	85.2	1497		11.687644	

Bin5 Statistics 26

Trial #	Pulse	Chirp (MHz)	Pulse Width (µS)	Pulse 1-2 spacing (uS)	Pulse 2-3 spacing (uS)	Pulse Start(S)	Detection (1:yes; 0:no)
0	2	6	77.3	1352		1.03192	1
1	2	12	50	1113		1.979719	
2	1	11	80.3			3.744103	
3	1	9	86			4.706806	
4	3	13	58	1864	1378	6.009675	
5	3	13	73.5	1274	1634	7.345737	
6	1	9	59.2			8.884338	
7	2	14	53.3	1705		10.247648	
8	2	20	81	1074		10.753027	

Bin5 Statistics 27

Trial #	Pulse	Chirp (MHz)	Pulse Width (µS)	Pulse 1-2 spacing (µS)	Pulse 2-3 spacing (µS)	Pulse Start(S)	Detection (1:yes; 0:no)
0	3	9	60.5	1374	1217	0.482798	1
1	2	13	58.9	1619		0.72799	
2	2	13	92.9	1416		1.33892	
3	1	10	53.4			2.199138	
4	2	8	61.4	1229		2.538386	
5	2	18	84.6	1003		3.290586	
6	1	14	77.6			4.027099	
7	2	14	79.4	1881		4.415254	
8	2	15	82.2	1451		4.870353	
9	2	5	62.1	1417		5.82996	
10	1	5	63.8			6.252134	
11	3	12	74.2	1822	1706	6.7122	
12	2	14	60.5	1281		7.331374	
13	1	20	74.2			8.145509	
14	2	9	59.9	1083		8.791046	
15	3	6	54.7	1231	1291	9.237745	
16	2	17	74.8	1245		9.702009	
17	2	7	57.4	1460		10.315834	
18	2	8	62.4	1636		10.984356	
19	2	10	90.1	1278		11.460925	

Bin5 Statistics 28

Trial #	Pulse	Chirp (MHz)	Pulse Width (µS)	Pulse 1-2 spacing (uS)	Pulse 2-3 spacing (uS)	Pulse Start(S)	Detection (1:yes; 0:no)
0	2	18	63.4	1727		0.064119	0
1	2	10	63.1	1789		1.203583	
2	1	15	80.9			1.715697	
3	2	14	97.8	1027		2.301889	
4	3	19	72.2	1189	1642	3.541294	
5	3	9	54	1576	1984	3.951844	
6	3	11	80.4	1389	1753	4.780412	
7	3	10	59.9	1899	1652	5.422228	
8	2	9	52.9	1703		6.524344	
9	1	14	55.2			7.290979	
10	2	6	91.7	1609		8.147096	
11	2	5	54	1819		8.933614	
12	2	10	84.3	1696		9.298809	
13	2	19	76	1072		10.468655	
14	2	11	66.5	1879		11.040027	
15	1	17	72.3			11.921746	

Bin5 Statistics 29

Trial #	Pulse	Chirp (MHz)	Pulse Width (µS)	Pulse 1-2 spacing (uS)	Pulse 2-3 spacing (uS)	Pulse Start(S)	Detection (1:yes; 0:no)
0	2	18	95.2	1316		0.488828	0
1	2	9	83.9	1293		1.366081	
2	2	19	63.9	1792		1.726929	
3	2	19	78.5	1093		3.14477	
4	2	19	76.8	1542		3.847317	
5	1	18	76.8			4.502597	
6	2	19	82.5	1512		5.192056	
7	1	15	77.4			6.320538	
8	1	13	84.2			7.228585	
9	1	8	78.8			7.805704	
10	1	12	83.7			9.322231	
11	1	17	77.5			9.805215	
12	3	17	84.8	1890	1107	10.420643	
13	1	17	81.2			11.866138	

Bin5 Statistics 30

Trial #	Pulse	Chirp (MHz)	Pulse Width (µS)	Pulse 1-2 spacing (uS)	Pulse 2-3 spacing (uS)	Pulse Start(S)	Detection (1:yes; 0:no)
0	2	7	90.2	1170		0.645227	1
1	1	20	84.5			1.39656	
2	1	13	96.9			1.427229	
3	1	12	71			2.276579	
4	2	5	65.9	1716		3.131571	
5	2	5	80.5	1328		4.205096	
6	2	5	77.7	1665		4.338771	
7	2	13	89	1456		5.541028	
8	1	13	70.2			5.890844	
9	2	20	64	1535		6.435669	
10	2	7	92.6	1791		7.211306	
11	1	6	60.3			8.033839	
12	3	13	83.6	1732	1952	8.512669	
13	2	17	90.6	1941		9.328886	
14	2	8	60.5	1603		10.177261	
15	1	17	92.9			10.686624	
16	3	20	91.2	1598	1681	11.459773	

Table-6 Radar Type 6 Statistical Performance

Trial #	Fc (MHz)	Pulse /Burst	Pulse Width (µS)	PRI (µs)	Detection (1:yes; 0:no)	Hopping Sequence
1	5290	9	1	333	1	5286.0, 5627.0, 5464.0, 5575.0, 5440.0, 5497.0, 5415.0, 5311.0, 5612.0, 5414.0, 5258.0, 5400.0, 5662.0, 5462.0, 5664.0, 5632.0, 5332.0, 5281.0, 5607.0, 5471.0, 5671.0, 5617.0, 5525.0, 5359.0, 5437.0, 5656.0, 5615.0, 5548.0, 5559.0, 5540.0, 5721.0, 5712.0, 5267.0, 5261.0, 5408.0, 5527.0, 5516.0, 5689.0, 5331.0, 5271.0, 5697.0, 5637.0, 5602.0, 5368.0, 5653.0, 5305.0, 5407.0, 5505.0, 5682.0, 5550.0, 5390.0, 5574.0, 5389.0, 5720.0, 5601.0, 5376.0, 5449.0, 5594.0, 5677.0, 5698.0, 5410.0, 5442.0, 5299.0, 5256.0, 5560.0, 5313.0, 5681.0, 5606.0, 5466.0, 5711.0, 5715.0, 5556.0, 5570.0, 5722.0, 5724.0, 5428.0, 5610.0, 5452.0, 5688.0, 5674.0, 5696.0, 5257.0, 5341.0, 5584.0, 5640.0, 5381.0, 5543.0, 5293.0, 5382.0, 5597.0, 5309.0, 5717.0, 5450.0, 5321.0, 5351.0, 5539.0, 5403.0, 5468.0, 5665.0, 5679.0 (number of hits: 7)
2	5290	9	1	333	1	5450.0, 5657.0, 5685.0, 5510.0, 5412.0, 5417.0, 5396.0, 5472.0, 5359.0, 5610.0, 5469.0, 5302.0, 5288.0, 5413.0, 5497.0, 5512.0, 5721.0, 5325.0, 5289.0, 5255.0, 5266.0, 5448.0, 5558.0, 5636.0, 5697.0, 5393.0, 5608.0, 5626.0, 5496.0, 5377.0, 5709.0, 5576.0, 5533.0, 5540.0, 5434.0, 5456.0, 5250.0, 5258.0, 5466.0, 5345.0, 5588.0, 5563.0, 5382.0, 5305.0, 5549.0, 5427.0, 5349.0, 5590.0, 5532.0, 5408.0, 5330.0, 5698.0, 5537.0, 5473.0, 5708.0, 5716.0, 5562.0, 5680.0, 5411.0, 5370.0, 5592.0, 5307.0, 5602.0, 5439.0, 5361.0, 5667.0, 5283.0, 5641.0, 5681.0, 5556.0, 5386.0, 5624.0, 5630.0, 5353.0, 5426.0, 5593.0, 5369.0, 5634.0, 5270.0, 5376.0, 5360.0, 5285.0, 5699.0, 5605.0, 5366.0, 5344.0, 5710.0, 5337.0, 5319.0, 5707.0, 5327.0, 5599.0, 5312.0, 5343.0, 5383.0, 5581.0, 5691.0, 5560.0, 5419.0, 5535.0 (number of hits: 7)
3	5290	9	1	333	1	5371.0, 5584.0, 5361.0, 5643.0, 5545.0, 5609.0, 5511.0, 5553.0, 5262.0, 5260.0, 5503.0, 5457.0, 5357.0, 5344.0, 5567.0, 5375.0, 5297.0, 5536.0, 5355.0, 5468.0, 5373.0, 5349.0, 5476.0, 5487.0, 5252.0, 5450.0, 5502.0, 5323.0, 5694.0, 5466.0, 5463.0, 5421.0, 5680.0, 5515.0, 5387.0, 5366.0, 5374.0, 5359.0, 5689.0, 5296.0, 5337.0, 5505.0, 5399.0, 5645.0, 5284.0, 5275.0, 5570.0, 5365.0, 5338.0, 5631.0, 5638.0, 5436.0, 5497.0, 5320.0, 5330.0, 5642.0, 5480.0, 5482.0, 5533.0, 5607.0,

						5354.0, 5683.0, 5316.0, 5635.0, 5261.0, 5637.0, 5496.0, 5510.0, 5702.0, 5580.0, 5537.0, 5312.0, 5586.0, 5383.0, 5585.0, 5659.0, 5489.0, 5668.0, 5350.0, 5501.0, 5566.0, 5267.0, 5396.0, 5564.0, 5465.0, 5588.0, 5384.0, 5353.0, 5508.0, 5327.0, 5309.0, 5529.0, 5577.0, 5540.0, 5494.0, 5426.0, 5520.0, 5440.0, 5271.0, 5617.0 (number of hits: 4)
4	5290	9	1	333	1	5592.0, 5722.0, 5437.0, 5325.0, 5573.0, 5570.0, 5410.0, 5516.0, 5299.0, 5712.0, 5679.0, 5617.0, 5715.0, 5649.0, 5422.0, 5510.0, 5253.0, 5688.0, 5319.0, 5275.0, 5508.0, 5255.0, 5678.0, 5691.0, 5459.0, 5469.0, 5390.0, 5406.0, 5392.0, 5452.0, 5357.0, 5645.0, 5639.0, 5295.0, 5571.0, 5338.0, 5349.0, 5450.0, 5658.0, 5341.0, 5443.0, 5384.0, 5331.0, 5335.0, 5567.0, 5676.0, 5632.0, 5690.0, 5333.0, 5724.0, 5555.0, 5305.0, 5368.0, 5584.0, 5484.0, 5610.0, 5383.0, 5350.0, 5716.0, 5664.0, 5283.0, 5252.0, 5373.0, 5485.0, 5653.0, 5583.0, 5339.0, 5523.0, 5486.0, 5611.0, 5704.0, 5351.0, 5387.0, 5354.0, 5562.0, 5631.0, 5320.0, 5661.0, 5366.0, 5375.0, 5416.0, 5269.0, 5431.0, 5587.0, 5380.0, 5624.0, 5585.0, 5371.0, 5633.0, 5655.0, 5539.0, 5438.0, 5554.0, 5602.0, 5488.0, 5675.0, 5352.0, 5625.0, 5613.0, 5620.0 (number of hits: 3)
5	5290	9	1	333	1	5402.0, 5679.0, 5392.0, 5708.0, 5623.0, 5412.0, 5618.0, 5325.0, 5289.0, 5351.0, 5333.0, 5701.0, 5327.0, 5308.0, 5500.0, 5464.0, 5457.0, 5302.0, 5638.0, 5443.0, 5532.0, 5319.0, 5444.0, 5287.0, 5683.0, 5328.0, 5693.0, 5427.0, 5633.0, 5585.0, 5544.0, 5306.0, 5602.0, 5410.0, 5255.0, 5563.0, 5430.0, 5379.0, 5640.0, 5284.0, 5489.0, 5390.0, 5467.0, 5386.0, 5322.0, 5516.0, 5664.0, 5476.0, 5714.0, 5383.0, 5702.0, 5300.0, 5537.0, 5505.0, 5270.0, 5521.0, 5607.0, 5507.0, 5334.0, 5454.0, 5274.0, 5629.0, 5518.0, 5466.0, 5428.0, 5557.0, 5348.0, 5568.0, 5372.0, 5564.0, 5490.0, 5630.0, 5686.0, 5559.0, 5530.0, 5250.0, 5580.0, 5256.0, 5596.0, 5310.0, 5359.0, 5654.0, 5323.0, 5496.0, 5605.0, 5331.0, 5499.0, 5424.0, 5354.0, 5458.0, 5565.0, 5545.0, 5385.0, 5262.0, 5626.0, 5404.0, 5272.0, 5313.0, 5676.0, 5301.0 (number of hits: 9)
6	5290	9	1	333	1	5416.0, 5409.0, 5435.0, 5492.0, 5454.0, 5640.0, 5263.0, 5589.0, 5719.0, 5254.0, 5393.0, 5295.0, 5404.0, 5513.0, 5659.0, 5347.0, 5292.0, 5721.0, 5537.0, 5679.0, 5356.0, 5646.0, 5464.0, 5565.0, 5451.0, 5622.0, 5324.0, 5588.0, 5644.0, 5555.0, 5471.0, 5486.0, 5434.0, 5284.0, 5505.0, 5603.0, 5430.0, 5322.0, 5658.0, 5516.0,

						5482.0, 5488.0, 5265.0, 5501.0, 5426.0, 5523.0, 5618.0, 5406.0, 5436.0, 5483.0, 5428.0, 5437.0, 5703.0, 5389.0, 5611.0, 5712.0, 5607.0, 5386.0, 5571.0, 5408.0, 5671.0, 5394.0, 5257.0, 5614.0, 5569.0, 5281.0, 5362.0, 5694.0, 5617.0, 5329.0, 5649.0, 5432.0, 5277.0, 5564.0, 5262.0, 5666.0, 5609.0, 5301.0, 5340.0, 5605.0, 5616.0, 5557.0, 5297.0, 5677.0, 5601.0, 5371.0, 5580.0, 5363.0, 5380.0, 5524.0, 5305.0, 5280.0, 5412.0, 5339.0, 5462.0, 5290.0, 5626.0, 5425.0, 5457.0, 5366.0 (number of hits: 6)
7	5290	9	1	333	1	5637.0, 5684.0, 5320.0, 5456.0, 5458.0, 5289.0, 5498.0, 5500.0, 5286.0, 5280.0, 5468.0, 5493.0, 5357.0, 5631.0, 5302.0, 5305.0, 5515.0, 5383.0, 5718.0, 5605.0, 5268.0, 5627.0, 5448.0, 5254.0, 5492.0, 5272.0, 5682.0, 5282.0, 5699.0, 5336.0, 5331.0, 5450.0, 5288.0, 5510.0, 5328.0, 5461.0, 5629.0, 5412.0, 5602.0, 5301.0, 5666.0, 5322.0, 5542.0, 5428.0, 5593.0, 5570.0, 5483.0, 5623.0, 5586.0, 5345.0, 5658.0, 5724.0, 5292.0, 5604.0, 5717.0, 5548.0, 5353.0, 5700.0, 5349.0, 5681.0, 5698.0, 5420.0, 5661.0, 5722.0, 5559.0, 5714.0, 5417.0, 5652.0, 5619.0, 5546.0, 5314.0, 5444.0, 5395.0, 5585.0, 5620.0, 5431.0, 5403.0, 5606.0, 5504.0, 5645.0, 5418.0, 5267.0, 5321.0, 5560.0, 5599.0, 5323.0, 5370.0, 5506.0, 5667.0, 5719.0, 5607.0, 5618.0, 5356.0, 5427.0, 5443.0, 5669.0, 5499.0, 5429.0, 5457.0, 5317.0 (number of hits: 8)
8	5290	9	1	333	1	5534.0, 5421.0, 5268.0, 5635.0, 5411.0, 5252.0, 5568.0, 5412.0, 5560.0, 5570.0, 5703.0, 5359.0, 5480.0, 5577.0, 5718.0, 5254.0, 5647.0, 5605.0, 5704.0, 5394.0, 5682.0, 5474.0, 5442.0, 5629.0, 5580.0, 5304.0, 5656.0, 5316.0, 5447.0, 5559.0, 5659.0, 5623.0, 5414.0, 5650.0, 5453.0, 5312.0, 5368.0, 5716.0, 5385.0, 5390.0, 5398.0, 5664.0, 5261.0, 5350.0, 5542.0, 5632.0, 5381.0, 5558.0, 5416.0, 5401.0, 5418.0, 5527.0, 5643.0, 5274.0, 5428.0, 5506.0, 5529.0, 5328.0, 5613.0, 5492.0, 5601.0, 5599.0, 5308.0, 5508.0, 5479.0, 5470.0, 5662.0, 5652.0, 5676.0, 5578.0, 5593.0, 5302.0, 5434.0, 5495.0, 5293.0, 5624.0, 5552.0, 5371.0, 5685.0, 5607.0, 5537.0, 5257.0, 5331.0, 5469.0, 5606.0, 5349.0, 5538.0, 5536.0, 5298.0, 5627.0, 5565.0, 5432.0, 5266.0, 5520.0, 5425.0, 5423.0, 5653.0, 5439.0, 5317.0, 5281.0 (number of hits: 6)
9	5290	9	1	333	1	5274.0, 5687.0, 5297.0, 5261.0, 5443.0, 5476.0, 5365.0, 5671.0, 5266.0, 5601.0, 5377.0, 5458.0, 5600.0, 5491.0, 5512.0, 5622.0, 5477.0, 5522.0, 5560.0, 5667.0,

						5485.0, 5279.0, 5582.0, 5323.0, 5463.0, 5543.0, 5561.0, 5672.0, 5252.0, 5674.0, 5482.0, 5677.0, 5405.0, 5644.0, 5338.0, 5457.0, 5318.0, 5386.0, 5317.0, 5263.0, 5566.0, 5347.0, 5314.0, 5721.0, 5510.0, 5284.0, 5612.0, 5282.0, 5453.0, 5427.0, 5697.0, 5374.0, 5664.0, 5475.0, 5494.0, 5531.0, 5698.0, 5659.0, 5273.0, 5360.0, 5541.0, 5565.0, 5312.0, 5333.0, 5409.0, 5296.0, 5584.0, 5341.0, 5366.0, 5524.0, 5554.0, 5503.0, 5688.0, 5627.0, 5624.0, 5483.0, 5618.0, 5623.0, 5387.0, 5391.0, 5339.0, 5449.0, 5658.0, 5267.0, 5707.0, 5570.0, 5438.0, 5497.0, 5521.0, 5508.0, 5614.0, 5689.0, 5714.0, 5321.0, 5663.0, 5530.0, 5342.0, 5534.0, 5527.0, 5401.0 (number of hits: 4)
10	5290	9	1	333	1	5569.0, 5507.0, 5273.0, 5304.0, 5690.0, 5529.0, 5315.0, 5378.0, 5271.0, 5313.0, 5398.0, 5446.0, 5615.0, 5683.0, 5383.0, 5542.0, 5415.0, 5563.0, 5649.0, 5650.0, 5250.0, 5296.0, 5587.0, 5686.0, 5526.0, 5367.0, 5631.0, 5562.0, 5571.0, 5603.0, 5485.0, 5505.0, 5381.0, 5262.0, 5458.0, 5428.0, 5355.0, 5320.0, 5626.0, 5389.0, 5280.0, 5452.0, 5573.0, 5551.0, 5328.0, 5416.0, 5356.0, 5699.0, 5517.0, 5411.0, 5555.0, 5274.0, 5568.0, 5484.0, 5487.0, 5663.0, 5353.0, 5375.0, 5566.0, 5330.0, 5652.0, 5677.0, 5377.0, 5386.0, 5554.0, 5713.0, 5483.0, 5473.0, 5348.0, 5675.0, 5583.0, 5254.0, 5323.0, 5504.0, 5578.0, 5499.0, 5325.0, 5664.0, 5509.0, 5642.0, 5460.0, 5279.0, 5667.0, 5689.0, 5685.0, 5679.0, 5393.0, 5719.0, 5638.0, 5256.0, 5405.0, 5298.0, 5616.0, 5336.0, 5390.0, 5670.0, 5253.0, 5437.0, 5466.0, 5513.0 (number of hits: 4)
11	5290	9	1	333	1	5637.0, 5338.0, 5348.0, 5421.0, 5433.0, 5591.0, 5321.0, 5630.0, 5685.0, 5690.0, 5602.0, 5701.0, 5356.0, 5483.0, 5325.0, 5398.0, 5561.0, 5397.0, 5560.0, 5255.0, 5540.0, 5447.0, 5436.0, 5500.0, 5659.0, 5522.0, 5326.0, 5261.0, 5711.0, 5636.0, 5650.0, 5557.0, 5319.0, 5576.0, 5303.0, 5632.0, 5665.0, 5267.0, 5550.0, 5677.0, 5526.0, 5330.0, 5653.0, 5720.0, 5358.0, 5361.0, 5275.0, 5647.0, 5583.0, 5716.0, 5375.0, 5478.0, 5264.0, 5675.0, 5269.0, 5569.0, 5582.0, 5450.0, 5604.0, 5476.0, 5518.0, 5462.0, 5473.0, 5678.0, 5590.0, 5633.0, 5285.0, 5635.0, 5407.0, 5263.0, 5588.0, 5294.0, 5471.0, 5558.0, 5666.0, 5495.0, 5505.0, 5265.0, 5366.0, 5692.0, 5343.0, 5566.0, 5509.0, 5424.0, 5489.0, 5289.0, 5598.0, 5607.0, 5511.0, 5502.0, 5440.0, 5497.0, 5485.0, 5291.0, 5295.0, 5428.0, 5374.0, 5660.0, 5512.0, 5514.0 (number of hits: 6)

12	5290	9	1	333	1	5389.0, 5372.0, 5701.0, 5643.0, 5358.0, 5566.0, 5499.0, 5427.0, 5474.0, 5332.0, 5712.0, 5656.0, 5315.0, 5576.0, 5708.0, 5431.0, 5440.0, 5342.0, 5504.0, 5507.0, 5688.0, 5256.0, 5391.0, 5517.0, 5269.0, 5344.0, 5647.0, 5475.0, 5678.0, 5642.0, 5498.0, 5583.0, 5416.0, 5545.0, 5426.0, 5660.0, 5283.0, 5496.0, 5641.0, 5473.0, 5323.0, 5715.0, 5674.0, 5318.0, 5397.0, 5557.0, 5542.0, 5463.0, 5611.0, 5561.0, 5349.0, 5340.0, 5459.0, 5610.0, 5608.0, 5619.0, 5574.0, 5425.0, 5390.0, 5396.0, 5357.0, 5447.0, 5252.0, 5350.0, 5483.0, 5305.0, 5664.0, 5650.0, 5604.0, 5375.0, 5696.0, 5442.0, 5287.0, 5489.0, 5540.0, 5523.0, 5490.0, 5333.0, 5648.0, 5325.0, 5544.0, 5591.0, 5330.0, 5407.0, 5484.0, 5360.0, 5429.0, 5471.0, 5351.0, 5528.0, 5415.0, 5311.0, 5717.0, 5670.0, 5381.0, 5506.0, 5584.0, 5361.0, 5512.0, 5288.0 (number of hits: 4)
13	5290	9	1	333	1	5566.0, 5717.0, 5613.0, 5423.0, 5267.0, 5656.0, 5252.0, 5338.0, 5722.0, 5354.0, 5441.0, 5576.0, 5701.0, 5608.0, 5392.0, 5403.0, 5528.0, 5273.0, 5474.0, 5664.0, 5291.0, 5317.0, 5439.0, 5623.0, 5391.0, 5631.0, 5305.0, 5253.0, 5436.0, 5678.0, 5497.0, 5380.0, 5629.0, 5360.0, 5386.0, 5326.0, 5295.0, 5277.0, 5633.0, 5543.0, 5344.0, 5282.0, 5577.0, 5704.0, 5303.0, 5653.0, 5385.0, 5579.0, 5323.0, 5314.0, 5652.0, 5353.0, 5709.0, 5540.0, 5672.0, 5525.0, 5713.0, 5351.0, 5440.0, 5515.0, 5627.0, 5276.0, 5427.0, 5570.0, 5359.0, 5345.0, 5365.0, 5635.0, 5603.0, 5569.0, 5410.0, 5464.0, 5461.0, 5332.0, 5335.0, 5655.0, 5694.0, 5519.0, 5562.0, 5292.0, 5283.0, 5260.0, 5516.0, 5398.0, 5606.0, 5250.0, 5433.0, 5573.0, 5673.0, 5556.0, 5637.0, 5572.0, 5355.0, 5401.0, 5560.0, 5721.0, 5527.0, 5602.0, 5329.0, 5289.0 (number of hits: 7)
14	5290	9	1	333	1	5308.0, 5536.0, 5681.0, 5268.0, 5370.0, 5504.0, 5517.0, 5356.0, 5357.0, 5498.0, 5259.0, 5610.0, 5331.0, 5301.0, 5666.0, 5616.0, 5266.0, 5651.0, 5544.0, 5277.0, 5661.0, 5579.0, 5636.0, 5467.0, 5702.0, 5545.0, 5367.0, 5429.0, 5521.0, 5649.0, 5722.0, 5288.0, 5275.0, 5586.0, 5589.0, 5291.0, 5342.0, 5571.0, 5507.0, 5705.0, 5311.0, 5519.0, 5580.0, 5445.0, 5621.0, 5351.0, 5612.0, 5256.0, 5289.0, 5568.0, 5477.0, 5264.0, 5643.0, 5596.0, 5386.0, 5652.0, 5630.0, 5465.0, 5439.0, 5333.0, 5401.0, 5684.0, 5593.0, 5399.0, 5334.0, 5570.0, 5479.0, 5720.0, 5376.0, 5349.0, 5484.0, 5412.0, 5383.0, 5451.0, 5696.0, 5293.0, 5638.0, 5690.0, 5624.0, 5711.0, 5410.0, 5668.0, 5419.0, 5271.0, 5600.0,

						5654.0, 5398.0, 5555.0, 5548.0, 5276.0, 5615.0, 5260.0, 5692.0, 5482.0, 5619.0, 5487.0, 5718.0, 5647.0, 5420.0, 5473.0 (number of hits: 7)
15	5290	9	1	333	1	5604.0, 5636.0, 5281.0, 5559.0, 5265.0, 5441.0, 5610.0, 5419.0, 5525.0, 5368.0, 5551.0, 5711.0, 5294.0, 5719.0, 5449.0, 5560.0, 5672.0, 5459.0, 5486.0, 5307.0, 5397.0, 5369.0, 5641.0, 5608.0, 5404.0, 5712.0, 5705.0, 5659.0, 5288.0, 5370.0, 5267.0, 5713.0, 5332.0, 5299.0, 5460.0, 5290.0, 5453.0, 5692.0, 5643.0, 5334.0, 5532.0, 5282.0, 5379.0, 5662.0, 5364.0, 5630.0, 5385.0, 5272.0, 5279.0, 5587.0, 5442.0, 5570.0, 5333.0, 5374.0, 5352.0, 5567.0, 5475.0, 5697.0, 5303.0, 5277.0, 5653.0, 5371.0, 5481.0, 5698.0, 5324.0, 5647.0, 5547.0, 5329.0, 5656.0, 5394.0, 5689.0, 5649.0, 5623.0, 5668.0, 5686.0, 5557.0, 5620.0, 5600.0, 5433.0, 5626.0, 5529.0, 5564.0, 5569.0, 5556.0, 5398.0, 5341.0, 5262.0, 5631.0, 5377.0, 5284.0, 5519.0, 5487.0, 5392.0, 5257.0, 5406.0, 5554.0, 5585.0, 5474.0, 5701.0, 5488.0 (number of hits: 6)
16	5290	9	1	333	1	5386.0, 5673.0, 5344.0, 5631.0, 5444.0, 5406.0, 5304.0, 5360.0, 5475.0, 5627.0, 5638.0, 5696.0, 5619.0, 5652.0, 5338.0, 5512.0, 5594.0, 5615.0, 5348.0, 5471.0, 5657.0, 5263.0, 5324.0, 5432.0, 5259.0, 5683.0, 5612.0, 5409.0, 5289.0, 5708.0, 5389.0, 5693.0, 5416.0, 5724.0, 5319.0, 5511.0, 5489.0, 5452.0, 5434.0, 5390.0, 5321.0, 5715.0, 5381.0, 5573.0, 5395.0, 5608.0, 5370.0, 5662.0, 5402.0, 5514.0, 5438.0, 5385.0, 5392.0, 5567.0, 5270.0, 5698.0, 5513.0, 5288.0, 5659.0, 5351.0, 5539.0, 5558.0, 5300.0, 5473.0, 5618.0, 5555.0, 5582.0, 5369.0, 5301.0, 5303.0, 5436.0, 5286.0, 5562.0, 5672.0, 5478.0, 5704.0, 5574.0, 5260.0, 5256.0, 5407.0, 5437.0, 5504.0, 5441.0, 5255.0, 5266.0, 5668.0, 5609.0, 5257.0, 5430.0, 5636.0, 5658.0, 5317.0, 5431.0, 5490.0, 5701.0, 5714.0, 5685.0, 5502.0, 5629.0, 5254.0 (number of hits: 7)
17	5290	9	1	333	1	5517.0, 5605.0, 5638.0, 5360.0, 5541.0, 5271.0, 5499.0, 5507.0, 5546.0, 5427.0, 5680.0, 5548.0, 5683.0, 5559.0, 5631.0, 5449.0, 5316.0, 5385.0, 5252.0, 5434.0, 5620.0, 5388.0, 5253.0, 5472.0, 5712.0, 5555.0, 5612.0, 5557.0, 5325.0, 5280.0, 5720.0, 5311.0, 5491.0, 5656.0, 5677.0, 5527.0, 5568.0, 5569.0, 5494.0, 5543.0, 5693.0, 5502.0, 5260.0, 5413.0, 5340.0, 5408.0, 5276.0, 5594.0, 5364.0, 5287.0, 5637.0, 5370.0, 5379.0, 5461.0, 5463.0, 5540.0, 5678.0, 5477.0, 5418.0, 5400.0, 5704.0, 5630.0, 5535.0, 5586.0, 5492.0,

						5498.0, 5376.0, 5668.0, 5628.0, 5356.0, 5684.0, 5708.0, 5613.0, 5506.0, 5694.0, 5279.0, 5676.0, 5347.0, 5362.0, 5270.0, 5643.0, 5523.0, 5695.0, 5573.0, 5519.0, 5604.0, 5504.0, 5529.0, 5282.0, 5350.0, 5428.0, 5440.0, 5489.0, 5375.0, 5380.0, 5465.0, 5665.0, 5686.0, 5652.0, 5556.0 (number of hits: 2)
18	5290	9	1	333	1	5576.0, 5628.0, 5375.0, 5358.0, 5282.0, 5613.0, 5713.0, 5603.0, 5456.0, 5411.0, 5439.0, 5535.0, 5438.0, 5636.0, 5489.0, 5427.0, 5430.0, 5717.0, 5567.0, 5418.0, 5454.0, 5690.0, 5409.0, 5699.0, 5464.0, 5673.0, 5470.0, 5328.0, 5465.0, 5527.0, 5620.0, 5547.0, 5702.0, 5389.0, 5455.0, 5648.0, 5555.0, 5630.0, 5327.0, 5595.0, 5577.0, 5343.0, 5379.0, 5360.0, 5686.0, 5349.0, 5451.0, 5251.0, 5281.0, 5507.0, 5257.0, 5461.0, 5679.0, 5275.0, 5259.0, 5283.0, 5287.0, 5398.0, 5394.0, 5723.0, 5405.0, 5505.0, 5665.0, 5528.0, 5600.0, 5683.0, 5563.0, 5646.0, 5645.0, 5546.0, 5339.0, 5698.0, 5446.0, 5674.0, 5564.0, 5484.0, 5333.0, 5331.0, 5632.0, 5309.0, 5414.0, 5434.0, 5496.0, 5571.0, 5453.0, 5607.0, 5487.0, 5406.0, 5369.0, 5716.0, 5700.0, 5553.0, 5334.0, 5296.0, 5279.0, 5556.0, 5431.0, 5291.0, 5703.0, 5647.0 (number of hits: 4)
19	5290	9	1	333	1	5560.0, 5499.0, 5489.0, 5691.0, 5473.0, 5577.0, 5620.0, 5603.0, 5651.0, 5375.0, 5679.0, 5530.0, 5515.0, 5424.0, 5551.0, 5628.0, 5262.0, 5456.0, 5659.0, 5461.0, 5680.0, 5454.0, 5275.0, 5545.0, 5359.0, 5710.0, 5718.0, 5627.0, 5431.0, 5632.0, 5558.0, 5715.0, 5502.0, 5586.0, 5503.0, 5660.0, 5433.0, 5599.0, 5444.0, 5570.0, 5388.0, 5510.0, 5325.0, 5338.0, 5539.0, 5708.0, 5568.0, 5308.0, 5478.0, 5430.0, 5467.0, 5521.0, 5671.0, 5683.0, 5390.0, 5700.0, 5605.0, 5639.0, 5274.0, 5684.0, 5376.0, 5713.0, 5284.0, 5654.0, 5537.0, 5591.0, 5584.0, 5379.0, 5459.0, 5267.0, 5411.0, 5343.0, 5582.0, 5405.0, 5694.0, 5409.0, 5277.0, 5647.0, 5429.0, 5449.0, 5719.0, 5435.0, 5585.0, 5704.0, 5414.0, 5327.0, 5638.0, 5276.0, 5543.0, 5389.0, 5590.0, 5367.0, 5370.0, 5625.0, 5670.0, 5665.0, 5555.0, 5600.0, 5557.0, 5481.0 (number of hits: 1)
20	5290	9	1	333	1	5354.0, 5348.0, 5681.0, 5272.0, 5451.0, 5441.0, 5333.0, 5582.0, 5584.0, 5406.0, 5359.0, 5660.0, 5504.0, 5291.0, 5633.0, 5715.0, 5617.0, 5619.0, 5564.0, 5321.0, 5557.0, 5444.0, 5303.0, 5302.0, 5439.0, 5638.0, 5378.0, 5255.0, 5383.0, 5409.0, 5708.0, 5585.0, 5592.0, 5560.0, 5477.0, 5484.0, 5447.0, 5435.0, 5637.0, 5514.0, 5311.0, 5694.0, 5541.0, 5289.0, 5462.0,

						5288.0, 5687.0, 5349.0, 5552.0, 5446.0, 5644.0, 5705.0, 5500.0, 5526.0, 5673.0, 5323.0, 5540.0, 5684.0, 5296.0, 5533.0, 5722.0, 5423.0, 5436.0, 5292.0, 5467.0, 5284.0, 5692.0, 5642.0, 5652.0, 5493.0, 5596.0, 5535.0, 5342.0, 5657.0, 5281.0, 5691.0, 5497.0, 5488.0, 5679.0, 5361.0, 5549.0, 5539.0, 5279.0, 5456.0, 5496.0, 5615.0, 5398.0, 5318.0, 5432.0, 5555.0, 5355.0, 5261.0, 5612.0, 5719.0, 5659.0, 5683.0, 5607.0, 5594.0, 5330.0, 5632.0 (number of hits: 8)
21	5290	9	1	333	1	5652.0, 5430.0, 5462.0, 5486.0, 5706.0, 5712.0, 5454.0, 5448.0, 5413.0, 5530.0, 5696.0, 5287.0, 5437.0, 5254.0, 5283.0, 5666.0, 5580.0, 5292.0, 5499.0, 5301.0, 5425.0, 5552.0, 5656.0, 5642.0, 5396.0, 5366.0, 5619.0, 5383.0, 5492.0, 5327.0, 5532.0, 5504.0, 5616.0, 5649.0, 5654.0, 5614.0, 5304.0, 5306.0, 5517.0, 5716.0, 5371.0, 5657.0, 5718.0, 5707.0, 5694.0, 5692.0, 5640.0, 5397.0, 5421.0, 5690.0, 5722.0, 5520.0, 5659.0, 5352.0, 5575.0, 5628.0, 5589.0, 5660.0, 5354.0, 5323.0, 5519.0, 5379.0, 5500.0, 5493.0, 5322.0, 5320.0, 5600.0, 5697.0, 5361.0, 5516.0, 5526.0, 5263.0, 5689.0, 5724.0, 5275.0, 5705.0, 5536.0, 5617.0, 5452.0, 5523.0, 5475.0, 5713.0, 5318.0, 5587.0, 5673.0, 5483.0, 5678.0, 5273.0, 5700.0, 5522.0, 5319.0, 5611.0, 5436.0, 5527.0, 5605.0, 5443.0, 5375.0, 5392.0, 5461.0, 5423.0 (number of hits: 5)
22	5290	9	1	333	1	5568.0, 5705.0, 5567.0, 5491.0, 5647.0, 5365.0, 5611.0, 5471.0, 5545.0, 5416.0, 5508.0, 5413.0, 5259.0, 5309.0, 5427.0, 5254.0, 5571.0, 5269.0, 5302.0, 5715.0, 5258.0, 5343.0, 5593.0, 5583.0, 5498.0, 5373.0, 5717.0, 5295.0, 5461.0, 5415.0, 5699.0, 5352.0, 5424.0, 5541.0, 5554.0, 5323.0, 5489.0, 5319.0, 5660.0, 5484.0, 5535.0, 5402.0, 5724.0, 5374.0, 5631.0, 5633.0, 5430.0, 5469.0, 5531.0, 5711.0, 5496.0, 5690.0, 5588.0, 5284.0, 5714.0, 5675.0, 5369.0, 5434.0, 5458.0, 5401.0, 5481.0, 5475.0, 5528.0, 5360.0, 5603.0, 5443.0, 5533.0, 5552.0, 5297.0, 5251.0, 5597.0, 5644.0, 5474.0, 5652.0, 5333.0, 5720.0, 5278.0, 5663.0, 5635.0, 5280.0, 5437.0, 5423.0, 5671.0, 5442.0, 5708.0, 5543.0, 5275.0, 5672.0, 5562.0, 5553.0, 5421.0, 5470.0, 5337.0, 5589.0, 5686.0, 5436.0, 5388.0, 5522.0, 5460.0, 5348.0 (number of hits: 4)
23	5290	9	1	333	1	5505.0, 5368.0, 5490.0, 5541.0, 5579.0, 5306.0, 5334.0, 5504.0, 5259.0, 5654.0, 5589.0, 5648.0, 5421.0, 5469.0, 5447.0, 5709.0, 5688.0, 5309.0, 5680.0, 5398.0, 5492.0, 5254.0, 5316.0, 5548.0, 5351.0,

						5637.0, 5357.0, 5373.0, 5423.0, 5340.0, 5386.0, 5551.0, 5313.0, 5415.0, 5397.0, 5527.0, 5325.0, 5341.0, 5625.0, 5401.0, 5525.0, 5604.0, 5588.0, 5494.0, 5384.0, 5639.0, 5403.0, 5573.0, 5487.0, 5646.0, 5602.0, 5308.0, 5412.0, 5453.0, 5496.0, 5273.0, 5616.0, 5429.0, 5590.0, 5301.0, 5361.0, 5395.0, 5445.0, 5290.0, 5298.0, 5346.0, 5605.0, 5370.0, 5582.0, 5470.0, 5299.0, 5714.0, 5481.0, 5567.0, 5707.0, 5569.0, 5668.0, 5493.0, 5315.0, 5699.0, 5681.0, 5482.0, 5394.0, 5463.0, 5652.0, 5294.0, 5526.0, 5276.0, 5684.0, 5406.0, 5407.0, 5486.0, 5454.0, 5673.0, 5392.0, 5666.0, 5566.0, 5581.0, 5257.0, 5559.0 (number of hits: 9)
24	5290	9	1	333	1	5541.0, 5568.0, 5384.0, 5563.0, 5714.0, 5668.0, 5417.0, 5655.0, 5546.0, 5407.0, 5481.0, 5290.0, 5416.0, 5390.0, 5402.0, 5282.0, 5442.0, 5618.0, 5718.0, 5275.0, 5305.0, 5267.0, 5705.0, 5538.0, 5394.0, 5419.0, 5716.0, 5673.0, 5385.0, 5557.0, 5287.0, 5325.0, 5376.0, 5318.0, 5552.0, 5608.0, 5480.0, 5607.0, 5518.0, 5598.0, 5594.0, 5619.0, 5659.0, 5461.0, 5676.0, 5692.0, 5310.0, 5710.0, 5359.0, 5582.0, 5602.0, 5581.0, 5296.0, 5542.0, 5635.0, 5411.0, 5570.0, 5627.0, 5596.0, 5255.0, 5706.0, 5294.0, 5274.0, 5368.0, 5516.0, 5524.0, 5617.0, 5523.0, 5361.0, 5257.0, 5497.0, 5672.0, 5391.0, 5695.0, 5593.0, 5595.0, 5450.0, 5258.0, 5431.0, 5422.0, 5522.0, 5679.0, 5263.0, 5535.0, 5270.0, 5334.0, 5638.0, 5484.0, 5544.0, 5712.0, 5492.0, 5643.0, 5379.0, 5366.0, 5543.0, 5485.0, 5412.0, 5360.0, 5509.0, 5678.0 (number of hits: 6)
25	5290	9	1	333	1	5641.0, 5505.0, 5698.0, 5623.0, 5310.0, 5346.0, 5642.0, 5298.0, 5371.0, 5270.0, 5647.0, 5654.0, 5278.0, 5543.0, 5318.0, 5347.0, 5393.0, 5311.0, 5432.0, 5562.0, 5489.0, 5608.0, 5515.0, 5377.0, 5392.0, 5512.0, 5502.0, 5624.0, 5325.0, 5534.0, 5668.0, 5266.0, 5456.0, 5458.0, 5447.0, 5538.0, 5343.0, 5387.0, 5331.0, 5425.0, 5552.0, 5487.0, 5473.0, 5622.0, 5454.0, 5596.0, 5695.0, 5334.0, 5337.0, 5522.0, 5366.0, 5664.0, 5697.0, 5584.0, 5287.0, 5289.0, 5645.0, 5293.0, 5545.0, 5469.0, 5477.0, 5463.0, 5423.0, 5648.0, 5391.0, 5711.0, 5701.0, 5352.0, 5301.0, 5712.0, 5665.0, 5509.0, 5626.0, 5482.0, 5374.0, 5537.0, 5597.0, 5493.0, 5588.0, 5592.0, 5299.0, 5717.0, 5466.0, 5541.0, 5514.0, 5326.0, 5556.0, 5328.0, 5565.0, 5721.0, 5666.0, 5667.0, 5540.0, 5329.0, 5277.0, 5480.0, 5321.0, 5602.0, 5274.0, 5250.0 (number of hits: 8)
26	5290	9	1	333	1	5355.0, 5695.0, 5594.0, 5344.0, 5696.0,

						5510.0, 5441.0, 5706.0, 5619.0, 5699.0, 5305.0, 5289.0, 5549.0, 5319.0, 5297.0, 5447.0, 5717.0, 5632.0, 5550.0, 5517.0, 5692.0, 5356.0, 5282.0, 5251.0, 5589.0, 5310.0, 5542.0, 5495.0, 5338.0, 5701.0, 5512.0, 5592.0, 5446.0, 5335.0, 5614.0, 5596.0, 5268.0, 5546.0, 5606.0, 5442.0, 5452.0, 5347.0, 5604.0, 5707.0, 5621.0, 5365.0, 5346.0, 5336.0, 5427.0, 5714.0, 5553.0, 5257.0, 5534.0, 5518.0, 5461.0, 5357.0, 5312.0, 5704.0, 5558.0, 5521.0, 5657.0, 5386.0, 5372.0, 5363.0, 5298.0, 5311.0, 5421.0, 5434.0, 5671.0, 5405.0, 5436.0, 5721.0, 5555.0, 5263.0, 5460.0, 5598.0, 5412.0, 5476.0, 5581.0, 5640.0, 5367.0, 5284.0, 5466.0, 5358.0, 5501.0, 5318.0, 5654.0, 5450.0, 5467.0, 5341.0, 5527.0, 5658.0, 5708.0, 5394.0, 5626.0, 5306.0, 5418.0, 5545.0, 5697.0, 5544.0 (number of hits: 8)
27	5290	9	1	333	1	5466.0, 5549.0, 5255.0, 5562.0, 5594.0, 5523.0, 5474.0, 5383.0, 5347.0, 5553.0, 5651.0, 5299.0, 5527.0, 5635.0, 5504.0, 5327.0, 5667.0, 5336.0, 5399.0, 5402.0, 5267.0, 5518.0, 5444.0, 5357.0, 5674.0, 5513.0, 5314.0, 5367.0, 5465.0, 5488.0, 5637.0, 5501.0, 5700.0, 5280.0, 5400.0, 5685.0, 5449.0, 5437.0, 5480.0, 5506.0, 5703.0, 5369.0, 5259.0, 5533.0, 5453.0, 5669.0, 5397.0, 5652.0, 5427.0, 5497.0, 5505.0, 5500.0, 5407.0, 5521.0, 5487.0, 5659.0, 5544.0, 5575.0, 5690.0, 5525.0, 5705.0, 5570.0, 5626.0, 5257.0, 5436.0, 5379.0, 5695.0, 5253.0, 5450.0, 5329.0, 5585.0, 5508.0, 5323.0, 5653.0, 5582.0, 5682.0, 5676.0, 5343.0, 5554.0, 5297.0, 5293.0, 5404.0, 5417.0, 5441.0, 5531.0, 5321.0, 5291.0, 5266.0, 5616.0, 5702.0, 5406.0, 5631.0, 5290.0, 5675.0, 5546.0, 5384.0, 5584.0, 5425.0, 5424.0, 5454.0 (number of hits: 6)
28	5290	9	1	333	1	5335.0, 5705.0, 5261.0, 5498.0, 5524.0, 5280.0, 5529.0, 5642.0, 5436.0, 5438.0, 5419.0, 5320.0, 5271.0, 5655.0, 5563.0, 5389.0, 5514.0, 5469.0, 5329.0, 5308.0, 5345.0, 5525.0, 5562.0, 5300.0, 5595.0, 5405.0, 5614.0, 5503.0, 5559.0, 5630.0, 5373.0, 5689.0, 5587.0, 5272.0, 5687.0, 5500.0, 5312.0, 5654.0, 5274.0, 5688.0, 5428.0, 5347.0, 5617.0, 5546.0, 5714.0, 5665.0, 5548.0, 5290.0, 5701.0, 5504.0, 5583.0, 5365.0, 5315.0, 5653.0, 5380.0, 5493.0, 5384.0, 5425.0, 5356.0, 5361.0, 5282.0, 5481.0, 5450.0, 5330.0, 5352.0, 5484.0, 5289.0, 5558.0, 5359.0, 5257.0, 5565.0, 5564.0, 5561.0, 5462.0, 5576.0, 5433.0, 5697.0, 5443.0, 5463.0, 5575.0, 5434.0, 5459.0, 5349.0, 5401.0, 5719.0, 5251.0, 5360.0, 5288.0, 5471.0, 5307.0,

						5656.0, 5396.0, 5507.0, 5336.0, 5526.0, 5410.0, 5678.0, 5578.0, 5619.0, 5608.0 (number of hits: 7)
29	5290	9	1	333	1	5492.0, 5341.0, 5586.0, 5542.0, 5544.0, 5457.0, 5602.0, 5367.0, 5691.0, 5720.0, 5630.0, 5351.0, 5650.0, 5509.0, 5570.0, 5666.0, 5546.0, 5269.0, 5463.0, 5508.0, 5715.0, 5661.0, 5444.0, 5263.0, 5428.0, 5423.0, 5506.0, 5478.0, 5576.0, 5498.0, 5561.0, 5709.0, 5274.0, 5291.0, 5599.0, 5276.0, 5620.0, 5464.0, 5560.0, 5403.0, 5493.0, 5446.0, 5592.0, 5629.0, 5399.0, 5293.0, 5395.0, 5569.0, 5717.0, 5357.0, 5635.0, 5536.0, 5469.0, 5680.0, 5686.0, 5690.0, 5458.0, 5405.0, 5396.0, 5652.0, 5303.0, 5621.0, 5610.0, 5649.0, 5252.0, 5317.0, 5579.0, 5575.0, 5333.0, 5558.0, 5675.0, 5397.0, 5309.0, 5678.0, 5589.0, 5349.0, 5414.0, 5659.0, 5363.0, 5433.0, 5389.0, 5430.0, 5256.0, 5479.0, 5280.0, 5481.0, 5450.0, 5667.0, 5710.0, 5287.0, 5440.0, 5510.0, 5655.0, 5375.0, 5668.0, 5410.0, 5555.0, 5718.0, 5625.0, 5325.0 (number of hits: 5)
30	5290	9	1	333	1	5378.0, 5517.0, 5475.0, 5567.0, 5687.0, 5719.0, 5622.0, 5656.0, 5522.0, 5591.0, 5272.0, 5467.0, 5347.0, 5328.0, 5258.0, 5324.0, 5393.0, 5617.0, 5423.0, 5564.0, 5455.0, 5270.0, 5442.0, 5511.0, 5720.0, 5521.0, 5598.0, 5462.0, 5329.0, 5530.0, 5632.0, 5294.0, 5369.0, 5697.0, 5670.0, 5320.0, 5389.0, 5312.0, 5671.0, 5520.0, 5296.0, 5280.0, 5717.0, 5358.0, 5600.0, 5496.0, 5590.0, 5367.0, 5468.0, 5278.0, 5408.0, 5394.0, 5465.0, 5461.0, 5414.0, 5463.0, 5492.0, 5484.0, 5348.0, 5336.0, 5666.0, 5274.0, 5513.0, 5416.0, 5506.0, 5647.0, 5434.0, 5418.0, 5445.0, 5499.0, 5549.0, 5619.0, 5289.0, 5559.0, 5366.0, 5724.0, 5572.0, 5625.0, 5524.0, 5535.0, 5430.0, 5417.0, 5331.0, 5699.0, 5531.0, 5385.0, 5459.0, 5615.0, 5604.0, 5481.0, 5300.0, 5593.0, 5452.0, 5527.0, 5381.0, 5483.0, 5299.0, 5466.0, 5254.0, 5629.0 (number of hits: 6)

5530 MHz, 80 MHz Bandwidth

Radar Signal Type	Waveform/Trial Number	Detection (%)	Limit (%)	Pass/Fail
Type 1A/1B	30	100 %	60%	Pass
Type 2	30	100 %	60%	Pass
Type 3	30	100 %	60%	Pass
Type 4	30	100 %	60%	Pass
Aggregate (Type1 to 4)	120	100 %	80%	Pass
Type 5	30	100 %	80%	Pass
Type 6	30	100 %	70%	Pass

Please refer to the following statistical tables:

Table-1 Radar Type 1A/1B Statistical Performance

Trial #	Fc (MHz)	Pulse/Burst	Pulse Width (μS)	PRI (μs)	Detection (1:yes; 0:no)
1	5530	59	1	898	1
2	5530	63	1	838	1
3	5530	67	1	798	1
4	5530	70	1	758	1
5	5530	18	1	3066	1
6	5530	61	1	878	1
7	5530	68	1	778	1
8	5530	72	1	738	1
9	5530	74	1	718	1
10	5530	65	1	818	1
11	5530	76	1	698	1
12	5530	86	1	618	1
13	5530	58	1	918	1
14	5530	95	1	558	1
15	5530	81	1	658	1
16	5530	61	1	868	1
17	5530	33	1	1603	1
18	5530	19	1	2811	1
19	5530	27	1	1977	1
20	5530	54	1	978	1
21	5530	22	1	2479	1
22	5530	23	1	2343	1
23	5530	29	1	1851	1
24	5530	34	1	1573	1
25	5530	30	1	1781	1
26	5530	22	1	2491	1
27	5530	34	1	1581	1
28	5530	53	1	1001	1
29	5530	18	1	3019	1
30	5530	46	1	1157	1
Detection Percentage: 100 % (>60%)					

Table-2 Radar Type 2 Statistical Performance

Trial #	Fc (MHz)	Pulse/Burst	Pulse Width (μS)	PRI (μs)	Detection (1:yes; 0:no)
1	5530	26	1.6	206	1
2	5530	23	3.1	205	1
3	5530	23	4.9	198	1
4	5530	29	2.3	212	1
5	5530	29	3.7	211	1
6	5530	27	3.5	152	1
7	5530	25	3	150	1
8	5530	29	3	169	1
9	5530	28	2.2	166	1
10	5530	26	2.4	166	1
11	5530	27	5	190	1
12	5530	24	3.8	183	1
13	5530	25	4.2	205	1
14	5530	24	2.3	197	1
15	5530	25	1.5	180	1
16	5530	27	4.1	225	1
17	5530	26	1.8	150	1
18	5530	24	2.8	203	1
19	5530	29	1.5	216	1
20	5530	27	2.6	150	1
21	5530	28	3.5	162	1
22	5530	27	2.6	219	1
23	5530	26	3.6	187	1
24	5530	24	4.2	207	1
25	5530	25	4.3	178	1
26	5530	27	4.9	166	1
27	5530	29	2.1	183	1
28	5530	28	1.6	155	1
29	5530	23	4.5	191	1
30	5530	23	1.7	216	1
Detection Percentage: 100 % (>60%)					

Table-3 Radar Type 3 Statistical Performance

Trial #	Fc (MHz)	Pulse/Burst	Pulse Width (μS)	PRI (μs)	Detection (1:yes; 0:no)
1	5530	16	6	395	1
2	5530	16	9.5	250	1
3	5530	16	6.2	487	1
4	5530	17	6.3	210	1
5	5530	16	6.5	495	1
6	5530	17	6.5	248	1
7	5530	18	8.9	283	1
8	5530	18	7.4	271	1
9	5530	17	7.8	277	1
10	5530	17	6.8	332	1
11	5530	17	9.2	355	1
12	5530	16	9.1	374	1
13	5530	18	9	391	1
14	5530	17	8.4	423	1
15	5530	17	8.6	495	1
16	5530	18	6.4	216	1
17	5530	16	8.7	440	1
18	5530	18	8.2	276	1
19	5530	18	7.8	241	1
20	5530	17	9.8	298	1
21	5530	18	9.6	263	1
22	5530	18	7.6	210	1
23	5530	16	7.3	422	1
24	5530	17	8	494	1
25	5530	18	8.9	492	1
26	5530	16	8.3	264	1
27	5530	17	6.4	216	1
28	5530	18	6.4	272	1
29	5530	17	8.6	488	1
30	5530	18	6.2	491	1
Detection Percentage: 100 % (>60%)					

Table-4 Radar Type 4 Statistical Performance

Trial #	Fc (MHz)	Pulse/Burst	Pulse Width (μS)	PRI (μs)	Detection (1:yes; 0:no)
1	5530	12	12.1	225	1
2	5530	13	14.7	364	1
3	5530	15	14.8	495	1
4	5530	16	19.6	272	1
5	5530	13	14.2	256	1
6	5530	13	17	414	1
7	5530	15	17.9	451	1
8	5530	13	17.4	498	1
9	5530	14	16.2	355	1
10	5530	13	12.6	295	1
11	5530	13	13.8	493	1
12	5530	13	17.7	436	1
13	5530	16	15.1	331	1
14	5530	13	14.2	361	1
15	5530	13	12.9	272	1
16	5530	13	11.3	266	1
17	5530	13	11	209	1
18	5530	14	18	410	1
19	5530	14	17.8	359	1
20	5530	16	14	472	1
21	5530	13	12.4	239	1
22	5530	14	11.6	457	1
23	5530	12	16.9	432	1
24	5530	16	15.9	448	1
25	5530	16	13.9	494	1
26	5530	12	14.3	319	1
27	5530	14	15.7	400	1
28	5530	12	14.1	295	1
29	5530	13	19.5	351	1
30	5530	13	14.7	418	1
Detection Percentage: 100 % (>60%)					

Table-5 Radar Type 5 Statistical Performance

Bin5 Statistics 1

Trial #	Pulse	Chirp (MHz)	Pulse Width (µS)	Pulse 1-2 spacing (uS)	Pulse 2-3 spacing (uS)	Pulse Start(S)	Detection (1:yes; 0:no)
0	2	20	52.6	1742		0.461714	1
1	3	8	55.6	1472	1820	0.968994	
2	2	10	82.8	1313		2.495804	
3	2	8	87	1820		2.942468	
4	2	9	79.7	1149		4.276917	
5	3	15	50.6	1568	1505	4.583171	
6	3	10	73.8	1029	1988	5.648342	
7	1	11	57.2			6.490072	
8	1	8	57.8			7.484766	
9	2	8	61.9	1328		8.449619	
10	1	19	65.9			8.827711	
11	2	16	61.9	1692		10.01347	
12	3	12	85.7	1596	1690	10.72863	
13	2	10	94.6	1899		11.810208	

Bin5 Statistics 2

Trial #	Pulse	Chirp (MHz)	Pulse Width (µS)	Pulse 1-2 spacing (uS)	Pulse 2-3 spacing (uS)	Pulse Start(S)	Detection (1:yes; 0:no)
0	3	16	60.7	1452	1376	0.672994	1
1	2	20	58.3	1128		2.357315	
2	1	11	69.7			2.68937	
3	2	6	98.2	1639		4.183984	
4	1	17	79.8			5.561409	
5	2	19	58.2	1099		6.739327	
6	3	17	64.1	1379	1082	8.046006	
7	2	5	88.7	1740		8.87525	
8	1	5	76.6			10.307606	
9	2	5	65.9	1642		11.846036	

Bin5 Statistics 3

Trial #	Pulse	Chirp (MHz)	Pulse Width (µS)	Pulse 1-2 spacing (µS)	Pulse 2-3 spacing (µS)	Pulse Start(S)	Detection (1:yes; 0:no)
0	1	6	55.7			0.216974	1
1	2	13	95.2	1419		1.572716	
2	1	15	52.1			2.829174	
3	1	15	87.2			4.018568	
4	2	10	63.3	1589		4.644519	
5	1	17	77			5.487232	
6	2	10	55.2	1412		6.808128	
7	2	10	58.4	1668		8.514109	
8	2	6	67.9	1811		9.504238	
9	1	14	55.7			10.034263	
10	2	8	54.7	1514		11.681205	

Bin5 Statistics 4

Trial #	Pulse	Chirp (MHz)	Pulse Width (µS)	Pulse 1-2 spacing (µS)	Pulse 2-3 spacing (µS)	Pulse Start(S)	Detection (1:yes; 0:no)
0	2	15	51	1500		0.000147	1
1	3	17	69.2	1346	1199	0.945911	
2	1	13	89.7			1.261516	
3	1	13	64.4			1.996422	
4	2	15	95.1	1254		2.447801	
5	2	13	51.4	1748		3.255703	
6	2	6	84.5	1076		3.975684	
7	1	7	55			4.390534	
8	3	11	66	1614	1872	4.978315	
9	1	7	55.3			5.57087	
10	2	15	55.8	1763		6.456968	
11	3	13	84.9	1580	1363	7.01281	
12	2	17	68.5	1240		7.384727	
13	1	9	67.6			7.889932	
14	2	15	80.7	1867		8.927933	
15	2	11	74.1	1298		9.320297	
16	2	13	81.1	1806		10.138522	
17	1	17	97.6			10.709757	
18	2	16	86	1058		11.113049	
19	2	11	85.3	1810		11.567135	

Bin5 Statistics 5

Trial #	Pulse	Chirp (MHz)	Pulse Width (µS)	Pulse 1-2 spacing (µS)	Pulse 2-3 spacing (µS)	Pulse Start(S)	Detection (1:yes; 0:no)
0	2	6	70.3	1407		0.421251	1
1	2	9	67.9	1887		1.122746	
2	2	14	99.8	1367		2.545016	
3	3	19	80.3	1451	1298	3.092957	
4	2	18	64.7	1713		4.232125	
5	1	20	87.5			4.704283	
6	2	16	92.7	1647		5.688246	
7	2	20	84.6	1837		6.24542	
8	2	12	61.5	1378		7.617744	
9	2	13	78.1	1662		8.335419	
10	1	6	63			8.639731	
11	3	17	80.9	1914	1005	10.197123	
12	3	15	80.1	1339	1420	10.413537	
13	1	14	99.2			11.602246	

Bin5 Statistics 6

Trial #	Pulse	Chirp (MHz)	Pulse Width (µS)	Pulse 1-2 spacing (µS)	Pulse 2-3 spacing (µS)	Pulse Start(S)	Detection (1:yes; 0:no)
0	3	14	60	1173	1651	0.655037	1
1	2	17	93.5	1321		0.724746	
2	2	18	90.2	1081		1.695692	
3	2	12	58.5	1077		2.041864	
4	3	15	54.8	1975	1204	2.95984	
5	2	19	58.5	1240		3.40912	
6	2	18	82.6	1563		4.429352	
7	1	11	71.8			4.891422	
8	2	15	87.1	1665		5.833149	
9	1	9	69.9			6.180791	
10	1	11	84.8			7.14634	
11	3	6	50.5	1772	1074	7.861602	
12	1	10	64.9			8.556401	
13	2	19	66.4	1971		8.881528	
14	1	8	97.3			9.415276	
15	3	16	85.8	1266	1033	10.000641	
16	3	9	90.1	1428	1260	11.191438	
17	3	12	92.2	1795	1707	11.762837	

Bin5 Statistics 7

Trial #	Pulse	Chirp (MHz)	Pulse Width (µS)	Pulse 1-2 spacing (µS)	Pulse 2-3 spacing (µS)	Pulse Start(S)	Detection (1:yes; 0:no)
0	2	17	61.2	1606		0.224159	1
1	2	8	93.9	1747		1.032446	
2	2	11	70.6	1119		2.742453	
3	1	14	97.9			3.408806	
4	1	19	52.5			4.540102	
5	2	19	95.7	1057		5.31749	
6	2	11	56.1	1292		6.286605	
7	2	18	52.7	1822		7.070753	
8	2	19	81.1	1974		8.490451	
9	2	6	80.6	1071		9.924192	
10	1	13	76			10.616594	

Bin5 Statistics 8

Trial #	Pulse	Chirp (MHz)	Pulse Width (µS)	Pulse 1-2 spacing (µS)	Pulse 2-3 spacing (µS)	Pulse Start(S)	Detection (1:yes; 0:no)
0	3	15	94	1429	1473	0.424754	1
1	3	15	77	1917	1263	1.06259	
2	2	16	78.4	1254		2.234871	
3	1	9	81.8			2.780371	
4	1	12	81.7			3.33953	
5	2	14	84.1	1863		4.042356	
6	2	14	56.3	1231		5.337421	
7	3	15	64.4	1408	1274	6.070232	
8	1	11	92			6.820526	
9	1	11	57.1			7.621321	
10	1	19	53.8			8.306276	
11	3	14	97.8	1422	1638	9.543216	
12	1	18	73.1			9.931765	
13	2	14	79.3	1937		11.110607	
14	2	16	86.3	1050		11.344548	

Bin5 Statistics 9

Trial #	Pulse	Chirp (MHz)	Pulse Width (µS)	Pulse 1-2 spacing (µS)	Pulse 2-3 spacing (µS)	Pulse Start(S)	Detection (1:yes; 0:no)
0	2	16	63	1358		0.034627	1
1	1	13	52.4			0.91602	
2	3	15	62.7	1054	1719	1.592241	
3	3	9	61	1349	1913	2.17549	
4	2	18	77	1275		2.66454	
5	2	6	58.6	1722		3.210446	
6	2	13	74.6	1270		4.083807	
7	3	16	69.9	1097	1650	4.223258	
8	3	7	66.7	1027	1270	5.179671	
9	2	12	60.5	1524		5.454817	
10	2	7	87.8	1639		6.446768	
11	2	20	51.1	1844		7.089714	
12	2	16	52.1	1615		7.592129	
13	1	19	66.3			8.275596	
14	1	10	94.3			8.784829	
15	1	17	77.2			9.318085	
16	3	18	86.7	1774	1622	10.143792	
17	1	11	80.7			10.291372	
18	2	5	69.2	1184		11.243005	
19	2	12	87.1	1633		11.423256	

Bin5 Statistics 10

Trial #	Pulse	Chirp (MHz)	Pulse Width (µS)	Pulse 1-2 spacing (µS)	Pulse 2-3 spacing (µS)	Pulse Start(S)	Detection (1:yes; 0:no)
0	2	9	78	1666		0.139318	1
1	1	11	62.3			1.435555	
2	2	8	86.9	1562		1.960848	
3	2	20	69.5	1971		2.316778	
4	2	17	82	1436		3.333648	
5	1	20	52.8			3.758016	
6	2	8	100	1412		4.767963	
7	3	14	93.5	1907	1122	5.518868	
8	1	18	88.8			6.03216	
9	3	14	82.3	1099	1902	7.339819	
10	3	11	85.8	1125	1214	7.834053	
11	3	12	77.3	1228	1257	8.488452	
12	3	13	82	1869	1267	9.047883	
13	1	19	89			9.94219	
14	3	6	89.5	1904	1181	10.526261	
15	2	10	90	1958		11.457234	

Bin5 Statistics 11

Trial #	Pulse	Chirp (MHz)	Pulse Width (µS)	Pulse 1-2 spacing (µS)	Pulse 2-3 spacing (µS)	Pulse Start(S)	Detection (1:yes; 0:no)
0	3	5	73.4	1846	1991	0.409845	1
1	1	17	82.7			1.236477	
2	1	7	59.2			1.685889	
3	2	20	51	1420		2.150372	
4	2	16	51.2	1722		3.249773	
5	3	18	77.8	1341	1951	3.940192	
6	2	9	75.4	1444		4.606994	
7	1	19	94.1			5.320886	
8	2	13	91.1	1795		6.203168	
9	2	14	66	1033		7.02858	
10	2	17	80.5	1773		7.154336	
11	2	9	92.4	1466		8.265447	
12	2	6	93.6	1536		8.508311	
13	3	13	58.9	1768	1231	9.45721	
14	2	9	55.9	1182		9.893158	
15	3	16	65.5	1532	1247	11.137216	
16	2	11	65.8	1019		11.662377	

Bin5 Statistics 12

Trial #	Pulse	Chirp (MHz)	Pulse Width (µS)	Pulse 1-2 spacing (uS)	Pulse 2-3 spacing (uS)	Pulse Start(S)	Detection (1:yes; 0:no)
0	2	13	98.9	1858		0.265919	1
1	3	19	76.3	1441	1465	2.565318	
2	3	12	94.6	1523	1945	3.507179	
3	2	8	73	1954		5.249485	
4	2	17	73.5	1687		6.337868	
5	3	9	67.8	1978	1950	8.220105	
6	3	19	92.7	1523	1736	9.671745	
7	1	19	73.7			11.368461	

Bin5 Statistics 13

Trial #	Pulse	Chirp (MHz)	Pulse Width (µS)	Pulse 1-2 spacing (uS)	Pulse 2-3 spacing (uS)	Pulse Start(S)	Detection (1:yes; 0:no)
0	2	9	81.2	1074		0.500152	1
1	2	14	91.2	1066		1.846386	
2	3	8	72.6	1596	1308	2.659365	
3	3	11	73	1221	1055	3.598544	
4	2	7	89.7	1921		4.499969	
5	3	8	74.9	1931	1347	5.710538	
6	2	13	63.7	1510		7.031205	
7	3	11	63.6	1957	1879	7.677001	
8	1	15	62.8			9.432767	
9	2	7	59.2	1030		9.975338	
10	2	17	76.8	1557		11.899477	

Bin5 Statistics 14

Trial #	Pulse	Chirp (MHz)	Pulse Width (µS)	Pulse 1-2 spacing (µS)	Pulse 2-3 spacing (µS)	Pulse Start(S)	Detection (1:yes; 0:no)
0	1	13	61			0.276424	1
1	1	12	72			1.247783	
2	3	11	79.9	1275	1734	2.109895	
3	2	18	52.4	1089		2.305483	
4	2	16	55.7	1855		3.327121	
5	2	6	95.1	1487		4.071724	
6	1	11	52.1			5.123176	
7	1	18	85.9			5.261486	
8	1	10	71.9			6.696465	
9	3	18	61.9	1997	1652	7.361473	
10	1	7	88.8			7.755518	
11	1	7	88.6			8.806071	
12	2	5	90.7	1716		9.658589	
13	1	17	72.4			10.474045	
14	2	15	51	1249		10.5022	
15	3	14	65.2	1027	1456	11.619285	

Bin5 Statistics 15

Trial #	Pulse	Chirp (MHz)	Pulse Width (µS)	Pulse 1-2 spacing (µS)	Pulse 2-3 spacing (µS)	Pulse Start(S)	Detection (1:yes; 0:no)
0	2	18	61.6	1996		0.336221	1
1	2	9	94.5	1916		1.006255	
2	3	20	98	1536	1816	2.55881	
3	2	18	68.7	1964		2.832445	
4	3	12	75.2	1290	1470	3.780309	
5	1	18	69.6			5.01194	
6	1	17	95.7			5.431898	
7	2	12	84.6	1118		6.224429	
8	2	15	59.9	1461		7.706527	
9	2	11	75.6	1001		8.194749	
10	3	11	51.6	1475	1844	9.119197	
11	2	10	50.9	1847		9.836764	
12	2	12	70.6	1955		10.903611	
13	3	18	82.8	1396	1470	11.709154	

Bin5 Statistics 16

Trial #	Pulse	Chirp (MHz)	Pulse Width (µS)	Pulse 1-2 spacing (µS)	Pulse 2-3 spacing (µS)	Pulse Start(S)	Detection (1:yes; 0:no)
0	2	15	91.4	1363		0.241648	1
1	1	12	81.4			0.996656	
2	2	17	91.9	1035		1.399638	
3	1	17	75.6			2.137995	
4	2	12	60.3	1320		2.760273	
5	2	9	84.5	1801		3.72295	
6	2	19	75.2	1527		4.559458	
7	2	7	93.6	1775		5.071792	
8	3	9	56.1	1873	1134	5.339141	
9	2	14	92.5	1255		6.545563	
10	2	14	57.6	1219		6.669817	
11	2	18	76.1	1498		7.832436	
12	3	14	94.7	1799	1224	8.208088	
13	1	18	73.4			8.997858	
14	1	7	68.1			9.718	
15	1	14	70.3			10.508695	
16	1	15	74			11.076998	
17	1	13	84			11.700174	

Bin5 Statistics 17

Trial #	Pulse	Chirp (MHz)	Pulse Width (µS)	Pulse 1-2 spacing (µS)	Pulse 2-3 spacing (µS)	Pulse Start(S)	Detection (1:yes; 0:no)
0	1	10	89.5			0.051019	1
1	1	11	95.7			1.482785	
2	2	15	85.4	1014		2.614868	
3	2	15	57.7	1369		3.285688	
4	1	8	72.5			4.083819	
5	2	15	75	1695		4.96204	
6	2	15	69.3	1244		6.145241	
7	1	18	53.6			7.251033	
8	3	15	53.8	1348	1813	7.46645	
9	1	15	60.9			8.85489	
10	2	20	94.8	1008		10.038848	
11	3	5	70.4	1531	1294	10.929231	
12	2	16	74	1473		11.545633	

Bin5 Statistics 18

Trial #	Pulse	Chirp (MHz)	Pulse Width (µS)	Pulse 1-2 spacing (uS)	Pulse 2-3 spacing (uS)	Pulse Start(S)	Detection (1:yes; 0:no)
0	1	13	66.1			0.136591	1
1	3	15	71.9	1965	1105	1.203523	
2	2	18	95.2	1278		1.919404	
3	2	14	97.5	1653		3.058669	
4	2	8	84.3	1210		3.678244	
5	2	11	90.5	1714		4.665159	
6	2	8	83.8	1365		5.403297	
7	2	14	82.2	1703		5.947541	
8	1	11	84.7			6.517991	
9	1	11	74.8			7.389042	
10	3	17	64.8	1067	1268	8.422062	
11	2	9	55.2	1540		9.124289	
12	1	13	75.8			9.681257	
13	3	7	84.6	1333	1674	11.143832	
14	3	16	58	1151	1944	11.787147	

Bin5 Statistics 19

Trial #	Pulse	Chirp (MHz)	Pulse Width (µS)	Pulse 1-2 spacing (uS)	Pulse 2-3 spacing (uS)	Pulse Start(S)	Detection (1:yes; 0:no)
0	2	6	64.8	1370		0.685382	1
1	2	9	56	1779		1.468563	
2	1	8	86.7			3.723374	
3	1	8	72.6			4.167164	
4	1	9	86.4			6.592814	
5	2	8	89.6	1620		7.122646	
6	2	9	73	1504		9.004666	
7	3	12	51.8	1377	1797	10.269614	
8	3	15	52.4	1067	1146	11.708507	

Bin5 Statistics 20

Trial #	Pulse	Chirp (MHz)	Pulse Width (µS)	Pulse 1-2 spacing (uS)	Pulse 2-3 spacing (uS)	Pulse Start(S)	Detection (1:yes; 0:no)
0	2	10	71	1109		0.09645	1
1	2	12	96.9	1972		1.15285	
2	2	11	89.6	1405		1.759942	
3	3	15	50.3	1080	1002	2.550055	
4	2	5	97.3	1361		2.92738	
5	3	12	64.2	1472	1964	3.792182	
6	2	9	55.8	1870		4.183006	
7	2	15	75.4	1759		4.80071	
8	1	20	96.8			5.337414	
9	3	6	80.3	1154	1401	6.240145	
10	1	8	80.9			6.84368	
11	2	6	79.3	1843		7.926881	
12	1	14	70.2			8.153097	
13	2	10	90	1469		9.043891	
14	1	14	72.7			9.943555	
15	2	19	75.4	1846		10.629261	
16	1	20	55.7			11.074815	
17	2	17	65.6	1235		11.616772	

Bin5 Statistics 21

Trial #	Pulse	Chirp (MHz)	Pulse Width (µS)	Pulse 1-2 spacing (uS)	Pulse 2-3 spacing (uS)	Pulse Start(S)	Detection (1:yes; 0:no)
0	3	17	55.3	1452	1830	0.616406	1
1	1	11	60.8			1.301581	
2	1	9	73			1.836728	
3	2	17	81.8	2000		2.540418	
4	3	8	71.4	1115	1366	3.765696	
5	2	13	79.2	1974		4.244113	
6	2	13	86.7	1796		5.262279	
7	2	6	54.3	1660		6.256476	
8	2	5	64.6	1637		7.051652	
9	2	6	69.5	1837		7.840395	
10	2	5	91.6	1756		8.497515	
11	1	12	60.2			8.975387	
12	2	7	61.9	1318		10.150444	
13	2	6	61.3	1483		10.680931	
14	2	7	71.1	1626		11.478067	

Bin5 Statistics 22

Trial #	Pulse	Chirp (MHz)	Pulse Width (µS)	Pulse 1-2 spacing (uS)	Pulse 2-3 spacing (uS)	Pulse Start(S)	Detection (1:yes; 0:no)
0	1	18	99.4			0.479433	1
1	2	16	91.1	1934		1.202467	
2	3	13	95	1831	1113	3.573801	
3	2	15	80.2	1563		4.01969	
4	1	15	52.5			5.473826	
5	1	13	74.1			6.674688	
6	3	17	93.6	1724	1368	8.332872	
7	1	13	99.6			9.451226	
8	1	12	55.2			10.752195	
9	1	9	54.5			11.631885	

Bin5 Statistics 23

Trial #	Pulse	Chirp (MHz)	Pulse Width (µS)	Pulse 1-2 spacing (uS)	Pulse 2-3 spacing (uS)	Pulse Start(S)	Detection (1:yes; 0:no)
0	2	15	58.1	1686		0.045079	1
1	3	9	64	1407	1807	2.238058	
2	2	14	73.2	1397		3.460637	
3	2	14	93.5	1740		4.857318	
4	3	13	93.5	1691	1051	6.550484	
5	2	16	83.7	1834		8.52132	
6	1	13	95.1			9.863595	
7	2	17	91.6	1958		11.53204	

Bin5 Statistics 24

Trial #	Pulse	Chirp (MHz)	Pulse Width (µS)	Pulse 1-2 spacing (uS)	Pulse 2-3 spacing (uS)	Pulse Start(S)	Detection (1:yes; 0:no)
0	1	20	81.8			0.125001	1
1	2	16	93	1366		1.114903	
2	2	11	93.5	1778		1.806559	
3	1	10	87.9			2.665961	
4	1	11	65.5			3.670007	
5	2	12	62.8	1516		4.556523	
6	2	11	74.3	1294		5.385442	
7	1	7	94.9			6.059136	
8	3	18	89.3	1053	1796	6.701069	
9	1	16	73.2			7.853319	
10	2	9	90.3	1168		8.033539	
11	2	16	82.4	1497		9.314347	
12	3	10	84.7	1201	1681	9.652951	
13	2	16	83.4	1160		10.962473	
14	1	7	74			11.739348	

Bin5 Statistics 25

Trial #	Pulse	Chirp (MHz)	Pulse Width (µS)	Pulse 1-2 spacing (uS)	Pulse 2-3 spacing (uS)	Pulse Start(S)	Detection (1:yes; 0:no)
0	3	7	99	1748	1161	0.708628	1
1	3	12	65.1	1499	1505	1.277731	
2	1	13	54.8			2.270071	
3	2	10	59.8	1220		2.797983	
4	3	9	70.7	1569	1788	4.030557	
5	3	6	72.5	1413	1933	5.11091	
6	2	18	55.3	1659		5.598684	
7	1	12	98.9			6.737778	
8	2	7	94.6	1657		6.938534	
9	3	16	73.3	1733	1074	8.526184	
10	2	9	68.9	1414		8.980284	
11	2	8	52.3	1695		10.234076	
12	3	18	79.7	1849	1148	10.838764	
13	2	7	67.2	1321		11.246802	

Bin5 Statistics 26

Trial #	Pulse	Chirp (MHz)	Pulse Width (µS)	Pulse 1-2 spacing (uS)	Pulse 2-3 spacing (uS)	Pulse Start(S)	Detection (1:yes; 0:no)
0	2	19	69.8	1076		0.188048	1
1	2	6	86	1661		0.986108	
2	2	5	76.3	1530		2.230728	
3	3	15	76	1944	1782	2.667809	
4	2	6	68.5	1310		3.385902	
5	2	18	68.4	1506		4.455365	
6	2	8	66	1920		4.820937	
7	2	16	65.6	1556		5.264765	
8	1	9	98.7			6.219665	
9	2	12	62.5	1683		6.904275	
10	2	12	59.4	1200		7.704762	
11	2	7	79.2	1132		8.293882	
12	2	17	79.1	1850		9.025981	
13	2	14	50.4	1432		9.761108	
14	3	5	83.9	1092	1174	10.693016	
15	1	14	89.4			11.585593	

Bin5 Statistics 27

Trial #	Pulse	Chirp (MHz)	Pulse Width (µS)	Pulse 1-2 spacing (uS)	Pulse 2-3 spacing (uS)	Pulse Start(S)	Detection (1:yes; 0:no)
0	2	13	55.5	1480		0.83758	1
1	2	9	51.9	1991		1.746847	
2	2	7	62.7	1829		3.097087	
3	1	10	51.2			4.013485	
4	2	14	59	1643		4.894788	
5	2	7	92.7	1126		5.929813	
6	2	13	65.2	1323		7.522778	
7	3	17	93.8	1173	1335	8.661073	
8	2	6	79.8	1415		9.028441	
9	2	6	63.1	1517		10.744706	
10	1	9	58.1			11.182376	

Bin5 Statistics 28

Trial #	Pulse	Chirp (MHz)	Pulse Width (µS)	Pulse 1-2 spacing (uS)	Pulse 2-3 spacing (uS)	Pulse Start(S)	Detection (1:yes; 0:no)
0	3	11	87	1667	1167	0.077929	1
1	3	14	69.7	1049	1028	0.943075	
2	3	7	99.9	1295	1372	1.703022	
3	1	19	66.6			2.534765	
4	3	5	89.8	1921	1919	3.303041	
5	1	19	89.2			4.723253	
6	2	20	83	1771		5.474554	
7	2	15	52.1	1917		6.032427	
8	2	12	57.9	1074		6.865478	
9	3	16	66.4	1593	1928	7.956759	
10	2	12	69.8	1421		8.036727	
11	2	10	75.1	1035		9.456135	
12	2	10	81.6	1977		9.919164	
13	2	9	51.3	1332		10.823915	
14	2	10	86	1430		11.429783	

Bin5 Statistics 29

Trial #	Pulse	Chirp (MHz)	Pulse Width (µS)	Pulse 1-2 spacing (uS)	Pulse 2-3 spacing (uS)	Pulse Start(S)	Detection (1:yes; 0:no)
0	2	9	82.6	1604		0.418736	1
1	1	16	55.7			1.493539	
2	3	14	71.5	1854	1932	2.523469	
3	2	19	55.8	1456		3.874956	
4	3	6	90.7	1439	1762	4.859562	
5	2	6	80	1858		6.618871	
6	1	18	61.4			7.497884	
7	1	7	76.5			9.577012	
8	2	15	74.3	1341		9.896715	
9	3	9	92.5	1502	1429	10.910394	

Bin5 Statistics 30

Trial #	Pulse	Chirp (MHz)	Pulse Width (µS)	Pulse 1-2 spacing (uS)	Pulse 2-3 spacing (uS)	Pulse Start(S)	Detection (1:yes; 0:no)
0	2	6	62.7	1097		0.466752	0
1	1	16	85.7			1.116445	
2	2	19	54	1506		1.760063	
3	2	16	75.9	1370		2.405605	
4	1	10	70.2			2.845875	
5	3	20	94.9	1451	1597	3.282041	
6	2	15	69.3	1947		4.062384	
7	2	7	54.6	1373		4.655763	
8	2	12	85.3	1388		5.62674	
9	2	7	99.9	1557		6.046534	
10	2	5	62.4	1498		6.897736	
11	1	11	75.9			7.016377	
12	3	8	71.9	1808	1281	8.003868	
13	2	12	90.7	1978		8.657261	
14	1	10	91			9.116065	
15	2	19	63.5	1456		9.530169	
16	2	16	71.5	1694		10.382244	
17	2	12	53.2	1111		10.911972	
18	2	11	89	1210		11.440396	

Table-6 Radar Type 6 Statistical Performance

Trial #	Fc (MHz)	Pulse /Burst	Pulse Width (μS)	PRI (μs)	Detection (1:yes; 0:no)	Hopping Sequence
1	5530	9	1	333	1	5368.0, 5534.0, 5390.0, 5525.0, 5626.0, 5661.0, 5288.0, 5405.0, 5428.0, 5590.0, 5630.0, 5459.0, 5607.0, 5535.0, 5271.0, 5718.0, 5587.0, 5455.0, 5403.0, 5290.0, 5389.0, 5327.0, 5580.0, 5582.0, 5352.0, 5668.0, 5393.0, 5313.0, 5263.0, 5511.0, 5385.0, 5643.0, 5601.0, 5274.0, 5361.0, 5266.0, 5342.0, 5320.0, 5591.0, 5291.0, 5549.0, 5382.0, 5695.0, 5490.0, 5418.0, 5477.0, 5652.0, 5461.0, 5599.0, 5278.0, 5451.0, 5627.0, 5264.0, 5370.0, 5653.0, 5348.0, 5558.0, 5304.0, 5686.0, 5557.0, 5624.0, 5562.0, 5307.0, 5503.0, 5427.0, 5487.0, 5312.0, 5289.0, 5502.0, 5253.0, 5401.0, 5689.0, 5565.0, 5337.0, 5513.0, 5438.0, 5434.0, 5295.0, 5723.0, 5538.0, 5256.0, 5261.0, 5364.0, 5629.0, 5524.0, 5529.0, 5425.0, 5305.0, 5713.0, 5522.0, 5618.0, 5408.0, 5639.0, 5458.0, 5508.0, 5602.0, 5357.0, 5596.0, 5453.0, 5611.0 (number of hits: 18)
2	5530	9	1	333	1	5578.0, 5433.0, 5258.0, 5263.0, 5517.0, 5710.0, 5445.0, 5557.0, 5472.0, 5368.0, 5339.0, 5570.0, 5596.0, 5721.0, 5346.0, 5256.0, 5688.0, 5280.0, 5545.0, 5523.0, 5609.0, 5283.0, 5542.0, 5508.0, 5642.0, 5589.0, 5693.0, 5607.0, 5572.0, 5639.0, 5294.0, 5363.0, 5668.0, 5561.0, 5450.0, 5357.0, 5348.0, 5562.0, 5686.0, 5403.0, 5543.0, 5511.0, 5415.0, 5656.0, 5489.0, 5449.0, 5537.0, 5717.0, 5476.0, 5293.0, 5633.0, 5439.0, 5443.0, 5296.0, 5255.0, 5585.0, 5512.0, 5291.0, 5507.0, 5317.0, 5358.0, 5628.0, 5583.0, 5434.0, 5709.0, 5471.0, 5658.0, 5531.0, 5625.0, 5558.0, 5560.0, 5547.0, 5436.0, 5491.0, 5338.0, 5700.0, 5678.0, 5451.0, 5619.0, 5399.0, 5654.0, 5536.0, 5430.0, 5412.0, 5408.0, 5575.0, 5577.0, 5275.0, 5652.0, 5481.0, 5253.0, 5530.0, 5614.0, 5432.0, 5447.0, 5540.0, 5644.0, 5592.0, 5259.0, 5351.0 (number of hits: 21)
3	5530	9	1	333	1	5575.0, 5398.0, 5286.0, 5526.0, 5501.0, 5259.0, 5626.0, 5624.0, 5255.0, 5483.0, 5374.0, 5498.0, 5527.0, 5395.0, 5477.0, 5482.0, 5282.0, 5528.0, 5548.0, 5313.0, 5452.0, 5408.0, 5510.0, 5599.0, 5484.0, 5629.0, 5380.0, 5710.0, 5326.0, 5550.0, 5424.0, 5455.0, 5593.0, 5684.0, 5458.0, 5272.0, 5410.0, 5649.0, 5251.0, 5638.0, 5328.0, 5656.0, 5620.0, 5409.0, 5385.0, 5486.0, 5536.0, 5703.0, 5285.0, 5670.0, 5634.0, 5714.0, 5434.0, 5592.0, 5573.0, 5263.0, 5370.0, 5654.0, 5366.0, 5421.0,

						5709.0, 5534.0, 5392.0, 5309.0, 5492.0, 5347.0, 5539.0, 5474.0, 5466.0, 5713.0, 5603.0, 5415.0, 5614.0, 5465.0, 5706.0, 5690.0, 5293.0, 5269.0, 5557.0, 5551.0, 5556.0, 5559.0, 5663.0, 5506.0, 5566.0, 5585.0, 5371.0, 5574.0, 5525.0, 5420.0, 5324.0, 5423.0, 5360.0, 5459.0, 5591.0, 5702.0, 5364.0, 5508.0, 5689.0, 5546.0 (number of hits: 21)
4	5530	9	1	333	1	5402.0, 5434.0, 5717.0, 5332.0, 5510.0, 5371.0, 5696.0, 5593.0, 5339.0, 5331.0, 5456.0, 5330.0, 5304.0, 5281.0, 5595.0, 5710.0, 5474.0, 5648.0, 5285.0, 5250.0, 5448.0, 5483.0, 5313.0, 5525.0, 5414.0, 5388.0, 5529.0, 5622.0, 5562.0, 5393.0, 5683.0, 5577.0, 5536.0, 5718.0, 5515.0, 5392.0, 5315.0, 5598.0, 5621.0, 5497.0, 5584.0, 5409.0, 5411.0, 5511.0, 5452.0, 5579.0, 5589.0, 5354.0, 5713.0, 5443.0, 5344.0, 5687.0, 5672.0, 5318.0, 5643.0, 5380.0, 5514.0, 5410.0, 5702.0, 5503.0, 5283.0, 5383.0, 5310.0, 5493.0, 5360.0, 5415.0, 5376.0, 5703.0, 5653.0, 5324.0, 5389.0, 5261.0, 5537.0, 5547.0, 5429.0, 5312.0, 5405.0, 5424.0, 5502.0, 5317.0, 5356.0, 5257.0, 5530.0, 5352.0, 5451.0, 5701.0, 5322.0, 5467.0, 5287.0, 5478.0, 5656.0, 5398.0, 5542.0, 5624.0, 5698.0, 5272.0, 5314.0, 5413.0, 5359.0, 5616.0 (number of hits: 16)
5	5530	9	1	333	1	5640.0, 5260.0, 5621.0, 5600.0, 5475.0, 5427.0, 5509.0, 5497.0, 5606.0, 5291.0, 5541.0, 5477.0, 5685.0, 5335.0, 5264.0, 5345.0, 5281.0, 5355.0, 5591.0, 5562.0, 5480.0, 5554.0, 5351.0, 5550.0, 5494.0, 5401.0, 5700.0, 5694.0, 5328.0, 5367.0, 5276.0, 5718.0, 5456.0, 5648.0, 5585.0, 5629.0, 5258.0, 5663.0, 5576.0, 5597.0, 5535.0, 5444.0, 5399.0, 5323.0, 5495.0, 5617.0, 5349.0, 5446.0, 5610.0, 5502.0, 5391.0, 5523.0, 5706.0, 5711.0, 5564.0, 5544.0, 5547.0, 5602.0, 5674.0, 5372.0, 5642.0, 5419.0, 5454.0, 5553.0, 5693.0, 5434.0, 5638.0, 5320.0, 5563.0, 5450.0, 5723.0, 5628.0, 5691.0, 5504.0, 5643.0, 5417.0, 5657.0, 5695.0, 5522.0, 5287.0, 5420.0, 5476.0, 5267.0, 5383.0, 5396.0, 5397.0, 5601.0, 5414.0, 5632.0, 5656.0, 5311.0, 5622.0, 5416.0, 5507.0, 5385.0, 5532.0, 5688.0, 5325.0, 5302.0, 5647.0 (number of hits: 20)
6	5530	9	1	333	1	5645.0, 5508.0, 5514.0, 5374.0, 5335.0, 5432.0, 5396.0, 5641.0, 5413.0, 5666.0, 5621.0, 5382.0, 5451.0, 5663.0, 5339.0, 5526.0, 5297.0, 5603.0, 5265.0, 5522.0, 5579.0, 5581.0, 5330.0, 5509.0, 5471.0, 5280.0, 5567.0, 5367.0, 5594.0, 5473.0, 5324.0, 5414.0, 5519.0, 5559.0, 5586.0, 5317.0, 5546.0, 5596.0, 5548.0, 5424.0,

						5364.0, 5470.0, 5371.0, 5614.0, 5664.0, 5713.0, 5269.0, 5551.0, 5631.0, 5450.0, 5411.0, 5295.0, 5582.0, 5478.0, 5538.0, 5296.0, 5441.0, 5385.0, 5665.0, 5252.0, 5630.0, 5649.0, 5650.0, 5537.0, 5253.0, 5592.0, 5329.0, 5679.0, 5288.0, 5458.0, 5711.0, 5654.0, 5321.0, 5569.0, 5517.0, 5545.0, 5634.0, 5274.0, 5646.0, 5333.0, 5479.0, 5530.0, 5383.0, 5410.0, 5683.0, 5365.0, 5282.0, 5408.0, 5483.0, 5390.0, 5486.0, 5610.0, 5341.0, 5351.0, 5393.0, 5332.0, 5476.0, 5334.0, 5717.0, 5549.0 (number of hits: 18)
7	5530	9	1	333	1	5357.0, 5297.0, 5327.0, 5655.0, 5352.0, 5525.0, 5422.0, 5702.0, 5601.0, 5557.0, 5590.0, 5697.0, 5325.0, 5465.0, 5497.0, 5694.0, 5586.0, 5381.0, 5603.0, 5271.0, 5677.0, 5621.0, 5424.0, 5328.0, 5370.0, 5542.0, 5322.0, 5659.0, 5450.0, 5492.0, 5632.0, 5407.0, 5536.0, 5534.0, 5452.0, 5552.0, 5284.0, 5423.0, 5267.0, 5615.0, 5444.0, 5389.0, 5437.0, 5690.0, 5556.0, 5660.0, 5698.0, 5390.0, 5581.0, 5405.0, 5430.0, 5408.0, 5692.0, 5398.0, 5277.0, 5285.0, 5644.0, 5433.0, 5489.0, 5290.0, 5613.0, 5524.0, 5276.0, 5396.0, 5453.0, 5362.0, 5416.0, 5651.0, 5447.0, 5329.0, 5689.0, 5258.0, 5260.0, 5652.0, 5361.0, 5393.0, 5612.0, 5279.0, 5366.0, 5464.0, 5457.0, 5300.0, 5360.0, 5266.0, 5365.0, 5514.0, 5337.0, 5460.0, 5315.0, 5695.0, 5435.0, 5563.0, 5265.0, 5330.0, 5674.0, 5310.0, 5456.0, 5703.0, 5508.0, 5707.0 (number of hits: 13)
8	5530	9	1	333	1	5530.0, 5554.0, 5389.0, 5502.0, 5337.0, 5468.0, 5470.0, 5640.0, 5457.0, 5353.0, 5507.0, 5392.0, 5438.0, 5524.0, 5603.0, 5561.0, 5320.0, 5462.0, 5706.0, 5292.0, 5553.0, 5577.0, 5339.0, 5429.0, 5325.0, 5718.0, 5537.0, 5691.0, 5605.0, 5439.0, 5476.0, 5644.0, 5464.0, 5522.0, 5699.0, 5382.0, 5318.0, 5442.0, 5635.0, 5314.0, 5616.0, 5528.0, 5523.0, 5411.0, 5541.0, 5674.0, 5466.0, 5506.0, 5377.0, 5326.0, 5399.0, 5500.0, 5513.0, 5376.0, 5540.0, 5597.0, 5697.0, 5551.0, 5387.0, 5415.0, 5600.0, 5410.0, 5297.0, 5479.0, 5579.0, 5548.0, 5294.0, 5275.0, 5393.0, 5405.0, 5477.0, 5656.0, 5309.0, 5715.0, 5654.0, 5703.0, 5707.0, 5358.0, 5263.0, 5702.0, 5348.0, 5499.0, 5445.0, 5367.0, 5612.0, 5472.0, 5270.0, 5671.0, 5617.0, 5388.0, 5643.0, 5299.0, 5583.0, 5515.0, 5354.0, 5255.0, 5252.0, 5490.0, 5563.0, 5487.0 (number of hits: 22)
9	5530	9	1	333	1	5695.0, 5464.0, 5697.0, 5418.0, 5271.0, 5368.0, 5604.0, 5717.0, 5577.0, 5256.0, 5280.0, 5607.0, 5600.0, 5424.0, 5363.0, 5403.0, 5718.0, 5631.0, 5385.0, 5293.0,

						5467.0, 5459.0, 5453.0, 5722.0, 5308.0, 5549.0, 5497.0, 5294.0, 5367.0, 5388.0, 5609.0, 5492.0, 5640.0, 5391.0, 5431.0, 5349.0, 5648.0, 5395.0, 5441.0, 5540.0, 5328.0, 5685.0, 5350.0, 5645.0, 5523.0, 5522.0, 5691.0, 5566.0, 5361.0, 5296.0, 5438.0, 5503.0, 5430.0, 5608.0, 5479.0, 5286.0, 5629.0, 5284.0, 5410.0, 5302.0, 5458.0, 5484.0, 5326.0, 5671.0, 5287.0, 5594.0, 5333.0, 5657.0, 5380.0, 5580.0, 5531.0, 5660.0, 5298.0, 5396.0, 5663.0, 5603.0, 5612.0, 5476.0, 5583.0, 5589.0, 5386.0, 5508.0, 5689.0, 5355.0, 5541.0, 5596.0, 5506.0, 5636.0, 5309.0, 5699.0, 5268.0, 5331.0, 5617.0, 5416.0, 5342.0, 5387.0, 5590.0, 5561.0, 5398.0, 5440.0 (number of hits: 13)
10	5530	9	1	333	1	5300.0, 5324.0, 5531.0, 5575.0, 5516.0, 5492.0, 5345.0, 5577.0, 5348.0, 5276.0, 5403.0, 5517.0, 5579.0, 5416.0, 5529.0, 5543.0, 5635.0, 5633.0, 5550.0, 5687.0, 5302.0, 5414.0, 5562.0, 5648.0, 5456.0, 5512.0, 5402.0, 5583.0, 5714.0, 5409.0, 5460.0, 5445.0, 5471.0, 5542.0, 5279.0, 5336.0, 5487.0, 5384.0, 5277.0, 5431.0, 5314.0, 5485.0, 5615.0, 5454.0, 5678.0, 5551.0, 5359.0, 5589.0, 5388.0, 5333.0, 5475.0, 5636.0, 5672.0, 5478.0, 5621.0, 5680.0, 5437.0, 5614.0, 5588.0, 5651.0, 5375.0, 5701.0, 5532.0, 5383.0, 5308.0, 5392.0, 5266.0, 5483.0, 5720.0, 5399.0, 5439.0, 5709.0, 5696.0, 5688.0, 5510.0, 5369.0, 5361.0, 5515.0, 5511.0, 5257.0, 5498.0, 5406.0, 5567.0, 5299.0, 5580.0, 5639.0, 5554.0, 5318.0, 5283.0, 5463.0, 5433.0, 5534.0, 5428.0, 5655.0, 5642.0, 5679.0, 5452.0, 5578.0, 5582.0, 5563.0 (number of hits: 20)
11	5530	9	1	333	1	5636.0, 5421.0, 5501.0, 5271.0, 5290.0, 5541.0, 5380.0, 5587.0, 5315.0, 5680.0, 5522.0, 5719.0, 5706.0, 5704.0, 5453.0, 5569.0, 5603.0, 5335.0, 5648.0, 5547.0, 5598.0, 5504.0, 5368.0, 5337.0, 5524.0, 5322.0, 5447.0, 5400.0, 5633.0, 5268.0, 5259.0, 5510.0, 5445.0, 5420.0, 5485.0, 5439.0, 5404.0, 5428.0, 5481.0, 5451.0, 5573.0, 5273.0, 5495.0, 5560.0, 5558.0, 5281.0, 5359.0, 5662.0, 5585.0, 5483.0, 5386.0, 5460.0, 5499.0, 5631.0, 5469.0, 5480.0, 5351.0, 5294.0, 5675.0, 5493.0, 5622.0, 5550.0, 5342.0, 5473.0, 5357.0, 5494.0, 5528.0, 5647.0, 5601.0, 5440.0, 5476.0, 5503.0, 5667.0, 5416.0, 5441.0, 5426.0, 5317.0, 5681.0, 5526.0, 5576.0, 5638.0, 5619.0, 5472.0, 5658.0, 5575.0, 5356.0, 5432.0, 5540.0, 5507.0, 5298.0, 5559.0, 5539.0, 5552.0, 5419.0, 5250.0, 5372.0, 5444.0, 5604.0, 5379.0, 5618.0 (number of hits: 23)

12	5530	9	1	333	1	5689.0, 5516.0, 5691.0, 5306.0, 5360.0, 5266.0, 5570.0, 5480.0, 5343.0, 5503.0, 5705.0, 5276.0, 5257.0, 5615.0, 5484.0, 5356.0, 5710.0, 5562.0, 5384.0, 5644.0, 5595.0, 5466.0, 5579.0, 5511.0, 5402.0, 5671.0, 5577.0, 5273.0, 5378.0, 5464.0, 5406.0, 5645.0, 5443.0, 5618.0, 5285.0, 5334.0, 5704.0, 5448.0, 5483.0, 5660.0, 5543.0, 5323.0, 5369.0, 5613.0, 5541.0, 5326.0, 5349.0, 5528.0, 5390.0, 5662.0, 5501.0, 5716.0, 5711.0, 5647.0, 5307.0, 5552.0, 5352.0, 5322.0, 5463.0, 5305.0, 5690.0, 5462.0, 5600.0, 5582.0, 5330.0, 5508.0, 5401.0, 5339.0, 5574.0, 5498.0, 5361.0, 5287.0, 5623.0, 5431.0, 5629.0, 5537.0, 5534.0, 5551.0, 5527.0, 5422.0, 5469.0, 5265.0, 5260.0, 5655.0, 5664.0, 5455.0, 5493.0, 5668.0, 5296.0, 5496.0, 5310.0, 5592.0, 5321.0, 5510.0, 5642.0, 5609.0, 5338.0, 5488.0, 5663.0, 5631.0 (number of hits: 18)
13	5530	9	1	333	1	5716.0, 5357.0, 5559.0, 5285.0, 5317.0, 5385.0, 5477.0, 5563.0, 5704.0, 5424.0, 5548.0, 5608.0, 5573.0, 5558.0, 5366.0, 5683.0, 5544.0, 5250.0, 5534.0, 5255.0, 5275.0, 5516.0, 5351.0, 5254.0, 5676.0, 5567.0, 5310.0, 5333.0, 5646.0, 5632.0, 5607.0, 5490.0, 5639.0, 5561.0, 5344.0, 5288.0, 5698.0, 5578.0, 5267.0, 5531.0, 5541.0, 5420.0, 5412.0, 5293.0, 5336.0, 5670.0, 5319.0, 5549.0, 5282.0, 5718.0, 5566.0, 5284.0, 5700.0, 5503.0, 5365.0, 5364.0, 5324.0, 5580.0, 5325.0, 5592.0, 5675.0, 5362.0, 5555.0, 5345.0, 5574.0, 5538.0, 5523.0, 5657.0, 5497.0, 5404.0, 5533.0, 5622.0, 5665.0, 5530.0, 5447.0, 5423.0, 5402.0, 5419.0, 5553.0, 5631.0, 5542.0, 5679.0, 5403.0, 5378.0, 5717.0, 5721.0, 5583.0, 5500.0, 5641.0, 5253.0, 5589.0, 5601.0, 5276.0, 5371.0, 5618.0, 5358.0, 5308.0, 5605.0, 5427.0, 5709.0 (number of hits: 24)
14	5530	9	1	333	1	5461.0, 5317.0, 5388.0, 5440.0, 5436.0, 5323.0, 5417.0, 5647.0, 5692.0, 5449.0, 5614.0, 5664.0, 5593.0, 5303.0, 5442.0, 5633.0, 5561.0, 5476.0, 5458.0, 5624.0, 5454.0, 5582.0, 5330.0, 5282.0, 5724.0, 5447.0, 5653.0, 5720.0, 5714.0, 5655.0, 5667.0, 5400.0, 5577.0, 5703.0, 5437.0, 5446.0, 5486.0, 5464.0, 5339.0, 5537.0, 5295.0, 5602.0, 5404.0, 5550.0, 5421.0, 5515.0, 5547.0, 5423.0, 5712.0, 5477.0, 5581.0, 5600.0, 5294.0, 5497.0, 5289.0, 5316.0, 5705.0, 5346.0, 5276.0, 5621.0, 5611.0, 5283.0, 5695.0, 5558.0, 5590.0, 5672.0, 5721.0, 5698.0, 5413.0, 5506.0, 5689.0, 5364.0, 5683.0, 5648.0, 5573.0, 5645.0, 5574.0, 5606.0, 5366.0, 5682.0, 5535.0, 5638.0, 5618.0, 5280.0, 5407.0,

						5269.0, 5548.0, 5386.0, 5465.0, 5533.0, 5403.0, 5687.0, 5499.0, 5557.0, 5519.0, 5709.0, 5332.0, 5517.0, 5281.0, 5524.0 (number of hits: 16)
15	5530	9	1	333	1	5378.0, 5372.0, 5563.0, 5558.0, 5484.0, 5307.0, 5421.0, 5560.0, 5330.0, 5319.0, 5710.0, 5538.0, 5481.0, 5500.0, 5561.0, 5262.0, 5258.0, 5405.0, 5420.0, 5652.0, 5443.0, 5476.0, 5676.0, 5274.0, 5589.0, 5674.0, 5285.0, 5432.0, 5548.0, 5597.0, 5631.0, 5566.0, 5564.0, 5448.0, 5332.0, 5343.0, 5551.0, 5339.0, 5544.0, 5291.0, 5635.0, 5671.0, 5328.0, 5436.0, 5574.0, 5395.0, 5718.0, 5519.0, 5259.0, 5447.0, 5388.0, 5254.0, 5645.0, 5313.0, 5428.0, 5689.0, 5639.0, 5398.0, 5703.0, 5479.0, 5312.0, 5577.0, 5260.0, 5408.0, 5504.0, 5296.0, 5368.0, 5401.0, 5515.0, 5357.0, 5437.0, 5547.0, 5552.0, 5266.0, 5572.0, 5525.0, 5667.0, 5655.0, 5275.0, 5255.0, 5310.0, 5299.0, 5264.0, 5344.0, 5658.0, 5543.0, 5435.0, 5468.0, 5660.0, 5440.0, 5422.0, 5583.0, 5354.0, 5615.0, 5351.0, 5305.0, 5678.0, 5646.0, 5677.0, 5279.0 (number of hits: 18)
16	5530	9	1	333	1	5628.0, 5666.0, 5363.0, 5466.0, 5625.0, 5327.0, 5660.0, 5530.0, 5590.0, 5561.0, 5711.0, 5537.0, 5586.0, 5482.0, 5534.0, 5287.0, 5540.0, 5259.0, 5415.0, 5512.0, 5538.0, 5474.0, 5308.0, 5343.0, 5272.0, 5616.0, 5503.0, 5697.0, 5424.0, 5627.0, 5597.0, 5467.0, 5448.0, 5318.0, 5667.0, 5325.0, 5596.0, 5274.0, 5377.0, 5279.0, 5686.0, 5425.0, 5626.0, 5594.0, 5428.0, 5564.0, 5320.0, 5556.0, 5565.0, 5656.0, 5342.0, 5402.0, 5618.0, 5278.0, 5324.0, 5520.0, 5504.0, 5668.0, 5314.0, 5582.0, 5285.0, 5290.0, 5409.0, 5692.0, 5698.0, 5689.0, 5292.0, 5719.0, 5438.0, 5500.0, 5495.0, 5673.0, 5638.0, 5588.0, 5678.0, 5405.0, 5449.0, 5595.0, 5347.0, 5712.0, 5619.0, 5391.0, 5340.0, 5326.0, 5523.0, 5681.0, 5379.0, 5458.0, 5315.0, 5536.0, 5491.0, 5675.0, 5338.0, 5362.0, 5704.0, 5571.0, 5481.0, 5349.0, 5653.0, 5432.0 (number of hits: 18)
17	5530	9	1	333	1	5403.0, 5353.0, 5432.0, 5558.0, 5622.0, 5595.0, 5266.0, 5581.0, 5341.0, 5578.0, 5442.0, 5630.0, 5301.0, 5477.0, 5546.0, 5537.0, 5591.0, 5441.0, 5458.0, 5719.0, 5709.0, 5349.0, 5329.0, 5285.0, 5406.0, 5648.0, 5294.0, 5678.0, 5577.0, 5489.0, 5260.0, 5667.0, 5632.0, 5547.0, 5481.0, 5300.0, 5651.0, 5417.0, 5582.0, 5293.0, 5460.0, 5684.0, 5653.0, 5606.0, 5610.0, 5450.0, 5485.0, 5446.0, 5556.0, 5718.0, 5277.0, 5324.0, 5317.0, 5468.0, 5605.0, 5361.0, 5567.0, 5670.0, 5280.0, 5543.0, 5326.0, 5493.0, 5683.0, 5616.0, 5385.0,

						5472.0, 5620.0, 5509.0, 5491.0, 5701.0, 5351.0, 5366.0, 5697.0, 5594.0, 5303.0, 5414.0, 5529.0, 5445.0, 5470.0, 5328.0, 5645.0, 5400.0, 5253.0, 5619.0, 5307.0, 5310.0, 5250.0, 5512.0, 5515.0, 5550.0, 5405.0, 5410.0, 5723.0, 5270.0, 5538.0, 5261.0, 5694.0, 5503.0, 5492.0, 5483.0 (number of hits: 17)
18	5530	9	1	333	1	5701.0, 5493.0, 5553.0, 5668.0, 5489.0, 5628.0, 5681.0, 5290.0, 5539.0, 5550.0, 5608.0, 5687.0, 5684.0, 5484.0, 5406.0, 5422.0, 5486.0, 5471.0, 5405.0, 5261.0, 5309.0, 5670.0, 5285.0, 5320.0, 5607.0, 5335.0, 5702.0, 5358.0, 5587.0, 5434.0, 5661.0, 5346.0, 5388.0, 5431.0, 5270.0, 5650.0, 5551.0, 5293.0, 5632.0, 5499.0, 5570.0, 5418.0, 5511.0, 5559.0, 5676.0, 5385.0, 5652.0, 5349.0, 5501.0, 5477.0, 5408.0, 5444.0, 5494.0, 5425.0, 5430.0, 5281.0, 5433.0, 5453.0, 5383.0, 5636.0, 5618.0, 5361.0, 5464.0, 5662.0, 5357.0, 5555.0, 5289.0, 5548.0, 5504.0, 5674.0, 5312.0, 5402.0, 5313.0, 5341.0, 5251.0, 5256.0, 5528.0, 5296.0, 5682.0, 5279.0, 5546.0, 5258.0, 5601.0, 5622.0, 5338.0, 5720.0, 5267.0, 5598.0, 5345.0, 5714.0, 5593.0, 5708.0, 5299.0, 5533.0, 5669.0, 5545.0, 5384.0, 5690.0, 5273.0, 5706.0 (number of hits: 17)
19	5530	9	1	333	1	5546.0, 5691.0, 5300.0, 5609.0, 5553.0, 5584.0, 5567.0, 5594.0, 5399.0, 5688.0, 5501.0, 5483.0, 5325.0, 5693.0, 5577.0, 5560.0, 5690.0, 5460.0, 5348.0, 5361.0, 5258.0, 5396.0, 5576.0, 5599.0, 5559.0, 5524.0, 5673.0, 5320.0, 5504.0, 5313.0, 5496.0, 5468.0, 5705.0, 5513.0, 5500.0, 5343.0, 5341.0, 5561.0, 5635.0, 5255.0, 5330.0, 5456.0, 5580.0, 5467.0, 5303.0, 5723.0, 5427.0, 5499.0, 5452.0, 5284.0, 5332.0, 5391.0, 5568.0, 5355.0, 5299.0, 5622.0, 5695.0, 5444.0, 5684.0, 5652.0, 5392.0, 5470.0, 5401.0, 5509.0, 5668.0, 5347.0, 5624.0, 5543.0, 5424.0, 5571.0, 5491.0, 5661.0, 5390.0, 5380.0, 5443.0, 5433.0, 5405.0, 5522.0, 5422.0, 5564.0, 5272.0, 5716.0, 5476.0, 5294.0, 5636.0, 5415.0, 5383.0, 5680.0, 5290.0, 5539.0, 5660.0, 5554.0, 5336.0, 5484.0, 5381.0, 5301.0, 5521.0, 5591.0, 5551.0, 5646.0 (number of hits: 23)
20	5530	9	1	333	1	5325.0, 5350.0, 5698.0, 5511.0, 5584.0, 5390.0, 5336.0, 5723.0, 5281.0, 5722.0, 5629.0, 5364.0, 5420.0, 5347.0, 5553.0, 5711.0, 5650.0, 5413.0, 5593.0, 5459.0, 5272.0, 5338.0, 5648.0, 5460.0, 5536.0, 5646.0, 5513.0, 5530.0, 5452.0, 5348.0, 5312.0, 5678.0, 5409.0, 5677.0, 5456.0, 5562.0, 5670.0, 5571.0, 5547.0, 5684.0, 5702.0, 5626.0, 5514.0, 5716.0, 5581.0,

						5291.0, 5563.0, 5467.0, 5518.0, 5344.0, 5524.0, 5319.0, 5704.0, 5502.0, 5282.0, 5384.0, 5596.0, 5274.0, 5649.0, 5483.0, 5267.0, 5474.0, 5523.0, 5627.0, 5510.0, 5439.0, 5586.0, 5591.0, 5387.0, 5298.0, 5431.0, 5500.0, 5341.0, 5340.0, 5352.0, 5392.0, 5429.0, 5585.0, 5613.0, 5605.0, 5656.0, 5564.0, 5583.0, 5402.0, 5476.0, 5447.0, 5636.0, 5540.0, 5362.0, 5354.0, 5397.0, 5361.0, 5411.0, 5517.0, 5533.0, 5611.0, 5693.0, 5333.0, 5526.0, 5660.0 (number of hits: 20)
21	5530	9	1	333	1	5335.0, 5355.0, 5325.0, 5485.0, 5347.0, 5554.0, 5484.0, 5539.0, 5392.0, 5603.0, 5490.0, 5622.0, 5569.0, 5694.0, 5612.0, 5312.0, 5660.0, 5503.0, 5353.0, 5336.0, 5358.0, 5357.0, 5557.0, 5499.0, 5680.0, 5364.0, 5646.0, 5693.0, 5690.0, 5400.0, 5608.0, 5369.0, 5265.0, 5527.0, 5418.0, 5706.0, 5607.0, 5548.0, 5407.0, 5256.0, 5532.0, 5487.0, 5329.0, 5506.0, 5362.0, 5363.0, 5501.0, 5641.0, 5395.0, 5401.0, 5343.0, 5606.0, 5530.0, 5372.0, 5516.0, 5469.0, 5422.0, 5558.0, 5394.0, 5549.0, 5371.0, 5596.0, 5296.0, 5406.0, 5665.0, 5266.0, 5550.0, 5289.0, 5450.0, 5567.0, 5308.0, 5433.0, 5324.0, 5586.0, 5519.0, 5253.0, 5533.0, 5566.0, 5327.0, 5448.0, 5290.0, 5420.0, 5280.0, 5474.0, 5719.0, 5396.0, 5559.0, 5345.0, 5397.0, 5291.0, 5581.0, 5609.0, 5272.0, 5442.0, 5382.0, 5451.0, 5491.0, 5724.0, 5552.0, 5652.0 (number of hits: 24)
22	5530	9	1	333	1	5656.0, 5456.0, 5405.0, 5551.0, 5516.0, 5620.0, 5425.0, 5538.0, 5293.0, 5371.0, 5270.0, 5629.0, 5598.0, 5590.0, 5628.0, 5442.0, 5314.0, 5661.0, 5605.0, 5376.0, 5380.0, 5385.0, 5546.0, 5701.0, 5569.0, 5722.0, 5393.0, 5580.0, 5331.0, 5597.0, 5335.0, 5599.0, 5585.0, 5640.0, 5622.0, 5266.0, 5576.0, 5282.0, 5366.0, 5436.0, 5330.0, 5452.0, 5272.0, 5611.0, 5703.0, 5663.0, 5565.0, 5428.0, 5356.0, 5446.0, 5508.0, 5382.0, 5337.0, 5302.0, 5706.0, 5297.0, 5367.0, 5370.0, 5251.0, 5252.0, 5261.0, 5503.0, 5267.0, 5480.0, 5383.0, 5328.0, 5312.0, 5652.0, 5529.0, 5658.0, 5514.0, 5536.0, 5326.0, 5485.0, 5572.0, 5379.0, 5307.0, 5489.0, 5487.0, 5681.0, 5401.0, 5555.0, 5351.0, 5477.0, 5526.0, 5377.0, 5540.0, 5618.0, 5568.0, 5678.0, 5531.0, 5530.0, 5549.0, 5473.0, 5339.0, 5361.0, 5685.0, 5403.0, 5497.0, 5437.0 (number of hits: 19)
23	5530	9	1	333	1	5380.0, 5310.0, 5563.0, 5418.0, 5405.0, 5340.0, 5644.0, 5454.0, 5324.0, 5263.0, 5515.0, 5323.0, 5382.0, 5402.0, 5262.0, 5441.0, 5678.0, 5459.0, 5538.0, 5642.0, 5551.0, 5468.0, 5582.0, 5417.0, 5381.0

						5509.0, 5658.0, 5671.0, 5709.0, 5701.0, 5724.0, 5304.0, 5377.0, 5663.0, 5524.0, 5518.0, 5722.0, 5549.0, 5507.0, 5384.0, 5506.0, 5312.0, 5514.0, 5489.0, 5299.0, 5368.0, 5617.0, 5434.0, 5388.0, 5715.0, 5333.0, 5261.0, 5403.0, 5372.0, 5292.0, 5415.0, 5630.0, 5661.0, 5553.0, 5375.0, 5557.0, 5635.0, 5439.0, 5502.0, 5442.0, 5276.0, 5306.0, 5660.0, 5696.0, 5627.0, 5599.0, 5654.0, 5558.0, 5650.0, 5376.0, 5580.0, 5572.0, 5513.0, 5452.0, 5498.0, 5270.0, 5272.0, 5657.0, 5320.0, 5552.0, 5694.0, 5540.0, 5334.0, 5283.0, 5326.0, 5332.0, 5640.0, 5564.0, 5543.0, 5311.0, 5653.0, 5255.0, 5669.0, 5708.0, 5264.0 (number of hits: 21)
24	5530	9	1	333	1	5481.0, 5407.0, 5652.0, 5359.0, 5622.0, 5254.0, 5427.0, 5699.0, 5354.0, 5281.0, 5583.0, 5488.0, 5404.0, 5586.0, 5384.0, 5498.0, 5569.0, 5439.0, 5695.0, 5282.0, 5617.0, 5380.0, 5311.0, 5679.0, 5331.0, 5599.0, 5718.0, 5300.0, 5395.0, 5643.0, 5559.0, 5356.0, 5317.0, 5510.0, 5577.0, 5670.0, 5667.0, 5358.0, 5598.0, 5669.0, 5459.0, 5472.0, 5634.0, 5604.0, 5429.0, 5525.0, 5468.0, 5690.0, 5487.0, 5458.0, 5268.0, 5505.0, 5286.0, 5575.0, 5447.0, 5476.0, 5661.0, 5513.0, 5521.0, 5302.0, 5258.0, 5544.0, 5434.0, 5452.0, 5570.0, 5325.0, 5552.0, 5653.0, 5310.0, 5438.0, 5251.0, 5658.0, 5339.0, 5584.0, 5403.0, 5349.0, 5628.0, 5655.0, 5674.0, 5675.0, 5277.0, 5549.0, 5486.0, 5715.0, 5638.0, 5631.0, 5684.0, 5659.0, 5260.0, 5265.0, 5315.0, 5561.0, 5623.0, 5590.0, 5385.0, 5416.0, 5554.0, 5270.0, 5482.0, 5691.0 (number of hits: 13)
25	5530	9	1	333	1	5470.0, 5275.0, 5560.0, 5251.0, 5421.0, 5599.0, 5416.0, 5441.0, 5586.0, 5539.0, 5693.0, 5306.0, 5290.0, 5329.0, 5581.0, 5394.0, 5434.0, 5724.0, 5282.0, 5585.0, 5649.0, 5618.0, 5296.0, 5572.0, 5278.0, 5595.0, 5589.0, 5335.0, 5458.0, 5466.0, 5429.0, 5655.0, 5426.0, 5562.0, 5267.0, 5366.0, 5661.0, 5352.0, 5538.0, 5374.0, 5389.0, 5482.0, 5445.0, 5556.0, 5500.0, 5399.0, 5334.0, 5405.0, 5678.0, 5519.0, 5372.0, 5431.0, 5668.0, 5461.0, 5628.0, 5614.0, 5386.0, 5375.0, 5535.0, 5665.0, 5546.0, 5709.0, 5638.0, 5569.0, 5605.0, 5257.0, 5492.0, 5436.0, 5390.0, 5496.0, 5344.0, 5359.0, 5670.0, 5715.0, 5317.0, 5430.0, 5487.0, 5510.0, 5512.0, 5379.0, 5553.0, 5387.0, 5272.0, 5613.0, 5708.0, 5346.0, 5381.0, 5653.0, 5450.0, 5675.0, 5488.0, 5327.0, 5271.0, 5277.0, 5261.0, 5401.0, 5393.0, 5590.0, 5623.0, 5706.0 (number of hits: 15)
26	5530	9	1	333	1	5550.0, 5368.0, 5494.0, 5626.0, 5683.0,

						5452.0, 5324.0, 5706.0, 5347.0, 5519.0, 5499.0, 5484.0, 5286.0, 5333.0, 5445.0, 5402.0, 5599.0, 5413.0, 5616.0, 5306.0, 5298.0, 5424.0, 5608.0, 5316.0, 5361.0, 5642.0, 5707.0, 5389.0, 5502.0, 5506.0, 5438.0, 5327.0, 5643.0, 5627.0, 5705.0, 5579.0, 5714.0, 5526.0, 5437.0, 5304.0, 5678.0, 5552.0, 5594.0, 5282.0, 5311.0, 5492.0, 5606.0, 5257.0, 5641.0, 5423.0, 5302.0, 5517.0, 5670.0, 5356.0, 5528.0, 5351.0, 5563.0, 5645.0, 5534.0, 5354.0, 5658.0, 5593.0, 5400.0, 5404.0, 5300.0, 5591.0, 5319.0, 5463.0, 5546.0, 5442.0, 5604.0, 5475.0, 5549.0, 5698.0, 5264.0, 5496.0, 5390.0, 5325.0, 5268.0, 5588.0, 5338.0, 5469.0, 5713.0, 5595.0, 5618.0, 5416.0, 5451.0, 5644.0, 5299.0, 5414.0, 5721.0, 5505.0, 5501.0, 5565.0, 5649.0, 5441.0, 5432.0, 5380.0, 5515.0, 5461.0 (number of hits: 20)
27	5530	9	1	333	1	5264.0, 5598.0, 5280.0, 5311.0, 5475.0, 5253.0, 5452.0, 5418.0, 5580.0, 5307.0, 5642.0, 5332.0, 5620.0, 5420.0, 5295.0, 5496.0, 5708.0, 5411.0, 5536.0, 5373.0, 5391.0, 5390.0, 5644.0, 5600.0, 5333.0, 5365.0, 5515.0, 5673.0, 5282.0, 5645.0, 5560.0, 5669.0, 5613.0, 5442.0, 5471.0, 5300.0, 5376.0, 5395.0, 5278.0, 5424.0, 5535.0, 5505.0, 5651.0, 5641.0, 5609.0, 5585.0, 5380.0, 5638.0, 5633.0, 5392.0, 5687.0, 5383.0, 5431.0, 5352.0, 5649.0, 5325.0, 5438.0, 5423.0, 5473.0, 5449.0, 5313.0, 5326.0, 5694.0, 5266.0, 5482.0, 5263.0, 5543.0, 5617.0, 5437.0, 5274.0, 5506.0, 5338.0, 5549.0, 5503.0, 5546.0, 5676.0, 5404.0, 5635.0, 5606.0, 5402.0, 5480.0, 5655.0, 5435.0, 5716.0, 5292.0, 5621.0, 5719.0, 5491.0, 5462.0, 5468.0, 5405.0, 5665.0, 5495.0, 5407.0, 5497.0, 5444.0, 5399.0, 5723.0, 5348.0, 5594.0 (number of hits: 14)
28	5530	9	1	333	1	5599.0, 5534.0, 5698.0, 5529.0, 5666.0, 5646.0, 5334.0, 5455.0, 5328.0, 5563.0, 5549.0, 5509.0, 5408.0, 5276.0, 5470.0, 5604.0, 5657.0, 5337.0, 5380.0, 5500.0, 5680.0, 5422.0, 5708.0, 5671.0, 5626.0, 5507.0, 5395.0, 5678.0, 5651.0, 5332.0, 5668.0, 5310.0, 5623.0, 5542.0, 5645.0, 5377.0, 5477.0, 5577.0, 5672.0, 5693.0, 5538.0, 5591.0, 5424.0, 5533.0, 5697.0, 5480.0, 5688.0, 5296.0, 5550.0, 5309.0, 5343.0, 5317.0, 5287.0, 5629.0, 5482.0, 5637.0, 5388.0, 5295.0, 5665.0, 5433.0, 5704.0, 5463.0, 5283.0, 5718.0, 5353.0, 5560.0, 5251.0, 5469.0, 5297.0, 5461.0, 5308.0, 5631.0, 5634.0, 5675.0, 5501.0, 5400.0, 5301.0, 5457.0, 5502.0, 5588.0, 5259.0, 5709.0, 5253.0, 5445.0, 5561.0, 5508.0, 5586.0, 5580.0, 5404.0, 5493.0

						5544.0, 5280.0, 5521.0, 5510.0, 5269.0, 5485.0, 5685.0, 5653.0, 5600.0, 5686.0 (number of hits: 20)
29	5530	9	1	333	1	5584.0, 5458.0, 5395.0, 5682.0, 5346.0, 5570.0, 5689.0, 5452.0, 5714.0, 5258.0, 5400.0, 5579.0, 5381.0, 5484.0, 5437.0, 5619.0, 5502.0, 5652.0, 5524.0, 5468.0, 5636.0, 5382.0, 5306.0, 5379.0, 5391.0, 5364.0, 5294.0, 5623.0, 5396.0, 5369.0, 5505.0, 5498.0, 5506.0, 5604.0, 5339.0, 5556.0, 5322.0, 5427.0, 5510.0, 5513.0, 5621.0, 5643.0, 5553.0, 5603.0, 5389.0, 5624.0, 5719.0, 5535.0, 5292.0, 5625.0, 5367.0, 5295.0, 5401.0, 5253.0, 5572.0, 5372.0, 5574.0, 5490.0, 5477.0, 5545.0, 5573.0, 5610.0, 5616.0, 5378.0, 5536.0, 5320.0, 5713.0, 5327.0, 5375.0, 5517.0, 5481.0, 5310.0, 5348.0, 5633.0, 5366.0, 5589.0, 5485.0, 5527.0, 5675.0, 5387.0, 5252.0, 5720.0, 5580.0, 5393.0, 5470.0, 5575.0, 5640.0, 5653.0, 5637.0, 5549.0, 5363.0, 5555.0, 5700.0, 5543.0, 5439.0, 5599.0, 5431.0, 5540.0, 5686.0, 5697.0 (number of hits: 19)
30	5530	9	1	333	1	5506.0, 5279.0, 5618.0, 5669.0, 5496.0, 5445.0, 5715.0, 5382.0, 5442.0, 5666.0, 5475.0, 5404.0, 5483.0, 5429.0, 5547.0, 5417.0, 5620.0, 5502.0, 5463.0, 5588.0, 5289.0, 5288.0, 5626.0, 5560.0, 5590.0, 5362.0, 5337.0, 5594.0, 5591.0, 5397.0, 5305.0, 5280.0, 5473.0, 5623.0, 5511.0, 5414.0, 5311.0, 5675.0, 5343.0, 5698.0, 5286.0, 5576.0, 5357.0, 5336.0, 5402.0, 5396.0, 5395.0, 5394.0, 5621.0, 5378.0, 5572.0, 5304.0, 5517.0, 5671.0, 5559.0, 5486.0, 5524.0, 5299.0, 5353.0, 5563.0, 5360.0, 5707.0, 5380.0, 5656.0, 5664.0, 5581.0, 5640.0, 5538.0, 5697.0, 5278.0, 5255.0, 5368.0, 5262.0, 5492.0, 5271.0, 5391.0, 5631.0, 5383.0, 5424.0, 5532.0, 5303.0, 5490.0, 5562.0, 5660.0, 5717.0, 5481.0, 5406.0, 5579.0, 5295.0, 5584.0, 5352.0, 5636.0, 5425.0, 5326.0, 5587.0, 5625.0, 5712.0, 5284.0, 5458.0, 5331.0 (number of hits: 15)

10 Exhibit A – Test Setup Photographs

10.1 DFS Test Setup View

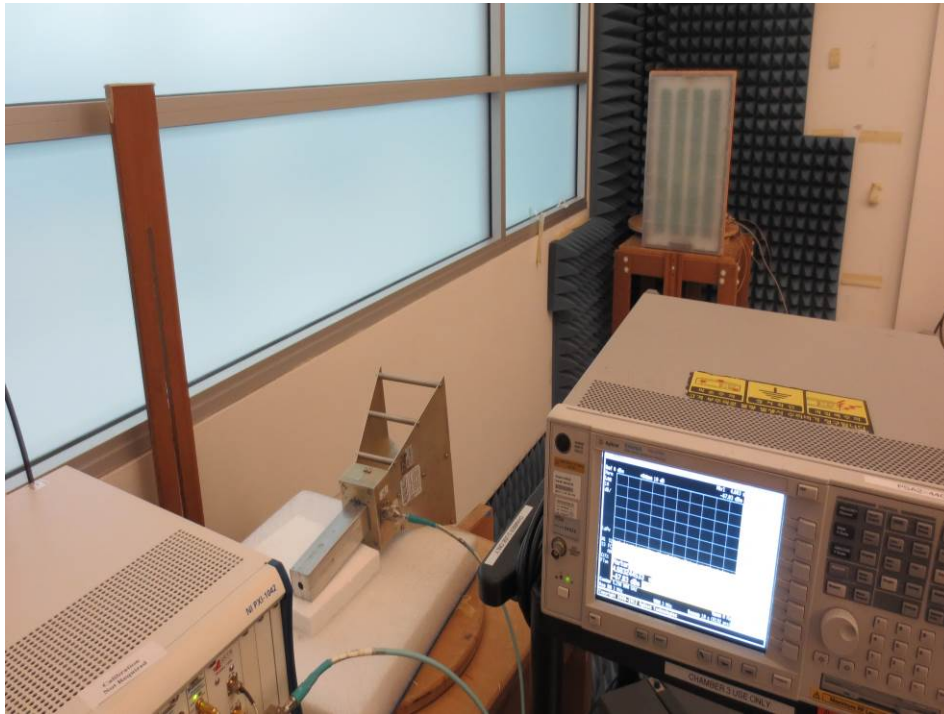

11 Exhibit B – EUT Photographs

11.1 EUT – Top View



11.2 EUT – Bottom View

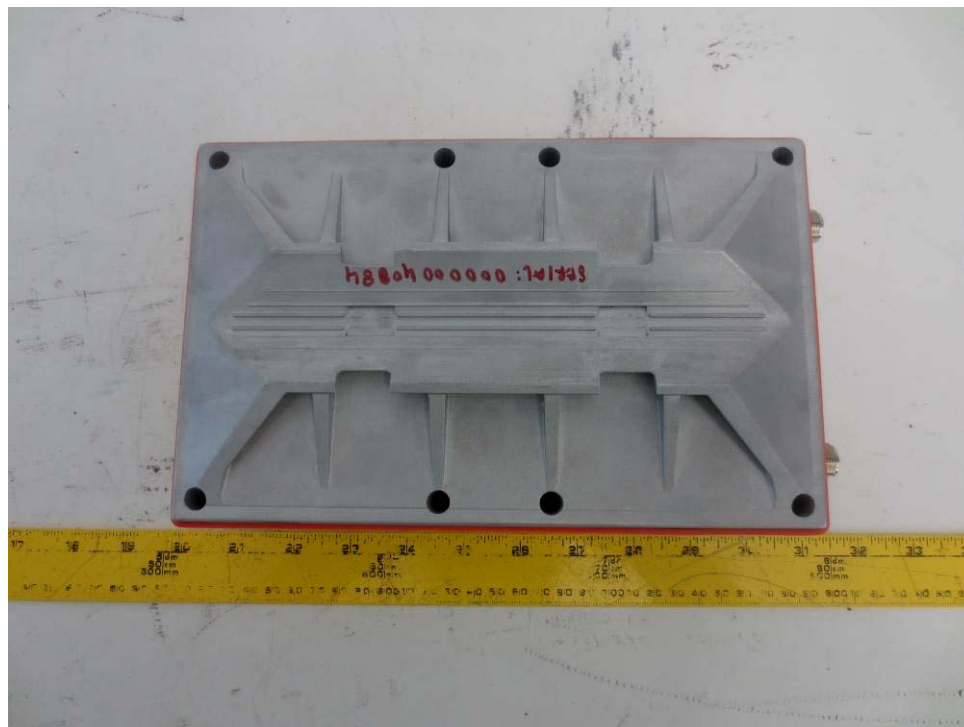

11.3 EUT – Side View



11.4 0 dBi Antenna View



11.5 25 dBi Antenna View



11.6 EUT – POE Top View



--- END OF REPORT ---