





FCC PART 15.407  
TEST AND MEASUREMENT REPORT

For

**Mimosa Networks**

300 Orchard City Dr., Suite 100,  
Campbell, CA 95008, USA

**FCC ID: 2ABZJ-100-00014**

<b>Report Type:</b> Original Report	<b>Product Type:</b> Point-to-Point Device
<b>Prepared By</b> Cipher Chu	
<b>Report Number</b> R1404042-407 W52 W58	
<b>Report Date</b> 2014-08-12	
<b>Reviewed By</b> Bo Li Test Engineer	
Bay Area Compliance Laboratories Corp. 1274 Anvilwood Avenue, Sunnyvale, CA 94089, USA Tel: (408) 732-9162 Fax: (408) 732-9164	

**Note:** This test report is prepared for the customer shown above and for the device described herein. It may not be duplicated or used in part without prior written consent from Bay Area Compliance Laboratories Corp. This report **must not** be used by the customer to claim product certification, approval, or endorsement by A2LA\* or any agency of the Federal Government.

\* This report may contain data that are not covered by the A2LA accreditation and are marked with an asterisk "\*" 08-13

## TABLE OF CONTENTS

<b>1</b>	<b>GENERAL DESCRIPTION.....</b>	<b>6</b>
1.1	PRODUCT DESCRIPTION FOR EQUIPMENT UNDER TEST (EUT).....	6
1.2	MECHANICAL DESCRIPTION OF EUT.....	6
1.3	OBJECTIVE.....	6
1.4	RELATED SUBMITTAL(S)/GRANT(S).....	6
1.5	TEST METHODOLOGY.....	6
1.6	MEASUREMENT UNCERTAINTY.....	6
1.7	TEST FACILITY.....	7
<b>2</b>	<b>EUT TEST CONFIGURATION.....</b>	<b>8</b>
2.1	JUSTIFICATION.....	8
2.2	EUT EXERCISE SOFTWARE.....	8
2.3	EQUIPMENT MODIFICATIONS.....	8
2.4	SPECIAL ACCESSORIES.....	8
2.5	LOCAL SUPPORT EQUIPMENT.....	8
2.6	INTERFACE PORTS AND CABLING.....	8
2.7	POWER SUPPLY AND LINE FILTERS.....	8
2.8	EUT INTERNAL CONFIGURATIONS.....	9
<b>3</b>	<b>SUMMARY OF TEST RESULTS.....</b>	<b>10</b>
<b>4</b>	<b>FCC §15.407(F) &amp; §2.1091 - RF EXPOSURE.....</b>	<b>11</b>
4.1	APPLICABLE STANDARD.....	11
4.2	MPE PREDICTION.....	11
4.3	MPE RESULTS.....	11
<b>5</b>	<b>FCC §15.203 – ANTENNA REQUIREMENTS.....</b>	<b>13</b>
5.1	APPLICABLE STANDARD.....	13
5.2	ANTENNA LIST.....	13
<b>6</b>	<b>FCC §15.207 - AC POWER LINE CONDUCTED EMISSIONS.....</b>	<b>14</b>
6.1	APPLICABLE STANDARDS.....	14
6.2	TEST SETUP.....	14
6.3	TEST PROCEDURE.....	14
6.4	TEST SETUP BLOCK DIAGRAM.....	15
6.5	CORRECTED AMPLITUDE & MARGIN CALCULATION.....	15
6.6	TEST EQUIPMENT LIST AND DETAILS.....	16
6.7	TEST ENVIRONMENTAL CONDITIONS.....	16
6.8	SUMMARY OF TEST RESULTS.....	16
6.9	CONDUCTED EMISSIONS TEST PLOTS AND DATA.....	17
<b>7</b>	<b>FCC §15.209 &amp; §15.407(B) - SPURIOUS RADIATED EMISSIONS AND OUT OF BAND EMISSIONS.....</b>	<b>19</b>
7.1	APPLICABLE STANDARD.....	19
7.2	TEST SETUP.....	20
7.3	TEST PROCEDURE.....	20
7.4	CORRECTED AMPLITUDE & MARGIN CALCULATION.....	21
7.5	TEST EQUIPMENT LIST AND DETAILS.....	21
7.6	TEST ENVIRONMENTAL CONDITIONS.....	21
7.7	SUMMARY OF TEST RESULTS.....	22
7.8	RADIATED EMISSIONS TEST DATA AND PLOTS.....	23
<b>8</b>	<b>FCC §15.407(A) &amp; §15.407(E) – EMISSION BANDWIDTH.....</b>	<b>50</b>

8.1	APPLICABLE STANDARD .....	50
8.2	MEASUREMENT PROCEDURE .....	50
8.3	TEST EQUIPMENT LIST AND DETAILS .....	50
8.4	TEST ENVIRONMENTAL CONDITIONS.....	50
8.5	TEST RESULTS .....	50
<b>9</b>	<b>FCC §15.407(A)(1) &amp; §15.407 (A)(3) - OUTPUT POWER.....</b>	<b>91</b>
9.1	APPLICABLE STANDARDS .....	91
9.2	MEASUREMENT PROCEDURE .....	91
9.3	TEST EQUIPMENT LIST AND DETAILS .....	91
9.4	TEST ENVIRONMENTAL CONDITIONS.....	92
9.5	TEST RESULTS .....	92
<b>10</b>	<b>FCC §15.407(B) - OUT OF BAND EMISSIONS.....</b>	<b>96</b>
10.1	APPLICABLE STANDARD .....	96
10.2	MEASUREMENT PROCEDURE .....	96
10.3	TEST EQUIPMENT LIST AND DETAILS .....	96
10.4	TEST ENVIRONMENTAL CONDITIONS.....	96
10.5	TEST RESULTS .....	97
<b>11</b>	<b>FCC §15.407(A)(1) &amp; (A)(3)- POWER SPECTRAL DENSITY .....</b>	<b>136</b>
11.1	APPLICABLE STANDARD .....	136
11.2	MEASUREMENT PROCEDURE .....	136
11.3	TEST EQUIPMENT LIST AND DETAILS .....	136
11.4	TEST ENVIRONMENTAL CONDITIONS.....	137
11.5	TEST RESULTS .....	137
<b>12</b>	<b>FCC §15.407(B) - SPURIOUS EMISSIONS AT ANTENNA TERMINALS .....</b>	<b>177</b>
12.1	APPLICABLE STANDARD .....	177
12.2	MEASUREMENT PROCEDURE .....	177
12.3	TEST EQUIPMENT LIST AND DETAILS .....	177
12.4	TEST ENVIRONMENTAL CONDITIONS.....	177
12.5	TEST RESULTS .....	177
<b>13</b>	<b>EXHIBIT A – FCC EQUIPMENT LABELLING REQUIREMENTS .....</b>	<b>250</b>
13.1	FCC ID LABEL REQUIREMENTS .....	250
13.2	FCC ID LABEL CONTENTS AND LOCATION .....	250
<b>14</b>	<b>EXHIBIT B - EUT SETUP PHOTOGRAPHS .....</b>	<b>252</b>
14.1	RADIATED EMISSION - BELOW 1 GHz FRONT VIEW-25 dBi ANTENNA.....	252
14.2	RADIATED EMISSION - BELOW 1 GHz FRONT VIEW-0 dBi ANTENNA.....	252
14.3	RADIATED EMISSION - BELOW 1 GHz REAR VIEW .....	253
14.4	RADIATED EMISSION - ABOVE 1 GHz FRONT VIEW- 25 dBi ANTENNA .....	253
14.5	RADIATED EMISSION - ABOVE 1 GHz REAR VIEW-25 dBi ANTENNA .....	254
14.6	RADIATED EMISSION - ABOVE 1 GHz FRONT VIEW-0 dBi ANTENNA .....	254
14.7	RADIATED EMISSION - ABOVE 1 GHz REAR VIEW -0 dBi ANTENNA .....	255
14.8	AC LINE CONDUCTED EMISSIONS - FRONT VIEW-25 dBi ANTENNA .....	255
14.9	AC LINE CONDUCTED EMISSIONS - SIDE VIEW -25 dBi ANTENNA.....	256
14.10	AC LINE CONDUCTED EMISSIONS - FRONT VIEW -0 dBi ANTENNA .....	256
14.11	AC LINE CONDUCTED EMISSIONS - SIDE VIEW – 0 dBi ANTENNA.....	257
<b>15</b>	<b>EXHIBIT C – EUT PHOTOGRAPHS .....</b>	<b>258</b>
15.1	EUT – TOP VIEW.....	258
15.2	EUT – BOTTOM VIEW .....	258
15.3	EUT – SIDE VIEW .....	259
15.4	EUT – ANTENNA VIEW-25 dBi ANTENNA.....	259
15.5	EUT – ANTENNA VIEW- 0 dBi ANTENNA.....	260
15.6	EUT – POE TOP VIEW .....	260

---

15.7	EUT – OPEN CASE TOP VIEW .....	261
15.8	EUT – MAIN PCB BOARD TOP VIEW .....	261
15.9	EUT – MAIN PCB BOARD BACK VIEW .....	262
15.10	EUT – MAIN PCB BOARD BACK VIEW WITHOUT SHIELDING.....	262
15.11	EUT – LTE VIEW.....	263

### DOCUMENT REVISION HISTORY

Revision Number	Report Number	Description of Revision	Date of Revision
0	R1404042-407 W52 W58	Original Report	2014-06-20
Rev A	R1404042-407 W52 W58	Revised Report	2014-07-10
Rev B	R1404042-407 W52 W58	Adding Low Gain Data	2014-08-12

## 1 General Description

---

### 1.1 Product Description for Equipment under Test (EUT)

This test and measurement report was prepared on behalf of *Mimosa Networks*, and their product model: *B5c*, *FCC ID: 2ABZJ-100-00014*, which will henceforth be referred to as the “EUT” (Equipment under Test) in this report. The EUT is a point-to-point device operates in 5 GHz bands.

### 1.2 Mechanical Description of EUT

The EUT measures approximately 17.3 cm (L) x 17.3 cm (W) x 7.3 cm (H) and weighs 3.2 kg.

*The test data gathered are from typical production sample, serial number: 13461M0028 assigned by manufacturer.*

### 1.3 Objective

This report is prepared on behalf of *Mimosa Networks* in accordance with FCC CFR47 §15.407

The objective is to determine compliance with FCC rules for Antenna Requirments, AC Line Conducted Emissions, Occupied Bandwidth, Maximum Peak Output Power, Power Spectral Density, Radiated and Conducted Spurious Emissions, and Band Edge.

### 1.4 Related Submittal(s)/Grant(s)

N/A

### 1.5 Test Methodology

All measurements contained in this report were conducted in accordance with ANSI C63.4-2009, American National Standard for Methods of Measurement of Radio-Noise Emissions from Low-Voltage Electrical and Electronic Equipment in the range of 9 kHz to 40 GHz and FCC KDB 789033 D02 General UNII Test Procedures v01: Guidelines for Compliance Testing of Unlicensed National Information Infrastructure (U-NII) Devices Part 15, Subpart E

### 1.6 Measurement Uncertainty

All measurements involve certain levels of uncertainties, especially in the field of EMC. The factors contributing to uncertainties are spectrum analyzer, cable loss, antenna factor calibration, antenna directivity, antenna factor variation with height, antenna phase center variation, antenna factor frequency interpolation, measurement distance variation, site imperfections, mismatch (average), and system repeatability.

Based on CISPR16-4-2: 2011, The Treatment of Uncertainty in EMC Measurements, the values ranging from  $\pm 2.0$  dB for Conducted Emissions tests and  $\pm 4.0$  dB for Radiated Emissions tests are the most accurate estimates pertaining to uncertainty of EMC measurements at BACL Corp.

All radiated and conducted emissions measurement was performed at Bay Area Compliance Laboratory, Corp. The radiated testing was performed at an antenna-to-EUT distance of 3 meters.

## 1.7 Test Facility

Bay area compliance Laboratories Corp. (BACL) is:

1- An independent Commercial Test Laboratory accredited to **ISO 17025: 2005** by **A2LA**, in the fields of: Electromagnetic Compatibility & Telecommunications covering Emissions, Immunity, Radio, RF Exposure, Safety and Telecom. This includes NEBS (Network Equipment Building System), Wireless RF, Telecommunications Terminal Equipment (TTE); Network Equipment; Information Technology Equipment (ITE); Medical Electrical Equipment; Industrial, Commercial, and Medical Test Equipment; Professional Audio and Video Equipment; Electronic (Digital) Products; Industrial and Scientific Instruments; Cabled Distribution Systems and Energy Efficiency Lighting.

2- An ENERGY STAR Recognized Laboratory, for the LM80 Testing, a wide variety of Luminaires and Computers.

3- A NIST Designated Phase-I and Phase-II CAB including: ACMA (Australian Communication and Media Authority), BSMI (Bureau of Standards, Metrology and Inspection of Taiwan), IDA (Infocomm Development Authority of Singapore), IC(Industry Canada), Korea ( Ministry of Communications Radio Research Laboratory), NCC (Formerly DGT; Directorate General of Telecommunication of Chinese Taipei) OFTA (Office of the Telecommunications Authority of Hong Kong), Vietnam, VCCI - Voluntary Control Council for Interference of Japan and a designated EU CAB (Conformity Assessment Body) (Notified Body) for the EMC and R&TTE Directives.

4- A Product Certification Body accredited to **ISO Guide 65: 1996** by **A2LA** to certify:

1- Unlicensed, Licensed radio frequency devices and Telephone Terminal Equipment for the FCC. Scope A1, A2, A3, A4, B1, B2, B3, B4 & C.

2. Radio Standards Specifications (RSS) in the Category I Equipment Standards List and All Broadcasting Technical Standards (BETS) in Category I Equipment Standards List for Industry Canada.

3. Radio Communication Equipment for Singapore.

4. Radio Equipment Specifications, GMDSS Marine Radio Equipment Specifications, and Fixed Network Equipment Specifications for Hong Kong.

5. Japan MIC Telecommunication Business Law (A1, A2) and Radio Law (B1, B2 and B3).

6. Audio/Video, Battery Charging Systems, Computers, Displays, Enterprise Servers, Imaging Equipment, Set-Top Boxes, Telephony, Televisions, Ceiling Fans, CFLs (Including GU24s), Decorative Light Strings, Integral LED Lamps, Luminaires, Residential Ventilating Fans.

The test site used by BACL Corp. to collect radiated and conducted emissions measurement data is located at its facility in Sunnyvale, California, USA.

The test site at BACL Corp. has been fully described in reports submitted to the Federal Communication Commission (FCC) and Voluntary Control Council for Interference (VCCI). The details of these reports have been found to be in compliance with the requirements of Section 2.948 of the FCC Rules on February 11 and December 10, 1997, and Article 8 of the VCCI regulations on December 25, 1997. The test site also complies with the test methods and procedures set forth in CISPR 22:2008 §10.4 for measurements below 1 GHz and §10.6 for measurements above 1 GHz as well as ANSI C63.4-2009, ANSI C63.4-2009, TIA/EIA-603 & CISPR 24:2010.

The Federal Communications Commission and Voluntary Control Council for Interference have the reports on file and they are listed under FCC registration number: 90464 and VCCI Registration No.: A-0027. The test site has been approved by the FCC and VCCI for public use and is listed in the FCC Public Access Link (PAL) database.

Additionally, BACL Corp. is an American Association for Laboratory Accreditation (A2LA) accredited laboratory (Lab Code 3297-02). The current scope of accreditations can be found at

<http://www.a2la.org/scopepdf/3297-02.pdf?CFID=1132286&CFTOKEN=e42a3240dac3f6ba-6DE17DCB-1851-9E57-477422F667031258&jsessionid=8430d44f1f47cf2996124343c704b367816b>

## 2 EUT Test Configuration

### 2.1 Justification

The EUT was configured for testing according to ANSI C63.4-2009 and FCC KDB 789033 D02 General UNII Test Procedures v01

The EUT was tested in a testing mode to represent worst-case results during the final qualification test.

The worst-case data rates are determined to be as follows for each mode based upon investigation by measuring the average power, peak power and PPSD across all data rates bandwidths, and modulations.

### 2.2 EUT Exercise Software

The test utility used version was 00.10.00-5 was provided by Mimosa Networks., and was verified Cipher Chu to comply with the standard requirements being tested against.

### 2.3 Equipment Modifications

No modifications were made to the EUT.

### 2.4 Special Accessories

There were no special accessories were required, included, or intended for use with EUT during these tests.

### 2.5 Local Support Equipment

Manufacturers	Description	Models	Serial Number
Lenovo	Laptop	T530	PK-0XD9H

### 2.6 Interface Ports and Cabling

Cable Description	Length (M)	From	To
RF Cable	<1.0	PSA	EUT

### 2.7 Power Supply and Line Filters

Manufacturer	Description	Model Number	Serial Number
Fortune Power	AC/DC Adaptor of POE	GRT 480125A	130669328



## 2.8 EUT Internal Configurations

Manufacturers	Descriptions	Models	Serial Numbers
Mimosa Networks	Main PCB Board	B5c	1346101000017

### 3 Summary of Test Results

FCC Rules	Description of Test	Result
§15.407(f), §2.1091	RF Exposure	Calculation
§15.203	Antenna Requirement	Compliant
§15.207	AC Power Line Conducted Emissions	Compliant
§15.209(a), §15.407(b)	Spurious Emissions	Compliant
§15.407(a)	Emission Bandwidth	Compliant
§15.407(a)(1)(iii) §15.407 (a)(3)	Output Power	Compliant
§2.1051, §15.407(b)	Undesirable Emissions	Compliant
§15.407(a)(1)(iii) §15.407(a)(3)	Power Spectral Density	Compliant
§15.407(h)	DFS	N/A*

Note: N/A\* not applicable for 5.2 GHz and 5.8 GHz Bands.

## 4 FCC §15.407(f) & §2.1091 - RF Exposure

### 4.1 Applicable Standard

According to FCC §15.407(f) and §1.1307(b)(1), systems operating under the provisions of this section shall be operated in a manner that ensures that the public is not exposed to radio frequency energy level in excess of the Commission's guidelines.

#### Limits for General Population/Uncontrolled Exposure

Frequency Range (MHz)	Electric Field Strength (V/m)	Magnetic Field Strength (A/m)	Power Density (mW/cm <sup>2</sup> )	Averaging Time (minutes)
Limits for General Population/Uncontrolled Exposure				
0.3-1.34	614	1.63	* (100)	30
1.34-30	824/f	2.19/f	* (180/f <sup>2</sup> )	30
30-300	27.5	0.073	0.2	30
300-1500	/	/	f/1500	30
1500-100,000	/	/	1.0	30

f = frequency in MHz

\* = Plane-wave equivalent power density

### 4.2 MPE Prediction

$$S = PG/4\pi R^2$$

Where: S = power density

P = power input to antenna

G = power gain of the antenna in the direction of interest relative to an isotropic radiator

R = distance to the center of radiation of the antenna

### 4.3 MPE Results

#### For 25 dBi antenna

5.2 GHz Band:

<u>Maximum peak output power at antenna input terminal (dBm):</u>	<u>17.25</u>
<u>Maximum peak output power at antenna input terminal (mW):</u>	<u>53.09</u>
<u>Prediction distance (cm):</u>	<u>37</u>
<u>Prediction frequency (MHz):</u>	<u>5200</u>
<u>Maximum Antenna Gain, typical (dBi):</u>	<u>25</u>
<u>Maximum Antenna Gain (numeric):</u>	<u>316.227</u>
<u>Power density of prediction frequency at 37 cm (mW/cm<sup>2</sup>):</u>	<u>0.975858</u>
<u>MPE limit for uncontrolled exposure at prediction frequency (mW/cm<sup>2</sup>):</u>	<u>1.0</u>

## 5.8 GHz Band:

<u>Maximum peak output power at antenna input terminal (dBm):</u>	<u>21.90</u>
<u>Maximum peak output power at antenna input terminal (mW):</u>	<u>154.882</u>
<u>Prediction distance (cm):</u>	<u>63</u>
<u>Prediction frequency (MHz):</u>	<u>5785</u>
<u>Maximum Antenna Gain, typical (dBi):</u>	<u>25</u>
<u>Maximum Antenna Gain (numeric):</u>	<u>316.227</u>
<u>Power density of prediction frequency at 63 cm (mW/cm<sup>2</sup>):</u>	<u>0.981994</u>
<u>MPE limit for uncontrolled exposure at prediction frequency (mW/cm<sup>2</sup>):</u>	<u>1.0</u>

**For 0 dBi antenna:**

## 5.2 GHz Band:

<u>Maximum peak output power at antenna input terminal (dBm):</u>	<u>29.8</u>
<u>Maximum peak output power at antenna input terminal (mW):</u>	<u>954.99</u>
<u>Prediction distance (cm):</u>	<u>20</u>
<u>Prediction frequency (MHz):</u>	<u>5200</u>
<u>Maximum Antenna Gain, typical (dBi):</u>	<u>0</u>
<u>Maximum Antenna Gain (numeric):</u>	<u>1</u>
<u>Power density of prediction frequency at 20 cm (mW/cm<sup>2</sup>):</u>	<u>0.1899</u>
<u>MPE limit for uncontrolled exposure at prediction frequency (mW/cm<sup>2</sup>):</u>	<u>1.0</u>

## 5.8 GHz Band:

<u>Maximum peak output power at antenna input terminal (dBm):</u>	<u>29.85</u>
<u>Maximum peak output power at antenna input terminal (mW):</u>	<u>966.05</u>
<u>Prediction distance (cm):</u>	<u>20</u>
<u>Prediction frequency (MHz):</u>	<u>5785</u>
<u>Maximum Antenna Gain, typical (dBi):</u>	<u>0</u>
<u>Maximum Antenna Gain (numeric):</u>	<u>1</u>
<u>Power density of prediction frequency at 20 cm (mW/cm<sup>2</sup>):</u>	<u>0.1921</u>
<u>MPE limit for uncontrolled exposure at prediction frequency (mW/cm<sup>2</sup>):</u>	<u>1.0</u>

The device meets FCC MPE requirement for uncontrolled exposure environment at 63 cm distance.

## 5 FCC §15.203 – Antenna Requirements

### 5.1 Applicable Standard

According to FCC §15.203, an intentional radiator shall be designed to ensure that no antenna other than that furnished by the responsible party shall be used with the device. The use of a permanently attached antenna or of an antenna that uses a unique coupling to the intentional radiator shall be considered sufficient to comply with the provisions of this Section. The manufacturer may design the unit so that a broken antenna can be replaced by the user, but the use of a standard antenna jack or electrical connector is prohibited.

And according to FCC §15.407 (a)(1) and (2), If transmitting antennas of directional gain greater than 6 dBi are used, both the maximum conducted output power and the maximum power spectral density shall be reduced by the amount in dB that the directional gain of the antenna exceeds 6 dBi.

And according to FCC §15.407 (a)(1) (iii) For fixed point-to-point access points operating in the band 5.15-5.25 GHz, the maximum conducted output power over the frequency band of operation shall not exceed 1 W. Fixed point-to-point U-NII devices may employ antennas with directional gain up to 23 dBi without any corresponding reduction in the maximum conducted output power or maximum power spectral density. For fixed point-to-point transmitters that employ a directional antenna gain greater than 23 dBi, a 1 dB reduction in maximum conducted output power and maximum power spectral density is required for each 1 dB of antenna gain in excess of 23 dBi. Fixed, point-to-point operations exclude the use of point-to-multipoint systems, omnidirectional applications, and multiple collocated transmitters transmitting the same information. The operator of the U-NII device, or if the equipment is professionally installed, the installer, is responsible for ensuring that systems employing high gain directional antennas are used exclusively for fixed, point-to-point operations.

And according to FCC §15.407 (a)(3) , However, fixed point-to-point U-NII devices operating in this band may employ transmitting antennas with directional gain greater than 6 dBi without any corresponding reduction in transmitter conducted power. Fixed, point-to-point operations exclude the use of point-to-multipoint systems, omnidirectional applications, and multiple collocated transmitters transmitting the same information. The operator of the U-NII device, or if the equipment is professionally installed, the installer, is responsible for ensuring that systems employing high gain directional antennas are used exclusively for fixed, point-to-point operations.

### 5.2 Antenna List

P/NO	Antenna Gain (dBi)
Center Fed Reflector/Pencil Beam	25
Center Fed Reflector/Pencil Beam	0

Note: This product shall be professional installation. The client provided the installation instruction to meet the FCC §15.203 requirement.

## 6 FCC §15.207 - AC Power Line Conducted Emissions

### 6.1 Applicable Standards

As per FCC §15.207 Conducted limits:

For an intentional radiator that is designed to be connected to the public utility (AC) power line, the radio frequency voltage that is conducted back onto the AC power line on any frequency or frequencies within the band 150 kHz to 30 MHz shall not exceed the limits in the following table, as measured using a 50  $\mu$ H/50 ohms line impedance stabilization network (LISN). Compliance with the provisions of this paragraph shall be based on the measurement of the radio frequency voltage between each power line and ground at the power terminal. The lower limit applies at the boundary between the frequencies ranges.

Frequency of Emission (MHz)	Conducted Limit (dBuV)	
	Quasi-Peak	Average
0.15-0.5	66 to 56 *	56 to 46 *
0.5-5	56	46
5-30	60	50

*\*Decreases with the logarithm of the frequency.*

### 6.2 Test Setup

The measurement was performed at shield room, using the setup per ANSI C63.4-2009 measurement procedure. The specification used was FCC §15.207 limits.

External I/O cables were draped along the edge of the test table and bundle when necessary.

The AC/DC power adapter of the EUT was connected with LISN-1 which provided 120 V/60 Hz AC power.

### 6.3 Test Procedure

During the conducted emissions test, the power cord of the EUT host system was connected to the mains outlet of the LISN-1.

Maximizing procedure was performed on the six (6) highest emissions of the EUT.

All data was recorded in the peak detection mode, quasi-peak and average. Quasi-Peak readings are distinguished with a "QP." Average readings are distinguished with an "Ave".

## 6.4 Test Setup Block Diagram

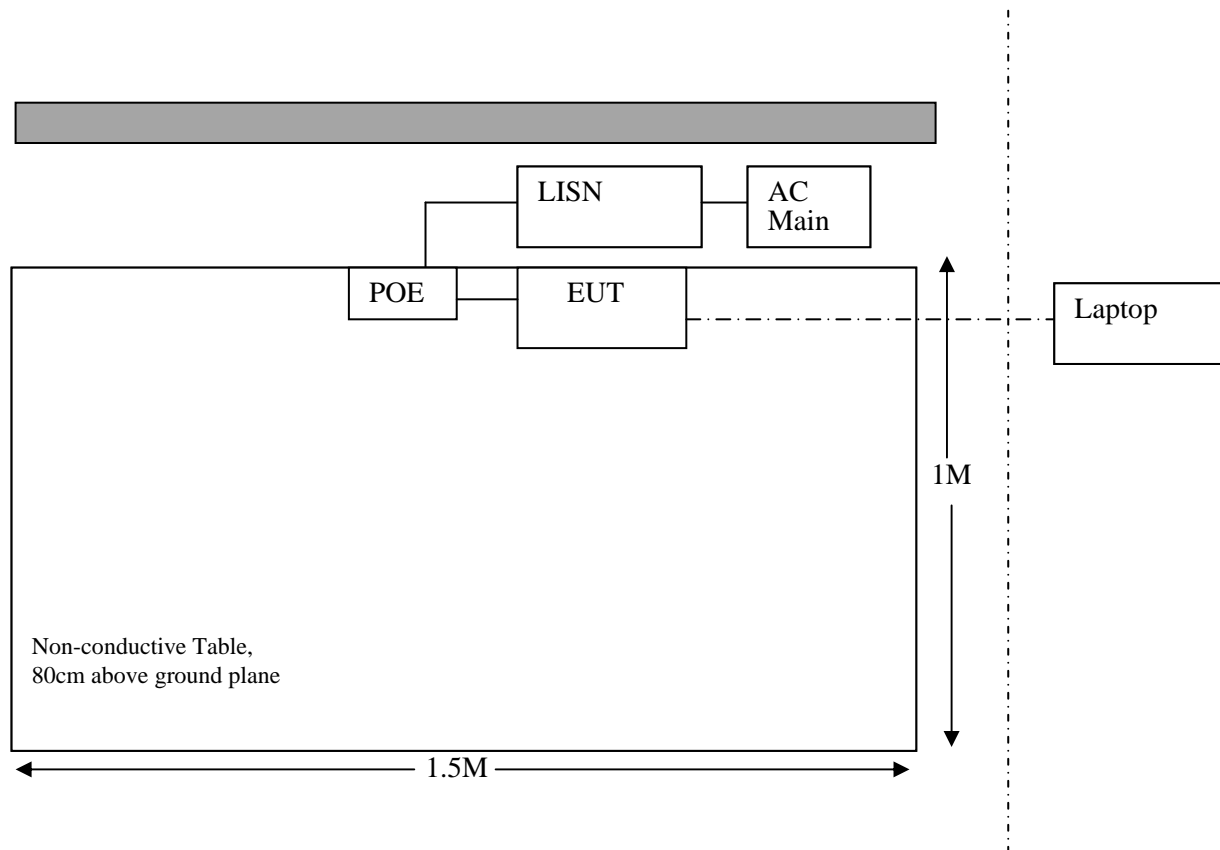

## 6.5 Corrected Amplitude & Margin Calculation

The Corrected Amplitude (CA) is calculated by adding the Cable Loss (CL), the Attenuator Factor (Atten) to indicated Amplitude ( $A_i$ ) reading. The basic equation is as follows:

$$CA = A_i + CL + \text{Atten}$$

For example, a corrected amplitude of 46.2 dBuV = Indicated Reading (32.5 dBuV) + Cable Loss (3.7 dB) + Attenuator (10 dB)

The “**Margin**” column of the following data tables indicates the degree of compliance within the applicable limit. For example, a margin of -7 dB means the emission is 7 dB below the maximum limit. The equation for margin calculation is as follows:

$$\text{Margin} = \text{Corrected Amplitude} - \text{Limit}$$

## 6.6 Test Equipment List and Details

Manufacturer	Description	Model No.	Serial No.	Calibration Date	Calibration Interval
Rohde & Schwarz	EMI Test Receiver	ESCI 1166.5950K03	100337	2013-09-28	1 year
Solar Electronics	LISN	9252-R-24-BNC	511205	2013-10-25	1 year
TTE	Filter, High Pass	H985-150k-50-720N	M1149	2013-10-30	1 year

**Statement of Traceability:** *BACL Corp.* attests that all calibrations have been performed per the A2LA requirements, traceable to the NIST.

## 6.7 Test Environmental Conditions

<b>Temperature:</b>	20 °C
<b>Relative Humidity:</b>	51 %
<b>ATM Pressure:</b>	101.1 kPa

The testing was performed by Cipher Chu on 2014-03-06 to 2014-03-14 at 10m chamber 1.

## 6.8 Summary of Test Results

According to the recorded data in following table, the EUT complied with the FCC standard's conducted emissions limits, with the margin reading of:

Connection: Connected to 120 V/60 Hz, AC			
Margin (dB)	Frequency (MHz)	Conductor Mode (Line/Neutral)	Range (MHz)
-1.76	4.602941	Neutral	0.15-30



### 6.9 Conducted Emissions Test Plots and Data

#### 120 V, 60 Hz – Line

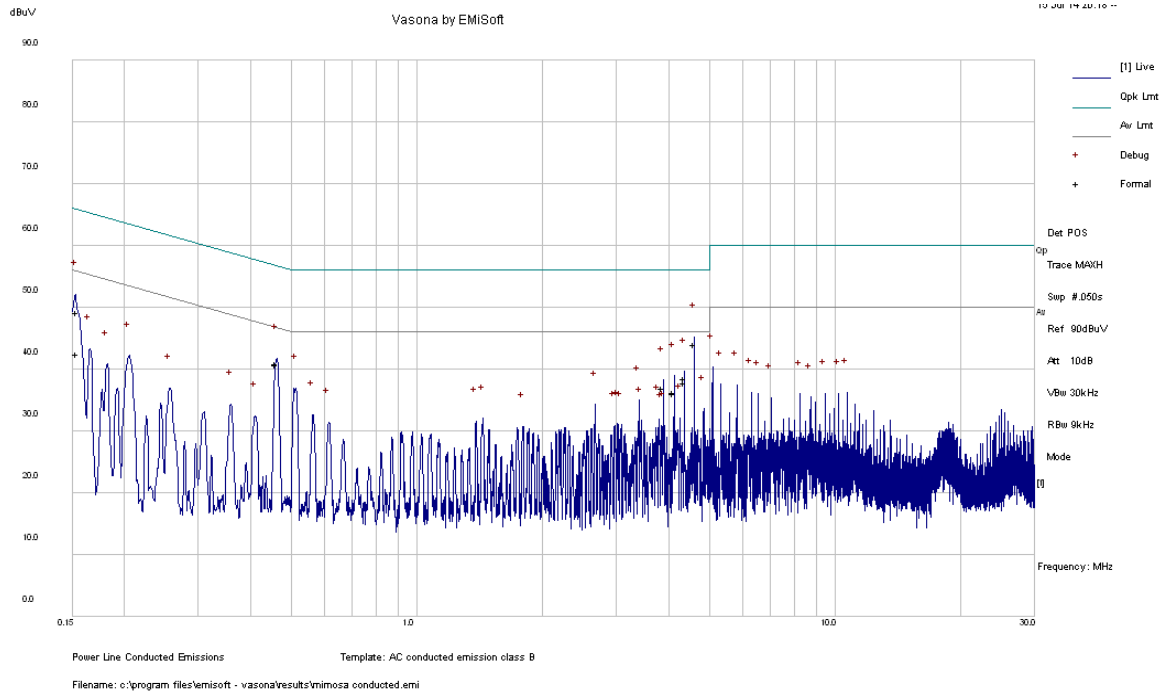

Frequency (MHz)	Corrected Amplitude (dBμV)	Conductor (Line/Neutral)	Limit (dBμV)	Margin (dB)	Detector (QP/Ave.)
4.603229	44.14	Line	56	-11.86	QP
0.153699	49.3	Line	65.8	-16.5	QP
0.462288	40.91	Line	56.65	-15.74	QP
4.361672	38.55	Line	56	-17.45	QP
4.120808	36.16	Line	56	-19.84	QP
3.876734	37.05	Line	56	-18.95	QP

Frequency (MHz)	Corrected Amplitude (dBμV)	Conductor (Line/Neutral)	Limit (dBμV)	Margin (dB)	Detector (QP/Ave.)
4.603229	44.1	Line	46	-1.9	Ave.
0.153699	42.47	Line	55.8	-13.33	Ave.
0.462288	40.86	Line	46.65	-5.79	Ave.
4.361672	37.79	Line	46	-8.21	Ave.
4.120808	36.27	Line	46	-9.73	Ave.
3.876734	37.03	Line	46	-8.97	Ave.

120 V, 60 Hz – Neutral

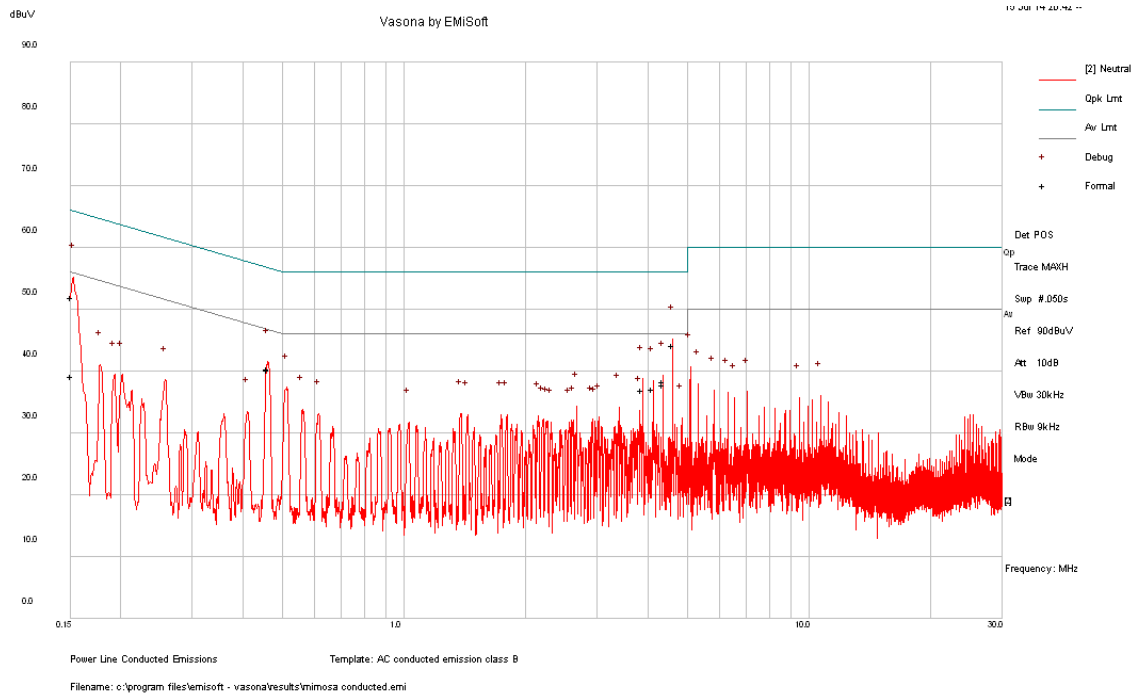

Frequency (MHz)	Corrected Amplitude (dBµV)	Conductor (Line/Neutral)	Limit (dBµV)	Margin (dB)	Detector (QP/Ave.)
0.151341	51.94	Neutral	65.93	-13.98	QP
4.602941	44.27	Neutral	56	-11.73	QP
0.462237	40.51	Neutral	56.65	-16.15	QP
4.361102	38.41	Neutral	56	-17.59	QP
3.877033	37.04	Neutral	56	-18.96	QP
4.119182	37.22	Neutral	56	-18.78	QP

Frequency (MHz)	Corrected Amplitude (dBµV)	Conductor (Line/Neutral)	Limit (dBµV)	Margin (dB)	Detector (QP/Ave.)
0.151341	39.28	Neutral	55.93	-16.64	Ave.
4.602941	44.24	Neutral	46	-1.76	Ave.
0.462237	40.31	Neutral	46.65	-6.34	Ave.
4.361102	37.81	Neutral	46	-8.19	Ave.
3.877033	36.95	Neutral	46	-9.05	Ave.
4.119182	37.2	Neutral	46	-8.8	Ave.

## 7 FCC §15.209 & §15.407(b) - Spurious Radiated Emissions And Out of Band Emissions

### 7.1 Applicable Standard

According to FCC §15.407(b)

For transmitters operating in the 5.15-5.25 GHz band: All emissions outside of the 5.15-5.35 GHz band shall not exceed an e.i.r.p. of  $-27$  dBm/MHz.

For transmitters operating in the 5.25-5.35 GHz band: All emissions outside of the 5.15-5.35 GHz band shall not exceed an e.i.r.p. of  $-27$  dBm/MHz.

For transmitters operating in the 5.47-5.725 GHz band: All emissions outside of the 5.47-5.725 GHz band shall not exceed an e.i.r.p. of  $-27$  dBm/MHz.

For transmitters operating in the 5.725-5.85 GHz band: All emissions within the frequency range from the band edge to 10 MHz above or below the band edge shall not exceed an e.i.r.p. of  $-17$  dBm/MHz; for frequencies 10 MHz or greater above or below the band edge, emissions shall not exceed an e.i.r.p. of  $-27$  dBm/MHz.

As per FCC §15.35(d): Unless otherwise specified, on any frequency or frequencies above 1000 MHz, the radiated emission limits are based on the use of measurement instrumentation employing an average detector function. Unless otherwise specified, measurements above 1000 MHz shall be performed using a minimum resolution bandwidth of 1 MHz.

As per FCC §15.209(a) and RSS-210: Except as provided elsewhere in this Subpart, the emissions from an intentional radiator shall not exceed the field strength levels specified in the following table

Frequency (MHz)	Field Strength (micro volts/meter)	Measurement Distance (meters)
0.009 - 0.490	2400/F(kHz)	300
0.490 - 1.705	24000/F(kHz)	30
1.705 - 30.0	30	30
30 - 88	100**	3
88 - 216	150**	3
216 - 960	200**	3
Above 960	500	3

\*\* Except as provided in paragraph (g), fundamental emissions from intentional radiators operating under this Section shall not be located in the frequency bands 54-72 MHz, 76-88 MHz, 174-216 MHz or 470-806 MHz. However, operation within these frequency bands is permitted under other sections of this Part, e.g., Sections 15.231 and 15.241.

As Per FCC §15.205(a) except as show in paragraph (d) of this section, only spurious emissions are permitted in any of the frequency bands listed below:

MHz	MHz	MHz	GHz
0.090 – 0.110	16.42 – 16.423	960 – 1240	4.5 – 5.15
0.495 – 0.505	16.69475 – 16.69525	1300 – 1427	5.35 – 5.46
2.1735 – 2.1905	25.5 – 25.67	1435 – 1626.5	7.25 – 7.75
4.125 – 4.128	37.5 – 38.25	1645.5 – 1646.5	8.025 – 8.5
4.17725 – 4.17775	73 – 74.6	1660 – 1710	9.0 – 9.2
4.20725 – 4.20775	74.8 – 75.2	1718.8 – 1722.2	9.3 – 9.5
6.215 – 6.218	108 – 121.94	2200 – 2300	10.6 – 12.7
6.26775 – 6.26825	123 – 138	2310 – 2390	13.25 – 13.4
6.31175 – 6.31225	149.9 – 150.05	2483.5 – 2500	14.47 – 14.5
8.291 – 8.294	156.52475 – 156.52525	2690 – 2900	15.35 – 16.2
8.362 – 8.366	156.7 – 156.9	3260 – 3267	17.7 – 21.4
8.37625 – 8.38675	162.0125 – 167.17	3332 – 3339	22.01 – 23.12
8.41425 – 8.41475	167.72 – 173.2	33458 – 3358	23.6 – 24.0
12.29 – 12.293	240 – 285	3.600 – 4.400	31.2 – 31.8
12.51975 – 12.52025	322 – 335.4		36.43 – 36.5
12.57675 – 12.57725	399.9 – 410		Above 38.6
13.36 – 13.41	608 – 614		

## 7.2 Test Setup

The radiated emissions tests were performed in the 10-meter Chamber, using the setup in accordance with ANSI C63.4-2009. The specification used was the FCC 15 Subpart E limits.

The spacing between the peripherals was 10 centimeters.

External I/O cables were draped along the edge of the test table and bundle when necessary.

## 7.3 Test Procedure

The measurements are base on FCC KDB 789033 D02 General UNII Test Procedures v01: Guidelines for Compliance Testing of Unlicensed National Information Infrastructure (U-NII) Devices Part 15, Subpart E Section H: Unwanted emissions measurement as well as ANSI C63.4: 2009 as described below:

For the radiated emissions test, the EUT host, and all support equipment power cords was connected to the AC floor outlet.

Maximizing procedure was performed on the highest emissions to ensure that the EUT complied with all installation combinations.

The EUT is set 10 meter away from the testing antenna, which is varied from 1-4 meter, and the EUT is placed on a turntable, which is 0.8 meter above ground plane, the table shall be rotated for 360 degrees to find out the highest emission. The receiving antenna should be changed the polarization both of horizontal and vertical.

The spectrum analyzer or receiver is set as:

Below 1000 MHz:

$$\text{RBW} = 100 \text{ kHz/VBW} = 300 \text{ kHz/Sweep} = \text{Auto}$$

Above 1000 MHz:

- (1) Peak: RBW = 1MHz/VBW = 1MHz/Sweep = Auto
- (2) Average: RBW = 1MHz/VBW = 10Hz/Sweep = Auto

## 7.4 Corrected Amplitude & Margin Calculation

The Corrected Amplitude (CA) is calculated by adding the Antenna Factor (AF), the Cable Loss (CL), the Attenuator Factor (Atten) and subtracting the Amplifier Gain (Ga) to indicated Amplitude (Ai) reading. The basic equation is as follows:

$$CA = Ai + AF + CL + Atten - Ga$$

For example, a corrected amplitude of 40.3 dBuV/m = Indicated Reading (32.5 dBuV) + Antenna Factor (+23.5dB) + Cable Loss (3.7 dB) + Attenuator (10 dB) - Amplifier Gain (29.4 dB)

The “**Margin**” column of the following data tables indicates the degree of compliance within the applicable limit. For example, a margin of -7 dB means the emission is 7 dB below the maximum limit. The equation for margin calculation is as follows:

$$\text{Margin} = \text{Corrected Amplitude} - \text{Limit}$$

## 7.5 Test Equipment List and Details

Manufacturer	Description	Model No.	Serial No.	Calibration Date	Calibration Interval
Agilent	Analyzer, Spectrum	E4440A	MY44303352	2013-10-16	1 year
EMCO	Antenna, Horn	3115	9511-4627	2013-10-17	1 year
Mini-Circuits	Pre-amplifier	ZVA-183-S	570400946	2013-05-09	1 year
Rohde & Schwarz	Receiver, EMI Test	ESCI 1166.5950K03	100337	2013-03-28	1 year
Sunol Sciences	Antenna, Biconi-Log	JB3	A020106-2	2013-08-12	1 year
HP	Pre-amplifier	8447D	2944A06639	2013-06-09	1 year
Sunol Science Corp	System Controller	SC99V	122303-1	N/R	N/R

**Statement of Traceability:** BACL attests that all calibrations have been performed per the A2LA requirements, traceable to NIST.

## 7.6 Test Environmental Conditions

<b>Temperature:</b>	20-23 °C
<b>Relative Humidity:</b>	51-59 %
<b>ATM Pressure:</b>	101.1-101.8 kPa

*The testing was performed by Cipher Chu on 2014-03-06 to 2014-03-14 at 10m Chamber and 5m chamber 3.*

## 7.7 Summary of Test Results

According to the data hereinafter, the EUT complied with the FCC Title 47, Part 15.407 standard's radiated emissions limits, and had the worst margin of:

**For 25 dBi antenna:**

**30-1000 MHz:**

Mode: Transmitting			
Margin (dB)	Frequency (MHz)	Polarization (Horizontal/Vertical)	Mode, Channel
-2.31	124.99675	Vertical	20 MHz bandwidth , Low

**1-40 GHz:**

Mode: Transmitting			
Margin (dB)	Frequency (MHz)	Polarization (Horizontal/Vertical)	Mode, Channel
-0.78	5350	Vertical	20 MHz bandwidth , Low

**For 0 dBi antenna:**

**30-1000 MHz:**

Mode: Transmitting			
Margin (dB)	Frequency (MHz)	Polarization (Horizontal/Vertical)	Mode, Channel
-1.62	125.0038	Vertical	20 MHz bandwidth , Low

**1-40 GHz:**

Mode: Transmitting			
Margin (dB)	Frequency (MHz)	Polarization (Horizontal/Vertical)	Mode, Channel
-3.985	4500	Vertical	20 MHz bandwidth , Low

Please refer to the following table and plots for specific test result details.

## 7.8 Radiated Emissions Test Data and Plots

### 1) 30 MHz–1 GHz, Quasi-Peak Measurements

#### 25 dBi Antenna:

Worst case: 20 MHz bandwidth, Low Channel

Frequency (MHz)	Corrected Amplitude (dB $\mu$ V/m)	Antenna Height (cm)	Antenna Polarity (H/V)	Turntable Azimuth (degrees)	Limit (dB $\mu$ V/m)	Margin (dB)
124.99675	41.19	98	V	150	43.5	-2.31
624.99625	40.93	123	H	218	46	-5.07
250.0035	40.17	353	H	104	46	-6.23
71.97675	32.9	107	V	268	40	-7.1
500.0065	39.3	149	H	120	46	-6.7
74.53225	27.75	98	V	128	40	-12.25

#### 0 dBi Antenna:

Worst case: 20 MHz bandwidth, Low Channel

Frequency (MHz)	Corrected Amplitude (dB $\mu$ V/m)	Antenna Height (cm)	Antenna Polarity (H/V)	Turntable Azimuth (degrees)	Limit (dB $\mu$ V/m)	Margin (dB)
125.0038	41.88	142	V	112	43.5	-1.62
622.7872	40.63	123	H	218	46	-5.37
71.97675	32.81	107	V	268	40	-7.19
501.0506	40.32	149	H	120	46	-5.86

## 2) 1-40 GHz, Measured at 3 meters

25 dBi antenna

5.2 GHz Band:

20 MHz Bandwidth

Frequency (MHz)	S.A. Reading (dBµV)	Turntable Azimuth (degrees)	Test Antenna			Cable Loss (dB)	Pre-Amp. (dB)	Cord. Reading (dBµV/m)	FCC		Comments
			Height (cm)	Polarity (H/V)	Factor (dB/m)				Limit (dBµV/m)	Margin (dB)	
Low Channel 5165 MHz, measured at 3 meters											
5165	104.80	0	135	V	33.92	4.62	0	143.34	-	-	Peak/Fund
5165	103.04	0	120	H	33.92	4.62	0	141.58	-	-	Peak/Fund
5165	96.83	0	135	V	33.92	4.62	0	135.37	-	-	Ave/Fund
5165	91.74	0	120	H	33.92	4.62	0	130.29	-	-	Ave/Fund
10330	27.27	0	100	V	38.85	6.20	27.70	44.62	74	-29.38	Peak
10330	31.23	0	100	H	38.85	6.20	27.70	48.57	74	-25.43	Peak
10330	15.21	0	100	V	38.85	6.20	27.70	32.56	54	-21.44	Ave
10330	15.28	0	100	H	38.85	6.20	27.70	32.62	54	-21.38	Ave
15495	31.17	0	100	V	42.94	8.31	27.58	54.84	74	-19.16	Peak
15495	27.08	0	100	H	42.94	8.31	27.58	50.75	74	-23.25	Peak
15495	13.56	0	100	V	42.94	8.31	27.58	37.23	54	-16.77	Ave
15495	17.85	0	100	H	42.94	8.31	27.58	41.52	54	-12.48	Ave
20660	31.92	0	100	V	49.67	9.74	27.06	64.27	74	-9.73	Peak
20660	32.29	0	100	H	49.67	9.74	27.06	64.64	74	-9.36	Peak
20660	13.72	0	100	V	49.67	9.74	27.06	46.07	54	-7.93	Ave
20660	16.42	0	100	H	49.67	9.74	27.06	48.77	54	-5.23	Ave
Middle Channel 5200 MHz, measured at 3 meters											
5200	115.58	0	135	V	33.922	4.62	0	154.13	-	-	Peak/Fund
5200	115.54	0	120	H	33.922	4.62	0	154.09	-	-	Peak/Fund
5200	102.17	0	135	V	33.922	4.62	0	140.72	-	-	Ave/Fund
5200	103.27	0	120	H	33.922	4.62	0	141.81	-	-	Ave/Fund
10400	34.14	0	100	V	38.845	6.2	27.7	51.49	74	-22.51	Peak
10400	33.99	0	100	H	38.845	6.2	27.7	51.33	74	-22.67	Peak
10400	16.46	0	100	V	38.845	6.2	27.7	33.80	54	-20.20	Ave
10400	15.55	0	100	H	38.845	6.2	27.7	32.90	54	-21.10	Ave
15600	30.05	0	100	V	42.941	8.31	27.58	53.72	74	-20.28	Peak
15600	29.75	0	100	H	42.941	8.31	27.58	53.42	74	-20.58	Peak
15600	17.71	0	100	V	42.941	8.31	27.58	41.38	54	-12.62	Ave
15600	17.43	0	100	H	42.941	8.31	27.58	41.10	54	-12.90	Ave
20800	26.85	0	100	V	49.67	9.74	27.06	59.20	74	-14.80	Peak
20800	27.15	0	100	H	49.67	9.74	27.06	59.50	74	-14.50	Peak
20800	13.98	0	100	V	49.67	9.74	27.06	46.33	54	-7.67	Ave
20800	14.83	0	100	H	49.67	9.74	27.06	47.18	54	-6.82	Ave



Frequency (MHz)	S.A. Reading (dB $\mu$ V)	Turntable Azimuth (degrees)	Test Antenna			Cable Loss (dB)	Pre-Amp. (dB)	Cord. Reading (dB $\mu$ V/m)	FCC		Comments
			Height (cm)	Polarity (H/V)	Factor (dB/m)				Limit (dB $\mu$ V/m)	Margin (dB)	
High Channel 5240 MHz, measured at 3 meters											
5240	109.60	0	135	V	33.922	4.62	0	148.15	-	-	Peak/Fund
5240	106.89	0	120	H	33.922	4.62	0	145.43	-	-	Peak/Fund
5240	96.02	0	135	V	33.922	4.62	0	134.56	-	-	Ave/Fund
5240	95.33	0	120	H	33.922	4.62	0	133.87	-	-	Ave/Fund
10480	28.84	0	100	V	38.845	6.2	27.7	46.18	74	-27.82	Peak
10480	30.24	0	100	H	38.845	6.2	27.7	47.58	74	-26.42	Peak
10480	14.69	0	100	V	38.845	6.2	27.7	32.03	54	-21.97	Ave
10480	16.13	0	100	H	38.845	6.2	27.7	33.48	54	-20.52	Ave
15720	31.63	0	100	V	42.941	8.31	27.58	55.30	74	-18.70	Peak
15720	30.34	0	100	H	42.941	8.31	27.58	54.01	74	-19.99	Peak
15720	16.34	0	100	V	42.941	8.31	27.58	40.01	54	-13.99	Ave
15720	17.17	0	100	H	42.941	8.31	27.58	40.84	54	-13.16	Ave
20960	30.32	0	100	V	49.67	9.74	27.06	62.67	74	-11.33	Peak
20960	27.57	0	100	H	49.67	9.74	27.06	59.92	74	-14.08	Peak
20960	16.15	0	100	V	49.67	9.74	27.06	48.50	54	-5.50	Ave
20960	16.35	0	100	H	49.67	9.74	27.06	48.70	54	-5.30	Ave

## 40 MHz Bandwidth

Frequency (MHz)	S.A. Reading (dBµV)	Turntable Azimuth (degrees)	Test Antenna			Cable Loss (dB)	Pre-Amp. (dB)	Cord. Reading (dBµV/m)	FCC		Comments
			Height (cm)	Polarity (H/V)	Factor (dB/m)				Limit (dBµV/m)	Margin (dB)	
Low Channel 5175 MHz, measured at 3 meters											
5175	104.38	0	135	V	33.92	4.62	0	142.92	-	-	Peak/Fund
5175	102.95	0	120	H	33.92	4.62	0	141.49	-	-	Peak/Fund
5175	93.38	0	135	V	33.92	4.62	0	131.93	-	-	Ave/Fund
5175	91.00	0	120	H	33.92	4.62	0	129.54	-	-	Ave/Fund
10350	28.15	0	100	V	38.85	6.20	27.70	45.49	74	-28.51	Peak
10350	27.89	0	100	H	38.85	6.20	27.70	45.23	74	-28.77	Peak
10350	14.32	0	100	V	38.85	6.20	27.70	31.66	54	-22.34	Ave
10350	16.61	0	100	H	38.85	6.20	27.70	33.96	54	-20.04	Ave
15525	27.77	0	100	V	42.94	8.31	27.58	51.44	74	-22.56	Peak
15525	26.97	0	100	H	42.94	8.31	27.58	50.64	74	-23.36	Peak
15525	18.20	0	100	V	42.94	8.31	27.58	41.88	54	-12.12	Ave
15525	17.85	0	100	H	42.94	8.31	27.58	41.52	54	-12.48	Ave
20700	28.28	0	100	V	49.67	9.74	27.06	60.63	74	-13.37	Peak
20700	31.74	0	100	H	49.67	9.74	27.06	64.09	74	-9.91	Peak
20700	15.90	0	100	V	49.67	9.74	27.06	48.25	54	-5.75	Ave
20700	13.82	0	100	H	49.67	9.74	27.06	46.17	54	-7.83	Ave
Middle Channel 5200 MHz, measured at 3 meters											
5200	112.61	0	135	V	33.922	4.62	0	151.15	-	-	Peak/Fund
5200	111.83	0	120	H	33.922	4.62	0	150.37	-	-	Peak/Fund
5200	102.38	0	135	V	33.922	4.62	0	140.92	-	-	Ave/Fund
5200	102.11	0	120	H	33.922	4.62	0	140.66	-	-	Ave/Fund
10400	28.93	0	100	V	38.845	6.2	27.7	46.27	74	-27.73	Peak
10400	27.07	0	100	H	38.845	6.2	27.7	44.42	74	-29.58	Peak
10400	16.92	0	100	V	38.845	6.2	27.7	34.27	54	-19.73	Ave
10400	12.81	0	100	H	38.845	6.2	27.7	30.15	54	-23.85	Ave
15600	31.20	0	100	V	42.941	8.31	27.58	54.87	74	-19.13	Peak
15600	30.16	0	100	H	42.941	8.31	27.58	53.83	74	-20.17	Peak
15600	15.48	0	100	V	42.941	8.31	27.58	39.16	54	-14.84	Ave
15600	16.98	0	100	H	42.941	8.31	27.58	40.65	54	-13.35	Ave
20800	29.41	0	100	V	49.67	9.74	27.06	61.76	74	-12.24	Peak
20800	31.11	0	100	H	49.67	9.74	27.06	63.46	74	-10.54	Peak
20800	15.79	0	100	V	49.67	9.74	27.06	48.14	54	-5.86	Ave
20800	15.34	0	100	H	49.67	9.74	27.06	47.69	54	-6.31	Ave

Frequency (MHz)	S.A. Reading (dB $\mu$ V)	Turntable Azimuth (degrees)	Test Antenna			Cable Loss (dB)	Pre-Amp. (dB)	Cord. Reading (dB $\mu$ V/m)	FCC		Comments
			Height (cm)	Polarity (H/V)	Factor (dB/m)				Limit (dB $\mu$ V/m)	Margin (dB)	
High Channel 5230 MHz, measured at 3 meters											
5230	107.20	0	135	V	33.922	4.62	0	145.74	-	-	Peak/Fund
5230	104.40	0	120	H	33.922	4.62	0	142.94	-	-	Peak/Fund
5230	96.19	0	135	V	33.922	4.62	0	134.74	-	-	Ave/Fund
5230	94.03	0	120	H	33.922	4.62	0	132.57	-	-	Ave/Fund
10460	35.21	0	100	V	38.845	6.2	27.7	52.56	74	-21.44	Peak
10460	34.57	0	100	H	38.845	6.2	27.7	51.91	74	-22.09	Peak
10460	19.10	0	100	V	38.845	6.2	27.7	36.44	54	-17.56	Ave
10460	17.38	0	100	H	38.845	6.2	27.7	34.73	54	-19.27	Ave
15690	34.67	0	100	V	42.941	8.31	27.58	58.34	74	-15.66	Peak
15690	35.73	0	100	H	42.941	8.31	27.58	59.40	74	-14.60	Peak
15690	21.66	0	100	V	42.941	8.31	27.58	45.33	54	-8.67	Ave
15690	19.01	0	100	H	42.941	8.31	27.58	42.68	54	-11.32	Ave
20920	35.42	0	100	V	49.67	9.74	27.06	67.77	74	-6.23	Peak
20920	32.24	0	100	H	49.67	9.74	27.06	64.59	74	-9.41	Peak
20920	14.48	0	100	V	49.67	9.74	27.06	46.83	54	-7.17	Ave
20920	16.87	0	100	H	49.67	9.74	27.06	49.22	54	-4.78	Ave

## 80 MHz Bandwidth

Frequency (MHz)	S.A. Reading (dBµV)	Turntable Azimuth (degrees)	Test Antenna			Cable Loss (dB)	Pre-Amp. (dB)	Cord. Reading (dBµV/m)	FCC		Comments
			Height (cm)	Polarity (H/V)	Factor (dB/m)				Limit (dBµV/m)	Margin (dB)	
Low Channel 5195 MHz, measured at 3 meters											
5195	101.70	0	135	V	33.922	4.62	0	140.24	-	-	Peak/Fund
5195	98.11	0	120	H	33.922	4.62	0	136.65	-	-	Peak/Fund
5195	84.89	0	135	V	33.922	4.62	0	123.43	-	-	Ave/Fund
5195	87.42	0	120	H	33.922	4.62	0	125.96	-	-	Ave/Fund
10390	30.44	0	100	V	38.845	6.2	27.7	47.79	74	-26.21	Peak
10390	28.13	0	100	H	38.845	6.2	27.7	45.48	74	-28.52	Peak
10390	15.73	0	100	V	38.845	6.2	27.7	33.07	54	-20.93	Ave
10390	17.94	0	100	H	38.845	6.2	27.7	35.29	54	-18.71	Ave
15585	30.55	0	100	V	42.941	8.31	27.58	54.23	74	-19.77	Peak
15585	28.23	0	100	H	42.941	8.31	27.58	51.91	74	-22.09	Peak
15585	16.85	0	100	V	42.941	8.31	27.58	40.52	54	-13.48	Ave
15585	16.47	0	100	H	42.941	8.31	27.58	40.14	54	-13.86	Ave
20780	29.72	0	100	V	49.67	9.74	27.06	62.07	74	-11.93	Peak
20780	30.64	0	100	H	49.67	9.74	27.06	62.99	74	-11.01	Peak
20780	16.84	0	100	V	49.67	9.74	27.06	49.19	54	-4.81	Ave
20780	14.02	0	100	H	49.67	9.74	27.06	46.37	54	-7.63	Ave
Middle Channel 5200 MHz, measured at 3 meters											
5200	114.04	0	135	V	33.922	4.62	0	152.58	-	-	Peak/Fund
5200	110.02	0	120	H	33.922	4.62	0	148.56	-	-	Peak/Fund
5200	99.35	0	135	V	33.922	4.62	0	137.89	-	-	Ave/Fund
5200	98.11	0	120	H	33.922	4.62	0	136.65	-	-	Ave/Fund
10400	27.06	0	100	V	38.845	6.2	27.7	44.40	74	-29.60	Peak
10400	29.72	0	100	H	38.845	6.2	27.7	47.06	74	-26.94	Peak
10400	13.65	0	100	V	38.845	6.2	27.7	31.00	54	-23.00	Ave
10400	15.14	0	100	H	38.845	6.2	27.7	32.48	54	-21.52	Ave
15600	28.95	0	100	V	42.941	8.31	27.58	52.62	74	-21.38	Peak
15600	26.69	0	100	H	42.941	8.31	27.58	50.36	74	-23.64	Peak
15600	17.27	0	100	V	42.941	8.31	27.58	40.94	54	-13.06	Ave
15600	17.60	0	100	H	42.941	8.31	27.58	41.27	54	-12.73	Ave
20800	30.58	0	100	V	49.67	9.74	27.06	62.93	74	-11.07	Peak
20800	31.80	0	100	H	49.67	9.74	27.06	64.15	74	-9.85	Peak
20800	16.78	0	100	V	49.67	9.74	27.06	49.13	54	-4.87	Ave
20800	16.82	0	100	H	49.67	9.74	27.06	49.17	54	-4.83	Ave

Frequency (MHz)	S.A. Reading (dBμV)	Turntable Azimuth (degrees)	Test Antenna			Cable Loss (dB)	Pre-Amp. (dB)	Cord. Reading (dBμV/m)	FCC		Comments
			Height (cm)	Polarity (H/V)	Factor (dB/m)				Limit (dBμV/m)	Margin (dB)	
High Channel 5210 MHz, measured at 3 meters											
5210	105.21	0	135	V	33.922	4.62	0	143.75	-	-	Peak/Fund
5210	104.13	0	120	H	33.922	4.62	0	142.67	-	-	Peak/Fund
5210	91.56	0	135	V	33.922	4.62	0	130.10	-	-	Ave/Fund
5210	92.01	0	120	H	33.922	4.62	0	130.55	-	-	Ave/Fund
10420	32.43	0	100	V	38.845	6.2	27.7	49.78	74	-24.22	Peak
10420	31.74	0	100	H	38.845	6.2	27.7	49.08	74	-24.92	Peak
10420	18.22	0	100	V	38.845	6.2	27.7	35.57	54	-18.43	Ave
10420	19.07	0	100	H	38.845	6.2	27.7	36.42	54	-17.58	Ave
15630	32.44	0	100	V	42.941	8.31	27.58	56.11	74	-17.89	Peak
15630	27.80	0	100	H	42.941	8.31	27.58	51.47	74	-22.53	Peak
15630	18.06	0	100	V	42.941	8.31	27.58	41.73	54	-12.27	Ave
15630	15.90	0	100	H	42.941	8.31	27.58	39.57	54	-14.43	Ave
20840	31.95	0	100	V	49.67	9.74	27.06	64.30	74	-9.70	Peak
20840	29.66	0	100	H	49.67	9.74	27.06	62.01	74	-11.99	Peak
20840	18.58	0	100	V	49.67	9.74	27.06	50.93	54	-3.07	Ave
20840	13.91	0	100	H	49.67	9.74	27.06	46.26	54	-7.74	Ave

**5.8 GHz Band:**

## 20 MHz Bandwidth

Frequency (MHz)	S.A. Reading (dBµV)	Turntable Azimuth (degrees)	Test Antenna			Cable Loss (dB)	Pre-Amp. (dB)	Cord. Reading (dBµV/m)	FCC		Comments
			Height (cm)	Polarity (H/V)	Factor (dB/m)				Limit (dBµV/m)	Margin (dB)	
Low Channel 5745 MHz, measured at 3 meters											
5745	116.29	0	135	V	33.922	4.62	0	154.83	-	-	Peak/Fund
5745	118.64	0	120	H	33.922	4.62	0	157.18	-	-	Peak/Fund
5745	104.91	0	135	V	33.922	4.62	0	143.45	-	-	Ave/Fund
5745	103.75	0	120	H	33.922	4.62	0	142.29	-	-	Ave/Fund
11490	37.59	0	100	V	38.845	6.2	27.7	54.94	74	-19.06	Peak
11490	41.16	0	100	H	38.845	6.2	27.7	58.50	74	-15.50	Peak
11490	18.56	0	100	V	38.845	6.2	27.7	35.90	54	-18.10	Ave
11490	20.17	0	100	H	38.845	6.2	27.7	37.52	54	-16.48	Ave
17235	27.25	0	100	V	42.941	8.31	27.58	50.92	99.79	-48.87	Peak
17235	29.41	0	100	H	42.941	8.31	27.58	53.08	99.78	-46.70	Peak
17235	15.43	0	100	V	42.941	8.31	27.58	39.10	87.32	-48.22	Ave
17235	16.75	0	100	H	42.941	8.31	27.58	40.42	88.06	-47.64	Ave
22980	28.80	0	100	V	49.67	9.74	27.06	61.15	74	-12.85	Peak
22980	27.16	0	100	H	49.67	9.74	27.06	59.51	74	-14.49	Peak
22980	13.29	0	100	V	49.67	9.74	27.06	45.64	54	-8.36	Ave
22980	12.92	0	100	H	49.67	9.74	27.06	45.27	54	-8.73	Ave
Middle Channel 5785 MHz, measured at 3 meters											
5785	116.45	0	135	V	33.922	4.62	0	154.99	-	-	Peak/Fund
5785	116.88	0	120	H	33.922	4.62	0	155.42	-	-	Peak/Fund
5785	104.55	0	135	V	33.922	4.62	0	143.09	-	-	Ave/Fund
5785	103.33	0	120	H	33.922	4.62	0	141.87	-	-	Ave/Fund
11570	32.81	0	100	V	38.845	6.2	27.7	50.16	74	-23.84	Peak
11570	32.68	0	100	H	38.845	6.2	27.7	50.03	74	-23.97	Peak
11570	17.27	0	100	V	38.845	6.2	27.7	34.62	54	-19.38	Ave
11570	16.07	0	100	H	38.845	6.2	27.7	33.41	54	-20.59	Ave
17355	28.74	0	100	V	42.941	8.31	27.58	52.41	99.17	-46.76	Peak
17355	28.15	0	100	H	42.941	8.31	27.58	51.82	99.52	-47.70	Peak
17355	16.00	0	100	V	42.941	8.31	27.58	39.68	86.6	-46.92	Ave
17355	15.50	0	100	H	42.941	8.31	27.58	39.18	87.66	-48.48	Ave
23140	27.58	0	100	V	49.67	9.74	27.06	59.93	99.17	-39.24	Peak
23140	27.31	0	100	H	49.67	9.74	27.06	59.66	99.52	-39.86	Peak
23140	16.54	0	100	V	49.67	9.74	27.06	48.89	86.6	-37.71	Ave
23140	15.24	0	100	H	49.67	9.74	27.06	47.59	87.66	-40.07	Ave

Frequency (MHz)	S.A. Reading (dBµV)	Turntable Azimuth (degrees)	Test Antenna			Cable Loss (dB)	Pre-Amp. (dB)	Cord. Reading (dBµV/m)	FCC		Comments
			Height (cm)	Polarity (H/V)	Factor (dB/m)				Limit (dBµV/m)	Margin (dB)	
High Channel 5825 MHz, measured at 3 meters											
5825	114.85	0	135	V	33.922	4.62	0	153.39	-	-	Peak/Fund
5825	113.98	0	120	H	33.922	4.62	0	152.53	-	-	Peak/Fund
5825	101.75	0	135	V	33.922	4.62	0	140.29	-	-	Ave/Fund
5825	104.64	0	120	H	33.922	4.62	0	143.18	-	-	Ave/Fund
11650	30.69	0	100	V	38.845	6.2	27.7	48.04	74	-25.96	Peak
11650	35.62	0	100	H	38.845	6.2	27.7	52.96	74	-21.04	Peak
11650	15.31	0	100	V	38.845	6.2	27.7	32.66	54	-21.34	Ave
11650	17.37	0	100	H	38.845	6.2	27.7	34.72	54	-19.28	Ave
17475	28.41	0	100	V	42.941	8.31	27.58	52.08	98.61	-46.53	Peak
17475	28.50	0	100	H	42.941	8.31	27.58	52.18	98.57	-46.39	Peak
17475	16.95	0	100	V	42.941	8.31	27.58	40.63	86.24	-45.61	Ave
17475	15.51	0	100	H	42.941	8.31	27.58	39.18	87.24	-48.06	Ave
23300	30.64	0	100	V	49.67	9.74	27.06	62.99	98.61	-35.62	Peak
23300	27.60	0	100	H	49.67	9.74	27.06	59.95	98.57	-38.62	Peak
23300	15.50	0	100	V	49.67	9.74	27.06	47.85	86.24	-38.39	Ave
23300	14.04	0	100	H	49.67	9.74	27.06	46.39	87.24	-40.85	Ave

## 40 MHz Bandwidth

Frequency (MHz)	S.A. Reading (dBµV)	Turntable Azimuth (degrees)	Test Antenna			Cable Loss (dB)	Pre-Amp. (dB)	Cord. Reading (dBµV/m)	FCC		Comments
			Height (cm)	Polarity (H/V)	Factor (dB/m)				Limit (dBµV/m)	Margin (dB)	
Low Channel 5755 MHz, measured at 3 meters											
5755	111.30	0	135	V	33.922	4.62	0	149.85	-	-	Peak/Fund
5755	112.34	0	120	H	33.922	4.62	0	150.88	-	-	Peak/Fund
5755	100.56	0	135	V	33.922	4.62	0	139.10	-	-	Ave/Fund
5755	104.47	0	120	H	33.922	4.62	0	143.01	-	-	Ave/Fund
11510	29.11	0	100	V	38.845	6.2	27.7	46.45	74	-27.55	Peak
11510	30.62	0	100	H	38.845	6.2	27.7	47.97	74	-26.03	Peak
11510	13.32	0	100	V	38.845	6.2	27.7	30.67	54	-23.33	Ave
11510	17.38	0	100	H	38.845	6.2	27.7	34.72	54	-19.28	Ave
17265	27.95	0	100	V	42.941	8.31	27.58	51.62	95.75	-44.13	Peak
17265	29.38	0	100	H	42.941	8.31	27.58	53.05	96.81	-43.76	Peak
17265	14.76	0	100	V	42.941	8.31	27.58	38.43	83.46	-45.03	Ave
17265	14.62	0	100	H	42.941	8.31	27.58	38.29	85.15	-46.86	Ave
23020	27.80	0	100	V	49.67	9.74	27.06	60.15	95.75	-35.60	Peak
23020	29.84	0	100	H	49.67	9.74	27.06	62.19	96.81	-34.62	Peak
23020	13.18	0	100	V	49.67	9.74	27.06	45.53	83.46	-37.93	Ave
23020	15.05	0	100	H	49.67	9.74	27.06	47.40	85.15	-37.75	Ave
Middle Channel 5785 MHz, measured at 3 meters											
5785	111.34	0	135	V	33.922	4.62	0	149.89	-	-	Peak/Fund
5785	112.75	0	120	H	33.922	4.62	0	151.29	-	-	Peak/Fund
5785	100.46	0	135	V	33.922	4.62	0	139.00	-	-	Ave/Fund
5785	100.92	0	120	H	33.922	4.62	0	139.46	-	-	Ave/Fund
11570	29.60	0	100	V	38.845	6.2	27.7	46.94	74	-27.06	Peak
11570	26.95	0	100	H	38.845	6.2	27.7	44.30	74	-29.70	Peak
11570	14.76	0	100	V	38.845	6.2	27.7	32.11	54	-21.89	Ave
11570	13.97	0	100	H	38.845	6.2	27.7	31.31	54	-22.69	Ave
17355	29.12	0	100	V	42.941	8.31	27.58	52.79	95.45	-42.66	Peak
17355	26.50	0	100	H	42.941	8.31	27.58	50.17	96.49	-46.32	Peak
17355	13.08	0	100	V	42.941	8.31	27.58	36.75	83.22	-46.47	Ave
17355	13.91	0	100	H	42.941	8.31	27.58	37.58	84.55	-46.97	Ave
23140	28.10	0	100	V	49.67	9.74	27.06	60.45	95.45	-35.00	Peak
23140	27.29	0	100	H	49.67	9.74	27.06	59.64	96.49	-36.85	Peak
23140	16.45	0	100	V	49.67	9.74	27.06	48.80	83.22	-34.42	Ave
23140	17.31	0	100	H	49.67	9.74	27.06	49.66	84.55	-34.89	Ave



Frequency (MHz)	S.A. Reading (dB $\mu$ V)	Turntable Azimuth (degrees)	Test Antenna			Cable Loss (dB)	Pre-Amp. (dB)	Cord. Reading (dB $\mu$ V/m)	FCC		Comments
			Height (cm)	Polarity (H/V)	Factor (dB/m)				Limit (dB $\mu$ V/m)	Margin (dB)	
High Channel 5815 MHz, measured at 3 meters											
5815	112.21	0	135	V	33.922	4.62	0	150.75	-	-	Peak/Fund
5815	113.25	0	120	H	33.922	4.62	0	151.79	-	-	Peak/Fund
5815	100.95	0	135	V	33.922	4.62	0	139.49	-	-	Ave/Fund
5815	102.76	0	120	H	33.922	4.62	0	141.30	-	-	Ave/Fund
11630	32.55	0	100	V	38.845	6.2	27.7	49.89	74	-24.11	Peak
11630	30.16	0	100	H	38.845	6.2	27.7	47.50	74	-26.50	Peak
11630	16.44	0	100	V	38.845	6.2	27.7	33.79	54	-20.21	Ave
11630	18.42	0	100	H	38.845	6.2	27.7	35.76	54	-18.24	Ave
17445	27.74	0	100	V	42.941	8.31	27.58	51.41	95.54	-44.13	Peak
17445	30.10	0	100	H	42.941	8.31	27.58	53.78	97.14	-43.36	Peak
17445	15.63	0	100	V	42.941	8.31	27.58	39.30	83.24	-43.94	Ave
17445	13.88	0	100	H	42.941	8.31	27.58	37.55	85.01	-47.46	Ave
23260	31.64	0	100	V	49.67	9.74	27.06	63.99	95.54	-31.55	Peak
23260	29.79	0	100	H	49.67	9.74	27.06	62.14	97.14	-35.00	Peak
23260	15.98	0	100	V	49.67	9.74	27.06	48.33	83.24	-34.91	Ave
23260	17.49	0	100	H	49.67	9.74	27.06	49.84	85.01	-35.17	Ave

## 80 MHz Bandwidth

Frequency (MHz)	S.A. Reading (dBμV)	Turntable Azimuth (degrees)	Test Antenna			Cable Loss (dB)	Pre-Amp. (dB)	Cord. Reading (dBμV/m)	FCC		Comments
			Height (cm)	Polarity (H/V)	Factor (dB/m)				Limit (dBμV/m)	Margin (dB)	
Low Channel 5775 MHz, measured at 3 meters											
5775	109.81	0	135	V	33.922	4.62	0	148.35	-	-	Peak/Fund
5775	112.23	0	120	H	33.922	4.62	0	150.77	-	-	Peak/Fund
5775	95.92	0	135	V	33.922	4.62	0	134.46	-	-	Ave/Fund
5775	100.48	0	120	H	33.922	4.62	0	139.02	-	-	Ave/Fund
11550	29.11	0	100	V	38.845	6.2	27.7	46.46	74	-27.54	Peak
11550	26.54	0	100	H	38.845	6.2	27.7	43.89	74	-30.11	Peak
11550	16.76	0	100	V	38.845	6.2	27.7	34.11	54	-19.89	Ave
11550	13.30	0	100	H	38.845	6.2	27.7	30.64	54	-23.36	Ave
17325	28.66	0	100	V	42.941	8.31	27.58	52.33	94.12	-41.79	Peak
17325	27.74	0	100	H	42.941	8.31	27.58	51.41	94.73	-43.32	Peak
17325	17.67	0	100	V	42.941	8.31	27.58	41.34	79.17	-37.83	Ave
17325	13.62	0	100	H	42.941	8.31	27.58	37.29	81.58	-44.29	Ave
23100	26.88	0	100	V	49.67	9.74	27.06	59.23	74	-14.77	Peak
23100	31.44	0	100	H	49.67	9.74	27.06	63.79	74	-10.21	Peak
23100	13.39	0	100	V	49.67	9.74	27.06	45.74	54	-8.26	Ave
23100	15.33	0	100	H	49.67	9.74	27.06	47.68	54	-6.32	Ave
High Channel 5795 MHz, measured at 3 meters											
5795	109.34	0	135	V	33.922	4.62	0	147.88	-	-	Peak/Fund
5795	111.80	0	120	H	33.922	4.62	0	150.34	-	-	Peak/Fund
5795	97.50	0	135	V	33.922	4.62	0	136.05	-	-	Ave/Fund
5795	96.55	0	120	H	33.922	4.62	0	135.09	-	-	Ave/Fund
11590	27.57	0	100	V	38.845	6.2	27.7	44.91	74	-29.09	Peak
11590	30.12	0	100	H	38.845	6.2	27.7	47.46	74	-26.54	Peak
11590	17.38	0	100	V	38.845	6.2	27.7	34.73	54	-19.27	Ave
11590	17.79	0	100	H	38.845	6.2	27.7	35.13	54	-18.87	Ave
17385	28.88	0	100	V	42.941	8.31	27.58	52.55	93.82	-41.27	Peak
17385	30.32	0	100	H	42.941	8.31	27.58	53.99	94.68	-40.69	Peak
17385	15.27	0	100	V	42.941	8.31	27.58	38.94	78.74	-39.80	Ave
17385	14.70	0	100	H	42.941	8.31	27.58	38.37	81.53	-43.16	Ave
23180	27.54	0	100	V	49.67	9.74	27.06	59.89	93.82	-33.93	Peak
23180	28.72	0	100	H	49.67	9.74	27.06	61.07	94.68	-33.61	Peak
23180	17.13	0	100	V	49.67	9.74	27.06	49.48	78.74	-29.26	Ave
23180	17.55	0	100	H	49.67	9.74	27.06	49.90	81.53	-31.63	Ave

**0 dBi antenna****5.2 GHz Band:**

20 MHz Bandwidth

Frequency (MHz)	S.A. Reading (dBµV)	Turntable Azimuth (degrees)	Test Antenna			Cable Loss (dB)	Pre-Amp. (dB)	Cord. Reading (dBµV/m)	FCC		Comments
			Height (cm)	Polarity (H/V)	Factor (dB/m)				Limit (dBµV/m)	Margin (dB)	
Low Channel 5165 MHz, measured at 3 meters											
5165	64.71	0	198	V	33.922	3.47	0	102.102	-	-	Peak/Fund
5165	62.95	0	189	H	33.922	3.47	0	100.342	-	-	Peak/Fund
5165	56.74	0	198	V	33.922	3.47	0	94.132	-	-	Ave/Fund
5165	51.65	0	189	H	33.922	3.47	0	89.042	-	-	Ave/Fund
10330	28.75	0	100	V	38.845	6.2	36.5	37.295	74	-36.705	Peak
10330	28.95	0	100	H	38.845	6.2	36.5	37.495	74	-36.505	Peak
10330	14.37	0	100	V	38.845	6.2	36.5	22.915	54	-31.085	Ave
10330	14.54	0	100	H	38.845	6.2	36.5	23.085	54	-30.915	Ave
15495	28.77	0	100	V	42.941	8.31	36.7	43.321	74	-30.679	Peak
15495	28.84	0	100	H	42.941	8.31	36.7	43.391	74	-30.609	Peak
15495	14.9	0	100	V	42.941	8.31	36.7	29.451	54	-24.549	Ave
15495	14.71	0	100	H	42.941	8.31	36.7	29.261	54	-24.739	Ave
20660	28.69	0	100	V	49.67	9.74	36.9	51.2	74	-22.8	Peak
20660	29.7	0	100	H	49.67	9.74	36.9	52.21	74	-21.79	Peak
20660	14.51	0	100	V	49.67	9.74	36.9	37.02	54	-16.98	Ave
20660	14.76	0	100	H	49.67	9.74	36.9	37.27	54	-16.73	Ave
Middle Channel 5200 MHz, measured at 3 meters											
5200	75.49	0	198	V	33.922	3.47	0	112.882	-	-	Peak/Fund
5200	75.45	0	189	H	33.922	3.47	0	112.842	-	-	Peak/Fund
5200	62.08	0	198	V	33.922	3.47	0	99.472	-	-	Ave/Fund
5200	63.18	0	189	H	33.922	3.47	0	100.572	-	-	Ave/Fund
10400	32.54	0	100	V	38.845	6.2	36.5	41.085	74	-32.915	Peak
10400	32.58	0	100	H	38.845	6.2	36.5	41.125	74	-32.875	Peak
10400	15.43	0	100	V	38.845	6.2	36.5	23.975	54	-30.025	Ave
10400	15.61	0	100	H	38.845	6.2	36.5	24.155	54	-29.845	Ave
15600	29.02	0	100	V	42.941	8.31	36.7	43.571	74	-30.429	Peak
15600	28.35	0	100	H	42.941	8.31	36.7	42.901	74	-31.099	Peak
15600	14.66	0	100	V	42.941	8.31	36.7	29.211	54	-24.789	Ave
15600	14.61	0	100	H	42.941	8.31	36.7	29.161	54	-24.839	Ave
20800	28.41	0	100	V	49.67	9.74	36.9	50.92	74	-23.08	Peak
20800	28.37	0	100	H	49.67	9.74	36.9	50.88	74	-23.12	Peak
20800	14.81	0	100	V	49.67	9.74	36.9	37.32	54	-16.68	Ave
20800	14.87	0	100	H	49.67	9.74	36.9	37.38	54	-16.62	Ave

Frequency (MHz)	S.A. Reading (dBµV)	Turntable Azimuth (degrees)	Test Antenna			Cable Loss (dB)	Pre-Amp. (dB)	Cord. Reading (dBµV/m)	FCC		Comments
			Height (cm)	Polarity (H/V)	Factor (dB/m)				Limit (dBµV/m)	Margin (dB)	
High Channel 5240 MHz, measured at 3 meters											
5240	69.51	0	198	V	33.922	3.47	0	106.902	-	-	Peak/Fund
5240	66.8	0	189	H	33.922	3.47	0	104.192	-	-	Peak/Fund
5240	55.93	0	198	V	33.922	3.47	0	93.322	-	-	Ave/Fund
5240	55.24	0	189	H	33.922	3.47	0	92.632	-	-	Ave/Fund
10480	29.68	0	100	V	38.845	6.2	36.5	38.225	74	-35.775	Peak
10480	29.39	0	100	H	38.845	6.2	36.5	37.935	74	-36.065	Peak
10480	15.27	0	100	V	38.845	6.2	36.5	23.815	54	-30.185	Ave
10480	15.37	0	100	H	38.845	6.2	36.5	23.915	54	-30.085	Ave
15720	29.75	0	100	V	42.941	8.31	36.7	44.301	74	-29.699	Peak
15720	30.48	0	100	H	42.941	8.31	36.7	45.031	74	-28.969	Peak
15720	15.94	0	100	V	42.941	8.31	36.7	30.491	54	-23.509	Ave
15720	15.87	0	100	H	42.941	8.31	36.7	30.421	54	-23.579	Ave
20960	30.9	0	100	V	49.67	9.74	36.9	53.41	74	-20.59	Peak
20960	29.31	0	100	H	49.67	9.74	36.9	51.82	74	-22.18	Peak
20960	15.71	0	100	V	49.67	9.74	36.9	38.22	54	-15.78	Ave
20960	15.69	0	100	H	49.67	9.74	36.9	38.2	54	-15.8	Ave

## 40 MHz Bandwidth

Frequency (MHz)	S.A. Reading (dBµV)	Turntable Azimuth (degrees)	Test Antenna			Cable Loss (dB)	Pre-Amp. (dB)	Cord. Reading (dBµV/m)	FCC		Comments
			Height (cm)	Polarity (H/V)	Factor (dB/m)				Limit (dBµV/m)	Margin (dB)	
Low Channel 5175 MHz, measured at 3 meters											
5175	64.29	0	198	V	33.922	3.47	0	101.682	-	-	Peak/Fund
5175	62.86	0	189	H	33.922	3.47	0	100.252	-	-	Peak/Fund
5175	53.29	0	198	V	33.922	3.47	0	90.682	-	-	Ave/Fund
5175	50.91	0	189	H	33.922	3.47	0	88.302	-	-	Ave/Fund
10350	28.75	0	100	V	38.845	6.2	36.5	37.295	74	-36.705	Peak
10350	28.95	0	100	H	38.845	6.2	36.5	37.495	74	-36.505	Peak
10350	14.37	0	100	V	38.845	6.2	36.5	22.915	54	-31.085	Ave
10350	14.54	0	100	H	38.845	6.2	36.5	23.085	54	-30.915	Ave
15525	28.77	0	100	V	42.941	8.31	36.7	43.321	74	-30.679	Peak
15525	28.84	0	100	H	42.941	8.31	36.7	43.391	74	-30.609	Peak
15525	14.9	0	100	V	42.941	8.31	36.7	29.451	54	-24.549	Ave
15525	14.71	0	100	H	42.941	8.31	36.7	29.261	54	-24.739	Ave
20700	28.69	0	100	V	49.67	9.74	36.9	51.2	74	-22.8	Peak
20700	29.7	0	100	H	49.67	9.74	36.9	52.21	74	-21.79	Peak
20700	14.51	0	100	V	49.67	9.74	36.9	37.02	54	-16.98	Ave
20700	14.76	0	100	H	49.67	9.74	36.9	37.27	54	-16.73	Ave
Middle Channel 5200 MHz, measured at 3 meters											
5200	72.52	0	198	V	33.922	3.47	0	109.912	-	-	Peak/Fund
5200	71.74	0	189	H	33.922	3.47	0	109.132	-	-	Peak/Fund
5200	62.29	0	198	V	33.922	3.47	0	99.682	-	-	Ave/Fund
5200	62.02	0	189	H	33.922	3.47	0	99.412	-	-	Ave/Fund
10400	32.54	0	100	V	38.845	6.2	36.5	41.085	74	-32.915	Peak
10400	32.58	0	100	H	38.845	6.2	36.5	41.125	74	-32.875	Peak
10400	15.43	0	100	V	38.845	6.2	36.5	23.975	54	-30.025	Ave
10400	15.61	0	100	H	38.845	6.2	36.5	24.155	54	-29.845	Ave
15600	29.02	0	100	V	42.941	8.31	36.7	43.571	74	-30.429	Peak
15600	28.35	0	100	H	42.941	8.31	36.7	42.901	74	-31.099	Peak
15600	14.66	0	100	V	42.941	8.31	36.7	29.211	54	-24.789	Ave
15600	14.61	0	100	H	42.941	8.31	36.7	29.161	54	-24.839	Ave
20800	28.41	0	100	V	49.67	9.74	36.9	50.92	74	-23.08	Peak
20800	28.37	0	100	H	49.67	9.74	36.9	50.88	74	-23.12	Peak
20800	14.81	0	100	V	49.67	9.74	36.9	37.32	54	-16.68	Ave
20800	14.87	0	100	H	49.67	9.74	36.9	37.38	54	-16.62	Ave

Frequency (MHz)	S.A. Reading (dBµV)	Turntable Azimuth (degrees)	Test Antenna			Cable Loss (dB)	Pre-Amp. (dB)	Cord. Reading (dBµV/m)	FCC		Comments
			Height (cm)	Polarity (H/V)	Factor (dB/m)				Limit (dBµV/m)	Margin (dB)	
High Channel 5230 MHz, measured at 3 meters											
5230	67.11	0	198	V	33.922	3.47	0	104.502	-	-	Peak/Fund
5230	64.31	0	189	H	33.922	3.47	0	101.702	-	-	Peak/Fund
5230	56.1	0	198	V	33.922	3.47	0	93.492	-	-	Ave/Fund
5230	53.94	0	189	H	33.922	3.47	0	91.332	-	-	Ave/Fund
10460	29.68	0	100	V	38.845	6.2	36.5	38.225	74	-35.775	Peak
10460	29.39	0	100	H	38.845	6.2	36.5	37.935	74	-36.065	Peak
10460	15.27	0	100	V	38.845	6.2	36.5	23.815	54	-30.185	Ave
10460	15.37	0	100	H	38.845	6.2	36.5	23.915	54	-30.085	Ave
15690	29.75	0	100	V	42.941	8.31	36.7	44.301	74	-29.699	Peak
15690	30.48	0	100	H	42.941	8.31	36.7	45.031	74	-28.969	Peak
15690	15.94	0	100	V	42.941	8.31	36.7	30.491	54	-23.509	Ave
15690	15.87	0	100	H	42.941	8.31	36.7	30.421	54	-23.579	Ave
20920	30.9	0	100	V	49.67	9.74	36.9	53.41	74	-20.59	Peak
20920	29.31	0	100	H	49.67	9.74	36.9	51.82	74	-22.18	Peak
20920	15.71	0	100	V	49.67	9.74	36.9	38.22	54	-15.78	Ave
20920	15.69	0	100	H	49.67	9.74	36.9	38.2	54	-15.8	Ave

## 80 MHz Bandwidth

Frequency (MHz)	S.A. Reading (dBµV)	Turntable Azimuth (degrees)	Test Antenna			Cable Loss (dB)	Pre-Amp. (dB)	Cord. Reading (dBµV/m)	FCC		Comments
			Height (cm)	Polarity (H/V)	Factor (dB/m)				Limit (dBµV/m)	Margin (dB)	
Low Channel 5195 MHz, measured at 3 meters											
5195	61.61	0	198	V	33.922	3.47	0	99.002	-	-	Peak/Fund
5195	58.02	0	189	H	33.922	3.47	0	95.412	-	-	Peak/Fund
5195	44.8	0	198	V	33.922	3.47	0	82.192	-	-	Ave/Fund
5195	47.33	0	189	H	33.922	3.47	0	84.722	-	-	Ave/Fund
10390	28.75	0	100	V	38.845	6.2	36.5	37.295	74	-36.705	Peak
10390	28.95	0	100	H	38.845	6.2	36.5	37.495	74	-36.505	Peak
10390	14.37	0	100	V	38.845	6.2	36.5	22.915	54	-31.085	Ave
10390	14.54	0	100	H	38.845	6.2	36.5	23.085	54	-30.915	Ave
15585	28.77	0	100	V	42.941	8.31	36.7	43.321	74	-30.679	Peak
15585	28.84	0	100	H	42.941	8.31	36.7	43.391	74	-30.609	Peak
15585	14.9	0	100	V	42.941	8.31	36.7	29.451	54	-24.549	Ave
15585	14.71	0	100	H	42.941	8.31	36.7	29.261	54	-24.739	Ave
20780	28.69	0	100	V	49.67	9.74	36.9	51.2	74	-22.8	Peak
20780	29.7	0	100	H	49.67	9.74	36.9	52.21	74	-21.79	Peak
20780	14.51	0	100	V	49.67	9.74	36.9	37.02	54	-16.98	Ave
20780	14.76	0	100	H	49.67	9.74	36.9	37.27	54	-16.73	Ave
Middle Channel 5200 MHz, measured at 3 meters											
5200	73.95	0	198	V	33.922	3.47	0	111.342	-	-	Peak/Fund
5200	69.93	0	189	H	33.922	3.47	0	107.322	-	-	Peak/Fund
5200	59.26	0	198	V	33.922	3.47	0	96.652	-	-	Ave/Fund
5200	58.02	0	189	H	33.922	3.47	0	95.412	-	-	Ave/Fund
10400	32.54	0	100	V	38.845	6.2	36.5	41.085	74	-32.915	Peak
10400	32.58	0	100	H	38.845	6.2	36.5	41.125	74	-32.875	Peak
10400	15.43	0	100	V	38.845	6.2	36.5	23.975	54	-30.025	Ave
10400	15.61	0	100	H	38.845	6.2	36.5	24.155	54	-29.845	Ave
15600	29.02	0	100	V	42.941	8.31	36.7	43.571	74	-30.429	Peak
15600	28.35	0	100	H	42.941	8.31	36.7	42.901	74	-31.099	Peak
15600	14.66	0	100	V	42.941	8.31	36.7	29.211	54	-24.789	Ave
15600	14.61	0	100	H	42.941	8.31	36.7	29.161	54	-24.839	Ave
20800	28.41	0	100	V	49.67	9.74	36.9	50.92	74	-23.08	Peak
20800	28.37	0	100	H	49.67	9.74	36.9	50.88	74	-23.12	Peak
20800	14.81	0	100	V	49.67	9.74	36.9	37.32	54	-16.68	Ave
20800	14.87	0	100	H	49.67	9.74	36.9	37.38	54	-16.62	Ave

Frequency (MHz)	S.A. Reading (dBμV)	Turntable Azimuth (degrees)	Test Antenna			Cable Loss (dB)	Pre-Amp. (dB)	Cord. Reading (dBμV/m)	FCC		Comments
			Height (cm)	Polarity (H/V)	Factor (dB/m)				Limit (dBμV/m)	Margin (dB)	
High Channel 5210 MHz, measured at 3 meters											
5210	65.12	0	198	V	33.922	3.47	0	102.512	-	-	Peak/Fund
5210	64.04	0	189	H	33.922	3.47	0	101.432	-	-	Peak/Fund
5210	51.47	0	198	V	33.922	3.47	0	88.862	-	-	Ave/Fund
5210	51.92	0	189	H	33.922	3.47	0	89.312	-	-	Ave/Fund
10420	29.68	0	100	V	38.845	6.2	36.5	38.225	74	-35.775	Peak
10420	29.39	0	100	H	38.845	6.2	36.5	37.935	74	-36.065	Peak
10420	15.27	0	100	V	38.845	6.2	36.5	23.815	54	-30.185	Ave
10420	15.37	0	100	H	38.845	6.2	36.5	23.915	54	-30.085	Ave
15630	29.75	0	100	V	42.941	8.31	36.7	44.301	74	-29.699	Peak
15630	30.48	0	100	H	42.941	8.31	36.7	45.031	74	-28.969	Peak
15630	15.94	0	100	V	42.941	8.31	36.7	30.491	54	-23.509	Ave
15630	15.87	0	100	H	42.941	8.31	36.7	30.421	54	-23.579	Ave
20840	30.9	0	100	V	49.67	9.74	36.9	53.41	74	-20.59	Peak
20840	29.31	0	100	H	49.67	9.74	36.9	51.82	74	-22.18	Peak
20840	15.71	0	100	V	49.67	9.74	36.9	38.22	54	-15.78	Ave
20840	15.69	0	100	H	49.67	9.74	36.9	38.2	54	-15.8	Ave



**5.8 GHz Band:**

## 20 MHz Bandwidth

Frequency (MHz)	S.A. Reading (dBµV)	Turntable Azimuth (degrees)	Test Antenna			Cable Loss (dB)	Pre-Amp. (dB)	Cord. Reading (dBµV/m)	FCC		Comments
			Height (cm)	Polarity (H/V)	Factor (dB/m)				Limit (dBµV/m)	Margin (dB)	
Low Channel 5745 MHz, measured at 3 meters											
5745	76.2	0	198	V	33.922	3.47	0	113.592	-	-	Peak/Fund
5745	78.55	0	189	H	33.922	3.47	0	115.942	-	-	Peak/Fund
5745	64.82	0	198	V	33.922	3.47	0	102.212	-	-	Ave/Fund
5745	63.66	0	189	H	33.922	3.47	0	101.052	-	-	Ave/Fund
11490	30.14	0	100	V	38.845	6.2	36.5	38.685	74	-35.315	Peak
11490	30.34	0	100	H	38.845	6.2	36.5	38.885	74	-35.115	Peak
11490	15.76	0	100	V	38.845	6.2	36.5	24.305	54	-29.695	Ave
11490	15.93	0	100	H	38.845	6.2	36.5	24.475	54	-29.525	Ave
17235	30.16	0	100	V	42.941	8.31	36.7	44.711	74	-29.289	Peak
17235	30.23	0	100	H	42.941	8.31	36.7	44.781	74	-29.219	Peak
17235	16.29	0	100	V	42.941	8.31	36.7	30.841	54	-23.159	Ave
17235	16.1	0	100	H	42.941	8.31	36.7	30.651	54	-23.349	Ave
22980	30.08	0	100	V	49.67	9.74	36.9	52.59	74	-21.41	Peak
22980	31.09	0	100	H	49.67	9.74	36.9	53.6	74	-20.4	Peak
22980	15.9	0	100	V	49.67	9.74	36.9	38.41	54	-15.59	Ave
22980	16.15	0	100	H	49.67	9.74	36.9	38.66	54	-15.34	Ave
Middle Channel 5785 MHz, measured at 3 meters											
5785	76.36	0	198	V	33.922	3.47	0	113.752	-	-	Peak/Fund
5785	76.79	0	189	H	33.922	3.47	0	114.182	-	-	Peak/Fund
5785	64.46	0	198	V	33.922	3.47	0	101.852	-	-	Ave/Fund
5785	63.24	0	189	H	33.922	3.47	0	100.632	-	-	Ave/Fund
11570	33.93	0	100	V	38.845	6.2	36.5	42.475	74	-31.525	Peak
11570	33.97	0	100	H	38.845	6.2	36.5	42.515	74	-31.485	Peak
11570	16.82	0	100	V	38.845	6.2	36.5	25.365	54	-28.635	Ave
11570	17	0	100	H	38.845	6.2	36.5	25.545	54	-28.455	Ave
17355	30.41	0	100	V	42.941	8.31	36.7	44.961	74	-29.039	Peak
17355	29.74	0	100	H	42.941	8.31	36.7	44.291	74	-29.709	Peak
17355	16.05	0	100	V	42.941	8.31	36.7	30.601	54	-23.399	Ave
17355	16	0	100	H	42.941	8.31	36.7	30.551	54	-23.449	Ave
23140	29.8	0	100	V	49.67	9.74	36.9	52.31	74	-21.69	Peak
23140	29.76	0	100	H	49.67	9.74	36.9	52.27	74	-21.73	Peak
23140	16.2	0	100	V	49.67	9.74	36.9	38.71	54	-15.29	Ave
23140	16.26	0	100	H	49.67	9.74	36.9	38.77	54	-15.23	Ave

Frequency (MHz)	S.A. Reading (dB $\mu$ V)	Turntable Azimuth (degrees)	Test Antenna			Cable Loss (dB)	Pre-Amp. (dB)	Cord. Reading (dB $\mu$ V/m)	FCC		Comments
			Height (cm)	Polarity (H/V)	Factor (dB/m)				Limit (dB $\mu$ V/m)	Margin (dB)	
High Channel 5825 MHz, measured at 3 meters											
5825	74.76	0	198	V	33.922	3.47	0	112.152	-	-	Peak/Fund
5825	73.89	0	189	H	33.922	3.47	0	111.282	-	-	Peak/Fund
5825	61.66	0	198	V	33.922	3.47	0	99.052	-	-	Ave/Fund
5825	64.55	0	189	H	33.922	3.47	0	101.942	-	-	Ave/Fund
11650	31.07	0	100	V	38.845	6.2	36.5	39.615	74	-34.385	Peak
11650	30.78	0	100	H	38.845	6.2	36.5	39.325	74	-34.675	Peak
11650	16.66	0	100	V	38.845	6.2	36.5	25.205	54	-28.795	Ave
11650	16.76	0	100	H	38.845	6.2	36.5	25.305	54	-28.695	Ave
17475	31.14	0	100	V	42.941	8.31	36.7	45.691	74	-28.309	Peak
17475	31.87	0	100	H	42.941	8.31	36.7	46.421	74	-27.579	Peak
17475	17.33	0	100	V	42.941	8.31	36.7	31.881	54	-22.119	Ave
17475	17.26	0	100	H	42.941	8.31	36.7	31.811	54	-22.189	Ave
23300	32.29	0	100	V	49.67	9.74	36.9	54.8	74	-19.2	Peak
23300	30.7	0	100	H	49.67	9.74	36.9	53.21	74	-20.79	Peak
23300	17.1	0	100	V	49.67	9.74	36.9	39.61	54	-14.39	Ave
23300	17.08	0	100	H	49.67	9.74	36.9	39.59	54	-14.41	Ave

## 40 MHz Bandwidth

Frequency (MHz)	S.A. Reading (dBµV)	Turntable Azimuth (degrees)	Test Antenna			Cable Loss (dB)	Pre-Amp. (dB)	Cord. Reading (dBµV/m)	FCC		Comments
			Height (cm)	Polarity (H/V)	Factor (dB/m)				Limit (dBµV/m)	Margin (dB)	
Low Channel 5755 MHz, measured at 3 meters											
5755	71.21	0	198	V	33.922	3.47	0	108.602	-	-	Peak/Fund
5755	72.25	0	189	H	33.922	3.47	0	109.642	-	-	Peak/Fund
5755	60.47	0	198	V	33.922	3.47	0	97.862	-	-	Ave/Fund
5755	64.38	0	189	H	33.922	3.47	0	101.772	-	-	Ave/Fund
11510	30.14	0	100	V	38.845	6.2	36.5	38.685	74	-35.315	Peak
11510	30.34	0	100	H	38.845	6.2	36.5	38.885	74	-35.115	Peak
11510	15.76	0	100	V	38.845	6.2	36.5	24.305	54	-29.695	Ave
11510	15.93	0	100	H	38.845	6.2	36.5	24.475	54	-29.525	Ave
17265	30.16	0	100	V	42.941	8.31	36.7	44.711	74	-29.289	Peak
17265	30.23	0	100	H	42.941	8.31	36.7	44.781	74	-29.219	Peak
17265	16.29	0	100	V	42.941	8.31	36.7	30.841	54	-23.159	Ave
17265	16.1	0	100	H	42.941	8.31	36.7	30.651	54	-23.349	Ave
23020	30.08	0	100	V	49.67	9.74	36.9	52.59	74	-21.41	Peak
23020	31.09	0	100	H	49.67	9.74	36.9	53.6	74	-20.4	Peak
23020	15.9	0	100	V	49.67	9.74	36.9	38.41	54	-15.59	Ave
23020	16.15	0	100	H	49.67	9.74	36.9	38.66	54	-15.34	Ave
Middle Channel 5785 MHz, measured at 3 meters											
5785	71.25	0	198	V	33.922	3.47	0	108.642	-	-	Peak/Fund
5785	72.66	0	189	H	33.922	3.47	0	110.052	-	-	Peak/Fund
5785	60.37	0	198	V	33.922	3.47	0	97.762	-	-	Ave/Fund
5785	60.83	0	189	H	33.922	3.47	0	98.222	-	-	Ave/Fund
11570	33.93	0	100	V	38.845	6.2	36.5	42.475	74	-31.525	Peak
11570	33.97	0	100	H	38.845	6.2	36.5	42.515	74	-31.485	Peak
11570	16.82	0	100	V	38.845	6.2	36.5	25.365	54	-28.635	Ave
11570	17	0	100	H	38.845	6.2	36.5	25.545	54	-28.455	Ave
17355	30.41	0	100	V	42.941	8.31	36.7	44.961	74	-29.039	Peak
17355	29.74	0	100	H	42.941	8.31	36.7	44.291	74	-29.709	Peak
17355	16.05	0	100	V	42.941	8.31	36.7	30.601	54	-23.399	Ave
17355	16	0	100	H	42.941	8.31	36.7	30.551	54	-23.449	Ave
23140	29.8	0	100	V	49.67	9.74	36.9	52.31	74	-21.69	Peak
23140	29.76	0	100	H	49.67	9.74	36.9	52.27	74	-21.73	Peak
23140	16.2	0	100	V	49.67	9.74	36.9	38.71	54	-15.29	Ave
23140	16.26	0	100	H	49.67	9.74	36.9	38.77	54	-15.23	Ave

Frequency (MHz)	S.A. Reading (dBµV)	Turntable Azimuth (degrees)	Test Antenna			Cable Loss (dB)	Pre-Amp. (dB)	Cord. Reading (dBµV/m)	FCC		Comments
			Height (cm)	Polarity (H/V)	Factor (dB/m)				Limit (dBµV/m)	Margin (dB)	
High Channel 5815 MHz, measured at 3 meters											
5815	72.12	0	198	V	33.922	3.47	0	109.512	-	-	Peak/Fund
5815	73.16	0	189	H	33.922	3.47	0	110.552	-	-	Peak/Fund
5815	60.86	0	198	V	33.922	3.47	0	98.252	-	-	Ave/Fund
5815	62.67	0	189	H	33.922	3.47	0	100.062	-	-	Ave/Fund
11630	31.07	0	100	V	38.845	6.2	36.5	39.615	74	-34.385	Peak
11630	30.78	0	100	H	38.845	6.2	36.5	39.325	74	-34.675	Peak
11630	16.66	0	100	V	38.845	6.2	36.5	25.205	54	-28.795	Ave
11630	16.76	0	100	H	38.845	6.2	36.5	25.305	54	-28.695	Ave
17445	31.14	0	100	V	42.941	8.31	36.7	45.691	74	-28.309	Peak
17445	31.87	0	100	H	42.941	8.31	36.7	46.421	74	-27.579	Peak
17445	17.33	0	100	V	42.941	8.31	36.7	31.881	54	-22.119	Ave
17445	17.26	0	100	H	42.941	8.31	36.7	31.811	54	-22.189	Ave
23260	32.29	0	100	V	49.67	9.74	36.9	54.8	74	-19.2	Peak
23260	30.7	0	100	H	49.67	9.74	36.9	53.21	74	-20.79	Peak
23260	17.1	0	100	V	49.67	9.74	36.9	39.61	54	-14.39	Ave
23260	17.08	0	100	H	49.67	9.74	36.9	39.59	54	-14.41	Ave

## 80 MHz Bandwidth

Frequency (MHz)	S.A. Reading (dBµV)	Turntable Azimuth (degrees)	Test Antenna			Cable Loss (dB)	Pre-Amp. (dB)	Cord. Reading (dBµV/m)	FCC		Comments
			Height (cm)	Polarity (H/V)	Factor (dB/m)				Limit (dBµV/m)	Margin (dB)	
Low Channel 5775 MHz, measured at 3 meters											
5775	69.72	0	198	V	33.922	3.47	0	107.112	-	-	Peak/Fund
5775	72.14	0	189	H	33.922	3.47	0	109.532	-	-	Peak/Fund
5775	55.83	0	198	V	33.922	3.47	0	93.222	-	-	Ave/Fund
5775	60.39	0	189	H	33.922	3.47	0	97.782	-	-	Ave/Fund
11550	30.14	0	100	V	38.845	6.2	36.5	38.685	74	-35.315	Peak
11550	30.34	0	100	H	38.845	6.2	36.5	38.885	74	-35.115	Peak
11550	15.76	0	100	V	38.845	6.2	36.5	24.305	54	-29.695	Ave
11550	15.93	0	100	H	38.845	6.2	36.5	24.475	54	-29.525	Ave
17325	30.16	0	100	V	42.941	8.31	36.7	44.711	74	-29.289	Peak
17325	30.23	0	100	H	42.941	8.31	36.7	44.781	74	-29.219	Peak
17325	16.29	0	100	V	42.941	8.31	36.7	30.841	54	-23.159	Ave
17325	16.1	0	100	H	42.941	8.31	36.7	30.651	54	-23.349	Ave
23100	30.08	0	100	V	49.67	9.74	36.9	52.59	74	-21.41	Peak
23100	31.09	0	100	H	49.67	9.74	36.9	53.6	74	-20.4	Peak
23100	15.9	0	100	V	49.67	9.74	36.9	38.41	54	-15.59	Ave
23100	16.15	0	100	H	49.67	9.74	36.9	38.66	54	-15.34	Ave
High Channel 5795 MHz, measured at 3 meters											
5795	69.25	0	198	V	33.922	3.47	0	106.642	-	-	Peak/Fund
5795	71.71	0	189	H	33.922	3.47	0	109.102	-	-	Peak/Fund
5795	57.41	0	198	V	33.922	3.47	0	94.802	-	-	Ave/Fund
5795	56.46	0	189	H	33.922	3.47	0	93.852	-	-	Ave/Fund
11590	31.07	0	100	V	38.845	6.2	36.5	39.615	74	-34.385	Peak
11590	30.78	0	100	H	38.845	6.2	36.5	39.325	74	-34.675	Peak
11590	16.66	0	100	V	38.845	6.2	36.5	25.205	54	-28.795	Ave
11590	16.76	0	100	H	38.845	6.2	36.5	25.305	54	-28.695	Ave
17385	31.14	0	100	V	42.941	8.31	36.7	45.691	74	-28.309	Peak
17385	31.87	0	100	H	42.941	8.31	36.7	46.421	74	-27.579	Peak
17385	17.33	0	100	V	42.941	8.31	36.7	31.881	54	-22.119	Ave
17385	17.26	0	100	H	42.941	8.31	36.7	31.811	54	-22.189	Ave
23180	32.29	0	100	V	49.67	9.74	36.9	54.8	74	-19.2	Peak
23180	30.7	0	100	H	49.67	9.74	36.9	53.21	74	-20.79	Peak
23180	17.1	0	100	V	49.67	9.74	36.9	39.61	54	-14.39	Ave
23180	17.08	0	100	H	49.67	9.74	36.9	39.59	54	-14.41	Ave

**3) Restricted Band Edge, Measured at 3 meters****25 dBi antenna****5.2 GHz Band:**

20 MHz bandwidth

Frequency (MHz)	S.A. Reading (dB $\mu$ V)	Turntable Azimuth (degrees)	Test Antenna			Cable Loss (dB)	Pre-Amp. (dB)	Cord. Reading (dB $\mu$ V/m)	FCC		Comments
			Height (cm)	Polarity (H/V)	Factor (dB/m)				Limit (dB $\mu$ V/m)	Margin (dB)	
Low Channel 5165 MHz, measured at 3 meters											
4500	28.99	0	135	V	33.835	4.56	0	67.38	74	-6.62	Peak
4500	28.52	0	120	H	33.835	4.56	0	66.92	74	-7.08	Peak
4500	12.51	0	135	V	33.835	4.56	0	50.91	54	-3.09	Ave
4500	11.59	0	120	H	33.835	4.56	0	49.99	54	-4.01	Ave
High Channel 5240 MHz, measured at 3 meters											
5350	24.45	0	135	V	33.835	4.56	0	62.84	74	-11.16	Peak
5350	22.76	0	120	H	33.835	4.56	0	61.15	74	-12.85	Peak
5350	12.16	0	135	V	33.835	4.56	0	50.55	54	-3.45	Ave
5350	10.08	0	120	H	33.835	4.56	0	48.48	54	-5.52	Ave

40 MHz bandwidth

Frequency (MHz)	S.A. Reading (dB $\mu$ V)	Turntable Azimuth (degrees)	Test Antenna			Cable Loss (dB)	Pre-Amp. (dB)	Cord. Reading (dB $\mu$ V/m)	FCC		Comments
			Height (cm)	Polarity (H/V)	Factor (dB/m)				Limit (dB $\mu$ V/m)	Margin (dB)	
Low Channel 5175 MHz, measured at 3 meters											
4500	29.67	0	135	V	33.835	4.56	0	68.07	74	-5.93	Peak
4500	29.29	0	120	H	33.835	4.56	0	67.68	74	-6.32	Peak
4500	14.00	0	135	V	33.835	4.56	0	52.39	54	-1.61	Ave
4500	12.77	0	120	H	33.835	4.56	0	51.17	54	-2.83	Ave
High Channel 5230 MHz, measured at 3 meters											
5350	24.01	0	135	V	33.835	4.56	0	62.41	74	-11.59	Peak
5350	22.69	0	120	H	33.835	4.56	0	61.08	74	-12.92	Peak
5350	11.41	0	135	V	33.835	4.56	0	49.81	54	-4.19	Ave
5350	10.55	0	120	H	33.835	4.56	0	48.95	54	-5.05	Ave

## 80 MHz bandwidth

Frequency (MHz)	S.A. Reading (dBμV)	Turntable Azimuth (degrees)	Test Antenna			Cable Loss (dB)	Pre-Amp. (dB)	Cord. Reading (dBμV/m)	FCC		Comments
			Height (cm)	Polarity (H/V)	Factor (dB/m)				Limit (dBμV/m)	Margin (dB)	
Channel 5195 MHz, measured at 3 meters											
4500	29.73	0	135	V	33.835	4.56	0	68.13	74	-5.87	Peak
4500	31.49	0	120	H	33.835	4.56	0	69.89	74	-4.11	Peak
4500	14.21	0	135	V	33.835	4.56	0	52.60	54	-1.40	Ave
4500	13.69	0	120	H	33.835	4.56	0	52.09	54	-1.91	Ave
Channel 5210 MHz, measured at 3 meters											
5350	24.19	0	135	V	33.835	4.56	0	62.58	74	-11.42	Peak
5350	22.34	0	120	H	33.835	4.56	0	60.73	74	-13.27	Peak
5350	11.59	0	135	V	33.835	4.56	0	49.99	54	-4.01	Ave
5350	10.61	0	120	H	33.835	4.56	0	49.00	54	-5.00	Ave

## 5.8 GHz Band:

## 20 MHz bandwidth

Frequency (MHz)	S.A. Reading (dBμV)	Turntable Azimuth (degrees)	Test Antenna			Cable Loss (dB)	Pre-Amp. (dB)	Cord. Reading (dBμV/m)	FCC		Comments
			Height (cm)	Polarity (H/V)	Factor (dB/m)				Limit (dBμV/m)	Margin (dB)	
Low Channel measured at 3 meters											
5350	30.26	0	135	V	33.122	4.62	0	68.00	74	-6.00	Peak
5350	28.36	0	120	H	33.122	4.62	0	66.10	74	-7.90	Peak
5350	15.47	0	135	V	33.122	4.62	0	53.22	54	-0.78	Ave
5350	14.76	0	120	H	33.122	4.62	0	52.50	54	-1.50	Ave

## 40 MHz bandwidth

Frequency (MHz)	S.A. Reading (dBμV)	Turntable Azimuth (degrees)	Test Antenna			Cable Loss (dB)	Pre-Amp. (dB)	Cord. Reading (dBμV/m)	FCC		Comments
			Height (cm)	Polarity (H/V)	Factor (dB/m)				Limit (dBμV/m)	Margin (dB)	
Low Channel measured at 3 meters											
5350	30.28	0	135	V	33.122	4.62	0	68.02	74	-5.98	Peak
5350	27.34	0	120	H	33.122	4.62	0	65.08	74	-8.92	Peak
5350	14.78	0	135	V	33.122	4.62	0	52.52	54	-1.48	Ave
5350	14.16	0	120	H	33.122	4.62	0	51.90	54	-2.10	Ave

## 80 MHz bandwidth

Frequency (MHz)	S.A. Reading (dBμV)	Turntable Azimuth (degrees)	Test Antenna			Cable Loss (dB)	Pre-Amp. (dB)	Cord. Reading (dBμV/m)	FCC		Comments
			Height (cm)	Polarity (H/V)	Factor (dB/m)				Limit (dBμV/m)	Margin (dB)	
Low Channel measured at 3 meters											
5350	30.40	0	135	V	33.122	4.62	0	68.14	74	-5.86	Peak
5350	26.93	0	120	H	33.122	4.62	0	64.67	74	-9.33	Peak
5350	15.19	0	135	V	33.122	4.62	0	52.93	54	-1.07	Ave
5350	13.13	0	120	H	33.122	4.62	0	50.88	54	-3.12	Ave

**0 dBi antenna****5.2 GHz Band:**

20 MHz bandwidth

Frequency (MHz)	S.A. Reading (dBμV)	Turntable Azimuth (degrees)	Test Antenna			Cable Loss (dB)	Pre-Amp. (dB)	Cord. Reading (dBμV/m)	FCC		Comments
			Height (cm)	Polarity (H/V)	Factor (dB/m)				Limit (dBμV/m)	Margin (dB)	
Low Channel 5165 MHz, measured at 3 meters											
4500	28.14	0	198	V	33.835	3.47	0	65.445	74	-8.555	Peak
4500	26.21	0	189	H	33.835	3.47	0	63.515	74	-10.485	Peak
4500	12.71	0	198	V	33.835	3.47	0	50.015	54	-3.985	Ave
4500	12.57	0	189	H	33.835	3.47	0	49.875	54	-4.125	Ave
High Channel 5240 MHz, measured at 3 meters											
5350	25.92	0	198	V	33.835	3.47	0	63.225	74	-10.775	Peak
5350	24.78	0	189	H	33.835	3.47	0	62.085	74	-11.915	Peak
5350	12.34	0	198	V	33.835	3.47	0	49.645	54	-4.355	Ave
5350	12.27	0	189	H	33.835	3.47	0	49.575	54	-4.425	Ave

40 MHz bandwidth

Frequency (MHz)	S.A. Reading (dBμV)	Turntable Azimuth (degrees)	Test Antenna			Cable Loss (dB)	Pre-Amp. (dB)	Cord. Reading (dBμV/m)	FCC		Comments
			Height (cm)	Polarity (H/V)	Factor (dB/m)				Limit (dBμV/m)	Margin (dB)	
Low Channel 5175 MHz, measured at 3 meters											
4500	28.33	0	198	V	33.835	3.47	0	65.635	74	-8.365	Peak
4500	27.05	0	189	H	33.835	3.47	0	64.355	74	-9.645	Peak
4500	12.65	0	198	V	33.835	3.47	0	49.955	54	-4.045	Ave
4500	11.44	0	189	H	33.835	3.47	0	48.745	54	-5.255	Ave
High Channel 5230 MHz, measured at 3 meters											
5350	25.34	0	198	V	33.835	3.47	0	62.645	74	-11.355	Peak
5350	24.66	0	189	H	33.835	3.47	0	61.965	74	-12.035	Peak
5350	12.56	0	198	V	33.835	3.47	0	49.865	54	-4.135	Ave
5350	11.14	0	189	H	33.835	3.47	0	48.445	54	-5.555	Ave



## 80 MHz bandwidth

Frequency (MHz)	S.A. Reading (dB $\mu$ V)	Turntable Azimuth (degrees)	Test Antenna			Cable Loss (dB)	Pre-Amp. (dB)	Cord. Reading (dB $\mu$ V/m)	FCC		Comments
			Height (cm)	Polarity (H/V)	Factor (dB/m)				Limit (dB $\mu$ V/m)	Margin (dB)	
Channel 5195 MHz, measured at 3 meters											
4500	26.38	0	198	V	33.835	3.47	0	63.685	74	-10.315	Peak
4500	25.89	0	189	H	33.835	3.47	0	63.195	74	-10.805	Peak
4500	12.54	0	198	V	33.835	3.47	0	49.845	54	-4.155	Ave
4500	11.67	0	189	H	33.835	3.47	0	48.975	54	-5.025	Ave
Channel 5210 MHz, measured at 3 meters											
5350	25.37	0	198	V	33.835	3.47	0	62.675	74	-11.325	Peak
5350	24.13	0	189	H	33.835	3.47	0	61.435	74	-12.565	Peak
5350	11.89	0	198	V	33.835	3.47	0	49.195	54	-4.805	Ave
5350	11.18	0	189	H	33.835	3.47	0	48.485	54	-5.515	Ave

## 5.8 GHz Band:

## 20 MHz bandwidth

Frequency (MHz)	S.A. Reading (dB $\mu$ V)	Turntable Azimuth (degrees)	Test Antenna			Cable Loss (dB)	Pre-Amp. (dB)	Cord. Reading (dB $\mu$ V/m)	FCC		Comments
			Height (cm)	Polarity (H/V)	Factor (dB/m)				Limit (dB $\mu$ V/m)	Margin (dB)	
Low Channel measured at 3 meters											
5350	27.87	0	135	V	33.835	3.47	0	65.175	74	-8.825	Peak
5350	25.97	0	120	H	33.835	3.47	0	63.275	74	-10.725	Peak
5350	13.08	0	135	V	33.835	3.47	0	50.385	54	-3.615	Ave
5350	12.37	0	120	H	33.835	3.47	0	49.675	54	-4.325	Ave

## 40 MHz bandwidth

Frequency (MHz)	S.A. Reading (dB $\mu$ V)	Turntable Azimuth (degrees)	Test Antenna			Cable Loss (dB)	Pre-Amp. (dB)	Cord. Reading (dB $\mu$ V/m)	FCC		Comments
			Height (cm)	Polarity (H/V)	Factor (dB/m)				Limit (dB $\mu$ V/m)	Margin (dB)	
Low Channel measured at 3 meters											
5350	27.89	0	198	V	33.835	3.47	0	65.195	74	-8.805	Peak
5350	24.95	0	189	H	33.835	3.47	0	62.255	74	-11.745	Peak
5350	12.39	0	198	V	33.835	3.47	0	49.695	54	-4.305	Ave
5350	11.77	0	189	H	33.835	3.47	0	49.075	54	-4.925	Ave

## 80 MHz bandwidth

Frequency (MHz)	S.A. Reading (dB $\mu$ V)	Turntable Azimuth (degrees)	Test Antenna			Cable Loss (dB)	Pre-Amp. (dB)	Cord. Reading (dB $\mu$ V/m)	FCC		Comments
			Height (cm)	Polarity (H/V)	Factor (dB/m)				Limit (dB $\mu$ V/m)	Margin (dB)	
Low Channel measured at 3 meters											
5350	28.01	0	198	V	33.835	3.47	0	65.315	74	-8.685	Peak
5350	24.54	0	189	H	33.835	3.47	0	61.845	74	-12.155	Peak
5350	12.8	0	198	V	33.835	3.47	0	50.105	54	-3.895	Ave
5350	11.74	0	189	H	33.835	3.47	0	49.045	54	-4.955	Ave

## 8 FCC §15.407(a) & §15.407(e) – Emission Bandwidth

### 8.1 Applicable Standard

FCC §15.407(a) and FCC §15.407(e)

### 8.2 Measurement Procedure

The measurements are base on FCC KDB 789033 D02 General UNII Test Procedures v01: Guidelines for Compliance Testing of Unlicensed National Information Infrastructure (U-NII) Devices section C: Emission bandwidth and section D: 99 Percent Occupied Bandwidth

### 8.3 Test Equipment List and Details

Manufacturer	Description	Model No.	Serial No.	Calibration Date	Calibration Interval
Agilent	Spectrum Analyzer	E4446A	US44300386	2013-09-29	1 year

*Statement of Traceability: BACL Corp. attests that all calibrations have been performed according to A2LA requirements, traceable to the NIST.*

### 8.4 Test Environmental Conditions

<b>Temperature:</b>	23 °C
<b>Relative Humidity:</b>	43 %
<b>ATM Pressure:</b>	101.3 kPa

*The testing was performed by Cipher Chu on 2014-04-04 to 2014-04-07 at the RF Site.*

Note: Normal transmission is worst case.

### 8.5 Test Results

Please refer to the following tables and plots

Note: (1) Chain1 and Chain 4 is Vertical, and Chain 2 and Chain 3 is Horizontal  
 (2) C1, C2, C3 and C4 stands for TX Chain1, Chain2, Chain3 and Chain4.

## 25 dBi Antenna

## 5.2 GHz Band:

<b>TX Chain</b>	<b>Channel</b>	<b>Frequency (MHz)</b>	<b>99% Emission Bandwidth (MHz)</b>	<b>26 dB Emission Bandwidth (MHz)</b>
20 MHz bandwidth				
C1	Low	5165	18.1023	24.164
	Middle	5200	19.0014	30.000
	High	5240	18.1573	24.255
C2	Low	5165	18.1598	24.777
	Middle	5200	18.1680	27.727
	High	5240	18.1662	26.375
C3	Low	5165	17.9493	23.823
	Middle	5200	18.0910	24.418
	High	5240	18.0100	24.236
C4	Low	5165	17.9589	25.537
	Middle	5200	18.4055	30.000
	High	5240	18.1026	29.763
40 MHz bandwidth				
C1	Low	5175	36.4038	42.615
	Middle	5200	36.2345	41.748
	High	5230	36.3435	42.278
C2	Low	5175	36.2139	41.520
	Middle	5200	36.3725	45.848
	High	5230	36.3118	53.165
C3	Low	5175	36.2265	41.631
	Middle	5200	36.3794	42.579
	High	5230	36.3154	42.099
C4	Low	5175	36.2155	41.439
	Middle	5200	37.2594	60.000
	High	5230	36.2982	50.772
80 MHz bandwidth				
C1	Low	5195	75.3313	82.169
	Middle	5200	76.4029	120.000
	High	5210	75.5415	90.728
C2	Low	5195	75.4490	81.916
	Middle	5200	75.3199	113.459
	High	5210	75.3351	102.178
C3	Low	5195	75.4045	81.943
	Middle	5200	76.5506	120.000
	High	5210	75.2697	81.001
C4	Low	5195	75.4286	80.867
	Middle	5200	75.3702	120.000
	High	5210	75.8519	110.876

**5.8 GHz Band:**

<b>TX Chain</b>	<b>Channel</b>	<b>Frequency (MHz)</b>	<b>99% Emission Bandwidth (MHz)</b>	<b>6 dB Emission Bandwidth (MHz)</b>	<b>Limit (kHz)</b>	<b>Results</b>
<b>20 MHz bandwidth</b>						
C1	Low	5745	17.7068	17.345	> 500	Compliant
	Middle	5785	17.7340	17.547	> 500	Compliant
	High	5825	17.7333	17.257	> 500	Compliant
C2	Low	5745	17.7129	17.361	> 500	Compliant
	Middle	5785	17.7433	17.534	> 500	Compliant
	High	5825	17.7341	17.254	> 500	Compliant
C3	Low	5745	17.7385	17.304	> 500	Compliant
	Middle	5785	17.7452	17.251	> 500	Compliant
	High	5825	17.7366	17.249	> 500	Compliant
C4	Low	5745	17.7131	17.345	> 500	Compliant
	Middle	5785	17.7336	17.547	> 500	Compliant
	High	5825	17.7495	17.336	> 500	Compliant
<b>40 MHz bandwidth</b>						
C1	Low	5755	36.1522	33.918	> 500	Compliant
	Middle	5785	36.1499	35.140	> 500	Compliant
	High	5815	36.0800	35.090	> 500	Compliant
C2	Low	5755	36.1584	33.924	> 500	Compliant
	Middle	5785	36.2103	35.209	> 500	Compliant
	High	5815	36.1236	32.627	> 500	Compliant
C3	Low	5755	36.1432	33.937	> 500	Compliant
	Middle	5785	36.1667	31.333	> 500	Compliant
	High	5815	36.1637	16.276	> 500	Compliant
C4	Low	5755	36.1199	34.962	> 500	Compliant
	Middle	5785	36.1795	21.353	> 500	Compliant
	High	5815	36.1150	34.988	> 500	Compliant
<b>80 MHz bandwidth</b>						
C1	Low	5775	75.3243	75.527	> 500	Compliant
	Middle	5785	75.4426	75.706	> 500	Compliant
	High	5795	75.3007	74.118	> 500	Compliant
C2	Low	5775	75.3140	75.527	> 500	Compliant
	Middle	5785	75.3622	75.752	> 500	Compliant
	High	5795	75.2641	74.576	> 500	Compliant
C3	Low	5775	75.3243	75.527	> 500	Compliant
	Middle	5785	75.3229	75.546	> 500	Compliant
	High	5795	75.3357	75.634	> 500	Compliant
C4	Low	5775	75.3060	75.402	> 500	Compliant
	Middle	5785	75.2644	74.294	> 500	Compliant
	High	5795	75.3402	75.536	> 500	Compliant

5.2 GHz Band:

20 MHz bandwidth, Low Channel, 5165 MHz

C1

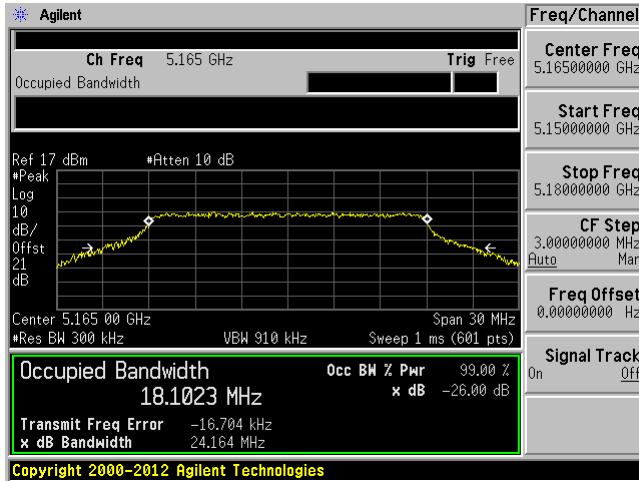

C2

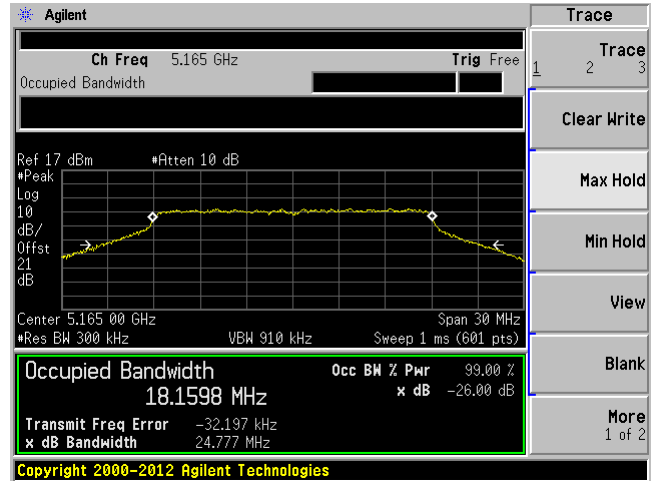

C3

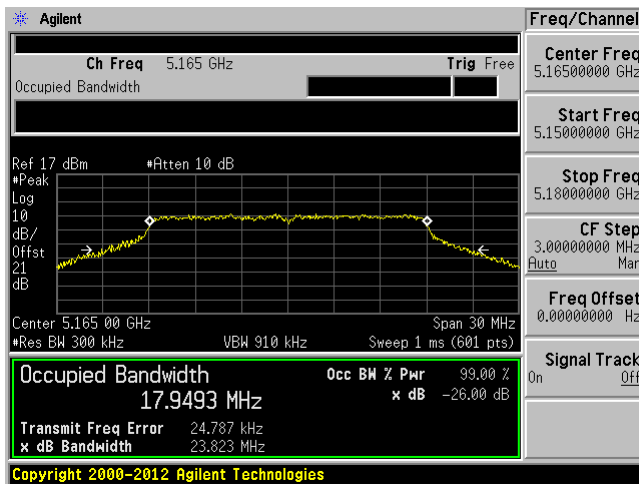

C4

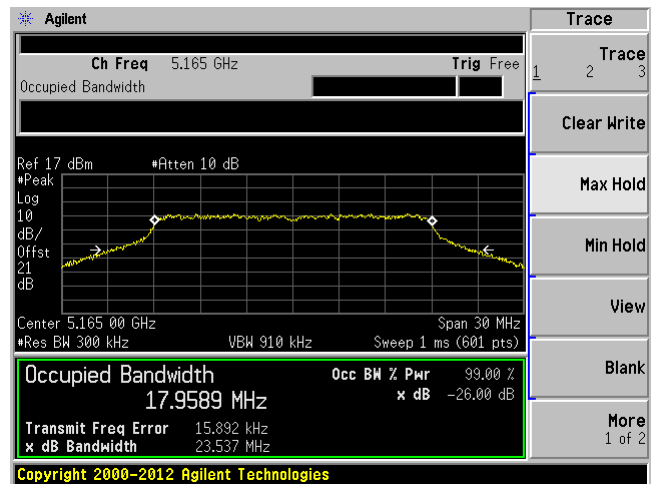

20 MHz bandwidth, Middle Channel, 5200 MHz

C1

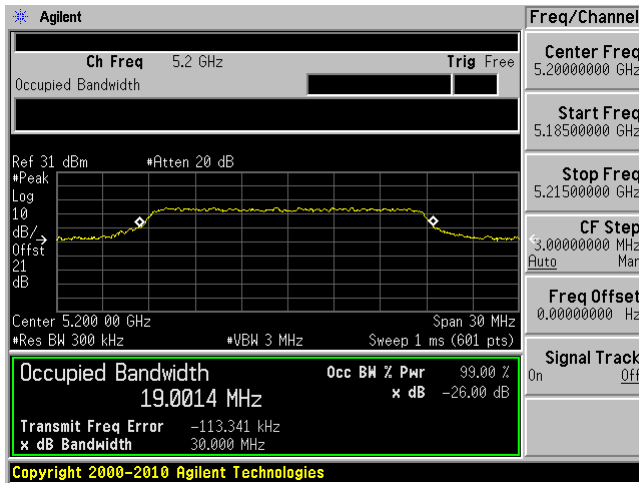

C2

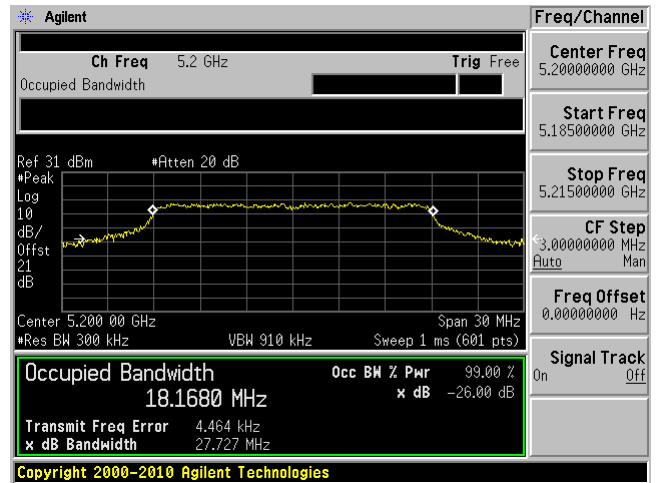

C3

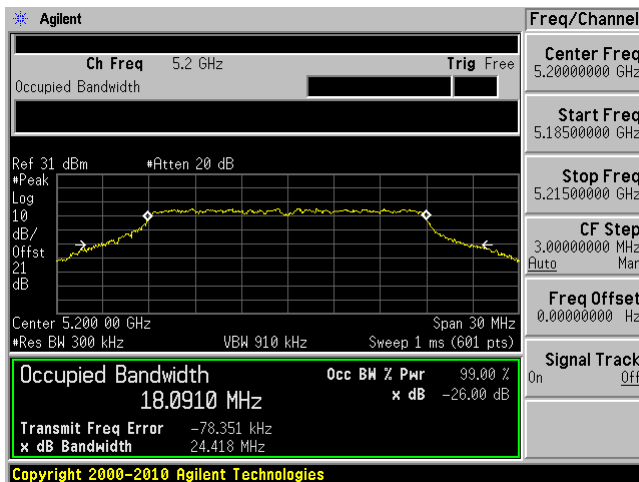

C4

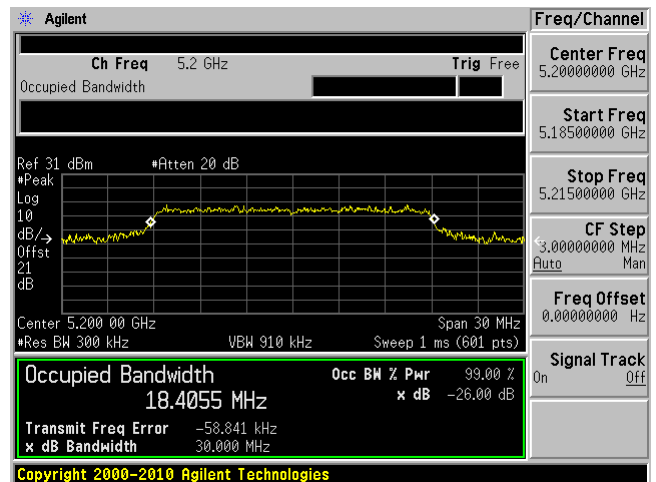

20 MHz bandwidth, High Channel, 5240 MHz

C1

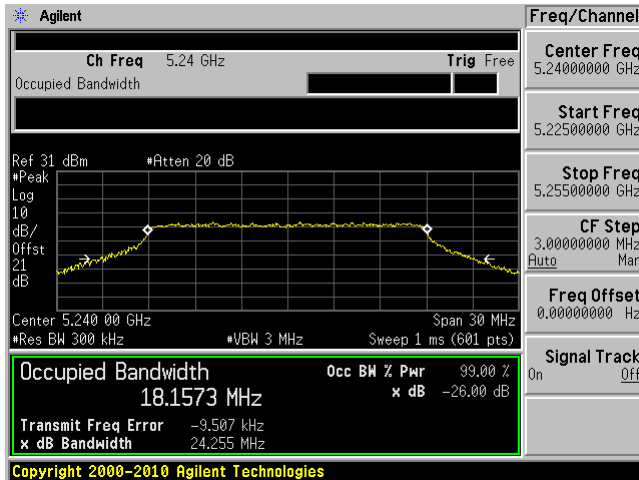

C2

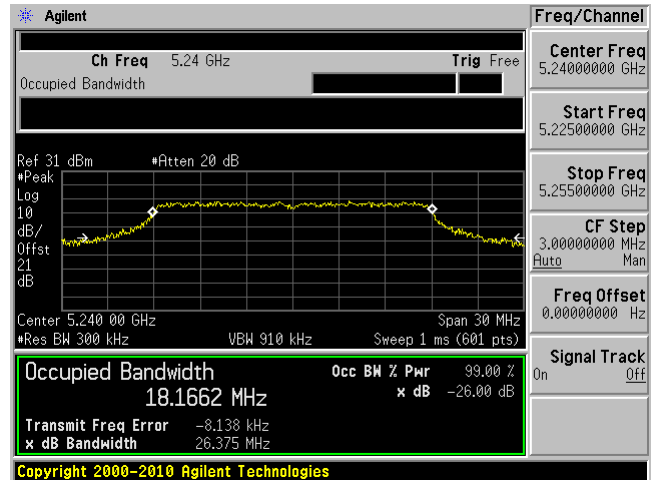

C3

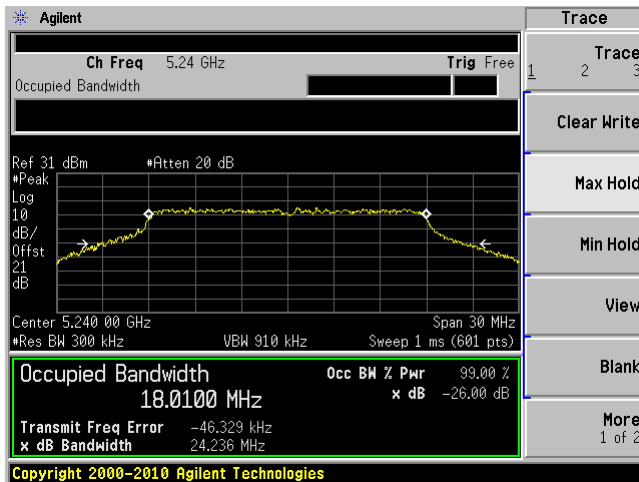

C4

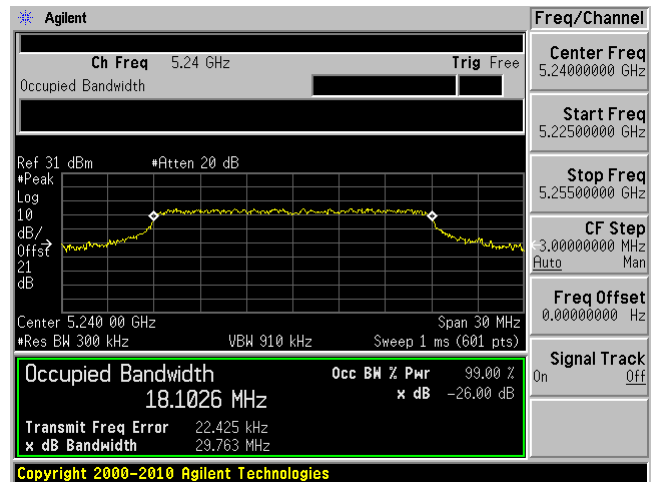

40 MHz bandwidth, Low Channel, 5175 MHz

C1

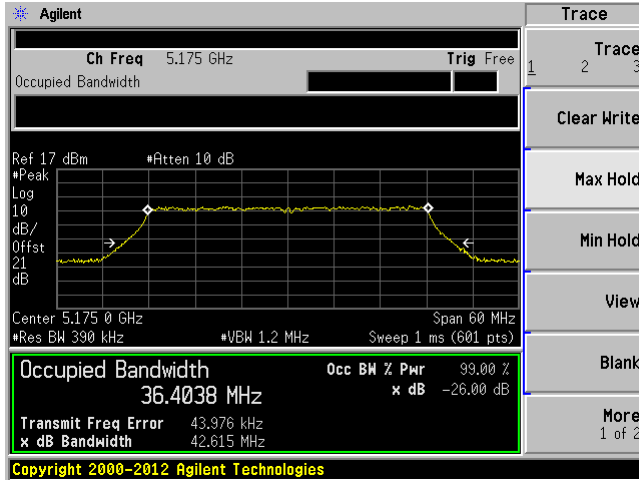

C2

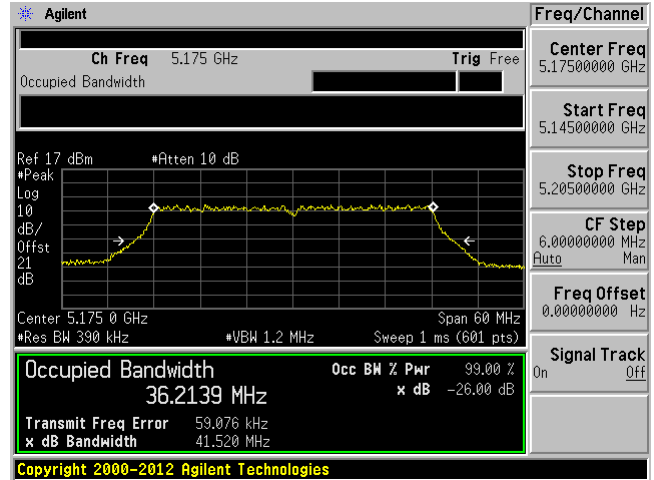

C3

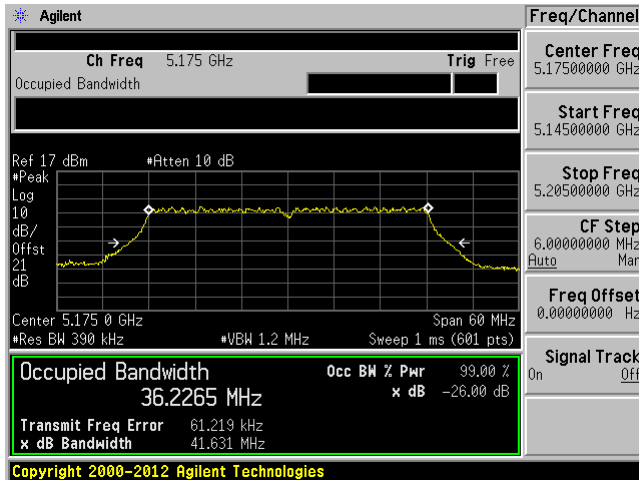

C4

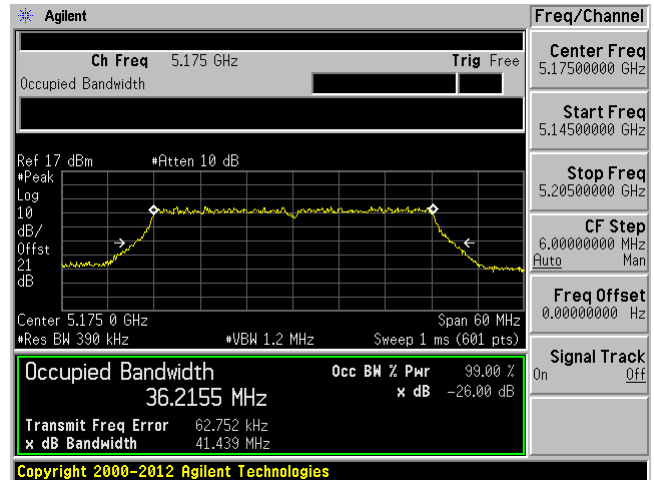



### 40 MHz bandwidth, Middle Channel, 5200 MHz

C1

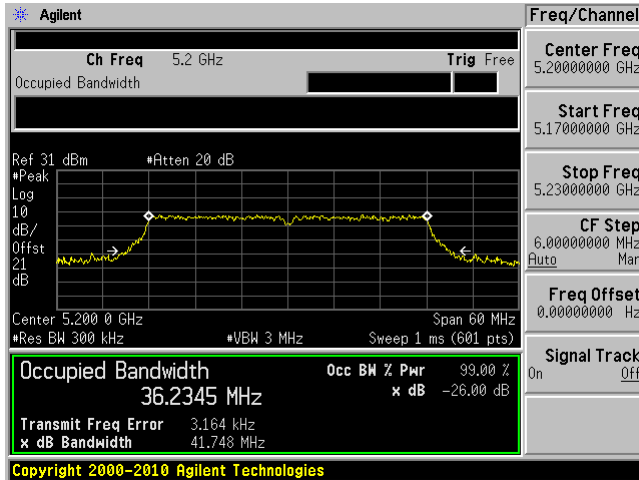

C2

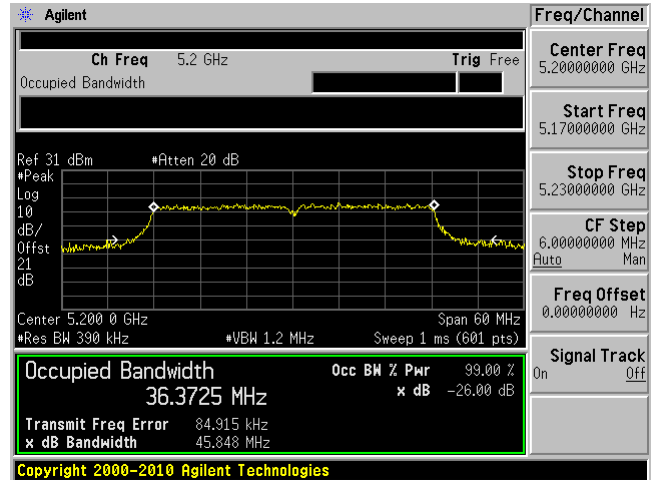

C3

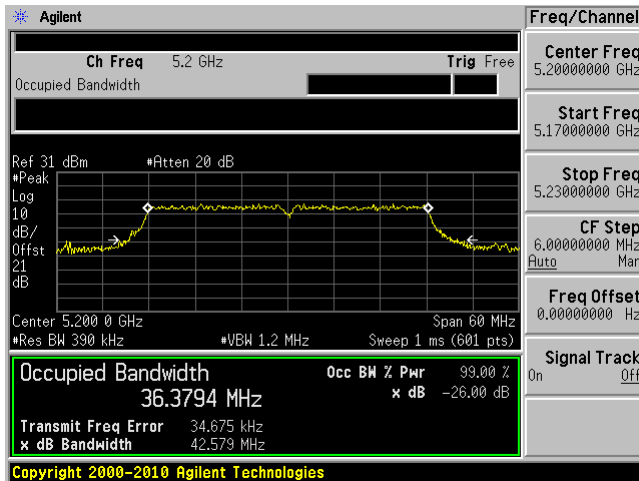

C4

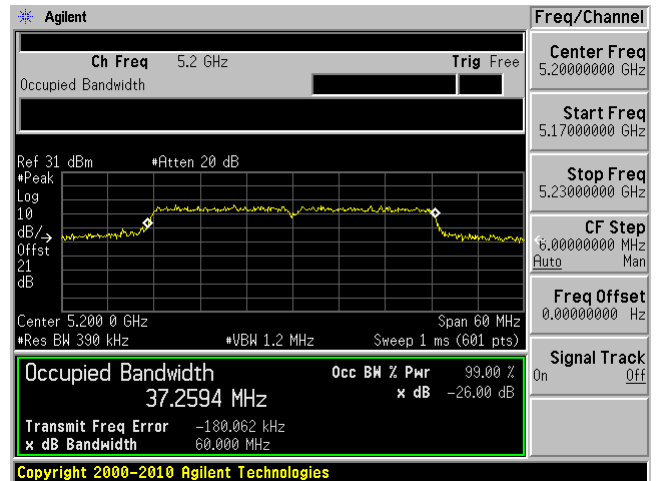

40 MHz bandwidth, High Channel, 5230 MHz

C1

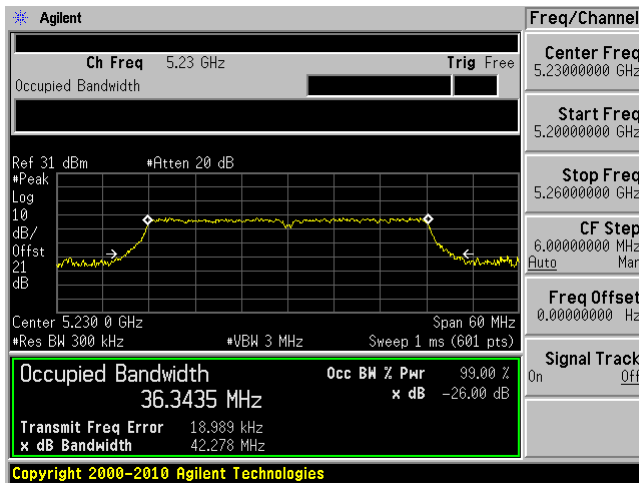

C2

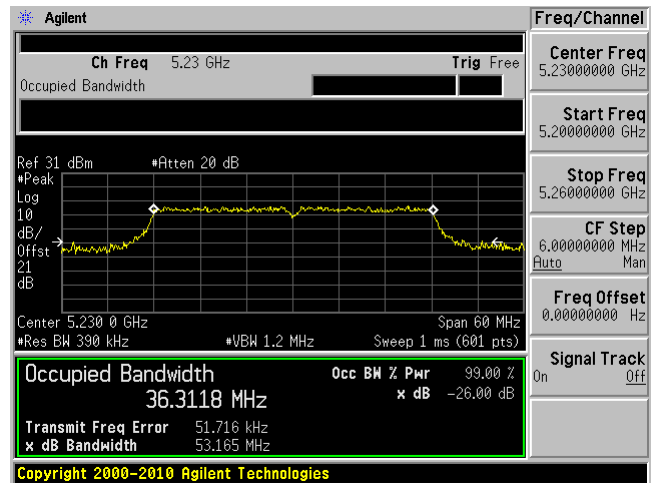

C3

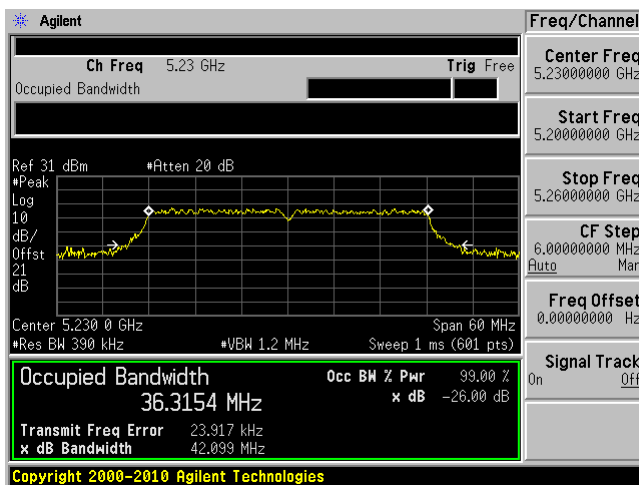

C4

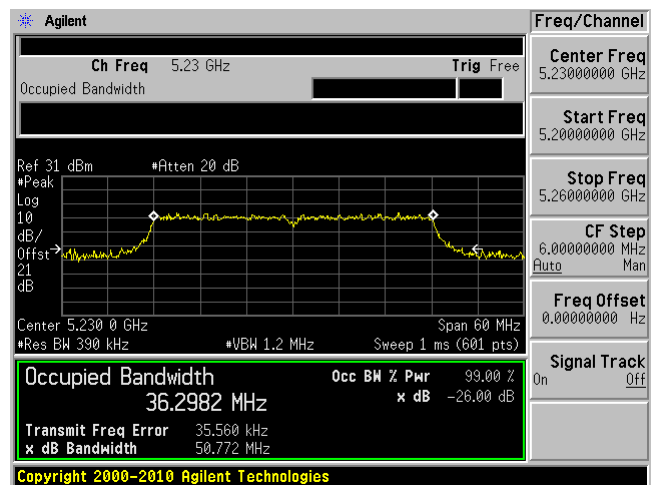

### 80 MHz bandwidth, Low Channel, 5195 MHz

C1

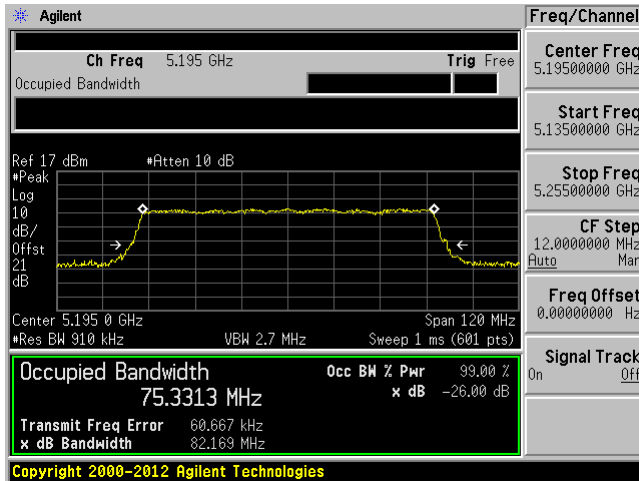

C2

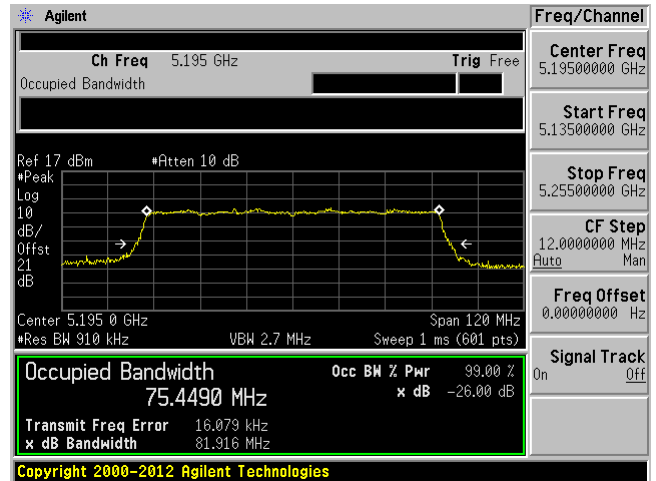

C3

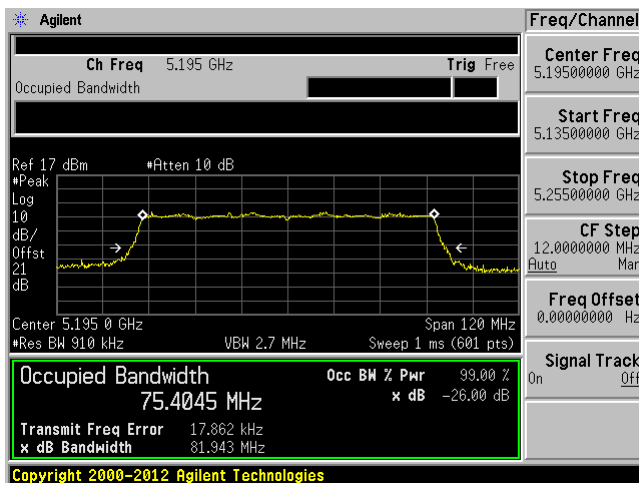

C4

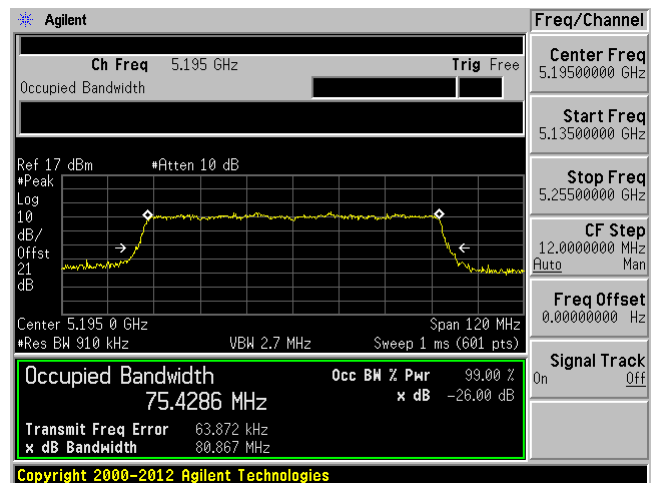

### 80 MHz bandwidth, Middle Channel, 5200 MHz

C1

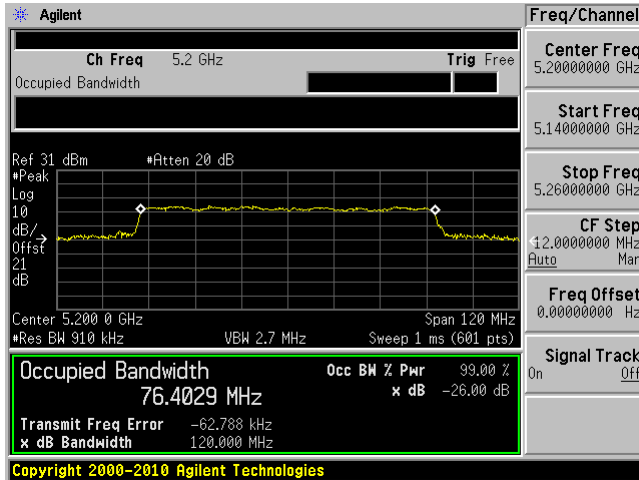

C2

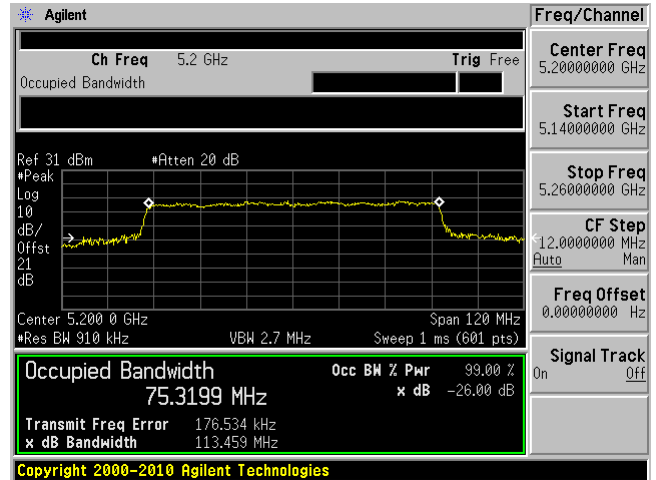

C3

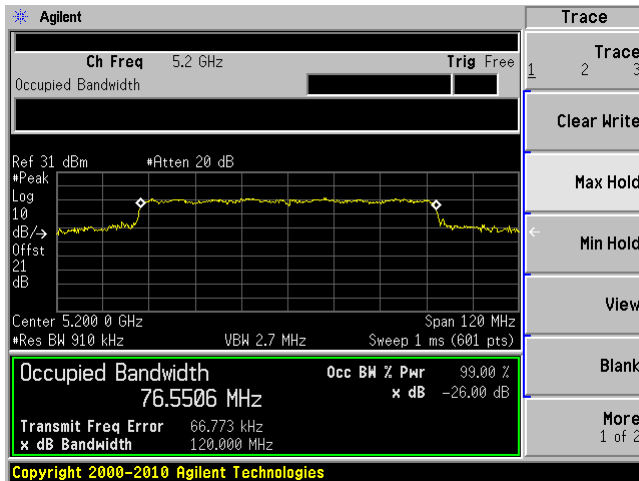

C4

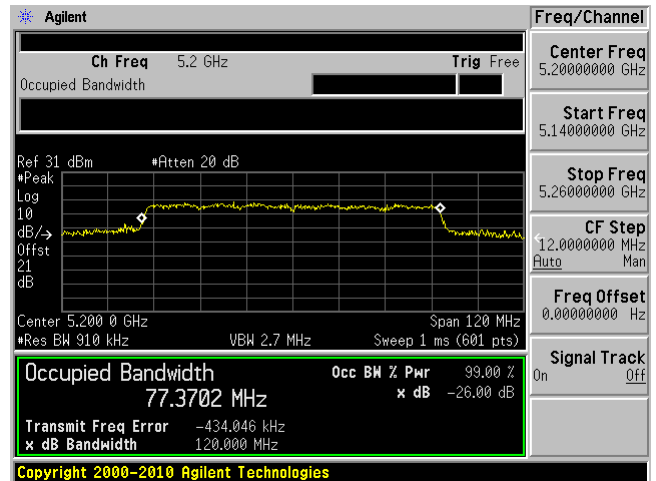

### 80 MHz bandwidth, High Channel, 5210 MHz

C1

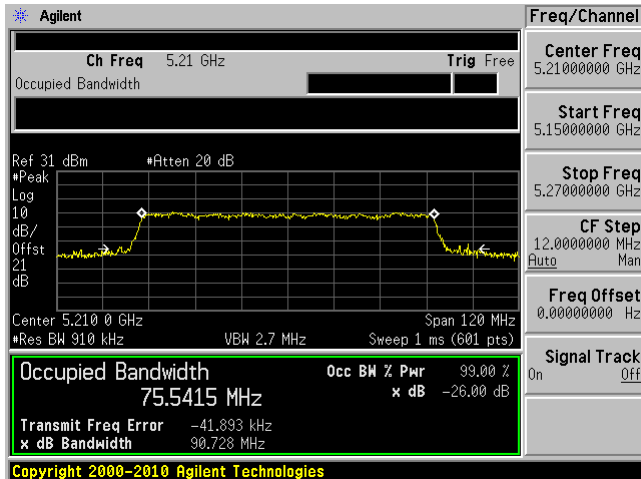

C2

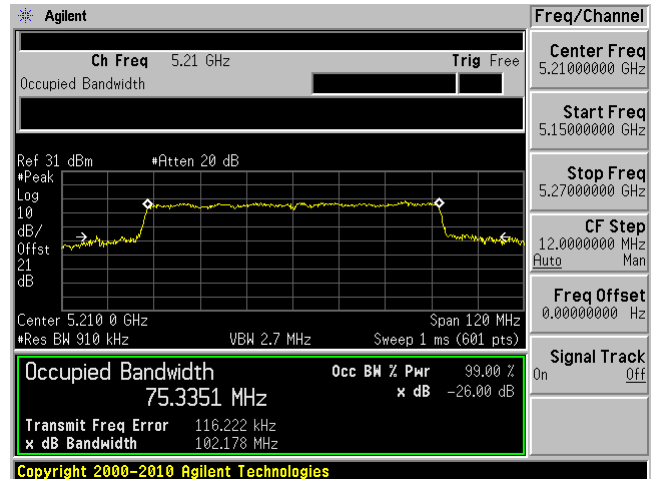

C3

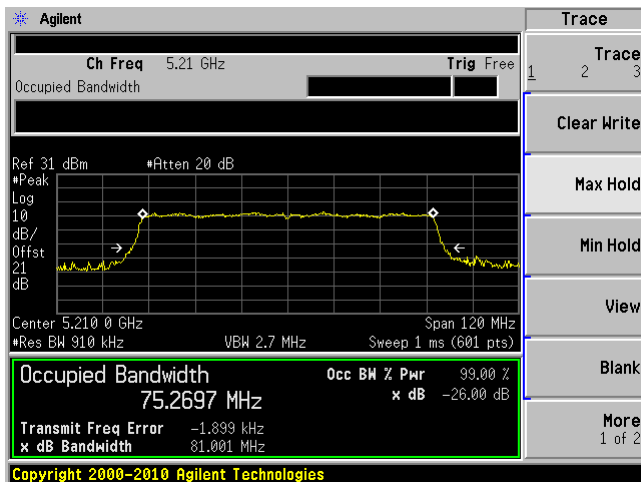

C4

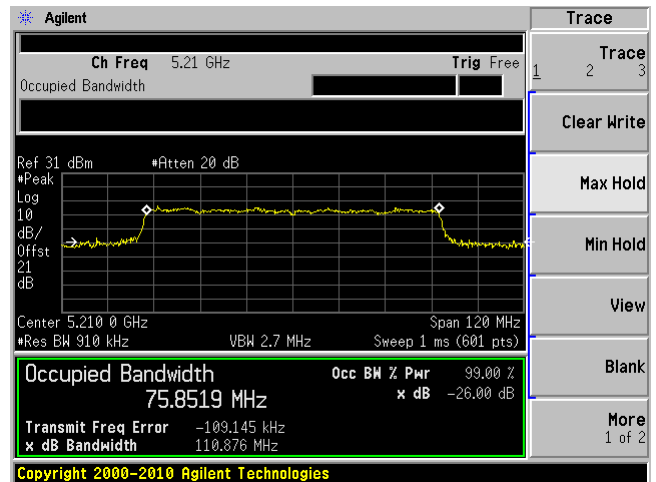

5.8 GHz Band:

20 MHz bandwidth, Low Channel, 5745 MHz

C1

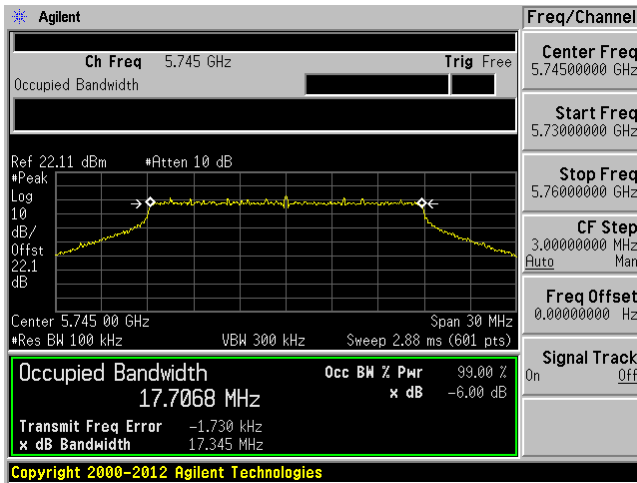

C2

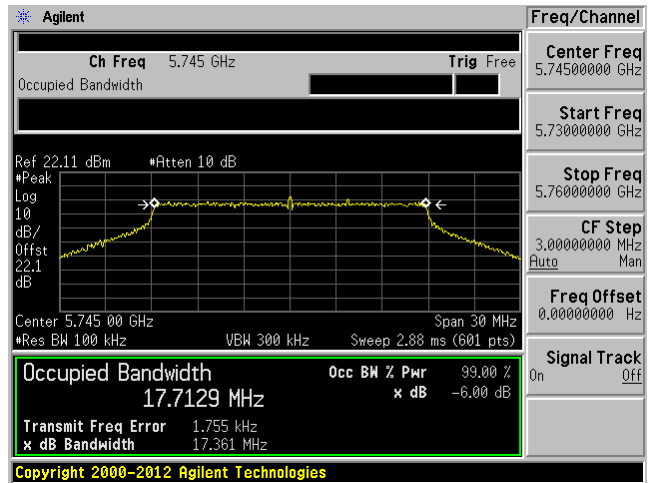

C3

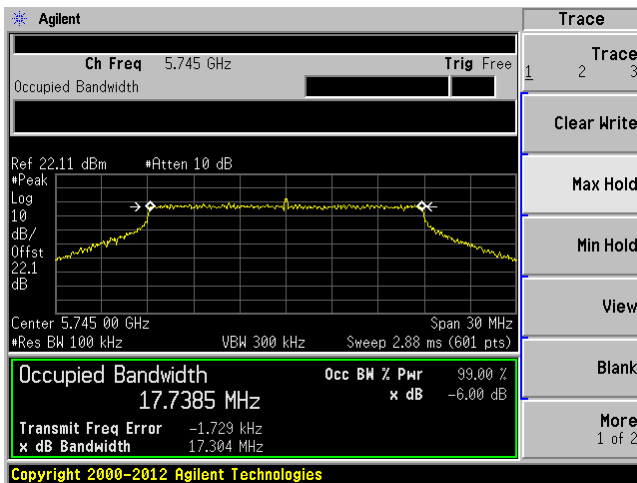

C4

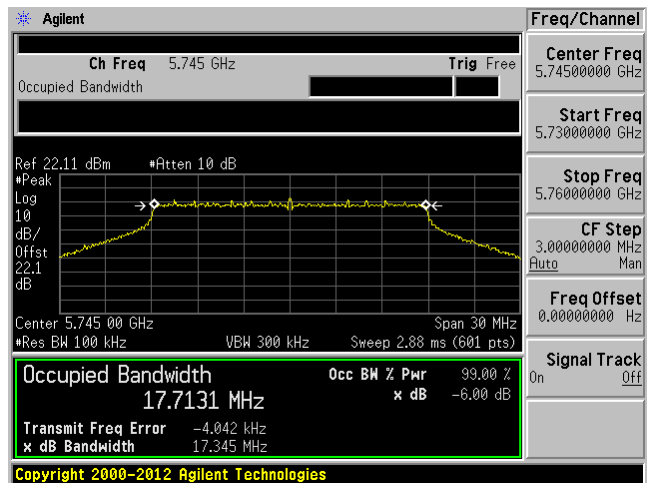

20 MHz bandwidth, Middle Channel, 5785 MHz

C1

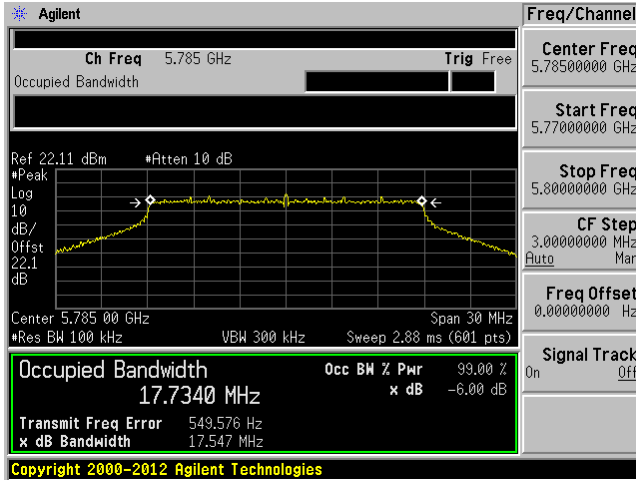

C2

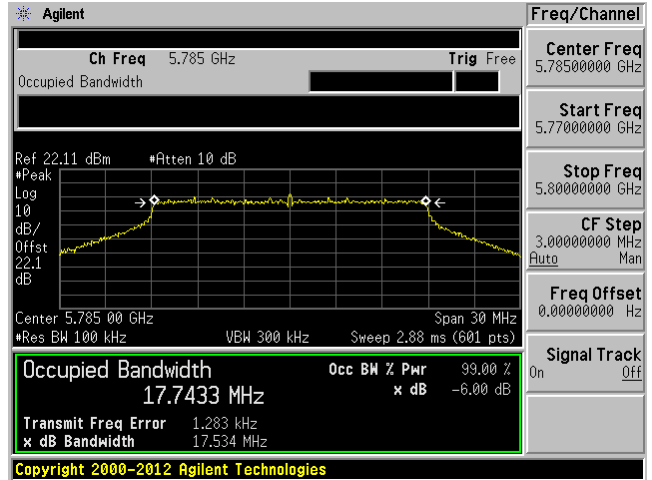

C3

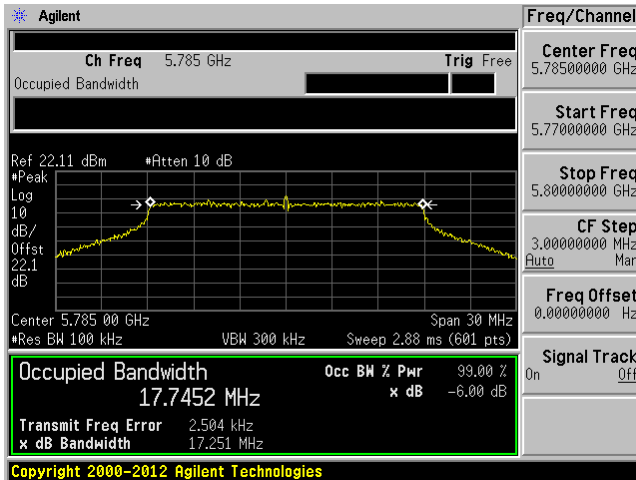

C4

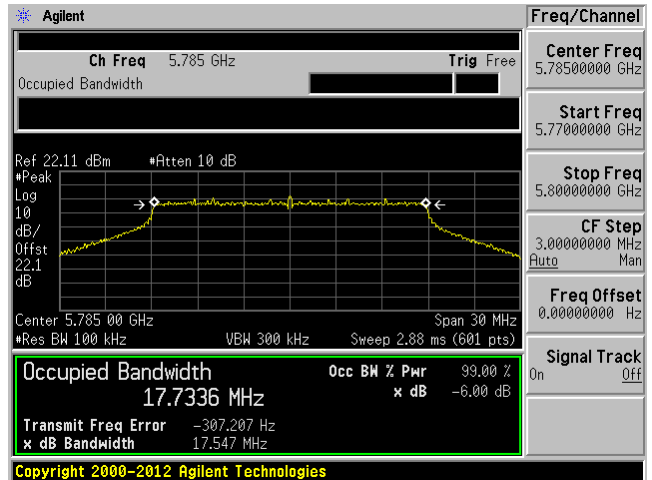

### 20 MHz bandwidth, High Channel, 5825 MHz

C1

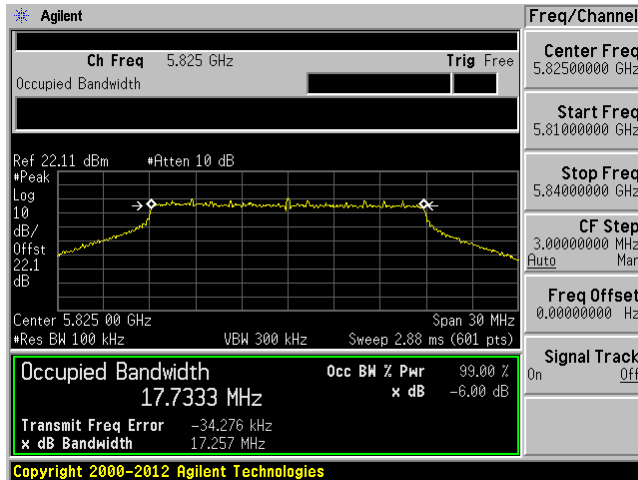

C2

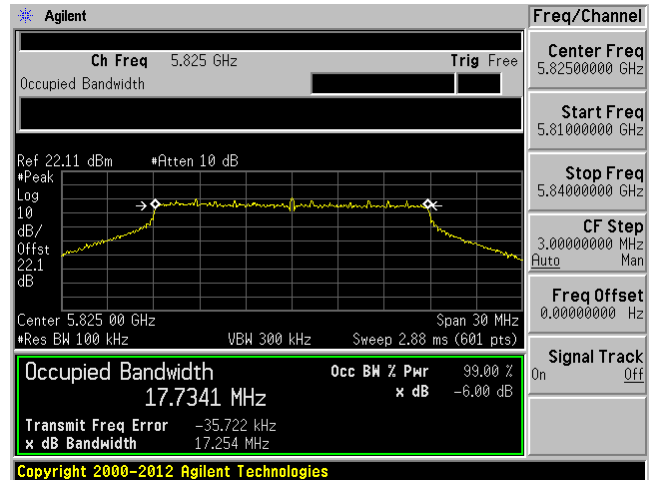

C3

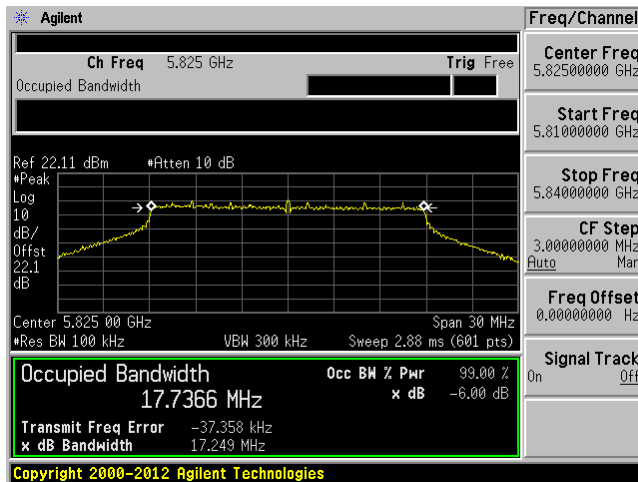

C4

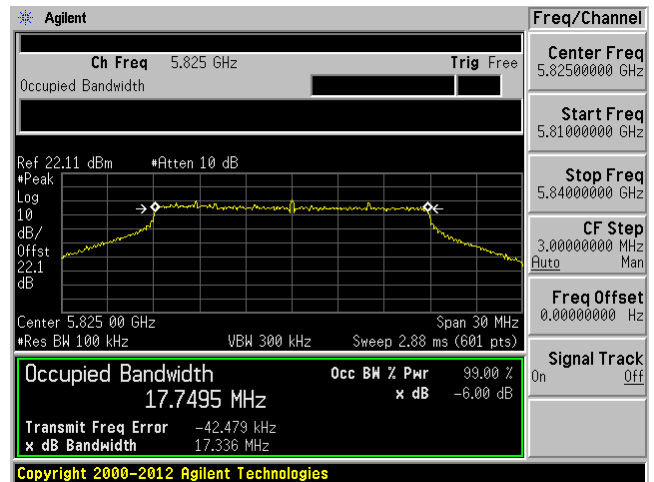



40 MHz bandwidth, Low Channel, 5755 MHz

C1

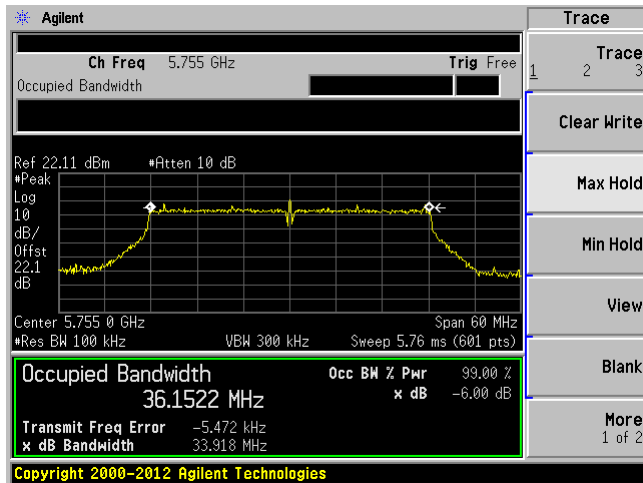

C2

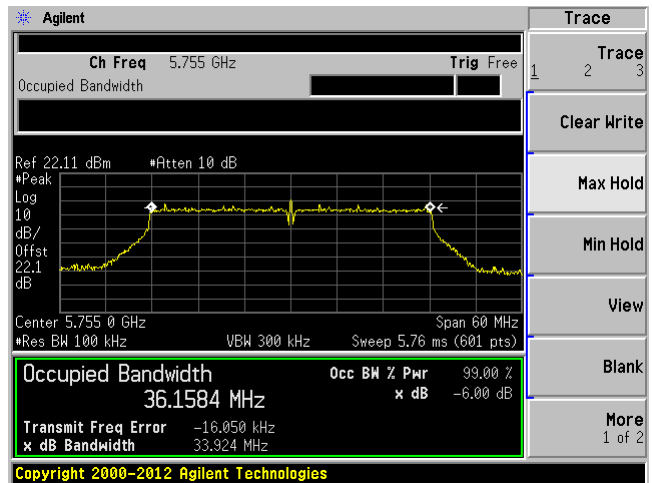

C3

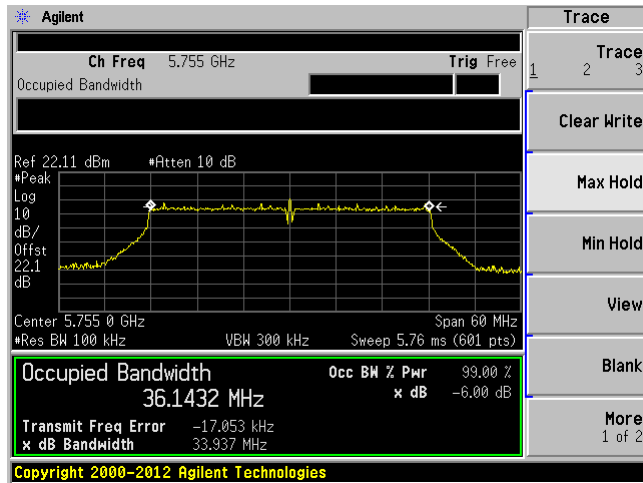

C4

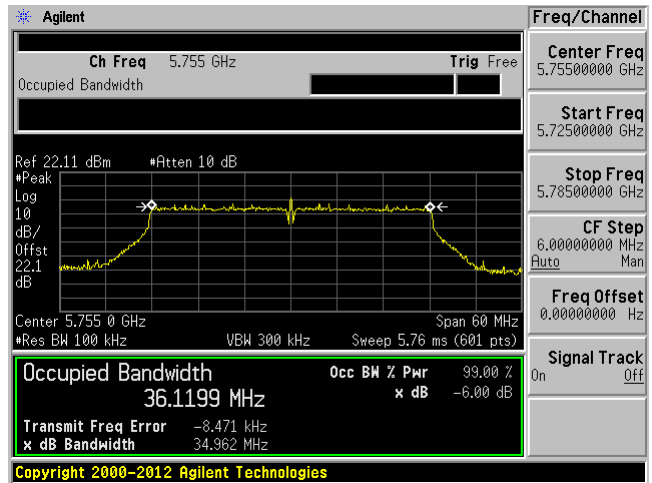

40 MHz bandwidth, Middle Channel, 5785 MHz

C1

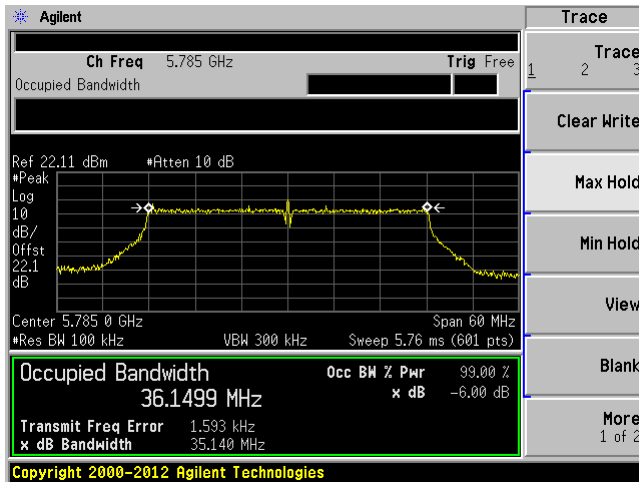

C2

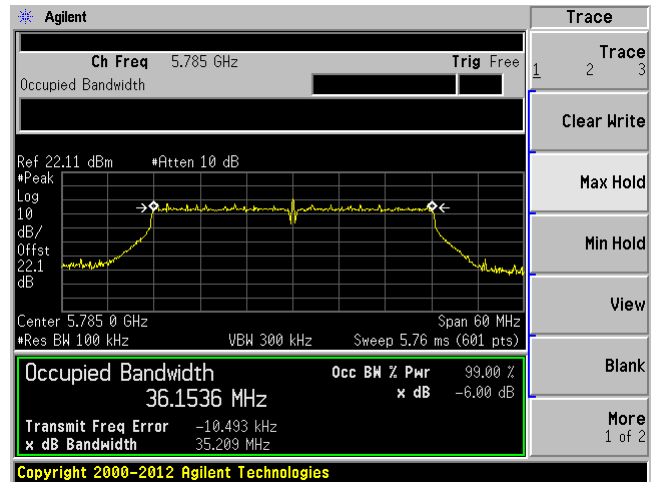

C3

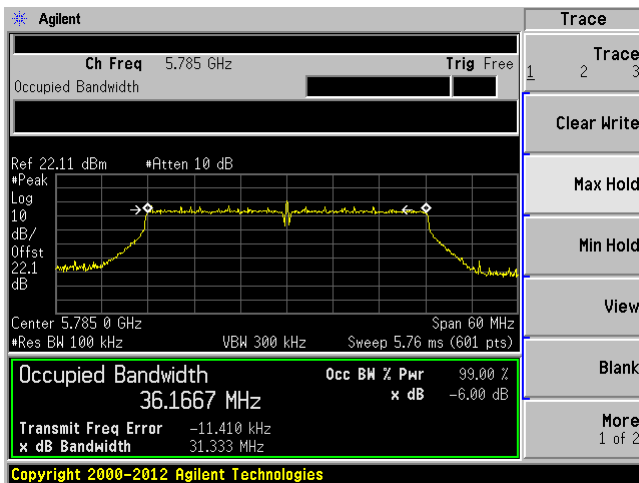

C4

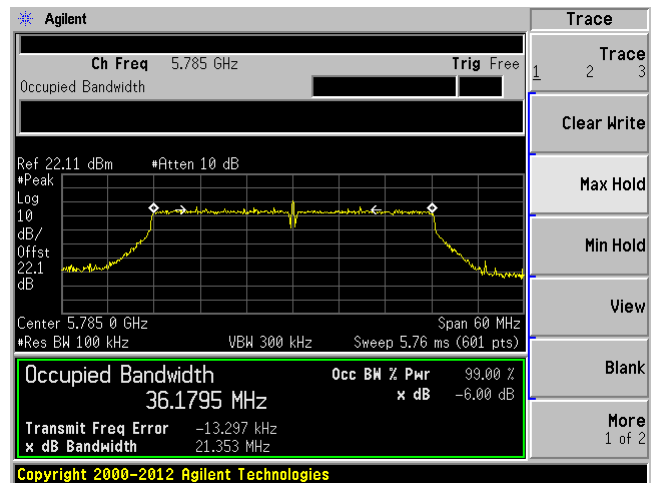

40 MHz bandwidth, High Channel, 5815 MHz

C1

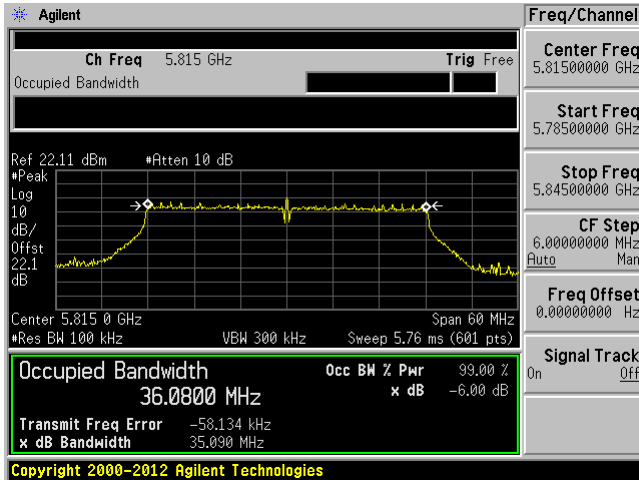

C2

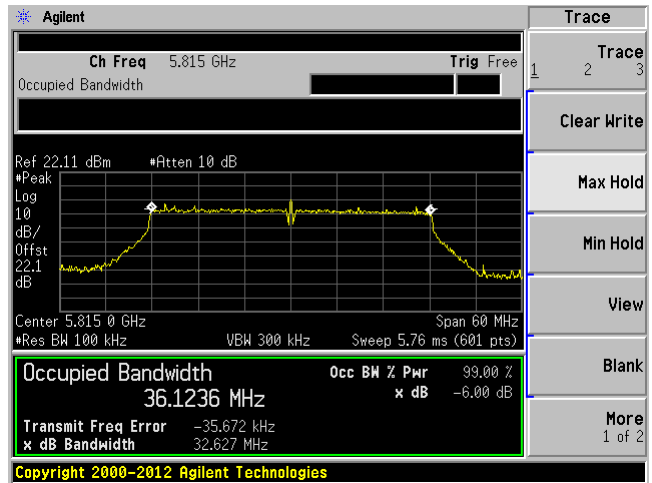

C3

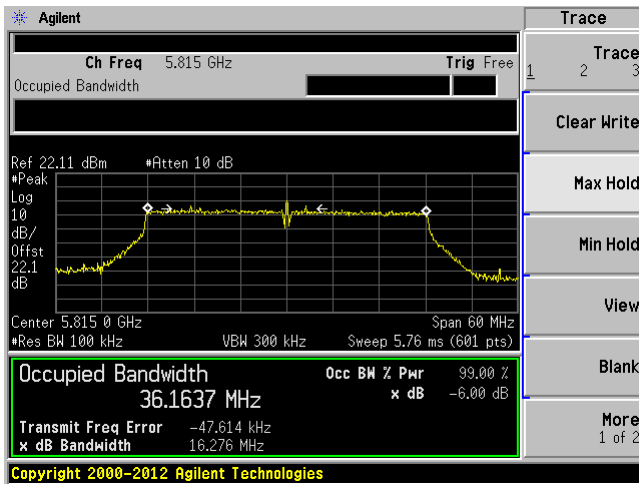

C4

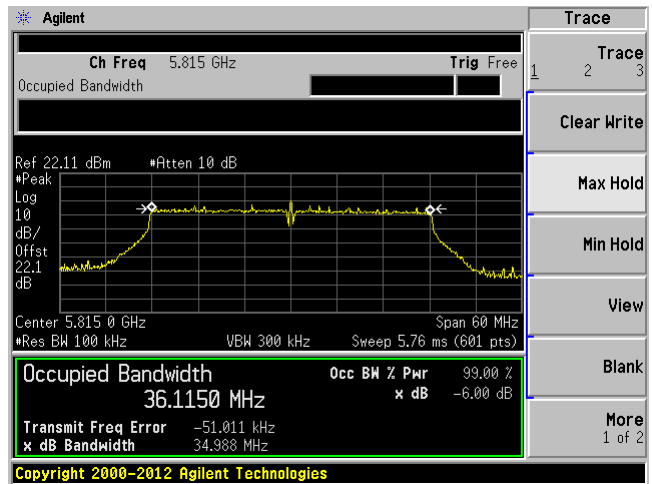

### 80 MHz bandwidth, Low Channel, 5775 MHz

C1

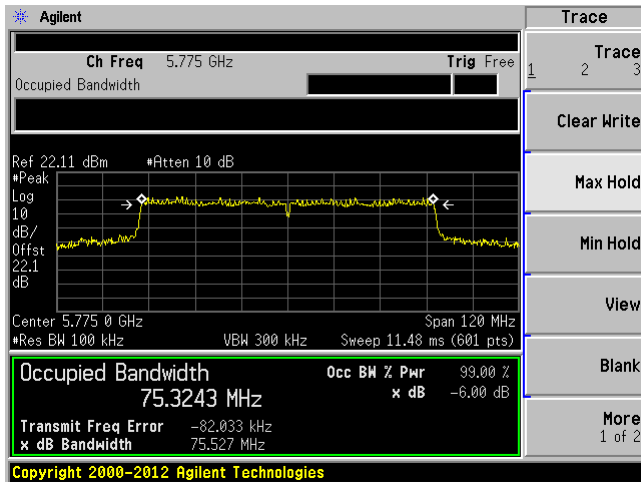

C2

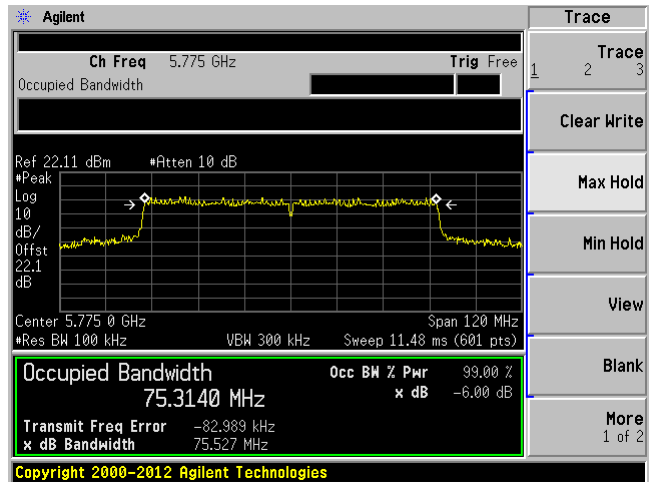

C3

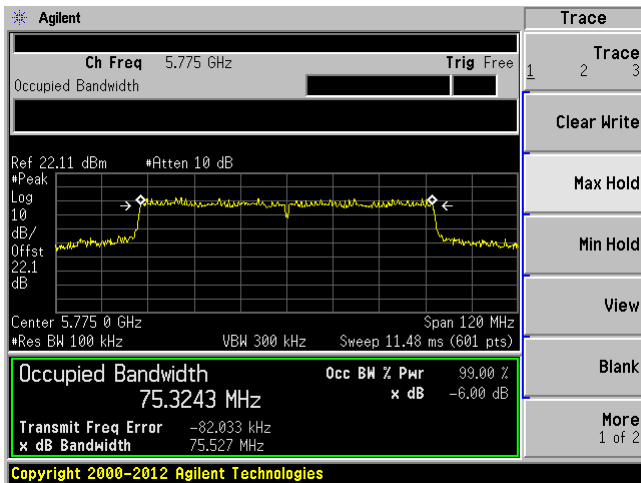

C4

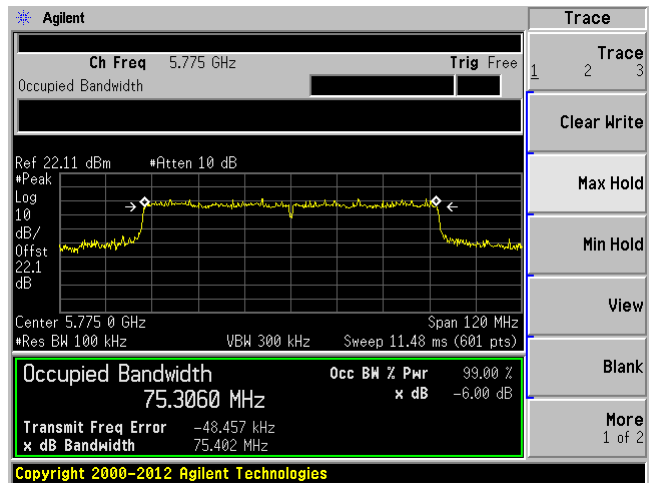

80 MHz bandwidth, Middle Channel, 5785 MHz

C1

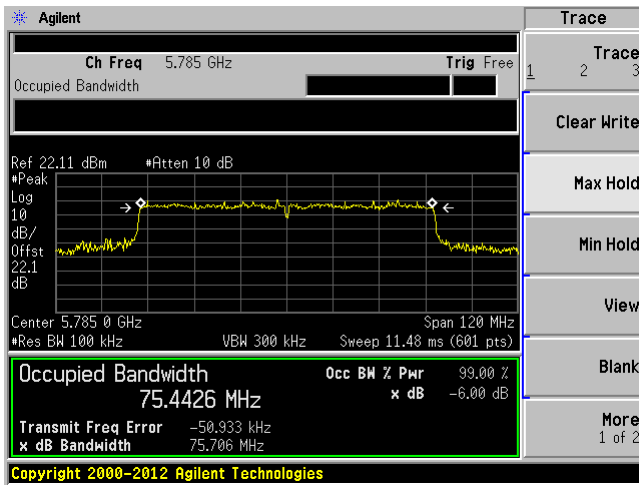

C2

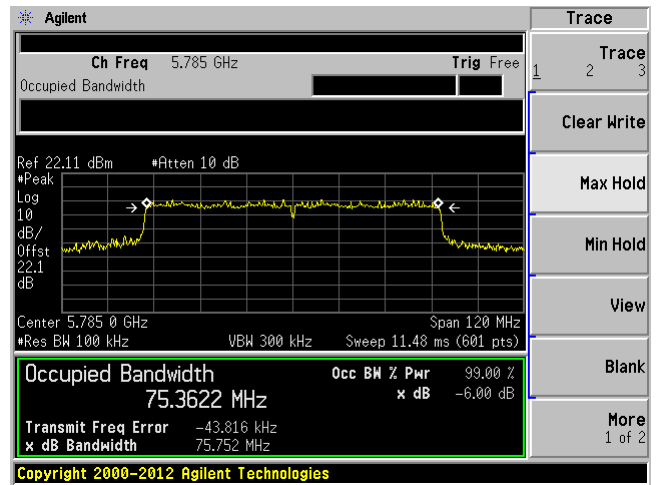

C3

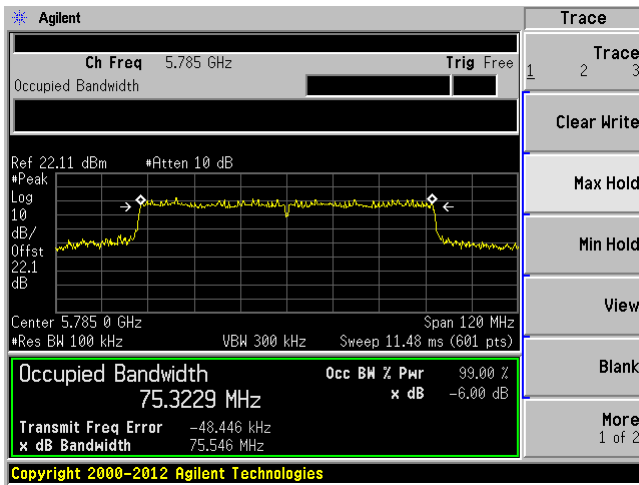

C4

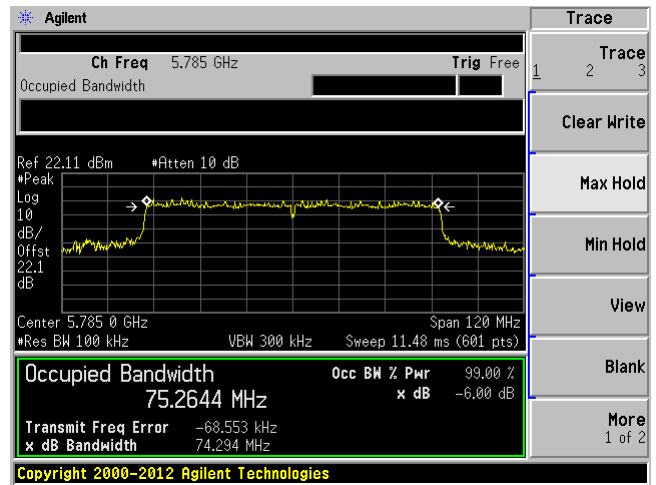

### 80 MHz bandwidth, High Channel, 5795 MHz

C1

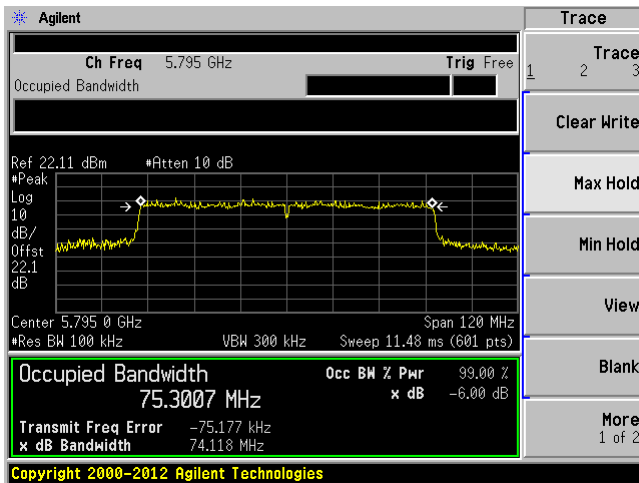

C2

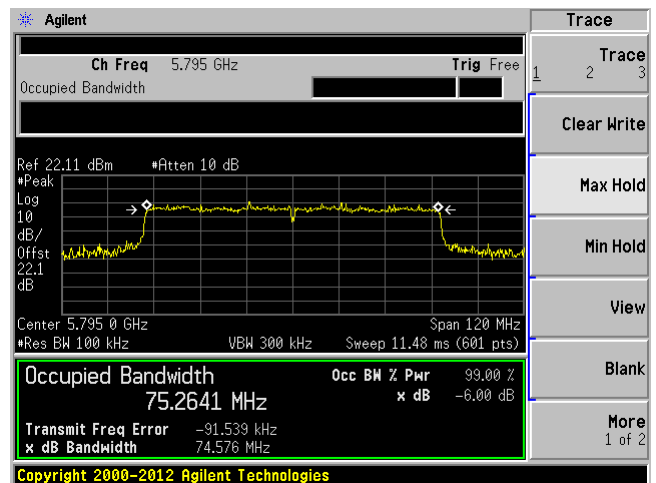

C3

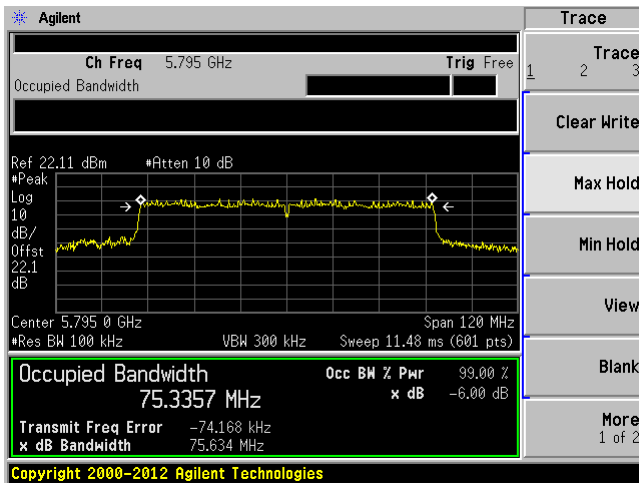

C4

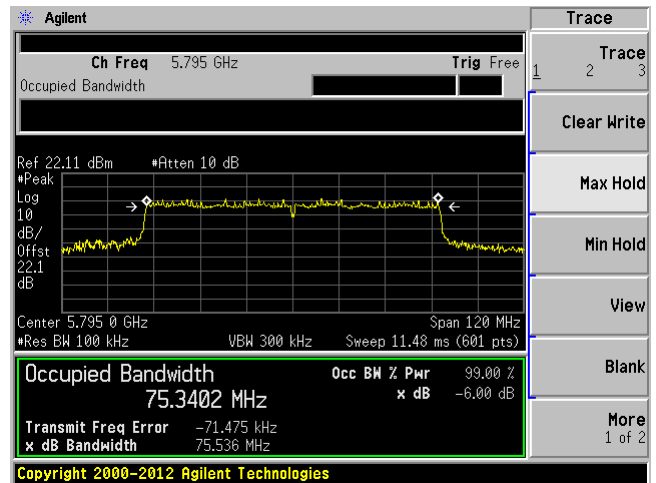

**0 dBi Antenna****5.2 GHz Band**

<b>TX Chain</b>	<b>Channel</b>	<b>Frequency (MHz)</b>	<b>99% Emission Bandwidth (MHz)</b>	<b>26 dB Emission Bandwidth (MHz)</b>
20 MHz bandwidth				
C1	Low	5165	18.3793	30
	Middle	5200	18.7431	30
	High	5240	18.337	30
C2	Low	5165	18.4514	29.858
	Middle	5200	18.4608	30
	High	5240	18.0486	29.742
C3	Low	5165	18.2986	30
	Middle	5200	18.959	30
	High	5240	18.1919	29.732
C4	Low	5165	18.3066	30
	Middle	5200	19.1252	30
	High	5240	18.104	29.757
40 MHz bandwidth				
C1	Low	5175	36.365	49.956
	Middle	5200	36.4572	50.242
	High	5230	36.3521	41.925
C2	Low	5175	36.2982	47.555
	Middle	5200	36.3971	45.444
	High	5230	36.3065	44.944
C3	Low	5175	36.4869	56.265
	Middle	5200	36.3772	53.254
	High	5230	36.386	42.914
C4	Low	5175	36.5316	57.027
	Middle	5200	36.3362	45.053
	High	5230	36.42	43.917
80 MHz bandwidth				
C1	Low	5195	75.5788	116.449
	Middle	5200	75.3964	112.69
	High	5210	75.511	115.728
C2	Low	5195	75.58	115.414
	Middle	5200	75.452	101.306
	High	5210	75.7047	108.9
C3	Low	5195	75.6386	113.48
	Middle	5200	75.5182	105.204
	High	5210	75.562	107.179
C4	Low	5195	75.4392	114.11
	Middle	5200	75.6405	115.584
	High	5210	75.5307	108.439

**5.8 GHz Band**

<b>TX Chain</b>	<b>Channel</b>	<b>Frequency (MHz)</b>	<b>99% Emission Bandwidth (MHz)</b>	<b>6 dB Emission Bandwidth (MHz)</b>	<b>Limit (MHz)</b>	<b>Results</b>
<b>20 MHz bandwidth</b>						
C1	Low	5745	18.0713	17.601	> 0.5	Compliant
	Middle	5785	18.2858	17.653	> 0.5	Compliant
	High	5825	17.7191	17.698	> 0.5	Compliant
C2	Low	5745	17.7747	17.817	> 0.5	Compliant
	Middle	5785	18.2933	17.654	> 0.5	Compliant
	High	5825	17.7233	17.658	> 0.5	Compliant
C3	Low	5745	17.7847	17.789	> 0.5	Compliant
	Middle	5785	17.9167	17.787	> 0.5	Compliant
	High	5825	17.7381	17.796	> 0.5	Compliant
C4	Low	5745	17.7733	17.814	> 0.5	Compliant
	Middle	5785	18.085	17.669	> 0.5	Compliant
	High	5825	17.7294	17.665	> 0.5	Compliant
<b>40 MHz bandwidth</b>						
C1	Low	5755	36.1872	36.439	> 0.5	Compliant
	Middle	5785	36.443	36.504	> 0.5	Compliant
	High	5815	36.2081	36.466	> 0.5	Compliant
C2	Low	5755	36.1664	36.448	> 0.5	Compliant
	Middle	5785	36.4606	36.39	> 0.5	Compliant
	High	5815	36.22	36.488	> 0.5	Compliant
C3	Low	5755	36.1698	36.041	> 0.5	Compliant
	Middle	5785	36.3901	36.351	> 0.5	Compliant
	High	5815	36.191	36.267	> 0.5	Compliant
C4	Low	5755	36.1881	36.439	> 0.5	Compliant
	Middle	5785	36.4153	36.414	> 0.5	Compliant
	High	5815	36.193	36.33	> 0.5	Compliant
<b>80 MHz bandwidth</b>						
C1	Low	5775	75.1612	71.624	> 0.5	Compliant
	Middle	5785	76.1187	74.114	> 0.5	Compliant
	High	5795	75.1813	74.199	> 0.5	Compliant
C2	Low	5775	75.3124	75.405	> 0.5	Compliant
	Middle	5785	76.1109	72.872	> 0.5	Compliant
	High	5795	75.2773	75.454	> 0.5	Compliant
C3	Low	5775	75.1613	75.251	> 0.5	Compliant
	Middle	5785	76.2163	74.267	> 0.5	Compliant
	High	5795	75.2008	75.67	> 0.5	Compliant
C4	Low	5775	75.1379	72.339	> 0.5	Compliant
	Middle	5785	76.0607	72.829	> 0.5	Compliant
	High	5795	75.187	75.673	> 0.5	Compliant



5.2 GHz Band:

20 MHz bandwidth, Low Channel, 5165 MHz

C1

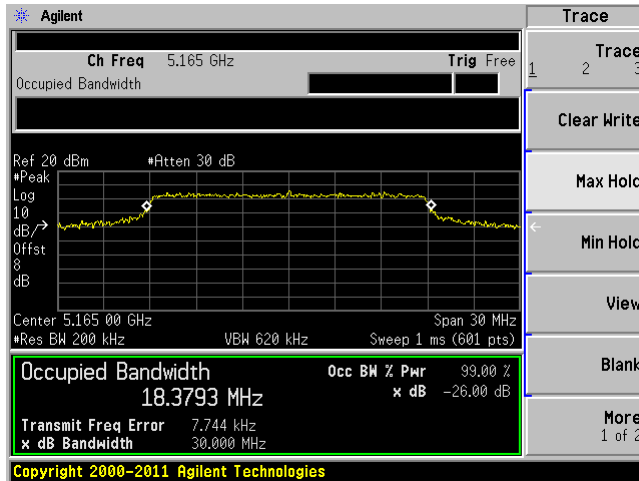

C2

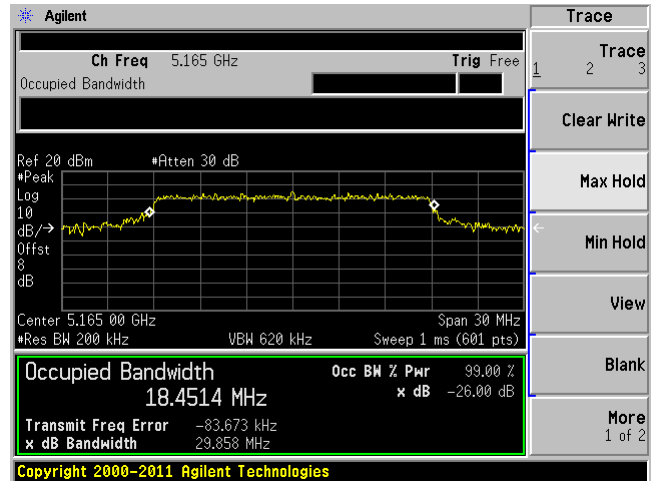

C3

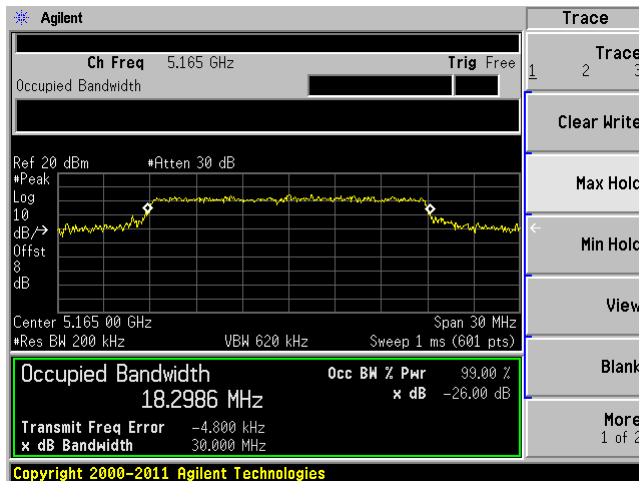

C4

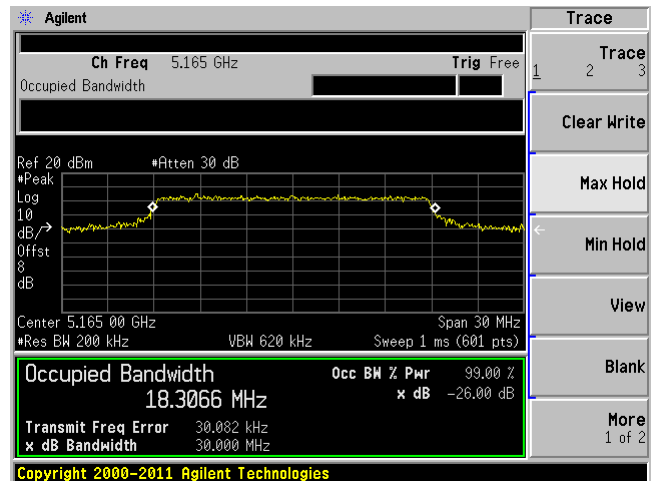

20 MHz bandwidth, Middle Channel, 5200 MHz

C1

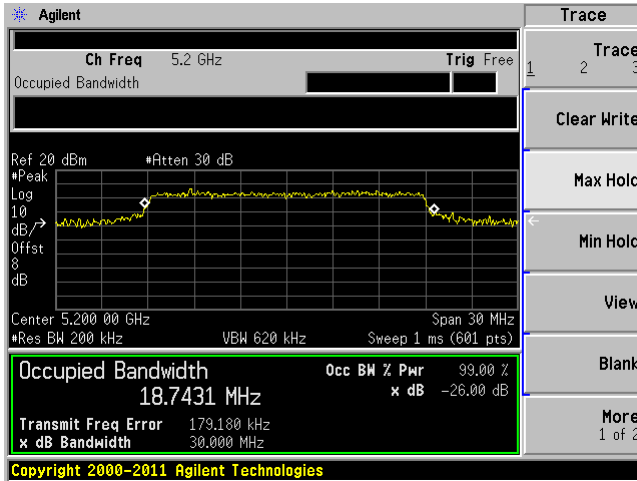

C2

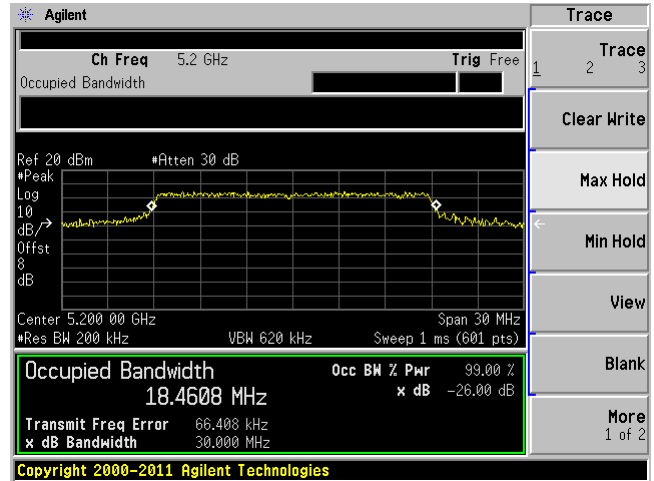

C3

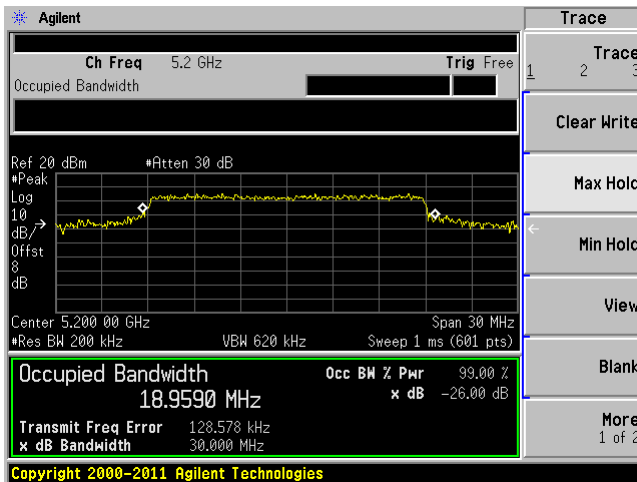

C4

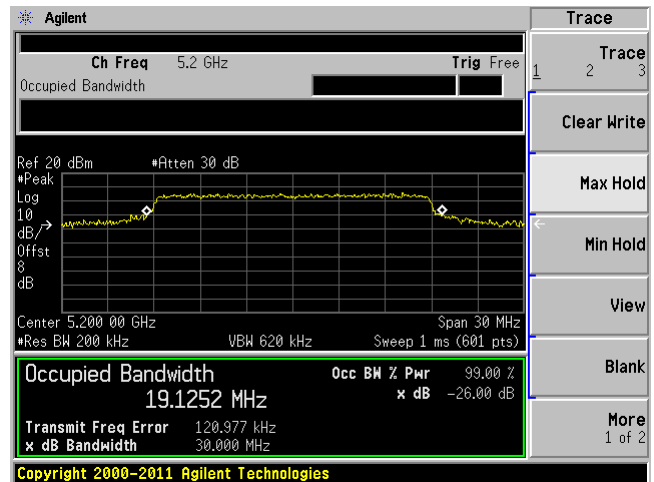

20 MHz bandwidth, High Channel, 5240 MHz

C1

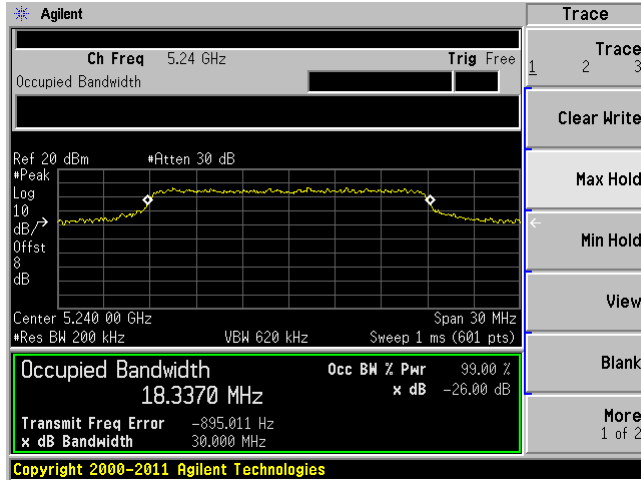

C2

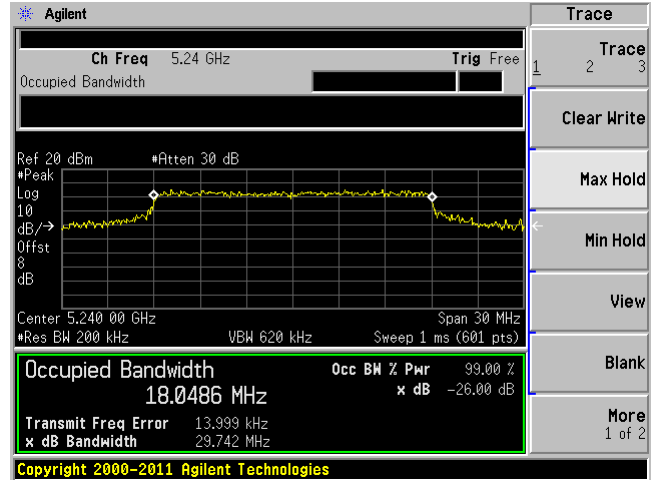

C3

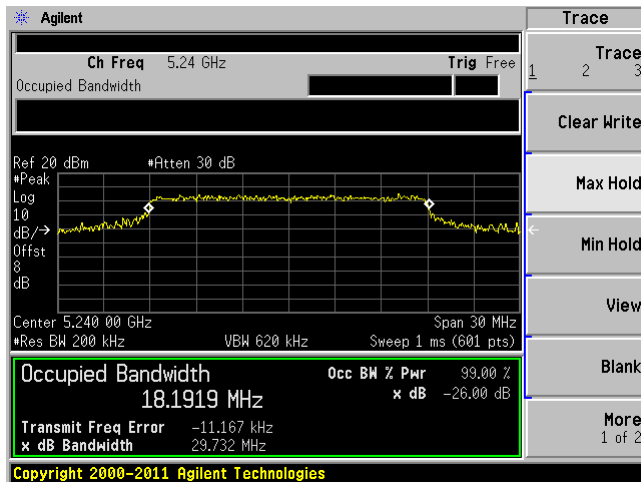

C4

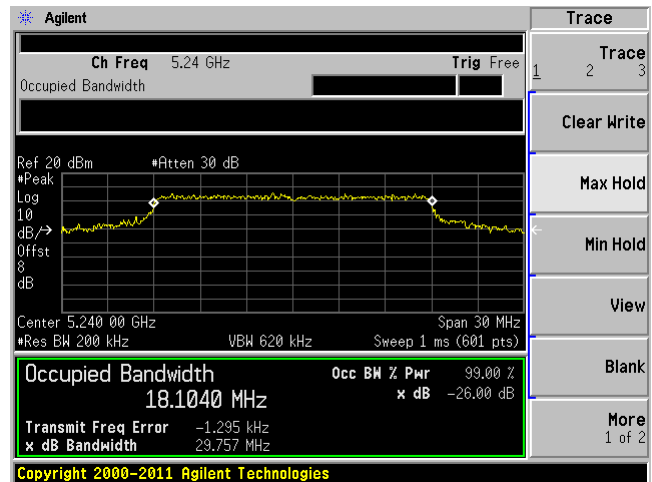

40 MHz bandwidth, Low Channel, 5175 MHz

C1

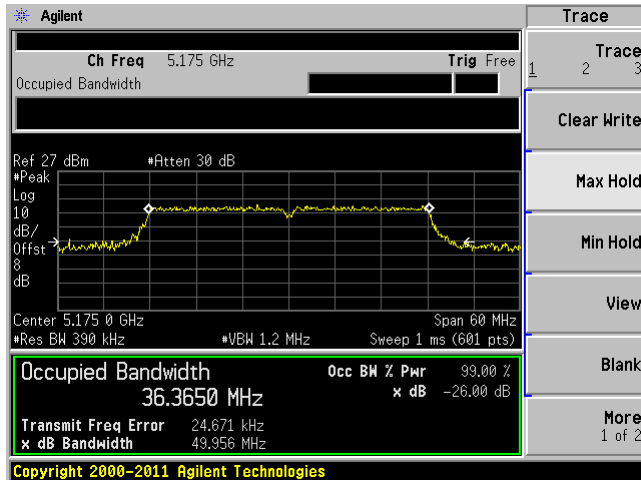

C2

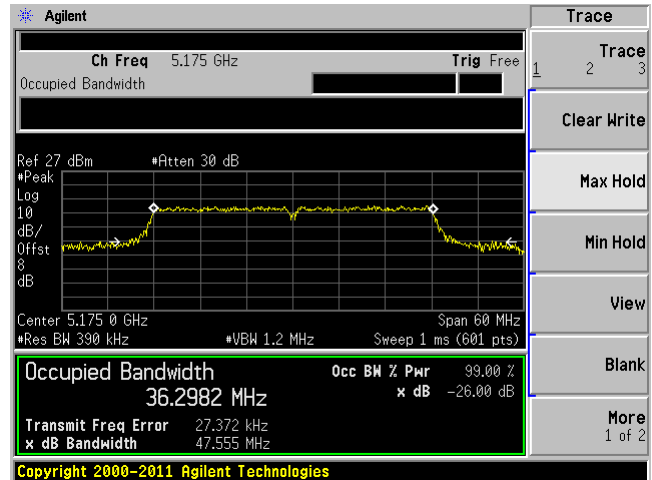

C3

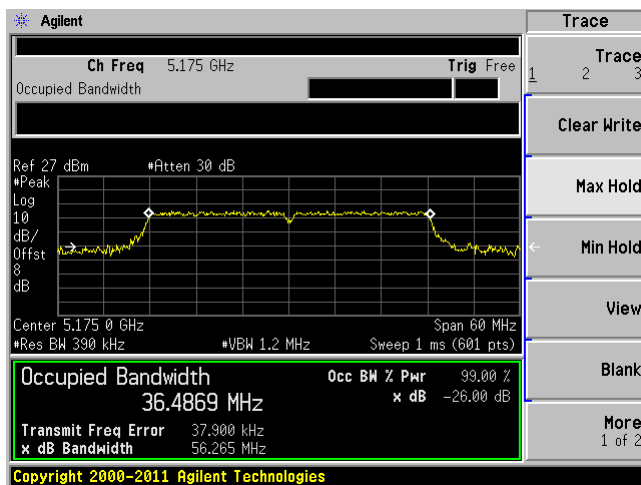

C4

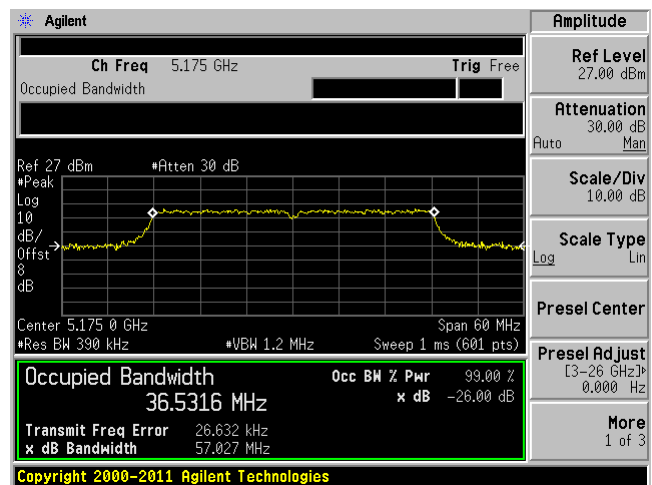

40 MHz bandwidth, Middle Channel, 5200 MHz

C1

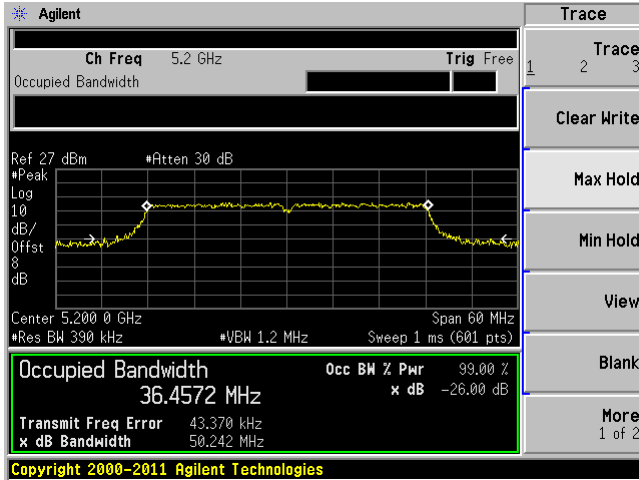

C2

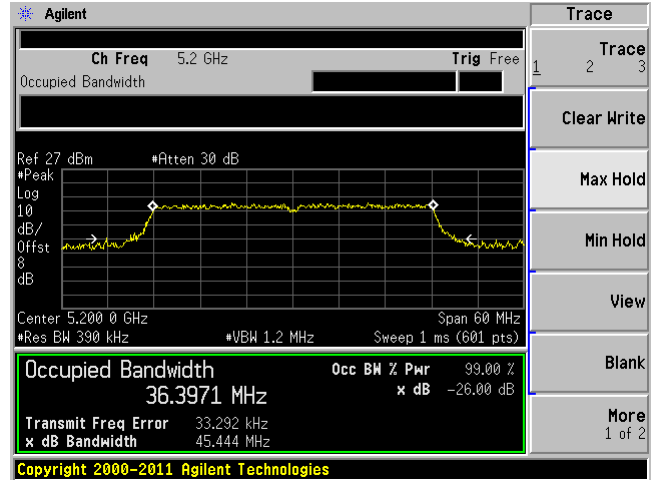

C3

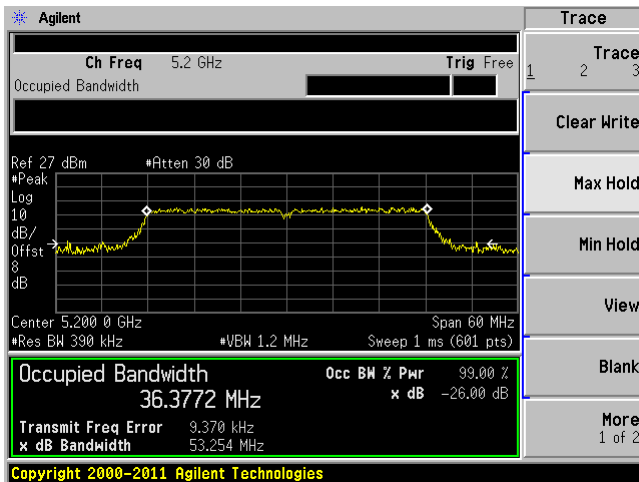

C4

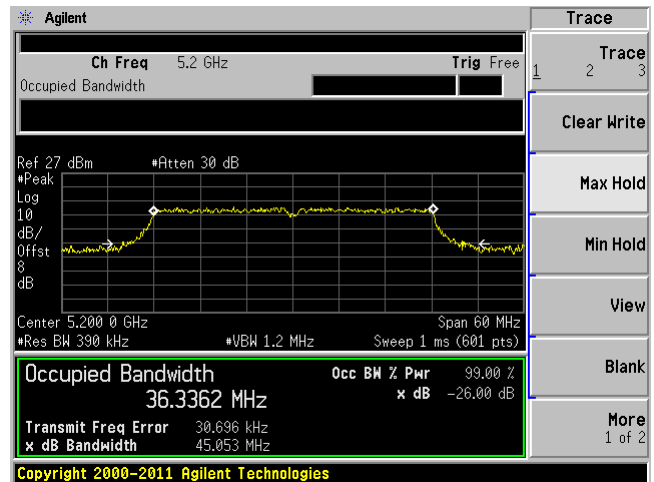

40 MHz bandwidth, High Channel, 5230 MHz

C1

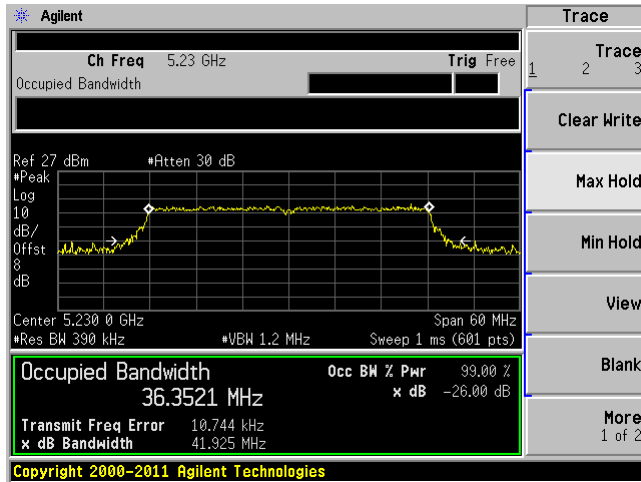

C2

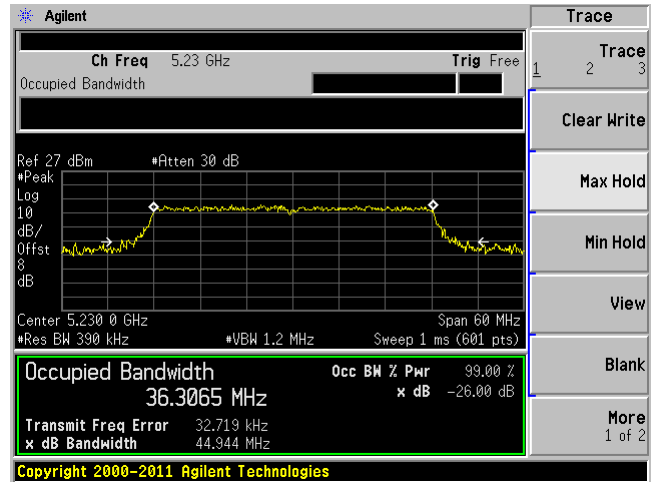

C3

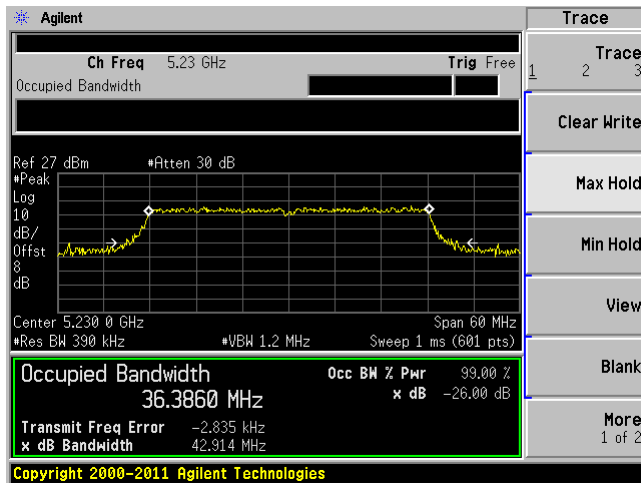

C4

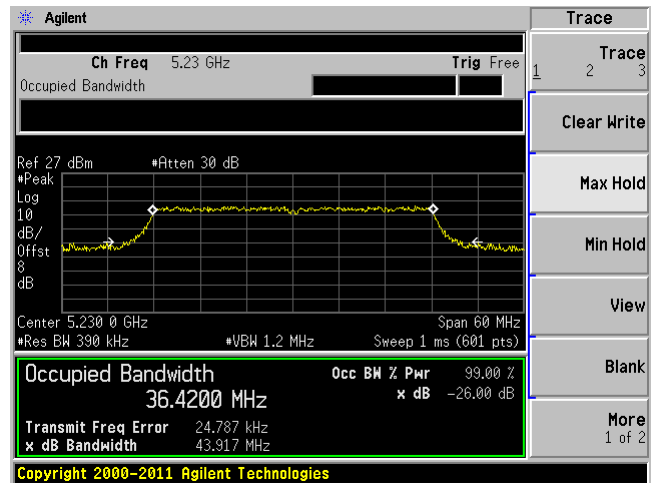

80 MHz bandwidth, Low Channel, 5195 MHz

C1

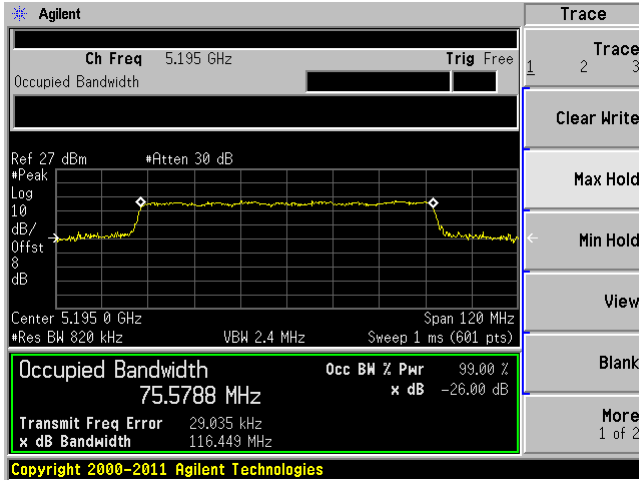

C2

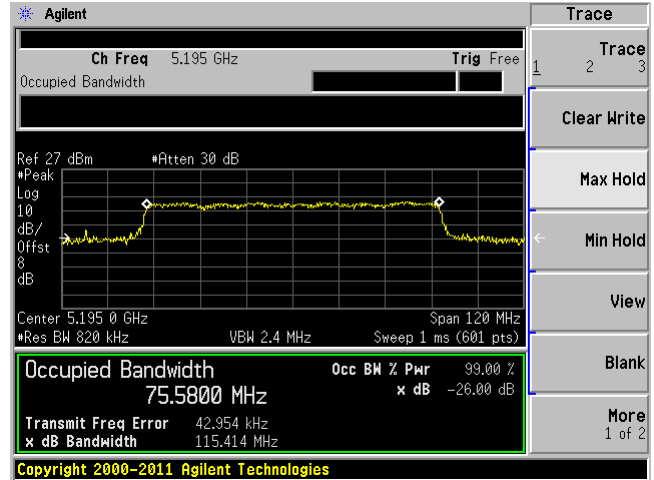

C3

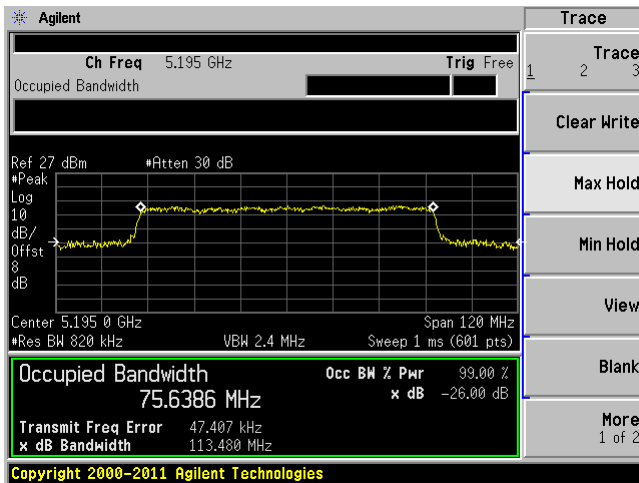

C4

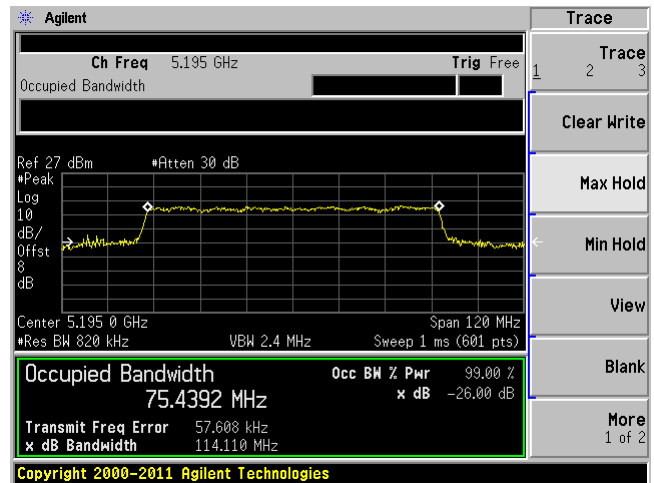

### 80 MHz bandwidth, Middle Channel, 5200 MHz

C1

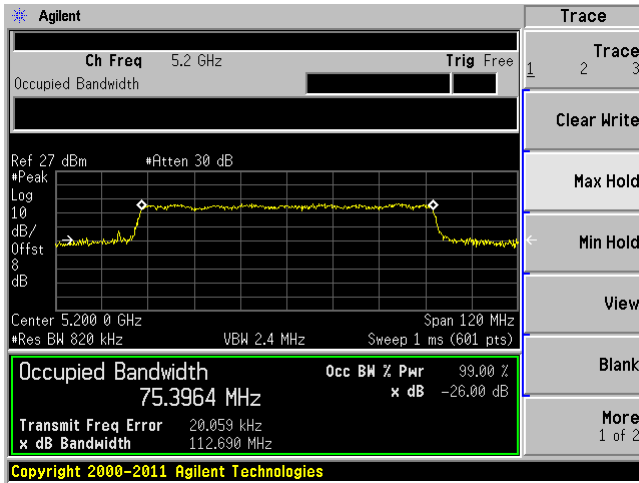

C2

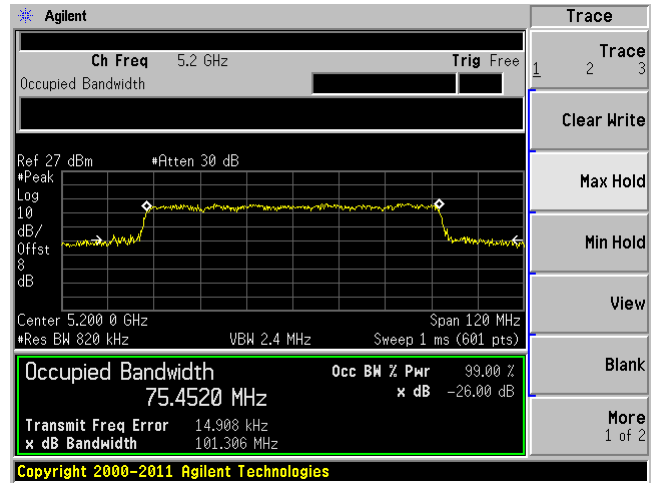

C3

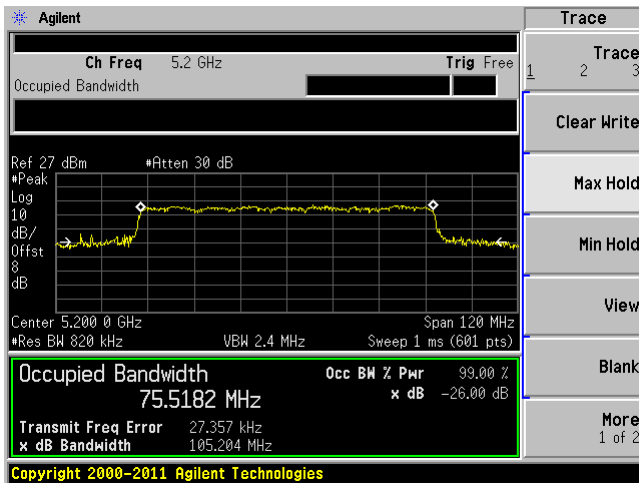

C4

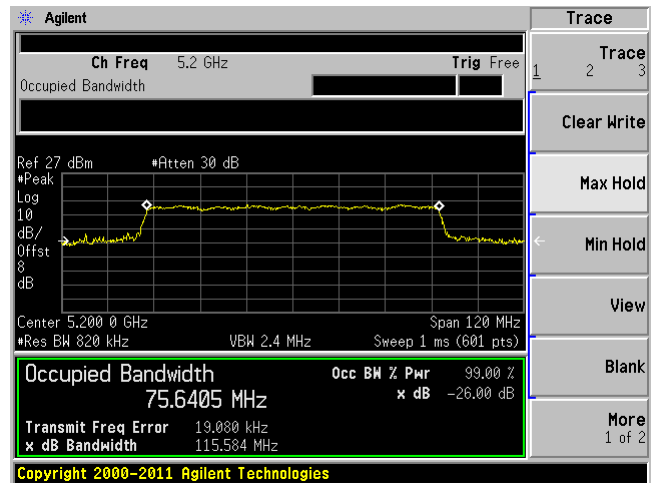



80 MHz bandwidth, High Channel, 5210 MHz

C1

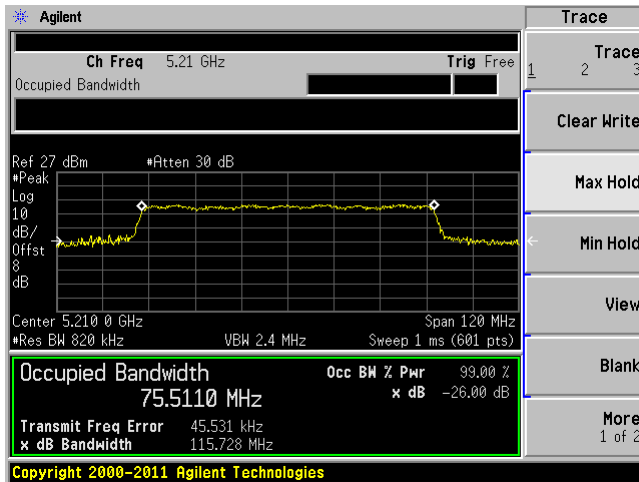

C2

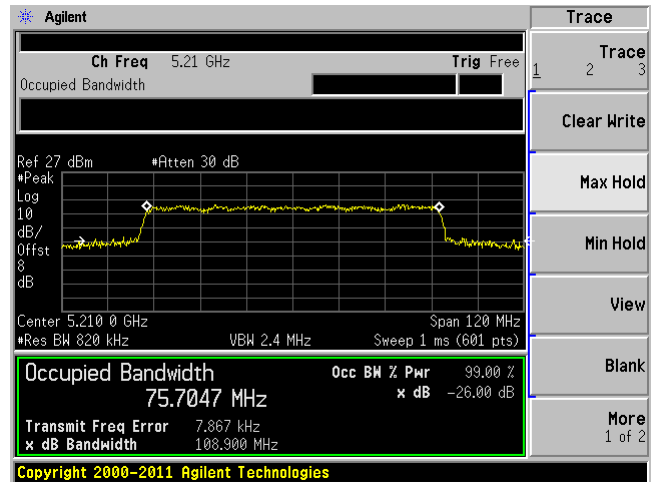

C3

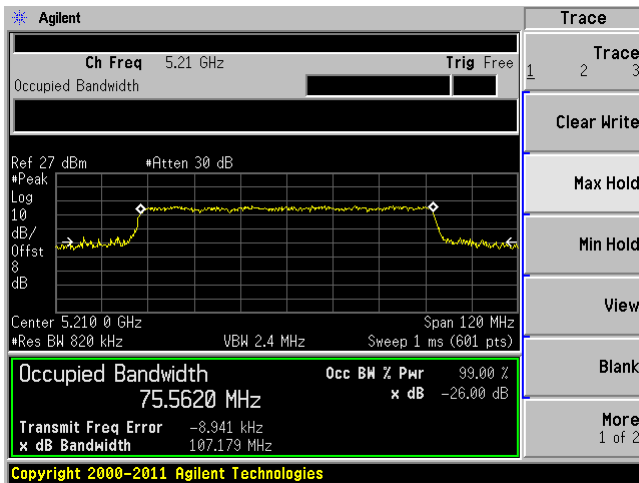

C4

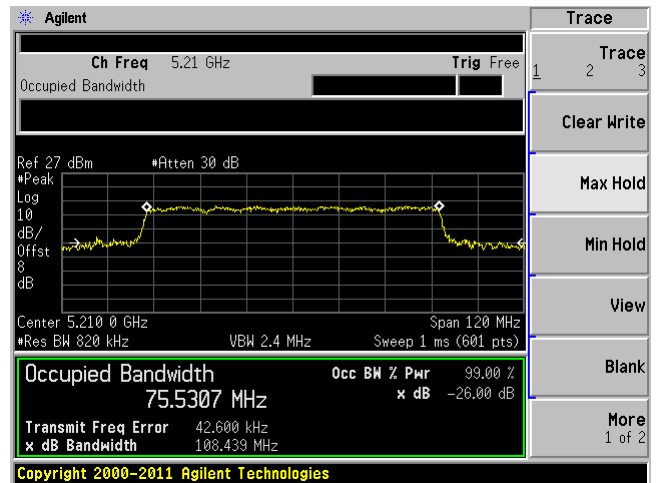

5.8 GHz Band:

20 MHz bandwidth, Low Channel, 5745 MHz

C1

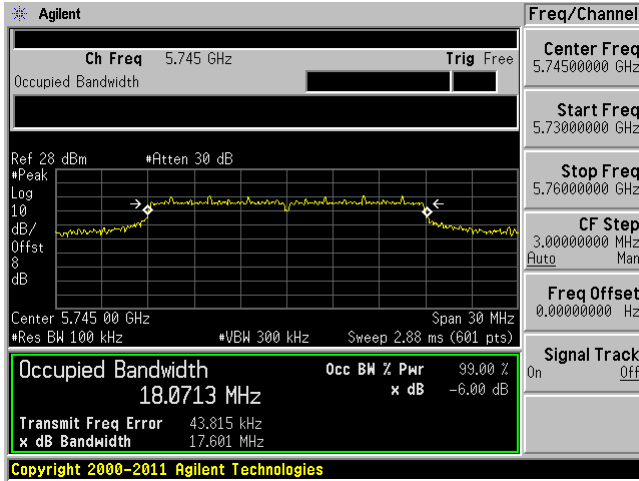

C2

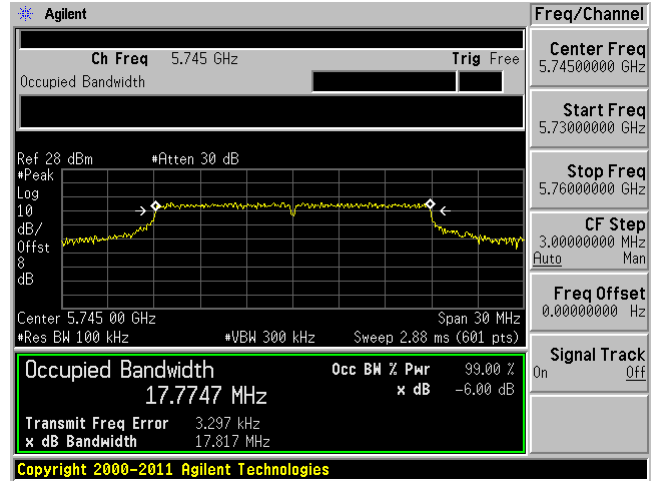

C3

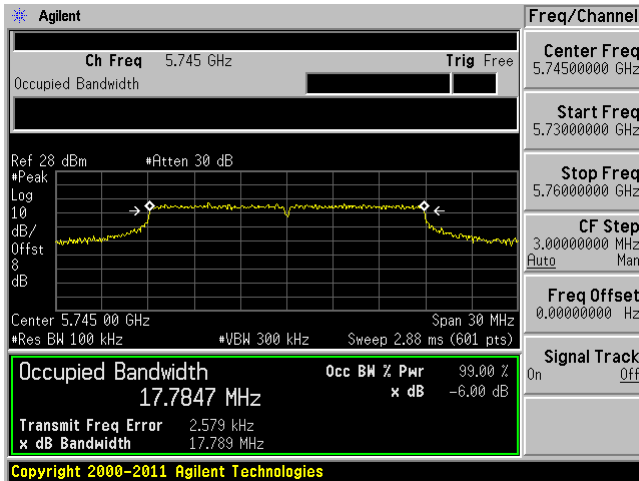

C4

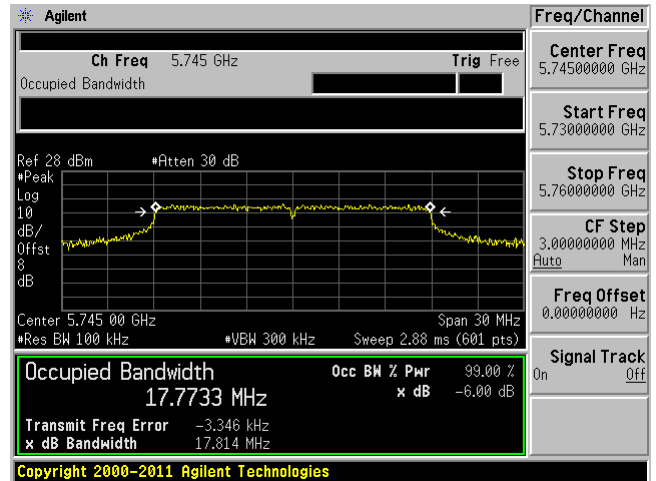

20 MHz bandwidth, Middle Channel, 5785 MHz

C1

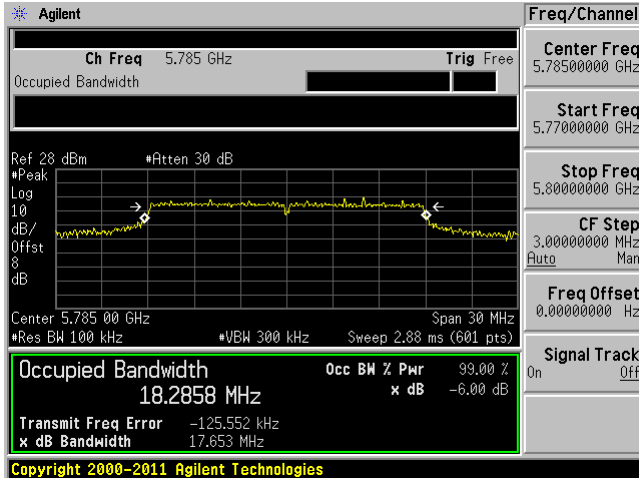

C2

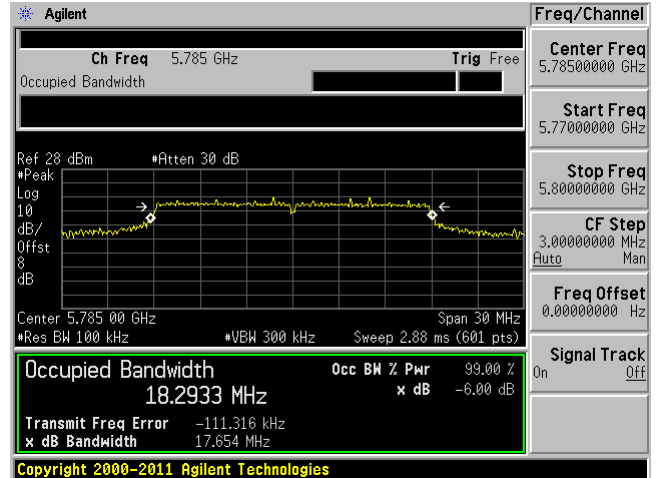

C3

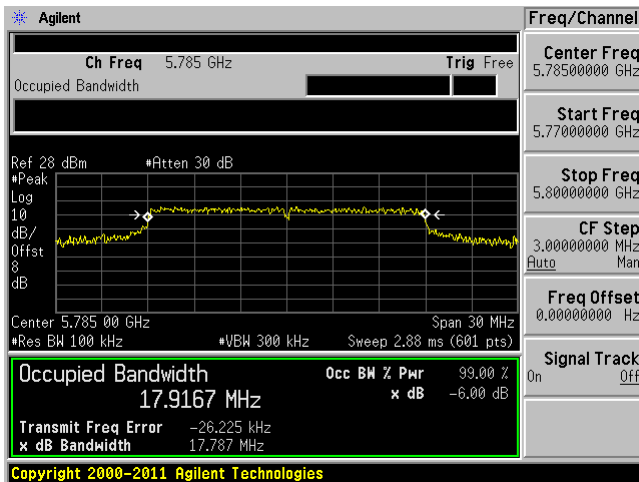

C4

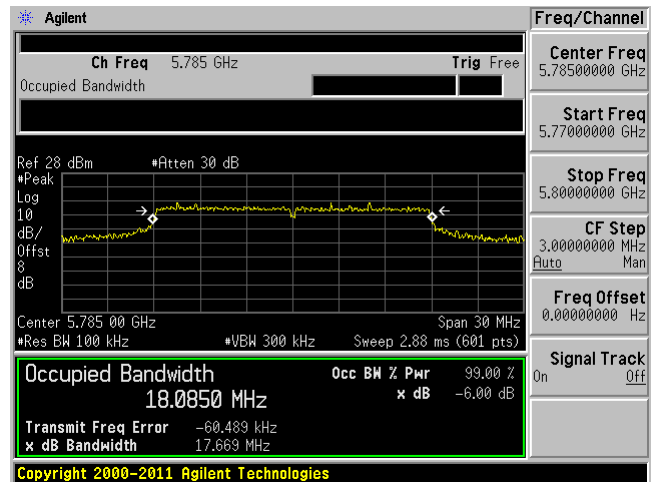

20 MHz bandwidth, High Channel, 5825 MHz

C1

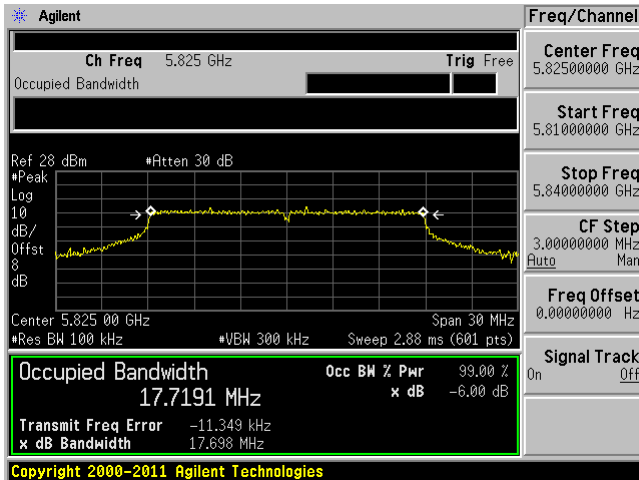

C2

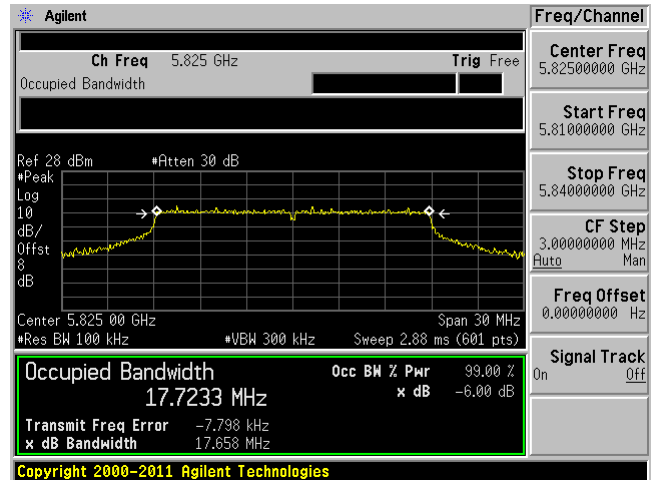

C3

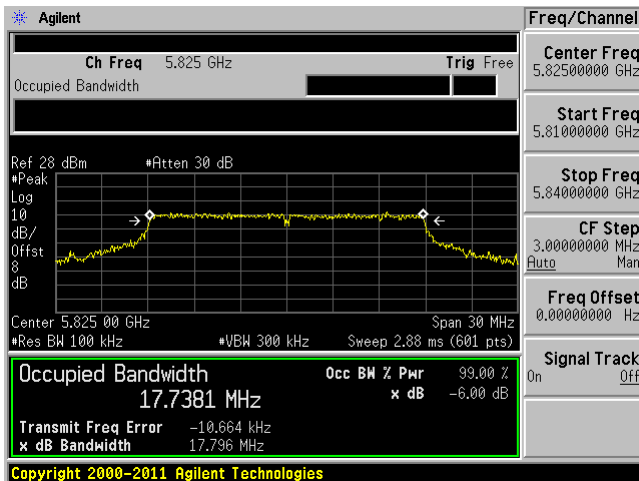

C4

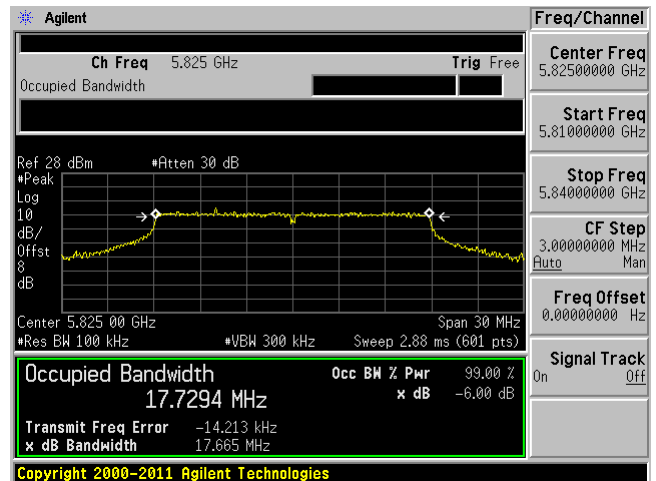

40 MHz bandwidth, Low Channel, 5755 MHz

C1

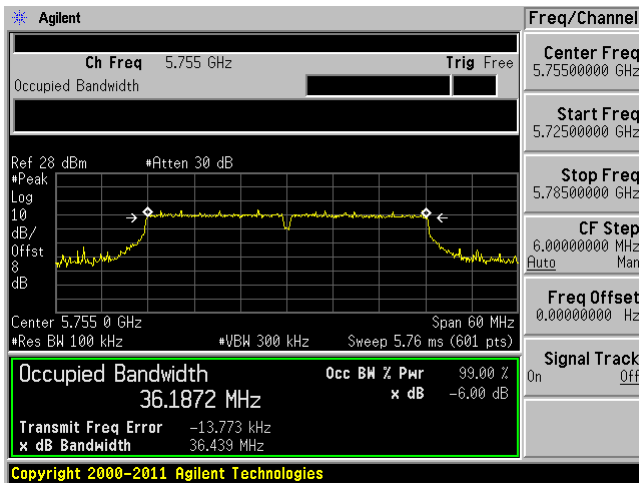

C2

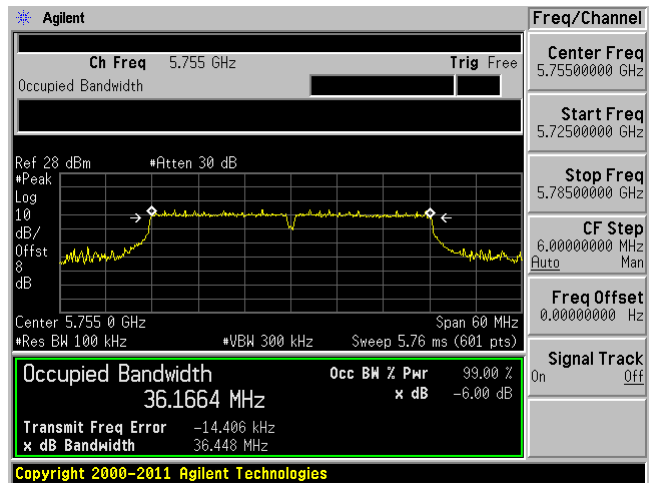

C3

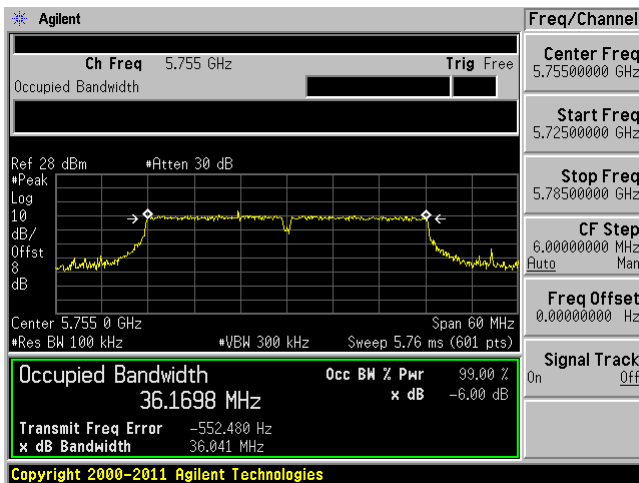

C4

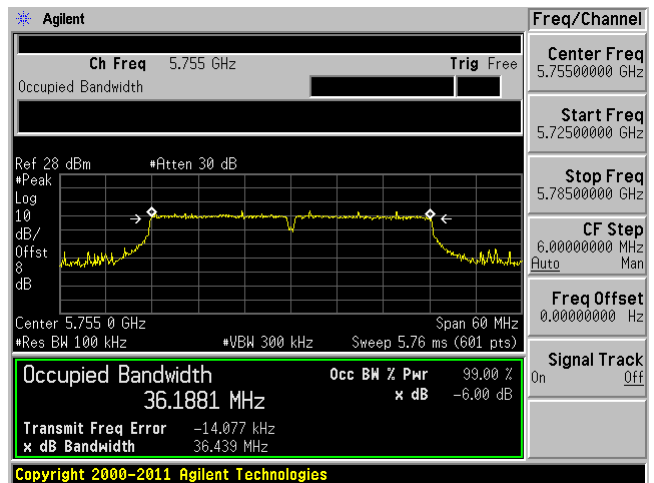

40 MHz bandwidth, Middle Channel, 5785 MHz

C1

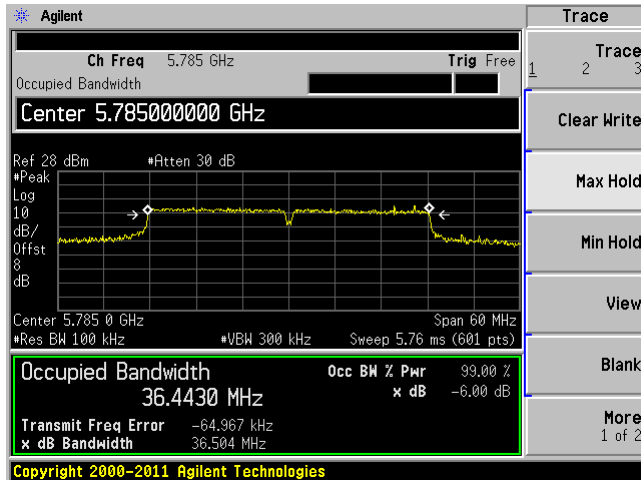

C2

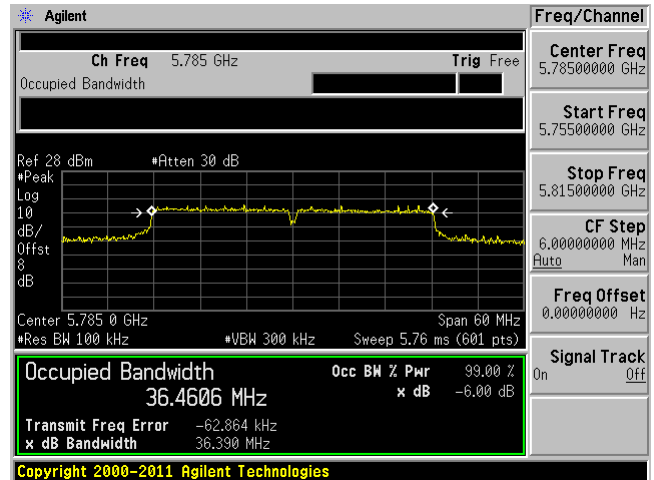

C3

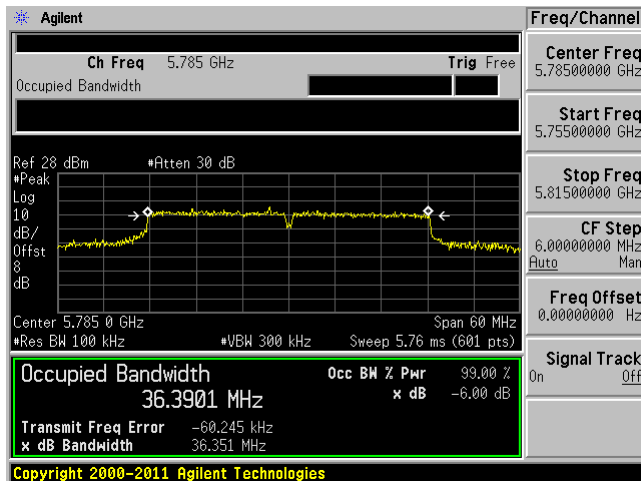

C4

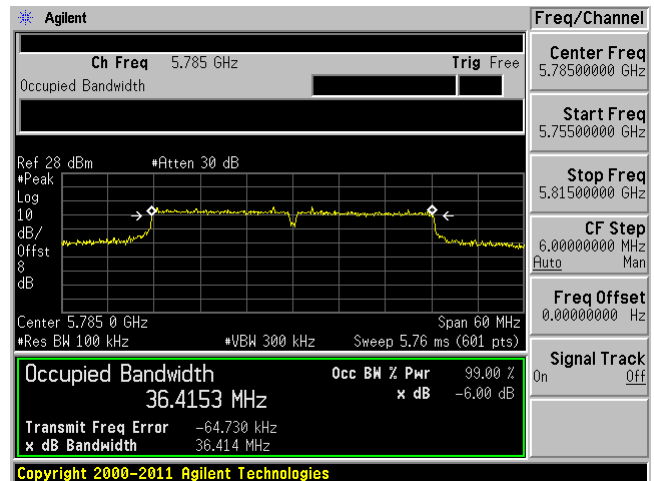

40 MHz bandwidth, High Channel, 5815 MHz

C1

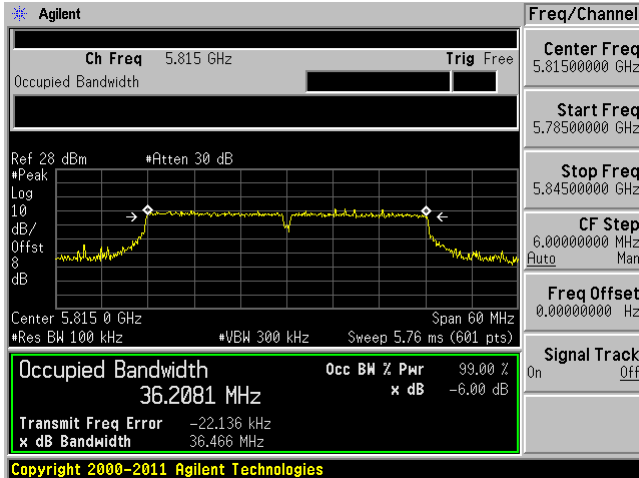

C2

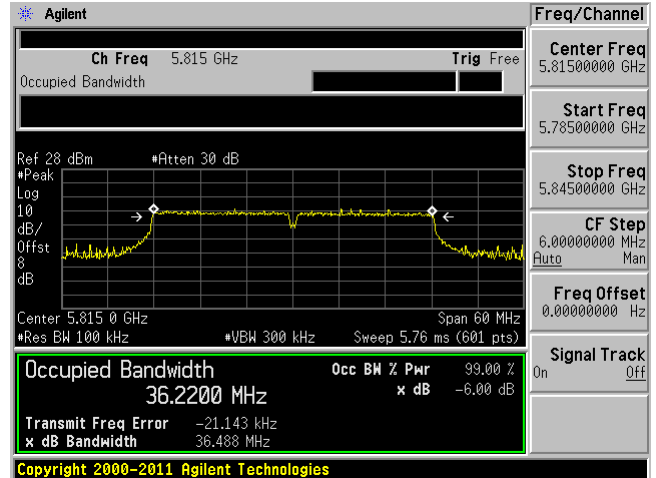

C3

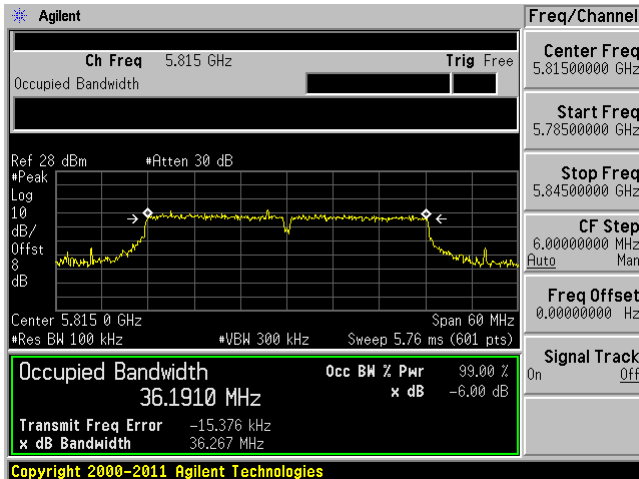

C4

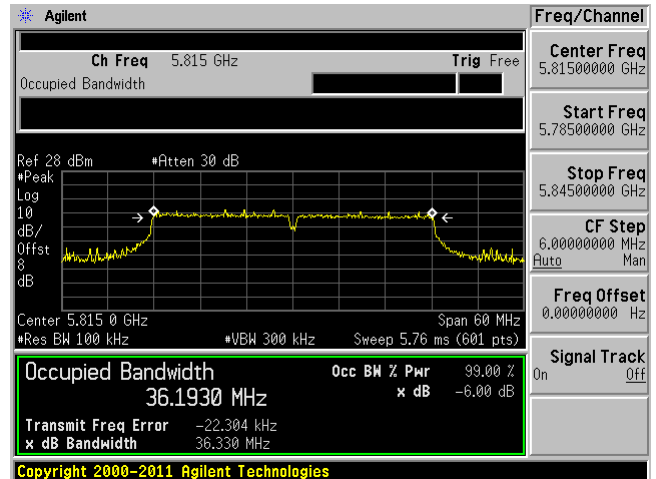

80 MHz bandwidth, Low Channel, 5775 MHz

C1

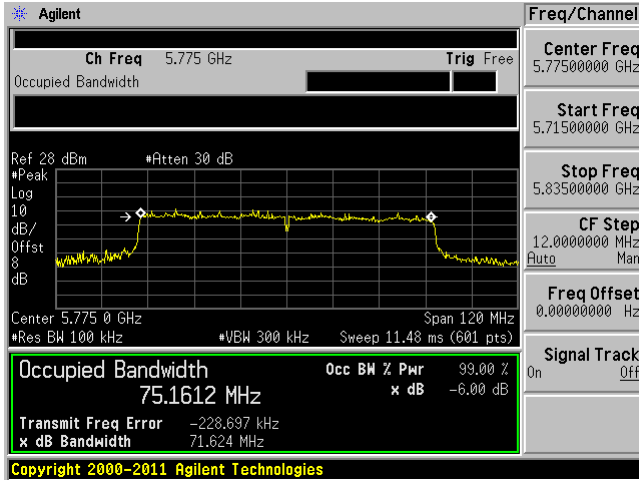

C2

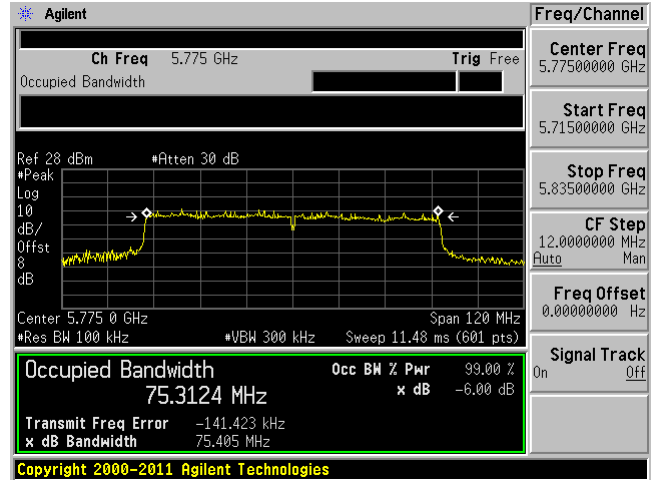

C3

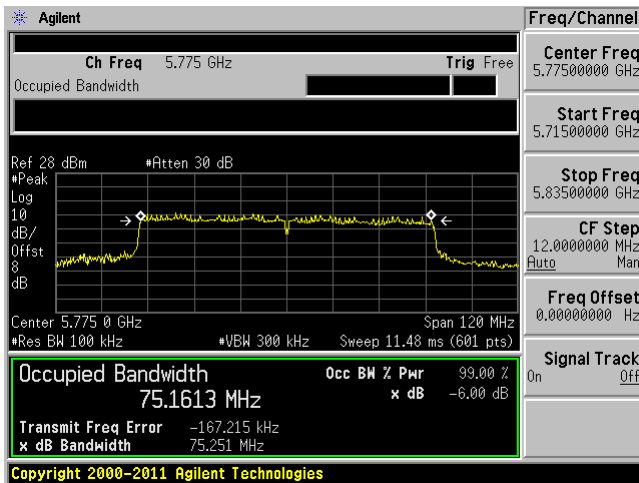

C4

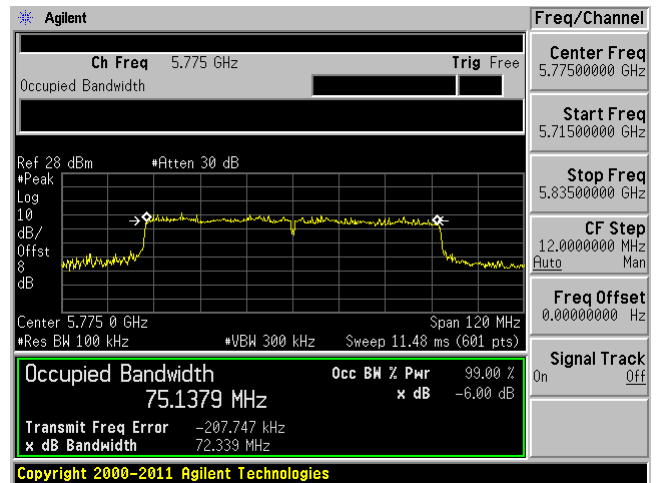



80 MHz bandwidth, Middle Channel, 5785 MHz

C1

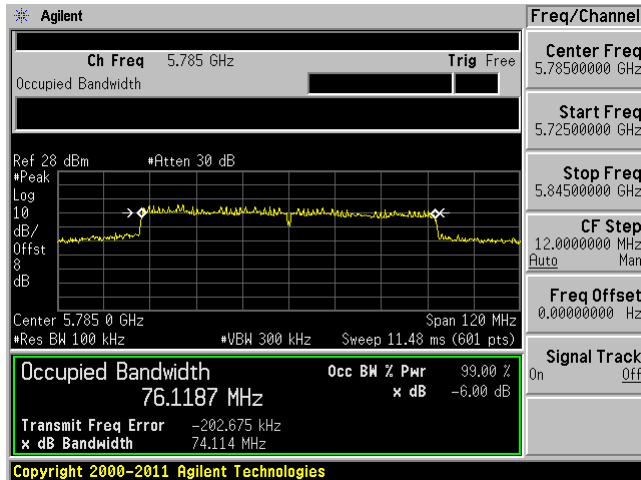

C2

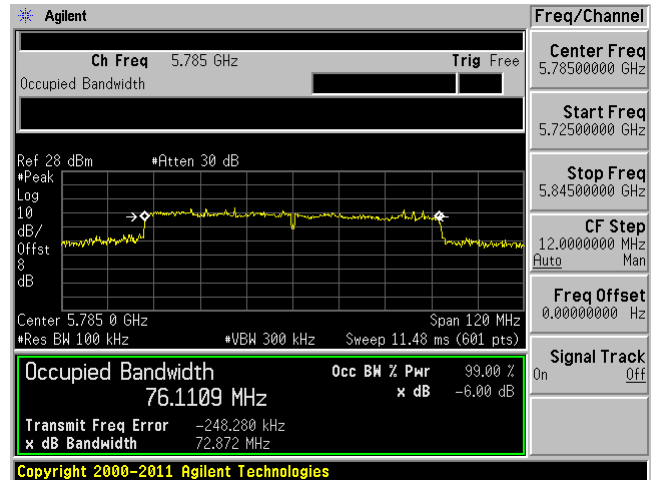

C3

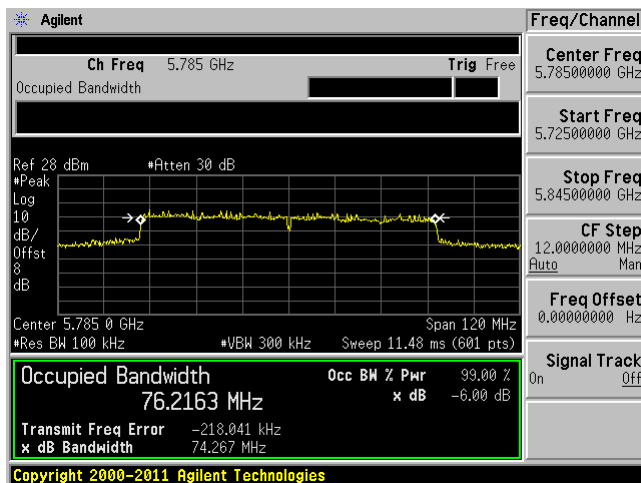

C4

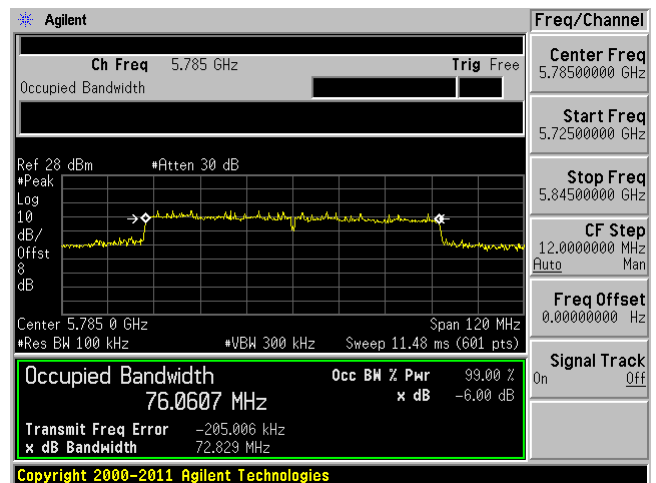

80 MHz bandwidth, High Channel, 5795 MHz

C1

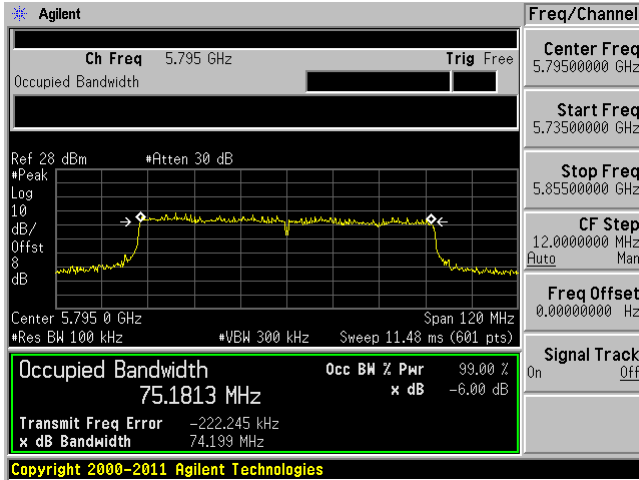

C2

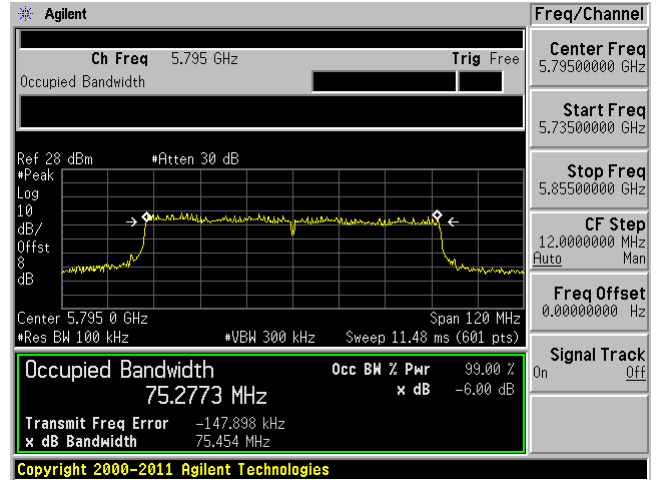

C3

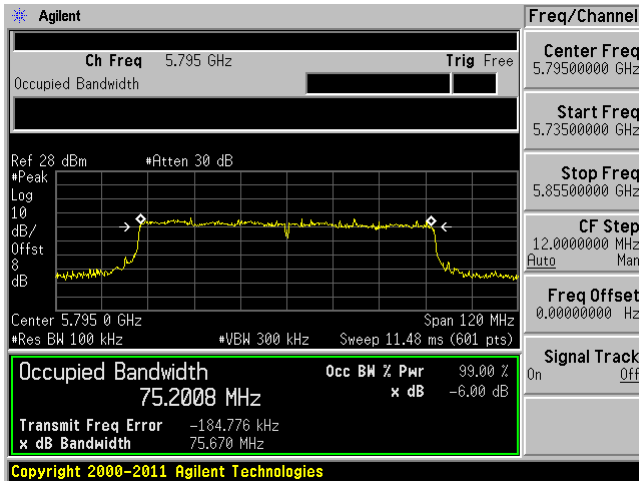

C4

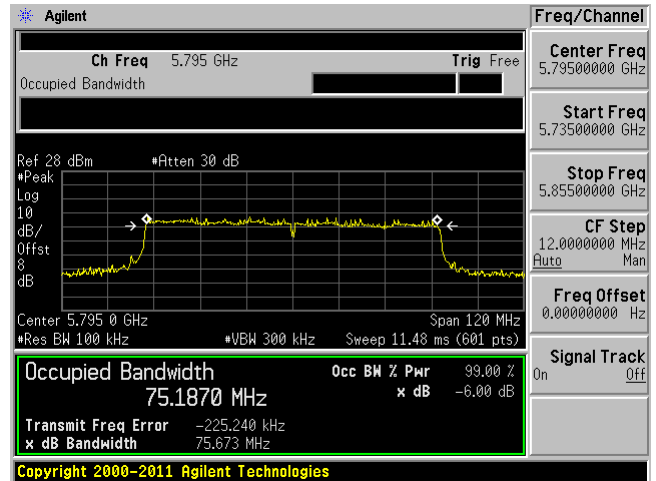

## 9 FCC §15.407(a)(1) & §15.407 (a)(3) - Output Power

### 9.1 Applicable Standards

#### According to FCC §15.407(a)(1)

For fixed point-to-point access points operating in the band 5.15-5.25 GHz, the maximum conducted output power over the frequency band of operation shall not exceed 1 W. Fixed point-to-point U-NII devices may employ antennas with directional gain up to 23 dBi without any corresponding reduction in the maximum conducted output power or maximum power spectral density. For fixed point-to-point transmitters that employ a directional antenna gain greater than 23 dBi, a 1 dB reduction in maximum conducted output power and maximum power spectral density is required for each 1 dB of antenna gain in excess of 23 dBi. Fixed, point-to-point operations exclude the use of point-to-multipoint systems, omnidirectional applications, and multiple collocated transmitters transmitting the same information. The operator of the U-NII device, or if the equipment is professionally installed, the installer, is responsible for ensuring that systems employing high gain directional antennas are used exclusively for fixed, point-to-point operations.

#### According to FCC §15.407(a)(3)

For the band 5.725-5.85 GHz, the maximum conducted output power over the frequency band of operation shall not exceed 1 W. In addition, the maximum power spectral density shall not exceed 30 dBm in any 500-kHz band. If transmitting antennas of directional gain greater than 6 dBi are used, both the maximum conducted output power and the maximum power spectral density shall be reduced by the amount in dB that the directional gain of the antenna exceeds 6 dBi. However, fixed point-to-point U-NII devices operating in this band may employ transmitting antennas with directional gain greater than 6 dBi without any corresponding reduction in transmitter conducted power. Fixed, point-to-point operations exclude the use of point-to-multipoint systems, omnidirectional applications, and multiple collocated transmitters transmitting the same information. The operator of the U-NII device, or if the equipment is professionally installed, the installer, is responsible for ensuring that systems employing high gain directional antennas are used exclusively for fixed, point-to-point operations.

### 9.2 Measurement Procedure

The measurements are based on FCC KDB 789033 D02 General UNII Test Procedures v01: Guidelines for Compliance Testing of Unlicensed National Information Infrastructure (U-NII) Devices section E: Maximum conducted output power

### 9.3 Test Equipment List and Details

Manufacturer	Description	Model No.	Serial No.	Calibration Date	Calibration Interval
Agilent	Spectrum Analyzer	E4446A	US44300386	2013-09-29	1 year

*Statement of Traceability: BACL Corp. attests that all calibrations have been performed according to A2LA requirements, traceable to the NIST.*

## 9.4 Test Environmental Conditions

<b>Temperature:</b>	21-23 °C
<b>Relative Humidity:</b>	43-48 %
<b>ATM Pressure:</b>	101.1-101.3 kPa

The testing was performed by Cipher Chu on 2014-04-04 to 2014-04-07 at the RF Site  
 Note: Normal transmission is worst case.

## 9.5 Test Results

Note: Chain 1 and Chain 4 is Vertical, and Chain 2 and Chain 3 is Horizontal  
 Note: C1, C2, C3 and C4 stands for Chain 1, Chain 2, Chain 3 and Chain 4.

### 25 dBi Antenna

#### 5.2 GHz Band Peak Output Power:

20 MHz bandwidth

Channel	Frequency (MHz)	Conducted Output Power C1/C2 (dBm)	Conducted Output Power C3/C4 (dBm)	Total Power C1, C2 (dBm)	Total Power C3, C4 (dBm)	Limit (dBm)
Low	5165	4.78/4.91	4.38/3.62	7.86	7.03	28
Middle	5200	19.12/22.04	21.73/20.69	23.83	<b>24.25</b>	28
High	5240	12.2/13.49	13.03/11.03	15.9	15.15	28

40 MHz bandwidth

Channel	Frequency (MHz)	Conducted Output Power C1/C2 (dBm)	Conducted Output Power C3/C4 (dBm)	Total Power C1, C2 (dBm)	Total Power C3, C4 (dBm)	Limit (dBm)
Low	5175	8.00/12.12	9.53/8.34	13.54	11.99	28
Middle	5200	17.07/20.40	19.36/16.48	22.06	21.16	28
High	5230	19.83/20.40	20.88/18.82	<b>23.13</b>	22.98	28

80 MHz bandwidth

Channel	Frequency (MHz)	Conducted Output Power C1/C2 (dBm)	Conducted Output Power C3/C4 (dBm)	Total Power C1, C2 (dBm)	Total Power C3, C4 (dBm)	Limit (dBm)
Low	5195	6.87/8.43	7.4/6.51	10.73	9.57	28
Middle	5200	10.78/17.76	10.92/13.64	<b>18.55</b>	15.50	28
High	5210	9.97/11.26	9.55/10.87	13.67	13.27	28

Note: Antenna gain of EUT is 25 dBi which is over 2 dB of 23 dBi allowed by FCC Part 15.407 (a)(1)(iii), a 1 dB reduction in maximum conducted output power and maximum power spectral density is required for each 1 dB of antenna gain in excess of 23 dBi

**5.8 GHz Band Peak Output Power:**

20 MHz bandwidth

Channel	Frequency (MHz)	Conducted Output Power C1/C2 (dBm)	Conducted Output Power C3/C4 (dBm)	Total Power C1, C2 (dBm)	Total Power C3, C4 (dBm)	Limit (dBm)
Low	5745	18.46/26.84	24.4/18.08	27.43	25.31	30
Middle	5785	20.72/28.18	26.92/23.16	<b>28.90</b>	28.77	30
High	5825	19.81/26.25	23.06/21.8	27.14	26.09	30

40 MHz bandwidth

Channel	Frequency (MHz)	Conducted Output Power C1/C2 (dBm)	Conducted Output Power C3/C4 (dBm)	Total Power C1, C2 (dBm)	Total Power C3, C4 (dBm)	Limit (dBm)
Low	5755	15.98/24.27	22.27/13.2	24.87	22.57	30
Middle	5785	21.07/26.89	25.48/23.12	<b>27.90</b>	27.47	30
High	5815	20.39/24.49	21.63/16.26	25.92	22.74	30

80 MHz bandwidth

Channel	Frequency (MHz)	Conducted Output Power C1/C2 (dBm)	Conducted Output Power C3/C4 (dBm)	Total Power C1, C2 (dBm)	Total Power C3, C4 (dBm)	Limit (dBm)
Low	5775	13.89/23.72	21.14/11.85	<b>24.15</b>	21.62	30
Middle	5785	15.58/23.49	20.8/12.14	24.14	21.35	30
High	5795	15.99/23.36	20.08/13.28	24.09	20.90	30

**0 dBi Antenna****5.2 GHz Band Peak Output Power:**

20 MHz bandwidth

Channel	Frequency (MHz)	Conducted Power C1 (dBm)	Conducted Power C2 (dBm)	Conducted Power C3 (dBm)	Conducted Power C4 (dBm)	Total Power C1,C2 (dBm)	Total Power C3,C4 (dBm)	Limit (dBm)
Low	5165	17.6	20.86	21.17	20.44	22.54	23.83	30
Middle	5200	25.14	26.7	26.14	27.36	29.00	29.80	30
High	5240	26.34	27.23	27.09	26.27	<b>29.82</b>	29.71	30

40 MHz bandwidth

Channel	Frequency (MHz)	Conducted Power C1 (dBm)	Conducted Power C2 (dBm)	Conducted Power C3 (dBm)	Conducted Power C4 (dBm)	Total Power C1,C2 (dBm)	Total Power C3,C4 (dBm)	Limit (dBm)
Low	5175	18.68	21.1	21.56	20.79	23.07	24.20	30
Middle	5200	21.67	26.52	26.04	23.77	27.75	28.06	30
High	5230	25.69	27.13	27.14	26.13	29.48	<b>29.67</b>	30

80 MHz bandwidth

Channel	Frequency (MHz)	Conducted Power C1 (dBm)	Conducted Power C2 (dBm)	Conducted Power C3 (dBm)	Conducted Power C4 (dBm)	Total Power C1,C2 (dBm)	Total Power C3,C4 (dBm)	Limit (dBm)
Low	5195	18.97	22.53	22.79	20.94	24.12	24.97	30
Middle	5200	19.27	22.33	23.03	20.54	24.07	24.97	30
High	5210	19.9	24.15	23.83	21.38	25.54	<b>25.79</b>	30

**5.8 GHz Band Peak Output Power:**

20 MHz bandwidth

Channel	Frequency (MHz)	Conducted Power C1 (dBm)	Conducted Power C2 (dBm)	Conducted Power C3 (dBm)	Conducted Power C4 (dBm)	Total Power C1,C2 (dBm)	Total Power C3,C4 (dBm)	Limit (dBm)
Low	5745	25.06	25.15	25.93	25.54	28.12	28.75	30
Middle	5785	25.94	25.21	25.47	26.22	28.60	28.87	30
High	5825	25.63	26.38	25.02	27.86	29.03	<b>29.68</b>	30

40 MHz bandwidth

Channel	Frequency (MHz)	Conducted Power C1 (dBm)	Conducted Power C2 (dBm)	Conducted Power C3 (dBm)	Conducted Power C4 (dBm)	Total Power C1,C2 (dBm)	Total Power C3,C4 (dBm)	Limit (dBm)
Low	5755	27.03	25.29	23.33	24.47	29.26	26.95	30
Middle	5785	27.39	26.22	26.34	26.66	<b>29.85</b>	29.51	30
High	5815	27.11	25.27	22.54	25.17	29.30	27.06	30

80 MHz bandwidth

Channel	Frequency (MHz)	Conducted Power C1 (dBm)	Conducted Power C2 (dBm)	Conducted Power C3 (dBm)	Conducted Power C4 (dBm)	Total Power C1,C2 (dBm)	Total Power C3,C4 (dBm)	Limit (dBm)
Low	5775	25.93	23.91	21.67	23.72	28.05	25.83	30
Middle	5785	26.63	24.35	22.45	23.8	<b>28.65</b>	26.19	30
High	5795	26.4	23.88	21.45	23.46	28.33	25.58	30

## 10 FCC §15.407(b) - Out of Band Emissions

### 10.1 Applicable Standard

#### According to FCC §15.407(b)

For transmitters operating in the 5.15-5.25 GHz band: All emissions outside of the 5.15-5.35 GHz band shall not exceed an e.i.r.p. of  $-27$  dBm/MHz.

For transmitters operating in the 5.25-5.35 GHz band: All emissions outside of the 5.15-5.35 GHz band shall not exceed an e.i.r.p. of  $-27$  dBm/MHz.

For transmitters operating in the 5.47-5.725 GHz band: All emissions outside of the 5.47-5.725 GHz band shall not exceed an e.i.r.p. of  $-27$  dBm/MHz.

For transmitters operating in the 5.725-5.85 GHz band: All emissions within the frequency range from the band edge to 10 MHz above or below the band edge shall not exceed an e.i.r.p. of  $-17$  dBm/MHz; for frequencies 10 MHz or greater above or below the band edge, emissions shall not exceed an e.i.r.p. of  $-27$  dBm/MHz.

### 10.2 Measurement Procedure

The measurements are base on FCC KDB 789033 D02 General UNII Test Procedures v01: Guidelines for Compliance Testing of Unlicensed National Information Infrastructure (U-NII) Devices section H: Unwanted emissions measurement

### 10.3 Test Equipment List and Details

Manufacturer	Description	Model No.	Serial No.	Calibration Date	Calibration Interval
Agilent	Spectrum Analyzer	E4446A	US44300386	2013-09-29	1 year

*Statement of Traceability: BACL Corp. attests that all calibrations have been performed according to A2LA requirements, traceable to the NIST.*

### 10.4 Test Environmental Conditions

<b>Temperature:</b>	24 °C
<b>Relative Humidity:</b>	45 %
<b>ATM Pressure:</b>	101.1 kPa

*The testing was performed by Cipher Chu on 2014-04-04 to 2014-04-07 at the RF Site*

Note: Normal transmission is worst case.

Note: The antenna gain already adds on the offset.

Note: Chain 1 and Chain 4 is Vertical, and Chain 2 and Chain 3 is Horizontal

Note: C1, C2, C3 and C4 stands for Chain 1, Chain 2, Chain 3 and Chain 4.



### 10.5 Test Results

Please refer to following pages for plots of band edge.

#### 25 dBi Antenna

#### 5.2 GHz Band:

#### 20 MHz bandwidth, Low Channel, 5165 MHz

C1

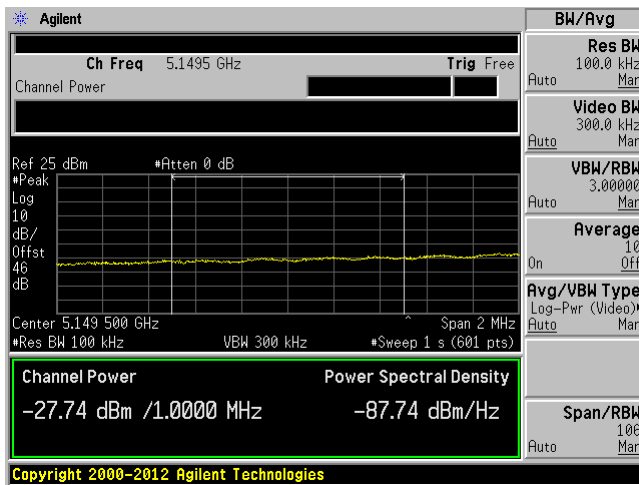

C2

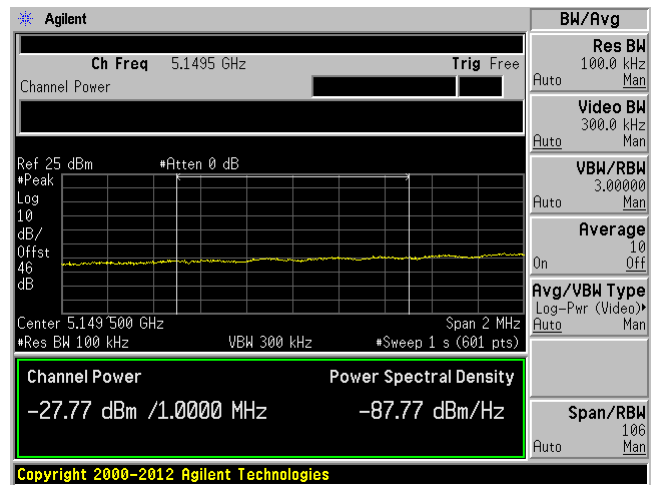

C3

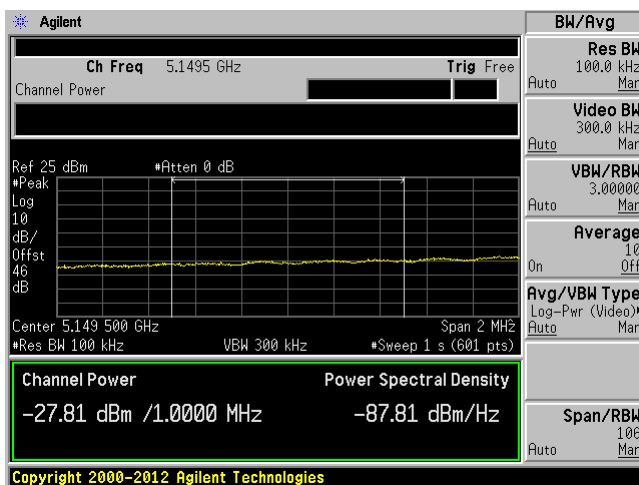

C4

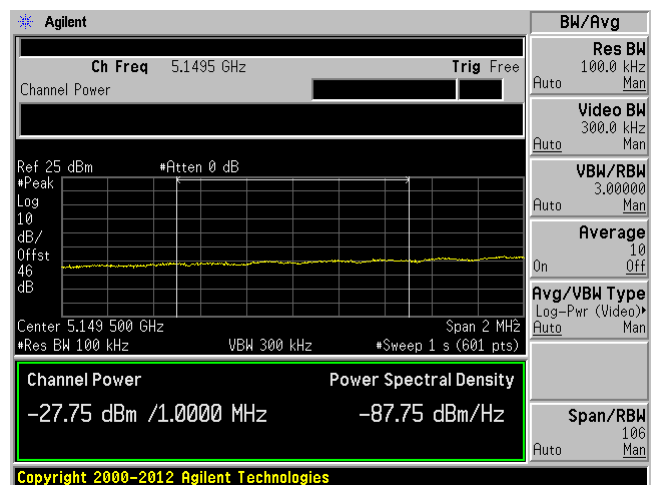

20 MHz bandwidth, Middle Channel, 5200 MHz

C1

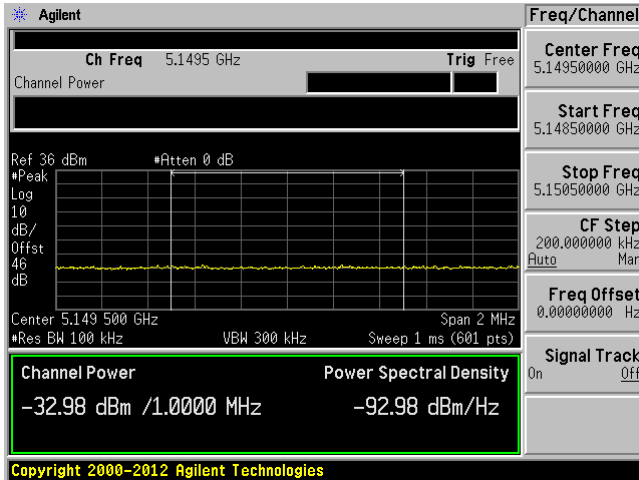

C2

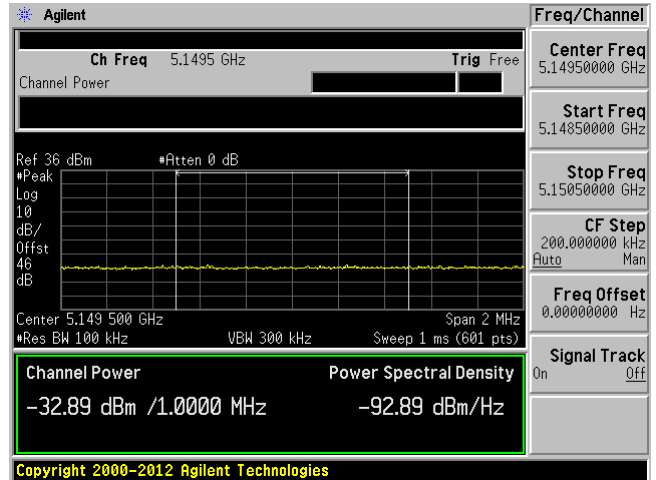

C3

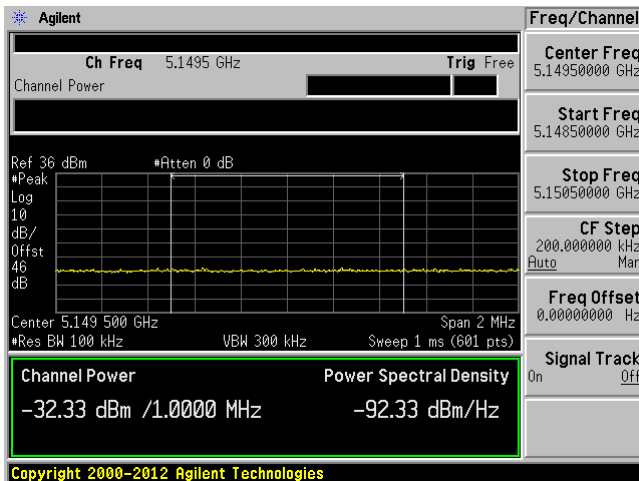

C4

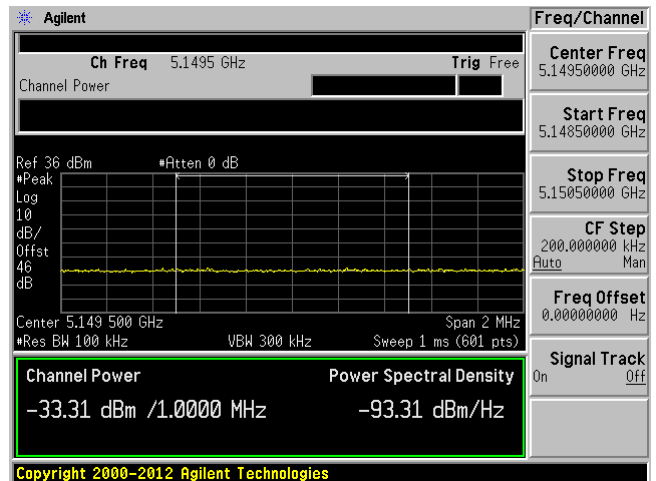

20 MHz bandwidth, High Channel, 5240 MHz

C1

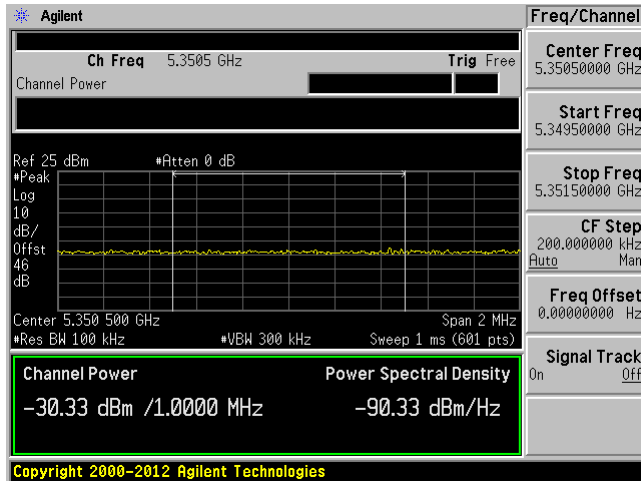

C2

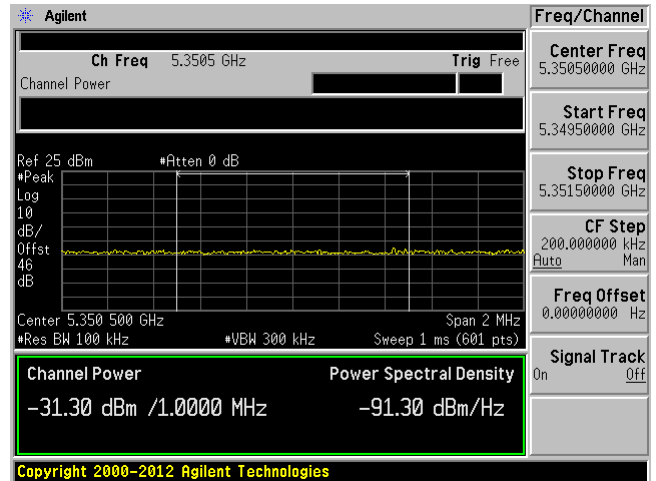

C3

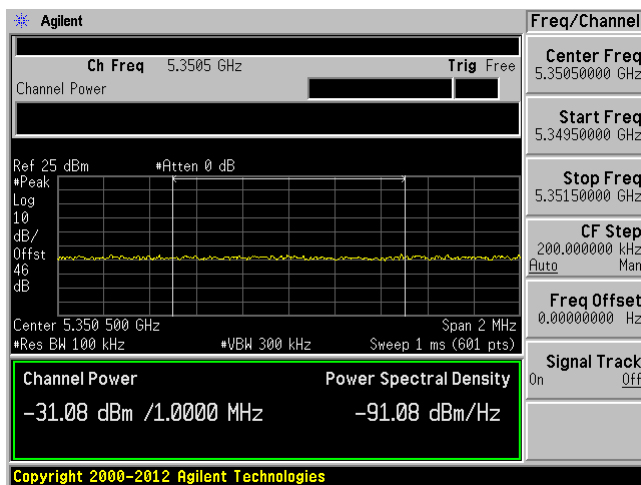

C4

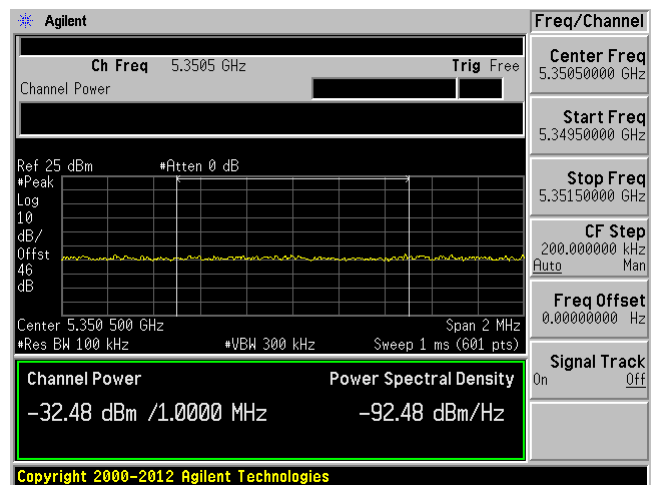

40 MHz bandwidth, Low Channel, 5175 MHz

C1

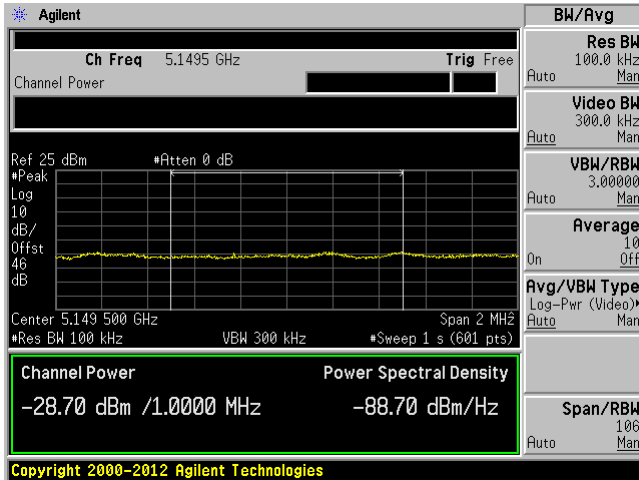

C2

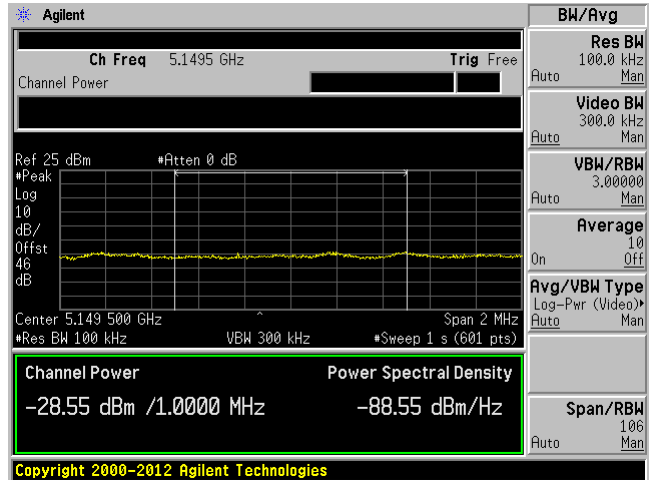

C3

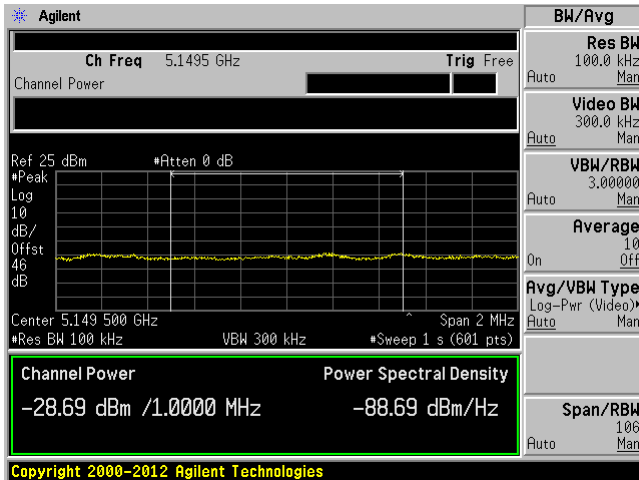

C4

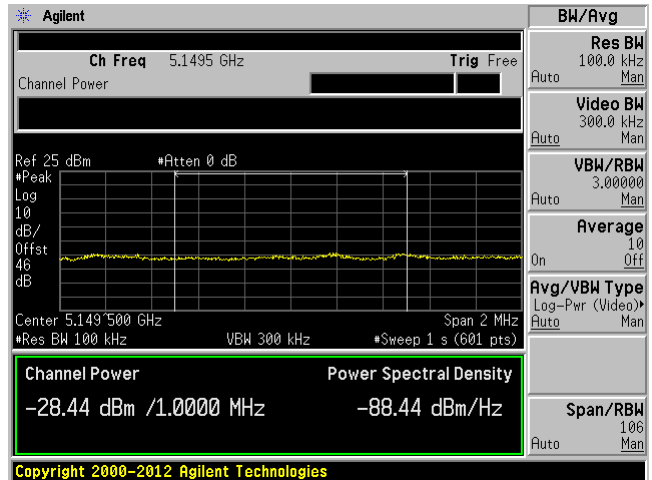

### 40 MHz bandwidth, Middle Channel, 5200 MHz

C1

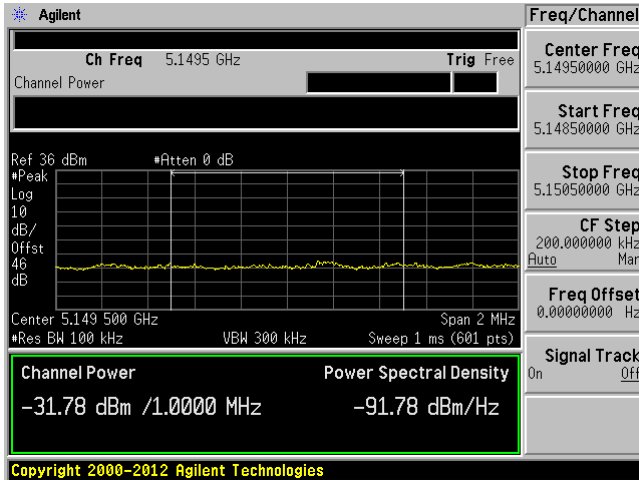

C2

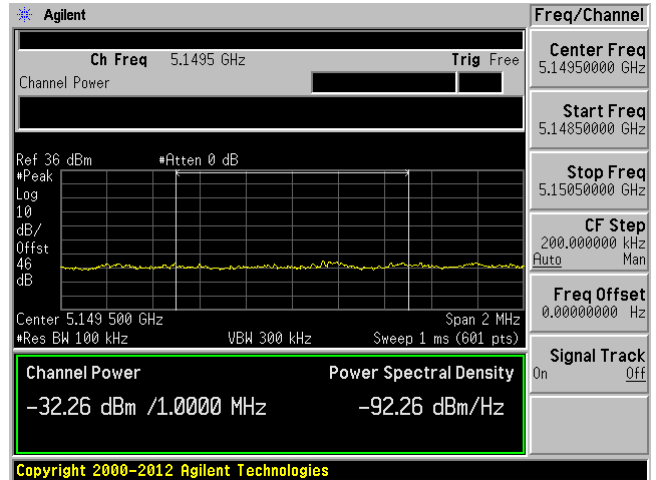

C3

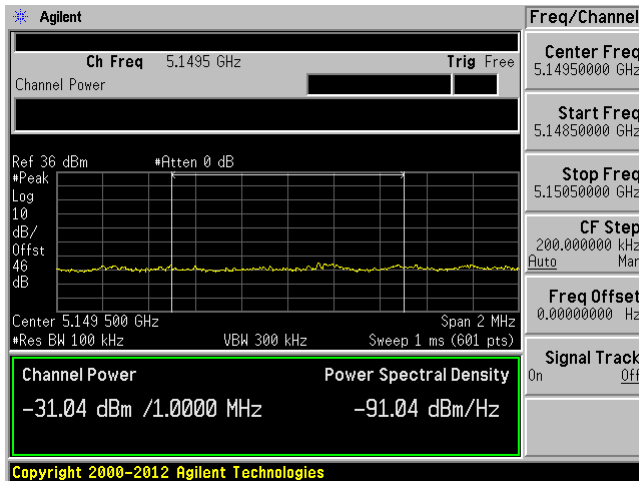

C4

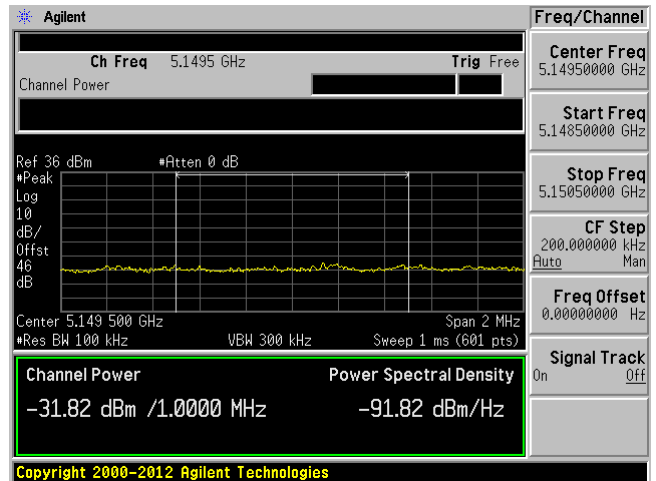

40 MHz bandwidth, High Channel, 5230 MHz

C1

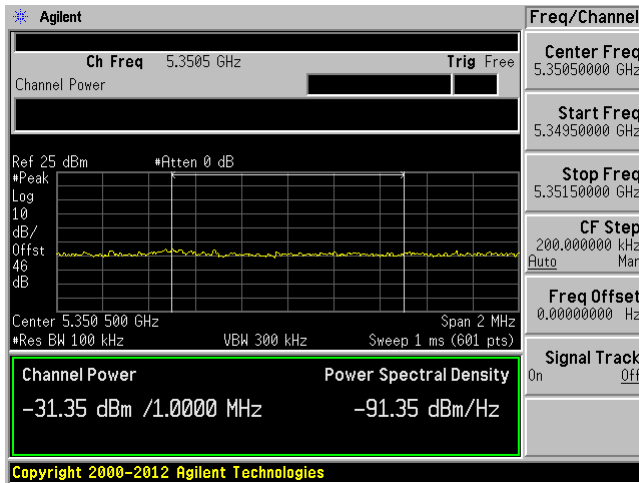

C2

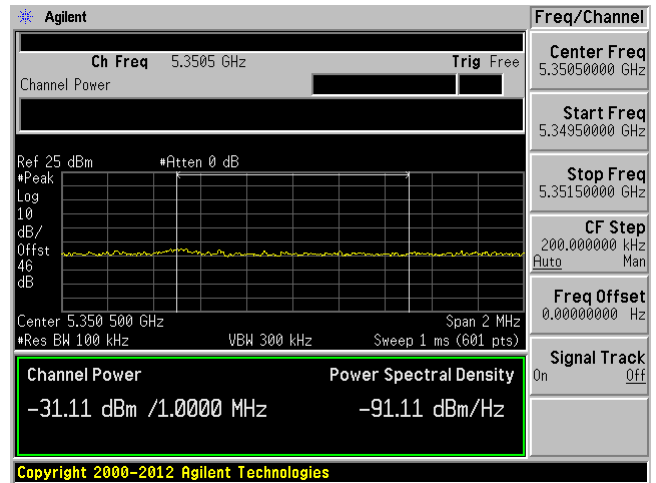

C3

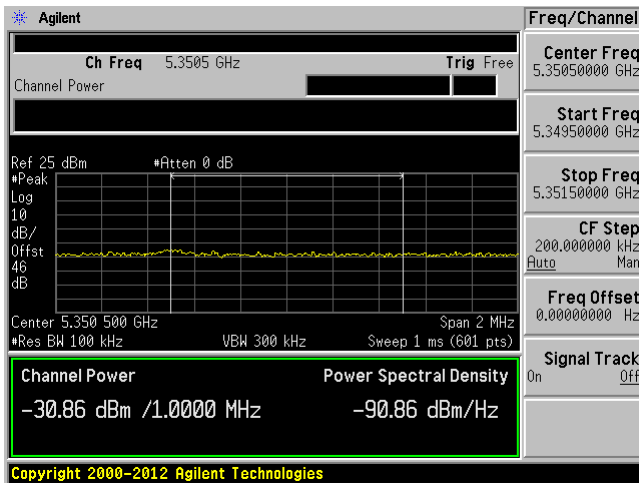

C4

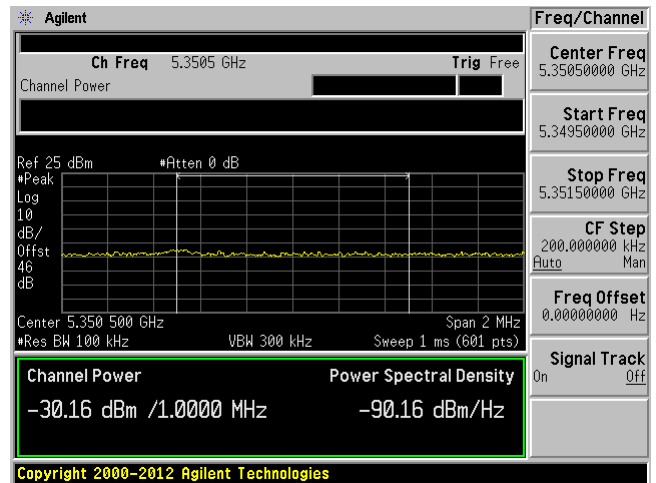

80 MHz bandwidth, Low Channel, 5195 MHz

C1

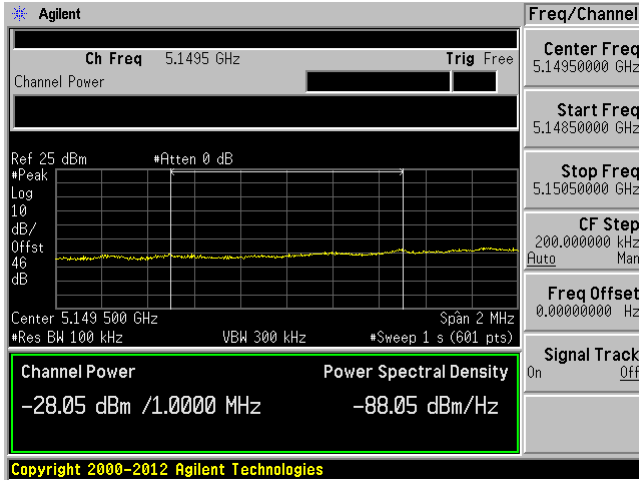

C2

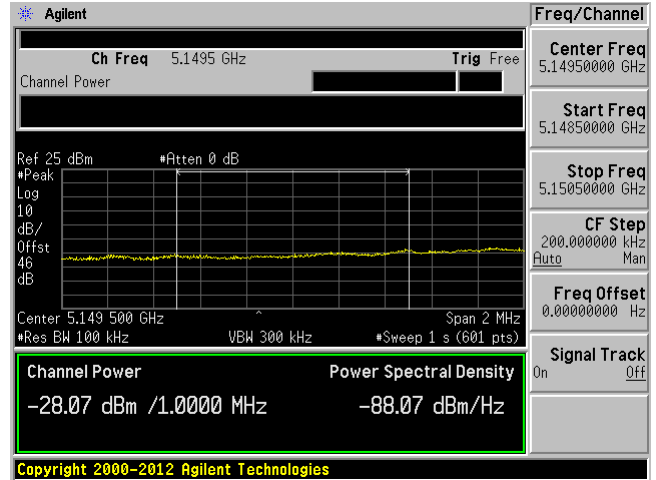

C3

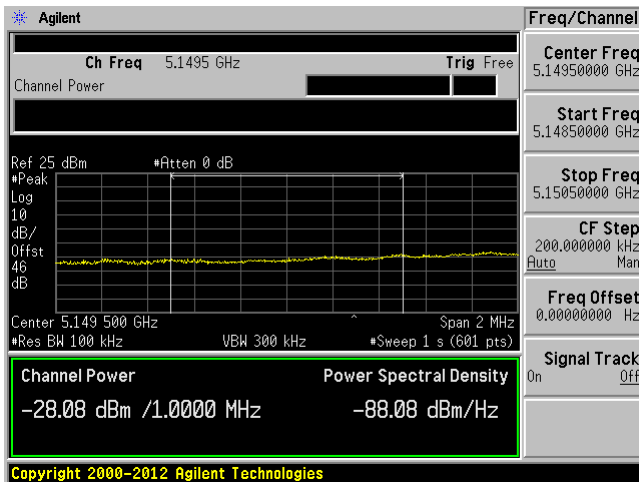

C4

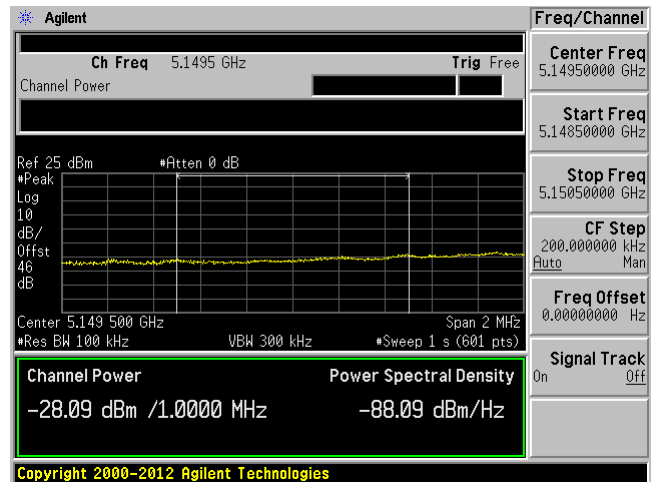

80 MHz bandwidth, Middle Channel, 5200 MHz

C1

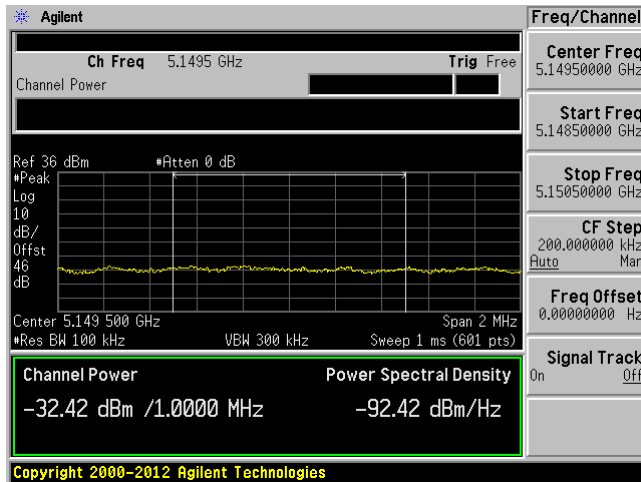

C2

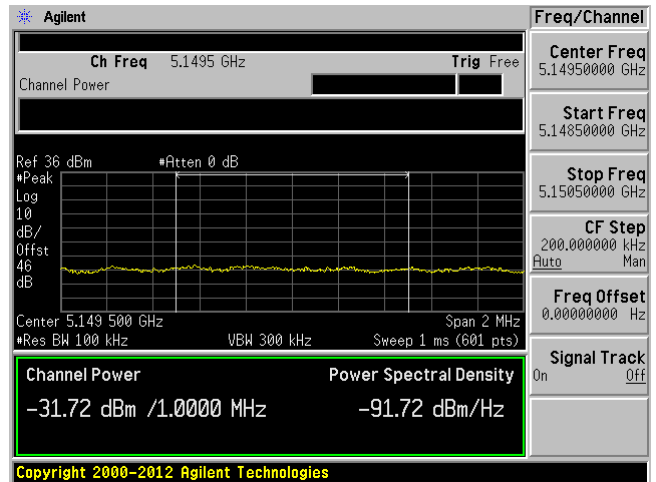

C3

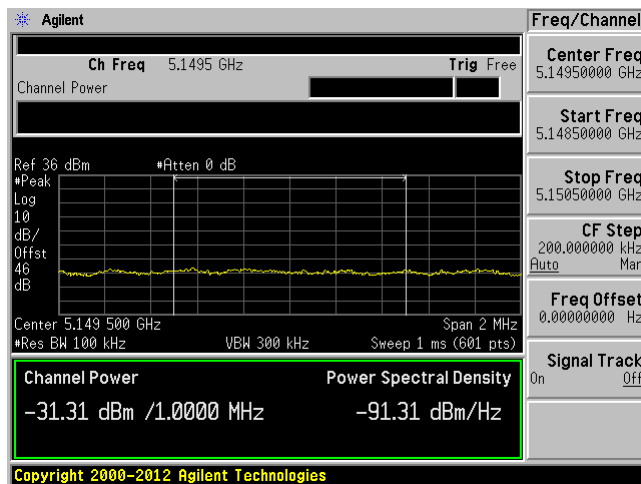

C4

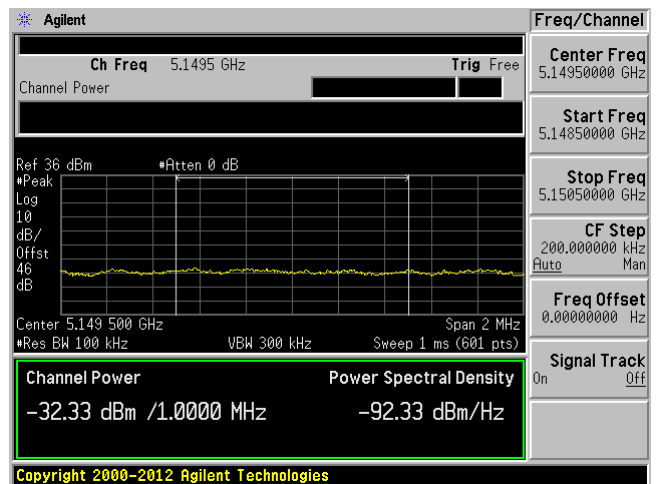



80 MHz bandwidth, High Channel, 5210 MHz

C1

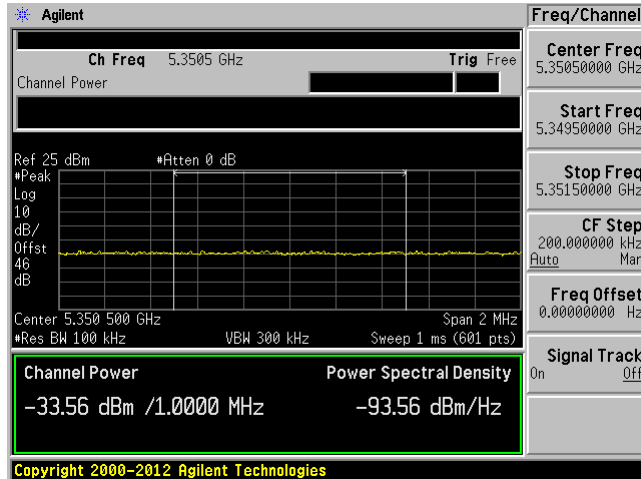

C2

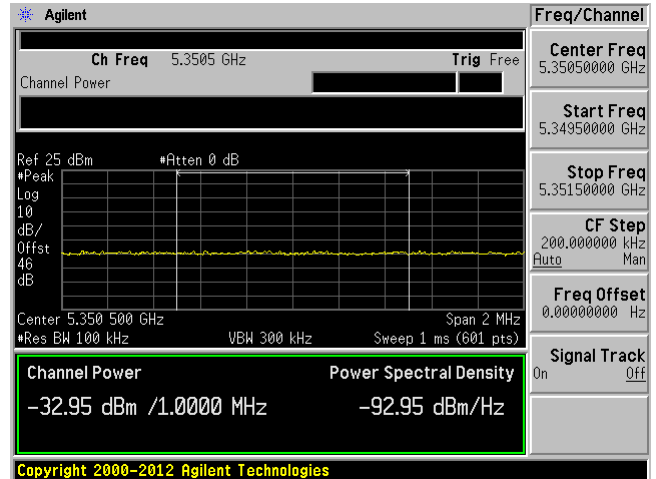

C3

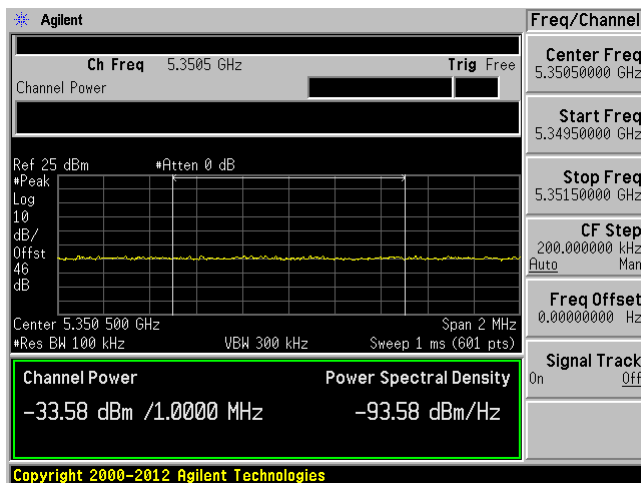

C4

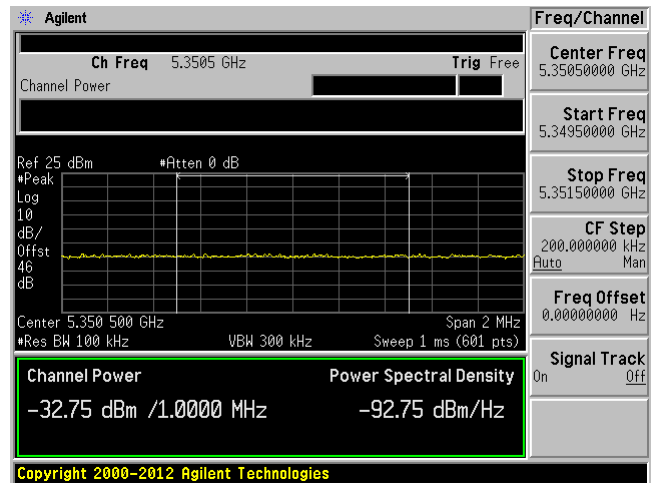

**5.8 GHz Band:**

-27 dBm/MHz EIRP

**20 MHz bandwidth, Low Channel, 5745 MHz**

**C1**

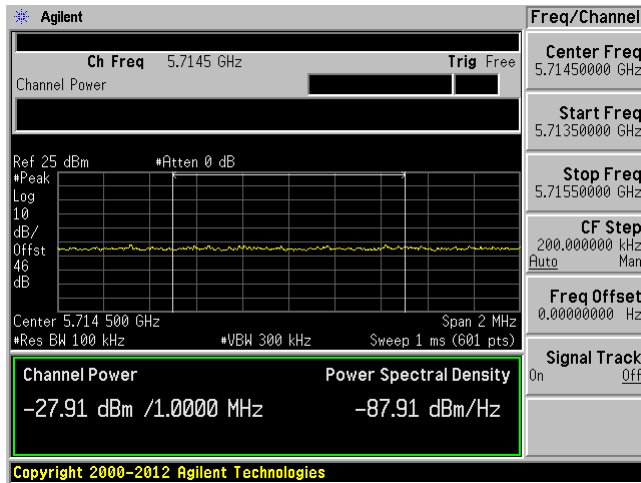

**C2**

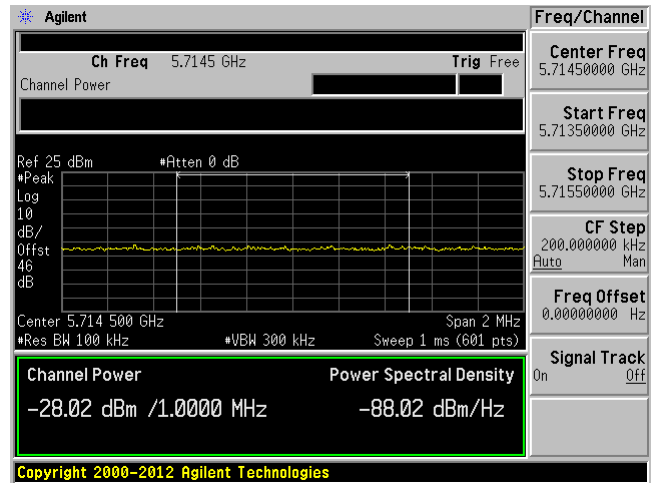

**C3**

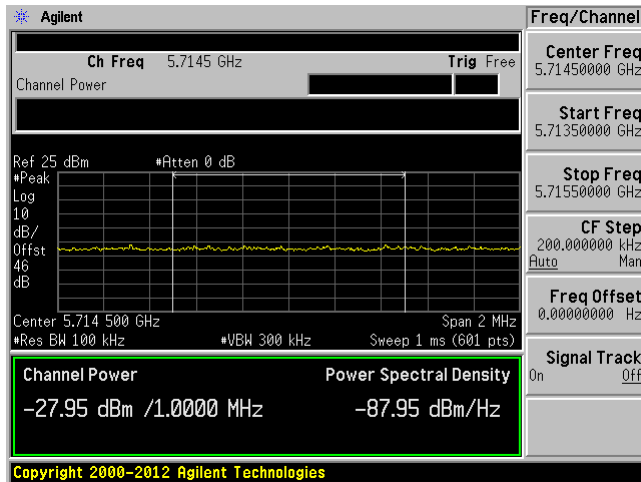

**C4**

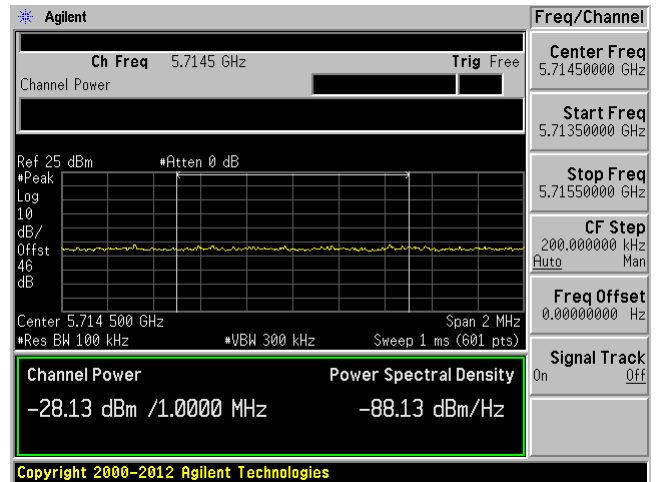

20 MHz bandwidth, High Channel, 5825 MHz

C1

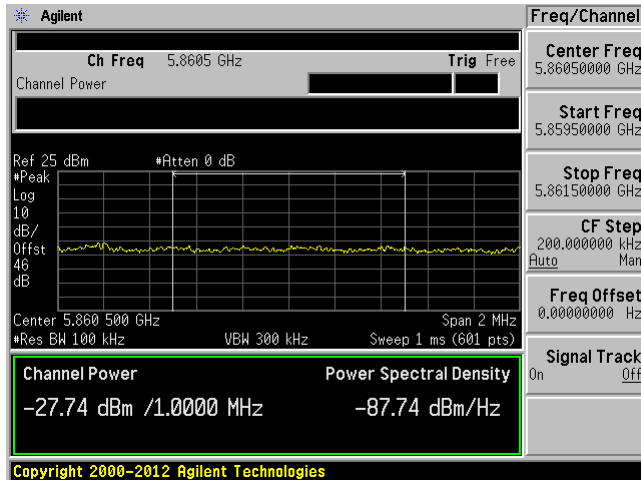

C2

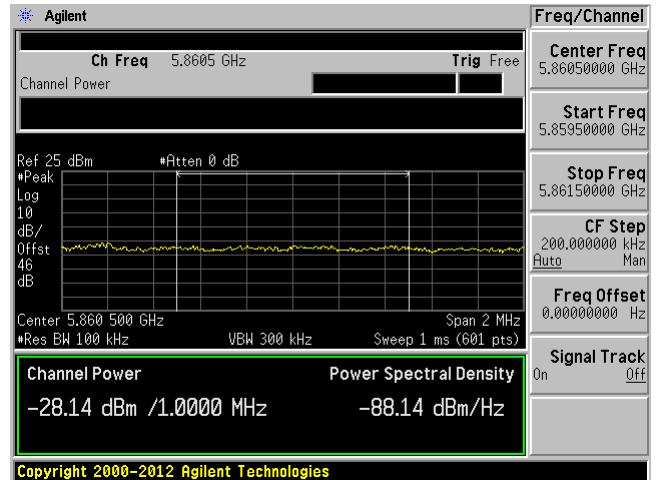

C3

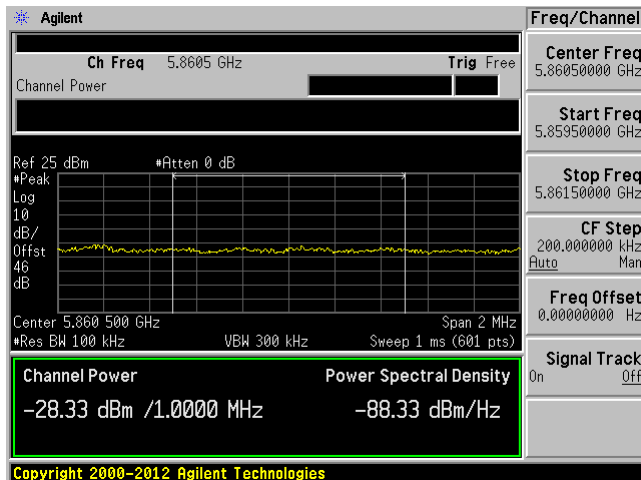

C4

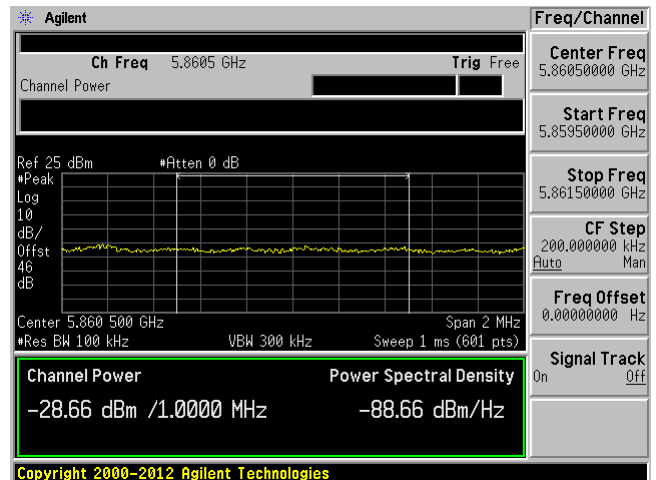

40 MHz bandwidth, Low Channel, 5755 MHz

C1

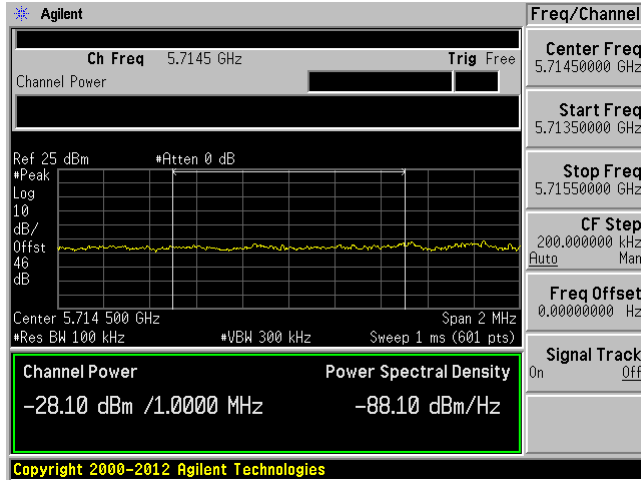

C2

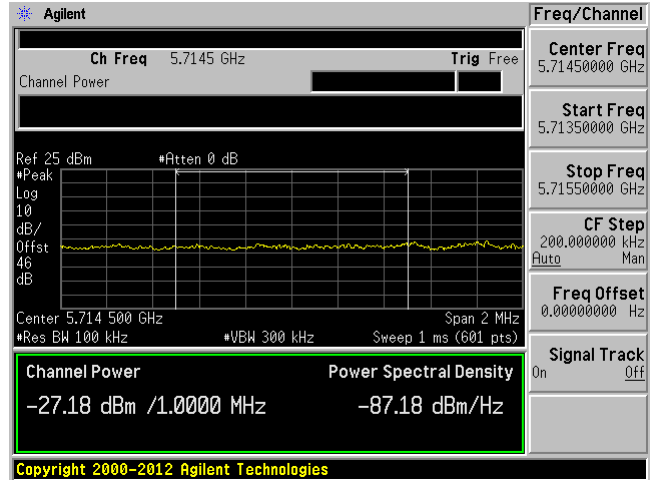

C3

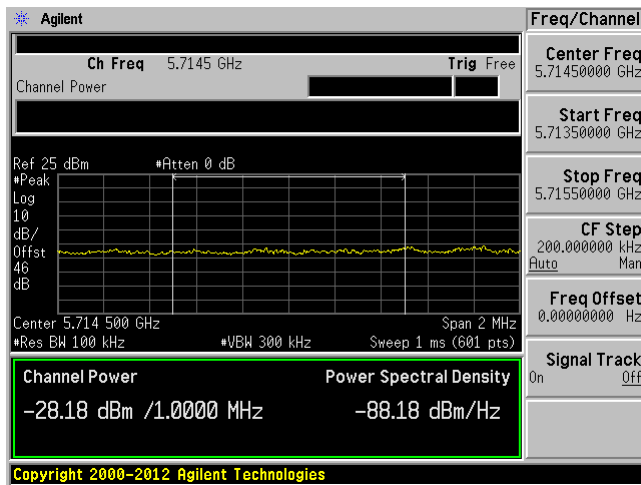

C4

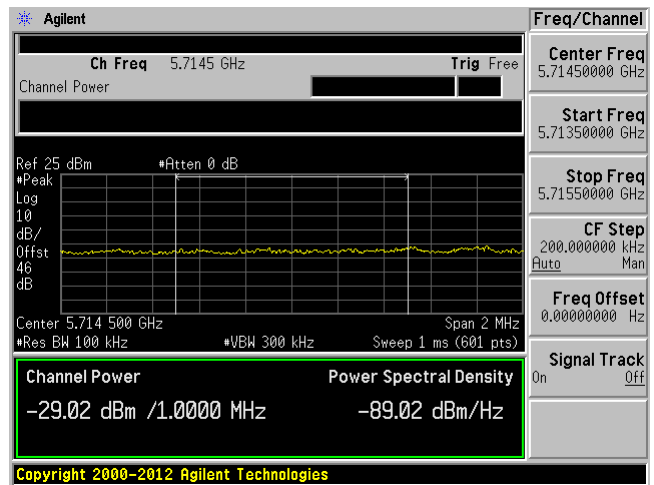

40 MHz bandwidth, High Channel, 5815 MHz

C1

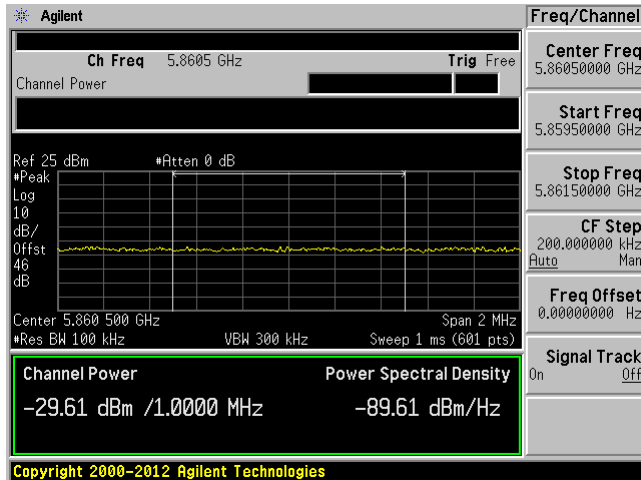

C2

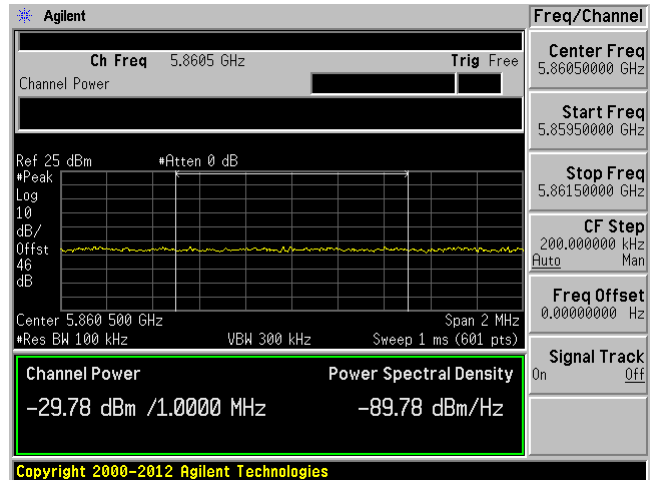

C3

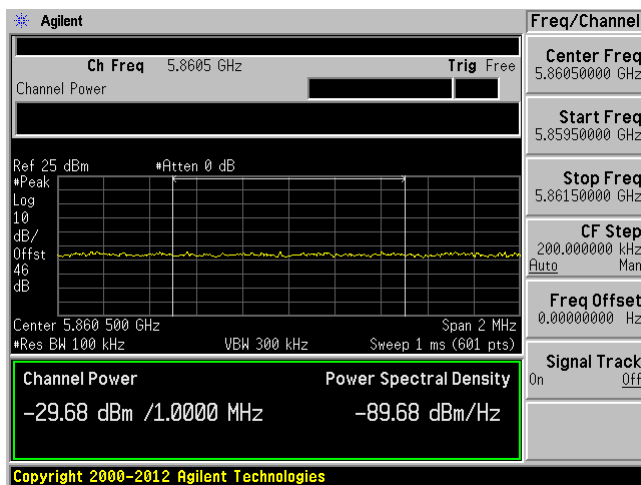

C4

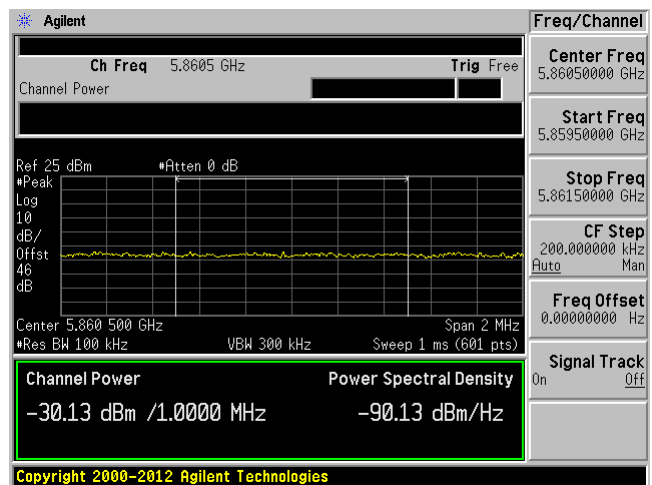

80 MHz bandwidth, Low Channel, 5775 MHz

C1

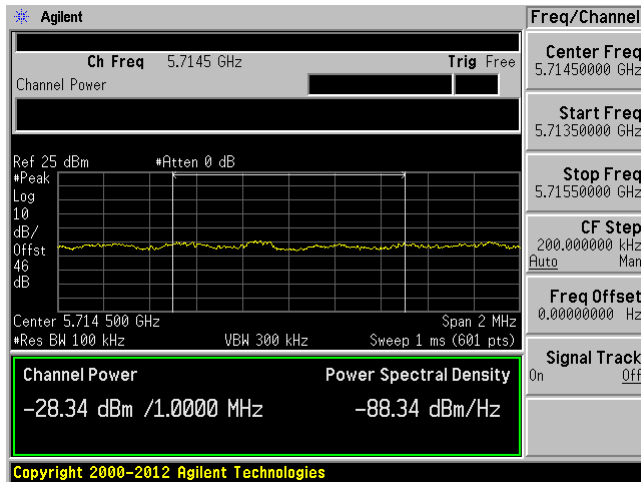

C2

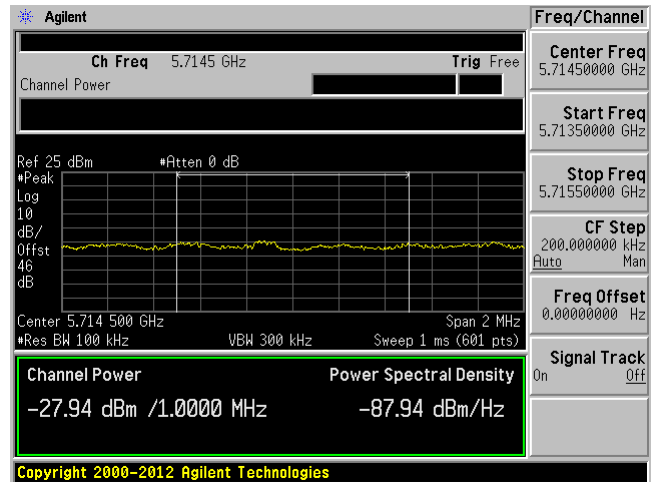

C3

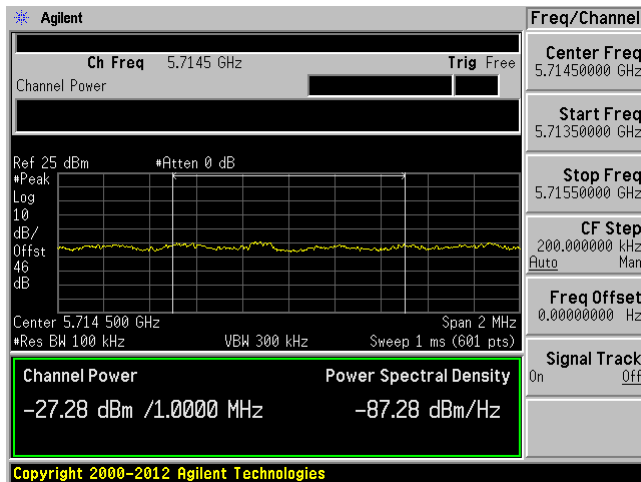

C4

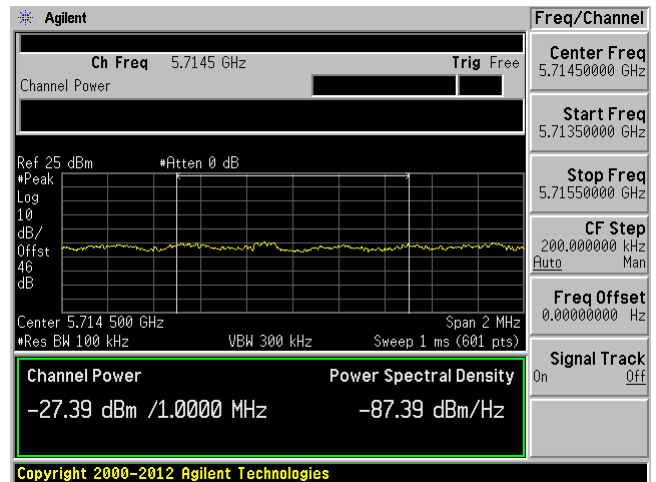

80 MHz bandwidth, High Channel, 5795 MHz

C1

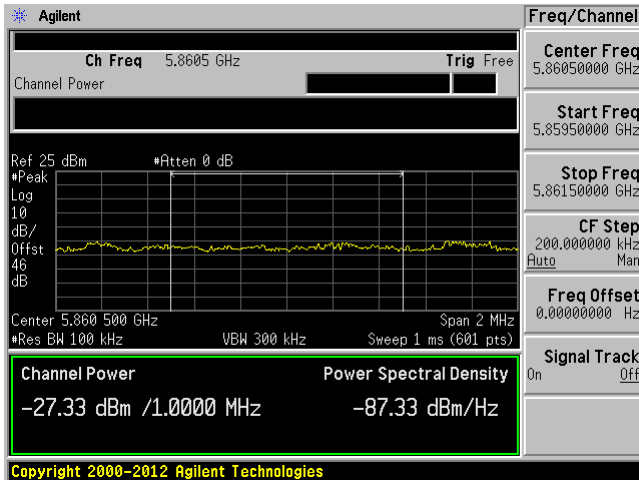

C2

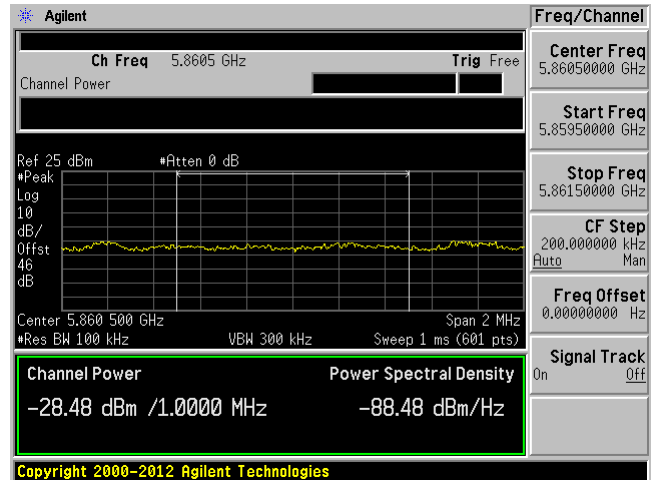

C3

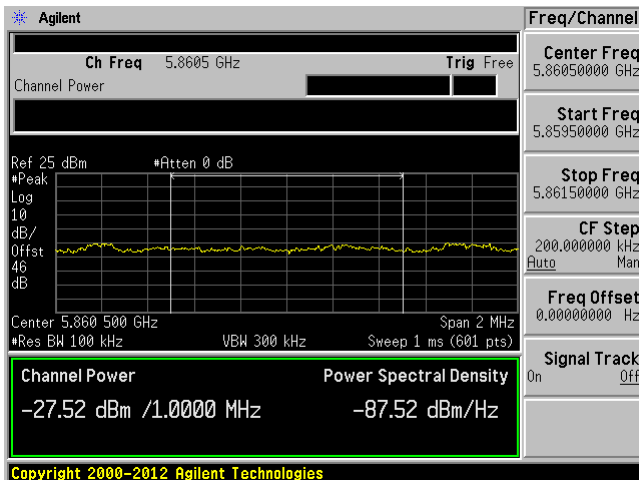

C4

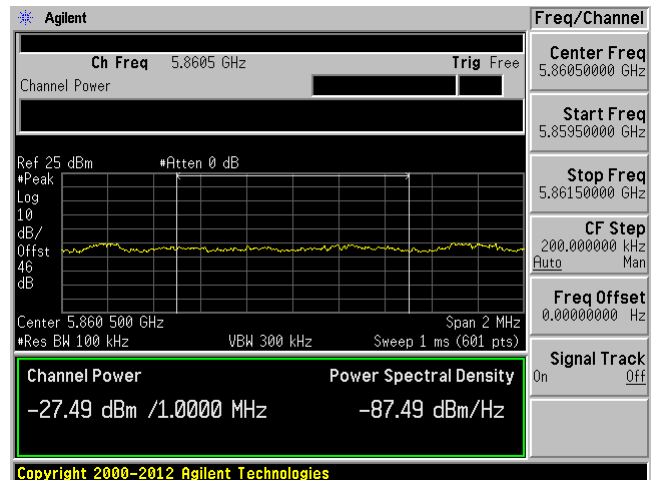

-17 dBm/MHz EIRP

20 MHz bandwidth, Low Channel, 5745 MHz

C1

C2

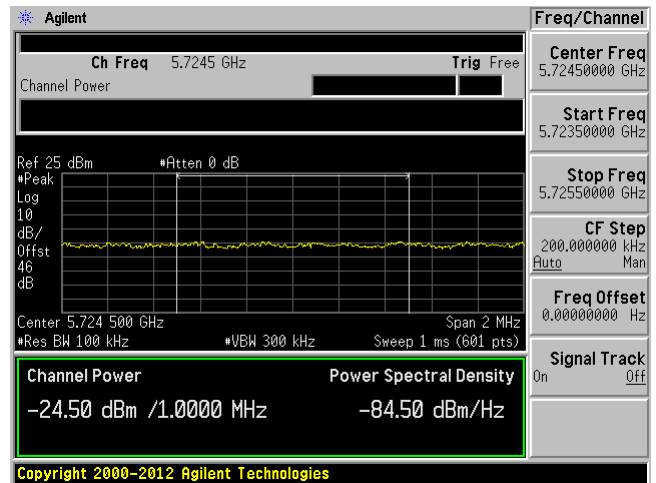
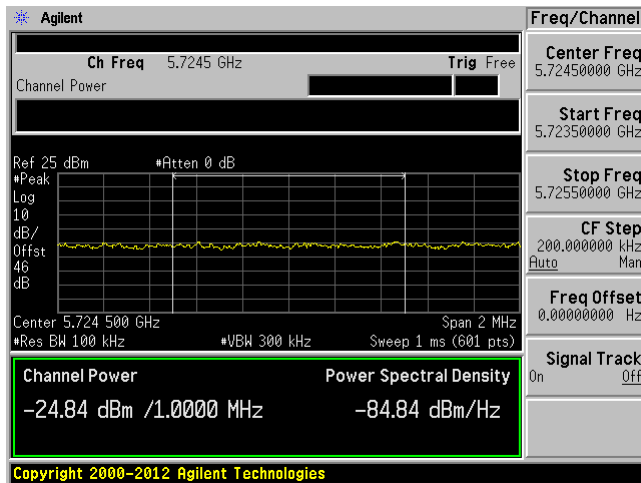

C3

C4

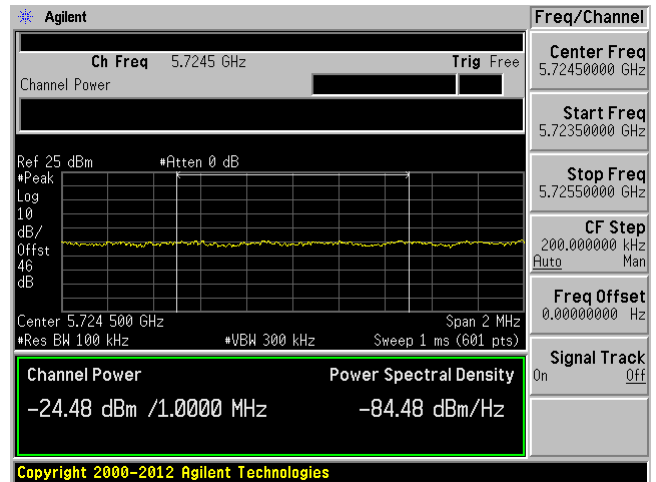
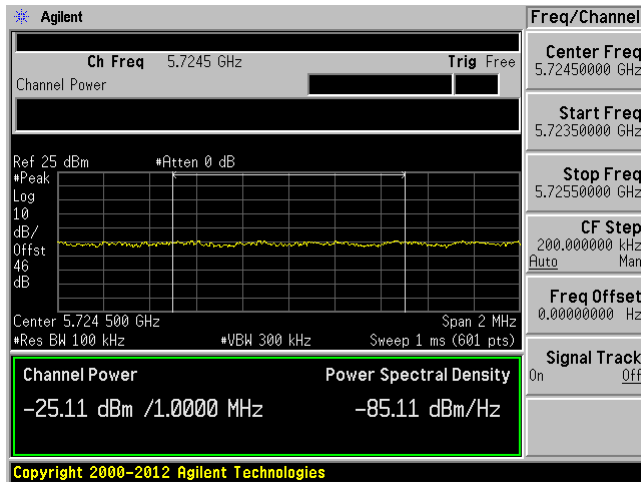



20 MHz bandwidth, High Channel, 5825 MHz

C1

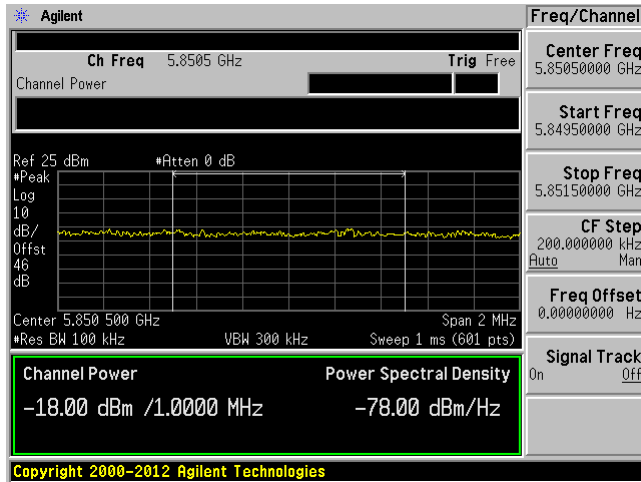

C2

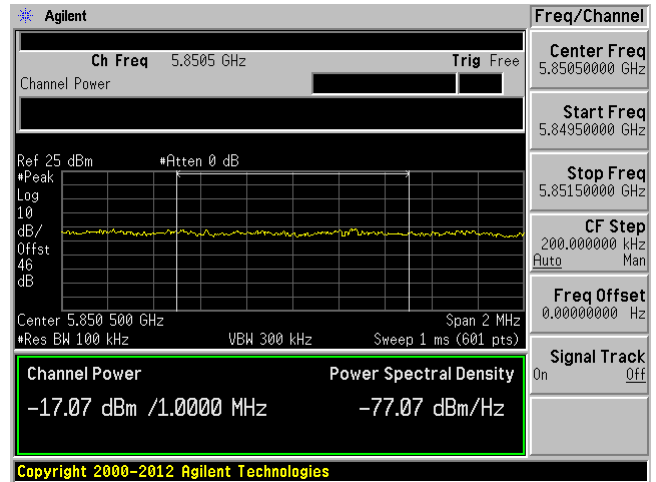

C3

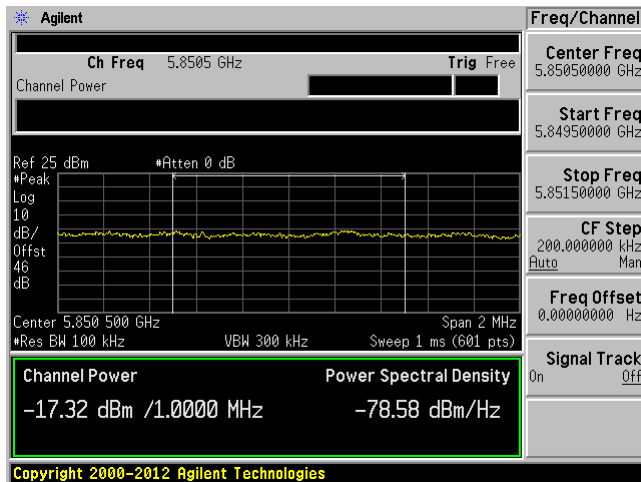

C4

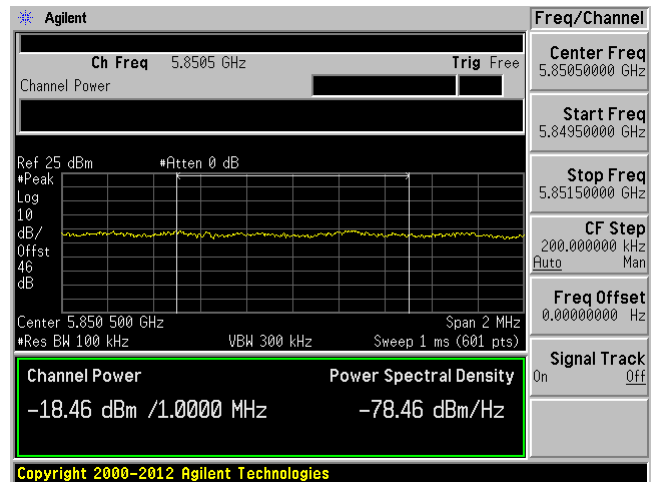

40 MHz bandwidth, Low Channel, 5755 MHz

C1

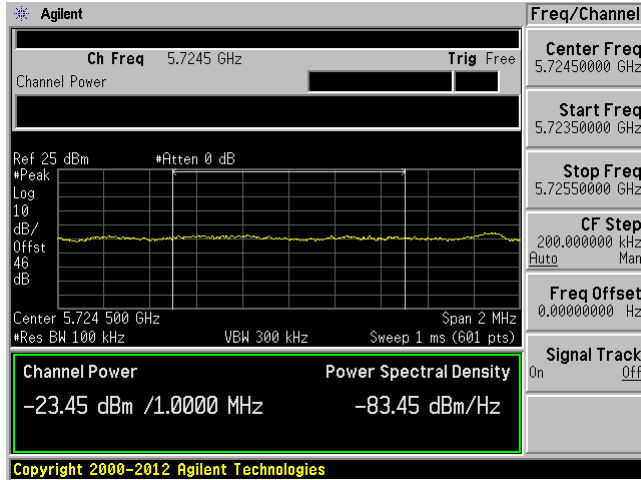

C2

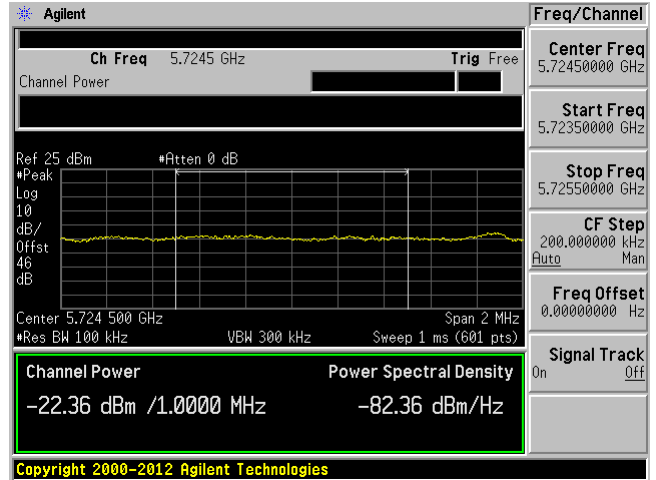

C3

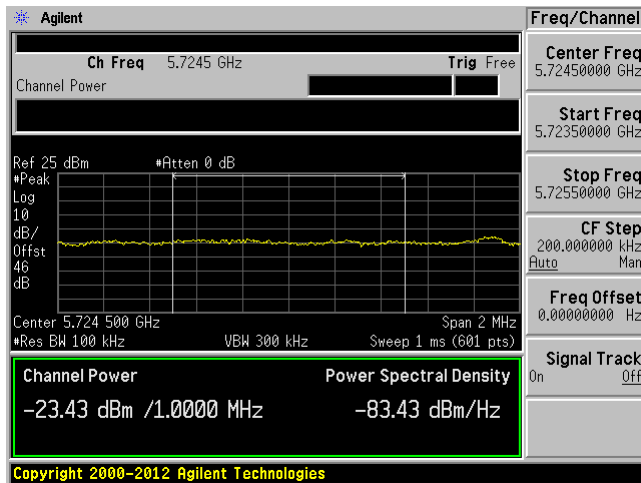

C4

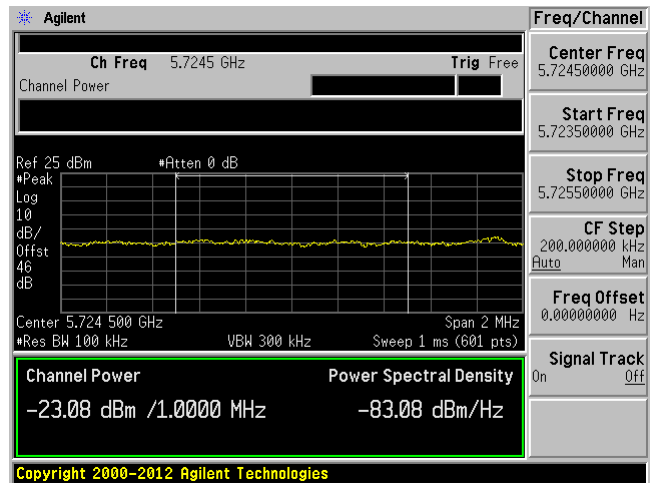

40 MHz bandwidth, High Channel, 5815 MHz

C1

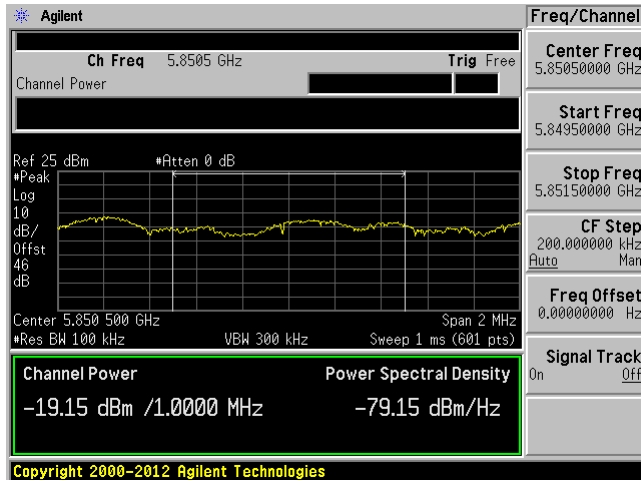

C2

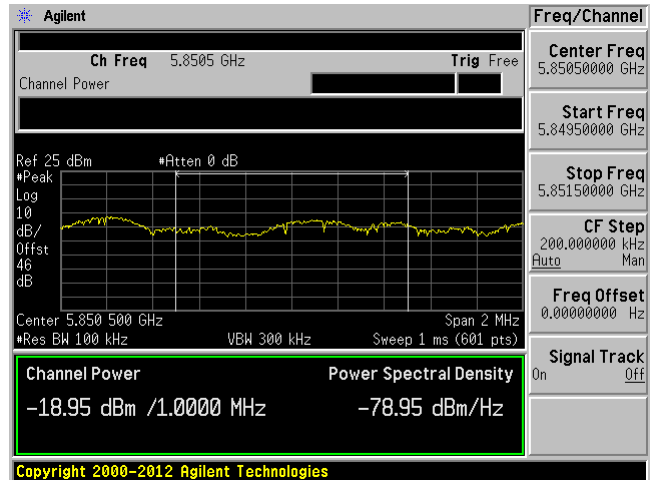

C3

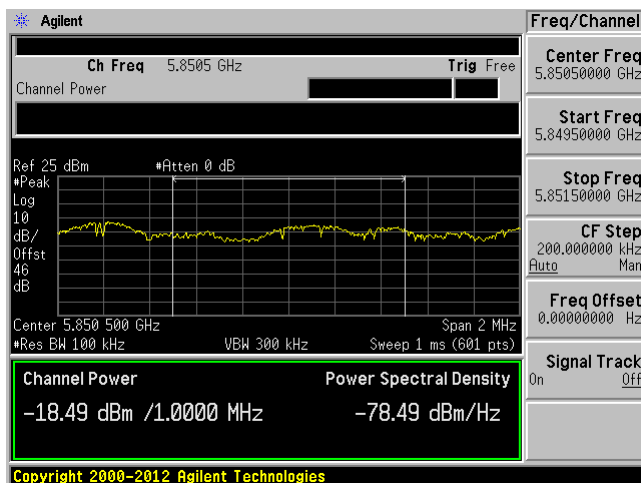

C4

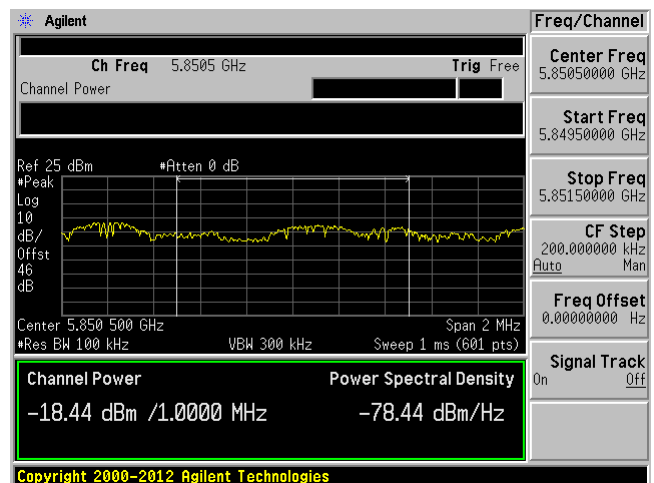

80 MHz bandwidth, Low Channel, 5775 MHz

C1

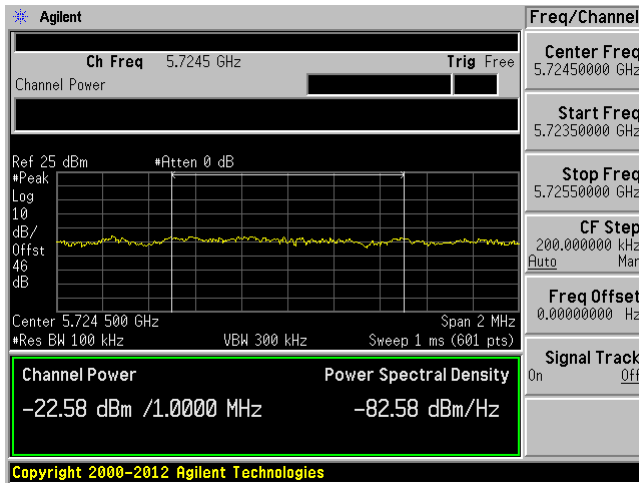

C2

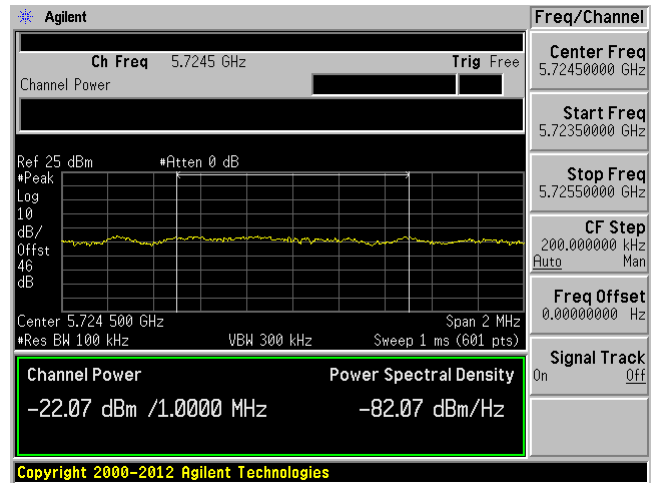

C3

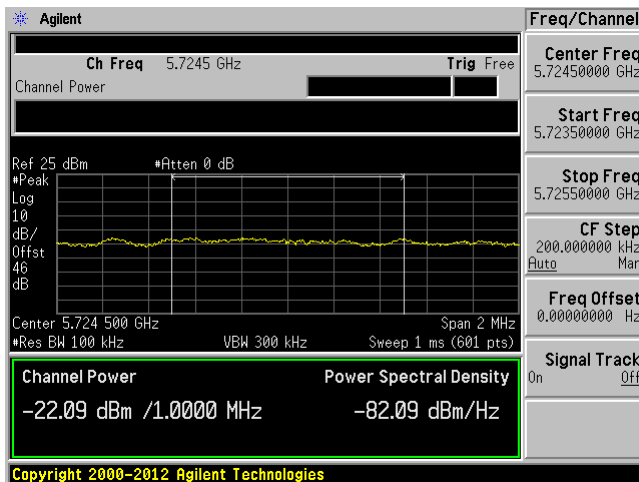

C4

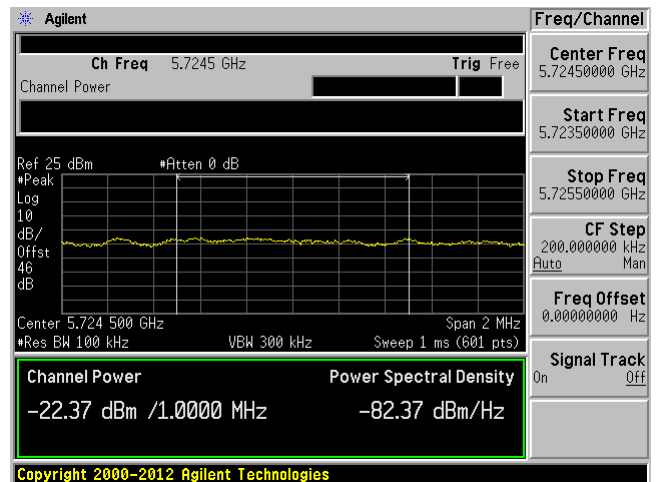

80 MHz bandwidth, High Channel, 5795 MHz

C1

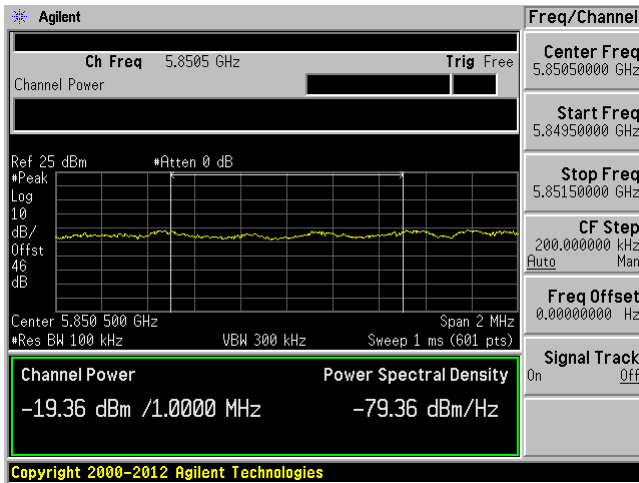

C2

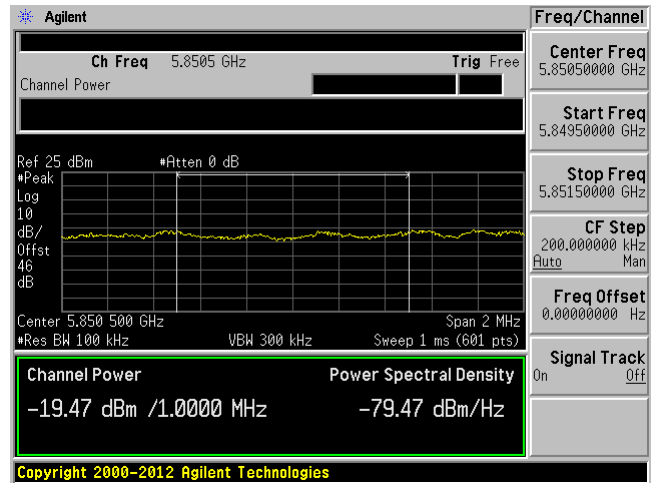

C3

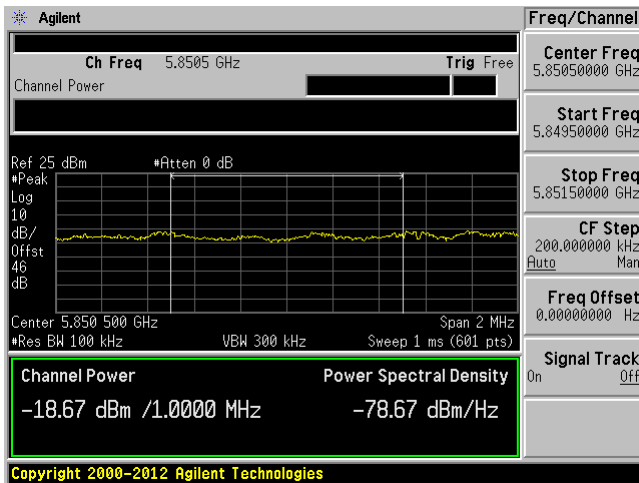

C4

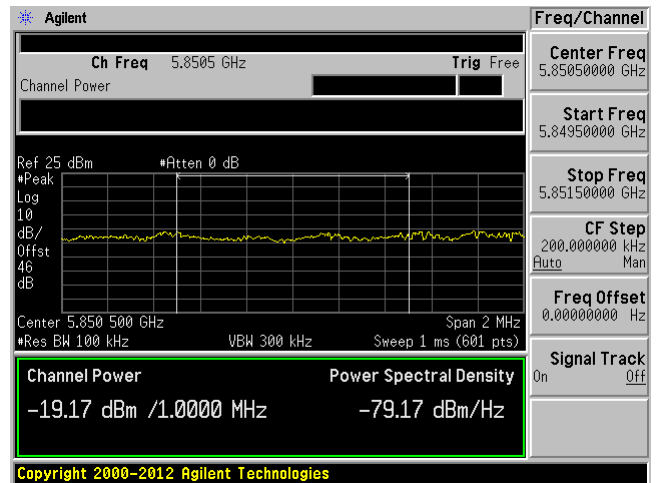

0 dBi Antenna

5.2 GHz Band:

20 MHz bandwidth, Low Channel, 5165 MHz

C1

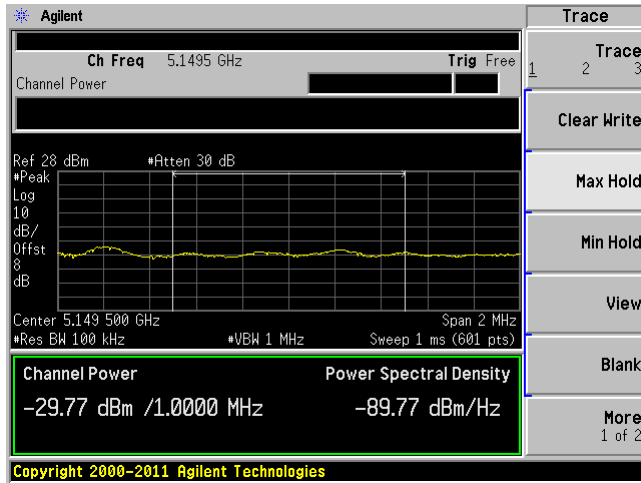

C2

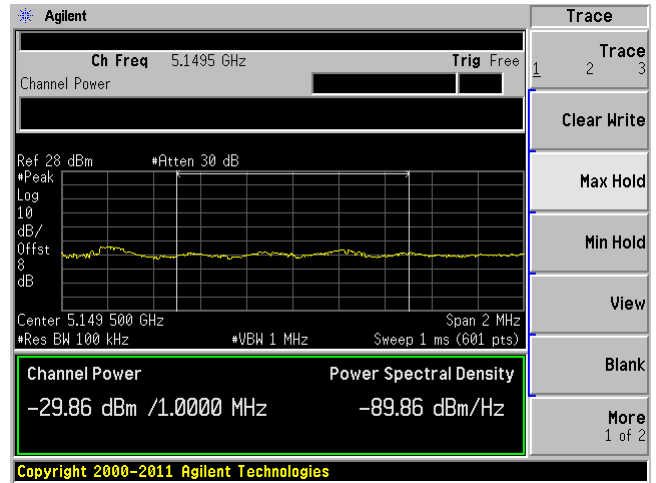

C3

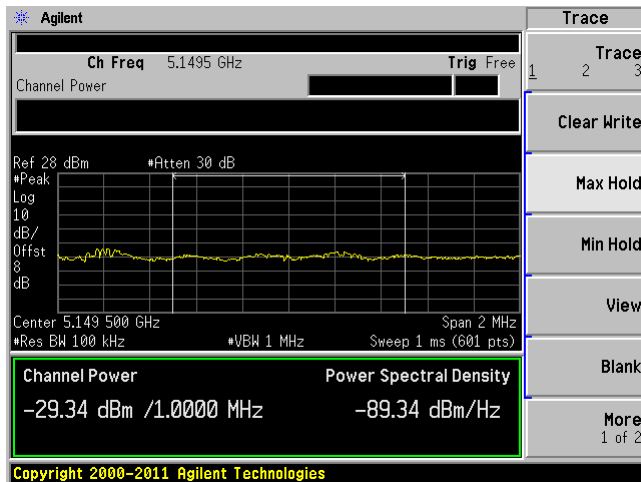

C4

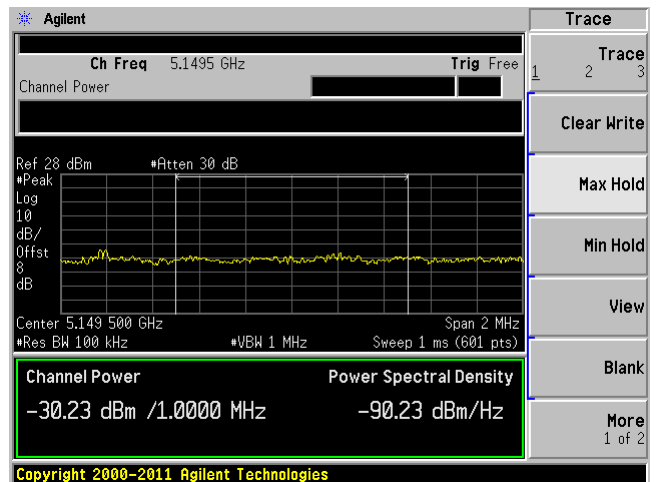

20 MHz bandwidth, High Channel, 5240 MHz

C1

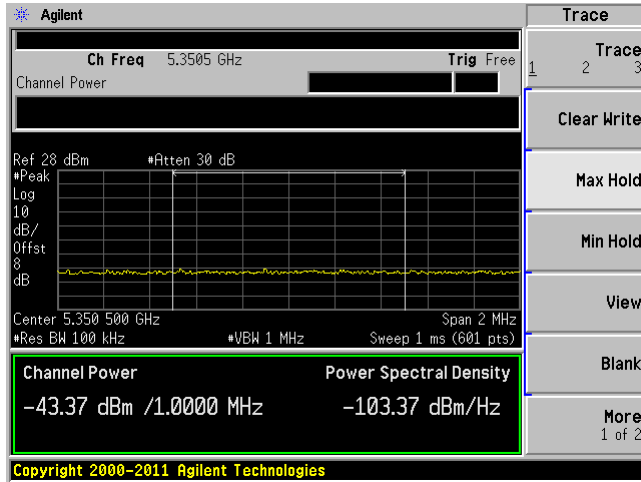

C2

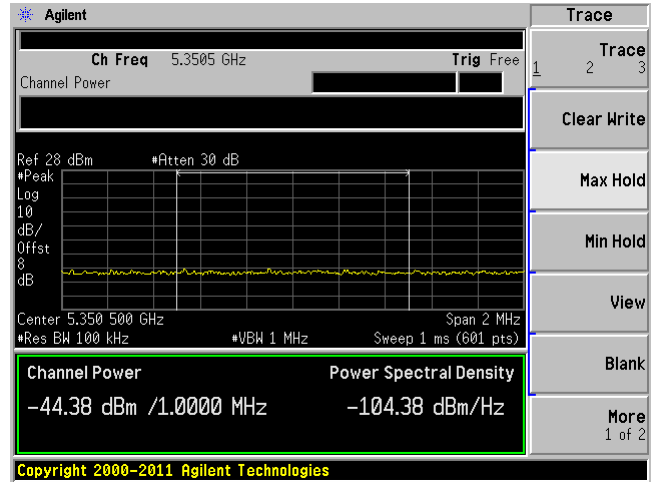

C3

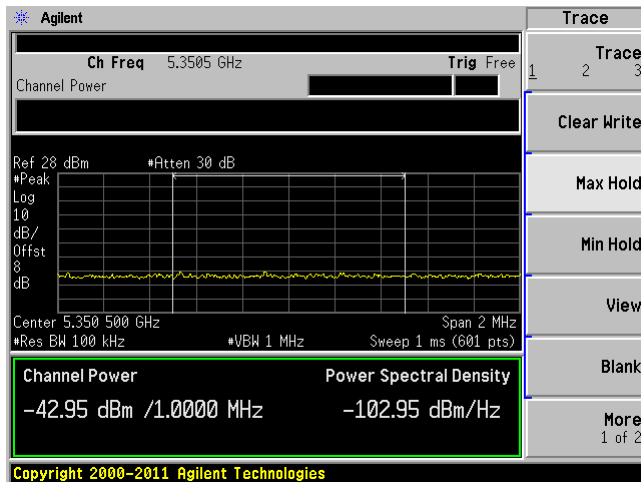

C4

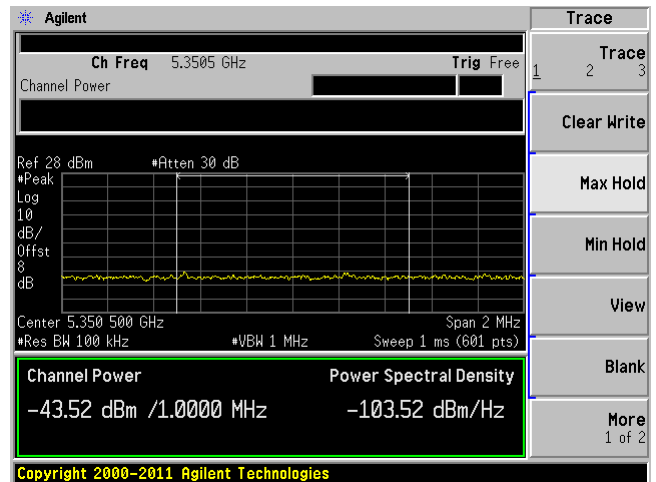

40 MHz bandwidth, Low Channel, 5175 MHz

C1

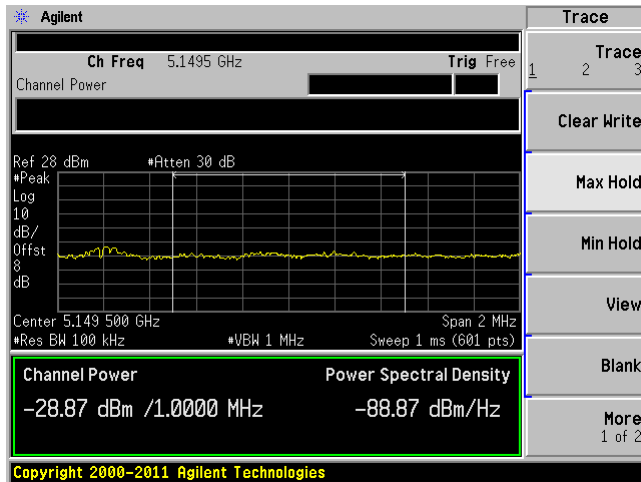

C2

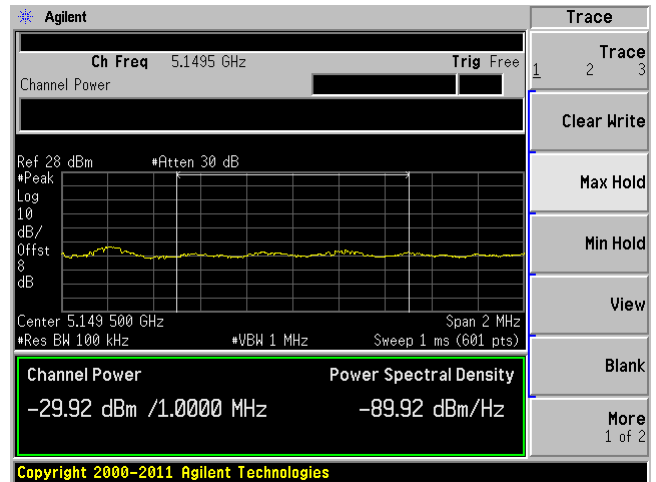

C3

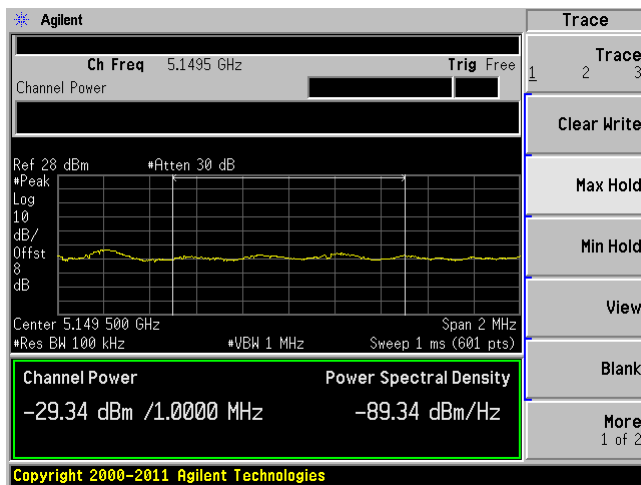

C4

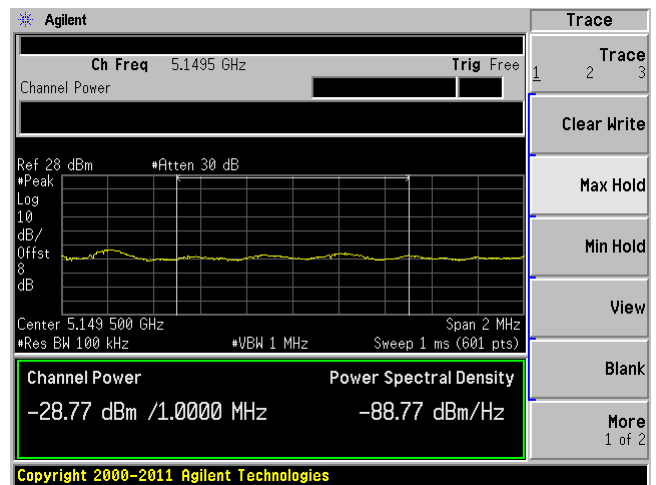



40 MHz bandwidth, High Channel, 5230 MHz

C1

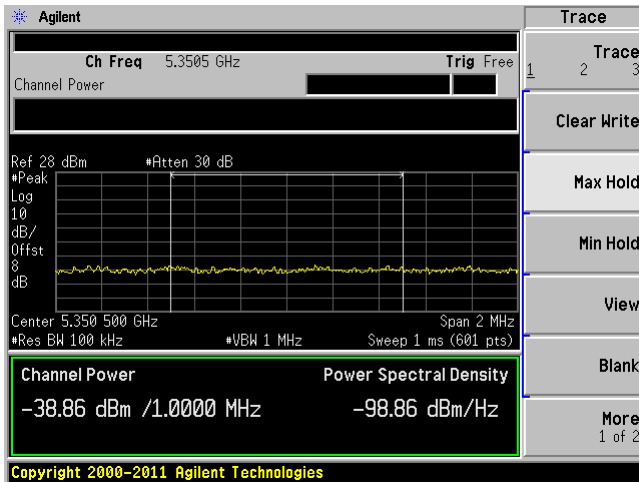

C2

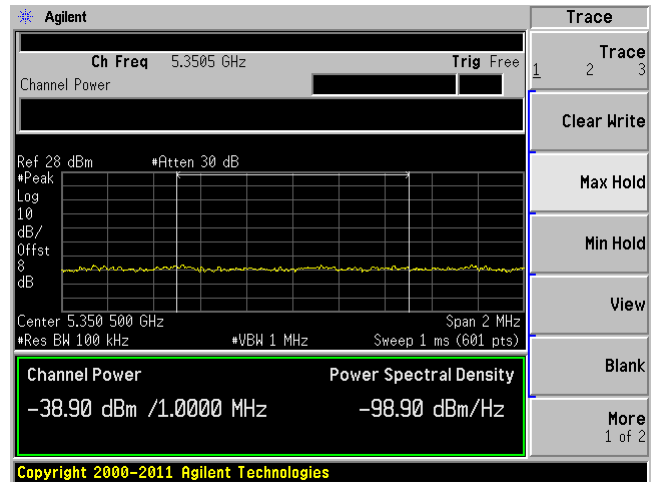

C3

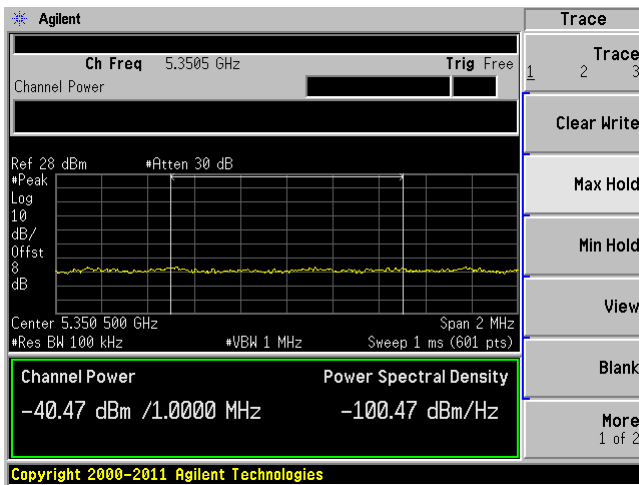

C4

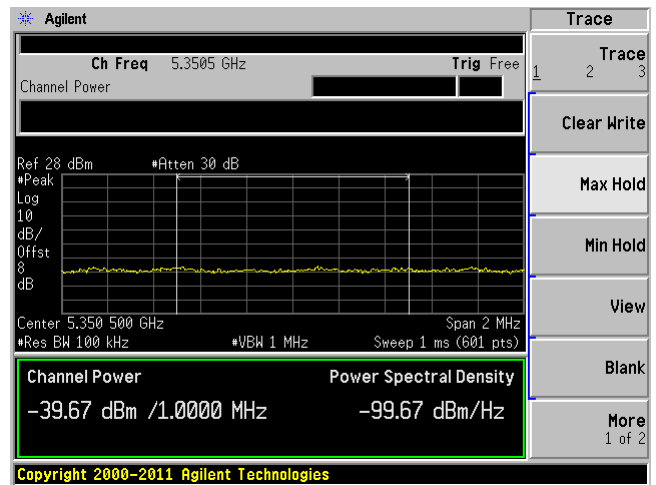

80 MHz bandwidth, Low Channel, 5195 MHz

C1

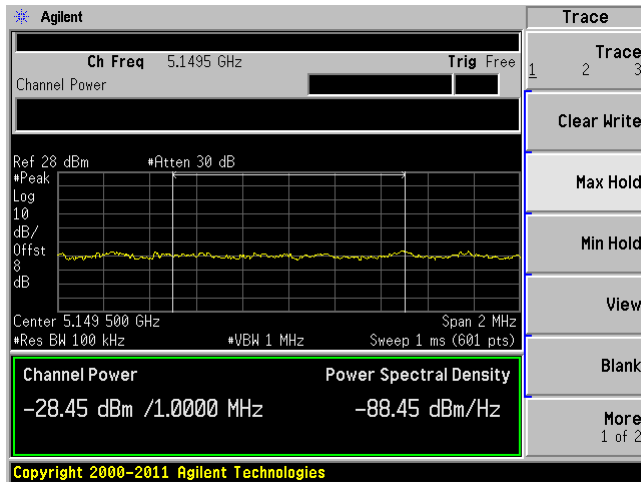

C2

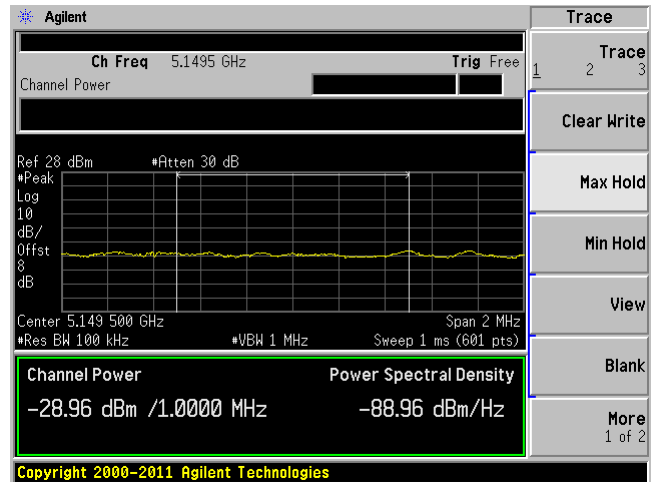

C3

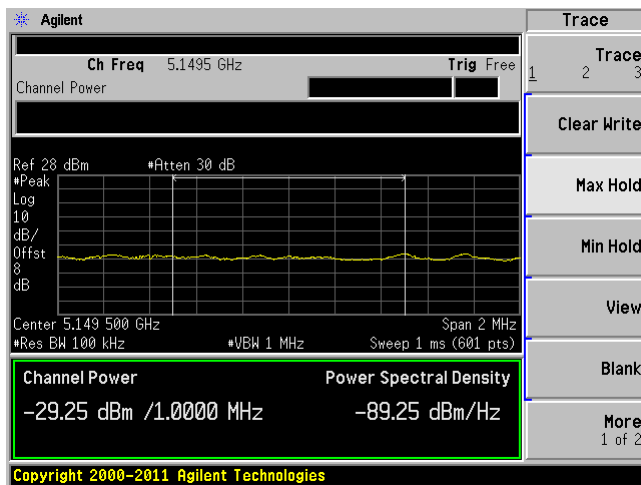

C4

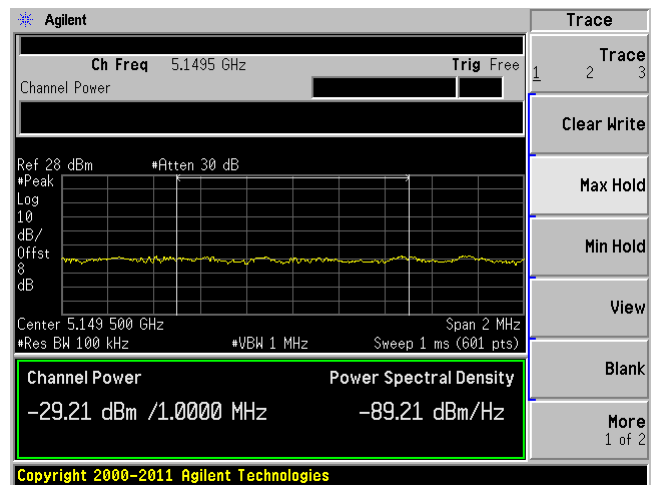

80 MHz bandwidth, High Channel, 5210 MHz

C1

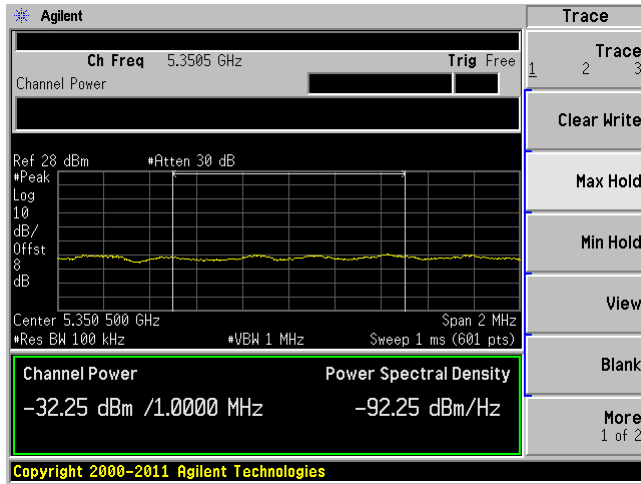

C2

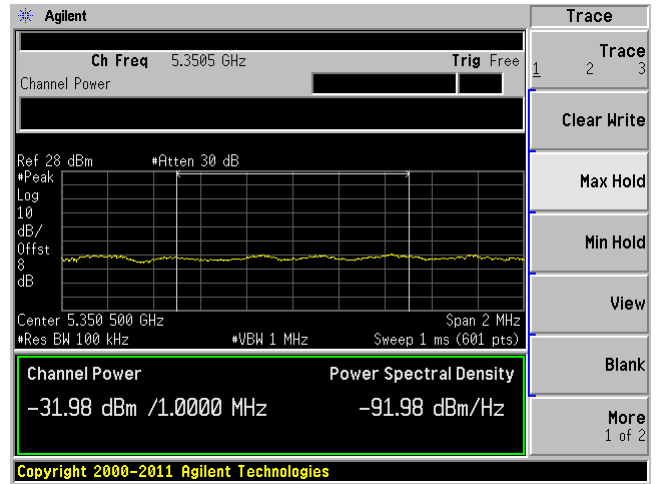

C3

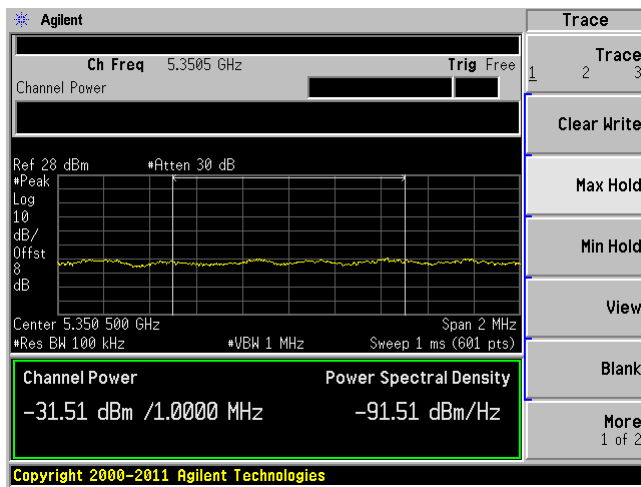

C4

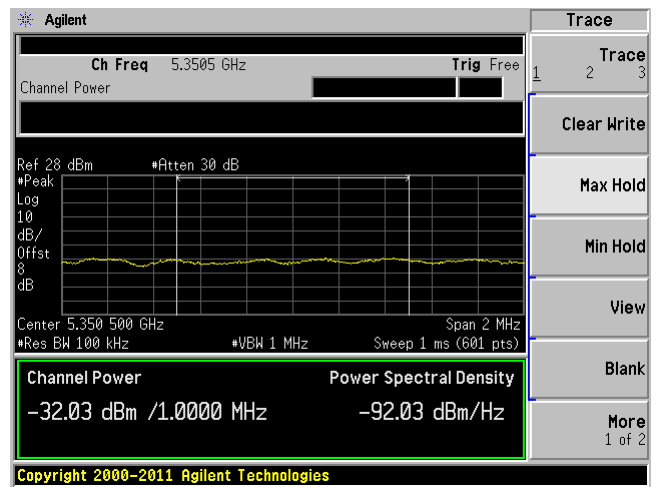

**5.8 GHz Band:**

-27 dBm/MHz EIRP

**20 MHz bandwidth, Low Channel, 5745 MHz**

**C1**

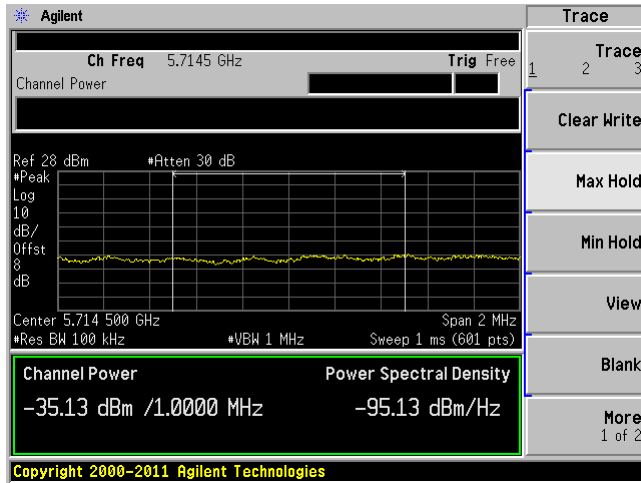

**C2**

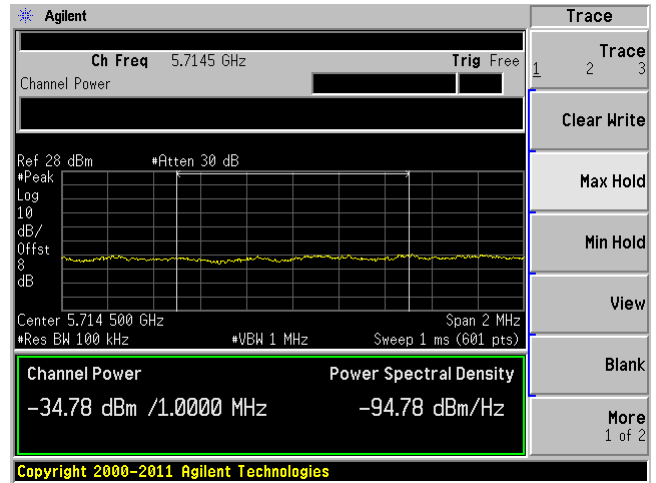

**C3**

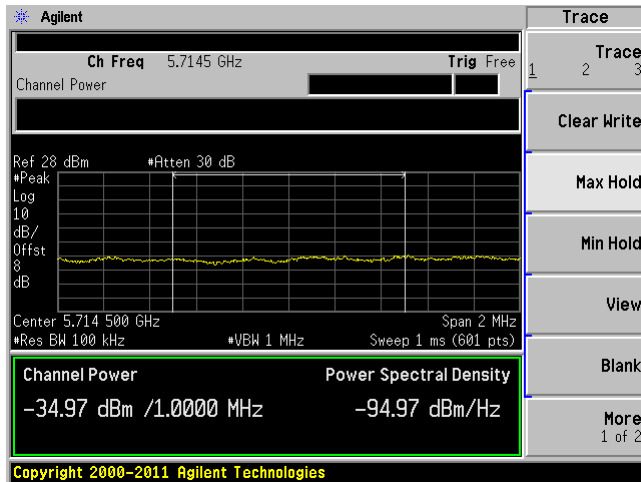

**C4**

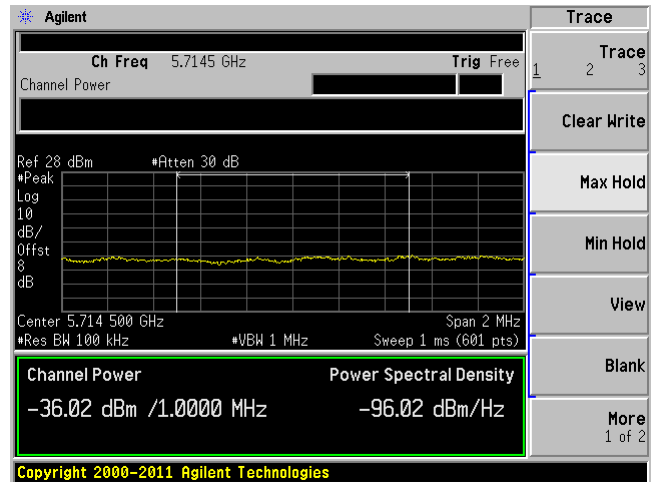

20 MHz bandwidth, High Channel, 5825 MHz

C1

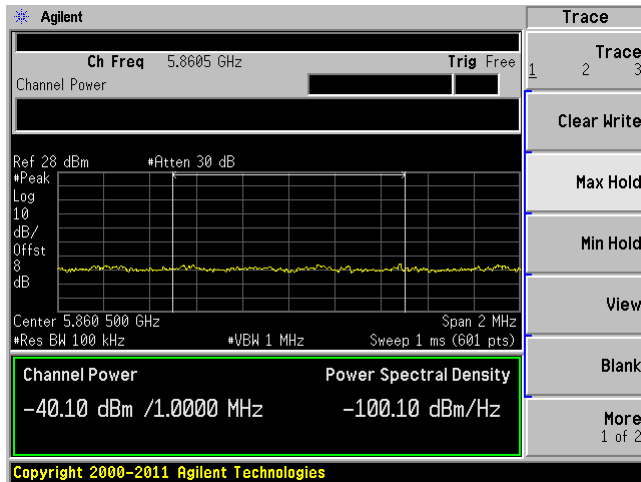

C2

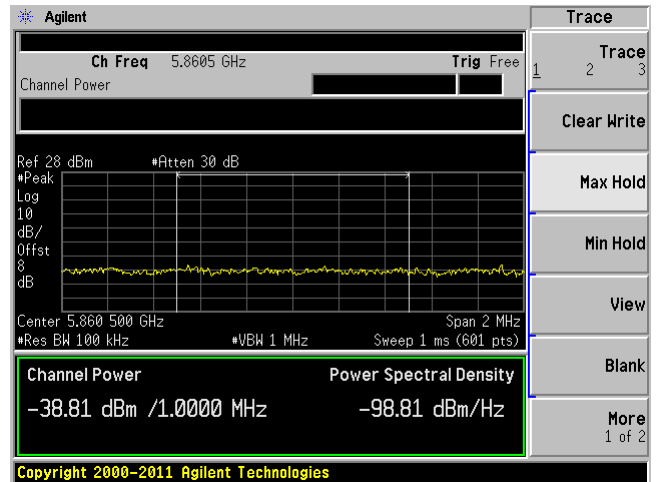

C3

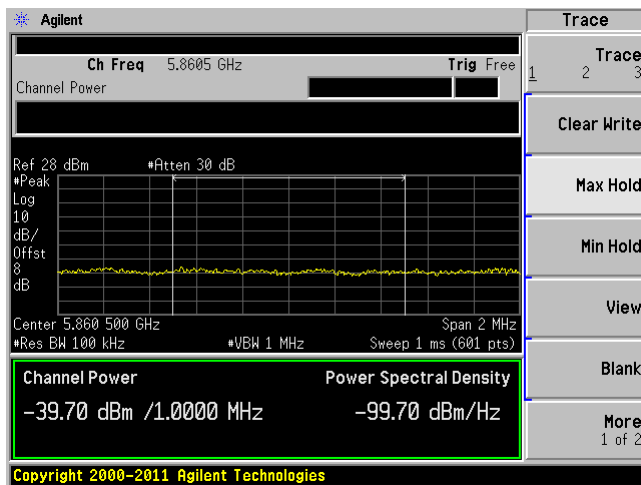

C4

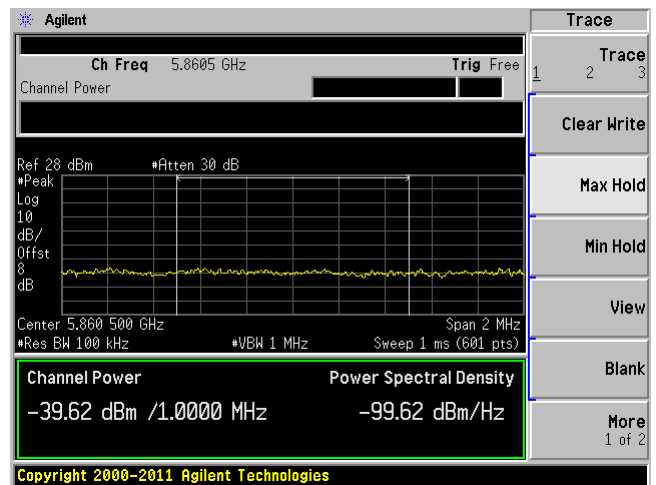

40 MHz bandwidth, Low Channel, 5755 MHz

C1

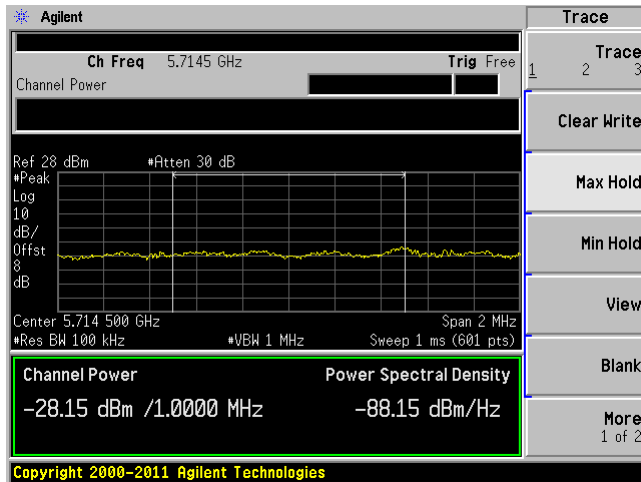

C2

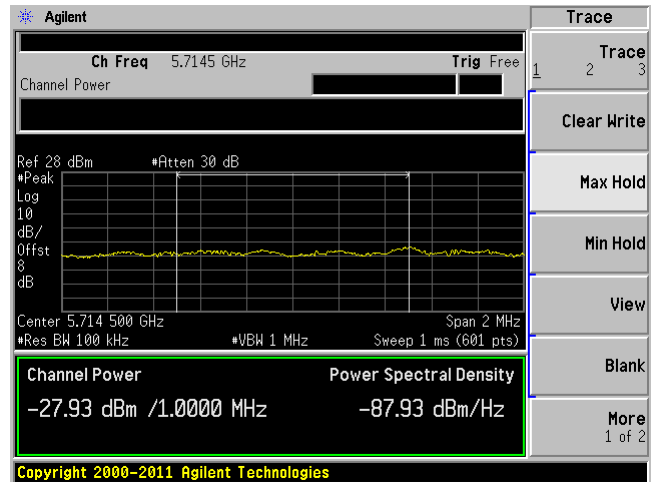

C3

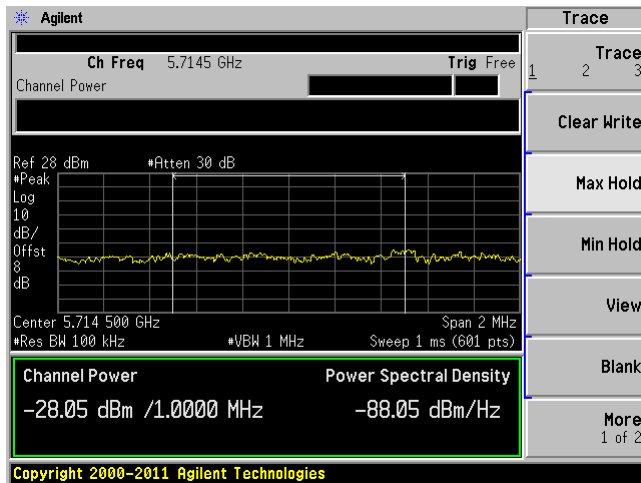

C4

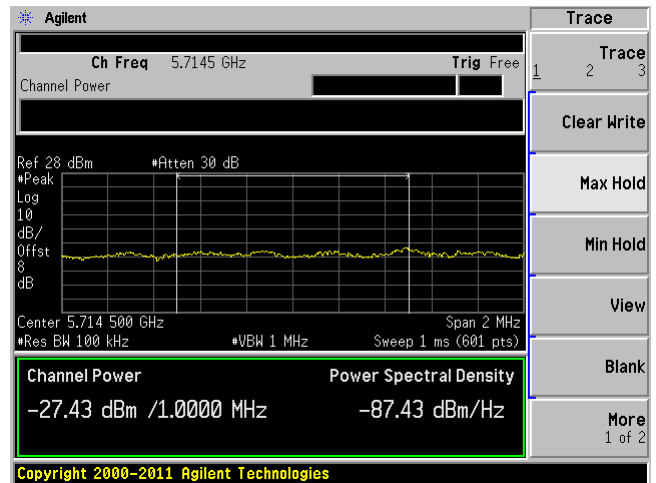

40 MHz bandwidth, High Channel, 5815 MHz

C1

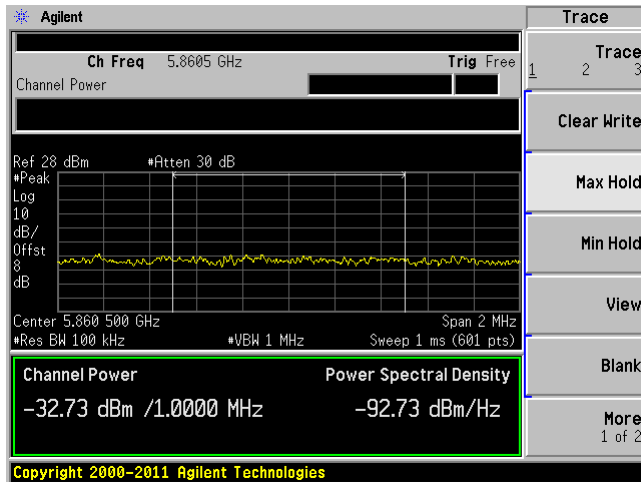

C2

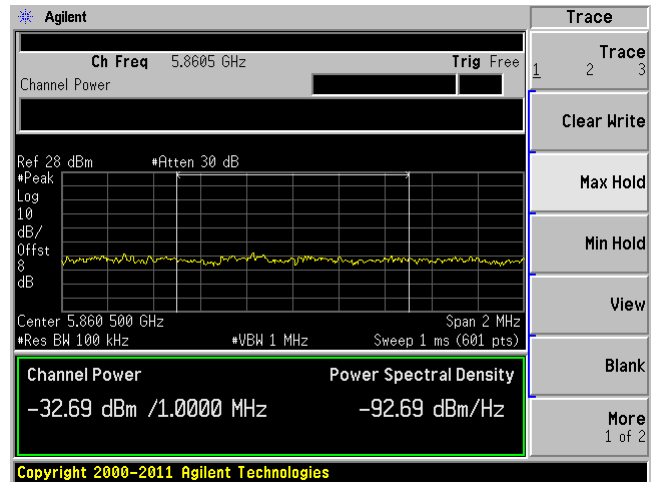

C3

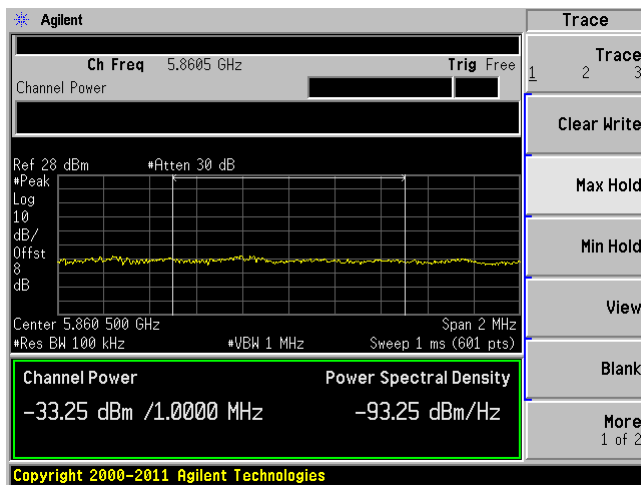

C4

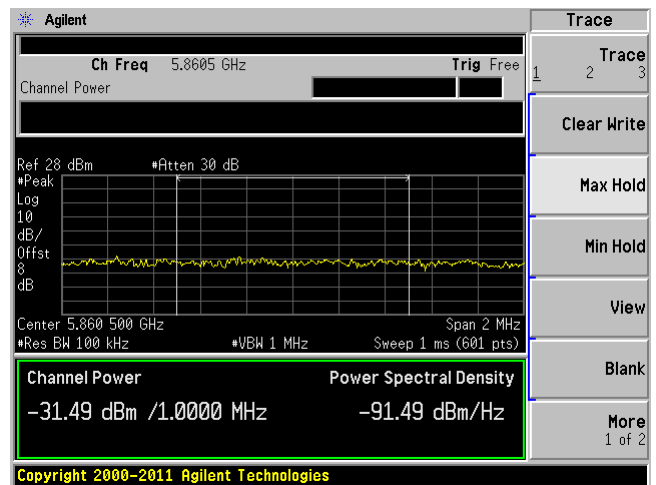

80 MHz bandwidth, Low Channel, 5775 MHz

C1

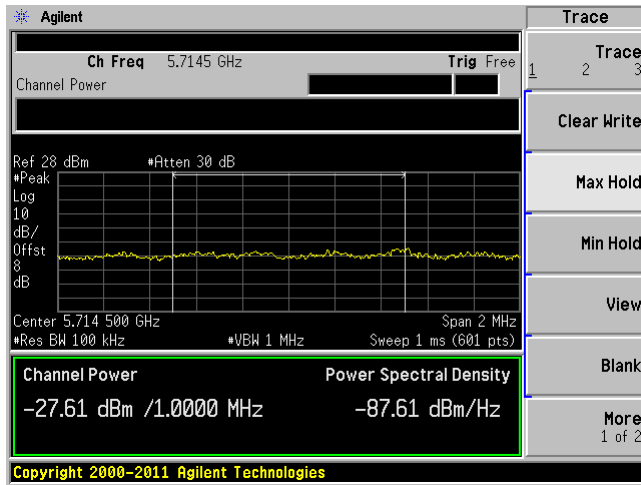

C2

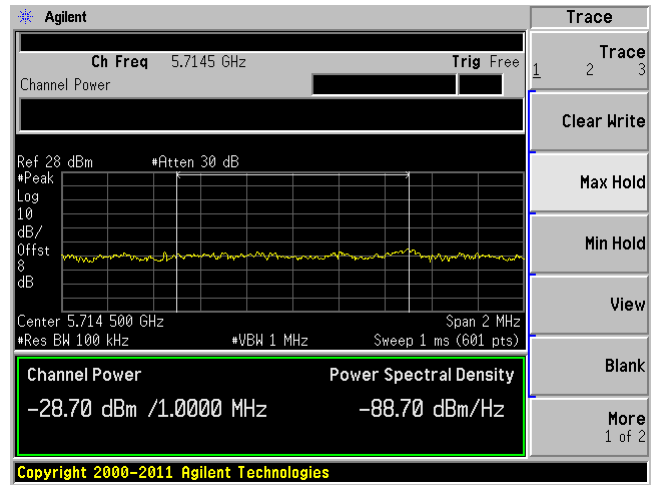

C3

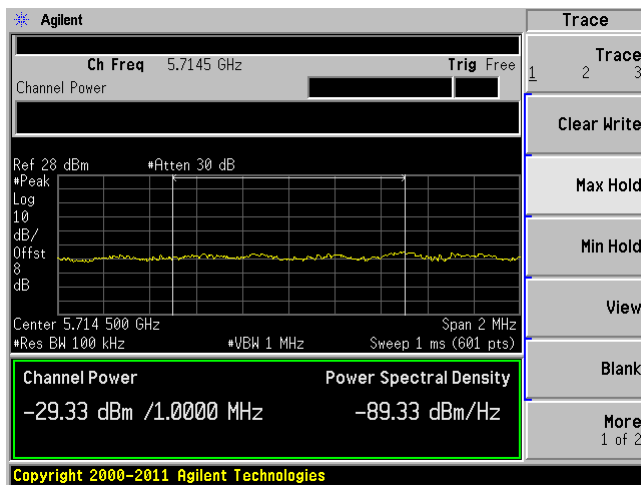

C4

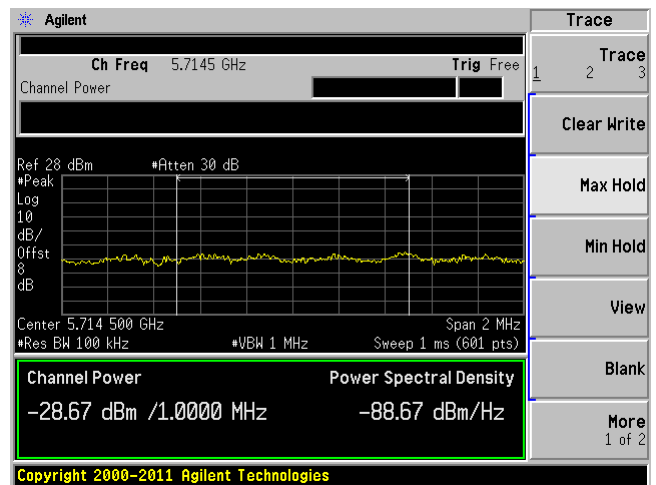



80 MHz bandwidth, High Channel, 5795 MHz

C1

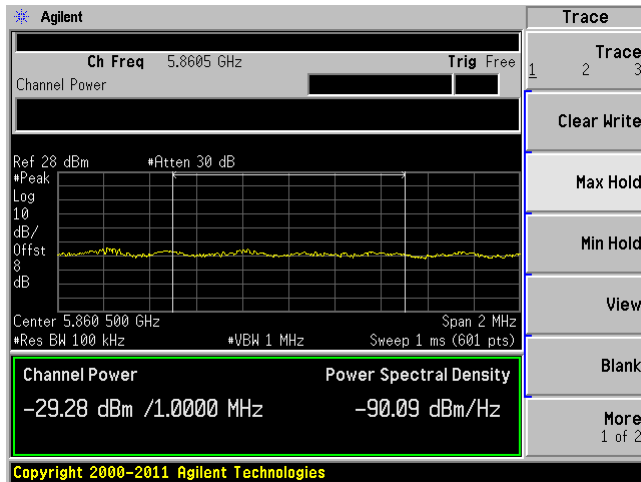

C2

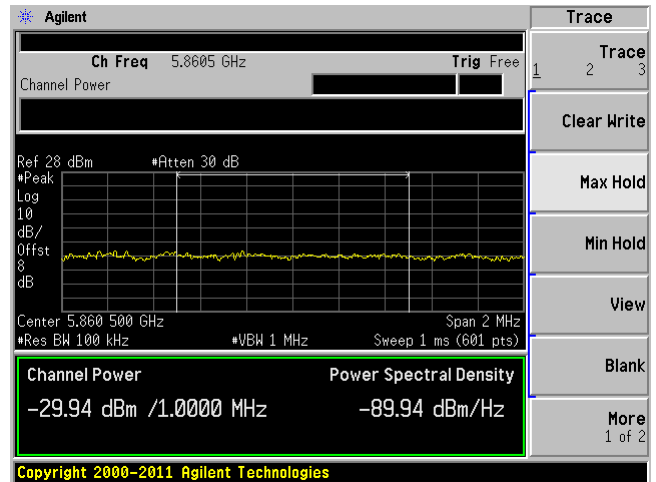

C3

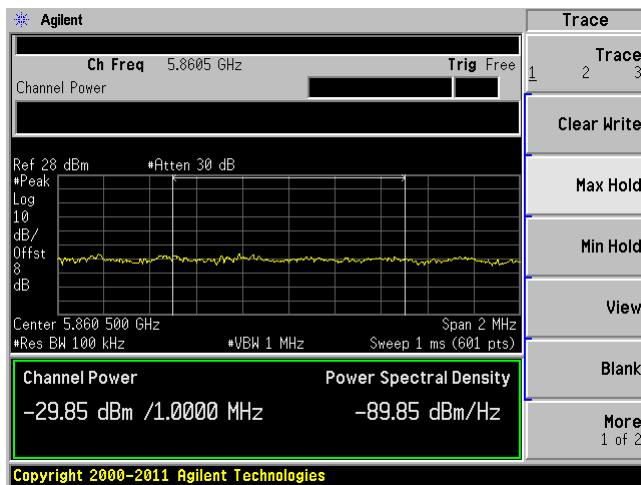

C4

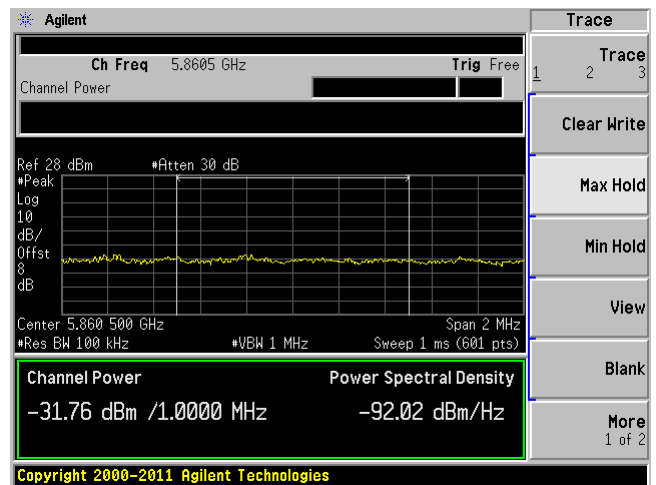

-17 dBm/MHz EIRP

20 MHz bandwidth, Low Channel, 5745 MHz

C1

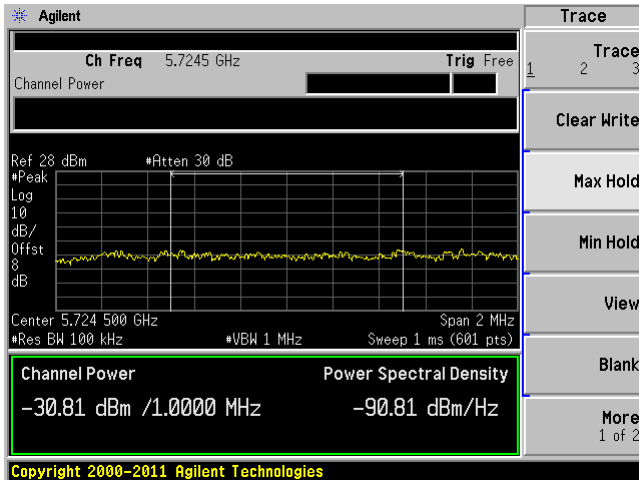

C2

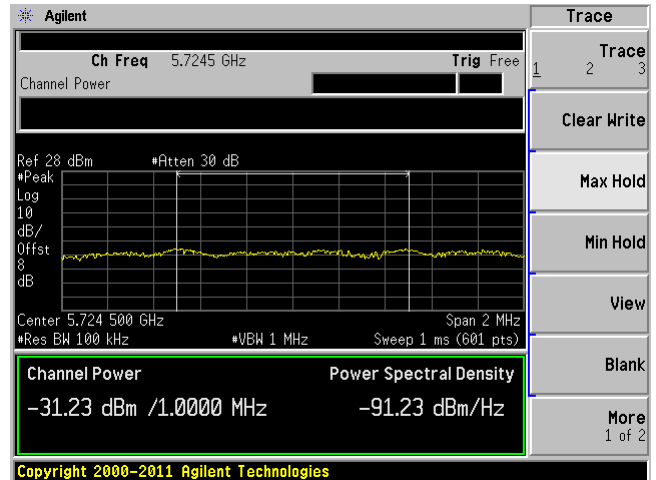

C3

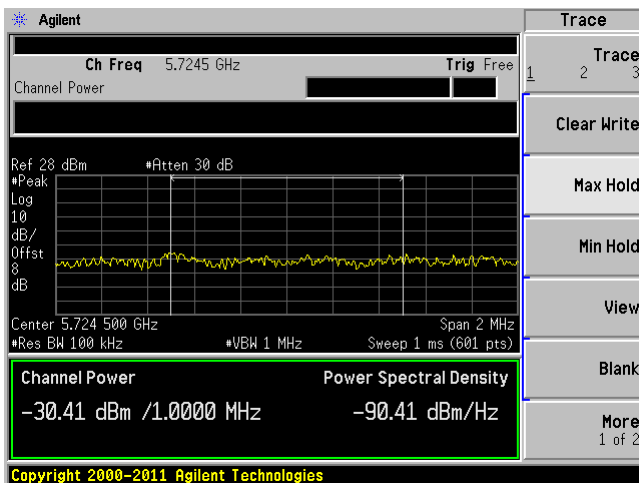

C4

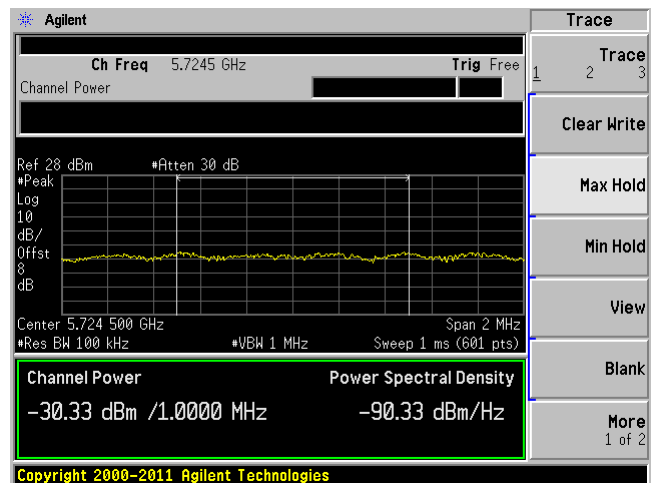

20 MHz bandwidth, High Channel, 5825 MHz

C1

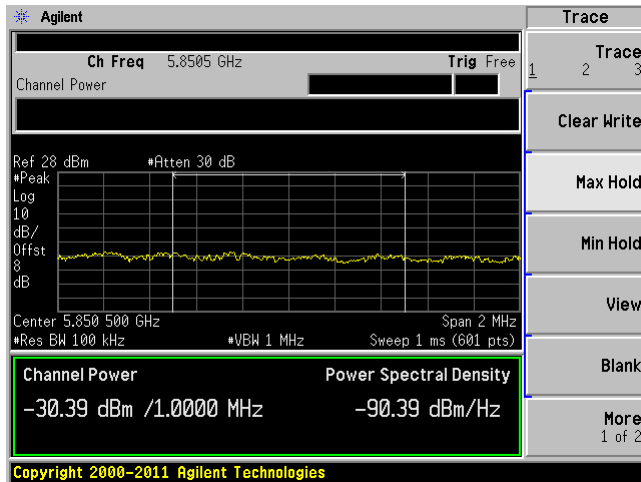

C2

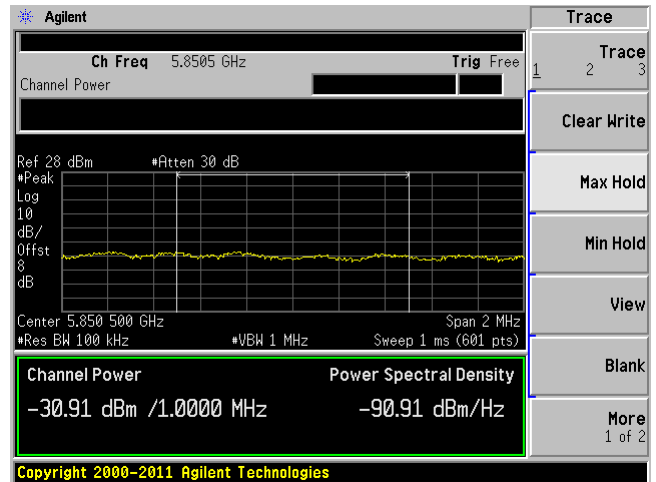

C3

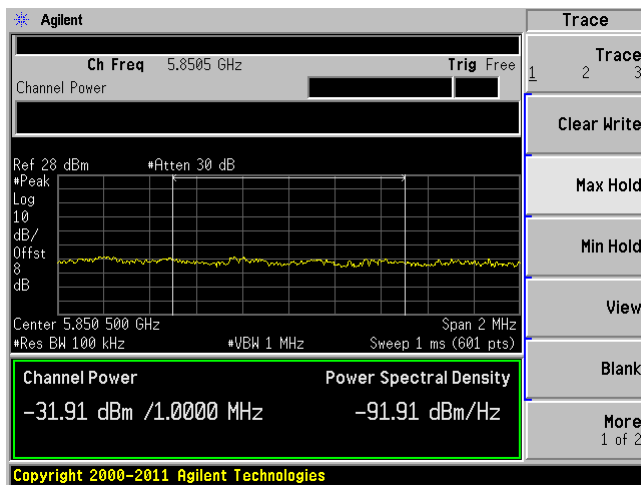

C4

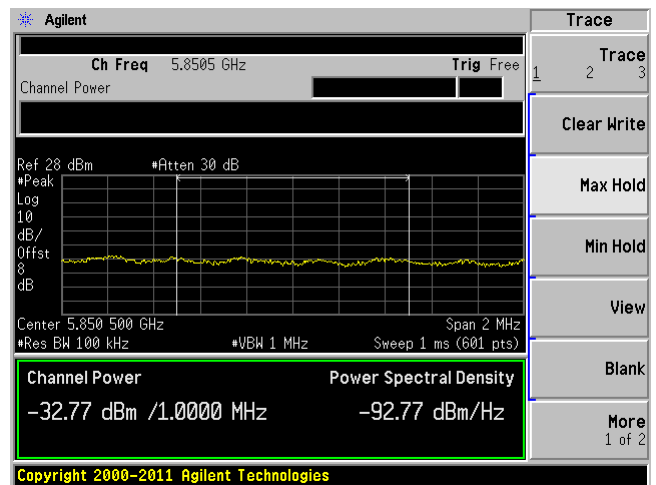

40 MHz bandwidth, Low Channel, 5755 MHz

C1

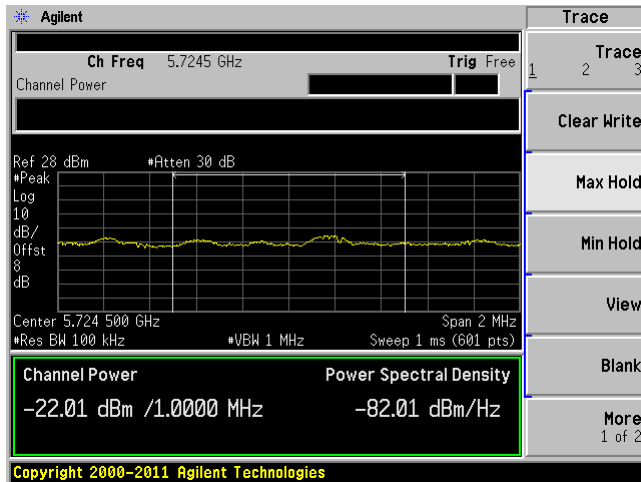

C2

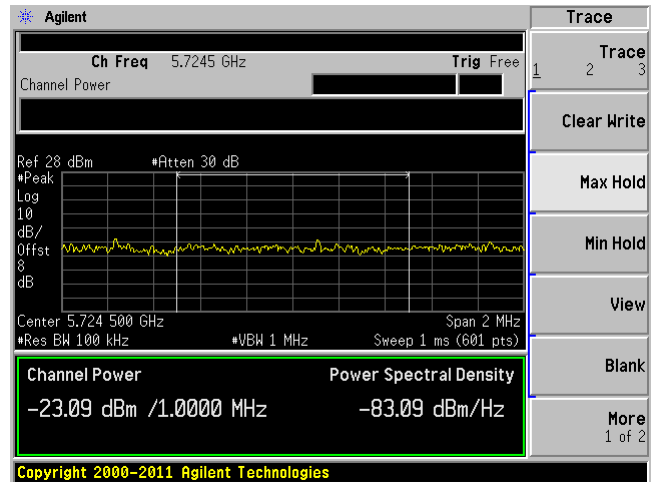

C3

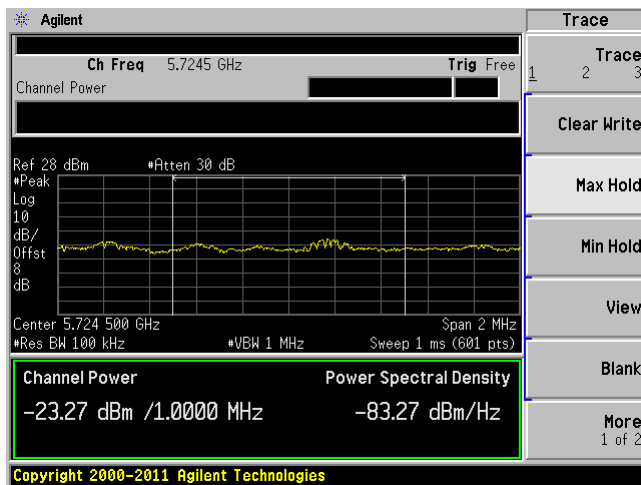

C4

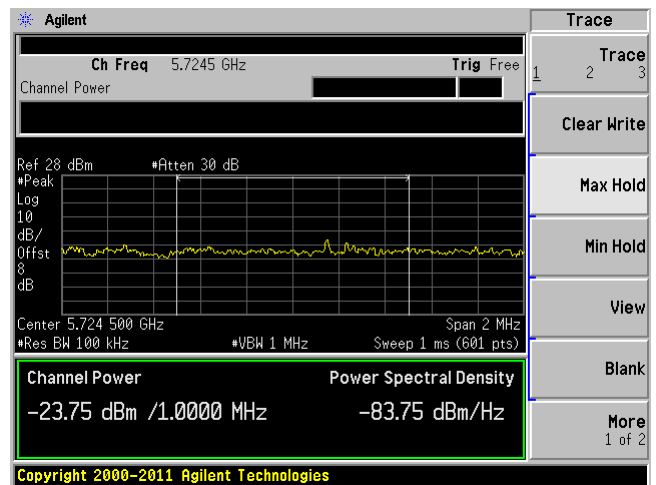

40 MHz bandwidth, High Channel, 5815 MHz

C1

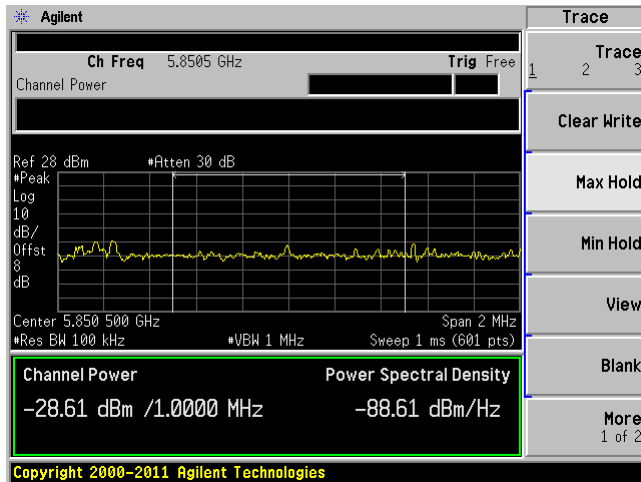

C2

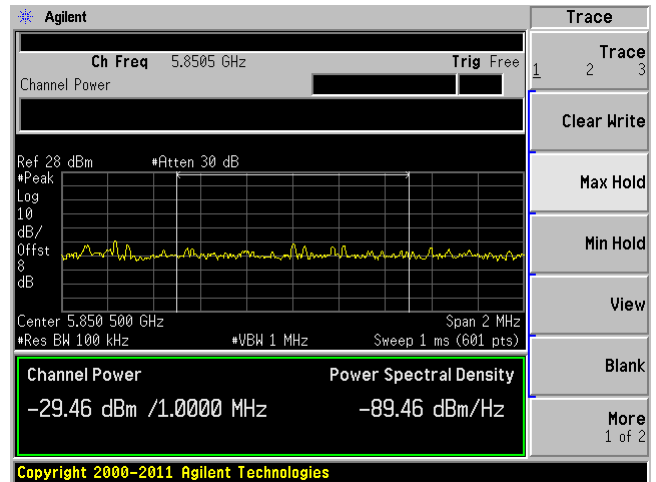

C3

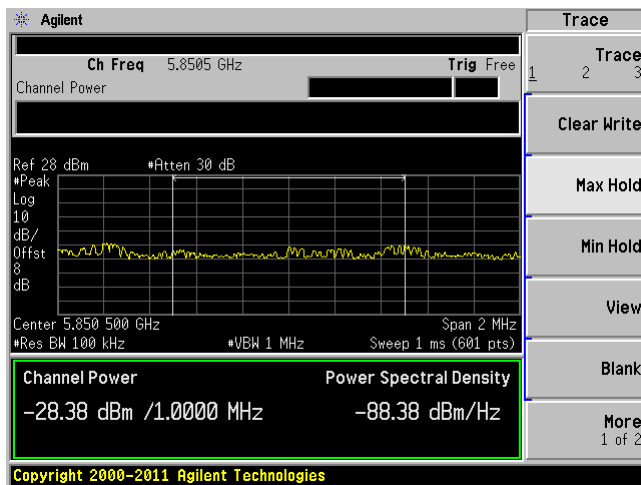

C4

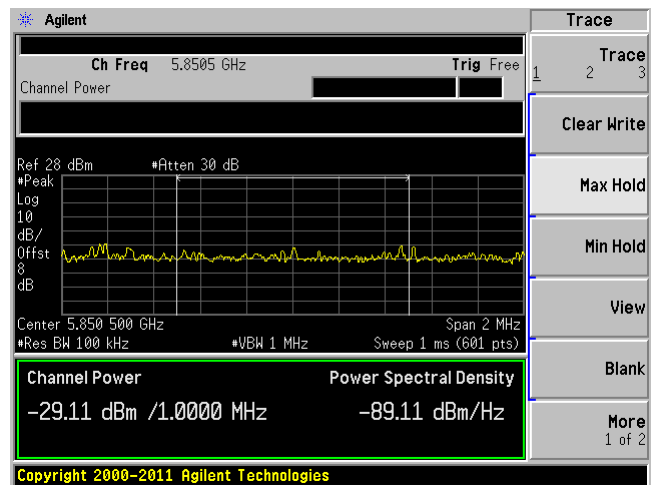

80 MHz bandwidth, Low Channel, 5775 MHz

C1

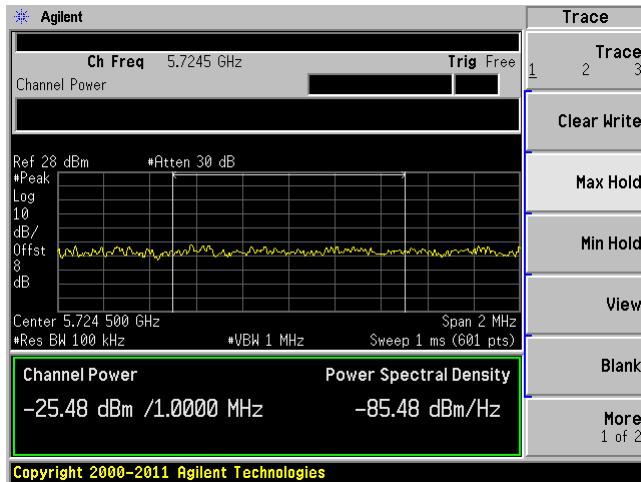

C2

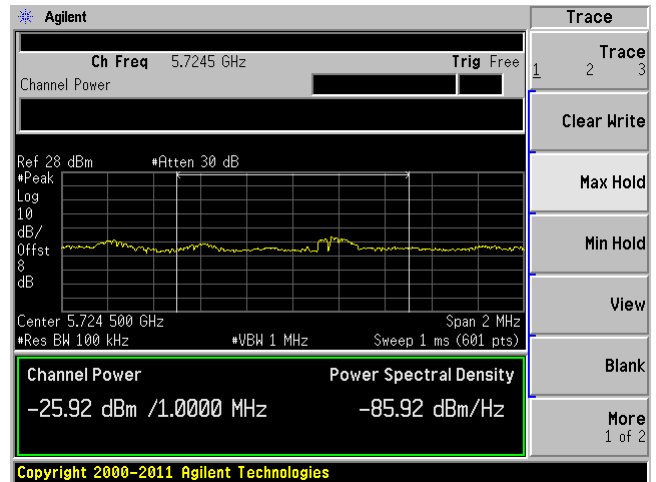

C3

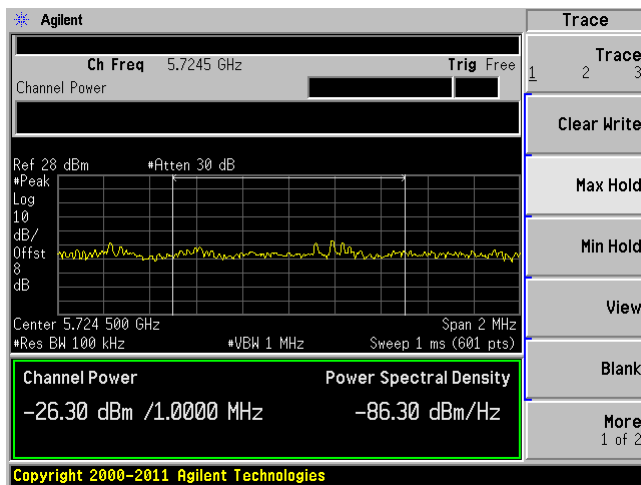

C4

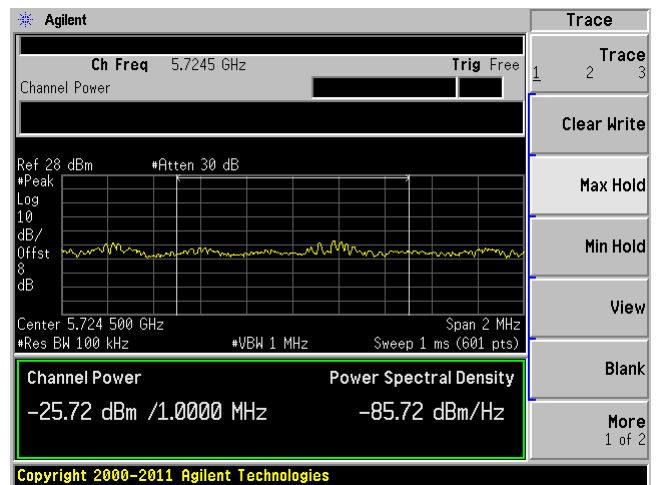

80 MHz bandwidth, High Channel, 5795 MHz

C1

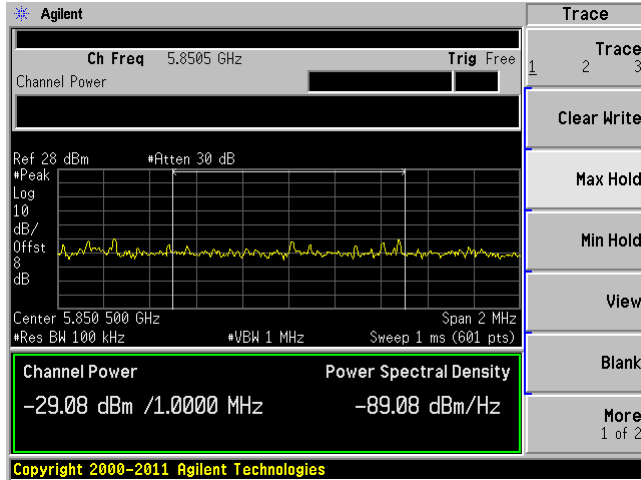

C2

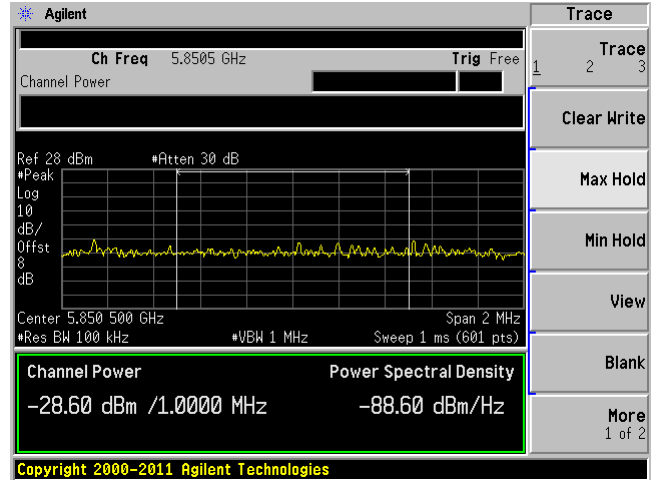

C3

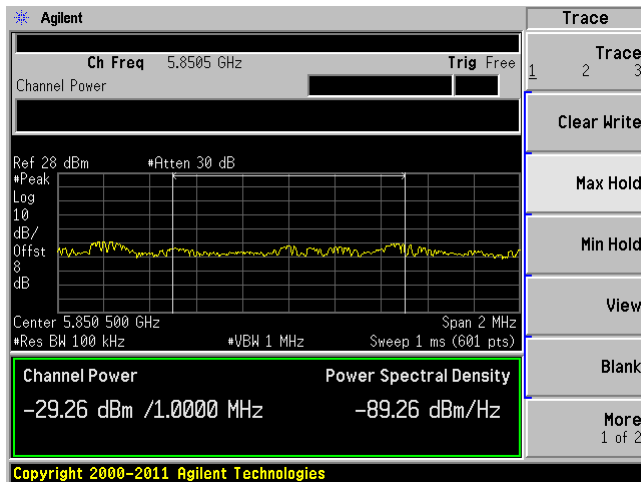

C4

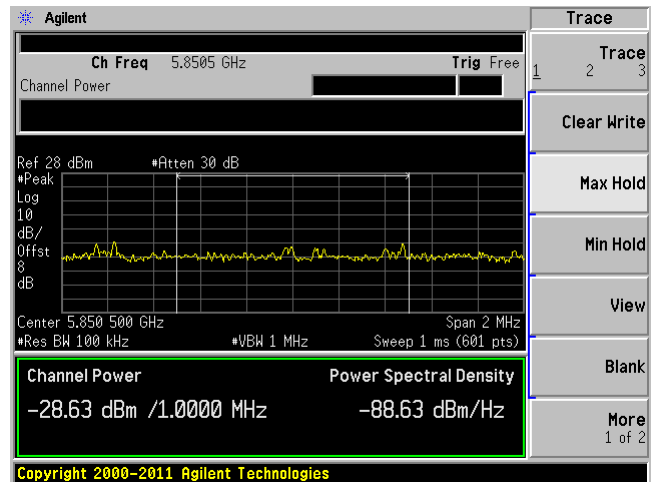

## 11 FCC §15.407(a)(1) & (a)(3)- Power Spectral Density

### 11.1 Applicable Standard

#### According to FCC §15.407(a)(1)

For the band 5.15–5.25 GHz, the maximum conducted output power over the frequency band of operation shall not exceed the lesser of 50 mW or 4 dBm + 10 log B, where B is the 26-dB emission bandwidth in MHz. In addition, the peak power spectral density shall not exceed 4 dBm in any 1-MHz band. If transmitting antennas of directional gain greater than 6 dBi are used, both the maximum conducted output power and the peak power spectral density shall be reduced by the amount in dB that the directional gain of the antenna exceeds 6 dBi.

For the 5.25–5.35 GHz and 5.47–5.725 GHz bands, the maximum conducted output power over the frequency bands of operation shall not exceed the lesser of 250 mW or 11 dBm + 10 log B, where B is the 226 dB Emission Bandwidth in megahertz. In addition, the peak power spectral density shall not exceed 11 dBm in any 1 megahertz band. If transmitting antennas of directional gain greater than 6 dBi are used, both the maximum conducted output power and the peak power spectral density shall be reduced by the amount in dB that the directional gain of the antenna exceeds 6 dBi.

#### According to FCC §15.407(a)(3)

For the band 5.725-5.85 GHz, the maximum conducted output power over the frequency band of operation shall not exceed 1 W. In addition, the maximum power spectral density shall not exceed 30 dBm in any 500-kHz band. If transmitting antennas of directional gain greater than 6 dBi are used, both the maximum conducted output power and the maximum power spectral density shall be reduced by the amount in dB that the directional gain of the antenna exceeds 6 dBi. However, fixed point-to-point U-NII devices operating in this band may employ transmitting antennas with directional gain greater than 6 dBi without any corresponding reduction in transmitter conducted power. Fixed, point-to-point operations exclude the use of point-to-multipoint systems, omnidirectional applications, and multiple collocated transmitters transmitting the same information. The operator of the U-NII device, or if the equipment is professionally installed, the installer, is responsible for ensuring that systems employing high gain directional antennas are used exclusively for fixed, point-to-point operations.

### 11.2 Measurement Procedure

The measurements are base on FCC KDB 789033 D02 General UNII Test Procedures v01: Guidelines for Compliance Testing of Unlicensed National Information Infrastructure (U-NII) Devices section F: Peak power spectral density (PPSD)

### 11.3 Test Equipment List and Details

Manufacturer	Description	Model No.	Serial No.	Calibration Date	Calibration Interval
Agilent	Spectrum Analyzer	E4446A	US44300386	2013-09-29	1 year

*Statement of Traceability: BACL Corp. attests that all calibrations have been performed according to A2LA requirements, traceable to the NIST.*



## 11.4 Test Environmental Conditions

<b>Temperature:</b>	21-23 °C
<b>Relative Humidity:</b>	43-48 %
<b>ATM Pressure:</b>	101.1-101.3 kPa

The testing was performed by Cipher Chu on 2014-04-04 to 2014-04-07 at the 10m chamber 1.

## 11.5 Test Results

Note: Chain 1 and Chain 4 is Vertical, and Chain 2 and Chain 3 is Horizontal

Note: C1, C2, C3 and C4 stands for Chain1, Chain 2, Chain 3 and Chain 4.

### 25 dBi Antenna

#### 5.2 GHz Band:

20 MHz bandwidth

Channel	Frequency (MHz)	Conducted PSD C1/C2 (dBm)	Conducted PSD C3/C4 (dBm)	Total PSD C1,C2 (dBm)	Total PSD C3,C4 (dBm)
Low	5165	-14.47/-14.1	-14.51/-14.38	-11.27	-11.44
Middle	5200	0.64/3.56	3.10/2.07	5.35	5.63
High	5240	-6.09/-5.51	-6.49/-6.61	-2.79	-3.54

40 MHz bandwidth

Channel	Frequency (MHz)	Conducted PSD C1/C2 (dBm)	Conducted PSD C3/C4 (dBm)	Total PSD C1,C2 (dBm)	Total PSD C3,C4 (dBm)
Low	5175	-13.63/-9.29	-11.87/-13.03	-7.93	-9.41
Middle	5200	-6.81/-0.79	-1.97/-4.93	0.18	-0.19
High	5230	-1.62/-9.00	-1.38/-2.75	-0.89	0.99

80 MHz bandwidth

Channel	Frequency (MHz)	Conducted PSD C1/C2 (dBm)	Conducted PSD C3/C4 (dBm)	Total PSD C1,C2 (dBm)	Total PSD C3,C4 (dBm)
Low	5195	-14.71/-14.96	-15.98/-17.98	-11.82	-13.81
Middle	5200	-12.54-5.64	-10.09/-12.98	-4.83	-8.29
High	5210	-12.21/-8.514	-12.581/-12.7	-6.97	-9.63

Note: Antenna gain of EUT is 25 dBi which is over 2 dB of 23 dBi allowed by FCC Part 15.407 (a)(1)(iii), a 1 dB reduction in maximum conducted output power and maximum power spectral density is required for each 1 dB of antenna gain in excess of 23 dBi

**5.8 GHz Band:**

## 20 MHz bandwidth

Channel	Frequency (MHz)	Conducted PSD C1/C2 (dBm)	Conducted PSD C3/C4 (dBm)	Total PSD C1,C2 (dBm)	Total PSD C3,C4 (dBm)
Low	5745	-2.27/6.47	3.71/-1.78	7.02	4.79
Middle	5785	0.03/7.53	4.45/3.66	8.25	7.09
High	5825	-0.88/5.87	3.44/1.53	6.71	5.60

## 40 MHz bandwidth

Channel	Frequency (MHz)	Conducted PSD C1/C2 (dBm)	Conducted PSD C3/C4 (dBm)	Total PSD C1,C2 (dBm)	Total PSD C3,C4 (dBm)
Low	5755	-7.91/1.37	-1.35/-9.80	1.86	-0.77
Middle	5785	-2.71/3.06	2.33/-0.31	4.07	4.21
High	5815	-3.28/1.56	-1.66/-6.58	2.80	-0.45

## 80 MHz bandwidth

Channel	Frequency (MHz)	Conducted PSD C1/C2 (dBm)	Conducted PSD C3/C4 (dBm)	Total PSD C1,C2 (dBm)	Total PSD C3,C4 (dBm)
Low	5775	-12.112/-2.02	-4.44/-13.42	-1.62	-3.93
Middle	5785	-10.30/-2.44	-5.19/-13.65	-1.79	-4.62
High	5795	-9.58/-2.67	-5.78/-12.32	-1.87	-4.91

**0 dBi Antenna****5.2 GHz Band:**

20 MHz bandwidth

Channel	Frequency (MHz)	Conducted PSD C1 (dBm)	Conducted PSD C2 (dBm)	Conducted PSD C3 (dBm)	Conducted PSD C4 (dBm)	Total PSD C1,C2 (dBm)	Total PSD C3,C4 (dBm)	Limit (dBm)
Low	5165	3.711	3.342	3.533	3.778	6.541	6.668	17
Middle	5200	5.326	4.692	4.225	4.746	8.031	7.504	17
High	5240	4.897	4.774	4.986	5.303	7.846	8.158	17

40 MHz bandwidth

Channel	Frequency (MHz)	Conducted PSD C1 (dBm)	Conducted PSD C2 (dBm)	Conducted PSD C3 (dBm)	Conducted PSD C4 (dBm)	Total PSD C1,C2 (dBm)	Total PSD C3,C4 (dBm)	Limit (dBm)
Low	5175	3.025	2.917	2.476	3.023	5.982	5.768	17
Middle	5200	3.446	3.38	3.891	4.056	6.423	6.985	17
High	5230	3.828	3.967	3.864	3.493	6.908	6.693	17

80 MHz bandwidth

Channel	Frequency (MHz)	Conducted PSD C1 (dBm)	Conducted PSD C2 (dBm)	Conducted PSD C3 (dBm)	Conducted PSD C4 (dBm)	Total PSD C1,C2 (dBm)	Total PSD C3,C4 (dBm)	Limit (dBm)
Low	5195	0.636	0.743	0.994	1.068	3.700	4.041	17
Middle	5200	0.818	0.717	0.574	0.637	3.778	3.616	17
High	5210	0.705	0.138	1.029	1.377	3.441	4.217	17

**5.8 GHz Band:**

## 20 MHz bandwidth

Channel	Frequency (MHz)	Conducted PSD C1 (dBm)	Conducted PSD C2 (dBm)	Conducted PSD C3 (dBm)	Conducted PSD C4 (dBm)	Factor (dB)	Total PSD C1,C2 (dBm)	Total PSD C3,C4 (dBm)	Limit (dBm)
Low	5745	-0.301	-0.454	-0.724	-0.509	6.99	9.623	9.385	30
Middle	5785	2.83	2.706	2.195	3.177	6.99	12.769	12.714	30
High	5825	1.431	0.799	0.935	1.22	6.99	11.127	11.080	30

## 40 MHz bandwidth

Channel	Frequency (MHz)	Conducted PSD C1 (dBm)	Conducted PSD C2 (dBm)	Conducted PSD C3 (dBm)	Conducted PSD C4 (dBm)	Factor (dBi)	Total PSD C1,C2 (dBm)	Total PSD C3,C4 (dBm)	Limit (dBm)
Low	5755	2.68	2.779	2.867	2.924	6.99	12.730	12.896	30
Middle	5785	2.246	2.263	2.206	2.183	6.99	12.255	12.195	30
High	5815	2.086	1.61	1.54	1.398	6.99	11.855	11.470	30

## 80 MHz bandwidth

Channel	Frequency (MHz)	Conducted PSD C1 (dBm)	Conducted PSD C2 (dBm)	Conducted PSD C3 (dBm)	Conducted PSD C4 (dBm)	Factor (dBi)	Total PSD C1,C2 (dBm)	Total PSD C3,C4 (dBm)	Limit (dBm)
Low	5775	-5.875	-6.212	-5.677	-5.303	6.99	3.960	4.514	30
Middle	5785	1.816	1.985	1.618	1.539	6.99	11.902	11.579	30
High	5795	-3.422	-4.918	-4.467	-3.795	6.99	5.894	5.882	30

Please refer to the following plots.

25 dBi Antenna

5.2 GHz Band:

20 MHz bandwidth, Low Channel, 5165 MHz

C1

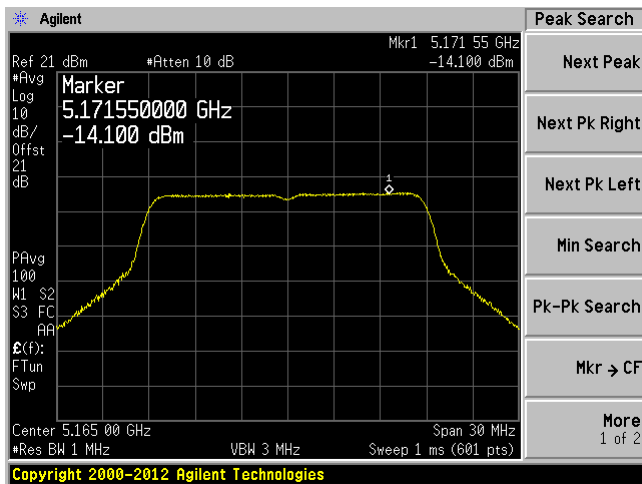

C2

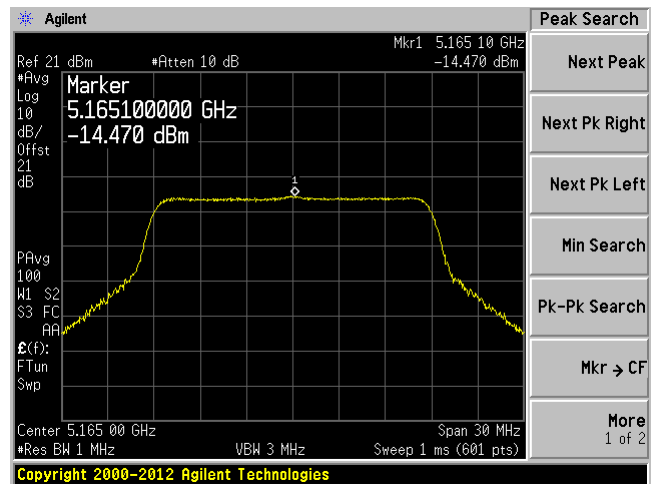

C3

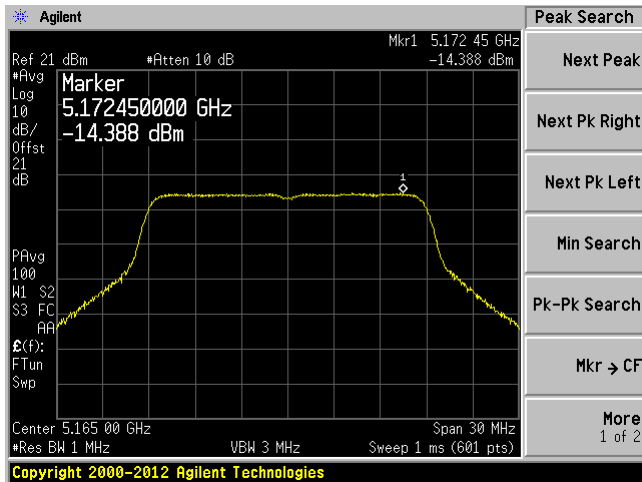

C4

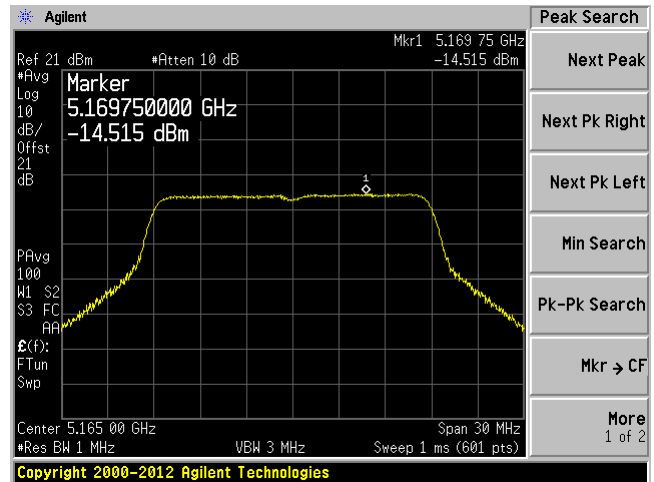

### 20 MHz bandwidth, Middle Channel, 5200 MHz

C1

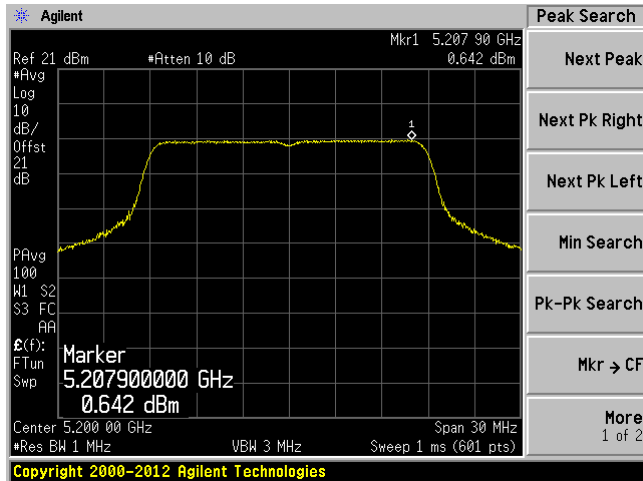

C2

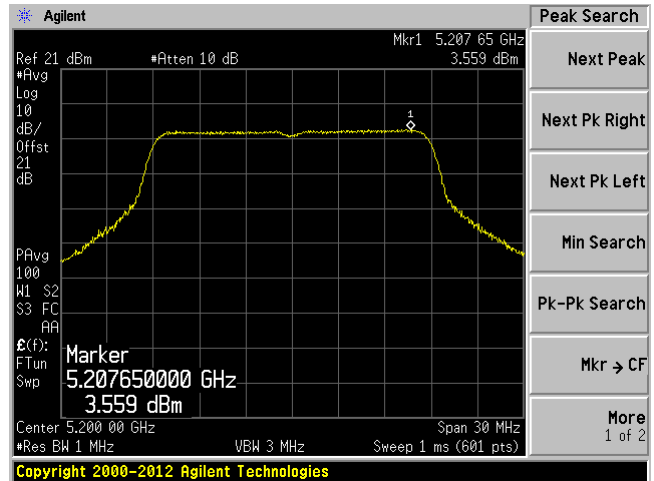

C3

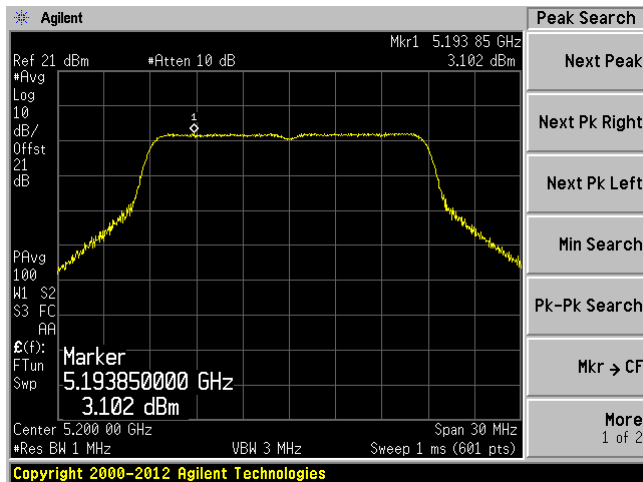

C4

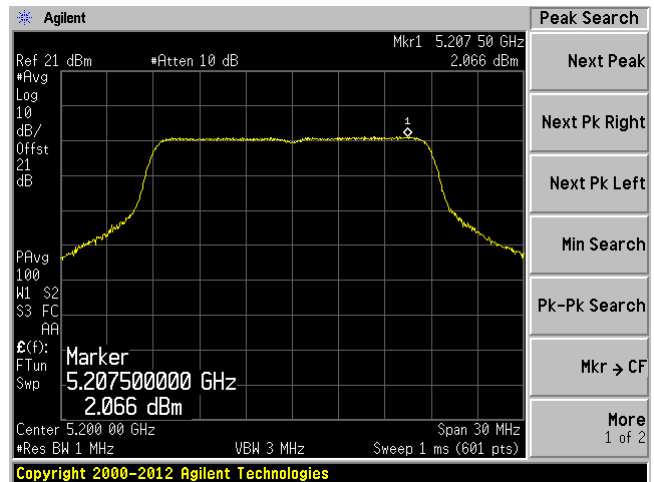

20 MHz bandwidth, High Channel, 5240 MHz

C1

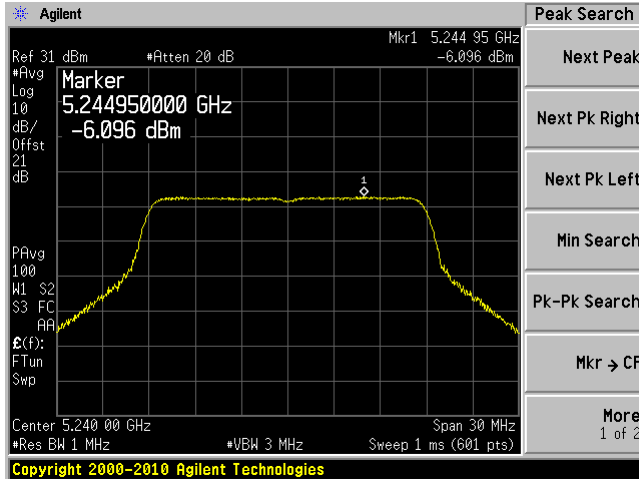

C2

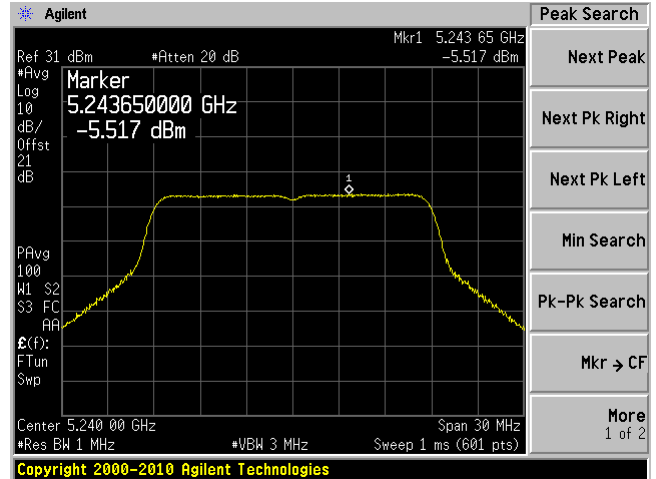

C3

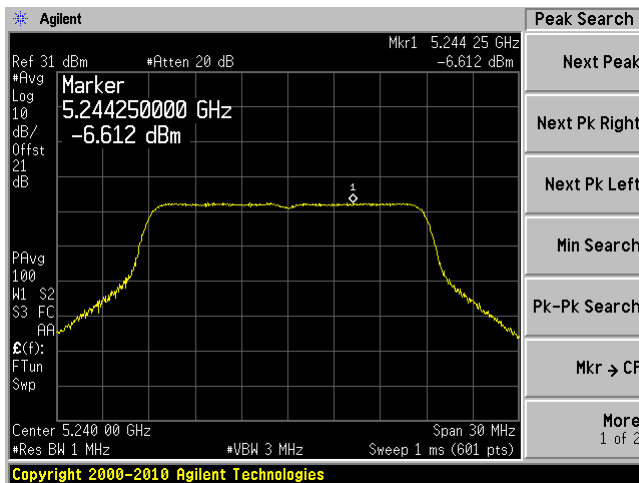

C4

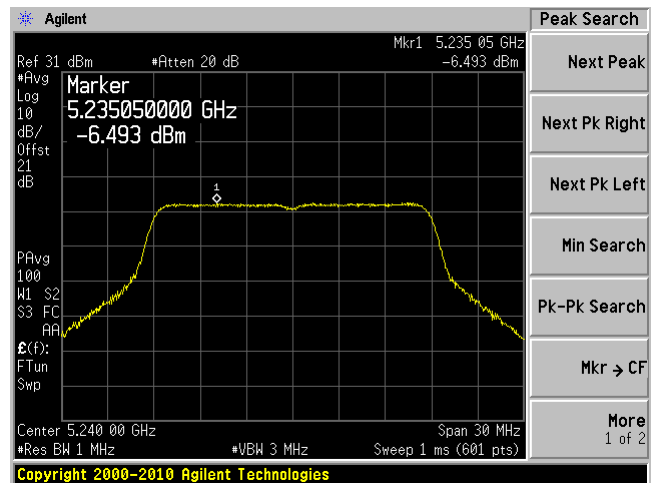

40 MHz bandwidth, Low Channel, 5175 MHz

C1

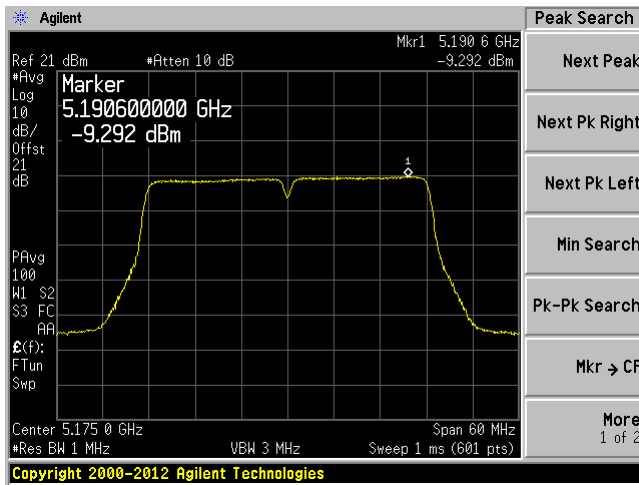

C2

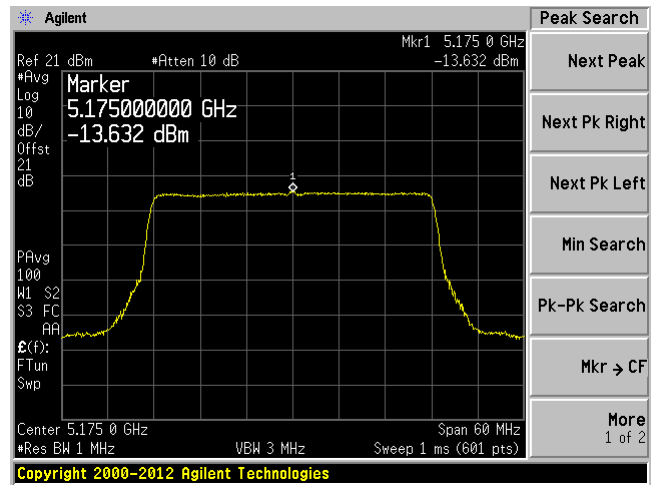

C3

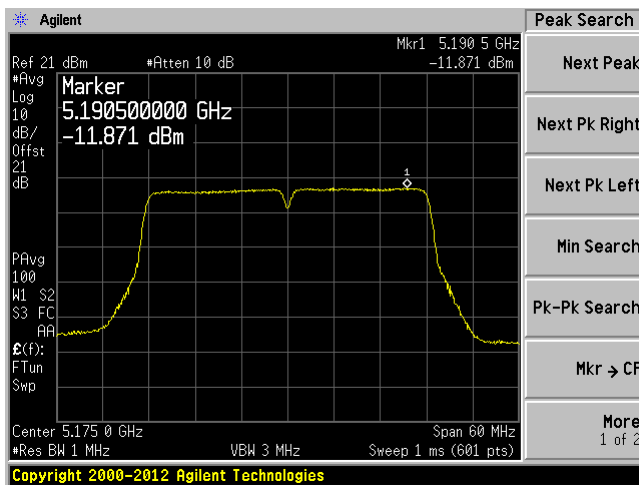

C4

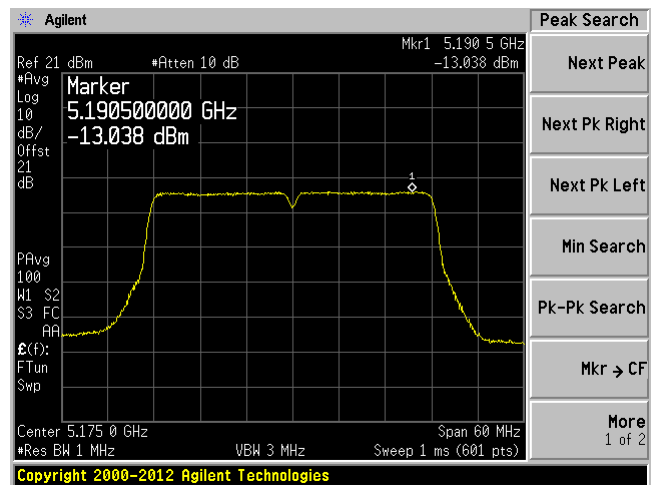



### 40 MHz bandwidth, Middle Channel, 5200 MHz

C1

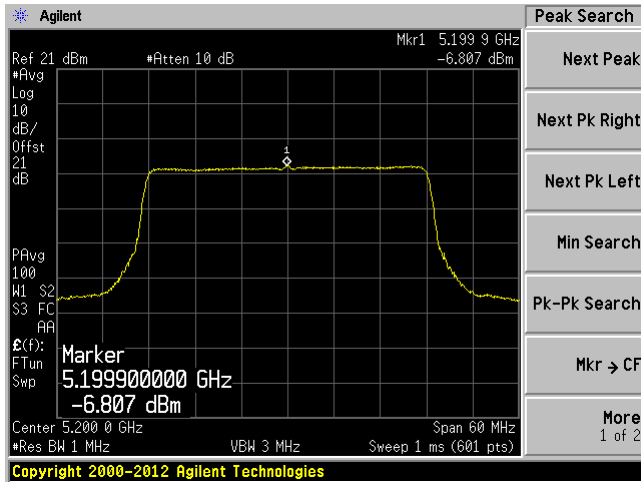

C2

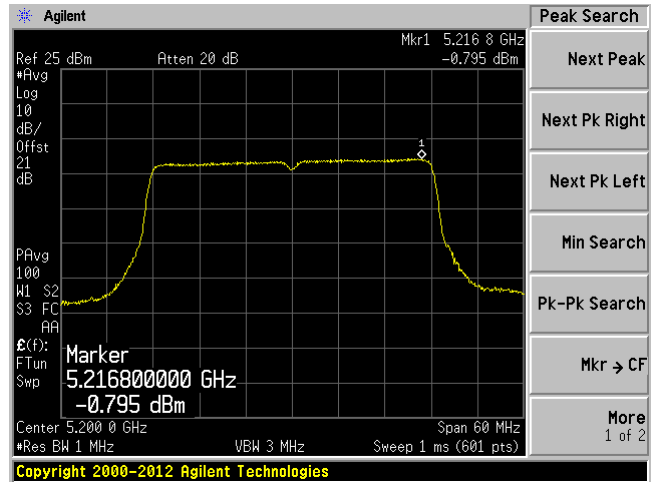

C3

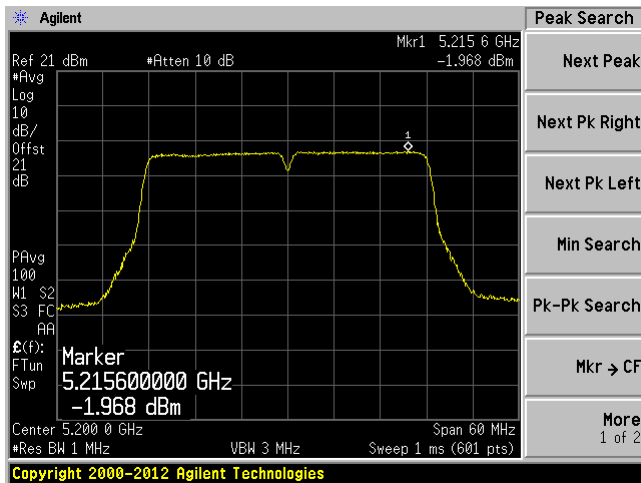

C4

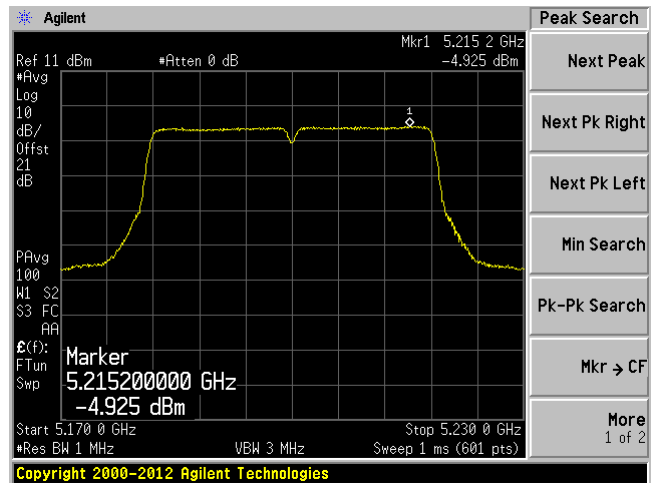

40 MHz bandwidth, High Channel, 5230 MHz

C1

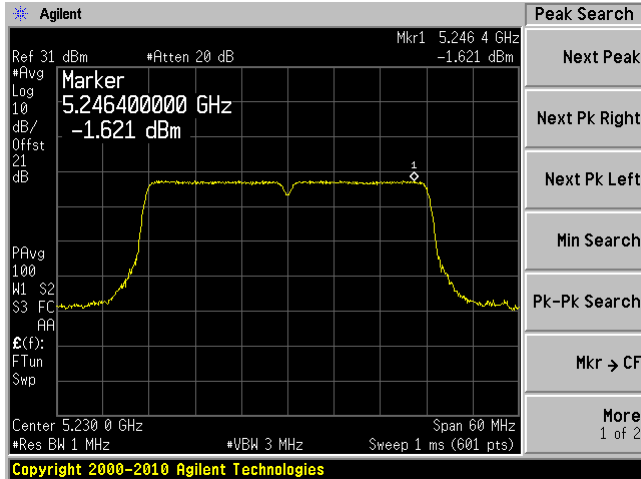

C2

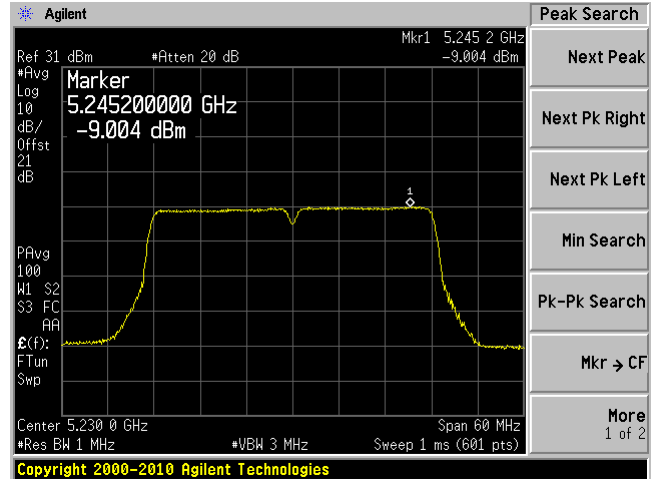

C3

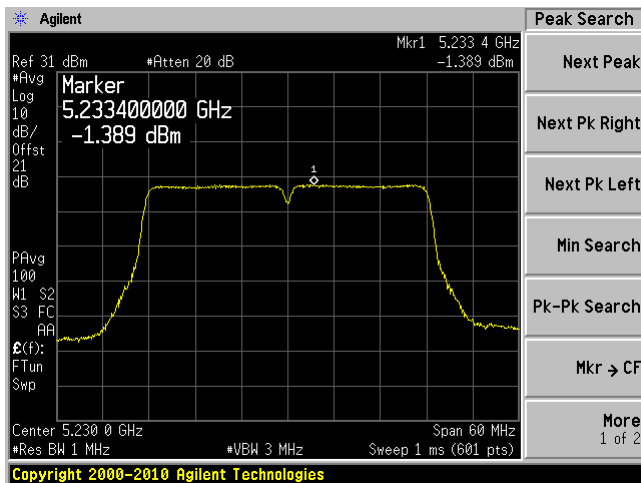

C4

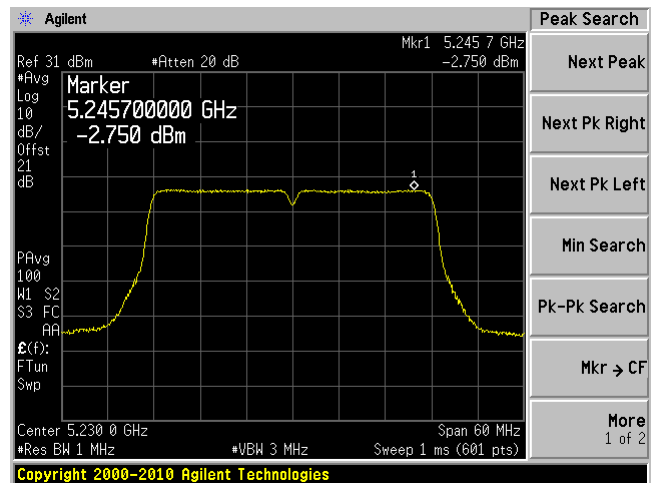

80 MHz bandwidth, Low Channel, 5195 MHz

C1

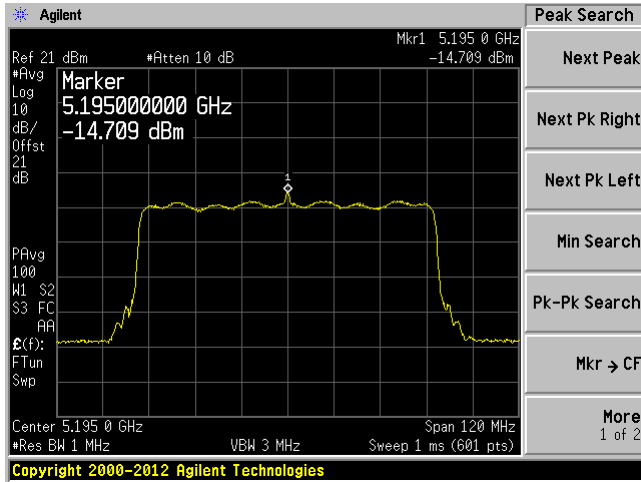

C2

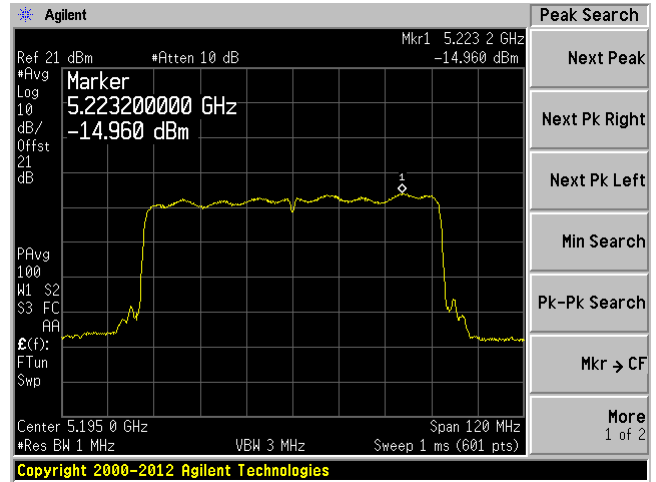

C3

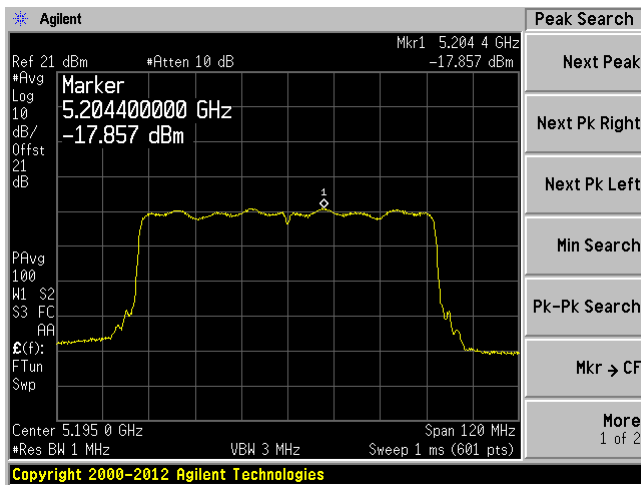

C4

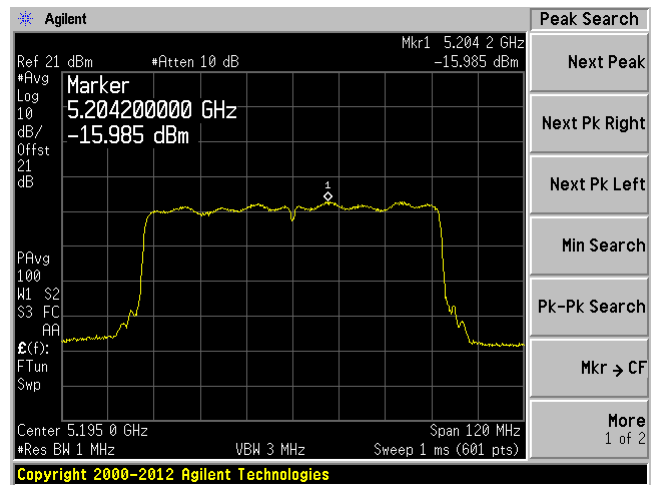

### 80 MHz bandwidth, Middle Channel, 5200 MHz

C1

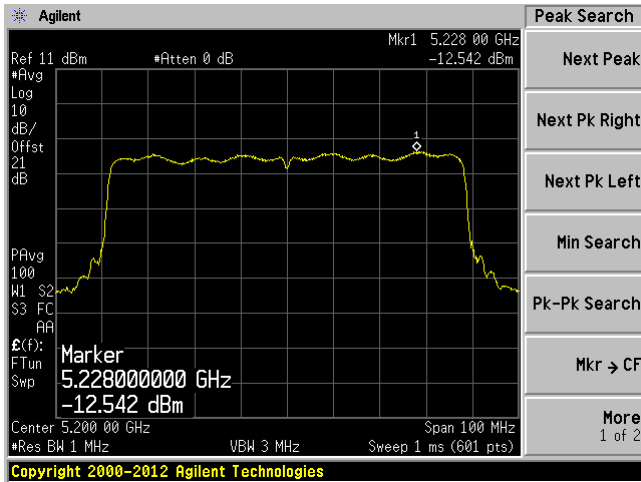

C2

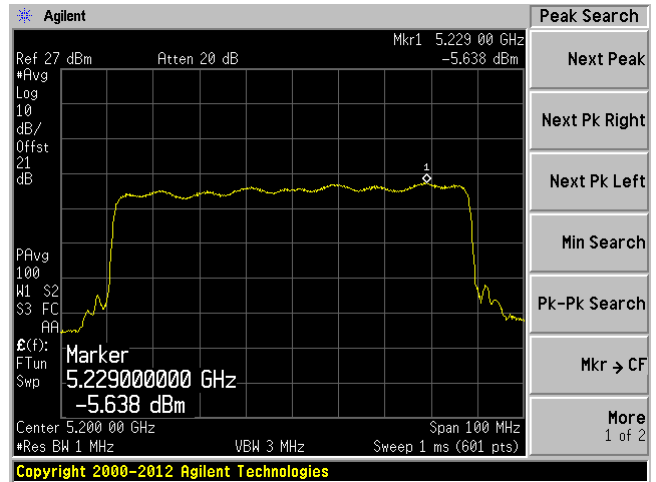

C3

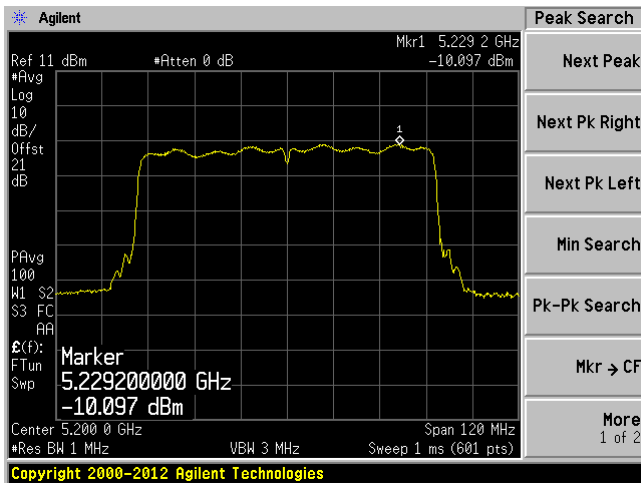

C4

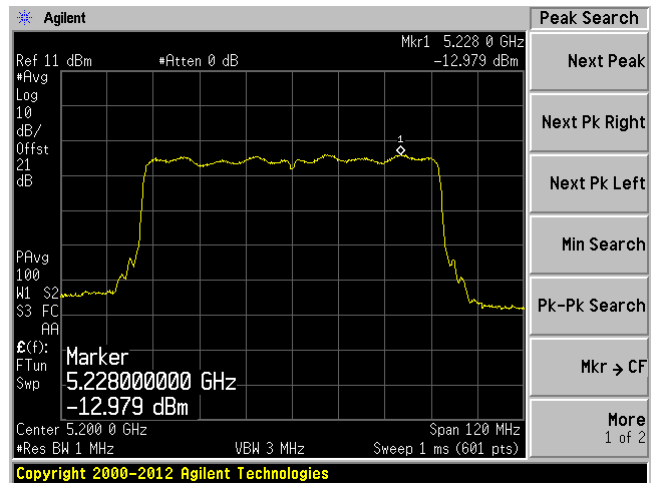

80 MHz bandwidth, High Channel, 5210 MHz

C1

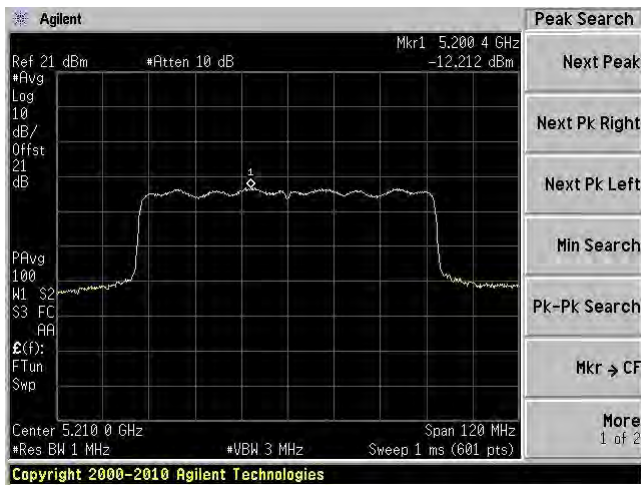

C2

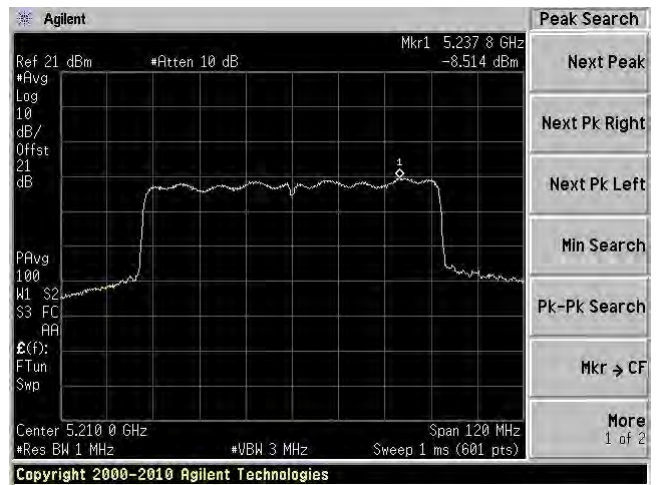

C3

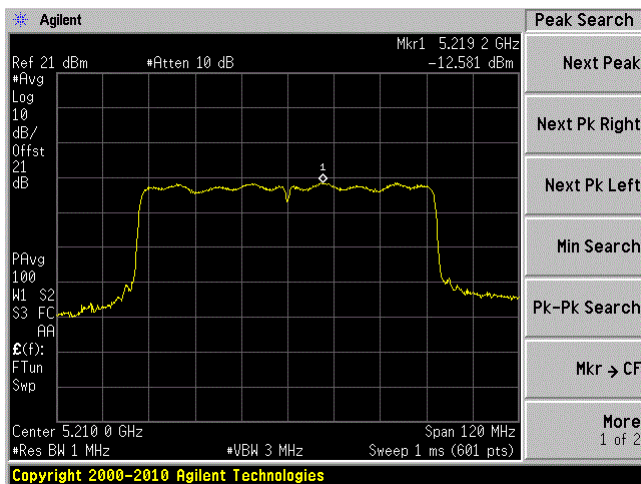

C4

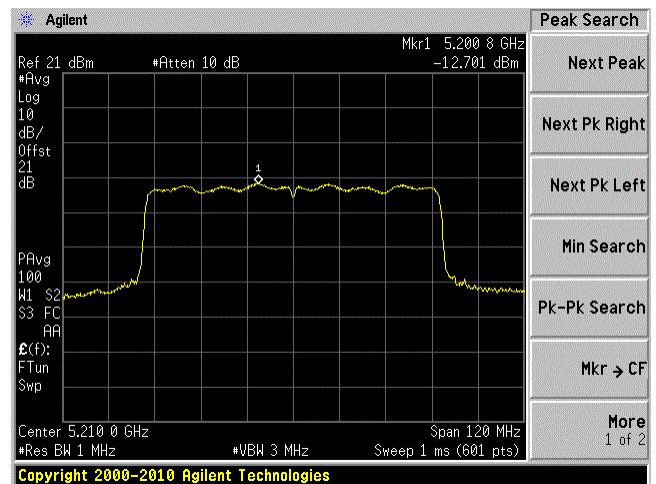

5.8 GHz Band:

20 MHz bandwidth, Low Channel, 5745 MHz

C1

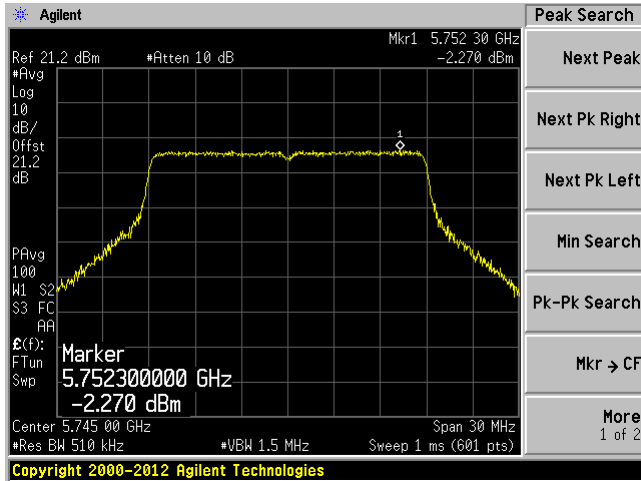

C2

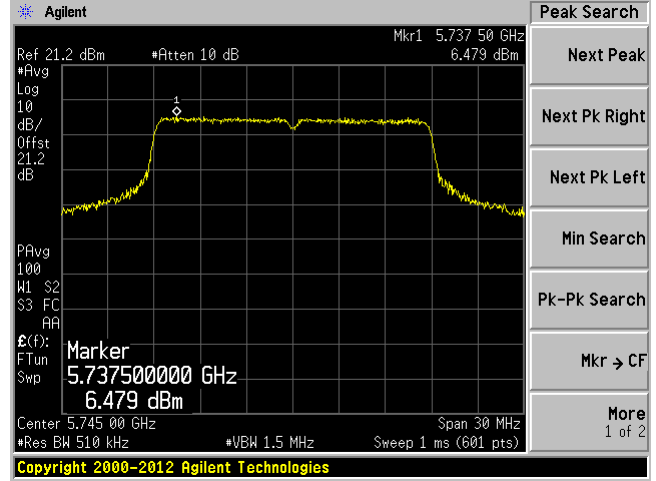

C3

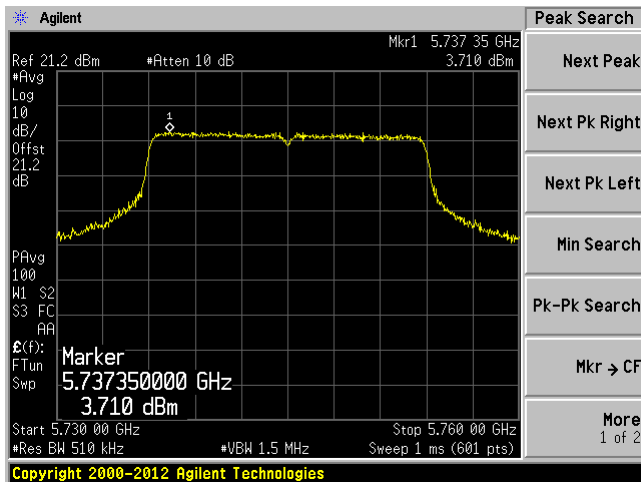

C4

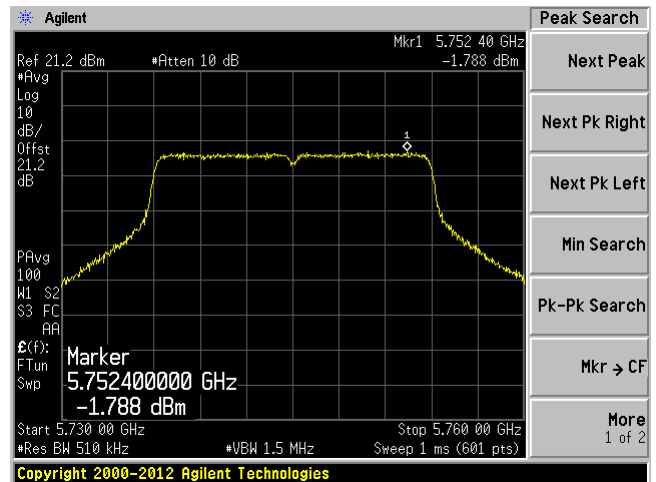

20 MHz bandwidth, Middle Channel, 5785 MHz

C1

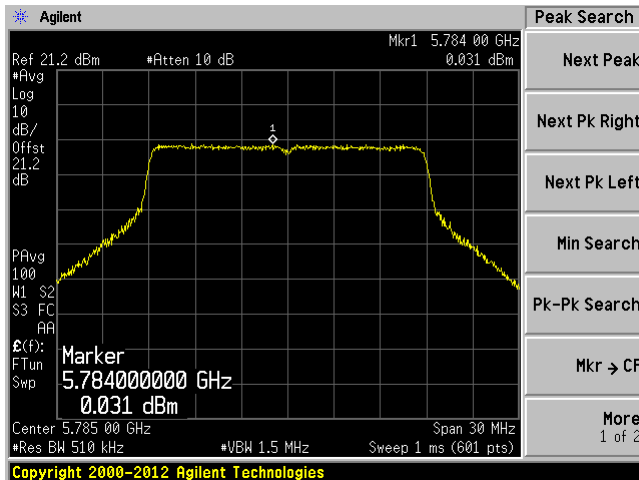

C2

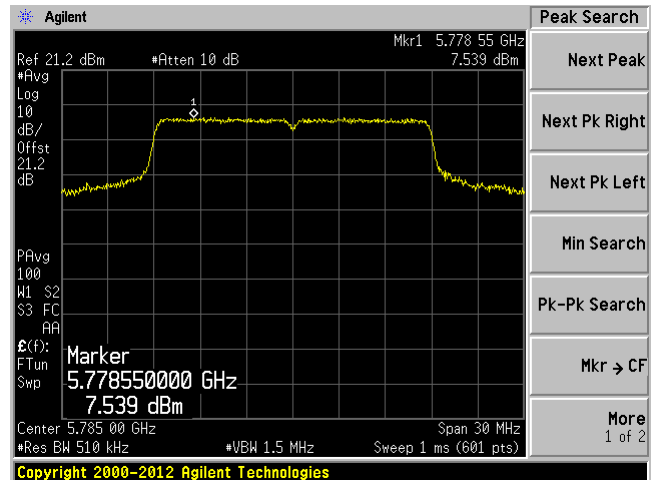

C3

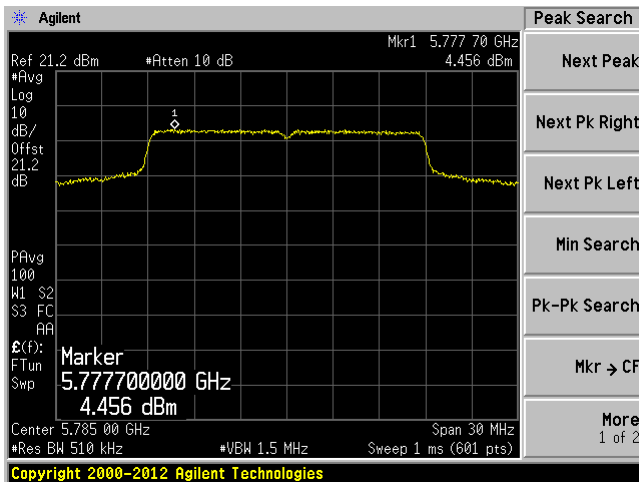

C4

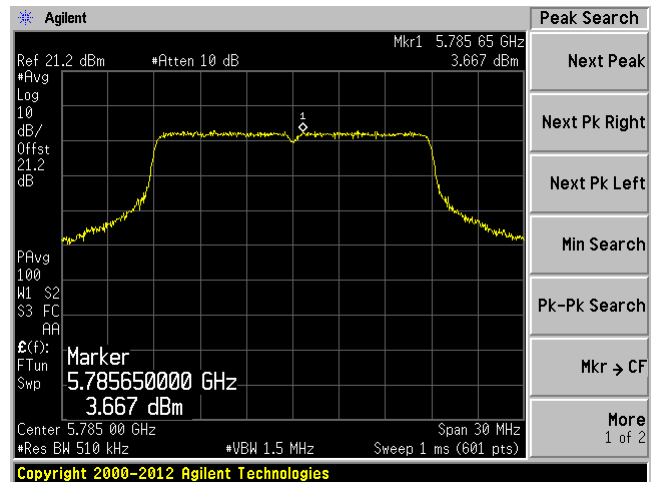

20 MHz bandwidth, High Channel, 5825 MHz

C1

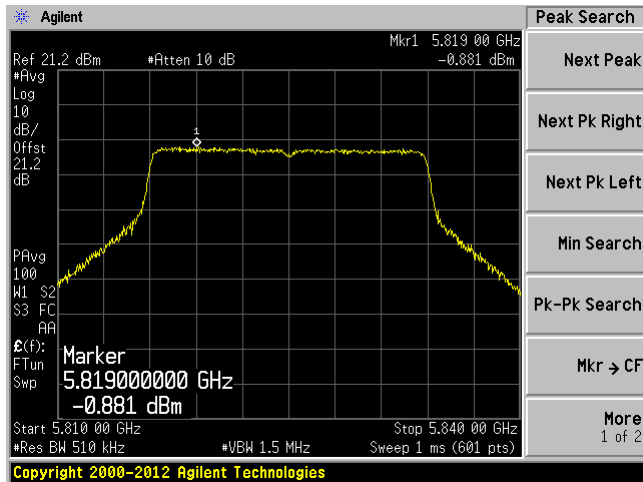

C2

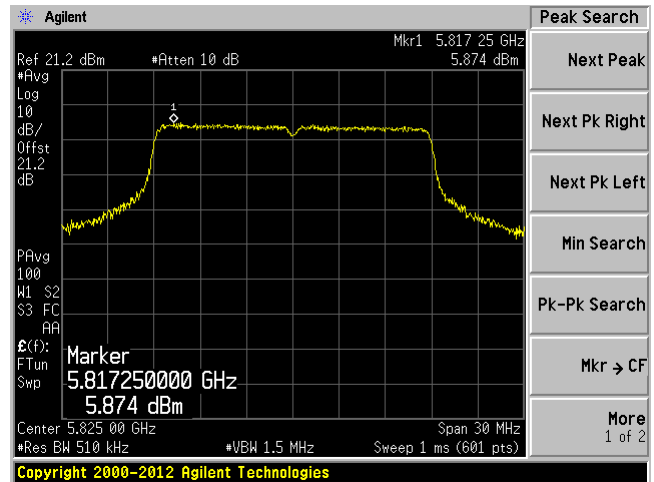

C3

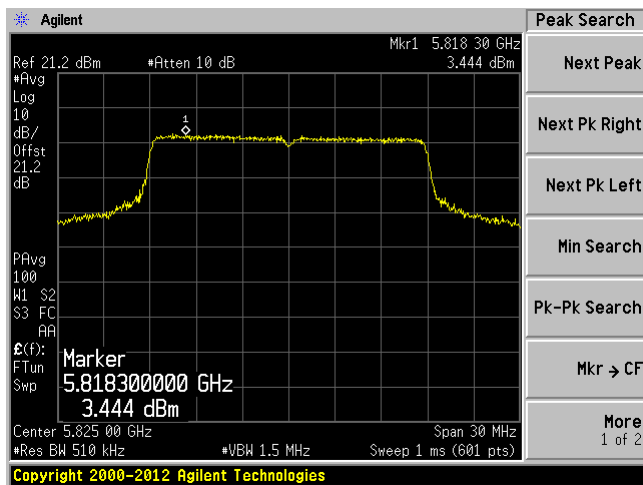

C4

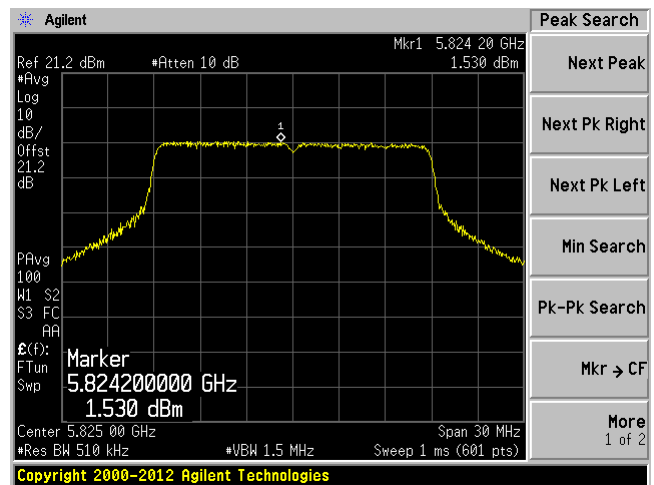



40 MHz bandwidth, Low Channel, 5755 MHz

C1

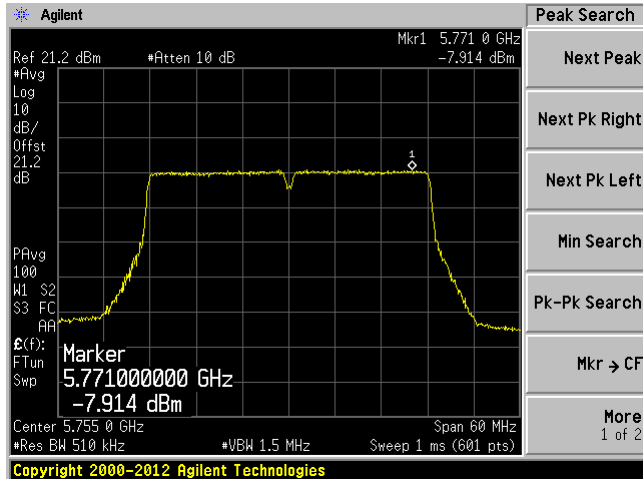

C2

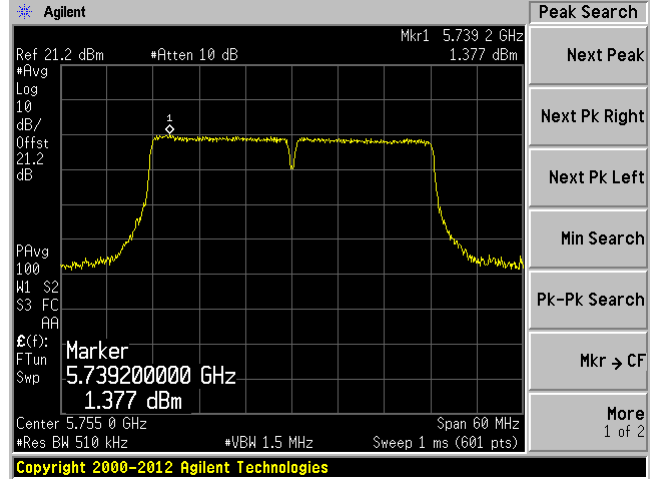

C3

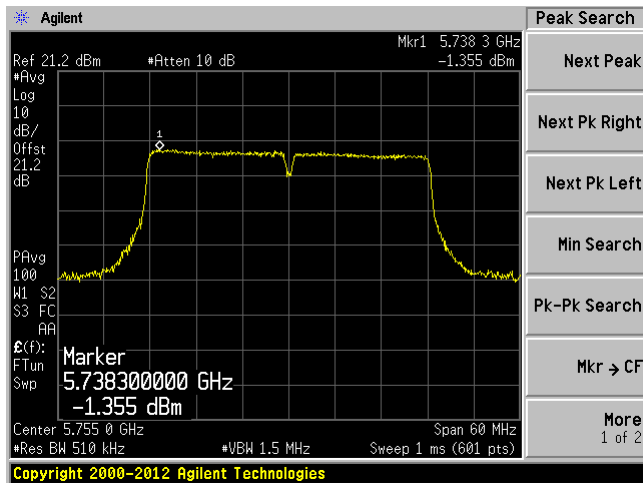

C4

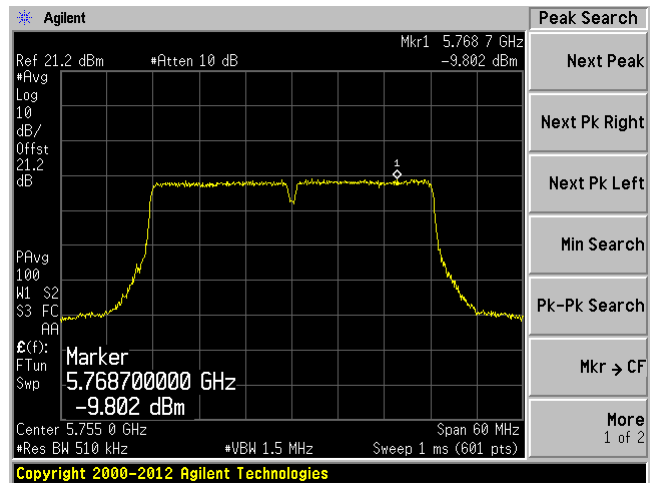

40 MHz bandwidth, Middle Channel, 5785 MHz

C1

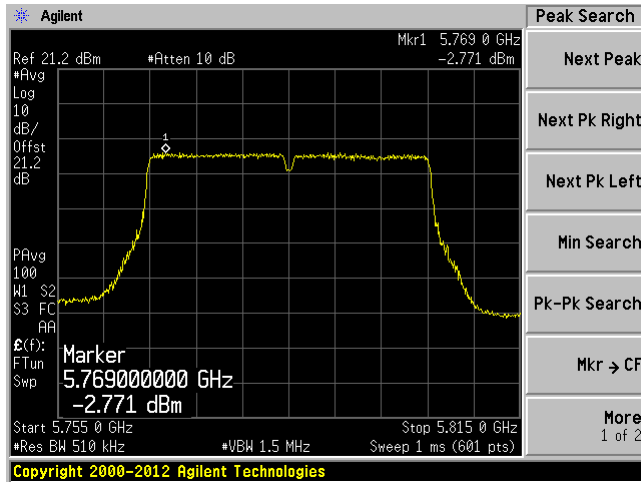

C2

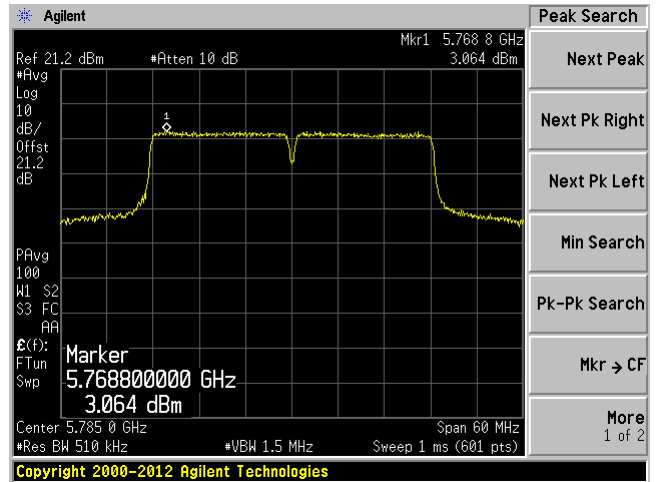

C3

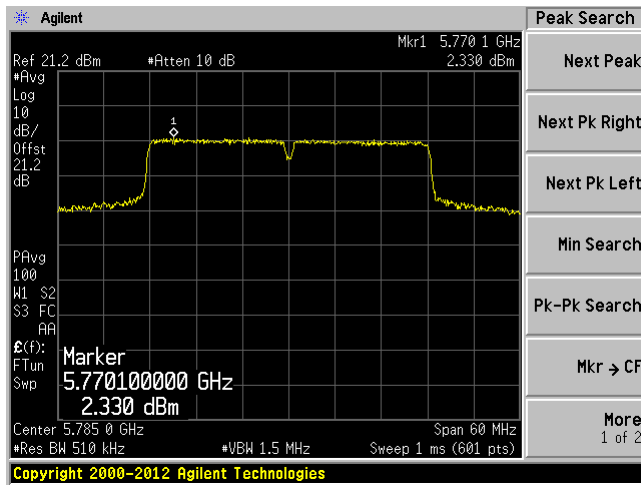

C4

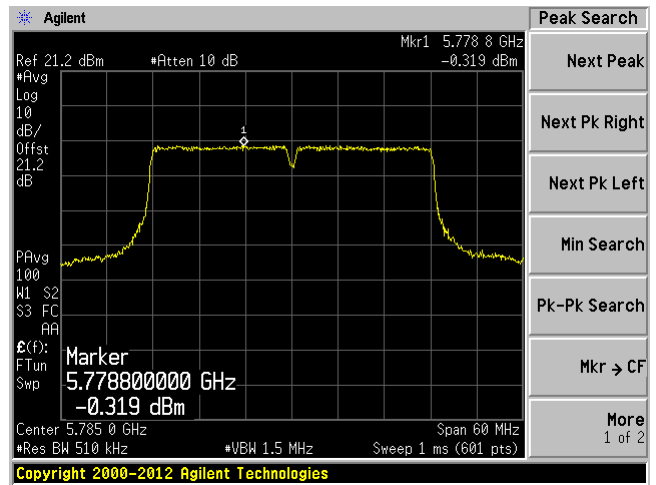

40 MHz bandwidth, High Channel, 5815 MHz

C1

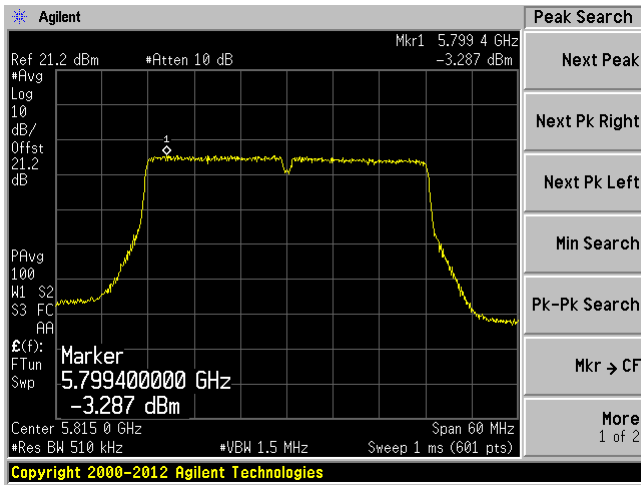

C2

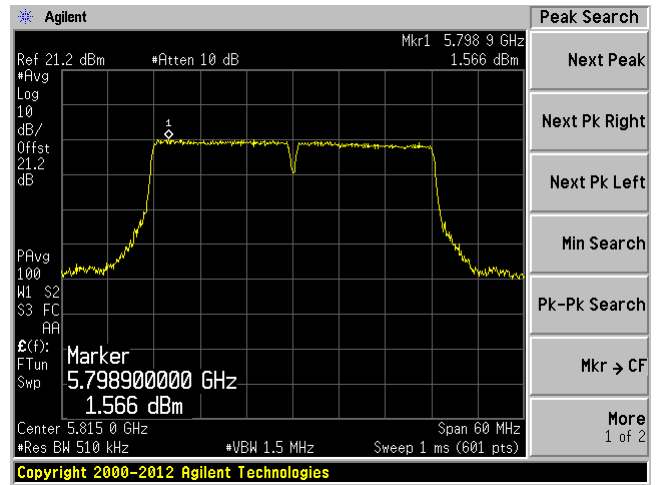

C3

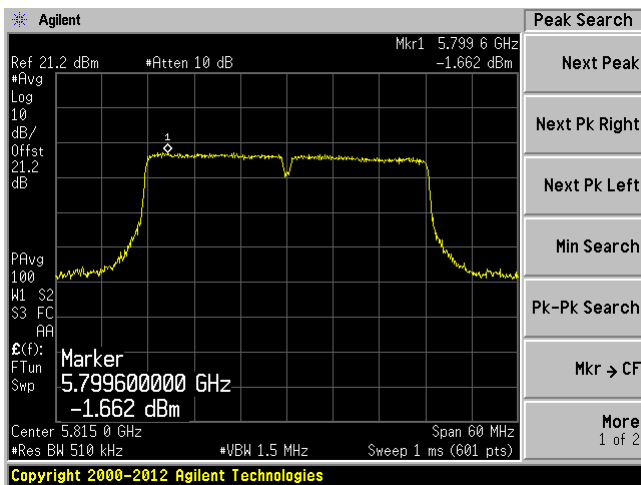

C4

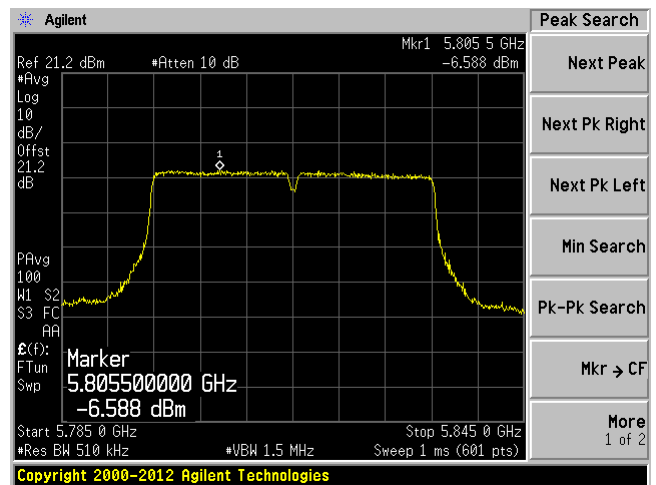

### 80 MHz bandwidth, Low Channel, 5775 MHz

C1

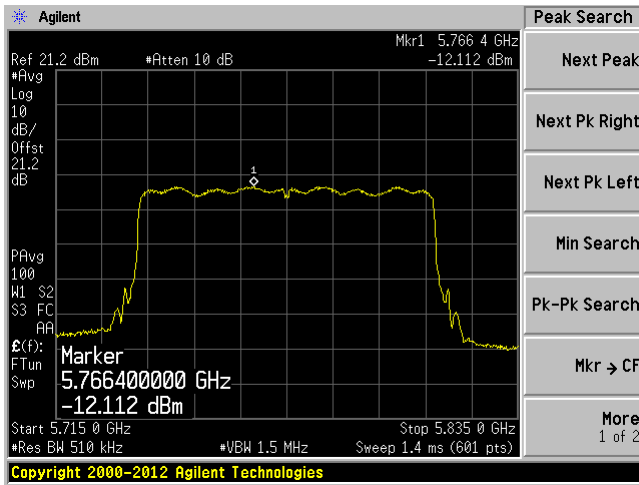

C2

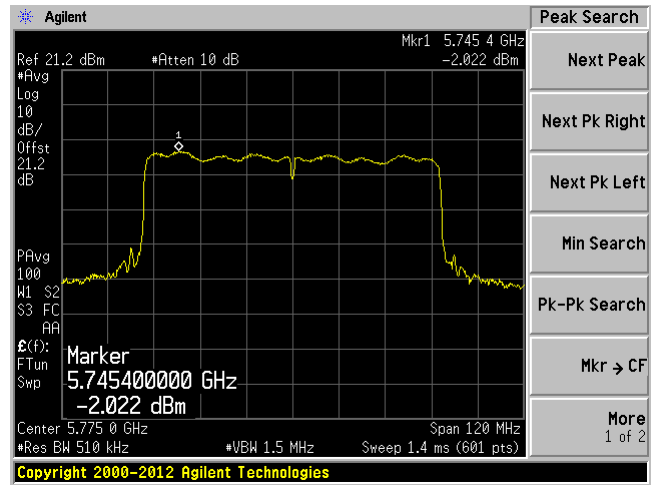

C3

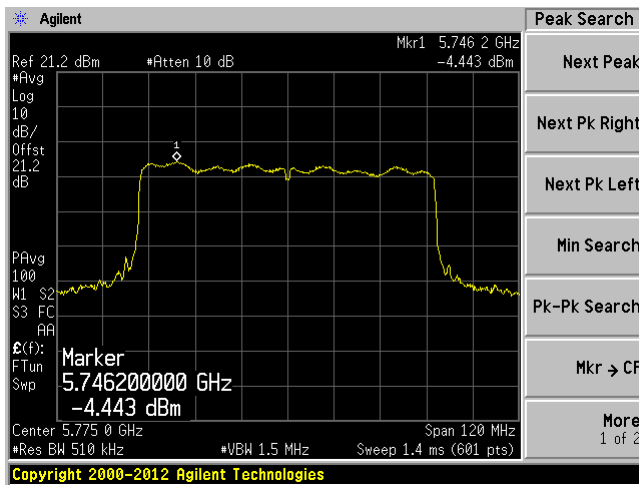

C4

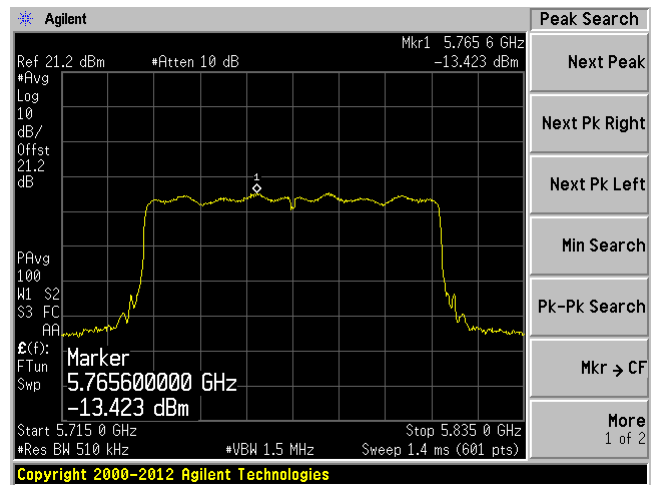

80 MHz bandwidth, Middle Channel, 5785 MHz

C1

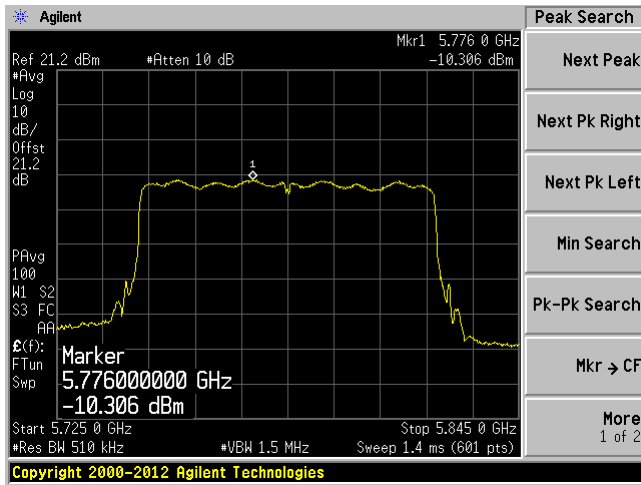

C2

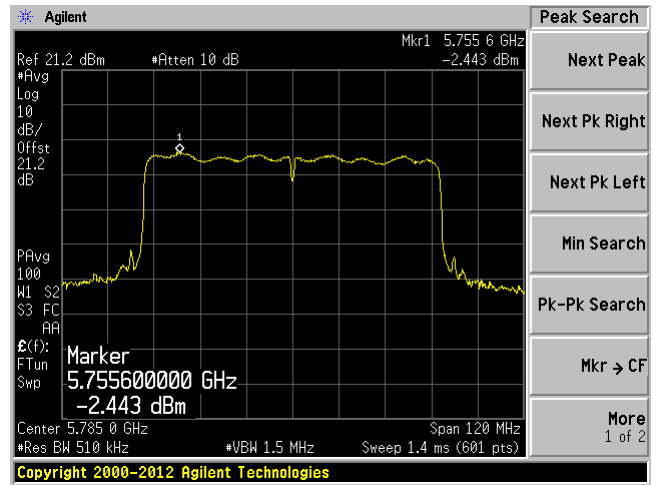

C3

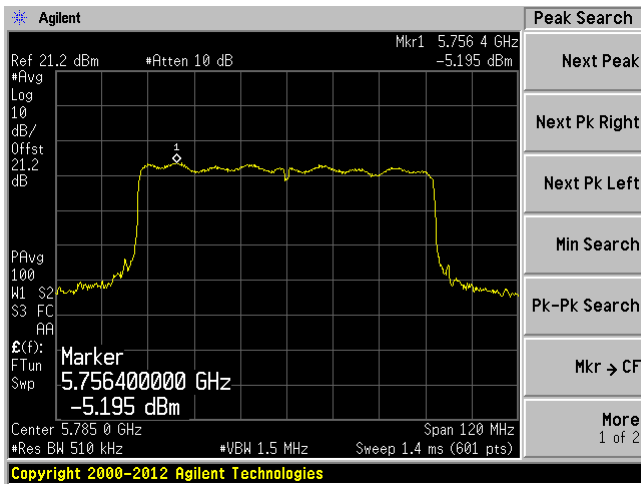

C4

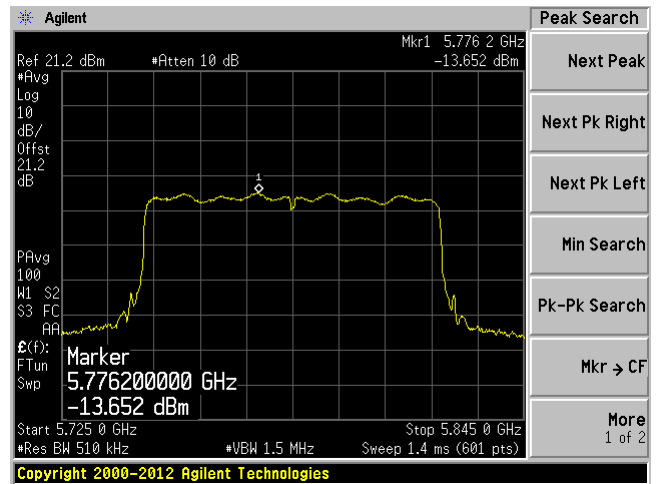

### 80 MHz bandwidth, High Channel, 5795 MHz

C1

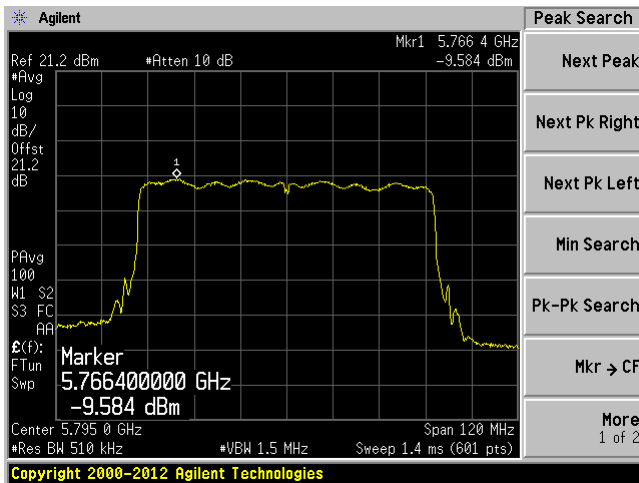

C2

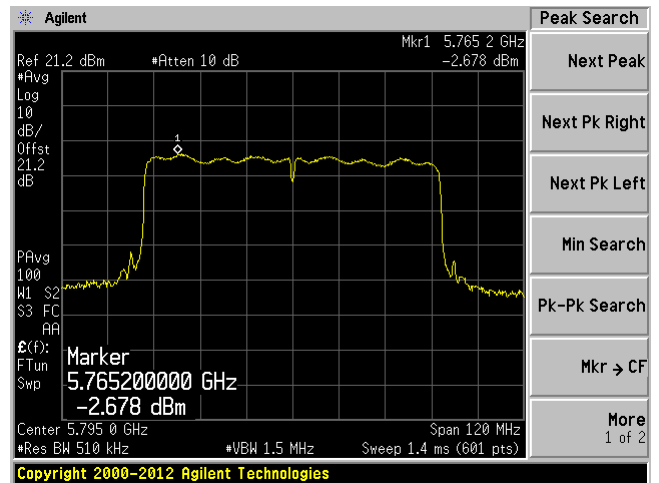

C3

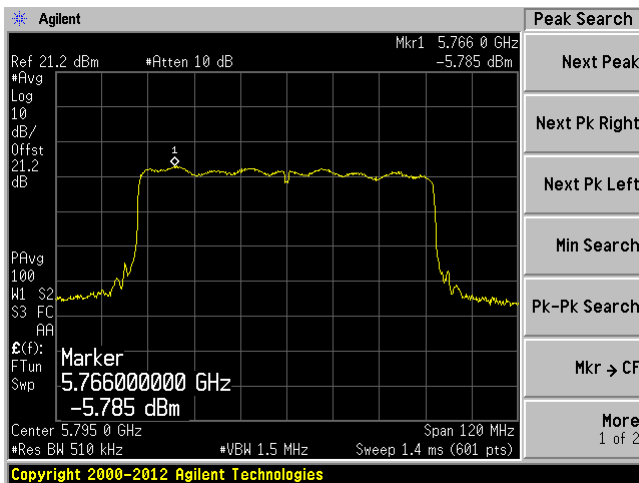

C4

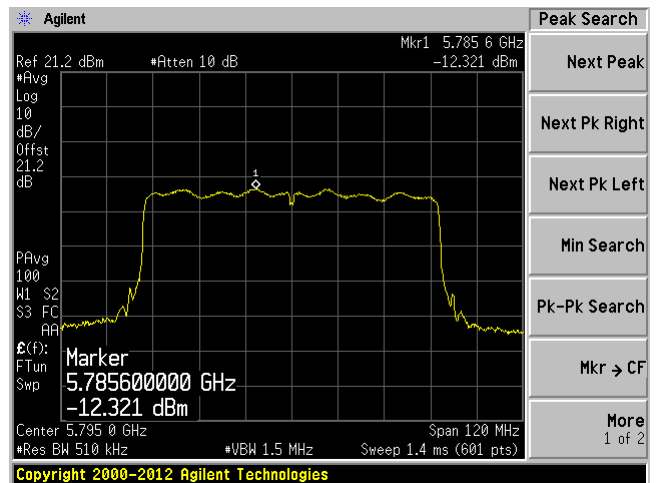

0 dBi Antenna

5.2 GHz Band:

20 MHz bandwidth, Low Channel, 5165 MHz

C1

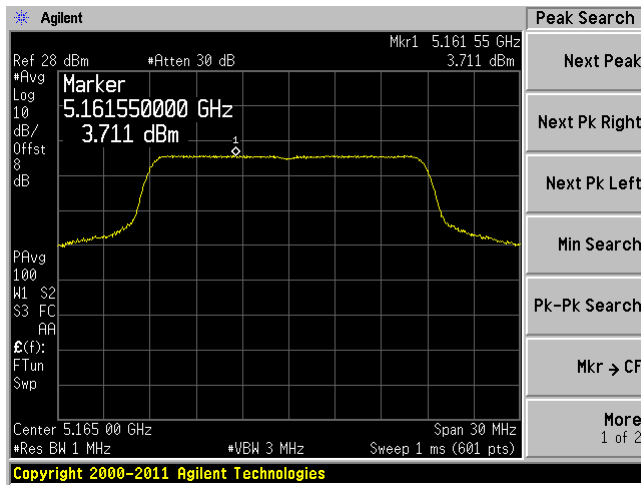

C2

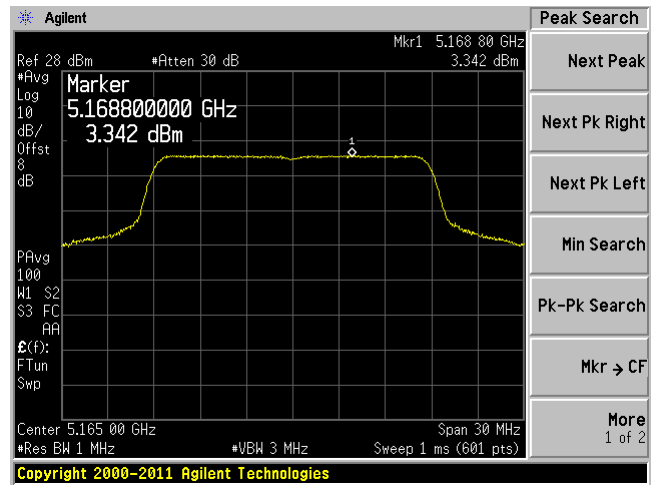

C3

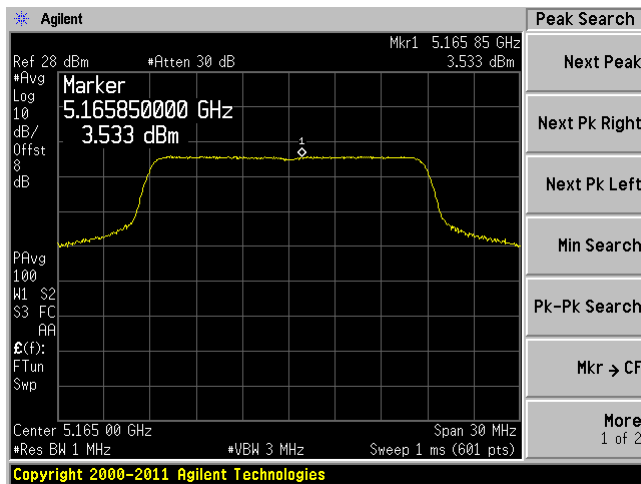

C4

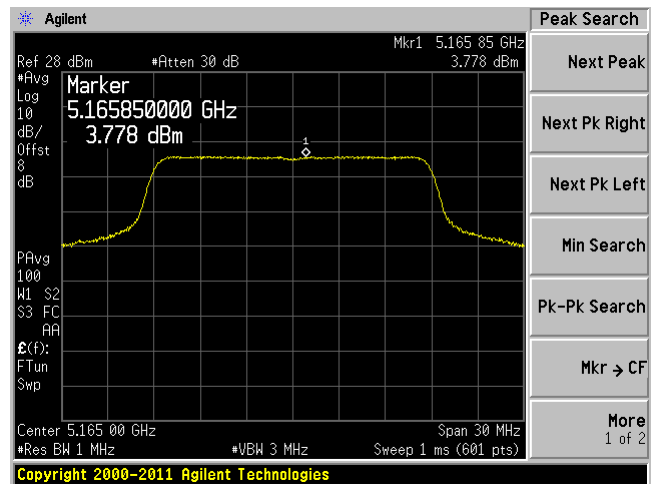

20 MHz bandwidth, Middle Channel, 5200 MHz

C1

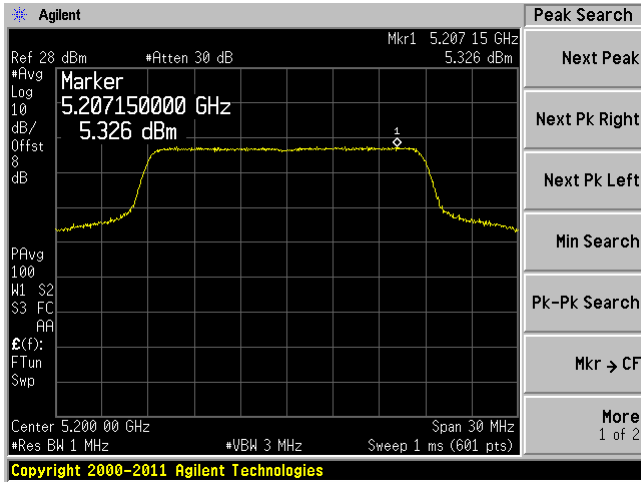

C2

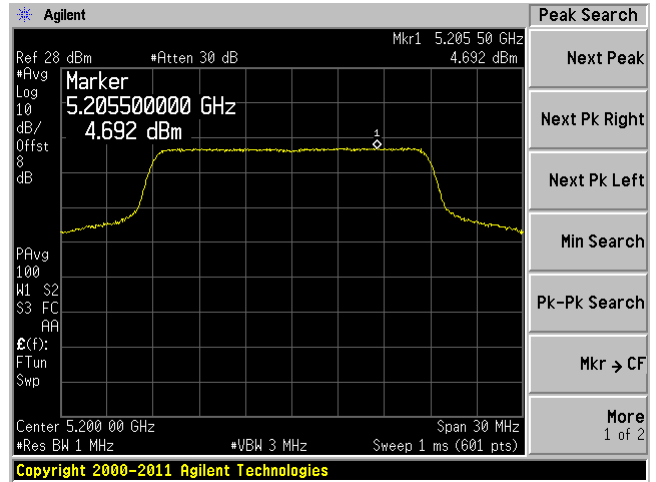

C3

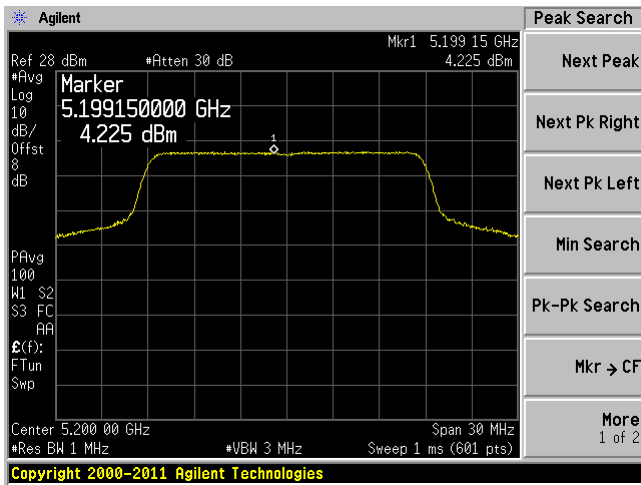

C4

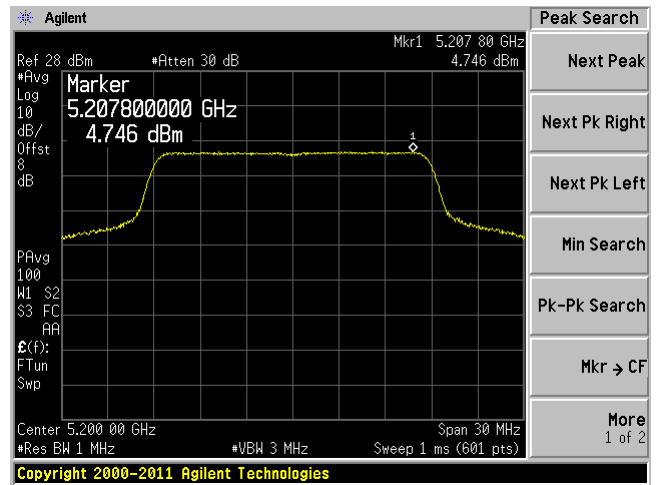



20 MHz bandwidth, High Channel, 5240 MHz

C1

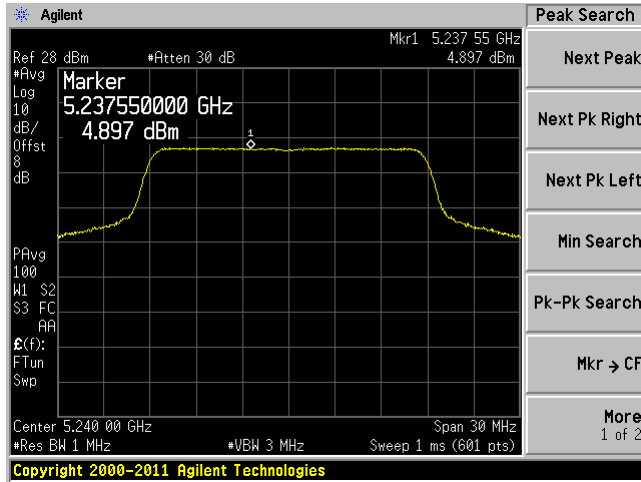

C2

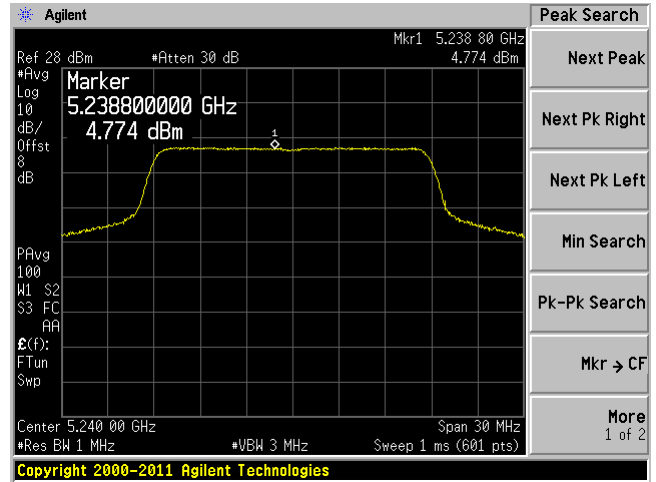

C3

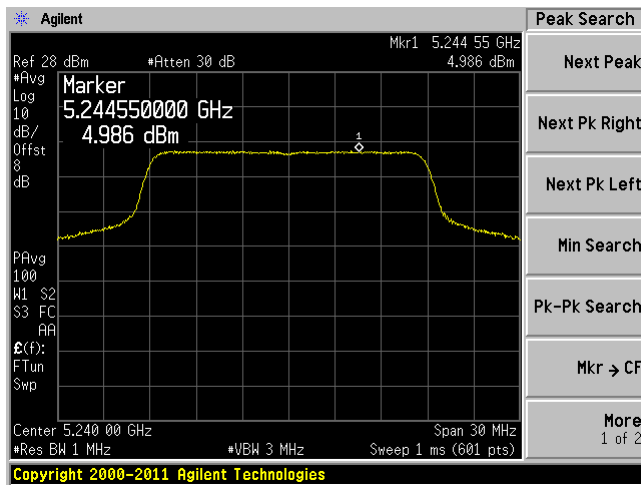

C4

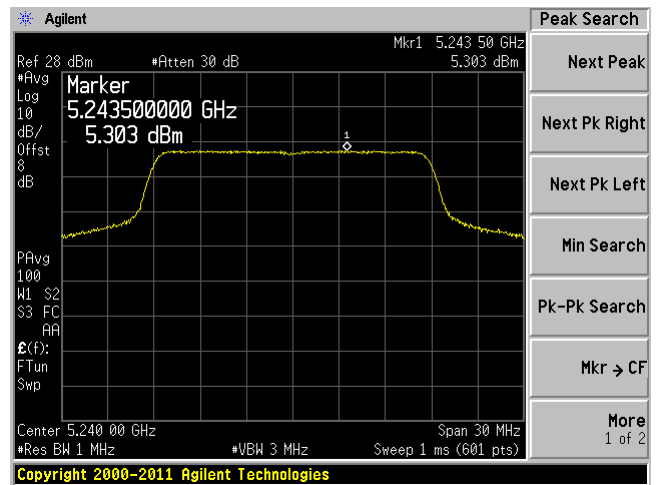

40 MHz bandwidth, Low Channel, 5175 MHz

C1

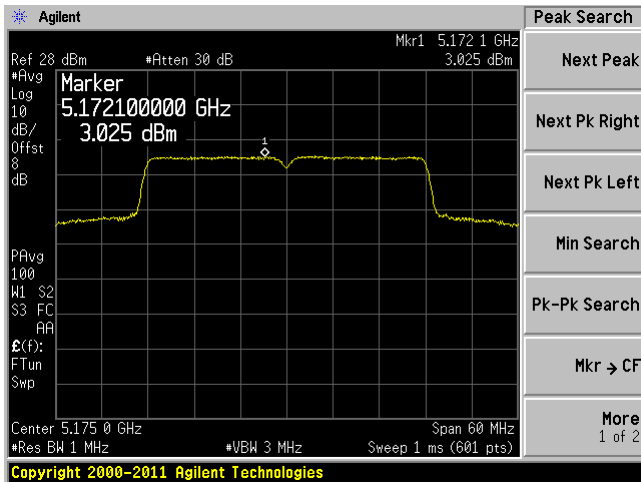

C2

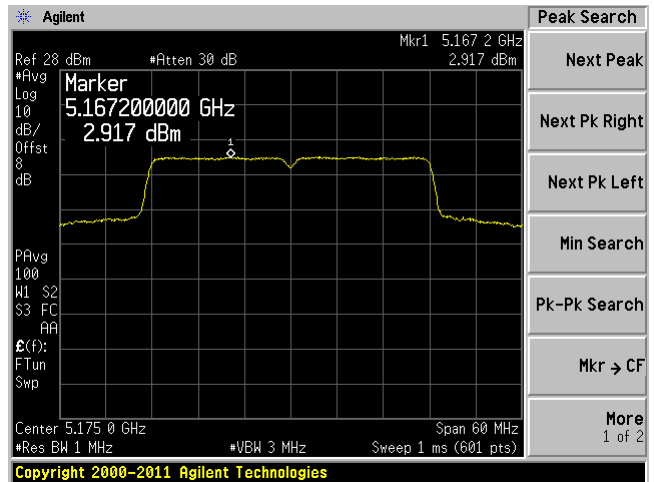

C3

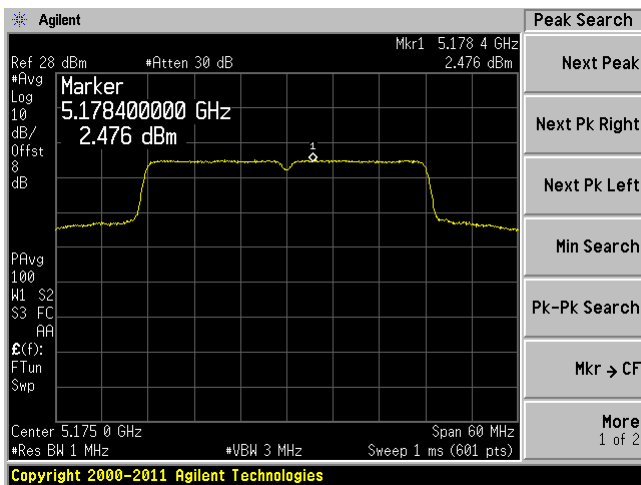

C4

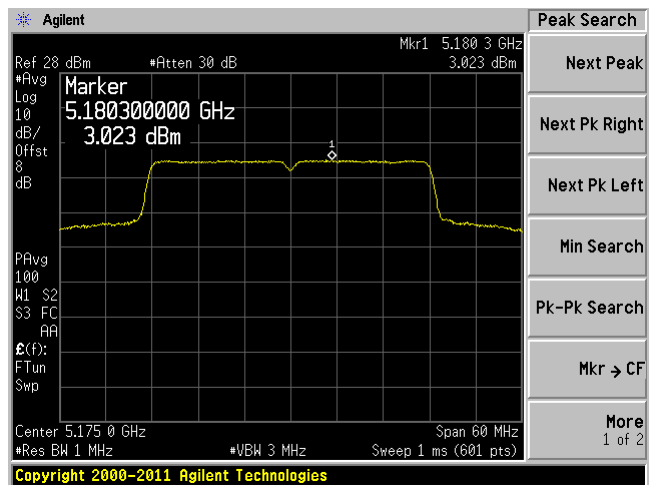

40 MHz bandwidth, Middle Channel, 5200 MHz

C1

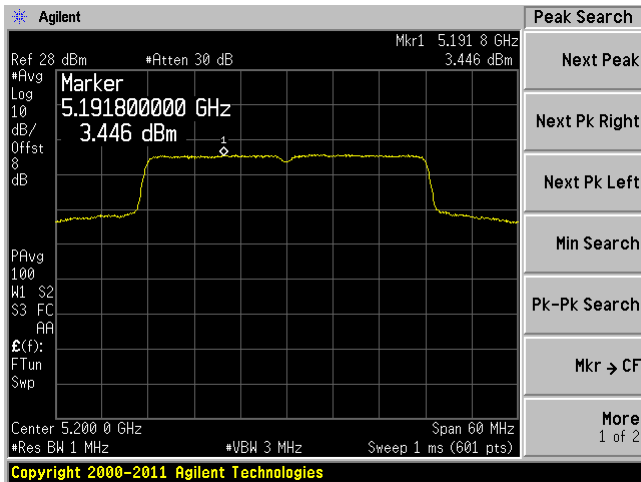

C2

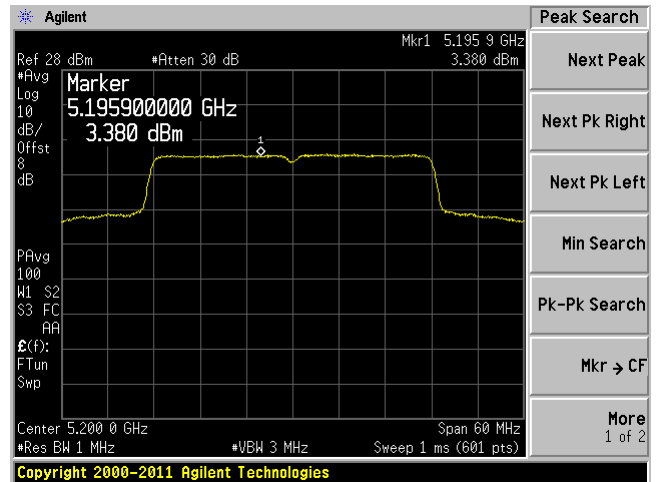

C3

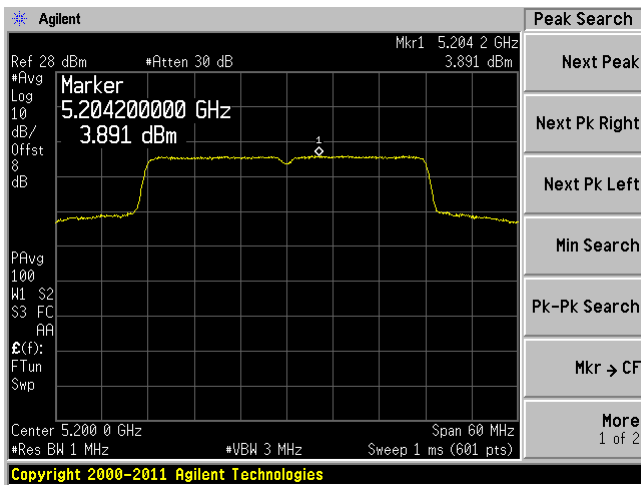

C4

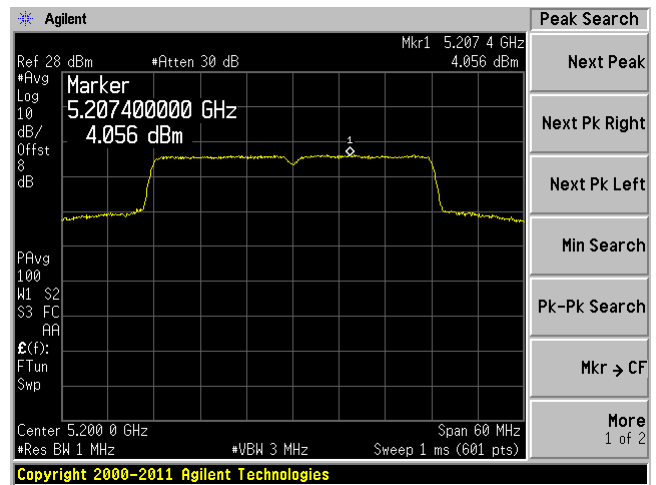

40 MHz bandwidth, High Channel, 5230 MHz

C1

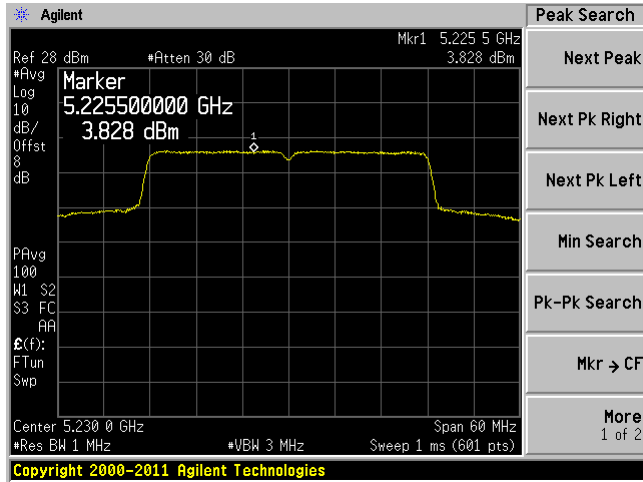

C2

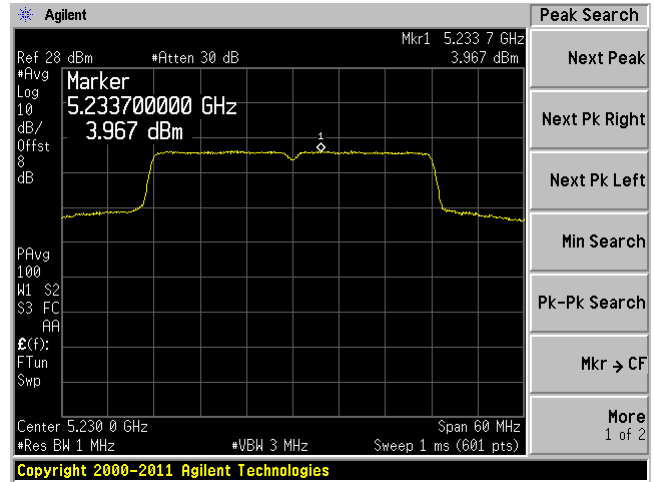

C3

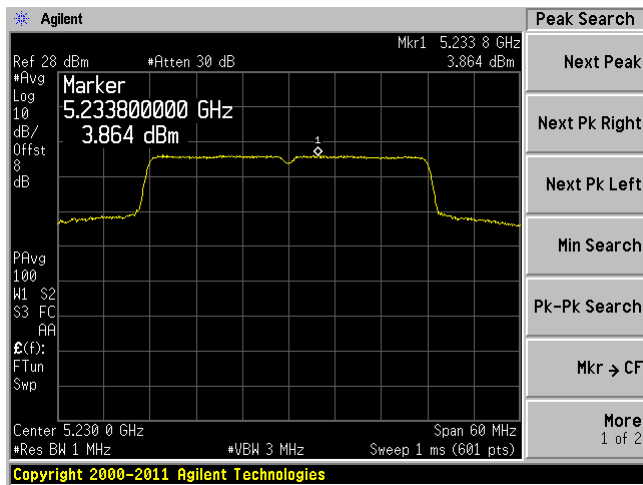

C4

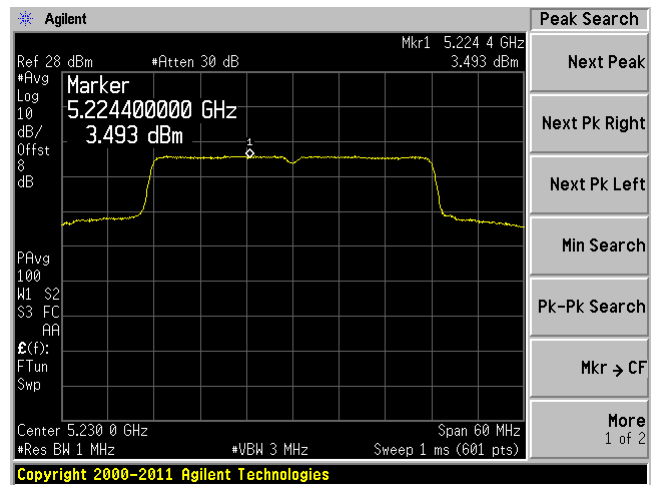

80 MHz bandwidth, Low Channel, 5195 MHz

C1

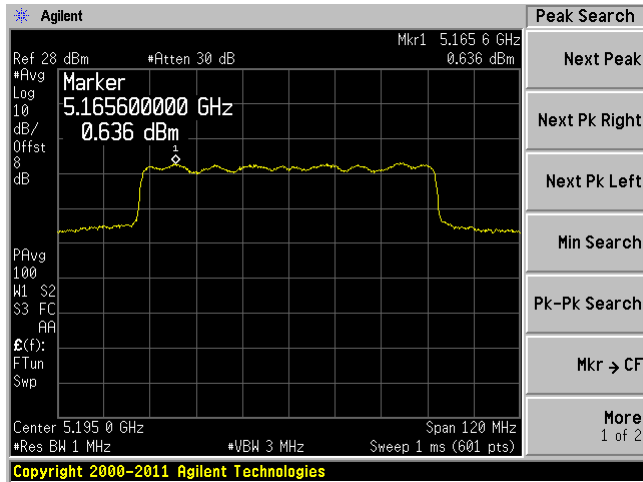

C2

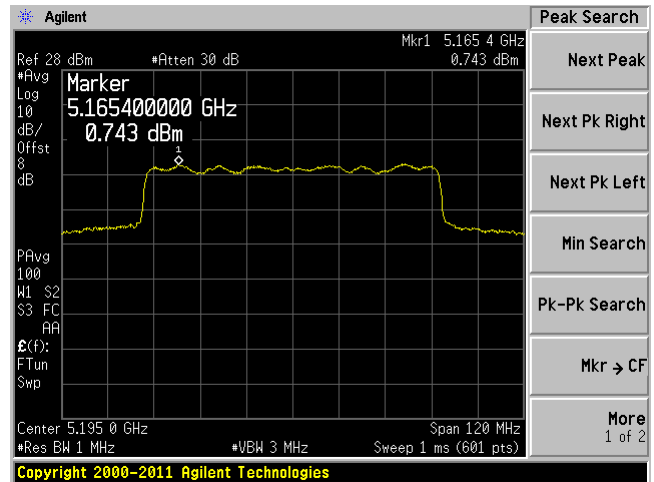

C3

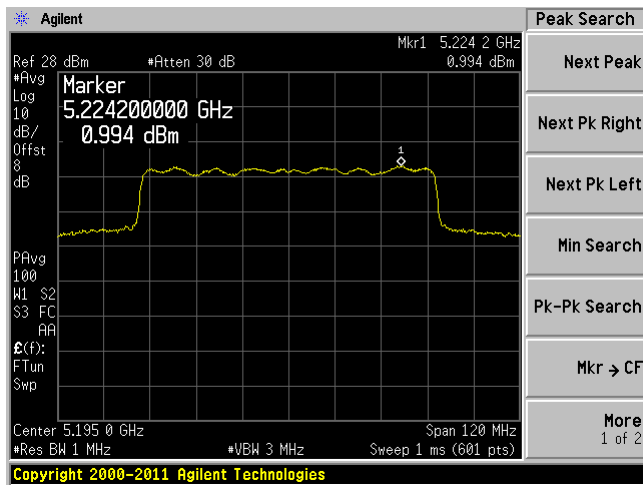

C4

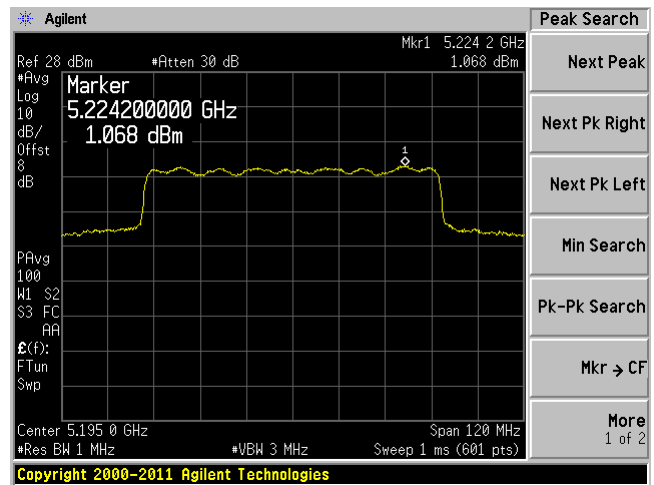

80 MHz bandwidth, Middle Channel, 5200 MHz

C1

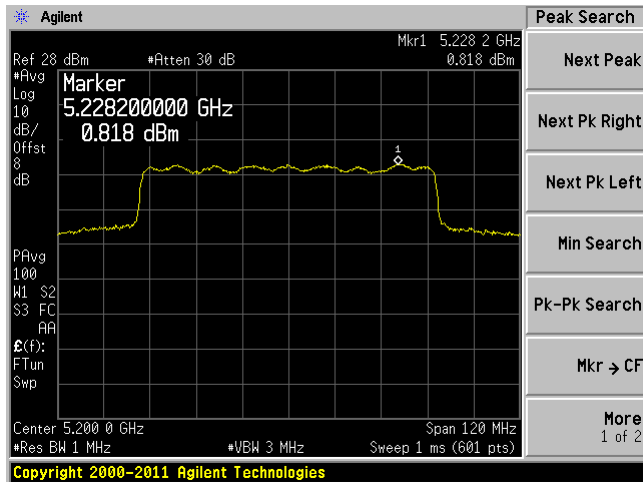

C2

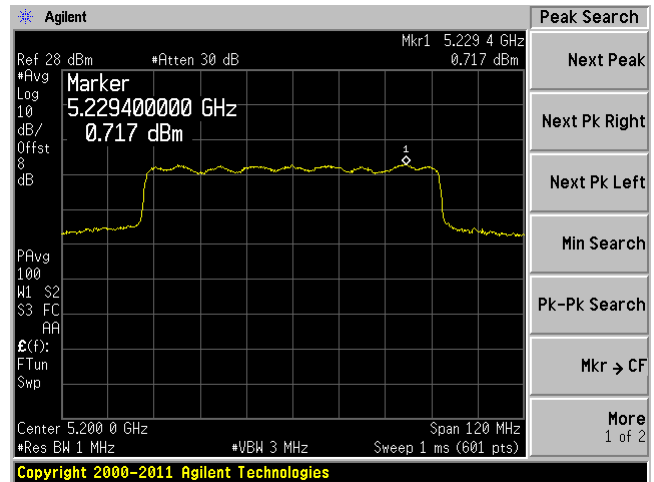

C3

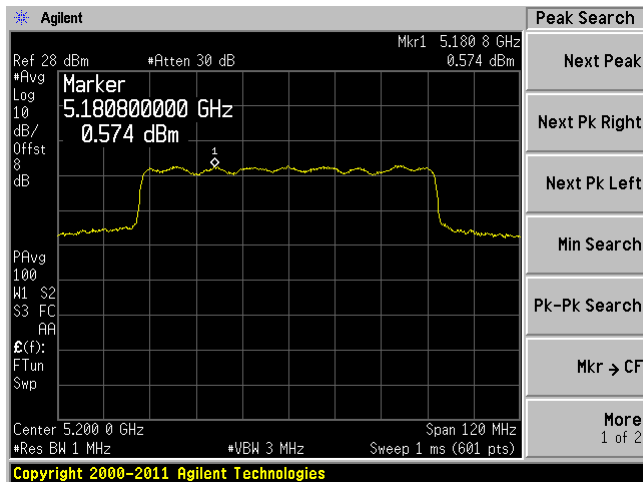

C4

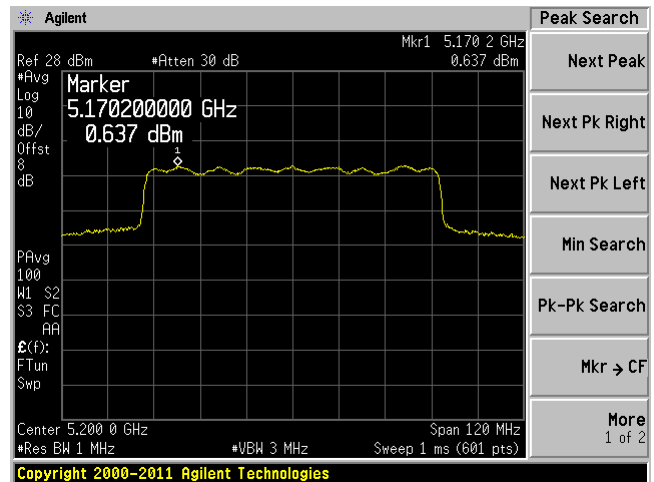

### 80 MHz bandwidth, High Channel, 5210 MHz

C1

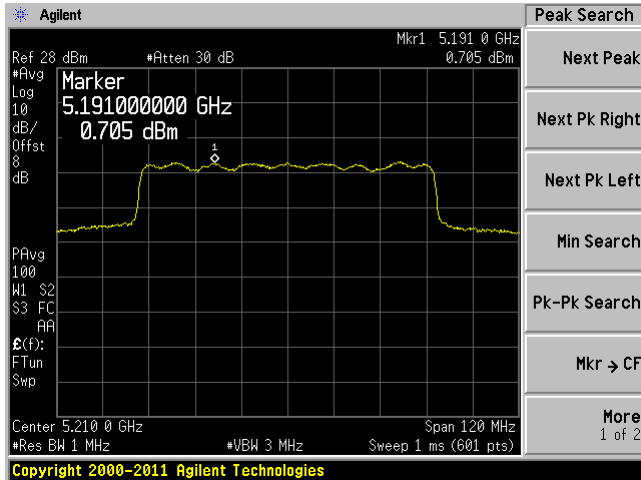

C2

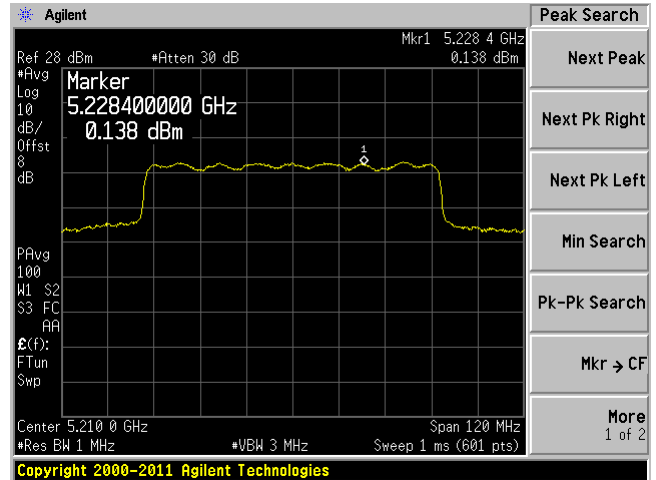

C3

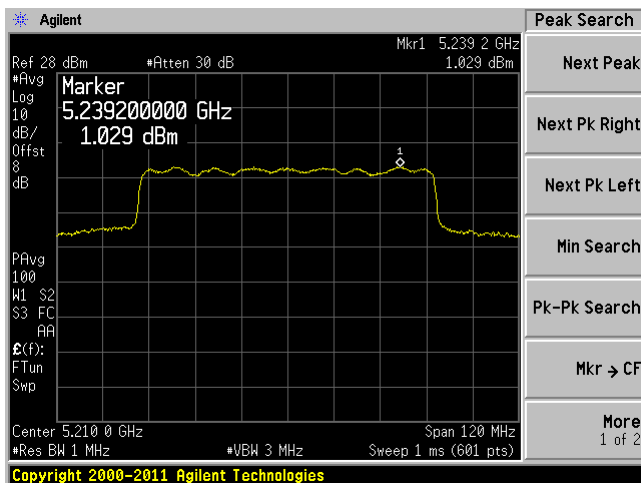

C4

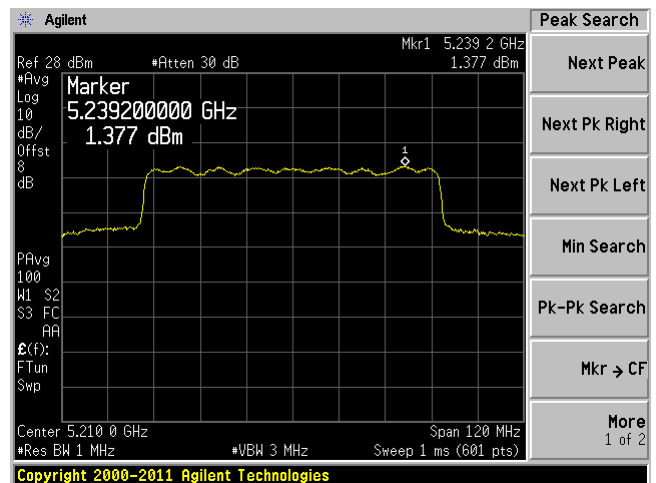

5.8 GHz Band:

20 MHz bandwidth, Low Channel, 5745 MHz

C1

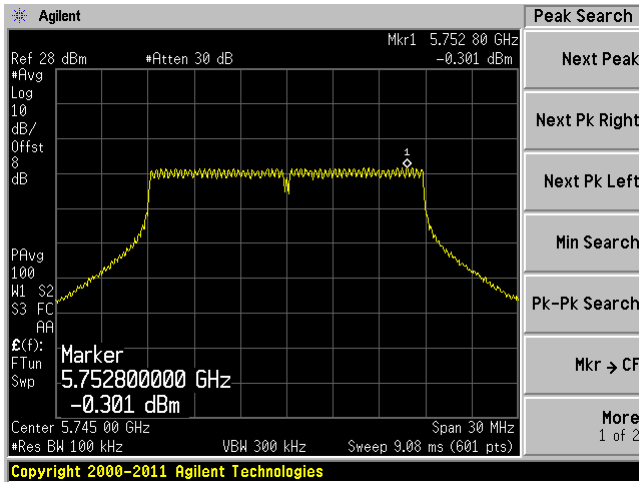

C2

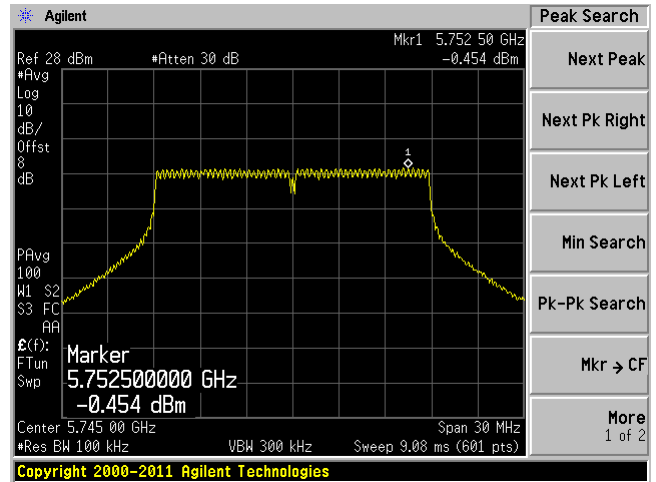

C3

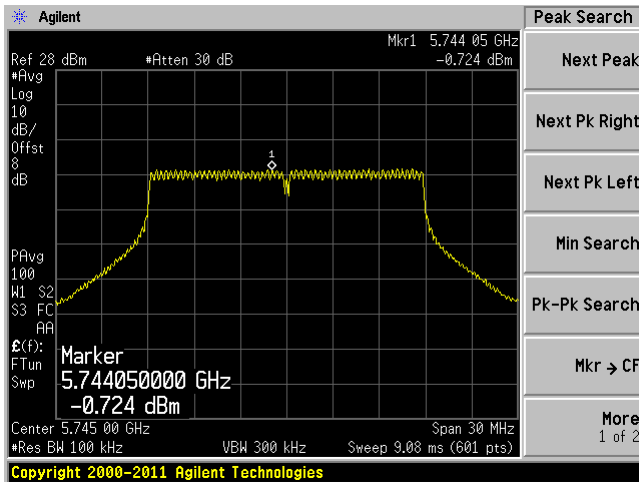

C4

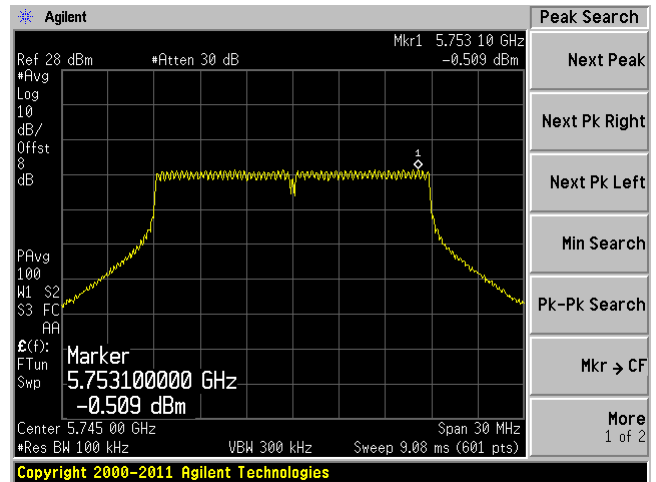



20 MHz bandwidth, Middle Channel, 5785 MHz

C1

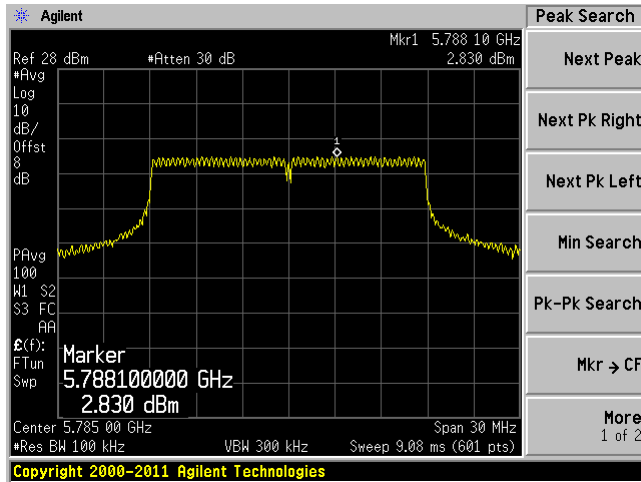

C2

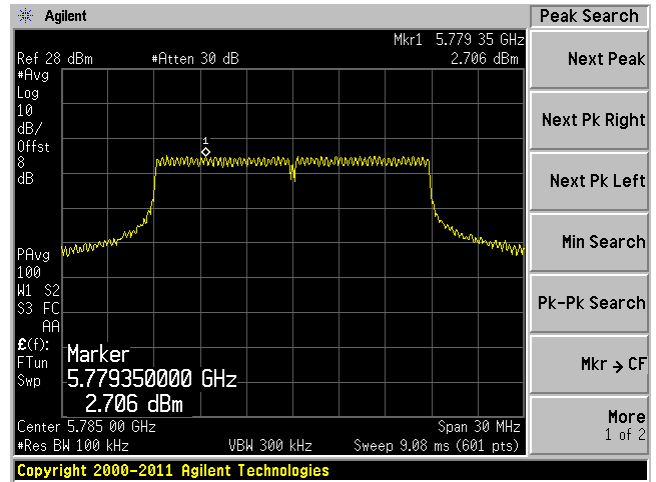

C3

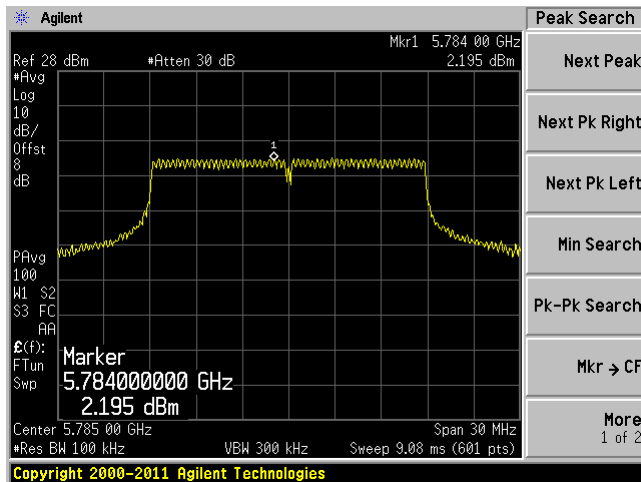

C4

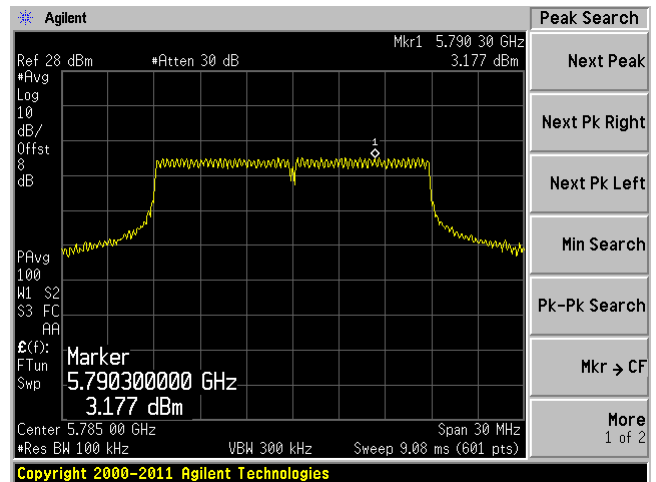

### 20 MHz bandwidth, High Channel, 5825 MHz

C1

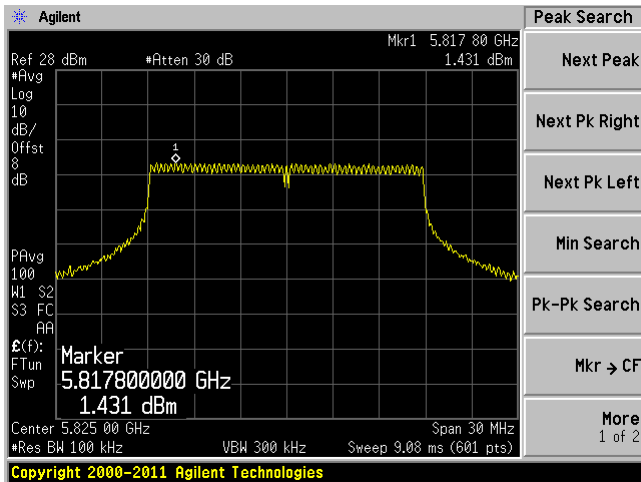

C2

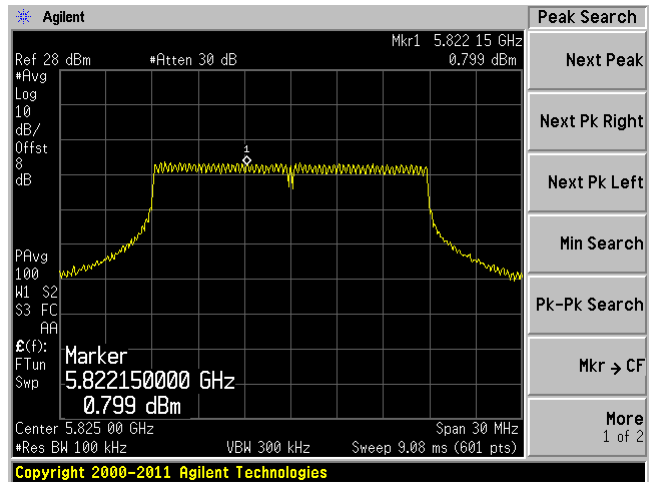

C3

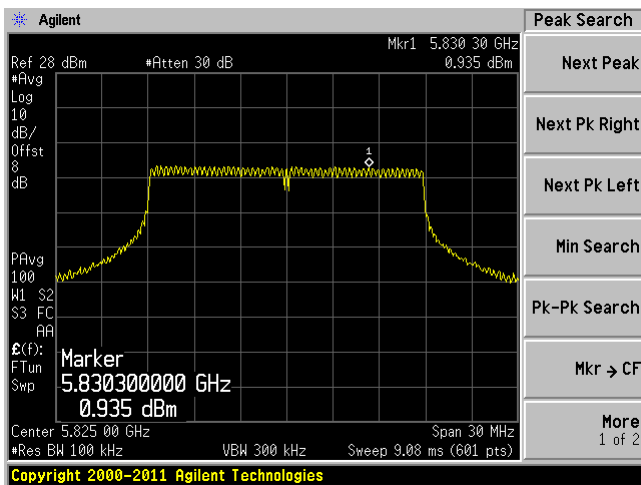

C4

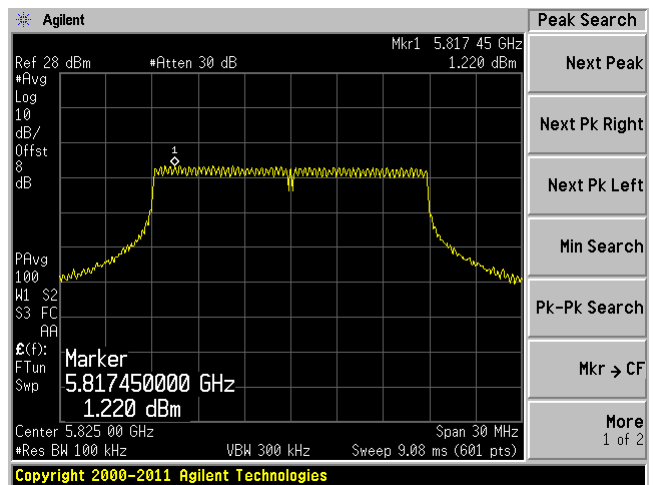

### 40 MHz bandwidth, Low Channel, 5755 MHz

C1

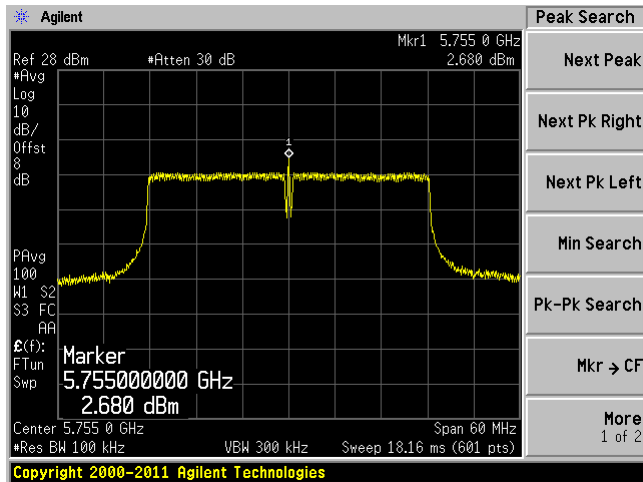

C2

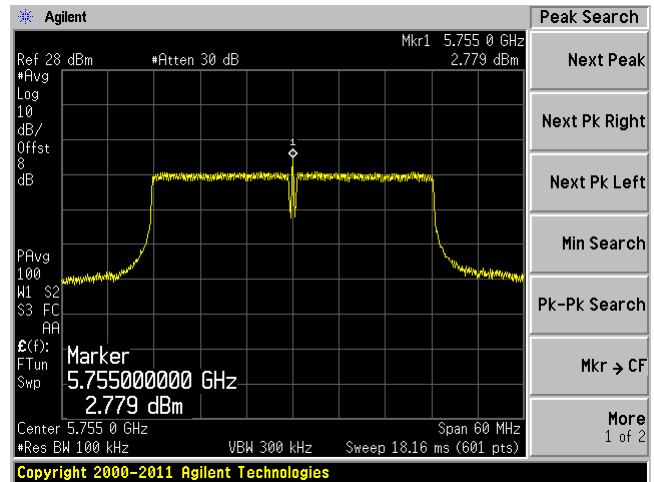

C3

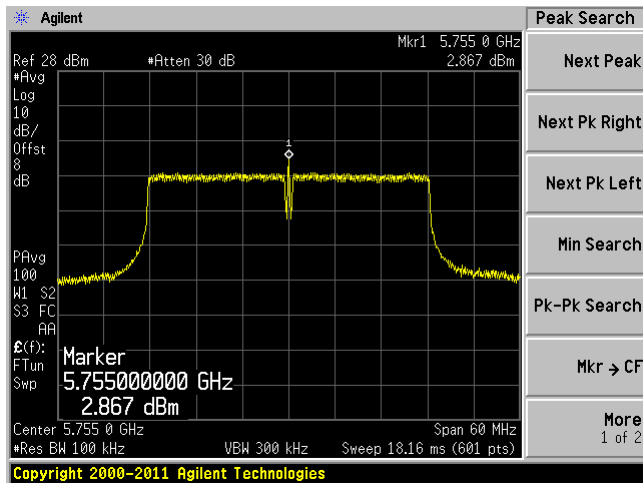

C4

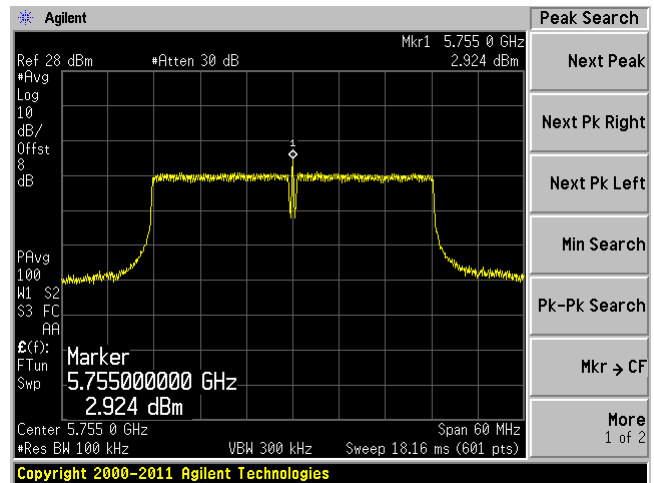

### 40 MHz bandwidth, Middle Channel, 5785 MHz

C1

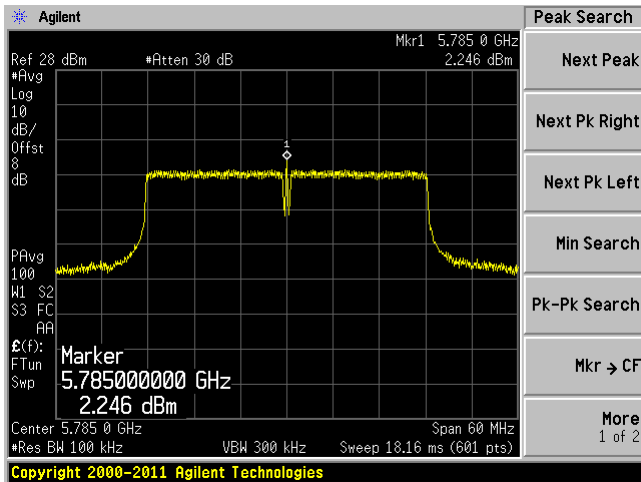

C2

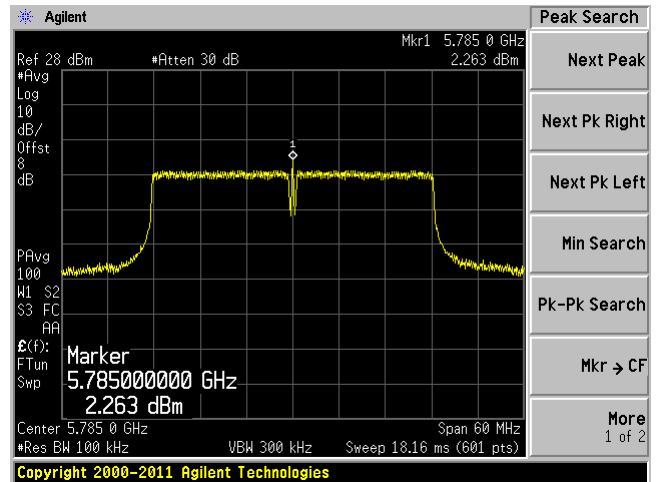

C3

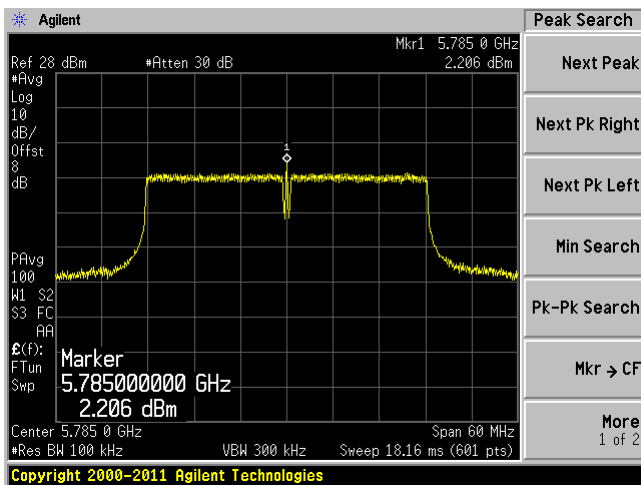

C4

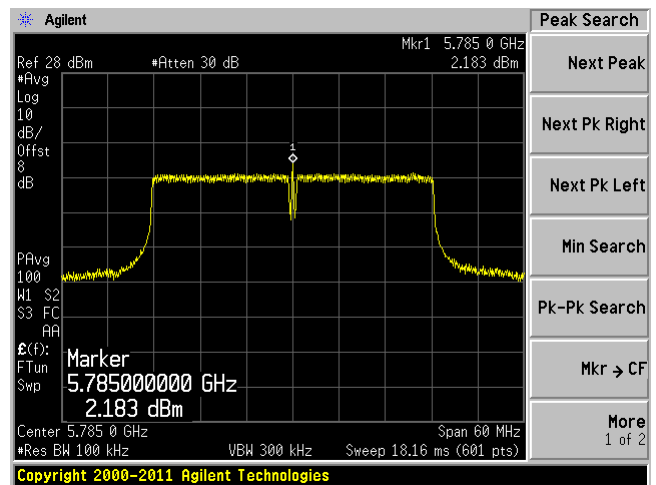

### 40 MHz bandwidth, High Channel, 5815 MHz

C1

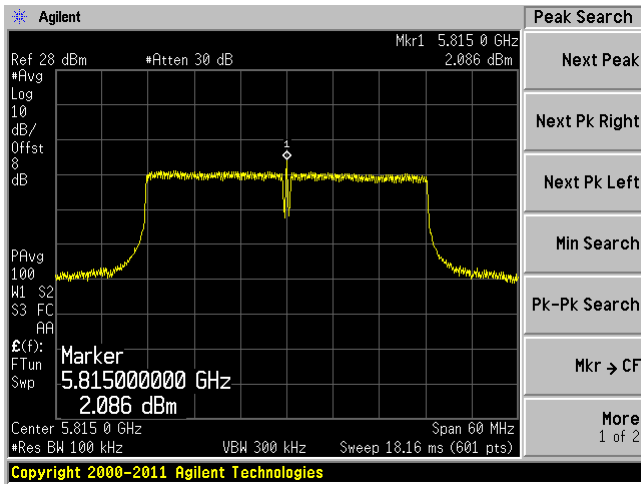

C2

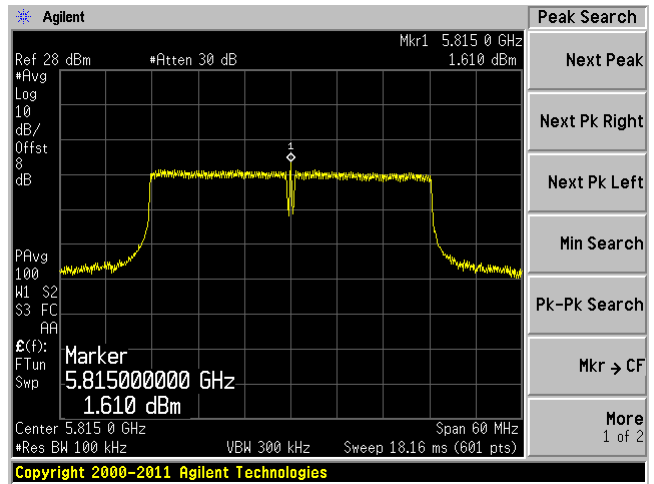

C3

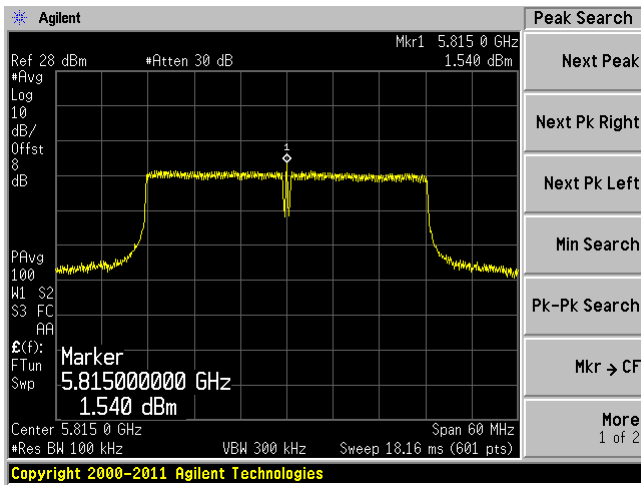

C4

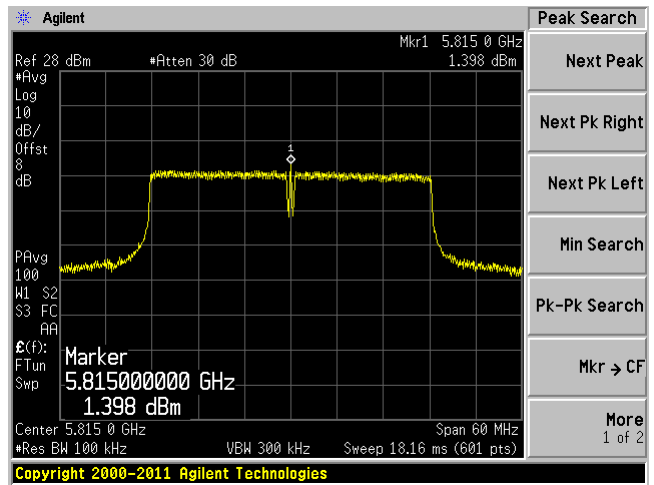

80 MHz bandwidth, Low Channel, 5775 MHz

C1

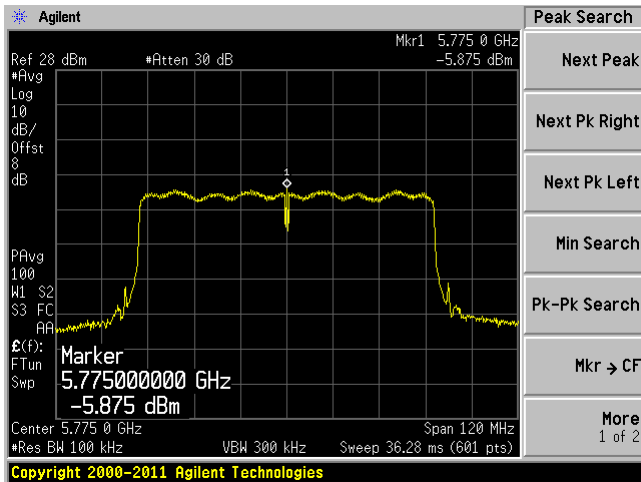

C2

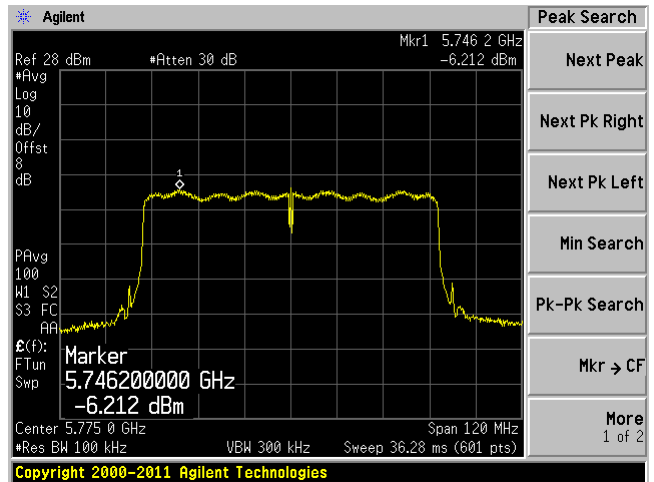

C3

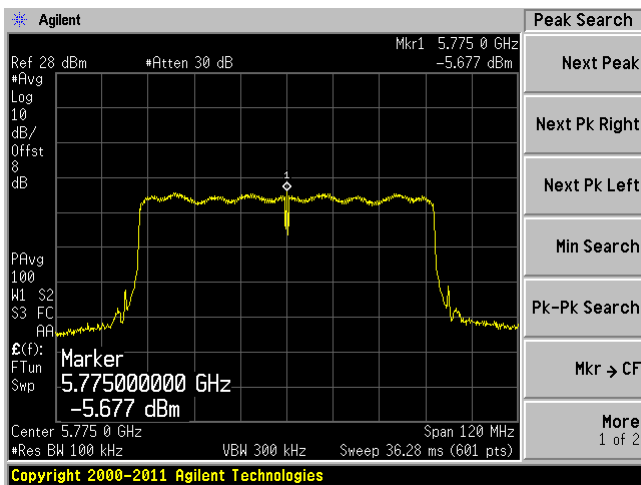

C4

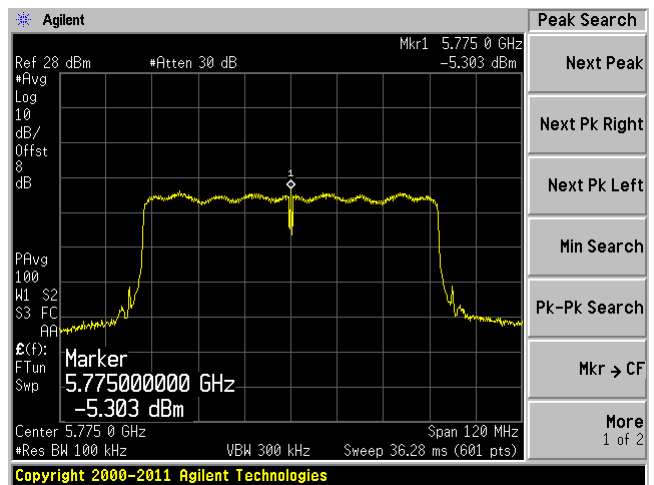

80 MHz bandwidth, Middle Channel, 5785 MHz

C1

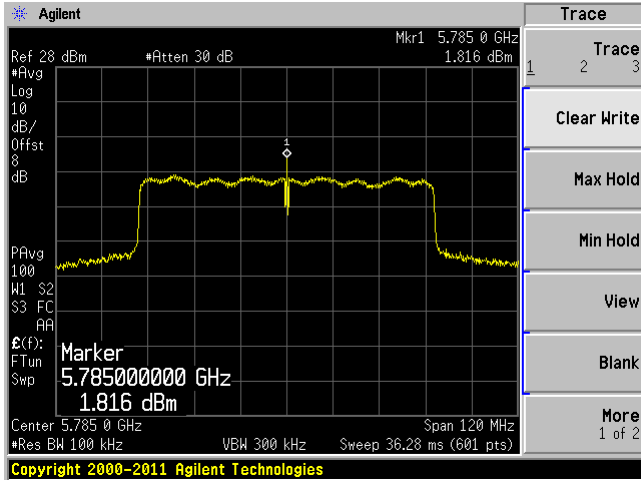

C2

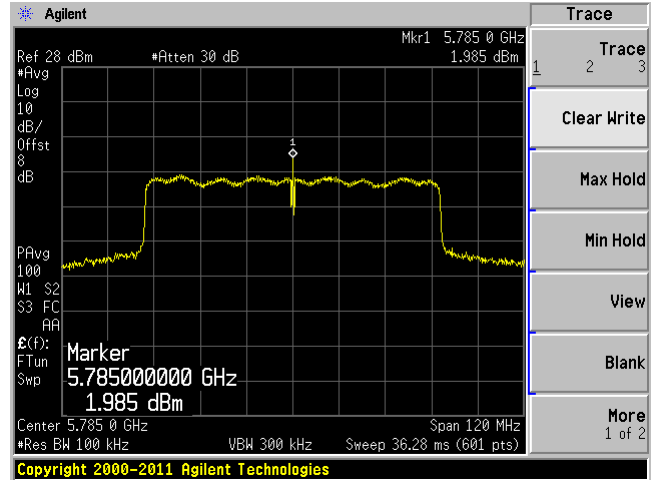

C3

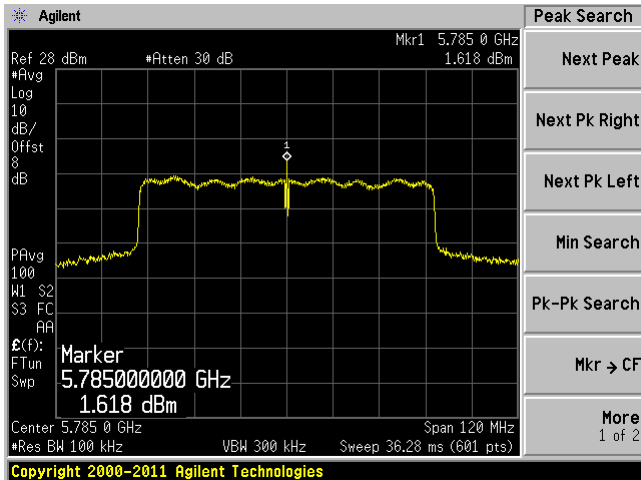

C4

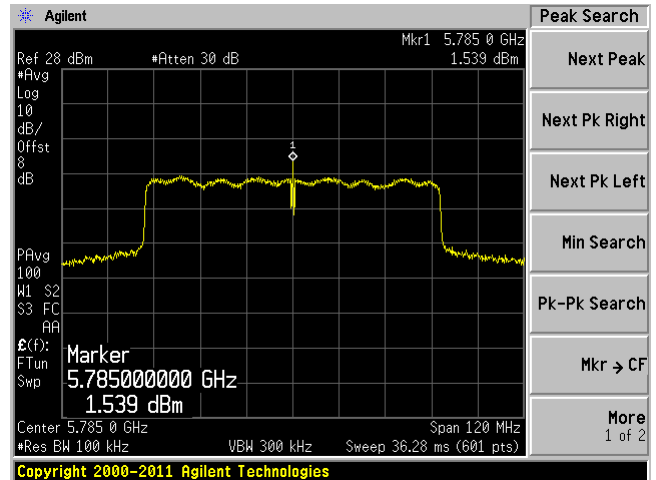

80 MHz bandwidth, High Channel, 5795 MHz

C1

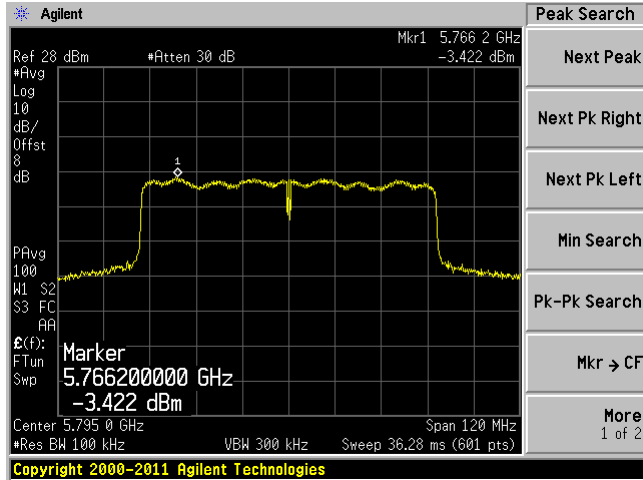

C2

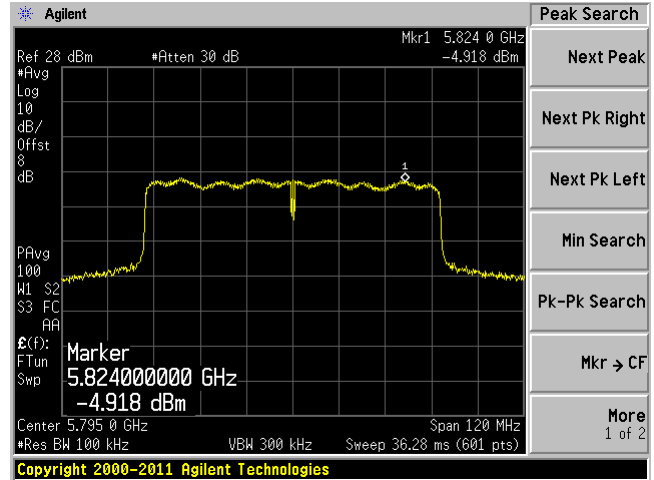

C3

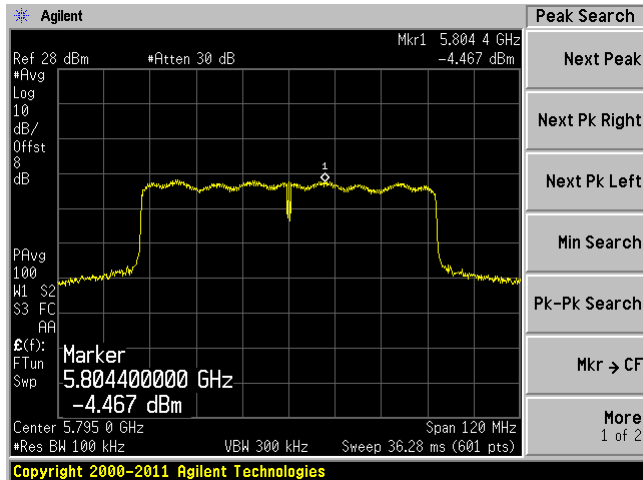

C4

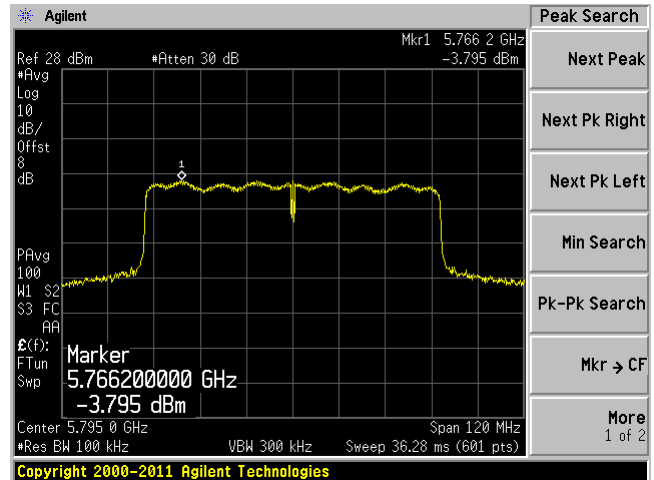



## 12 FCC §15.407(b) - Spurious Emissions at Antenna Terminals

### 12.1 Applicable Standard

#### According to FCC §15.407(b)

For transmitters operating in the 5.15-5.25 GHz band: All emissions outside of the 5.15-5.35 GHz band shall not exceed an e.i.r.p. of  $-27$  dBm/MHz.

For transmitters operating in the 5.25-5.35 GHz band: All emissions outside of the 5.15-5.35 GHz band shall not exceed an e.i.r.p. of  $-27$  dBm/MHz.

For transmitters operating in the 5.47-5.725 GHz band: All emissions outside of the 5.47-5.725 GHz band shall not exceed an e.i.r.p. of  $-27$  dBm/MHz.

For transmitters operating in the 5.725-5.85 GHz band: All emissions within the frequency range from the band edge to 10 MHz above or below the band edge shall not exceed an e.i.r.p. of  $-17$  dBm/MHz; for frequencies 10 MHz or greater above or below the band edge, emissions shall not exceed an e.i.r.p. of  $-27$  dBm/MHz.

### 12.2 Measurement Procedure

The measurements are base on FCC KDB 789033 D02 General UNII Test Procedures v01: Guidelines for Compliance Testing of Unlicensed National Information Infrastructure (U-NII) Devices section H: Unwanted emissions measurement

### 12.3 Test Equipment List and Details

Manufacturer	Description	Model No.	Serial No.	Calibration Date	Calibration Interval
Agilent	Spectrum Analyzer	E4446A	US44300386	2013-09-29	1 year

*Statement of Traceability: BACL Corp. attests that all calibrations have been performed per the A2LA requirements, traceable to the NIST.*

### 12.4 Test Environmental Conditions

<b>Temperature:</b>	22-24 °C
<b>Relative Humidity:</b>	42-45 %
<b>ATM Pressure:</b>	101-102 kPa

*The testing was performed by Cipher Chu on 2014-04-04 to 2014-04-07 at the RF Site*

### 12.5 Test Results

Please refer to following plots of spurious emissions.

Note: for the 30 MHz-6 GHz, the magin already covers the antenna gain 25dBi, and for the 6GHz-40GHz, there are all noise floors, there is no unwanted emission.

Note: Chain 1 and Chain 4 is Vertical, and Chain 2 and Chain 3 is Horizontal

Note: C1, C2, C3 and C4 stands for Chain1, Chain 2, Chain 3 and Chain 4.

25 dBi Antenna

5.2 GHz Band:

20 MHz bandwidth, Low Channel, 5165 MHz

C1 30 MHz-6 GHz

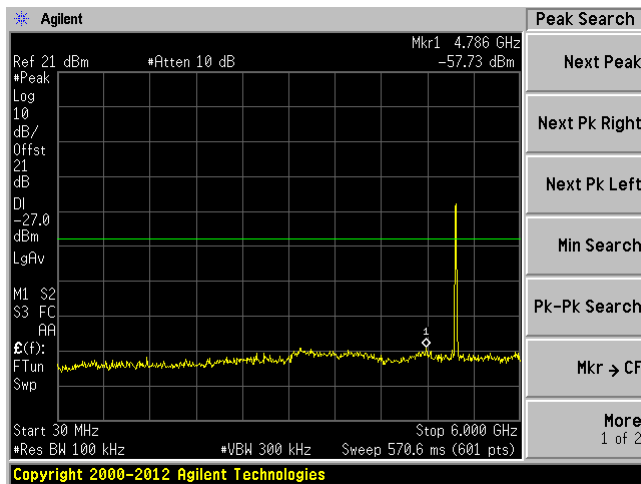

C1 6 GHz-40 GHz

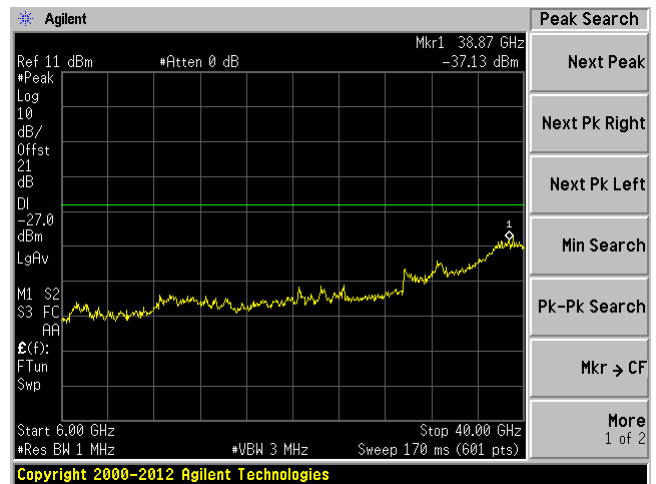

C2 30 MHz-6 GHz

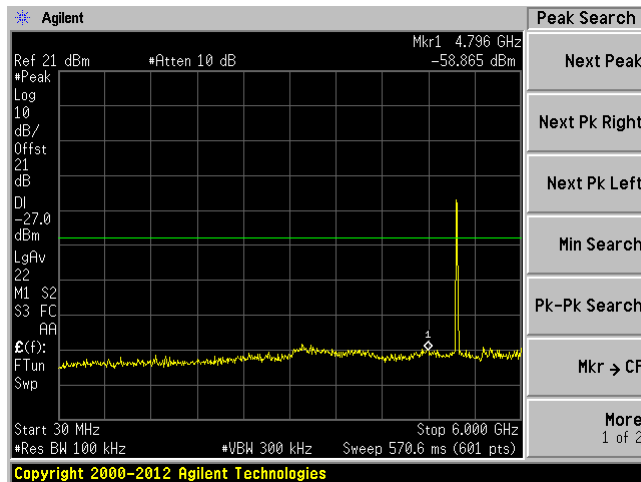

C2 6 GHz-40 GHz

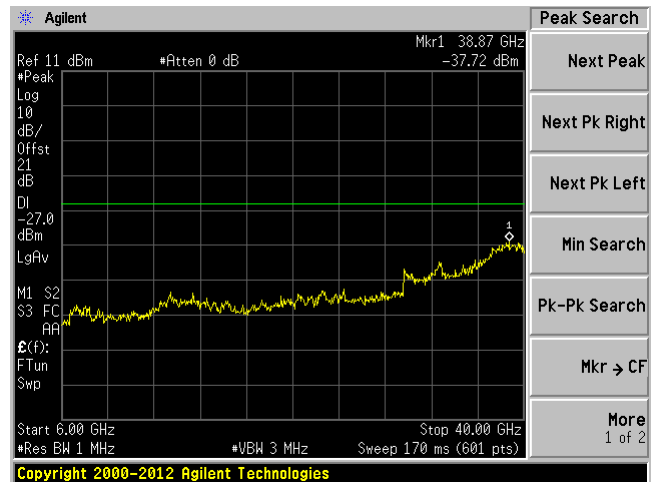

### C3 30 MHz-6 GHz

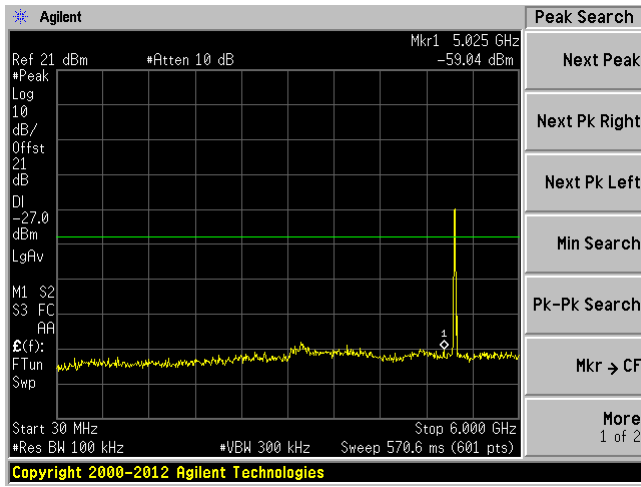

### C3 6 GHz-40 GHz

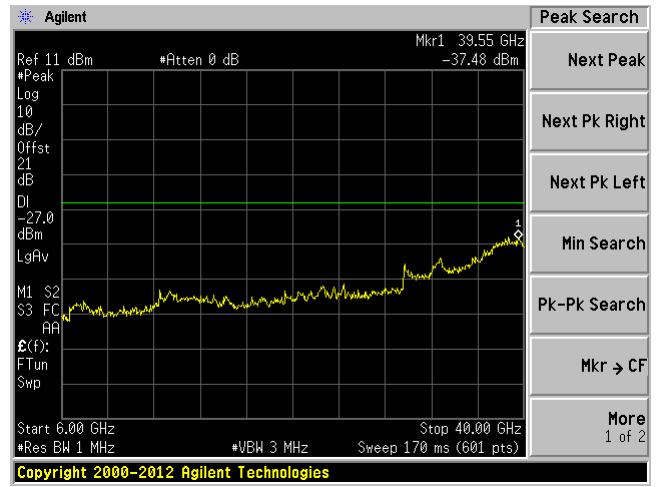

### C4 30 MHz-6 GHz

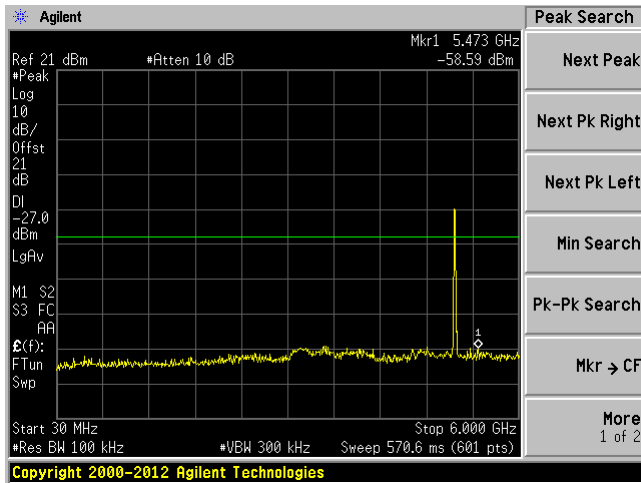

### C4 6 GHz-40 GHz

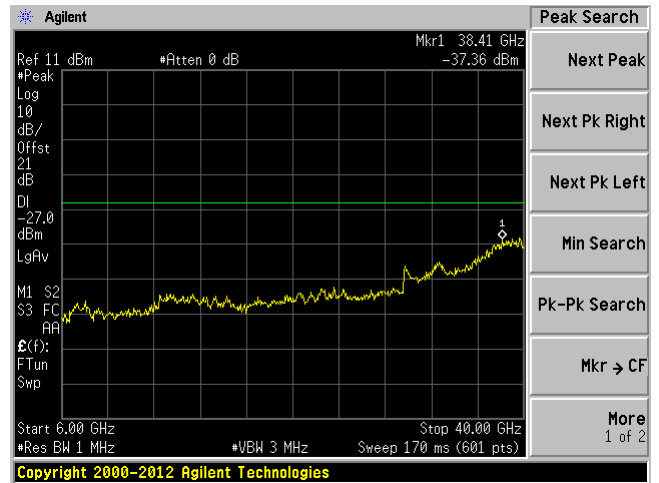

20 MHz bandwidth, Middle Channel, 5200 MHz

C1 30 MHz-6 GHz

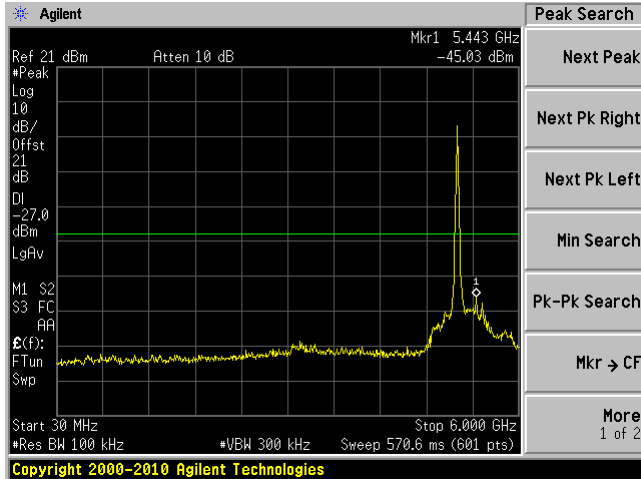

C1 6 GHz-40 GHz

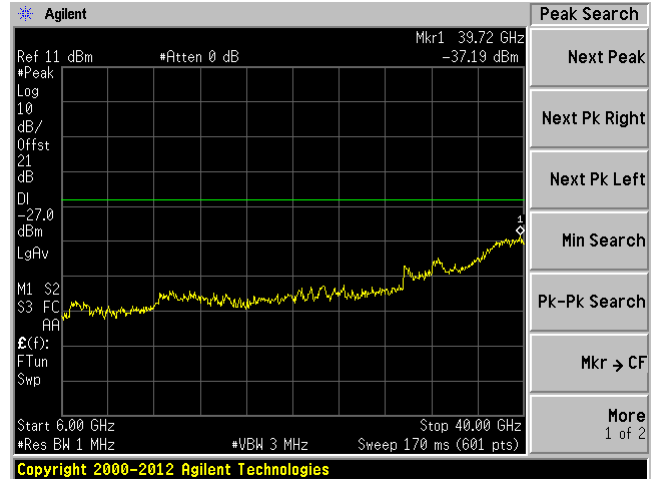

C2 30 MHz-6 GHz

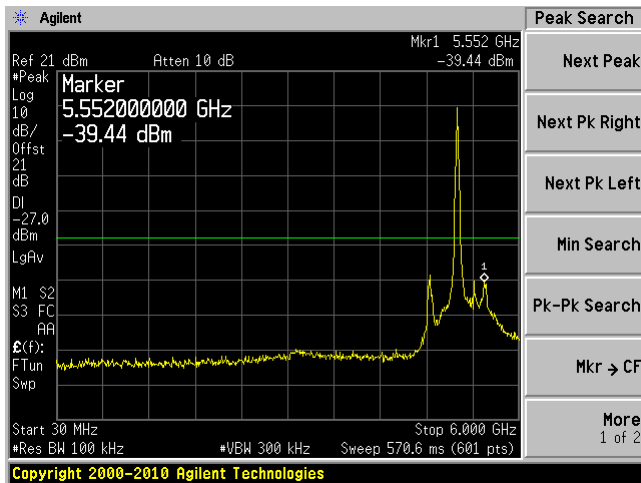

C2 6 GHz-40 GHz

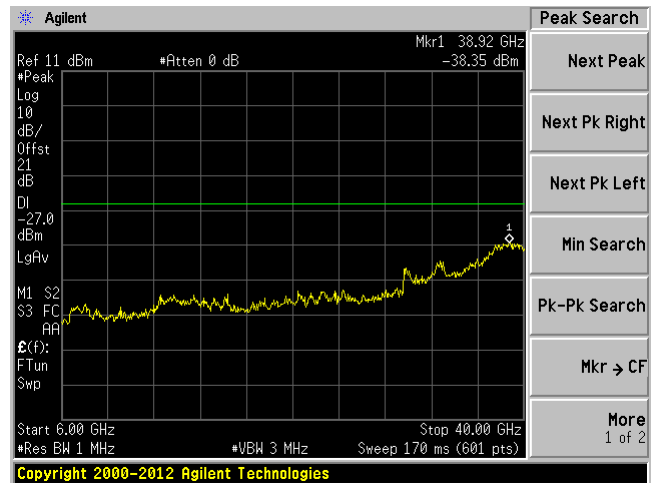

**C3 30 MHz-6 GHz**

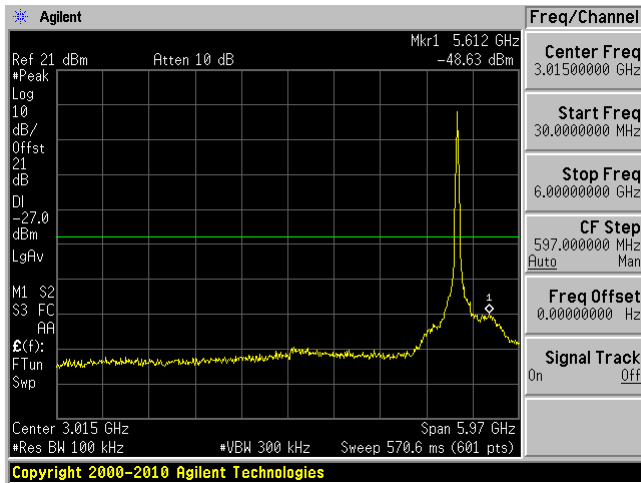

**C3 6 GHz-40 GHz**

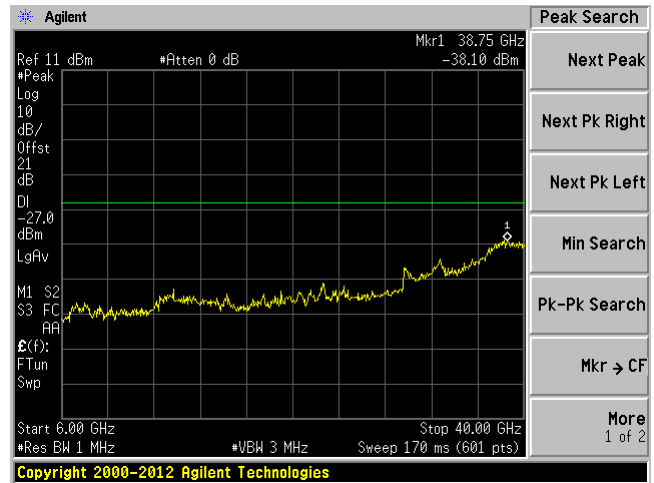

**C4 30 MHz-6 GHz**

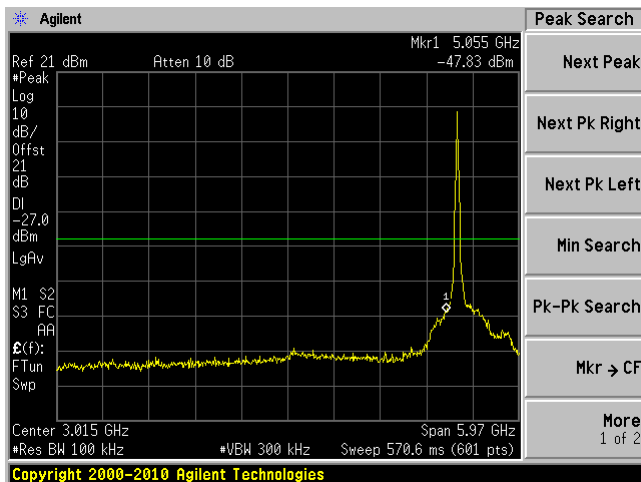

**C4 6 GHz-40 GHz**

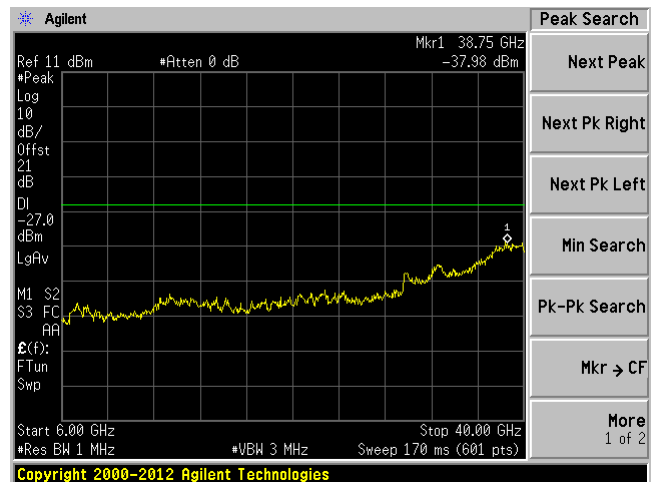

20 MHz bandwidth, High Channel, 5240 MHz

C1 30 MHz-6 GHz

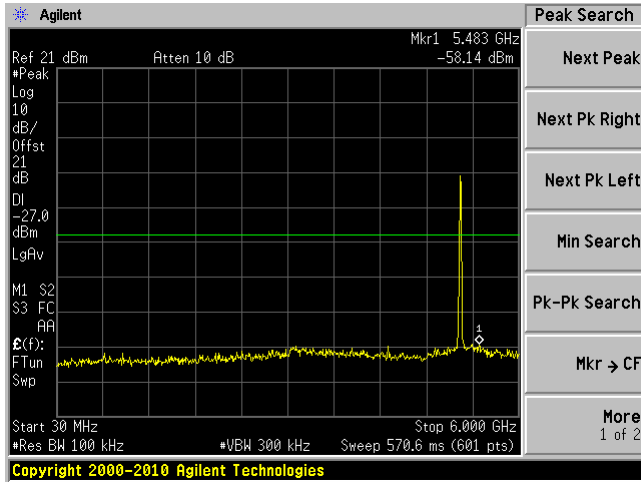

C1 6 GHz-40 GHz

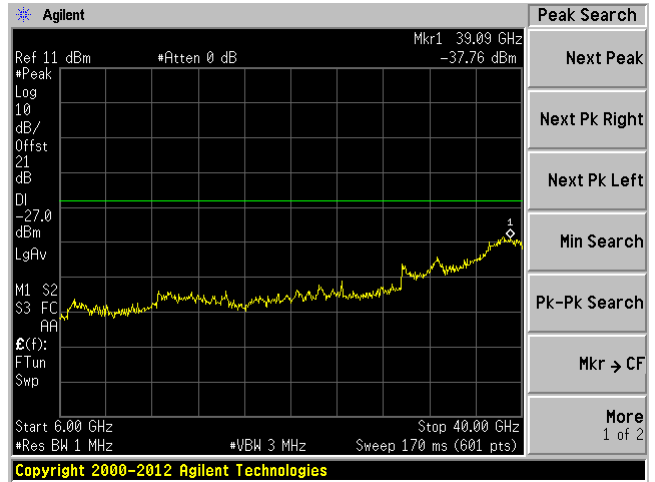

C2 30 MHz-6 GHz

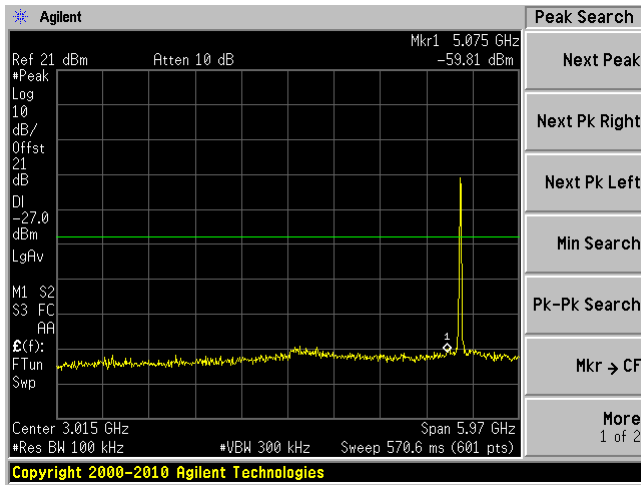

C2 6 GHz-40 GHz

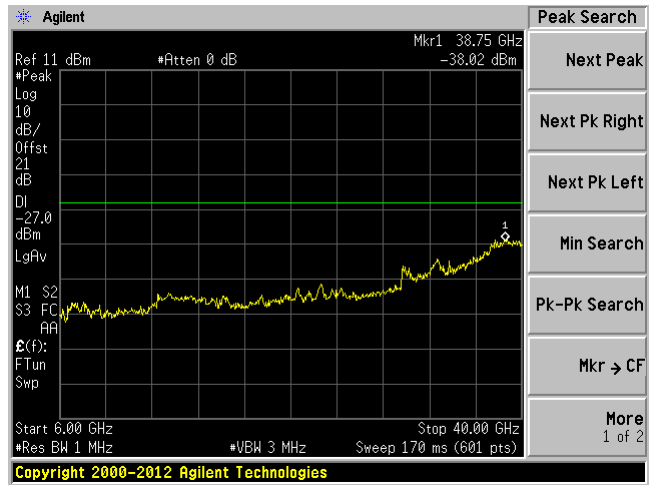

### C3 30 MHz-6 GHz

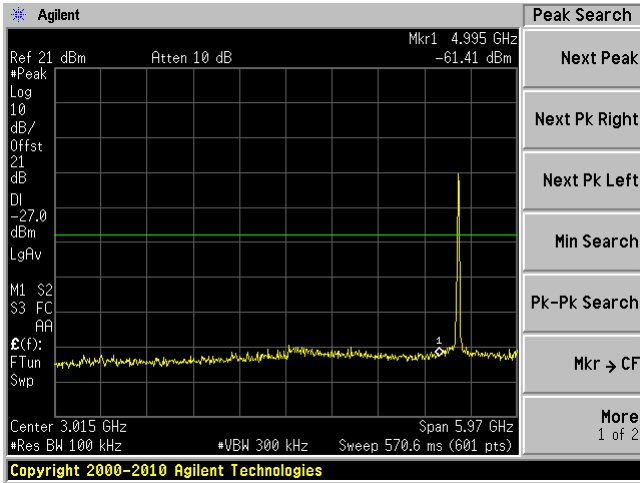

### C3 6 GHz-40 GHz

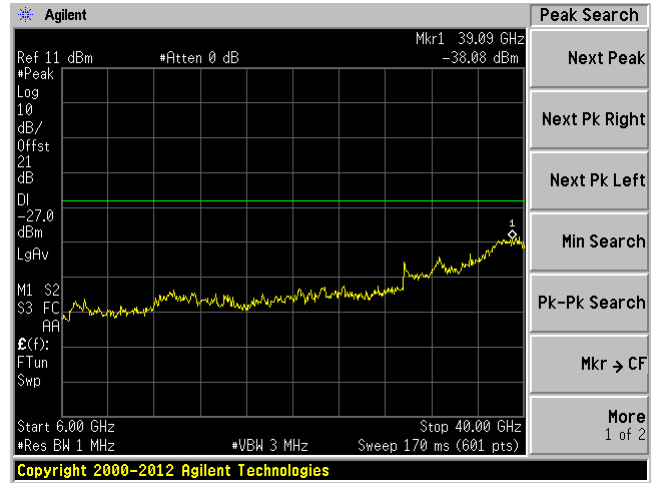

### C4 30 MHz-6 GHz

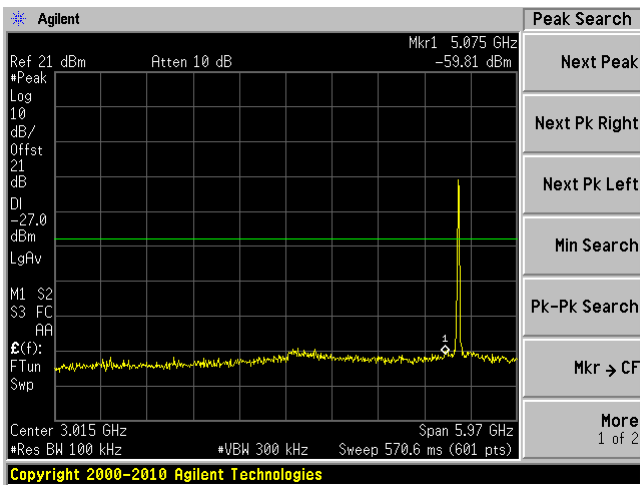

### C4 6 GHz-40 GHz

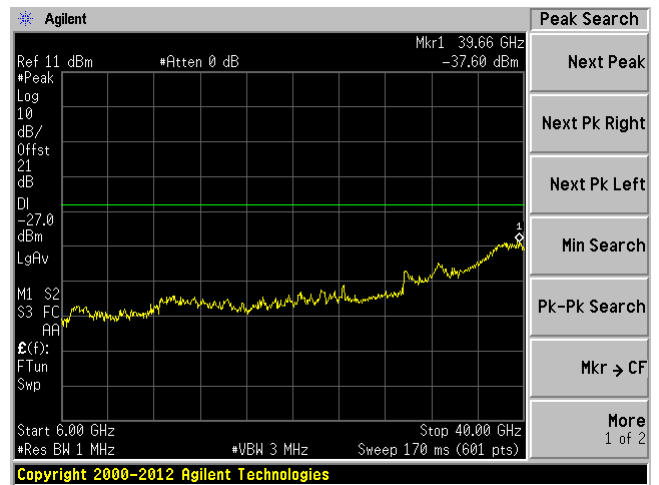

40 MHz bandwidth, Low Channel, 5175 MHz

C1 30 MHz-6 GHz

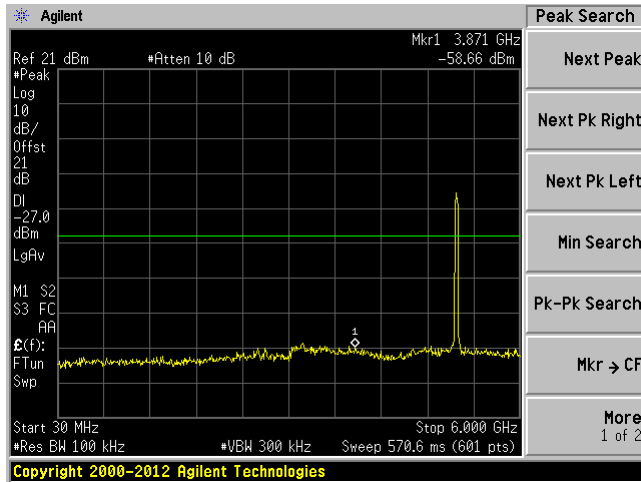

C1 6 GHz-40 GHz

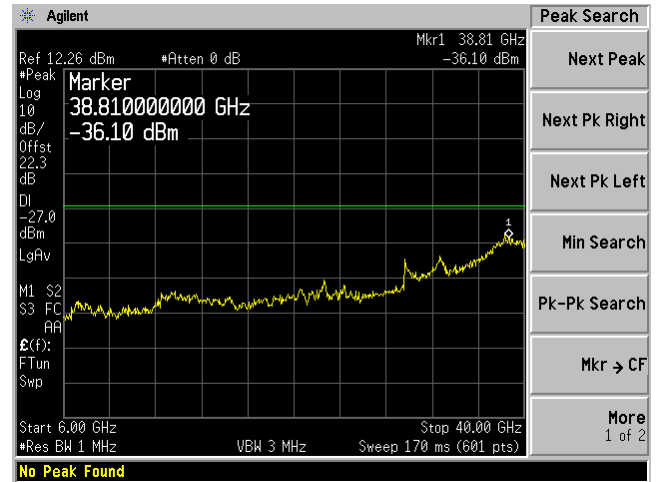

C2 30 MHz-6 GHz

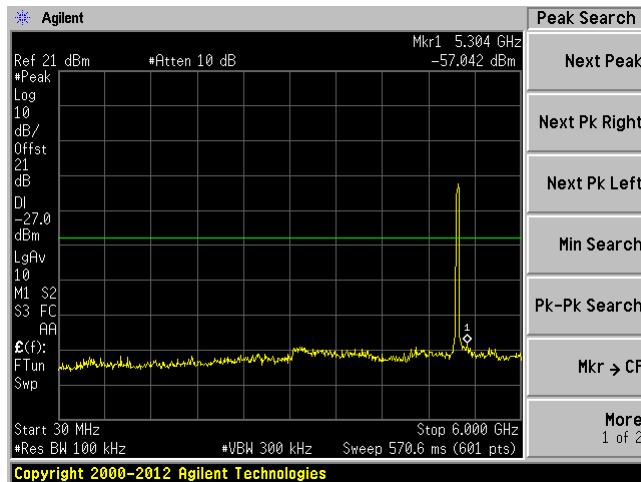

C2 6 GHz-40 GHz

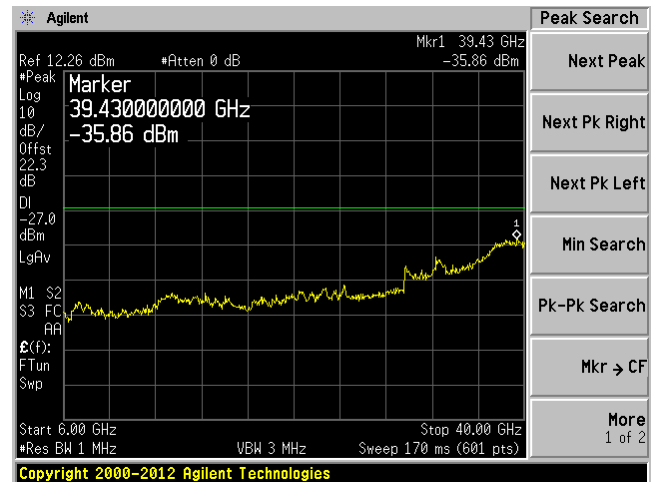



**C3 30 MHz-6 GHz**

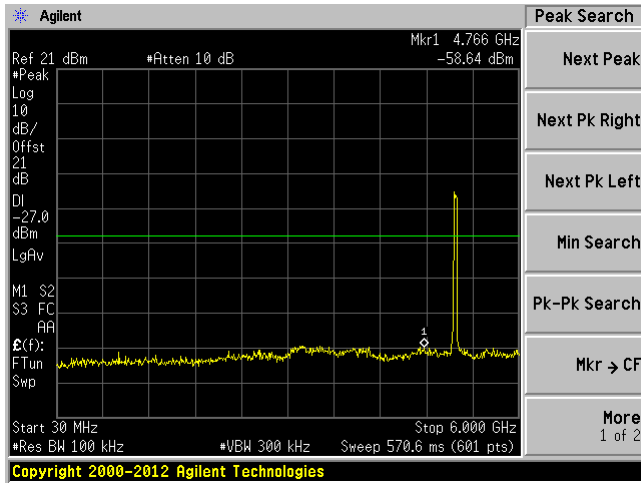

**C3 6 GHz-40 GHz**

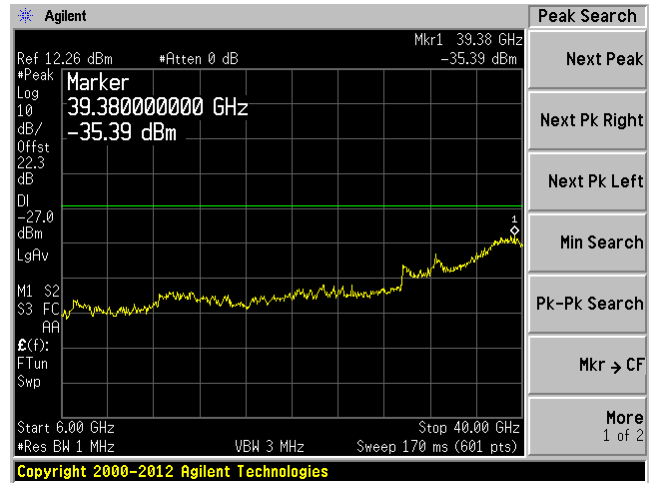

**C4 30 MHz-6 GHz**

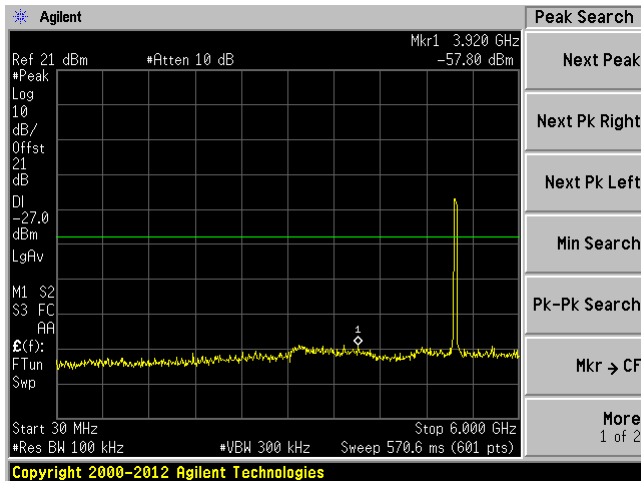

**C4 6 GHz-40 GHz**

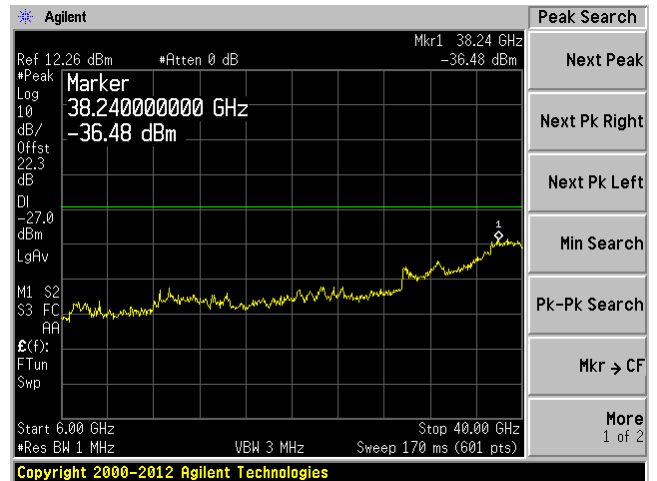

40 MHz bandwidth, Middle Channel, 5200 MHz

C1 30 MHz-6 GHz

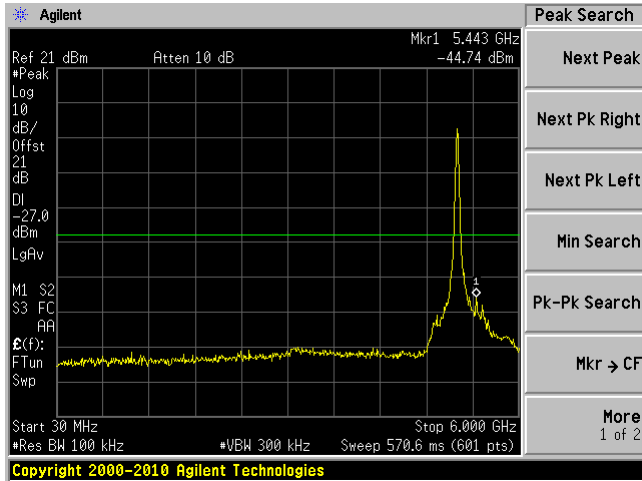

C1 6 GHz-40 GHz



C2 30 MHz-6 GHz

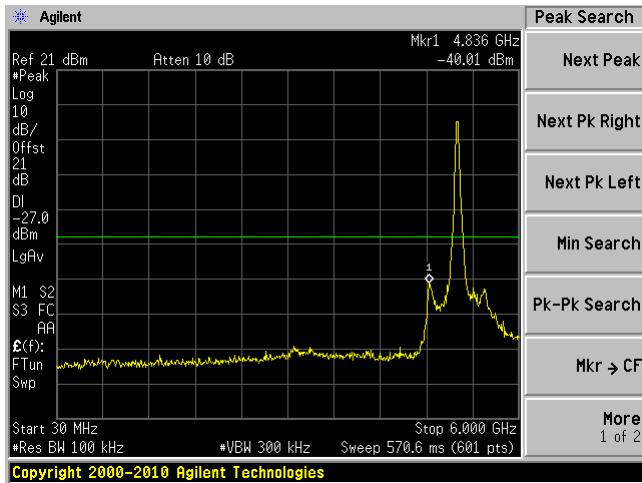

C2 6 GHz-40 GHz

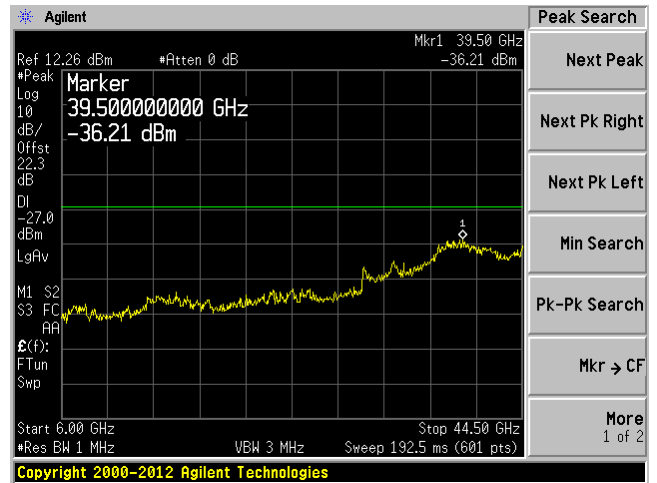

**C3 30 MHz-6 GHz**

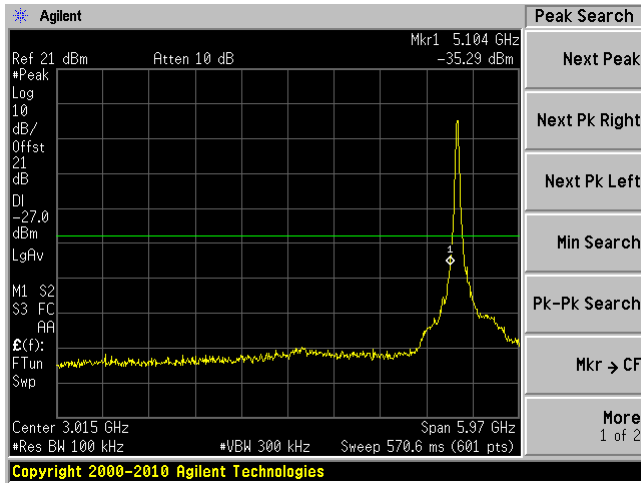

**C3 6 GHz-40 GHz**

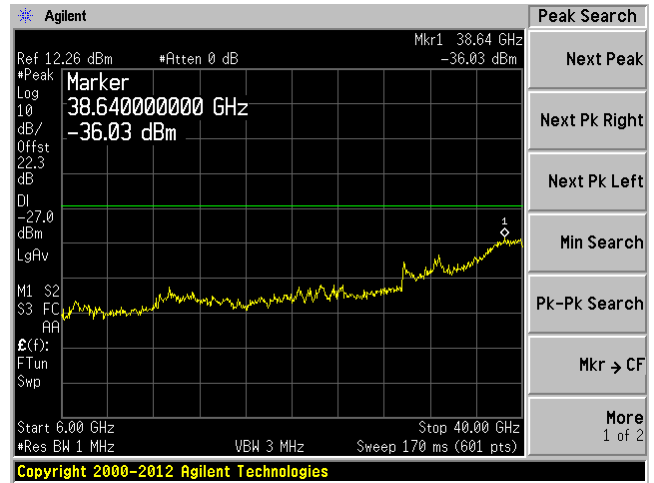

**C4 30 MHz-6 GHz**

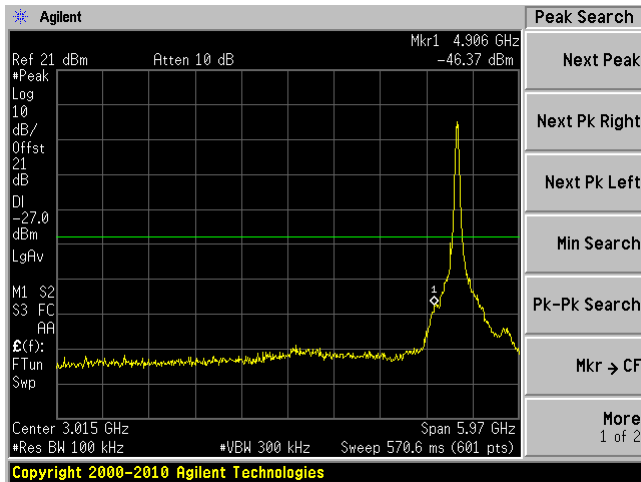

**C4 6 GHz-40 GHz**

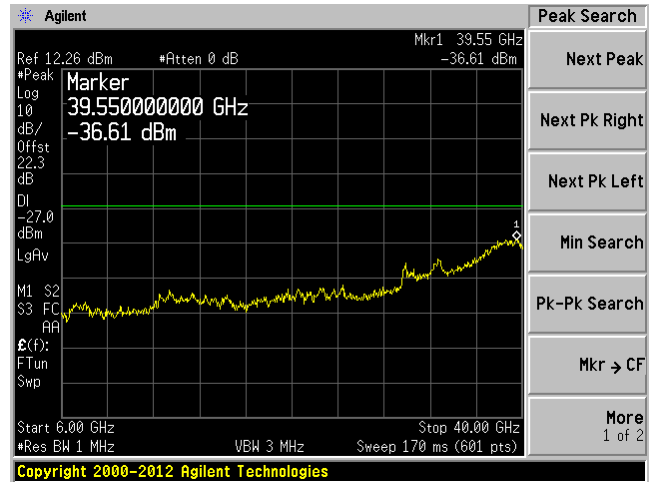

40 MHz bandwidth, High Channel, 5230 MHz

C1 30 MHz-6 GHz

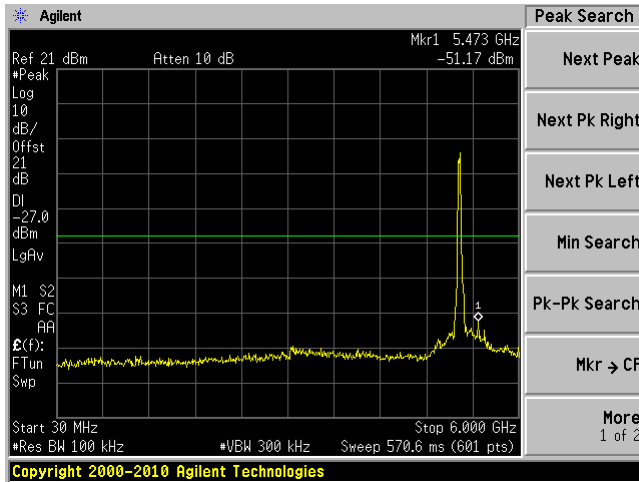

C1 6 GHz-40 GHz

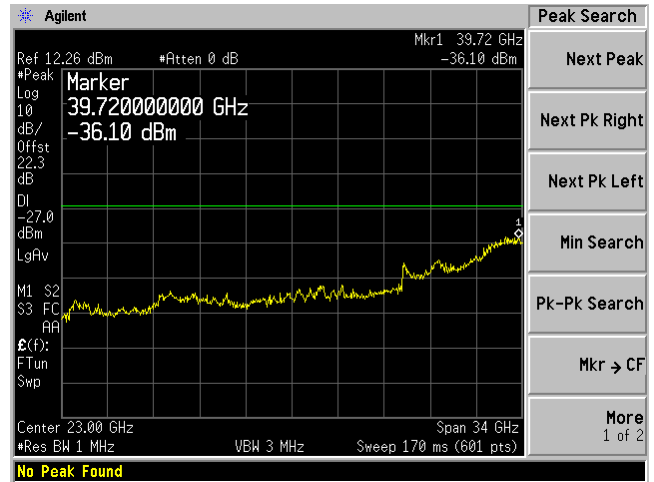

C2 30 MHz-6 GHz

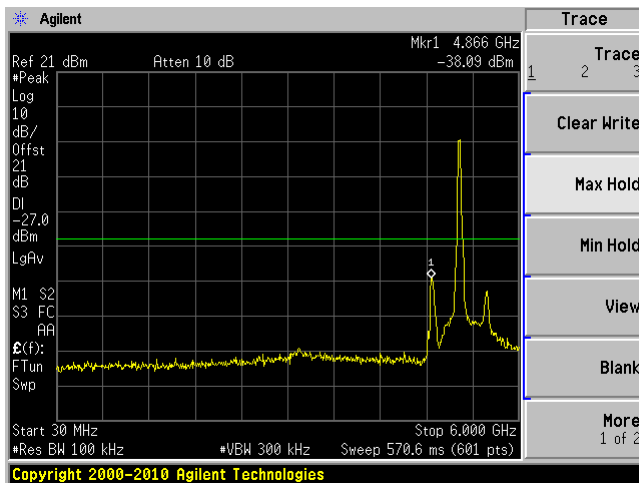

C2 6 GHz-40 GHz

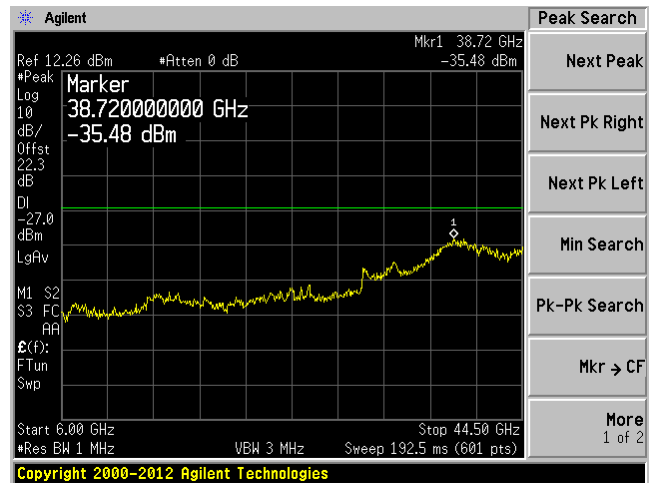

**C3 30 MHz-6 GHz**

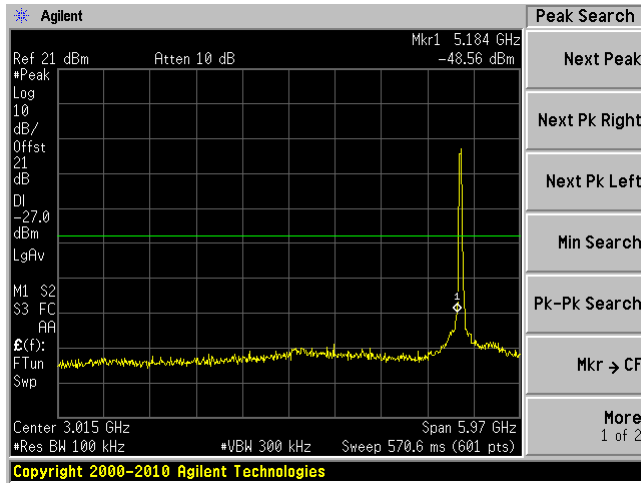

**C3 6 GHz-40 GHz**

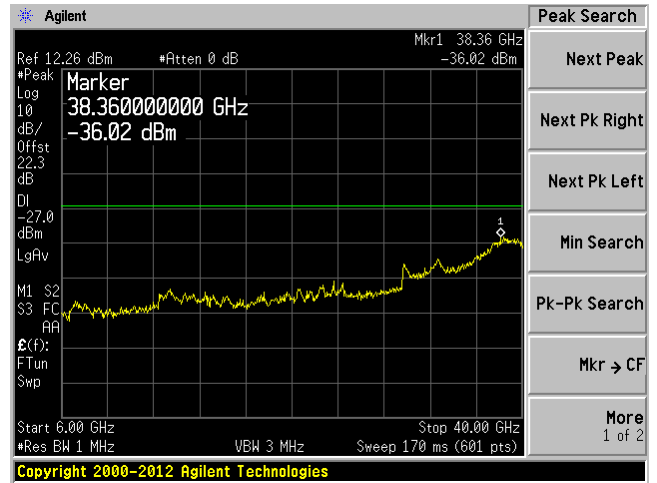

**C4 30 MHz-6 GHz**

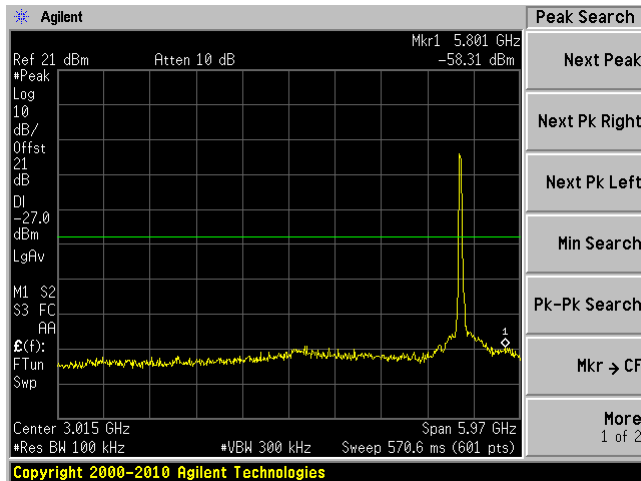

**C4 6 GHz-40 GHz**

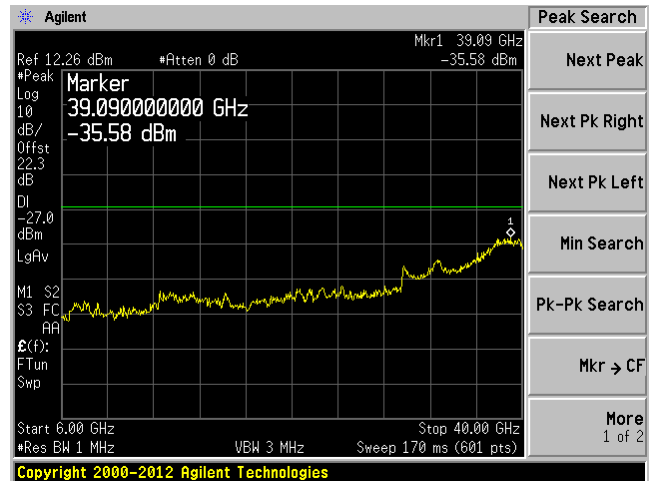

80 MHz bandwidth, Low Channel, 5195 MHz

C1 30 MHz-6 GHz

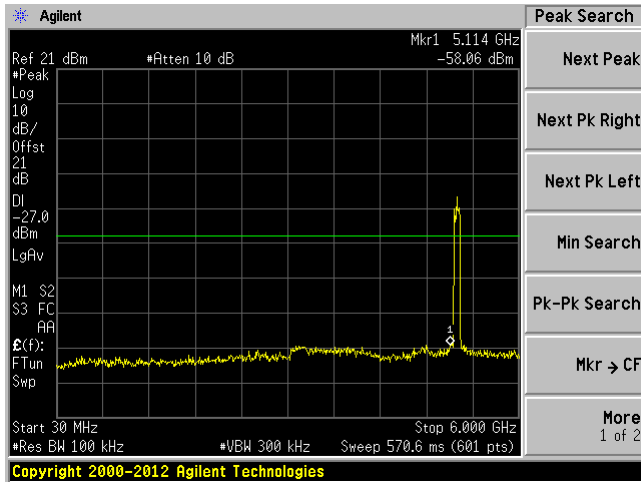

C1 6 GHz-40 GHz

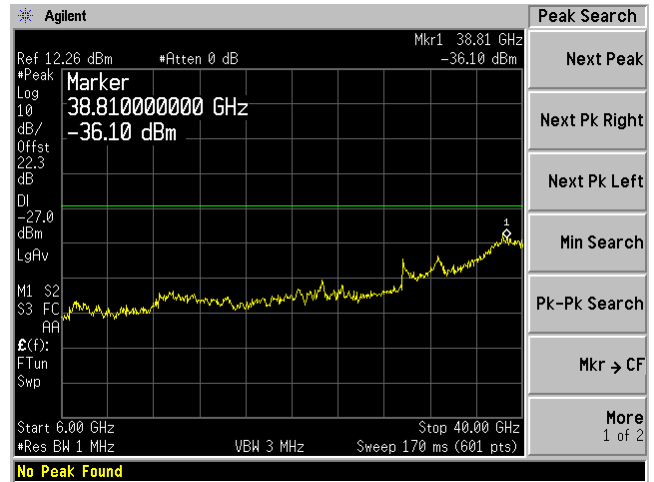

C2 30 MHz-6 GHz

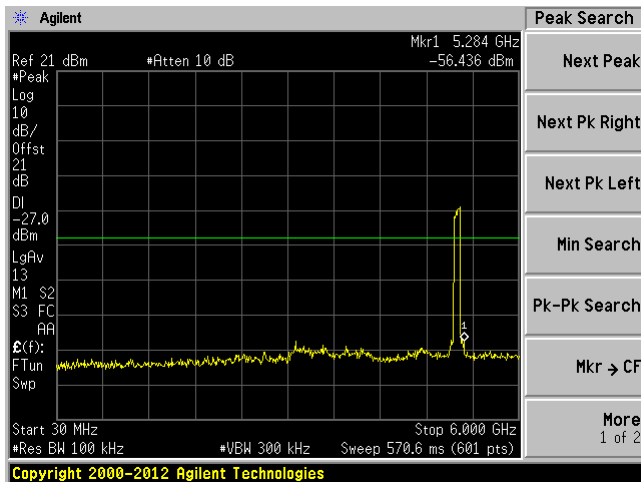

C2 6 GHz-40 GHz

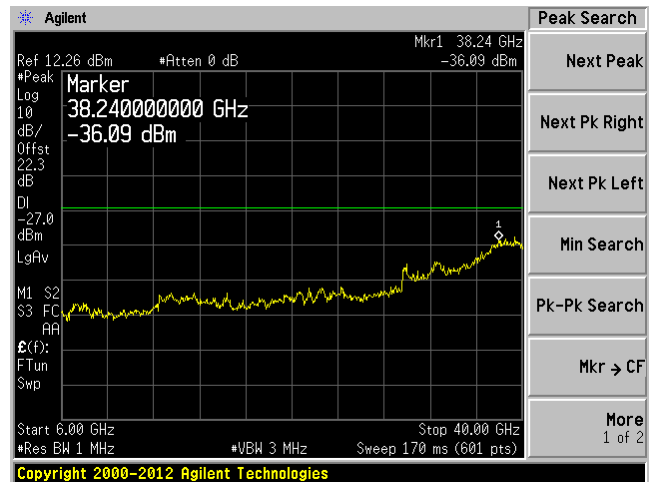

### C3 30 MHz-6 GHz

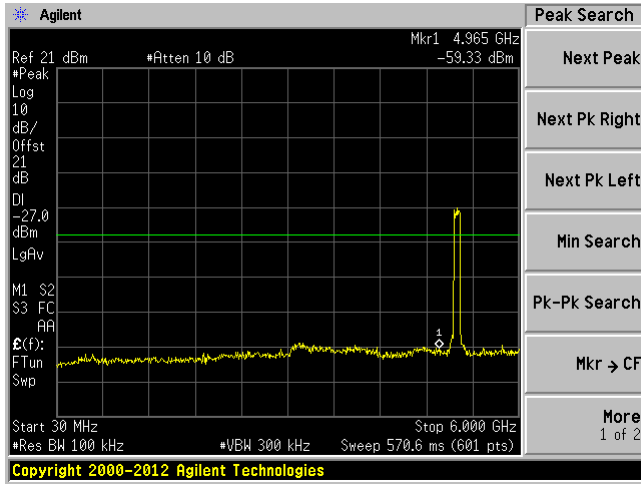

### C3 6 GHz-40 GHz

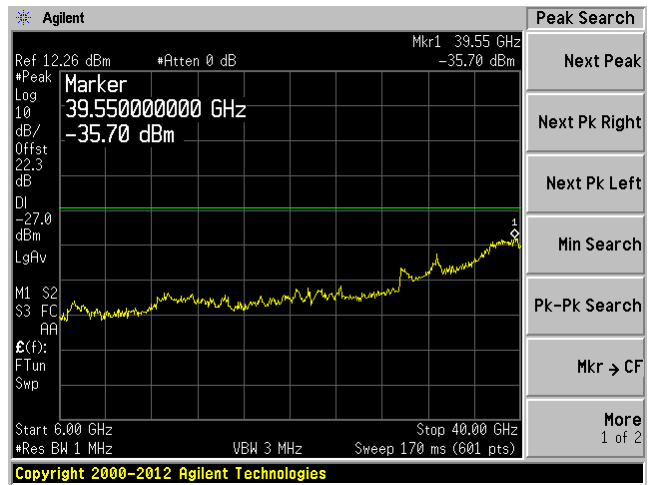

### C4 30 MHz-6 GHz

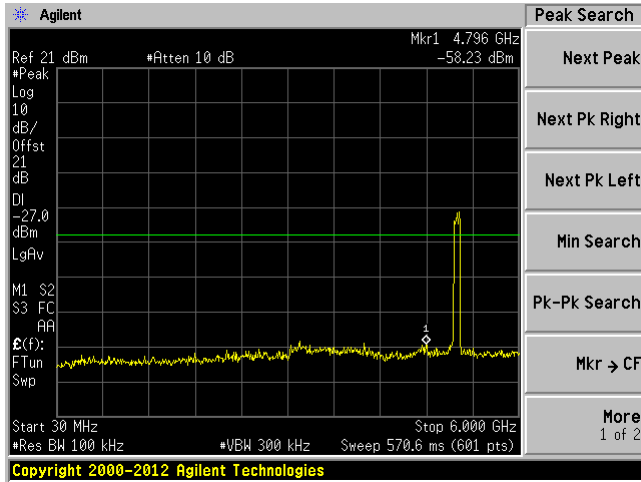

### C4 6 GHz-40 GHz

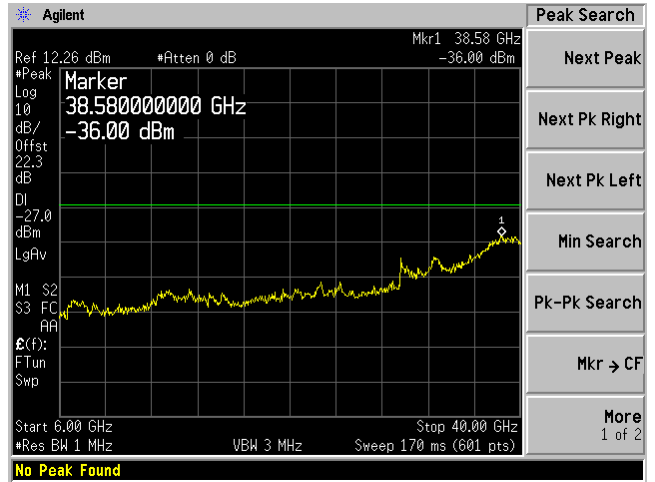

80 MHz bandwidth, Middle Channel, 5200 MHz

C1 30 MHz-6 GHz

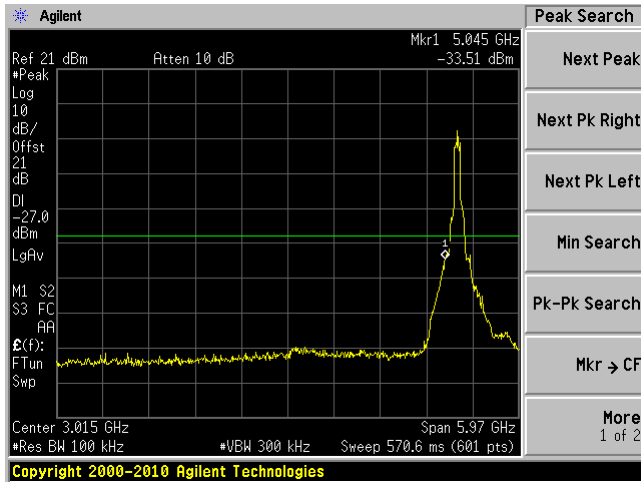

C1 6 GHz-40 GHz

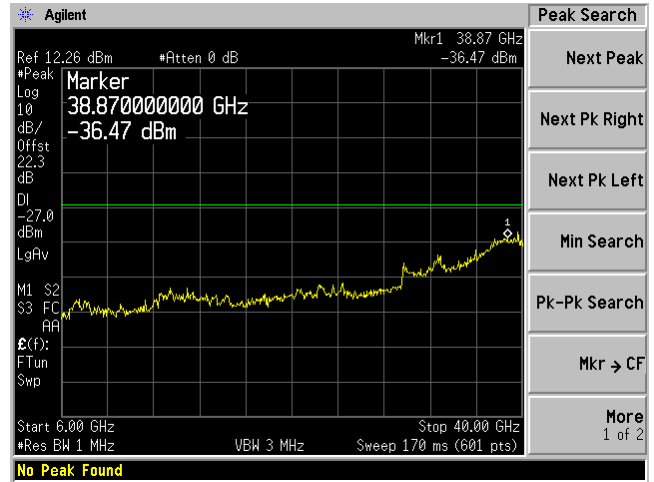

C2 30 MHz-6 GHz

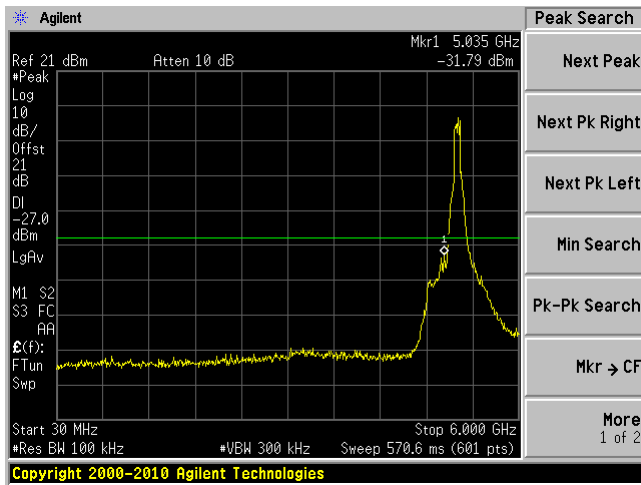

C2 6 GHz-40 GHz

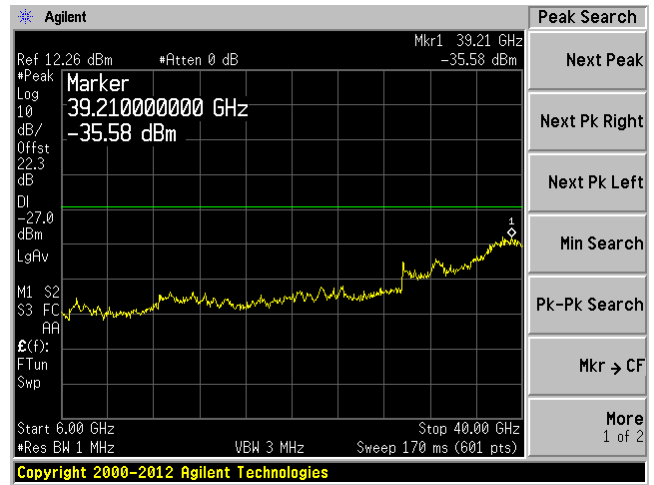



**C3 30 MHz-6 GHz**

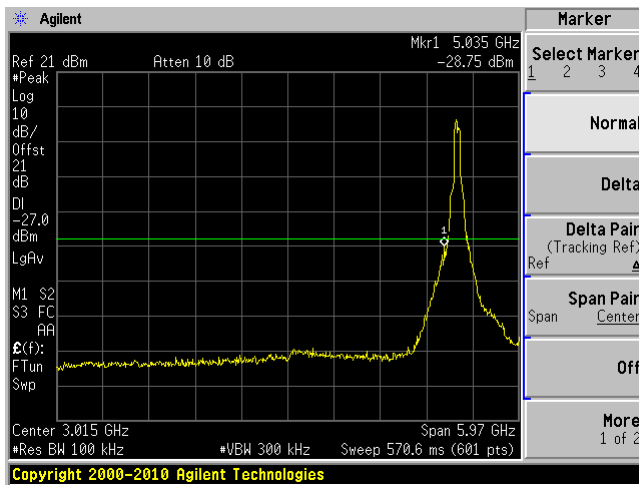

**C3 6 GHz-40 GHz**

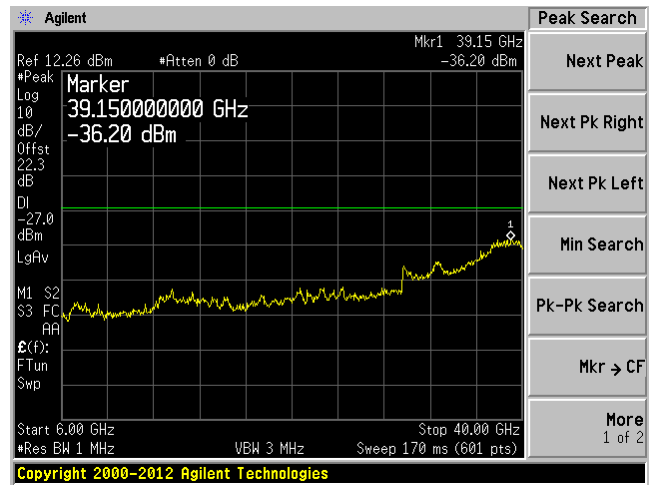

**C4 30 MHz-6 GHz**

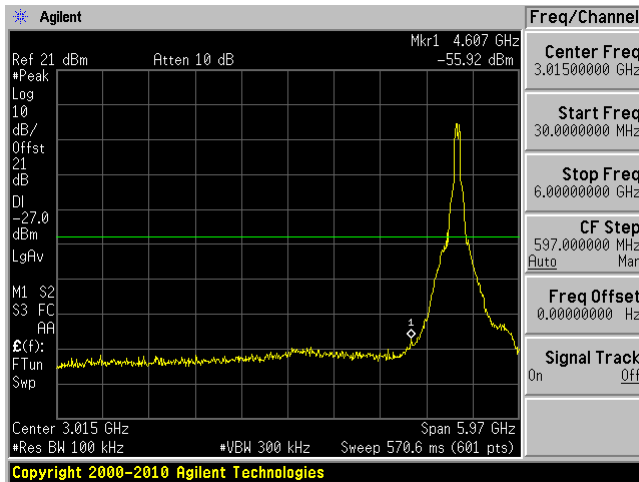

**C4 6 GHz-40 GHz**

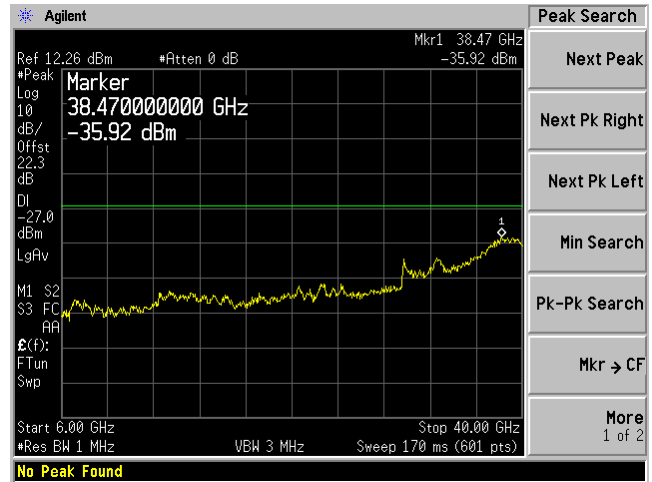

### 80 MHz bandwidth, High Channel, 5210 MHz

#### C1 30 MHz-6 GHz

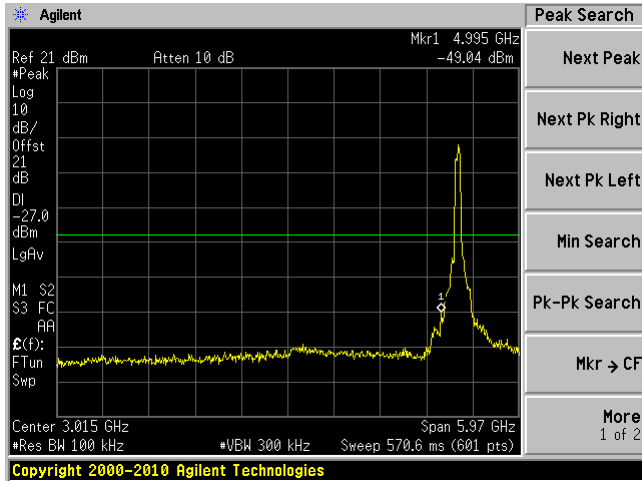

#### C1 6 GHz-40 GHz

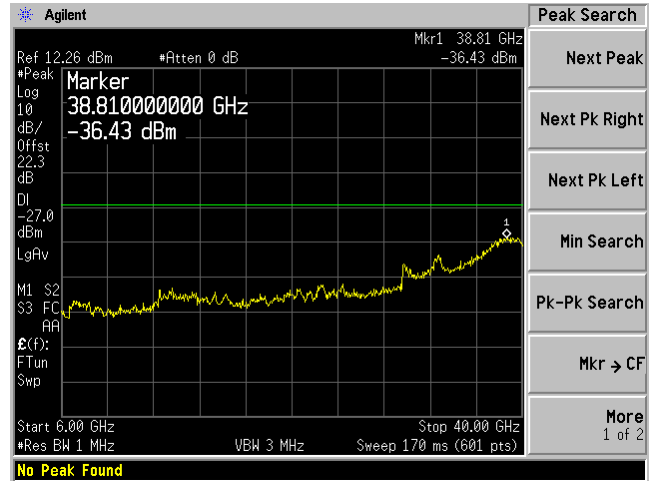

#### C2 30 MHz-6 GHz

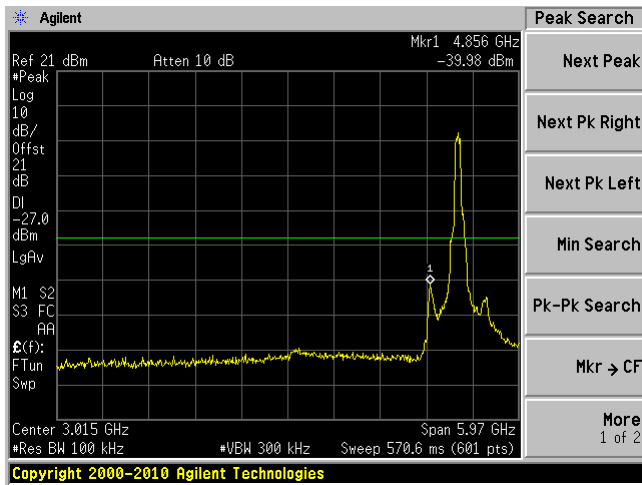

#### C2 6 GHz-40 GHz

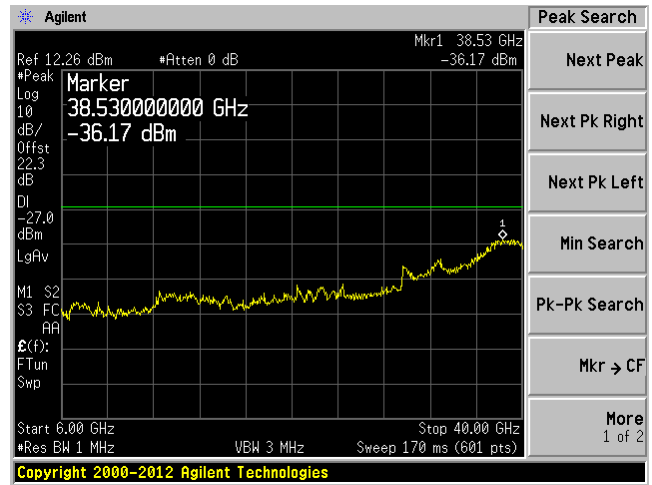

### C3 30 MHz-6 GHz

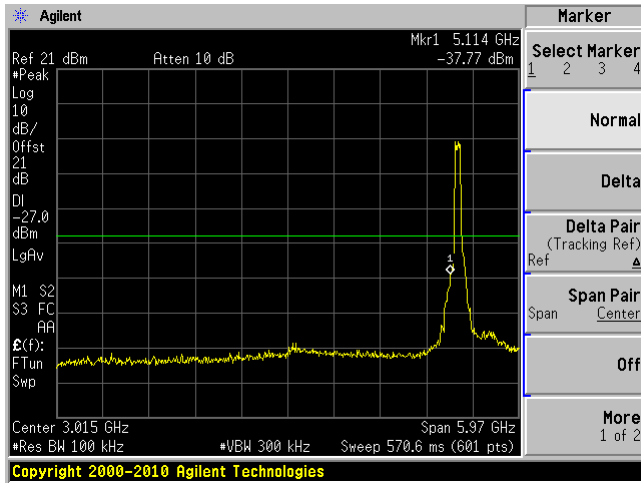

### C3 6 GHz-40 GHz

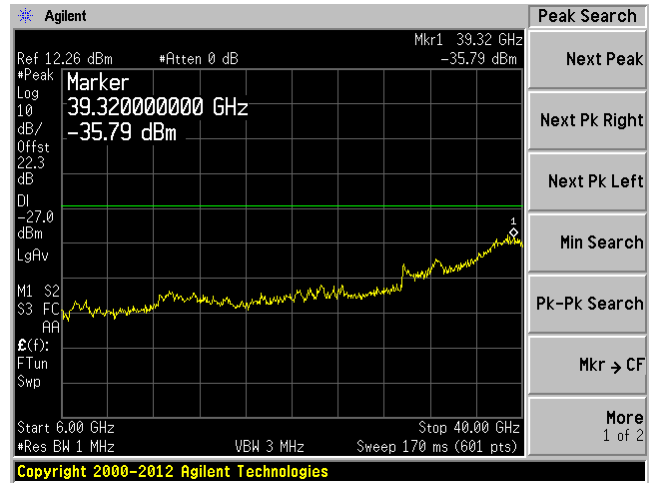

### C4 30 MHz-6 GHz

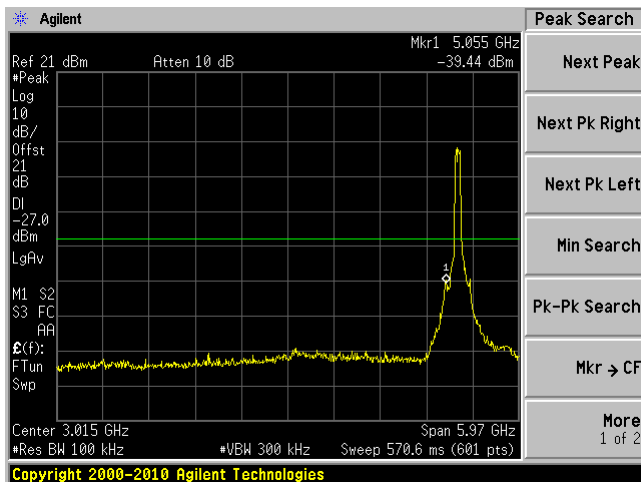

### C4 6 GHz-40 GHz

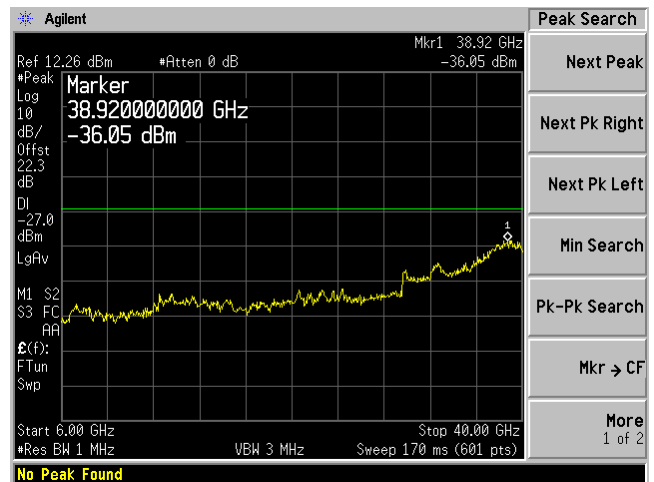

5.8 GHz Band:

20 MHz bandwidth, Low Channel, 5745 MHz

C1 30 MHz-6 GHz

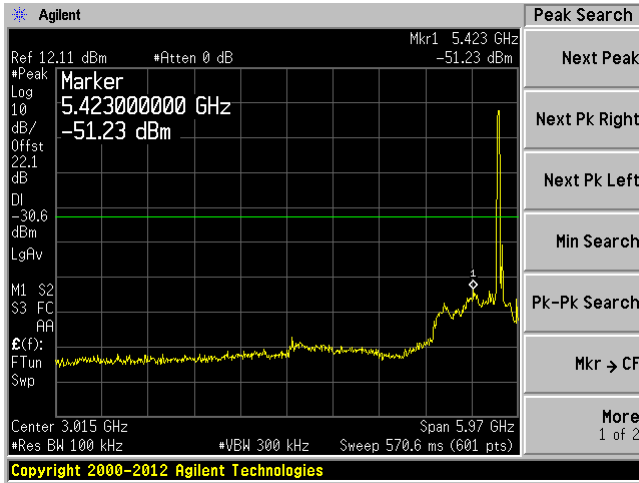

C1 6 GHz-40 GHz

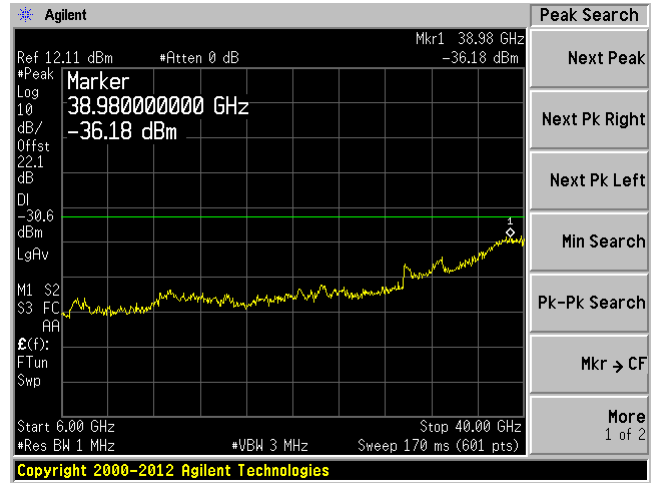

C2 30 MHz-6 GHz

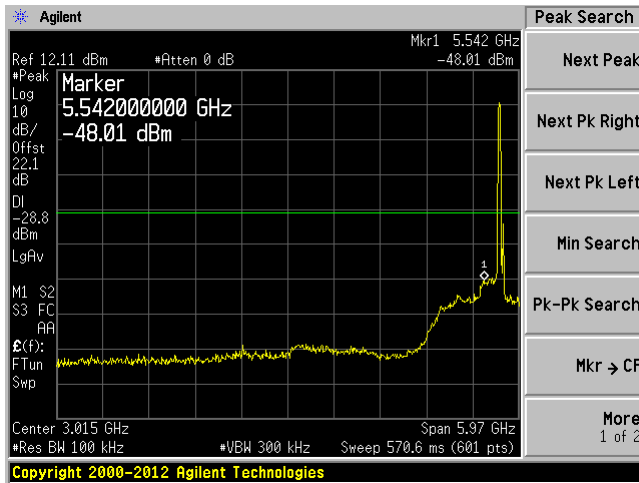

C2 6 GHz-40 GHz

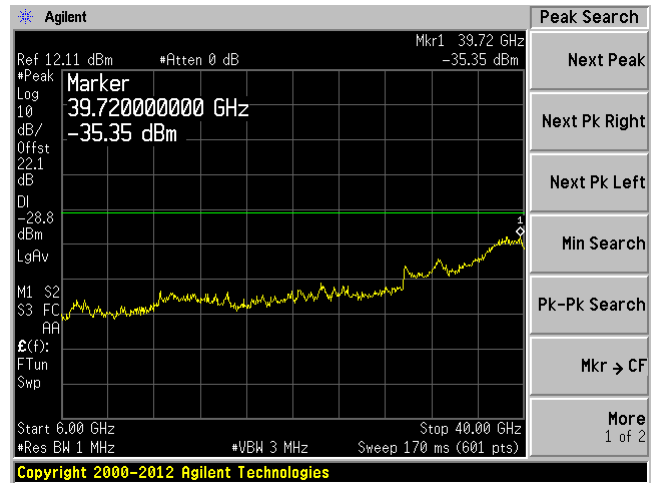

**C3 30 MHz-6 GHz**

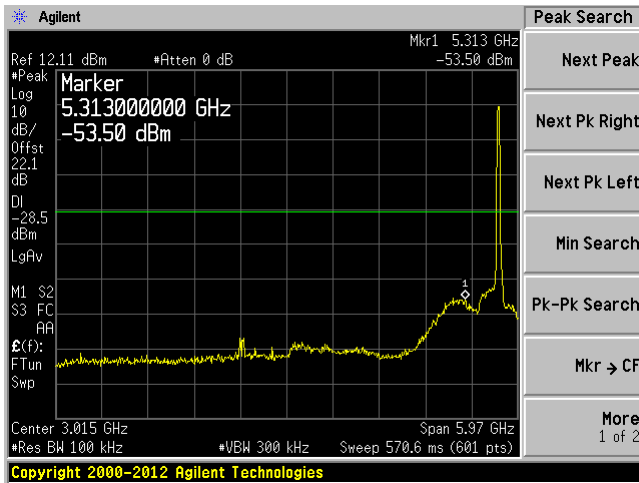

**C3 6 GHz-40 GHz**

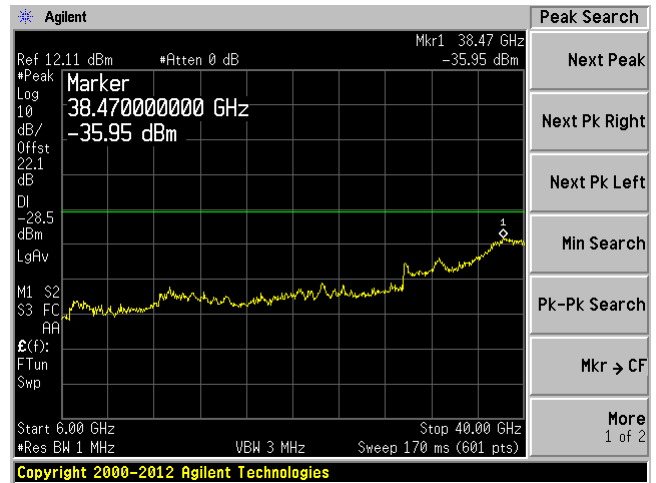

**C4 30 MHz-6 GHz**

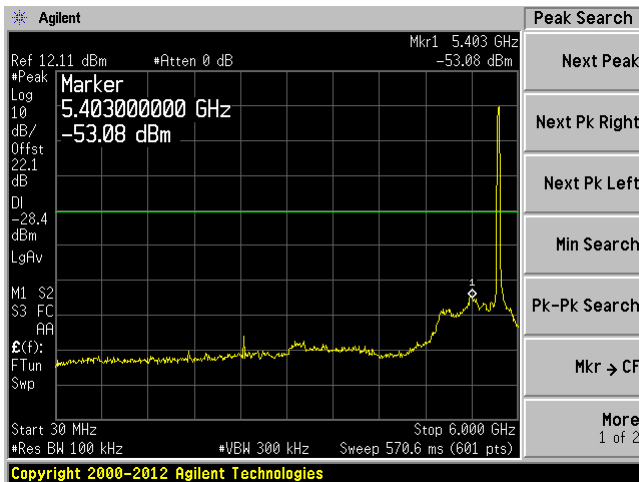

**C4 6 GHz-40 GHz**

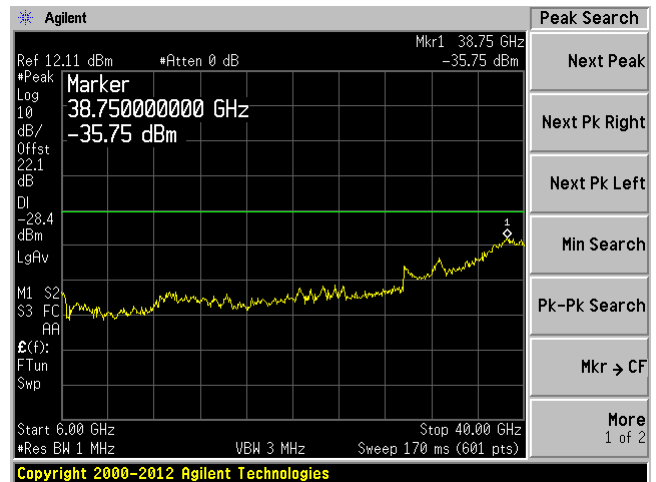

20 MHz bandwidth, Middle Channel, 5785 MHz

C1 30 MHz-6 GHz

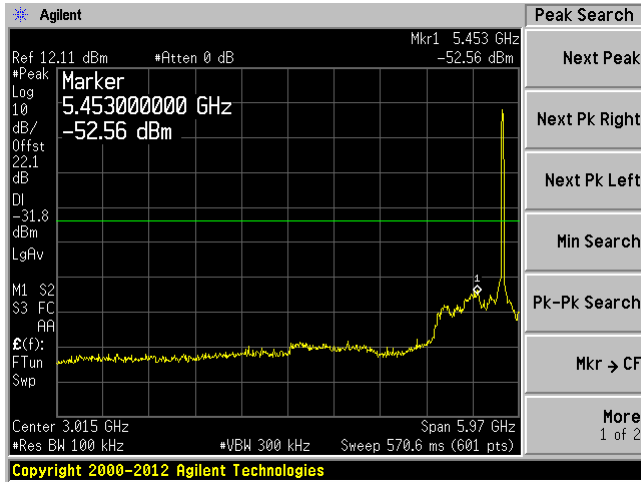

C1 6 GHz-40 GHz

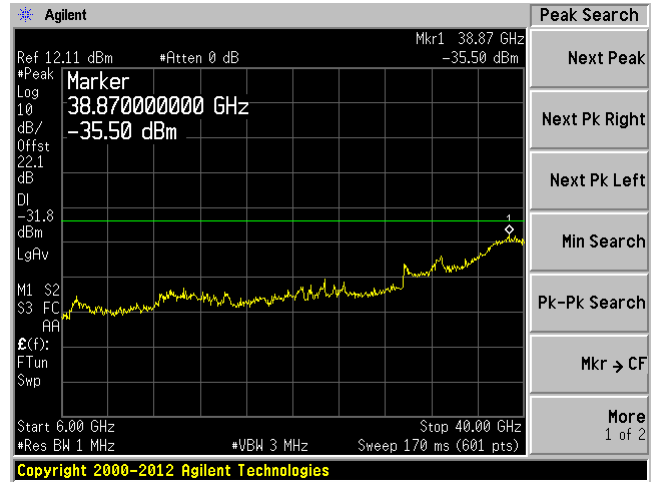

C2 30 MHz-6 GHz

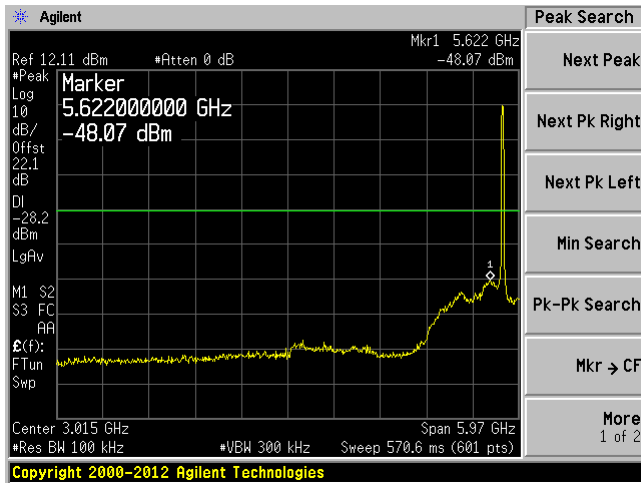

C2 6 GHz-40 GHz

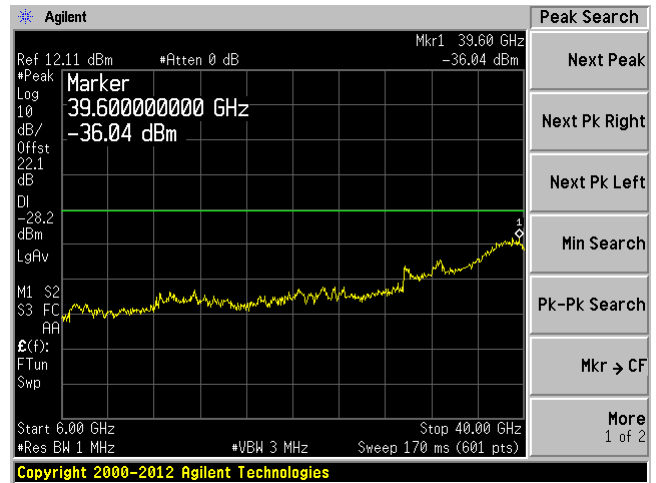

**C3 30 MHz-6 GHz**

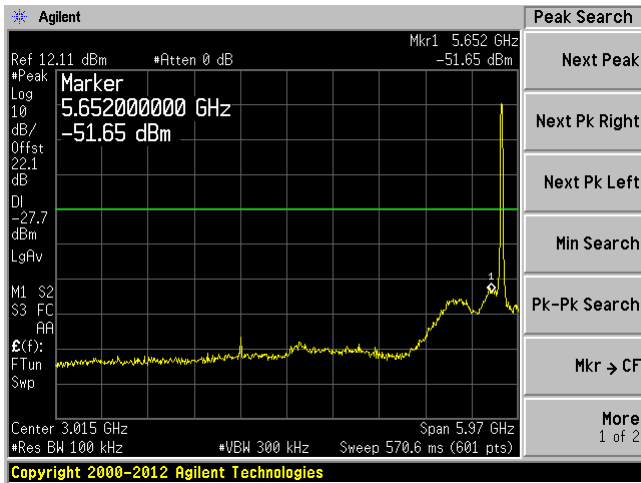

**C3 6 GHz-40 GHz**

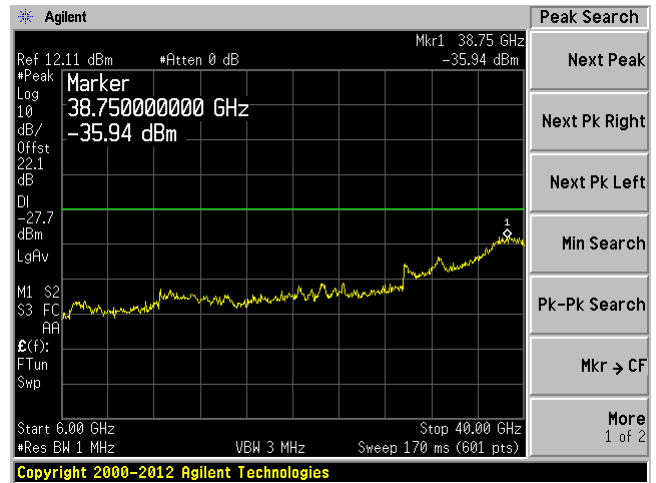

**C4 30 MHz-6 GHz**

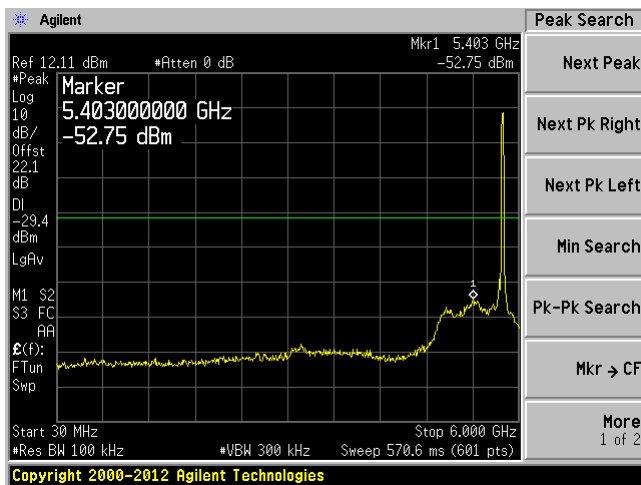

**C4 6 GHz-40 GHz**

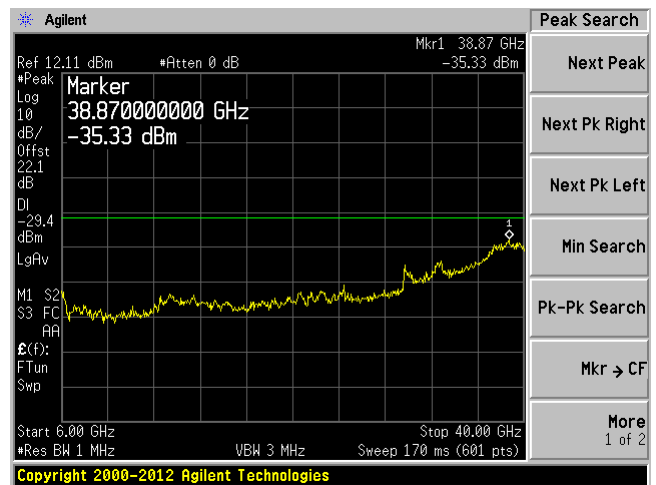

20 MHz bandwidth, High Channel, 5825 MHz

C1 30 MHz-6 GHz

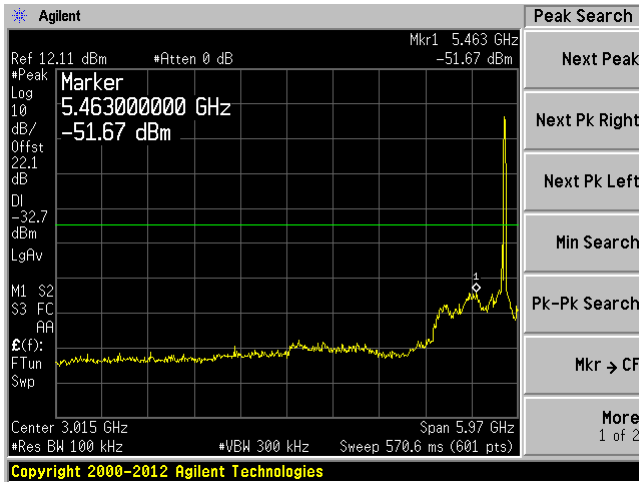

C1 6 GHz-40 GHz

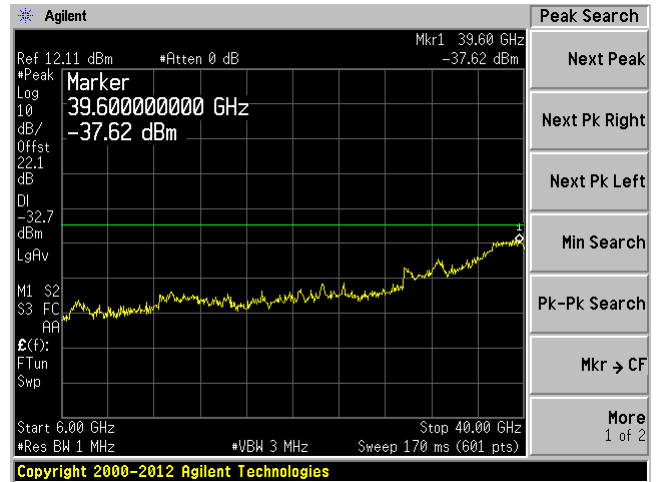

C2 30 MHz-6 GHz

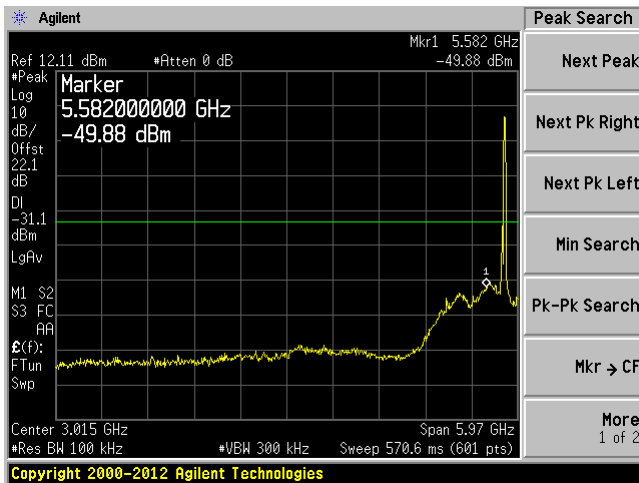

C2 6 GHz-40 GHz

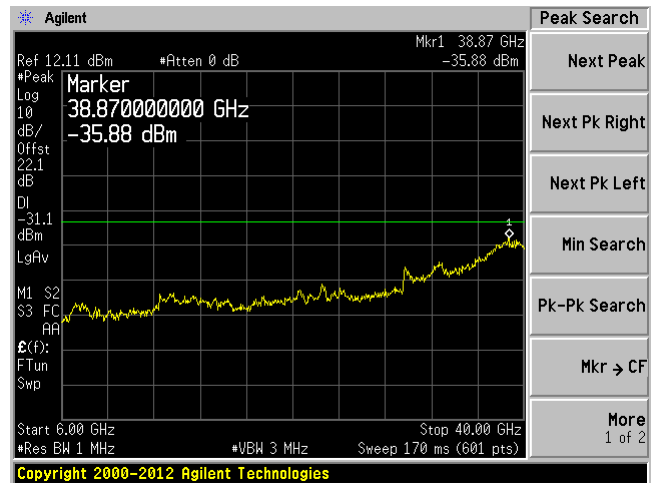



### C3 30 MHz-6 GHz

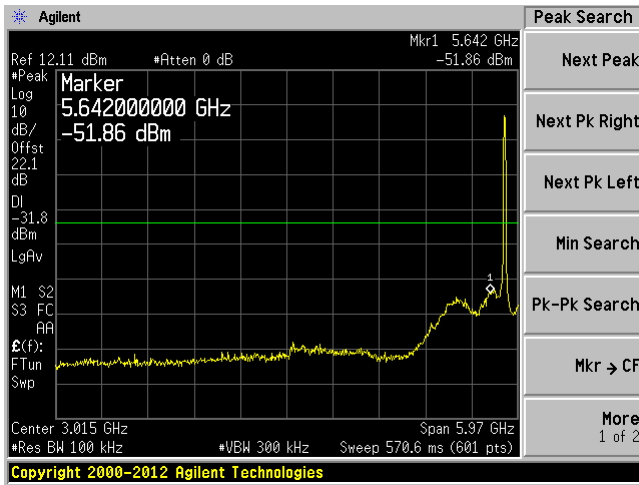

### C3 6 GHz-40 GHz

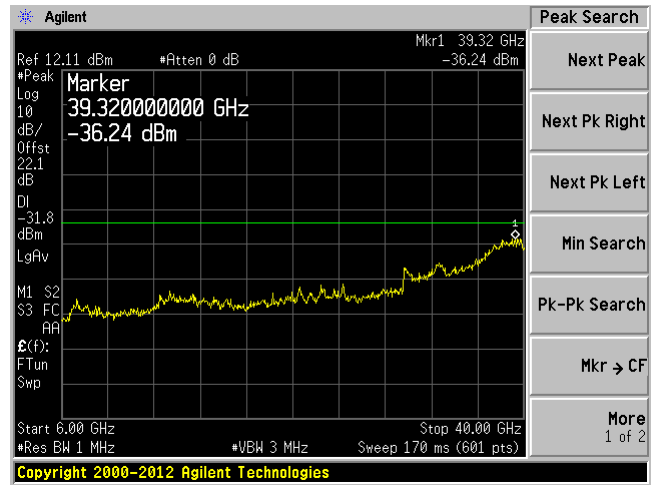

### C4 30 MHz-6 GHz

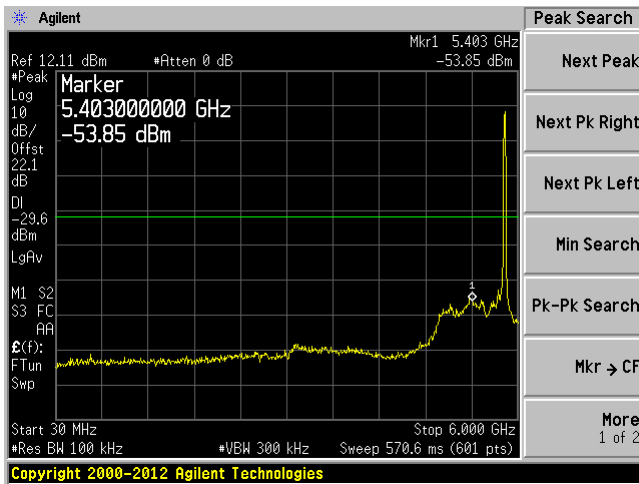

### C4 6 GHz-40 GHz

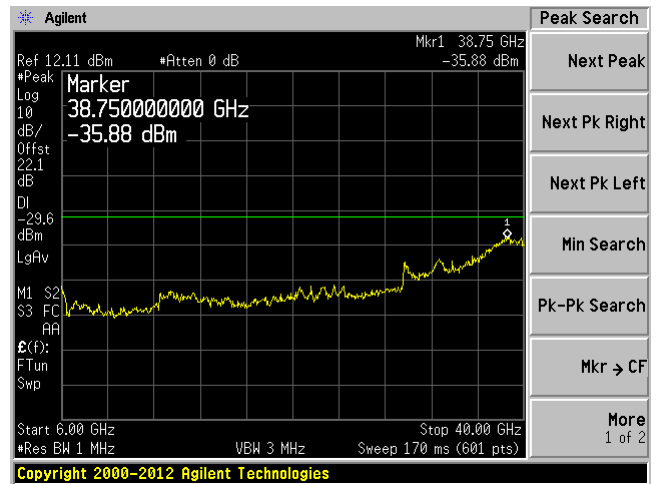

40 MHz bandwidth, Low Channel, 5755 MHz

C1 30 MHz-6 GHz

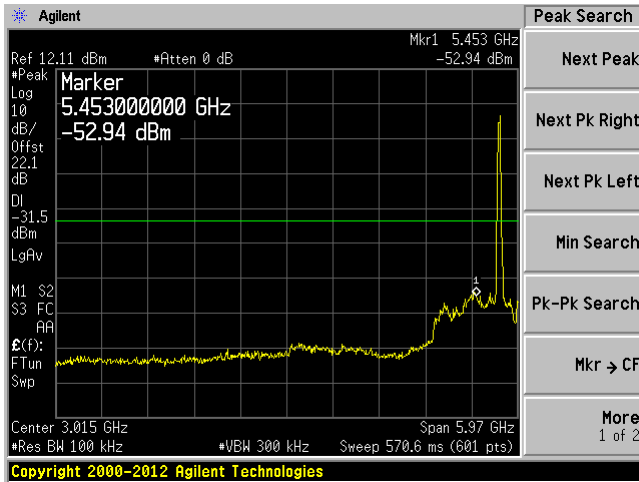

C1 6 GHz-40 GHz

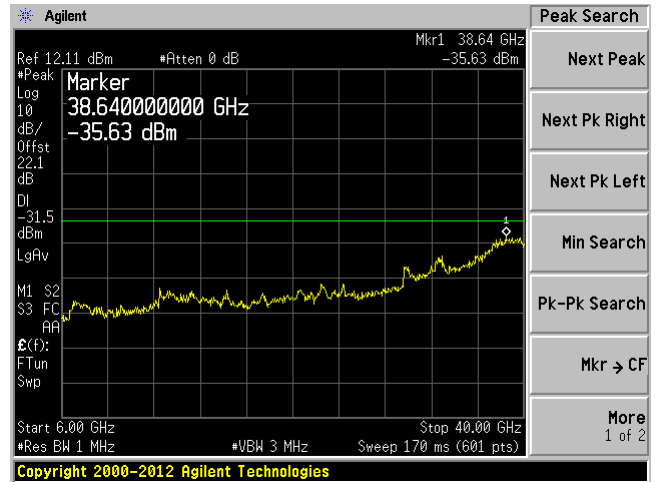

C2 30 MHz-6 GHz

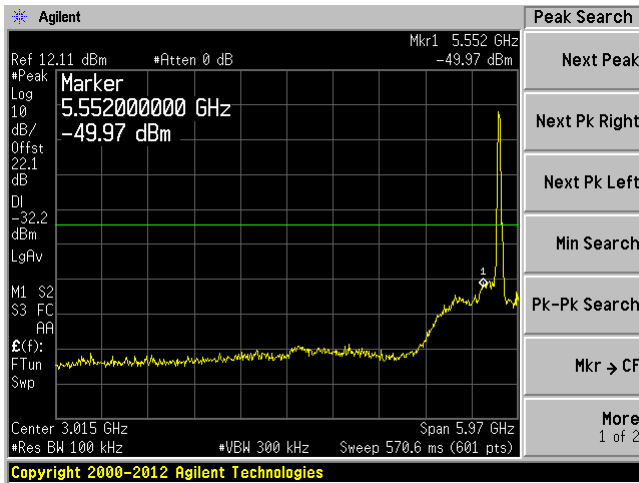

C2 6 GHz-40 GHz

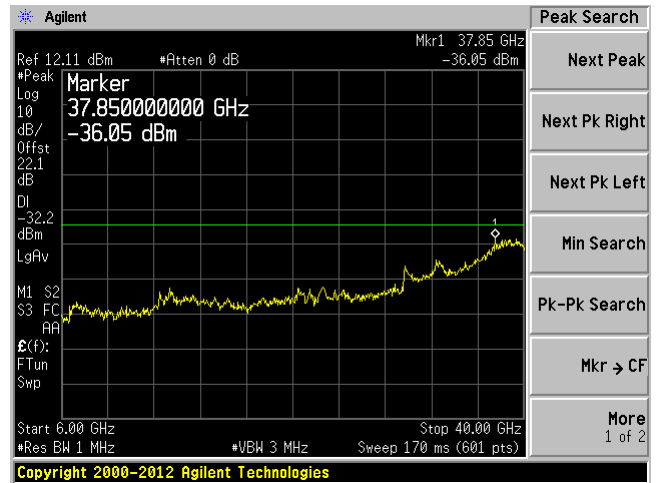

### C3 30 MHz-6 GHz

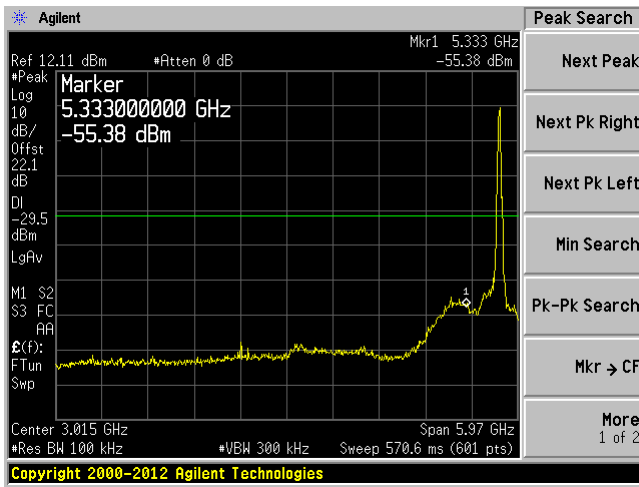

### C3 6 GHz-40 GHz

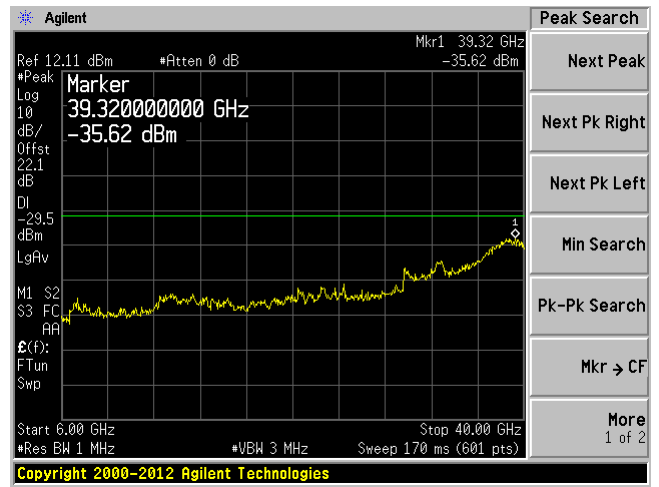

### C4 30 MHz-6 GHz

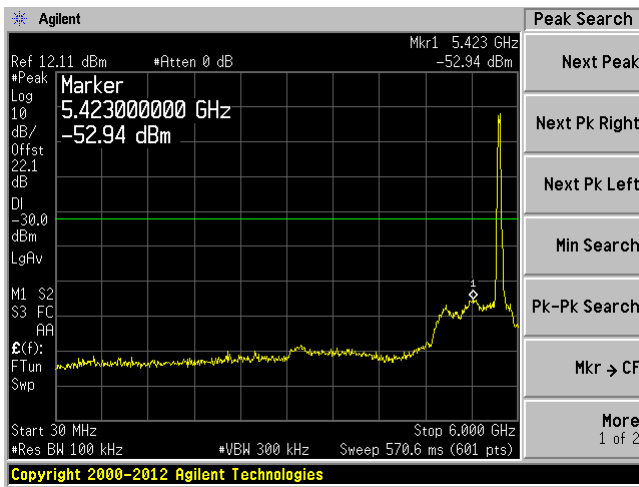

### C4 6 GHz-40 GHz

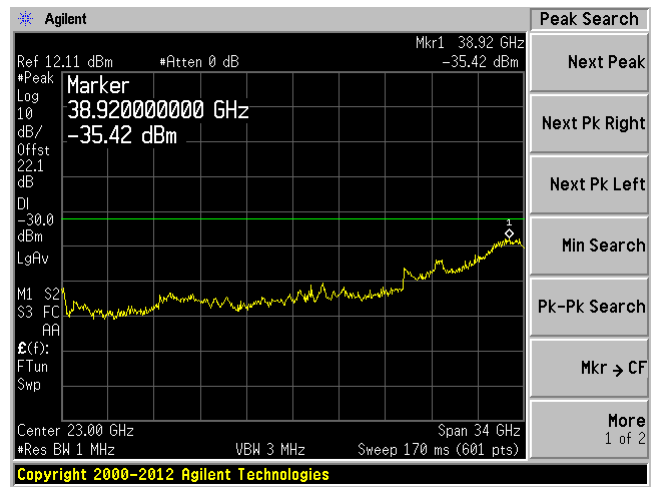

### 40 MHz bandwidth, Middle Channel, 5785 MHz

#### C1 30 MHz-6 GHz

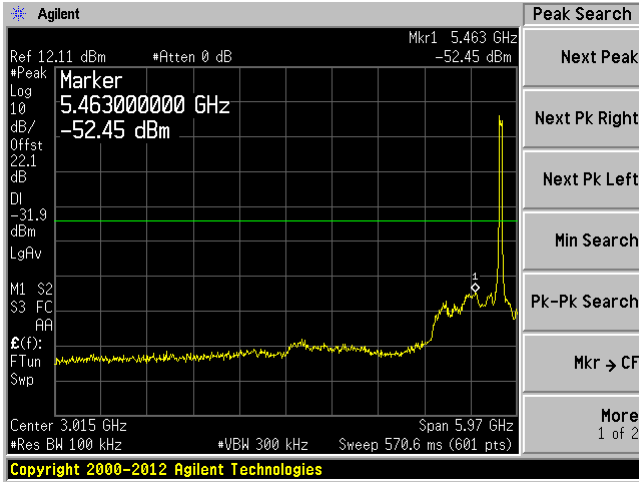

#### C1 6 GHz-40 GHz



#### C2 30 MHz-6 GHz

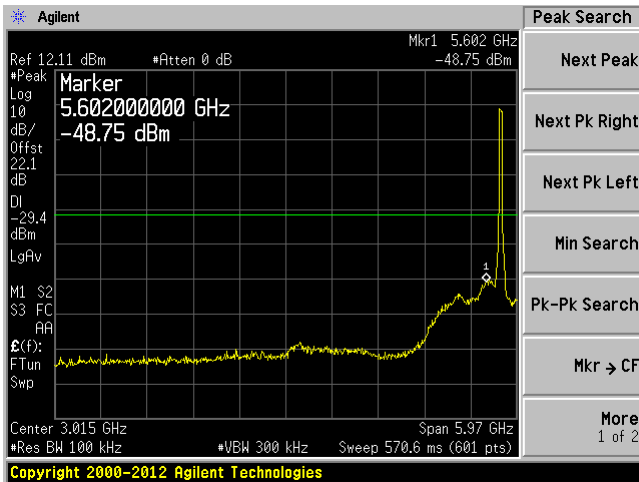

#### C2 6 GHz-40 GHz

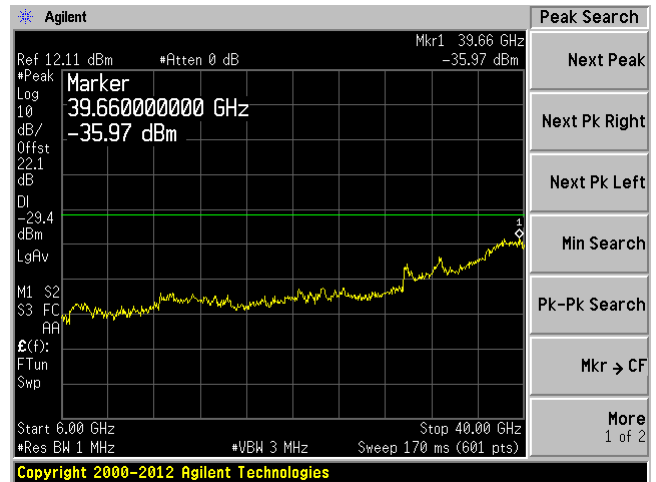

### C3 30 MHz-6 GHz

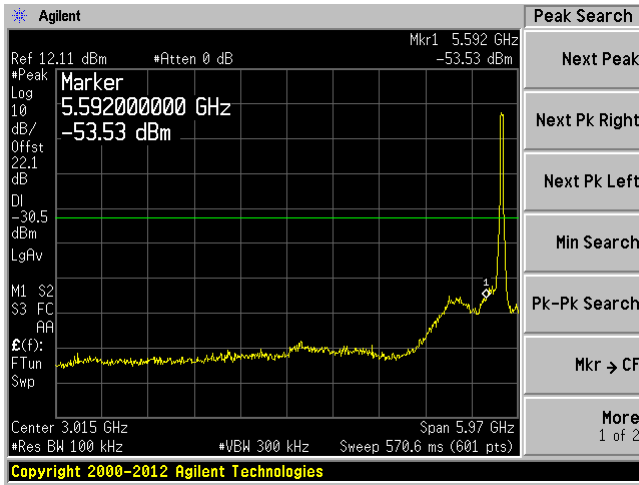

### C3 6 GHz-40 GHz

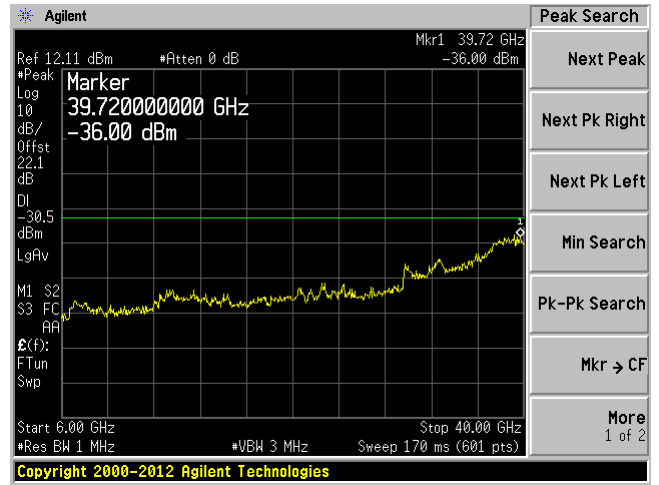

### C4 30 MHz-6 GHz

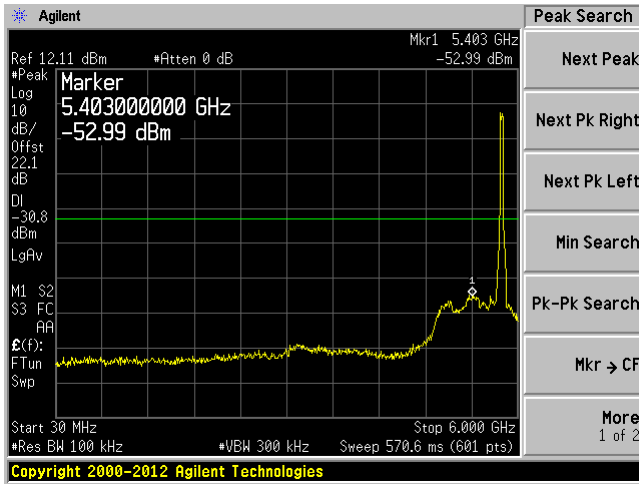

### C4 6 GHz-40 GHz

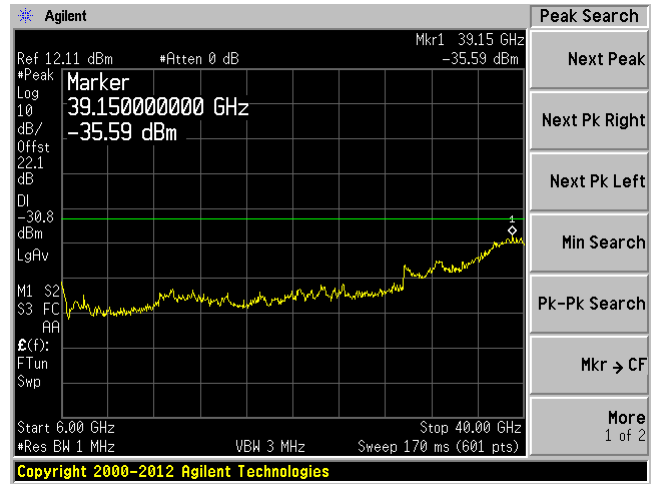

40 MHz bandwidth, High Channel, 5815 MHz

C1 30 MHz-6 GHz

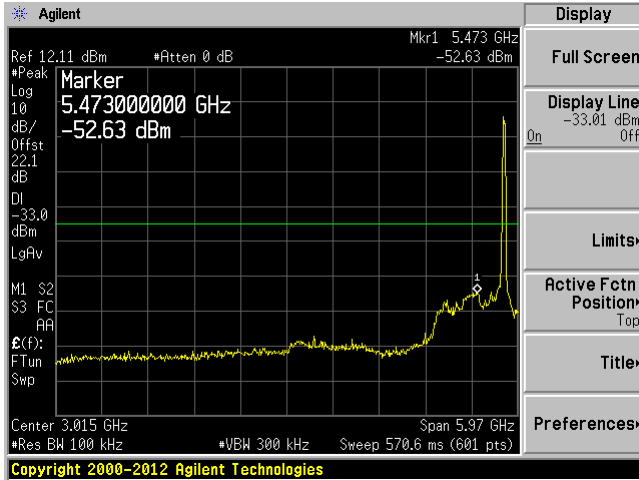

C1 6 GHz-40 GHz

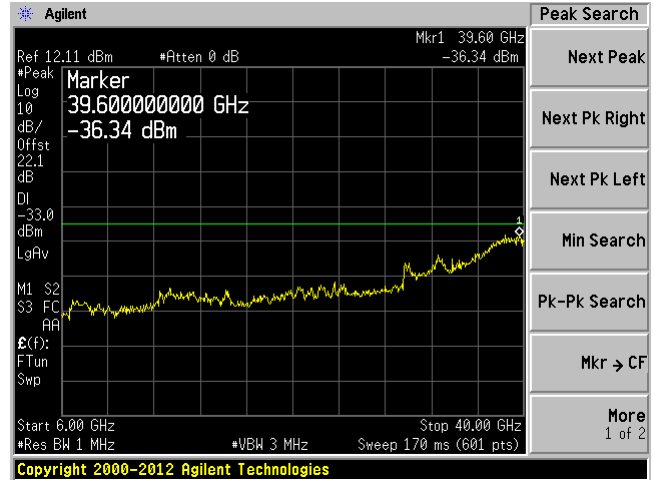

C2 30 MHz-6 GHz

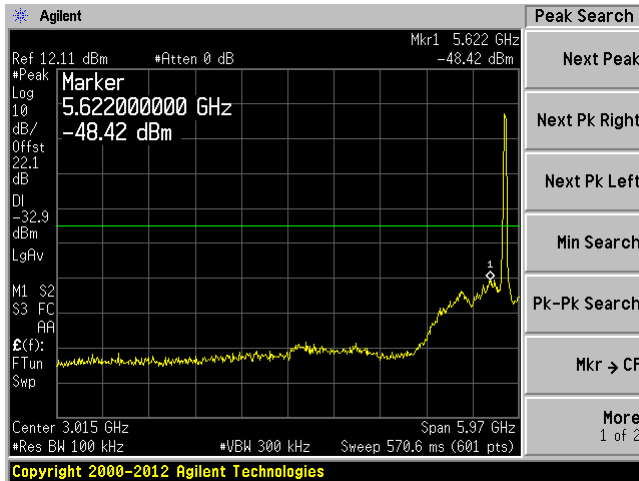

C2 6 GHz-40 GHz

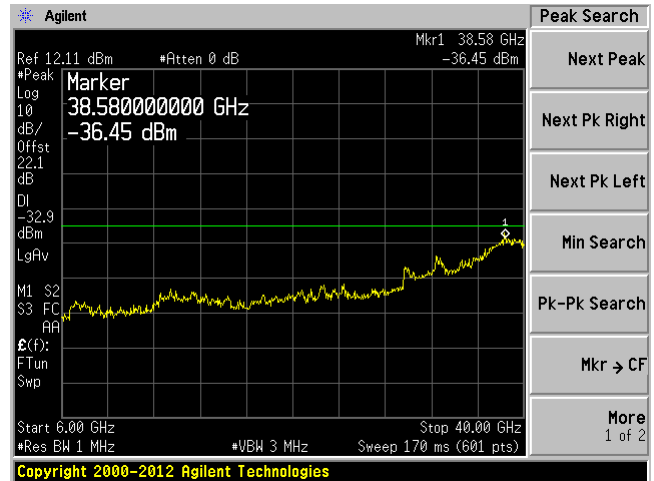

**C3 30 MHz-6 GHz**

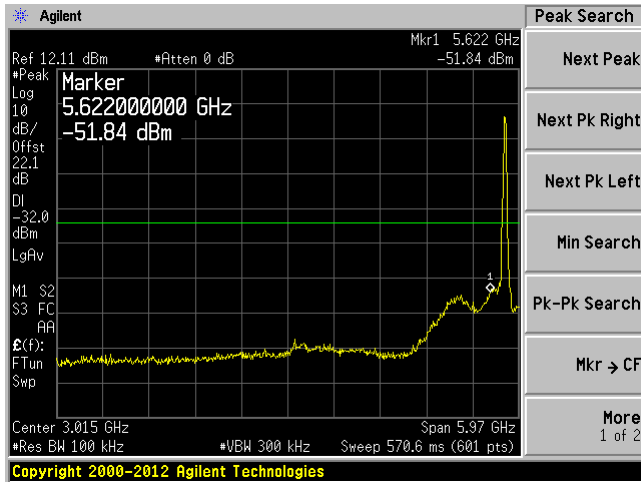

**C3 6 GHz-40 GHz**

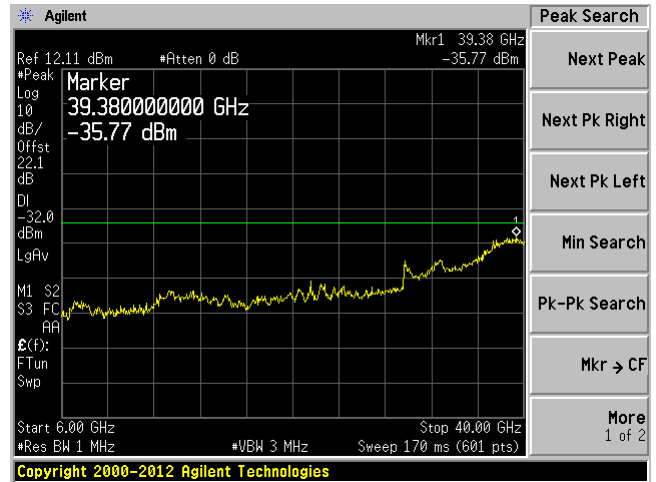

**C4 30 MHz-6 GHz**

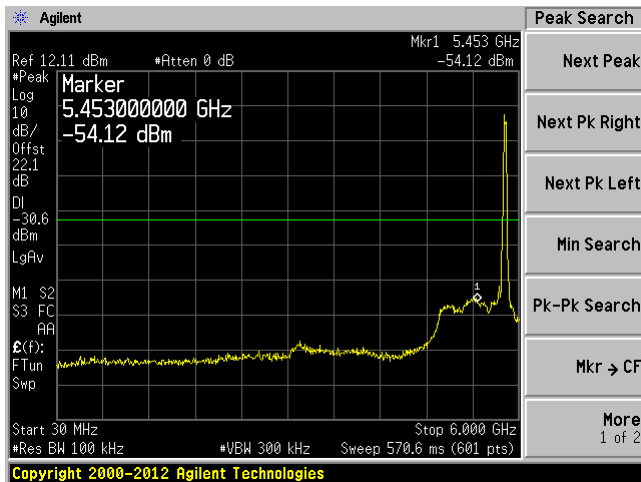

**C4 6 GHz-40 GHz**

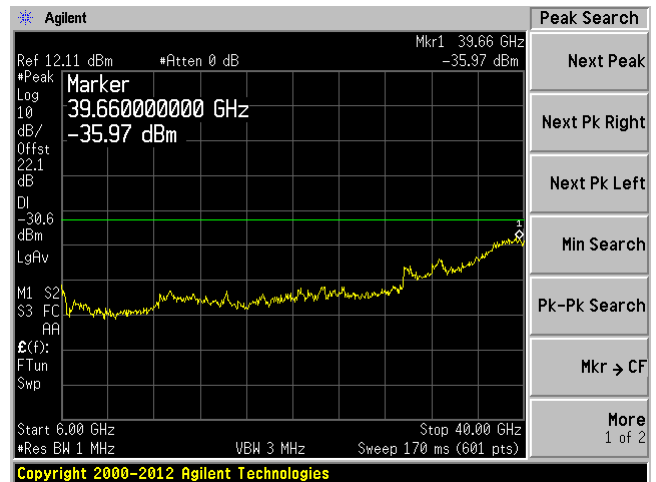

80 MHz bandwidth, Low Channel, 5775 MHz

C1 30 MHz-6 GHz

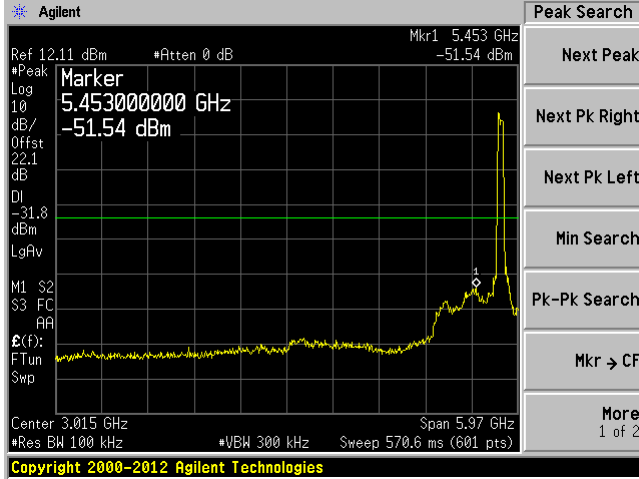

C1 6 GHz-40 GHz

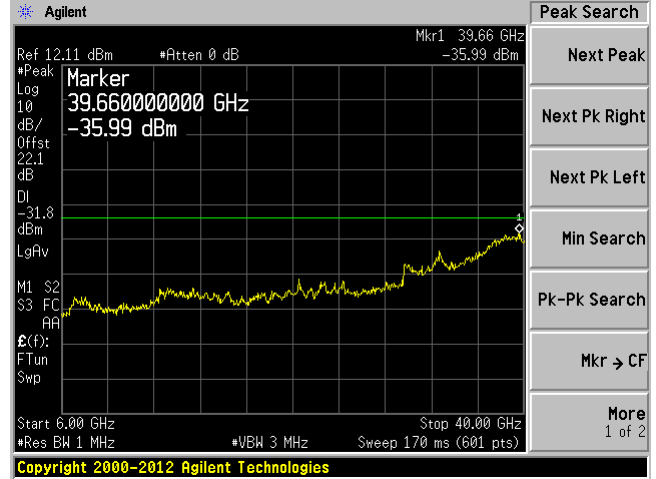

C2 30 MHz-6 GHz

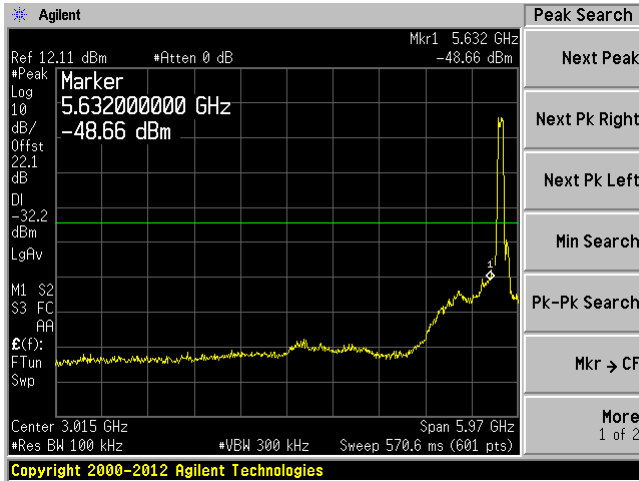

C2 6 GHz-40 GHz

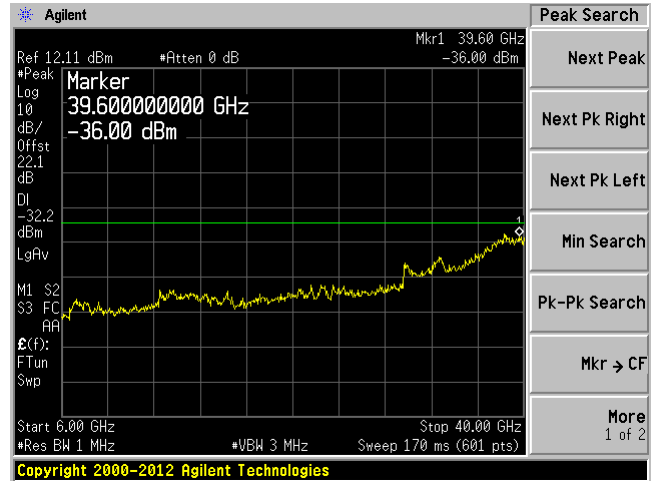



### C3 30 MHz-6 GHz

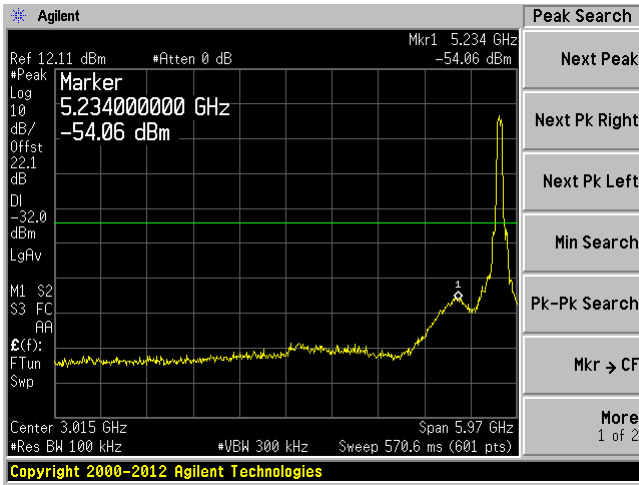

### C3 6 GHz-40 GHz

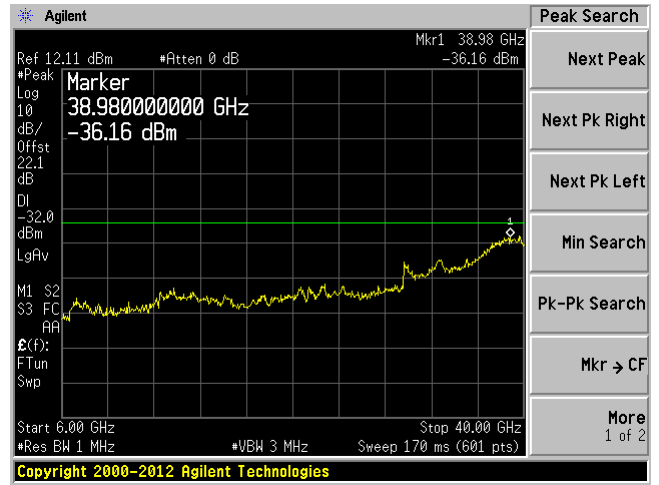

### C4 30 MHz-6 GHz

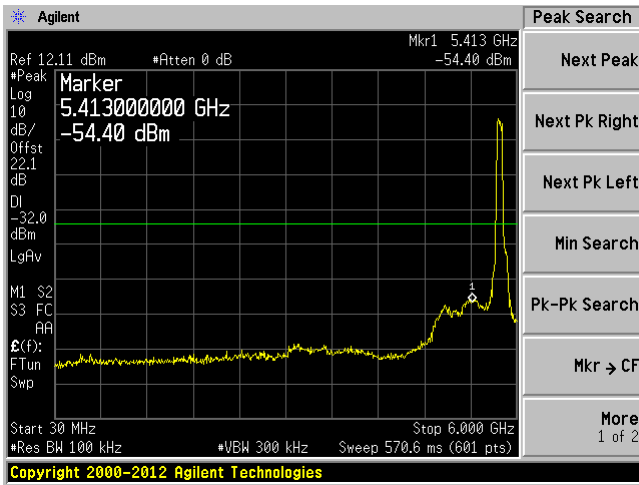

### C4 6 GHz-40 GHz

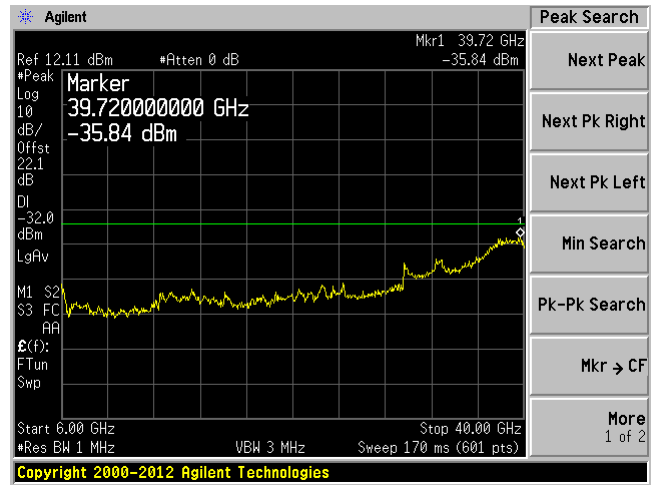

80 MHz bandwidth, Middle Channel, 5785 MHz

C1 30 MHz-6 GHz

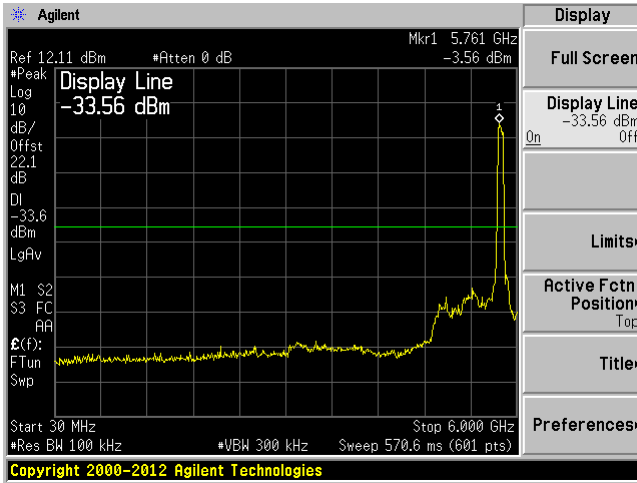

C1 6 GHz-40 GHz



C2 30 MHz-6 GHz

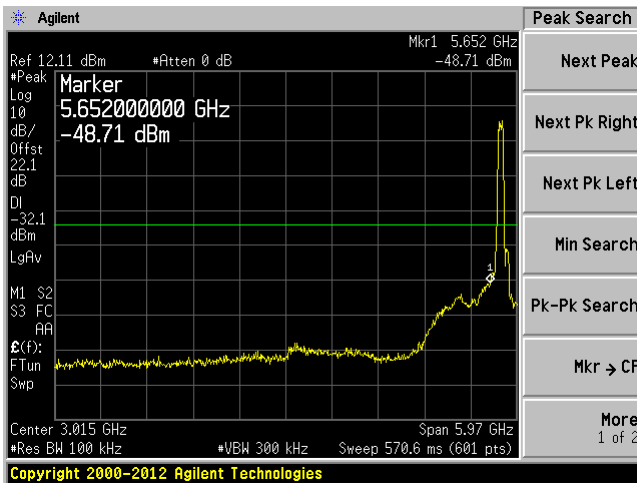

C2 6 GHz-40 GHz

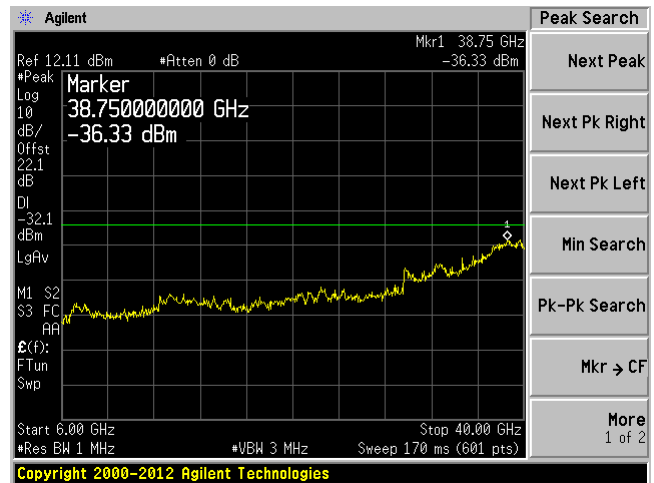

### C3 30 MHz-6 GHz

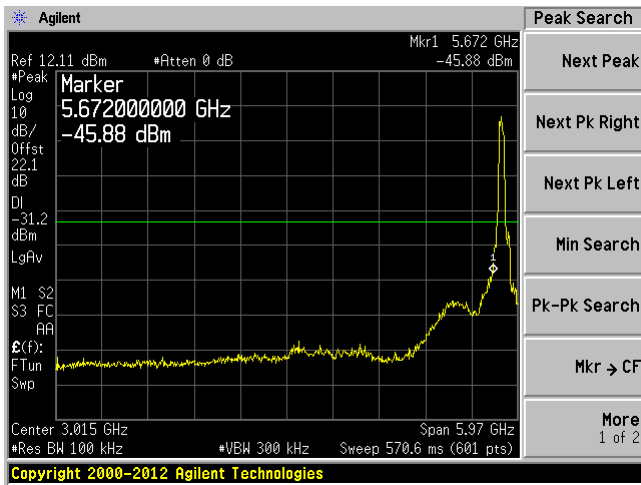

### C3 6 GHz-40 GHz

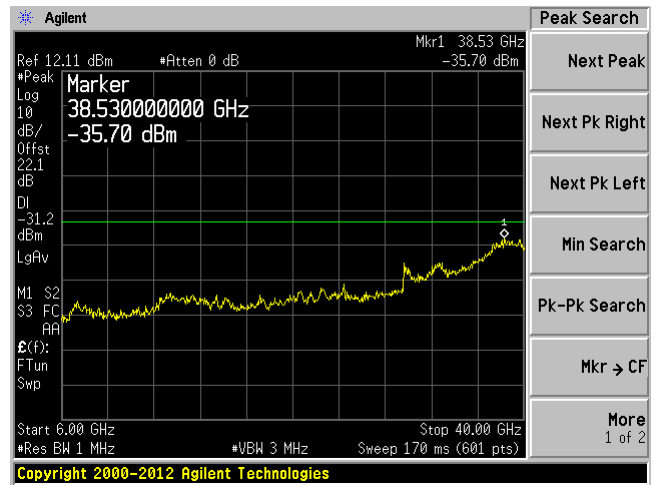

### C4 30 MHz-6 GHz

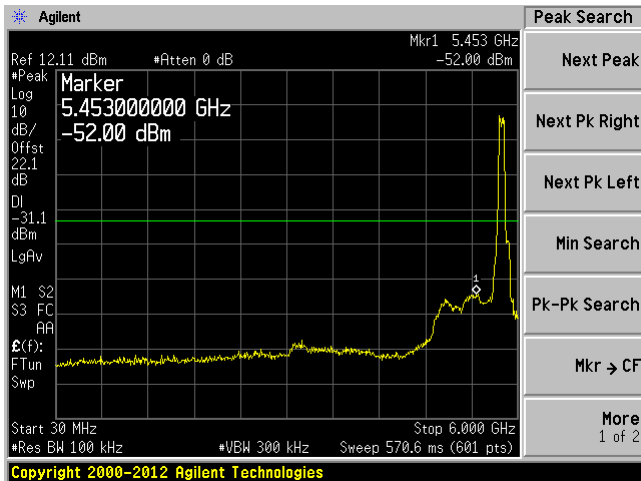

### C4 6 GHz-40 GHz

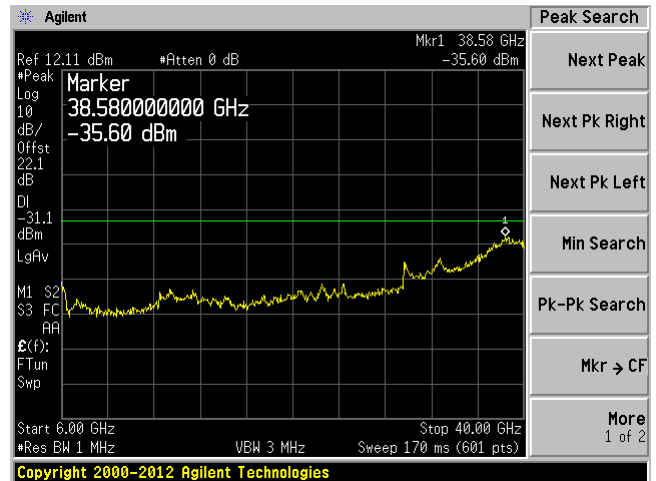

80 MHz bandwidth, High Channel, 5795 MHz

C1 30 MHz-6 GHz

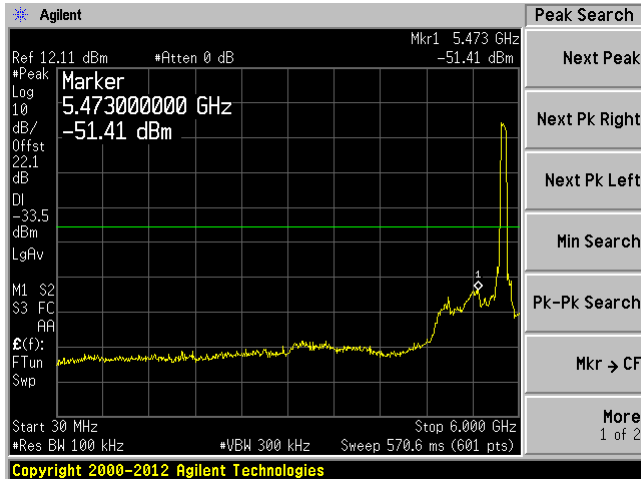

C1 6 GHz-40 GHz

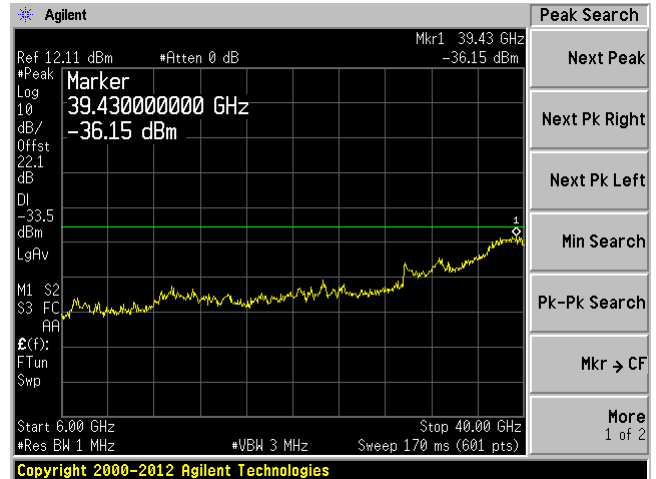

C2 30 MHz-6 GHz

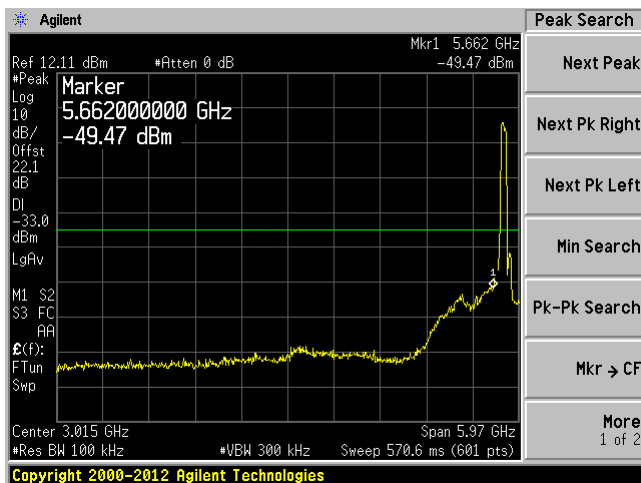

C2 6 GHz-40 GHz

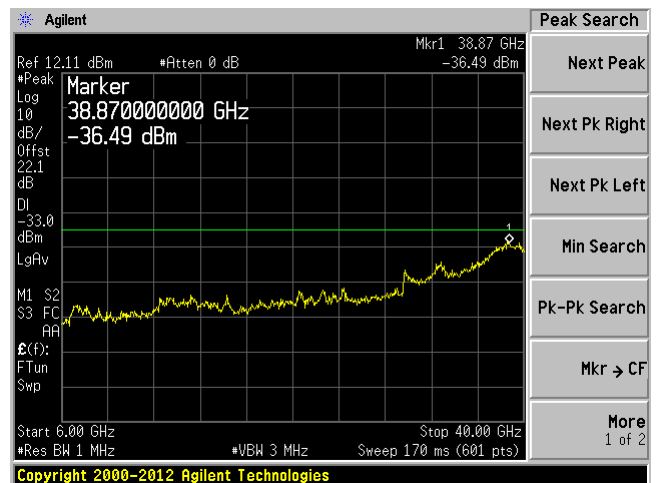

### C3 30 MHz-6 GHz

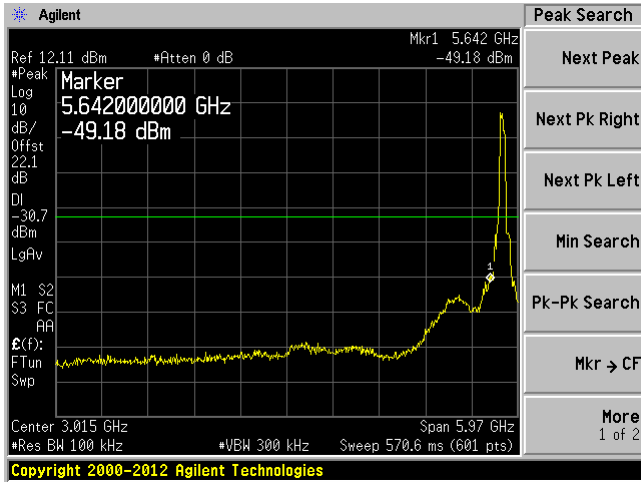

### C3 6 GHz-40 GHz

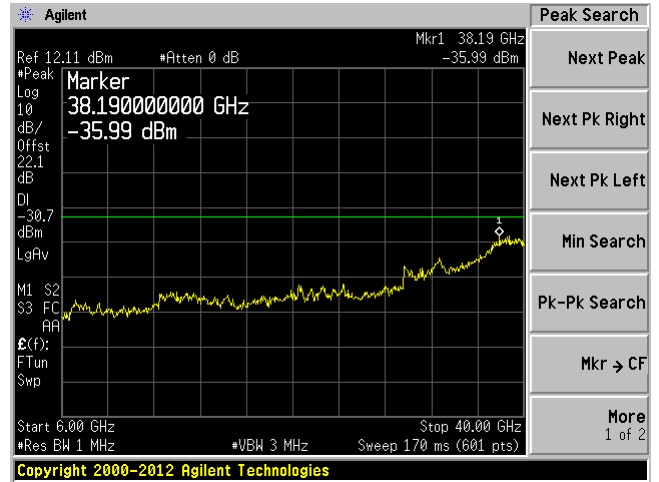

### C4 30 MHz-6 GHz

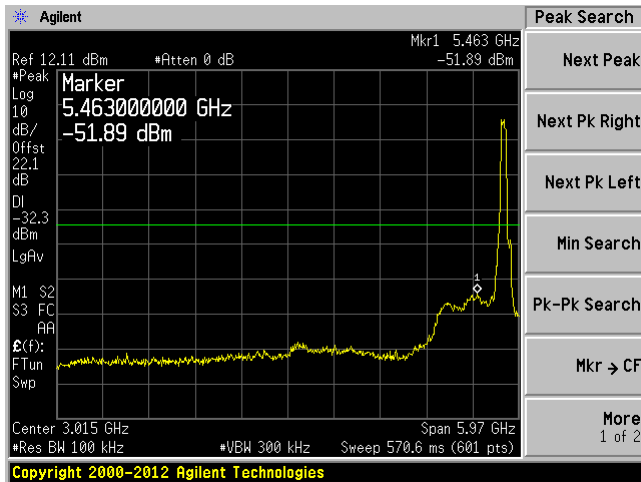

### C4 6 GHz-40 GHz

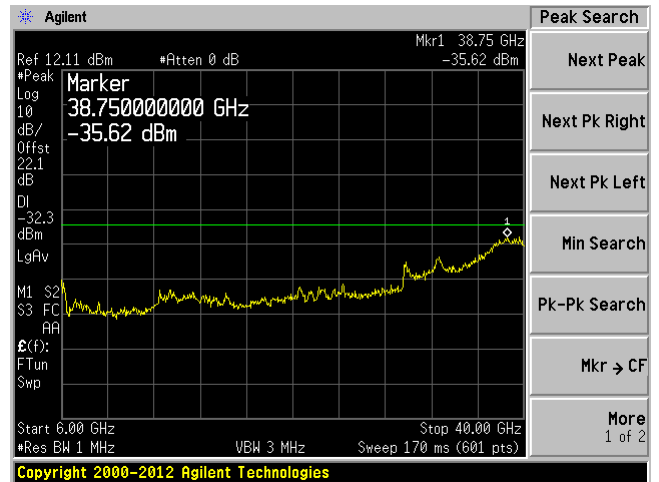

0 dBi Antenna

5.2 GHz Band:

20 MHz bandwidth, Low Channel, 5165 MHz

C1 30 MHz-6 GHz

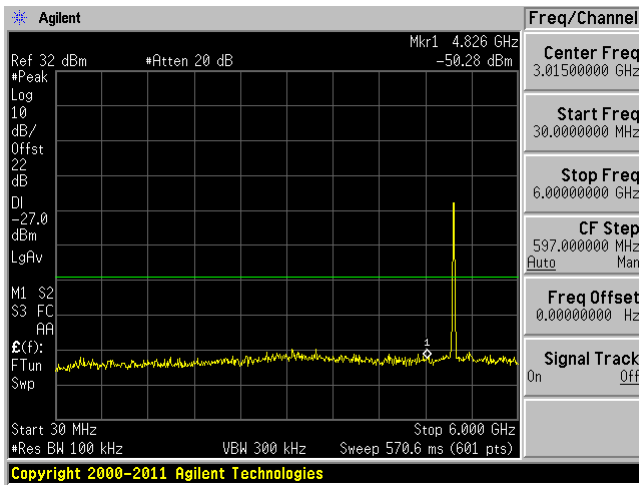

C1 6 GHz-40 GHz

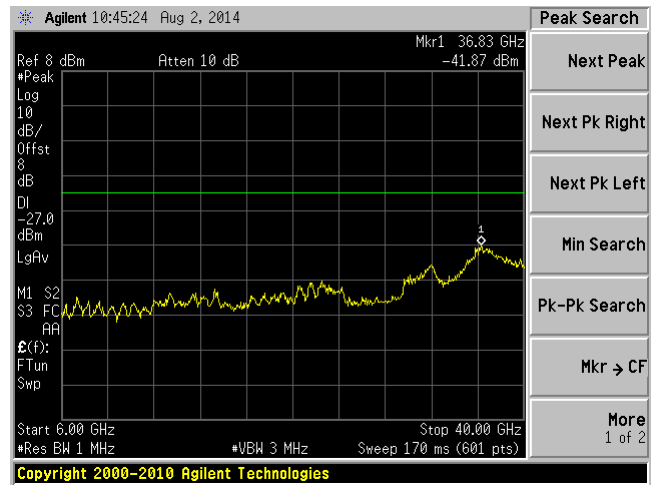

C2 30 MHz-6 GHz

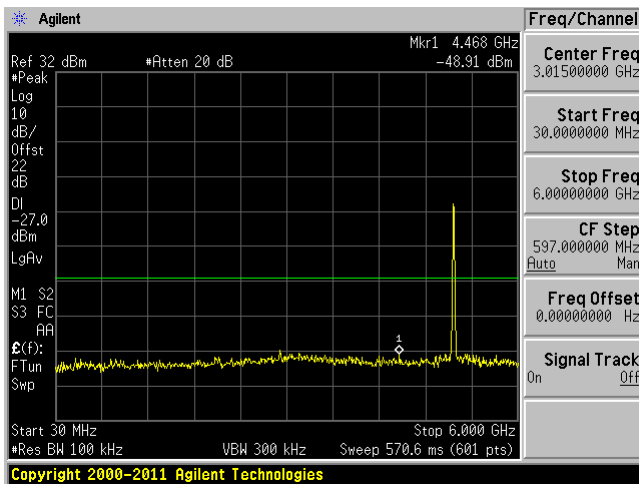

C2 6 GHz-40 GHz

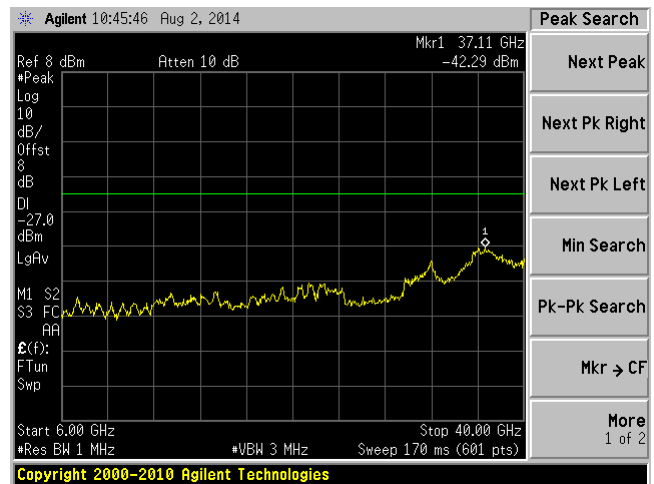

**C3 30 MHz-6 GHz**

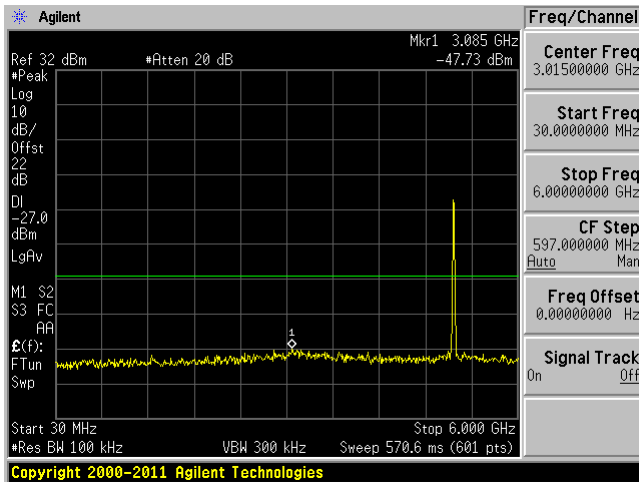

**C3 6 GHz-40 GHz**

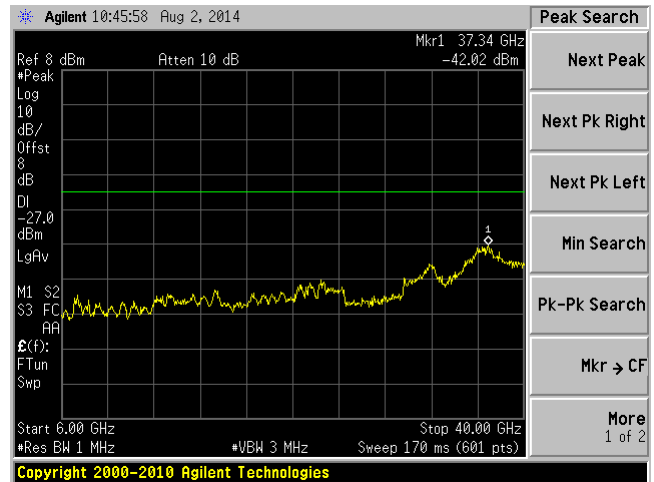

**C4 30 MHz-6 GHz**

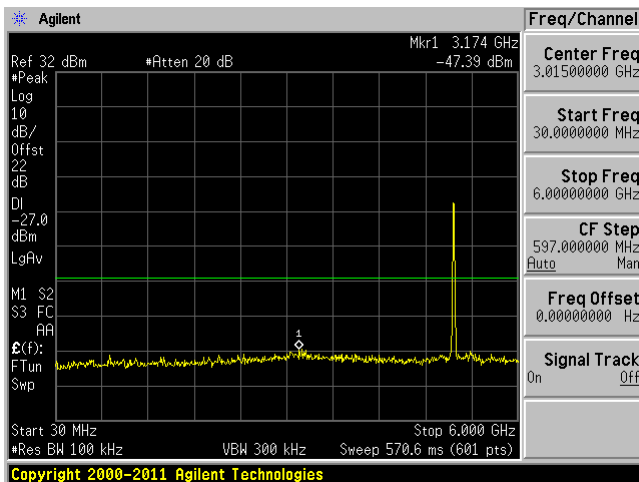

**C4 6 GHz-40 GHz**

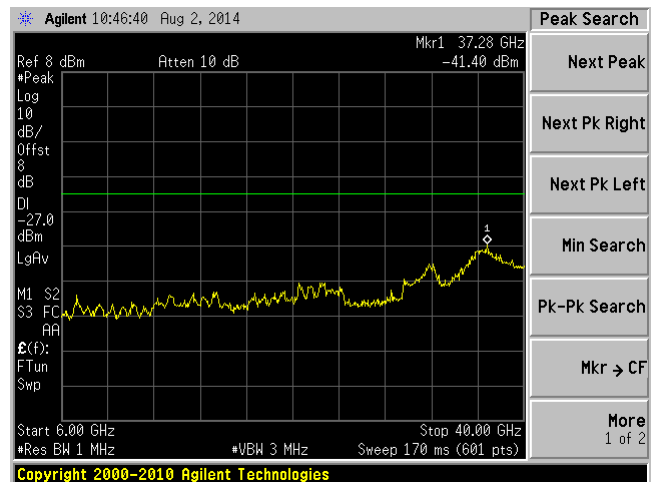

20 MHz bandwidth, Middle Channel, 5200 MHz

C1 30 MHz-6 GHz

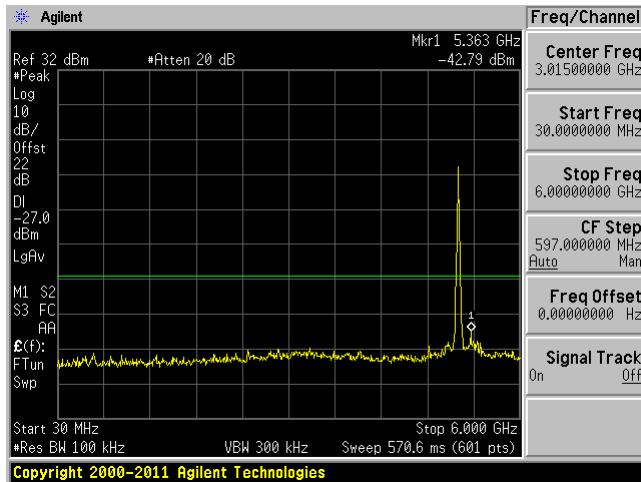

C1 6 GHz-40 GHz

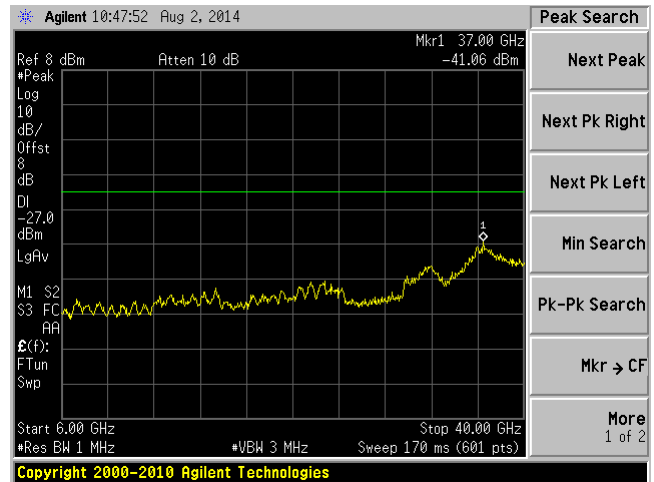

C2 30 MHz-6 GHz

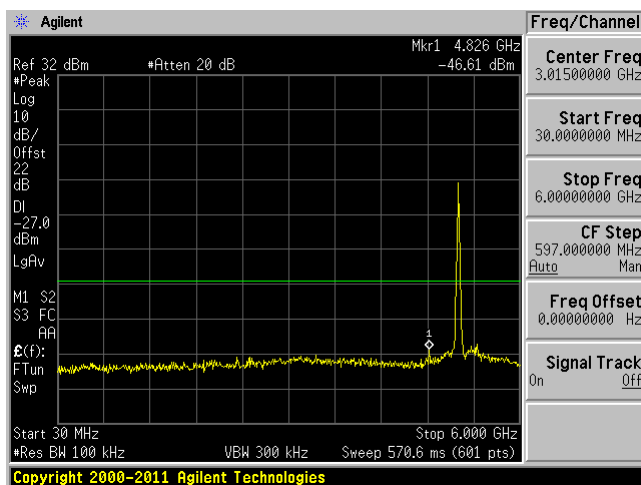

C2 6 GHz-40 GHz

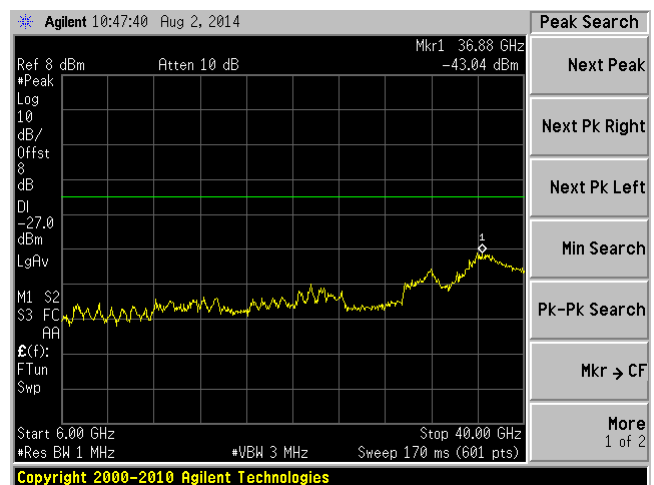



**C3 30 MHz-6 GHz**

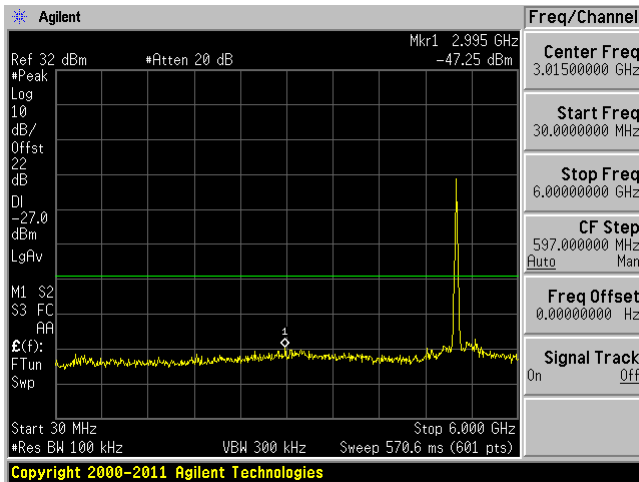

**C3 6 GHz-40 GHz**

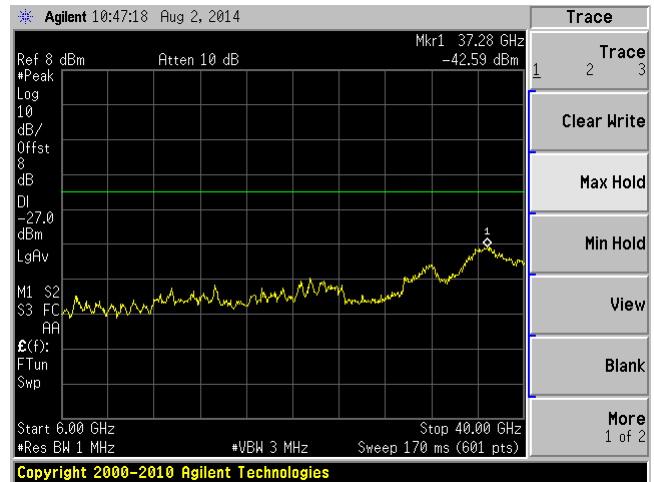

**C4 30 MHz-6 GHz**

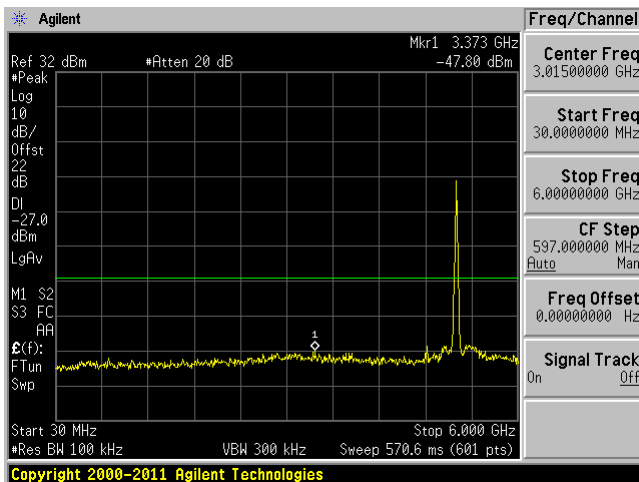

**C4 6 GHz-40 GHz**

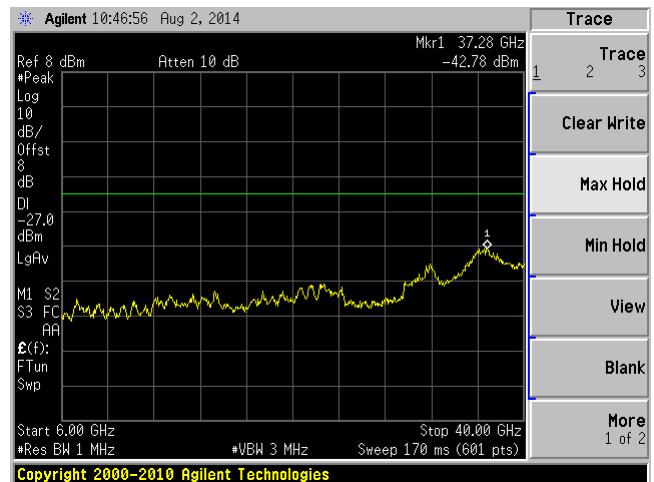

20 MHz bandwidth, High Channel, 5240 MHz

C1 30 MHz-6 GHz

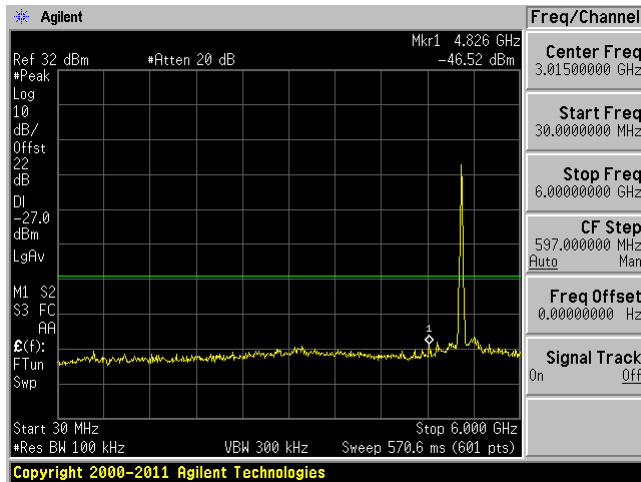

C1 6 GHz-40 GHz

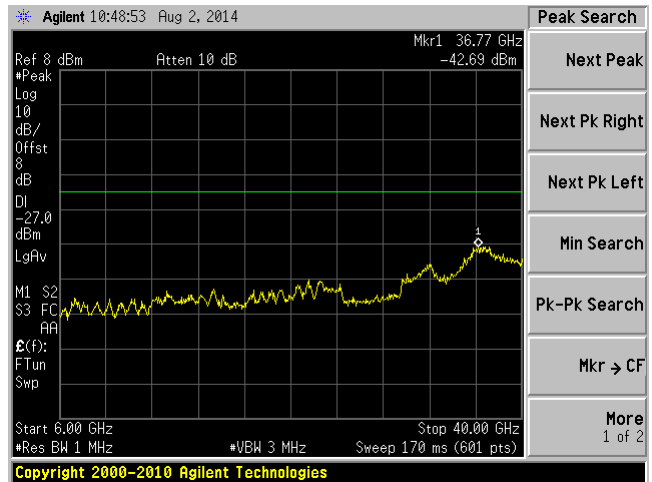

C2 30 MHz-6 GHz

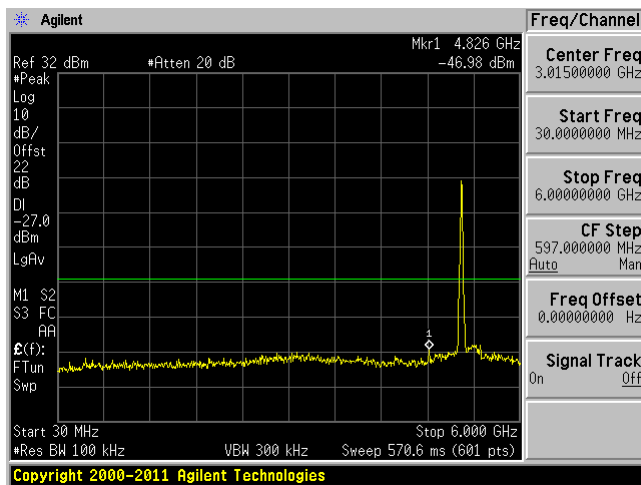

C2 6 GHz-40 GHz

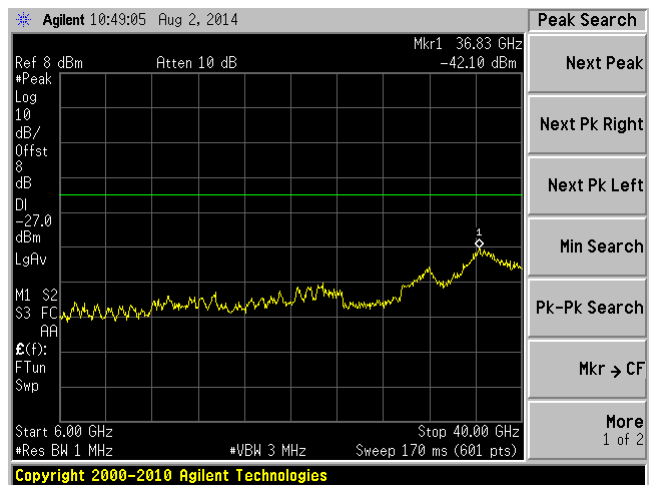

**C3 30 MHz-6 GHz**

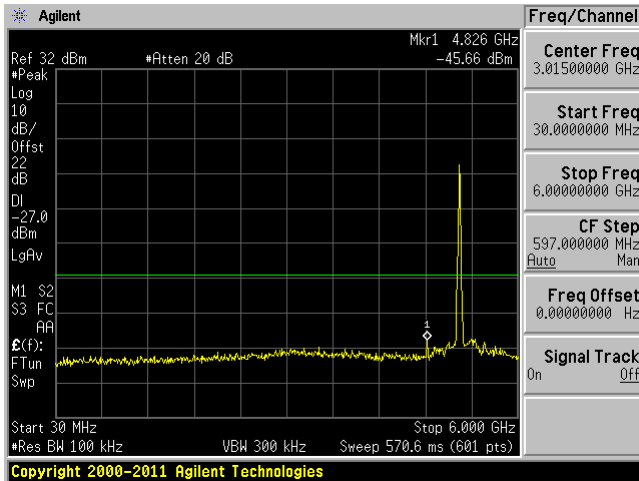

**C3 6 GHz-40 GHz**

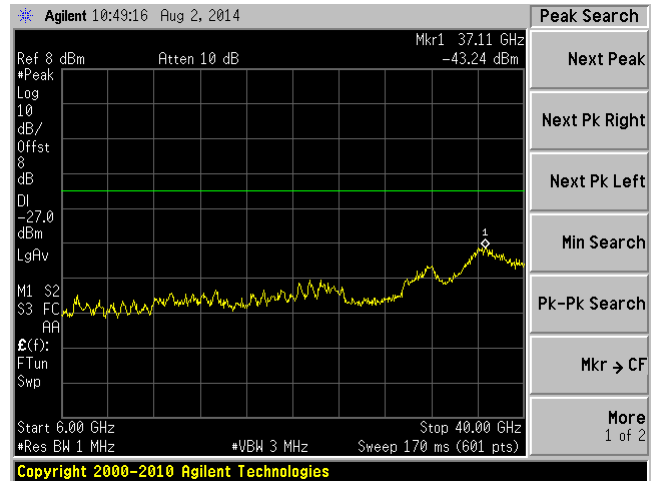

**C4 30 MHz-6 GHz**

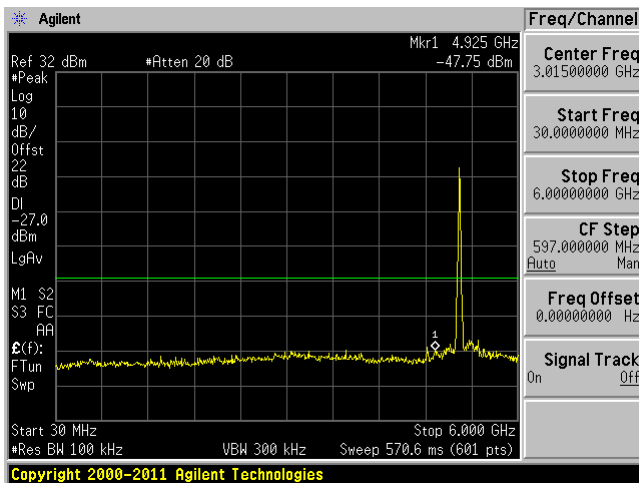

**C4 6 GHz-40 GHz**

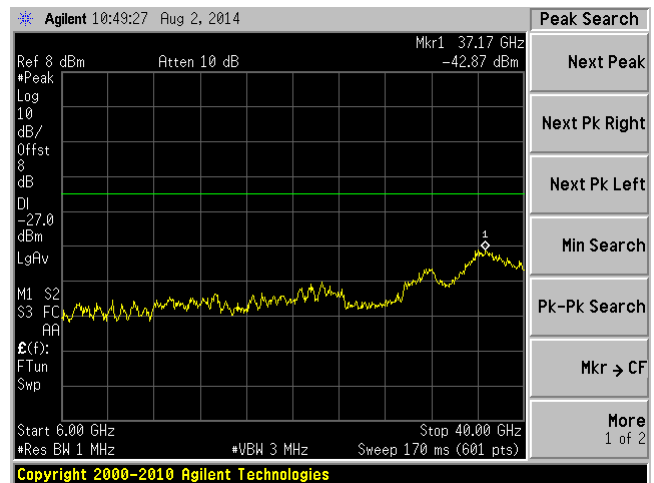

40 MHz bandwidth, Low Channel, 5175 MHz

C1 30 MHz-6 GHz

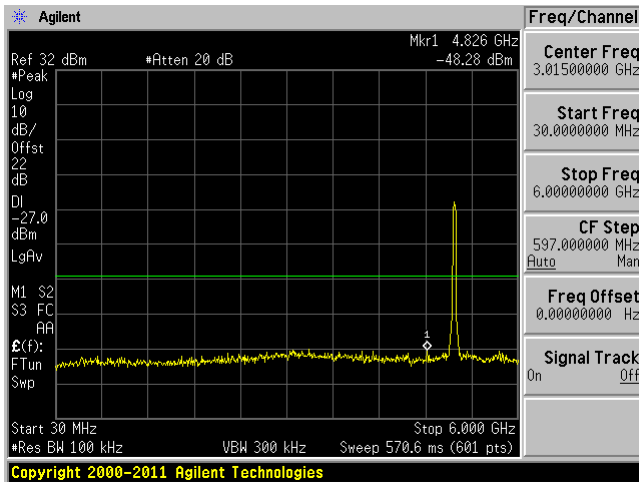

C1 6 GHz-40 GHz

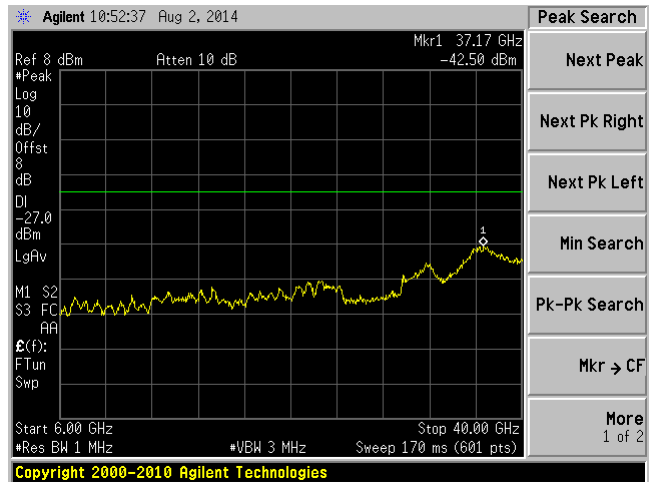

C2 30 MHz-6 GHz

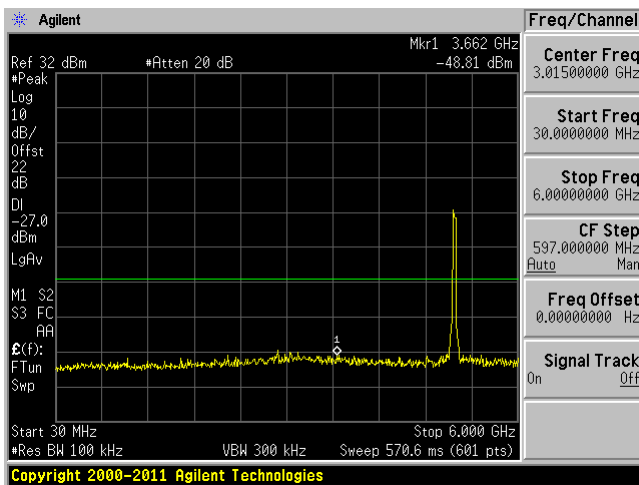

C2 6 GHz-40 GHz

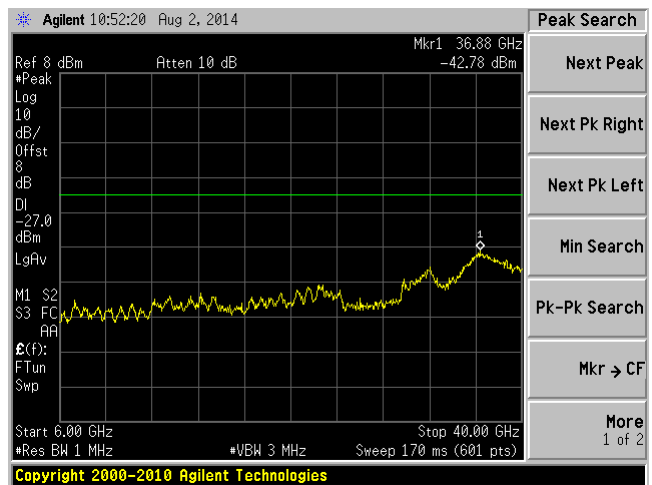

**C3 30 MHz-6 GHz**

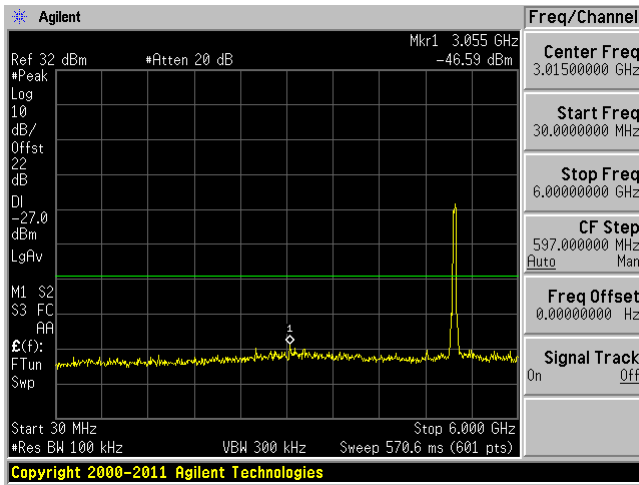

**C3 6 GHz-40 GHz**

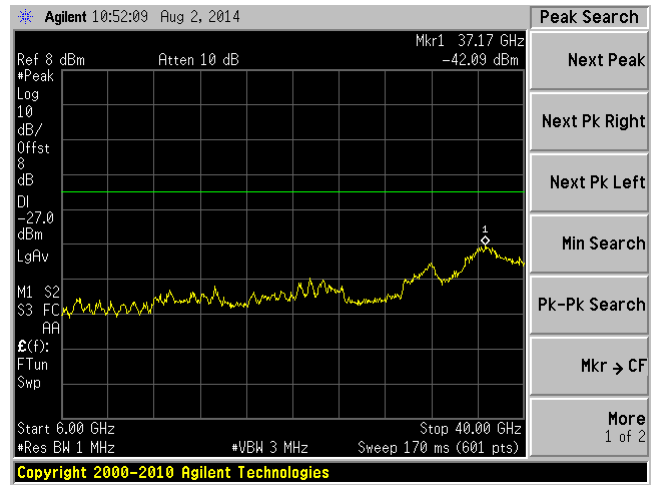

**C4 30 MHz-6 GHz**

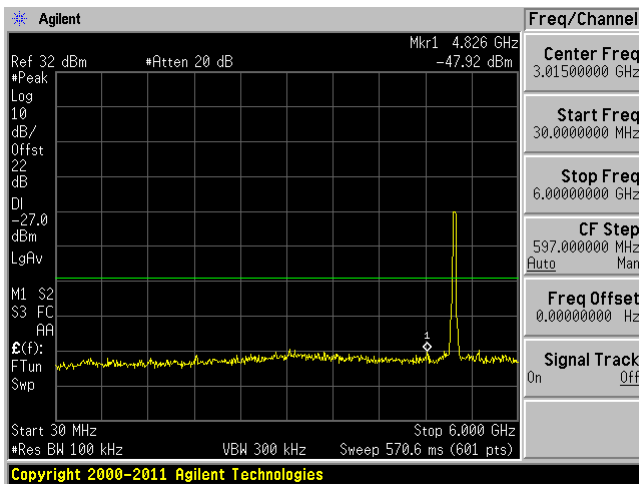

**C4 6 GHz-40 GHz**

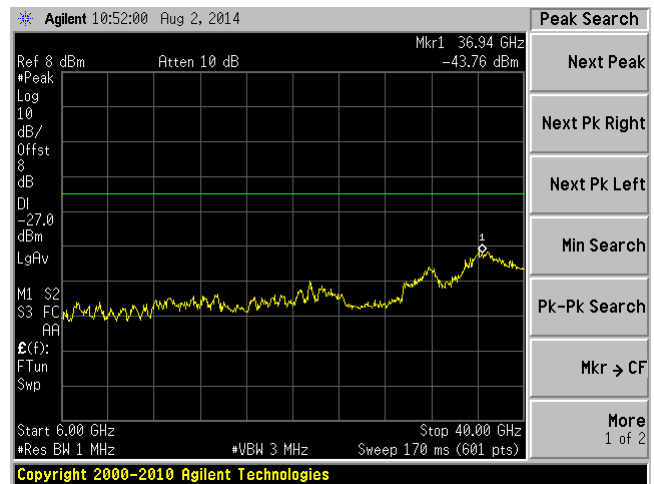

40 MHz bandwidth, Middle Channel, 5200 MHz

C1 30 MHz-6 GHz

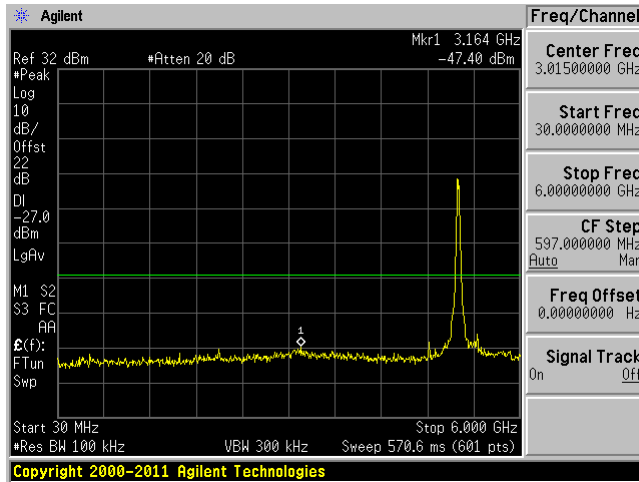

C1 6 GHz-40 GHz

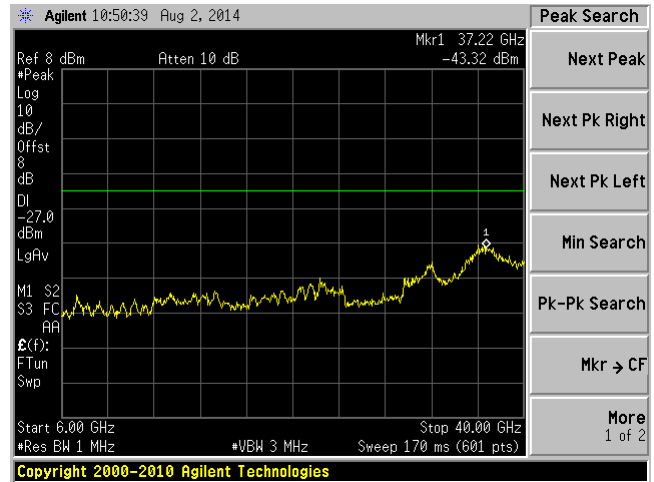

C2 30 MHz-6 GHz

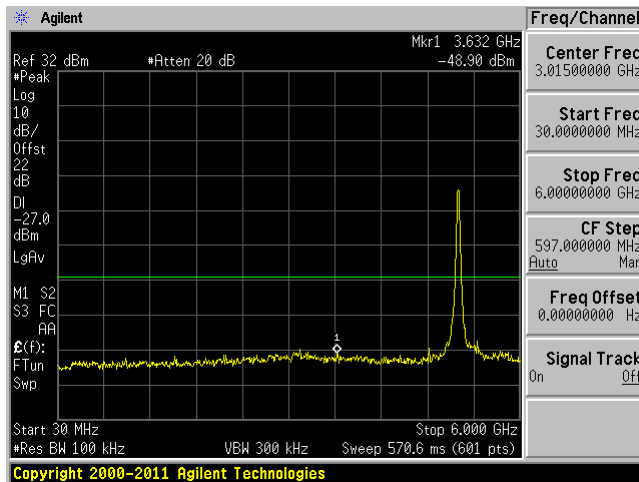

C2 6 GHz-40 GHz

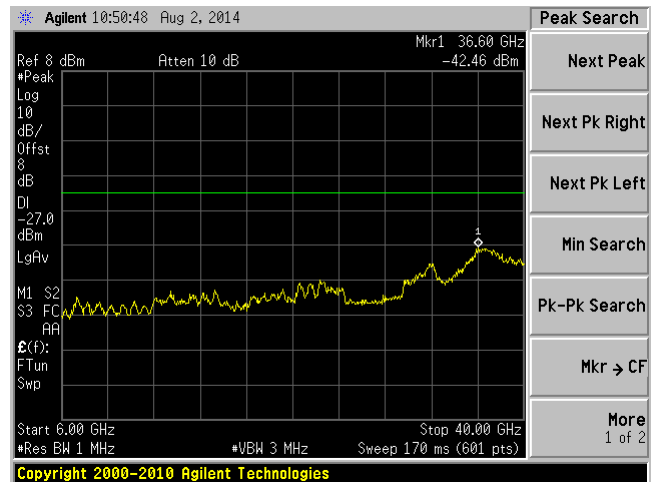

**C3 30 MHz-6 GHz**

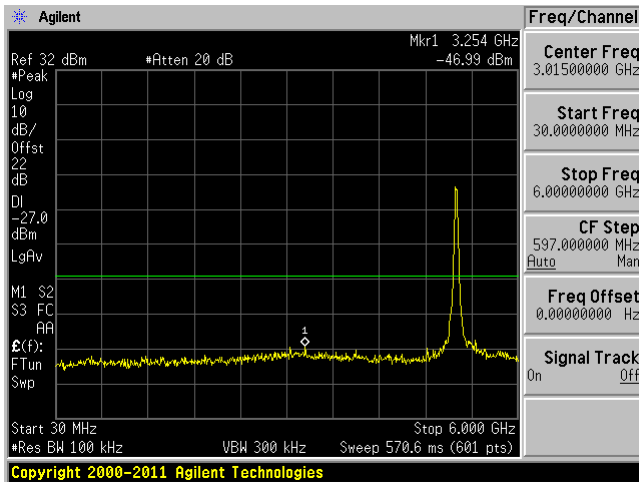

**C3 6 GHz-40 GHz**

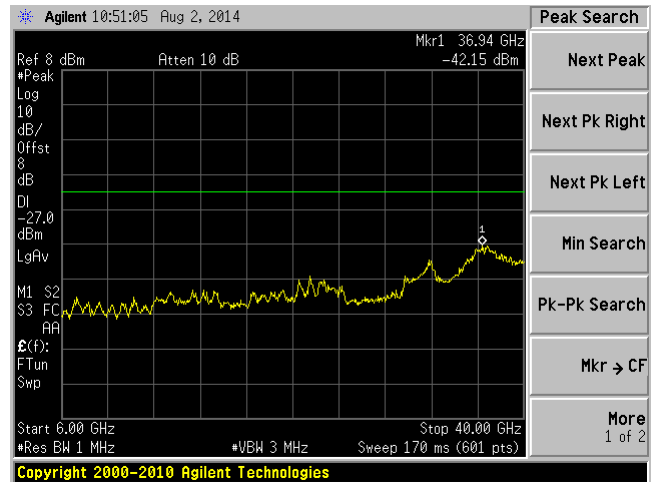

**C4 30 MHz-6 GHz**

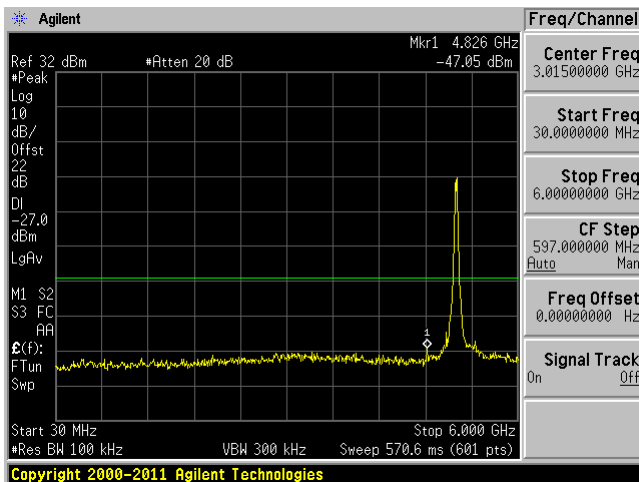

**C4 6 GHz-40 GHz**

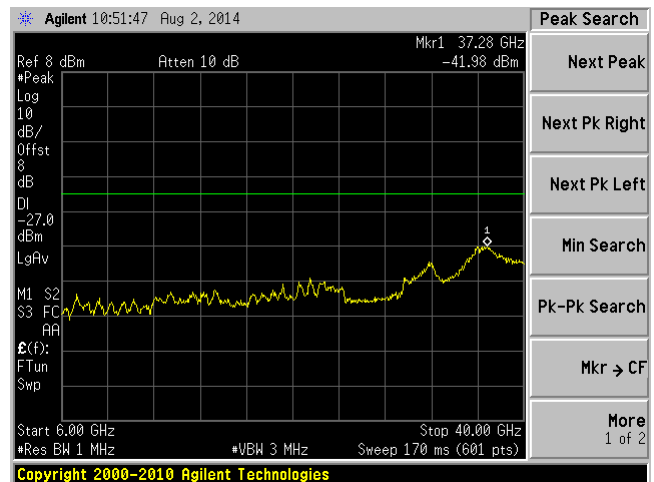

40 MHz bandwidth, High Channel, 5230 MHz

C1 30 MHz-6 GHz

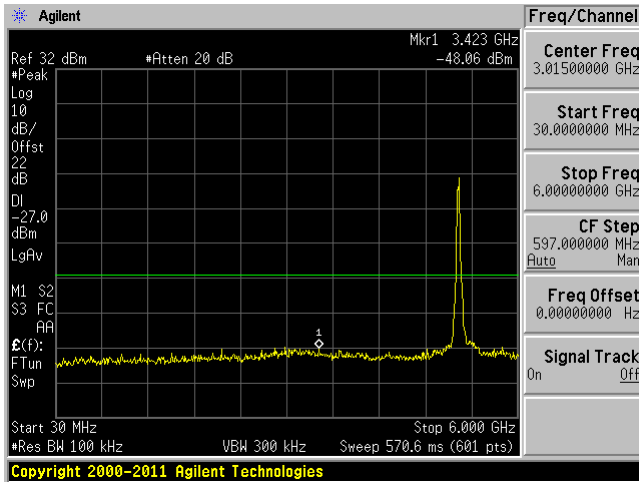

C1 6 GHz-40 GHz

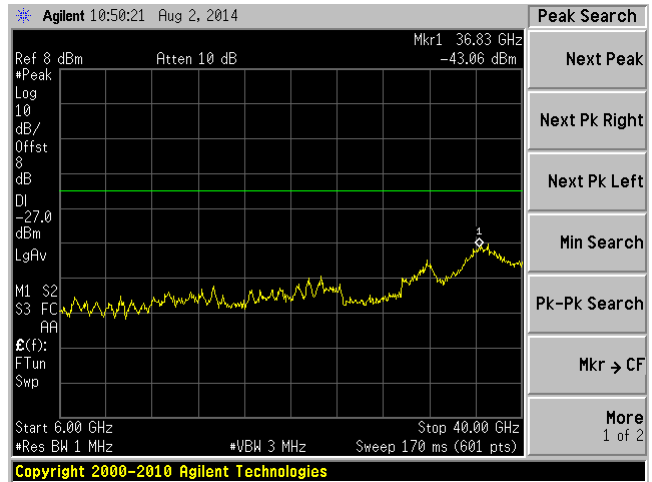

C2 30 MHz-6 GHz

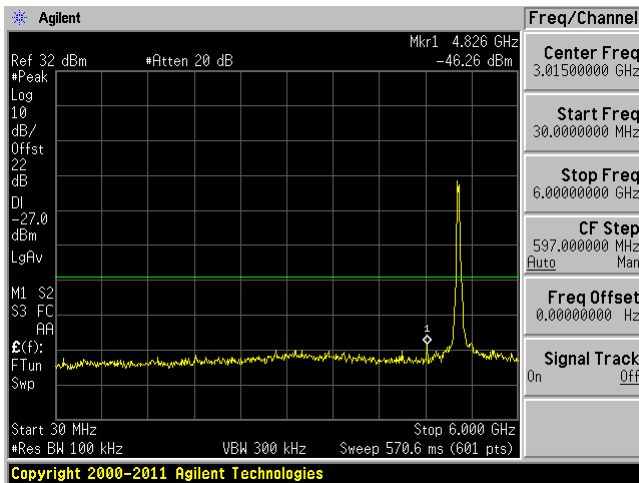

C2 6 GHz-40 GHz

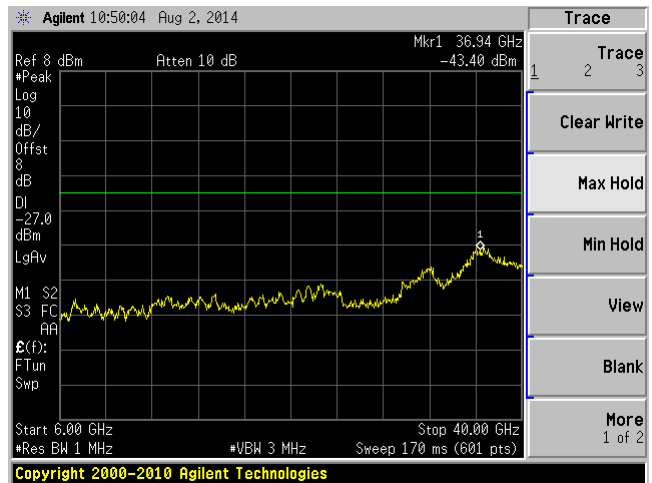



**C3 30 MHz-6 GHz**

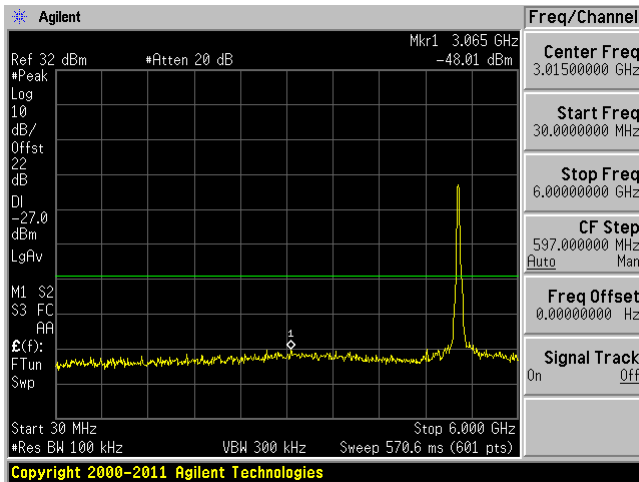

**C3 6 GHz-40 GHz**

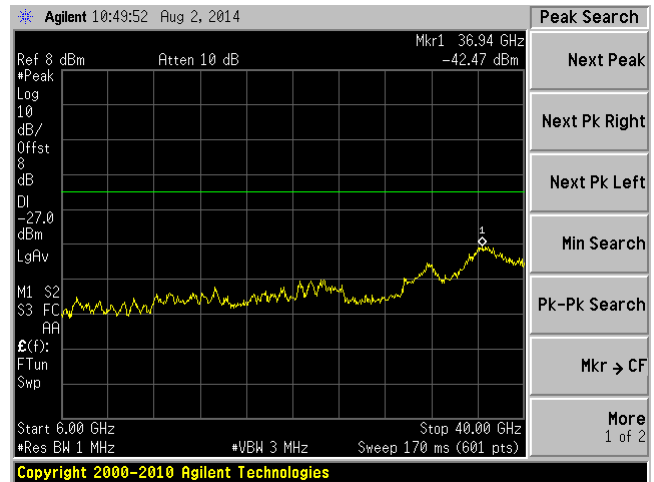

**C4 30 MHz-6 GHz**

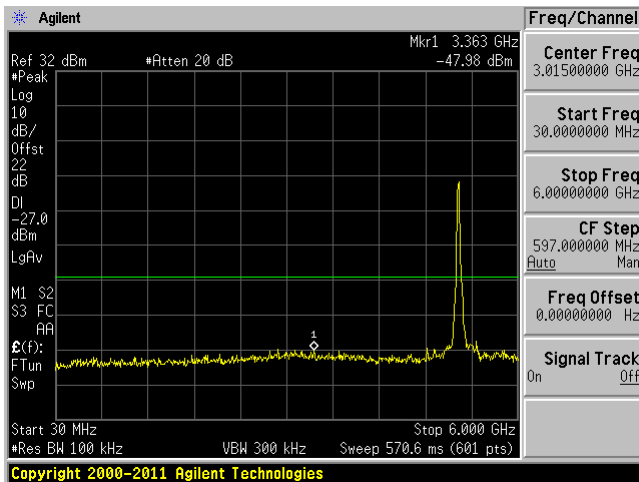

**C4 6 GHz-40 GHz**

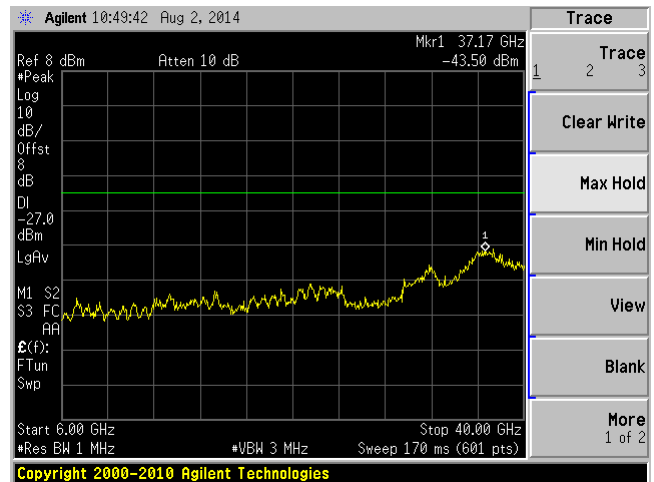

80 MHz bandwidth, Low Channel, 5195 MHz

C1 30 MHz-6 GHz

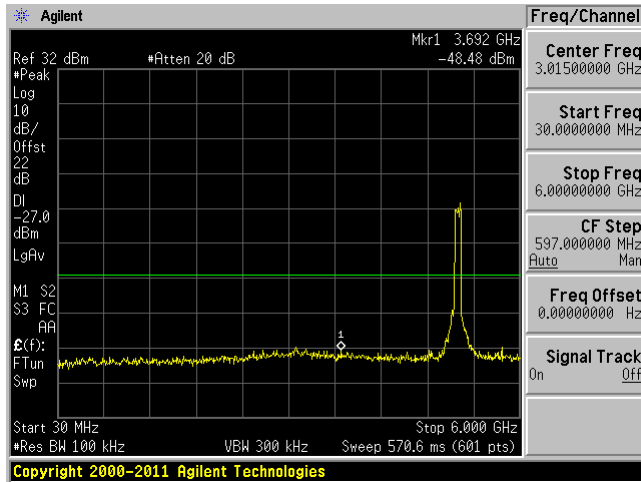

C1 6 GHz-40 GHz

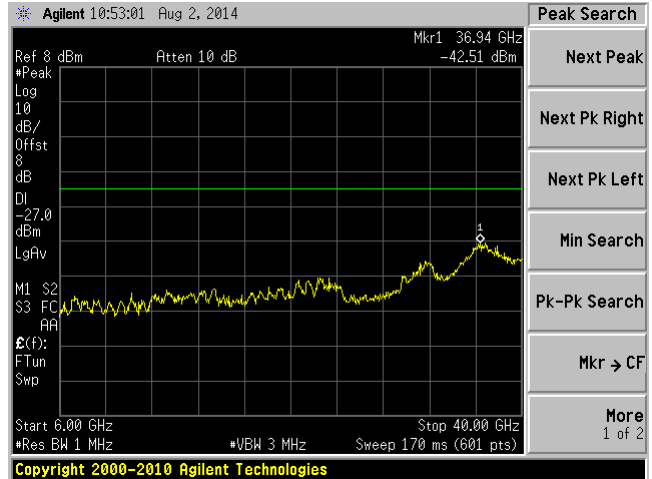

C2 30 MHz-6 GHz

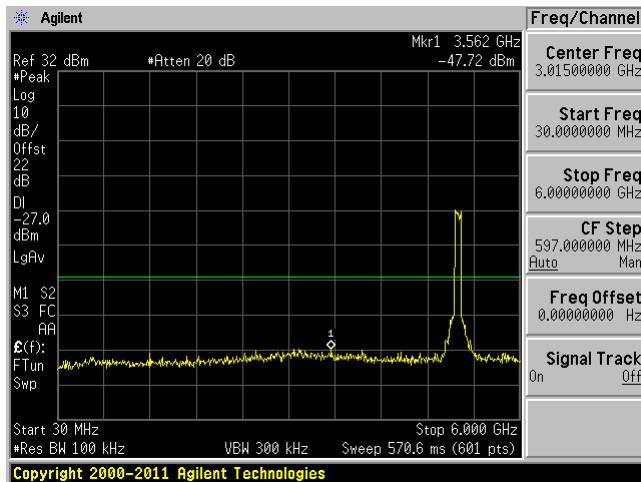

C2 6 GHz-40 GHz

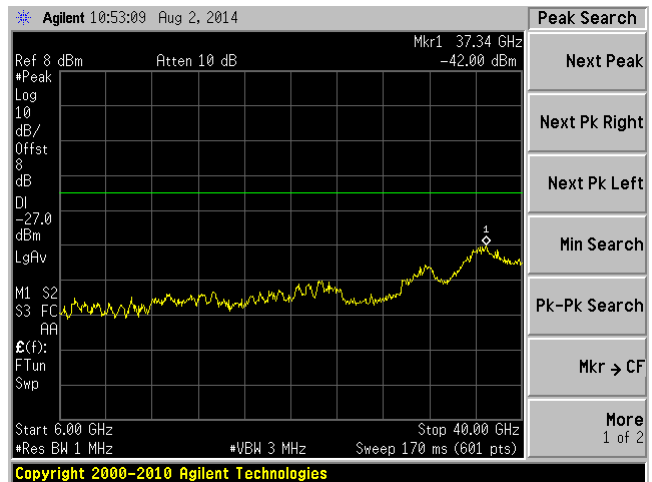

### C3 30 MHz-6 GHz

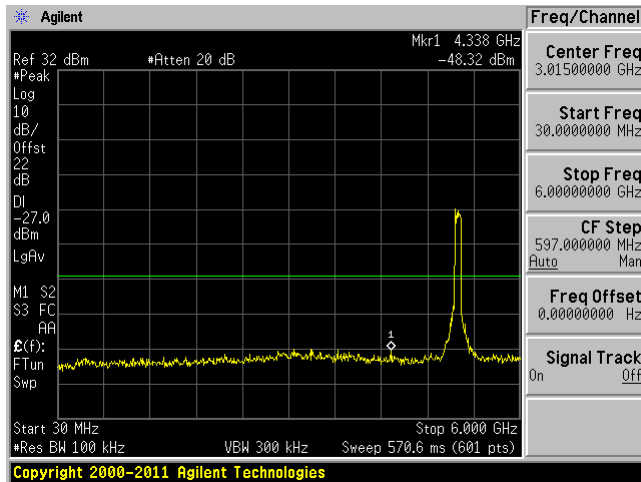

### C3 6 GHz-40 GHz

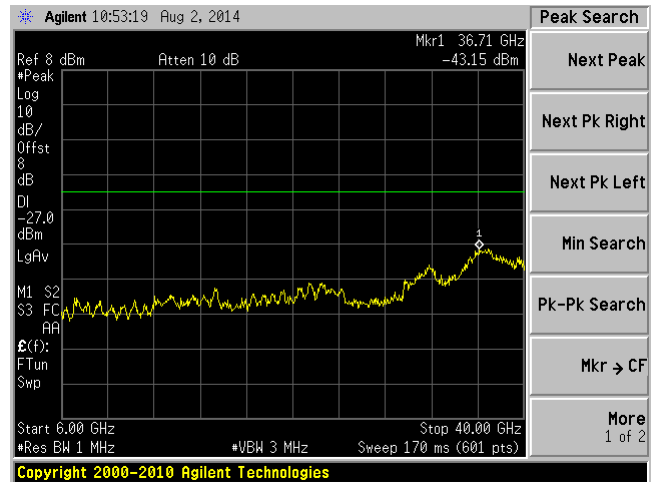

### C4 30 MHz-6 GHz

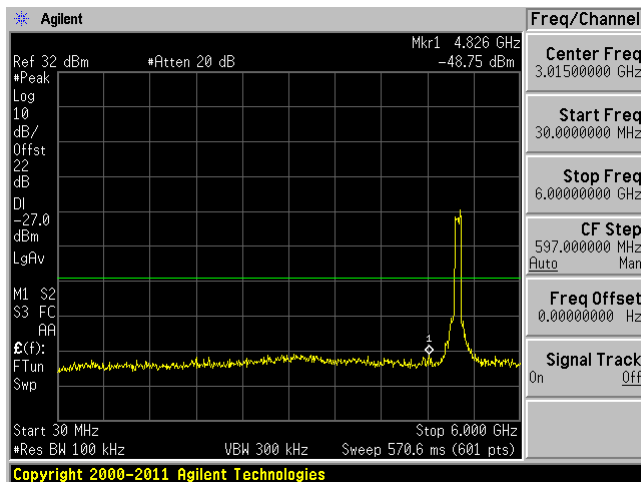

### C4 6 GHz-40 GHz

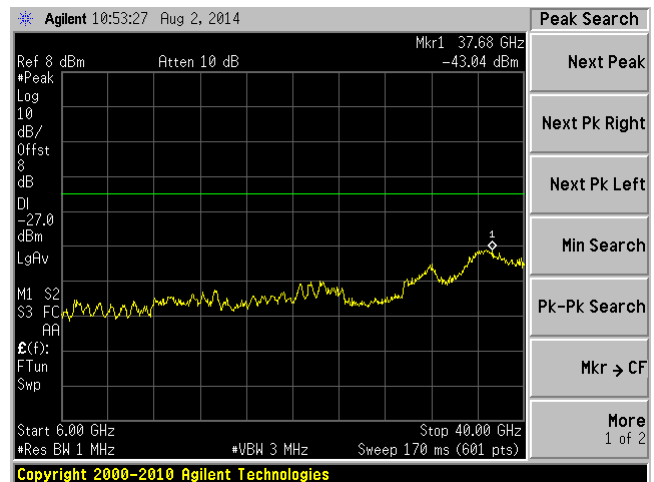

80 MHz bandwidth, Middle Channel, 5200 MHz

C1 30 MHz-6 GHz

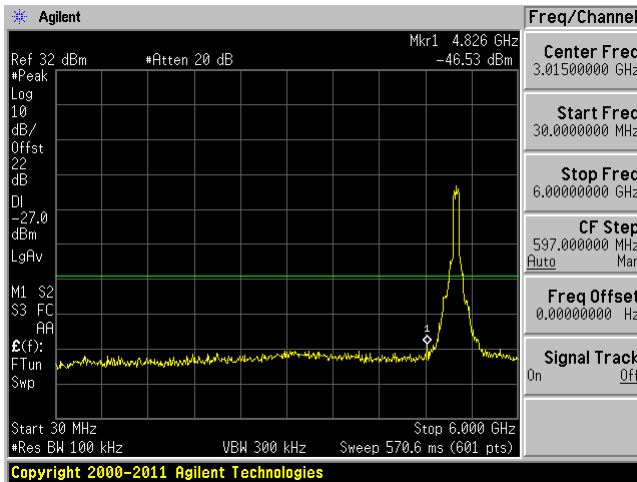

C1 6 GHz-40 GHz

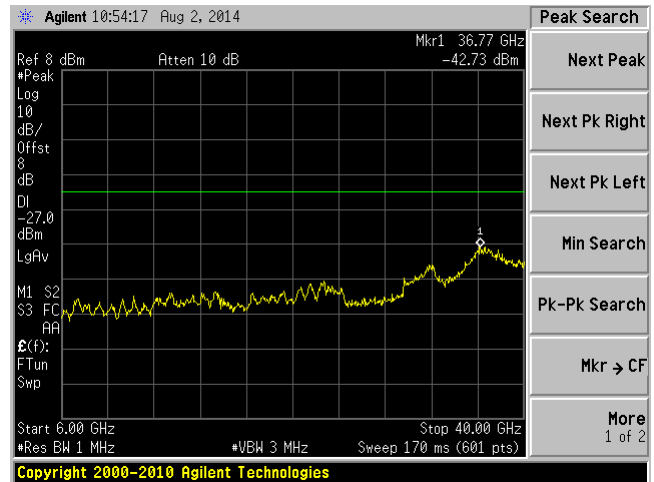

C2 30 MHz-6 GHz

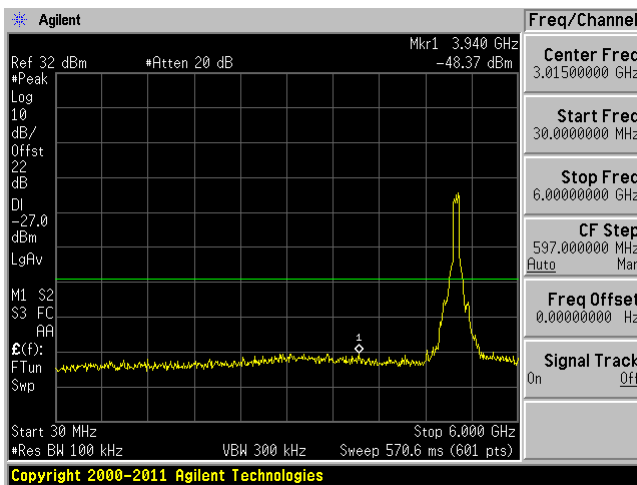

C2 6 GHz-40 GHz

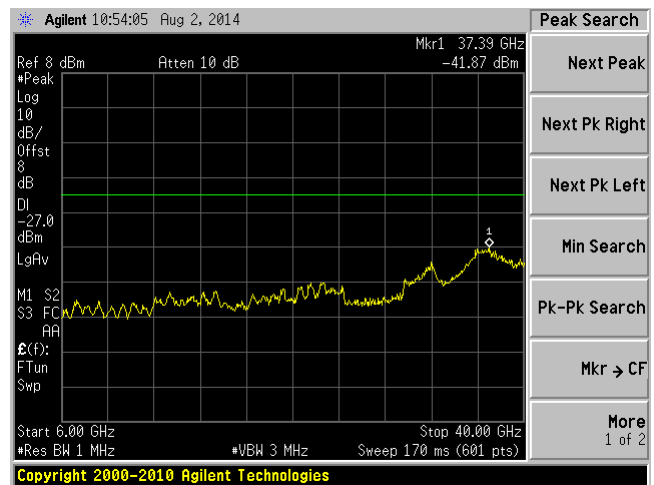

**C3 30 MHz-6 GHz**

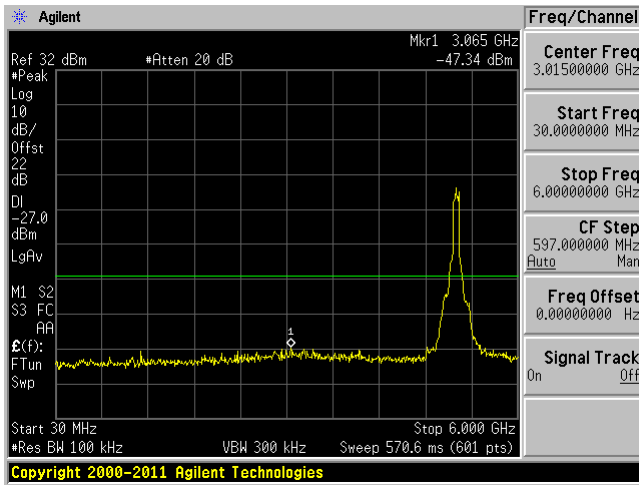

**C3 6 GHz-40 GHz**

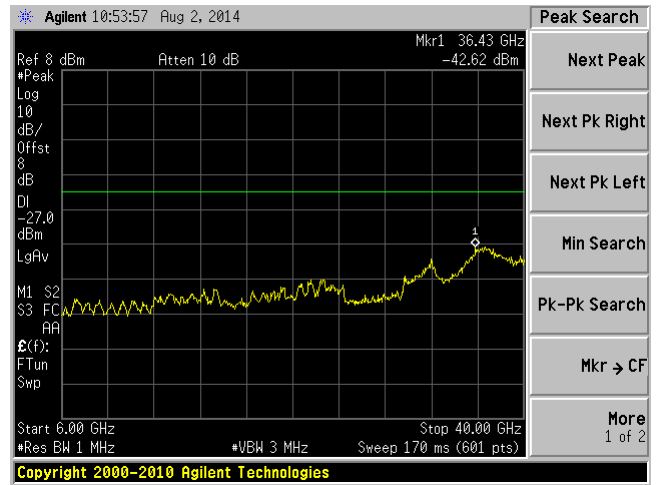

**C4 30 MHz-6 GHz**

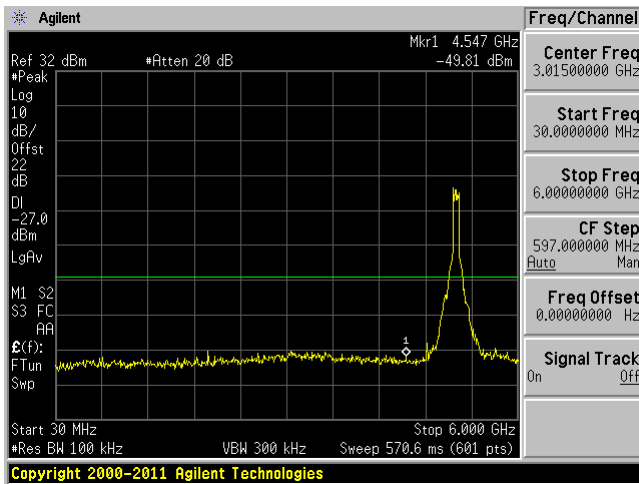

**C4 6 GHz-40 GHz**

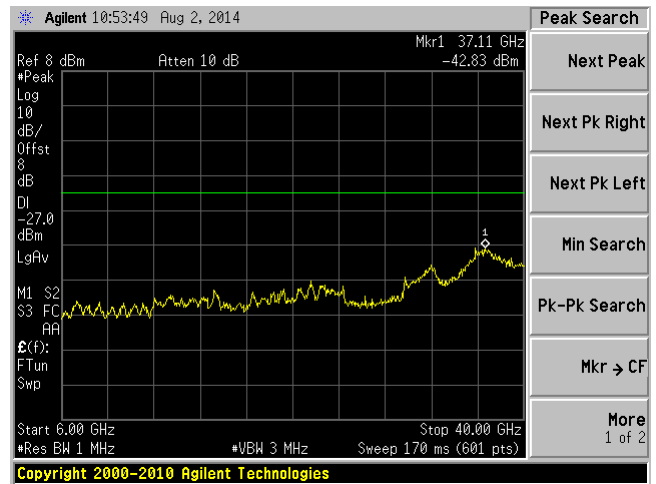

80 MHz bandwidth, High Channel, 5210 MHz

C1 30 MHz-6 GHz

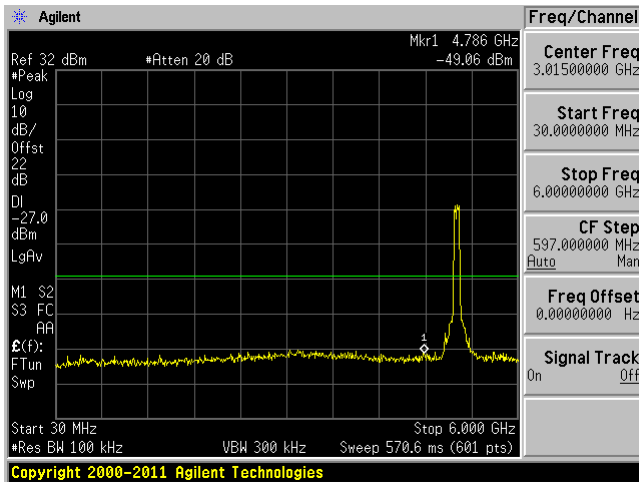

C1 6 GHz-40 GHz

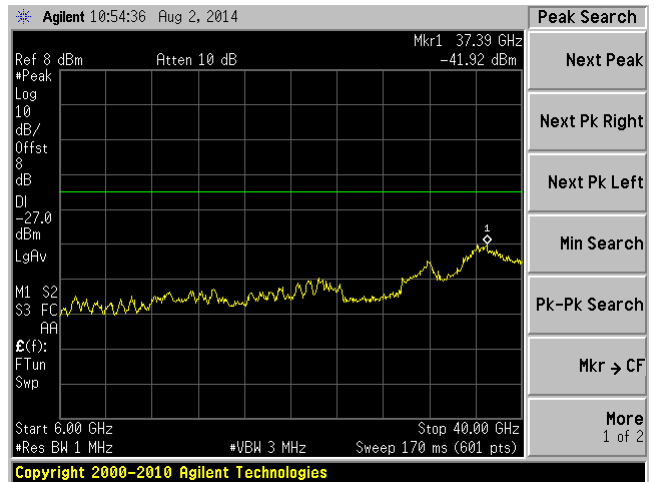

C2 30 MHz-6 GHz

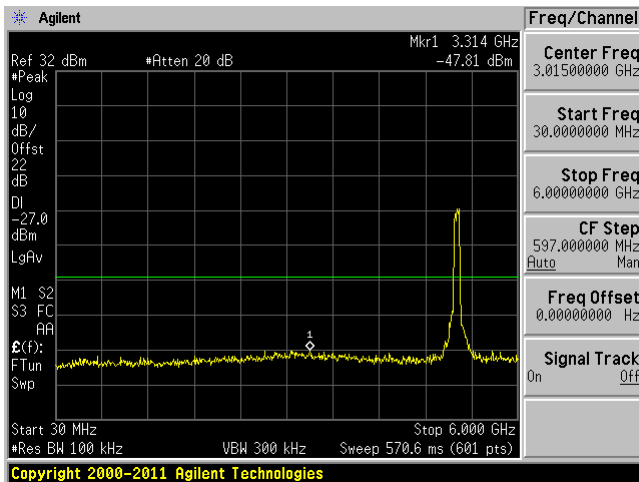

C2 6 GHz-40 GHz

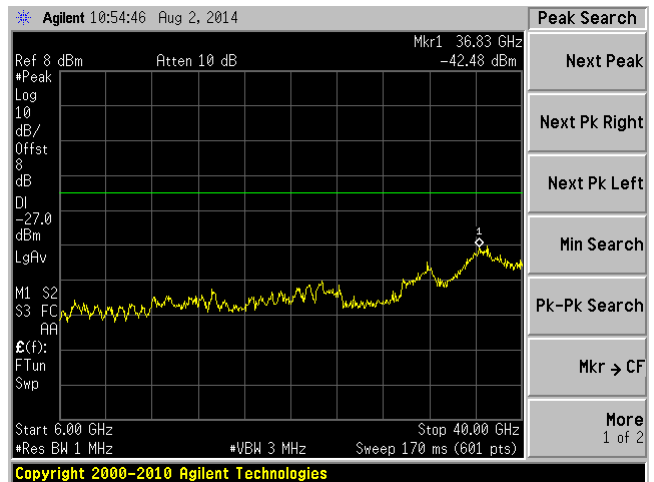

**C3 30 MHz-6 GHz**

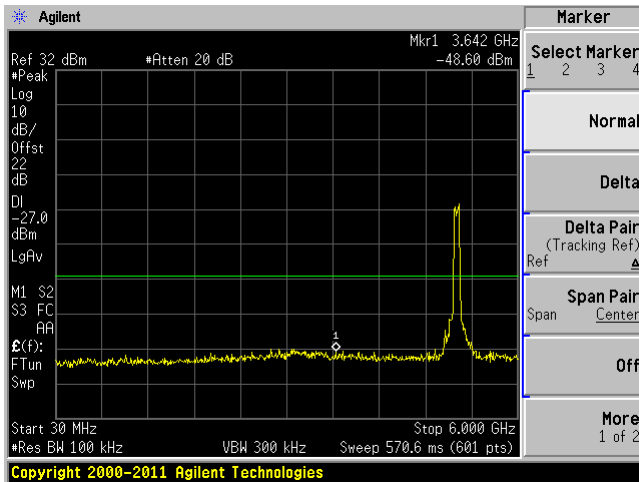

**C3 6 GHz-40 GHz**

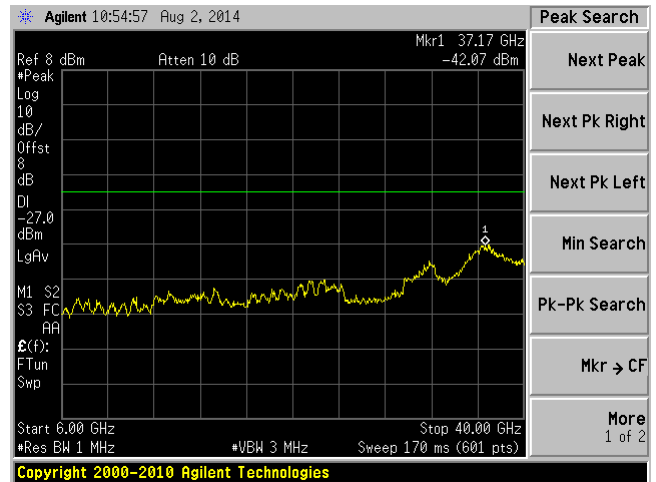

**C4 30 MHz-6 GHz**

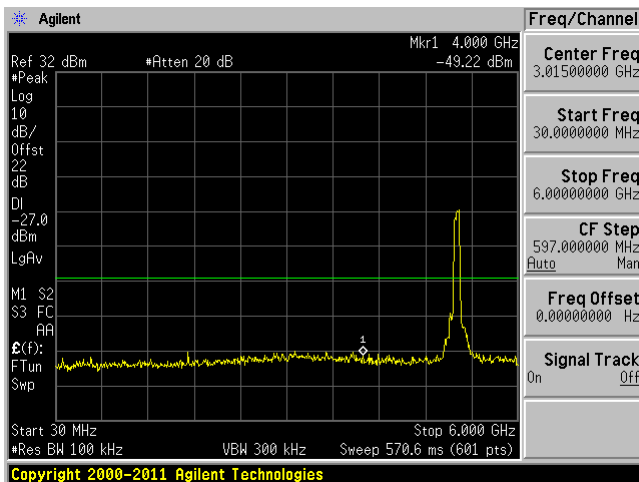

**C4 6 GHz-40 GHz**

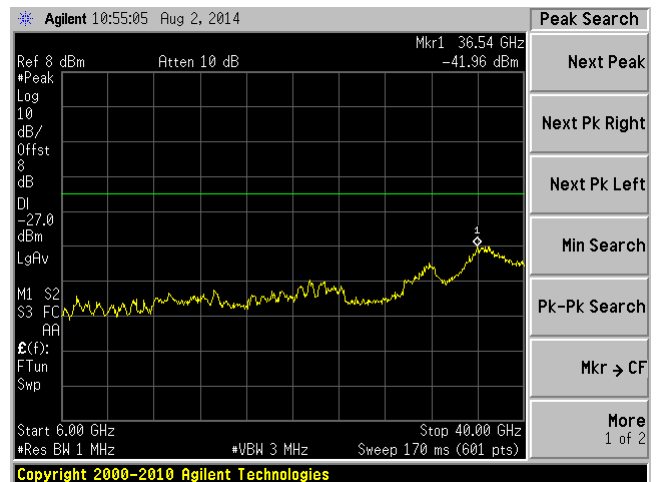

**5.8 GHz Band:**

**20 MHz bandwidth, Low Channel, 5745 MHz**

**C1 30 MHz-6 GHz**

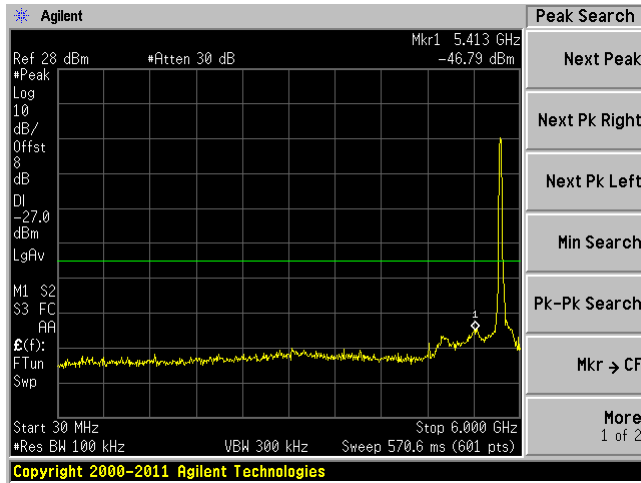

**C1 6 GHz-40 GHz**

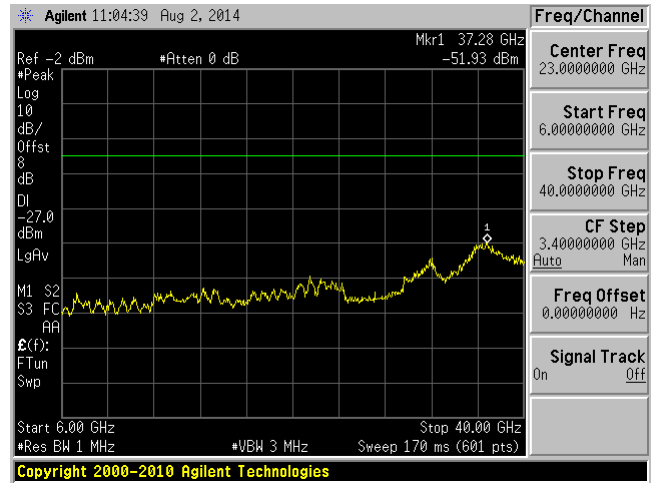

**C2 30 MHz-6 GHz**

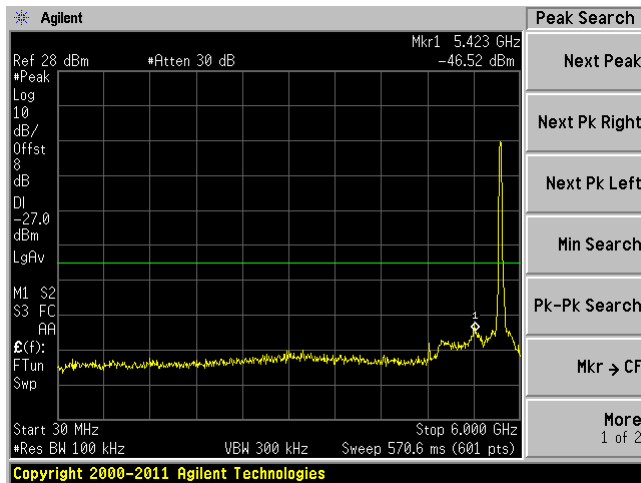

**C2 6 GHz-40 GHz**

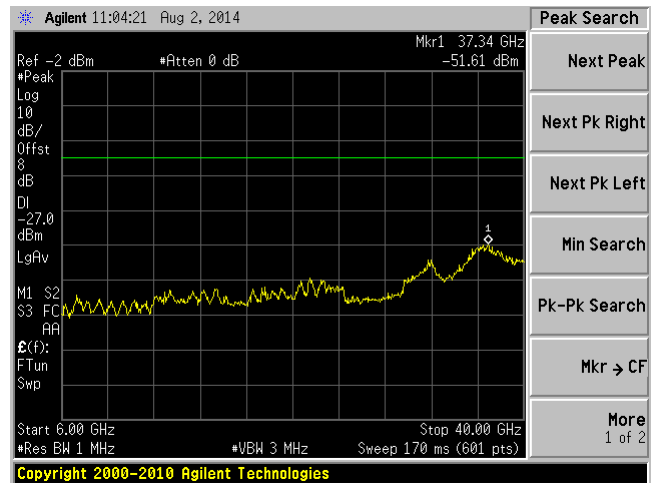



**C3 30 MHz-6 GHz**

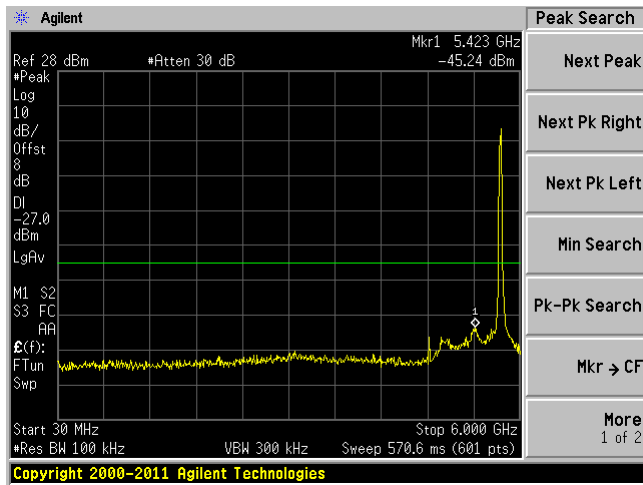

**C3 6 GHz-40 GHz**

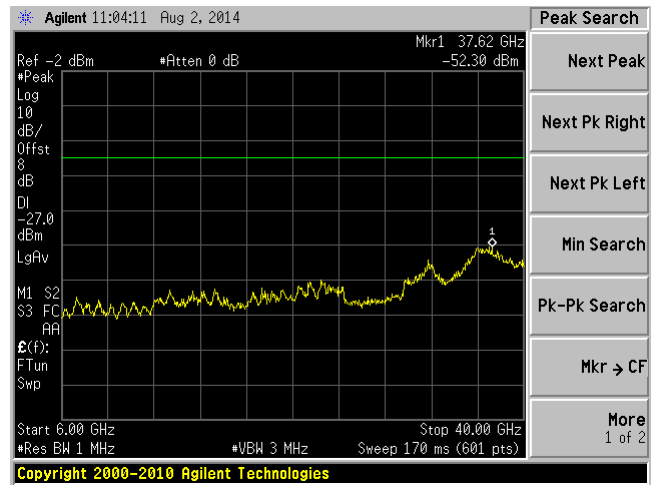

**C4 30 MHz-6 GHz**

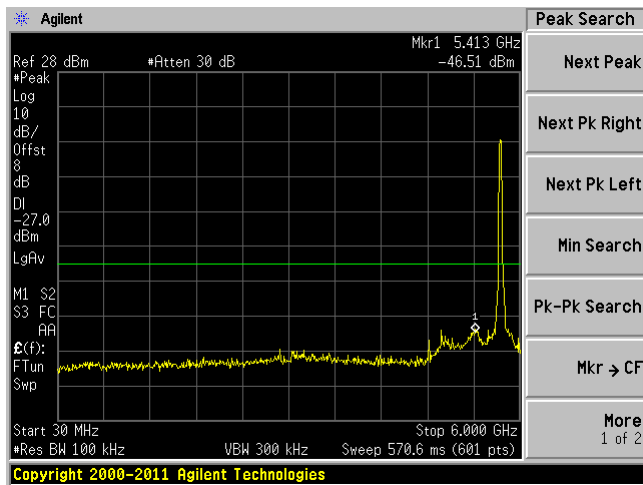

**C4 6 GHz-40 GHz**

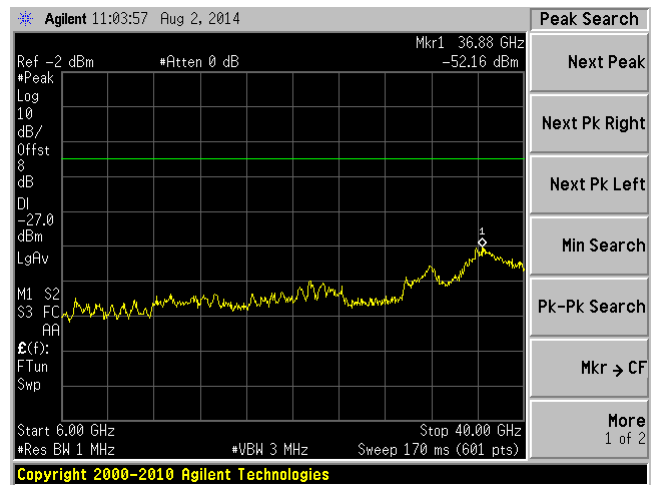

20 MHz bandwidth, Middle Channel, 5785 MHz

C1 30 MHz-6 GHz

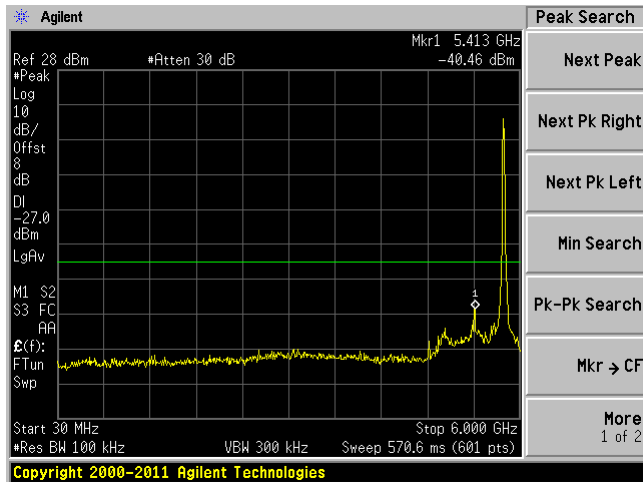

C1 6 GHz-40 GHz

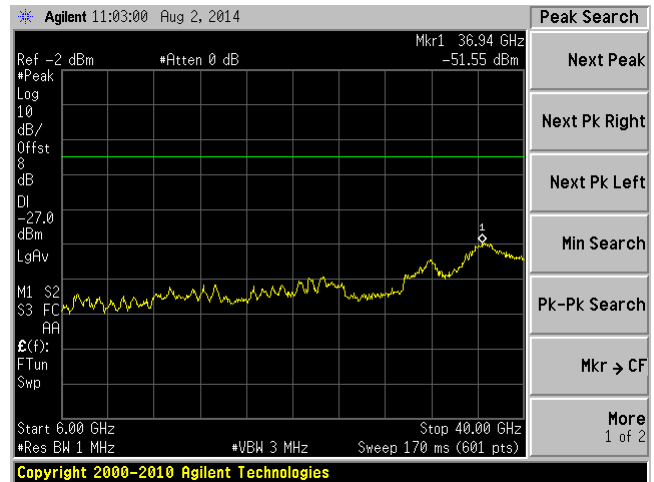

C2 30 MHz-6 GHz

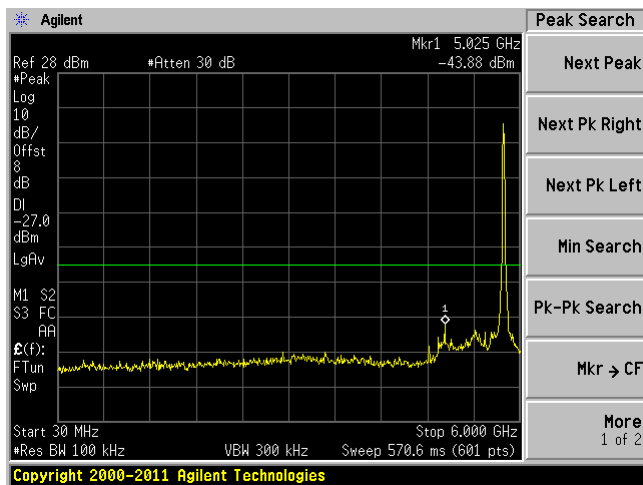

C2 6 GHz-40 GHz

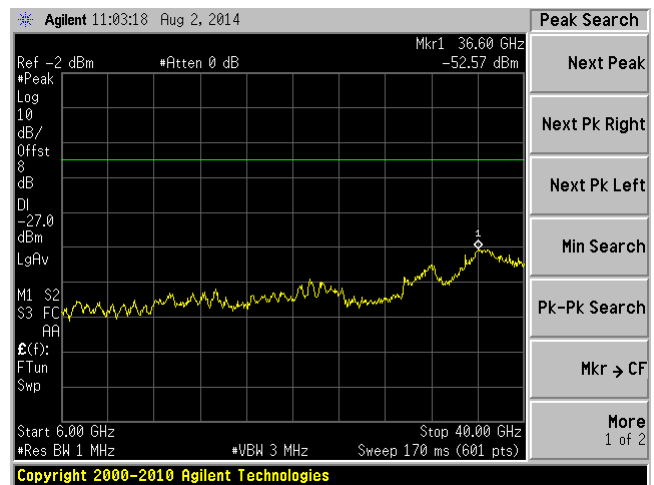

**C3 30 MHz-6 GHz**

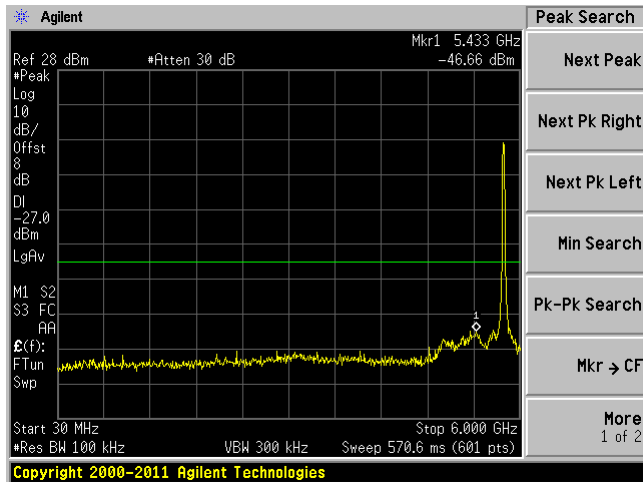

**C3 6 GHz-40 GHz**

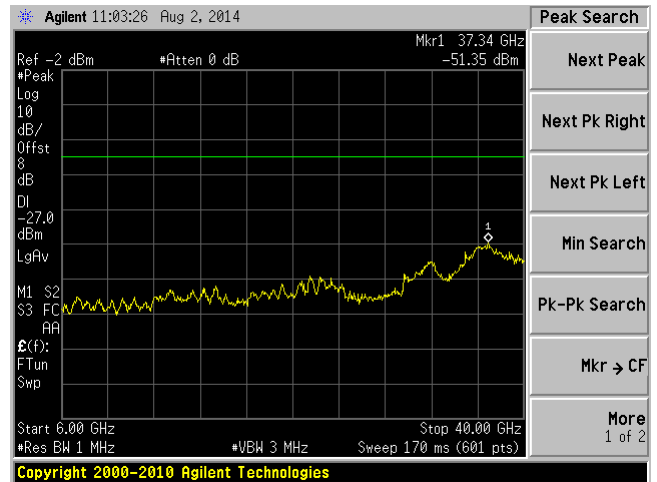

**C4 30 MHz-6 GHz**

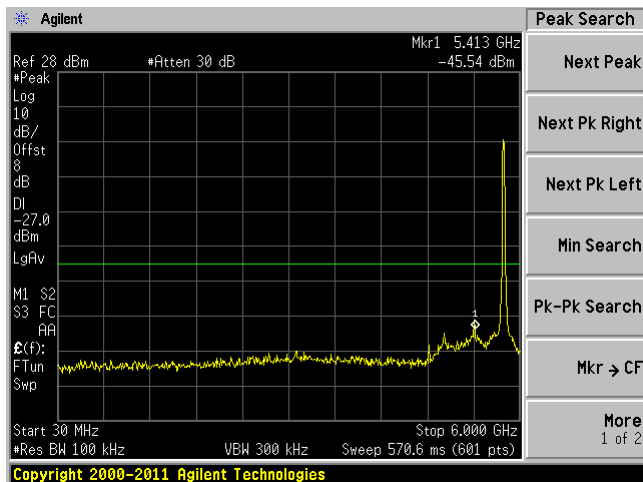

**C4 6 GHz-40 GHz**

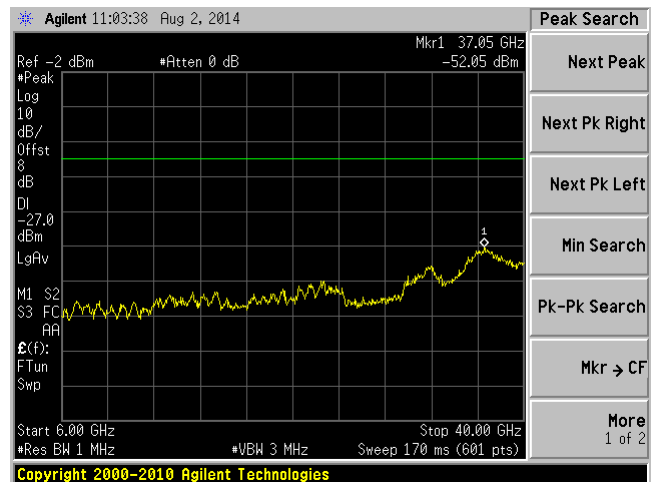

20 MHz bandwidth, High Channel, 5825 MHz

C1 30 MHz-6 GHz

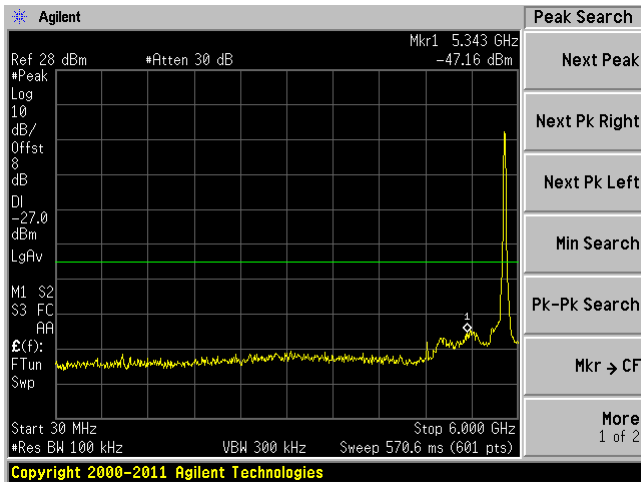

C1 6 GHz-40 GHz

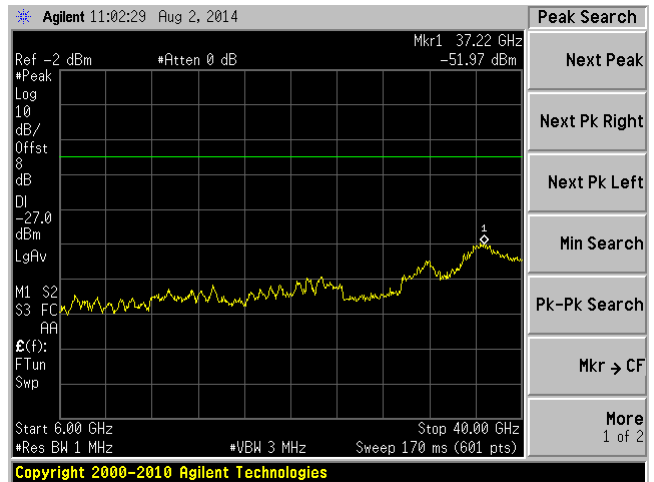

C2 30 MHz-6 GHz

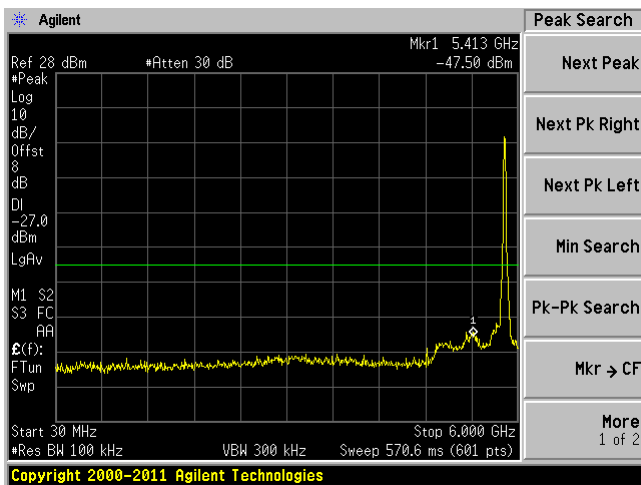

C2 6 GHz-40 GHz

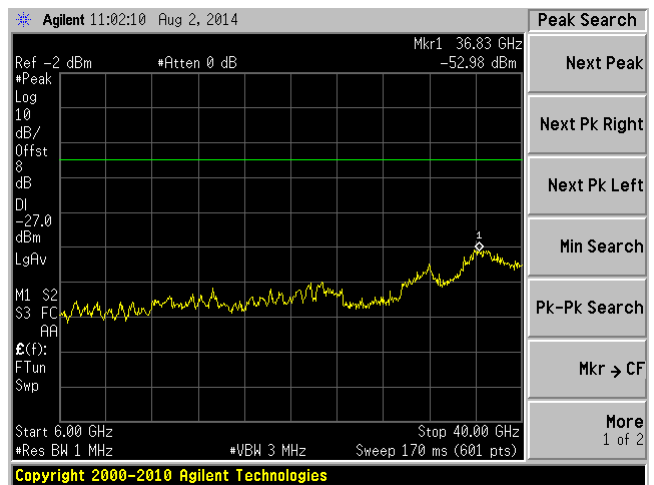

**C3 30 MHz-6 GHz**

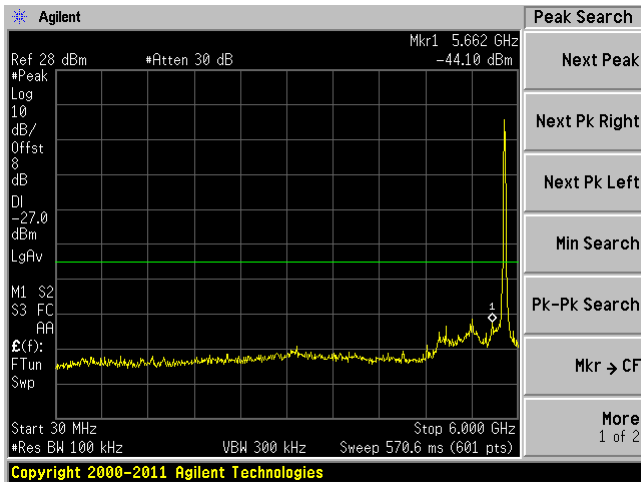

**C3 6 GHz-40 GHz**

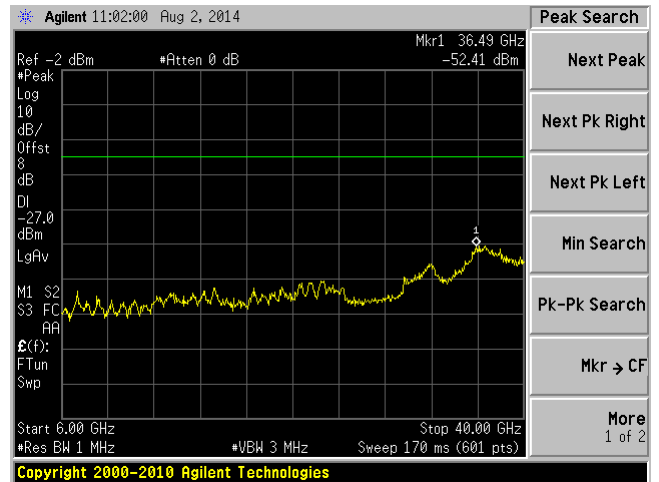

**C4 30 MHz-6 GHz**

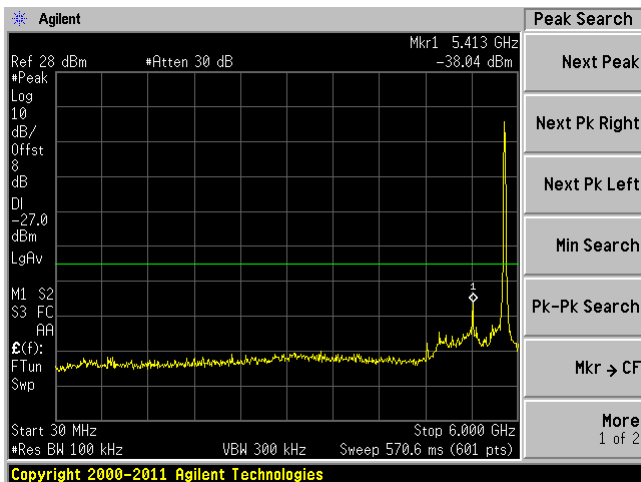

**C4 6 GHz-40 GHz**

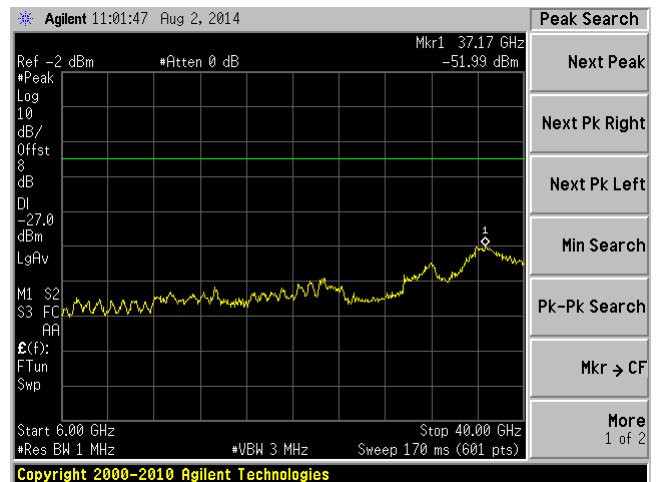

40 MHz bandwidth, Low Channel, 5755 MHz

C1 30 MHz-6 GHz

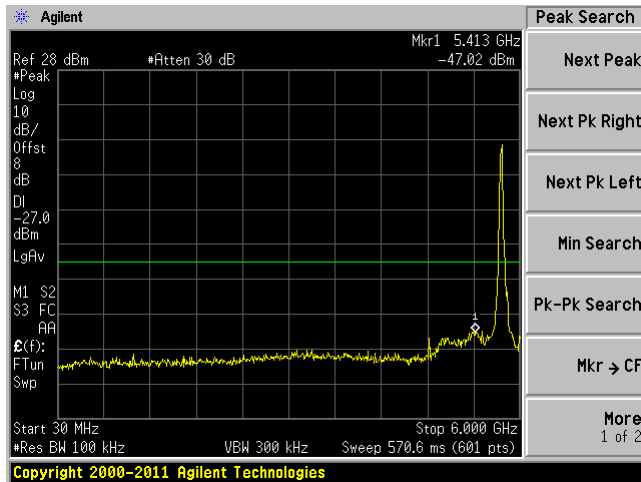

C1 6 GHz-40 GHz

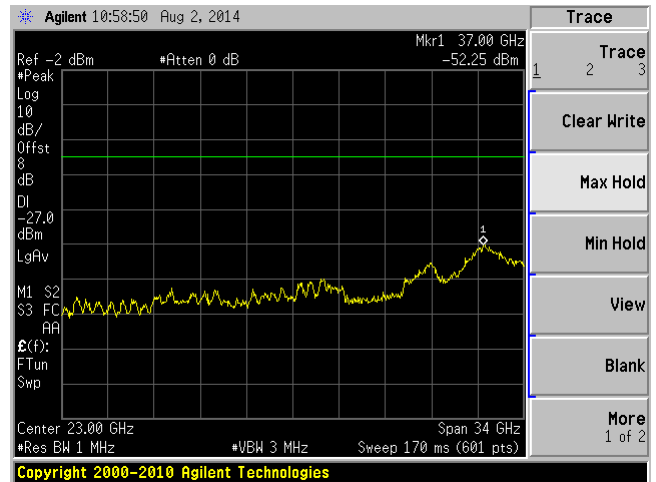

C2 30 MHz-6 GHz

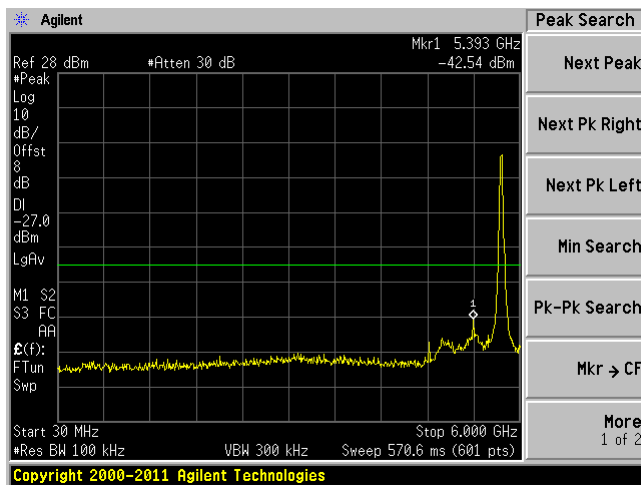

C2 6 GHz-40 GHz

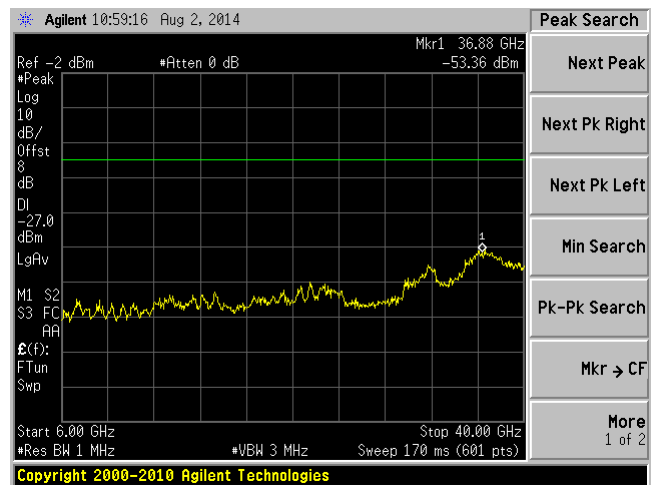

**C3 30 MHz-6 GHz**

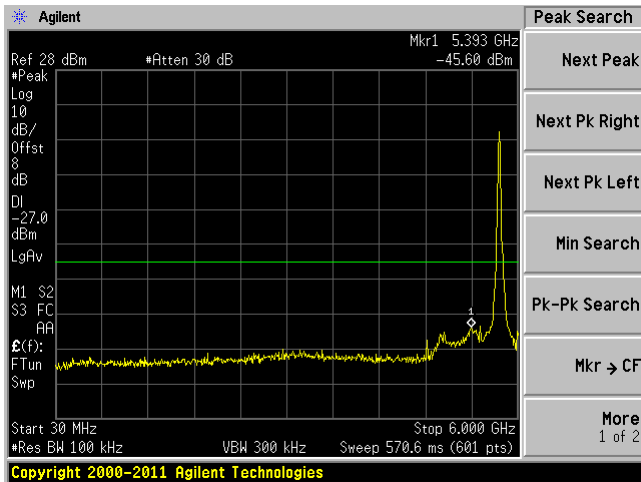

**C3 6 GHz-40 GHz**

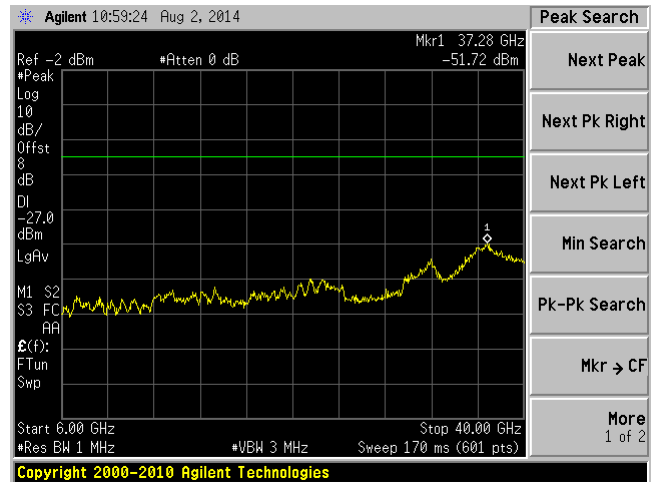

**C4 30 MHz-6 GHz**

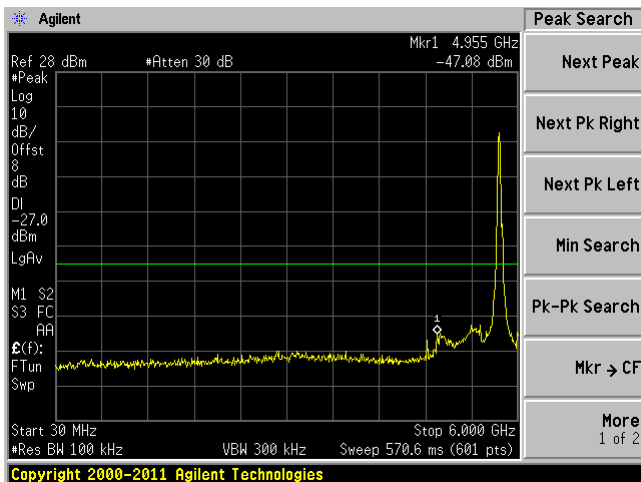

**C4 6 GHz-40 GHz**

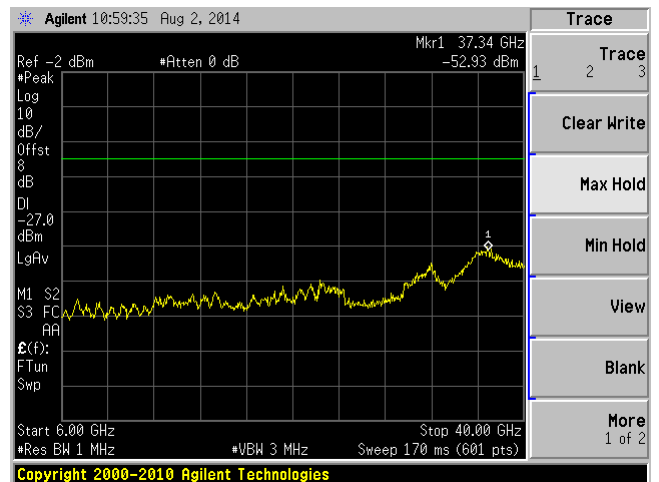

40 MHz bandwidth, Middle Channel, 5785 MHz

C1 30 MHz-6 GHz

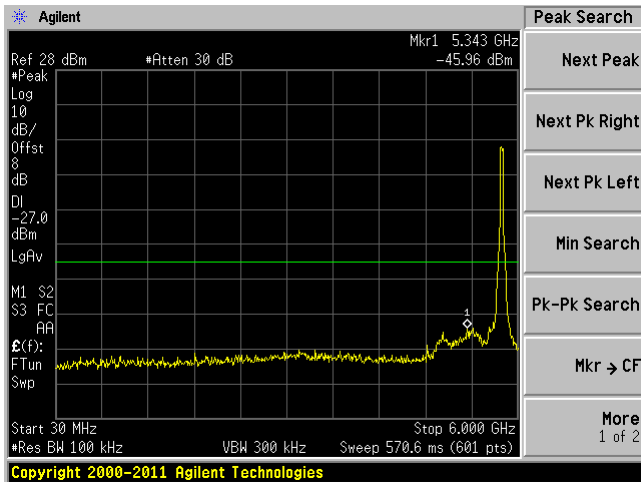

C1 6 GHz-40 GHz

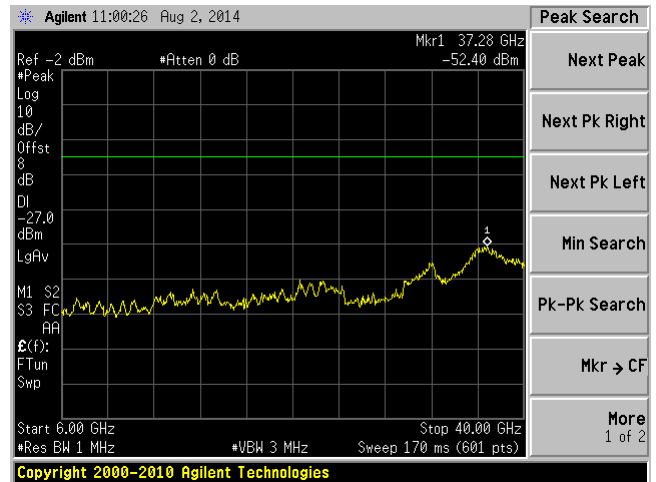

C2 30 MHz-6 GHz

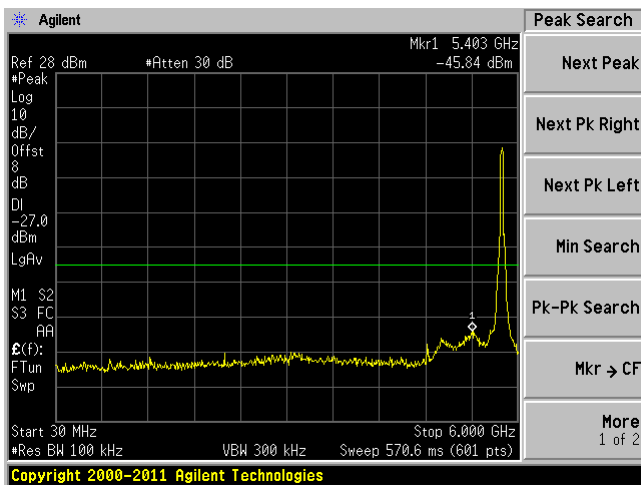

C2 6 GHz-40 GHz

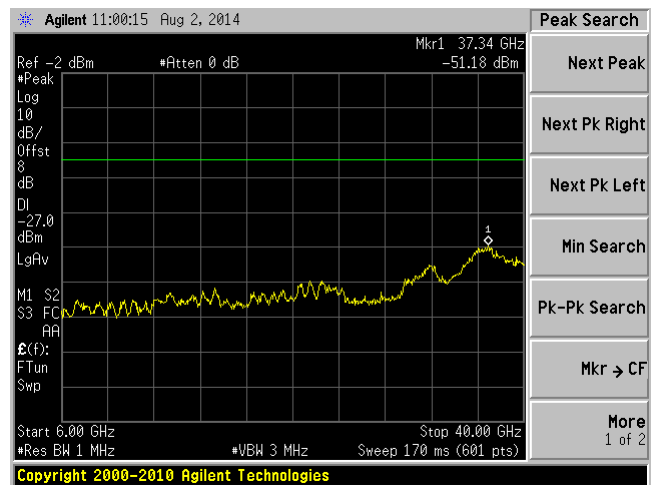



### C3 30 MHz-6 GHz

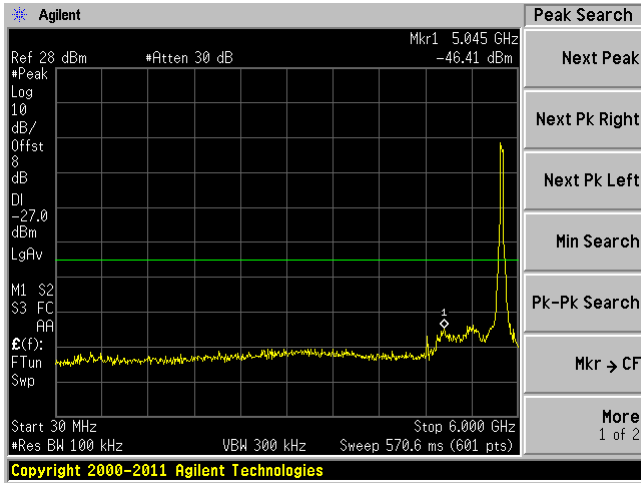

### C3 6 GHz-40 GHz

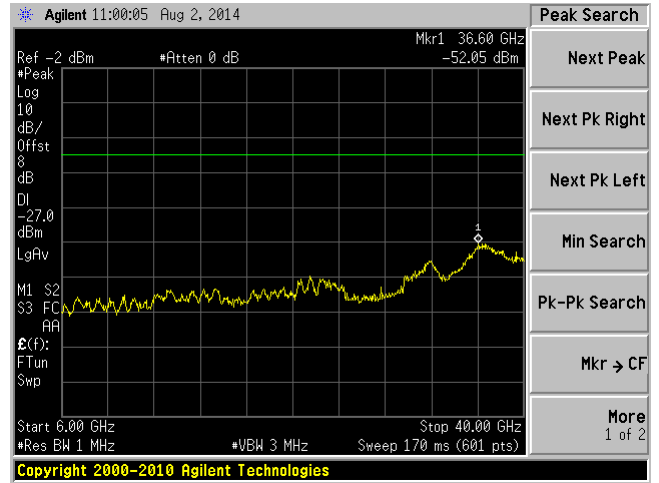

### C4 30 MHz-6 GHz

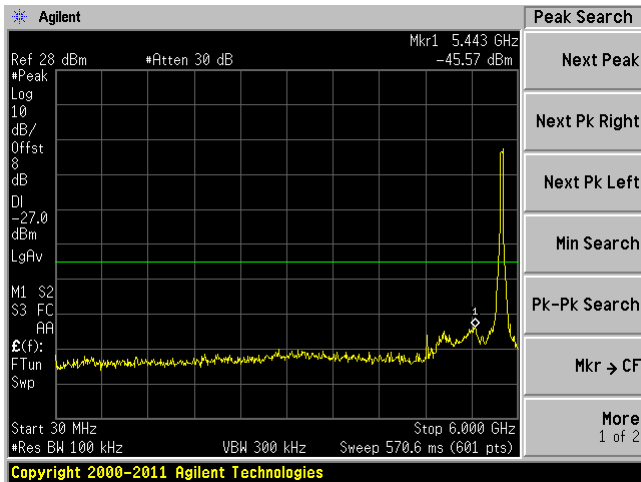

### C4 6 GHz-40 GHz

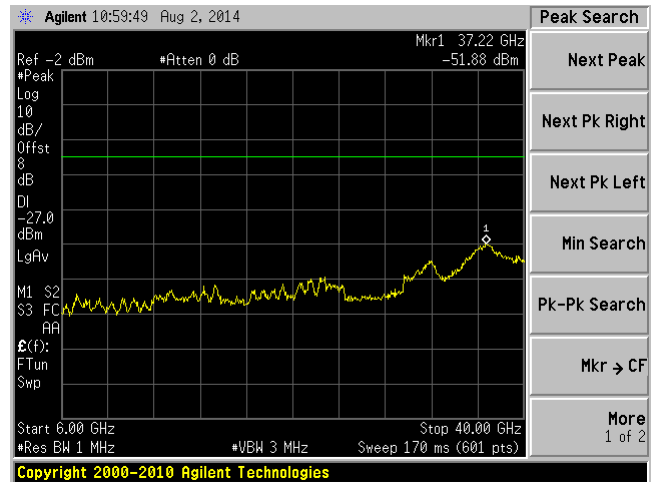

40 MHz bandwidth, High Channel, 5815 MHz

C1 30 MHz-6 GHz

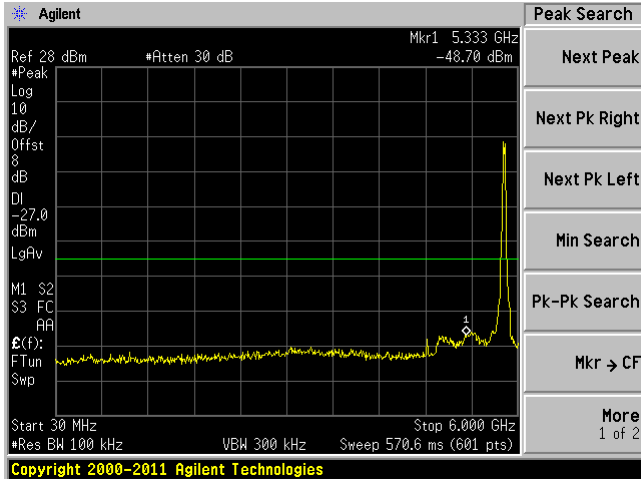

C1 6 GHz-40 GHz

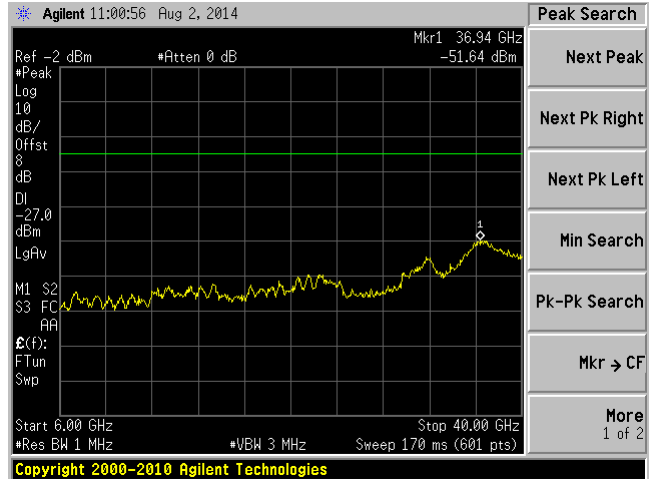

C2 30 MHz-6 GHz

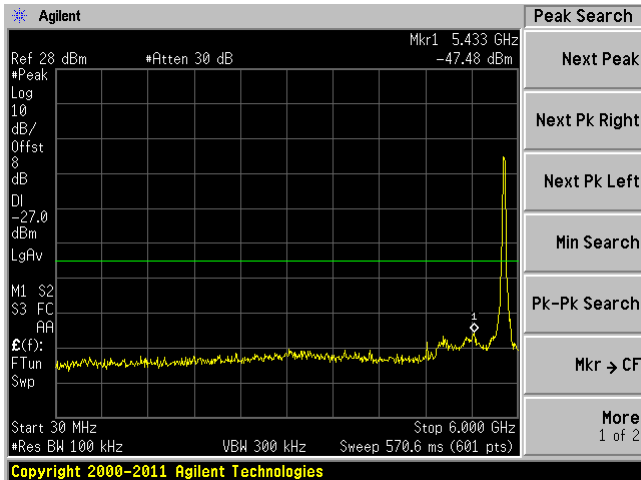

C2 6 GHz-40 GHz

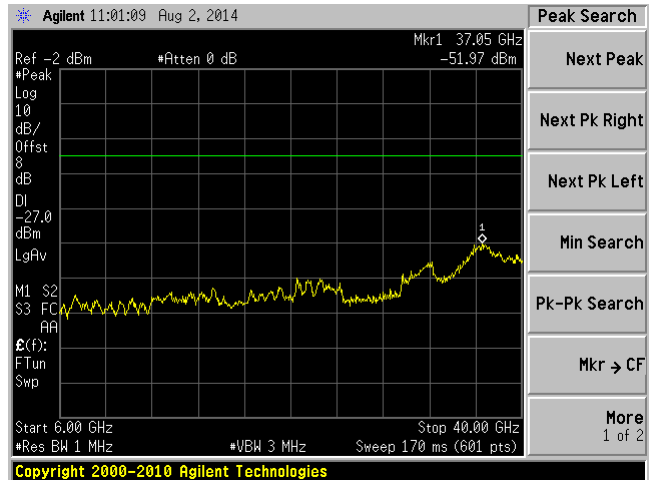

### C3 30 MHz-6 GHz

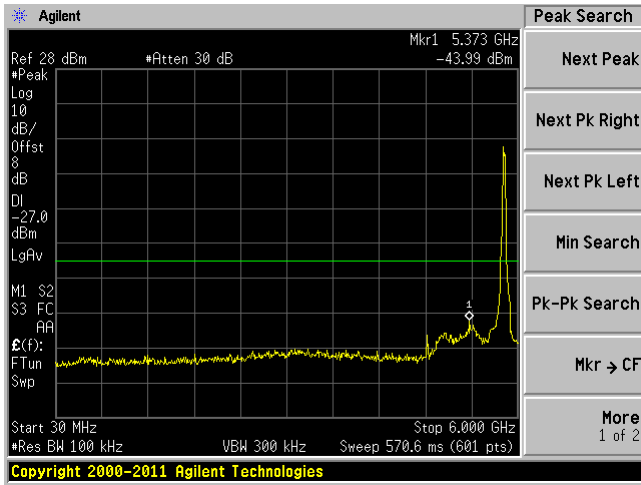

### C3 6 GHz-40 GHz

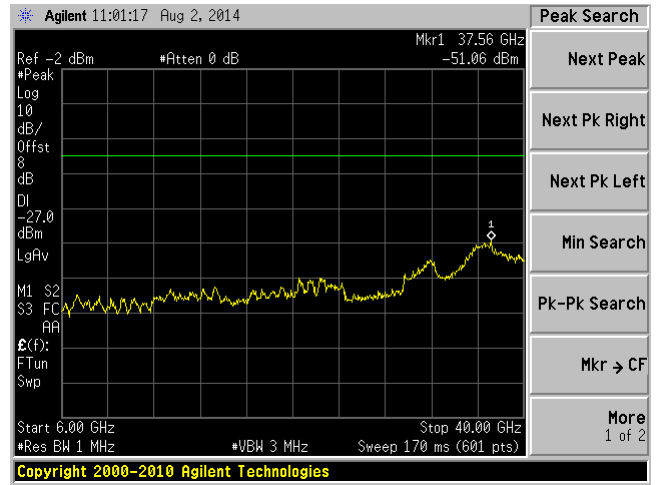

### C4 30 MHz-6 GHz

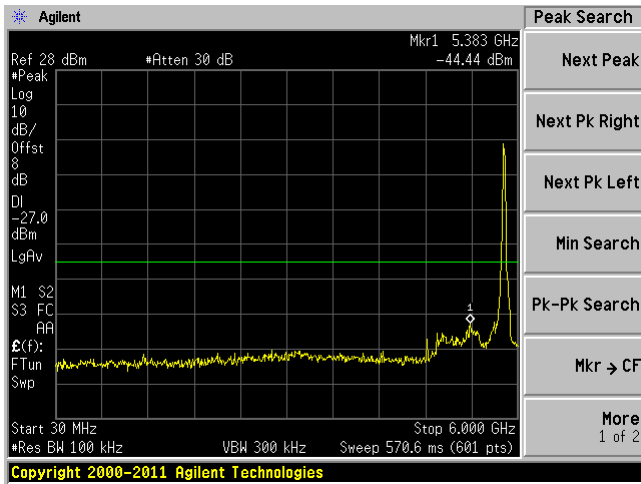

### C4 6 GHz-40 GHz

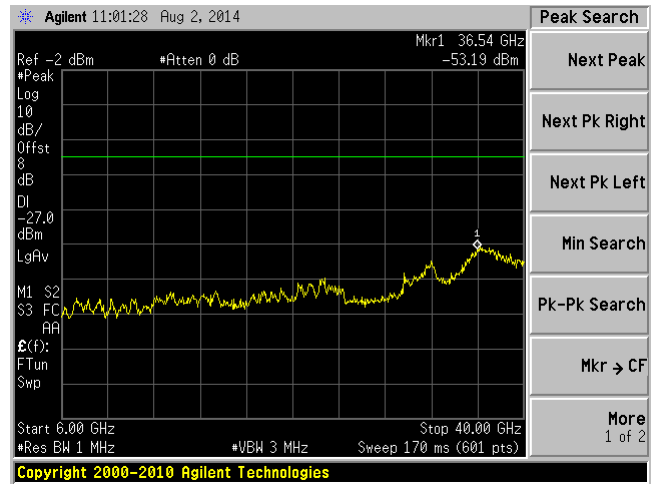

80 MHz bandwidth, Low Channel, 5775 MHz

C1 30 MHz-6 GHz

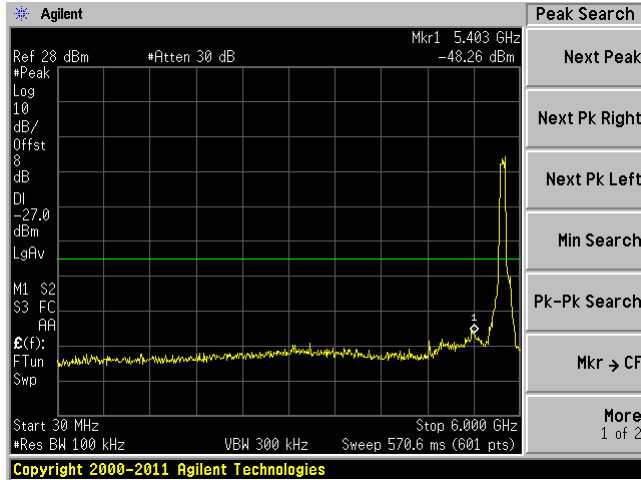

C1 6 GHz-40 GHz

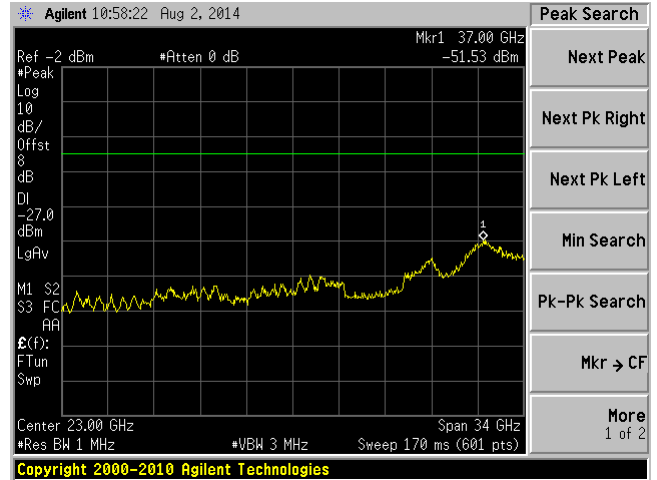

C2 30 MHz-6 GHz

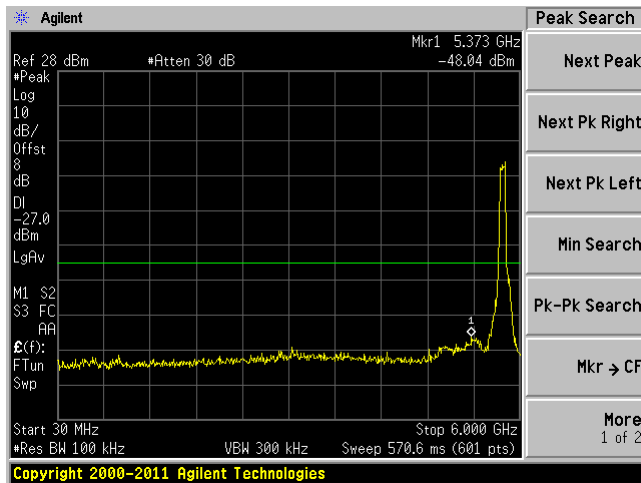

C2 6 GHz-40 GHz

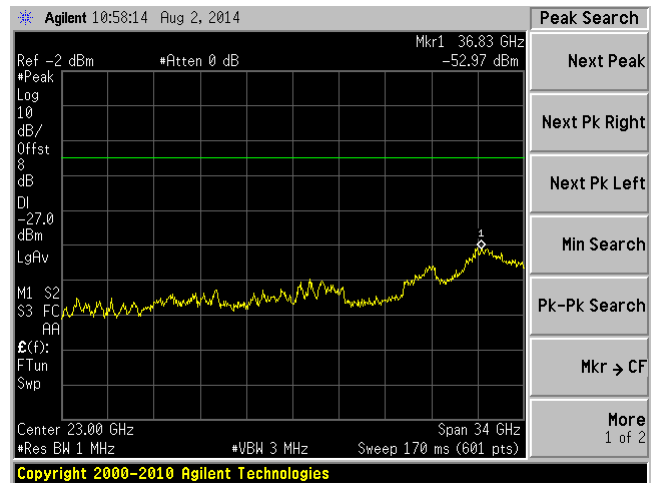

**C3 30 MHz-6 GHz**

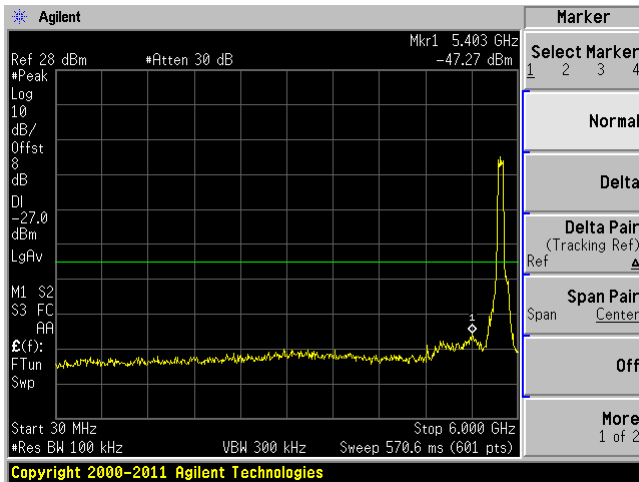

**C3 6 GHz-40 GHz**

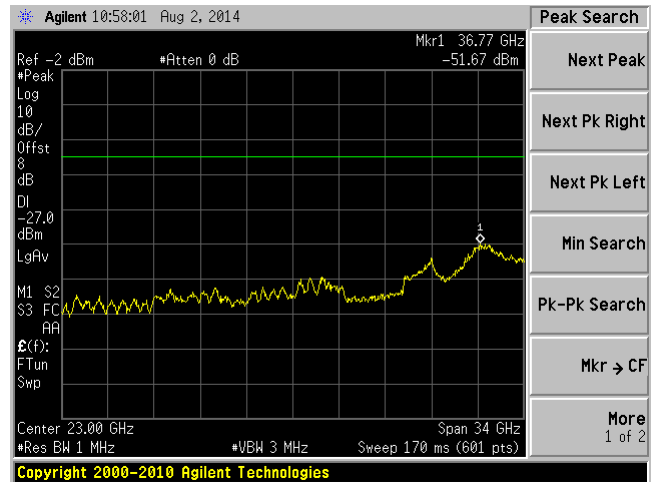

**C4 30 MHz-6 GHz**

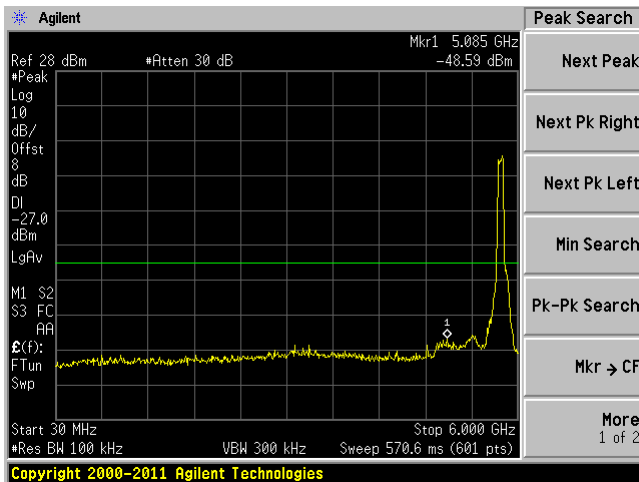

**C4 6 GHz-40 GHz**

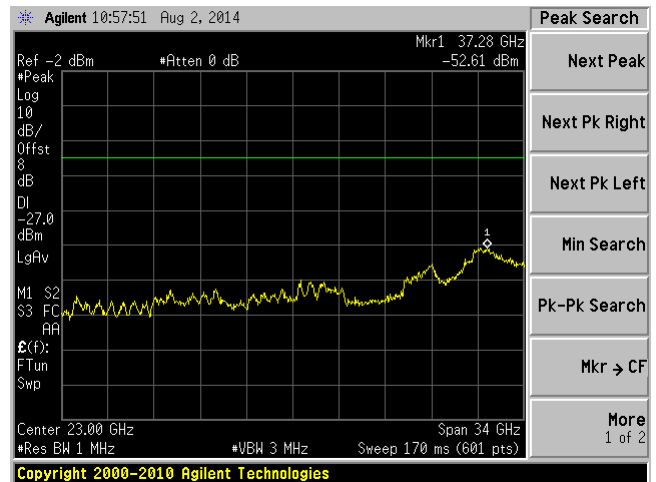

80 MHz bandwidth, Middle Channel, 5785 MHz

C1 30 MHz-6 GHz

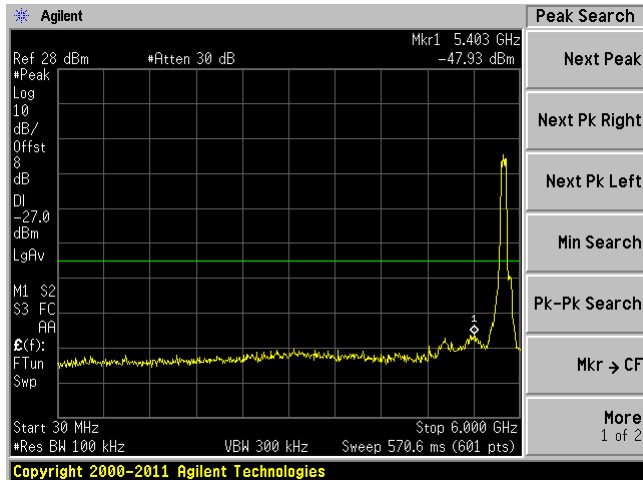

C1 6 GHz-40 GHz

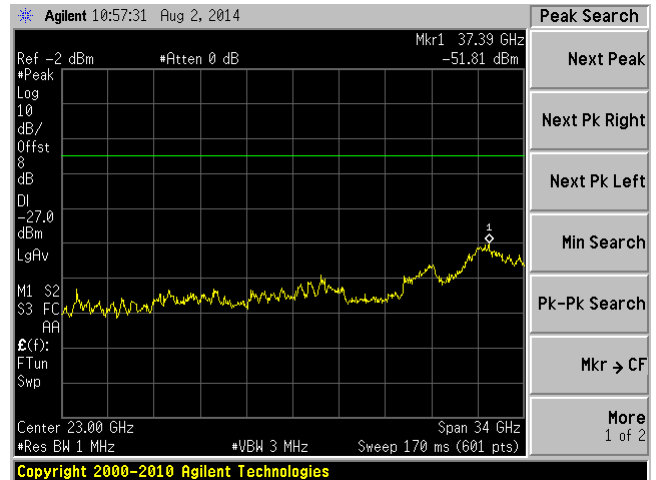

C2 30 MHz-6 GHz

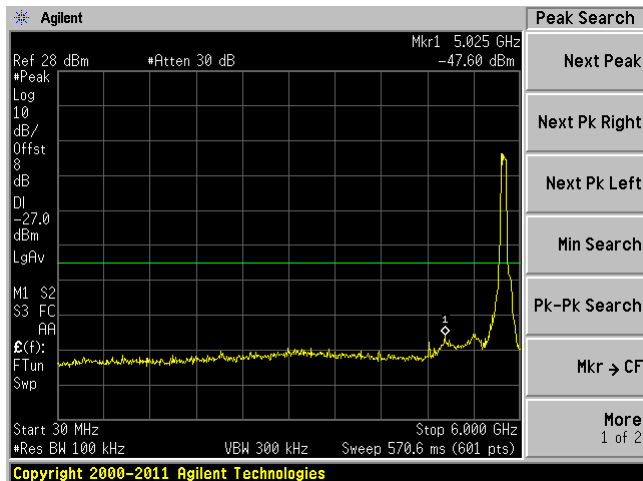

C2 6 GHz-40 GHz

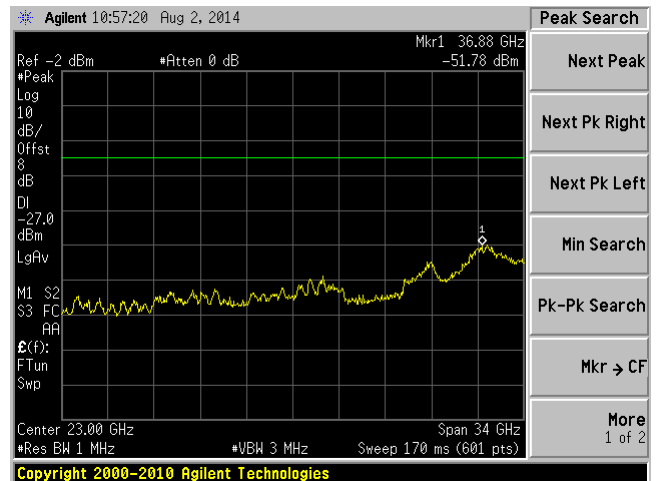

**C3 30 MHz-6 GHz**

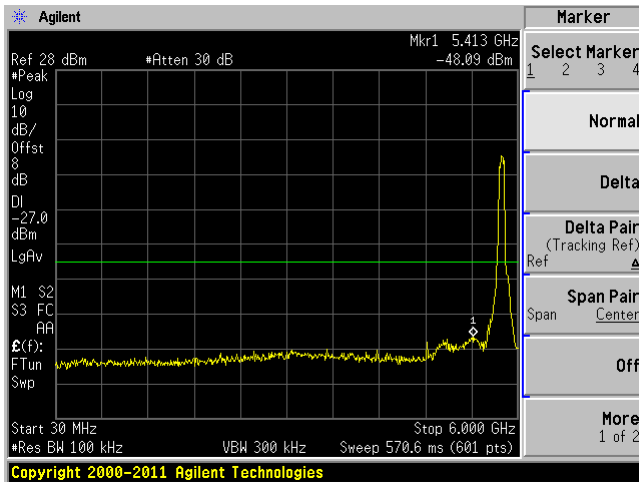

**C3 6 GHz-40 GHz**

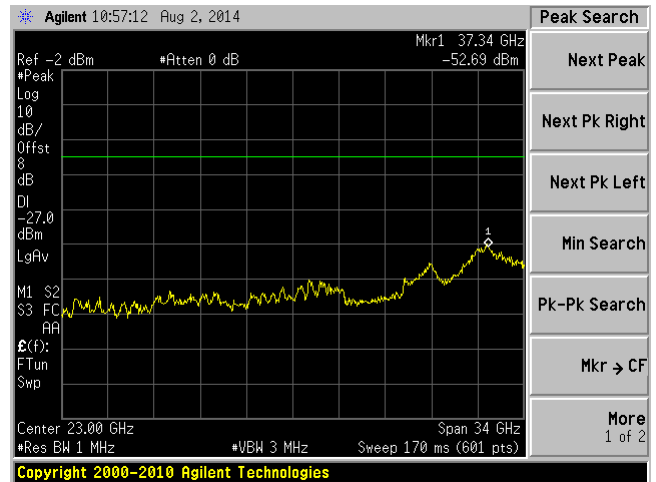

**C4 30 MHz-6 GHz**

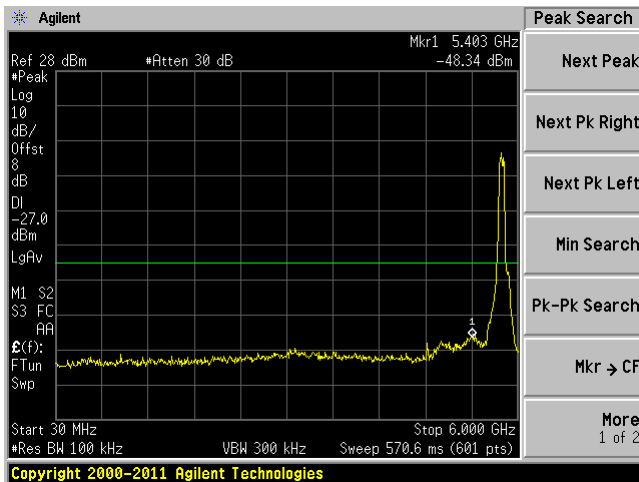

**C4 6 GHz-40 GHz**

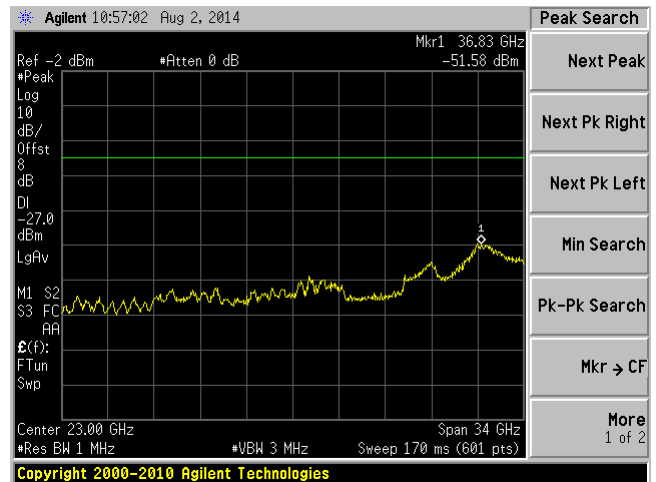

80 MHz bandwidth, High Channel, 5795 MHz

C1 30 MHz-6 GHz

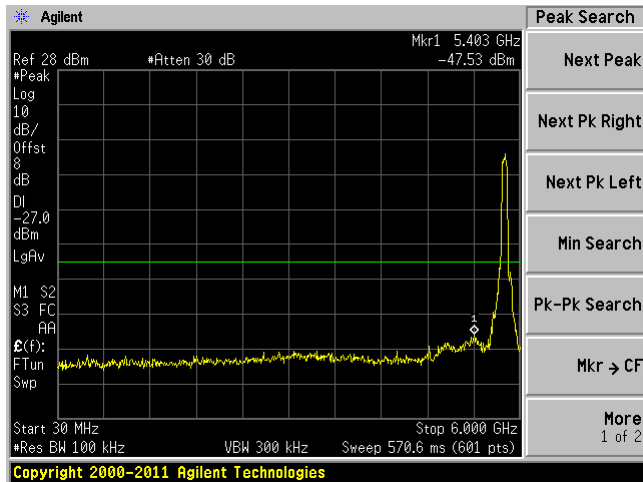

C1 6 GHz-40 GHz

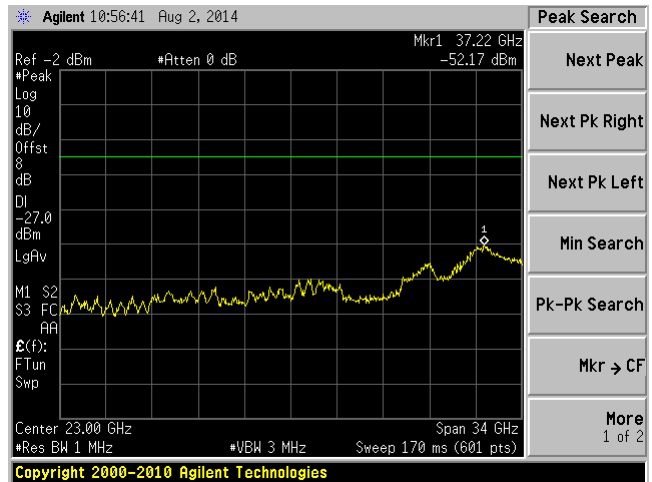

C2 30 MHz-6 GHz

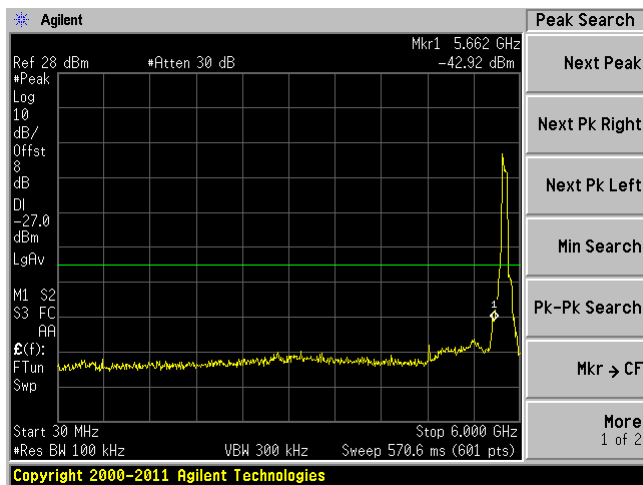

C2 6 GHz-40 GHz

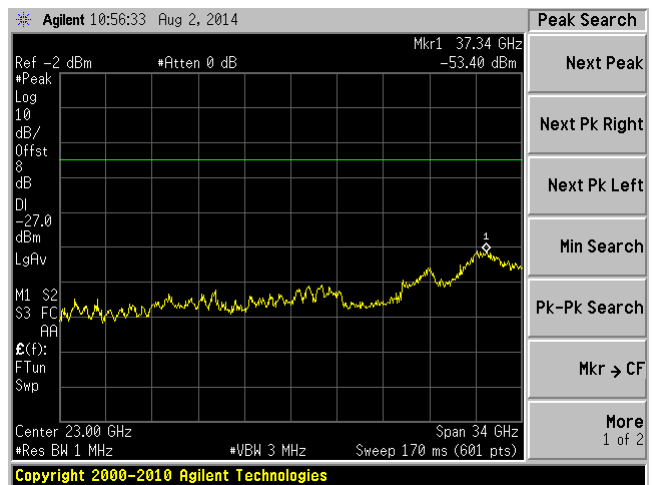



### C3 30 MHz-6 GHz

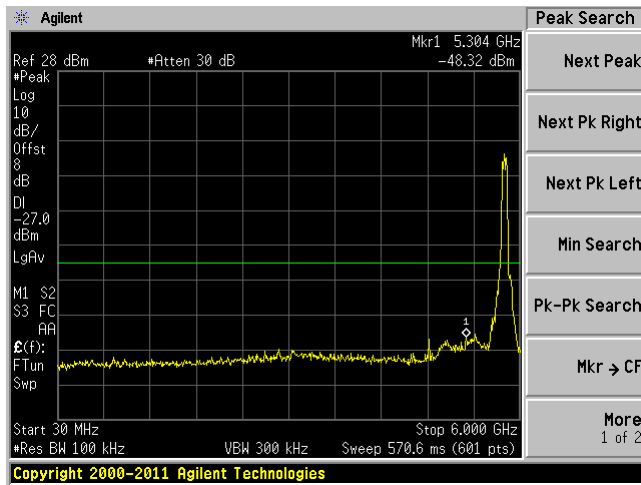

### C3 6 GHz-40 GHz

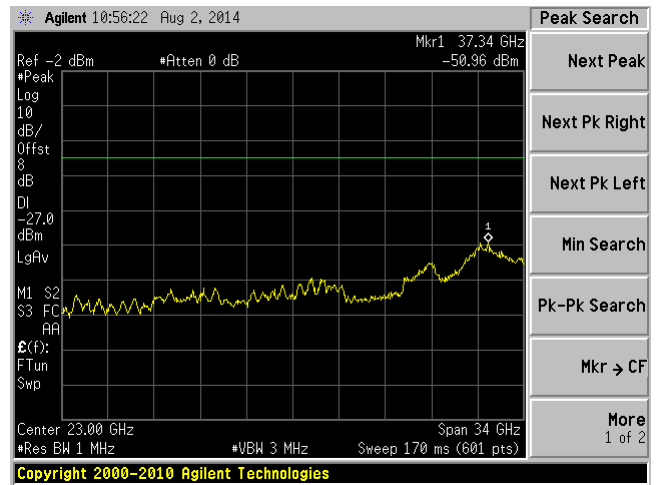

### C4 30 MHz-6 GHz

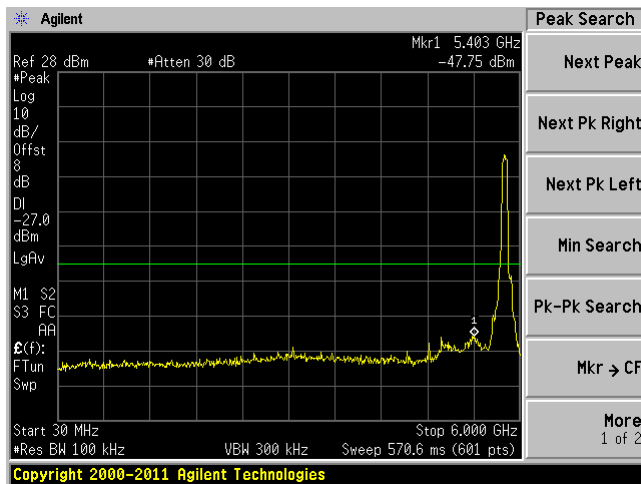

### C4 6 GHz-40 GHz

