

Company: Mimosa Networks

Test of: A5 Wireless Access Point

To: FCC CFR 47 Part 15 Subpart E 15.407

Report No.: MIMO05-U6a Rev A

CONDUCTED, RADIATED TEST REPORT



CONDUCTED, RADIATED TEST REPORT

FROM



Test of: Mimosa Networks A5 Wireless Access Point

to

To: FCC CFR 47 Part 15 Subpart E 15.407

Test Report Serial No.: MIMO05-U6a Rev A

This report supersedes: NONE

Applicant: Mimosa Networks
469 El Camino Real, Suite 100
Santa Clara, California 95050
USA

Product Function: Wireless Access Point

Issue Date: 4th November 2015

This Test Report is Issued Under the Authority of:

MiCOM Labs, Inc.
575 Boulder Court
Pleasanton California 94566
USA
Phone: +1 (925) 462-0304
Fax: +1 (925) 462-0306
www.micomlabs.com



MiCOM Labs is an ISO 17025 Accredited Testing Laboratory



Table of Contents

1. ACCREDITATION, LISTINGS & RECOGNITION	4
1.1. TESTING ACCREDITATION.....	4
1.2. RECOGNITION	5
1.3. PRODUCT CERTIFICATION	6
2. DOCUMENT HISTORY	7
3. TEST RESULT CERTIFICATE	8
4. REFERENCES AND MEASUREMENT UNCERTAINTY	9
4.1. Normative References	9
4.2. Test and Uncertainty Procedure	10
5. PRODUCT DETAILS AND TEST CONFIGURATIONS	11
5.1. Technical Details	11
5.2. Scope Of Test Program	12
5.3. Equipment Model(s) and Serial Number(s)	13
5.4. Antenna Details	13
5.5. Cabling and I/O Ports	13
5.6. Test Configurations.....	14
5.7. Equipment Modifications	15
5.8. Deviations from the Test Standard	15
6. TEST SUMMARY	16
7. TEST EQUIPMENT CONFIGURATION(S)	17
7.1. Conducted	17
7.2. Radiated	19
7.3. ac Wireline Emission Test Set-up	21
8. MEASUREMENT AND PRESENTATION OF TEST DATA	22
9. TEST RESULTS	23
9.1. Peak Transmit Power	23
9.2. 26 dB & 99% Bandwidth	41
9.3. Power Spectral Density	58
9.4. Radiated	76
9.4.1. Restricted Band Emissions	79
9.4.2. Restricted Band-Edge Emissions	88
9.4.3. Digital Emissions.....	110
9.5. ac Wireline Emissions.....	113
A. APPENDIX - GRAPHICAL IMAGES	115
A.1. 26 dB & 99% Bandwidth	116
A.2. Power Spectral Density	224
A.3. Radiated	350
A.3.1. Restricted Band Emissions.....	350
A.3.2. Restricted Band-Edge Emissions.....	359

This test report may be reproduced in full only. The document may only be updated by MiCOM Labs personnel. All changes will be noted in the Document History section of the report.

1. ACCREDITATION, LISTINGS & RECOGNITION

1.1. TESTING ACCREDITATION

MiCOM Labs, Inc. is an accredited Electrical testing laboratory per the international standard ISO/IEC 17025:2005. The company is accredited by the American Association for Laboratory Accreditation (A2LA) www.a2la.org test laboratory number 2381.01. MiCOM Labs test schedule is available at the following URL; <http://www.a2la.org/scopepdf/2381-01.pdf>



This test report may be reproduced in full only. The document may only be updated by MiCOM Labs personnel. All changes will be noted in the Document History section of the report.



1.2. RECOGNITION

MiCOM Labs, Inc has widely recognized wireless testing capabilities. Our international recognition includes Conformity Assessment Body designation by APEC MRA countries. MiCOM Labs test reports are accepted globally.

Country	Recognition Body	Status	Phase	Identification No.
USA	Federal Communications Commission (FCC)	TCB	-	US0159 Listing #: 102167
Canada	Industry Canada (IC)	FCB	APEC MRA 2	US0159 Listing #: 4143A-2 4143A-3
Japan	MIC (Ministry of Internal Affairs and Communication)	CAB	APEC MRA 2	RCB 210
	VCCI	--	--	A-0012
Europe	European Commission	NB	EU MRA	NB 2280
Australia	Australian Communications and Media Authority (ACMA)	CAB	APEC MRA 1	US0159
Hong Kong	Office of the Telecommunication Authority (OFTA)	CAB	APEC MRA 1	
Korea	Ministry of Information and Communication Radio Research Laboratory (RRL)	CAB	APEC MRA 1	
Singapore	Infocomm Development Authority (IDA)	CAB	APEC MRA 1	
Taiwan	National Communications Commission (NCC) Bureau of Standards, Metrology and Inspection (BSMI)	CAB	APEC MRA 1	
Vietnam	Ministry of Communication (MIC)	CAB	APEC MRA 1	

EU MRA – European Union Mutual Recognition Agreement.

NB – Notified Body

APEC MRA – Asia Pacific Economic Community Mutual Recognition Agreement. Recognition agreement under which test lab is accredited to regulatory standards of the APEC member countries.

Phase I - recognition for product testing

Phase II – recognition for both product testing and certification

1.3. PRODUCT CERTIFICATION

MiCOM Labs, Inc. is an accredited Product Certification Body per the international standard ISO/IEC 17065:2012. The company is accredited by the American Association for Laboratory Accreditation (A2LA) www.a2la.org test laboratory number 2381.02. MiCOM Labs test schedule is available at the following URL; <http://www.a2la.org/scopepdf/2381-02.pdf>



American Association for Laboratory Accreditation

Accredited Product Certification Body

A2LA has accredited

MICOM LABS

Pleasanton, CA

for technical competence as a

Product Certification Body

This product certification body is accredited in accordance with the recognized International Standard ISO/IEC 17065:2012 - *Requirements for bodies certifying products, processes and services*. This accreditation demonstrates technical competence for a defined scope and the operation of a quality management system.

Presented this 28th day of February 2014.



President & CEO
For the Accreditation Council
Certificate Number 2381.02
Valid to November 30, 2015



For the product certification schemes to which this accreditation applies, please refer to the organization's Product Certification Scope of Accreditation

United States of America – Telecommunication Certification Body (TCB)
Industry Canada – Certification Body, CAB Identifier – US0159
Europe – Notified Body (NB), NB Identifier - 2280
Japan – Recognized Certification Body (RCB), RCB Identifier - 210

This test report may be reproduced in full only. The document may only be updated by MiCOM Labs personnel. All changes will be noted in the Document History section of the report.



Title: Mimosa Networks A5 Wireless Access Point
To: FCC CFR 47 Part 15 Subpart E 15.407
Serial #: MIMO05-6a Rev A
Issue Date: 4th November 2015
Page: 7 of 372

2. DOCUMENT HISTORY

Document History		
Revision	Date	Comments
Draft	23 rd October 2015	
Draft #2	1 st November 2015	
Rev A	4 th November 2015	Initial Release
.		
.		
.		
.		
.		

In the above table the latest report revision will replace all earlier versions.

This test report may be reproduced in full only. The document may only be updated by MiCOM Labs personnel. All changes will be noted in the Document History section of the report.



Title: Mimosa Networks A5 Wireless Access Point
To: FCC CFR 47 Part 15 Subpart E 15.407
Serial #: MIMO05-6a Rev A
Issue Date: 4th November 2015
Page: 8 of 372

3. TEST RESULT CERTIFICATE

Manufacturer: Mimosa Networks 469 El Camino Real, Suite 100 Santa Clara, CA 95050 USA	Tested By: MiCOM Labs, Inc. 575 Boulder Court Pleasanton California 94566 USA
Model: A5	Telephone: +1 925 462 0304 e: Fax: +1 925 462 0306
Equipment Type: Wireless Access Point	
S/N's: Development Model	
Test Date(s): 26 July - 15 October 2015	Website: www.micomlabs.com

STANDARD(S)	TEST RESULTS
FCC CFR 47 Part 15 Subpart E 15.407	EQUIPMENT COMPLIES

MiCOM Labs, Inc. tested the equipment mentioned in accordance with the requirements set forth in the above standards. Test results indicate that the equipment tested is capable of demonstrating compliance with the requirements as documented within this report.

Notes:

1. This document reports conditions under which testing was conducted and the results of testing performed.
2. Details of test methods used have been recorded and kept on file by the laboratory.
3. Test results apply only to the item(s) tested.

Approved & Released for MiCOM Labs, Inc. by:





Graeme Grieve
Quality Manager MiCOM Labs, Inc.

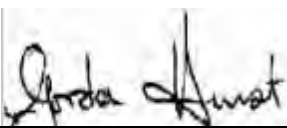

Gordon Hurst
President & CEO MiCOM Labs, Inc.

This test report may be reproduced in full only. The document may only be updated by MiCOM Labs personnel. All changes will be noted in the Document History section of the report.

4. REFERENCES AND MEASUREMENT UNCERTAINTY

4.1. Normative References

REF.	PUBLICATION	YEAR	TITLE
I	KDB 662911	Oct 31 2013	Guidance for measurement of output emission of devices that employ single transmitter with multiple outputs or systems with multiple transmitters operating simultaneously in the same frequency band
II	KDB 905462 D07 v01	10th June 2015	Test guidance to demonstrate compliance for U-NII devices subject to DFS requirements.
III	KDB 926956 DO1 v01r02	17th October 2014	U-NII Device Transition Plan
IV	KDB 789033 D02 v01	6th June 2014	General UNII Test Procedures New Rules V01
V	A2LA	June 2015	R105 - Requirement's When Making Reference to A2LA Accreditation Status
VI	ANSI C63.10	2013	American National Standard for Testing Unlicensed Wireless Devices
VII	ANSI C63.4	2009	American National Standards for Methods of Measurement of Radio-Noise Emissions from Low-Voltage Electrical and Electronic Equipment in the Range of 9 kHz to 40 GHz
VIII	CISPR 22	2008	Information technology equipment - Radio disturbance characteristics - Limits and methods of measurement
IX	ETSI TR 100 028	2001-12	Parts 1 and 2 Electromagnetic compatibility and Radio Spectrum Matters (ERM); Uncertainties in the measurement of mobile radio equipment characteristics
X	FCC 06-96	Jun 3 2006	Memorandum Opinion and Order
XI	FCC 47 CFR Part 15.407	2014	Radio Frequency Devices; Subpart E –Unlicensed National Information Infrastructure Devices
XII	ICES-003	Issue 5 2012	Spectrum Management and Telecommunications; Interference-Causing Equipment Standard. Information Technology Equipment (ITE) – Limits and methods of measurement.
XIII	M 3003	Edition 3 Nov. 2012	Expression of Uncertainty and Confidence in Measurements
XIV	RSS-247 Issue 1	May 2015	Digital Transmission Systems (DTSS), Frequency Hopping System (FHSs) and Licence-Exempt Local Area Network (LE-LEN) Devices
XV	RSS-Gen Issue 4	November 2014	General Requirements and Information for the Certification of Radiocommunication Equipment
XVI	KDB 644545 D03 v01	August 14th 2014	Guidance for IEEE 802.11ac New Rules
XVII	FCC 47 CFR Part 2.1033	2014	FCC requirements and rules regarding photographs and test setup diagrams.

This test report may be reproduced in full only. The document may only be updated by MiCOM Labs personnel. All changes will be noted in the Document History section of the report.



Title: Mimosa Networks A5 Wireless Access Point
To: FCC CFR 47 Part 15 Subpart E 15.407
Serial #: MIMO05-6a Rev A
Issue Date: 4th November 2015
Page: 10 of 372

4.2. Test and Uncertainty Procedure

Conducted and radiated emission measurements were conducted in accordance with American National Standards Institute ANSI C63.4, listed in the Normative References section of this report.

Measurement uncertainty figures are calculated in accordance with ETSI TR 100 028 Parts 1 and 2.

Measurement uncertainties stated are based on a standard uncertainty multiplied by a coverage factor $k = 2$, providing a level of confidence of approximately 95 % in accordance with UKAS document M 3003 listed in the Normative References section of this report.

This test report may be reproduced in full only. The document may only be updated by MiCOM Labs personnel. All changes will be noted in the Document History section of the report.



Title: Mimosa Networks A5 Wireless Access Point
To: FCC CFR 47 Part 15 Subpart E 15.407
Serial #: MIMO05-6a Rev A
Issue Date: 4th November 2015
Page: 11 of 372

5. PRODUCT DETAILS AND TEST CONFIGURATIONS

5.1. Technical Details

Details	Description
Purpose:	Test of the Mimosa Networks A5 to FCC CFR 47 Part 15 Subpart E 15.407. Radio Frequency Devices; Subpart E – Unlicensed National Information Infrastructure Devices
Applicant:	Mimosa Networks 469 El Camino Real, Suite 100 Santa Clara, California 95050 USA
Manufacturer:	As Applicant
Laboratory performing the tests:	MiCOM Labs, Inc. 575 Boulder Court Pleasanton California 94566 USA
Test report reference number:	MIMO05-U6a
Date EUT received:	15th June 2015
Standard(s) applied:	FCC CFR 47 Part 15 Subpart E 15.407
Dates of test (from - to):	26 th July – 15 th October 2015
No of Units Tested:	6
Type of Equipment:	4 antenna port 802.11 a/n/ac Wireless Access Point
Product Family Name:	Access Point
Model(s):	A5
Location for use:	Indoor and Outdoor
Declared Frequency Range(s):	5150 - 5250 MHz; 5250 - 5350 MHz; 5470 - 5725 MHz; 5725 - 5850 MHz;
Primary function of equipment:	Wireless Access Point
Secondary function of equipment:	None Provided
Type of Modulation:	OFDM
EUT Modes of Operation:	802.11a; 802.11n HT-20/40, 802.11ac-80
Transmit/Receive Operation:	Transceiver - Half Duplex
Rated Input Voltage and Current:	POE (POE adaptor sold with unit) 48Vdc
Operating Temperature Range:	Declared Range -40°C to 55°C
ITU Emission Designator:	802.11a: 16M7D1D 802.11ac-80: 75M8D1D 802.11n HT-20: 18M0D1D 802.11n HT-40: 36M3D1D
Equipment Dimensions:	5 dBi: Height 321 mm x Length 142 mm 8 dBi: Height 643 mm x Length 142 mm
Weight:	5 dBi: 4 lbs 8 dBi: 8 lbs
Hardware Rev:	Rev I
Software Rev:	2.0.0

This test report may be reproduced in full only. The document may only be updated by MiCOM Labs personnel. All changes will be noted in the Document History section of the report.

5.2. Scope Of Test Program

Mimosa Networks A5

The scope of the test program was to test the Mimosa Networks A5, 4 antenna port 802.11 a/n/ac Wireless Access Point configurations in the frequency ranges 5150 - 5250 MHz; 5250 - 5350 MHz; 5470 - 5725 MHz; 5725 - 5850 MHz; for compliance against the following specification:

FCC CFR 47 Part 15 Subpart E 15.407

Radio Frequency Devices; Subpart E – Unlicensed National Information Infrastructure Devices

NOTE: for the Mimosa A5 wireless access point has four antenna ports however each are orientated 90° to each other with no overlap of the radiated spectrum, see photograph below.

Mimosa Networks A5

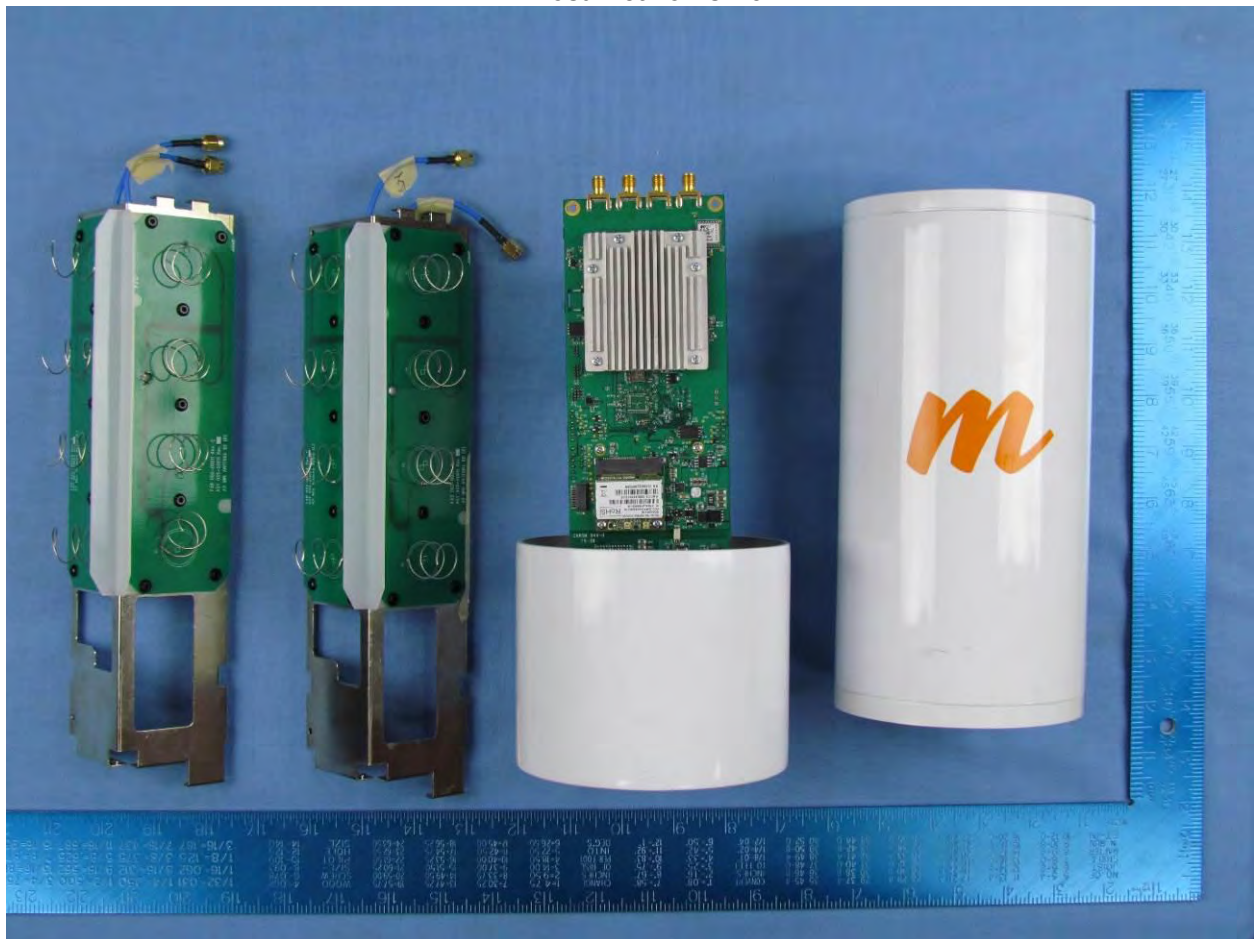

This test report may be reproduced in full only. The document may only be updated by MiCOM Labs personnel. All changes will be noted in the Document History section of the report.



Title: Mimosa Networks A5 Wireless Access Point
To: FCC CFR 47 Part 15 Subpart E 15.407
Serial #: MIMO05-6a Rev A
Issue Date: 4th November 2015
Page: 13 of 372

5.3. Equipment Model(s) and Serial Number(s)

Type (EUT/Support)	Equipment Description (Including Brand Name)	Mfr	Model No.	Serial No.
EUT	Access Point	Mimosa Networks	A5	unknown
EUT	POE Input: 100-240Vac 50-60Hz Output: 56Vdc, 0.72A	PhiHong	POE50U-560DG	Not Available
Support	Laptop PC	IBM	Thinkpad	None

5.4. Antenna Details

Type	Manufacturer	Model	Family	Gain (dBi)	BF Gain	Dir BW	X-Pol	Frequency Band (MHz)
integral	Mimosa Networks	Not Provided	Circular Polarized Panel	5.0	-	360	-	5150 – 5250 5250 – 5350 5470 – 5725 5725 - 5850
integral	Mimosa Networks	Not Provided	Circular Polarized Panel	8.0	-	360	-	5150 – 5250 5250 – 5350 5470 – 5725 5725 - 5850

BF Gain - Beamforming Gain
Dir BW - Directional BeamWidth
X-Pol - Cross Polarization

5.5. Cabling and I/O Ports

Port Type	Max Cable Length	# Of Ports	Screened	Conn Type	Data Type
Ethernet	100m	1	Y	RJ-45	Packet Data

This test report may be reproduced in full only. The document may only be updated by MiCOM Labs personnel. All changes will be noted in the Document History section of the report.



5.6. Test Configurations

Results for the following configurations are provided in this report:

Operational Mode(s) (802.11a/b/g/n/ac)	Data Rate with Highest Power MBit/s	Channel Frequency (MHz)		
		Low	Mid	High
5150 - 5250 MHz				
802.11a	6	5,165.00	5,200.00	5,240.00
802.11n HT20	6.5	5,165.00	5,200.00	5,240.00
802.11n HT-40	13.5	5,175.00	5,200.00	5,230.00
802.11ac-80	29.3	5,195.00	5,210.00	5,240.00
5250 - 5350 MHz				
802.11a	6	5,260.00	5,300.00	5,335.00
802.11n HT20	6.5	5,260.00	5,300.00	5,335.00
802.11n HT-40	13.5	5,270.00	5,300.00	5,330.00
802.11ac-80	29.3	5,290.00	5,300.00	5,310.00
5470 - 5725 MHz				
802.11a	6	5,485.00	5,590.00	5,715.00
802.11n HT20	6.5	5,485.00	5,590.00	5,715.00
802.11n HT-40	13.5	5,485.00	5,590.00	5,705.00
802.11ac-80	29.3	5,530.00	5,545.00	5,560.00
5725 - 5850 MHz				
802.11a	6	5,745.00	5,785.00	5,825.00
802.11n HT20	6.5	5,745.00	5,785.00	5,825.00
802.11n HT-40	13.5	5,755.00	5,785.00	5,815.00
802.11ac-80	29.3	5,775.00	5,785.00	5,795.00

This test report may be reproduced in full only. The document may only be updated by MiCOM Labs personnel. All changes will be noted in the Document History section of the report.



Title: Mimosa Networks A5 Wireless Access Point
To: FCC CFR 47 Part 15 Subpart E 15.407
Serial #: MIMO05-6a Rev A
Issue Date: 4th November 2015
Page: 15 of 372

5.7. Equipment Modifications

The following modifications were required to bring the equipment into compliance:

1. NONE.

However the equipment only met FCC Class A when setup in a Remote Located Device Configuration (See ANSI C64.3:2014 6.2.3.2). The EUT may not be installed in residential environment.

5.8. Deviations from the Test Standard

The following deviations from the test standard were required in order to complete the test program:

1. NONE

This test report may be reproduced in full only. The document may only be updated by MiCOM Labs personnel. All changes will be noted in the Document History section of the report.



Title: Mimosa Networks A5 Wireless Access Point
To: FCC CFR 47 Part 15 Subpart E 15.407
Serial #: MIMO05-6a Rev A
Issue Date: 4th November 2015
Page: 16 of 372

6. TEST SUMMARY

List of Measurements

Test Header	Result	Data Link
(a) Peak Transmit Power	Complies	View Data
(a) 26 dB & 99% Bandwidth	Complies	View Data
(a)(5) Power Spectral Density	Complies	View Data
(b)(2) Radiated	Complies	
i).. Restricted Band Emissions	Complies	View Data
ii).. Restricted Band-Edge Emissions	Complies	View Data
iv).. Digital Emissions	Complies*	View Data
15.207 ac Wireline Emissions	Complies*	View Data

*Digital Emissions - Class A compliance

This test report may be reproduced in full only. The document may only be updated by MiCOM Labs personnel. All changes will be noted in the Document History section of the report.

7. TEST EQUIPMENT CONFIGURATION(S)

7.1. Conducted

Conducted RF Emission Test Set-up(s)

The following tests were performed using the conducted test set-up shown in the diagram below.

1. Peak Transmit power
2. 26 dB and 99% Bandwidth
3. Power Spectral Density

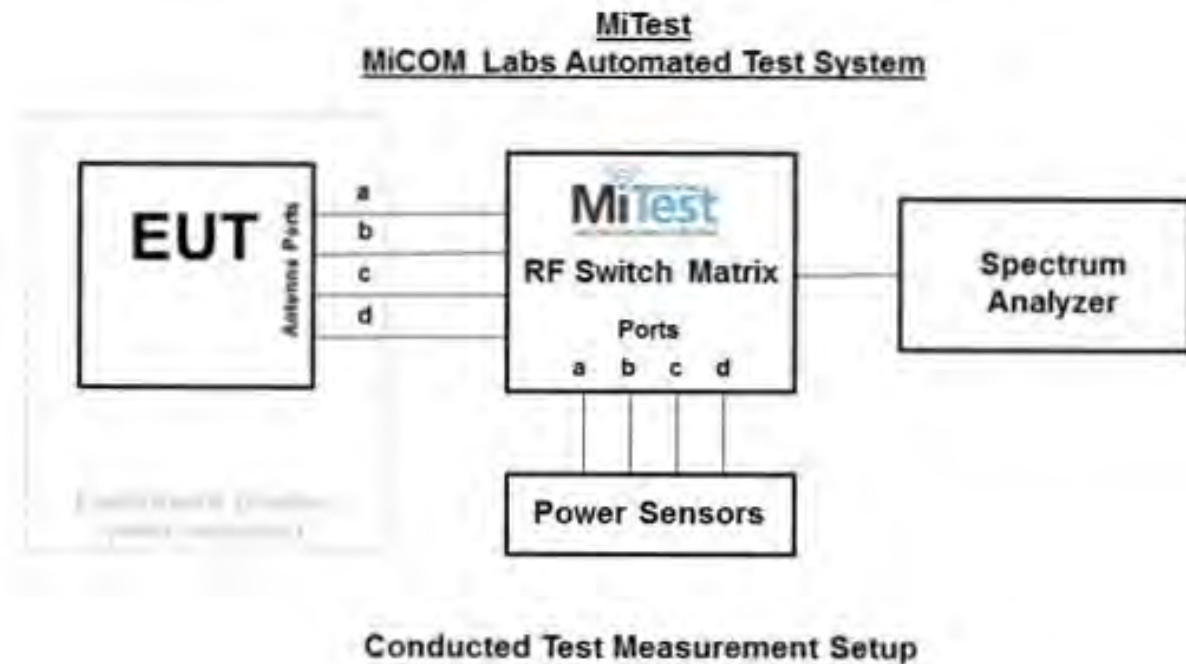

A full system calibration was performed on the test station and any resulting system losses (or gains) were taken into account in the production of all final measurement data.



Title: Mimosa Networks A5 Wireless Access Point
To: FCC CFR 47 Part 15 Subpart E 15.407
Serial #: MIMO05-6a Rev A
Issue Date: 4th November 2015
Page: 18 of 372

Asset#	Description	Manufacturer	Model#	Serial#	Calibration Due Date
158	Barometer/Thermometer	Control Company	4196	E2846	04 Dec 2015
193	Receiver 20 Hz to 7 GHz	Rhode & Schwarz	ESI 7	838496/007	14 Jan 2016
249	Resistance Thermometer	Thermotronics	GR2105-02	9340 #2	30 Oct 2015
287	Rohde & Schwarz 40 GHz Receiver	Rhode & Schwarz	ESIB40	100201	27 Aug 2016
361	Desktop for RF#1, Labview Software installed	Dell	Vostro 220	WS RF#1	Not Required
378	Rohde & Schwarz 40 GHz Receiver with Generator	Rhode & Schwarz	ESIB40	100107/040	04 Aug 2016
380	4x4 RF Switch Box	MiCOM Labs	MiTest RF Switch Box	MIC001	20 Dec 2015
390	USB Power Head 50MHz - 24GHz -60 to +20dBm	Agilent	U2002A	MY50000103	17 Oct 2016
398	Test Software	MiCOM	MiTest ATS	Version 3.0.0.16	Not Required
405	DC Power Supply 0-60V	Agilent	6654A	MY4001826	Cal when used
408	USB to GPIB interface	National Instruments	GPIB-USB HS	14C0DE9	Not Required
436	USB Wideband Power Sensor	Boonton	55006	8731	31 Jul 2016
437	USB Wideband Power Sensor	Boonton	55006	8759	31 Jul 2016
75	Environmental Chamber	Thermatron	SE-300-2-2	27946	28 Nov 2015
RF#1 GPIB#1	GPIB cable to Power Supply	HP	GPIB	None	Not Required
RF#1 SMA SA #452	Precision SMA Male RG-402 Spectrun Analyzer	Fairview Microwave	Precision SMA Male RG 402 coax	None	20 Dec 2015
RF#1 SMA#1	EUT to Mitest box port 1	Flexco	SMA Cable port1	None	20 Dec 2015
RF#1 SMA#2	EUT to Mitest box port 2	Flexco	SMA Cable port2	None	20 Dec 2015
RF#1 SMA#3	EUT to Mitest box port 3	Flexco	SMA Cable port3	None	20 Dec 2015
RF#1 SMA#4	EUT to Mitest box port 4	Flexco	SMA Cable port4	None	20 Dec 2015
RF#1 USB#1	USB Cable to Mitest Box	Dynex	USB Cable	None	Not Required

This test report may be reproduced in full only. The document may only be updated by MiCOM Labs personnel. All changes will be noted in the Document History section of the report.

7.2. Radiated

The following tests were performed using the radiated test set-up shown in the diagram. Radiated emissions below 1GHz. Radiated Emissions above 1GHz.

- 1).. Restricted Band Emissions
- 2).. Restricted Band-Edge Emissions
- 3).. Digital Emissions

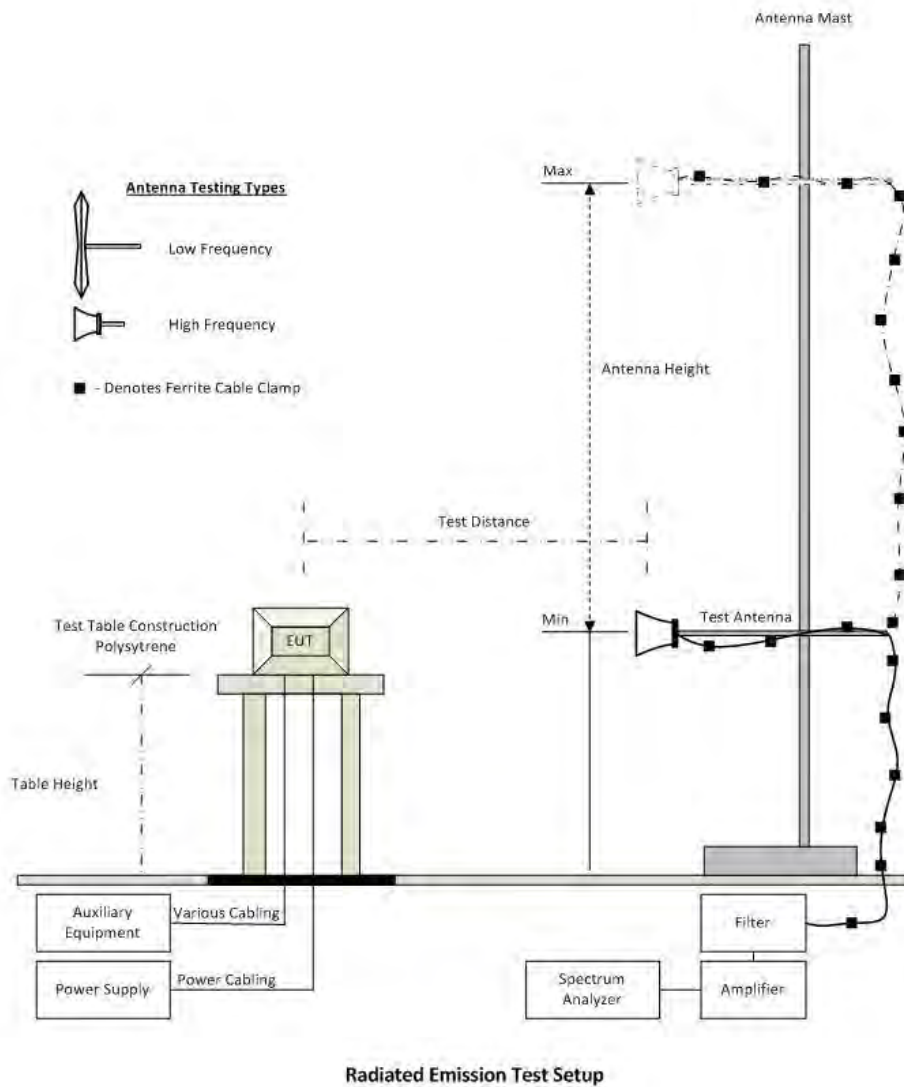

This test report may be reproduced in full only. The document may only be updated by MiCOM Labs personnel. All changes will be noted in the Document History section of the report.



Title: Mimosa Networks A5 Wireless Access Point
To: FCC CFR 47 Part 15 Subpart E 15.407
Serial #: MIMO05-6a Rev A
Issue Date: 4th November 2015
Page: 20 of 372

A full system calibration was performed on the test station and any resulting system losses (or gains) were taken into account in the production of all final measurement data.

Asset#	Description	Manufacturer	Model#	Serial#	Calibration Due Date
158	Barometer/Thermometer	Control Company	4196	E2846	04 Dec 2015
170	Video System Controller for Semi Anechoic Chamber	Panasonic	WV-CY101	04R08507	Not Required
287	Rohde & Schwarz 40 GHz Receiver	Rhode & Schwarz	ESIB40	100201	27 Aug 2016
310	SMA Cable	Micro-Coax	UFA210A-0-0787-3G03G0	209089-001	30 Oct 2015
338	Sunol 30 to 3000 MHz Antenna	Sunol	JB3	A052907	15 Aug 2016
377	Band Rejection Filter 5150 to 5880MHz	Microtronics	BRM50716	034	18 Aug 2016
393	DC - 1050 MHz Low Pass Filter	Microcircuits	VLFX-1050	N/A	08 Oct 2016
397	Amp 10 - 2500MHz	MiCOM Labs	Amp 10 - 2500 MHz	NA	24 Feb 2016
399	ETS 1-18 GHz Horn Antenna	ETS	3117	00154575	10 Nov 2015
406	Amplifier for Radiated Emissions	MiCOM Labs	40dB 1 to 18GHz Amp	0406	28 May 2016
410	Desktop Computer	Dell	Inspiron 620	WS38	Not Required
412	USB to GPIB Interface	National Instruments	GPIB-USB HS	11B8DC2	Not Required
413	Mast Controller	Sunol Science	TWR95-4	030801-3	Not Required
415	Turntable Controller	Sunol Sciences	Turntable Controller	None	Not Required
416	Gigabit ethernet filter	ETS-Lingren	Gigafoil 260366	None	Not Required
447	Rad Emissions Test Software	MiCOM	Test Software Version 1.0.73	447	Not Required
462	Schwarzbeck cable from Antenna to Amplifier.	Schwarzbeck	AK 9513	462	25 Feb 2016
463	Schwarzbeck cable from Amplifier to Bulkhead.	Schwarzbeck	AK 9513	463	25 Feb 2016
464	Schwarzbeck cable from Bulkhead to Receiver	Schwarzbeck	AK 9513	464	25 Feb 2016
480	Cable - Bulkhead to Amp	SRC Haverhill	157-157-3050360	480	11 Aug 2016
481	Cable - Bulkhead to Receiver	SRC Haverhill	151-151-3050787	481	11 Aug 2016
482	Cable - Amp to Antenna	SRC Haverhill	157-157-3051574	482	11 Aug 2016

This test report may be reproduced in full only. The document may only be updated by MiCOM Labs personnel. All changes will be noted in the Document History section of the report.

7.3. ac Wireline Emission Test Set-up

The following tests were performed using the conducted test set-up shown in the diagram below.

1. Section 9.6 ac Wireline Conducted Emissions

Test Measurement Set up

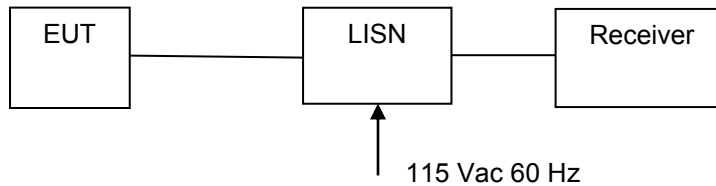

Measurement set up for AC Wireline Conducted Emissions Test

Traceability of Test Equipment Utilized for ac Wireline Emission Testing

Asset#	Description	Manufacturer	Model#	Serial#	Calibration Due Date
158	Barometer/Thermometer	Control Company	4196	E2846	04 Dec 2015
184	Pulse Limiter	Rhode & Schwarz	ESH3Z2	357.8810.52	Cal when used
190	LISN (two-line V-network)	Rhode & Schwarz	ESH3Z5	836679/006	12 Sep 2016
287	Rohde & Schwarz 40 GHz Receiver	Rhode & Schwarz	ESIB40	100201	31 Jul 2016
316	Dell desktop computer workstation with Vasona	Dell	Desktop	WS04	Not Required

This test report may be reproduced in full only. The document may only be updated by MiCOM Labs personnel. All changes will be noted in the Document History section of the report.

8. MEASUREMENT AND PRESENTATION OF TEST DATA

The measurement and graphical data presented in this test report was generated automatically using state-of-the-art technology creating an easy to read report structure. Numerical measurement data is separated from supporting graphical data (plots) through hyperlinks. Numerical measurement data can be reviewed without scrolling through numerous graphical pages to arrive at the next data matrix.

Plots have been relegated into the Appendix 'Graphical Data'.

Test and report automation was performed by [MiTest](#). [MiTest](#) is an automated test system developed by MiCOM Labs. [MiTest](#) is the first cloud based modular test system enabling end-to-end automation of regulatory compliance testing for conducted RF testing.



The MiCOM Labs "[MiTest](#)" Automated Test System" (Patent Pending)

This test report may be reproduced in full only. The document may only be updated by MiCOM Labs personnel. All changes will be noted in the Document History section of the report.



9. TEST RESULTS

9.1. Peak Transmit Power

Conducted Test Conditions for Maximum Conducted Output Power			
Standard:	FCC CFR 47:15.407	Ambient Temp. (°C):	24.0 - 27.5
Test Heading:	Maximum Conducted Output Power	Rel. Humidity (%):	32 - 45
Standard Section(s):	15.407 (a)	Pressure (mBars):	999 - 1001
Reference Document(s):	See Normative References		

Test Procedure for Maximum Conducted Output Power Measurement

Method PM (Measurement using an RF average power meter). KDB 789033 defines a methodology using an average wideband power meter. Measurements were made while the EUT was operating in a continuous transmission mode (100% duty cycle) at the appropriate center frequency. All operational modes and frequency bands were measured independently and the resultant calculated. Where the device operated with multiple antenna ports i.e. MIMO device, each port was measured and reported separately. A summation (Σ) of each antenna port output power is provided which includes any offset due to Duty Cycle Correction Factor (DCCF). Testing was performed under ambient conditions at nominal voltage.

Test configuration and setup used for the measurement was per the Conducted Test Set-up section specified in this document.

Supporting Information

Calculated Power = $A + G + Y + 10 \log (1/x)$ dBm

A = Total Power [$10 \cdot \text{Log}_{10} (10^{a/10} + 10^{b/10} + 10^{c/10} + 10^{d/10})$]

G = Antenna Gain

Y = Beamforming Gain

x = Duty Cycle (average power measurements only)

Limits Maximum Conducted Output Power

Operating Frequency Band 5150-5250 MHz

15.407 (a)(1)

(i) For an outdoor access point operating in the band 5.15-5.25 GHz, the maximum conducted output power over the frequency band of operation shall not exceed 1 W provided the maximum antenna gain does not exceed 6 dBi. In addition, the maximum power spectral density shall not exceed 17 dBm in any 1 megahertz band. If transmitting antennas of directional gain greater than 6 dBi are used, both the maximum conducted output power and the maximum power spectral density shall be reduced by the amount in dB that the directional gain of the antenna exceeds 6 dBi. The maximum e.i.r.p. at any elevation angle above 30 degrees as measured from the horizon must not exceed 125 mW (21 dBm).

(ii) For an indoor access point operating in the band 5.15-5.25 GHz, the maximum conducted output power over the frequency band of operation shall not exceed 1 W provided the maximum antenna gain does not exceed 6 dBi. In addition, the maximum power spectral density shall not exceed 17 dBm in any 1 megahertz band. If transmitting antennas of directional gain greater than 6 dBi are used, both the maximum conducted output power and the maximum power spectral density shall be reduced by the amount in dB that the directional gain of the antenna exceeds 6 dBi.

(iii) For fixed point-to-point access points operating in the band 5.15-5.25 GHz, the maximum conducted output power over the frequency band of operation shall not exceed 1 W. In addition, the maximum power spectral density shall not exceed 17 dBm in any 1 megahertz band. Fixed point-to-point U-NII devices may employ antennas with directional gain up to 23 dBi without any corresponding reduction in the maximum conducted output power or maximum power spectral density. For fixed point-to-point transmitters that employ a directional antenna gain greater than 23 dBi, a 1 dB reduction in maximum conducted output power and maximum power spectral density is required for each 1 dB of antenna gain in excess of 23 dBi. Fixed, point-to-point operations exclude the use of point-to-multipoint systems, omnidirectional applications, and multiple collocated transmitters transmitting the same information. The operator of the U-NII device, or if the equipment is professionally installed, the installer, is responsible for ensuring

This test report may be reproduced in full only. The document may only be updated by MiCOM Labs personnel. All changes will be noted in the Document History section of the report.



Title: Mimosa Networks A5 Wireless Access Point
To: FCC CFR 47 Part 15 Subpart E 15.407
Serial #: MIMO05-6a Rev A
Issue Date: 4th November 2015
Page: 24 of 372

that systems employing high gain directional antennas are used exclusively for fixed, point-to-point operations.

(iv) For mobile and portable client devices in the 5.15-5.25 GHz band, the maximum conducted output power over the frequency band of operation shall not exceed 250 mW provided the maximum antenna gain does not exceed 6 dBi. In addition, the maximum power spectral density shall not exceed 11 dBm in any 1 megahertz band. If transmitting antennas of directional gain greater than 6 dBi are used, both the maximum conducted output power and the maximum power spectral density shall be reduced by the amount in dB that the directional gain of the antenna exceeds 6 dBi.

Operating Frequency Band 5250-5350 and 5470 – 5725 MHz

15. 407 (a)(2)

For the 5.25-5.35 GHz and 5.47-5.725 GHz bands, the maximum conducted output power over the frequency bands of operation shall not exceed the lesser of 250 mW or $11 \text{ dBm} + 10 \log B$, where B is the 26 dB emission bandwidth in megahertz. In addition, the maximum power spectral density shall not exceed 11 dBm in any 1 megahertz band. If transmitting antennas of directional gain greater than 6 dBi are used, both the maximum conducted output power and the maximum power spectral density shall be reduced by the amount in dB that the directional gain of the antenna exceeds 6 dBi.

Operating Frequency Band 5725 – 5850 MHz

15. 407 (a)(3)

For the band 5.725-5.85 GHz, the maximum conducted output power over the frequency band of operation shall not exceed 1 W. In addition, the maximum power spectral density shall not exceed 30 dBm in any 500-kHz band. If transmitting antennas of directional gain greater than 6 dBi are used, both the maximum conducted output power and the maximum power spectral density shall be reduced by the amount in dB that the directional gain of the antenna exceeds 6 dBi. However, fixed point-to-point U-NII devices operating in this band may employ transmitting antennas with directional gain greater than 6 dBi without any corresponding reduction in transmitter conducted power. Fixed, point-to-point operations exclude the use of point-to-multipoint systems, omnidirectional applications, and multiple collocated transmitters transmitting the same information. The operator of the U-NII device, or if the equipment is professionally installed, the installer, is responsible for ensuring that systems employing high gain directional antennas are used exclusively for fixed, point-to-point operations.

This test report may be reproduced in full only. The document may only be updated by MiCOM Labs personnel. All changes will be noted in the Document History section of the report.



Title: Mimosa Networks A5 Wireless Access Point
To: FCC CFR 47 Part 15 Subpart E 15.407
Serial #: MIMO05-6a Rev A
Issue Date: 4th November 2015
Page: 25 of 372

Equipment Configuration for Peak Transmit Power

Variant:	802.11a	Duty Cycle (%):	98.1
Data Rate:	6 M Bit/s	Antenna Gain (dBi):	5.00
Modulation:	OFDM	Beam Forming Gain (Y)(dB):	Not Applicable
TPC:	Not Applicable	Tested By:	GMH
Engineering Test Notes:			

Test Measurement Results

Test Frequency	Measured Conducted Output Power (dBm)				Calculated Total Power Σ Port(s) dBm	Minimum 26 dB Bandwidth MHz	Limit dBm	Margin dBm	EUT Power Setting
	Port(s)								
MHz	a	b	c	d					
5165.0	20.35	21.45	21.12	21.00	27.10	--	30.00	-2.90	23.00
5200.0	20.72	20.99	20.59	20.23	26.74	--	30.00	-3.26	23.00
5240.0	21.25	21.51	21.43	21.14	27.44	--	30.00	-2.56	23.00

Traceability to Industry Recognized Test Methodologies

Work Instruction:	WI-01 MEASURING RF OUTPUT POWER
Measurement Uncertainty:	± 1.33 dB

DCCF - Duty Cycle Correction Factor

This test report may be reproduced in full only. The document may only be updated by MiCOM Labs personnel. All changes will be noted in the Document History section of the report.



Title: Mimosa Networks A5 Wireless Access Point
To: FCC CFR 47 Part 15 Subpart E 15.407
Serial #: MIMO05-6a Rev A
Issue Date: 4th November 2015
Page: 26 of 372

Equipment Configuration for Peak Transmit Power

Variant:	802.11a	Duty Cycle (%):	98.1
Data Rate:	6.00 MBit/s	Antenna Gain (dBi):	5.00
Modulation:	OFDM	Beam Forming Gain (Y)(dB):	Not Applicable
TPC:	Not Applicable	Tested By:	GMH
Engineering Test Notes:			

Test Measurement Results

Test Frequency	Measured Conducted Output Power (dBm)				Calculated Total Power	Minimum 26 dB Bandwidth	Limit	Margin	EUT Power Setting
	Port(s)								
MHz	a	b	c	d	Σ Port(s) dBm	MHz	dBm	dBm	
5260.0	17.79	17.78	17.84	17.24	23.77	21.643	24.00	-0.23	14.00
5300.0	17.18	17.46	17.14	16.86	23.27	21.643	24.00	-0.73	14.00
5335.0	17.37	17.92	17.29	17.31	23.58	21.443	24.00	-0.42	14.00

Traceability to Industry Recognized Test Methodologies

Work Instruction:	WI-03 MEASURING RF SPECTRUM MASK
Measurement Uncertainty:	±2.81 dB

DCCF - Duty Cycle Correction Factor

This test report may be reproduced in full only. The document may only be updated by MiCOM Labs personnel. All changes will be noted in the Document History section of the report.



Title: Mimosa Networks A5 Wireless Access Point
To: FCC CFR 47 Part 15 Subpart E 15.407
Serial #: MIMO05-6a Rev A
Issue Date: 4th November 2015
Page: 27 of 372

Equipment Configuration for Peak Transmit Power

Variant:	802.11a	Duty Cycle (%):	98.1
Data Rate:	6.00 MBit/s	Antenna Gain (dBi):	5.00
Modulation:	OFDM	Beam Forming Gain (Y)(dB):	Not Applicable
TPC:	Not Applicable	Tested By:	GMH
Engineering Test Notes:			

Test Measurement Results

Test Frequency	Measured Conducted Output Power (dBm)				Calculated Total Power	Minimum 26 dB Bandwidth	Limit	Margin	EUT Power Setting
	Port(s)								
MHz	a	b	c	d	Σ Port(s) dBm	MHz	dBm	dBm	
5485.0	18.05	17.33	18.50	17.21	23.91	20.240	24.00	-0.09	14.00
5590.0	17.85	17.04	18.16	16.60	23.56	21.443	24.00	-0.44	14.00
5715.0	15.88	15.92	19.75	18.07	23.82	21.643	24.00	-0.18	19.00

Traceability to Industry Recognized Test Methodologies

Work Instruction:	WI-03 MEASURING RF SPECTRUM MASK
Measurement Uncertainty:	±2.81 dB

DCCF - Duty Cycle Correction Factor

This test report may be reproduced in full only. The document may only be updated by MiCOM Labs personnel. All changes will be noted in the Document History section of the report.



Title: Mimosa Networks A5 Wireless Access Point
To: FCC CFR 47 Part 15 Subpart E 15.407
Serial #: MIMO05-6a Rev A
Issue Date: 4th November 2015
Page: 28 of 372

Equipment Configuration for Peak Transmit Power			
Variant:	802.11a	Duty Cycle (%):	98.1
Data Rate:	6 M Bit/s	Antenna Gain (dBi):	5.00
Modulation:	OFDM	Beam Forming Gain (Y)(dB):	Not Applicable
TPC:	Not Applicable	Tested By:	GMH
Engineering Test Notes:			

Test Measurement Results									
Test Frequency	Measured Conducted Output Power (dBm)				Calculated Total Power	Minimum 26 dB Bandwidth	Limit	Margin	EUT Power Setting
	Port(s)								
MHz	a	b	c	d	Σ Port(s) dBm	MHz	dBm	dBm	
5745.0	16.27	16.08	19.57	18.34	23.92	--	30.00	-6.08	23.00
5785.0	15.54	16.38	19.63	18.51	23.92	--	30.00	-6.08	23.00
5825.0	15.53	16.15	19.19	17.97	23.56	--	30.00	-6.44	23.00

Traceability to Industry Recognized Test Methodologies	
Work Instruction:	WI-01 MEASURING RF OUTPUT POWER
Measurement Uncertainty:	±1.33 dB

DCCF - Duty Cycle Correction Factor

This test report may be reproduced in full only. The document may only be updated by MiCOM Labs personnel. All changes will be noted in the Document History section of the report.



Title: Mimosa Networks A5 Wireless Access Point
To: FCC CFR 47 Part 15 Subpart E 15.407
Serial #: MIMO05-6a Rev A
Issue Date: 4th November 2015
Page: 29 of 372

Equipment Configuration for Peak Transmit Power			
Variant:	802.11ac-80	Duty Cycle (%):	96.9
Data Rate:	29.3 M Bit/s	Antenna Gain (dBi):	5.00
Modulation:	OFDM	Beam Forming Gain (Y)(dB):	Not Applicable
TPC:	Not Applicable	Tested By:	GMH
Engineering Test Notes:			

Test Measurement Results									
Test Frequency	Measured Conducted Output Power (dBm)				Calculated Total Power	Minimum 26 dB Bandwidth	Limit	Margin	EUT Power Setting
	Port(s)								
MHz	a	b	c	d	Σ Port(s) dBm	MHz	dBm	dBm	
5195.0	20.40	21.18	20.87	20.37	26.88	--	30.00	-3.12	23.00
5200.0	20.47	21.29	20.67	20.43	26.89	--	30.00	-3.11	23.00
5210.0	20.52	20.81	20.73	20.49	26.80	--	30.00	-3.20	23.00

Traceability to Industry Recognized Test Methodologies	
Work Instruction:	WI-01 MEASURING RF OUTPUT POWER
Measurement Uncertainty:	±1.33 dB

DCCF - Duty Cycle Correction Factor

This test report may be reproduced in full only. The document may only be updated by MiCOM Labs personnel. All changes will be noted in the Document History section of the report.



Title: Mimosa Networks A5 Wireless Access Point
To: FCC CFR 47 Part 15 Subpart E 15.407
Serial #: MIMO05-6a Rev A
Issue Date: 4th November 2015
Page: 30 of 372

Equipment Configuration for Peak Transmit Power			
Variant:	802.11ac-80	Duty Cycle (%):	96.9
Data Rate:	29.30 MBit/s	Antenna Gain (dBi):	5.00
Modulation:	OFDM	Beam Forming Gain (Y)(dB):	Not Applicable
TPC:	Not Applicable	Tested By:	GMH
Engineering Test Notes:			

Test Measurement Results									
Test Frequency	Measured Conducted Output Power (dBm)				Calculated Total Power	Minimum 26 dB Bandwidth	Limit	Margin	EUT Power Setting
	Port(s)								
MHz	a	b	c	d	Σ Port(s) dBm	MHz	dBm	dBm	
5290.0	17.26	17.56	17.39	16.59	23.37	81.363	24.00	-0.63	14.00
5300.0	16.82	17.72	17.35	17.04	23.40	79.359	24.00	-0.60	14.00
5310.0	17.20	17.61	17.33	16.66	23.37	78.958	24.00	-0.63	14.00

Traceability to Industry Recognized Test Methodologies	
Work Instruction:	WI-03 MEASURING RF SPECTRUM MASK
Measurement Uncertainty:	±2.81 dB

DCCF - Duty Cycle Correction Factor

This test report may be reproduced in full only. The document may only be updated by MiCOM Labs personnel. All changes will be noted in the Document History section of the report.



Title: Mimosa Networks A5 Wireless Access Point
To: FCC CFR 47 Part 15 Subpart E 15.407
Serial #: MIMO05-6a Rev A
Issue Date: 4th November 2015
Page: 31 of 372

Equipment Configuration for Peak Transmit Power			
Variant:	802.11ac-80	Duty Cycle (%):	96.9
Data Rate:	29.30 MBit/s	Antenna Gain (dBi):	5.00
Modulation:	OFDM	Beam Forming Gain (Y)(dB):	Not Applicable
TPC:	Not Applicable	Tested By:	GMH
Engineering Test Notes:			

Test Measurement Results									
Test Frequency	Measured Conducted Output Power (dBm)				Calculated Total Power	Minimum 26 dB Bandwidth	Limit	Margin	EUT Power Setting
	Port(s)								
MHz	a	b	c	d	Σ Port(s) dBm	MHz	dBm	dBm	
5530.0	18.18	17.25	18.12	17.00	23.83	78.557	24.00	-0.17	14.00
5545.0	17.68	17.42	17.91	16.78	23.62	78.557	24.00	-0.38	14.00
5560.0	17.78	17.30	17.82	16.24	23.49	78.557	24.00	-0.51	14.00

Traceability to Industry Recognized Test Methodologies	
Work Instruction:	WI-03 MEASURING RF SPECTRUM MASK
Measurement Uncertainty:	± 2.81 dB

DCCF - Duty Cycle Correction Factor

This test report may be reproduced in full only. The document may only be updated by MiCOM Labs personnel. All changes will be noted in the Document History section of the report.



Title: Mimosa Networks A5 Wireless Access Point
To: FCC CFR 47 Part 15 Subpart E 15.407
Serial #: MIMO05-6a Rev A
Issue Date: 4th November 2015
Page: 32 of 372

Equipment Configuration for Peak Transmit Power			
Variant:	802.11ac-80	Duty Cycle (%):	96.9
Data Rate:	29.30 MBit/s	Antenna Gain (dBi):	5.00
Modulation:	OFDM	Beam Forming Gain (Y)(dB):	Not Applicable
TPC:	Not Applicable	Tested By:	GMH
Engineering Test Notes:			

Test Measurement Results									
Test Frequency	Measured Conducted Output Power (dBm)				Calculated Total Power	Minimum 26 dB Bandwidth	Limit	Margin	EUT Power Setting
	Port(s)								
MHz	a	b	c	d	Σ Port(s) dBm	MHz	dBm	dBm	
5775.0	15.36	16.18	19.41	18.06	23.70	--	30.00	-6.30	23.00
5785.0	15.35	16.38	19.87	18.01	23.90	--	30.00	-6.10	23.00
5795.0	15.39	16.36	19.77	17.81	23.81	--	30.00	-6.19	23.00

Traceability to Industry Recognized Test Methodologies	
Work Instruction:	WI-03 MEASURING RF SPECTRUM MASK
Measurement Uncertainty:	± 2.81 dB

DCCF - Duty Cycle Correction Factor

This test report may be reproduced in full only. The document may only be updated by MiCOM Labs personnel. All changes will be noted in the Document History section of the report.



Title: Mimosa Networks A5 Wireless Access Point
To: FCC CFR 47 Part 15 Subpart E 15.407
Serial #: MIMO05-6a Rev A
Issue Date: 4th November 2015
Page: 33 of 372

Equipment Configuration for Peak Transmit Power

Variant:	802.11n HT-20	Duty Cycle (%):	98.9
Data Rate:	6.5 M Bit/s	Antenna Gain (dBi):	5.00
Modulation:	OFDM	Beam Forming Gain (Y)(dB):	Not Applicable
TPC:	Not Applicable	Tested By:	GMH
Engineering Test Notes:			

Test Measurement Results

Test Frequency	Measured Conducted Output Power (dBm)				Calculated Total Power	Minimum 26 dB Bandwidth	Limit	Margin	EUT Power Setting
	Port(s)								
MHz	a	b	c	d	Σ Port(s) dBm	MHz	dBm	dBm	
5165.0	20.01	21.32	21.16	20.73	26.90	--	30.00	-3.10	23.00
5200.0	20.20	21.27	20.53	20.44	26.70	--	30.00	-3.30	23.00
5240.0	21.01	21.83	20.98	21.23	27.34	--	30.00	-2.66	23.00

Traceability to Industry Recognized Test Methodologies

Work Instruction:	WI-01 MEASURING RF OUTPUT POWER
Measurement Uncertainty:	±1.33 dB

DCCF - Duty Cycle Correction Factor

This test report may be reproduced in full only. The document may only be updated by MiCOM Labs personnel. All changes will be noted in the Document History section of the report.



Title: Mimosa Networks A5 Wireless Access Point
To: FCC CFR 47 Part 15 Subpart E 15.407
Serial #: MIMO05-6a Rev A
Issue Date: 4th November 2015
Page: 34 of 372

Equipment Configuration for Peak Transmit Power

Variant:	802.11n HT-20	Duty Cycle (%):	98.9
Data Rate:	6.50 MBit/s	Antenna Gain (dBi):	5.00
Modulation:	OFDM	Beam Forming Gain (Y)(dB):	Not Applicable
TPC:	Not Applicable	Tested By:	GMH
Engineering Test Notes:			

Test Measurement Results

Test Frequency	Measured Conducted Output Power (dBm)				Calculated Total Power	Minimum 26 dB Bandwidth	Limit	Margin	EUT Power Setting
	Port(s)								
MHz	a	b	c	d	Σ Port(s) dBm	MHz	dBm	dBm	
5260.0	17.56	17.99	17.47	17.04	23.60	23.146	24.00	-0.40	14.00
5300.0	16.71	17.46	17.27	16.67	23.11	23.246	24.00	-0.89	14.00
5335.0	17.14	17.65	17.38	16.87	23.34	23.146	24.00	-0.66	14.00

Traceability to Industry Recognized Test Methodologies

Work Instruction:	WI-03 MEASURING RF SPECTRUM MASK
Measurement Uncertainty:	±2.81 dB

DCCF - Duty Cycle Correction Factor

This test report may be reproduced in full only. The document may only be updated by MiCOM Labs personnel. All changes will be noted in the Document History section of the report.



Title: Mimosa Networks A5 Wireless Access Point
To: FCC CFR 47 Part 15 Subpart E 15.407
Serial #: MIMO05-6a Rev A
Issue Date: 4th November 2015
Page: 35 of 372

Equipment Configuration for Peak Transmit Power			
Variant:	802.11n HT-20	Duty Cycle (%):	98.9
Data Rate:	6.50 MBit/s	Antenna Gain (dBi):	5.00
Modulation:	OFDM	Beam Forming Gain (Y)(dB):	Not Applicable
TPC:	Not Applicable	Tested By:	GMH
Engineering Test Notes:			

Test Measurement Results									
Test Frequency	Measured Conducted Output Power (dBm)				Calculated Total Power	Minimum 26 dB Bandwidth	Limit	Margin	EUT Power Setting
	Port(s)								
MHz	a	b	c	d	Σ Port(s) dBm	MHz	dBm	dBm	
5485.0	18.00	17.27	18.45	17.05	23.80	21.944	24.00	-0.20	14.00
5590.0	17.82	17.04	17.86	16.62	23.44	22.946	24.00	-0.56	14.00
5715.0	15.72	15.85	19.27	17.89	23.51	22.946	24.00	-0.49	19.00

Traceability to Industry Recognized Test Methodologies	
Work Instruction:	WI-03 MEASURING RF SPECTRUM MASK
Measurement Uncertainty:	± 2.81 dB

DCCF - Duty Cycle Correction Factor

This test report may be reproduced in full only. The document may only be updated by MiCOM Labs personnel. All changes will be noted in the Document History section of the report.



Title: Mimosa Networks A5 Wireless Access Point
To: FCC CFR 47 Part 15 Subpart E 15.407
Serial #: MIMO05-6a Rev A
Issue Date: 4th November 2015
Page: 36 of 372

Equipment Configuration for Peak Transmit Power

Variant:	802.11n HT-20	Duty Cycle (%):	98.9
Data Rate:	6.5 M Bit/s	Antenna Gain (dBi):	5.00
Modulation:	OFDM	Beam Forming Gain (Y)(dB):	Not Applicable
TPC:	Not Applicable	Tested By:	GMH
Engineering Test Notes:			

Test Measurement Results

Test Frequency	Measured Conducted Output Power (dBm)				Calculated Total Power	Minimum 26 dB Bandwidth	Limit	Margin	EUT Power Setting
	Port(s)								
MHz	a	b	c	d	Σ Port(s) dBm	MHz	dBm	dBm	
5745.0	16.15	16.26	19.89	18.34	24.01	--	30.00	-5.99	23.00
5785.0	15.45	16.39	19.48	18.11	23.70	--	30.00	-6.30	23.00
5825.0	15.44	16.30	18.53	17.58	23.19	--	30.00	-6.81	23.00

Traceability to Industry Recognized Test Methodologies

Work Instruction:	WI-01 MEASURING RF OUTPUT POWER
Measurement Uncertainty:	±1.33 dB

DCCF - Duty Cycle Correction Factor

This test report may be reproduced in full only. The document may only be updated by MiCOM Labs personnel. All changes will be noted in the Document History section of the report.



Title: Mimosa Networks A5 Wireless Access Point
To: FCC CFR 47 Part 15 Subpart E 15.407
Serial #: MIMO05-6a Rev A
Issue Date: 4th November 2015
Page: 37 of 372

Equipment Configuration for Peak Transmit Power			
Variant:	802.11n HT-40	Duty Cycle (%):	97.1
Data Rate:	13.5 M Bit/s	Antenna Gain (dBi):	5.00
Modulation:	OFDM	Beam Forming Gain (Y)(dB):	Not Applicable
TPC:	Not Applicable	Tested By:	GMH
Engineering Test Notes:			

Test Measurement Results									
Test Frequency	Measured Conducted Output Power (dBm)				Calculated Total Power	Minimum 26 dB Bandwidth	Limit	Margin	EUT Power Setting
	Port(s)								
MHz	a	b	c	d	Σ Port(s) dBm	MHz	dBm	dBm	
5175.0	19.58	20.62	20.54	20.06	26.37	--	30.00	-3.63	23.00
5200.0	20.20	20.95	20.29	19.88	26.50	--	30.00	-3.50	23.00
5230.0	20.66	20.91	20.50	20.63	26.83	--	30.00	-3.17	23.00

Traceability to Industry Recognized Test Methodologies	
Work Instruction:	WI-01 MEASURING RF OUTPUT POWER
Measurement Uncertainty:	±1.33 dB

DCCF - Duty Cycle Correction Factor

This test report may be reproduced in full only. The document may only be updated by MiCOM Labs personnel. All changes will be noted in the Document History section of the report.



Title: Mimosa Networks A5 Wireless Access Point
To: FCC CFR 47 Part 15 Subpart E 15.407
Serial #: MIMO05-6a Rev A
Issue Date: 4th November 2015
Page: 38 of 372

Equipment Configuration for Peak Transmit Power			
Variant:	802.11n HT-40	Duty Cycle (%):	97.1
Data Rate:	13.50 MBit/s	Antenna Gain (dBi):	5.00
Modulation:	OFDM	Beam Forming Gain (Y)(dB):	Not Applicable
TPC:	Not Applicable	Tested By:	GMH
Engineering Test Notes:			

Test Measurement Results									
Test Frequency	Measured Conducted Output Power (dBm)				Calculated Total Power	Minimum 26 dB Bandwidth	Limit	Margin	EUT Power Setting
	Port(s)								
MHz	a	b	c	d	Σ Port(s) dBm	MHz	dBm	dBm	
5270.0	17.18	17.67	17.23	16.85	23.39	41.082	24.00	-0.61	14.00
5300.0	16.65	17.38	17.04	16.68	23.10	41.283	24.00	-0.90	14.00
5330.0	16.88	17.42	17.05	17.07	23.26	41.082	24.00	-0.74	14.00

Traceability to Industry Recognized Test Methodologies	
Work Instruction:	WI-03 MEASURING RF SPECTRUM MASK
Measurement Uncertainty:	±2.81 dB

DCCF - Duty Cycle Correction Factor

This test report may be reproduced in full only. The document may only be updated by MiCOM Labs personnel. All changes will be noted in the Document History section of the report.



Title: Mimosa Networks A5 Wireless Access Point
To: FCC CFR 47 Part 15 Subpart E 15.407
Serial #: MIMO05-6a Rev A
Issue Date: 4th November 2015
Page: 39 of 372

Equipment Configuration for Peak Transmit Power			
Variant:	802.11n HT-40	Duty Cycle (%):	97.1
Data Rate:	13.50 MBit/s	Antenna Gain (dBi):	5.00
Modulation:	OFDM	Beam Forming Gain (Y)(dB):	Not Applicable
TPC:	Not Applicable	Tested By:	GMH
Engineering Test Notes:			

Test Measurement Results									
Test Frequency	Measured Conducted Output Power (dBm)				Calculated Total Power	Minimum 26 dB Bandwidth	Limit	Margin	EUT Power Setting
	Port(s)								
MHz	a	b	c	d	Σ Port(s) dBm	MHz	dBm	dBm	
5495.0	17.95	17.19	18.13	17.06	23.76	39.880	24.00	-0.24	14.00
5590.0	17.50	17.32	17.89	16.45	23.47	40.681	24.00	-0.53	14.00
5705.0	15.61	15.87	19.09	17.62	23.43	41.082	24.00	-0.57	20.00

Traceability to Industry Recognized Test Methodologies	
Work Instruction:	WI-03 MEASURING RF SPECTRUM MASK
Measurement Uncertainty:	±2.81 dB

DCCF - Duty Cycle Correction Factor

This test report may be reproduced in full only. The document may only be updated by MiCOM Labs personnel. All changes will be noted in the Document History section of the report.



Title: Mimosa Networks A5 Wireless Access Point
To: FCC CFR 47 Part 15 Subpart E 15.407
Serial #: MIMO05-6a Rev A
Issue Date: 4th November 2015
Page: 40 of 372

Equipment Configuration for Peak Transmit Power			
Variant:	802.11n HT-40	Duty Cycle (%):	97.1
Data Rate:	13.5 M Bit/s	Antenna Gain (dBi):	5.00
Modulation:	OFDM	Beam Forming Gain (Y)(dB):	Not Applicable
TPC:	Not Applicable	Tested By:	GMH
Engineering Test Notes:			

Test Measurement Results									
Test Frequency	Measured Conducted Output Power (dBm)				Calculated Total Power	Minimum 26 dB Bandwidth	Limit	Margin	EUT Power Setting
	Port(s)								
MHz	a	b	c	d	Σ Port(s) dBm	MHz	dBm	dBm	
5755.0	15.38	16.35	19.25	18.03	23.66	--	30.00	-6.34	23.00
5785.0	15.57	16.43	19.34	18.25	23.80	--	30.00	-6.20	23.00
5815.0	15.51	16.35	19.11	17.94	23.60	--	30.00	-6.40	23.00

Traceability to Industry Recognized Test Methodologies	
Work Instruction:	WI-01 MEASURING RF OUTPUT POWER
Measurement Uncertainty:	±1.33 dB

DCCF - Duty Cycle Correction Factor

This test report may be reproduced in full only. The document may only be updated by MiCOM Labs personnel. All changes will be noted in the Document History section of the report.



Title: Mimosa Networks A5 Wireless Access Point
To: FCC CFR 47 Part 15 Subpart E 15.407
Serial #: MIMO05-6a Rev A
Issue Date: 4th November 2015
Page: 41 of 372

9.2. 26 dB & 99% Bandwidth

Conducted Test Conditions for 26 dB and 99% Bandwidth			
Standard:	FCC CFR 47:15.407	Ambient Temp. (°C):	24.0 - 27.5
Test Heading:	26 dB and 99 % Bandwidth	Rel. Humidity (%):	32 - 45
Standard Section(s):	15.407 (a)	Pressure (mBars):	999 - 1001
Reference Document(s):	See Normative References		
Test Procedure for 26 dB and 99% Bandwidth Measurement The bandwidth at 26 dB and 99 % is measured with a spectrum analyzer connected to the antenna terminal, while EUT is operating in transmission mode at the appropriate center frequency. The Resolution Bandwidth was set to approximately 1% of the emission bandwidth. Testing was performed under ambient conditions at nominal voltage. Where the device operated with multiple antenna ports i.e. MIMO device, each port was measured and reported. Test configuration and setup used for the measurement was per the Conducted Test Set-up section specified in this document.			

This test report may be reproduced in full only. The document may only be updated by MiCOM Labs personnel. All changes will be noted in the Document History section of the report.



Title: Mimosa Networks A5 Wireless Access Point
To: FCC CFR 47 Part 15 Subpart E 15.407
Serial #: MIMO05-6a Rev A
Issue Date: 4th November 2015
Page: 42 of 372

Equipment Configuration for 26 dB & 99% Occupied Bandwidth

Variant:	802.11a	Duty Cycle (%):	98.1
Data Rate:	6.00 MBit/s	Antenna Gain (dBi):	14.00
Modulation:	OFDM	Beam Forming Gain (Y)(dB):	Not Applicable
TPC:	Not Applicable	Tested By:	SB
Engineering Test Notes:			

Test Measurement Results

Test Frequency	Measured 26 dB Bandwidth (MHz)				26 dB Bandwidth (MHz)			
	Port(s)				Highest	Lowest		
MHz	a	b	c	d				
5165.0	21.844				21.844	21.844		
5200.0	22.044				22.044	22.044		
5240.0	21.443				21.443	21.443		

Test Frequency	Measured 99% Bandwidth (MHz)				99% Bandwidth (MHz)			
	Port(s)				Highest	Lowest		
MHz	a	b	c	d				
5165.0	16.633				16.633	16.633		
5200.0	16.633				16.633	16.633		
5240.0	16.633				16.633	16.633		

Traceability to Industry Recognized Test Methodologies

Work Instruction:	WI-03 MEASURING RF SPECTRUM MASK
Measurement Uncertainty:	±2.81 dB

Note: click the links in the above matrix to view the graphical image (plot).

This test report may be reproduced in full only. The document may only be updated by MiCOM Labs personnel. All changes will be noted in the Document History section of the report.



Title: Mimosa Networks A5 Wireless Access Point
To: FCC CFR 47 Part 15 Subpart E 15.407
Serial #: MIMO05-6a Rev A
Issue Date: 4th November 2015
Page: 43 of 372

Equipment Configuration for 26 dB & 99% Occupied Bandwidth			
Variant:	802.11a	Duty Cycle (%):	98.1
Data Rate:	6.00 MBit/s	Antenna Gain (dBi):	5.00
Modulation:	OFDM	Beam Forming Gain (Y)(dB):	Not Applicable
TPC:	Not Applicable	Tested By:	GMH
Engineering Test Notes:			

Test Measurement Results								
Test Frequency	Measured 26 dB Bandwidth (MHz)				26 dB Bandwidth (MHz)			
	Port(s)				Highest	Lowest		
MHz	a	b	c	d				
5260.0	21.643				21.643	21.643		
5300.0	21.643				21.643	21.643		
5335.0	21.443				21.443	21.443		

Test Frequency	Measured 99% Bandwidth (MHz)				99% Bandwidth (MHz)			
	Port(s)				Highest	Lowest		
MHz	a	b	c	d				
5260.0	16.633				16.633	16.633		
5300.0	16.633				16.633	16.633		
5335.0	16.633				16.633	16.633		

Traceability to Industry Recognized Test Methodologies	
Work Instruction:	WI-03 MEASURING RF SPECTRUM MASK
Measurement Uncertainty:	±2.81 dB

Note: click the links in the above matrix to view the graphical image (plot).

This test report may be reproduced in full only. The document may only be updated by MiCOM Labs personnel. All changes will be noted in the Document History section of the report.



Title: Mimosa Networks A5 Wireless Access Point
To: FCC CFR 47 Part 15 Subpart E 15.407
Serial #: MIMO05-6a Rev A
Issue Date: 4th November 2015
Page: 44 of 372

Equipment Configuration for 26 dB & 99% Occupied Bandwidth			
Variant:	802.11a	Duty Cycle (%):	98.1
Data Rate:	6.00 MBit/s	Antenna Gain (dBi):	5.00
Modulation:	OFDM	Beam Forming Gain (Y)(dB):	Not Applicable
TPC:	Not Applicable	Tested By:	GMH
Engineering Test Notes:			

Test Measurement Results								
Test Frequency	Measured 26 dB Bandwidth (MHz)				26 dB Bandwidth (MHz)			
	Port(s)				Highest	Lowest		
MHz	a	b	c	d				
5485.0	20.240				20.240	20.240		
5590.0	21.443				21.443	21.443		
5715.0	21.643				21.643	21.643		

Test Frequency	Measured 99% Bandwidth (MHz)				99% Bandwidth (MHz)			
	Port(s)				Highest	Lowest		
MHz	a	b	c	d				
5485.0	16.633				16.633	16.633		
5590.0	16.733				16.733	16.733		
5715.0	16.633				16.633	16.633		

Traceability to Industry Recognized Test Methodologies	
Work Instruction:	WI-03 MEASURING RF SPECTRUM MASK
Measurement Uncertainty:	±2.81 dB

Note: click the links in the above matrix to view the graphical image (plot).

This test report may be reproduced in full only. The document may only be updated by MiCOM Labs personnel. All changes will be noted in the Document History section of the report.



Title: Mimosa Networks A5 Wireless Access Point
To: FCC CFR 47 Part 15 Subpart E 15.407
Serial #: MIMO05-6a Rev A
Issue Date: 4th November 2015
Page: 45 of 372

Equipment Configuration for 26 dB & 99% Occupied Bandwidth			
Variant:	802.11a	Duty Cycle (%):	98.1
Data Rate:	6.00 MBit/s	Antenna Gain (dBi):	5.00
Modulation:	OFDM	Beam Forming Gain (Y)(dB):	Not Applicable
TPC:	Not Applicable	Tested By:	GMH
Engineering Test Notes:			

Test Measurement Results								
Test Frequency	Measured 26 dB Bandwidth (MHz)				26 dB Bandwidth (MHz)			
	Port(s)				Highest	Lowest		
MHz	a	b	c	d				
5745.0	21.643				21.643	21.643		
5785.0	21.944				21.944	21.944		
5825.0	21.643				21.643	21.643		

Test Frequency	Measured 99% Bandwidth (MHz)				99% Bandwidth (MHz)			
	Port(s)				Highest	Lowest		
MHz	a	b	c	d				
5745.0	16.633				16.633	16.633		
5785.0	16.633				16.633	16.633		
5825.0	16.633				16.633	16.633		

Traceability to Industry Recognized Test Methodologies	
Work Instruction:	WI-03 MEASURING RF SPECTRUM MASK
Measurement Uncertainty:	±2.81 dB

Note: click the links in the above matrix to view the graphical image (plot).

This test report may be reproduced in full only. The document may only be updated by MiCOM Labs personnel. All changes will be noted in the Document History section of the report.



Title: Mimosa Networks A5 Wireless Access Point
To: FCC CFR 47 Part 15 Subpart E 15.407
Serial #: MIMO05-6a Rev A
Issue Date: 4th November 2015
Page: 46 of 372

Equipment Configuration for 26 dB & 99% Occupied Bandwidth			
Variant:	802.11ac-80	Duty Cycle (%):	96.9
Data Rate:	29.30 MBit/s	Antenna Gain (dBi):	5.00
Modulation:	OFDM	Beam Forming Gain (Y)(dB):	Not Applicable
TPC:	Not Applicable	Tested By:	GMH
Engineering Test Notes:			

Test Measurement Results								
Test Frequency	Measured 26 dB Bandwidth (MHz)				26 dB Bandwidth (MHz)			
	Port(s)				Highest	Lowest		
MHz	a	b	c	d				
5195.0	81.764				81.764	81.764		
5200.0	81.764				81.764	81.764		
5210.0	81.764				81.764	81.764		

Test Frequency	Measured 99% Bandwidth (MHz)				99% Bandwidth (MHz)			
	Port(s)				Highest	Lowest		
MHz	a	b	c	d				
5195.0	75.752				75.752	75.752		
5200.0	75.351				75.351	75.351		
5210.0	75.752				75.752	75.752		

Traceability to Industry Recognized Test Methodologies	
Work Instruction:	WI-03 MEASURING RF SPECTRUM MASK
Measurement Uncertainty:	±2.81 dB

Note: click the links in the above matrix to view the graphical image (plot).

This test report may be reproduced in full only. The document may only be updated by MiCOM Labs personnel. All changes will be noted in the Document History section of the report.



Title: Mimosa Networks A5 Wireless Access Point
To: FCC CFR 47 Part 15 Subpart E 15.407
Serial #: MIMO05-6a Rev A
Issue Date: 4th November 2015
Page: 47 of 372

Equipment Configuration for 26 dB & 99% Occupied Bandwidth			
Variant:	802.11ac-80	Duty Cycle (%):	96.9
Data Rate:	29.30 MBit/s	Antenna Gain (dBi):	5.00
Modulation:	OFDM	Beam Forming Gain (Y)(dB):	Not Applicable
TPC:	Not Applicable	Tested By:	GMH
Engineering Test Notes:			

Test Measurement Results								
Test Frequency	Measured 26 dB Bandwidth (MHz)				26 dB Bandwidth (MHz)			
	Port(s)				Highest	Lowest		
MHz	a	b	c	d	Highest	Lowest		
5290.0	81.363				81.363	81.363		
5300.0	84.168				84.168	84.168		
5310.0	84.168				84.168	84.168		

Test Frequency	Measured 99% Bandwidth (MHz)				99% Bandwidth (MHz)			
	Port(s)				Highest	Lowest		
MHz	a	b	c	d	Highest	Lowest		
5290.0	75.752				75.752	75.752		
5300.0	75.752				75.752	75.752		
5310.0	75.752				75.752	75.752		

Traceability to Industry Recognized Test Methodologies	
Work Instruction:	WI-03 MEASURING RF SPECTRUM MASK
Measurement Uncertainty:	±2.81 dB

Note: click the links in the above matrix to view the graphical image (plot).

This test report may be reproduced in full only. The document may only be updated by MiCOM Labs personnel. All changes will be noted in the Document History section of the report.



Title: Mimosa Networks A5 Wireless Access Point
To: FCC CFR 47 Part 15 Subpart E 15.407
Serial #: MIMO05-6a Rev A
Issue Date: 4th November 2015
Page: 48 of 372

Equipment Configuration for 26 dB & 99% Occupied Bandwidth			
Variant:	802.11ac-80	Duty Cycle (%):	96.9
Data Rate:	29.30 MBit/s	Antenna Gain (dBi):	5.00
Modulation:	OFDM	Beam Forming Gain (Y)(dB):	Not Applicable
TPC:	Not Applicable	Tested By:	GMH
Engineering Test Notes:			

Test Measurement Results								
Test Frequency	Measured 26 dB Bandwidth (MHz)				26 dB Bandwidth (MHz)			
	Port(s)				Highest	Lowest		
MHz	a	b	c	d				
5530.0	78.557				78.557	78.557		
5545.0	81.363				81.363	81.363		
5560.0	81.764				81.764	81.764		

Test Frequency	Measured 99% Bandwidth (MHz)				99% Bandwidth (MHz)			
	Port(s)				Highest	Lowest		
MHz	a	b	c	d				
5530.0	75.351				75.351	75.351		
5545.0	75.351				75.351	75.351		
5560.0	75.351				75.351	75.351		

Traceability to Industry Recognized Test Methodologies	
Work Instruction:	WI-03 MEASURING RF SPECTRUM MASK
Measurement Uncertainty:	±2.81 dB

Note: click the links in the above matrix to view the graphical image (plot).

This test report may be reproduced in full only. The document may only be updated by MiCOM Labs personnel. All changes will be noted in the Document History section of the report.



Title: Mimosa Networks A5 Wireless Access Point
To: FCC CFR 47 Part 15 Subpart E 15.407
Serial #: MIMO05-6a Rev A
Issue Date: 4th November 2015
Page: 49 of 372

Equipment Configuration for 26 dB & 99% Occupied Bandwidth			
Variant:	802.11ac-80	Duty Cycle (%):	96.9
Data Rate:	29.30 MBit/s	Antenna Gain (dBi):	5.00
Modulation:	OFDM	Beam Forming Gain (Y)(dB):	Not Applicable
TPC:	Not Applicable	Tested By:	GMH
Engineering Test Notes:			

Test Measurement Results								
Test Frequency	Measured 26 dB Bandwidth (MHz)				26 dB Bandwidth (MHz)			
	Port(s)				Highest	Lowest		
MHz	a	b	c	d				
5775.0	79.760				79.760	79.760		
5785.0	81.363				81.363	81.363		
5795.0	81.363				81.363	81.363		

Test Frequency	Measured 99% Bandwidth (MHz)				99% Bandwidth (MHz)			
	Port(s)				Highest	Lowest		
MHz	a	b	c	d				
5775.0	75.752				75.752	75.752		
5785.0	75.351				75.351	75.351		
5795.0	75.351				75.351	75.351		

Traceability to Industry Recognized Test Methodologies	
Work Instruction:	WI-03 MEASURING RF SPECTRUM MASK
Measurement Uncertainty:	±2.81 dB

Note: click the links in the above matrix to view the graphical image (plot).

This test report may be reproduced in full only. The document may only be updated by MiCOM Labs personnel. All changes will be noted in the Document History section of the report.



Title: Mimosa Networks A5 Wireless Access Point
To: FCC CFR 47 Part 15 Subpart E 15.407
Serial #: MIMO05-6a Rev A
Issue Date: 4th November 2015
Page: 50 of 372

Equipment Configuration for 26 dB & 99% Occupied Bandwidth

Variant:	802.11n HT-20	Duty Cycle (%):	98.9
Data Rate:	6.50 MBit/s	Antenna Gain (dBi):	5.00
Modulation:	OFDM	Beam Forming Gain (Y)(dB):	Not Applicable
TPC:	Not Applicable	Tested By:	GMH
Engineering Test Notes:			

Test Measurement Results

Test Frequency	Measured 26 dB Bandwidth (MHz)				26 dB Bandwidth (MHz)			
	Port(s)				Highest	Lowest		
MHz	a	b	c	d				
5165.0	23.246				23.246	23.246		
5200.0	23.146				23.146	23.146		
5240.0	23.046				23.046	23.046		

Test Frequency	Measured 99% Bandwidth (MHz)				99% Bandwidth (MHz)			
	Port(s)				Highest	Lowest		
MHz	a	b	c	d				
5165.0	17.936				17.936	17.936		
5200.0	17.936				17.936	17.936		
5240.0	17.936				17.936	17.936		

Traceability to Industry Recognized Test Methodologies

Work Instruction:	WI-03 MEASURING RF SPECTRUM MASK
Measurement Uncertainty:	±2.81 dB

Note: click the links in the above matrix to view the graphical image (plot).

This test report may be reproduced in full only. The document may only be updated by MiCOM Labs personnel. All changes will be noted in the Document History section of the report.



Title: Mimosa Networks A5 Wireless Access Point
To: FCC CFR 47 Part 15 Subpart E 15.407
Serial #: MIMO05-6a Rev A
Issue Date: 4th November 2015
Page: 51 of 372

Equipment Configuration for 26 dB & 99% Occupied Bandwidth			
Variant:	802.11n HT-20	Duty Cycle (%):	98.9
Data Rate:	6.50 MBit/s	Antenna Gain (dBi):	5.00
Modulation:	OFDM	Beam Forming Gain (Y)(dB):	Not Applicable
TPC:	Not Applicable	Tested By:	GMH
Engineering Test Notes:			

Test Measurement Results								
Test Frequency	Measured 26 dB Bandwidth (MHz)				26 dB Bandwidth (MHz)			
	Port(s)				Highest	Lowest		
MHz	a	b	c	d				
5260.0	23.146				23.146	23.146		
5300.0	23.246				23.246	23.246		
5335.0	23.146				23.146	23.146		

Test Frequency	Measured 99% Bandwidth (MHz)				99% Bandwidth (MHz)			
	Port(s)				Highest	Lowest		
MHz	a	b	c	d				
5260.0	17.936				17.936	17.936		
5300.0	17.936				17.936	17.936		
5335.0	17.936				17.936	17.936		

Traceability to Industry Recognized Test Methodologies	
Work Instruction:	WI-03 MEASURING RF SPECTRUM MASK
Measurement Uncertainty:	±2.81 dB

Note: click the links in the above matrix to view the graphical image (plot).

This test report may be reproduced in full only. The document may only be updated by MiCOM Labs personnel. All changes will be noted in the Document History section of the report.



Title: Mimosa Networks A5 Wireless Access Point
To: FCC CFR 47 Part 15 Subpart E 15.407
Serial #: MIMO05-6a Rev A
Issue Date: 4th November 2015
Page: 52 of 372

Equipment Configuration for 26 dB & 99% Occupied Bandwidth			
Variant:	802.11n HT-20	Duty Cycle (%):	98.9
Data Rate:	6.50 MBit/s	Antenna Gain (dBi):	5.00
Modulation:	OFDM	Beam Forming Gain (Y)(dB):	Not Applicable
TPC:	Not Applicable	Tested By:	GMH
Engineering Test Notes:			

Test Measurement Results								
Test Frequency	Measured 26 dB Bandwidth (MHz)				26 dB Bandwidth (MHz)			
	Port(s)				Highest	Lowest		
MHz	a	b	c	d				
5485.0	21.944				21.944	21.944		
5590.0	22.946				22.946	22.946		
5715.0	22.946				22.946	22.946		

Test Frequency	Measured 99% Bandwidth (MHz)				99% Bandwidth (MHz)			
	Port(s)				Highest	Lowest		
MHz	a	b	c	d				
5485.0	17.936				17.936	17.936		
5590.0	18.036				18.036	18.036		
5715.0	18.036				18.036	18.036		

Traceability to Industry Recognized Test Methodologies	
Work Instruction:	WI-03 MEASURING RF SPECTRUM MASK
Measurement Uncertainty:	±2.81 dB

Note: click the links in the above matrix to view the graphical image (plot).

This test report may be reproduced in full only. The document may only be updated by MiCOM Labs personnel. All changes will be noted in the Document History section of the report.



Title: Mimosa Networks A5 Wireless Access Point
To: FCC CFR 47 Part 15 Subpart E 15.407
Serial #: MIMO05-6a Rev A
Issue Date: 4th November 2015
Page: 53 of 372

Equipment Configuration for 26 dB & 99% Occupied Bandwidth			
Variant:	802.11n HT-20	Duty Cycle (%):	98.9
Data Rate:	6.50 MBit/s	Antenna Gain (dBi):	5.00
Modulation:	OFDM	Beam Forming Gain (Y)(dB):	Not Applicable
TPC:	Not Applicable	Tested By:	GMH
Engineering Test Notes:			

Test Measurement Results								
Test Frequency	Measured 26 dB Bandwidth (MHz)				26 dB Bandwidth (MHz)			
	Port(s)				Highest	Lowest		
MHz	a	b	c	d				
5745.0	23.046				23.046	23.046		
5785.0	23.046				23.046	23.046		
5825.0	23.146				23.146	23.146		

Test Frequency	Measured 99% Bandwidth (MHz)				99% Bandwidth (MHz)			
	Port(s)				Highest	Lowest		
MHz	a	b	c	d				
5745.0	17.936				17.936	17.936		
5785.0	17.936				17.936	17.936		
5825.0	17.936				17.936	17.936		

Traceability to Industry Recognized Test Methodologies	
Work Instruction:	WI-03 MEASURING RF SPECTRUM MASK
Measurement Uncertainty:	±2.81 dB

Note: click the links in the above matrix to view the graphical image (plot).

This test report may be reproduced in full only. The document may only be updated by MiCOM Labs personnel. All changes will be noted in the Document History section of the report.



Title: Mimosa Networks A5 Wireless Access Point
To: FCC CFR 47 Part 15 Subpart E 15.407
Serial #: MIMO05-6a Rev A
Issue Date: 4th November 2015
Page: 54 of 372

Equipment Configuration for 26 dB & 99% Occupied Bandwidth

Variant:	802.11n HT-40	Duty Cycle (%):	97.1
Data Rate:	13.50 MBit/s	Antenna Gain (dBi):	5.00
Modulation:	OFDM	Beam Forming Gain (Y)(dB):	Not Applicable
TPC:	Not Applicable	Tested By:	GMH
Engineering Test Notes:			

Test Measurement Results

Test Frequency	Measured 26 dB Bandwidth (MHz)				26 dB Bandwidth (MHz)			
	Port(s)				Highest	Lowest		
MHz	a	b	c	d				
5175.0	41.082				41.082	41.082		
5200.0	41.283				41.283	41.283		
5230.0	41.283				41.283	41.283		

Test Frequency	Measured 99% Bandwidth (MHz)				99% Bandwidth (MHz)			
	Port(s)				Highest	Lowest		
MHz	a	b	c	d				
5175.0	36.273				36.273	36.273		
5200.0	36.273				36.273	36.273		
5230.0	36.273				36.273	36.273		

Traceability to Industry Recognized Test Methodologies

Work Instruction:	WI-03 MEASURING RF SPECTRUM MASK
Measurement Uncertainty:	±2.81 dB

Note: click the links in the above matrix to view the graphical image (plot).

This test report may be reproduced in full only. The document may only be updated by MiCOM Labs personnel. All changes will be noted in the Document History section of the report.



Title: Mimosa Networks A5 Wireless Access Point
To: FCC CFR 47 Part 15 Subpart E 15.407
Serial #: MIMO05-6a Rev A
Issue Date: 4th November 2015
Page: 55 of 372

Equipment Configuration for 26 dB & 99% Occupied Bandwidth			
Variant:	802.11n HT-40	Duty Cycle (%):	97.1
Data Rate:	13.50 MBit/s	Antenna Gain (dBi):	5.00
Modulation:	OFDM	Beam Forming Gain (Y)(dB):	Not Applicable
TPC:	Not Applicable	Tested By:	GMH
Engineering Test Notes:			

Test Measurement Results								
Test Frequency	Measured 26 dB Bandwidth (MHz)				26 dB Bandwidth (MHz)			
	Port(s)				Highest	Lowest		
MHz	a	b	c	d				
5270.0	41.082				41.082	41.082		
5300.0	41.283				41.283	41.283		
5330.0	41.082				41.082	41.082		

Test Frequency	Measured 99% Bandwidth (MHz)				99% Bandwidth (MHz)			
	Port(s)				Highest	Lowest		
MHz	a	b	c	d				
5270.0	36.273				36.273	36.273		
5300.0	36.273				36.273	36.273		
5330.0	36.273				36.273	36.273		

Traceability to Industry Recognized Test Methodologies	
Work Instruction:	WI-03 MEASURING RF SPECTRUM MASK
Measurement Uncertainty:	±2.81 dB

Note: click the links in the above matrix to view the graphical image (plot).

This test report may be reproduced in full only. The document may only be updated by MiCOM Labs personnel. All changes will be noted in the Document History section of the report.



Title: Mimosa Networks A5 Wireless Access Point
To: FCC CFR 47 Part 15 Subpart E 15.407
Serial #: MIMO05-6a Rev A
Issue Date: 4th November 2015
Page: 56 of 372

Equipment Configuration for 26 dB & 99% Occupied Bandwidth			
Variant:	802.11n HT-40	Duty Cycle (%):	97.1
Data Rate:	13.50 MBit/s	Antenna Gain (dBi):	5.00
Modulation:	OFDM	Beam Forming Gain (Y)(dB):	Not Applicable
TPC:	Not Applicable	Tested By:	GMH
Engineering Test Notes:			

Test Measurement Results								
Test Frequency	Measured 26 dB Bandwidth (MHz)				26 dB Bandwidth (MHz)			
	Port(s)				Highest	Lowest		
MHz	a	b	c	d				
5495.0	39.880				39.880	39.880		
5590.0	40.681				40.681	40.681		
5705.0	41.082				41.082	41.082		

Test Frequency	Measured 99% Bandwidth (MHz)				99% Bandwidth (MHz)			
	Port(s)				Highest	Lowest		
MHz	a	b	c	d				
5495.0	36.273				36.273	36.273		
5590.0	36.273				36.273	36.273		
5705.0	36.273				36.273	36.273		

Traceability to Industry Recognized Test Methodologies	
Work Instruction:	WI-03 MEASURING RF SPECTRUM MASK
Measurement Uncertainty:	±2.81 dB

Note: click the links in the above matrix to view the graphical image (plot).

This test report may be reproduced in full only. The document may only be updated by MiCOM Labs personnel. All changes will be noted in the Document History section of the report.



Title: Mimosa Networks A5 Wireless Access Point
To: FCC CFR 47 Part 15 Subpart E 15.407
Serial #: MIMO05-6a Rev A
Issue Date: 4th November 2015
Page: 57 of 372

Equipment Configuration for 26 dB & 99% Occupied Bandwidth			
Variant:	802.11n HT-40	Duty Cycle (%):	97.1
Data Rate:	13.50 MBit/s	Antenna Gain (dBi):	5.00
Modulation:	OFDM	Beam Forming Gain (Y)(dB):	Not Applicable
TPC:	Not Applicable	Tested By:	GMH
Engineering Test Notes:			

Test Measurement Results								
Test Frequency	Measured 26 dB Bandwidth (MHz)				26 dB Bandwidth (MHz)			
	Port(s)				Highest	Lowest		
MHz	a	b	c	d				
5755.0	41.283				41.283	41.283		
5785.0	41.283				41.283	41.283		
5815.0	41.283				41.283	41.283		

Test Frequency	Measured 99% Bandwidth (MHz)				99% Bandwidth (MHz)			
	Port(s)				Highest	Lowest		
MHz	a	b	c	d				
5755.0	36.273				36.273	36.273		
5785.0	36.273				36.273	36.273		
5815.0	36.273				36.273	36.273		

Traceability to Industry Recognized Test Methodologies	
Work Instruction:	WI-03 MEASURING RF SPECTRUM MASK
Measurement Uncertainty:	±2.81 dB

Note: click the links in the above matrix to view the graphical image (plot).

This test report may be reproduced in full only. The document may only be updated by MiCOM Labs personnel. All changes will be noted in the Document History section of the report.



9.3. Power Spectral Density

Conducted Test Conditions for Power Spectral Density			
Standard:	FCC CFR 47:15.407	Ambient Temp. (°C):	24.0 - 27.5
Test Heading:	Power Spectral Density	Rel. Humidity (%):	32 - 45
Standard Section(s):	15.407 (a)	Pressure (mBars):	999 - 1001
Reference Document(s):	See Normative References		

Test Procedure for Power Spectral Density

The in-band power spectral density was measured using the test technique specified in KDB 789033. A 1 MHz measurement bandwidth was implemented for the analyzer sweep. Once the sweep is complete the analyzer trace data is downloaded and used for post processing purposes.

Where the device operated with multiple antenna ports i.e. MIMO device, each port was measured separately. The Peak Power Spectral Density is the highest level found across the emission bandwidth. With multiple antenna port measurements the numerical analyzer data from each port is summed (\hat{a}) and a link to this additional graphic is provided.

Test configuration and setup used for the measurement was per the Conducted Test Set-up section specified in this document.

Measure and sum the spectra across the outputs. With this technique, spectra are measured at each output of the device at the required resolution bandwidth. The individual spectra are then summed mathematically in linear power units. Unlike in-band power measurements, in which the sum involves a single measured value (output power) from each output, measurements for compliance with PSD limits involve summing entire spectra across corresponding frequency bins on the various outputs. Consistency is maintained for any device with multiple transmitter outputs to be certain the individual outputs are all aligned with the same span and same number of points. In this instance, the linear power spectrum value within the first spectral bin of output 0 is summed with that in the first spectral bin of output 1, and the first spectral bin of output 2, and so on up to the Nth output to obtain the true value for the first frequency bin of the summed spectrum. The summed spectrum value for each frequency bin is computed in this fashion. These summed spectral values were post processed and the resulting numerical and graphical data presented.

NOTE: It may be observed that spectrum in some plots break the limit line however this in itself does NOT constitute a failure. In all cases a spectrum summation plot is provided in order to prove compliance. A failure occurs only after the summation of all spectrum plots have been summed and are found to be greater than the limit line.

Supporting Information

Calculated Power = $A + 10 \log (1/x)$ dBm

A = Total Power Spectral Density [$10^{\ast} \text{Log}_{10} (10^{a/10} + 10^{b/10} + 10^{c/10} + 10^{d/10})$]

x = Duty Cycle

Limits Power Spectral Density

Operating Frequency Band 5150-5250 MHz

15.407 (a)(1)

(i) For an outdoor access point operating in the band 5.15-5.25 GHz, the maximum conducted output power over the frequency band of operation shall not exceed 1 W provided the maximum antenna gain does not exceed 6 dBi. In addition, the maximum power spectral density shall not exceed 17 dBm in any 1 megahertz band. If transmitting antennas of directional gain greater than 6 dBi are used, both the maximum conducted output power and the maximum power spectral density shall be reduced by the amount in dB that the directional gain of the antenna exceeds 6 dBi. The maximum e.i.r.p. at any elevation angle above 30 degrees as measured from the horizon must not exceed 125 mW (21 dBm).

(ii) For an indoor access point operating in the band 5.15-5.25 GHz, the maximum conducted output power over the frequency band of operation shall not exceed 1 W provided the maximum antenna gain does not exceed 6 dBi. In addition, the maximum power spectral density shall not exceed 17 dBm in any 1 megahertz band. If transmitting antennas of directional gain greater than 6 dBi are used, both the maximum conducted output power and the maximum power spectral density shall be reduced by the amount in dB that

This test report may be reproduced in full only. The document may only be updated by MiCOM Labs personnel. All changes will be noted in the Document History section of the report.



Title: Mimosa Networks A5 Wireless Access Point
To: FCC CFR 47 Part 15 Subpart E 15.407
Serial #: MIMO05-6a Rev A
Issue Date: 4th November 2015
Page: 59 of 372

the directional gain of the antenna exceeds 6 dBi.

(iii) For fixed point-to-point access points operating in the band 5.15-5.25 GHz, the maximum conducted output power over the frequency band of operation shall not exceed 1 W. In addition, the maximum power spectral density shall not exceed 17 dBm in any 1 megahertz band. Fixed point-to-point U-NII devices may employ antennas with directional gain up to 23 dBi without any corresponding reduction in the maximum conducted output power or maximum power spectral density. For fixed point-to-point transmitters that employ a directional antenna gain greater than 23 dBi, a 1 dB reduction in maximum conducted output power and maximum power spectral density is required for each 1 dB of antenna gain in excess of 23 dBi. Fixed, point-to-point operations exclude the use of point-to-multipoint systems, omnidirectional applications, and multiple collocated transmitters transmitting the same information. The operator of the U-NII device, or if the equipment is professionally installed, the installer, is responsible for ensuring that systems employing high gain directional antennas are used exclusively for fixed, point-to-point operations.

(iv) For mobile and portable client devices in the 5.15-5.25 GHz band, the maximum conducted output power over the frequency band of operation shall not exceed 250 mW provided the maximum antenna gain does not exceed 6 dBi. In addition, the maximum power spectral density shall not exceed 11 dBm in any 1 megahertz band. If transmitting antennas of directional gain greater than 6 dBi are used, both the maximum conducted output power and the maximum power spectral density shall be reduced by the amount in dB that the directional gain of the antenna exceeds 6 dBi.

Operating Frequency Band 5250-5350 and 5470 – 5725 MHz

15. 407 (a)(2)

For the 5.25-5.35 GHz and 5.47-5.725 GHz bands, the maximum conducted output power over the frequency bands of operation shall not exceed the lesser of 250 mW or 11 dBm + 10 log B, where B is the 26 dB emission bandwidth in megahertz. In addition, the maximum power spectral density shall not exceed 11 dBm in any 1 megahertz band. If transmitting antennas of directional gain greater than 6 dBi are used, both the maximum conducted output power and the maximum power spectral density shall be reduced by the amount in dB that the directional gain of the antenna exceeds 6 dBi.

Operating Frequency Band 5725 – 5850 MHz

15. 407 (a)(3)

For the band 5.725-5.85 GHz, the maximum conducted output power over the frequency band of operation shall not exceed 1 W. In addition, the maximum power spectral density shall not exceed 30 dBm in any 500-kHz band. If transmitting antennas of directional gain greater than 6 dBi are used, both the maximum conducted output power and the maximum power spectral density shall be reduced by the amount in dB that the directional gain of the antenna exceeds 6 dBi. However, fixed point-to-point U-NII devices operating in this band may employ transmitting antennas with directional gain greater than 6 dBi without any corresponding reduction in transmitter conducted power. Fixed, point-to-point operations exclude the use of point-to-multipoint systems, omnidirectional applications, and multiple collocated transmitters transmitting the same information. The operator of the U-NII device, or if the equipment is professionally installed, the installer, is responsible for ensuring that systems employing high gain directional antennas are used exclusively for fixed, point-to-point operations.

NOTE: for the Mimosa A5 device there are four antennas however each are orientated 90° to each other with no overlapping of the radiated spectrum. For this reason the Power Spectral Density test does not compare all 4 antenna's to the limit but it measures the antenna port with the maximum power and compares the maximum emission to the limit for a single chain.

This test report may be reproduced in full only. The document may only be updated by MiCOM Labs personnel. All changes will be noted in the Document History section of the report.



Title: Mimosa Networks A5 Wireless Access Point
To: FCC CFR 47 Part 15 Subpart E 15.407
Serial #: MIMO05-6a Rev A
Issue Date: 4th November 2015
Page: 60 of 372

Equipment Configuration for Power Spectral Density

Variant:	802.11a	Duty Cycle (%):	98.1
Data Rate:	6 M Bit/s	Antenna Gain (dBi):	5.00
Modulation:	OFDM	Beam Forming Gain (Y)(dB):	Not Applicable
TPC:	Not Applicable	Tested By:	GMH
Engineering Test Notes:			

Test Measurement Results

Test Frequency	Measured Power Spectral Density				Amplitude Summation + DCCF (+0.09 dB)	Limit	Margin
	Port(s) (dBm/MHz)						
MHz	a	b	c	d	dBm/MHz	dBm/MHz	dB
5165.0	9.237				9.320	17.0	-7.7
5200.0	9.288				9.371	17.0	-7.6
5240.0	9.781				9.864	17.0	-7.1

Traceability to Industry Recognized Test Methodologies

Work Instruction:	WI-03 MEASURING RF SPECTRUM MASK
Measurement Uncertainty:	±2.81 dB

DCCF - Duty Cycle Correction Factor

Note: click the links in the above matrix to view the graphical image (plot).

This test report may be reproduced in full only. The document may only be updated by MiCOM Labs personnel. All changes will be noted in the Document History section of the report.



Title: Mimosa Networks A5 Wireless Access Point
To: FCC CFR 47 Part 15 Subpart E 15.407
Serial #: MIMO05-6a Rev A
Issue Date: 4th November 2015
Page: 61 of 372

Equipment Configuration for Power Spectral Density			
Variant:	802.11a	Duty Cycle (%):	98.1
Data Rate:	6 M Bit/s	Antenna Gain (dBi):	5.00
Modulation:	OFDM	Beam Forming Gain (Y)(dB):	Not Applicable
TPC:	Not Applicable	Tested By:	GMH
Engineering Test Notes:			

Test Measurement Results							
Test Frequency	Measured Power Spectral Density				Amplitude Summation + DCCF (+0.09 dB)	Limit	Margin
	Port(s) (dBm/MHz)						
MHz	a	b	c	d	dBm/MHz	dBm/MHz	dB
5260.0	6.690				6.773	11.0	-4.2
5300.0	5.956				6.039	11.0	-5.0
5335.0	6.438				6.521	11.0	-4.5

Traceability to Industry Recognized Test Methodologies	
Work Instruction:	WI-03 MEASURING RF SPECTRUM MASK
Measurement Uncertainty:	±2.81 dB

DCCF - Duty Cycle Correction Factor

Note: click the links in the above matrix to view the graphical image (plot).

This test report may be reproduced in full only. The document may only be updated by MiCOM Labs personnel. All changes will be noted in the Document History section of the report.



Title: Mimosa Networks A5 Wireless Access Point
To: FCC CFR 47 Part 15 Subpart E 15.407
Serial #: MIMO05-6a Rev A
Issue Date: 4th November 2015
Page: 62 of 372

Equipment Configuration for Power Spectral Density			
Variant:	802.11a	Duty Cycle (%):	98.1
Data Rate:	6 M Bit/s	Antenna Gain (dBi):	5.00
Modulation:	OFDM	Beam Forming Gain (Y)(dB):	Not Applicable
TPC:	Not Applicable	Tested By:	GMH
Engineering Test Notes:			

Test Measurement Results							
Test Frequency	Measured Power Spectral Density				Amplitude Summation + DCCF (+0.09 dB)	Limit	Margin
	Port(s) (dBm/MHz)						
MHz	a	b	c	d	dBm/MHz	dBm/MHz	dB
5485.0	8.528				8.611	11.0	-2.4
5590.0	6.831				6.914	11.0	-4.1
5715.0	4.767				4.850	11.0	-6.1

Traceability to Industry Recognized Test Methodologies	
Work Instruction:	WI-03 MEASURING RF SPECTRUM MASK
Measurement Uncertainty:	±2.81 dB

DCCF - Duty Cycle Correction Factor

Note: click the links in the above matrix to view the graphical image (plot).

This test report may be reproduced in full only. The document may only be updated by MiCOM Labs personnel. All changes will be noted in the Document History section of the report.



Title: Mimosa Networks A5 Wireless Access Point
To: FCC CFR 47 Part 15 Subpart E 15.407
Serial #: MIMO05-6a Rev A
Issue Date: 4th November 2015
Page: 63 of 372

Equipment Configuration for Power Spectral Density			
Variant:	802.11a	Duty Cycle (%):	98.1
Data Rate:	6 M Bit/s	Antenna Gain (dBi):	5.00
Modulation:	OFDM	Beam Forming Gain (Y)(dB):	Not Applicable
TPC:	Not Applicable	Tested By:	GMH
Engineering Test Notes:			

Test Measurement Results							
Test Frequency	Measured Power Spectral Density				Amplitude Summation + DCCF (+0.09 dB)	Limit	Margin
	Port(s) (dBm/500 KHz)						
MHz	a	b	c	d	dBm/500 KHz	dBm/500 KHz	dB
5745.0	2.061				2.144	17.0	-14.9
5785.0	1.412				1.495	17.0	-15.5
5825.0	1.224				1.307	17.0	-15.7

Traceability to Industry Recognized Test Methodologies	
Work Instruction:	WI-03 MEASURING RF SPECTRUM MASK
Measurement Uncertainty:	±2.81 dB

DCCF - Duty Cycle Correction Factor

Note: click the links in the above matrix to view the graphical image (plot).

This test report may be reproduced in full only. The document may only be updated by MiCOM Labs personnel. All changes will be noted in the Document History section of the report.



Title: Mimosa Networks A5 Wireless Access Point
To: FCC CFR 47 Part 15 Subpart E 15.407
Serial #: MIMO05-6a Rev A
Issue Date: 4th November 2015
Page: 64 of 372

Equipment Configuration for Power Spectral Density

Variant:	802.11ac-80	Duty Cycle (%):	96.9
Data Rate:	29.3 M Bit/s	Antenna Gain (dBi):	5.00
Modulation:	OFDM	Beam Forming Gain (Y)(dB):	Not Applicable
TPC:	Not Applicable	Tested By:	GMH
Engineering Test Notes:			

Test Measurement Results

Test Frequency	Measured Power Spectral Density				Amplitude Summation + DCCF (+0.13 dB)	Limit	Margin
	Port(s) (dBm/MHz)						
MHz	a	b	c	d	dBm/MHz	dBm/MHz	dB
5195.0	3.258				3.388	17.0	-13.61
5200.0	-4.602				-4.732	17.0	-21.73
5210.0	-4.577				-4.707	17.0	-21.71

Traceability to Industry Recognized Test Methodologies

Work Instruction:	WI-03 MEASURING RF SPECTRUM MASK
Measurement Uncertainty:	±2.81 dB

DCCF - Duty Cycle Correction Factor

Note: click the links in the above matrix to view the graphical image (plot).

This test report may be reproduced in full only. The document may only be updated by MiCOM Labs personnel. All changes will be noted in the Document History section of the report.



Title: Mimosa Networks A5 Wireless Access Point
To: FCC CFR 47 Part 15 Subpart E 15.407
Serial #: MIMO05-6a Rev A
Issue Date: 4th November 2015
Page: 65 of 372

Equipment Configuration for Power Spectral Density			
Variant:	802.11ac-80	Duty Cycle (%):	96.9
Data Rate:	29.3 M Bit/s	Antenna Gain (dBi):	5.00
Modulation:	OFDM	Beam Forming Gain (Y)(dB):	Not Applicable
TPC:	Not Applicable	Tested By:	GMH
Engineering Test Notes:			

Test Measurement Results							
Test Frequency	Measured Power Spectral Density				Amplitude Summation + DCCF (+0.13 dB)	Limit	Margin
	Port(s) (dBm/MHz)						
MHz	a	b	c	d	dBm/MHz	dBm/MHz	dB
5290.0	0.399				0.529	11.0	-10.47
5300.0	-7.012				-6.882	11.0	-17.88
5310.0	-6.748				-6.628	11.0	-17.63

Traceability to Industry Recognized Test Methodologies	
Work Instruction:	WI-03 MEASURING RF SPECTRUM MASK
Measurement Uncertainty:	±2.81 dB

DCCF - Duty Cycle Correction Factor

Note: click the links in the above matrix to view the graphical image (plot).

This test report may be reproduced in full only. The document may only be updated by MiCOM Labs personnel. All changes will be noted in the Document History section of the report.



Title: Mimosa Networks A5 Wireless Access Point
To: FCC CFR 47 Part 15 Subpart E 15.407
Serial #: MIMO05-6a Rev A
Issue Date: 4th November 2015
Page: 66 of 372

Equipment Configuration for Power Spectral Density			
Variant:	802.11ac-80	Duty Cycle (%):	96.9
Data Rate:	29.30 MBit/s	Antenna Gain (dBi):	5.00
Modulation:	OFDM	Beam Forming Gain (Y)(dB):	Not Applicable
TPC:	Not Applicable	Tested By:	GMH
Engineering Test Notes:			

Test Measurement Results							
Test Frequency	Measured Power Spectral Density				Amplitude Summation + DCCF (+0.13 dB)	Limit	Margin
	Port(s) (dBm/MHz)						
MHz	a	b	c	d	dBm/MHz	dBm/MHz	dB
5530.0	3.848				3.978	11.0	-6.70
5545.0	-6.622				-6.492	11.0	-17.49
5560.0	-6.982				-6.852	11.0	-17.85

Traceability to Industry Recognized Test Methodologies	
Work Instruction:	WI-03 MEASURING RF SPECTRUM MASK
Measurement Uncertainty:	±2.81 dB

DCCF - Duty Cycle Correction Factor

Note: click the links in the above matrix to view the graphical image (plot).

This test report may be reproduced in full only. The document may only be updated by MiCOM Labs personnel. All changes will be noted in the Document History section of the report.



Title: Mimosa Networks A5 Wireless Access Point
To: FCC CFR 47 Part 15 Subpart E 15.407
Serial #: MIMO05-6a Rev A
Issue Date: 4th November 2015
Page: 67 of 372

Equipment Configuration for Power Spectral Density			
Variant:	802.11ac-80	Duty Cycle (%):	96.9
Data Rate:	29.3 M Bit/s	Antenna Gain (dBi):	5.00
Modulation:	OFDM	Beam Forming Gain (Y)(dB):	Not Applicable
TPC:	Not Applicable	Tested By:	GMH
Engineering Test Notes:			

Test Measurement Results							
Test Frequency	Measured Power Spectral Density				Amplitude Summation + DCCF (+0.13 dB)	Limit	Margin
	Port(s) (dBm/500 KHz)						
MHz	a	b	c	d	dBm/500 KHz	dBm/500 KHz	dB
5775.0	-4.552				-4.422	17.0	-21.42
5785.0	-7.389				-7.259	17.0	-24.26
5795.0	-7.969				-7.839	17.0	-24.84

Traceability to Industry Recognized Test Methodologies	
Work Instruction:	WI-03 MEASURING RF SPECTRUM MASK
Measurement Uncertainty:	±2.81 dB

DCCF - Duty Cycle Correction Factor

Note: click the links in the above matrix to view the graphical image (plot).

This test report may be reproduced in full only. The document may only be updated by MiCOM Labs personnel. All changes will be noted in the Document History section of the report.



Title: Mimosa Networks A5 Wireless Access Point
To: FCC CFR 47 Part 15 Subpart E 15.407
Serial #: MIMO05-6a Rev A
Issue Date: 4th November 2015
Page: 68 of 372

Equipment Configuration for Power Spectral Density

Variant:	802.11n HT-20	Duty Cycle (%):	98.9
Data Rate:	6.5 M Bit/s	Antenna Gain (dBi):	5.00
Modulation:	OFDM	Beam Forming Gain (Y)(dB):	Not Applicable
TPC:	Not Applicable	Tested By:	GMH
Engineering Test Notes:			

Test Measurement Results

Test Frequency	Measured Power Spectral Density				Amplitude Summation + DCCF (+0.04 dB)	Limit	Margin
	Port(s) (dBm/MHz)						
MHz	a	b	c	d	dBm/MHz	dBm/MHz	dB
5165.0	8.709				<u>8.757</u>	17.0	-8.2
5200.0	8.863				<u>8.911</u>	17.0	-8.1
5240.0	8.959				<u>9.007</u>	17.0	-8.0

Traceability to Industry Recognized Test Methodologies

Work Instruction:	WI-03 MEASURING RF SPECTRUM MASK
Measurement Uncertainty:	±2.81 dB

DCCF - Duty Cycle Correction Factor

Note: click the links in the above matrix to view the graphical image (plot).

This test report may be reproduced in full only. The document may only be updated by MiCOM Labs personnel. All changes will be noted in the Document History section of the report.



Title: Mimosa Networks A5 Wireless Access Point
To: FCC CFR 47 Part 15 Subpart E 15.407
Serial #: MIMO05-6a Rev A
Issue Date: 4th November 2015
Page: 69 of 372

Equipment Configuration for Power Spectral Density			
Variant:	802.11n HT-20	Duty Cycle (%):	98.9
Data Rate:	6.5 M Bit/s	Antenna Gain (dBi):	5.00
Modulation:	OFDM	Beam Forming Gain (Y)(dB):	Not Applicable
TPC:	Not Applicable	Tested By:	GMH
Engineering Test Notes:			

Test Measurement Results							
Test Frequency	Measured Power Spectral Density				Amplitude Summation + DCCF (+0.04 dB)	Limit	Margin
	Port(s) (dBm/MHz)						
MHz	a	b	c	d	dBm/MHz	dBm/MHz	dB
5260.0	6.261				<u>6.309</u>	11.0	-4.7
5300.0	5.559				<u>5.607</u>	11.0	-5.4
5335.0	5.919				<u>5.967</u>	11.0	-5.0

Traceability to Industry Recognized Test Methodologies	
Work Instruction:	WI-03 MEASURING RF SPECTRUM MASK
Measurement Uncertainty:	±2.81 dB

DCCF - Duty Cycle Correction Factor

Note: click the links in the above matrix to view the graphical image (plot).

This test report may be reproduced in full only. The document may only be updated by MiCOM Labs personnel. All changes will be noted in the Document History section of the report.



Title: Mimosa Networks A5 Wireless Access Point
To: FCC CFR 47 Part 15 Subpart E 15.407
Serial #: MIMO05-6a Rev A
Issue Date: 4th November 2015
Page: 70 of 372

Equipment Configuration for Power Spectral Density			
Variant:	802.11n HT-20	Duty Cycle (%):	98.9
Data Rate:	6.50 MBit/s	Antenna Gain (dBi):	5.00
Modulation:	OFDM	Beam Forming Gain (Y)(dB):	Not Applicable
TPC:	Not Applicable	Tested By:	GMH
Engineering Test Notes:			

Test Measurement Results							
Test Frequency	Measured Power Spectral Density				Amplitude Summation + DCCF (+0.04 dB)	Limit	Margin
	Port(s) (dBm/MHz)						
MHz	a	b	c	d	dBm/MHz	dBm/MHz	dB
5485.0	8.508				<u>8.556</u>	11.0	-2.4
5590.0	6.552				<u>6.600</u>	11.0	-4.4
5715.0	4.474				<u>4.522</u>	11.0	-6.5

Traceability to Industry Recognized Test Methodologies	
Work Instruction:	WI-03 MEASURING RF SPECTRUM MASK
Measurement Uncertainty:	±2.81 dB

DCCF - Duty Cycle Correction Factor

Note: click the links in the above matrix to view the graphical image (plot).

This test report may be reproduced in full only. The document may only be updated by MiCOM Labs personnel. All changes will be noted in the Document History section of the report.



Title: Mimosa Networks A5 Wireless Access Point
To: FCC CFR 47 Part 15 Subpart E 15.407
Serial #: MIMO05-6a Rev A
Issue Date: 4th November 2015
Page: 71 of 372

Equipment Configuration for Power Spectral Density			
Variant:	802.11n HT-20	Duty Cycle (%):	98.9
Data Rate:	6.5 M Bit/s	Antenna Gain (dBi):	5.00
Modulation:	OFDM	Beam Forming Gain (Y)(dB):	Not Applicable
TPC:	Not Applicable	Tested By:	GMH
Engineering Test Notes:			

Test Measurement Results							
Test Frequency	Measured Power Spectral Density				Amplitude Summation + DCCF (+0.04 dB)	Limit	Margin
	Port(s) (dBm/500 KHz)						
MHz	a	b	c	d	dBm/500 KHz	dBm/500 KHz	dB
5745.0	1.621				<u>1.669</u>	17.0	-15.3
5785.0	1.242				<u>1.290</u>	17.0	-15.7
5825.0	0.883				<u>0.931</u>	17.0	-16.1

Traceability to Industry Recognized Test Methodologies	
Work Instruction:	WI-03 MEASURING RF SPECTRUM MASK
Measurement Uncertainty:	±2.81 dB

DCCF - Duty Cycle Correction Factor

Note: click the links in the above matrix to view the graphical image (plot).

This test report may be reproduced in full only. The document may only be updated by MiCOM Labs personnel. All changes will be noted in the Document History section of the report.



Title: Mimosa Networks A5 Wireless Access Point
To: FCC CFR 47 Part 15 Subpart E 15.407
Serial #: MIMO05-6a Rev A
Issue Date: 4th November 2015
Page: 72 of 372

Equipment Configuration for Power Spectral Density

Variant:	802.11n HT-40	Duty Cycle (%):	97.1
Data Rate:	13.5 M Bit/s	Antenna Gain (dBi):	5.00
Modulation:	OFDM	Beam Forming Gain (Y)(dB):	Not Applicable
TPC:	Not Applicable	Tested By:	GMH
Engineering Test Notes:			

Test Measurement Results

Test Frequency	Measured Power Spectral Density				Amplitude Summation + DCCF (+0.13 dB)	Limit	Margin
	Port(s) (dBm/MHz)						
MHz	a	b	c	d	dBm/MHz	dBm/MHz	dB
5175.0	5.135				<u>5.263</u>	17.0	-11.7
5200.0	5.944				<u>6.072</u>	17.0	-10.9
5230.0	5.993				<u>6.121</u>	17.0	-10.9

Traceability to Industry Recognized Test Methodologies

Work Instruction:	WI-03 MEASURING RF SPECTRUM MASK
Measurement Uncertainty:	±2.81 dB

DCCF - Duty Cycle Correction Factor

Note: click the links in the above matrix to view the graphical image (plot).

This test report may be reproduced in full only. The document may only be updated by MiCOM Labs personnel. All changes will be noted in the Document History section of the report.



Title: Mimosa Networks A5 Wireless Access Point
To: FCC CFR 47 Part 15 Subpart E 15.407
Serial #: MIMO05-6a Rev A
Issue Date: 4th November 2015
Page: 73 of 372

Equipment Configuration for Power Spectral Density

Variant:	802.11n HT-40	Duty Cycle (%):	97.1
Data Rate:	13.5 M Bit/s	Antenna Gain (dBi):	5.00
Modulation:	OFDM	Beam Forming Gain (Y)(dB):	Not Applicable
TPC:	Not Applicable	Tested By:	GMH
Engineering Test Notes:			

Test Measurement Results

Test Frequency	Measured Power Spectral Density				Amplitude Summation + DCCF (+0.13 dB)	Limit	Margin
	Port(s) (dBm/MHz)						
MHz	a	b	c	d	dBm/MHz	dBm/MHz	dB
5270.0	2.803				2.931	11.0	-8.1
5300.0	2.537				2.665	11.0	-8.3
5330.0	3.048				3.176	11.0	-7.8

Traceability to Industry Recognized Test Methodologies

Work Instruction:	WI-03 MEASURING RF SPECTRUM MASK
Measurement Uncertainty:	±2.81 dB

DCCF - Duty Cycle Correction Factor

Note: click the links in the above matrix to view the graphical image (plot).

This test report may be reproduced in full only. The document may only be updated by MiCOM Labs personnel. All changes will be noted in the Document History section of the report.



Title: Mimosa Networks A5 Wireless Access Point
To: FCC CFR 47 Part 15 Subpart E 15.407
Serial #: MIMO05-6a Rev A
Issue Date: 4th November 2015
Page: 74 of 372

Equipment Configuration for Power Spectral Density			
Variant:	802.11n HT-40	Duty Cycle (%):	97.1
Data Rate:	13.50 MBit/s	Antenna Gain (dBi):	5.00
Modulation:	OFDM	Beam Forming Gain (Y)(dB):	Not Applicable
TPC:	Not Applicable	Tested By:	GMH
Engineering Test Notes:			

Test Measurement Results							
Test Frequency	Measured Power Spectral Density				Amplitude Summation + DCCF (+0.13 dB)	Limit	Margin
	Port(s) (dBm/MHz)						
MHz	a	b	c	d	dBm/MHz	dBm/MHz	dB
5495.0	6.234				6.362	11.0	-4.6
5590.0	3.376				3.504	11.0	-7.5
5705.0	1.127				1.255	11.0	-9.7

Traceability to Industry Recognized Test Methodologies	
Work Instruction:	WI-03 MEASURING RF SPECTRUM MASK
Measurement Uncertainty:	±2.81 dB

DCCF - Duty Cycle Correction Factor

Note: click the links in the above matrix to view the graphical image (plot).

This test report may be reproduced in full only. The document may only be updated by MiCOM Labs personnel. All changes will be noted in the Document History section of the report.



Title: Mimosa Networks A5 Wireless Access Point
To: FCC CFR 47 Part 15 Subpart E 15.407
Serial #: MIMO05-6a Rev A
Issue Date: 4th November 2015
Page: 75 of 372

Equipment Configuration for Power Spectral Density			
Variant:	802.11n HT-40	Duty Cycle (%):	97.1
Data Rate:	13.5 M Bit/s	Antenna Gain (dBi):	5.00
Modulation:	OFDM	Beam Forming Gain (Y)(dB):	Not Applicable
TPC:	Not Applicable	Tested By:	GMH
Engineering Test Notes:			

Test Measurement Results							
Test Frequency	Measured Power Spectral Density				Amplitude Summation + DCCF (+0.13 dB)	Limit	Margin
	Port(s) (dBm/500 KHz)						
MHz	a	b	c	d	dBm/500 KHz	dBm/500 KHz	dB
5755.0	-2.345				-2.217	17.0	-19.2
5785.0	-2.071				-1.943	17.0	-18.9
5815.0	-2.268				-2.140	17.0	-19.1

Traceability to Industry Recognized Test Methodologies	
Work Instruction:	WI-03 MEASURING RF SPECTRUM MASK
Measurement Uncertainty:	±2.81 dB

DCCF - Duty Cycle Correction Factor

Note: click the links in the above matrix to view the graphical image (plot).

This test report may be reproduced in full only. The document may only be updated by MiCOM Labs personnel. All changes will be noted in the Document History section of the report.



9.4. Radiated

Radiated Test Conditions for Radiated Spurious and Band-Edge Emissions			
Standard:	FCC CFR 47:15.407	Ambient Temp. (°C):	20.0 - 24.5
Test Heading:	Radiated Spurious and Band-Edge Emissions	Rel. Humidity (%):	32 - 45
Standard Section(s):	15.407 (b), 15.205, 15.209	Pressure (mBars):	999 - 1001
Reference Document(s):	See Normative References		

Test Procedure for Radiated Spurious and Band-Edge Emissions

Radiated emissions for restricted bands above 1 GHz are measured in the anechoic chamber at a 3-meter distance on every azimuth in both horizontal and vertical polarities. The emissions are recorded and maximized as a function of azimuth by rotation through 360° with a spectrum analyzer in peak hold mode. Depending on the frequency band spanned a notch filter and waveguide filter was used to remove the fundamental frequency. The highest emissions relative to the limit are listed for each frequency spanned. Measurements on any restricted band frequency or frequencies above 1 GHz are based on the use of measurement instrumentation employing peak and average detectors. All measurements were performed using a resolution bandwidth of 1 MHz.

Test configuration and setup for Undesirable Measurement were per the Radiated Test Set-up specified in this document.

15.407 (b) Undesirable emission limits. Except as shown in paragraph (b)(7) of this section, the maximum emissions outside of the frequency bands of operation shall be attenuated in accordance with the following limits:

- (1) For transmitters operating in the 5.15-5.25 GHz band: All emissions outside of the 5.15-5.35 GHz band shall not exceed an e.i.r.p. of -27 dBm/MHz.
- (2) For transmitters operating in the 5.25-5.35 GHz band: All emissions outside of the 5.15-5.35 GHz band shall not exceed an e.i.r.p. of -27 dBm/MHz.
- (3) For transmitters operating in the 5.47-5.725 GHz band: All emissions outside of the 5.47-5.725 GHz band shall not exceed an e.i.r.p. of -27 dBm/MHz.
- (4) For transmitters operating in the 5.725-5.85 GHz band: All emissions within the frequency range from the band edge to 10 MHz above or below the band edge shall not exceed an e.i.r.p. of -17 dBm/MHz; for frequencies 10 MHz or greater above or below the band edge, emissions shall not exceed an e.i.r.p. of -27 dBm/MHz.
- (5) The emission measurements shall be performed using a minimum resolution bandwidth of 1 MHz. A lower resolution bandwidth may be employed near the band edge, when necessary, provided the measured energy is integrated to show the total power over 1 MHz.
- (6) Unwanted emissions below 1 GHz must comply with the general field strength limits set forth in §15.209. Further, any U-NII devices using an AC power line are required to comply also with the conducted limits set forth in §15.207.
- (7) The provisions of §15.205 apply to intentional radiators operating under this section.
- (8) When measuring the emission limits, the nominal carrier frequency shall be adjusted as close to the upper and lower frequency band edges as the design of the equipment permits.

Limits for Restricted Bands (15.205, 15.209)

Peak emission: 74 dBuV/m

Average emission: 54 dBuV/m

Field Strength Calculation

The field strength is calculated by adding the Antenna Factor and Cable Loss, and subtracting Amplifier Gain from the measured reading. All factors are included in the reported data.

This test report may be reproduced in full only. The document may only be updated by MiCOM Labs personnel. All changes will be noted in the Document History section of the report.



$$FS = R + AF + CORR - FO$$

where:

- FS = Field Strength
- R = Measured Spectrum analyzer Input Amplitude
- AF = Antenna Factor
- CORR = Correction Factor = CL – AG + NFL
- CL = Cable Loss
- AG = Amplifier Gain
- FO = Distance Falloff Factor
- NFL = Notch Filter Loss or Waveguide Loss

Example:

The following formula is used to convert the equipment isotropic radiated power (eirp) to field strength (dBµV/m);

$$E = 1000000 \times \sqrt[3]{30P} / 3 \text{ } \mu\text{V/m}$$

where P is the EIRP in Watts

Therefore: -27 dBm/MHz equates to 68.23 dBuV/m

Conversion between dBmV/m (or dBmV) and mV/m (or mV) are as follows:

$$\text{Level (dBmV/m)} = 20 * \text{Log (level (mV/m))}$$

40 dBmV/m = 100 mV/m

48 dBmV/m = 250 mV/m

Restricted Bands of Operation (15.205)

(a) Except as shown in paragraph (d) of this section, only spurious emissions are permitted in any of the frequency bands listed below:

Frequency Band			
MHz	MHz	MHz	GHz
0.090-0.110	16.42-16.423	399.9-410	4.5-5.15
0.495-0.505	16.69475-16.69525	608-614	5.35-5.46
2.1735-2.1905	16.80425-16.80475	960-1240	7.25-7.75
4.125-4.128	25.5-25.67	1300-1427	8.025-8.5
4.17725-4.17775	37.5-38.25	1435-1626.5	9.0-9.2
4.20725-4.20775	73-74.6	1645.5-1646.5	9.3-9.5
6.215-6.218	74.8-75.2	1660-1710	10.6-12.7
6.26775-6.26825	108-121.94	1718.8-1722.2	13.25-13.4
6.31175-6.31225	123-138	2200-2300	14.47-14.5
8.291-8.294	149.9-150.05	2310-2390	15.35-16.2
8.362-8.366	156.52475-156.52525	2483.5-2500	17.7-21.4
8.37625-8.38675	156.7-156.9	2690-2900	22.01-23.12
8.41425-8.41475	162.0125-167.17	3260-3267	23.6-24.0
12.29-12.293	167.72-173.2	3332-3339	31.2-31.8

This test report may be reproduced in full only. The document may only be updated by MiCOM Labs personnel. All changes will be noted in the Document History section of the report.



Title: Mimosa Networks A5 Wireless Access Point
To: FCC CFR 47 Part 15 Subpart E 15.407
Serial #: MIMO05-6a Rev A
Issue Date: 4th November 2015
Page: 78 of 372

12.51975-12.52025	240-285	3345.8-3358	36.43-36.5
12.57675-12.57725	322-335.4	3600-4400	Above 38.6
13.36-13.41			

(b) Except as provided in paragraphs (d) and (e) of this section, the field strength of emissions appearing within these frequency bands shall not exceed the limits shown in §15.209. At frequencies equal to or less than 1000 MHz, compliance with the limits in §15.209 shall be demonstrated using measurement instrumentation employing a CISPR quasi-peak detector. Above 1000 MHz, compliance with the emission limits in §15.209 shall be demonstrated based on the average value of the measured emissions. The provisions in §15.35 apply to these measurements.

(c) Except as provided in paragraphs (d) and (e) of this section, regardless of the field strength limits specified elsewhere in this subpart, the provisions of this section apply to emissions from any intentional radiator.

(d) The following devices are exempt from the requirements of this section:

(1) Swept frequency field disturbance sensors operating between 1.705 and 37 MHz provided their emissions only sweep through the bands listed in paragraph (a) of this section, the sweep is never stopped with the fundamental emission within the bands listed in paragraph (a) of this section, and the fundamental emission is outside of the bands listed in paragraph (a) of this section more than 99% of the time the device is actively transmitting, without compensation for duty cycle.

(2) Transmitters used to detect buried electronic markers at 101.4 kHz which are employed by telephone companies.

(3) Cable locating equipment operated pursuant to §15.213.

(4) Any equipment operated under the provisions of §15.253, 15.255, and 15.256 in the frequency band 75-85 GHz, or §15.257 of this part.

(5) Biomedical telemetry devices operating under the provisions of §15.242 of this part are not subject to the restricted band 608-614 MHz but are subject to compliance within the other restricted bands.

(6) Transmitters operating under the provisions of subparts D or F of this part.

(7) Devices operated pursuant to §15.225 are exempt from complying with this section for the 13.36-13.41 MHz band only.

(8) Devices operated in the 24.075-24.175 GHz band under §15.245 are exempt from complying with the requirements of this section for the 48.15-48.35 GHz and 72.225-72.525 GHz bands only, and shall not exceed the limits specified in §15.245(b).

(9) Devices operated in the 24.0-24.25 GHz band under §15.249 are exempt from complying with the requirements of this section for the 48.0-48.5 GHz and 72.0-72.75 GHz bands only, and shall not exceed the limits specified in §15.249(a).

(e) Harmonic emissions appearing in the restricted bands above 17.7 GHz from field disturbance sensors operating under the provisions of §15.245 shall not exceed the limits specified in §15.245(b).

This test report may be reproduced in full only. The document may only be updated by MiCOM Labs personnel. All changes will be noted in the Document History section of the report.



Title: Mimosa Networks A5 Wireless Access Point
To: FCC CFR 47 Part 15 Subpart E 15.407
Serial #: MIMO05-6a Rev A
Issue Date: 4th November 2015
Page: 79 of 372

9.4.1. Restricted Band Emissions

Equipment Configuration for Radiated Spurious - Restricted Band Emissions

Antenna:	Circularly Polarized	Variant:	802.11a
Antenna Gain (dBi):	8.00	Modulation:	OFDM
Beam Forming Gain (Y):	Not Applicable	Duty Cycle (%):	98.7
Channel Frequency (MHz):	5165.00	Data Rate:	6.00 MBit/s
Power Setting:	16	Tested By:	SB

Test Measurement Results

Num	Frequency MHz	Raw dBµV	Cable Loss	AF dB	Level dBµV/m	Measurement Type	Pol	Hgt cm	Azt Deg	Limit dBµV/m	Margin dB	Pass /Fail
#1	1326.10	40.49	2.24	-14.98	27.75	Max Avg	Vertical	148	164	54.0	26.3	Pass
#2	1326.10	66.30	2.24	-14.98	53.56	Max Peak	Vertical	148	164	74.0	-20.4	Pass
#3	1326.10	57.08	2.24	-14.98	44.34	Peak (Scan)	Vertical	148	1	--	--	
#4	5171.74	54.06	3.70	-11.53	46.23	Peak (Scan)	Vertical	148	1	--	--	
#5	5171.74	54.06	3.70	-11.53	46.23	Fundamental	Vertical	148	1	--	--	
#6	6886.62	56.10	4.11	-7.59	52.62	Peak (Scan)	Vertical	151	1	--	--	
#7	6886.62	56.37	4.11	-7.59	52.89	Max Avg	Vertical	147	349	54.0	1.1	Pass
#8	6886.62	59.24	4.11	-7.59	55.76	Max Peak	Vertical	147	349	74.0	-18.2	Pass

Test Notes: laptop & poe inside chamber

This test report may be reproduced in full only. The document may only be updated by MiCOM Labs personnel. All changes will be noted in the Document History section of the report.



Title: Mimosa Networks A5 Wireless Access Point
To: FCC CFR 47 Part 15 Subpart E 15.407
Serial #: MIMO05-6a Rev A
Issue Date: 4th November 2015
Page: 80 of 372

Equipment Configuration for Radiated Spurious - Restricted Band Emissions

Antenna:	Circularly Polarized	Variant:	802.11a
Antenna Gain (dBi):	8.00	Modulation:	OFDM
Beam Forming Gain (Y):	Not Applicable	Duty Cycle (%):	98.7
Channel Frequency (MHz):	5200.00	Data Rate:	6.00 MBit/s
Power Setting:	16	Tested By:	SB

Test Measurement Results

Num	Frequency MHz	Raw dBµV	Cable Loss	AF dB	Level dBµV/m	Measurement Type	Pol	Hgt cm	Azt Deg	Limit dBµV/m	Margin dB	Pass /Fail
#1	1330.90	45.35	2.24	-15.02	32.57	Max Avg	Horizontal	102	294	54.0	21.4	Pass
#2	1330.90	70.25	2.24	-15.02	57.47	Max Peak	Horizontal	102	294	74.0	-16.5	Pass
#3	1330.90	51.28	2.24	-15.02	38.50	Peak (Scan)	Horizontal	100	1	--	--	
#4	5194.19	55.99	3.67	-11.47	48.19	Fundamental	Vertical	151	1	--	--	
#5	6933.35	57.48	4.11	-7.49	54.10	Max Avg	Vertical	136	12	54.0	-0.1	Pass
#6	6933.35	60.33	4.11	-7.49	56.95	Max Peak	Vertical	136	12	74.0	-17.1	Pass
#7	6933.35	52.96	4.11	-7.49	49.58	Peak (Scan)	Vertical	100	1	--	--	

Test Notes: laptop & poe inside chamber

This test report may be reproduced in full only. The document may only be updated by MiCOM Labs personnel. All changes will be noted in the Document History section of the report.



Title: Mimosa Networks A5 Wireless Access Point
To: FCC CFR 47 Part 15 Subpart E 15.407
Serial #: MIMO05-6a Rev A
Issue Date: 4th November 2015
Page: 81 of 372

Equipment Configuration for Radiated Spurious - Restricted Band Emissions

Antenna:	Circularly Polarized	Variant:	802.11a
Antenna Gain (dBi):	8.00	Modulation:	OFDM
Beam Forming Gain (Y):	Not Applicable	Duty Cycle (%):	98.7
Channel Frequency (MHz):	5240.00	Data Rate:	6.00 MBit/s
Power Setting:	16	Tested By:	SB

Test Measurement Results

Num	Frequency MHz	Raw dBµV	Cable Loss	AF dB	Level dBµV/m	Measurement Type	Pol	Hgt cm	Azt Deg	Limit dBµV/m	Margin dB	Pass /Fail
#1	1327.38	54.09	2.25	-14.99	41.35	Peak (Scan)	Vertical	148	1	--	--	
#2	1327.38	41.94	2.25	-14.99	29.20	Max Avg	Vertical	100	134	54.0	24.8	Pass
#3	1327.38	63.70	2.25	-14.99	50.96	Max Peak	Vertical	100	134	74.0	-23.0	Pass
#4	5230.66	58.75	3.64	-11.39	51.00	Fundamental	Horizontal	151	1	--	--	
#5	6980.00	51.74	4.14	-7.45	48.43	Peak (Scan)	Vertical	151	1	--	--	
#6	6980.00	55.45	4.14	-7.45	52.14	Max Avg	Vertical	139	356	54.0	1.9	Pass
#7	6980.00	58.72	4.14	-7.45	55.41	Max Peak	Vertical	139	356	74.0	-18.6	Pass

Test Notes: laptop & poe inside chamber

This test report may be reproduced in full only. The document may only be updated by MiCOM Labs personnel. All changes will be noted in the Document History section of the report.



Title: Mimosa Networks A5 Wireless Access Point
To: FCC CFR 47 Part 15 Subpart E 15.407
Serial #: MIMO05-6a Rev A
Issue Date: 4th November 2015
Page: 82 of 372

Equipment Configuration for Radiated Spurious - Restricted Band Emissions

Antenna:	Circularly Polarized	Variant:	802.11a
Antenna Gain (dBi):	8.00	Modulation:	OFDM
Beam Forming Gain (Y):	Not Applicable	Duty Cycle (%):	98.7
Channel Frequency (MHz):	5260.00	Data Rate:	6.00 MBit/s
Power Setting:	16	Tested By:	SB

Test Measurement Results

Num	Frequency MHz	Raw dB μ V	Cable Loss	AF dB	Level dB μ V/m	Measurement Type	Pol	Hgt cm	Azt Deg	Limit dB μ V/m	Margin dB	Pass /Fail
#1	1329.78	45.89	2.25	-15.01	33.13	Max Avg	Horizontal	100	292	54.0	20.9	Pass
#2	1329.78	68.05	2.25	-15.01	55.29	Max Peak	Horizontal	100	292	74.0	-18.7	Pass
#3	1329.78	52.67	2.25	-15.01	39.91	Peak (Scan)	Horizontal	151	1	--	--	
#4	5255.67	60.55	3.64	-11.31	52.88	Peak (Scan)	Horizontal	148	1	--	--	
#5	5255.67	60.55	3.64	-11.31	52.88	Fundamental	Horizontal	148	1	--	--	
#6	7013.42	52.06	4.18	-7.42	48.82	Max Avg	Horizontal	136	1	54.0	5.2	Pass
#7	7013.42	55.84	4.18	-7.42	52.60	Max Peak	Horizontal	136	1	74.0	-21.4	Pass

Test Notes: laptop & poe inside chamber

This test report may be reproduced in full only. The document may only be updated by MiCOM Labs personnel. All changes will be noted in the Document History section of the report.



Title: Mimosa Networks A5 Wireless Access Point
To: FCC CFR 47 Part 15 Subpart E 15.407
Serial #: MIMO05-6a Rev A
Issue Date: 4th November 2015
Page: 83 of 372

Equipment Configuration for Radiated Spurious - Restricted Band Emissions

Antenna:	Circularly Polarized	Variant:	802.11a
Antenna Gain (dBi):	8.00	Modulation:	OFDM
Beam Forming Gain (Y):	Not Applicable	Duty Cycle (%):	98.7
Channel Frequency (MHz):	5300.00	Data Rate:	6.00 MBit/s
Power Setting:	16	Tested By:	SB

Test Measurement Results

Num	Frequency MHz	Raw dBµV	Cable Loss	AF dB	Level dBµV/m	Measurement Type	Pol	Hgt cm	Azt Deg	Limit dBµV/m	Margin dB	Pass /Fail
#1	1332.00	54.05	2.24	-15.03	41.26	Peak (Scan)	Horizontal	148	1	--	--	
#2	1332.00	43.65	2.24	-15.03	30.86	Max Avg	Horizontal	108	295	54.0	23.1	Pass
#3	1332.00	67.93	2.24	-15.03	55.14	Max Peak	Horizontal	108	295	74.0	-18.9	Pass
#4	5294.47	60.99	3.78	-11.12	53.65	Fundamental	Horizontal	151	1	--	--	
#5	7134.05	35.96	4.17	-7.36	32.77	Max Avg	Vertical	142	284	54.0	21.2	Pass
#6	7134.05	48.76	4.17	-7.36	45.57	Max Peak	Vertical	142	284	74.0	-28.4	Pass
#7	7134.05	46.00	4.17	-7.36	42.81	Peak (Scan)	Vertical	113	112	--	--	

Test Notes: laptop & poe inside chamber

This test report may be reproduced in full only. The document may only be updated by MiCOM Labs personnel. All changes will be noted in the Document History section of the report.



Title: Mimosa Networks A5 Wireless Access Point
To: FCC CFR 47 Part 15 Subpart E 15.407
Serial #: MIMO05-6a Rev A
Issue Date: 4th November 2015
Page: 84 of 372

Equipment Configuration for Radiated Spurious - Restricted Band Emissions

Antenna:	Circularly Polarized	Variant:	802.11a
Antenna Gain (dBi):	8.00	Modulation:	OFDM
Beam Forming Gain (Y):	Not Applicable	Duty Cycle (%):	98.7
Channel Frequency (MHz):	5335.00	Data Rate:	6.00 MBit/s
Power Setting:	16	Tested By:	SB

Test Measurement Results

Num	Frequency MHz	Raw dBµV	Cable Loss	AF dB	Level dBµV/m	Measurement Type	Pol	Hgt cm	Azt Deg	Limit dBµV/m	Margin dB	Pass /Fail
#1	1329.14	59.29	2.25	-15.01	46.53	Peak (Scan)	Vertical	100	1	--	--	
#2	1329.14	46.37	2.25	-15.01	33.61	Max Avg	Vertical	100	140	54.0	20.4	Pass
#3	1329.14	66.29	2.25	-15.01	53.53	Max Peak	Vertical	100	140	74.0	-20.5	Pass
#4	1329.14	46.46	2.25	-15.01	33.70	Max Avg	Horizontal	109	293	54.0	20.3	Pass
#5	1329.14	69.18	2.25	-15.01	56.42	Max Peak	Horizontal	109	293	74.0	-17.6	Pass
#6	5330.06	58.41	3.69	-11.05	51.05	Fundamental	Horizontal	151	1	--	--	
#7	7113.31	53.86	4.19	-7.34	50.71	Max Avg	Vertical	146	5	54.0	3.3	Pass
#8	7113.31	57.26	4.19	-7.34	54.11	Max Peak	Vertical	146	5	74.0	-19.9	Pass
#9	7113.31	49.99	4.19	-7.34	46.84	Max Avg	Horizontal	108	27	54.0	7.2	Pass
#10	7113.31	54.61	4.19	-7.34	51.46	Max Peak	Horizontal	108	27	74.0	-22.5	Pass
#11	7113.31	52.96	4.19	-7.34	49.81	Peak (Scan)	Vertical	151	1	--	--	

Test Notes: laptop & poe inside chamber

This test report may be reproduced in full only. The document may only be updated by MiCOM Labs personnel. All changes will be noted in the Document History section of the report.



Title: Mimosa Networks A5 Wireless Access Point
To: FCC CFR 47 Part 15 Subpart E 15.407
Serial #: MIMO05-6a Rev A
Issue Date: 4th November 2015
Page: 85 of 372

Equipment Configuration for Radiated Spurious - Restricted Band Emissions			
--	--	--	--

Antenna:	Circularly Polarized	Variant:	802.11a
Antenna Gain (dBi):	8.00	Modulation:	OFDM
Beam Forming Gain (Y):	Not Applicable	Duty Cycle (%):	98.7
Channel Frequency (MHz):	5485.00	Data Rate:	6.00 MBit/s
Power Setting:	16	Tested By:	SB

Test Measurement Results

Click here to view measurement data...
Test Notes: laptop & poe inside chamber

This test report may be reproduced in full only. The document may only be updated by MiCOM Labs personnel. All changes will be noted in the Document History section of the report.



Title: Mimosa Networks A5 Wireless Access Point
To: FCC CFR 47 Part 15 Subpart E 15.407
Serial #: MIMO05-6a Rev A
Issue Date: 4th November 2015
Page: 86 of 372

Equipment Configuration for Radiated Spurious - Restricted Band Emissions			
--	--	--	--

Antenna:	Circularly Polarized	Variant:	802.11a
Antenna Gain (dBi):	8.00	Modulation:	OFDM
Beam Forming Gain (Y):	Not Applicable	Duty Cycle (%):	98.7
Channel Frequency (MHz):	5590.00	Data Rate:	6.00 MBit/s
Power Setting:	6	Tested By:	SB

Test Measurement Results

Click here to view measurement data...
Test Notes: laptop & poe inside chamber

This test report may be reproduced in full only. The document may only be updated by MiCOM Labs personnel. All changes will be noted in the Document History section of the report.



Title: Mimosa Networks A5 Wireless Access Point
To: FCC CFR 47 Part 15 Subpart E 15.407
Serial #: MIMO05-6a Rev A
Issue Date: 4th November 2015
Page: 87 of 372

Equipment Configuration for Radiated Spurious - Restricted Band Emissions			
--	--	--	--

Antenna:	Circularly Polarized	Variant:	802.11a
Antenna Gain (dBi):	8.00	Modulation:	OFDM
Beam Forming Gain (Y):	Not Applicable	Duty Cycle (%):	98.7
Channel Frequency (MHz):	5715.00	Data Rate:	6.00 MBit/s
Power Setting:	6	Tested By:	SB

Test Measurement Results

Click here to view measurement data...
Test Notes: laptop & poe inside chamber

This test report may be reproduced in full only. The document may only be updated by MiCOM Labs personnel. All changes will be noted in the Document History section of the report.



Title: Mimosa Networks A5 Wireless Access Point
To: FCC CFR 47 Part 15 Subpart E 15.407
Serial #: MIMO05-6a Rev A
Issue Date: 4th November 2015
Page: 88 of 372

9.4.2. Restricted Band-Edge Emissions

RESULTS SUMMARY FOR RADIATED BAND-EDGE EMISSIONS

Mimosa 8.0 dBi		Band-Edge Freq	Peak (Limit 74.0dB μ V/m)	Average (Limit 54.0dB μ V/m)	Power Setting
Operational Mode	Operating Frequency (MHz)	MHz	dB μ V/m	dB μ V/m	
802.11a	5165.00	5150.00	66.29	46.66	5.00
	5335.00	5350.00	66.78	52.64	2.00
	5485.00	5470.00	66.82	49.44	15.00
802.11ac-80	5195.00	5150.00	64.18	44.61	5.00
	5310.00	5350.00	68.03	53.38	12.00
	5530.00	5470.00	67.01	53.09	0.00
802.11nHT-20	5165.00	5150.00	64.46	49.91	5.00
	5335.00	5350.00	65.67	52.77	4.00
	5485.00	5470.00	64.19	52.35	19.00
802.11nHT-40	5175.00	5150.00	67.63	53.09	9.00
	5330.00	5350.00	66.60	53.42	8.00
	5495.00	5470.00	66.22	50.98	13.00

Click on the links to view the data.

This test report may be reproduced in full only. The document may only be updated by MiCOM Labs personnel. All changes will be noted in the Document History section of the report.



Title: Mimosa Networks A5 Wireless Access Point
To: FCC CFR 47 Part 15 Subpart E 15.407
Serial #: MIMO05-6a Rev A
Issue Date: 4th November 2015
Page: 89 of 372

RESULTS SUMMARY FOR RADIATED BAND-EDGE EMISSIONS 5725 & 5850 MHz Band-Edge

Mimosa 8.0 dBi		Band-Edge Freq	Peak (Limit -27.0 dBm)	Average (Limit -43.0 dBm)	Power Setting
Operational Mode	Operating Frequency (MHz)	MHz	dB μ V/m	dB μ V/m	
802.11a	5745.00	5725.00	-34.94	-44.32	22.00
	5825.00	5850.00	-34.17	-44.10	24.00
802.11ac-80	5775.00	5725.00	-28.91	-44.04	23.00
	5795.00	5850.00	-28.28	-45.51	20.00
802.11nHT-20	5745.00	5725.00	-32.42	-44.11	24.00
	5825.00	5850.00	-33.45	-44.39	24.00
802.11nHT-40	5755.00	5725.00	-32.00	-43.52	23.00
	5815.00	5850.00	-29.93	-43.52	22.00

This test report may be reproduced in full only. The document may only be updated by MiCOM Labs personnel. All changes will be noted in the Document History section of the report.



Title: Mimosa Networks A5 Wireless Access Point
To: FCC CFR 47 Part 15 Subpart E 15.407
Serial #: MIMO05-6a Rev A
Issue Date: 4th November 2015
Page: 90 of 372

Equipment Configuration for Restricted Lower Band-Edge Emissions

Antenna:	Circularly Polarized	Variant:	802.11a
Antenna Gain (dBi):	8.00	Modulation:	OFDM
Beam Forming Gain (Y):	Not Applicable	Duty Cycle (%):	100
Channel Frequency (MHz):	5165.00	Data Rate:	6.00 MBit/s
Power Setting:	5	Tested By:	JMH

Test Measurement Results

Num	Frequency MHz	Raw dBµV	Cable Loss	AF dB	Level dBµV/m	Measurement Type	Pol	Hgt cm	Azt Deg	Limit dBµV/m	Margin dB	Pass /Fail
#1	5150.00	54.58	3.67	-11.59	46.66	Max Avg	Vertical	182	110	54.0	-7.3	Pass
#2	5150.00	74.21	3.67	-11.59	66.29	Max Peak	Vertical	182	110	74.0	-7.7	Pass

Test Notes: EUT at 150cm connected to laptop, powered by Pihong POE PS. 8.0 dBi Antenna

This test report may be reproduced in full only. The document may only be updated by MiCOM Labs personnel. All changes will be noted in the Document History section of the report.



Title: Mimosa Networks A5 Wireless Access Point
To: FCC CFR 47 Part 15 Subpart E 15.407
Serial #: MIMO05-6a Rev A
Issue Date: 4th November 2015
Page: 91 of 372

Equipment Configuration for Restricted Lower Band-Edge Emissions

Antenna:	Circularly Polarized	Variant:	802.11a
Antenna Gain (dBi):	8.00	Modulation:	OFDM
Beam Forming Gain (Y):	Not Applicable	Duty Cycle (%):	100
Channel Frequency (MHz):	5485.00	Data Rate:	6.00 MBit/s
Power Setting:	15	Tested By:	JMH

Test Measurement Results

Num	Frequency MHz	Raw dB μ V	Cable Loss	AF dB	Level dB μ V/m	Measurement Type	Pol	Hgt cm	Azt Deg	Limit dB μ V/m	Margin dB	Pass /Fail
#1	5459.56	74.25	3.79	-11.22	66.82	Max Peak	Horizontal	196	198	74.0	-7.2	Pass
#2	5460.00	56.87	3.79	-11.22	49.44	Max Avg	Horizontal	196	198	54.0	-4.6	Pass

Test Notes: EUT at 150cm powered by pihong POE. Antenna 8.0 dBi

This test report may be reproduced in full only. The document may only be updated by MiCOM Labs personnel. All changes will be noted in the Document History section of the report.



Title: Mimosa Networks A5 Wireless Access Point
To: FCC CFR 47 Part 15 Subpart E 15.407
Serial #: MIMO05-6a Rev A
Issue Date: 4th November 2015
Page: 92 of 372

Equipment Configuration for Restricted Upper Band-Edge Emissions

Antenna:	Circularly Polarized	Variant:	802.11a
Antenna Gain (dBi):	8.00	Modulation:	OFDM
Beam Forming Gain (Y):	Not Applicable	Duty Cycle (%):	100
Channel Frequency (MHz):	5335.00	Data Rate:	6.00 MBit/s
Power Setting:	2	Tested By:	JMH

Test Measurement Results

Num	Frequency MHz	Raw dBµV	Cable Loss	AF dB	Level dBµV/m	Measurement Type	Pol	Hgt cm	Azt Deg	Limit dBµV/m	Margin dB	Pass /Fail
#1	5350.00	59.96	3.70	-11.02	52.64	Max Avg	Vertical	193	133	54.0	-1.4	Pass
#2	5350.00	74.10	3.70	-11.02	66.78	Max Peak	Vertical	193	133	74.0	-7.2	Pass

Test Notes: EUT at 150cm connected to laptop, powered by Pihong POE PS. 8.0 dBi Antenna

This test report may be reproduced in full only. The document may only be updated by MiCOM Labs personnel. All changes will be noted in the Document History section of the report.



802.11a 5725 MHz Band-Edge Emission

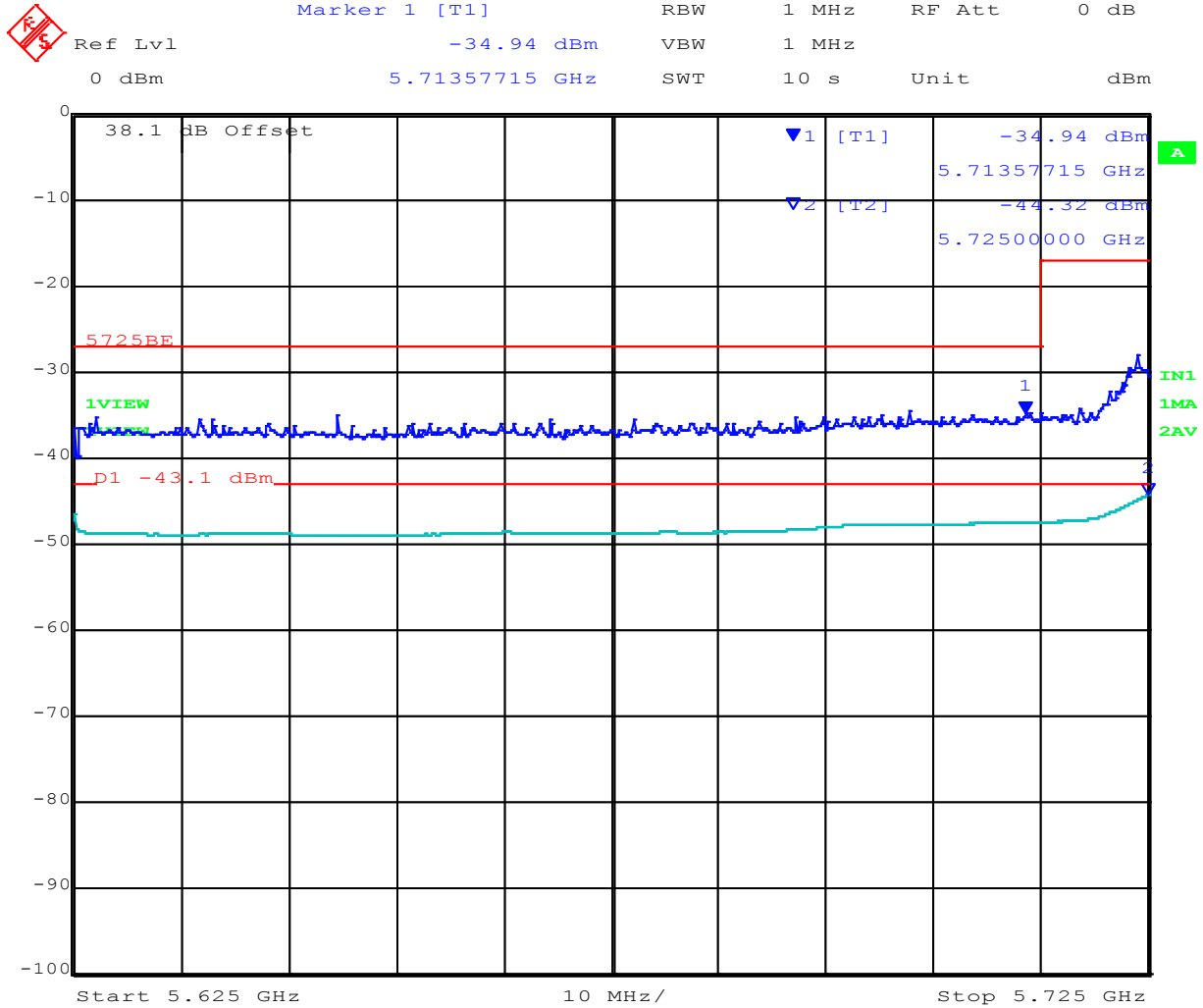

Date: 1.JAN.1997 01:06:40

This test report may be reproduced in full only. The document may only be updated by MiCOM Labs personnel. All changes will be noted in the Document History section of the report.



802.11a 5850 MHz Band-Edge Emission

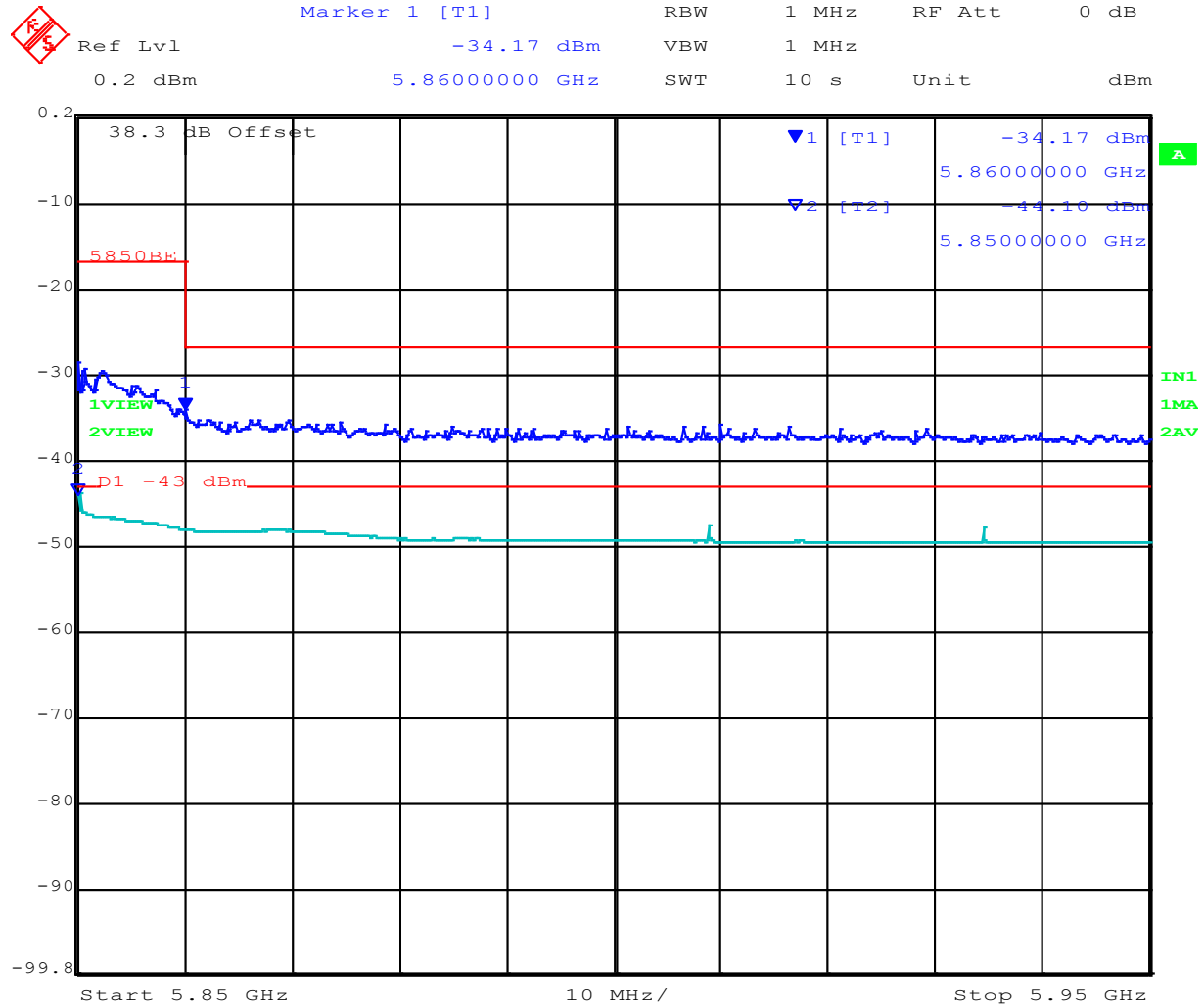

Date: 1.JAN.1997 01:32:24

This test report may be reproduced in full only. The document may only be updated by MiCOM Labs personnel. All changes will be noted in the Document History section of the report.



Title: Mimosa Networks A5 Wireless Access Point
To: FCC CFR 47 Part 15 Subpart E 15.407
Serial #: MIMO05-6a Rev A
Issue Date: 4th November 2015
Page: 95 of 372

Equipment Configuration for Restricted Lower Band-Edge Emissions

Antenna:	Circularly Polarized	Variant:	802.11n HT-20
Antenna Gain (dBi):	8.00	Modulation:	OFDM
Beam Forming Gain (Y):	Not Applicable	Duty Cycle (%):	100
Channel Frequency (MHz):	5165.00	Data Rate:	6.50 MBit/s
Power Setting:	5	Tested By:	JMH

Test Measurement Results

Num	Frequency MHz	Raw dBµV	Cable Loss	AF dB	Level dBµV/m	Measurement Type	Pol	Hgt cm	Azt Deg	Limit dBµV/m	Margin dB	Pass /Fail
#1	5150.00	57.83	3.67	-11.59	49.91	Max Avg	Vertical	182	110	54.0	-4.1	Pass
#2	5150.00	73.40	3.67	-11.59	65.48	Max Peak	Vertical	182	110	74.0	-8.5	Pass

Test Notes: EUT at 150cm connected to laptop, powered by Phihong POE PS

This test report may be reproduced in full only. The document may only be updated by MiCOM Labs personnel. All changes will be noted in the Document History section of the report.



Title: Mimosa Networks A5 Wireless Access Point
To: FCC CFR 47 Part 15 Subpart E 15.407
Serial #: MIMO05-6a Rev A
Issue Date: 4th November 2015
Page: 96 of 372

Equipment Configuration for Restricted Lower Band-Edge Emissions

Antenna:	Circularly Polarized	Variant:	802.11n HT-20
Antenna Gain (dBi):	8.00	Modulation:	OFDM
Beam Forming Gain (Y):	Not Applicable	Duty Cycle (%):	100
Channel Frequency (MHz):	5485.00	Data Rate:	6.50 MBit/s
Power Setting:	19	Tested By:	JMH

Test Measurement Results

Num	Frequency MHz	Raw dB μ V	Cable Loss	AF dB	Level dB μ V/m	Measurement Type	Pol	Hgt cm	Azt Deg	Limit dB μ V/m	Margin dB	Pass /Fail
#1	5460.00	59.78	3.79	-11.22	52.35	Max Avg	Horizontal	196	198	54.0	-1.7	Pass
#2	5460.00	71.62	3.79	-11.22	64.19	Max Peak	Horizontal	196	198	74.0	-9.8	Pass

Test Notes: EUT at 150cm powered by pihong POE. Antenna 8.0 dBi

This test report may be reproduced in full only. The document may only be updated by MiCOM Labs personnel. All changes will be noted in the Document History section of the report.



Title: Mimosa Networks A5 Wireless Access Point
To: FCC CFR 47 Part 15 Subpart E 15.407
Serial #: MIMO05-6a Rev A
Issue Date: 4th November 2015
Page: 97 of 372

Equipment Configuration for Restricted Upper Band-Edge Emissions

Antenna:	Circularly Polarized	Variant:	802.11n HT-20
Antenna Gain (dBi):	8.00	Modulation:	OFDM
Beam Forming Gain (Y):	Not Applicable	Duty Cycle (%):	100
Channel Frequency (MHz):	5335.00	Data Rate:	6.50 MBit/s
Power Setting:	4	Tested By:	JMH

Test Measurement Results

Num	Frequency MHz	Raw dB μ V	Cable Loss	AF dB	Level dB μ V/m	Measurement Type	Pol	Hgt cm	Azt Deg	Limit dB μ V/m	Margin dB	Pass /Fail
#1	5350.00	60.09	3.70	-11.02	52.77	Max Avg	Vertical	193	133	54.0	-1.2	Pass
#2	5350.44	72.99	3.70	-11.02	65.67	Max Peak	Vertical	193	133	74.0	-8.3	Pass

Test Notes: EUT at 150cm connected to laptop, powered by Pihong POE PS. 8.0 dBi Antenna

This test report may be reproduced in full only. The document may only be updated by MiCOM Labs personnel. All changes will be noted in the Document History section of the report.



Title: Mimosa Networks A5 Wireless Access Point
To: FCC CFR 47 Part 15 Subpart E 15.407
Serial #: MIMO05-6a Rev A
Issue Date: 4th November 2015
Page: 98 of 372

802.11n HT-20 5725 MHz Band-Edge Emission

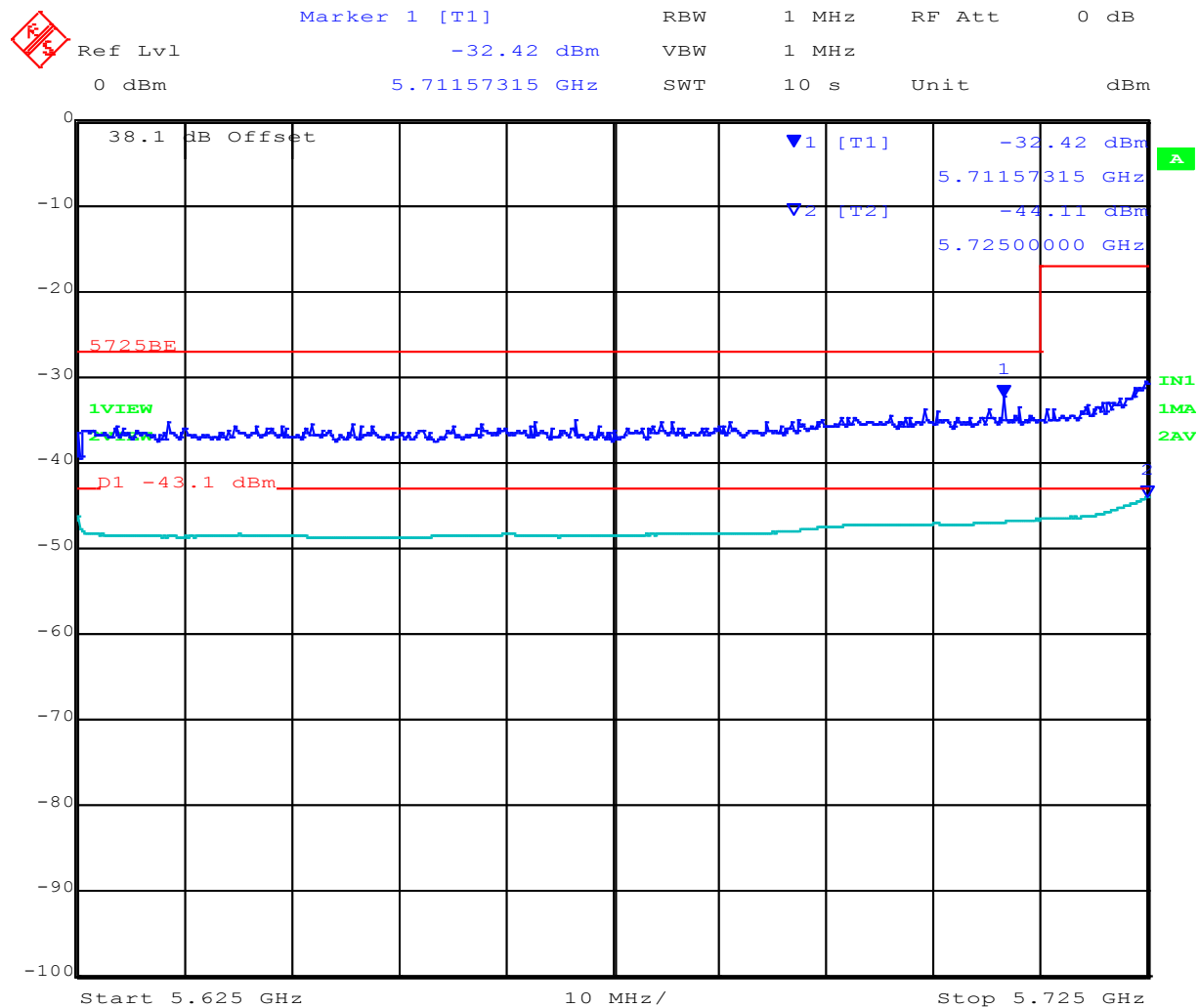

Date: 1.JAN.1997 01:00:59

This test report may be reproduced in full only. The document may only be updated by MiCOM Labs personnel. All changes will be noted in the Document History section of the report.



802.11n HT-20 5850 MHz Band-Edge Emission

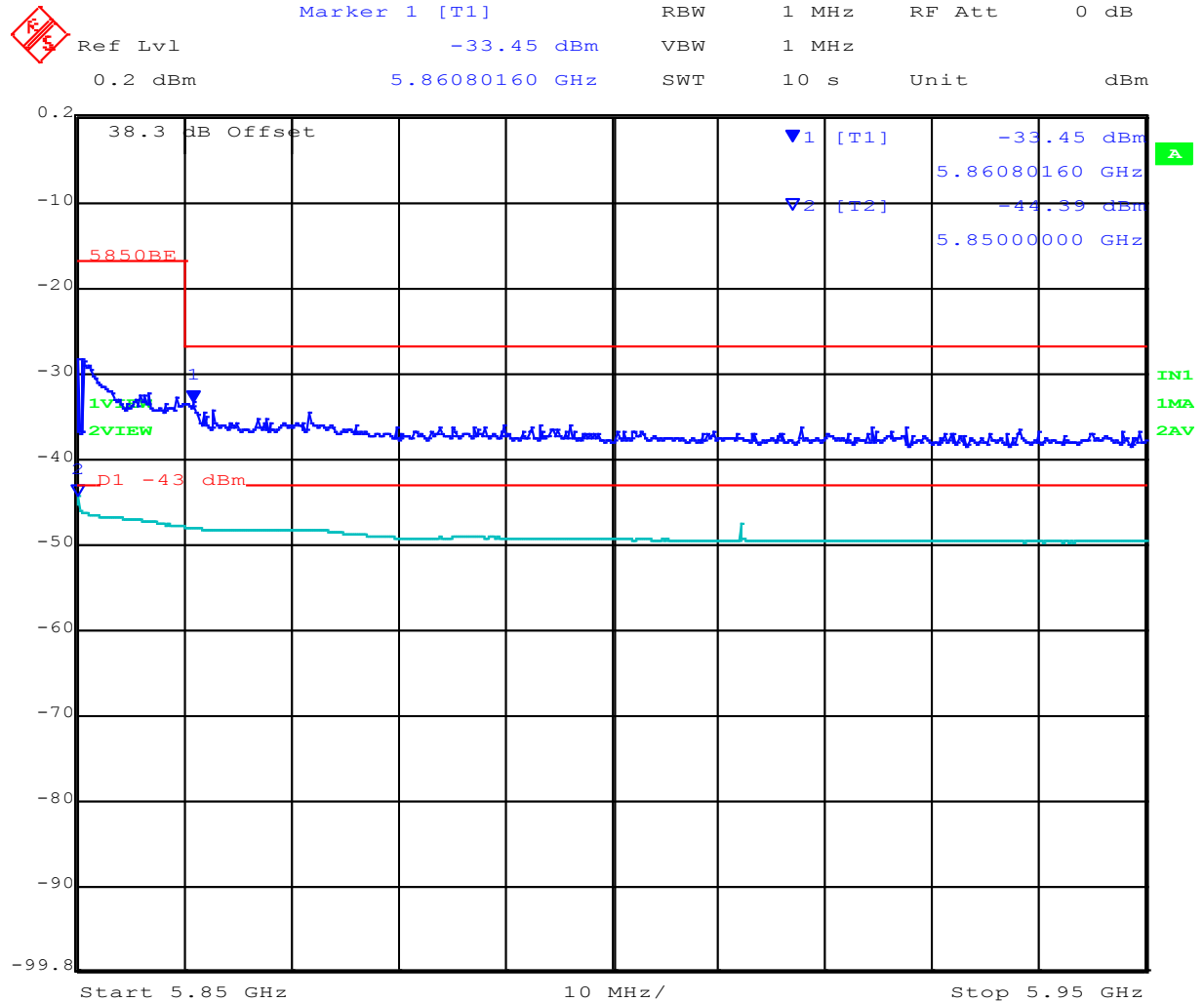

Date: 1.JAN.1997 01:36:58

This test report may be reproduced in full only. The document may only be updated by MiCOM Labs personnel. All changes will be noted in the Document History section of the report.



Title: Mimosa Networks A5 Wireless Access Point
To: FCC CFR 47 Part 15 Subpart E 15.407
Serial #: MIMO05-6a Rev A
Issue Date: 4th November 2015
Page: 100 of 372

Equipment Configuration for Restricted Lower Band-Edge Emissions

Antenna:	Circularly Polarized	Variant:	802.11n HT-40
Antenna Gain (dBi):	8.00	Modulation:	OFDM
Beam Forming Gain (Y):	Not Applicable	Duty Cycle (%):	100
Channel Frequency (MHz):	5175.00	Data Rate:	13.50 MBit/s
Power Setting:	9	Tested By:	JMH

Test Measurement Results

Num	Frequency MHz	Raw dBµV	Cable Loss	AF dB	Level dBµV/m	Measurement Type	Pol	Hgt cm	Azt Deg	Limit dBµV/m	Margin dB	Pass /Fail
#1	5126.55	75.57	3.67	-11.61	67.63	Max Peak	Vertical	182	110	74.0	-6.4	Pass
#2	5129.16	61.01	3.68	-11.60	53.09	Max Avg	Vertical	182	110	54.0	-0.9	Pass

Test Notes: EUT at 150cm connected to laptop, powered by Pihong POE PS.8.0 dBi Antenna

This test report may be reproduced in full only. The document may only be updated by MiCOM Labs personnel. All changes will be noted in the Document History section of the report.



Title: Mimosa Networks A5 Wireless Access Point
To: FCC CFR 47 Part 15 Subpart E 15.407
Serial #: MIMO05-6a Rev A
Issue Date: 4th November 2015
Page: 101 of 372

Equipment Configuration for Restricted Lower Band-Edge Emissions

Antenna:	Circularly Polarized	Variant:	802.11n HT-40
Antenna Gain (dBi):	8.00	Modulation:	OFDM
Beam Forming Gain (Y):	Not Applicable	Duty Cycle (%):	100
Channel Frequency (MHz):	5495.00	Data Rate:	13.50 MBit/s
Power Setting:	13	Tested By:	JMH

Test Measurement Results

Num	Frequency MHz	Raw dB μ V	Cable Loss	AF dB	Level dB μ V/m	Measurement Type	Pol	Hgt cm	Azt Deg	Limit dB μ V/m	Margin dB	Pass /Fail
#1	5444.79	73.69	3.76	-11.23	66.22	Max Peak	Horizontal	196	198	74.0	-7.8	Pass
#2	5445.67	58.45	3.76	-11.23	50.98	Max Avg	Horizontal	196	198	54.0	-3.0	Pass

Test Notes: EUT at 150cm powered by phihong POE. Antenna 8.0 dBi

This test report may be reproduced in full only. The document may only be updated by MiCOM Labs personnel. All changes will be noted in the Document History section of the report.



Title: Mimosa Networks A5 Wireless Access Point
To: FCC CFR 47 Part 15 Subpart E 15.407
Serial #: MIMO05-6a Rev A
Issue Date: 4th November 2015
Page: 102 of 372

Equipment Configuration for Restricted Upper Band-Edge Emissions

Antenna:	Circularly Polarized	Variant:	802.11n HT-40
Antenna Gain (dBi):	8.00	Modulation:	OFDM
Beam Forming Gain (Y):	Not Applicable	Duty Cycle (%):	100
Channel Frequency (MHz):	5330.00	Data Rate:	13.50 MBit/s
Power Setting:	8	Tested By:	JMH

Test Measurement Results

Num	Frequency MHz	Raw dBµV	Cable Loss	AF dB	Level dBµV/m	Measurement Type	Pol	Hgt cm	Azt Deg	Limit dBµV/m	Margin dB	Pass /Fail
#1	5350.00	60.74	3.70	-11.02	53.42	Max Avg	Vertical	193	133	54.0	-0.6	Pass
#2	5350.00	73.92	3.70	-11.02	66.60	Max Peak	Vertical	193	133	74.0	-7.4	Pass

Test Notes: EUT at 150cm connected to laptop, powered by Pihong POE PS. 8.0 dBi Antenna,

This test report may be reproduced in full only. The document may only be updated by MiCOM Labs personnel. All changes will be noted in the Document History section of the report.



Title: Mimosa Networks A5 Wireless Access Point
To: FCC CFR 47 Part 15 Subpart E 15.407
Serial #: MIMO05-6a Rev A
Issue Date: 4th November 2015
Page: 103 of 372

802.11n HT-40 5725 MHz Band-Edge Emission

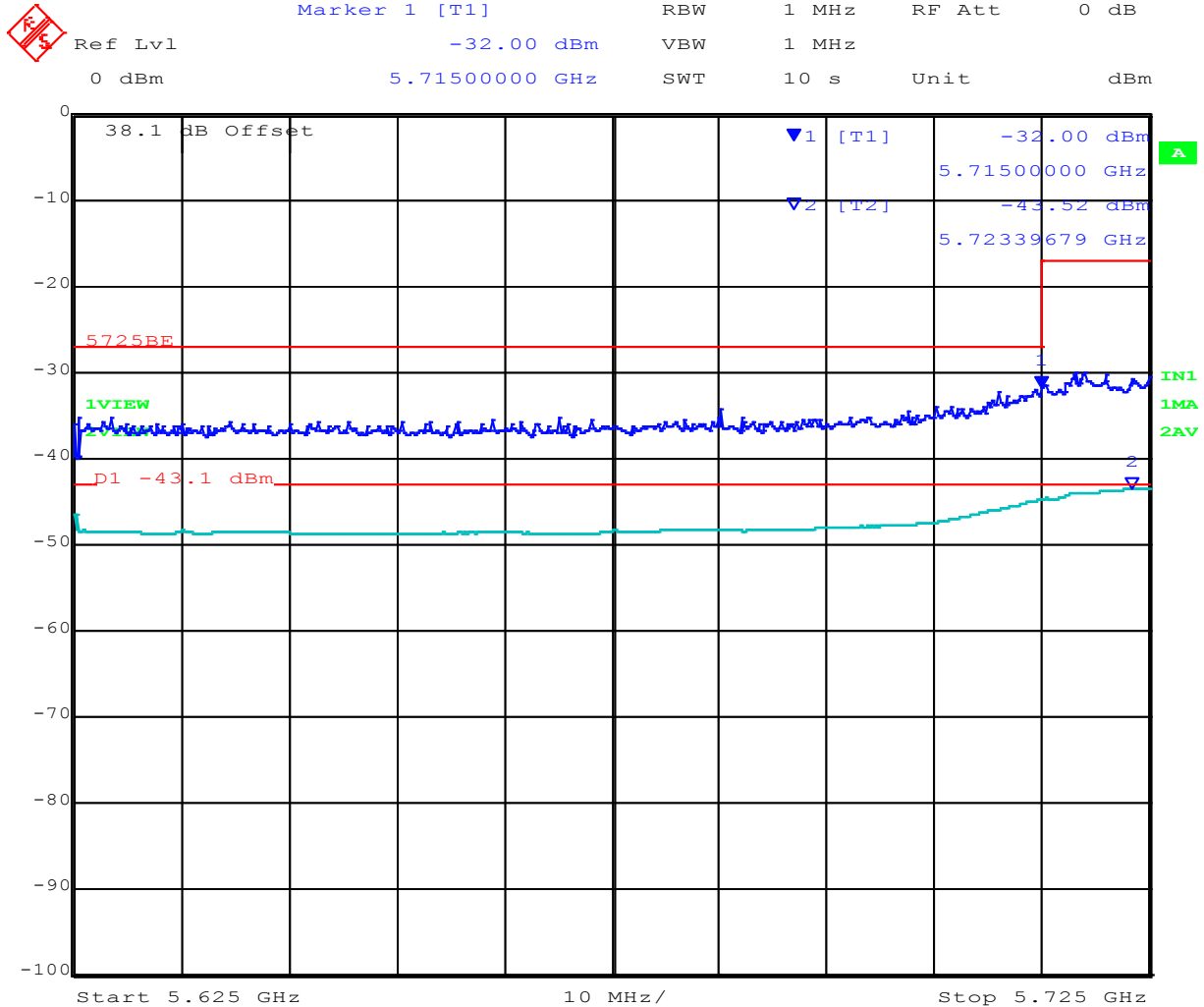

Date: 1.JAN.1997 00:55:58

This test report may be reproduced in full only. The document may only be updated by MiCOM Labs personnel. All changes will be noted in the Document History section of the report.



802.11n HT-40 5850 MHz Band-Edge Emission

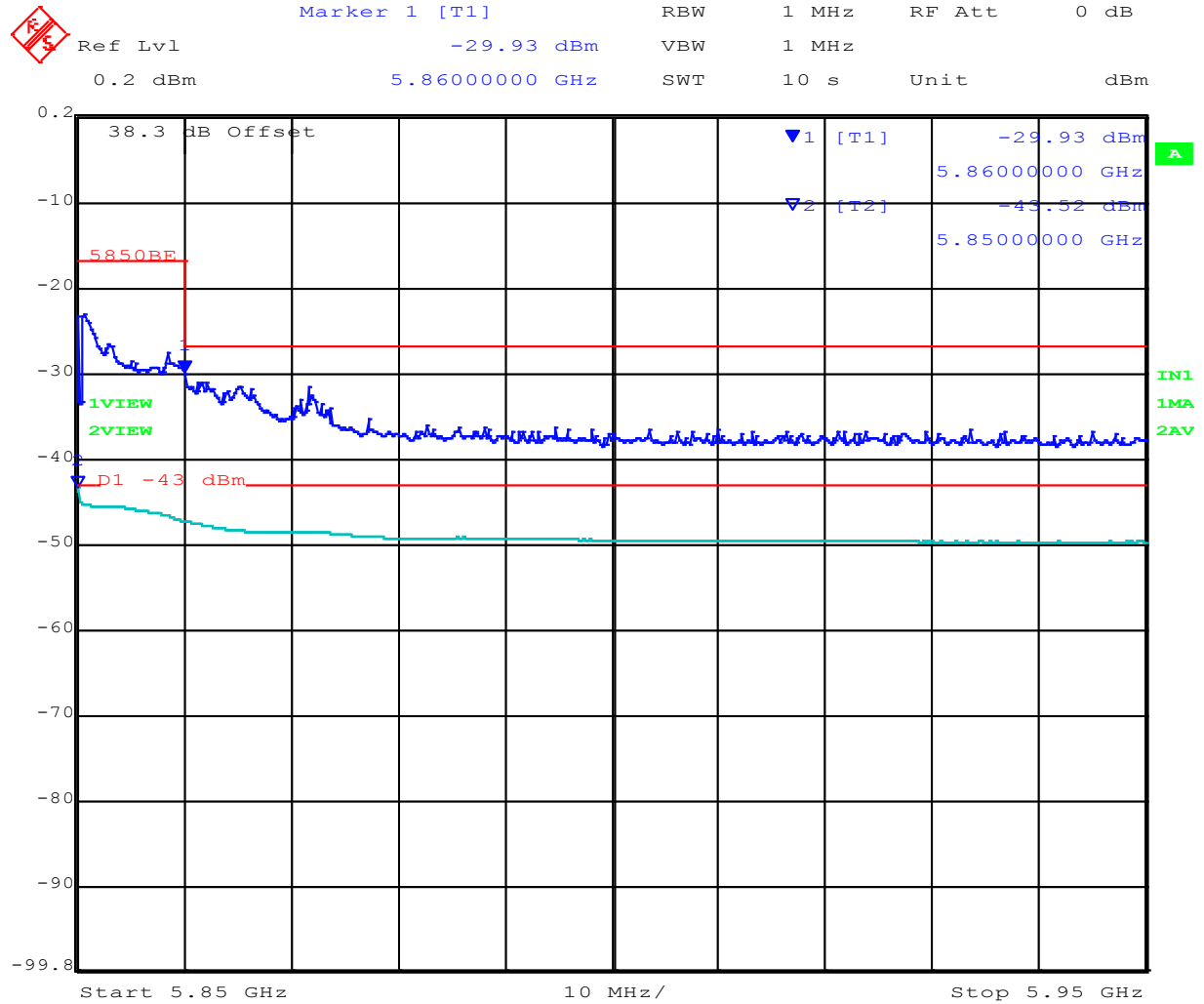

Date: 1.JAN.1997 01:43:01

This test report may be reproduced in full only. The document may only be updated by MiCOM Labs personnel. All changes will be noted in the Document History section of the report.



Title: Mimosa Networks A5 Wireless Access Point
To: FCC CFR 47 Part 15 Subpart E 15.407
Serial #: MIMO05-6a Rev A
Issue Date: 4th November 2015
Page: 105 of 372

Equipment Configuration for Restricted Lower Band-Edge Emissions

Antenna:	Circular Polarized	Variant:	802.11ac-80
Antenna Gain (dBi):	8.00	Modulation:	OFDM
Beam Forming Gain (Y):	Not Applicable	Duty Cycle (%):	100
Channel Frequency (MHz):	5195.00	Data Rate:	29.30 MBit/s
Power Setting:	5	Tested By:	JMH

Test Measurement Results

Num	Frequency MHz	Raw dBµV	Cable Loss	AF dB	Level dBµV/m	Measurement Type	Pol	Hgt cm	Azt Deg	Limit dBµV/m	Margin dB	Pass /Fail
#1	5144.79	72.09	3.69	-11.60	64.18	Max Peak	Vertical	182	110	74.0	-9.8	Pass
#2	5147.39	52.52	3.68	-11.59	44.61	Max Avg	Vertical	182	110	54.0	-9.4	Pass

Test Notes: EUT at 150cm connected to laptop, powered by Pihong POE PS. 8.0 dBi Antenna

This test report may be reproduced in full only. The document may only be updated by MiCOM Labs personnel. All changes will be noted in the Document History section of the report.



Title: Mimosa Networks A5 Wireless Access Point
To: FCC CFR 47 Part 15 Subpart E 15.407
Serial #: MIMO05-6a Rev A
Issue Date: 4th November 2015
Page: 106 of 372

Equipment Configuration for Restricted Lower Band-Edge Emissions

Antenna:	Circular Polarized	Variant:	802.11ac-80
Antenna Gain (dBi):	8.00	Modulation:	OFDM
Beam Forming Gain (Y):	Not Applicable	Duty Cycle (%):	100
Channel Frequency (MHz):	5530.00	Data Rate:	29.30 MBit/s
Power Setting:	12	Tested By:	JMH

Test Measurement Results

Num	Frequency MHz	Raw dB μ V	Cable Loss	AF dB	Level dB μ V/m	Measurement Type	Pol	Hgt cm	Azt Deg	Limit dB μ V/m	Margin dB	Pass /Fail
#1	5459.56	74.44	3.79	-11.22	67.01	Max Peak	Horizontal	196	198	74.0	-7.0	Pass
#2	5459.78	60.52	3.79	-11.22	53.09	Max Avg	Horizontal	196	198	54.0	-0.9	Pass

Test Notes: EUT at 150cm powered by pihong POE. Antenna 8.0 dBi

This test report may be reproduced in full only. The document may only be updated by MiCOM Labs personnel. All changes will be noted in the Document History section of the report.



Title: Mimosa Networks A5 Wireless Access Point
To: FCC CFR 47 Part 15 Subpart E 15.407
Serial #: MIMO05-6a Rev A
Issue Date: 4th November 2015
Page: 107 of 372

Equipment Configuration for Restricted Upper Band-Edge Emissions

Antenna:	Circular Polarized	Variant:	802.11ac-80
Antenna Gain (dBi):	8.00	Modulation:	OFDM
Beam Forming Gain (Y):	Not Applicable	Duty Cycle (%):	100
Channel Frequency (MHz):	5310.00	Data Rate:	29.30 MBit/s
Power Setting:	0	Tested By:	JMH

Test Measurement Results

Num	Frequency MHz	Raw dBµV	Cable Loss	AF dB	Level dBµV/m	Measurement Type	Pol	Hgt cm	Azt Deg	Limit dBµV/m	Margin dB	Pass /Fail
#1	5350.00	75.35	3.70	-11.02	68.03	Max Peak	Vertical	193	133	74.0	-6.0	Pass
#2	5351.76	60.70	3.71	-11.03	53.38	Max Avg	Vertical	193	133	54.0	-0.6	Pass

Test Notes: EUT at 150cm connected to laptop, powered by Pihong POE PS. 8.0 dBi Antenna,

This test report may be reproduced in full only. The document may only be updated by MiCOM Labs personnel. All changes will be noted in the Document History section of the report.



802.11ac-80 5725 MHz Band-Edge Emission

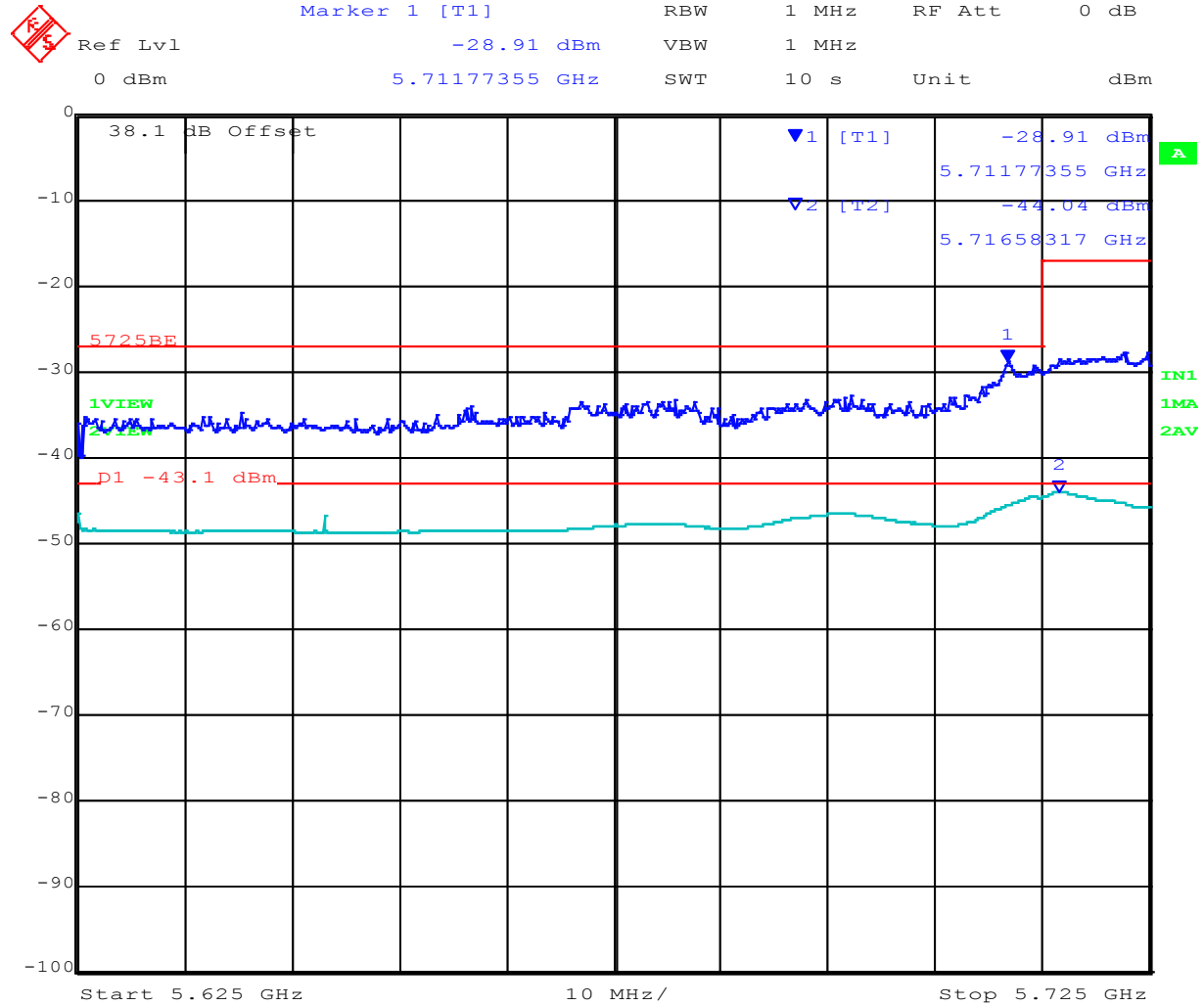

Date: 1.JAN.1997 00:42:27

This test report may be reproduced in full only. The document may only be updated by MiCOM Labs personnel. All changes will be noted in the Document History section of the report.



802.11ac-80 5850 MHz Band-Edge Emission

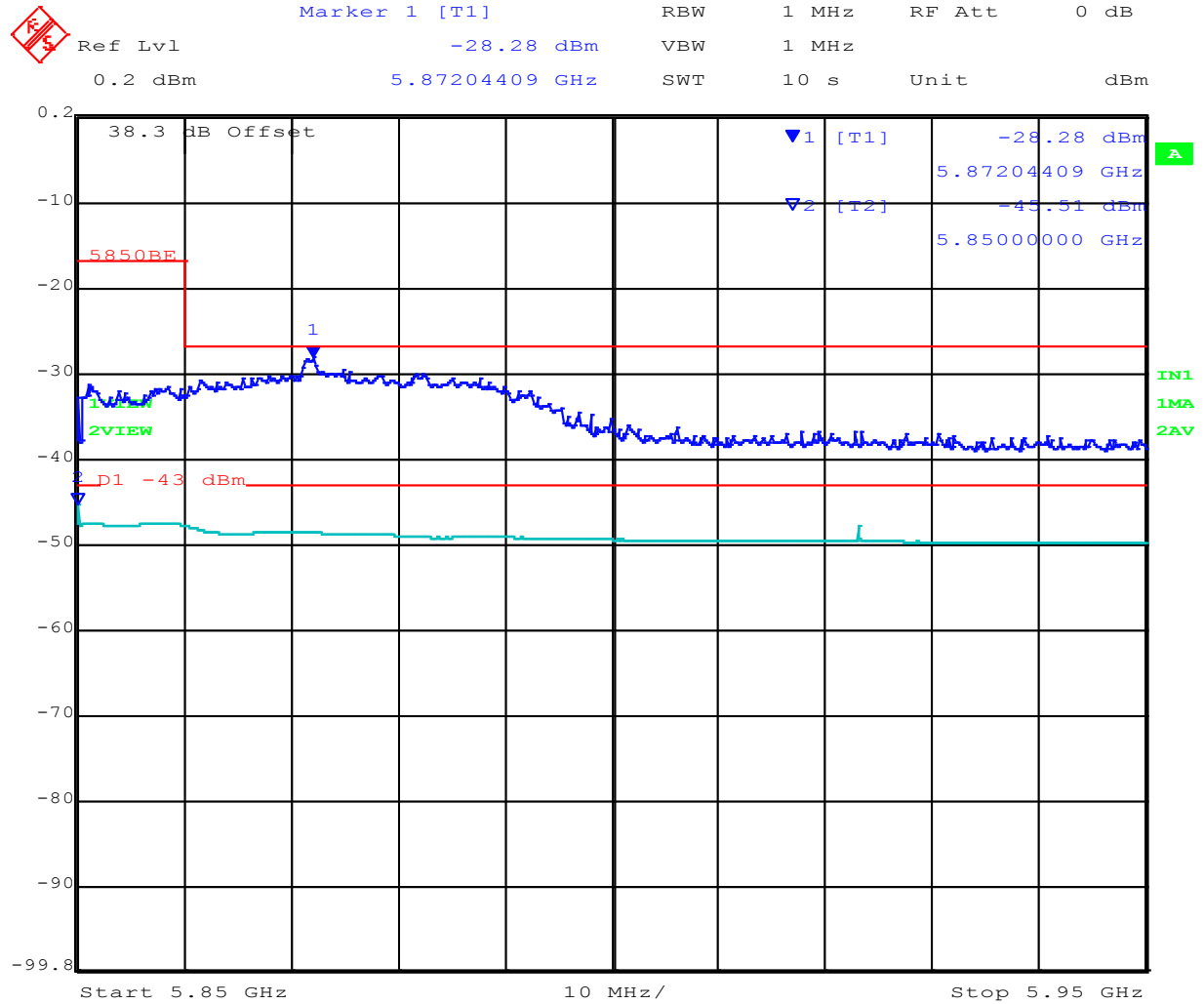

Date: 1.JAN.1997 01:49:20

This test report may be reproduced in full only. The document may only be updated by MiCOM Labs personnel. All changes will be noted in the Document History section of the report.



Title: Mimosa Networks A5 Wireless Access Point
To: FCC CFR 47 Part 15 Subpart E 15.407
Serial #: MIMO05-6a Rev A
Issue Date: 4th November 2015
Page: 110 of 372

9.4.3. Digital Emissions

Radiated Test Conditions for Radiated Digital Emissions (0.03 – 1 GHz)			
Standard:	FCC CFR 47:15.247	Ambient Temp. (°C):	20.0 - 24.5
Test Heading:	Digital Emissions	Rel. Humidity (%):	32 - 45
Standard Section(s):	15.209	Pressure (mBars):	999 - 1001
Reference Document(s):	See Normative References		

Test Procedure for Radiated Digital Emissions (0.03 – 1 GHz)

Testing 30M-1 GHz was performed in a 3-meter anechoic chamber using a CISPR compliant receiver. Preliminary radiated emissions were measured on every azimuth and with the receiving antenna in both horizontal and vertical polarizations. To further maximize emissions the receive antenna was varied between 1 and 4 meters. The emissions are recorded with receiver in peak hold mode. Emissions closest to the limits are measured in the quasi-peak mode with the tuned receiver using a bandwidth of 120 kHz. Only the highest emissions relative to the limit are listed.

Test configuration and setup for Radiated Spurious and Band-Edge Measurement were per the Radiated Test Set-up specified in this document.

Field Strength Calculation

The field strength is calculated by adding the Antenna Factor and Cable Loss, and subtracting Amplifier Gain from the measured reading. In this test facility, the Antenna Factor, Cable Loss, and Amplifier Gains are loaded into the Rohde & Schwarz Receiver and the corrected field strength can be read directly on the receiver.

$$FS = R + AF + CORR$$

where:

FS = Field Strength

R = Measured Receiver Input Amplitude

AF = Antenna Factor

CORR = Correction Factor = CL – AG + NFL

CL = Cable Loss

AG = Amplifier Gain

For example:

Given a Receiver input reading of 51.5dBmV; Antenna Factor of 8.5dB; Cable Loss of 1.3dB; Falloff Factor of 0dB, an Amplifier Gain of 26dB and Notch Filter Loss of 1dB. The Field Strength of the measured emission is:

$$FS = 51.5 + 8.5 + 1.3 - 26.0 + 1 = 36.3\text{dBmV/m}$$

Conversion between dBmV/m (or dBmV) and mV/m (or mV) are done as:

$$\text{Level (dBmV/m)} = 20 * \text{Log (level (mV/m))}$$

$$40 \text{ dBmV/m} = 100\text{mV/m}$$

$$48 \text{ dBmV/m} = 250\text{mV/m}$$

Limits for Radiated Digital Emissions (0.03 – 1 GHz) (15.209)

This test report may be reproduced in full only. The document may only be updated by MiCOM Labs personnel. All changes will be noted in the Document History section of the report.



Title: Mimosa Networks A5 Wireless Access Point
To: FCC CFR 47 Part 15 Subpart E 15.407
Serial #: MIMO05-6a Rev A
Issue Date: 4th November 2015
Page: 111 of 372

(a) Except as provided elsewhere in this subpart, the emissions from an intentional radiator shall not exceed the field strength levels specified in the following table:

Frequency (MHz)	Field Strength		Measurement Distance (m)
	$\mu\text{V/m}$ (microvolts/meter)	$\text{dB}\mu\text{V/m}$ (dB microvolts/meter)	
0.009-0.490	2400/F(kHz)	--	300
0.490-1.705	24000/F(kHz)	--	30
1.705-30.0	30	29.5	30
30-88	100**	40	3
88-216	150**	43.5	3
216-960	200**	46.0	3
Above 960	500	54.0	3

**Except as provided in paragraph (g), fundamental emissions from intentional radiators operating under this section shall not be located in the frequency bands 54-72 MHz, 76-88 MHz, 174-216 MHz or 470-806 MHz. However, operation within these frequency bands is permitted under other sections of this part, e.g., §§15.231 and 15.241.

(b) In the emission table above, the tighter limit applies at the band edges. (c) The level of any unwanted emissions from an intentional radiator operating under these general provisions shall not exceed the level of the fundamental emission. For intentional radiators which operate under the provisions of other sections within this part and which are required to reduce their unwanted emissions to the limits specified in this table, the limits in this table are based on the frequency of the unwanted emission and not the fundamental frequency. However, the level of any unwanted emissions shall not exceed the level of the fundamental frequency. (d) The emission limits shown in the above table are based on measurements employing a CISPR quasi-peak detector except for the frequency bands 9-90 kHz, 110-490 kHz and above 1000 MHz. Radiated emission limits in these three bands are based on measurements employing an average detector. (e) The provisions in §§15.31, 15.33, and 15.35 for measuring emissions at distances other than the distances specified in the above table, determining the frequency range over which radiated emissions are to be measured, and limiting peak emissions apply to all devices operated under this part. (f) In accordance with §15.33(a), in some cases the emissions from an intentional radiator must be measured to beyond the tenth harmonic of the highest fundamental frequency designed to be emitted by the intentional radiator because of the incorporation of a digital device. If measurements above the tenth harmonic are so required, the radiated emissions above the tenth harmonic shall comply with the general radiated emission limits applicable to the incorporated digital device, as shown in §15.109 and as based on the frequency of the emission being measured, or, except for emissions contained in the restricted frequency bands shown in §15.205, the limit on spurious emissions specified for the intentional radiator, whichever is the higher limit. Emissions which must be measured above the tenth harmonic of the highest fundamental frequency designed to be emitted by the intentional radiator and which fall within the restricted bands shall comply with the general radiated emission limits in §15.109 that are applicable to the incorporated digital device. (g) Perimeter protection systems may operate in the 54-72 MHz and 76-88 MHz bands under the provisions of this section. The use of such perimeter protection systems is limited to industrial, business and commercial applications.

This test report may be reproduced in full only. The document may only be updated by MiCOM Labs personnel. All changes will be noted in the Document History section of the report.



Title: Mimosa Networks A5 Wireless Access Point
To: FCC CFR 47 Part 15 Subpart E 15.407
Serial #: MIMO05-6a Rev A
Issue Date: 4th November 2015
Page: 112 of 372



Variant: Dig Em, Test Freq: 30-1000 MHz, Antenna: 5 dBi, Power Setting: NA, Duty Cycle (%): NA

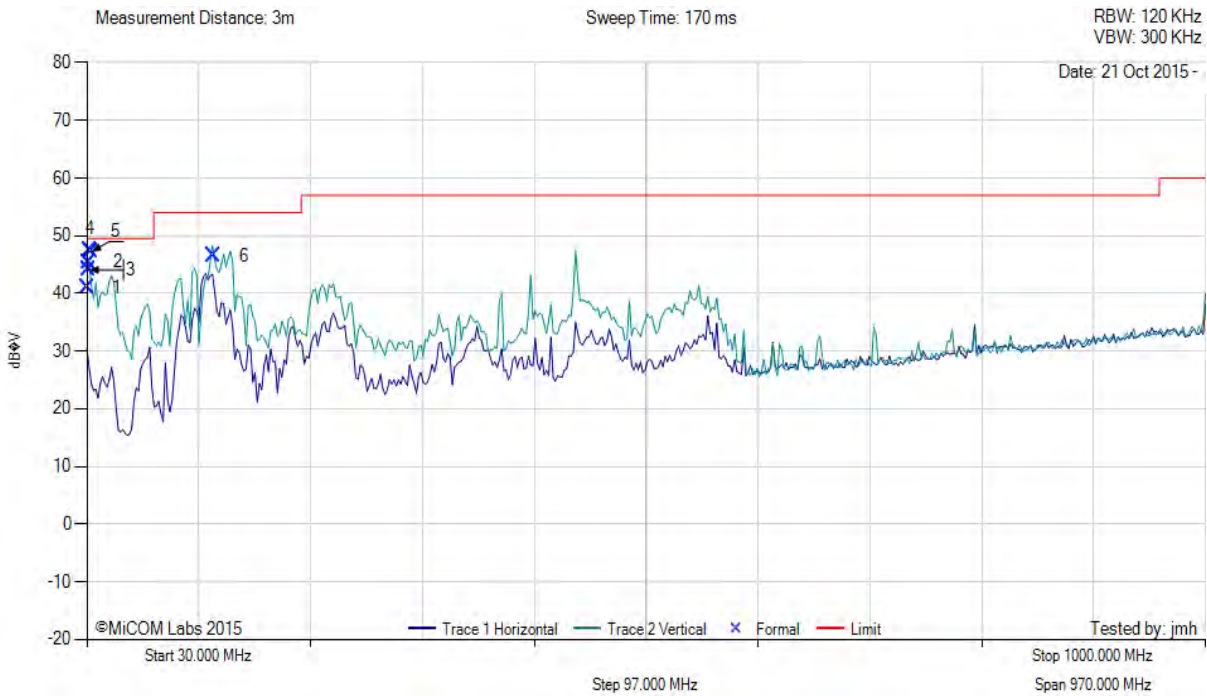

Num	Frequency MHz	Raw dBµV	Cable Loss	AF dB	Level dBµV/m	Measurement Type	Pol	Hgt cm	Azt Deg	Limit dBµV/m	Margin dB	Pass /Fail
1	30.70	48.14	3.43	-10.61	40.96	MaxQP	Vertical	101	352	49.5	-8.5	Pass
2	31.20	52.62	3.43	-10.61	45.44	MaxQP	Vertical	100	351	49.5	-4.1	Pass
3	31.72	51.87	3.44	-11.21	44.10	MaxQP	Vertical	100	11	49.5	-5.4	Pass
4	33.01	56.23	3.44	-12.09	47.60	MaxQP	Vertical	150	51	49.5	-1.9	Pass
5	33.51	56.55	3.45	-12.88	47.20	MaxQP	Vertical	150	54	49.5	-2.3	Pass
6	140.24	60.59	4.08	-18.15	46.52	MaxQP	Vertical	100	155	54.0	-7.5	Pass

Test Notes: EUT connected to POE (PhiHong POE50U-560DG) on ground-plane with long (100m) shielded cat6 ethernet. Laptop connected to POE also on ground-plane. (Remotely located device setup – ANSI C63.4 (2014) 6.2.3.2)....

This test report may be reproduced in full only. The document may only be updated by MiCOM Labs personnel. All changes will be noted in the Document History section of the report.



Title: Mimosa Networks A5 Wireless Access Point
To: FCC CFR 47 Part 15 Subpart E 15.407
Serial #: MIMO05-6a Rev A
Issue Date: 4th November 2015
Page: 113 of 372

9.5. ac Wireline Emissions

**FCC, Part 15 Subpart C §15.207
RSS-247**

Test Procedure

The EUT is configured in accordance with ANSI C63.4. The conducted emissions are measured in a shielded room with a spectrum analyzer in peak hold in the first instance. Emissions closest to the limit are measured in the quasi-peak mode (QP) with the tuned receiver using a bandwidth of 9 kHz. The emissions are maximized further by cable manipulation. The highest emissions relative to the limit are listed.

This test report may be reproduced in full only. The document may only be updated by MiCOM Labs personnel. All changes will be noted in the Document History section of the report.



Title: Mimosa Networks A5 Wireless Access Point
To: FCC CFR 47 Part 15 Subpart E 15.407
Serial #: MIMO05-6a Rev A
Issue Date: 4th November 2015
Page: 114 of 372

Measurement Results for ac Wireline Conducted Emissions (150 kHz – 30 MHz)

Model Number	A5 Rev1	Engineer	JMH
Variant	AC Wireline 120V	Temp (°C)	25
Freq. Range	0.150 MHz - 30 MHz	Rel. Hum.(%)	37
Power Setting	N/A	Press. (mBars)	1005
Antenna			
Test Notes 1	PhiHong POE PS Model POE61U-560DG Output 56V DC 1.1 A		
Test Notes 2	Class A Limits		

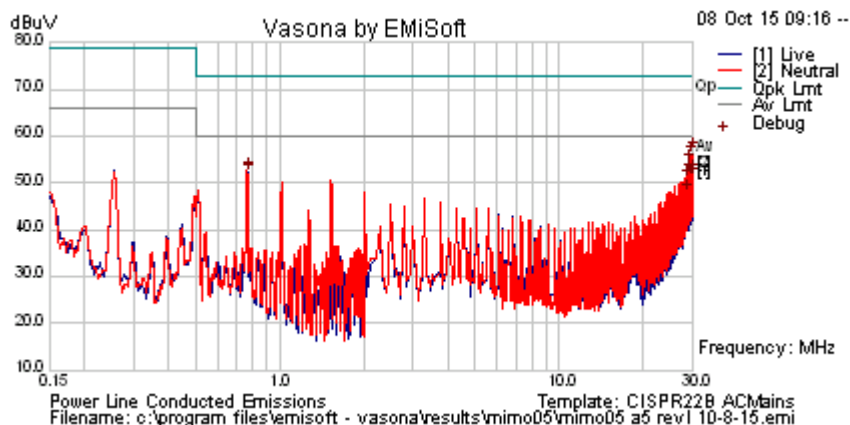

Formally measured emission peaks

Frequency MHz	Raw dBuV	Cable Loss	Factors dB	Level dBuV	Measurement Type	Line	Limit dBuV	Margin dB	Pass /Fail	Comments
0.763	42.8	9.8	0.090	52.630	Quasi Peak	NEutral	73	-20.4	Pass	
0.763	42.2	9.8	0.090	52.040	Average	Neutral	60	-8.0	Pass	
28.447	40.4	9.7	0.940	50.930	Quasi Peak	Neutral	73	-22.1	Pass	
28.447	37.1	9.7	0.9	47.7	Average	Neutral	60	-12.4	Pass	
28.954	43.6	9.7	0.9	54.2	Quasi Peak	Neutral	73	-18.8	Pass	
28.954	41.5	9.7	0.9	52.1	Average	Neutral	60	-7.9	Pass	
29.464	40.6	9.7	0.9	51.2	Average	Neutral	60	-8.8	Pass	
29.464	45.4	9.7	0.9	55.9	Quasi Peak	Neutral	73	-17.1	Pass	
29.973	41.5	9.7	0.9	52.1	Average	Neutral	60	-7.9	Pass	
29.973	46.0	9.7	0.9	56.6	Quasi Peak	Neutral	73	-16.4	Pass	
29.776	40.6	9.7	0.9	51.2	Peak [Scan]	Neutral	60	-8.8	Pass	

Legend: DIG = Digital Device Emission; TX = Transmitter Emission; FUND = Fundamental Frequency
 NRB = Non-Restricted Band, Limit is 20 dB below Fundamental; RB = Restricted Band

This test report may be reproduced in full only. The document may only be updated by MiCOM Labs personnel. All changes will be noted in the Document History section of the report.



Title: Mimosa Networks A5 Wireless Access Point
To: FCC CFR 47 Part 15 Subpart E 15.407
Serial #: MIMO05-6a Rev A
Issue Date: 4th November 2015
Page: 115 of 372

A. APPENDIX - GRAPHICAL IMAGES

This test report may be reproduced in full only. The document may only be updated by MiCOM Labs personnel. All changes will be noted in the Document History section of the report.



A.1. 26 dB & 99% Bandwidth



26 dB & 99% BANDWIDTH

Variant: 802.11a, Channel: 5165.00 MHz, Chain a, Temp: Ambient, Voltage: 48 Vdc

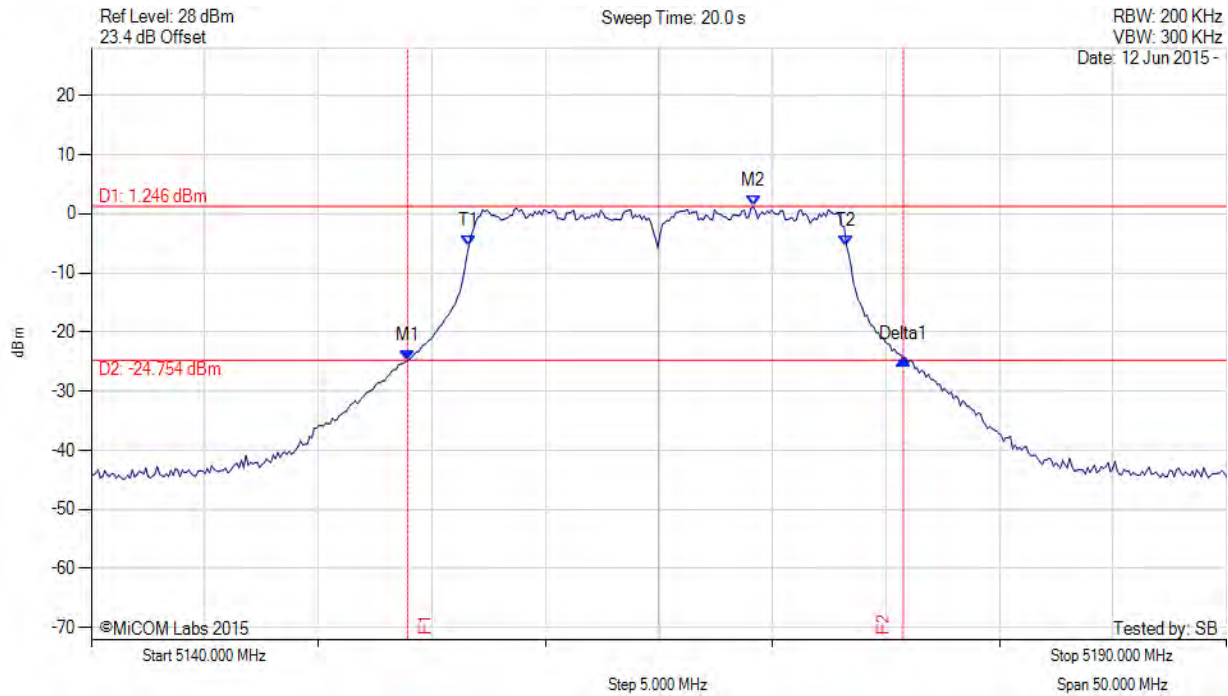

Analyser Setup	Marker:Frequency:Amplitude	Test Results
Detector = MAX PEAK Sweep Count = 0 RF Atten (dB) = 20 Trace Mode = MAX HOLD	M1 : 5153.928 MHz : -24.800 dBm M2 : 5169.158 MHz : 1.246 dBm Delta1 : 21.844 MHz : 0.254 dB T1 : 5156.633 MHz : -5.384 dBm T2 : 5173.267 MHz : -5.421 dBm OBW : 16.633 MHz	Measured 26 dB Bandwidth: 21.844 MHz Measured 99% Bandwidth: 16.633 MHz

[back to matrix](#)

This test report may be reproduced in full only. The document may only be updated by MiCOM Labs personnel. All changes will be noted in the Document History section of the report.



Title: Mimosa Networks A5 Wireless Access Point
To: FCC CFR 47 Part 15 Subpart E 15.407
Serial #: MIMO05-6a Rev A
Issue Date: 4th November 2015
Page: 117 of 372



26 dB & 99% BANDWIDTH

Variant: 802.11a, Channel: 5165.00 MHz, Chain a, Temp: Ambient, Voltage: 48 Vdc

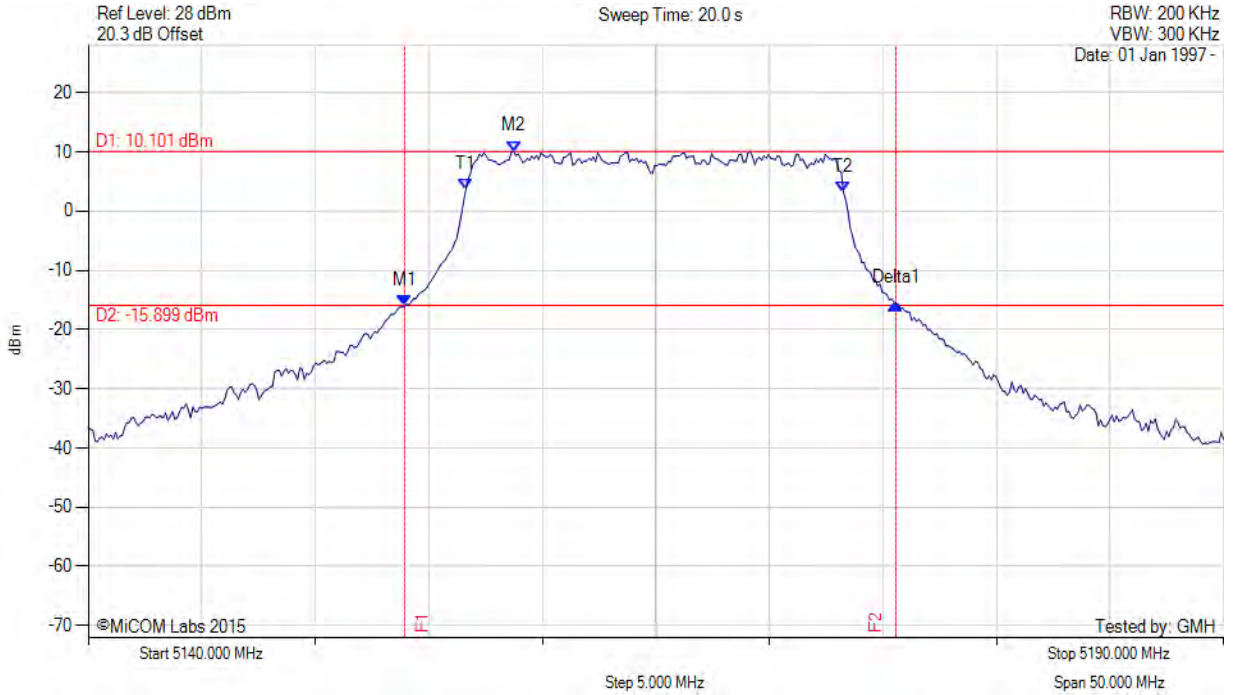

Analyser Setup	Marker:Frequency:Amplitude	Test Results
Detector = MAX PEAK Sweep Count = 0 RF Atten (dB) = 20 Trace Mode = MAX HOLD	M1 : 5153.928 MHz : -16.047 dBm M2 : 5158.737 MHz : 10.101 dBm Delta1 : 21.643 MHz : 0.435 dB T1 : 5156.633 MHz : 3.660 dBm T2 : 5173.267 MHz : 3.168 dBm OBW : 16.633 MHz	Channel Frequency: 5165.00 MHz

[back to matrix](#)

This test report may be reproduced in full only. The document may only be updated by MiCOM Labs personnel. All changes will be noted in the Document History section of the report.



Title: Mimosa Networks A5 Wireless Access Point
To: FCC CFR 47 Part 15 Subpart E 15.407
Serial #: MIMO05-6a Rev A
Issue Date: 4th November 2015
Page: 118 of 372

26 dB & 99% BANDWIDTH



Variant: 802.11a, Channel: 5165.00 MHz, Chain b, Temp: Ambient, Voltage: 48 Vdc

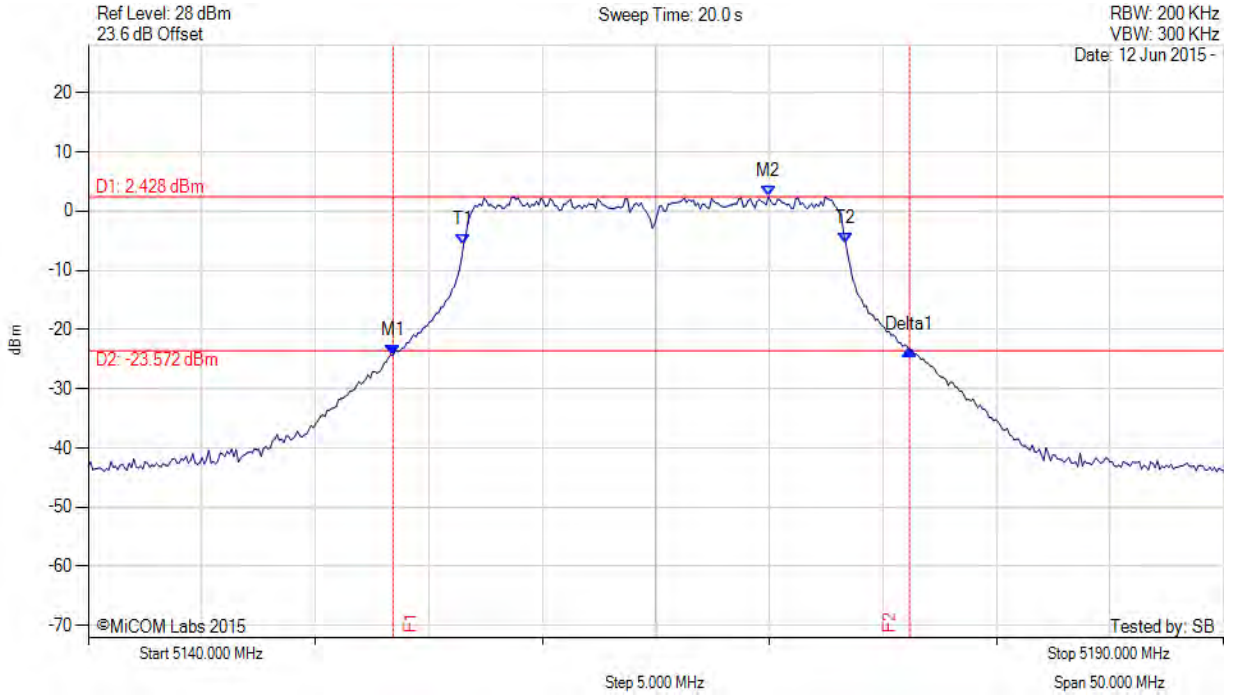

Analyser Setup	Marker:Frequency:Amplitude	Test Results
Detector = MAX PEAK Sweep Count = 0 RF Atten (dB) = 20 Trace Mode = MAX HOLD	M1 : 5153.427 MHz : -24.430 dBm M2 : 5169.960 MHz : 2.428 dBm Delta1 : 22.745 MHz : 0.927 dB T1 : 5156.533 MHz : -5.715 dBm T2 : 5173.367 MHz : -5.445 dBm OBW : 16.834 MHz	Measured 26 dB Bandwidth: 22.745 MHz Measured 99% Bandwidth: 16.834 MHz

[back to matrix](#)

This test report may be reproduced in full only. The document may only be updated by MiCOM Labs personnel. All changes will be noted in the Document History section of the report.



26 dB & 99% BANDWIDTH

Variant: 802.11a, Channel: 5165.00 MHz, Chain c, Temp: Ambient, Voltage: 48 Vdc

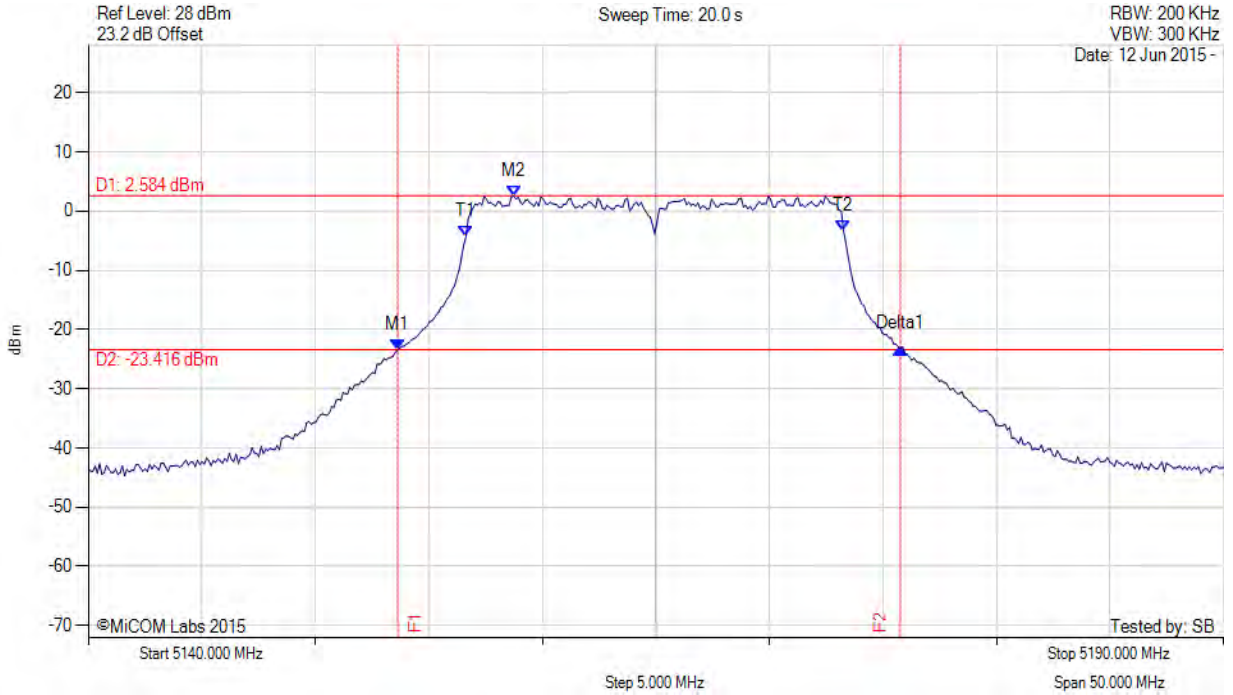

Analyser Setup	Marker:Frequency:Amplitude	Test Results
Detector = MAX PEAK Sweep Count = 0 RF Atten (dB) = 20 Trace Mode = MAX HOLD	M1 : 5153.627 MHz : -23.503 dBm M2 : 5158.737 MHz : 2.584 dBm Delta1 : 22.144 MHz : 0.386 dB T1 : 5156.633 MHz : -4.349 dBm T2 : 5173.267 MHz : -3.320 dBm OBW : 16.633 MHz	Measured 26 dB Bandwidth: 22.144 MHz Measured 99% Bandwidth: 16.633 MHz

[back to matrix](#)

This test report may be reproduced in full only. The document may only be updated by MiCOM Labs personnel. All changes will be noted in the Document History section of the report.



26 dB & 99% BANDWIDTH

Variant: 802.11a, Channel: 5165.00 MHz, Chain d, Temp: Ambient, Voltage: 48 Vdc

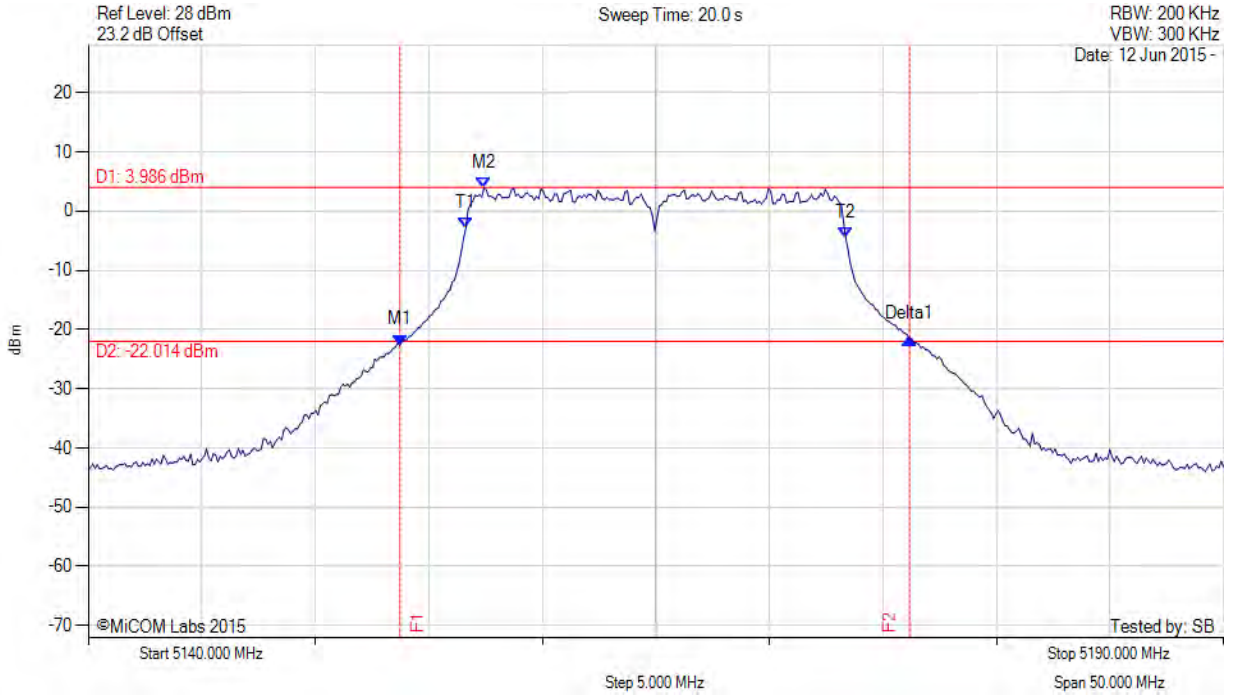

Analyser Setup	Marker:Frequency:Amplitude	Test Results
Detector = MAX PEAK Sweep Count = 0 RF Atten (dB) = 20 Trace Mode = MAX HOLD	M1 : 5153.727 MHz : -22.626 dBm M2 : 5157.435 MHz : 3.986 dBm Delta1 : 22.445 MHz : 0.999 dB T1 : 5156.633 MHz : -2.779 dBm T2 : 5173.367 MHz : -4.577 dBm OBW : 16.733 MHz	Measured 26 dB Bandwidth: 22.445 MHz Measured 99% Bandwidth: 16.733 MHz

[back to matrix](#)

This test report may be reproduced in full only. The document may only be updated by MiCOM Labs personnel. All changes will be noted in the Document History section of the report.



Title: Mimosa Networks A5 Wireless Access Point
To: FCC CFR 47 Part 15 Subpart E 15.407
Serial #: MIMO05-6a Rev A
Issue Date: 4th November 2015
Page: 121 of 372



26 dB & 99% BANDWIDTH

Variant: 802.11a, Channel: 5200.00 MHz, Chain a, Temp: Ambient, Voltage: 48 Vdc

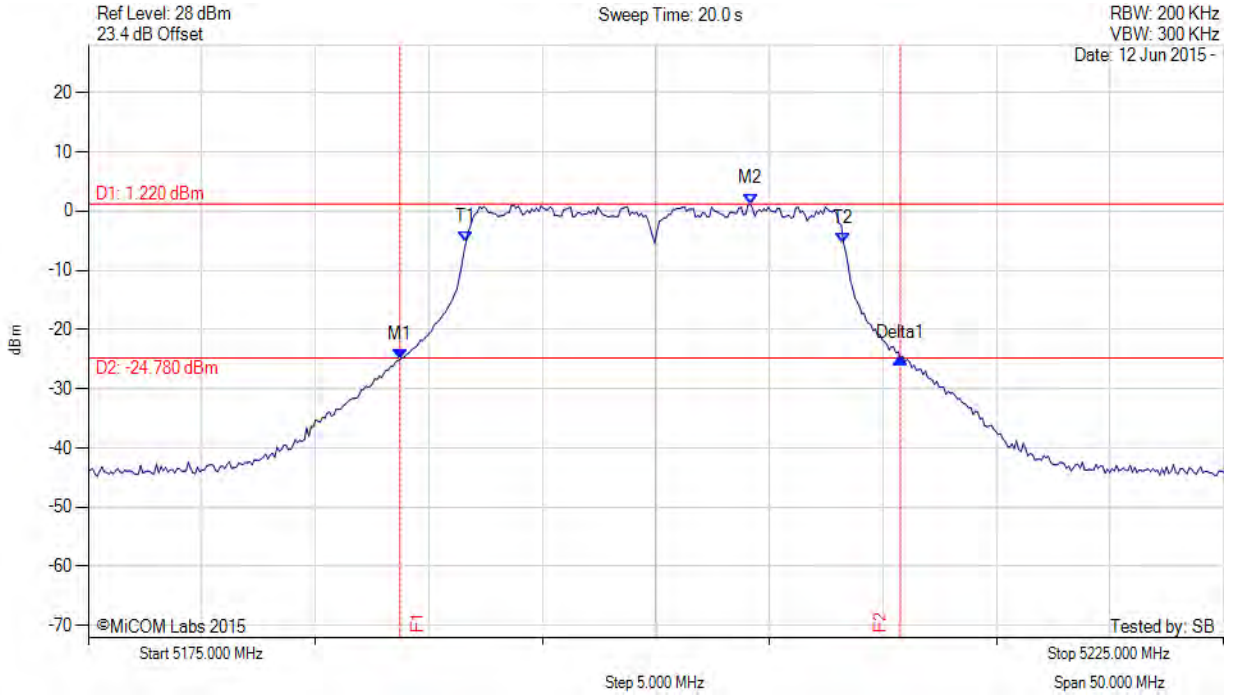

Analyser Setup	Marker:Frequency:Amplitude	Test Results
Detector = MAX PEAK Sweep Count = 0 RF Atten (dB) = 20 Trace Mode = MAX HOLD	M1 : 5188.727 MHz : -25.095 dBm M2 : 5204.158 MHz : 1.220 dBm Delta1 : 22.044 MHz : 0.234 dB T1 : 5191.633 MHz : -5.313 dBm T2 : 5208.267 MHz : -5.386 dBm OBW : 16.633 MHz	Measured 26 dB Bandwidth: 22.044 MHz Measured 99% Bandwidth: 16.633 MHz

[back to matrix](#)

This test report may be reproduced in full only. The document may only be updated by MiCOM Labs personnel. All changes will be noted in the Document History section of the report.



26 dB & 99% BANDWIDTH

Variant: 802.11a, Channel: 5200.00 MHz, Chain a, Temp: Ambient, Voltage: 48 Vdc

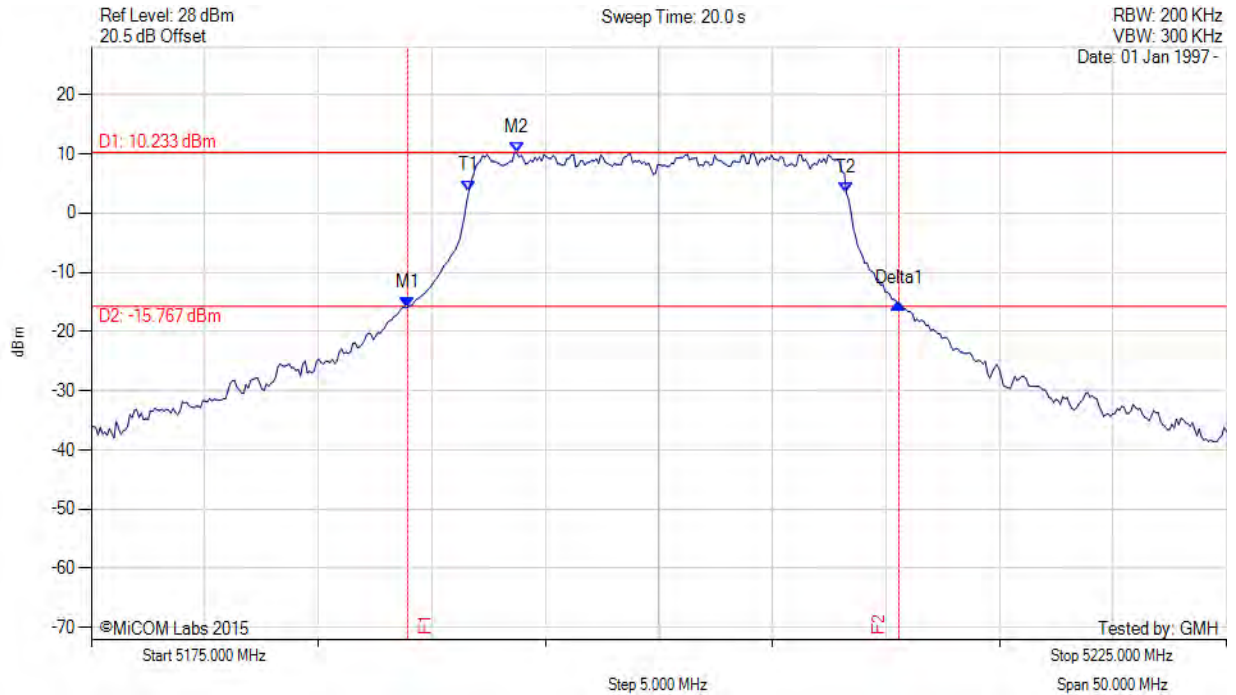

Analyser Setup	Marker:Frequency:Amplitude	Test Results
Detector = MAX PEAK Sweep Count = 0 RF Atten (dB) = 20 Trace Mode = MAX HOLD	M1 : 5188.928 MHz : -15.931 dBm M2 : 5193.737 MHz : 10.233 dBm Delta1 : 21.643 MHz : 0.574 dB T1 : 5191.633 MHz : 3.774 dBm T2 : 5208.267 MHz : 3.343 dBm OBW : 16.633 MHz	Channel Frequency: 5200.00 MHz

[back to matrix](#)

This test report may be reproduced in full only. The document may only be updated by MiCOM Labs personnel. All changes will be noted in the Document History section of the report.



26 dB & 99% BANDWIDTH

Variant: 802.11a, Channel: 5200.00 MHz, Chain b, Temp: Ambient, Voltage: 48 Vdc

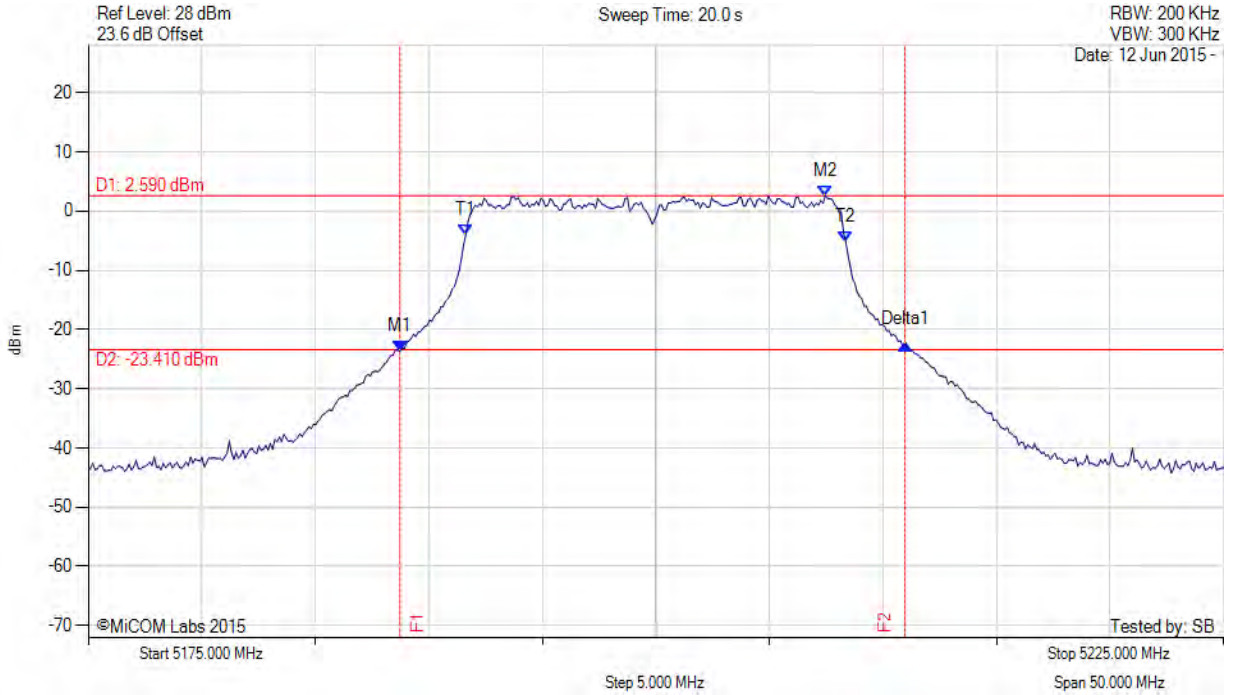

Analyser Setup	Marker:Frequency:Amplitude	Test Results
Detector = MAX PEAK Sweep Count = 0 RF Atten (dB) = 20 Trace Mode = MAX HOLD	M1 : 5188.727 MHz : -23.641 dBm M2 : 5207.465 MHz : 2.590 dBm Delta1 : 22.244 MHz : 1.194 dB T1 : 5191.633 MHz : -3.946 dBm T2 : 5208.367 MHz : -5.286 dBm OBW : 16.733 MHz	Measured 26 dB Bandwidth: 22.244 MHz Measured 99% Bandwidth: 16.733 MHz

[back to matrix](#)

This test report may be reproduced in full only. The document may only be updated by MiCOM Labs personnel. All changes will be noted in the Document History section of the report.



26 dB & 99% BANDWIDTH

Variant: 802.11a, Channel: 5200.00 MHz, Chain c, Temp: Ambient, Voltage: 48 Vdc

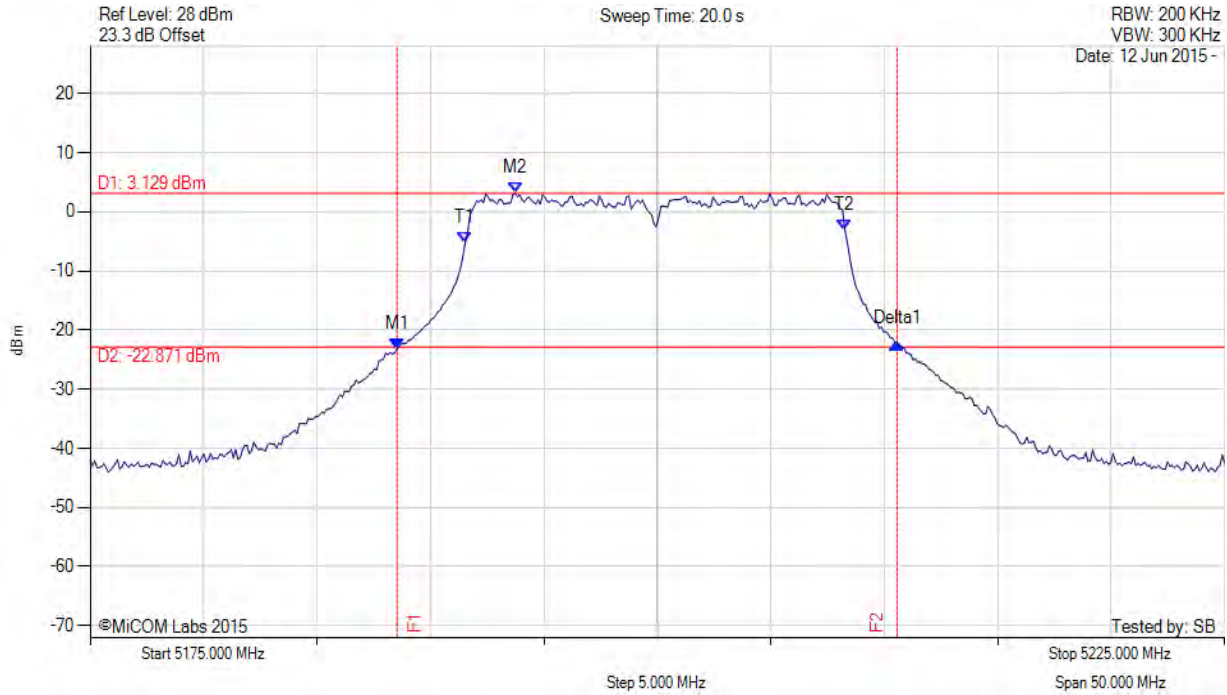

Analyser Setup	Marker:Frequency:Amplitude	Test Results
Detector = MAX PEAK Sweep Count = 0 RF Atten (dB) = 20 Trace Mode = MAX HOLD	M1 : 5188.527 MHz : -23.267 dBm M2 : 5193.737 MHz : 3.129 dBm Delta1 : 22.044 MHz : 1.005 dB T1 : 5191.533 MHz : -5.170 dBm T2 : 5208.267 MHz : -3.017 dBm OBW : 16.733 MHz	Measured 26 dB Bandwidth: 22.044 MHz Measured 99% Bandwidth: 16.733 MHz

[back to matrix](#)

This test report may be reproduced in full only. The document may only be updated by MiCOM Labs personnel. All changes will be noted in the Document History section of the report.



Title: Mimosa Networks A5 Wireless Access Point
To: FCC CFR 47 Part 15 Subpart E 15.407
Serial #: MIMO05-6a Rev A
Issue Date: 4th November 2015
Page: 125 of 372



26 dB & 99% BANDWIDTH

Variant: 802.11a, Channel: 5200.00 MHz, Chain d, Temp: Ambient, Voltage: 48 Vdc

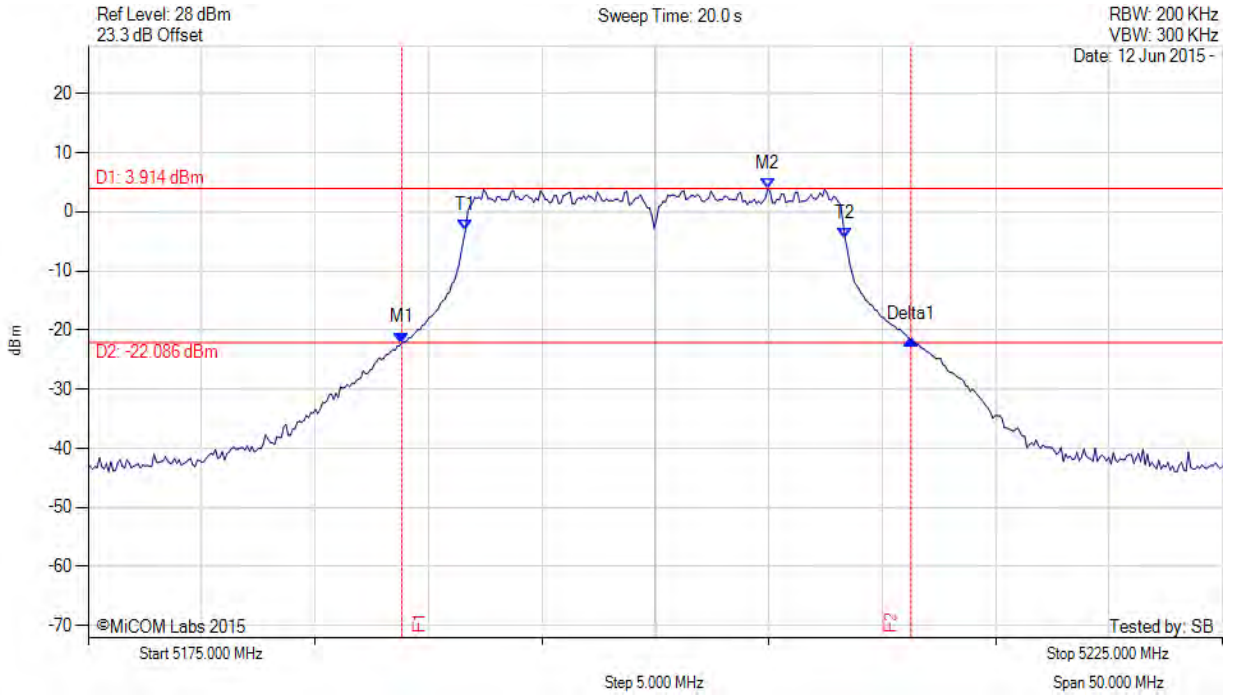

Analyser Setup	Marker:Frequency:Amplitude	Test Results
Detector = MAX PEAK Sweep Count = 0 RF Atten (dB) = 20 Trace Mode = MAX HOLD	M1 : 5188.828 MHz : -22.148 dBm M2 : 5204.960 MHz : 3.914 dBm Delta1 : 22.445 MHz : 0.506 dB T1 : 5191.633 MHz : -3.086 dBm T2 : 5208.367 MHz : -4.489 dBm OBW : 16.733 MHz	Measured 26 dB Bandwidth: 22.445 MHz Measured 99% Bandwidth: 16.733 MHz

[back to matrix](#)

This test report may be reproduced in full only. The document may only be updated by MiCOM Labs personnel. All changes will be noted in the Document History section of the report.



26 dB & 99% BANDWIDTH

Variant: 802.11a, Channel: 5240.00 MHz, Chain a, Temp: Ambient, Voltage: 48 Vdc

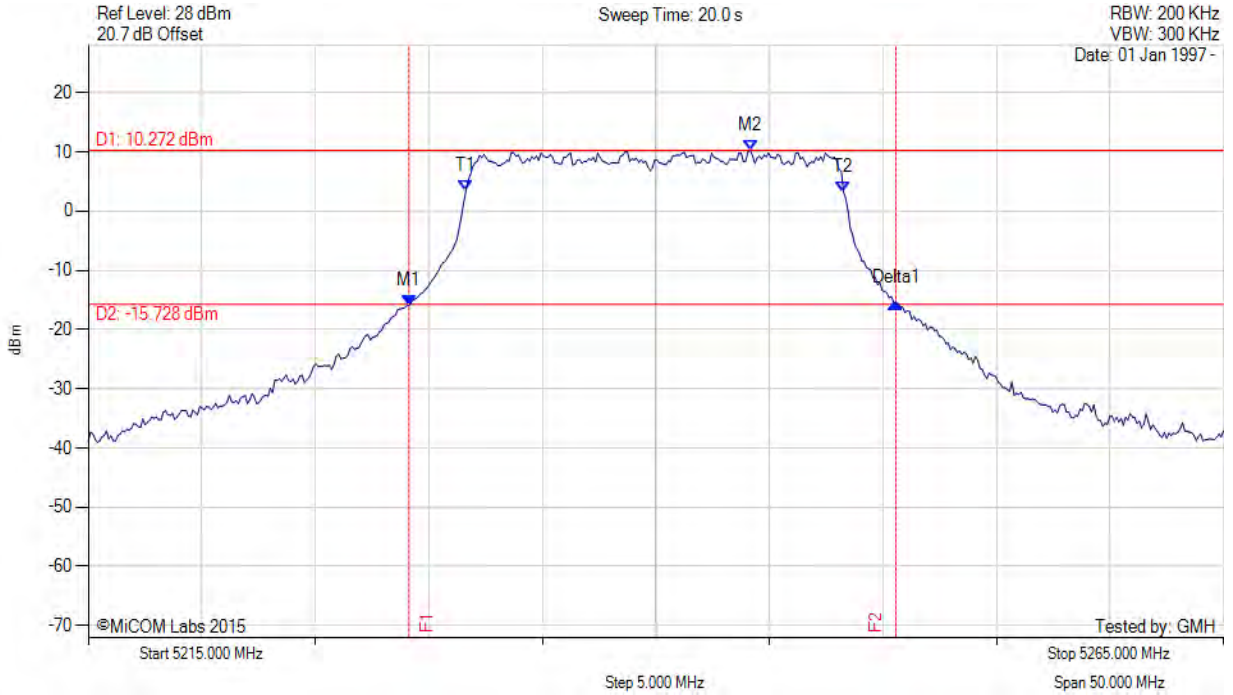

Analyser Setup	Marker:Frequency:Amplitude	Test Results
Detector = MAX PEAK Sweep Count = 0 RF Atten (dB) = 20 Trace Mode = MAX HOLD	M1 : 5229.128 MHz : -15.982 dBm M2 : 5244.158 MHz : 10.272 dBm Delta1 : 21.443 MHz : 0.423 dB T1 : 5231.633 MHz : 3.447 dBm T2 : 5248.267 MHz : 3.251 dBm OBW : 16.633 MHz	Measured 26 dB Bandwidth: 21.443 MHz Measured 99% Bandwidth: 16.633 MHz

[back to matrix](#)

This test report may be reproduced in full only. The document may only be updated by MiCOM Labs personnel. All changes will be noted in the Document History section of the report.



Title: Mimosa Networks A5 Wireless Access Point
To: FCC CFR 47 Part 15 Subpart E 15.407
Serial #: MIMO05-6a Rev A
Issue Date: 4th November 2015
Page: 127 of 372



26 dB & 99% BANDWIDTH

Variant: 802.11a, Channel: 5240.00 MHz, Chain a, Temp: Ambient, Voltage: 48 Vdc

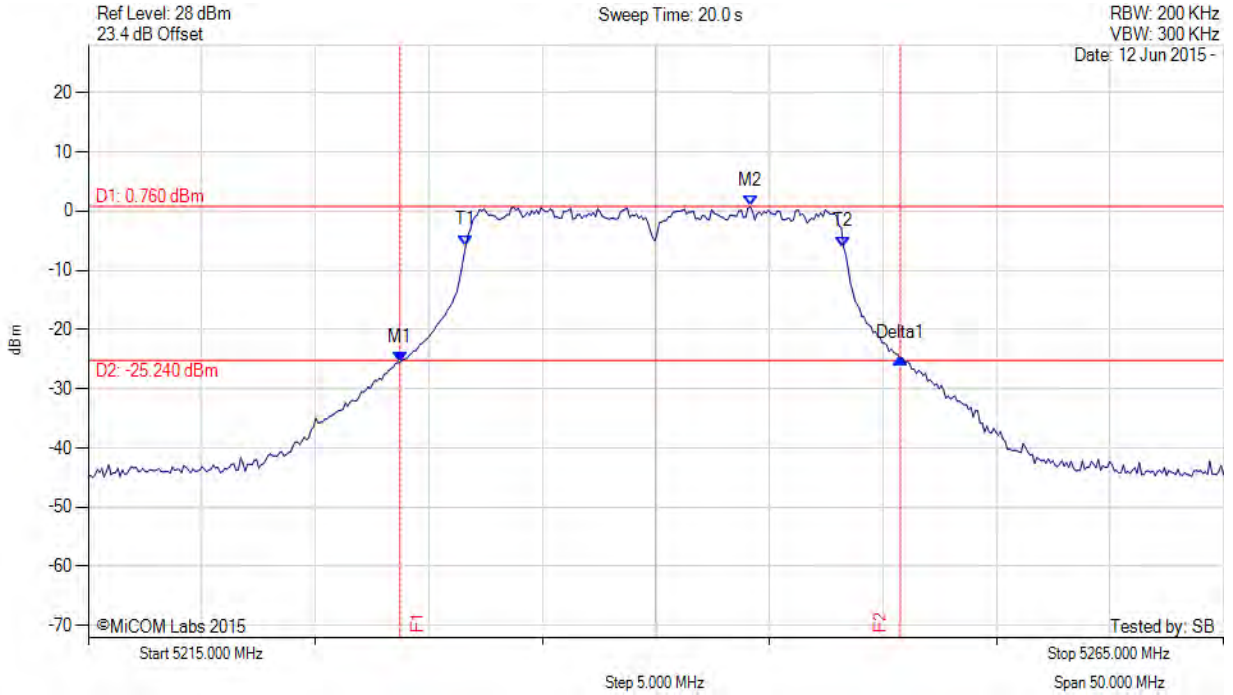

Analyser Setup	Marker:Frequency:Amplitude	Test Results
Detector = MAX PEAK Sweep Count = 0 RF Atten (dB) = 20 Trace Mode = MAX HOLD	M1 : 5228.727 MHz : -25.559 dBm M2 : 5244.158 MHz : 0.760 dBm Delta1 : 22.044 MHz : 0.665 dB T1 : 5231.633 MHz : -5.787 dBm T2 : 5248.267 MHz : -6.029 dBm OBW : 16.633 MHz	Channel Frequency: 5240.00 MHz

[back to matrix](#)

This test report may be reproduced in full only. The document may only be updated by MiCOM Labs personnel. All changes will be noted in the Document History section of the report.



26 dB & 99% BANDWIDTH

Variant: 802.11a, Channel: 5240.00 MHz, Chain b, Temp: Ambient, Voltage: 48 Vdc

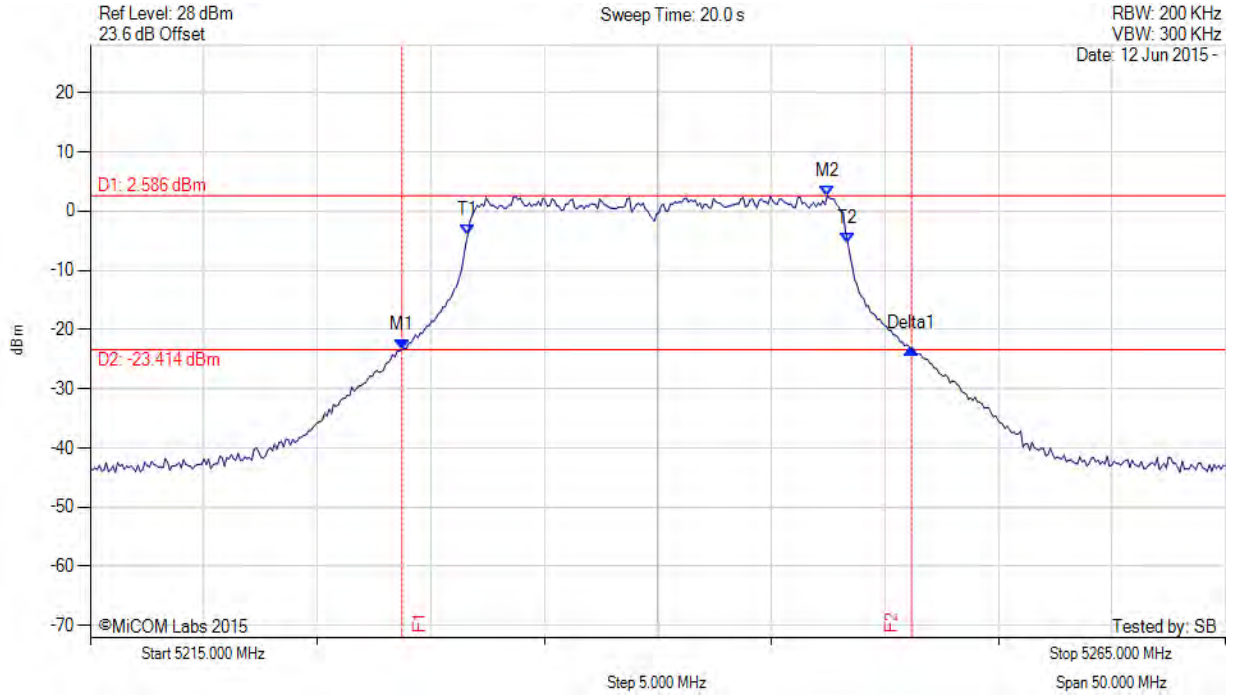

Analyser Setup	Marker:Frequency:Amplitude	Test Results
Detector = MAX PEAK Sweep Count = 0 RF Atten (dB) = 20 Trace Mode = MAX HOLD	M1 : 5228.727 MHz : -23.433 dBm M2 : 5247.465 MHz : 2.586 dBm Delta1 : 22.445 MHz : 0.197 dB T1 : 5231.633 MHz : -4.009 dBm T2 : 5248.367 MHz : -5.351 dBm OBW : 16.733 MHz	Measured 26 dB Bandwidth: 22.445 MHz Measured 99% Bandwidth: 16.733 MHz

[back to matrix](#)

This test report may be reproduced in full only. The document may only be updated by MiCOM Labs personnel. All changes will be noted in the Document History section of the report.



26 dB & 99% BANDWIDTH

Variant: 802.11a, Channel: 5240.00 MHz, Chain c, Temp: Ambient, Voltage: 48 Vdc

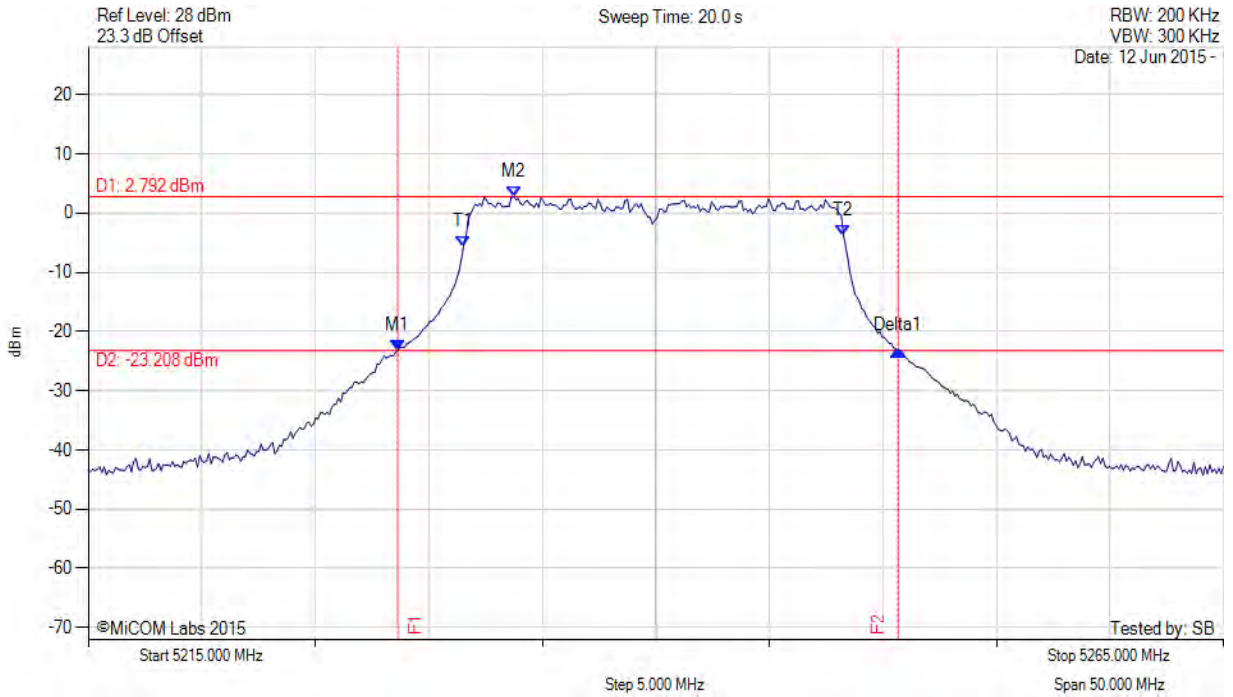

Analyser Setup	Marker:Frequency:Amplitude	Test Results
Detector = MAX PEAK Sweep Count = 0 RF Atten (dB) = 20 Trace Mode = MAX HOLD	M1 : 5228.627 MHz : -23.254 dBm M2 : 5233.737 MHz : 2.792 dBm Delta1 : 22.044 MHz : 0.041 dB T1 : 5231.533 MHz : -5.597 dBm T2 : 5248.267 MHz : -3.737 dBm OBW : 16.733 MHz	Measured 26 dB Bandwidth: 22.044 MHz Measured 99% Bandwidth: 16.733 MHz

[back to matrix](#)

This test report may be reproduced in full only. The document may only be updated by MiCOM Labs personnel. All changes will be noted in the Document History section of the report.



Title: Mimosa Networks A5 Wireless Access Point
To: FCC CFR 47 Part 15 Subpart E 15.407
Serial #: MIMO05-6a Rev A
Issue Date: 4th November 2015
Page: 130 of 372



26 dB & 99% BANDWIDTH

Variant: 802.11a, Channel: 5240.00 MHz, Chain d, Temp: Ambient, Voltage: 48 Vdc

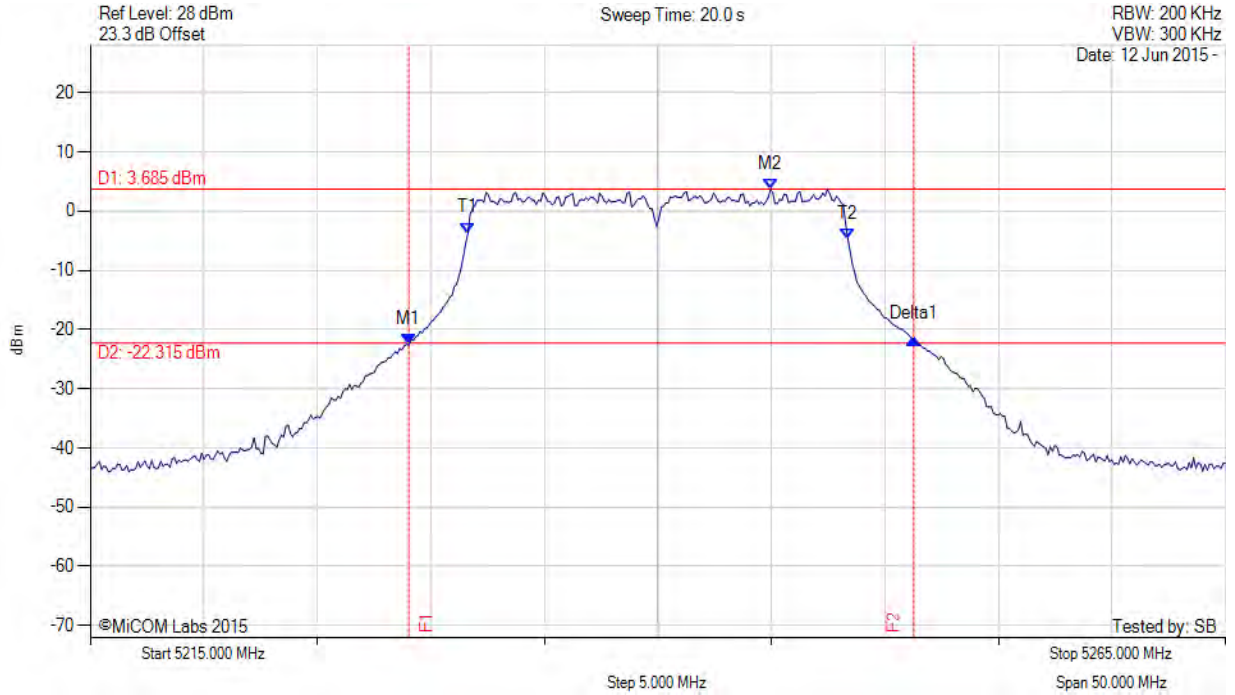

Analyser Setup	Marker:Frequency:Amplitude	Test Results
Detector = MAX PEAK Sweep Count = 0 RF Atten (dB) = 20 Trace Mode = MAX HOLD	M1 : 5229.028 MHz : -22.569 dBm M2 : 5244.960 MHz : 3.685 dBm Delta1 : 22.244 MHz : 0.901 dB T1 : 5231.633 MHz : -3.706 dBm T2 : 5248.367 MHz : -4.688 dBm OBW : 16.733 MHz	Measured 26 dB Bandwidth: 22.244 MHz Measured 99% Bandwidth: 16.733 MHz

[back to matrix](#)

This test report may be reproduced in full only. The document may only be updated by MiCOM Labs personnel. All changes will be noted in the Document History section of the report.



26 dB & 99% BANDWIDTH

Variant: 802.11a, Channel: 5260.00 MHz, Chain a, Temp: Ambient, Voltage: 48 Vdc

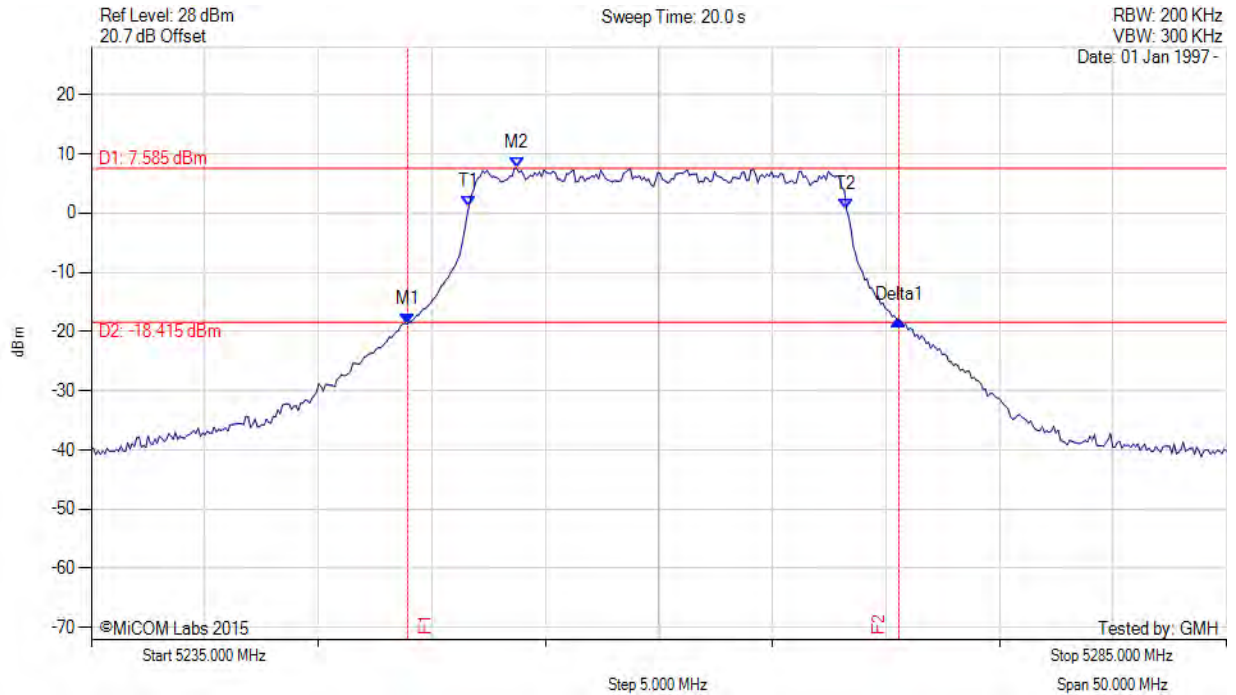

Analyser Setup	Marker:Frequency:Amplitude	Test Results
Detector = MAX PEAK Sweep Count = 0 RF Atten (dB) = 20 Trace Mode = MAX HOLD	M1 : 5248.928 MHz : -18.735 dBm M2 : 5253.737 MHz : 7.585 dBm Delta1 : 21.643 MHz : 0.618 dB T1 : 5251.633 MHz : 1.161 dBm T2 : 5268.267 MHz : 0.593 dBm OBW : 16.633 MHz	Measured 26 dB Bandwidth: 21.643 MHz Measured 99% Bandwidth: 16.633 MHz

[back to matrix](#)

This test report may be reproduced in full only. The document may only be updated by MiCOM Labs personnel. All changes will be noted in the Document History section of the report.



26 dB & 99% BANDWIDTH



Variant: 802.11a, Channel: 5300.00 MHz, Chain a, Temp: Ambient, Voltage: 48 Vdc

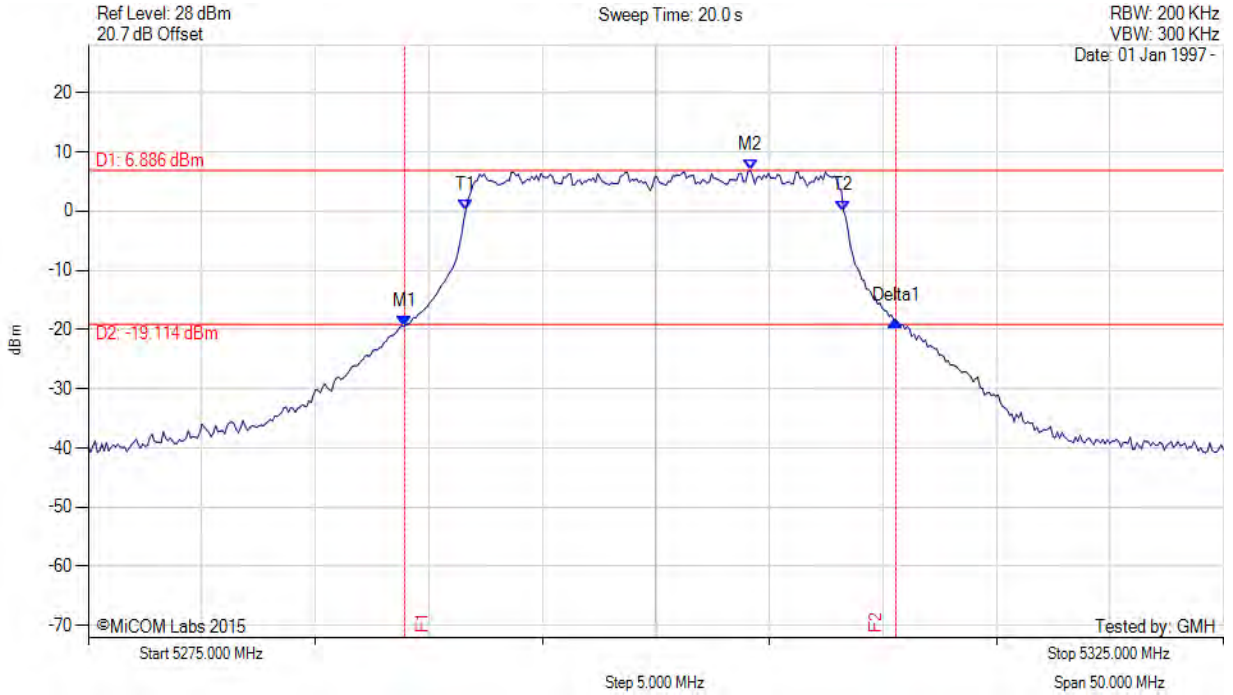

Analyser Setup	Marker:Frequency:Amplitude	Test Results
Detector = MAX PEAK Sweep Count = 0 RF Atten (dB) = 20 Trace Mode = MAX HOLD	M1 : 5288.928 MHz : -19.480 dBm M2 : 5304.158 MHz : 6.886 dBm Delta1 : 21.643 MHz : 1.019 dB T1 : 5291.633 MHz : 0.219 dBm T2 : 5308.267 MHz : 0.054 dBm OBW : 16.633 MHz	Measured 26 dB Bandwidth: 21.643 MHz Measured 99% Bandwidth: 16.633 MHz

[back to matrix](#)

This test report may be reproduced in full only. The document may only be updated by MiCOM Labs personnel. All changes will be noted in the Document History section of the report.



26 dB & 99% BANDWIDTH

Variant: 802.11a, Channel: 5335.00 MHz, Chain a, Temp: Ambient, Voltage: 48 Vdc

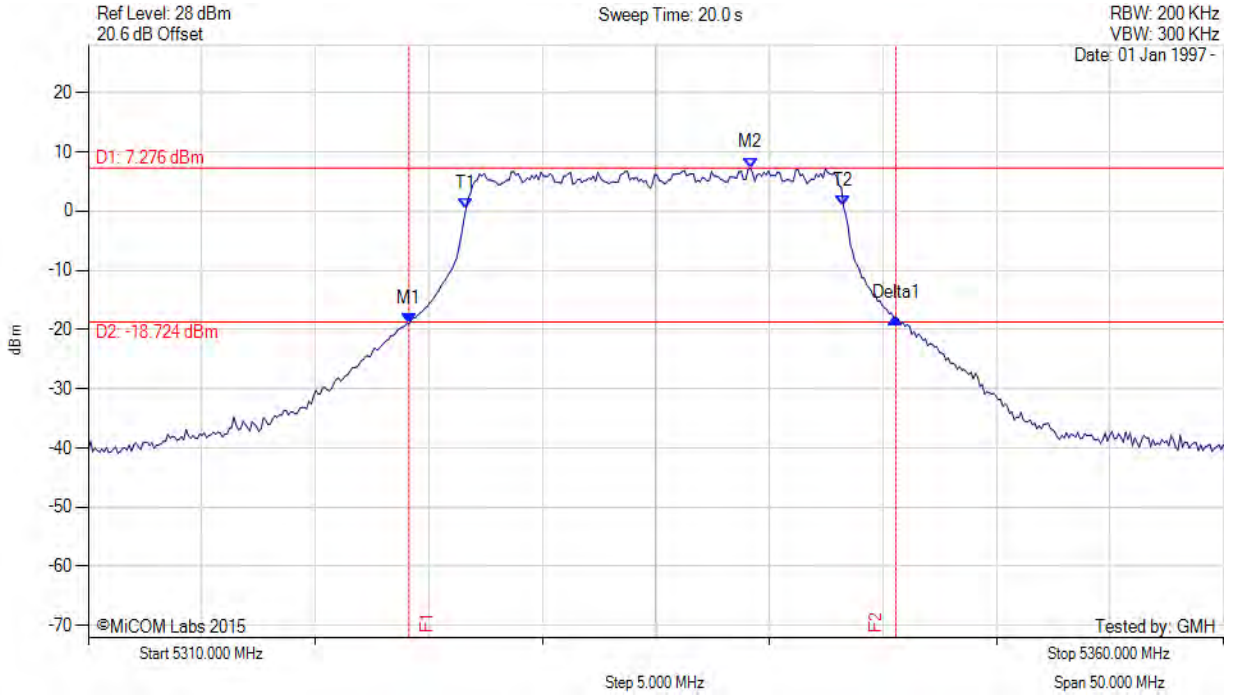

Analyser Setup	Marker:Frequency:Amplitude	Test Results
Detector = MAX PEAK Sweep Count = 0 RF Atten (dB) = 20 Trace Mode = MAX HOLD	M1 : 5324.128 MHz : -19.020 dBm M2 : 5339.158 MHz : 7.276 dBm Delta1 : 21.443 MHz : 1.033 dB T1 : 5326.633 MHz : 0.298 dBm T2 : 5343.267 MHz : 0.760 dBm OBW : 16.633 MHz	Measured 26 dB Bandwidth: 21.443 MHz Measured 99% Bandwidth: 16.633 MHz

[back to matrix](#)

This test report may be reproduced in full only. The document may only be updated by MiCOM Labs personnel. All changes will be noted in the Document History section of the report.



26 dB & 99% BANDWIDTH

Variant: 802.11a, Channel: 5485.00 MHz, Chain a, Temp: Ambient, Voltage: 48 Vdc

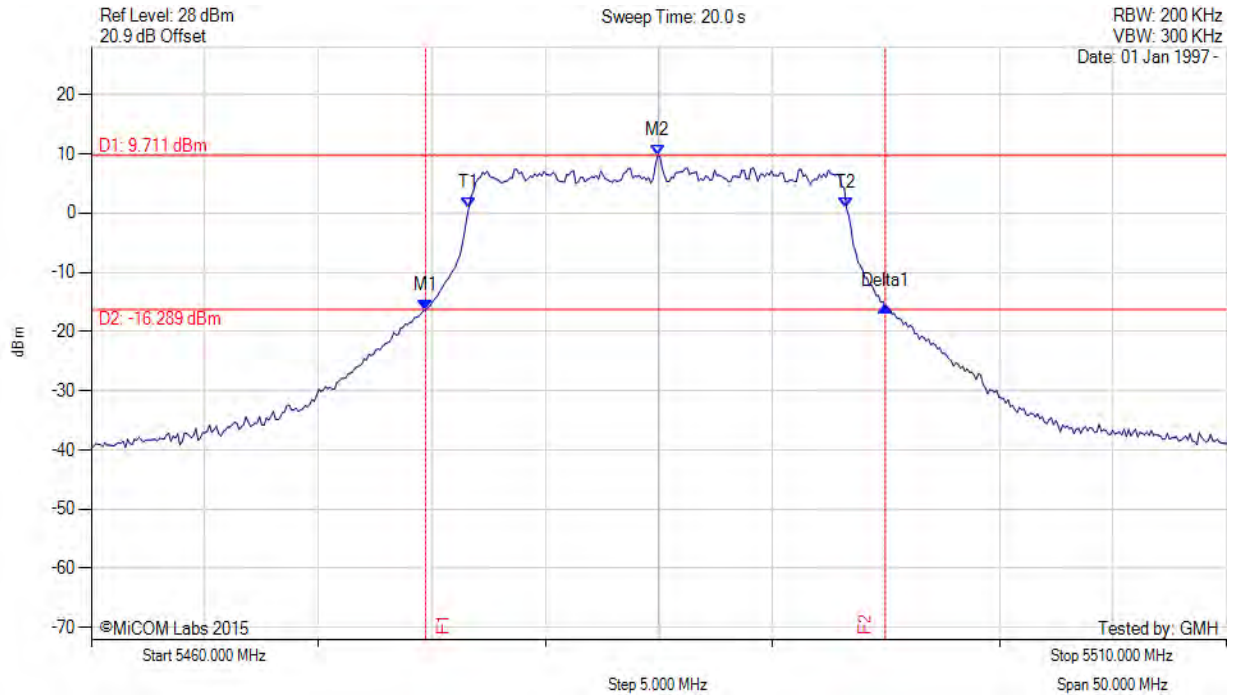

Analyser Setup	Marker:Frequency:Amplitude	Test Results
Detector = MAX PEAK Sweep Count = 0 RF Atten (dB) = 20 Trace Mode = MAX HOLD	M1 : 5474.729 MHz : -16.382 dBm M2 : 5484.950 MHz : 9.711 dBm Delta1 : 20.240 MHz : 0.559 dB T1 : 5476.633 MHz : 0.941 dBm T2 : 5493.267 MHz : 0.856 dBm OBW : 16.633 MHz	Measured 26 dB Bandwidth: 20.240 MHz Measured 99% Bandwidth: 16.633 MHz

[back to matrix](#)

This test report may be reproduced in full only. The document may only be updated by MiCOM Labs personnel. All changes will be noted in the Document History section of the report.



26 dB & 99% BANDWIDTH



Variant: 802.11a, Channel: 5590.00 MHz, Chain a, Temp: Ambient, Voltage: 48 Vdc

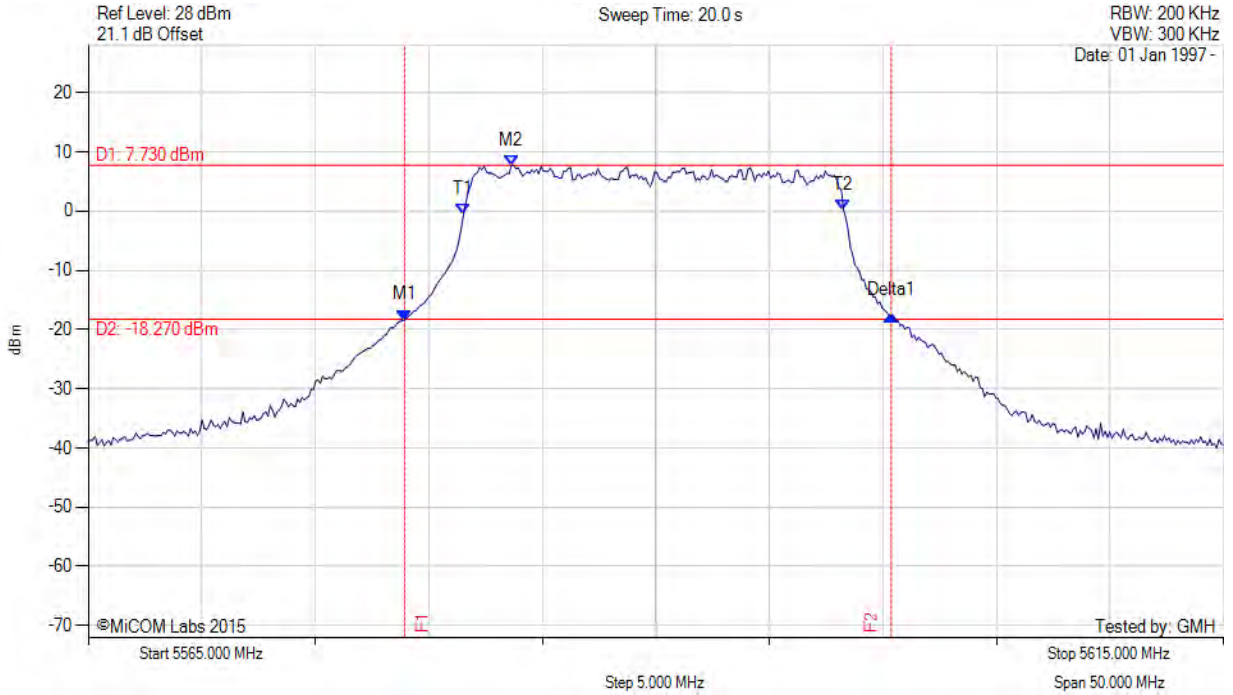

Analyser Setup	Marker:Frequency:Amplitude	Test Results
Detector = MAX PEAK Sweep Count = 0 RF Atten (dB) = 20 Trace Mode = MAX HOLD	M1 : 5578.928 MHz : -18.424 dBm M2 : 5583.637 MHz : 7.730 dBm Delta1 : 21.443 MHz : 0.811 dB T1 : 5581.533 MHz : -0.531 dBm T2 : 5598.267 MHz : 0.197 dBm OBW : 16.733 MHz	Measured 26 dB Bandwidth: 21.443 MHz Measured 99% Bandwidth: 16.733 MHz

[back to matrix](#)

This test report may be reproduced in full only. The document may only be updated by MiCOM Labs personnel. All changes will be noted in the Document History section of the report.



Title: Mimosa Networks A5 Wireless Access Point
To: FCC CFR 47 Part 15 Subpart E 15.407
Serial #: MIMO05-6a Rev A
Issue Date: 4th November 2015
Page: 136 of 372



26 dB & 99% BANDWIDTH

Variant: 802.11a, Channel: 5715.00 MHz, Chain a, Temp: Ambient, Voltage: 48 Vdc

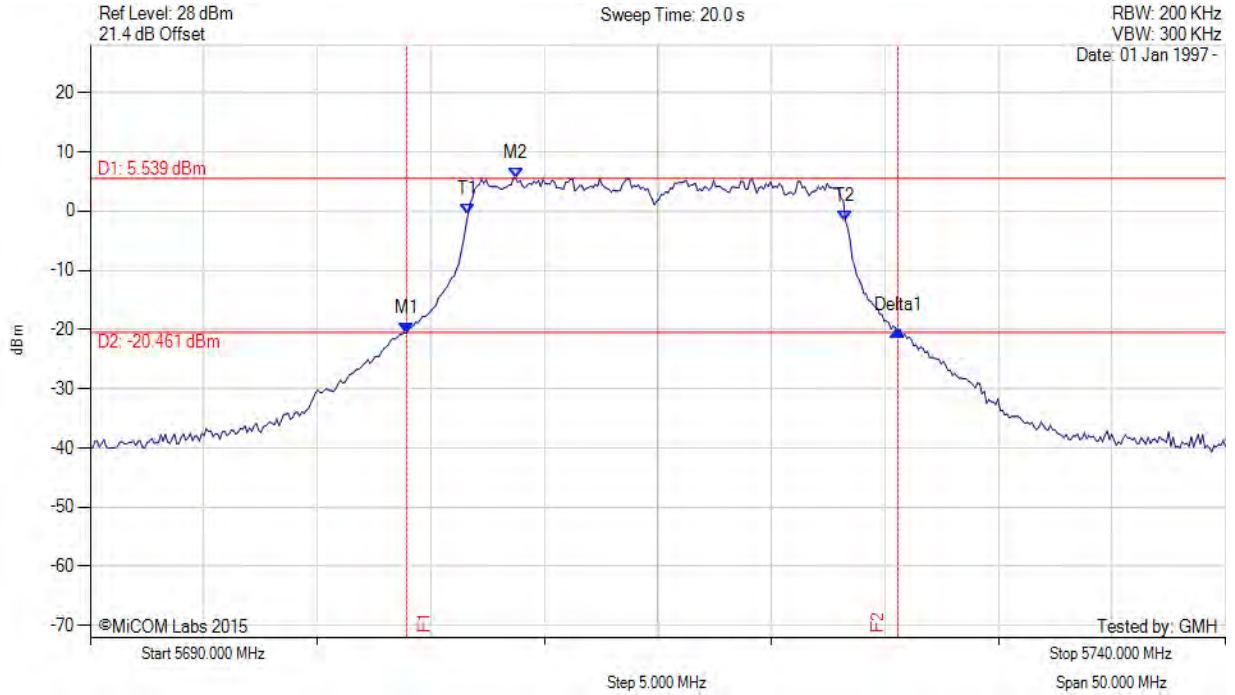

Analyser Setup	Marker:Frequency:Amplitude	Test Results
Detector = MAX PEAK Sweep Count = 0 RF Atten (dB) = 20 Trace Mode = MAX HOLD	M1 : 5703.928 MHz : -20.552 dBm M2 : 5708.737 MHz : 5.539 dBm Delta1 : 21.643 MHz : 0.447 dB T1 : 5706.633 MHz : -0.592 dBm T2 : 5723.267 MHz : -1.666 dBm OBW : 16.633 MHz	Measured 26 dB Bandwidth: 21.643 MHz Measured 99% Bandwidth: 16.633 MHz

[back to matrix](#)

This test report may be reproduced in full only. The document may only be updated by MiCOM Labs personnel. All changes will be noted in the Document History section of the report.



26 dB & 99% BANDWIDTH

Variant: 802.11a, Channel: 5745.00 MHz, Chain a, Temp: Ambient, Voltage: 48 Vdc

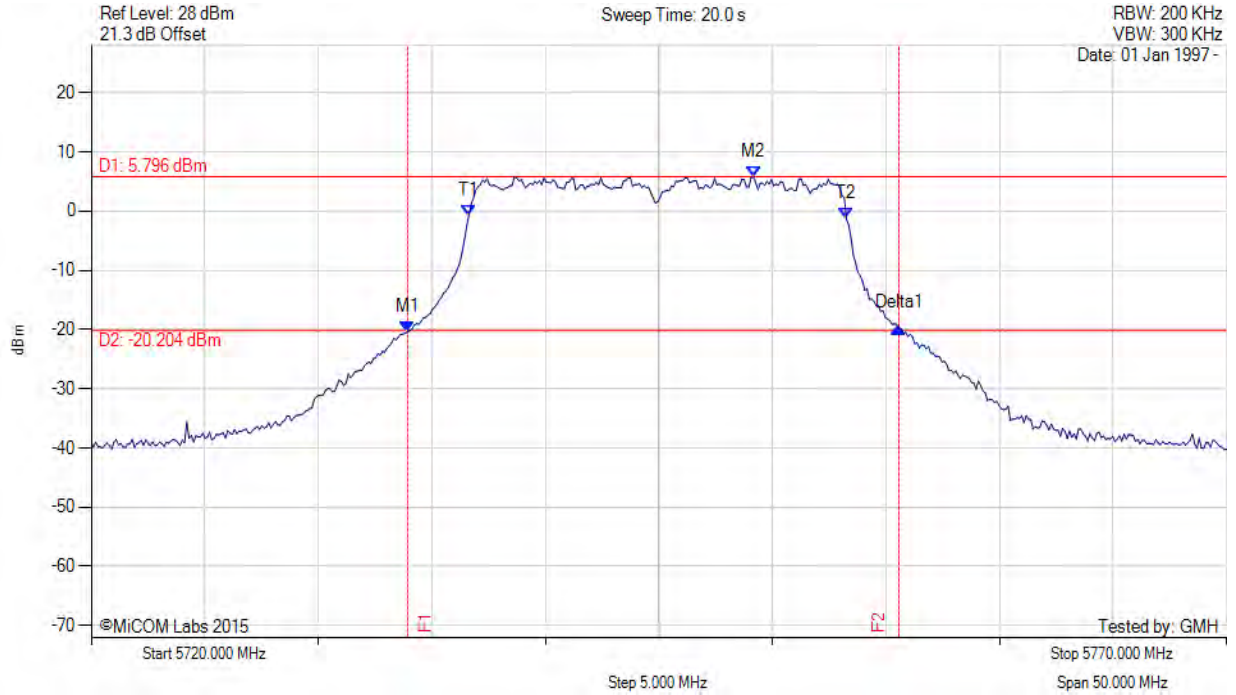

Analyser Setup	Marker:Frequency:Amplitude	Test Results
Detector = MAX PEAK Sweep Count = 0 RF Atten (dB) = 20 Trace Mode = MAX HOLD	M1 : 5733.928 MHz : -20.423 dBm M2 : 5749.158 MHz : 5.796 dBm Delta1 : 21.643 MHz : 0.673 dB T1 : 5736.633 MHz : -0.702 dBm T2 : 5753.267 MHz : -1.335 dBm OBW : 16.633 MHz	Measured 26 dB Bandwidth: 21.643 MHz Measured 99% Bandwidth: 16.633 MHz

[back to matrix](#)

This test report may be reproduced in full only. The document may only be updated by MiCOM Labs personnel. All changes will be noted in the Document History section of the report.



26 dB & 99% BANDWIDTH

Variant: 802.11a, Channel: 5785.00 MHz, Chain a, Temp: Ambient, Voltage: 48 Vdc

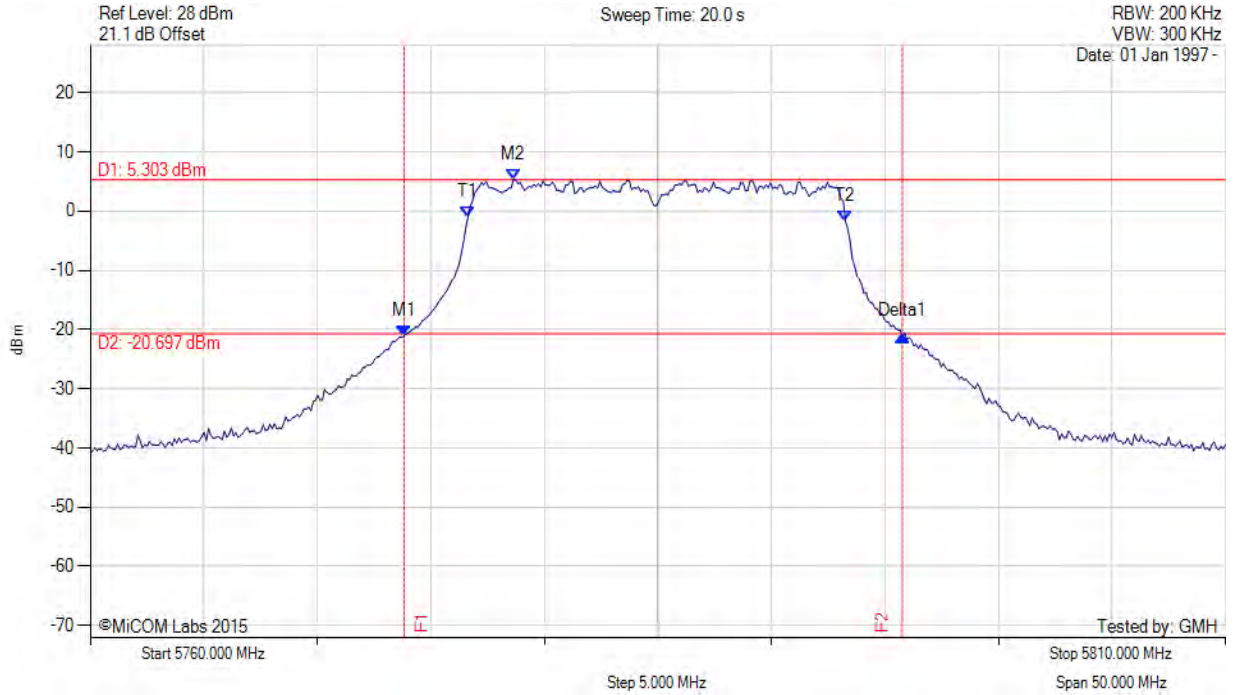

Analyser Setup	Marker:Frequency:Amplitude	Test Results
Detector = MAX PEAK Sweep Count = 0 RF Atten (dB) = 20 Trace Mode = MAX HOLD	M1 : 5773.828 MHz : -21.038 dBm M2 : 5778.637 MHz : 5.303 dBm Delta1 : 21.944 MHz : -0.045 dB T1 : 5776.633 MHz : -1.099 dBm T2 : 5793.267 MHz : -1.774 dBm OBW : 16.633 MHz	Measured 26 dB Bandwidth: 21.944 MHz Measured 99% Bandwidth: 16.633 MHz

[back to matrix](#)

This test report may be reproduced in full only. The document may only be updated by MiCOM Labs personnel. All changes will be noted in the Document History section of the report.



26 dB & 99% BANDWIDTH

Variant: 802.11a, Channel: 5825.00 MHz, Chain a, Temp: Ambient, Voltage: 48 Vdc

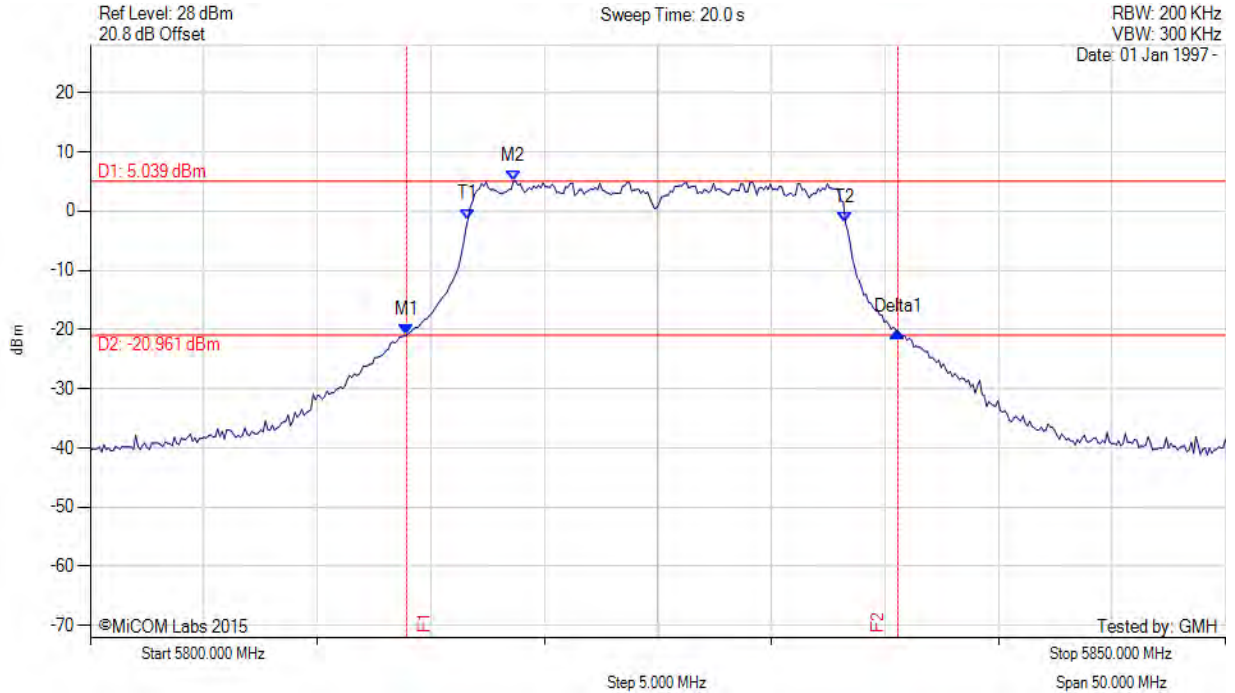

Analyser Setup	Marker:Frequency:Amplitude	Test Results
Detector = MAX PEAK Sweep Count = 0 RF Atten (dB) = 20 Trace Mode = MAX HOLD	M1 : 5813.928 MHz : -20.973 dBm M2 : 5818.637 MHz : 5.039 dBm Delta1 : 21.643 MHz : 0.622 dB T1 : 5816.633 MHz : -1.353 dBm T2 : 5833.267 MHz : -2.014 dBm OBW : 16.633 MHz	Measured 26 dB Bandwidth: 21.643 MHz Measured 99% Bandwidth: 16.633 MHz

[back to matrix](#)

This test report may be reproduced in full only. The document may only be updated by MiCOM Labs personnel. All changes will be noted in the Document History section of the report.



26 dB & 99% BANDWIDTH

Variant: 802.11ac-80, Channel: 5195.00 MHz, Chain a, Temp: Ambient, Voltage: 48 Vdc

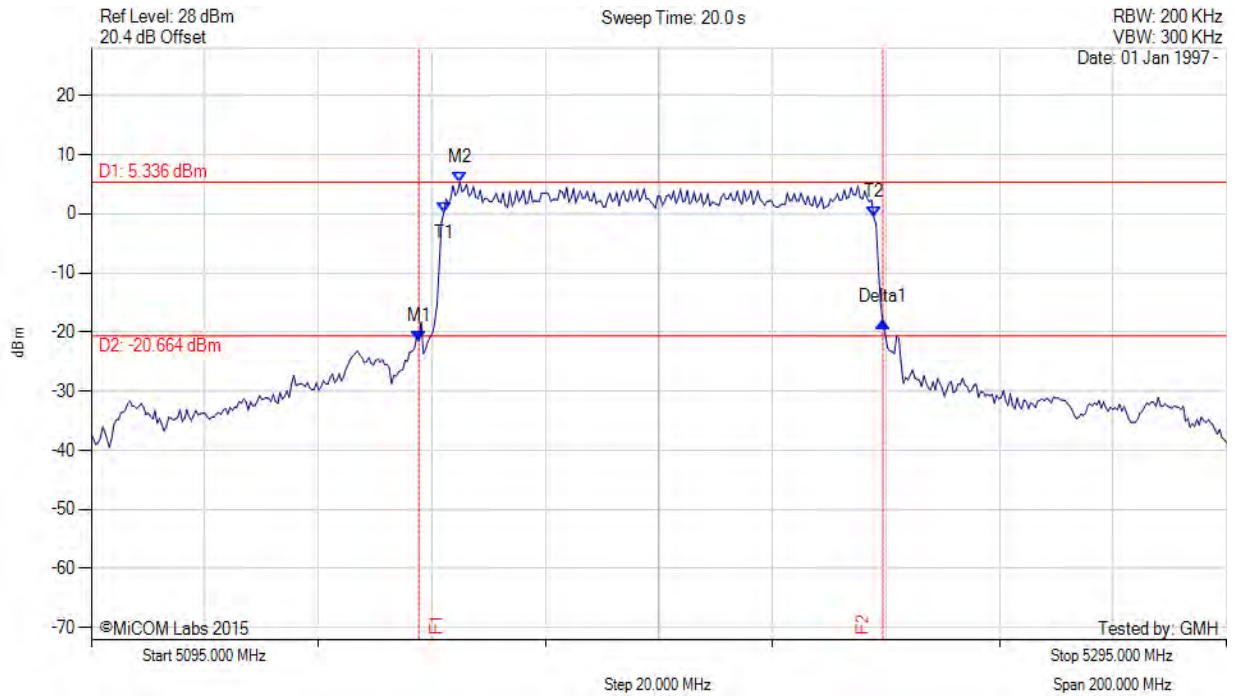

Analyser Setup	Marker:Frequency:Amplitude	Test Results
Detector = MAX PEAK Sweep Count = 0 RF Atten (dB) = 20 Trace Mode = MAX HOLD	M1 : 5152.715 MHz : -21.550 dBm M2 : 5159.930 MHz : 5.336 dBm Delta1 : 81.764 MHz : 3.148 dB T1 : 5157.124 MHz : 0.209 dBm T2 : 5232.876 MHz : -0.603 dBm OBW : 75.752 MHz	Measured 26 dB Bandwidth: 81.764 MHz Measured 99% Bandwidth: 75.752 MHz

[back to matrix](#)

This test report may be reproduced in full only. The document may only be updated by MiCOM Labs personnel. All changes will be noted in the Document History section of the report.



Title: Mimosa Networks A5 Wireless Access Point
To: FCC CFR 47 Part 15 Subpart E 15.407
Serial #: MIMO05-6a Rev A
Issue Date: 4th November 2015
Page: 141 of 372



26 dB & 99% BANDWIDTH

Variant: 802.11ac-80, Channel: 5195.00 MHz, Chain a, Temp: Ambient, Voltage: 48 Vdc

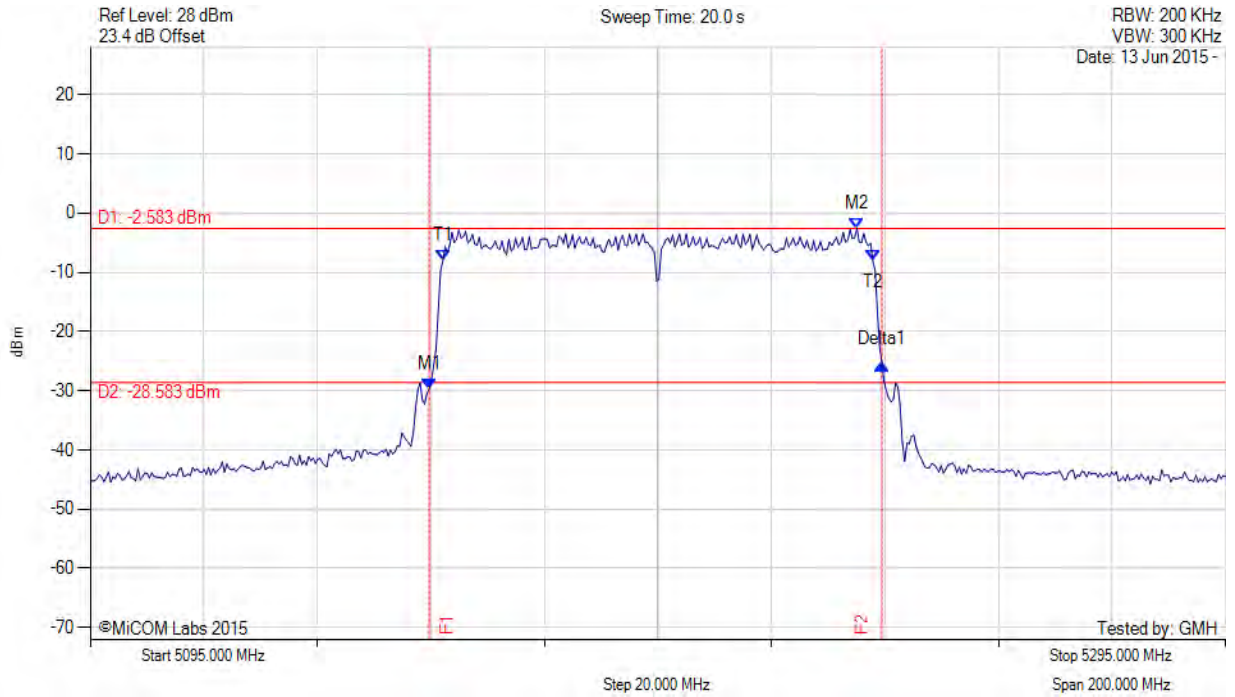

Analyser Setup	Marker:Frequency:Amplitude	Test Results
Detector = MAX PEAK Sweep Count = 0 RF Atten (dB) = 20 Trace Mode = MAX HOLD	M1 : 5154.719 MHz : -29.746 dBm M2 : 5230.070 MHz : -2.583 dBm Delta1 : 79.760 MHz : 4.216 dB T1 : 5157.124 MHz : -8.060 dBm T2 : 5232.876 MHz : -8.085 dBm OBW : 75.752 MHz	Channel Frequency: 5195.00 MHz

[back to matrix](#)

This test report may be reproduced in full only. The document may only be updated by MiCOM Labs personnel. All changes will be noted in the Document History section of the report.



26 dB & 99% BANDWIDTH

Variant: 802.11ac-80, Channel: 5195.00 MHz, Chain b, Temp: Ambient, Voltage: 48 Vdc

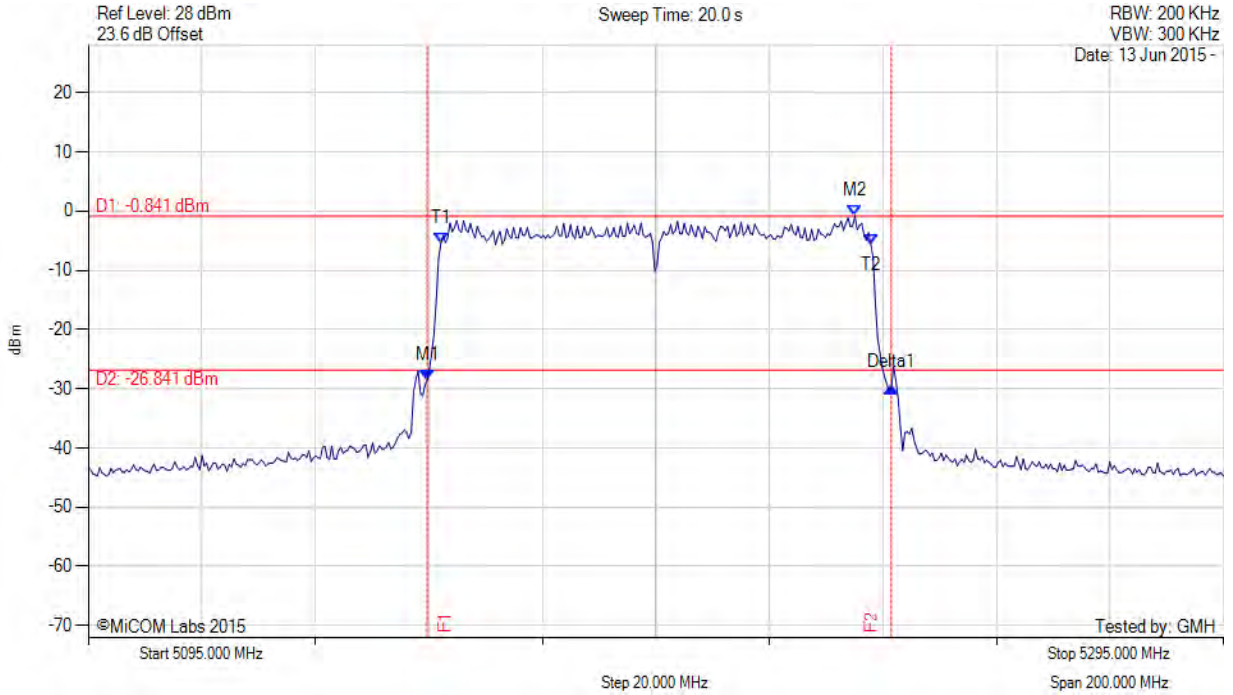

Analyser Setup	Marker:Frequency:Amplitude	Test Results
Detector = MAX PEAK Sweep Count = 0 RF Atten (dB) = 20 Trace Mode = MAX HOLD	M1 : 5154.719 MHz : -28.599 dBm M2 : 5230.070 MHz : -0.841 dBm Delta1 : 81.764 MHz : -1.245 dB T1 : 5157.124 MHz : -5.439 dBm T2 : 5232.876 MHz : -5.608 dBm OBW : 75.752 MHz	Measured 26 dB Bandwidth: 81.764 MHz Measured 99% Bandwidth: 75.752 MHz

[back to matrix](#)

This test report may be reproduced in full only. The document may only be updated by MiCOM Labs personnel. All changes will be noted in the Document History section of the report.



Title: Mimosa Networks A5 Wireless Access Point
To: FCC CFR 47 Part 15 Subpart E 15.407
Serial #: MIMO05-6a Rev A
Issue Date: 4th November 2015
Page: 143 of 372



26 dB & 99% BANDWIDTH

Variant: 802.11ac-80, Channel: 5195.00 MHz, Chain c, Temp: Ambient, Voltage: 48 Vdc

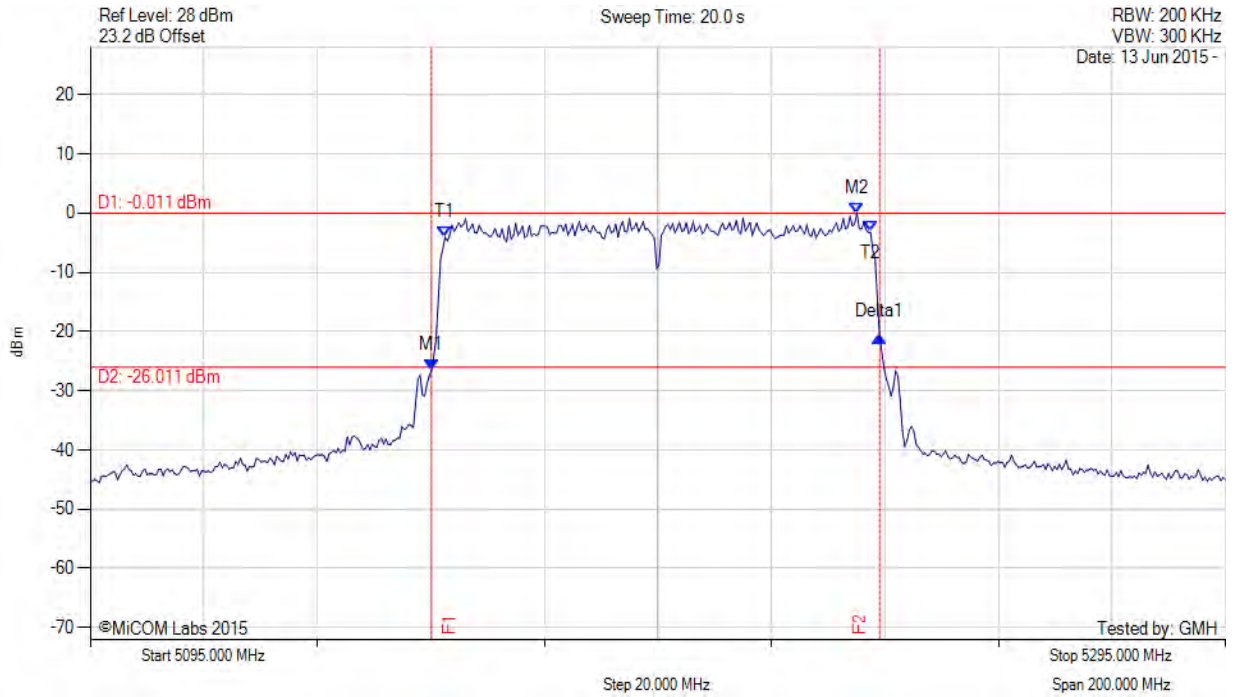

Analyser Setup	Marker:Frequency:Amplitude	Test Results
Detector = MAX PEAK Sweep Count = 0 RF Atten (dB) = 20 Trace Mode = MAX HOLD	M1 : 5155.120 MHz : -26.551 dBm M2 : 5230.070 MHz : -0.011 dBm Delta1 : 78.958 MHz : 5.770 dB T1 : 5157.525 MHz : -4.042 dBm T2 : 5232.475 MHz : -3.210 dBm OBW : 74.950 MHz	Measured 26 dB Bandwidth: 78.958 MHz Measured 99% Bandwidth: 74.950 MHz

[back to matrix](#)

This test report may be reproduced in full only. The document may only be updated by MiCOM Labs personnel. All changes will be noted in the Document History section of the report.



Title: Mimosa Networks A5 Wireless Access Point
To: FCC CFR 47 Part 15 Subpart E 15.407
Serial #: MIMO05-6a Rev A
Issue Date: 4th November 2015
Page: 144 of 372



26 dB & 99% BANDWIDTH

Variant: 802.11ac-80, Channel: 5195.00 MHz, Chain d, Temp: Ambient, Voltage: 48 Vdc

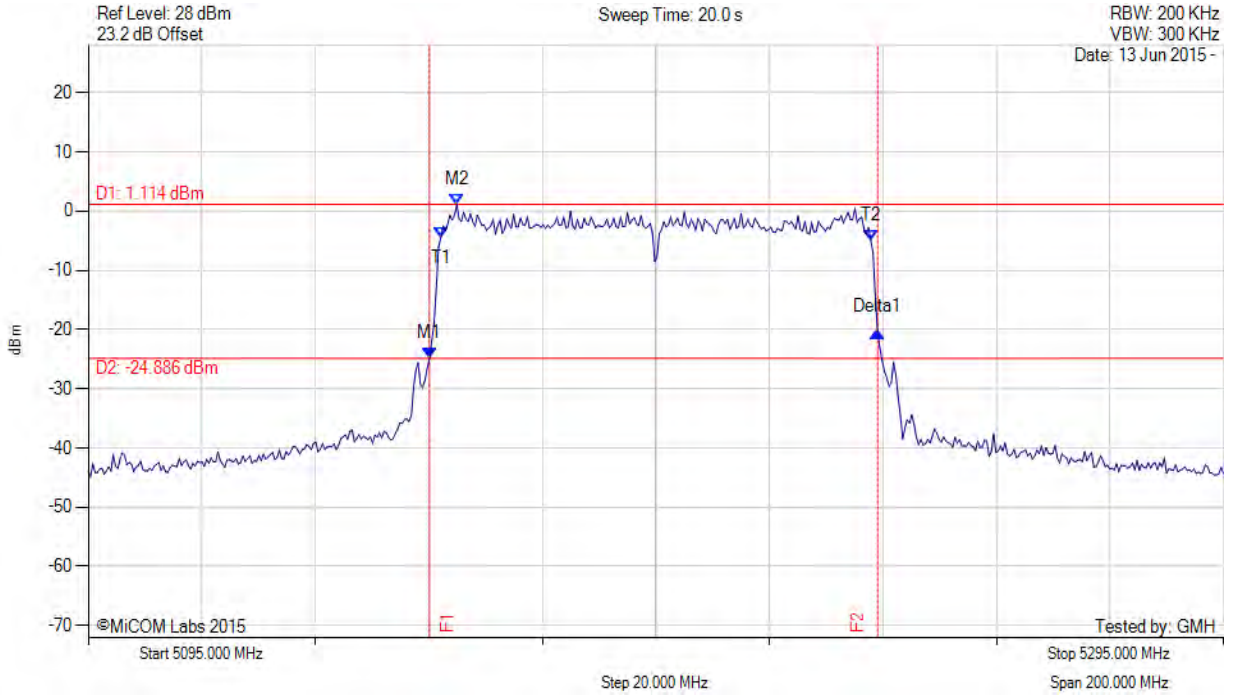

Analyser Setup	Marker:Frequency:Amplitude	Test Results
Detector = MAX PEAK Sweep Count = 0 RF Atten (dB) = 20 Trace Mode = MAX HOLD	M1 : 5155.120 MHz : -24.904 dBm M2 : 5159.930 MHz : 1.114 dBm Delta1 : 78.958 MHz : 4.472 dB T1 : 5157.124 MHz : -4.418 dBm T2 : 5232.876 MHz : -5.020 dBm OBW : 75.752 MHz	Measured 26 dB Bandwidth: 78.958 MHz Measured 99% Bandwidth: 75.752 MHz

[back to matrix](#)

This test report may be reproduced in full only. The document may only be updated by MiCOM Labs personnel. All changes will be noted in the Document History section of the report.



Title: Mimosa Networks A5 Wireless Access Point
To: FCC CFR 47 Part 15 Subpart E 15.407
Serial #: MIMO05-6a Rev A
Issue Date: 4th November 2015
Page: 145 of 372



26 dB & 99% BANDWIDTH

Variant: 802.11ac-80, Channel: 5200.00 MHz, Chain a, Temp: Ambient, Voltage: 48 Vdc

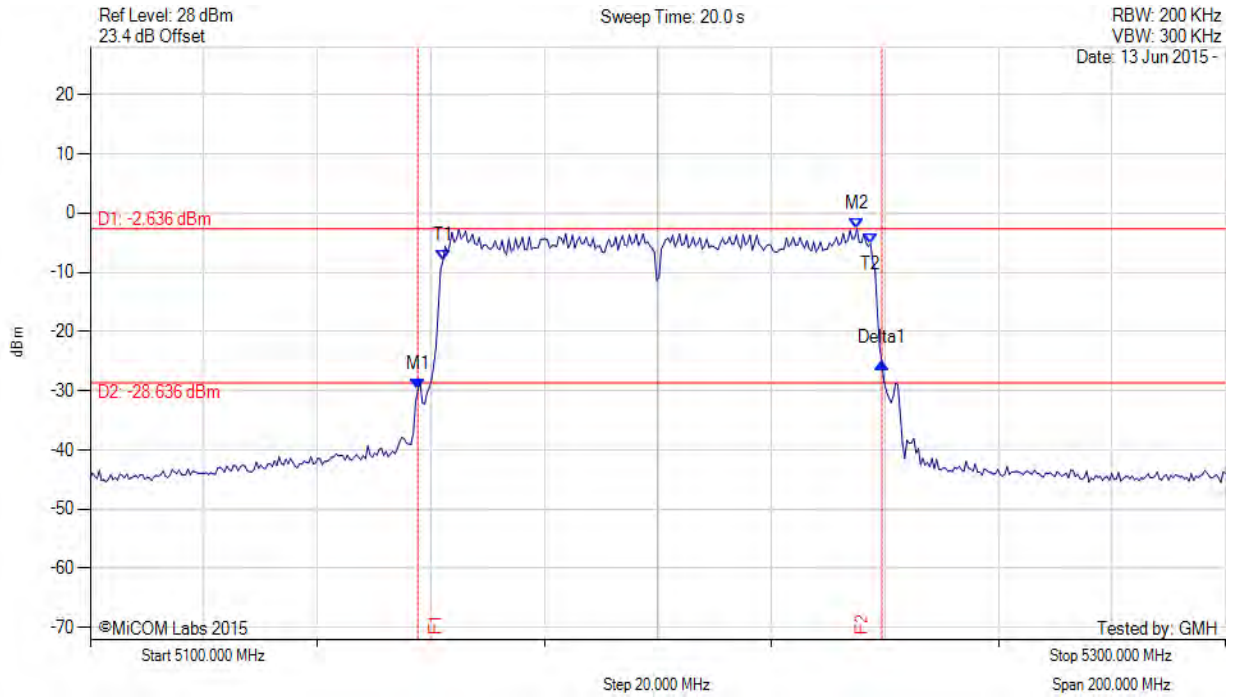

Analyser Setup	Marker:Frequency:Amplitude	Test Results
Detector = MAX PEAK Sweep Count = 0 RF Atten (dB) = 20 Trace Mode = MAX HOLD	M1 : 5157.715 MHz : -29.789 dBm M2 : 5235.070 MHz : -2.636 dBm Delta1 : 81.764 MHz : 4.383 dB T1 : 5162.124 MHz : -8.036 dBm T2 : 5237.475 MHz : -5.172 dBm OBW : 75.351 MHz	Measured 26 dB Bandwidth: 81.764 MHz Measured 99% Bandwidth: 75.351 MHz

[back to matrix](#)

This test report may be reproduced in full only. The document may only be updated by MiCOM Labs personnel. All changes will be noted in the Document History section of the report.



Title: Mimosa Networks A5 Wireless Access Point
To: FCC CFR 47 Part 15 Subpart E 15.407
Serial #: MIMO05-6a Rev A
Issue Date: 4th November 2015
Page: 146 of 372



26 dB & 99% BANDWIDTH

Variant: 802.11ac-80, Channel: 5200.00 MHz, Chain a, Temp: Ambient, Voltage: 48 Vdc

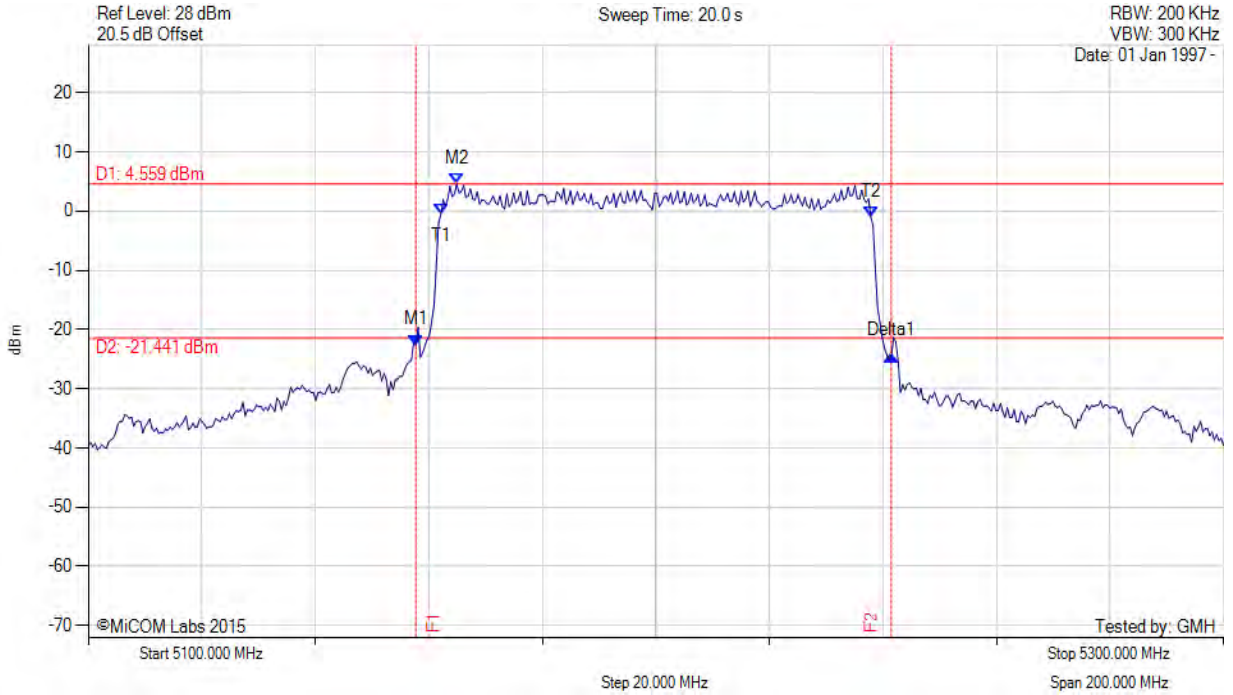

Analyser Setup	Marker:Frequency:Amplitude	Test Results
Detector = MAX PEAK Sweep Count = 0 RF Atten (dB) = 20 Trace Mode = MAX HOLD	M1 : 5157.715 MHz : -22.620 dBm M2 : 5164.930 MHz : 4.559 dBm Delta1 : 83.768 MHz : -1.861 dB T1 : 5162.124 MHz : -0.552 dBm T2 : 5237.876 MHz : -1.046 dBm OBW : 75.752 MHz	Channel Frequency: 5200.00 MHz

[back to matrix](#)

This test report may be reproduced in full only. The document may only be updated by MiCOM Labs personnel. All changes will be noted in the Document History section of the report.



26 dB & 99% BANDWIDTH

Variant: 802.11ac-80, Channel: 5200.00 MHz, Chain b, Temp: Ambient, Voltage: 48 Vdc

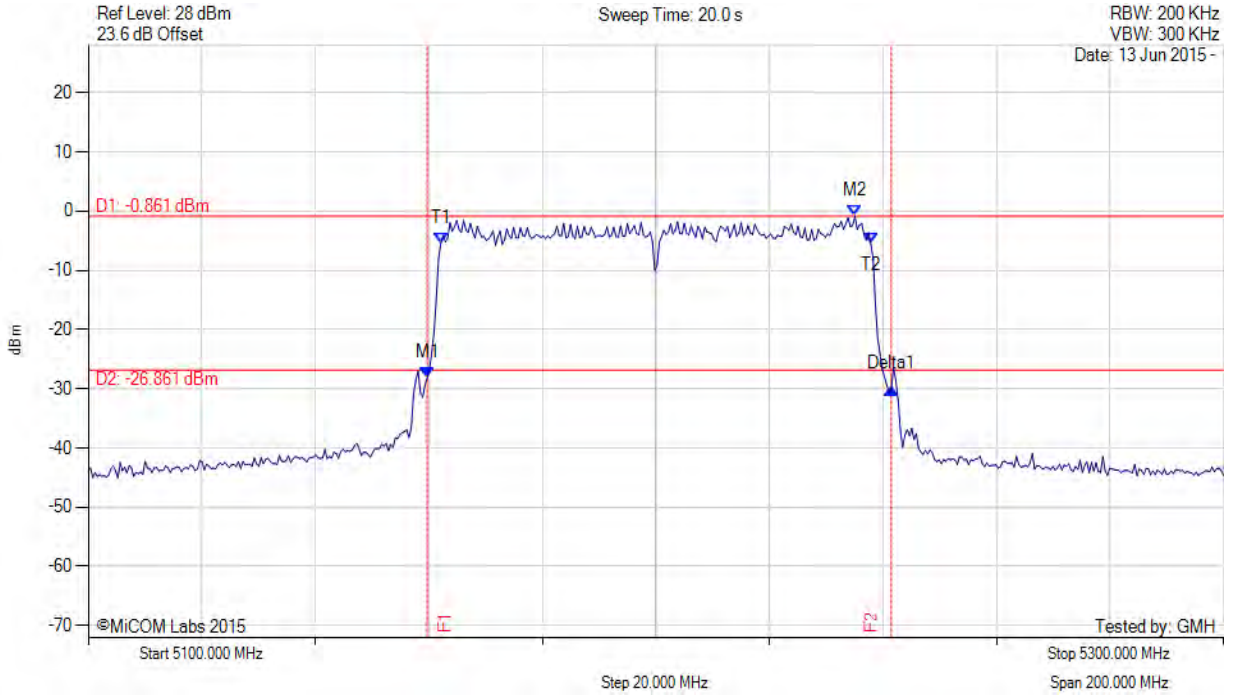

Analyser Setup	Marker:Frequency:Amplitude	Test Results
Detector = MAX PEAK Sweep Count = 0 RF Atten (dB) = 20 Trace Mode = MAX HOLD	M1 : 5159.719 MHz : -28.203 dBm M2 : 5235.070 MHz : -0.861 dBm Delta1 : 81.764 MHz : -1.747 dB T1 : 5162.124 MHz : -5.376 dBm T2 : 5237.876 MHz : -5.524 dBm OBW : 75.752 MHz	Measured 26 dB Bandwidth: 81.764 MHz Measured 99% Bandwidth: 75.752 MHz

[back to matrix](#)

This test report may be reproduced in full only. The document may only be updated by MiCOM Labs personnel. All changes will be noted in the Document History section of the report.



Title: Mimosa Networks A5 Wireless Access Point
To: FCC CFR 47 Part 15 Subpart E 15.407
Serial #: MIMO05-6a Rev A
Issue Date: 4th November 2015
Page: 148 of 372



26 dB & 99% BANDWIDTH

Variant: 802.11ac-80, Channel: 5200.00 MHz, Chain c, Temp: Ambient, Voltage: 48 Vdc

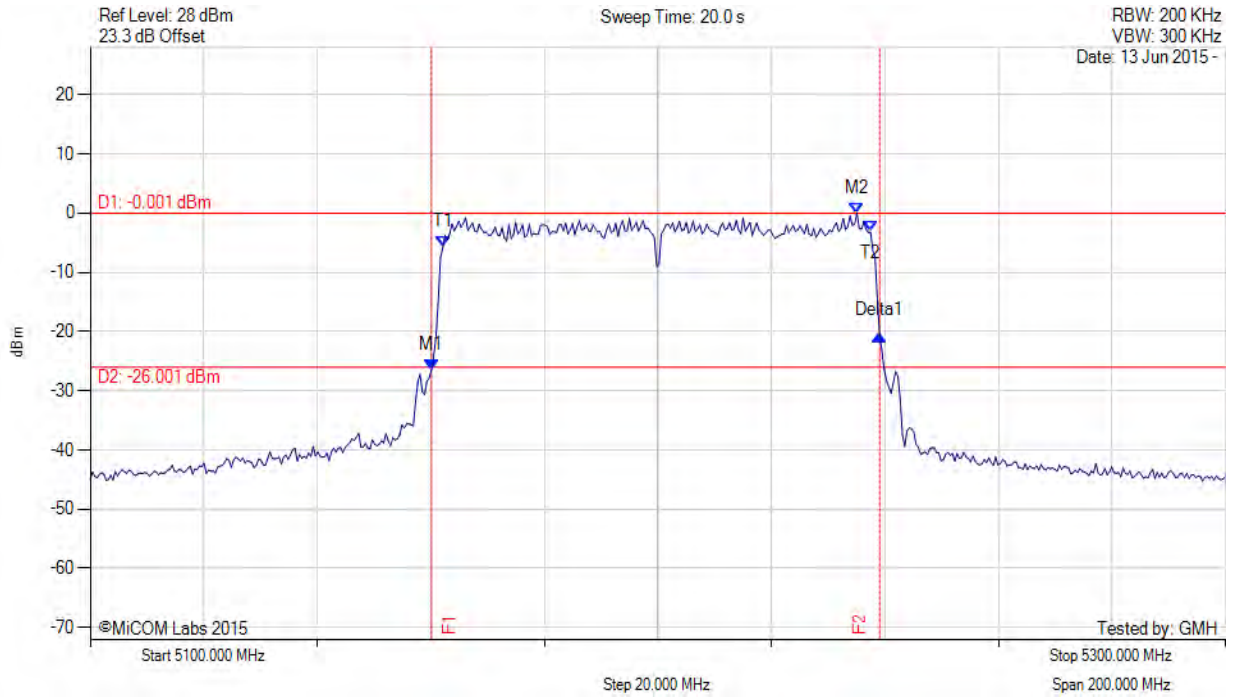

Analyser Setup	Marker:Frequency:Amplitude	Test Results
Detector = MAX PEAK Sweep Count = 0 RF Atten (dB) = 20 Trace Mode = MAX HOLD	M1 : 5160.120 MHz : -26.403 dBm M2 : 5235.070 MHz : -0.001 dBm Delta1 : 78.958 MHz : 5.839 dB T1 : 5162.124 MHz : -5.742 dBm T2 : 5237.475 MHz : -3.187 dBm OBW : 75.351 MHz	Measured 26 dB Bandwidth: 78.958 MHz Measured 99% Bandwidth: 75.351 MHz

[back to matrix](#)

This test report may be reproduced in full only. The document may only be updated by MiCOM Labs personnel. All changes will be noted in the Document History section of the report.



Title: Mimosa Networks A5 Wireless Access Point
To: FCC CFR 47 Part 15 Subpart E 15.407
Serial #: MIMO05-6a Rev A
Issue Date: 4th November 2015
Page: 149 of 372



26 dB & 99% BANDWIDTH

Variant: 802.11ac-80, Channel: 5200.00 MHz, Chain d, Temp: Ambient, Voltage: 48 Vdc

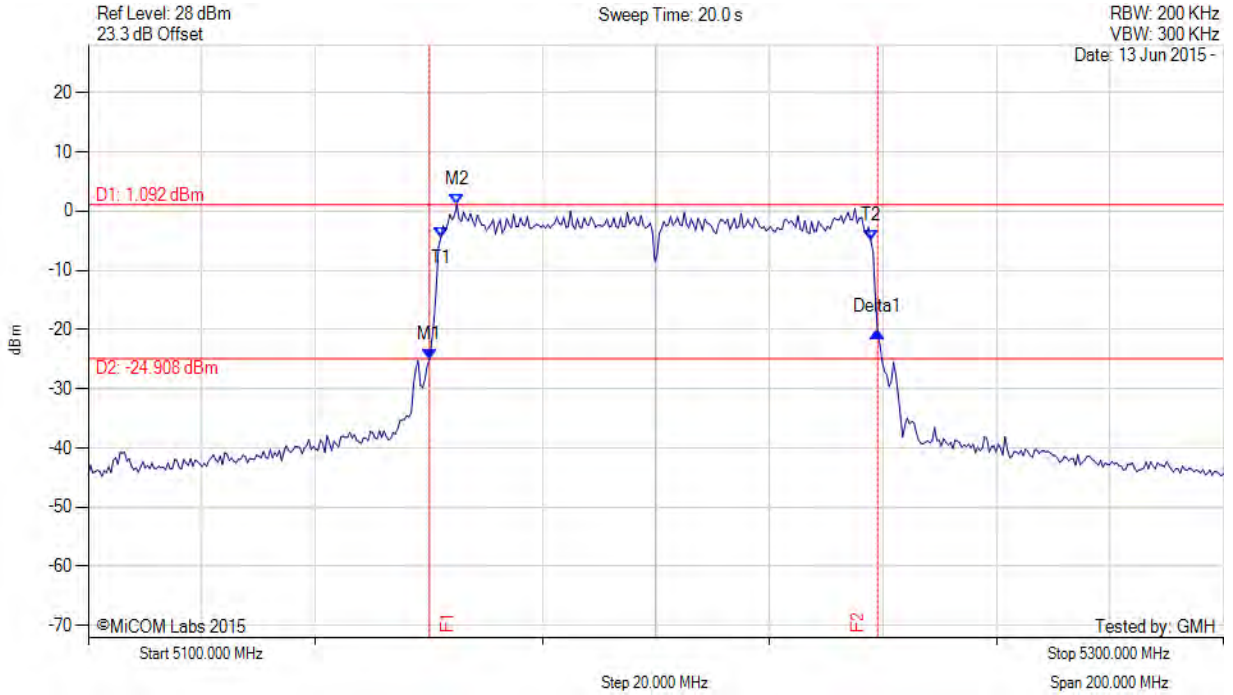

Analyser Setup	Marker:Frequency:Amplitude	Test Results
Detector = MAX PEAK Sweep Count = 0 RF Atten (dB) = 20 Trace Mode = MAX HOLD	M1 : 5160.120 MHz : -25.134 dBm M2 : 5164.930 MHz : 1.092 dBm Delta1 : 78.958 MHz : 4.649 dB T1 : 5162.124 MHz : -4.414 dBm T2 : 5237.876 MHz : -4.991 dBm OBW : 75.752 MHz	Measured 26 dB Bandwidth: 78.958 MHz Measured 99% Bandwidth: 75.752 MHz

[back to matrix](#)

This test report may be reproduced in full only. The document may only be updated by MiCOM Labs personnel. All changes will be noted in the Document History section of the report.



Title: Mimosa Networks A5 Wireless Access Point
To: FCC CFR 47 Part 15 Subpart E 15.407
Serial #: MIMO05-6a Rev A
Issue Date: 4th November 2015
Page: 150 of 372



26 dB & 99% BANDWIDTH

Variant: 802.11ac-80, Channel: 5210.00 MHz, Chain a, Temp: Ambient, Voltage: 48 Vdc

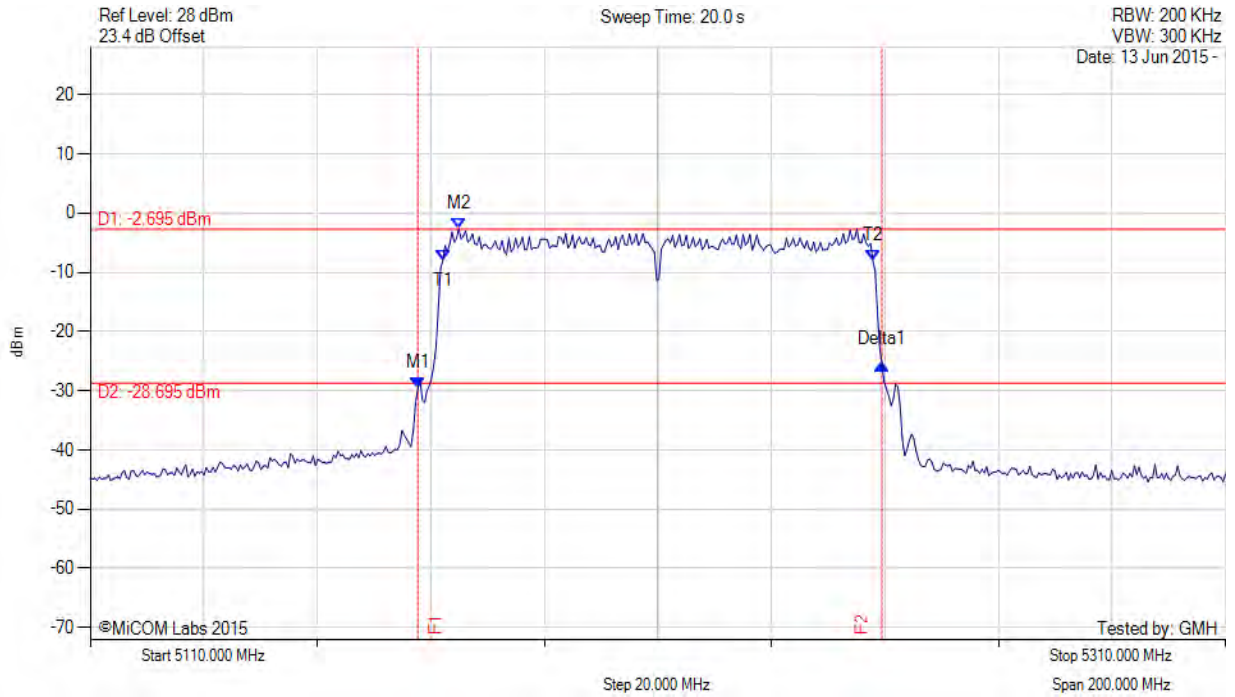

Analyser Setup	Marker:Frequency:Amplitude	Test Results
Detector = MAX PEAK Sweep Count = 0 RF Atten (dB) = 20 Trace Mode = MAX HOLD	M1 : 5167.715 MHz : -29.608 dBm M2 : 5174.930 MHz : -2.695 dBm Delta1 : 81.764 MHz : 3.962 dB T1 : 5172.124 MHz : -7.942 dBm T2 : 5247.876 MHz : -7.983 dBm OBW : 75.752 MHz	Measured 26 dB Bandwidth: 81.764 MHz Measured 99% Bandwidth: 75.752 MHz

[back to matrix](#)

This test report may be reproduced in full only. The document may only be updated by MiCOM Labs personnel. All changes will be noted in the Document History section of the report.



Title: Mimosa Networks A5 Wireless Access Point
To: FCC CFR 47 Part 15 Subpart E 15.407
Serial #: MIMO05-6a Rev A
Issue Date: 4th November 2015
Page: 151 of 372



26 dB & 99% BANDWIDTH

Variant: 802.11ac-80, Channel: 5210.00 MHz, Chain a, Temp: Ambient, Voltage: 48 Vdc

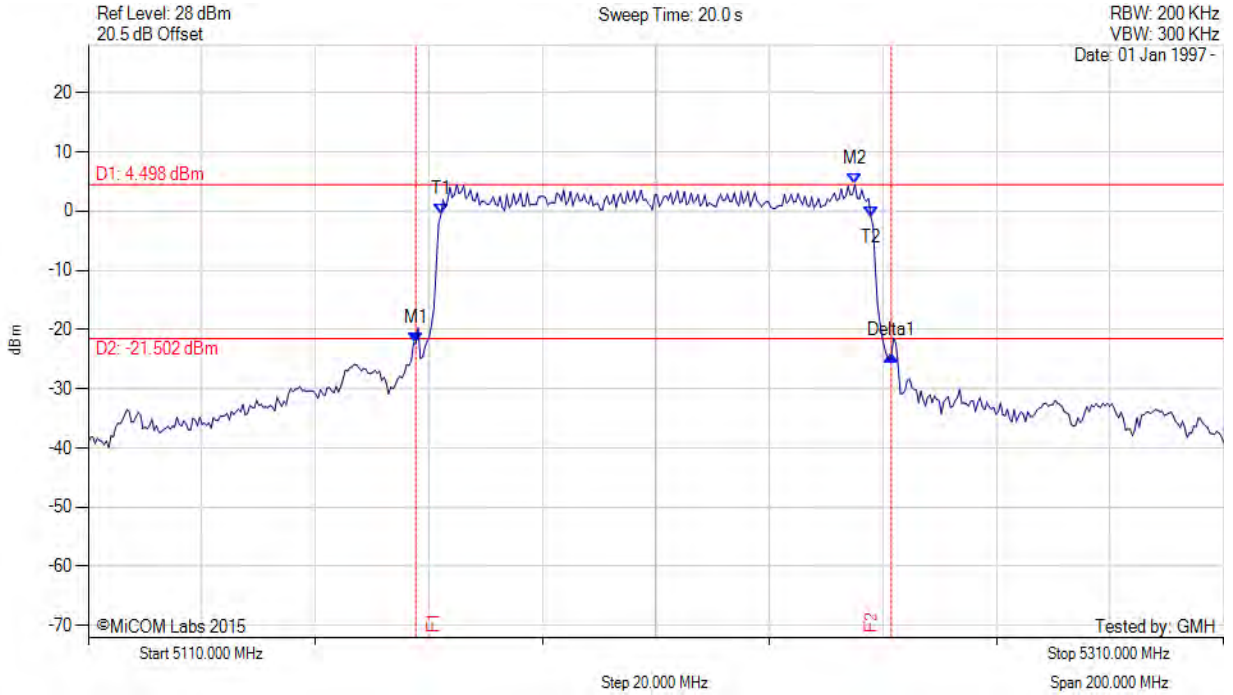

Analyser Setup	Marker:Frequency:Amplitude	Test Results
Detector = MAX PEAK Sweep Count = 0 RF Atten (dB) = 20 Trace Mode = MAX HOLD	M1 : 5167.715 MHz : -22.378 dBm M2 : 5245.070 MHz : 4.498 dBm Delta1 : 83.768 MHz : -1.965 dB T1 : 5172.124 MHz : -0.635 dBm T2 : 5247.876 MHz : -0.922 dBm OBW : 75.752 MHz	Channel Frequency: 5210.00 MHz

[back to matrix](#)

This test report may be reproduced in full only. The document may only be updated by MiCOM Labs personnel. All changes will be noted in the Document History section of the report.



26 dB & 99% BANDWIDTH

Variant: 802.11ac-80, Channel: 5210.00 MHz, Chain b, Temp: Ambient, Voltage: 48 Vdc

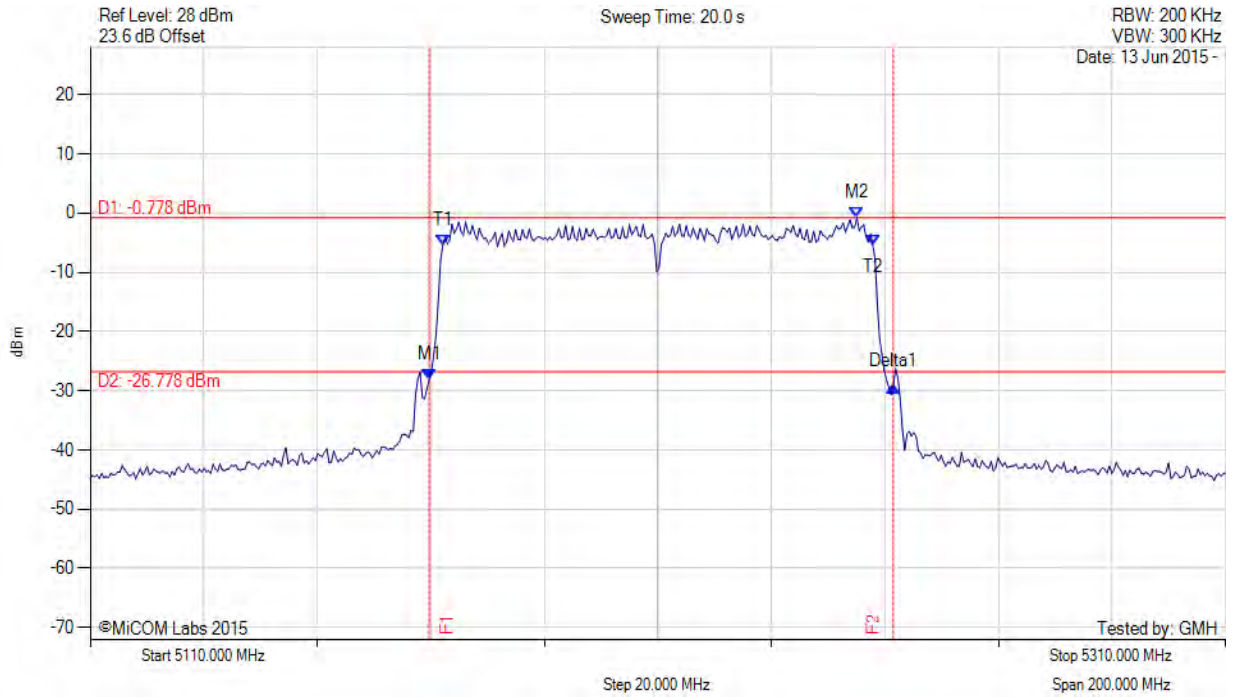

Analyser Setup	Marker:Frequency:Amplitude	Test Results
Detector = MAX PEAK Sweep Count = 0 RF Atten (dB) = 20 Trace Mode = MAX HOLD	M1 : 5169.719 MHz : -28.079 dBm M2 : 5245.070 MHz : -0.778 dBm Delta1 : 81.764 MHz : -1.212 dB T1 : 5172.124 MHz : -5.372 dBm T2 : 5247.876 MHz : -5.488 dBm OBW : 75.752 MHz	Measured 26 dB Bandwidth: 81.764 MHz Measured 99% Bandwidth: 75.752 MHz

[back to matrix](#)

This test report may be reproduced in full only. The document may only be updated by MiCOM Labs personnel. All changes will be noted in the Document History section of the report.



26 dB & 99% BANDWIDTH

Variant: 802.11ac-80, Channel: 5210.00 MHz, Chain c, Temp: Ambient, Voltage: 48 Vdc

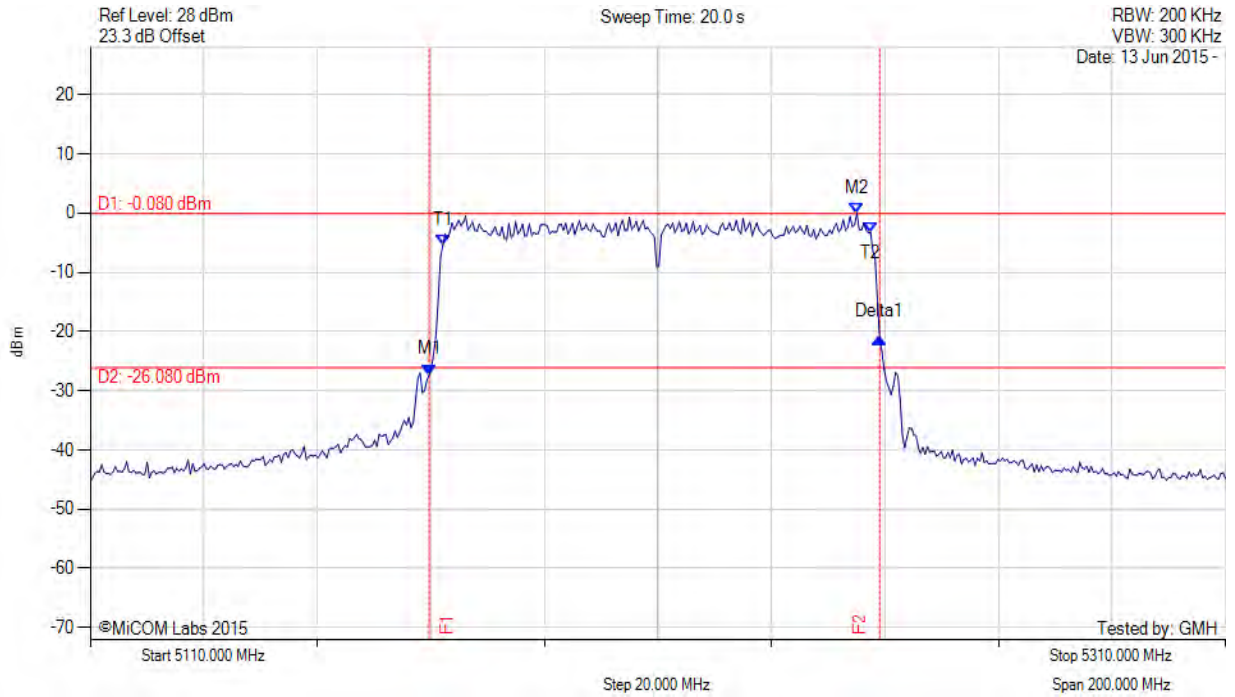

Analyser Setup	Marker:Frequency:Amplitude	Test Results
Detector = MAX PEAK Sweep Count = 0 RF Atten (dB) = 20 Trace Mode = MAX HOLD	M1 : 5169.719 MHz : -27.300 dBm M2 : 5245.070 MHz : -0.080 dBm Delta1 : 79.359 MHz : 6.311 dB T1 : 5172.124 MHz : -5.419 dBm T2 : 5247.475 MHz : -3.228 dBm OBW : 75.351 MHz	Measured 26 dB Bandwidth: 79.359 MHz Measured 99% Bandwidth: 75.351 MHz

[back to matrix](#)

This test report may be reproduced in full only. The document may only be updated by MiCOM Labs personnel. All changes will be noted in the Document History section of the report.



Title: Mimosa Networks A5 Wireless Access Point
To: FCC CFR 47 Part 15 Subpart E 15.407
Serial #: MIMO05-6a Rev A
Issue Date: 4th November 2015
Page: 154 of 372



26 dB & 99% BANDWIDTH

Variant: 802.11ac-80, Channel: 5210.00 MHz, Chain d, Temp: Ambient, Voltage: 48 Vdc

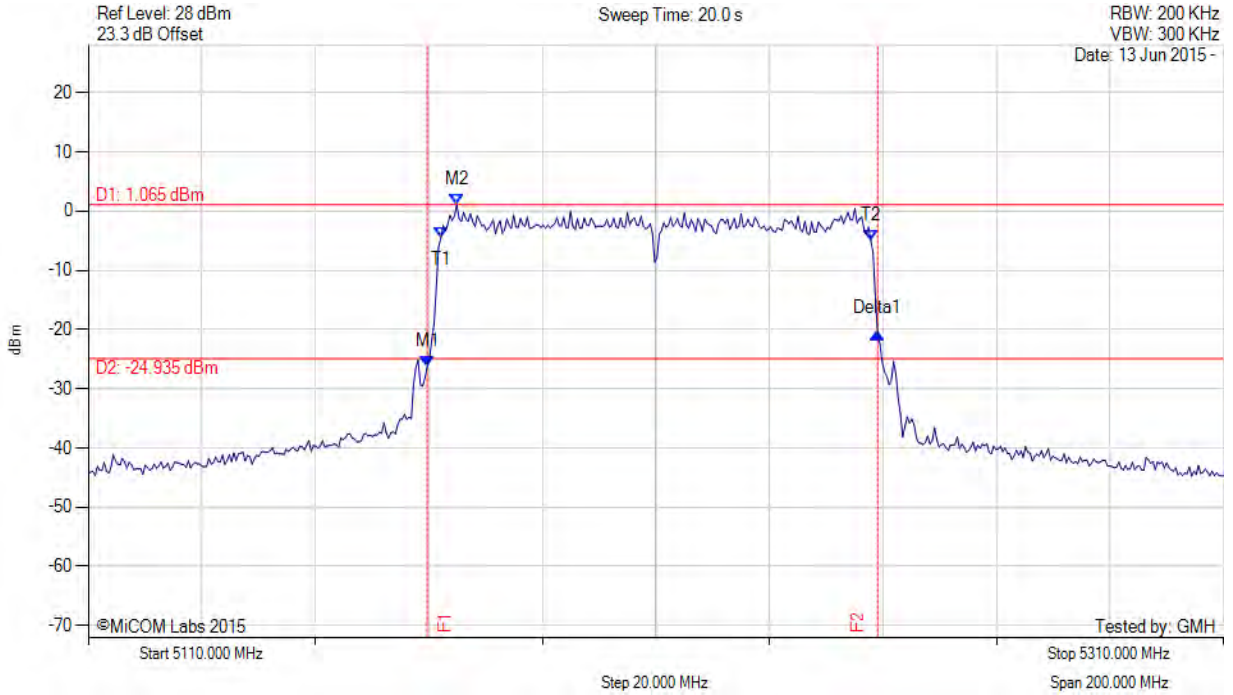

Analyser Setup	Marker:Frequency:Amplitude	Test Results
Detector = MAX PEAK Sweep Count = 0 RF Atten (dB) = 20 Trace Mode = MAX HOLD	M1 : 5169.719 MHz : -26.264 dBm M2 : 5174.930 MHz : 1.065 dBm Delta1 : 79.359 MHz : 5.625 dB T1 : 5172.124 MHz : -4.556 dBm T2 : 5247.876 MHz : -5.006 dBm OBW : 75.752 MHz	Measured 26 dB Bandwidth: 79.359 MHz Measured 99% Bandwidth: 75.752 MHz

[back to matrix](#)

This test report may be reproduced in full only. The document may only be updated by MiCOM Labs personnel. All changes will be noted in the Document History section of the report.



26 dB & 99% BANDWIDTH

Variant: 802.11ac-80, Channel: 5290.00 MHz, Chain a, Temp: Ambient, Voltage: 48 Vdc



Analyser Setup	Marker:Frequency:Amplitude	Test Results
Detector = MAX PEAK Sweep Count = 0 RF Atten (dB) = 20 Trace Mode = MAX HOLD	M1 : 5247.715 MHz : -24.774 dBm M2 : 5290.200 MHz : 2.580 dBm Delta1 : 81.363 MHz : 6.115 dB T1 : 5252.124 MHz : -3.057 dBm T2 : 5327.876 MHz : -3.722 dBm OBW : 75.752 MHz	Measured 26 dB Bandwidth: 81.363 MHz Measured 99% Bandwidth: 75.752 MHz

[back to matrix](#)

This test report may be reproduced in full only. The document may only be updated by MiCOM Labs personnel. All changes will be noted in the Document History section of the report.



26 dB & 99% BANDWIDTH

Variant: 802.11ac-80, Channel: 5290.00 MHz, Chain a, Temp: Ambient, Voltage: 48 Vdc

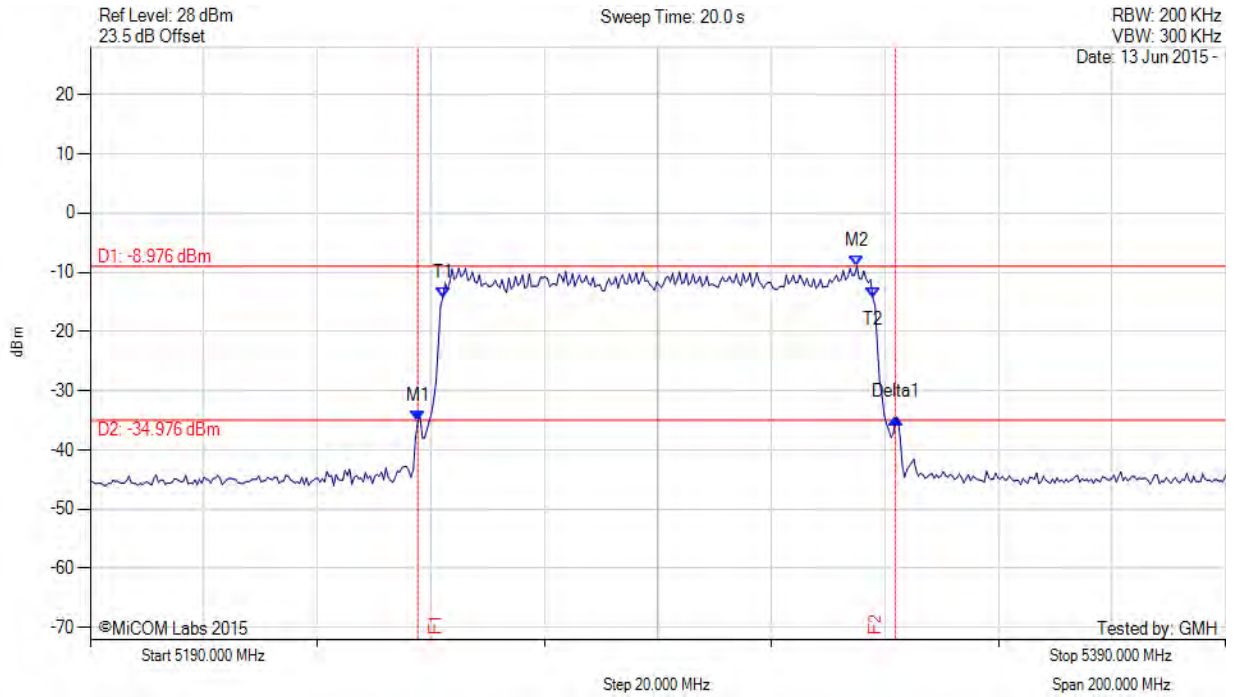

Analyser Setup	Marker:Frequency:Amplitude	Test Results
Detector = MAX PEAK Sweep Count = 0 RF Atten (dB) = 20 Trace Mode = MAX HOLD	M1 : 5247.715 MHz : -35.042 dBm M2 : 5325.070 MHz : -8.976 dBm Delta1 : 84.168 MHz : 0.500 dB T1 : 5252.124 MHz : -14.231 dBm T2 : 5327.876 MHz : -14.357 dBm OBW : 75.752 MHz	Channel Frequency: 5290.00 MHz

[back to matrix](#)

This test report may be reproduced in full only. The document may only be updated by MiCOM Labs personnel. All changes will be noted in the Document History section of the report.



Title: Mimosa Networks A5 Wireless Access Point
To: FCC CFR 47 Part 15 Subpart E 15.407
Serial #: MIMO05-6a Rev A
Issue Date: 4th November 2015
Page: 157 of 372



26 dB & 99% BANDWIDTH

Variant: 802.11ac-80, Channel: 5290.00 MHz, Chain b, Temp: Ambient, Voltage: 48 Vdc



Analyser Setup	Marker:Frequency:Amplitude	Test Results
Detector = MAX PEAK Sweep Count = 0 RF Atten (dB) = 20 Trace Mode = MAX HOLD	M1 : 5249.719 MHz : -33.846 dBm M2 : 5325.070 MHz : -5.835 dBm Delta1 : 81.764 MHz : -0.476 dB T1 : 5252.124 MHz : -10.936 dBm T2 : 5327.876 MHz : -10.607 dBm OBW : 75.752 MHz	Measured 26 dB Bandwidth: 81.764 MHz Measured 99% Bandwidth: 75.752 MHz

[back to matrix](#)

This test report may be reproduced in full only. The document may only be updated by MiCOM Labs personnel. All changes will be noted in the Document History section of the report.



Title: Mimosa Networks A5 Wireless Access Point
To: FCC CFR 47 Part 15 Subpart E 15.407
Serial #: MIMO05-6a Rev A
Issue Date: 4th November 2015
Page: 158 of 372



26 dB & 99% BANDWIDTH

Variant: 802.11ac-80, Channel: 5290.00 MHz, Chain c, Temp: Ambient, Voltage: 48 Vdc

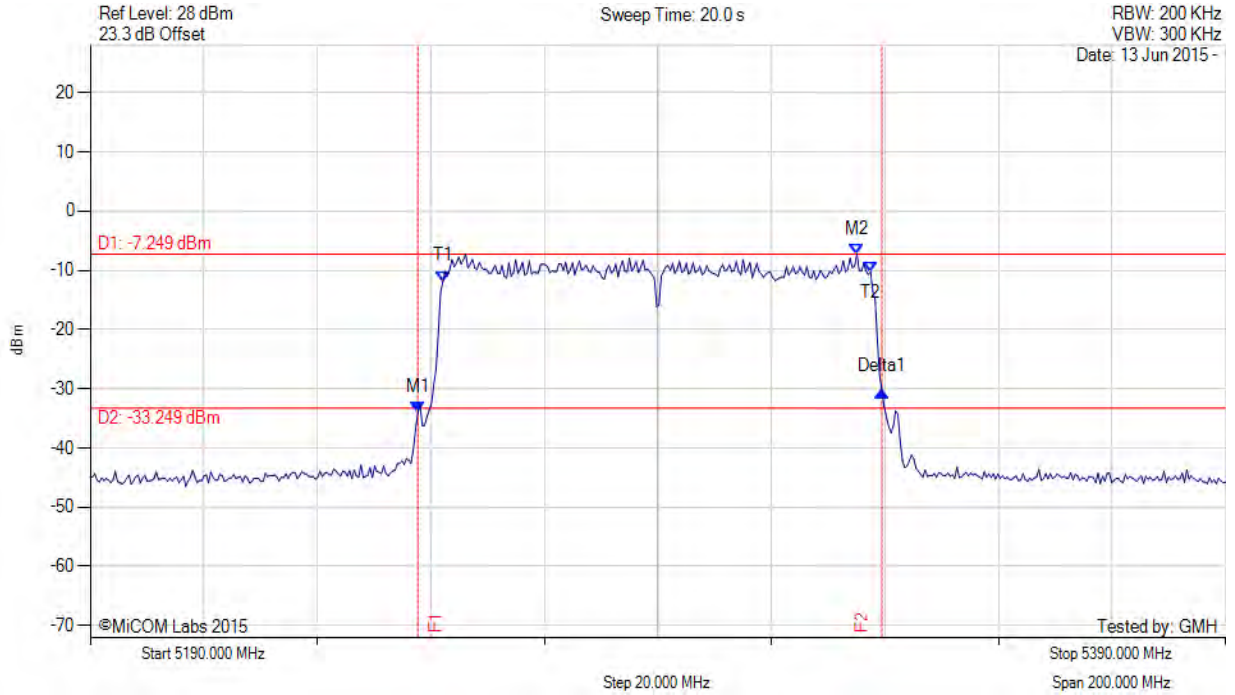

Analyser Setup	Marker:Frequency:Amplitude	Test Results
Detector = MAX PEAK Sweep Count = 0 RF Atten (dB) = 20 Trace Mode = MAX HOLD	M1 : 5247.715 MHz : -33.972 dBm M2 : 5325.070 MHz : -7.249 dBm Delta1 : 81.764 MHz : 3.512 dB T1 : 5252.124 MHz : -11.884 dBm T2 : 5327.475 MHz : -10.287 dBm OBW : 75.351 MHz	Measured 26 dB Bandwidth: 81.764 MHz Measured 99% Bandwidth: 75.351 MHz

[back to matrix](#)

This test report may be reproduced in full only. The document may only be updated by MiCOM Labs personnel. All changes will be noted in the Document History section of the report.



Title: Mimosa Networks A5 Wireless Access Point
To: FCC CFR 47 Part 15 Subpart E 15.407
Serial #: MIMO05-6a Rev A
Issue Date: 4th November 2015
Page: 159 of 372



26 dB & 99% BANDWIDTH

Variant: 802.11ac-80, Channel: 5290.00 MHz, Chain d, Temp: Ambient, Voltage: 48 Vdc

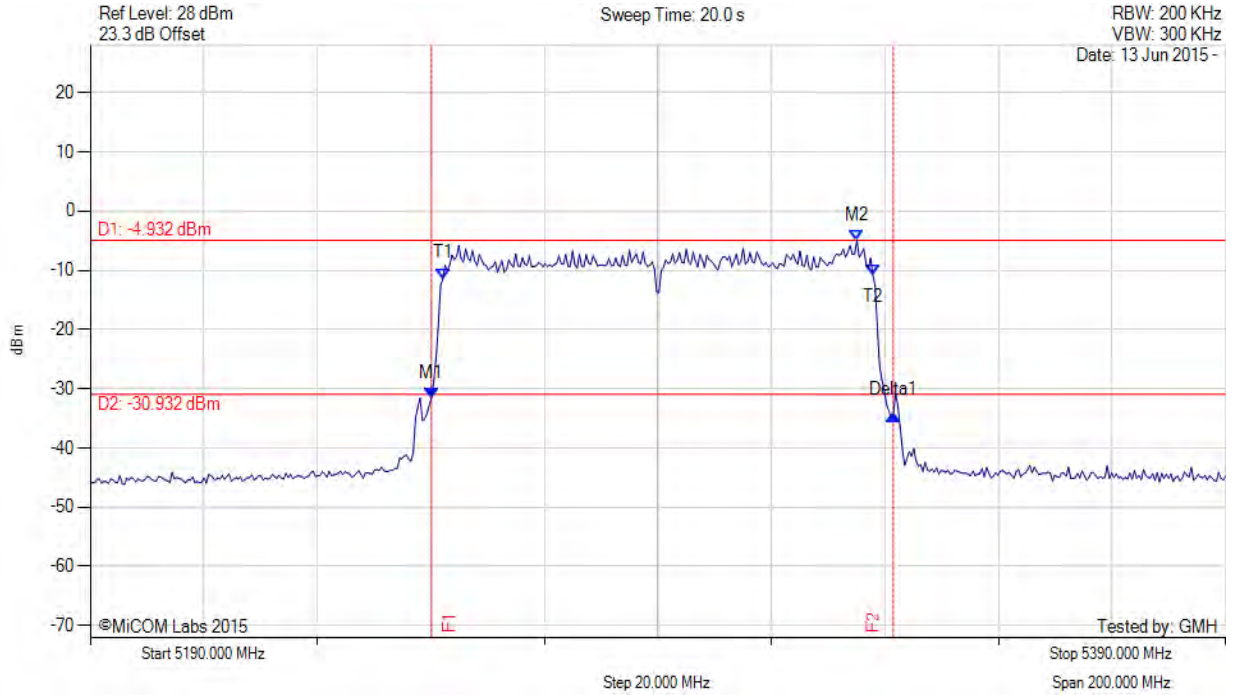

Analyser Setup	Marker:Frequency:Amplitude	Test Results
Detector = MAX PEAK Sweep Count = 0 RF Atten (dB) = 20 Trace Mode = MAX HOLD	M1 : 5250.120 MHz : -31.570 dBm M2 : 5325.070 MHz : -4.932 dBm Delta1 : 81.363 MHz : -2.906 dB T1 : 5252.124 MHz : -11.410 dBm T2 : 5327.876 MHz : -10.808 dBm OBW : 75.752 MHz	Measured 26 dB Bandwidth: 81.363 MHz Measured 99% Bandwidth: 75.752 MHz

[back to matrix](#)

This test report may be reproduced in full only. The document may only be updated by MiCOM Labs personnel. All changes will be noted in the Document History section of the report.



26 dB & 99% BANDWIDTH

Variant: 802.11ac-80, Channel: 5300.00 MHz, Chain a, Temp: Ambient, Voltage: 48 Vdc

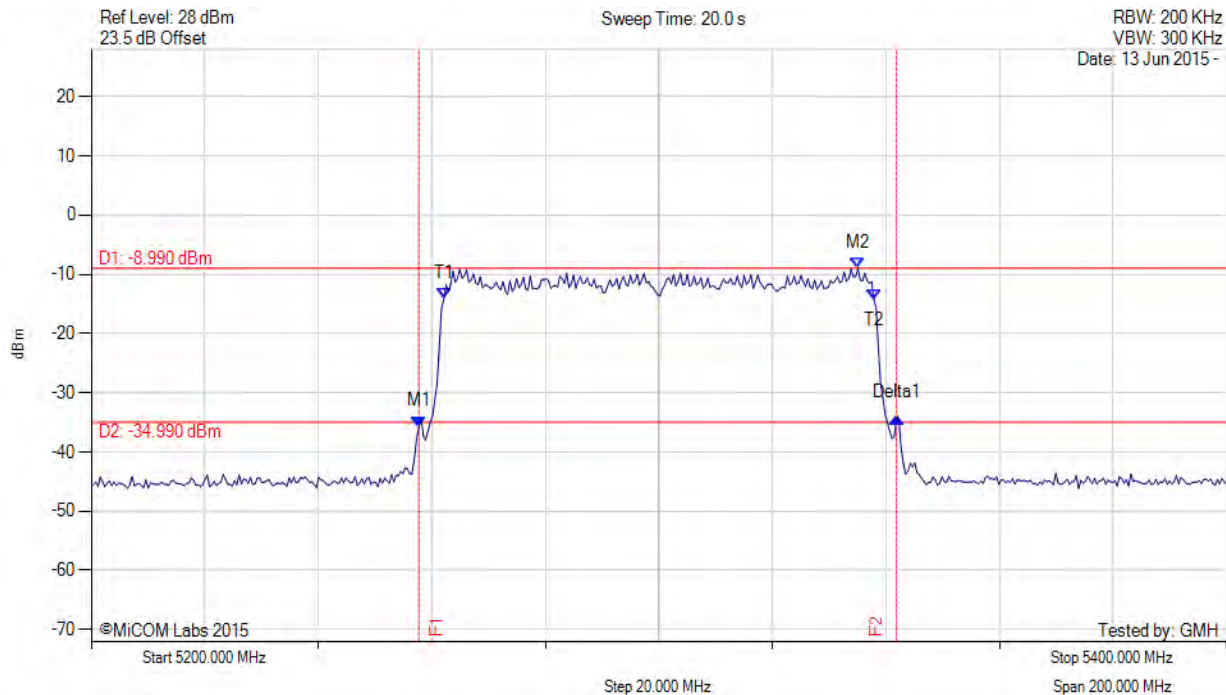

Analyser Setup	Marker:Frequency:Amplitude	Test Results
Detector = MAX PEAK Sweep Count = 0 RF Atten (dB) = 20 Trace Mode = MAX HOLD	M1 : 5257.715 MHz : -35.711 dBm M2 : 5335.070 MHz : -8.990 dBm Delta1 : 84.168 MHz : 1.572 dB T1 : 5262.124 MHz : -14.196 dBm T2 : 5337.876 MHz : -14.200 dBm OBW : 75.752 MHz	Measured 26 dB Bandwidth: 84.168 MHz Measured 99% Bandwidth: 75.752 MHz

[back to matrix](#)

This test report may be reproduced in full only. The document may only be updated by MiCOM Labs personnel. All changes will be noted in the Document History section of the report.



26 dB & 99% BANDWIDTH

Variant: 802.11ac-80, Channel: 5300.00 MHz, Chain a, Temp: Ambient, Voltage: 48 Vdc

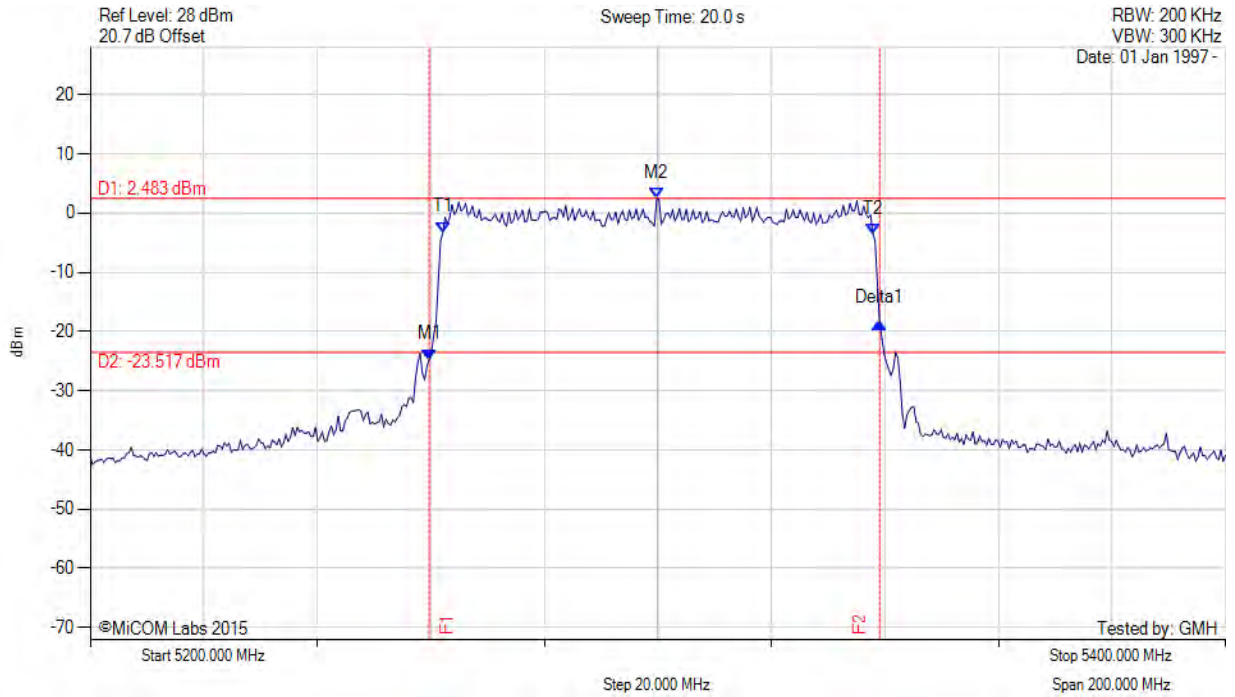

Analyser Setup	Marker:Frequency:Amplitude	Test Results
Detector = MAX PEAK Sweep Count = 0 RF Atten (dB) = 20 Trace Mode = MAX HOLD	M1 : 5259.719 MHz : -24.741 dBm M2 : 5299.800 MHz : 2.483 dBm Delta1 : 79.359 MHz : 6.290 dB T1 : 5262.124 MHz : -3.236 dBm T2 : 5337.876 MHz : -3.480 dBm OBW : 75.752 MHz	Channel Frequency: 5300.00 MHz

[back to matrix](#)

This test report may be reproduced in full only. The document may only be updated by MiCOM Labs personnel. All changes will be noted in the Document History section of the report.



Title: Mimosa Networks A5 Wireless Access Point
To: FCC CFR 47 Part 15 Subpart E 15.407
Serial #: MIMO05-6a Rev A
Issue Date: 4th November 2015
Page: 162 of 372



26 dB & 99% BANDWIDTH

Variant: 802.11ac-80, Channel: 5300.00 MHz, Chain b, Temp: Ambient, Voltage: 48 Vdc

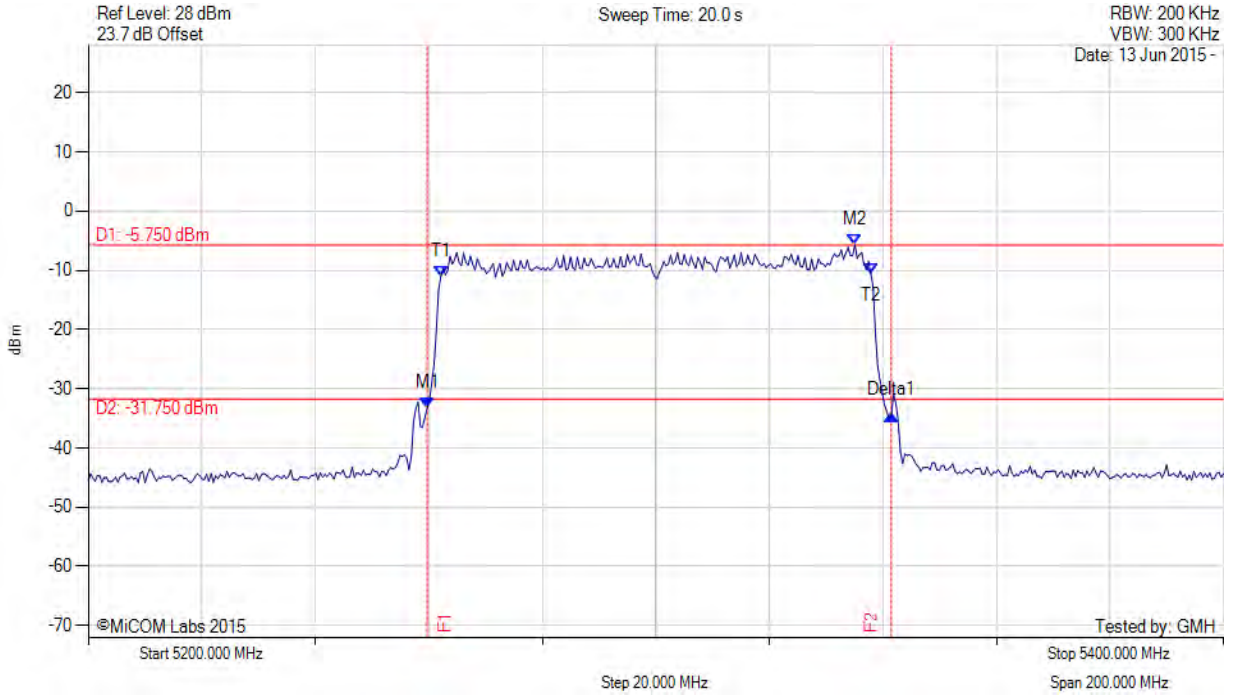

Analyser Setup	Marker:Frequency:Amplitude	Test Results
Detector = MAX PEAK Sweep Count = 0 RF Atten (dB) = 20 Trace Mode = MAX HOLD	M1 : 5259.719 MHz : -33.218 dBm M2 : 5335.070 MHz : -5.750 dBm Delta1 : 81.764 MHz : -1.287 dB T1 : 5262.124 MHz : -10.983 dBm T2 : 5337.876 MHz : -10.570 dBm OBW : 75.752 MHz	Measured 26 dB Bandwidth: 81.764 MHz Measured 99% Bandwidth: 75.752 MHz

[back to matrix](#)

This test report may be reproduced in full only. The document may only be updated by MiCOM Labs personnel. All changes will be noted in the Document History section of the report.



26 dB & 99% BANDWIDTH

Variant: 802.11ac-80, Channel: 5300.00 MHz, Chain c, Temp: Ambient, Voltage: 48 Vdc

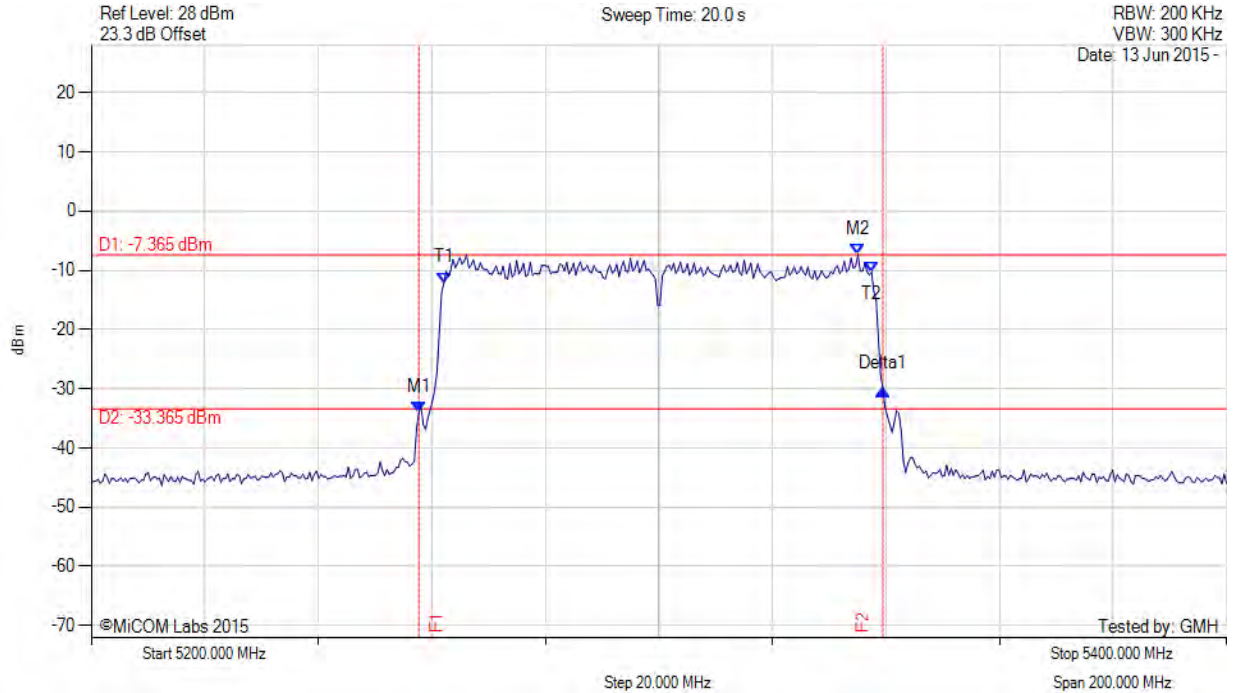

Analyser Setup	Marker:Frequency:Amplitude	Test Results
Detector = MAX PEAK Sweep Count = 0 RF Atten (dB) = 20 Trace Mode = MAX HOLD	M1 : 5257.715 MHz : -33.966 dBm M2 : 5335.070 MHz : -7.365 dBm Delta1 : 81.764 MHz : 3.874 dB T1 : 5262.124 MHz : -12.108 dBm T2 : 5337.475 MHz : -10.338 dBm OBW : 75.351 MHz	Measured 26 dB Bandwidth: 81.764 MHz Measured 99% Bandwidth: 75.351 MHz

[back to matrix](#)

This test report may be reproduced in full only. The document may only be updated by MiCOM Labs personnel. All changes will be noted in the Document History section of the report.



Title: Mimosa Networks A5 Wireless Access Point
To: FCC CFR 47 Part 15 Subpart E 15.407
Serial #: MIMO05-6a Rev A
Issue Date: 4th November 2015
Page: 164 of 372



26 dB & 99% BANDWIDTH

Variant: 802.11ac-80, Channel: 5300.00 MHz, Chain d, Temp: Ambient, Voltage: 48 Vdc

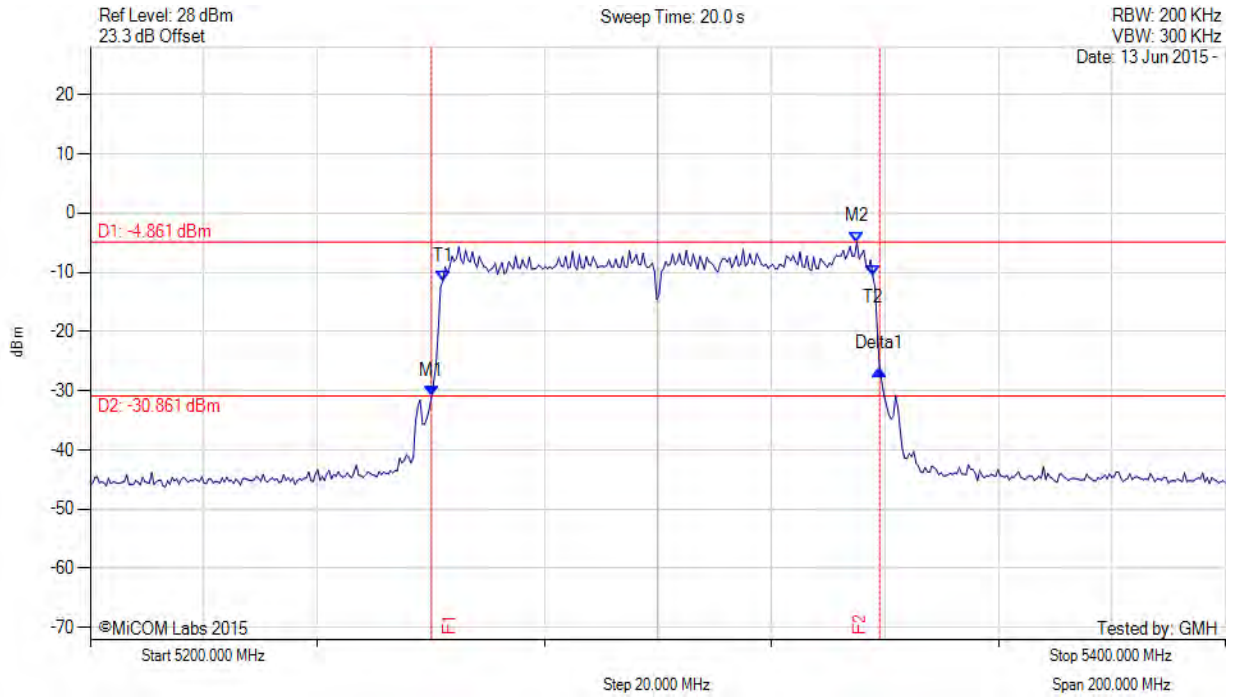

Analyser Setup	Marker:Frequency:Amplitude	Test Results
Detector = MAX PEAK Sweep Count = 0 RF Atten (dB) = 20 Trace Mode = MAX HOLD	M1 : 5260.120 MHz : -30.889 dBm M2 : 5335.070 MHz : -4.861 dBm Delta1 : 78.958 MHz : 4.517 dB T1 : 5262.124 MHz : -11.426 dBm T2 : 5337.876 MHz : -10.662 dBm OBW : 75.752 MHz	Measured 26 dB Bandwidth: 78.958 MHz Measured 99% Bandwidth: 75.752 MHz

[back to matrix](#)

This test report may be reproduced in full only. The document may only be updated by MiCOM Labs personnel. All changes will be noted in the Document History section of the report.



Title: Mimosa Networks A5 Wireless Access Point
To: FCC CFR 47 Part 15 Subpart E 15.407
Serial #: MIMO05-6a Rev A
Issue Date: 4th November 2015
Page: 165 of 372



26 dB & 99% BANDWIDTH

Variant: 802.11ac-80, Channel: 5310.00 MHz, Chain a, Temp: Ambient, Voltage: 48 Vdc

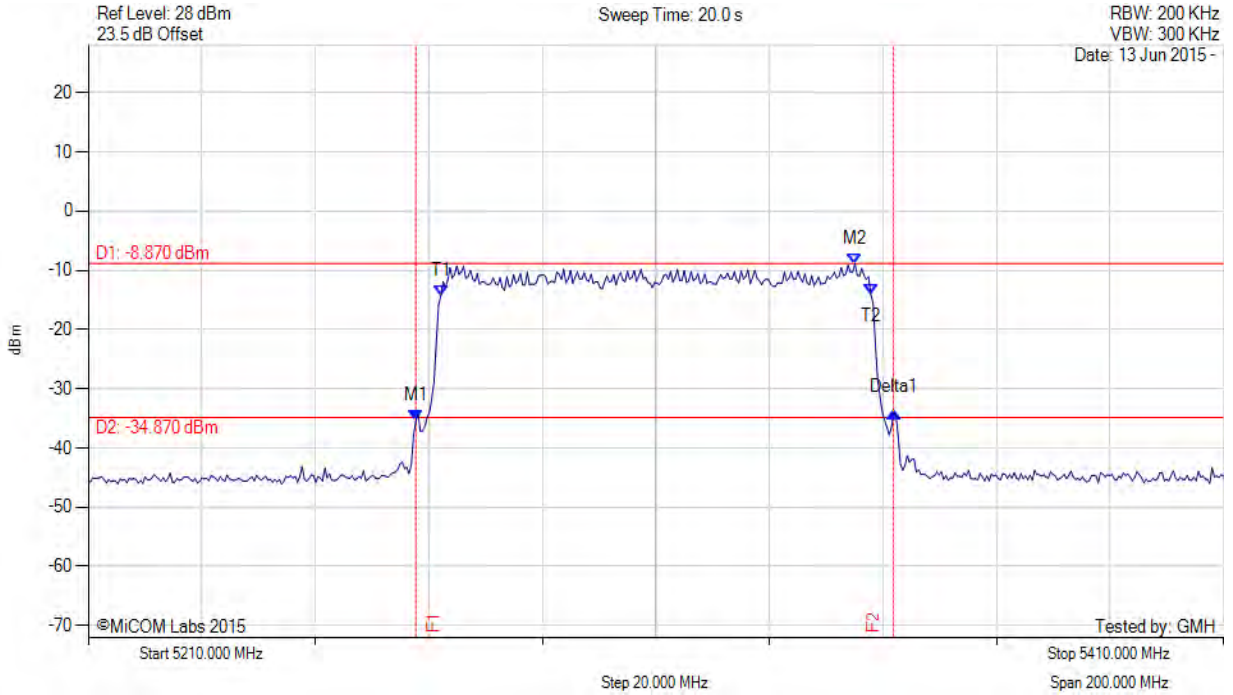

Analyser Setup	Marker:Frequency:Amplitude	Test Results
Detector = MAX PEAK Sweep Count = 0 RF Atten (dB) = 20 Trace Mode = MAX HOLD	M1 : 5267.715 MHz : -35.437 dBm M2 : 5345.070 MHz : -8.870 dBm Delta1 : 84.168 MHz : 1.501 dB T1 : 5272.124 MHz : -14.247 dBm T2 : 5347.876 MHz : -14.127 dBm OBW : 75.752 MHz	Measured 26 dB Bandwidth: 84.168 MHz Measured 99% Bandwidth: 75.752 MHz

[back to matrix](#)

This test report may be reproduced in full only. The document may only be updated by MiCOM Labs personnel. All changes will be noted in the Document History section of the report.



26 dB & 99% BANDWIDTH

Variant: 802.11ac-80, Channel: 5310.00 MHz, Chain a, Temp: Ambient, Voltage: 48 Vdc

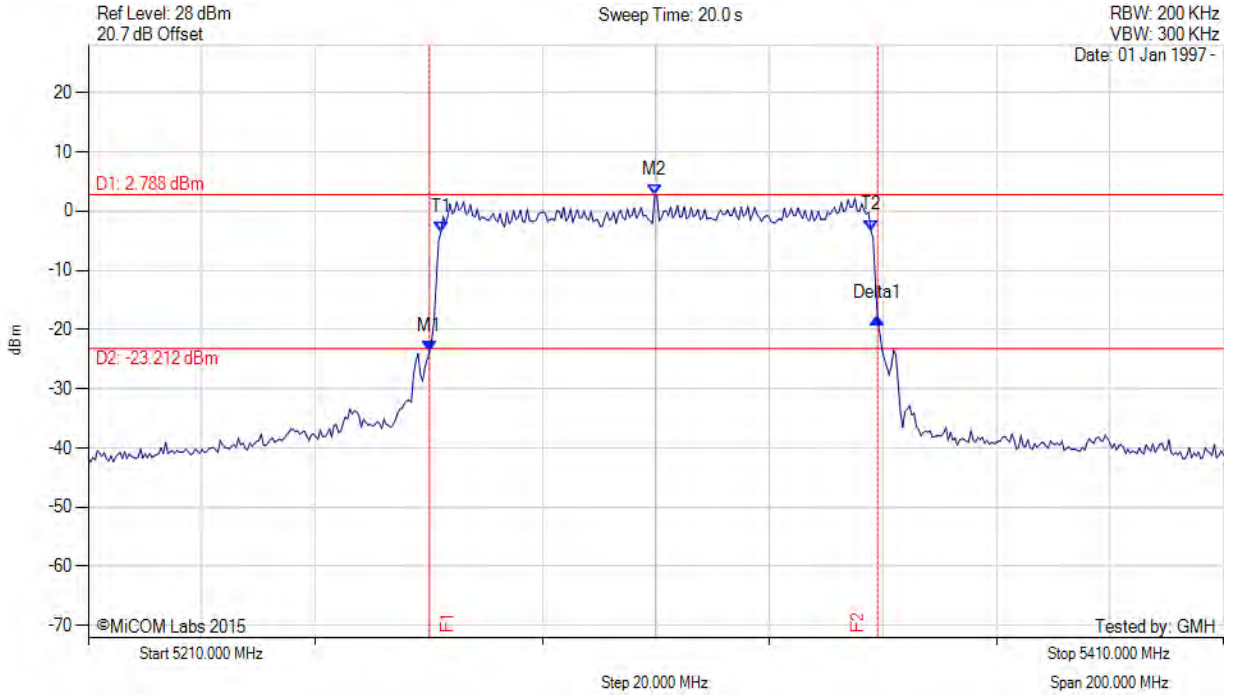

Analyser Setup	Marker:Frequency:Amplitude	Test Results
Detector = MAX PEAK Sweep Count = 0 RF Atten (dB) = 20 Trace Mode = MAX HOLD	M1 : 5270.120 MHz : -23.655 dBm M2 : 5309.800 MHz : 2.788 dBm Delta1 : 78.958 MHz : 5.538 dB T1 : 5272.124 MHz : -3.578 dBm T2 : 5347.876 MHz : -3.236 dBm OBW : 75.752 MHz	Channel Frequency: 5310.00 MHz

[back to matrix](#)

This test report may be reproduced in full only. The document may only be updated by MiCOM Labs personnel. All changes will be noted in the Document History section of the report.



26 dB & 99% BANDWIDTH

Variant: 802.11ac-80, Channel: 5310.00 MHz, Chain b, Temp: Ambient, Voltage: 48 Vdc

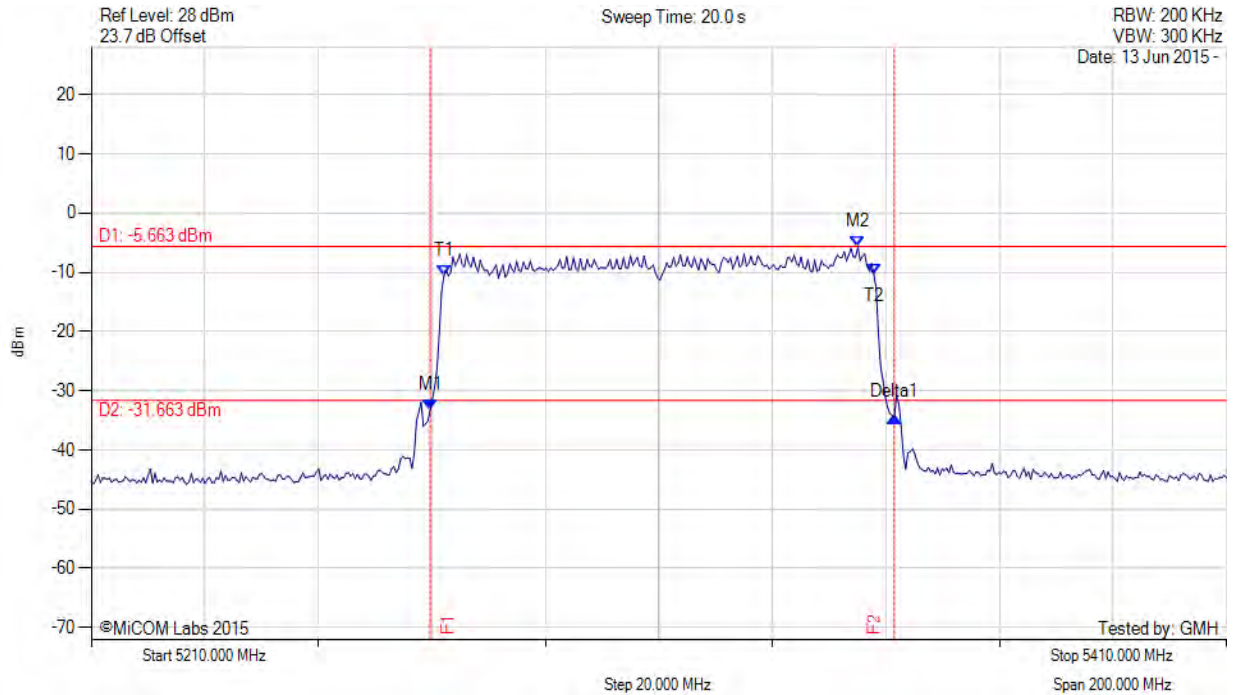

Analyser Setup	Marker:Frequency:Amplitude	Test Results
Detector = MAX PEAK Sweep Count = 0 RF Atten (dB) = 20 Trace Mode = MAX HOLD	M1 : 5269.719 MHz : -33.248 dBm M2 : 5345.070 MHz : -5.663 dBm Delta1 : 81.764 MHz : -1.188 dB T1 : 5272.124 MHz : -10.639 dBm T2 : 5347.876 MHz : -10.393 dBm OBW : 75.752 MHz	Measured 26 dB Bandwidth: 81.764 MHz Measured 99% Bandwidth: 75.752 MHz

[back to matrix](#)

This test report may be reproduced in full only. The document may only be updated by MiCOM Labs personnel. All changes will be noted in the Document History section of the report.



Title: Mimosa Networks A5 Wireless Access Point
To: FCC CFR 47 Part 15 Subpart E 15.407
Serial #: MIMO05-6a Rev A
Issue Date: 4th November 2015
Page: 168 of 372



26 dB & 99% BANDWIDTH

Variant: 802.11ac-80, Channel: 5310.00 MHz, Chain c, Temp: Ambient, Voltage: 48 Vdc

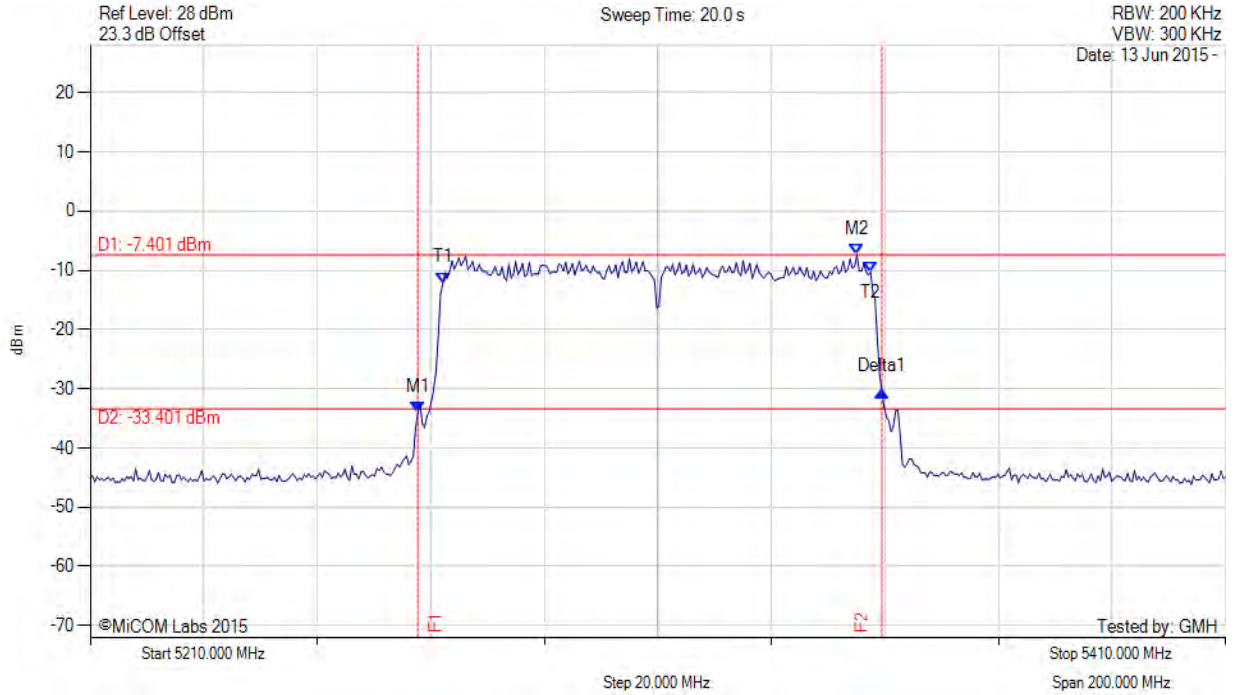

Analyser Setup	Marker:Frequency:Amplitude	Test Results
Detector = MAX PEAK Sweep Count = 0 RF Atten (dB) = 20 Trace Mode = MAX HOLD	M1 : 5267.715 MHz : -34.037 dBm M2 : 5345.070 MHz : -7.401 dBm Delta1 : 81.764 MHz : 3.602 dB T1 : 5272.124 MHz : -12.108 dBm T2 : 5347.475 MHz : -10.316 dBm OBW : 75.351 MHz	Measured 26 dB Bandwidth: 81.764 MHz Measured 99% Bandwidth: 75.351 MHz

[back to matrix](#)

This test report may be reproduced in full only. The document may only be updated by MiCOM Labs personnel. All changes will be noted in the Document History section of the report.



Title: Mimosa Networks A5 Wireless Access Point
To: FCC CFR 47 Part 15 Subpart E 15.407
Serial #: MIMO05-6a Rev A
Issue Date: 4th November 2015
Page: 169 of 372



26 dB & 99% BANDWIDTH

Variant: 802.11ac-80, Channel: 5310.00 MHz, Chain d, Temp: Ambient, Voltage: 48 Vdc

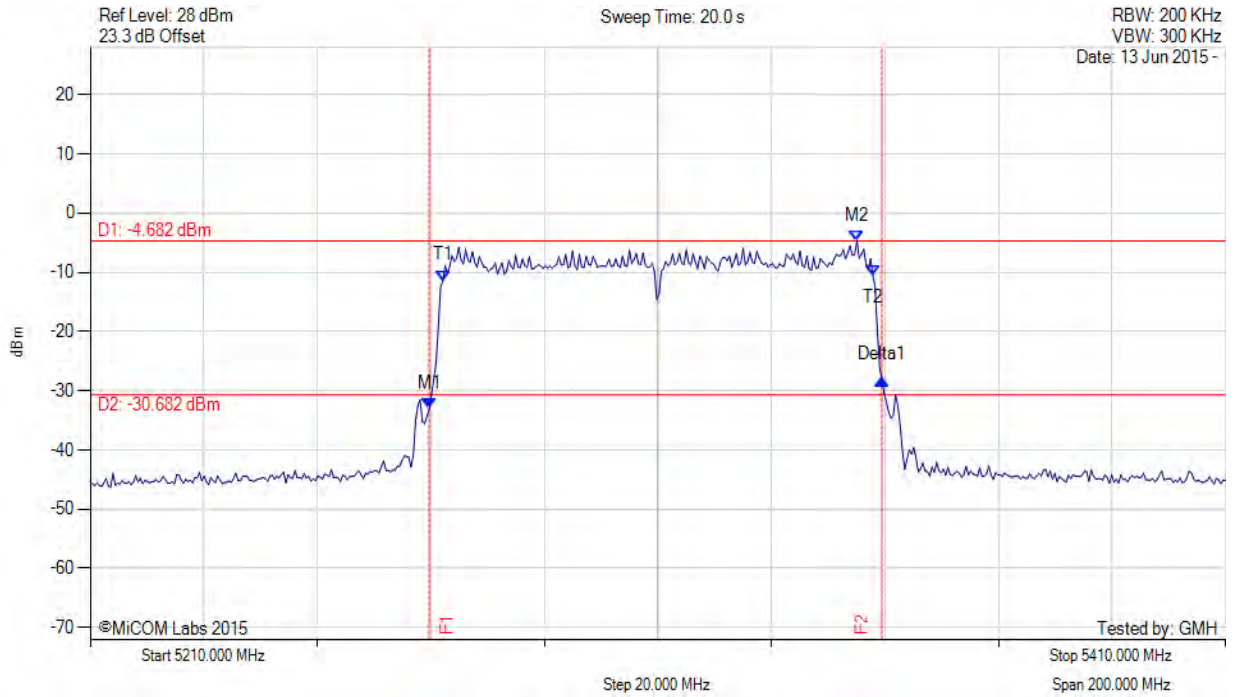

Analyser Setup	Marker:Frequency:Amplitude	Test Results
Detector = MAX PEAK Sweep Count = 0 RF Atten (dB) = 20 Trace Mode = MAX HOLD	M1 : 5269.719 MHz : -33.082 dBm M2 : 5345.070 MHz : -4.682 dBm Delta1 : 79.760 MHz : 4.865 dB T1 : 5272.124 MHz : -11.414 dBm T2 : 5347.876 MHz : -10.578 dBm OBW : 75.752 MHz	Measured 26 dB Bandwidth: 79.760 MHz Measured 99% Bandwidth: 75.752 MHz

[back to matrix](#)

This test report may be reproduced in full only. The document may only be updated by MiCOM Labs personnel. All changes will be noted in the Document History section of the report.



Title: Mimosa Networks A5 Wireless Access Point
To: FCC CFR 47 Part 15 Subpart E 15.407
Serial #: MIMO05-6a Rev A
Issue Date: 4th November 2015
Page: 170 of 372



26 dB & 99% BANDWIDTH

Variant: 802.11ac-80, Channel: 5530.00 MHz, Chain a, Temp: Ambient, Voltage: 48 Vdc

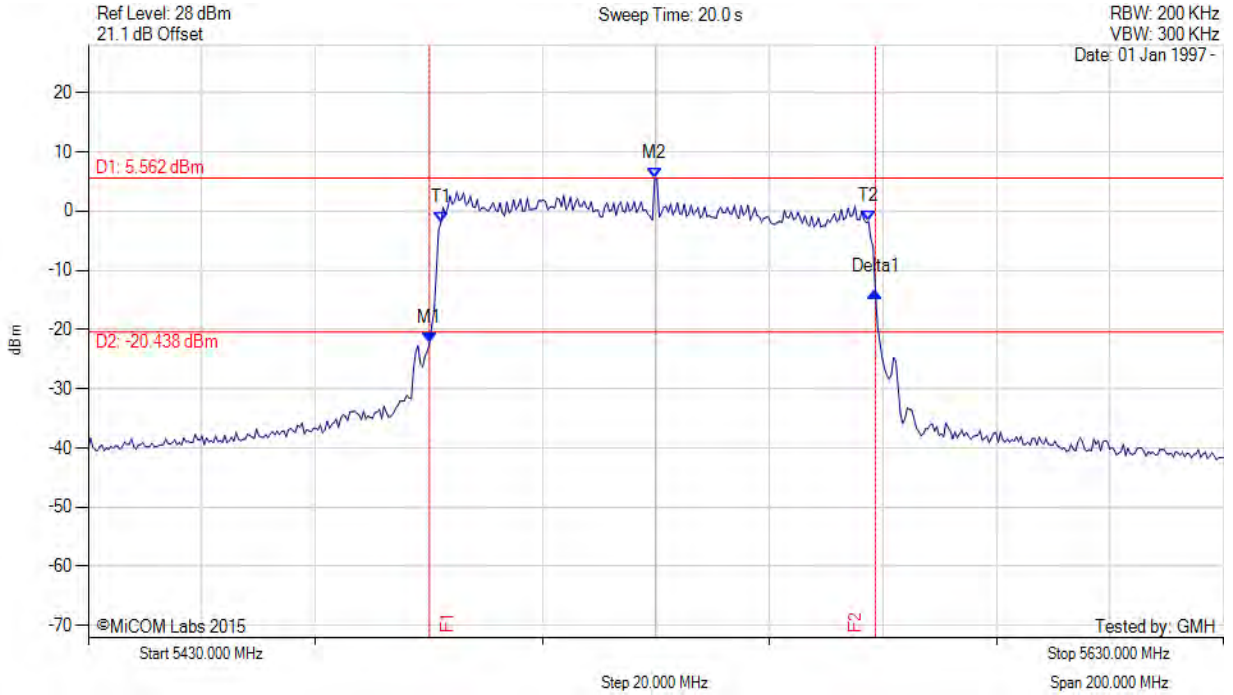

Analyser Setup	Marker:Frequency:Amplitude	Test Results
Detector = MAX PEAK Sweep Count = 0 RF Atten (dB) = 20 Trace Mode = MAX HOLD	M1 : 5490.120 MHz : -22.286 dBm M2 : 5529.800 MHz : 5.562 dBm Delta1 : 78.557 MHz : 8.613 dB T1 : 5492.124 MHz : -1.849 dBm T2 : 5567.475 MHz : -1.741 dBm OBW : 75.351 MHz	Measured 26 dB Bandwidth: 78.557 MHz Measured 99% Bandwidth: 75.351 MHz

[back to matrix](#)

This test report may be reproduced in full only. The document may only be updated by MiCOM Labs personnel. All changes will be noted in the Document History section of the report.



26 dB & 99% BANDWIDTH



Variant: 802.11ac-80, Channel: 5530.00 MHz, Chain a, Temp: Ambient, Voltage: 48 Vdc



Analyser Setup	Marker:Frequency:Amplitude	Test Results
Detector = MAX PEAK Sweep Count = 0 RF Atten (dB) = 20 Trace Mode = MAX HOLD	M1 : 5487.315 MHz : -35.561 dBm M2 : 5494.930 MHz : -7.025 dBm Delta1 : 81.764 MHz : 6.976 dB T1 : 5492.124 MHz : -11.894 dBm T2 : 5567.475 MHz : -11.914 dBm OBW : 75.351 MHz	Channel Frequency: 5530.00 MHz

[back to matrix](#)

This test report may be reproduced in full only. The document may only be updated by MiCOM Labs personnel. All changes will be noted in the Document History section of the report.



Title: Mimosa Networks A5 Wireless Access Point
To: FCC CFR 47 Part 15 Subpart E 15.407
Serial #: MIMO05-6a Rev A
Issue Date: 4th November 2015
Page: 172 of 372



26 dB & 99% BANDWIDTH

Variant: 802.11ac-80, Channel: 5530.00 MHz, Chain b, Temp: Ambient, Voltage: 48 Vdc

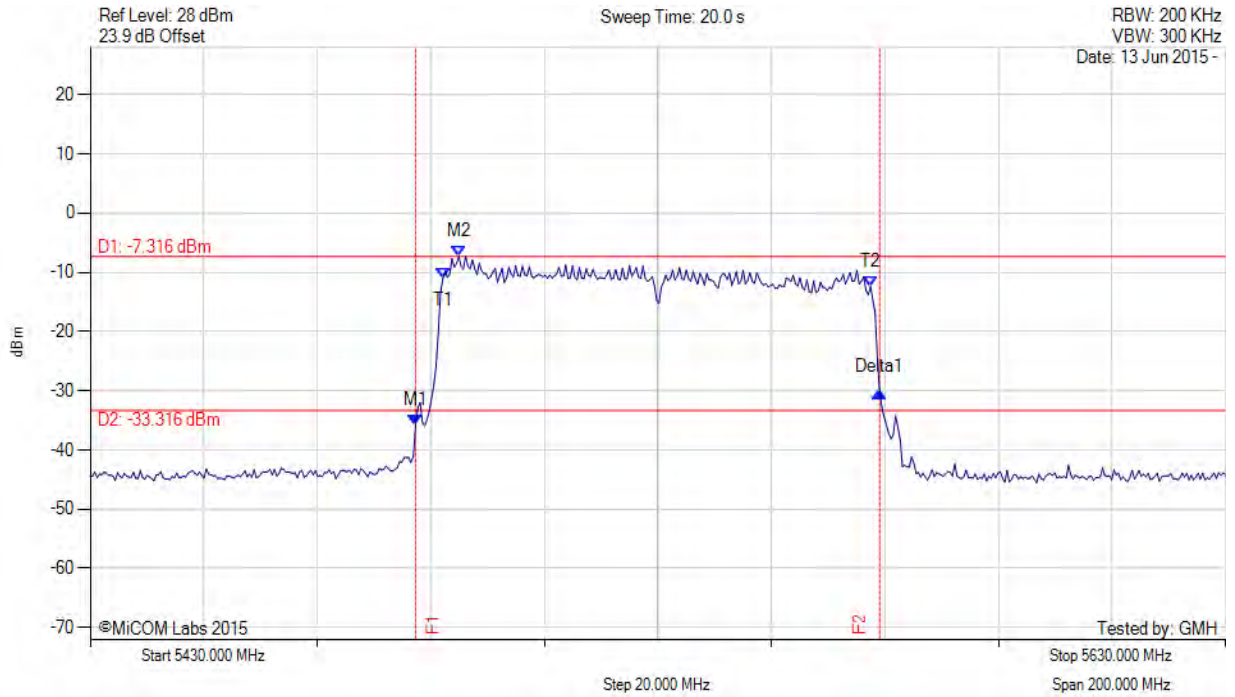

Analyser Setup	Marker:Frequency:Amplitude	Test Results
Detector = MAX PEAK Sweep Count = 0 RF Atten (dB) = 20 Trace Mode = MAX HOLD	M1 : 5487.315 MHz : -35.884 dBm M2 : 5494.930 MHz : -7.316 dBm Delta1 : 81.764 MHz : 5.682 dB T1 : 5492.124 MHz : -11.066 dBm T2 : 5567.475 MHz : -12.457 dBm OBW : 75.351 MHz	Measured 26 dB Bandwidth: 81.764 MHz Measured 99% Bandwidth: 75.351 MHz

[back to matrix](#)

This test report may be reproduced in full only. The document may only be updated by MiCOM Labs personnel. All changes will be noted in the Document History section of the report.



Title: Mimosa Networks A5 Wireless Access Point
To: FCC CFR 47 Part 15 Subpart E 15.407
Serial #: MIMO05-6a Rev A
Issue Date: 4th November 2015
Page: 173 of 372



26 dB & 99% BANDWIDTH

Variant: 802.11ac-80, Channel: 5530.00 MHz, Chain c, Temp: Ambient, Voltage: 48 Vdc

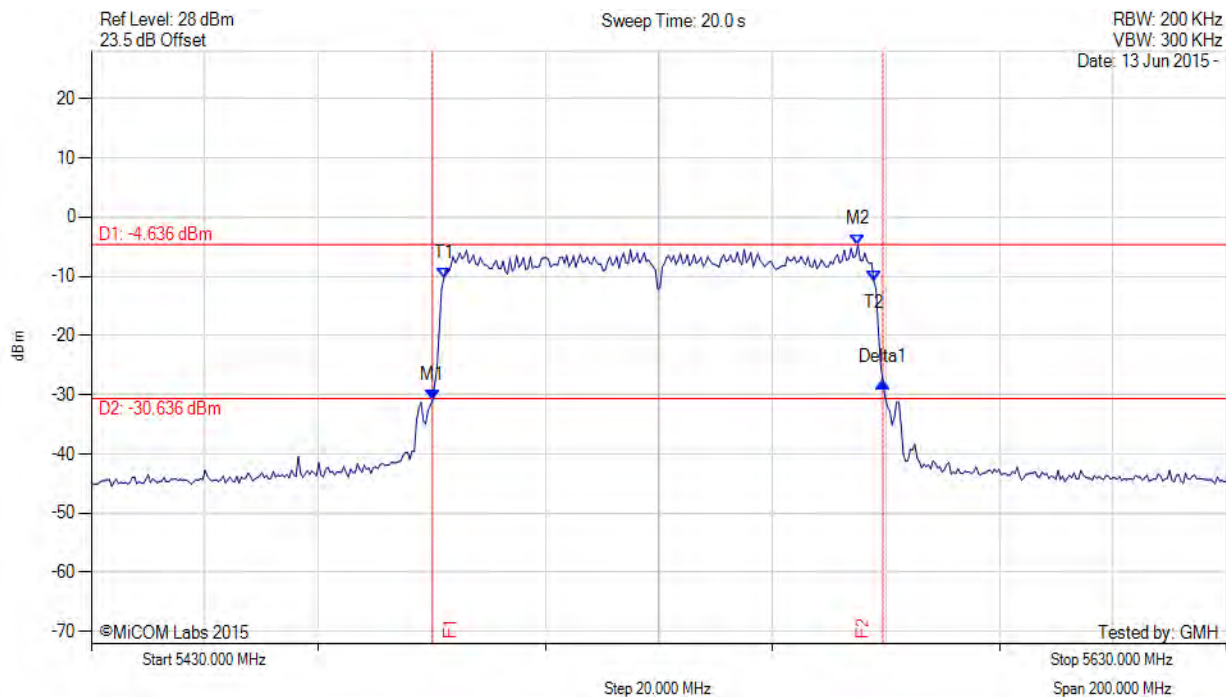

Analyser Setup	Marker:Frequency:Amplitude	Test Results
Detector = MAX PEAK Sweep Count = 0 RF Atten (dB) = 20 Trace Mode = MAX HOLD	M1 : 5490.120 MHz : -30.887 dBm M2 : 5565.070 MHz : -4.636 dBm Delta1 : 79.359 MHz : 2.994 dB T1 : 5492.124 MHz : -10.273 dBm T2 : 5567.876 MHz : -10.824 dBm OBW : 75.752 MHz	Measured 26 dB Bandwidth: 79.359 MHz Measured 99% Bandwidth: 75.752 MHz

[back to matrix](#)

This test report may be reproduced in full only. The document may only be updated by MiCOM Labs personnel. All changes will be noted in the Document History section of the report.



26 dB & 99% BANDWIDTH

Variant: 802.11ac-80, Channel: 5530.00 MHz, Chain d, Temp: Ambient, Voltage: 48 Vdc

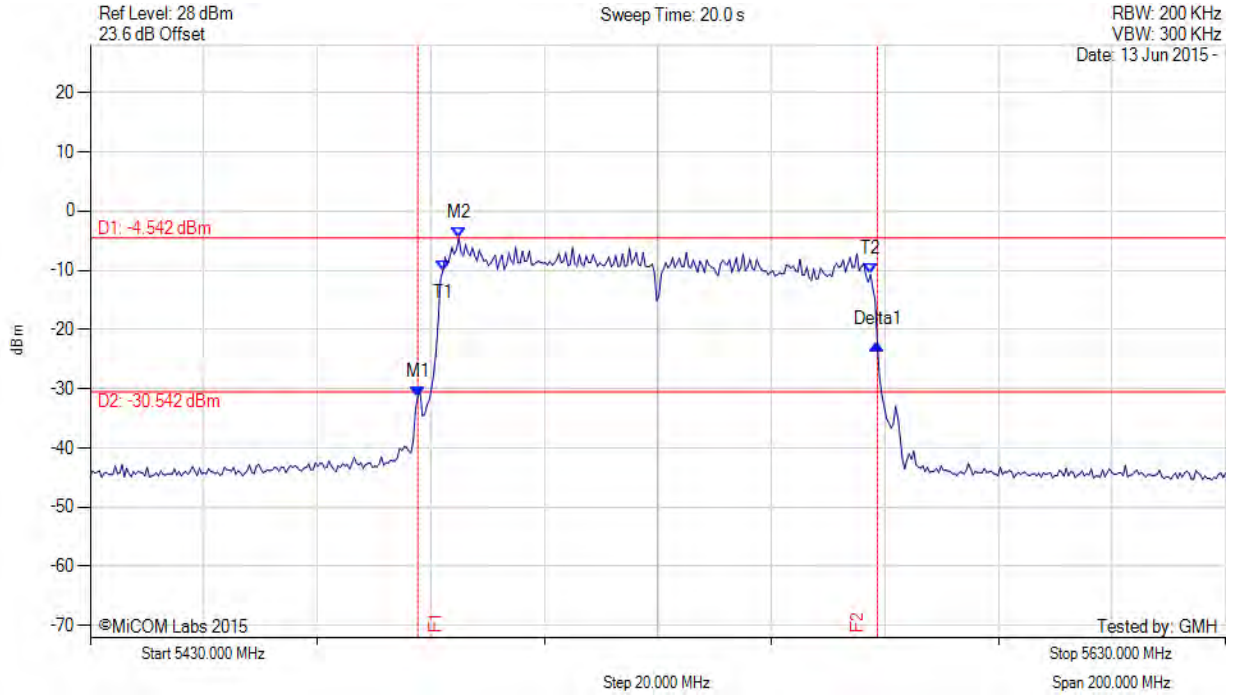

Analyser Setup	Marker:Frequency:Amplitude	Test Results
Detector = MAX PEAK Sweep Count = 0 RF Atten (dB) = 20 Trace Mode = MAX HOLD	M1 : 5487.715 MHz : -31.345 dBm M2 : 5494.930 MHz : -4.542 dBm Delta1 : 80.962 MHz : 8.808 dB T1 : 5492.124 MHz : -10.147 dBm T2 : 5567.475 MHz : -10.690 dBm OBW : 75.351 MHz	Measured 26 dB Bandwidth: 80.962 MHz Measured 99% Bandwidth: 75.351 MHz

[back to matrix](#)

This test report may be reproduced in full only. The document may only be updated by MiCOM Labs personnel. All changes will be noted in the Document History section of the report.



26 dB & 99% BANDWIDTH

Variant: 802.11ac-80, Channel: 5545.00 MHz, Chain a, Temp: Ambient, Voltage: 48 Vdc

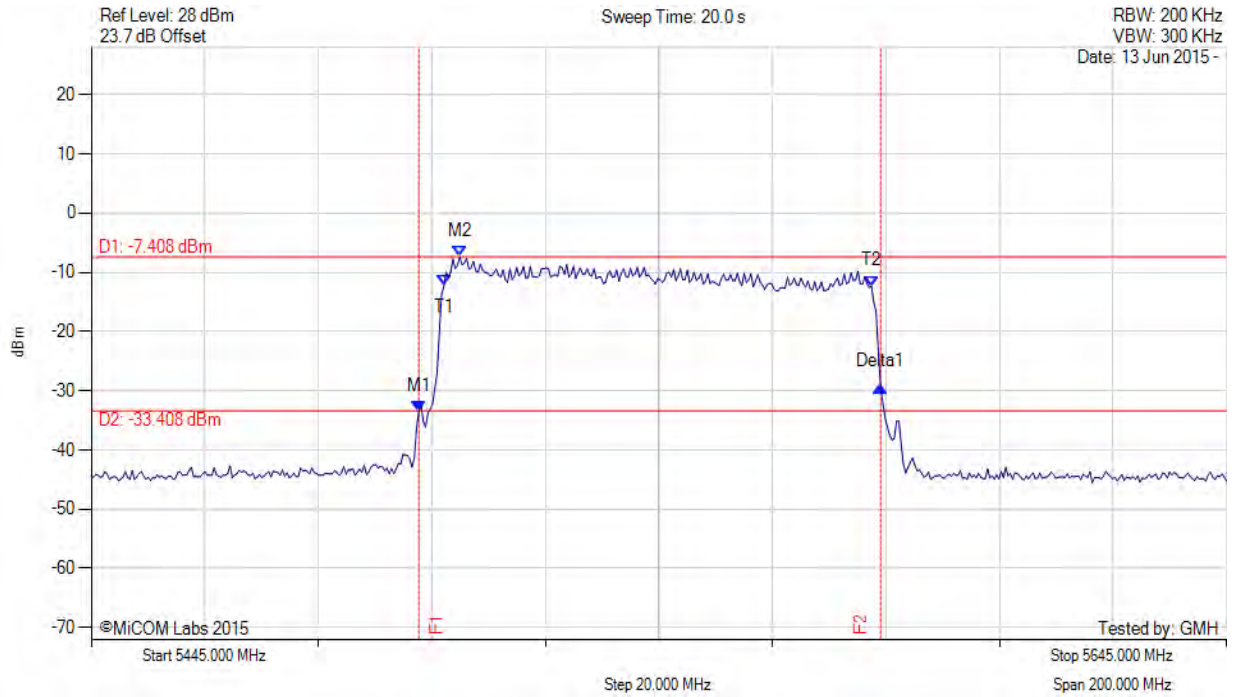

Analyser Setup	Marker:Frequency:Amplitude	Test Results
Detector = MAX PEAK Sweep Count = 0 RF Atten (dB) = 20 Trace Mode = MAX HOLD	M1 : 5502.715 MHz : -33.429 dBm M2 : 5509.930 MHz : -7.408 dBm Delta1 : 81.363 MHz : 4.061 dB T1 : 5507.124 MHz : -12.297 dBm T2 : 5582.475 MHz : -12.343 dBm OBW : 75.351 MHz	Measured 26 dB Bandwidth: 81.363 MHz Measured 99% Bandwidth: 75.351 MHz

[back to matrix](#)

This test report may be reproduced in full only. The document may only be updated by MiCOM Labs personnel. All changes will be noted in the Document History section of the report.



26 dB & 99% BANDWIDTH



Variant: 802.11ac-80, Channel: 5545.00 MHz, Chain a, Temp: Ambient, Voltage: 48 Vdc

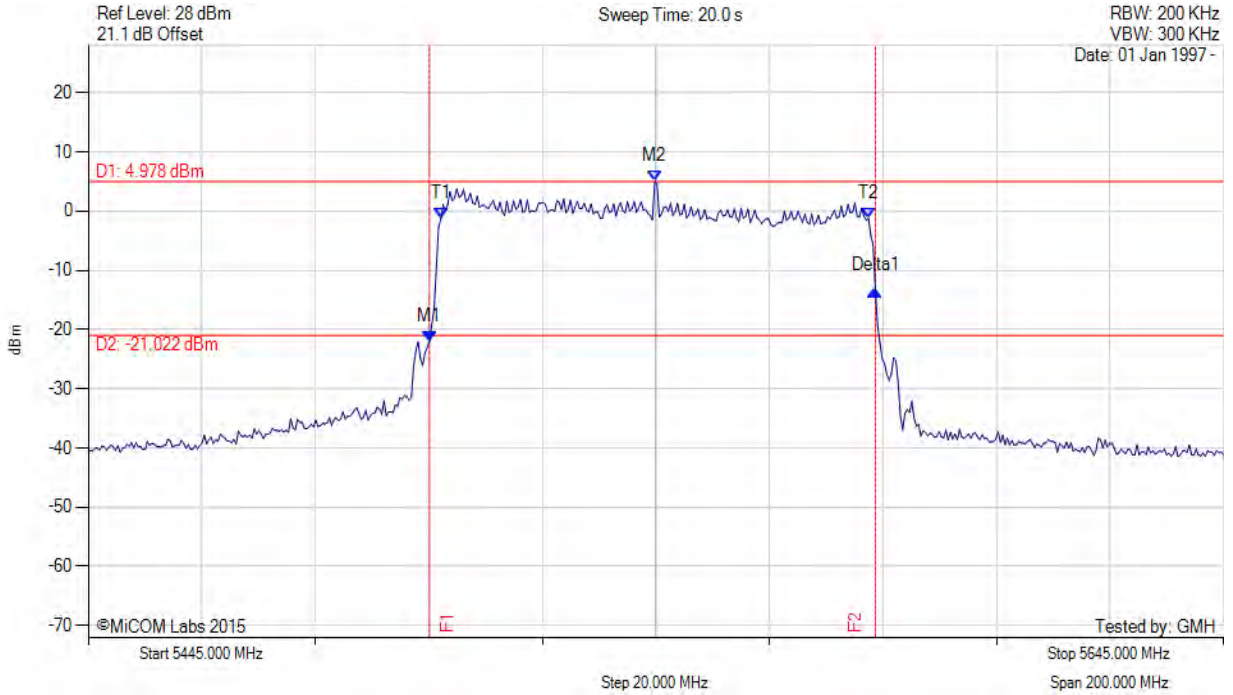

Analyser Setup	Marker:Frequency:Amplitude	Test Results
Detector = MAX PEAK Sweep Count = 0 RF Atten (dB) = 20 Trace Mode = MAX HOLD	M1 : 5505.120 MHz : -21.965 dBm M2 : 5544.800 MHz : 4.978 dBm Delta1 : 78.557 MHz : 8.580 dB T1 : 5507.124 MHz : -1.276 dBm T2 : 5582.475 MHz : -1.211 dBm OBW : 75.351 MHz	Channel Frequency: 5545.00 MHz

[back to matrix](#)

This test report may be reproduced in full only. The document may only be updated by MiCOM Labs personnel. All changes will be noted in the Document History section of the report.



26 dB & 99% BANDWIDTH

Variant: 802.11ac-80, Channel: 5545.00 MHz, Chain b, Temp: Ambient, Voltage: 48 Vdc

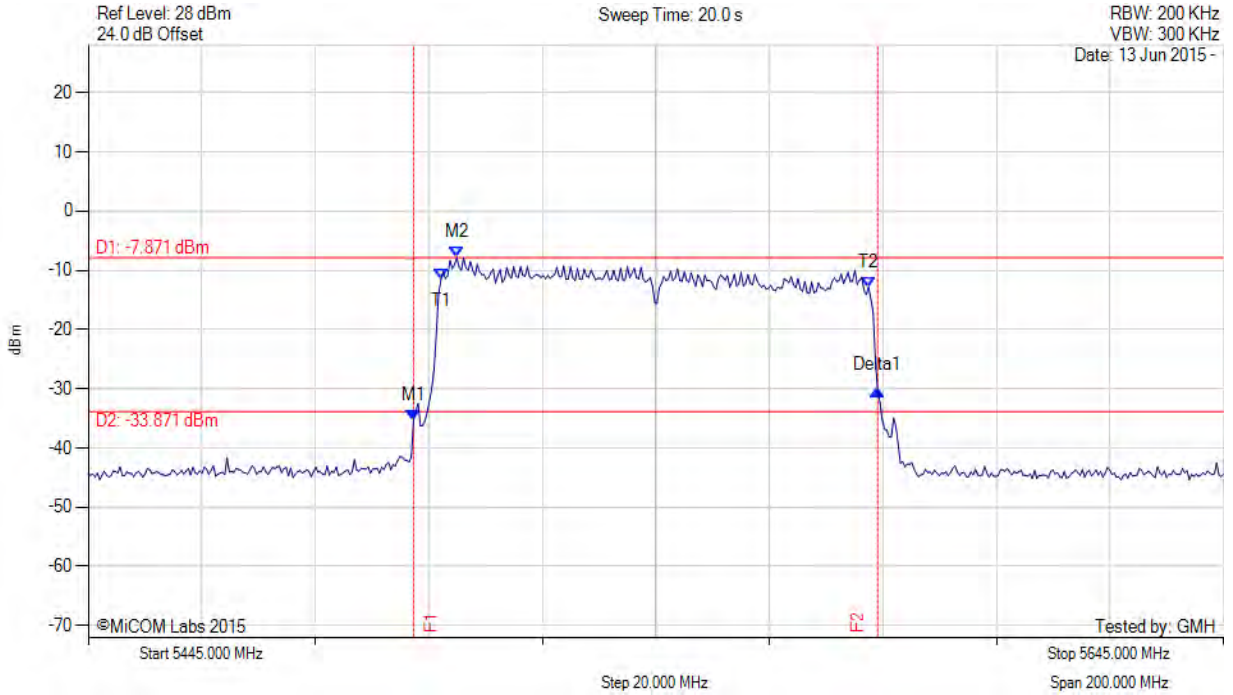

Analyser Setup	Marker:Frequency:Amplitude	Test Results
Detector = MAX PEAK Sweep Count = 0 RF Atten (dB) = 20 Trace Mode = MAX HOLD	M1 : 5502.315 MHz : -35.317 dBm M2 : 5509.930 MHz : -7.871 dBm Delta1 : 81.764 MHz : 5.015 dB T1 : 5507.124 MHz : -11.589 dBm T2 : 5582.475 MHz : -12.878 dBm OBW : 75.351 MHz	Measured 26 dB Bandwidth: 81.764 MHz Measured 99% Bandwidth: 75.351 MHz

[back to matrix](#)

This test report may be reproduced in full only. The document may only be updated by MiCOM Labs personnel. All changes will be noted in the Document History section of the report.



Title: Mimosa Networks A5 Wireless Access Point
To: FCC CFR 47 Part 15 Subpart E 15.407
Serial #: MIMO05-6a Rev A
Issue Date: 4th November 2015
Page: 178 of 372



26 dB & 99% BANDWIDTH

Variant: 802.11ac-80, Channel: 5545.00 MHz, Chain c, Temp: Ambient, Voltage: 48 Vdc

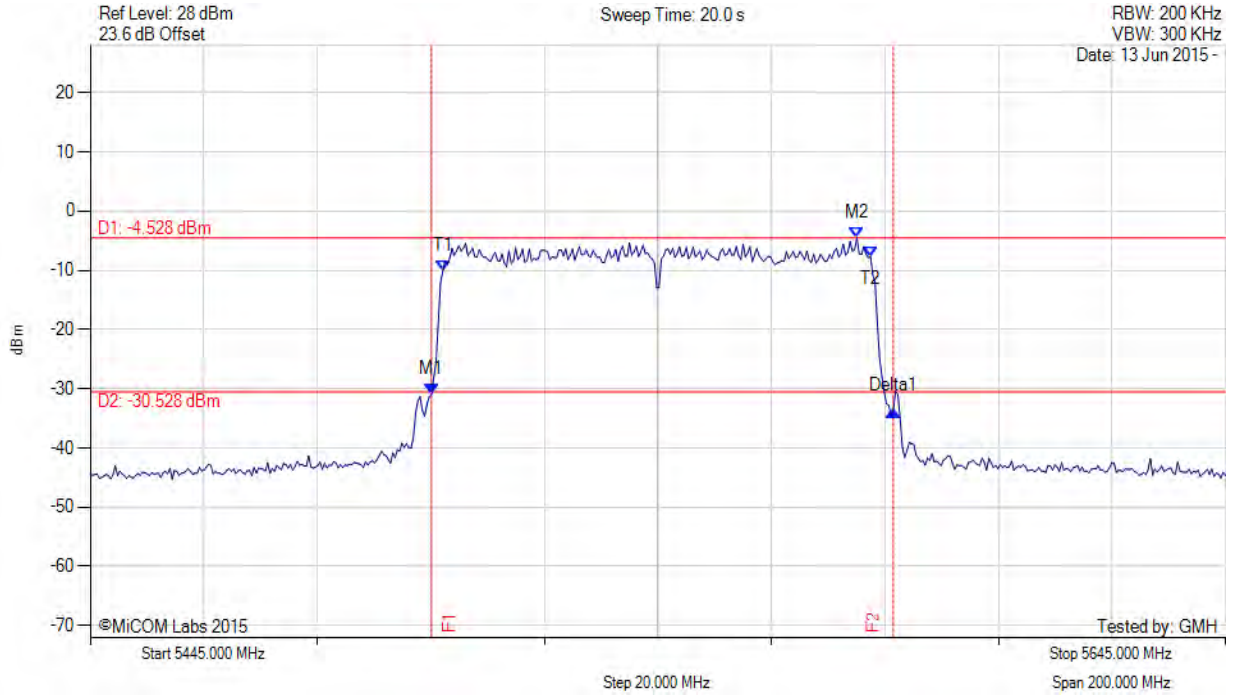

Analyser Setup	Marker:Frequency:Amplitude	Test Results
Detector = MAX PEAK Sweep Count = 0 RF Atten (dB) = 20 Trace Mode = MAX HOLD	M1 : 5505.120 MHz : -30.999 dBm M2 : 5580.070 MHz : -4.528 dBm Delta1 : 81.363 MHz : -2.646 dB T1 : 5507.124 MHz : -10.118 dBm T2 : 5582.475 MHz : -7.751 dBm OBW : 75.351 MHz	Measured 26 dB Bandwidth: 81.363 MHz Measured 99% Bandwidth: 75.351 MHz

[back to matrix](#)

This test report may be reproduced in full only. The document may only be updated by MiCOM Labs personnel. All changes will be noted in the Document History section of the report.



Title: Mimosa Networks A5 Wireless Access Point
To: FCC CFR 47 Part 15 Subpart E 15.407
Serial #: MIMO05-6a Rev A
Issue Date: 4th November 2015
Page: 179 of 372



26 dB & 99% BANDWIDTH

Variant: 802.11ac-80, Channel: 5545.00 MHz, Chain d, Temp: Ambient, Voltage: 48 Vdc

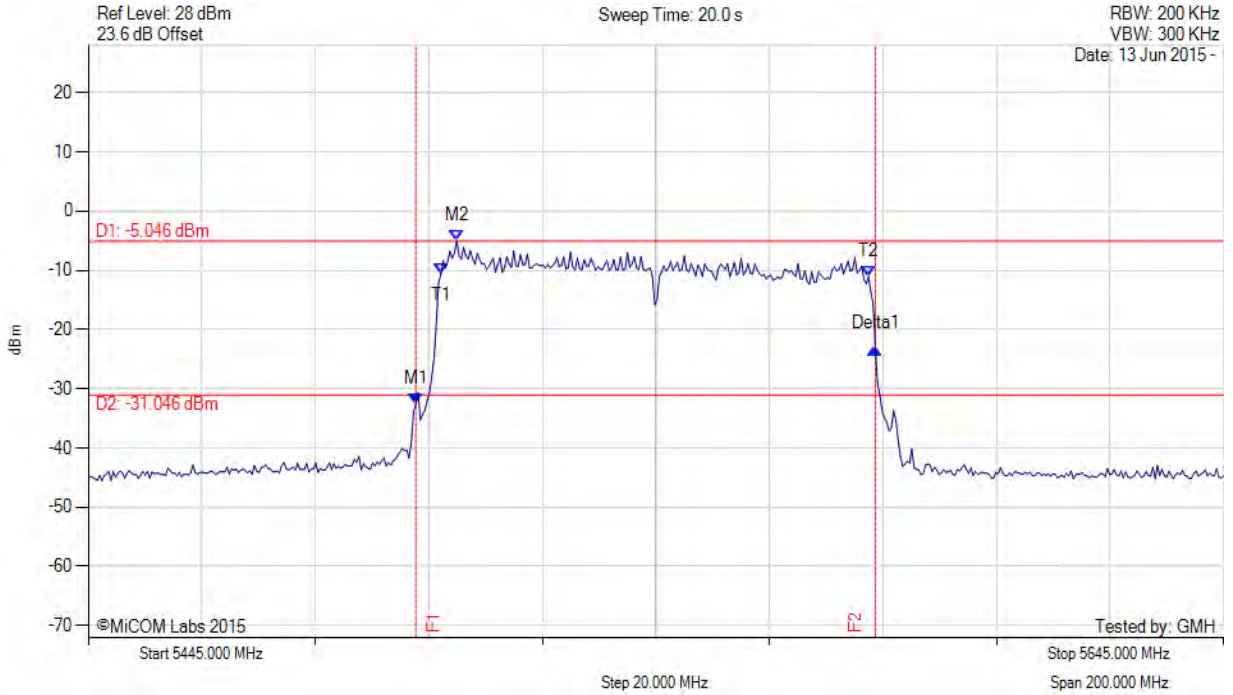

Analyser Setup	Marker:Frequency:Amplitude	Test Results
Detector = MAX PEAK Sweep Count = 0 RF Atten (dB) = 20 Trace Mode = MAX HOLD	M1 : 5502.715 MHz : -32.573 dBm M2 : 5509.930 MHz : -5.046 dBm Delta1 : 80.962 MHz : 9.284 dB T1 : 5507.124 MHz : -10.645 dBm T2 : 5582.475 MHz : -11.062 dBm OBW : 75.351 MHz	Measured 26 dB Bandwidth: 80.962 MHz Measured 99% Bandwidth: 75.351 MHz

[back to matrix](#)

This test report may be reproduced in full only. The document may only be updated by MiCOM Labs personnel. All changes will be noted in the Document History section of the report.



26 dB & 99% BANDWIDTH

Variant: 802.11ac-80, Channel: 5560.00 MHz, Chain a, Temp: Ambient, Voltage: 48 Vdc

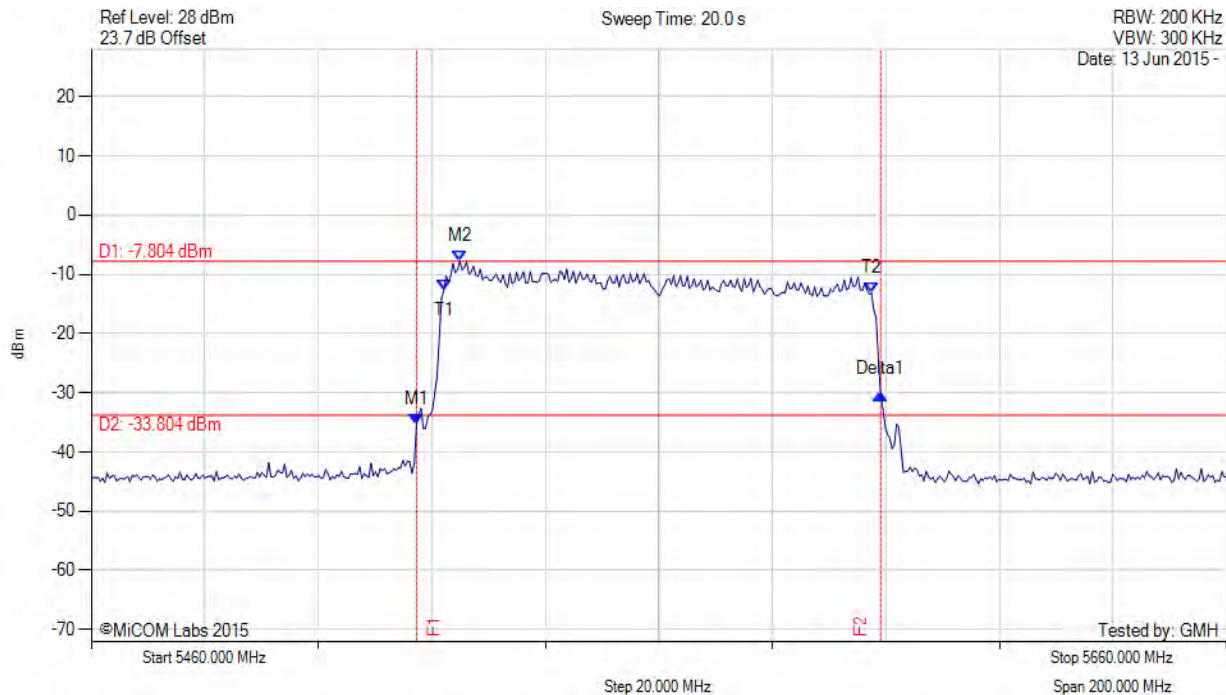

Analyser Setup	Marker:Frequency:Amplitude	Test Results
Detector = MAX PEAK Sweep Count = 0 RF Atten (dB) = 20 Trace Mode = MAX HOLD	M1 : 5517.315 MHz : -35.433 dBm M2 : 5524.930 MHz : -7.804 dBm Delta1 : 81.764 MHz : 5.237 dB T1 : 5522.124 MHz : -12.606 dBm T2 : 5597.475 MHz : -13.179 dBm OBW : 75.351 MHz	Measured 26 dB Bandwidth: 81.764 MHz Measured 99% Bandwidth: 75.351 MHz

[back to matrix](#)

This test report may be reproduced in full only. The document may only be updated by MiCOM Labs personnel. All changes will be noted in the Document History section of the report.



26 dB & 99% BANDWIDTH



Variant: 802.11ac-80, Channel: 5560.00 MHz, Chain a, Temp: Ambient, Voltage: 48 Vdc

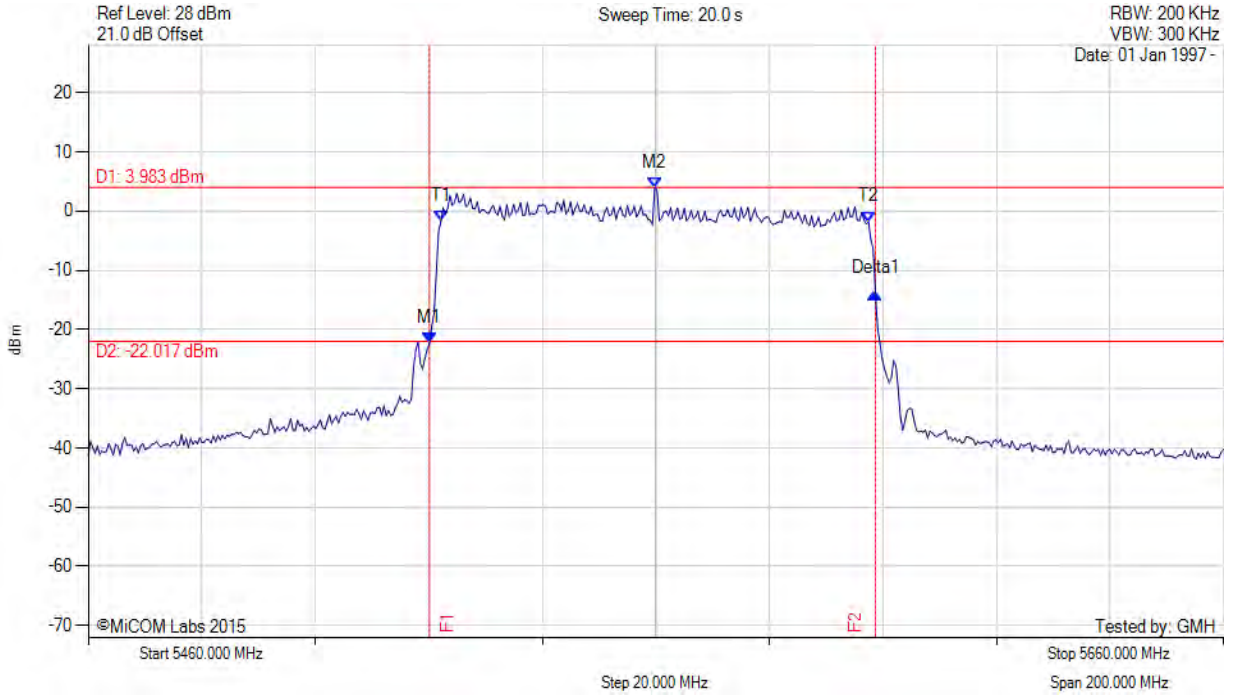

Analyser Setup	Marker:Frequency:Amplitude	Test Results
Detector = MAX PEAK Sweep Count = 0 RF Atten (dB) = 20 Trace Mode = MAX HOLD	M1 : 5520.120 MHz : -22.317 dBm M2 : 5559.800 MHz : 3.983 dBm Delta1 : 78.557 MHz : 8.387 dB T1 : 5522.124 MHz : -1.764 dBm T2 : 5597.475 MHz : -1.839 dBm OBW : 75.351 MHz	Channel Frequency: 5560.00 MHz

[back to matrix](#)

This test report may be reproduced in full only. The document may only be updated by MiCOM Labs personnel. All changes will be noted in the Document History section of the report.



Title: Mimosa Networks A5 Wireless Access Point
To: FCC CFR 47 Part 15 Subpart E 15.407
Serial #: MIMO05-6a Rev A
Issue Date: 4th November 2015
Page: 182 of 372



26 dB & 99% BANDWIDTH

Variant: 802.11ac-80, Channel: 5560.00 MHz, Chain b, Temp: Ambient, Voltage: 48 Vdc

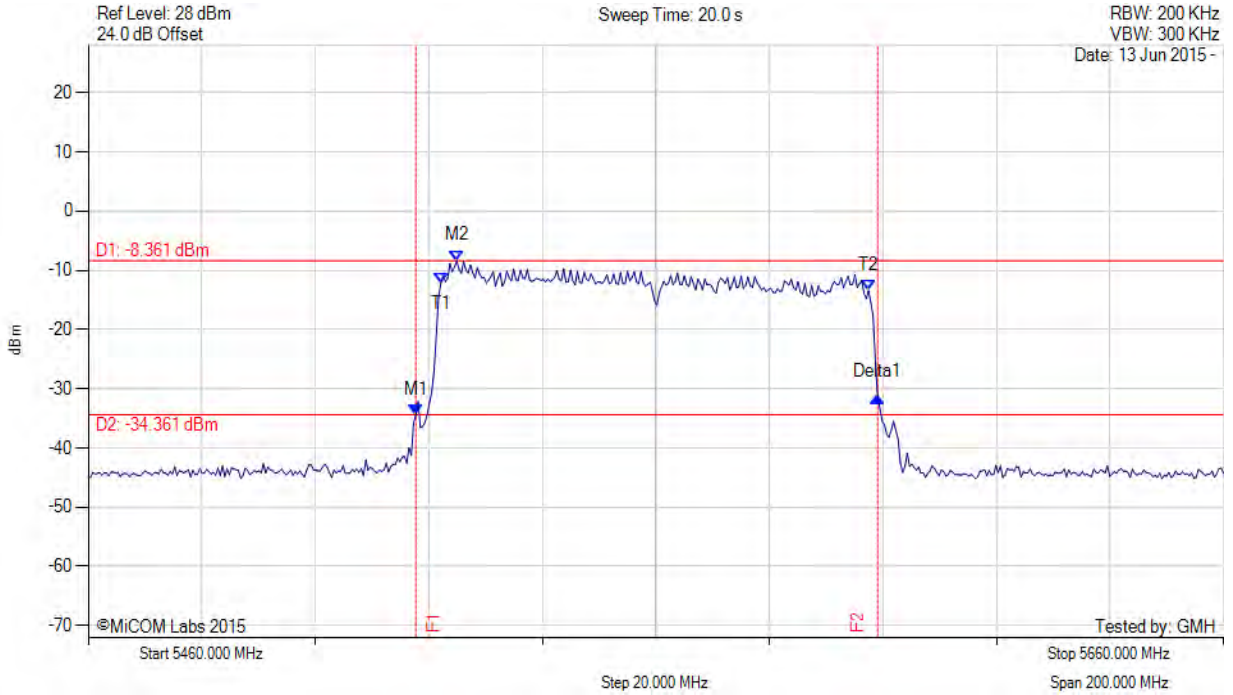

Analyser Setup	Marker:Frequency:Amplitude	Test Results
Detector = MAX PEAK Sweep Count = 0 RF Atten (dB) = 20 Trace Mode = MAX HOLD	M1 : 5517.715 MHz : -34.424 dBm M2 : 5524.930 MHz : -8.361 dBm Delta1 : 81.363 MHz : 3.014 dB T1 : 5522.124 MHz : -12.132 dBm T2 : 5597.475 MHz : -13.448 dBm OBW : 75.351 MHz	Measured 26 dB Bandwidth: 81.363 MHz Measured 99% Bandwidth: 75.351 MHz

[back to matrix](#)

This test report may be reproduced in full only. The document may only be updated by MiCOM Labs personnel. All changes will be noted in the Document History section of the report.



Title: Mimosa Networks A5 Wireless Access Point
To: FCC CFR 47 Part 15 Subpart E 15.407
Serial #: MIMO05-6a Rev A
Issue Date: 4th November 2015
Page: 183 of 372



26 dB & 99% BANDWIDTH

Variant: 802.11ac-80, Channel: 5560.00 MHz, Chain c, Temp: Ambient, Voltage: 48 Vdc

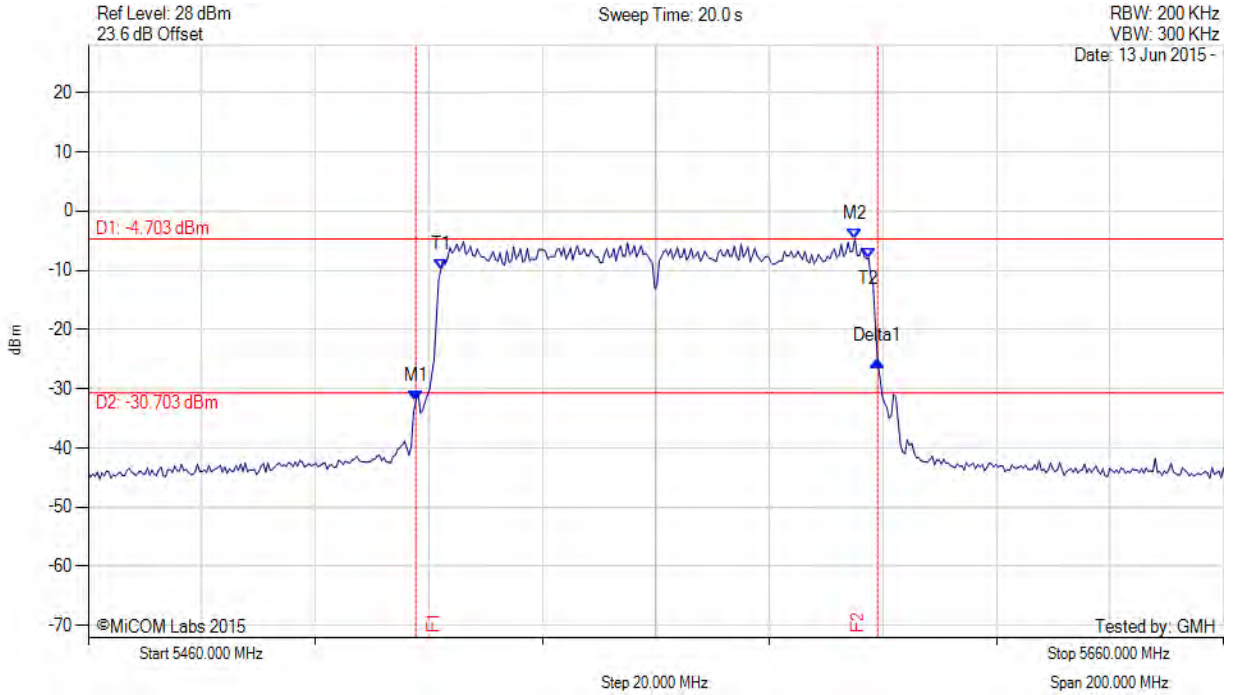

Analyser Setup	Marker:Frequency:Amplitude	Test Results
Detector = MAX PEAK Sweep Count = 0 RF Atten (dB) = 20 Trace Mode = MAX HOLD	M1 : 5517.715 MHz : -32.061 dBm M2 : 5595.070 MHz : -4.703 dBm Delta1 : 81.363 MHz : 6.772 dB T1 : 5522.124 MHz : -9.826 dBm T2 : 5597.475 MHz : -7.896 dBm OBW : 75.351 MHz	Measured 26 dB Bandwidth: 81.363 MHz Measured 99% Bandwidth: 75.351 MHz

[back to matrix](#)

This test report may be reproduced in full only. The document may only be updated by MiCOM Labs personnel. All changes will be noted in the Document History section of the report.



26 dB & 99% BANDWIDTH

Variant: 802.11ac-80, Channel: 5560.00 MHz, Chain d, Temp: Ambient, Voltage: 48 Vdc

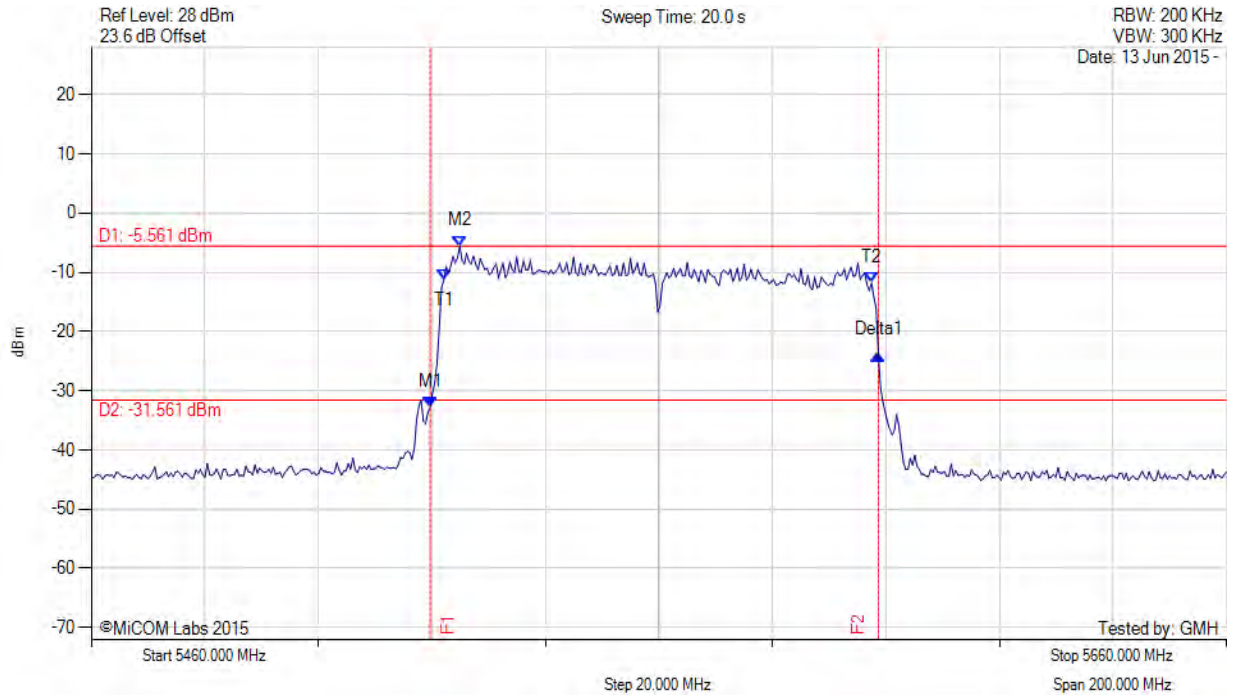

Analyser Setup	Marker:Frequency:Amplitude	Test Results
Detector = MAX PEAK Sweep Count = 0 RF Atten (dB) = 20 Trace Mode = MAX HOLD	M1 : 5519.719 MHz : -32.815 dBm M2 : 5524.930 MHz : -5.561 dBm Delta1 : 78.958 MHz : 8.859 dB T1 : 5522.124 MHz : -11.239 dBm T2 : 5597.475 MHz : -11.780 dBm OBW : 75.351 MHz	Measured 26 dB Bandwidth: 78.958 MHz Measured 99% Bandwidth: 75.351 MHz

[back to matrix](#)

This test report may be reproduced in full only. The document may only be updated by MiCOM Labs personnel. All changes will be noted in the Document History section of the report.



Title: Mimosa Networks A5 Wireless Access Point
To: FCC CFR 47 Part 15 Subpart E 15.407
Serial #: MIMO05-6a Rev A
Issue Date: 4th November 2015
Page: 185 of 372



26 dB & 99% BANDWIDTH

Variant: 802.11ac-80, Channel: 5775.00 MHz, Chain a, Temp: Ambient, Voltage: 48 Vdc

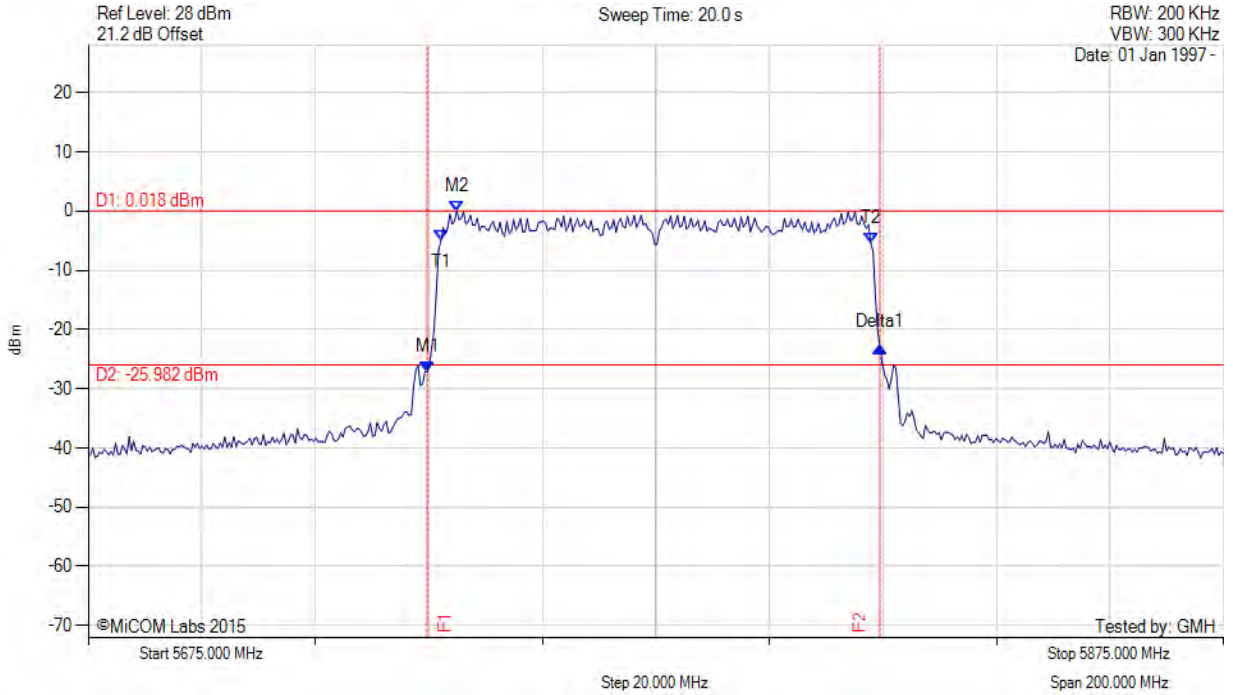

Analyser Setup	Marker:Frequency:Amplitude	Test Results
Detector = MAX PEAK Sweep Count = 0 RF Atten (dB) = 20 Trace Mode = MAX HOLD	M1 : 5734.719 MHz : -27.180 dBm M2 : 5739.930 MHz : 0.018 dBm Delta1 : 79.760 MHz : 4.263 dB T1 : 5737.124 MHz : -5.018 dBm T2 : 5812.876 MHz : -5.488 dBm OBW : 75.752 MHz	Measured 26 dB Bandwidth: 79.760 MHz Measured 99% Bandwidth: 75.752 MHz

[back to matrix](#)

This test report may be reproduced in full only. The document may only be updated by MiCOM Labs personnel. All changes will be noted in the Document History section of the report.



Title: Mimosa Networks A5 Wireless Access Point
To: FCC CFR 47 Part 15 Subpart E 15.407
Serial #: MIMO05-6a Rev A
Issue Date: 4th November 2015
Page: 186 of 372



26 dB & 99% BANDWIDTH

Variant: 802.11ac-80, Channel: 5775.00 MHz, Chain a, Temp: Ambient, Voltage: 48 Vdc

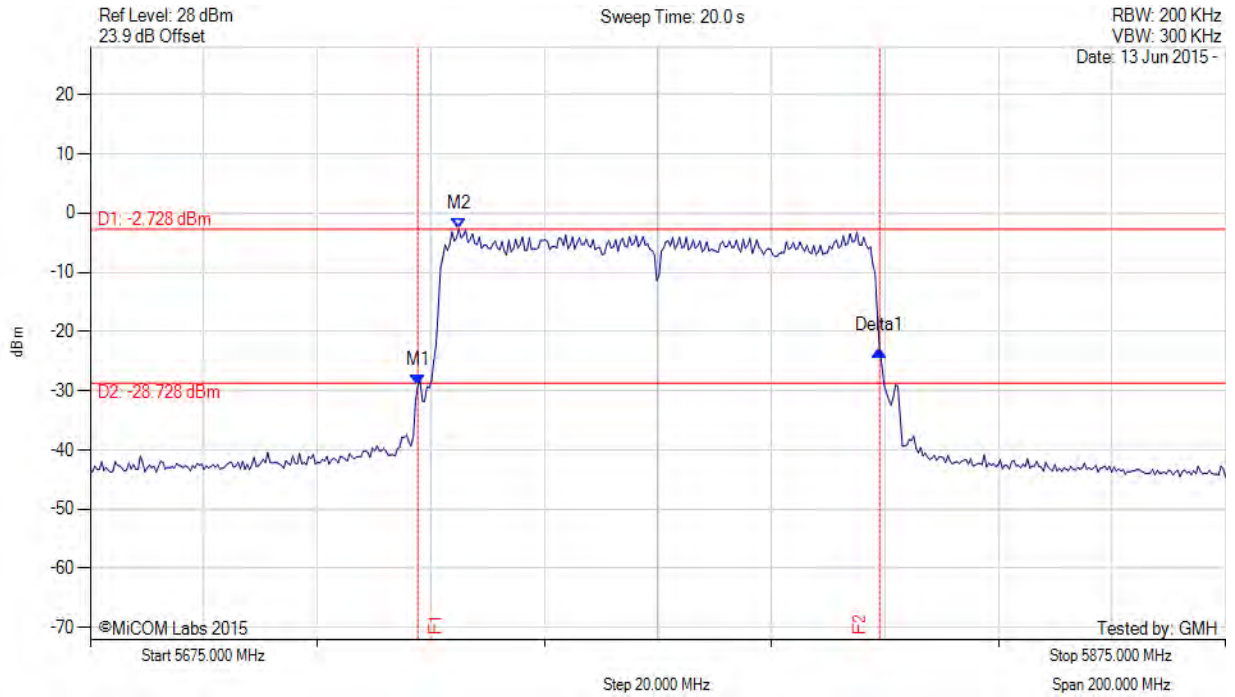

Analyser Setup	Marker:Frequency:Amplitude	Test Results
Detector = MAX PEAK Sweep Count = 0 RF Atten (dB) = 20 Trace Mode = MAX HOLD	M1 : 5732.715 MHz : -29.114 dBm M2 : 5739.930 MHz : -2.728 dBm Delta1 : 81.363 MHz : 5.916 dB T1 : 0 Hz : 500.000 dBm T2 : 0 Hz : 500.000 dBm OBW : 75.351 MHz	Channel Frequency: 5775.00 MHz

[back to matrix](#)

This test report may be reproduced in full only. The document may only be updated by MiCOM Labs personnel. All changes will be noted in the Document History section of the report.



Title: Mimosa Networks A5 Wireless Access Point
To: FCC CFR 47 Part 15 Subpart E 15.407
Serial #: MIMO05-6a Rev A
Issue Date: 4th November 2015
Page: 187 of 372



26 dB & 99% BANDWIDTH

Variant: 802.11ac-80, Channel: 5775.00 MHz, Chain b, Temp: Ambient, Voltage: 48 Vdc

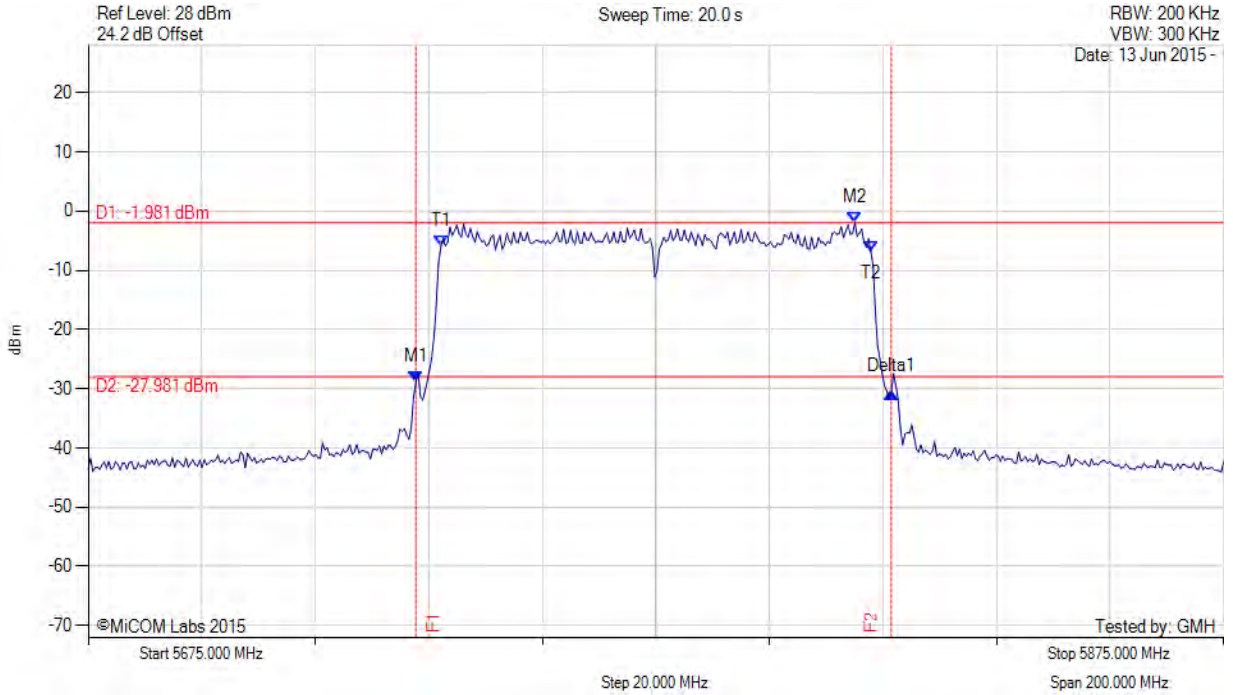

Analyser Setup	Marker:Frequency:Amplitude	Test Results
Detector = MAX PEAK Sweep Count = 0 RF Atten (dB) = 20 Trace Mode = MAX HOLD	M1 : 5732.715 MHz : -28.859 dBm M2 : 5810.070 MHz : -1.981 dBm Delta1 : 83.768 MHz : -1.704 dB T1 : 5737.124 MHz : -5.966 dBm T2 : 5812.876 MHz : -6.867 dBm OBW : 75.752 MHz	Measured 26 dB Bandwidth: 83.768 MHz Measured 99% Bandwidth: 75.752 MHz

[back to matrix](#)

This test report may be reproduced in full only. The document may only be updated by MiCOM Labs personnel. All changes will be noted in the Document History section of the report.



26 dB & 99% BANDWIDTH



Variant: 802.11ac-80, Channel: 5775.00 MHz, Chain c, Temp: Ambient, Voltage: 48 Vdc

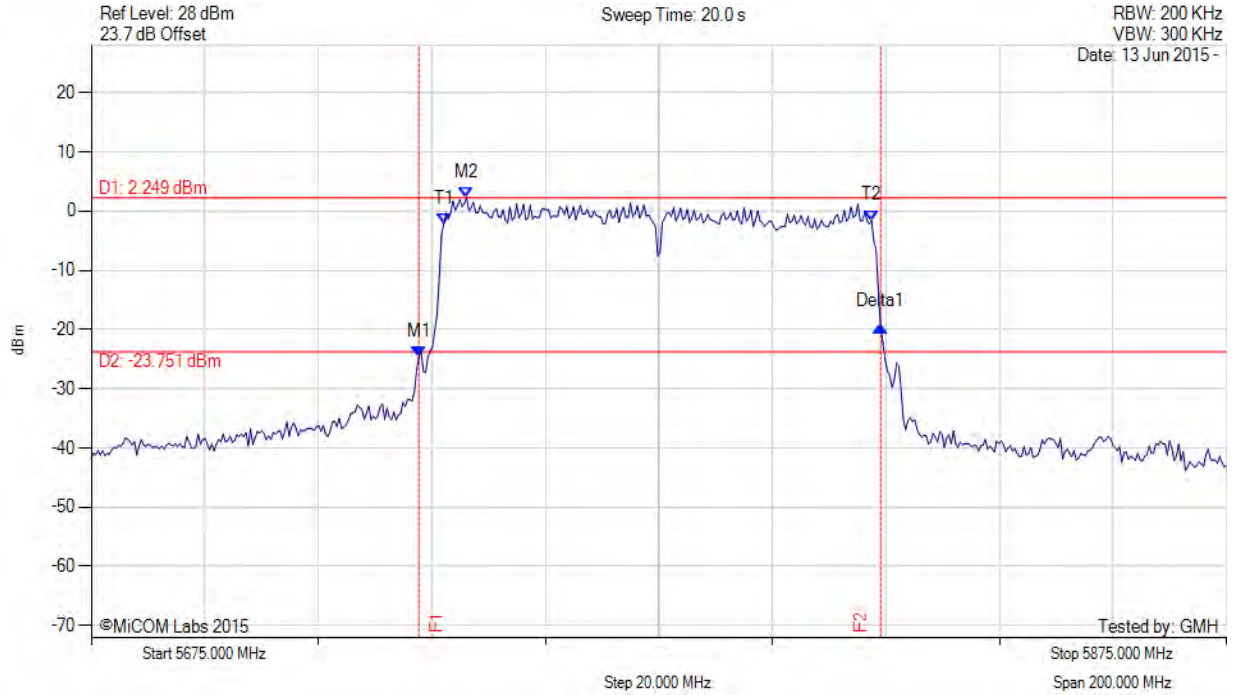

Analyser Setup	Marker:Frequency:Amplitude	Test Results
Detector = MAX PEAK Sweep Count = 0 RF Atten (dB) = 20 Trace Mode = MAX HOLD	M1 : 5732.715 MHz : -24.511 dBm M2 : 5741.132 MHz : 2.249 dBm Delta1 : 81.363 MHz : 4.942 dB T1 : 5737.124 MHz : -2.081 dBm T2 : 5812.475 MHz : -1.583 dBm OBW : 75.351 MHz	Measured 26 dB Bandwidth: 81.363 MHz Measured 99% Bandwidth: 75.351 MHz

[back to matrix](#)

This test report may be reproduced in full only. The document may only be updated by MiCOM Labs personnel. All changes will be noted in the Document History section of the report.



Title: Mimosa Networks A5 Wireless Access Point
To: FCC CFR 47 Part 15 Subpart E 15.407
Serial #: MIMO05-6a Rev A
Issue Date: 4th November 2015
Page: 189 of 372



26 dB & 99% BANDWIDTH

Variant: 802.11ac-80, Channel: 5775.00 MHz, Chain d, Temp: Ambient, Voltage: 48 Vdc

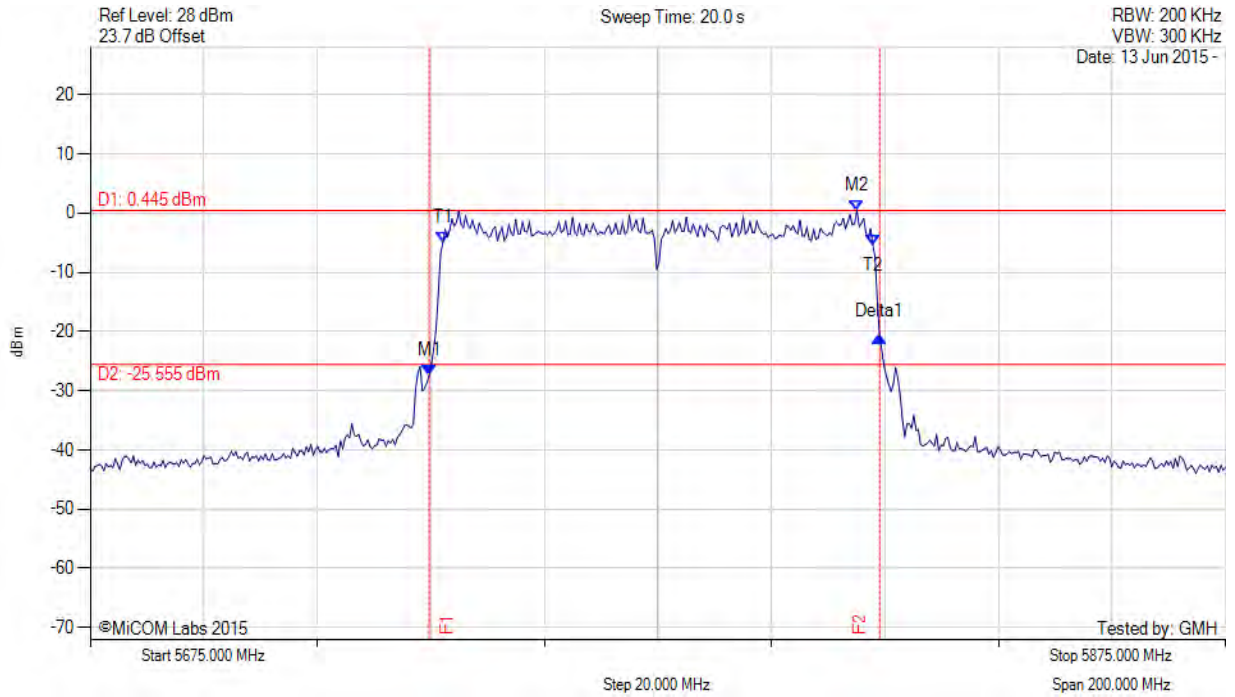

Analyser Setup	Marker:Frequency:Amplitude	Test Results
Detector = MAX PEAK Sweep Count = 0 RF Atten (dB) = 20 Trace Mode = MAX HOLD	M1 : 5734.719 MHz : -27.466 dBm M2 : 5810.070 MHz : 0.445 dBm Delta1 : 79.359 MHz : 6.656 dB T1 : 5737.124 MHz : -4.955 dBm T2 : 5812.876 MHz : -5.398 dBm OBW : 75.752 MHz	Measured 26 dB Bandwidth: 79.359 MHz Measured 99% Bandwidth: 75.752 MHz

[back to matrix](#)

This test report may be reproduced in full only. The document may only be updated by MiCOM Labs personnel. All changes will be noted in the Document History section of the report.



Title: Mimosa Networks A5 Wireless Access Point
To: FCC CFR 47 Part 15 Subpart E 15.407
Serial #: MIMO05-6a Rev A
Issue Date: 4th November 2015
Page: 190 of 372



26 dB & 99% BANDWIDTH

Variant: 802.11ac-80, Channel: 5785.00 MHz, Chain a, Temp: Ambient, Voltage: 48 Vdc

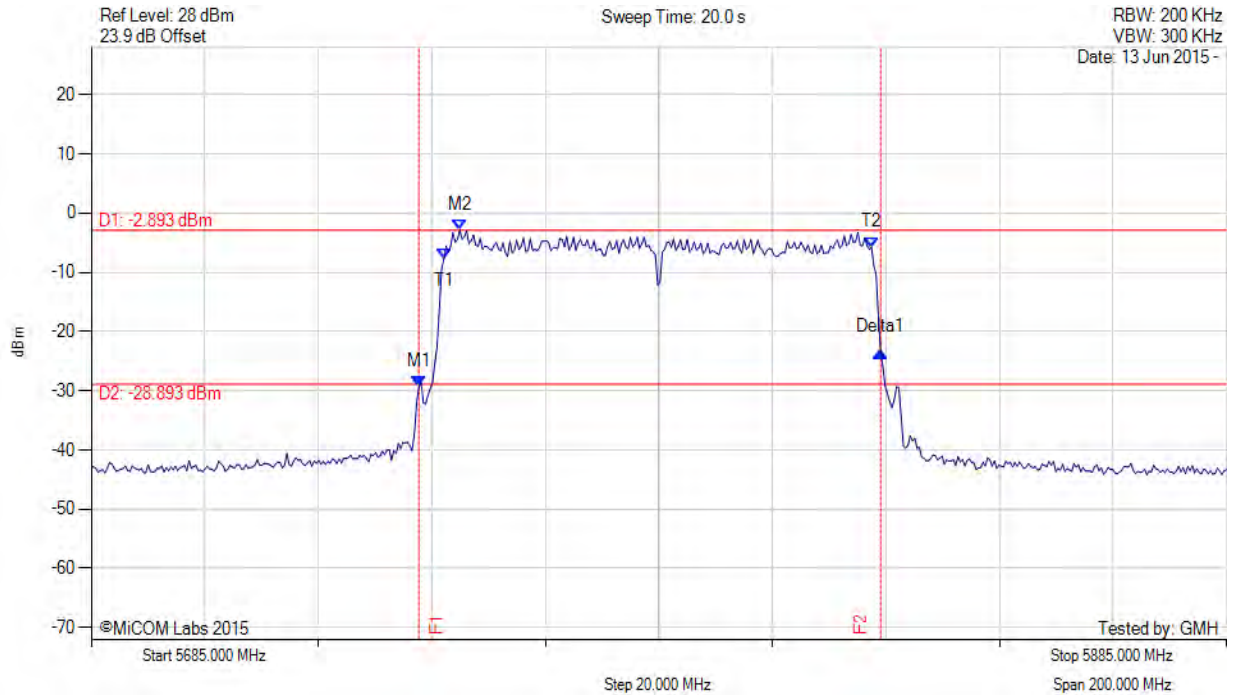

Analyser Setup	Marker:Frequency:Amplitude	Test Results
Detector = MAX PEAK Sweep Count = 0 RF Atten (dB) = 20 Trace Mode = MAX HOLD	M1 : 5742.715 MHz : -29.323 dBm M2 : 5749.930 MHz : -2.893 dBm Delta1 : 81.363 MHz : 5.827 dB T1 : 5747.124 MHz : -7.772 dBm T2 : 5822.475 MHz : -5.813 dBm OBW : 75.351 MHz	Measured 26 dB Bandwidth: 81.363 MHz Measured 99% Bandwidth: 75.351 MHz

[back to matrix](#)

This test report may be reproduced in full only. The document may only be updated by MiCOM Labs personnel. All changes will be noted in the Document History section of the report.



26 dB & 99% BANDWIDTH

Variant: 802.11ac-80, Channel: 5785.00 MHz, Chain a, Temp: Ambient, Voltage: 48 Vdc

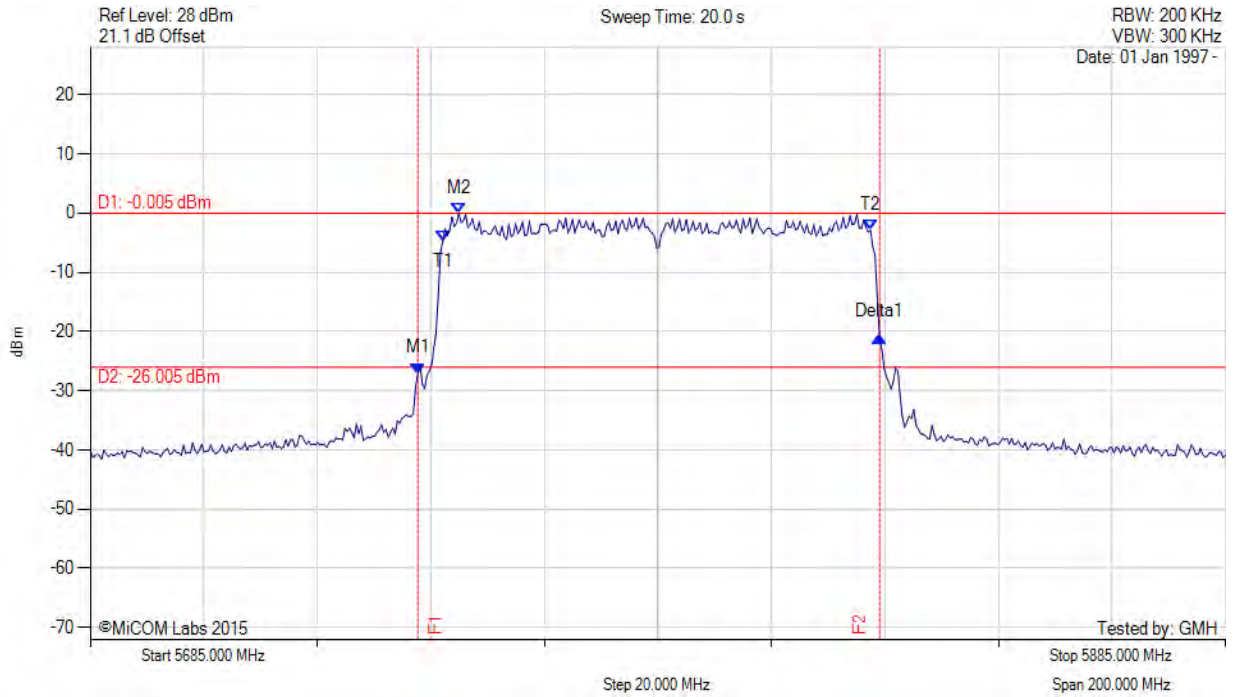

Analyser Setup	Marker:Frequency:Amplitude	Test Results
Detector = MAX PEAK Sweep Count = 0 RF Atten (dB) = 20 Trace Mode = MAX HOLD	M1 : 5742.715 MHz : -27.068 dBm M2 : 5749.930 MHz : -0.005 dBm Delta1 : 81.363 MHz : 6.099 dB T1 : 5747.124 MHz : -4.658 dBm T2 : 5822.475 MHz : -2.907 dBm OBW : 75.351 MHz	Channel Frequency: 5785.00 MHz

[back to matrix](#)

This test report may be reproduced in full only. The document may only be updated by MiCOM Labs personnel. All changes will be noted in the Document History section of the report.



Title: Mimosa Networks A5 Wireless Access Point
To: FCC CFR 47 Part 15 Subpart E 15.407
Serial #: MIMO05-6a Rev A
Issue Date: 4th November 2015
Page: 192 of 372



26 dB & 99% BANDWIDTH

Variant: 802.11ac-80, Channel: 5785.00 MHz, Chain b, Temp: Ambient, Voltage: 48 Vdc

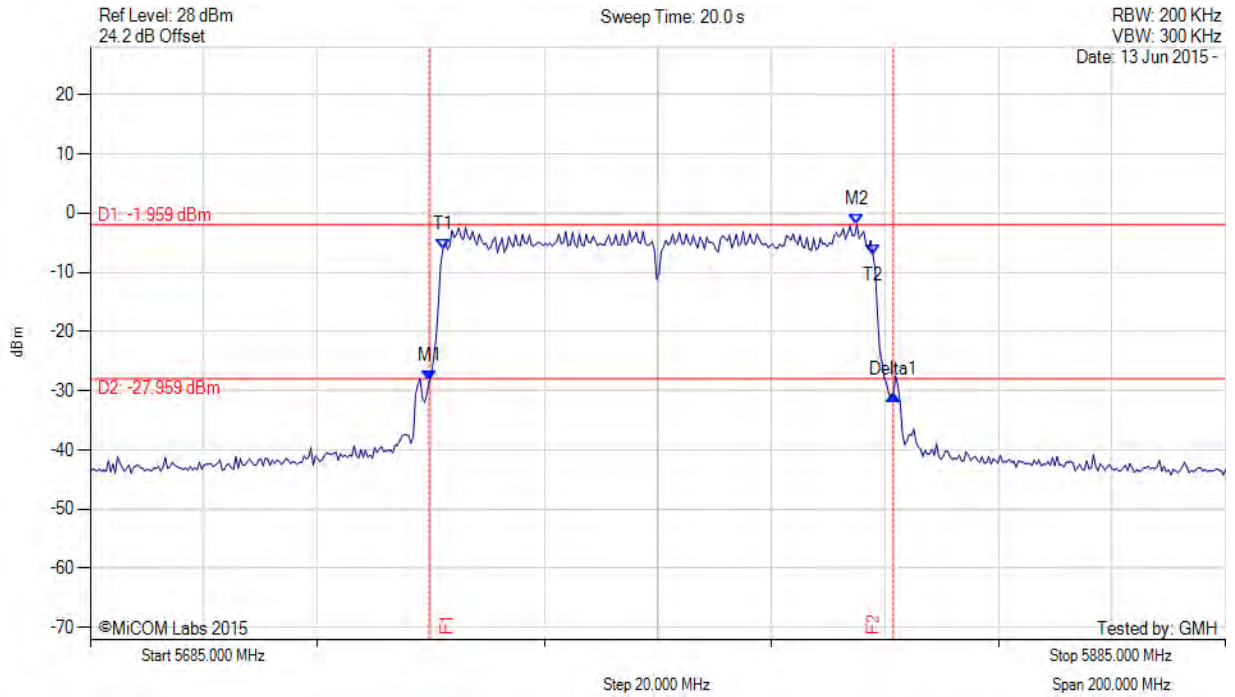

Analyser Setup	Marker:Frequency:Amplitude	Test Results
Detector = MAX PEAK Sweep Count = 0 RF Atten (dB) = 20 Trace Mode = MAX HOLD	M1 : 5744.719 MHz : -28.422 dBm M2 : 5820.070 MHz : -1.959 dBm Delta1 : 81.764 MHz : -2.351 dB T1 : 5747.124 MHz : -6.159 dBm T2 : 5822.876 MHz : -6.964 dBm OBW : 75.752 MHz	Measured 26 dB Bandwidth: 81.764 MHz Measured 99% Bandwidth: 75.752 MHz

[back to matrix](#)

This test report may be reproduced in full only. The document may only be updated by MiCOM Labs personnel. All changes will be noted in the Document History section of the report.



Title: Mimosa Networks A5 Wireless Access Point
To: FCC CFR 47 Part 15 Subpart E 15.407
Serial #: MIMO05-6a Rev A
Issue Date: 4th November 2015
Page: 193 of 372

26 dB & 99% BANDWIDTH



Variant: 802.11ac-80, Channel: 5785.00 MHz, Chain c, Temp: Ambient, Voltage: 48 Vdc

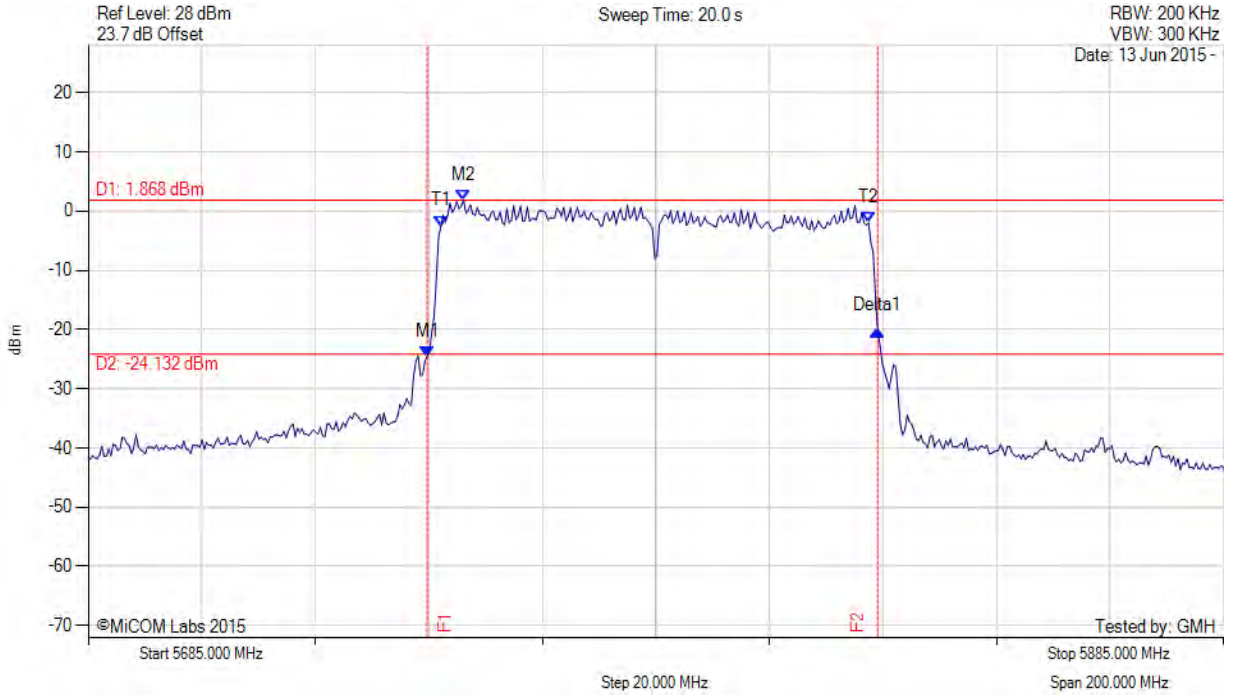

Analyser Setup	Marker:Frequency:Amplitude	Test Results
Detector = MAX PEAK Sweep Count = 0 RF Atten (dB) = 20 Trace Mode = MAX HOLD	M1 : 5744.719 MHz : -24.528 dBm M2 : 5751.132 MHz : 1.868 dBm Delta1 : 79.359 MHz : 4.421 dB T1 : 5747.124 MHz : -2.537 dBm T2 : 5822.475 MHz : -1.981 dBm OBW : 75.351 MHz	Measured 26 dB Bandwidth: 79.359 MHz Measured 99% Bandwidth: 75.351 MHz

[back to matrix](#)

This test report may be reproduced in full only. The document may only be updated by MiCOM Labs personnel. All changes will be noted in the Document History section of the report.



Title: Mimosa Networks A5 Wireless Access Point
To: FCC CFR 47 Part 15 Subpart E 15.407
Serial #: MIMO05-6a Rev A
Issue Date: 4th November 2015
Page: 194 of 372



26 dB & 99% BANDWIDTH

Variant: 802.11ac-80, Channel: 5785.00 MHz, Chain d, Temp: Ambient, Voltage: 48 Vdc

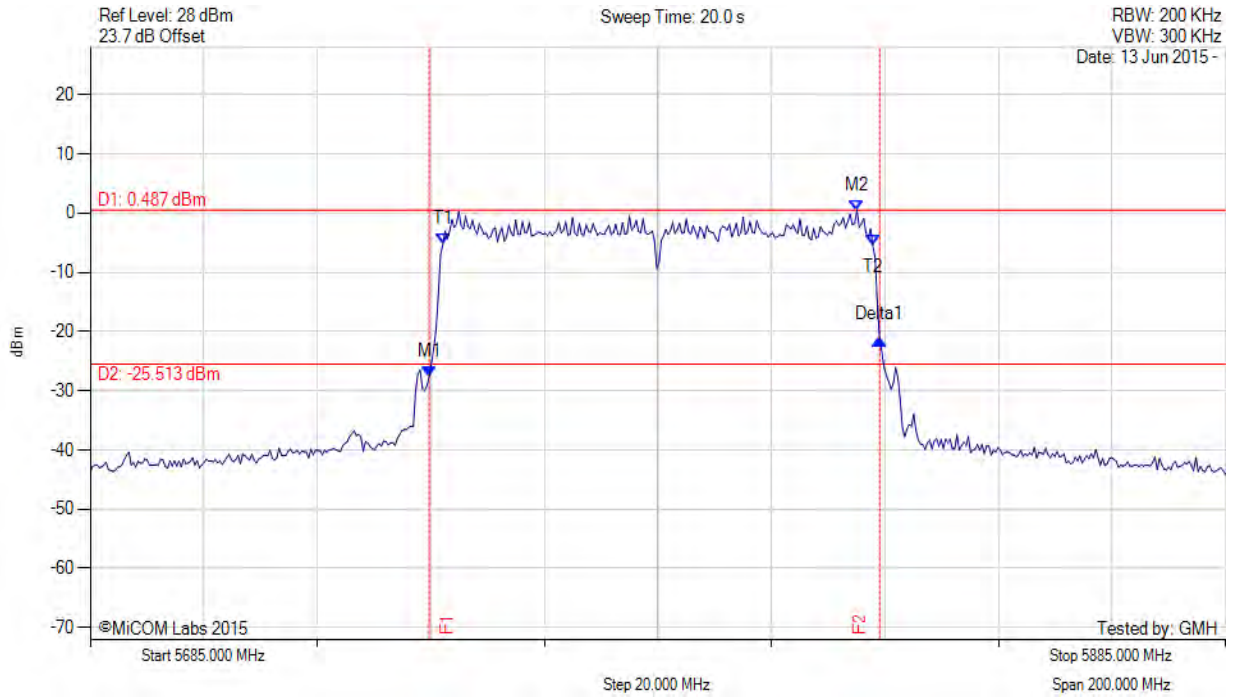

Analyser Setup	Marker:Frequency:Amplitude	Test Results
Detector = MAX PEAK Sweep Count = 0 RF Atten (dB) = 20 Trace Mode = MAX HOLD	M1 : 5744.719 MHz : -27.552 dBm M2 : 5820.070 MHz : 0.487 dBm Delta1 : 79.359 MHz : 6.211 dB T1 : 5747.124 MHz : -5.248 dBm T2 : 5822.876 MHz : -5.473 dBm OBW : 75.752 MHz	Measured 26 dB Bandwidth: 79.359 MHz Measured 99% Bandwidth: 75.752 MHz

[back to matrix](#)

This test report may be reproduced in full only. The document may only be updated by MiCOM Labs personnel. All changes will be noted in the Document History section of the report.



Title: Mimosa Networks A5 Wireless Access Point
To: FCC CFR 47 Part 15 Subpart E 15.407
Serial #: MIMO05-6a Rev A
Issue Date: 4th November 2015
Page: 195 of 372



26 dB & 99% BANDWIDTH

Variant: 802.11ac-80, Channel: 5795.00 MHz, Chain a, Temp: Ambient, Voltage: 48 Vdc

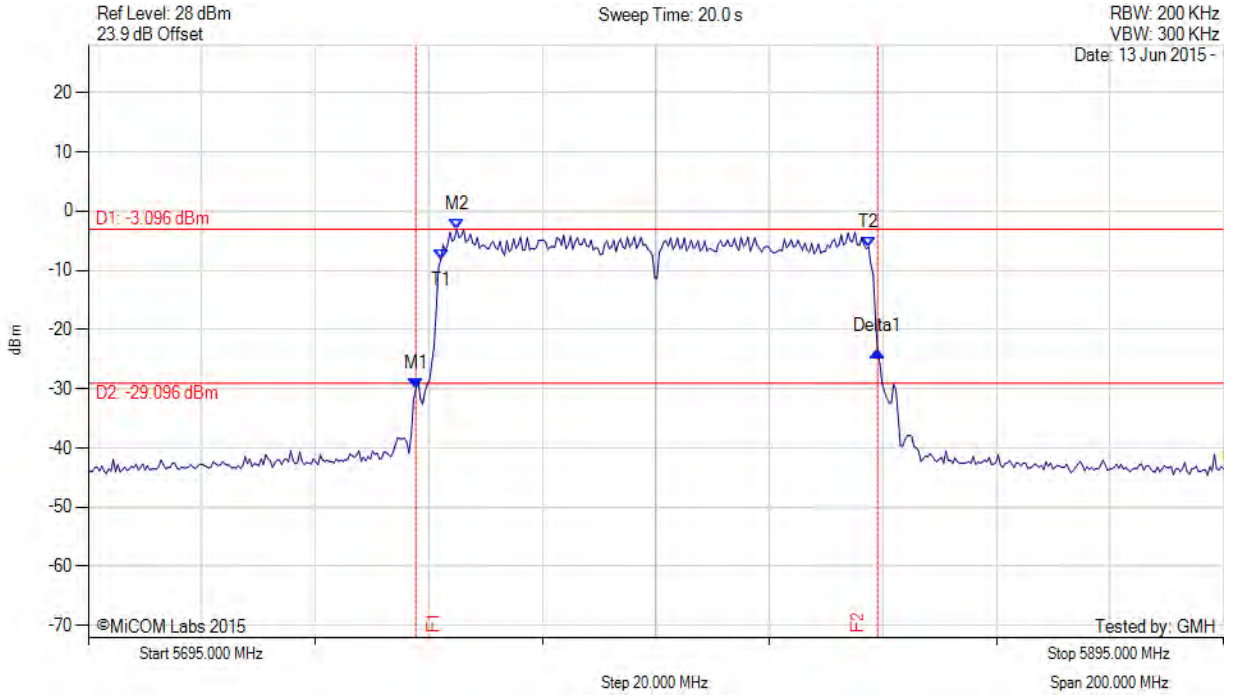

Analyser Setup	Marker:Frequency:Amplitude	Test Results
Detector = MAX PEAK Sweep Count = 0 RF Atten (dB) = 20 Trace Mode = MAX HOLD	M1 : 5752.715 MHz : -30.037 dBm M2 : 5759.930 MHz : -3.096 dBm Delta1 : 81.363 MHz : 6.313 dB T1 : 5757.124 MHz : -8.127 dBm T2 : 5832.475 MHz : -6.073 dBm OBW : 75.351 MHz	Measured 26 dB Bandwidth: 81.363 MHz Measured 99% Bandwidth: 75.351 MHz

[back to matrix](#)

This test report may be reproduced in full only. The document may only be updated by MiCOM Labs personnel. All changes will be noted in the Document History section of the report.



26 dB & 99% BANDWIDTH

Variant: 802.11ac-80, Channel: 5795.00 MHz, Chain a, Temp: Ambient, Voltage: 48 Vdc

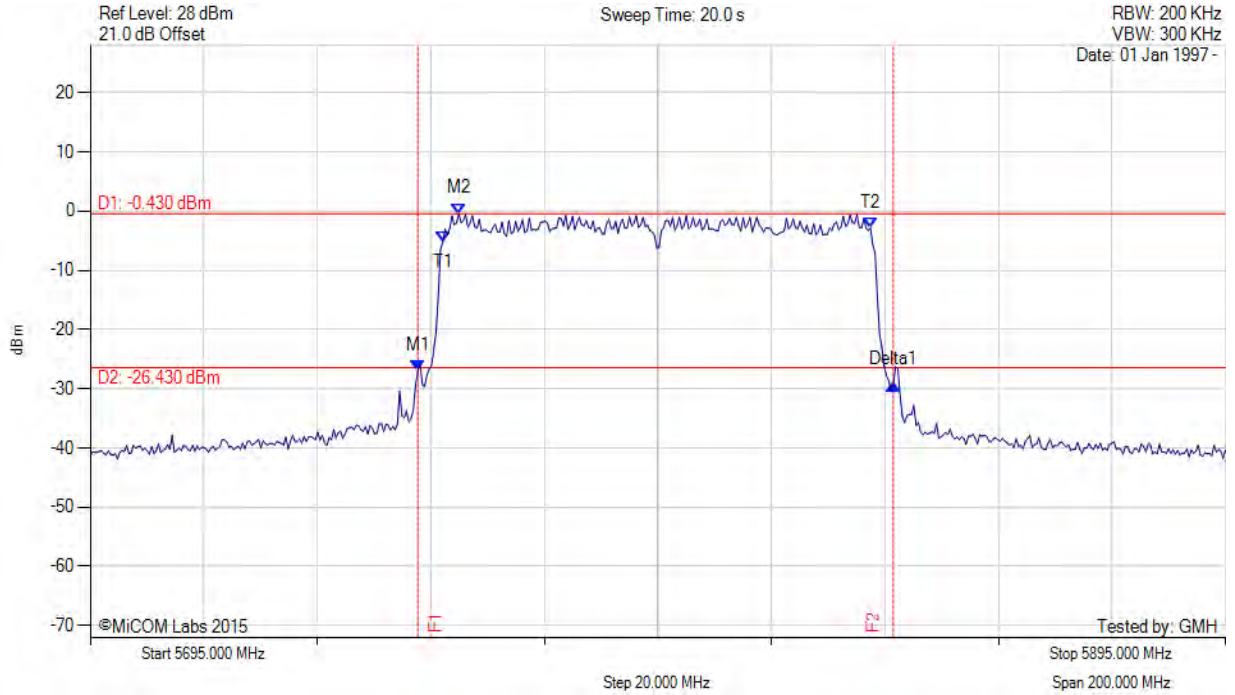

Analyser Setup	Marker:Frequency:Amplitude	Test Results
Detector = MAX PEAK Sweep Count = 0 RF Atten (dB) = 20 Trace Mode = MAX HOLD	M1 : 5752.715 MHz : -26.913 dBm M2 : 5759.930 MHz : -0.430 dBm Delta1 : 83.768 MHz : -2.475 dB T1 : 5757.124 MHz : -5.156 dBm T2 : 5832.475 MHz : -2.905 dBm OBW : 75.351 MHz	Channel Frequency: 5795.00 MHz

[back to matrix](#)

This test report may be reproduced in full only. The document may only be updated by MiCOM Labs personnel. All changes will be noted in the Document History section of the report.



26 dB & 99% BANDWIDTH

Variant: 802.11ac-80, Channel: 5795.00 MHz, Chain b, Temp: Ambient, Voltage: 48 Vdc

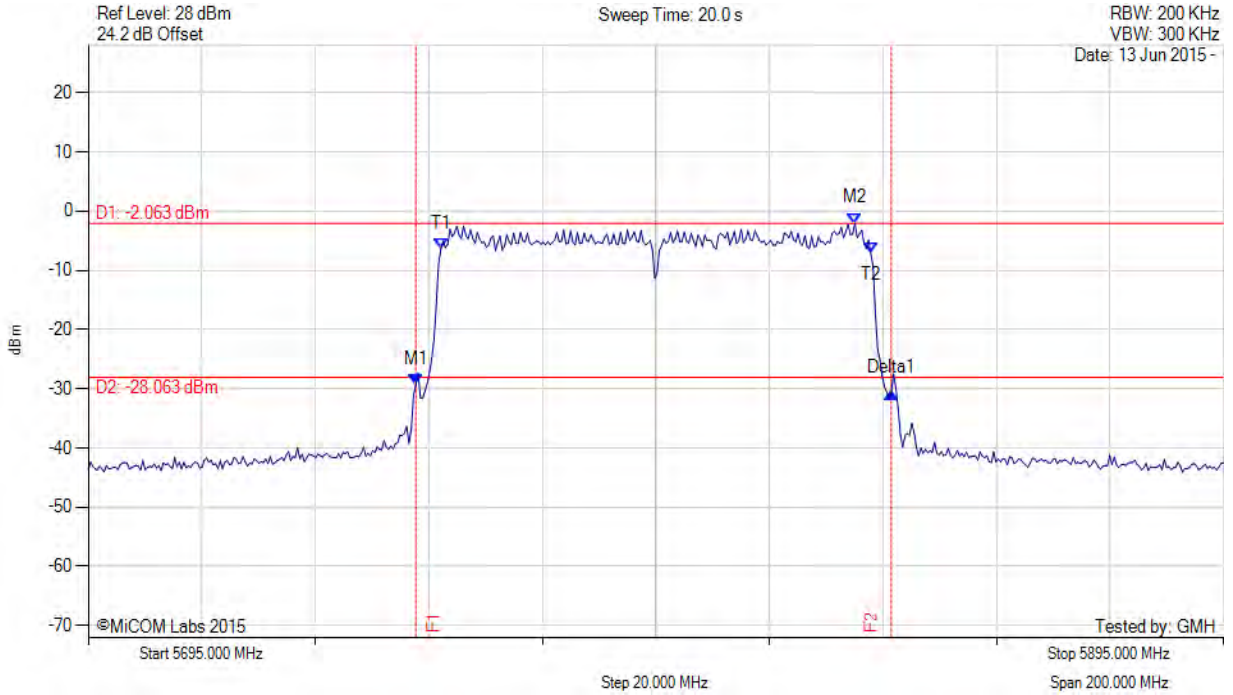

Analyser Setup	Marker:Frequency:Amplitude	Test Results
Detector = MAX PEAK Sweep Count = 0 RF Atten (dB) = 20 Trace Mode = MAX HOLD	M1 : 5752.715 MHz : -29.301 dBm M2 : 5830.070 MHz : -2.063 dBm Delta1 : 83.768 MHz : -1.289 dB T1 : 5757.124 MHz : -6.417 dBm T2 : 5832.876 MHz : -7.182 dBm OBW : 75.752 MHz	Measured 26 dB Bandwidth: 83.768 MHz Measured 99% Bandwidth: 75.752 MHz

[back to matrix](#)

This test report may be reproduced in full only. The document may only be updated by MiCOM Labs personnel. All changes will be noted in the Document History section of the report.



Title: Mimosa Networks A5 Wireless Access Point
To: FCC CFR 47 Part 15 Subpart E 15.407
Serial #: MIMO05-6a Rev A
Issue Date: 4th November 2015
Page: 198 of 372

26 dB & 99% BANDWIDTH



Variant: 802.11ac-80, Channel: 5795.00 MHz, Chain c, Temp: Ambient, Voltage: 48 Vdc

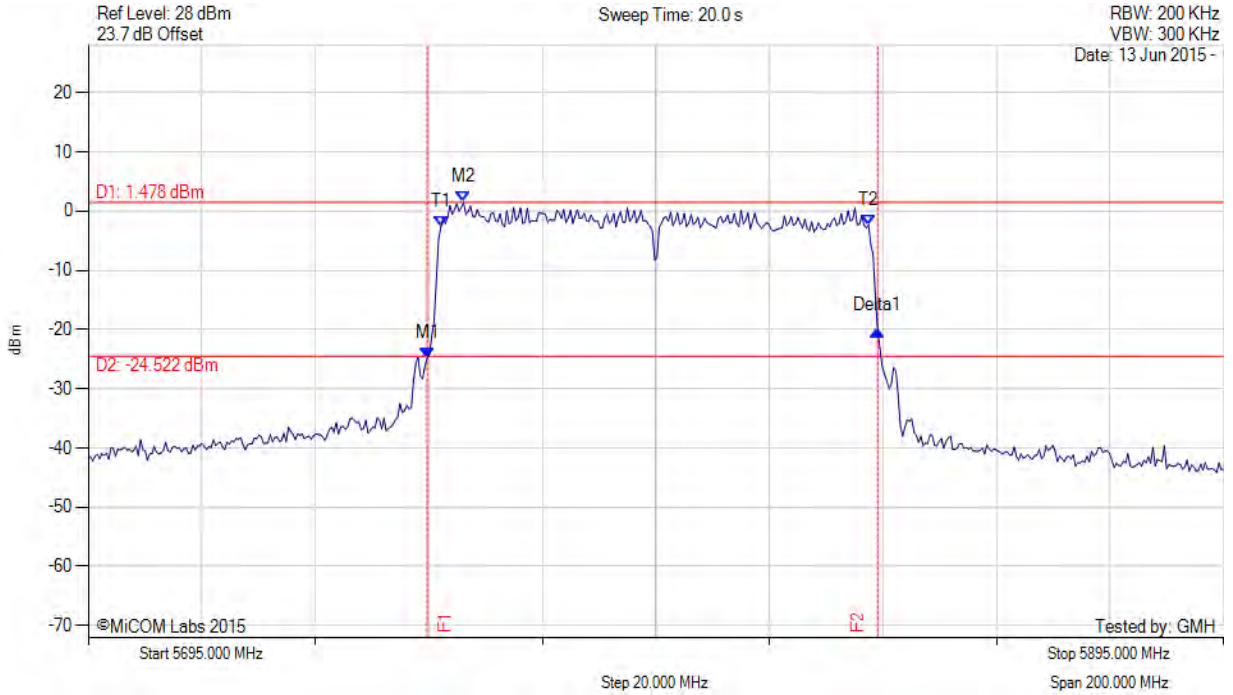

Analyser Setup	Marker:Frequency:Amplitude	Test Results
Detector = MAX PEAK Sweep Count = 0 RF Atten (dB) = 20 Trace Mode = MAX HOLD	M1 : 5754.719 MHz : -24.790 dBm M2 : 5761.132 MHz : 1.478 dBm Delta1 : 79.359 MHz : 4.692 dB T1 : 5757.124 MHz : -2.687 dBm T2 : 5832.475 MHz : -2.325 dBm OBW : 75.351 MHz	Measured 26 dB Bandwidth: 79.359 MHz Measured 99% Bandwidth: 75.351 MHz

[back to matrix](#)

This test report may be reproduced in full only. The document may only be updated by MiCOM Labs personnel. All changes will be noted in the Document History section of the report.



Title: Mimosa Networks A5 Wireless Access Point
To: FCC CFR 47 Part 15 Subpart E 15.407
Serial #: MIMO05-6a Rev A
Issue Date: 4th November 2015
Page: 199 of 372



26 dB & 99% BANDWIDTH

Variant: 802.11ac-80, Channel: 5795.00 MHz, Chain d, Temp: Ambient, Voltage: 48 Vdc

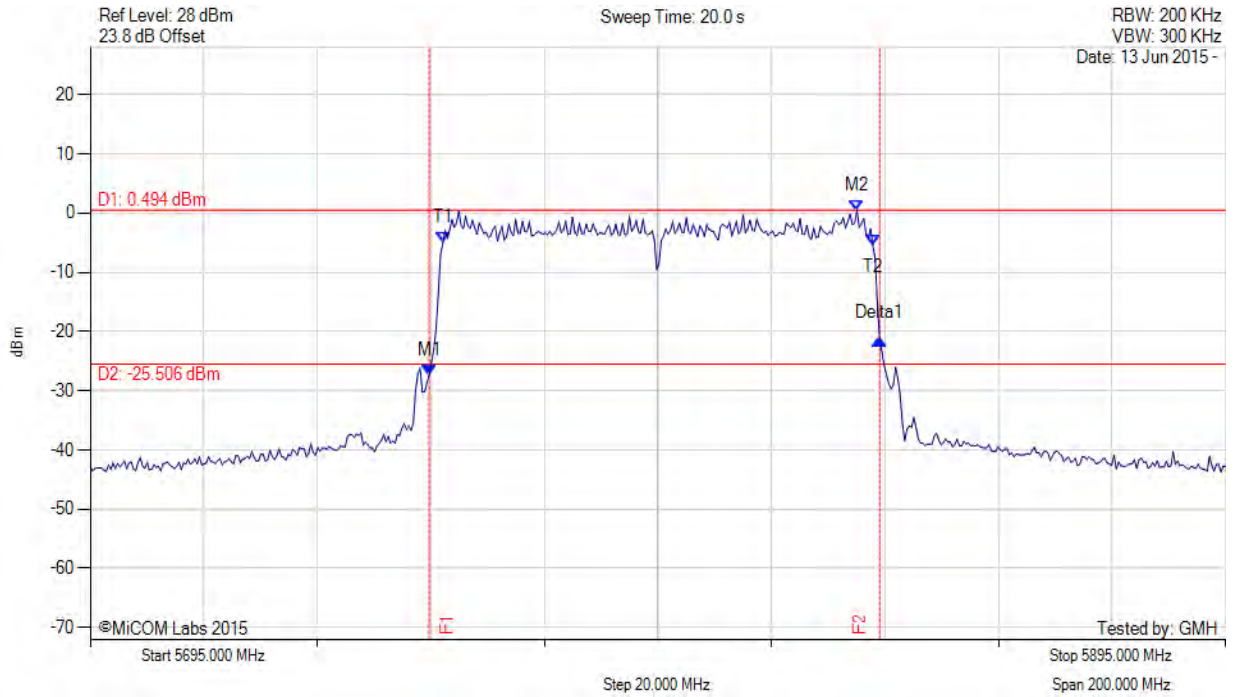

Analyser Setup	Marker:Frequency:Amplitude	Test Results
Detector = MAX PEAK Sweep Count = 0 RF Atten (dB) = 20 Trace Mode = MAX HOLD	M1 : 5754.719 MHz : -27.324 dBm M2 : 5830.070 MHz : 0.494 dBm Delta1 : 79.359 MHz : 6.103 dB T1 : 5757.124 MHz : -5.063 dBm T2 : 5832.876 MHz : -5.419 dBm OBW : 75.752 MHz	Measured 26 dB Bandwidth: 79.359 MHz Measured 99% Bandwidth: 75.752 MHz

[back to matrix](#)

This test report may be reproduced in full only. The document may only be updated by MiCOM Labs personnel. All changes will be noted in the Document History section of the report.



Title: Mimosa Networks A5 Wireless Access Point
To: FCC CFR 47 Part 15 Subpart E 15.407
Serial #: MIMO05-6a Rev A
Issue Date: 4th November 2015
Page: 200 of 372



26 dB & 99% BANDWIDTH

Variant: 802.11n HT-20, Channel: 5165.00 MHz, Chain a, Temp: Ambient, Voltage: 48 Vdc

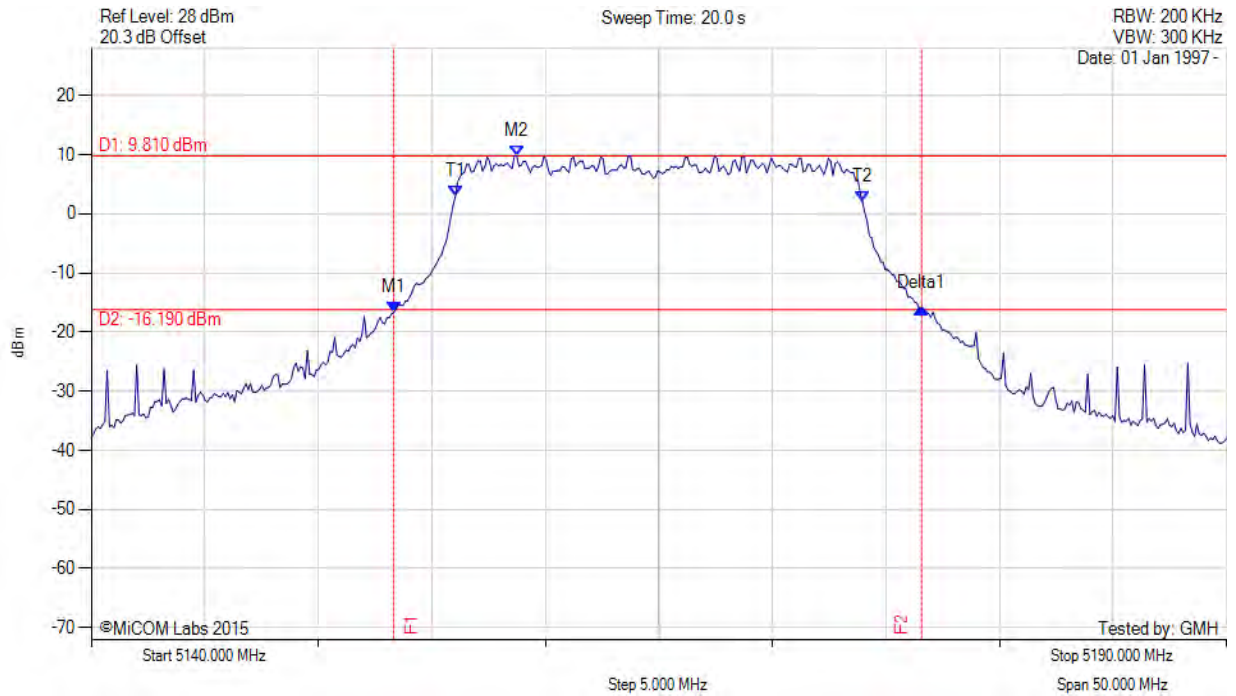

Analyser Setup	Marker:Frequency:Amplitude	Test Results
Detector = MAX PEAK Sweep Count = 0 RF Atten (dB) = 20 Trace Mode = MAX HOLD	M1 : 5153.327 MHz : -16.704 dBm M2 : 5158.737 MHz : 9.810 dBm Delta1 : 23.246 MHz : 0.830 dB T1 : 5156.032 MHz : 2.879 dBm T2 : 5173.968 MHz : 1.988 dBm OBW : 17.936 MHz	Measured 26 dB Bandwidth: 23.246 MHz Measured 99% Bandwidth: 17.936 MHz

[back to matrix](#)

This test report may be reproduced in full only. The document may only be updated by MiCOM Labs personnel. All changes will be noted in the Document History section of the report.



26 dB & 99% BANDWIDTH

Variant: 802.11n HT-20, Channel: 5200.00 MHz, Chain a, Temp: Ambient, Voltage: 48 Vdc

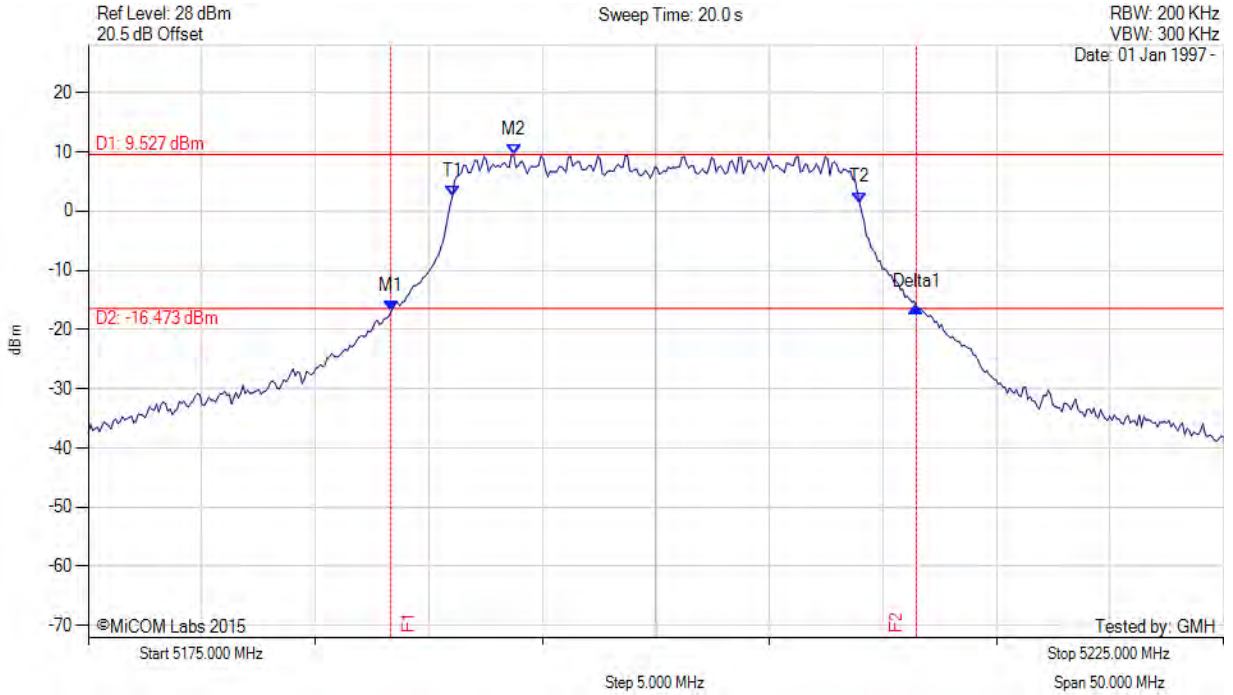

Analyser Setup	Marker:Frequency:Amplitude	Test Results
Detector = MAX PEAK Sweep Count = 0 RF Atten (dB) = 20 Trace Mode = MAX HOLD	M1 : 5188.327 MHz : -16.999 dBm M2 : 5193.737 MHz : 9.527 dBm Delta1 : 23.146 MHz : 0.875 dB T1 : 5191.032 MHz : 2.415 dBm T2 : 5208.968 MHz : 1.456 dBm OBW : 17.936 MHz	Measured 26 dB Bandwidth: 23.146 MHz Measured 99% Bandwidth: 17.936 MHz

[back to matrix](#)

This test report may be reproduced in full only. The document may only be updated by MiCOM Labs personnel. All changes will be noted in the Document History section of the report.



26 dB & 99% BANDWIDTH

Variant: 802.11n HT-20, Channel: 5240.00 MHz, Chain a, Temp: Ambient, Voltage: 48 Vdc

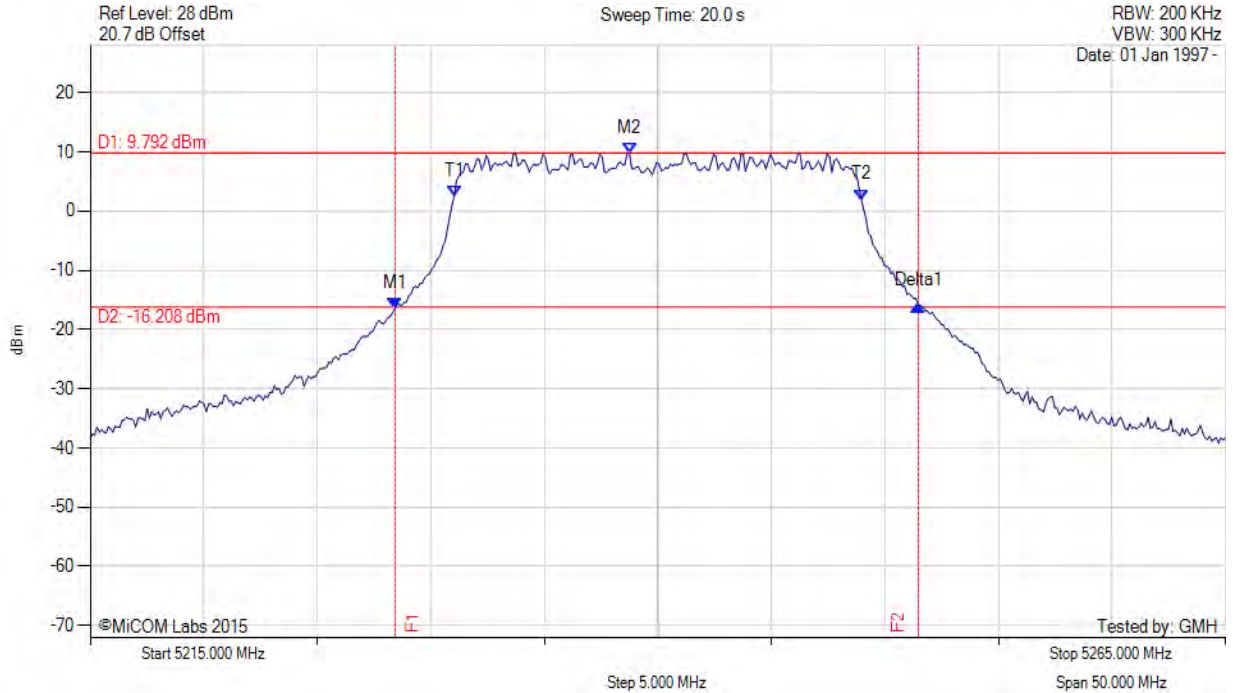

Analyser Setup	Marker:Frequency:Amplitude	Test Results
Detector = MAX PEAK Sweep Count = 0 RF Atten (dB) = 20 Trace Mode = MAX HOLD	M1 : 5228.427 MHz : -16.411 dBm M2 : 5238.747 MHz : 9.792 dBm Delta1 : 23.046 MHz : 0.533 dB T1 : 5231.032 MHz : 2.568 dBm T2 : 5248.968 MHz : 1.903 dBm OBW : 17.936 MHz	Measured 26 dB Bandwidth: 23.046 MHz Measured 99% Bandwidth: 17.936 MHz

[back to matrix](#)

This test report may be reproduced in full only. The document may only be updated by MiCOM Labs personnel. All changes will be noted in the Document History section of the report.



26 dB & 99% BANDWIDTH



Variant: 802.11n HT-20, Channel: 5260.00 MHz, Chain a, Temp: Ambient, Voltage: 48 Vdc

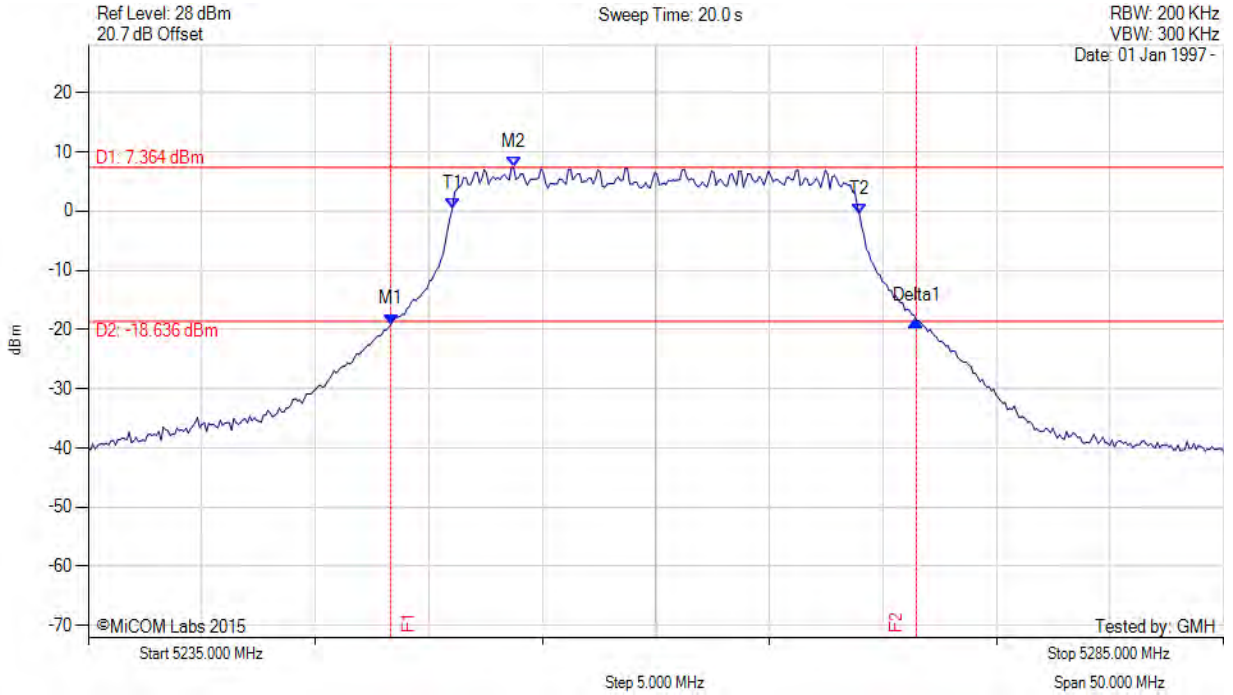

Analyser Setup	Marker:Frequency:Amplitude	Test Results
Detector = MAX PEAK Sweep Count = 0 RF Atten (dB) = 20 Trace Mode = MAX HOLD	M1 : 5248.327 MHz : -19.118 dBm M2 : 5253.737 MHz : 7.364 dBm Delta1 : 23.146 MHz : 0.679 dB T1 : 5251.032 MHz : 0.367 dBm T2 : 5268.968 MHz : -0.580 dBm OBW : 17.936 MHz	Measured 26 dB Bandwidth: 23.146 MHz Measured 99% Bandwidth: 17.936 MHz

[back to matrix](#)

This test report may be reproduced in full only. The document may only be updated by MiCOM Labs personnel. All changes will be noted in the Document History section of the report.



26 dB & 99% BANDWIDTH



Variant: 802.11n HT-20, Channel: 5300.00 MHz, Chain a, Temp: Ambient, Voltage: 48 Vdc

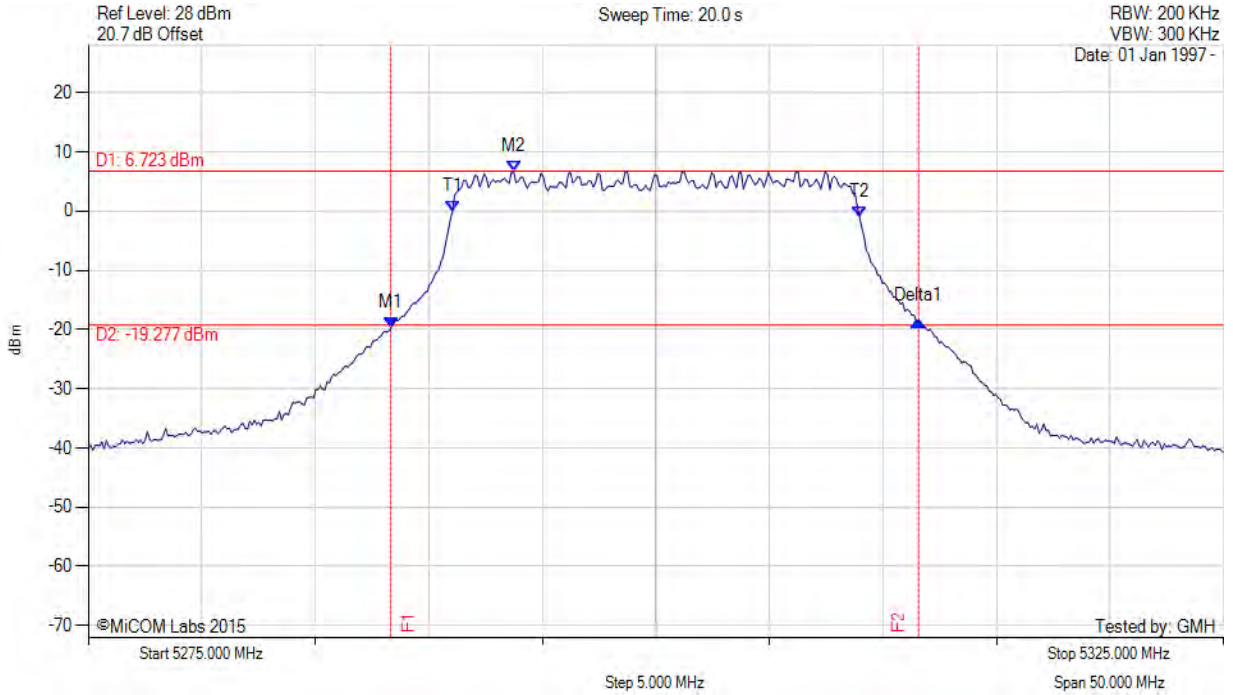

Analyser Setup	Marker:Frequency:Amplitude	Test Results
Detector = MAX PEAK Sweep Count = 0 RF Atten (dB) = 20 Trace Mode = MAX HOLD	M1 : 5288.327 MHz : -19.728 dBm M2 : 5293.737 MHz : 6.723 dBm Delta1 : 23.246 MHz : 1.198 dB T1 : 5291.032 MHz : -0.114 dBm T2 : 5308.968 MHz : -0.969 dBm OBW : 17.936 MHz	Measured 26 dB Bandwidth: 23.246 MHz Measured 99% Bandwidth: 17.936 MHz

[back to matrix](#)

This test report may be reproduced in full only. The document may only be updated by MiCOM Labs personnel. All changes will be noted in the Document History section of the report.



26 dB & 99% BANDWIDTH



Variant: 802.11n HT-20, Channel: 5335.00 MHz, Chain a, Temp: Ambient, Voltage: 48 Vdc

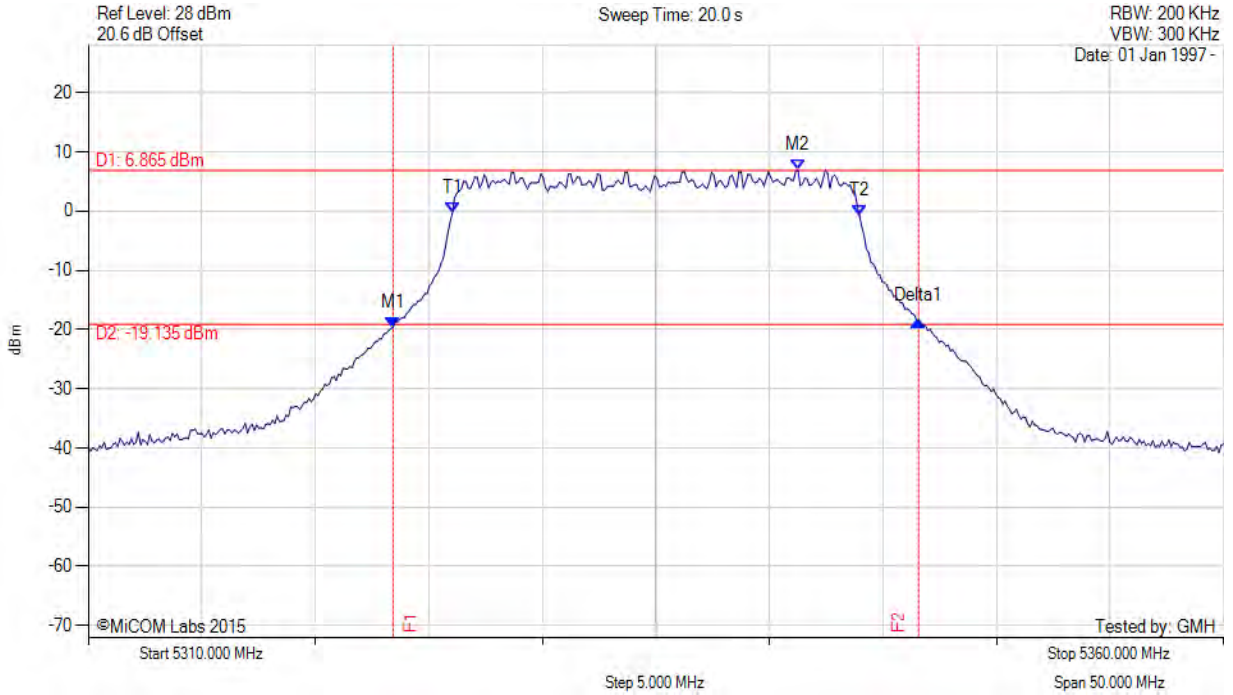

Analyser Setup	Marker:Frequency:Amplitude	Test Results
Detector = MAX PEAK Sweep Count = 0 RF Atten (dB) = 20 Trace Mode = MAX HOLD	M1 : 5323.427 MHz : -19.622 dBm M2 : 5341.263 MHz : 6.865 dBm Delta1 : 23.146 MHz : 1.137 dB T1 : 5326.032 MHz : -0.399 dBm T2 : 5343.968 MHz : -0.822 dBm OBW : 17.936 MHz	Measured 26 dB Bandwidth: 23.146 MHz Measured 99% Bandwidth: 17.936 MHz

[back to matrix](#)

This test report may be reproduced in full only. The document may only be updated by MiCOM Labs personnel. All changes will be noted in the Document History section of the report.



26 dB & 99% BANDWIDTH



Variant: 802.11n HT-20, Channel: 5485.00 MHz, Chain a, Temp: Ambient, Voltage: 48 Vdc

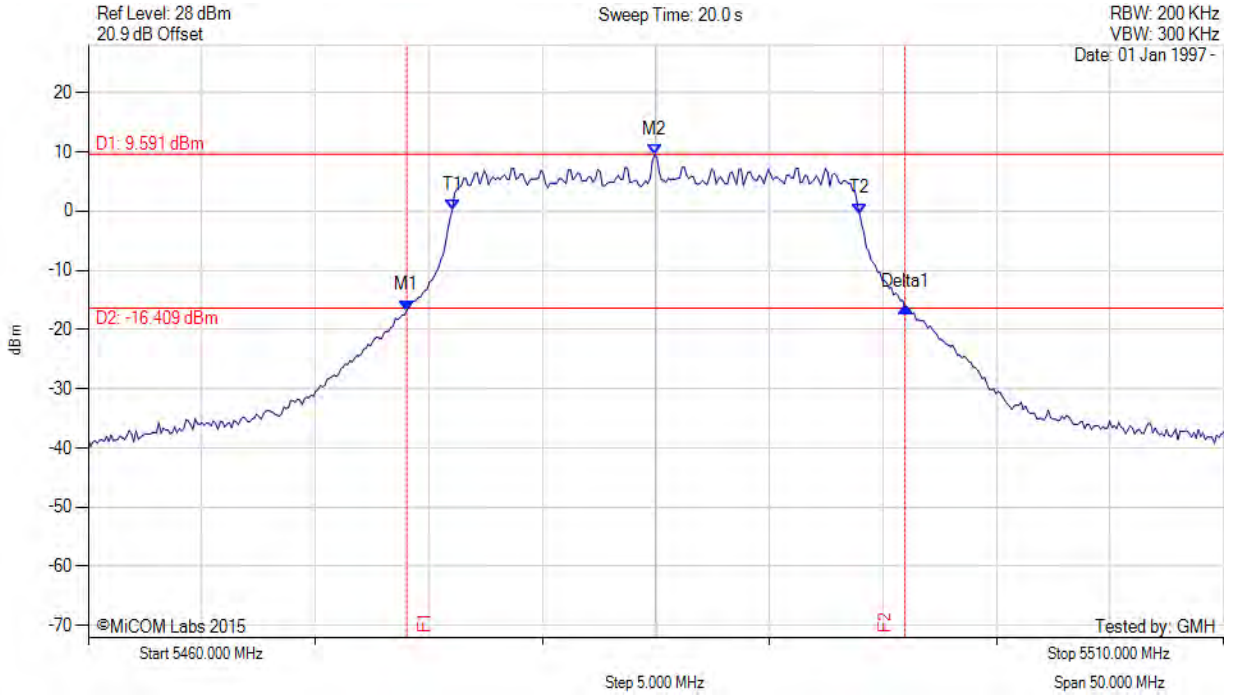

Analyser Setup	Marker:Frequency:Amplitude	Test Results
Detector = MAX PEAK Sweep Count = 0 RF Atten (dB) = 20 Trace Mode = MAX HOLD	M1 : 5474.028 MHz : -16.779 dBm M2 : 5484.950 MHz : 9.591 dBm Delta1 : 21.944 MHz : 0.525 dB T1 : 5476.032 MHz : 0.215 dBm T2 : 5493.968 MHz : -0.434 dBm OBW : 17.936 MHz	Measured 26 dB Bandwidth: 21.944 MHz Measured 99% Bandwidth: 17.936 MHz

[back to matrix](#)

This test report may be reproduced in full only. The document may only be updated by MiCOM Labs personnel. All changes will be noted in the Document History section of the report.



26 dB & 99% BANDWIDTH



Variant: 802.11n HT-20, Channel: 5590.00 MHz, Chain a, Temp: Ambient, Voltage: 48 Vdc

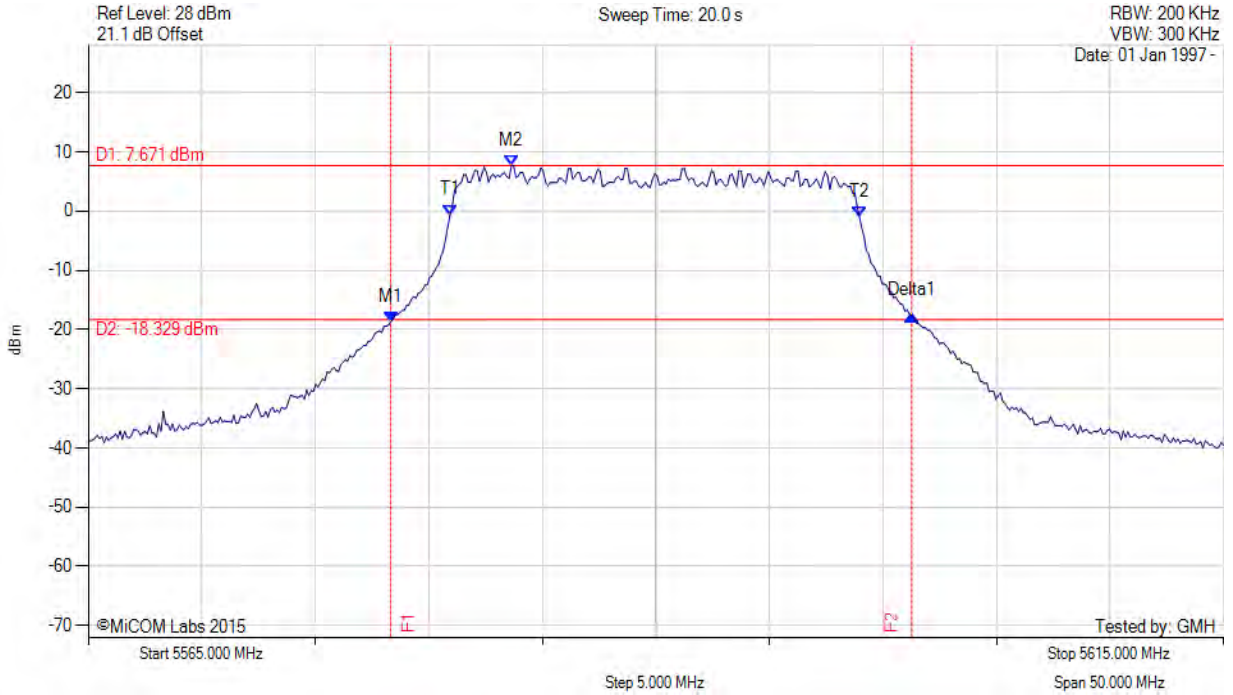

Analyser Setup	Marker:Frequency:Amplitude	Test Results
Detector = MAX PEAK Sweep Count = 0 RF Atten (dB) = 20 Trace Mode = MAX HOLD	M1 : 5578.327 MHz : -18.687 dBm M2 : 5583.637 MHz : 7.671 dBm Delta1 : 22.946 MHz : 0.988 dB T1 : 5580.932 MHz : -0.653 dBm T2 : 5598.968 MHz : -1.052 dBm OBW : 18.036 MHz	Measured 26 dB Bandwidth: 22.946 MHz Measured 99% Bandwidth: 18.036 MHz

[back to matrix](#)

This test report may be reproduced in full only. The document may only be updated by MiCOM Labs personnel. All changes will be noted in the Document History section of the report.



26 dB & 99% BANDWIDTH



Variant: 802.11n HT-20, Channel: 5715.00 MHz, Chain a, Temp: Ambient, Voltage: 48 Vdc

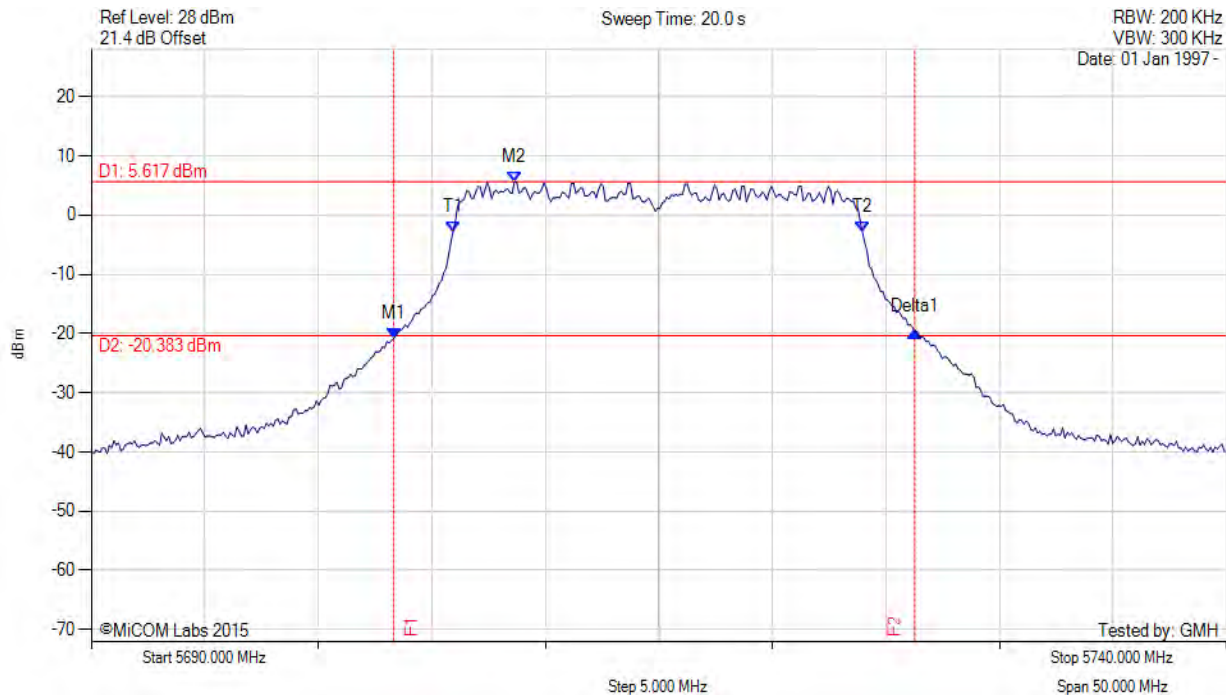

Analyser Setup	Marker:Frequency:Amplitude	Test Results
Detector = MAX PEAK Sweep Count = 0 RF Atten (dB) = 20 Trace Mode = MAX HOLD	M1 : 5703.327 MHz : -20.800 dBm M2 : 5708.637 MHz : 5.617 dBm Delta1 : 22.946 MHz : 1.068 dB T1 : 5705.932 MHz : -2.779 dBm T2 : 5723.968 MHz : -2.939 dBm OBW : 18.036 MHz	Measured 26 dB Bandwidth: 22.946 MHz Measured 99% Bandwidth: 18.036 MHz

[back to matrix](#)

This test report may be reproduced in full only. The document may only be updated by MiCOM Labs personnel. All changes will be noted in the Document History section of the report.



26 dB & 99% BANDWIDTH

Variant: 802.11n HT-20, Channel: 5745.00 MHz, Chain a, Temp: Ambient, Voltage: 48 Vdc

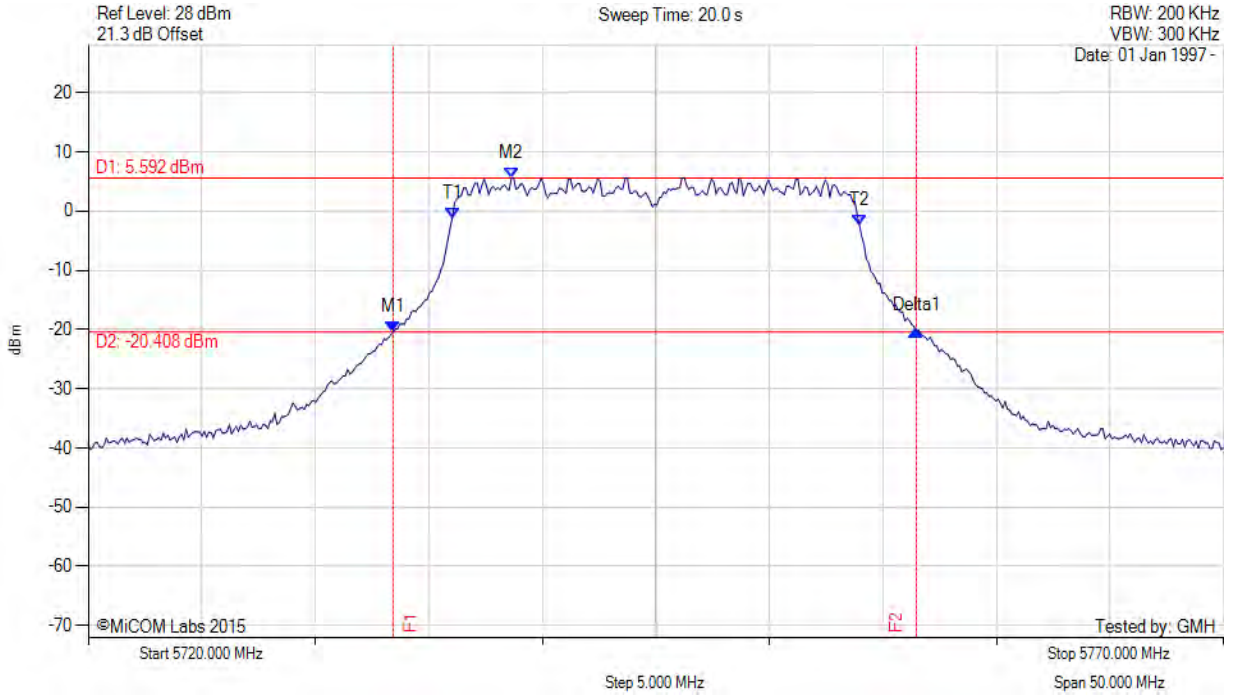

Analyser Setup	Marker:Frequency:Amplitude	Test Results
Detector = MAX PEAK Sweep Count = 0 RF Atten (dB) = 20 Trace Mode = MAX HOLD	M1 : 5733.427 MHz : -20.462 dBm M2 : 5738.637 MHz : 5.592 dBm Delta1 : 23.046 MHz : 0.195 dB T1 : 5736.032 MHz : -1.144 dBm T2 : 5753.968 MHz : -2.407 dBm OBW : 17.936 MHz	Measured 26 dB Bandwidth: 23.046 MHz Measured 99% Bandwidth: 17.936 MHz

[back to matrix](#)

This test report may be reproduced in full only. The document may only be updated by MiCOM Labs personnel. All changes will be noted in the Document History section of the report.



26 dB & 99% BANDWIDTH

Variant: 802.11n HT-20, Channel: 5785.00 MHz, Chain a, Temp: Ambient, Voltage: 48 Vdc

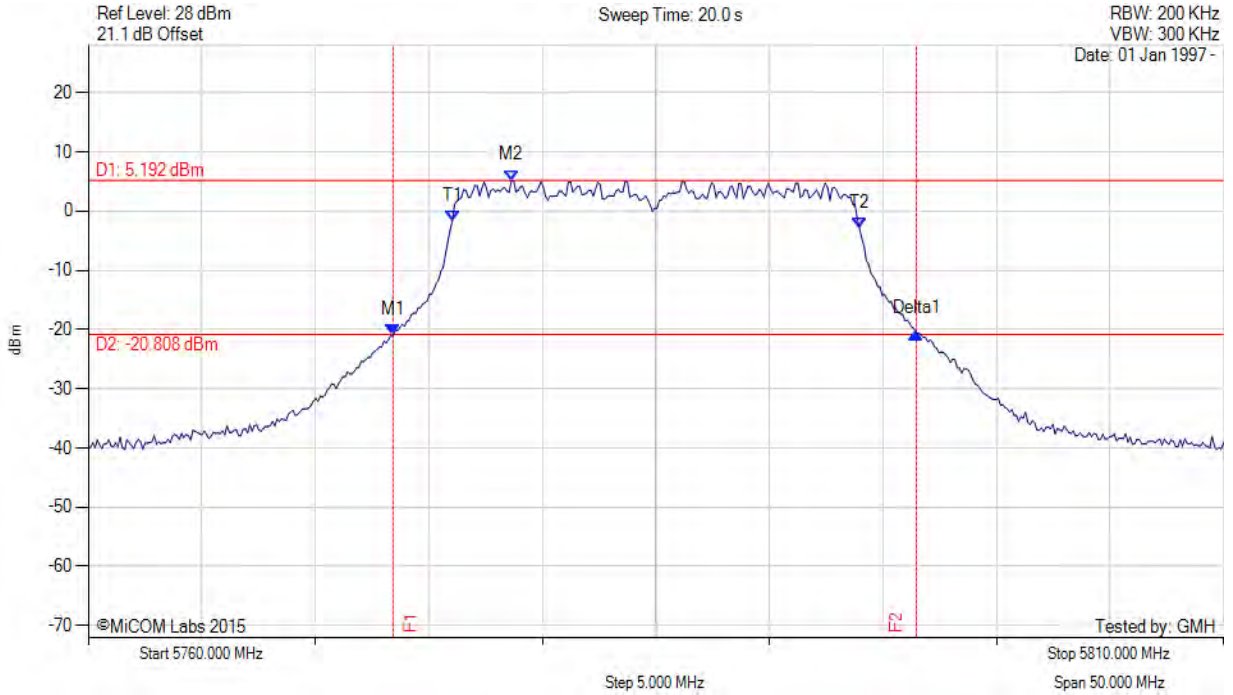

Analyser Setup	Marker:Frequency:Amplitude	Test Results
Detector = MAX PEAK Sweep Count = 0 RF Atten (dB) = 20 Trace Mode = MAX HOLD	M1 : 5773.427 MHz : -20.952 dBm M2 : 5778.637 MHz : 5.192 dBm Delta1 : 23.046 MHz : 0.268 dB T1 : 5776.032 MHz : -1.711 dBm T2 : 5793.968 MHz : -2.913 dBm OBW : 17.936 MHz	Measured 26 dB Bandwidth: 23.046 MHz Measured 99% Bandwidth: 17.936 MHz

[back to matrix](#)

This test report may be reproduced in full only. The document may only be updated by MiCOM Labs personnel. All changes will be noted in the Document History section of the report.



Title: Mimosa Networks A5 Wireless Access Point
To: FCC CFR 47 Part 15 Subpart E 15.407
Serial #: MIMO05-6a Rev A
Issue Date: 4th November 2015
Page: 211 of 372



26 dB & 99% BANDWIDTH

Variant: 802.11n HT-20, Channel: 5825.00 MHz, Chain a, Temp: Ambient, Voltage: 48 Vdc

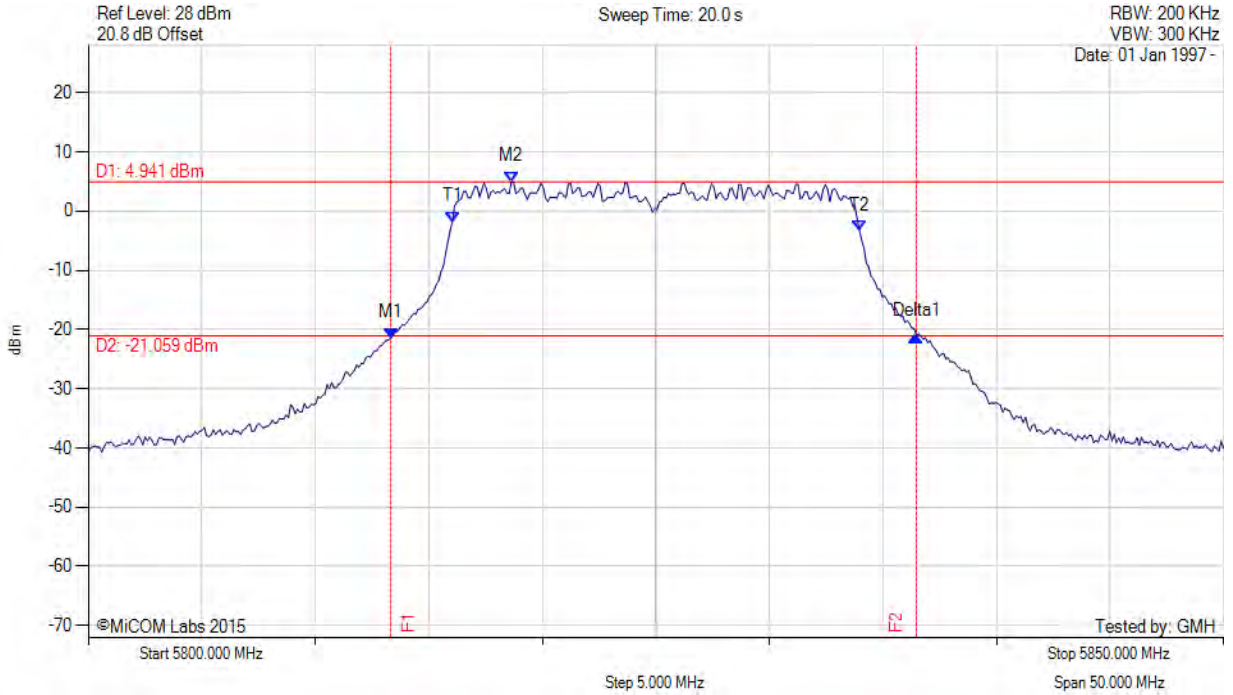

Analyser Setup	Marker:Frequency:Amplitude	Test Results
Detector = MAX PEAK Sweep Count = 0 RF Atten (dB) = 20 Trace Mode = MAX HOLD	M1 : 5813.327 MHz : -21.449 dBm M2 : 5818.637 MHz : 4.941 dBm Delta1 : 23.146 MHz : 0.423 dB T1 : 5816.032 MHz : -1.825 dBm T2 : 5833.968 MHz : -3.267 dBm OBW : 17.936 MHz	Measured 26 dB Bandwidth: 23.146 MHz Measured 99% Bandwidth: 17.936 MHz

[back to matrix](#)

This test report may be reproduced in full only. The document may only be updated by MiCOM Labs personnel. All changes will be noted in the Document History section of the report.



Title: Mimosa Networks A5 Wireless Access Point
To: FCC CFR 47 Part 15 Subpart E 15.407
Serial #: MIMO05-6a Rev A
Issue Date: 4th November 2015
Page: 212 of 372



26 dB & 99% BANDWIDTH

Variant: 802.11n HT-40, Channel: 5175.00 MHz, Chain a, Temp: Ambient, Voltage: 48 Vdc

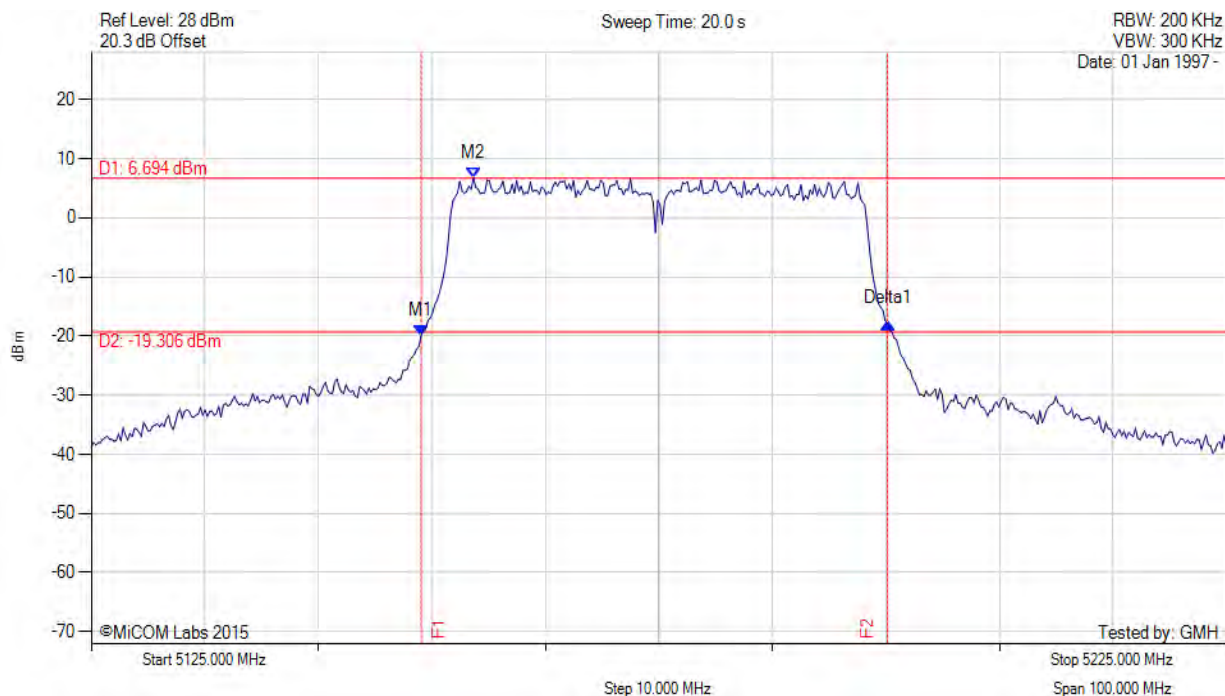

Analyser Setup	Marker:Frequency:Amplitude	Test Results
Detector = MAX PEAK Sweep Count = 0 RF Atten (dB) = 20 Trace Mode = MAX HOLD	M1 : 5154.058 MHz : -19.939 dBm M2 : 5158.667 MHz : 6.694 dBm Delta1 : 41.082 MHz : 2.160 dB T1 : 0 Hz : 500.000 dBm T2 : 0 Hz : 500.000 dBm OBW : 36.273 MHz	Measured 26 dB Bandwidth: 41.082 MHz Measured 99% Bandwidth: 36.273 MHz

[back to matrix](#)

This test report may be reproduced in full only. The document may only be updated by MiCOM Labs personnel. All changes will be noted in the Document History section of the report.



Title: Mimosa Networks A5 Wireless Access Point
To: FCC CFR 47 Part 15 Subpart E 15.407
Serial #: MIMO05-6a Rev A
Issue Date: 4th November 2015
Page: 213 of 372



26 dB & 99% BANDWIDTH

Variant: 802.11n HT-40, Channel: 5200.00 MHz, Chain a, Temp: Ambient, Voltage: 48 Vdc

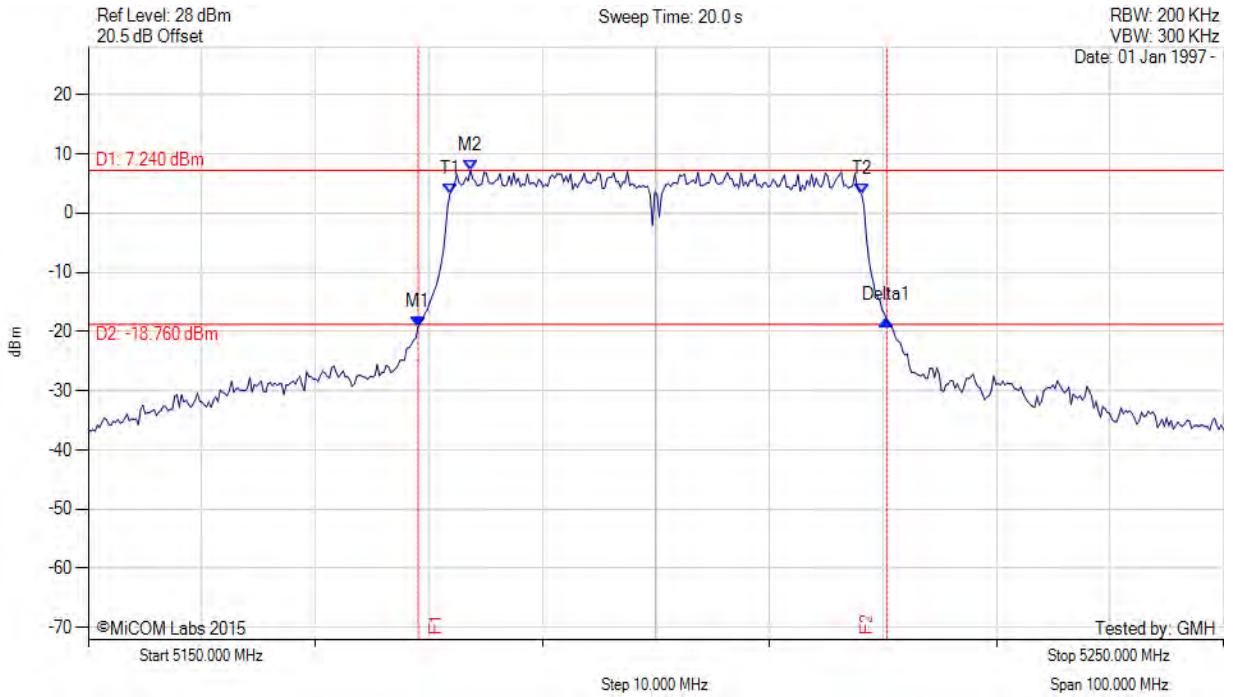

Analyser Setup	Marker:Frequency:Amplitude	Test Results
Detector = MAX PEAK Sweep Count = 0 RF Atten (dB) = 20 Trace Mode = MAX HOLD	M1 : 5179.058 MHz : -19.156 dBm M2 : 5183.667 MHz : 7.240 dBm Delta1 : 41.283 MHz : 1.019 dB T1 : 5181.864 MHz : 3.272 dBm T2 : 5218.136 MHz : 3.190 dBm OBW : 36.273 MHz	Measured 26 dB Bandwidth: 41.283 MHz Measured 99% Bandwidth: 36.273 MHz

[back to matrix](#)

This test report may be reproduced in full only. The document may only be updated by MiCOM Labs personnel. All changes will be noted in the Document History section of the report.



26 dB & 99% BANDWIDTH

Variant: 802.11n HT-40, Channel: 5230.00 MHz, Chain a, Temp: Ambient, Voltage: 48 Vdc

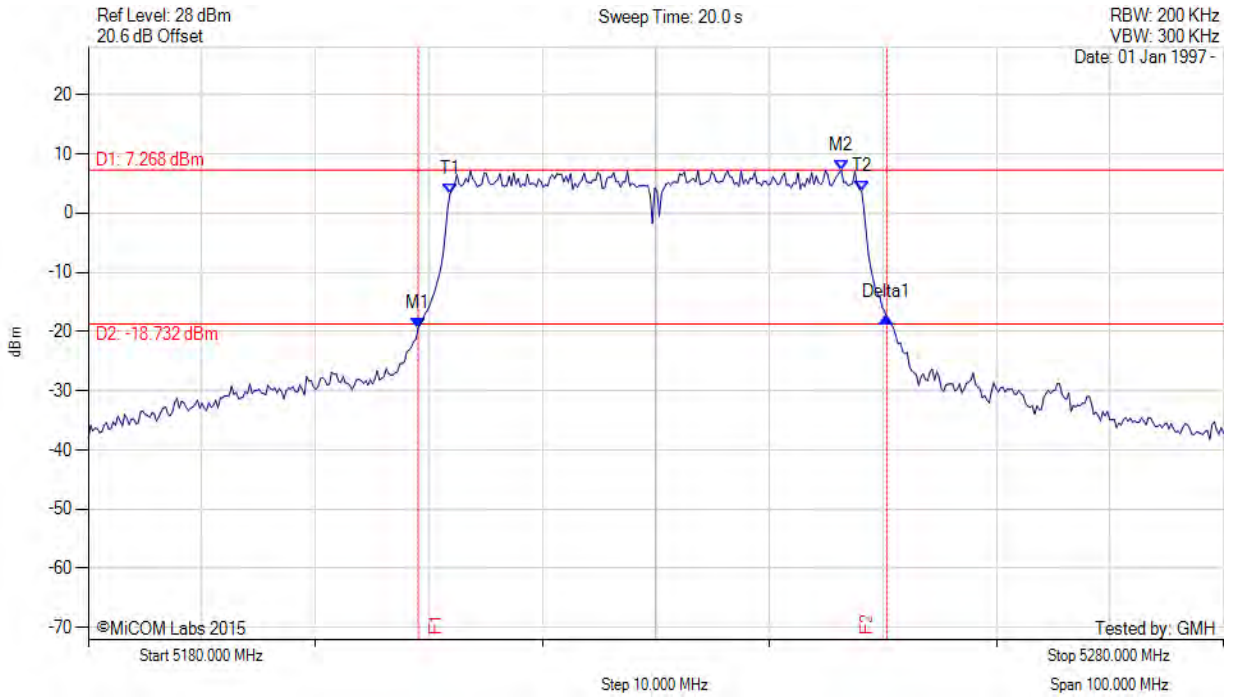

Analyser Setup	Marker:Frequency:Amplitude	Test Results
Detector = MAX PEAK Sweep Count = 0 RF Atten (dB) = 20 Trace Mode = MAX HOLD	M1 : 5209.058 MHz : -19.498 dBm M2 : 5246.333 MHz : 7.268 dBm Delta1 : 41.283 MHz : 1.857 dB T1 : 5211.864 MHz : 3.221 dBm T2 : 5248.136 MHz : 3.703 dBm OBW : 36.273 MHz	Measured 26 dB Bandwidth: 41.283 MHz Measured 99% Bandwidth: 36.273 MHz

[back to matrix](#)

This test report may be reproduced in full only. The document may only be updated by MiCOM Labs personnel. All changes will be noted in the Document History section of the report.



26 dB & 99% BANDWIDTH

Variant: 802.11n HT-40, Channel: 5270.00 MHz, Chain a, Temp: Ambient, Voltage: 48 Vdc

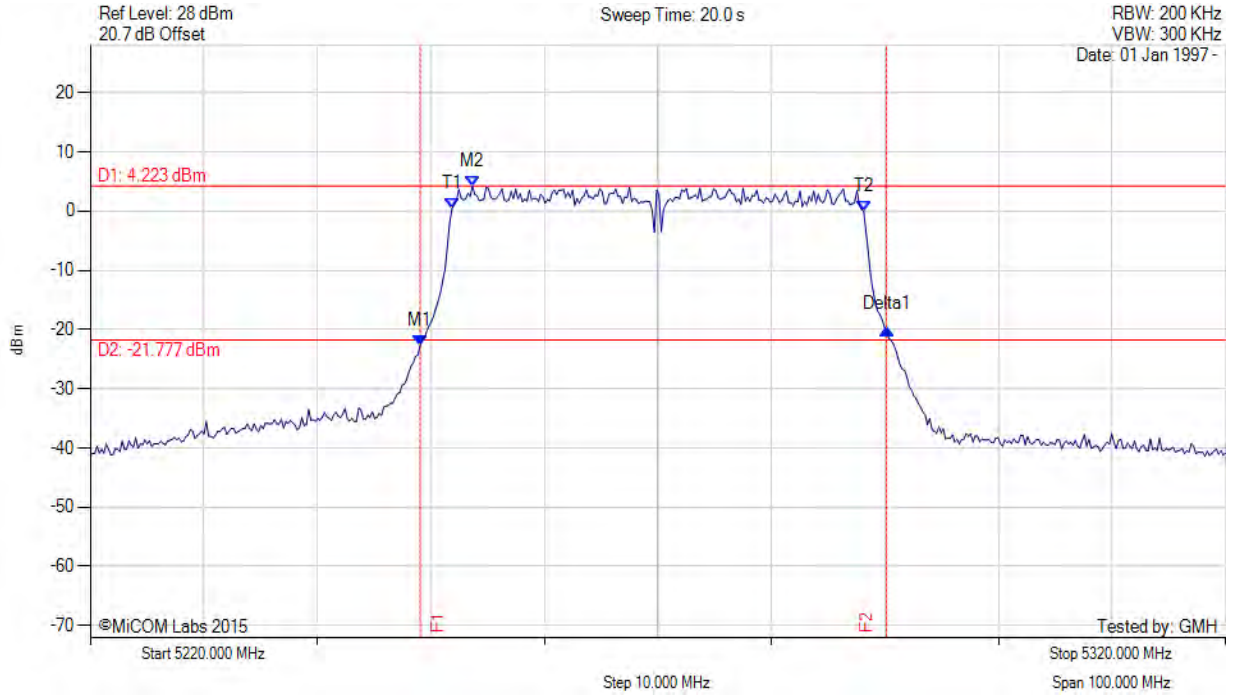

Analyser Setup	Marker:Frequency:Amplitude	Test Results
Detector = MAX PEAK Sweep Count = 0 RF Atten (dB) = 20 Trace Mode = MAX HOLD	M1 : 5249.058 MHz : -22.762 dBm M2 : 5253.667 MHz : 4.223 dBm Delta1 : 41.082 MHz : 2.886 dB T1 : 5251.864 MHz : 0.400 dBm T2 : 5288.136 MHz : -0.011 dBm OBW : 36.273 MHz	Measured 26 dB Bandwidth: 41.082 MHz Measured 99% Bandwidth: 36.273 MHz

[back to matrix](#)

This test report may be reproduced in full only. The document may only be updated by MiCOM Labs personnel. All changes will be noted in the Document History section of the report.



Title: Mimosa Networks A5 Wireless Access Point
To: FCC CFR 47 Part 15 Subpart E 15.407
Serial #: MIMO05-6a Rev A
Issue Date: 4th November 2015
Page: 216 of 372



26 dB & 99% BANDWIDTH

Variant: 802.11n HT-40, Channel: 5300.00 MHz, Chain a, Temp: Ambient, Voltage: 48 Vdc

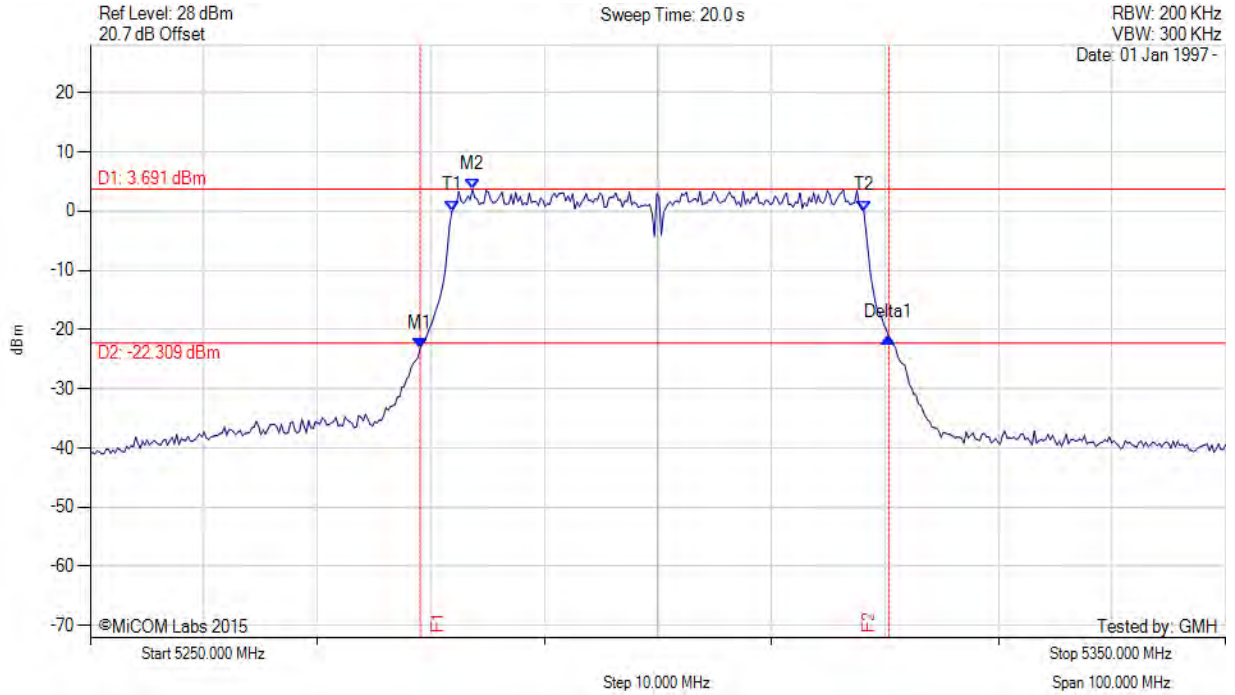

Analyser Setup	Marker:Frequency:Amplitude	Test Results
Detector = MAX PEAK Sweep Count = 0 RF Atten (dB) = 20 Trace Mode = MAX HOLD	M1 : 5279.058 MHz : -23.281 dBm M2 : 5283.667 MHz : 3.691 dBm Delta1 : 41.283 MHz : 1.987 dB T1 : 5281.864 MHz : 0.042 dBm T2 : 5318.136 MHz : 0.030 dBm OBW : 36.273 MHz	Measured 26 dB Bandwidth: 41.283 MHz Measured 99% Bandwidth: 36.273 MHz

[back to matrix](#)

This test report may be reproduced in full only. The document may only be updated by MiCOM Labs personnel. All changes will be noted in the Document History section of the report.



26 dB & 99% BANDWIDTH

Variant: 802.11n HT-40, Channel: 5330.00 MHz, Chain a, Temp: Ambient, Voltage: 48 Vdc

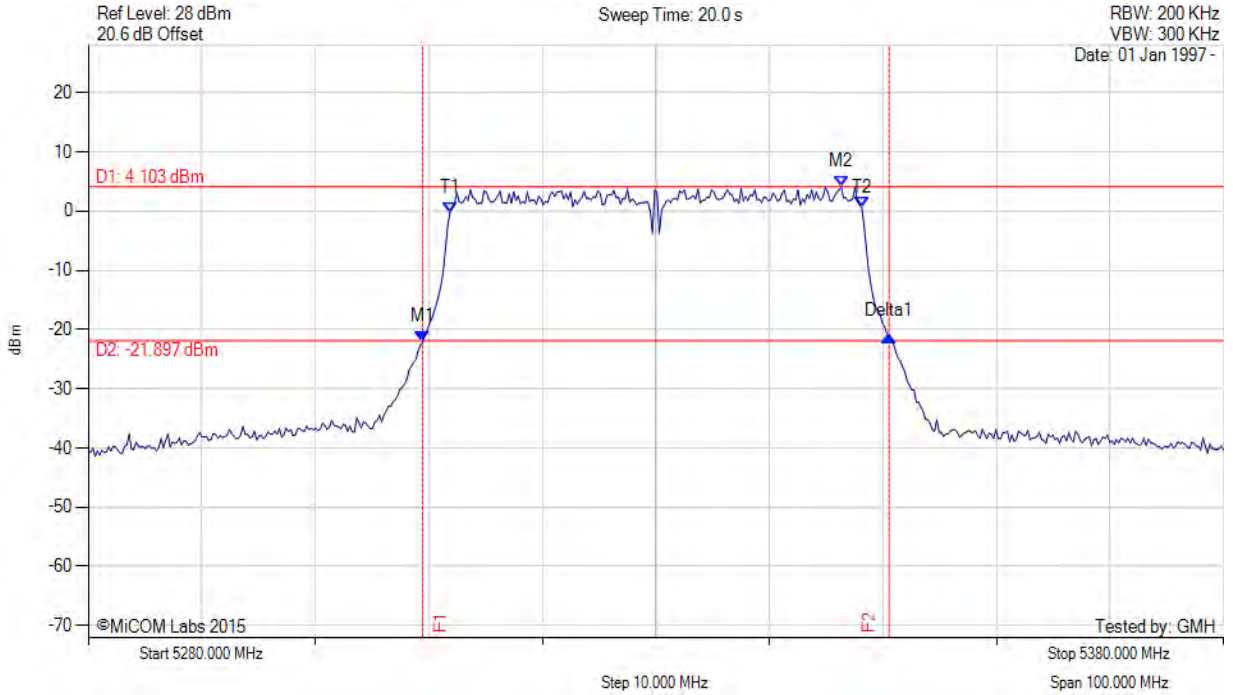

Analyser Setup	Marker:Frequency:Amplitude	Test Results
Detector = MAX PEAK Sweep Count = 0 RF Atten (dB) = 20 Trace Mode = MAX HOLD	M1 : 5309.459 MHz : -22.130 dBm M2 : 5346.333 MHz : 4.103 dBm Delta1 : 41.082 MHz : 1.100 dB T1 : 5311.864 MHz : -0.212 dBm T2 : 5348.136 MHz : 0.626 dBm OBW : 36.273 MHz	Measured 26 dB Bandwidth: 41.082 MHz Measured 99% Bandwidth: 36.273 MHz

[back to matrix](#)

This test report may be reproduced in full only. The document may only be updated by MiCOM Labs personnel. All changes will be noted in the Document History section of the report.



26 dB & 99% BANDWIDTH



Variant: 802.11n HT-40, Channel: 5495.00 MHz, Chain a, Temp: Ambient, Voltage: 48 Vdc

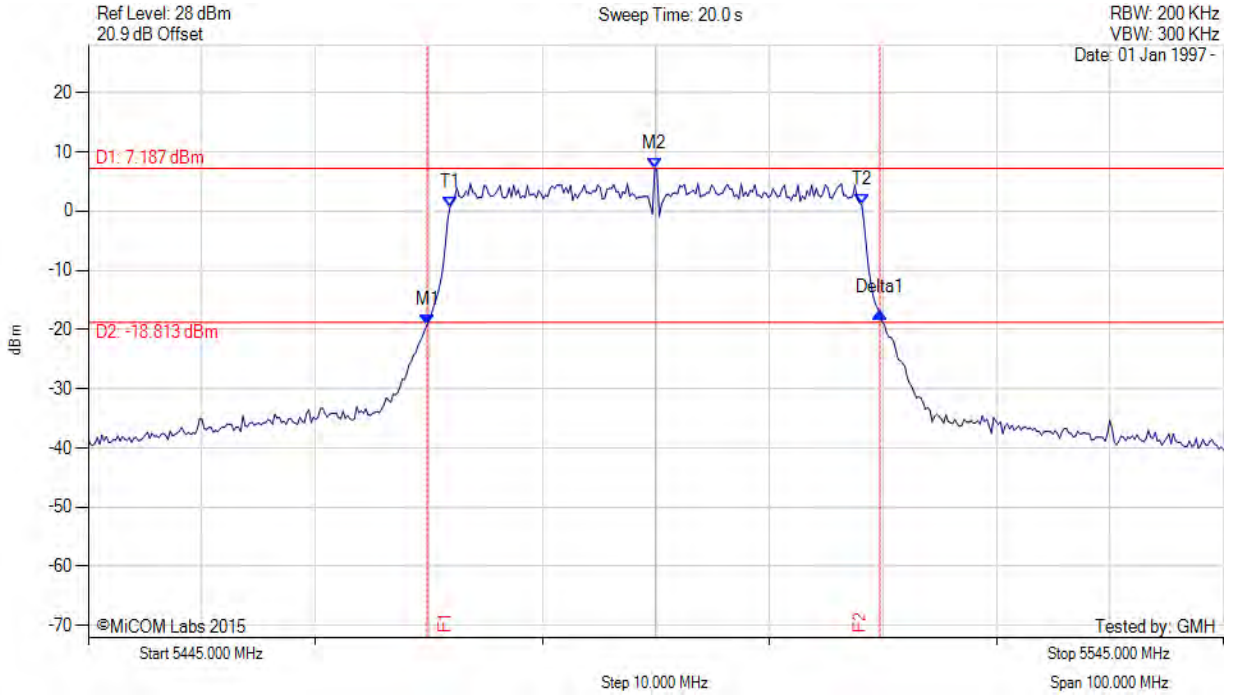

Analyser Setup	Marker:Frequency:Amplitude	Test Results
Detector = MAX PEAK Sweep Count = 0 RF Atten (dB) = 20 Trace Mode = MAX HOLD	M1 : 5474.860 MHz : -19.173 dBm M2 : 5494.900 MHz : 7.187 dBm Delta1 : 39.880 MHz : 2.050 dB T1 : 5476.864 MHz : 0.644 dBm T2 : 5513.136 MHz : 1.059 dBm OBW : 36.273 MHz	Measured 26 dB Bandwidth: 39.880 MHz Measured 99% Bandwidth: 36.273 MHz

[back to matrix](#)

This test report may be reproduced in full only. The document may only be updated by MiCOM Labs personnel. All changes will be noted in the Document History section of the report.



Title: Mimosa Networks A5 Wireless Access Point
To: FCC CFR 47 Part 15 Subpart E 15.407
Serial #: MIMO05-6a Rev A
Issue Date: 4th November 2015
Page: 219 of 372



26 dB & 99% BANDWIDTH

Variant: 802.11n HT-40, Channel: 5590.00 MHz, Chain a, Temp: Ambient, Voltage: 48 Vdc

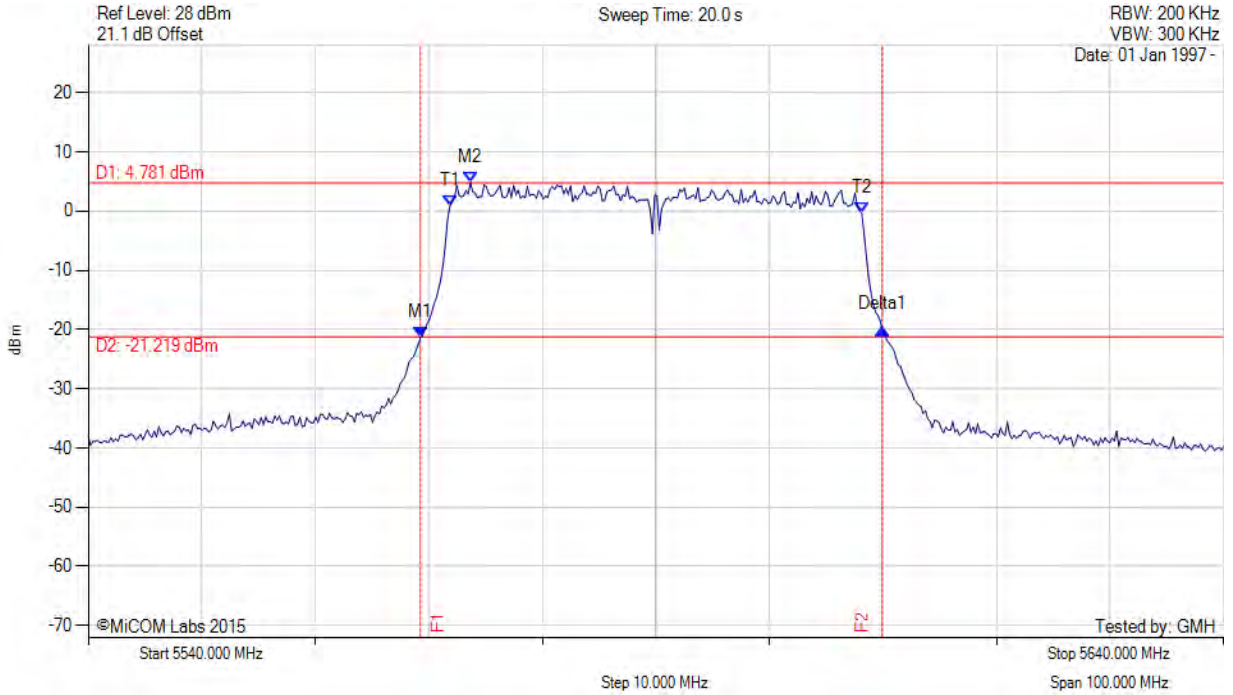

Analyser Setup	Marker:Frequency:Amplitude	Test Results
Detector = MAX PEAK Sweep Count = 0 RF Atten (dB) = 20 Trace Mode = MAX HOLD	M1 : 5569.259 MHz : -21.363 dBm M2 : 5573.667 MHz : 4.781 dBm Delta1 : 40.681 MHz : 1.432 dB T1 : 5571.864 MHz : 0.937 dBm T2 : 5608.136 MHz : -0.312 dBm OBW : 36.273 MHz	Measured 26 dB Bandwidth: 40.681 MHz Measured 99% Bandwidth: 36.273 MHz

[back to matrix](#)

This test report may be reproduced in full only. The document may only be updated by MiCOM Labs personnel. All changes will be noted in the Document History section of the report.



26 dB & 99% BANDWIDTH

Variant: 802.11n HT-40, Channel: 5705.00 MHz, Chain a, Temp: Ambient, Voltage: 48 Vdc

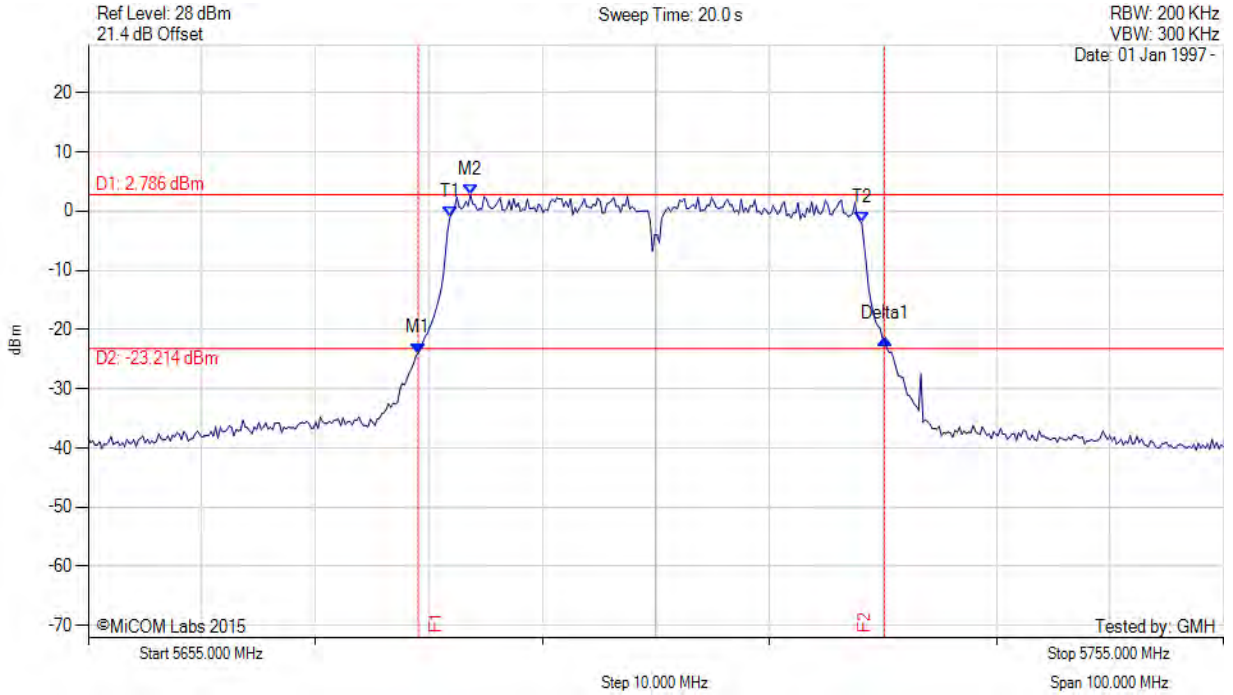

Analyser Setup	Marker:Frequency:Amplitude	Test Results
Detector = MAX PEAK Sweep Count = 0 RF Atten (dB) = 20 Trace Mode = MAX HOLD	M1 : 5684.058 MHz : -24.015 dBm M2 : 5688.667 MHz : 2.786 dBm Delta1 : 41.082 MHz : 2.538 dB T1 : 5686.864 MHz : -1.015 dBm T2 : 5723.136 MHz : -1.945 dBm OBW : 36.273 MHz	Measured 26 dB Bandwidth: 41.082 MHz Measured 99% Bandwidth: 36.273 MHz

[back to matrix](#)

This test report may be reproduced in full only. The document may only be updated by MiCOM Labs personnel. All changes will be noted in the Document History section of the report.



Title: Mimosa Networks A5 Wireless Access Point
To: FCC CFR 47 Part 15 Subpart E 15.407
Serial #: MIMO05-6a Rev A
Issue Date: 4th November 2015
Page: 221 of 372



26 dB & 99% BANDWIDTH

Variant: 802.11n HT-40, Channel: 5755.00 MHz, Chain a, Temp: Ambient, Voltage: 48 Vdc

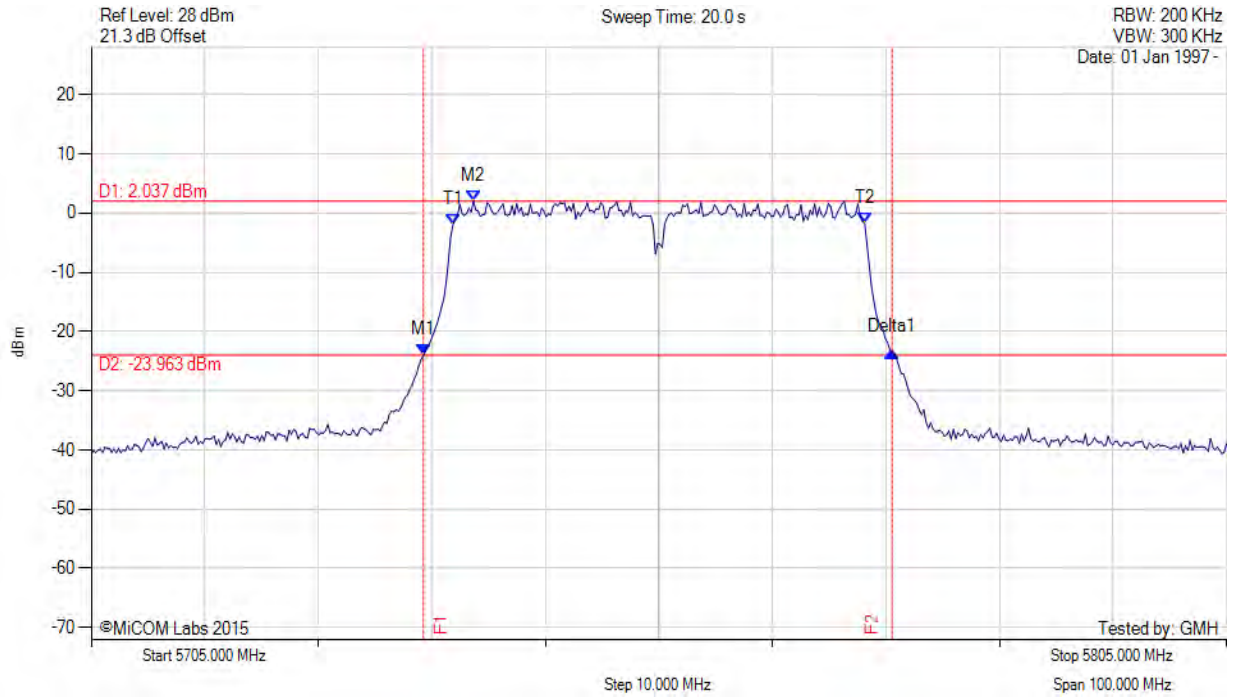

Analyser Setup	Marker:Frequency:Amplitude	Test Results
Detector = MAX PEAK Sweep Count = 0 RF Atten (dB) = 20 Trace Mode = MAX HOLD	M1 : 5734.259 MHz : -24.013 dBm M2 : 5738.667 MHz : 2.037 dBm Delta1 : 41.283 MHz : 0.614 dB T1 : 5736.864 MHz : -1.937 dBm T2 : 5773.136 MHz : -1.764 dBm OBW : 36.273 MHz	Measured 26 dB Bandwidth: 41.283 MHz Measured 99% Bandwidth: 36.273 MHz

[back to matrix](#)

This test report may be reproduced in full only. The document may only be updated by MiCOM Labs personnel. All changes will be noted in the Document History section of the report.



Title: Mimosa Networks A5 Wireless Access Point
To: FCC CFR 47 Part 15 Subpart E 15.407
Serial #: MIMO05-6a Rev A
Issue Date: 4th November 2015
Page: 222 of 372



26 dB & 99% BANDWIDTH

Variant: 802.11n HT-40, Channel: 5785.00 MHz, Chain a, Temp: Ambient, Voltage: 48 Vdc

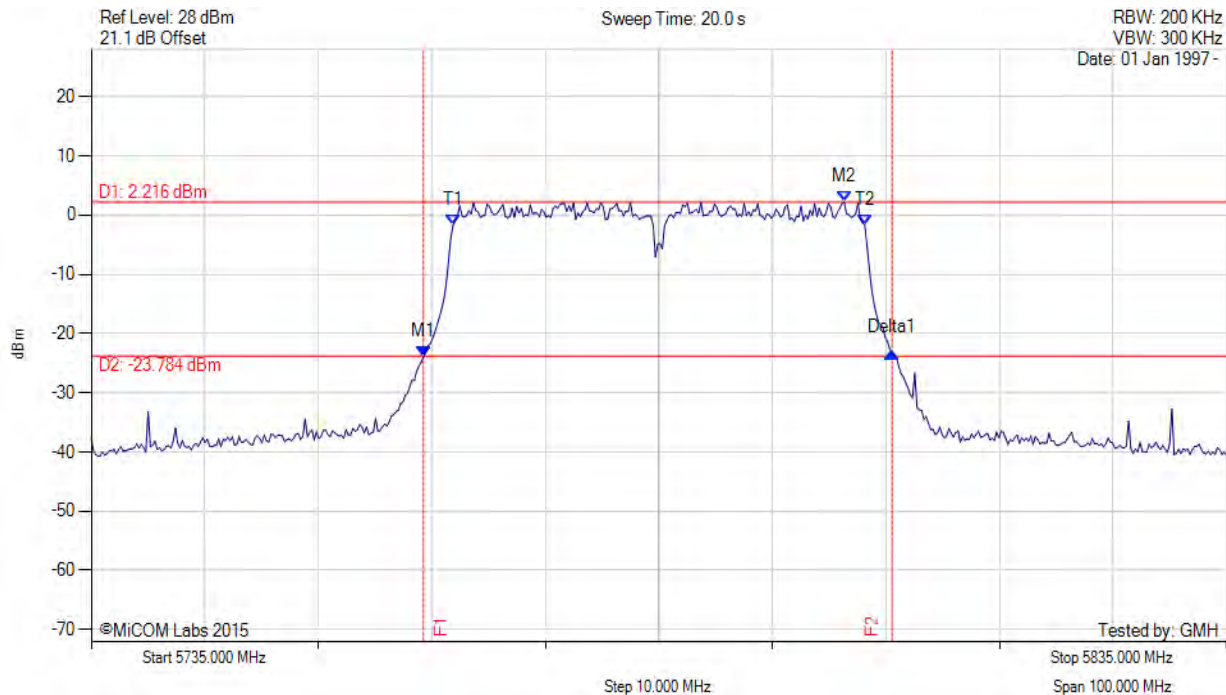

Analyser Setup	Marker:Frequency:Amplitude	Test Results
Detector = MAX PEAK Sweep Count = 0 RF Atten (dB) = 20 Trace Mode = MAX HOLD	M1 : 5764.259 MHz : -23.942 dBm M2 : 5801.333 MHz : 2.216 dBm Delta1 : 41.283 MHz : 0.728 dB T1 : 5766.864 MHz : -1.786 dBm T2 : 5803.136 MHz : -1.632 dBm OBW : 36.273 MHz	Measured 26 dB Bandwidth: 41.283 MHz Measured 99% Bandwidth: 36.273 MHz

[back to matrix](#)

This test report may be reproduced in full only. The document may only be updated by MiCOM Labs personnel. All changes will be noted in the Document History section of the report.



Title: Mimosa Networks A5 Wireless Access Point
To: FCC CFR 47 Part 15 Subpart E 15.407
Serial #: MIMO05-6a Rev A
Issue Date: 4th November 2015
Page: 223 of 372



26 dB & 99% BANDWIDTH

Variant: 802.11n HT-40, Channel: 5815.00 MHz, Chain a, Temp: Ambient, Voltage: 48 Vdc

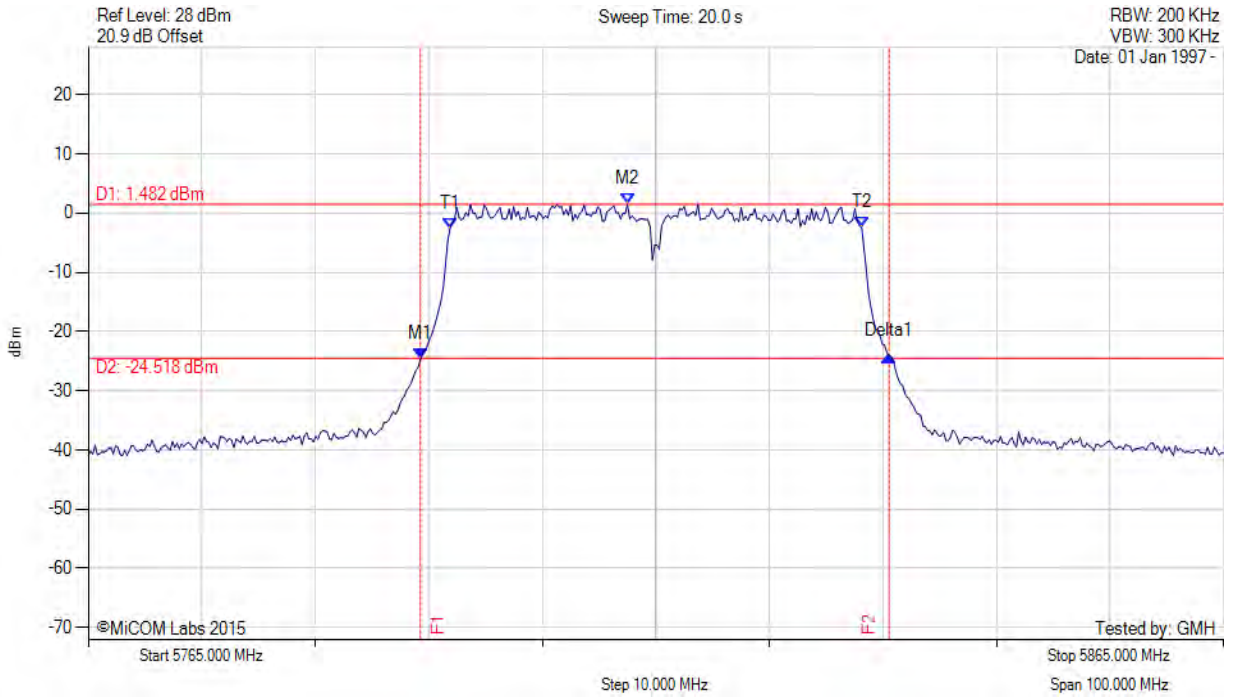

Analyser Setup	Marker:Frequency:Amplitude	Test Results
Detector = MAX PEAK Sweep Count = 0 RF Atten (dB) = 20 Trace Mode = MAX HOLD	M1 : 5794.259 MHz : -24.650 dBm M2 : 5812.495 MHz : 1.482 dBm Delta1 : 41.283 MHz : 0.574 dB T1 : 5796.864 MHz : -2.596 dBm T2 : 5833.136 MHz : -2.449 dBm OBW : 36.273 MHz	Measured 26 dB Bandwidth: 41.283 MHz Measured 99% Bandwidth: 36.273 MHz

[back to matrix](#)

This test report may be reproduced in full only. The document may only be updated by MiCOM Labs personnel. All changes will be noted in the Document History section of the report.