

RF Test Report

Test in accordance with
Federal Communications Commission(FCC)
CFR TITLE 47, Parts 2, 22, 24

Product Name : Life Alert HELP PERS (915)
Model No. : Life Alert HELP PERS (915)
FCC ID : **2ABZ7-915**

Applicant : Life Alert Emergency Response,inc.
Address : 16027 Ventura Blvd., Suite 400.

Report Type : Original test report
Report Number : UL15820150518FCC042-1
Report Version : V1.0
Date of Report : 24-05-2015
Date of Test : 18-05-2015~24-05-2015

Notes:

The test results only relate to these samples which have been tested.
Partly using this report will not be admitted unless been allowed by Unilab.
Unilab is only responsible for the complete report with the reported stamp of Unilab.

Test Report Certification

Issued Date : 24-05-2015
Report No. : UL15820150518FCC042-1

Product Name : Life Alert HELP PERS (915)
Model No. : Life Alert HELP PERS (915)
Applicant : Life Alert Emergency Response,inc.
Address : 16027 Ventura Blvd., Suite 400.
Manufacturer : Life Alert Emergency Response,inc.
Address : 16027 Ventura Blvd., Suite 400.
EUT Voltage : MIN: 3.6V, NOR: 3.8V, MAX: 4.2V
Brand Name : Life Alert HELP PERS
FCC ID : **2ABZ7-915**
Applicable Standard : ANSI/TIA-603-C-2004; FCC CFR Title 47 Part 2;
FCC CFR Title 47 Part 22 Subpart H;
FCC CFR Title 47 Part24 Subpart E;
Test Result : Complied
Performed Location : Unilab (Shanghai) Co., Ltd.
FCC 2.948 register number is 714465
IC register number is 11025A-1
No. 1350, Lianxi Rd. Pudong New District, Shanghai, China
TEL: +86-21-50275125 FAX: +86-21-50277862

Documented By :

Paul Yang

(Technical Engineer: Paul Yang)

Reviewed By :

Forest Cao

(Senior Engineer: Forest Cao)

Approved By :

Eva Wang

(Supervisor: Eva Wang)

TABLE OF CONTENTS

SUMMARY OF TEST RESULT	4
1. General Information.....	5
1.1. EUT Description	5
1.2. Mode of Operation	5
1.3. Tested System Details.....	6
1.4. Configuration of Tested System.....	7
1.5. EUT Exercise Software	7
2. Technical Test	7
2.1. Test Environment	7
3. Peak Output Power	8
3.1. Test Equipment	8
3.2. Test Setup	8
3.3. Limit	9
3.4. Test Procedure	10
3.5. Uncertainty	10
3.6. Test Result	11
4. Occupied Bandwidth	16
4.1. Test Equipment	16
4.2. Test Setup	16
4.3. Limit	16
4.4. Test Procedure	16
4.5. Uncertainty	16
4.6. Test Result	17
5.Spurious Emission At Antenna Terminals (+/- 1MHz)	29
5.1. Test Equipment	29
5.2. Test Setup	29
5.3. Limit	29
5.4. Test Procedure	29
5.5. Uncertainty	29
5.6. Test Result	30
6.Spurious Emission.....	32
6.1. Test Equipment	32
6.2. Test Setup	32
6.4. Test Procedure	33
6.5. Uncertainty	34
6.6. Test Result	35
7. Frequency Stability Under Temperature & Voltage Variations	40
7.1. Test Equipment	40
7.2. Test Setup	40
7.3. Limit	40
7.4. Test Procedure	41
7.5. Uncertainty	41
7.6. Test Result	41
8. Peak to Average	43
8.1. Test Equipment	43
8.2. Test Setup	43
8.3. Limit	43
8.4. Test Procedure	43
8.5. Uncertainty	44
8.6. Test Result	44
9.Attachment.....	45

SUMMARY OF TEST RESULT

Report Section	SPECIFICATION		Description	Limit	Result
	FCC CFR 47	IC			
3	part2.1046	N/A	Conducted Output Power	N/A	PASS
3	part 22.913(a)(2)	RSS-132, 5.4	Effective Radiated Power	<7 Watts	PASS
3	part 24.232(c)	RSS-133, 6.4	Equivalent Isotropic Radiated Power	<2 Watts	PASS
4	part 2.1046	RSS-132, 5.2 RSS-133, 6.2 RSS-139, 6.2	Modulation Characteristic	N/A	PASS
4	part 2.1049 part 22.917(a) part 24.238(a)	RSS-GEN, 4.6	Occupied Bandwidth	N/A	PASS
5	part 2.1051 part 22.917(a) part 24.238(a)	RSS-132, 5.5 RSS-133, 6.5 RSS-139, 6.5	Band Edge Measurement	<43+10lg(P[Watts])	PASS
6	part 2.1051 part 22.917(a) part 24.238(a)	RSS-GEN, 4.9 RSS-132, 5.5 RSS-133, 6.5 RSS-139, 6.5	Conducted Spurious Emission	<43+10lg(P[Watts])	PASS
6	part 2.1053 part 22.917(a) part 24.238(a)	RSS-GEN, 4.9 RSS-132, 5.5 RSS-133, 6.5 RSS-139, 6.5	Field Strength of Spurious Radiation	<43+10lg(P[Watts])	PASS
7	part 2.1055 part 22.355 part 24.235	RSS-132, 5.3 RSS-133, 6.3 RSS-139, 6.3	Frequency Stability for Temperature & Voltage	<2.5 ppm	PASS
8	part 24.232(d)	RSS-133,6.4	Peak-to-Average	<13dB	PASS

1.General Information

1.1. EUT Description

Product Name:	Life Alert HELP PERS (915)
Model Name:	Life Alert HELP PERS (915)
Hardware Version:	V. 915
Software Version:	V1.00
RF Exposure Environment:	Uncontrolled
WCDMA	
Support Band:	WCDMA Band II / WCDMA Band V
Tx Frequency Range:	WCDMA Band II : 1850MHz ~1910MHz WCDMA Band V: 824MHz ~849MHz
Rx Frequency Range:	WCDMA Band II : 1930MHz ~1990MHz WCDMA Band V: 869MHz ~894MHz
Type of modulation:	WCDMA(UMTS): QPSK
Antenna Type:	PIFA Antenna
Antenna Peak Gain:	WCDMA Band II : 1.07dBi WCDMA Band V: 0.9dBi
Note:The above EUT's information was declared by manufacturer. Please refer to the specifications or user's manual for more detailed description.	

1.2. Mode of Operation

Unilab has verified the construction and function in typical operation. EUT is inlink mode with base station emulator at maximum power level. All the test modes were carried out with the EUT in normal operation, which was shown in this test report is the worst test mode and defined as:

Test Mode		
Band	Radiated TCs	Conducted TCs
WCDMA Band V	RMC 12.2Kbps Link	RMC 12.2Kbps Link
WCDMA Band II	RMC 12.2Kbps Link	RMC 12.2Kbps Link

Note:

1. Regards to the frequency band operation: the lowest, middle and highest frequency of channel were selected to perform the test, then shown on this report.
2. The maximum power levels are RMC 12.2Kbps mode for WCDMA Band V and RMC 12.2Kbps mode for WCDMA Band II, only these modes were used for all tests.
3. For the ERP/EIRP and radiated emission test, every axis (X, Y, Z) was verified, and show the worst (Z axis) result on this report.

The conducted power table is as follows:

Conducted Power (Unit: dBm)						
Band	WCDMA V			WCDMA II		
TX Channel	4132	4182	4233	9262	9400	9538
RX Channel	4357	4407	4458	9662	9800	9938
Frequency	826.4	836.4	846.6	1852.4	1880	1907.6
RMC 12.2Kbps	23.07	23.32	23.14	23.11	23.35	23.20
AMC 12.2Kbps	23.13	23.21	23.17	23.32	23.30	23.31
HSDPA Subtest-1	23.02	23.01	22.98	23.00	23.01	23.01
HSDPA Subtest-2	22.15	22.43	22.61	22.16	22.21	22.05
HSDPA Subtest-3	21.15	21.09	21.37	21.09	21.13	21.43
HSDPA Subtest-4	20.12	20.04	20.16	20.11	20.34	20.25
HSUPA Subtest-1	23.01	23.09	23.08	23.09	23.01	23.01
HSUPA Subtest-2	22.31	22.21	22.22	22.20	22.16	22.07
HSUPA Subtest-3	21.21	21.31	21.22	21.24	21.16	21.13
HSUPA Subtest-4	20.15	20.31	20.21	20.13	20.41	20.04

1.3. Tested System Details

The types for all equipments, plus descriptions of all cables used in the tested system (including inserted cards) are:

Product	Manufacturer	Model	Serial No.	Power Cord
1 Agilent8960	Agilent	E5515C	GB46581718	N/A

1.4. Configuration of Tested System

Connection Diagram

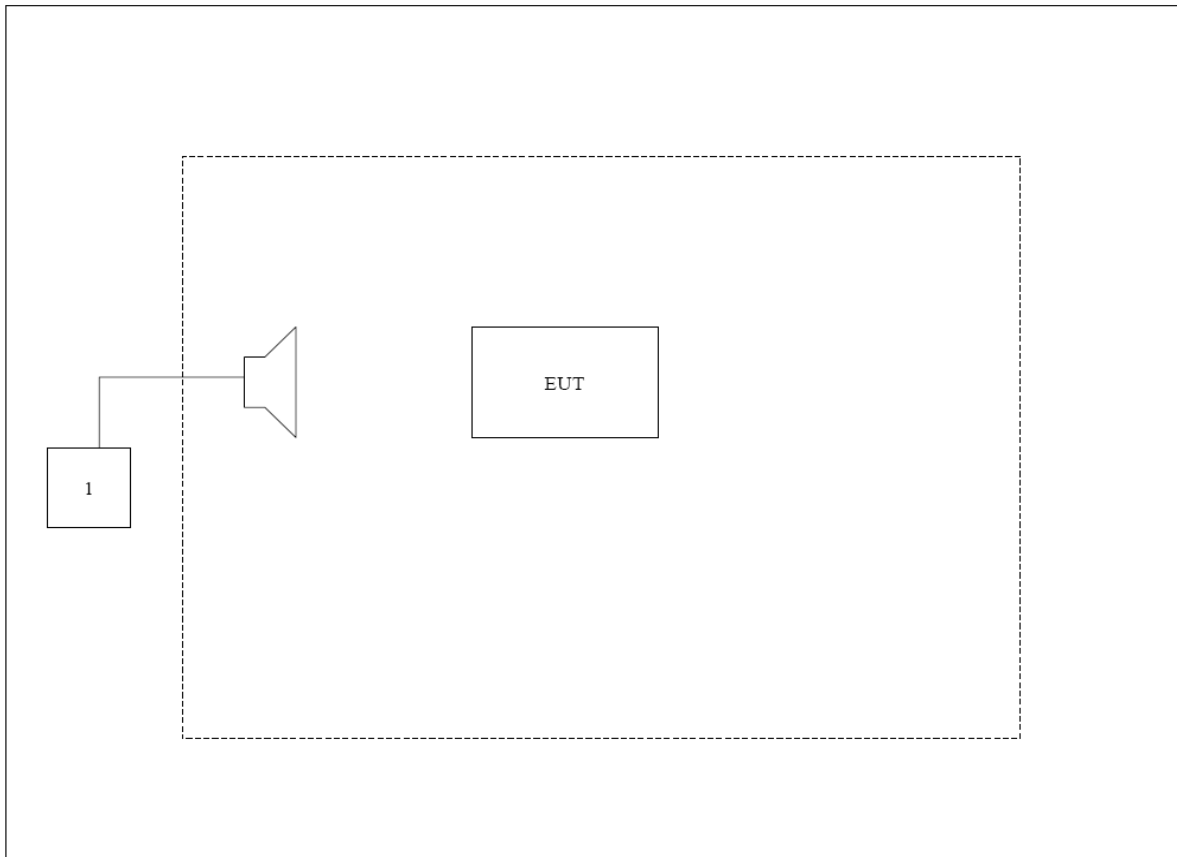

1.5. EUT Exercise Software

1	Setup the EUT and simulators as shown on above.
2	Turn on the power of all equipment.
3	EUT Communicate with E5515C, then select channel to test.

2. Technical Test

2.1. Test Environment

Items	Required (IEC 68-1)	Actual
Temperature (°C)	15-35	23
Humidity (%RH)	25-75	51
Barometric pressure (mbar)	860-1060	950-1000

3. Peak Output Power

3.1. Test Equipment

Instrument	Manufacturer	Model	Serial No.	Cali. Due Date
Spectrum Analyzer	Agilent	N9038A	MY51210142	26/12/2015
Radio Communication Tester	Agilent	E5515C	GB46581718	11/11/2015
Signal Generator	Agilent	N5183A	MY50140938	02/01/2016
Microwave Preamplifier	EM Electronics	EM30180	3008A02425	27/02/2016
Power Splitter	Agilent	11667C/ 52401	MY53806148	27/02/2016
DC Power Supply	R&S	NGSM32/10	3212	05/01/2016
Bilog Antenna	Schwarzbeck	VULB9160	3316	19/09/2016
VHF-UHF-Biconical Antenna	Schwarzbeck	VUBA9117	9117-263	19/09/2016
Broad-Band Horn Antenna	Schwarzbeck	BBHA9120D	942	19/09/2016
Broad-Band Horn Antenna	Schwarzbeck	BBHA9120D	943	19/09/2016

The measure equipment had been calibrated once a year.

3.2. Test Setup

Conducted Power Measurement:

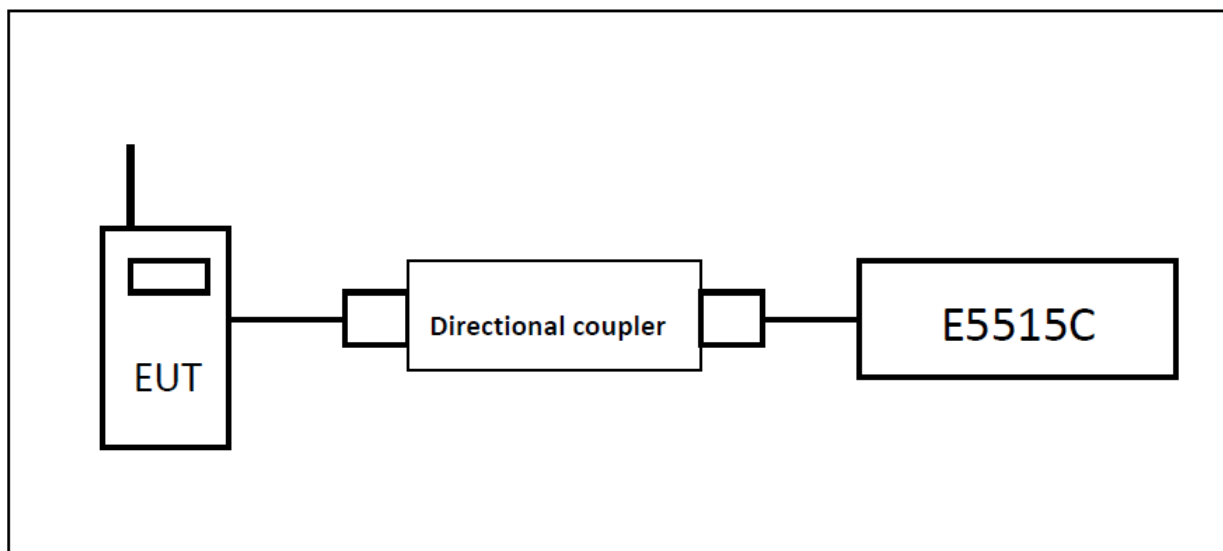

Radiated Spurious Measurement: below 1GHz

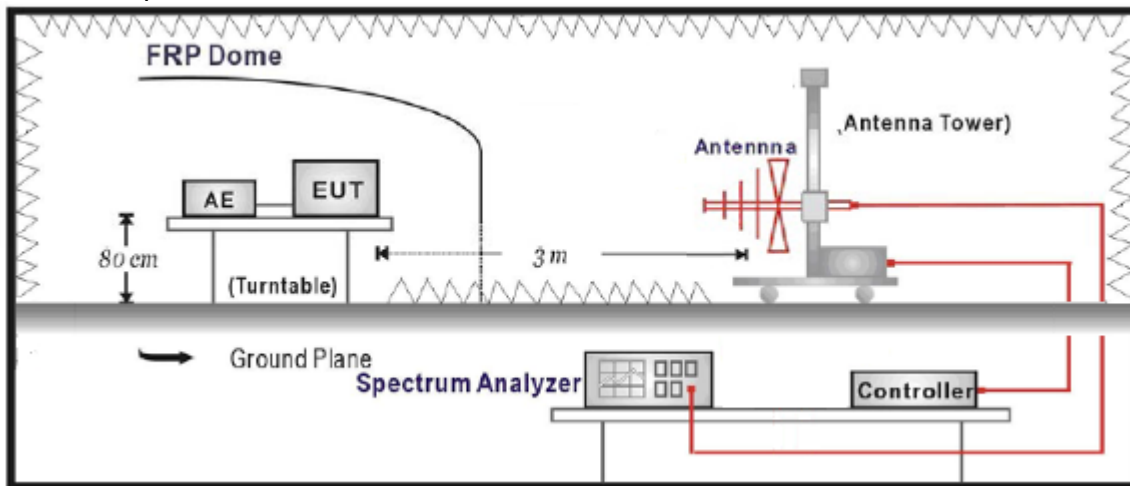

Radiated Spurious Measurement: above 1GHz

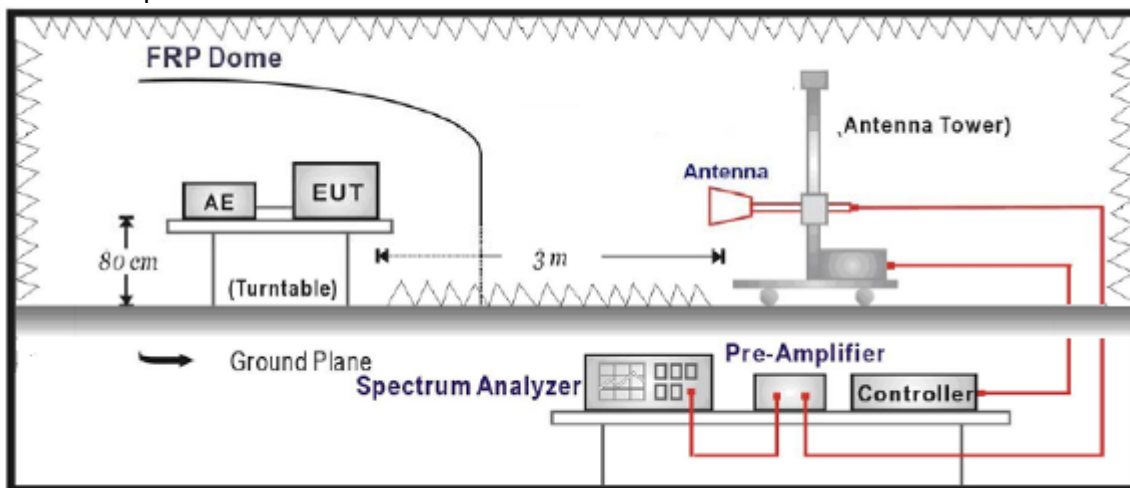

3.3. Limit

For FCC Part 22.913(a)(2):

The ERP of mobile transmitters and auxiliary test transmitters must not exceed 7 Watts.

For FCC Part 24.232(c):

The EIRP of mobile transmitters and auxiliary test transmitters must not exceed 2 Watts.

3.4. Test Procedure

Conducted Power Measurement:

- a. Place the EUT on a bench and set it in transmitting mode.
- b. Connect a low loss RF cable from the antenna port to E5515C by a Directional Couple.
- c. EUT Communicate with E5515C, then selects a channel for testing.
- d. Add a correction factor to the display of spectrum, and then test.

Radiated Power Measurement:

- a. The EUT shall be placed at the specified height on a support, and in the position closest to normal use as declared by provider.
- b. The test antenna shall be oriented initially for vertical polarization and shall be chosen to correspond to the frequency of the transmitter
- c. The output of the test antenna shall be connected to the measuring receiver.
- d. The transmitter shall be switched on and the measuring receiver shall be tuned to the frequency of the transmitter under test.
- e. The test antenna shall be raised and lowered through the specified range of height until a maximum signal level is detected by the measuring receiver.
- f. The transmitter shall then be rotated through 360° in the horizontal plane, until the maximum signal level is detected by the measuring receiver.
- g. The test antenna shall be raised and lowered again through the specified range of height until a maximum signal level is detected by the measuring receiver.
- h. The maximum signal level detected by the measuring receiver shall be noted.
- i. The transmitter shall be replaced by a substitution antenna.
- j. The substitution antenna shall be orientated for vertical polarization and the length of the substitution antenna shall be adjusted to correspond to the frequency of the transmitter.
- k. The substitution antenna shall be connected to a calibrated signal generator.
- l. If necessary, the input attenuator setting of the measuring receiver shall be adjusted in order to increase the sensitivity of the measuring receiver.
- m. The test antenna shall be raised and lowered through the specified range of height to ensure that the maximum signal is received.
- n. The input signal to the substitution antenna shall be adjusted to the level that produces a level detected by the measuring receiver, that is equal to the level noted while the transmitter radiated power was measured, corrected for the change of input attenuator setting of the measuring receiver.
- o. The measurement shall be repeated with the test antenna and the substitution antenna orientated for horizontal polarization.
- p. The measure of the effective radiated power is the larger of the two levels recorded at the input to the substitution antenna, corrected for gain of the substitution antenna if necessary.
- q. Test site anechoic chamber refer to ANSI C63.4: 2009.

3.5. Uncertainty

The measurement uncertainty is defined as for Conducted Power Measurement ± 1.1 dB,
for Radiated Power Measurement ± 3.1 dB

3.6. Test Result

The following table shows the conducted power measured:

Table 1

WCDMA				
Modes	Channel	Frequency (MHz)	Conducted Power (dBm)	Conducted Power (W)
WCDMA Band V	4132(Low)	826.4	23.07	0.20
	4182(Mid)	836.4	23.32	0.21
	4233(High)	846.6	23.14	0.21
WCDMA Band II	9262(Low)	1852.4	23.11	0.20
	9400(Mid)	1880.0	23.35	0.22
	9538(High)	1907.6	23.20	0.21

HSDPA(Subtest-1)				
Modes	Channel	Frequency (MHz)	Conducted Power (dBm)	Conducted Power (W)
Band V	4132(Low)	826.4	23.02	0.20
	4182(Mid)	836.4	23.01	0.20
	4233(High)	846.6	22.98	0.20
Band II	9262(Low)	1852.4	23.00	0.20
	9400(Mid)	1880.0	23.01	0.20
	9538(High)	1907.6	23.01	0.20

HSUPA(Subtest-1)				
Modes	Channel	Frequency (MHz)	Conducted Power (dBm)	Conducted Power (W)
Band V	4132(Low)	826.4	23.01	0.20
	4182(Mid)	836.4	23.09	0.20
	4233(High)	846.6	23.08	0.20
Band II	9262(Low)	1852.4	23.09	0.20
	9400(Mid)	1880.0	23.01	0.20
	9538(High)	1907.6	23.01	0.20

The following table shows the Radiated power measured :

WCDMA Band V

Frequency (MHz)	Ant. Pol. (H/V)	SG Reading (dBm)	Cable Loss (dB)	Gain (dBd)	ERP (dBm)	ERP (W)
Low Channel 4132(826.4MHz)						
826.4	H	20.91	3.83	8.25	25.33	0.34
826.4	V	19.43	3.83	8.25	23.85	0.24
Middle Channel 4182 (836.4MHz)						
836.4	H	20.63	3.96	8.28	24.95	0.31
836.4	V	19.26	3.96	8.28	23.58	0.23
High Channel 4233 (846.6MHz)						
846.6	H	19.73	3.97	8.29	24.05	0.25
846.6	V	18.50	3.97	8.29	22.82	0.19

WCDMA Band II

Frequency (MHz)	Ant. Pol. (H/V)	SG Reading (dBm)	Cable Loss (dB)	Gain (dBi)	EIRP (dBm)	EIRP (W)
Low Channel 9262(1852.40MHz)						
1850.2	H	20.43	6.26	10.40	24.57	0.29
1850.2	V	19.53	6.26	10.40	23.67	0.23
Middle Channel 9400 (1880.00MHz)						
1880.0	H	20.19	6.19	10.43	24.43	0.28
1880.0	V	19.05	6.19	10.43	23.29	0.21
High Channel 9538 (1907.60MHz)						
1909.8	H	19.70	6.15	10.44	23.99	0.25
1909.8	V	18.99	6.15	10.44	23.28	0.21

HSDPA Band V

Frequency (MHz)	Ant. (H/V)	Pol.	SG Reading (dBm)	Cable Loss (dB)	Gain (dBd)	ERP (dBm)	ERP (W)
Low Channel 4132(826.4MHz)							
826.4	H		20.59	3.83	8.25	25.01	0.32
826.4	V		19.58	3.83	8.25	24.00	0.25
Middle Channel 4182 (836.4MHz)							
836.4	H		20.29	3.96	8.28	24.61	0.29
836.4	V		19.77	3.96	8.28	24.09	0.26
High Channel 4233 (846.6MHz)							
846.6	H		19.78	3.97	8.29	24.10	0.26
846.6	V		18.97	3.97	8.29	23.29	0.21

HSDPA Band II

Frequency (MHz)	Ant. (H/V)	Pol.	SG Reading (dBm)	Cable Loss (dB)	Gain (dBi)	EIRP (dBm)	EIRP (W)
Low Channel 9262(1852.40MHz)							
1850.2	H		20.15	6.26	10.40	24.29	0.27
1850.2	V		19.38	6.26	10.40	23.52	0.22
Middle Channel 9400 (1880.00MHz)							
1880.0	H		20.07	6.19	10.43	24.31	0.27
1880.0	V		19.35	6.19	10.43	23.59	0.22
High Channel 9538 (1907.60MHz)							
1909.8	H		19.98	6.15	10.44	24.27	0.27
1909.8	V		18.92	6.15	10.44	23.21	0.21

HSUPA Band V

Frequency (MHz)	Ant. (H/V)	Pol.	SG Reading (dBm)	Cable Loss (dB)	Gain (dBd)	ERP (dBm)	ERP (W)
Low Channel 4132(826.4MHz)							
826.4	H		20.57	3.83	8.25	24.99	0.32
826.4	V		20.01	3.83	8.25	24.43	0.28
Middle Channel 4182 (836.4MHz)							
836.4	H		20.28	3.96	8.28	24.60	0.29
836.4	V		19.76	3.96	8.28	24.08	0.26
High Channel 4233 (846.6MHz)							
846.6	H		19.79	3.97	8.29	24.11	0.26
846.6	V		18.64	3.97	8.29	22.96	0.20

HSUPA Band II

Frequency (MHz)	Ant. (H/V)	Pol.	SG Reading (dBm)	Cable Loss (dB)	Gain (dBi)	EIRP (dBm)	EIRP (W)
Low Channel 9262(1852.40MHz)							
1850.2	H		20.15	6.26	10.40	24.29	0.27
1850.2	V		19.84	6.26	10.40	23.98	0.25
Middle Channel 9400 (1880.00MHz)							
1880.0	H		20.03	6.19	10.43	24.27	0.27
1880.0	V		19.26	6.19	10.43	23.50	0.22
High Channel 9538 (1907.60MHz)							
1909.8	H		19.84	6.15	10.44	24.13	0.26
1909.8	V		19.02	6.15	10.44	23.31	0.21

4. Occupied Bandwidth

4.1. Test Equipment

Instrument	Manufacturer	Model	Serial No	Cal. Date
Radio Communication Tester	Agilent	E5515C	GB46581718	11/11/2015
Spectrum Analyzer	Agilent	N9038A	MY51210142	26/12/2015
Power Splitter	Agilent	11667C/ 52401	MY53806148	27/02/2016
DC Power Supply	R&S	NGSM32/10	3212	05/01/2016

The measure equipment had been calibrated once a year.

4.2. Test Setup

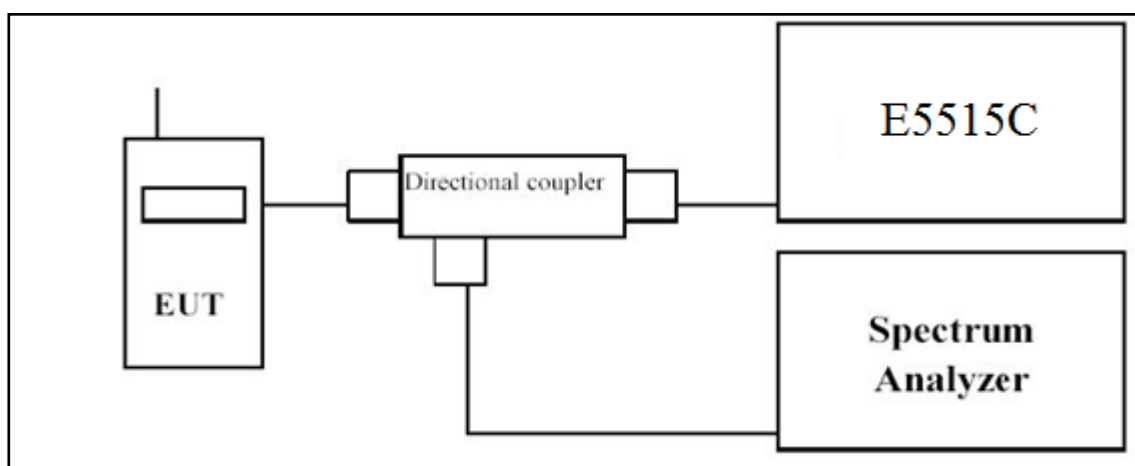

4.3. Limit

N/A

4.4. Test Procedure

Using Occupied Bandwidth measurement function of spectrum analyzer, and setting as follows:
For WCDMA Band V and WCDMA BAND II test --- RBW = 100 kHz and VBW = 300 kHz

4.5. Uncertainty

The measurement uncertainty is defined as ± 10 Hz

4.6. Test Result

WCDMA Band V

Channel No.	Frequency (MHz)	-26dB Occupied Bandwidth (MHz)	99% Occupied Bandwidth (MHz)
4132	826.40	4.668	4.161
4182	836.40	4.675	4.162
4233	846.40	4.665	4.153

WCDMA Band V, Channel 4132

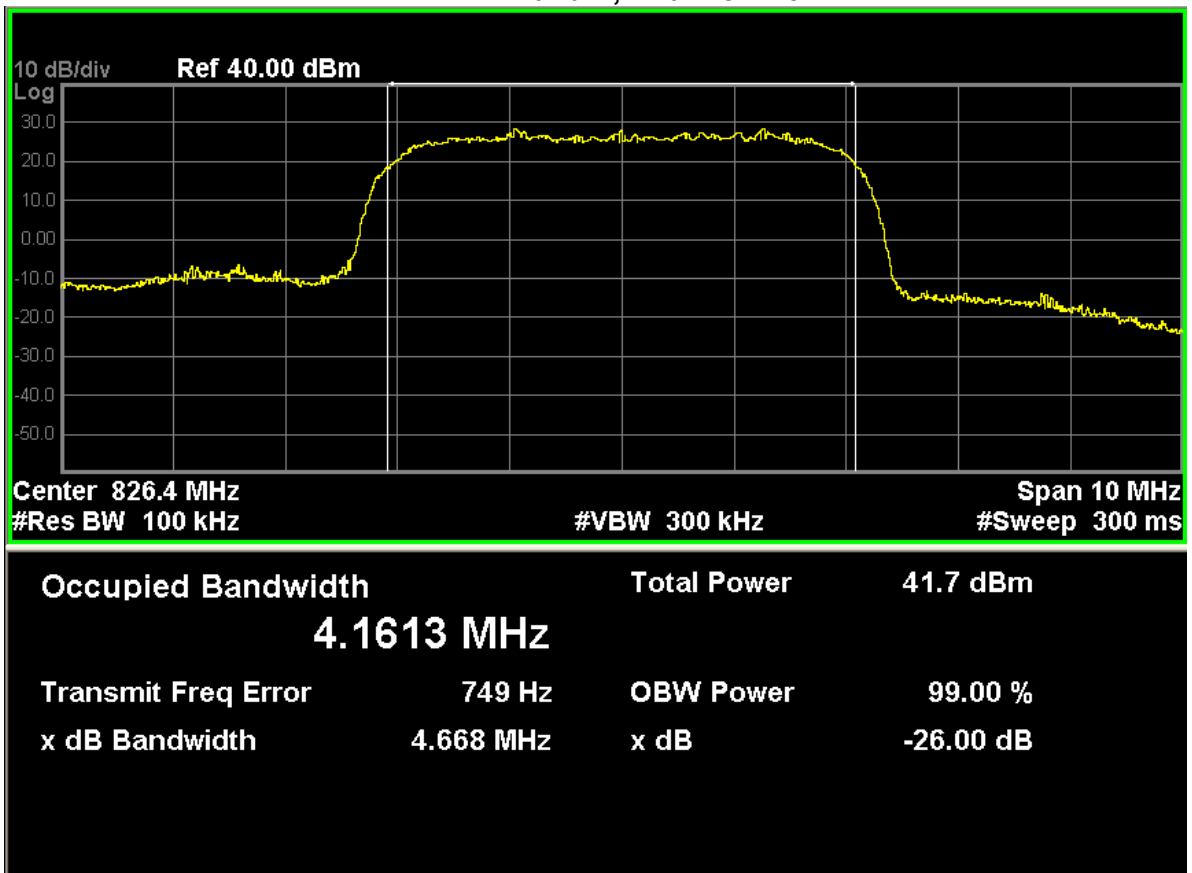

WCDMA Band V, Channel 4182

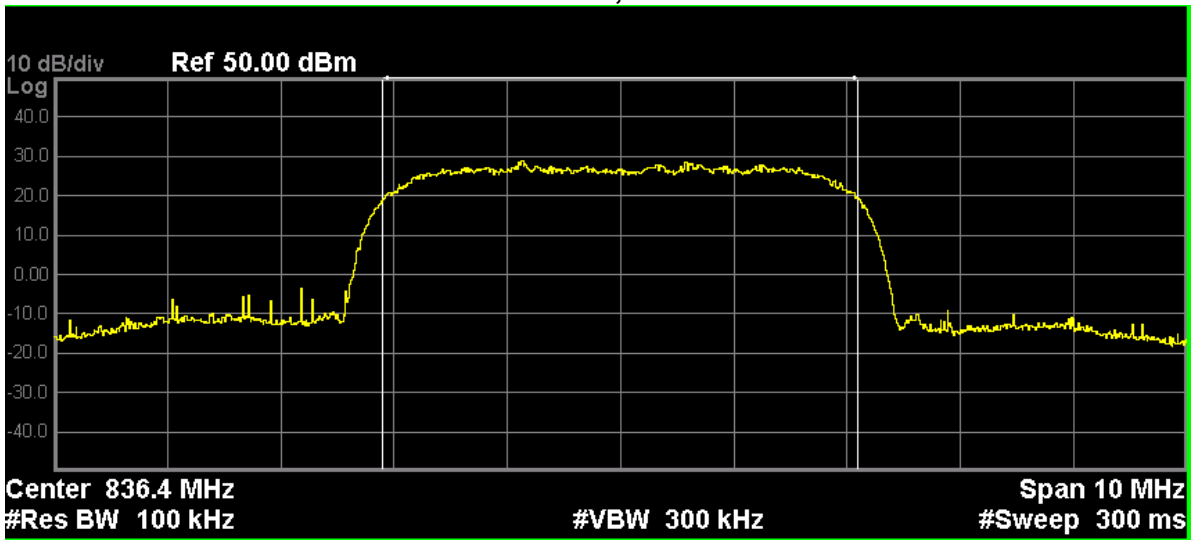

Occupied Bandwidth	Total Power	42.1 dBm	
4.1616 MHz			
Transmit Freq Error	3.928 kHz	OBW Power	99.00 %
x dB Bandwidth	4.675 MHz	x dB	-26.00 dB

WCDMA Band V, Channel 4233

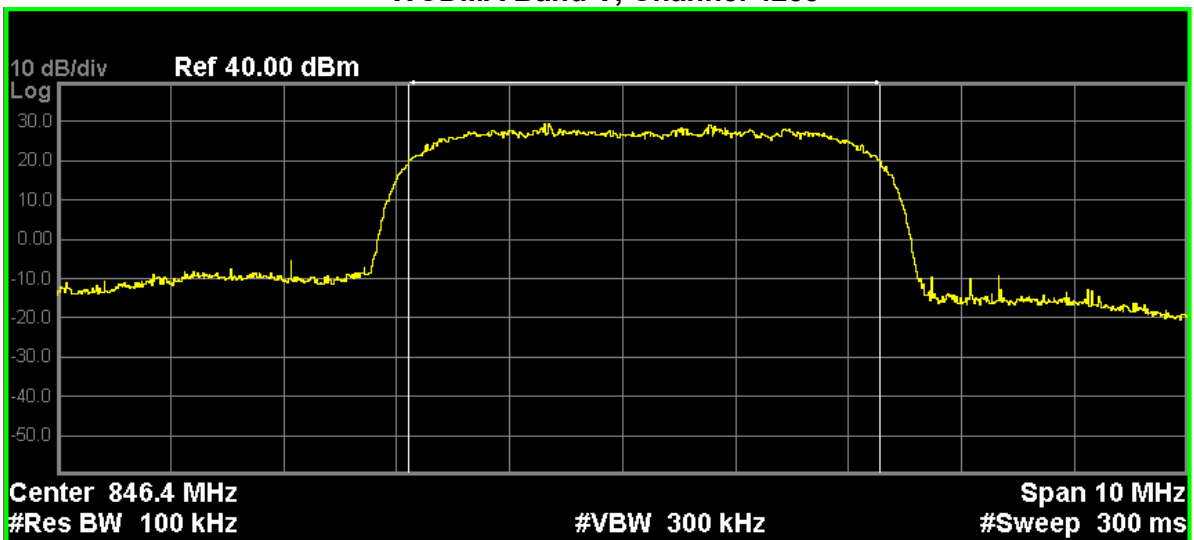

Occupied Bandwidth	Total Power	42.5 dBm	
4.1527 MHz			
Transmit Freq Error	195.30 kHz	OBW Power	99.00 %
x dB Bandwidth	4.665 MHz	x dB	-26.00 dB

WCDMA Band II

Channel No.	Frequency (MHz)	-26dB Occupied Bandwidth (MHz)	99% Occupied Bandwidth (MHz)
9262	1852.4	4.700	4.178
9400	1880.0	4.674	4.166
9538	1907.6	4.678	4.173

WCDMA Band II, Channel 9262

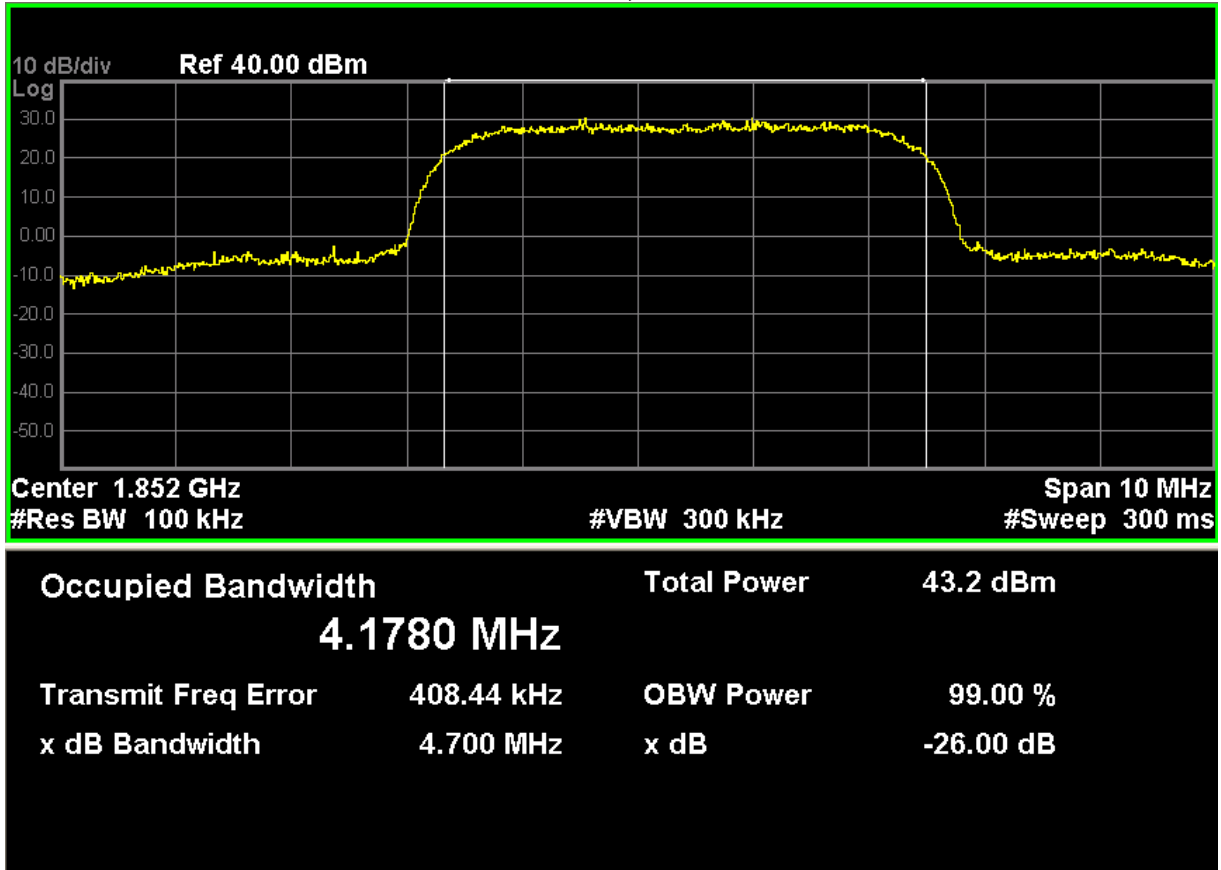

WCDMA Band II, Channel 9400

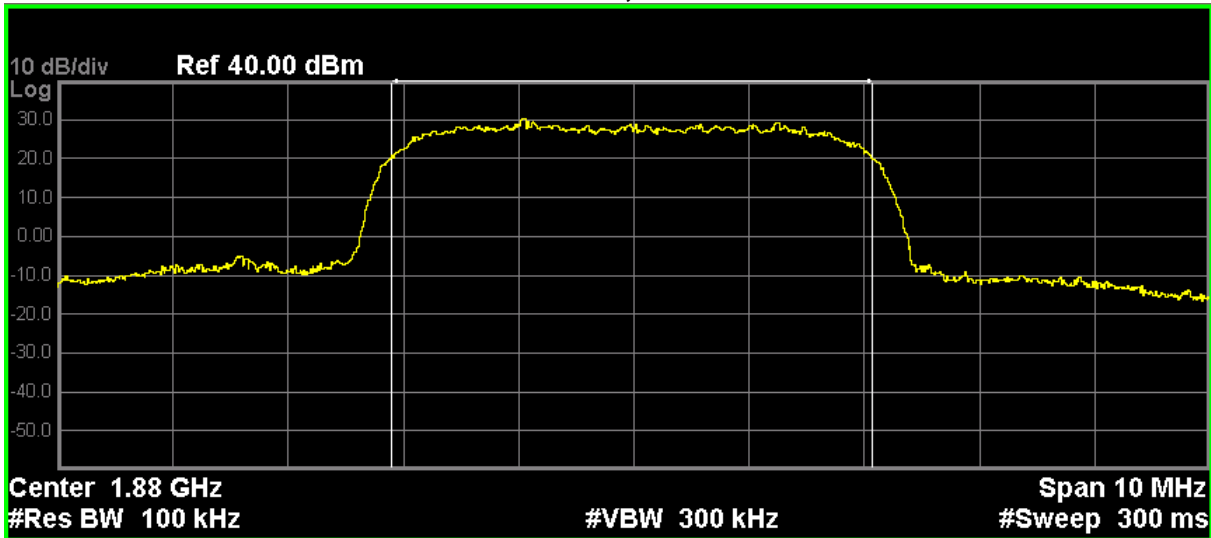

Occupied Bandwidth	Total Power	43.2 dBm
4.1659 MHz		
Transmit Freq Error	-14.438 kHz	OBW Power
		99.00 %
x dB Bandwidth	4.674 MHz	x dB
		-26.00 dB

WCDMA Band II, Channel 9538

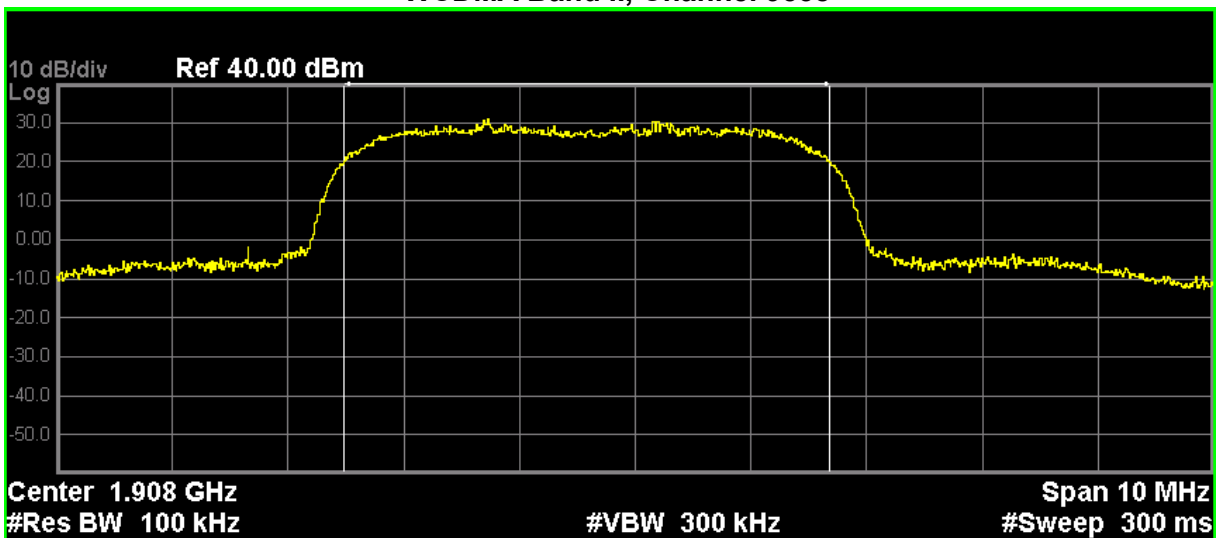

Occupied Bandwidth	Total Power	43.4 dBm
4.1728 MHz		
Transmit Freq Error	-410.28 kHz	OBW Power
		99.00 %
x dB Bandwidth	4.678 MHz	x dB
		-26.00 dB

HSDPA Band V

Channel No.	Frequency (MHz)	-26dB Occupied Bandwidth (MHz)	99% Occupied Bandwidth (MHz)
4132	826.40	4.652	4.143
4182	836.40	4.648	4.149
4233	846.40	4.654	4.148

HSDPA Band V, Channel 4132

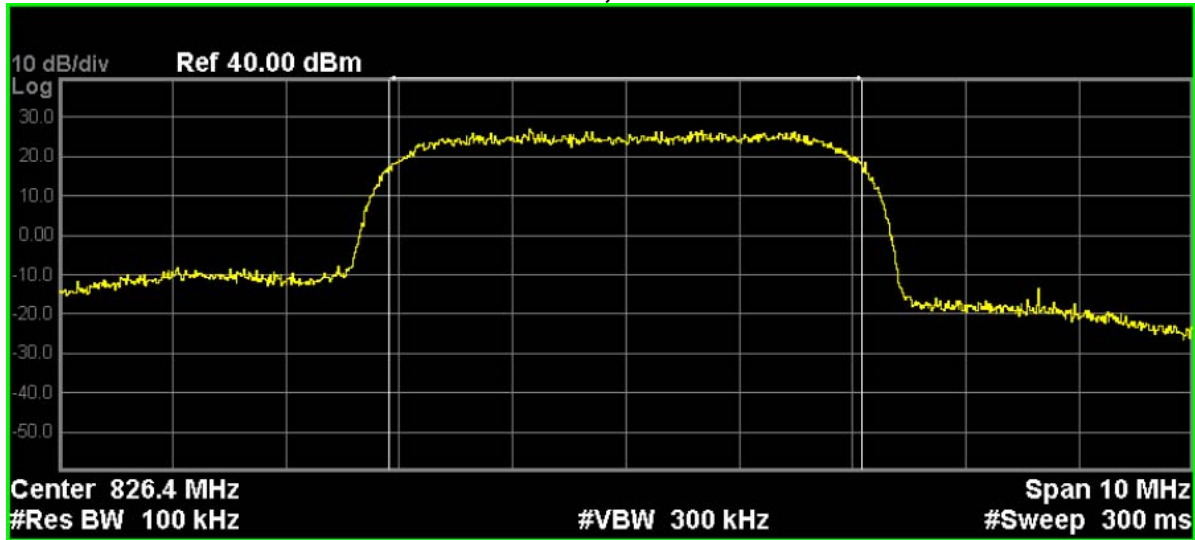

Occupied Bandwidth		Total Power	40.1 dBm
	4.1431 MHz		
Transmit Freq Error	2.634 kHz	OBW Power	99.00 %
x dB Bandwidth	4.652 MHz	x dB	-26.00 dB

HSDPA Band V, Channel 4182

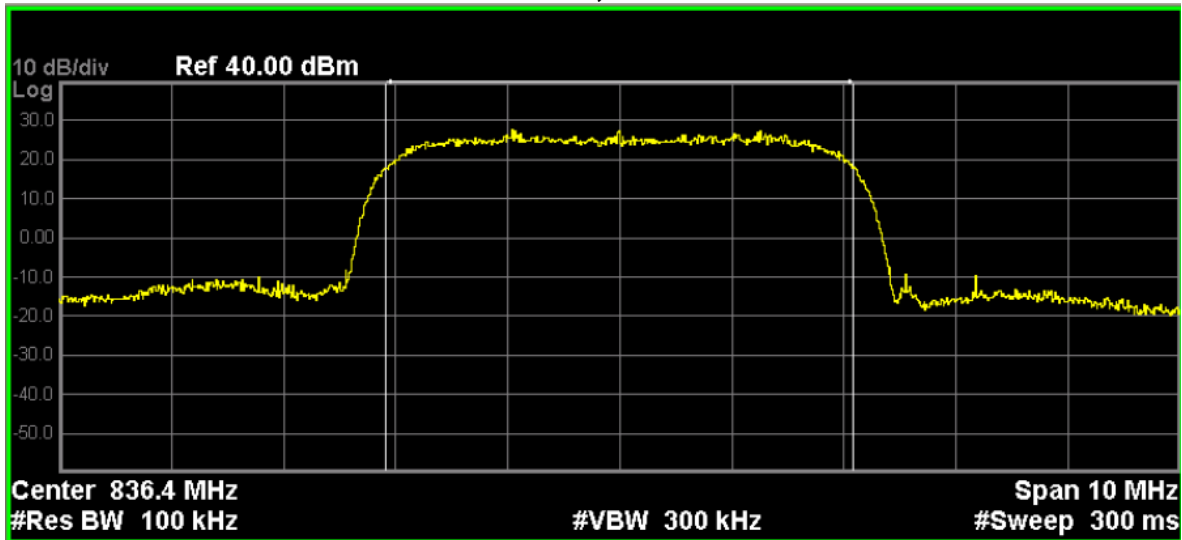

Occupied Bandwidth	Total Power	40.5 dBm
4.1485 MHz		
Transmit Freq Error	-2.019 kHz	OBW Power
x dB Bandwidth	4.648 MHz	x dB
		99.00 %
		-26.00 dB

HSDPA Band V, Channel 4233

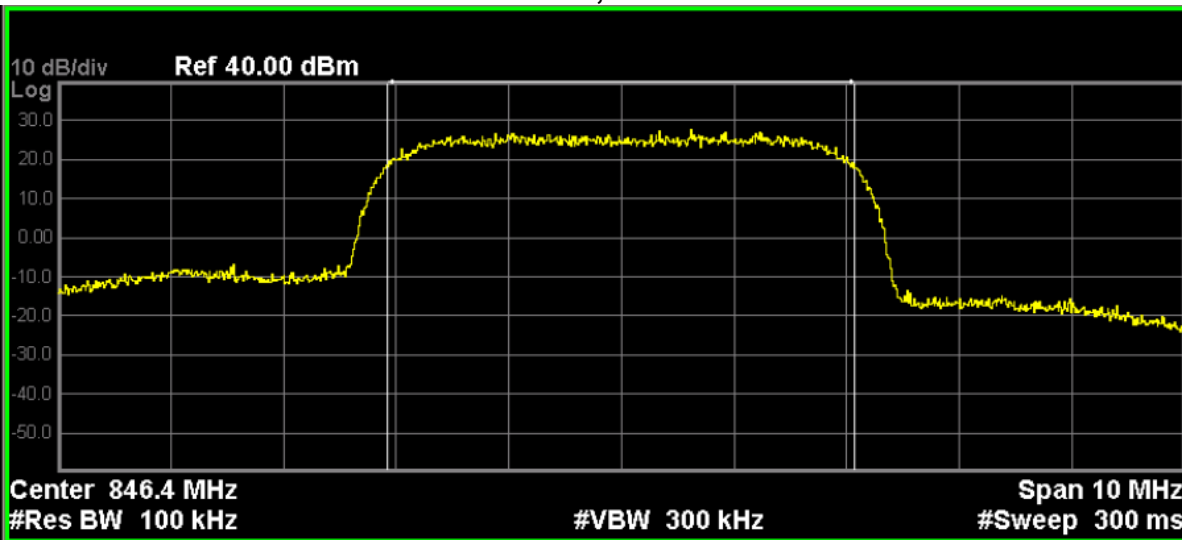

Occupied Bandwidth	Total Power	40.5 dBm
4.1480 MHz		
Transmit Freq Error	-4.852 kHz	OBW Power
x dB Bandwidth	4.654 MHz	x dB
		99.00 %
		-26.00 dB

HSDPA Band II

Channel No.	Frequency (MHz)	-26dB Occupied Bandwidth (MHz)	99% Occupied Bandwidth (MHz)
9262	1852.4	4.699	4.156
9400	1880.0	4.660	4.158
9538	1907.6	4.680	4.155

HSDPA Band II, Channel 9262

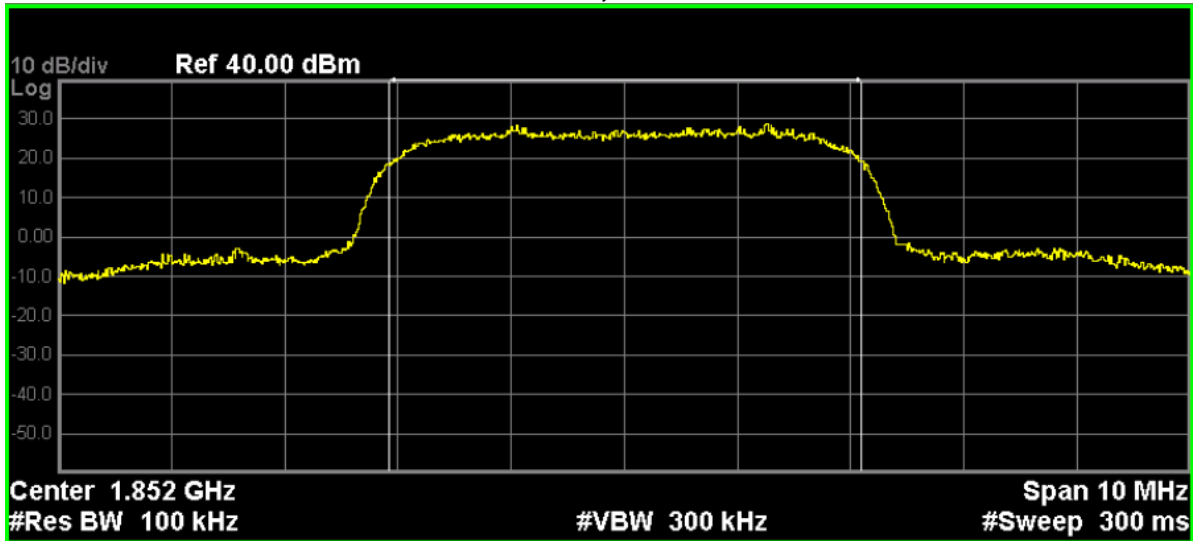

Occupied Bandwidth	4.1557 MHz	Total Power	41.5 dBm
Transmit Freq Error	14.362 kHz	OBW Power	99.00 %
x dB Bandwidth	4.699 MHz	x dB	-26.00 dB

HSDPA Band II, Channel 9400

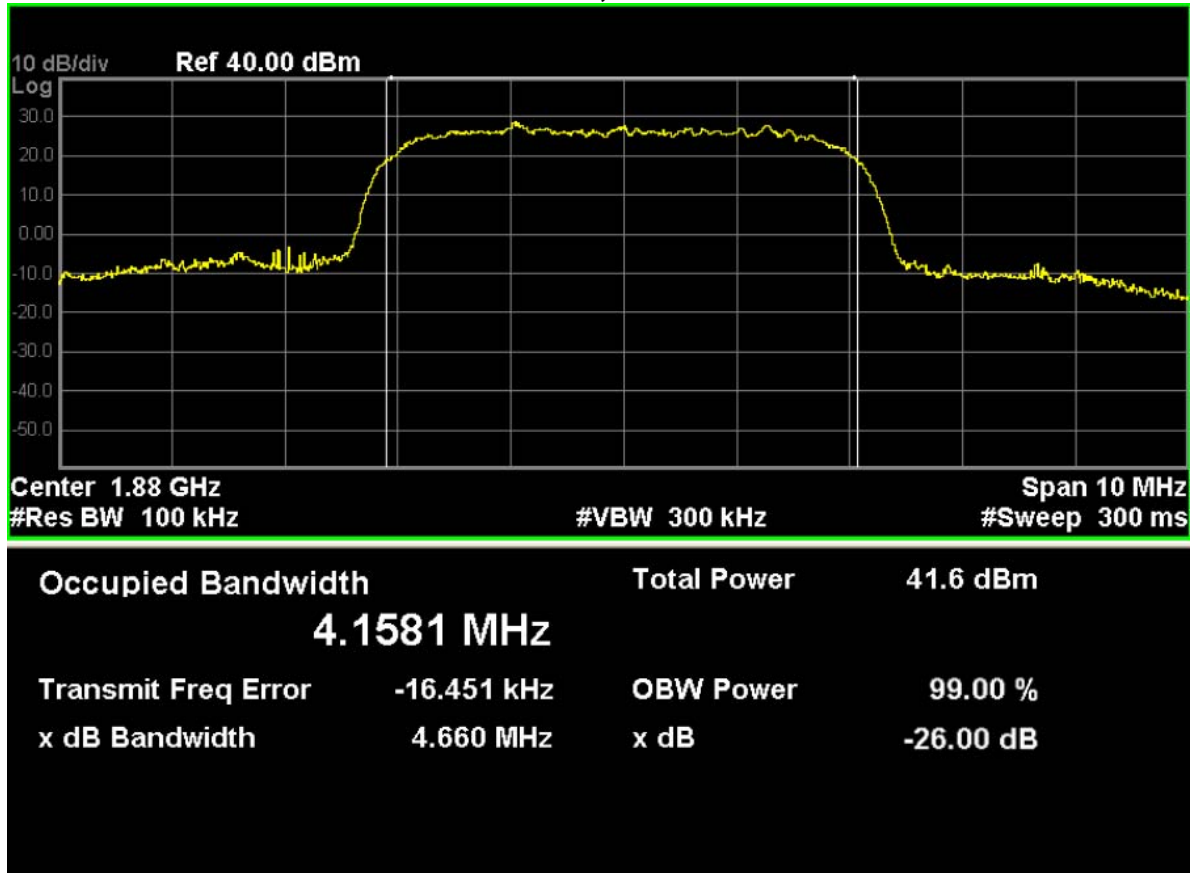

HSDPA Band II, Channel 9538

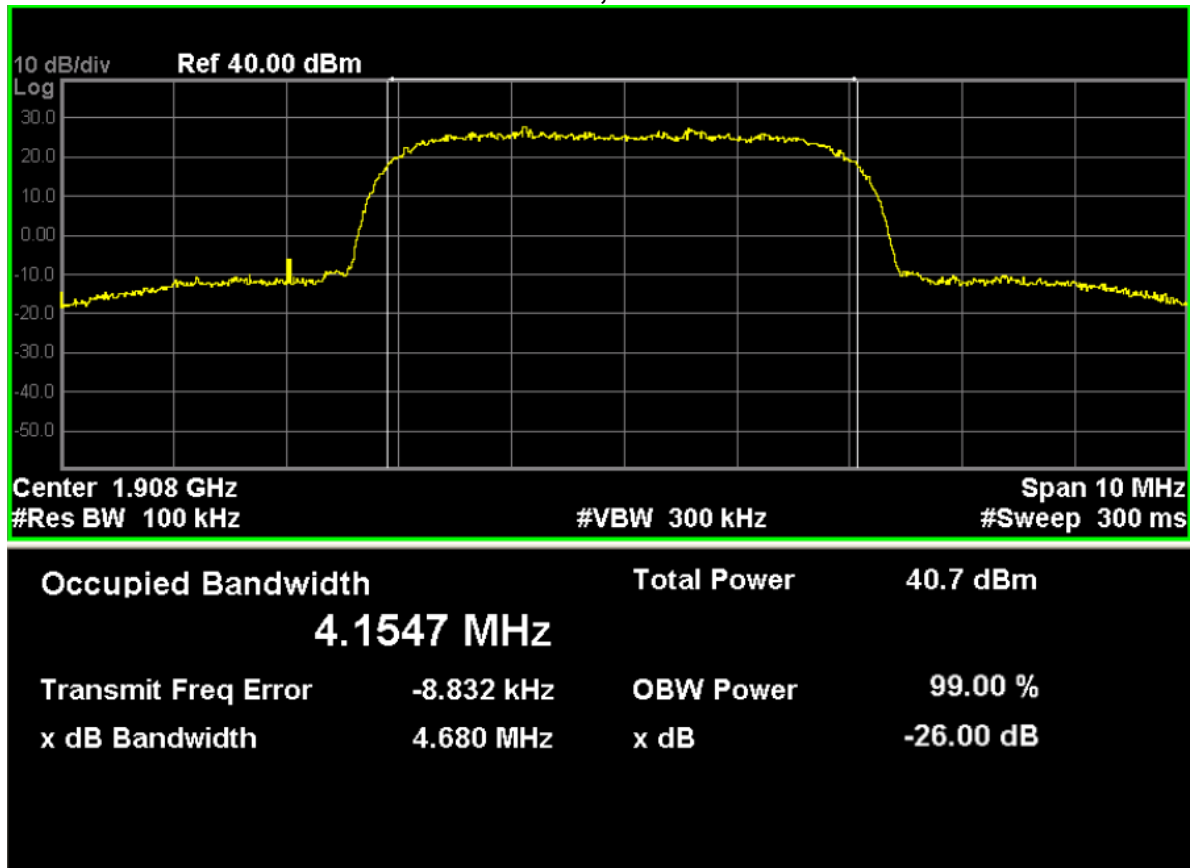

HSUPA Band V

Channel No.	Frequency (MHz)	-26dB Occupied Bandwidth (MHz)	99% Occupied Bandwidth (MHz)
4132	826.40	4.648	4.141
4182	836.40	4.656	4.129
4233	846.40	4.649	4.137

HSUPA Band V, Channel 4132

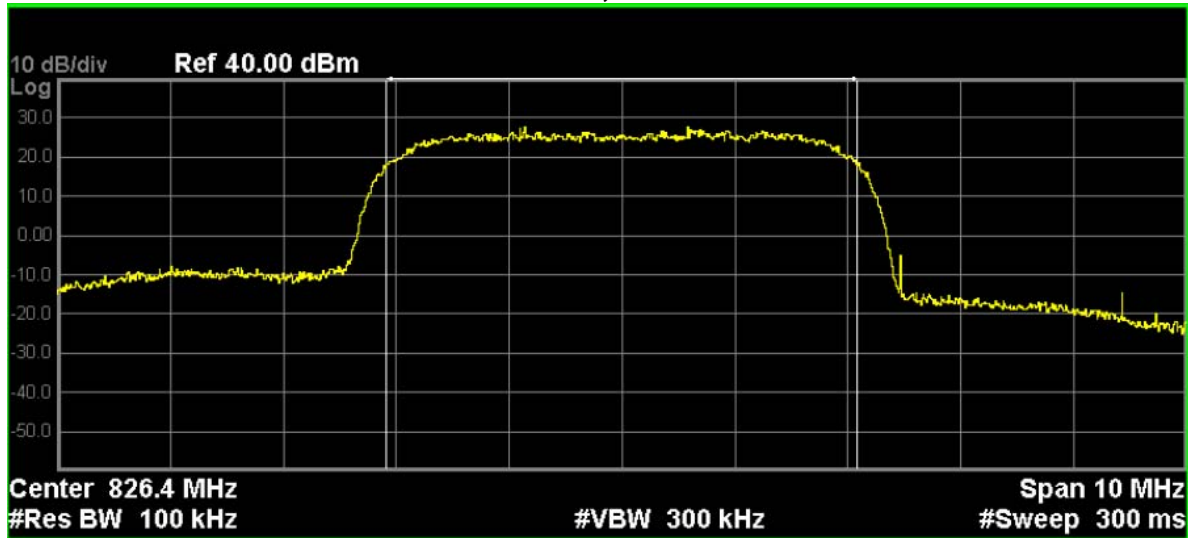

Occupied Bandwidth		Total Power	40.7 dBm
	4.1407 MHz		
Transmit Freq Error	2.994 kHz	OBW Power	99.00 %
x dB Bandwidth	4.648 MHz	x dB	-26.00 dB

HSUPA Band V, Channel 4182

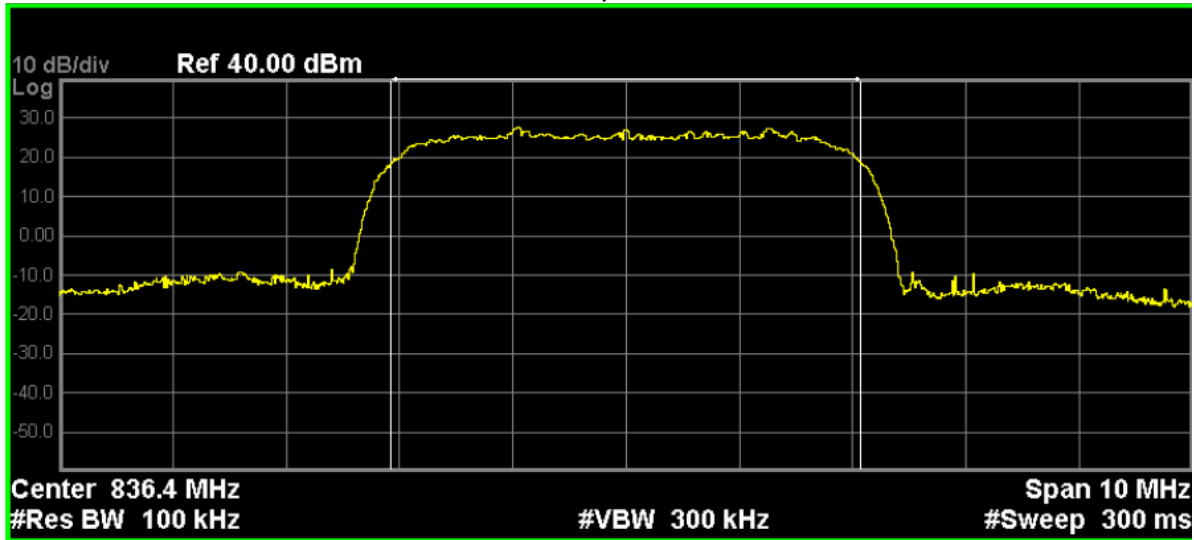

Occupied Bandwidth	Total Power	41.0 dBm
4.1288 MHz		
Transmit Freq Error	630 Hz	OBW Power
x dB Bandwidth	4.656 MHz	x dB
		99.00 %
		-26.00 dB

HSUPA Band V, Channel 4233

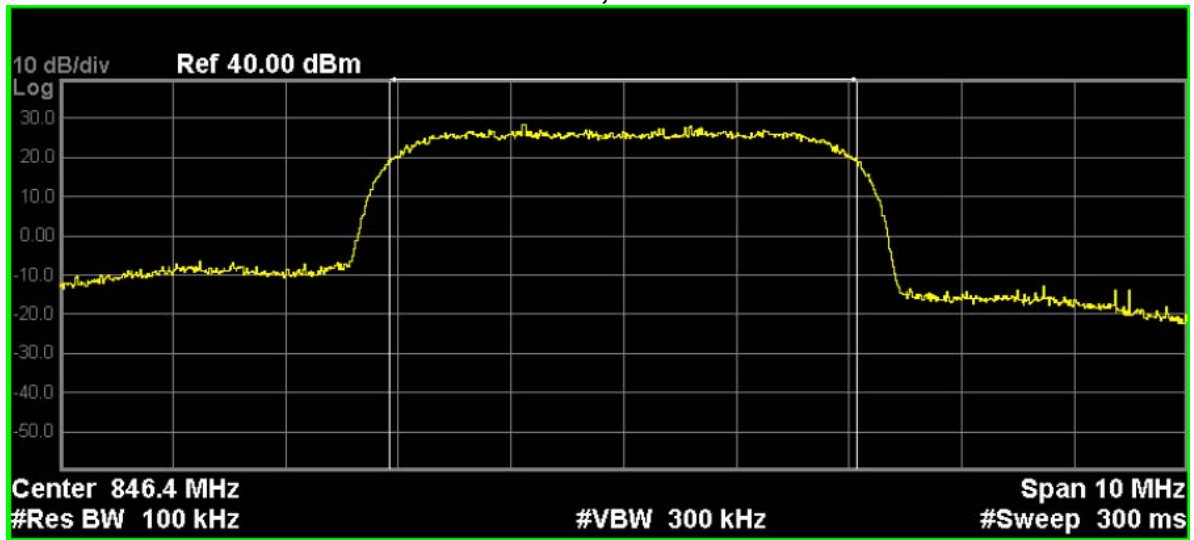

Occupied Bandwidth	Total Power	41.3 dBm
4.1369 MHz		
Transmit Freq Error	-5.288 kHz	OBW Power
x dB Bandwidth	4.649 MHz	x dB
		99.00 %
		-26.00 dB

HSUPA Band II

Channel No.	Frequency (MHz)	-26dB Occupied Bandwidth (MHz)	99% Occupied Bandwidth (MHz)
9262	1852.4	4.690	4.138
9400	1880.0	4.664	4.122
9538	1907.6	4.676	4.157

HSUPA Band II, Channel 9262

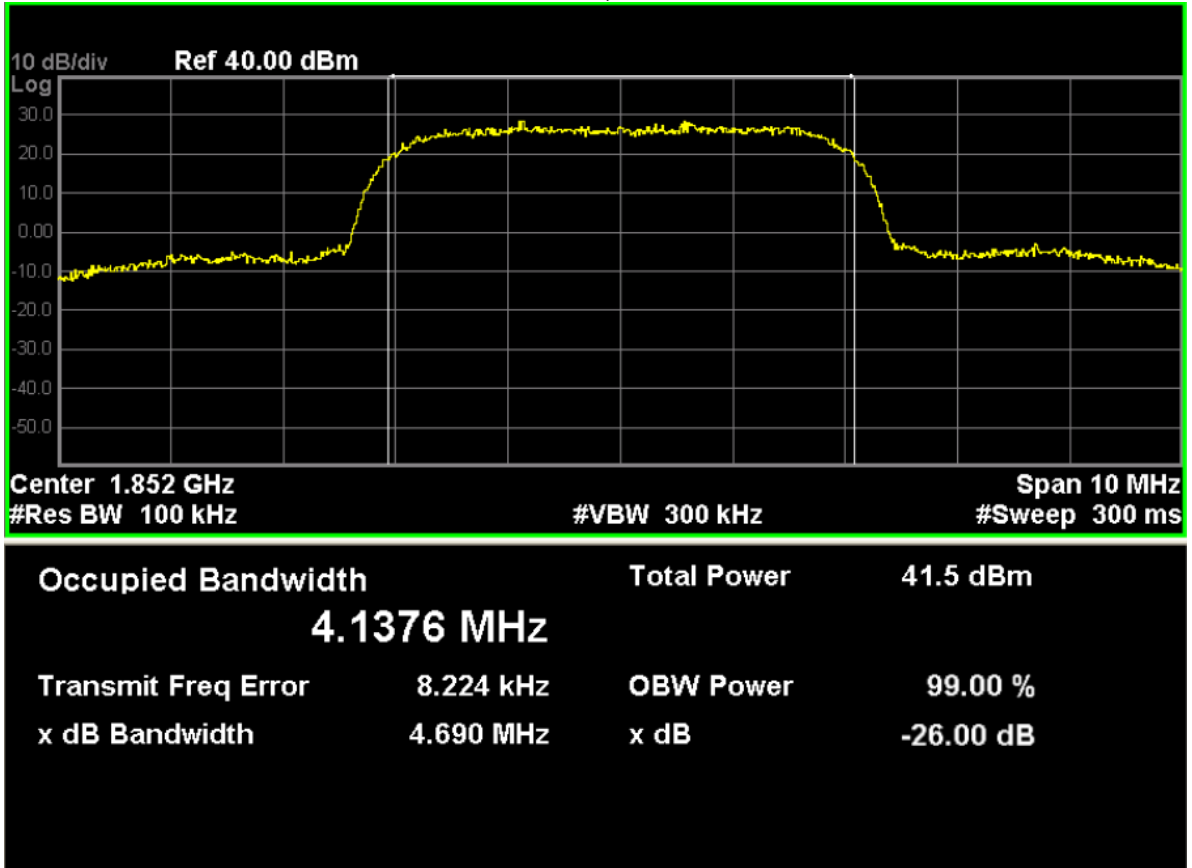

HSUPA Band II, Channel 9400

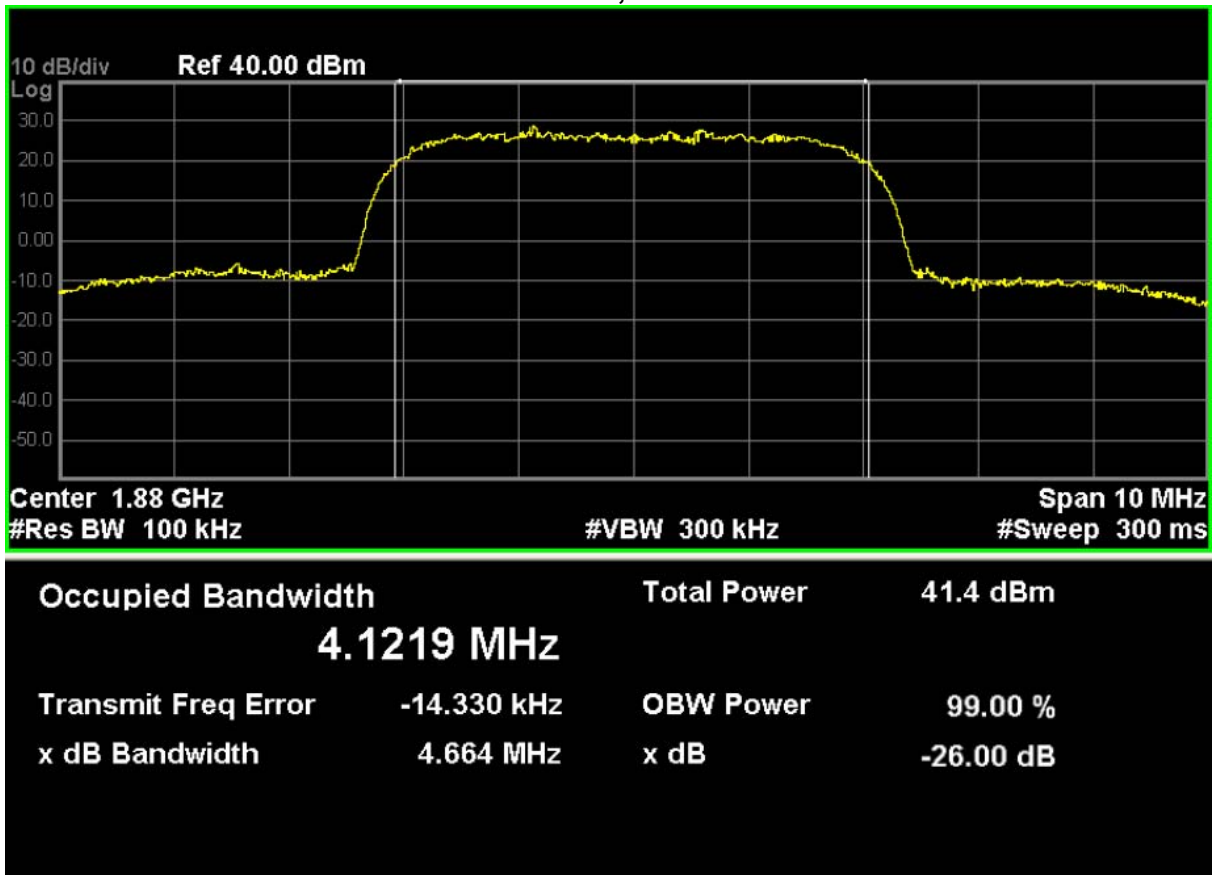

HSUPA Band II, Channel 9538

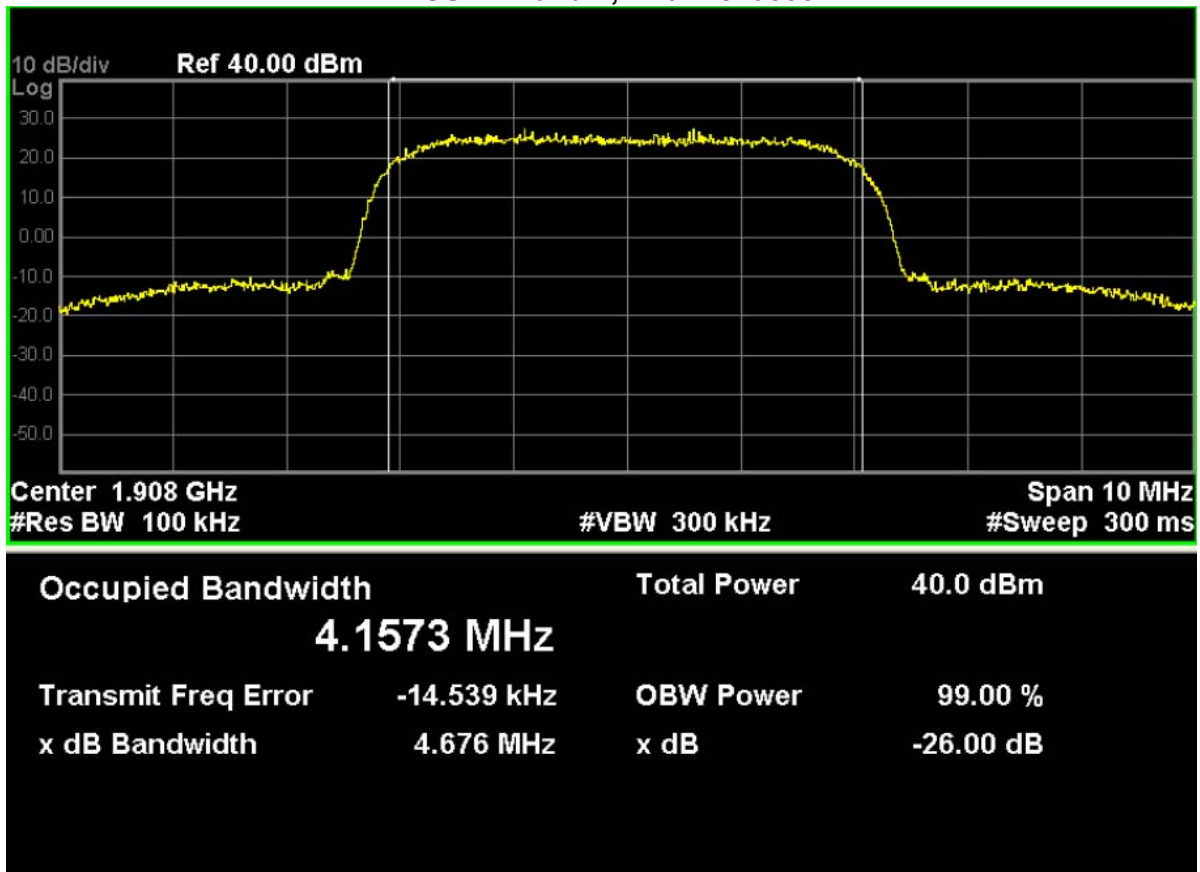

5. Spurious Emission At Antenna Terminals (+/- 1MHz)

5.1. Test Equipment

Instrument	Manufacturer	Model	Serial No	Cal. Date
Radio Communication Tester	Agilent	E5515C	GB46581718	11/11/2015
Spectrum Analyzer	Agilent	N9038A	MY51210142	26/12/2015
Power Splitter	Agilent	11667C/ 52401	MY53806148	27/02/2016
DC Power Supply	R&S	NGSM32/10	3212	05/01/2016

The measure equipment had been calibrated once a year.

5.2. Test Setup

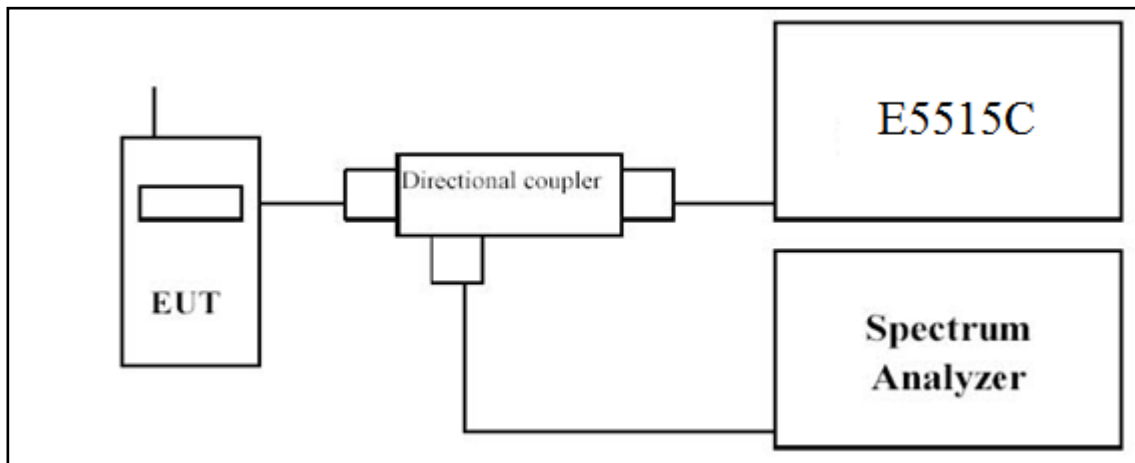

5.3. Limit

The power of any emission outside of the authorized operating frequency ranges must be attenuated below the transmitting power (P) by a factor of at least $43 + 10\log(P)$ dB.

5.4. Test Procedure

In the 1MHz bands immediately outside and adjacent to the frequency block a resolution bandwidth of at least one percent of the emission bandwidth of the fundamental emission of the transmitter may be employed to measure the out of band Emissions.

5.5. Uncertainty

The measurement uncertainty is defined as ± 1.2 dB.

5.6. Test Result

WCDMA Band V, Channel 4132

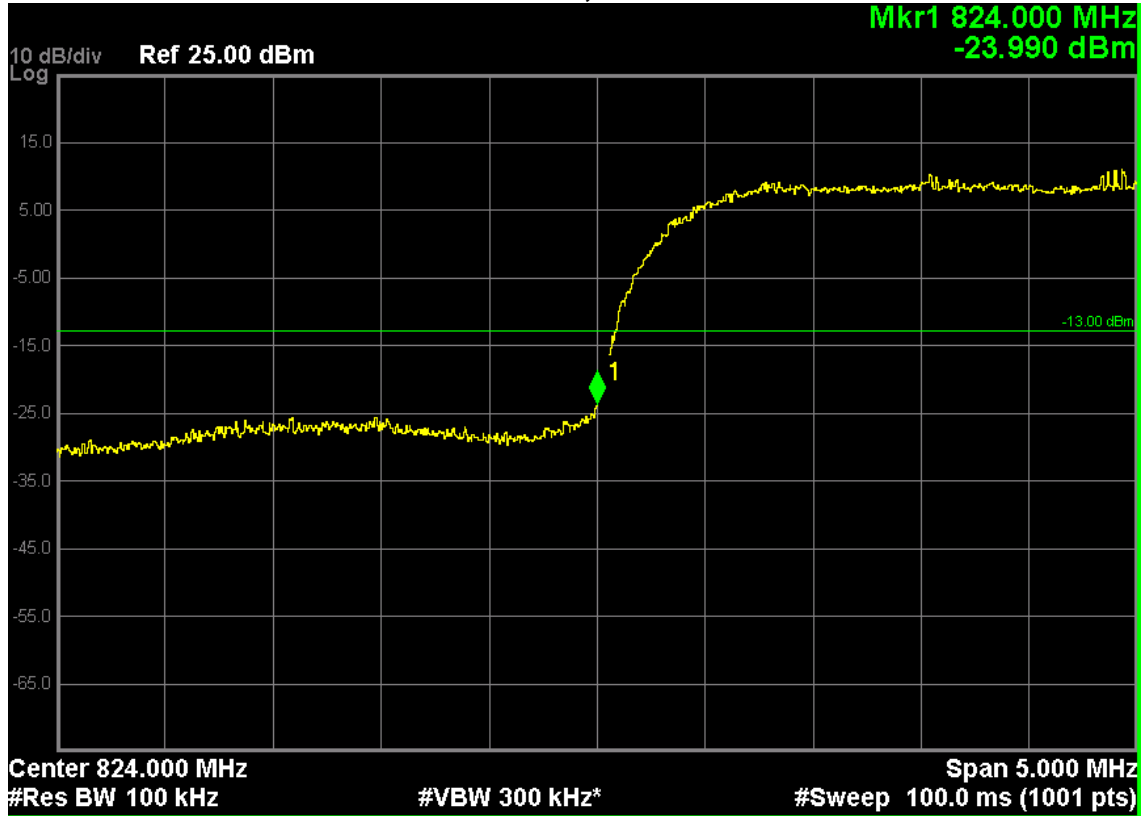

WCDMA Band V, Channel 4233

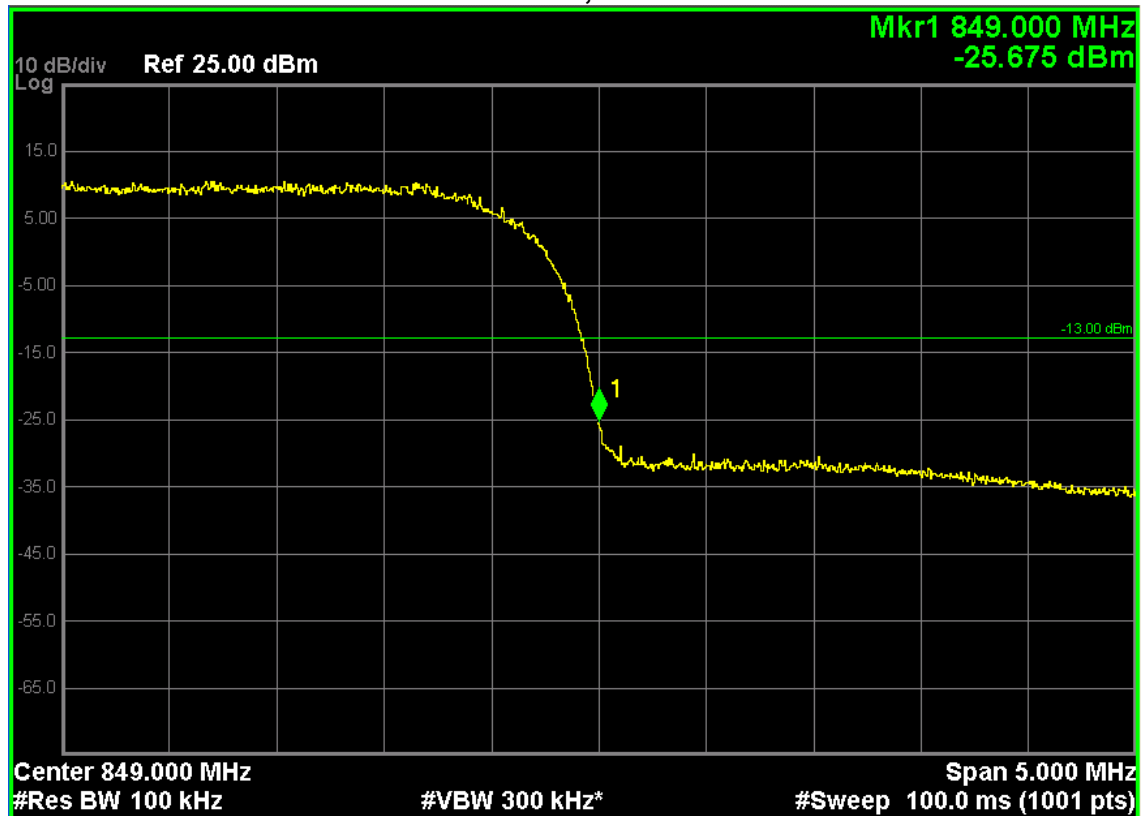

WCDMA Band II, Channel 9262

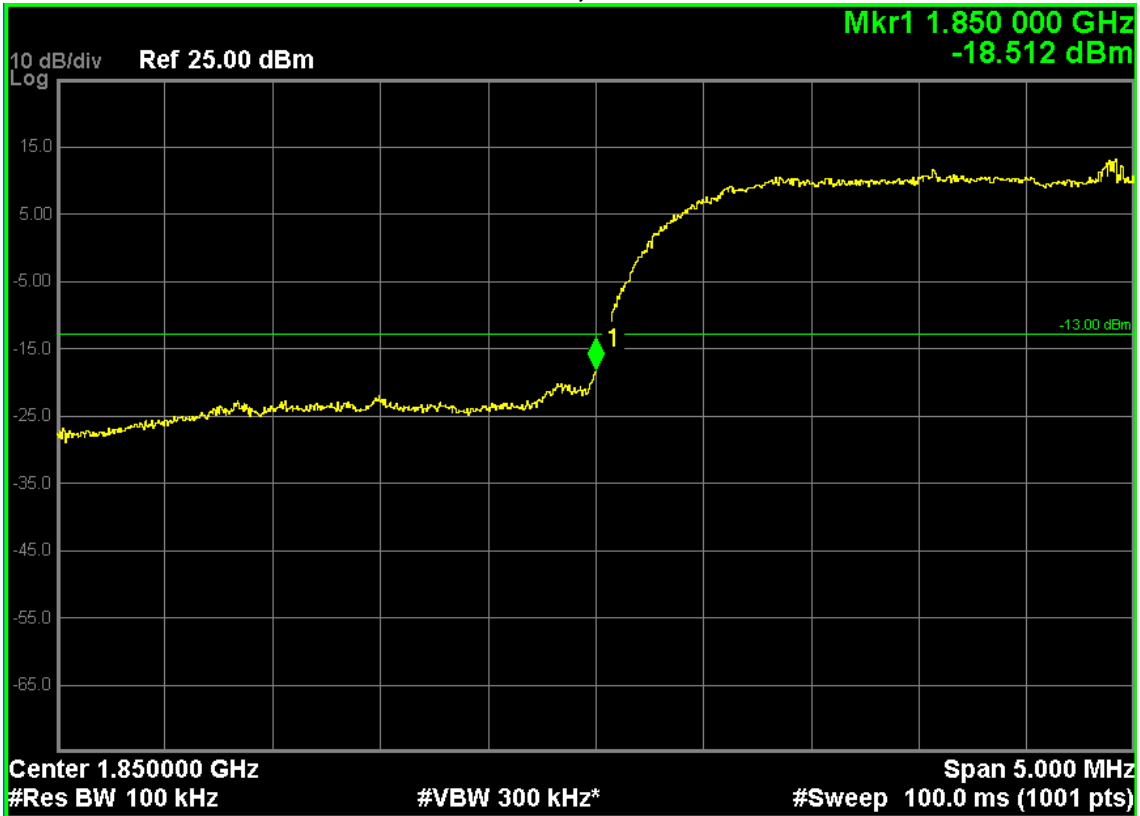

WCDMA Band II, Channel 9538

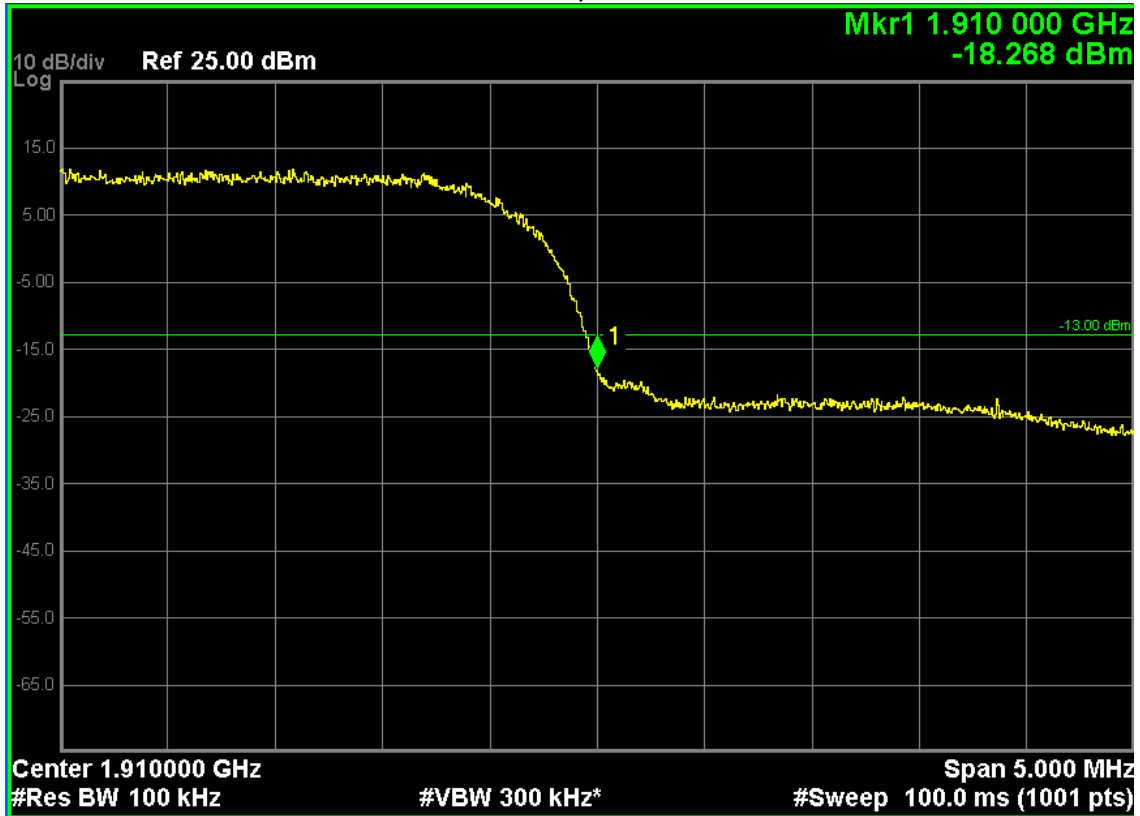

6.Spurious Emission

6.1. Test Equipment

Instrument	Manufacturer	Model	Serial No.	Cali. Due Date
Spectrum Analyzer	Agilent	N9038A	MY51210142	26/12/2015
Radio Communication Tester	Agilent	E5515C	GB46581718	11/11/2015
Signal Generator	Agilent	N5183A	MY50140938	02/01/2016
Power Splitter	Agilent	11667C/ 52401	MY53806148	27/02/2016
Preamplifier	CEM	EM30180	3008A0245	27/02/2016
Loop Antenna	Schwarzbeck	FMZB1519	1519-020	25/03/2016
Bilog Antenna	Schwarzbeck	VULB9160	3316	19/09/2016
VHF-UHF-Biconical Antenna	Schwarzbeck	VUBA9117	9117-263	19/09/2016
Broad-Band Horn Antenna	Schwarzbeck	BBHA9120D	9120D-942	19/09/2016
Broad-Band Horn Antenna	Schwarzbeck	BBHA9120D	9120D-943	19/09/2016

The measure equipment had been calibrated once a year.

6.2. Test Setup

Conducted Spurious Emission Measurement:

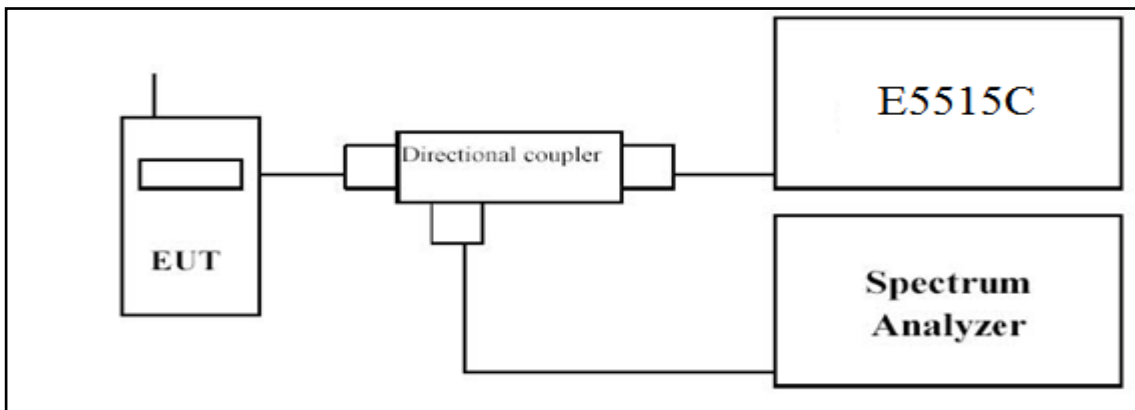

Radiated Spurious Measurement: below 30MHz

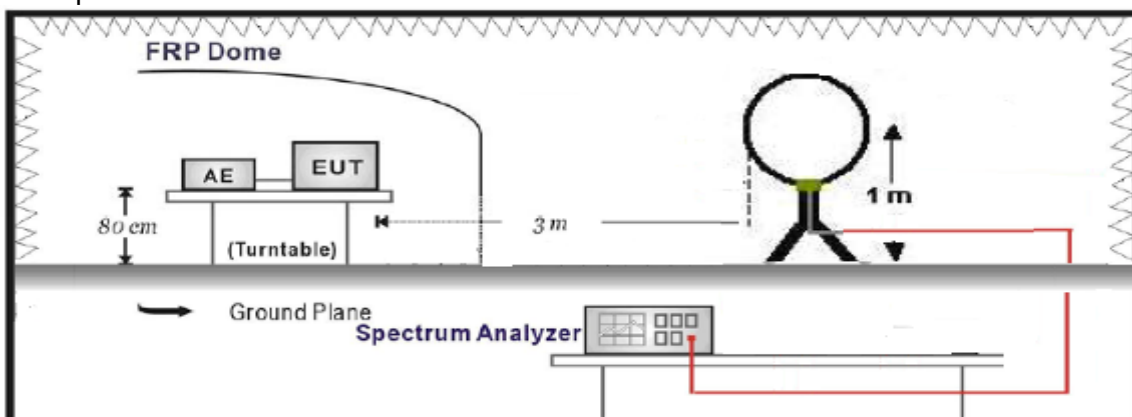

Radiated Spurious Measurement: 30MHz to 1GHz

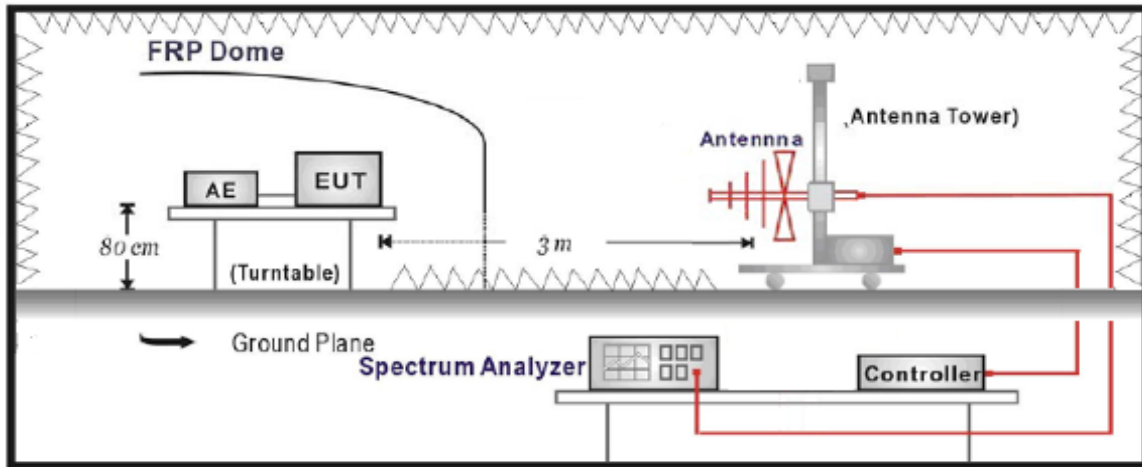

Radiated Spurious Measurement: above 1GHz

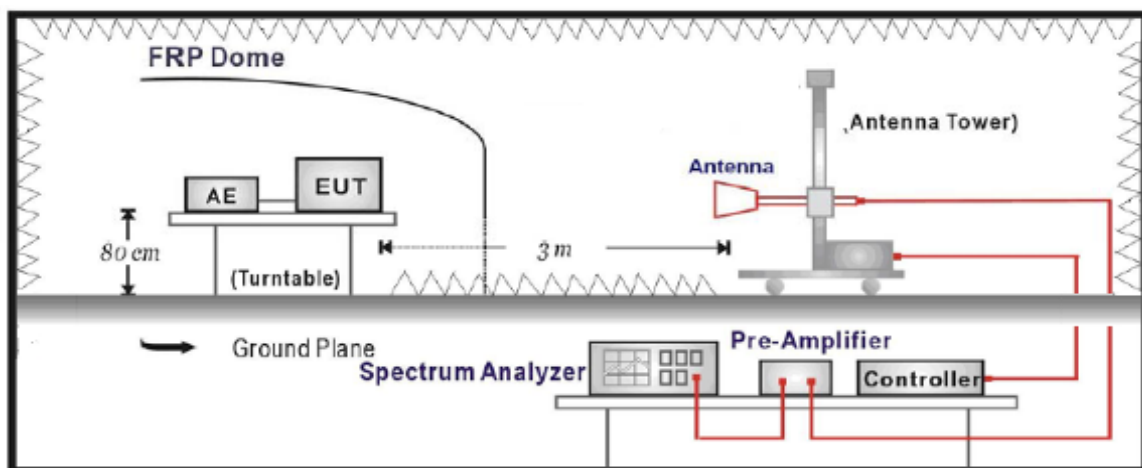

6.3. Limit

The power of any emission outside of the authorized operating frequency ranges must be attenuated below the transmitting power (P) by a factor of at least $43 + 10\log(P)$ dB.

6.4. Test Procedure

Conducted Spurious Measurement:

- Place the EUT on a bench and set it in transmitting mode.
- Connect a low loss RF cable from the antenna port to a spectrum analyzer and E5515C by a Directional Couple.
- EUT Communicate with E5515C, then select a channel for testing.
- Add a correction factor to the display of spectrum, and then test.
- The resolution bandwidth of the spectrum analyzer was set at 1 MHz, sufficient scans were taken to show the out of band Emission if any up to 10th harmonic.

Radiated Spurious Measurement:

- a. The EUT shall be placed at the specified height on a support, and in the position closest to normal use as declared by provider.
- b. The test antenna shall be oriented initially for vertical polarization and shall be chosen to correspond to the frequency of the transmitter
- c. The output of the test antenna shall be connected to the measuring receiver. The transmitter shall be switched on and the measuring receiver shall be tuned to the frequency of the transmitter under test.
- d. The test antenna shall be raised and lowered through the specified range of height until a maximum signal level is detected by the measuring receiver.
- e. The transmitter shall then be rotated through 360° in the horizontal plane, until the maximum signal level is detected by the measuring receiver.
- f. The test antenna shall be raised and lowered again through the specified range of height until a maximum signal level is detected by the measuring receiver.
- h. The maximum signal level detected by the measuring receiver shall be noted.
- i. The transmitter shall be replaced by a substitution antenna.
- j. The substitution antenna shall be orientated for vertical polarization and the length of the substitution antenna shall be adjusted to correspond to the frequency of the transmitter.
- k. The substitution antenna shall be connected to a calibrated signal generator.
- l. If necessary, the input attenuator setting of the measuring receiver shall be adjusted in order to increase the sensitivity of the measuring receiver.
- m. The test antenna shall be raised and lowered through the specified range of height to ensure that the maximum signal is received.
- n. The input signal to the substitution antenna shall be adjusted to the level that produces a level detected by the measuring receiver, that is equal to the level noted while the transmitter radiated power was measured, corrected for the change of input attenuator setting of the measuring receiver.
- o. The measurement shall be repeated with the test antenna and the substitution antenna orientated for horizontal polarization.
- p. The measure of the effective radiated power is the larger of the two levels recorded at the input to the substitution antenna, corrected for gain of the substitution antenna if necessary.
- q. The frequency range was checked up to 10th harmonic.
- r. Test site anechoic chamber refer to ANSI/TIA-603-C-2004.

6.5. Uncertainty

The measurement uncertainty is defined as 3.2 dB for Radiated Power Measurement.

6.6. Test Result

Conducted Spurious Measurement:

WCDMA Band V, Channel 4182

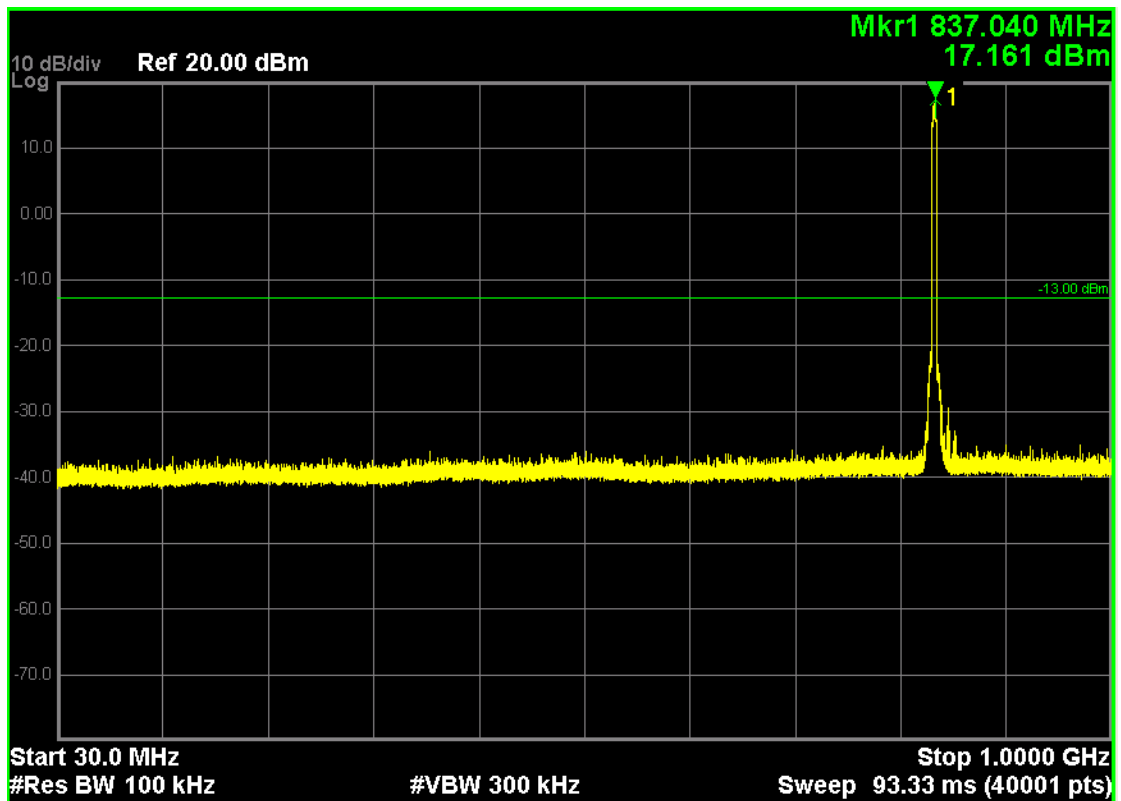
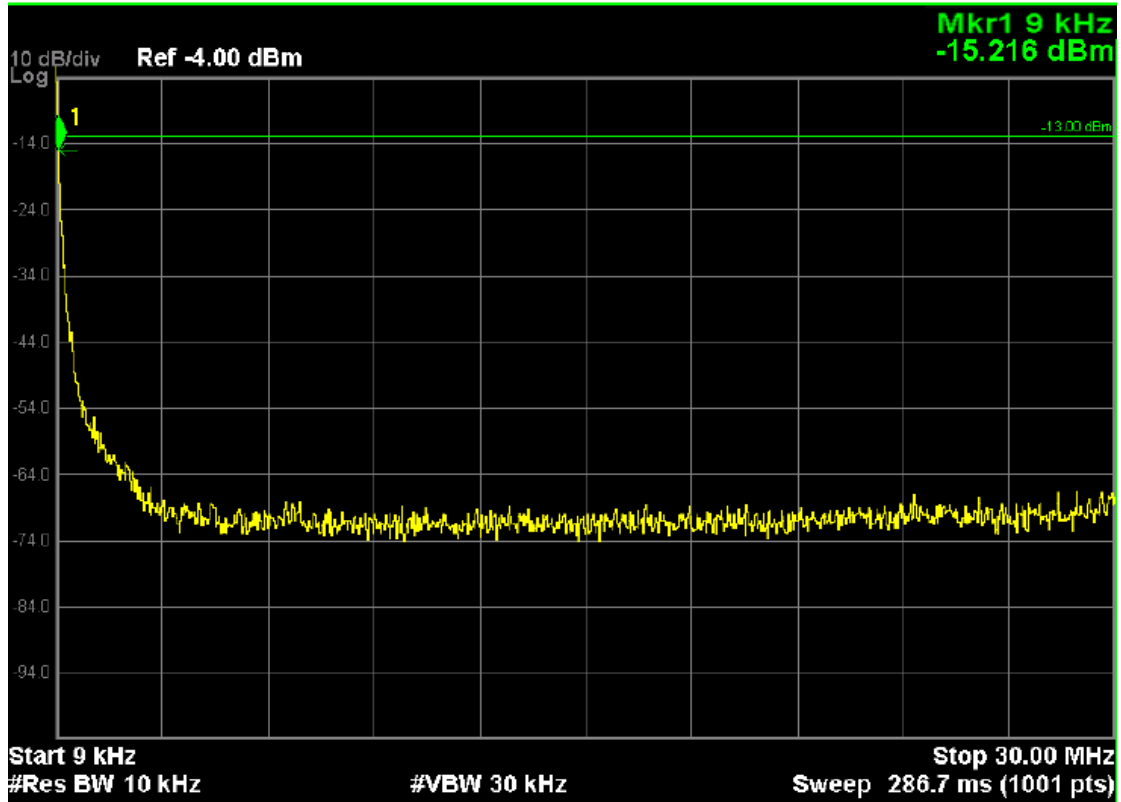

Note: The signal at point 1 is carrier

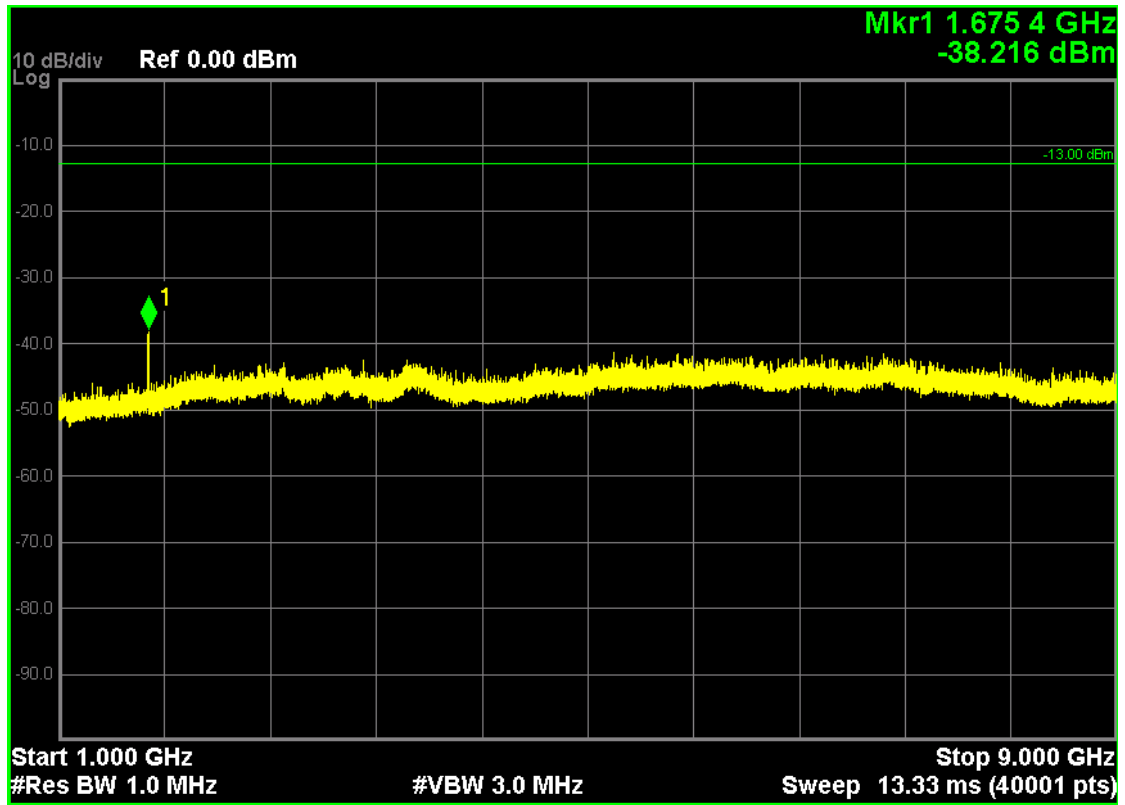

WCDMA Band II, Channel 9400

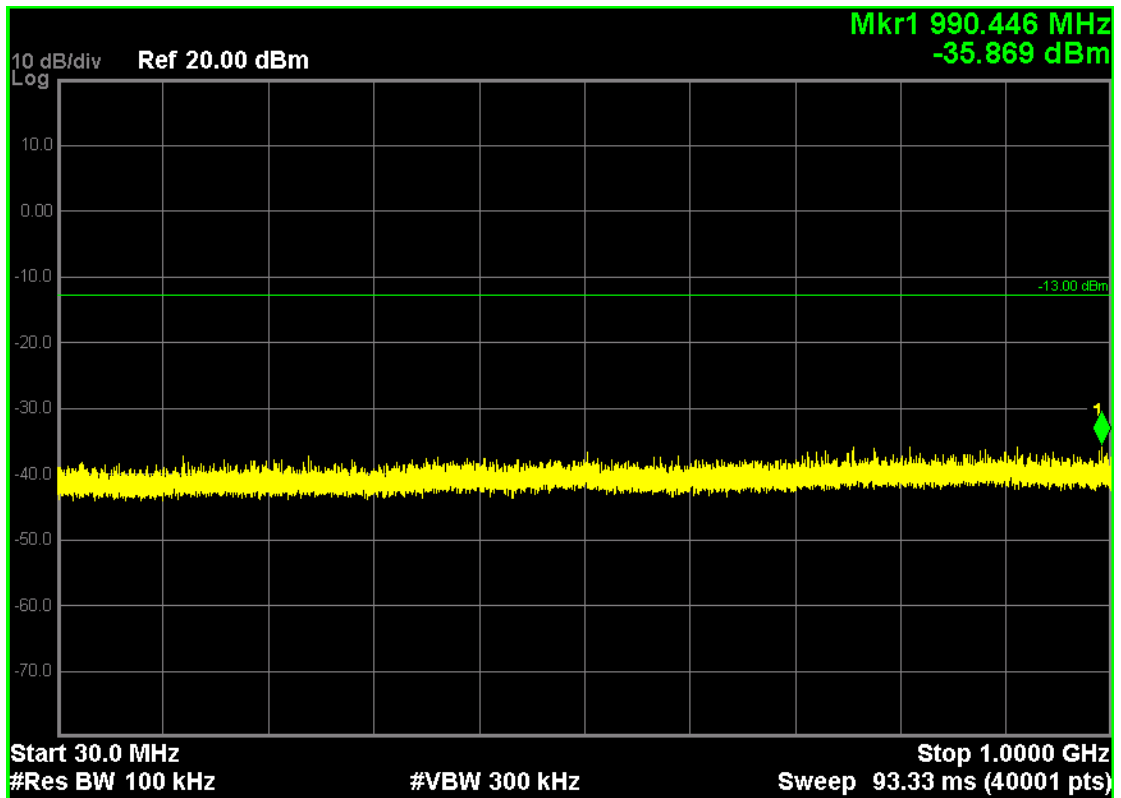
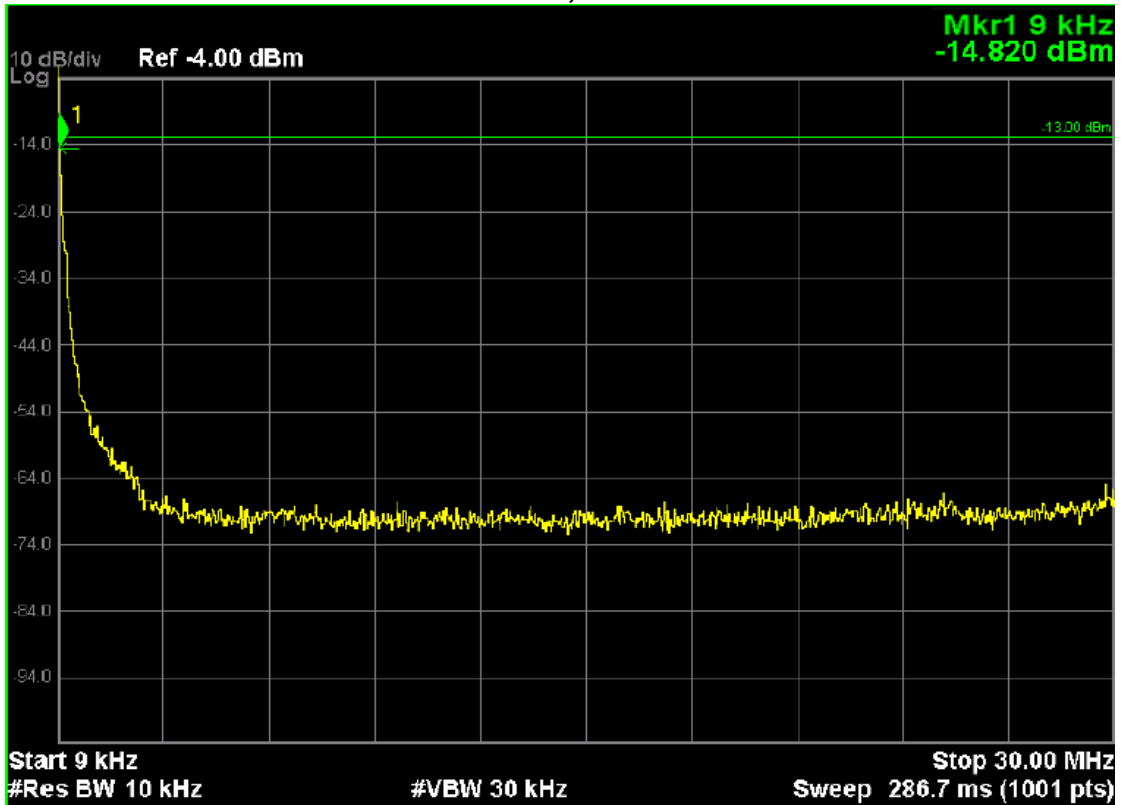

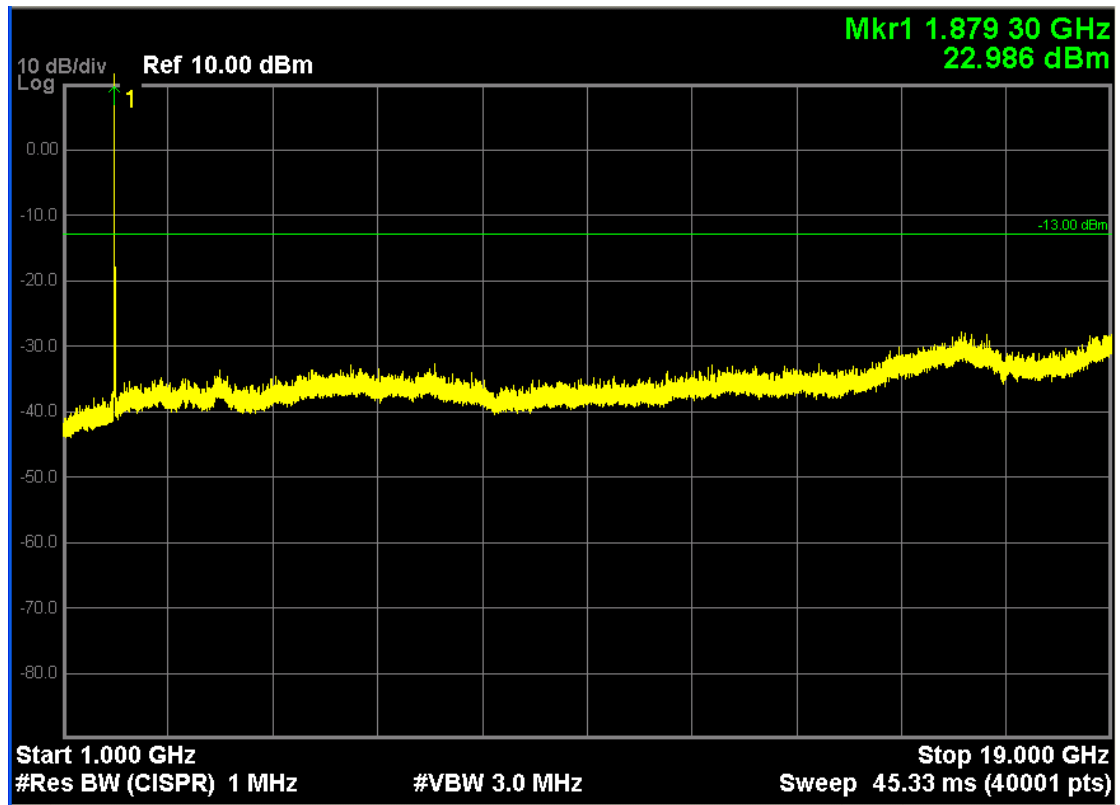

Note: The signal at point 1 is carrier

Radiated Spurious Measurement:

WCDMA Band V 9KHz to 30MHz

The low frequency, which started from 9KHz to 30MHz, was pre-scanned and the result which was 20dB lower than the limit line, and that was not reported per 2.1057 (c).

WCDMA Band V 30MHz to 1GHz

Frequency (MHz)	Ant. Pol. (H/V)	SG Reading (dBm)	Cable Loss (dB)	Gain (dBd)	ERP (dBm)	Limit (dBm)	Margin (dB)
Middle Channel 4182 (836.40MHz)							
795.2	H	-48.26	3.69	8.01	-43.94	-13.00	-30.94
795.2	V	-49.38	3.69	8.01	-45.06	-13.00	-32.06

WCDMA Band V Above 1GHz

Frequency (MHz)	Ant. Pol. (H/V)	SG Reading (dBm)	Cable Loss (dB)	Gain (dBd)	ERP (dBm)	Limit (dBm)	Margin (dB)
Middle Channel 4182 (836.40MHz)							
1672.8	H	-40.25	6.13	9.98	-36.40	-13.00	-23.40
1672.8	V	-43.64	6.13	9.98	-39.97	-13.00	-26.97

WCDMA Band II 9KHz to 30MHz

The low frequency, which started from 9KHz to 30MHz, was pre-scanned and the result which was 20dB lower than the limit line, and that was not reported per 2.1057 (c).

WCDMA Band II 30MHz to 1GHz

Frequency (MHz)	Ant. Pol. (H/V)	SG Reading (dBm)	Cable Loss (dB)	Gain (dBi)	EIRP (dBm)	Limit (dBm)	Margin (dB)
Middle Channel 9400 (1880MHz)							
791.7	H	-47.78	3.56	7.94	-43.40	-13.00	-30.40
791.7	V	-48.19	3.56	7.94	-43.81	-13.00	-30.81

WCDMA Band II Above 1GHz

Frequency (MHz)	Ant. Pol. (H/V)	SG Reading (dBm)	Cable Loss (dB)	Gain (dBi)	EIRP (dBm)	Limit (dBm)	Margin (dB)
Middle Channel 9400 (1880MHz)							
3760	H	-42.93	10.16	15.72	-37.37	-13.00	-24.37
3760	V	-41.86	10.16	15.72	-36.30	-13.00	-23.30

7. Frequency Stability Under Temperature & Voltage Variations

7.1. Test Equipment

Instrument	Manufacturer	Model	Serial No.	Cali. Due Date
Spectrum Analyzer	Agilent	N9038A	MY51210142	26/12/2015
Radio Communication Tester	Agilent	E5515C	GB46581718	11/11/2015
Power Splitter	Agilent	11667C/ 52401	MY53806148	27/02/2016
DC Power Supply	R&S	NGSM32/10	3212	05/01/2016
Temperature Chamber	WEISS	DU/20/40	58226017340050	03/01/2016

The measure equipment had been calibrated once a year.

7.2. Test Setup

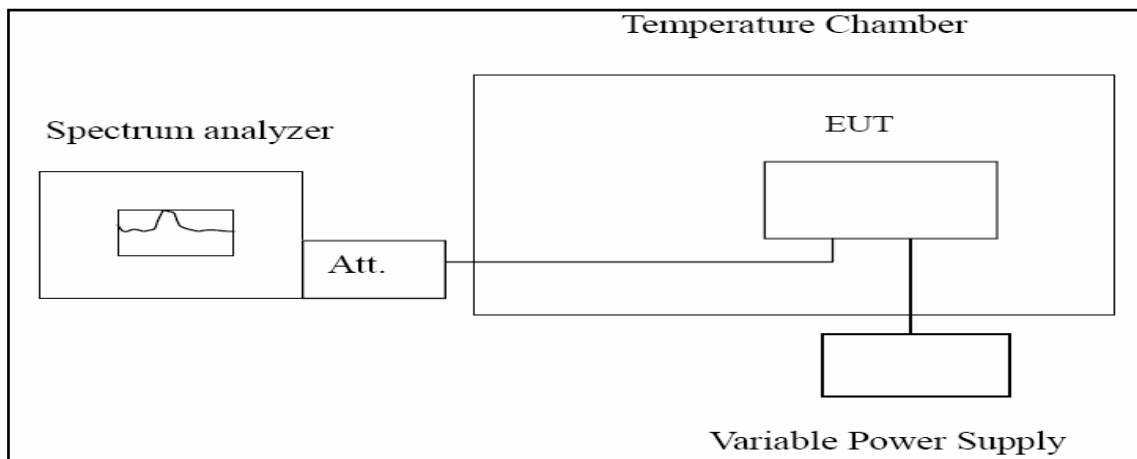

7.3. Limit

The frequency stability shall be sufficient to ensure that the fundamental emission stays within the authorized frequency block.

Limit	< ± 2.5 ppm
-------	-----------------

7.4. Test Procedure

Frequency Stability Under Temperature Variations:

The equipment under test was connected to an external AC or DC power supply and input rated voltage. RF output was connected to a frequency counter or spectrum analyzer via feed through attenuators. The EUT was placed inside the temperature chamber. Set the spectrum analyzer RBW low enough to obtain the desired frequency resolution and measure EUT 20°C operating frequency as reference frequency. Turn EUT off and set the chamber temperature to -30°C. After the temperature stabilized for approximately 30 minutes recorded the frequency. Repeat step measure with 10°C increased per stage until the highest temperature of +50°C reached.

Frequency Stability Under Voltage Variations:

Set chamber temperature to 20°C. Use a variable AC power supply / DC power source to power the EUT and set the voltage to rated voltage. Set the spectrum analyzer RBW low enough to obtain the desired frequency resolution and recorded the frequency.

Reduce the input voltage to specify extreme voltage variation ($\pm 15\%$) and endpoint, record the maximum frequency change.

7.5. Uncertainty

The measurement uncertainty is defined as ± 10 Hz.

7.6. Test Result

WCDMA Band V:

Frequency Stability under Temperature

Temperature Interval (°C)	Test Frequency (MHz)	Deviation (Hz)	Limit(Hz)
-30	836.40	15.19	± 2091
-10	836.40	21.22	± 2091
0	836.40	-25.65	± 2091
10	836.40	-18.44	± 2091
20	836.40	-27.39	± 2091
30	836.40	-24.13	± 2091
40	836.40	15.88	± 2091
50	836.40	19.82	± 2091

Frequency Stability under Voltage

DC Voltage (V)	Test Frequency (MHz)	Deviation (Hz)	Limit(Hz)
3.6	836.40	20.47	± 2091
3.8	836.40	23.56	± 2091
4.2	836.40	-17.68	± 2091

WCDMA Band II:

Frequency Stability under Temperature

Temperature Interval (°C)	Test Frequency (MHz)	Deviation (Hz)	Limit (Hz)
-30	1880.00	16.56	±4700
-10	1880.00	14.59	±4700
0	1880.00	29.38	±4700
10	1880.00	-15.43	±4700
20	1880.00	-21.98	±4700
30	1880.00	-26.77	±4700
40	1880.00	17.28	±4700
50	1880.00	27.25	±4700

Frequency Stability under Voltage

DC Voltage (V)	Test Frequency (MHz)	Deviation (Hz)	Limit(Hz)
3.6	1880.00	-21.57	±4700
3.8	1880.00	28.34	±4700
4.2	1880.00	-16.44	±4700

8. Peak to Average

8.1. Test Equipment

Instrument	Manufacturer	Model	Serial No.	Cali. Due Date
Spectrum Analyzer	Agilent	N9038A	MY51210142	26/12/2015
Radio Communication Tester	Agilent	E5515C	GB46581718	11/11/2015
Signal Generator	Agilent	N5183A	MY50140938	02/01/2016
Power Splitter	Agilent	11667C/52401	MY53806148	27/02/2016
DC Power Supply	R&S	NGSM32/10	3212	05/01/2016

8.2. Test Setup

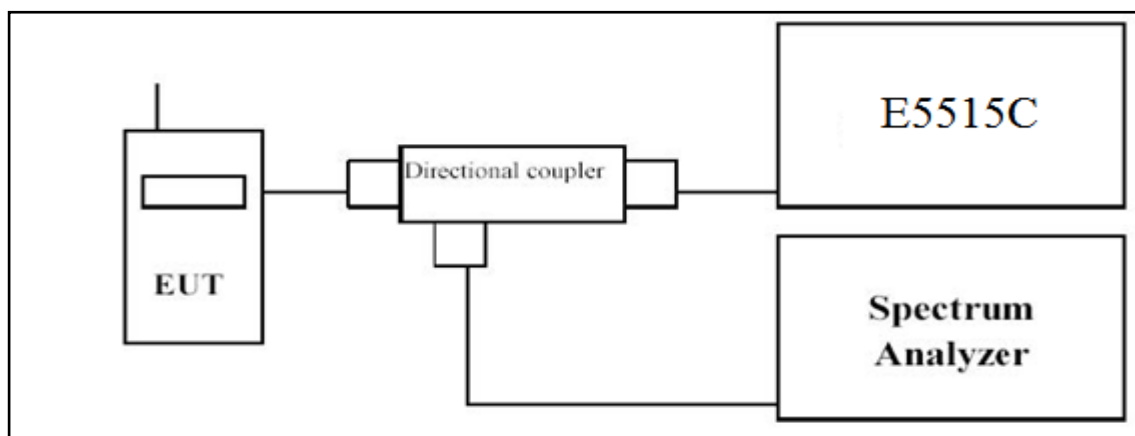

8.3. Limit

In addition, the transmitter's peak-to-average power ratio (PAPR) shall not exceed 13 dB for more than 0.1% of the time using a signal corresponding to the highest PAPR during periods of continuous transmission.

8.4. Test Procedure

A peak to average ratio measurement is performed at the conducted port of the EUT. For WCDMA signals, the spectrum analyzers Complementary Cumulative Distribution Function (CCDF) measurement profile is used to determine the largest deviation between the average and the peak power of the EUT in a given bandwidth. The CCDF curve shows how much time the peak waveform spends at or above a given average power level. The percent of time the signal spends at or above the level defines the probability for that particular power level. For GSM signals, an average and a peak trace are used on a spectrum analyzer to determine the largest deviation between the average and the peak power of the EUT in a bandwidth greater than the emission bandwidth. The traces are generated with the spectrum analyzer set to zero span mode.

Procedure:

- a. Place the EUT on a bench and set it in transmitting mode.
- b. Connect a low loss RF cable from the antenna port to a spectrum analyzer and E5515C by a Directional Couple.
- c. EUT Communicate with E5515C, then select a channel for testing.
- d. Add a correction factor to the display of spectrum, and then test.
- e. The resolution bandwidth of the spectrum analyzer was set at 1 MHz.

8.5. Uncertainty

The measurement uncertainty is defined as ± 1.2 dB.

8.6. Test Result

Band	Channel No.	Limit (dB)	Result (dB)
WCDMA BAND II	9800	< 13	2.86

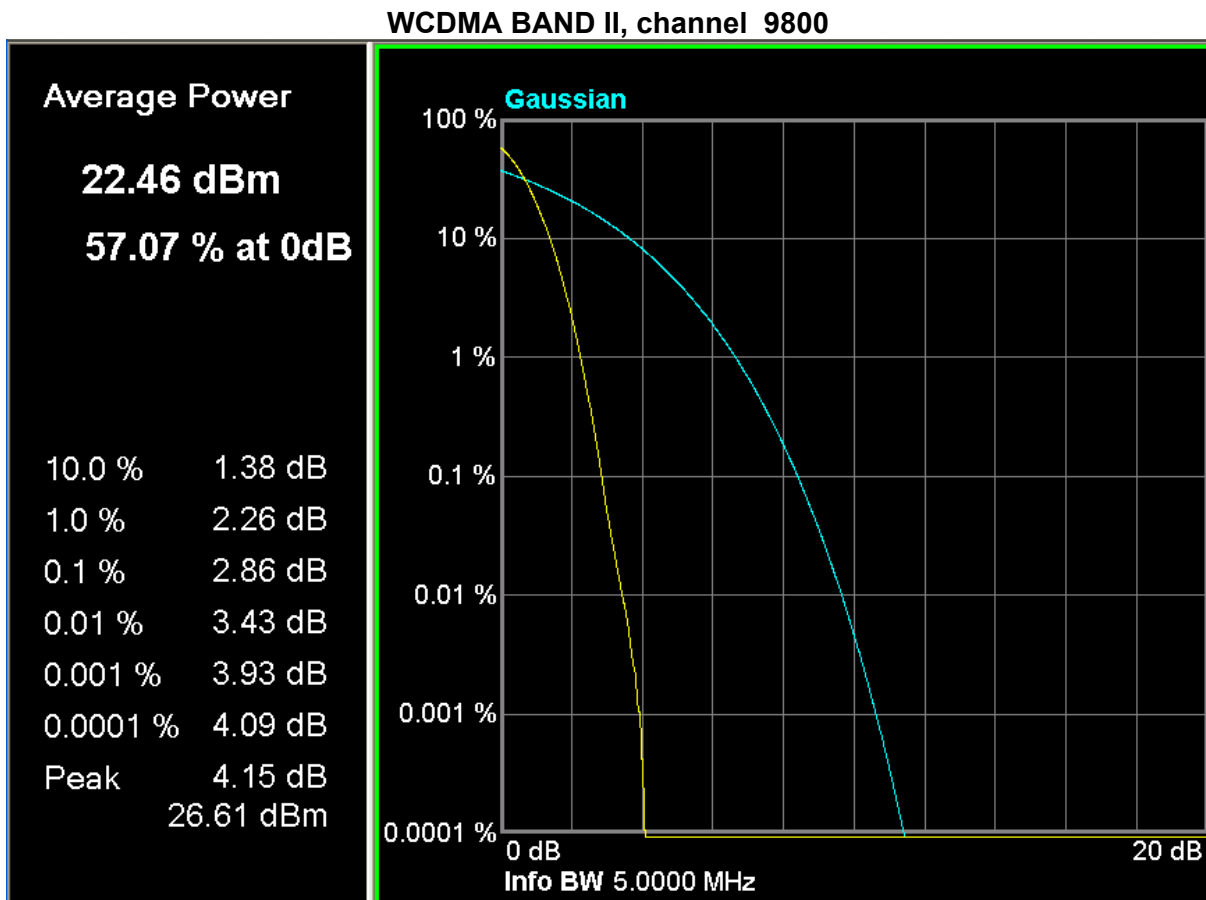

9.Attachment

PHOTOGRAPHS OF TEST SETUP

Please refer to the file named "2ABZ7-915_Part22&24 Setup Photos".

PHOTOGRAPHS OF EUT

Please refer to the two files named "2ABZ7-915_EUT External Photos" and "2ABZ7-915_EUT Internal Photos".

----End of the report----