



# FCC RADIO TEST REPORT

**FCC ID** : 2ABZ2-EF14A  
**Equipment** : Smart Phone  
**Brand Name** : ONEPLUS  
**Model Name** : LE2125  
**Applicant** : OnePlus Technology (Shenzhen) Co., Ltd.  
18C02, 18C03, 18C04 and 18C05, Shum Yip Terra  
Building, Binhe Avenue North, Futian District, Shenzhen  
**Manufacturer** : OnePlus Technology (Shenzhen) Co., Ltd.  
18C02, 18C03, 18C04 and 18C05, Shum Yip Terra  
Building, Binhe Avenue North, Futian District, Shenzhen  
**Standard** : FCC 47 CFR Part 2, and 30

The product was received on Dec. 02, 2020 and testing was started from Dec. 11, 2020 and completed on Jan. 08, 2021. We, SPORTON INTERNATIONAL INC. EMC & Wireless Communications Laboratory, would like to declare that the tested sample has been evaluated in accordance with the test procedures ANSI C63.26-2015 and has been in compliance with the applicable technical standards.

The test results in this report apply exclusively to the tested model / sample. Without written approval of SPORTON INTERNATIONAL INC. EMC & Wireless Communications Laboratory, the test report shall not be reproduced except in full.

*Louis Wu*

Approved by: Louis Wu

**SPORTON INTERNATIONAL INC. EMC & Wireless Communications Laboratory**  
No. 52, Huaya 1st Rd., Guishan Dist., Taoyuan City, Taiwan (R.O.C.)



# Table of Contents

**History of this test report..... 3**

**Summary of Test Result..... 4**

**1 General Description ..... 5**

    1.1 Feature of Equipment Under Test..... 5

    1.2 Product Specification of Equipment Under Test ..... 6

    1.3 Modification of EUT ..... 6

    1.4 Testing Location ..... 7

    1.5 Applied Standards ..... 7

**2 Test Configuration of Equipment Under Test ..... 8**

    2.1 Test Mode..... 8

    2.2 Connection Diagram of Test System ..... 9

    2.3 Support Unit used in test configuration ..... 9

    2.4 Measurement Results Explanation Example ..... 9

    2.5 Far Field Condition for Frequency above 18GHz..... 10

    2.6 Frequency List of Low/Middle/High Channels..... 11

**3 Radiated Test Items ..... 12**

    3.1 Measuring Instruments..... 12

    3.2 Test Setup ..... 12

    3.3 Test Result of Radiated Test..... 14

    3.4 EIRP Measurement ..... 15

    3.5 Occupied Bandwidth ..... 16

    3.6 Radiated Spurious Emission Measurement..... 17

    3.7 Frequency Stability Measurement..... 18

**4 List of Measuring Equipment..... 19**

**5 Uncertainty of Evaluation ..... 20**

**Appendix A. Test Results of EIRP and Radiated Test**

**Appendix B. Test Setup Photos**

**Appendix C. R&S Mixer Certificate**





### Summary of Test Result

Report Clause	Ref Std. Clause	Test Items	Limit	Result (PASS/FAIL)	Remark
3.4	§2.1046 §30.202	EIRP Measurement	+43dBm	Pass	-
3.5	§2.1049	Occupied Bandwidth	Not Applicable	Reporting only	-
3.6	§2.1053 §30.203	Radiated Spurious Emission	-5dBm/MHz -13dBm/MHz	Pass	-
3.7	§2.1055	Frequency Stability for Temperature & Voltage	Within the band	Pass	-

**Remark:** Since the test data is not affected by model name changing, the FG002623-06A report reuse test data from the FG002623-02D report.

**Declaration of Conformity:**

The test results with all measurement uncertainty excluded are presented in accordance with the regulation limits or requirements declared by manufacturers.

**Comments and Explanations:**

The declared of product specification for EUT presented in the report are provided by the manufacturer, and the manufacturer takes all the responsibilities for the accuracy of product specification.

**Reviewed by:** Wii Chang

**Report Producer:** Dara Chiu



# 1 General Description

## 1.1 Feature of Equipment Under Test

Product Feature & Specification	
Equipment	Smart Phone
Brand Name	ONEPLUS
Model Name	LE2125
FCC ID	2ABZ2-EF14A
IMEI Code	990016750028548
EUT supports Radios application	GSM/EGPRS/WCDMA/HSPA/LTE/5G NR/GNSS/NFC WLAN 11b/g/n HT20/HT40 WLAN 11a/n HT20/HT40 WLAN 11ac VHT20/VHT40/VHT80/VHT160 WLAN 11ax HE20/HE40/HE80/HE160 Bluetooth BR/EDR/LE ANT+ WPC/WPT
EUT Stage	Identical Prototype

**Remark:** The above EUT's information was declared by manufacturer. Please refer to Comments and Explanations in report summary.

## 1.2 Product Specification of Equipment Under Test

Product Specification subjective to this standard	
Device Category in Part 30	Mobile station
Tx Frequency	NR band n258a: 24.25GHz ~ 24.45GHz NR band n258b: 24.75GHz ~ 25.25GHz NR band n260: 37GHz ~ 40GHz NR band n261: 27.5GHz ~ 28.35GHz
Rx Frequency	NR band n258a: 24.25GHz ~ 24.45GHz NR band n258b: 24.75GHz ~ 25.25GHz NR band n260: 37GHz ~ 40GHz NR band n261: 27.5GHz ~ 28.35GHz
Support Bandwidth	NR band n258a: 50 MHz and 100 MHz, NR band n258b: 50 MHz and 100 MHz, NR band n260: 50 MHz and 100 MHz, NR band n261: 50 MHz and 100 MHz
Maximum Number of contiguous CC	2
Maximum Aggregated Bandwidth	200MHz
Maximum Output Power (EIRP)	NR band n258a: <b>Module 0: 26.59 dBm</b> Module 1: 24.07 dBm Module 2: 26.37 dBm NR band n258b: Module 0: 25.46 dBm Module 1: 21.75 dBm <b>Module 2: 25.73 dBm</b> NR band n260: <b>Module 0: 27.35 dBm</b> Module 1: 25.17 dBm Module 2: 26.01 dBm NR band n261: <b>Module 0: 25.44 dBm</b> Module 1: 22.88 dBm Module 2: 23.96 dBm
Type of Modulation	CP-OFDM: QPSK / 16QAM / 64QAM DFT-s-OFDM: QPSK / 16QAM / 64QAM

**Remark:** The above EUT's information was declared by manufacturer. Please refer to Comments and Explanations in report summary.

## 1.3 Modification of EUT

No modifications are made to the EUT during all test items.



### 1.4 Testing Location

<b>Test Site</b>	SPORTON INTERNATIONAL INC. EMC & Wireless Communications Laboratory			
<b>Test Site Location</b>	No.58, Aly. 75, Ln. 564, Wenhua 3rd, Rd., Guishan Dist., Taoyuan City, Taiwan (R.O.C.) TEL: +886-3-327-0868 FAX: +886-3-327-0855			
<b>Test Site Information</b>	Site No.	Engineer	Temperature	Humidity
	03CH10-HY	Yu Wang	23~24°C	46~47 %
	03CH18-HY	Yu Wang	22~23°C	46~48 %

FCC Designation No. TW1190 and TW0007

### 1.5 Applied Standards

According to the specifications of the manufacturer, the EUT must comply with the requirements of the following standards:

- ♦ FCC 47 CFR Part 2, 30
- ♦ ANSI C63.26-2015
- ♦ FCC KDB 971168 D01 Power Meas. License Digital Systems v03r01
- ♦ FCC KDB 842590 D01 Upper Microwave Flexible Use Service v01r01

**Remark:**

1. All test items were verified and recorded according to the standards and without any deviation during the test.
2. This EUT has also been tested and complied with the requirements of FCC Part 15, Subpart B, recorded in a separate test report.
3. The TAF code is not including all the FCC KDB listed without accreditation.



## 2 Test Configuration of Equipment Under Test

EUT has total 2 millimeter wave antenna modules and up to 2 beams operation for each module.

Any antenna module cannot transmit simultaneously with the other antenna modules.

Preliminary EIRP test was performed for all beam configurations in the anechoic chamber at the manufacturer’s facility so the EIRP worst case beam-pair were identified.

EUT configured to transmit a single beam at a time and combine the measured value together for both beams by math calculation in linear form method.

The NR radio operation is controlled by software tool QRCT FTM mode (factory mode) and system simulator. During the test, in FTM mode the EUT is forced to run continuously at the maximum output power (duty cycle is 100%).

### 2.1 Test Mode

For radiated measurement, the pre-scan is performed to find the worst cases EUT position.

Test Items	Band	Bandwidth (MHz)			Modulation				RB #			Test Channel		
		50	100	200	BPSK	QPSK	16QAM	64QAM	1	-	Full	L	M	H
EIRP	n258a n258b n260 n261	v	v	v	v	v	v	v	v		v	v	v	v
99% Occupied Bandwidth	n258a n258b n260 n261	v	v	v	v	v	v	v			v	v	v	v
Out of Band Emission	n258a n258b n260 n261	v	v	v	v	v	v	v	v		v	v		v
Spurious Emission	n258a n258b n260 n261	v	v	v	v	v			v			v	v	v
Frequency Stability	n258a n258b n260 n261	CW tone											v	
Remark	<ol style="list-style-type: none"> <li>The mark "v " means that this configuration is chosen for testing</li> <li>The device is investigated from 30MHz to 200GHz of fundamental signal for radiated spurious emission test under different RB size and modulations in exploratory test. Subsequently, only the worst case emissions are reported.</li> <li>All the radiated test cases were performed with built-in battery and was controlled by supported unit (Sec.2.2).</li> <li>The out of band emission (AG0&amp;AG1) and spurious emissions were measured radiated EIRP.</li> <li>The out of band emission (AG0+AG1) (&gt;10%OB) and spurious emissions were measured radiated EIRP</li> <li>The out of band emission (AG0+AG1) (0~10%OB) were measured conducted emission level.</li> </ol>													



## 2.2 Connection Diagram of Test System

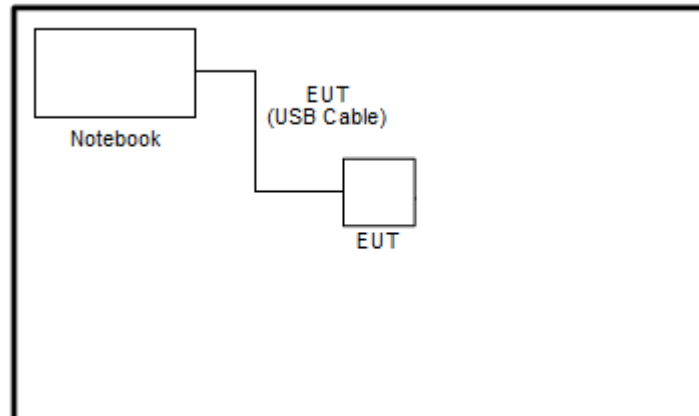

## 2.3 Support Unit used in test configuration

Item	Equipment	Trade Name	Model No.	FCC ID	Data Cable	Power Cord
1.	Notebook	Dell	P111G	N/A	N/A	AC I/P: Unshielded, 1.2 m DC O/P: Shielded, 1.8 m

## 2.4 Measurement Results Explanation Example

According to ANSI C63.26-2015 Section 5.2.7

$$\text{EIRP (dBm)} = \text{E(dBuV/m)} + 20\log(D) - 104.8.$$

where D is the measurement distance (in the far field region) in m.

$$\text{E (dBuV/m)} = \text{Spectrum Reading Level (dBm)} + \text{Antenna Factor (dB/m)} + \text{Cable Loss (dB)} + 107$$

Hence, the spectrum analyzer *Offset* is derived including RF cable loss and antenna factor.

$$\text{Offset} = \text{Antenna Factor (dB/m)} + \text{Cable Loss (dB)} + 107 + 20\log(D) - 104.8$$

The conversion loss of RF mixer is also included by the mixer table of spectrum analyzer when measurement frequency is above 40GHz.

Example :

$$\begin{aligned} \text{Offset} &= \text{Antenna Factor (dB/m)} + \text{Cable Loss (dB)} + 107 + 20\log(D) - 104.8 \\ &= 42.3 + 3.0 + 107 + 20\log(1) - 104.8 \\ &= 47.5 \text{ (dB)} \end{aligned}$$



### 2.5 Far Field Condition for Frequency above 18GHz

Horn Antenna	Frequency (GHz)	Antenna Dimension A (mm)	Wavelength ( $\lambda$ ) (m)	Far field R (m) $\geq 2A^2 / \lambda$	Measurement Distance (D) (m)	Distance Factor $20\log(D)$ (dB)
BBHA 9170	18	60	0.0167	0.43	1	0.00
	40	60	0.0075	0.96		
QWH-UPRR00	40	48	0.0075	0.61	1	0.00
	60	48	0.0050	0.92		
QWH-EPRR00	60	31	0.0050	0.38	1	0.00
	90	31	0.0033	0.58		
QWH-FPRR00	90	21	0.0033	0.26	1	0.00
	140	21	0.0021	0.41		
QWH-GPRR00	140	15	0.0021	0.21	0.5	-6.02
	220	15	0.0014	0.33		



## 2.6 Frequency List of Low/Middle/High Channels

NR Band n258a Channel and Frequency List				
BW [MHz]	Channel/Frequency(MHz)	Lowest	Middle	Highest
50	Frequency	24275	24350	24425
100	Frequency	24300	24350	24400
200	Frequency 1	-	24300	-
	Frequency 2	-	24400	-

NR Band n258b Channel and Frequency List				
BW [MHz]	Channel/Frequency(MHz)	Lowest	Middle	Highest
50	Frequency	24775	25000	25225
100	Frequency	24800	25000	25200
200	Frequency 1	24800	24950	25100
	Frequency 2	24900	25050	25200

NR Band n260 Channel and Frequency List				
BW [MHz]	Channel/Frequency(MHz)	Lowest	Middle	Highest
50	Frequency	37025	38500	39975
100	Frequency	37050	38500	39950
200	Frequency 1	37050	38350	39650
	Frequency 2	37150	38450	39750

NR Band n261 Channel and Frequency List				
BW [MHz]	Channel/Frequency(MHz)	Lowest	Middle	Highest
50	Frequency	27525	27925	28325
100	Frequency	27550	27925	28300
200	Frequency 1	27550	27775	28000
	Frequency 2	27650	27875	28100

### 3 Radiated Test Items

#### 3.1 Measuring Instruments

See list of measuring instruments of this test report.

#### 3.2 Test Setup

For radiated emissions from 30MHz to 1GHz

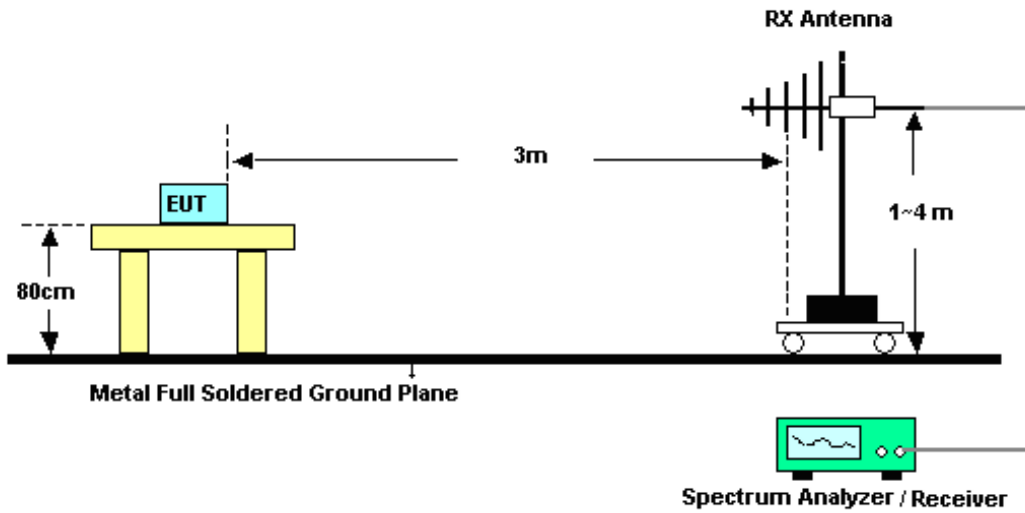

For radiated emissions 1GHz to 18GHz

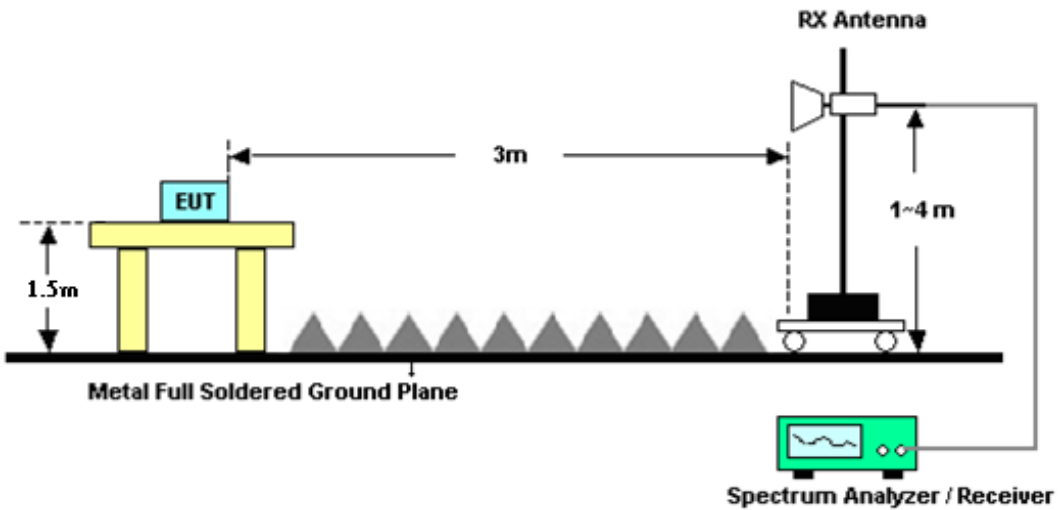

For radiated emissions above 18GHz up to 40GHz

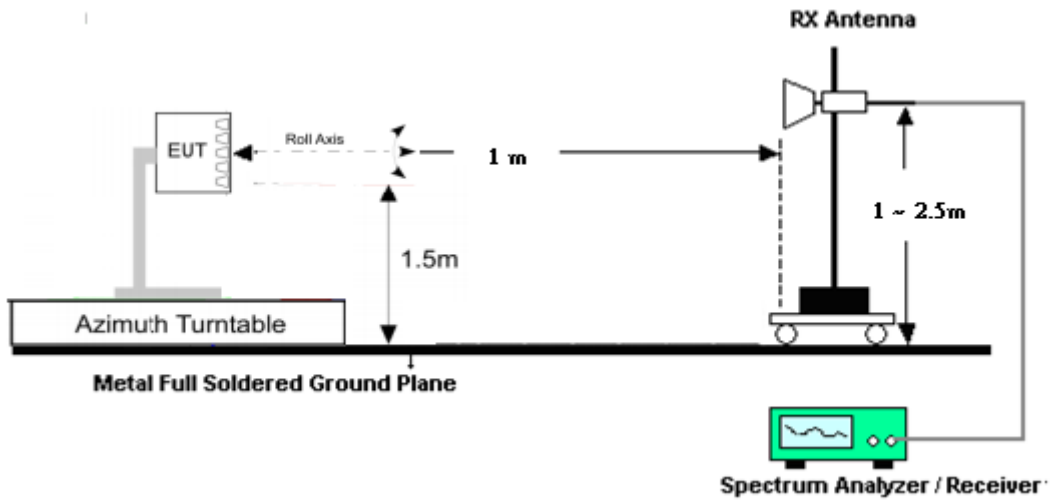

For radiated emissions above 40GHz up to 140GHz

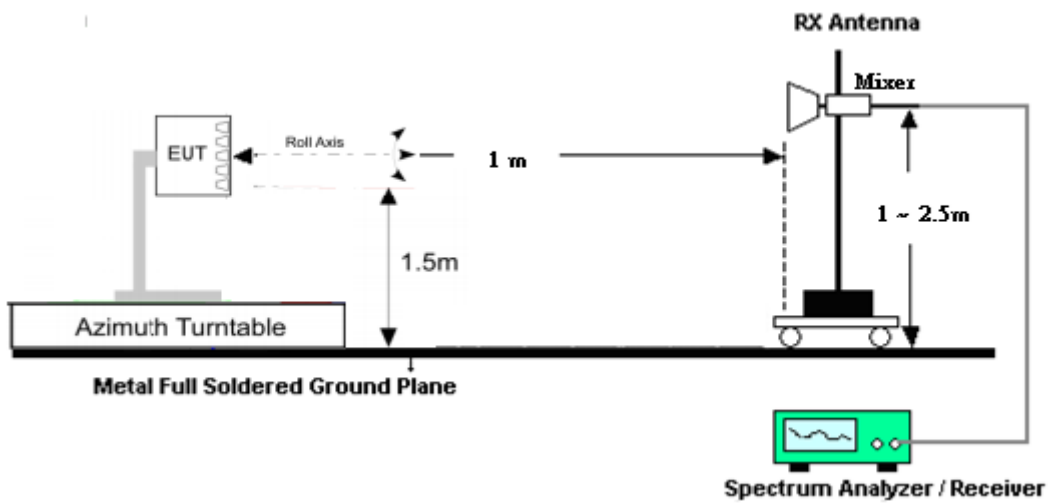

For radiated emissions above 140GHz up to 200GHz

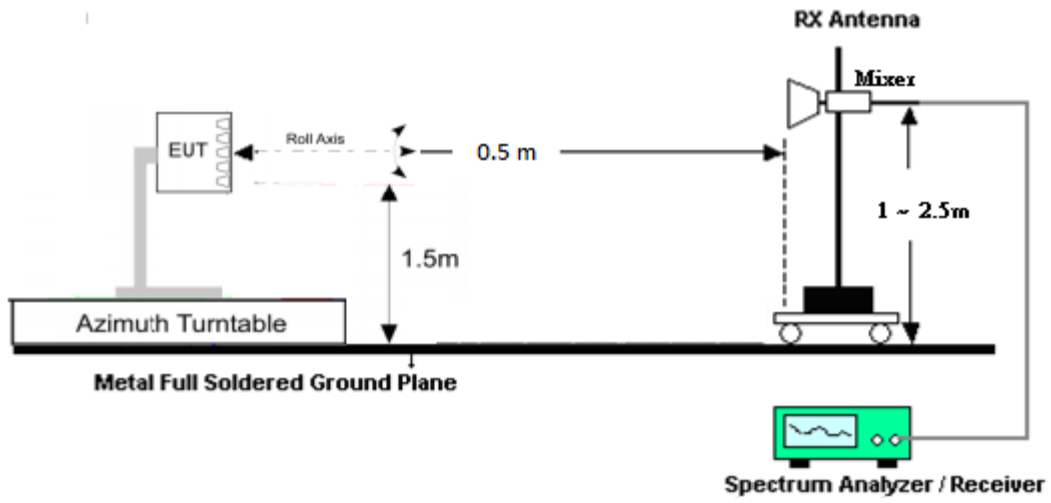

For Frequency Stability

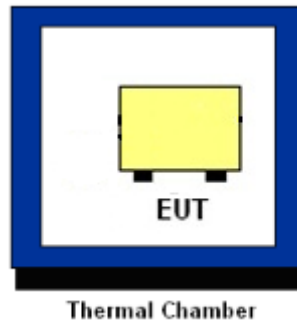

### 3.3 Test Result of Radiated Test

Please refer to Appendix A.



### 3.4 EIRP Measurement

#### 3.4.1 Description of EIRP Measurement

For mobile stations, the average power of the sum of all antenna elements is limited to a maximum EIRP of +43 dBm.

#### 3.4.2 Test Procedures

1. Set EUT at maximum output power.
2. Select lowest, middle, and highest channels for each band and different modulation.
3. Enable channel power function of spectrum analyzer
4. Set frequency would like to be investigated.
5. Set Detector = RMS
6. Set Trace mode = trace average
7. Set Sweep time = auto couple
8. Set sweep points  $\geq 2 \times \text{Span/RBW}$
9. Set sweep count 100 and wait until the trace to be stabilized
10. Make the measurement with the spectrum analyzer's RBW = 1MHz, VBW = 3MHz, taking the record of maximum spurious emission.
11. Measure and record the power level from the spectrum analyzer.
12. The test result is calculated according to

ANSI C63.26-2015 Section 5.2.7

$$\text{EIRP (dBm)} = \text{E(dBuV/m)} + 20\log(D) - 104.8.$$

where D is the measurement distance (in the far field region) in m.

$$\text{E (dBuV/m)} = \text{Spectrum Level (dBm)} + \text{Antenna Factor (dB/m)} + \text{Cable Loss (dB)} + 107$$

That is, set the spectrum offset including sum of

$$\text{Antenna Factor (dB/m)} + \text{Cable Loss (dB)} + 107 + 20\log(D) - 104.8$$



## **3.5 Occupied Bandwidth**

### **3.5.1 Description of Occupied Bandwidth Measurement**

This is for reporting only.

The occupied bandwidth is the width of a frequency band such that, below the lower and above the upper frequency limits, the mean powers emitted are each equal to a specified percentage 0.5% of the total mean transmitted power.

### **3.5.2 Test Procedures**

The testing follows ANSI C63.26-2015 Section 5.4.4

1. The spectrum analyzer center frequency is set to the nominal EUT channel center frequency. The span range for the spectrum analyzer shall be at least 1.5 times the anticipated OBW.
2. The nominal resolution bandwidth (RBW) shall be in the range of 1 to 5 % of the anticipated OBW, and the VBW shall be at least 3 times the RBW.
3. Set the detection mode to peak, and the trace mode to max hold.
4. Use the 99 % power bandwidth function of the spectrum analyzer and report the measured bandwidth.





### 3.6 Radiated Spurious Emission Measurement

#### 3.6.1 Description of Radiated Spurious Emission Measurement

The spectrum is scanned from 30 MHz up to 200GHz.

The conductive power or the total radiated power of any emission outside a licensee's frequency block shall be -13 dBm/MHz or lower. However, in the bands immediately outside and adjacent to the licensee's frequency block, having a bandwidth equal to 10 percent of the channel bandwidth, the conductive power or the total radiated power of any emission shall be -5 dBm/MHz or lower.

#### 3.6.2 Test Procedures

1. Set EUT at maximum output power..
2. Select lowest, middle, and highest channels for each band and different modulation.
3. Measure and record the power level from the spectrum analyzer.
4. Set frequency would like to be investigated.
5. Set Detector = RMS, Trace mode = trace average, sweep time = auto couple
6. Set sweep points  $\geq 2 \times \text{Span/RBW}$ , sweep count 100 and wait until the trace to be stabilized.
7. Make the measurement with the spectrum analyzer's RBW = 1MHz, VBW = 3MHz, taking the record of maximum spurious emission.

8. For measurement frequency from 30MHz to 18GHz,  
 An antenna was substituted in place of the EUT and was driven by a signal generator.  
 Tune the output power of signal generator to the same emission level with EUT maximum spurious emission. Take record of output power and repeat for another polarization.

9. For measurement frequency above 18GHz, the test result is calculated according to ANSI C63.26-2015 Section 5.2.7 and 5.7.3 and 5.7.4

$$\text{EIRP (dBm)} = \text{E(dBuV/m)} + 20\log(D) - 104.8.$$

where D is the measurement distance (in the far field region) in m.

$$\text{E (dBuV/m)} = \text{Spectrum Level (dBm)} + \text{Antenna Factor (dB/m)} + \text{Cable Loss (dB)} + 107$$

That is, set the spectrum offset including sum of

$$\text{Antenna Factor (dB/m)} + \text{Cable Loss (dB)} + 107 + 20\log(D) - 104.8$$

For AG0+AG1 band edge (0~10% OB) the antenna gain offset is included in order to compare to the conductive limit.

	Module 0	Module 1	Module 2
Antenna Gain (dBi)	AG0+AG1	AG0+AG1	AG0+AG1
n258	7.89	6.09	6.73
n260	8.05	5.78	5.96
n261	9	6.95	7.82

Note: The antenna gain value in the table is declared by the manufacturer.

10. The conversion loss of RF mixer is also included in conversion loss table of the spectrum analyzer when measurement frequency is above 40GHz.



## **3.7 Frequency Stability Measurement**

### **3.7.1 Description of Frequency Stability Measurement**

The frequency stability shall be measured by variation of ambient temperature and variation of primary supply voltage to ensure that the fundamental emission stays within the authorized frequency block.

### **3.7.2 Test Procedures for Temperature Variation**

The testing follows FCC KDB 971168 D01 v03r01 Section 9.

1. The EUT was set up in the thermal chamber.
2. With power OFF, the temperature was decreased to -30°C and the EUT was stabilized before testing. Power was applied and the maximum change in frequency was recorded within one minute.
3. With power OFF, the temperature was raised in 10°C step up to 50°C. The EUT was stabilized at each step for at least half an hour. Power was applied and the maximum frequency change was recorded within one minute.

### **3.7.3 Test Procedures for Voltage Variation**

The testing follows FCC KDB 971168 D01 v03r01 Section 9.

1. The EUT was placed in a temperature chamber at 20° C.
2. The power supply voltage to the EUT was varied from 85% to 115% of the nominal value measured at the input to the EUT.
3. The variation in frequency was measured for the worst case.



## 4 List of Measuring Equipment

Instrument	Brand Name	Model No.	Serial No.	Characteristics	Calibration Date	Test Date	Due Date	Remark
Amplifier	SONOMA	310N	187311	9kHz~1GHz	Oct. 21, 2020	Jan. 02, 2021 ~ Jan. 03, 2021	Oct. 20, 2021	Radiation (03CH10-HY)
Bilog Antenna	TESEQ	CBL 6111D & 00800N1D01N-06	35413 & 02	30MHz~1GHz	Feb. 11, 2020	Jan. 02, 2021 ~ Jan. 03, 2021	Feb. 10, 2021	Radiation (03CH10-HY)
Horn Antenna	SCHWARZECK	BBHA 9120 D	9120D-02114	1GHz~18GHz	Aug. 04, 2020	Jan. 02, 2021 ~ Jan. 03, 2021	Aug. 03, 2021	Radiation (03CH10-HY)
Preamplifier	Jet-Power	JAP00101800-30-10P	160118550004	1GHz~18GHz	Mar. 02, 2020	Jan. 02, 2021 ~ Jan. 03, 2021	Mar. 01, 2021	Radiation (03CH10-HY)
Spectrum Analyzer	Keysight	N9010A	MY54200485	10Hz~44GHz	Feb. 10, 2020	Jan. 02, 2021 ~ Jan. 03, 2021	Feb. 09, 2021	Radiation (03CH10-HY)
Controller	EMEC	EM 1000	N/A	Control Turn table & Ant Mast	N/A	Jan. 02, 2021 ~ Jan. 03, 2021	N/A	Radiation (03CH10-HY)
Antenna Mast	EMEC	AM-BS-4500-B	N/A	1~4m	N/A	Jan. 02, 2021 ~ Jan. 03, 2021	N/A	Radiation (03CH10-HY)
Turn Table	EMEC	TT 2200	N/A	0~360 Degree	N/A	Jan. 02, 2021 ~ Jan. 03, 2021	N/A	Radiation (03CH10-HY)
Software	Audix	E3 6.2009-8-24	RK-001042	N/A	N/A	Jan. 02, 2021 ~ Jan. 03, 2021	N/A	Radiation (03CH10-HY)
EMI Test Receiver	Agilent	N9038A(MXE)	MY53290045	20MHz~8.4GHz	Jan. 18, 2020	Jan. 02, 2021 ~ Jan. 03, 2021	Jan. 17, 2021	Radiation (03CH10-HY)
RF Cable	HUBER + SUHNER	SUCOFLEX 104 / 102	MY11692/4PE, MY11693/4PE, MY2855/2	30MHz~1GHz	Nov. 06, 2020	Jan. 02, 2021 ~ Jan. 03, 2021	Nov. 05, 2021	Radiation (03CH10-HY)
RF Cable	HUBER + SUHNER	SUCOFLEX 104 / 102	MY11692/4PE, MY11693/4PE, MY2855/2	1GHz~18GHz	Nov. 06, 2020	Jan. 02, 2021 ~ Jan. 03, 2021	Nov. 05, 2021	Radiation (03CH10-HY)
SHF-EHF Horn Antenna	SCHWARZECK	BBHA 9170	BBHA9170584	18GHz~40GHz	Dec. 11, 2020	Dec. 11, 2020 ~ Jan. 08, 2021	Dec. 10, 2021	Radiation (03CH18-HY)
Signal Analyzer	R&S	FSV3044	101009	10Hz~44GHz	Nov. 05, 2020	Dec. 11, 2020 ~ Jan. 08, 2021	Nov. 04, 2021	Radiation (03CH18-HY)
RF Cable	HUBER + SUHNER	SF102/2*11SK252	MY4278/2	9kHz~40GHz	Jul. 03, 2020	Dec. 11, 2020 ~ Jan. 08, 2021	Jul. 02, 2021	Radiation (03CH18-HY)
Spectrum Analyzer	Rohde & Schwarz	FSV30	103738	9kHz to 30GHz	May 14, 2020	Dec. 31, 2020	May 13, 2021	Radiation (03CH18-HY)
Harmonic Mixer (*)	Rohde & Schwarz	RPG FS-Z140	101128	90 ~ 140 GHz	Sep. 03, 2018	Dec. 31, 2020	Sep. 02, 2021	Radiation (03CH18-HY)
Harmonic Mixer (*)	Rohde & Schwarz	RPG FS-Z60	100986	40 ~ 60 GHz	Oct. 31, 2018	Dec. 31, 2020	Oct. 30, 2021	Radiation (03CH18-HY)
Harmonic Mixer (*)	Rohde & Schwarz	FS-Z90	101811	60 ~ 90 GHz	Jul. 16, 2018	Dec. 31, 2020	Jul. 15, 2021	Radiation (03CH18-HY)
Harmonic Mixer (*)	Rohde & Schwarz	RPG FS-Z220	101014	140 ~ 220 GHz	Aug. 27, 2018	Dec. 31, 2020	Aug. 26, 2021	Radiation (03CH18-HY)
Standard Horn Antenna	Quinstar	QWH-EPRR00	784600034	60 ~ 90 GHz	Aug. 17, 2018	Dec. 31, 2020	Aug. 16, 2021	Radiation (03CH18-HY)
Standard Horn Antenna	Quinstar	QWH-GPRR00	923900001	140 ~ 220 GHz	Aug. 17, 2018	Dec. 31, 2020	Aug. 16, 2021	Radiation (03CH18-HY)
Standard Horn Antenna	Quinstar	QWH-FPRR00	923800008	90 ~ 140 GHz	Aug. 17, 2018	Dec. 31, 2020	Aug. 16, 2021	Radiation (03CH18-HY)
Standard Horn Antenna	Quinstar	QWH-UPRR00	923600007	40 ~ 60 GHz	Aug. 17, 2018	Dec. 31, 2020	Aug. 16, 2021	Radiation (03CH18-HY)
Thermal Chamber	ESPEC	SU-641	92013721	-30℃ ~ -70℃	Nov. 10, 2020	Dec. 31, 2020	Nov. 09, 2021	Radiation (03CH18-HY)

Note: (\*) Equipment manufacturer's Calibration Certificate.



## 5 Uncertainty of Evaluation

### Uncertainty of Radiated Emission Measurement (30 MHz ~ 1000 MHz)

Measuring Uncertainty for a Level of Confidence of 95% (U = 2Uc(y))	3.02
---	------

### Uncertainty of Radiated Emission Measurement (1 GHz ~ 18 GHz)

Measuring Uncertainty for a Level of Confidence of 95% (U = 2Uc(y))	3.26
---	------

### Uncertainty of Radiated Emission Measurement (18 GHz ~ 40 GHz)

Measuring Uncertainty for a Level of Confidence of 95% (U = 2Uc(y))	4.03
---	------

### Uncertainty of Radiated Emission Measurement (40 GHz ~ 140 GHz)

Measuring Uncertainty for a Level of Confidence of 95% (U = 2Uc(y))	5.80
---	------

### Uncertainty of Radiated Emission Measurement (140 GHz ~ 200 GHz)

Measuring Uncertainty for a Level of Confidence of 95% (U = 2Uc(y))	6.80
---	------



## Appendix A. Test Results of EIRP and Radiated Test

### EIRP Power(Average Power)

#### NR Band n258A Module 0

NR Band n258A Module 0 AG0 (Beam ID: 36)					
Maximum Average EIRP [dBm]					
	BW [MHz]	Waveform	Modulation	Inner 1RB	Inner Full
Lowest	50	DFT-S	BPSK	22.66	22.77
	50	DFT-S	QPSK	22.58	22.76
	50	DFT-S	16QAM	20.23	20.52
	50	DFT-S	64QAM	18.08	18.56
	100	DFT-S	BPSK	23.29	23.35
	100	DFT-S	QPSK	23.93	23.28
	100	DFT-S	16QAM	21.3	21.24
	100	DFT-S	64QAM	18.69	19.2
Middle	<b>BW [MHz]</b>	<b>Waveform</b>	<b>Modulation</b>	<b>Inner 1RB</b>	<b>Inner Full</b>
	50	DFT-S	BPSK	23.62	23.57
	50	DFT-S	QPSK	23.96	23.48
	50	DFT-S	16QAM	21.24	21.57
	50	DFT-S	64QAM	18.96	19.33
	100	DFT-S	BPSK	23.8	23.66
	100	DFT-S	QPSK	23.99	23.77
	100	DFT-S	16QAM	22.21	21.6
	100	DFT-S	64QAM	18.91	19.5
	200	DFT-S	BPSK	17.31	20.08
	200	DFT-S	QPSK	16.71	20.17
	200	DFT-S	16QAM	17.58	19.33
200	DFT-S	64QAM	17.61	17.53	



NR Band n258A Module 0 AG0 (Beam ID: 36)					
Maximum Average EIRP [dBm]					
Highest	BW [MHz]	Waveform	Modulation	Inner 1RB	Inner Full
	50	DFT-S	BPSK	24.79	24.48
	50	DFT-S	QPSK	24.96	24.55
	50	DFT-S	16QAM	23.15	22.38
	50	DFT-S	64QAM	20.05	20.16
	100	DFT-S	BPSK	24.76	24.66
	100	DFT-S	QPSK	24.89	24.85
	100	DFT-S	16QAM	23.15	22.58
	100	DFT-S	64QAM	19.67	20.41

Note: The 200MHz Bw is carrier aggregation by 2CC of 100MHz.



NR Band n258A Module 0 AG1 (Beam ID: 163)					
Maximum Average EIRP [dBm]					
	BW [MHz]	Waveform	Modulation	Inner 1RB	Inner Full
<b>Lowest</b>	50	DFT-S	BPSK	23.84	24.08
	50	DFT-S	QPSK	24.01	23.89
	50	DFT-S	16QAM	21.94	21.76
	50	DFT-S	64QAM	18.81	19.67
	100	DFT-S	BPSK	23.32	23.66
	100	DFT-S	QPSK	24.1	23.6
	100	DFT-S	16QAM	21.7	21.4
	100	DFT-S	64QAM	19.28	19.46
<b>Middle</b>	<b>BW [MHz]</b>	<b>Waveform</b>	<b>Modulation</b>	<b>Inner 1RB</b>	<b>Inner Full</b>
	50	DFT-S	BPSK	23.92	24.12
	50	DFT-S	QPSK	24.51	24.2
	50	DFT-S	16QAM	22.22	21.91
	50	DFT-S	64QAM	19.8	19.82
	100	DFT-S	BPSK	23.81	24.21
	100	DFT-S	QPSK	24.45	24.23
	100	DFT-S	16QAM	21.97	21.97
	100	DFT-S	64QAM	19.73	19.96
	200	DFT-S	BPSK	17.27	19.98
	200	DFT-S	QPSK	16.81	20
	200	DFT-S	16QAM	17.07	19.16
200	DFT-S	64QAM	17.79	17.38	
<b>Highest</b>	<b>BW [MHz]</b>	<b>Waveform</b>	<b>Modulation</b>	<b>Inner 1RB</b>	<b>Inner Full</b>
	50	DFT-S	BPSK	24.5	24.54
	50	DFT-S	QPSK	25.02	24.43
	50	DFT-S	16QAM	22.65	22.32
	50	DFT-S	64QAM	20.45	20.17
	100	DFT-S	BPSK	24.71	24.72
	100	DFT-S	QPSK	25.26	24.88
	100	DFT-S	16QAM	22.91	22.52
100	DFT-S	64QAM	20.43	20.49	

Note: The 200MHz Bw is carrier aggregation by 2CC of 100MHz.



NR Band n258A Module 0 AG0+1 (Beam ID:36+164)					
Maximum Average EIRP [dBm]					
	BW [MHz]	Waveform	Modulation	Inner 1RB	Inner Full
<b>Lowest</b>	50	DFT-S	BPSK	26.05	26.16
	50	DFT-S	QPSK	25.94	26.31
	50	DFT-S	16QAM	24.07	24.1
	50	DFT-S	64QAM	21.28	21.89
	100	DFT-S	BPSK	26.16	26.47
	100	DFT-S	QPSK	26.1	<b>26.59</b>
	100	DFT-S	16QAM	24.31	24.49
	100	DFT-S	64QAM	21.82	22.32
	<b>Middle</b>	<b>BW [MHz]</b>	<b>Waveform</b>	<b>Modulation</b>	<b>Inner 1RB</b>
50		DFT-S	BPSK	25.99	26.01
50		DFT-S	QPSK	25.96	25.66
50		DFT-S	16QAM	24.13	23.84
50		DFT-S	64QAM	21.3	21.68
100		DFT-S	BPSK	26.21	26.34
100		DFT-S	QPSK	26.22	26.32
100		DFT-S	16QAM	24.44	24.43
100		DFT-S	64QAM	21.65	22.09
200		DFT-S	BPSK	19.27	22.59
200		DFT-S	QPSK	19.6	22.56
200		DFT-S	16QAM	19.55	21.9
200		DFT-S	64QAM	20.93	20
<b>Highest</b>	<b>BW [MHz]</b>	<b>Waveform</b>	<b>Modulation</b>	<b>Inner 1RB</b>	<b>Inner Full</b>
	50	DFT-S	BPSK	26.1	26.36
	50	DFT-S	QPSK	26.24	26.41
	50	DFT-S	16QAM	24.36	24.37
	50	DFT-S	64QAM	21.55	22.11
	100	DFT-S	BPSK	26.47	26.21
	100	DFT-S	QPSK	26.25	26.51
	100	DFT-S	16QAM	24.46	24.43
100	DFT-S	64QAM	21.68	22.19	

Note: The 200MHz Bw is carrier aggregation by 2CC of 100MHz.



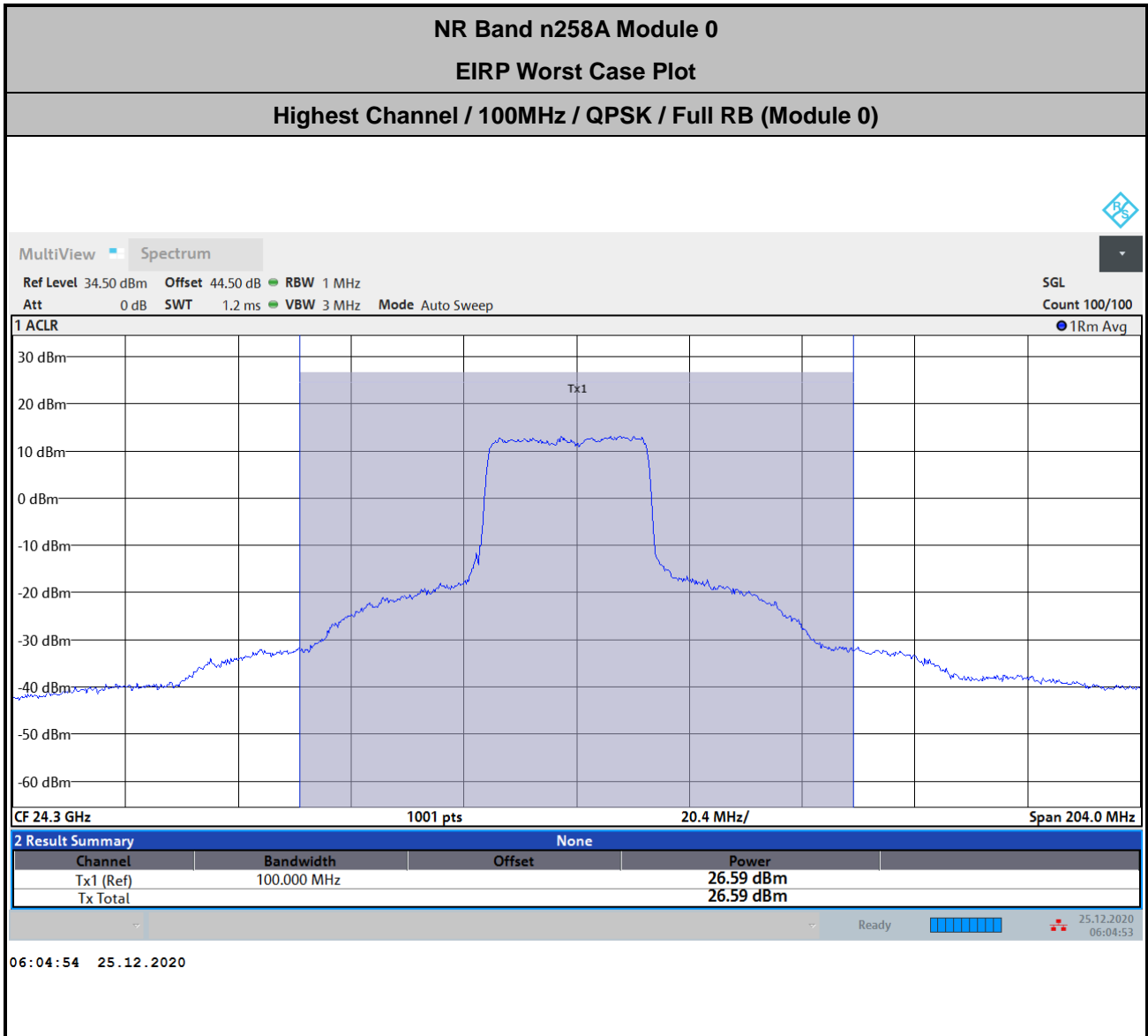

Note:  $Offset = Antenna\ Factor\ (dB/m) + Cable\ Loss\ (dB) + 107 + 20\log(D) - 104.8$   
 $= 40.5 + 1.8 + 107 + 20\log(1) - 104.8 = 44.5\ (dB)$



NR Band n258A Module 1

NR Band n258A Module 1 AG0 (Beam ID: 39)					
Maximum Average EIRP [dBm]					
	BW [MHz]	Waveform	Modulation	Inner 1RB	Inner Full
<b>Lowest</b>	50	DFT-S	BPSK	17.92	17.93
	50	DFT-S	QPSK	18.26	18.11
	50	DFT-S	16QAM	15.6	15.7
	50	DFT-S	64QAM	13.31	13.83
	100	DFT-S	BPSK	19.33	19.81
	100	DFT-S	QPSK	19.77	19.73
	100	DFT-S	16QAM	17.64	17.58
	100	DFT-S	64QAM	15.14	15.64
<b>Middle</b>	<b>BW [MHz]</b>	<b>Waveform</b>	<b>Modulation</b>	<b>Inner 1RB</b>	<b>Inner Full</b>
	50	DFT-S	BPSK	18.94	19.13
	50	DFT-S	QPSK	19.28	19.41
	50	DFT-S	16QAM	17.6	16.71
	50	DFT-S	64QAM	14.58	14.74
	100	DFT-S	BPSK	19.71	20
	100	DFT-S	QPSK	20.01	19.79
	100	DFT-S	16QAM	17.69	17.62
	100	DFT-S	64QAM	15.46	15.74
	200	DFT-S	BPSK	13.41	16.33
	200	DFT-S	QPSK	13.46	16.26
	200	DFT-S	16QAM	13.27	15.42
200	DFT-S	64QAM	13.81	13.86	
<b>Highest</b>	<b>BW [MHz]</b>	<b>Waveform</b>	<b>Modulation</b>	<b>Inner 1RB</b>	<b>Inner Full</b>
	50	DFT-S	BPSK	20.57	20.59
	50	DFT-S	QPSK	20.91	20.66
	50	DFT-S	16QAM	19.01	18.16
	50	DFT-S	64QAM	16.32	16.16
	100	DFT-S	BPSK	20.89	20.72
	100	DFT-S	QPSK	21.23	20.67
	100	DFT-S	16QAM	19.02	18.47
100	DFT-S	64QAM	16.57	16.5	

Note: The 200MHz Bw is carrier aggregation by 2CC of 100MHz.



NR Band n258A Module 1 AG1 (Beam ID: 156)					
Maximum Average EIRP [dBm]					
	BW [MHz]	Waveform	Modulation	Inner 1RB	Inner Full
<b>Lowest</b>	50	DFT-S	BPSK	21.27	21.34
	50	DFT-S	QPSK	21.48	21.44
	50	DFT-S	16QAM	19.76	19
	50	DFT-S	64QAM	16.91	16.95
	100	DFT-S	BPSK	21.15	22.03
	100	DFT-S	QPSK	21.41	21.46
	100	DFT-S	16QAM	19.41	19.16
	100	DFT-S	64QAM	16.87	17.27
<b>Middle</b>	<b>BW [MHz]</b>	<b>Waveform</b>	<b>Modulation</b>	<b>Inner 1RB</b>	<b>Inner Full</b>
	50	DFT-S	BPSK	20.08	20.36
	50	DFT-S	QPSK	20.3	20.27
	50	DFT-S	16QAM	17.97	18.57
	50	DFT-S	64QAM	15.48	16.13
	100	DFT-S	BPSK	20.85	21.04
	100	DFT-S	QPSK	20.74	20.66
	100	DFT-S	16QAM	18.7	18.64
	100	DFT-S	64QAM	16.41	16.84
	200	DFT-S	BPSK	14.47	17.26
	200	DFT-S	QPSK	14.32	17.32
	200	DFT-S	16QAM	14.29	16.47
200	DFT-S	64QAM	15.21	14.78	
<b>Highest</b>	<b>BW [MHz]</b>	<b>Waveform</b>	<b>Modulation</b>	<b>Inner 1RB</b>	<b>Inner Full</b>
	50	DFT-S	BPSK	21.86	21.7
	50	DFT-S	QPSK	21.75	21.61
	50	DFT-S	16QAM	19.59	19.74
	50	DFT-S	64QAM	17.28	17.49
	100	DFT-S	BPSK	21.69	21.72
	100	DFT-S	QPSK	21.53	21.73
	100	DFT-S	16QAM	19.54	19.55
100	DFT-S	64QAM	17.23	17.45	

Note: The 200MHz Bw is carrier aggregation by 2CC of 100MHz.



NR Band n258A Module 1 AG0+1 (Beam ID:39+167)					
Maximum Average EIRP [dBm]					
Lowest	BW [MHz]	Waveform	Modulation	Inner 1RB	Inner Full
	50	DFT-S	BPSK	22.77	23.01
	50	DFT-S	QPSK	22.68	22.94
	50	DFT-S	16QAM	20.67	20.8
	50	DFT-S	64QAM	18.11	18.72
	100	DFT-S	BPSK	23.71	24.02
	100	DFT-S	QPSK	23.94	24.03
	100	DFT-S	16QAM	21.67	21.74
	100	DFT-S	64QAM	19.14	19.67
Middle	BW [MHz]	Waveform	Modulation	Inner 1RB	Inner Full
	50	DFT-S	BPSK	23.7	23.88
	50	DFT-S	QPSK	23.7	23.9
	50	DFT-S	16QAM	21.53	21.62
	50	DFT-S	64QAM	19.04	19.7
	100	DFT-S	BPSK	23.73	23.87
	100	DFT-S	QPSK	23.72	23.88
	100	DFT-S	16QAM	21.6	21.58
	100	DFT-S	64QAM	19.25	19.47
	200	DFT-S	BPSK	17.08	19.92
	200	DFT-S	QPSK	16.83	19.87
	200	DFT-S	16QAM	16.64	19.1
	200	DFT-S	64QAM	17.7	17.44
Highest	BW [MHz]	Waveform	Modulation	Inner 1RB	Inner Full
	50	DFT-S	BPSK	24.04	23.9
	50	DFT-S	QPSK	24.01	<b>24.07</b>
	50	DFT-S	16QAM	21.82	21.82
	50	DFT-S	64QAM	19.34	19.82
	100	DFT-S	BPSK	23.67	23.85
	100	DFT-S	QPSK	23.83	23.62
	100	DFT-S	16QAM	22.09	21.75
100	DFT-S	64QAM	19	19.53	

Note: The 200MHz Bw is carrier aggregation by 2CC of 100MHz.

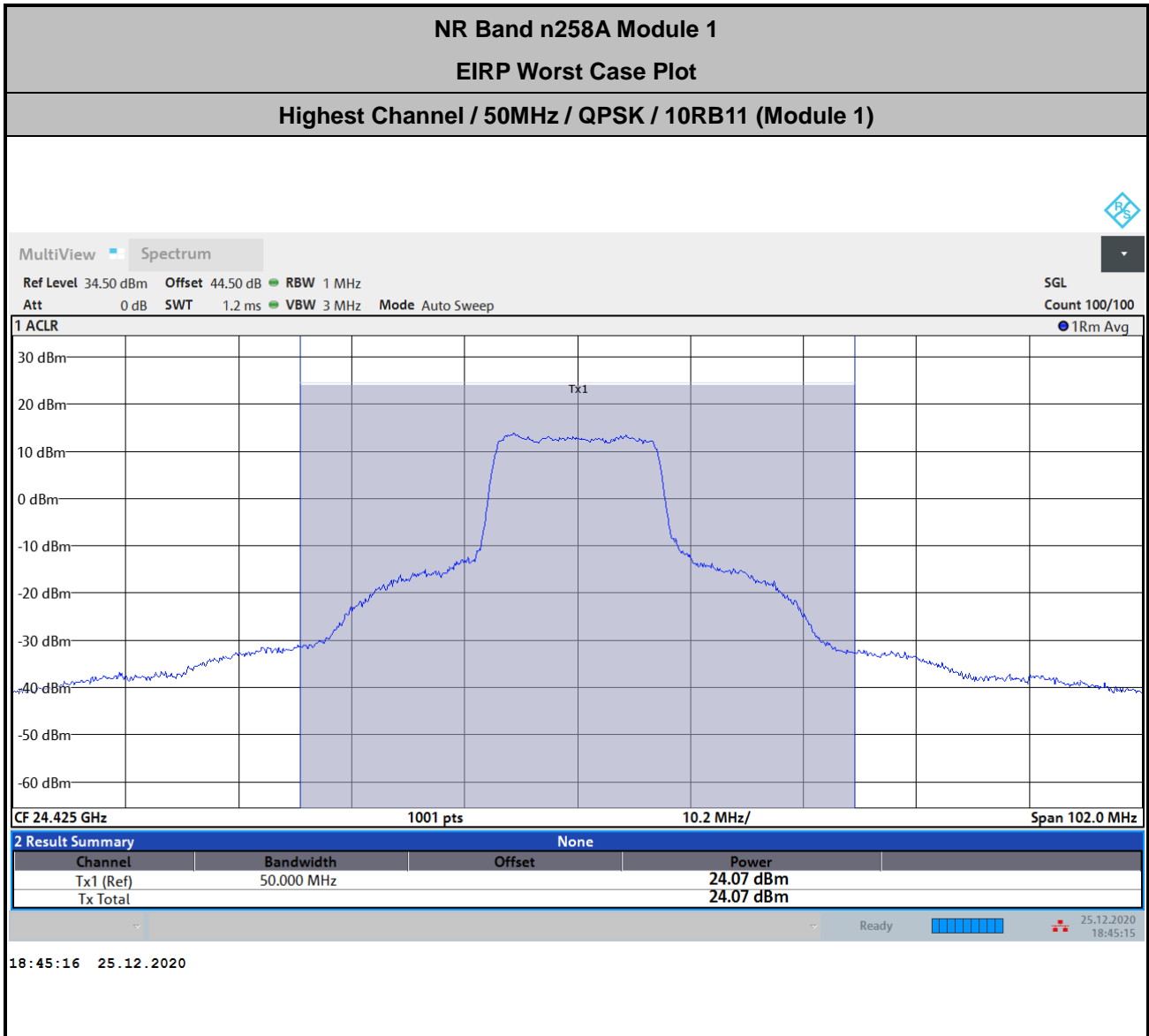

Note :  $Offset = Antenna\ Factor\ (dB/m) + Cable\ Loss\ (dB) + 107 + 20\log(D) - 104.8$   
 $= 40.5 + 1.8 + 107 + 20\log(1) - 104.8 = 44.5\ (dB)$



NR Band n258A Module 2

NR Band n258A Module 2 AG0 (Beam ID: 42)					
Maximum Average EIRP [dBm]					
	BW [MHz]	Waveform	Modulation	Inner 1RB	Inner Full
<b>Lowest</b>	50	DFT-S	BPSK	20.61	20.52
	50	DFT-S	QPSK	20.59	20.25
	50	DFT-S	16QAM	18.55	18.89
	50	DFT-S	64QAM	16.61	17.02
	100	DFT-S	BPSK	21.72	21.57
	100	DFT-S	QPSK	21.5	21.6
	100	DFT-S	16QAM	19.58	19.89
	100	DFT-S	64QAM	17.56	17.84
<b>Middle</b>	<b>BW [MHz]</b>	<b>Waveform</b>	<b>Modulation</b>	<b>Inner 1RB</b>	<b>Inner Full</b>
	50	DFT-S	BPSK	21.52	21.44
	50	DFT-S	QPSK	21.72	20.93
	50	DFT-S	16QAM	19.51	19.67
	50	DFT-S	64QAM	17.54	17.72
	100	DFT-S	BPSK	21.96	21.66
	100	DFT-S	QPSK	21.68	21.8
	100	DFT-S	16QAM	19.86	20.07
	100	DFT-S	64QAM	17.85	17.95
	200	DFT-S	BPSK	16.23	19.43
	200	DFT-S	QPSK	15.74	19.08
	200	DFT-S	16QAM	16.11	18.41
200	DFT-S	64QAM	16.03	16.29	
<b>Highest</b>	<b>BW [MHz]</b>	<b>Waveform</b>	<b>Modulation</b>	<b>Inner 1RB</b>	<b>Inner Full</b>
	50	DFT-S	BPSK	21.3	21.11
	50	DFT-S	QPSK	21.23	21.04
	50	DFT-S	16QAM	19.74	19.33
	50	DFT-S	64QAM	17.57	17.33
	100	DFT-S	BPSK	22.13	21.79
	100	DFT-S	QPSK	21.82	21.64
	100	DFT-S	16QAM	20.35	19.95
100	DFT-S	64QAM	17.96	17.95	

Note: The 200MHz Bw is carrier aggregation by 2CC of 100MHz.



NR Band n258A Module 2 AG1 (Beam ID: 160)					
Maximum Average EIRP [dBm]					
	BW [MHz]	Waveform	Modulation	Inner 1RB	Inner Full
<b>Lowest</b>	50	DFT-S	BPSK	22.3	22.41
	50	DFT-S	QPSK	22.17	22.44
	50	DFT-S	16QAM	20.6	20.56
	50	DFT-S	64QAM	18.54	18.71
	100	DFT-S	BPSK	22.54	22.83
	100	DFT-S	QPSK	22.31	22.8
	100	DFT-S	16QAM	20.41	21.1
	100	DFT-S	64QAM	18.85	18.99
<b>Middle</b>	<b>BW [MHz]</b>	<b>Waveform</b>	<b>Modulation</b>	<b>Inner 1RB</b>	<b>Inner Full</b>
	50	DFT-S	BPSK	22.45	22.68
	50	DFT-S	QPSK	22.31	22.64
	50	DFT-S	16QAM	20.35	21.04
	50	DFT-S	64QAM	19.03	18.93
	100	DFT-S	BPSK	22.69	22.49
	100	DFT-S	QPSK	22.55	22.73
	100	DFT-S	16QAM	20.55	20.99
	100	DFT-S	64QAM	19.09	18.86
	200	DFT-S	BPSK	16.03	19.34
	200	DFT-S	QPSK	15.84	19.37
	200	DFT-S	16QAM	15.62	18.43
200	DFT-S	64QAM	16.01	16.32	
<b>Highest</b>	<b>BW [MHz]</b>	<b>Waveform</b>	<b>Modulation</b>	<b>Inner 1RB</b>	<b>Inner Full</b>
	50	DFT-S	BPSK	23.62	23.71
	50	DFT-S	QPSK	23.63	23.76
	50	DFT-S	16QAM	21.51	22.15
	50	DFT-S	64QAM	20.13	20.03
	100	DFT-S	BPSK	23.41	23.22
	100	DFT-S	QPSK	23.32	23.28
	100	DFT-S	16QAM	21.23	21.43
100	DFT-S	64QAM	19.79	19.57	

Note: The 200MHz Bw is carrier aggregation by 2CC of 100MHz.



NR Band n258A Module 2 AG0+1 (Beam ID:42+170)					
Maximum Average EIRP [dBm]					
	BW [MHz]	Waveform	Modulation	Inner 1RB	Inner Full
Lowest	50	DFT-S	BPSK	24.02	24.2
	50	DFT-S	QPSK	23.94	24.22
	50	DFT-S	16QAM	22.29	22.7
	50	DFT-S	64QAM	19.28	20.26
	100	DFT-S	BPSK	25.08	25.56
	100	DFT-S	QPSK	24.94	25.69
	100	DFT-S	16QAM	23.17	23.87
	100	DFT-S	64QAM	20.07	21.77
Middle	<b>BW [MHz]</b>	<b>Waveform</b>	<b>Modulation</b>	<b>Inner 1RB</b>	<b>Inner Full</b>
	50	DFT-S	BPSK	25.1	25.08
	50	DFT-S	QPSK	25.04	25.46
	50	DFT-S	16QAM	23.58	23.85
	50	DFT-S	64QAM	20.59	21.52
	100	DFT-S	BPSK	25.2	25.61
	100	DFT-S	QPSK	25.51	25.74
	100	DFT-S	16QAM	23.86	24.08
	100	DFT-S	64QAM	20.74	21.96
	200	DFT-S	BPSK	18.7	21.75
	200	DFT-S	QPSK	18.57	22.03
	200	DFT-S	16QAM	18.8	21.45
200	DFT-S	64QAM	18.37	19.1	
Highest	<b>BW [MHz]</b>	<b>Waveform</b>	<b>Modulation</b>	<b>Inner 1RB</b>	<b>Inner Full</b>
	50	DFT-S	BPSK	26.17	26.04
	50	DFT-S	QPSK	26.11	26.27
	50	DFT-S	16QAM	24.48	24.42
	50	DFT-S	64QAM	22.1	22.41
	100	DFT-S	BPSK	<b>26.37</b>	26.02
	100	DFT-S	QPSK	26.28	25.93
	100	DFT-S	16QAM	24.49	24.45
100	DFT-S	64QAM	22.25	22.29	

Note: The 200MHz Bw is carrier aggregation by 2CC of 100MHz.



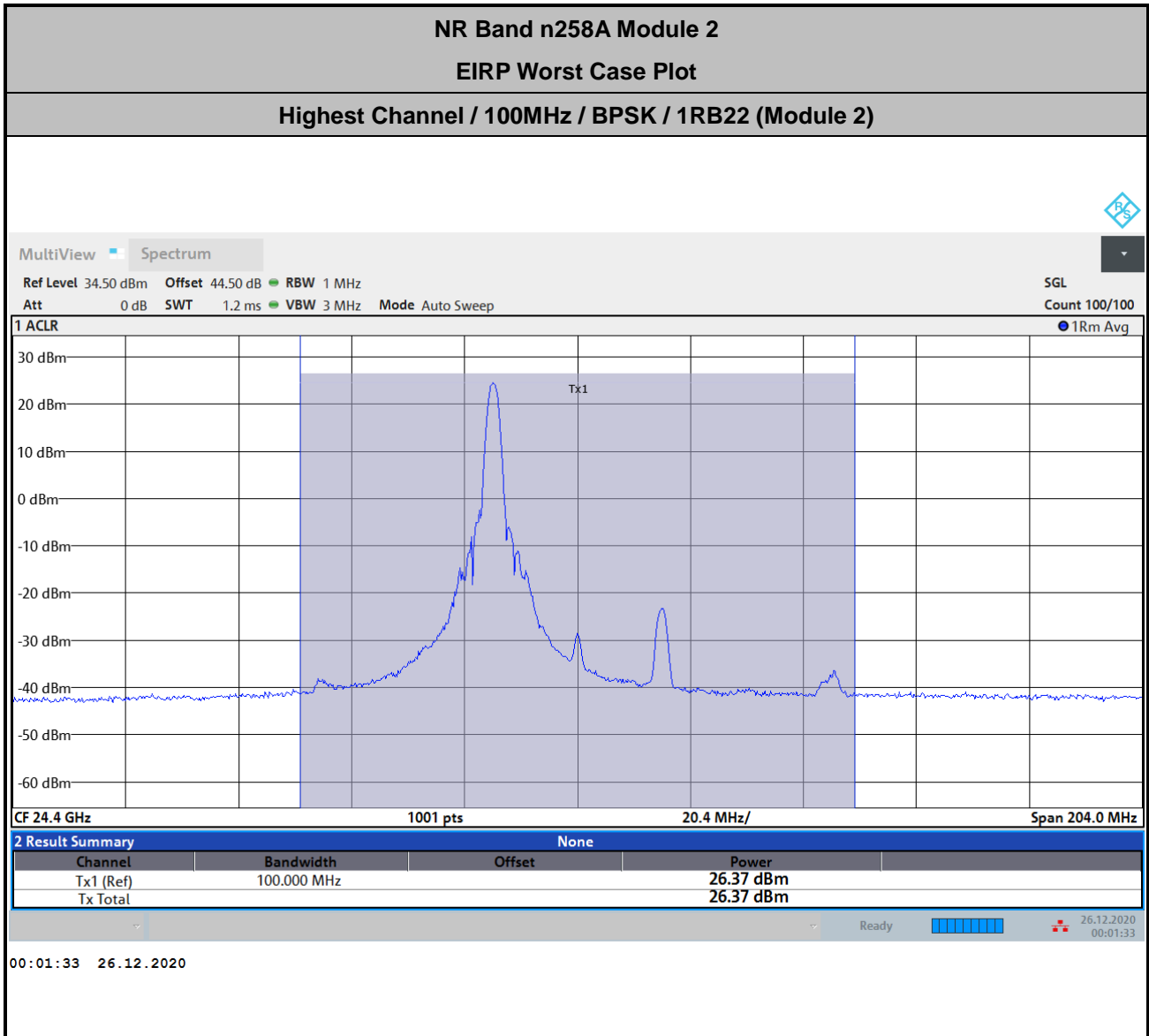

Note:  $Offset = Antenna\ Factor\ (dB/m) + Cable\ Loss\ (dB) + 107 + 20\log(D) - 104.8$   
 $= 40.5 + 1.8 + 107 + 20\log(1) - 104.8 = 44.5\ (dB)$



NR Band n258B Module 0

NR Band n258B Module 0 AGO (Beam ID: 36)					
Maximum Average EIRP [dBm]					
	BW [MHz]	Waveform	Modulation	Inner 1RB	Inner Full
Lowest	50	DFT-S	BPSK	23.58	23.71
	50	DFT-S	QPSK	24.05	23.7
	50	DFT-S	16QAM	21.42	21.65
	50	DFT-S	64QAM	19.5	19.59
	100	DFT-S	BPSK	23.84	23.7
	100	DFT-S	QPSK	24.28	23.43
	100	DFT-S	16QAM	21.8	21.62
	100	DFT-S	64QAM	19.71	19.45
	200	DFT-S	BPSK	16.6	19.46
	200	DFT-S	QPSK	16.37	19.48
	200	DFT-S	16QAM	17.37	18.76
	200	DFT-S	64QAM	17.62	16.78
	Middle	50	DFT-S	BPSK	23.32
50		DFT-S	QPSK	23.79	23.44
50		DFT-S	16QAM	21.26	21.19
50		DFT-S	64QAM	19.05	19.12
100		DFT-S	BPSK	23.49	23.21
100		DFT-S	QPSK	23.77	23.31
100		DFT-S	16QAM	21.25	21.22
100		DFT-S	64QAM	18.89	19.05
200		DFT-S	BPSK	16.3	19.15
200		DFT-S	QPSK	15.76	19.14
200		DFT-S	16QAM	16.82	18.4
200		DFT-S	64QAM	17.18	16.53



NR Band n258B Module 0 AG0 (Beam ID: 36)					
Maximum Average EIRP [dBm]					
Highest	BW [MHz]	Waveform	Modulation	Inner 1RB	Inner Full
	50	DFT-S	BPSK	23.87	23.6
	50	DFT-S	QPSK	23.45	23.74
	50	DFT-S	16QAM	21.76	21.71
	50	DFT-S	64QAM	18.09	19.53
	100	DFT-S	BPSK	23.89	24.01
	100	DFT-S	QPSK	23.36	23.98
	100	DFT-S	16QAM	21.98	21.78
	100	DFT-S	64QAM	18.22	19.76
	200	DFT-S	BPSK	16.72	19.84
	200	DFT-S	QPSK	16.33	19.9
	200	DFT-S	16QAM	17.19	19.01
	200	DFT-S	64QAM	16.72	17.24

Note: The 200MHz Bw is carrier aggregation by 2CC of 100MHz.



NR Band n258B Module 0 AG1 (Beam ID: 163)					
Maximum Average EIRP [dBm]					
	BW [MHz]	Waveform	Modulation	Inner 1RB	Inner Full
<b>Lowest</b>	50	DFT-S	BPSK	22.3	22.95
	50	DFT-S	QPSK	23.14	22.83
	50	DFT-S	16QAM	20.69	20.68
	50	DFT-S	64QAM	18.37	18.72
	100	DFT-S	BPSK	23.31	23.98
	100	DFT-S	QPSK	24.27	24.19
	100	DFT-S	16QAM	21.83	22.04
	100	DFT-S	64QAM	19.59	19.77
	200	DFT-S	BPSK	16.6	19.64
	200	DFT-S	QPSK	16.94	19.78
	200	DFT-S	16QAM	16.31	19.03
	200	DFT-S	64QAM	17.81	17.11
	<b>Middle</b>	50	DFT-S	BPSK	22.67
50		DFT-S	QPSK	23.4	23.33
50		DFT-S	16QAM	21.11	21.18
50		DFT-S	64QAM	18.75	19.18
100		DFT-S	BPSK	22.32	22.99
100		DFT-S	QPSK	23.08	23.15
100		DFT-S	16QAM	20.72	20.99
100		DFT-S	64QAM	18.48	18.71
200		DFT-S	BPSK	16	19.16
200		DFT-S	QPSK	16.45	19.32
200		DFT-S	16QAM	15.81	18.52
200		DFT-S	64QAM	17.29	16.79



NR Band n258B Module 0 AG1 (Beam ID: 163)					
Maximum Average EIRP [dBm]					
Highest	BW [MHz]	Waveform	Modulation	Inner 1RB	Inner Full
	50	DFT-S	BPSK	23.29	22.77
	50	DFT-S	QPSK	23.2	22.88
	50	DFT-S	16QAM	20.32	20.56
	50	DFT-S	64QAM	18.01	18.65
	100	DFT-S	BPSK	23.82	23.39
	100	DFT-S	QPSK	23.46	23.59
	100	DFT-S	16QAM	20.69	21.39
	100	DFT-S	64QAM	18.39	18.99
	200	DFT-S	BPSK	15.5	19.02
	200	DFT-S	QPSK	15.71	19.2
	200	DFT-S	16QAM	15.55	18.44
	200	DFT-S	64QAM	15.4	16.29

Note: The 200MHz Bw is carrier aggregation by 2CC of 100MHz.



NR Band n258B Module 0 AG0+1 (Beam ID:36+164)					
Maximum Average EIRP [dBm]					
	BW [MHz]	Waveform	Modulation	Inner 1RB	Inner Full
<b>Lowest</b>	50	DFT-S	BPSK	24.81	24.87
	50	DFT-S	QPSK	25.3	24.73
	50	DFT-S	16QAM	22.24	22.68
	50	DFT-S	64QAM	20.22	20.75
	100	DFT-S	BPSK	25.28	<b>25.46</b>
	100	DFT-S	QPSK	25.36	25.44
	100	DFT-S	16QAM	22.27	23.4
	100	DFT-S	64QAM	20.64	21.23
	200	DFT-S	BPSK	16.95	20.09
	200	DFT-S	QPSK	16.3	21
	200	DFT-S	16QAM	16.1	19.81
	200	DFT-S	64QAM	17.92	17.78
	<b>Middle</b>	<b>BW [MHz]</b>	<b>Waveform</b>	<b>Modulation</b>	<b>Inner 1RB</b>
50		DFT-S	BPSK	23.33	23.88
50		DFT-S	QPSK	23.85	24.04
50		DFT-S	16QAM	20.69	21.84
50		DFT-S	64QAM	18.67	19.81
100		DFT-S	BPSK	24.36	24.31
100		DFT-S	QPSK	24.82	24.1
100		DFT-S	16QAM	21.55	21.95
100		DFT-S	64QAM	20.17	20.25
200		DFT-S	BPSK	17.26	20.15
200		DFT-S	QPSK	16.67	20.25
200		DFT-S	16QAM	16.49	19.48
200		DFT-S	64QAM	18.29	17.55



NR Band n258B Module 0 AG0+1 (Beam ID:36+164)					
Maximum Average EIRP [dBm]					
Highest	BW [MHz]	Waveform	Modulation	Inner 1RB	Inner Full
	50	DFT-S	BPSK	23.71	23.96
	50	DFT-S	QPSK	23.35	24.08
	50	DFT-S	16QAM	21.69	22.03
	50	DFT-S	64QAM	18.97	19.7
	100	DFT-S	BPSK	24.58	24.75
	100	DFT-S	QPSK	23.99	24.72
	100	DFT-S	16QAM	22.61	22.57
	100	DFT-S	64QAM	19.58	20.55
	200	DFT-S	BPSK	17.59	20.79
	200	DFT-S	QPSK	17.26	20.9
	200	DFT-S	16QAM	17.93	19.93
	200	DFT-S	64QAM	17.35	18.1

Note: The 200MHz Bw is carrier aggregation by 2CC of 100MHz.

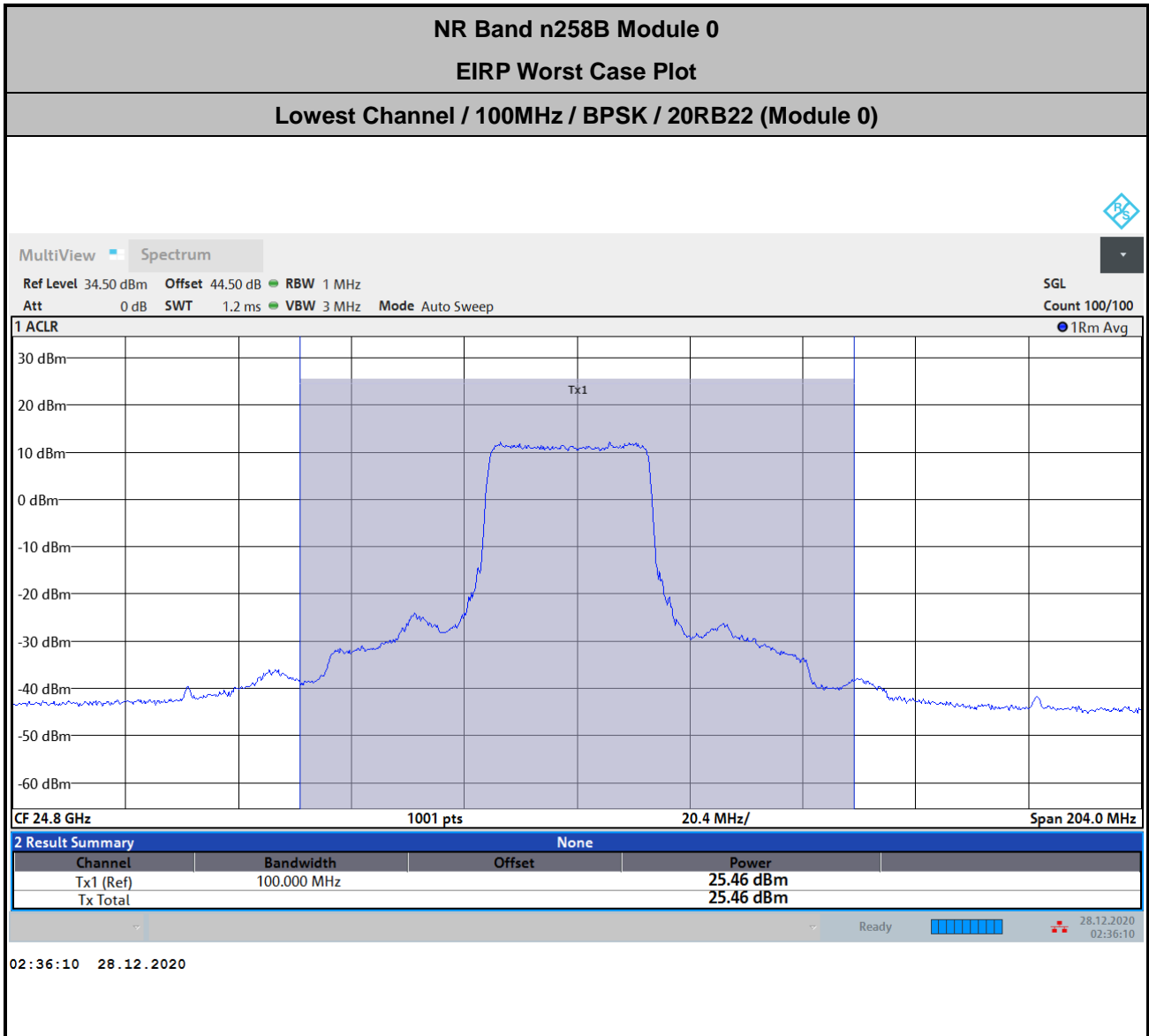

Note:  $Offset = Antenna\ Factor\ (dB/m) + Cable\ Loss\ (dB) + 107 + 20\log(D) - 104.8$   
 $= 40.5 + 1.8 + 107 + 20\log(1) - 104.8 = 44.5\ (dB)$





NR Band n258B Module 1

NR Band n258B Module 1 AGO (Beam ID: 39)					
Maximum Average EIRP [dBm]					
	BW [MHz]	Waveform	Modulation	Inner 1RB	Inner Full
Lowest	50	DFT-S	BPSK	20.01	19.99
	50	DFT-S	QPSK	20.42	20.13
	50	DFT-S	16QAM	18.55	17.83
	50	DFT-S	64QAM	16.06	15.75
	100	DFT-S	BPSK	20.53	20.91
	100	DFT-S	QPSK	20.96	20.85
	100	DFT-S	16QAM	18.65	18.79
	100	DFT-S	64QAM	16.71	16.87
	200	DFT-S	BPSK	14.31	17.07
	200	DFT-S	QPSK	14.16	17.11
	200	DFT-S	16QAM	13.93	16.32
	200	DFT-S	64QAM	14.6	14.47
	Middle	50	DFT-S	BPSK	20.7
50		DFT-S	QPSK	21.15	20.92
50		DFT-S	16QAM	19.3	18.73
50		DFT-S	64QAM	17.03	16.57
100		DFT-S	BPSK	20.58	20.73
100		DFT-S	QPSK	21.1	20.7
100		DFT-S	16QAM	18.9	18.54
100		DFT-S	64QAM	16.89	16.59
200		DFT-S	BPSK	14.17	17.46
200		DFT-S	QPSK	13.95	17.52
200		DFT-S	16QAM	13.61	15.88
200		DFT-S	64QAM	14.29	14.11



NR Band n258B Module 1 AG0 (Beam ID: 39)					
Maximum Average EIRP [dBm]					
Highest	BW [MHz]	Waveform	Modulation	Inner 1RB	Inner Full
	50	DFT-S	BPSK	20.56	20.24
	50	DFT-S	QPSK	19.96	20.25
	50	DFT-S	16QAM	17.62	18.1
	50	DFT-S	64QAM	16.45	16.27
	100	DFT-S	BPSK	20.41	19.89
	100	DFT-S	QPSK	19.45	19.91
	100	DFT-S	16QAM	17.57	17.97
	100	DFT-S	64QAM	16.15	15.61
	200	DFT-S	BPSK	12.79	15.73
	200	DFT-S	QPSK	12.9	15.88
	200	DFT-S	16QAM	13.63	15.18
	200	DFT-S	64QAM	13.57	13.27

Note: The 200MHz Bw is carrier aggregation by 2CC of 100MHz.



NR Band n258B Module 1 AG1 (Beam ID: 156)					
Maximum Average EIRP [dBm]					
Lowest	BW [MHz]	Waveform	Modulation	Inner 1RB	Inner Full
	50	DFT-S	BPSK	20.43	20.79
	50	DFT-S	QPSK	20.47	20.75
	50	DFT-S	16QAM	18.84	18.49
	50	DFT-S	64QAM	16.27	16.11
	100	DFT-S	BPSK	21.11	21.08
	100	DFT-S	QPSK	21.19	21.16
	100	DFT-S	16QAM	19.11	19.1
	100	DFT-S	64QAM	16.88	16.99
	200	DFT-S	BPSK	14.81	17.36
	200	DFT-S	QPSK	14.93	17.33
	200	DFT-S	16QAM	14.75	16.53
	200	DFT-S	64QAM	15.07	14.97
	Middle	BW [MHz]	Waveform	Modulation	Inner 1RB
50		DFT-S	BPSK	21.08	21.09
50		DFT-S	QPSK	21.11	21.02
50		DFT-S	16QAM	18.92	18.73
50		DFT-S	64QAM	16.78	16.64
100		DFT-S	BPSK	20.83	20.75
100		DFT-S	QPSK	21.06	20.85
100		DFT-S	16QAM	18.79	18.83
100		DFT-S	64QAM	16.58	16.56
200		DFT-S	BPSK	14.97	17.66
200		DFT-S	QPSK	15.11	17.55
200		DFT-S	16QAM	14.88	16.69
200		DFT-S	64QAM	15.3	15.08



NR Band n258B Module 1 AG1 (Beam ID: 156)					
Maximum Average EIRP [dBm]					
Highest	BW [MHz]	Waveform	Modulation	Inner 1RB	Inner Full
	50	DFT-S	BPSK	21.75	21.48
	50	DFT-S	QPSK	21.68	21.46
	50	DFT-S	16QAM	18.87	19.42
	50	DFT-S	64QAM	18.2	17.5
	100	DFT-S	BPSK	20.94	21.23
	100	DFT-S	QPSK	20.91	21.24
	100	DFT-S	16QAM	18.48	19.17
	100	DFT-S	64QAM	17.51	16.92
	200	DFT-S	BPSK	15.25	17.76
	200	DFT-S	QPSK	14.45	17.85
	200	DFT-S	16QAM	15.04	17.09
	200	DFT-S	64QAM	14.73	15.2

Note: The 200MHz Bw is carrier aggregation by 2CC of 100MHz.



NR Band n258B Module 1 AG0+1 (Beam ID:39+167)					
Maximum Average EIRP [dBm]					
Lowest	BW [MHz]	Waveform	Modulation	Inner 1RB	Inner Full
	50	DFT-S	BPSK	20.53	20.74
	50	DFT-S	QPSK	20.64	20.75
	50	DFT-S	16QAM	19.05	18.49
	50	DFT-S	64QAM	16.17	16.39
	100	DFT-S	BPSK	21.26	21.34
	100	DFT-S	QPSK	21.42	21.23
	100	DFT-S	16QAM	19.57	18.96
	100	DFT-S	64QAM	16.93	17.15
	200	DFT-S	BPSK	14.28	17.05
	200	DFT-S	QPSK	14.29	17.02
	200	DFT-S	16QAM	14.19	16.1
	200	DFT-S	64QAM	15.23	14.57
	Middle	BW [MHz]	Waveform	Modulation	Inner 1RB
50		DFT-S	BPSK	20.68	20.55
50		DFT-S	QPSK	20.89	20.68
50		DFT-S	16QAM	18.71	18.39
50		DFT-S	64QAM	16.36	16.5
100		DFT-S	BPSK	20.71	20.67
100		DFT-S	QPSK	21.23	20.75
100		DFT-S	16QAM	18.56	18.39
100		DFT-S	64QAM	16.48	16.81
200		DFT-S	BPSK	14.09	16.92
200		DFT-S	QPSK	14.06	16.95
200		DFT-S	16QAM	14.18	16.02
200		DFT-S	64QAM	14.96	14.4



NR Band n258B Module 1 AG0+1 (Beam ID:39+167)					
Maximum Average EIRP [dBm]					
Highest	BW [MHz]	Waveform	Modulation	Inner 1RB	Inner Full
	50	DFT-S	BPSK	21.27	21.07
	50	DFT-S	QPSK	21.1	21.04
	50	DFT-S	16QAM	18.87	18.79
	50	DFT-S	64QAM	17.22	17.16
	100	DFT-S	BPSK	20.08	20.99
	100	DFT-S	QPSK	19.98	20.61
	100	DFT-S	16QAM	17.53	18.13
	100	DFT-S	64QAM	15.78	15.98
	200	DFT-S	BPSK	13.13	15.76
	200	DFT-S	QPSK	12.36	15.73
	200	DFT-S	16QAM	13.06	14.88
	200	DFT-S	64QAM	13.05	13.24

Note: The 200MHz Bw is carrier aggregation by 2CC of 100MHz.



NR Band n258B Module 1

EIRP Worst Case Plot

Highest Channel / 50MHz / BPSK / 1RB11 (Module 1)

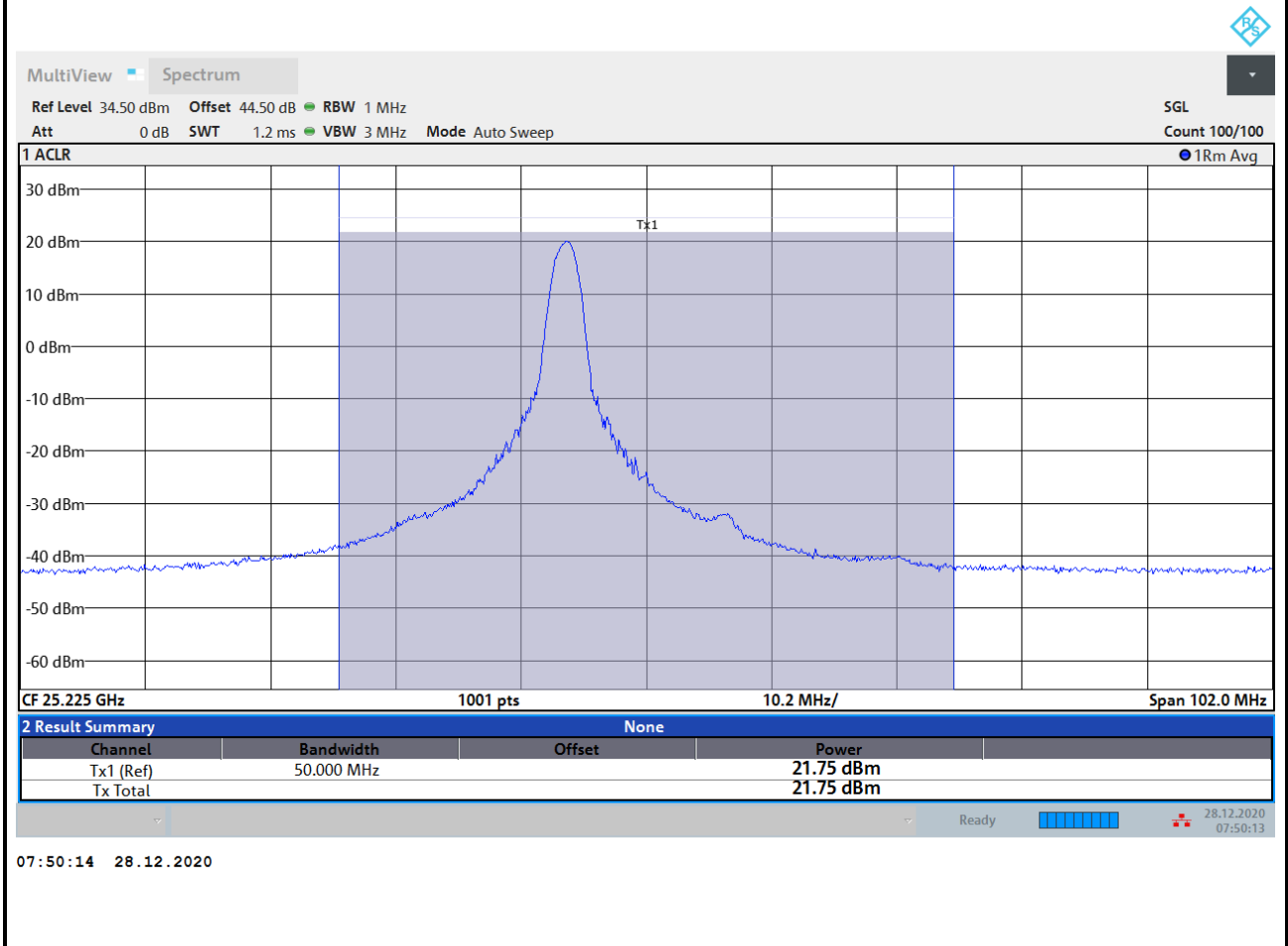

Note:  $Offset = Antenna\ Factor\ (dB/m) + Cable\ Loss\ (dB) + 107 + 20\log(D) - 104.8$   
 $= 40.5 + 1.8 + 107 + 20\log(1) - 104.8 = 44.5\ (dB)$



NR Band n258B Module 2

NR Band n258B Module 2 AG0 (Beam ID: 42)					
Maximum Average EIRP [dBm]					
Lowest	BW [MHz]	Waveform	Modulation	Inner 1RB	Inner Full
	50	DFT-S	BPSK	24.07	23.84
	50	DFT-S	QPSK	23.72	23.76
	50	DFT-S	16QAM	21.88	22.22
	50	DFT-S	64QAM	19.96	20.18
	100	DFT-S	BPSK	24.62	24.53
	100	DFT-S	QPSK	23.96	24.58
	100	DFT-S	16QAM	22.37	23.05
	100	DFT-S	64QAM	20.4	20.83
	200	DFT-S	BPSK	17.75	21.01
	200	DFT-S	QPSK	17.32	21.04
	200	DFT-S	16QAM	17.25	20.3
	200	DFT-S	64QAM	17.19	17.92
	Middle	BW [MHz]	Waveform	Modulation	Inner 1RB
50		DFT-S	BPSK	24.82	24.53
50		DFT-S	QPSK	24.4	24.56
50		DFT-S	16QAM	22.56	22.74
50		DFT-S	64QAM	20.77	20.86
100		DFT-S	BPSK	24.78	24.46
100		DFT-S	QPSK	24.21	24.52
100		DFT-S	16QAM	22.55	22.95
100		DFT-S	64QAM	20.42	20.65
200		DFT-S	BPSK	17.79	20.56
200		DFT-S	QPSK	17.17	20.8
200		DFT-S	16QAM	17.12	19.96
200		DFT-S	64QAM	16.93	17.57





NR Band n258B Module 2 AG0 (Beam ID: 42)					
Maximum Average EIRP [dBm]					
Highest	BW [MHz]	Waveform	Modulation	Inner 1RB	Inner Full
	50	DFT-S	BPSK	23.69	24.28
	50	DFT-S	QPSK	24.02	24.32
	50	DFT-S	16QAM	22.6	22.87
	50	DFT-S	64QAM	19.51	20.62
	100	DFT-S	BPSK	23.35	23.74
	100	DFT-S	QPSK	23.49	23.68
	100	DFT-S	16QAM	22.47	22.18
	100	DFT-S	64QAM	19.14	20.2
	200	DFT-S	BPSK	17.37	20.48
	200	DFT-S	QPSK	16.66	20.46
	200	DFT-S	16QAM	16.91	19.69
	200	DFT-S	64QAM	15.67	17.65

Note: The 200MHz Bw is carrier aggregation by 2CC of 100MHz.



NR Band n258B Module 2 AG1 (Beam ID: 160)					
Maximum Average EIRP [dBm]					
	BW [MHz]	Waveform	Modulation	Inner 1RB	Inner Full
<b>Lowest</b>	50	DFT-S	BPSK	23.69	24.28
	50	DFT-S	QPSK	24.02	24.32
	50	DFT-S	16QAM	22.6	22.87
	50	DFT-S	64QAM	19.51	20.62
	100	DFT-S	BPSK	23.35	23.74
	100	DFT-S	QPSK	23.49	23.68
	100	DFT-S	16QAM	22.47	22.18
	100	DFT-S	64QAM	19.14	20.2
	200	DFT-S	BPSK	17.37	20.48
	200	DFT-S	QPSK	16.66	20.46
	200	DFT-S	16QAM	16.91	19.69
	200	DFT-S	64QAM	15.67	17.65
	<b>Middle</b>	50	DFT-S	BPSK	25.53
50		DFT-S	QPSK	25.37	25.34
50		DFT-S	16QAM	23.58	23.71
50		DFT-S	64QAM	21.63	21.77
100		DFT-S	BPSK	25.36	25.21
100		DFT-S	QPSK	25.15	25.09
100		DFT-S	16QAM	23.95	23.6
100		DFT-S	64QAM	21.1	21.52
200		DFT-S	BPSK	18.14	21.48
200		DFT-S	QPSK	18.12	21.46
200		DFT-S	16QAM	18.44	20.7
200		DFT-S	64QAM	17.67	18.53



NR Band n258B Module 2 AG1 (Beam ID: 160)					
Maximum Average EIRP [dBm]					
Highest	BW [MHz]	Waveform	Modulation	Inner 1RB	Inner Full
	50	DFT-S	BPSK	25.68	25.38
	50	DFT-S	QPSK	25.36	25.27
	50	DFT-S	16QAM	23.35	23.95
	50	DFT-S	64QAM	20.91	21.81
	100	DFT-S	BPSK	25.07	24.71
	100	DFT-S	QPSK	24.6	24.76
	100	DFT-S	16QAM	22.32	23.1
	100	DFT-S	64QAM	19.9	21.07
	200	DFT-S	BPSK	18.44	21.37
	200	DFT-S	QPSK	18.15	21.25
	200	DFT-S	16QAM	17.49	20.52
	200	DFT-S	64QAM	17.16	18.37

Note: The 200MHz Bw is carrier aggregation by 2CC of 100MHz.



NR Band n258B Module 2 AG0+1 (Beam ID:42+170)					
Maximum Average EIRP [dBm]					
Lowest	BW [MHz]	Waveform	Modulation	Inner 1RB	Inner Full
	50	DFT-S	BPSK	24.96	24.98
	50	DFT-S	QPSK	24.69	25.13
	50	DFT-S	16QAM	22.85	23.26
	50	DFT-S	64QAM	20.97	21.32
	100	DFT-S	BPSK	25.02	25.2
	100	DFT-S	QPSK	25.15	25.13
	100	DFT-S	16QAM	23.06	23.47
	100	DFT-S	64QAM	20.98	21.52
	200	DFT-S	BPSK	18.69	21.9
	200	DFT-S	QPSK	18.44	21.72
	200	DFT-S	16QAM	18.11	21.06
	200	DFT-S	64QAM	18.14	18.98
	Middle	BW [MHz]	Waveform	Modulation	Inner 1RB
50		DFT-S	BPSK	<b>25.73</b>	25.69
50		DFT-S	QPSK	25.51	25.54
50		DFT-S	16QAM	23.55	24.02
50		DFT-S	64QAM	21.7	21.99
100		DFT-S	BPSK	25.62	25.5
100		DFT-S	QPSK	25.44	25.6
100		DFT-S	16QAM	23.42	24.07
100		DFT-S	64QAM	21.45	21.92
200		DFT-S	BPSK	18.64	21.77
200		DFT-S	QPSK	18.46	21.96
200		DFT-S	16QAM	18.13	21.13
200		DFT-S	64QAM	18.27	18.92



NR Band n258B Module 2 AG0+1 (Beam ID:42+170)					
Maximum Average EIRP [dBm]					
Highest	BW [MHz]	Waveform	Modulation	Inner 1RB	Inner Full
	50	DFT-S	BPSK	25.45	25.64
	50	DFT-S	QPSK	25.55	25.61
	50	DFT-S	16QAM	23.97	24.13
	50	DFT-S	64QAM	21.26	22.06
	100	DFT-S	BPSK	25.25	25.36
	100	DFT-S	QPSK	25.14	25.52
	100	DFT-S	16QAM	23.71	23.78
	100	DFT-S	64QAM	21.26	21.8
	200	DFT-S	BPSK	18.84	22.02
	200	DFT-S	QPSK	18.75	22.12
	200	DFT-S	16QAM	18.77	21.45
	200	DFT-S	64QAM	18.13	19.21

Note: The 200MHz Bw is carrier aggregation by 2CC of 100MHz.

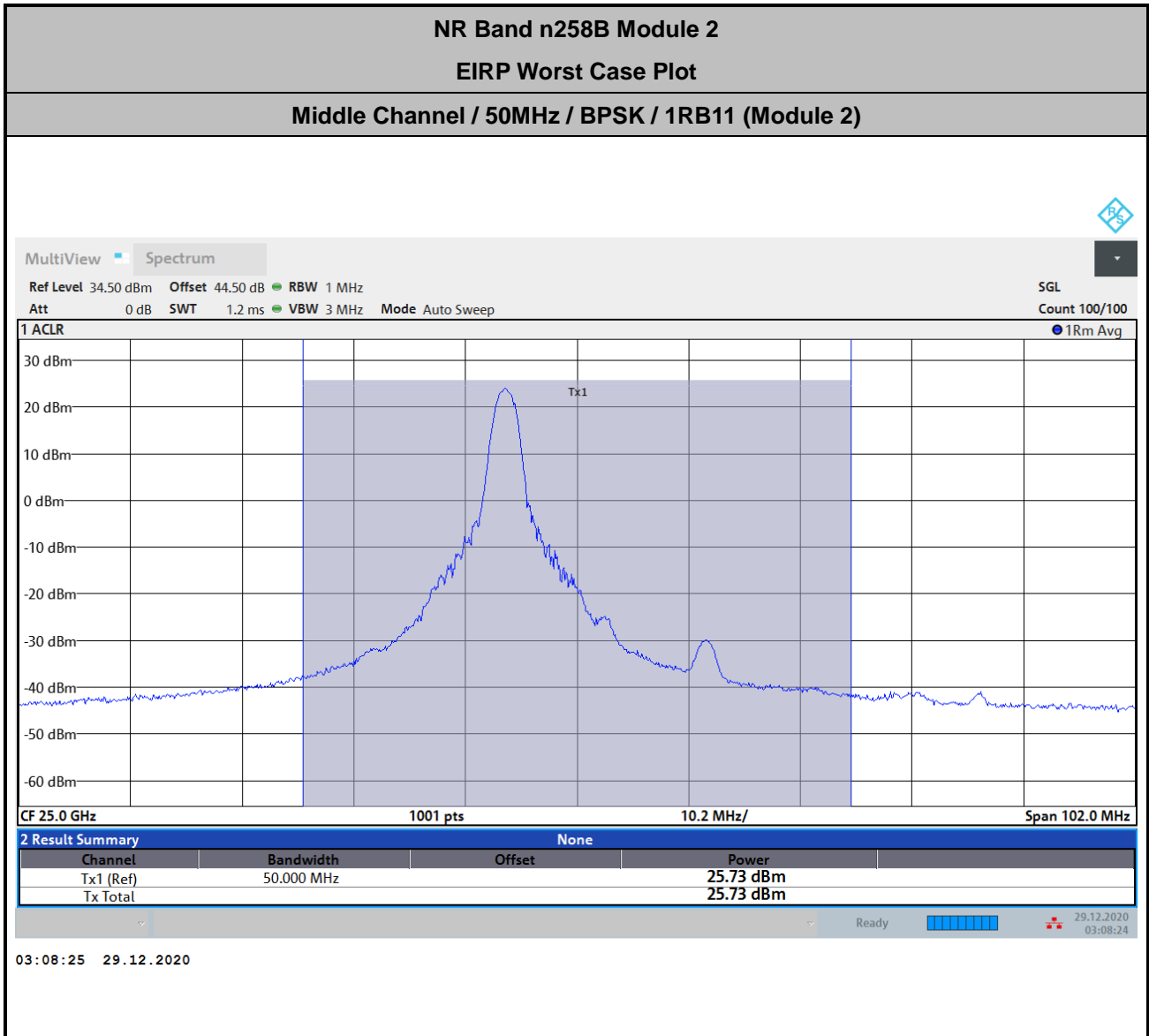

Note:  $Offset = Antenna\ Factor\ (dB/m) + Cable\ Loss\ (dB) + 107 + 20\log(D) - 104.8$   
 $= 40.5 + 1.8 + 107 + 20\log(1) - 104.8 = 44.5\ (dB)$



NR Band n260 Module 0

NR Band n260 Module 0 AG0 (Beam ID: 24)					
Maximum Average EIRP [dBm]					
	BW [MHz]	Waveform	Modulation	Inner 1RB	Inner Full
Lowest	50	DFT-S	BPSK	20.1	20.72
	50	DFT-S	QPSK	20.54	20.77
	50	DFT-S	16QAM	18.2	18.46
	50	DFT-S	64QAM	16.04	16.11
	100	DFT-S	BPSK	19	19.26
	100	DFT-S	QPSK	19.27	19.32
	100	DFT-S	16QAM	16.94	17.24
	100	DFT-S	64QAM	14.92	14.7
	200	DFT-S	BPSK	16.03	18.4
	200	DFT-S	QPSK	15.75	18.47
	200	DFT-S	16QAM	15.77	17.38
	200	DFT-S	64QAM	16.87	15.93
	Middle	50	DFT-S	BPSK	20.94
50		DFT-S	QPSK	21.55	21.38
50		DFT-S	16QAM	19.31	19.13
50		DFT-S	64QAM	16.39	17.32
100		DFT-S	BPSK	20.77	20.94
100		DFT-S	QPSK	21.36	21.24
100		DFT-S	16QAM	19.14	19.06
100		DFT-S	64QAM	16.28	17.11
200		DFT-S	BPSK	15.75	19.49
200		DFT-S	QPSK	15.66	19.79
200		DFT-S	16QAM	16	18.71
200		DFT-S	64QAM	16.59	16.08



NR Band n260 Module 0 AG0 (Beam ID: 24)					
Maximum Average EIRP [dBm]					
Highest	BW [MHz]	Waveform	Modulation	Inner 1RB	Inner Full
	50	DFT-S	BPSK	19.8	20.19
	50	DFT-S	QPSK	19.95	20.16
	50	DFT-S	16QAM	17.98	18.16
	50	DFT-S	64QAM	15.77	15.76
	100	DFT-S	BPSK	18.7	18.96
	100	DFT-S	QPSK	18.84	19.36
	100	DFT-S	16QAM	16.95	17.06
	100	DFT-S	64QAM	14.9	14.82
	200	DFT-S	BPSK	13.95	17.12
	200	DFT-S	QPSK	13.46	17.28
	200	DFT-S	16QAM	13.77	16.07
	200	DFT-S	64QAM	14.87	14.16

Note: The 200MHz Bw is carrier aggregation by 2CC of 100MHz.





NR Band n260 Module 0 AG1 (Beam ID: 165)					
Maximum Average EIRP [dBm]					
Lowest	BW [MHz]	Waveform	Modulation	Inner 1RB	Inner Full
	50	DFT-S	BPSK	21.57	21.89
	50	DFT-S	QPSK	21.73	21.74
	50	DFT-S	16QAM	19.37	19.78
	50	DFT-S	64QAM	17.39	17.03
	100	DFT-S	BPSK	20.03	20.27
	100	DFT-S	QPSK	20.21	20.11
	100	DFT-S	16QAM	17.64	18.08
	100	DFT-S	64QAM	15.83	15.65
	200	DFT-S	BPSK	15.77	18.41
	200	DFT-S	QPSK	15.42	18.39
	200	DFT-S	16QAM	15.51	17.34
	200	DFT-S	64QAM	16.38	15.98
	Middle	BW [MHz]	Waveform	Modulation	Inner 1RB
50		DFT-S	BPSK	22.54	22.42
50		DFT-S	QPSK	22.72	22.4
50		DFT-S	16QAM	19.96	20.4
50		DFT-S	64QAM	17.68	18.17
100		DFT-S	BPSK	20.95	21.28
100		DFT-S	QPSK	21.48	21.26
100		DFT-S	16QAM	18.72	19.33
100		DFT-S	64QAM	16.33	17.44
200		DFT-S	BPSK	14.59	19.14
200		DFT-S	QPSK	15	19.32
200		DFT-S	16QAM	15.4	18.2
200		DFT-S	64QAM	15.65	15.71



NR Band n260 Module 0 AG1 (Beam ID: 165)					
Maximum Average EIRP [dBm]					
Highest	BW [MHz]	Waveform	Modulation	Inner 1RB	Inner Full
	50	DFT-S	BPSK	23.38	23.5
	50	DFT-S	QPSK	23.47	23.48
	50	DFT-S	16QAM	21.3	21.49
	50	DFT-S	64QAM	18.79	18.86
	100	DFT-S	BPSK	19.87	20.45
	100	DFT-S	QPSK	19.01	19.78
	100	DFT-S	16QAM	16.69	17.96
	100	DFT-S	64QAM	14.43	15.26
	200	DFT-S	BPSK	16.42	19.63
	200	DFT-S	QPSK	16.14	19.62
	200	DFT-S	16QAM	16.19	18.64
	200	DFT-S	64QAM	17.18	16.76

Note: The 200MHz Bw is carrier aggregation by 2CC of 100MHz.



NR Band n260 Module 0 AG0+1 (Beam ID: 24+152)					
Maximum Average EIRP [dBm]					
Lowest	BW [MHz]	Waveform	Modulation	Inner 1RB	Inner Full
	50	DFT-S	BPSK	23.6	24.07
	50	DFT-S	QPSK	23.98	24.02
	50	DFT-S	16QAM	21.82	21.94
	50	DFT-S	64QAM	18.9	19.53
	100	DFT-S	BPSK	22.2	22.67
	100	DFT-S	QPSK	22.49	22.63
	100	DFT-S	16QAM	19.96	20.38
	100	DFT-S	64QAM	17.61	18.2
	200	DFT-S	BPSK	17.8	20.2
	200	DFT-S	QPSK	17.75	20.19
	200	DFT-S	16QAM	17.98	19.45
	200	DFT-S	64QAM	18.16	17.45
	Middle	BW [MHz]	Waveform	Modulation	Inner 1RB
50		DFT-S	BPSK	27.09	27.27
50		DFT-S	QPSK	27.17	<b>27.35</b>
50		DFT-S	16QAM	25.46	25.16
50		DFT-S	64QAM	22.82	23.21
100		DFT-S	BPSK	26.65	26.84
100		DFT-S	QPSK	26.99	26.81
100		DFT-S	16QAM	25.05	24.65
100		DFT-S	64QAM	22.34	22.82
200		DFT-S	BPSK	19.17	22.42
200		DFT-S	QPSK	19.23	22.96
200		DFT-S	16QAM	19.99	22.15
200		DFT-S	64QAM	19.95	19.43



NR Band n260 Module 0 AG0+1 (Beam ID: 24+152)					
Maximum Average EIRP [dBm]					
Highest	BW [MHz]	Waveform	Modulation	Inner 1RB	Inner Full
	50	DFT-S	BPSK	23.33	23.2
	50	DFT-S	QPSK	23.11	23.32
	50	DFT-S	16QAM	20.55	21.35
	50	DFT-S	64QAM	18.85	19.01
	100	DFT-S	BPSK	22.46	22.71
	100	DFT-S	QPSK	22.41	22.55
	100	DFT-S	16QAM	19.62	20.49
	100	DFT-S	64QAM	18.22	18.58
	200	DFT-S	BPSK	16.26	19.48
	200	DFT-S	QPSK	16.32	19.38
	200	DFT-S	16QAM	16.06	18.52
	200	DFT-S	64QAM	17.13	16.3

Note: The 200MHz Bw is carrier aggregation by 2CC of 100MHz.

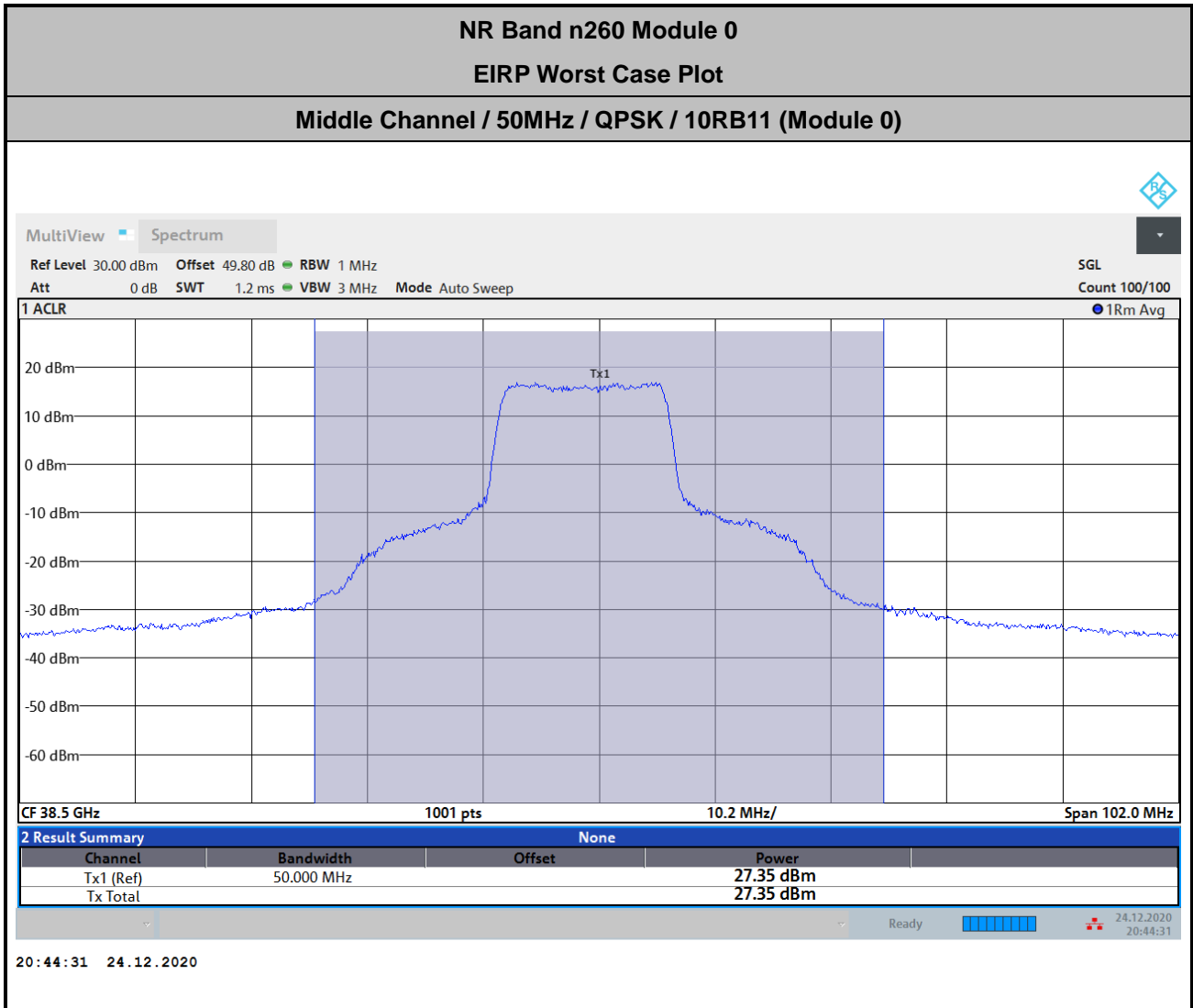

Note:  $Offset = Antenna\ Factor\ (dB/m) + Cable\ Loss\ (dB) + 107 + 20\log(D) - 104.8$   
 $= 45.1 + 2.5 + 107 + 20\log(1) - 104.8 = 49.8\ (dB)$



NR Band n260 Module 1

NR Band n260 Module 1 AG0 (Beam ID:29 )					
Maximum Average EIRP [dBm]					
	BW [MHz]	Waveform	Modulation	Inner 1RB	Inner Full
Lowest	50	DFT-S	BPSK	18.22	18.36
	50	DFT-S	QPSK	18.51	18.34
	50	DFT-S	16QAM	16.24	16.17
	50	DFT-S	64QAM	13.8	13.85
	100	DFT-S	BPSK	17.35	17.5
	100	DFT-S	QPSK	17.54	17.53
	100	DFT-S	16QAM	15.35	15.31
	100	DFT-S	64QAM	13.07	12.93
	200	DFT-S	BPSK	10.08	13.6
	200	DFT-S	QPSK	10.21	13.36
	200	DFT-S	16QAM	10.66	12.21
	200	DFT-S	64QAM	10.59	10.74
	Middle	50	DFT-S	BPSK	19.65
50		DFT-S	QPSK	20.34	20.14
50		DFT-S	16QAM	17.66	17.86
50		DFT-S	64QAM	15.32	15.75
100		DFT-S	BPSK	19.05	19.46
100		DFT-S	QPSK	19.66	19.48
100		DFT-S	16QAM	17.31	17.34
100		DFT-S	64QAM	14.86	15.53
200		DFT-S	BPSK	12.32	16.35
200		DFT-S	QPSK	12.42	16.32
200		DFT-S	16QAM	13.52	15.49
200		DFT-S	64QAM	13.02	12.64



NR Band n260 Module 1 AG0 (Beam ID:29 )					
Maximum Average EIRP [dBm]					
Highest	BW [MHz]	Waveform	Modulation	Inner 1RB	Inner Full
	50	DFT-S	BPSK	18.88	19.26
	50	DFT-S	QPSK	18.94	19.2
	50	DFT-S	16QAM	17.1	17.12
	50	DFT-S	64QAM	14.51	14.95
	100	DFT-S	BPSK	18.77	19.24
	100	DFT-S	QPSK	19.12	19.3
	100	DFT-S	16QAM	17.01	17.05
	100	DFT-S	64QAM	14.8	14.89
	200	DFT-S	BPSK	10.7	14.2
	200	DFT-S	QPSK	10.99	14.27
	200	DFT-S	16QAM	11.61	13.31
	200	DFT-S	64QAM	11.47	11.37

Note: The 200MHz Bw is carrier aggregation by 2CC of 100MHz.



NR Band n260 Module 1 AG1 (Beam ID:156 )					
Maximum Average EIRP [dBm]					
Lowest	BW [MHz]	Waveform	Modulation	Inner 1RB	Inner Full
	50	DFT-S	BPSK	20.28	20.39
	50	DFT-S	QPSK	20.32	20.34
	50	DFT-S	16QAM	18.06	18.2
	50	DFT-S	64QAM	15.42	15.71
	100	DFT-S	BPSK	20.21	20.08
	100	DFT-S	QPSK	20.41	20.26
	100	DFT-S	16QAM	17.99	18.06
	100	DFT-S	64QAM	15.55	15.76
	200	DFT-S	BPSK	11.95	14.75
	200	DFT-S	QPSK	11.94	14.76
	200	DFT-S	16QAM	12.48	13.82
	200	DFT-S	64QAM	12.35	12.5
	Middle	BW [MHz]	Waveform	Modulation	Inner 1RB
50		DFT-S	BPSK	22.04	22.27
50		DFT-S	QPSK	22.77	22.21
50		DFT-S	16QAM	20.12	20.19
50		DFT-S	64QAM	17.96	17.99
100		DFT-S	BPSK	20.89	21.3
100		DFT-S	QPSK	21.63	21.38
100		DFT-S	16QAM	18.94	19.37
100		DFT-S	64QAM	16.91	17.2
200		DFT-S	BPSK	14.66	18.45
200		DFT-S	QPSK	14.68	18.27
200		DFT-S	16QAM	14.16	17.47
200		DFT-S	64QAM	14.62	14.63





NR Band n260 Module 1 AG1 (Beam ID:156 )					
Maximum Average EIRP [dBm]					
Highest	BW [MHz]	Waveform	Modulation	Inner 1RB	Inner Full
	50	DFT-S	BPSK	18.71	18.92
	50	DFT-S	QPSK	18.74	18.91
	50	DFT-S	16QAM	16.46	16.83
	50	DFT-S	64QAM	14.3	14.48
	100	DFT-S	BPSK	17.11	17.57
	100	DFT-S	QPSK	17.46	17.58
	100	DFT-S	16QAM	15.28	15.42
	100	DFT-S	64QAM	13.39	13.1
	200	DFT-S	BPSK	10.68	14.15
	200	DFT-S	QPSK	10.61	14.35
	200	DFT-S	16QAM	11.19	13.31
	200	DFT-S	64QAM	9.92	11.39

Note: The 200MHz Bw is carrier aggregation by 2CC of 100MHz.



NR Band n260 Module 1 AG0+1 (Beam ID:28+156)					
Maximum Average EIRP [dBm]					
Lowest	BW [MHz]	Waveform	Modulation	Inner 1RB	Inner Full
	50	DFT-S	BPSK	24.72	24.97
	50	DFT-S	QPSK	25.04	24.87
	50	DFT-S	16QAM	22.05	22.91
	50	DFT-S	64QAM	20.07	20.56
	100	DFT-S	BPSK	23.97	24.3
	100	DFT-S	QPSK	24.15	24.28
	100	DFT-S	16QAM	21.27	22.11
	100	DFT-S	64QAM	19.5	19.92
	200	DFT-S	BPSK	17.76	20.53
	200	DFT-S	QPSK	17.37	20.73
	200	DFT-S	16QAM	17.75	19.85
	200	DFT-S	64QAM	18.34	18.07
	Middle	BW [MHz]	Waveform	Modulation	Inner 1RB
50		DFT-S	BPSK	24.88	25
50		DFT-S	QPSK	<b>25.17</b>	24.96
50		DFT-S	16QAM	23.01	22.87
50		DFT-S	64QAM	19.72	20.74
100		DFT-S	BPSK	24.19	24.43
100		DFT-S	QPSK	24.71	24.59
100		DFT-S	16QAM	22.67	22.48
100		DFT-S	64QAM	19.48	20.46
200		DFT-S	BPSK	16.98	20.6
200		DFT-S	QPSK	16.92	20.7
200		DFT-S	16QAM	17.29	19.86
200		DFT-S	64QAM	17.23	16.9



NR Band n260 Module 1 AG0+1 (Beam ID:28+156)					
Maximum Average EIRP [dBm]					
Highest	BW [MHz]	Waveform	Modulation	Inner 1RB	Inner Full
	50	DFT-S	BPSK	19.6	19.66
	50	DFT-S	QPSK	19.29	19.56
	50	DFT-S	16QAM	17.33	17.35
	50	DFT-S	64QAM	15.24	15.2
	100	DFT-S	BPSK	18.06	18.31
	100	DFT-S	QPSK	17.64	18.2
	100	DFT-S	16QAM	15.74	16.14
	100	DFT-S	64QAM	14.15	14.23
	200	DFT-S	BPSK	10.68	13.97
	200	DFT-S	QPSK	10.08	13.67
	200	DFT-S	16QAM	10.42	13
	200	DFT-S	64QAM	11.47	10.95

Note: The 200MHz Bw is carrier aggregation by 2CC of 100MHz.

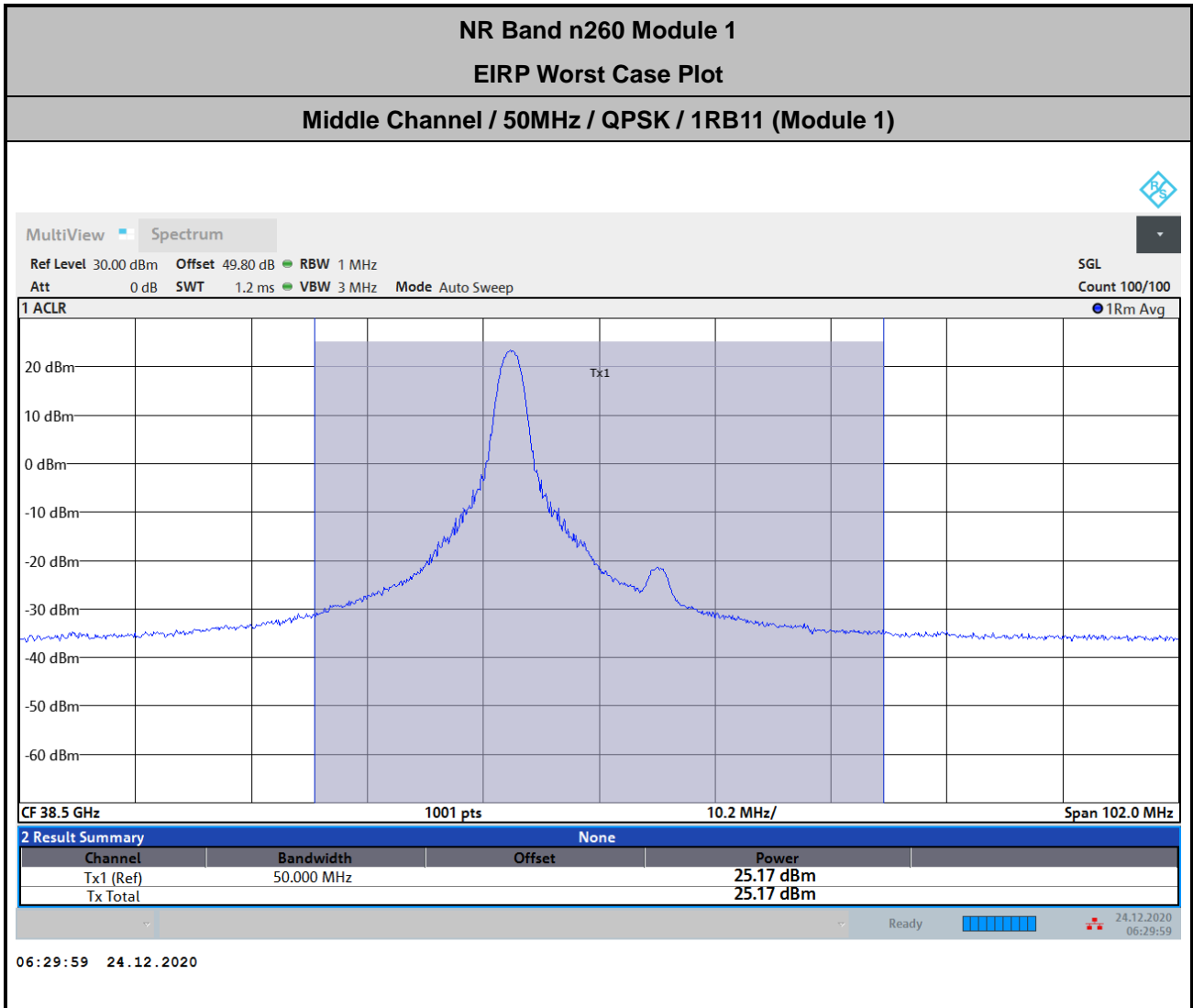

Note:  $Offset = Antenna\ Factor\ (dB/m) + Cable\ Loss\ (dB) + 107 + 20\log(D) - 104.8$   
 $= 45.1 + 2.5 + 107 + 20\log(1) - 104.8 = 49.8\ (dB)$



NR Band n260 Module 2

NR Band n260 Module 2 AG0 (Beam ID: 33)					
Maximum Average EIRP [dBm]					
	BW [MHz]	Waveform	Modulation	Inner 1RB	Inner Full
Lowest	50	DFT-S	BPSK	23.27	23.19
	50	DFT-S	QPSK	23.44	23.14
	50	DFT-S	16QAM	21.21	21.13
	50	DFT-S	64QAM	18.43	18.79
	100	DFT-S	BPSK	22.49	22.18
	100	DFT-S	QPSK	22.71	22.5
	100	DFT-S	16QAM	20.52	19.92
	100	DFT-S	64QAM	17.76	17.9
	200	DFT-S	BPSK	17.12	19.09
	200	DFT-S	QPSK	17.26	19.19
	200	DFT-S	16QAM	16.51	18.44
	200	DFT-S	64QAM	17.97	16.93
	Middle	50	DFT-S	BPSK	24.24
50		DFT-S	QPSK	24.35	24.15
50		DFT-S	16QAM	21.75	22
50		DFT-S	64QAM	20.33	20.1
100		DFT-S	BPSK	23.19	23.18
100		DFT-S	QPSK	23.29	23.12
100		DFT-S	16QAM	20.66	21.01
100		DFT-S	64QAM	19.11	19.1
200		DFT-S	BPSK	16.59	19.68
200		DFT-S	QPSK	16.1	19.55
200		DFT-S	16QAM	16.66	18.77
200		DFT-S	64QAM	16.07	16.09



NR Band n260 Module 2 AG0 (Beam ID: 33)					
Maximum Average EIRP [dBm]					
Highest	BW [MHz]	Waveform	Modulation	Inner 1RB	Inner Full
	50	DFT-S	BPSK	20.51	20.5
	50	DFT-S	QPSK	20.64	20.51
	50	DFT-S	16QAM	18.52	18.47
	50	DFT-S	64QAM	15.6	16.34
	100	DFT-S	BPSK	20.82	20.98
	100	DFT-S	QPSK	20.39	20.95
	100	DFT-S	16QAM	18.5	18.93
	100	DFT-S	64QAM	16.42	16.78
	200	DFT-S	BPSK	13.59	16.69
	200	DFT-S	QPSK	13.95	16.8
	200	DFT-S	16QAM	13.73	16.06
	200	DFT-S	64QAM	15.32	14.27

Note: The 200MHz Bw is carrier aggregation by 2CC of 100MHz.



NR Band n260 Module 2 AG1 (Beam ID: 161)					
Maximum Average EIRP [dBm]					
Lowest	BW [MHz]	Waveform	Modulation	Inner 1RB	Inner Full
	50	DFT-S	BPSK	23.27	23.19
	50	DFT-S	QPSK	23.44	23.14
	50	DFT-S	16QAM	21.21	21.13
	50	DFT-S	64QAM	18.43	18.79
	100	DFT-S	BPSK	22.49	22.18
	100	DFT-S	QPSK	22.71	22.5
	100	DFT-S	16QAM	20.52	19.92
	100	DFT-S	64QAM	17.76	17.9
	200	DFT-S	BPSK	17.12	19.09
	200	DFT-S	QPSK	17.26	19.19
	200	DFT-S	16QAM	16.51	18.44
	200	DFT-S	64QAM	17.97	16.93
	Middle	BW [MHz]	Waveform	Modulation	Inner 1RB
50		DFT-S	BPSK	24.92	24.89
50		DFT-S	QPSK	24.82	24.83
50		DFT-S	16QAM	23.12	22.51
50		DFT-S	64QAM	21.3	20.74
100		DFT-S	BPSK	24.38	24.17
100		DFT-S	QPSK	24.22	24.09
100		DFT-S	16QAM	22.43	21.93
100		DFT-S	64QAM	20.42	19.9
200		DFT-S	BPSK	16.55	20.5
200		DFT-S	QPSK	16.91	20.48
200		DFT-S	16QAM	16.57	19.68
200		DFT-S	64QAM	17.23	17.12



NR Band n260 Module 2 AG1 (Beam ID: 161)					
Maximum Average EIRP [dBm]					
Highest	BW [MHz]	Waveform	Modulation	Inner 1RB	Inner Full
	50	DFT-S	BPSK	24.14	24.19
	50	DFT-S	QPSK	24.02	24.23
	50	DFT-S	16QAM	22.33	22.04
	50	DFT-S	64QAM	20.14	20.1
	100	DFT-S	BPSK	22.02	22.38
	100	DFT-S	QPSK	21.85	22.31
	100	DFT-S	16QAM	20.08	20.31
	100	DFT-S	64QAM	17.95	18.17
	200	DFT-S	BPSK	14.68	18.14
	200	DFT-S	QPSK	15.18	18.04
	200	DFT-S	16QAM	14.34	17.12
	200	DFT-S	64QAM	16.53	15.44

Note: The 200MHz Bw is carrier aggregation by 2CC of 100MHz.





NR Band n260 Module 2 AG0+1 (Beam ID:33+161)					
Maximum Average EIRP [dBm]					
Lowest	BW [MHz]	Waveform	Modulation	Inner 1RB	Inner Full
	50	DFT-S	BPSK	23.27	23.19
	50	DFT-S	QPSK	23.44	23.14
	50	DFT-S	16QAM	21.21	21.13
	50	DFT-S	64QAM	18.43	18.79
	100	DFT-S	BPSK	22.49	22.18
	100	DFT-S	QPSK	22.71	22.5
	100	DFT-S	16QAM	20.52	19.92
	100	DFT-S	64QAM	17.76	17.9
	200	DFT-S	BPSK	17.12	19.09
	200	DFT-S	QPSK	17.26	19.19
	200	DFT-S	16QAM	16.51	18.44
	200	DFT-S	64QAM	17.97	16.93
	Middle	BW [MHz]	Waveform	Modulation	Inner 1RB
50		DFT-S	BPSK	25.26	25.52
50		DFT-S	QPSK	<b>26.01</b>	25.59
50		DFT-S	16QAM	23.31	23.48
50		DFT-S	64QAM	21.63	21.6
100		DFT-S	BPSK	24.93	25.16
100		DFT-S	QPSK	24.58	25.1
100		DFT-S	16QAM	23.04	23.03
100		DFT-S	64QAM	21.19	20.84
200		DFT-S	BPSK	17.78	21.27
200		DFT-S	QPSK	18.04	21.43
200		DFT-S	16QAM	18.26	20.76
200		DFT-S	64QAM	17.72	17.82



NR Band n260 Module 2 AG0+1 (Beam ID:33+161)					
Maximum Average EIRP [dBm]					
Highest	BW [MHz]	Waveform	Modulation	Inner 1RB	Inner Full
	50	DFT-S	BPSK	23.17	23.15
	50	DFT-S	QPSK	23.24	23.4
	50	DFT-S	16QAM	21.23	21.1
	50	DFT-S	64QAM	18.93	19.22
	100	DFT-S	BPSK	23.35	23.66
	100	DFT-S	QPSK	23.34	23.77
	100	DFT-S	16QAM	21.21	21.77
	100	DFT-S	64QAM	19.27	19.61
	200	DFT-S	BPSK	16.53	19.39
	200	DFT-S	QPSK	16.73	19.53
	200	DFT-S	16QAM	16.93	18.89
	200	DFT-S	64QAM	17.35	16.89

Note: The 200MHz Bw is carrier aggregation by 2CC of 100MHz.

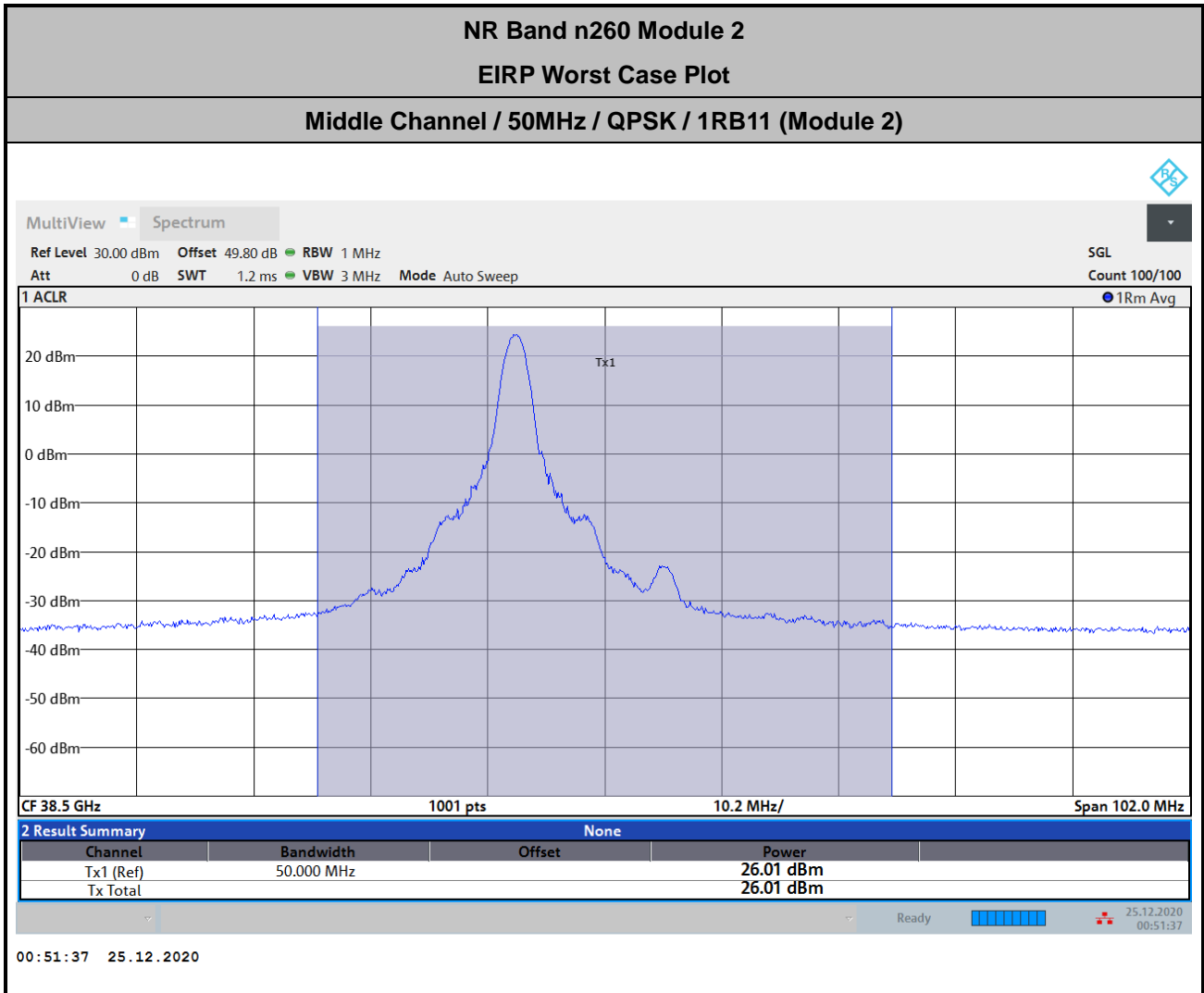

Note:  $Offset = Antenna\ Factor\ (dB/m) + Cable\ Loss\ (dB) + 107 + 20\log(D) - 104.8$   
 $= 45.1 + 2.5 + 107 + 20\log(1) - 104.8 = 49.8\ (dB)$



NR Band n261 Module 0

NR Band n261 Module 0 AG0 (Beam ID: 23)					
Maximum Average EIRP [dBm]					
Lowest	BW [MHz]	Waveform	Modulation	Inner 1RB	Inner Full
	50	DFT-S	BPSK	22.94	23.16
	50	DFT-S	QPSK	22.52	23.18
	50	DFT-S	16QAM	20.45	20.92
	50	DFT-S	64QAM	19.24	18.89
	100	DFT-S	BPSK	23.39	23.51
	100	DFT-S	QPSK	23	23.44
	100	DFT-S	16QAM	20.83	21.28
	100	DFT-S	64QAM	19.71	19.19
	200	DFT-S	BPSK	17.95	20.3
	200	DFT-S	QPSK	17.92	20.28
	200	DFT-S	16QAM	17.84	19.55
	200	DFT-S	64QAM	18.77	17.94
	Middle	BW [MHz]	Waveform	Modulation	Inner 1RB
50		DFT-S	BPSK	20.05	22.35
50		DFT-S	QPSK	20.78	22.33
50		DFT-S	16QAM	19.43	20.19
50		DFT-S	64QAM	17.72	18.1
100		DFT-S	BPSK	20.12	21.43
100		DFT-S	QPSK	21.13	21.39
100		DFT-S	16QAM	19.61	19.21
100		DFT-S	64QAM	17.95	17.29
200		DFT-S	BPSK	17.41	20.26
200		DFT-S	QPSK	17.38	20.25
200		DFT-S	16QAM	17.23	19.41
200		DFT-S	64QAM	17.59	17.84



NR Band n261 Module 0 AG0 (Beam ID: 23)					
Maximum Average EIRP [dBm]					
Highest	BW [MHz]	Waveform	Modulation	Inner 1RB	Inner Full
	50	DFT-S	BPSK	22.29	22.39
	50	DFT-S	QPSK	22.16	22.33
	50	DFT-S	16QAM	20.31	20.06
	50	DFT-S	64QAM	18.42	17.84
	100	DFT-S	BPSK	22.84	22.79
	100	DFT-S	QPSK	22.67	22.83
	100	DFT-S	16QAM	20.66	20.45
	100	DFT-S	64QAM	18.84	18.71
	200	DFT-S	BPSK	16.88	19.73
	200	DFT-S	QPSK	17.03	19.64
	200	DFT-S	16QAM	16.87	18.89
	200	DFT-S	64QAM	17.25	17.31

Note: The 200MHz Bw is carrier aggregation by 2CC of 100MHz.



NR Band n261 Module 0 AG1 (Beam ID: 165)					
Maximum Average EIRP [dBm]					
Lowest	BW [MHz]	Waveform	Modulation	Inner 1RB	Inner Full
	50	DFT-S	BPSK	23.33	23.07
	50	DFT-S	QPSK	22.6	23.17
	50	DFT-S	16QAM	20.8	21.13
	50	DFT-S	64QAM	19.12	18.91
	100	DFT-S	BPSK	23.38	23.42
	100	DFT-S	QPSK	22.97	23.36
	100	DFT-S	16QAM	21.34	21.25
	100	DFT-S	64QAM	19.69	18.99
	200	DFT-S	BPSK	18.34	20.83
	200	DFT-S	QPSK	18.31	20.85
	200	DFT-S	16QAM	18.06	20.23
	200	DFT-S	64QAM	19.5	18.64
	Middle	BW [MHz]	Waveform	Modulation	Inner 1RB
50		DFT-S	BPSK	22.45	22.48
50		DFT-S	QPSK	22.32	22.37
50		DFT-S	16QAM	20.29	20.42
50		DFT-S	64QAM	18.1	18.19
100		DFT-S	BPSK	22.38	21.96
100		DFT-S	QPSK	22.03	22.1
100		DFT-S	16QAM	19.89	19.94
100		DFT-S	64QAM	17.93	17.98
200		DFT-S	BPSK	17.95	20.8
200		DFT-S	QPSK	18.02	20.84
200		DFT-S	16QAM	18.11	20.02
200		DFT-S	64QAM	17.92	18.32



NR Band n261 Module 0 AG1 (Beam ID: 165)					
Maximum Average EIRP [dBm]					
Highest	BW [MHz]	Waveform	Modulation	Inner 1RB	Inner Full
	50	DFT-S	BPSK	22.72	22.73
	50	DFT-S	QPSK	22.97	22.71
	50	DFT-S	16QAM	20.64	20.66
	50	DFT-S	64QAM	18.32	18.5
	100	DFT-S	BPSK	22.6	22.55
	100	DFT-S	QPSK	22.44	22.62
	100	DFT-S	16QAM	20.65	20.35
	100	DFT-S	64QAM	18.67	18.51
	200	DFT-S	BPSK	16.76	19.19
	200	DFT-S	QPSK	16.71	19.16
	200	DFT-S	16QAM	16.88	18.32
	200	DFT-S	64QAM	16.85	16.72

Note: The 200MHz Bw is carrier aggregation by 2CC of 100MHz.



NR Band n261 Module 0 AG0+1 (Beam ID:37+165)					
Maximum Average EIRP [dBm]					
Lowest	BW [MHz]	Waveform	Modulation	Inner 1RB	Inner Full
	50	DFT-S	BPSK	25.27	25.21
	50	DFT-S	QPSK	25.24	25.19
	50	DFT-S	16QAM	22.73	22.97
	50	DFT-S	64QAM	21.07	21.04
	100	DFT-S	BPSK	25.28	25.03
	100	DFT-S	QPSK	25.24	25.09
	100	DFT-S	16QAM	22.64	22.96
	100	DFT-S	64QAM	21.26	20.85
	200	DFT-S	BPSK	18.4	21.19
	200	DFT-S	QPSK	18.65	21.21
	200	DFT-S	16QAM	18.7	20.49
	200	DFT-S	64QAM	19.39	18.7
	Middle	BW [MHz]	Waveform	Modulation	Inner 1RB
50		DFT-S	BPSK	24.53	24.83
50		DFT-S	QPSK	24.98	24.91
50		DFT-S	16QAM	23.17	22.82
50		DFT-S	64QAM	20.69	20.59
100		DFT-S	BPSK	24.74	25.2
100		DFT-S	QPSK	25.15	25.25
100		DFT-S	16QAM	23.1	23.19
100		DFT-S	64QAM	20.68	21.22
200		DFT-S	BPSK	19.21	21.47
200		DFT-S	QPSK	18.43	21.56
200		DFT-S	16QAM	18.36	20.74
200		DFT-S	64QAM	19.2	19.11





NR Band n261 Module 0 AG0+1 (Beam ID: 37+165)					
Maximum Average EIRP [dBm]					
Highest	BW [MHz]	Waveform	Modulation	Inner 1RB	Inner Full
	50	DFT-S	BPSK	25.03	25.37
	50	DFT-S	QPSK	<b>25.44</b>	25.26
	50	DFT-S	16QAM	23.72	23.22
	50	DFT-S	64QAM	21.18	20.95
	100	DFT-S	BPSK	25.21	25.16
	100	DFT-S	QPSK	25.31	25.19
	100	DFT-S	16QAM	23.55	23.15
	100	DFT-S	64QAM	21.15	21.18
	200	DFT-S	BPSK	18.31	20.62
	200	DFT-S	QPSK	17.64	20.77
	200	DFT-S	16QAM	17.41	19.89
	200	DFT-S	64QAM	18.25	18.33

Note: The 200MHz Bw is carrier aggregation by 2CC of 100MHz.

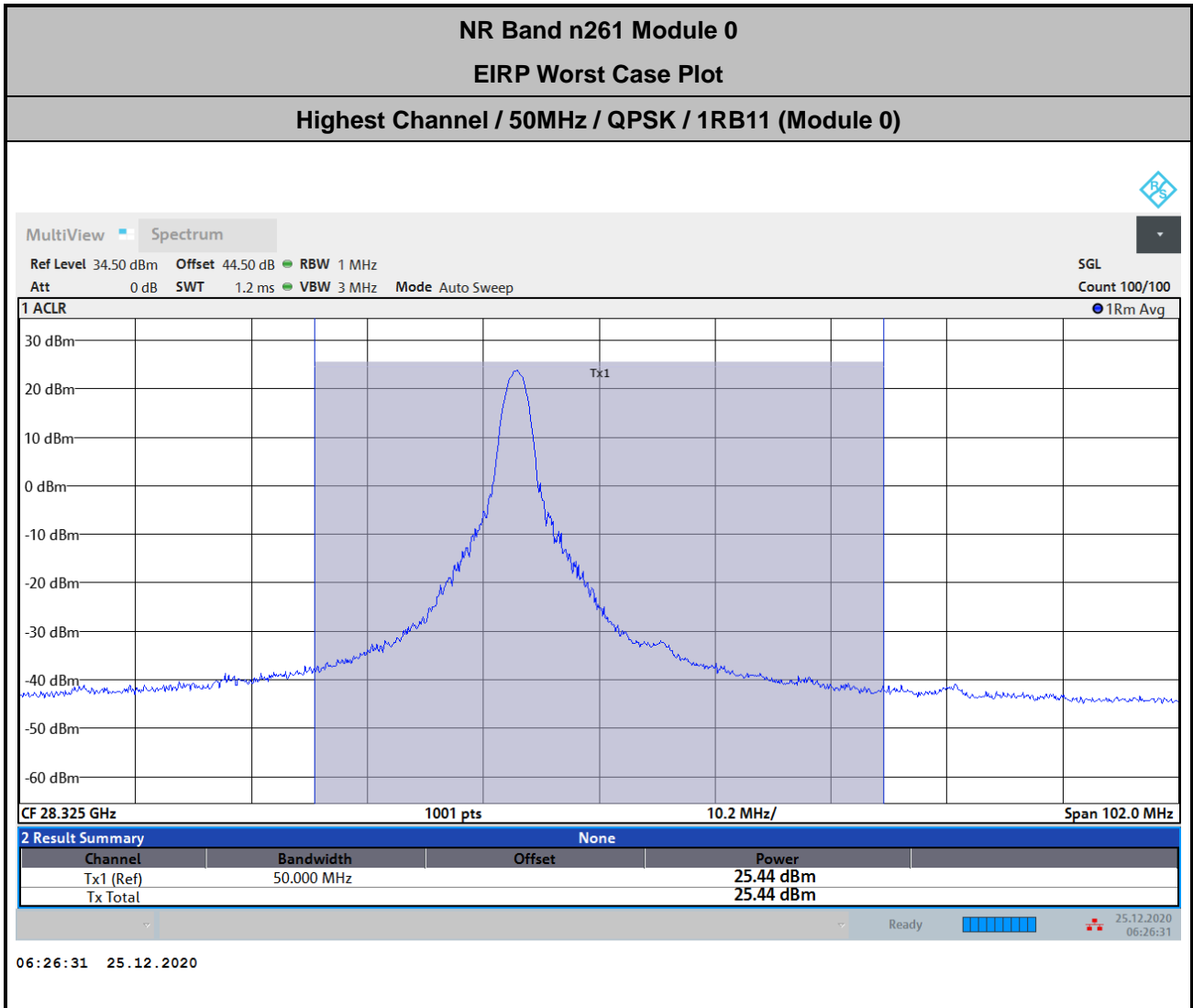

Note: Offset = Antenna Factor (dB/m) + Cable Loss (dB) + 107 + 20log(D) – 104.8  
 = 40.5 + 1.8 + 107 + 20log(1) – 104.8 = 44.5 (dB)



NR Band n261 Module 1

NR Band n261 Module 1 AG0 (Beam ID: 42)					
Maximum Average EIRP [dBm]					
Lowest	BW [MHz]	Waveform	Modulation	Inner 1RB	Inner Full
	50	DFT-S	BPSK	20.24	20.55
	50	DFT-S	QPSK	20.36	20.56
	50	DFT-S	16QAM	17.65	18.46
	50	DFT-S	64QAM	15.94	16.28
	100	DFT-S	BPSK	19.82	20.1
	100	DFT-S	QPSK	19.66	20.14
	100	DFT-S	16QAM	17.26	17.97
	100	DFT-S	64QAM	15.52	15.86
	200	DFT-S	BPSK	13.72	16.49
	200	DFT-S	QPSK	13.98	16.41
	200	DFT-S	16QAM	14.57	15.75
	200	DFT-S	64QAM	14.99	14.27
	Middle	BW [MHz]	Waveform	Modulation	Inner 1RB
50		DFT-S	BPSK	19.36	19.45
50		DFT-S	QPSK	19.72	19.42
50		DFT-S	16QAM	17.71	17.46
50		DFT-S	64QAM	15.35	15.02
100		DFT-S	BPSK	19.75	19.81
100		DFT-S	QPSK	20.28	19.89
100		DFT-S	16QAM	18.18	17.59
100		DFT-S	64QAM	15.86	15.99
200		DFT-S	BPSK	13.86	16.54
200		DFT-S	QPSK	13.21	16.45
200		DFT-S	16QAM	13.81	15.54
200		DFT-S	64QAM	13.74	14.06



NR Band n261 Module 1 AG0 (Beam ID: 42)					
Maximum Average EIRP [dBm]					
Highest	BW [MHz]	Waveform	Modulation	Inner 1RB	Inner Full
	50	DFT-S	BPSK	18.94	19.04
	50	DFT-S	QPSK	19.33	19.16
	50	DFT-S	16QAM	17.47	17.29
	50	DFT-S	64QAM	15.01	14.85
	100	DFT-S	BPSK	19.05	19.23
	100	DFT-S	QPSK	19.26	19.38
	100	DFT-S	16QAM	17.49	17.05
	100	DFT-S	64QAM	15.05	15.29
	200	DFT-S	BPSK	12.38	14.74
	200	DFT-S	QPSK	12.43	14.82
	200	DFT-S	16QAM	11.98	14.06
	200	DFT-S	64QAM	12.75	12.49

Note: The 200MHz Bw is carrier aggregation by 2CC of 100MHz.



NR Band n261 Module 1 AG1 (Beam ID: 170)					
Maximum Average EIRP [dBm]					
	BW [MHz]	Waveform	Modulation	Inner 1RB	Inner Full
<b>Lowest</b>	50	DFT-S	BPSK	20.21	20.09
	50	DFT-S	QPSK	20.23	20.15
	50	DFT-S	16QAM	17.66	18.05
	50	DFT-S	64QAM	15.81	15.9
	100	DFT-S	BPSK	19.73	19.3
	100	DFT-S	QPSK	19.87	19.23
	100	DFT-S	16QAM	17.4	17.08
	100	DFT-S	64QAM	15.28	15.05
	200	DFT-S	BPSK	12.72	15.57
	200	DFT-S	QPSK	13.39	15.52
	200	DFT-S	16QAM	13.21	14.59
	200	DFT-S	64QAM	13.74	13.22
	<b>Middle</b>	50	DFT-S	BPSK	19.46
50		DFT-S	QPSK	19.32	19.71
50		DFT-S	16QAM	17.88	17.4
50		DFT-S	64QAM	15.42	15.15
100		DFT-S	BPSK	19.78	19.59
100		DFT-S	QPSK	19.53	19.62
100		DFT-S	16QAM	17.94	17.31
100		DFT-S	64QAM	15.87	15.41
200		DFT-S	BPSK	13.64	16.18
200		DFT-S	QPSK	13.44	16.26
200		DFT-S	16QAM	13.25	15.11
200		DFT-S	64QAM	13.94	13.71



NR Band n261 Module 1 AG1 (Beam ID: 170)					
Maximum Average EIRP [dBm]					
Highest	BW [MHz]	Waveform	Modulation	Inner 1RB	Inner Full
	50	DFT-S	BPSK	19.65	19.55
	50	DFT-S	QPSK	19.77	19.53
	50	DFT-S	16QAM	17.21	17.42
	50	DFT-S	64QAM	15.36	15.02
	100	DFT-S	BPSK	19.11	19.14
	100	DFT-S	QPSK	19.5	19.29
	100	DFT-S	16QAM	16.91	17.16
	100	DFT-S	64QAM	15.06	15.01
	200	DFT-S	BPSK	12.13	14.66
	200	DFT-S	QPSK	12.04	14.71
	200	DFT-S	16QAM	12.15	14.05
	200	DFT-S	64QAM	12.46	12.34

Note: The 200MHz Bw is carrier aggregation by 2CC of 100MHz.



NR Band n261 Module 1 AG0+1 (Beam ID: 42+170)					
Maximum Average EIRP [dBm]					
Lowest	BW [MHz]	Waveform	Modulation	Inner 1RB	Inner Full
	50	DFT-S	BPSK	22.5	22.77
	50	DFT-S	QPSK	22.74	<b>22.88</b>
	50	DFT-S	16QAM	20.56	20.93
	50	DFT-S	64QAM	18.48	18.62
	100	DFT-S	BPSK	22.81	22.55
	100	DFT-S	QPSK	22.74	22.63
	100	DFT-S	16QAM	20.53	20.46
	100	DFT-S	64QAM	18.84	18.38
	200	DFT-S	BPSK	16.32	18.29
	200	DFT-S	QPSK	16.18	18.35
	200	DFT-S	16QAM	15.9	17.54
	200	DFT-S	64QAM	16.77	16.02
	Middle	BW [MHz]	Waveform	Modulation	Inner 1RB
50		DFT-S	BPSK	20.92	21.05
50		DFT-S	QPSK	20.78	21.06
50		DFT-S	16QAM	18.83	18.86
50		DFT-S	64QAM	16.56	16.83
100		DFT-S	BPSK	20.74	21.03
100		DFT-S	QPSK	20.56	20.88
100		DFT-S	16QAM	18.58	18.53
100		DFT-S	64QAM	16.68	16.99
200		DFT-S	BPSK	14.54	17.16
200		DFT-S	QPSK	14.3	17.04
200		DFT-S	16QAM	14.87	16.31
200		DFT-S	64QAM	14.77	14.67



NR Band n261 Module 1 AG0+1 (Beam ID: 42+170)					
Maximum Average EIRP [dBm]					
Highest	BW [MHz]	Waveform	Modulation	Inner 1RB	Inner Full
	50	DFT-S	BPSK	20.59	20.72
	50	DFT-S	QPSK	20.43	20.58
	50	DFT-S	16QAM	18.5	18.48
	50	DFT-S	64QAM	16.48	16.43
	100	DFT-S	BPSK	21.08	20.91
	100	DFT-S	QPSK	20.76	20.94
	100	DFT-S	16QAM	18.89	18.84
	100	DFT-S	64QAM	16.78	16.98
	200	DFT-S	BPSK	14.08	16.7
	200	DFT-S	QPSK	13.99	16.69
	200	DFT-S	16QAM	14.47	15.87
	200	DFT-S	64QAM	14.57	14.28

Note: The 200MHz Bw is carrier aggregation by 2CC of 100MHz.



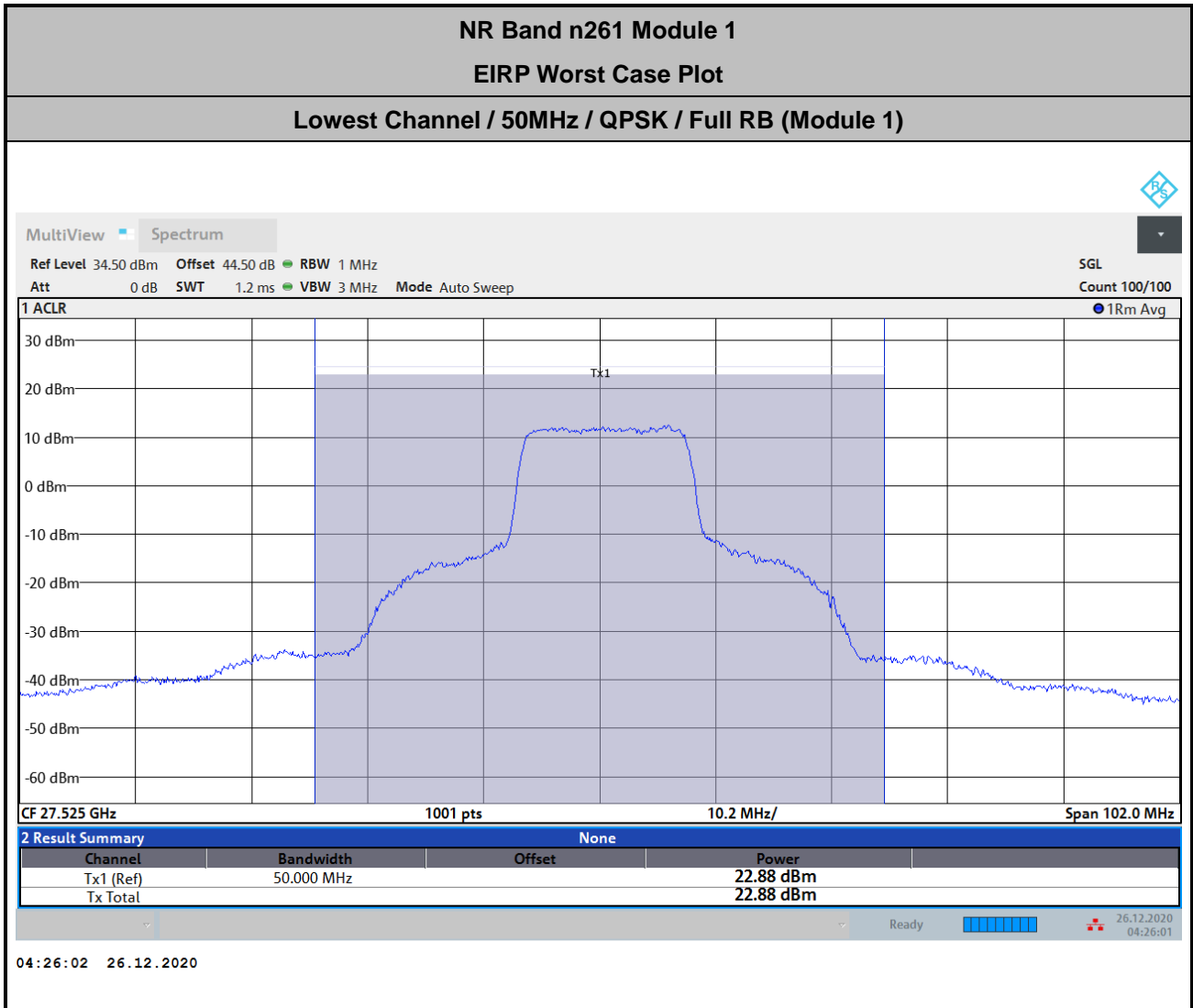

Note: Offset = Antenna Factor (dB/m) + Cable Loss (dB) + 107 + 20log(D) – 104.8  
 = 40.5 + 1.8 + 107 + 20log(1) – 104.8 = 44.5 (dB)



NR Band n261 Module 2

NR Band n261 Module 2 AG0 (Beam ID: 42)					
Maximum Average EIRP [dBm]					
Lowest	BW [MHz]	Waveform	Modulation	Inner 1RB	Inner Full
	50	DFT-S	BPSK	20.41	20.39
	50	DFT-S	QPSK	20.27	20.41
	50	DFT-S	16QAM	18.57	18.93
	50	DFT-S	64QAM	16.98	16.71
	100	DFT-S	BPSK	19.87	19.73
	100	DFT-S	QPSK	19.55	19.74
	100	DFT-S	16QAM	17.82	18.15
	100	DFT-S	64QAM	16.37	16.19
	200	DFT-S	BPSK	13.31	16.51
	200	DFT-S	QPSK	12.99	16.7
	200	DFT-S	16QAM	13.04	15.88
	200	DFT-S	64QAM	13.56	13.73
	Middle	BW [MHz]	Waveform	Modulation	Inner 1RB
50		DFT-S	BPSK	18.74	18.72
50		DFT-S	QPSK	20.06	19.99
50		DFT-S	16QAM	20.1	18.92
50		DFT-S	64QAM	17.28	16.94
100		DFT-S	BPSK	18.51	18.77
100		DFT-S	QPSK	19.71	19.94
100		DFT-S	16QAM	18.8	18.71
100		DFT-S	64QAM	16.81	16.75
200		DFT-S	BPSK	13.49	16.1
200		DFT-S	QPSK	13.5	16.11
200		DFT-S	16QAM	12.76	15.27
200		DFT-S	64QAM	13.98	13.32



NR Band n261 Module 2 AG0 (Beam ID: 42)					
Maximum Average EIRP [dBm]					
Highest	BW [MHz]	Waveform	Modulation	Inner 1RB	Inner Full
	50	DFT-S	BPSK	20.81	20.67
	50	DFT-S	QPSK	21.15	20.65
	50	DFT-S	16QAM	19.78	19.11
	50	DFT-S	64QAM	18.2	17.22
	100	DFT-S	BPSK	20.18	20.04
	100	DFT-S	QPSK	20.47	20.06
	100	DFT-S	16QAM	19.36	18.36
	100	DFT-S	64QAM	17.87	16.46
	200	DFT-S	BPSK	13.02	16.24
	200	DFT-S	QPSK	13.31	16.27
	200	DFT-S	16QAM	13.46	15.4
	200	DFT-S	64QAM	13.89	13.42

Note: The 200MHz Bw is carrier aggregation by 2CC of 100MHz.



NR Band n261 Module 2 AG1 (Beam ID: 170)					
Maximum Average EIRP [dBm]					
	BW [MHz]	Waveform	Modulation	Inner 1RB	Inner Full
<b>Lowest</b>	50	DFT-S	BPSK	20.09	20.1
	50	DFT-S	QPSK	20.06	20.08
	50	DFT-S	16QAM	18.54	18.58
	50	DFT-S	64QAM	16.75	16.48
	100	DFT-S	BPSK	19.56	19.23
	100	DFT-S	QPSK	19.42	19.36
	100	DFT-S	16QAM	17.98	17.77
	100	DFT-S	64QAM	16.17	15.83
	200	DFT-S	BPSK	12.88	15.83
	200	DFT-S	QPSK	12.77	15.9
	200	DFT-S	16QAM	12.69	15.2
	200	DFT-S	64QAM	13.17	13.02
	<b>Middle</b>	50	DFT-S	BPSK	20.66
50		DFT-S	QPSK	20.26	20.67
50		DFT-S	16QAM	18.99	19.02
50		DFT-S	64QAM	17.71	17.38
100		DFT-S	BPSK	20.81	20.8
100		DFT-S	QPSK	20.09	20.87
100		DFT-S	16QAM	18.97	19.35
100		DFT-S	64QAM	17.66	17.15
200		DFT-S	BPSK	14.59	17.32
200		DFT-S	QPSK	13.89	17.28
200		DFT-S	16QAM	14.19	16.62
200		DFT-S	64QAM	15.06	14.19



NR Band n261 Module 2 AG1 (Beam ID: 170)					
Maximum Average EIRP [dBm]					
Highest	BW [MHz]	Waveform	Modulation	Inner 1RB	Inner Full
	50	DFT-S	BPSK	20.67	20.58
	50	DFT-S	QPSK	20.13	20.45
	50	DFT-S	16QAM	18.75	18.88
	50	DFT-S	64QAM	17.53	17.17
	100	DFT-S	BPSK	20.51	20.23
	100	DFT-S	QPSK	19.84	20.13
	100	DFT-S	16QAM	18.53	18.69
	100	DFT-S	64QAM	17.18	16.55
	200	DFT-S	BPSK	13.42	16.22
	200	DFT-S	QPSK	12.82	16.26
	200	DFT-S	16QAM	13.2	15.59
	200	DFT-S	64QAM	13.82	13.23

Note: The 200MHz Bw is carrier aggregation by 2CC of 100MHz.



NR Band n261 Module 2 AG0+1 (Beam ID: 46+170)					
Maximum Average EIRP [dBm]					
Lowest	BW [MHz]	Waveform	Modulation	Inner 1RB	Inner Full
	50	DFT-S	BPSK	23.43	23.54
	50	DFT-S	QPSK	23.37	23.52
	50	DFT-S	16QAM	21.65	22.12
	50	DFT-S	64QAM	20.08	19.83
	100	DFT-S	BPSK	22.61	22.38
	100	DFT-S	QPSK	22.58	22.41
	100	DFT-S	16QAM	20.9	20.93
	100	DFT-S	64QAM	19.24	18.91
	200	DFT-S	BPSK	15.61	18.65
	200	DFT-S	QPSK	15.48	18.7
	200	DFT-S	16QAM	15.31	17.98
	200	DFT-S	64QAM	15.81	15.79
	Middle	BW [MHz]	Waveform	Modulation	Inner 1RB
50		DFT-S	BPSK	23.57	23.72
50		DFT-S	QPSK	23.51	23.69
50		DFT-S	16QAM	22.03	21.99
50		DFT-S	64QAM	20.9	20.46
100		DFT-S	BPSK	23.69	23.82
100		DFT-S	QPSK	23.83	<b>23.96</b>
100		DFT-S	16QAM	22.18	22.52
100		DFT-S	64QAM	21.14	20.66
200		DFT-S	BPSK	17.21	20.4
200		DFT-S	QPSK	17.38	20.23
200		DFT-S	16QAM	17.26	19.7
200		DFT-S	64QAM	18.16	17.61



NR Band n261 Module 2 AG0+1 (Beam ID: 46+170)					
Maximum Average EIRP [dBm]					
Highest	BW [MHz]	Waveform	Modulation	Inner 1RB	Inner Full
	50	DFT-S	BPSK	23.24	23.38
	50	DFT-S	QPSK	23.16	23.31
	50	DFT-S	16QAM	21.48	21.63
	50	DFT-S	64QAM	20.42	20.1
	100	DFT-S	BPSK	23.35	23.31
	100	DFT-S	QPSK	23.15	23.36
	100	DFT-S	16QAM	21.47	21.7
	100	DFT-S	64QAM	20.67	19.81
	200	DFT-S	BPSK	15.99	19.07
	200	DFT-S	QPSK	16.01	19.13
	200	DFT-S	16QAM	15.86	18.38
	200	DFT-S	64QAM	16.86	16.38

Note: The 200MHz Bw is carrier aggregation by 2CC of 100MHz.

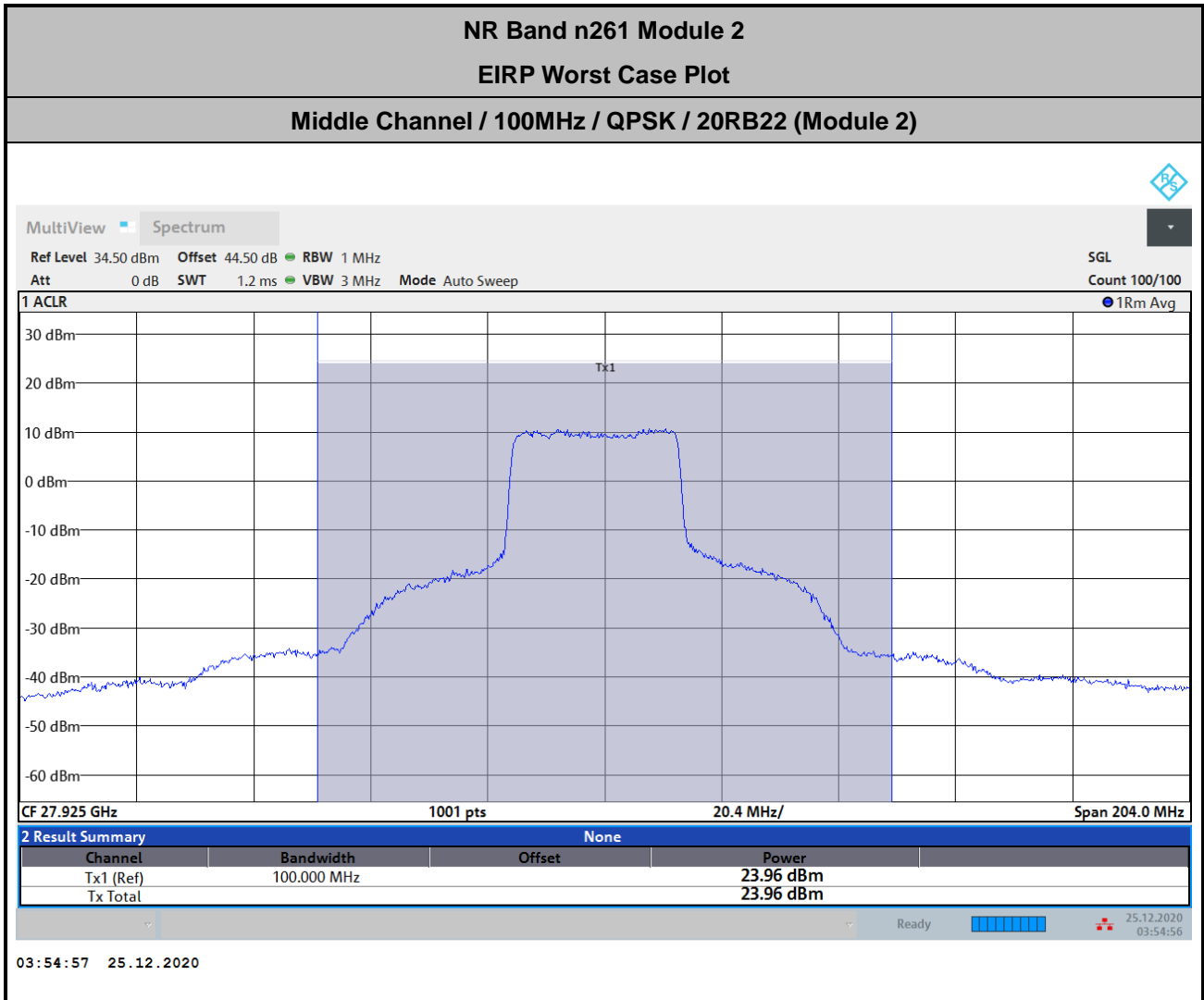

Note: Offset = Antenna Factor (dB/m) + Cable Loss (dB) + 107 + 20log (D) – 104.8  
 = 40.5 + 1.8 + 107 + 20log(1) – 104.8 = 44.5 (dB)





# NR Band n258A Module 0

## Occupied Bandwidth

AG0

Mode	DFT-s-OFDM Module 0 NR Band n258A : 99%OBW(MHz)											
BW	50MHz				100MHz				200MHz			
Mod.	BPSK	QPSK	16QAM	64QAM	BPSK	QPSK	16QAM	64QAM	BPSK	QPSK	16QAM	64QAM
Lowest CH	45.11	45.10	45.21	45.03	90.29	90.45	90.02	89.78	-	-	-	-
Middle CH	45.15	45.13	45.25	45.14	90.41	90.23	90.16	90.14	189.06	188.65	188.49	188.65
Highest CH	45.19	45.31	45.11	45.17	90.04	89.98	89.90	89.71	-	-	-	-



DFT-s-OFDM Module 0

NR Band n258A

Lowest Channel / 50MHz / BPSK

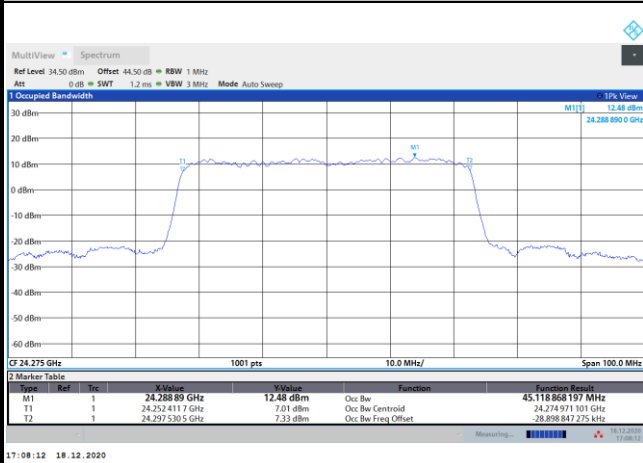

Lowest Channel / 50MHz / QPSK

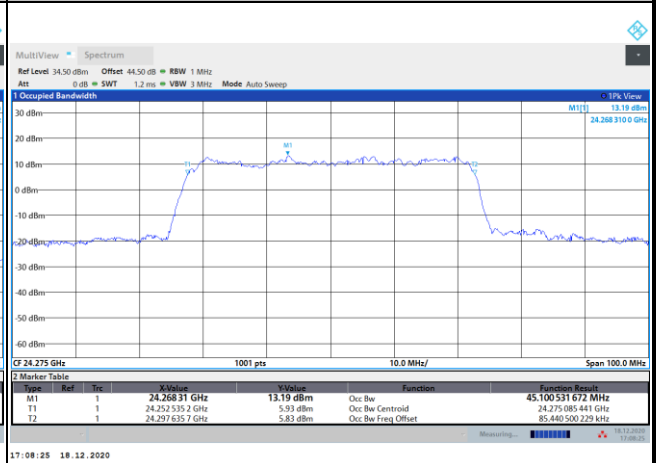

Middle Channel / 50MHz / BPSK

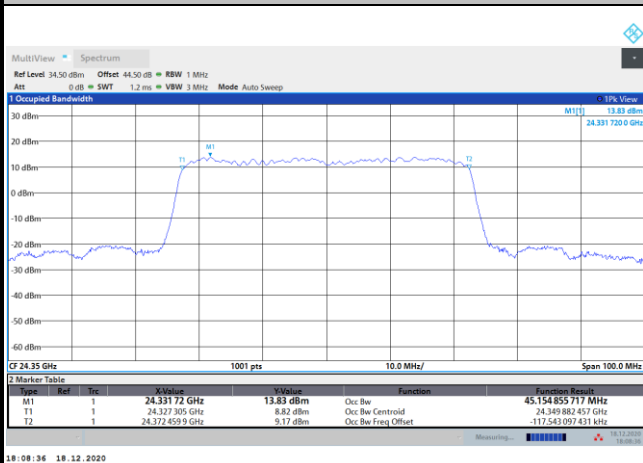

Middle Channel / 50MHz / QPSK

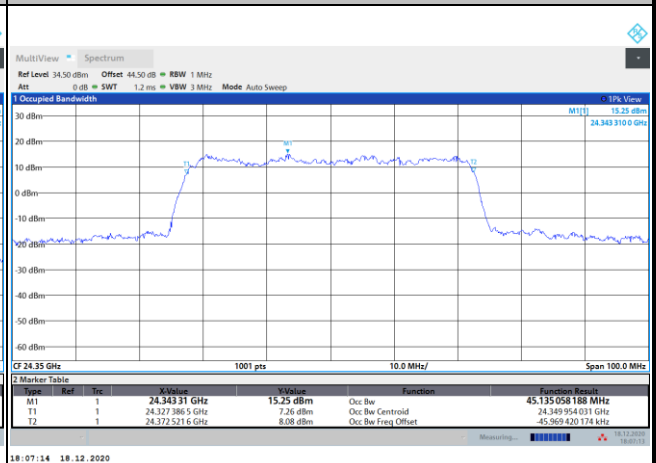

Highest Channel / 50MHz / BPSK

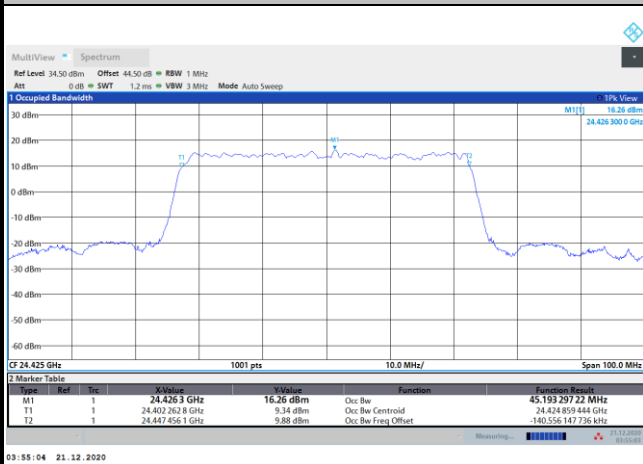

Highest Channel / 50MHz / QPSK

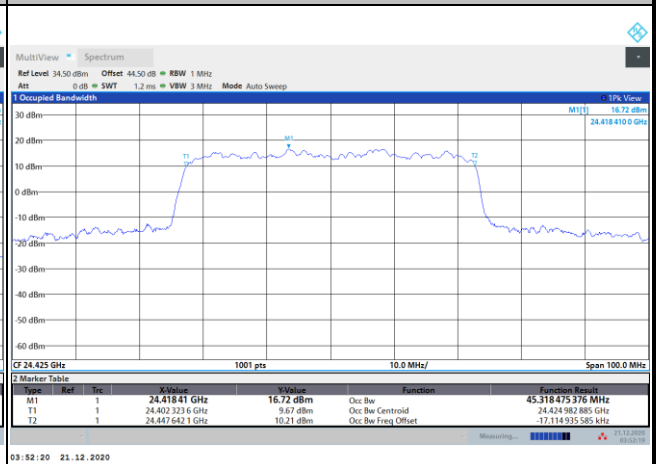



DFT-s-OFDM Module 0

NR Band n258A

Lowest Channel / 50MHz / 16QAM

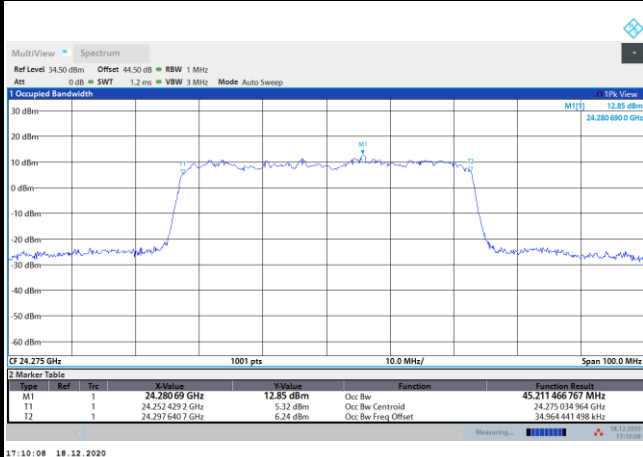

Lowest Channel / 50MHz / 64QAM

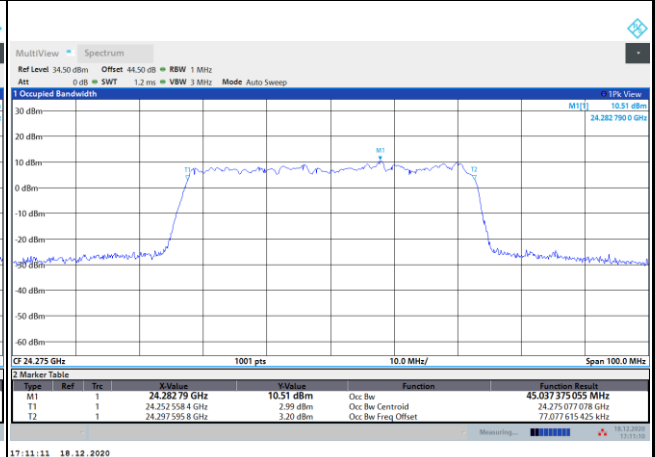

Middle Channel / 50MHz / 16QAM

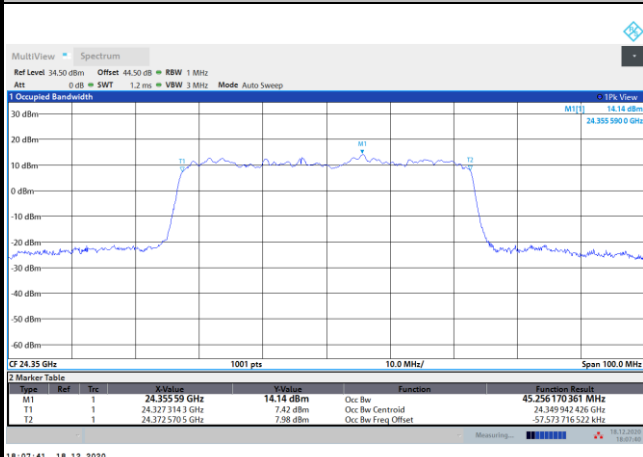

Middle Channel / 50MHz / 64QAM

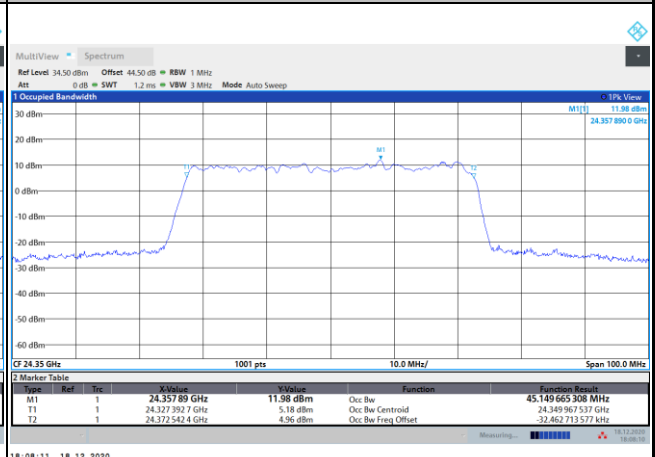

Highest Channel / 50MHz / 16QAM

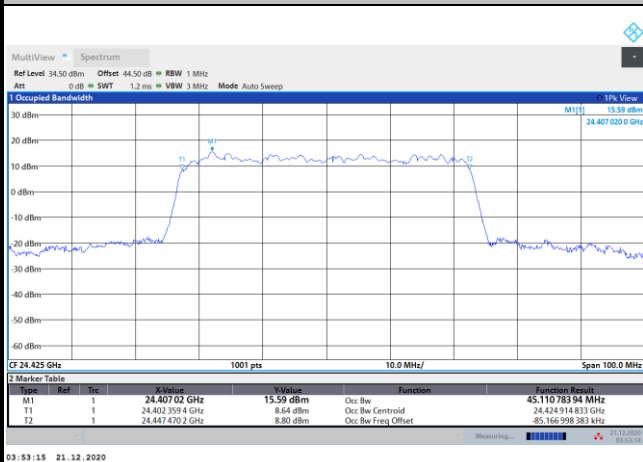

Highest Channel / 50MHz / 64QAM

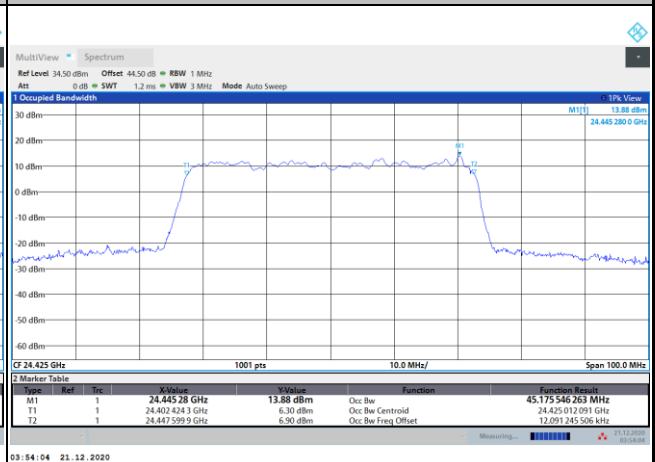



DFT-s-OFDM Module 0

NR Band n258A

Lowest Channel / 100MHz / BPSK

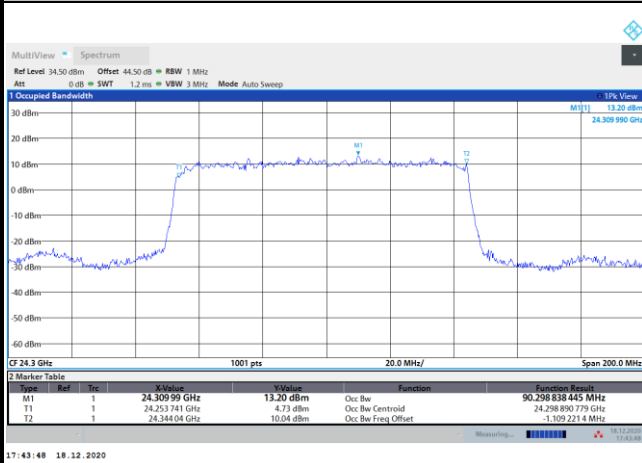

Lowest Channel / 100MHz / QPSK

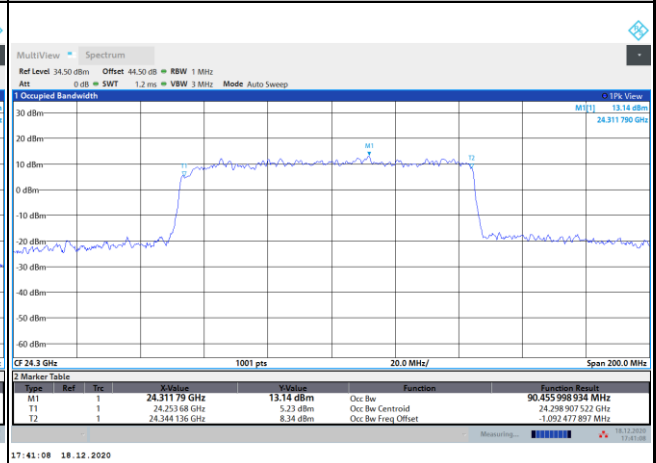

Middle Channel / 100MHz / BPSK

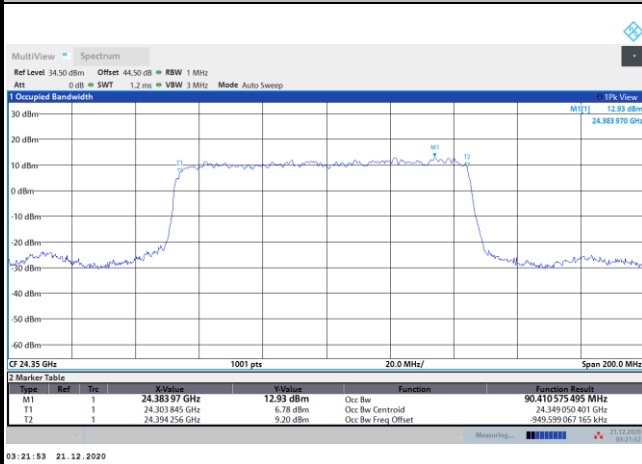

Middle Channel / 100MHz / QPSK

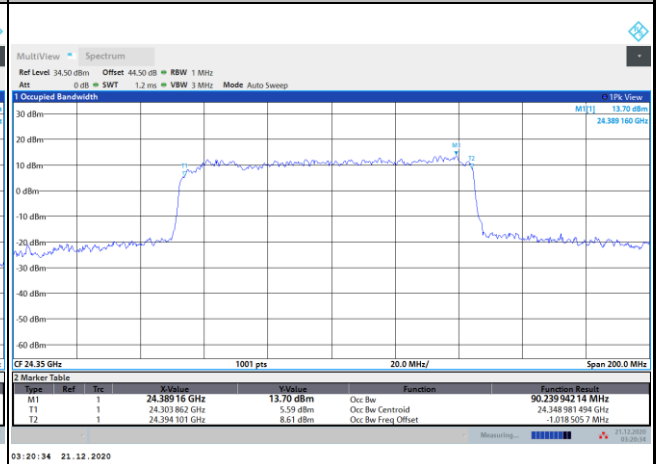

Highest Channel / 100MHz / BPSK

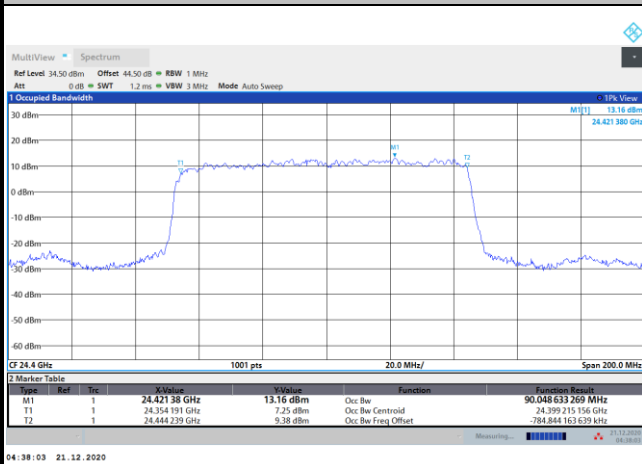

Highest Channel / 100MHz / QPSK

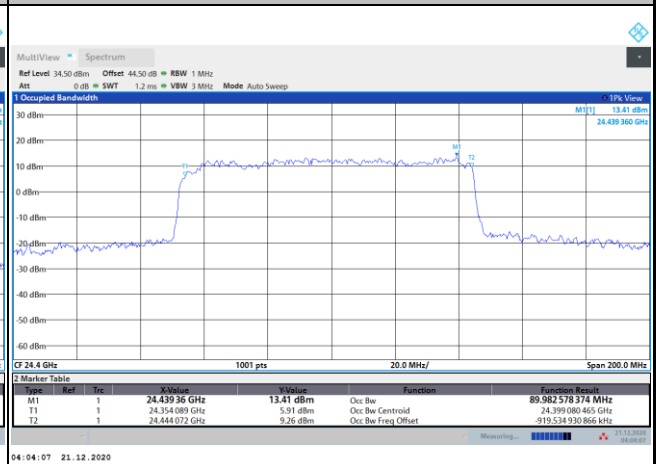



DFT-s-OFDM Module 0

NR Band n258A

Lowest Channel / 100MHz / 16QAM

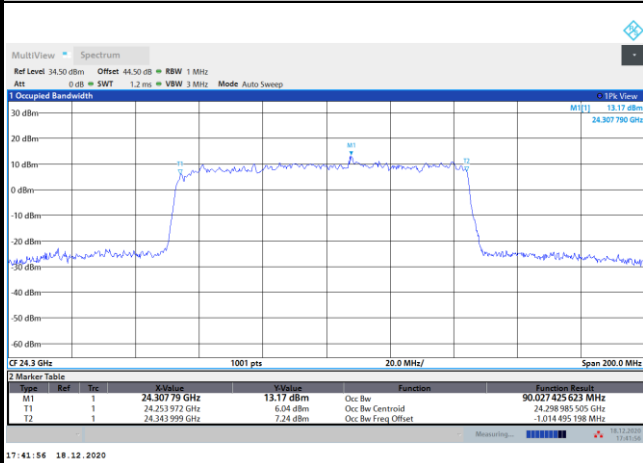

Lowest Channel / 100MHz / 64QAM

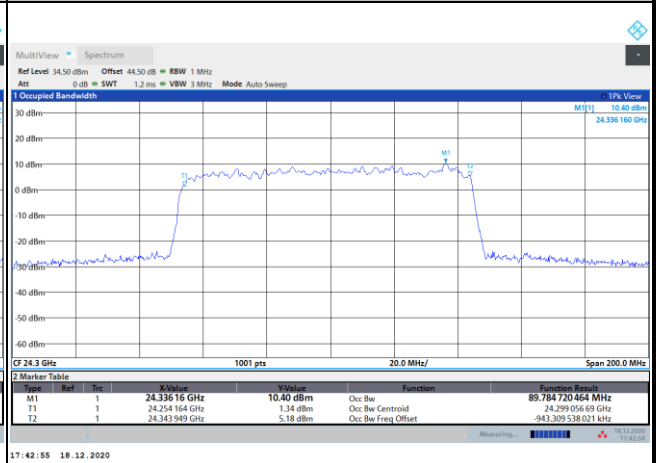

Middle Channel / 100MHz / 16QAM

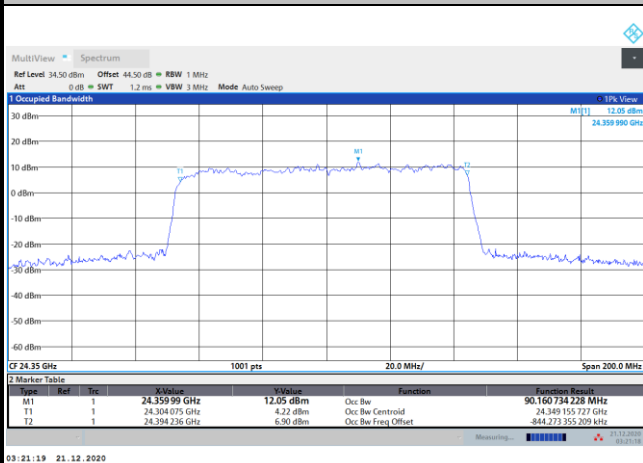

Middle Channel / 100MHz / 64QAM

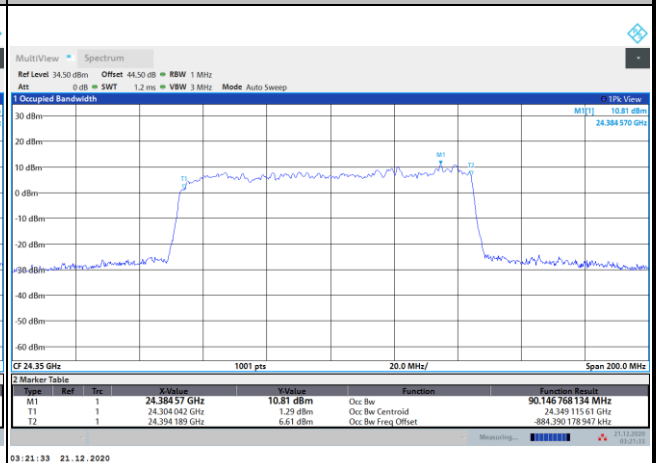

Highest Channel / 100MHz / 16QAM

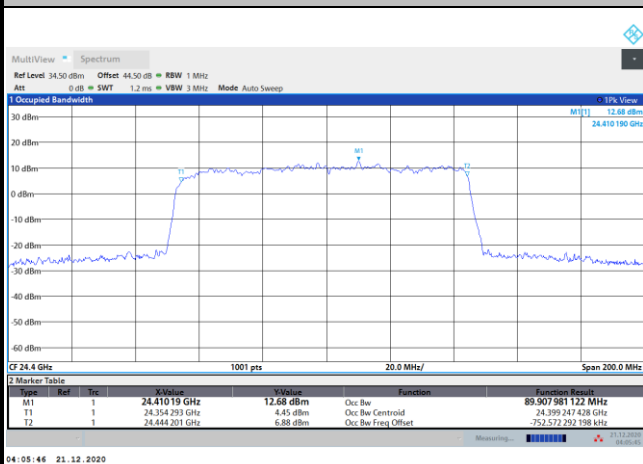

Highest Channel / 100MHz / 64QAM

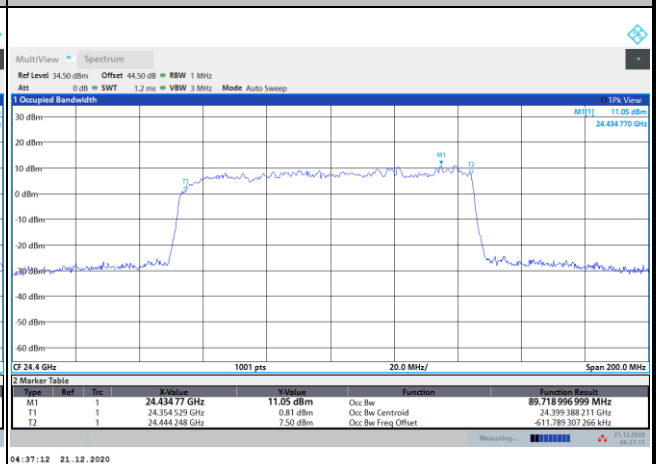



DFT-s-OFDM Module 0

NR Band n258A

Middle Channel / 200MHz / BPSK

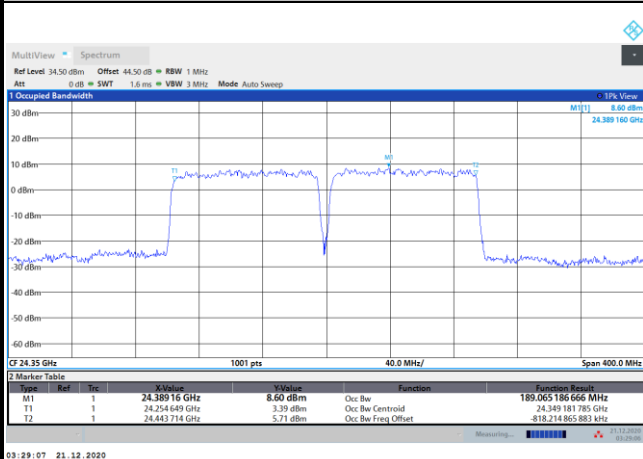

Middle Channel / 200MHz / QPSK

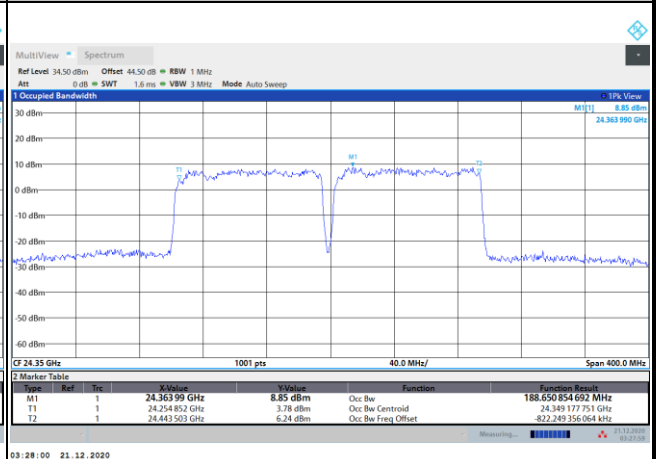

Middle Channel / 200MHz / 16QAM

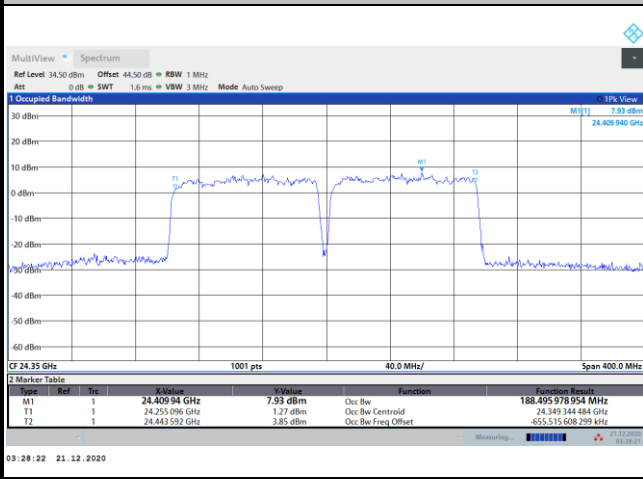

Middle Channel / 200MHz / 64QAM

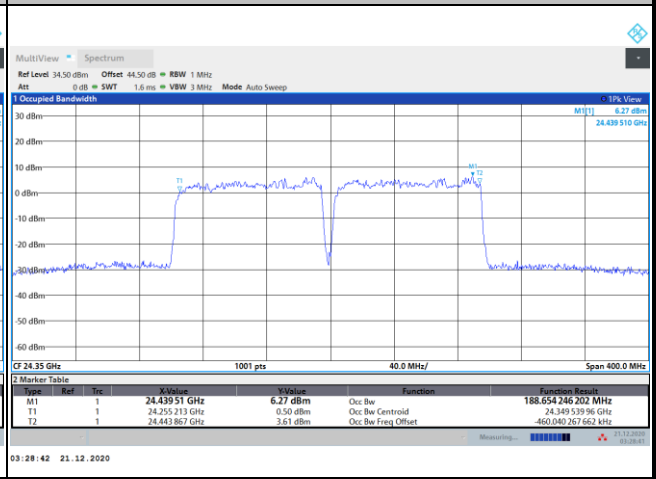



AG1

Mode	DFT-s-OFDM Module 0 NR Band n258A : 99%OBW(MHz)											
BW	50MHz				100MHz				200MHz			
Mod.	BPSK	QPSK	16QAM	64QAM	BPSK	QPSK	16QAM	64QAM	BPSK	QPSK	16QAM	64QAM
Lowest CH	45.12	45.16	45.05	45.11	90.49	89.80	89.84	89.83	-	-	-	-
Middle CH	45.08	45.05	45.13	45.27	90.86	90.34	90.30	90.49	189.16	188.48	188.46	188.56
Highest CH	45.08	45.08	45.13	45.25	90.37	89.81	89.83	89.80	-	-	-	-



DFT-s-OFDM Module 0

NR Band n258A

Lowest Channel / 50MHz / BPSK

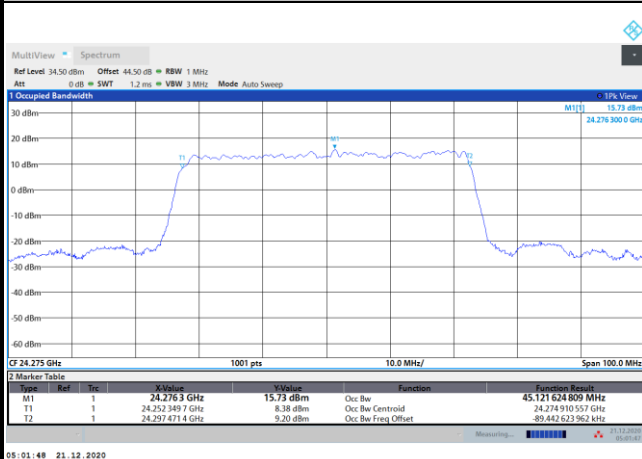

Lowest Channel / 50MHz / QPSK

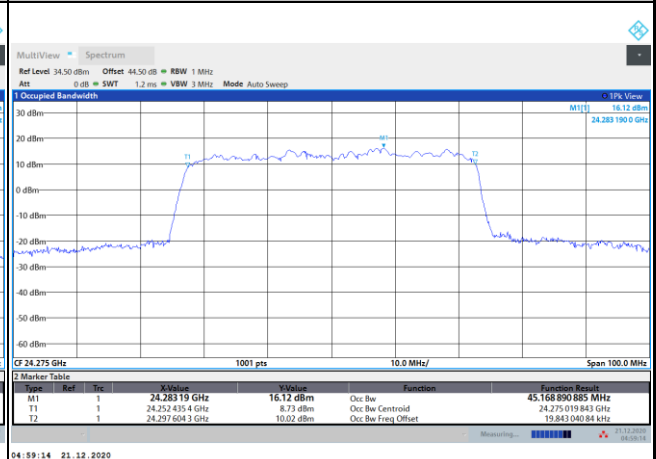

Middle Channel / 50MHz / BPSK

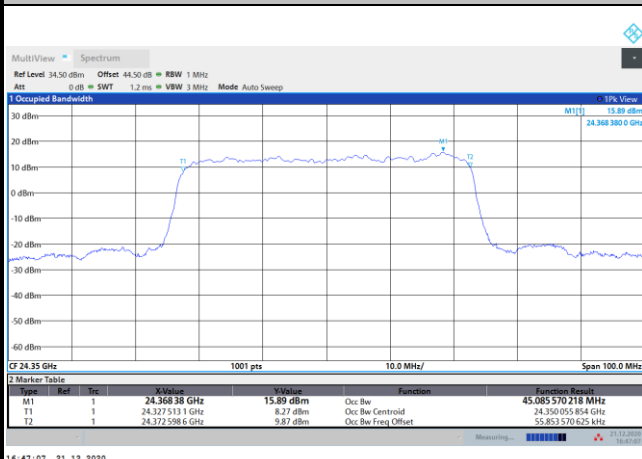

Middle Channel / 50MHz / QPSK

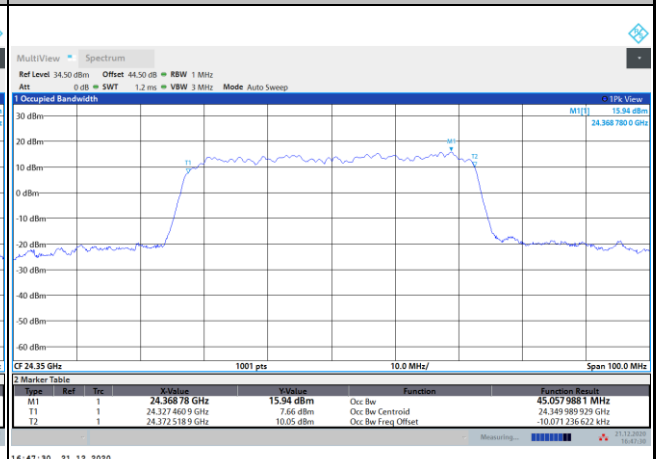

Highest Channel / 50MHz / BPSK

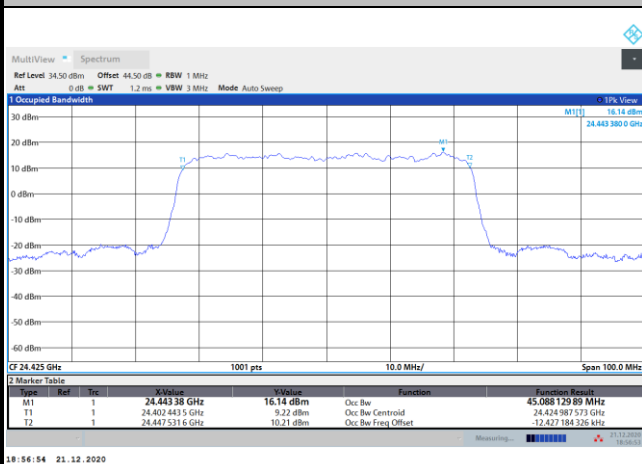

Highest Channel / 50MHz / QPSK

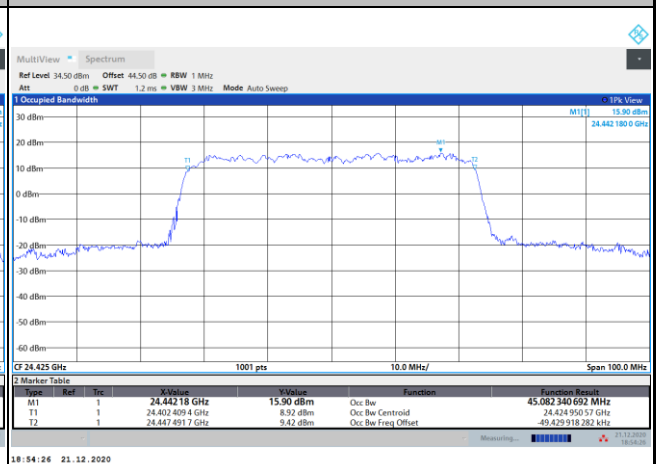





DFT-s-OFDM Module 0

NR Band n258A

Lowest Channel / 50MHz / 16QAM

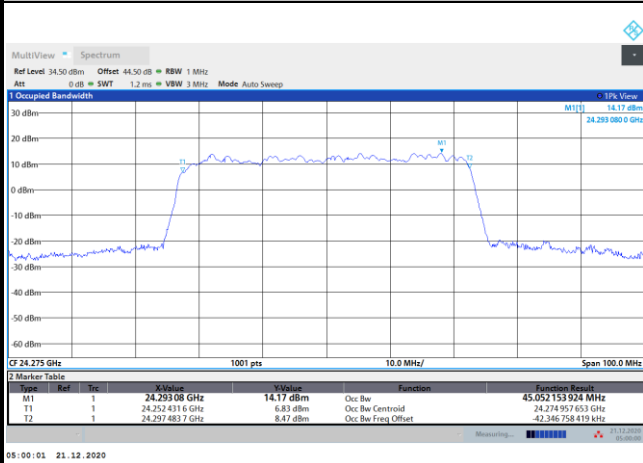

Lowest Channel / 50MHz / 64QAM

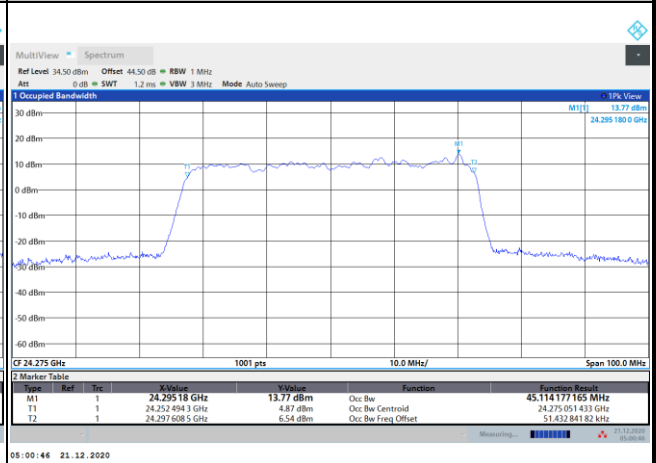

Middle Channel / 50MHz / 16QAM

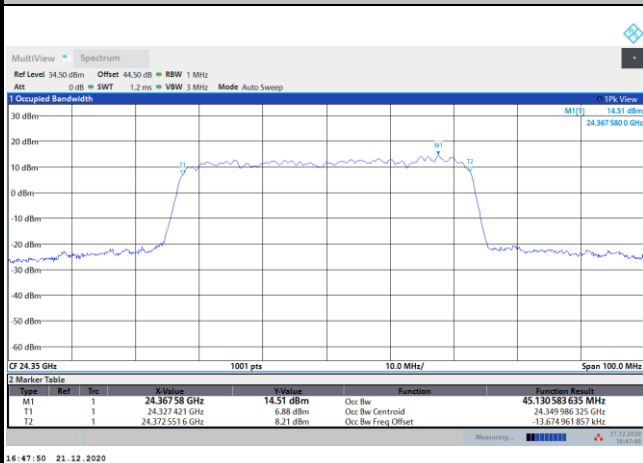

Middle Channel / 50MHz / 64QAM

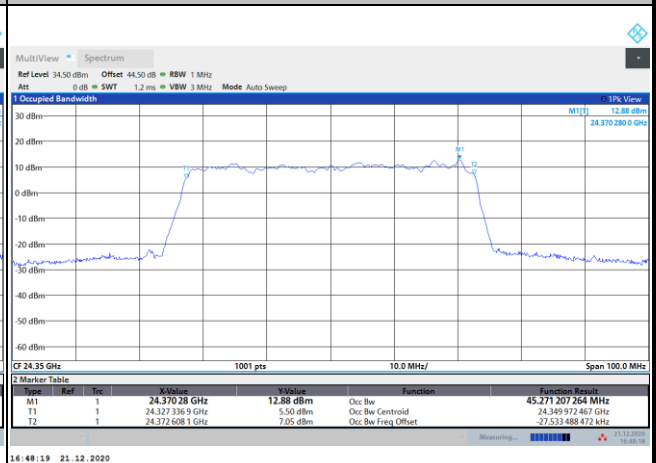

Highest Channel / 50MHz / 16QAM

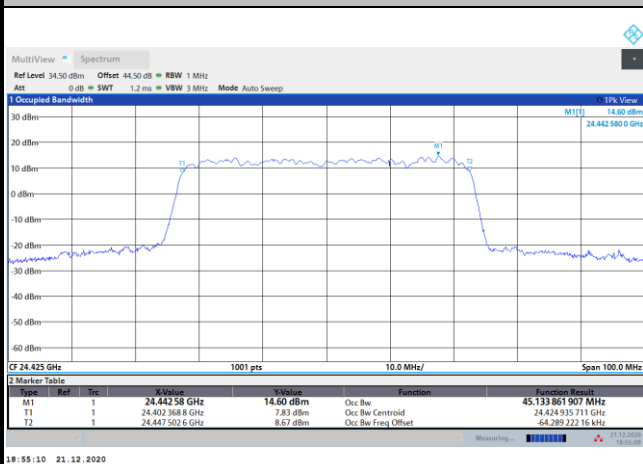

Highest Channel / 50MHz / 64QAM

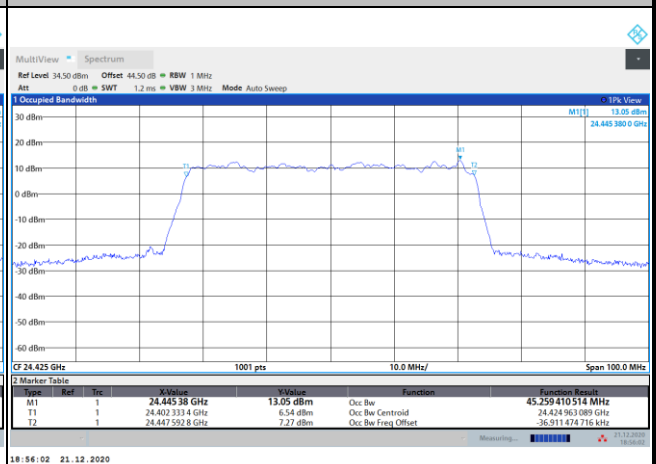



DFT-s-OFDM Module 0

NR Band n258A

Lowest Channel / 100MHz / BPSK

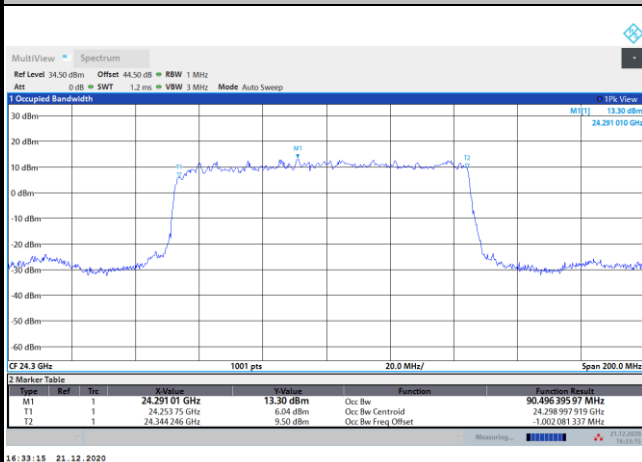

Lowest Channel / 100MHz / QPSK

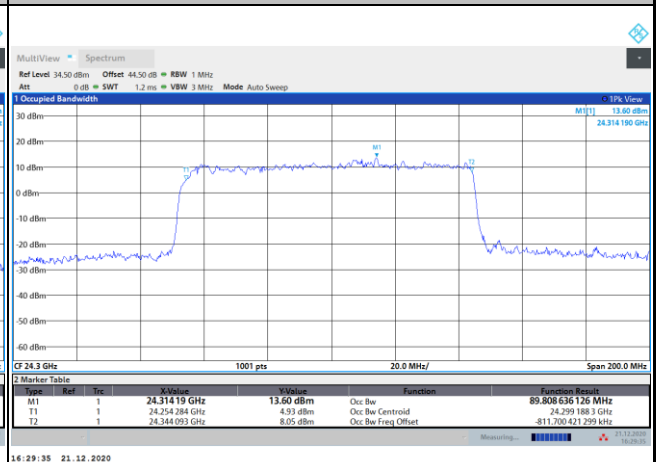

Middle Channel / 100MHz / BPSK

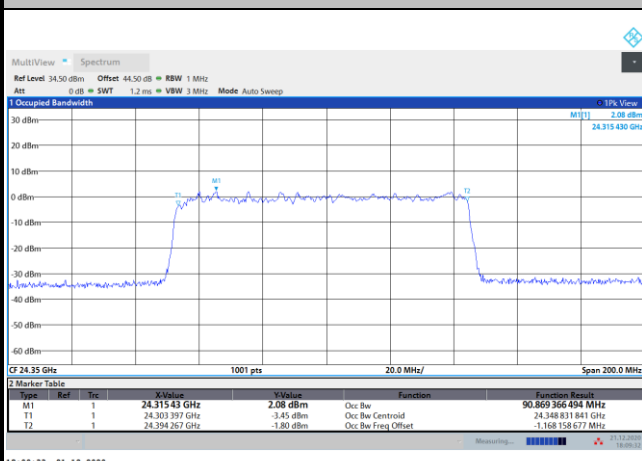

Middle Channel / 100MHz / QPSK

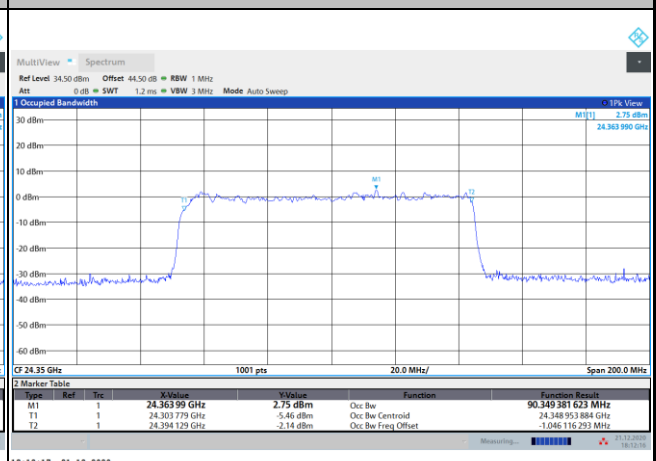

Highest Channel / 100MHz / BPSK

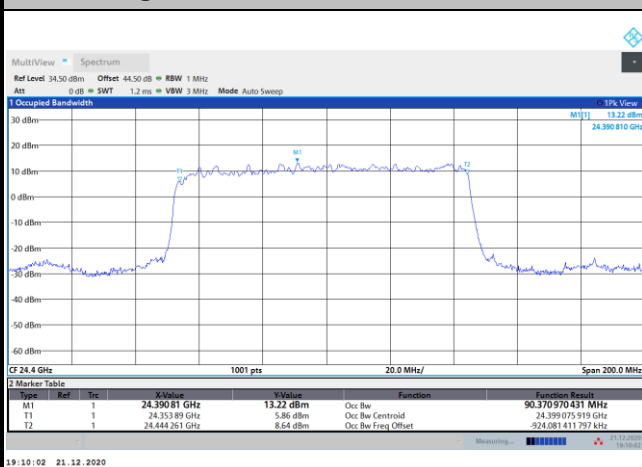

Highest Channel / 100MHz / QPSK

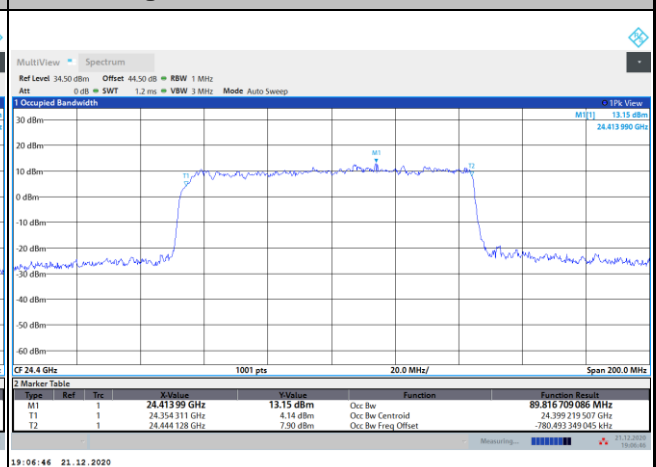



DFT-s-OFDM Module 0

NR Band n258A

Lowest Channel / 100MHz / 16QAM

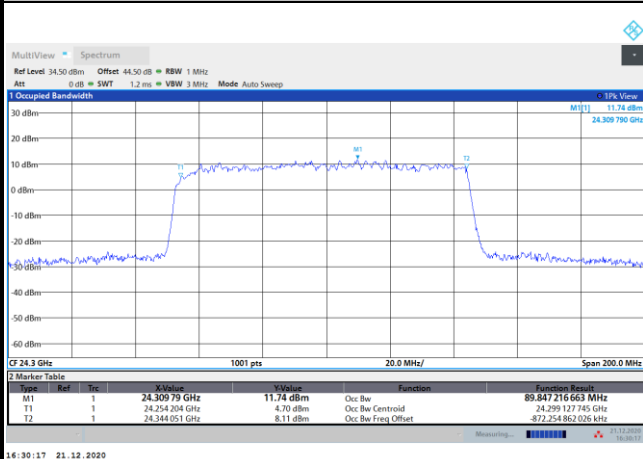

Lowest Channel / 100MHz / 64QAM

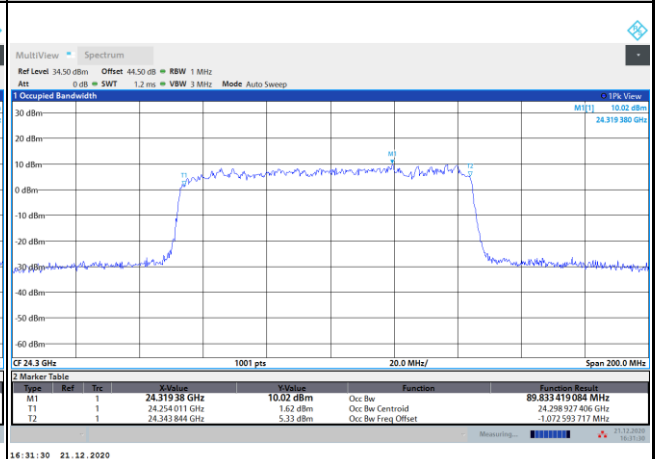

Middle Channel / 100MHz / 16QAM

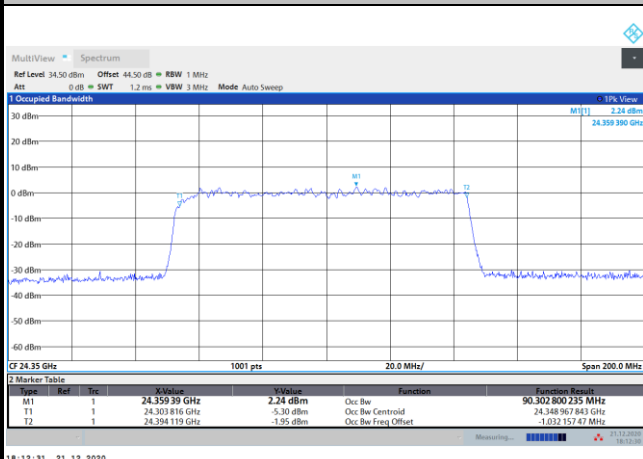

Middle Channel / 100MHz / 64QAM

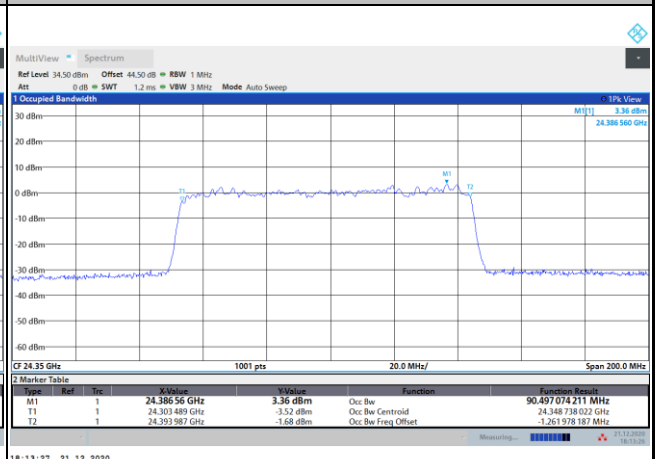

Highest Channel / 100MHz / 16QAM

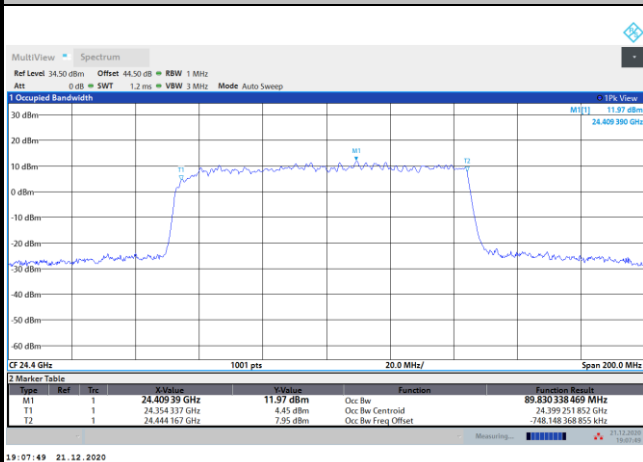

Highest Channel / 100MHz / 64QAM

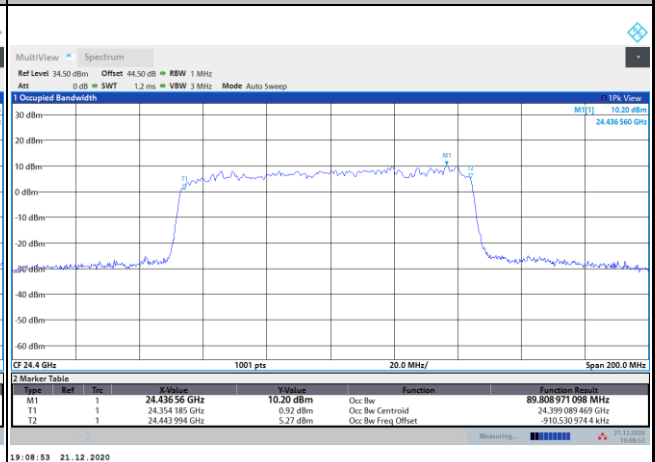



DFT-s-OFDM Module 0

NR Band n258A

Middle Channel / 200MHz / BPSK

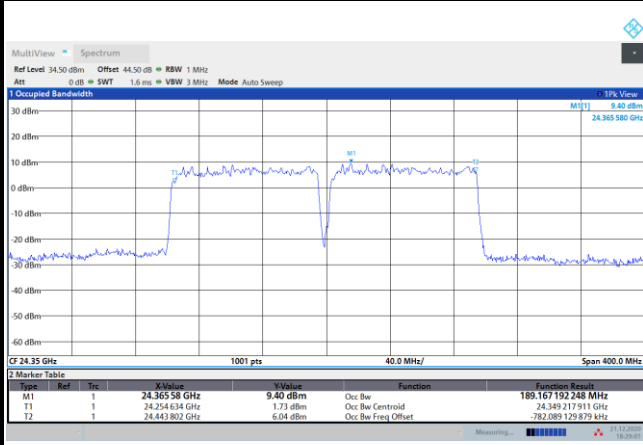

Middle Channel / 200MHz / QPSK

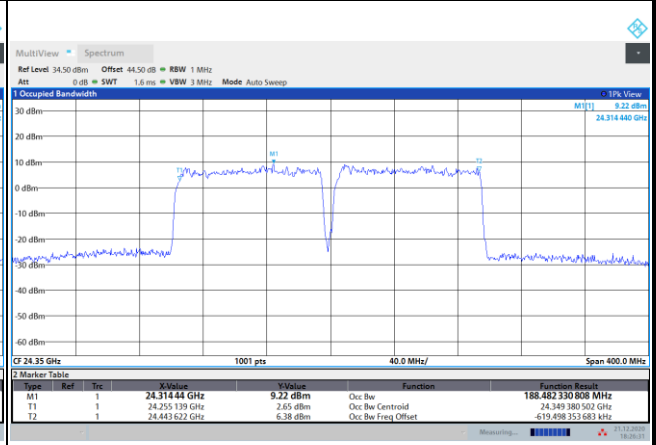

Middle Channel / 200MHz / 16QAM

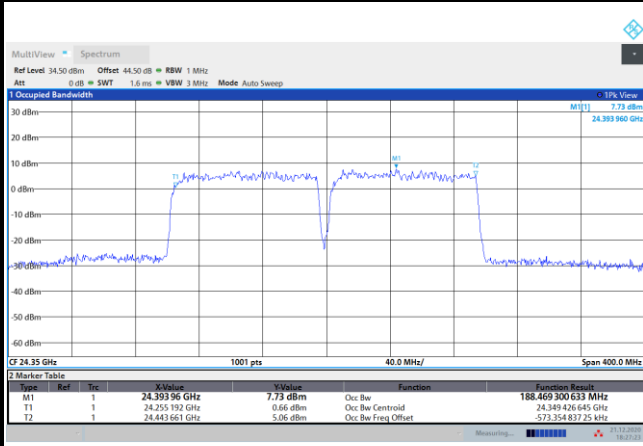

Middle Channel / 200MHz / 64QAM

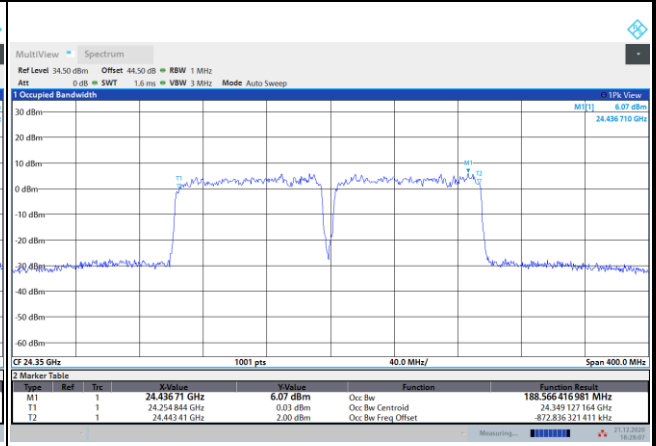



AG0+1

Mode	DFT-s-OFDM Module 0 NR Band n258A : 99%OBW(MHz)											
BW	50MHz				100MHz				200MHz			
Mod.	BPSK	QPSK	16QAM	64QAM	BPSK	QPSK	16QAM	64QAM	BPSK	QPSK	16QAM	64QAM
Lowest CH	45.36	45.31	45.25	45.30	89.98	90.55	90.06	89.94	-	-	-	-
Middle CH	45.39	45.36	45.27	45.32	90.09	90.70	90.22	90.13	188.43	188.71	188.96	188.73
Highest CH	45.32	45.22	45.18	45.26	90.06	90.57	90.08	89.97	-	-	-	-



DFT-s-OFDM Module 0

NR Band n258A

Lowest Channel / 50MHz / BPSK

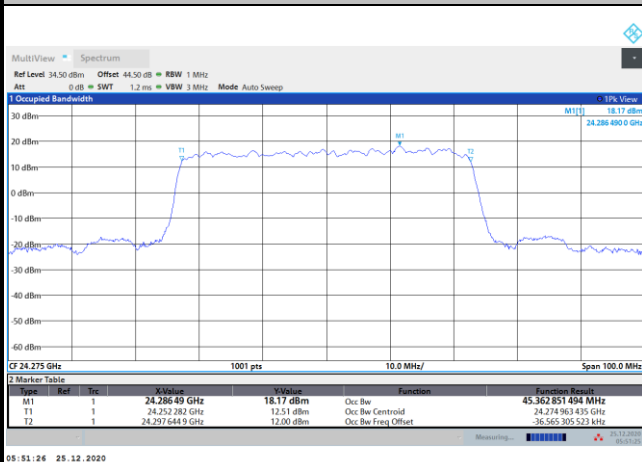

Lowest Channel / 50MHz / QPSK

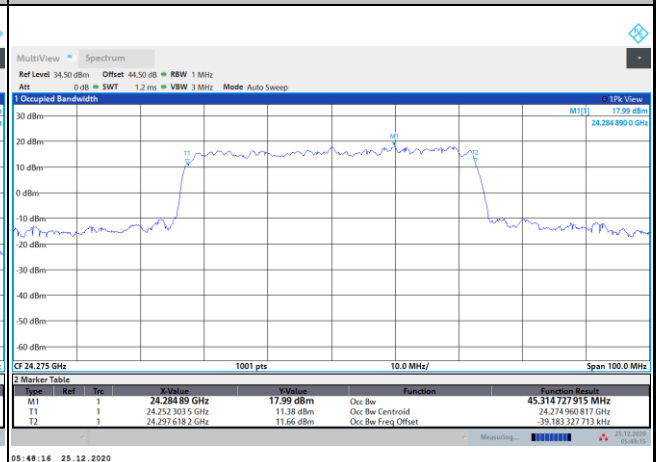

Middle Channel / 50MHz / BPSK

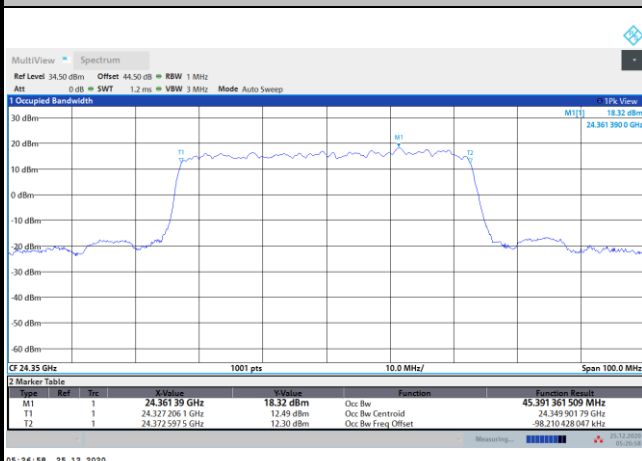

Middle Channel / 50MHz / QPSK

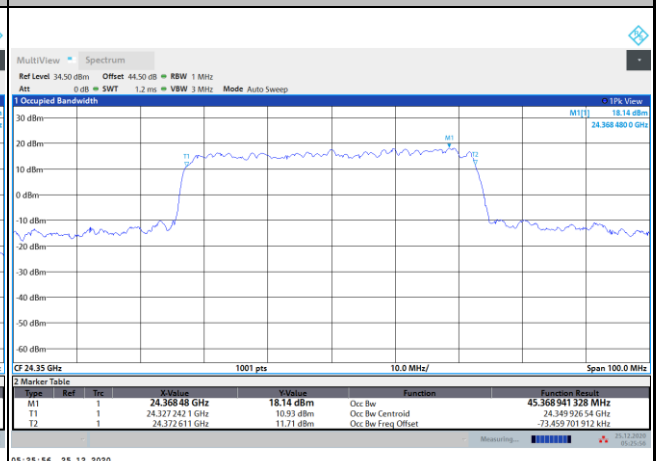

Highest Channel / 50MHz / BPSK

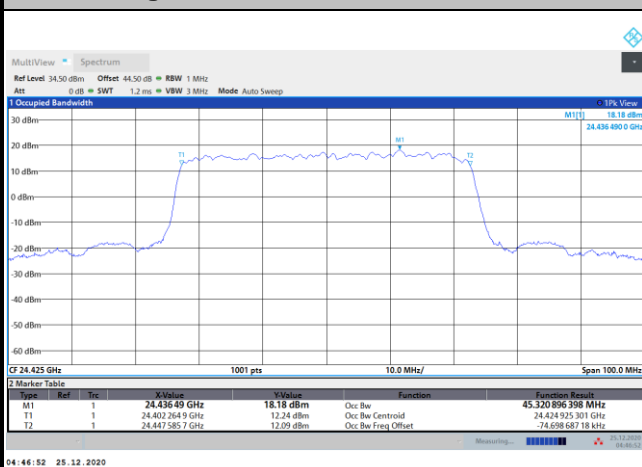

Highest Channel / 50MHz / QPSK

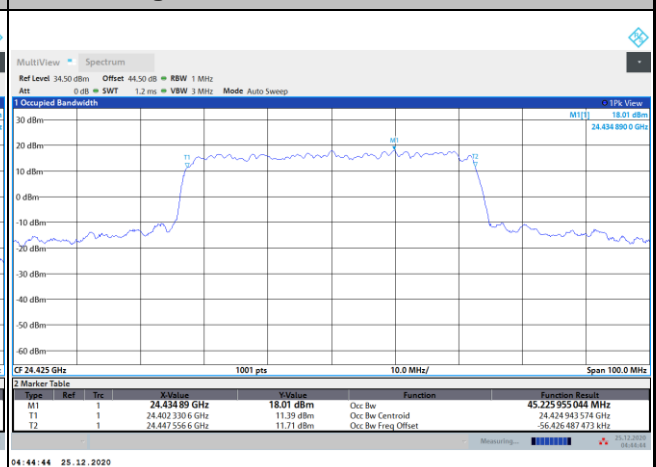



DFT-s-OFDM Module 0

NR Band n258A

Lowest Channel / 50MHz / 16QAM

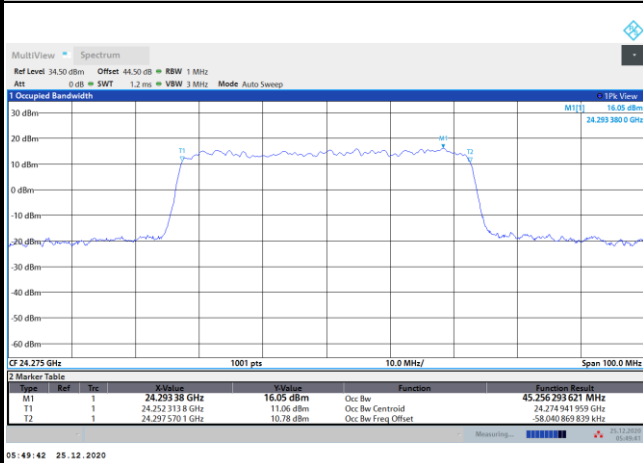

Lowest Channel / 50MHz / 64QAM

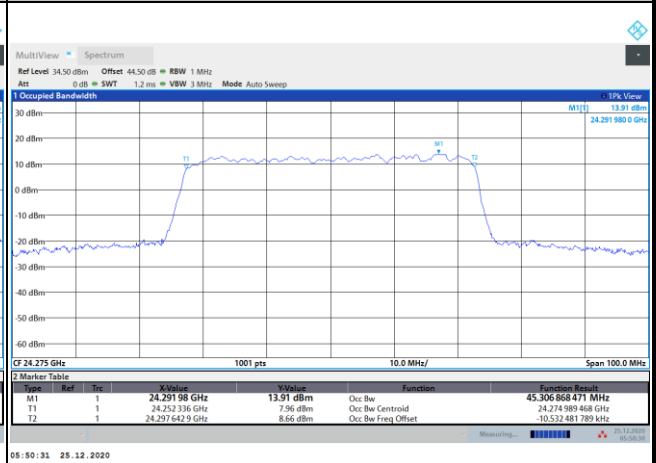

Middle Channel / 50MHz / 16QAM

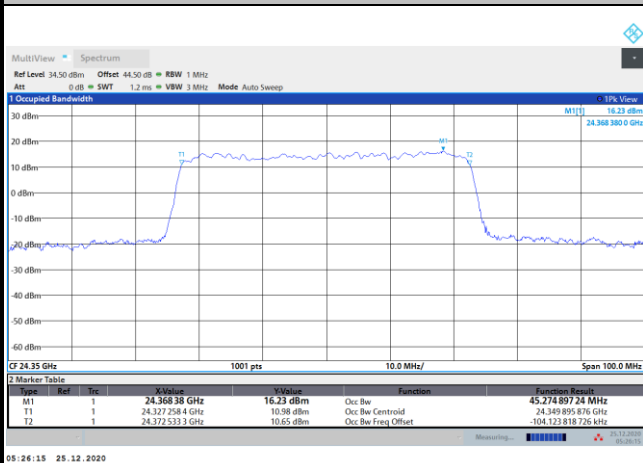

Middle Channel / 50MHz / 64QAM

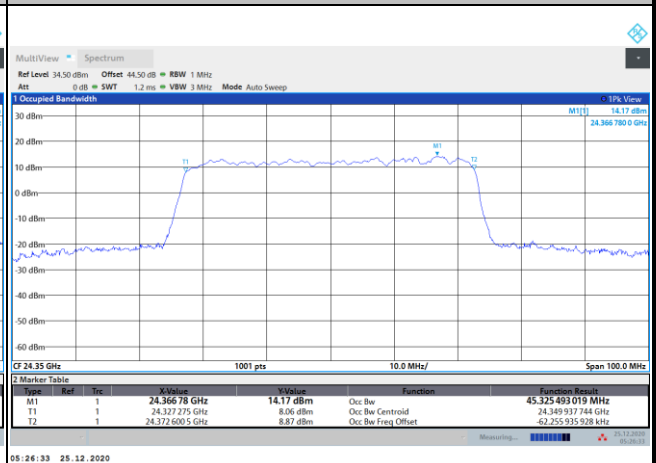

Highest Channel / 50MHz / 16QAM

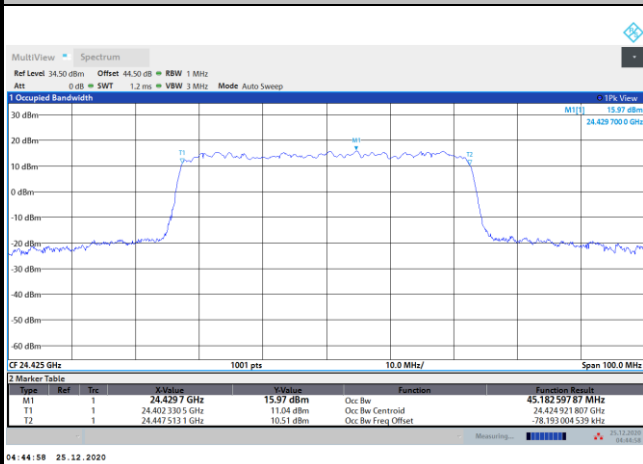

Highest Channel / 50MHz / 64QAM

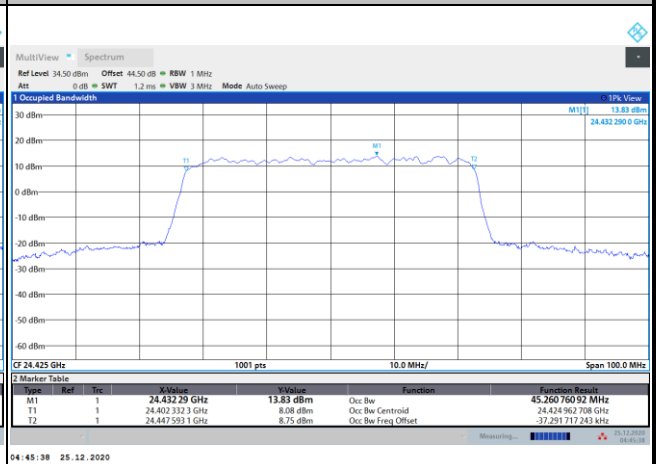



DFT-s-OFDM Module 0

NR Band n258A

Lowest Channel / 100MHz / BPSK

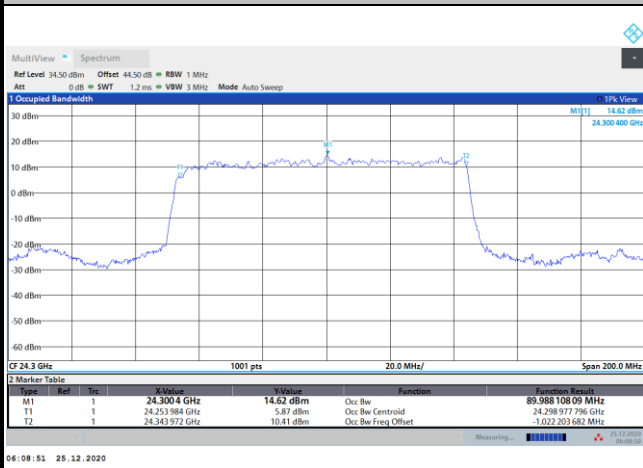

Lowest Channel / 100MHz / QPSK

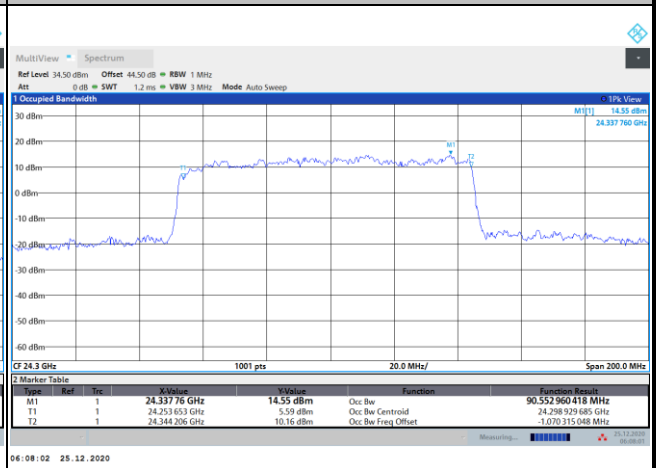

Middle Channel / 100MHz / BPSK

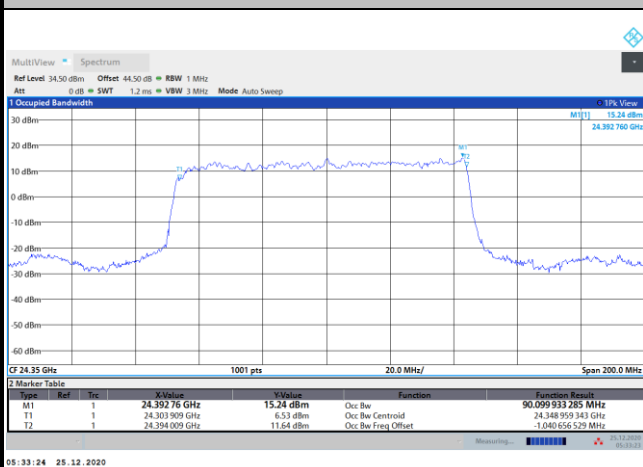

Middle Channel / 100MHz / QPSK

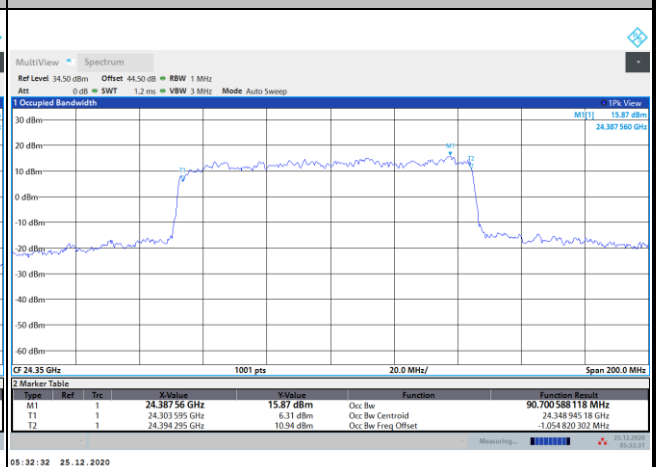

Highest Channel / 100MHz / BPSK

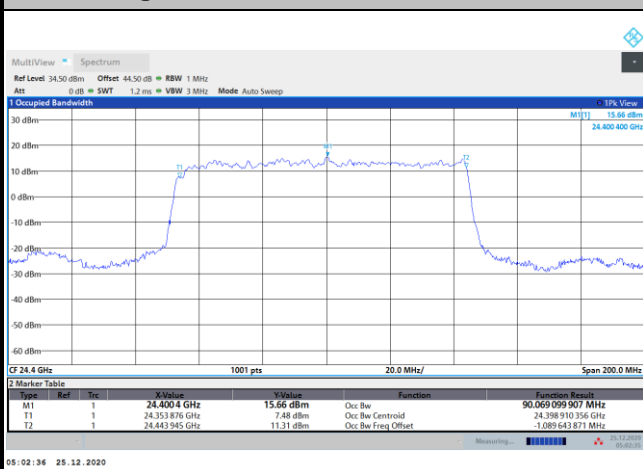

Highest Channel / 100MHz / QPSK

