



FCC RF Test Report

APPLICANT : OnePlus Technology (Shenzhen) Co., Ltd
EQUIPMENT : Smart Phone
BRAND NAME : ONEPLUS
MODEL NAME : AC2003
FCC ID : 2ABZ2-EF014
STANDARD : FCC Part 15 Subpart E §15.407
CLASSIFICATION : (NII) Unlicensed National Information Infrastructure

The product was received on Apr. 20, 2020 and testing was completed on May 19, 2020. We, Sporton International (ShenZhen) Inc., would like to declare that the tested sample has been evaluated in accordance with the test procedures and has been in compliance with the applicable technical standards.

The test results in this report apply exclusively to the tested model / sample. Without written approval of Sporton International (ShenZhen) Inc., the test report shall not be reproduced except in full.

Reviewed by: Derreck Chen / Supervisor

Approved by: Eric Shih / Manager



Sporton International (ShenZhen) Inc.

1/F, 2/F, Bldg 5, Shiling Industrial Zone, Xinwei Village, Xili, Nanshan, Shenzhen, 518055
 People's Republic of China



TABLE OF CONTENTS

REVISION HISTORY..... 3

SUMMARY OF TEST RESULT 4

1 GENERAL DESCRIPTION 5

 1.1 Applicant 5

 1.2 Manufacturer 5

 1.3 Product Feature of Equipment Under Test..... 5

 1.4 Product Specification of Equipment Under Test..... 6

 1.5 Modification of EUT 6

 1.6 Testing Location 7

 1.7 Test Software 7

 1.8 Applicable Standards..... 7

2 TEST CONFIGURATION OF EQUIPMENT UNDER TEST 8

 2.1 Carrier Frequency and Channel 8

 2.2 Test Mode 9

 2.3 Connection Diagram of Test System 10

 2.4 Support Unit used in test configuration and system 11

 2.5 EUT Operation Test Setup 11

 2.6 Measurement Results Explanation Example..... 11

3 TEST RESULT 12

 3.1 6dB and 26dB and 99% Occupied Bandwidth Measurement 12

 3.2 Maximum Conducted Output Power Measurement 15

 3.3 Power Spectral Density Measurement 16

 3.4 Unwanted Emissions Measurement 19

 3.5 AC Conducted Emission Measurement..... 23

 3.6 Automatically Discontinue Transmission 25

 3.7 Antenna Requirements 26

4 LIST OF MEASURING EQUIPMENT 27

5 UNCERTAINTY OF EVALUATION 28

APPENDIX A. CONDUCTED TEST RESULTS

APPENDIX B. AC CONDUCTED EMISSION TEST RESULT

APPENDIX C. RADIATED SPURIOUS EMISSION

APPENDIX D. DUTY CYCLE PLOTS

APPENDIX E. SETUP PHOTOGRAPHS



REVISION HISTORY

REPORT NO.	VERSION	DESCRIPTION	ISSUED DATE
FR042007-02G	Rev. 01	Initial issue of report	Jun. 15, 2020



SUMMARY OF TEST RESULT

Report Section	FCC Rule	Description	Limit	Result	Remark
3.1	15.403(i)	6dB, 26dB and 99% Occupied Bandwidth	> 500kHz	Pass	-
3.2	15.407(a)	Maximum Conducted Output Power	≤ 30 dBm	Pass	-
3.3	15.407(a)	Power Spectral Density	≤ 30 dBm/500kHz	Pass	-
3.4	15.407(b)	Unwanted Emissions	15.407(b)(4)(i) & 15.209(a)	Pass	Under limit 8.42 dB at 57.160 MHz
3.5	15.207	AC Conducted Emission	15.207(a)	Pass	Under limit 16.16 dB at 8.240 MHz
3.6	15.407(c)	Automatically Discontinue Transmission	Discontinue Transmission	Pass	-
3.7	15.203 & 15.407(a)	Antenna Requirement	N/A	Pass	-

Declaration of Conformity:
The test results with all measurement uncertainty excluded are presented in accordance with the regulation limits or requirements declared by manufacturers.
Comments and Explanations:
The declared of product specification for EUT presented in the report are provided by the manufacturer, and the manufacturer takes all the responsibilities for the accuracy of product specification.



1 General Description

1.1 Applicant

OnePlus Technology (Shenzhen) Co., Ltd

18C02, 18C03, 18C04 and 18C05, Shum Yip Terra Building, Binhe Avenue North, Futian District, Shenzhen

1.2 Manufacturer

OnePlus Technology (Shenzhen) Co., Ltd

18C02, 18C03, 18C04 and 18C05, Shum Yip Terra Building, Binhe Avenue North, Futian District, Shenzhen

1.3 Product Feature of Equipment Under Test

Product Feature	
Equipment	Smart Phone
Brand Name	ONEPLUS
Model Name	AC2003
FCC ID	2ABZ2-EF014
EUT supports Radios application	GSM/WCDMA/LTE/5G NR WLAN 2.4GHz 802.11b/g/n HT20/HT40 WLAN 5GHz 802.11a/n HT20/HT40 WLAN 5GHz 802.11ac VHT20/VHT40/VHT80 Bluetooth BR/EDR/LE / ANT+ GNSS/NFC
IMEI Code	Conducted: 001004119993252 Conduction: 867958040036791/867958040036783 Radiation: 867958040036536/867958040036528
HW Version	14
SW Version	Oxygen OS 10.5.0.AC01BA
EUT Stage	Production Unit

Remark: The above EUT's information was declared by manufacturer. Please refer to the specifications or user's manual for more detailed description.



1.4 Product Specification of Equipment Under Test

Standards-related Product Specification							
Tx/Rx Channel Frequency Range	5745 MHz ~ 5825 MHz						
Maximum Output Power	<p><MIMO Ant.1+2> <5745 MHz ~ 5825 MHz> 802.11a : 20.33 dBm / 0.1079 W 802.11n HT20 : 20.24 dBm / 0.1057 W 802.11n HT40 : 20.18 dBm / 0.1042 W 802.11ac VHT20: 20.18 dBm / 0.1042 W 802.11ac VHT40: 20.13 dBm / 0.1030 W 802.11ac VHT80: 19.05 dBm / 0.0804 W</p>						
99% Occupied Bandwidth	<p><MIMO Ant.1+2> 802.11a : 16.73 MHz 802.11n HT20 : 17.88 MHz 802.11n HT40 : 36.66 MHz 802.11ac VHT80 : 76.60 MHz</p>						
Type of Modulation	802.11a/n : OFDM (BPSK / QPSK / 16QAM / 64QAM) 802.11ac : OFDM (BPSK / QPSK / 16QAM / 64QAM / 256QAM)						
Antenna Type / Gain	<Ant. 1> : Monopole Antenna with gain -3.00 dBi <Ant. 2> : Monopole Antenna with gain -3.00 dBi						
Antenna Function Description	<table border="1"> <thead> <tr> <th></th> <th>Ant. 1</th> <th>Ant. 2</th> </tr> </thead> <tbody> <tr> <td>802.11 a/n/ac MIMO</td> <td>V</td> <td>V</td> </tr> </tbody> </table>		Ant. 1	Ant. 2	802.11 a/n/ac MIMO	V	V
	Ant. 1	Ant. 2					
802.11 a/n/ac MIMO	V	V					

Note:

- For 802.11n HT20 / ac VHT20 and 802.11n HT40 / ac VHT40 mode, the whole testing have assessed only 802.11n HT20/ HT40 by referring to their maximum conducted power.
- The EUT supports for MIMO mode only.

1.5 Modification of EUT

No modifications are made to the EUT during all test items.



1.6 Testing Location

Sporton International (Shenzhen) Inc. is accredited to ISO/IEC 17025:2017 by American Association for Laboratory Accreditation with Certificate Number 5145.01.

Test Firm	Sporton International (Shenzhen) Inc.		
Test Site Location	1/F, 2/F, Bldg 5, Shiling Industrial Zone, Xinwei Village, Xili, Nanshan, Shenzhen, 518055 People's Republic of China TEL: +86-755-86379589 FAX: +86-755-86379595		
Test Site No.	Sporton Site No.	FCC Designation No.	FCC Test Firm Registration No.
	CO01-SZ TH01-SZ	CN1256	421272

Test Firm	Sporton International (Shenzhen) Inc.		
Test Site Location	No. 3 Bldg the third floor of south, Shahe River west, Fengzeyuan Warehouse, Nanshan Shenzhen, 518055 People's Republic of China TEL: +86-755-33202398		
Test Site No.	Sporton Site No.	FCC Designation No.	FCC Test Firm Registration No.
	03CH04-SZ	CN1256	421272

1.7 Test Software

Item	Site	Manufacture	Name	Version
1.	03CH04-SZ	AUDIX	E3	6.2009-8-24
2.	CO01-SZ	AUDIX	E3	6.120613b

1.8 Applicable Standards

According to the specifications of the manufacturer, the EUT must comply with the requirements of the following standards:

- ♦ 47 CFR Part 15 Subpart E
- ♦ FCC KDB 789033 D02 General UNII Test Procedures New Rules v02r01.
- ♦ FCC KDB 662911 D01 Multiple Transmitter Output v02r01.
- ♦ ANSI C63.10-2013

Remark:

1. All test items were verified and recorded according to the standards and without any deviation during the test.
2. This EUT has also been tested and complied with the requirements of FCC Part 15, Subpart B, recorded in a separate test report.



2 Test Configuration of Equipment Under Test

- a. The EUT has been associated with peripherals and configuration operated in a manner tended to maximize its emission characteristics in a typical application. Frequency range investigated: conduction emission (150 kHz to 30 MHz), radiation emission (9 kHz to the 10th harmonic of the highest fundamental frequency or to 40 GHz, whichever is lower). For radiated measurement, pre-scanned in three orthogonal panels, X, Y, Z. The worst cases (X plane) were recorded in this report.
- b. AC power line Conducted Emission was tested under maximum output power.

2.1 Carrier Frequency and Channel

Frequency Band	Channel	Freq. (MHz)	Channel	Freq. (MHz)
5745-5825 MHz Band 4 (U-NII-3)	149	5745	157	5785
	151*	5755	159*	5795
	153	5765	161	5805
	155#	5775	165	5825

Note:

- 1. The above Frequency and Channel in "*" were 802.11n HT40 and 802.11ac VHT40.
- 2. The above Frequency and Channel in "#n" were 802.11ac VHT80.



2.2 Test Mode

Final test modes are considering the modulation and worse data rates as below table.

MIMO Mode

Modulation	Data Rate
802.11a	6 Mbps
802.11n HT20	MCS0
802.11n HT40	MCS0
802.11ac VHT80	MCS0

AC Conducted Emission	Mode 1 : GSM 850 Idle + Bluetooth Link + WLAN Link(5G) + USB Cable 1(Charging from Adapter 1)
Remark: For Radiated Test Cases, The tests were performed with Adapter 1 and USB Cable 1.	

Ch. #		Band IV : 5745-5825 MHz			
		802.11a	802.11n HT20	802.11n HT40	802.11ac VHT80
L	Low	149	149	151	-
M	Middle	157	157	-	155
H	High	165	165	159	-

2.3 Connection Diagram of Test System

For Radiation

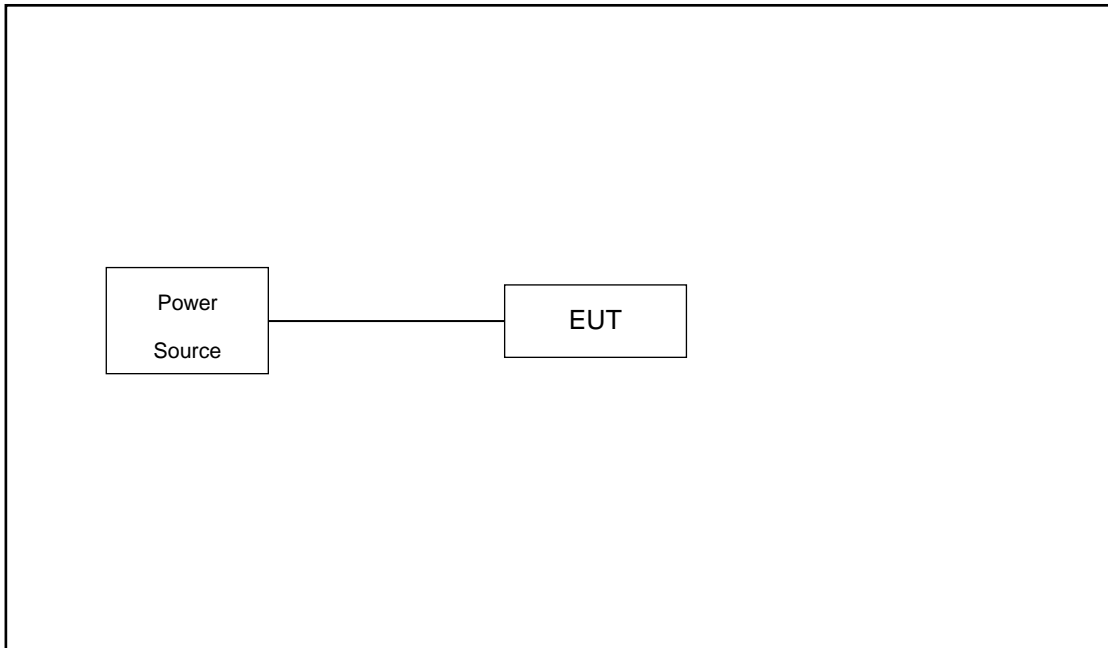

For Conducted Emission

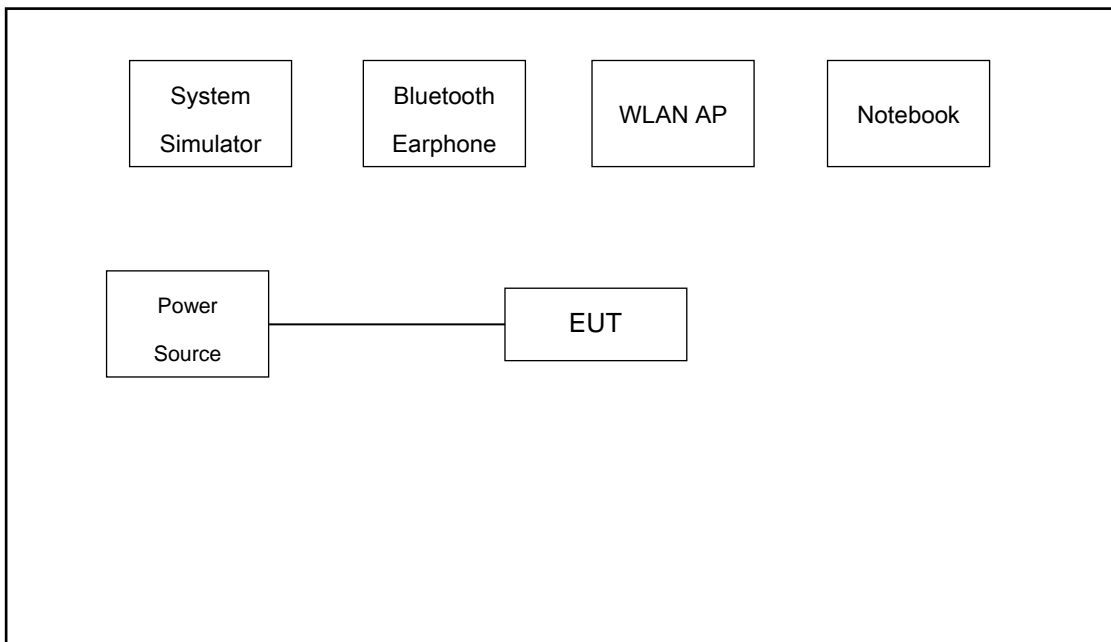



2.4 Support Unit used in test configuration and system

Item	Equipment	Trade Name	Model Name	FCC ID	Data Cable	Power Cord
1.	Base Station	Anritsu	MT8820C	N/A	N/A	Unshielded,1.8m
2.	Bluetooth Earphone	Samsung	EO-MG900	PYAHS-107W	N/A	N/A
3.	WLAN AP	D-link	DIR-820L	KA2IR820LA1	N/A	Unshielded,1.8m
4.	Notebook	Lenovo	E540	FCC DoC	N/A	AC I/P: Unshielded, 1.2 m DC O/P: Shielded, 1.8 m

2.5 EUT Operation Test Setup

For WLAN RF test items, an engineering test program was provided and enabled to make EUT continuous transmit/receive.

For AC power line conducted emissions, the EUT was set to connect with the WLAN AP under large package sizes transmission.

2.6 Measurement Results Explanation Example

For all conducted test items:

The offset level is set in the spectrum analyzer to compensate the RF cable loss and attenuator factor between EUT conducted output port and spectrum analyzer. With the offset compensation, the spectrum analyzer reading level is exactly the EUT RF output level.

Example :

The spectrum analyzer offset is derived from RF cable loss and attenuator factor.

Offset = RF cable loss + attenuator factor.

Following shows an offset computation example with cable loss 2.5 dB and 10dB attenuator.

$$\begin{aligned}
 \text{Offset(dB)} &= \text{RF cable loss(dB)} + \text{attenuator factor(dB)}. \\
 &= 2.5 + 20 = 22.5 \text{ (dB)}
 \end{aligned}$$

3 Test Result

3.1 6dB and 26dB and 99% Occupied Bandwidth Measurement

3.1.1 Description of 6dB and 26dB and 99% Occupied Bandwidth

The minimum 6 dB bandwidth shall be at least 500 kHz.

26dB and 99% Occupied bandwidth are reporting only.

3.1.2 Measuring Instruments

The measuring equipment is listed in the section 4 of this test report.

3.1.3 Test Procedures

1. The testing follows FCC KDB 789033 D02 General UNII Test Procedures New Rules v02r01. Section C) Emission bandwidth for the band 5.725-5.85GHz
2. Set RBW = 100kHz.
3. Set the VBW $\geq 3 \times$ RBW.
4. Detector = Peak.
5. Trace mode = max hold
6. Measure the maximum width of the emission that is 6 dB down from the peak of the emission.
7. Measure and record the results in the test report.

3.1.4 Test Setup

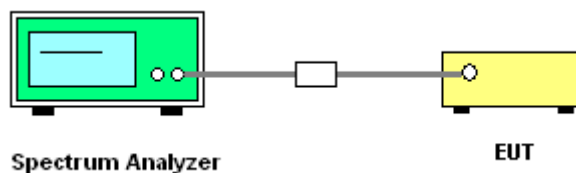



3.1.5 Test Result of 6dB Bandwidth

Please refer to Appendix A.

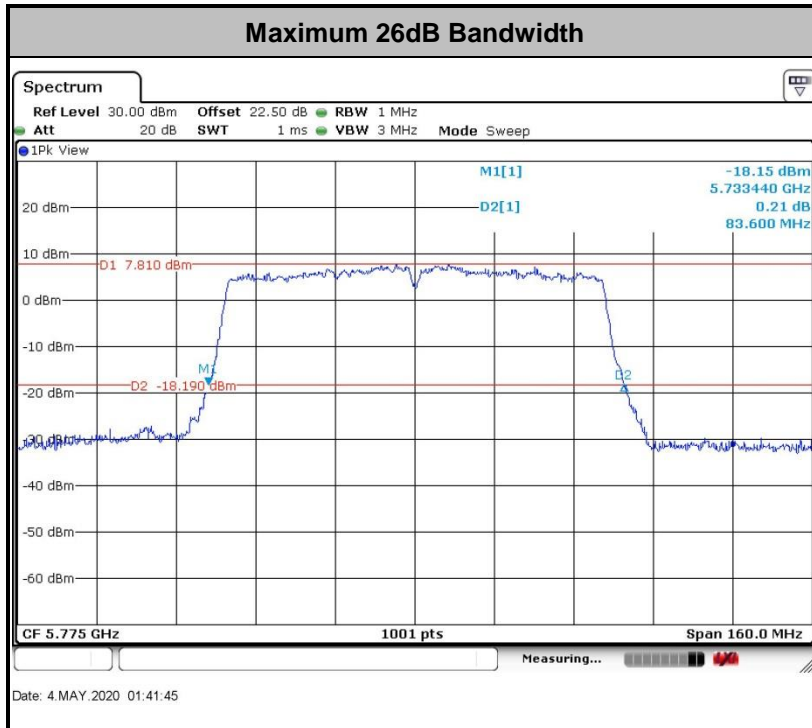
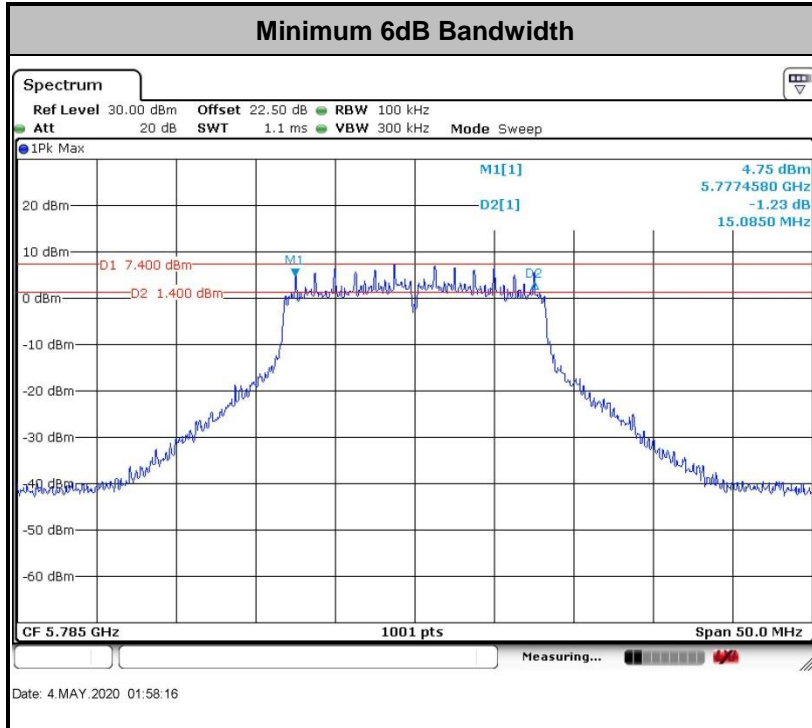

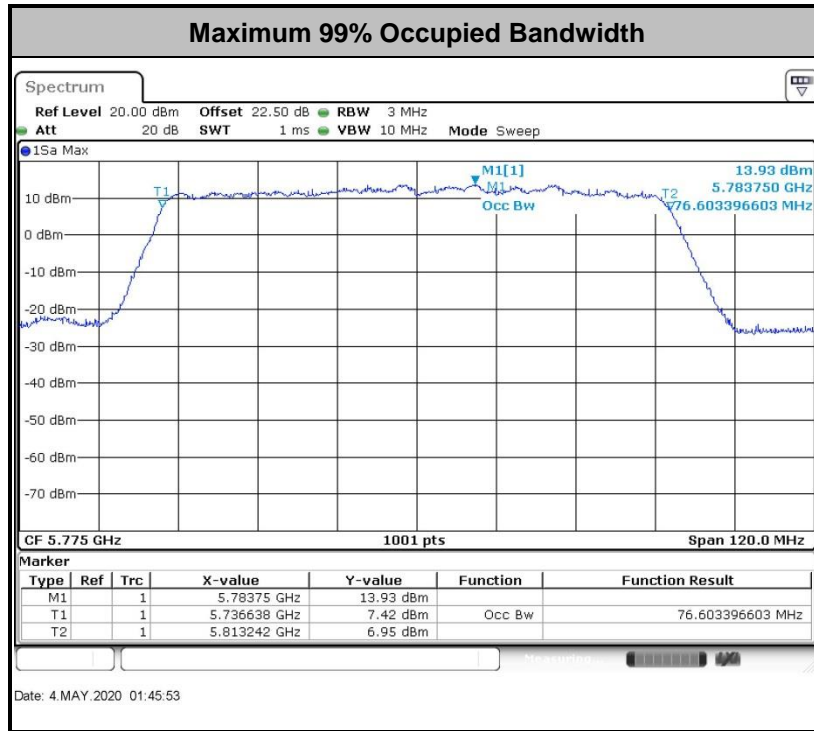

Note: The occupied channel bandwidth is maintained within the band of operation for all of the modulations.

3.2 Maximum Conducted Output Power Measurement

3.2.1 Limit of Maximum Conducted Output Power

For the band 5.725–5.85 GHz, the maximum conducted output power over the frequency band of operation shall not exceed 1 W.

If transmitting antennas of directional gain greater than 6 dBi are used, the peak output power shall be reduced by the amount in dB that the directional gain of the antenna exceeds 6 dBi.

3.2.2 Measuring Instruments

The measuring equipment is listed in the section 4 of this test report.

3.2.3 Test Procedures

The testing follows Method PM of FCC KDB 789033 D02 General UNII Test Procedures New Rules v02r01.

Method PM (Measurement using an RF average power meter):

1. Measurement is performed using a wideband RF power meter.
2. The EUT is configured to transmit continuously with a consistent duty cycle at its maximum power control level.
3. Measure the average power of the transmitter, and the average power is corrected with duty factor, $10 \log(1/x)$, where x is the duty cycle.

3.2.4 Test Setup

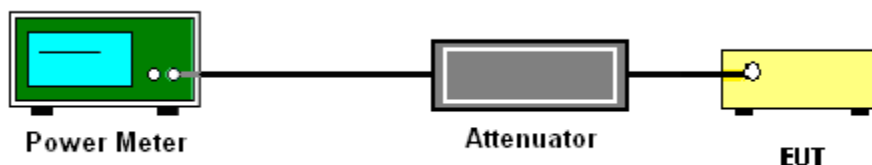

3.2.5 Test Result of Maximum Conducted Output Power

Please refer to Appendix A.



3.3 Power Spectral Density Measurement

3.3.1 Limit of Power Spectral Density

For the band 5.725–5.85 GHz, the maximum power spectral density shall not exceed 30 dBm in any 500-kHz band.

If transmitting antennas of directional gain greater than 6 dBi are used, the peak output power shall be reduced by the amount in dB that the directional gain of the antenna exceeds 6 dBi.

3.3.2 Measuring Instruments

The measuring equipment is listed in the section 4 of this test report.

3.3.3 Test Procedures

The testing follows FCC KDB 789033 D02 General UNII Test Procedures New Rules v02r01. Section F) Maximum power spectral density.

Method SA-2

(trace averaging across on and off times of the EUT transmissions, followed by duty cycle correction).

- Measure the duty cycle.
- Set span to encompass the entire emission bandwidth (EBW) of the signal.
- Set RBW = 300 kHz.
- Set VBW \geq 1 MHz.
- Number of points in sweep \geq 2 Span / RBW.
- Sweep time = auto.
- Detector = RMS
- Trace average at least 100 traces in power averaging mode.
- Add $10 \log(500\text{kHz}/\text{RBW})$ to the test result.
- Add $10 \log(1/x)$, where x is the duty cycle, to the measured power in order to compute the average power during the actual transmission times. For example, add $10 \log(1/0.25) = 6$ dB if the duty cycle is 25 percent.

1. The RF output of EUT was connected to the spectrum analyzer by a low loss cable.
2. Each plot has already offset with cable loss, and attenuator loss. Measure the PPSD and record it.
3. For MIMO mode, calculation method follows FCC KDB 662911 D01 Multiple Transmitter Output v02r01.

Method (c): Measure and add $10 \log(N_{\text{ANT}})$ dB.

With this technique, spectrum measurements are performed at each output of the device, but rather than summing the spectra or the spectral peaks across the outputs, the quantity $10 \log(N_{\text{ANT}})$ dB is added to each spectrum value before comparing to the emission limit. The addition of $10 \log(N_{\text{ANT}})$ dB serves to apportion the emission limit among the N_{ANT} outputs so that each output is permitted to contribute no more than $1/N_{\text{ANT}}^{\text{th}}$ of the PSD limit.

3.3.4 Test Setup

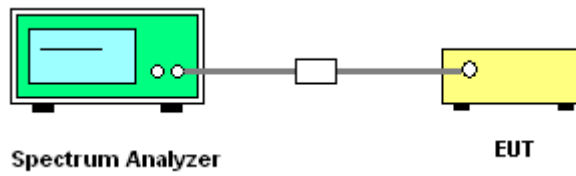



3.3.5 Test Result of Power Spectral Density

Please refer to Appendix A.

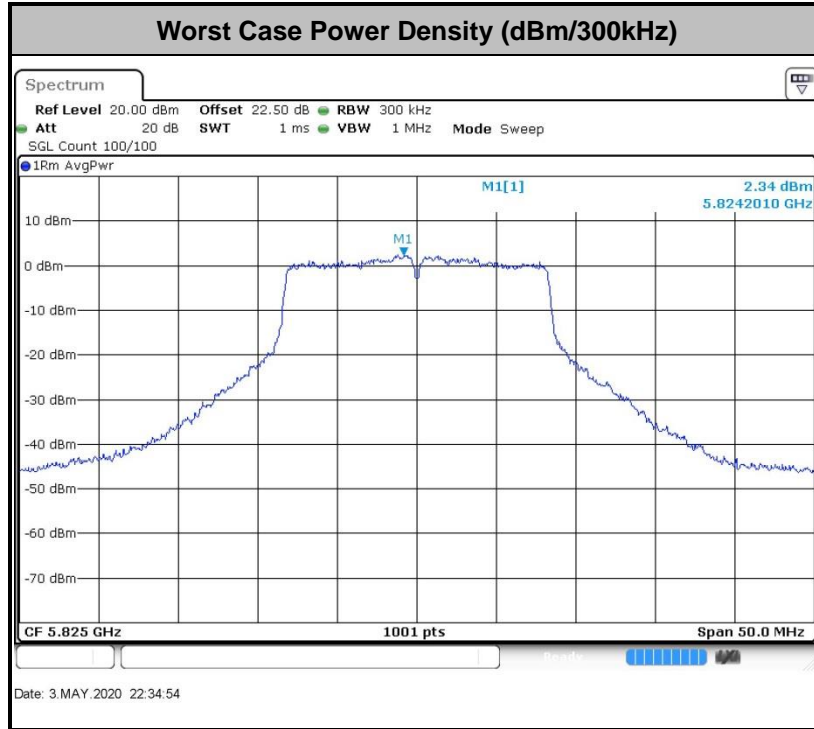



3.4 Unwanted Emissions Measurement

This section is to measure unwanted emissions through radiated measurement for band edge spurious emissions and out of band emissions measurement.

3.4.1 Limit of Unwanted Emissions

- (1) For transmitters operating in the 5.725-5.85 GHz band:
 15.407(b)(4)(i) All emissions shall be limited to a level of -27 dBm/MHz at 75 MHz or more above or below the band edge increasing linearly to 10 dBm/MHz at 25 MHz above or below the band edge, and from 25 MHz above or below the band edge increasing linearly to a level of 15.6 dBm/MHz at 5 MHz above or below the band edge, and from 5 MHz above or below the band edge increasing linearly to a level of 27 dBm/MHz at the band edge.
- (2) Unwanted spurious emissions fallen in restricted bands shall comply with the general field strength limits as below table,

Frequency (MHz)	Field Strength (microvolts/meter)	Measurement Distance (meters)
0.009 – 0.490	2400/F(kHz)	300
0.490 – 1.705	24000/F(kHz)	30
1.705 – 30.0	30	30
30 – 88	100	3
88 – 216	150	3
216 - 960	200	3
Above 960	500	3

EIRP (dBm)	Field Strength at 3m (dBµV/m)
- 27	68.3

Note: The following formula is used to convert the EIRP to field strength.

$$EIRP = E_{Meas} + 20\log (d_{Meas}) -104.7$$

where

EIRP is the equivalent isotropically radiated power, in dBm

E_{Meas} is the field strength of the emission at the measurement distance, in dBµV/m

d_{Meas} is the measurement distance, in m

3.4.2 Measuring Instruments

The measuring equipment is listed in the section 4 of this test report.



3.4.3 Test Procedures

1. The testing follows FCC KDB 789033 D02 General UNII Test Procedures New Rules v02r01. Section G) Unwanted emissions measurement.
 - (1) Procedure for Unwanted Emissions Measurements Below 1000MHz
 - RBW = 120 kHz
 - VBW = 300 kHz
 - Detector = Peak
 - Trace mode = max hold
 - (2) Procedure for Peak Unwanted Emissions Measurements Above 1000 MHz
 - RBW = 1 MHz
 - VBW \geq 3 MHz
 - Detector = Peak
 - Sweep time = auto
 - Trace mode = max hold
 - (3) Procedures for Average Unwanted Emissions Measurements Above 1000MHz
 - RBW = 1 MHz
 - VBW = 10 Hz, when duty cycle is no less than 98 percent.
 - VBW \geq 1/T, when duty cycle is less than 98 percent where T is the minimum transmission duration over which the transmitter is on and is transmitting at its maximum power control level for the tested mode of operation.
2. The EUT was placed on a turntable with 0.8 meter for frequency below 1GHz and 1.5 meter for frequency above 1GHz respectively above ground.
3. The EUT was set 3 meters from the interference receiving antenna which was mounted on the top of a variable height antenna tower.
4. The antenna is a broadband antenna and its height is adjusted between one meter and four meters above ground to find the maximum value of the field strength for both horizontal polarization and vertical polarization of the antenna.
5. For each suspected emission, the EUT was arranged to its worst case and then adjust the antenna tower (from 1 m to 4 m) and turntable (from 0 degree to 360 degrees) to find the maximum reading.
6. For testing below 1GHz, if the emission level of the EUT in peak mode was 3 dB lower than the limit specified, then peak values of EUT will be reported, otherwise, the emissions will be repeated one by one using the CISPR quasi-peak method and reported.
7. For testing above 1GHz, the emission level of the EUT in peak mode was 20dB lower than average limit (that means the emission level in average mode also complies with the limit in average mode), then peak values of EUT will be reported, otherwise, the emissions will be measured in average mode again and reported.

3.4.4 Test Setup

For radiated emissions below 30MHz

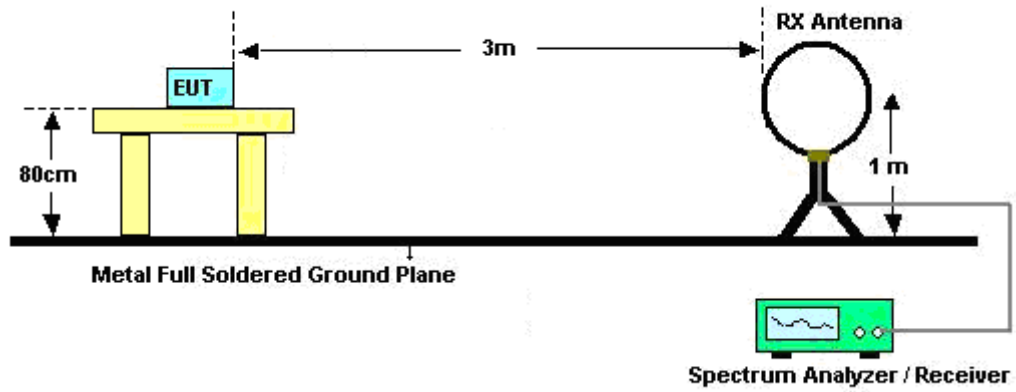

For radiated emissions from 30MHz to 1GHz

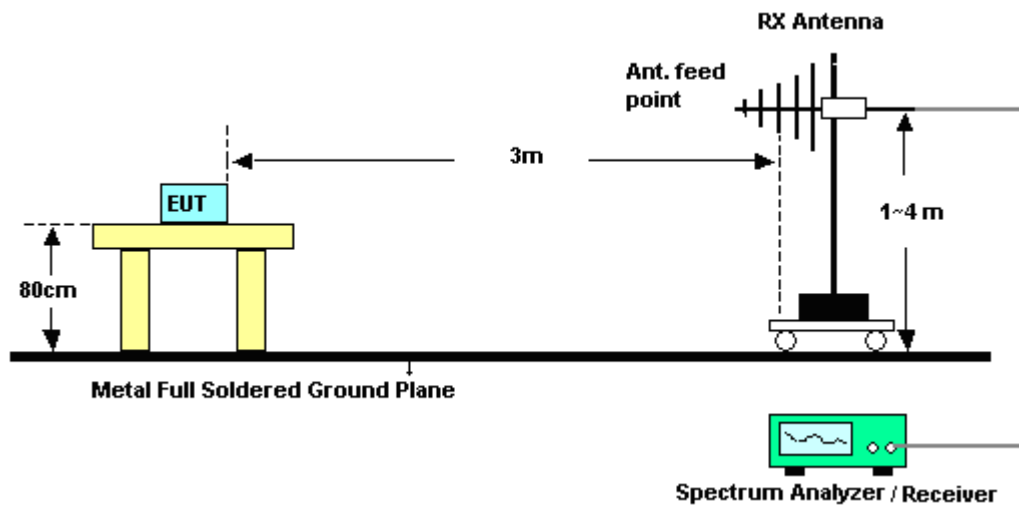

For radiated emissions above 1GHz



3.4.5 Test Results of Radiated Emissions (9 kHz ~ 30 MHz)

The low frequency, which started from 9 kHz to 30MHz, was pre-scanned and the result which was 20dB lower than the limit line was not reported.

There is a comparison data of both open-field test site and semi-Anechoic chamber, and the result came out very similar.

3.4.6 Test Result of Radiated Band Edges

Please refer to Appendix C.

3.4.7 Duty Cycle

Please refer to Appendix D.

3.4.8 Test Result of Unwanted Radiated Emission (30MHz ~ 10th Harmonic)

Please refer to Appendix C.



3.5 AC Conducted Emission Measurement

3.5.1 Limit of AC Conducted Emission

For equipment that is designed to be connected to the public utility (AC) power line, the radio frequency voltage that is conducted back onto the AC power line on any frequency or frequencies within the band 150 kHz to 30 MHz shall not exceed the limits in the following table.

Frequency of emission (MHz)	Conducted limit (dBµV)	
	Quasi-peak	Average
0.15-0.5	66 to 56*	56 to 46*
0.5-5	56	46
5-30	60	50

*Decreases with the logarithm of the frequency.

3.5.2 Measuring Instruments

The measuring equipment is listed in the section 4 of this test report.

3.5.3 Test Procedures

1. The EUT was placed 0.4 meter from the conducting wall of the shielding room was kept at least 80 centimeters from any other grounded conducting surface.
2. Connect EUT to the power mains through a line impedance stabilization network (LISN).
3. All the support units are connecting to the other LISN.
4. The LISN provides 50 ohm coupling impedance for the measuring instrument.
5. The FCC states that a 50 ohm, 50 microhenry LISN should be used.
6. Both sides of AC line were checked for maximum conducted interference.
7. The frequency range from 150 kHz to 30 MHz was searched.
8. Set the test-receiver system to Peak Detect Function and specified bandwidth with Maximum Hold Mode.

3.5.4 Test Setup



3.5.5 Test Result of AC Conducted Emission

Please refer to Appendix B.



3.6 Automatically Discontinue Transmission

3.6.1 Limit of Automatically Discontinue Transmission

The device shall automatically discontinue transmission in case of either absence of information to transmit or operational failure. These provisions are not intended to preclude the transmission of control or signaling information or the use of repetitive codes used by certain digital technologies to complete frame or burst intervals. Applicants shall include in their application for equipment authorization to describe how this requirement is met.

3.6.2 Measuring Instruments

The measuring equipment is listed in the section 4 of this test report.

3.6.3 Test Result of Automatically Discontinue Transmission

While the EUT is not transmitting any information, the EUT can automatically discontinue transmission and become standby mode for power saving. The EUT can detect the controlling signal of ACK message transmitting from remote device and verify whether it shall resend or discontinue transmission.



3.7 Antenna Requirements

3.7.1 Standard Applicable

If transmitting antenna directional gain is greater than 6 dBi, both the peak transmit power and the peak power spectral density shall be reduced by the amount in dB that the directional gain of the antenna exceeds 6 dBi.

3.7.2 Antenna Anti-Replacement Construction

An embedded-in antenna design is used.

3.7.3 Antenna Gain

The antenna peak gain of EUT is less than 6 dBi. Therefore, it is not necessary to reduce maximum peak output power limit.

FCC KDB 662911 D01 Multiple Transmitter Output v02r01

For CDD transmissions, directional gain is calculated as

Directional gain = G_{ANT} + Array Gain, where Array Gain is as follows.

For power spectral density (PSD) measurements on all devices,

Array Gain = 10 log(NANT/NSS=1) dB.

For power measurements on IEEE 802.11 devices,

Array Gain = 0 dB (i.e., no array gain) for NANT ≤ 4.

Directional gain may be calculated by using the formulas applicable to equal gain antennas with G_{ANT} set equal to the gain of the antenna having the highest gain;

The EUT supports CDD mode.

For power, the directional gain G_{ANT} is set equal to the antenna having the highest gain, i.e., F)2)f)i).

For PSD, the directional gain calculation is following F)2)f)ii) of KDB 662911 D01 v02r01.

The power and PSD limit should be modified if the directional gain of EUT is over 6 dBi,

The directional gain "DG" is calculated as following table.

<CDD Modes>						
			DG for Power (dBi)	DG for PSD (dBi)	Power Limit Reduction (dB)	PSD Limit Reduction (dB)
	Ant. 1 (dBi)	Ant. 2 (dBi)				
Band IV	-3.00	-3.00	-3.00	0.01	0.00	0.00

Power Limit Reduction = DG(Power) – 6dBi, (min = 0)

PSD Limit Reduction = DG(PSD) – 6dBi, (min = 0)



4 List of Measuring Equipment

Instrument	Manufacturer	Model No.	Serial No.	Characteristics	Calibration Date	Test Date	Due Date	Remark
Spectrum Analyzer	R&S	FSV40	101078	10Hz~40GHz	Apr. 16, 2020	May 03, 2020~ May 04, 2020	Apr. 15, 2021	Conducted (TH01-SZ)
Pulse Power Sensor	Anritsu	MA2411B	1207253	30MHz~40GHz	Dec. 26, 2019	May 03, 2020~ May 04, 2020	Dec. 25, 2020	Conducted (TH01-SZ)
Power Meter	Anritsu	ML2495A	1218010	50MHz Bandwidth	Dec. 26, 2019	May 03, 2020~ May 04, 2020	Dec. 25, 2020	Conducted (TH01-SZ)
EMI Test Receiver	R&S	ESR7	101404	9kHz~7GHz	Apr. 17, 2020	May 15, 2020	Apr. 16, 2021	Radiation (03CH04-SZ)
EXA Spectrum Analyzer	KEYSIGHT	N9010A	MY551502 13	10Hz~44GHz	Apr. 17, 2020	May 15, 2020	Apr. 16, 2021	Radiation (03CH04-SZ)
Loop Antenna	R&S	HFH2-Z2	100354	9kHz~30MHz	May 29, 2019	May 15, 2020	May 28, 2020	Radiation (03CH04-SZ)
Bilog Antenna	TeseQ	CBL6111D	41909	30MHz~1GHz	Aug. 27, 2019	May 15, 2020	Aug. 26, 2020	Radiation (03CH04-SZ)
Double Ridge Horn Antenna	SCHWARZBECK	BBHA9120D	9120D-147 4	1GHz~18GHz	Apr. 01, 2020	May 15, 2020	Mar. 31, 2021	Radiation (03CH04-SZ)
Horn Antenna	SCHWARZBECK	BBHA9170	9170#679	15GHz~40GHz	Apr. 17, 2020	May 15, 2020	Apr. 16, 2021	Radiation (03CH04-SZ)
Amplifier	Burgeon	BPA-530	102211	0.01Hz ~3000MHz	Oct. 18, 2019	May 15, 2020	Oct. 17, 2020	Radiation (03CH04-SZ)
HF Amplifier	MITEQ	AMF-7D-0010 1800-30-10P-R	1943528	1GHz~18GHz	Oct. 18, 2019	May 15, 2020	Oct. 17, 2020	Radiation (03CH04-SZ)
HF Amplifier	MITEQ	TTA1840-35-HG	1871923	18GHz~40GHz	Jul. 22, 2019	May 15, 2020	Jul. 21, 2020	Radiation (03CH04-SZ)
Amplifier	Agilent Technologies	83017A	MY532701 56	500MHz~26.5G Hz	Aug. 26, 2019	May 15, 2020	Aug. 25, 2020	Radiation (03CH04-SZ)
AC Power Source	Chroma	61601	N/A	N/A	NCR	May 15, 2020	NCR	Radiation (03CH04-SZ)
Turn Table	EM	EM1000	N/A	0~360 degree	NCR	May 15, 2020	NCR	Radiation (03CH04-SZ)
Antenna Mast	EM	EM1000	N/A	1 m~4 m	NCR	May 15, 2020	NCR	Radiation (03CH04-SZ)
EMI Receiver	R&S	ESR7	101630	9kHz~7GHz;	Dec. 26, 2019	May 19, 2020	Dec. 25, 2020	Conduction (CO01-SZ)
AC LISN	EMCO	3816/2SH	00103912	9kHz~30MHz	Oct. 17, 2019	May 19, 2020	Oct. 16, 2020	Conduction (CO01-SZ)
AC LISN (for auxiliary equipment)	EMCO	3816/2SH	00103892	9kHz~30MHz	Oct. 17, 2019	May 19, 2020	Oct. 16, 2020	Conduction (CO01-SZ)
AC Power Source	Chroma	61602	616020000 891	100Vac~250Vac	Jul. 23, 2019	May 19, 2020	Jul. 22, 2020	Conduction (CO01-SZ)

NCR: No Calibration Required



5 Uncertainty of Evaluation

The measurement uncertainties shown below were calculated in accordance with the requirements of ANSI 63.10-2013. All the measurement uncertainty value were shown with a coverage K=2 to indicate 95% level of confidence. The measurement data show herein meets or exceeds the CISPR measurement uncertainty values specified in CISPR 16-4-2 and can be compared directly to specified limit to determine compliance.

Uncertainty of Conducted Emission Measurement (150kHz ~ 30MHz)

Measuring Uncertainty for a Level of Confidence of 95% (U = 2Uc(y))	2.6dB
---	-------

Uncertainty of Radiated Emission Measurement (30 MHz ~ 1000 MHz)

Measuring Uncertainty for a Level of Confidence of 95% (U = 2Uc(y))	5.0dB
---	-------

Uncertainty of Radiated Emission Measurement (1000 MHz ~ 18000 MHz)

Measuring Uncertainty for a Level of Confidence of 95% (U = 2Uc(y))	4.8dB
---	-------

Uncertainty of Radiated Emission Measurement (18000 MHz ~ 40000 MHz)

Measuring Uncertainty for a Level of Confidence of 95% (U = 2Uc(y))	5.1dB
---	-------



Appendix A. Conducted Test Results

Report Number : FR042007-02G

Test Engineer:	Zhang Jiang	Temperature:	21~25	°C
Test Date:	2020/5/3~2020/5/4	Relative Humidity:	51~54	%

TEST RESULTS DATA
6dB and 26dB EBW and 99% OBW

Band IV													
Mod.	Data Rate	NTX	CH.	Freq. (MHz)	99% Bandwidth (MHz)		26dB Bandwidth (MHz)		6 dB Bandwidth (MHz)		6 dB Bandwidth Min. Limit (MHz)		Pass/Fail
					Ant 1	Ant 2	Ant 1	Ant 2	Ant 1	Ant 2	Ant 1	Ant 2	
11a	6Mbps	2	149	5745	16.73	16.58	24.43	23.43	15.29	15.39	0.5	0.5	Pass
11a	6Mbps	2	157	5785	16.73	16.63	24.28	23.63	15.29	15.09	0.5	0.5	Pass
11a	6Mbps	2	165	5825	16.73	16.63	24.53	23.58	15.53	15.68	0.5	0.5	Pass
HT20	MCS0	2	149	5745	17.88	17.78	25.92	24.88	15.93	15.14	0.5	0.5	Pass
HT20	MCS0	2	157	5785	17.88	17.83	25.57	24.93	15.09	15.09	0.5	0.5	Pass
HT20	MCS0	2	165	5825	17.88	17.83	25.82	25.43	15.93	15.44	0.5	0.5	Pass
HT40	MCS0	2	151	5755	36.56	36.46	41.90	42.08	35.07	35.34	0.5	0.5	Pass
HT40	MCS0	2	159	5795	36.66	36.46	41.72	41.90	35.25	35.07	0.5	0.5	Pass
VHT80	MCS0	2	155	5775	76.60	76.60	83.60	82.80	75.12	75.12	0.5	0.5	Pass

TEST RESULTS DATA
Average Power Table

Band IV														
Mod.	Data Rate	NTX	CH.	Freq. (MHz)	Duty Factor (dB)		Average Conducted Power (dBm)			FCC Conducted Power Limit (dBm)		DG (dBi)		Pass/Fail
					Ant 1	Ant 2	Ant 1	Ant 2	SUM	Ant 1	Ant 2	Ant 1	Ant 2	
11a	6Mbps	2	149	5745	0.09	0.11	17.41	17.00	20.22	30.00		-3.00		Pass
11a	6Mbps	2	157	5785	0.09	0.11	17.67	16.95	20.33	30.00		-3.00		Pass
11a	6Mbps	2	165	5825	0.09	0.11	17.75	16.56	20.20	30.00		-3.00		Pass
HT20	MCS0	2	149	5745	0.14	0.18	17.33	16.95	20.15	30.00		-3.00		Pass
HT20	MCS0	2	157	5785	0.14	0.18	17.57	16.86	20.24	30.00		-3.00		Pass
HT20	MCS0	2	165	5825	0.14	0.18	17.58	16.44	20.06	30.00		-3.00		Pass
HT40	MCS0	2	151	5755	0.30	0.30	17.44	16.79	20.13	30.00		-3.00		Pass
HT40	MCS0	2	159	5795	0.30	0.30	17.58	16.72	20.18	30.00		-3.00		Pass
VHT20	MCS0	2	149	5745	0.27	0.34	17.26	16.91	20.09	30.00		-3.00		Pass
VHT20	MCS0	2	157	5785	0.27	0.34	17.50	16.82	20.18	30.00		-3.00		Pass
VHT20	MCS0	2	165	5825	0.27	0.34	17.51	16.40	20.00	30.00		-3.00		Pass
VHT40	MCS0	2	151	5755	0.48	0.59	17.37	16.77	20.09	30.00		-3.00		Pass
VHT40	MCS0	2	159	5795	0.48	0.59	17.51	16.68	20.13	30.00		-3.00		Pass
VHT80	MCS0	2	155	5775	0.92	0.91	16.51	15.50	19.05	30.00		-3.00		Pass

TEST RESULTS DATA
Power Spectral Density

Band IV																
Mod.	Data Rate	NTX	CH.	Freq. (MHz)	Duty Factor (dB)		10log (500kHz /RBW) Factor (dB)		Average Power Density (dBm/500kHz)			Average PSD Limit (dBm/500kHz)		DG (dBi)		Pass /Fail
					Ant 1	Ant 2	Ant 1	Ant 2	Ant 1	Ant 2	SUM	Ant 1	Ant 2	Ant 1	Ant 2	
11a	6Mbps	2	149	5745	0.09	0.11	2.22				7.13	30.00	0.01		Pass	
11a	6Mbps	2	157	5785	0.09	0.11	2.22				7.54	30.00	0.01		Pass	
11a	6Mbps	2	165	5825	0.09	0.11	2.22				7.66	30.00	0.01		Pass	
HT20	MCS0	2	149	5745	0.14	0.18	2.22				6.86	30.00	0.01		Pass	
HT20	MCS0	2	157	5785	0.14	0.18	2.22				7.13	30.00	0.01		Pass	
HT20	MCS0	2	165	5825	0.14	0.18	2.22				7.26	30.00	0.01		Pass	
HT40	MCS0	2	151	5755	0.30	0.30	2.22				3.41	30.00	0.01		Pass	
HT40	MCS0	2	159	5795	0.30	0.30	2.22				3.92	30.00	0.01		Pass	
VHT80	MCS0	2	155	5775	0.92	0.91	2.22				-0.31	30.00	0.01		Pass	



Appendix B. AC Conducted Emission Test Results

Test Engineer :	Doom Wu	Temperature :	22~25°C
		Relative Humidity :	50~55%
Test Voltage :	120Vac / 60Hz	Phase :	Line
Remark :	All emissions not reported here are more than 10 dB below the prescribed limit.		

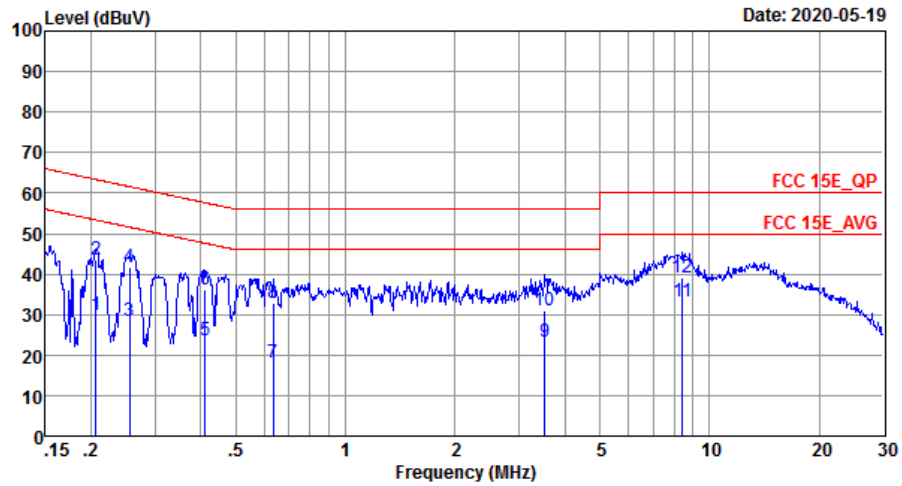

Site : CO01-SZ
 Condition: FCC 15E QP LISN 20190719 L LINE

	Freq	Level	Over Limit	Limit Line	Read Level	LISN Factor	Cable Loss	Remark
	MHz	dBuV	dB	dBuV	dBuV	dB	dB	
1	0.21	29.74	-23.62	53.36	19.70	0.03	10.01	Average
2	0.21	43.64	-19.72	63.36	33.60	0.03	10.01	QP
3	0.25	28.34	-23.26	51.60	18.30	0.03	10.01	Average
4	0.25	41.64	-19.96	61.60	31.60	0.03	10.01	QP
5	0.41	23.55	-24.04	47.59	13.50	0.03	10.02	Average
6	0.41	36.05	-21.54	57.59	26.00	0.03	10.02	QP
7	0.63	18.09	-27.91	46.00	8.00	0.02	10.07	Average
8	0.63	32.69	-23.31	56.00	22.60	0.02	10.07	QP
9	3.53	23.38	-22.62	46.00	13.10	0.17	10.11	Average
10	3.53	30.98	-25.02	56.00	20.70	0.17	10.11	QP
11 *	8.41	33.13	-16.87	50.00	22.60	0.30	10.23	Average
12	8.41	39.03	-20.97	60.00	28.50	0.30	10.23	QP



Test Engineer :	Doom Wu	Temperature :	22~25°C
		Relative Humidity :	50~55%
Test Voltage :	120Vac / 60Hz	Phase :	Neutral
Remark :	All emissions not reported here are more than 10 dB below the prescribed limit.		

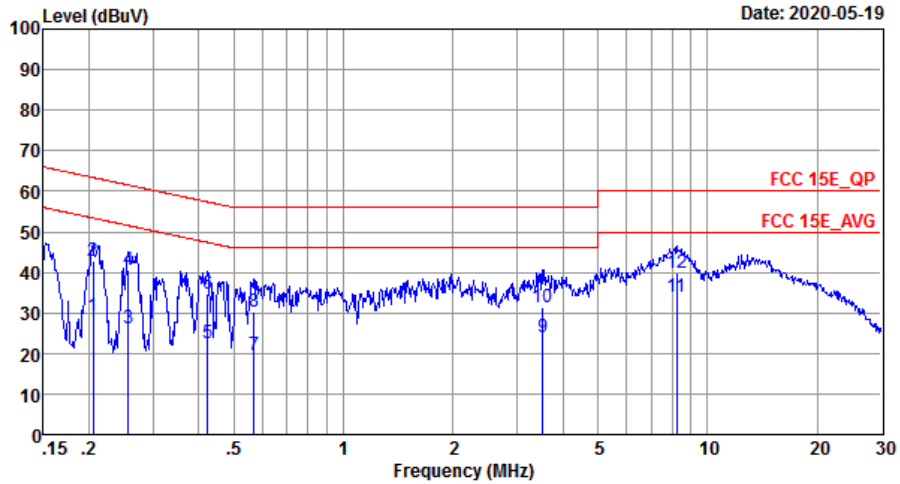

Site : CO01-SZ
 Condition: FCC 15E_QP LISN_20190719_N NEUTRAL

	Freq	Level	Over Limit	Limit Line	Read Level	LISN Factor	Cable Loss	Remark
	MHz	dBuV	dB	dBuV	dBuV	dB	dB	
1	0.21	29.14	-24.26	53.40	19.10	0.03	10.01	Average
2	0.21	42.84	-20.56	63.40	32.80	0.03	10.01	QP
3	0.26	26.24	-25.32	51.56	16.20	0.03	10.01	Average
4	0.26	40.64	-20.92	61.56	30.60	0.03	10.01	QP
5	0.42	22.34	-25.03	47.37	12.30	0.02	10.02	Average
6	0.42	34.84	-22.53	57.37	24.80	0.02	10.02	QP
7	0.57	19.68	-26.32	46.00	9.60	0.02	10.06	Average
8	0.57	30.08	-25.92	56.00	20.00	0.02	10.06	QP
9	3.53	23.96	-22.04	46.00	13.81	0.04	10.11	Average
10	3.53	31.36	-24.64	56.00	21.21	0.04	10.11	QP
11 *	8.24	33.84	-16.16	50.00	23.50	0.11	10.23	Average
12	8.24	39.74	-20.26	60.00	29.40	0.11	10.23	QP

Note:

- Level(dBμV) = Read Level(dBμV) + LISN Factor(dB) + Cable Loss(dB)
- Over Limit(dB) = Level(dBμV) – Limit Line(dBμV)



Appendix C. Radiated Spurious Emission

Band 4 - 5725~5850MHz
WIFI 802.11a (Band Edge @ 3m)

WIFI Ant.	Note	Frequency	Level	Over Limit	Limit Line	Read Level	Antenna Factor	Cable Loss	Preamp Factor	Ant Pos	Table Pos	Peak Avg.	Pol.
1+2		(MHz)	(dBμV/m)	(dB)	(dBμV/m)	(dBμV)	(dB/m)	(dB)	(dB)	(cm)	(deg)	(P/A)	(H/V)
802.11a CH 149 5745MHz		5632.2	50.76	-17.44	68.2	41.2	32.39	9.84	32.67	100	67	P	H
		5679.6	54.05	-36.09	90.14	44.36	32.43	9.92	32.66	100	67	P	H
		5717	61.88	-48.08	109.96	52.06	32.46	10.01	32.65	100	67	P	H
		5724.6	64.31	-56.98	121.29	54.47	32.48	10.01	32.65	100	67	P	H
		5745	112.32	-	-	102.39	32.49	10.09	32.65	100	67	P	H
		5745	107.26	-	-	97.33	32.49	10.09	32.65	100	67	A	H
		5623	50.28	-17.92	68.2	40.72	32.39	9.84	32.67	388	95	P	V
		5674	51.42	-34.58	86	41.74	32.43	9.92	32.67	388	95	P	V
		5718.8	56	-54.46	110.46	46.16	32.48	10.01	32.65	388	95	P	V
		5723.2	59.97	-58.13	118.1	50.13	32.48	10.01	32.65	388	95	P	V
		5745	108.1	-	-	98.17	32.49	10.09	32.65	388	95	P	V
		5745	103.61	-	-	93.68	32.49	10.09	32.65	388	95	A	V



WIFI Ant. 1+2	Note	Frequency (MHz)	Level (dBμV/m)	Over Limit (dB)	Limit Line (dBμV/m)	Read Level (dBμV)	Antenna Factor (dB/m)	Cable Loss (dB)	Preamp Factor (dB)	Ant Pos (cm)	Table Pos (deg)	Peak Avg. (P/A)	Pol. (H/V)
802.11a CH 157 5785MHz		5611	50.24	-17.96	68.2	40.76	32.39	9.76	32.67	100	65	P	H
		5694.2	50.78	-50.14	100.92	41.07	32.45	9.92	32.66	100	65	P	H
		5717.2	52.94	-57.08	110.02	43.12	32.46	10.01	32.65	100	65	P	H
		5724	54.06	-65.86	119.92	44.22	32.48	10.01	32.65	100	65	P	H
		5785	111.1	-	-	101.05	32.52	10.17	32.64	100	65	P	H
		5785	106.58	-	-	96.53	32.52	10.17	32.64	100	65	A	H
		5851.6	52.01	-66.54	118.55	41.81	32.58	10.25	32.63	100	65	P	H
		5856.2	52.26	-58.2	110.46	41.96	32.6	10.33	32.63	100	65	P	H
		5914.2	51.72	-24.45	76.17	41.19	32.72	10.42	32.61	100	65	P	H
		5949	51.18	-17.02	68.2	40.49	32.8	10.5	32.61	100	65	P	H
		5647.8	49.83	-18.37	68.2	40.26	32.4	9.84	32.67	383	96	P	V
		5688	50.58	-45.77	96.35	40.87	32.45	9.92	32.66	383	96	P	V
		5702.8	50.12	-55.87	105.99	40.31	32.46	10.01	32.66	383	96	P	V
		5724.4	51.22	-69.61	120.83	41.38	32.48	10.01	32.65	383	96	P	V
		5785	107.84	-	-	97.79	32.52	10.17	32.64	383	96	P	V
		5785	102.69	-	-	92.64	32.52	10.17	32.64	383	96	A	V
		5852.2	48.98	-68.2	117.18	38.78	32.58	10.25	32.63	383	96	P	V
		5855.8	50.15	-60.43	110.58	39.85	32.6	10.33	32.63	383	96	P	V
	5883	50.42	-48.84	99.26	40.07	32.64	10.33	32.62	383	96	P	V	
	5946.6	49.84	-18.36	68.2	39.15	32.8	10.5	32.61	383	96	P	V	



WiFi Ant. 1+2	Note	Frequency (MHz)	Level (dBμV/m)	Over Limit (dB)	Limit Line (dBμV/m)	Read Level (dBμV)	Antenna Factor (dB/m)	Cable Loss (dB)	Preamp Factor (dB)	Ant Pos (cm)	Table Pos (deg)	Peak Avg. (P/A)	Pol. (H/V)
802.11a CH 165 5825MHz		5825	112.75	-	-	102.56	32.57	10.25	32.63	100	85	P	H
		5825	96.77	-	-	86.58	32.57	10.25	32.63	100	85	A	H
		5853.8	60.79	-52.75	113.54	50.57	32.6	10.25	32.63	100	85	P	H
		5859.2	58.76	-50.86	109.62	48.45	32.6	10.33	32.62	100	85	P	H
		5882.8	52.46	-46.95	99.41	42.11	32.64	10.33	32.62	100	85	P	H
		5938.4	50.63	-17.57	68.2	39.98	32.76	10.5	32.61	100	85	P	H
		5825	107.15	-	-	96.96	32.57	10.25	32.63	379	101	P	V
		5825	102.42	-	-	92.23	32.57	10.25	32.63	379	101	A	V
		5852.8	56.33	-59.49	115.82	46.13	32.58	10.25	32.63	379	101	P	V
		5856	54.28	-56.24	110.52	43.98	32.6	10.33	32.63	379	101	P	V
		5913.4	51.53	-25.23	76.76	41	32.72	10.42	32.61	379	101	P	V
		5928.4	50.69	-17.51	68.2	40.12	32.76	10.42	32.61	379	101	P	V
Remark	<ol style="list-style-type: none"> No other spurious found. All results are PASS against Peak and Average limit line. 												



Band 4 5725~5850MHz

WIFI 802.11a (Harmonic @ 3m)

WIFI Ant. 1+2	Note	Frequency (MHz)	Level (dBμV/m)	Over Limit (dB)	Limit Line (dBμV/m)	Read Level (dBμV)	Antenna Factor (dB/m)	Cable Loss (dB)	Preamp Factor (dB)	Ant Pos (cm)	Table Pos (deg)	Peak Avg. (P/A)	Pol. (H/V)
802.11a CH 149 5745MHz		11490	50.45	-23.55	74	56.05	39.28	12.88	57.76	160	360	P	H
		17235	50.91	-17.39	68.3	50.13	43.04	15.71	57.97	170	360	P	H
		11490	50.38	-23.62	74	55.98	39.28	12.88	57.76	160	360	P	V
		17235	50.92	-17.38	68.3	50.14	43.04	15.71	57.97	170	360	P	V
802.11a CH 157 5785MHz		11570	49.56	-24.44	74	55	39.3	12.93	57.67	175	198	P	H
		17355	50.66	-17.64	68.3	48.85	43.81	15.8	57.8	189	185	P	H
		11570	49.97	-24.03	74	55.41	39.3	12.93	57.67	175	198	P	V
		17355	50.57	-17.73	68.3	48.76	43.81	15.8	57.8	189	185	P	V
802.11a CH 165 5825MHz		11650	50.2	-23.8	74	55.5	39.3	12.99	57.59	156	347	P	H
		17475	49.84	-18.46	68.3	47.01	44.58	15.89	57.64	160	0	P	H
		11650	49.06	-24.94	74	54.36	39.3	12.99	57.59	156	347	P	V
		17475	50.28	-18.02	68.3	47.45	44.58	15.89	57.64	150	360	P	V
Remark	1. No other spurious found. 2. All results are PASS against Peak and Average limit line.												



Band 4 5725~5850MHz
WIFI 802.11n HT20 (Band Edge @ 3m)

Table with 14 columns: WIFI Ant. 1+2, Note, Frequency (MHz), Level (dBµV/m), Over Limit (dB), Limit Line (dBµV/m), Read Level (dBµV), Antenna Factor (dB/m), Cable Loss (dB), Preamp Factor (dB), Ant Pos (cm), Table Pos (deg), Peak Avg. (P/A), Pol. (H/V). Rows include frequencies from 5643 to 5745 MHz with various level and limit values.



WIFI Ant. 1+2	Note	Frequency (MHz)	Level (dBμV/m)	Over Limit (dB)	Limit Line (dBμV/m)	Read Level (dBμV)	Antenna Factor (dB/m)	Cable Loss (dB)	Preamp Factor (dB)	Ant Pos (cm)	Table Pos (deg)	Peak Avg. (P/A)	Pol. (H/V)
802.11n HT20 CH 157 5785MHz		5628.2	49.79	-18.41	68.2	40.23	32.39	9.84	32.67	100	61	P	H
		5699.8	51.99	-53.06	105.05	42.19	32.45	10.01	32.66	100	61	P	H
		5713.2	51.55	-57.35	108.9	41.73	32.46	10.01	32.65	100	61	P	H
		5724	53.24	-66.68	119.92	43.4	32.48	10.01	32.65	100	61	P	H
		5785	111.79	-	-	101.74	32.52	10.17	32.64	100	61	P	H
		5785	105.22	-	-	95.17	32.52	10.17	32.64	100	61	A	H
		5850	53.14	-69.06	122.2	42.94	32.58	10.25	32.63	100	61	P	H
		5860.2	50.87	-58.47	109.34	40.56	32.6	10.33	32.62	100	61	P	H
		5876	51.36	-53.1	104.46	41.01	32.64	10.33	32.62	100	61	P	H
		5936.6	50.35	-17.85	68.2	39.7	32.76	10.5	32.61	100	61	P	H
		5649.6	49.27	-18.93	68.2	39.68	32.42	9.84	32.67	362	102	P	V
		5657.2	50.52	-23.03	73.55	40.93	32.42	9.84	32.67	362	102	P	V
		5720	49.86	-60.94	110.8	40.02	32.48	10.01	32.65	362	102	P	V
		5724.8	48.61	-73.13	121.74	38.77	32.48	10.01	32.65	362	102	P	V
		5785	109.1	-	-	99.05	32.52	10.17	32.64	362	102	P	V
		5785	103.28	-	-	93.23	32.52	10.17	32.64	362	102	A	V
		5851	50.45	-69.47	119.92	40.25	32.58	10.25	32.63	362	102	P	V
		5855.6	49.71	-60.92	110.63	39.41	32.6	10.33	32.63	362	102	P	V
	5882.4	49.95	-49.75	99.7	39.6	32.64	10.33	32.62	362	102	P	V	
	5935.6	50.17	-18.03	68.2	39.52	32.76	10.5	32.61	362	102	P	V	



WIFI Ant. 1+2	Note	Frequency (MHz)	Level (dBμV/m)	Over Limit (dB)	Limit Line (dBμV/m)	Read Level (dBμV)	Antenna Factor (dB/m)	Cable Loss (dB)	Preamp Factor (dB)	Ant Pos (cm)	Table Pos (deg)	Peak Avg. (P/A)	Pol. (H/V)
802.11n HT20 CH 165 5825MHz		5825	113.1	-	-	102.91	32.57	10.25	32.63	100	87	P	H
		5825	106.71	-	-	96.52	32.57	10.25	32.63	100	87	A	H
		5854.6	59.75	-51.96	111.71	49.53	32.6	10.25	32.63	100	87	P	H
		5856.2	57.78	-52.68	110.46	47.48	32.6	10.33	32.63	100	87	P	H
		5876.6	52.92	-51.09	104.01	42.57	32.64	10.33	32.62	100	87	P	H
		5927	50.29	-17.91	68.2	39.72	32.76	10.42	32.61	100	87	P	H
		5825	107.42	-	-	97.23	32.57	10.25	32.63	358	100	P	V
		5825	102.85	-	-	92.66	32.57	10.25	32.63	358	100	A	V
		5850.8	56.56	-63.82	120.38	46.36	32.58	10.25	32.63	358	100	P	V
		5858	55.13	-54.83	109.96	44.82	32.6	10.33	32.62	358	100	P	V
		5897.6	51.13	-37.31	88.44	40.65	32.68	10.42	32.62	358	100	P	V
	5944.6	50.46	-17.74	68.2	39.77	32.8	10.5	32.61	358	100	P	V	
Remark	<ol style="list-style-type: none"> No other spurious found. All results are PASS against Peak and Average limit line. 												



Band 4 5725~5850MHz
WIFI 802.11n HT20 (Harmonic @ 3m)

Table with 14 columns: WIFI Ant. 1+2, Note, Frequency (MHz), Level (dBµV/m), Over Limit (dB), Limit Line (dBµV/m), Read Level (dBµV), Antenna Factor (dB/m), Cable Loss (dB), Preamp Factor (dB), Ant Pos (cm), Table Pos (deg), Peak Avg. (P/A), Pol. (H/V). Rows include test results for channels 149, 157, and 165 at various frequencies.



**Band 4 5725~5850MHz
WIFI 802.11n HT40 (Band Edge @ 3m)**

WIFI Ant. 1+2	Note	Frequency (MHz)	Level (dBμV/m)	Over Limit (dB)	Limit Line (dBμV/m)	Read Level (dBμV)	Antenna Factor (dB/m)	Cable Loss (dB)	Preamp Factor (dB)	Ant Pos (cm)	Table Pos (deg)	Peak Avg. (P/A)	Pol. (H/V)
802.11n HT40 CH 151 5755MHz		5647	51.55	-16.65	68.2	41.98	32.4	9.84	32.67	100	89	P	H
		5693	58.37	-41.67	100.04	48.66	32.45	9.92	32.66	100	89	P	H
		5714	64.37	-44.75	109.12	54.55	32.46	10.01	32.65	100	89	P	H
		5724.6	63.97	-57.32	121.29	54.13	32.48	10.01	32.65	100	89	P	H
		5755	110.04	-	-	100.09	32.51	10.09	32.65	100	89	P	H
		5755	103.58	-	-	93.63	32.51	10.09	32.65	100	89	A	H
		5850.8	51.99	-68.39	120.38	41.79	32.58	10.25	32.63	100	89	P	H
		5859.4	52.62	-56.95	109.57	42.31	32.6	10.33	32.62	100	89	P	H
		5878	50.89	-52.08	102.97	40.54	32.64	10.33	32.62	100	89	P	H
		5927.2	49.42	-18.78	68.2	38.85	32.76	10.42	32.61	100	89	P	H
		5630	50.38	-17.82	68.2	40.82	32.39	9.84	32.67	369	98	P	V
		5697.8	55.72	-47.86	103.58	46.01	32.45	9.92	32.66	369	98	P	V
		5719.4	60.6	-50.03	110.63	50.76	32.48	10.01	32.65	369	98	P	V
		5723	60.13	-57.51	117.64	50.29	32.48	10.01	32.65	369	98	P	V
		5755	105.88	-	-	95.93	32.51	10.09	32.65	369	98	P	V
		5755	99.3	-	-	89.35	32.51	10.09	32.65	369	98	A	V
		5854.4	49.76	-62.41	112.17	39.54	32.6	10.25	32.63	369	98	P	V
		5860.6	50.03	-59.2	109.23	39.72	32.6	10.33	32.62	369	98	P	V
	5917.2	49.66	-24.29	73.95	39.13	32.72	10.42	32.61	369	98	P	V	
	5930.4	50.87	-17.33	68.2	40.3	32.76	10.42	32.61	369	98	P	V	



WIFI Ant. 1+2	Note	Frequency (MHz)	Level (dBμV/m)	Over Limit (dB)	Limit Line (dBμV/m)	Read Level (dBμV)	Antenna Factor (dB/m)	Cable Loss (dB)	Preamp Factor (dB)	Ant Pos (cm)	Table Pos (deg)	Peak Avg. (P/A)	Pol. (H/V)
802.11n HT40 CH 159 5795MHz		5613.2	50.08	-18.12	68.2	40.6	32.39	9.76	32.67	106	90	P	H
		5697	51.81	-51.18	102.99	42.1	32.45	9.92	32.66	106	90	P	H
		5717	52.46	-57.5	109.96	42.64	32.46	10.01	32.65	106	90	P	H
		5723.4	52.44	-66.11	118.55	42.6	32.48	10.01	32.65	106	90	P	H
		5795	109.58	-	-	99.51	32.54	10.17	32.64	106	90	P	H
		5795	103.65	-	-	93.58	32.54	10.17	32.64	106	90	A	H
		5852.2	57.13	-60.05	117.18	46.93	32.58	10.25	32.63	106	90	P	H
		5855	58.37	-52.43	110.8	48.15	32.6	10.25	32.63	106	90	P	H
		5892.8	52.73	-39.26	91.99	42.34	32.68	10.33	32.62	106	90	P	H
		5927.6	49.63	-18.57	68.2	39.06	32.76	10.42	32.61	106	90	P	H
		5631	49.09	-19.11	68.2	39.53	32.39	9.84	32.67	362	100	P	V
		5669.6	49.86	-32.88	82.74	40.18	32.43	9.92	32.67	362	100	P	V
		5719.4	51.24	-59.39	110.63	41.4	32.48	10.01	32.65	362	100	P	V
		5723.8	51.71	-67.75	119.46	41.87	32.48	10.01	32.65	362	100	P	V
		5795	106.04	-	-	95.97	32.54	10.17	32.64	362	100	P	V
		5795	98.83	-	-	88.76	32.54	10.17	32.64	362	100	A	V
		5851.8	54.8	-63.3	118.1	44.6	32.58	10.25	32.63	362	100	P	V
		5867.2	52.67	-54.71	107.38	42.36	32.6	10.33	32.62	362	100	P	V
	5888.2	50.82	-44.58	95.4	40.43	32.68	10.33	32.62	362	100	P	V	
	5927.2	49.82	-18.38	68.2	39.25	32.76	10.42	32.61	362	100	P	V	
Remark	1. No other spurious found. 2. All results are PASS against Peak and Average limit line.												



Band 4 5725~5850MHz
WIFI 802.11n HT40 (Harmonic @ 3m)

Table with 14 columns: WIFI Ant. 1+2, Note, Frequency (MHz), Level (dBµV/m), Over Limit (dB), Limit Line (dBµV/m), Read Level (dBµV), Antenna Factor (dB/m), Cable Loss (dB), Preamp Factor (dB), Ant Pos (cm), Table Pos (deg), Peak Avg. (P/A), Pol. (H/V). Rows include test results for 802.11n HT40 and 5795MHz channels.



Band 4 5725~5850MHz
WIFI 802.11ac VHT80 (Band Edge @ 3m)

Table with 14 columns: WIFI Ant. 1+2, Note, Frequency (MHz), Level (dBµV/m), Over Limit (dB), Limit Line (dBµV/m), Read Level (dBµV), Antenna Factor (dB/m), Cable Loss (dB), Preamp Factor (dB), Ant Pos (cm), Table Pos (deg), Peak Avg. (P/A), Pol. (H/V). Rows include frequency measurements from 5645.2 to 5936.8 MHz.

Remark
1. No other spurious found.
2. All results are PASS against Peak and Average limit line.



Band 4 5725~5850MHz

WIFI 802.11ac VHT80 (Harmonic @ 3m)

WIFI Ant. 1+2	Note	Frequency (MHz)	Level (dBμV/m)	Over Limit (dB)	Limit Line (dBμV/m)	Read Level (dBμV)	Antenna Factor (dB/m)	Cable Loss (dB)	Preamp Factor (dB)	Ant Pos (cm)	Table Pos (deg)	Peak Avg. (P/A)	Pol. (H/V)
802.11ac		11550	49.23	-24.77	74	54.68	39.3	12.93	57.68	160	41	P	H
VHT80		17325	50.66	-17.64	68.3	49.12	43.59	15.8	57.85	170	24	P	H
CH 155		11550	49.85	-24.15	74	55.3	39.3	12.93	57.68	160	242	P	V
5775MHz		17325	50.47	-17.83	68.3	48.93	43.59	15.8	57.85	124	154	P	V
Remark	1. No other spurious found. 2. All results are PASS against Peak and Average limit line.												



Emission below 1GHz

5GHz WIFI 802. 11ac VHT80 (LF @ 3m)

WIFI	Note	Frequency	Level	Over	Limit	Read	Antenna	Cable	Preamp	Ant	Table	Peak	Pol.
Ant.				Limit	Line	Level	Factor	Loss	Factor	Pos	Pos	Avg.	
1+2		(MHz)	(dBμV/m)	(dB)	(dBμV/m)	(dBμV)	(dB/m)	(dB)	(dB)	(cm)	(deg)	(P/A)	(H/V)
5GHz 802. 11ac VHT80 LF		30.97	22.19	-17.81	40	30.13	23.72	0.54	32.2	-	-	P	H
		62.01	19.97	-20.03	40	39.44	12.34	0.79	32.6	-	-	P	H
		99.84	21.53	-21.97	43.5	36.31	16.8	1.02	32.6	-	-	P	H
		206.54	21.38	-22.12	43.5	36.59	15.5	1.46	32.17	-	-	P	H
		293.84	27.93	-18.07	46	39.11	19.04	1.78	32	-	-	P	H
		395.69	29.15	-16.85	46	37.47	21.5	2.09	31.91	100	85	P	H
		41.64	27.62	-12.38	40	41.12	18.47	0.63	32.6	-	-	P	V
		57.16	31.58	-8.42	40	50.52	12.9	0.76	32.6	100	142	P	V
		98.87	25.24	-18.26	43.5	40.22	16.61	1.01	32.6	-	-	P	V
		165.8	21.45	-22.05	43.5	36.71	15.77	1.31	32.34	-	-	P	V
		402.48	24.27	-21.73	46	32.41	21.65	2.11	31.9	-	-	P	V
	505.3	25.54	-20.46	46	31.85	23.46	2.34	32.11	-	-	P	V	
Remark	1. No other spurious found. 2. All results are PASS against limit line.												



Note symbol

*	Fundamental Frequency which can be ignored. However, the level of any unwanted emissions shall not exceed the level of the fundamental frequency.
!	Test result is over limit line.
P/A	Peak or Average
H/V	Horizontal or Vertical



A calculation example for radiated spurious emission is shown as below:

WIFI	Note	Frequency	Level	Over	Limit	Read	Antenna	Cable	Preamp	Ant	Table	Peak	Pol.
Ant.				Limit	Line	Level	Factor	Loss	Factor	Pos	Pos	Avg.	
1+2		(MHz)	(dBμV/m)	(dB)	(dBμV/m)	(dBμV)	(dB/m)	(dB)	(dB)	(cm)	(deg)	(P/A)	(H/V)
802.11b		2390	55.45	-18.55	74	54.51	32.22	4.58	35.86	103	308	P	H
CH 01													
2412MHz		2390	43.54	-10.46	54	42.6	32.22	4.58	35.86	103	308	A	H

- Level(dBμV/m) =
Antenna Factor(dB/m) + Cable Loss(dB) + Read Level(dBμV) - Preamp Factor(dB)
- Over Limit(dB) = Level(dBμV/m) – Limit Line(dBμV/m)

For Peak Limit @ 2390MHz:

- Level(dBμV/m)
= Antenna Factor(dB/m) + Cable Loss(dB) + Read Level(dBμV) - Preamp Factor(dB)
= 32.22(dB/m) + 4.58(dB) + 54.51(dBμV) – 35.86 (dB)
= 55.45 (dBμV/m)
- Over Limit(dB)
= Level(dBμV/m) – Limit Line(dBμV/m)
= 55.45(dBμV/m) – 74(dBμV/m)
= -18.55(dB)

For Average Limit @ 2390MHz:

- Level(dBμV/m)
= Antenna Factor(dB/m) + Cable Loss(dB) + Read Level(dBμV) - Preamp Factor(dB)
= 32.22(dB/m) + 4.58(dB) + 42.6(dBμV) – 35.86 (dB)
= 43.54 (dBμV/m)
- Over Limit(dB)
= Level(dBμV/m) – Limit Line(dBμV/m)
= 43.54(dBμV/m) – 54(dBμV/m)
= -10.46(dB)

Both peak and average measured complies with the limit line, so test result is “PASS”.



Appendix D. Duty Cycle Plots

Antenna	Band	Duty Cycle(%)	T(ms)	1/T(kHz)	VBW Setting
1+2	802.11a	97.93	2.058	0.486	1kHz
1+2	802.11n HT20	96.73	1.928	0.519	1kHz
1+2	802.11n HT40	93.41	0.945	1.058	3kHz
1+2	802.11ac VHT80	80.82	0.257	3.898	10kHz

<MIMO Ant.1+2>

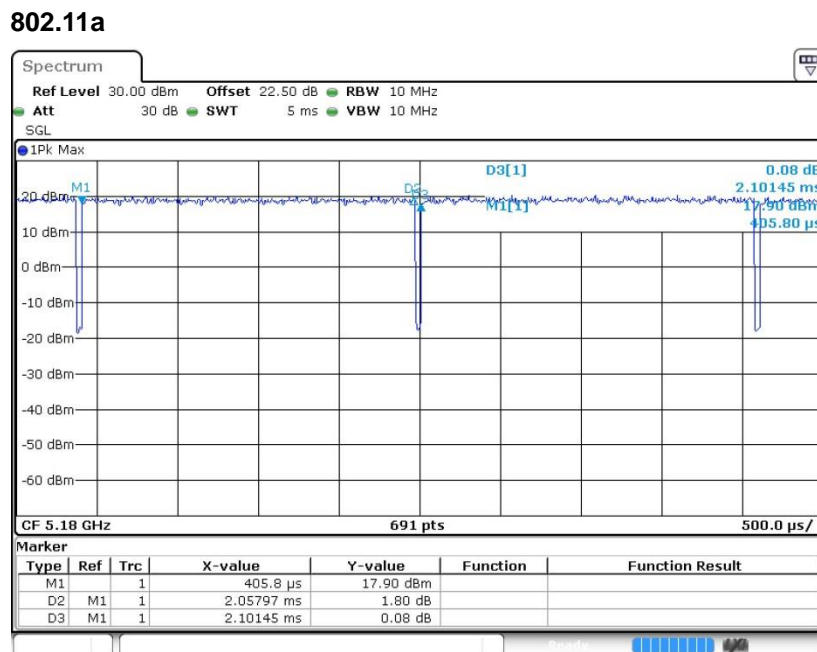



802.11n HT20

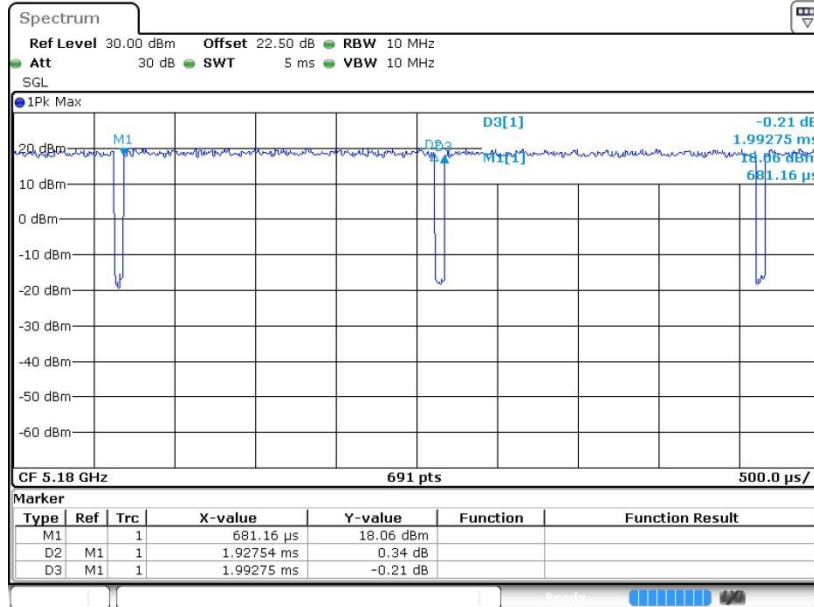

802.11n HT40

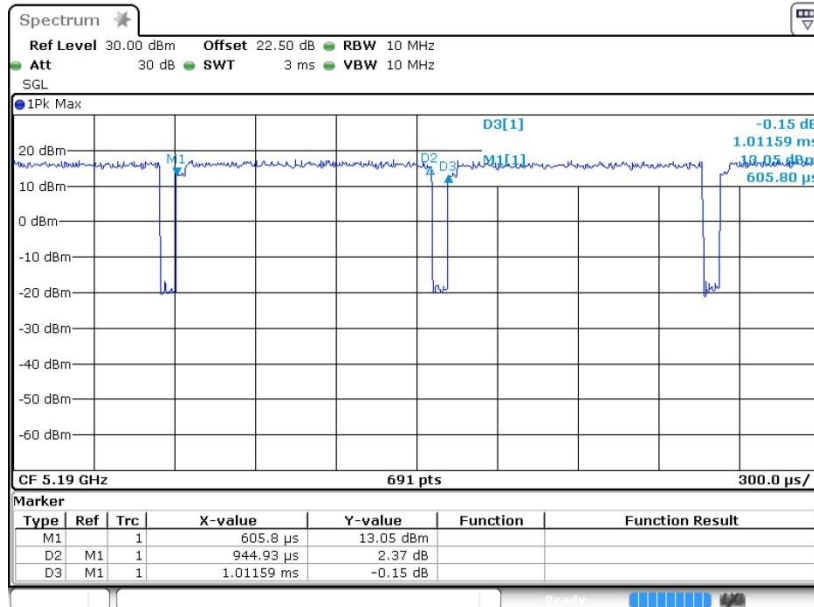



802.11ac VHT80

