



RF Exposure Report

(Part 2: Test Under Dynamic Transmission Condition)

FCC ID : 2ABZ2-EE149
Equipment : Smart Phone
Brand Name : ONEPLUS
Model Name : IN2019
Applicant : OnePlus Technology (Shenzhen) Co., Ltd
18C02, 18C03, 18C04 and 18C05, Shum Yip Terra
Building, Binhe Avenue North, Futian District,
Shenzhen

We, SPORTON INTERNATIONAL INC., would like to declare that the tested sample has been evaluated in accordance with the test procedures and has been in compliance with the applicable technical standards.

The test results in this report apply exclusively to the tested model / sample. Without written approval of SPORTON INTERNATIONAL INC. EMC & Wireless Communications Laboratory, the test report shall not be reproduced except in full.

Approved by: Cona Huang / Deputy Manager

Sporton International Inc.

No. 52, Huaya 1st Rd., Guishan Dist., Taoyuan City, Taiwan



Contents

1 Introduction	5
2 Tx Varying Transmission Test Cases and Test Proposal	6
3 SAR Time Averaging Validation Test Procedures	9
3.1 Test sequence determination for validation	9
3.2 Test configuration selection criteria for validating Smart Transmit feature	9
3.2.1 Test configuration selection for time-varying Tx power transmission	9
3.2.2 Test configuration selection for change in call	10
3.2.3 Test configuration selection for change in technology/band	10
3.2.4 Test configuration selection for change in DSI	10
3.2.5 Test configuration selection for SAR exposure switching	10
3.3 Test procedures for conducted power measurements	11
3.3.1 Time-varying Tx power transmission scenario	11
3.3.2 Change in call scenario	13
3.3.3 Change in technology and band	14
3.3.4 Change in antenna	15
3.3.5 Change in DSI	15
3.3.6 Change in time window	16
3.3.7 SAR exposure switching	17
3.4 Test procedure for time-varying SAR measurements	18
4 PD Time Averaging Validation Test Procedures	20
4.1 Test sequence for validation in mmW NR transmission	20
4.2 Test configuration selection criteria for validating Smart Transmit feature	20
4.2.1 Test configuration selection for time-varying Tx power transmission	20
4.2.2 Test configuration selection for change in antenna configuration (beam)	20
4.2.3 Test configuration selection for SAR vs. PD exposure switch during transmission	20
4.3 Test procedures for mmW radiated power measurements	20
4.3.1 Time-varying Tx power scenario	21
4.3.2 Switch in SAR vs. PD exposure during transmission	22
4.3.3 Change in antenna configuration (beam)	24
4.4 Test procedure for time-varying PD measurements	26
5 Test Configurations	28
5.1 WWAN (sub-6) transmission	28
5.2 LTE + mmW NR transmission	33
6 Conducted Power Test Results for Sub-6 Smart Transmit Feature Validation	34
6.1 Measurement setup	34
6.2 P_{limit} and P_{max} measurement results	37
6.3 Time-varying Tx power measurement results	38
6.3.1 LTE Band 7	39
6.3.2 LTE Band 30	41
6.3.3 WCDMA Band 4	43
6.3.4 WCDMA Band 5	45
6.3.5 GSM Band 850	47
6.3.6 GSM Band 1900	49
6.3.7 Sub6 NR Band 2	51
6.3.8 Sub6 NR Band 66	53
6.4 Change in Call Test Results	55



6.5 Change in technology/band test results56

6.6 Change in DSI test results57

6.7 Change in Time window / antenna switch test results.....59

 6.7.1 Test case 1: transition from LTE Band 7 to LTE Band 48 (i.e., 100s to 60s),
 then back to LTE Band 7.....59

 6.7.2 Test case 2: transition from LTE Band 48 to LTE Band 7 (i.e., 60s to 100s),
 then back to LTE Band 48.....61

6.8 Switch in SAR exposure test results63

7 SAR Test Results for Sub-6 Smart Transmit Feature Validation65

 7.1 Measurement setup65

 7.2 SAR measurement results for time-varying Tx power transmission scenario66

 7.2.1 LTE Band 7 SAR test results67

 7.2.2 LTE Band 30 SAR test results69

 7.2.3 WCDMA Band 4 SAR test results.....71

 7.2.4 WCDMA Band 5 SAR test results.....73

 7.2.5 GSM Band 850 SAR test results75

 7.2.6 GSM Band 1900 SAR test results77

 7.2.7 Sub6 NR Band 2 SAR test results79

 7.2.8 Sub6 NR Band 66 SAR test results81

8 Radiated Power Test Results for mmW Smart Transmit Feature Validation83

 8.1 Measurement Setup.....83

 8.2 mmW NR radiated power test results84

 8.2.1 Maximum Tx power test results for n26186

 8.2.2 Maximum Tx power test results for n26088

 8.2.3 Switch in SAR vs. PD exposure test results for n26190

 8.2.4 Switch in SAR vs. PD exposure test results for n26092

 8.2.5 Change in Beam test results for n26194

 8.2.6 Change in Beam test results for n26096

9 PD Test Results for mmW Smart Transmit Feature Validation98

 9.1 Measurement setup98

 9.2 PD measurement results for maximum power transmission scenario.....99

 9.2.1 PD test results for n261100

 9.2.2 PD test results for n260101

10 Conclusions102



1 Introduction

The equipment under test (EUT) is a portable handset (FCC ID: 2ABZ2-EE149), it contains the Qualcomm SM8250 modem supporting 2G/3G/4G technologies and SDX55 modem supporting mmW 5G NR bands. Both of these modems are enabled with Qualcomm Smart Transmit feature to control and manage transmitting power in real time and to ensure at all times the time-averaged RF exposure is in compliance with the FCC requirement.

This purpose of the Part 2 report is to demonstrate the EUT complies with FCC RF exposure requirement under Tx varying transmission scenarios, thereby validity of Qualcomm Smart Transmit feature for FCC equipment authorization

The P_{limit} and *input.power.limit* used in this report is determined in Part 0 and Part 1 reports.

Refer to PART 0 SAR AND POWER DENSITY CHAR REPORT, for product description and terminology used in this report.

Test Lab Information

Test Firm Name	Sporton International Inc.
Test Firm Information	No. 52, Huaya 1st Rd., Guishan Dist., Taoyuan City, Taiwan TEL: +886-3-327-3456 FAX: +886-3-328-4978
Test Firm Registration Number for FCC	553509
Date of Start during the Test	02/11/2020
Date of End during the Test	02/25/2020
Test Engineers	Steven Chang, Aaron Chen
Report Producer	Wan Liu



2 Tx Varying Transmission Test Cases and Test Proposal

To validate time averaging feature and demonstrate the compliance in Tx varying transmission conditions, the following transmission scenarios are covered in Part 2 test:

1. During a time-varying Tx power transmission: To prove that the Smart Transmit feature accounts for Tx power variations in time accurately.
2. During a call disconnect and re-establish scenario: To prove that the Smart Transmit feature accounts for history of past Tx power transmissions accurately.
3. During technology/band handover: To prove that the Smart Transmit feature functions correctly during transitions in technology/band.
4. During DSI (Device State Index) change: To prove that the Smart Transmit feature functions correctly during transition from one device state (DSI) to another.
5. During antenna (or beam) switch: To prove that the Smart Transmit feature functions correctly during transitions in antenna (such as AsDiv scenario) or beams (different antenna array configurations).
6. SAR vs. PD exposure switching during sub-6+mmW transmission: To prove that the Smart Transmit feature functions correctly and ensures total RF exposure compliance during transitions in SAR dominant exposure, SAR+PD exposure, and PD dominant exposure scenarios.
7. SAR exposure switching between two active radios (radio1 and radio2): To prove that the Smart Transmit feature functions correctly and ensures total RF exposure compliance when exposure varies among SAR_radio1 only, SAR_radio1 + SAR_radio2, and SAR_radio2 only scenarios.

As described in Part 0 report, the RF exposure is proportional to the Tx power for a SAR- and PD-characterized wireless device. Thus, feature validation in Part 2 can be effectively performed through conducted (for $f < 6\text{GHz}$) and radiated (for $f \geq 6\text{GHz}$) power measurement. Therefore, the compliance demonstration under dynamic transmission conditions and feature validation are done in conducted/radiated power measurement setup for transmission scenario 1 through 8.

To add confidence in the feature validation, the time-averaged SAR and PD measurements are also performed but only performed for transmission scenario 1 to avoid the complexity in SAR and PD measurement (such as, for scenario 3 requiring change in SAR probe calibration file to accommodate different bands and/or tissue simulating liquid).

The strategy for testing in Tx varying transmission condition is outlined as follows:

- Demonstrate the total RF exposure averaged over FCC defined time windows does not exceed FCC's SAR and PD limits, through time-averaged power measurements
 - Measure conducted Tx power (for $f < 6\text{GHz}$) versus time, and radiated Tx power (EIRP for $f > 10\text{GHz}$) versus time.
 - Convert it into RF exposure and divide by respective FCC limits to get normalized exposure versus time.
 - Perform running time-averaging over FCC defined time windows.



- Demonstrate that the total normalized time-averaged RF exposure is less than 1 for all transmission scenarios at all times.

Mathematical expression:

- For sub-6 transmission only:

$$1g_or_10gSAR(t) = \frac{conducted_Tx_power(t)}{conducted_Tx_power_P_{limit}} * 1g_or_10gSAR_P_{limit} \quad (1a)$$

$$\frac{\frac{1}{T_{SAR}} \int_{t-T_{SAR}}^t 1g_or_10gSAR(t) dt}{FCC\ SAR\ limit} \leq 1 \quad (1b)$$

- For sub-6+mmW transmission:

$$1g_or_10gSAR(t) = \frac{conducted_Tx_power(t)}{conducted_Tx_power_P_{limit}} * 1g_or_10gSAR_P_{limit} \quad (2a)$$

$$4cm^2 PD(t) = \frac{radiated_Tx_power(t)}{radiated_Tx_power_input.power.limit} * 4cm^2 PD_input.power.limit$$

(2b)

$$\frac{\frac{1}{T_{SAR}} \int_{t-T_{SAR}}^t 1g_or_10gSAR(t) dt}{FCC\ SAR\ limit} + \frac{\frac{1}{T_{PD}} \int_{t-T_{PD}}^t 4cm^2 PD(t) dt}{FCC\ 4cm^2\ PD\ limit} \leq 1 \quad (2c)$$

where, *conducted_Tx_power(t)*, *conducted_Tx_power_P_{limit}*, and *1g_or_10gSAR_P_{limit}* correspond to the measured instantaneous conducted Tx power, measured conducted Tx power at *P_{limit}*, and measured *1gSAR* or *10gSAR* values at *P_{limit}* corresponding to sub-6 transmission. Similarly, *radiated_Tx_power(t)*, *radiated_Tx_power_input.power.limit*, and *4cm²PD_input.power.limit* correspond to the measured instantaneous radiated Tx power, radiated Tx power at *input.power.limit* (i.e., radiated power limit), and *4cm²PD* value at *input.power.limit* corresponding to mmW transmission. Both *P_{limit}* and *input.power.limit* are the parameters pre-defined in Part 0 and loaded via Embedded File System (EFS) onto the EUT. *T_{SAR}* is the FCC defined time window for sub-6 radio; *T_{PD}* is the FCC defined time window for mmW radio.

- Demonstrate the total RF exposure averaged over FCC defined time windows does not exceed FCC’s SAR and PD limits, through time-averaged SAR and PD measurements. Note as mentioned earlier, this measurement is performed for transmission scenario 1 only.
 - For sub-6 transmission only, measure instantaneous SAR versus time; for LTE+sub6 NR transmission, request low power (or all-down bits) on LTE so that measured SAR predominantly corresponds to sub6 NR.

- For LTE + mmW transmission, measure instantaneous E-field versus time for mmW radio and instantaneous conducted power versus time for LTE radio.
- Convert it into RF exposure and divide by respective FCC limits to obtain normalized exposure versus time.
- Perform time averaging over FCC defined time window.
- Demonstrate that the total normalized time-averaged RF exposure is less than 1 for transmission scenario 1 at all times.

Mathematical expression:

- For sub-6 transmission only:

$$1g_or_10gSAR(t) = \frac{pointSAR(t)}{pointSAR_P_{limit}} * 1g_or_10gSAR(t)_P_{limit} \quad (3a)$$

$$\frac{\frac{1}{T_{SAR}} \int_{t-T_{SAR}}^t 1g_or_10gSAR(t) dt}{FCC\ SAR\ limit} \leq 1 \quad (3b)$$

- For LTE+mmW transmission:

$$1g_or_10gSAR(t) = \frac{conducted_Tx_power(t)}{conducted_Tx_power_P_{limit}} * 1g_or_10gSAR_P_{limit} \quad (4a)$$

$$4cm^2PD(t) = \frac{[pointE(t)]^2}{[pointE_input.power.limit]^2} * 4cm^2PD_input.power.limit \quad (4b)$$

$$\frac{\frac{1}{T_{SAR}} \int_{t-T_{SAR}}^t 1g_or_10gSAR(t) dt}{FCC\ SAR\ limit} + \frac{\frac{1}{T_{PD}} \int_{t-T_{PD}}^t 4cm^2PD(t) dt}{FCC\ 4cm^2PD\ limit} \leq 1 \quad (4c)$$

where, $pointSAR(t)$, $pointSAR_P_{limit}$, and $1g_or_10gSAR_P_{limit}$ correspond to the measured instantaneous point SAR, measured point SAR at P_{limit} , and measured $1gSAR$ or $10gSAR$ values at P_{limit} corresponding to sub-6 transmission. Similarly, $pointE(t)$, $pointE_input.power.limit$, and $4cm^2PD_input.power.limit$ correspond to the measured instantaneous E-field, E-field at $input.power.limit$, and $4cm^2PD$ value at $input.power.limit$ corresponding to mmW transmission.

NOTE: cDASY6 measurement system by Schmid & Partner Engineering AG (SPEAG) of Zurich, Switzerland measures relative E-field, and provides ratio of $\frac{[pointE(t)]^2}{[pointE_input.power.limit]^2}$ versus time.



3 SAR Time Averaging Validation Test Procedures

This chapter provides the test plan and test procedure for validating Qualcomm Smart Transmit feature for sub-6 transmission. The 100 seconds time window for operating $f < 3\text{GHz}$ is used as an example to detail the test procedures in this chapter.

3.1 Test sequence determination for validation

Following the FCC recommendation, two test sequences having time-variation in Tx power are predefined for sub-6 ($f < 6\text{GHz}$) validation:

- Test sequence 1: request EUT's Tx power to be at maximum power, measured P_{max}^{\dagger} , for 80s, then requesting for half of the maximum power, i.e., measured $P_{max}/2$, for the rest of the time.
- Test sequence 2: request EUT's Tx power to vary with time. This sequence is generated relative to measured P_{max} , measured P_{limit} and calculated $P_{reserve}$ (= measured P_{limit} in dBm - Reserve_power_margin in dB) of EUT based on measured P_{limit} .

The details for generating these two test sequences is described and listed in Appendix A.

NOTE: For test sequence generation, “measured P_{limit} ” and “measured P_{max} ” are used instead of the “ P_{limit} ” specified in EFS entry and “ P_{max} ” specified for the device, because Smart Transmit feature operates against the actual power level of the “ P_{limit} ” that was calibrated for the EUT. The “measured P_{limit} ” accurately reflects what the feature is referencing to, therefore, it should be used during feature validation testing. The RF tune up and device-to-device variation are already considered in Part 0 report prior to determining P_{limit} .

3.2 Test configuration selection criteria for validating Smart Transmit feature

For validating Smart Transmit feature, this section provides a general guidance to select test cases. In practice, an adjustment can be made in test case selection. The justification/clarification may be provided.

3.2.1 Test configuration selection for time-varying Tx power transmission

The Smart Transmit time averaging feature operation is independent of bands, modes, and channels for a given technology. Hence, validation of Smart Transmit in one band/mode/channel per technology is sufficient.

The criteria for the selection are based on the P_{limit} values determined in Part 0 report. Select the band in each supported technology that corresponds to the P_{limit} value that is less than P_{max} for validating Smart Transmit.

*



3.2.2 Test configuration selection for change in call

The criteria to select a test configuration for call-drop measurement is:

- Select technology/band with least P_{limit} among all supported technologies/bands, and select the radio configuration (e.g., # of RBs, channel#) in this technology/band that corresponds to the highest *measured* 1gSAR at P_{limit} listed in Part 1 report.
- In case of multiple bands having same least P_{limit} , then select the band having the highest *measured* 1gSAR at P_{limit} in Part 1 report.

This test is performed with the EUT's Tx power requested to be at maximum power, the above band selection will result in Tx power enforcement (i.e., EUT forced to have Tx power at $P_{reserve}$) for longest duration in one FCC defined time window. The call change (call drop/reestablish) is performed during the Tx power enforcement duration (i.e., during the time when EUT is forced to have Tx power at $P_{reserve}$). One test is sufficient as the feature operation is independent of technology and band.

3.2.3 Test configuration selection for change in technology/band

The selection criteria for this measurement is, for a given antenna, to have EUT switch from a technology/band with lowest P_{limit} within the technology group (in case of multiple bands having the same P_{limits} , then select the band with highest *measured* 1gSAR at P_{limit}) to a technology/band with highest P_{limit} within the technology group, in case of multiple bands having the same P_{limits} , then select the band with lowest *measured* 1gSAR at P_{limit} in Part 1 report, or vice versa.

This test is performed with the EUT's Tx power requested to be at maximum power, the technology/band switch is performed during Tx power enforcement duration (i.e., during the time when EUT is forced to have Tx power at $P_{reserve}$).

3.2.4 Test configuration selection for change in DSI

The criteria to select a test configuration for DSI change test is

- Select a technology/band having the $P_{limit} < P_{max}$ within any technology and DSI group, and for the same technology/band having a different P_{limit} in any other DSI group. Note that the selected DSI transition need to be supported by the device.

This test is performed with the EUT's Tx power requested to be at maximum power in selected technology/band, and DSI change is conducted during Tx power enforcement duration (i.e., during the time when EUT is forced to have Tx power at $P_{reserve}$).

3.2.5 Test configuration selection for SAR exposure switching

If supported, the test configuration for SAR exposure switching should cover

1. SAR exposure switch when two active radios are in the same time window
2. SAR exposure switch when two active radios are in different time windows. One test with two active radios in any two different time windows is sufficient as Smart Transmit operation is the same for RF exposure switch in any combination of two different time windows. For device supporting LTE + mmW NR, this test is covered in Section 8.2.3 and 8.2.4.



The Smart Transmit time averaging operation is independent of the source of SAR exposure (for example, LTE vs. Sub6 NR) and ensures total time-averaged RF exposure compliance. Hence, validation of Smart Transmit in any one simultaneous SAR transmission scenario (i.e., one combination for LTE + Sub6 NR transmission) is sufficient, where the SAR exposure varies among SAR_{radio1} only, SAR_{radio1} + SAR_{radio2}, and SAR_{radio2} only scenarios.

The criteria to select a test configuration for validating Smart Transmit feature during SAR exposure switching scenarios is

- Select any two < 6GHz technologies/bands that the EUT supports simultaneous transmission (for example, LTE+Sub6 NR).
- Among all supported simultaneous transmission configurations, the selection order is
 1. select one configuration where both P_{limit} of radio1 and radio2 is less than their corresponding P_{max} , preferably, with different P_{limits} . If this configuration is not available, then,
 2. select one configuration that has P_{limit} less than its P_{max} for at least one radio. If this can not be found, then,
 3. select one configuration that has P_{limit} of radio1 and radio2 greater than P_{max} but with least ($P_{limit} - P_{max}$) delta.

Test for one simultaneous transmission scenario is sufficient as the feature operation is the same.

3.3 Test procedures for conducted power measurements

This section provides general conducted power measurement procedures to perform compliance test under dynamic transmission scenarios described in Section 2. In practice, an adjustment can be made in these procedures. The justification/clarification may be provided.

3.3.1 Time-varying Tx power transmission scenario

This test is performed with the two pre-defined test sequences described in Section 3.1 for all the technologies and bands selected in Section 3.2.1. The purpose of the test is to demonstrate the effectiveness of power limiting enforcement and that the time-averaged SAR (corresponding time-averaged Tx power) does not exceed the FCC limit at all times (see Eq. (1a) and (1b)).

Test procedure

1. Measure P_{max} , measure P_{limit} and calculate $P_{reserve}$ (= measured P_{limit} in dBm – Reserve_power_margin in dB) and follow Section 3.1 to generate the test sequences for all the technologies and bands selected in Section 3.2.1. Both test sequence 1 and test sequence 2 are created based on measured P_{max} and measured P_{limit} of the EUT. Test condition to measure P_{max} and P_{limit} is:
 - Measure P_{max} with Smart Transmit disabled and callbox set to request maximum power.

- Measure P_{limit} with Smart Transmit enabled and *Reserve_power_margin* set to 0 dB, callbox set to request maximum power.
- 2. Set *Reserve_power_margin* to actual (intended) value (3dB for this EUT based on Part 1 report) and reset power on EUT to enable Smart Transmit, establish radio link in desired radio configuration, with callbox requesting the EUT’s Tx power to be at pre-defined test sequence 1, measure and record Tx power versus time, and then convert the conducted Tx power into 1gSAR or 10gSAR value (see Eq. (1a)) using measured P_{limit} from above Step 1. Perform running time average to determine time-averaged power and 1gSAR or 10gSAR versus time as illustrated in Figure 3-1 where using 100-seconds time window as an example.

NOTE: In Eq.(1a), instantaneous Tx power is converted into instantaneous 1gSAR or 10gSAR value by applying the measured worst-case 1gSAR or 10gSAR value at P_{limit} for the corresponding technology/band/antenna/DSI reported in Part 1 report.

NOTE: For an easier computation of the running time average, 0 dBm can be added at the beginning of the test sequences the length of the responding time window, for example, add 0dBm for 100-seconds so the running time average can be directly performed starting with the first 100-seconds data using excel spreadsheet. This technique applies to all tests performed in this Part 2 report for easier time-averaged computation using excel spreadsheet.

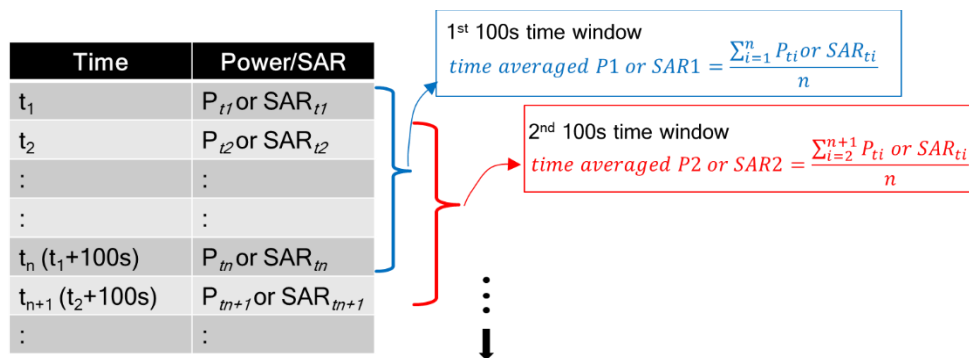

Figure 3-1 100s running average illustration

- 3. Make one plot containing:
 - a. Instantaneous Tx power versus time measured in Step 2,
 - b. Requested Tx power used in Step 2 (test sequence 1),
 - c. Computed time-averaged power versus time determined in Step 2,
 - d. Time-averaged power limit (corresponding to FCC SAR limit of 1.6 W/kg for 1gSAR or 4.0W/kg for 10gSAR) given by

$$Time\ avearged\ power\ limit = meas.P_{limit} + 10 \times \log\left(\frac{FCC\ SAR\ limit}{meas.SAR_Plimit}\right) \quad (5a)$$

where $meas.P_{limit}$ and $meas.SAR_Plimit$ correspond to measured power at P_{limit} and measured SAR at P_{limit} .



4. Make another plot containing:
 - a. Computed time-averaged 1gSAR or 10gSAR versus time determined in Step 2
 - b. FCC $1gSAR_{limit}$ of 1.6W/kg or FCC $10gSAR_{limit}$ of 4.0W/kg.
5. Repeat Steps 2 ~ 4 for pre-defined test sequence 2 and replace the requested Tx power (test sequence 1) in Step 2 with test sequence 2.
6. Repeat Steps 2 ~ 5 for all the selected technologies and bands.

The validation criteria are, at all times, the time-averaged power versus time shown in Step 3 plot shall not exceed the time-averaged power limit (defined in Eq. (5a)), in turn, the time-averaged 1gSAR or 10gSAR versus time shown in Step 4 plot shall not exceed the FCC limit of 1.6 W/kg for 1gSAR or 4.0 W/kg for 10gSAR (i.e., Eq. (1b)).

3.3.2 Change in call scenario

This test is to demonstrate that Smart Transmit feature accurately accounts for the past Tx powers during time-averaging when a new call is established.

The call disconnect and re-establishment needs to be performed during power limit enforcement, i.e., when the EUT's Tx power is at $P_{reserve}$ level, to demonstrate the continuity of RF exposure management and limiting in call change scenario. In other words, the RF exposure averaged over any FCC defined time window (including the time windows containing the call change) doesn't exceed FCC limit of 1.6 W/kg for 1gSAR or 4.0 W/kg for 10gSAR.

Test procedure

1. Measure P_{limit} for the technology/band selected in Section 3.2.2. Measure P_{limit} with Smart Transmit enabled and *Reserve_power_margin* set to 0 dB, callbox set to request maximum power.
2. Set *Reserve_power_margin* to actual (intended) value and reset power on EUT to enable Smart Transmit.
3. Establish radio link with callbox in the selected technology/band.
4. Request EUT's Tx power at 0 dBm for at least one time window specified for the selected technology/band, followed by requesting EUT's Tx power to be at maximum power for about ~60 seconds, and then drop the call for ~10 seconds. Afterwards, re-establish another call in the same radio configuration (i.e., same technology/band/channel) and continue callbox requesting EUT's Tx power to be at maximum power for the remaining time of at least another full duration of the specified time window. Measure and record Tx power versus time. Once the measurement is done, extract instantaneous Tx power versus time, convert the measured conducted Tx power into 1gSAR or 10gSAR value using Eq. (1a), and then perform the running time average to determine time-averaged power and 1gSAR or 10gSAR versus time.

NOTE: In Eq.(1a), instantaneous Tx power is converted into instantaneous 1gSAR or 10gSAR value by applying the measured worst-case 1gSAR or 10gSAR value at P_{limit} for the corresponding technology/band/antenna/DSI reported in Part 1 report.



5. Make one plot containing: (a) instantaneous Tx power versus time, (b) requested power, (c) computed time-averaged power, (d) time-averaged power limit calculated using Eq.(5a).
6. Make another plot containing: (a) computed time-averaged 1gSAR or 10gSAR versus time, and (b) FCC limit of 1.6 W/kg for 1gSAR or 4.0 W/kg for 10gSAR.

The validation criteria are, at all times, the time-averaged power versus time shall not exceed the time-averaged power limit (defined in Eq.(5a)), in turn, the time-averaged 1gSAR or 10gSAR versus time shall not exceed the FCC limit of 1.6 W/kg for 1gSAR or 4.0 W/kg for 10gSAR (i.e., Eq. (1b)).

3.3.3 Change in technology and band

This test is to demonstrate the correct power control by Smart Transmit during technology switches and/or band handovers.

Similar to the change in call test in Section 3.3.2, to validate the continuity of RF exposure limiting during the transition, the technology and band handover needs to be performed when EUT's Tx power is at $P_{reserve}$ level (i.e., during Tx power enforcement) to make sure that the EUT's Tx power from previous $P_{reserve}$ level to the new $P_{reserve}$ level (corresponding to new technology/band). Since the P_{limit} could vary with technology and band, Eq. (1a) can be written as follows to convert the instantaneous Tx power in 1gSAR or 10gSAR exposure for the two given radios, respectively:

$$1g_or_10gSAR_1(t) = \frac{conducted_Tx_power_1(t)}{conducted_Tx_power_P_{limit_1}} * 1g_or_10gSAR_P_{limit_1} \quad (6a)$$

$$1g_or_10gSAR_2(t) = \frac{conducted_Tx_power_2(t)}{conducted_Tx_power_P_{limit_2}} * 1g_or_10gSAR_P_{limit_2} \quad (6b)$$

$$\frac{1}{T_{SAR}} \left[\int_{t-T_{SAR}}^{t_1} \frac{1g_or_10gSAR_1(t)}{FCC\ SAR\ limit} dt + \int_{t-T_{SAR}}^t \frac{1g_or_10gSAR_2(t)}{FCC\ SAR\ limit} dt \right] \leq 1 \quad (6c)$$

where, $conducted_Tx_power_1(t)$, $conducted_Tx_power_P_{limit_1}$, and $1g_or_10gSAR_P_{limit_1}$ correspond to the measured instantaneous conducted Tx power, measured conducted Tx power at P_{limit} , and measured 1gSAR or 10gSAR value at P_{limit} of technology1/band1; $conducted_Tx_power_2(t)$, $conducted_Tx_power_P_{limit_2}(t)$, and $1g_or_10gSAR_P_{limit_2}$ correspond to the measured instantaneous conducted Tx power, measured conducted Tx power at P_{limit} , and measured 1gSAR or 10gSAR value at P_{limit} of technology2/band2. Transition from technology1/band1 to the technology2/band2 happens at time-instant ' t_f '.

Test procedure

1. Measure P_{limit} for both the technologies and bands selected in Section 3.2.3. Measure P_{limit} with Smart Transmit enabled and *Reserve_power_margin* set to 0 dB, callbox set to request maximum power.
2. Set *Reserve_power_margin* to actual (intended) value and reset power on EUT to enable Smart Transmit
3. Establish radio link with callbox in first technology/band selected.
4. Request EUT's Tx power at 0 dBm for at least one time window specified for the selected technology/band, followed by requesting EUT's Tx power to be at maximum



power for about ~60 seconds, and then switch to second technology/band selected. Continue with callbox requesting EUT's Tx power to be at maximum power for the remaining time of at least another full duration of the specified time window. Measure and record Tx power versus time for the full duration of the test.

5. Once the measurement is done, extract instantaneous Tx power versus time, and convert the conducted Tx power into 1gSAR or 10gSAR value using Eq. (6a) and (6b) and corresponding measured P_{limit} values from Step 1 of this section. Perform the running time average to determine time-averaged power and 1gSAR or 10gSAR versus time.

NOTE: In Eq.(6a) & (6b), instantaneous Tx power is converted into instantaneous 1gSAR or 10gSAR value by applying the measured worst-case 1gSAR or 10gSAR value at P_{limit} for the corresponding technology/band/antenna/DSI reported in Part 1 report.

6. Make one plot containing: (a) instantaneous Tx power versus time, (b) requested power, (c) computed time-averaged power, (d) time-averaged power limit calculated using Eq.(5a).
7. Make another plot containing: (a) computed time-averaged 1gSAR or 10gSAR versus time, and (b) FCC limit of 1.6 W/kg for 1gSAR or 4.0 W/kg for 10gSAR.

The validation criteria are, at all times, the time-averaged 1gSAR or 10gSAR versus time shall not exceed the FCC limit of 1.6 W/kg for 1gSAR or 4.0 W/kg for 10gSAR (i.e., Eq. (6c)).

3.3.4 Change in antenna

This test is to demonstrate the correct power control by Smart Transmit during antenna switches from one antenna to another. The test procedure is identical to Section 3.3.3, by replacing technology/band switch operation with antenna switch. The validation criteria are, at all times, the time-averaged 1gSAR or 10gSAR versus time shall not exceed FCC limit of 1.6 W/kg for 1gSAR or 4.0 W/kg for 10gSAR.

NOTE: If the EUT does not support antenna switch within the same technology/band, but has multiple antennas to support different frequency bands, then the antenna switch test is included as part of change in technology and band (Section 3.3.3) test.

3.3.5 Change in DSI

This test is to demonstrate the correct power control by Smart Transmit during DSI switches from one DSI to another. The test procedure is identical to Section 3.3.3, by replacing technology/band switch operation with DSI switch. The validation criteria are, at all times, the time-averaged 1gSAR or 10gSAR versus time shall not exceed FCC limit of 1.6 W/kg for 1gSAR or 4.0 W/kg for 10gSAR.

3.3.6 Change in time window

This test is to demonstrate the correct power control by Smart Transmit during the change in averaging time window when a specific band handover occurs. FCC specifies time-averaging windows of 100s for Tx frequency < 3GHz, and 60s for Tx frequency between 3GHz and 6GHz.

To validate the continuity of RF exposure limiting during the transition, the band handover test needs to be performed when EUT handovers from operation band less than 3GHz to greater than 3GHz and vice versa. The equations (3a) and (3b) in Section 2 can be written as follows for transmission scenario having change in time window,

$$1gSAR_1(t) = \frac{\text{conducted_Tx_power_1}(t)}{\text{conducted_Tx_power_Plimit_1}} * 1g_or\ 10g_SAR_Plimit_1 \quad (7a)$$

$$1gSAR_2(t) = \frac{\text{conducted_Tx_power_2}(t)}{\text{conducted_Tx_power_Plimit_2}} * 1g_or\ 10g_SAR_Plimit_2 \quad (7b)$$

$$\frac{1}{T1_{SAR}} \left[\int_{t-T1_{SAR}}^{t_1} \frac{1g_or\ 10g_SAR_1(t)}{FCC\ SAR\ limit} dt \right] + \frac{1}{T2_{SAR}} \left[\int_{t-T2_{SAR}}^t \frac{1g_or\ 10g_SAR_2(t)}{FCC\ SAR\ limit} dt \right] \leq 1 \quad (7c)$$

where, *conducted_Tx_power_1(t)*, *conducted_Tx_power_Plimit_1(t)*, and *1g_ or 10g_SAR_Plimit_1* correspond to the instantaneous Tx power, conducted Tx power at *P_{limit}*, and compliance *1g_ or 10g_SAR* values at *P_{limit_1}* of band1 with time-averaging window '*T1_{SAR}*'; *conducted_Tx_power_2(t)*, *conducted_Tx_power_Plimit_2(t)*, and *1g_ or 10g_SAR_Plimit_2* correspond to the instantaneous Tx power, conducted Tx power at *P_{limit}*, and compliance *1g_ or 10g_SAR* values at *P_{limit_2}* of band2 with time-averaging window '*T2_{SAR}*'. One of the two bands is less than 3GHz, another is greater than 3GHz. Transition from first band with time-averaging window '*T1_{SAR}*' to the second band with time-averaging window '*T2_{SAR}*' happens at time-instant '*t_j*'.

Test procedure

8. Measure *P_{limit}* for both the technologies and bands selected in Section 3.2.6. Measure *P_{limit}* with Smart Transmit enabled and *Reserve_power_margin* set to 0 dB, callbox set to request maximum power.
9. Set *Reserve_power_margin* to actual (intended) value and enable Smart Transmit

Transition from 100s time window to 60s time window, and vice versa

10. Establish radio link with callbox in the technology/band having 100s time window selected in Section 3.2.6.
11. Request EUT's Tx power to be at 0 dBm for at least 100 seconds, followed by requesting EUT's Tx power to be at maximum power for about ~140 seconds, and then switch to second technology/band (having 60s time window) selected in Section 3.2.6. Continue with callbox requesting EUT's Tx power to be at maximum power for about ~60s in this second technology/band, and then switch back to the first technology/band. Continue with callbox requesting EUT's Tx power to be at maximum power for at least another 100s. Measure and record Tx power versus time for the entire duration of the test.
12. Once the measurement is done, extract instantaneous Tx power versus time, and convert the conducted Tx power into 1gSAR or 10gSAR value (see Eq. (7a) and (7b)) using corresponding technology/band Step 1 result, and then perform 100s running average to determine time-averaged 1gSAR or 10gSAR versus time. Note that in



Eq.(7a) & (7b), instantaneous Tx power is converted into instantaneous 1gSAR or 10gSAR value by applying the worst-case 1gSAR or 10gSAR value tested in Part 1 for the selected technologies/bands at P_{limit} .

13. Make one plot containing: (a) instantaneous Tx power versus time measured in Step 4.
14. Make another plot containing: (a) instantaneous 1gSAR versus time determined in Step 5, (b) computed time-averaged 1gSAR versus time determined in Step 5, and (c) corresponding regulatory $1gSAR_{limit}$ of 1.6W/kg or $10gSAR_{limit}$ of 4.0W/kg.

Transition from 60s time window to 100s time window, and vice versa

15. Establish radio link with callbox in the technology/band having 60s time window selected in Section 3.2.6.
16. Request EUT's Tx power to be at 0 dBm for at least 60 seconds, followed by requesting EUT's Tx power to be at maximum power for about ~80 seconds, and then switch to second technology/band (having 100s time window) selected in Section 3.2.6. Continue with callbox requesting EUT's Tx power to be at maximum power for about ~100s in this second technology/band, and then switch back to the first technology/band. Continue with callbox requesting EUT's Tx power to be at maximum power for the remaining time for a total test time of 500 seconds. Measure and record Tx power versus time for the entire duration of the test.

17. Repeat above Step 5~7 to generate the plots

The validation criteria is, at all times, the time-averaged 1gSAR or 10gSAR versus time shall not exceed the regulatory $1gSAR_{limit}$ of 1.6W/kg or $10gSAR_{limit}$ of 4.0W/kg

3.3.7 SAR exposure switching

This test is to demonstrate that Smart Transmit feature is accurately accounts for switching in exposures among SAR from radio1 only, SAR from both radio1 and radio2, and SAR from radio2 only scenarios, and ensures total time-averaged RF exposure complies with the FCC limit. Here, radio1 represents primary radio (for example, LTE anchor in a NR non-standalone mode call) and radio2 represents secondary radio (for example, sub6 NR or mmW NR). The detailed test procedure for SAR exposure switching in the case of LTE+Sub6 NR non-standalone mode transmission scenario is provided in Appendix B.2.

Test procedure:

1. Measure conducted Tx power corresponding to P_{limit} for radio1 and radio2 in selected band. Test condition to measure conducted P_{limit} is:
 - Establish device in call with the callbox for radio1 technology/band. Measure conducted Tx power corresponding to radio1 P_{limit} with Smart Transmit enabled and Reserve_power_margin set to 0 dB, callbox set to request maximum power.
 - Repeat above step to measure conducted Tx power corresponding to radio2 P_{limit} . If radio2 is dependent on radio1 (for example, non-standalone mode of Sub6 NR requiring radio1 LTE as anchor), then establish radio1 + radio2 call with callbox, and request all down bits for radio1 LTE. In this scenario, with callbox requesting



maximum power from radio2 Sub6 NR, measured conducted Tx power corresponds to radio2 P_{limit} (as radio1 LTE is at all-down bits)

2. Set *Reserve_power_margin* to actual (intended) value, with EUT setup for radio1 + radio2 call. In this description, it is assumed that radio2 has lower priority than radio1. Establish device in radio1+radio2 call, and request all-down bits or low power on radio1, with callbox requesting EUT's Tx power to be at maximum power in radio2 for at least one time window. After one time window, set callbox to request EUT's Tx power to be at maximum power on radio1, i.e., all-up bits. Continue radio1+radio2 call with both radios at maximum power for at least one time window, and drop (or request all-down bits on) radio2. Continue radio1 at maximum power for at least one time window. Record the conducted Tx power for both radio1 and radio2 for the entire duration of this test.
3. Once the measurement is done, extract instantaneous Tx power versus time for both radio1 and radio2 links. Convert the conducted Tx power for both these radios into 1gSAR or 10gSAR value (see Eq. (6a) and (6b)) using corresponding technology/band P_{limit} measured in Step 1, and then perform the running time average to determine time-averaged 1gSAR or 10gSAR versus time.
4. Make one plot containing: (a) instantaneous Tx power versus time measured in Step 2.
5. Make another plot containing: (a) instantaneous 1gSAR versus time determined in Step 3, (b) computed time-averaged 1gSAR versus time determined in Step 3, and (c) corresponding regulatory $1gSAR_{limit}$ of 1.6W/kg or $10gSAR_{limit}$ of 4.0W/kg.

The validation criteria is, at all times, the time-averaged 1gSAR or 10gSAR versus time shall not exceed the regulatory $1gSAR_{limit}$ of 1.6W/kg or $10gSAR_{limit}$ of 4.0W/kg.

3.4 Test procedure for time-varying SAR measurements

This section provides general time-varying SAR measurement procedures to perform compliance test under dynamic transmission scenarios described in Section 2. In practice, an adjustment can be made in these procedures. The justification/clarification may be provided.

To perform the validation through SAR measurement for transmission scenario 1 described in Section 2, the "path loss" between callbox antenna and EUT needs to be calibrated to ensure that the EUT Tx power reacts to the requested power from callbox in a radiated call. It should be noted that when signaling in closed loop mode, protocol-level power control is in play, resulting in EUT not solely following callbox TPC (Tx power control) commands. In other words, EUT response has many dependencies (RSSI, quality of signal, path loss variation, fading, etc.) other than just TPC commands. These dependencies have less impact in conducted setup (as it is a controlled environment and the path loss can be very well calibrated) but have significant impact on radiated testing in an uncontrolled environment, such as SAR test setup. Therefore, the deviation in EUT Tx power from callbox requested power is expected, however the time-averaged SAR should not exceed FCC SAR requirement at all times as Smart Transmit controls Tx power at EUT.

The following steps are for time averaging feature validation through SAR measurement:



1. "Path Loss" calibration: Place the EUT against the phantom in the worst-case position determined based on Section 3.2.1. For each band selected, prior to SAR measurement, perform "path loss" calibration between callbox antenna and EUT. Since the SAR test environment is not controlled and well calibrated for OTA (Over the Air) test, extreme care needs to be taken to avoid the influence from reflections. The test setup is described in Section 7.1.
2. Time averaging feature validation:
 - i For a given radio configuration (technology/band) selected in Section 3.2.1, enable Smart Transmit and set *Reserve_power_margin* to 0 dB, with callbox to request maximum power, perform area scan, conduct pointSAR measurement at peak location of the area scan. This point SAR value, *pointSAR_P_{limit}*, corresponds to point SAR at the measured *P_{limit}* (i.e., measured *P_{limit}* from the EUT in Step 1 of Section 3.3.1).
 - ii Set *Reserve_power_margin* to actual (intended) value and reset power on EUT to enable Smart Transmit. Note, if *Reserve_power_margin* cannot be set wirelessly, care must be taken to re-position the EUT in the exact same position relative to the SAM phantom as in above Step 2.i. Establish radio link in desired radio configuration, with callbox requesting the EUT's Tx power at power levels described by test sequence 1 generated in Step 1 of Section 3.3.1, conduct point SAR measurement versus time at peak location of the area scan determined in Step 2.i of this section. Once the measurement is done, extract instantaneous point SAR vs time data, *pointSAR(t)*, and convert it into instantaneous 1gSAR or 10gSAR vs. time using Eq. (3a), re-written below:

$$1g_or_10gSAR(t) = \frac{pointSAR(t)}{pointSAR_P_{limit}} * 1g_or_10gSAR_P_{limit}$$

where, *pointSAR_P_{limit}* is the value determined in Step 2.i, and *pointSAR(t)* is the instantaneous point SAR measured in Step 2.ii, *1g_or_10gSAR_P_{limit}* is the measured 1gSAR or 10gSAR value listed in Part 1 report.

- iii Perform 100s running average to determine time-averaged 1gSAR or 10gSAR versus time.
- iv Make one plot containing: (a) time-averaged 1gSAR or 10gSAR versus time determined in Step 2.iii of this section, (b) FCC limit of 1.6 W/kg for 1gSAR or 4.0 W/kg for 10gSAR.
- v Repeat 2.ii ~ 2.iv for test sequence 2 generated in Step 1 of Section 3.3.1.
- vi Repeat 2.i ~ 2.v for all the technologies and bands selected in Section 3.2.1.

The time-averaging validation criteria for SAR measurement is that, at all times, the time-averaged 1gSAR or 10gSAR versus time shall not exceed FCC limit of 1.6 W/kg for 1gSAR or 4.0 W/kg for 10gSAR (i.e., Eq. (3b)).



4 PD Time Averaging Validation Test Procedures

This chapter provides the test plan and test procedures for validating Qualcomm Smart Transmit feature for mmW transmission. For this EUT, millimeter wave (mmW) transmission is only in non-standalone mode, i.e., it requires an LTE link as anchor.

4.1 Test sequence for validation in mmW NR transmission

In 5G mmW NR transmission, the test sequence for validation is with the callbox requesting EUT's Tx power in 5G mmW NR at maximum power all the time.

4.2 Test configuration selection criteria for validating Smart Transmit feature

4.2.1 Test configuration selection for time-varying Tx power transmission

The Smart Transmit time averaging feature operation is independent of bands, modes, channels, and antenna configurations (beams) for a given technology. Hence, validation of Smart Transmit in any one band/mode/channel per technology is sufficient.

4.2.2 Test configuration selection for change in antenna configuration (beam)

The Smart Transmit time averaging feature operation is independent of bands, modes, channels, and antenna configurations (beams) for a given technology. Hence, validation of Smart Transmit with beam switch between any two beams is sufficient.

4.2.3 Test configuration selection for SAR vs. PD exposure switch during transmission

The Smart Transmit time averaging feature operation is independent of the nature of exposure (SAR vs. PD) and ensures total time-averaged RF exposure compliance. Hence, validation of Smart Transmit in any one band/mode/channel/beam for mmW + sub-6 (LTE) transmission is sufficient, where the exposure varies among SAR dominant scenario, SAR+PD scenario, and PD dominant scenario.

4.3 Test procedures for mmW radiated power measurements

Perform conducted power measurement (for $f < 6\text{GHz}$) and radiated power measurement (for $f > 6\text{GHz}$) for LTE + mmW transmission to validate Smart Transmit time averaging feature in the various transmission scenarios described in Section 2.

This section provides general conducted power measurement procedures to perform compliance test under dynamic transmission scenarios described in Section 2. In practice, an adjustment can be made in these procedures. The justification/clarification may be provided.



4.3.1 Time-varying Tx power scenario

The purpose of the test is to demonstrate the effectiveness of power limiting enforcement and that the time-averaged Tx power when converted into RF exposure values does not exceed the FCC limit at all times (see Eq. (2a), (2b) & (2c) in Section 2).

Test procedure:

1. Measure conducted Tx power corresponding to P_{limit} for LTE in selected band, and measure radiated Tx power corresponding to *input.power.limit* in desired mmW band/channel/beam by following below steps:
 - a. Measure radiated power corresponding to mmW *input.power.limit* by setting up the EUT's Tx power in desired band/channel/beam at *input.power.limit* in Factory Test Mode (FTM). This test is performed in a calibrated anechoic chamber. Rotate the EUT to obtain maximum radiated Tx power, keep the EUT in this position and do not disturb the position of the EUT inside the anechoic chamber for the rest of this test.
 - b. Reset EUT to place in online mode and establish radio link in LTE, measure conducted Tx power corresponding to LTE P_{limit} with Smart Transmit enabled and *Reserve_power_margin* set to 0 dB, callbox set to request maximum power.
2. Set *Reserve_power_margin* to actual (intended) value and reset power on EUT to enable Smart Transmit. With EUT setup for a mmW NR call in the desired/selected LTE band and mmW NR band, perform the following steps:
 - a. Establish LTE and mmW NR connection in desired band/channel/beam used in Step 1. As soon as the mmW connection is established, immediately request all-down bits on LTE link. With callbox requesting EUT's Tx power to be at maximum mmW power to test predominantly PD exposure scenario (as SAR exposure is less when LTE's Tx power is at low power).
 - b. After 120s, request LTE to go all-up bits for at least 100s. SAR exposure is dominant. There are two scenarios:
 - i. If $P_{limit} < P_{max}$ for LTE, then the RF exposure margin (provided to mmW NR) gradually runs out (due to high SAR exposure). This results in gradual reduction in the 5G mmW NR transmission power and eventually seized 5G mmW NR transmission when LTE goes to $P_{reserve}$ level.
 - ii. If $P_{limit} \geq P_{max}$ for LTE, then the 5G mmW NR transmission's averaged power should gradually reduce but the mmW NR connection can sustain all the time (assuming TxAGC uncertainty = 0dB).
 - c. Record the conducted Tx power of LTE and radiated Tx power of mmW for the full duration of this test of at least 300s.
3. Once the measurement is done, extract instantaneous Tx power versus time for both LTE and mmW links. Convert the conducted Tx power for LTE into 1gSAR or 10gSAR value using Eq. (2a) and P_{limit} measured in Step 1.b, and then divide by FCC limit of 1.6 W/kg for 1gSAR or 4.0 W/kg for 10gSAR to obtain instantaneous normalized 1gSAR or 10gSAR versus time. Perform 100s running average to determine normalized 100s-averaged 1gSAR or 10gSAR versus time.



NOTE: In Eq.(2a), instantaneous Tx power is converted into instantaneous 1gSAR or 10gSAR value by applying the measured worst-case 1gSAR or 10gSAR value at P_{limit} for the corresponding technology/band/antenna/DSI reported in Part 1 report.

- Similarly, convert the radiated Tx power for mmW into $4\text{cm}^2\text{PD}$ value using Eq. (2b) and the radiated Tx power limit (i.e., radiated Tx power at *input.power.limit*) measured in Step 1.a, then divide by FCC $4\text{cm}^2\text{PD}$ limit of $10\text{W}/\text{m}^2$ to obtain instantaneous normalized $4\text{cm}^2\text{PD}$ versus time. Perform 4s running average to determine normalized 4s-averaged $4\text{cm}^2\text{PD}$ versus time.

NOTE: In Eq.(2b), instantaneous radiated Tx power is converted into instantaneous $4\text{cm}^2\text{PD}$ by applying the worst-case $4\text{cm}^2\text{PD}$ value measured at *input.power.limit* for the selected band/beam in Part 1 report.

- Make one plot containing: (a) instantaneous conducted Tx power for LTE versus time, (b) computed 100s-averaged conducted Tx power for LTE versus time, (c) instantaneous radiated Tx power for mmW versus time, as measured in Step 2, (d) computed 4s-averaged radiated Tx power for mmW versus time, and (e) time-averaged conducted and radiated power limits for LTE and mmW radio using Eq. (5a) & (5b), respectively:

$$\text{Time avearged LTE power limit} = \text{meas. } P_{limit} + 10 \times \log\left(\frac{\text{FCC SAR limit}}{\text{meas.SAR_Plimit}}\right) \quad (5a)$$

$$\text{Time avearged mmW NR power limit} = \text{meas. } EIRP_{input.power.limit} + 10 \times \log\left(\frac{\text{FCC PD limit}}{\text{meas.PD_input.power.limit}}\right) \quad (5b)$$

where *meas. EIRP_{input.power.limit}* and *meas. PD_{input.power.limit}* correspond to measured EIRP at *input.power.limit* and measured power density at *input.power.limit*.

- Make another plot containing: (a) computed normalized 100s-averaged 1gSAR or 10gSAR versus time determined in Step 3, (b) computed normalized 4s-averaged $4\text{cm}^2\text{PD}$ versus time determined in Step 4, and (c) corresponding total normalized time-averaged RF exposure (sum of steps (6.a) and (6.b)) versus time.

The validation criteria are, at all times, the total normalized time-averaged RF exposure versus time determined in Step 6.c shall not exceed the normalized limit of 1.0 of FCC requirement (i.e., Eq. (2c)).

4.3.2 Switch in SAR vs. PD exposure during transmission

This test is to demonstrate that Smart Transmit feature is independent of the nature of exposure (SAR vs. PD), accurately accounts for switching in exposures among SAR dominant, SAR+PD, and PD dominant scenarios, and ensures total time-averaged RF exposure compliance.

Test procedure:

- Measure conducted Tx power corresponding to P_{limit} for LTE in selected band, and measure radiated Tx power corresponding to *input.power.limit* in desired mmW band/channel/beam by following below steps:



- a. Measure radiated power corresponding to *input.power.limit* by setting up the EUT's Tx power in desired band/channel/beam at *input.power.limit* in FTM. This test is performed in a calibrated anechoic chamber. Rotate the EUT to obtain maximum radiated Tx power, keep the EUT in this position and do not disturb the position of the EUT inside the anechoic chamber for the rest of this test.
 - b. Reset EUT to place in online mode and establish radio link in LTE, measure conducted Tx power corresponding to LTE P_{limit} with Smart Transmit enabled and *Reserve_power_margin* set to 0 dB, callbox set to request maximum power.
2. Set *Reserve_power_margin* to actual (intended) value and reset power in EUT, with EUT setup for LTE + mmW call, perform the following steps:
- a. Establish LTE (sub-6) and mmW NR connection with callbox.
 - b. As soon as the mmW connection is established, immediately request all-down bits on LTE link. Continue LTE (all-down bits) + mmW transmission for more than 100s duration to test predominantly PD exposure scenario (as SAR exposure is negligible from all-down bits in LTE).
 - c. After 120s, request LTE to go all-up bits, mmW transmission should gradually run out of RF exposure margin if LTE's $P_{limit} < P_{max}$ and seize mmW transmission (SAR only scenario); or mmW transmission should gradually reduce in Tx power and will sustain the connection if LTE's $P_{limit} > P_{max}$.
 - d. After 120s, request LTE to go all-down bits, mmW transmission should start getting back RF exposure margin and resume transmission again.
 - e. Record the conducted Tx power of LTE and radiated Tx power of mmW for the entire duration of this test of at least 300s.
3. Once the measurement is done, extract instantaneous Tx power versus time for both LTE and mmW links. Convert the conducted Tx power for LTE into 1gSAR or 10gSAR value using Eq. (2a) and P_{limit} measured in Step 1.b, and then divide by FCC limit of 1.6 W/kg for 1gSAR or 4.0 W/kg for 10gSAR to obtain instantaneous normalized 1gSAR or 10gSAR versus time. Perform 100s running average to determine normalized 100s-averaged 1gSAR or 10gSAR versus time.

NOTE: In Eq.(2a), instantaneous Tx power is converted into instantaneous 1gSAR or 10gSAR value by applying the measured worst-case 1gSAR or 10gSAR value at P_{limit} for the corresponding technology/band/antenna/DSI reported in Part 1 report.

4. Similarly, convert the radiated Tx power for mmW into $4\text{cm}^2\text{PD}$ value using Eq. (2b) and the radiated Tx power limit (i.e., radiated Tx power at *input.power.limit*) measured in Step 1.a, then divide this by FCC $4\text{cm}^2\text{PD}$ limit of $10\text{W}/\text{m}^2$ to obtain instantaneous normalized $4\text{cm}^2\text{PD}$ versus time. Perform 4s running average to determine normalized 4s-averaged $4\text{cm}^2\text{PD}$ versus time.

NOTE: In Eq.(2b), instantaneous radiated Tx power is converted into instantaneous $4\text{cm}^2\text{PD}$ by applying the worst-case $4\text{cm}^2\text{PD}$ value measured at *input.power.limit* for the selected band/beam in Part 1 report.

5. Make one plot containing: (a) instantaneous conducted Tx power for LTE versus time, (b) computed 100s-averaged conducted Tx power for LTE versus time, (c) instantaneous radiated Tx power for mmW versus time, as measured in Step 2, (d) computed 4s-averaged radiated Tx power for mmW versus time, and (e) time-averaged conducted and radiated power limits for LTE and mmW radio using Eq. (5a) & (5b), respectively.
6. Make another plot containing: (a) computed normalized 100s-averaged 1gSAR or 10gSAR versus time determined in Step 3, (b) computed normalized 4s-averaged 4cm²PD versus time determined in Step 4, and (c) corresponding total normalized time-averaged RF exposure (sum of steps (6.a) and (6.b)) versus time.

The validation criteria are, at all times, the total normalized time-averaged RF exposure versus time determined in Step 6.c shall not exceed the normalized limit of 1.0 of FCC requirement (i.e., Eq. (2c)).

4.3.3 Change in antenna configuration (beam)

This test is to demonstrate the correct power control by Smart Transmit during changes in antenna configuration (beam). Since the *input.power.limit* varies with beam, the Eq. (2a), (2b) and (2c) in Section 2 are written as below for transmission scenario having change in beam,

$$1g_or_10gSAR(t) = \frac{conducted_Tx_power(t)}{conducted_Tx_power_P_{limit}} * 1g_or_10gSAR_P_{limit} \quad (8a)$$

$$4cm^2PD_1(t) = \frac{radiated_Tx_power_1(t)}{radiated_Tx_power_input.power.limit_1} * 4cm^2PD_input.power.limit_1 \quad (8b)$$

$$4cm^2PD_2(t) = \frac{radiated_Tx_power_2(t)}{radiated_Tx_power_input.power.limit_2} * 4cm^2PD_input.power.limit_2 \quad (8c)$$

$$\frac{\frac{1}{T_{SAR}} \int_{t-T_{SAR}}^t 1g_or_10gSAR(t) dt}{FCC\ SAR\ limit} + \frac{\frac{1}{T_{PD}} \left[\int_{t-T_{PD}}^{t_1} 4cm^2PD_1(t) dt + \int_{t_1}^t 4cm^2PD_2(t) dt \right]}{FCC\ 4cm^2\ PD\ limit} \leq 1 \quad (8d)$$

where, *conducted_Tx_power(t)*, *conducted_Tx_power_P_{limit}*, and *1g_or_10gSAR_P_{limit}* correspond to the measured instantaneous conducted Tx power, measured conducted Tx power at *P_{limit}*, and measured 1gSAR or 10gSAR values at *P_{limit}* corresponding to LTE transmission. Similarly, *radiated_Tx_power_1(t)*, *radiated_Tx_power_input.power.limit_1*, and *4cm²PD_input.power.limit_1* correspond to the measured instantaneous radiated Tx power, radiated Tx power at *input.power.limit*, and 4cm²PD value at *input.power.limit* of beam 1; *radiated_Tx_power_2(t)*, *radiated_Tx_power_input.power.limit_2*, and *4cm²PD_input.power.limit_2* correspond to the measured instantaneous radiated Tx power, radiated Tx power at *input.power.limit*, and 4cm²PD value at *input.power.limit* of beam 2 corresponding to mmW transmission.

**Test procedure:**

1. Measure conducted Tx power corresponding to P_{limit} for LTE in selected band, and measure radiated Tx power corresponding to *input.power.limit* in desired mmW band/channel/beam by following below steps:
 - a. Measure radiated power corresponding to mmW *input.power.limit* by setting up the EUT's Tx power in desired band/channel at *input.power.limit* of beam 1 in FTM. Do not disturb the position of the EUT inside the anechoic chamber for the rest of this test. Repeat this Step 1.a for beam 2.
 - b. Reset EUT to place in online mode and establish radio link in LTE, measure conducted Tx power corresponding to LTE P_{limit} with Smart Transmit enabled and *Reserve_power_margin* set to 0 dB, callbox set to request maximum power.
2. Set *Reserve_power_margin* to actual (intended) value and reset power in EUT, With EUT setup for LTE + mmW connection, perform the following steps:
 - a. Establish LTE (sub-6) and mmW NR connection in beam 1. As soon as the mmW connection is established, immediately request all-down bits on LTE link with the callbox requesting EUT's Tx power to be at maximum mmW power.
 - b. After beam 1 continues transmission for at least 20s, request the EUT to change from beam 1 to beam 2, and continue transmitting with beam 2 for at least 20s.
 - c. Record the conducted Tx power of LTE and radiated Tx power of mmW for the entire duration of this test.
3. Once the measurement is done, extract instantaneous Tx power versus time for both LTE and mmW links. Convert the conducted Tx power for LTE into 1gSAR or 10gSAR value using the similar approach described in Step 3 of Section 4.3.2. Perform 100s running average to determine normalized 100s-averaged 1gSAR versus time.
4. Similarly, convert the radiated Tx power for mmW NR into $4\text{cm}^2\text{PD}$ value using Eq. (8b), (8c) and the radiated Tx power limits (i.e., radiated Tx power at *input.power.limit*) measured in Step 1.a for beam 1 and beam 2, respectively, and then divide the resulted PD values by FCC $4\text{cm}^2\text{PD}$ limit of $10\text{W}/\text{m}^2$ to obtain instantaneous normalized $4\text{cm}^2\text{PD}$ versus time for beam 1 and beam 2. Perform 4s running average to determine normalized 4s-averaged $4\text{cm}^2\text{PD}$ versus time.

NOTE: In Eq.(8b) and (8c), instantaneous radiated Tx power of beam 1 and beam 2 is converted into instantaneous $4\text{cm}^2\text{PD}$ by applying the worst-case $4\text{cm}^2\text{PD}$ value measured at the *input.power.limit* of beam 1 and beam 2 in Part 1 report, respectively.

5. Since the measured radiated powers for beam 1 and beam 2 in Step 1.a were performed at an arbitrary rotation of EUT in anechoic chamber, repeat Step 1.a of this procedure by rotating the EUT to determine maximum radiated power at *input.power.limit* in FTM mode for both beams separately. Re-scale the measured instantaneous radiated power in Step 2.c by the delta in radiated power measured in



Step 5 and the radiated power measured in Step 1.a for plotting purposes in next Step. In other words, this step essentially converts measured instantaneous radiated power during the measurement in Step 2 into maximum instantaneous radiated power for both beams. Perform 4s running average to compute 4s-averaged radiated Tx power. Additionally, use these EIRP values measured at *input.power.limit* at respective peak locations to determine the EIRP limits (using Eq. (5b)) for both these beams.

6. Make one plot containing: (a) instantaneous conducted Tx power for LTE versus time, (b) computed 100s-averaged conducted Tx power for LTE versus time, (c) instantaneous radiated Tx power for mmW versus time, as obtained in Step 5, (d) computed 4s-averaged radiated Tx power for mmW versus time, as obtained in Step 5, and (e) time-averaged conducted and radiated power limits for LTE and mmW radio, respectively.
7. Make another plot containing: (a) computed normalized 100s-averaged 1gSAR versus time determined in Step 3, (b) computed normalized 4s-averaged 4cm²PD versus time determined in Step 4, and (c) corresponding total normalized time-averaged RF exposure (sum of steps (6.a) and (6.b)) versus time.

The validation criteria are, at all times, the total normalized time-averaged RF exposure versus time determined in Step 6.c shall not exceed the normalized limit of 1.0 of FCC requirement (i.e., (8d)).

4.4 Test procedure for time-varying PD measurements

The following steps are used to perform the validation through PD measurement for transmission scenario 1 described in Section 2:

1. Place the EUT on the cDASY6 platform to perform PD measurement in the worst-case position/surface for the selected mmW band/beam. In PD measurement, the callbox is set to request maximum Tx power from EUT all the time. Hence, “path loss” calibration between callbox antenna and EUT is not needed in this test.
2. Time averaging feature validation:
 - a. Measure conducted Tx power corresponding to P_{limit} for LTE in selected band, and measure point E-field corresponding to *input.power.limit* in desired mmW band/channel/beam by following the below steps:
 - i. Measure conducted Tx power corresponding to LTE P_{limit} with Smart Transmit enabled and *Reserve_power_margin* set to 0 dB, with callbox set to request maximum power.
 - ii. Measure point E-field at peak location of fast area scan corresponding to *input.power.limit* by setting up the EUT’s Tx power in desired mmW band/channel/beam at *input.power.limit* in FTM. Do not disturb the position of EUT and mmW cDASY6 probe.
 - b. Set *Reserve_power_margin* to actual value (i.e., intended value) and reset power on EUT, place EUT in online mode. With EUT setup for LTE (sub-6) + mmW NR call, as soon as the mmW NR connection is established, request all-down bits on LTE link. Continue LTE (all-down bits) + mmW transmission for more than 100s duration to test predominantly PD exposure scenario. After 120s, request LTE to go all-up bits, mmW transmission should gradually reduce. Simultaneously,



record the conducted Tx power of LTE transmission using power meter and point E-field (in terms of ratio of $\frac{[pointE(t)]^2}{[pointE_input.power.limit]^2}$) of mmW transmission using cDASY6 E-field probe at peak location identified in Step 2.a.ii for the entire duration of this test of at least 300s.

- c. Once the measurement is done, extract instantaneous conducted Tx power versus time for LTE transmission and $\frac{[pointE(t)]^2}{[pointE_input.power.limit]^2}$ ratio versus time from cDASY6 system for mmW transmission. Convert the conducted Tx power for LTE into 1gSAR or 10gSAR value using Eq. (4a) and P_{limit} measured in Step 2.a.i, and then divide this by FCC limit of 1.6 W/kg for 1gSAR or 4.0 W/kg for 10gSAR to obtain instantaneous normalized 1gSAR or 10gSAR versus time. Perform 100s running average to determine normalized 100s-averaged 1gSAR or 10gSAR versus time

NOTE: In Eq.(4a), instantaneous Tx power is converted into instantaneous 1gSAR or 10gSAR value by applying the measured worst-case 1gSAR or 10gSAR value at P_{limit} for the corresponding technology/band reported in Part 1 report.

- d. Similarly, convert the point E-field for mmW transmission into $4cm^2PD$ value using Eq. (4b) and radiated power limit measured in Step 2.a.ii, and then divide this by FCC $4cm^2PD$ limit of $10W/m^2$ to obtain instantaneous normalized $4cm^2PD$ versus time. Perform 4s running average to determine normalized 4s-averaged $4cm^2PD$ versus time.
- e. Make one plot containing: (i) computed normalized 100s-averaged 1gSAR or 10gSAR versus time determined in Step 2.c, (ii) computed normalized 4s-averaged $4cm^2PD$ versus time determined in Step 2.d, and (iii) corresponding total normalized time-averaged RF exposure (sum of steps (2.e.i) and (2.e.ii)) versus time.

The validation criteria are, at all times, the total normalized time-averaged RF exposure versus time determined in Step 2.e.iii shall not exceed the normalized limit of 1.0 of FCC requirement (i.e., Eq. (4c)).



5 Test Configurations

5.1 WWAN (sub-6) transmission

The P_{limit} values, corresponding to SAR_design_target, for technologies and bands supported by EUT are derived in Part 0 report and summarized in Table 5-1. Note all P_{limit} power levels entered in Table 5-1 correspond to average power levels after accounting for duty cycle in the case of TDD modulation schemes (for e.g., GSM, LTE TDD & Sub6 NR TDD).

Table 5-1: P_{limit} for supported technologies and bands (P_{limit} in EFS file)

Exposure Scenario:			Head	Head	Hotspot	Body-worn	Extremity	Pmax(*)
Averaging Volume:			1g	1g	1g	1g	10g	
Spacing:			0	0	10	15	0	
DSI			2	3	4	0	1	
Band	Antenna		P _{limit} corresponding to SAR design target					
GSM850 (**) (GSM/GPRS/EDGE)	UAT	0	24.5	22.7	22.7	28.3	28.3	25.2
GSM1900 (**) (GSM/GPRS/EDGE)	UAT	3	16.7	16.7	19.7	29.4	28.2	22.0
WCDMA II	UAT	3	16.7	16.7	18.0	25.1	20.7	22.5
WCDMA IV	UAT	3	16.1	16.1	17.5	24.0	21.5	22.3
WCDMA V	UAT	0	23.7	21.0	22.8	27.4	27.4	22.8
LTE B25/2	UAT	3	16.7	16.7	17.0	24.9	20.8	22.3
LTE B66/4	UAT	3	16.1	16.1	17.0	23.6	20.6	22.3
LTE B5	UAT	0	22.6	22.6	22.5	26.3	26.3	23.8
LTE B7	UAT	3	15.5	15.5	17.0	25.0	18.8	21.8
LTE B12/17	UAT	0	29.3	29.3	28.4	33.9	33.9	22.8
LTE B13	UAT	0	25.8	20.5	25.7	29.7	29.7	23.8
LTE B26	UAT	0	23.9	21.5	22.8	27.4	27.4	22.8
LTE B30	UAT	3	17.1	15.0	17.0	25.2	20.7	22.8
LTE B41/38 (**)	UAT	3	15.0	15.0	17.5	26.1	26.1	20.8
LTE B48(**)	UAT	3	13.2	13.2	16.0	23.6	23.6	21.0
LTE B48(**)	UAT	6	22.7	22.7	22.7	28.9	28.9	22.7
LTE B71	UAT	0	30.1	30.1	29.9	35.3	35.3	22.8
Sub NR B5	UAT	0	24.7	23.2	24.2	28.6	28.6	22.8
Sub NR B2	UAT	3	17.2	15.0	18.5	25.4	21.2	22.8
Sub NR B66	UAT	3	16.5	14.5	18.1	24.4	21.4	22.8



Table 5-2: P_{limit} for supported technologies and bands (P_{limit} in EFS file)

Exposure Scenario:			Head	Hotspot	Body-worn	Extremity	Pmax(*) (dBm)
Averaging Volume:			1g	1g	1g	10g	
Spacing:			0	10	15	0	
DSI			5	7	5	6	
Band	Antenna		P _{limit} corresponding to SAR design target				
GSM850 (**) (GSM/GPRS/EDGE)	LAT	1	28.3	26.5	28.3	28.3	25.2
GSM1900 (**) (GSM/GPRS/EDGE)	LAT	2	28.5	25.3	28.5	28.5	20.0
WCDMA II	LAT	2	25.9	21.7	25.9	25.9	20.5
WCDMA IV	LAT	2	26.4	22.9	26.4	26.4	20.5
WCDMA V	LAT	1	27.7	26.2	27.7	27.7	22.5
LTE B25/2	LAT	2	26.1	23.1	26.1	26.1	23.2
LTE B66/4	LAT	2	26.2	22.2	26.2	23.8	23.8
LTE B5	LAT	1	27.0	25.0	27.0	27.0	23.8
LTE B7	LAT	2	24.2	21.2	24.2	24.2	20.8
LTE B12/17	LAT	1	30.5	29.7	30.5	30.5	22.8
LTE B13	LAT	1	27.1	27.1	27.1	27.1	23.8
LTE B26	LAT	1	28.1	26.1	28.1	28.1	22.8
LTE B30	LAT	2	26.5	22.3	26.5	26.5	20.8
LTE B41/38 (**)	LAT	2	26.2	20.8	26.2	26.2	18.8
LTE B71	LAT	1	30.8	29.4	30.8	30.8	22.8
Sub NR B5	LAT	1	28.5	26.8	28.5	28.5	22.8
Sub NR B2	LAT	2	26.7	24.2	26.7	26.7	21.4
Sub NR B66	LAT	2	28.4	23.9	28.4	28.4	22.8

*Pmax is used for RF tune up procedure. The maximum allowed output power is equal to Pmax + device uncertainty.

**All P_{limit} power levels entered in the Table correspond to average power levels after accounting for duty cycle in the case TDD modulation schemes (for e.g., GSM & LTE TDD & NR TDD).

Based on selection criteria described in Section 3.2.1, the selected technologies/bands for testing time-varying test sequences are listed in Table 5-3, the



Reserve_power_margin (dB) for 2ABZ2-EE149 is set to 3dB in EFS, and is used in Part 2 test.

The radio configurations used in Part 2 test for selected technologies, bands, DSIs and antennas are listed in Table 5-3. The corresponding worst-case radio configuration 1gSAR or 10gSAR values for selected technology/band/DSI are extracted from Part 1 report and are listed in the last column of Table 5-3.

Based on equations (1a), (2a), (3a) and (4a), it is clear that Part 2 testing outcome is normalized quantity, which implies that it can be applied to any radio configuration within a selected technology/band/DSI. Thus, as long as applying the worst-case SAR obtained from the worst radio configuration in Part 1 testing to calculate time-varying SAR exposure in equations (1a), (2a), (3a) and (4a), the accuracy in compliance demonstration remains the same.

Table 5-3: Radio configurations selected for Part 2 test

Test case#	Test scenario	Part 2 test configurations											Part 1 worst-case radio config 1g or 10g SAR measured at Plimit(W/kg)
		Tech	Band	Ant	DSI	Channel	Freq (MHz)	RB/offset	mode	position	Position details	Detail	
1	time-varying Tx power transmission	LTE	7	3	2	21350	2560	100/0	QPSK	Right Tilted	Head, 0mm		0.857
2			30	3	3	27710	2310	25/12	QPSK	Left Tilted	Head, 0mm		0.511
3		WCDMA	4	3	2	1513	1752.6		RMC	Right Cheek	Head, 0mm		0.776
4		WCDMA	5	0	3	4182	836.4		RMC	Right Cheek	Head, 0mm		0.419
5		GSM	850	0	3	128	824.2		GPRS(3TX)	Right Cheek	Head, 0mm		0.369
6		GSM	1900	3	2	512	1850.2		GPRS(3TX)	Right Cheek	Head, 0mm		0.735
7		sub6 NR	n66	3	3	349000	1745	1/1	DFT-S-OFDM QPSK	Right Cheek	Head, 0mm		0.537
8		sub6 NR	n2	3	3	380000	1900	1/1	DFT-S-OFDM QPSK	Right Cheek	Head, 0mm		0.512
9	change in call	LTE	30	3	3	27710	2310	25/12	QPSK	Left Tilted	Head, 0mm		0.511
10	Tech/band switch/Antenna switch	LTE	30	3	3	27710	2310	25/12	QPSK	Left Tilted	Head, 0mm		0.511
		WCDMA	5	0	3	4182	836.4		RMC	Right Cheek	Head, 0mm		0.419
11	DSI switch	LTE	30	3	3	27710	2310	25/12	QPSK	Left Tilted	Head, 0mm		0.511
		LTE	30	3	2	27710	2310	50/0	RMC	Left Tilted	Head, 0mm		0.87
12	Time window	LTE	7	3	2	21350	2560	100/0	QPSK	Right Tilted	Head, 0mm		0.857
		LTE	48	3	2	56640	3690	1/0	QPSK	Right Tilted	Head, 0mm		0.989
13	SAR1 vs SAR2	LTE	13	0	3	23230	782	25/25	QPSK	Left Cheek	Head, 0mm		0.53
		sub6 NR	n66	3	3	349000	1745	1/1	DFT-S-OFDM QPSK	Right Cheek	Head, 0mm		0.537

Note that the EUT has a seven DSI states to manage power for different RF exposure conditions, detail DSI states and trigger conditions shown on the following table, the



maximum 1gSAR/or 10gSAR among all exposure scenarios is used in Smart Transmit feature for time averaging operation.

Exposure conditions	Trigger Conditions	DSI	Antenna	SAR design target	W/kg
Body Worn	-	0	Top antenna	1g SAR design target	0.715
Extremity	Top sensor on	1	Top antenna	10g SAR design target	2.2
Head	Earpiece on	2	Top antenna	1g SAR design target	0.87
Head (Wifi On)	Earpiece on with Wifi on	3	Top antenna	1g SAR design target	0.556
Hotspot	Hotspot On	4	Top antenna	1g SAR design target	0.476
Head/Body Worn	-	5	Bottom Antenna	1g SAR design target	0.87
Extremity	(Bottom sensor on)	6	Bottom Antenna	10g SAR design target	2.2
Hotspot	Hotspot On	7	Bottom Antenna	1g SAR design target	0.87



Based on the selection criteria described in Section 3.2, the radio configurations for the Tx varying transmission test cases listed in Section 2 are:

1. Technologies and bands for time-varying Tx power transmission: The test case 1~5 listed in Table 5-3 are selected to test with the test sequences defined in Section 3.1 in both time-varying conducted power measurement and time-varying SAR measurement.
2. Technology and band for change in call test: The test case 9 listed in Table 5-3 are selected for performing the call drop test in conducted power setup. LTE B30 having the lowest P_{limit} among all technologies and bands
3. Technologies and bands for change in technology/band test: The test case 10 listed in Table 5-3 is selected for handover test from a technology/band to another technology/band, in conducted power setup.
4. Technologies and bands for change in DSI: The test case 11 listed in Table 5-3 is selected for DSI switch test by establishing a call in LTE B30 in DSI=3, and then handing over to DSI = 2 exposure scenario in conducted power setup.
5. Technologies and bands for change in time-window/antenna: The test case 12 listed in Table 5-3 is selected for time window switch between 60s window (LTE B48) and 100s window (LTE B7) in conducted power setup. LTE B48 is using different antenna from LTE B7, so this test also address the antenna change.
6. Technologies and bands for switch in SAR exposure: The test case 13 listed in Table 5-3 are selected for SAR exposure switching test in one of the supported simultaneous WWAN transmission scenario, i.e., LTE + Sub6 NR active in the same 100s time window, in conducted power setup. Since this device supports LTE+mmW NR, test for Section 3.2.7 Scenario 2 for RF exposure switch is covered in Sections 8.2.3 and 8.2.4 between LTE (100s window) and mmW NR (4s window)



5.2 LTE + mmW NR transmission

Based on the selection criteria described in Section 4.2, the selections for LTE and mmW NR validation test are listed in Table 5-4. The radio configurations used in this test are listed in Table 5-5.

Table 5-4 Selections for LTE + mmW NR validation measurements

Transmission Scenario	Test	Technology and Band	mmW Beam
Time-varying Tx power test	1. Cond. & Rad. Power meas.	LTE Band 66 and n261	Beam ID 20
	2. PD meas.	LTE Band 66 and n260	Beam ID 31
Switch in SAR vs. PD	1. Cond. & Rad. Power meas.	LTE Band 66 and n261	Beam ID 20
		LTE Band 66 and n260	Beam ID 31
Beam switch test	1. Cond. & Rad. Power meas.	LTE Band 66 and n261	Beam ID 20 to Beam ID 0
		LTE Band 66 and n260	Beam ID 43 to Beam ID 2

Table 5-5: Test configuration for LTE + mmW NR validation

Tech	Band	Bean ID	Antenna	DSI	Mode	UL Duty Cycle
LTE	66	-	3	2	QPSK	100%
mmW NR	N261	20,0	Module 0	--	DFT-S-OFDM, QPSK	>75%*
	N260	31,43,2	Module 2	--	DFT-S-OFDM, QPSK	>75%*

* mmW NR callbox UL duty cycle should be configured to be greater than 75% for all LTE+mmW NR Part 2 tests. The base station uplink is configured in 76 slots among total 79 slots.



6 Conducted Power Test Results for Sub-6 Smart Transmit Feature Validation

6.1 Measurement setup

The Rohde & Schwarz CMW500 callbox is used in this test. The test setup schematic are shown in Figures 6-1. For single antenna measurement, one port (RF1 COM) of the callbox is connected to the RF port of the EUT using a directional coupler. For antenna & technology switch measurement, two ports (RF1 COM and RF3 COM) of the callbox used for signaling two different technologies are connected to a combiner, which is in turn connected to a directional coupler. The other end of the directional coupler is connected to a splitter to connect to two RF ports of the EUT corresponding to the two antennas of interest. In both the setups, power meter is used to tap the directional coupler for measuring the conducted output power of the EUT. For time averaging validation test (Section 3.3.1), call drop test (Section 3.3.2), and DSI switch test (Section 3.3.4), only RF1 COM port of the callbox is used to communicate with the EUT. For technology/band switch measurement (Section. 3.3.3), both RF1 COM and RF3 COM port of callbox are used to switch from one technology communicating on RF1 COM port to another technology communicating on RF3 COM port. All the path losses from RF port of EUT to the callbox RF COM port and to the power meter are calibrated and automatically entered as offsets in the callbox and the power meter via test scripts on the PC used to control callbox and power meter.

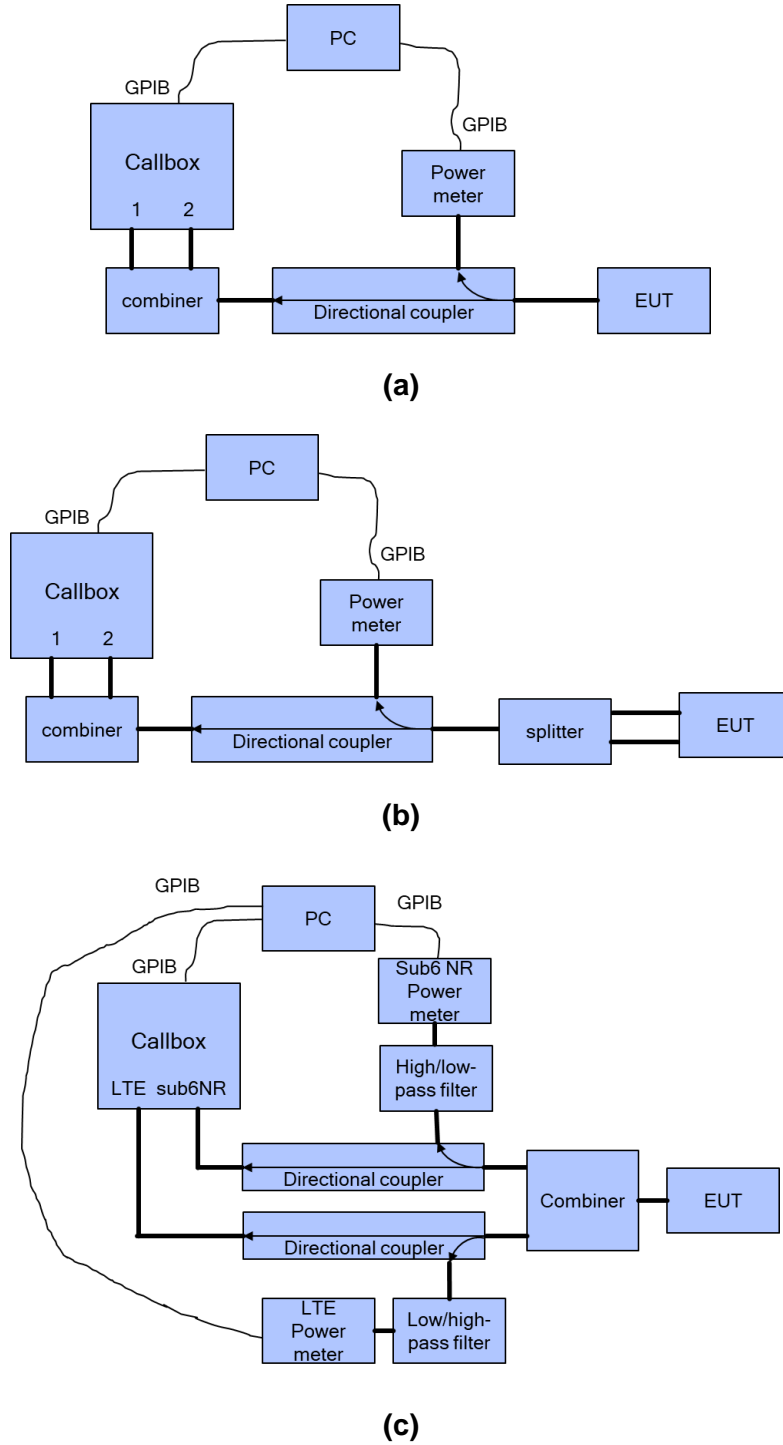

Figure 6-1 Conducted power measurement setup

Both the callbox and power meter are connected to the PC using GPIB cables. Two test scripts are custom made for automation, and the test duration set in the test scripts is 500 seconds.



For time-varying Tx power measurement, the PC runs the 1st test script to send GPIB commands to control the callbox's requested power versus time, while at the same time to record the conducted power measured at EUT RF port using the power meter. The commands sent to the callbox to request power are:

- 0dBm for 100 seconds
- test sequence 1 or test sequence 2 (defined in Section 3.1 and generated in Section 3.2.1), for 360 seconds
- stay at the last power level of test sequence 1 or test sequence 2 for the remaining time.

Power meter readings are periodically recorded every 100ms. A running average of this measured Tx power over 100 seconds is performed in the post-data processing to determine the 100s-time averaged power.

For call drop, technology/band/antenna switch, and DSI switch tests, after the call is established, the callbox is set to request the EUT's Tx power at 0dBm for 100 seconds while simultaneously starting the 2nd test script runs at the same time to start recording the Tx power measured at EUT RF port using the power meter. After the initial 100 seconds since starting the Tx power recording, the callbox is set to request maximum power from the EUT for the rest of the test. Note that the call drop/re-establish, or technology/band/antenna switch or DSI switch is manually performed when the Tx power of EUT is at $P_{reserve}$ level. See Section 3.3 for detailed test procedure of call drop test, technology/band/antenna switch test and DSI switch test.



6.2 P_{limit} and P_{max} measurement results

The measured P_{limit} for all the selected radio configurations given in Table 5-2 are listed in below Table 6-1. P_{max} was also measured for radio configurations selected for testing time-varying Tx power transmission scenarios in order to generate test sequences following the test procedures in Section 3.1.

Table 6-1: Measured P_{limit} and P_{max} of selected radio configurations

Test case#	Test scenario	Tech	Band	Ant	DSI	Channel	Freq (MHz)	RB/offset	mode	position	Position details	Plimit EFS setting(dBm)	Tune up target power pmax (dBm)(avg power)	measured plimit (dBm)	measured pmax (dBm)
1	time-varying Tx power transmission	LTE	7	3	2	21350	2560	100/0	QPSK	Right Tilted	Head, 0mm	15.5	22.8	15.47	22.21
2			30	3	3	27710	2310	25/12	QPSK	Left Tilted	Head, 0mm	15	22.8	15.28	21.89
3		WCDMA	4	3	2	1513	1752.6		RMC	Right Cheek	Head, 0mm	16.1	23.3	15.66	22.6
4		WCDMA	5	0	3	4182	836.4		RMC	Right Cheek	Head, 0mm	21	23.8	21.3	23.31
5		GSM	850	0	3	128	824.2		GPRS(3TX)	Right Cheek	Head, 0mm	27	26.24	22.76	24.82
6		GSM	1900	3	2	512	1850.2		GPRS(3TX)	Right Cheek	Head, 0mm	21	22.74	16.59	21.14
7		sub6 NR	n66	3	3	349000	1745	1/1	DFT-S-OFDM QPSK	Right Cheek	Head, 0mm	14.5	23.8	15	22.9
8		sub6 NR	n2	3	3	380000	1900	1/1	DFT-S-OFDM QPSK	Right Cheek	Head, 0mm	15	23.8	15.3	22.9
9	change in call	LTE	30	3	3	27710	2310	25/12	QPSK	Left Tilted	Head, 0mm	15	22.8	15.28	21.89
10	Tech/band switch/Antenna switch	LTE	30	3	3	27710	2310	25/12	QPSK	Left Tilted	Head, 0mm	15	22.8	15.28	21.89
		WCDMA	5	0	3	4182	836.4		RMC	Right Cheek	Head, 0mm	21	23.8	21.3	23.31
11	DSI switch	LTE	30	3	3	27710	2310	25/12	QPSK	Left Tilted	Head, 0mm	15	22.8	15.28	21.89
		LTE	30	3	2	27710	2310	50/0	RMC	Left Tilted	Head, 0mm	17.1	22.8	17.09	21.02
12	Time Window	LTE	7	3	2	21350	2560	100/0	QPSK	Right Tilted	Head, 0mm	15.5	22.8	15.47	22.21
		LTE	48	3	2	56640	3690	1/0	QPSK	Right Tilted	Head, 0mm	15.2	22	13.94	21.2
13	SAR1 vs SAR2	LTE	13	0	3	23230	782	25/25	QPSK	Left Cheek	Head, 0mm	20.5	24.8	21.2	23.3
		sub6 NR	n66	3	3	349000	1745	1/1	DFT-S-OFDM QPSK	Right Cheek	Head, 0mm	14.5	23.8	15	22.9

Note: the device uncertainty of P_{max} is +1dB/-1dB as provided by manufacturer.



6.3 Time-varying Tx power measurement results

The measurement setup is shown in Figures 6-1(a) and 6-1(c). The purpose of the time-varying Tx power measurement is to demonstrate the effectiveness of power limiting enforcement and that the time-averaged Tx power when represented in time-averaged 1gSAR or 10gSAR values does not exceed FCC limit as shown in Eq. (1a) and (1b), rewritten below:

$$1g_or_10gSAR(t) = \frac{conducted_Tx_power(t)}{conducted_Tx_power_P_{limit}} * 1g_or_10gSAR_P_{limit} \quad (1a)$$

$$\frac{\frac{1}{T_{SAR}} \int_{t-T_{SAR}}^t 1g_or_10gSAR(t) dt}{FCC\ SAR\ limit} \leq 1 \quad (1b)$$

where, $conducted_Tx_power(t)$, $conducted_Tx_power_P_{limit}$, and $1g_or_10gSAR_P_{limit}$ correspond to the measured instantaneous conducted Tx power, measured conducted Tx power at P_{limit} , and measured 1gSAR and 10gSAR values at P_{limit} reported in Part 1 test (listed in Table 5-2 of this report as well).

Following the test procedure in Section 3.3, the conducted Tx power measurement for all selected configurations are reported in this section. In all the conducted Tx power plots, the dotted line represents the requested power by callbox (test sequence 1 or test sequence 2), the blue curve represents the instantaneous conducted Tx power measured using power meter, the green curve represents time-averaged power and red line represents the conducted power limit that corresponds to FCC limit of 1.6 W/kg for 1gSAR or 4.0 W/kg for 10gSAR.

Similarly, in all the 1g or 10gSAR plots (when converted using Eq. (1a)), the green curve represents the 100s/60s-time averaged 1gSAR or 10gSAR value calculated based on instantaneous 1gSAR or 10gSAR; and the red line limit represents the FCC limit of 1.6 W/kg for 1gSAR or 4.0 W/kg for 10gSAR.



6.3.1 LTE Band 7

Test result for test sequence 1:

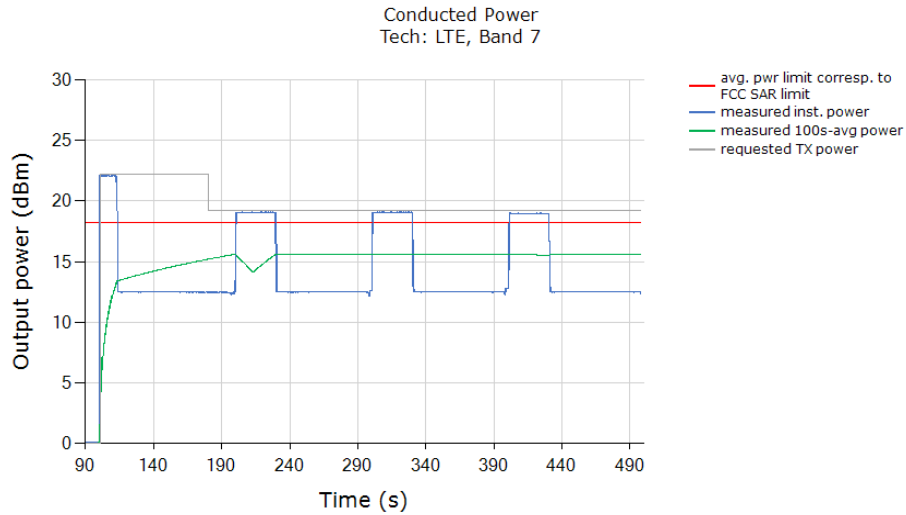

Above time-averaged conducted Tx power is converted/calculated into time-averaged 1gSAR using Equation (1a) and plotted below to demonstrate that the time-averaged 1gSAR versus time does not exceed the FCC limit of 1.6 W/kg for 1gSAR:

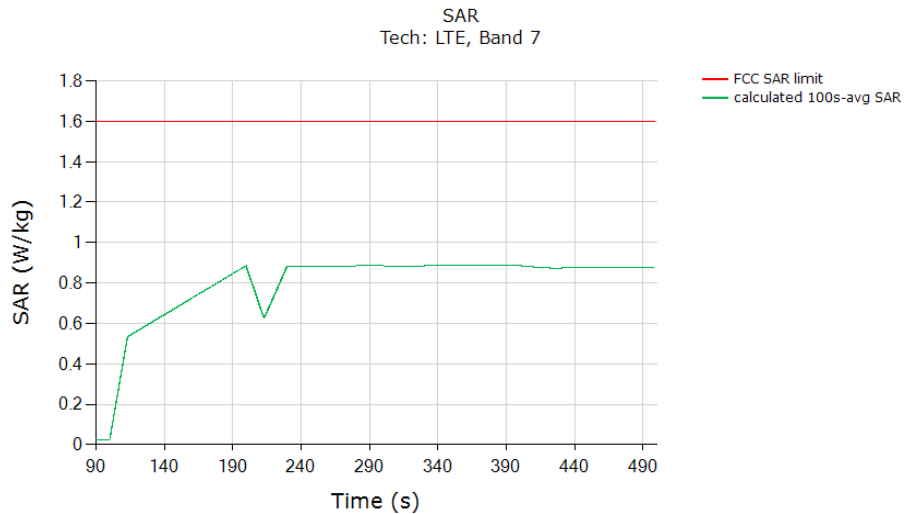

	(W/kg)
FCC 1gSAR limit	1.6
Max 100s-time averaged 1gSAR (green curve)	0.888
Validated: Max time averaged SAR (green curve) does not exceed measured SAR at Plimit +1.0dB device uncertainty	



Test result for test sequence 2:

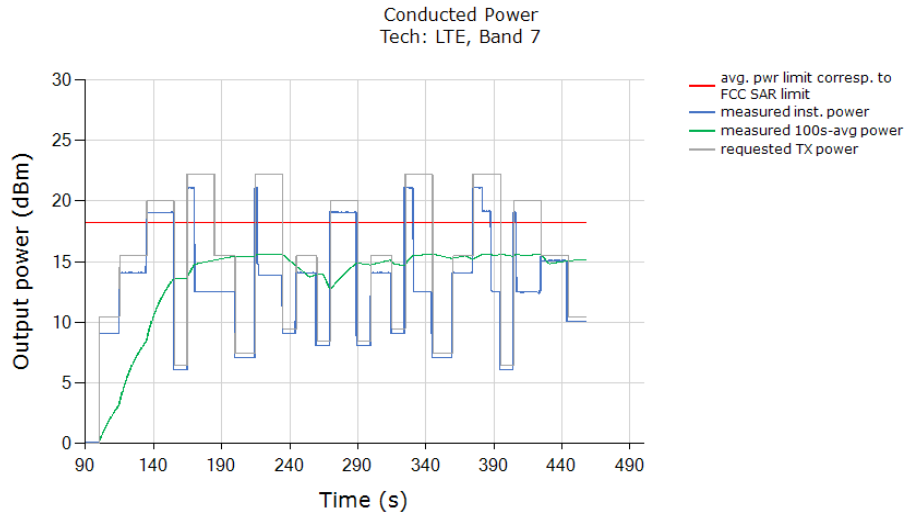

Above time-averaged conducted Tx power is converted/calculated into time-averaged 1gSAR using Equation (1a) and plotted below to demonstrate that the time-averaged 1gSAR versus time does not exceed the FCC limit of 1.6W/kg for 1gSAR:

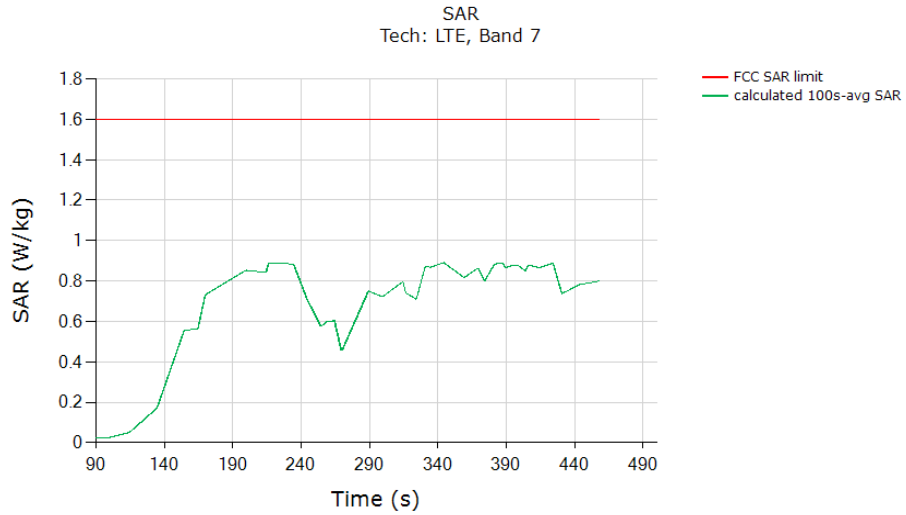

	(W/kg)
FCC 1gSAR limit	1.6
Max 100s-time averaged 1gSAR (green curve)	0.89
Validated: Max time averaged SAR (green curve) does not exceed measured SAR at Plimit +1.0dB device uncertainty	



6.3.2 LTE Band 30

Test result for test sequence 1:

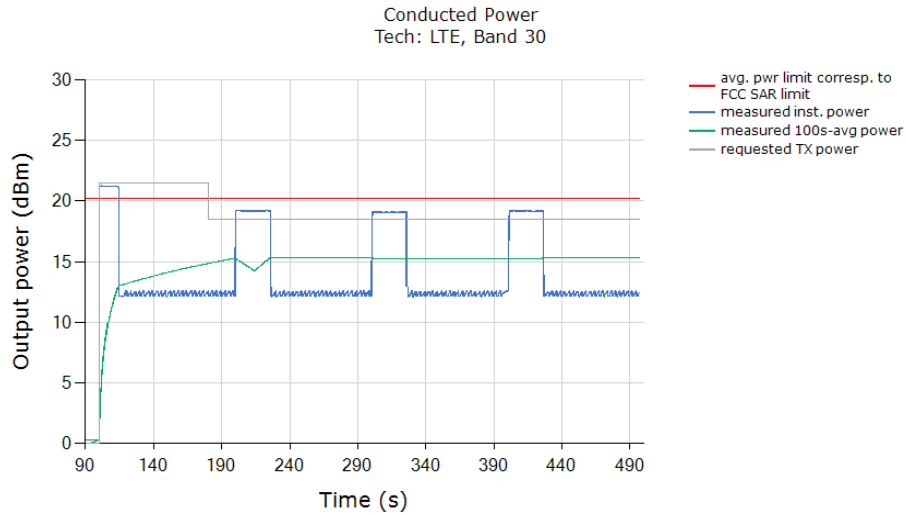

Above time-averaged conducted Tx power is converted/calculated into time-averaged 1gSAR using Equation (1a) and plotted below to demonstrate that the time-averaged 1gSAR versus time does not exceed the FCC limit of 1.6 W/kg for 1gSAR:

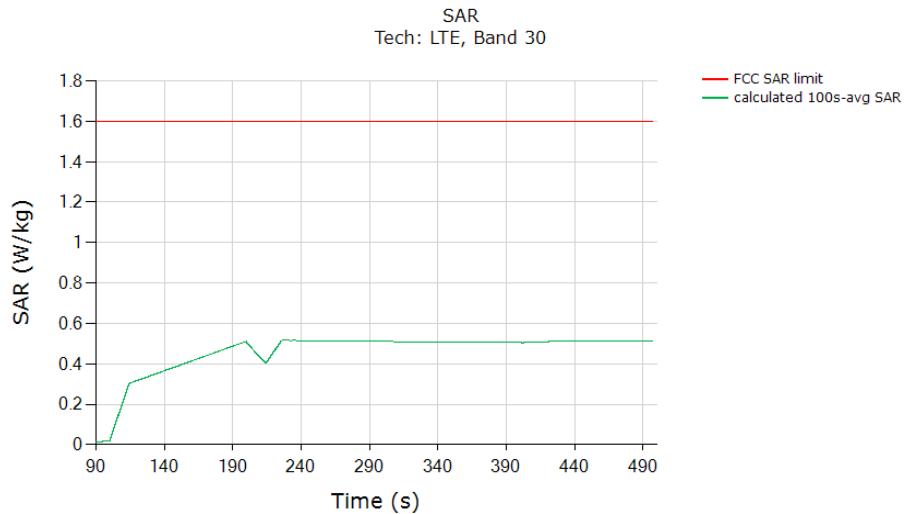

	(W/kg)
FCC 1gSAR limit	1.6
Max 100s-time averaged 1gSAR (green curve)	0.515
Validated: Max time averaged SAR (green curve) does not exceed measured SAR at P _{limit} +1.0dB device uncertainty	



Test result for test sequence 2:

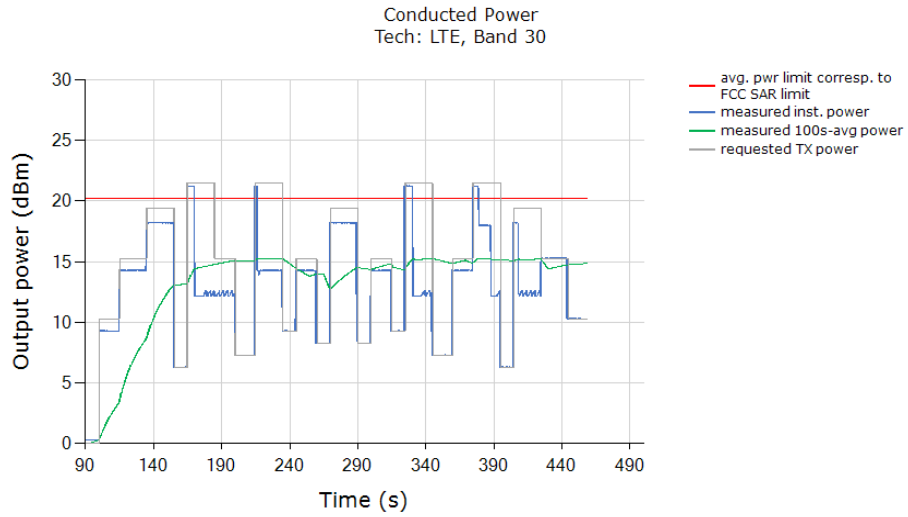

Above time-averaged conducted Tx power is converted/calculated into time-averaged 1gSAR using Equation (1a) and plotted below to demonstrate that the time-averaged 1gSAR versus time does not exceed the FCC limit of 1.6 W/kg for 1gSAR:

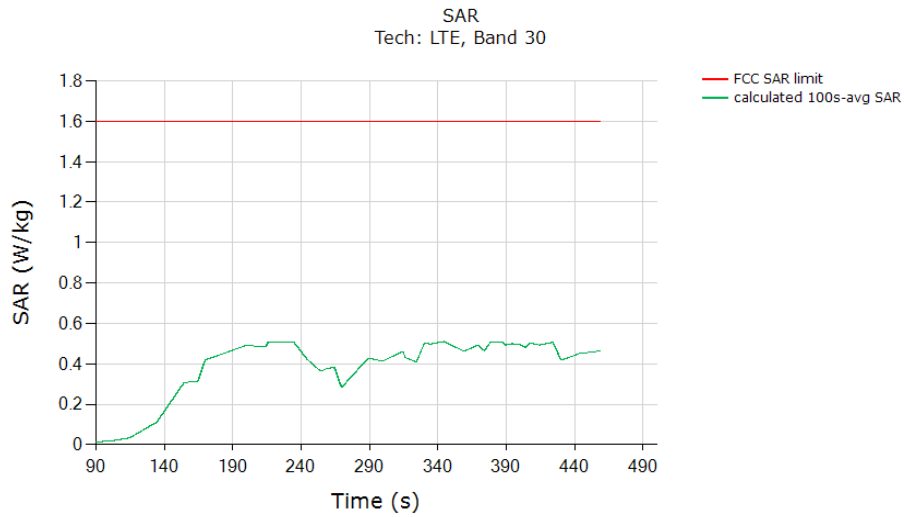

	(W/kg)
FCC 1gSAR limit	1.6
Max 100s-time averaged 1gSAR (green curve)	0.51
Validated: Max time averaged SAR (green curve) does not exceed measured SAR at Plimit +1.0dB device uncertainty	



6.3.3 WCDMA Band 4

Test result for test sequence 1:

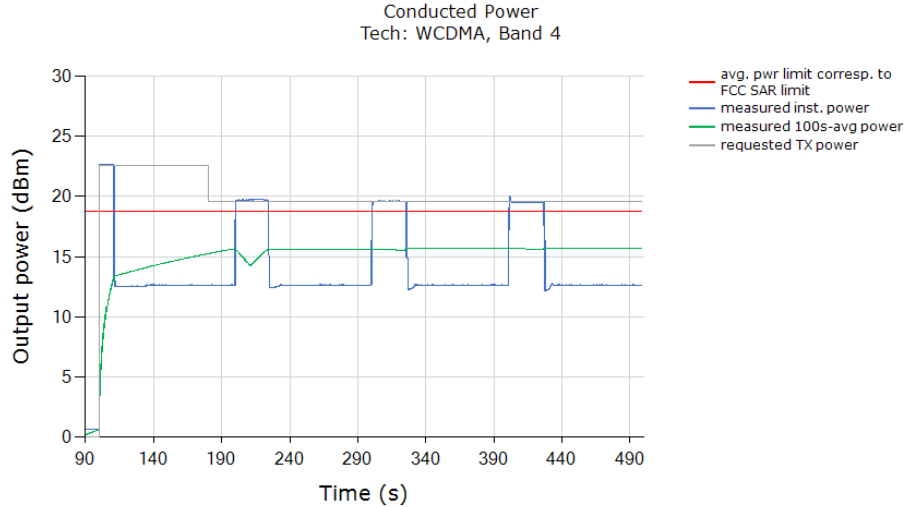

Above time-averaged conducted Tx power is converted/calculated into time-averaged 1gSAR using Equation (1a) and plotted below to demonstrate that the time-averaged 1gSAR versus time does not exceed the FCC limit of 1.6 W/kg for 1gSAR:

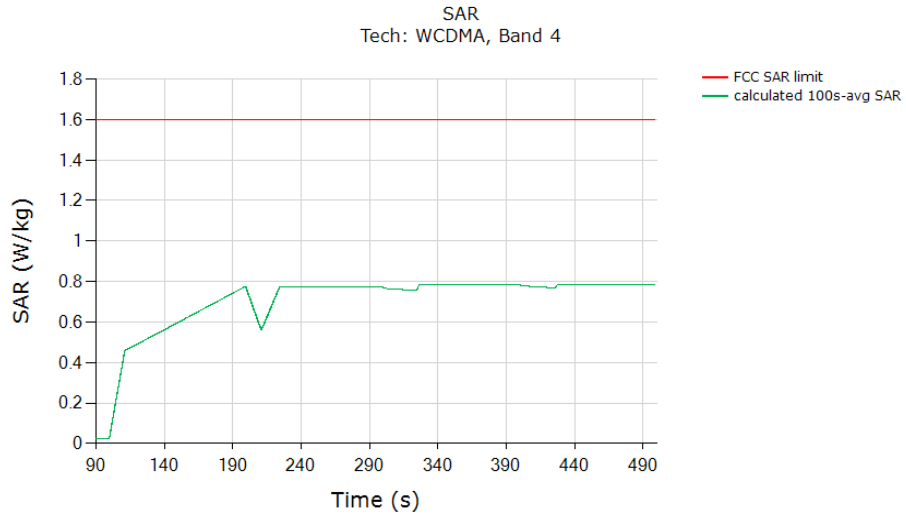

	(W/kg)
FCC 1gSAR limit	1.6
Max 100s-time averaged 10gSAR (green curve)	0.783
<i>Validated:</i> Max time averaged SAR (green curve) does not exceed measured SAR at P _{limit} +1.0dB device uncertainty	



Test result for test sequence 2:

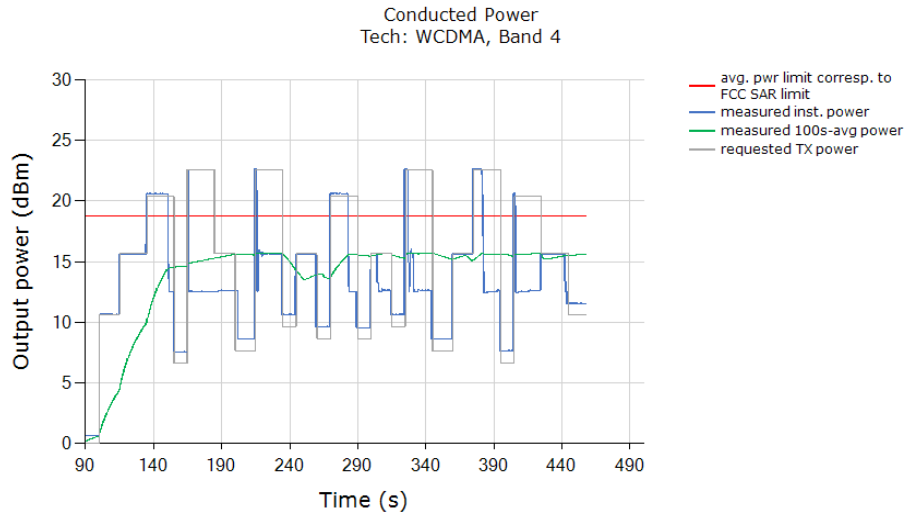

Above time-averaged conducted Tx power is converted/calculated into time-averaged 1gSAR using Equation (1a) and plotted below to demonstrate that the time-averaged 1gSAR versus time does not exceed the FCC limit of 1.6 W/kg for 1gSAR:

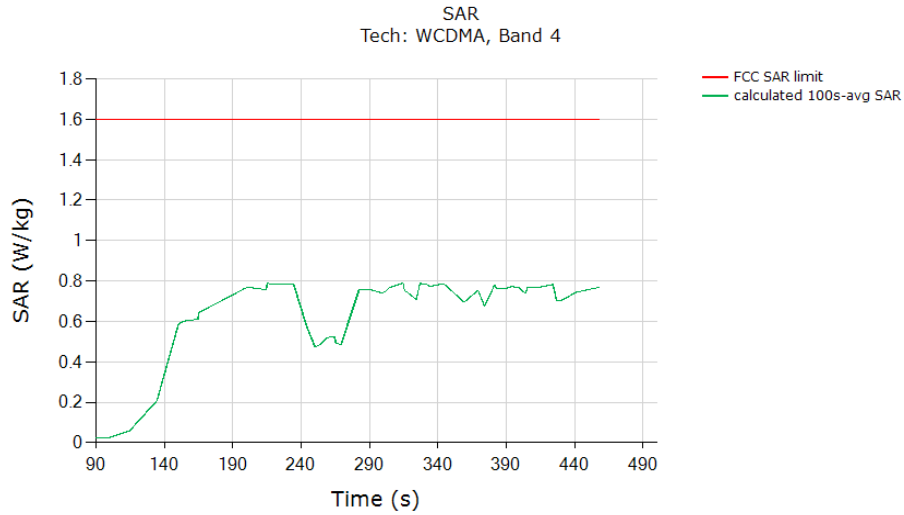

	(W/kg)
FCC 1gSAR limit	1.6
Max 100s-time averaged 1gSAR (green curve)	0.789
Validated: Max time averaged SAR (green curve) does not exceed measured SAR at Plimit +1.0dB device uncertainty	



6.3.4 WCDMA Band 5

Test result for test sequence 1:

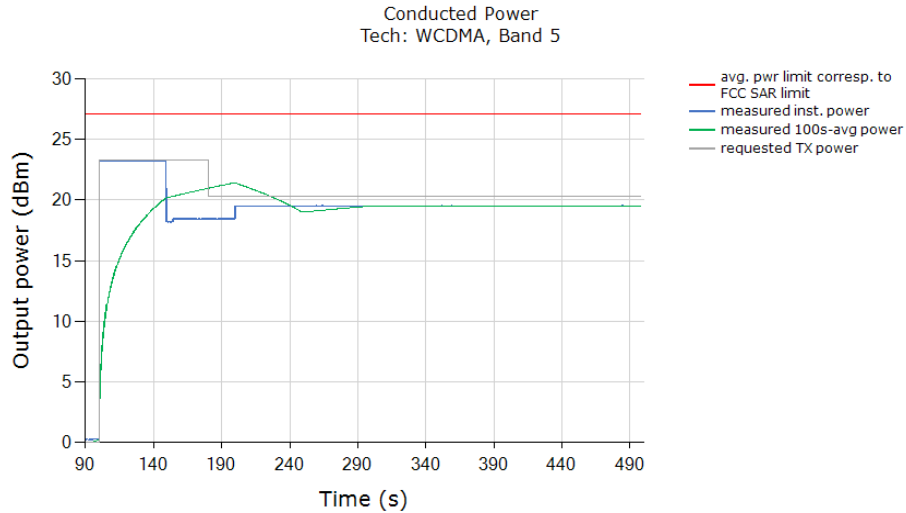

Above time-averaged conducted Tx power is converted/calculated into time-averaged 1gSAR using Equation (1a) and plotted below to demonstrate that the time-averaged 1gSAR versus time does not exceed the FCC limit of 1.6 W/kg for 1gSAR:

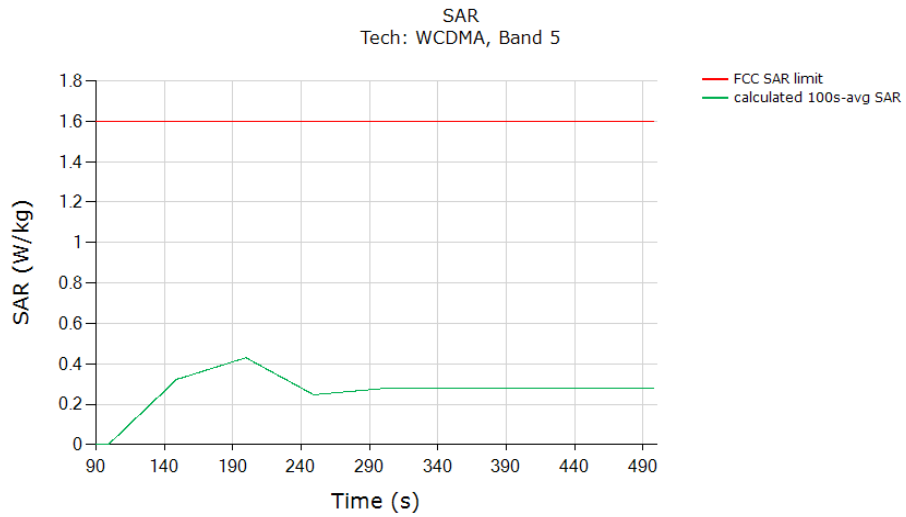

	(W/kg)
FCC 1gSAR limit	1.6
Max 100s-time averaged 10gSAR (green curve)	0.43
Validated: Max time averaged SAR (green curve) does not exceed measured SAR at Plimit +1.0dB device uncertainty	



Test result for test sequence 2:

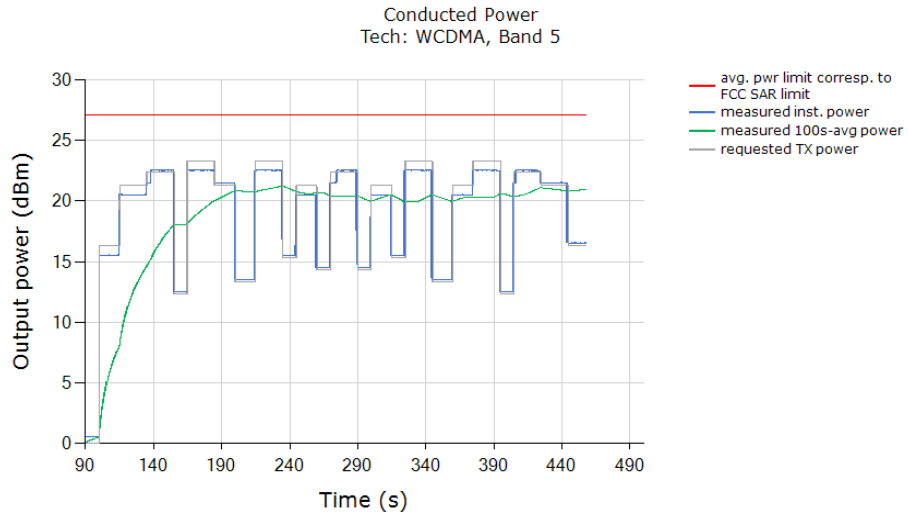

Above time-averaged conducted Tx power is converted/calculated into time-averaged 1gSAR using Equation (1a) and plotted below to demonstrate that the time-averaged 1gSAR versus time does not exceed the FCC limit of 1.6 W/kg for 1gSAR:

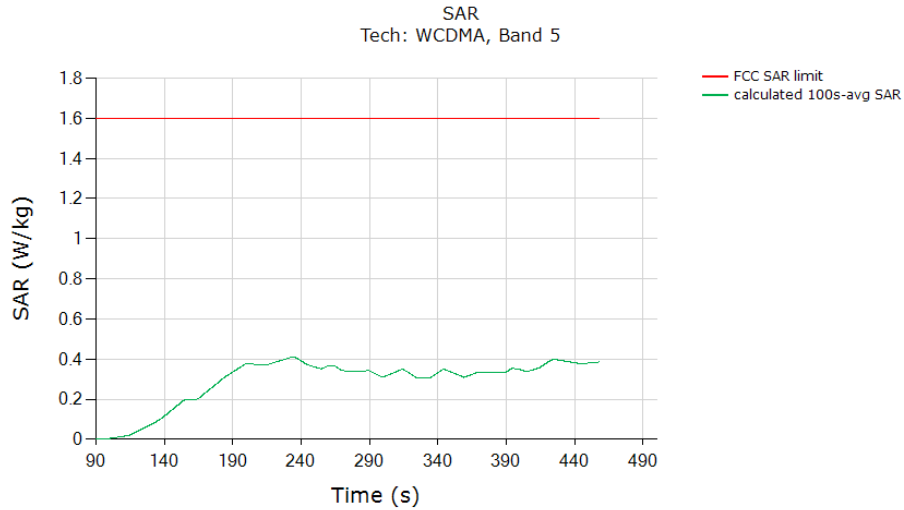

	(W/kg)
FCC 1gSAR limit	1.6
Max 100s-time averaged 1gSAR (green curve)	0.412
Validated: Max time averaged SAR (green curve) does not exceed measured SAR at Plimit +1.0dB device uncertainty	



6.3.5 GSM Band 850

Test result for test sequence 1:

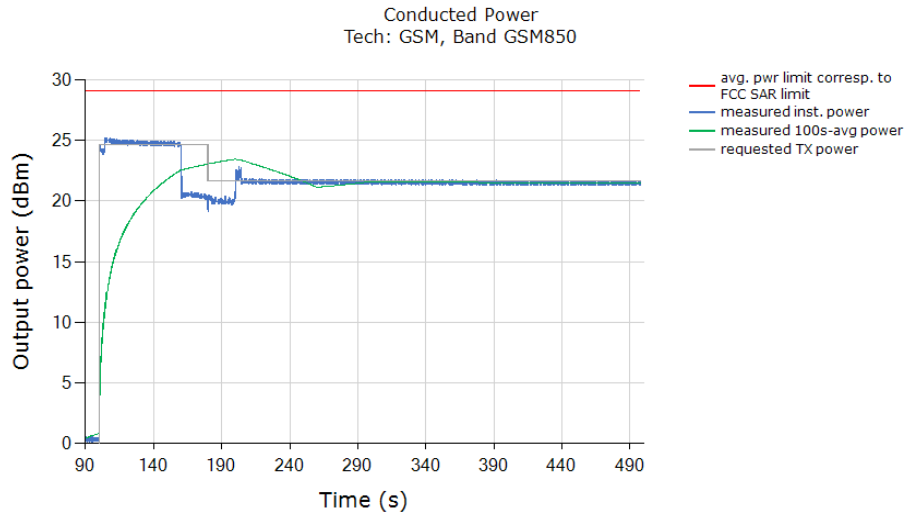

Above time-averaged conducted Tx power is converted/calculated into time-averaged 1gSAR using Equation (1a) and plotted below to demonstrate that the time-averaged 1gSAR versus time does not exceed the FCC limit of 1.6 W/kg for 1gSAR:

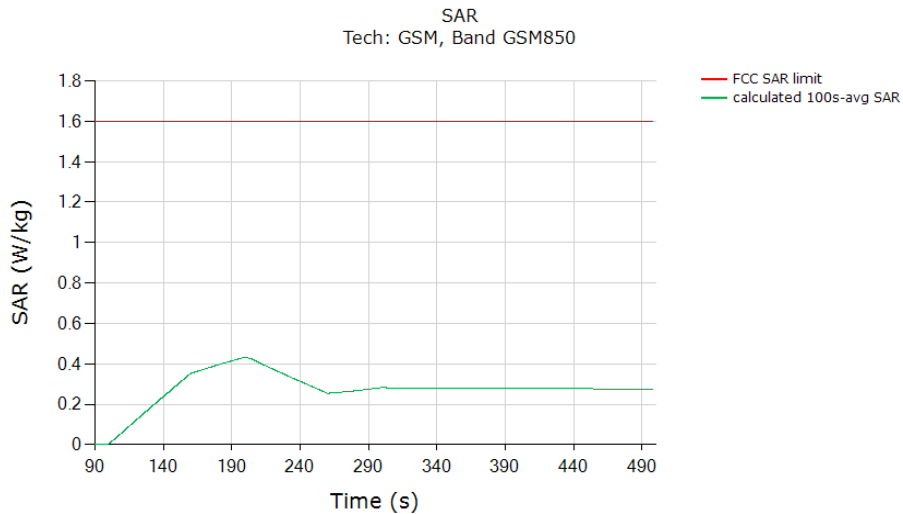

	(W/kg)
FCC 1gSAR limit	1.6
Max 100s-time averaged 1gSAR (green curve)	0.433
Validated: Max time averaged SAR (green curve) does not exceed measured SAR at P _{limit} +1.0dB device uncertainty	



Test result for test sequence 2:

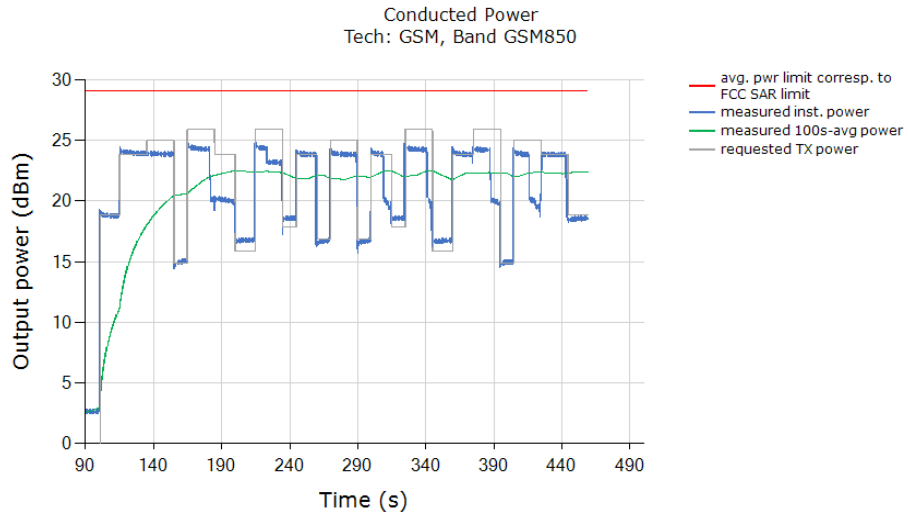

Above time-averaged conducted Tx power is converted/calculated into time-averaged 1gSAR using Equation (1a) and plotted below to demonstrate that the time-averaged 1gSAR versus time does not exceed the FCC limit of 1.6 W/kg for 1gSAR:

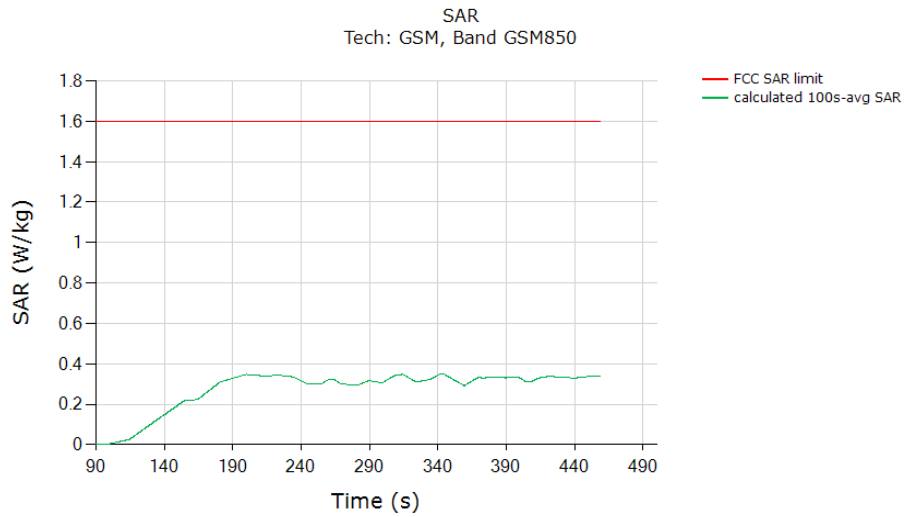

	(W/kg)
FCC 1gSAR limit	1.6
Max 100s-time averaged 1gSAR (green curve)	0.349
Validated: Max time averaged SAR (green curve) does not exceed measured SAR at Plimit +1.0dB device uncertainty	



6.3.6 GSM Band 1900

Test result for test sequence 1:

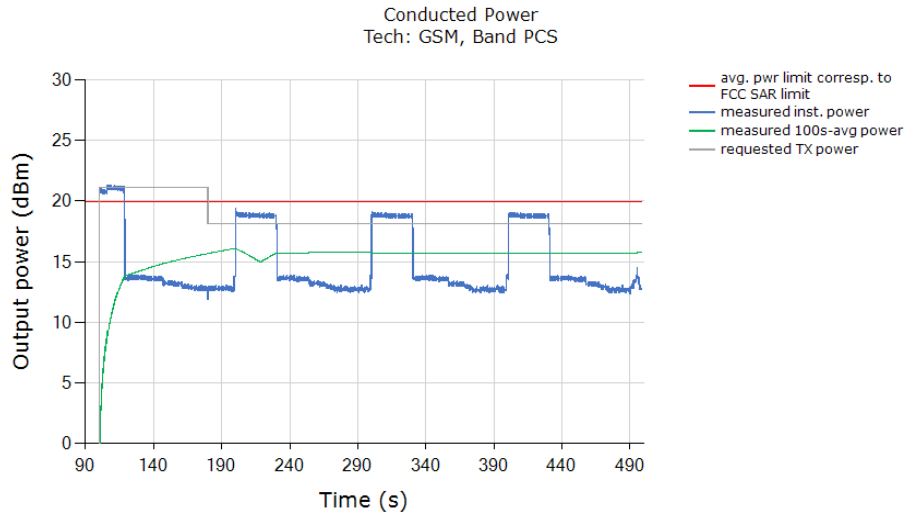

Above time-averaged conducted Tx power is converted/calculated into time-averaged 1gSAR using Equation (1a) and plotted below to demonstrate that the time-averaged 1gSAR versus time does not exceed the FCC limit of 1.6 W/kg for 1gSAR:

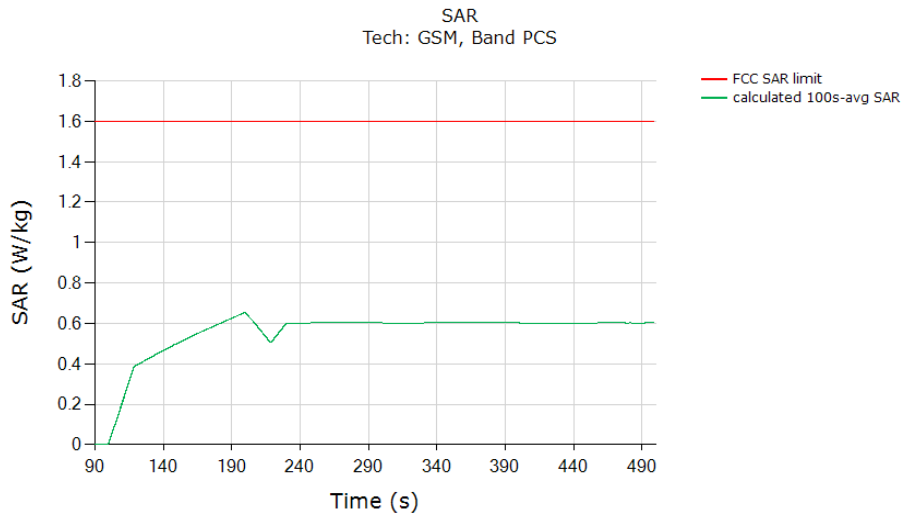

	(W/kg)
FCC 1gSAR limit	1.6
Max 100s-time averaged 1gSAR (green curve)	0.655
Validated: Max time averaged SAR (green curve) does not exceed measured SAR at P _{limit} +1.0dB device uncertainty	



Test result for test sequence 2:

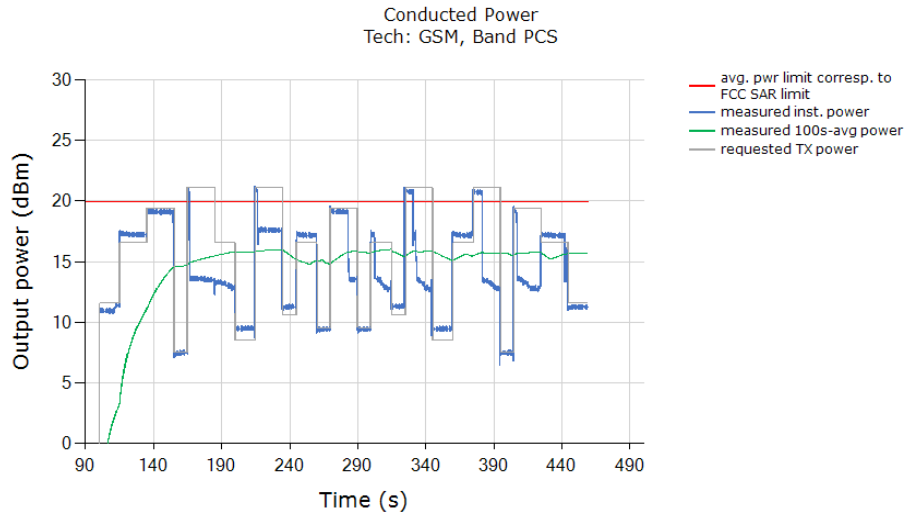

Above time-averaged conducted Tx power is converted/calculated into time-averaged 1gSAR using Equation (1a) and plotted below to demonstrate that the time-averaged 1gSAR versus time does not exceed the FCC limit of 1.6 W/kg for 1gSAR:

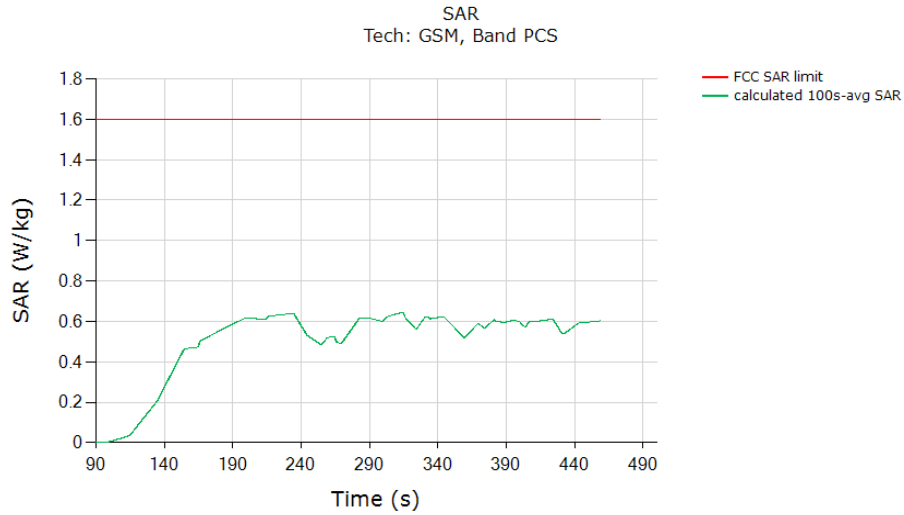

	(W/kg)
FCC 1gSAR limit	1.6
Max 100s-time averaged 1gSAR (green curve)	0.644
Validated: Max time averaged SAR (green curve) does not exceed measured SAR at Plimit +1.0dB device uncertainty	



6.3.7 Sub6 NR Band 2

Test result for test sequence 1:

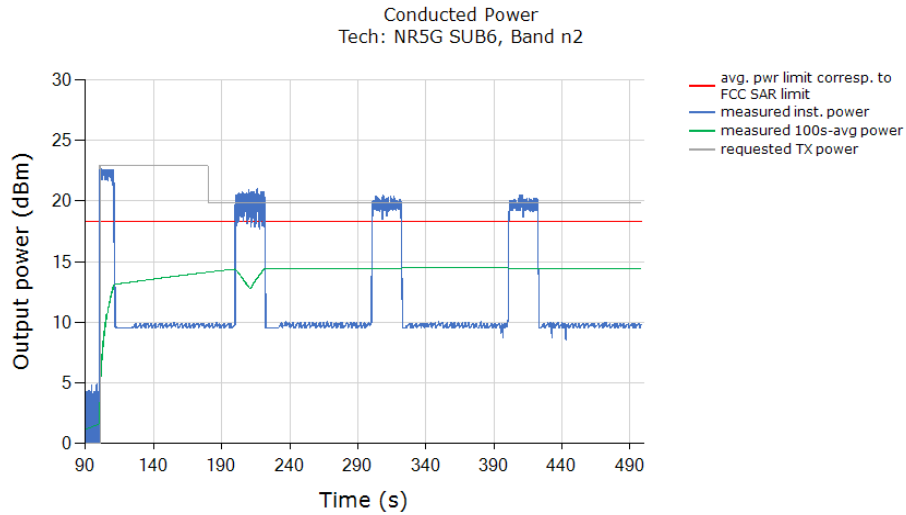

Above time-averaged conducted Tx power is converted/calculated into time-averaged 1gSAR using Equation (1a) and plotted below to demonstrate that the time-averaged 1gSAR versus time does not exceed the FCC limit of 1.6 W/kg for 1gSAR:

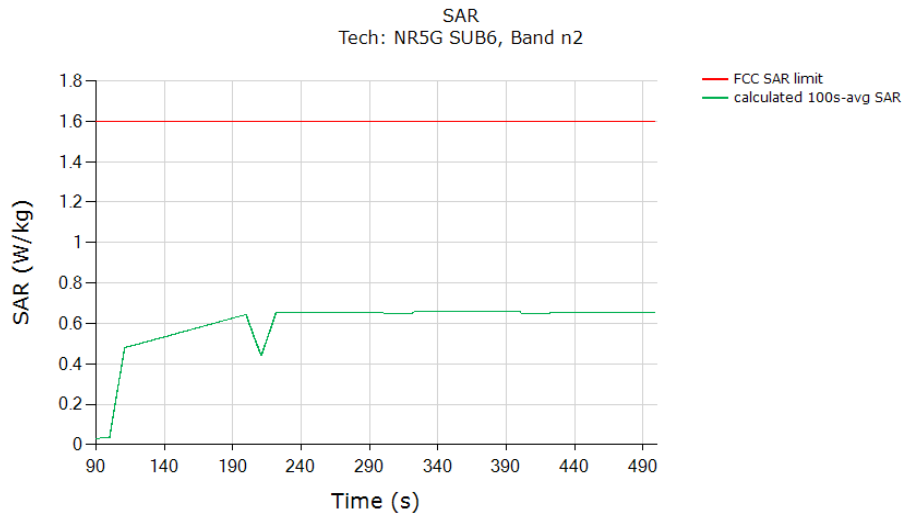

	(W/kg)
FCC 1gSAR limit	1.6
Max 100s-time averaged 1gSAR (green curve)	0.658
Validated: Max time averaged SAR (green curve) does not exceed "75% (with 3dB Reserve_Power_Margin) of measured SAR at Plimit, +1dB device uncertainty"	



Test result for test sequence 2:

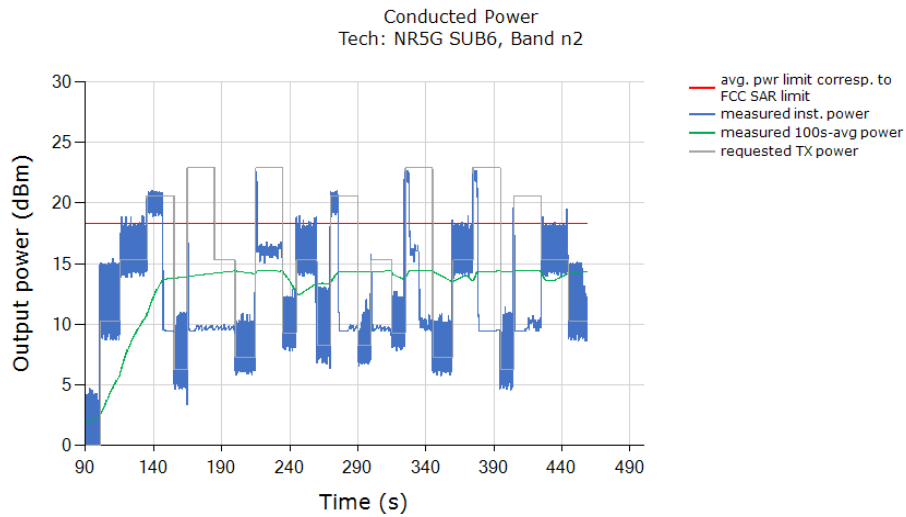

Above time-averaged conducted Tx power is converted/calculated into time-averaged 1gSAR using Equation (1a) and plotted below to demonstrate that the time-averaged 1gSAR versus time does not exceed the FCC limit of 1.6 W/kg for 1gSAR:

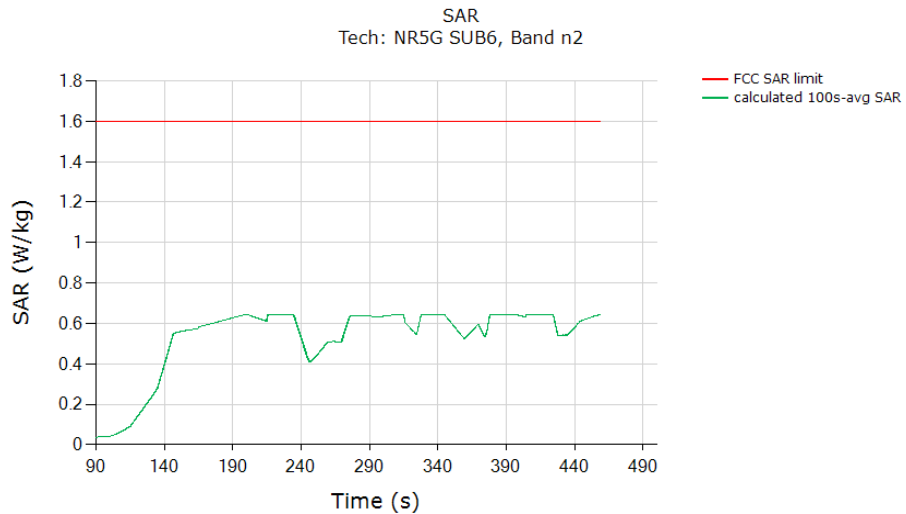

	(W/kg)
FCC 1gSAR limit	1.6
Max 100s-time averaged 1gSAR (green curve)	0.645
Validated: Max time averaged SAR (green curve) does not exceed "75% (with 3dB Reserve_Power_Margin) of measured SAR at Plimit, +1dB device uncertainty"	



6.3.8 Sub6 NR Band 66

Test result for test sequence 1:

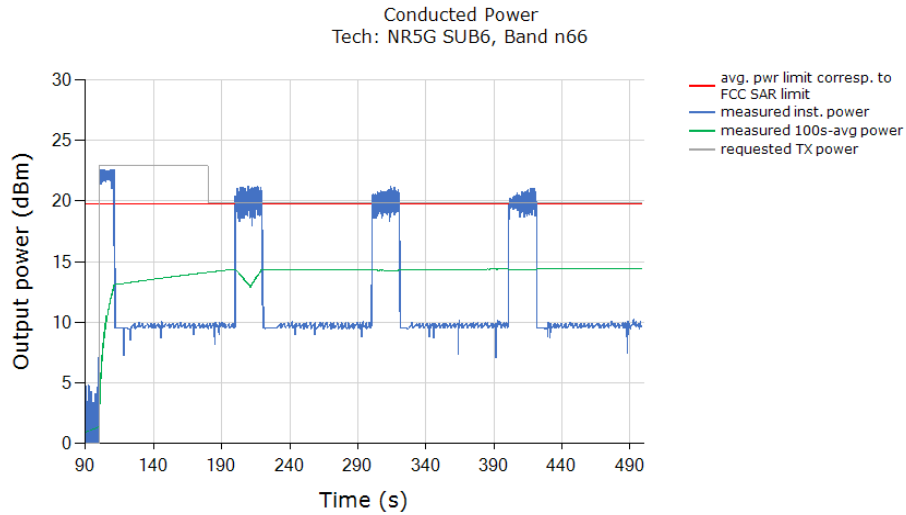

Above time-averaged conducted Tx power is converted/calculated into time-averaged 1gSAR using Equation (1a) and plotted below to demonstrate that the time-averaged 1gSAR versus time does not exceed the FCC limit of 1.6 W/kg for 1gSAR:

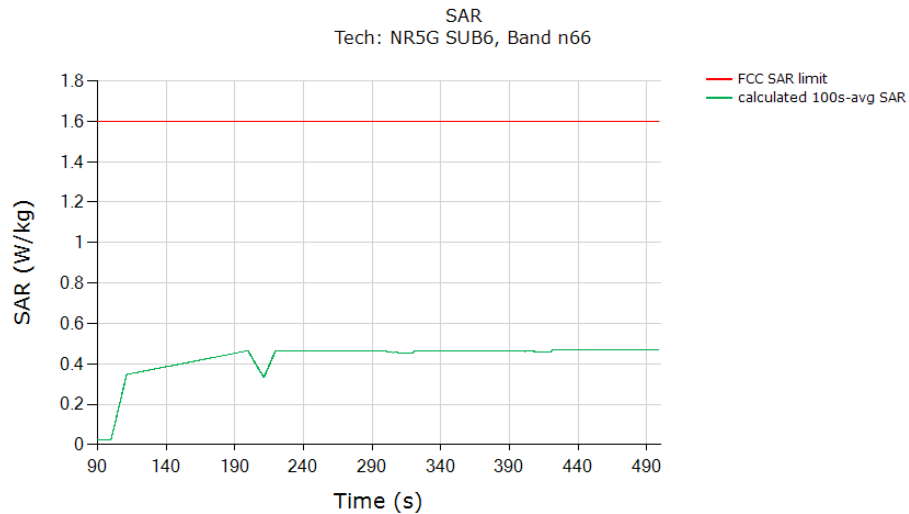

	(W/kg)
FCC 1gSAR limit	1.6
Max 100s-time averaged 1gSAR (green curve)	0.468
Validated: Max time averaged SAR (green curve) does not exceed "75% (with 3dB Reserve_Power_Margin) of measured SAR at Plimit, +1dB device uncertainty"	



Test result for test sequence 2:

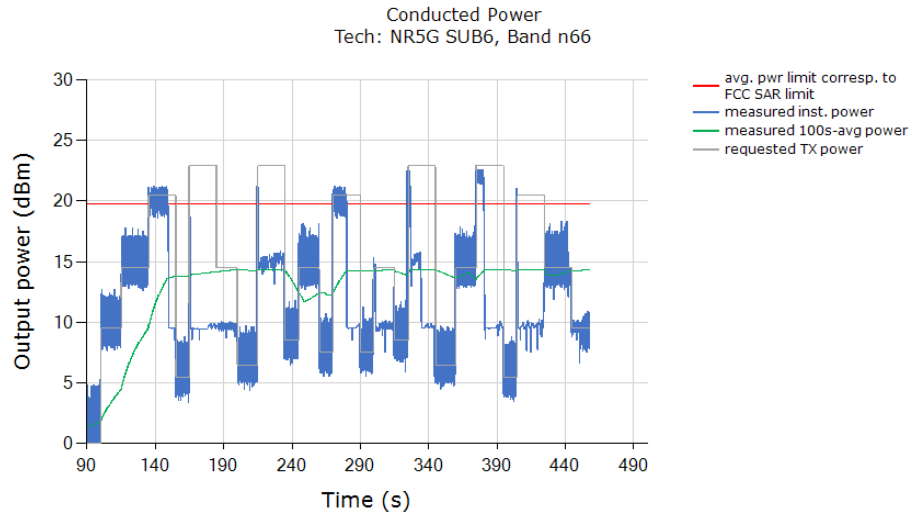

Above time-averaged conducted Tx power is converted/calculated into time-averaged 1gSAR using Equation (1a) and plotted below to demonstrate that the time-averaged 1gSAR versus time does not exceed the FCC limit of 1.6 W/kg for 1gSAR:

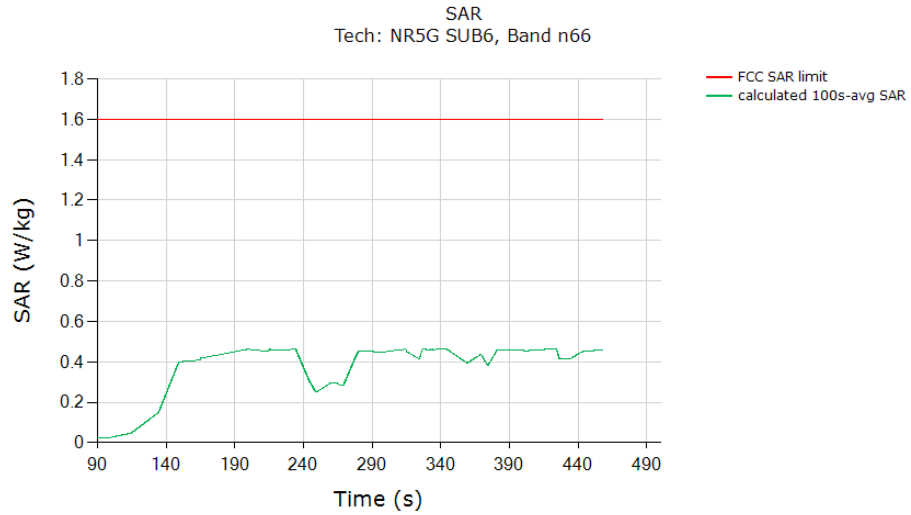

	(W/kg)
FCC 1gSAR limit	1.6
Max 100s-time averaged 1gSAR (green curve)	0.463
Validated: Max time averaged SAR (green curve) does not exceed "75% (with 3dB Reserve_Power_Margin) of measured SAR at Plimit, +1dB device uncertainty"	



6.4 Change in Call Test Results

This test was measured with LTE B30, DSI=3, and with callbox requesting maximum power. The call drop was manually performed when the EUT is transmitting at $P_{reserve}$ level as shown in the plot below (dotted black region). The measurement setup is shown in Figure 6-1. The detailed test procedure is described in Section 3.3.2.

Call drop test result:

Plot 1: Measured Tx power (dBm) versus time shows that the transmitting power kept the same $P_{reserve}$ level of LTE Band 30 after the call was re-established:

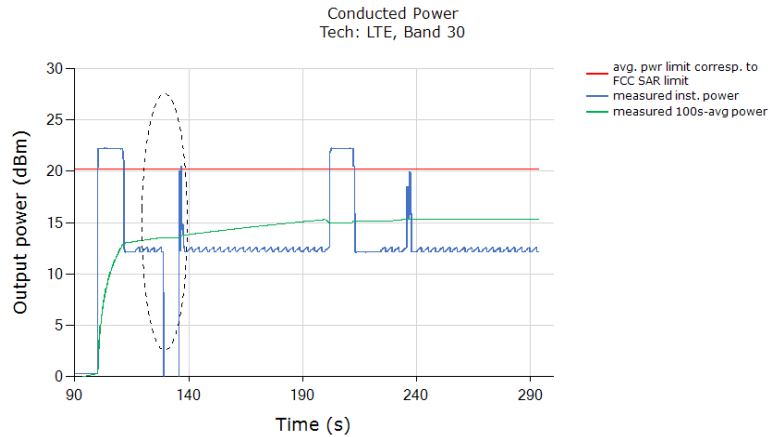

Plot Notes: ... The conducted power plot shows expected Tx transition.

Plot 2: Above time-averaged conducted Tx power is converted/calculated into time-averaged 1gSAR using Equation (1a) and plotted below to demonstrate that the time-averaged 1gSAR versus time does not exceed the FCC limit of 1.6 W/kg for 1gSAR:

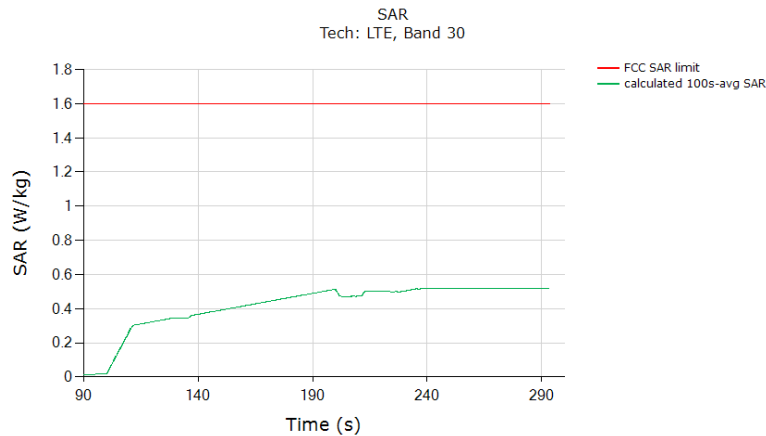

	(W/kg)
FCC 1gSAR limit	1.6
Max 100s-time averaged 1gSAR (green curve)	0.517
Validated	

The test result validated the continuity of power limiting in DSI switch scenario.



6.5 Change in technology/band test results

This test was conducted with callbox requesting maximum power, and with antenna & technology switch from LTE 30, DSI = 3 to WCDMA B5, DSI = 3. Following procedure detailed in Section 3.3.3, and using the measurement setup shown in Figure 6-1(a) and (c), the technology/band switch was performed when the EUT is transmitting at $P_{reserve}$ level as shown in the plot below (dotted black region).

Plot 1: Measured Tx power (dBm) versus time shows that the transmitting power changed from LTE 30, DSI =3 $P_{reserve}$ level to WCDMA 5, DSI = 3

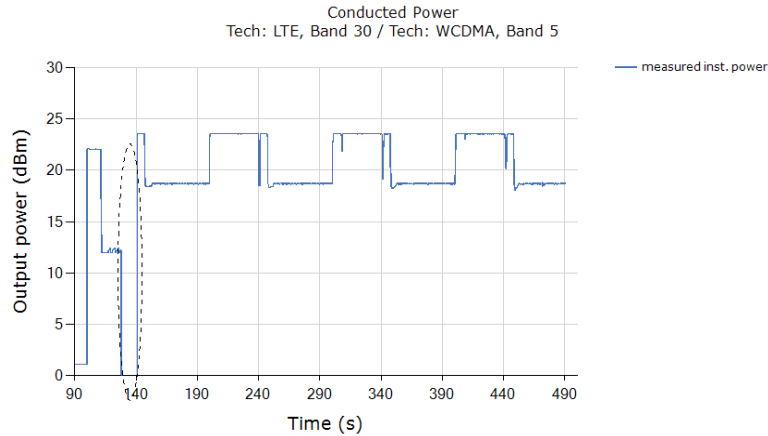

Plot 2: All the time-averaged conducted Tx power measurement results were converted into time-averaged normalized SAR values using Equation (6a), (6b) and (6c), and plotted below to demonstrate that the time-averaged normalized exposure versus time does not exceed the normalized FCC limit of 1.0:

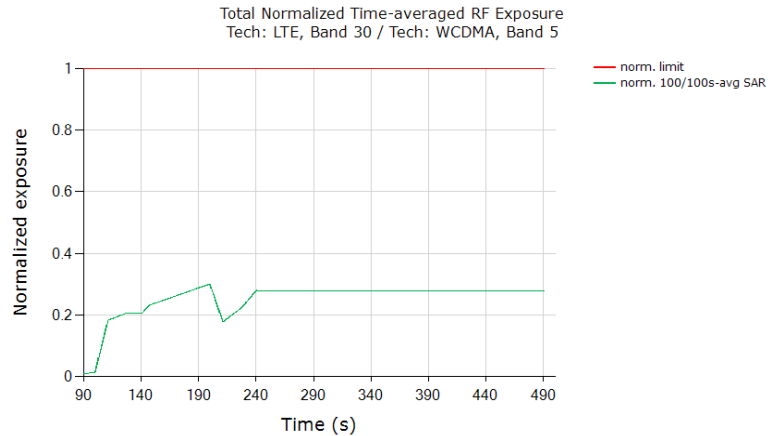

	Exposure Ratio
FCC normalized Exposure Ratio limit	1.0
Max 100s-time averaged normalized Exposure Ratio (green curve)	0.301
Validated	

The test result validated the continuity of power limiting in technology/band switch scenario.



6.6 Change in DSI test results

This test was conducted with callbox requesting maximum power, and with DSI switch from LTE B30 DSI = 3 to DSI = 2. Following procedure detailed in Section 3.3.5 using the measurement setup shown in Figure 6-1(a) and (c), the DSI switch was performed when the EUT is transmitting at $P_{reserve}$ level as shown in the plot below (dotted black circle).

Test result for change in DSI:

Plot 1: Measured Tx power (dBm) versus time shows that the transmitting power changed when DSI = 3 switches to DSI = 2.

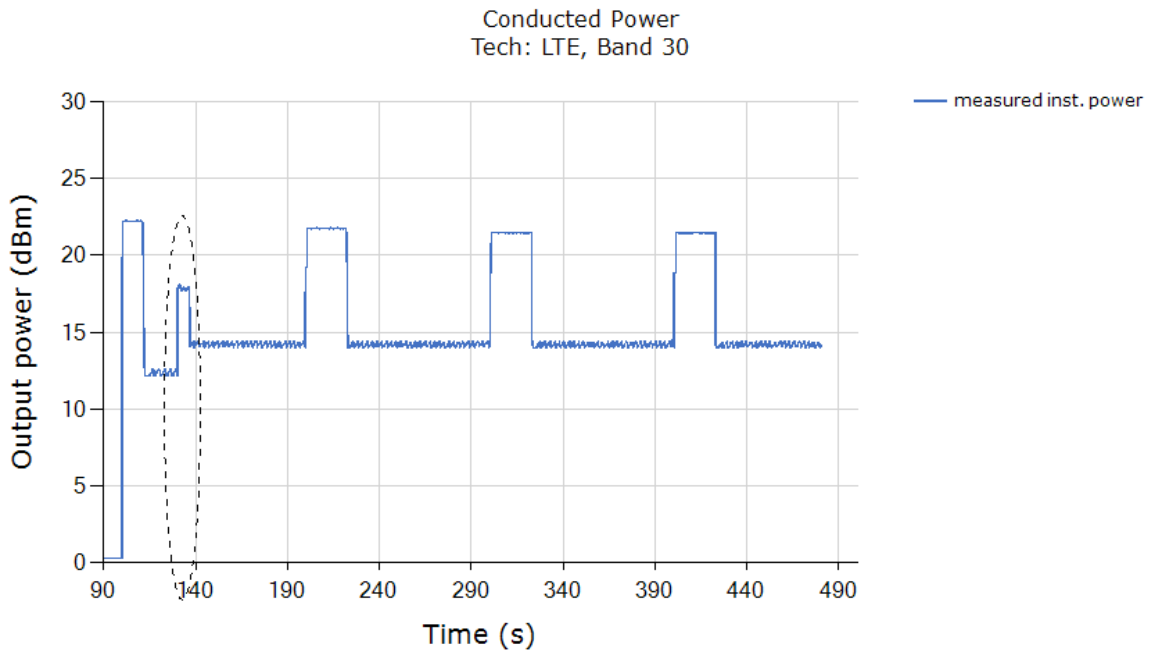



Plot 2: All the time-averaged conducted Tx power measurement results were converted into time-averaged normalized SAR values using Equation (6a), (6b) and (6c), and plotted below to demonstrate that the time-averaged normalized Exposure versus time does not exceed the FCC limit of 1 unit.

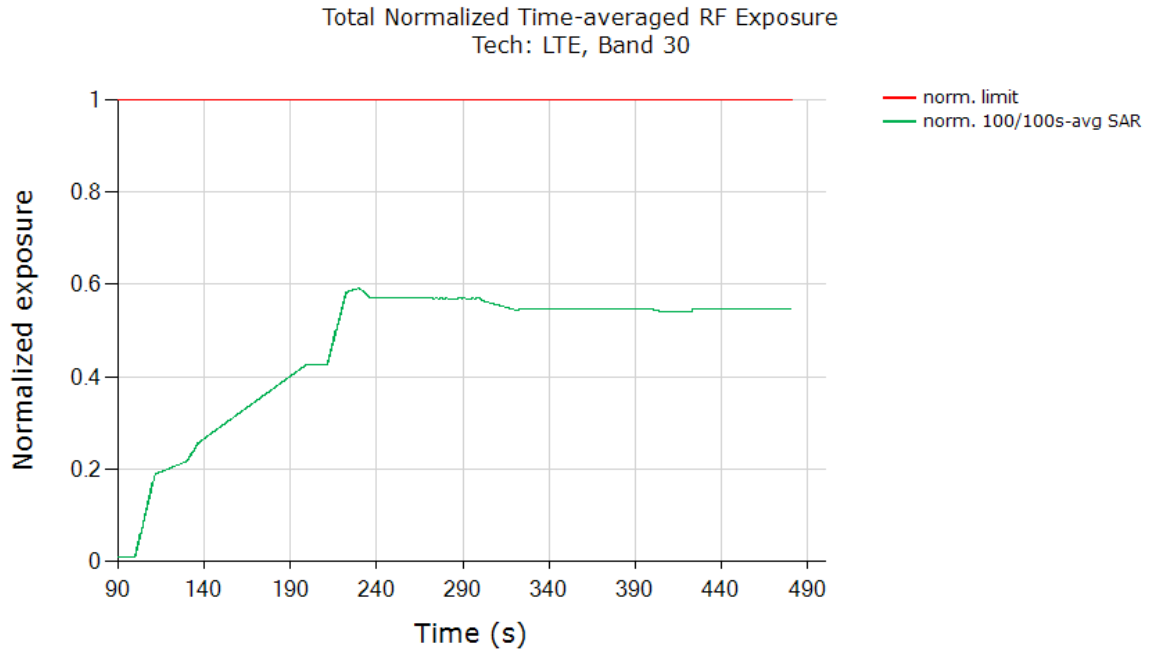

	Exposure Ratio
FCC normalized Exposure Ratio limit	1.0
Max 100s-time averaged normalized Exposure Ratio (green curve)	0.592
Validated	

The test result validated the continuity of power limiting in DSI switch scenario.



6.7 Change in Time window / antenna switch test results

6.7.1 Test case 1: transition from LTE Band 7 to LTE Band 48 (i.e., 100s to 60s), then back to LTE Band 7

Test result for change in time-window (from 100s to 60s to 100s):

Plot 1: Measured Tx power (dBm) versus time shows that the transmitting power changed when LTE Band 7 switches to LTE Band 48 (~240 seconds timestamp) and switches back to LTE Band 48 (~335 seconds timestamp):

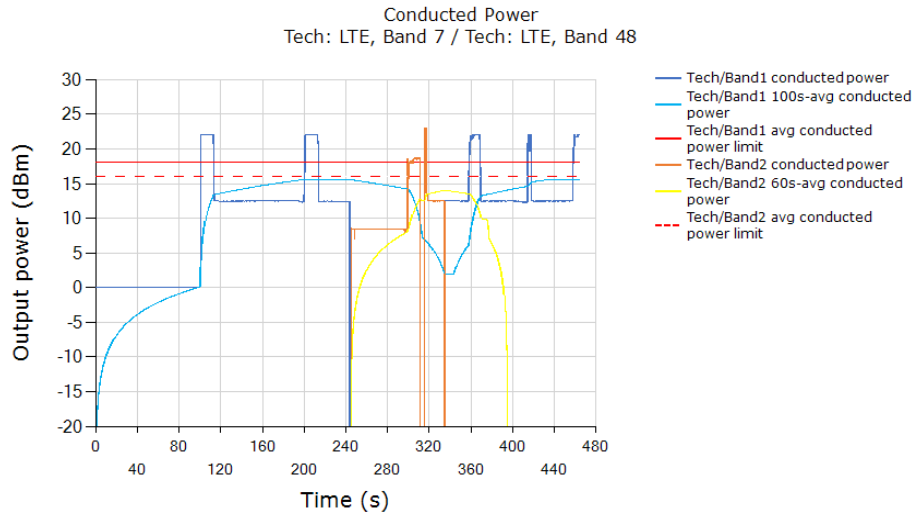

Plot Notes: ... The conducted power plot shows expected transitions in Tx power at ~240 seconds (100s-to-60s transition) and at ~335 seconds (60s-to-100s transition) in order to maintain total time-averaged RF exposure compliance across time windows, as show in next plot.



Plot 2: All the conducted Tx power measurement results were converted into time-averaged normalized SAR values using Equation (7a), (7b) and (7c), and plotted below to demonstrate that the time-averaged normalized SAR versus time does not exceed the FCC limit of 1 unit. Equation (7a) is used to convert the Tx power of device to obtain 100s-averaged normalized SAR in LTE Band 7 as shown in black curve. Similarly, equation (7b) is used to obtain 60s-averaged normalized SAR in LTE Band 48 as shown in orange curve. Equation (7c) is used to obtain total time-averaged normalized SAR as shown in green curve (i.e., sum of black and orange curves).

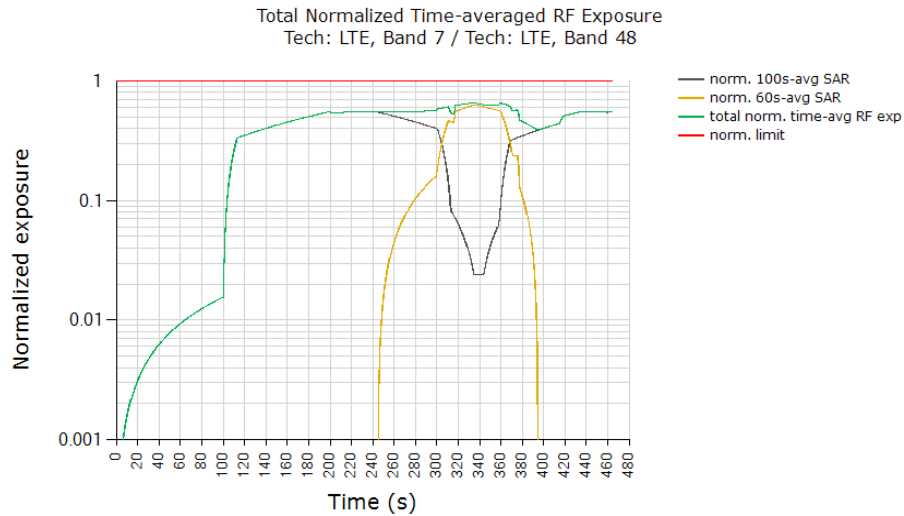

	Exposure Ratio
FCC normalized Exposure Ratio	1.0
Max time averaged normalized Exposure Ratio (green curve)	0.656
Validated	

Plot Notes:

Maximum power is requested by callbox for the entire duration of the test, with tech/band switches from 100s-to-60s window at ~240s time stamp, and from 60s-to-100s window at ~335s time stamp. Smart Transmit controls the Tx power during these time-window switches to ensure total time-averaged RF exposure, i.e., sum of black and orange curves given by equation (7c), is always compliant. In time-window switch test, at all times the total time averaged normalized RF exposure (green curve) should not exceed normalized SAR_design_target + 1.0dB device uncertainty. In this test, with a maximum normalized SAR of 0.656 being ≤ 0.68 ($= 0.87/1.6 + 1.0\text{dB}$ device uncertainty), the above test result validated the continuity of power limiting in time-window switch scenario.



6.7.2 Test case 2: transition from LTE Band 48 to LTE Band 7 (i.e., 60s to 100s), then back to LTE Band 48

Test result for change in time-window (from 60s to 100s to 60s):

Plot 1: Measured Tx power (dBm) versus time shows that the transmitting power changed when LTE Band 48 switches to LTE Band 7 (~190 seconds timestamp) and switches back to LTE Band 48 (~295 seconds timestamp):

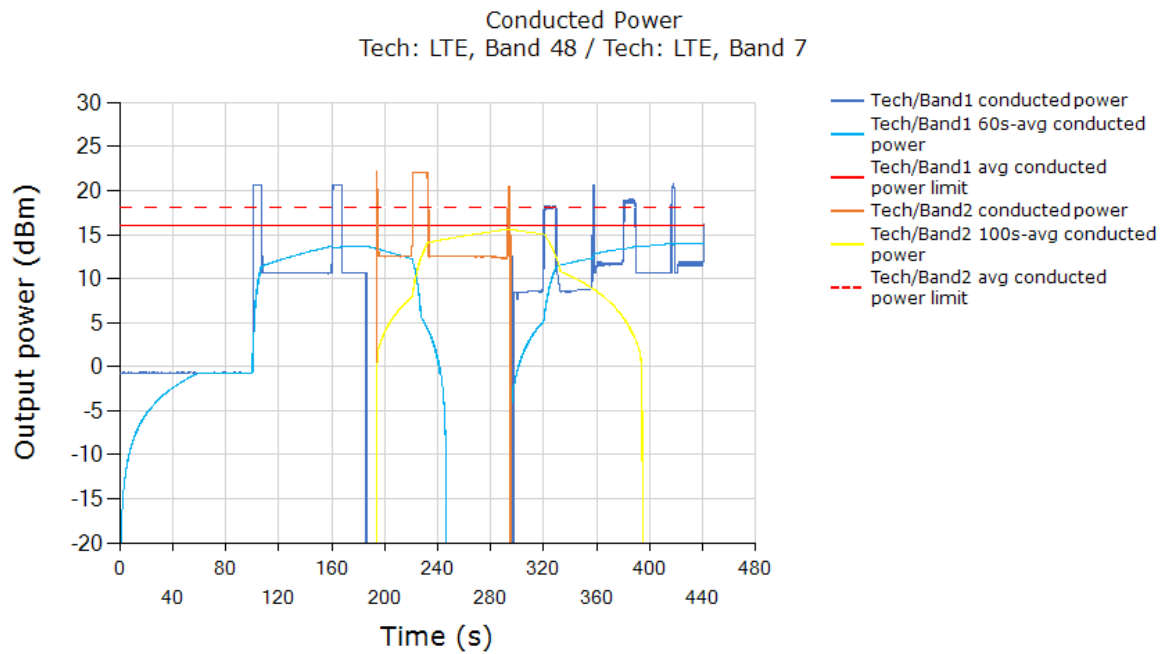

Plot Notes: ... The conducted power plot shows expected transitions in Tx power at ~190 seconds (60s-to-100s transition) and at ~295 seconds (100s-to-60s transition) in order to maintain total time-averaged RF exposure compliance across time windows, as show in next plot.



Plot 2: All the conducted Tx power measurement results were converted into time-averaged normalized SAR values using Equation (7a), (7b) and (7c), and plotted below to demonstrate that the time-averaged normalized SAR versus time does not exceed the FCC limit of 1 unit. Equation (7a) is used to convert the Tx power of device to obtain 60s-averaged normalized SAR in LTE Band 48 as shown in black curve. Similarly, equation (7b) is used to obtain 100s-averaged normalized SAR in LTE Band 7 as shown in orange curve. Equation (7c) is used to obtain total time-averaged normalized SAR as shown in green curve (i.e., sum of black and orange curves).

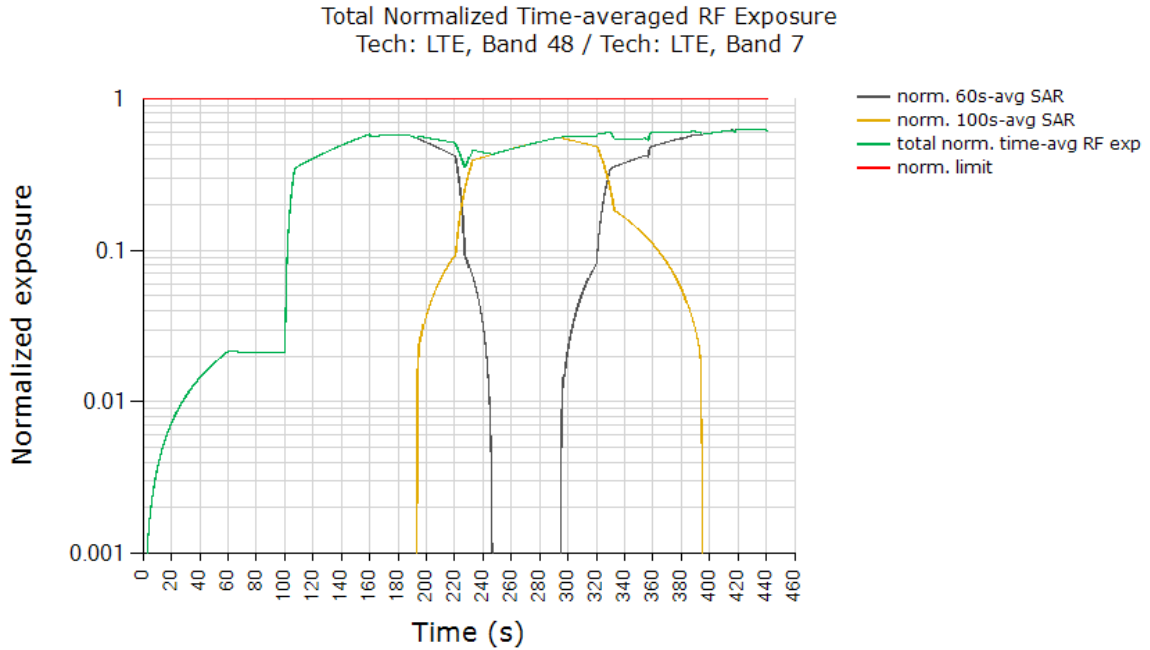

	Exposure Ratio
FCC normalized Exposure Ratio limit	1.0
Max time averaged normalized Exposure Ratio (green curve)	0.624
Validated	

Plot Notes:

Maximum power is requested by callbox for the entire duration of the test, with tech/band switches from 60s-to-100s window at ~190s time stamp, and from 100s-to-60s window at ~295s time stamp. Smart Transmit controls the Tx power during these time-window switches to ensure total time-averaged RF exposure, i.e., sum of black and orange curves given by equation (7c), is always compliant. In time-window switch test, at all times the total time averaged normalized RF exposure (green curve) should not exceed normalized SAR_design_target + 1.0dB device uncertainty. In this test, with a maximum normalized SAR of 0.624 being ≤ 0.68 ($= 0.87/1.6 + 1.0\text{dB}$ device uncertainty), the above test result validated the continuity of power limiting in time-window switch scenario.



6.8 Switch in SAR exposure test results

This test was conducted with callbox requesting maximum power, and with the EUT in LTE 13 + Sub6 NR Band 66 call. Following procedure detailed in Section 3.3.7 and Appendix B.2, and using the measurement setup shown in Figure 6-1, the SAR exposure switch measurement is performed with the EUT in various SAR exposure scenarios.

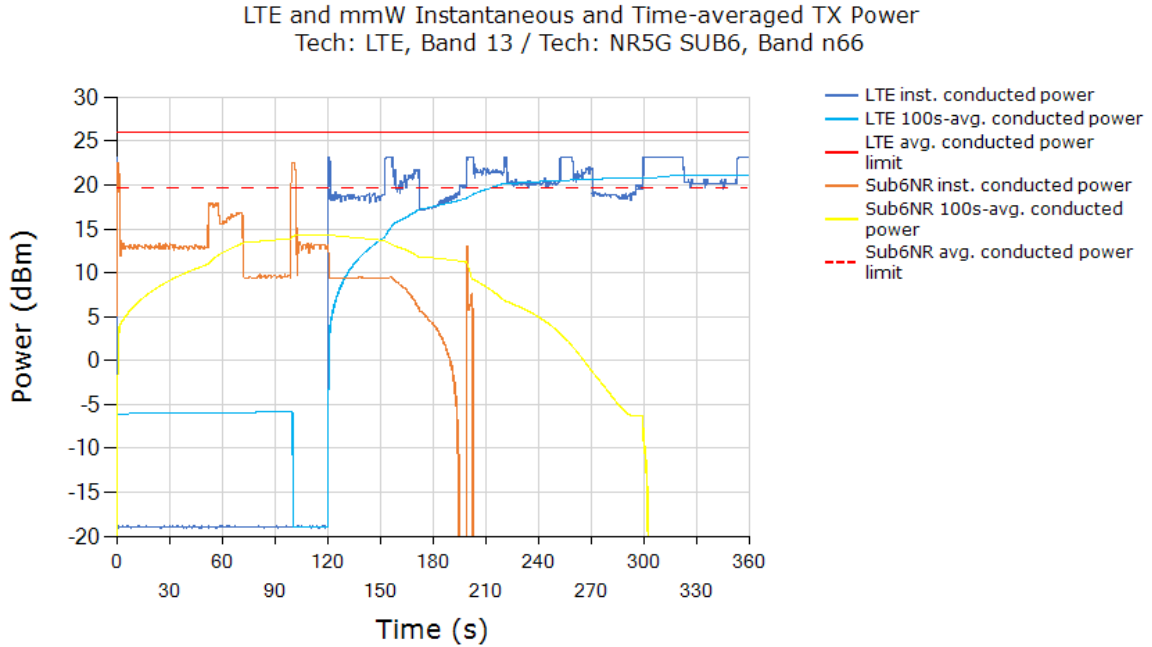

Plot 2: All the conducted Tx power measurement results were converted into time-averaged normalized SAR values using Equation (7a), (7b) and (7c), and plotted below to demonstrate that the time-averaged normalized SAR versus time does not exceed the FCC limit of 1 unit. Equation (7a) is used to convert the LTE Tx power of device to obtain 100s-averaged normalized SAR in LTE B13 as shown in black curve. Similarly, equation (7b) is used to obtain 100s-averaged normalized SAR in Sub6 NR n66 as shown in orange curve. Equation (7c) is used to obtain total time-averaged normalized SAR as shown in green curve (i.e., sum of black and orange curves).



Total Normalized Time-averaged RF Exposure
Tech: LTE, Band 13 / Tech: NR5G SUB6, Band n66

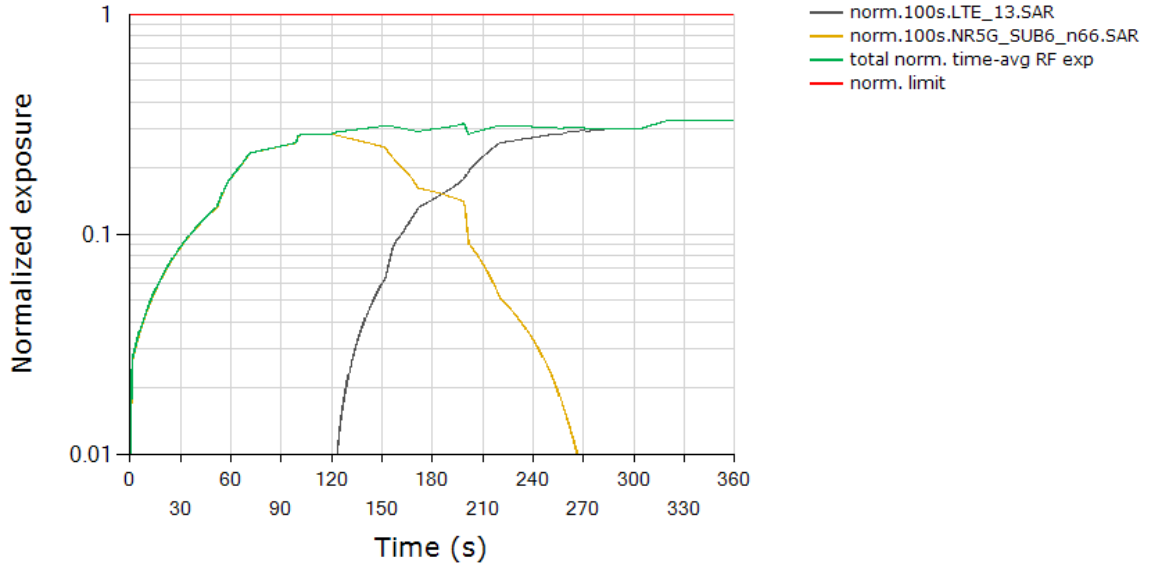

	Exposure Ratio
FCC normalized Exposure Ratio limit	1.0
Max time averaged normalized Exposure Ratio (green curve)	0.33
Validated	

Plot Notes:

Device starts predominantly in Sub6 NR SAR exposure scenario between 0s and 120s, and in LTE SAR + Sub6 NR SAR exposure scenario between 120s and 200s, and in predominantly in LTE SAR exposure scenario after t=200s. Here, Smart Transmit allocates a maximum of 75% of exposure margin (based on 3dB reserve margin setting) for Sub6 NR. This corresponds to a normalized 1gSAR exposure value = 75% * 0.537W/kg measured SAR at Sub6 NR Plimit / 1.6W/kg limit = 0.252+ “+1.0dB~ -1.0dB” device related uncertainty (see orange curve between 0s~120s). For predominantly LTE SAR exposure scenario, maximum normalized 1gSAR exposure should correspond to 100% exposure margin = 0.530W/kg measured SAR at LTE Plimit /1.6W/kg limit = 0.331 “+1.0dB~ -1.0dB” device related uncertainty (see black curve after t = 200s). Additionally, in SAR exposure switch test, at all times the total time-averaged normalized RF exposure (green curve) should not exceed normalized SAR_design_target + 1dB device uncertainty. In this test, with a maximum normalized SAR of 0.33 being ≤ 0.348 ($= 0.556/1.6 + 1dB$ device uncertainty), the above test result validated the continuity of power limiting in SAR exposure switch scenario.



7 SAR Test Results for Sub-6 Smart Transmit Feature Validation

7.1 Measurement setup

The measurement setup in Figure 7-1 is similar to normal SAR measurements (see Appendix E). The difference in SAR measurement setup for time averaging feature validation is that the callbox is signaling in close loop power control mode (instead of requesting maximum power in open loop control mode) and callbox is connected to the PC using GPIB so that the test script executed on PC can send GPIB commands to control the callbox's requested power over time (test sequence). The same test script used in conducted setup for time-varying Tx power measurements is also used in this section for running the test sequences during SAR measurements, and the recorded values from the disconnected power meter by the test script were discarded.

As mentioned in Section 3.4, for EUT to follow TPC command sent from the callbox wirelessly, the "path loss" between callbox antenna and the EUT needs to be very well calibrated. Since the SAR chamber is in uncontrolled environment, precautions must be taken to minimize the environmental influences on "path loss". Similarly, in the case of time-varying SAR measurements in Sub6 NR (with LTE as anchor), "path loss" between callbox antenna and the EUT needs to be carefully calibrated for both LTE link as well as for Sub6 NR link.

The EUT is placed in worst-case position according to Table 5-2.



7.2 SAR measurement results for time-varying Tx power transmission scenario

Following Section 3.4 procedure, time-averaged SAR measurements are conducted using EX3DV4 probe at peak location of area scan over 500 seconds. cDASY6 system verification for SAR measurement is provided in Appendix C, and the associated SPEAG certificates are attached in Appendix D.

SAR probe integration times depend on the communication signal being tested. Integration times used by SPEAG for their probe calibrations can be downloaded from here (integration time is listed on the bottom of the first page for each tech):

<https://www.speag.com/assets/downloads/services/cs/UIDSummary171205.pdf>

Since the sampling rate used by cDASY6 for pointSAR measurements is not in user control, the number of points in 100s or 60s interval is determined from the scan duration setting in cDASY6 time-average pointSAR measurement by (100s or 60s / cDASY6_scan_duration * total number of pointSAR values recorded). Running average is performed over these number of points in excel spreadsheet to obtain 100s-/60s-averaged pointSAR.

Following Section 3.4, for each of selected technology/band (listed in Table 5-2):

7. With *Reserve_power_margin* set to 0 dB, area scan is performed at P_{limit} , and time-averaged pointSAR measurements are conducted to determine the pointSAR at P_{limit} at peak location, denoted as $pointSAR_{P_{limit}}$.
8. With *Reserve_power_margin* set to actual (intended) value, two more time-averaged pointSAR measurements are performed at the same peak location for test sequences 1 and 2.

To demonstrate compliance, all the pointSAR measurement results were converted into 1gSAR or 10gSAR values by using Equation (3a), rewritten below:

$$1g_or_10gSAR(t) = \frac{pointSAR(t)}{pointSAR_{P_{limit}}} * 1g_or_10gSAR_{P_{limit}} \quad (3a)$$

where, $pointSAR(t)$, $pointSAR_{P_{limit}}$, and $1g_or_10gSAR_{P_{limit}}$ correspond to the measured instantaneous point SAR, measured point SAR at P_{limit} from above step 1 and 2, and measured 1gSAR or 10gSAR values at P_{limit} obtained from Part 1 report and listed in Table 5-2 in Section 5.1 of this report.



7.2.1 LTE Band 7 SAR test results

SAR test results for test sequence 1:

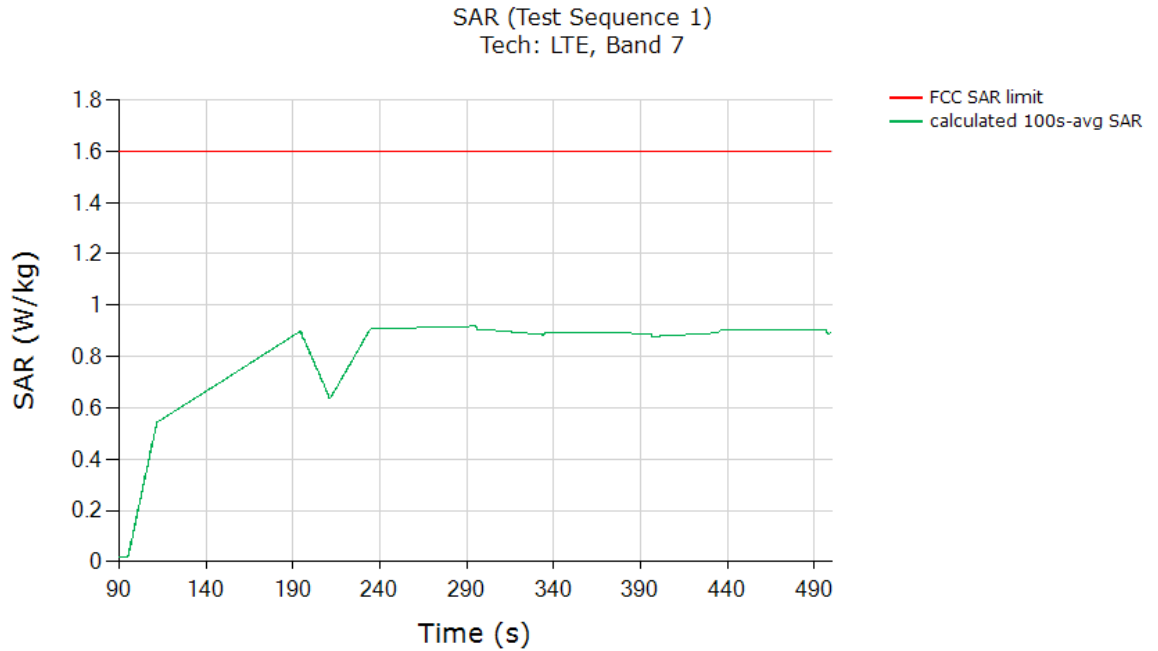

	(W/kg)
FCC 1gSAR limit	1.6
Max 100s-time averaged 1gSAR (green curve)	0.918
Validated: Max time averaged SAR (green curve) does not exceed measured SAR at Plimit +1.0dB device uncertainty	



SAR test results for test sequence 2:

SAR (Test Sequence 2)
Tech: LTE, Band 7

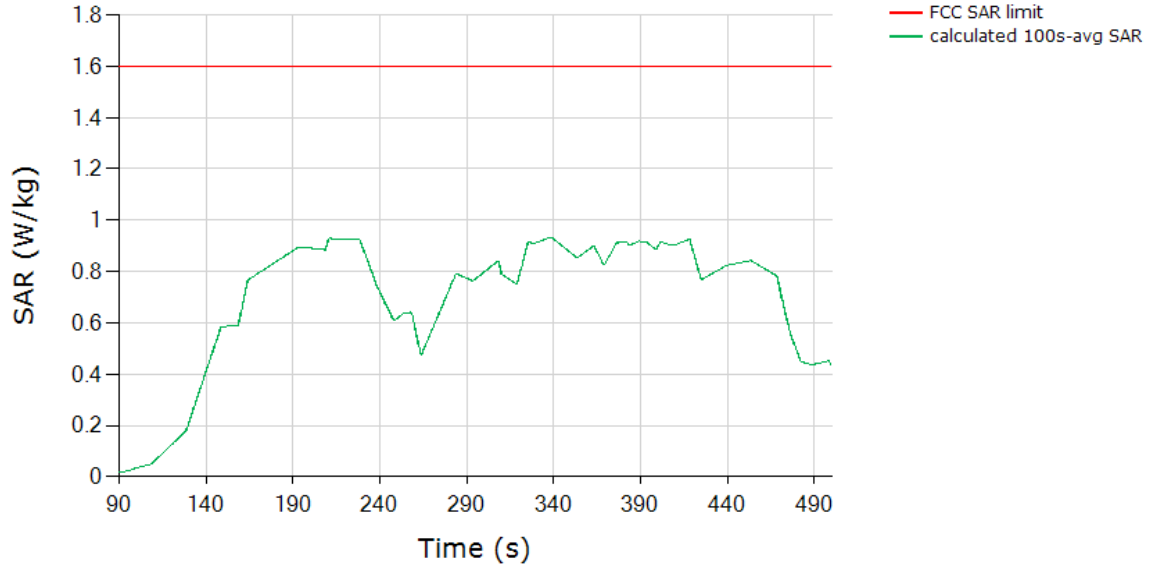

	(W/kg)
FCC 1gSAR limit	1.6
Max 100s-time averaged 1gSAR (green curve)	0.933
Validated: Max time averaged SAR (green curve) does not exceed measured SAR at Plimit +1.0dB device uncertainty	



7.2.2 LTE Band 30 SAR test results

SAR test results for test sequence 1:

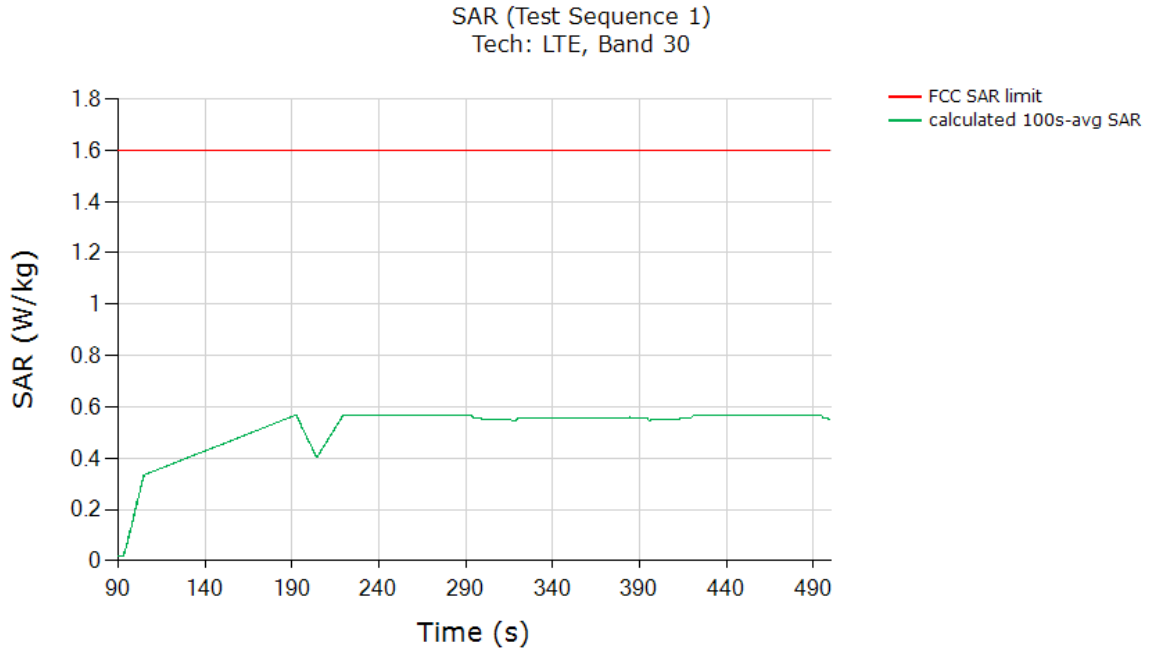

	(W/kg)
FCC 1gSAR limit	1.6
Max 100s-time averaged 1gSAR (green curve)	0.568
<i>Validated:</i> Max time averaged SAR (green curve) does not exceed measured SAR at Plimit +1.0dB device uncertainty	



SAR test results for test sequence 2:

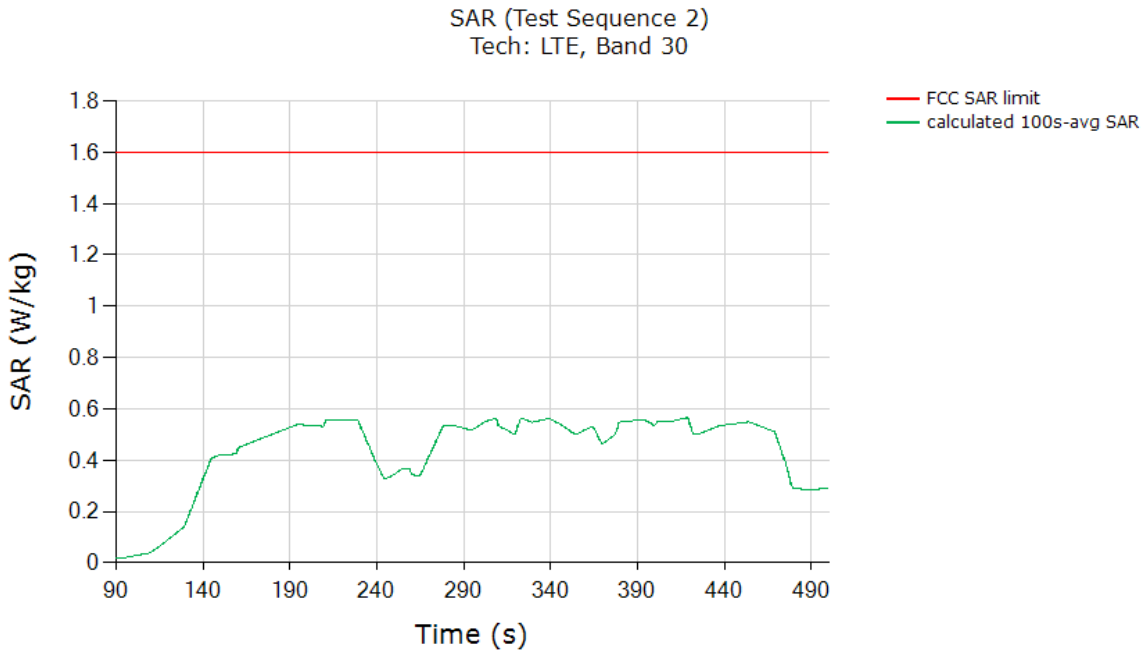

	(W/kg)
FCC 1gSAR limit	1.6
Max 100s-time averaged 1gSAR (green curve)	0.565
<i>Validated:</i> Max time averaged SAR (green curve) does not exceed measured SAR at Plimit +1.0dB device uncertainty	



7.2.3 WCDMA Band 4 SAR test results

SAR test results for test sequence 1:

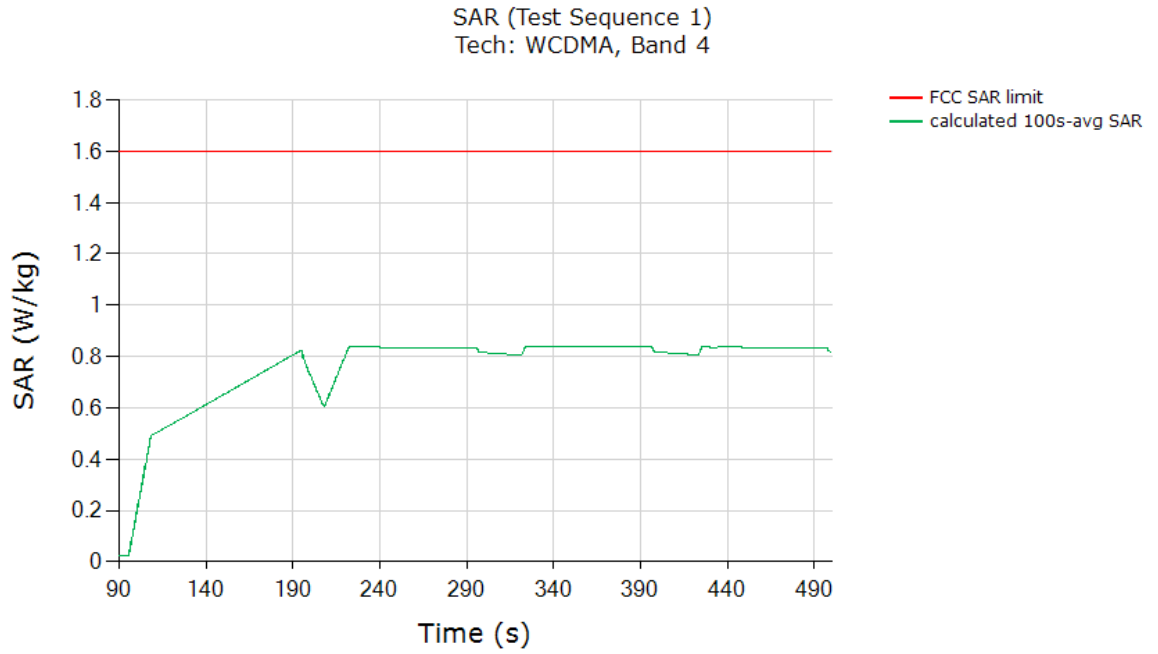

	(W/kg)
FCC 1gSAR limit	1.6
Max 100s-time averaged 1gSAR (green curve)	0.836
Validated: Max time averaged SAR (green curve) does not exceed measured SAR at Plimit +1.0dB device uncertainty	



SAR test results for test sequence 2:

SAR (Test Sequence 1)
Tech: WCDMA, Band 4

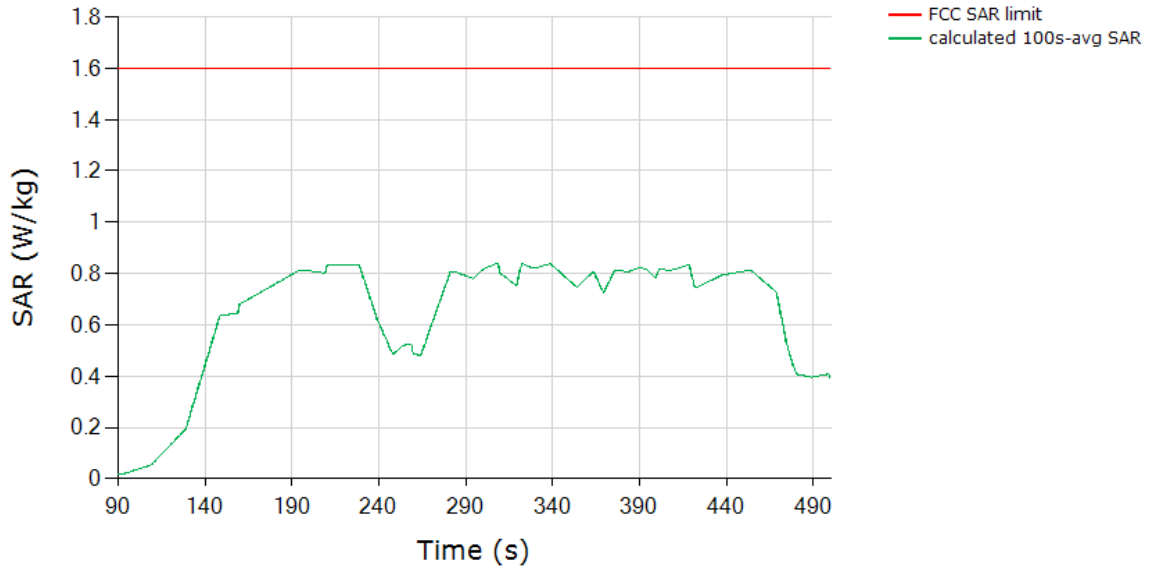

	(W/kg)
FCC 1gSAR limit	1.6
Max 100s-time averaged 1gSAR (green curve)	0.84
Validated: Max time averaged SAR (green curve) does not exceed measured SAR at Plimit +1.0dB device uncertainty	



7.2.4 WCDMA Band 5 SAR test results

SAR test results for test sequence 1:

SAR (Test Sequence 1)
Tech: WCDMA, Band 5

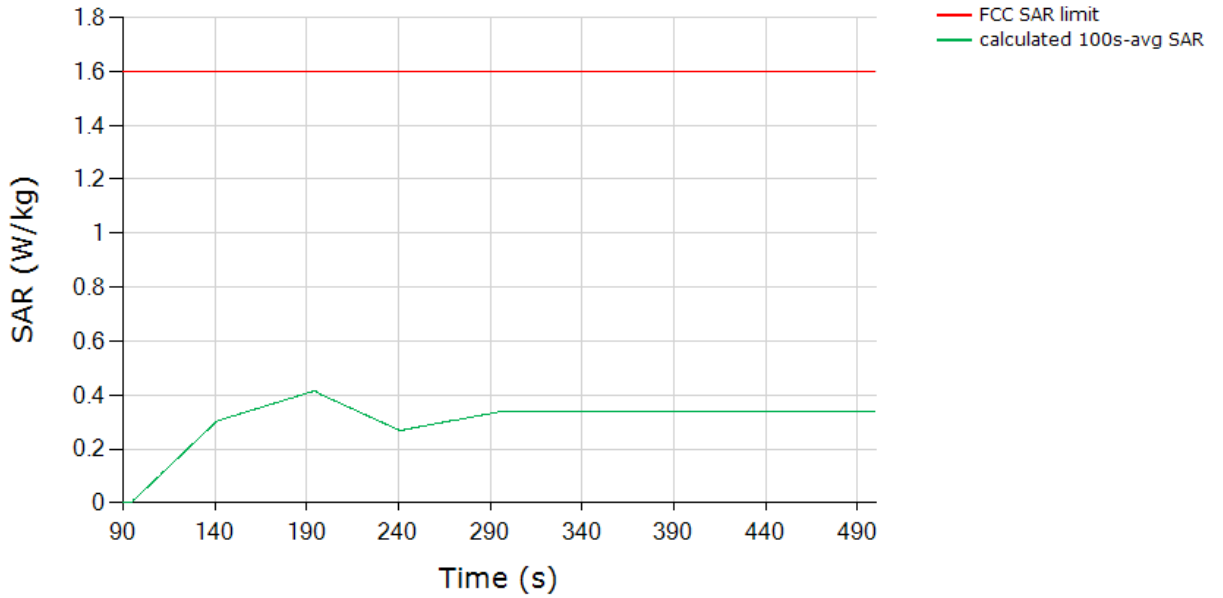

	(W/kg)
FCC 1gSAR limit	1.6
Max 100s-time averaged 1gSAR (green curve)	0.415
Validated: Max time averaged SAR (green curve) does not exceed measured SAR at Plimit +0.5dB device uncertainty	



SAR test results for test sequence 2:

SAR (Test Sequence 2)
Tech: WCDMA, Band 5

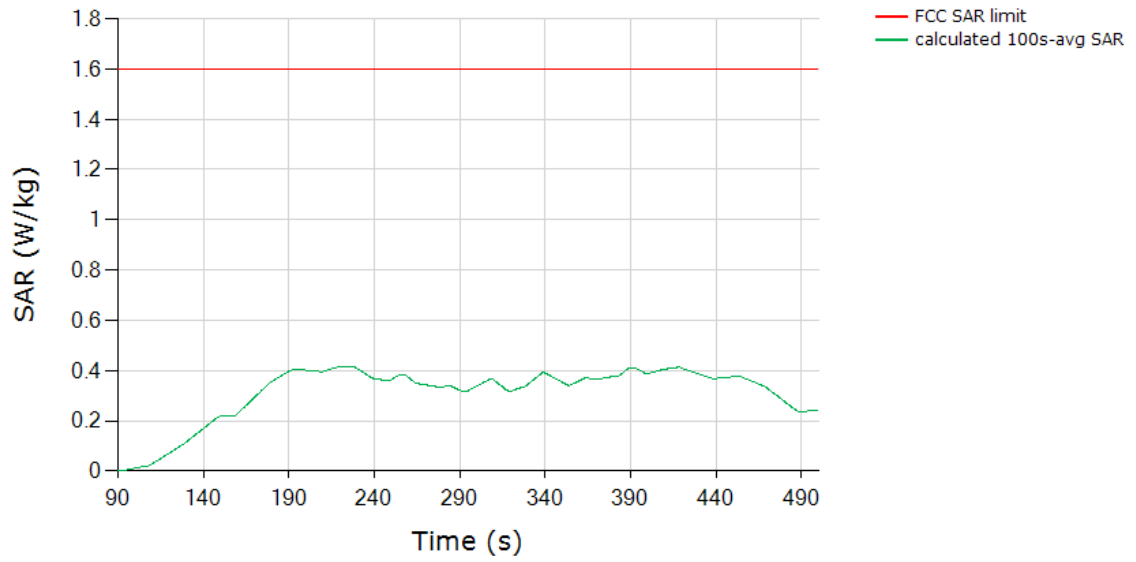

	(W/kg)
FCC 1gSAR limit	1.6
Max 100s-time averaged 1gSAR (green curve)	0.413
Validated: Max time averaged SAR (green curve) does not exceed measured SAR at Plimit +0.5dB device uncertainty	



7.2.5 GSM Band 850 SAR test results

SAR test results for test sequence 1:

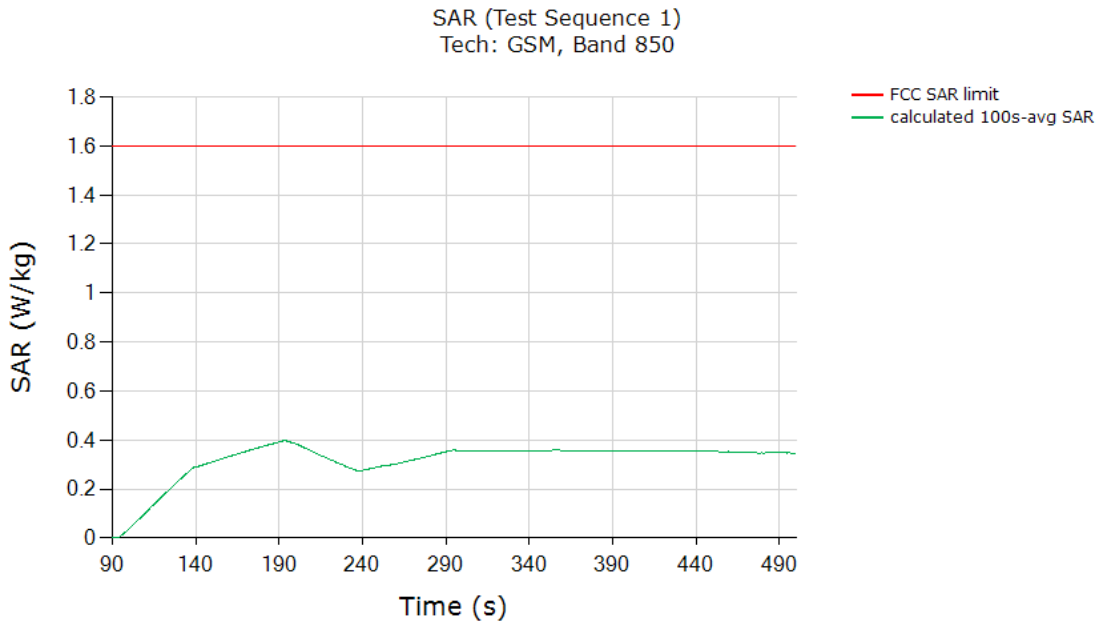

	(W/kg)
FCC 1gSAR limit	1.6
Max 100s-time averaged 1gSAR (green curve)	0.399
<i>Validated:</i> Max time averaged SAR (green curve) does not exceed measured SAR at Plimit +0.5dB device uncertainty	



SAR test results for test sequence 2:

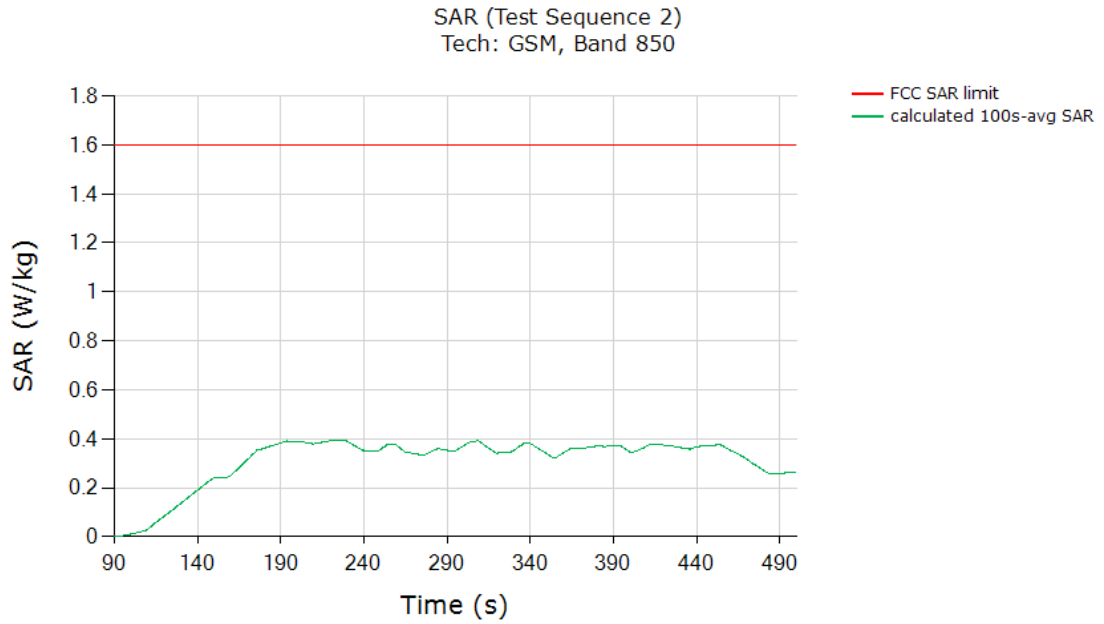

	(W/kg)
FCC 1gSAR limit	1.6
Max 100s-time averaged 1gSAR (green curve)	0.393
Validated: Max time averaged SAR (green curve) does not exceed measured SAR at Plimit +0.5dB device uncertainty	



7.2.6 GSM Band 1900 SAR test results

SAR test results for test sequence 1:

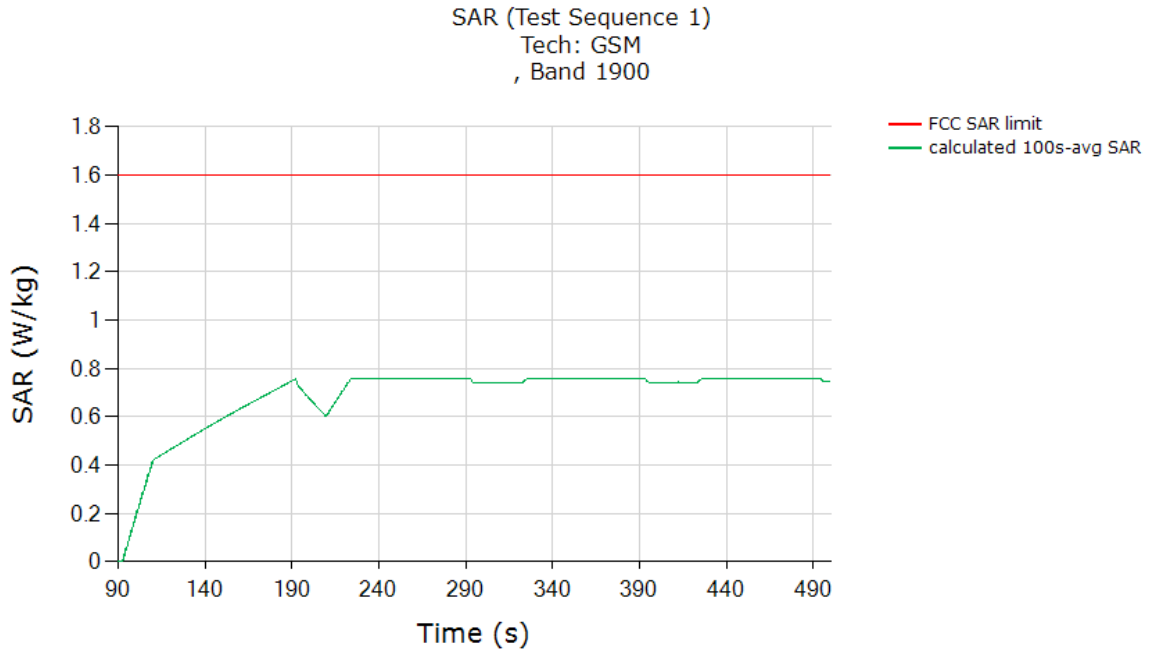

	(W/kg)
FCC 1gSAR limit	1.6
Max 100s-time averaged 1gSAR (green curve)	0.758
Validated: Max time averaged SAR (green curve) does not exceed measured SAR at Plimit +1.0dB device uncertainty	



SAR test results for test sequence 2:

SAR (Test Sequence 2)
Tech: GSM
, Band 1900

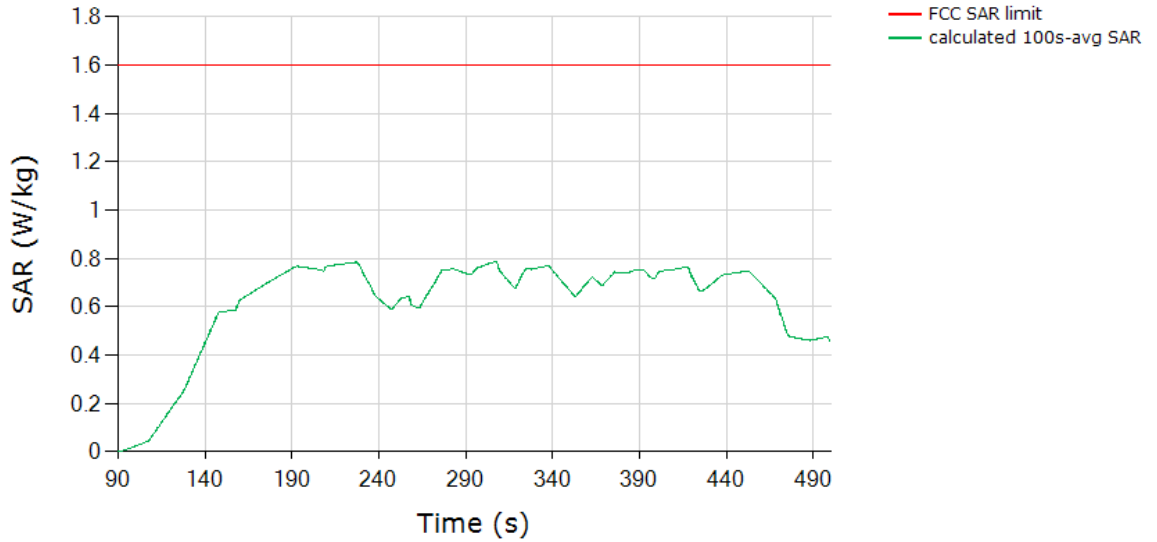

	(W/kg)
FCC 1gSAR limit	1.6
Max 100s-time averaged 1gSAR (green curve)	0.787
Validated: Max time averaged SAR (green curve) does not exceed measured SAR at Plimit +1.0dB device uncertainty	



7.2.7 Sub6 NR Band 2 SAR test results

SAR test results for test sequence 1:

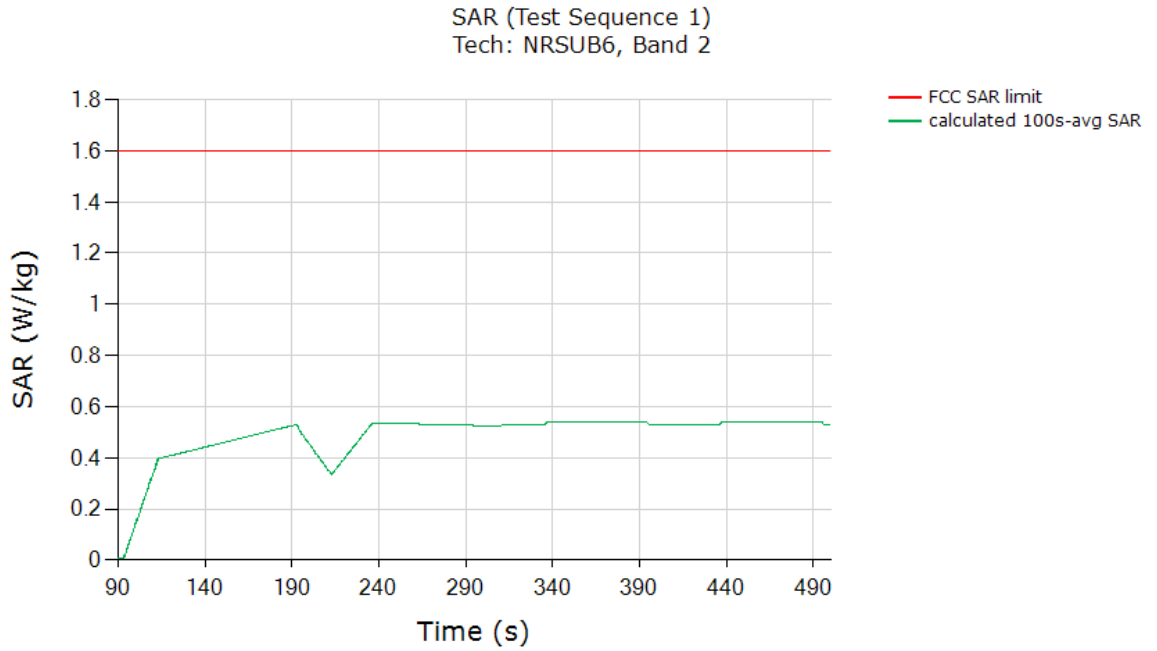

	(W/kg)
FCC 1gSAR limit	1.6
Max 100s-time averaged 1gSAR (green curve)	0.54
Validated: Max time averaged SAR (green curve) does not exceed "75% (with 3dB Reserve_Power_Margin) of measured SAR at P _{limit} , +1dB device uncertainty"	



SAR test results for test sequence 2:

SAR (Test Sequence 2)
Tech: NRSUB6, Band 2

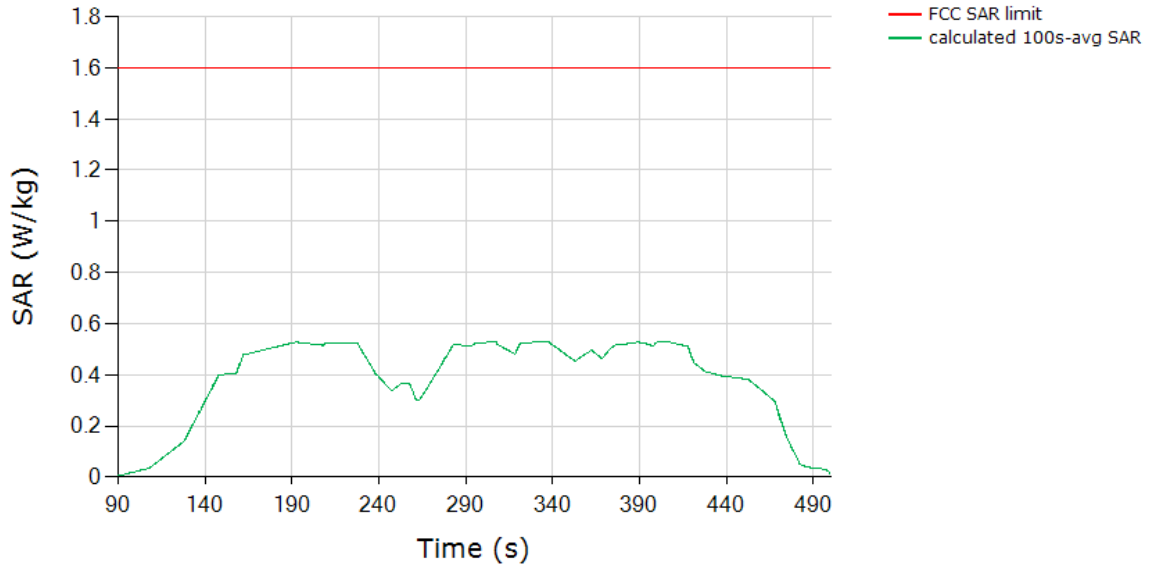

	(W/kg)
FCC 1gSAR limit	1.6
Max 100s-time averaged 1gSAR (green curve)	0.531
<i>Validated:</i> Max time averaged SAR (green curve) is within +1 ~ -1dB device uncertainty of 75% (with 3dB Reserve_Power_Margin) of measured SAR at P_{limit}	



7.2.8 Sub6 NR Band 66 SAR test results

SAR test results for test sequence 1:

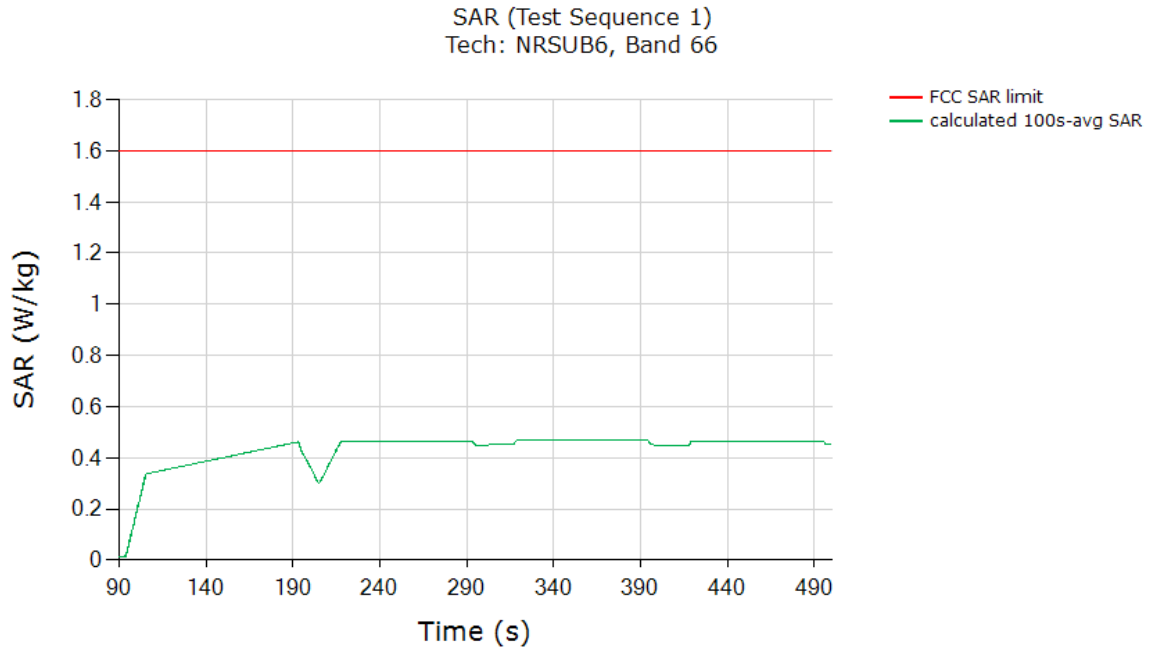

	(W/kg)
FCC 1gSAR limit	1.6
Max 100s-time averaged 1gSAR (green curve)	0.467
<i>Validated:</i> Max time averaged SAR (green curve) does not exceed "75% (with 3dB Reserve_Power_Margin) of measured SAR at P _{limit} , +1dB device uncertainty"	



SAR test results for test sequence 2:

SAR (Test Sequence 2)
Tech: NRSUB6, Band 66

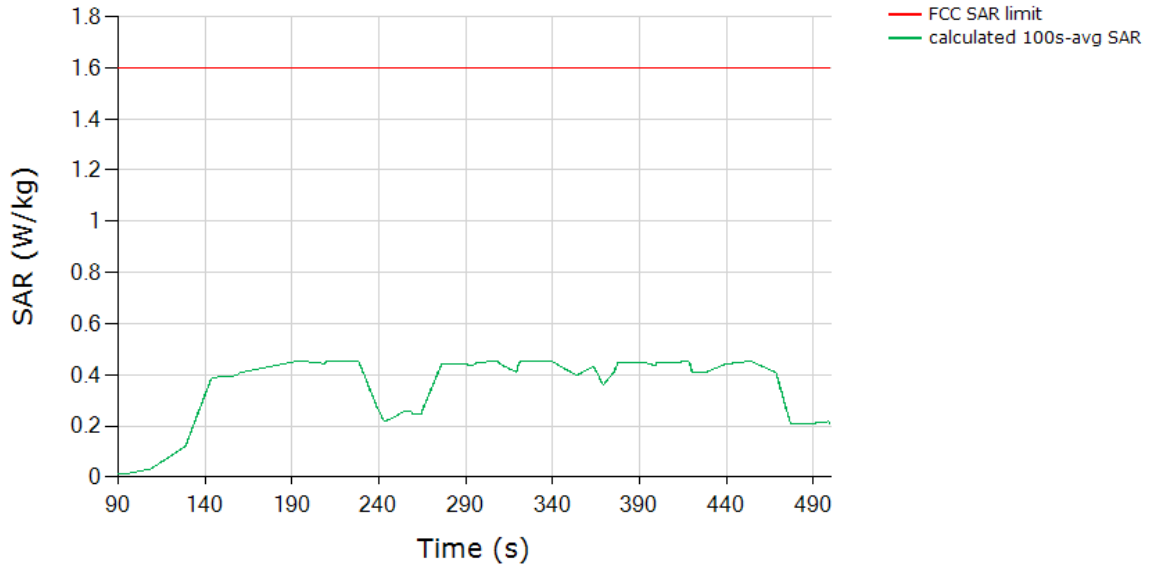

	(W/kg)
FCC 1gSAR limit	1.6
Max 100s-time averaged 1gSAR (green curve)	0.455
<i>Validated:</i> Max time averaged SAR (green curve) is within +1 ~ -1dB device uncertainty of 75% (with 3dB Reserve_Power_Margin) of measured SAR at P_{limit}	

8 Radiated Power Test Results for mmW Smart Transmit Feature Validation

8.1 Measurement Setup

The Keysight Technologies E7515B UXM callbox is used in this test. The test setup is shown in Figure 8-1a and the schematic of the setup is shown in Figure 8-1b (see Appendix E for missing figures). The UXM callbox has two RF radio heads to up/down convert IF to mmW frequencies, which in turn are connected to two horn antennas for V- and H-polarizations for downlink communication. In the uplink, a directional coupler is used in the path of one of the horn antennas to measure and record radiated power using a Rohde & Schwarz NR50S power sensor. Note here that the isolation of the directional coupler may not be sufficient to attenuate the downlink signal from the callbox, which will result in high noise floor masking the recording of radiated power from EUT. In that case, either lower the downlink signal strength emanating from the RF radio heads of callbox or add an attenuator between callbox radio heads and directional coupler. Additionally, note that since the measurements performed in this validation are all relative, measurement of EUT's radiated power in one polarization is sufficient. The EUT is placed inside an anechoic chamber with V- and H-pol horn antennas to establish the radio link as shown in Figure 8-1. The callbox's LTE port is directly connected to the EUT's RF port via a directional coupler to measure the EUT's conducted Tx power using a Rohde & Schwarz NR8S power sensor. Additionally, EUT is connected to the PC via USB connection for sending beam switch command. Care is taken to route the USB cable and RF cable (for LTE connection) away from the EUT's mmW antenna modules.

Setup in Figure 8-1 is used for the test scenario 1, 5 and 6 described in Section 2. The test procedures described in Section 4 are followed. The path losses from the EUT to both the power meters are calibrated and used as offset in the power meter.

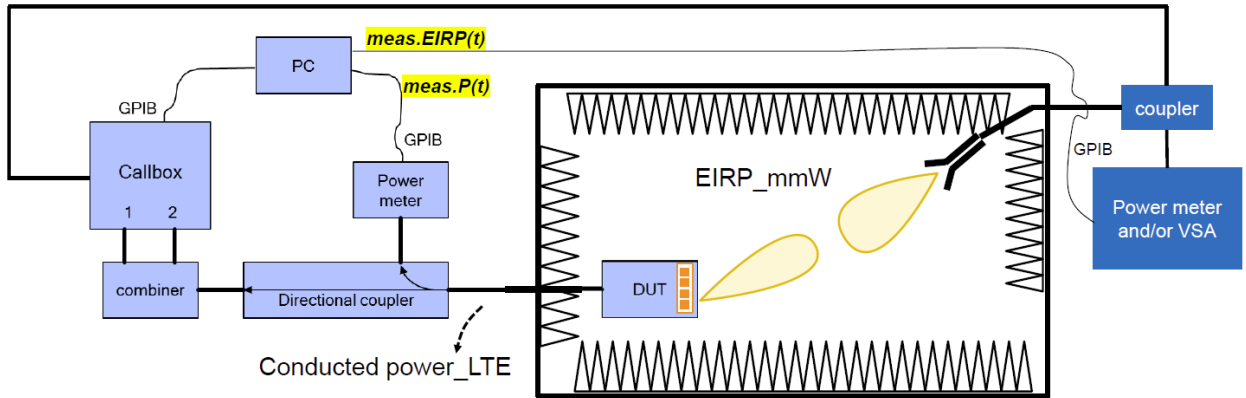

Figure 8-1 mmW NR radiated power measurement setup

Both the callbox and power meters are connected to the PC using USB cables. Test scripts are custom made for automation of establishing LTE + mmW call, conducted Tx power recording for LTE and radiated Tx power recording for mmW. These tests are manually stopped after desired time duration. Test script is programmed to set LTE Tx



power to all-down bits on the callbox immediately after the mmW link is established, and programmed to set toggle between all-up and all-down bits depending on the transmission scenario being evaluated. Similarly, test script is also programmed to send beam switch command manually to the EUT via USB connection. For all the tests, the callbox is set to request maximum Tx power in mmW NR radio from EUT all the time.

Test configurations for this validation are detailed in Section 5.2. Test procedures are listed in Section 4.3.

8.2 mmW NR radiated power test results

To demonstrate the compliance, the conducted Tx power of LTE Band 2 in DSI = 5 is converted to 1gSAR exposure by applying the corresponding worst-case 1gSAR value at P_{limit} as reported in Part 1 report and listed in Table 5-2 of this report.

Similarly, following Step 4 in Section 4.3.1, radiated Tx power of mmW Band n261 and n260 for the beams tested is converted by applying the corresponding worst-case $4cm^2PD$ values from Part 1 report, and listed in below Table 8-1. Qualcomm Smart Transmit feature operates based on time-averaged Tx power reported on a per symbol basis, which is independent of modulation, channel and bandwidth (RBs), therefore the worst-case $4cm^2PD$ was conducted with the EUT in FTM mode, with CW modulation and 100% duty cycle. cDASY6 system verification for power density measurement is provided in Appendix C, and the associated SPEAG certificates are attached in Appendix D.

Both the worst-case 1gSAR and $4cm^2PD$ values used in this section are listed in Table 8-1. The measured EIRP at *input.power.limit* for the beams tested in this section are also listed in Table 8-1.

Table 8-1: Worst-case 1gSAR, $4cm^2$ avg. PD and EIRP measured at *input.power.limit* for the selected configurations

Tech	Band	Antenna	Beam ID	Input.power.limit (dBm)	Meas. $4cm^2PD$		Meas. EIRP at Input.power.limit (dBm)
					at Input.power.limit (W/m2)	configuration	
mmW NR	N261	Module 0	20	3.3	4.22	Back	13.93
			0	9.3	2.35	Back	9.71
mmW NR	N260	Module 2	31	2.1	2.81	Right Side	9.04
mmW NR	N260		43	2.3	3.13	Right Side	11.43
mmW NR	N260		2	7.7	4.56	Right Side	5.78

Tech	Band	Antenna	DSI	Meas. Plimit (dBm)	Meas. 1gSAR	
					At Plimit (W/kg)	configuration
LTE	66	3	2	16.52	0.872	Right Cheek

The $4cm^2$ -averaged PD distributions for the highest PD value per band, as listed in Table 8-1, are plotted below:

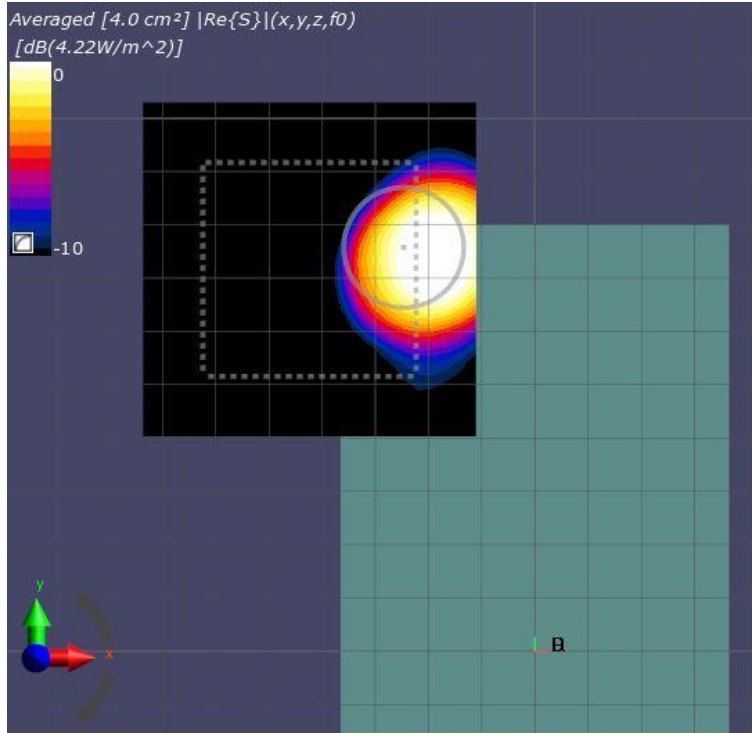

Figure 8-2: 4cm²-averaged power density distribution measured at *input.power.limit* of 3.3 dBm on the back surface for n261 beam 20

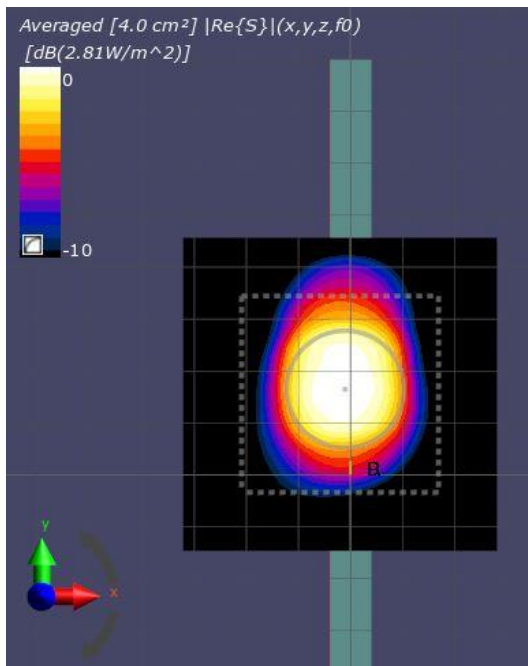

Figure 8-3: 4cm²-averaged power density distribution measured at *input.power.limit* of 2.1 dBm on the Right Side for n260 beam 31



8.2.1 Maximum Tx power test results for n261

This test was measured with LTE Band 66 (DSI=2) and mmW Band n261 Beam ID 20, by following the detailed test procedure described in Section 4.3.1.

Instantaneous and 100s-averaged conducted LTE Tx power versus time, instantaneous and 4s-averaged radiated mmW Tx power versus time, time-averaged conducted LTE Tx power limit and time-averaged radiated mmW Tx power limit:

1

Above time-averaged conducted Tx power for LTE B66 and radiated Tx power for mmW NR n261 beam 20 are converted into time-averaged 1gSAR and time-averaged 4cm²PD using Equation (2a) and (2b), which are divided by FCC 1gSAR limit of 1.6 W/kg and 4cm²PD limit of 10 W/m², respectively, to obtain normalized exposures versus time. Below plot shows (a) normalized time-averaged 1gSAR versus time, (b) normalized time-averaged 4cm²-avg.PD versus time, (c) sum of normalized time-averaged 1gSAR and normalized time-averaged 4cm²-avg.PD:

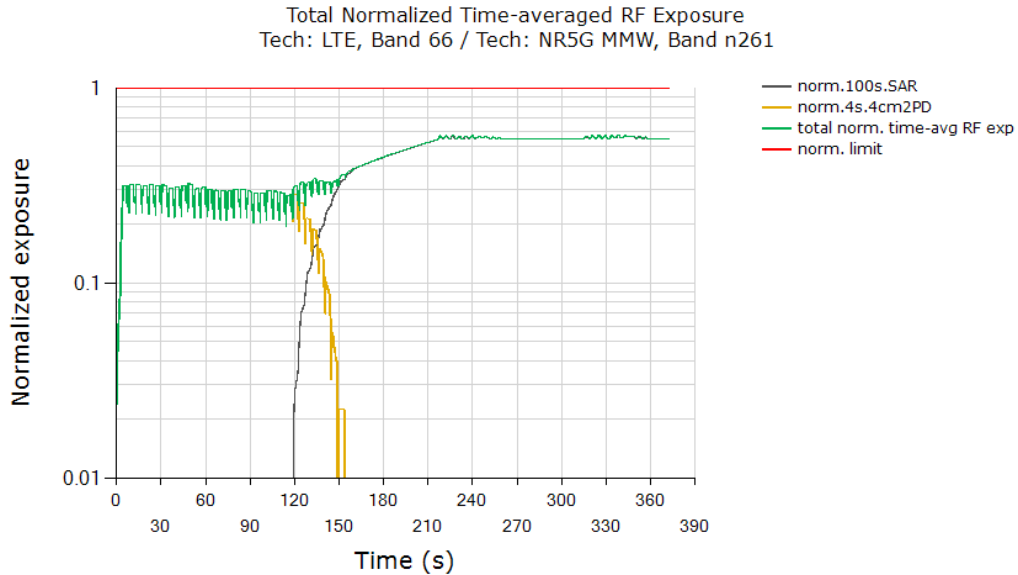

	Exposure ratio
FCC requirement for total RF exposure (normalized)	1.0
Max total normalized time-averaged RF exposure (green curve)	0.574
Validated	

Plot notes: ...

5G mmW NR call was established at ~0s time mark and LTE was placed in all-down bits immediately after 5G mmW NR call was established. Between 0s~120s, mmW exposure is the dominant contributor. Here, Smart Transmit feature allocates a maximum of 75% for mmW. From Table 8-1, this corresponds to a normalized 4cm²PD exposure value for Beam ID 20 of (75% * 4.22 W/m²)/(10 W/m²) = 31.7% ± 2.1dB device related uncertainty (see green/orange curve between 0s~120s). At ~120s time mark, LTE is set



to all-up bits, taking away margin from mmW exposure gradually. Towards the end of test, LTE is the dominant contributor towards RF exposure, i.e., corresponding normalized 1gSAR exposure value of $(100\% * 0.872 \text{ W/kg}) / (1.6 \text{ W/kg}) = 54.5\%$ +“+1.0dB~ -1.0dB” design related uncertainty.

As can be seen, the power limiting enforcement is effective and the total normalized time-averaged RF exposure does not exceed 1.0. Therefore, Qualcomm® Smart Transmit time averaging feature is validated.



8.2.2 Maximum Tx power test results for n260

This test was measured with LTE Ban66 (DSI=2) and mmW Band n260 Beam ID 31, by following the detailed test procedure described in Section 4.3.1.

Instantaneous and 100s-averaged conducted LTE Tx power versus time, instantaneous and 4s-averaged radiated mmW Tx power versus time, time-averaged conducted LTE Tx power limit and time-averaged radiated mmW Tx power limit:

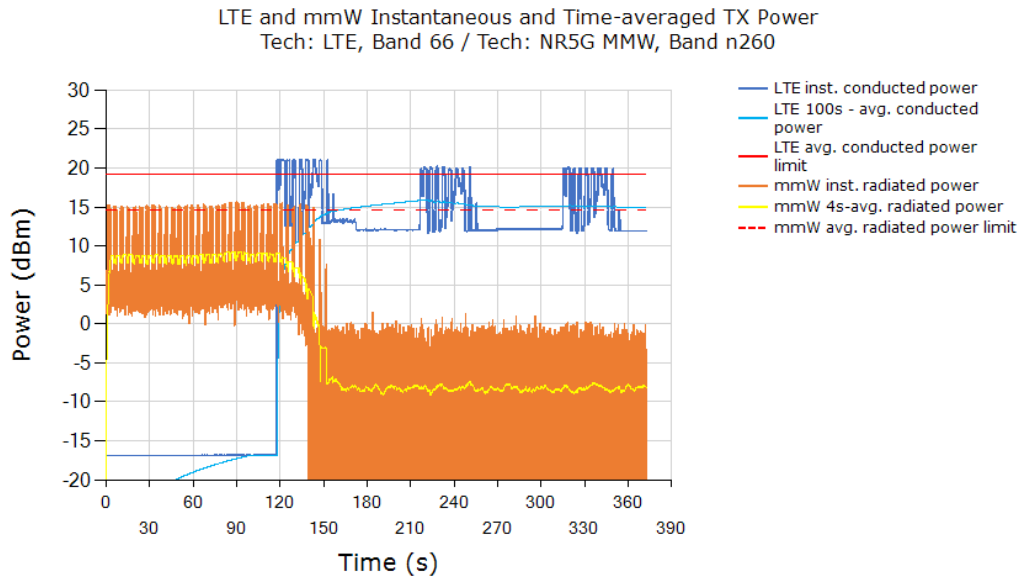

Above time-averaged conducted Tx power for LTE B66 and radiated Tx power for mmW NR n260 beam 31 are converted into time-averaged 1gSAR and time-averaged 4cm²PD using Equation (2a) and (2b), which are divided by FCC 1gSAR limit of 1.6 W/kg and 4cm²PD limit of 10 W/m², respectively, to obtain normalized exposures versus time. Below plot shows (a) normalized time-averaged 1gSAR versus time, (b) normalized time-averaged 4cm²-avg.PD versus time, (c) sum of normalized time-averaged 1gSAR and normalized time-averaged 4cm²-avg.PD:



Total Normalized Time-averaged RF Exposure
Tech: LTE, Band 66 / Tech: NR5G MMW, Band n260

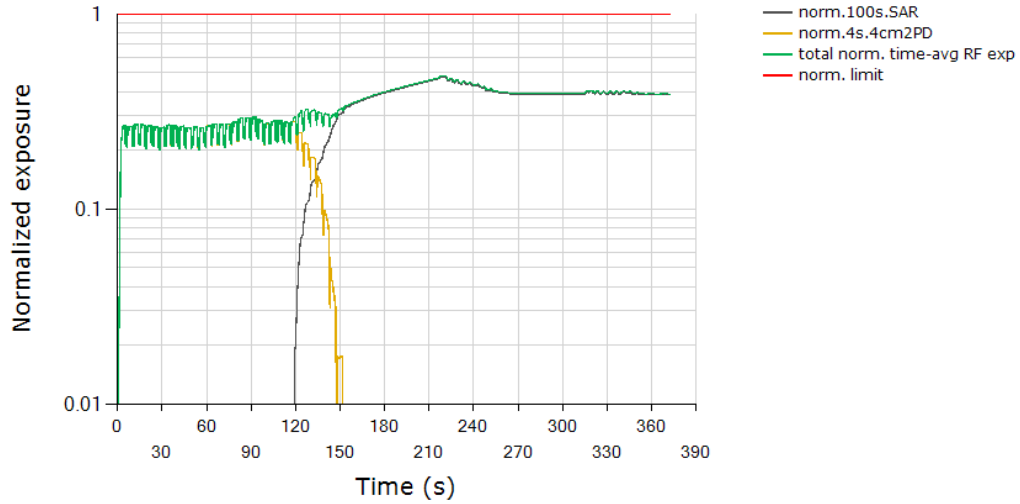

	Exposure Ratio
FCC requirement for total RF exposure (normalized)	1.0
Max total normalized time-averaged RF exposure (green curve)	0.485
Validated	

Plot notes: ...

5G mmW NR call was established at 0s time mark and LTE was placed in all-down bits immediately after 5G mmW NR call was established. Between 0s~120s, mmW exposure is the dominant contributor. Here, Smart Transmit feature allocates a maximum of 75% for mmW. From Table 8-1, this corresponds to a normalized 4cm2PD exposure value for Beam ID 31 of $(75\% * 2.81 \text{ W/m}^2) / (10 \text{ W/m}^2) = 21.1\% \pm 2.1\text{dB}$ device related uncertainty (see green/orange curve between 0s~120s). At ~120s time mark, LTE is set to all-up bits, taking away margin from mmW exposure gradually. Towards the end of test, LTE is the dominant contributor towards RF exposure, i.e., corresponding normalized 1gSAR exposure value of $(100\% * 0.872 \text{ W/kg}) / (1.6 \text{ W/kg}) = 54.5\% + " +1.0\text{dB} \sim -1.0\text{dB} "$ design related uncertainty.

As can be seen, the power limiting enforcement is effective and the total normalized time-averaged RF exposure does not exceed 1.0. Therefore, Qualcomm® Smart Transmit time averaging feature is validated.



8.2.3 Switch in SAR vs. PD exposure test results for n261

This test was measured with LTE Band 66 (DSI =2) and mmW Band n261 Beam ID 20, by following the detailed test procedure is described in Section 4.3.2.

Instantaneous and 100s-averaged conducted LTE Tx power versus time, instantaneous and 4s-averaged radiated mmW Tx power versus time, time-averaged conducted LTE Tx power limit and time-averaged radiated mmW Tx power limit:

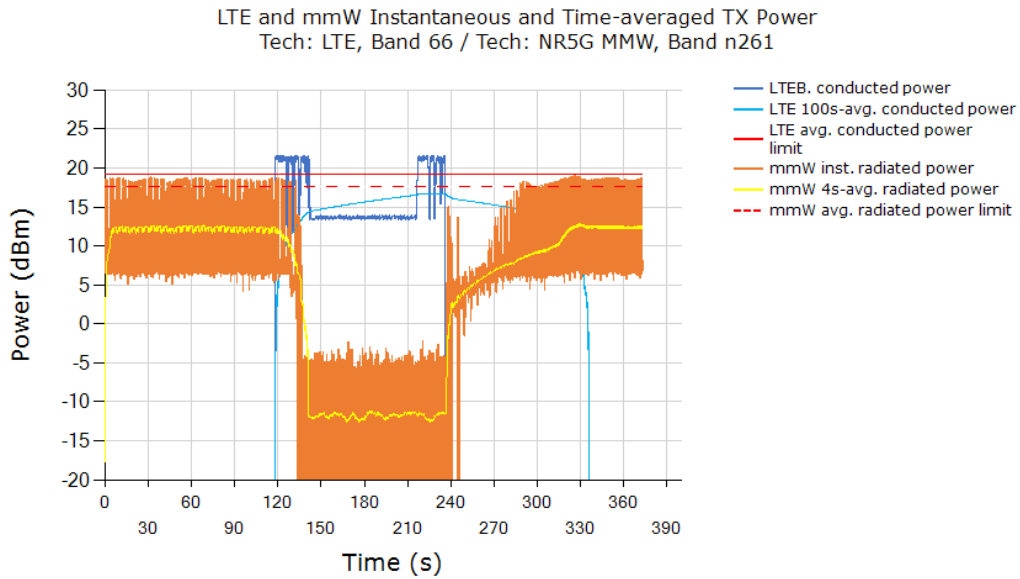

From the above plot, it is predominantly instantaneous PD exposure between 0s ~ 120s, it is instantaneous SAR+PD exposure between 120s ~ 140s, it is predominantly instantaneous SAR exposure between 140s ~ 240s, and above 240s, it is predominantly instantaneous PD exposure.

Normalized time-averaged exposures for LTE (1gSAR) and mmW (4cm²PD), as well as total normalized time-averaged exposure versus time:



Total Normalized Time-averaged RF Exposure
 Tech: LTE, Band 66 / Tech: NR5G MMW, Band n261

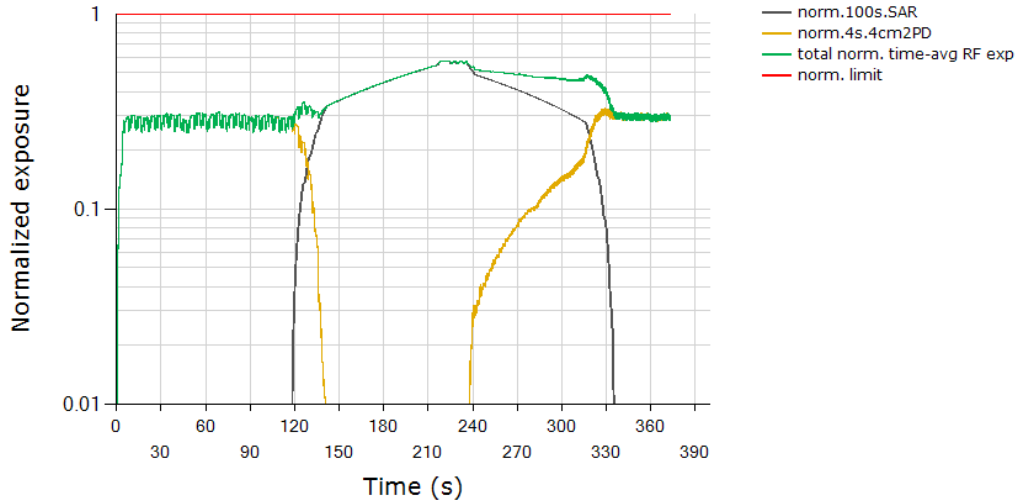

	Exposure Ratio
FCC requirement for total RF exposure (normalized)	1.0
Max total normalized time-averaged RF exposure (green curve)	0.573
Validated	

Plot notes: ...

5G mmW NR call was established at ~0s time mark and LTE was placed in all-down bits immediately after 5G mmW NR call was established. Between 0s~120s, mmW exposure is the dominant contributor. Here, Smart Transmit feature allocates a maximum of 75% for mmW. From Table 8-1, this corresponds to a normalized 4cm2PD exposure value for Beam ID 20 of $(75\% * 4.22 \text{ W/m}^2) / (10 \text{ W/m}^2) = 31.7\% \pm 2.1\text{dB}$ device related uncertainty (see orange/green curve between 0s~120s). At ~120s time mark, LTE is set to all-up bits, taking away margin from mmW exposure gradually (orange curve for mmW exposure goes down while black curve for LTE exposure goes up). At ~240s time mark, LTE is set to all-down bits, which results in mmW getting back RF margin slowly as seen by gradual increase in mmW exposure (orange curve for mmW exposure goes up while black curve for LTE exposure goes down). The calculated maximum RF exposure from LTE corresponds to normalized 1gSAR exposure value of $(100\% * 0.872 \text{ W/kg}) / (1.6 \text{ W/kg}) = 54.5\% +1.0\text{dB} \sim -1.0\text{dB}$ design related uncertainty.

As can be seen, the power limiting enforcement is effective during transmission when SAR and PD exposures are switched, and the total normalized time-averaged RF exposure does not exceed 1.0. Therefore, Qualcomm® Smart Transmit time averaging feature is validated.



8.2.4 Switch in SAR vs. PD exposure test results for n260

This test was measured with LTE Band 66 (DSI =2) and mmW Band n260 Beam ID 31, by following the detailed test procedure is described in Section 4.3.2.

Instantaneous and 100s-averaged conducted LTE Tx power versus time, instantaneous and 4s-averaged radiated mmW Tx power versus time, time-averaged conducted LTE Tx power limit and time-averaged radiated mmW Tx power limit:

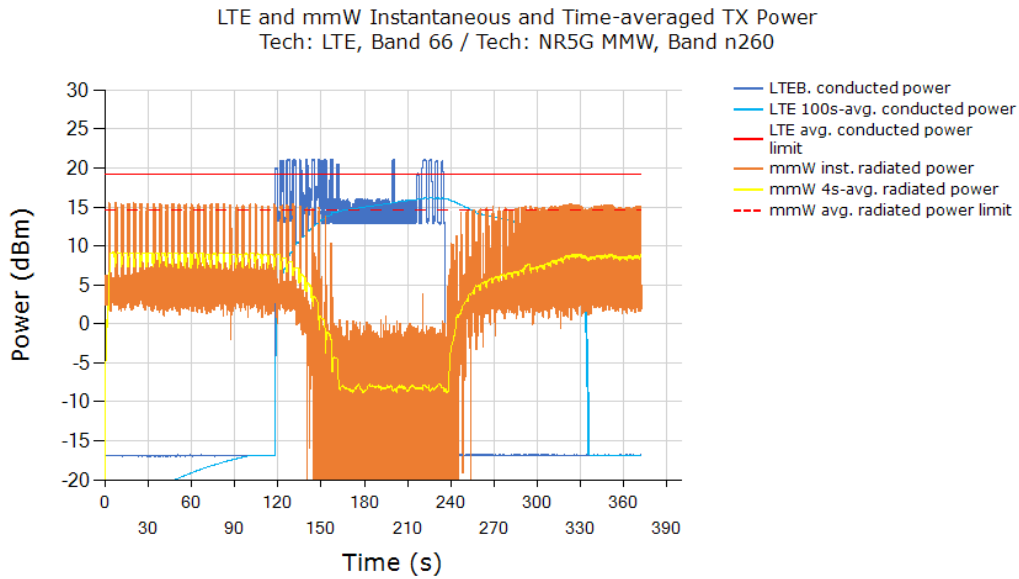

From the above plot, it is predominantly instantaneous PD exposure between 0s ~ 120s, it is instantaneous SAR+PD exposure between 120s ~ 160s, it is predominantly instantaneous SAR exposure between 160s ~ 240s, and above 240s, it is predominantly instantaneous PD exposure.

Normalized time-averaged exposures for LTE (1gSAR) and mmW (4cm²PD), as well as total normalized time-averaged exposure versus time:



Total Normalized Time-averaged RF Exposure
 Tech: LTE, Band 66 / Tech: NR5G MMW, Band n260

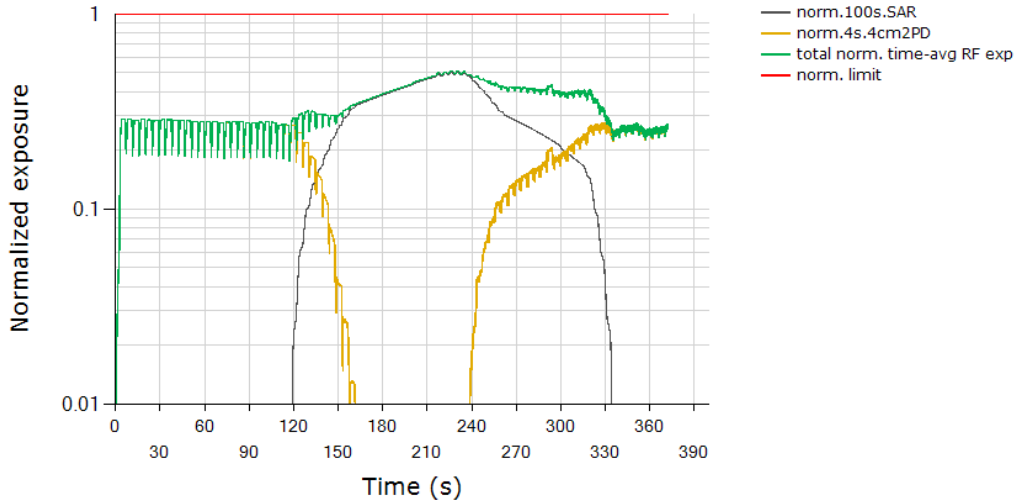

	Exposure Ratio
FCC requirement for total RF exposure (normalized)	1.0
Max total normalized time-averaged RF exposure (green curve)	0.513
Validated	

Plot notes: ...

5G mmW NR call was established at ~0s time mark and LTE was placed in all-downbits immediately after 5G mmW NR call was established. Between 0s~120s, mmW exposure is the dominant contributor. Here, Smart Transmit feature allocates a maximum of 75% for mmW. From Table 8-1, this corresponds to a normalized 4cm2PD exposure value for Beam ID 31 of $(75\% * 2.81 \text{ W/m}^2)/(10 \text{ W/m}^2) = 21.1\% \pm 2.1\text{dB}$ device related uncertainty (see orange/green curve between 0s~120s). At ~120s time mark, LTE is set to all-up bits, taking away margin from mmW exposure gradually (orange curve for mmW exposure goes down while black curve for LTE exposure goes up). At ~240s time mark, LTE is set to all-down bits, which results in mmW getting back RF margin slowly as seen by gradual increase in mmW exposure (orange curve for mmW exposure goes up while black curve for LTE exposure goes down). The calculated maximum RF exposure from LTE corresponds to normalized 1gSAR exposure value of $(100\% * 0.872 \text{ W/kg})/(1.6 \text{ W/kg}) = 54.5\% +\text{"}+1.0\text{dB} \sim -1.0\text{dB}\text{"}$ design related uncertainty

As can be seen, the power limiting enforcement is effective during transmission when SAR and PD exposures are switched, and the total normalized time-averaged RF exposure does not exceed 1.0. Therefore, Qualcomm® Smart Transmit time averaging feature is validated



8.2.5 Change in Beam test results for n261

This test was measured with LTE Band 66 (DSI = 2) and mmW Band n261, with beam switch from Beam ID 20 to Beam ID 0, by following the test procedure is described in Section 4.3.3.

Instantaneous conducted LTE Tx power versus time, instantaneous and 4s-averaged radiated mmW Tx power versus time, time-averaged radiated mmW Tx power limits for beam 20 and beam 0:

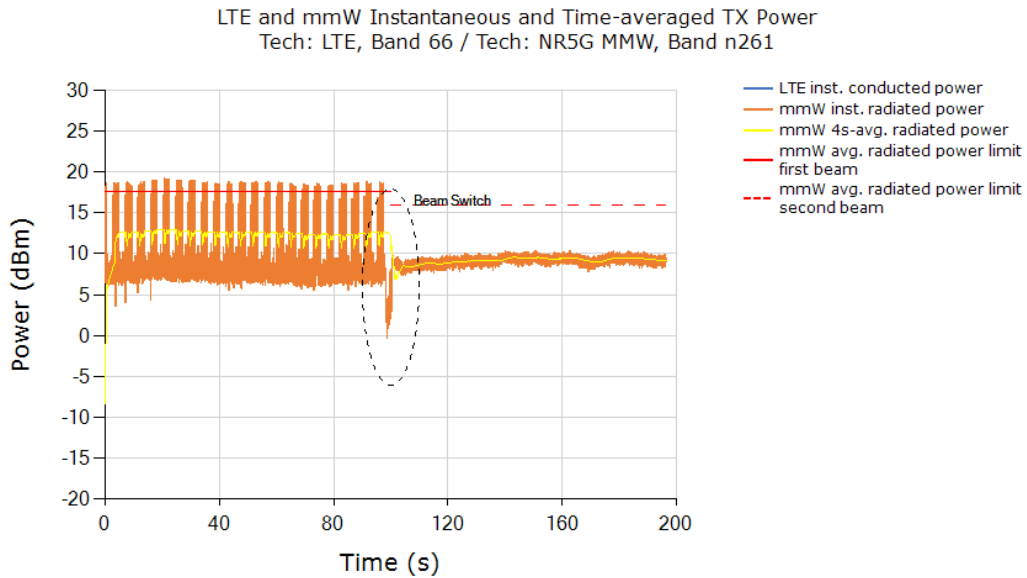

Normalized time-averaged exposures for LTE and mmW ($4\text{cm}^2\text{PD}$), as well as total normalized time-averaged exposure versus time:



Total Normalized Time-averaged RF Exposure
Tech: LTE, Band 66 / Tech: NR5G MMW, Band n261

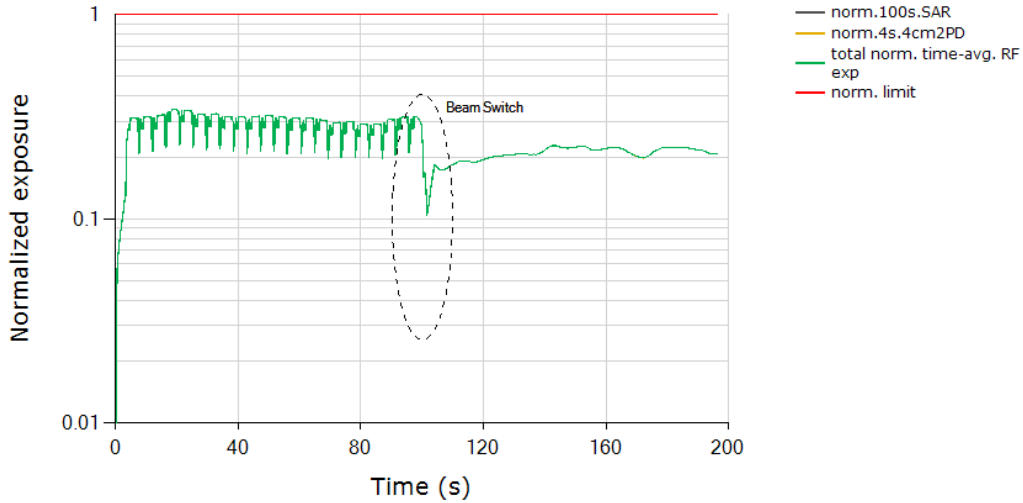

	Exposure Ratio
FCC requirement for total RF exposure (normalized)	1.0
Max total normalized time-averaged RF exposure (green curve)	0.341
Validated	

Plot notes: ...

5G mmW NR call was established at ~10s time mark and LTE was placed in all-down bits during the test. For this test, mmW exposure is the dominant contributor as LTE is left in all-down bits. Here, Smart Transmit feature allocates a maximum of 75% for mmW. From Table 8-1 exposure between 10s ~100s corresponds to a normalized 4cm2PD exposure value for Beam ID 20 of $(75\% * 4.22 \text{ W/m}^2)/(10 \text{ W/m}^2) = 31.7\% \pm 2.1\text{dB}$ device related uncertainty. At ~100s time mark (shown in black dotted ellipse), beam was switched to Beam ID 0 resulting in a normalized 4cm2PD exposure value of $(75\% * 2.35 \text{ W/m}^2)/(10 \text{ W/m}^2) = 17.63\% \pm 2.1\text{dB}$ device related uncertainty. Additionally, during the switch, the ratio between the averaged radiated powers of the two beams (yellow curve) should correspond to the difference in EIRPs measured at each corresponding input.power.limit for these beams listed in Table 8-1, i.e., $2.1\text{dB} \pm 2.1\text{dB}$ device uncertainty.

As can be seen, the power limiting enforcement is effective during transmission when SAR and PD exposures are switched, and the total normalized time-averaged RF exposure does not exceed 1.0. Therefore, Qualcomm® Smart Transmit time averaging feature is validated



8.2.6 Change in Beam test results for n260

This test was measured with LTE Band 66 (DSI = 2) and mmW Band n260, with beam switch from Beam ID 43 to Beam ID 2, by following the test procedure is described in Section 4.3.3.

Instantaneous conducted LTE Tx power versus time, instantaneous and 4s-averaged radiated mmW Tx power versus time, time-averaged radiated mmW Tx power limits for beam 43 and beam 2:

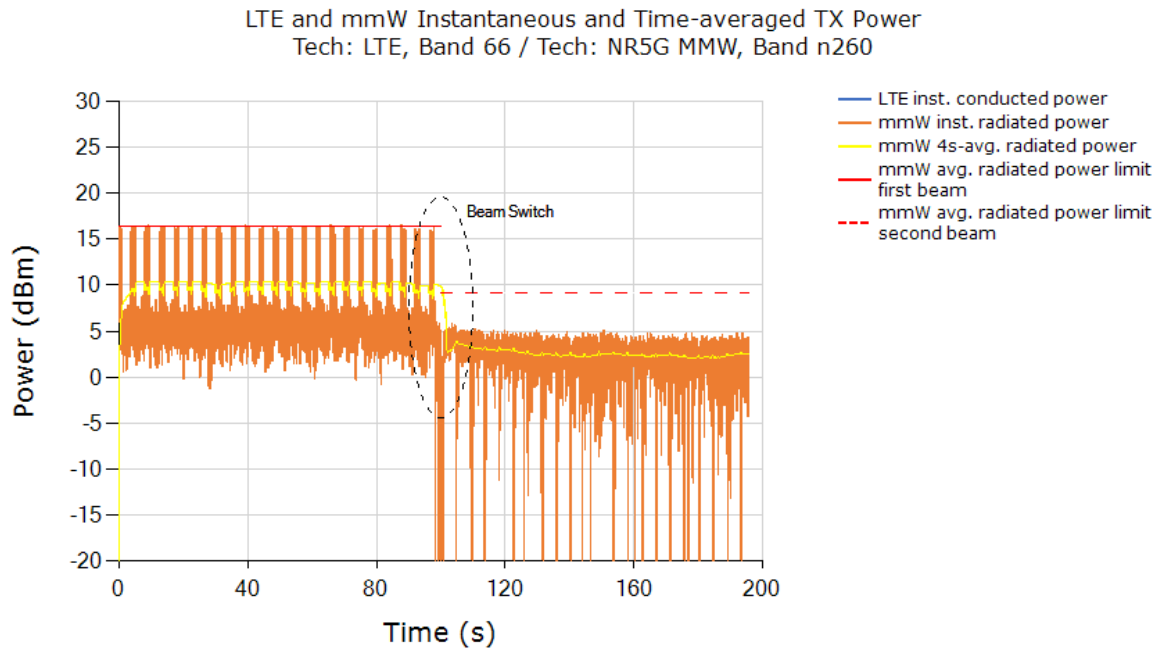

Normalized time-averaged exposures for LTE and mmW (4cm²PD), as well as total normalized time-averaged exposure versus time:



Total Normalized Time-averaged RF Exposure
Tech: LTE, Band 66 / Tech: NR5G MMW, Band n260

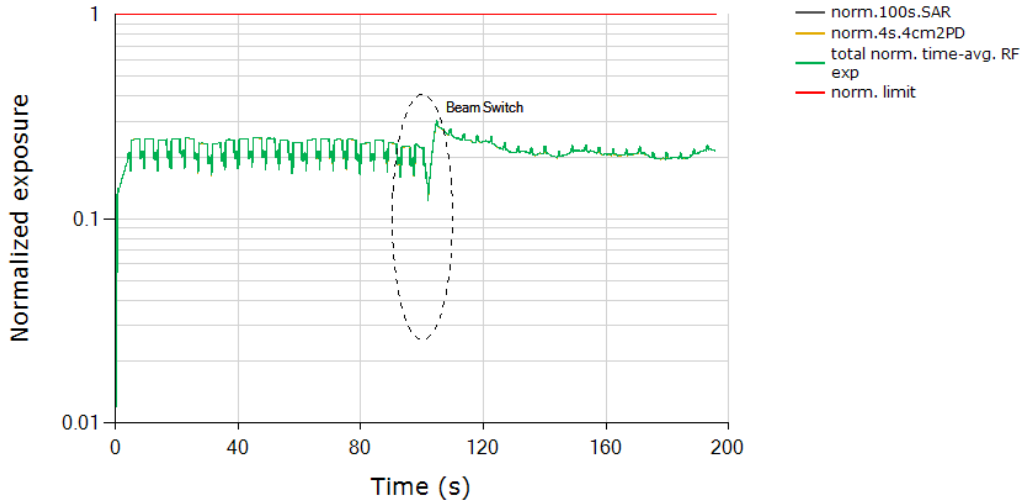

	Exposure ratio
FCC requirement for total RF exposure (normalized)	1.0
Max total normalized time-averaged RF exposure (green curve)	0.301
Validated	

Plot notes: ...

5G mmW NR call was established at ~10s time mark and LTE was placed in all-down bits during this test. For this test, mmW exposure is the dominant contributor as LTE is left in all-down bits. Here, Smart Transmit feature allocates a maximum of 75% for mmW. From Table 8-1 exposure between 10s ~100s corresponds to a normalized 4cm2PD exposure value for Beam ID 43 of $(75\% * 3.13 \text{ W/m}^2) / (10 \text{ W/m}^2) = 23.5\% \pm 2.1\text{dB}$ device related uncertainty. At ~100s time mark (shown in black dotted ellipse), beam was switched to Beam ID 2 resulting in a normalized 4cm2PD exposure value of $(75\% * 4.56 \text{ W/m}^2) / (10 \text{ W/m}^2) = 34.2\% \pm 2.1\text{dB}$ device related uncertainty. Additionally, during the switch, the ratio between the averaged radiated powers of the two beams (yellow curve) should correspond to the difference in EIRPs measured at each corresponding input.power.limit for these beams listed in Table 8-1, i.e., $2.1\text{dB} \pm 2.1\text{dB}$ device uncertainty.

As can be seen, the power limiting enforcement is effective during switching beam switching, and the normalized time-averaged RF exposure does not exceed 1.0. Therefore, Qualcomm® Smart Transmit time averaging feature is validated

9 PD Test Results for mmW Smart Transmit Feature Validation

9.1 Measurement setup

The measurement setup is similar to normal PD measurements, the EUT is positioned on cDASY6 platform, and is connected with the callbox (conducted for LTE and wirelessly for mmW). Keysight UXM callbox is set to request maximum mmW Tx power from EUT all the time. Hence, “path loss” calibration between callbox antenna and EUT is not needed in this test. The callbox’s LTE port is directly connected to the EUT’s RF port via a directional coupler to measure the EUT’s conducted Tx power using a Rohde & Schwarz NR8S power sensor. Additionally, EUT is connected to the PC via USB connection for toggling between FTM and online mode with Smart Transmit enabled following the test procedures described Section 4.4.

Figure 9-1 shows the schematic of this measurement setup.

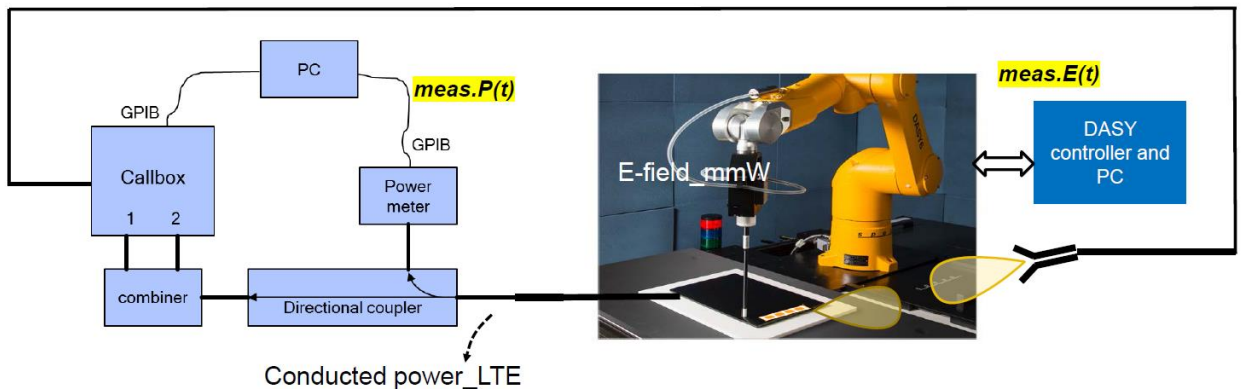

Figure 9-1 PD measurement setup

Both callbox and power meters are connected to the PC using USB cables. Test scripts are custom made for automation of establishing LTE + mmW call, and for conducted Tx power recording of LTE transmission. These tests are manually stopped after desired time duration. Once the mmW link is established, LTE Tx power is programmed to toggle between all-up and all-down bits on the callbox. For all the tests, the callbox is set to request maximum Tx power in mmW NR radio from EUT all the time. Therefore, the calibration for the pathloss between the EUT and the horn antenna connected to the remote radio head of the callbox is not required.

Power meter readings are periodically recorded every 10ms on NR8S power sensor for LTE conducted Tx power. Time-averaged E-field measurements are performed using EUmmWVx mmW probe at peak location of fast area scan. The distance between EUmmWVx mmW probe tip to EUT surface is ~0.5 mm, and the distance between EUmmWVx mmW probe sensor to probe tip is 1.5 mm. cDASY6 records relative point E-field (i.e., ratio $\frac{[pointE(t)]^2}{[pointE_input.power.limit]^2}$) versus time for mmW NR transmission.



9.2 PD measurement results for maximum power transmission scenario

The following configurations were measured by following the detailed test procedure is described in Section 4.4:

1. LTE Band 66 (DSI =2) and mmW Band n261 Beam ID 20
2. LTE Band 66 (DSI =2) and mmW Band n260 Beam ID 31

The measured conducted Tx power of LTE and ratio of $\frac{[pointE(t)]^2}{[pointE_input.power.limit]^2}$ of mmW is converted into 1gSAR and 4cm²PD value, respectively, using Eq. (4a) and (4b), rewritten below:

$$1g_or_10gSAR(t) = \frac{conducted_Tx_power(t)}{conducted_Tx_power_P_limit} * 1g_or_10gSAR_P_limit \quad (4a)$$

$$4cm^2PD(t) = \frac{[pointE(t)]^2}{[pointE_input.power.limit]^2} * 4cm^2PD_input.power.limit \quad (4b)$$

$$\frac{\frac{1}{T_{SAR}} \int_{t-T_{SAR}}^t 1g_or_10gSAR(t) dt}{FCC SAR limit} + \frac{\frac{1}{T_{PD}} \int_{t-T_{PD}}^t 4cm^2PD(t) dt}{FCC 4cm^2PD limit} \leq 1 \quad (4c)$$

where, *conducted_Tx_power(t)*, *conducted_Tx_power_P_limit*, and *1g_or_10gSAR_P_limit* correspond to the measured instantaneous conducted Tx power, measured conducted Tx power at *P_limit*, and measured 1gSAR or 10gSAR values at *P_limit* corresponding to LTE transmission. Similarly, *pointE(t)*, *pointE_input.power.limit*, and *4cm²PD@input.power.limit* correspond to the measured instantaneous E-field, E-field at *input.power.limit*, and 4cm²PD value at *input.power.limit* corresponding to mmW transmission.

NOTE: cDASY6 system measures relative E-field, and provides ratio of

$$\frac{[pointE(t)]^2}{[pointE_input.power.limit]^2} \text{ versus time.}$$

The radio configurations tested are described in Table 5-3 and 5-4. The 1gSAR at *P_limit* for LTE Band 66 DSI = 2, the measured 4cm²PD at *input.power.limit* of mmW n261 beam 20, and n260 beam 31, are all listed in Table 8-1.



9.2.1 PD test results for n261

Step 2.e plot (in Section 4.4) for normalized instantaneous and time-averaged exposures for LTE and mmW n261 beam 20:

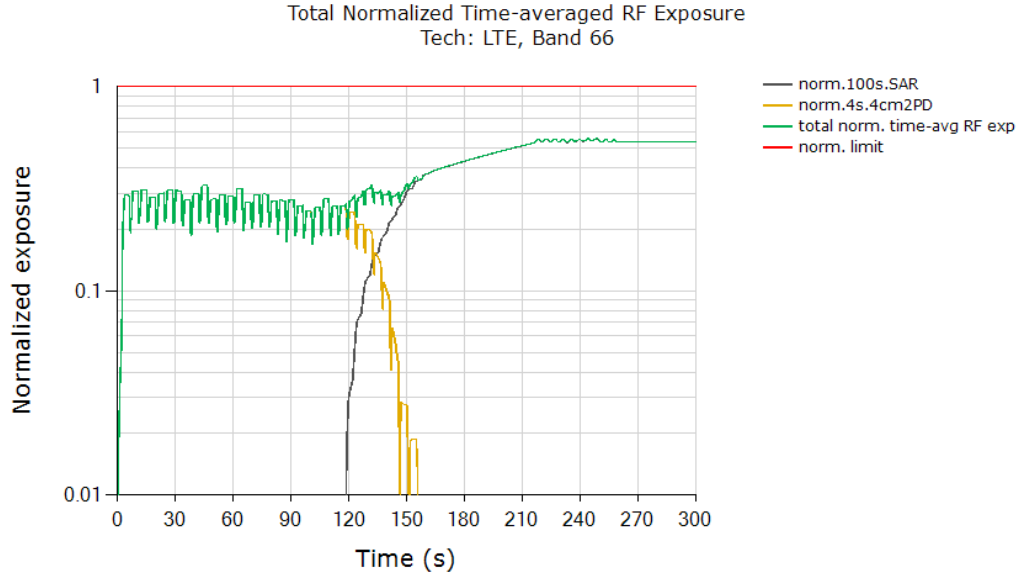

FCC limit for total RF exposure (normalized)	1.0
Max total normalized time-averaged RF exposure (green curve)	0.555
Validated	

Plot notes: ...

LTE was placed in all-down bits immediately after 5G mmW NR call was established. Between 0s~120s, mmW exposure is the dominant contributor. Here, Smart Transmit feature allocates a maximum of 75% for mmW. From Table 8-1, this corresponds to a normalized 4cm2PD exposure value for Beam ID 20 of $(75\% * 4.22 \text{ W/m}^2)/(10 \text{ W/m}^2) = 31.7\% \pm 2.1\text{dB}$ device related uncertainty (see orange/green curve between 0s~120s). Around 120s time mark, LTE is set to all-up bits, taking away margin from mmW exposure gradually. Towards the end of the test, LTE is the dominant contributor towards RF exposure, i.e., corresponding normalized 1gSAR exposure value of $(100\% * 0.872 \text{ W/kg})/(1.6 \text{ W/kg}) = 54.5\% + " +1.0\text{dB} \sim -1.0\text{dB} "$ design related uncertainty.

As can be seen, the power limiting enforcement is effective and the total normalized time-averaged RF exposure does not exceed 1.0. Therefore, Qualcomm® Smart Transmit time averaging feature is validated.



9.2.2 PD test results for n260

Step 2.e plot (in Section4.4) for normalized instantaneous and time-averaged exposures for LTE and mmW n260 beam 31

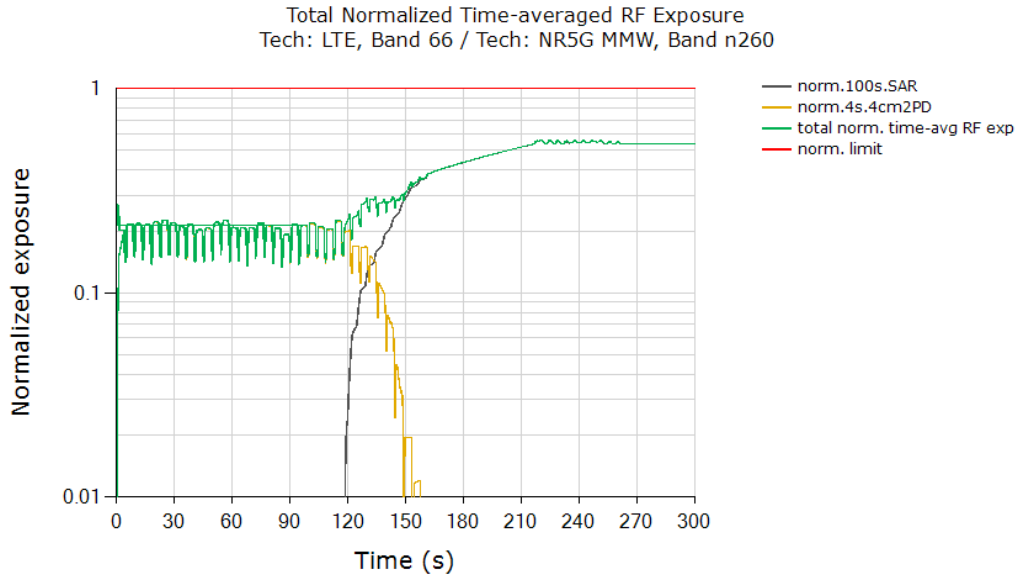

FCC limit for total RF exposure	1.0
Max total normalized time-averaged RF exposure (green curve)	0.557
Validated	

Plot notes:

LTE was placed in all-down bits immediately after 5G mmW NR call was established. Between 0s~120s, mmW exposure is the dominant contributor. Here, Smart Transmit feature allocates a maximum of 75% for mmW. From Table 8-1, this corresponds to a normalized 4cm2PD exposure value for Beam ID 31 of $(75\% * 2.81 \text{ W/m}^2)/(10 \text{ W/m}^2) = 21.1\% \pm 2.1\text{dB}$ device related uncertainty (see orange/green curve between 0s~120s). Around 120s time mark, LTE is set to all-up bits, taking away margin from mmW exposure gradually. Towards the end of the test, LTE is the dominant contributor towards RF exposure, i.e., corresponding normalized 1gSAR exposure value of $(100\% * 0.872 \text{ W/kg})/(1.6 \text{ W/kg}) = 54.5\% +\text{"}+1.0\text{dB} \sim -1.0\text{dB}\text{"}$ design related uncertainty.

As can be seen, the power limiting enforcement is effective and the total normalized time-averaged RF exposure does not exceed 1.0. Therefore, Qualcomm® Smart Transmit time averaging feature is validated



10 Conclusions

Qualcomm Smart Transmit feature employed in ZNFV600VM has been validated through the conducted/radiated power measurement (as demonstrated in Chapters 6 and 8), as well as SAR and PD measurement (as demonstrated in Chapters 7 and 9).

As demonstrated in this report, the power limiting enforcement is effective and the total normalized time-averaged RF exposure does not exceed 1.0 for all the transmission scenarios described in Section 2. Therefore, the EUT complies with FCC RF exposure requirement



Appendix A. Test Sequences

1. Test sequence is generated based on below parameters of the EUT:
 - a. Measured maximum power (P_{max})
 - b. Measured Tx_power_at_SAR_design_target (P_{limit})
 - c. Reserve_power_margin (dB)
 - $P_{reserve}$ (dBm) = measured P_{limit} (dBm) – Reserve_power_margin (dB)
 - d. SAR_time_window (100s for FCC)
2. Test Sequence 1 Waveform:

Based on the parameters above, the Test Sequence 1 is generated with one transition between high and low Tx powers. Here, high power = P_{max} ; low power = $P_{max}/2$, and the transition occurs after 80 seconds at high power P_{max} . As long as the power enforcement is taking into effective during one 100s/60s time window, the validation test with this defined test sequence 1 is valid, otherwise, select other radio configuration (band/DSI within the same technology group) having lower P_{limit} for this test. The Test sequence 1 waveform is shown below:

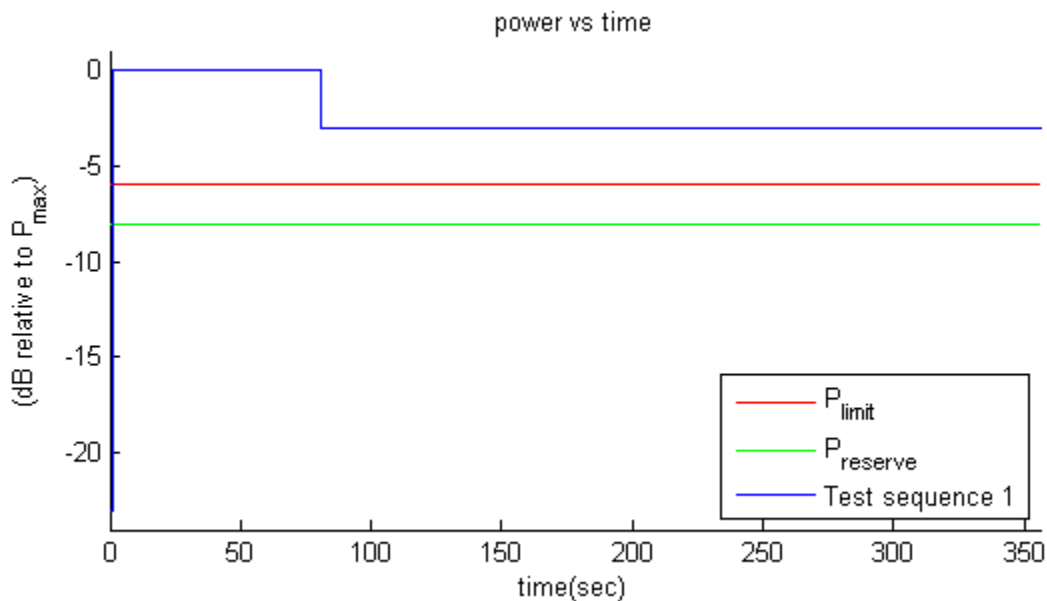

Figure 0-1 Test sequence 1 waveform



3. Test Sequence 2 Waveform:

Based on the parameters in A-1, the Test Sequence 2 is generated as described in Table 10-1, which contains two 170 second-long sequences (yellow and green highlighted rows) that are mirrored around the center row of 20s, resulting in a total duration of 360 seconds:

Table 0-1 Test Sequence 2

Time duration (seconds)	dB relative to P_{limit} or $P_{reserve}$
15	$P_{reserve} - 2$
20	P_{limit}
20	$(P_{limit} + P_{max})/2$ averaged in mW and rounded to nearest 0.1 dB step
10	$P_{reserve} - 6$
20	P_{max}
15	P_{limit}
15	$P_{reserve} - 5$
20	P_{max}
10	$P_{reserve} - 3$
15	P_{limit}
10	$P_{reserve} - 4$
20	$(P_{limit} + P_{max})/2$ averaged in mW and rounded to nearest 0.1 dB step
10	$P_{reserve} - 4$
15	P_{limit}
10	$P_{reserve} - 3$
20	P_{max}
15	$P_{reserve} - 5$
15	P_{limit}
20	P_{max}
10	$P_{reserve} - 6$
20	$(P_{limit} + P_{max})/2$ averaged in mW and rounded to nearest 0.1 dB step
20	P_{limit}
15	$P_{reserve} - 2$



The Test Sequence 2 waveform is shown in Figure A-2.

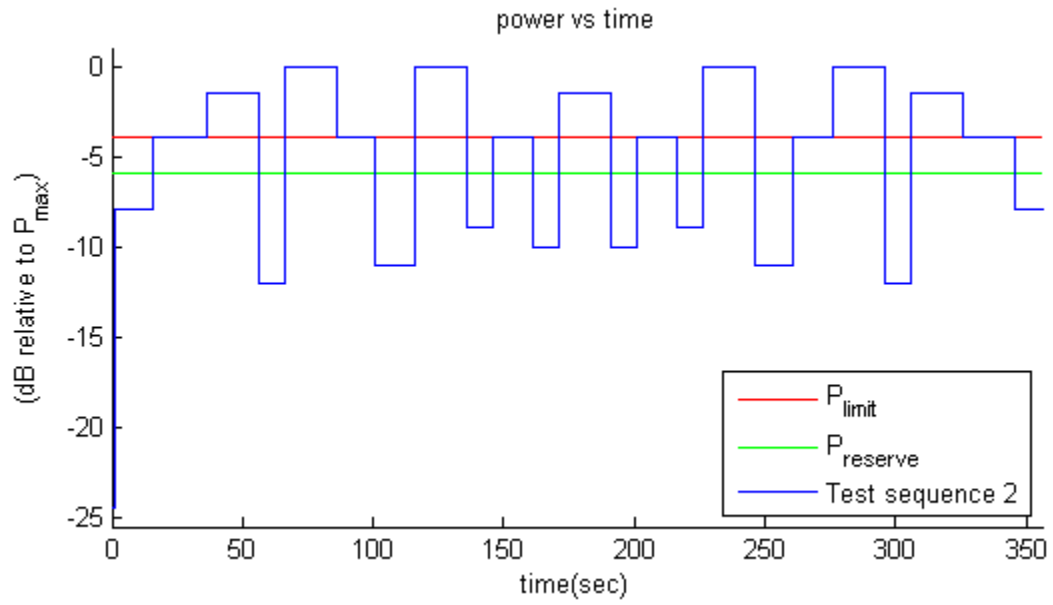



Appendix B. Test Procedures for sub6 NR + LTE Radio

Appendix B provides the test procedures for validating Qualcomm Smart Transmit feature for LTE + Sub6 NR non-standalone (NSA) mode transmission scenario, where sub-6GHz LTE link acts as an anchor.

1 Time-varying Tx power test for sub6 NR in NSA mode

Follows Section 3.2.1 to select test configurations for time-varying test. This test is performed with two pre-defined test sequences (described in Section 3.1) applied to Sub6 NR (with LTE on all-down bits or low power for the entire test after establishing the LTE+Sub6 NR call with the callbox). Follow the test procedures described in Section 3.3.1 to demonstrate the effectiveness of power limiting enforcement and that the time averaged Tx power of Sub6 NR when converted into 1gSAR values does not exceed the regulatory limit at all times (see Eq. (1a) and (1b)). Sub6 NR response to test sequence1 and test sequence2 will be similar to other technologies (say, LTE), and are shown in Sections 6.3.7 and 6.3.8.

2 Switch in SAR exposure between LTE vs. Sub6 NR during transmission

This test is to demonstrate that Smart Transmit feature accurately accounts for switching in exposures among SAR for LTE radio only, SAR from both LTE radio and sub6 NR, and SAR from sub6 NR only scenarios, and ensures total time-averaged RF exposure compliance with FCC limit.

Test procedure:

1. Measure conducted Tx power corresponding to P_{limit} for LTE and sub6 NR in selected band. Test condition to measure conducted P_{limit} is:
 - Establish device in call with the callbox for LTE in desired band. Measure conducted Tx power corresponding to LTE P_{limit} with Smart Transmit enabled and *Reserve_power_margin* set to 0 dB, callbox set to request maximum power.
 - Repeat above step to measure conducted Tx power corresponding to Sub6 NR P_{limit} . If testing LTE+Sub6 NR in non-standalone mode, then establish LTE+Sub6 NR call with callbox and request all down bits for radio1 LTE. In this scenario, with callbox requesting maximum power from Sub6 NR, measured conducted Tx power corresponds to radio2 P_{limit} (as radio1 LTE is at all-down bits)
2. Set *Reserve_power_margin* to actual (intended) value with EUT setup for LTE + Sub6 NR call. First, establish LTE connection in all-up bits with the callbox, and then Sub6 NR connection is added with callbox requesting UE to transmit at maximum power in Sub6 NR. As soon as the Sub6 NR connection is established, request all-down bits on LTE link (otherwise, Sub6 NR will not have sufficient RF exposure margin to sustain the call with LTE in all-up bits). Continue LTE (all-down bits)+Sub6 NR transmission for more than one time-window duration to test predominantly Sub6 NR SAR exposure scenario (as SAR exposure is negligible from all-down bits in



LTE). After at least one time-window, request LTE to go all-up bits to test LTE SAR and Sub6 NR SAR exposure scenario. After at least one more time-window, drop (or request all-down bits) Sub6 NR transmission to test predominantly LTE SAR exposure scenario. Continue the test for at least one more time-window. Record the conducted Tx powers for both LTE and Sub6 NR for the entire duration of this test.

3. Once the measurement is done, extract instantaneous Tx power versus time for both LTE and Sub6 NR links. Similar to technology/band switch test in Section 3.3.3, convert the conducted Tx power for both these radios into 1gSAR value (see Eq. (6a) and (6b)) using corresponding technology/band P_{limit} measured in Step 1, and then perform 100s running average to determine time-averaged 1gSAR versus time as illustrated in Figure 3-1.
4. Make one plot containing: (a) instantaneous Tx power versus time measured in Step 2.
5. Make another plot containing: (a) instantaneous 1gSAR versus time determined in Step 3, (b) computed time-averaged 1gSAR versus time determined in Step 3, and (c) corresponding regulatory $1gSAR_{limit}$ of 1.6W/kg.

The validation criteria is, at all times, the time-averaged 1gSAR versus time shall not exceed the regulatory $1gSAR_{limit}$ of 1.6W/kg.



Appendix C. cDASY6 System Verification

1. EUmmWave Probe

The probe design allows measurements at distances as small as 2 mm from the sensors to the surface of the device under test (DUT). The typical sensor to probe tip distance is 1.5 mm.

Frequency	750 MHz – 110 GHz
Probe Overall Length	320 mm
Probe Body Diameter	8.0 mm
Tip Length	23.0 mm
Tip Diameter	8.0 mm
Probe's two dipoles length	0.9 mm – Diode loaded
Dynamic Range	< 20 V/m - 10000 V/m with PRE-10 (min < 50 V/m - 3000 V/m)
Position Precision	< 0.2 mm
Distance between diode sensors and probe's tip	1.5 mm
Minimum Mechanical separation between probe tip and a Surface	0.5 mm
Applications	E-field measurements of 5G devices and other mm-wave transmitters operating above 10GHz in < 2 mm distance from device (free-space) Power density, H-field and far-field analysis using total field reconstruction.
Compatibility	cDASY6 + 5G-Module SW1.0 and higher

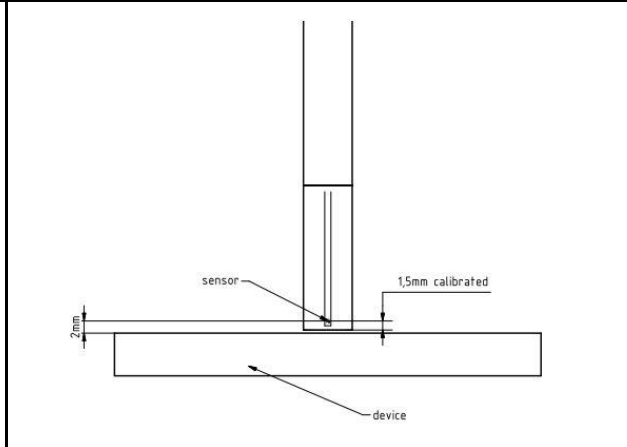
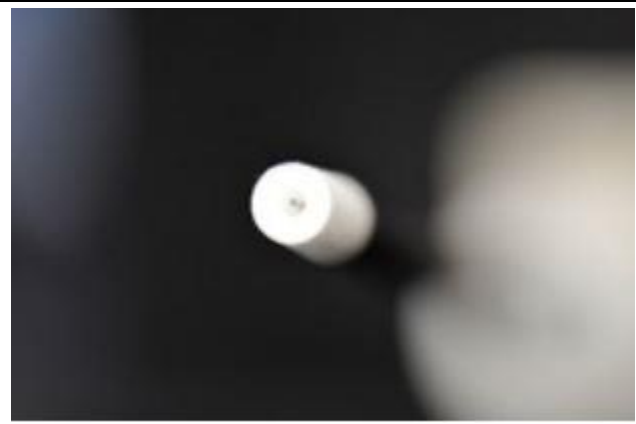

2. E UmmWave Verification source

Model	Ka-band horn antenna
Calibrated frequency:	30 GHz at 10mm from the case surface
Frequency accuracy	± 100 MHz
E-field polarization	linear
Harmonics	-20 dBc
Total radiated power	14 dBm
Power stability	0.05 dB
Power consumption	5 W
Size	00 x 100 x 100 mm
Weight	1 kg

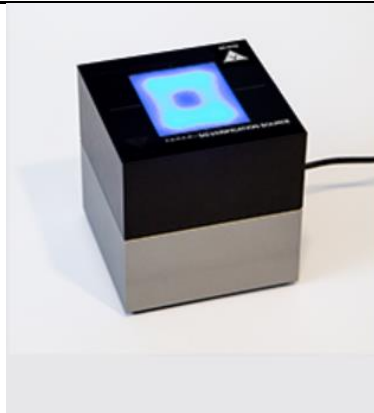

3. SAR E-Field Probe

Construction	Symmetric design with triangular core Built-in shielding against static charges PEEK enclosure material (resistant to organic solvents, e.g., DGBE)	
Frequency	10 MHz – >6 GHz Linearity: ±0.2 dB (30 MHz – 6 GHz)	
Directivity	±0.3 dB in TSL (rotation around probe axis) ±0.5 dB in TSL (rotation normal to probe axis)	
Dynamic Range	10 µW/g – >100 mW/g Linearity: ±0.2 dB (noise: typically <1 µW/g)	
Dimensions	Overall length: 337 mm (tip: 20 mm) Tip diameter: 2.5 mm (body: 12 mm) Typical distance from probe tip to dipole centers: 1 mm	



4. Data Acquisition Electronics (DAE)

The data acquisition electronics (DAE) consists of a highly sensitive electrometer-grade preamplifier with auto-zeroing, a channel and gain-switching multiplexer, a fast 16 bit AD-converter and a command decoder and control logic unit. Transmission to the measurement server is accomplished through an optical downlink for data and status information as well as an optical uplink for commands and the clock.

The input impedance of the DAE is 200 MOhm; the inputs are symmetrical and floating. Common mode rejection is above 80 dB.

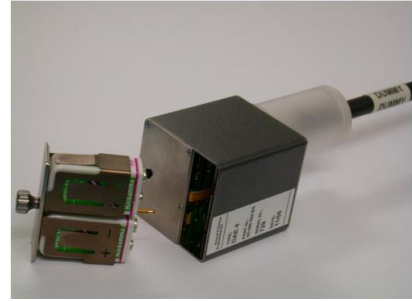



5. Test Equipment List

Manufacturer	Name of Equipment	Type/Model	Serial Number	Calibration	
				Last Cal.	Due Date
Keysight	Wireless Communication Test Set	UXM	MY58300712	Jun. 27, 2019	Jun. 26, 2020
Bojay	mmwave measurement horn antenna	AQRH-15	000023	Note 1	
R&S	Base Station	CMW500	115793	Jun. 04, 2019	Jun. 03, 2020
R&S	Power Sensor	NRP50S	100983	Aug. 09, 2019	Aug. 08, 2020
R&S	Power Sensor	NRP8S	103999	Jan. 13, 2020	Jan. 12, 2021
SPEAG	835MHz System Validation Kit	D835V2	4d167	Nov. 25, 2019	Nov. 24, 2020
SPEAG	1750MHz System Validation Kit	D1750V2	1068	Nov. 19, 2018	Nov. 17, 2020
SPEAG	1900MHz System Validation Kit	D1900V2	5d041	Sep. 11, 2018	Sep. 09, 2020
SPEAG	2300MHz System Validation Kit	D2300V2	1006	Jan. 28, 2019	Jan. 26, 2021
SPEAG	2600MHz System Validation Kit	D2600V2	1078	Mar. 06, 2019	Mar. 05, 2020
SPEAG	5G Verification Source	30 GHz	1007	Nov. 19, 2019	Nov. 18, 2020
SPEAG	Data Acquisition Electronics	DAE4	376	Dec. 06, 2019	Dec. 05, 2020
SPEAG	Dosimetric E-Field Probe	EX3DV4	3931	Sep. 26, 2019	Sep. 25, 2020
SPEAG	E-Field mmWave Probe	EUmmWV4	9461	Nov. 05, 2019	Nov. 04, 2020
RCPTWN	Thermometer	HTC-1	TM685-1	Nov. 12, 2019	Nov. 11, 2020
Testo	Hygro meter	608-H1	34893240	Nov. 07, 2019	Nov. 06, 2020
Anritsu	Power Meter	ML2495A	1419002	May. 29, 2019	May. 28, 2020
Anritsu	Power Sensor	MA2411B	1339124	May. 29, 2019	May. 28, 2020
Mini-Circuits	Power Amplifier	ZHL-42W+	321501827	Aug. 12, 2019	Aug. 11, 2020
Agilent	Spectrum Analyzer	N9010A	MY54200486	Oct. 28, 2019	Oct. 27, 2020
Rohde & Schwarz	Signal Generator	SMB100A	101107	Aug. 27, 2019	Aug. 26, 2020
SCHWARZBECK	18-40 GHz Horn antenna	BBHA9170	BBHA9170576	May. 14, 2019	May. 13, 2020
Warison	10-50 GHz Directional Coupler	WCOU-10-50S-10	WR889BMC481	Note 1	
ATM	500M-18GHz Dual Directional Coupler	C122H-10	P610410z-02	Note 1	
Woken	Attenuator 1	WK0602-XX	N/A	Note 1	
PE	Attenuator 2	PE7005-10	N/A	Note 1	
PE	Attenuator 3	PE7005- 3	N/A	Note 1	

General Note:

1. Prior to system verification and validation, the path loss from the signal generator to the system check source and the power meter, which includes the amplifier, cable, attenuator and directional coupler, was measured by the network analyzer. The reading of the power meter was offset by the path loss difference between the path to the power meter and the path to the system check source to monitor the actual power level fed to the system check source.
2. Referring to KDB 865664 D01v01r04, the dipole calibration interval can be extended to 3 years with justification. The dipoles are also not physically damaged, or repaired during the interval.
3. The justification data of dipole D1750V2, SN: 1068, D1900V2, SN: 5d041, D2300V2, SN: 1006 can be found in appendix C. The return loss is < -20dB, within 20% of prior calibration, the impedance is within 5 ohm of prior calibration.



6. SAR system verification and validation

6.1 Tissue Verification

The following tissue formulations are provided for reference only as some of the parameters have not been thoroughly verified. The composition of ingredients may be modified accordingly to achieve the desired target tissue parameters required for routine SAR evaluation.

Frequency (MHz)	Water (%)	Sugar (%)	Cellulose (%)	Salt (%)	Preventol (%)	DGBE (%)	Conductivity (σ)	Permittivity (ϵ_r)
835	40.3	57.9	0.2	1.4	0.2	0	0.90	41.5
1750, 1900, 2000	55.2	0	0	0.3	0	44.5	1.40	40.0
2300	55.0	0	0	0	0	45.0	1.67	39.5
2600	54.8	0	0	0.1	0	45.1	1.96	39.0

Simulating Liquid for 5GHz, Manufactured by SPEAG

Ingredients	(% by weight)
Water	64~78%
Mineral oil	11~18%
Emulsifiers	9~15%
Additives and Salt	2~3%

<Tissue Check Results>

Frequency (MHz)	Liquid Temp. (°C)	Conductivity (σ)	Permittivity (ϵ_r)	Conductivity Target (σ)	Permittivity Target (ϵ_r)	Delta (σ) (%)	Delta (ϵ_r) (%)	Limit (%)
835	22.3	0.890	42.400	0.90	41.50	-1.11	2.17	±5
1750	22.5	1.360	39.700	1.37	40.10	-0.73	-1.00	±5
1900	22.6	1.400	40.600	1.40	40.00	0.00	1.50	±5
2300	22.2	1.650	40.900	1.67	39.50	-1.20	3.54	±5
2600	22.4	1.980	39.800	1.96	39.00	1.02	2.05	±5

6.2 System Verification

Comparing to the original SAR value provided by SPEAG, the verification data should be within its specification of 10 %. Below table shows the target SAR and measured SAR after normalized to 1W input power. The table below indicates the system performance check can meet the variation criterion and the plots can be referred to Appendix D.

<System Verification Results>

Frequency (MHz)	Input Power (mW)	Dipole S/N	Probe S/N	DAE S/N	Measured 1g SAR (W/kg)	Targeted 1g SAR (W/kg)	Normalized 1g SAR (W/kg)	Deviation (%)	Date
835	250	D835V2-4d167	EX3DV4 - SN3931	DAE4 Sn376	2.28	9.55	9.12	-4.50	2020/2/25
1750	250	D1750V2-1068	EX3DV4 - SN3931	DAE4 Sn376	8.95	37.10	35.8	-3.50	2020/2/25
1900	250	D1900V2-5d041	EX3DV4 - SN3931	DAE4 Sn376	9.85	40.20	39.4	-1.99	2020/2/25
2300	250	D2300V2-1006	EX3DV4 - SN3931	DAE4 Sn376	11.10	48.70	44.4	-8.83	2020/2/25
2600	250	D2600V2-1078	EX3DV4 - SN3931	DAE4 Sn376	13.80	57.60	55.2	-4.17	2020/2/25



7. Power Density system verification and validation

The system performance check verifies that the system operates within its specifications.

The EUT is replaced by a calibrated source, the same spatial resolution, measurement region and the test separation used in the calibration was applied to system check. Through visual inspection into the measured power density distribution, both spatially (shape) and numerically (level) have no noticeable difference. The measured results should be within 0.6dB of the calibrated targets.

Frequency [GHz]	Grid step	Grid extent X/Y [mm]	Measurement points
10	0.25 ($\frac{\lambda}{4}$)	120/120	16 × 16
30	0.25 ($\frac{\lambda}{4}$)	60/60	24 × 24
60	0.25 ($\frac{\lambda}{4}$)	32.5/32.5	26 × 26
90	0.25 ($\frac{\lambda}{4}$)	30/30	36 × 36

Settings for measurement of verification sources

<PD System Verification Results>

Date	Frequency (GHz)	5G Verification Source	Probe S/N	DAE S/N	Distance (mm)	Measured 4 cm ² (W/m ²)	Targeted 4 cm ² (W/m ²)	Deviation (dB)
2020/2/15	30	30GHz-1009	9461	376	10	30.8	34.1	-0.44