



FCC RF Test Report

APPLICANT : OnePlus Technology (Shenzhen) Co., Ltd
EQUIPMENT : Smart Phone
BRAND NAME : ONEPLUS
MODEL NAME : HD1905
FCC ID : 2ABZ2-EE133
STANDARD : 47 CFR Part 2, 27(L), 27(F), 27(H)
CLASSIFICATION : PCS Licensed Transmitter Held to Ear (PCE)

The product was received on Jul. 04, 2019 and completely tested on Aug. 07, 2019. We, Sporton International (ShenZhen) Inc., would like to declare that the tested sample has been evaluated in accordance with the procedures given in ANSI C63.26-2015 and shown compliance with the applicable technical standards.

The test results in this report apply exclusively to the tested model / sample. Without written approval of Sporton International (ShenZhen) Inc., the test report shall not be reproduced except in full.

Derreck Chen

Reviewed by: Derreck Chen / Supervisor

Eric Shih

Approved by: Eric Shih / Manager



Sporton International (ShenZhen) Inc.

1/F, 2/F, Bldg 5, Shiling Industrial Zone, Xinwei Village, Xili, Nanshan, Shenzhen, 518055

People's Republic of China



TABLE OF CONTENTS

REVISION HISTORY... 3
SUMMARY OF TEST RESULT ... 4
1 GENERAL DESCRIPTION ... 5
1.1 Applicant ... 5
1.2 Manufacturer ... 5
1.3 Product Feature of Equipment Under Test ... 5
1.4 Product Specification of Equipment Under Test ... 6
1.5 Modification of EUT ... 6
1.6 Maximum ERP/EIRP, Frequency Tolerance, and Emission Designator ... 7
1.7 Testing Location ... 10
1.8 Applicable Standards ... 10
2 TEST CONFIGURATION OF EQUIPMENT UNDER TEST ... 11
2.1 Test Mode ... 11
2.2 Connection Diagram of Test System ... 13
2.3 Support Unit used in test configuration and system ... 13
2.4 Measurement Results Explanation Example ... 13
2.5 Frequency List of Low/Middle/High Channels ... 14
3 CONDUCTED TEST ITEMS ... 16
3.1 Measuring Instruments ... 16
3.2 Test Setup ... 16
3.3 Test Result of Conducted Test ... 16
3.4 Conducted Output Power and ERP/EIRP ... 17
3.5 Peak-to-Average Ratio ... 18
3.6 Occupied Bandwidth ... 19
3.7 Conducted Band Edge ... 20
3.8 Conducted Spurious Emission ... 22
3.9 Frequency Stability ... 23
4 RADIATED TEST ITEMS ... 24
4.1 Measuring Instruments ... 24
4.2 Test Setup ... 24
4.3 Test Result of Radiated Test ... 24
4.4 Radiated Spurious Emission ... 25
5 LIST OF MEASURING EQUIPMENT ... 26
6 UNCERTAINTY OF EVALUATION ... 27
APPENDIX A. TEST RESULTS OF CONDUCTED TEST
APPENDIX B. TEST RESULTS OF RADIATED TEST
APPENDIX C. TEST SETUP PHOTOGRAPHS



SUMMARY OF TEST RESULT

Report Section	FCC Rule	Description	Limit	Result	Remark
3.4	§2.1046	Conducted Output Power	Reporting Only	PASS	-
	§27.50(b)(10) §27.50(c)(10)	Effective Radiated Power (Band 12) (Band 13) (Band 17)	ERP < 3 Watt	PASS	-
	§27.50(d)(4)	Equivalent Isotropic Radiated Power (Band 4) (Band 66)	EIRP < 1Watt	PASS	-
3.5	N/A	Peak-to-Average Ratio	<13 dB	PASS	-
3.6	§2.1049	Occupied Bandwidth	Reporting Only	PASS	-
3.7	§2.1051 §27.53(c)(2)(4) §27.53(g) §27.53(h)	Conducted Band Edge Measurement (Band 4)(Band 12) (Band 13) (Band 17)(Band 66)	< 43+10log ₁₀ (P[Watts])	PASS	-
3.8	§2.1051 §27.53(c)(2) §27.53(g) §27.53(h)	Conducted Spurious Emission (Band 4)(Band 12) (Band 13) (Band 17)(Band 66)	< 43+10log ₁₀ (P[Watts])	PASS	-
3.9	§2.1055 §24.235 §27.54	Frequency Stability Temperature & Voltage	Within Authorized Band	PASS	-
4.4	§2.1053 §27.53(c)(2) §27.53(f) §27.53(g) §27.53(h)	Radiated Spurious Emission (Band 4)(Band 12) (Band 13) (Band 17)(Band 66)	< 43+10log ₁₀ (P[Watts])	PASS	Under limit 24.99 dB at 1559.500 MHz



1 General Description

1.1 Applicant

OnePlus Technology (Shenzhen) Co., Ltd

18C02, 18C03, 18C04 and 18C05, Shum Yip Terra Building, Binhe Avenue North, Futian District, Shenzhen

1.2 Manufacturer

OnePlus Technology (Shenzhen) Co., Ltd

18C02, 18C03, 18C04 and 18C05, Shum Yip Terra Building, Binhe Avenue North, Futian District, Shenzhen

1.3 Product Feature of Equipment Under Test

Product Feature	
Equipment	Smart Phone
Brand Name	ONEPLUS
Model Name	HD1905
FCC ID	2ABZ2-EE133
EUT supports Radios application	CDMA/EVDO/GSM/GPRS/EGPRS/WCDMA/HSPA/DC-HSDPA/HSPA+ /LTE WLAN 2.4GHz 802.11b/g/n HT20/HT40 WLAN 2.4GHz 802.11ac VHT20/VHT40 WLAN 5GHz 802.11a/n HT20/HT40 WLAN 5GHz 802.11ac VHT20/VHT40/VHT80 Bluetooth BR/EDR/LE GNSS/NFC
IMEI Code	Conducted: 990013830029836 Radiation: 990013610030707
HW Version	14
SW Version	Oxygen OS 10.0.HD65AA
EUT Stage	Production Unit

Remark:

This is a variant report for HD1905. The difference between previous and current is changing from single SIM card to dual SIM card, and the model name changed. Since the test result is not affected by the changes, all the test results are leveraged from original report which can be referred to Sporton Report Number FG970213C.



1.4 Product Specification of Equipment Under Test

Standards-related Product Specification	
Tx Frequency	LTE Band 4 : 1710.7 MHz ~ 1754.3 MHz LTE Band 12 : 699.7 MHz ~ 715.3 MHz LTE Band 13 : 779.5 MHz ~ 784.5 MHz LTE Band 17 : 706.5 MHz ~ 713.5 MHz LTE Band 66 : 1710.7 MHz ~ 1779.3 MHz
Rx Frequency	LTE Band 4 : 2110.7 MHz ~ 2154.3 MHz LTE Band 12 : 729.7 MHz ~ 745.3 MHz LTE Band 13 : 748.5 MHz ~ 753.5 MHz LTE Band 17 : 736.5 MHz ~ 743.5 MHz LTE Band 66 : 2110.7 MHz~ 2199.3 MHz
Bandwidth	LTE Band 4 : 1.4MHz / 3MHz / 5MHz / 10MHz / 15MHz / 20MHz LTE Band 12 : 1.4MHz / 3MHz / 5MHz / 10MHz LTE Band 13 : 5MHz / 10MHz LTE Band 17 : 5MHz / 10MHz LTE Band 66 : 1.4MHz / 3MHz / 5MHz / 10MHz / 15MHz / 20MHz
Maximum Output Power to Antenna	LTE Band 4 : 23.12 dBm LTE Band 12 : 22.91 dBm LTE Band 13 : 22.95 dBm LTE Band 17 : 22.93 dBm LTE Band 66 : 23.13 dBm
Antenna Gain	Top Antenna: LTE Band 4 : -1.0 dBi LTE Band 12 : -2.0 dBi LTE Band 13 : -2.0 dBi LTE Band 17 : -2.0 dBi LTE Band 66 : -1.0 dBi Bottom Antenna: LTE Band 4 : -0.5 dBi LTE Band 66 : -0.5 dBi
Type of Modulation	QPSK / 16QAM / 64QAM

Note:

1. The Maximum ERP/EIRP is calculated from Max Output power and Max antenna gain.
2. The LTE Band 12/13/17 can transmit in Top antenna only.

1.5 Modification of EUT

No modifications are made to the EUT during all test items.



1.6 Maximum ERP/EIRP, Frequency Tolerance, and Emission Designator

LTE Band 4		QPSK			16QAM		
BW (MHz)	Frequency Range (MHz)	Emission Designator (99%OBW)	Frequency Tolerance (ppm)	Maximum EIRP(W)	Emission Designator (99%OBW)	Frequency Tolerance (ppm)	Maximum EIRP(W)
1.4	1710.7 ~ 1754.3	1M09G7D	-	0.1754	1M10W7D	-	0.1472
3	1711.5 ~ 1753.5	2M72G7D	-	0.1799	2M71W7D	-	0.1514
5	1712.5 ~ 1752.5	4M50G7D	-	0.1762	4M51W7D	-	0.1483
10	1715.0 ~ 1750.0	9M07G7D	0.0019	0.1754	9M05W7D	-	0.1486
15	1717.5 ~ 1747.5	13M4G7D	-	0.1811	13M5W7D	-	0.1507
20	1720.0 ~ 1745.0	18M4G7D	-	0.1828	18M4W7D	-	0.1545
LTE Band 4		64QAM					
BW (MHz)	Frequency Range (MHz)	Emission Designator (99%OBW)		Frequency Tolerance (ppm)	Maximum EIRP(W)		
1.4	1710.7 ~ 1754.3	1M09W7D		-	0.1112		
3	1711.5 ~ 1753.5	2M72W7D		-	0.1125		
5	1712.5 ~ 1752.5	4M52W7D		-	0.1119		
10	1715.0 ~ 1750.0	9M05W7D		-	0.1107		
15	1717.5 ~ 1747.5	13M5W7D		-	0.1156		
20	1720.0 ~ 1745.0	18M5W7D		-	0.1167		
LTE Band 12		QPSK			16QAM		
BW (MHz)	Frequency Range (MHz)	Emission Designator (99%OBW)	Frequency Tolerance (ppm)	Maximum ERP(W)	Emission Designator (99%OBW)	Frequency Tolerance (ppm)	Maximum ERP(W)
1.4	699.7 ~ 715.3	1M09G7D	-	0.0741	1M09W7D	-	0.0630
3	700.5 ~ 714.5	2M72G7D	-	0.0746	2M75W7D	-	0.0646
5	701.5 ~ 713.5	4M49G7D	-	0.0746	4M50W7D	-	0.0637
10	704.0 ~ 711.0	9M05G7D	0.0016	0.0752	9M03W7D	-	0.0628
LTE Band 12		64QAM					
BW (MHz)	Frequency Range (MHz)	Emission Designator (99%OBW)		Frequency Tolerance (ppm)	Maximum ERP(W)		
1.4	699.7 ~ 715.3	1M09W7D		-	0.0500		
3	700.5 ~ 714.5	2M73W7D		-	0.0513		
5	701.5 ~ 713.5	4M50W7D		-	0.0502		
10	704.0 ~ 711.0	9M07W7D		-	0.0501		



LTE Band 13		QPSK			16QAM		
BW (MHz)	Frequency Range (MHz)	Emission Designator (99%OBW)	Frequency Tolerance (ppm)	Maximum ERP(W)	Emission Designator (99%OBW)	Frequency Tolerance (ppm)	Maximum ERP(W)
5	779.5 ~ 784.5	4M50G7D	-	0.0750	4M50W7D	-	0.0634
10	782.0	9M01G7D	0.0018	0.0759	8M97W7D	-	0.0635
LTE Band 13		64QAM					
BW (MHz)	Frequency Range (MHz)	Emission Designator (99%OBW)		Frequency Tolerance (ppm)	Maximum ERP(W)		
5	779.5 ~ 784.5	4M51W7D		-	0.0484		
10	782.0	9M03W7D		-	0.0482		
LTE Band 17		QPSK			16QAM		
BW (MHz)	Frequency Range (MHz)	Emission Designator (99%OBW)	Frequency Tolerance (ppm)	Maximum ERP(W)	Emission Designator (99%OBW)	Frequency Tolerance (ppm)	Maximum ERP(W)
5	706.5 ~ 713.5	4M52G7D	-	0.0748	4M50W7D	-	0.0640
10	709.0 ~ 711.0	9M05G7D	0.0017	0.0755	9M05W7D	-	0.0643
LTE Band 17		64QAM					
BW (MHz)	Frequency Range (MHz)	Emission Designator (99%OBW)		Frequency Tolerance (ppm)	Maximum ERP(W)		
5	706.5 ~ 713.5	4M50W7D		-	0.0504		
10	709.0 ~ 711.0	9M09W7D		-	0.0506		



LTE Band 66		QPSK			16QAM		
BW (MHz)	Frequency Range (MHz)	Emission Designator (99%OBW)	Frequency Tolerance (ppm)	Maximum EIRP(W)	Emission Designator (99%OBW)	Frequency Tolerance (ppm)	Maximum EIRP(W)
1.4	1710.7 ~ 1779.3	1M09G7D	-	0.1754	1M09W7D	-	0.1489
3	1711.5 ~ 1778.5	2M73G7D	-	0.1766	2M73W7D	-	0.1493
5	1712.5 ~ 1777.5	4M50G7D	-	0.1758	4M49W7D	-	0.1476
10	1715.0 ~ 1775.0	9M07G7D	0.0007	0.1746	9M05W7D	-	0.1472
15	1717.5 ~ 1772.5	13M5G7D	-	0.1824	13M4W7D	-	0.1542
20	1720.0 ~ 1770.0	18M4G7D	-	0.1832	18M4W7D	-	0.1542
LTE Band 66		64QAM					
BW (MHz)	Frequency Range (MHz)	Emission Designator (99%OBW)	Frequency Tolerance (ppm)		Maximum EIRP(W)		
1.4	1710.7 ~ 1779.3	1M09W7D	-		0.1208		
3	1711.5 ~ 1778.5	2M74W7D	-		0.1183		
5	1712.5 ~ 1777.5	4M49W7D	-		0.1164		
10	1715.0 ~ 1775.0	9M03W7D	-		0.1146		
15	1717.5 ~ 1772.5	13M4W7D	-		0.1202		
20	1720.0 ~ 1770.0	18M4W7D	-		0.1211		



1.7 Testing Location

Sporton International (Shenzhen) Inc. is accredited to ISO/IEC 17025:2017 by American Association for Laboratory Accreditation with Certificate Number 5145.01.

Test Firm	Sporton International (Shenzhen) Inc.		
Test Site Location	1/F, 2/F, Bldg 5, Shiling Industrial Zone, Xinwei Village, Xili, Nanshan, Shenzhen, 518055 People's Republic of China TEL: +86-755-86379589 FAX: +86-755-86379595		
Test Site No.	Sporton Site No.	FCC Designation No.	FCC Test Firm Registration No.
	TH01-SZ	CN1256	421272

Test Firm	Sporton International (Shenzhen) Inc.		
Test Site Location	No. 3 Bldg the third floor of south, Shahe River west, Fengzeyuan Warehouse, Nanshan Shenzhen, 518055 People's Republic of China TEL: +86-755-33202398		
Test Site No.	Sporton Site No.	FCC Designation No.	FCC Test Firm Registration No.
	03CH02-SZ	CN1256	421272

1.8 Applicable Standards

According to the specifications of the manufacturer, the EUT must comply with the requirements of the following standards:

- 47 CFR Part 2, 27(L), 27(F), 27(H)
- ANSI C63.26-2015
- FCC KDB 971168 D01 Power Meas License Digital Systems v03r01
- FCC KDB 412172 D01 Determining ERP and EIRP v01r01

Remark:

1. All test items were verified and recorded according to the standards and without any deviation during the test.
2. This EUT has also been tested and complied with the requirements of FCC Part 15, Subpart B, recorded in a separate test report.



2 Test Configuration of Equipment Under Test

2.1 Test Mode

Antenna port conducted and radiated test items listed below are performed according to KDB 971168 D01 Power Meas License Digital Systems v03r01 with maximum output power.

Radiated measurements are performed by rotating the EUT in three different orthogonal test planes to find the maximum emission.

Test Items	Band	Bandwidth (MHz)						Modulation			RB #			Test Channel		
		1.4	3	5	10	15	20	QPSK	16QAM	64QAM	1	Half	Full	L	M	H
Max. Output Power	4	v	v	v	v	v	v	v	v	v	v	v	v	v	v	v
	12	v	v	v	v	-	-	v	v	v	v	v	v	v	v	v
	13	-	-	v		-	-	v	v	v	v	v	v	v	v	v
		-	-		v	-	-	v	v	v	v	v	v		v	
	17	-	-	v	v	-	-	v	v	v	v	v	v	v	v	v
	66	v	v	v	v	v	v	v	v	v	v	v	v	v	v	v
Peak-to-Average Ratio	4						v	v	v	v	v		v	v	v	v
	12				v	-	-	v	v	v	v		v	v	v	v
	13	-	-		v	-	-	v	v	v	v		v		v	
	17	-	-		v	-	-	v	v	v	v		v	v	v	v
	66						v	v	v	v	v		v	v	v	v
26dB and 99% Bandwidth	4	v	v	v	v	v	v	v	v	v			v	v	v	v
	12	v	v	v	v	-	-	v	v	v			v	v	v	v
	13	-	-	v		-	-	v	v	v			v	v	v	v
		-	-		v	-	-	v	v	v			v		v	
	17	-	-	v	v	-	-	v	v	v			v	v	v	v
	66	v	v	v	v	v	v	v	v	v			v	v	v	v
Conducted Band Edge	4	v	v	v	v	v	v	v	v	v	v		v	v		v
	12	v	v	v	v	-	-	v	v	v	v		v	v		v
	13	-	-	v		-	-	v	v	v	v		v	v		v
		-	-		v	-	-	v	v	v	v		v		v	
	17	-	-	v	v	-	-	v	v	v	v		v	v		v
	66	v	v	v	v	v	v	v	v	v	v		v	v		v



Test Items	Band	Bandwidth (MHz)						Modulation			RB #			Test Channel		
		1.4	3	5	10	15	20	QPSK	16QAM	64QAM	1	Half	Full	L	M	H
Conducted Spurious Emission	4	v	v	v	v	v	v	v	v	v	v			v	v	v
	12	v	v	v	v	-	-	v	v	v	v			v	v	v
	13	-	-	v		-	-	v	v	v	v			v	v	v
		-	-		v	-	-	v	v	v	v				v	
	17	-	-	v	v	-	-	v	v	v	v			v	v	v
	66	v	v	v	v	v	v	v	v	v	v			v	v	v
Frequency Stability	4				v			v					v		v	
	12				v	-	-	v					v		v	
	13	-	-		v	-	-	v					v		v	
	17	-	-		v	-	-	v					v		v	
	66				v			v					v		v	
E.R.P / E.I.R.P	4	v	v	v	v	v	v	v	v	v	v			v	v	v
	12	v	v	v	v	-	-	v	v	v	v			v	v	v
	13	-	-	v		-	-	v	v	v	v			v	v	v
		-	-		v	-	-	v	v	v	v				v	
	17	-	-	v	v	-	-	v	v	v	v			v	v	v
	66	v	v	v	v	v	v	v	v	v	v			v	v	v
Radiated Spurious Emission	4	v	v	v	v	v	v	v			v			v	v	v
	12	v	v	v	v			v			v			v	v	v
	13	-	-	v		-	-	v			v			v	v	v
					v			v			v				v	
	17	-	-	v	v	-	-	v			v			v	v	v
	66	v	v	v	v	v	v	v			v			v	v	v
Note	<ol style="list-style-type: none"> The mark "v" means that this configuration is chosen for testing The mark "-" means that this bandwidth is not supported. The device is investigated from 30MHz to 10 times of fundamental signal for radiated spurious emission test under different RB size/offset and modulations in exploratory test. Subsequently, only the worst case emissions are reported. 															

2.2 Connection Diagram of Test System

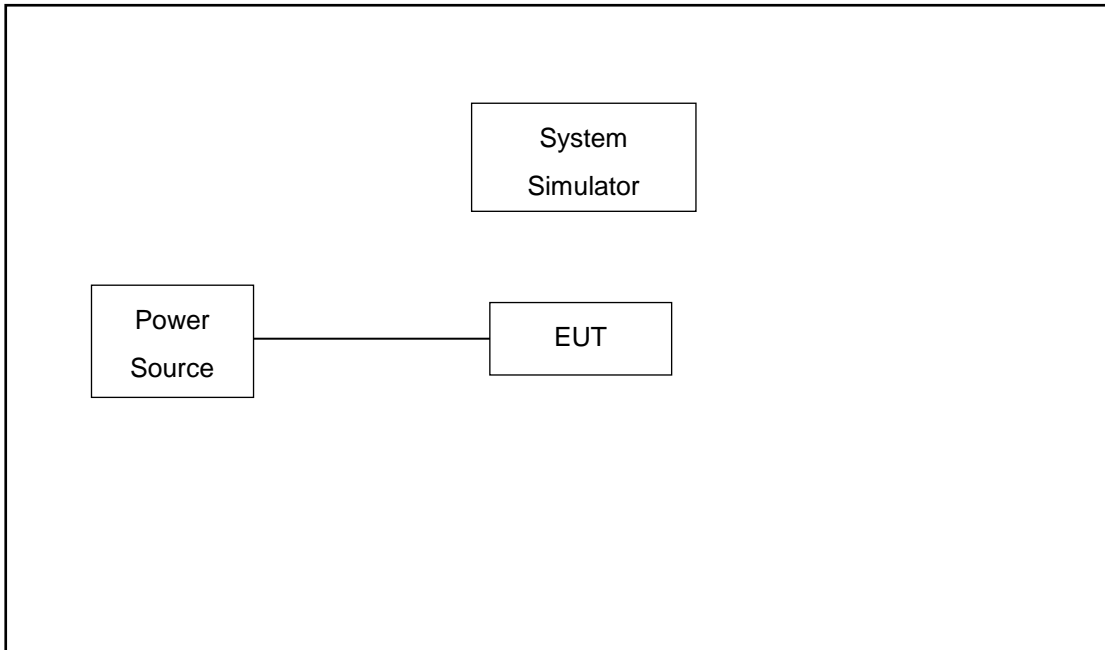

2.3 Support Unit used in test configuration and system

Item	Equipment	Trade Name	Model No.	FCC ID	Data Cable	Power Cord
1.	LTE Base Station	Anritsu	MT8820C	N/A	N/A	Unshielded, 1.8 m
2.	DC Power Supply	GW	GPS-3030D	N/A	N/A	Unshielded, 1.8 m

2.4 Measurement Results Explanation Example

For all conducted test items:

The offset level is set in the spectrum analyzer to compensate the RF cable loss and attenuator factor between EUT conducted output port and spectrum analyzer. With the offset compensation, the spectrum analyzer reading level is exactly the EUT RF output level.

The spectrum analyzer offset is derived from RF cable loss and attenuator factor.

Offset = RF cable loss + attenuator factor.

Following shows an offset computation example with cable loss 4.0 dB and 10dB attenuator.

Example :

$$\begin{aligned}
 \text{Offset(dB)} &= \text{RF cable loss(dB)} + \text{attenuator factor(dB)}. \\
 &= 4.0 + 10 = 14.0 \text{ (dB)}
 \end{aligned}$$



2.5 Frequency List of Low/Middle/High Channels

LTE Band 4 Channel and Frequency List				
BW [MHz]	Channel/Frequency(MHz)	Lowest	Middle	Highest
20	Channel	20050	20175	20300
	Frequency	1720	1732.5	1745
15	Channel	20025	20175	20325
	Frequency	1717.5	1732.5	1747.5
10	Channel	20000	20175	20350
	Frequency	1715	1732.5	1750
5	Channel	19975	20175	20375
	Frequency	1712.5	1732.5	1752.5
3	Channel	19965	20175	20385
	Frequency	1711.5	1732.5	1753.5
1.4	Channel	19957	20175	20393
	Frequency	1710.7	1732.5	1754.3

LTE Band 12 Channel and Frequency List				
BW [MHz]	Channel/Frequency(MHz)	Lowest	Middle	Highest
10	Channel	23060	23095	23130
	Frequency	704	707.5	711
5	Channel	23035	23095	23155
	Frequency	701.5	707.5	713.5
3	Channel	23025	23095	23165
	Frequency	700.5	707.5	714.5
1.4	Channel	23017	23095	23173
	Frequency	699.7	707.5	715.3

LTE Band 13 Channel and Frequency List				
BW [MHz]	Channel/Frequency(MHz)	Lowest	Middle	Highest
10	Channel	-	23230	-
	Frequency	-	782	-
5	Channel	23205	23230	23255
	Frequency	779.5	782	784.5



LTE Band 17 Channel and Frequency List				
BW [MHz]	Channel/Frequency(MHz)	Lowest	Middle	Highest
10	Channel	23780	23790	23800
	Frequency	709	710	711
5	Channel	23755	23790	23825
	Frequency	706.5	710	713.5

LTE Band 66 Channel and Frequency List				
BW [MHz]	Channel/Frequency(MHz)	Lowest	Middle	Highest
20	Channel	132072	132322	132572
	Frequency	1720	1745	1770
15	Channel	132047	132322	132597
	Frequency	1717.5	1745	1772.5
10	Channel	132022	132322	132622
	Frequency	1715	1745	1775
5	Channel	131997	132322	132647
	Frequency	1712.5	1745	1777.5
3	Channel	131987	132322	132657
	Frequency	1711.5	1745	1778.5
1.4	Channel	131979	132322	132665
	Frequency	1710.7	1745	1779.3

3 Conducted Test Items

3.1 Measuring Instruments

See list of measuring instruments of this test report.

3.2 Test Setup

3.2.1 Conducted Output Power

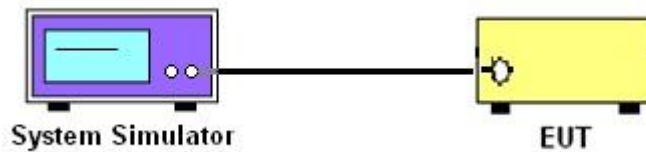

3.2.2 Peak-to-Average Ratio, Occupied Bandwidth ,Conducted Band-Edge and Conducted Spurious Emission

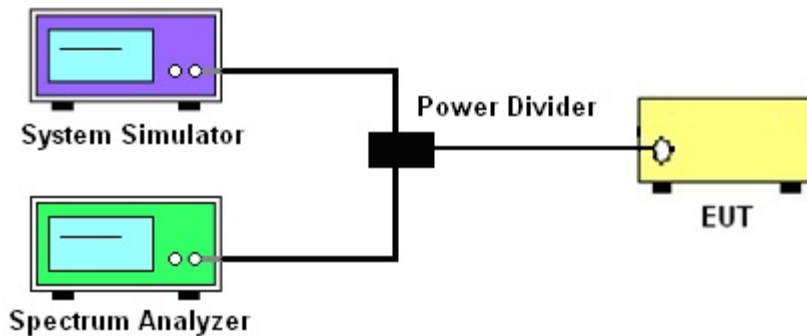

3.2.3 Frequency Stability

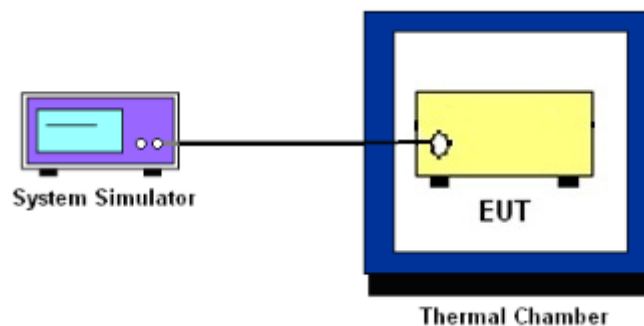

3.3 Test Result of Conducted Test

Please refer to Appendix A.



3.4 Conducted Output Power and ERP/EIRP

3.4.1 Description of the Conducted Output Power Measurement and ERP/EIRP Measurement

A system simulator was used to establish communication with the EUT. Its parameters were set to force the EUT transmitting at maximum output power. The measured power in the radio frequency on the transmitter output terminals shall be reported.

The ERP of mobile transmitters must not exceed 3 Watts for LTE Band 12, Band 13 and Band 17

The EIRP of mobile transmitters must not exceed 1 Watts for LTE Band 4 and Band 66.

According to KDB 412172 D01 Power Approach,

$EIRP = P_T + G_T - L_C$, $ERP = EIRP - 2.15$, where

P_T = transmitter output power in dBm

G_T = gain of the transmitting antenna in dBi

L_C = signal attenuation in the connecting cable between the transmitter and antenna in dB

3.4.2 Test Procedures

1. The testing follows ANSI C63.26 Section 5.2
2. The transmitter output port was connected to the system simulator.
3. Set EUT at maximum power through the system simulator.
4. Select lowest, middle, and highest channels for each band and different modulation.
5. Measure and record the power level from the system simulator.



3.5 Peak-to-Average Ratio

3.5.1 Description of the PAR Measurement

Power Complementary Cumulative Distribution Function (CCDF) curves provide a means for characterizing the power peaks of a digitally modulated signal on a statistical basis. A CCDF curve depicts the probability of the peak signal amplitude exceeding the average power level. Most contemporary measurement instrumentation include the capability to produce CCDF curves for an input signal provided that the instrument's resolution bandwidth can be set wide enough to accommodate the entire input signal bandwidth. In measuring transmissions in this band using an average power technique, the peak-to-average ratio (PAR) of the transmission may not exceed 13 dB.

3.5.2 Test Procedures

1. The testing follows ANSI C63.26 Section 5.2.3.4 (CCDF).
2. The EUT was connected to spectrum and system simulator via a power divider.
3. Set the CCDF (Complementary Cumulative Distribution Function) option in spectrum analyzer.
4. The highest RF powers were measured and recorded the maximum PAPR level associated with a probability of 0.1 %.
5. Record the deviation as Peak to Average Ratio.



3.6 Occupied Bandwidth

3.6.1 Description of Occupied Bandwidth Measurement

The occupied bandwidth is the width of a frequency band such that, below the lower and above the upper frequency limits, the mean powers emitted are each equal to a specified percentage 0.5% of the total mean transmitted power.

The 26 dB emission bandwidth is defined as the frequency range between two points, one above and one below the carrier frequency, at which the spectral density of the emission is attenuated 26 dB below the maximum in-band spectral density of the modulated signal. Spectral density (power per unit bandwidth) is to be measured with a detector of resolution bandwidth equal to approximately 1.0% of the emission bandwidth.

3.6.2 Test Procedures

1. The testing follows ANSI C63.26 Section 5.4
2. The EUT was connected to spectrum analyzer and system simulator via a power divider.
3. The spectrum analyzer center frequency is set to the nominal EUT channel center frequency. The span range for the spectrum analyzer shall be between two and five times the anticipated OBW.
4. The nominal resolution bandwidth (RBW) shall be in the range of 1 to 5 % of the anticipated OBW, and the VBW shall be at least 3 times the RBW.
5. Set the detection mode to peak, and the trace mode to max hold.
6. Determine the reference value: Set the EUT to transmit a modulated signal. Allow the trace to stabilize. Set the spectrum analyzer marker to the highest level of the displayed trace.
(this is the reference value)
7. Determine the “-26 dB down amplitude” as equal to (Reference Value – X).
8. Place two markers, one at the lowest and the other at the highest frequency of the envelope of the spectral display such that each marker is at or slightly below the “-X dB down amplitude” determined in step 6. If a marker is below this “-X dB down amplitude” value it shall be placed as close as possible to this value. The OBW is the positive frequency difference between the two markers.
9. Use the 99 % power bandwidth function of the spectrum analyzer and report the measured bandwidth.



3.7 Conducted Band Edge

3.7.1 Description of Conducted Band Edge Measurement

27.53 (c)

For operations in the 776-788 MHz band, the FCC limit is $43 + 10\log_{10}(P[\text{Watts}])$ dB below the transmitter power $P(\text{Watts})$ in a 100 kHz bandwidth. However, in the 100 kHz bands immediately outside and adjacent to the frequency block, a resolution bandwidth of at least 30 kHz may be employed. In addition, the power of any unwanted emissions in any 6.25 kHz bandwidth for all frequencies between 763-775 MHz and 793-806 MHz shall be attenuated below the transmitter power, P (dBW), by at least $65 + 10 \log_{10} p(\text{watts})$, dB, for mobile and portable equipment.

27.53 (g)

For operations in the 600MHz band and 698 -746 MHz band, the FCC limit is $43 + 10\log_{10}(P[\text{Watts}])$ dB below the transmitter power $P(\text{Watts})$ in a 100 kHz bandwidth. However, in the 100 kilohertz bands immediately outside and adjacent to a licensee's frequency block, a resolution bandwidth of at least 30 kHz may be employed.

27.53 (h)

For operations in the 1710 – 1755 MHz band, the FCC limit is $43 + 10\log_{10}(P[\text{Watts}])$ dB below the transmitter power $P(\text{Watts})$ in a 1 MHz bandwidth. However, in the 1MHz bands immediately outside and adjacent to the licensee's frequency block, a resolution bandwidth of at least one percent of the emission bandwidth of the fundamental emission of the transmitter may be employed.



3.7.2 Test Procedures

1. The testing follows ANSI C63.26 section 5.7
2. The EUT was connected to spectrum analyzer and system simulator via a power divider.
3. The band edges of low and high channels for the highest RF powers were measured.
4. Set RBW \geq 1% EBW in the 1MHz band immediately outside and adjacent to the band edge.
5. Beyond the 1 MHz band from the band edge, RBW=1MHz was used or a narrower RBW was used and the measured power was integrated over the full required measurement bandwidth of 1 MHz.
6. Set spectrum analyzer with RMS detector.
7. The RF fundamental frequency should be excluded against the limit line in the operating frequency band.
8. Checked that all the results comply with the emission limit line.

Example:

The limit line is derived from $43 + 10\log(P)$ dB below the transmitter power P(Watts)

$$= P(W) - [43 + 10\log(P)] \text{ (dB)}$$

$$= [30 + 10\log(P)] \text{ (dBm)} - [43 + 10\log(P)] \text{ (dB)} = -13\text{dBm}.$$



3.8 Conducted Spurious Emission

3.8.1 Description of Conducted Spurious Emission Measurement

The power of any emission outside of the authorized operating frequency ranges must be lower than the transmitter power (P) by a factor of at least $43 + 10 \log (P)$ dB.

It is measured by means of a calibrated spectrum analyzer and scanned from 30 MHz up to a frequency including its 10th harmonic.

3.8.2 Test Procedures

1. The testing follows ANSI C63.26 section 5.7
2. The EUT was connected to spectrum analyzer and system simulator via a power divider.
3. The RF output of EUT was connected to the spectrum analyzer by RF cable and attenuator. The path loss was compensated to the results for each measurement.
4. The middle channel for the highest RF power within the transmitting frequency was measured.
5. The conducted spurious emission for the whole frequency range was taken.
6. Make the measurement with the spectrum analyzer's RBW = 1MHz, VBW = 3MHz.
7. Set spectrum analyzer with RMS detector.
8. Taking the record of maximum spurious emission.
9. The RF fundamental frequency should be excluded against the limit line in the operating frequency band.
10. The limit line is derived from $43 + 10\log(P)$ dB below the transmitter power P(Watts)
= P(W)- [43 + 10log(P)] (dB)
= [30 + 10log(P)] (dBm) - [43 + 10log(P)] (dB)
= -13dBm.



3.9 Frequency Stability

3.9.1 Description of Frequency Stability Measurement

The frequency stability shall be measured by variation of ambient temperature and variation of primary supply voltage to ensure that the fundamental emission stays within the authorized frequency block. The frequency stability of the transmitter shall be maintained within $\pm 0.00025\%$ ($\pm 2.5\text{ppm}$) of the center frequency.

3.9.2 Test Procedures for Temperature Variation

1. The testing follows ANSI C63.26 section 5.6.4
2. The EUT was set up in the thermal chamber and connected with the system simulator.
3. With power OFF, the temperature was decreased to -30°C and the EUT was stabilized before testing. Power was applied and the maximum change in frequency was recorded within one minute.
4. With power OFF, the temperature was raised in 10°C step up to 50°C . The EUT was stabilized at each step for at least half an hour. Power was applied and the maximum frequency change was recorded within one minute.

3.9.3 Test Procedures for Voltage Variation

1. The testing follows ANSI C63.26 section 5.6.5
2. The EUT was placed in a temperature chamber at $20\pm 5^{\circ}\text{C}$ and connected with the system simulator.
3. The power supply voltage to the EUT was varied from 85% to 115% of the nominal value for other than hand carried battery equipment.
4. For hand carried, battery powered equipment, reduce the primary ac or dc supply voltage to the battery operating end point, which shall be specified by the manufacturer.
5. The variation in frequency was measured for the worst case.

4 Radiated Test Items

4.1 Measuring Instruments

See list of measuring instruments of this test report.

4.2 Test Setup

4.2.1 For radiated test from 30MHz to 1GHz

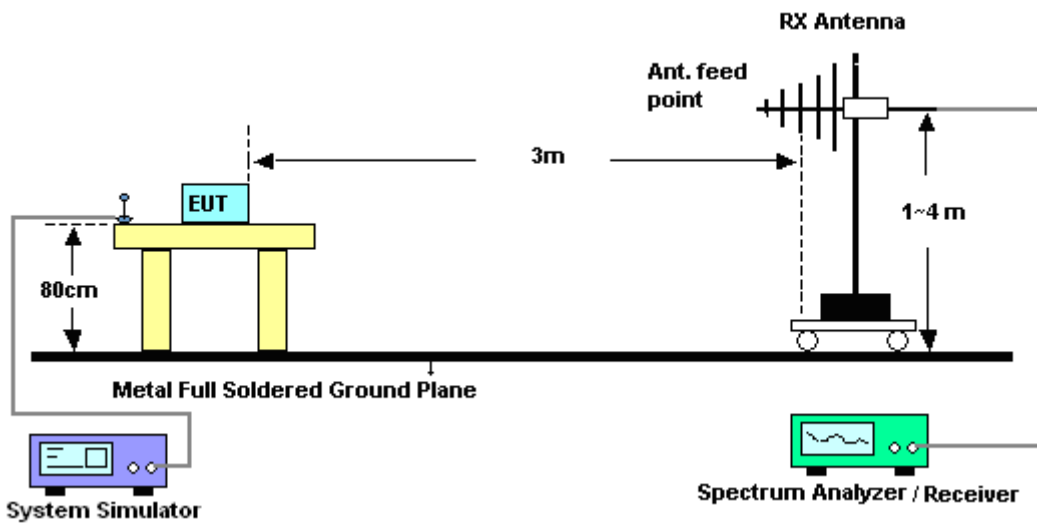

4.2.2 For radiated test above 1GHz

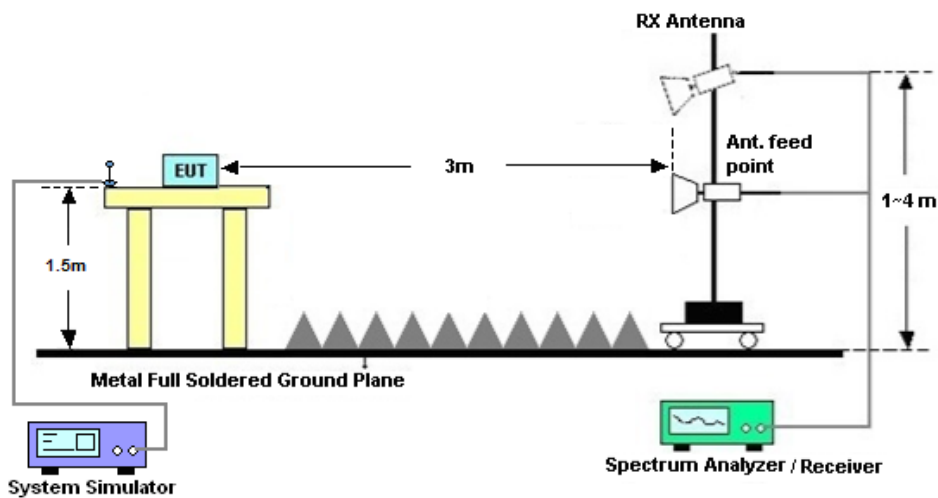

4.3 Test Result of Radiated Test

Please refer to Appendix B.



4.4 Radiated Spurious Emission

4.4.1 Description of Radiated Spurious Emission

The radiated spurious emission was measured by substitution method according to ANSI C63.26. The power of any emission outside of the authorized operating frequency ranges must be attenuated below the transmitter power (P) by a factor of at least $43 + 10 \log (P)$ dB.

For LTE Band 13

For operations in the 746-758 MHz, 775-788 MHz, and 805-806 MHz bands, emissions in the band 1559-1610 MHz shall be limited to -70 dBW/MHz equivalent isotropically radiated power (EIRP) for wideband signals, and -80 dBW EIRP for discrete emissions of less than 700 Hz bandwidth.

The spectrum is scanned from 30 MHz up to a frequency including its 10th harmonic.

4.4.2 Test Procedures

1. The testing follows ANSI C63.26 Section 5.5
2. The EUT was placed on a turntable with 0.8 meter height for frequency below 1GHz and 1.5 meter height for frequency above 1GHz respectively above ground.
3. The EUT was set 3 meters from the receiving antenna mounted on the antenna tower.
4. The table was rotated 360 degrees to determine the position of the highest spurious emission.
5. The height of the receiving antenna is varied between 1m to 4m to search the maximum spurious emission for both horizontal and vertical polarizations.
6. During the measurement, the system simulator parameters were set to force the EUT transmitting at maximum output power.
7. Make the measurement with the spectrum analyzer's RBW = 1MHz, VBW = 3MHz, taking the record of maximum spurious emission.
8. A horn antenna was substituted in place of the EUT and was driven by a signal generator.
9. Tune the output power of signal generator to the same emission level with EUT maximum spurious emission.
10. $EIRP (dBm) = S.G. Power - Tx Cable Loss + Tx Antenna Gain$
11. $ERP (dBm) = EIRP - 2.15$
12. The RF fundamental frequency should be excluded against the limit line in the operating frequency band.

The limit line is derived from $43 + 10\log(P)$ dB below the transmitter power P(Watts)
 $= P(W) - [43 + 10\log(P)] (dB)$
 $= [30 + 10\log(P)] (dBm) - [43 + 10\log(P)] (dB)$
 $= -13dBm.$



5 List of Measuring Equipment

Instrument	Manufacturer	Model No.	Serial No.	Characteristics	Calibration Date	Test Date	Due Date	Remark
Spectrum Analyzer	R&S	FSV40	101078	10Hz~40GHz	Apr. 18, 2019	Jul. 14, 2019~ Jul. 24, 2019	Apr. 17, 2020	Conducted (TH01-SZ)
Thermal Chamber	Ten Billion Hongzhangroup	LP-150U	H2014081803	-40~+150°C	Dec. 22, 2018	Jul. 14, 2019~ Jul. 24, 2019	Dec. 21, 2019	Conducted (TH01-SZ)
EXA Spectrum Analyzer	KEYSIGHT	N9010A	MY55150213	10Hz~44GHz	Apr. 19, 2019	Aug. 07, 2019	Apr. 18, 2020	Radiation (03CH02-SZ)
Bilog Antenna	TeseQ	CBL6112D	35407	30MHz-2GHz	Jun. 05, 2019	Aug. 07, 2019	Jun. 04, 2020	Radiation (03CH02-SZ)
Double Ridge Horn Antenna	SCHWARZBECK	BBHA 9120D	9120D-1285	1GHz~18GHz	Jan. 07, 2019	Aug. 07, 2019	Jan. 06, 2020	Radiation (03CH02-SZ)
HF Amplifier	MITEQ	TTA1840-35-HG	1871923	18GHz~40GHz	Jul. 18, 2019	Aug. 07, 2019	Jul. 17, 2020	Radiation (03CH02-SZ)
SHF-EHF Horn	com-power	AH-840	101071	18Ghz-40GHz	Mar. 30, 2019	Aug. 07, 2019	Mar. 29, 2020	Radiation (03CH02-SZ)
LF Amplifier	Burgeon	BPA-530	102211	0.01~3000Mhz	Oct. 18, 2018	Aug. 07, 2019	Oct. 18, 2019	Radiation (03CH02-SZ)
HF Amplifier	Agilent	8449B	3008A01023	1GHz~26.5GHz	Oct. 18, 2018	Aug. 07, 2019	Oct. 17, 2019	Radiation (03CH02-SZ)
AC Power Source	Chroma	61601	616010002470	N/A	NCR	Aug. 07, 2019	NCR	Radiation (03CH02-SZ)
Turn Table	Chaintek	T-200	N/A	0~360 degree	NCR	Aug. 07, 2019	NCR	Radiation (03CH02-SZ)
Antenna Mast	Chaintek	MBS-400	N/A	1 m~4 m	NCR	Aug. 07, 2019	NCR	Radiation (03CH02-SZ)

NCR: No Calibration Required



6 Uncertainty of Evaluation

The measurement uncertainties shown below were calculated in accordance with the requirements of ANSI 63.26-2015. All the measurement uncertainty value were shown with a coverage K=2 to indicate 95% level of confidence. The measurement data show herein meets or exceeds the CISPR measurement uncertainty values specified in CISPR 16-4-2 and can be compared directly to specified limit to determine compliance.

Uncertainty of Radiated Emission Measurement (30 MHz ~ 1000 MHz)

Measuring Uncertainty for a Level of Confidence of 95% (U = 2Uc(y))	2.5dB
---	-------

Uncertainty of Radiated Emission Measurement (1 GHz ~ 18 GHz)

Measuring Uncertainty for a Level of Confidence of 95% (U = 2Uc(y))	3.3dB
---	-------

Uncertainty of Radiated Emission Measurement (18 GHz ~ 40 GHz)

Measuring Uncertainty for a Level of Confidence of 95% (U = 2Uc(y))	3.7dB
---	-------



Appendix A. Test Results of Conducted Test

Conducted Output Power(Average power)

Top Antenna

LTE Band 12 Maximum Average Power [dBm]						
BW [MHz]	RB Size	RB Offset	Mod	Lowest	Middle	Highest
10	1	0	QPSK	22.86	22.91	22.85
10	1	25		22.79	22.83	22.81
10	1	49		22.84	22.73	22.84
10	25	0		21.90	21.98	21.93
10	25	12		21.92	21.95	21.96
10	25	25		21.93	21.94	21.93
10	50	0		21.92	21.95	21.94
10	1	0	16-QAM	22.04	22.13	22.08
10	1	25		22.10	22.07	22.08
10	1	49		22.08	22.13	22.07
10	25	0		20.95	20.92	20.95
10	25	12		20.96	20.97	20.96
10	25	25		20.94	20.98	20.93
10	50	0		20.94	20.95	20.96
10	1	0	64QAM	21.09	21.13	21.10
10	1	25		21.09	21.05	21.07
10	1	49		21.14	21.15	21.13
10	25	0		19.92	19.92	19.95
10	25	12		19.97	19.97	19.98
10	25	25		19.93	20.01	19.94
10	50	0		19.98	19.99	19.97
5	1	0	QPSK	22.69	22.74	22.79
5	1	12		22.85	22.85	22.88
5	1	24		22.81	22.88	22.85
5	12	0		21.85	21.89	21.89
5	12	7		21.98	21.92	21.95
5	12	13		21.92	21.98	21.95
5	25	0		21.89	21.86	21.90



5	1	0	16-QAM	22.05	22.04	22.04
5	1	12		22.19	22.15	22.16
5	1	24		22.15	22.07	22.16
5	12	0		20.90	20.88	20.89
5	12	7		21.01	20.94	20.96
5	12	13		21.01	20.95	21.00
5	25	0		20.95	20.88	20.90
5	1	0	64-QAM	20.98	20.99	21.05
5	1	12		21.15	21.11	21.16
5	1	24		21.13	21.07	21.16
5	12	0		20.01	19.96	19.98
5	12	7		20.10	20.01	20.08
5	12	13		20.09	20.04	20.08
5	25	0		20.01	19.93	19.94



LTE Band 12 Maximum Average Power [dBm]						
BW [MHz]	RB Size	RB Offset	Mod	Lowest	Middle	Highest
3	1	0	QPSK	22.70	22.73	22.71
3	1	8		22.88	22.84	22.82
3	1	14		22.79	22.81	22.80
3	8	0		21.82	21.90	21.85
3	8	4		21.96	21.93	21.89
3	8	7		21.91	21.96	21.91
3	15	0		21.87	21.91	21.88
3	1	0	16-QAM	21.99	21.98	22.03
3	1	8		22.20	22.18	22.25
3	1	14		22.11	22.09	22.10
3	8	0		20.94	20.93	20.98
3	8	4		21.05	20.95	21.03
3	8	7		21.03	21.00	21.04
3	15	0		20.94	20.88	20.93
3	1	0	64-QAM	21.02	21.02	21.00
3	1	8		21.24	21.17	21.25
3	1	14		21.17	21.07	21.14
3	8	0		20.01	19.94	19.99
3	8	4		20.12	20.01	20.07
3	8	7		20.09	20.06	20.11
3	15	0		20.00	19.98	19.98
1.4	1	0	QPSK	22.65	22.72	22.70
1.4	1	3		22.79	22.85	22.83
1.4	1	5		22.70	22.81	22.75
1.4	3	0		22.77	22.77	22.74
1.4	3	1		22.80	22.77	22.77
1.4	3	3		22.76	22.81	22.76
1.4	6	0		21.82	21.79	21.78
1.4	1	0	16-QAM	21.98	22.00	22.00
1.4	1	3		22.12	22.10	22.14
1.4	1	5		22.03	22.01	22.01
1.4	3	0		21.84	21.76	21.83
1.4	3	1		21.88	21.81	21.84



1.4	3	3	64-QAM	21.82	21.85	21.81
1.4	6	0		20.93	20.90	20.90
1.4	1	0		21.04	21.00	21.01
1.4	1	3		21.14	21.14	21.14
1.4	1	5		21.08	21.03	21.04
1.4	3	0		21.05	20.95	21.04
1.4	3	1		21.08	21.01	21.08
1.4	3	3		21.02	21.03	21.09
1.4	6	0		19.90	19.90	19.89



LTE Band 13 Maximum Average Power [dBm]						
BW [MHz]	RB Size	RB Offset	Mod	Lowest	Middle	Highest
10	1	0	QPSK		22.95	
10	1	25			22.92	
10	1	49			22.82	
10	25	0			22.05	
10	25	12			22.02	
10	25	25			22.01	
10	50	0			22.01	
10	1	0	16-QAM	-	22.13	
10	1	25			22.18	
10	1	49			22.06	
10	25	0			21.01	
10	25	12			21.02	
10	25	25			21.02	
10	50	0			21.04	
10	1	0	64-QAM		20.89	
10	1	25			20.98	
10	1	49			20.86	
10	25	0			19.88	
10	25	12			19.91	
10	25	25			19.91	
10	50	0			19.88	
5	1	0	QPSK	22.58	22.79	22.77
5	1	12		22.90	22.89	22.85
5	1	24		22.90	22.85	22.81
5	12	0		22.00	21.94	21.91
5	12	7		22.06	22.01	21.93
5	12	13		22.03	22.02	21.96
5	25	0		22.07	21.94	21.93
5	1	0	16-QAM	21.77	22.10	22.06
5	1	12		22.13	22.16	22.17
5	1	24		22.13	22.12	22.10
5	12	0		21.03	20.98	20.93
5	12	7		21.06	21.06	20.98



5	12	13	64QAM	21.04	21.06	20.98
5	25	0		21.09	20.97	20.98
5	1	0		20.68	20.92	20.85
5	1	12		20.76	20.98	20.94
5	1	24		21.00	20.96	20.84
5	12	0		19.65	19.87	19.87
5	12	7		19.98	19.95	19.89
5	12	13		19.92	19.96	19.90
5	25	0		19.97	19.82	19.80



LTE Band 17 Maximum Average Power [dBm]						
BW [MHz]	RB Size	RB Offset	Mod	Lowest	Middle	Highest
10	1	0	QPSK	22.81	22.93	22.85
10	1	25		22.78	22.79	22.77
10	1	49		22.71	22.71	22.69
10	25	0		21.88	21.96	21.89
10	25	12		21.92	21.92	21.94
10	25	25		21.90	21.93	21.91
10	50	0		21.91	21.92	21.90
10	1	0	16-QAM	22.12	22.23	22.10
10	1	25		22.07	22.02	22.06
10	1	49		22.06	22.12	22.08
10	25	0		20.91	20.90	20.89
10	25	12		20.92	20.94	20.94
10	25	25		20.92	20.93	20.95
10	50	0		20.92	20.93	20.95
10	1	0	64QAM	21.13	21.19	21.17
10	1	25		21.04	21.08	21.08
10	1	49		21.14	21.11	21.18
10	25	0		19.96	19.96	19.93
10	25	12		19.98	19.97	19.99
10	25	25		19.97	19.99	20.02
10	50	0		19.95	19.96	20.00
5	1	0	QPSK	22.72	22.70	22.71
5	1	12		22.89	22.85	22.83
5	1	24		22.87	22.83	22.79
5	12	0		21.86	21.88	21.84
5	12	7		21.99	21.95	21.98
5	12	13		21.97	21.91	21.94
5	25	0		21.91	21.93	21.89
5	1	0	16-QAM	22.06	21.97	22.02
5	1	12		22.20	22.13	22.21
5	1	24		22.10	22.13	22.20
5	12	0		20.94	20.89	20.87
5	12	7		21.02	20.96	21.04



5	12	13	64QAM	20.96	20.93	21.01
5	25	0		20.97	20.93	20.94
5	1	0		21.06	20.99	20.94
5	1	12		21.15	21.08	21.17
5	1	24		21.10	21.16	21.17
5	12	0		20.02	19.95	19.97
5	12	7		20.09	20.04	20.11
5	12	13		20.06	20.04	20.08
5	25	0		19.98	19.99	20.00



Bottom Antenna

LTE Band 4 Maximum Average Power [dBm]						
BW [MHz]	RB Size	RB Offset	Mod	Lowest	Middle	Highest
20	1	0	QPSK	22.95	23.12	23.01
20	1	49		22.97	22.97	23.00
20	1	99		22.98	22.91	22.88
20	50	0		22.12	22.16	22.12
20	50	24		22.14	22.12	22.15
20	50	50		22.06	22.08	22.10
20	100	0		22.12	22.15	22.14
20	1	0	16-QAM	22.24	22.39	22.28
20	1	49		22.25	22.24	22.24
20	1	99		22.22	22.14	22.18
20	50	0		21.17	21.16	21.16
20	50	24		21.15	21.13	21.15
20	50	50		21.07	21.07	21.09
20	100	0		21.09	21.09	21.10
20	1	0	64-QAM	21.09	21.17	21.05
20	1	49		21.06	21.05	21.02
20	1	99		21.08	21.01	20.99
20	50	0		20.01	20.04	19.99
20	50	24		20.30	20.02	19.97
20	50	50		19.89	19.98	19.95
20	100	0		19.88	20.01	19.96
15	1	0	QPSK	22.99	23.07	23.08
15	1	37		22.93	23.03	22.96
15	1	74		22.93	23.00	22.96
15	36	0		22.10	22.14	22.14
15	36	20		22.10	22.16	22.14
15	36	39		22.07	22.10	22.08
15	75	0		22.06	22.13	22.12
15	1	0	16-QAM	22.24	22.28	22.26
15	1	37		22.13	22.22	22.27
15	1	74		22.16	22.20	22.16
15	36	0		21.10	21.13	21.09
15	36	20		21.10	21.14	21.10



15	36	39	64-QAM	21.04	21.08	21.03
15	75	0		21.09	21.13	21.10
15	1	0		20.89	21.10	21.13
15	1	37		20.80	21.06	21.01
15	1	74		20.82	21.00	21.02
15	36	0		19.82	19.98	20.00
15	36	20		19.84	19.97	19.99
15	36	39		19.79	19.93	19.93
15	75	0		19.78	19.94	19.95



LTE Band 4 Maximum Average Power [dBm]						
BW [MHz]	RB Size	RB Offset	Mod	Lowest	Middle	Highest
10	1	0	QPSK	22.94	22.91	22.90
10	1	25		22.92	22.94	22.88
10	1	49		22.73	22.84	22.75
10	25	0		21.97	22.05	22.00
10	25	12		21.99	22.02	22.02
10	25	25		21.89	21.97	21.91
10	50	0		21.95	22.02	21.96
10	1	0	16-QAM	22.15	22.22	22.19
10	1	25		22.14	22.20	22.20
10	1	49		22.02	22.06	22.06
10	25	0		20.98	21.06	20.97
10	25	12		21.01	21.04	20.98
10	25	25		20.92	20.95	20.91
10	50	0		20.95	20.99	20.97
10	1	0	64-QAM	20.80	20.91	20.90
10	1	25		20.78	20.94	20.94
10	1	49		20.67	20.80	20.78
10	25	0		19.66	19.80	19.83
10	25	12		19.66	19.81	19.83
10	25	25		19.57	19.74	19.75
10	50	0		19.63	19.80	19.79
5	1	0	QPSK	22.79	22.88	22.88
5	1	12		22.87	22.96	22.94
5	1	24		22.82	22.85	22.80
5	12	0		21.92	21.98	21.92
5	12	7		22.01	22.04	22.03
5	12	13		21.99	22.03	21.96
5	25	0		21.97	21.96	22.00
5	1	0	16-QAM	22.02	22.13	22.14
5	1	12		22.14	22.21	22.18
5	1	24		21.98	22.05	22.07
5	12	0		20.93	20.97	20.95
5	12	7		21.03	21.06	21.01



5	12	13	64-QAM	20.96	20.96	21.00
5	25	0		20.96	20.98	20.99
5	1	0		20.73	20.90	20.90
5	1	12		20.79	20.99	20.90
5	1	24		20.72	20.89	20.81
5	12	0		19.64	19.81	19.79
5	12	7		19.74	19.92	19.88
5	12	13		19.68	19.85	19.84
5	25	0		19.64	19.74	19.78



LTE Band 4 Maximum Average Power [dBm]						
BW [MHz]	RB Size	RB Offset	Mod	Lowest	Middle	Highest
3	1	0	QPSK	22.80	22.86	22.86
3	1	8		22.97	23.05	23.03
3	1	14		22.85	22.88	22.87
3	8	0		21.98	21.93	21.96
3	8	4		22.00	22.09	22.05
3	8	7		21.97	22.04	22.00
3	15	0		21.94	22.05	22.01
3	1	0	16-QAM	21.97	22.08	22.11
3	1	8		22.18	22.28	22.30
3	1	14		21.99	22.12	22.10
3	8	0		20.98	21.01	21.02
3	8	4		21.11	21.08	21.06
3	8	7		21.03	21.04	21.02
3	15	0		20.98	21.03	20.99
3	1	0	64-QAM	20.65	20.84	20.80
3	1	8		20.90	21.01	20.99
3	1	14		20.75	20.86	20.87
3	8	0		19.67	19.77	19.76
3	8	4		19.74	19.91	19.84
3	8	7		19.68	19.84	19.80
3	15	0		19.66	19.83	19.78
1.4	1	0	QPSK	22.68	22.82	22.72
1.4	1	3		22.46	22.94	22.89
1.4	1	5		22.78	22.85	22.83
1.4	3	0		22.84	22.85	22.81
1.4	3	1		22.90	22.94	22.81
1.4	3	3		22.89	22.93	22.88
1.4	6	0		21.89	21.98	21.85
1.4	1	0	16-QAM	21.93	22.03	21.96
1.4	1	3		22.11	22.18	22.14
1.4	1	5		22.03	22.09	22.07
1.4	3	0		21.86	21.90	21.81
1.4	3	1		21.90	21.96	21.87



1.4	3	3	64-QAM	21.89	21.91	21.91
1.4	6	0		20.96	21.01	20.92
1.4	1	0		20.81	20.83	20.87
1.4	1	3		20.87	20.96	20.92
1.4	1	5		20.80	20.85	20.81
1.4	3	0		20.81	20.84	20.80
1.4	3	1		20.84	20.95	20.87
1.4	3	3		20.85	20.91	20.88
1.4	6	0		19.80	19.89	19.81



LTE Band 66 Maximum Average Power [dBm]						
BW [MHz]	RB Size	RB Offset	Mod	Lowest	Middle	Highest
20	1	0	QPSK	23.04	23.13	23.12
20	1	49		22.98	22.97	22.96
20	1	99		22.85	22.92	22.76
20	50	0		22.20	22.21	22.17
20	50	24		22.14	22.14	22.15
20	50	50		22.04	22.07	22.01
20	100	0		22.13	22.14	22.13
20	1	0	16-QAM	22.32	22.32	22.38
20	1	49		22.28	22.22	22.21
20	1	99		22.09	22.21	22.02
20	50	0		21.22	21.22	21.18
20	50	24		21.14	21.18	21.13
20	50	50		21.04	21.09	21.02
20	100	0		21.15	21.12	21.10
20	1	0	64-QAM	21.17	21.33	21.24
20	1	49		21.01	21.23	21.11
20	1	99		20.94	21.21	21.01
20	50	0		20.10	20.26	20.12
20	50	24		20.06	20.20	20.08
20	50	50		19.97	20.12	19.97
20	100	0		20.05	20.18	20.05
15	1	0	QPSK	23.10	23.11	23.08
15	1	37		23.03	22.98	22.90
15	1	74		22.92	22.90	22.82
15	36	0		22.19	22.24	22.17
15	36	20		22.13	22.16	22.11
15	36	39		22.04	22.09	22.00
15	75	0		22.13	22.15	22.10
15	1	0	16-QAM	22.38	22.38	22.28
15	1	37		22.24	22.22	22.11
15	1	74		22.16	22.18	22.03
15	36	0		21.20	21.18	21.16
15	36	20		21.20	21.18	21.17



15	36	39	64-QAM	21.06	21.07	21.01
15	75	0		21.15	21.13	21.09
15	1	0		21.22	21.22	21.17
15	1	37		21.17	21.30	20.94
15	1	74		21.13	21.12	20.84
15	36	0		20.05	20.25	20.12
15	36	20		20.03	20.18	20.04
15	36	39		19.96	20.11	19.95
15	75	0		19.97	20.17	20.01



LTE Band 66 Maximum Average Power [dBm]						
BW [MHz]	RB Size	RB Offset	Mod	Lowest	Middle	Highest
10	1	0	QPSK	22.92	22.89	22.84
10	1	25		22.88	22.88	22.83
10	1	49		22.86	22.83	22.77
10	25	0		22.02	21.98	21.98
10	25	12		22.00	21.98	21.96
10	25	25		21.93	21.94	21.89
10	50	0		21.97	21.97	21.93
10	1	0	16-QAM	22.13	22.17	22.15
10	1	25		22.15	22.18	22.09
10	1	49		22.06	22.10	22.06
10	25	0		21.01	21.03	20.98
10	25	12		21.01	20.99	20.91
10	25	25		20.92	20.93	20.88
10	50	0		20.95	20.99	20.92
10	1	0	64-QAM	20.99	21.09	20.93
10	1	25		20.93	21.07	20.89
10	1	49		20.91	21.08	20.86
10	25	0		19.87	20.06	19.85
10	25	12		19.88	20.02	19.85
10	25	25		19.79	19.95	19.77
10	50	0		19.90	20.00	19.84
5	1	0	QPSK	22.82	22.86	22.76
5	1	12		22.89	22.93	22.82
5	1	24		22.95	22.91	22.87
5	12	0		21.96	21.94	21.93
5	12	7		22.01	22.02	21.98
5	12	13		21.98	22.04	21.94
5	25	0		22.01	21.96	21.93
5	1	0	16-QAM	22.09	22.10	22.02
5	1	12		22.12	22.14	22.10
5	1	24		22.15	22.19	22.15
5	12	0		20.99	20.99	20.90
5	12	7		21.01	20.98	20.99



5	12	13		21.01	21.00	20.99
5	25	0		20.99	20.99	20.95
5	1	0	64-QAM	20.89	21.05	20.87
5	1	12		20.97	21.14	20.97
5	1	24		21.06	21.16	21.00
5	12	0		19.96	20.02	19.81
5	12	7		19.94	20.05	19.91
5	12	13		19.92	20.10	19.92
5	25	0		19.88	19.99	19.86



LTE Band 66 Maximum Average Power [dBm]						
BW [MHz]	RB Size	RB Offset	Mod	Lowest	Middle	Highest
3	1	0	QPSK	22.83	22.87	22.79
3	1	8		22.96	22.97	22.92
3	1	14		22.88	22.92	22.82
3	8	0		21.99	21.94	21.91
3	8	4		22.04	21.97	21.93
3	8	7		22.01	22.01	21.95
3	15	0		21.98	21.95	21.90
3	1	0	16-QAM	22.09	22.16	22.02
3	1	8		22.24	22.23	22.14
3	1	14		22.19	22.16	22.03
3	8	0		21.06	20.97	20.91
3	8	4		21.10	21.00	21.01
3	8	7		21.01	21.06	20.95
3	15	0		21.04	20.94	20.95
3	1	0	64-QAM	20.94	21.05	20.94
3	1	8		21.10	21.23	21.11
3	1	14		21.01	21.13	21.00
3	8	0		19.86	20.02	19.85
3	8	4		19.94	20.06	19.91
3	8	7		19.92	20.04	19.85
3	15	0		19.89	19.94	19.82
1.4	1	0	QPSK	22.90	22.86	22.71
1.4	1	3		22.81	22.93	22.86
1.4	1	5		22.84	22.86	22.76
1.4	3	0		22.94	22.84	22.75
1.4	3	1		22.89	22.94	22.80
1.4	3	3		22.90	22.92	22.84
1.4	6	0		22.03	21.91	21.83
1.4	1	0	16-QAM	22.22	22.12	21.98
1.4	1	3		22.13	22.23	22.15
1.4	1	5		21.88	22.12	22.03
1.4	3	0		21.91	21.87	21.79
1.4	3	1		21.85	21.93	21.81



1.4	3	3	64-QAM	21.98	21.84	21.86
1.4	6	0		20.89	21.01	20.90
1.4	1	0		21.03	21.17	20.96
1.4	1	3		21.17	21.32	21.08
1.4	1	5		21.01	21.18	20.94
1.4	3	0		20.86	21.08	20.80
1.4	3	1		20.97	21.19	20.95
1.4	3	3		20.94	21.13	20.99
1.4	6	0		19.87	19.83	19.80

Remark: For Top/Bottom Antenna, the higher Conducted power is shown in this report.



ERP/EIRP

LTE Band 4 (GT - LC = -0.50 dB) QPSK									
Bandwidth	1.4M			3M			5M		
Channel	19957	20175	20393	19965	20175	20385	19975	20175	20375
	(Low)	(Mid)	(High)	(Low)	(Mid)	(High)	(Low)	(Mid)	(High)
Frequency	1710.7	1732.5	1754.3	1711.5	1732.5	1753.5	1712.5	1732.5	1752.5
(MHz)									
Conducted Power (dBm)	22.46	22.94	22.89	22.97	23.05	23.03	22.87	22.96	22.94
Conducted Power (Watts)	0.1762	0.1968	0.1945	0.1982	0.2018	0.2009	0.1936	0.1977	0.1968
EIRP(dBm)	21.96	22.44	22.39	22.47	22.55	22.53	22.37	22.46	22.44
EIRP(Watts)	0.1570	0.1754	0.1734	0.1766	0.1799	0.1791	0.1726	0.1762	0.1754

LTE Band 4 (GT - LC = -0.50 dB) QPSK									
Bandwidth	10M			15M			20M		
Channel	20000	20175	20350	20025	20175	20325	20050	20175	20300
	(Low)	(Mid)	(High)	(Low)	(Mid)	(High)	(Low)	(Mid)	(High)
Frequency	1715	1732.5	1750	1717.5	1732.5	1747.5	1720	1732.5	1745
(MHz)									
Conducted Power (dBm)	22.92	22.94	22.88	22.99	23.07	23.08	22.95	23.12	23.01
Conducted Power (Watts)	0.1959	0.1968	0.1941	0.1991	0.2028	0.2032	0.1972	0.2051	0.2000
EIRP(dBm)	22.42	22.44	22.38	22.49	22.57	22.58	22.45	22.62	22.51
EIRP(Watts)	0.1746	0.1754	0.1730	0.1774	0.1807	0.1811	0.1758	0.1828	0.1782



LTE Band 4 (GT - LC = -0.50 dB) 16QAM									
Bandwidth	1.4M			3M			5M		
Channel	19957	20175	20393	19965	20175	20385	19975	20175	20375
	(Low)	(Mid)	(High)	(Low)	(Mid)	(High)	(Low)	(Mid)	(High)
Frequency (MHz)	1710.7	1732.5	1754.3	1711.5	1732.5	1753.5	1712.5	1732.5	1752.5
Conducted Power (dBm)	22.11	22.18	22.14	22.18	22.28	22.30	22.14	22.21	22.18
Conducted Power (Watts)	0.1626	0.1652	0.1637	0.1652	0.1690	0.1698	0.1637	0.1663	0.1652
EIRP(dBm)	21.61	21.68	21.64	21.68	21.78	21.80	21.64	21.71	21.68
EIRP(Watts)	0.1449	0.1472	0.1459	0.1472	0.1507	0.1514	0.1459	0.1483	0.1472

LTE Band 4 (GT - LC = -0.50 dB) 16QAM									
Bandwidth	10M			15M			20M		
Channel	20000	20175	20350	20025	20175	20325	20050	20175	20300
	(Low)	(Mid)	(High)	(Low)	(Mid)	(High)	(Low)	(Mid)	(High)
Frequency (MHz)	1715	1732.5	1750	1717.5	1732.5	1747.5	1720	1732.5	1745
Conducted Power (dBm)	22.15	22.22	22.19	22.24	22.28	22.26	22.24	22.39	22.28
Conducted Power (Watts)	0.1641	0.1667	0.1656	0.1675	0.1690	0.1683	0.1675	0.1734	0.1690
EIRP(dBm)	21.65	21.72	21.69	21.74	21.78	21.76	21.74	21.89	21.78
EIRP(Watts)	0.1462	0.1486	0.1476	0.1493	0.1507	0.1500	0.1493	0.1545	0.1507



LTE Band 4 (GT - LC = -0.50 dB) 64QAM									
Bandwidth	1.4M			3M			5M		
Channel	19957	20175	20393	19965	20175	20385	19975	20175	20375
	(Low)	(Mid)	(High)	(Low)	(Mid)	(High)	(Low)	(Mid)	(High)
Frequency (MHz)	1710.7	1732.5	1754.3	1711.5	1732.5	1753.5	1712.5	1732.5	1752.5
Conducted Power (dBm)	20.87	20.96	20.92	20.90	21.01	20.99	20.79	20.99	20.90
Conducted Power (Watts)	0.1222	0.1247	0.1236	0.1230	0.1262	0.1256	0.1199	0.1256	0.1230
EIRP(dBm)	20.37	20.46	20.42	20.40	20.51	20.49	20.29	20.49	20.40
EIRP(Watts)	0.1089	0.1112	0.1102	0.1096	0.1125	0.1119	0.1069	0.1119	0.1096

LTE Band 4 (GT - LC = -0.50 dB) 64QAM									
Bandwidth	10M			15M			20M		
Channel	20000	20175	20350	20025	20175	20325	20050	20175	20300
	(Low)	(Mid)	(High)	(Low)	(Mid)	(High)	(Low)	(Mid)	(High)
Frequency (MHz)	1715	1732.5	1750	1717.5	1732.5	1747.5	1720	1732.5	1745
Conducted Power (dBm)	20.78	20.94	20.94	20.89	21.10	21.13	21.09	21.17	21.05
Conducted Power (Watts)	0.1197	0.1242	0.1242	0.1227	0.1288	0.1297	0.1285	0.1309	0.1274
EIRP(dBm)	20.28	20.44	20.44	20.39	20.60	20.63	20.59	20.67	20.55
EIRP(Watts)	0.1067	0.1107	0.1107	0.1094	0.1148	0.1156	0.1146	0.1167	0.1135



LTE Band 66 (GT - LC = -0.50 dB) QPSK									
Bandwidth	1.4M			3M			5M		
Channel	131979	132322	132665	131987	132322	132657	131997	132322	132647
	(Low)	(Mid)	(High)	(Low)	(Mid)	(High)	(Low)	(Mid)	(High)
Frequency (MHz)	1710.7	1745	1779.3	1711.5	1745	1778.5	1712.5	1745	1777.5
Conducted Power (dBm)	22.94	22.84	22.75	22.96	22.97	22.92	22.95	22.91	22.87
Conducted Power (Watts)	0.1968	0.1923	0.1884	0.1977	0.1982	0.1959	0.1972	0.1954	0.1936
EIRP(dBm)	22.44	22.34	22.25	22.46	22.47	22.42	22.45	22.41	22.37
EIRP(Watts)	0.1754	0.1714	0.1679	0.1762	0.1766	0.1746	0.1758	0.1742	0.1726

LTE Band 66 (GT - LC = -0.50 dB) QPSK									
Bandwidth	10M			15M			20M		
Channel	132022	132322	132622	132047	132322	132597	132072	132322	132572
	(Low)	(Mid)	(High)	(Low)	(Mid)	(High)	(Low)	(Mid)	(Mid)
Frequency (MHz)	1715	1745	1775	1717.5	1745	1772.5	1720	1745	1770
Conducted Power (dBm)	22.92	22.89	22.84	23.10	23.11	23.08	23.04	23.13	23.12
Conducted Power (Watts)	0.1959	0.1945	0.1923	0.2042	0.2046	0.2032	0.2014	0.2056	0.2051
EIRP(dBm)	22.42	22.39	22.34	22.60	22.61	22.58	22.54	22.63	22.62
EIRP(Watts)	0.1746	0.1734	0.1714	0.1820	0.1824	0.1811	0.1795	0.1832	0.1828



LTE Band 66 (GT - LC = -0.50 dB) 16QAM									
Bandwidth	1.4M			3M			5M		
Channel	131979	132322	132665	131987	132322	132657	131997	132322	132647
	(Low)	(Mid)	(High)	(Low)	(Mid)	(High)	(Low)	(Mid)	(High)
Frequency (MHz)	1710.7	1745	1779.3	1711.5	1745	1778.5	1712.5	1745	1777.5
Conducted Power (dBm)	22.13	22.23	22.15	22.24	22.23	22.14	22.15	22.19	22.15
Conducted Power (Watts)	0.1633	0.1671	0.1641	0.1675	0.1671	0.1637	0.1641	0.1656	0.1641
EIRP(dBm)	21.63	21.73	21.65	21.74	21.73	21.64	21.65	21.69	21.65
EIRP(Watts)	0.1455	0.1489	0.1462	0.1493	0.1489	0.1459	0.1462	0.1476	0.1462

LTE Band 66 (GT - LC = -0.50 dB) 16QAM									
Bandwidth	10M			15M			20M		
Channel	132022	132322	132622	132047	132322	132597	132072	132322	132572
	(Low)	(Mid)	(High)	(Low)	(Mid)	(High)	(Low)	(Mid)	(Mid)
Frequency (MHz)	1715	1745	1775	1717.5	1745	1772.5	1720	1745	1770
Conducted Power (dBm)	22.15	22.18	22.09	22.38	22.38	22.28	22.32	22.32	22.38
Conducted Power (Watts)	0.1641	0.1652	0.1618	0.1730	0.1730	0.1690	0.1706	0.1706	0.1730
EIRP(dBm)	21.65	21.68	21.59	21.88	21.88	21.78	21.82	21.82	21.88
EIRP(Watts)	0.1462	0.1472	0.1442	0.1542	0.1542	0.1507	0.1521	0.1521	0.1542



LTE Band 66 (GT - LC = -0.50 dB) 64QAM									
Bandwidth	1.4M			3M			5M		
Channel	131979	132322	132665	131987	132322	132657	131997	132322	132647
	(Low)	(Mid)	(High)	(Low)	(Mid)	(High)	(Low)	(Mid)	(High)
Frequency (MHz)	1710.7	1745	1779.3	1711.5	1745	1778.5	1712.5	1745	1777.5
Conducted Power (dBm)	21.17	21.32	21.08	21.10	21.23	21.11	21.06	21.16	21.00
Conducted Power (Watts)	0.1309	0.1355	0.1282	0.1288	0.1327	0.1291	0.1276	0.1306	0.1259
EIRP(dBm)	20.67	20.82	20.58	20.60	20.73	20.61	20.56	20.66	20.50
EIRP(Watts)	0.1167	0.1208	0.1143	0.1148	0.1183	0.1151	0.1138	0.1164	0.1122

LTE Band 66 (GT - LC = -0.50 dB) 64QAM									
Bandwidth	10M			15M			20M		
Channel	132022	132322	132622	132047	132322	132597	132072	132322	132572
	(Low)	(Mid)	(High)	(Low)	(Mid)	(High)	(Low)	(Mid)	(Mid)
Frequency (MHz)	1715	1745	1775	1717.5	1745	1772.5	1720	1745	1770
Conducted Power (dBm)	20.99	21.09	20.93	21.17	21.30	20.94	21.17	21.33	21.24
Conducted Power (Watts)	0.1256	0.1285	0.1239	0.1309	0.1349	0.1242	0.1309	0.1358	0.1330
EIRP(dBm)	20.49	20.59	20.43	20.67	20.80	20.44	20.67	20.83	20.74
EIRP(Watts)	0.1119	0.1146	0.1104	0.1167	0.1202	0.1107	0.1167	0.1211	0.1186



LTE Band 12 (GT - LC = -1.50 dB) QPSK									
Bandwidth	1.4M			3M			5M		
Channel	23017	23095	23173	23025	23095	23165	23035	23095	23155
	(Low)	(Mid)	(High)	(Low)	(Mid)	(High)	(Low)	(Mid)	(High)
Frequency (MHz)	699.7	707.5	715.3	700.5	707.5	714.5	701.5	707.5	713.5
Conducted Power (dBm)	22.79	22.85	22.83	22.88	22.84	22.82	22.81	22.88	22.85
Conducted Power (Watts)	0.1901	0.1928	0.1919	0.1941	0.1923	0.1914	0.1910	0.1941	0.1928
ERP(dBm)	18.64	18.70	18.68	18.73	18.69	18.67	18.66	18.73	18.70
ERP(Watts)	0.0731	0.0741	0.0738	0.0746	0.0740	0.0736	0.0735	0.0746	0.0741

LTE Band 12 (GT - LC = -1.50 dB) QPSK			
Bandwidth	10M		
Channel	23060	23095	23130
	(Low)	(Mid)	(High)
Frequency (MHz)	704	707.5	711
Conducted Power (dBm)	22.86	22.91	22.85
Conducted Power (Watts)	0.1932	0.1954	0.1928
ERP(dBm)	18.71	18.76	18.70
ERP(Watts)	0.0743	0.0752	0.0741



LTE Band 12 (GT - LC = -1.50 dB) 16QAM									
Bandwidth	1.4M			3M			5M		
Channel	23017	23095	23173	23025	23095	23165	23035	23095	23155
	(Low)	(Mid)	(High)	(Low)	(Mid)	(High)	(Low)	(Mid)	(High)
Frequency (MHz)	699.7	707.5	715.3	700.5	707.5	714.5	701.5	707.5	713.5
Conducted Power (dBm)	22.12	22.10	22.14	22.20	22.18	22.25	22.19	22.15	22.16
Conducted Power (Watts)	0.1629	0.1622	0.1637	0.1660	0.1652	0.1679	0.1656	0.1641	0.1644
ERP(dBm)	17.97	17.95	17.99	18.05	18.03	18.10	18.04	18.00	18.01
ERP(Watts)	0.0627	0.0624	0.0630	0.0638	0.0635	0.0646	0.0637	0.0631	0.0632

LTE Band 12 (GT - LC = -1.50dB) 16QAM			
Bandwidth	10M		
Channel	23060	23095	23130
	(Low)	(Mid)	(High)
Frequency (MHz)	704	707.5	711
Conducted Power (dBm)	22.04	22.13	22.08
Conducted Power (Watts)	0.1600	0.1633	0.1614
ERP(dBm)	17.89	17.98	17.93
ERP(Watts)	0.0615	0.0628	0.0621



LTE Band 12 (GT - LC = -1.50 dB) 64QAM									
Bandwidth	1.4M			3M			5M		
Channel	23017	23095	23173	23025	23095	23165	23035	23095	23155
	(Low)	(Mid)	(High)	(Low)	(Mid)	(High)	(Low)	(Mid)	(High)
Frequency (MHz)	699.7	707.5	715.3	700.5	707.5	714.5	701.5	707.5	713.5
Conducted Power (dBm)	21.14	21.14	21.14	21.24	21.17	21.25	21.13	21.07	21.16
Conducted Power (Watts)	0.1300	0.1300	0.1300	0.1330	0.1309	0.1334	0.1297	0.1279	0.1306
ERP(dBm)	16.99	16.99	16.99	17.09	17.02	17.10	16.98	16.92	17.01
ERP(Watts)	0.0500	0.0500	0.0500	0.0512	0.0504	0.0513	0.0499	0.0492	0.0502

LTE Band 12 (GT - LC = -1.50 dB) 64QAM			
Bandwidth	10M		
Channel	23060	23095	23130
	(Low)	(Mid)	(High)
Frequency (MHz)	704	707.5	711
Conducted Power (dBm)	21.14	21.15	21.13
Conducted Power (Watts)	0.1300	0.1303	0.1297
ERP(dBm)	16.99	17.00	16.98
ERP(Watts)	0.0500	0.0501	0.0499



LTE Band 13 (GT - LC = -2.00 dB) QPSK						
Bandwidth	5M			10M		
Channel	23205	23230	23255	23230		
	(Low)	(Mid)	(High)	-	(Mid)	-
Frequency	779.5	782	784.5	-	782	-
(MHz)						
Conducted Power (dBm)	22.90	22.89	22.85	-	22.95	-
Conducted Power (Watts)	0.1950	0.1945	0.1928	-	0.1972	-
ERP(dBm)	18.75	18.74	18.70	-	18.80	-
ERP(Watts)	0.0750	0.0748	0.0741	-	0.0759	-

LTE Band 13 (GT - LC = -2.00 dB) 16QAM						
Bandwidth	5M			10M		
Channel	23205	23230	23255	23230		
	(Low)	(Mid)	(High)	-	(Mid)	-
Frequency	779.5	782	784.5	-	782	-
(MHz)						
Conducted Power (dBm)	22.13	22.16	22.17	-	22.18	-
Conducted Power (Watts)	0.1633	0.1644	0.1648	-	0.1652	-
ERP(dBm)	17.98	18.01	18.02	-	18.03	-
ERP(Watts)	0.0628	0.0632	0.0634	-	0.0635	-

LTE Band 13 (GT - LC = -2.00 dB) 64QAM						
Bandwidth	5M			10M		
Channel	23205	23230	23255	23230		
	(Low)	(Mid)	(High)	-	(Mid)	-
Frequency	779.5	782	784.5	-	782	-
(MHz)						
Conducted Power (dBm)	21.00	20.96	20.84	-	20.98	-
Conducted Power (Watts)	0.1259	0.1247	0.1213	-	0.1253	-
ERP(dBm)	16.85	16.81	16.69	-	16.83	-
ERP(Watts)	0.0484	0.0480	0.0467	-	0.0482	-



LTE Band 17 (GT - LC = -2.00 dB) QPSK						
Bandwidth	5M			10M		
Channel	23755	23790	23825	23780	23790	23800
	(Low)	(Mid)	(High)	(Low)	(Mid)	(High)
Frequency	706.5	710	713.5	709	710	711
(MHz)						
Conducted Power (dBm)	22.89	22.85	22.83	22.81	22.93	22.85
Conducted Power (Watts)	0.1945	0.1928	0.1919	0.1910	0.1963	0.1928
ERP(dBm)	18.74	18.70	18.68	18.66	18.78	18.70
ERP(Watts)	0.0748	0.0741	0.0738	0.0735	0.0755	0.0741

LTE Band 17 (GT - LC = -2.00 dB) 16QAM						
Bandwidth	5M			10M		
Channel	23755	23790	23825	23780	23790	23800
	(Low)	(Mid)	(High)	(Low)	(Mid)	(High)
Frequency	706.5	710	713.5	709	710	711
(MHz)						
Conducted Power (dBm)	22.20	22.13	22.21	22.12	22.23	22.10
Conducted Power (Watts)	0.1660	0.1633	0.1663	0.1629	0.1671	0.1622
ERP(dBm)	18.05	17.98	18.06	17.97	18.08	17.95
ERP(Watts)	0.0638	0.0628	0.0640	0.0627	0.0643	0.0624

LTE Band 17 (GT - LC = -2.00 dB) 64QAM						
Bandwidth	5M			10M		
Channel	23755	23790	23825	23780	23790	23800
	(Low)	(Mid)	(High)	(Low)	(Mid)	(High)
Frequency	706.5	710	713.5	709	710	711
(MHz)						
Conducted Power (dBm)	21.15	21.08	21.17	21.13	21.19	21.17
Conducted Power (Watts)	0.1303	0.1282	0.1309	0.1297	0.1315	0.1309
ERP(dBm)	17.00	16.93	17.02	16.98	17.04	17.02
ERP(Watts)	0.0501	0.0493	0.0504	0.0499	0.0506	0.0504



Peak-to-Average Ratio

Mode	LTE Band 4 / 20MHz				
Mod.	QPSK		16QAM		Limit: 13dB
RB Size	1RB	Full RB	1RB	Full RB	Result
Lowest CH	3.57	4.96	4.20	5.94	PASS
Middle CH	3.68	5.07	4.75	5.91	
Highest CH	3.48	4.90	4.00	5.88	
Mode	LTE Band 4 / 20MHz				
Mod.	64QAM				Limit: 13dB
RB Size	1RB	Full RB			Result
Lowest CH	4.06	5.88			PASS
Middle CH	4.32	5.86			
Highest CH	4.14	5.88			

Mode	LTE Band 12 / 10MHz				
Mod.	QPSK		16QAM		Limit: 13dB
RB Size	1RB	Full RB	1RB	Full RB	Result
Lowest CH	3.74	5.10	4.38	6.06	PASS
Middle CH	3.74	5.01	4.49	5.83	
Highest CH	3.59	5.07	4.38	5.91	
Mod.	64QAM				Limit: 13dB
RB Size	1RB	Full RB			Result
Lowest CH	4.52	5.97			PASS
Middle CH	4.35	5.86			
Highest CH	4.32	5.88			



Mode	LTE Band 13 / 10MHz				
Mod.	QPSK		16QAM		Limit: 13dB
RB Size	1RB	Full RB	1RB	Full RB	Result
Lowest CH	-	-	-	-	PASS
Middle CH	3.45	4.99	4.14	5.91	
Highest CH	-	-	-	-	
Mode	LTE Band 13 / 10MHz				
Mod.	64QAM				Limit: 13dB
RB Size	1RB	Full RB			Result
Lowest CH	-	-			PASS
Middle CH	4.26	5.88			
Highest CH	-	-			

Mode	LTE Band 17 / 10MHz				
Mod.	QPSK		16QAM		Limit: 13dB
RB Size	1RB	Full RB	1RB	Full RB	Result
Lowest CH	3.91	5.10	4.43	6.03	PASS
Middle CH	3.83	5.22	4.70	6.03	
Highest CH	3.83	5.25	4.32	6.06	
Mode	LTE Band 17 / 10MHz				
Mod.	64QAM				Limit: 13dB
RB Size	1RB	Full RB			Result
Lowest CH	4.58	6.03			PASS
Middle CH	4.70	6.00			
Highest CH	4.35	6.03			

Mode	LTE Band 66 / 20MHz				
Mod.	QPSK		16QAM		Limit: 13dB
RB Size	1RB	Full RB	1RB	Full RB	Result
Lowest CH	3.51	5.07	4.17	5.86	PASS
Middle CH	3.51	4.96	4.23	5.91	
Highest CH	3.57	4.93	4.03	5.83	
Mode	LTE Band 66 / 20MHz				
Mod.	64QAM				Limit: 13dB
RB Size	1RB	Full RB			Result
Lowest CH	4.32	5.91			PASS
Middle CH	4.29	5.83			
Highest CH	4.06	5.80			



LTE Band 4 / 20MHz / QPSK

Lowest Channel / 1RB

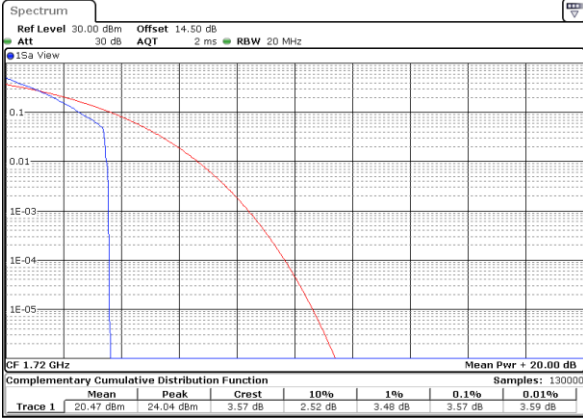

Date: 17_JUL_2019 01:47:19

Lowest Channel / Full RB

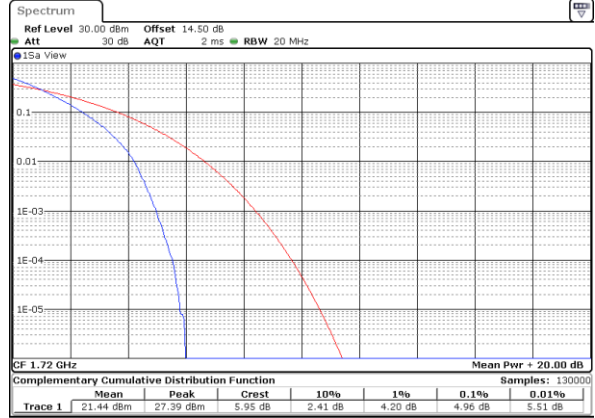

Date: 17_JUL_2019 01:48:04

Middle Channel / 1RB

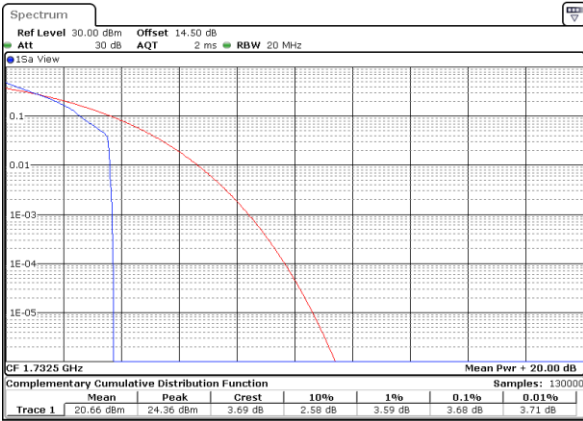

Date: 17_JUL_2019 01:44:24

Middle Channel / Full RB

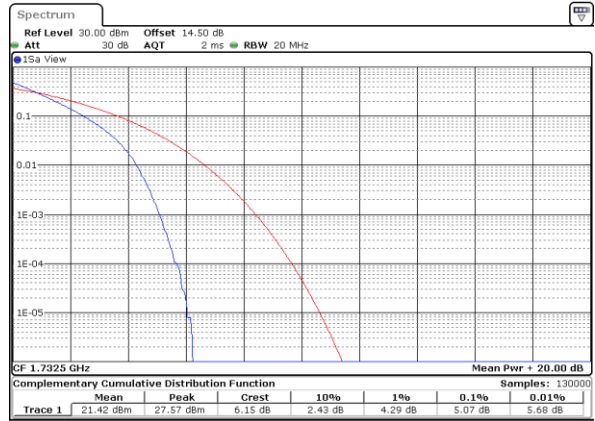

Date: 17_JUL_2019 01:44:39

Highest Channel / 1RB

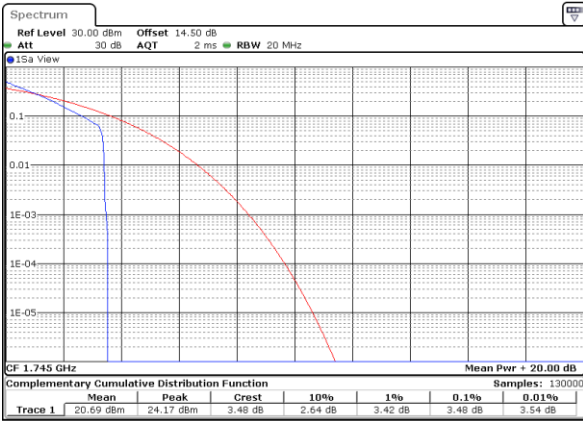

Date: 17_JUL_2019 01:43:26

Highest Channel / Full RB

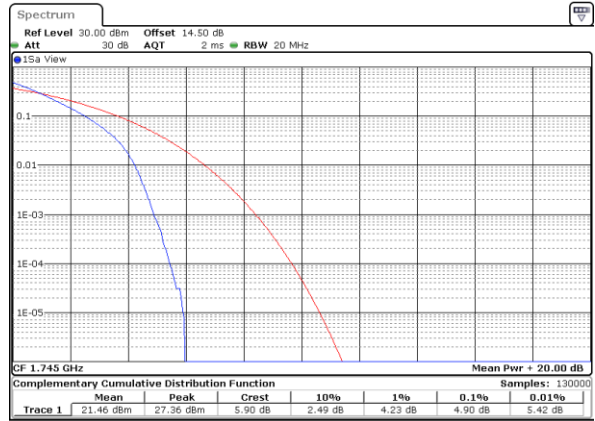

Date: 17_JUL_2019 01:43:07



LTE Band 4 / 20MHz / 16QAM

Lowest Channel / 1RB

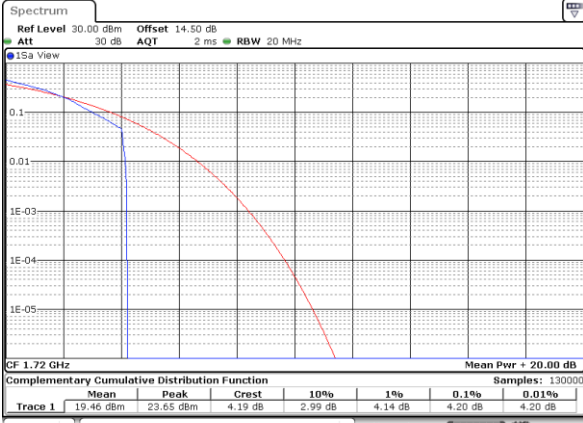

Date: 17_JUL_2019 01:47:33

Lowest Channel / Full RB

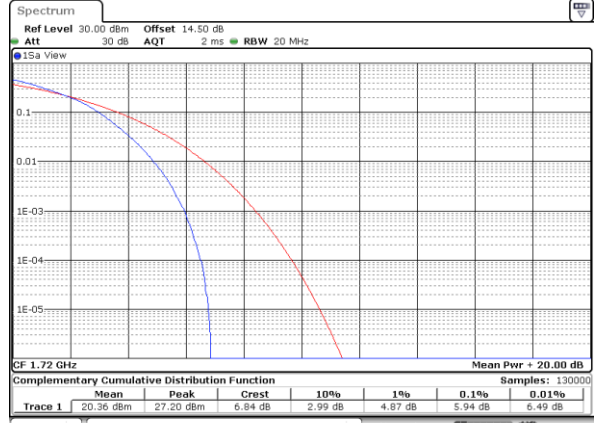

Date: 17_JUL_2019 01:47:49

Middle Channel / 1RB

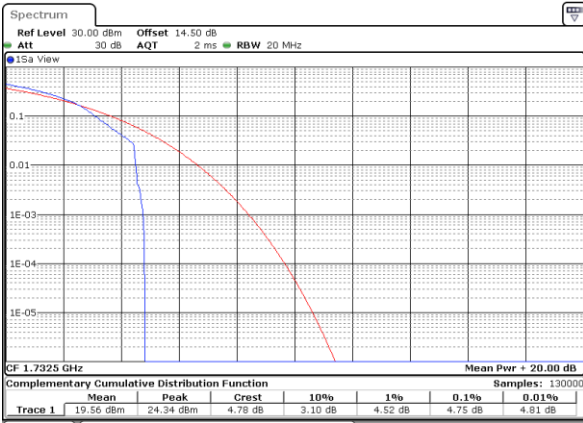

Date: 17_JUL_2019 01:44:09

Middle Channel / Full RB

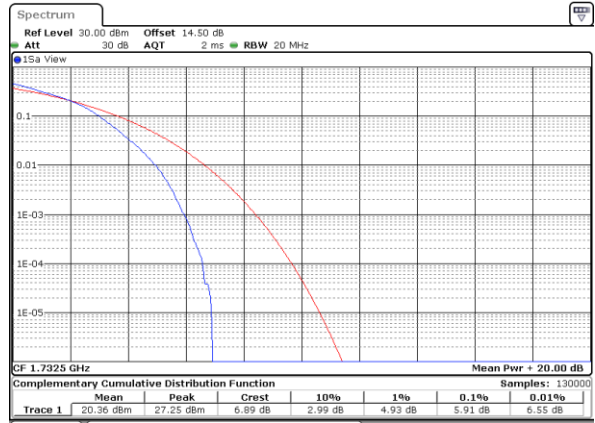

Date: 17_JUL_2019 01:44:54

Highest Channel / 1RB

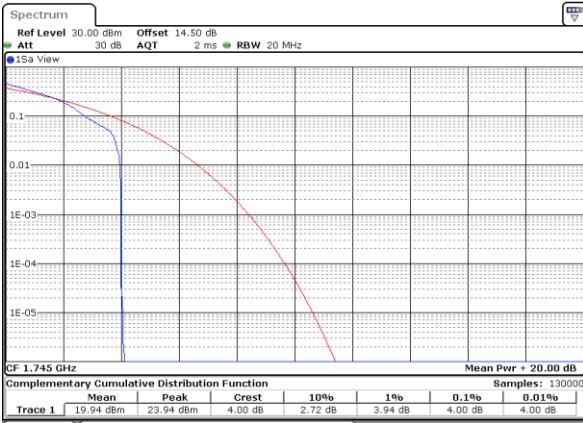

Date: 17_JUL_2019 01:43:47

Highest Channel / Full RB

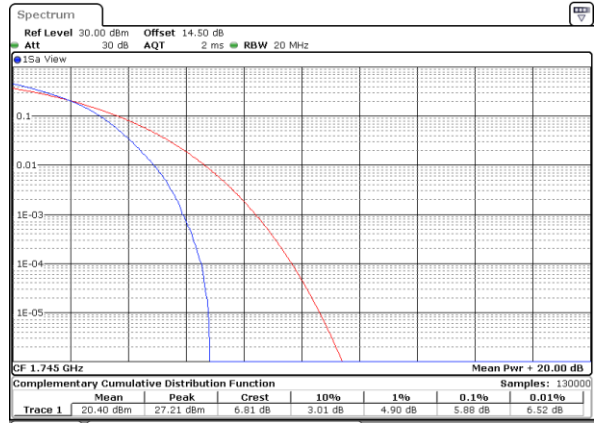

Date: 17_JUL_2019 01:44:53



LTE Band 4 / 20MHz / 64QAM

Lowest Channel / 1RB

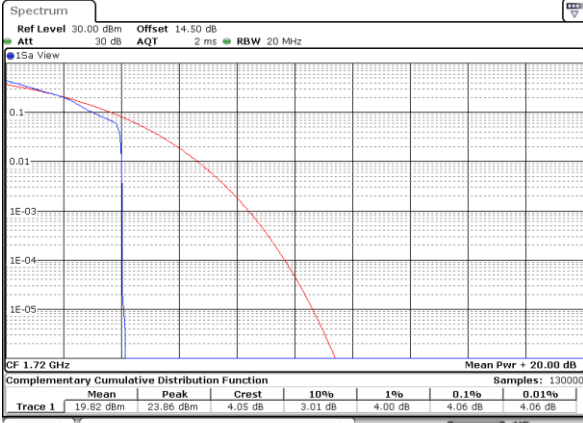

Date: 17_JUL_2019 01:34:43

Lowest Channel / Full RB

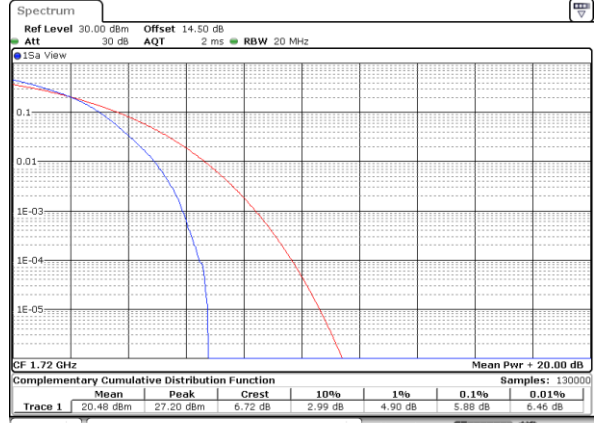

Date: 17_JUL_2019 01:34:52

Middle Channel / 1RB

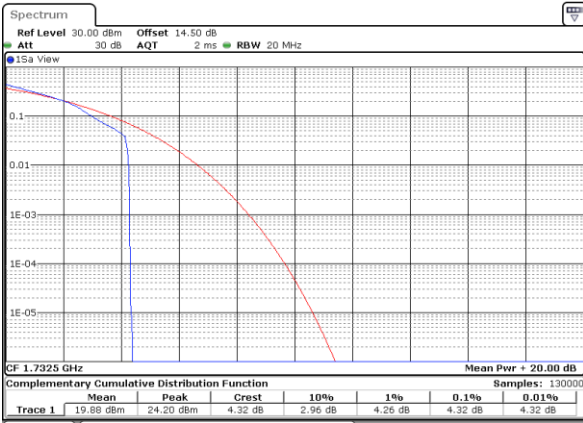

Date: 17_JUL_2019 01:35:00

Middle Channel / Full RB

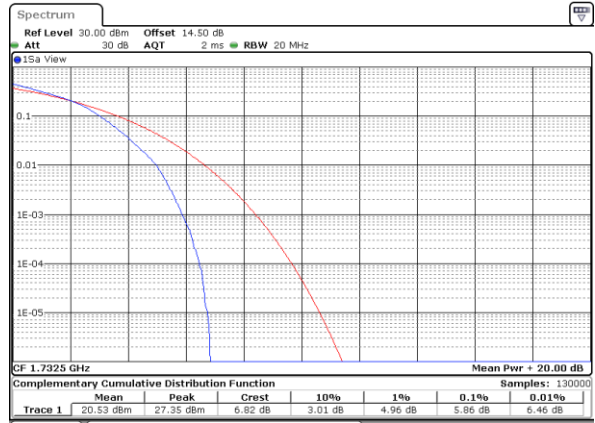

Date: 17_JUL_2019 01:35:09

Highest Channel / 1RB

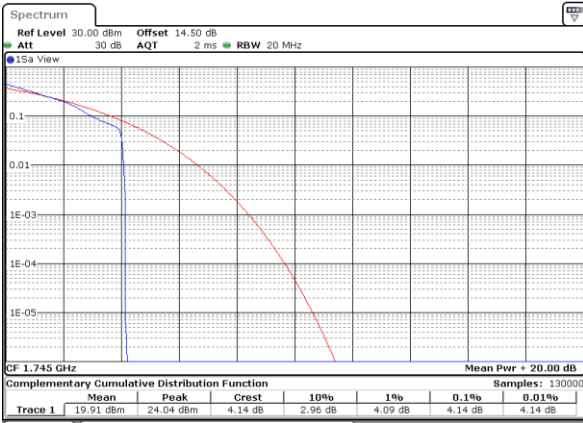

Date: 17_JUL_2019 01:35:18

Highest Channel / Full RB

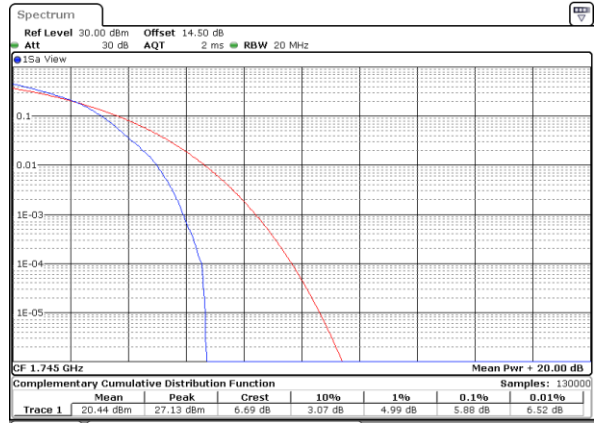

Date: 17_JUL_2019 01:35:26



LTE Band 12 / 10MHz / QPSK

Lowest Channel / 1RB

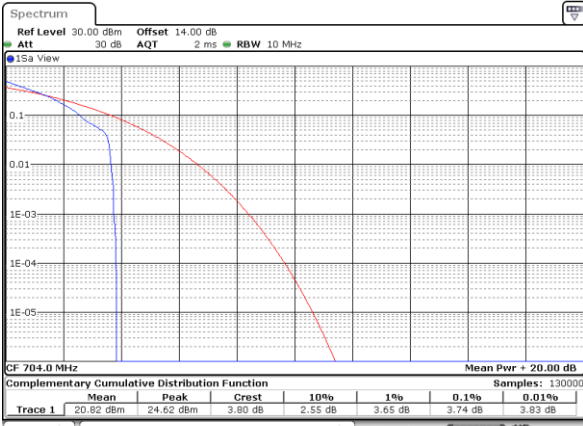

Date: 14 JUL 2019 14:09:06

Lowest Channel / Full RB

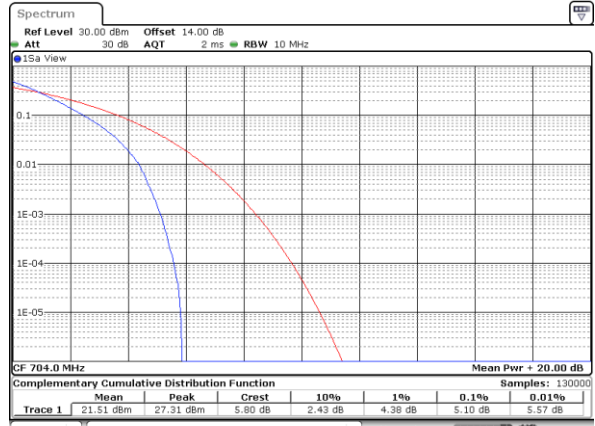

Date: 14 JUL 2019 14:09:15

Middle Channel / 1RB

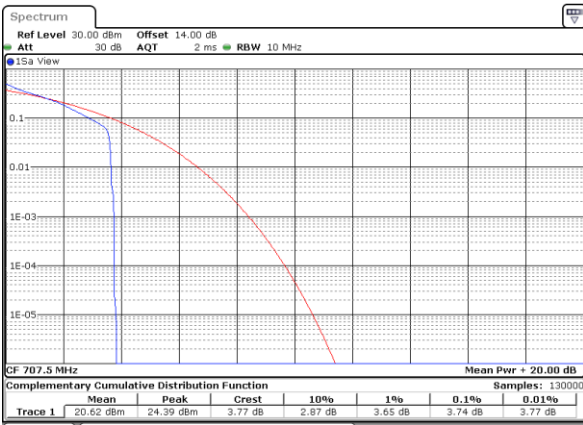

Date: 14 JUL 2019 14:09:24

Middle Channel / Full RB

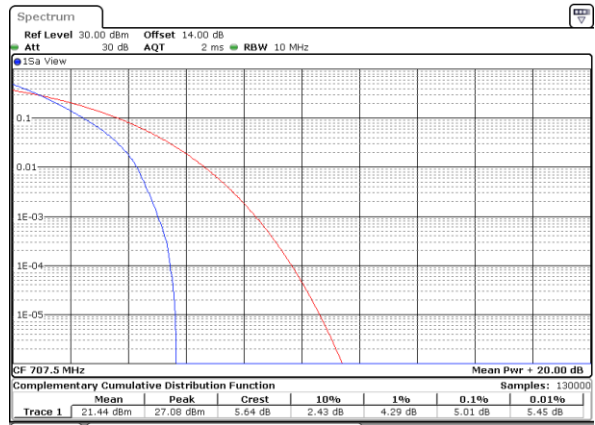

Date: 14 JUL 2019 14:09:29

Highest Channel / 1RB

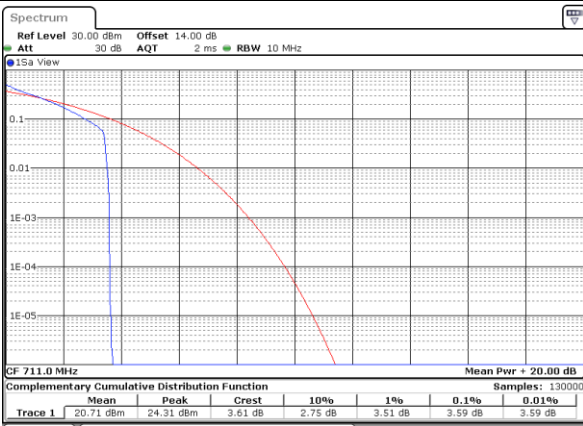

Date: 14 JUL 2019 14:09:49

Highest Channel / Full RB

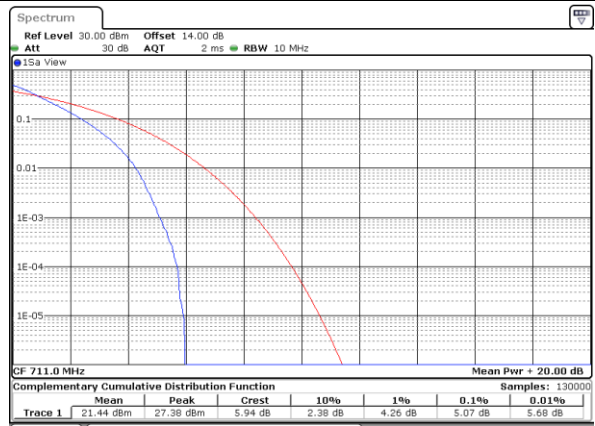

Date: 14 JUL 2019 14:09:58



LTE Band 12 / 10MHz / 16QAM

Lowest Channel / 1RB

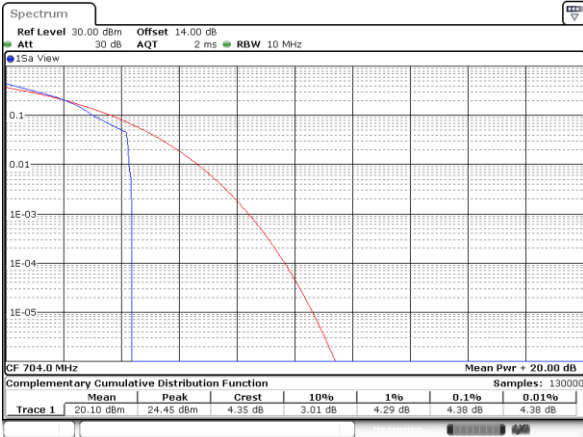

Date: 14 JUL 2019 14:08:07

Lowest Channel / Full RB

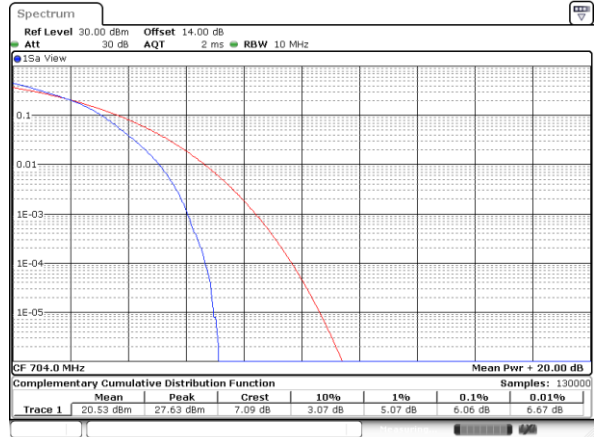

Date: 14 JUL 2019 14:08:17

Middle Channel / 1RB

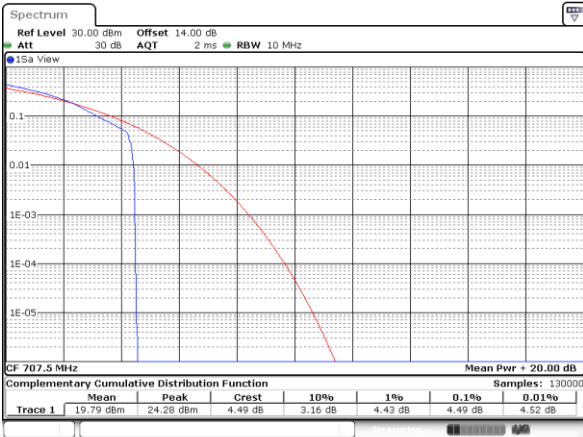

Date: 14 JUL 2019 14:08:26

Middle Channel / Full RB

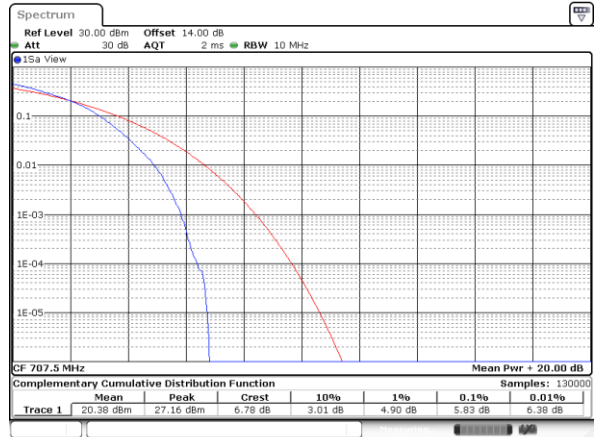

Date: 14 JUL 2019 14:08:29

Highest Channel / 1RB

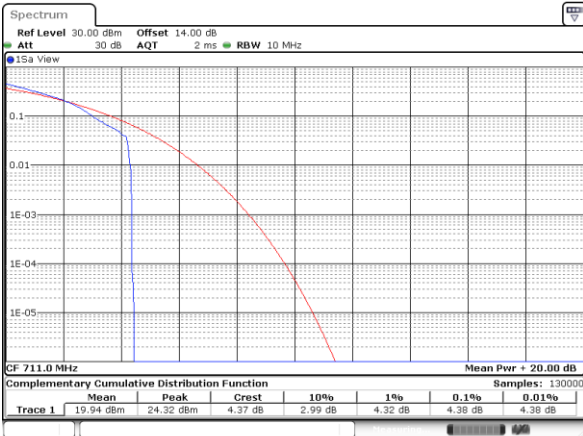

Date: 14 JUL 2019 14:08:48

Highest Channel / Full RB

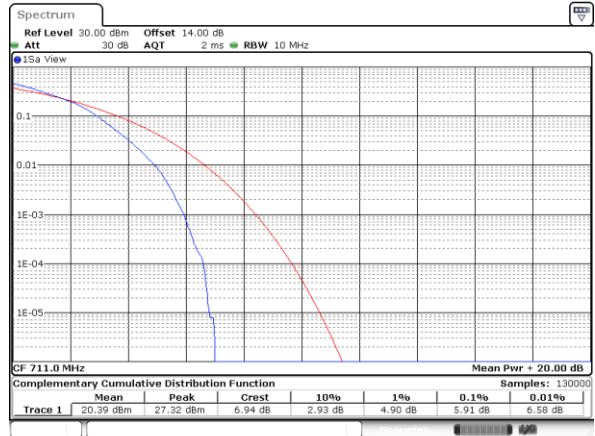

Date: 14 JUL 2019 14:08:58



LTE Band 12 / 10MHz / 64QAM

Lowest Channel / 1RB

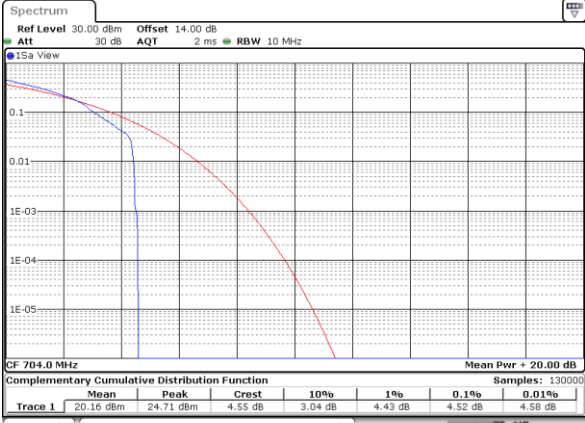

Date: 14 JUL 2019 15:26:07

Lowest Channel / Full RB

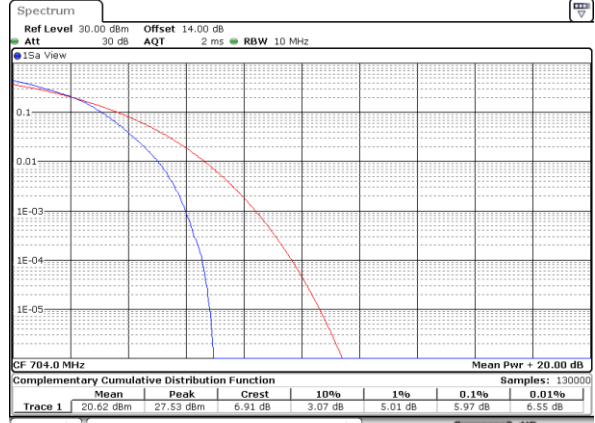

Date: 14 JUL 2019 15:26:22

Middle Channel / 1RB

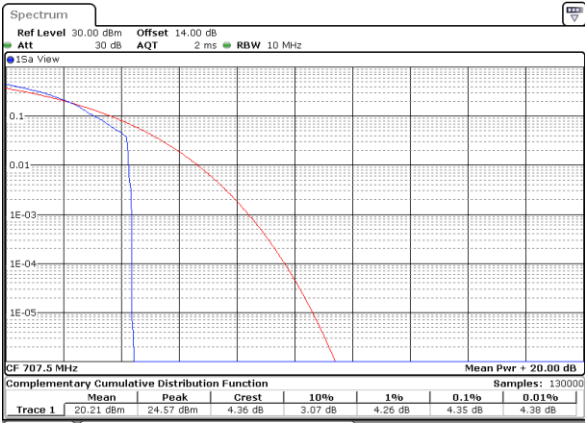

Date: 14 JUL 2019 15:26:39

Middle Channel / Full RB

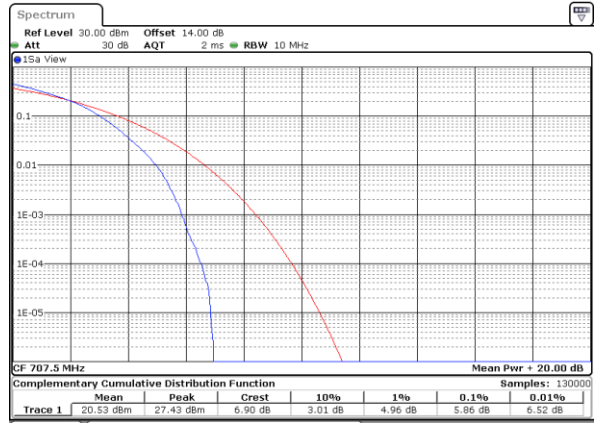

Date: 14 JUL 2019 15:26:48

Highest Channel / 1RB

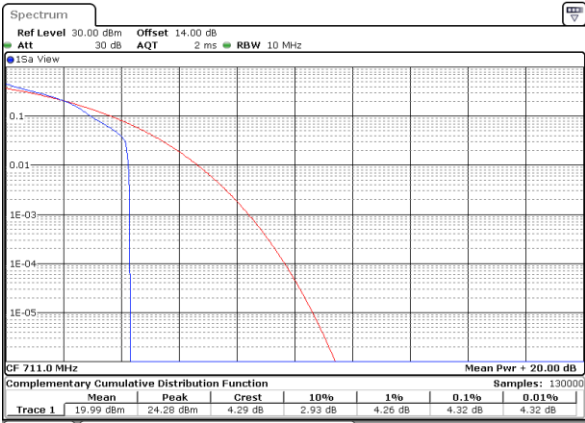

Date: 14 JUL 2019 15:27:07

Highest Channel / Full RB

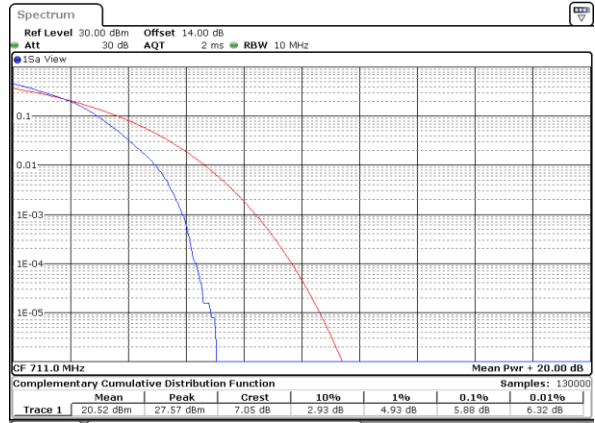

Date: 14 JUL 2019 15:27:21



LTE Band 13 / 10MHz / QPSK

Middle Channel / 1RB

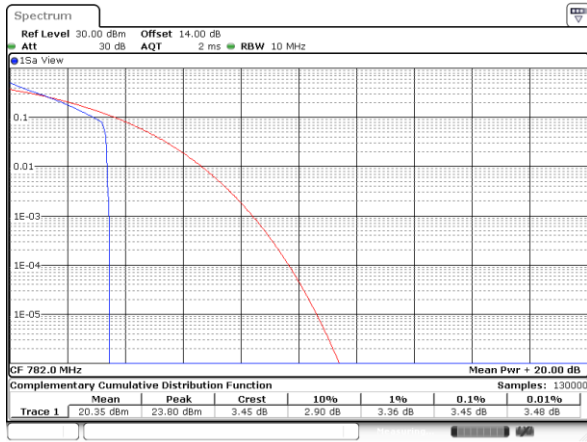

Date: 22 JUL 2019 14:47:36

Middle Channel / Full RB

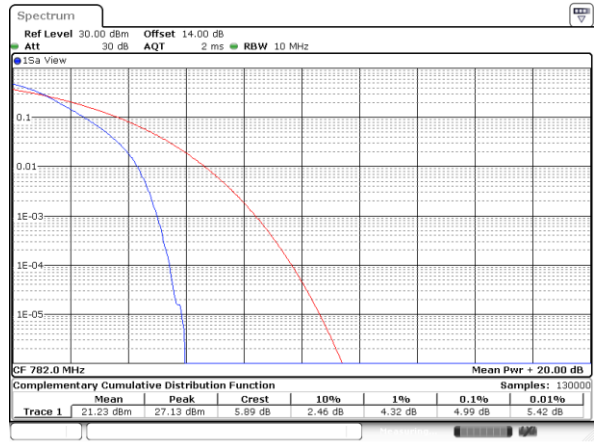

Date: 22 JUL 2019 14:47:45

LTE Band 13 / 10MHz / 16QAM

Middle Channel / 1RB

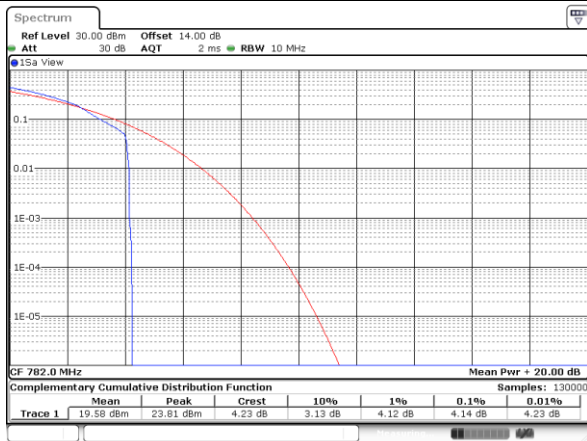

Date: 22 JUL 2019 14:47:17

Middle Channel / Full RB

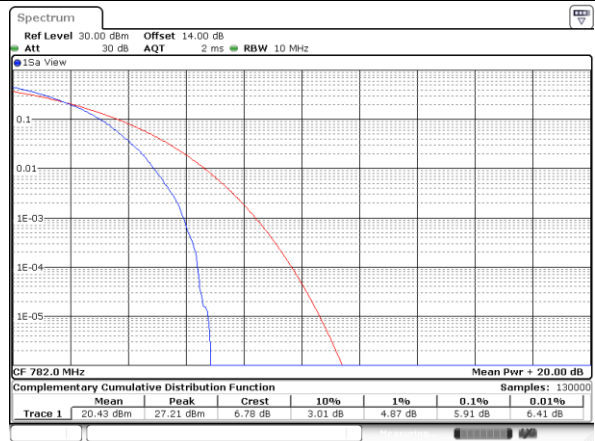

Date: 22 JUL 2019 14:47:27

LTE Band 13 / 10MHz / 64QAM

Middle Channel / 1RB

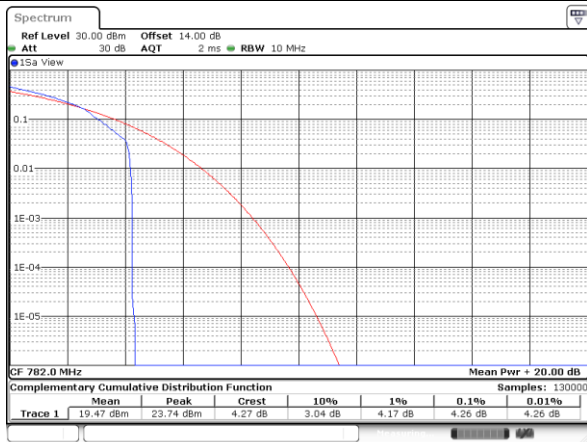

Date: 22 JUL 2019 14:41:24

Middle Channel / Full RB

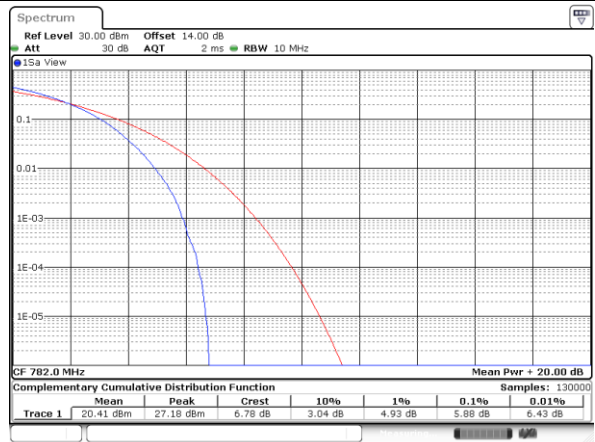

Date: 22 JUL 2019 14:41:47



LTE Band 17 / 10MHz / QPSK

Lowest Channel / 1RB

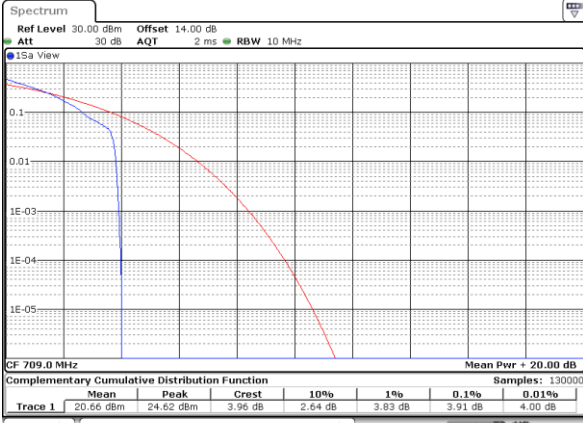

Date: 22 JUL 2019 11:32:12

Lowest Channel / Full RB

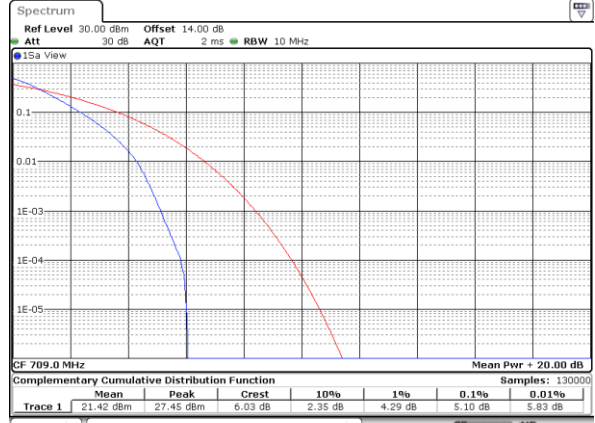

Date: 22 JUL 2019 11:32:22

Middle Channel / 1RB

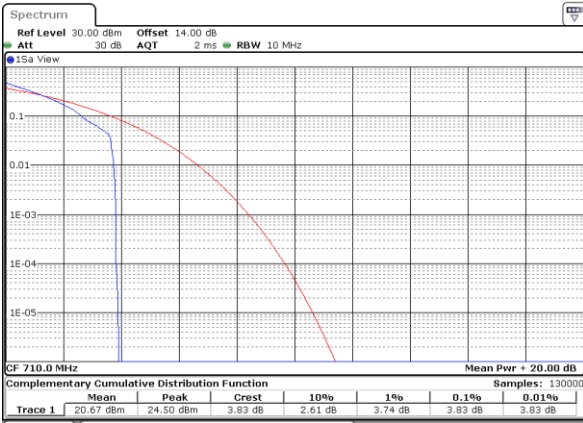

Date: 22 JUL 2019 11:32:38

Middle Channel / Full RB

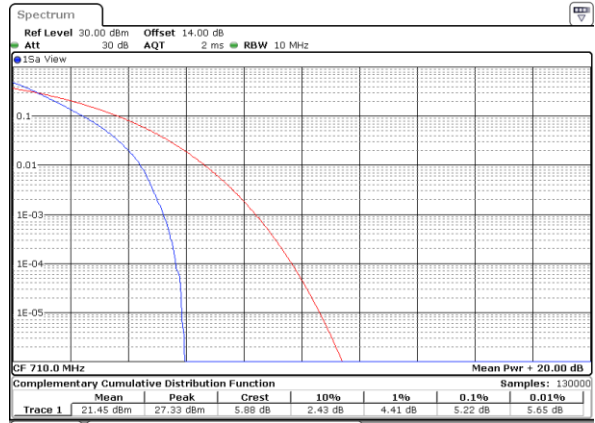

Date: 22 JUL 2019 11:32:50

Highest Channel / 1RB

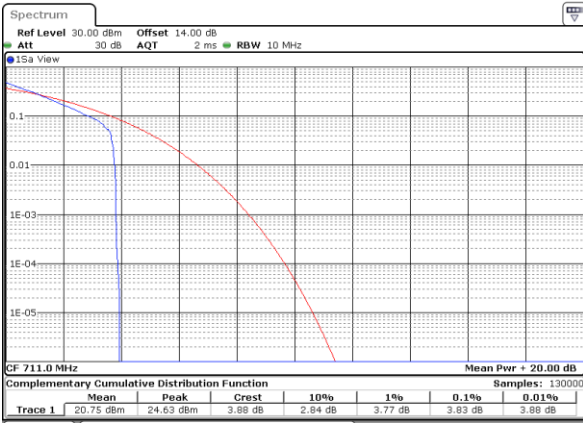

Date: 22 JUL 2019 11:33:01

Highest Channel / Full RB

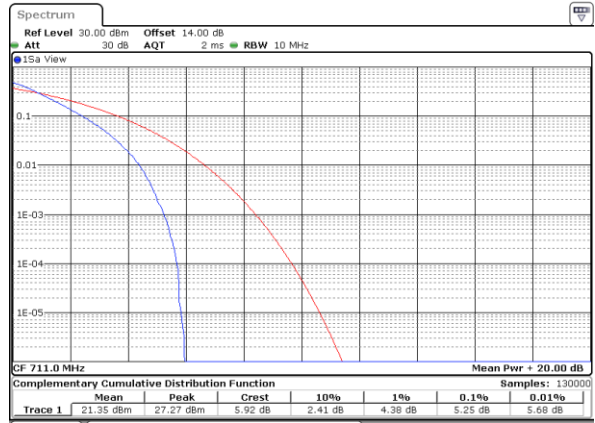

Date: 22 JUL 2019 11:33:12



LTE Band 17 / 10MHz / 16QAM

Lowest Channel / 1RB

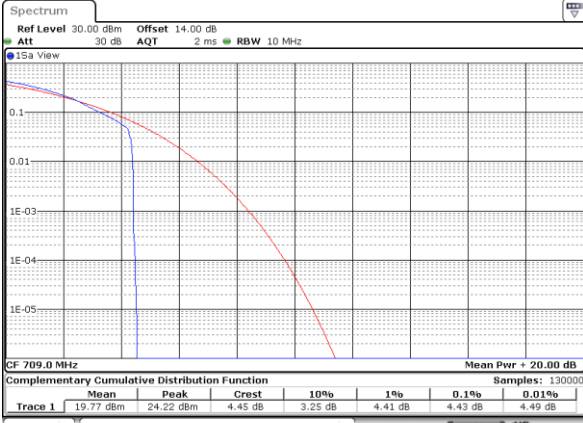

Date: 22 JUL 2019 10:53:43

Lowest Channel / Full RB

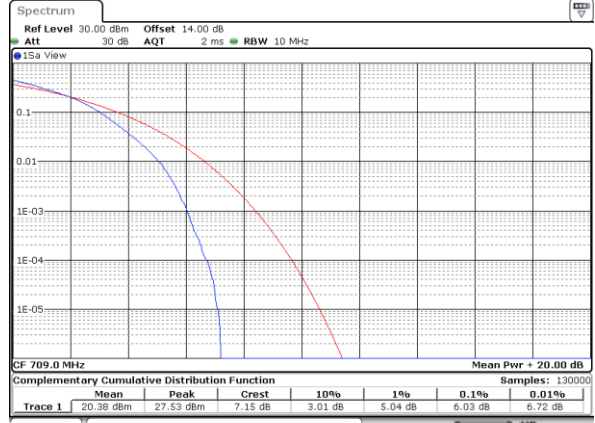

Date: 22 JUL 2019 10:53:54

Middle Channel / 1RB

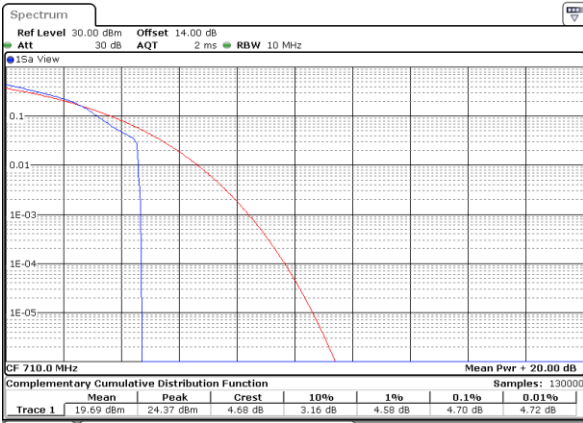

Date: 22 JUL 2019 10:54:24

Middle Channel / Full RB

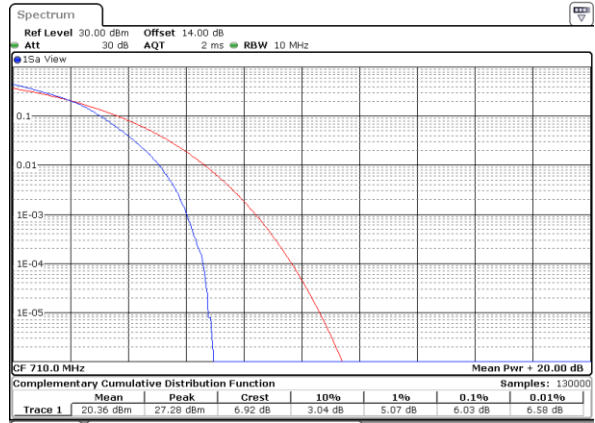

Date: 22 JUL 2019 10:54:44

Highest Channel / 1RB

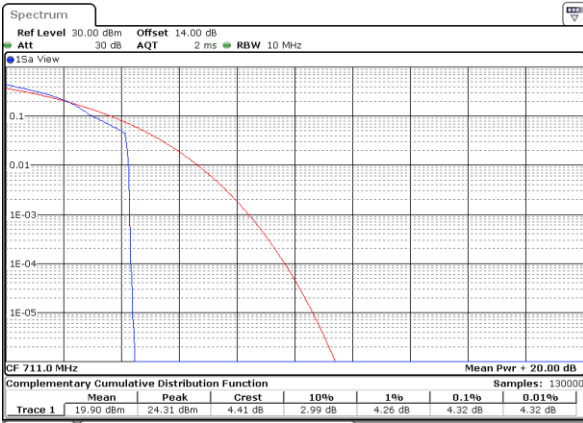

Date: 22 JUL 2019 10:54:59

Highest Channel / Full RB

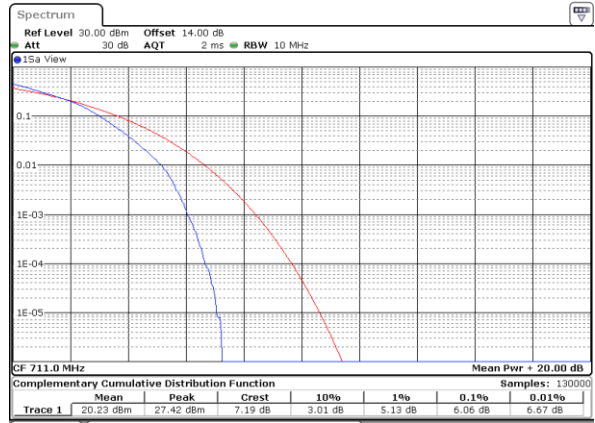

Date: 22 JUL 2019 10:55:16



LTE Band 17 / 10MHz / 64QAM

Lowest Channel / 1RB

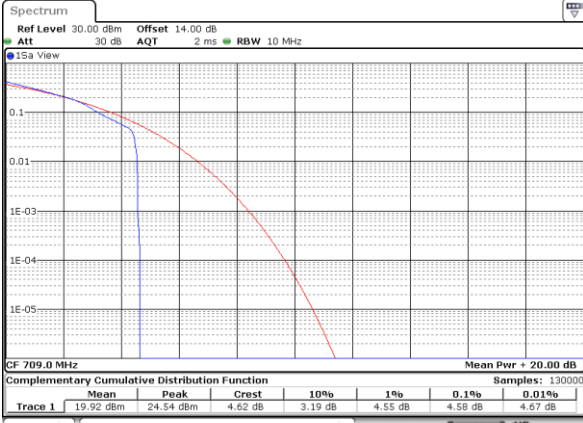

Date: 22 JUL 2019 11:20:33

Lowest Channel / Full RB

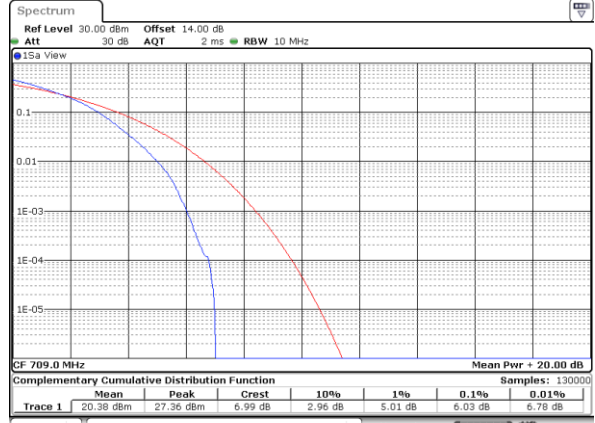

Date: 22 JUL 2019 11:20:42

Middle Channel / 1RB

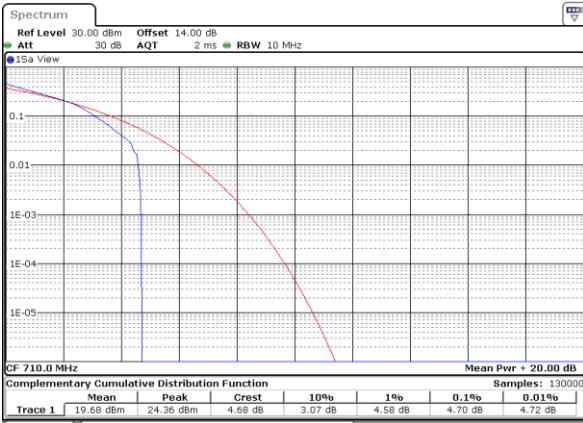

Date: 22 JUL 2019 11:20:52

Middle Channel / Full RB

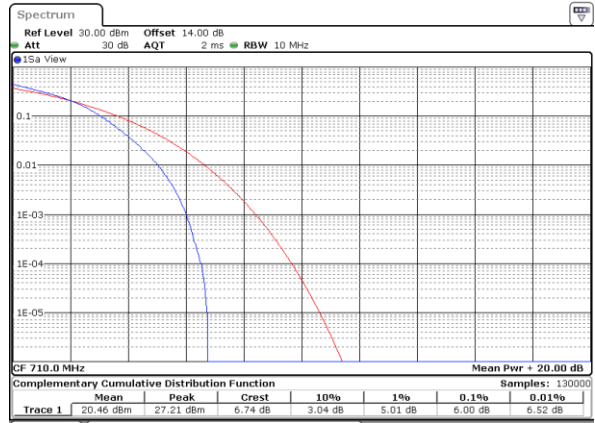

Date: 22 JUL 2019 11:21:02

Highest Channel / 1RB

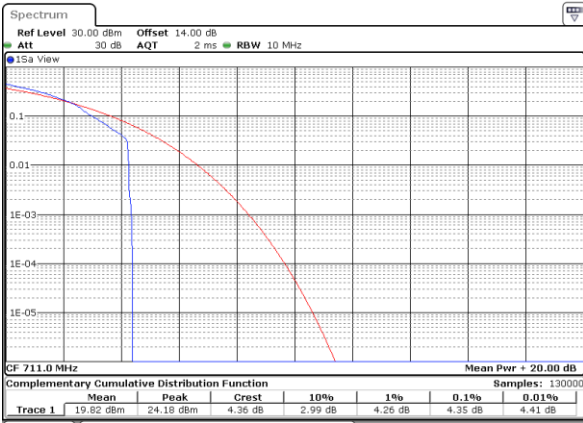

Date: 22 JUL 2019 11:21:11

Highest Channel / Full RB

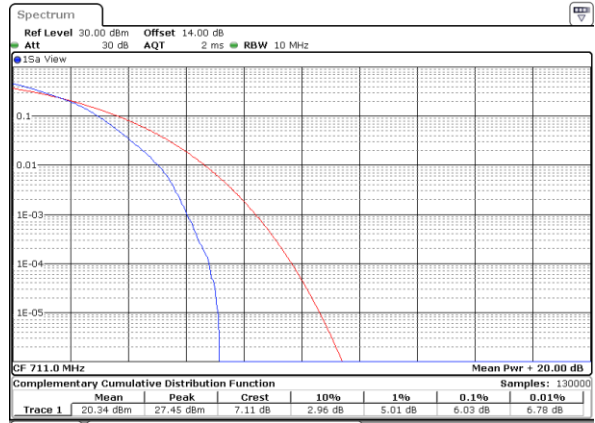

Date: 22 JUL 2019 11:21:21



LTE Band 66 / 20MHz / QPSK

Lowest Channel / 1RB

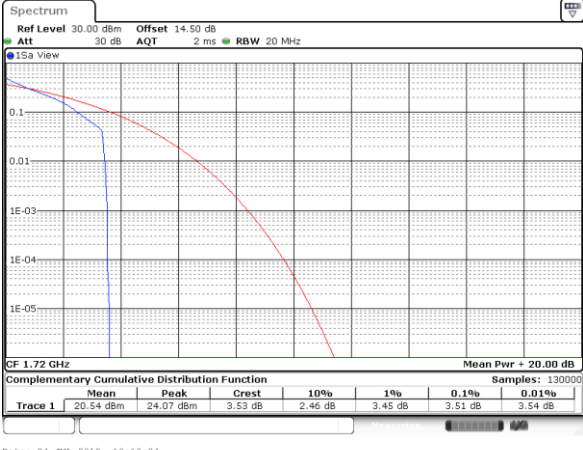

Date: 24_JUL_2019 10:13:34

Lowest Channel / Full RB

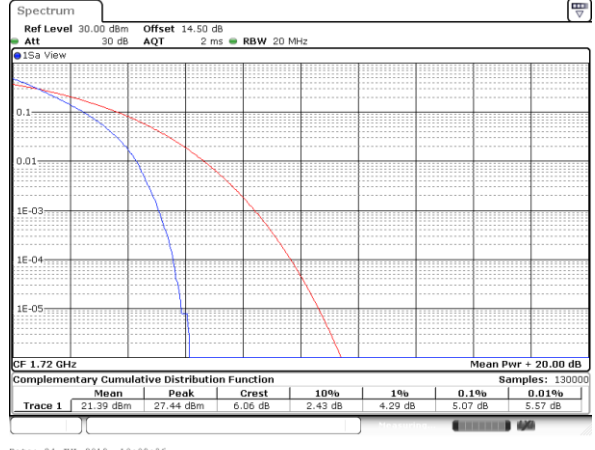

Date: 24_JUL_2019 10:10:36

Middle Channel / 1RB

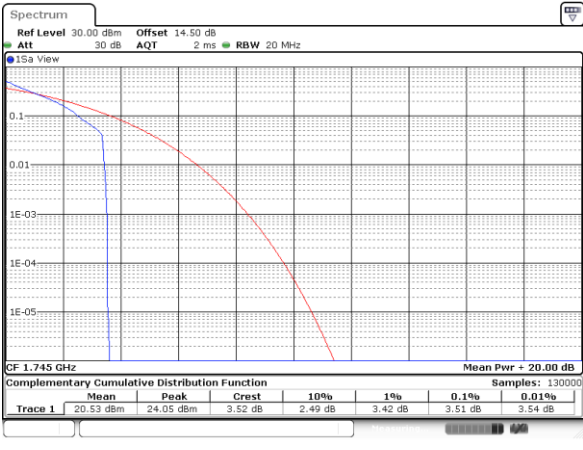

Date: 24_JUL_2019 10:14:38

Middle Channel / Full RB

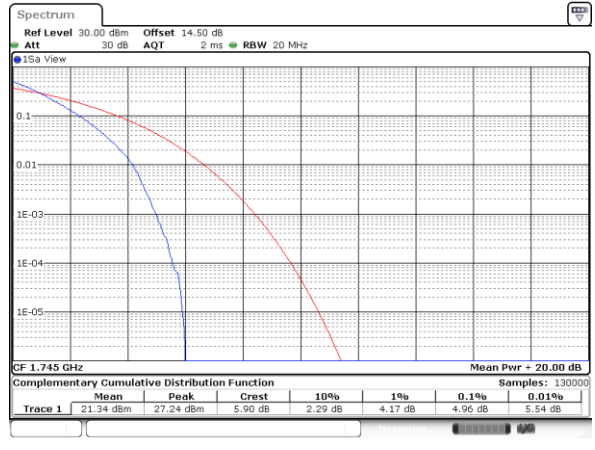

Date: 24_JUL_2019 10:18:19

Highest Channel / 1RB

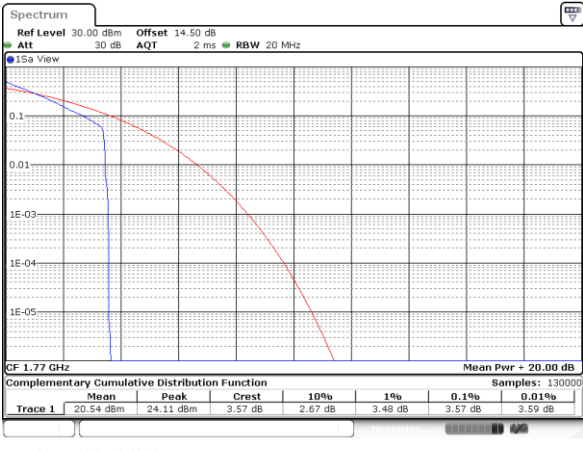

Date: 24_JUL_2019 10:23:19

Highest Channel / Full RB

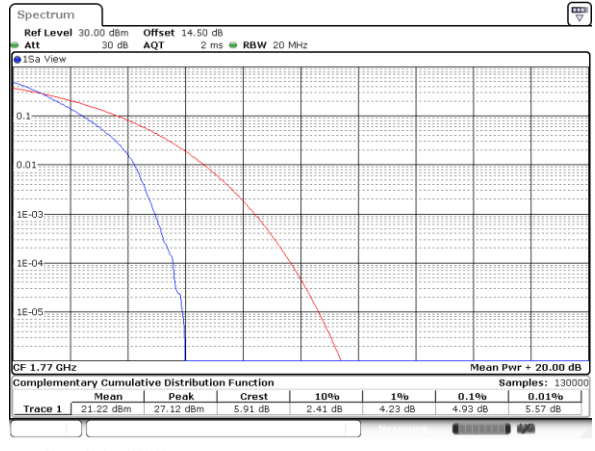

Date: 24_JUL_2019 10:20:24



LTE Band 66 / 20MHz / 16QAM

Lowest Channel / 1RB

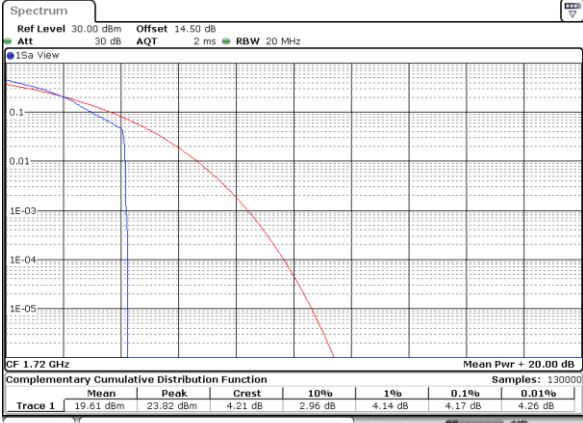

Date: 24_JUL_2019 10:13:12

Lowest Channel / Full RB

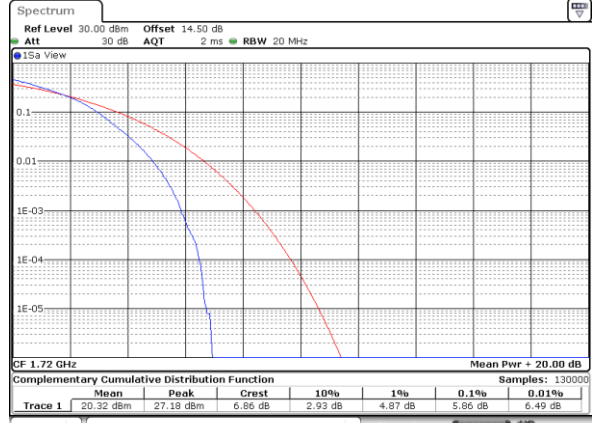

Date: 24_JUL_2019 10:11:45

Middle Channel / 1RB

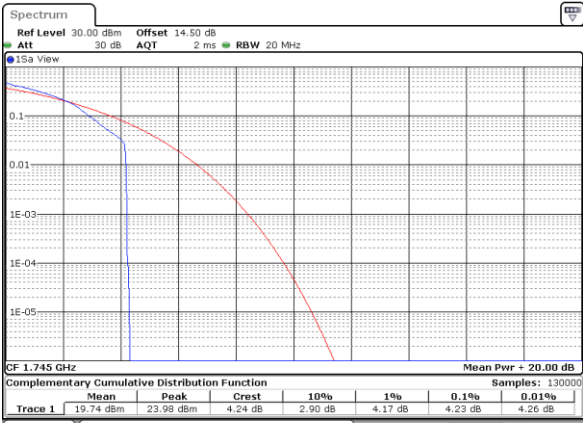

Date: 24_JUL_2019 10:15:02

Middle Channel / Full RB

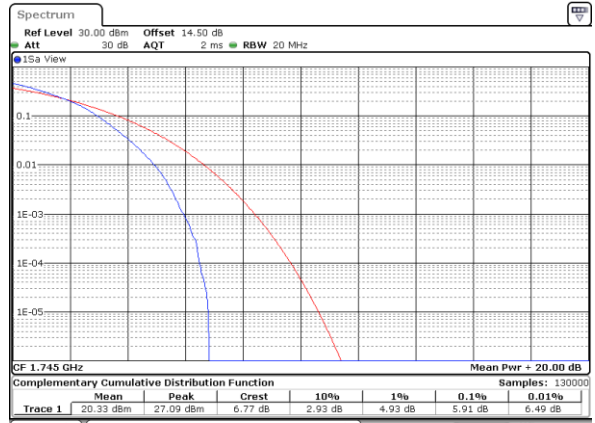

Date: 24_JUL_2019 10:17:54

Highest Channel / 1RB

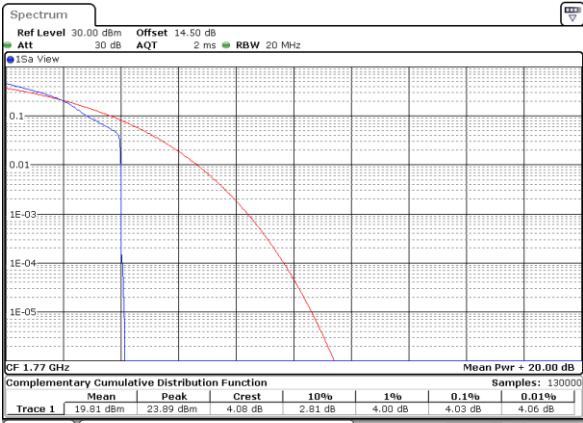

Date: 24_JUL_2019 10:23:01

Highest Channel / Full RB

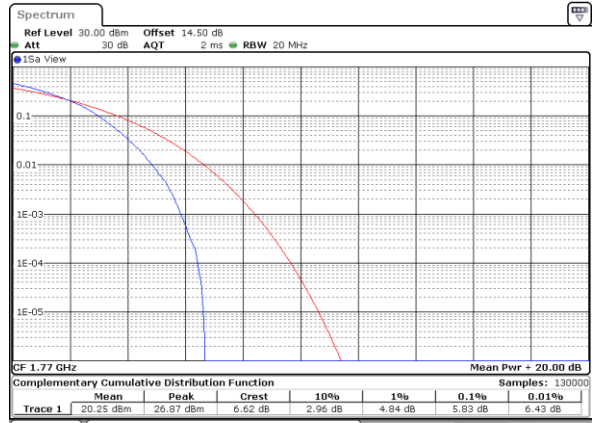

Date: 24_JUL_2019 10:20:59



LTE Band 66 / 20MHz / 64QAM

Lowest Channel / 1RB

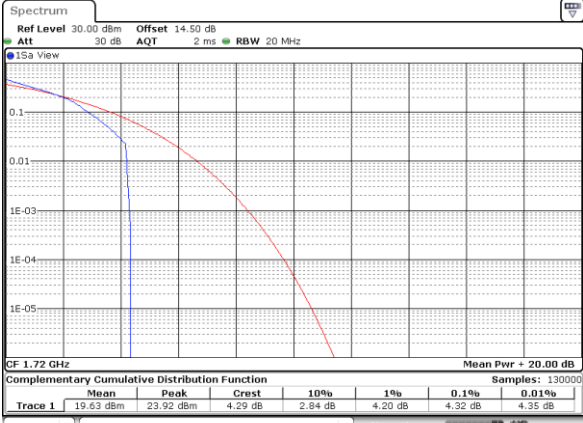

Date: 24_JUL_2019 10:12:53

Lowest Channel / Full RB

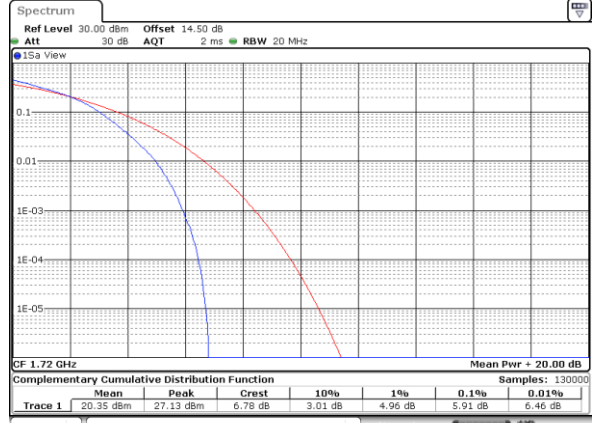

Date: 24_JUL_2019 10:12:24

Middle Channel / 1RB

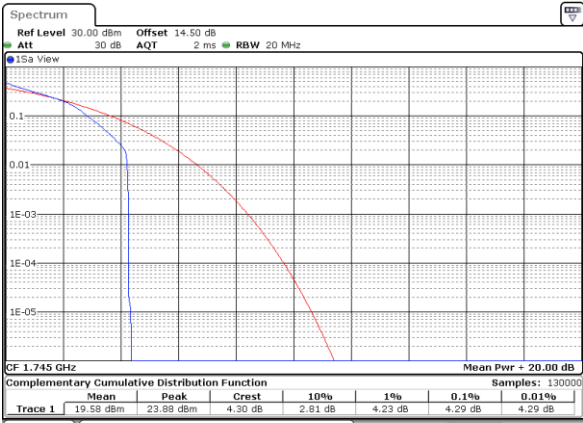

Date: 24_JUL_2019 10:15:57

Middle Channel / Full RB

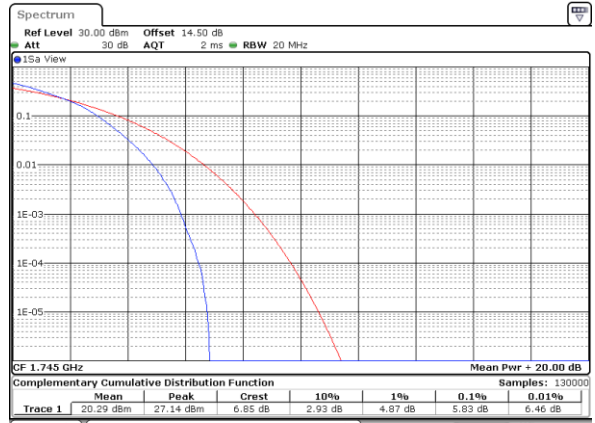

Date: 24_JUL_2019 10:16:34

Highest Channel / 1RB

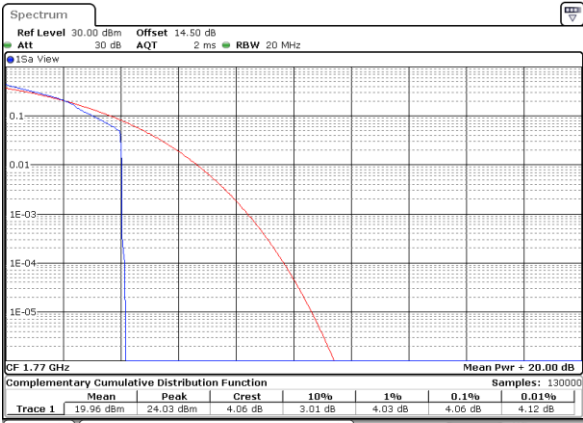

Date: 24_JUL_2019 10:22:40

Highest Channel / Full RB

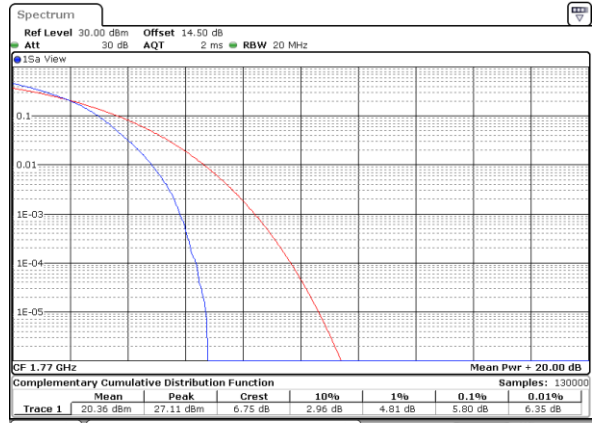

Date: 24_JUL_2019 10:21:41



26dB Bandwidth

Mode	LTE Band 4 : 26dB BW(MHz)											
BW	1.4MHz		3MHz		5MHz		10MHz		15MHz		20MHz	
Mod.	QPSK	16QAM	QPSK	16QAM	QPSK	16QAM	QPSK	16QAM	QPSK	16QAM	QPSK	16QAM
Lowest CH	1.236	1.242	3.015	3.003	4.845	4.855	9.79	9.89	14.236	14.326	20.30	20.14
Middle CH	1.228	1.228	3.075	3.045	4.885	4.815	9.87	9.89	14.326	14.386	20.18	20.18
Highest CH	1.231	1.206	3.021	3.021	4.905	4.945	9.69	9.77	14.266	14.356	20.22	20.06

Mode	LTE Band 4: 26dB BW(MHz)											
BW	1.4MHz		3MHz		5MHz		10MHz		15MHz		20MHz	
Mod.	64QAM		64QAM		64QAM		64QAM		64QAM		64QAM	
Lowest CH	1.220		3.009		4.905		9.81		14.326		20.18	
Middle CH	1.234		2.997		4.935		9.83		14.446		20.22	
Highest CH	1.231		3.033		4.805		9.69		14.416		20.14	

Mode	LTE Band 12 : 26dB BW(MHz)											
BW	1.4MHz		3MHz		5MHz		10MHz		1.4MHz	3MHz	5MHz	10MHz
Mod.	QPSK	16QAM	QPSK	16QAM	QPSK	16QAM	QPSK	16QAM	64QAM	64QAM	64QAM	64QAM
Lowest CH	1.236	1.236	3.009	3.039	4.865	4.875	9.65	9.79	1.231	3.021	4.905	9.69
Middle CH	1.231	1.245	3.003	3.015	4.905	4.895	9.81	9.83	1.236	2.985	4.895	9.81
Highest CH	1.220	1.225	3.033	3.039	4.925	4.955	9.85	9.91	1.228	3.039	4.935	9.81

Mode	LTE Band 13 : 26dB BW(MHz)							
BW	5MHz		10MHz		5MHz		10MHz	
Mod.	QPSK	16QAM	QPSK	16QAM	64QAM		64QAM	
Lowest CH	4.915	4.905	-	-	4.845		-	
Middle CH	4.875	4.865	9.79	9.87	4.855		9.65	
Highest CH	4.875	4.895	-	-	4.885		-	



Mode	LTE Band 17 : 26dB BW(MHz)							
BW	5MHz		10MHz		5MHz		10MHz	
Mod.	QPSK	16QAM	QPSK	16QAM	64QAM		64QAM	
Lowest CH	4.915	4.845	9.93	9.73	4.965		9.71	
Middle CH	4.885	4.885	9.75	9.77	4.815		9.83	
Highest CH	4.945	4.885	9.65	9.73	4.885		9.77	

Mode	LTE Band 66 : 26dB BW(MHz)											
BW	1.4MHz		3MHz		5MHz		10MHz		15MHz		20MHz	
Mod.	QPSK	16QAM	QPSK	16QAM	QPSK	16QAM	QPSK	16QAM	QPSK	16QAM	QPSK	16QAM
Lowest CH	1.236	1.231	3.021	3.015	4.895	4.915	9.77	9.83	14.326	14.416	20.26	20.26
Middle CH	1.240	1.220	3.045	3.057	4.975	4.915	9.77	9.83	14.236	14.326	20.22	20.14
Highest CH	1.225	1.228	3.039	3.057	4.925	4.905	9.87	9.65	14.476	14.565	20.30	20.22

Mode	LTE Band 66 : 26dB BW(MHz)											
BW	1.4MHz		3MHz		5MHz		10MHz		15MHz		20MHz	
Mod.	64QAM		64QAM		64QAM		64QAM		64QAM		64QAM	
Lowest CH	1.225		3.033		4.825		9.87		14.206		20.22	
Middle CH	1.220		2.967		4.915		9.65		14.146		20.26	
Highest CH	1.234		3.051		4.925		9.63		14.266		20.26	



LTE Band 4

Lowest Channel / 1.4MHz / QPSK

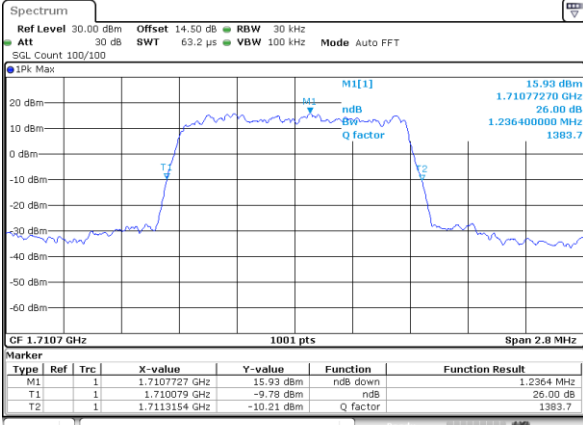

Date: 16_JUL_2019 22:31:52

Lowest Channel / 1.4MHz / 16QAM

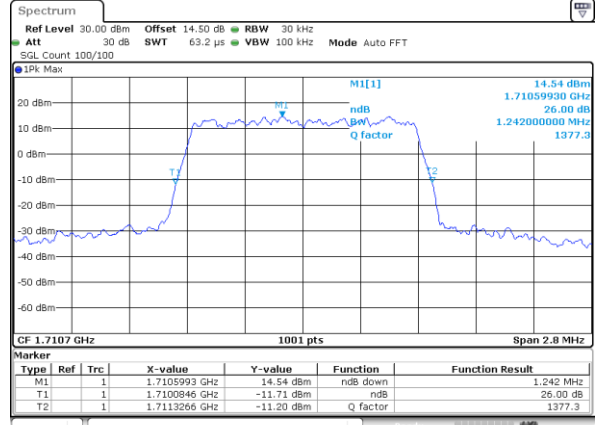

Date: 16_JUL_2019 22:32:02

Middle Channel / 1.4MHz / QPSK

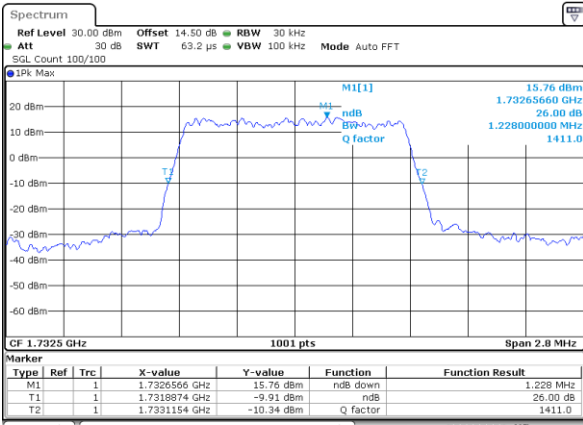

Date: 16_JUL_2019 22:38:57

Middle Channel / 1.4MHz / 16QAM

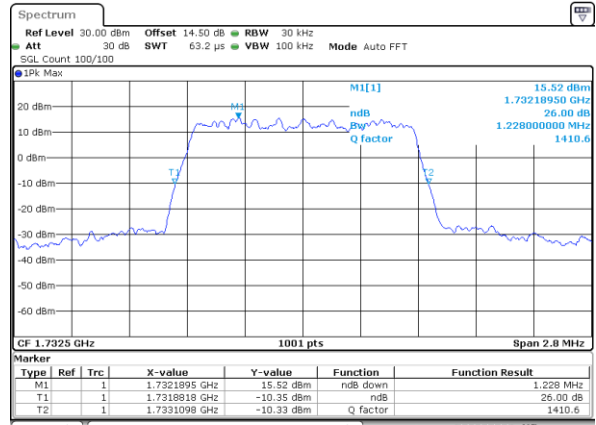

Date: 16_JUL_2019 22:39:08

Highest Channel / 1.4MHz / QPSK

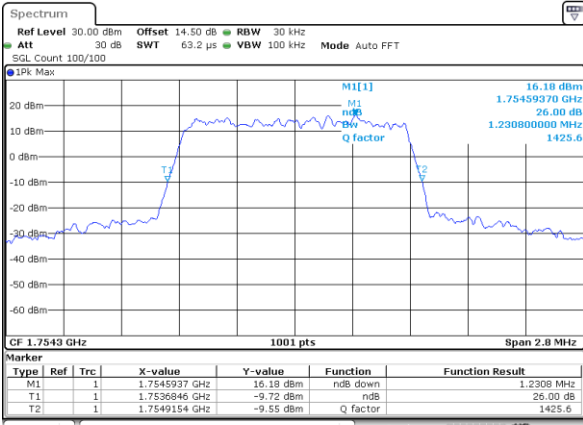

Date: 16_JUL_2019 22:41:27

Highest Channel / 1.4MHz / 16QAM

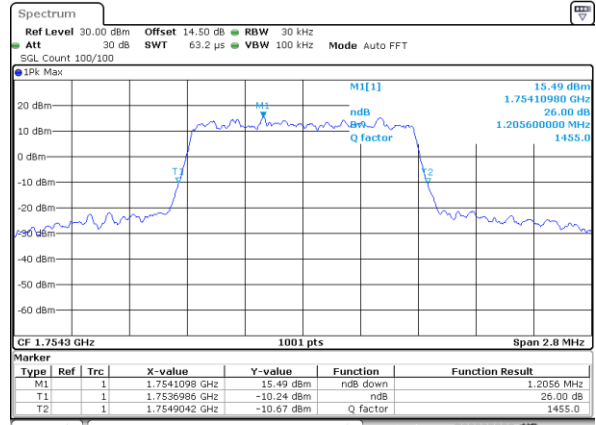

Date: 16_JUL_2019 22:41:37



LTE Band 4

Lowest Channel / 3MHz / QPSK

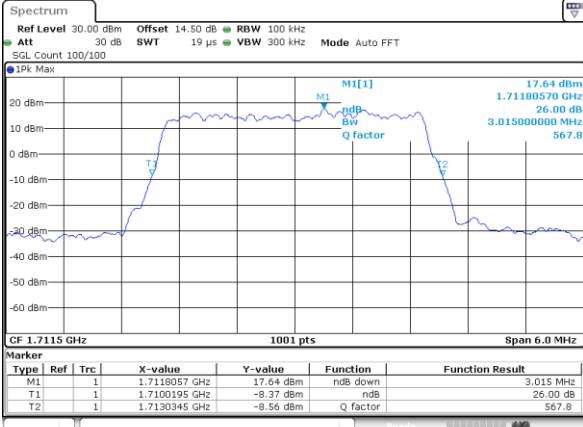

Date: 16_JUL_2019 22:54:51

Lowest Channel / 3MHz / 16QAM

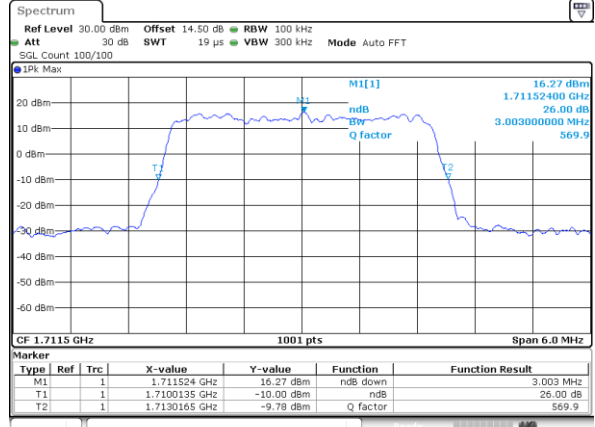

Date: 16_JUL_2019 22:55:01

Middle Channel / 3MHz / QPSK

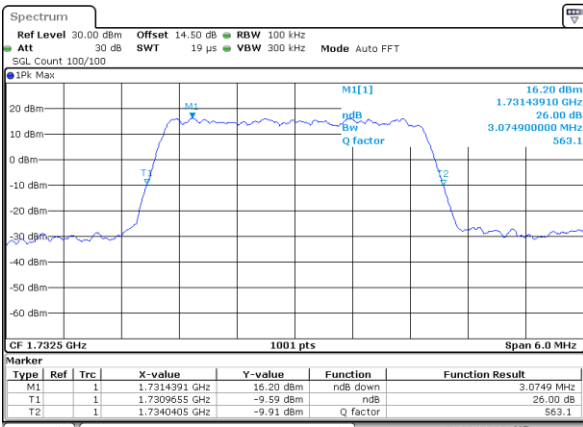

Date: 16_JUL_2019 23:01:06

Middle Channel / 3MHz / 16QAM

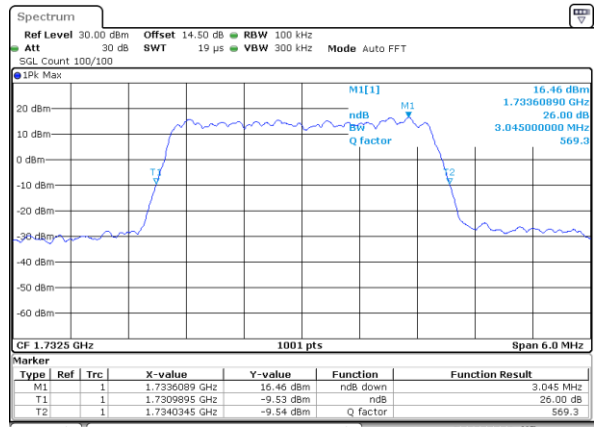

Date: 16_JUL_2019 23:02:06

Highest Channel / 3MHz / QPSK

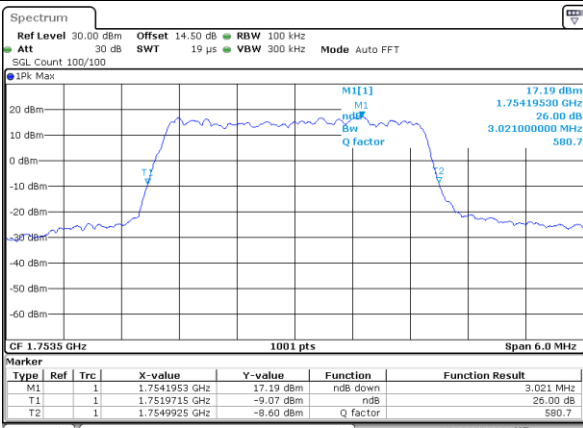

Date: 16_JUL_2019 23:04:24

Highest Channel / 3MHz / 16QAM

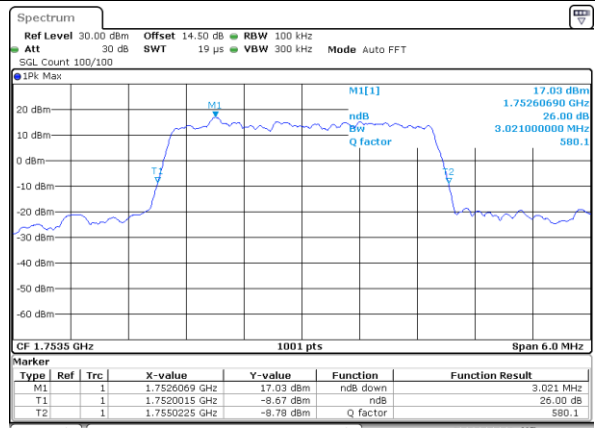

Date: 16_JUL_2019 23:04:35



LTE Band 4

Lowest Channel / 5MHz / QPSK

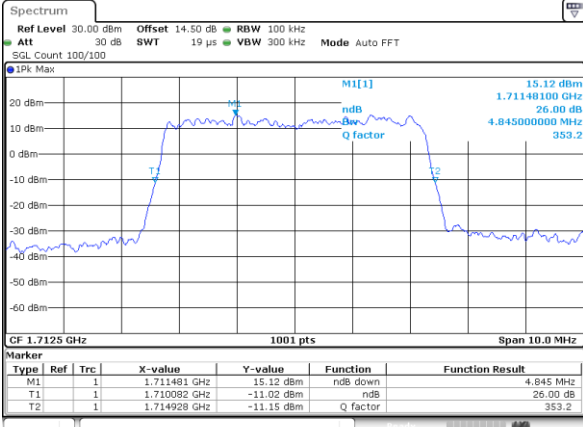

Date: 16_JUL_2019 23:11:54

Lowest Channel / 5MHz / 16QAM

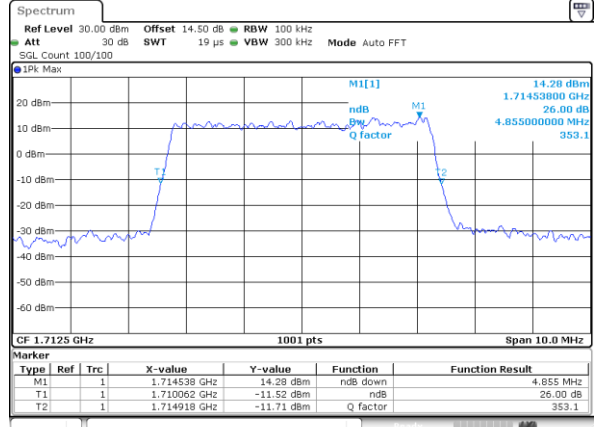

Date: 16_JUL_2019 23:12:04

Middle Channel / 5MHz / QPSK

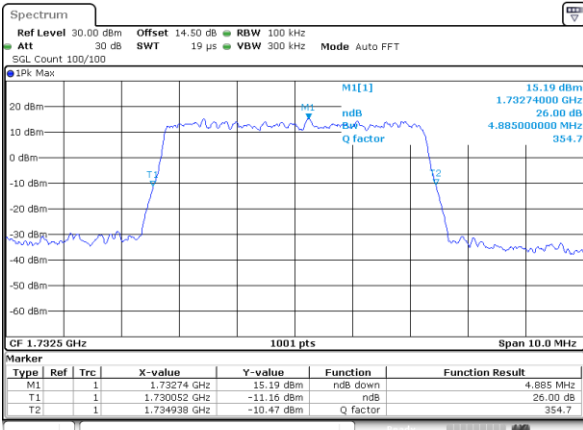

Date: 16_JUL_2019 23:18:58

Middle Channel / 5MHz / 16QAM

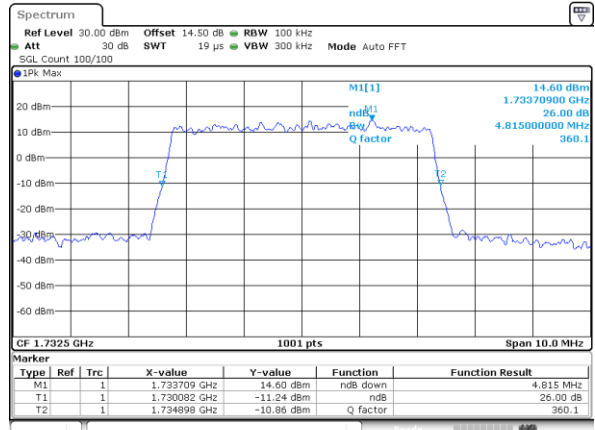

Date: 16_JUL_2019 23:19:08

Highest Channel / 5MHz / QPSK

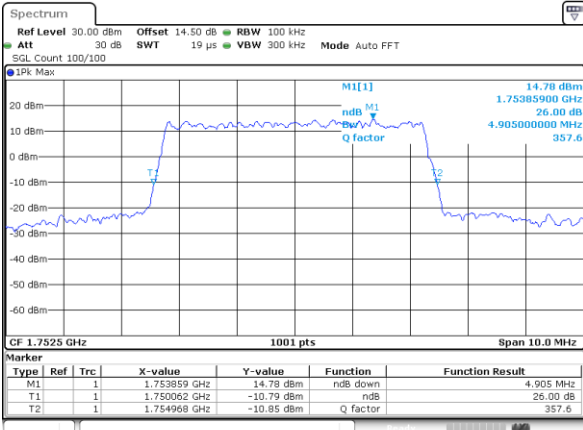

Date: 16_JUL_2019 23:21:27

Highest Channel / 5MHz / 16QAM

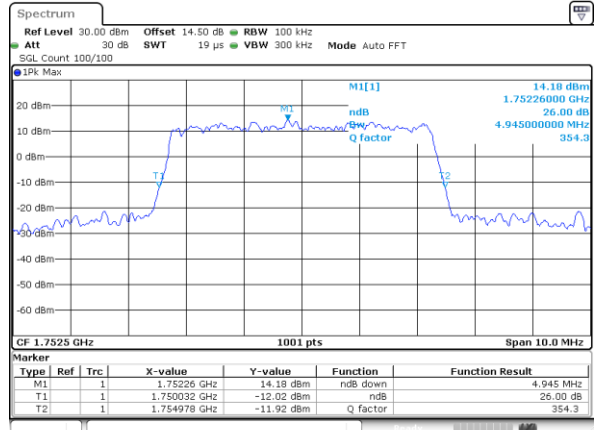

Date: 16_JUL_2019 23:21:37