

57_Bluetooth_DH5 1Mbps_Top Side_10mm_Ch39

Communication System: Bluetooth; Frequency: 2441 MHz; Duty Cycle: 1:1.299
Medium: HSL_2450_200102 Medium parameters used: $f = 2441$ MHz; $\sigma = 1.847$ S/m; $\epsilon_r = 37.702$;
 $\rho = 1000$ kg/m³
Ambient Temperature : 23.4 °C ; Liquid Temperature : 22.4 °C

DASY5 Configuration:

- Probe: EX3DV4 - SN3819; ConvF(7.21, 7.21, 7.21); Calibrated: 2019.03.01;
- Sensor-Surface: 1.4mm (Mechanical Surface Detection)
- Electronics: DAE4 Sn715; Calibrated: 2019.01.23
- Phantom: SAM (Front) with CRP v5.0; Type: QD000P40CD; Serial: TP:1795
- Measurement SW: DASY52, Version 52.8 (8); SEMCAD X Version 14.6.10 (7331)

Area Scan (41x81x1): Interpolated grid: dx=1.200 mm, dy=1.200 mm
Maximum value of SAR (interpolated) = 0.260 W/kg

Zoom Scan (7x7x7)/Cube 0: Measurement grid: dx=5mm, dy=5mm, dz=5mm
Reference Value = 12.24 V/m; Power Drift = 0.10 dB
Peak SAR (extrapolated) = 0.397 W/kg
SAR(1 g) = 0.195 W/kg; SAR(10 g) = 0.084 W/kg
Maximum value of SAR (measured) = 0.245 W/kg

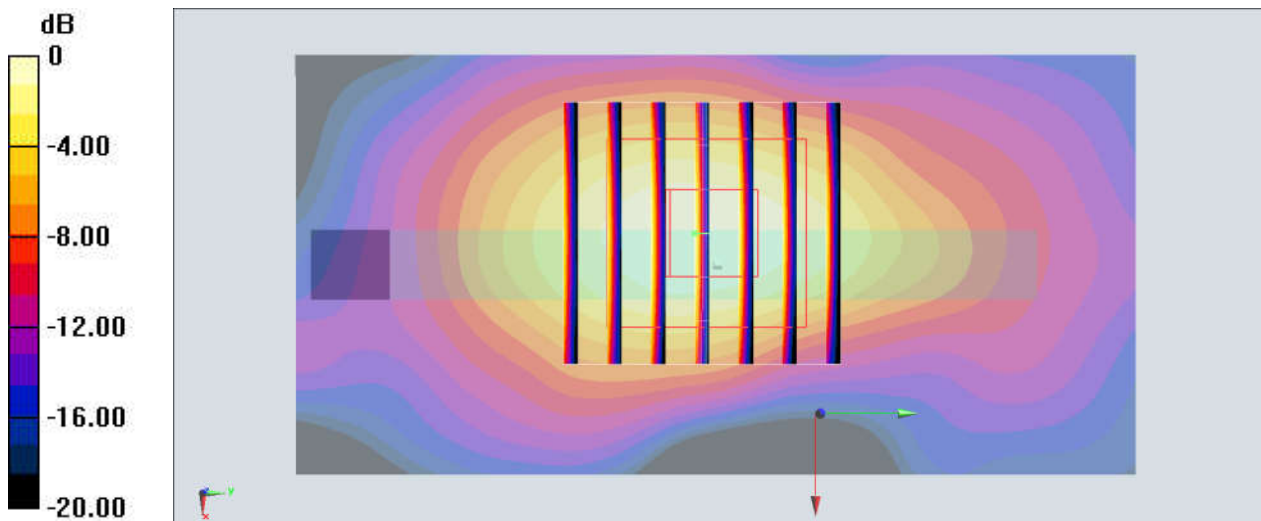

0 dB = 0.245 W/kg = -6.11 dBW/kg

58_GSM850_GPRS(3 Tx slots)_Back_15mm_Ch189

Communication System: UID 0, GPRS/EDGE11 (0); Frequency: 836.4 MHz; Duty Cycle: 1:2.77
Medium: HSL_835_191224 Medium parameters used: $f = 836.4$ MHz; $\sigma = 0.929$ S/m; $\epsilon_r = 42.712$;
 $\rho = 1000$ kg/m³
Ambient Temperature : 23.4 °C; Liquid Temperature : 22.5 °C

DASY5 Configuration:

- Probe: EX3DV4 - SN3819; ConvF(9.57, 9.57, 9.57); Calibrated: 2019.03.01;
- Sensor-Surface: 1.4mm (Mechanical Surface Detection)
- Electronics: DAE4 Sn715; Calibrated: 2019.01.23
- Phantom: SAM (Front) with CRP v5.0; Type: QD000P40CD; Serial: TP:1795
- Measurement SW: DASY52, Version 52.8 (8); SEMCAD X Version 14.6.10 (7331)

Ch189/Area Scan (71x131x1): Interpolated grid: dx=15mm, dy=15mm
Maximum value of SAR (interpolated) = 0.400 W/kg

Ch189/Zoom Scan (5x5x7)/Cube 0: Measurement grid: dx=8mm, dy=8mm, dz=5mm
Reference Value = 11.90 V/m; Power Drift = -0.07 dB
Peak SAR (extrapolated) = 0.470 W/kg
SAR(1 g) = 0.307 W/kg; SAR(10 g) = 0.194 W/kg
Maximum value of SAR (measured) = 0.395 W/kg

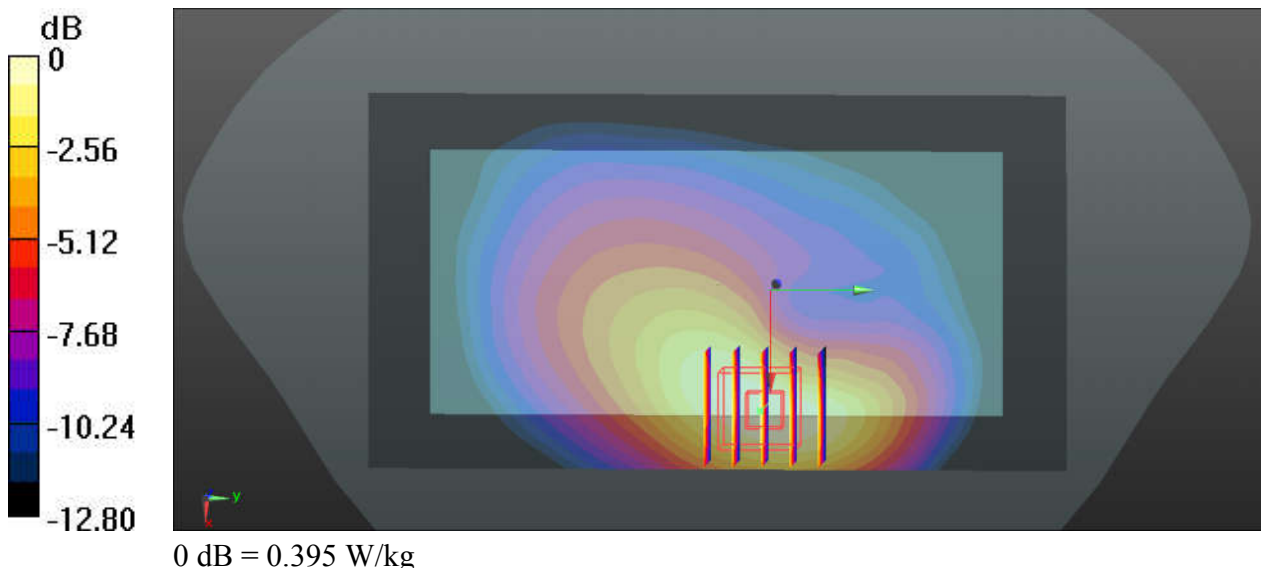

59_GSM1900_GPRS(3 Tx slots)_Back_15mm_Ch810

Communication System: UID 0, GPRS/EDGE11 (0); Frequency: 1909.8 MHz; Duty Cycle: 1:2.77
Medium: HSL_1900_191218 Medium parameters used: $f = 1910$ MHz; $\sigma = 1.427$ S/m; $\epsilon_r = 41.106$;
 $\rho = 1000$ kg/m³
Ambient Temperature : 23.5 °C; Liquid Temperature : 22.7 °C

DASY5 Configuration:

- Probe: EX3DV4 - SN3819; ConvF(8.27, 8.27, 8.27); Calibrated: 2019.03.01;
- Sensor-Surface: 1.4mm (Mechanical Surface Detection)
- Electronics: DAE4 Sn715; Calibrated: 2019.01.23
- Phantom: SAM (Front) with CRP v5.0; Type: QD000P40CD; Serial: TP:1795
- Measurement SW: DASY52, Version 52.8 (8); SEMCAD X Version 14.6.10 (7331)

Ch810/Area Scan (71x121x1): Interpolated grid: dx=15mm, dy=15mm
Maximum value of SAR (interpolated) = 0.368 W/kg

Ch810/Zoom Scan (5x5x7)/Cube 0: Measurement grid: dx=8mm, dy=8mm, dz=5mm
Reference Value = 6.608 V/m; Power Drift = 0.18 dB
Peak SAR (extrapolated) = 0.505 W/kg
SAR(1 g) = 0.290 W/kg; SAR(10 g) = 0.168 W/kg
Maximum value of SAR (measured) = 0.399 W/kg

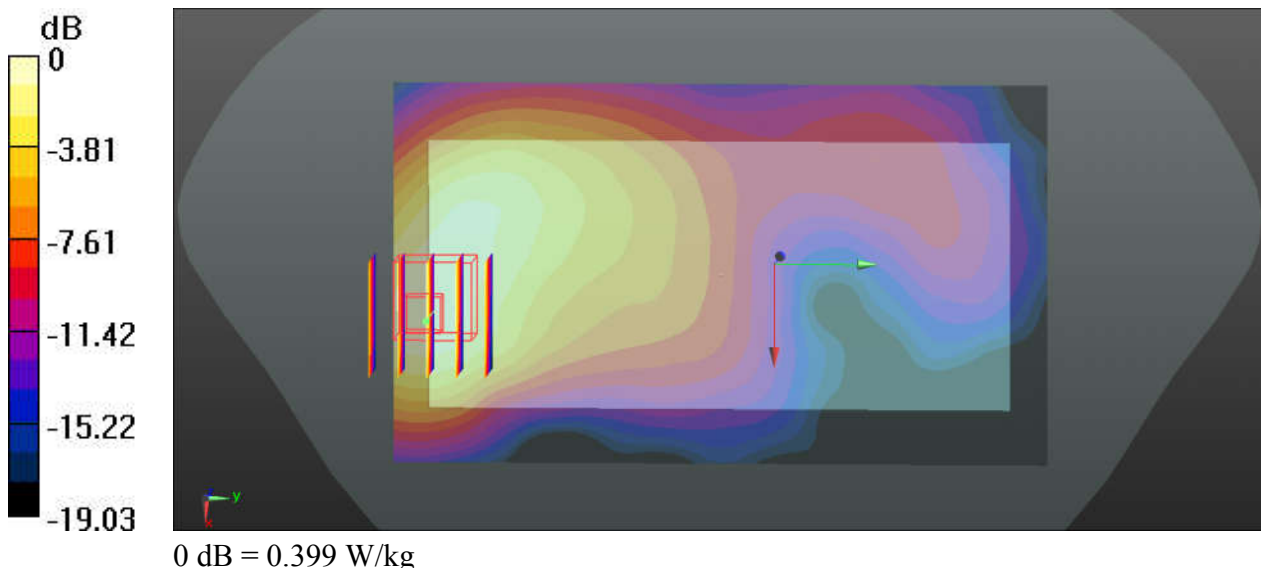

60_WCDMA V_RMC 12.2Kbps_Back_15mm_Ch4182

Communication System: UID 0, UMTS (0); Frequency: 836.4 MHz; Duty Cycle: 1:1
Medium: HSL_835_191224 Medium parameters used: $f = 836.4$ MHz; $\sigma = 0.929$ S/m; $\epsilon_r = 42.712$;
 $\rho = 1000$ kg/m³
Ambient Temperature : 23.4 °C; Liquid Temperature : 22.5 °C

DASY5 Configuration:

- Probe: EX3DV4 - SN3819; ConvF(9.57, 9.57, 9.57); Calibrated: 2019.03.01;
- Sensor-Surface: 1.4mm (Mechanical Surface Detection)
- Electronics: DAE4 Sn715; Calibrated: 2019.01.23
- Phantom: SAM (Front) with CRP v5.0; Type: QD000P40CD; Serial: TP:1795
- Measurement SW: DASY52, Version 52.8 (8); SEMCAD X Version 14.6.10 (7331)

Ch4182/Area Scan (71x131x1): Interpolated grid: dx=15mm, dy=15mm
Maximum value of SAR (interpolated) = 0.416 W/kg

Ch4182/Zoom Scan (5x5x7)/Cube 0: Measurement grid: dx=8mm, dy=8mm, dz=5mm
Reference Value = 11.23 V/m; Power Drift = -0.19 dB
Peak SAR (extrapolated) = 0.500 W/kg
SAR(1 g) = 0.329 W/kg; SAR(10 g) = 0.209 W/kg
Maximum value of SAR (measured) = 0.423 W/kg

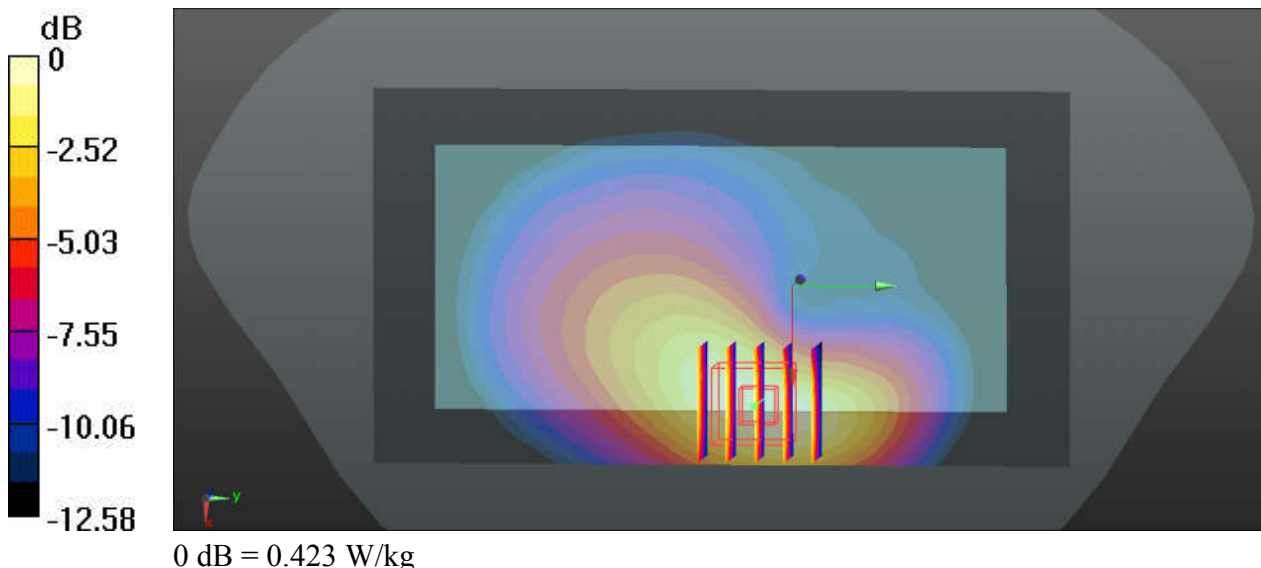

61_WCDMA IV_RMC 12.2Kbps_Back_15mm_Ch1312

Communication System: UID 0, UMTS (0); Frequency: 1712.4 MHz; Duty Cycle: 1:1
Medium: HSL_1750_191221 Medium parameters used: $f = 1712.4$ MHz; $\sigma = 1.36$ S/m; $\epsilon_r = 39.954$;
 $\rho = 1000$ kg/m³
Ambient Temperature : 23.5 °C ; Liquid Temperature : 22.4 °C

DASY5 Configuration:

- Probe: EX3DV4 - SN3819; ConvF(8.54, 8.54, 8.54); Calibrated: 2019.03.01;
- Sensor-Surface: 1.4mm (Mechanical Surface Detection)
- Electronics: DAE4 Sn715; Calibrated: 2019.01.23
- Phantom: SAM (Front) with CRP v5.0; Type: QD000P40CD; Serial: TP:1795
- Measurement SW: DASY52, Version 52.8 (8); SEMCAD X Version 14.6.10 (7331)

Ch1312/Area Scan (71x131x1): Interpolated grid: dx=15mm, dy=15mm
Maximum value of SAR (interpolated) = 0.654 W/kg

Ch1312/Zoom Scan (5x5x7)/Cube 0: Measurement grid: dx=8mm, dy=8mm, dz=5mm
Reference Value = 4.230 V/m; Power Drift = 0.10 dB
Peak SAR (extrapolated) = 0.740 W/kg
SAR(1 g) = 0.513 W/kg; SAR(10 g) = 0.328 W/kg
Maximum value of SAR (measured) = 0.629 W/kg

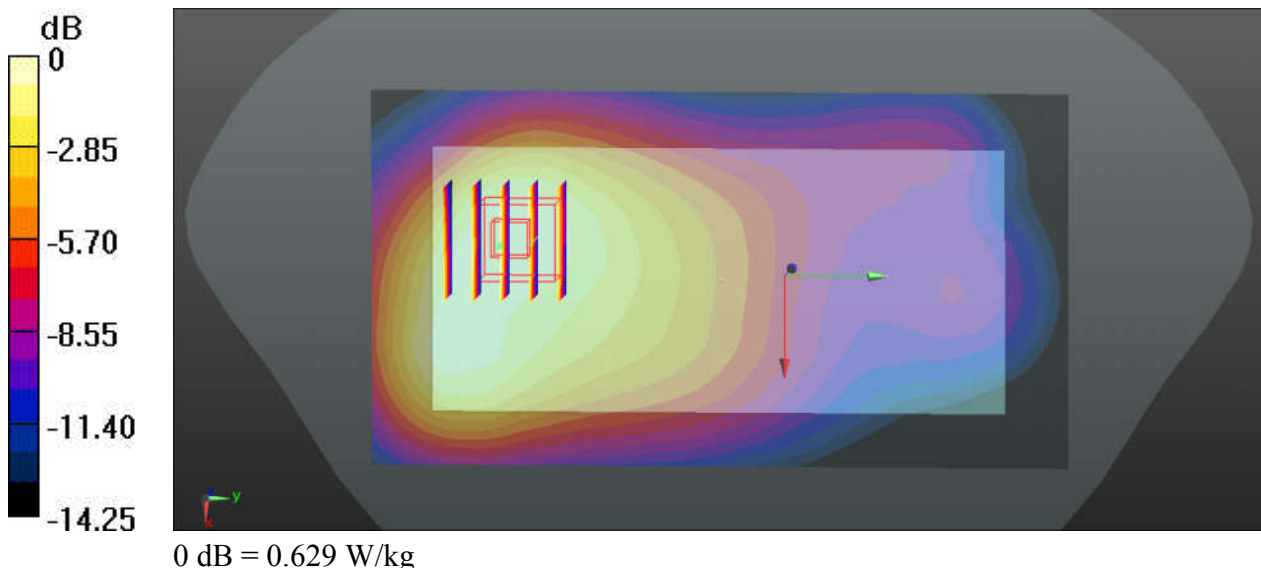

62_WCDMA II_RMC 12.2Kbps_Back_15mm_Ch9538

Communication System: UID 0, UMTS (0); Frequency: 1907.6 MHz; Duty Cycle: 1:1
Medium: HSL_1900_191218 Medium parameters used: $f = 1908$ MHz; $\sigma = 1.426$ S/m; $\epsilon_r = 41.113$;
 $\rho = 1000$ kg/m³
Ambient Temperature : 23.5 °C; Liquid Temperature : 22.7 °C

DASY5 Configuration:

- Probe: EX3DV4 - SN3819; ConvF(8.27, 8.27, 8.27); Calibrated: 2019.03.01;
- Sensor-Surface: 1.4mm (Mechanical Surface Detection)
- Electronics: DAE4 Sn715; Calibrated: 2019.01.23
- Phantom: SAM (Front) with CRP v5.0; Type: QD000P40CD; Serial: TP:1795
- Measurement SW: DASY52, Version 52.8 (8); SEMCAD X Version 14.6.10 (7331)

Ch9538/Area Scan (71x131x1): Interpolated grid: dx=15mm, dy=15mm
Maximum value of SAR (interpolated) = 0.805 W/kg

Ch9538/Zoom Scan (5x5x7)/Cube 0: Measurement grid: dx=8mm, dy=8mm, dz=5mm
Reference Value = 3.047 V/m; Power Drift = 0.09 dB
Peak SAR (extrapolated) = 1.02 W/kg
SAR(1 g) = 0.557 W/kg; SAR(10 g) = 0.349 W/kg
Maximum value of SAR (measured) = 0.811 W/kg

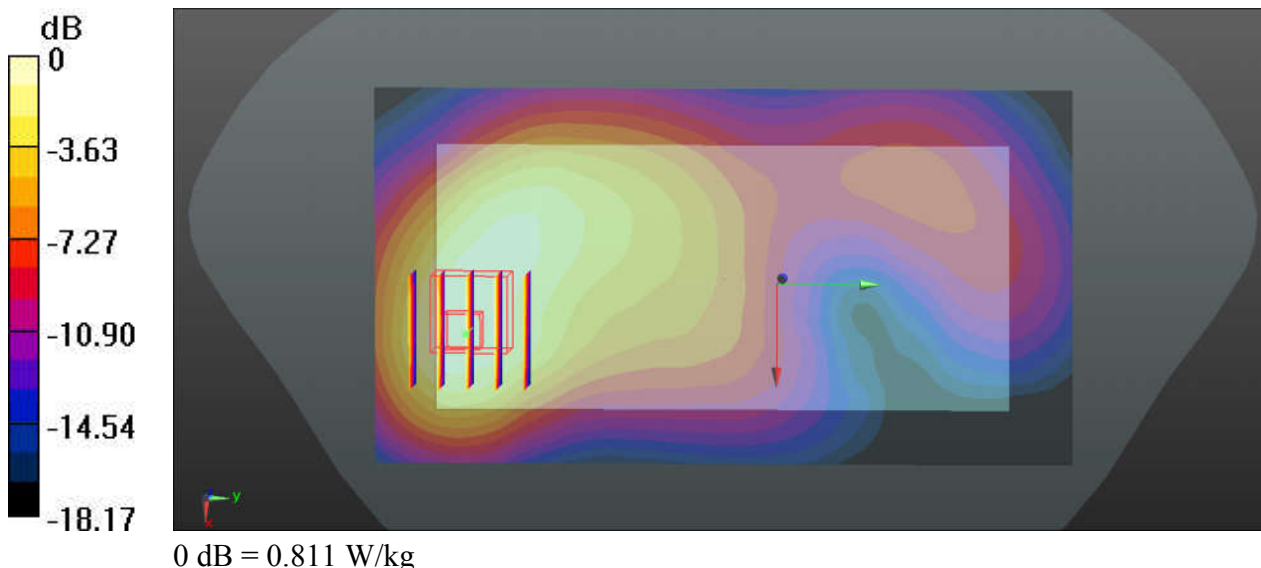

63_CDMA2000 BC0_RC3 SO32 (F+SCH) _Back_15mm_Ch384

Communication System: UID 0, CDMA2000 (0); Frequency: 836.52 MHz; Duty Cycle: 1:1
Medium: HSL_835_191224 Medium parameters used: $f = 837$ MHz; $\sigma = 0.93$ S/m; $\epsilon_r = 42.705$; $\rho = 1000$ kg/m³
Ambient Temperature : 23.4 °C; Liquid Temperature : 22.5 °C

DASY5 Configuration:

- Probe: EX3DV4 - SN3819; ConvF(9.57, 9.57, 9.57); Calibrated: 2019.03.01;
- Sensor-Surface: 1.4mm (Mechanical Surface Detection)
- Electronics: DAE4 Sn715; Calibrated: 2019.01.23
- Phantom: SAM (Front) with CRP v5.0; Type: QD000P40CD; Serial: TP:1795
- Measurement SW: DASY52, Version 52.8 (8); SEMCAD X Version 14.6.10 (7331)

Ch384/Area Scan (71x121x1): Interpolated grid: dx=15mm, dy=15mm
Maximum value of SAR (interpolated) = 0.314 W/kg

Ch384/Zoom Scan (5x5x7)/Cube 0: Measurement grid: dx=8mm, dy=8mm, dz=5mm
Reference Value = 14.35 V/m; Power Drift = 0.01 dB
Peak SAR (extrapolated) = 0.343 W/kg
SAR(1 g) = 0.264 W/kg; SAR(10 g) = 0.190 W/kg
Maximum value of SAR (measured) = 0.308 W/kg

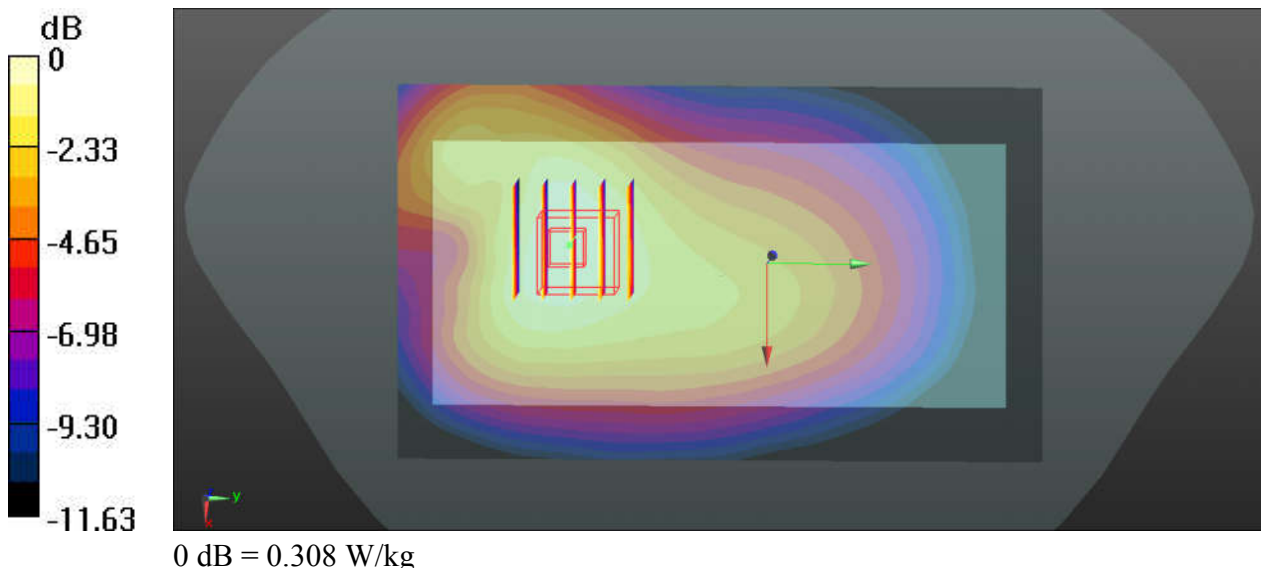

64_CDMA2000 BC10_RC3 SO32 (F+SCH) _Back_15mm_Ch476

Communication System: UID 0, CDMA2000 (0); Frequency: 817.9 MHz; Duty Cycle: 1:1
Medium: HSL_835_191224 Medium parameters used: $f = 817.9$ MHz; $\sigma = 0.911$ S/m; $\epsilon_r = 42.951$;
 $\rho = 1000$ kg/m³
Ambient Temperature : 23.4 °C; Liquid Temperature : 22.5 °C

DASY5 Configuration:

- Probe: EX3DV4 - SN3819; ConvF(9.57, 9.57, 9.57); Calibrated: 2019.03.01;
- Sensor-Surface: 1.4mm (Mechanical Surface Detection)
- Electronics: DAE4 Sn715; Calibrated: 2019.01.23
- Phantom: SAM (Front) with CRP v5.0; Type: QD000P40CD; Serial: TP:1795
- Measurement SW: DASY52, Version 52.8 (8); SEMCAD X Version 14.6.10 (7331)

Ch476/Area Scan (71x121x1): Interpolated grid: dx=15mm, dy=15mm
Maximum value of SAR (interpolated) = 0.304 W/kg

Ch476/Zoom Scan (5x5x7)/Cube 0: Measurement grid: dx=8mm, dy=8mm, dz=5mm
Reference Value = 18.63 V/m; Power Drift = 0.06 dB
Peak SAR (extrapolated) = 0.335 W/kg
SAR(1 g) = 0.263 W/kg; SAR(10 g) = 0.193 W/kg
Maximum value of SAR (measured) = 0.302 W/kg

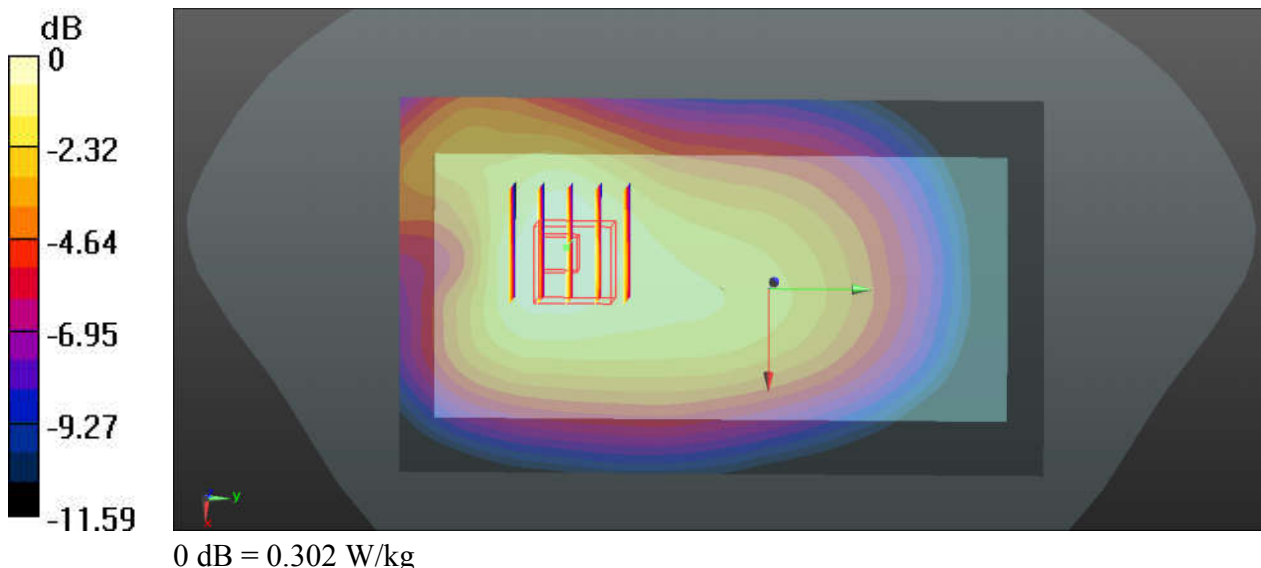

65_CDMA2000 BC1_RC3 SO32 (F+SCH) _Back_15mm_Ch1175

Communication System: CDMA2000; Frequency: 1908.75 MHz; Duty Cycle: 1:1

Medium: HSL_1900_191218 Medium parameters used: $f = 1909$ MHz; $\sigma = 1.426$ S/m; $\epsilon_r = 41.109$; $\rho = 1000$ kg/m³

Ambient Temperature : 23.7 °C ; Liquid Temperature : 22.7 °C

DASY5 Configuration:

- Probe: EX3DV4 - SN3819; ConvF(8.27, 8.27, 8.27); Calibrated: 2019.03.01;
- Sensor-Surface: 1.4mm (Mechanical Surface Detection)
- Electronics: DAE4 Sn715; Calibrated: 2019.01.23
- Phantom: SAM (Front) with CRP v5.0; Type: QD000P40CD; Serial: TP:1795
- Measurement SW: DASY52, Version 52.8 (8); SEMCAD X Version 14.6.10 (7331)

Area Scan (71x131x1): Interpolated grid: dx=1.500 mm, dy=1.500 mm

Maximum value of SAR (interpolated) = 0.829 W/kg

Zoom Scan (5x5x7)/Cube 0: Measurement grid: dx=8mm, dy=8mm, dz=5mm

Reference Value = 2.516 V/m; Power Drift = 0.13 dB

Peak SAR (extrapolated) = 1.06 W/kg

SAR(1 g) = 0.600 W/kg; SAR(10 g) = 0.357 W/kg

Maximum value of SAR (measured) = 0.837 W/kg

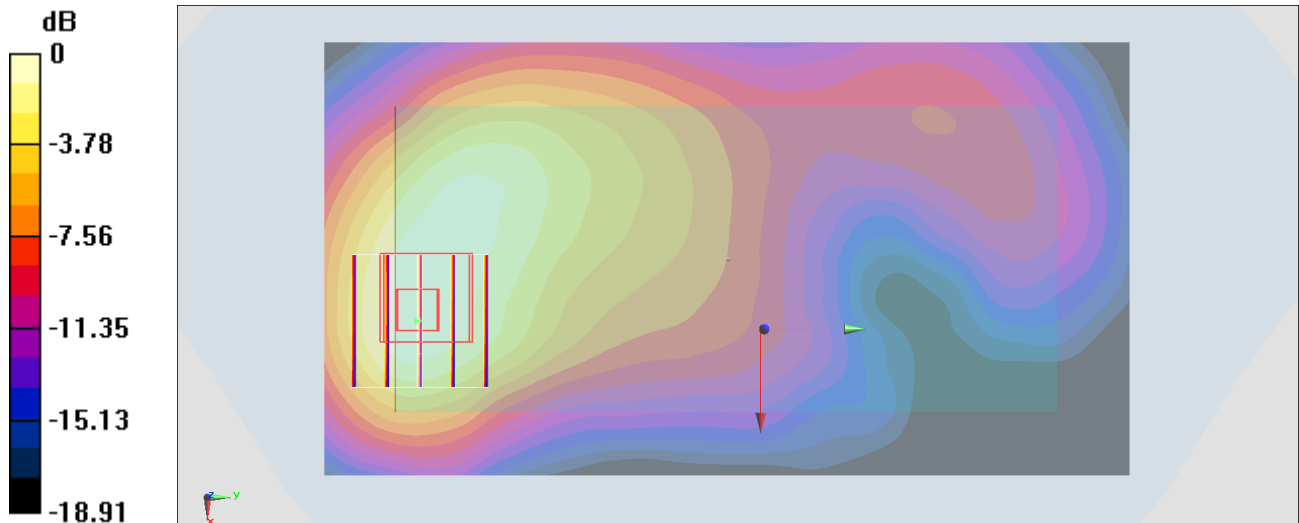

0 dB = 0.837 W/kg = -0.77 dBW/kg

66_LTE Band 71_20M_QPSK_1RB_0Offset_Back_15mm_Ch133322

Communication System: UID 0, LTE (0); Frequency: 673 MHz; Duty Cycle: 1:1
 Medium: HSL_750_191227 Medium parameters used: $f = 673 \text{ MHz}$; $\sigma = 0.838 \text{ S/m}$; $\epsilon_r = 43.022$; $\rho = 1000 \text{ kg/m}^3$
 Ambient Temperature : 23.4 °C; Liquid Temperature : 22.4 °C

DASY5 Configuration:

- Probe: EX3DV4 - SN3819; ConvF(10, 10, 10); Calibrated: 2019.03.01;
- Sensor-Surface: 1.4mm (Mechanical Surface Detection)
- Electronics: DAE4 Sn715; Calibrated: 2019.01.23
- Phantom: SAM (Front) with CRP v5.0; Type: QD000P40CD; Serial: TP:1795
- Measurement SW: DASY52, Version 52.8 (8); SEMCAD X Version 14.6.10 (7331)

Ch133322/Area Scan (71x131x1): Interpolated grid: $dx=15\text{mm}$, $dy=15\text{mm}$
 Maximum value of SAR (interpolated) = 0.344 W/kg

Ch133322/Zoom Scan (5x5x7)/Cube 0: Measurement grid: $dx=8\text{mm}$, $dy=8\text{mm}$, $dz=5\text{mm}$
 Reference Value = 15.48 V/m; Power Drift = -0.07 dB
 Peak SAR (extrapolated) = 0.393 W/kg
SAR(1 g) = 0.276 W/kg; SAR(10 g) = 0.181 W/kg
 Maximum value of SAR (measured) = 0.340 W/kg

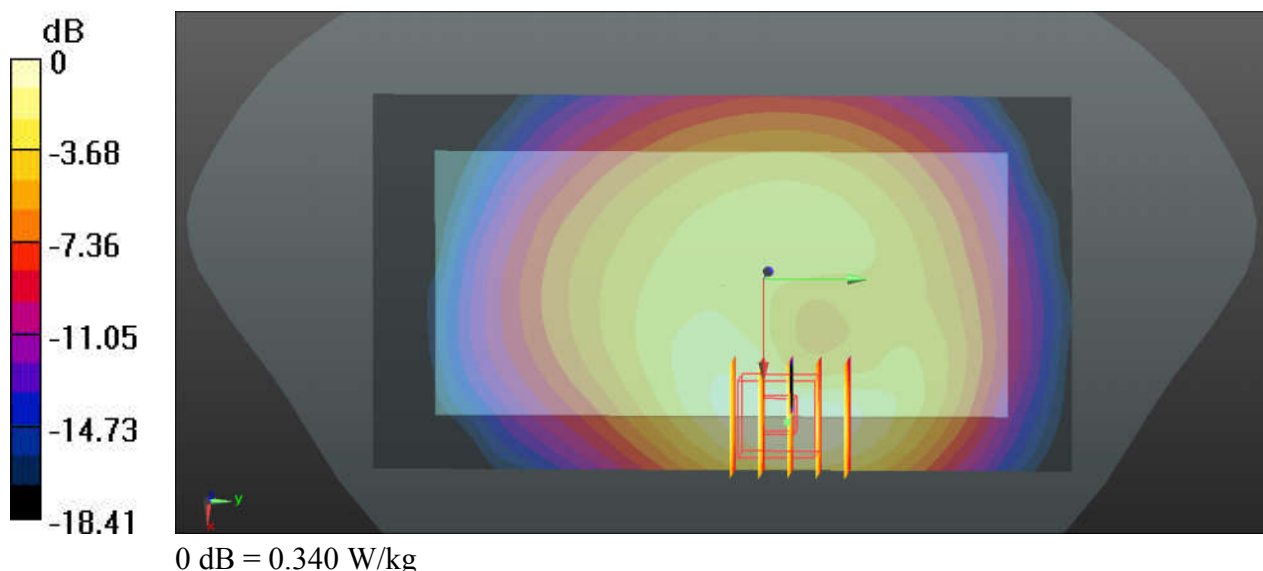

67_LTE Band 12_10M_QPSK_1RB_25Offset_Back_15mm_Ch23095

Communication System: UID 0, LTE (0); Frequency: 707.5 MHz; Duty Cycle: 1:1
Medium: HSL_750_191227 Medium parameters used: $f = 707.5$ MHz; $\sigma = 0.864$ S/m; $\epsilon_r = 42.44$; $\rho = 1000$ kg/m³
Ambient Temperature : 23.4 °C; Liquid Temperature : 22.4 °C

DASY5 Configuration:

- Probe: EX3DV4 - SN3819; ConvF(10, 10, 10); Calibrated: 2019.03.01;
- Sensor-Surface: 1.4mm (Mechanical Surface Detection)
- Electronics: DAE4 Sn715; Calibrated: 2019.01.23
- Phantom: SAM (Front) with CRP v5.0; Type: QD000P40CD; Serial: TP:1795
- Measurement SW: DASY52, Version 52.8 (8); SEMCAD X Version 14.6.10 (7331)

Ch23095/Area Scan (71x121x1): Interpolated grid: dx=15mm, dy=15mm
Maximum value of SAR (interpolated) = 0.373 W/kg

Ch23095/Zoom Scan (5x5x7)/Cube 0: Measurement grid: dx=8mm, dy=8mm, dz=5mm
Reference Value = 21.24 V/m; Power Drift = -0.03 dB
Peak SAR (extrapolated) = 0.418 W/kg
SAR(1 g) = 0.323 W/kg; SAR(10 g) = 0.242 W/kg
Maximum value of SAR (measured) = 0.372 W/kg

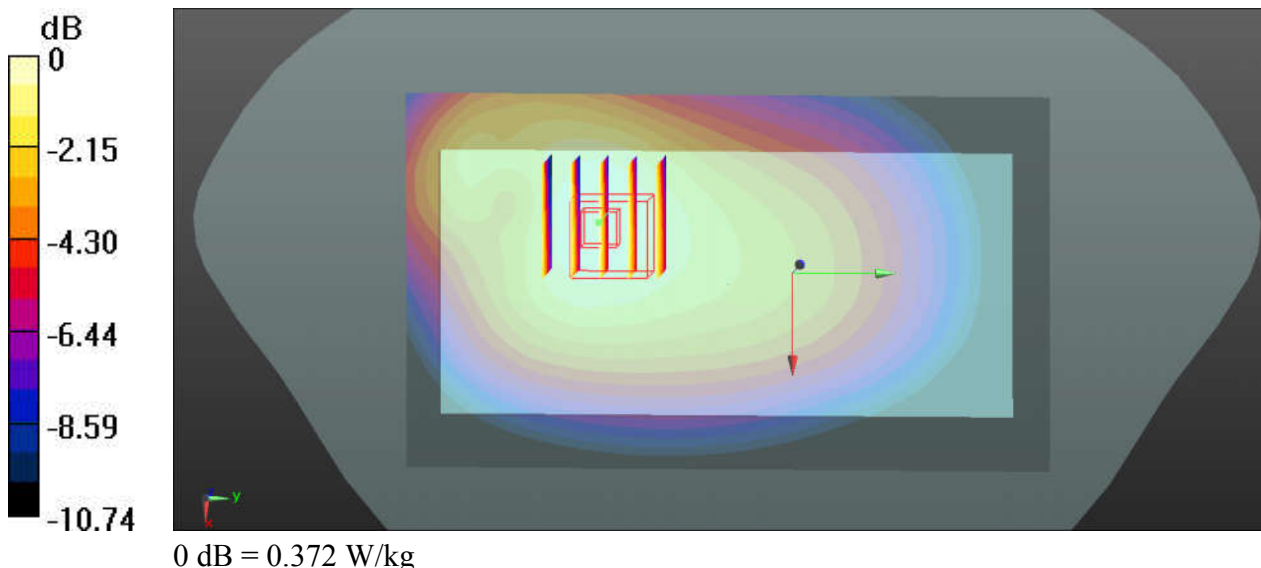

68_LTE Band 13_10M_QPSK_1RB_0Offset_Back_15mm_Ch23230

Communication System: UID 0, LTE (0); Frequency: 782 MHz; Duty Cycle: 1:1
Medium: HSL_750_191227 Medium parameters used: $f = 782 \text{ MHz}$; $\sigma = 0.904 \text{ S/m}$; $\epsilon_r = 40.826$; $\rho = 1000 \text{ kg/m}^3$
Ambient Temperature : 23.4 °C; Liquid Temperature : 22.4 °C

DASY5 Configuration:

- Probe: EX3DV4 - SN3819; ConvF(10, 10, 10); Calibrated: 2019.03.01;
- Sensor-Surface: 1.4mm (Mechanical Surface Detection)
- Electronics: DAE4 Sn715; Calibrated: 2019.01.23
- Phantom: SAM (Front) with CRP v5.0; Type: QD000P40CD; Serial: TP:1795
- Measurement SW: DASY52, Version 52.8 (8); SEMCAD X Version 14.6.10 (7331)

Ch23230/Area Scan (71x121x1): Interpolated grid: $dx=15\text{mm}$, $dy=15\text{mm}$
Maximum value of SAR (interpolated) = 0.401 W/kg

Ch23230/Zoom Scan (5x5x7)/Cube 0: Measurement grid: $dx=8\text{mm}$, $dy=8\text{mm}$, $dz=5\text{mm}$
Reference Value = 9.843 V/m; Power Drift = 0.13 dB
Peak SAR (extrapolated) = 0.460 W/kg
SAR(1 g) = 0.316 W/kg; SAR(10 g) = 0.206 W/kg
Maximum value of SAR (measured) = 0.397 W/kg

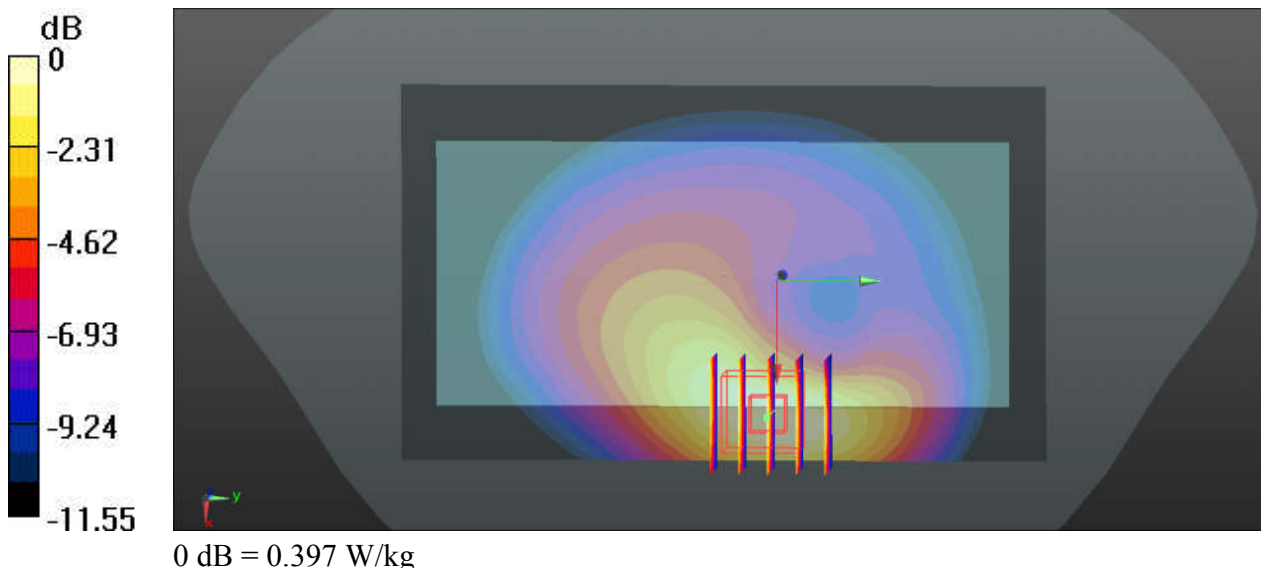

69_LTE Band 5_10M_QPSK_1RB_49Offset_Back_15mm_Ch20525

Communication System: UID 0, LTE (0); Frequency: 836.5 MHz; Duty Cycle: 1:1
Medium: HSL_835_191224 Medium parameters used: $f = 836.5$ MHz; $\sigma = 0.93$ S/m; $\epsilon_r = 42.711$; $\rho = 1000$ kg/m³
Ambient Temperature : 23.4 °C; Liquid Temperature : 22.5 °C

DASY5 Configuration:

- Probe: EX3DV4 - SN3819; ConvF(9.57, 9.57, 9.57); Calibrated: 2019.03.01;
- Sensor-Surface: 1.4mm (Mechanical Surface Detection)
- Electronics: DAE4 Sn715; Calibrated: 2019.01.23
- Phantom: SAM (Front) with CRP v5.0; Type: QD000P40CD; Serial: TP:1795
- Measurement SW: DASY52, Version 52.8 (8); SEMCAD X Version 14.6.10 (7331)

Ch20525/Area Scan (71x121x1): Interpolated grid: dx=15mm, dy=15mm
Maximum value of SAR (interpolated) = 0.375 W/kg

Ch20525/Zoom Scan (5x5x7)/Cube 0: Measurement grid: dx=8mm, dy=8mm, dz=5mm
Reference Value = 10.63 V/m; Power Drift = -0.12 dB
Peak SAR (extrapolated) = 0.438 W/kg
SAR(1 g) = 0.288 W/kg; SAR(10 g) = 0.182 W/kg
Maximum value of SAR (measured) = 0.372 W/kg

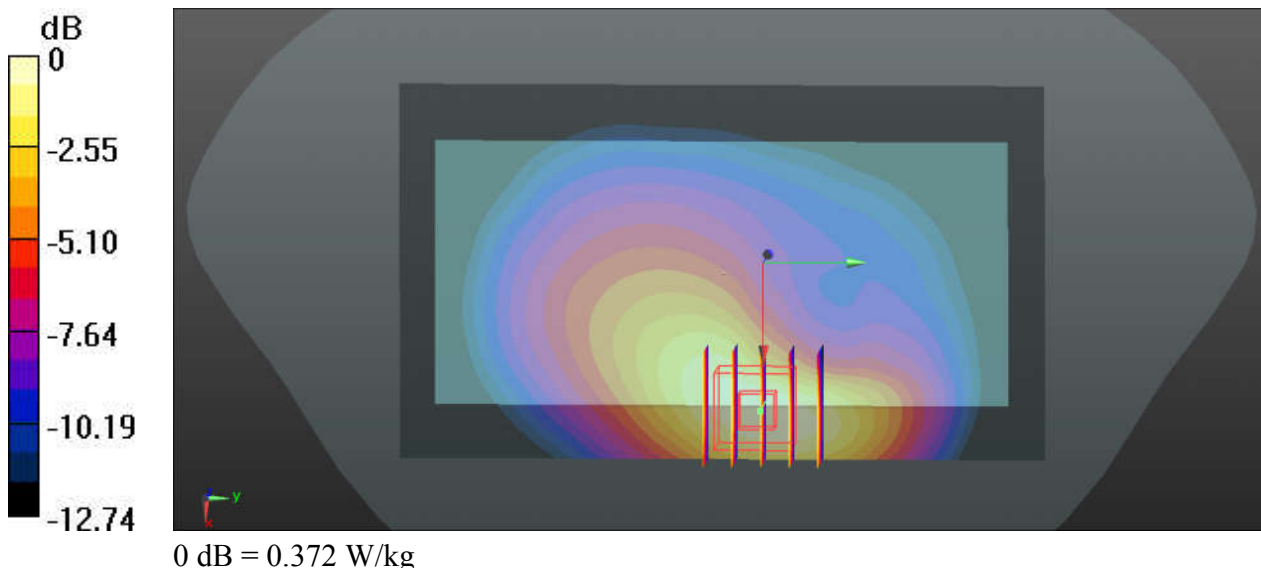

70_LTE Band 26_15M_QPSK_1RB_0Offset_Back_15mm_Ch26965

Communication System: UID 0, LTE (0); Frequency: 841.5 MHz; Duty Cycle: 1:1
Medium: HSL_835_191224 Medium parameters used: $f = 841.5$ MHz; $\sigma = 0.934$ S/m; $\epsilon_r = 42.647$;
 $\rho = 1000$ kg/m³
Ambient Temperature : 23.4 °C ; Liquid Temperature : 22.5 °C

DASY5 Configuration:

- Probe: EX3DV4 - SN3819; ConvF(9.57, 9.57, 9.57); Calibrated: 2019.03.01;
- Sensor-Surface: 1.4mm (Mechanical Surface Detection)
- Electronics: DAE4 Sn715; Calibrated: 2019.01.23
- Phantom: SAM (Front) with CRP v5.0; Type: QD000P40CD; Serial: TP:1795
- Measurement SW: DASY52, Version 52.8 (8); SEMCAD X Version 14.6.10 (7331)

Ch26965/Area Scan (71x61x1): Interpolated grid: dx=15mm, dy=15mm
Maximum value of SAR (interpolated) = 0.426 W/kg

Ch26965/Zoom Scan (5x5x7)/Cube 0: Measurement grid: dx=8mm, dy=8mm, dz=5mm
Reference Value = 13.07 V/m; Power Drift = -0.14 dB
Peak SAR (extrapolated) = 0.508 W/kg
SAR(1 g) = 0.335 W/kg; SAR(10 g) = 0.213 W/kg
Maximum value of SAR (measured) = 0.428 W/kg

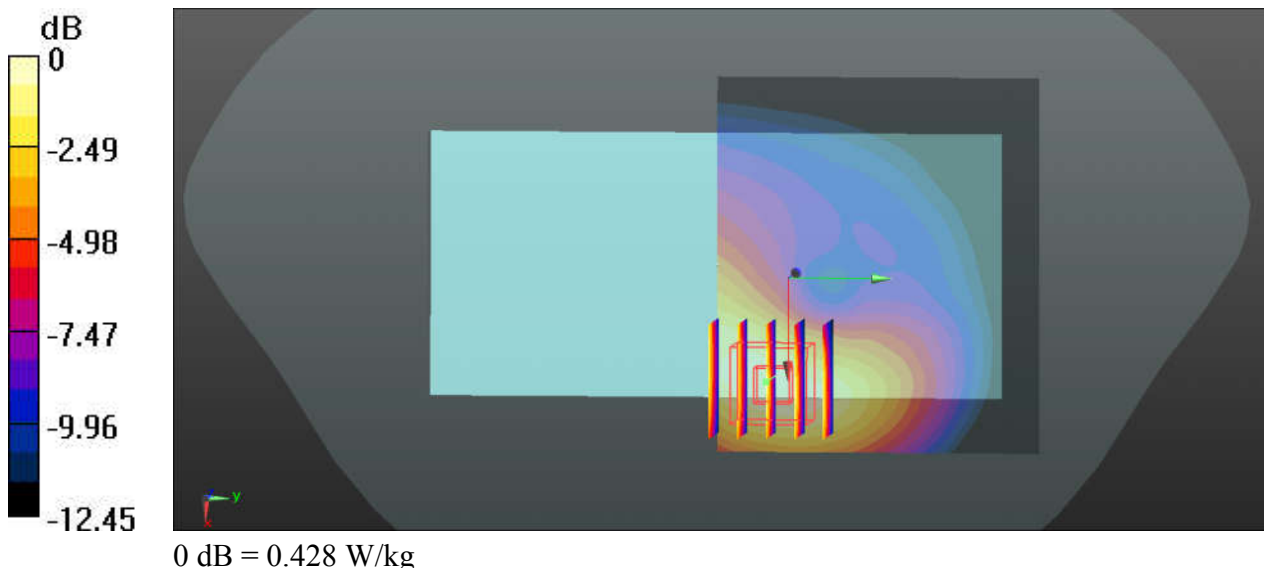

71_LTE Band 66_20M_QPSK_1RB_0Offset_Back_15mm_Ch132072

Communication System: UID 0, LTE (0); Frequency: 1720 MHz; Duty Cycle: 1:1
Medium: HSL_1750_191221 Medium parameters used: $f = 1720$ MHz; $\sigma = 1.369$ S/m; $\epsilon_r = 39.981$;
 $\rho = 1000$ kg/m³
Ambient Temperature : 23.5 °C; Liquid Temperature : 22.4 °C

DASY5 Configuration:

- Probe: EX3DV4 - SN3819; ConvF(8.54, 8.54, 8.54); Calibrated: 2019.03.01;
- Sensor-Surface: 1.4mm (Mechanical Surface Detection)
- Electronics: DAE4 Sn715; Calibrated: 2019.01.23
- Phantom: SAM (Front) with CRP v5.0; Type: QD000P40CD; Serial: TP:1795
- Measurement SW: DASY52, Version 52.8 (8); SEMCAD X Version 14.6.10 (7331)

Ch132072/Area Scan (71x61x1): Interpolated grid: dx=15mm, dy=15mm
Maximum value of SAR (interpolated) = 0.495 W/kg

Ch132072/Zoom Scan (5x5x7)/Cube 0: Measurement grid: dx=8mm, dy=8mm, dz=5mm
Reference Value = 10.21 V/m; Power Drift = 0.06 dB
Peak SAR (extrapolated) = 0.716 W/kg
SAR(1 g) = 0.502 W/kg; SAR(10 g) = 0.320 W/kg
Maximum value of SAR (measured) = 0.627 W/kg

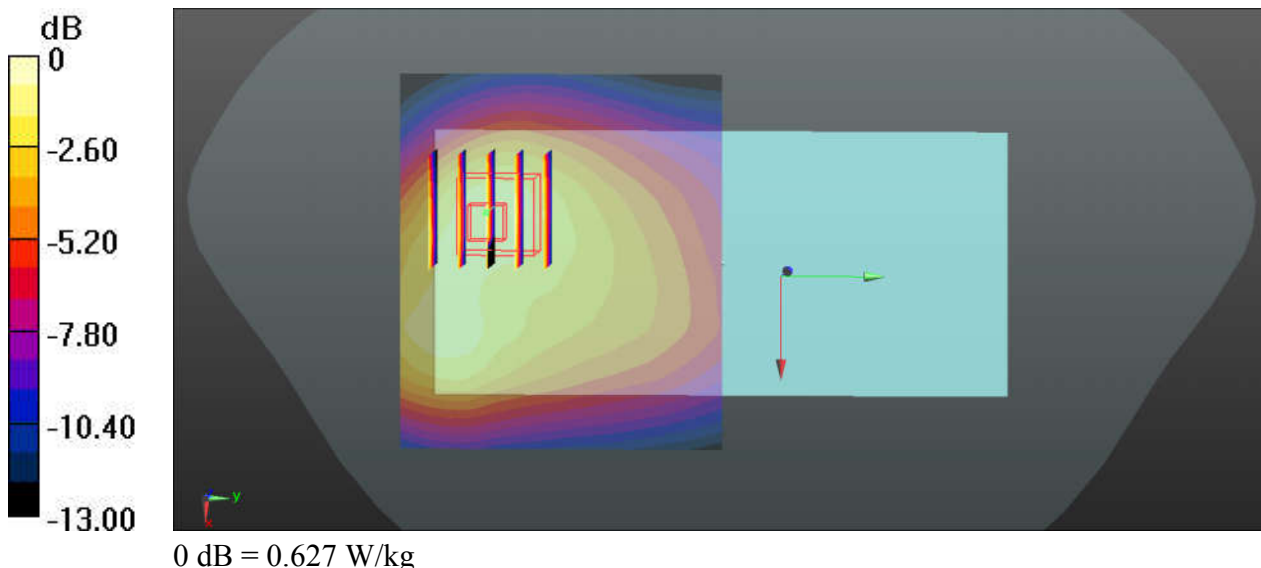

72_LTE Band 25_20M_QPSK_1RB_0Offset_Back_15mm_Ch26590

Communication System: UID 0, LTE (0); Frequency: 1905 MHz; Duty Cycle: 1:1
Medium: HSL_1900_191218 Medium parameters used: $f = 1905$ MHz; $\sigma = 1.424$ S/m; $\epsilon_r = 41.122$;
 $\rho = 1000$ kg/m³
Ambient Temperature : 23.5 °C; Liquid Temperature : 22.7 °C

DASY5 Configuration:

- Probe: EX3DV4 - SN3819; ConvF(8.27, 8.27, 8.27); Calibrated: 2019.03.01;
- Sensor-Surface: 1.4mm (Mechanical Surface Detection)
- Electronics: DAE4 Sn715; Calibrated: 2019.01.23
- Phantom: SAM (Front) with CRP v5.0; Type: QD000P40CD; Serial: TP:1795
- Measurement SW: DASY52, Version 52.8 (8); SEMCAD X Version 14.6.10 (7331)

Ch26590/Area Scan (71x131x1): Interpolated grid: dx=15mm, dy=15mm
Maximum value of SAR (interpolated) = 0.805 W/kg

Ch26590/Zoom Scan (5x5x7)/Cube 0: Measurement grid: dx=8mm, dy=8mm, dz=5mm
Reference Value = 12.23 V/m; Power Drift = 0.01 dB
Peak SAR (extrapolated) = 0.995 W/kg
SAR(1 g) = 0.584 W/kg; SAR(10 g) = 0.342 W/kg
Maximum value of SAR (measured) = 0.796 W/kg

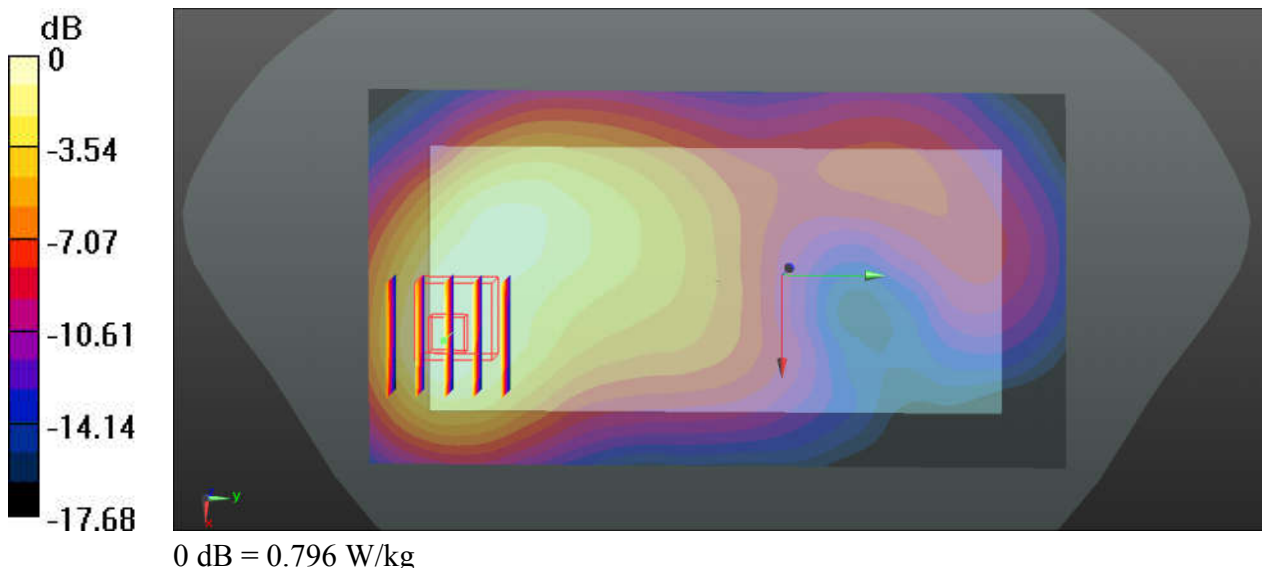

73_LTE Band 30_10M_QPSK_1RB_0Offset_Back_15mm_Ch27710

Communication System: UID 0, LTE (0); Frequency: 2310 MHz; Duty Cycle: 1:1
Medium: HSL_2300_191230 Medium parameters used: $f = 2310$ MHz; $\sigma = 1.682$ S/m; $\epsilon_r = 38.704$;
 $\rho = 1000$ kg/m³
Ambient Temperature : 23.4 °C; Liquid Temperature : 22.7 °C

DASY5 Configuration:

- Probe: EX3DV4 - SN3819; ConvF(7.64, 7.64, 7.64); Calibrated: 2019.03.01;
- Sensor-Surface: 1.4mm (Mechanical Surface Detection)
- Electronics: DAE4 Sn715; Calibrated: 2019.01.23
- Phantom: SAM (Front) with CRP v5.0; Type: QD000P40CD; Serial: TP:1795
- Measurement SW: DASY52, Version 52.8 (8); SEMCAD X Version 14.6.10 (7331)

Ch27710/Area Scan (81x161x1): Interpolated grid: dx=12mm, dy=12mm
Maximum value of SAR (interpolated) = 0.786 W/kg

Ch27710/Zoom Scan (7x7x7)/Cube 0: Measurement grid: dx=5mm, dy=5mm, dz=5mm
Reference Value = 12.48 V/m; Power Drift = 0.03 dB
Peak SAR (extrapolated) = 1.18 W/kg
SAR(1 g) = 0.643 W/kg; SAR(10 g) = 0.361 W/kg
Maximum value of SAR (measured) = 0.790 W/kg

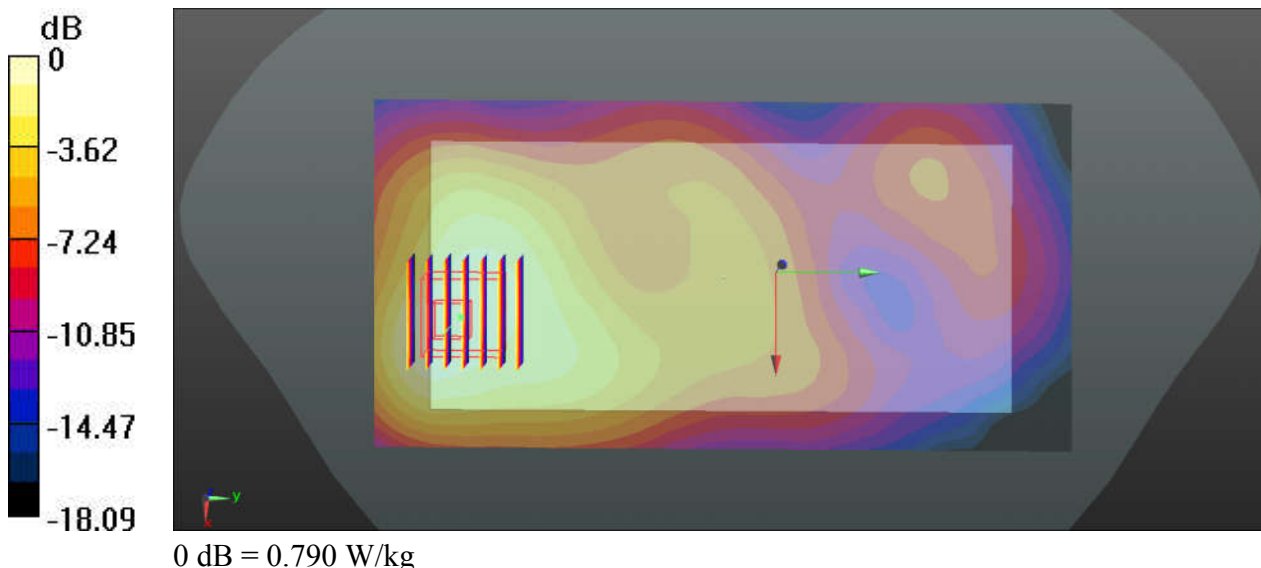

74_LTE Band 7_20M_QPSK_1RB_0Offset_Back_15mm_Ch21350

Communication System: UID 0, LTE (0); Frequency: 2560 MHz; Duty Cycle: 1:1
Medium: HSL_2600_200105 Medium parameters used: $f = 2560$ MHz; $\sigma = 2.009$ S/m; $\epsilon_r = 37.777$;
 $\rho = 1000$ kg/m³
Ambient Temperature : 23.6 °C ; Liquid Temperature : 22.4 °C

DASY5 Configuration:

- Probe: EX3DV4 - SN3819; ConvF(7.06, 7.06, 7.06); Calibrated: 2019.03.01;
- Sensor-Surface: 1.4mm (Mechanical Surface Detection)
- Electronics: DAE4 Sn715; Calibrated: 2019.01.23
- Phantom: SAM (Front) with CRP v5.0; Type: QD000P40CD; Serial: TP:1795
- Measurement SW: DASY52, Version 52.8 (8); SEMCAD X Version 14.6.10 (7331)

Ch21350/Area Scan (81x161x1): Interpolated grid: dx=12 mm, dy=12mm
Maximum value of SAR (interpolated) = 0.921 W/kg

Ch21350/Zoom Scan (7x7x7)/Cube 0: Measurement grid: dx=5mm, dy=5mm, dz=5mm
Reference Value = 9.342 V/m; Power Drift = -0.17 dB
Peak SAR (extrapolated) = 1.51 W/kg
SAR(1 g) = 0.710 W/kg; SAR(10 g) = 0.349 W/kg
Maximum value of SAR (measured) = 0.921 W/kg

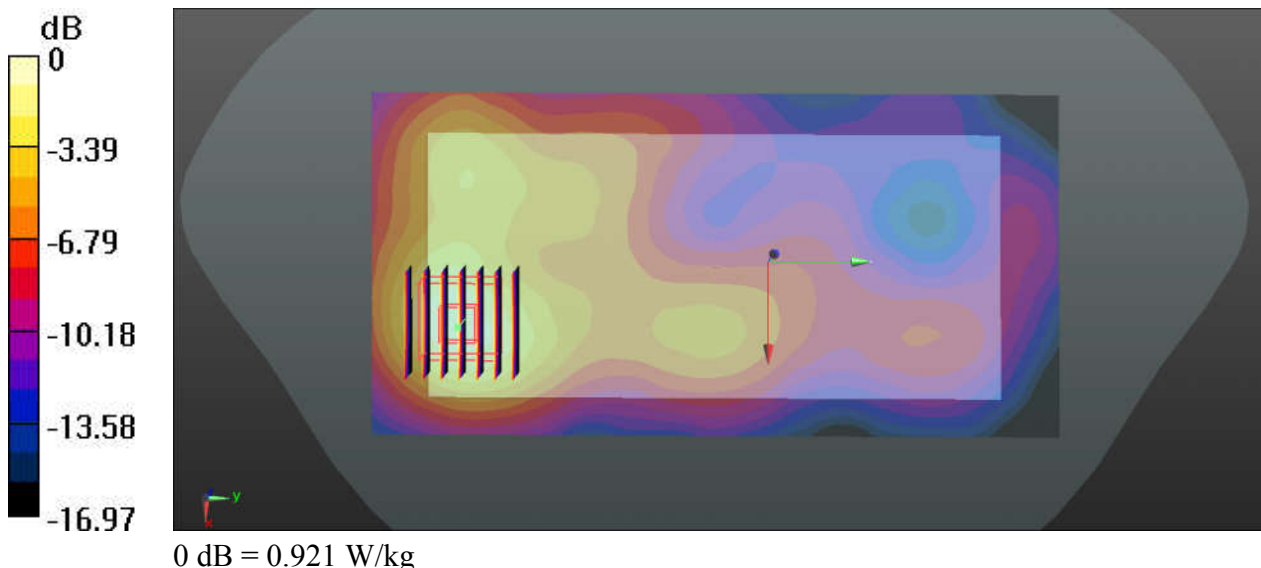

75_LTE Band 41_20M_QPSK_1RB_49Offset_Back_15mm_Ch40620

Communication System: LTE; Frequency: 2593 MHz; Duty Cycle: 1:1
Medium: HSL_2600_200105 Medium parameters used: $f = 2593$ MHz; $\sigma = 2.047$ S/m; $\epsilon_r = 37.615$;
 $\rho = 1000$ kg/m³
Ambient Temperature : 23.6 °C ; Liquid Temperature : 22.4 °C

DASY5 Configuration:

- Probe: EX3DV4 - SN3819; ConvF(7.06, 7.06, 7.06); Calibrated: 2019.03.01;
- Sensor-Surface: 1.4mm (Mechanical Surface Detection)
- Electronics: DAE4 Sn715; Calibrated: 2019.01.23
- Phantom: SAM (Front) with CRP v5.0; Type: QD000P40CD; Serial: TP:1795
- Measurement SW: DASY52, Version 52.8 (8); SEMCAD X Version 14.6.10 (7331)

Area Scan (81x81x1): Interpolated grid: dx=1.200 mm, dy=1.200 mm
Maximum value of SAR (interpolated) = 0.635 W/kg

Zoom Scan (7x7x7)/Cube 0: Measurement grid: dx=5mm, dy=5mm, dz=5mm
Reference Value = 7.545 V/m; Power Drift = -0.06 dB
Peak SAR (extrapolated) = 1.05 W/kg
SAR(1 g) = 0.479 W/kg; SAR(10 g) = 0.241 W/kg
Maximum value of SAR (measured) = 0.629 W/kg

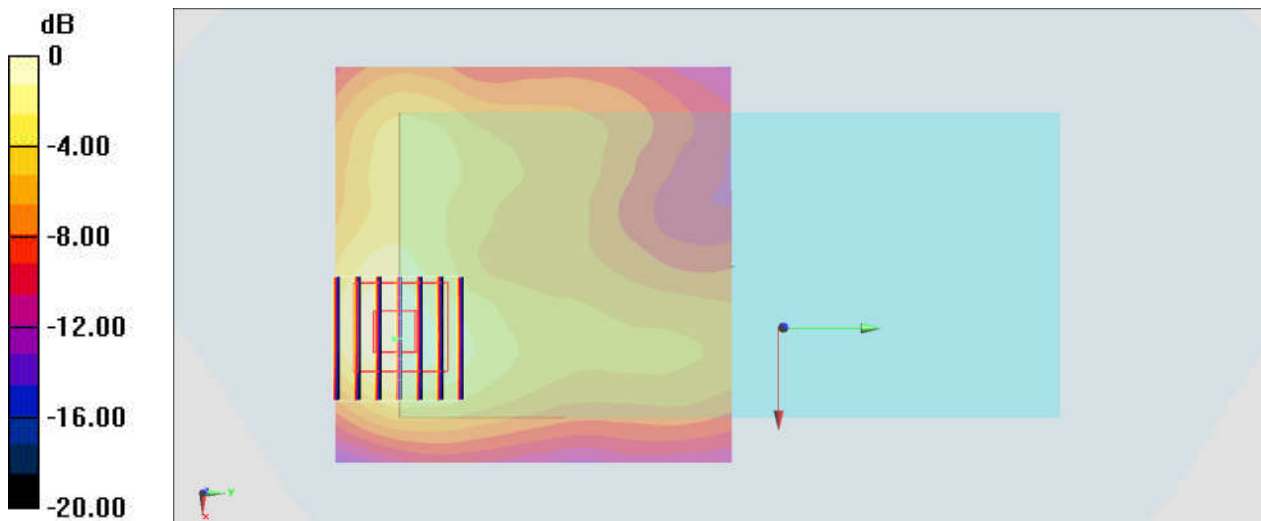

0 dB = 0.629 W/kg = -2.01 dBW/kg

76_LTE Band 48_20M_QPSK_1RB_49Offset_Back_15mm_Ch56640

Communication System: UID 0, LTE (0); Frequency: 3690 MHz; Duty Cycle: 1:1.59
Medium: HSL_3700_200109 Medium parameters used: $f = 3690$ MHz; $\sigma = 3.046$ S/m; $\epsilon_r = 38.387$;
 $\rho = 1000$ kg/m³
Ambient Temperature : 23.6 °C; Liquid Temperature : 22.8 °C

DASY5 Configuration:

- Probe: EX3DV4 - SN3819; ConvF(6.67, 6.67, 6.67); Calibrated: 2019.03.01;
- Sensor-Surface: 1.4mm (Mechanical Surface Detection)
- Electronics: DAE4 Sn715; Calibrated: 2019.01.23
- Phantom: SAM (Front) with CRP v5.0; Type: QD000P40CD; Serial: TP:1795
- Measurement SW: DASY52, Version 52.8 (8); SEMCAD X Version 14.6.10 (7331)

Ch56640/Area Scan (81x81x1): Interpolated grid: dx=12mm, dy=12mm
Maximum value of SAR (interpolated) = 0.592 W/kg

Ch56640/Zoom Scan (8x7x7)/Cube 0: Measurement grid: dx=5mm, dy=5mm, dz=1.4mm
Reference Value = 13.46 V/m; Power Drift = -0.03 dB
Peak SAR (extrapolated) = 0.969 W/kg
SAR(1 g) = 0.330 W/kg; SAR(10 g) = 0.146 W/kg
Maximum value of SAR (measured) = 0.612 W/kg

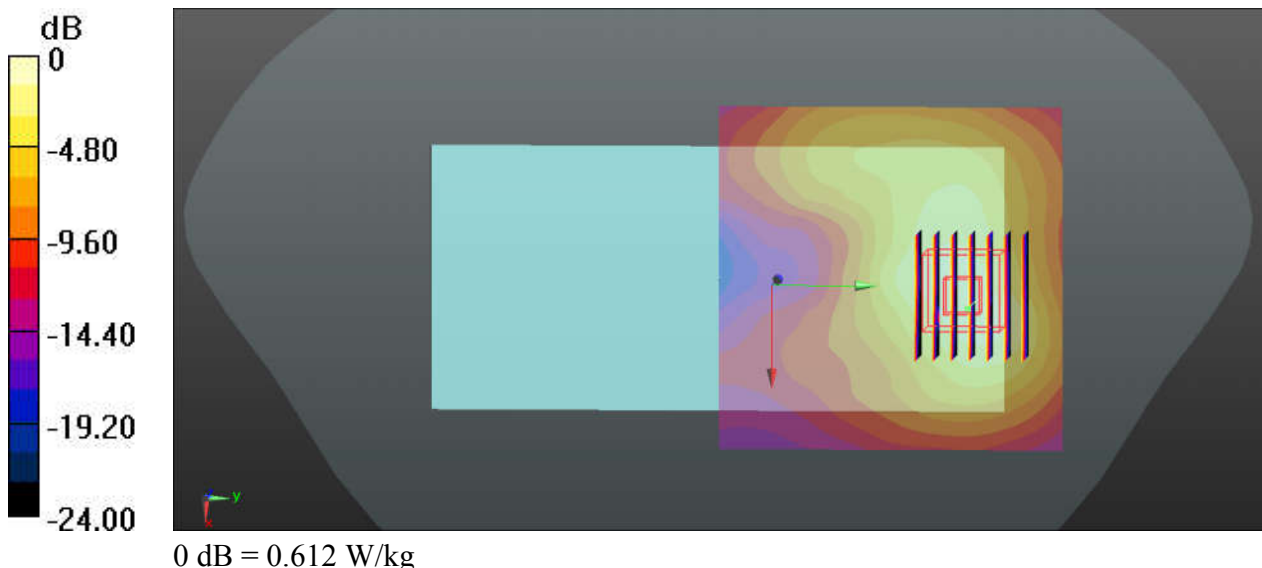

77_N2_20M_PI/2 BPSK_50_0_Back_15mm_Ch376000

Communication System: NR; Frequency: 1880 MHz; Duty Cycle: 1:1

Medium: HSL_1900_200206 Medium parameters used: $f = 1880$ MHz; $\sigma = 1.419$ S/m; $\epsilon_r = 40.407$; $\rho = 1000$ kg/m³

Ambient Temperature : 23.6 °C ; Liquid Temperature : 22.6 °C

DASY5 Configuration:

- Probe: EX3DV4 - SN7346; ConvF(8.07, 8.07, 8.07) @ 1880 MHz; Calibrated: 2019/4/25
- Sensor-Surface: 1.4mm (Mechanical Surface Detection)
- Electronics: DAE4 Sn853; Calibrated: 2019/7/18
- Phantom: SAM_Left; Type: QD000P40CD; Serial: TP:1477
- Measurement SW: DASY52, Version 52.10 (2); SEMCAD X Version 14.6.12 (7470)

Area Scan (71x71x1): Interpolated grid: dx=1.500 mm, dy=1.500 mm

Maximum value of SAR (interpolated) = 0.701 W/kg

Zoom Scan (5x5x7)/Cube 0: Measurement grid: dx=8mm, dy=8mm, dz=5mm

Reference Value = 10.57 V/m; Power Drift = -0.18 dB

Peak SAR (extrapolated) = 0.743 W/kg

SAR(1 g) = 0.449 W/kg; SAR(10 g) = 0.279 W/kg

Maximum value of SAR (measured) = 0.624 W/kg

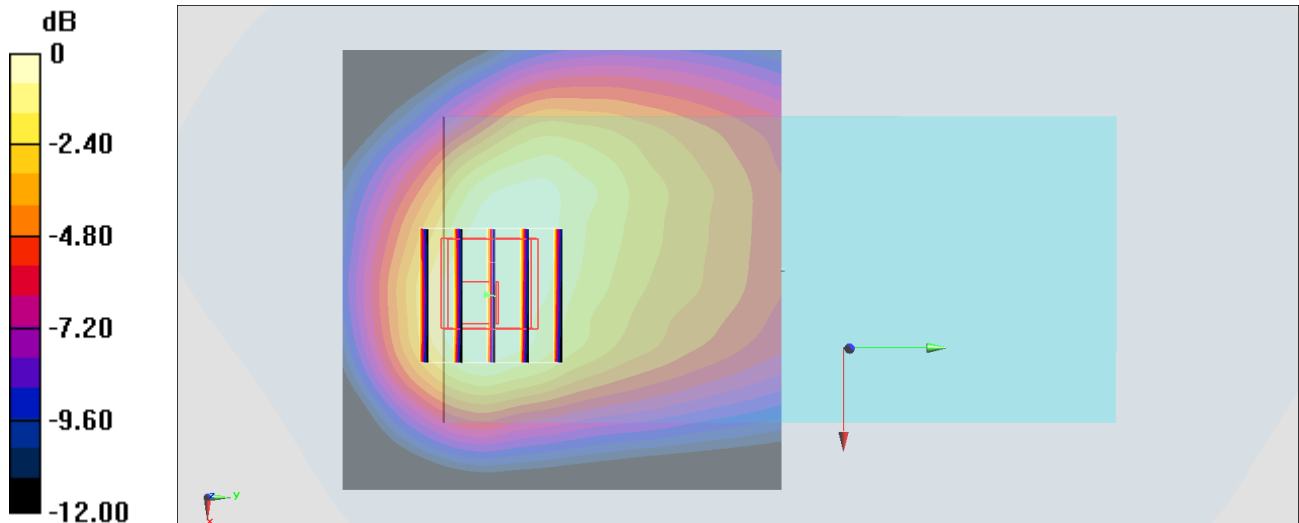

0 dB = 0.624 W/kg = -2.05 dBW/kg

78_N5_20M_PI/2 BPSK_50_0_Back_15mm_Ch167300

Communication System: NR; Frequency: 836.5 MHz; Duty Cycle: 1:1

Medium: HSL_850_200207 Medium parameters used: $f = 836.5$ MHz; $\sigma = 0.898$ S/m; $\epsilon_r = 40.799$; $\rho = 1000$ kg/m³

Ambient Temperature : 23.1 °C; Liquid Temperature : 22.1 °C

DASY5 Configuration:

- Probe: ES3DV3 - SN3184; ConvF(6.41, 6.41, 6.41) @ 836.5 MHz; Calibrated: 2019/9/25
- Sensor-Surface: 3mm (Mechanical Surface Detection)
- Electronics: DAE4 Sn1305; Calibrated: 2019/4/30
- Phantom: SAM_Right; Type: QD000P40CD; Serial: TP:1683
- Measurement SW: DASY52, Version 52.10 (2); SEMCAD X Version 14.6.12 (7470)

Area Scan (71x121x1): Interpolated grid: dx=1.500 mm, dy=1.500 mm

Maximum value of SAR (interpolated) = 0.229 W/kg

Zoom Scan (5x5x7)/Cube 0: Measurement grid: dx=8mm, dy=8mm, dz=5mm

Reference Value = 12.40 V/m; Power Drift = -0.18 dB

Peak SAR (extrapolated) = 0.262 W/kg

SAR(1 g) = 0.191 W/kg; SAR(10 g) = 0.123 W/kg

Maximum value of SAR (measured) = 0.223 W/kg

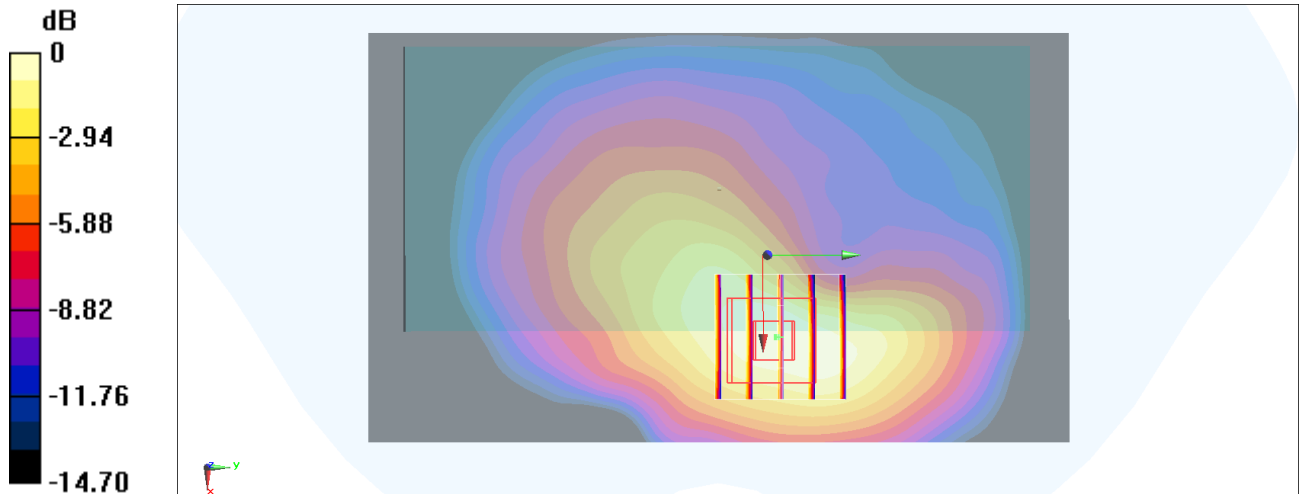

0 dB = 0.223 W/kg = -6.52 dBW/kg

79_N41_100M_PI/2 BPSK_1_1_Back_15mm_Ch509200

Communication System: NR; Frequency: 2546 MHz; Duty Cycle: 1:4

Medium: HSL_2600_200207 Medium parameters used: $f = 2546$ MHz; $\sigma = 1.965$ S/m; $\epsilon_r = 39.157$; $\rho = 1000$ kg/m³

Ambient Temperature : 23.9 °C ; Liquid Temperature : 22.9 °C

DASY5 Configuration:

- Probe: EX3DV4 - SN3642; ConvF(7.14, 7.14, 7.14) @ 2546 MHz; Calibrated: 2019/4/29
- Sensor-Surface: 1.4mm (Mechanical Surface Detection)
- Electronics: DAE4 Sn854; Calibrated: 2019/5/21
- Phantom: SAM_Left; Type: QD000P40CD; Serial: TP:1682
- Measurement SW: DASY52, Version 52.10 (2); SEMCAD X Version 14.6.12 (7470)

Area Scan (91x91x1): Interpolated grid: dx=1.200 mm, dy=1.200 mm

Maximum value of SAR (interpolated) = 0.709 W/kg

Zoom Scan (7x7x7)/Cube 0: Measurement grid: dx=5mm, dy=5mm, dz=5mm

Reference Value = 13.13 V/m; Power Drift = 0.07 dB

Peak SAR (extrapolated) = 0.857 W/kg

SAR(1 g) = 0.438 W/kg; SAR(10 g) = 0.229 W/kg

Maximum value of SAR (measured) = 0.692 W/kg

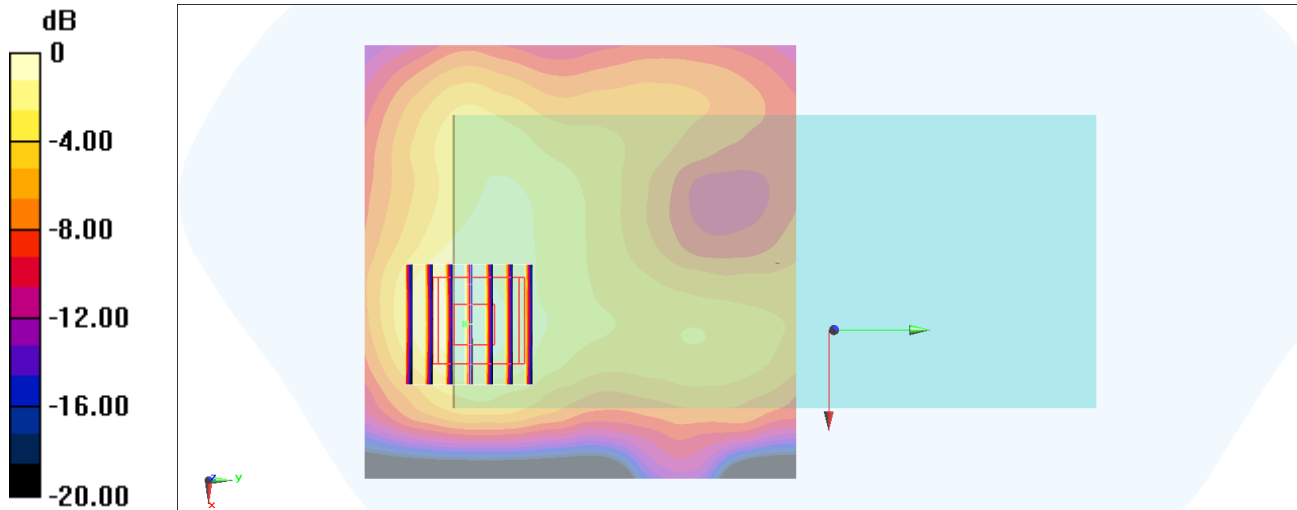

0 dB = 0.692 W/kg = -1.60 dBW/kg

80_N66_20M_PI/2 BPSK_1_1_Back_15mm_Ch344000

Communication System: NR; Frequency: 1720 MHz; Duty Cycle: 1:1

Medium: HSL_1750_200207 Medium parameters used: $f = 1720$ MHz; $\sigma = 1.326$ S/m; $\epsilon_r = 39.731$; $\rho = 1000$ kg/m³

Ambient Temperature : 23.3 °C; Liquid Temperature : 22.3 °C

DASY5 Configuration:

- Probe: EX3DV4 - SN7346; ConvF(8.5, 8.5, 8.5) @ 1720 MHz; Calibrated: 2019/4/25
- Sensor-Surface: 1.4mm (Mechanical Surface Detection)
- Electronics: DAE4 Sn853; Calibrated: 2019/7/18
- Phantom: SAM_Left; Type: QD000P40CD; Serial: TP:1477
- Measurement SW: DASY52, Version 52.10 (2); SEMCAD X Version 14.6.12 (7470)

Area Scan (71x71x1): Interpolated grid: dx=1.500 mm, dy=1.500 mm

Maximum value of SAR (interpolated) = 0.504 W/kg

Zoom Scan (5x5x7)/Cube 0: Measurement grid: dx=8mm, dy=8mm, dz=5mm

Reference Value = 10.95 V/m; Power Drift = -0.14 dB

Peak SAR (extrapolated) = 0.580 W/kg

SAR(1 g) = 0.378 W/kg; SAR(10 g) = 0.245 W/kg

Maximum value of SAR (measured) = 0.500 W/kg

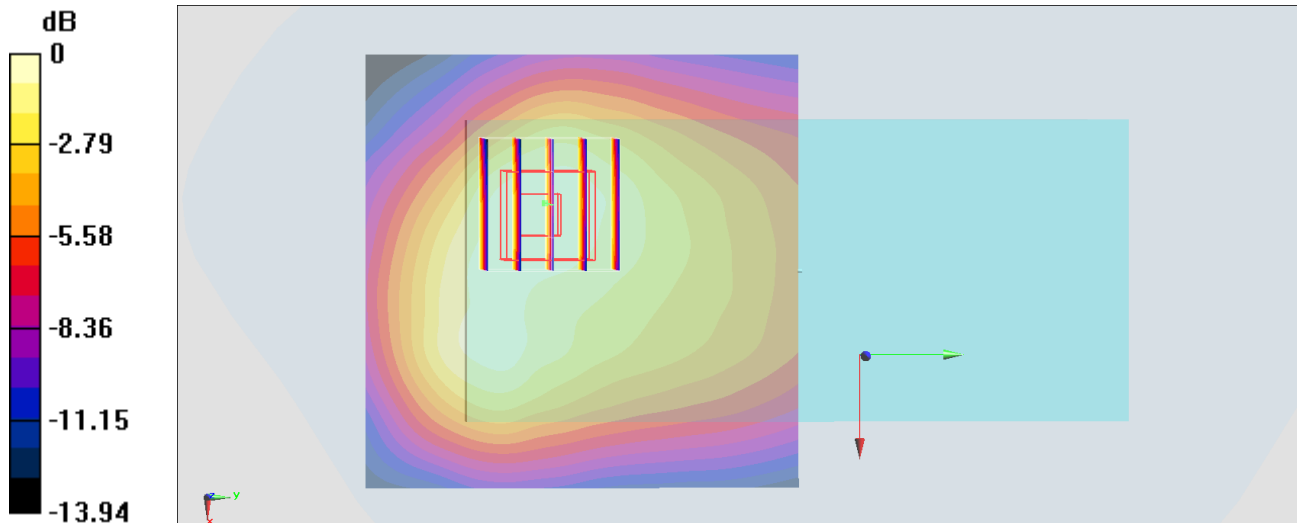

0 dB = 0.500 W/kg = -3.01 dBW/kg

81_N71_20M_PI/2 BPSK_50_56_Back_15mm_Ch136100

Communication System: NR; Frequency: 680.5 MHz; Duty Cycle: 1:1

Medium: HSL_750_200208 Medium parameters used: $f = 680.5$ MHz; $\sigma = 0.827$ S/m; $\epsilon_r = 42.282$; $\rho = 1000$ kg/m³

Ambient Temperature : 23.6 °C ; Liquid Temperature : 22.6 °C

DASY5 Configuration:

- Probe: ES3DV3 - SN3184; ConvF(6.61, 6.61, 6.61) @ 680.5 MHz; Calibrated: 2019/9/25
- Sensor-Surface: 3mm (Mechanical Surface Detection)
- Electronics: DAE4 Sn1305; Calibrated: 2019/4/30
- Phantom: SAM_Right; Type: QD000P40CD; Serial: TP:1683
- Measurement SW: DASY52, Version 52.10 (2); SEMCAD X Version 14.6.12 (7470)

Area Scan (71x131x1): Interpolated grid: dx=1.500 mm, dy=1.500 mm

Maximum value of SAR (interpolated) = 0.234 W/kg

Zoom Scan (5x5x7)/Cube 0: Measurement grid: dx=8mm, dy=8mm, dz=5mm

Reference Value = 12.03 V/m; Power Drift = -0.16 dB

Peak SAR (extrapolated) = 0.269 W/kg

SAR(1 g) = 0.201 W/kg; SAR(10 g) = 0.135 W/kg

Maximum value of SAR (measured) = 0.225 W/kg

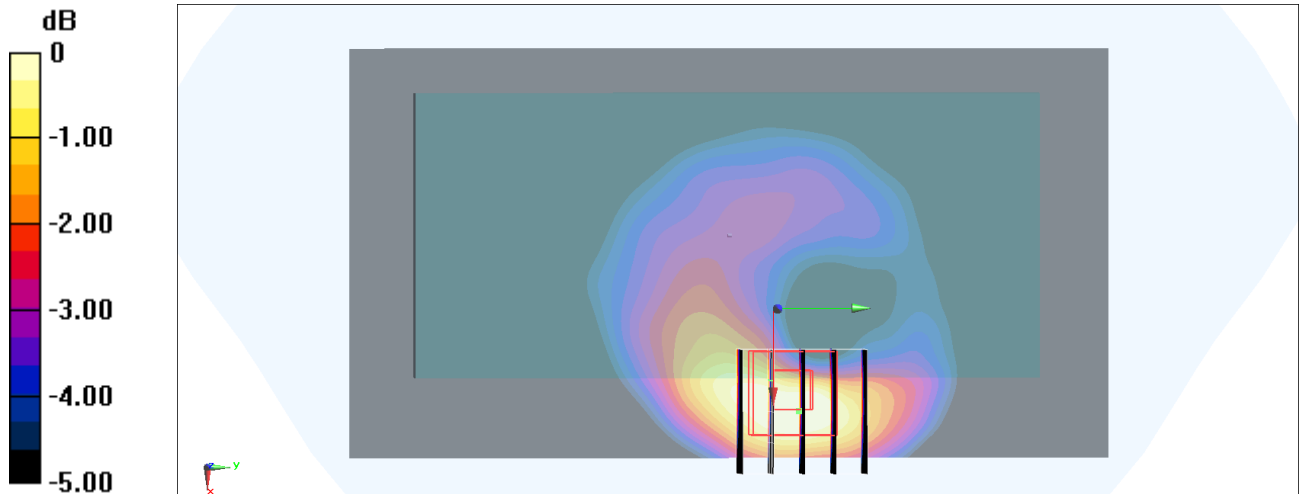

0 dB = 0.225 W/kg = -6.47 dBW/kg

82_WLAN2.4GHz_802.11b 1Mbps_Back_15mm_Ch6

Communication System: UID 0, WIFI (0); Frequency: 2437 MHz; Duty Cycle: 1:1
Medium: HSL_2450_200102 Medium parameters used: $f = 2437$ MHz; $\sigma = 1.843$ S/m; $\epsilon_r = 37.718$;
 $\rho = 1000$ kg/m³
Ambient Temperature : 23.4 °C ; Liquid Temperature : 22.6 °C

DASY5 Configuration:

- Probe: EX3DV4 - SN3819; ConvF(7.21, 7.21, 7.21); Calibrated: 2019.03.01;
- Sensor-Surface: 1.4mm (Mechanical Surface Detection)
- Electronics: DAE4 Sn715; Calibrated: 2019.01.23
- Phantom: SAM (Front) with CRP v5.0; Type: QD000P40CD; Serial: TP:1795
- Measurement SW: DASY52, Version 52.8 (8); SEMCAD X Version 14.6.10 (7331)

Ch6/Area Scan (81x81x1): Interpolated grid: dx=12mm, dy=12mm
Maximum value of SAR (interpolated) = 0.544 W/kg

Ch6/Zoom Scan (7x7x7)/Cube 0: Measurement grid: dx=5mm, dy=5mm, dz=5mm
Reference Value = 3.393 V/m; Power Drift = 0.15 dB
Peak SAR (extrapolated) = 0.853 W/kg
SAR(1 g) = 0.409 W/kg; SAR(10 g) = 0.191 W/kg
Maximum value of SAR (measured) = 0.537 W/kg

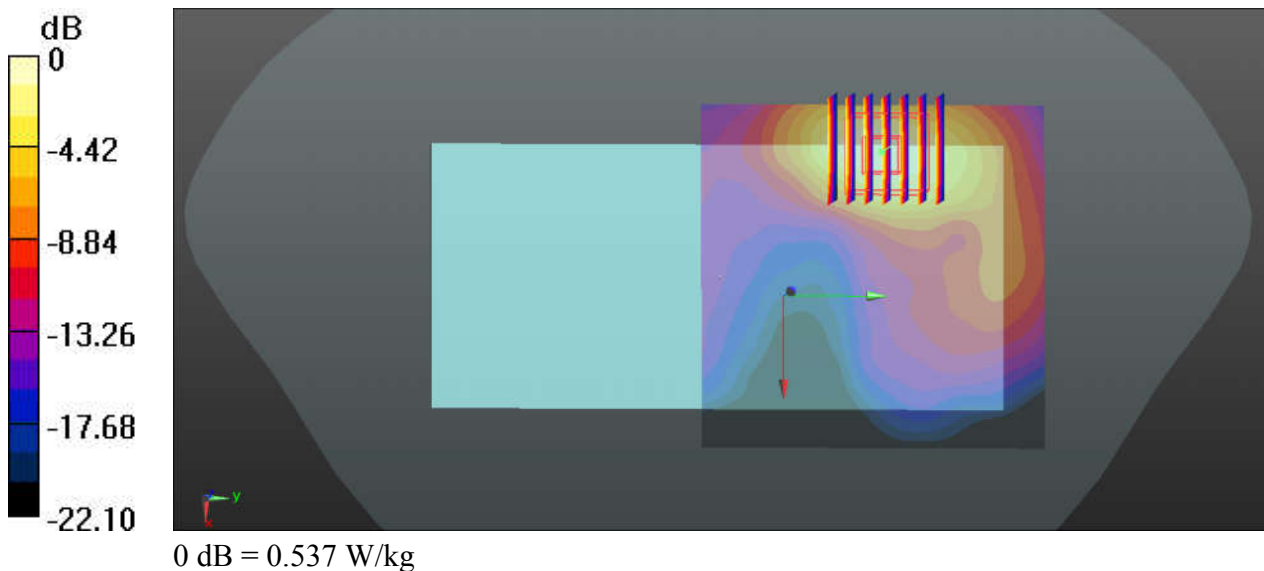

83_WLAN5GHz_802.11n-HT40 MCS0_Back_15mm_Ch54

Communication System: UID 0, WIFI (0); Frequency: 5270 MHz; Duty Cycle: 1:1.02
Medium: HSL_5250_200114 Medium parameters used: $f = 5270$ MHz; $\sigma = 4.665$ S/m; $\epsilon_r = 37.062$;
 $\rho = 1000$ kg/m³
Ambient Temperature : 23.7 °C ; Liquid Temperature : 22.4 °C

DASY5 Configuration:

- Probe: EX3DV4 - SN3819; ConvF(5.07, 5.07, 5.07); Calibrated: 2019.03.01;
- Sensor-Surface: 1.4mm (Mechanical Surface Detection)
- Electronics: DAE4 Sn715; Calibrated: 2019.01.23
- Phantom: SAM (Front) with CRP v5.0; Type: QD000P40CD; Serial: TP:1795
- Measurement SW: DASY52, Version 52.8 (8); SEMCAD X Version 14.6.10 (7331)

Ch54/Area Scan (101x91x1): Interpolated grid: dx=10mm, dy=10mm

Maximum value of SAR (interpolated) = 1.19 W/kg

Ch54/Zoom Scan (7x7x7)/Cube 0: Measurement grid: dx=4mm, dy=4mm, dz=1.4mm

Reference Value = 2.298 V/m; Power Drift = 0.02 dB

Peak SAR (extrapolated) = 1.96 W/kg

SAR(1 g) = 0.541 W/kg; SAR(10 g) = 0.204 W/kg

Maximum value of SAR (measured) = 1.20 W/kg

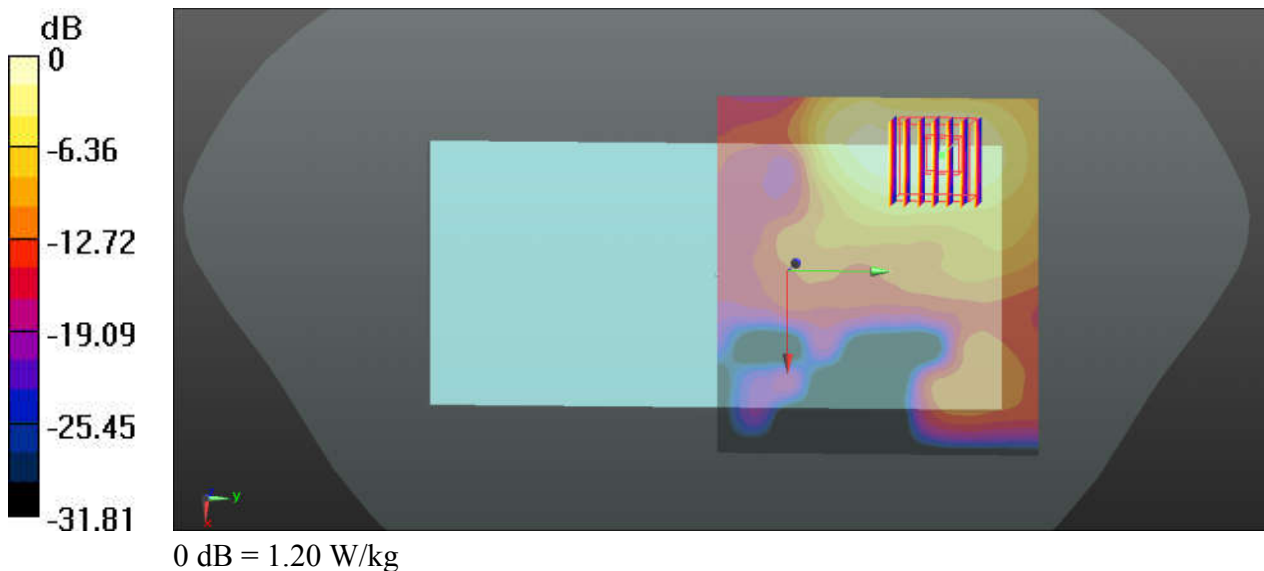

84_WLAN5GHz_802.11n-HT40 MCS0_Back_15mm_Ch134

Communication System: UID 0, WIFI (0); Frequency: 5670 MHz; Duty Cycle: 1:1.02
Medium: HSL_5600_200113 Medium parameters used: $f = 5670$ MHz; $\sigma = 5.124$ S/m; $\epsilon_r = 36.429$;
 $\rho = 1000$ kg/m³
Ambient Temperature : 23.7 °C ; Liquid Temperature : 22.5 °C

DASY5 Configuration:

- Probe: EX3DV4 - SN3819; ConvF(4.7, 4.7, 4.7); Calibrated: 2019.03.01;
- Sensor-Surface: 1.4mm (Mechanical Surface Detection)
- Electronics: DAE4 Sn715; Calibrated: 2019.01.23
- Phantom: SAM (Front) with CRP v5.0; Type: QD000P40CD; Serial: TP:1795
- Measurement SW: DASY52, Version 52.8 (8); SEMCAD X Version 14.6.10 (7331)

Ch134/Area Scan (101x91x1): Interpolated grid: dx=10mm, dy=10mm
Maximum value of SAR (interpolated) = 1.42 W/kg

Ch134/Zoom Scan (7x7x7)/Cube 0: Measurement grid: dx=4mm, dy=4mm, dz=1.4mm
Reference Value = 0 V/m; Power Drift = 0.03 dB
Peak SAR (extrapolated) = 2.46 W/kg
SAR(1 g) = 0.602 W/kg; SAR(10 g) = 0.213 W/kg
Maximum value of SAR (measured) = 1.40 W/kg

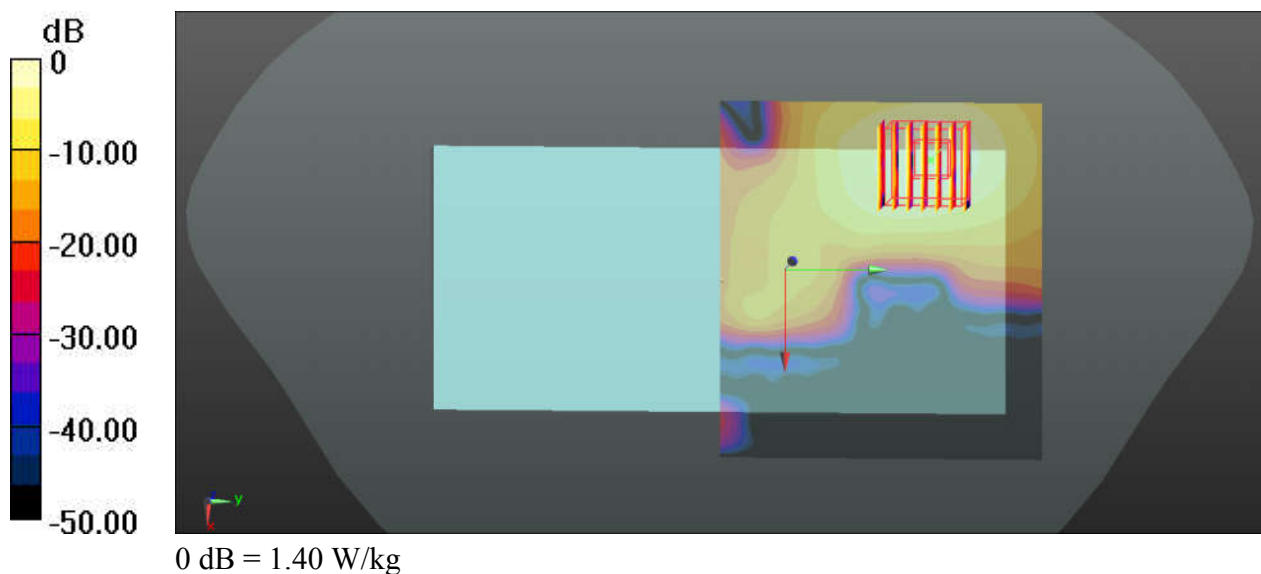

85_WLAN5GHz_802.11n-HT40 MCS0_Back_15mm_Ch159

Communication System: UID 0, WIFI (0); Frequency: 5795 MHz; Duty Cycle: 1:1.02
Medium: HSL_5750_200115 Medium parameters used: $f = 5795$ MHz; $\sigma = 5.268$ S/m; $\epsilon_r = 36.208$;
 $\rho = 1000$ kg/m³
Ambient Temperature : 23.7 °C ; Liquid Temperature : 22.6 °C

DASY5 Configuration:

- Probe: EX3DV4 - SN3819; ConvF(4.77, 4.77, 4.77); Calibrated: 2019.03.01;
- Sensor-Surface: 1.4mm (Mechanical Surface Detection)
- Electronics: DAE4 Sn715; Calibrated: 2019.01.23
- Phantom: SAM (Front) with CRP v5.0; Type: QD000P40CD; Serial: TP:1795
- Measurement SW: DASY52, Version 52.8 (8); SEMCAD X Version 14.6.10 (7331)

Ch159/Area Scan (101x91x1): Interpolated grid: dx=10mm, dy=10mm
Maximum value of SAR (interpolated) = 1.21 W/kg

Ch159/Zoom Scan (7x7x7)/Cube 0: Measurement grid: dx=4mm, dy=4mm, dz=1.4mm
Reference Value = 3.637 V/m; Power Drift = 0.04 dB
Peak SAR (extrapolated) = 2.06 W/kg
SAR(1 g) = 0.521 W/kg; SAR(10 g) = 0.179 W/kg
Maximum value of SAR (measured) = 1.21 W/kg

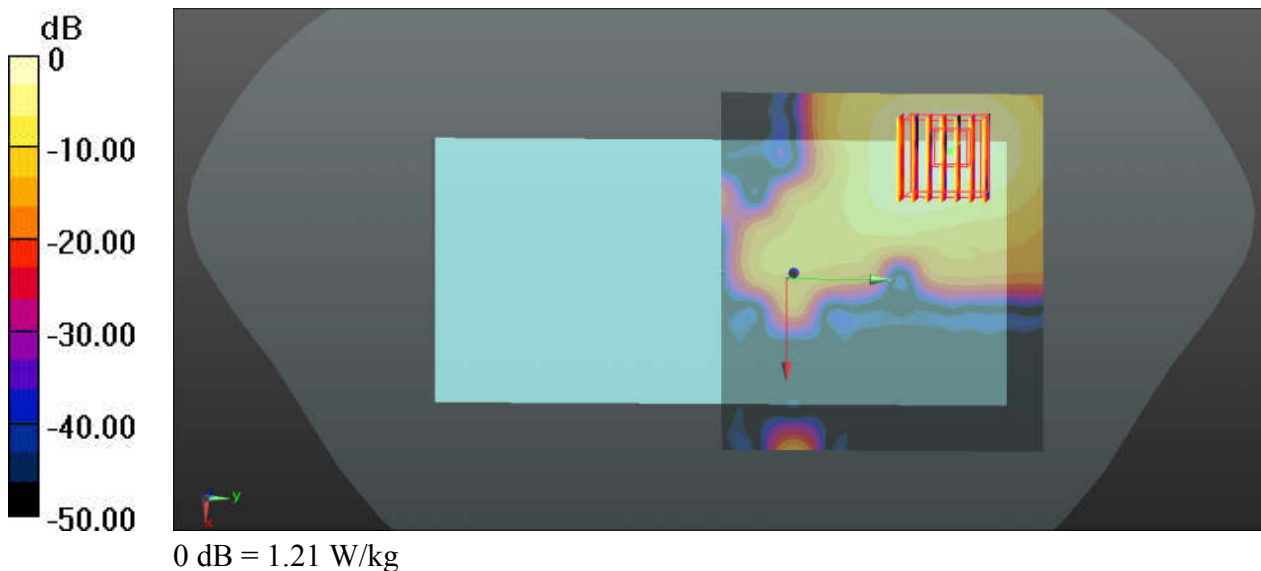

86_Bluetooth_DH5 1Mbps_Back_15mm_Ch39

Communication System: Bluetooth; Frequency: 2441 MHz; Duty Cycle: 1:1.309
Medium: HSL_2450_200102 Medium parameters used: $f = 2441$ MHz; $\sigma = 1.847$ S/m; $\epsilon_r = 37.702$;
 $\rho = 1000$ kg/m³
Ambient Temperature : 23.4 °C ; Liquid Temperature : 22.6 °C

DASY5 Configuration:

- Probe: EX3DV4 - SN3819; ConvF(7.21, 7.21, 7.21); Calibrated: 2019.03.01;
- Sensor-Surface: 1.4mm (Mechanical Surface Detection)
- Electronics: DAE4 Sn715; Calibrated: 2019.01.23
- Phantom: SAM (Front) with CRP v5.0; Type: QD000P40CD; Serial: TP:1795
- Measurement SW: DASY52, Version 52.8 (8); SEMCAD X Version 14.6.10 (7331)

Area Scan (91x81x1): Interpolated grid: dx=1.200 mm, dy=1.200 mm
Maximum value of SAR (interpolated) = 0.141 W/kg

Zoom Scan (7x7x7)/Cube 0: Measurement grid: dx=5mm, dy=5mm, dz=5mm
Reference Value = 1.771 V/m; Power Drift = -0.14 dB
Peak SAR (extrapolated) = 0.251 W/kg
SAR(1 g) = 0.048 W/kg; SAR(10 g) = 0.018 W/kg
Maximum value of SAR (measured) = 0.0652 W/kg

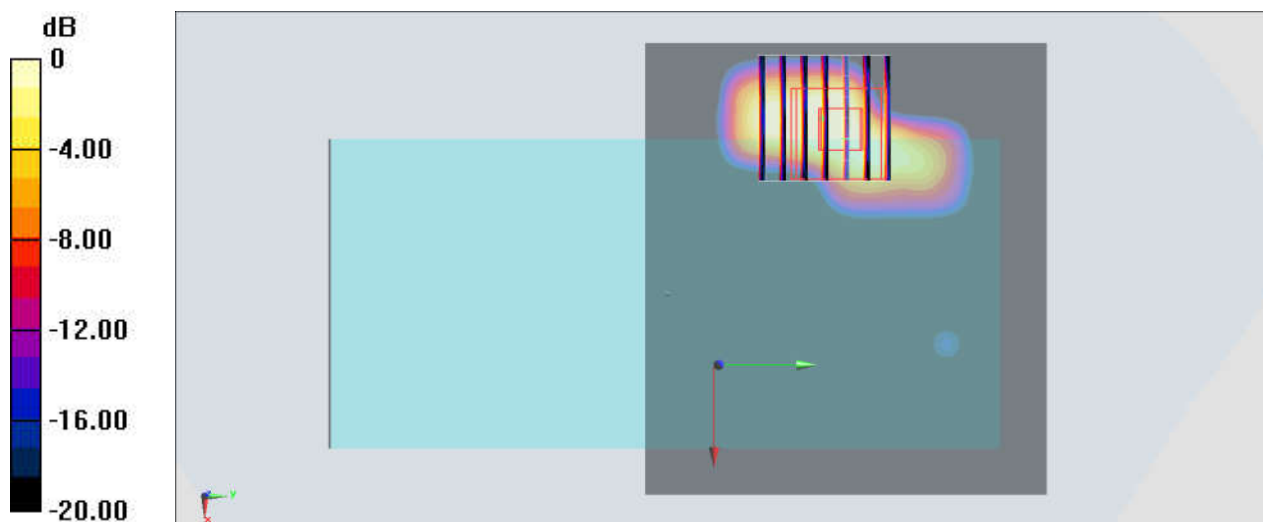

0 dB = 0.0652 W/kg = -11.86 dBW/kg

87_WCDMA IV_RMC 12.2Kbps_Back_0mm_Ch1413

Communication System: UMTS; Frequency: 1732.6 MHz; Duty Cycle: 1:1
 Medium: HSL_1750_191221 Medium parameters used: $f = 1733 \text{ MHz}$; $\sigma = 1.382 \text{ S/m}$; $\epsilon_r = 40.016$;
 $\rho = 1000 \text{ kg/m}^3$
 Ambient Temperature : $23.5 \text{ }^\circ\text{C}$; Liquid Temperature : $22.4 \text{ }^\circ\text{C}$

DASY5 Configuration:

- Probe: EX3DV4 - SN3819; ConvF(8.54, 8.54, 8.54); Calibrated: 2019.03.01;
- Sensor-Surface: 1.4mm (Mechanical Surface Detection)
- Electronics: DAE4 Sn715; Calibrated: 2019.01.23
- Phantom: SAM (Front) with CRP v5.0; Type: QD000P40CD; Serial: TP:1795
- Measurement SW: DASY52, Version 52.8 (8); SEMCAD X Version 14.6.10 (7331)

Area Scan (71x131x1): Interpolated grid: $dx=1.500 \text{ mm}$, $dy=1.500 \text{ mm}$
 Maximum value of SAR (interpolated) = 6.40 W/kg

Zoom Scan (5x5x7)/Cube 0: Measurement grid: $dx=8\text{mm}$, $dy=8\text{mm}$, $dz=5\text{mm}$
 Reference Value = 4.435 V/m ; Power Drift = 0.18 dB
 Peak SAR (extrapolated) = 9.45 W/kg
SAR(1 g) = 4.04 W/kg ; SAR(10 g) = 1.67 W/kg
 Maximum value of SAR (measured) = 6.45 W/kg

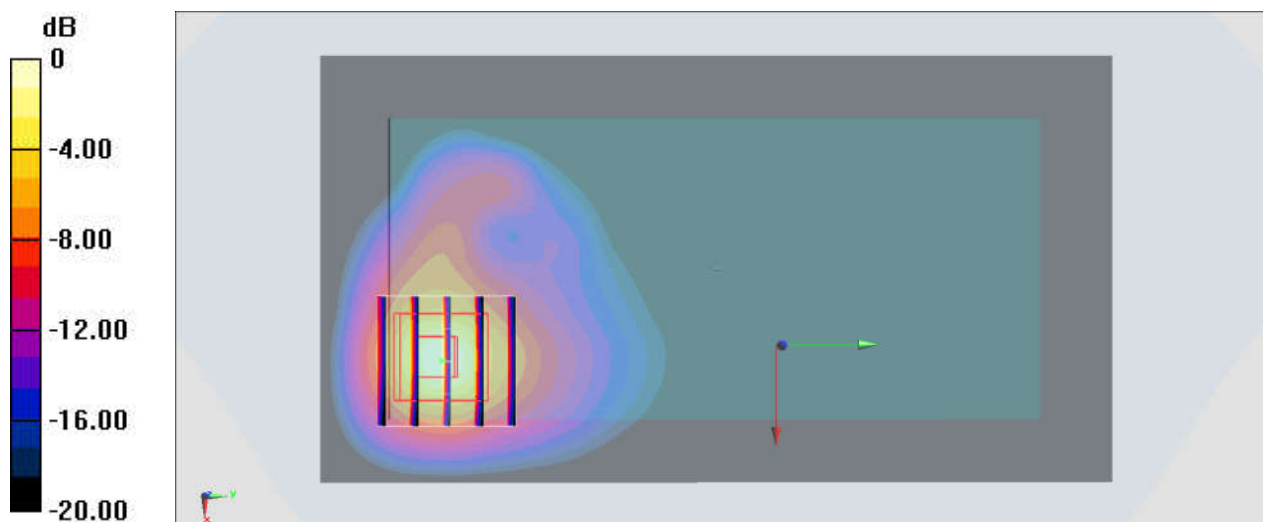

0 dB = $6.45 \text{ W/kg} = 8.10 \text{ dBW/kg}$

88_WCDMA II_RMC 12.2Kbps_Back_0mm_Ch9400

Communication System: UMTS; Frequency: 1880 MHz; Duty Cycle: 1:1
Medium: HSL_1900_191218 Medium parameters used: $f = 1880$ MHz; $\sigma = 1.408$ S/m; $\epsilon_r = 41.203$;
 $\rho = 1000$ kg/m³
Ambient Temperature : 23.5 °C; Liquid Temperature : 22.7 °C

DASY5 Configuration:

- Probe: EX3DV4 - SN3819; ConvF(8.27, 8.27, 8.27); Calibrated: 2019.03.01;
- Sensor-Surface: 1.4mm (Mechanical Surface Detection)
- Electronics: DAE4 Sn715; Calibrated: 2019.01.23
- Phantom: SAM (Front) with CRP v5.0; Type: QD000P40CD; Serial: TP:1795
- Measurement SW: DASY52, Version 52.8 (8); SEMCAD X Version 14.6.10 (7331)

Area Scan (71x131x1): Interpolated grid: dx=1.500 mm, dy=1.500 mm
Maximum value of SAR (interpolated) = 4.37 W/kg

Zoom Scan (5x5x7)/Cube 0: Measurement grid: dx=8mm, dy=8mm, dz=5mm
Reference Value = 3.813 V/m; Power Drift = 0.18 dB
Peak SAR (extrapolated) = 8.00 W/kg
SAR(1 g) = 3.37 W/kg; SAR(10 g) = 1.43 W/kg
Maximum value of SAR (measured) = 5.54 W/kg

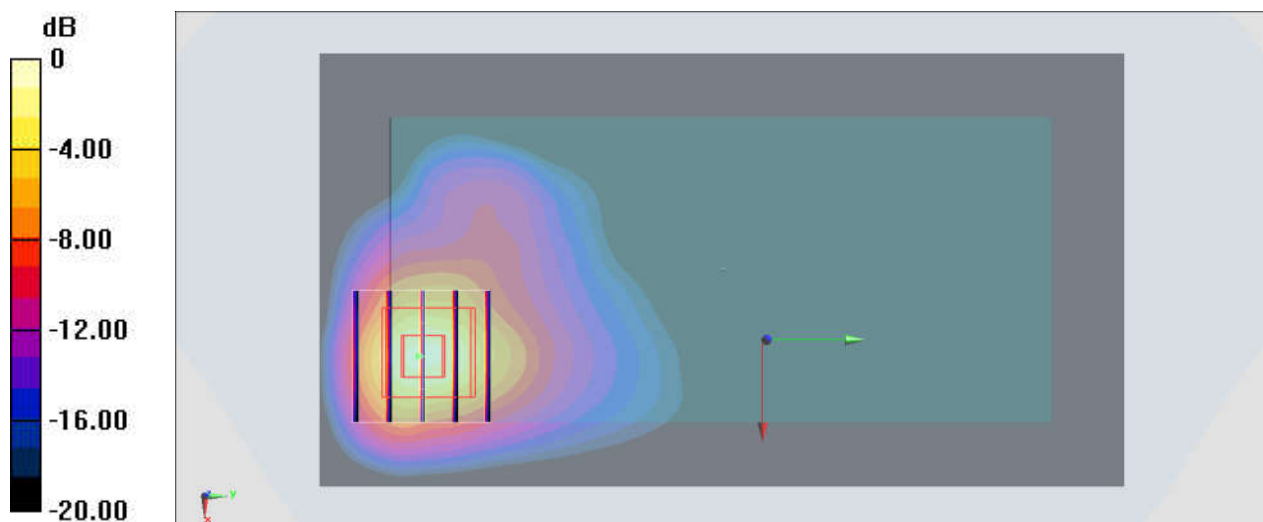

0 dB = 5.54 W/kg = 7.44 dBW/kg

89_CDMA2000 BC1_RTAP 153.6Kbps _Back_0mm_Ch1175

Communication System: CDMA2000; Frequency: 1908.75 MHz; Duty Cycle: 1:1

Medium: HSL_1900_191218 Medium parameters used: $f = 1909$ MHz; $\sigma = 1.426$ S/m; $\epsilon_r = 41.109$; $\rho = 1000$ kg/m³

Ambient Temperature : 23.5 °C ; Liquid Temperature : 22.5 °C

DASY5 Configuration:

- Probe: EX3DV4 - SN3819; ConvF(8.27, 8.27, 8.27) @ 1908.75 MHz; Calibrated: 2019/3/1
- Sensor-Surface: 1.4mm (Mechanical Surface Detection)
- Electronics: DAE4 Sn715; Calibrated: 2019/1/23
- Phantom: SAM (Front) with CRP v5.0; Type: QD000P40CD; Serial: TP:1795
- Measurement SW: DASY52, Version 52.10 (2); SEMCAD X Version 14.6.12 (7470)

Area Scan (71x61x1): Interpolated grid: dx=1.500 mm, dy=1.500 mm

Maximum value of SAR (interpolated) = 7.29 W/kg

Zoom Scan (5x5x7)/Cube 0: Measurement grid: dx=8mm, dy=8mm, dz=5mm

Reference Value = 2.172 V/m; Power Drift = 0.13 dB

Peak SAR (extrapolated) = 10.5 W/kg

SAR(1 g) = 4.3 W/kg; SAR(10 g) = 1.67 W/kg

Maximum value of SAR (measured) = 6.69 W/kg

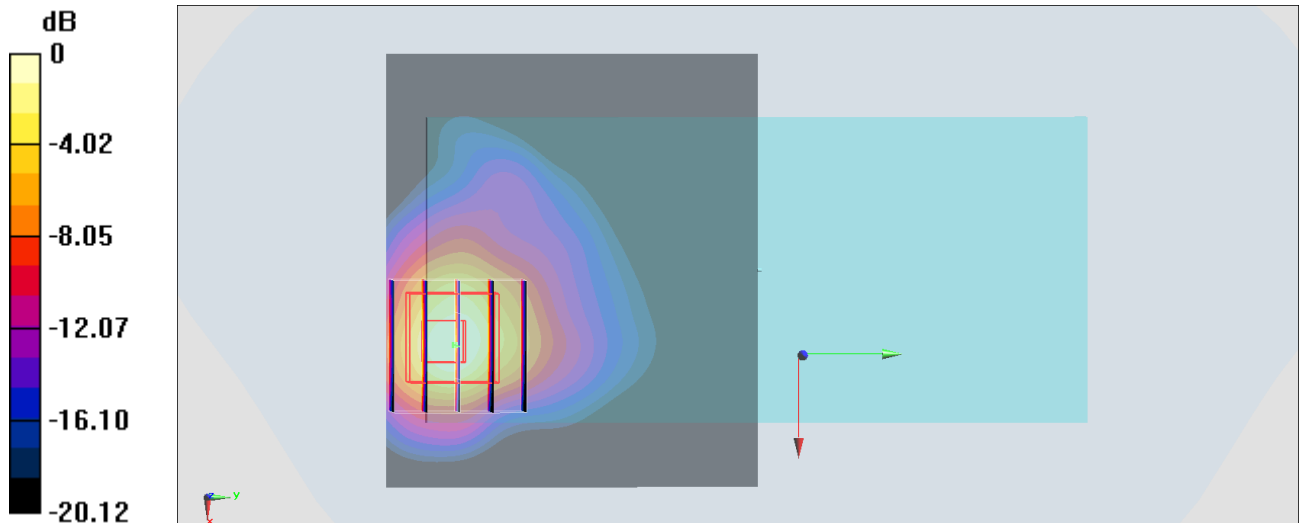

0 dB = 6.69 W/kg = 8.25 dBW/kg

90_LTE Band 26_15M_QPSK_1RB_0Offset_Left Side_0mm_Ch26865

Communication System: LTE; Frequency: 831.5 MHz; Duty Cycle: 1:1
Medium: HSL_835_191224 Medium parameters used : $f = 831.5$ MHz; $\sigma = 0.925$ S/m; $\epsilon_r = 42.773$;
 $\rho = 1000$ kg/m³
Ambient Temperature : 23.4 °C; Liquid Temperature : 22.5 °C

DASY5 Configuration:

- Probe: EX3DV4 - SN3819; ConvF(9.57, 9.57, 9.57); Calibrated: 2019.03.01;
- Sensor-Surface: 1.4mm (Mechanical Surface Detection)
- Electronics: DAE4 Sn715; Calibrated: 2019.01.23
- Phantom: SAM (Front) with CRP v5.0; Type: QD000P40CD; Serial: TP:1795
- Measurement SW: DASY52, Version 52.8 (8); SEMCAD X Version 14.6.10 (7331)

Area Scan (41x131x1): Interpolated grid: dx=1.500 mm, dy=1.500 mm
Maximum value of SAR (interpolated) = 4.88 W/kg

Zoom Scan (5x5x7)/Cube 0: Measurement grid: dx=8mm, dy=8mm, dz=5mm
Reference Value = 34.77 V/m; Power Drift = 0.09 dB
Peak SAR (extrapolated) = 10.7 W/kg
SAR(1 g) = 2.96 W/kg; SAR(10 g) = 1.14 W/kg
Maximum value of SAR (measured) = 6.54 W/kg

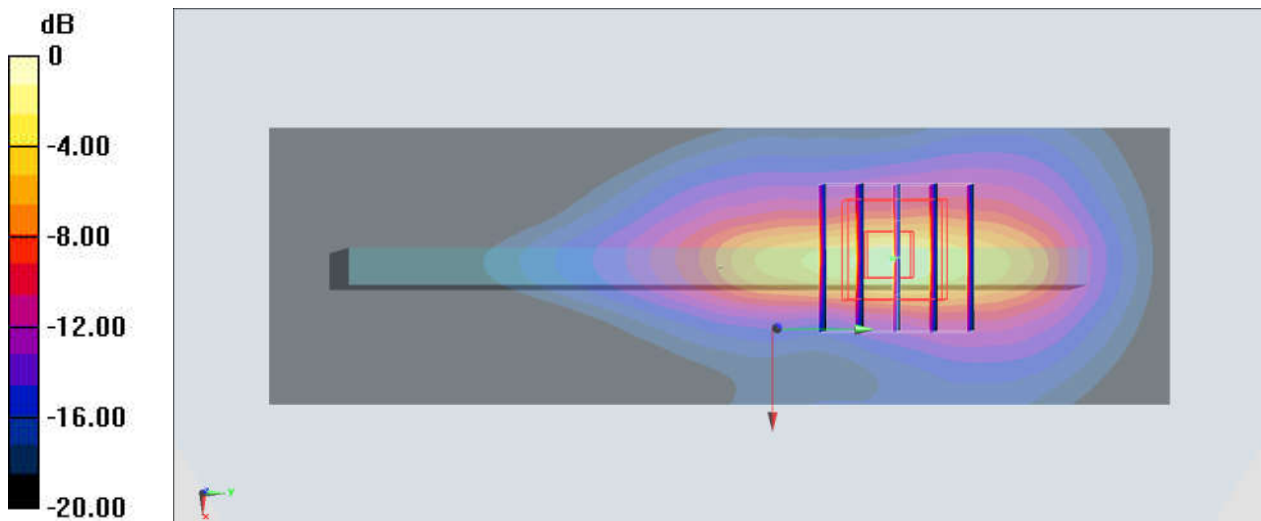

0 dB = 6.54 W/kg = 8.16 dBW/kg

91_LTE Band 66_20M_QPSK_50RB_24Offset_Back_0mm_Ch132572

Communication System: LTE; Frequency: 1770 MHz; Duty Cycle: 1:1
Medium: HSL_1750_191221 Medium parameters used: $f = 1770$ MHz; $\sigma = 1.405$ S/m; $\epsilon_r = 39.765$;
 $\rho = 1000$ kg/m³
Ambient Temperature : 23.5 °C ; Liquid Temperature : 22.4 °C

DASY5 Configuration:

- Probe: EX3DV4 - SN3819; ConvF(8.54, 8.54, 8.54); Calibrated: 2019.03.01;
- Sensor-Surface: 1.4mm (Mechanical Surface Detection)
- Electronics: DAE4 Sn715; Calibrated: 2019.01.23
- Phantom: SAM (Front) with CRP v5.0; Type: QD000P40CD; Serial: TP:1795
- Measurement SW: DASY52, Version 52.8 (8); SEMCAD X Version 14.6.10 (7331)

Area Scan (71x61x1): Interpolated grid: dx=1.500 mm, dy=1.500 mm
Maximum value of SAR (interpolated) = 6.83 W/kg

Zoom Scan (5x5x7)/Cube 0: Measurement grid: dx=8mm, dy=8mm, dz=5mm
Reference Value = 1.748 V/m; Power Drift = 0.15 dB
Peak SAR (extrapolated) = 10.9 W/kg
SAR(1 g) = 4.45 W/kg; SAR(10 g) = 1.8 W/kg
Maximum value of SAR (measured) = 6.95 W/kg

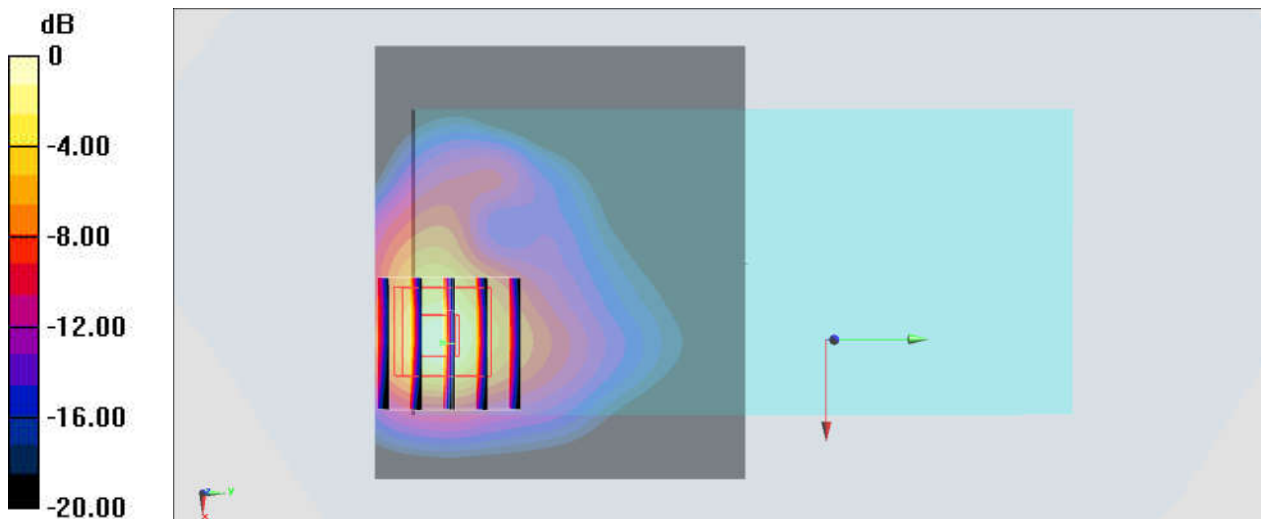

0 dB = 6.95 W/kg = 8.42 dBW/kg

92_LTE Band 25_20M_QPSK_1RB_0Offset_Top Side_0mm_Ch26140

Communication System: LTE; Frequency: 1860 MHz; Duty Cycle: 1:1
Medium: HSL_1900_191218 Medium parameters used: $f = 1860$ MHz; $\sigma = 1.387$ S/m; $\epsilon_r = 41.277$;
 $\rho = 1000$ kg/m³
Ambient Temperature : 23.5 °C; Liquid Temperature : 22.7 °C

DASY5 Configuration:

- Probe: EX3DV4 - SN3819; ConvF(8.27, 8.27, 8.27); Calibrated: 2019.03.01;
- Sensor-Surface: 1.4mm (Mechanical Surface Detection)
- Electronics: DAE4 Sn715; Calibrated: 2019.01.23
- Phantom: SAM (Front) with CRP v5.0; Type: QD000P40CD; Serial: TP:1795
- Measurement SW: DASY52, Version 52.8 (8); SEMCAD X Version 14.6.10 (7331)

Area Scan (41x71x1): Interpolated grid: dx=1.500 mm, dy=1.500 mm
Maximum value of SAR (interpolated) = 10.6 W/kg

Zoom Scan (5x5x7)/Cube 0: Measurement grid: dx=8mm, dy=8mm, dz=5mm
Reference Value = 15.82 V/m; Power Drift = -0.12 dB
Peak SAR (extrapolated) = 15.9 W/kg
SAR(1 g) = 5.66 W/kg; SAR(10 g) = 2.13 W/kg
Maximum value of SAR (measured) = 11.2 W/kg

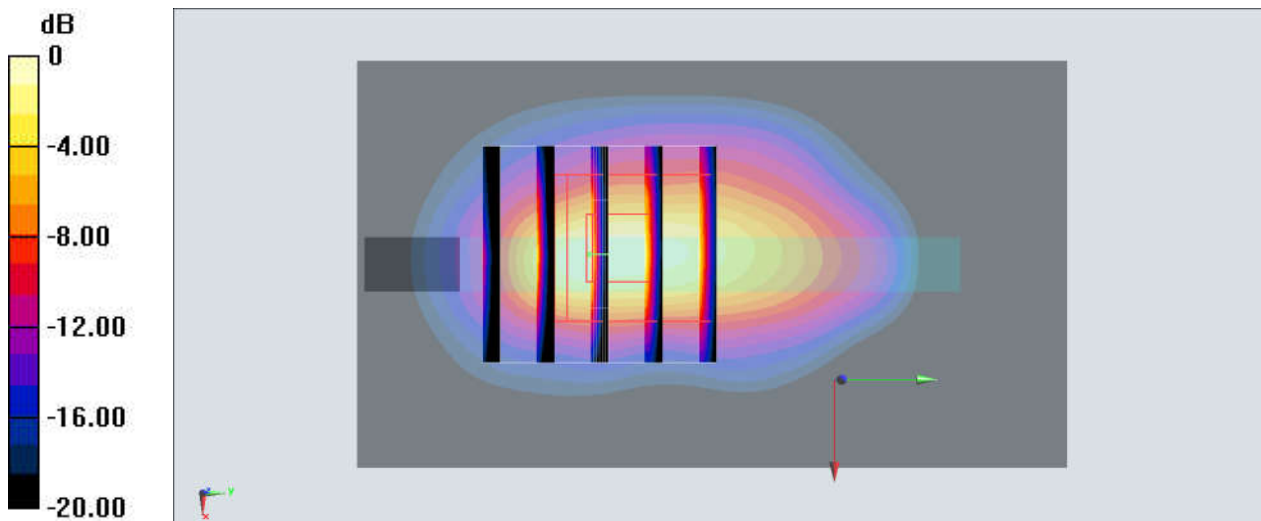

93_LTE Band 30_10M_QPSK_1RB_0Offset_Top Side_0mm_Ch27710

Communication System: LTE; Frequency: 2310 MHz; Duty Cycle: 1:1
Medium: HSL_2300_191230 Medium parameters used: $f = 2310$ MHz; $\sigma = 1.689$ S/m; $\epsilon_r = 38.197$;
 $\rho = 1000$ kg/m³
Ambient Temperature : 23.4 °C ; Liquid Temperature : 22.7 °C

DASY5 Configuration:

- Probe: EX3DV4 - SN3819; ConvF(7.64, 7.64, 7.64); Calibrated: 2019.03.01;
- Sensor-Surface: 1.4mm (Mechanical Surface Detection)
- Electronics: DAE4 Sn715; Calibrated: 2019.01.23
- Phantom: SAM (Front) with CRP v5.0; Type: QD000P40CD; Serial: TP:1795
- Measurement SW: DASY52, Version 52.8 (8); SEMCAD X Version 14.6.10 (7331)

Area Scan (41x81x1): Interpolated grid: dx=1.200 mm, dy=1.200 mm
Maximum value of SAR (interpolated) = 5.18 W/kg

Zoom Scan (7x7x7)/Cube 0: Measurement grid: dx=5mm, dy=5mm, dz=5mm
Reference Value = 37.03 V/m; Power Drift = 0.13 dB
Peak SAR (extrapolated) = 16.4 W/kg
SAR(1 g) = 4.29 W/kg; SAR(10 g) = 1.56 W/kg
Maximum value of SAR (measured) = 6.72 W/kg

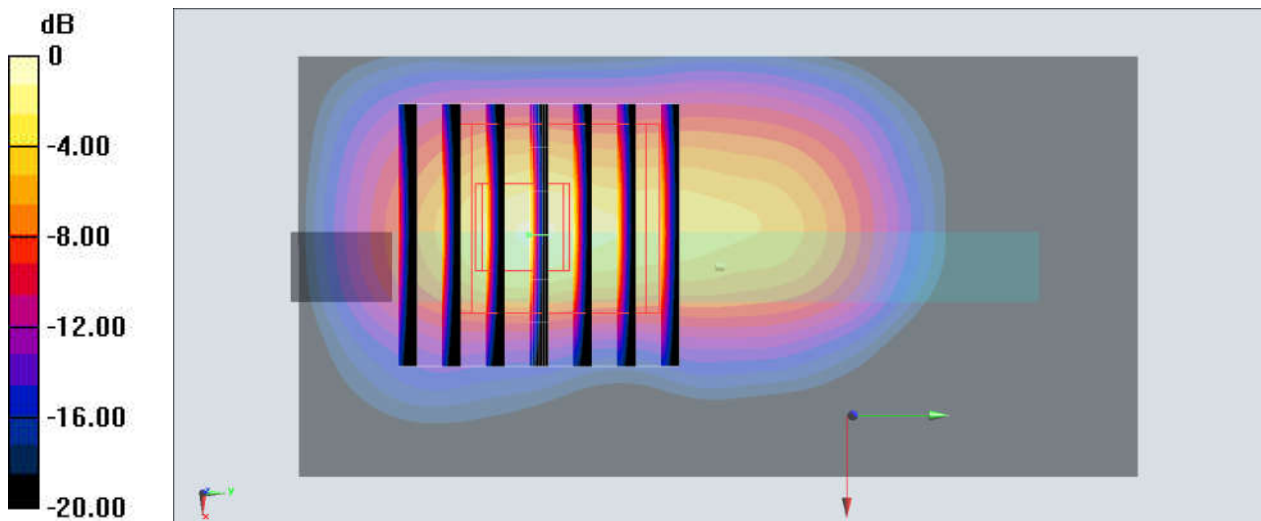

0 dB = 6.72 W/kg = 8.27 dBW/kg

94_LTE Band 7_20M_QPSK_50RB_24Offset_Back_0mm_Ch20850

Communication System: LTE; Frequency: 2510 MHz; Duty Cycle: 1:1
Medium: HSL_2600_200105 Medium parameters used: $f = 2510$ MHz; $\sigma = 1.953$ S/m; $\epsilon_r = 37.916$;
 $\rho = 1000$ kg/m³
Ambient Temperature : 23.6 °C ; Liquid Temperature : 22.4 °C

DASY5 Configuration:

- Probe: EX3DV4 - SN3819; ConvF(7.06, 7.06, 7.06); Calibrated: 2019.03.01;
- Sensor-Surface: 1.4mm (Mechanical Surface Detection)
- Electronics: DAE4 Sn715; Calibrated: 2019.01.23
- Phantom: SAM (Front) with CRP v5.0; Type: QD000P40CD; Serial: TP:1795
- Measurement SW: DASY52, Version 52.8 (8); SEMCAD X Version 14.6.10 (7331)

Area Scan (81x81x1): Interpolated grid: dx=1.200 mm, dy=1.200 mm
Maximum value of SAR (interpolated) = 10.8 W/kg

Zoom Scan (7x7x7)/Cube 0: Measurement grid: dx=5mm, dy=5mm, dz=5mm
Reference Value = 3.137 V/m; Power Drift = 0.14 dB
Peak SAR (extrapolated) = 18.6 W/kg
SAR(1 g) = 5.41 W/kg; SAR(10 g) = 2.12 W/kg
Maximum value of SAR (measured) = 10.9 W/kg

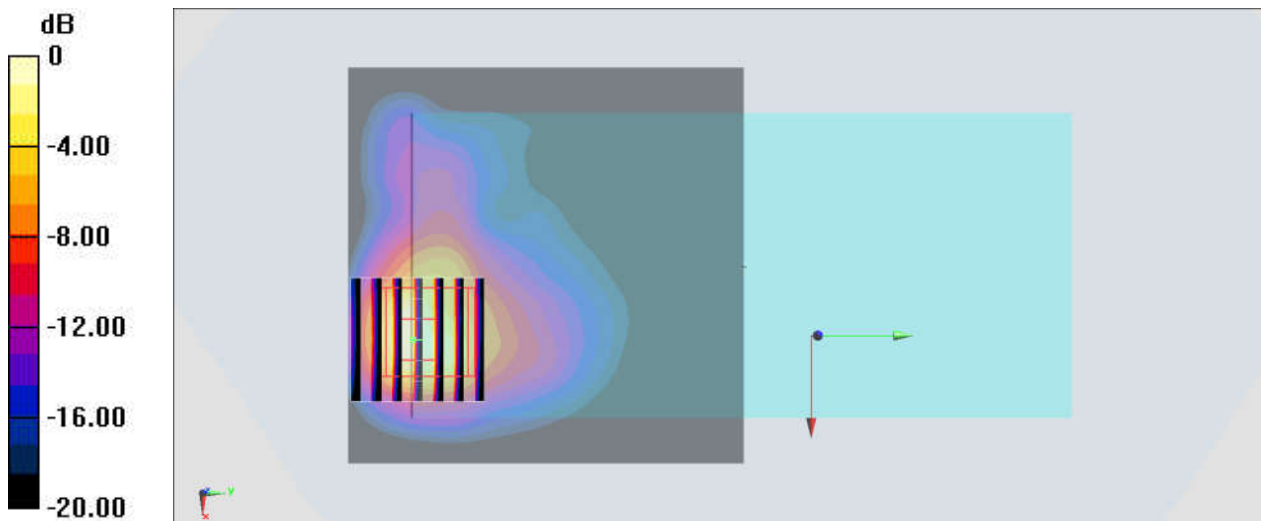

0 dB = 10.9 W/kg = 10.37 dBW/kg

95_LTE Band 41_20M_QPSK_1RB_49Offset_Top Side_0mm_Ch41490

Communication System: LTE; Frequency: 2680 MHz; Duty Cycle: 1:2.33
Medium: HSL_2600_200105 Medium parameters used: $f = 2680$ MHz; $\sigma = 2.153$ S/m; $\epsilon_r = 37.291$;
 $\rho = 1000$ kg/m³
Ambient Temperature : 23.6 °C ; Liquid Temperature : 22.4 °C

DASY5 Configuration:

- Probe: EX3DV4 - SN3819; ConvF(7.06, 7.06, 7.06); Calibrated: 2019.03.01;
- Sensor-Surface: 1.4mm (Mechanical Surface Detection)
- Electronics: DAE4 Sn715; Calibrated: 2019.01.23
- Phantom: SAM (Front) with CRP v5.0; Type: QD000P40CD; Serial: TP:1795
- Measurement SW: DASY52, Version 52.8 (8); SEMCAD X Version 14.6.10 (7331)

Area Scan (41x81x1): Interpolated grid: dx=1.200 mm, dy=1.200 mm
Maximum value of SAR (interpolated) = 9.98 W/kg

Zoom Scan (7x7x7)/Cube 0: Measurement grid: dx=5mm, dy=5mm, dz=5mm
Reference Value = 39.98 V/m; Power Drift = 0.09 dB
Peak SAR (extrapolated) = 20.8 W/kg
SAR(1 g) = 6.06 W/kg; SAR(10 g) = 1.698 W/kg
Maximum value of SAR (measured) = 12.2 W/kg

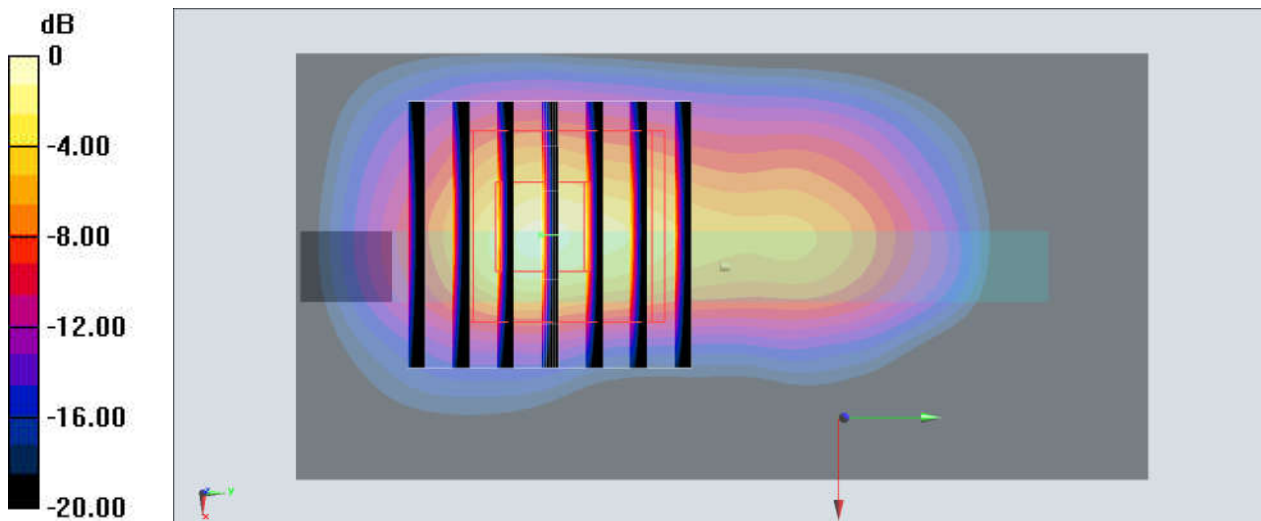

0 dB = 12.2 W/kg = 10.86 dBW/kg

96_LTE Band 48_20M_QPSK_1RB_49Offset_Top Side_0mm_Ch56640

Communication System: LTE; Frequency: 3690 MHz; Duty Cycle: 1:1.59
Medium: HSL_3700_200109 Medium parameters used : $f = 3690$ MHz; $\sigma = 3.046$ S/m; $\epsilon_r = 38.387$;
 $\rho = 1000$ kg/m³
Ambient Temperature : 23.6 °C; Liquid Temperature : 22.8 °C

DASY5 Configuration:

- Probe: EX3DV4 - SN3819; ConvF(6.67, 6.67, 6.67); Calibrated: 2019.03.01;
- Sensor-Surface: 1.4mm (Mechanical Surface Detection)
- Electronics: DAE4 Sn715; Calibrated: 2019.01.23
- Phantom: SAM (Front) with CRP v5.0; Type: QD000P40CD; Serial: TP:1795
- Measurement SW: DASY52, Version 52.8 (8); SEMCAD X Version 14.6.10 (7331)

Area Scan (41x81x1): Interpolated grid: dx=1.200 mm, dy=1.200 mm
Maximum value of SAR (interpolated) = 9.16 W/kg

Zoom Scan (7x7x7)/Cube 0: Measurement grid: dx=5mm, dy=5mm, dz=1.4mm
Reference Value = 22.28 V/m; Power Drift = 0.11 dB
Peak SAR (extrapolated) = 30.7 W/kg
SAR(1 g) = 5.84 W/kg; SAR(10 g) = 1.45 W/kg
Maximum value of SAR (measured) = 17.9 W/kg

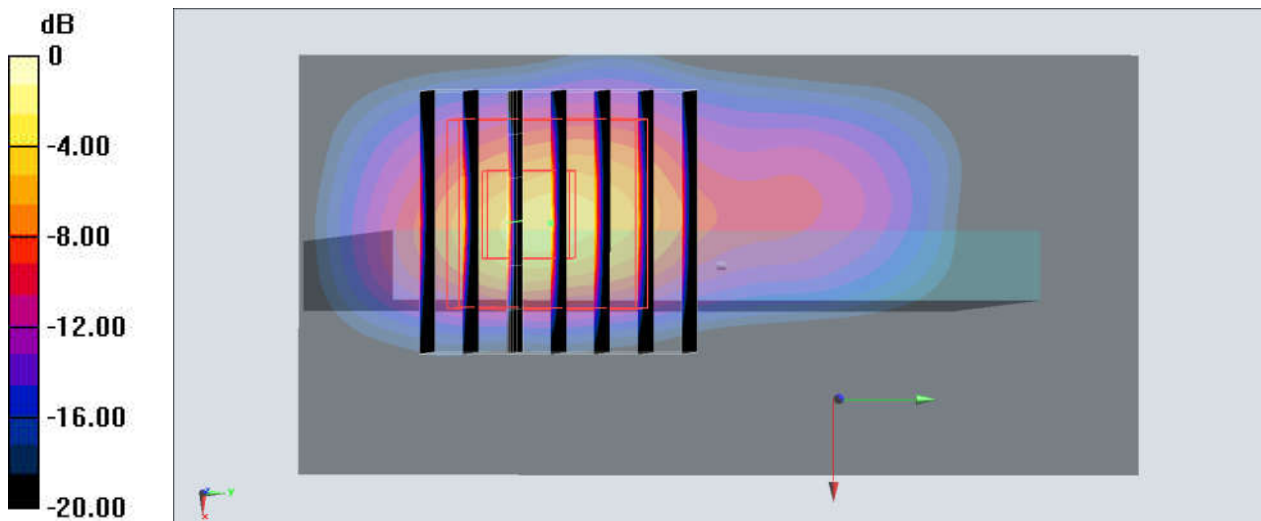

0 dB = 17.9 W/kg = 12.53 dBW/kg

97_WLAN2.4GHz_802.11b 1Mbps_Back_0mm_Ch11

Communication System: WIFI; Frequency: 2462 MHz; Duty Cycle: 1:1

Medium: HSL_2450_200102 Medium parameters used: $f = 2462$ MHz; $\sigma = 1.87$ S/m; $\epsilon_r = 37.627$; $\rho = 1000$ kg/m³

Ambient Temperature : 23.4 °C; Liquid Temperature : 22.6 °C

DASY5 Configuration:

- Probe: EX3DV4 - SN3819; ConvF(7.21, 7.21, 7.21); Calibrated: 2019.03.01;
- Sensor-Surface: 1.4mm (Mechanical Surface Detection)
- Electronics: DAE4 Sn715; Calibrated: 2019.01.23
- Phantom: SAM (Front) with CRP v5.0; Type: QD000P40CD; Serial: TP:1795
- Measurement SW: DASY52, Version 52.8 (8); SEMCAD X Version 14.6.10 (7331)

Area Scan (81x81x1): Interpolated grid: dx=1.200 mm, dy=1.200 mm

Maximum value of SAR (interpolated) = 6.05 W/kg

Zoom Scan (7x7x7)/Cube 0: Measurement grid: dx=5mm, dy=5mm, dz=5mm

Reference Value = 1.978 V/m; Power Drift = -0.09 dB

Peak SAR (extrapolated) = 13.5 W/kg

SAR(1 g) = 4.1 W/kg; SAR(10 g) = 1.41 W/kg

Maximum value of SAR (measured) = 5.63 W/kg

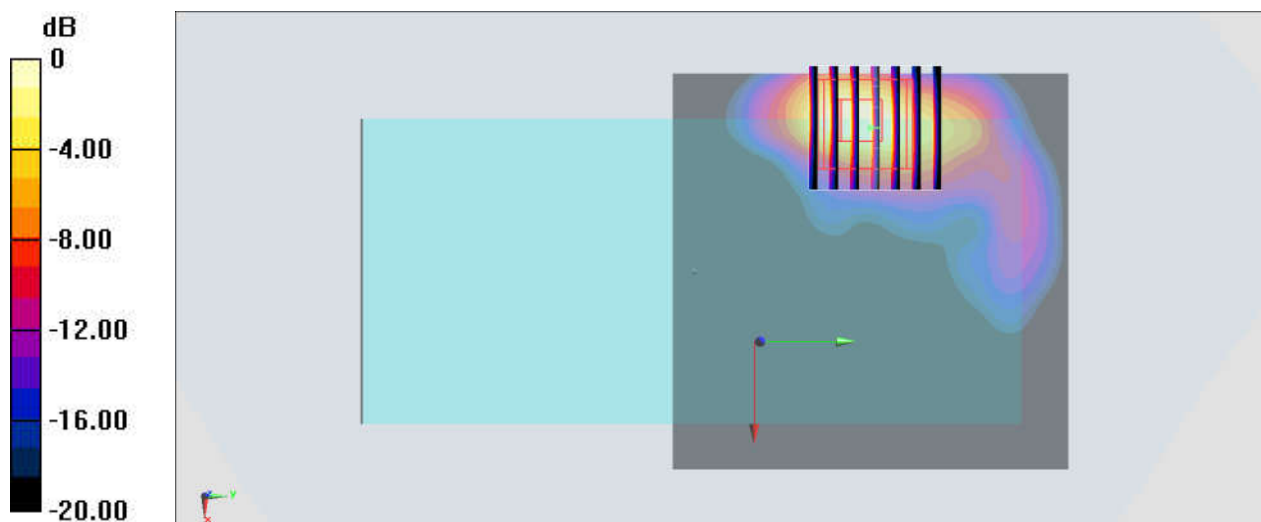

0 dB = 5.63 W/kg = 7.51 dBW/kg

98_WLAN5GHz_802.11n-HT40 MCS0_Back_0mm_Ch46

Communication System: WIFI; Frequency: 5230 MHz; Duty Cycle: 1:1.02
Medium: HSL_5250_200114 Medium parameters used: $f = 5230$ MHz; $\sigma = 4.617$ S/m; $\epsilon_r = 37.129$;
 $\rho = 1000$ kg/m³
Ambient Temperature : 23.7 °C; Liquid Temperature : 22.4 °C

DASY5 Configuration:

- Probe: EX3DV4 - SN3819; ConvF(5.07, 5.07, 5.07); Calibrated: 2019.03.01;
- Sensor-Surface: 1.4mm (Mechanical Surface Detection)
- Electronics: DAE4 Sn715; Calibrated: 2019.01.23
- Phantom: SAM (Front) with CRP v5.0; Type: QD000P40CD; Serial: TP:1795
- Measurement SW: DASY52, Version 52.8 (8); SEMCAD X Version 14.6.10 (7331)

Area Scan (101x91x1): Interpolated grid: dx=1.000 mm, dy=1.000 mm
Maximum value of SAR (interpolated) = 12.3 W/kg

Zoom Scan (7x7x7)/Cube 0: Measurement grid: dx=4mm, dy=4mm, dz=1.4mm
Reference Value = 0 V/m; Power Drift = 0.00 dB
Peak SAR (extrapolated) = 29.7 W/kg
SAR(1 g) = 5.59 W/kg; SAR(10 g) = 1.29 W/kg
Maximum value of SAR (measured) = 15.3 W/kg

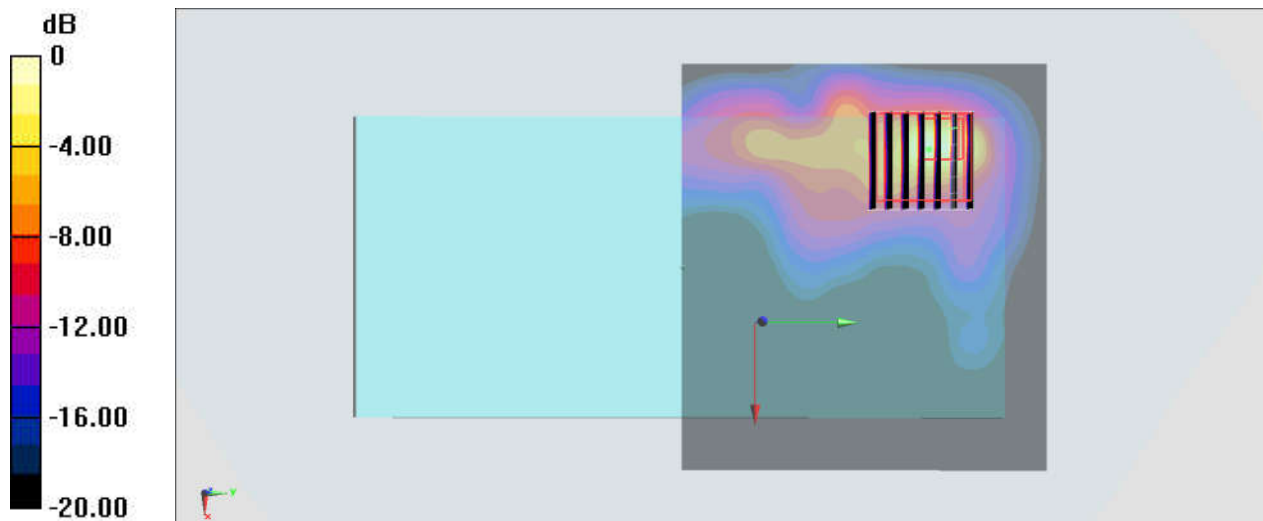

0 dB = 15.3 W/kg = 11.85 dBW/kg

99_WLAN5GHz_802.11n-HT40 MCS0_Back_0mm_Ch54

Communication System: WIFI; Frequency: 5270 MHz; Duty Cycle: 1:1.02
Medium: HSL_5250_200114 Medium parameters used: $f = 5270$ MHz; $\sigma = 4.666$ S/m; $\epsilon_r = 37.062$;
 $\rho = 1000$ kg/m³
Ambient Temperature : 23.7 °C; Liquid Temperature : 22.4 °C

DASY5 Configuration:

- Probe: EX3DV4 - SN3819; ConvF(5.07, 5.07, 5.07); Calibrated: 2019.03.01;
- Sensor-Surface: 1.4mm (Mechanical Surface Detection)
- Electronics: DAE4 Sn715; Calibrated: 2019.01.23
- Phantom: SAM (Front) with CRP v5.0; Type: QD000P40CD; Serial: TP:1795
- Measurement SW: DASY52, Version 52.8 (8); SEMCAD X Version 14.6.10 (7331)

Area Scan (101x91x1): Interpolated grid: dx=1.000 mm, dy=1.000 mm
Maximum value of SAR (interpolated) = 20.6 W/kg

Zoom Scan (7x7x7)/Cube 0: Measurement grid: dx=4mm, dy=4mm, dz=1.4mm
Reference Value = 0.8640 V/m; Power Drift = 0.12 dB
Peak SAR (extrapolated) = 33.8 W/kg
SAR(1 g) = 6.35 W/kg; SAR(10 g) = 1.46 W/kg
Maximum value of SAR (measured) = 20.1 W/kg

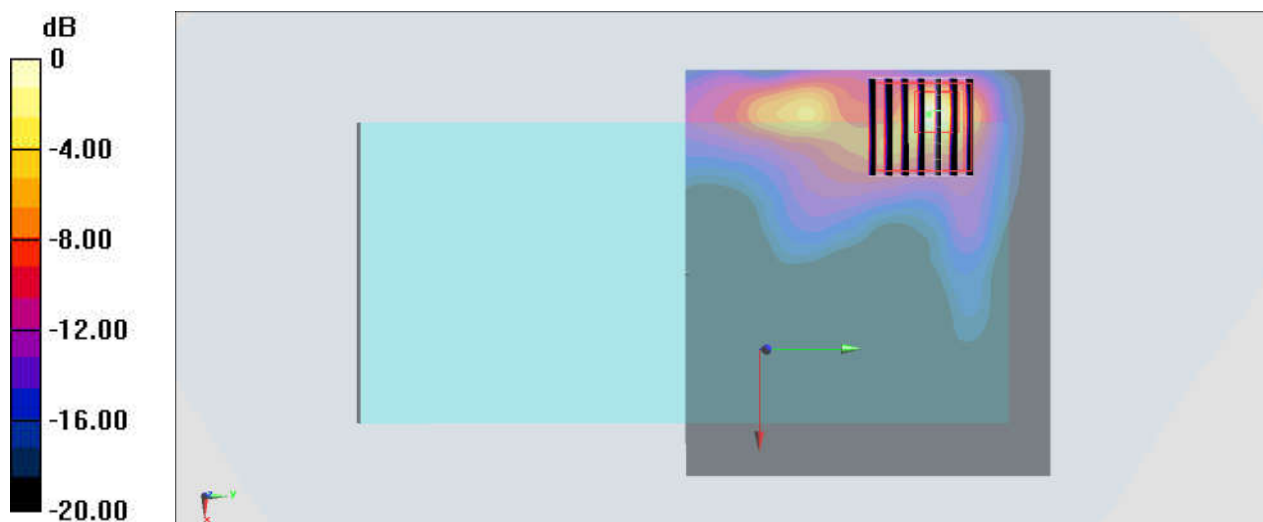

0 dB = 20.1 W/kg = 13.03 dBW/kg

100_WLAN5GHz_802.11n-HT40 MCS0_Back_0mm_Ch134

Communication System: WIFI; Frequency: 5670 MHz; Duty Cycle: 1:1.02
Medium: HSL_5600 Medium parameters used: $f = 5670$ MHz; $\sigma = 5.124$ S/m; $\epsilon_r = 36.429$; $\rho = 1000$ kg/m³
Ambient Temperature : 23.7 °C; Liquid Temperature : 22.5 °C

DASY5 Configuration:

- Probe: EX3DV4 - SN3819; ConvF(4.7, 4.7, 4.7); Calibrated: 2019.03.01;
- Sensor-Surface: 1.4mm (Mechanical Surface Detection)
- Electronics: DAE4 Sn715; Calibrated: 2019.01.23
- Phantom: SAM (Front) with CRP v5.0; Type: QD000P40CD; Serial: TP:1795
- Measurement SW: DASY52, Version 52.8 (8); SEMCAD X Version 14.6.10 (7331)

Area Scan (101x91x1): Interpolated grid: dx=1.000 mm, dy=1.000 mm
Maximum value of SAR (interpolated) = 16.4 W/kg

Zoom Scan (7x7x7)/Cube 0: Measurement grid: dx=4mm, dy=4mm, dz=1.4mm
Reference Value = 0 V/m; Power Drift = 0.00 dB
Peak SAR (extrapolated) = 48.0 W/kg
SAR(1 g) = 7.51 W/kg; SAR(10 g) = 1.55 W/kg
Maximum value of SAR (measured) = 21.0 W/kg

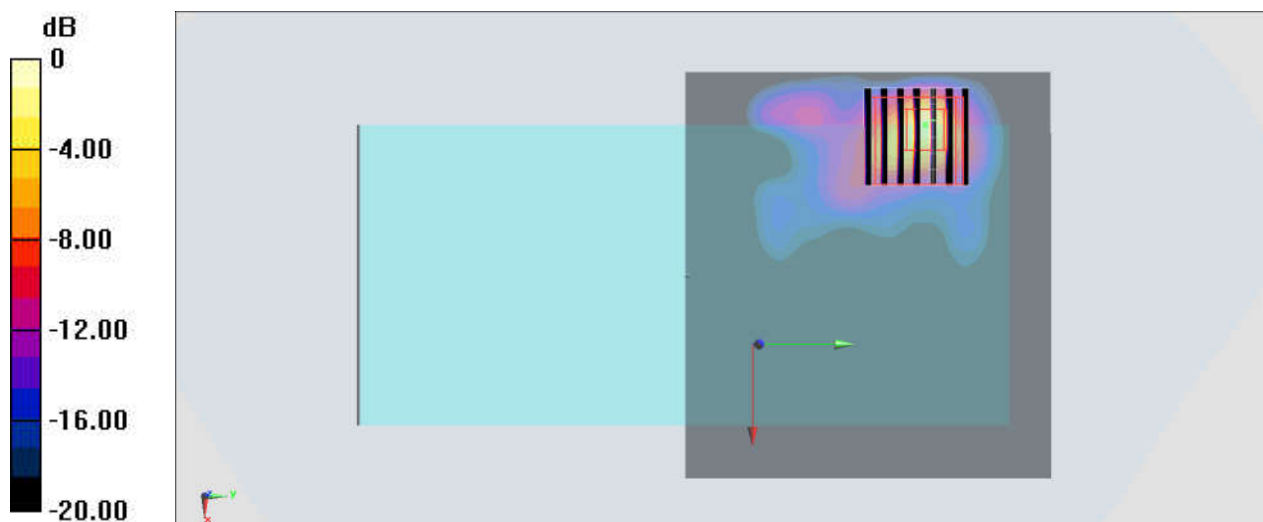

0 dB = 21.0 W/kg = 13.22 dBW/kg

101_WLAN5GHz_802.11n-HT40 MCS0_Back_0mm_Ch159

Communication System: WIFI; Frequency: 5795 MHz; Duty Cycle: 1:1.02

Medium: HSL_5750 Medium parameters used: $f = 5795$ MHz; $\sigma = 5.268$ S/m; $\epsilon_r = 36.208$; $\rho = 1000$ kg/m³

Ambient Temperature : 23.7 °C; Liquid Temperature : 22.6 °C

DASY5 Configuration:

- Probe: EX3DV4 - SN3819; ConvF(4.77, 4.77, 4.77); Calibrated: 2019.03.01;
- Sensor-Surface: 1.4mm (Mechanical Surface Detection)
- Electronics: DAE4 Sn715; Calibrated: 2019.01.23
- Phantom: SAM (Front) with CRP v5.0; Type: QD000P40CD; Serial: TP:1795
- Measurement SW: DASY52, Version 52.8 (8); SEMCAD X Version 14.6.10 (7331)

Area Scan (101x91x1): Interpolated grid: dx=1.000 mm, dy=1.000 mm

Maximum value of SAR (interpolated) = 15.5 W/kg

Zoom Scan (7x7x7)/Cube 0: Measurement grid: dx=4mm, dy=4mm, dz=1.4mm

Reference Value = 0 V/m; Power Drift = 0.00 dB

Peak SAR (extrapolated) = 58.5 W/kg

SAR(1 g) = 7.85 W/kg; SAR(10 g) = 1.51 W/kg

Maximum value of SAR (measured) = 25.0 W/kg

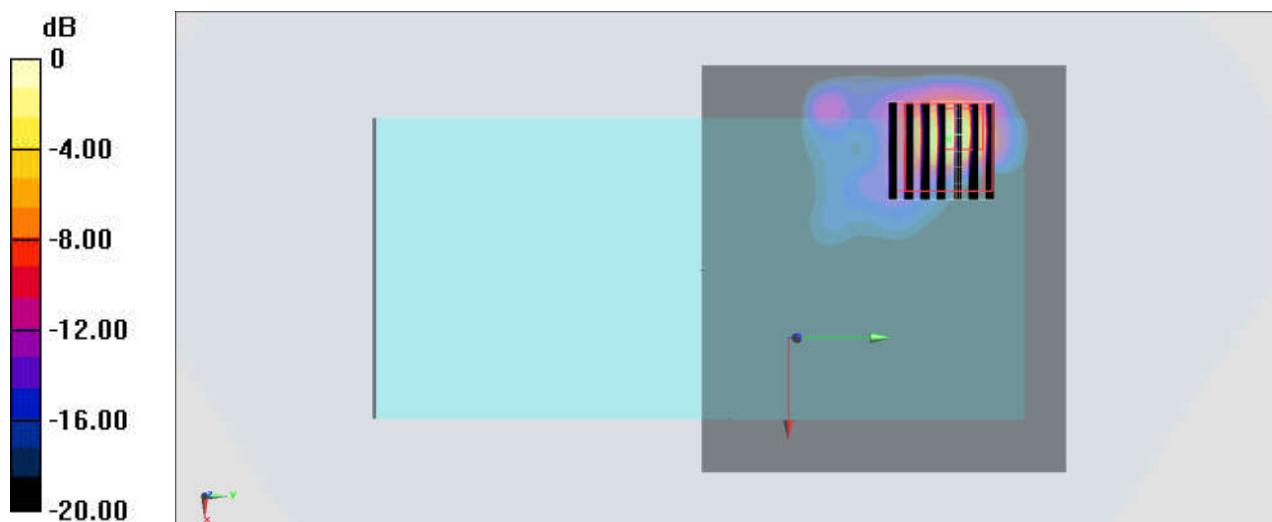

0 dB = 25.0 W/kg = 13.98 dBW/kg