



Appendix B. Plots of SAR Measurement

The plots are shown as follows.

01_GSM850_GPRS(3 Tx slots)_Left Cheek_Ch251

Communication System: UID 0, GPRS/EDGE11 (0); Frequency: 848.8 MHz; Duty Cycle: 1:2.77
Medium: HSL_835_191224 Medium parameters used: $f = 849$ MHz; $\sigma = 0.942$ S/m; $\epsilon_r = 42.559$; $\rho = 1000$ kg/m³
Ambient Temperature : 23.4 °C; Liquid Temperature : 22.5 °C

DASY5 Configuration:

- Probe: EX3DV4 - SN3819; ConvF(9.57, 9.57, 9.57); Calibrated: 2019.03.01;
- Sensor-Surface: 1.4mm (Mechanical Surface Detection)
- Electronics: DAE4 Sn715; Calibrated: 2019.01.23
- Phantom: SAM (Front) with CRP v5.0; Type: QD000P40CD; Serial: TP:1795
- Measurement SW: DASY52, Version 52.8 (8); SEMCAD X Version 14.6.10 (7331)

Ch251/Area Scan (71x121x1): Interpolated grid: dx=15mm, dy=15mm
Maximum value of SAR (interpolated) = 0.526 W/kg

Ch251/Zoom Scan (5x5x7)/Cube 0: Measurement grid: dx=8mm, dy=8mm, dz=5mm
Reference Value = 5.337 V/m; Power Drift = -0.07 dB
Peak SAR (extrapolated) = 0.686 W/kg
SAR(1 g) = 0.352 W/kg; SAR(10 g) = 0.184 W/kg
Maximum value of SAR (measured) = 0.535 W/kg

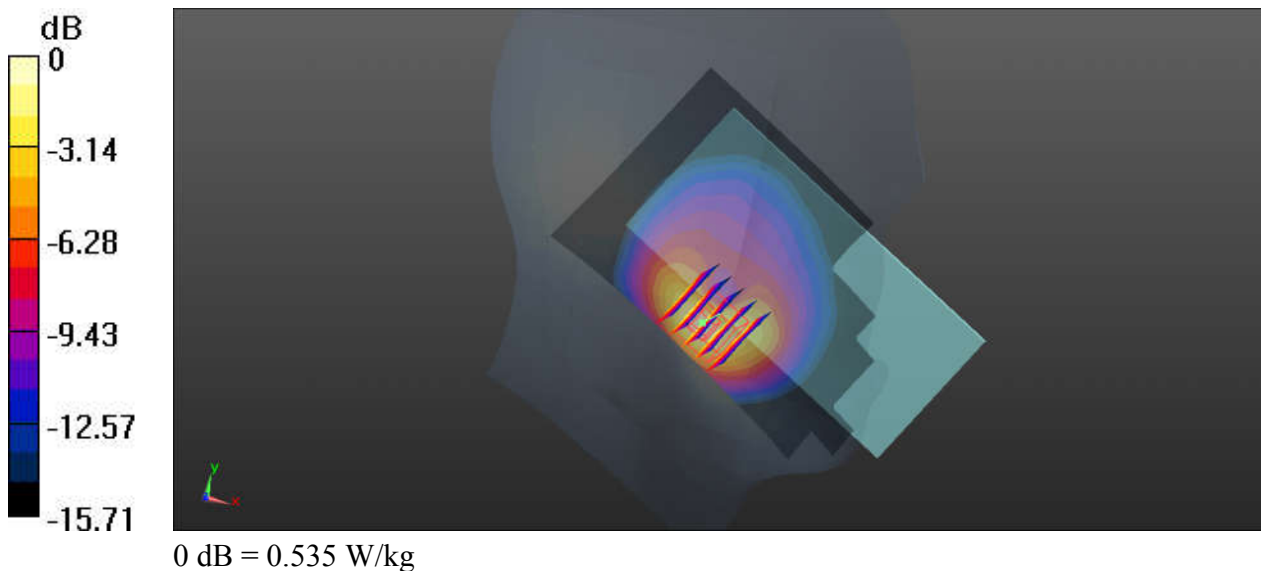

02_GSM1900_GPRS(3 Tx slots)_Right Tilted_Ch810

Communication System: UID 0, GPRS/EDGE11 (0); Frequency: 1909.8 MHz; Duty Cycle: 1:2.77
Medium: HSL_1900_191218 Medium parameters used: $f = 1910$ MHz; $\sigma = 1.427$ S/m; $\epsilon_r = 41.106$;
 $\rho = 1000$ kg/m³
Ambient Temperature : 23.5 °C; Liquid Temperature : 22.7 °C

DASY5 Configuration:

- Probe: EX3DV4 - SN3819; ConvF(8.27, 8.27, 8.27); Calibrated: 2019.03.01;
- Sensor-Surface: 1.4mm (Mechanical Surface Detection)
- Electronics: DAE4 Sn715; Calibrated: 2019.01.23
- Phantom: SAM (Front) with CRP v5.0; Type: QD000P40CD; Serial: TP:1795
- Measurement SW: DASY52, Version 52.8 (8); SEMCAD X Version 14.6.10 (7331)

Ch810/Area Scan (71x121x1): Interpolated grid: dx=15mm, dy=15mm
Maximum value of SAR (interpolated) = 0.645 W/kg

Ch810/Zoom Scan (5x5x7)/Cube 0: Measurement grid: dx=8mm, dy=8mm, dz=5mm
Reference Value = 14.22 V/m; Power Drift = 0.04 dB
Peak SAR (extrapolated) = 0.857 W/kg
SAR(1 g) = 0.393 W/kg; SAR(10 g) = 0.177 W/kg
Maximum value of SAR (measured) = 0.603 W/kg

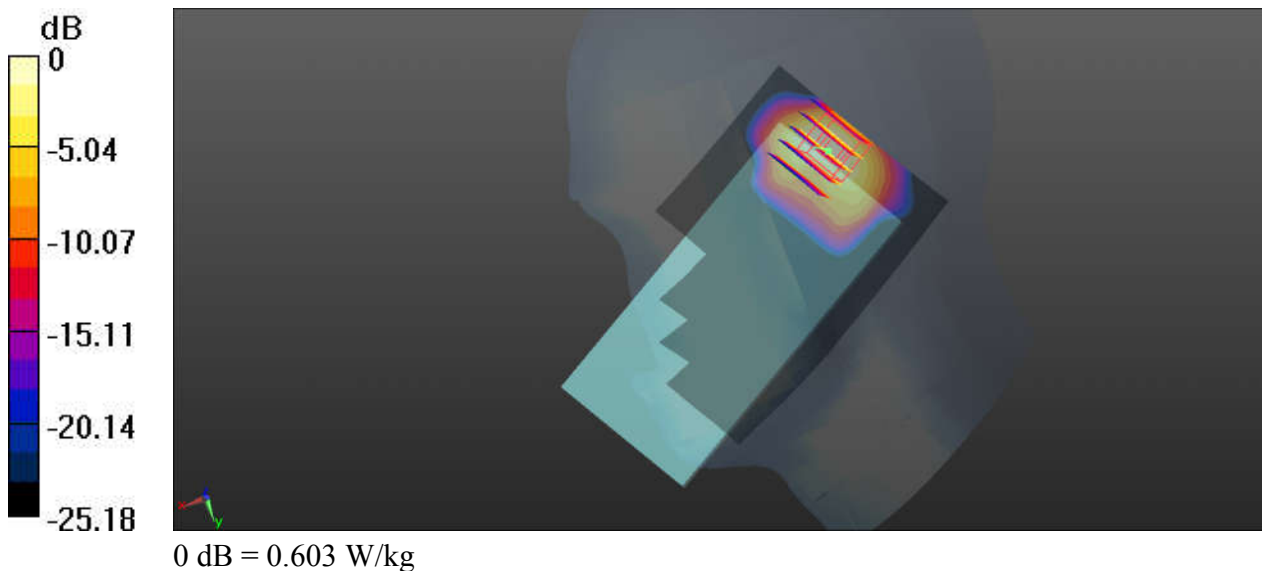

03_WCDMA V_RMC 12.2Kbps_Left Cheek_Ch4233

Communication System: UID 0, UMTS (0); Frequency: 846.6 MHz; Duty Cycle: 1:1
 Medium: HSL_835_191224 Medium parameters used: $f = 847 \text{ MHz}$; $\sigma = 0.94 \text{ S/m}$; $\epsilon_r = 42.579$; $\rho = 1000 \text{ kg/m}^3$
 Ambient Temperature : $23.4 \text{ }^\circ\text{C}$; Liquid Temperature : $22.5 \text{ }^\circ\text{C}$

DASY5 Configuration:

- Probe: EX3DV4 - SN3819; ConvF(9.57, 9.57, 9.57); Calibrated: 2019.03.01;
- Sensor-Surface: 1.4mm (Mechanical Surface Detection)
- Electronics: DAE4 Sn715; Calibrated: 2019.01.23
- Phantom: SAM (Front) with CRP v5.0; Type: QD000P40CD; Serial: TP:1795
- Measurement SW: DASY52, Version 52.8 (8); SEMCAD X Version 14.6.10 (7331)

Ch4233/Area Scan (71x121x1): Interpolated grid: $dx=15\text{mm}$, $dy=15\text{mm}$
 Maximum value of SAR (interpolated) = 0.735 W/kg

Ch4233/Zoom Scan (5x5x7)/Cube 0: Measurement grid: $dx=8\text{mm}$, $dy=8\text{mm}$, $dz=5\text{mm}$
 Reference Value = 4.926 V/m ; Power Drift = -0.06 dB
 Peak SAR (extrapolated) = 1.06 W/kg
SAR(1 g) = 0.521 W/kg ; SAR(10 g) = 0.272 W/kg
 Maximum value of SAR (measured) = 0.747 W/kg

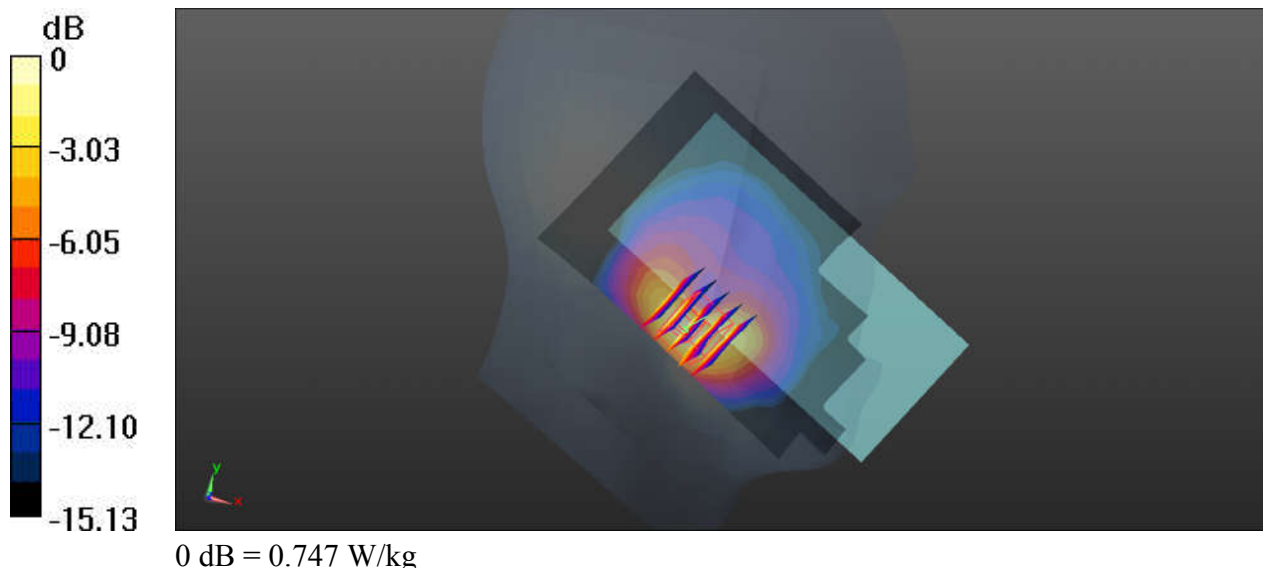

04_WCDMA IV_RMC 12.2Kbps_Right Tilted_Ch1513

Communication System: UID 0, UMTS (0); Frequency: 1752.6 MHz; Duty Cycle: 1:1
 Medium: HSL_1750_191221 Medium parameters used: $f = 1753 \text{ MHz}$; $\sigma = 1.395 \text{ S/m}$; $\epsilon_r = 39.944$;
 $\rho = 1000 \text{ kg/m}^3$
 Ambient Temperature : $23.5 \text{ }^\circ\text{C}$; Liquid Temperature : $22.4 \text{ }^\circ\text{C}$

DASY5 Configuration:

- Probe: EX3DV4 - SN3819; ConvF(8.54, 8.54, 8.54); Calibrated: 2019.03.01;
- Sensor-Surface: 1.4mm (Mechanical Surface Detection)
- Electronics: DAE4 Sn715; Calibrated: 2019.01.23
- Phantom: SAM (Front) with CRP v5.0; Type: QD000P40CD; Serial: TP:1795
- Measurement SW: DASY52, Version 52.8 (8); SEMCAD X Version 14.6.10 (7331)

Ch1513/Area Scan (71x131x1): Interpolated grid: $dx=15\text{mm}$, $dy=15\text{mm}$
 Maximum value of SAR (interpolated) = 0.722 W/kg

Ch1513/Zoom Scan (5x5x7)/Cube 0: Measurement grid: $dx=8\text{mm}$, $dy=8\text{mm}$, $dz=5\text{mm}$
 Reference Value = 17.89 V/m ; Power Drift = 0.13 dB
 Peak SAR (extrapolated) = 1.10 W/kg
SAR(1 g) = 0.566 W/kg ; SAR(10 g) = 0.273 W/kg
 Maximum value of SAR (measured) = 0.835 W/kg

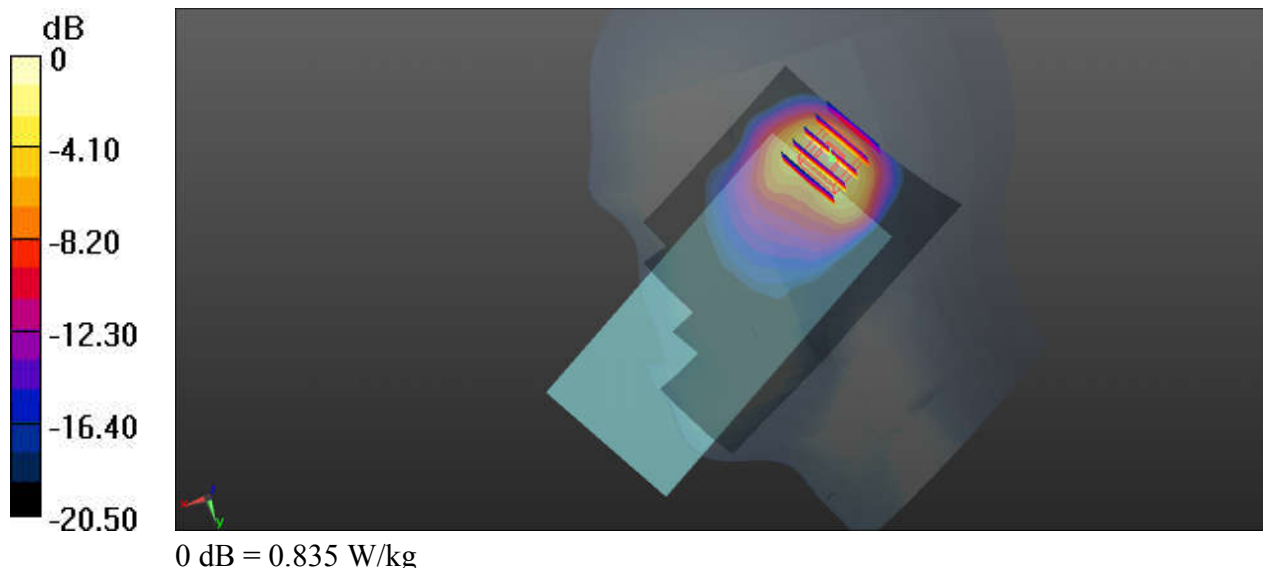

05_WCDMA II_RMC 12.2Kbps_Right Tilted_Ch9400

Communication System: UID 0, UMTS (0); Frequency: 1880 MHz; Duty Cycle: 1:1
Medium: HSL_1900_191218 Medium parameters used: $f = 1880$ MHz; $\sigma = 1.408$ S/m; $\epsilon_r = 41.203$;
 $\rho = 1000$ kg/m³
Ambient Temperature : 23.5 °C; Liquid Temperature : 22.7 °C

DASY5 Configuration:

- Probe: EX3DV4 - SN3819; ConvF(8.27, 8.27, 8.27); Calibrated: 2019.03.01;
- Sensor-Surface: 1.4mm (Mechanical Surface Detection)
- Electronics: DAE4 Sn715; Calibrated: 2019.01.23
- Phantom: SAM (Front) with CRP v5.0; Type: QD000P40CD; Serial: TP:1795
- Measurement SW: DASY52, Version 52.8 (8); SEMCAD X Version 14.6.10 (7331)

Ch9400/Area Scan (71x131x1): Interpolated grid: dx=15mm, dy=15mm
Maximum value of SAR (interpolated) = 0.851 W/kg

Ch9400/Zoom Scan (5x5x7)/Cube 0: Measurement grid: dx=8mm, dy=8mm, dz=5mm
Reference Value = 19.97 V/m; Power Drift = 0.04 dB
Peak SAR (extrapolated) = 1.41 W/kg
SAR(1 g) = 0.654 W/kg; SAR(10 g) = 0.298 W/kg
Maximum value of SAR (measured) = 1.08 W/kg

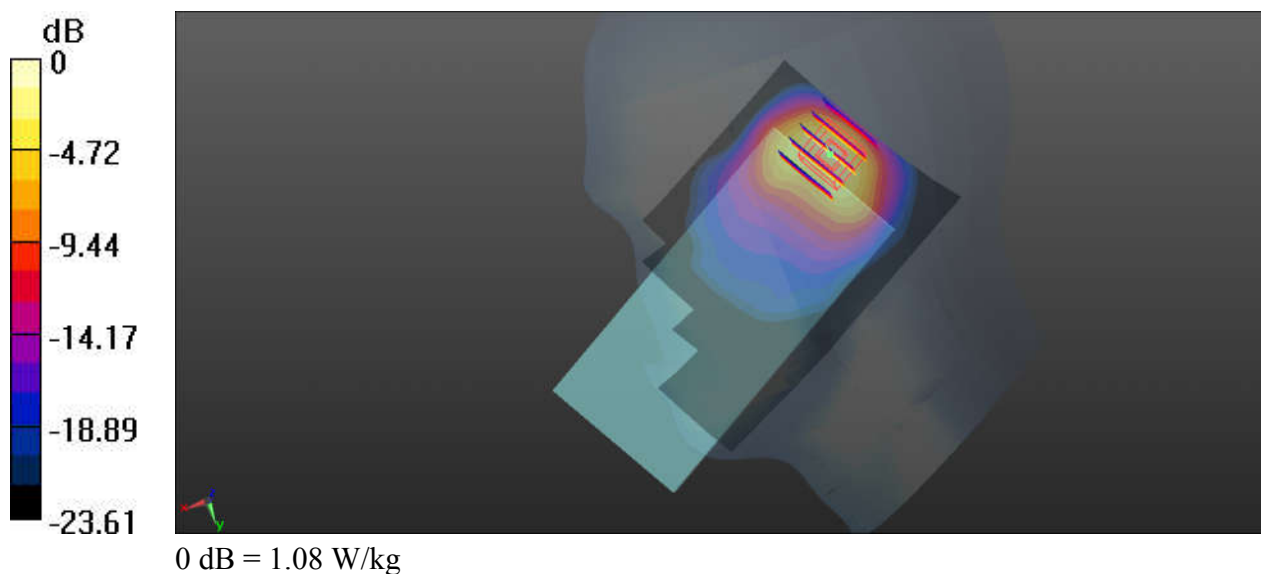

06_CDMA2000 BC0_RC3+SO55_Left Cheek_Ch777

Communication System: UID 0, CDMA2000 (0); Frequency: 848.31 MHz; Duty Cycle: 1:1
Medium: HSL_835_191224 Medium parameters used: $f = 848.31$ MHz; $\sigma = 0.941$ S/m; $\epsilon_r = 42.565$;
 $\rho = 1000$ kg/m³
Ambient Temperature : 23.4 °C ; Liquid Temperature : 22.5 °C

DASY5 Configuration:

- Probe: EX3DV4 - SN3819; ConvF(9.57, 9.57, 9.57); Calibrated: 2019.03.01;
- Sensor-Surface: 1.4mm (Mechanical Surface Detection)
- Electronics: DAE4 Sn715; Calibrated: 2019.01.23
- Phantom: SAM (Front) with CRP v5.0; Type: QD000P40CD; Serial: TP:1795
- Measurement SW: DASY52, Version 52.8 (8); SEMCAD X Version 14.6.10 (7331)

Ch777/Area Scan (71x121x1): Interpolated grid: dx=15mm, dy=15mm
Maximum value of SAR (interpolated) = 0.698 W/kg

Ch777/Zoom Scan (5x5x7)/Cube 0: Measurement grid: dx=8mm, dy=8mm, dz=5mm
Reference Value = 5.961 V/m; Power Drift = 0.04 dB
Peak SAR (extrapolated) = 0.943 W/kg
SAR(1 g) = 0.487 W/kg; SAR(10 g) = 0.259 W/kg
Maximum value of SAR (measured) = 0.690 W/kg

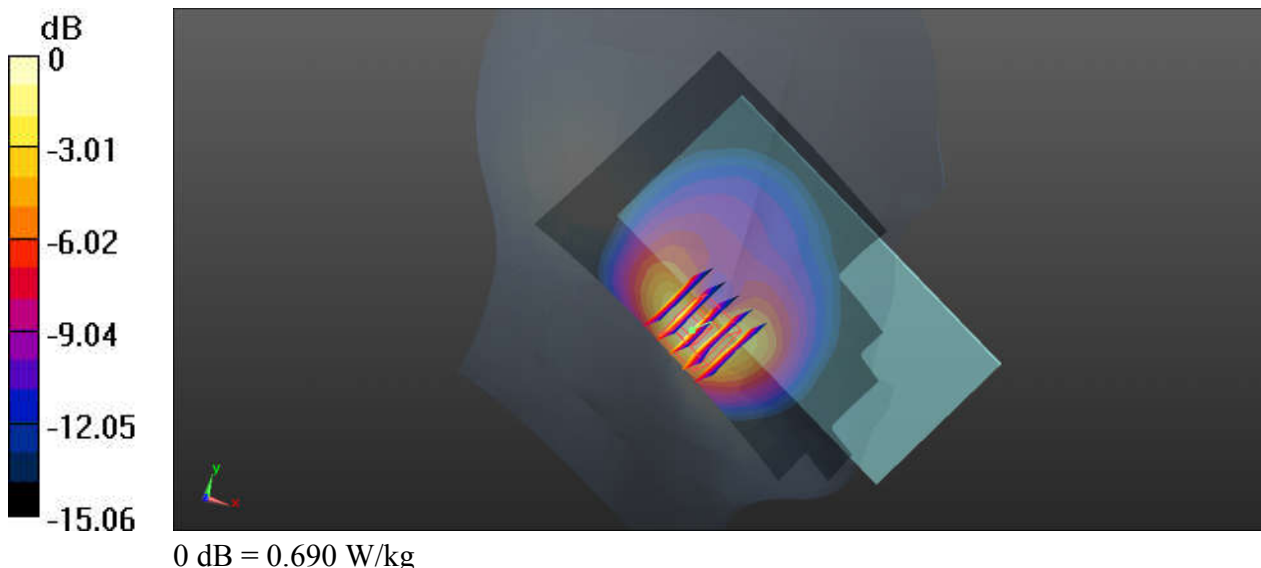

07_CDMA2000 BC10_RC3+SO55_Left Cheek_Ch580

Communication System: UID 0, CDMA2000 (0); Frequency: 820.5 MHz; Duty Cycle: 1:1
Medium: HSL_835_191224 Medium parameters used: $f = 820.5$ MHz; $\sigma = 0.914$ S/m; $\epsilon_r = 42.919$;
 $\rho = 1000$ kg/m³
Ambient Temperature : 23.4 °C ; Liquid Temperature : 22.5 °C

DASY5 Configuration:

- Probe: EX3DV4 - SN3819; ConvF(9.57, 9.57, 9.57); Calibrated: 2019.03.01;
- Sensor-Surface: 1.4mm (Mechanical Surface Detection)
- Electronics: DAE4 Sn715; Calibrated: 2019.01.23
- Phantom: SAM (Front) with CRP v5.0; Type: QD000P40CD; Serial: TP:1795
- Measurement SW: DASY52, Version 52.8 (8); SEMCAD X Version 14.6.10 (7331)

Ch580/Area Scan (71x121x1): Interpolated grid: dx=15mm, dy=15mm
Maximum value of SAR (interpolated) = 0.742 W/kg

Ch580/Zoom Scan (5x5x7)/Cube 0: Measurement grid: dx=8mm, dy=8mm, dz=5mm
Reference Value = 10.71 V/m; Power Drift = 0.02 dB
Peak SAR (extrapolated) = 1.03 W/kg
SAR(1 g) = 0.515 W/kg; SAR(10 g) = 0.273 W/kg
Maximum value of SAR (measured) = 0.749 W/kg

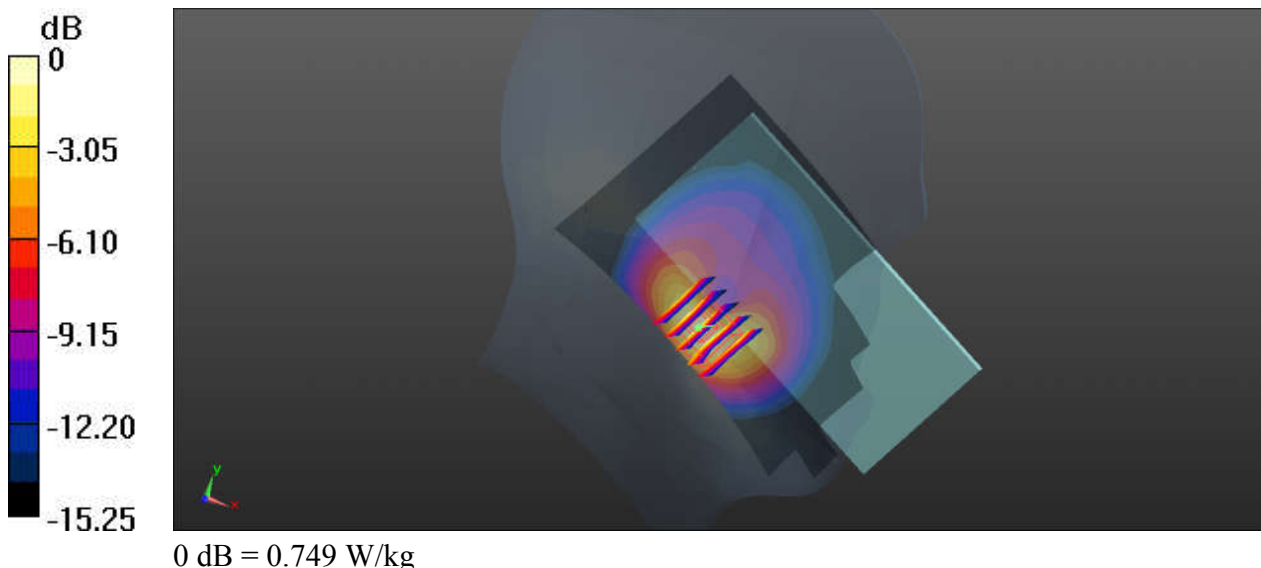

08_CDMA BC1_1xRTT RC3 SO55_Right Cheek_Ch600

Communication System: CDMA; Frequency: 1880 MHz; Duty Cycle: 1:1

Medium: HSL_1900_200208 Medium parameters used: $f = 1880$ MHz; $\sigma = 1.434$ S/m; $\epsilon_r = 40.563$; $\rho = 1000$ kg/m³

Ambient Temperature : 23.5 °C; Liquid Temperature : 22.5 °C

DASY5 Configuration:

- Probe: EX3DV4 - SN7346; ConvF(8.07, 8.07, 8.07) @ 1880 MHz; Calibrated: 2019/4/25
- Sensor-Surface: 1.4mm (Mechanical Surface Detection)
- Electronics: DAE4 Sn853; Calibrated: 2019/7/18
- Phantom: SAM_Left; Type: QD000P40CD; Serial: TP:1477
- Measurement SW: DASY52, Version 52.10 (2); SEMCAD X Version 14.6.12 (7470)

Area Scan (71x61x1): Interpolated grid: dx=1.500 mm, dy=1.500 mm

Maximum value of SAR (interpolated) = 0.826 W/kg

Zoom Scan (5x5x7)/Cube 0: Measurement grid: dx=8mm, dy=8mm, dz=5mm

Reference Value = 15.65 V/m; Power Drift = -0.14 dB

Peak SAR (extrapolated) = 1.30 W/kg

SAR(1 g) = 0.592 W/kg; SAR(10 g) = 0.271 W/kg

Maximum value of SAR (measured) = 1.09 W/kg

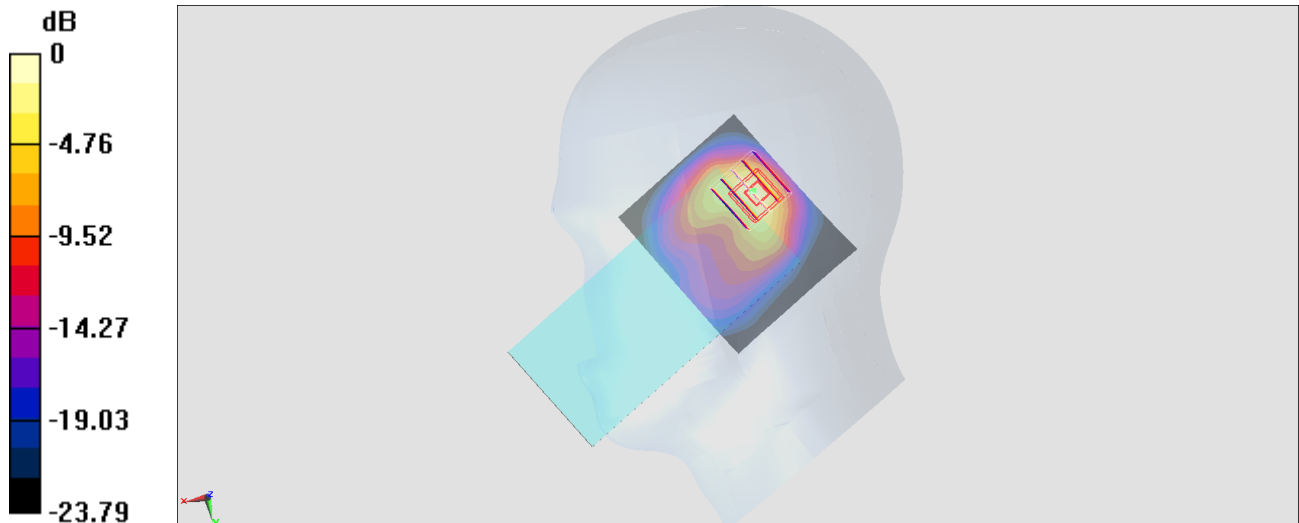

09_LTE Band 71_20M_QPSK_50RB_24Offset_Left Cheek_Ch133322

Communication System: UID 0, LTE (0); Frequency: 673 MHz; Duty Cycle: 1:1
Medium: HSL_750_191227 Medium parameters used: $f = 673$ MHz; $\sigma = 0.843$ S/m; $\epsilon_r = 43.001$; $\rho = 1000$ kg/m³
Ambient Temperature : 23.4 °C; Liquid Temperature : 22.4 °C

DASY5 Configuration:

- Probe: EX3DV4 - SN3819; ConvF(10, 10, 10); Calibrated: 2019.03.01;
- Sensor-Surface: 1.4mm (Mechanical Surface Detection)
- Electronics: DAE4 Sn715; Calibrated: 2019.01.23
- Phantom: SAM (Front) with CRP v5.0; Type: QD000P40CD; Serial: TP:1795
- Measurement SW: DASY52, Version 52.8 (8); SEMCAD X Version 14.6.10 (7331)

Ch133322/Area Scan (81x71x1): Interpolated grid: dx=15mm, dy=15mm
Maximum value of SAR (interpolated) = 0.711 W/kg

Ch133322/Zoom Scan (5x5x7)/Cube 0: Measurement grid: dx=8mm, dy=8mm, dz=5mm
Reference Value = 7.877 V/m; Power Drift = 0.16 dB
Peak SAR (extrapolated) = 1.04 W/kg
SAR(1 g) = 0.505 W/kg; SAR(10 g) = 0.269 W/kg
Maximum value of SAR (measured) = 0.702 W/kg

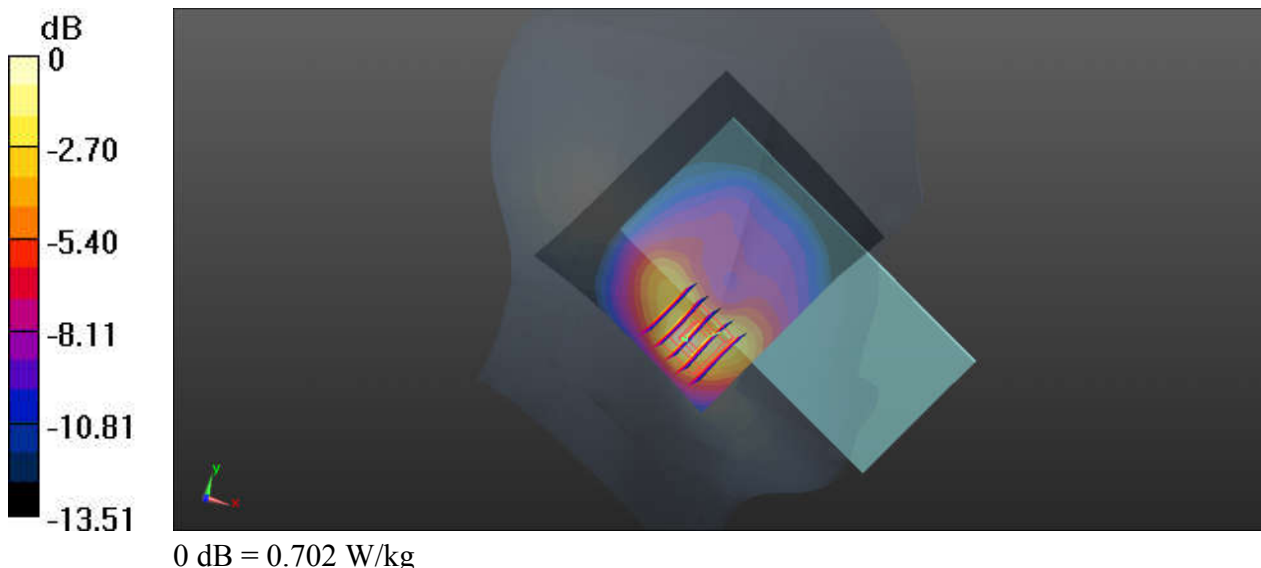

10_LTE Band 12_10M_QPSK_25RB_12Offset_Left Cheek_Ch23095

Communication System: UID 0, LTE (0); Frequency: 707.5 MHz; Duty Cycle: 1:1
Medium: HSL_750_191227 Medium parameters used: $f = 707.5$ MHz; $\sigma = 0.864$ S/m; $\epsilon_r = 42.44$; $\rho = 1000$ kg/m³
Ambient Temperature : 23.4 °C; Liquid Temperature : 22.4 °C

DASY5 Configuration:

- Probe: EX3DV4 - SN3819; ConvF(10, 10, 10); Calibrated: 2019.03.01;
- Sensor-Surface: 1.4mm (Mechanical Surface Detection)
- Electronics: DAE4 Sn715; Calibrated: 2019.01.23
- Phantom: SAM (Front) with CRP v5.0; Type: QD000P40CD; Serial: TP:1795
- Measurement SW: DASY52, Version 52.8 (8); SEMCAD X Version 14.6.10 (7331)

Ch23095/Area Scan (71x121x1): Interpolated grid: dx=15mm, dy=15mm
Maximum value of SAR (interpolated) = 0.699 W/kg

Ch23095/Zoom Scan (5x5x7)/Cube 0: Measurement grid: dx=8mm, dy=8mm, dz=5mm
Reference Value = 7.355 V/m; Power Drift = 0.13 dB
Peak SAR (extrapolated) = 0.885 W/kg
SAR(1 g) = 0.470 W/kg; SAR(10 g) = 0.259 W/kg
Maximum value of SAR (measured) = 0.681 W/kg

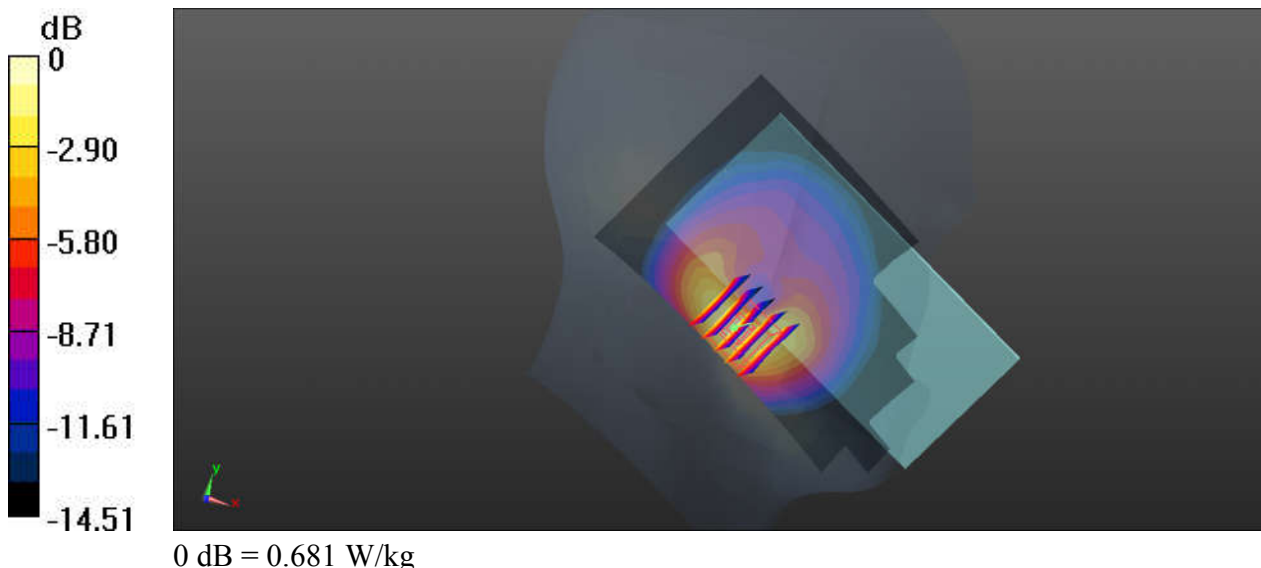

11_LTE Band 13_10M_QPSK_1RB_0Offset_Left Cheek_Ch23230

Communication System: UID 0, LTE (0); Frequency: 782 MHz; Duty Cycle: 1:1
 Medium: HSL_750_191227 Medium parameters used: $f = 782 \text{ MHz}$; $\sigma = 0.904 \text{ S/m}$; $\epsilon_r = 40.826$; $\rho = 1000 \text{ kg/m}^3$
 Ambient Temperature : 23.4 °C; Liquid Temperature : 22.4 °C

DASY5 Configuration:

- Probe: EX3DV4 - SN3819; ConvF(10, 10, 10); Calibrated: 2019.03.01;
- Sensor-Surface: 1.4mm (Mechanical Surface Detection)
- Electronics: DAE4 Sn715; Calibrated: 2019.01.23
- Phantom: SAM (Front) with CRP v5.0; Type: QD000P40CD; Serial: TP:1795
- Measurement SW: DASY52, Version 52.8 (8); SEMCAD X Version 14.6.10 (7331)

Ch23230/Area Scan (71x121x1): Interpolated grid: $dx=15\text{mm}$, $dy=15\text{mm}$
 Maximum value of SAR (interpolated) = 0.794 W/kg

Ch23230/Zoom Scan (5x5x7)/Cube 0: Measurement grid: $dx=8\text{mm}$, $dy=8\text{mm}$, $dz=5\text{mm}$
 Reference Value = 6.816 V/m; Power Drift = 0.09 dB
 Peak SAR (extrapolated) = 1.11 W/kg
SAR(1 g) = 0.554 W/kg; SAR(10 g) = 0.295 W/kg
 Maximum value of SAR (measured) = 0.771 W/kg

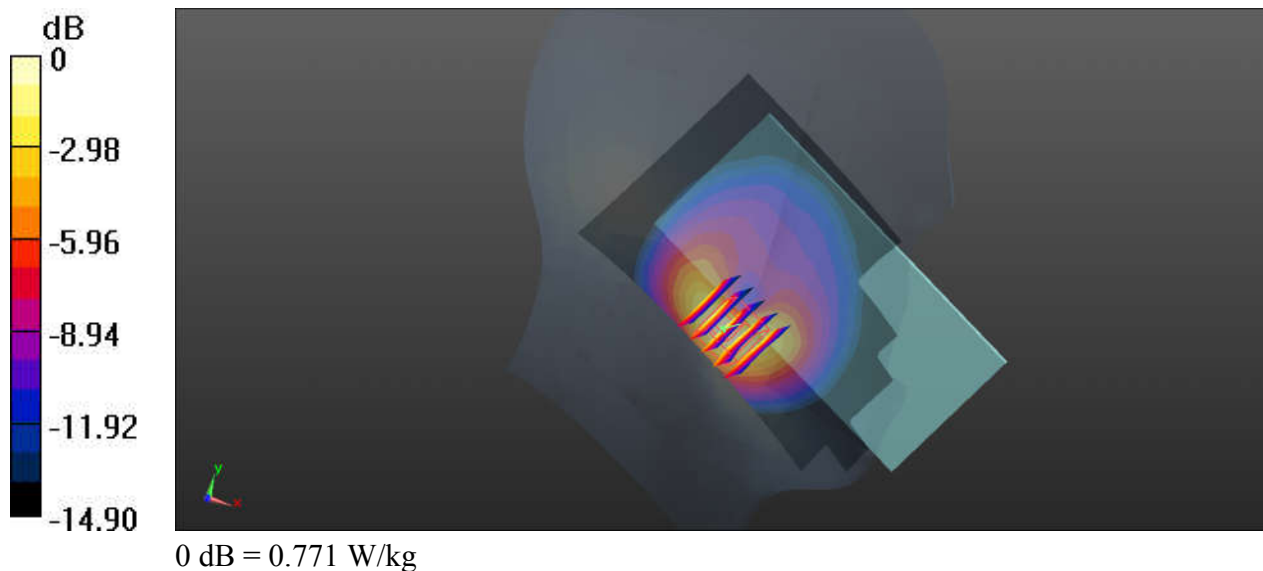

12_LTE Band 5_10M_QPSK_1RB_49Offset_Left Cheek_Ch20525

Communication System: LTE; Frequency: 836.5 MHz; Duty Cycle: 1:1
Medium: HSL_835_191224 Medium parameters used : $f = 836.5$ MHz; $\sigma = 0.93$ S/m; $\epsilon_r = 42.711$; $\rho = 1000$ kg/m³
Ambient Temperature : 23.4 °C; Liquid Temperature : 22.5 °C

DASY5 Configuration:

- Probe: EX3DV4 - SN3819; ConvF(9.57, 9.57, 9.57); Calibrated: 2019.03.01;
- Sensor-Surface: 1.4mm (Mechanical Surface Detection)
- Electronics: DAE4 Sn715; Calibrated: 2019.01.23
- Phantom: SAM (Front) with CRP v5.0; Type: QD000P40CD; Serial: TP:1795
- Measurement SW: DASY52, Version 52.8 (8); SEMCAD X Version 14.6.10 (7331)

Area Scan (71x61x1): Interpolated grid: dx=1.500 mm, dy=1.500 mm
Maximum value of SAR (interpolated) = 0.668 W/kg

Zoom Scan (5x5x7)/Cube 0: Measurement grid: dx=8mm, dy=8mm, dz=5mm
Reference Value = 6.254 V/m; Power Drift = -0.13 dB
Peak SAR (extrapolated) = 0.927 W/kg
SAR(1 g) = 0.450 W/kg; SAR(10 g) = 0.247 W/kg
Maximum value of SAR (measured) = 0.689 W/kg

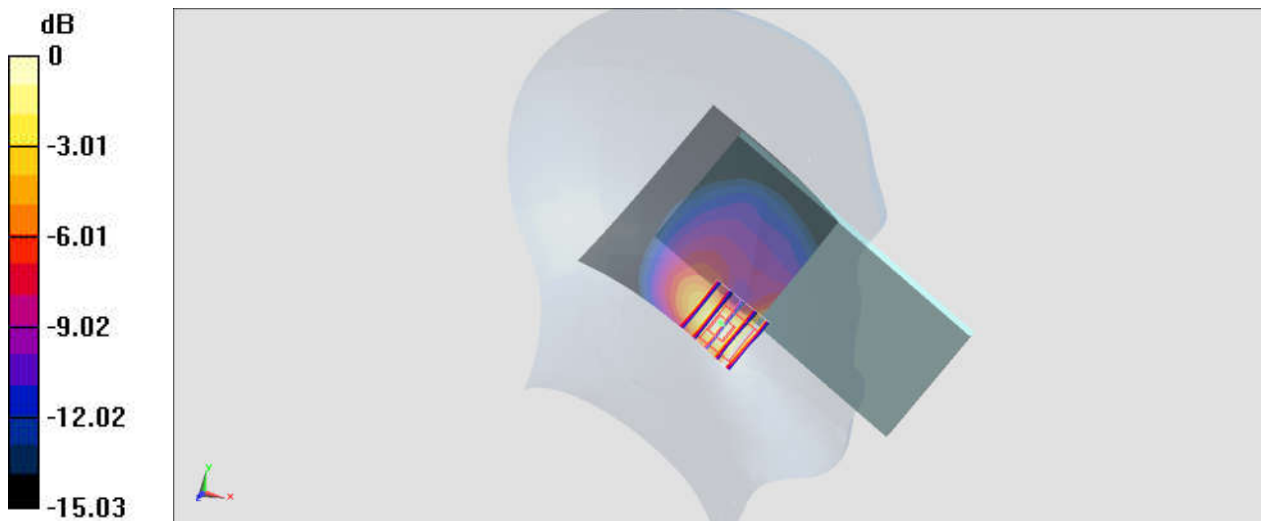

0 dB = 0.689 W/kg = -1.62 dBW/kg

13_LTE Band 26_15M_QPSK_36RB_20Offset_Left Cheek_Ch26965

Communication System: UID 0, LTE (0); Frequency: 841.5 MHz; Duty Cycle: 1:1
Medium: HSL_835_191224 Medium parameters used: $f = 841.5$ MHz; $\sigma = 0.934$ S/m; $\epsilon_r = 42.647$;
 $\rho = 1000$ kg/m³
Ambient Temperature : 23.4 °C ; Liquid Temperature : 22.5 °C

DASY5 Configuration:

- Probe: EX3DV4 - SN3819; ConvF(9.57, 9.57, 9.57); Calibrated: 2019.03.01;
- Sensor-Surface: 1.4mm (Mechanical Surface Detection)
- Electronics: DAE4 Sn715; Calibrated: 2019.01.23
- Phantom: SAM (Front) with CRP v5.0; Type: QD000P40CD; Serial: TP:1795
- Measurement SW: DASY52, Version 52.8 (8); SEMCAD X Version 14.6.10 (7331)

Ch26965/Area Scan (71x121x1): Interpolated grid: dx=15mm, dy=15mm
Maximum value of SAR (interpolated) = 0.790 W/kg

Ch26965/Zoom Scan (5x5x7)/Cube 0: Measurement grid: dx=8mm, dy=8mm, dz=5mm
Reference Value = 6.670 V/m; Power Drift = 0.09 dB
Peak SAR (extrapolated) = 1.10 W/kg
SAR(1 g) = 0.534 W/kg; SAR(10 g) = 0.296 W/kg
Maximum value of SAR (measured) = 0.784 W/kg

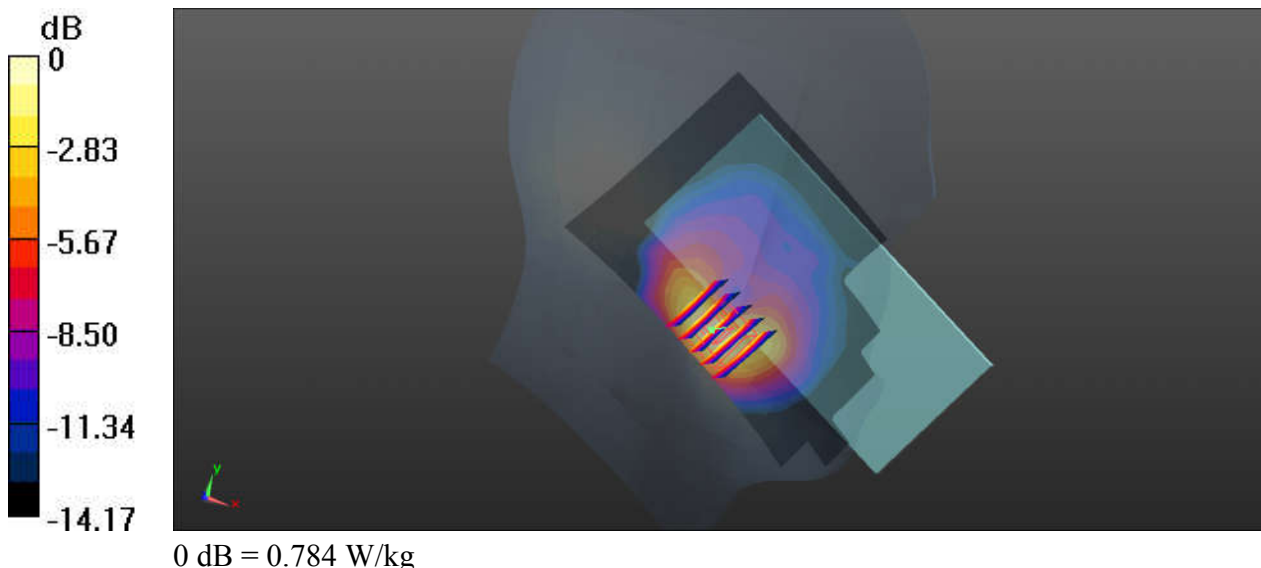

14_LTE Band 66_20M_QPSK_50RB_24Offset_Right Tilted_Ch132572

Communication System: UID 0, LTE (0); Frequency: 1770 MHz; Duty Cycle: 1:1
Medium: HSL_1750_191221 Medium parameters used: $f = 1770$ MHz; $\sigma = 1.405$ S/m; $\epsilon_r = 39.765$;
 $\rho = 1000$ kg/m³
Ambient Temperature : 23.5 °C; Liquid Temperature : 22.4 °C

DASY5 Configuration:

- Probe: EX3DV4 - SN3819; ConvF(8.54, 8.54, 8.54); Calibrated: 2019.03.01;
- Sensor-Surface: 1.4mm (Mechanical Surface Detection)
- Electronics: DAE4 Sn715; Calibrated: 2019.01.23
- Phantom: SAM (Front) with CRP v5.0; Type: QD000P40CD; Serial: TP:1795
- Measurement SW: DASY52, Version 52.8 (8); SEMCAD X Version 14.6.10 (7331)

Ch132572/Area Scan (71x121x1): Interpolated grid: dx=15mm, dy=15mm
Maximum value of SAR (interpolated) = 0.802 W/kg

Ch132572/Zoom Scan (5x5x7)/Cube 0: Measurement grid: dx=8mm, dy=8mm, dz=5mm
Reference Value = 16.06 V/m; Power Drift = 0.12 dB
Peak SAR (extrapolated) = 1.17 W/kg
SAR(1 g) = 0.583 W/kg; SAR(10 g) = 0.274 W/kg
Maximum value of SAR (measured) = 0.933 W/kg

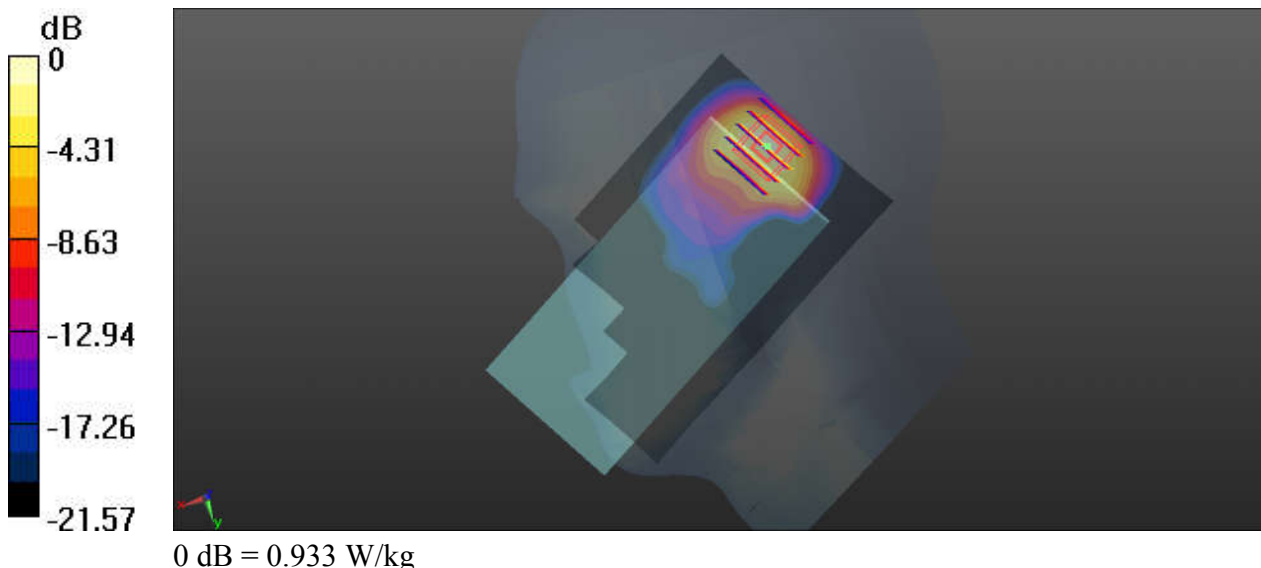

15_LTE Band 25_20M_QPSK_100RB_0Offset_Right Tilted_Ch26590

Communication System: UID 0, LTE (0); Frequency: 1905 MHz; Duty Cycle: 1:1
Medium: HSL_1900_191218 Medium parameters used: $f = 1905$ MHz; $\sigma = 1.424$ S/m; $\epsilon_r = 41.122$;
 $\rho = 1000$ kg/m³
Ambient Temperature : 23.5 °C; Liquid Temperature : 22.7 °C

DASY5 Configuration:

- Probe: EX3DV4 - SN3819; ConvF(8.27, 8.27, 8.27); Calibrated: 2019.03.01;
- Sensor-Surface: 1.4mm (Mechanical Surface Detection)
- Electronics: DAE4 Sn715; Calibrated: 2019.01.23
- Phantom: SAM (Front) with CRP v5.0; Type: QD000P40CD; Serial: TP:1795
- Measurement SW: DASY52, Version 52.8 (8); SEMCAD X Version 14.6.10 (7331)

Ch26590/Area Scan (71x121x1): Interpolated grid: dx=15mm, dy=15mm
Maximum value of SAR (interpolated) = 0.967 W/kg

Ch26590/Zoom Scan (5x5x7)/Cube 0: Measurement grid: dx=8mm, dy=8mm, dz=5mm
Reference Value = 24.18 V/m; Power Drift = 0.04 dB
Peak SAR (extrapolated) = 1.67 W/kg
SAR(1 g) = 0.773 W/kg; SAR(10 g) = 0.348 W/kg
Maximum value of SAR (measured) = 1.28 W/kg

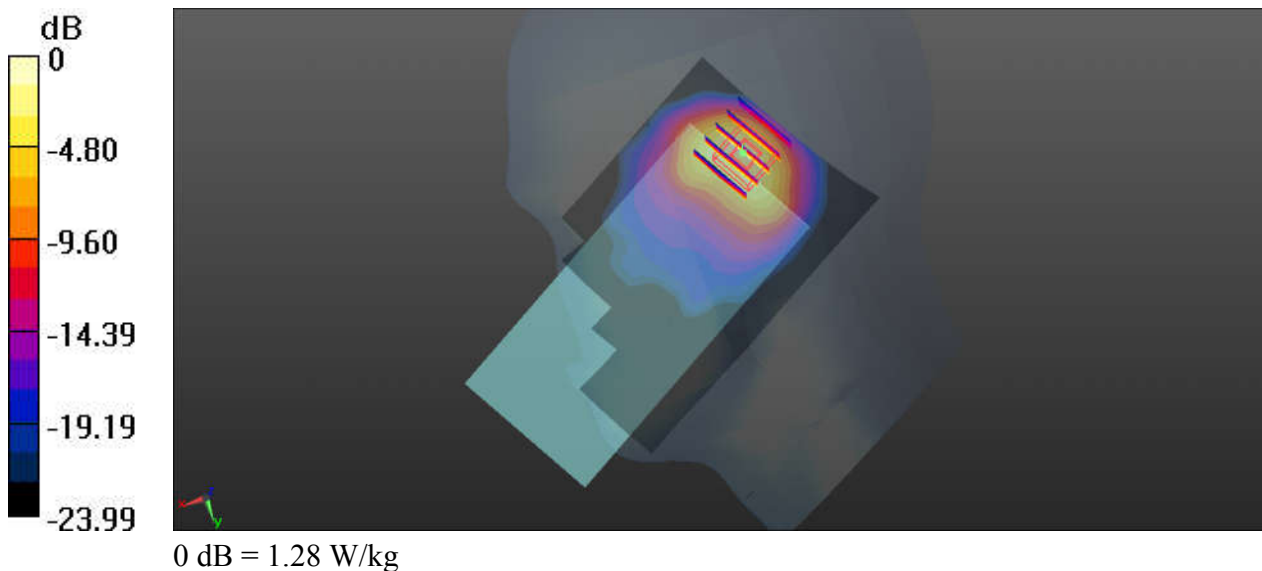

16_LTE Band 30_10M_QPSK_25RB_12Offset_Right Tilted_Ch27710

Communication System: UID 0, LTE (0); Frequency: 2310 MHz; Duty Cycle: 1:1
Medium: HSL_2300_191230 Medium parameters used: $f = 2310$ MHz; $\sigma = 1.682$ S/m; $\epsilon_r = 38.704$;
 $\rho = 1000$ kg/m³
Ambient Temperature : 23.4 °C; Liquid Temperature : 22.7 °C

DASY5 Configuration:

- Probe: EX3DV4 - SN3819; ConvF(7.64, 7.64, 7.64); Calibrated: 2019.03.01;
- Sensor-Surface: 1.4mm (Mechanical Surface Detection)
- Electronics: DAE4 Sn715; Calibrated: 2019.01.23
- Phantom: SAM (Front) with CRP v5.0; Type: QD000P40CD; Serial: TP:1795
- Measurement SW: DASY52, Version 52.8 (8); SEMCAD X Version 14.6.10 (7331)

Ch27710/Area Scan (81x81x1): Interpolated grid: dx=12mm, dy=12mm
Maximum value of SAR (interpolated) = 0.959 W/kg

Ch27710/Zoom Scan (7x7x7)/Cube 0: Measurement grid: dx=5mm, dy=5mm, dz=5mm
Reference Value = 21.51 V/m; Power Drift = -0.02 dB
Peak SAR (extrapolated) = 2.13 W/kg
SAR(1 g) = 0.777 W/kg; SAR(10 g) = 0.324 W/kg
Maximum value of SAR (measured) = 1.05 W/kg

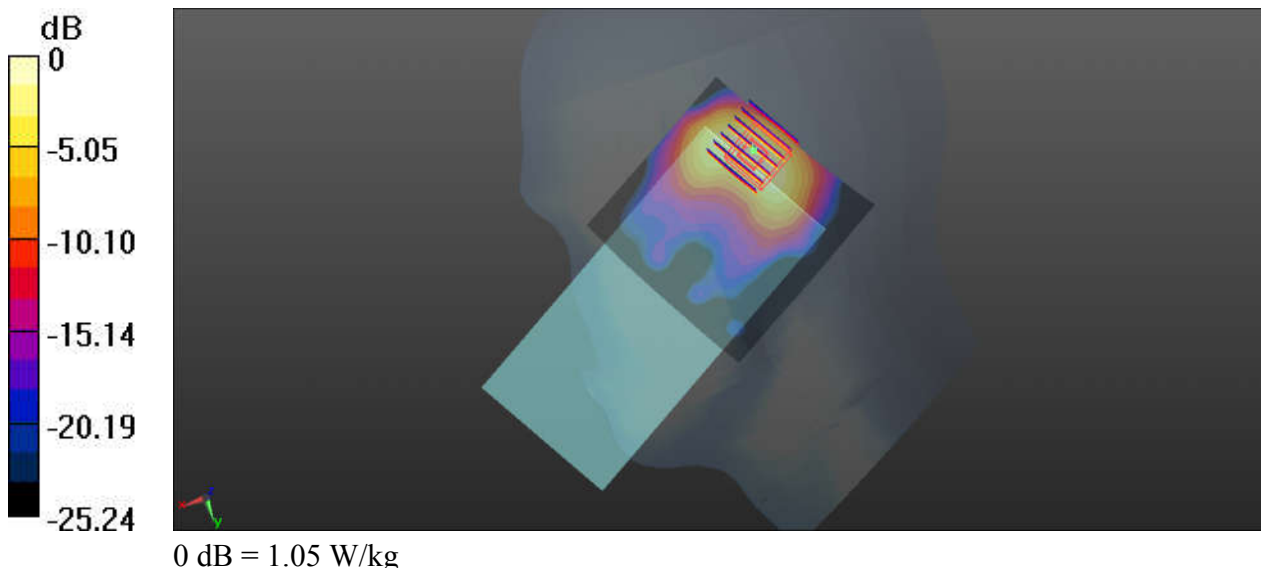

17_LTE Band 7_20M_QPSK_1RB_0Offset_Right Cheek_Ch20850

Communication System: UID 0, LTE (0); Frequency: 2510 MHz; Duty Cycle: 1:1
Medium: HSL_2600_200207 Medium parameters used: $f = 2510$ MHz; $\sigma = 1.95$ S/m; $\epsilon_r = 38.647$; $\rho = 1000$ kg/m³
Ambient Temperature : 23.4 °C; Liquid Temperature : 22.8 °C

DASY5 Configuration:

- Probe: EX3DV4 - SN3819; ConvF(7.06, 7.06, 7.06); Calibrated: 2019.03.01;
- Sensor-Surface: 1.4mm (Mechanical Surface Detection)
- Electronics: DAE4 Sn1386 ; Calibrated: 2019.09.09
- Phantom: SAM (Front) with CRP v5.0; Type: QD000P40CD; Serial: TP:1795
- Measurement SW: DASY52, Version 52.8 (8); SEMCAD X Version 14.6.10 (7331)

Ch20850/Area Scan (81x81x1): Interpolated grid: dx=12mm, dy=12mm
Maximum value of SAR (interpolated) = 0.860 W/kg

Ch20850/Zoom Scan (7x7x7)/Cube 0: Measurement grid: dx=5mm, dy=5mm, dz=5mm
Reference Value = 18.77 V/m; Power Drift = 0.07 dB
Peak SAR (extrapolated) = 1.96 W/kg
SAR(1 g) = 0.688 W/kg; SAR(10 g) = 0.275 W/kg
Maximum value of SAR (measured) = 0.955 W/kg

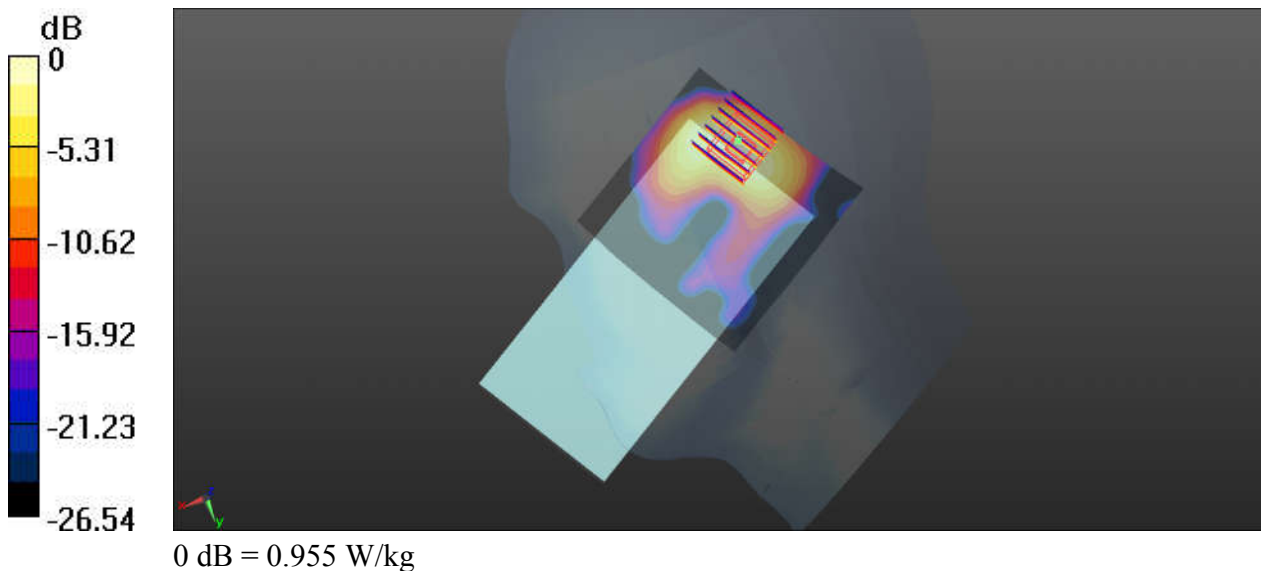

18_LTE Band 41_20M_QPSK_50RB_24Offset_Right Cheek_Ch39750

Communication System: LTE; Frequency: 2506 MHz; Duty Cycle: 1:1.59
Medium: HSL_2600_200105 Medium parameters used: $f = 2506$ MHz; $\sigma = 1.948$ S/m; $\epsilon_r = 37.931$;
 $\rho = 1000$ kg/m³
Ambient Temperature : 23.4 °C; Liquid Temperature : 22.4 °C

DASY5 Configuration:

- Probe: EX3DV4 - SN3819; ConvF(7.06, 7.06, 7.06); Calibrated: 2019.03.01;
- Sensor-Surface: 1.4mm (Mechanical Surface Detection)
- Electronics: DAE4 Sn715; Calibrated: 2019.01.23
- Phantom: SAM (Front) with CRP v5.0; Type: QD000P40CD; Serial: TP:1795
- Measurement SW: DASY52, Version 52.8 (8); SEMCAD X Version 14.6.10 (7331)

Area Scan (81x81x1): Interpolated grid: dx=1.200 mm, dy=1.200 mm
Maximum value of SAR (interpolated) = 0.900 W/kg

Zoom Scan (7x7x7)/Cube 0: Measurement grid: dx=5mm, dy=5mm, dz=5mm
Reference Value = 15.84 V/m; Power Drift = -0.05 dB
Peak SAR (extrapolated) = 1.83 W/kg
SAR(1 g) = 0.663 W/kg; SAR(10 g) = 0.261 W/kg
Maximum value of SAR (measured) = 0.944 W/kg

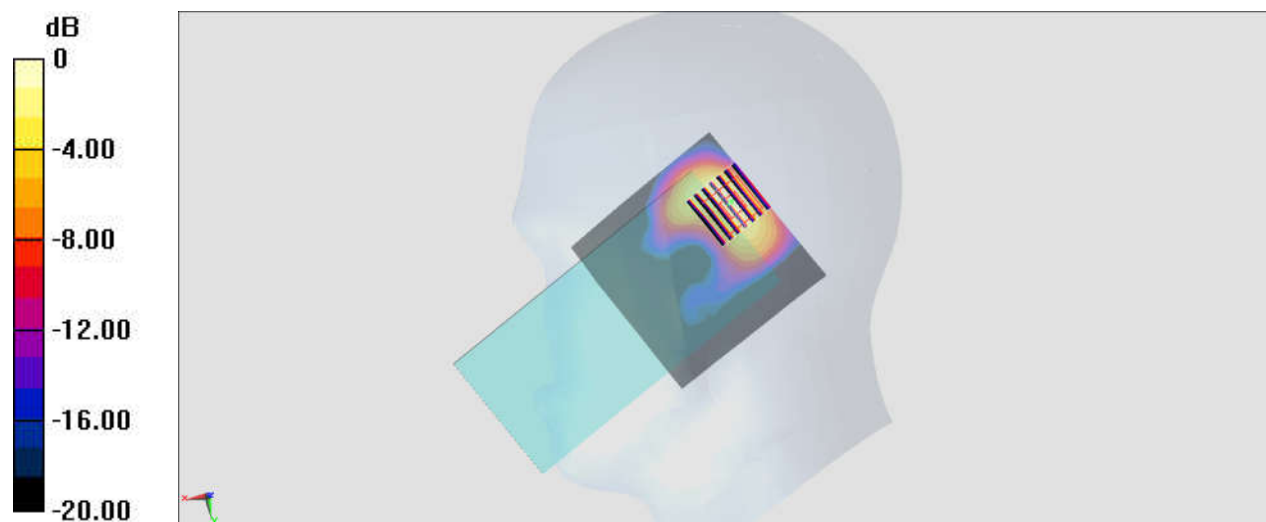

0 dB = 0.944 W/kg = -0.25 dBW/kg

19_LTE Band 48_20M_QPSK_50RB_24Offset_Right Tilted_Ch56640

Communication System: LTE; Frequency: 3690 MHz; Duty Cycle: 1:1.59
Medium: HSL_3700_200109 Medium parameters used : $f = 3690$ MHz; $\sigma = 3.046$ S/m; $\epsilon_r = 38.387$;
 $\rho = 1000$ kg/m³
Ambient Temperature : 23.6 °C; Liquid Temperature : 22.8 °C

DASY5 Configuration:

- Probe: EX3DV4 - SN3819; ConvF(6.67, 6.67, 6.67); Calibrated: 2019.03.01;
- Sensor-Surface: 1.4mm (Mechanical Surface Detection)
- Electronics: DAE4 Sn715; Calibrated: 2019.01.23
- Phantom: SAM (Front) with CRP v5.0; Type: QD000P40CD; Serial: TP:1795
- Measurement SW: DASY52, Version 52.8 (8); SEMCAD X Version 14.6.10 (7331)

Area Scan (81x71x1): Interpolated grid: dx=1.200 mm, dy=1.200 mm
Maximum value of SAR (interpolated) = 1.52 W/kg

Zoom Scan (7x7x7)/Cube 0: Measurement grid: dx=5mm, dy=5mm, dz=1.4mm
Reference Value = 13.06 V/m; Power Drift = 0.10 dB
Peak SAR (extrapolated) = 3.16 W/kg
SAR(1 g) = 0.846 W/kg; SAR(10 g) = 0.266 W/kg
Maximum value of SAR (measured) = 2.05 W/kg

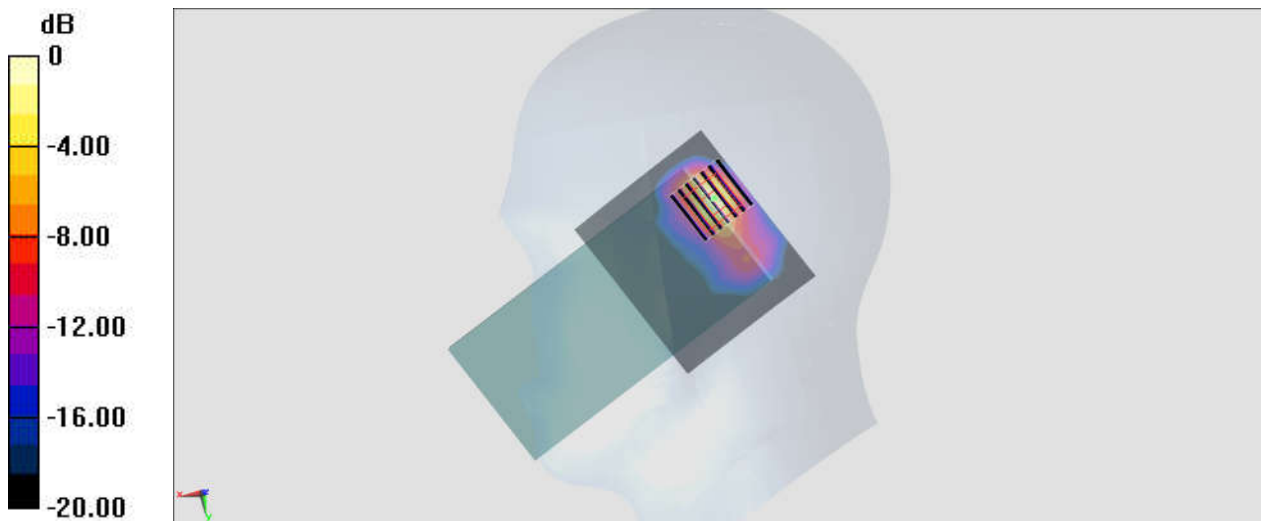

0 dB = 2.05 W/kg = 3.12 dBW/kg

20_LTE N2_20M_PI/2 BPSK_1_53_Right Tilted_Ch380000

Communication System: NR; Frequency: 1900 MHz; Duty Cycle: 1:1

Medium: HSL_1900_200213 Medium parameters used: $f = 1900$ MHz; $\sigma = 1.413$ S/m; $\epsilon_r = 40.359$; $\rho = 1000$ kg/m³

Ambient Temperature : 23.6 °C; Liquid Temperature : 22.6 °C

DASY5 Configuration:

- Probe: ES3DV3 - SN3184; ConvF(5.23, 5.23, 5.23) @ 1900 MHz; Calibrated: 2019/9/25
- Sensor-Surface: 3mm (Mechanical Surface Detection)
- Electronics: DAE4 Sn1305; Calibrated: 2019/4/30
- Phantom: SAM_Left; Type: QD000P40CD; Serial: TP:1684
- Measurement SW: DASY52, Version 52.10 (2); SEMCAD X Version 14.6.12 (7470)

Area Scan (71x71x1): Interpolated grid: dx=1.500 mm, dy=1.500 mm

Maximum value of SAR (interpolated) = 0.980 W/kg

Zoom Scan (5x5x7)/Cube 0: Measurement grid: dx=8mm, dy=8mm, dz=5mm

Reference Value = 9.730 V/m; Power Drift = -0.15 dB

Peak SAR (extrapolated) = 1.10 W/kg

SAR(1 g) = 0.576 W/kg; SAR(10 g) = 0.261 W/kg

Maximum value of SAR (measured) = 0.783 W/kg

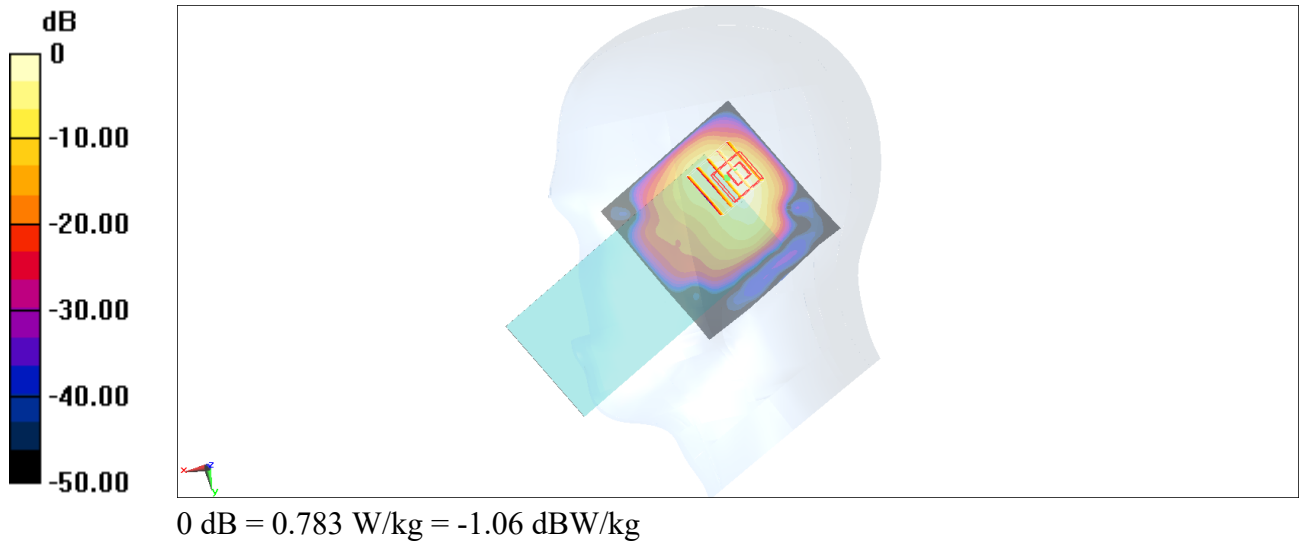

21_N5_20M_PI/2 BPSK_50_0_Left Cheek_Ch167800

Communication System: NR; Frequency: 839 MHz; Duty Cycle: 1:1

Medium: HSL_850_200207 Medium parameters used: $f = 839$ MHz; $\sigma = 0.9$ S/m; $\epsilon_r = 40.774$; $\rho = 1000$ kg/m³

Ambient Temperature : 23.1 °C; Liquid Temperature : 22.1 °C

DASY5 Configuration:

- Probe: ES3DV3 - SN3184; ConvF(6.41, 6.41, 6.41) @ 839 MHz; Calibrated: 2019/9/25
- Sensor-Surface: 3mm (Mechanical Surface Detection)
- Electronics: DAE4 Sn1305; Calibrated: 2019/4/30
- Phantom: SAM_Right; Type: QD000P40CD; Serial: TP:1683
- Measurement SW: DASY52, Version 52.10 (2); SEMCAD X Version 14.6.12 (7470)

Area Scan (71x131x1): Interpolated grid: dx=1.500 mm, dy=1.500 mm

Maximum value of SAR (interpolated) = 0.366 W/kg

Zoom Scan (5x5x7)/Cube 0: Measurement grid: dx=8mm, dy=8mm, dz=5mm

Reference Value = 8.174 V/m; Power Drift = -0.15 dB

Peak SAR (extrapolated) = 0.557 W/kg

SAR(1 g) = 0.286 W/kg; SAR(10 g) = 0.151 W/kg

Maximum value of SAR (measured) = 0.330 W/kg

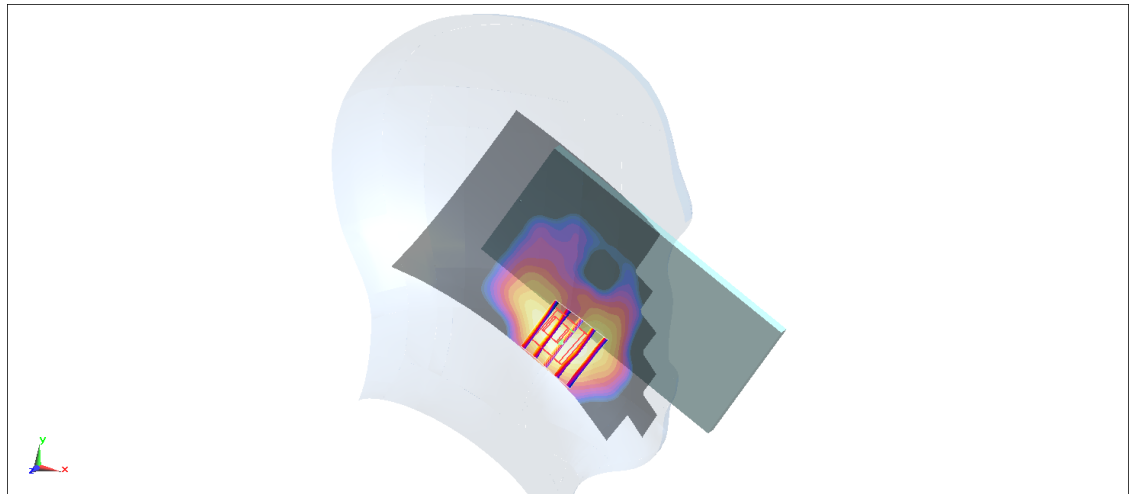
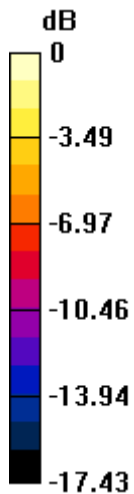

0 dB = 0.330 W/kg = -4.82 dBW/kg

22_LTE N41_100M_PI/2 BPSK_135_69_Right Tilted_Ch528000

Communication System: NR; Frequency: 2640 MHz; Duty Cycle: 1:4

Medium: HSL_2600_200213 Medium parameters used: $f = 2640$ MHz; $\sigma = 2.009$ S/m; $\epsilon_r = 38.685$; $\rho = 1000$ kg/m³

Ambient Temperature : 23.6 °C; Liquid Temperature : 22.6 °C

DASY5 Configuration:

- Probe: ES3DV3 - SN3184; ConvF(4.49, 4.49, 4.49) @ 2640 MHz; Calibrated: 2019/9/25
- Sensor-Surface: 3mm (Mechanical Surface Detection)
- Electronics: DAE4 Sn1305; Calibrated: 2019/4/30
- Phantom: SAM_Right; Type: QD000P40CD; Serial: TP:1683
- Measurement SW: DASY52, Version 52.10 (2); SEMCAD X Version 14.6.12 (7470)

Area Scan (91x91x1): Interpolated grid: dx=1.200 mm, dy=1.200 mm

Maximum value of SAR (interpolated) = 0.770 W/kg

Zoom Scan (7x7x7)/Cube 0: Measurement grid: dx=5mm, dy=5mm, dz=5mm

Reference Value = 8.300 V/m; Power Drift = -0.19 dB

Peak SAR (extrapolated) = 1.44 W/kg

SAR(1 g) = 0.556 W/kg; SAR(10 g) = 0.213 W/kg

Maximum value of SAR (measured) = 0.767 W/kg

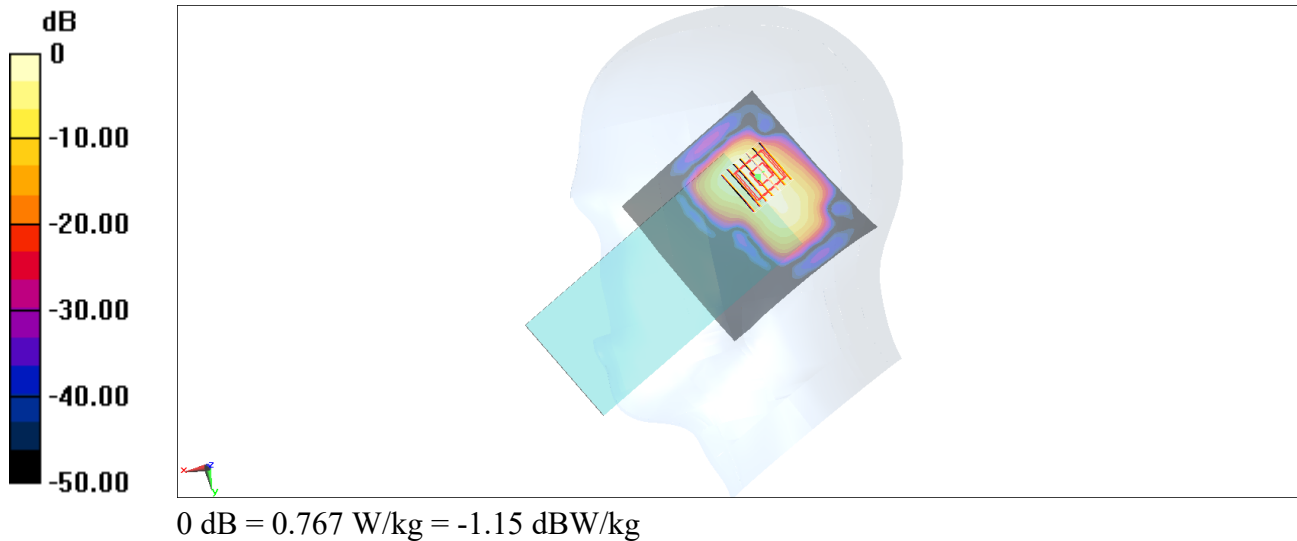

23_N66_20M_PI/2 BPSK_50_0_Right Tilted_Ch354000

Communication System: NR; Frequency: 1770 MHz; Duty Cycle: 1:1

Medium: HSL_1750_200207 Medium parameters used: $f = 1770$ MHz; $\sigma = 1.372$ S/m; $\epsilon_r = 39.529$; $\rho = 1000$ kg/m³

Ambient Temperature : 23.3 °C; Liquid Temperature : 22.3 °C

DASY5 Configuration:

- Probe: EX3DV4 - SN7346; ConvF(8.5, 8.5, 8.5) @ 1770 MHz; Calibrated: 2019/4/25
- Sensor-Surface: 1.4mm (Mechanical Surface Detection)
- Electronics: DAE4 Sn853; Calibrated: 2019/7/18
- Phantom: SAM_Left; Type: QD000P40CD; Serial: TP:1477
- Measurement SW: DASY52, Version 52.10 (2); SEMCAD X Version 14.6.12 (7470)

Area Scan (71x81x1): Interpolated grid: dx=1.500 mm, dy=1.500 mm

Maximum value of SAR (interpolated) = 0.740 W/kg

Zoom Scan (5x5x7)/Cube 0: Measurement grid: dx=8mm, dy=8mm, dz=5mm

Reference Value = 22.84 V/m; Power Drift = -0.09 dB

Peak SAR (extrapolated) = 1.231 W/kg

SAR(1 g) = 0.533 W/kg; SAR(10 g) = 0.259 W/kg

Maximum value of SAR (measured) = 0.945 W/kg

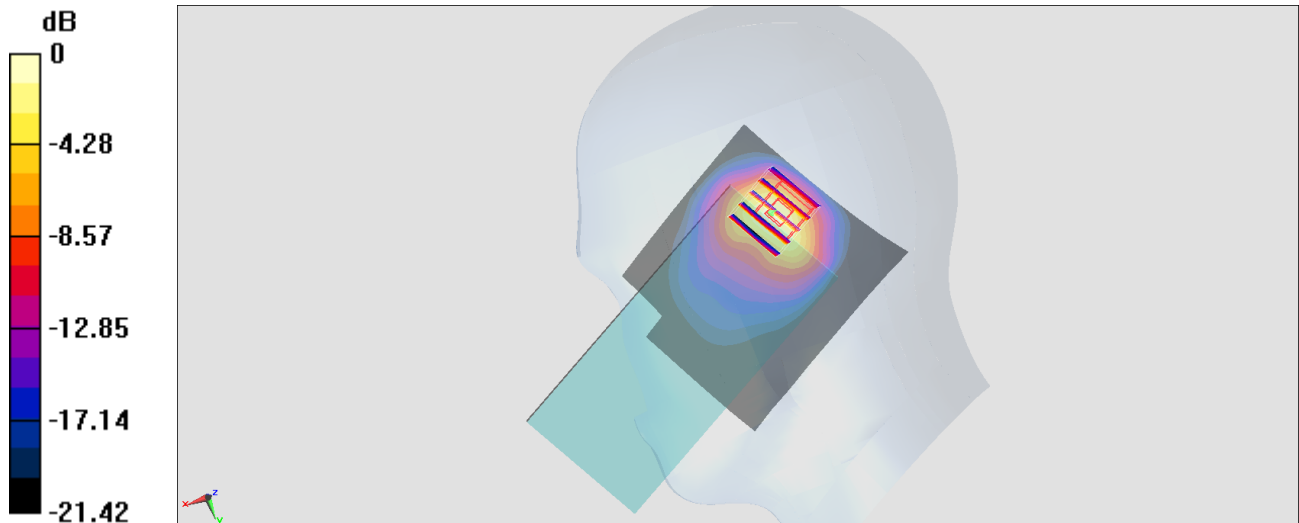

24_N71_20M_PI/2 BPSK_50_0_Left Cheek_Ch136100

Communication System: NR; Frequency: 680.5 MHz; Duty Cycle: 1:1

Medium: HSL_750_200208 Medium parameters used: $f = 680.5$ MHz; $\sigma = 0.827$ S/m; $\epsilon_r = 42.282$; $\rho = 1000$ kg/m³

Ambient Temperature : 23.6 °C ; Liquid Temperature : 22.6 °C

DASY5 Configuration:

- Probe: ES3DV3 - SN3184; ConvF(6.61, 6.61, 6.61) @ 680.5 MHz; Calibrated: 2019/9/25
- Sensor-Surface: 3mm (Mechanical Surface Detection)
- Electronics: DAE4 Sn1305; Calibrated: 2019/4/30
- Phantom: SAM_Right; Type: QD000P40CD; Serial: TP:1683
- Measurement SW: DASY52, Version 52.10 (2); SEMCAD X Version 14.6.12 (7470)

Area Scan (71x131x1): Interpolated grid: dx=1.500 mm, dy=1.500 mm

Maximum value of SAR (interpolated) = 0.293 W/kg

Zoom Scan (5x5x7)/Cube 0: Measurement grid: dx=8mm, dy=8mm, dz=5mm

Reference Value = 7.733 V/m; Power Drift = 0.05 dB

Peak SAR (extrapolated) = 0.438 W/kg

SAR(1 g) = 0.231 W/kg; SAR(10 g) = 0.123 W/kg

Maximum value of SAR (measured) = 0.267 W/kg

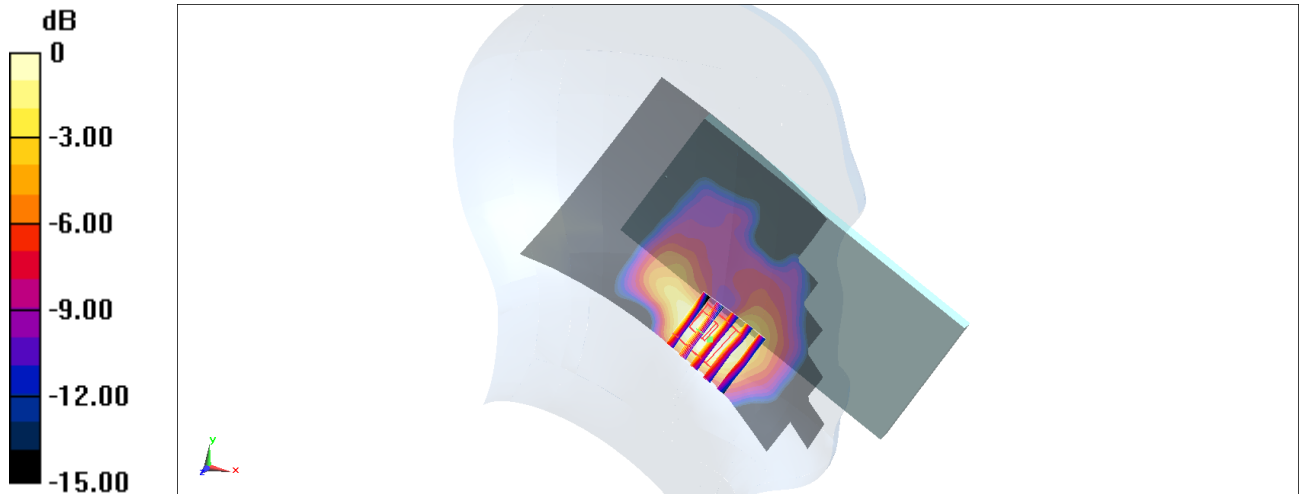

0 dB = 0.267 W/kg = -5.74 dBW/kg

25_WLAN2.4GHz_802.11b 1Mbps_Left Cheek_Ch11

Communication System: WIFI; Frequency: 2462 MHz; Duty Cycle: 1:1

Medium: HSL_2450_200102 Medium parameters used: $f = 2462$ MHz; $\sigma = 1.87$ S/m; $\epsilon_r = 37.627$; $\rho = 1000$ kg/m³

Ambient Temperature : 23.4 °C; Liquid Temperature : 22.4 °C

DASY5 Configuration:

- Probe: EX3DV4 - SN3819; ConvF(7.21, 7.21, 7.21); Calibrated: 2019.03.01;
- Sensor-Surface: 1.4mm (Mechanical Surface Detection)
- Electronics: DAE4 Sn715; Calibrated: 2019.01.23
- Phantom: SAM (Front) with CRP v5.0; Type: QD000P40CD; Serial: TP:1795
- Measurement SW: DASY52, Version 52.8 (8); SEMCAD X Version 14.6.10 (7331)

Area Scan (81x81x1): Interpolated grid: dx=1.200 mm, dy=1.200 mm

Maximum value of SAR (interpolated) = 0.899 W/kg

Zoom Scan (7x7x7)/Cube 0: Measurement grid: dx=5mm, dy=5mm, dz=5mm

Reference Value = 10.09 V/m; Power Drift = -0.01 dB

Peak SAR (extrapolated) = 1.55 W/kg

SAR(1 g) = 0.645 W/kg; SAR(10 g) = 0.245 W/kg

Maximum value of SAR (measured) = 0.883 W/kg

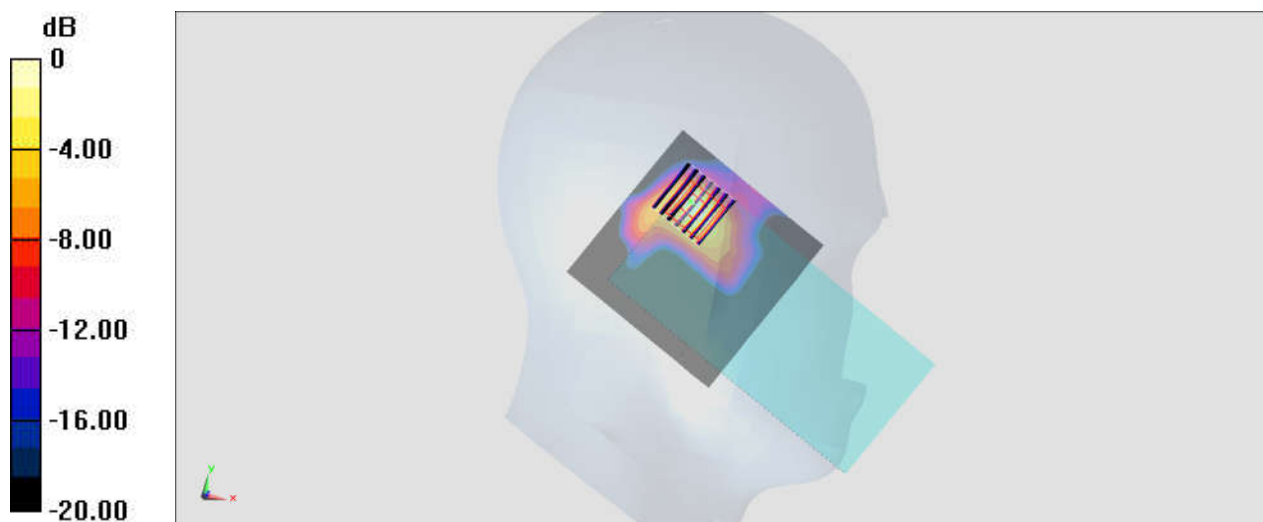

0 dB = 0.883 W/kg = -0.54 dBW/kg

26_WLAN5GHz_802.11n-HT40 MCS0_Left Tilted_Ch62

Communication System: WIFI; Frequency: 5310 MHz; Duty Cycle: 1:1.02

Medium: HSL_5250_200114 Medium parameters used: $f = 5310$ MHz; $\sigma = 4.708$ S/m; $\epsilon_r = 37.006$;
 $\rho = 1000$ kg/m³

Ambient Temperature : 23.7 °C ; Liquid Temperature : 22.4 °C

DASY5 Configuration:

- Probe: EX3DV4 - SN3819; ConvF(5.07, 5.07, 5.07); Calibrated: 2019.03.01;
- Sensor-Surface: 1.4mm (Mechanical Surface Detection)
- Electronics: DAE4 Sn715; Calibrated: 2019.01.23
- Phantom: SAM (Front) with CRP v5.0; Type: QD000P40CD; Serial: TP:1795
- Measurement SW: DASY52, Version 52.8 (8); SEMCAD X Version 14.6.10 (7331)

Area Scan (101x101x1): Interpolated grid: dx=1.000 mm, dy=1.000 mm

Maximum value of SAR (interpolated) = 0.851 W/kg

Zoom Scan (7x7x7)/Cube 0: Measurement grid: dx=4mm, dy=4mm, dz=1.4mm

Reference Value = 6.004 V/m; Power Drift = 0.15 dB

Peak SAR (extrapolated) = 1.79 W/kg

SAR(1 g) = 0.347 W/kg; SAR(10 g) = 0.102 W/kg

Maximum value of SAR (measured) = 0.929 W/kg

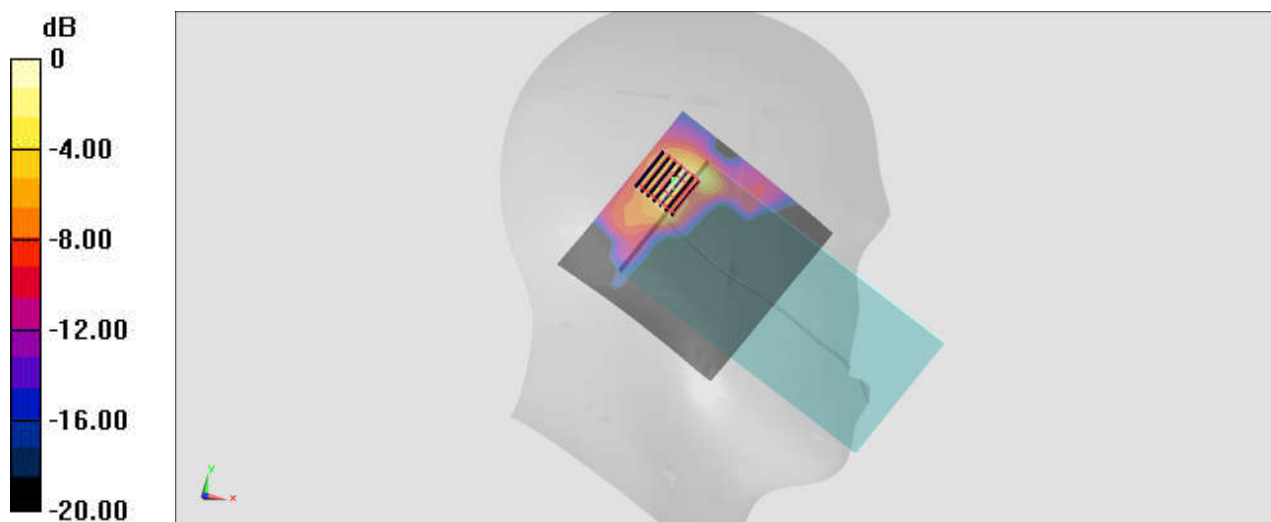

0 dB = 0.929 W/kg = -0.32 dBW/kg

27_WLAN5GHz_802.11n-HT40 MCS0_Left Tilted_Ch110

Communication System: WIFI; Frequency: 5550 MHz; Duty Cycle: 1:1.02
 Medium: HSL_5600_200113 Medium parameters used: $f = 5550 \text{ MHz}$; $\sigma = 4.989 \text{ S/m}$; $\epsilon_r = 36.631$;
 $\rho = 1000 \text{ kg/m}^3$
 Ambient Temperature : $23.7 \text{ }^\circ\text{C}$; Liquid Temperature : $22.5 \text{ }^\circ\text{C}$

DASY5 Configuration:

- Probe: EX3DV4 - SN3819; ConvF(4.7, 4.7, 4.7); Calibrated: 2019.03.01;
- Sensor-Surface: 1.4mm (Mechanical Surface Detection)
- Electronics: DAE4 Sn715; Calibrated: 2019.01.23
- Phantom: SAM (Front) with CRP v5.0; Type: QD000P40CD; Serial: TP:1795
- Measurement SW: DASY52, Version 52.8 (8); SEMCAD X Version 14.6.10 (7331)

Area Scan (101x101x1): Interpolated grid: $dx=1.000 \text{ mm}$, $dy=1.000 \text{ mm}$
 Maximum value of SAR (interpolated) = 0.449 W/kg

Zoom Scan (7x7x7)/Cube 0: Measurement grid: $dx=4\text{mm}$, $dy=4\text{mm}$, $dz=1.4\text{mm}$
 Reference Value = 0 V/m ; Power Drift = 0.00 dB
 Peak SAR (extrapolated) = 0.528 W/kg
SAR(1 g) = 0.099 W/kg ; SAR(10 g) = 0.037 W/kg
 Maximum value of SAR (measured) = 0.311 W/kg

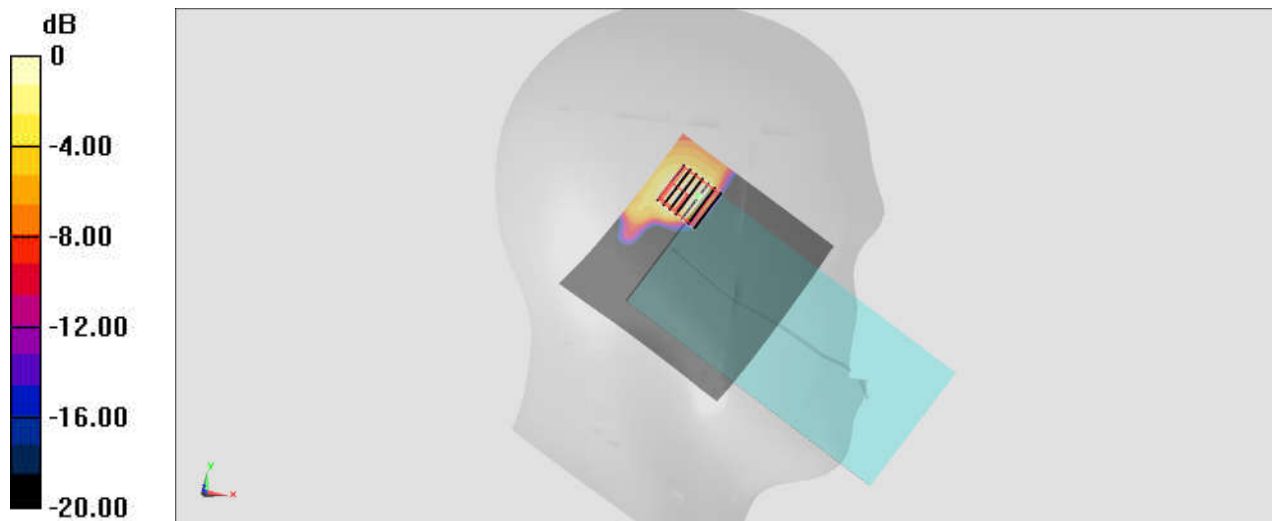

0 dB = $0.311 \text{ W/kg} = -5.07 \text{ dBW/kg}$

28_WLAN5GHz_802.11n-HT40 MCS0_Left Tilted_Ch151

Communication System: WIFI; Frequency: 5755 MHz; Duty Cycle: 1:1.02
Medium: HSL_5750_200115 Medium parameters used: $f = 5755$ MHz; $\sigma = 5.227$ S/m; $\epsilon_r = 36.272$;
 $\rho = 1000$ kg/m³
Ambient Temperature : 23.4 °C; Liquid Temperature : 22.4 °C

DASY5 Configuration:

- Probe: EX3DV4 - SN3819; ConvF(4.77, 4.77, 4.77); Calibrated: 2019.03.01;
- Sensor-Surface: 1.4mm (Mechanical Surface Detection)
- Electronics: DAE4 Sn715; Calibrated: 2019.01.23
- Phantom: SAM (Front) with CRP v5.0; Type: QD000P40CD; Serial: TP:1795
- Measurement SW: DASY52, Version 52.8 (8); SEMCAD X Version 14.6.10 (7331)

Area Scan (101x101x1): Interpolated grid: dx=1.000 mm, dy=1.000 mm
Maximum value of SAR (interpolated) = 0.317 W/kg

Zoom Scan (9x9x7)/Cube 0: Measurement grid: dx=4mm, dy=4mm, dz=1.4mm
Reference Value = 0 V/m; Power Drift = 0.00 dB
Peak SAR (extrapolated) = 0.607 W/kg
SAR(1 g) = 0.062 W/kg; SAR(10 g) = 0.024 W/kg
Maximum value of SAR (measured) = 0.197 W/kg

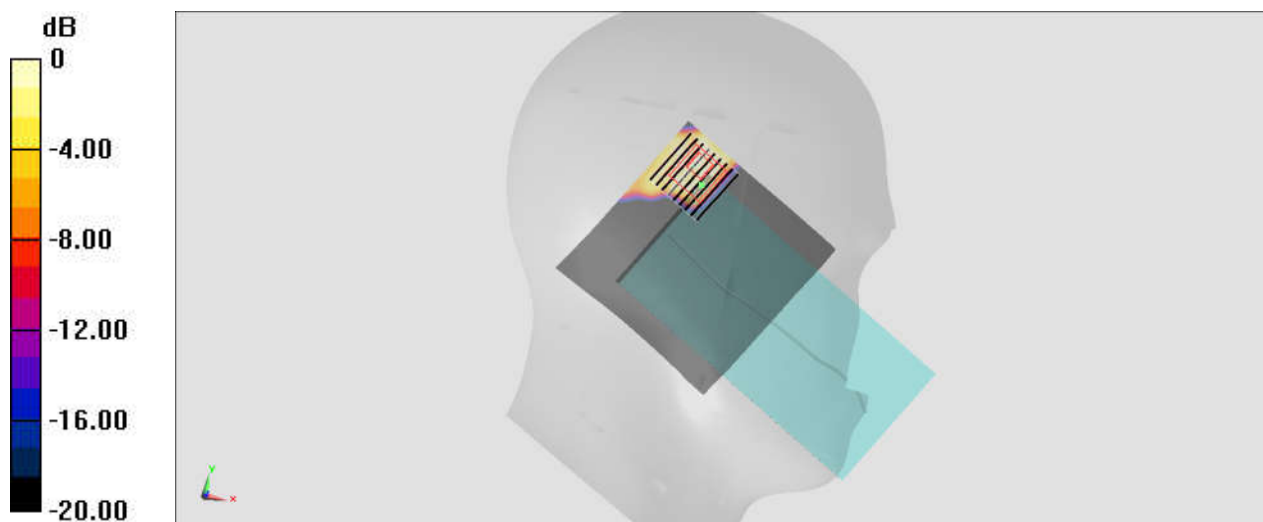

0 dB = 0.197 W/kg = -7.06 dBW/kg

29_Bluetooth_DH5 1Mbps_Left Cheek_Ch39

Communication System: Bluetooth; Frequency: 2441 MHz; Duty Cycle: 1:1.299
Medium: HSL_2450_200102 Medium parameters used: $f = 2441$ MHz; $\sigma = 1.847$ S/m; $\epsilon_r = 37.702$;
 $\rho = 1000$ kg/m³
Ambient Temperature : 23.4 °C; Liquid Temperature : 22.6 °C

DASY5 Configuration:

- Probe: EX3DV4 - SN3819; ConvF(7.21, 7.21, 7.21); Calibrated: 2019.03.01;
- Sensor-Surface: 1.4mm (Mechanical Surface Detection)
- Electronics: DAE4 Sn715; Calibrated: 2019.01.23
- Phantom: SAM (Front) with CRP v5.0; Type: QD000P40CD; Serial: TP:1795
- Measurement SW: DASY52, Version 52.8 (8); SEMCAD X Version 14.6.10 (7331)

Area Scan (81x81x1): Interpolated grid: dx=1.200 mm, dy=1.200 mm
Maximum value of SAR (interpolated) = 0.238 W/kg

Zoom Scan (7x7x7)/Cube 0: Measurement grid: dx=5mm, dy=5mm, dz=5mm
Reference Value = 6.014 V/m; Power Drift = 0.01 dB
Peak SAR (extrapolated) = 0.421 W/kg
SAR(1 g) = 0.174 W/kg; SAR(10 g) = 0.065 W/kg
Maximum value of SAR (measured) = 0.243 W/kg

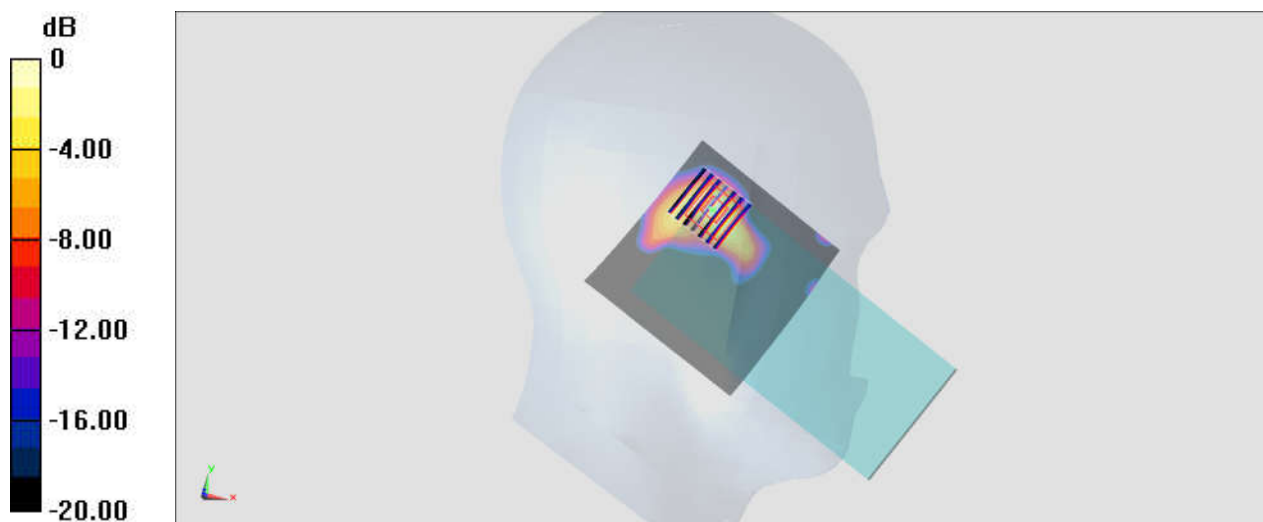

0 dB = 0.243 W/kg = -6.14 dBW/kg

30_GSM850_GPRS(3 Tx slots)_Left Side_10mm_Ch189

Communication System: GPRS; Frequency: 836.4 MHz; Duty Cycle: 1:2.77
Medium: HSL_835_191224 Medium parameters used : $f = 836.4$ MHz; $\sigma = 0.929$ S/m; $\epsilon_r = 42.712$;
 $\rho = 1000$ kg/m³
Ambient Temperature : 23.4 °C; Liquid Temperature : 22.5 °C

DASY5 Configuration:

- Probe: EX3DV4 - SN3819; ConvF(9.57, 9.57, 9.57); Calibrated: 2019.03.01;
- Sensor-Surface: 1.4mm (Mechanical Surface Detection)
- Electronics: DAE4 Sn715; Calibrated: 2019.01.23
- Phantom: SAM (Front) with CRP v5.0; Type: QD000P40CD; Serial: TP:1795
- Measurement SW: DASY52, Version 52.8 (8); SEMCAD X Version 14.6.10 (7331)

Area Scan (41x121x1): Interpolated grid: dx=1.500 mm, dy=1.500 mm
Maximum value of SAR (interpolated) = 0.891 W/kg

Zoom Scan (5x5x7)/Cube 0: Measurement grid: dx=8mm, dy=8mm, dz=5mm
Reference Value = 3.403 V/m; Power Drift = 0.11 dB
Peak SAR (extrapolated) = 1.13 W/kg
SAR(1 g) = 0.649 W/kg; SAR(10 g) = 0.361 W/kg
Maximum value of SAR (measured) = 0.911 W/kg

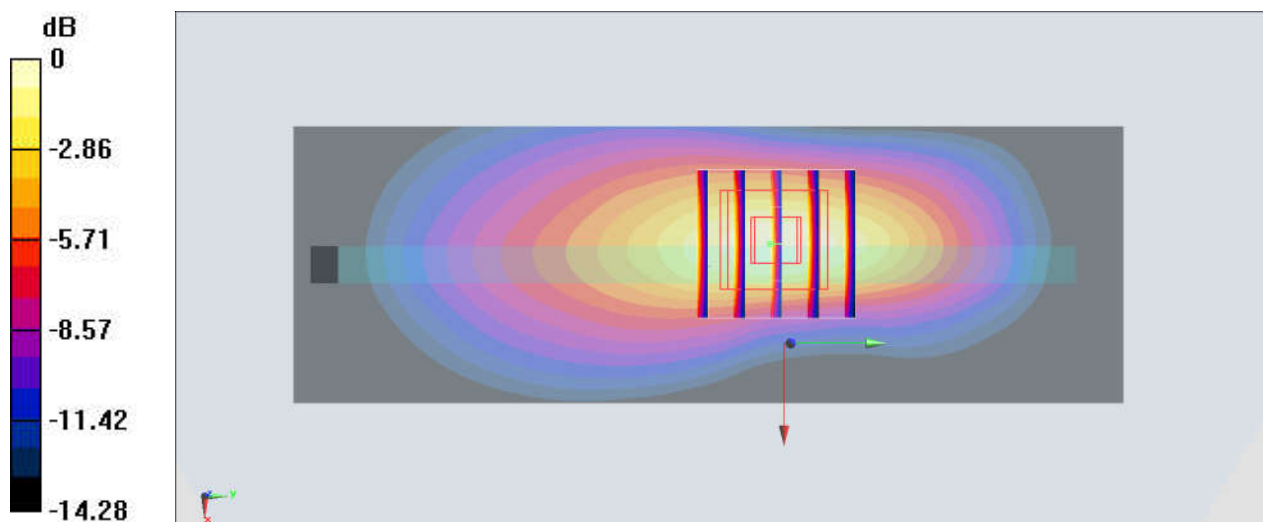

0 dB = 0.911 W/kg = -0.40 dBW/kg

31_GSM1900_GPRS(3 Tx slots)_Bottom Side_10mm_Ch661

Communication System: GPRS; Frequency: 1880 MHz; Duty Cycle: 1:2.77
 Medium: HSL_1900_191218 Medium parameters used: $f = 1880$ MHz; $\sigma = 1.408$ S/m; $\epsilon_r = 41.203$;
 $\rho = 1000$ kg/m³
 Ambient Temperature : 23.5 °C; Liquid Temperature : 22.7 °C

DASY5 Configuration:

- Probe: EX3DV4 - SN3819; ConvF(8.27, 8.27, 8.27); Calibrated: 2019.03.01;
- Sensor-Surface: 1.4mm (Mechanical Surface Detection)
- Electronics: DAE4 Sn715; Calibrated: 2019.01.23
- Phantom: SAM (Front) with CRP v5.0; Type: QD000P40CD; Serial: TP:1795
- Measurement SW: DASY52, Version 52.8 (8); SEMCAD X Version 14.6.10 (7331)

Area Scan (41x71x1): Interpolated grid: dx=1.500 mm, dy=1.500 mm
 Maximum value of SAR (interpolated) = 0.819 W/kg

Zoom Scan (5x5x7)/Cube 0: Measurement grid: dx=8mm, dy=8mm, dz=5mm
 Reference Value = 23.40 V/m; Power Drift = 0.06 dB
 Peak SAR (extrapolated) = 0.990 W/kg
SAR(1 g) = 0.554 W/kg; SAR(10 g) = 0.302 W/kg
 Maximum value of SAR (measured) = 0.768 W/kg

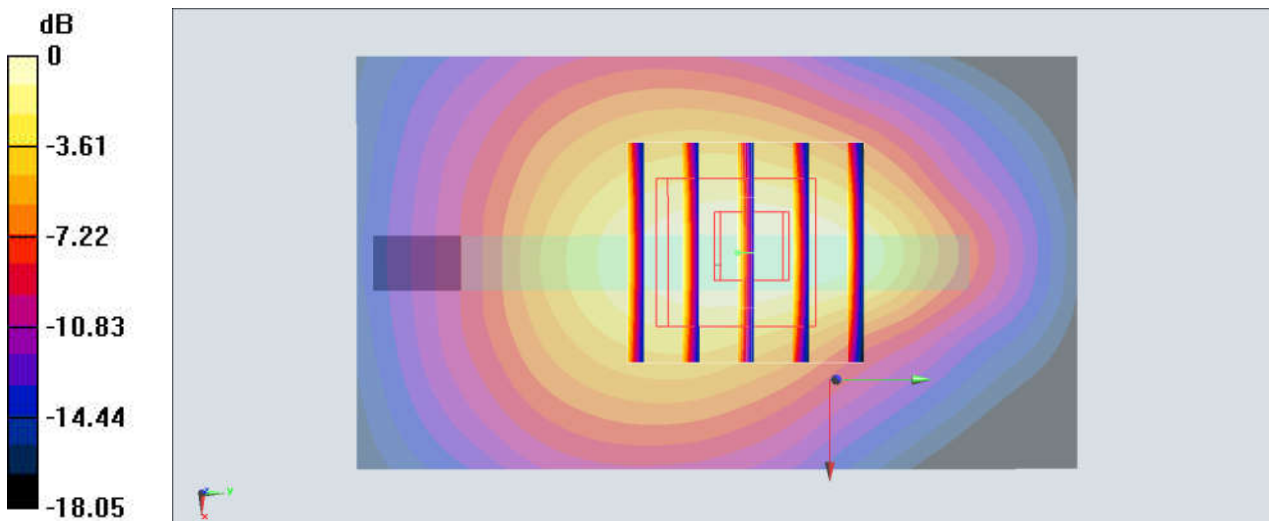

0 dB = 0.768 W/kg = -1.15 dBW/kg

32_WCDMA V_RMC 12.2Kbps_Left Side_10mm_Ch4182

Communication System: UMTS; Frequency: 836.4 MHz; Duty Cycle: 1:1
 Medium: HSL_835_191224 Medium parameters used : $f = 836.4 \text{ MHz}$; $\sigma = 0.929 \text{ S/m}$; $\epsilon_r = 42.712$;
 $\rho = 1000 \text{ kg/m}^3$
 Ambient Temperature : $23.4 \text{ }^\circ\text{C}$; Liquid Temperature : $22.5 \text{ }^\circ\text{C}$

DASY5 Configuration:

- Probe: EX3DV4 - SN3819; ConvF(9.57, 9.57, 9.57); Calibrated: 2019.03.01;
- Sensor-Surface: 1.4mm (Mechanical Surface Detection)
- Electronics: DAE4 Sn715; Calibrated: 2019.01.23
- Phantom: SAM (Front) with CRP v5.0; Type: QD000P40CD; Serial: TP:1795
- Measurement SW: DASY52, Version 52.8 (8); SEMCAD X Version 14.6.10 (7331)

Area Scan (41x121x1): Interpolated grid: $dx=1.500 \text{ mm}$, $dy=1.500 \text{ mm}$
 Maximum value of SAR (interpolated) = 0.951 W/kg

Zoom Scan (5x5x7)/Cube 0: Measurement grid: $dx=8\text{mm}$, $dy=8\text{mm}$, $dz=5\text{mm}$
 Reference Value = 3.098 V/m ; Power Drift = 0.11 dB
 Peak SAR (extrapolated) = 1.26 W/kg
SAR(1 g) = 0.699 W/kg ; SAR(10 g) = 0.384 W/kg
 Maximum value of SAR (measured) = 1.00 W/kg

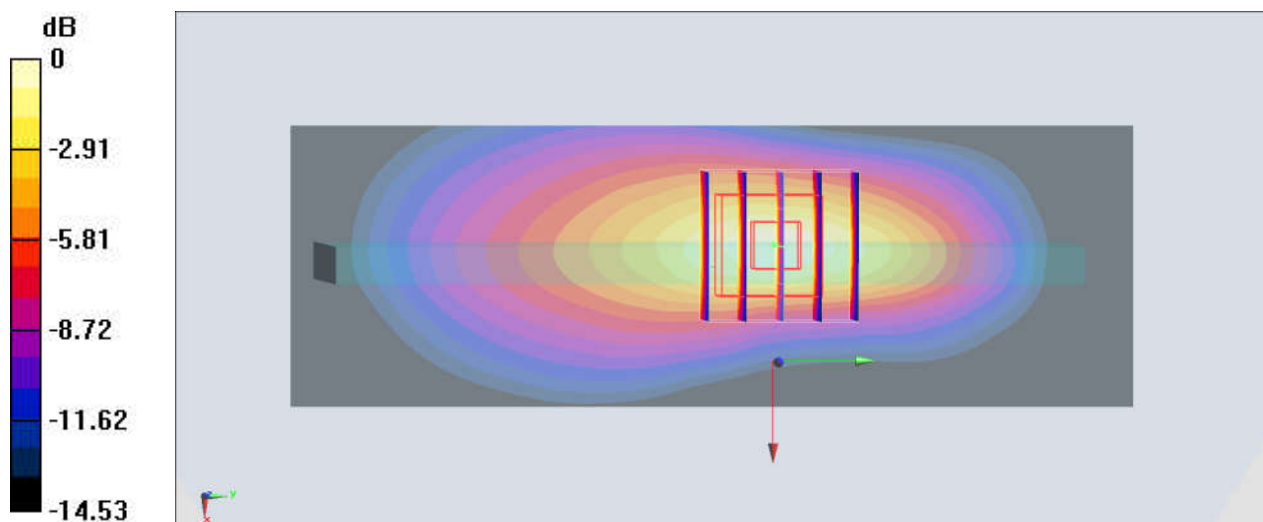

0 dB = 1.00 W/kg = 0.00 dBW/kg

33_WCDMA IV_RMC 12.2Kbps_Bottom Side_10mm_Ch1312

Communication System: UMTS; Frequency: 1712.4 MHz; Duty Cycle: 1:1
Medium: HSL_1750_191221 Medium parameters used : $f = 1712.4 \text{ MHz}$; $\sigma = 1.36 \text{ S/m}$; $\epsilon_r = 39.954$; $\rho = 1000 \text{ kg/m}^3$
Ambient Temperature : $23.5 \text{ }^\circ\text{C}$; Liquid Temperature : $22.4 \text{ }^\circ\text{C}$

DASY5 Configuration:

- Probe: EX3DV4 - SN3819; ConvF(8.54, 8.54, 8.54); Calibrated: 2019.03.01;
- Sensor-Surface: 1.4mm (Mechanical Surface Detection)
- Electronics: DAE4 Sn715; Calibrated: 2019.01.23
- Phantom: SAM (Front) with CRP v5.0; Type: QD000P40CD; Serial: TP:1795
- Measurement SW: DASY52, Version 52.8 (8); SEMCAD X Version 14.6.10 (7331)

Area Scan (41x71x1): Interpolated grid: $dx=1.500 \text{ mm}$, $dy=1.500 \text{ mm}$
Maximum value of SAR (interpolated) = 1.02 W/kg

Zoom Scan (5x5x7)/Cube 0: Measurement grid: $dx=8\text{mm}$, $dy=8\text{mm}$, $dz=5\text{mm}$
Reference Value = 24.51 V/m ; Power Drift = 0.09 dB
Peak SAR (extrapolated) = 1.26 W/kg
SAR(1 g) = 0.734 W/kg ; SAR(10 g) = 0.403 W/kg
Maximum value of SAR (measured) = 1.01 W/kg

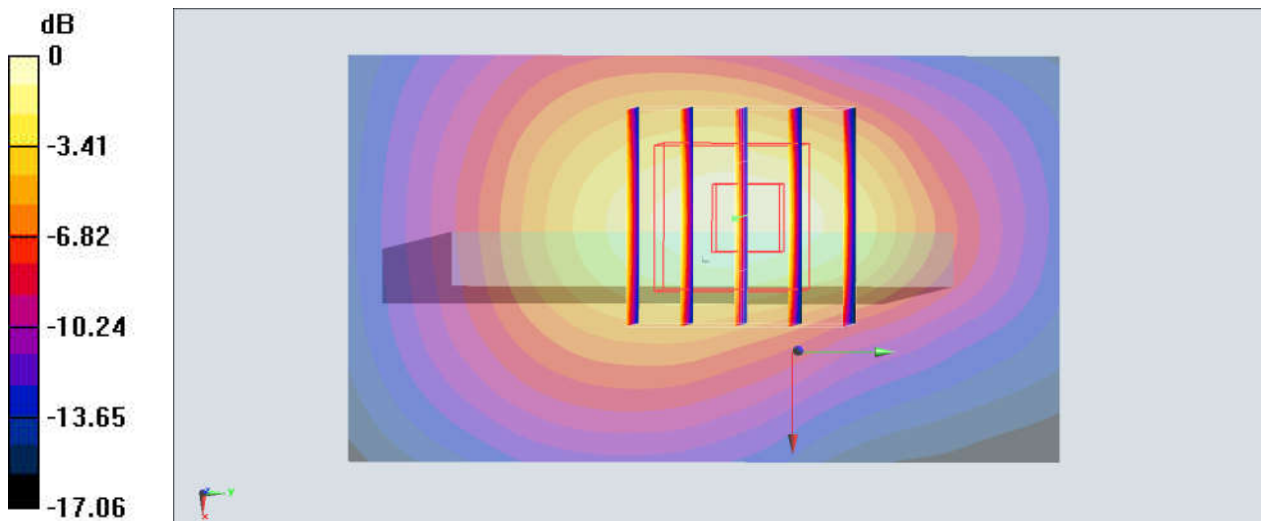

0 dB = 1.01 W/kg = 0.04 dBW/kg

34_WCDMA II_RMC 12.2Kbps_Top Side_10mm_Ch9538

Communication System: UMTS; Frequency: 1907.6 MHz; Duty Cycle: 1:1
Medium: HSL_1900_191218 Medium parameters used: $f = 1908$ MHz; $\sigma = 1.467$ S/m; $\epsilon_r = 39.203$;
 $\rho = 1000$ kg/m³
Ambient Temperature : 23.5 °C ; Liquid Temperature : 22.7 °C

DASY5 Configuration:

- Probe: EX3DV4 - SN3819; ConvF(8.27, 8.27, 8.27); Calibrated: 2019.03.01;
- Sensor-Surface: 1.4mm (Mechanical Surface Detection)
- Electronics: DAE4 Sn715; Calibrated: 2019.01.23
- Phantom: SAM (Front) with CRP v5.0; Type: QD000P40CD; Serial: TP:1795
- Measurement SW: DASY52, Version 52.8 (8); SEMCAD X Version 14.6.10 (7331)

Area Scan (41x71x1): Interpolated grid: dx=1.500 mm, dy=1.500 mm
Maximum value of SAR (interpolated) = 1.07 W/kg

Zoom Scan (5x5x7)/Cube 0: Measurement grid: dx=8mm, dy=8mm, dz=5mm
Reference Value = 22.10 V/m; Power Drift = 0.18 dB
Peak SAR (extrapolated) = 1.41 W/kg
SAR(1 g) = 0.716 W/kg; SAR(10 g) = 0.370 W/kg
Maximum value of SAR (measured) = 1.07 W/kg

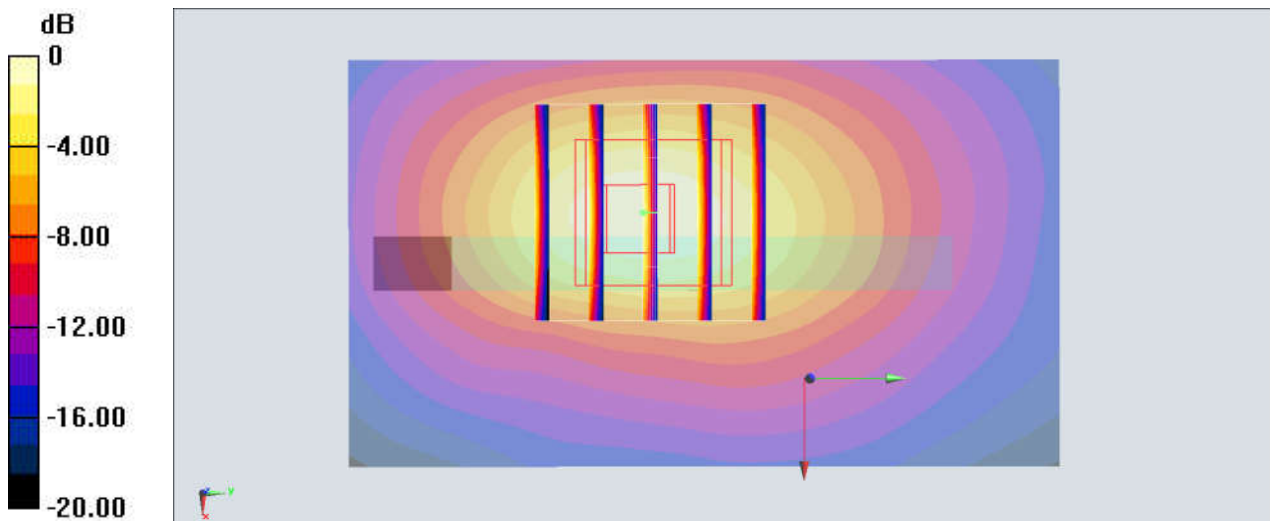

0 dB = 1.07 W/kg = 0.29 dBW/kg

35_CDMA2000 BC0_RTAP 153.6Kbps_Left Side_10mm_Ch777

Communication System: CDMA; Frequency: 848.31 MHz; Duty Cycle: 1:1
Medium: HSL_835_191224 Medium parameters used : $f = 848.31$ MHz; $\sigma = 0.941$ S/m; $\epsilon_r = 42.565$; $\rho = 1000$ kg/m³
Ambient Temperature : 23.4 °C; Liquid Temperature : 22.5 °C

DASY5 Configuration:

- Probe: EX3DV4 - SN3819; ConvF(9.57, 9.57, 9.57); Calibrated: 2019.03.01;
- Sensor-Surface: 1.4mm (Mechanical Surface Detection)
- Electronics: DAE4 Sn715; Calibrated: 2019.01.23
- Phantom: SAM (Front) with CRP v5.0; Type: QD000P40CD; Serial: TP:1795
- Measurement SW: DASY52, Version 52.8 (8); SEMCAD X Version 14.6.10 (7331)

Area Scan (41x121x1): Interpolated grid: dx=1.500 mm, dy=1.500 mm
Maximum value of SAR (interpolated) = 0.728 W/kg

Zoom Scan (5x5x7)/Cube 0: Measurement grid: dx=8mm, dy=8mm, dz=5mm
Reference Value = 22.66 V/m; Power Drift = -0.18 dB
Peak SAR (extrapolated) = 0.977 W/kg
SAR(1 g) = 0.543 W/kg; SAR(10 g) = 0.296 W/kg
Maximum value of SAR (measured) = 0.772 W/kg

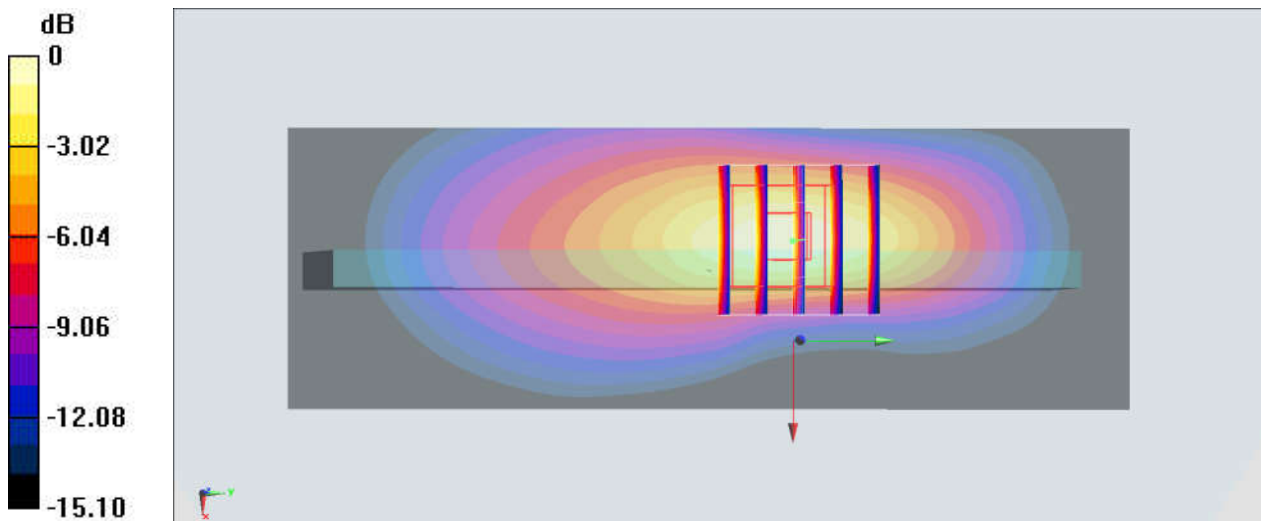

0 dB = 0.772 W/kg = -1.12 dBW/kg

36_CDMA2000 BC10_RTAP 153.6Kbps_Left Side_10mm_Ch476

Communication System: CDMA; Frequency: 817.9 MHz; Duty Cycle: 1:1
Medium: HSL_835_191224 Medium parameters used : $f = 817.9$ MHz; $\sigma = 0.911$ S/m; $\epsilon_r = 42.951$;
 $\rho = 1000$ kg/m³
Ambient Temperature : 23.4 °C; Liquid Temperature : 22.4 °C

DASY5 Configuration:

- Probe: EX3DV4 - SN3819; ConvF(9.57, 9.57, 9.57); Calibrated: 2019.03.01;
- Sensor-Surface: 1.4mm (Mechanical Surface Detection)
- Electronics: DAE4 Sn715; Calibrated: 2019.01.23
- Phantom: SAM (Front) with CRP v5.0; Type: QD000P40CD; Serial: TP:1795
- Measurement SW: DASY52, Version 52.8 (8); SEMCAD X Version 14.6.10 (7331)

Area Scan (41x121x1): Interpolated grid: dx=1.500 mm, dy=1.500 mm
Maximum value of SAR (interpolated) = 0.753 W/kg

Zoom Scan (5x5x7)/Cube 0: Measurement grid: dx=8mm, dy=8mm, dz=5mm
Reference Value = 23.65 V/m; Power Drift = -0.13 dB
Peak SAR (extrapolated) = 0.977 W/kg
SAR(1 g) = 0.546 W/kg; SAR(10 g) = 0.300 W/kg
Maximum value of SAR (measured) = 0.779 W/kg

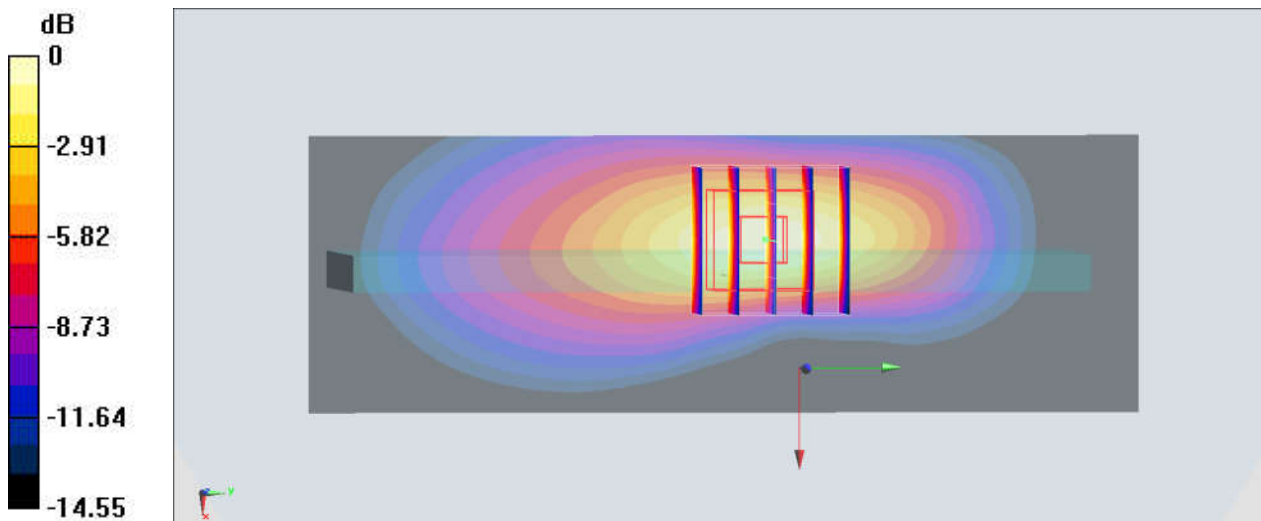

0 dB = 0.779 W/kg = -1.08 dBW/kg

37_CDMA2000 BC1_RTAP 153.6Kbps_Bottom Side_10mm_Ch1175

Communication System: CDMA2000 ; Frequency: 1908.75 MHz; Duty Cycle: 1:1

Medium: HSL_1900_191218 Medium parameters used: $f = 1909$ MHz; $\sigma = 1.426$ S/m; $\epsilon_r = 41.109$; $\rho = 1000$ kg/m³

Ambient Temperature : 23.5 °C ; Liquid Temperature : 22.7 °C

DASY5 Configuration:

- Probe: EX3DV4 - SN3819; ConvF(8.27, 8.27, 8.27); Calibrated: 2019.03.01;
- Sensor-Surface: 2mm (Mechanical Surface Detection)
- Electronics: DAE4 Sn715; Calibrated: 2019.01.23
- Phantom: SAM (Front) with CRP v5.0; Type: QD000P40CD; Serial: TP:1795
- Measurement SW: DASY52, Version 52.8 (8); SEMCAD X Version 14.6.10 (7331)

Area Scan (41x71x1): Interpolated grid: dx=1.500 mm, dy=1.500 mm

Maximum value of SAR (interpolated) = 0.911 W/kg

Zoom Scan (5x5x7)/Cube 0: Measurement grid: dx=8mm, dy=8mm, dz=5mm

Reference Value = 1.200 V/m; Power Drift = 0.09 dB

Peak SAR (extrapolated) = 1.06 W/kg

SAR(1 g) = 0.600 W/kg; SAR(10 g) = 0.332 W/kg

Maximum value of SAR (measured) = 0.779 W/kg

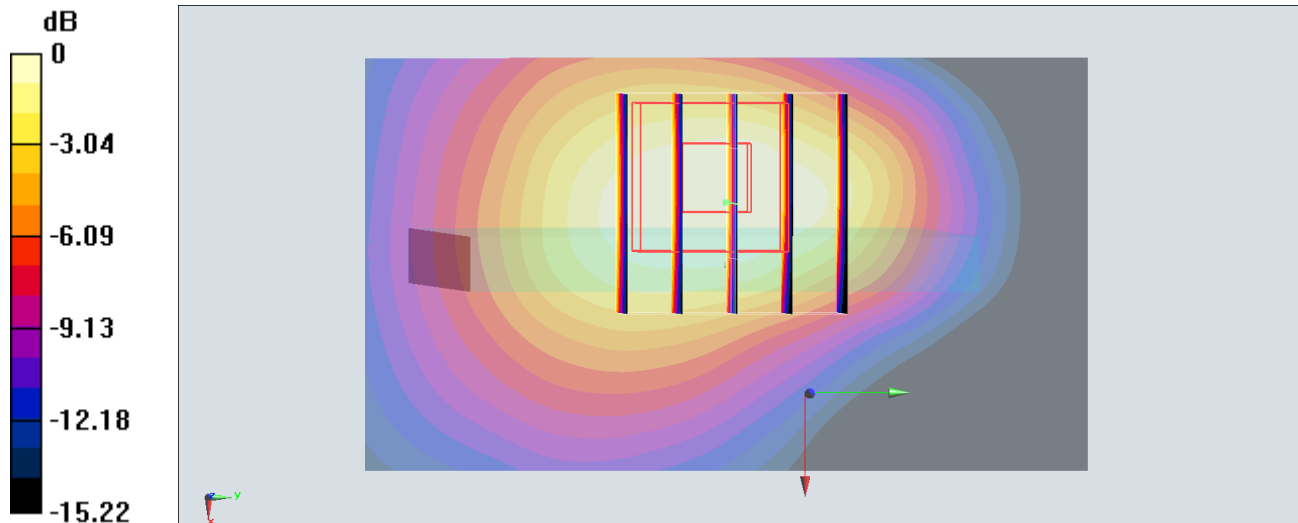

38_LTE Band 71_20M_QPSK_1RB_0Offset_Left Side_10mm_Ch133322

Communication System: LTE; Frequency: 673 MHz; Duty Cycle: 1:1
Medium: HSL_750_191227 Medium parameters used : $f = 673$ MHz; $\sigma = 0.838$ S/m; $\epsilon_r = 43.022$; $\rho = 1000$ kg/m³
Ambient Temperature : 23.4 °C; Liquid Temperature : 22.4 °C

DASY5 Configuration:

- Probe: EX3DV4 - SN3819; ConvF(10, 10, 10); Calibrated: 2019.03.01;
- Sensor-Surface: 1.4mm (Mechanical Surface Detection)
- Electronics: DAE4 Sn715; Calibrated: 2019.01.23
- Phantom: SAM (Front) with CRP v5.0; Type: QD000P40CD; Serial: TP:1795
- Measurement SW: DASY52, Version 52.8 (8); SEMCAD X Version 14.6.10 (7331)

Area Scan (41x121x1): Interpolated grid: dx=1.500 mm, dy=1.500 mm
Maximum value of SAR (interpolated) = 0.755 W/kg

Zoom Scan (5x5x7)/Cube 0: Measurement grid: dx=8mm, dy=8mm, dz=5mm
Reference Value = 12.59 V/m; Power Drift = -0.04 dB
Peak SAR (extrapolated) = 1.01 W/kg
SAR(1 g) = 0.633 W/kg; SAR(10 g) = 0.355 W/kg
Maximum value of SAR (measured) = 0.840 W/kg

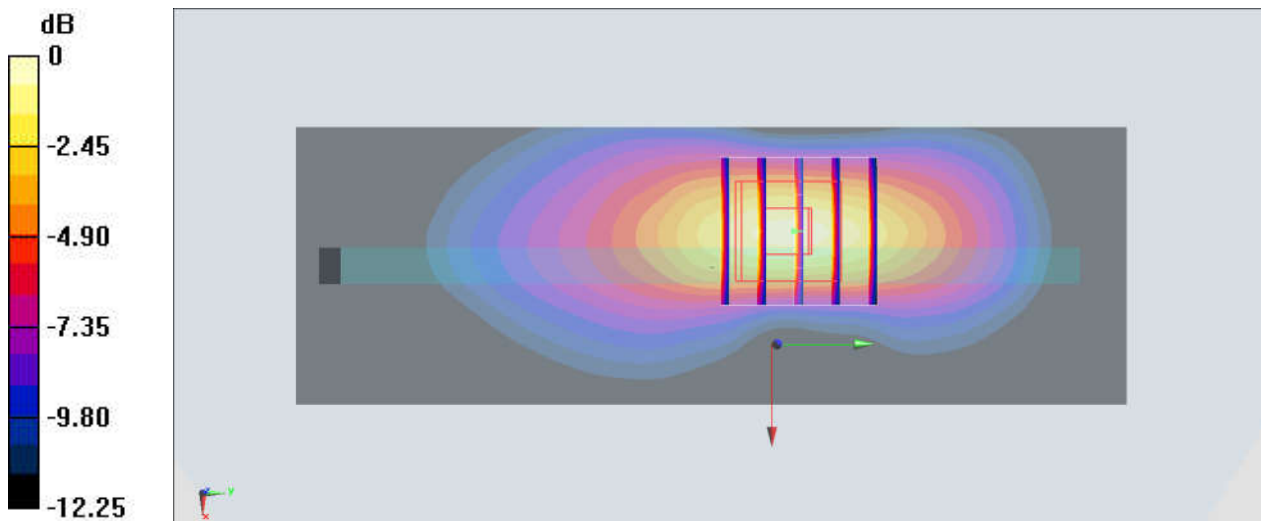

39_LTE Band 12_10M_QPSK_1RB_25Offset_Left Side_10mm_Ch23095

Communication System: LTE; Frequency: 707.5 MHz; Duty Cycle: 1:1
Medium: HSL_750_191227 Medium parameters used : $f = 707.5$ MHz; $\sigma = 0.864$ S/m; $\epsilon_r = 42.44$; $\rho = 1000$ kg/m³
Ambient Temperature : 23.4 °C; Liquid Temperature : 22.4 °C

DASY5 Configuration:

- Probe: EX3DV4 - SN3819; ConvF(10, 10, 10); Calibrated: 2019.03.01;
- Sensor-Surface: 1.4mm (Mechanical Surface Detection)
- Electronics: DAE4 Sn715; Calibrated: 2019.01.23
- Phantom: SAM (Front) with CRP v5.0; Type: QD000P40CD; Serial: TP:1795
- Measurement SW: DASY52, Version 52.8 (8); SEMCAD X Version 14.6.10 (7331)

Area Scan (41x131x1): Interpolated grid: dx=1.500 mm, dy=1.500 mm
Maximum value of SAR (interpolated) = 0.986 W/kg

Zoom Scan (5x5x7)/Cube 0: Measurement grid: dx=8mm, dy=8mm, dz=5mm
Reference Value = 25.56 V/m; Power Drift = 0.17 dB
Peak SAR (extrapolated) = 1.24 W/kg
SAR(1 g) = 0.737 W/kg; SAR(10 g) = 0.423 W/kg
Maximum value of SAR (measured) = 1.01 W/kg

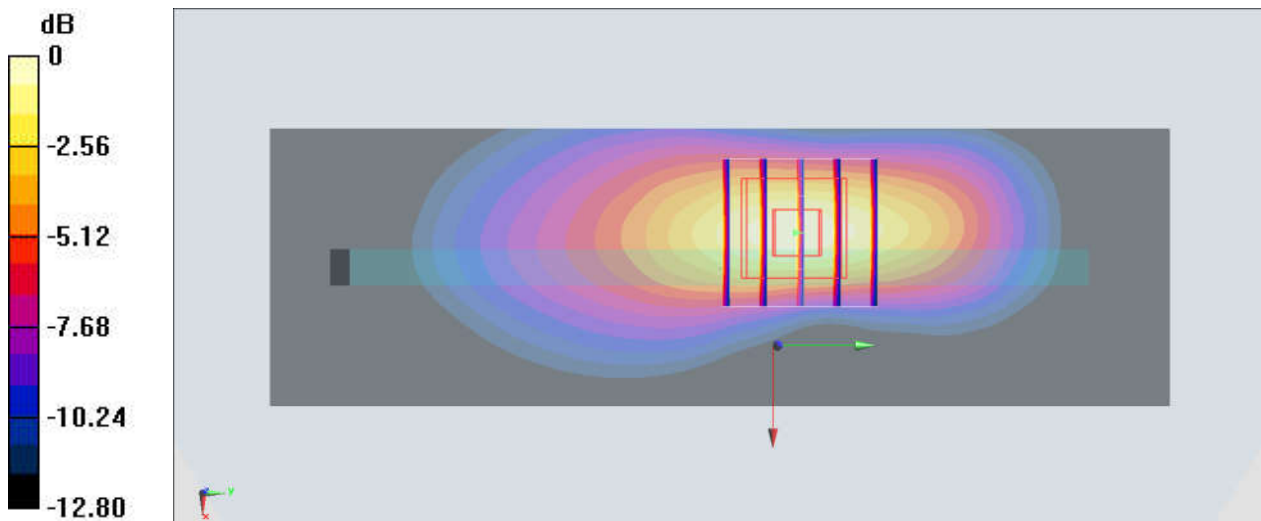

0 dB = 1.01 W/kg = 0.04 dBW/kg

40_LTE Band 13_10M_QPSK_25RB_12Offset_Left Side_10mm_Ch23230

Communication System: LTE; Frequency: 782 MHz; Duty Cycle: 1:1
Medium: HSL_750_191227 Medium parameters used: $f = 782 \text{ MHz}$; $\sigma = 0.904 \text{ S/m}$; $\epsilon_r = 40.826$; $\rho = 1000 \text{ kg/m}^3$
Ambient Temperature : $23.4 \text{ }^\circ\text{C}$; Liquid Temperature : $22.4 \text{ }^\circ\text{C}$

DASY5 Configuration:

- Probe: EX3DV4 - SN3819; ConvF(10, 10, 10); Calibrated: 2019.03.01;
- Sensor-Surface: 1.4mm (Mechanical Surface Detection)
- Electronics: DAE4 Sn715; Calibrated: 2019.01.23
- Phantom: SAM (Front) with CRP v5.0; Type: QD000P40CD; Serial: TP:1795
- Measurement SW: DASY52, Version 52.8 (8); SEMCAD X Version 14.6.10 (7331)

Area Scan (41x131x1): Interpolated grid: $dx=1.500 \text{ mm}$, $dy=1.500 \text{ mm}$
Maximum value of SAR (interpolated) = 0.790 W/kg

Zoom Scan (5x5x7)/Cube 0: Measurement grid: $dx=8\text{mm}$, $dy=8\text{mm}$, $dz=5\text{mm}$
Reference Value = 23.03 V/m ; Power Drift = 0.16 dB
Peak SAR (extrapolated) = 1.01 W/kg
SAR(1 g) = 0.585 W/kg ; SAR(10 g) = 0.330 W/kg
Maximum value of SAR (measured) = 0.821 W/kg

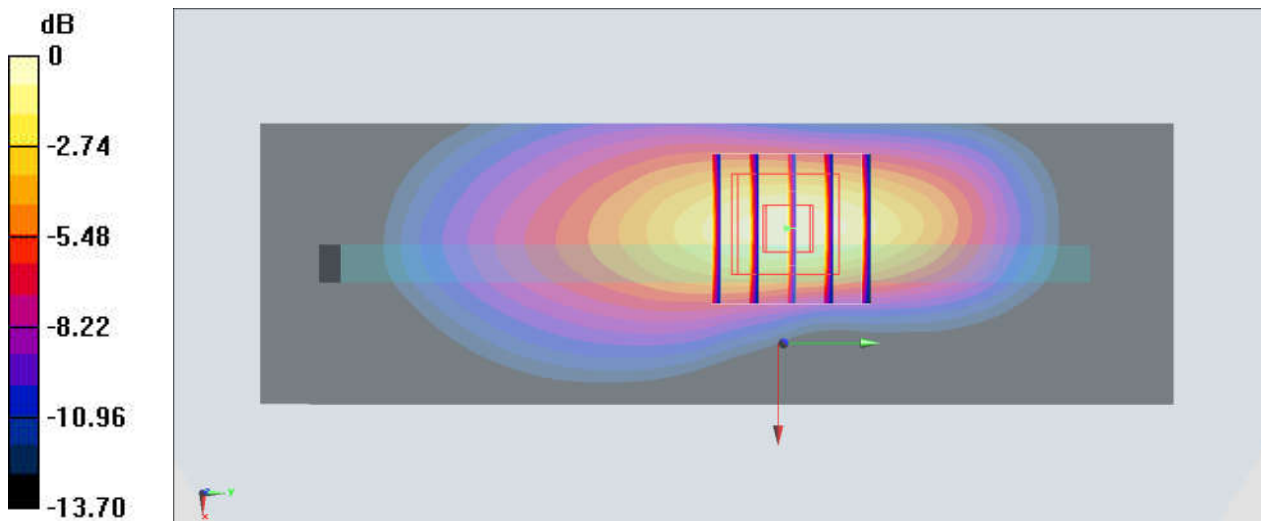

0 dB = $0.821 \text{ W/kg} = -0.86 \text{ dBW/kg}$

41_LTE Band 5_10M_QPSK_50RB_0Offset_Left Side_10mm_Ch20525

Communication System: LTE; Frequency: 836.5 MHz; Duty Cycle: 1:1
Medium: HSL_835_191224 Medium parameters used : $f = 836.5$ MHz; $\sigma = 0.93$ S/m; $\epsilon_r = 42.711$; $\rho = 1000$ kg/m³
Ambient Temperature : 23.4 °C; Liquid Temperature : 22.5 °C

DASY5 Configuration:

- Probe: EX3DV4 - SN3819; ConvF(9.57, 9.57, 9.57); Calibrated: 2019.03.01;
- Sensor-Surface: 1.4mm (Mechanical Surface Detection)
- Electronics: DAE4 Sn715; Calibrated: 2019.01.23
- Phantom: SAM (Front) with CRP v5.0; Type: QD000P40CD; Serial: TP:1795
- Measurement SW: DASY52, Version 52.8 (8); SEMCAD X Version 14.6.10 (7331)

Area Scan (41x131x1): Interpolated grid: dx=1.500 mm, dy=1.500 mm
Maximum value of SAR (interpolated) = 0.820 W/kg

Zoom Scan (5x5x7)/Cube 0: Measurement grid: dx=8mm, dy=8mm, dz=5mm
Reference Value = 1.876 V/m; Power Drift = 0.18 dB
Peak SAR (extrapolated) = 1.06 W/kg
SAR(1 g) = 0.595 W/kg; SAR(10 g) = 0.327 W/kg
Maximum value of SAR (measured) = 0.850 W/kg

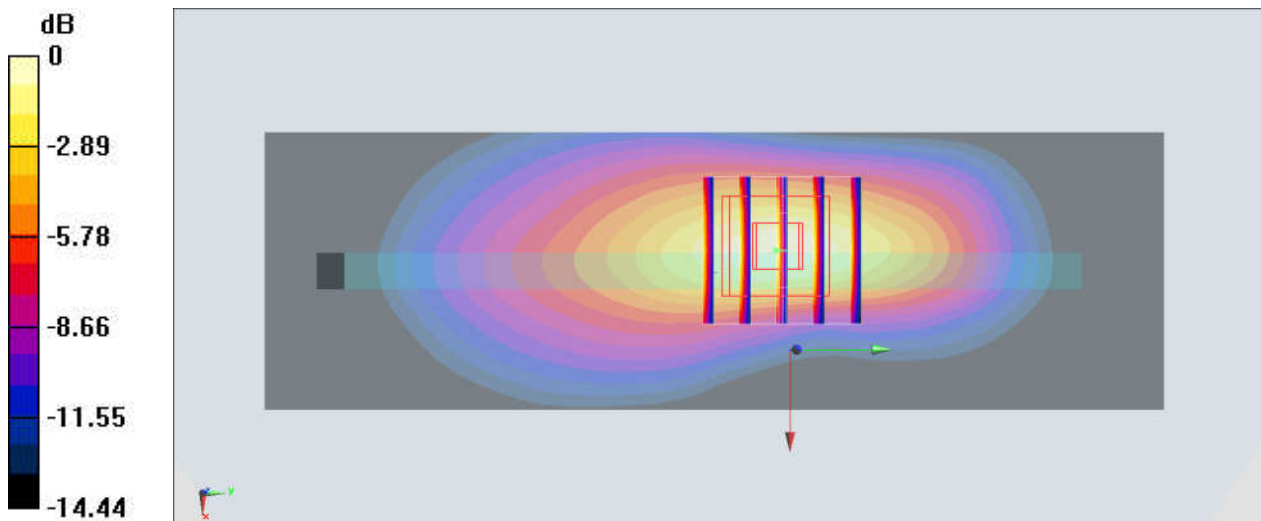

0 dB = 0.850 W/kg = -0.71 dBW/kg

42_LTE Band 26_15M_QPSK_36RB_20Offset_Left Side_10mm_Ch26965

Communication System: LTE; Frequency: 841.5 MHz; Duty Cycle: 1:1
Medium: HSL_835_191224 Medium parameters used : $f = 841.5$ MHz; $\sigma = 0.93$ S/m; $\epsilon_r = 42.711$; $\rho = 1000$ kg/m³
Ambient Temperature : 23.4 °C; Liquid Temperature : 22.5 °C

DASY5 Configuration:

- Probe: EX3DV4 - SN3819; ConvF(9.57, 9.57, 9.57); Calibrated: 2019.03.01;
- Sensor-Surface: 1.4mm (Mechanical Surface Detection)
- Electronics: DAE4 Sn715; Calibrated: 2019.01.23
- Phantom: SAM (Front) with CRP v5.0; Type: QD000P40CD; Serial: TP:1795
- Measurement SW: DASY52, Version 52.8 (8); SEMCAD X Version 14.6.10 (7331)

Area Scan (41x131x1): Interpolated grid: dx=1.500 mm, dy=1.500 mm
Maximum value of SAR (interpolated) = 0.899 W/kg

Zoom Scan (5x5x7)/Cube 0: Measurement grid: dx=8mm, dy=8mm, dz=5mm
Reference Value = 1.859 V/m; Power Drift = -0.15 dB
Peak SAR (extrapolated) = 1.16 W/kg
SAR(1 g) = 0.652 W/kg; SAR(10 g) = 0.362 W/kg
Maximum value of SAR (measured) = 0.928 W/kg

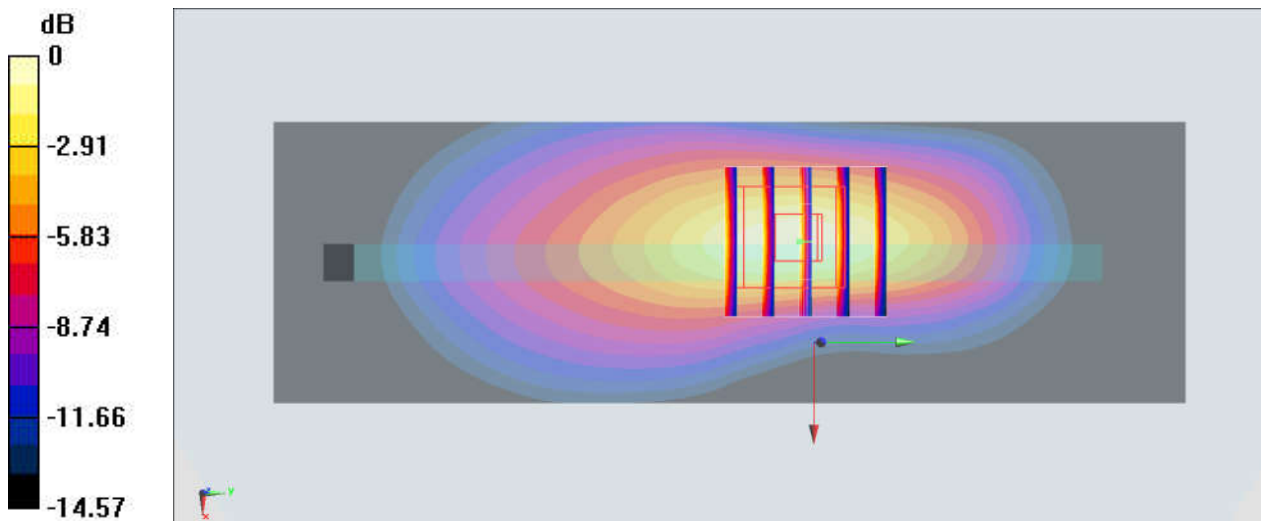

0 dB = 0.928 W/kg = -0.32 dBW/kg

43_LTE Band 66_20M_QPSK_1RB_0Offset_Top Side_10mm_Ch132572

Communication System: LTE; Frequency: 1770 MHz; Duty Cycle: 1:1
Medium: HSL_1750_191221 Medium parameters used: $f = 1770$ MHz; $\sigma = 1.405$ S/m; $\epsilon_r = 39.765$;
 $\rho = 1000$ kg/m³
Ambient Temperature : 23.5 °C ; Liquid Temperature : 22.4 °C

DASY5 Configuration:

- Probe: EX3DV4 - SN3819; ConvF(8.54, 8.54, 8.54); Calibrated: 2019.03.01;
- Sensor-Surface: 1.4mm (Mechanical Surface Detection)
- Electronics: DAE4 Sn715; Calibrated: 2019.01.23
- Phantom: SAM (Front) with CRP v5.0; Type: QD000P40CD; Serial: TP:1795
- Measurement SW: DASY52, Version 52.8 (8); SEMCAD X Version 14.6.10 (7331)

Area Scan (41x71x1): Interpolated grid: dx=1.500 mm, dy=1.500 mm
Maximum value of SAR (interpolated) = 0.961 W/kg

Zoom Scan (5x5x7)/Cube 0: Measurement grid: dx=8mm, dy=8mm, dz=5mm
Reference Value = 11.71 V/m; Power Drift = 0.09 dB
Peak SAR (extrapolated) = 1.26 W/kg
SAR(1 g) = 0.685 W/kg; SAR(10 g) = 0.375 W/kg
Maximum value of SAR (measured) = 1.03 W/kg

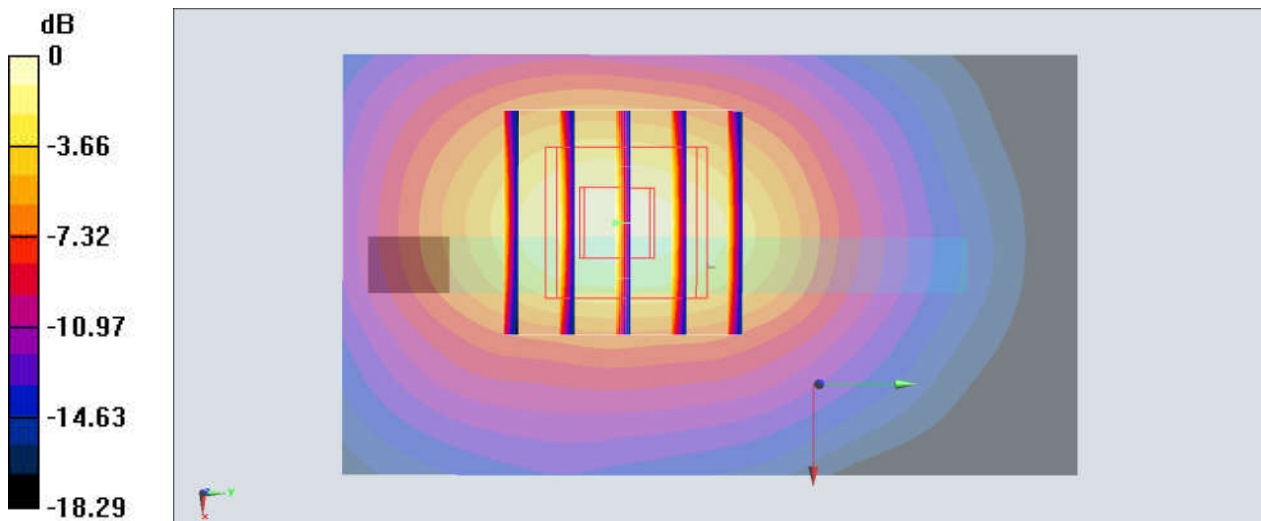

0 dB = 1.03 W/kg = 0.13 dBW/kg

44_LTE Band 25_20M_QPSK_50RB_24Offset_Top Side_10mm_Ch26590

Communication System: LTE; Frequency: 1905 MHz; Duty Cycle: 1:1
Medium: HSL_1900_191218 Medium parameters used : $f = 1905$ MHz; $\sigma = 1.424$ S/m; $\epsilon_r = 41.122$;
 $\rho = 1000$ kg/m³
Ambient Temperature : 23.5 °C ; Liquid Temperature : 22.7 °C

DASY5 Configuration:

- Probe: EX3DV4 - SN3819; ConvF(8.27, 8.27, 8.27); Calibrated: 2019.03.01;
- Sensor-Surface: 1.4mm (Mechanical Surface Detection)
- Electronics: DAE4 Sn715; Calibrated: 2019.01.23
- Phantom: SAM (Front) with CRP v5.0; Type: QD000P40CD; Serial: TP:1795
- Measurement SW: DASY52, Version 52.8 (8); SEMCAD X Version 14.6.10 (7331)

Area Scan (41x71x1): Interpolated grid: dx=1.500 mm, dy=1.500 mm
Maximum value of SAR (interpolated) = 0.774 W/kg

Zoom Scan (5x5x7)/Cube 0: Measurement grid: dx=8mm, dy=8mm, dz=5mm
Reference Value = 1.329 V/m; Power Drift = 0.16 dB
Peak SAR (extrapolated) = 1.03 W/kg
SAR(1 g) = 0.561 W/kg; SAR(10 g) = 0.284 W/kg
Maximum value of SAR (measured) = 0.806 W/kg

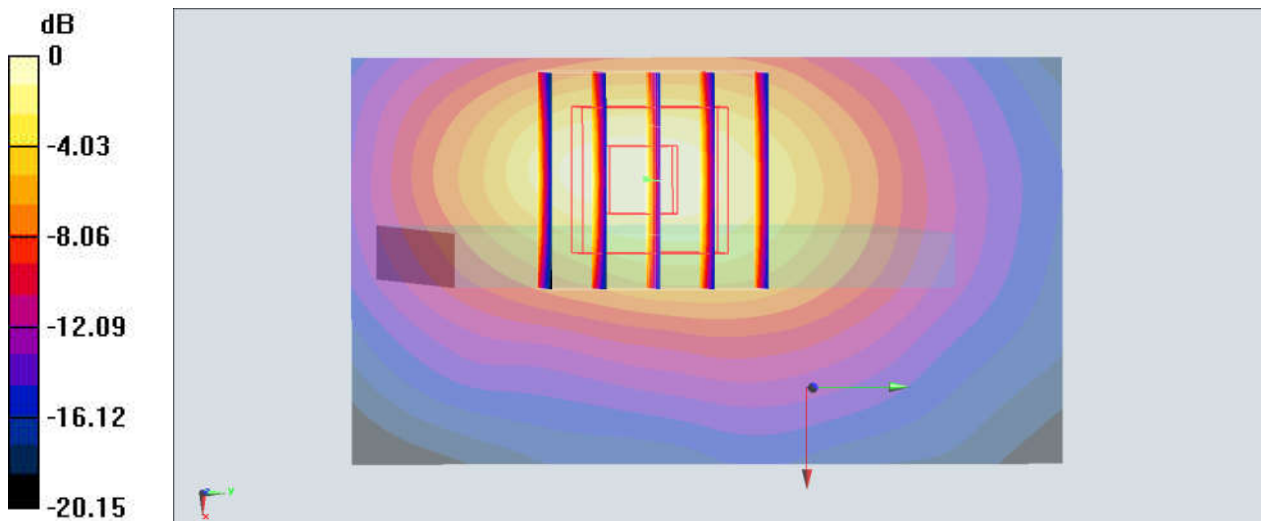

0 dB = 0.806 W/kg = -0.94 dBW/kg

45_LTE Band 30_10M_QPSK_1RB_0Offset_Top Side_10mm_Ch27710

Communication System: LTE; Frequency: 2310 MHz; Duty Cycle: 1:1
Medium: HSL_2300_191230 Medium parameters used: $f = 2310$ MHz; $\sigma = 1.682$ S/m; $\epsilon_r = 38.704$;
 $\rho = 1000$ kg/m³
Ambient Temperature : 23.4 °C ; Liquid Temperature : 22.7 °C

DASY5 Configuration:

- Probe: EX3DV4 - SN3819; ConvF(7.64, 7.64, 7.64); Calibrated: 2019.03.01;
- Sensor-Surface: 1.4mm (Mechanical Surface Detection)
- Electronics: DAE4 Sn715; Calibrated: 2019.01.23
- Phantom: SAM (Front) with CRP v5.0; Type: QD000P40CD; Serial: TP:1795
- Measurement SW: DASY52, Version 52.8 (8); SEMCAD X Version 14.6.10 (7331)

Area Scan (41x81x1): Interpolated grid: dx=1.200 mm, dy=1.200 mm
Maximum value of SAR (interpolated) = 1.24 W/kg

Zoom Scan (7x7x7)/Cube 0: Measurement grid: dx=5mm, dy=5mm, dz=5mm
Reference Value = 22.98 V/m; Power Drift = 0.06 dB
Peak SAR (extrapolated) = 1.66 W/kg
SAR(1 g) = 0.793 W/kg; SAR(10 g) = 0.387 W/kg
Maximum value of SAR (measured) = 1.22 W/kg

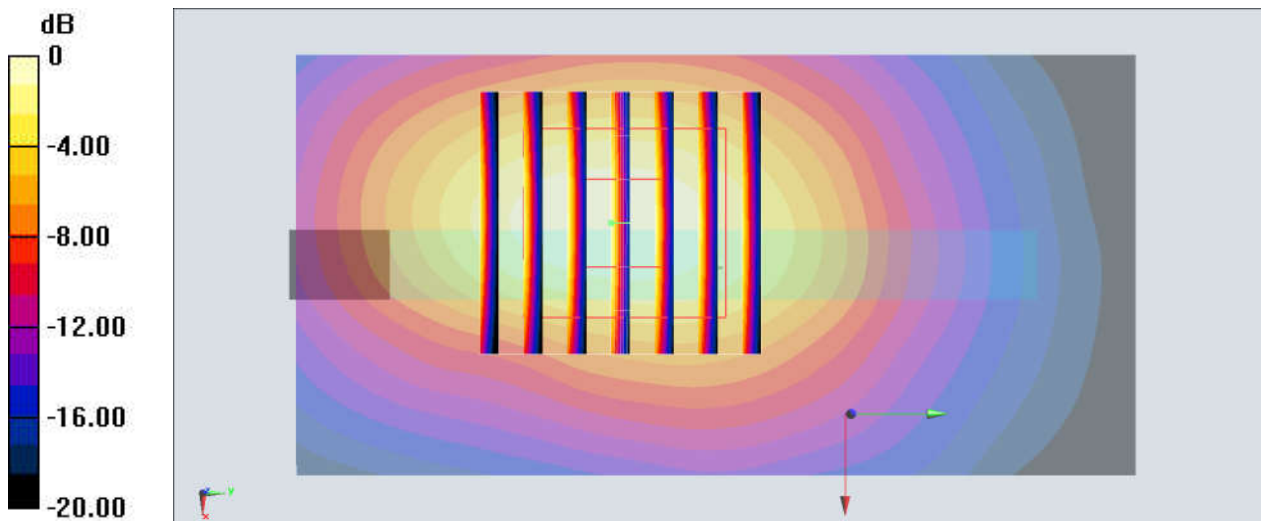

0 dB = 1.22 W/kg = 0.86 dBW/kg

46_LTE Band 7_20M_QPSK_100RB_0Offset_Top Side_10mm_Ch20850

Communication System: LTE; Frequency: 2510 MHz; Duty Cycle: 1:1
Medium: HSL_2600_200105 Medium parameters used: $f = 2510$ MHz; $\sigma = 1.953$ S/m; $\epsilon_r = 37.916$;
 $\rho = 1000$ kg/m³
Ambient Temperature : 23.6 °C ; Liquid Temperature : 22.4 °C

DASY5 Configuration:

- Probe: EX3DV4 - SN3819; ConvF(7.06, 7.06, 7.06); Calibrated: 2019.03.01;
- Sensor-Surface: 1.4mm (Mechanical Surface Detection)
- Electronics: DAE4 Sn715; Calibrated: 2019.01.23
- Phantom: SAM (Front) with CRP v5.0; Type: QD000P40CD; Serial: TP:1795
- Measurement SW: DASY52, Version 52.8 (8); SEMCAD X Version 14.6.10 (7331)

Area Scan (41x81x1): Interpolated grid: dx=1.200 mm, dy=1.200 mm
Maximum value of SAR (interpolated) = 1.28 W/kg

Zoom Scan (7x7x7)/Cube 0: Measurement grid: dx=5mm, dy=5mm, dz=5mm
Reference Value = 20.51 V/m; Power Drift = 0.14 dB
Peak SAR (extrapolated) = 1.68 W/kg
SAR(1 g) = 0.800 W/kg; SAR(10 g) = 0.376 W/kg
Maximum value of SAR (measured) = 1.22 W/kg

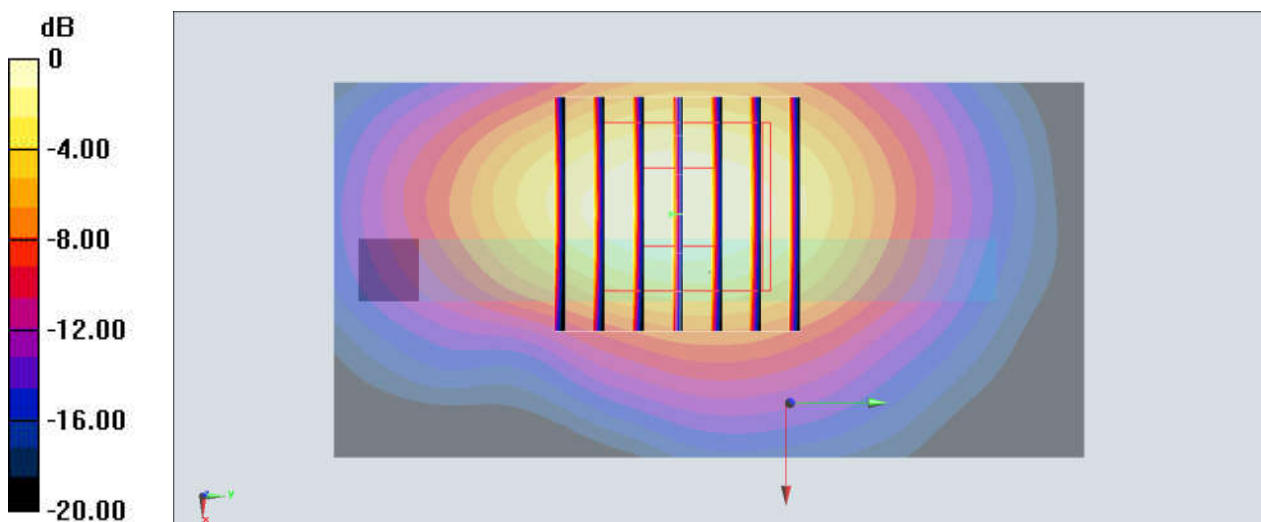

0 dB = 1.22 W/kg = 0.86 dBW/kg

47_LTE Band 41_20M_QPSK_50RB_24Offset_Top Side_10mm_Ch39750

Communication System: LTE; Frequency: 2506 MHz; Duty Cycle: 1:1.59
Medium: HSL_2600_200105 Medium parameters used: $f = 2506$ MHz; $\sigma = 1.948$ S/m; $\epsilon_r = 37.931$;
 $\rho = 1000$ kg/m³
Ambient Temperature : 23.6 °C ; Liquid Temperature : 22.4 °C

DASY5 Configuration:

- Probe: EX3DV4 - SN3819; ConvF(7.06, 7.06, 7.06); Calibrated: 2019.03.01;
- Sensor-Surface: 1.4mm (Mechanical Surface Detection)
- Electronics: DAE4 Sn715; Calibrated: 2019.01.23
- Phantom: SAM (Front) with CRP v5.0; Type: QD000P40CD; Serial: TP:1795
- Measurement SW: DASY52, Version 52.8 (8); SEMCAD X Version 14.6.10 (7331)

Area Scan (41x81x1): Interpolated grid: dx=1.200 mm, dy=1.200 mm
Maximum value of SAR (interpolated) = 1.38 W/kg

Zoom Scan (7x7x7)/Cube 0: Measurement grid: dx=5mm, dy=5mm, dz=5mm
Reference Value = 25.38 V/m; Power Drift = 0.12 dB
Peak SAR (extrapolated) = 1.86 W/kg
SAR(1 g) = 0.771 W/kg; SAR(10 g) = 0.393 W/kg
Maximum value of SAR (measured) = 1.34 W/kg

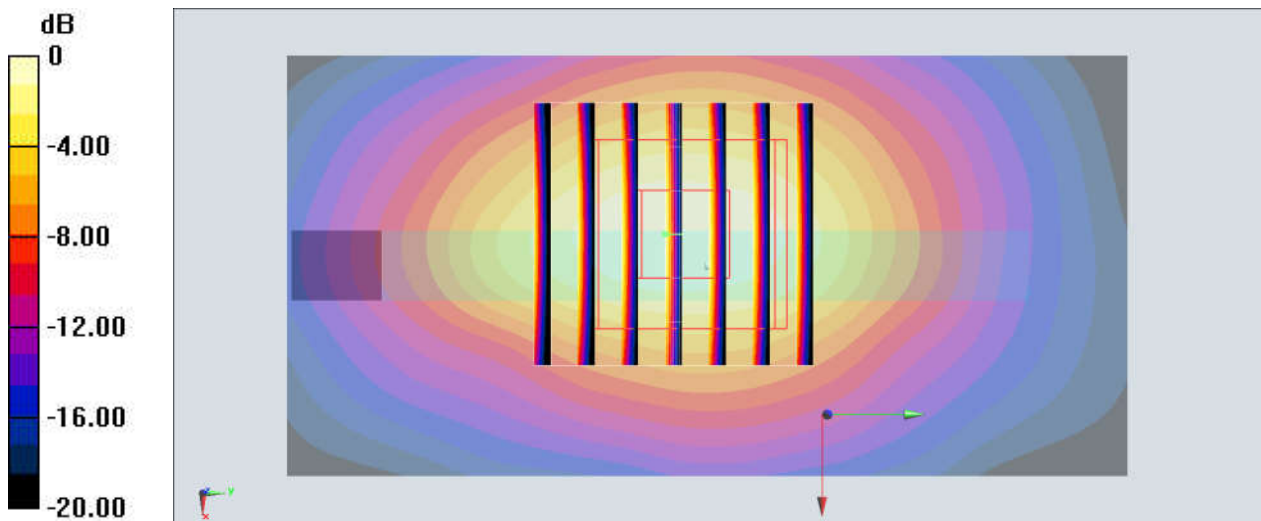

0 dB = 1.34 W/kg = 1.27 dBW/kg

48_LTE Band 48_20M_QPSK_1RB_49Offset_Top Side_10mm_Ch56640

Communication System: LTE; Frequency: 3690 MHz; Duty Cycle: 1:1.59
Medium: HSL_3700_200109 Medium parameters used : $f = 3690$ MHz; $\sigma = 3.046$ S/m; $\epsilon_r = 38.387$;
 $\rho = 1000$ kg/m³
Ambient Temperature : 23.6 °C ; Liquid Temperature : 22.8 °C

DASY5 Configuration:

- Probe: EX3DV4 - SN3819; ConvF(6.67, 6.67, 6.67); Calibrated: 2019.03.01;
- Sensor-Surface: 1.4mm (Mechanical Surface Detection)
- Electronics: DAE4 Sn715; Calibrated: 2019.01.23
- Phantom: SAM (Front) with CRP v5.0; Type: QD000P40CD; Serial: TP:1795
- Measurement SW: DASY52, Version 52.8 (8); SEMCAD X Version 14.6.10 (7331)

Area Scan (41x81x1): Interpolated grid: dx=1.200 mm, dy=1.200 mm
Maximum value of SAR (interpolated) = 1.17 W/kg

Zoom Scan (7x7x7)/Cube 0: Measurement grid: dx=5mm, dy=5mm, dz=1.4mm
Reference Value = 13.23 V/m; Power Drift = 0.14 dB
Peak SAR (extrapolated) = 1.91 W/kg
SAR(1 g) = 0.636 W/kg; SAR(10 g) = 0.250 W/kg
Maximum value of SAR (measured) = 1.28 W/kg

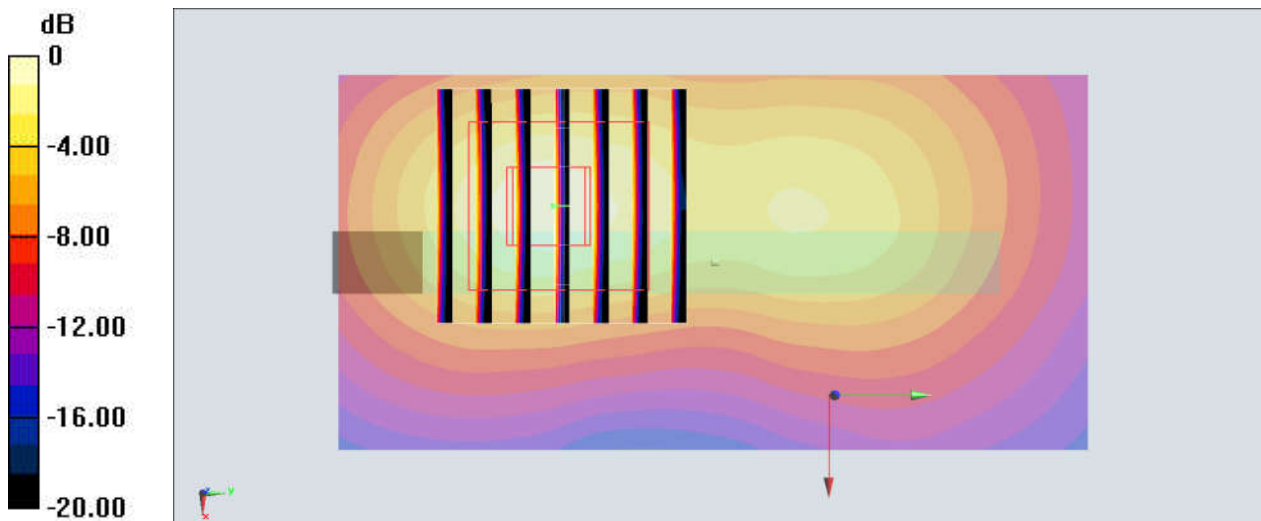

0 dB = 1.28 W/kg = 1.07 dBW/kg

49_N2_20M_PI/2 BPSK_50_0_Bottom Side_10mm_Ch376000

Communication System: NR; Frequency: 1880 MHz; Duty Cycle: 1:1

Medium: HSL_1900_200206 Medium parameters used: $f = 1880$ MHz; $\sigma = 1.419$ S/m; $\epsilon_r = 40.407$; $\rho = 1000$ kg/m³

Ambient Temperature : 23.6 °C ; Liquid Temperature : 22.6 °C

DASY5 Configuration:

- Probe: EX3DV4 - SN7346; ConvF(8.07, 8.07, 8.07) @ 1880 MHz; Calibrated: 2019/4/25
- Sensor-Surface: 1.4mm (Mechanical Surface Detection)
- Electronics: DAE4 Sn853; Calibrated: 2019/7/18
- Phantom: SAM_Left; Type: QD000P40CD; Serial: TP:1477
- Measurement SW: DASY52, Version 52.10 (2); SEMCAD X Version 14.6.12 (7470)

Area Scan (41x81x1): Interpolated grid: dx=1.500 mm, dy=1.500 mm

Maximum value of SAR (interpolated) = 0.884 W/kg

Zoom Scan (5x5x7)/Cube 0: Measurement grid: dx=8mm, dy=8mm, dz=5mm

Reference Value = 22.73 V/m; Power Drift = -0.15 dB

Peak SAR (extrapolated) = 0.936 W/kg

SAR(1 g) = 0.561 W/kg; SAR(10 g) = 0.326 W/kg

Maximum value of SAR (measured) = 0.805 W/kg

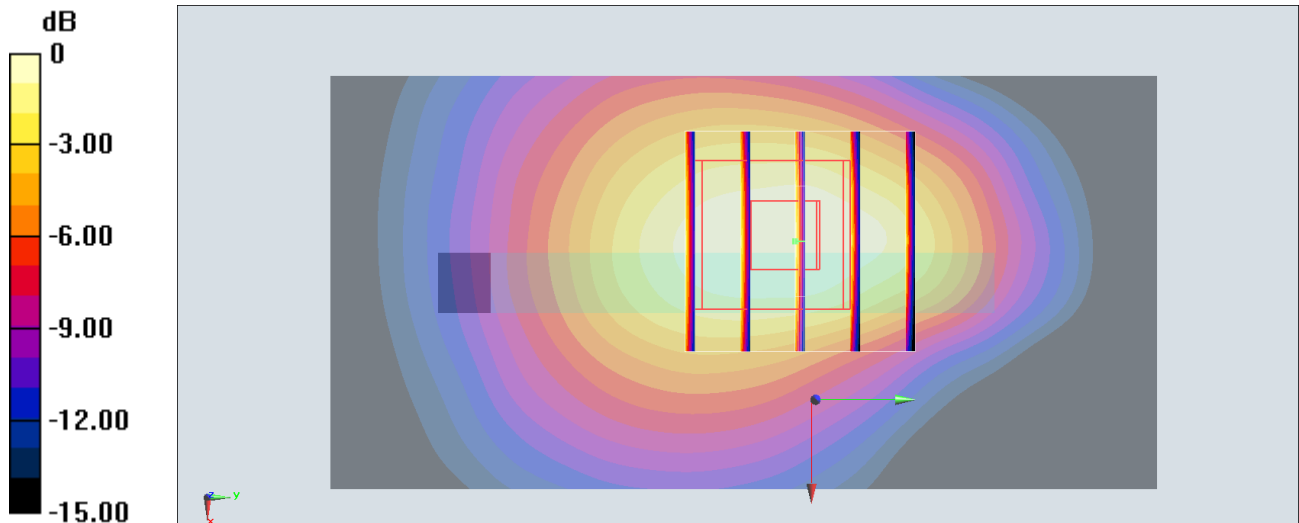

0 dB = 0.805 W/kg = -0.94 dBW/kg

50_N5_20M_PI/2 BPSK_50_0_Left Side_10mm_Ch167800

Communication System: NR; Frequency: 839 MHz; Duty Cycle: 1:1

Medium: HSL_850_200207 Medium parameters used: $f = 839$ MHz; $\sigma = 0.9$ S/m; $\epsilon_r = 40.774$; $\rho = 1000$ kg/m³

Ambient Temperature : 23.1 °C ; Liquid Temperature : 22.1 °C

DASY5 Configuration:

- Probe: ES3DV3 - SN3184; ConvF(6.41, 6.41, 6.41) @ 839 MHz; Calibrated: 2019/9/25
- Sensor-Surface: 3mm (Mechanical Surface Detection)
- Electronics: DAE4 Sn1305; Calibrated: 2019/4/30
- Phantom: SAM_Right; Type: QD000P40CD; Serial: TP:1683
- Measurement SW: DASY52, Version 52.10 (2); SEMCAD X Version 14.6.12 (7470)

Area Scan (51x121x1): Interpolated grid: dx=1.500 mm, dy=1.500 mm

Maximum value of SAR (interpolated) = 0.329 W/kg

Zoom Scan (5x5x7)/Cube 0: Measurement grid: dx=8mm, dy=8mm, dz=5mm

Reference Value = 11.09 V/m; Power Drift = 0.07 dB

Peak SAR (extrapolated) = 0.382 W/kg

SAR(1 g) = 0.246 W/kg; SAR(10 g) = 0.139 W/kg

Maximum value of SAR (measured) = 0.302 W/kg

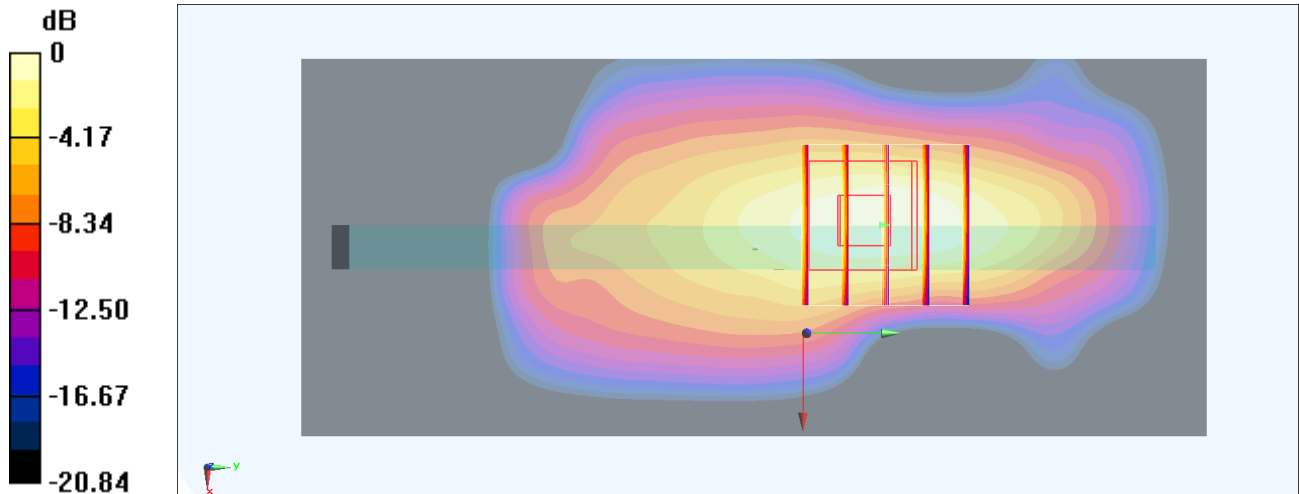

0 dB = 0.302 W/kg = -5.20 dBW/kg

51_N41_100M_PI/2 BPSK_135_0_Top Side_10mm_Ch528000

Communication System: NR; Frequency: 2640 MHz; Duty Cycle: 1:4

Medium: HSL_2600_200213 Medium parameters used: $f = 2640$ MHz; $\sigma = 2.009$ S/m; $\epsilon_r = 38.685$; $\rho = 1000$ kg/m³

Ambient Temperature : 23.6 °C ; Liquid Temperature : 22.6 °C

DASY5 Configuration:

- Probe: ES3DV3 - SN3184; ConvF(4.49, 4.49, 4.49) @ 2640 MHz; Calibrated: 2019/9/25
- Sensor-Surface: 3mm (Mechanical Surface Detection)
- Electronics: DAE4 Sn1305; Calibrated: 2019/4/30
- Phantom: SAM_Right; Type: QD000P40CD; Serial: TP:1683
- Measurement SW: DASY52, Version 52.10 (2); SEMCAD X Version 14.6.12 (7470)

Area Scan (51x91x1): Interpolated grid: dx=1.200 mm, dy=1.200 mm

Maximum value of SAR (interpolated) = 0.921 W/kg

Zoom Scan (7x7x7)/Cube 0: Measurement grid: dx=5mm, dy=5mm, dz=5mm

Reference Value = 16.16 V/m; Power Drift = 0.19 dB

Peak SAR (extrapolated) = 1.225 W/kg

SAR(1 g) = 0.687 W/kg; SAR(10 g) = 0.326 W/kg

Maximum value of SAR (measured) = 0.897 W/kg

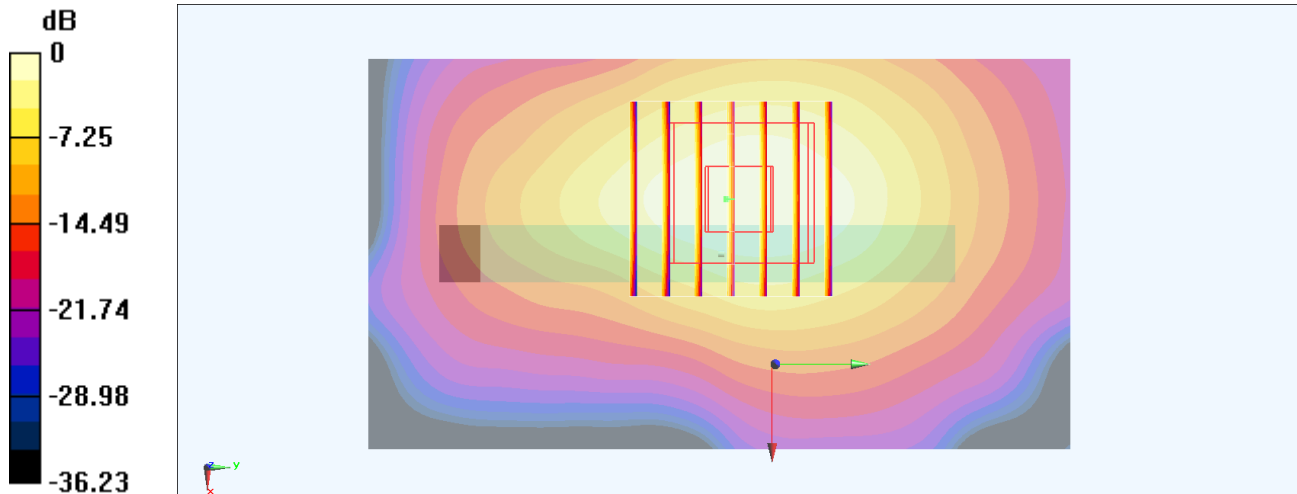

52_N66_20M_PI/2 BPSK_1_1_Bottom Side_10mm_Ch354000

Communication System: NR; Frequency: 1770 MHz; Duty Cycle: 1:1

Medium: HSL_1750_200207 Medium parameters used: $f = 1770$ MHz; $\sigma = 1.372$ S/m; $\epsilon_r = 39.529$; $\rho = 1000$ kg/m³

Ambient Temperature : 23.3 °C ; Liquid Temperature : 22.3 °C

DASY5 Configuration:

- Probe: EX3DV4 - SN7346; ConvF(8.5, 8.5, 8.5) @ 1770 MHz; Calibrated: 2019/4/25
- Sensor-Surface: 1.4mm (Mechanical Surface Detection)
- Electronics: DAE4 Sn853; Calibrated: 2019/7/18
- Phantom: SAM_Left; Type: QD000P40CD; Serial: TP:1477
- Measurement SW: DASY52, Version 52.10 (2); SEMCAD X Version 14.6.12 (7470)

Area Scan (41x81x1): Interpolated grid: dx=1.500 mm, dy=1.500 mm

Maximum value of SAR (interpolated) = 1.03 W/kg

Zoom Scan (5x5x7)/Cube 0: Measurement grid: dx=8mm, dy=8mm, dz=5mm

Reference Value = 2.984 V/m; Power Drift = 0.04 dB

Peak SAR (extrapolated) = 1.12 W/kg

SAR(1 g) = 0.661 W/kg; SAR(10 g) = 0.381 W/kg

Maximum value of SAR (measured) = 0.964 W/kg

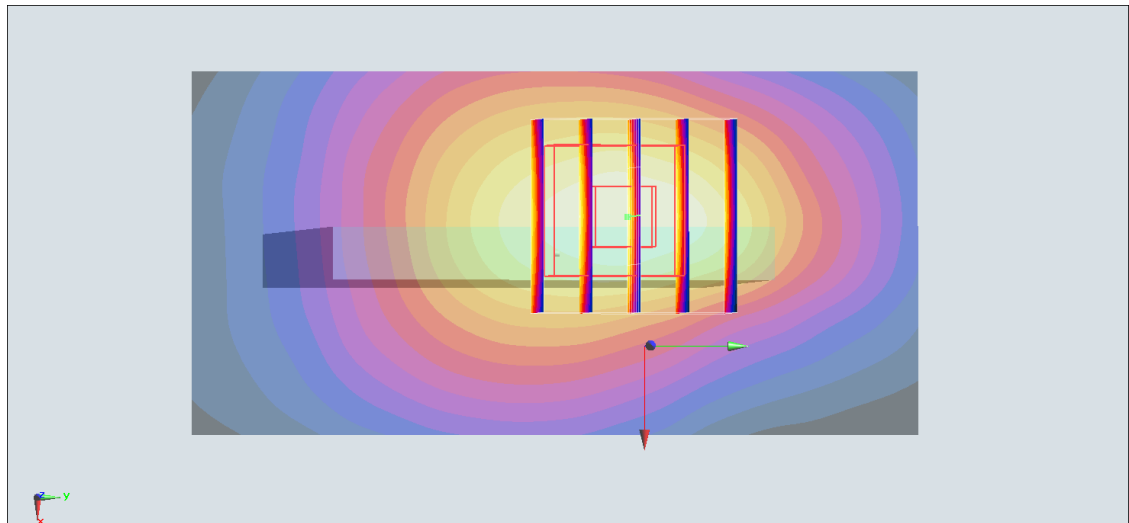
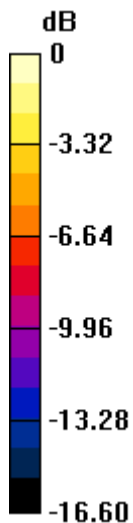

0 dB = 0.964 W/kg = -0.16 dBW/kg

53_N71_20M_PI/2 BPSK_1_1_Left Side_10mm_Ch134600

Communication System: NR; Frequency: 673 MHz; Duty Cycle: 1:1

Medium: HSL_750_200208 Medium parameters used: $f = 673$ MHz; $\sigma = 0.82$ S/m; $\epsilon_r = 42.382$; $\rho = 1000$ kg/m³

Ambient Temperature : 23.6 °C ; Liquid Temperature : 22.6 °C

DASY5 Configuration:

- Probe: ES3DV3 - SN3184; ConvF(6.61, 6.61, 6.61) @ 673 MHz; Calibrated: 2019/9/25
- Sensor-Surface: 3mm (Mechanical Surface Detection)
- Electronics: DAE4 Sn1305; Calibrated: 2019/4/30
- Phantom: SAM_Right; Type: QD000P40CD; Serial: TP:1683
- Measurement SW: DASY52, Version 52.10 (2); SEMCAD X Version 14.6.12 (7470)

Area Scan (41x131x1): Interpolated grid: dx=1.500 mm, dy=1.500 mm

Maximum value of SAR (interpolated) = 0.251 W/kg

Zoom Scan (5x5x7)/Cube 0: Measurement grid: dx=8mm, dy=8mm, dz=5mm

Reference Value = 7.085 V/m; Power Drift = -0.14 dB

Peak SAR (extrapolated) = 0.290 W/kg

SAR(1 g) = 0.193 W/kg; SAR(10 g) = 0.112 W/kg

Maximum value of SAR (measured) = 0.238 W/kg

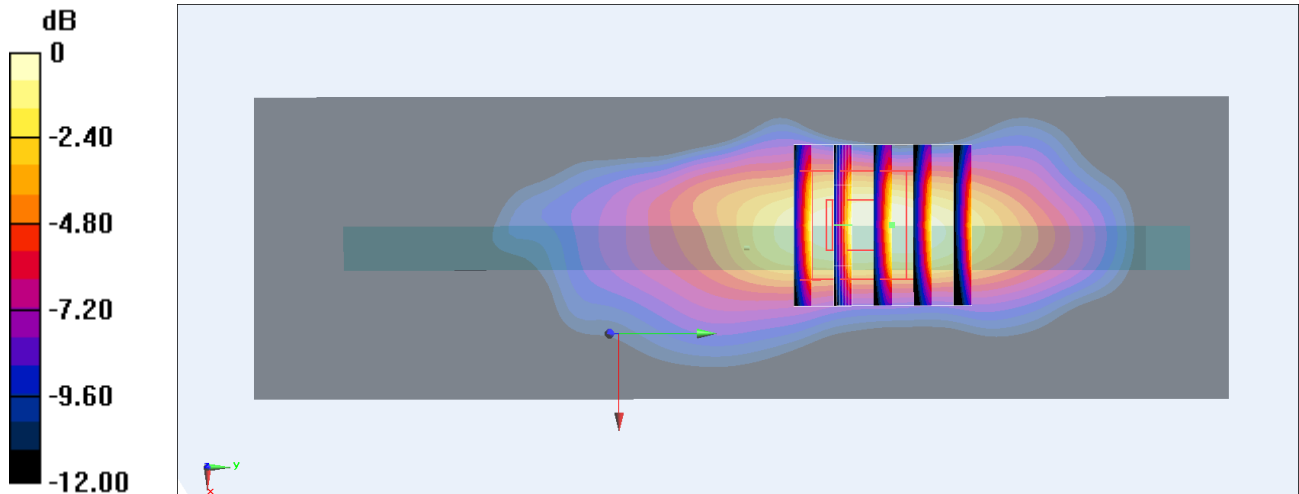

0 dB = 0.238 W/kg = -6.24 dBW/kg

54_WLAN2.4GHz_802.11b 1Mbps_Back_10mm_Ch11

Communication System: WIFI; Frequency: 2462 MHz; Duty Cycle: 1:1
Medium: HSL_2450_200102 Medium parameters used: $f = 2462$ MHz; $\sigma = 1.87$ S/m; $\epsilon_r = 37.627$; $\rho = 1000$ kg/m³
Ambient Temperature : 23.4 °C; Liquid Temperature : 22.6 °C

DASY5 Configuration:

- Probe: EX3DV4 - SN3819; ConvF(7.21, 7.21, 7.21); Calibrated: 2019.03.01;
- Sensor-Surface: 1.4mm (Mechanical Surface Detection)
- Electronics: DAE4 Sn715; Calibrated: 2019.01.23
- Phantom: SAM (Front) with CRP v5.0; Type: QD000P40CD; Serial: TP:1795
- Measurement SW: DASY52, Version 52.8 (8); SEMCAD X Version 14.6.10 (7331)

Area Scan (81x81x1): Interpolated grid: dx=1.200 mm, dy=1.200 mm
Maximum value of SAR (interpolated) = 0.921 W/kg

Zoom Scan (7x7x7)/Cube 0: Measurement grid: dx=5mm, dy=5mm, dz=5mm
Reference Value = 3.964 V/m; Power Drift = 0.16 dB
Peak SAR (extrapolated) = 1.60 W/kg
SAR(1 g) = 0.684 W/kg; SAR(10 g) = 0.287 W/kg
Maximum value of SAR (measured) = 0.933 W/kg

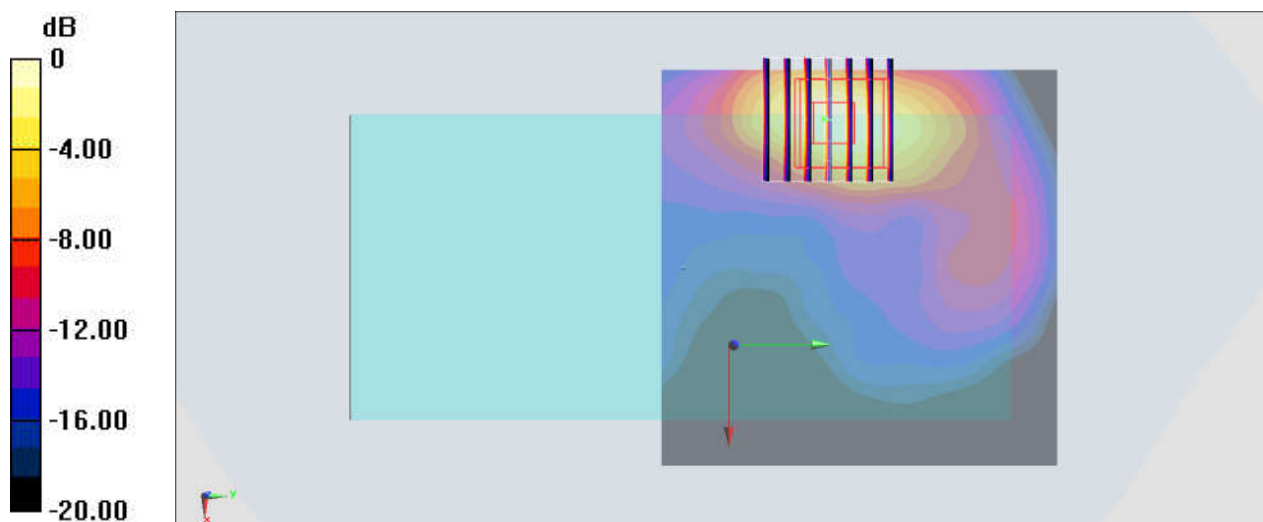

0 dB = 0.933 W/kg = -0.30 dBW/kg

55_WLAN5GHz_802.11n-HT40 MCS0_Back_10mm_Ch46

Communication System: WIFI; Frequency: 5230 MHz; Duty Cycle: 1:1.02
Medium: HSL_5250_200114 Medium parameters used: $f = 5230$ MHz; $\sigma = 4.617$ S/m; $\epsilon_r = 37.129$;
 $\rho = 1000$ kg/m³
Ambient Temperature : 23.7 °C ; Liquid Temperature : 22.4 °C

DASY5 Configuration:

- Probe: EX3DV4 - SN3819; ConvF(5.07, 5.07, 5.07); Calibrated: 2019.03.01;
- Sensor-Surface: 1.4mm (Mechanical Surface Detection)
- Electronics: DAE4 Sn715; Calibrated: 2019.01.23
- Phantom: SAM (Front) with CRP v5.0; Type: QD000P40CD; Serial: TP:1795
- Measurement SW: DASY52, Version 52.8 (8); SEMCAD X Version 14.6.10 (7331)

Area Scan (101x91x1): Interpolated grid: dx=1.000 mm, dy=1.000 mm
Maximum value of SAR (interpolated) = 1.18 W/kg

Zoom Scan (7x7x7)/Cube 0: Measurement grid: dx=4mm, dy=4mm, dz=1.4mm
Reference Value = 2.088 V/m; Power Drift = 0.16 dB
Peak SAR (extrapolated) = 2.03 W/kg
SAR(1 g) = 0.531 W/kg; SAR(10 g) = 0.175 W/kg
Maximum value of SAR (measured) = 1.25 W/kg

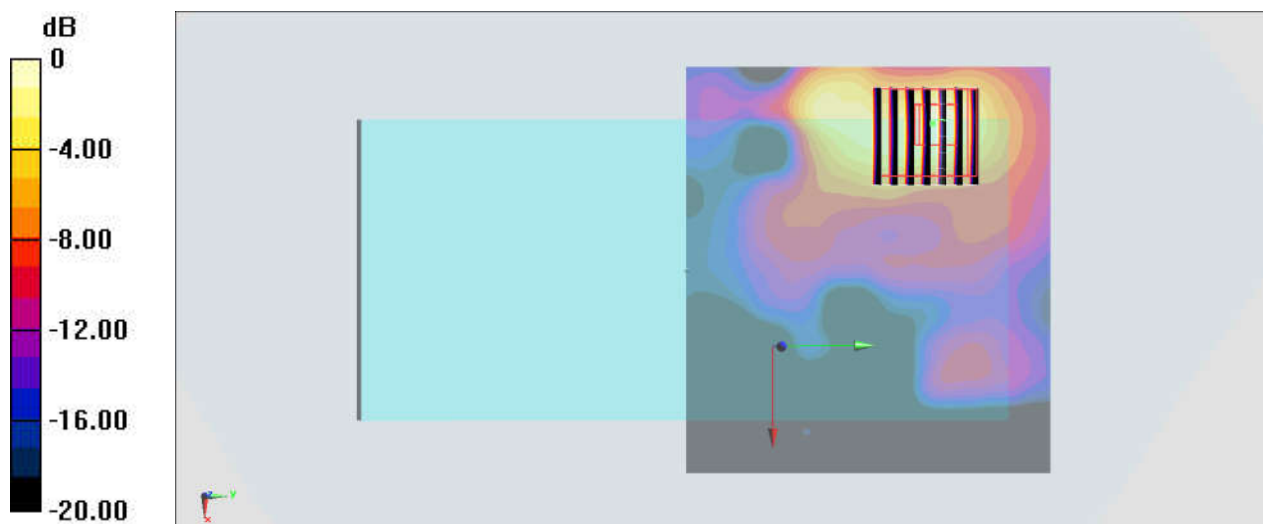

0 dB = 1.25 W/kg = 0.97 dBW/kg

56_WLAN5GHz_802.11n-HT40 MCS0_Back_10mm_Ch159

Communication System: WIFI; Frequency: 5795 MHz; Duty Cycle: 1:1.02
Medium: HSL_5750 Medium parameters used: $f = 5795$ MHz; $\sigma = 5.268$ S/m; $\epsilon_r = 36.208$; $\rho = 1000$ kg/m³
Ambient Temperature : 23.7 °C; Liquid Temperature : 22.6 °C

DASY5 Configuration:

- Probe: EX3DV4 - SN3819; ConvF(4.77, 4.77, 4.77); Calibrated: 2019.03.01;
- Sensor-Surface: 1.4mm (Mechanical Surface Detection)
- Electronics: DAE4 Sn715; Calibrated: 2019.01.23
- Phantom: SAM (Front) with CRP v5.0; Type: QD000P40CD; Serial: TP:1795
- Measurement SW: DASY52, Version 52.8 (8); SEMCAD X Version 14.6.10 (7331)

Area Scan (101x181x1): Interpolated grid: dx=1.000 mm, dy=1.000 mm
Maximum value of SAR (interpolated) = 1.55 W/kg

Zoom Scan (7x7x7)/Cube 0: Measurement grid: dx=4mm, dy=4mm, dz=1.4mm
Reference Value = 1.333 V/m; Power Drift = 0.07 dB
Peak SAR (extrapolated) = 2.79 W/kg
SAR(1 g) = 0.655 W/kg; SAR(10 g) = 0.200 W/kg
Maximum value of SAR (measured) = 1.57 W/kg

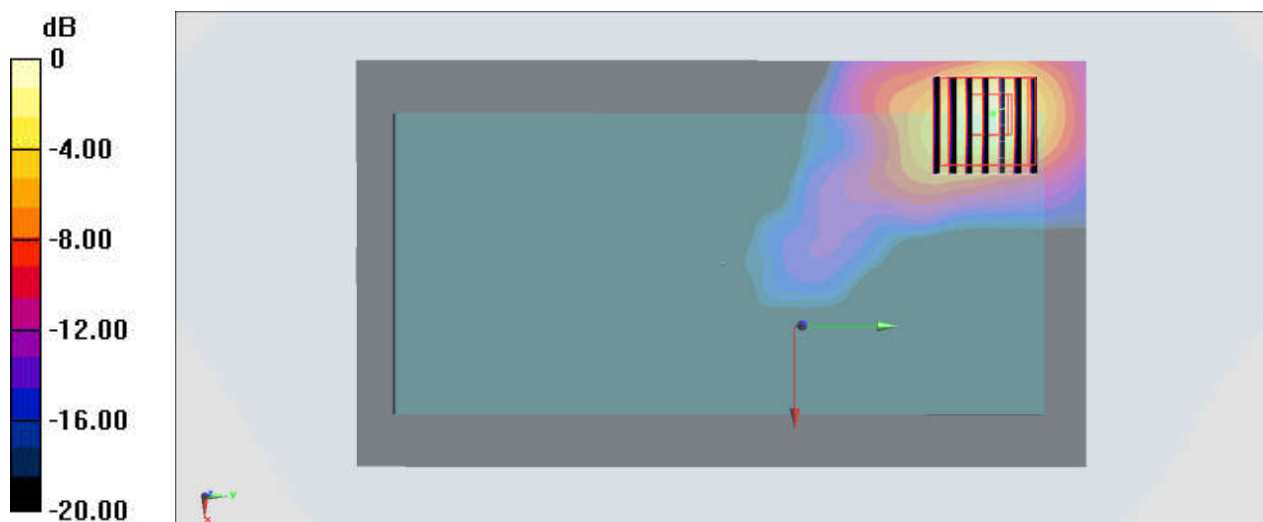

0 dB = 1.57 W/kg = 1.96 dBW/kg