

# FCC RF Test Report

APPLICANT : OnePlus Technology (Shenzhen) Co., Ltd  
EQUIPMENT : Smart Phone  
BRAND NAME : ONEPLUS  
MODEL NAME : IN2025  
FCC ID : 2ABZ2-EE007  
STANDARD : 47 CFR Part 2, 27(D)  
CLASSIFICATION : PCS Licensed Transmitter Held to Ear (PCE)

The product was received on Nov. 20, 2019 and completely tested on Jan. 23, 2020. We, Sporton International (ShenZhen) Inc., would like to declare that the tested sample has been evaluated in accordance with the procedures given in ANSI C63.26-2015 and shown compliance with the applicable technical standards.

The test results in this report apply exclusively to the tested model / sample. Without written approval of Sporton International (ShenZhen) Inc., the test report shall not be reproduced except in full.



Reviewed by: Derreck Chen / Supervisor



Approved by: Eric Shih / Manager



**Sporton International (ShenZhen) Inc.**

1/F, 2/F, Bldg 5, Shiling Industrial Zone, Xinwei Village, Xili, Nanshan, Shenzhen, 518055

People's Republic of China



TABLE OF CONTENTS

REVISION HISTORY..... 3
SUMMARY OF TEST RESULT ..... 4
1 GENERAL DESCRIPTION ..... 5
1.1 Applicant ..... 5
1.2 Manufacturer ..... 5
1.3 Product Feature of Equipment Under Test ..... 5
1.4 Product Specification of Equipment Under Test ..... 6
1.5 Modification of EUT ..... 6
1.6 Maximum Conducted power, Frequency Tolerance and Emission Designator ..... 6
1.7 Testing Site ..... 7
1.8 Test Software ..... 7
1.9 Applied Standards ..... 7
2 TEST CONFIGURATION OF EQUIPMENT UNDER TEST ..... 8
2.1 Test Mode ..... 8
2.2 Connection Diagram of Test System ..... 9
2.3 Support Unit used in test configuration and system ..... 9
2.4 Measurement Results Explanation Example ..... 9
2.5 Frequency List of Low/Middle/High Channels ..... 10
3 CONDUCTED TEST ITEMS ..... 11
3.1 Measuring Instruments ..... 11
3.2 Test Setup ..... 11
3.3 Test Result of Conducted Test ..... 11
3.4 Conducted Output Power Measurement ..... 12
3.5 Peak-to-Average Ratio ..... 13
3.6 EIRP Power Density ..... 14
3.7 Occupied Bandwidth ..... 15
3.8 Conducted Band Edge Measurement ..... 16
3.9 Conducted Spurious Emission Measurement ..... 17
3.10 Frequency Stability Measurement ..... 18
4 RADIATED TEST ITEMS ..... 19
4.1 Measuring Instruments ..... 19
4.2 Test Setup ..... 19
4.3 Test Result of Radiated Test ..... 19
4.4 Radiated Spurious Emission Measurement ..... 20
5 LIST OF MEASURING EQUIPMENT ..... 21
6 UNCERTAINTY OF EVALUATION ..... 22
APPENDIX A. TEST RESULTS OF CONDUCTED TEST
APPENDIX B. TEST RESULTS OF RADIATED TEST
APPENDIX C. TEST SETUP PHOTOGRAPHS



**REVISION HISTORY**

<b>REPORT NO.</b>	<b>VERSION</b>	<b>DESCRIPTION</b>	<b>ISSUED DATE</b>
FW9N2009-01E	Rev. 01	Initial issue of report	Mar. 19, 2020

## SUMMARY OF TEST RESULT

Report Section	FCC Rule	Description	Limit	Result	Remark
3.4	§2.1046	Conducted Output Power	Reporting Only	PASS	-
3.5	-	Peak-to-Average Ratio	<13dB	N/A	Reporting only
3.6	§27.50 (a)(3)	EIRP Power Density	EIRP < 250mW/5MHz	PASS	-
3.7	§2.1049	Occupied Bandwidth	Reporting Only	PASS	-
3.8	§2.1051 §27.53 (a)(4)	Conducted Band Edge Measurement	Refer standard	PASS	-
3.9	§2.1051 §27.53 (a)(4)	Conducted Spurious Emission	< 70+10log <sub>10</sub> (P[Watts])	PASS	-
3.10	§2.1055 §27.54	Frequency Stability Temperature & Voltage	Within the band	PASS	-
4.4	§2.1053 §27.53 (a)(4)	Radiated Spurious Emission	< 70+10log <sub>10</sub> (P[Watts])	PASS	Under limit 16.34 dB at 9222.00 MHz

**Declaration of Conformity:**

The test results with all measurement uncertainty excluded are presented in accordance with the regulation limits or requirements declared by manufacturers.

**Comments and Explanations:**

The declared of product specification for EUT presented in the report are provided by the manufacturer, and the manufacturer takes all the responsibilities for the accuracy of product specification.

# 1 General Description

## 1.1 Applicant

**OnePlus Technology (Shenzhen) Co., Ltd**

18C02, 18C03, 18C04 and 18C05, Shum Yip Terra Building, Binhe Avenue North, Futian District, Shenzhen

## 1.2 Manufacturer

**OnePlus Technology (Shenzhen) Co., Ltd**

18C02, 18C03, 18C04 and 18C05, Shum Yip Terra Building, Binhe Avenue North, Futian District, Shenzhen

## 1.3 Product Feature of Equipment Under Test

Product Feature	
<b>Equipment</b>	Smart Phone
<b>Brand Name</b>	ONEPLUS
<b>Model Name</b>	IN2025
<b>FCC ID</b>	2ABZ2-EE007
<b>EUT supports Radios application</b>	CDMA/GSM/WCDMA/LTE/5G NR WLAN 2.4GHz 802.11b/g/n HT20 WLAN 2.4GHz 802.11ax HE20/HE40 WLAN 5GHz 802.11a/n HT20/HT40 WLAN 5GHz 802.11ac VHT20/VHT40/VHT80 WLAN 5GHz 802.11ax HE20/HE40/HE80 Bluetooth BR/EDR/LE GNSS/NFC/WPC
<b>IMEI Code</b>	Conducted: 865422040000457/865422040002982 Radiation: 865422040066037/865422040066029
<b>HW Version</b>	15
<b>SW Version</b>	Oxygen OS 10.5.IN11AA
<b>EUT Stage</b>	Production Unit

### 1.4 Product Specification of Equipment Under Test

Product Feature	
Tx Frequency	LTE Band 30 : 2307.5 MHz ~ 2312.5 MHz
Rx Frequency	LTE Band 30 : 2352.5 MHz ~ 2357.5 MHz
Bandwidth	5MHz / 10MHz
Maximum Output Power to Antenna	Top Antenna: LTE Band 30 : 20.51 dBm Bottom Antenna: LTE Band 30 : 22.12 dBm
Antenna Gain	Top Antenna: -2.0 dBi Bottom Antenna: -2.0 dBi
Type of Modulation	QPSK / 16QAM / 64QAM / 256QAM

Remark: Bottom antenna ERP is worse than the top antenna, so choose the bottom antenna for full test.

### 1.5 Modification of EUT

No modifications are made to the EUT during all test items.

### 1.6 Maximum Conducted power, Frequency Tolerance and Emission Designator

LTE Band 30		QPSK			16QAM		
BW (MHz)	Frequency Range (MHz)	Emission Designator (99%OBW)	Frequency Tolerance (ppm)	Maximum Conducted power(W)	Emission Designator (99%OBW)	Frequency Tolerance (ppm)	Maximum Conducted power(W)
5	2307.5 ~ 2312.5	4M51G7D	-	0.1622	4M51W7D	-	0.1409
10	2310.0	8M97G7D	0.0124	0.1629	9M05W7D	-	0.1384
LTE Band 30		64QAM					
BW (MHz)	Frequency Range (MHz)	Emission Designator (99%OBW)	Frequency Tolerance (ppm)	Maximum Conducted power(W)			
5	2307.5 ~ 2312.5	4M49W7D	-	0.1072			
10	2310.0	8M99W7D	-	0.0995			

## 1.7 Testing Site

Sporton International (Shenzhen) Inc. is accredited to ISO/IEC 17025:2017 by American Association for Laboratory Accreditation with Certificate Number 5145.01.

<b>Test Firm</b>	Sporton International (Shenzhen) Inc.		
<b>Test Site Location</b>	1/F, 2/F, Bldg 5, Shiling Industrial Zone, Xinwei Village, Xili, Nanshan, Shenzhen, 518055 People's Republic of China TEL: +86-755-86379589 FAX: +86-755-86379595		
<b>Test Site No.</b>	<b>Sporton Site No.</b>	<b>FCC Designation No.</b>	<b>FCC Test Firm Registration No.</b>
	TH01-SZ	CN1256	421272

<b>Test Firm</b>	Sporton International (Shenzhen) Inc.		
<b>Test Site Location</b>	No. 3 Bldg the third floor of south, Shahe River west, Fengzeyuan Warehouse, Nanshan Shenzhen, 518055 People's Republic of China TEL: +86-755-33202398		
<b>Test Site No.</b>	<b>Sporton Site No.</b>	<b>FCC Designation No.</b>	<b>FCC Test Firm Registration No.</b>
	03CH02-SZ	CN1256	421272

## 1.8 Test Software

Item	Site	Manufacture	Name	Version
1.	03CH02-SZ	AUDIX	E3	6.2009-8-24a

## 1.9 Applied Standards

According to the specifications of the manufacturer, the EUT must comply with the requirements of the following standards:

- ♦ 47 CFR Part 2, Part 27(D)
- ♦ ANSI C63.26-2015
- ♦ FCC KDB 971168 Power Meas License Digital Systems D01 v03r01

**Remark:**

1. All test items were verified and recorded according to the standards and without any deviation during the test.
2. This EUT has also been tested and complied with the requirements of FCC Part 15, Subpart B, recorded in a separate test report.



## 2 Test Configuration of Equipment Under Test

### 2.1 Test Mode

Antenna port conducted and radiated test items listed below are performed according to KDB 971168 D01 Power Meas. License Digital Systems v03r01 with maximum output power.

Radiated measurements are performed by rotating the EUT in three different orthogonal test planes to find the maximum emission.

Conducted Test Cases	Band	Bandwidth (MHz)						Modulation			RB #			Test Channel			
		1.4	3	5	10	15	20	QPSK	16QAM	64QAM	1	Half	Full	L	M	H	
Max. Output Power	30	-	-	V		-	-	V	V	V	V	V	V	V	V	V	V
		-	-		V	-	-	V	V	V	V	V	V		V		
Peak-to-Average Ratio	30	-	-		V	-	-	V	V	V	V		V		V		
E.I.R.P PSD	30	-	-	V		-	-	V	V	V	V			V	V	V	
		-	-		V	-	-	V	V	V	V				V		
26dB and 99% Bandwidth	30	-	-	V		-	-	V	V	V			V	V	V	V	
		-	-		V	-	-	V	V	V			V		V		
Conducted Band Edge	30	-	-	V		-	-	V	V	V	V		V	V		V	
		-	-		V	-	-	V	V	V	V		V		V		
Conducted Spurious Emission	30	-	-	V		-	-	V	V	V	V			V	V	V	
		-	-		V	-	-	V	V	V	V				V		
Frequency Stability	30	-	-		V	-	-	V					V		V		
Radiated Spurious Emission	30	-	-	V		-	-	V			V			V	V	V	
					V			V			V				V		

- Note**
1. The mark "v " means that this configuration is chosen for testing
  2. The mark "- " means that this bandwidth is not supported.
  3. The device is investigated from 30MHz to 10 times of fundamental signal for radiated spurious emission test under different RB size/offset and modulations in exploratory test. Subsequently, only the worst case emissions are reported.



## 2.2 Connection Diagram of Test System

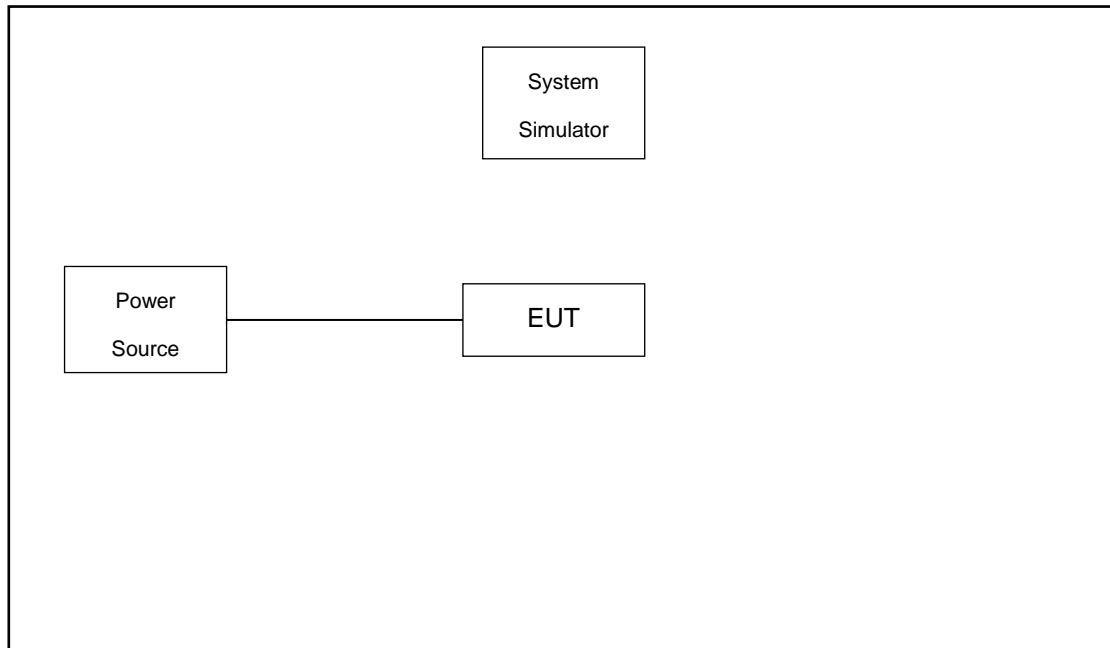

## 2.3 Support Unit used in test configuration and system

Item	Equipment	Trade Name	Model No.	FCC ID	Data Cable	Power Cord
1.	LTE Base Station	Anritsu	MT8820C	N/A	N/A	Unshielded, 1.8 m

## 2.4 Measurement Results Explanation Example

### For all conducted test items:

The offset level is set in the spectrum analyzer to compensate the RF cable loss and attenuator factor between EUT conducted output port and spectrum analyzer. With the offset compensation, the spectrum analyzer reading level is exactly the EUT RF output level.

The spectrum analyzer offset is derived from RF cable loss and attenuator factor.

*Offset = RF cable loss + attenuator factor.*

Following shows an offset computation example with cable loss 5.0 dB and 10dB attenuator.

Example :

$$\begin{aligned}
 \text{Offset(dB)} &= \text{RF cable loss(dB)} + \text{attenuator factor(dB)}. \\
 &= 5.0 + 10 = 15.0 \text{ (dB)}
 \end{aligned}$$



## 2.5 Frequency List of Low/Middle/High Channels

LTE Band 30 Channel and Frequency List				
BW [MHz]	Channel/Frequency(MHz)	Lowest	Middle	Highest
10	Channel	-	27710	-
	Frequency	-	2310	-
5	Channel	27685	27710	27735
	Frequency	2307.5	2310	2312.5

### 3 Conducted Test Items

#### 3.1 Measuring Instruments

See list of measuring instruments of this test report.

#### 3.2 Test Setup

##### 3.2.1 Conducted Output Power

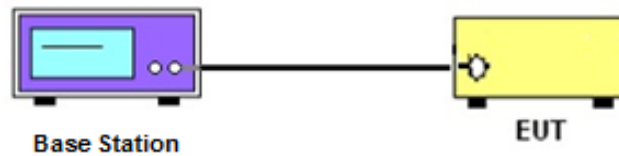

##### 3.2.2 Peak-to-Average Ratio, Occupied / 26dB Bandwidth, Band-Edge and Conducted Spurious Emission

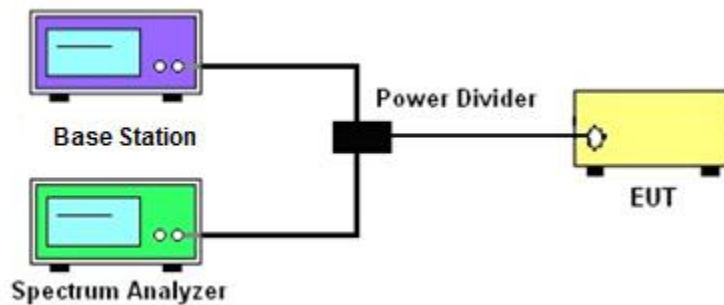

##### 3.2.3 Frequency Stability



### 3.3 Test Result of Conducted Test

Please refer to Appendix A.



## **3.4 Conducted Output Power Measurement**

### **3.4.1 Description of the Conducted Output Power Measurement**

A base station simulator was used to establish communication with the EUT. Its parameters were set to transmit the maximum power on the EUT. The measured power in the radio frequency on the transmitter output terminals shall be reported.

### **3.4.2 Test Procedures**

1. The testing follows ANSI C63.26 Section 5.2
2. The transmitter output port was connected to the system simulator.
3. Set EUT at maximum power through the system simulator.
4. Select lowest, middle, and highest channels for each band and different modulation.
5. Measure and record the power level from the system simulator.

## 3.5 Peak-to-Average Ratio

### 3.5.1 Description of the PAR Measurement

Power Complementary Cumulative Distribution Function (CCDF) curves provide a means for characterizing the power peaks of a digitally modulated signal on a statistical basis. A CCDF curve depicts the probability of the peak signal amplitude exceeding the average power level. Most contemporary measurement instrumentation include the capability to produce CCDF curves for an input signal provided that the instrument's resolution bandwidth can be set wide enough to accommodate the entire input signal bandwidth. In measuring transmissions in this band using an average power technique, the peak-to-average ratio (PAR) of the transmission may not exceed 13 dB.

### 3.5.2 Test Procedures

1. The testing follows ANSI C63.26 Section 5.2.3.4 (CCDF).
2. The EUT was connected to spectrum and system simulator via a power divider.
3. Set the CCDF (Complementary Cumulative Distribution Function) option in spectrum analyzer.
4. The highest RF powers were measured and recorded the maximum PAPR level associated with a probability of 0.1 %.
5. Record the deviation as Peak to Average Ratio.

## 3.6 EIRP Power Density

### 3.6.1 Description of EIRP Power Density

For mobile and portable stations transmitting in the 2305-2315 MHz band or the 2350-2360 MHz band, the average EIRP must not exceed 50 milliwatts within any 1 megahertz of authorized bandwidth, *except that* for mobile and portable stations compliant with 3GPP LTE standards or another advanced mobile broadband protocol that avoids concentrating energy at the edge of the operating band the average EIRP must not exceed 250 milliwatts within any 5 megahertz of authorized bandwidth but may exceed 50 milliwatts within any 1 megahertz of authorized bandwidth. For mobile and portable stations using time division duplexing (TDD) technology, the duty cycle must not exceed 38 percent in the 2305-2315 MHz and 2350-2360 MHz bands. Mobile and portable stations using FDD technology are restricted to transmitting in the 2305-2315 MHz band. Power averaging shall not include intervals in which the transmitter is off.

### 3.6.2 Test Procedures

1. The testing follows ANSI C63.26 Section 5.2.4.5
2. Set instrument center frequency to OBW center frequency.
3. Set span to at least 1.5 times the OBW.
4. Set the RBW to the specified reference bandwidth (5MHz).
5. Set VBW  $\geq 3 \times$  RBW.
6. Detector = RMS (power averaging).
7. Ensure that the number of measurement points in the sweep  $\geq 2 \times$  span/RBW.
8. Sweep time = auto couple.
9. Employ trace averaging (RMS) mode over a minimum of 100 traces.
10. Use the peak marker function to determine the maximum amplitude level within the reference bandwidth (PSD).

## 3.7 Occupied Bandwidth

### 3.7.1 Description of Occupied Bandwidth Measurement

The occupied bandwidth is the width of a frequency band such that, below the lower and above the upper frequency limits, the mean powers emitted are each equal to a specified percentage 0.5% of the total mean transmitted power.

The 26 dB emission bandwidth is defined as the frequency range between two points, one above and one below the carrier frequency, at which the spectral density of the emission is attenuated 26 dB below the maximum in-band spectral density of the modulated signal. Spectral density (power per unit bandwidth) is to be measured with a detector of resolution bandwidth equal to approximately 1.0% of the emission bandwidth.

### 3.7.2 Test Procedures

1. The testing follows ANSI C63.26 Section 5.4
2. The EUT was connected to spectrum analyzer and system simulator via a power divider.
3. The spectrum analyzer center frequency is set to the nominal EUT channel center frequency. The span range for the spectrum analyzer shall be between two and five times the anticipated OBW.
4. The nominal resolution bandwidth (RBW) shall be in the range of 1 to 5 % of the anticipated OBW, and the VBW shall be at least 3 times the RBW.
5. Set the detection mode to peak, and the trace mode to max hold.
6. Determine the reference value: Set the EUT to transmit a modulated signal. Allow the trace to stabilize. Set the spectrum analyzer marker to the highest level of the displayed trace.  
(this is the reference value)
7. Determine the “-26 dB down amplitude” as equal to (Reference Value – X).
8. Place two markers, one at the lowest and the other at the highest frequency of the envelope of the spectral display such that each marker is at or slightly below the “-X dB down amplitude” determined in step 6. If a marker is below this “-X dB down amplitude” value it shall be placed as close as possible to this value. The OBW is the positive frequency difference between the two markers.
9. Use the 99 % power bandwidth function of the spectrum analyzer and report the measured bandwidth.

## 3.8 Conducted Band Edge Measurement

### 3.8.1 Description of Conducted Band Edge Measurement

27.53 (a)(4)

For mobile and portable stations operating in the 2305-2315 MHz and 2350-2360 MHz bands:

- (i) By a factor of not less than:  $43 + 10 \log (P)$  dB on all frequencies between 2305 and 2320 MHz and on all frequencies between 2345 and 2360 MHz that are outside the licensed band(s) of operation, not less than  $55 + 10 \log (P)$  dB on all frequencies between 2320 and 2324 MHz and on all frequencies between 2341 and 2345 MHz, not less than  $61 + 10 \log (P)$  dB on all frequencies between 2324 and 2328 MHz and on all frequencies between 2337 and 2341 MHz, and not less than  $67 + 10 \log (P)$  dB on all frequencies between 2328 and 2337 MHz;
- (ii) By a factor of not less than  $43 + 10 \log (P)$  dB on all frequencies between 2300 and 2305 MHz,  $55 + 10 \log (P)$  dB on all frequencies between 2296 and 2300 MHz,  $61 + 10 \log (P)$  dB on all frequencies between 2292 and 2296 MHz,  $67 + 10 \log (P)$  dB on all frequencies between 2288 and 2292 MHz, and  $70 + 10 \log (P)$  dB below 2288 MHz;
- (iii) By a factor of not less than  $43 + 10 \log (P)$  dB on all frequencies between 2360 and 2365 MHz, and not less than  $70 + 10 \log (P)$  dB above 2365 MHz.

### 3.8.2 Test Procedures

1. The testing follows ANSI C63.26 section 5.7
2. The EUT was connected to spectrum analyzer and system simulator via a power divider.
3. The band edges of low and high channels for the highest RF powers were measured.
4. Set RBW  $\geq$  1% EBW in the 1MHz band immediately outside and adjacent to the band edge.
5. Beyond the 1 MHz band from the band edge, RBW=1MHz was used.
6. Set spectrum analyzer with RMS detector.
7. The RF fundamental frequency should be excluded against the limit line in the operating frequency band.
8. Checked that all the results comply with the emission limit line.

Example:

$$\begin{aligned} & \text{The limit line is derived from } 43 + 10\log(P)\text{dB below the transmitter power } P(\text{Watts}) \\ & = P(\text{W}) - [43 + 10\log(P)] \text{ (dB)} \\ & = [30 + 10\log(P)] \text{ (dBm)} - [43 + 10\log(P)] \text{ (dB)} = -13\text{dBm}. \end{aligned}$$



## 3.9 Conducted Spurious Emission Measurement

### 3.9.1 Description of Conducted Spurious Emission Measurement

The power of any emission outside of the authorized operating frequency ranges must be lower than the transmitter power (P) by a factor of at least  $70 + 10 \log (P)$  dB.

It is measured by means of a calibrated spectrum analyzer and scanned from 9 kHz up to a frequency including its 10<sup>th</sup> harmonic.

### 3.9.2 Test Procedures

1. The testing follows ANSI C63.26 section 5.7
2. The EUT was connected to spectrum analyzer and system simulator via a power divider.
3. The RF output of EUT was connected to the spectrum analyzer by RF cable and attenuator. The path loss was compensated to the results for each measurement.
4. The middle channel for the highest RF power within the transmitting frequency was measured.
5. The conducted spurious emission for the whole frequency range was taken.
6. Make the measurement with the spectrum analyzer's RBW = 1MHz, VBW = 3MHz.
7. Set spectrum analyzer with RMS detector.
8. Taking the record of maximum spurious emission.
9. The RF fundamental frequency should be excluded against the limit line in the operating frequency band.
10. The limit line is derived from  $70 + 10\log(P)$ dB below the transmitter power P(Watts)  
=  $P(W) - [70 + 10\log(P)]$  (dB)  
=  $[30 + 10\log(P)]$  (dBm) -  $[70 + 10\log(P)]$  (dB)  
= -40dBm

## 3.10 Frequency Stability Measurement

### 3.10.1 Description of Frequency Stability Measurement

The frequency stability shall be measured by variation of ambient temperature and variation of primary supply voltage to ensure that the fundamental emission stays within the authorized frequency block. The frequency stability of the transmitter shall be maintained within  $\pm 0.00025\%$  ( $\pm 2.5\text{ppm}$ ) of the center frequency.

### 3.10.2 Test Procedures for Temperature Variation

1. The testing follows ANSI C63.26 section 5.6.4
2. The EUT was set up in the thermal chamber and connected with the system simulator.
3. With power OFF, the temperature was decreased to  $-30^{\circ}\text{C}$  and the EUT was stabilized before testing. Power was applied and the maximum change in frequency was recorded within one minute.
4. With power OFF, the temperature was raised in  $10^{\circ}\text{C}$  step up to  $50^{\circ}\text{C}$ . The EUT was stabilized at each step for at least half an hour. Power was applied and the maximum frequency change was recorded within one minute.

### 3.10.3 Test Procedures for Voltage Variation

1. The testing follows ANSI C63.26 section 5.6.5.
2. The EUT was placed in a temperature chamber at  $20\pm 5^{\circ}\text{C}$  and connected with the system simulator.
3. The power supply voltage to the EUT was varied from 85% to 115% of the nominal value for other than hand carried battery equipment.
4. For hand carried, battery powered equipment, reduce the primary ac or dc supply voltage to the battery operating end point, which shall be specified by the manufacturer.
5. The variation in frequency was measured for the worst case.

## 4 Radiated Test Items

### 4.1 Measuring Instruments

See list of measuring instruments of this test report.

### 4.2 Test Setup

#### 4.2.1 For radiated test from 30MHz to 1GHz

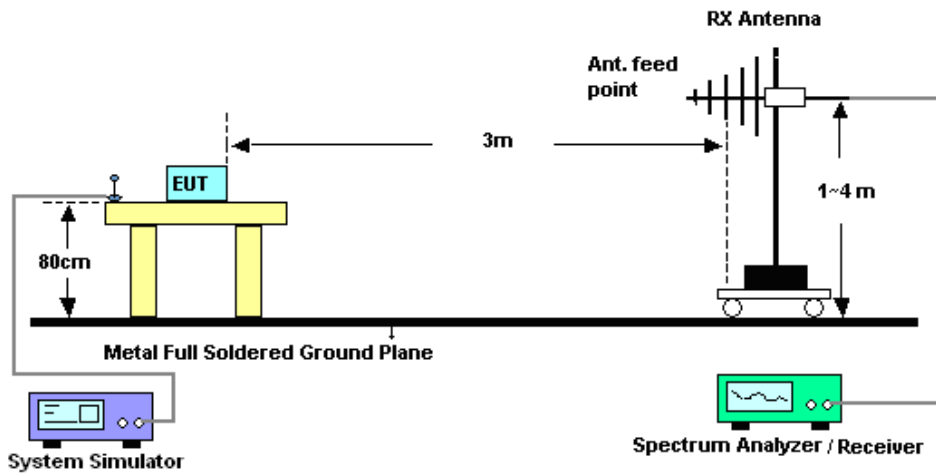

#### 4.2.2 For radiated test above 1GHz

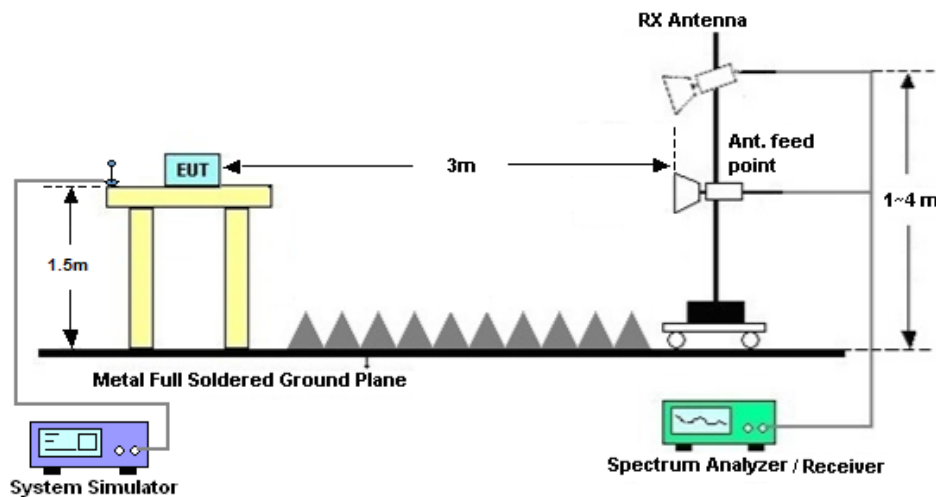

### 4.3 Test Result of Radiated Test

Please refer to Appendix B.

## 4.4 Radiated Spurious Emission Measurement

### 4.4.1 Description of Radiated Spurious Emission

The radiated spurious emission was measured by substitution method according to ANSI/TIA-603-E. The power of any emission outside of the authorized operating frequency ranges must be attenuated below the transmitter power (P) by a factor of at least  $70 + 10 \log(P)$  dB.

The spectrum is scanned from 30 MHz up to a frequency including its 10th harmonic.

### 4.4.2 Test Procedures

1. The testing follows ANSI C63.26 Section 5.5
2. The EUT was placed on a turntable with 0.8 meter height for frequency below 1GHz and 1.5 meter height for frequency above 1GHz respectively above ground.
3. The EUT was set 3 meters from the receiving antenna mounted on the antenna tower.
4. The table was rotated 360 degrees to determine the position of the highest spurious emission.
5. The height of the receiving antenna is varied between 1m to 4m to search the maximum spurious emission for both horizontal and vertical polarizations.
6. During the measurement, the system simulator parameters were set to force the EUT transmitting at maximum output power.
7. Make the measurement with the spectrum analyzer's RBW = 1MHz, VBW = 3MHz, taking the record of maximum spurious emission.
8. A horn antenna was substituted in place of the EUT and was driven by a signal generator.
9. Tune the output power of signal generator to the same emission level with EUT maximum spurious emission.

$$\text{EIRP (dBm)} = \text{S.G. Power} - \text{Tx Cable Loss} + \text{Tx Antenna Gain}$$

$$\text{ERP (dBm)} = \text{EIRP} - 2.15$$

10. The RF fundamental frequency should be excluded against the limit line in the operating frequency band.

The limit line is derived from  $70 + 10\log(P)$ dB below the transmitter power P(Watts)

$$= P(W) - [70 + 10\log(P)] \text{ (dB)}$$

$$= [30 + 10\log(P)] \text{ (dBm)} - [70 + 10\log(P)] \text{ (dB)}$$

$$= -40\text{dBm.}$$



## 5 List of Measuring Equipment

Instrument	Manufacturer	Model No.	Serial No.	Characteristics	Calibration Date	Test Date	Due Date	Remark
Spectrum Analyzer	R&S	FSV40	101078	10Hz~40GHz	Apr. 18, 2019	Dec. 13, 2019~ Dec. 16, 2019	Apr. 17, 2020	Conducted (TH01-SZ)
Thermal Chamber	Ten Billion Hongzhangroup	LP-150U	H2014081803	-40~+150°C	Dec. 22, 2018	Dec. 13, 2019~ Dec. 16, 2019	Dec. 21, 2019	Conducted (TH01-SZ)
EXA Spectrum Analyzer	KEYSIGHT	N9010A	MY55150213	10Hz~44GHz	Apr. 19, 2019	Jan. 23, 2020	Apr. 18, 2020	Radiation (03CH02-SZ)
Bilog Antenna	TeseQ	CBL6112D	35407	30MHz-2GHz	Jul. 19, 2019	Jan. 23, 2020	Jul. 18, 2020	Radiation (03CH02-SZ)
Double Ridge Horn Antenna	ETS-Lindgren	3117	00119436	1GHz~18GHz	Aug. 27, 2019	Jan. 23, 2020	Aug. 26, 2020	Radiation (03CH02-SZ)
SHF-EHF Horn	com-power	AH-840	101071	18Ghz-40GHz	Apr.18, 2019	Jan. 23, 2020	Apr. 17, 2020	Radiation (03CH02-SZ)
HF Amplifier	MITEQ	TTA1840-35-HG	1871923	18GHz~40GHz	Jul. 22, 2019	Jan. 23, 2020	Jul. 21, 2020	Radiation (03CH02-SZ)
LF Amplifier	Burgeon	BPA-530	102211	0.01~3000Mhz	Oct. 18, 2019	Jan. 23, 2020	Oct. 17, 2020	Radiation (03CH02-SZ)
HF Amplifier	KEYSIGHT	83017A	MY53270105	0.5GHz~26.5Ghz	Oct. 18, 2019	Jan. 23, 2020	Oct. 17, 2020	Radiation (03CH02-SZ)
AC Power Source	Chroma	61601	616010002470	N/A	NCR	Jan. 23, 2020	NCR	Radiation (03CH02-SZ)
Turn Table	Chaintek	T-200	N/A	0~360 degree	NCR	Jan. 23, 2020	NCR	Radiation (03CH02-SZ)
Antenna Mast	Chaintek	MBS-400	N/A	1 m~4 m	NCR	Jan. 23, 2020	NCR	Radiation (03CH02-SZ)

NCR: No Calibration Required



## 6 Uncertainty of Evaluation

The measurement uncertainties shown below were calculated in accordance with the requirements of ANSI 63.26-2015. All the measurement uncertainty value were shown with a coverage K=2 to indicate 95% level of confidence. The measurement data show herein meets or exceeds the CISPR measurement uncertainty values specified in CISPR 16-4-2 and can be compared directly to specified limit to determine compliance.

### Uncertainty of Radiated Emission Measurement (30 MHz ~ 1000 MHz)

Measuring Uncertainty for a Level of Confidence of 95% (U = 2Uc(y))	2.5dB
---	-------

### Uncertainty of Radiated Emission Measurement (1 GHz ~ 18 GHz)

Measuring Uncertainty for a Level of Confidence of 95% (U = 2Uc(y))	3.3dB
---	-------



## Appendix A. Test Results of Conducted Test

### Conducted Output Power(Average power)

Top Antenna:

LTE Band 30 Maximum Average Power [dBm]						
BW [MHz]	RB Size	RB Offset	Mod	Lowest	Middle	Highest
5	1	0	QPSK	20.29	20.35	20.40
5	1	12		20.50	20.50	20.47
5	1	24		20.44	20.34	20.39
5	12	0		19.48	19.49	19.52
5	12	7		19.60	19.51	19.56
5	12	13		19.55	19.49	19.54
5	25	0		19.55	19.48	19.51
5	1	0	16-QAM	19.71	19.68	19.75
5	1	12		19.86	19.80	19.79
5	1	24		19.76	19.69	19.68
5	12	0		18.52	18.53	18.54
5	12	7		18.62	18.56	18.61
5	12	13		18.57	18.50	18.54
5	25	0		18.57	18.51	18.55
5	1	0	64QAM	18.39	18.38	18.39
5	1	12		18.51	18.45	18.42
5	1	24		18.39	18.34	18.32
5	12	0		17.22	17.23	17.27
5	12	7		17.33	17.29	17.35
5	12	13		17.29	17.22	17.28
5	25	0		17.25	17.22	17.24



LTE Band 30 Maximum Average Power [dBm]						
BW [MHz]	RB Size	RB Offset	Mod	Lowest	Middle	Highest
10	1	0	QPSK		20.51	
10	1	25			20.43	
10	1	49			20.44	
10	25	0			19.44	
10	25	12			19.51	
10	25	25			19.40	
10	50	0			19.44	
10	1	0	16-QAM	-	19.83	-
10	1	25			19.81	
10	1	49			19.76	
10	25	0			18.45	
10	25	12			18.56	
10	25	25			18.39	
10	50	0			18.43	
10	1	0	64QAM		18.38	
10	1	25			18.45	
10	1	49			18.33	
10	25	0			17.14	
10	25	12			17.24	
10	25	25			17.11	
10	50	0			17.18	





Bottom Antenna:

LTE Band 30 Maximum Average Power [dBm]						
BW [MHz]	RB Size	RB Offset	Mod	Lowest	Middle	Highest
5	1	0	QPSK	21.94	21.94	22.06
5	1	12		22.10	21.98	22.09
5	1	24		22.03	21.97	21.98
5	12	0		21.08	21.09	21.16
5	12	7		21.21	21.14	21.17
5	12	13		21.15	21.07	21.10
5	25	0		21.15	21.08	21.12
5	1	0	16-QAM	21.30	21.32	21.36
5	1	12		21.46	21.49	21.37
5	1	24		21.37	21.30	21.27
5	12	0		20.09	20.12	20.15
5	12	7		20.21	20.15	20.22
5	12	13		20.17	20.13	20.13
5	25	0		20.15	20.12	20.16
5	1	0	64QAM	20.15	20.16	20.27
5	1	12		20.25	20.30	20.29
5	1	24		20.23	20.18	20.25
5	12	0		19.11	19.17	19.17
5	12	7		19.23	19.20	19.21
5	12	13		19.17	19.14	19.18
5	25	0		19.15	19.10	19.16



LTE Band 30 Maximum Average Power [dBm]						
BW [MHz]	RB Size	RB Offset	Mod	Lowest	Middle	Highest
10	1	0	QPSK		22.12	
10	1	25			22.05	
10	1	49			21.99	
10	25	0			21.03	
10	25	12			21.08	
10	25	25			21.01	
10	50	0			21.03	
10	1	0	16-QAM	-	21.39	-
10	1	25			21.41	
10	1	49			21.38	
10	25	0			20.05	
10	25	12			20.09	
10	25	25			20.02	
10	50	0			20.02	
10	1	0	64QAM		19.89	
10	1	25			19.98	
10	1	49			19.86	
10	25	0			18.99	
10	25	12			19.12	
10	25	25			18.99	
10	50	0			19.01	



Peak-to-Average Ratio

Mode	LTE Band 30 / 10MHz				
Mod.	QPSK		16QAM		Limit: 13dB
RB Size	1RB	Full RB	1RB	Full RB	Result
Lowest CH	-	-	-	-	PASS
Middle CH	3.62	5.04	5.10	5.97	
Highest CH	-	-	-	-	
Mode	LTE Band 30 / 10MHz				
Mod.	64QAM		-		Limit: 13dB
RB Size	1RB	Full RB	-	-	Result
Lowest CH	-	-	-	-	PASS
Middle CH	5.25	5.88	-	-	
Highest CH	-	-	-	-	



LTE Band 30 / 10MHz / QPSK

Middle Channel / 1RB

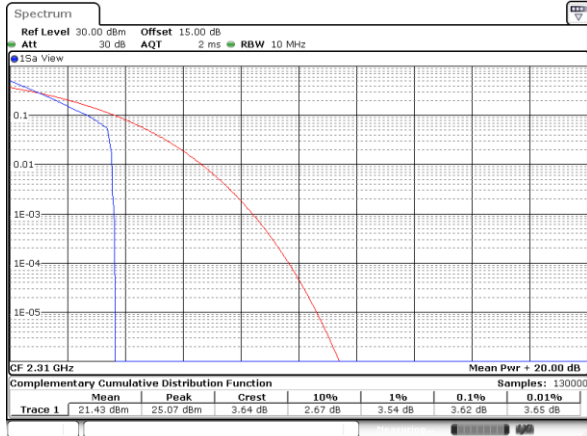

Date: 13.Dec.2019 16:35:26

Middle Channel / Full RB

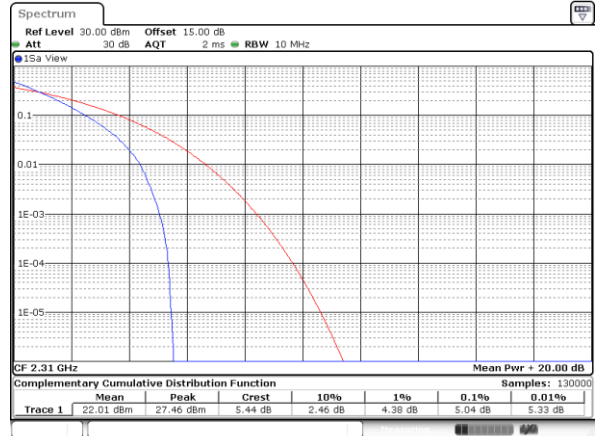

Date: 13.Dec.2019 16:35:37

LTE Band 30 / 10MHz / 16QAM

Middle Channel / 1RB

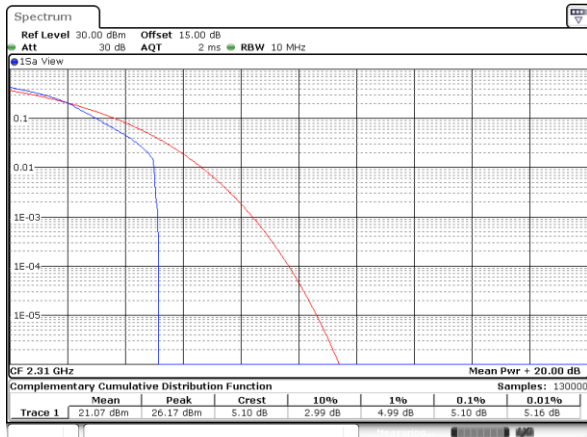

Date: 13.Dec.2019 16:35:05

Middle Channel / Full RB

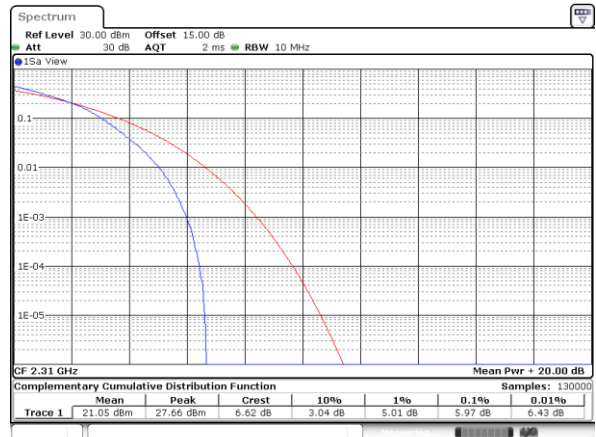

Date: 13.Dec.2019 16:35:15



LTE Band 30 / 10MHz / 64QAM

Middle Channel / 1RB

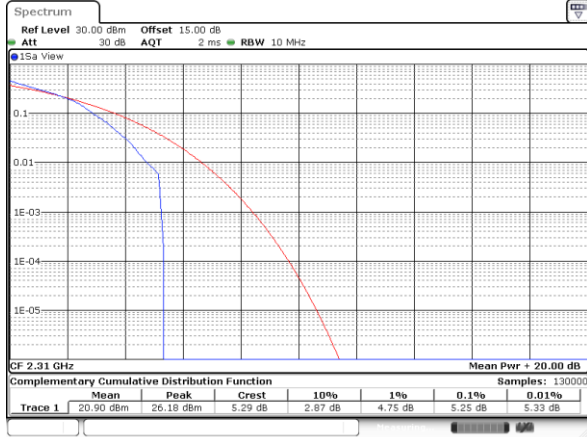

Date: 13.DEC.2019 16:34:44

Middle Channel / Full RB

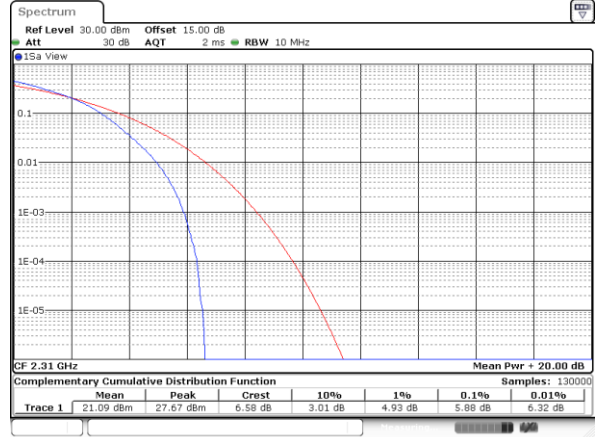

Date: 13.DEC.2019 16:34:54



### EIRP Power Density

Mode	LTE Band 30 : Conducted Power Density (dBm/5MHz)					
	5MHz		10MHz		5MHz	10MHz
	QPSK	16QAM	QPSK	16QAM	64QAM	64QAM
Lowest CH	23.95	23.31	-	-	23.10	-
Middle CH	23.84	23.27	24.00	23.37	23.16	23.36
Highest CH	23.83	23.44	-	-	23.30	-

Mode	LTE Band 30 : EIRP Power Density (dBm/5MHz)					
	5MHz		10MHz		5MHz	10MHz
	QPSK	16QAM	QPSK	16QAM	64QAM	64QAM
Lowest CH	21.95	21.31	-	-	21.10	-
Middle CH	21.84	21.27	22.00	21.37	21.16	21.36
Highest CH	21.83	21.44	-	-	21.30	-
Antenna Gain	-2.0 dBi					
Limit	250mW / 5MHz = 24dBm / 5MHz					
Result	Pass					



LTE Band 30 / 5MHz

Lowest Channel / 5MHz / 1RB0 / QPSK

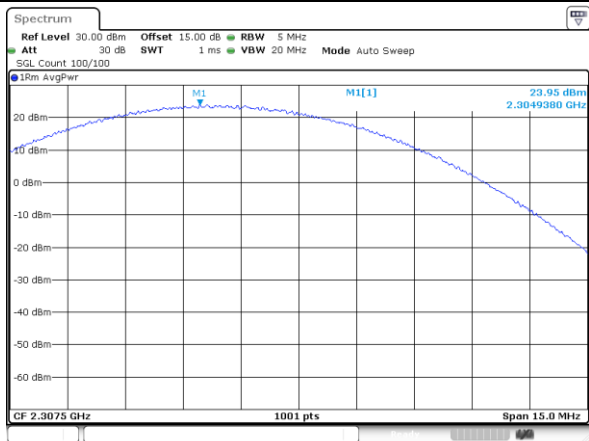

Date: 16, DEC, 2019 22:22:49

Lowest Channel / 5MHz / 1RB0 / 16QAM

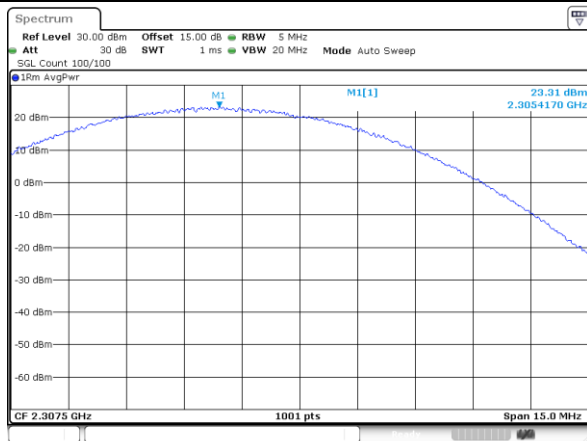

Date: 16, DEC, 2019 22:20:23

Middle Channel / 5MHz / 1RB0 / QPSK

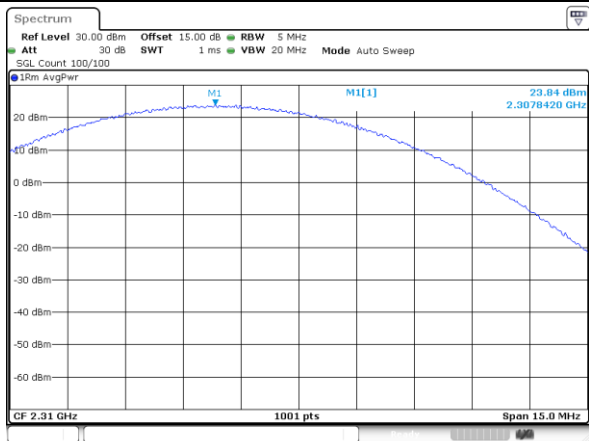

Date: 16, DEC, 2019 22:24:25

Middle Channel / 5MHz / 1RB0 / 16QAM

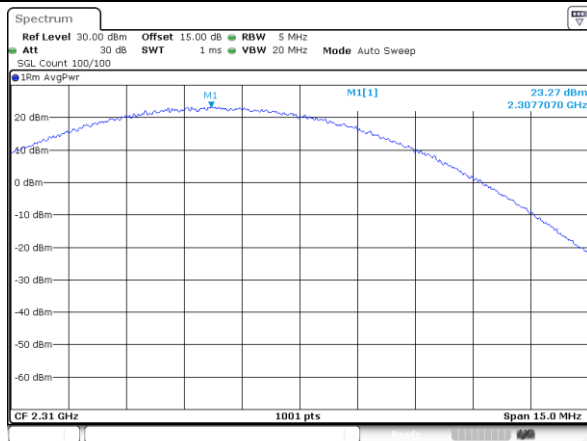

Date: 16, DEC, 2019 22:24:48

Highest Channel / 5MHz / 1RB0 / QPSK

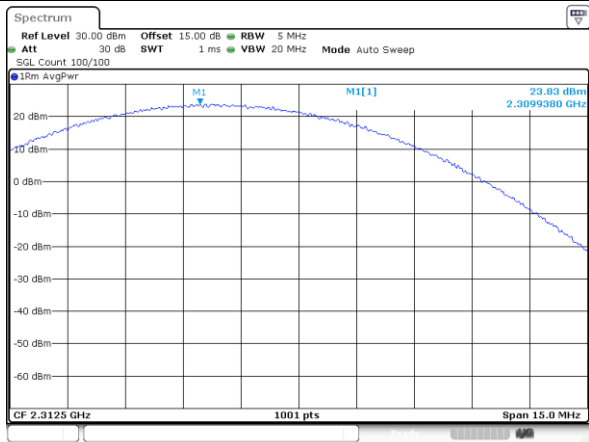

Date: 16, DEC, 2019 22:27:01

Highest Channel / 5MHz / 1RB0 / 16QAM

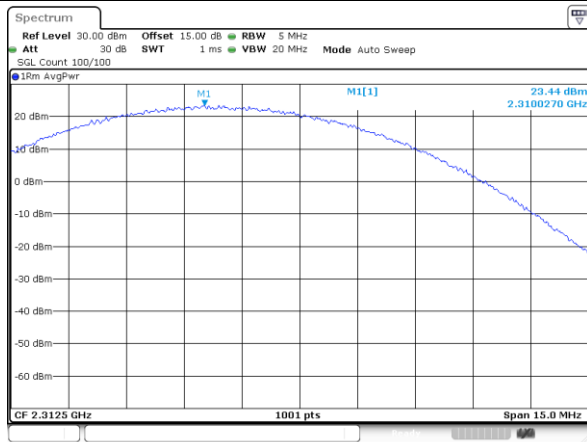

Date: 16, DEC, 2019 22:26:31



LTE Band 30 / 5MHz

Lowest Channel / 5MHz / 1RB0 / 64QAM

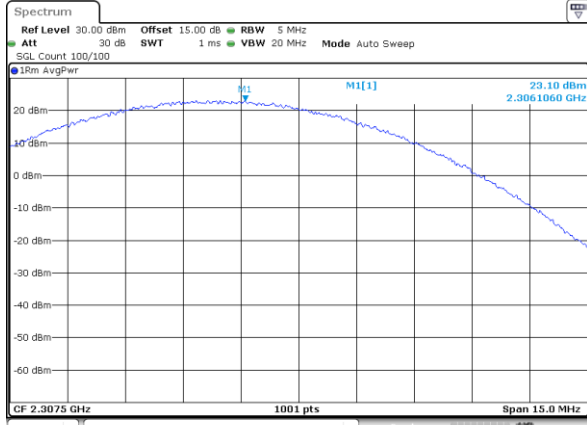

Date: 16,DEC,2019 22:20:00

Middle Channel / 5MHz / 1RB0 / 64QAM

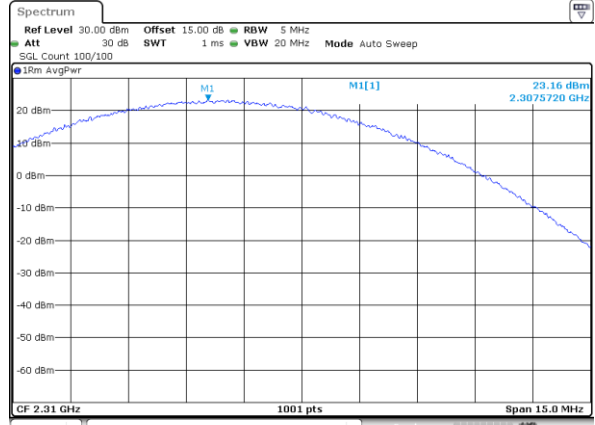

Date: 16,DEC,2019 22:25:20

Highest Channel / 5MHz / 1RB0 / 64QAM

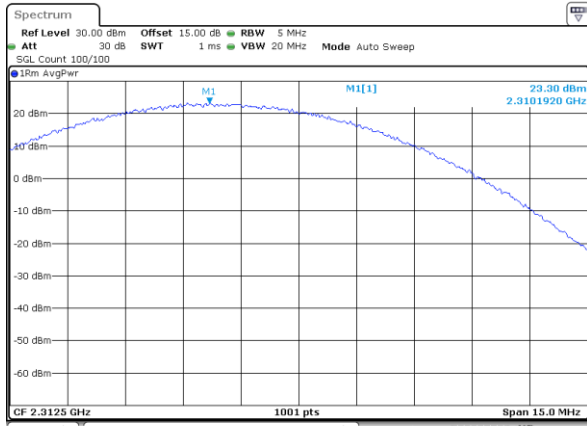

Date: 16,DEC,2019 22:25:43





LTE Band 30 / 10MHz

Lowest Channel / 10MHz / 1RB0 / QPSK

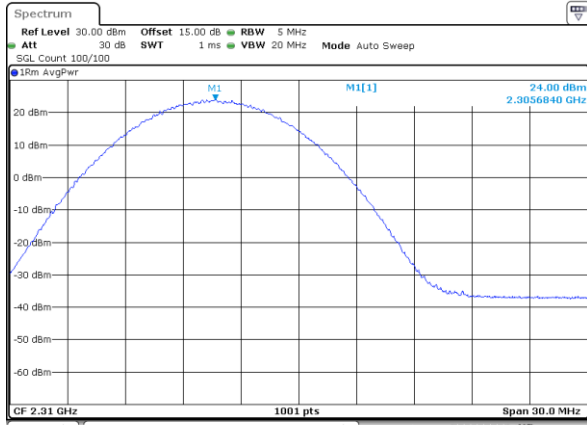

Date: 16,DEC,2019 22:17:16

Lowest Channel / 10MHz / 1RB0 / 16QAM

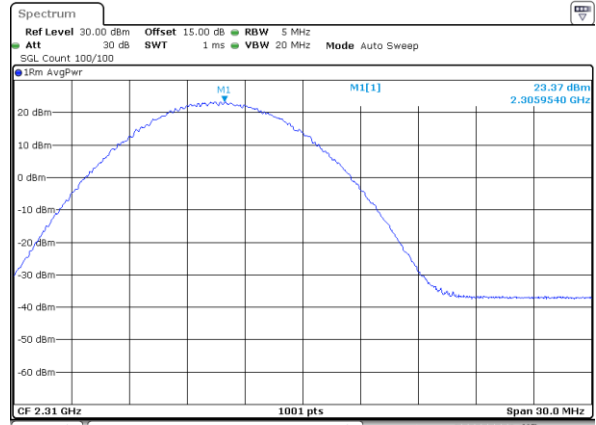

Date: 16,DEC,2019 22:16:51

Lowest Channel / 10MHz / 1RB0 / 64QAM

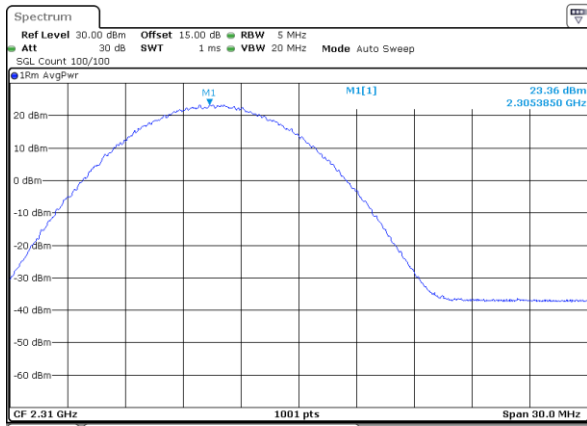

Date: 16,DEC,2019 22:16:31



**26dB Bandwidth**

Mode	LTE Band 30 : 26dB BW(MHz)					
	5MHz		10MHz		5MHz	10MHz
	QPSK	16QAM	QPSK	16QAM	64QAM	64QAM
Lowest CH	4.96	4.93	-	-	4.83	-
Middle CH	4.82	4.91	9.75	9.71	4.92	9.85
Highest CH	4.86	4.92	-	-	4.96	-



LTE Band 30

Lowest Channel / 5MHz / QPSK

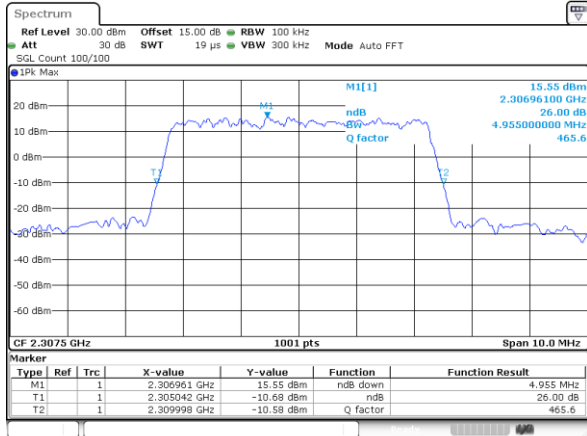

Lowest Channel / 5MHz / 16QAM

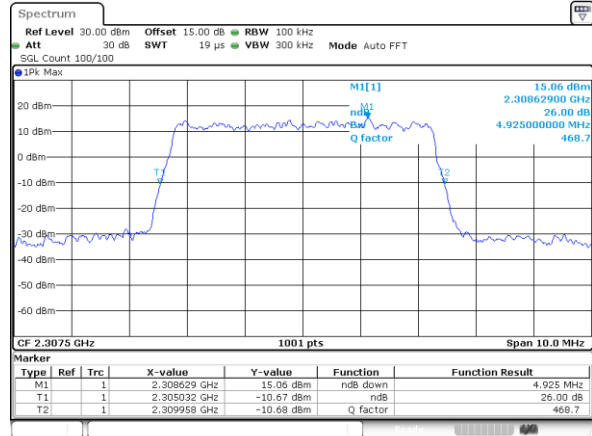

Middle Channel / 5MHz / QPSK

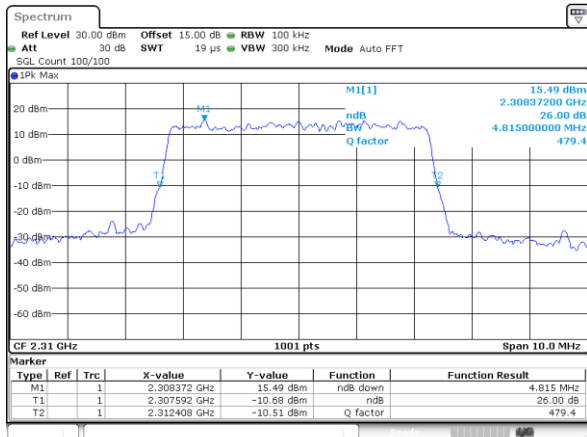

Middle Channel / 5MHz / 16QAM

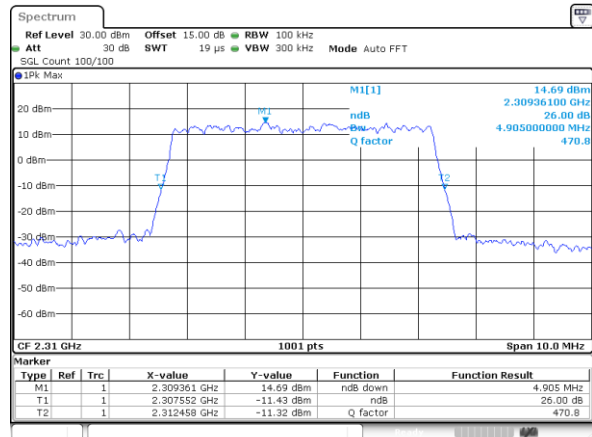

Highest Channel / 5MHz / QPSK

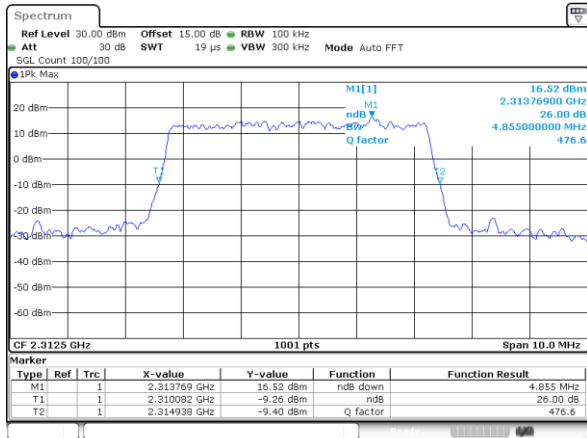

Highest Channel / 5MHz / 16QAM

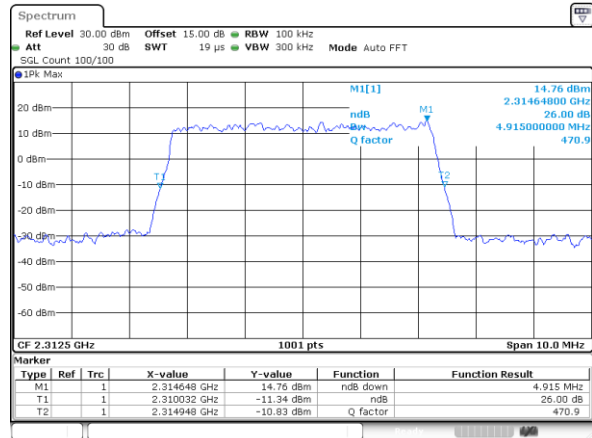

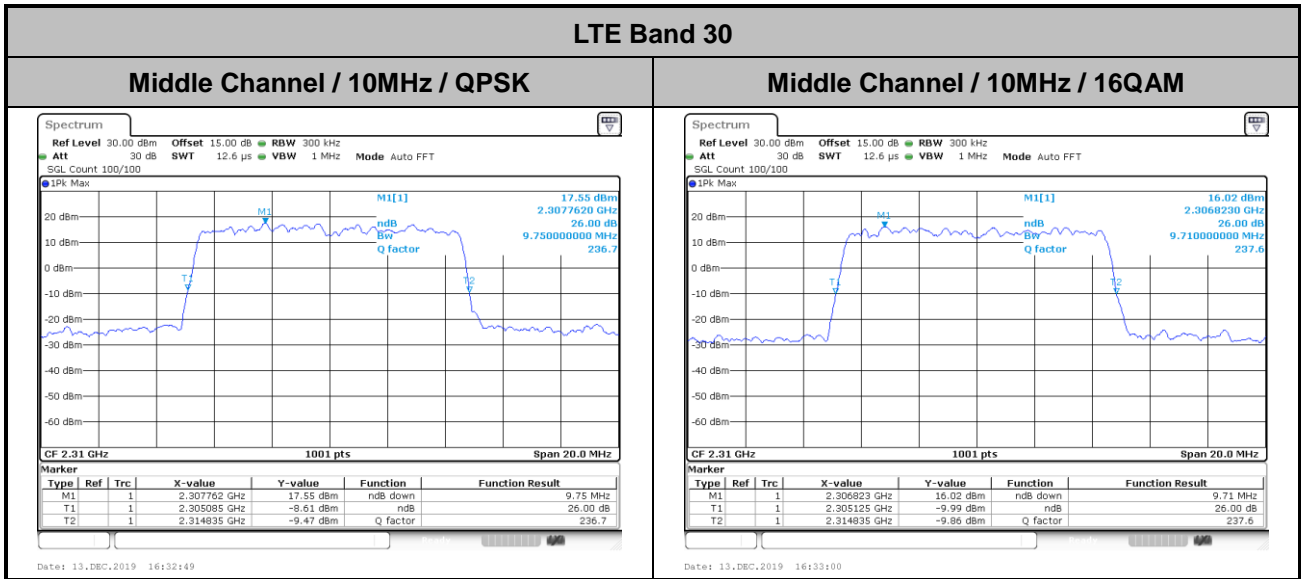



LTE Band 30

Lowest Channel / 5MHz / 64QAM

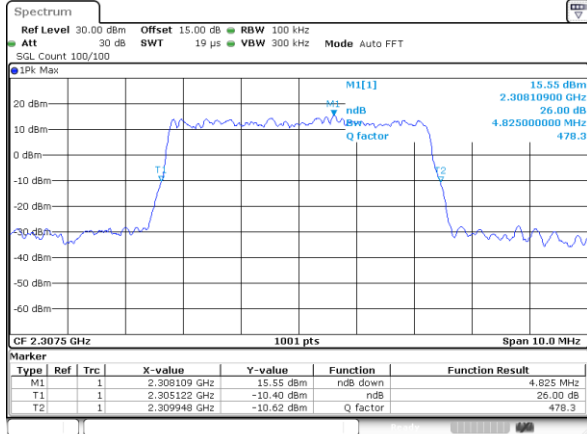

Date: 13, DEC, 2019 16:33:22

Middle Channel / 5MHz / 64QAM

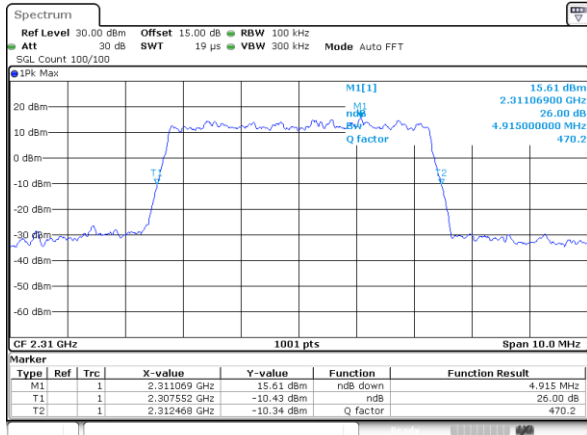

Date: 13, DEC, 2019 16:33:45

Middle Channel / 10MHz / 64QAM

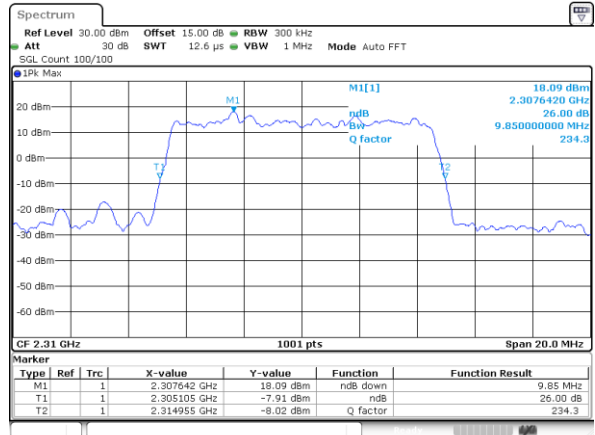

Date: 13, DEC, 2019 16:34:29

Highest Channel / 5MHz / 64QAM

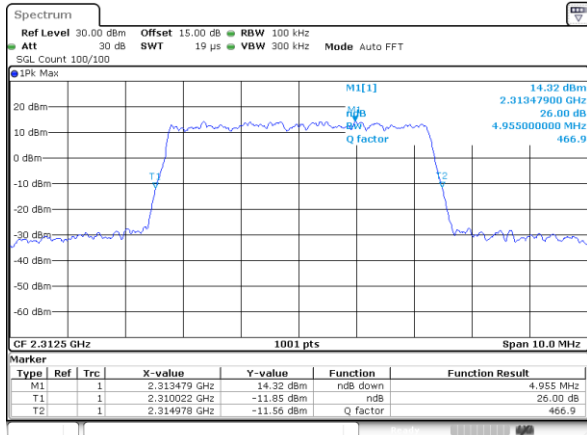

Date: 13, DEC, 2019 16:34:07



### Occupied Bandwidth

Mode	LTE Band 30 : 99%OBW(MHz)					
	5MHz		10MHz		5MHz	10MHz
	QPSK	16QAM	QPSK	16QAM	64QAM	64QAM
Lowest CH	4.51	4.51	-	-	4.49	-
Middle CH	4.49	4.48	8.97	9.05	4.49	8.99
Highest CH	4.49	4.49	-	-	4.46	-



LTE Band 30

Lowest Channel / 5MHz / QPSK

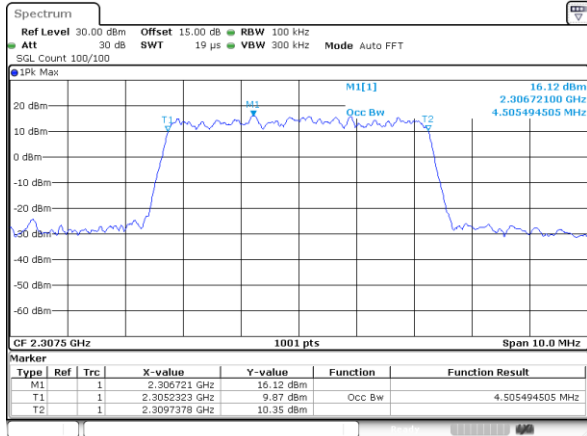

Date: 13.DEC.2019 16:30:12

Lowest Channel / 5MHz / 16QAM

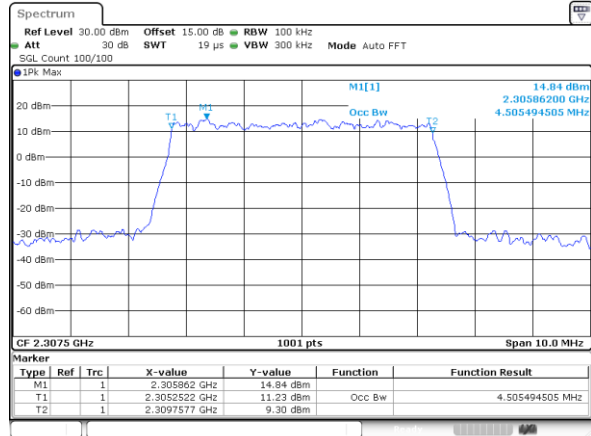

Date: 13.DEC.2019 16:30:24

Middle Channel / 5MHz / QPSK

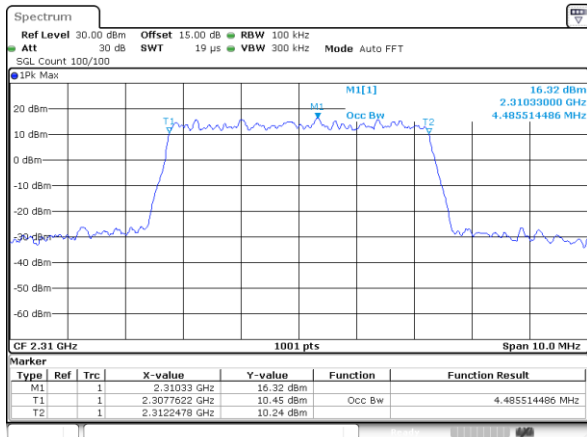

Date: 13.DEC.2019 16:30:57

Middle Channel / 5MHz / 16QAM

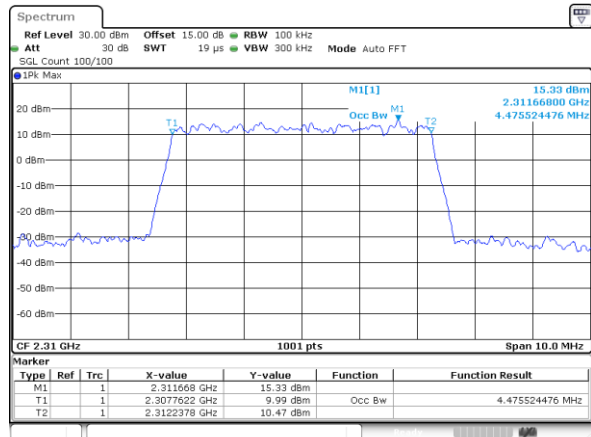

Date: 13.DEC.2019 16:31:09

Highest Channel / 5MHz / QPSK

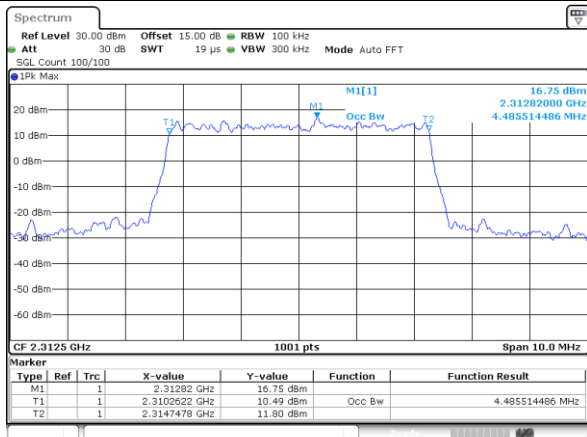

Date: 13.DEC.2019 16:31:42

Highest Channel / 5MHz / 16QAM

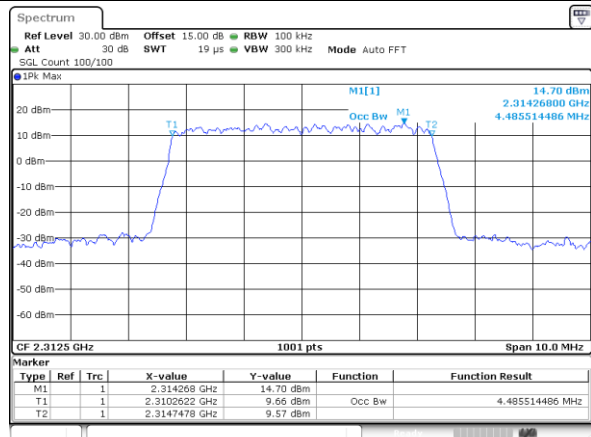

Date: 13.DEC.2019 16:31:53

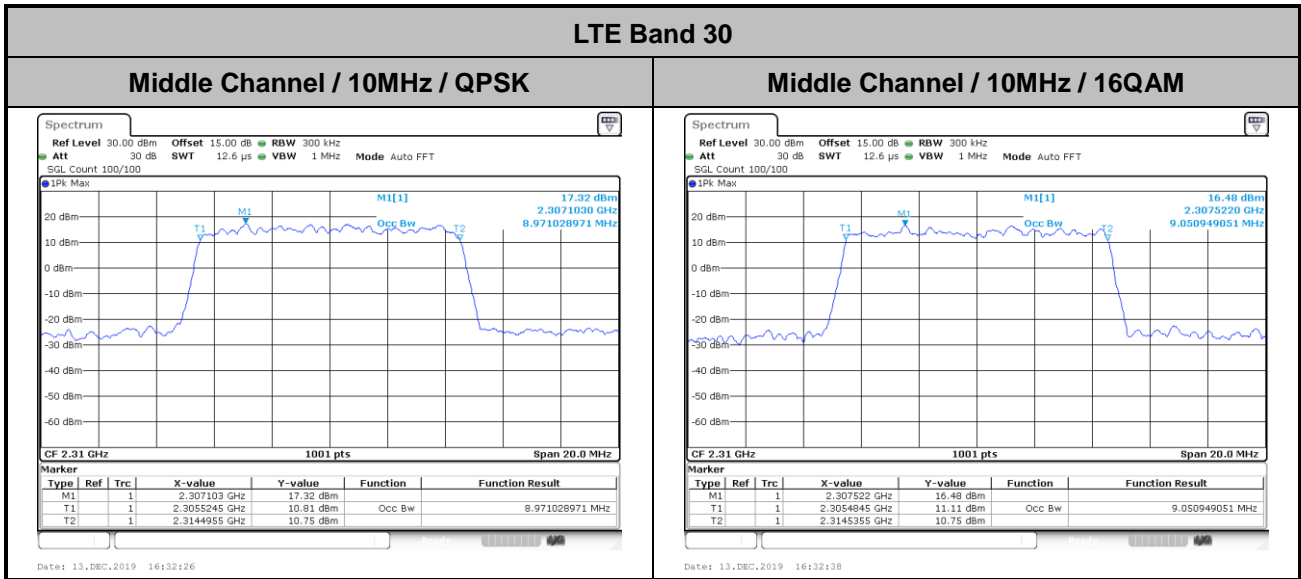





LTE Band 30

Lowest Channel / 5MHz / 64QAM

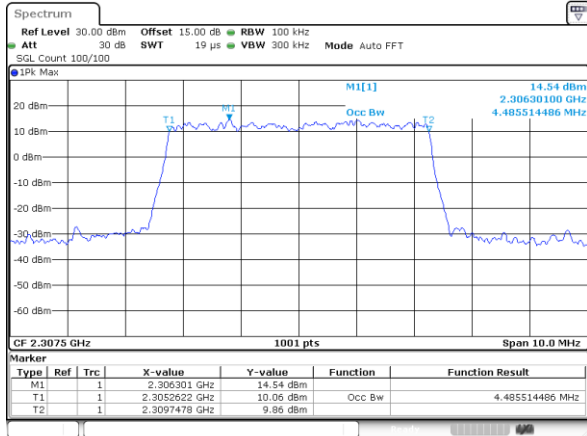

Date: 13, DEC, 2019 16:33:11

Middle Channel / 5MHz / 64QAM

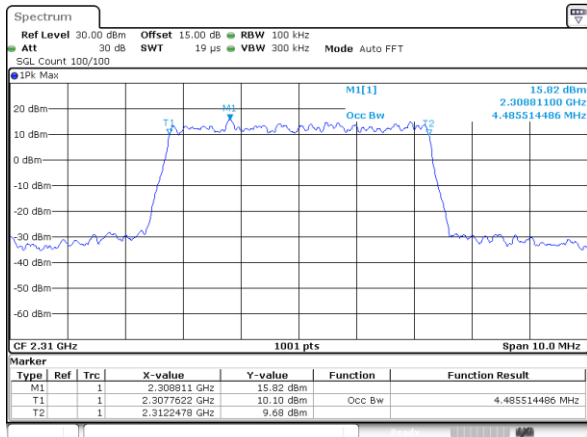

Date: 13, DEC, 2019 16:33:33

Middle Channel / 10MHz / 64QAM

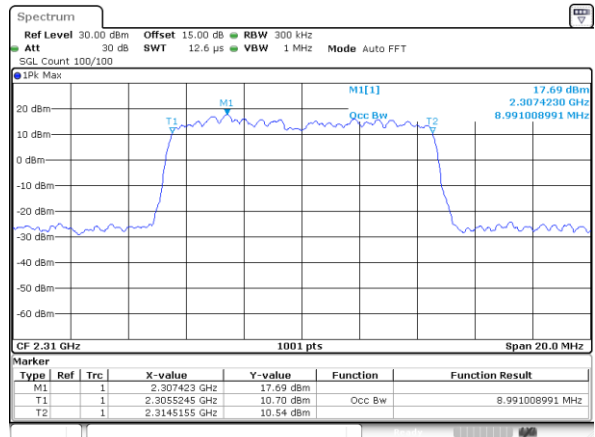

Date: 13, DEC, 2019 16:34:18

Highest Channel / 5MHz / 64QAM

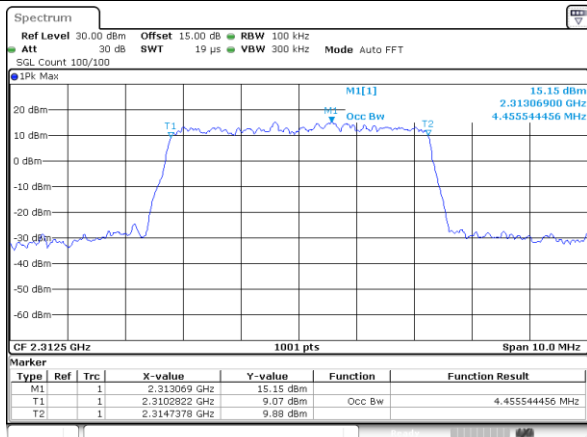

Date: 13, DEC, 2019 16:33:56



Conducted Band Edge

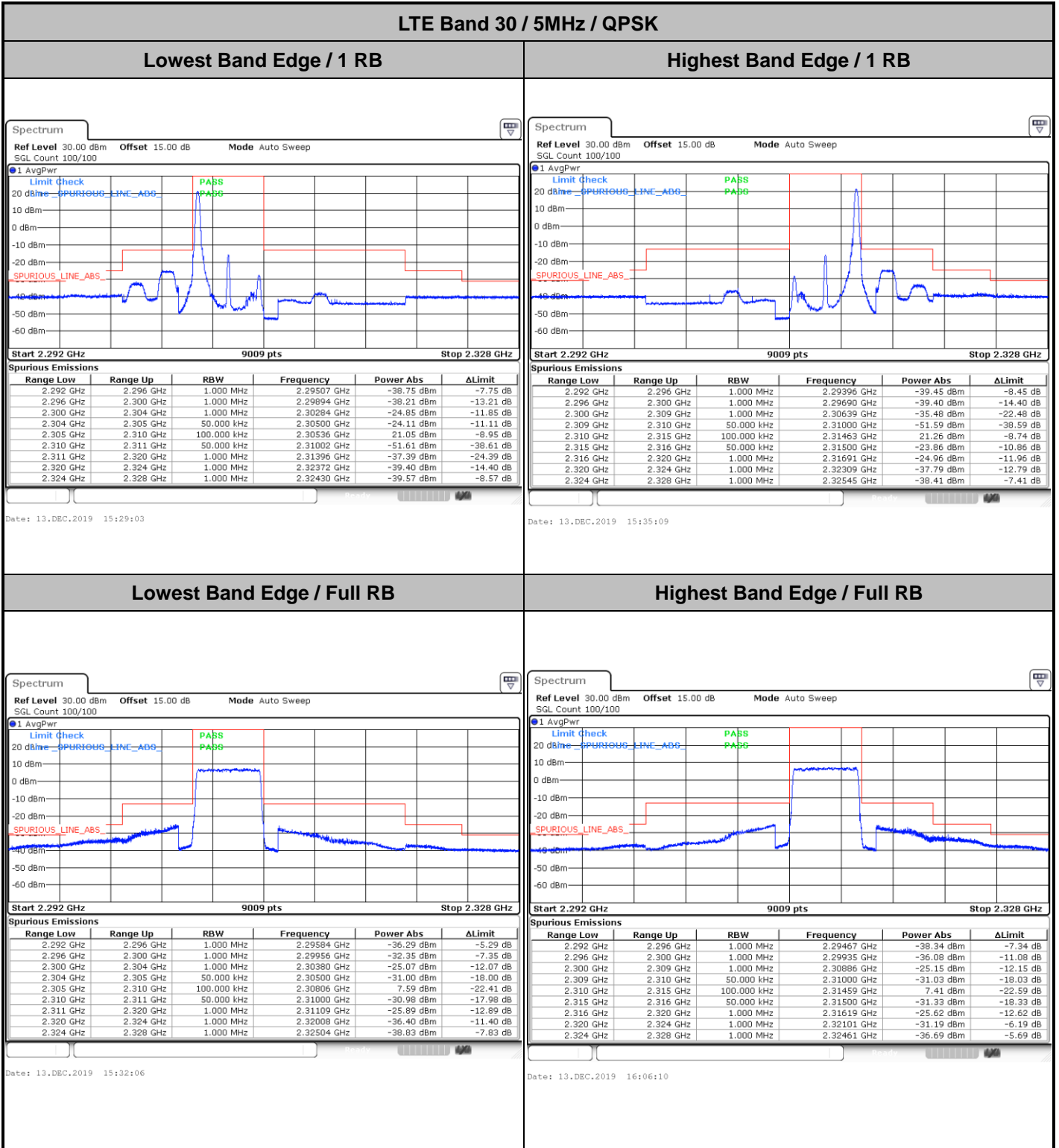



LTE Band 30 / 5MHz / 16QAM

Lowest Band Edge / 1RB

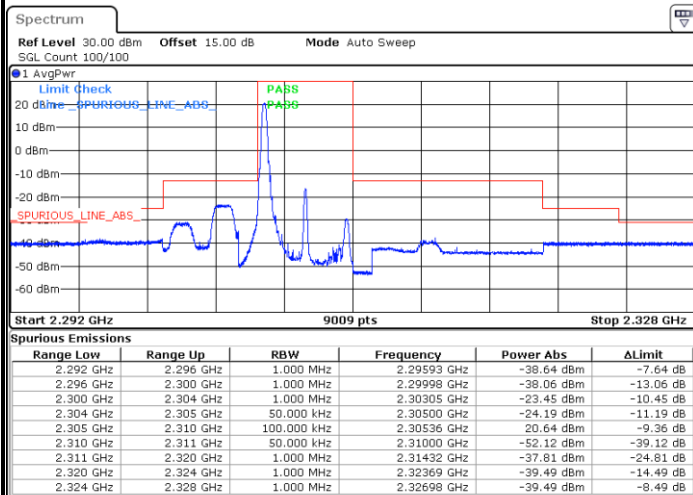

Date: 13.DEC.2019 15:30:04

Highest Band Edge / 1 RB

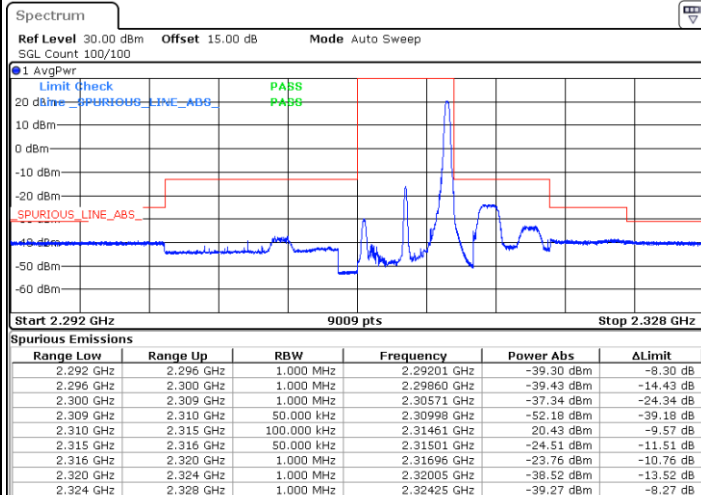

Date: 13.DEC.2019 15:36:10

Lowest Band Edge / Full RB

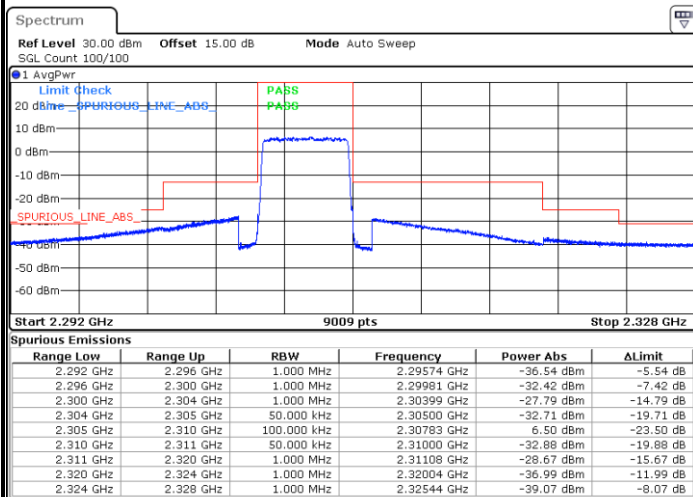

Date: 13.DEC.2019 15:33:07

Highest Band Edge / Full RB

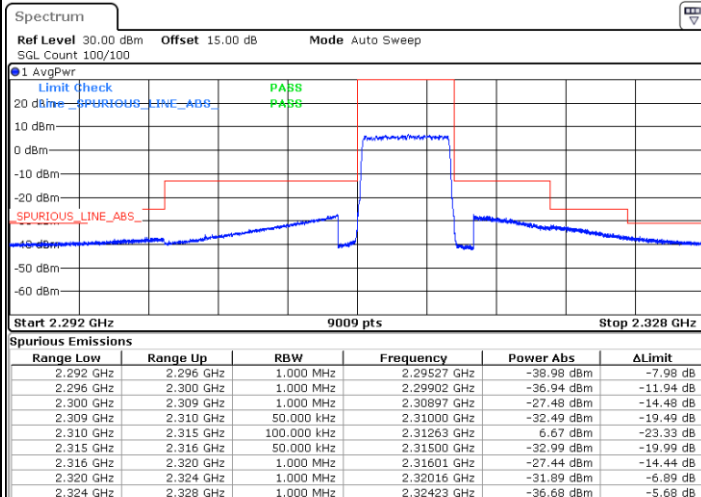

Date: 13.DEC.2019 16:07:11

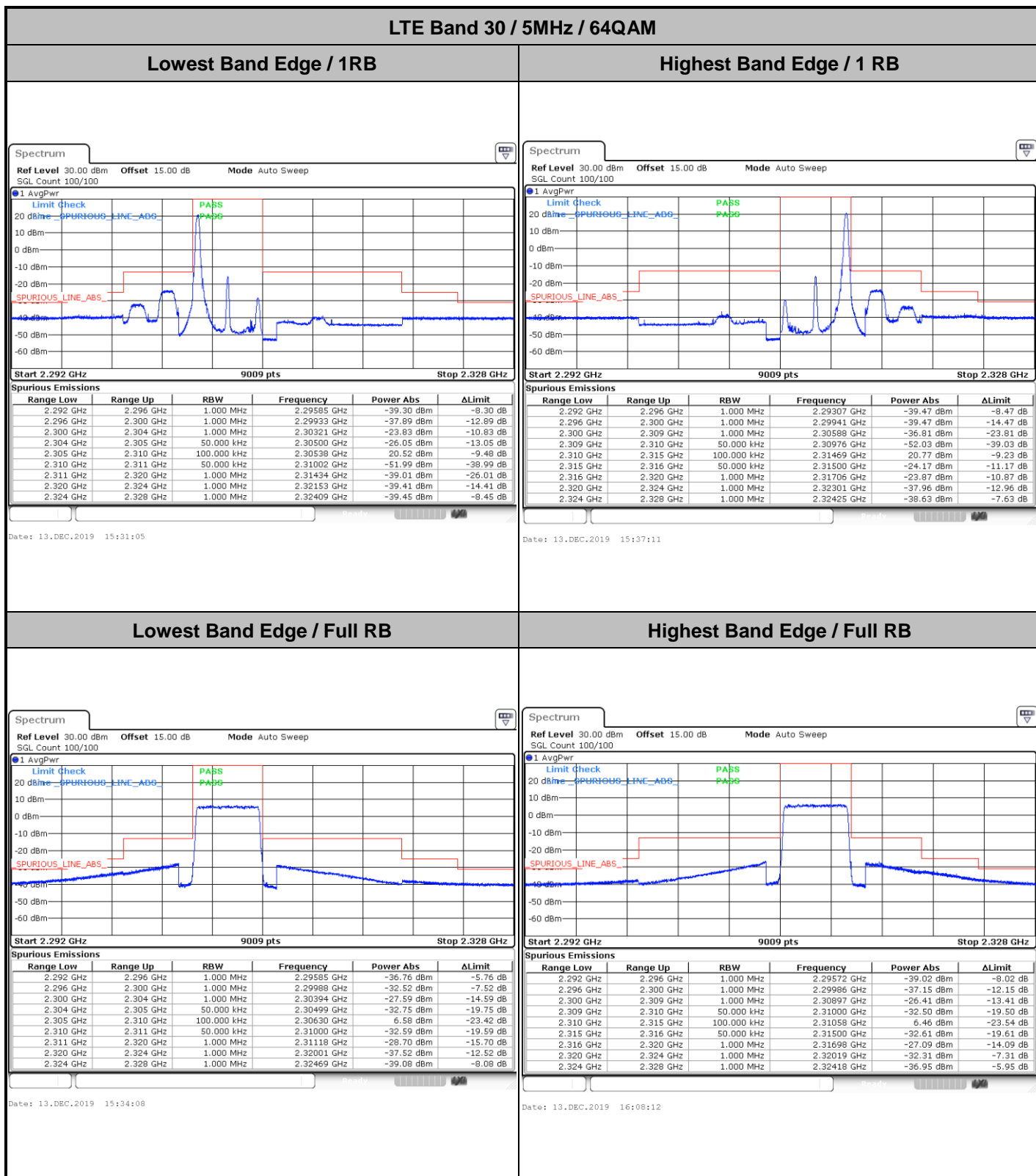

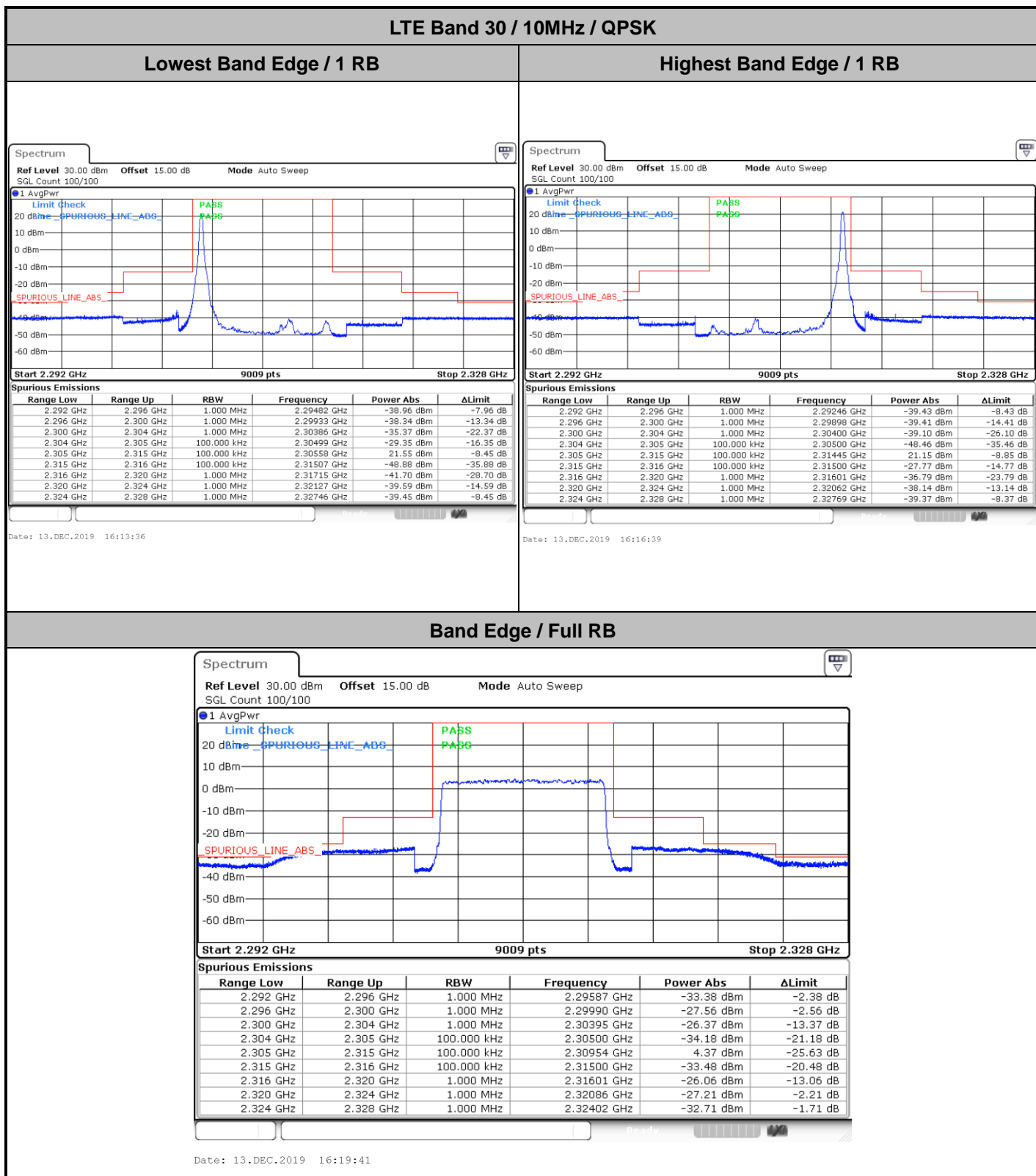

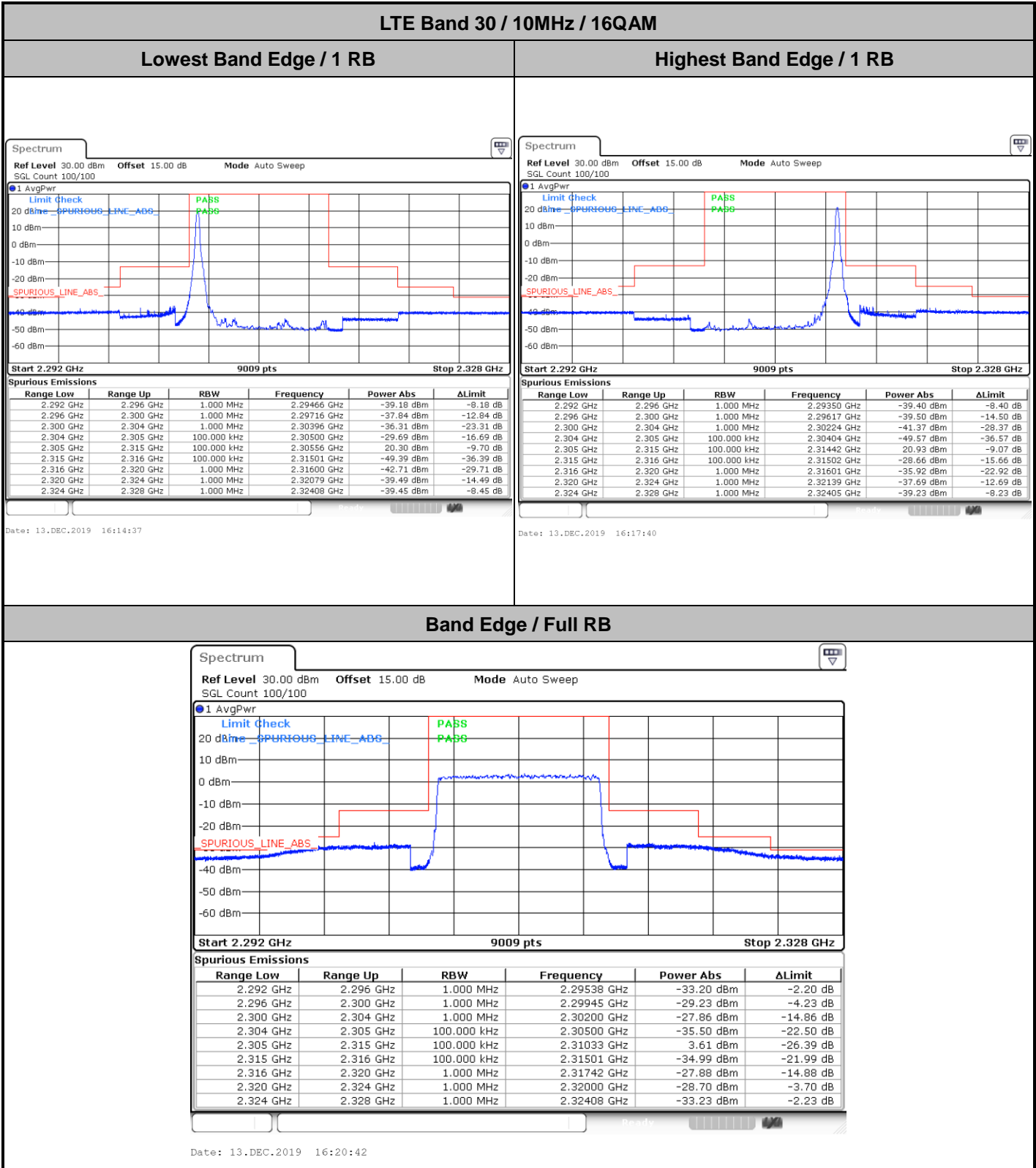

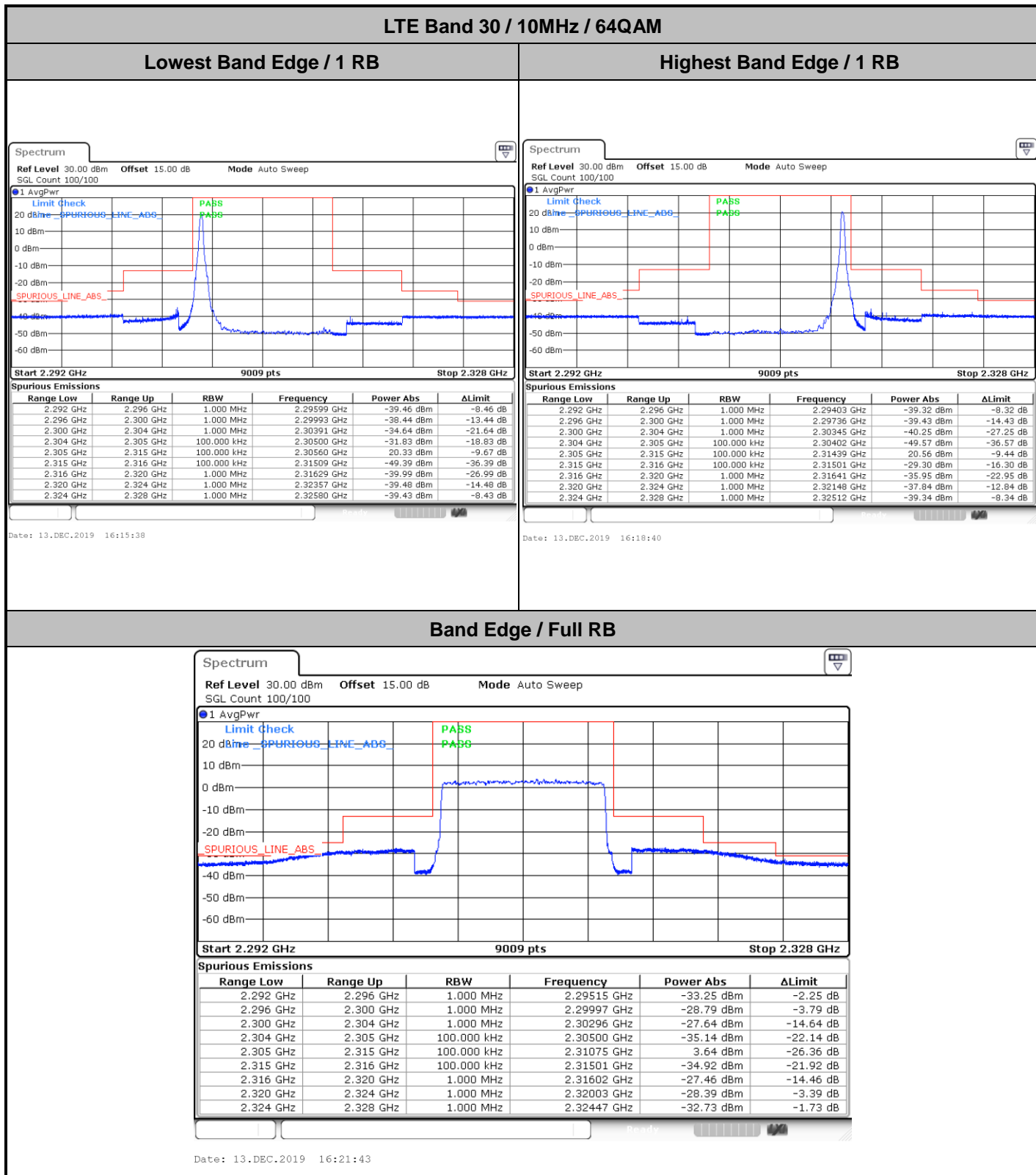



# Conducted Spurious Emission

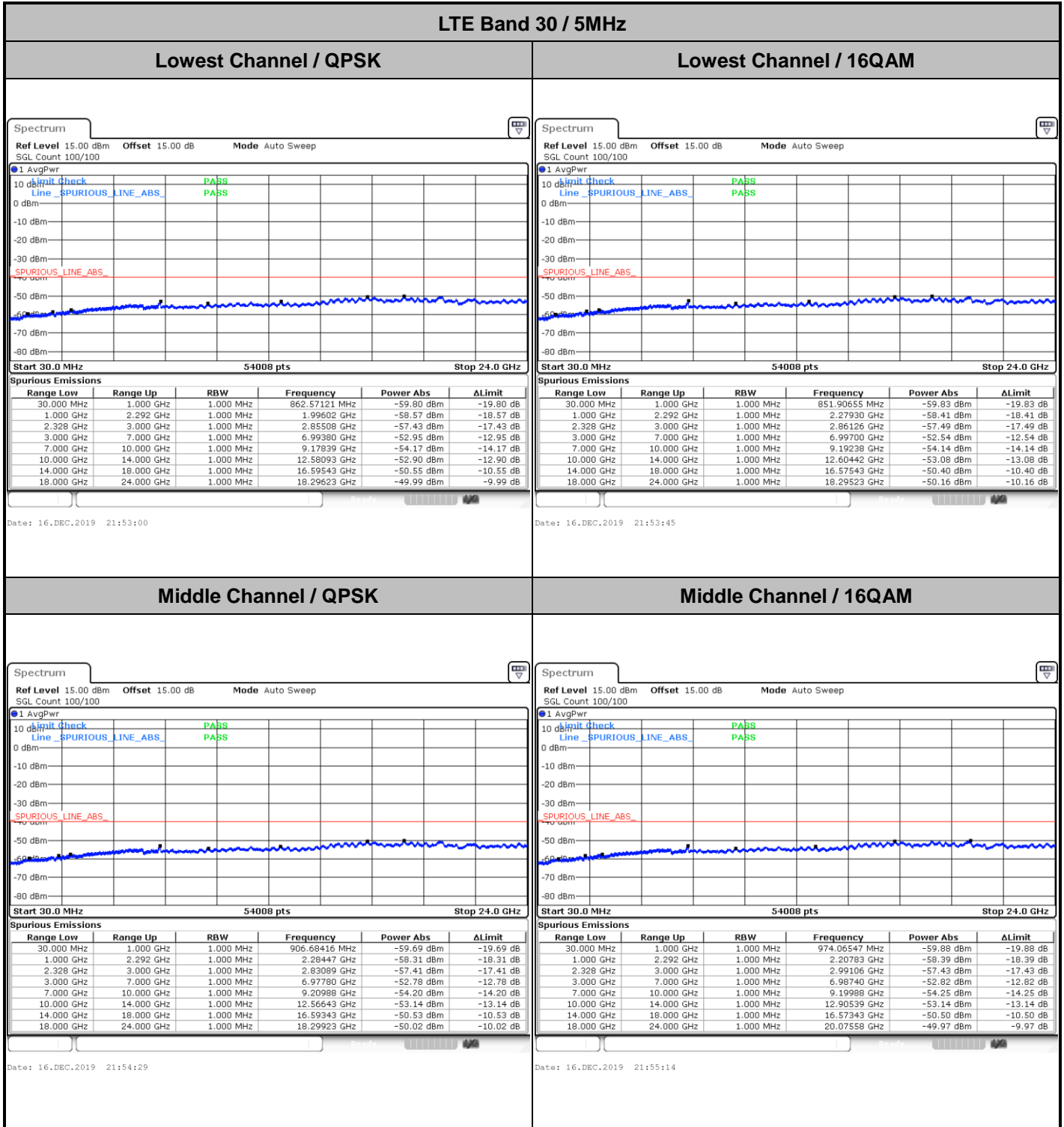



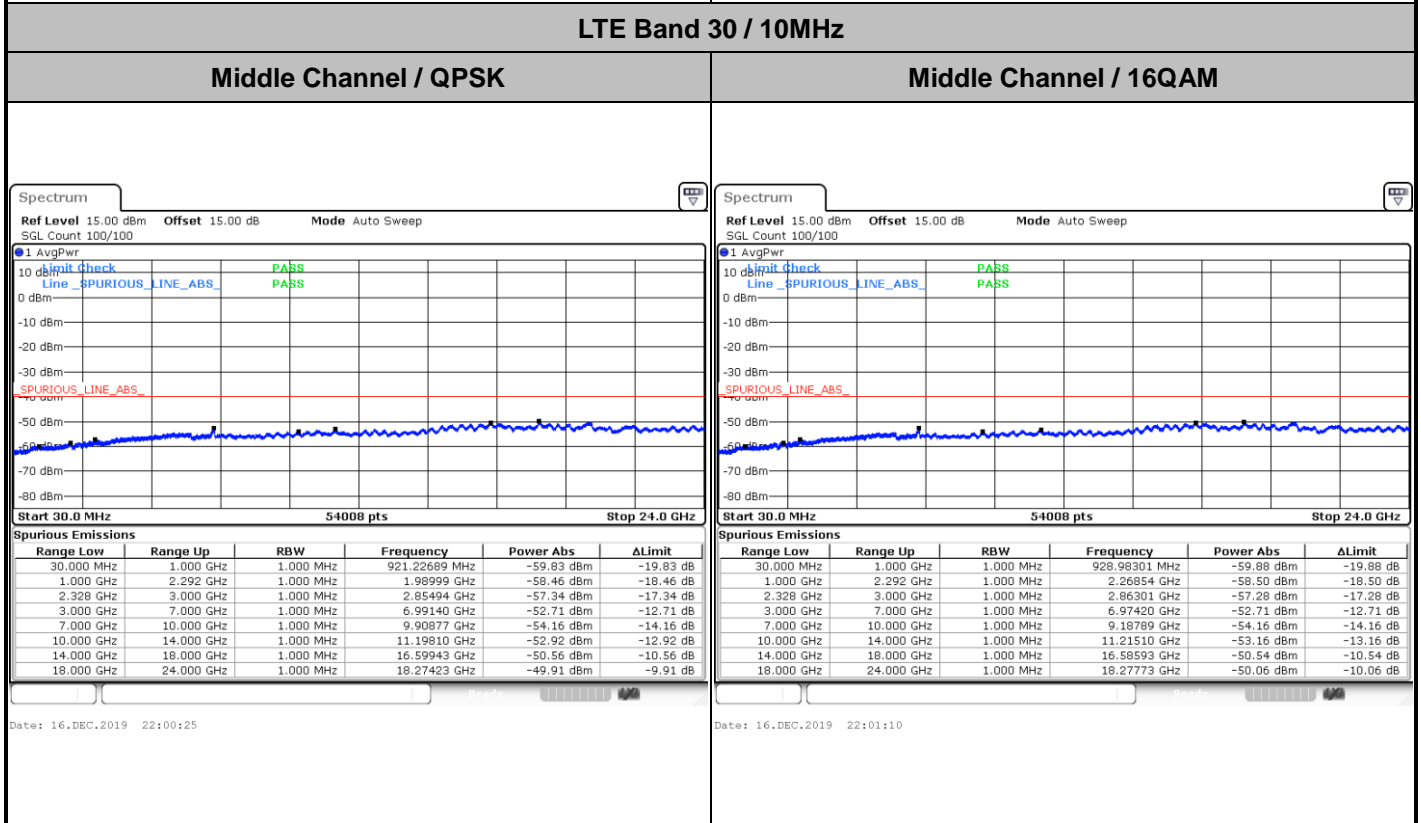
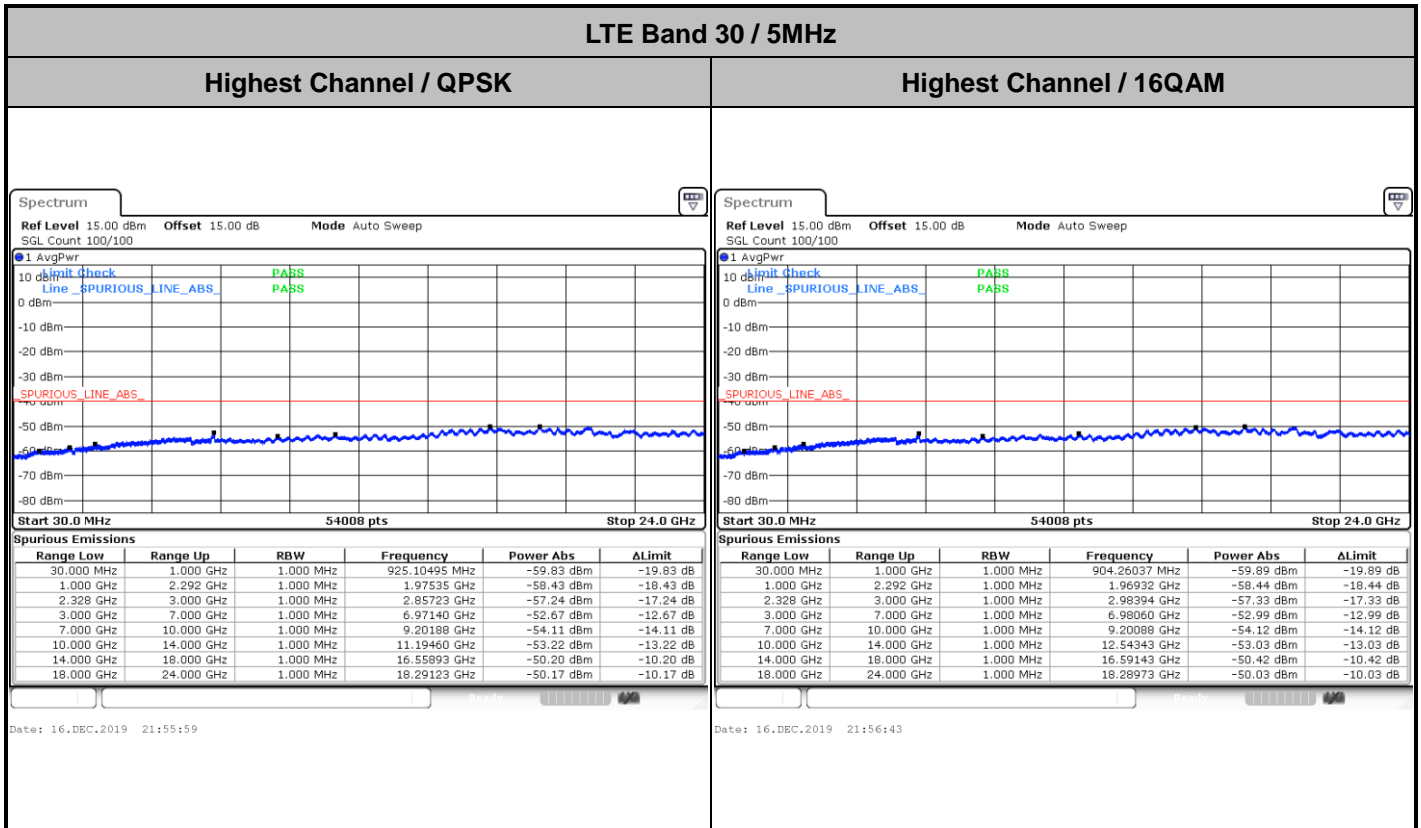

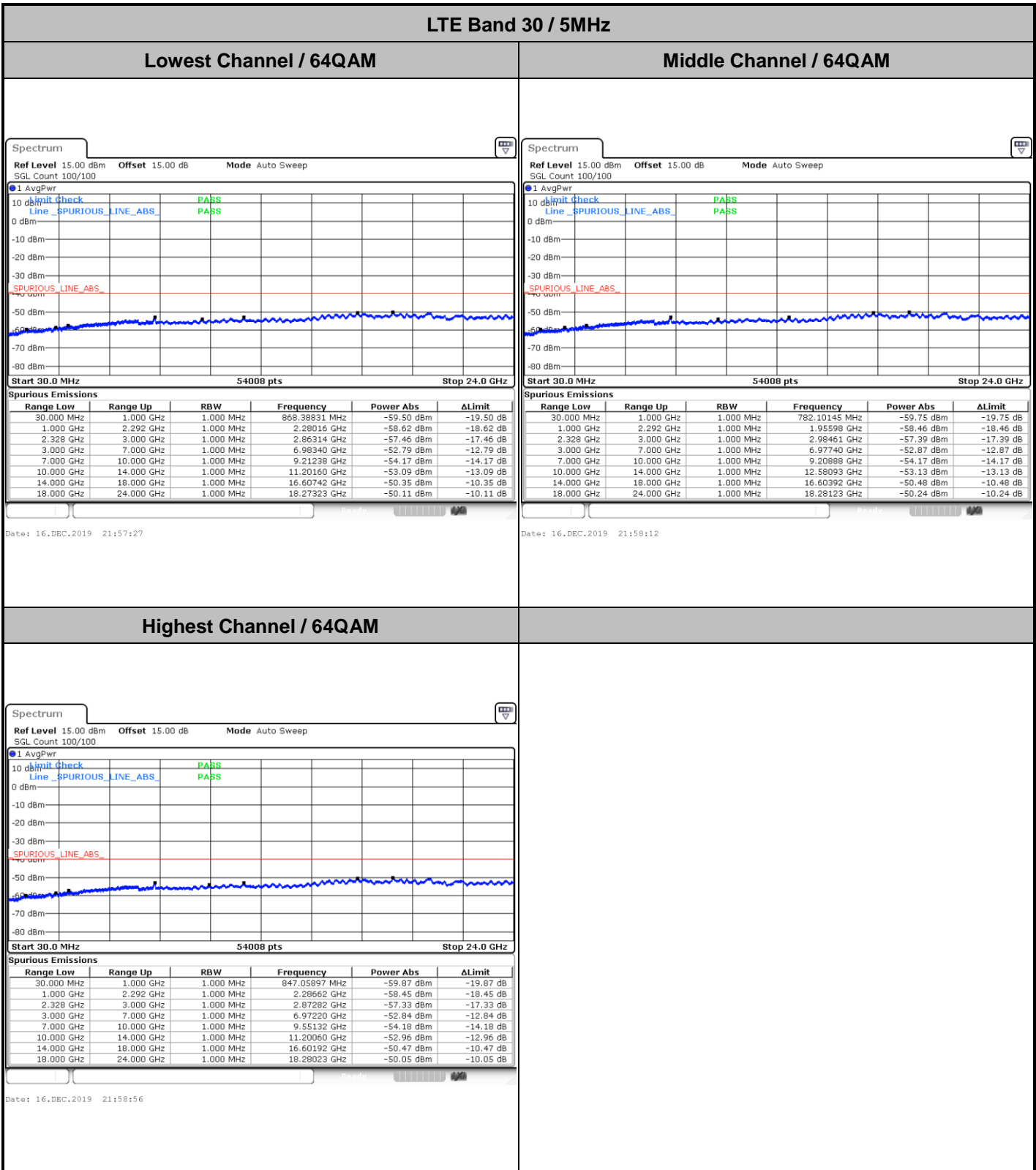

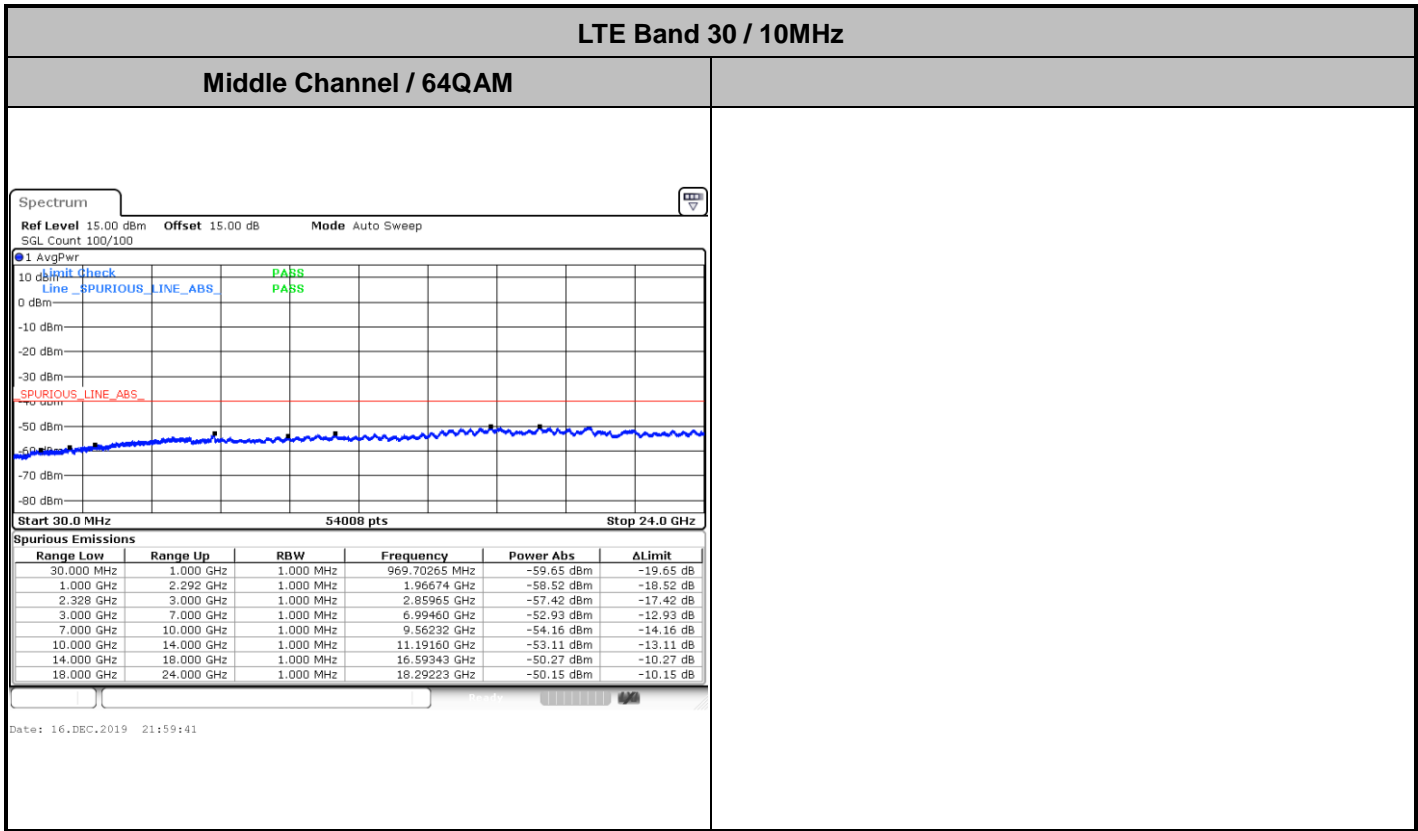



Frequency Stability

Test Conditions		LTE Band 30 (QPSK) / Middle Channel	Limit
Temperature (°C)	Voltage (Volt)	BW 10MHz	Note 2.
		Deviation (ppm)	Result
50	Normal Voltage	0.0088	PASS
40	Normal Voltage	0.0124	
30	Normal Voltage	0.0051	
20(Ref.)	Normal Voltage	0.0000	
10	Normal Voltage	0.0096	
0	Normal Voltage	0.0006	
-10	Normal Voltage	0.0079	
-20	Normal Voltage	0.0029	
-30	Normal Voltage	0.0026	
20	Maximum Voltage	0.0038	
20	Normal Voltage	0.0004	
20	Battery End Point	0.0118	

Note:

1. Normal Voltage =3.87 V. ; Battery End Point (BEP) =3.6 V. ; Maximum Voltage =4.45 V.
2. Note: The frequency fundamental emissions stay within the authorized frequency block.



## Appendix B. Test Results of Radiated Test

### Radiated Spurious Emission

Top Antenna:

LTE Band 30 / 5MHz / QPSK / RB Size 1 Offset 0									
Channel	Frequency ( MHz )	EIRP ( dBm )	Limit ( dBm )	Over Limit ( dB )	SPA Reading (dBm)	S.G. Power ( dBm )	TX Cable loss ( dB )	TX Antenna Gain (dBi)	Polarization (H/V)
Lowest	4610.50	-59.14	-40	-19.14	-58.42	-65.39	6.30	12.55	H
	6915.75	-58.51	-40	-18.51	-58.48	-61.91	8.25	11.65	H
	9221.00	-58.85	-40	-18.85	-59.77	-61.20	9.50	11.85	H
	4610.50	-58.93	-40	-18.93	-58.34	-65.18	6.30	12.55	V
	6915.75	-57.42	-40	-17.42	-58.49	-60.82	8.25	11.65	V
	9221.00	-56.71	-40	-16.71	-59.86	-59.06	9.50	11.85	V
Middle	4615.50	-58.71	-40	-18.71	-57.95	-64.96	6.45	12.70	H
	6923.25	-58.28	-40	-18.28	-58.25	-61.68	8.40	11.80	H
	9231.00	-59.22	-40	-19.22	-60.14	-61.57	9.65	12.00	H
	4615.50	-58.77	-40	-18.77	-58.17	-65.02	6.45	12.70	V
	6923.25	-57.47	-40	-17.47	-58.54	-60.87	8.40	11.80	V
	9231.00	-56.86	-40	-16.86	-60.01	-59.21	9.65	12.00	V
Highest	4620.50	-59.02	-40	-19.02	-58.26	-65.27	6.61	12.86	H
	6930.75	-58.38	-40	-18.38	-58.37	-61.76	8.56	11.94	H
	9241.00	-58.88	-40	-18.88	-59.85	-61.23	9.81	12.16	H
	4620.50	-59.04	-40	-19.04	-58.44	-65.29	6.61	12.86	V
	6930.75	-57.31	-40	-17.31	-58.22	-60.69	8.56	11.94	V
	9241.00	-57.14	-40	-17.14	-60.26	-59.49	9.81	12.16	V

Remark: Spurious emissions within 30-1000MHz were found more than 20dB below limit line.

LTE Band 30 / 10MHz / QPSK / RB Size 1 Offset 0									
Channel	Frequency ( MHz )	EIRP ( dBm )	Limit ( dBm )	Over Limit ( dB )	SPA Reading (dBm)	S.G. Power ( dBm )	TX Cable loss ( dB )	TX Antenna Gain (dBi)	Polarization (H/V)
Middle	4611.00	-59.14	-40	-19.14	-58.42	-65.39	6.45	12.70	H
	6916.50	-58.39	-40	-18.39	-58.36	-61.79	8.40	11.80	H
	9222.00	-58.75	-40	-18.75	-59.67	-61.10	9.65	12.00	H
	4611.00	-59.10	-40	-19.10	-58.51	-65.35	6.45	12.70	V
	6916.50	-56.61	-40	-16.61	-57.68	-60.01	8.40	11.80	V
	9222.00	-56.34	-40	-16.34	-59.49	-58.69	9.65	12.00	V

Remark: Spurious emissions within 30-1000MHz were found more than 20dB below limit line.



Bottom Antenna:

LTE Band 30 / 5MHz / QPSK / RB Size 1 Offset 0									
Channel	Frequency ( MHz )	EIRP ( dBm )	Limit ( dBm )	Over Limit ( dB )	SPA Reading (dBm)	S.G. Power ( dBm )	TX Cable loss ( dB )	TX Antenna Gain (dBi)	Polarization (H/V)
Lowest	4610.50	-59.43	-40	-19.43	-58.71	-65.68	6.30	12.55	H
	6915.75	-58.48	-40	-18.48	-58.45	-61.88	8.25	11.65	H
	9221.00	-58.95	-40	-18.95	-59.87	-61.30	9.50	11.85	H
	4610.50	-58.64	-40	-18.64	-58.05	-64.89	6.30	12.55	V
	6915.75	-57.50	-40	-17.50	-58.57	-60.90	8.25	11.65	V
	9221.00	-56.88	-40	-16.88	-60.03	-59.23	9.50	11.85	V
Middle	4615.50	-58.74	-40	-18.74	-57.98	-64.99	6.45	12.70	H
	6923.25	-58.39	-40	-18.39	-58.36	-61.79	8.40	11.80	H
	9231.00	-59.09	-40	-19.09	-60.01	-61.44	9.65	12.00	H
	4615.50	-58.77	-40	-18.77	-58.17	-65.02	6.45	12.70	V
	6923.25	-57.68	-40	-17.68	-58.75	-61.08	8.40	11.80	V
	9231.00	-56.96	-40	-16.96	-60.11	-59.31	9.65	12.00	V
Highest	4620.50	-58.95	-40	-18.95	-58.19	-65.20	6.61	12.86	H
	6930.75	-58.01	-40	-18.01	-58.00	-61.39	8.56	11.94	H
	9241.00	-59.35	-40	-19.35	-60.32	-61.70	9.81	12.16	H
	4620.50	-58.56	-40	-18.56	-57.96	-64.81	6.61	12.86	V
	6930.75	-57.24	-40	-17.24	-58.15	-60.62	8.56	11.94	V
	9241.00	-57.19	-40	-17.19	-60.31	-59.54	9.81	12.16	V

Remark: Spurious emissions within 30-1000MHz were found more than 20dB below limit line.

LTE Band 30 / 10MHz / QPSK / RB Size 1 Offset 0									
Channel	Frequency ( MHz )	EIRP ( dBm )	Limit ( dBm )	Over Limit ( dB )	SPA Reading (dBm)	S.G. Power ( dBm )	TX Cable loss ( dB )	TX Antenna Gain (dBi)	Polarization (H/V)
Middle	4611.00	-59.46	-40	-19.46	-58.74	-65.71	6.45	12.70	H
	6916.50	-58.24	-40	-18.24	-58.21	-61.64	8.40	11.80	H
	9222.00	-58.94	-40	-18.94	-59.86	-61.29	9.65	12.00	H
	4611.00	-58.96	-40	-18.96	-58.37	-65.21	6.45	12.70	V
	6916.50	-57.40	-40	-17.40	-58.47	-60.80	8.40	11.80	V
	9222.00	-56.98	-40	-16.98	-60.13	-59.33	9.65	12.00	V

Remark: Spurious emissions within 30-1000MHz were found more than 20dB below limit line.