



Certificate # 2861.01



Page 1 of 81

Test Report

Verified code: 449142

Report No.: E20220927529001-2

Customer: OnePlus Technology (Shenzhen) Co., Ltd.
Address: 18C02, 18C03, 18C04 and 18C05, Shum Yip Terra Building, Binhe Avenue North, Futian District, Shenzhen, China
Sample Name: Wireless Earbuds
Sample Model: E508A
Receive Sample Date: Sep.29,2022
Test Date: Oct.08,2022 ~ Oct.25,2022
Reference Document: CFR 47, FCC Part 15 Subpart C
RADIO FREQUENCY DEVICES:Subpart C—Intentional Radiators
Test Result: Pass

Prepared by: *Chen Xiacong* Reviewed by: *Wu Haoting*



GUANGZHOU GRG METROLOGY & TEST CO., LTD

Issued Date: 2022-11-08

GUANGZHOU GRG METROLOGY & TEST CO., LTD.

Address: No.163, Pingyun Road, West of Huangpu Avenue, Guangzhou, Guangdong, China
Tel: (+86) 400-602-0999 FAX: (+86) 020-38698685 Web: <http://www.grgtest.com>



Statement

1. The report is invalid without "special seal for inspection and testing"; some copies are invalid; The report is invalid if it is altered or missing; The report is invalid without the signature of the person who prepared, reviewed and approved it.
2. The sample information is provided by the client and responsible for its authenticity; The content of the report is only valid for the samples sent this time.
3. When there are reports in both Chinese and English, the Chinese version will prevail when the language problems are inconsistent.
4. If there is any objection concerning the report, please inform us within 15 days from the date of receiving the report.
5. Without the agreement of the laboratory, the client is not authorized to use the test results for unapproved propaganda.

----- The following blanks -----

TABLE OF CONTENTS

1.	TEST RESULT SUMMARY.....	6
2.	GENERAL DESCRIPTION OF EUT.....	7
2.1	APPLICANT.....	7
2.2	MANUFACTURER.....	7
2.3	FACTORY.....	7
2.4	BASIC DESCRIPTION OF EQUIPMENT UNDER TEST.....	7
2.5	CHANNELLIST.....	8
2.6	TEST OPERATION MODE.....	8
2.7	LOCAL SUPPORTIVE.....	9
2.8	CONFIGURATION OF SYSTEM UNDER TEST.....	9
2.9	DUTY CYCLE.....	10
3.	LABORATORY AND ACCREDITATIONS.....	12
3.1	LABORATORY.....	12
3.2	ACCREDITATIONS.....	12
4.	MEASUREMENT UNCERTAINTY.....	13
5.	LIST OF USED TEST EQUIPMENT AT GRGT.....	14
6.	CONDUCTED EMISSION MEASUREMENT.....	15
6.1	LIMITS.....	15
6.2	TEST PROCEDURES.....	15
6.3	TEST SETUP.....	16
6.4	DATA SAMPLE.....	16
6.5	TEST RESULTS.....	17
7.	RADIATED SPURIOUS EMISSIONS.....	21
7.1	LIMITS.....	21
7.2	TEST PROCEDURES.....	21
7.3	TEST SETUP.....	24
7.4	DATA SAMPLE.....	25
7.5	TEST RESULTS.....	26
8.	6dB BANDWIDTH.....	46
8.1	LIMITS.....	46
8.2	TEST PROCEDURES.....	46
8.3	TEST SETUP.....	46
8.4	TEST RESULTS.....	46
9.	MAXIMUM PEAK OUTPUT POWER.....	50
9.1	LIMITS.....	50
9.2	TEST PROCEDURES.....	50
9.3	TEST SETUP.....	50
9.4	TEST RESULTS.....	50
10.	POWER SPECTRAL DENSITY.....	51
10.1	LIMITS.....	51
10.2	TEST PROCEDURES.....	51

10.3 TEST SETUP 51

10.4 TEST RESULTS 51

11. CONDUCTED BAND EDGES AND SPURIOUS EMISSIONS 55

11.1 LIMITS..... 55

11.2 TEST PROCEDURES 55

11.3 TEST SETUP 55

11.4 TEST RESULTS 56

12. RESTRICTED BANDS OF OPERATION..... 69

12.1 LIMITS..... 69

12.2 TEST PROCEDURES 70

12.3 TEST SETUP 70

12.4 TEST RESULTS 71

APPENDIX A. PHOTOGRAPH OF THE TEST CONNECTION DIAGRAM 81

APPENDIX B. PHOTOGRAPH OF THE EUT 81

----- The following blanks -----

REPORT ISSUED HISTORY

Report Version	Report No.	Description	Compile Date
1.0	E20220927529001-2	Original Issue	2022-10-26

----- The following blanks -----

1. TEST RESULT SUMMARY

Technical Requirements		
FCC 47 CFR Part 15 Subpart C 15.247 ANSI C63.10-2013 KDB 558074 D01 15.247 measurement guidance v05r02		
Limit / Severity	Item	Result
§15.203	Antenna Requirement	Pass
§15.207(a)	Conducted Emission	Pass
§15.247(d)&15.205& 15.209	Radiated Spurious Emission	Pass
§15.247(b)(3)	Maximum Peak Output Power	Pass
§15.247(e)	Power Spectral Density	Pass
§15.247(a)(2)	6dB bandwidth	Pass
§15.247(d)	Conducted band edges and Spurious Emission	Pass
§15.247(d)&15.205& 15.209	Restricted bands of operation	Pass

Note: The antenna is FPC antenna. The max gain of antenna is -1.5dBi, which accordance 15.203, is considered sufficient to comply with the provisions of this section.

----- The following blanks -----

2. GENERAL DESCRIPTION OF EUT

2.1 APPLICANT

Name: OnePlus Technology (Shenzhen) Co., Ltd.
Address: 18C02, 18C03, 18C04 and 18C05, Shum Yip Terra Building, Binhe Avenue North, Futian District, Shenzhen, China

2.2 MANUFACTURER

Name: OnePlus Technology (Shenzhen) Co., Ltd.
Address: 18C02, 18C03, 18C04 and 18C05, Shum Yip Terra Building, Binhe Avenue North, Futian District, Shenzhen, China

2.3 FACTORY

Name: Jiangxi Risound Electronics Co., Ltd.
Address: No.271, Innovation Avenue, Jinggangshan Economic and Technological Development Zone, Ji'an City, Jiangxi Province

2.4 BASIC DESCRIPTION OF EQUIPMENT UNDER TEST

Equipment: Wireless Earbuds
Model No.: E508A
Adding Model: /
Trade Name: ONEPLUS
FCC ID: 2ABZ2-E508A
Power supply: DC 3.8V power supplied by battery
DC 5V power supplied by E508A charging case or DC 3.7V power supplied by charging case battery
Input: 5V --- 0.9A
Charging Case: Output: 5V --- 0.3A
Rated Capacity: 480mAh, 1.77Wh
Model: 751443-1
Charging Case Nominal Voltage: 3.7Vdc
Battery Specification: Rated Capacity: 480mAh, 1.77Wh
Manufacturer: Xinyu Ganfeng Electronics Co., LTD.
Model: 1058
Earbuds Battery 1 Specification: Ratings: 3.8Vdc, 41mAh, 0.155Wh
Manufacturer: Chongqing VDL Electronics Co., Ltd.
Model: 1058PF3
Earbuds Battery 2 Specification: Ratings: 3.8Vdc, 41mAh, 0.155Wh
Frequency Band: 2402-2480MHz
Transmit Power: Left earbuds GFSK for 1Mbps: 5.65dBm
Right earbuds GFSK for 1Mbps: 5.16dBm
Modulation type: Bluetooth LE with 1M: GFSK
Channel space: 2MHz

Antenna Specification: Left earbuds:-1.5dBi
Right earbuds: -1.5dBi

Temperature Range: 0°C ~+35°C

Hardware Version: 07

Software Version: X22E6_07_A.1.0.0

Sample No: E20220927529001-0001,E20220927529001-0002

Note:

Earbuds battery have two manufacturers, the manufacturer of Earbuds Battery 1 is Xinyu Ganfeng Electronics Co., LTD. The manufacturer of Earbuds Battery 2 is Chongqing VDL Electronics Co., Ltd. Just different manufacturers, the Earbuds Battery specifications, size and capacity are the same, earbuds is just the battery manufacturer is different, other technical parameters are the same, after assessment, the EUT of earbuds battery 1 is fully tested. The data of earbuds battery 2 is need to test the radiation spurious emission of 30MHz-1GHz.

2.5 CHANNELLIST

Channel	Frequency (MHz)	Channel	Frequency (MHz)	Channel	Frequency (MHz)	Channel	Frequency (MHz)
*00	2402	10	2422	20	2442	30	2462
01	2404	11	2424	21	2444	31	2464
02	2406	12	2426	22	2446	32	2466
03	2408	13	2428	23	2448	33	2468
04	2410	14	2430	24	2450	34	2470
05	2412	15	2432	25	2452	35	2472
06	2414	16	2434	26	2454	36	2474
07	2416	17	2436	27	2456	37	2476
08	2418	18	2438	28	2458	38	2478
09	2420	*19	2440	29	2460	*39	2480

* is the test frequency

2.6 TEST OPERATION MODE

Mode No.	Description of the modes
1	Bluetooth (BLE) fixed frequency transmitting

2.7 LOCAL SUPPORTIVE

Name of equipment	Manufacturer	Model	Serial number	Note
Notebook	DELL	Latitude3490	5GSXKP2	/
Test board	/	/	/	/

No.	Cable Type	Qty.	Shielded Type	Ferrite Core(Qty.)	Length
1	DC cable	1	No	0	Unshielded 0.15m
2	USB extension cable	1	No	0	Unshielded 1m

2.8 CONFIGURATION OF SYSTEM UNDER TEST

For Conducted Emission, 6dB bandwidth, Maximum Peak Output Power, Power Spectral Density, Conducted band edges and Spurious Emission

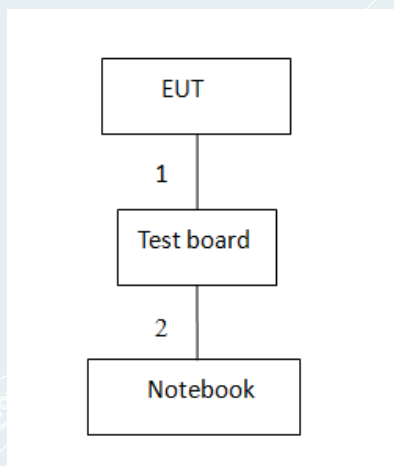

For Radiated Spurious Emission, Restricted bands of operation



Test software:

Software version	Test level
BQB	Default

2.9 DUTY CYCLE

Environment: 25.0°C/45%RH/101.0kPa
 Tested By: Qin Tingting

Voltage: DC 3.8V
 Date: 2022-10-12

Left earbuds

Test Mode	Antenna	Frequency [MHz]	ON Time [ms]	Period [ms]	DC [%]	T [s]
BLE_1M	Ant1	2440	0.40	0.63	63.49	0.00040

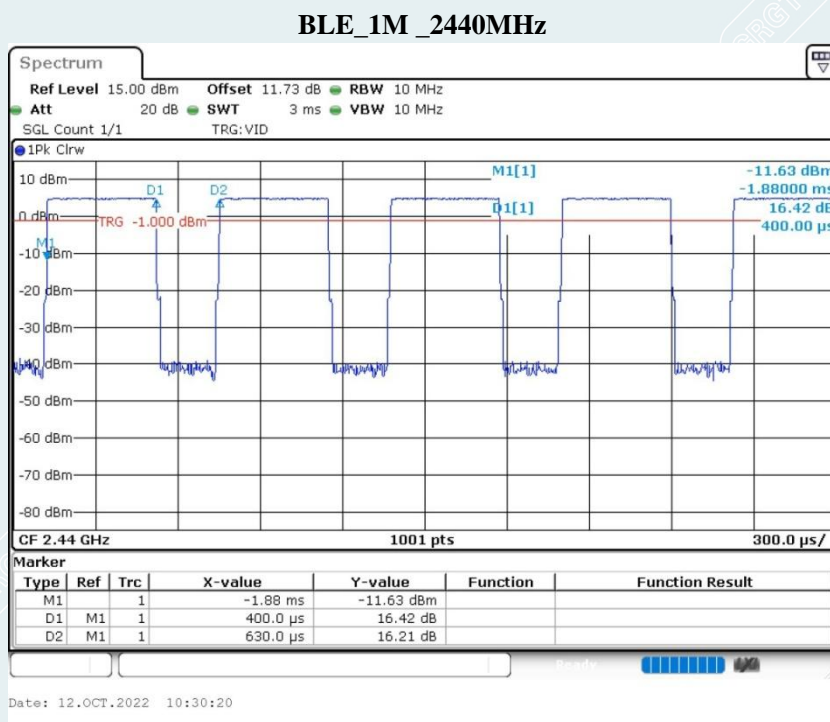

----- The following blanks -----

Right earbuds

Test Mode	Antenna	Frequency [MHz]	ON Time [ms]	Period [ms]	DC [%]	T [s]
BLE_1M	Ant1	2440	0.40	0.63	63.49	0.00040

BLE_1M_2440MHz

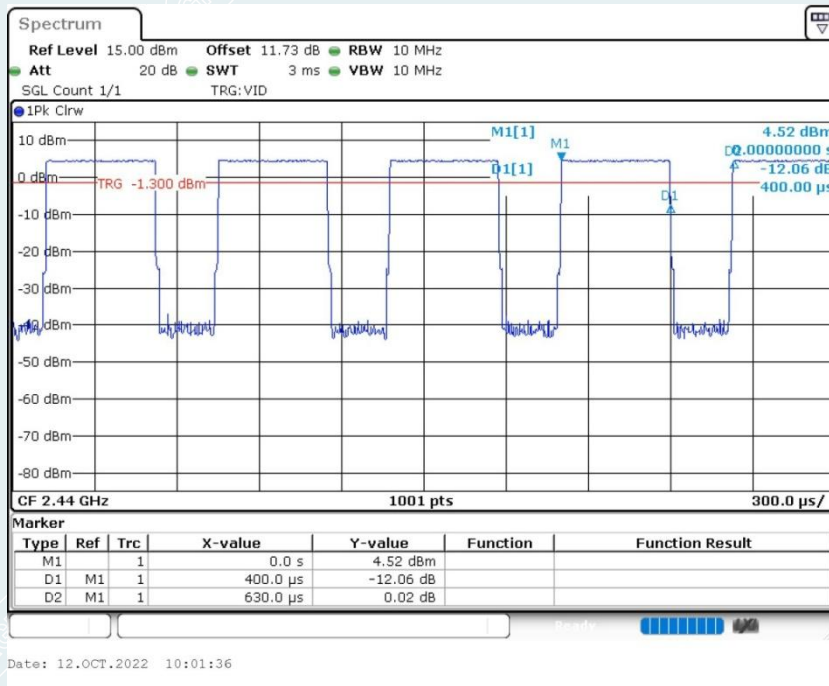

----- The following blanks -----

3. LABORATORY AND ACCREDITATIONS

3.1 LABORATORY

The tests & measurements refer to this report were performed by Shenzhen EMC Laboratory of Guangzhou GRG Metrology & Test Co., Ltd.

Add : No.1301 Guangang Road Xinlan Community, Guanlan Street, Longhua District
Shenzhen, 518110, People's Republic of China

P.C. : 518110

Tel : 0755-61180008

Fax : 0755-61180008

3.2 ACCREDITATIONS

Our laboratories are accredited and approved by the following approval agencies according to GB/T 27025(ISO/IEC 17025:2017)

USA A2LA(Certificate #2861.01)

The measuring facility of laboratories has been authorized or registered by the following approval agencies.

Canada ISED (Company Number: 24897, CAB identifier:CN0069)

USA FCC (Registration Number: 759402, Designation Number:CN1198)

Copies of granted accreditation certificates are available for downloading from our web site,
<http://www.grgtest.com>

----- The following blanks -----

4. MEASUREMENT UNCERTAINTY

Where relevant, the following measurement uncertainty levels have been estimated for tests performed on the EUT as specified in CISPR 16-4-2:

Measurement		Frequency	Uncertainty
Radiated Emission	Horizontal	9kHz~30MHz	5.1dB ¹⁾
		30MHz~200MHz	4.5dB ¹⁾
		200MHz~1000MHz	4.4dB ¹⁾
		1GHz~18GHz	5.6dB ¹⁾
		18GHz~26.5GHz	3.7dB ¹⁾
	Vertical	9kHz~30MHz	5.1dB ¹⁾
		30MHz~200MHz	4.4dB ¹⁾
		200MHz~1000MHz	4.5dB ¹⁾
		1GHz~18GHz	5.6dB ¹⁾
		18GHz~26.5GHz	3.7dB ¹⁾
Conduction Emission		150kHz~30MHz	3.40dB ¹⁾

Measurement	Uncertainty
RF frequency	6.0×10^{-6}
RF power conducted	0.78dB
Occupied channel bandwidth	0.4dB
Unwanted emission, conducted	0.68dB
Humidity	6%
Temperature	2°C

Note:

¹⁾ This uncertainty represents an expanded uncertainty expressed at approximately the 95%.

This uncertainty represents an expanded uncertainty factor of $k=2$.

----- The following blanks -----

5. LIST OF USED TEST EQUIPMENT AT GRGT

Name of Equipment	Manufacturer	Model	Serial Number	Calibration Due
Conducted Emissions				
EMI TEST RECEIVER	R&S	ESCI	100783	2023-08-28
LISN(EUT)	R&S	ENV216	101543	2023-09-13
Test S/W	EZ	CCS-3A1-CE		
Radiated Spurious Emission&Restricted bands of operation				
Test S/W	EZ	CCS-03A1		
Test Receiver	R&S	ESR7	102444	2023-09-02
Preamplifier	EMEC	EM330	I00426	2023-03-05
Bi-log Antenna	Schwarzbeck	VULB9160	VULB9160-3401	2022-10-27
Loop Antenna	TESEQ	HLA6121	52599	2023-04-02
Spectrum Analyzer	KEYSIGHT	N9010A	MY52221469	2023-06-29
Horn Antenna	Schwarzbeck	BBHA9120D	02143	2023-10-15
Board-Band Horn Antenna	Schwarzbeck	BBHA 9170	BBHA 9170-497	2023-10-14
Amplifier	Tonscend	TAP01018048	AP20E8060075	2023-05-05
Amplifier	Tonscend	TAP184050	AP20E806071	2023-05-05
Amplifier	SHIRONG ELECTRONIC	DLNA-1G18G-G4 0	20200928005	2023-05-08
Test S/W	Tonscend	JS36-RE/2.5.1.5		
6dB Bandwidth&Conducted band edges and Spurious Emission&Power Spectral Density				
Spectrum Analyzer	R&S	FSV30	104381	2022-12-10
BT/WIFI System	Tonscend	JS0806		
Maximum Peak Output Power				
Pulse power sensor	Anritsu	MA2411B	1126150	2023-03-01
Power meter	Anritsu	ML2495A	1204003	2023-02-28

Note: The calibration interval of the above test instruments is 12 months.

6. CONDUCTED EMISSION MEASUREMENT

6.1 LIMITS

Frequency range	Limits (dB μ V)	
	Quasi-peak	Average
150kHz~0.5MHz	66~56	56~46
0.5MHz~5MHz	56	46
5MHz~30MHz	60	50

NOTE: (1) The lower limit shall apply at the transition frequencies.

(2) The limit decreases in line with the logarithm of the frequency in the range of 150kHz to 0.5MHz.

6.2 TEST PROCEDURES

Procedure of Preliminary Test

Test procedures follow ANSI C63.10:2013.

For measurement of the disturbance voltage the equipment under test (EUT) is connected to the power supply mains and any other extended network via one or more artificial network(s). An EUT, whether intended to be grounded or not, and which is to be used on a table is configured as follows:

– Either the bottom or the rear of the EUT shall be at a controlled distance of 40 cm from a reference ground plane. This ground plane is normally the wall or floor of a shielded room. It may also be a grounded metal plane of at least 2 m by 2 m. This is physically accomplished as follows:

- 1) place the EUT on a table of non-conducting material which is at least 80 cm high. Place the EUT so that it is 40 cm from the wall of the shielded room, or
- 2) place the EUT on a table of non-conducting material which is 40 cm high so that the bottom of the EUT is 40 cm above the ground plane;

– All other conductive surfaces of the EUT shall be at least 80 cm from the reference ground plane;

– The EUT are placed on the floor that one side of the housings is 40 cm from the vertical reference ground plane and other metallic parts;

– Interconnecting cables that hang closer than 40 cm to the ground plane shall be folded back and forth forming a bundle 30 cm to 40 cm long, hanging approximately in the middle between the ground plane and the table.

– I/O cables that are connected to a peripheral shall be bundled in the centre. The end of the cable may be terminated if required using correct terminating impedance. The total length shall not exceed 1 m.

The test mode(s) described in Item 2.6 were scanned during the preliminary test. After the preliminary scan, we found the test mode described in Item 2.6 producing the highest emission level. The EUT configuration and cable configuration of the above highest emission levels were recorded for reference of the final test.

Procedure of Final Test

EUT and support equipment were set up on the test bench as per the configuration with highest emission level in the preliminary test. A scan was taken on both power lines, recording at least the six highest emissions. Emission frequency and amplitude were recorded into a computer in which correction factors were used to calculate the emission level and compare reading to the applicable limit. The test data of the worst-case condition(s) was recorded.

6.3 TEST SETUP

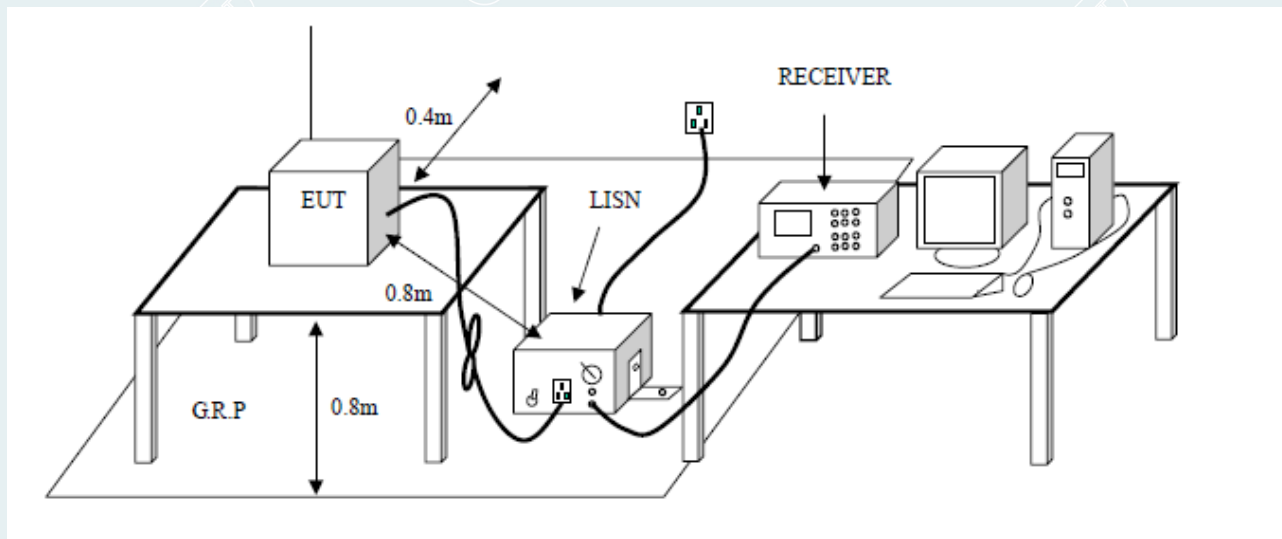

6.4 DATA SAMPLE

Frequency (MHz)	QuasiPeak Reading (dBuV)	Average Reading (dBuV)	Correction Factor (dB)	QuasiPeak Result (dBuV)	Average Result (dBuV)	QuasiPeak Limit (dBuV)	Average Limit (dBuV)	QuasiPeak Margin (dB)	Average Margin (dB)	Remark (Pass/Fail)
X.XXXX	32.69	25.65	11.52	44.21	37.17	65.78	55.79	-21.57	-18.62	Pass

- Factor = Insertion loss of LISN + Cable Loss
- Result = Quasi-peak Reading/ Average Reading + Factor
- Limit =Limit stated in standard
- Margin = Result (dBuV) – Limit (dBuV)

----- The following blanks -----

6.5 TEST RESULTS

Pre-test all test mode and recorded the worst case BLE 2480MHz test results in the report.

Left earbuds

EUT Name	Wireless Earbuds	Model	E508A
Environmental Conditions	22.5°C/45%RH/101.0kPa	Test Mode	BLE 1M 2480MHz
Tested By	Tang Shenghui	Line	L
Tested Date	2022-10-18	Test Voltage	AC 120V/ 60Hz

(The chart below shows the highest readings taken from the final data.)

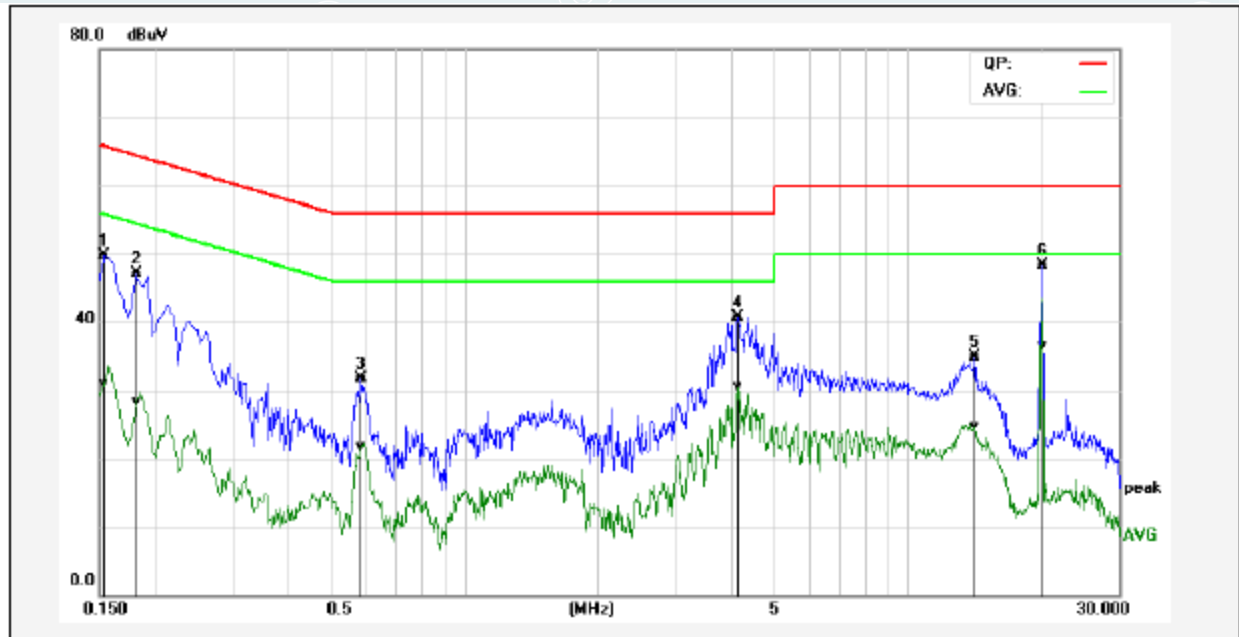

No.	Frequency (MHz)	QuasiPeak reading (dBuV)	Average reading (dBuV)	Correction factor (dB)	QuasiPeak result (dBuV)	Average result (dBuV)	QuasiPeak limit (dBuV)	Average limit (dBuV)	QuasiPeak margin (dB)	Average margin (dB)	Remark
1	0.1539	40.10	21.35	9.61	49.71	30.96	65.78	55.79	-16.07	-24.83	Pass
2	0.1819	37.43	18.80	9.60	47.03	28.40	64.39	54.40	-17.36	-26.00	Pass
3	0.5860	22.06	12.17	9.60	31.66	21.77	56.00	46.00	-24.34	-24.23	Pass
4	4.1540	31.13	20.90	9.66	40.79	30.56	56.00	46.00	-15.21	-15.44	Pass
5	14.2060	25.12	15.03	9.74	34.86	24.77	60.00	50.00	-25.14	-25.23	Pass
6*	20.1940	38.49	26.65	9.86	48.35	36.51	60.00	50.00	-11.65	-13.49	Pass

REMARKS: L = Live Line

Pre-scan all mode and recorded the worst case results in this report (TX- Highest Channel(1Mbps))

EUT Name	Wireless Earbuds	Model	E508A
Environmental Conditions	22.5°C/45%RH/101.0kPa	Test Mode	BLE 1M 2480MHz
Tested By	Tang Shenghui	Line	N
Tested Date	2022-10-18	Test Voltage	AC 120V/ 60Hz

(The chart below shows the highest readings taken from the final data.)

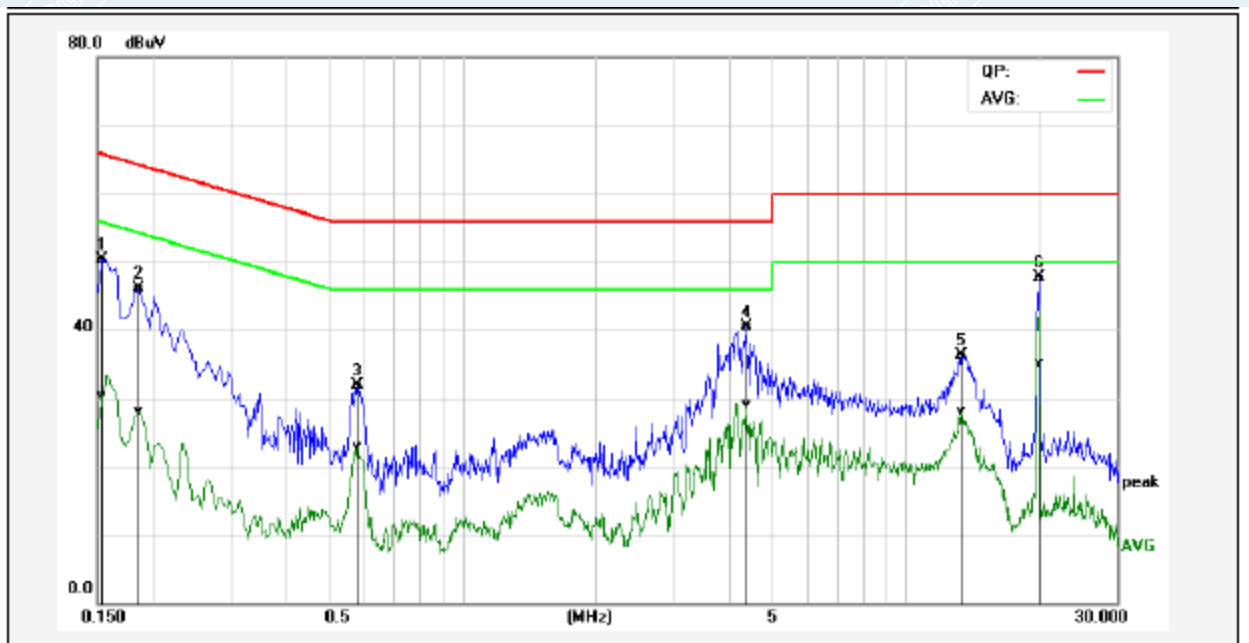

No.	Frequency (MHz)	QuasiPeak reading (dBuV)	Average reading (dBuV)	Correction factor (dB)	QuasiPeak result (dBuV)	Average result (dBuV)	QuasiPeak limit (dBuV)	Average limit (dBuV)	QuasiPeak margin (dB)	Average margin (dB)	Remark
1	0.1539	40.77	20.62	9.60	50.37	30.22	65.78	55.79	-15.41	-25.57	Pass
2	0.1860	36.57	18.51	9.59	46.16	28.10	64.21	54.21	-18.05	-26.11	Pass
3	0.5820	22.41	13.27	9.59	32.00	22.86	56.00	46.00	-24.00	-23.14	Pass
4	4.3740	30.84	19.45	9.65	40.49	29.10	56.00	46.00	-15.51	-16.90	Pass
5	13.3940	26.43	18.41	9.78	36.21	28.19	60.00	50.00	-23.79	-21.81	Pass
6*	19.9940	37.87	25.30	9.89	47.76	35.19	60.00	50.00	-12.24	-14.81	Pass

REMARKS: N = Neutral Line.

Pre-scan all mode and recorded the worst case results in this report (TX- Highest Channel(1Mbps))

Pre-test all test mode and recorded the worst case BLE 2402MHz test results in the report.

Right earbuds

EUT Name	Wireless Earbuds	Model	E508A
Environmental Conditions	22.5°C/45%RH/101.0kPa	Test Mode	BLE 1M 2402MHz
Tested By	Tang Shenghui	Line	L
Tested Date	2022-10-18	Test Voltage	AC 120V/ 60Hz

(The chart below shows the highest readings taken from the final data.)

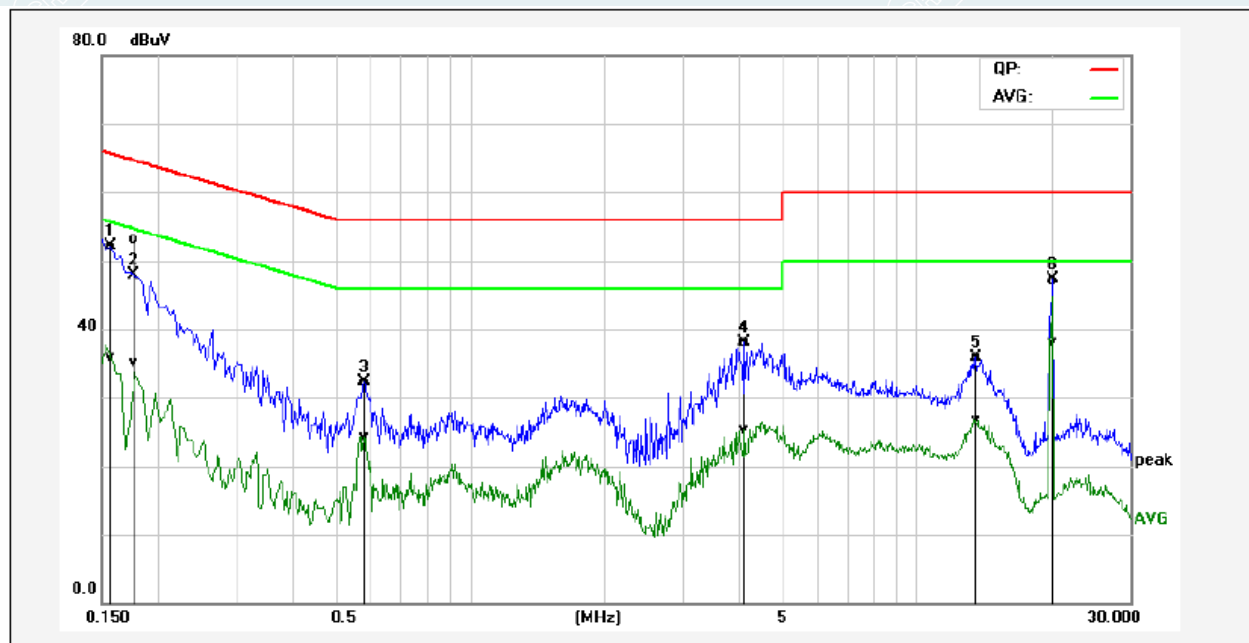

No.	Frequency (MHz)	QuasiPeak reading (dBuV)	Average reading (dBuV)	Correction factor (dB)	QuasiPeak result (dBuV)	Average result (dBuV)	QuasiPeak limit (dBuV)	Average limit (dBuV)	QuasiPeak margin (dB)	Average margin (dB)	Remark
1	0.1580	42.56	26.27	9.61	52.17	35.88	65.56	55.57	-13.39	-19.69	Pass
2*	0.1787	43.47	25.56	9.60	53.07	35.16	64.54	54.55	-11.47	-19.39	Pass
3	0.5820	22.63	14.69	9.60	32.23	24.29	56.00	46.00	-23.77	-21.71	Pass
4	4.1340	28.38	15.59	9.66	38.04	25.25	56.00	46.00	-17.96	-20.75	Pass
5	13.6220	26.24	17.01	9.73	35.97	26.74	60.00	50.00	-24.03	-23.26	Pass
6	20.1700	37.34	28.34	9.86	47.20	38.20	60.00	50.00	-12.80	-11.80	Pass

REMARKS: L = Live Line

Pre-scan all mode and recorded the worst case results in this report (TX- Lowest Channel(1Mbps))

EUT Name	Wireless Earbuds	Model	E508A
Environmental Conditions	22.5°C/45%RH/101.0kPa	Test Mode	BLE 1M 2402MHz
Tested By	Tang Shenghui	Line	N
Tested Date	2022-10-18	Test Voltage	AC 120V/ 60Hz

(The chart below shows the highest readings taken from the final data.)

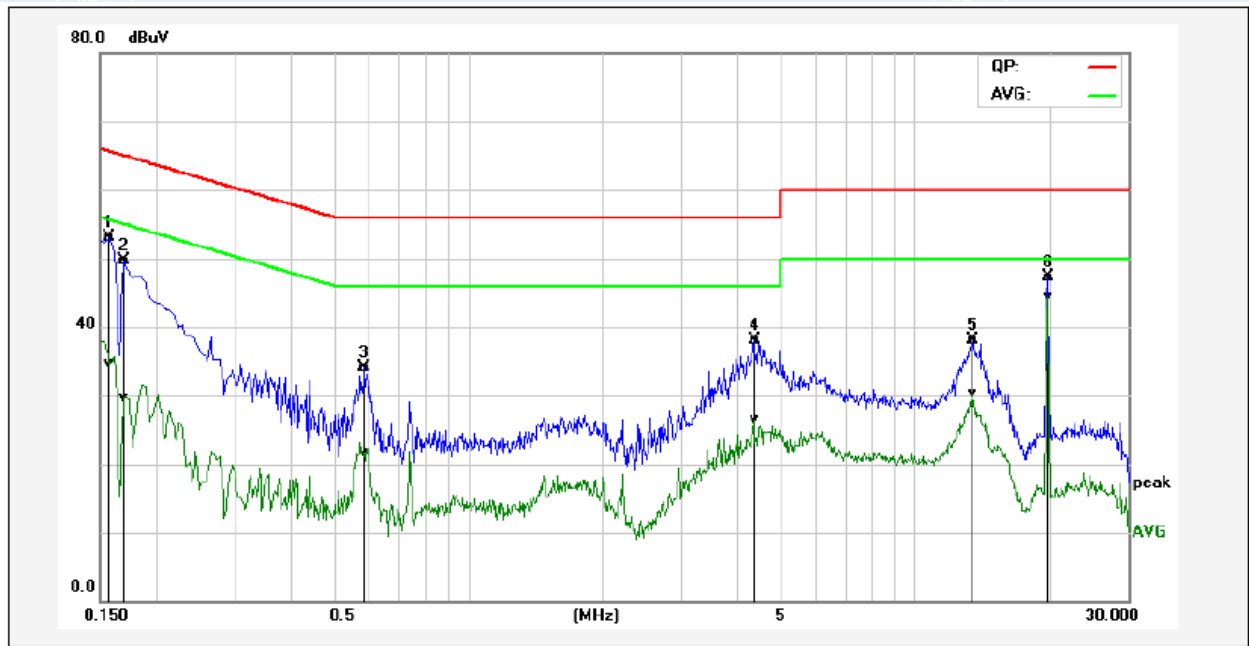

No.	Frequency (MHz)	QuasiPeak reading (dBuV)	Average reading (dBuV)	Correction factor (dB)	QuasiPeak result (dBuV)	Average result (dBuV)	QuasiPeak limit (dBuV)	Average limit (dBuV)	QuasiPeak margin (dB)	Average margin (dB)	Remark
1	0.1580	43.60	25.18	9.60	53.20	34.78	65.56	55.57	-12.36	-20.79	Pass
2	0.1700	40.20	20.19	9.60	49.80	29.79	64.96	54.96	-15.16	-25.17	Pass
3	0.5860	24.43	12.15	9.59	34.02	21.74	56.00	46.00	-21.98	-24.26	Pass
4	4.3659	28.47	16.82	9.65	38.12	26.47	56.00	46.00	-17.88	-19.53	Pass
5	13.4220	28.40	20.49	9.78	38.18	30.27	60.00	50.00	-21.82	-19.73	Pass
6*	19.9180	37.32	34.33	9.89	47.21	44.22	60.00	50.00	-12.79	-5.78	Pass

REMARKS: N = Neutral Line.

Pre-scan all mode and recorded the worst case results in this report (TX- Lowest Channel(1Mbps))

7. RADIATED SPURIOUS EMISSIONS

7.1 LIMITS

In any 100kHz bandwidth outside the frequency band in which the spread spectrum or digitally modulated intentional radiator is operating, the radio frequency power that is produced by the intentional radiator shall be at least 20dB below that in the 100kHz bandwidth within the band that contains the highest level of the desired power, based on either an RF conducted or a radiated measurement, provided the transmitter demonstrates compliance with the peak conducted power limits. If the transmitter complies with the conducted power limits based on the use of RMS averaging over a time interval, as permitted under paragraph (b)(3) of this section, the attenuation required under this paragraph shall be 30dB instead of 20dB. Attenuation below the general limits specified in §15.209(a) is not required.

Frequency (MHz)	Quasi-peak($\mu\text{V}/\text{m}$)	Measurement distance(m)	Quasi-peak(dB $\mu\text{V}/\text{m}$)@distance 3m
0.009-0.490	2400/F(kHz)	300	128.5~93.8
0.490-1.705	24000/F(kHz)	30	73.8~63
1.705-30.0	30	30	69.5
30 ~ 88	100	3	40
88~216	150	3	43.5
216 ~ 960	200	3	46
Above 960	500	3	54

NOTE:

- (1) The emission limits for the ranges 9-90kHz and 110-490kHz are based on measurements employing a linear average detector.
- (2) The lower limit shall apply at the transition frequencies.
- (3) Above 18GHz test distance is 1m, so the Peak Limit= $74+20*\log(3/1)=83.54$ (dB $\mu\text{V}/\text{m}$).
The Avg Limit= $54+20*\log(3/1)=63.54$ (dB $\mu\text{V}/\text{m}$).

7.2 TEST PROCEDURES

1) Sequence of testing 9kHz to 30MHz

Setup:

- The equipment was set up to simulate a typical usage like described in the user manual or described by manufacturer.
- If the EUT is a tabletop system, a rotatable table with 0.8m height is used.
- If the EUT is a floor standing device, it is placed on the ground.
- Auxiliary equipment and cables were positioned to simulate normal operation conditions.
- The AC power port of the EUT (if available) is connected to a power outlet below the turntable.
- The measurement distance is 3meter.
- The EUT was set into operation.

Pre measurement:

- The turntable rotates from 0 ° to 360 °.
- The antenna height is 1.0 meter.
- The antenna is polarized X,Y and Z.
- At each turntable position the analyzer sweeps with peak detection to find the maximum of all emissions

Final measurement:

- Identified emissions during the pre measurement the software maximizes by rotating the turntable

position (0 ° to 360 °) and by rotating the elevation axes (0 ° to 360 °).

--- The final measurement will be done in the position (turntable and elevation) causing the highest emissions with QP detector.

--- The final levels, frequency, measuring time, bandwidth, turntable position, correction factor, margin to the limit and limit will be recorded. Also a plot with the graph of the pre measurement and the limit will be stored.

2) Sequence of testing 30MHz to 1GHz

Setup:

--- The equipment was set up to simulate a typical usage like described in the user manual or described by manufacturer.

--- If the EUT is a tabletop system, a table with 0.8m height is used, which is placed on the ground plane.

--- If the EUT is a floor standing device, it is placed on the ground plane with insulation between both.

--- Auxiliary equipment and cables were positioned to simulate normal operation conditions

--- The AC power port of the EUT (if available) is connected to a power outlet below the turntable.

--- The measurement distance is 3 meter.

--- The EUT was set into operation.

Pre measurement:

--- The turntable rotates from 0 ° to 360 °.

--- The antenna is polarized vertical and horizontal.

--- The antenna height changes from 1 to 4 meter.

--- At each turntable position, antenna polarization and height the analyzer sweeps three times in peak to find the maximum of all emissions.

Final measurement:

--- The final measurement will be performed with minimum the six highest peaks.

--- According to the maximum antenna and turntable positions of pre measurement the software maximize the peaks by changing turntable rotates from 0 ° to 360 ° and antenna movement between 1 and 4 meter.

--- The final measurement will be done with QP detector with an EMI receiver.

--- The final levels, frequency, measuring time, bandwidth, antenna height, antenna polarization, turntable angle, correction factor, margin to the limit and limit will be recorded. Also a plot with the graph of the pre measurement with marked maximum final measurements and the limit will be stored.

3) Sequence of testing 1GHz to 18GHz

Setup:

--- The equipment was set up to simulate a typical usage like described in the user manual or described by manufacturer.

--- If the EUT is a tabletop system, a rotatable table with 1.5m height is used.

--- If the EUT is a floor standing device, it is placed on the ground plane with insulation between both.

--- Auxiliary equipment and cables were positioned to simulate normal operation conditions

--- The AC power port of the EUT (if available) is connected to a power outlet below the turntable.

--- The measurement distance is 3 meter.

--- The EUT was set into operation.

Pre measurement:

- The turntable rotates from 0 ° to 360 °.
- The antenna is polarized vertical and horizontal.
- The antenna height scan range is 1 meter to 4 meter.
- At each turntable position and antenna polarization the analyzer sweeps with peak detection to find the maximum of all emissions.

Final measurement:

- The final measurement will be performed with minimum the six highest peaks.
- According to the maximum antenna and turntable positions of pre measurement the software maximize the peaks by changing turntable rotates from 0 ° to 360 ° and antenna movement between 1 and 4 meter. This procedure is repeated for both antenna polarizations.
- The final measurement will be done in the position (turntable, EUT-table and antenna polarization) causing the highest emissions with Peak and Average detector.
- The final levels, frequency, measuring time, bandwidth, turntable position, EUT-table position, antenna polarization, correction factor, margin to the limit and limit will be recorded. Also a plot with the graph of the pre measurement with marked maximum final measurements and the limit will be stored.

4) Sequence of testing above 18GHz**Setup:**

- The equipment was set up to simulate a typical usage like described in the user manual or described by manufacturer.
- If the EUT is a tabletop system, a rotatable table with 1.5 m height is used.
- If the EUT is a floor standing device, it is placed on the ground plane with insulation between both.
- Auxiliary equipment and cables were positioned to simulate normal operation conditions
- The AC power port of the EUT (if available) is connected to a power outlet below the turntable.
- The measurement distance is 1 meter.
- The EUT was set into operation.

Pre measurement:

- The antenna is moved spherical over the EUT in different polarisations of the antenna.

Final measurement:

- The final measurement will be performed at the position and antenna orientation for all detected emissions that were found during the pre measurements with Peak and Average detector.
- The final levels, frequency, measuring time, bandwidth, correction factor, margin to the limit and limit will be recorded. Also a plot with the graph of the pre measurement and the limit will be stored.

NOTE:

- (a). The frequency from 9kHz to 150kHz, Set RBW=300Hz (for Peak & AVG), VBW=300Hz (for Peak & AVG). The frequency from 150kHz to 30MHz, Set RBW=9kHz, VBW=9kHz, (for QP Detector).
- (b). The frequency from 30MHz to 1GHz, Set RBW=120kHz, VBW=300kHz, (for QP Detector).
- (c). The frequency above 1GHz, for Peak detector: Set RBW=1MHz, VBW=3MHz.
- (d). The frequency above 1GHz, for Avg detector: Set RBW=1MHz, if the EUT is configured to transmit with duty cycle $\geq 98\%$, set $VBW \leq RBW/100$ (i.e., 10kHz) but not less than 10 Hz. If the EUT duty cycle is $< 98\%$, set $VBW \geq 1/T$, Where T is defined in section 2.9.

7.3 TEST SETUP

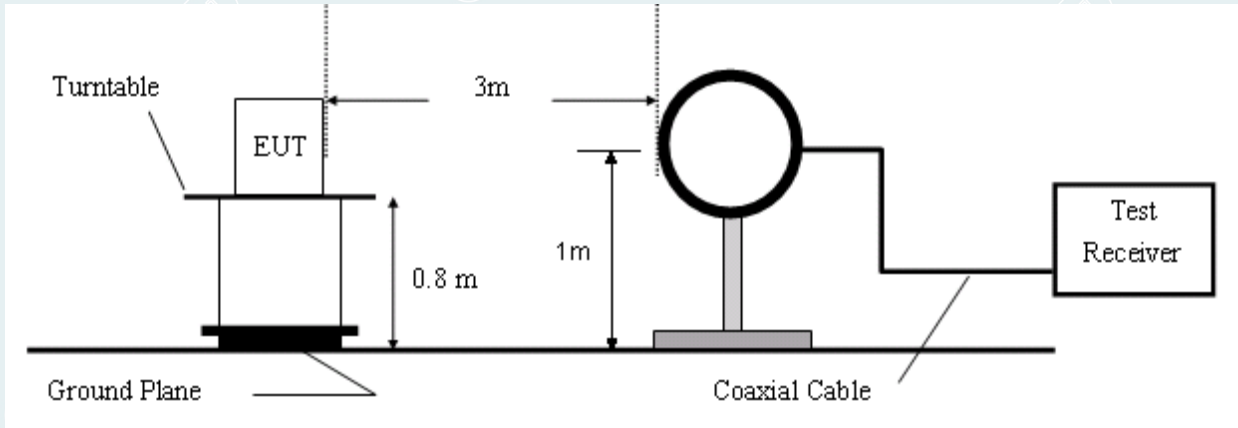

Figure 1. 9kHz to 30MHz radiated emissions test configuration

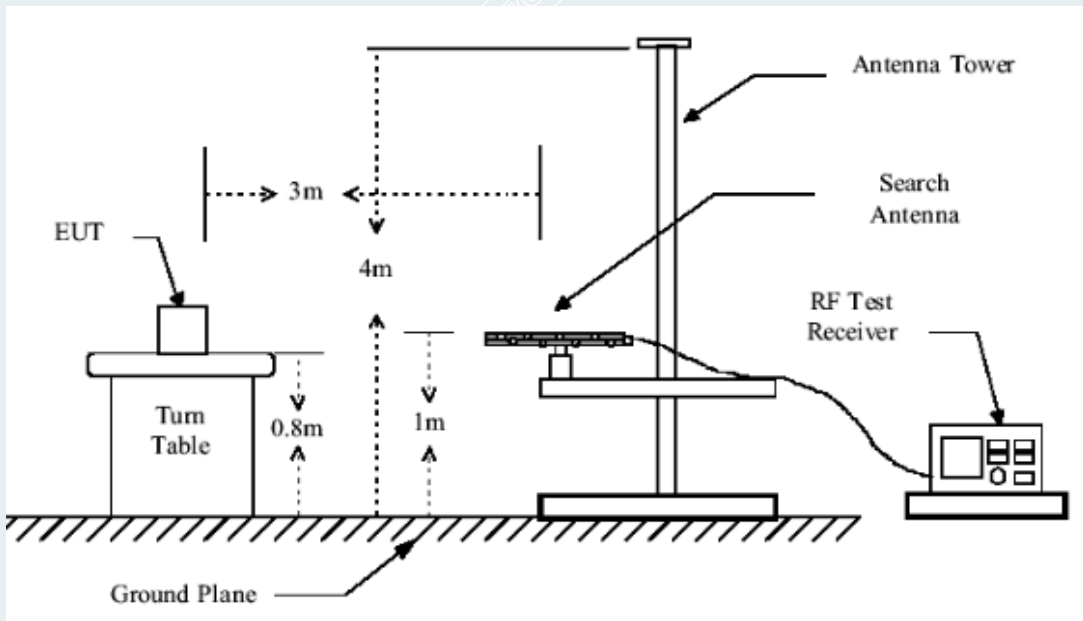

Figure 2. 30MHz to 1GHz radiated emissions test configuration

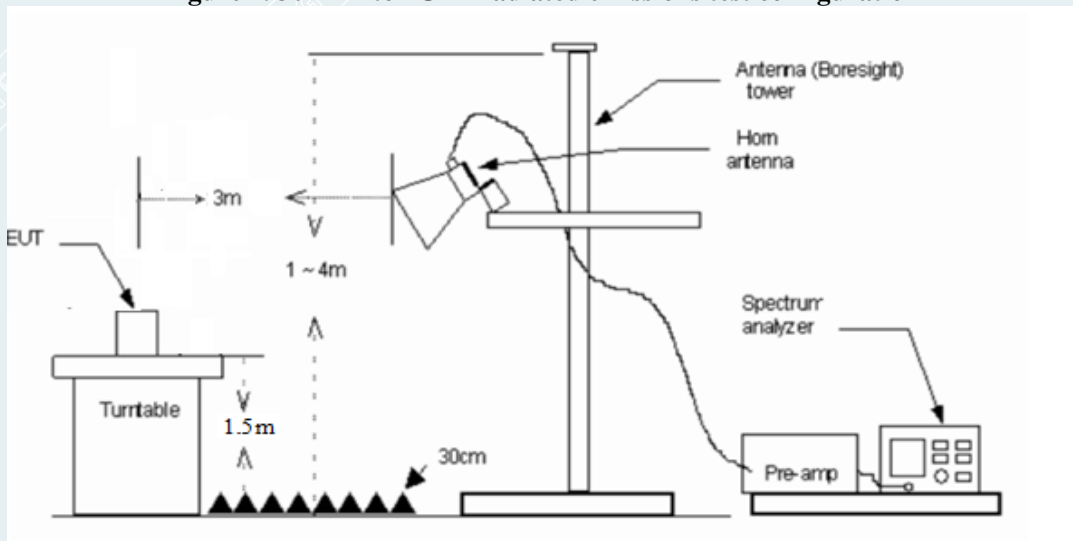

Figure 3. 1GHz to 18GHz radiated emissions test configuration

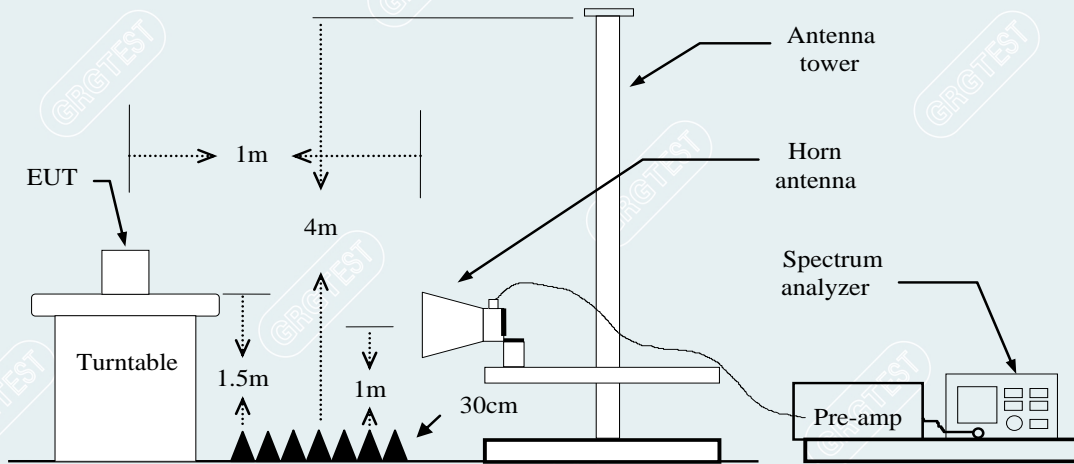

Figure 4. 18GHz to 26.5GHz radiated emissions test configuration

7.4 DATA SAMPLE

30MHz to 1GHz

No.	Frequency (MHz)	Reading (dBuV/m)	Correct Factor(dB/m)	Result (dBuV/m)	Limit (dBuV/m)	Margin (dB)	Remark	Pole
xxx	xxx	37.06	-15.48	21.58	40.00	-18.42	QP	Vertical

1GHz to 18GHz

No.	Frequency (MHz)	Reading (dBuV/m)	Correct Factor(dB/m)	Result (dBuV/m)	Limit (dBuV/m)	Margin (dB)	Remark	Pole
xxx	xxx	65.45	-11.12	54.33	74.00	-19.67	Peak	Vertical
xxx	xxx	63.00	-11.12	51.88	54.00	-2.12	AVG	Vertical

Above 18GHz

No.	Frequency (MHz)	Reading (dBuV/m)	Factor (dB)	Level (dBuV/m)	Limit (dBuV/m)	Margin (dB)	Remark	Pole
xxx	xxx	68.86	57.66	-11.20	83.54	25.88	peak	Vertical
xxx	xxx	68.89	-11.20	57.69	63.54	5.85	AVG	Vertical

- Frequency (MHz) = Emission frequency in MHz
- Ant.Pol. (H/V) = Antenna polarization
- Reading (dBuV) = Uncorrected Analyzer / Receiver reading
- Correction Factor (dB/m) = Antenna factor + Cable loss – Amplifier gain
- Result (dBuV/m) = Reading (dBuV) + Correction Factor (dB/m)
- Limit (dBuV/m) = Limit stated in standard
- Margin (dB) = Remark Result (dBuV/m) – Limit (dBuV/m)
- Peak = Peak Reading
- QP = Quasi-peak Reading
- AVG = Average Reading

7.5 TEST RESULTS

Left earbuds

Battery 1

Below 1GHz

The chart below shows the highest readings taken from the final data.

EUT Name	Wireless Earbuds	Model	E508A
Environmental Conditions	24.2°C/41%RH/101.0kPa	Test Voltage	DC 3.8V
Test Mode	TX/ BLE_1M (2440MHz)	Polarity	Vertical
Tested By	Huang Xinlong	Tested Date	2022-10-18

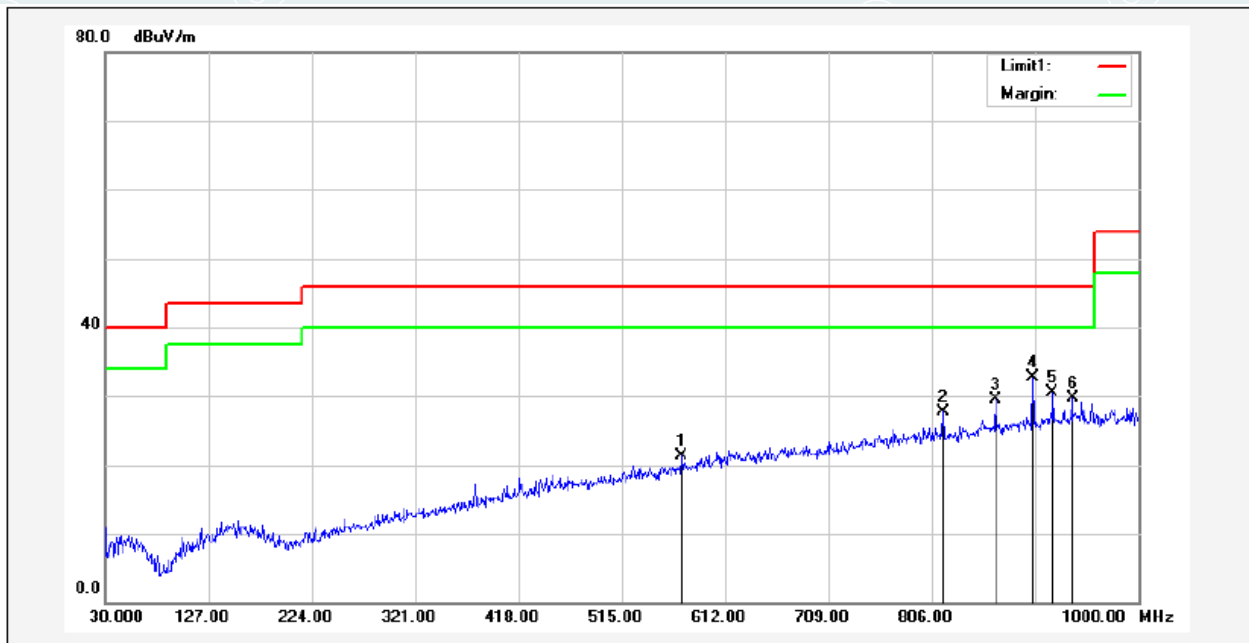

No.	Frequency (MHz)	Reading (dBuV)	Correction factor(dB/m)	Result (dBuV/m)	Limit (dBuV/m)	Over (dB)	Degree (deg.)	Height (cm)	Remark
1	571.2600	37.27	-15.96	21.31	46.00	-24.69	360	183	QP
2	816.6700	38.94	-11.32	27.62	46.00	-18.38	360	162	QP
3	866.1400	40.17	-10.65	29.52	46.00	-16.48	360	100	QP
4*	901.0600	42.82	-10.09	32.73	46.00	-13.27	329	100	QP
5	919.4900	40.36	-9.83	30.53	46.00	-15.47	308	100	QP
6	937.9200	39.19	-9.57	29.62	46.00	-16.38	292	100	QP

Pre-scan all mode and recorded the worst case results in this report (TX- Midest Channel(1Mbps))

EUT Name	Wireless Earbuds	Model	E508A
Environmental Conditions	24.2°C/41%RH/101.0kPa	Test Voltage	DC 3.8V
Test Mode	TX/ BLE_1M (2440MHz)	Polarity	Horizontal
Tested By	Huang Xinlong	Tested Date	2022-10-18

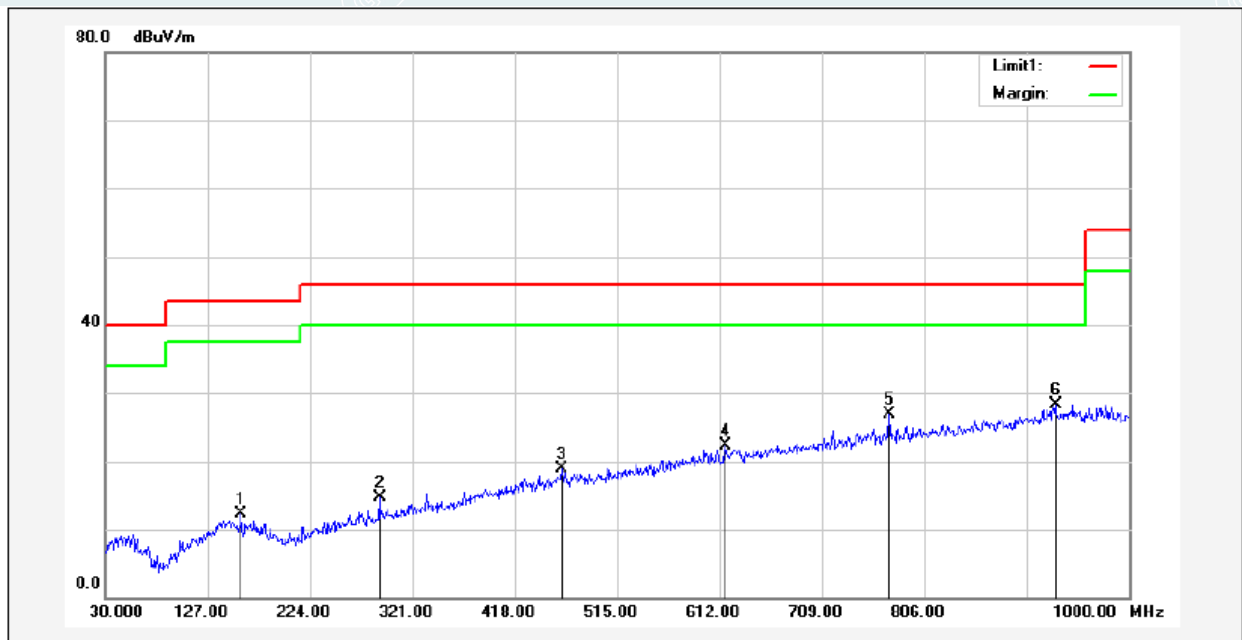

No.	Frequency (MHz)	Reading (dBuV)	Correction factor(dB/m)	Result (dBuV/m)	Limit (dBuV/m)	Over (dB)	Degree (deg.)	Height (cm)	Remark
1	159.0100	37.24	-24.97	12.27	43.50	-31.23	48	100	QP
2	289.9600	38.64	-23.93	14.71	46.00	-31.29	176	200	QP
3	462.6200	37.40	-18.52	18.88	46.00	-27.12	170	200	QP
4	617.8200	37.04	-14.77	22.27	46.00	-23.73	126	200	QP
5	773.0200	38.90	-11.92	26.98	46.00	-19.02	121	200	QP
6*	930.1600	37.96	-9.69	28.27	46.00	-17.73	206	200	QP

Pre-scan all mode and recorded the worst case results in this report (TX- Midest Channel(1Mbps))

Battery 2

Below 1GHz

The chart below shows the highest readings taken from the final data.

EUT Name	Wireless Earbuds	Model	E508A
Environmental Conditions	24.5°C/40%RH/101.0kPa	Test Voltage	DC 3.8V
Test Mode	TX/ BLE_1M (2402MHz)	Polarity	Vertical
Tested By	Huang Xinlong	Tested Date	2022-10-21

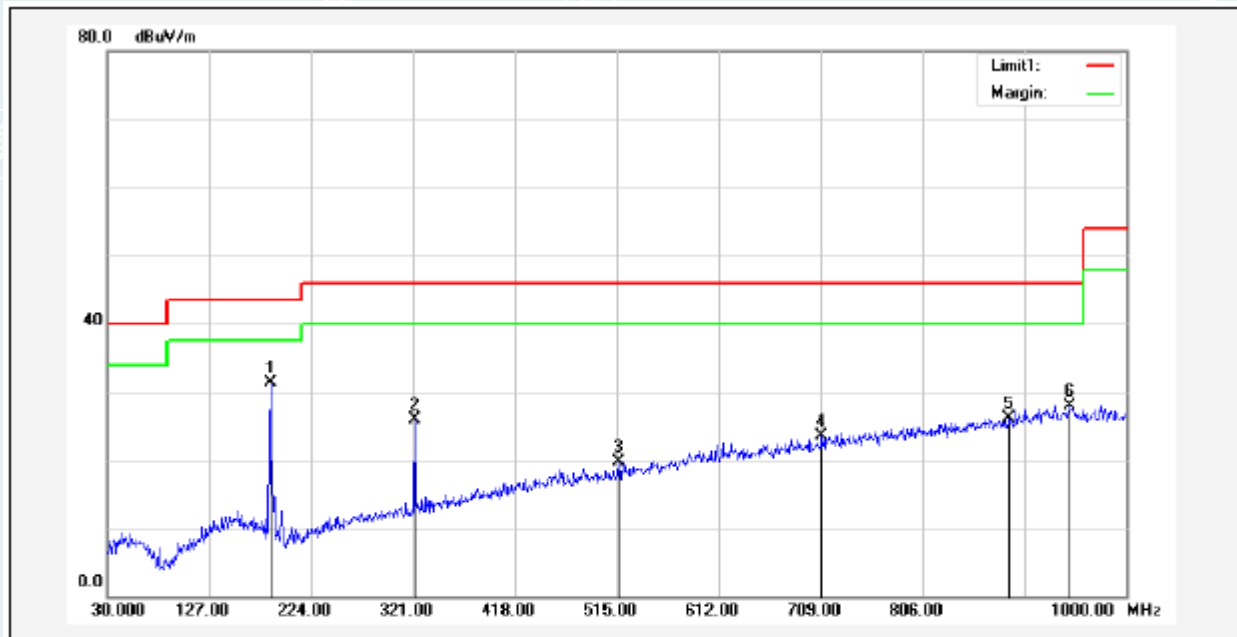

No.	Frequency (MHz)	Reading (dBuV)	Correction factor(dB/m)	Result (dBuV/m)	Limit (dBuV/m)	Over (dB)	Degree (deg.)	Height (cm)	Remark
1*	185.2000	57.73	-26.50	31.23	43.50	-12.27	306	100	QP
2	322.9400	48.97	-23.00	25.97	46.00	-20.03	306	100	QP
3	516.9400	37.26	-17.47	19.79	46.00	-26.21	118	200	QP
4	709.9700	36.66	-13.11	23.55	46.00	-22.45	123	100	QP
5	888.4500	36.41	-10.29	26.12	46.00	-19.88	264	200	QP
6	946.6500	37.38	-9.44	27.94	46.00	-18.06	21	100	QP

Pre-scan all mode and recorded the worst case results in this report (TX- Lowest Channel(1Mbps))

EUT Name	Wireless Earbuds	Model	E508A
Environmental Conditions	24.5°C/40%RH/101.0kPa	Test Voltage	DC 3.8V
Test Mode	TX/ BLE_1M (2402MHz)	Polarity	Horizontal
Tested By	Huang Xinlong	Tested Date	2022-10-21

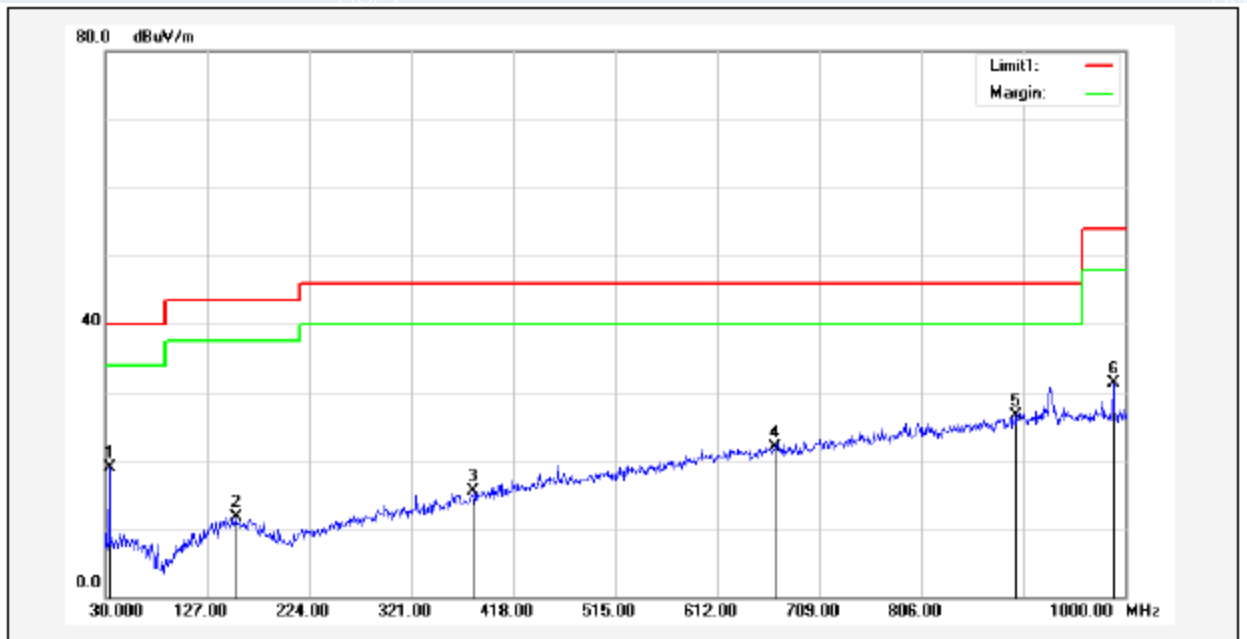

No.	Frequency (MHz)	Reading (dBuV)	Correction factor(dB/m)	Result (dBuV/m)	Limit (dBuV/m)	Over (dB)	Degree (deg.)	Height (cm)	Remark
1	33.8800	46.81	-27.99	18.82	40.00	-21.18	1	200	QP
2	154.1600	36.61	-24.88	11.73	43.50	-31.77	281	100	QP
3	380.1700	36.65	-21.23	15.42	46.00	-30.58	208	100	QP
4	667.2900	35.93	-13.95	21.98	46.00	-24.02	360	146	QP
5*	896.2100	36.61	-10.17	26.44	46.00	-19.56	283	200	QP
6	988.3600	40.31	-8.94	31.37	54.00	-22.63	21	200	QP

Pre-scan all mode and recorded the worst case results in this report (TX- Lowest Channel(1Mbps))

Right earbuds

Battery 1

Below 1GHz

The chart below shows the highest readings taken from the final data.

EUT Name	Wireless Earbuds	Model	E508A
Environmental Conditions	24.2°C/41%RH/101.0kPa	Test Voltage	DC 3.8V
Test Mode	TX/ BLE_1M (2402MHz)	Polarity	Vertical
Tested By	Huang Xinlong	Tested Date	2022-10-18

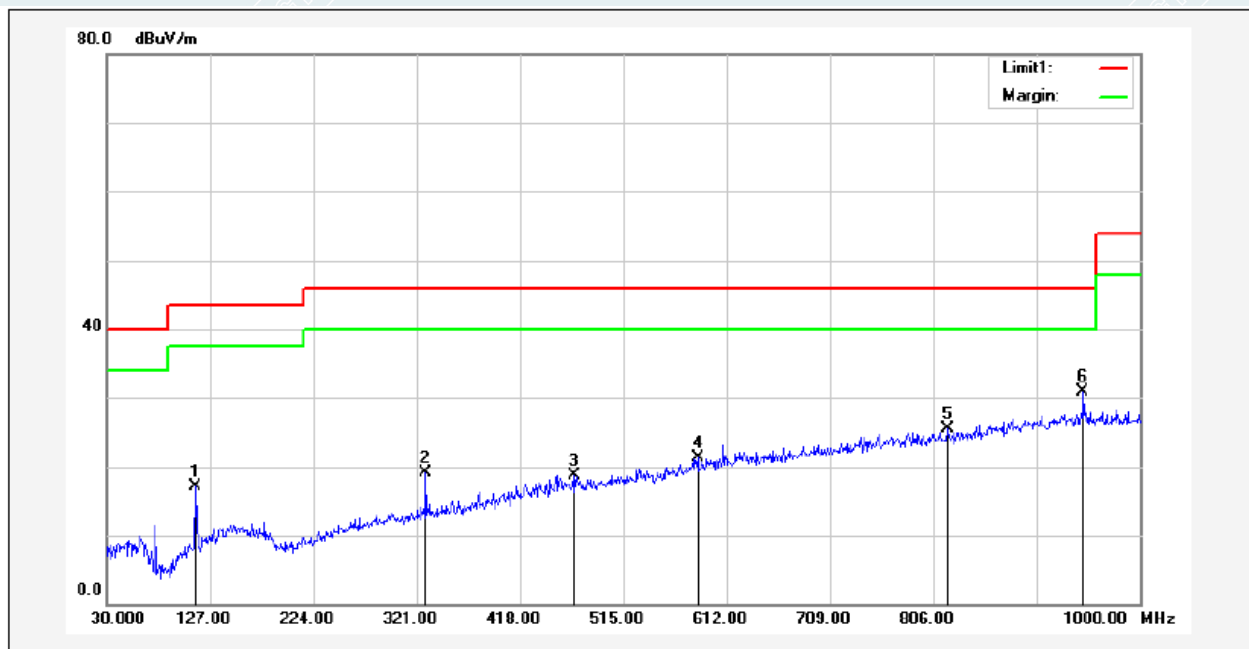

No.	Frequency (MHz)	Reading (dBuV)	Correction factor(dB/m)	Result (dBuV/m)	Limit (dBuV/m)	Over (dB)	Degree (deg.)	Height (cm)	Remark
1	113.4200	44.69	-27.66	17.03	43.50	-26.47	360	124	QP
2	329.7300	41.84	-22.83	19.01	46.00	-26.99	147	100	QP
3	468.4400	37.20	-18.44	18.76	46.00	-27.24	278	200	QP
4	584.8400	36.79	-15.52	21.27	46.00	-24.73	129	100	QP
5	819.5800	36.79	-11.28	25.51	46.00	-20.49	80	200	QP
6*	946.6500	40.35	-9.44	30.91	46.00	-15.09	128	200	QP

Pre-scan all mode and recorded the worst case results in this report (TX- Lowest Channel(1Mbps))

EUT Name	Wireless Earbuds	Model	E508A
Environmental Conditions	24.2°C/41%RH/101.0kPa	Test Voltage	DC 3.8V
Test Mode	TX/ BLE_1M (2402MHz)	Polarity	Horizontal
Tested By	Huang Xinlong	Tested Date	2022-10-18

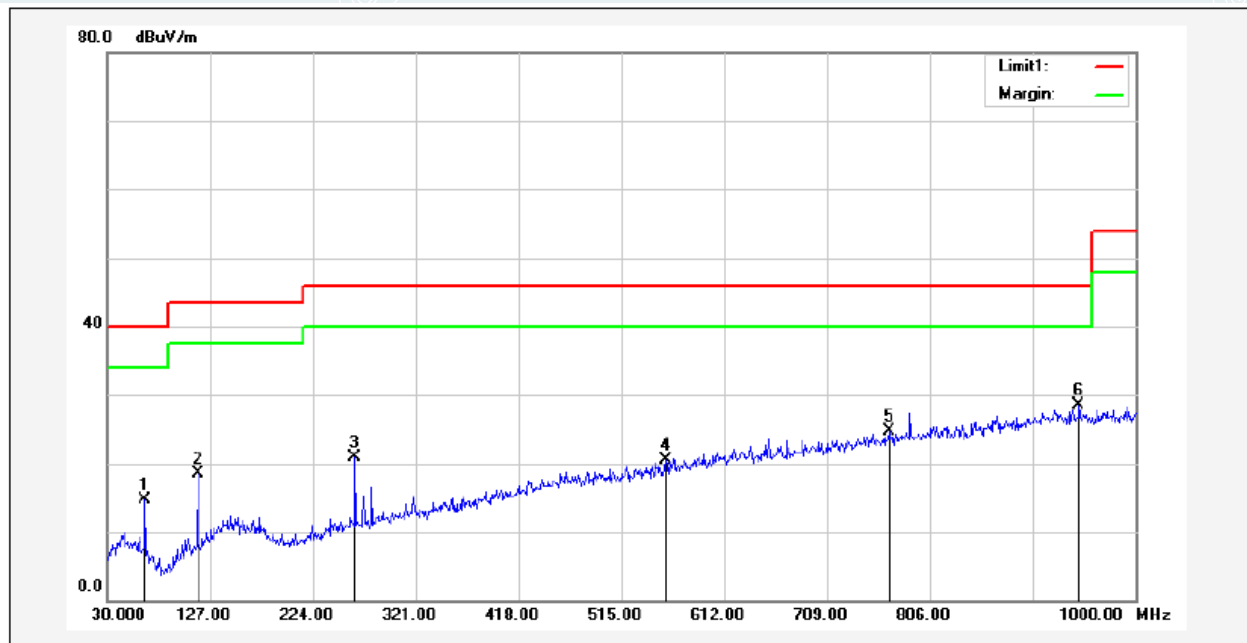

No.	Frequency (MHz)	Reading (dBuV)	Correction factor(dB/m)	Result (dBuV/m)	Limit (dBuV/m)	Over (dB)	Degree (deg.)	Height (cm)	Remark
1	65.8900	43.12	-28.50	14.62	40.00	-25.38	233	100	QP
2	115.3600	45.99	-27.53	18.46	43.50	-25.04	229	200	QP
3	263.7700	45.80	-24.86	20.94	46.00	-25.06	1	100	QP
4	556.7100	36.94	-16.41	20.53	46.00	-25.47	57	200	QP
5	767.2000	36.69	-12.01	24.68	46.00	-21.32	337	200	QP
6*	946.6500	37.94	-9.44	28.50	46.00	-17.50	6	100	QP

Pre-scan all mode and recorded the worst case results in this report (TX- Lowest Channel(1Mbps))

Battery 2

Below 1GHz

The chart below shows the highest readings taken from the final data.

EUT Name	Wireless Earbuds	Model	E508A
Environmental Conditions	24.5°C/40%RH/101.0kPa	Test Voltage	DC 3.8V
Test Mode	TX/ BLE_1M (2480MHz)	Polarity	Vertical
Tested By	Huang Xinlong	Tested Date	2022-10-21

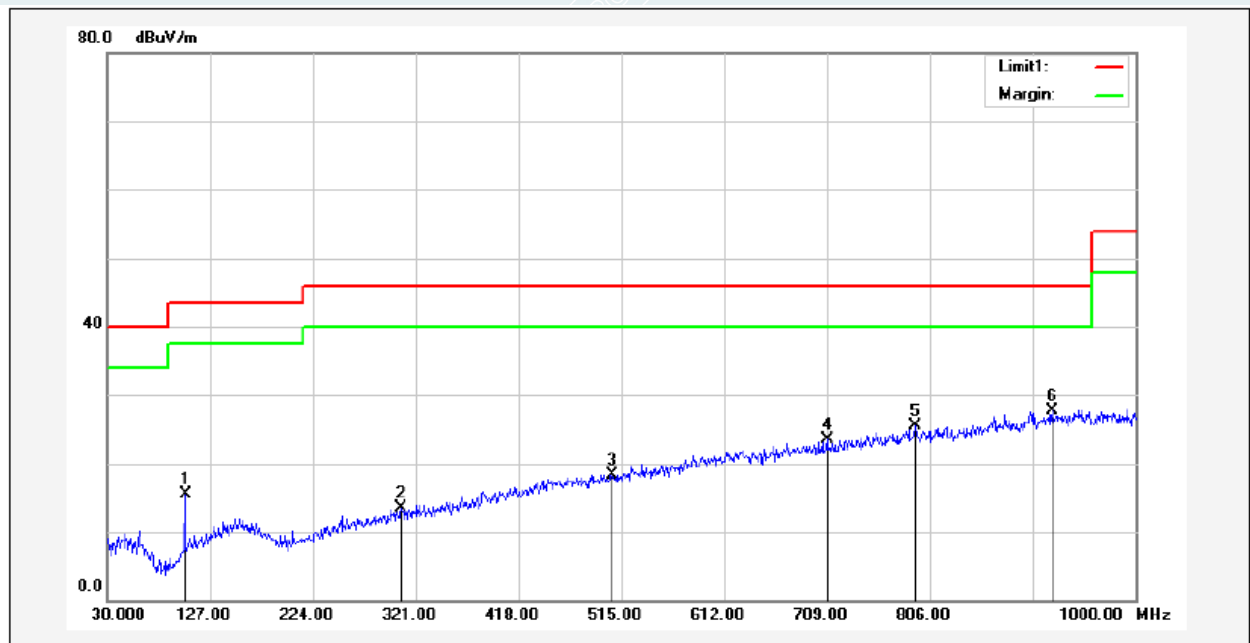

No.	Frequency (MHz)	Reading (dBuV)	Correction factor(dB/m)	Result (dBuV/m)	Limit (dBuV/m)	Over (dB)	Degree (deg.)	Height (cm)	Remark
1	103.7200	44.17	-28.75	15.42	43.50	-28.08	360	142	QP
2	307.4200	36.84	-23.38	13.46	46.00	-32.54	255	200	QP
3	506.2700	36.09	-17.74	18.35	46.00	-27.65	17	200	QP
4	709.0000	36.54	-13.13	23.41	46.00	-22.59	310	200	QP
5	792.4200	37.12	-11.64	25.48	46.00	-20.52	59	100	QP
6*	921.4300	37.56	-9.81	27.75	46.00	-18.25	244	200	QP

Pre-scan all mode and recorded the worst case results in this report (TX- Highest Channel(1Mbps))

EUT Name	Wireless Earbuds	Model	E508A
Environmental Conditions	24.5°C/40%RH/101.0kPa	Test Voltage	DC 3.8V
Test Mode	TX/ BLE_1M (2480MHz)	Polarity	Horizontal
Tested By	Huang Xinlong	Tested Date	2022-10-21

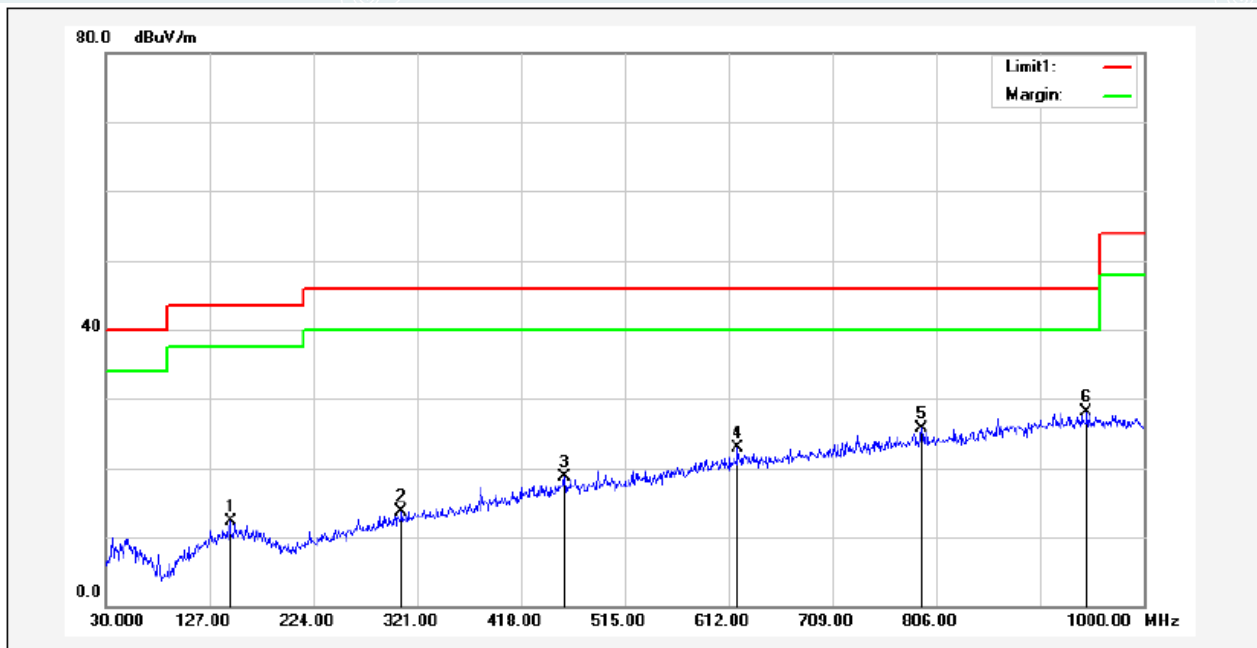

No.	Frequency (MHz)	Reading (dBuV)	Correction factor(dB/m)	Result (dBuV/m)	Limit (dBuV/m)	Over (dB)	Degree (deg.)	Height (cm)	Remark
1	146.4000	37.24	-25.00	12.24	43.50	-31.26	225	200	QP
2	306.4500	37.10	-23.41	13.69	46.00	-32.31	111	200	QP
3	458.7400	37.30	-18.60	18.70	46.00	-27.30	138	200	QP
4	620.7300	37.56	-14.73	22.83	46.00	-23.17	338	100	QP
5	792.4200	37.29	-11.64	25.65	46.00	-20.35	107	100	QP
6*	946.6500	37.53	-9.44	28.09	46.00	-17.91	337	200	QP

Pre-scan all mode and recorded the worst case results in this report (TX- Highest Channel(1Mbps))

Remark:

- 1 No emission found between lowest internal used/generated frequency to 30MHz.
- 2 Radiated emissions measured in frequency range from 9kHz to 1GHz were made with an instrument using Quasi-peak detector mode.
- 3 The IF bandwidth of Receiver between 30MHz to 1GHz was 120kHz.

Left earbuds**1GHz-18GHz:**

Mode: TX/ BLE_1M

Lowest Frequency (2402MHz)

Environment: 25.1°C/51%RH/101.0kPa

Tested By:Zhang Zishan

Voltage: DC 3.8V

Date: 2022-10-13

Suspected Data List									
NO.	Freq. [MHz]	Reading [dB μ V/m]	Level [dB μ V/m]	Factor [dB]	Limit [dB μ V/m]	Margin [dB]	Height [cm]	Angle [°]	Polarity
1	1250.2	59.49	37.59	-21.90	74.00	36.41	200	337	Horizontal
2	1898.2	59.74	38.70	-21.04	74.00	35.30	200	244	Horizontal
3	2846.2	58.60	42.22	-16.38	74.00	31.78	100	126	Horizontal
4	3598.5	56.95	41.12	-15.83	74.00	32.88	200	266	Horizontal
5	4954.5	56.10	44.36	-11.74	74.00	29.64	100	293	Horizontal
6	7191	54.27	50.21	-4.06	74.00	23.79	200	11	Horizontal
7	1246.2	48.91	26.86	-22.05	54.00	27.14	100	359	Horizontal
8	1895	49.65	28.57	-21.08	54.00	25.43	200	309	Horizontal
9	2828.4	47.47	30.66	-16.81	54.00	23.34	100	83	Horizontal
10	3604.5	47.50	31.56	-15.94	54.00	22.44	200	38	Horizontal
11	4938	44.89	32.80	-12.09	54.00	21.20	200	76	Horizontal
12	7293	42.11	39.21	-2.90	54.00	14.79	100	345	Horizontal

Suspected Data List									
NO.	Freq. [MHz]	Reading [dB μ V/m]	Level [dB μ V/m]	Factor [dB]	Limit [dB μ V/m]	Margin [dB]	Height [cm]	Angle [°]	Polarity
1	1075.4	60.46	37.84	-22.62	74.00	36.16	200	243	Vertical
2	1397.2	59.58	38.03	-21.55	74.00	35.97	100	81	Vertical
3	1713.8	60.16	38.69	-21.47	74.00	35.31	200	199	Vertical
4	2978.6	58.77	42.09	-16.68	74.00	31.91	100	212	Vertical
5	3595.5	56.64	41.09	-15.55	74.00	32.91	200	106	Vertical
6	5916	55.01	45.99	-9.02	74.00	28.01	200	317	Vertical
7	1094.2	49.09	26.75	-22.34	54.00	27.25	100	145	Vertical
8	1420.8	48.87	27.20	-21.67	54.00	26.80	100	321	Vertical
9	1722	48.72	27.19	-21.53	54.00	26.81	200	359	Vertical
10	2973.6	47.37	30.61	-16.76	54.00	23.39	200	132	Vertical
11	3598.5	45.87	30.42	-15.45	54.00	23.58	100	346	Vertical
12	5911.5	43.55	34.59	-8.96	54.00	19.41	100	119	Vertical

Mode: TX/ BLE_1M
 Middle Frequency (2440MHz)
 Environment: 25.1°C/51%RH/101.0kPa
 Tested By: Zhang Zishan

Voltage: DC 3.8V
 Date: 2022-10-13

Suspected Data List									
NO.	Freq. [MHz]	Reading [dB μ V/m]	Level [dB μ V/m]	Factor [dB]	Limit [dB μ V/m]	Margin [dB]	Height [cm]	Angle [°]	Polarity
1	1262.2	60.07	37.96	-22.11	74.00	36.04	100	59	Horizontal
2	1894	59.28	38.18	-21.10	74.00	35.82	100	360	Horizontal
3	2227.8	58.80	40.50	-18.30	74.00	33.50	100	257	Horizontal
4	2843.6	58.50	42.06	-16.44	74.00	31.94	100	16	Horizontal
5	3573	57.38	41.03	-16.35	74.00	32.97	100	102	Horizontal
6	4683	57.52	44.67	-12.85	74.00	29.33	100	259	Horizontal
7	1246	49.11	27.05	-22.06	54.00	26.95	200	44	Horizontal
8	1895.2	49.87	28.79	-21.08	54.00	25.21	100	272	Horizontal
9	2200.4	47.64	29.74	-17.90	54.00	24.26	100	300	Horizontal
10	2845.2	47.05	30.65	-16.40	54.00	23.35	100	272	Horizontal
11	3661.5	48.40	31.03	-17.37	54.00	22.97	100	115	Horizontal
12	4665	45.13	32.70	-12.43	54.00	21.30	200	303	Horizontal

Suspected Data List									
NO.	Freq. [MHz]	Reading [dB μ V/m]	Level [dB μ V/m]	Factor [dB]	Limit [dB μ V/m]	Margin [dB]	Height [cm]	Angle [°]	Polarity
1	1354.6	60.28	38.34	-21.94	74.00	35.66	200	355	Vertical
2	2033.8	59.92	39.99	-19.93	74.00	34.01	100	180	Vertical
3	2973	58.53	41.76	-16.77	74.00	32.24	100	14	Vertical
4	4636.5	56.45	44.15	-12.30	74.00	29.85	200	24	Vertical
5	8187	52.37	51.39	-0.98	74.00	22.61	200	196	Vertical
6	10698	48.75	53.12	4.37	74.00	20.88	100	27	Vertical
7	1405.6	48.92	27.36	-21.56	54.00	26.64	200	16	Vertical
8	2048.6	47.94	28.23	-19.71	54.00	25.77	100	360	Vertical
9	2995	47.05	30.63	-16.42	54.00	23.37	200	272	Vertical
10	4668	45.12	32.65	-12.47	54.00	21.35	200	89	Vertical
11	8181	41.22	40.20	-1.02	54.00	13.80	200	24	Vertical
12	10698	37.65	42.02	4.37	54.00	11.98	100	186	Vertical

Mode: TX/ BLE_1M

Highest Frequency (2480MHz)

Environment: 25.1°C/51%RH/101.0kPa

Tested By: Zhang Zishan

Voltage: DC 3.8V

Date: 2022-10-13

Suspected Data List									
NO.	Freq. [MHz]	Reading [dB μ V/m]	Level [dB μ V/m]	Factor [dB]	Limit [dB μ V/m]	Margin [dB]	Height [cm]	Angle [°]	Polarity
1	1277.6	61.43	39.06	-22.37	74.00	34.94	100	56	Horizontal
2	2194.6	59.27	41.10	-18.17	74.00	32.90	200	16	Horizontal
3	2867	58.92	42.01	-16.91	74.00	31.99	100	296	Horizontal
4	3913.5	56.52	40.82	-15.70	74.00	33.18	100	196	Horizontal
5	5145	55.48	44.41	-11.07	74.00	29.59	100	196	Horizontal
6	9787.5	50.75	53.20	2.45	74.00	20.80	200	343	Horizontal
7	1248.8	48.85	26.90	-21.95	54.00	27.10	100	154	Horizontal
8	2219.8	48.21	30.02	-18.19	54.00	23.98	100	229	Horizontal
9	2860.6	47.73	31.06	-16.67	54.00	22.94	200	312	Horizontal
10	3721.5	49.24	32.08	-17.16	54.00	21.92	100	84	Horizontal
11	5652	43.80	34.05	-9.75	54.00	19.95	200	48	Horizontal
12	9796.5	39.41	41.98	2.57	54.00	12.02	100	209	Horizontal

Suspected Data List									
NO.	Freq. [MHz]	Reading [dB μ V/m]	Level [dB μ V/m]	Factor [dB]	Limit [dB μ V/m]	Margin [dB]	Height [cm]	Angle [°]	Polarity
1	1110.2	60.92	38.33	-22.59	74.00	35.67	200	326	Vertical
2	2205.6	58.24	39.21	-19.03	74.00	34.79	200	283	Vertical
3	3304.5	58.21	41.11	-17.10	74.00	32.89	200	159	Vertical
4	4575	56.57	43.45	-13.12	74.00	30.55	100	169	Vertical
5	5644.5	55.65	45.89	-9.76	74.00	28.11	200	171	Vertical
6	8832	51.28	51.20	-0.08	74.00	22.80	100	169	Vertical
7	1072.8	49.47	26.80	-22.67	54.00	27.20	100	257	Vertical
8	2272.8	47.78	28.90	-18.88	54.00	25.10	200	16	Vertical
9	3279	46.88	29.86	-17.02	54.00	24.14	100	345	Vertical
10	4656	45.04	32.90	-12.14	54.00	21.10	100	101	Vertical
11	5916	43.74	34.72	-9.02	54.00	19.28	200	307	Vertical
12	9238.5	39.89	40.85	0.96	54.00	13.15	100	266	Vertical

Remark:

- 1 Measuring frequencies from 1GHz to the 10th harmonic of highest fundamental frequency.
- 2 Radiated emissions measured in frequency above 1000MHz were made with an instrument using peak/average detector mode.
- 3 Average test would be performed if the peak result were greater than the average limit or as required by the applicant.
- 4 Measurements above show only up to 6 maximum emissions noted, or would be lesser, with " N/A " remark, if no specific emissions from the EUT are recorded (ie: margin>20dB from the applicable limit) and considered that's already beyond the background noise floor.

Right earbuds**1GHz-18GHz:**

Mode: TX/ BLE_1M

Lowest Frequency (2402MHz)

Environment: 25.1°C/51%RH/101.0kPa

Tested By:Zhang Zishan

Voltage: DC 3.8V

Date: 2022-10-13

Suspected Data List									
NO.	Freq. [MHz]	Reading [dB μ V/m]	Level [dB μ V/m]	Factor [dB]	Limit [dB μ V/m]	Margin [dB]	Height [cm]	Angle [°]	Polarity
1	1245.8	60.27	38.20	-22.07	74.00	35.80	100	272	Horizontal
2	1894.4	59.78	38.68	-21.10	74.00	35.32	200	199	Horizontal
3	2862.6	58.72	41.97	-16.75	74.00	32.03	100	14	Horizontal
4	3886.5	57.12	41.14	-15.98	74.00	32.86	200	158	Horizontal
5	7288.5	53.52	50.52	-3.00	74.00	23.48	100	33	Horizontal
6	9907.5	50.25	52.66	2.41	74.00	21.34	100	222	Horizontal
7	1251.6	48.81	26.88	-21.93	54.00	27.12	100	242	Horizontal
8	1895.2	49.42	28.34	-21.08	54.00	25.66	100	350	Horizontal
9	2852.6	47.21	30.83	-16.38	54.00	23.17	100	272	Horizontal
10	3604.5	47.96	32.02	-15.94	54.00	21.98	100	315	Horizontal
11	7263	42.28	38.76	-3.52	54.00	15.24	200	185	Horizontal
12	9774	39.83	42.11	2.28	54.00	11.89	100	235	Horizontal

Suspected Data List									
NO.	Freq. [MHz]	Reading [dB μ V/m]	Level [dB μ V/m]	Factor [dB]	Limit [dB μ V/m]	Margin [dB]	Height [cm]	Angle [°]	Polarity
1	1358.4	60.06	38.16	-21.90	74.00	35.84	200	220	Vertical
2	2078	59.22	39.05	-20.17	74.00	34.95	200	357	Vertical
3	2988.6	58.23	41.71	-16.52	74.00	32.29	100	16	Vertical
4	4639.5	56.04	43.81	-12.23	74.00	30.19	100	346	Vertical
5	7275	53.23	50.45	-2.78	74.00	23.55	200	252	Vertical
6	10507.5	50.61	53.48	2.87	74.00	20.52	100	144	Vertical
7	1372.4	49.19	27.41	-21.78	54.00	26.59	200	72	Vertical
8	2049.6	47.95	28.27	-19.68	54.00	25.73	100	271	Vertical
9	2985.6	47.18	30.61	-16.57	54.00	23.39	200	314	Vertical
10	4651.5	44.56	32.54	-12.02	54.00	21.46	200	222	Vertical
11	7285.5	42.07	39.43	-2.64	54.00	14.57	100	171	Vertical
12	10407	38.82	42.40	3.58	54.00	11.60	100	346	Vertical

Mode: TX/ BLE_1M
 Middle Frequency (2440MHz)
 Environment: 25.1°C/51%RH/101.0kPa
 Tested By: Zhang Zishan

Voltage: DC 3.8V
 Date: 2022-10-13

Suspected Data List									
NO.	Freq. [MHz]	Reading [dBμV/m]	Level [dBμV/m]	Factor [dB]	Limit [dBμV/m]	Margin [dB]	Height [cm]	Angle [°]	Polarity
1	1247.6	60.70	38.70	-22.00	74.00	35.30	200	255	Horizontal
2	1894.8	60.17	39.09	-21.08	74.00	34.91	100	28	Horizontal
3	3592.5	56.62	40.67	-15.95	74.00	33.33	200	173	Horizontal
4	5997	54.56	45.47	-9.09	74.00	28.53	100	91	Horizontal
5	8430	51.88	50.46	-1.42	74.00	23.54	200	63	Horizontal
6	10477.5	50.00	53.03	3.03	74.00	20.97	200	0	Horizontal
7	1263.2	48.97	26.84	-22.13	54.00	27.16	100	178	Horizontal
8	1895	49.70	28.62	-21.08	54.00	25.38	100	28	Horizontal
9	3661.5	48.27	30.90	-17.37	54.00	23.10	200	129	Horizontal
10	5649	43.89	34.14	-9.75	54.00	19.86	100	159	Horizontal
11	8185.5	41.25	39.75	-1.50	54.00	14.25	100	12	Horizontal
12	10425	38.82	41.83	3.01	54.00	12.17	100	267	Horizontal

Suspected Data List									
NO.	Freq. [MHz]	Reading [dBμV/m]	Level [dBμV/m]	Factor [dB]	Limit [dBμV/m]	Margin [dB]	Height [cm]	Angle [°]	Polarity
1	1389	60.15	38.53	-21.62	74.00	35.47	100	273	Vertical
2	2047	58.63	38.90	-19.73	74.00	35.10	100	231	Vertical
3	2970.2	59.10	42.29	-16.81	74.00	31.71	200	258	Vertical
4	4758	56.85	43.45	-13.40	74.00	30.55	200	288	Vertical
5	8865	51.49	51.65	0.16	74.00	22.35	100	48	Vertical
6	10423.5	49.79	53.38	3.59	74.00	20.62	200	262	Vertical
7	1422.4	48.85	27.17	-21.68	54.00	26.83	200	351	Vertical
8	2036.2	48.08	28.18	-19.90	54.00	25.82	200	351	Vertical
9	2991.2	47.01	30.53	-16.48	54.00	23.47	200	70	Vertical
10	4650	45.11	33.13	-11.98	54.00	20.87	100	318	Vertical
11	8836.5	40.36	40.33	-0.03	54.00	13.67	100	34	Vertical
12	10425	38.74	42.32	3.58	54.00	11.68	200	34	Vertical

Mode: TX/ BLE_1M
 Highest Frequency (2480MHz)
 Environment: 25.1°C/51%RH/101.0kPa
 Tested By: Zhang Zishan

Voltage: DC 3.8V
 Date: 2022-10-13

Suspected Data List									
NO.	Freq. [MHz]	Reading [dB μ V/m]	Level [dB μ V/m]	Factor [dB]	Limit [dB μ V/m]	Margin [dB]	Height [cm]	Angle [°]	Polarity
1	1214.6	61.18	37.85	-23.33	74.00	36.15	200	164	Horizontal
2	1897.6	59.34	38.30	-21.04	74.00	35.70	200	148	Horizontal
3	3589.5	56.72	40.70	-16.02	74.00	33.30	100	108	Horizontal
4	5517	55.03	44.50	-10.53	74.00	29.50	200	91	Horizontal
5	9261	50.69	51.81	1.12	74.00	22.19	200	203	Horizontal
6	10566	49.78	53.46	3.68	74.00	20.54	200	292	Horizontal
7	1248.8	48.70	26.75	-21.95	54.00	27.25	100	124	Horizontal
8	1894.8	48.75	27.67	-21.08	54.00	26.33	100	322	Horizontal
9	3721.5	48.10	30.94	-17.16	54.00	23.06	200	254	Horizontal
10	5517	43.95	33.42	-10.53	54.00	20.58	100	0	Horizontal
11	9270	39.82	41.00	1.18	54.00	13.00	200	306	Horizontal
12	10590	38.99	42.48	3.49	54.00	11.52	100	108	Horizontal

Suspected Data List									
NO.	Freq. [MHz]	Reading [dB μ V/m]	Level [dB μ V/m]	Factor [dB]	Limit [dB μ V/m]	Margin [dB]	Height [cm]	Angle [°]	Polarity
1	1072	60.80	38.12	-22.68	74.00	35.88	200	147	Vertical
2	1704.8	59.34	37.95	-21.39	74.00	36.05	100	215	Vertical
3	2997.6	58.39	42.02	-16.37	74.00	31.98	200	81	Vertical
4	3585	57.42	41.50	-15.92	74.00	32.50	100	276	Vertical
5	5202	55.37	44.28	-11.09	74.00	29.72	200	289	Vertical
6	9814.5	49.56	52.27	2.71	74.00	21.73	100	21	Vertical
7	1074.6	49.55	26.91	-22.64	54.00	27.09	100	82	Vertical
8	1736.6	48.60	26.95	-21.65	54.00	27.05	200	256	Vertical
9	2976.2	47.30	30.59	-16.71	54.00	23.41	100	300	Vertical
10	3621	46.16	30.25	-15.91	54.00	23.75	200	20	Vertical
11	5197.5	45.03	34.00	-11.03	54.00	20.00	200	196	Vertical
12	9790.5	39.74	42.48	2.74	54.00	11.52	100	195	Vertical

Remark:

- 1 Measuring frequencies from 1GHz to the 10th harmonic of highest fundamental frequency.
- 2 Radiated emissions measured in frequency above 1000MHz were made with an instrument using peak/average detector mode.
- 3 Average test would be performed if the peak result were greater than the average limit or as required by the applicant.
- 4 Measurements above show only up to 6 maximum emissions noted, or would be lesser, with “ N/A ” remark, if no specific emissions from the EUT are recorded (ie: margin>20dB from the applicable limit) and considered that's already beyond the background noise floor.

Left earbuds

18GHz to 26.5GHz

According to C63.10, if the peak (or quasi-peak) measured value complies with the average limit, it is unnecessary to perform an average measurement, so AV emission value did not show in below table if the peak value complies with average limit.

Mode: TX/ BLE_1M
 Lowest Frequency (2402MHz)
 Environment: 24.8°C/54%RH/101.0kPa
 Tested By: Zhang Zishan

Voltage: DC 3.8V
 Date: 2022-10-18

Suspected Data List									
NO.	Freq. [MHz]	Reading [dBμV/m]	Level [dBμV/m]	Factor [dB]	Limit [dBμV/m]	Margin [dB]	Height [cm]	Angle [°]	Polarity
1	18422.875	52.80	40.53	-12.27	83.54	43.01	150	183	Horizontal
2	19586.1	51.28	39.95	-11.33	83.54	43.59	150	344	Horizontal
3	20156.875	50.90	39.99	-10.91	83.54	43.55	150	135	Horizontal
4	21215.55	50.80	40.76	-10.04	83.54	42.78	150	40	Horizontal
5	21919.775	47.84	38.07	-9.77	83.54	45.47	150	312	Horizontal
6	22597.65	46.70	37.68	-9.02	83.54	45.86	150	344	Horizontal

Suspected Data List									
NO.	Freq. [MHz]	Reading [dBμV/m]	Level [dBμV/m]	Factor [dB]	Limit [dBμV/m]	Margin [dB]	Height [cm]	Angle [°]	Polarity
1	18433.5	53.16	40.97	-12.19	83.54	42.57	150	81	Vertical
2	18957.525	51.97	40.15	-11.82	83.54	43.39	150	288	Vertical
3	19493.025	53.81	42.38	-11.43	83.54	41.16	150	33	Vertical
4	20370.65	50.74	40.19	-10.55	83.54	43.35	150	241	Vertical
5	21131.4	49.90	39.92	-9.98	83.54	43.62	150	208	Vertical
6	22598.075	47.15	38.13	-9.02	83.54	45.41	150	241	Vertical

----- The following blanks -----

Mode: TX/ BLE_1M
 Middle Frequency (2440MHz)
 Environment: 24.8°C/54%RH/101.0kPa
 Tested By: Zhang Zishan

Voltage: DC 3.8V
 Date: 2022-10-18

Suspected Data List									
NO.	Freq. [MHz]	Reading [dBμV/m]	Level [dBμV/m]	Factor [dB]	Limit [dBμV/m]	Margin [dB]	Height [cm]	Angle [°]	Polarity
1	18463.25	53.03	40.79	-12.24	83.54	42.75	150	282	Horizontal
2	19052.725	51.69	39.93	-11.76	83.54	43.61	150	154	Horizontal
3	19458.175	52.10	40.65	-11.45	83.54	42.89	150	104	Horizontal
4	20553.4	49.19	38.74	-10.45	83.54	44.80	150	137	Horizontal
5	21962.275	48.53	38.76	-9.77	83.54	44.78	150	10	Horizontal
6	22597.65	47.43	38.41	-9.02	83.54	45.13	150	121	Horizontal

Suspected Data List									
NO.	Freq. [MHz]	Reading [dBμV/m]	Level [dBμV/m]	Factor [dB]	Limit [dBμV/m]	Margin [dB]	Height [cm]	Angle [°]	Polarity
1	18485.35	52.04	39.91	-12.13	83.54	43.63	150	192	Vertical
2	19299.65	51.51	39.94	-11.57	83.54	43.60	150	224	Vertical
3	20268.65	51.55	40.86	-10.69	83.54	42.68	150	273	Vertical
4	21134.8	49.94	39.97	-9.97	83.54	43.57	150	128	Vertical
5	21959.725	48.03	38.36	-9.67	83.54	45.18	150	192	Vertical
6	23580.675	43.72	35.11	-8.61	83.54	48.43	150	49	Vertical

----- The following blanks -----

Mode: TX/ BLE_1M

Highest Frequency (2480MHz)

Environment: 24.8°C/54%RH/101.0kPa

Tested By: Zhang Zishan

Voltage: DC 3.8V

Date: 2022-10-18

Suspected Data List									
NO.	Freq. [MHz]	Reading [dB μ V/m]	Level [dB μ V/m]	Factor [dB]	Limit [dB μ V/m]	Margin [dB]	Height [cm]	Angle [°]	Polarity
1	18375.275	52.22	39.92	-12.30	83.54	43.62	150	353	Horizontal
2	18982.6	52.71	40.90	-11.81	83.54	42.64	150	240	Horizontal
3	19589.925	51.65	40.33	-11.32	83.54	43.21	150	209	Horizontal
4	21101.65	50.18	40.10	-10.08	83.54	43.44	150	144	Horizontal
5	21853.05	47.76	37.99	-9.77	83.54	45.55	150	79	Horizontal
6	22598.075	46.82	37.80	-9.02	83.54	45.74	150	96	Horizontal

Suspected Data List									
NO.	Freq. [MHz]	Reading [dB μ V/m]	Level [dB μ V/m]	Factor [dB]	Limit [dB μ V/m]	Margin [dB]	Height [cm]	Angle [°]	Polarity
1	18436.9	52.25	40.06	-12.19	83.54	43.48	150	153	Vertical
2	18902.7	52.50	40.64	-11.86	83.54	42.90	150	267	Vertical
3	19607.775	51.45	40.18	-11.27	83.54	43.36	150	267	Vertical
4	20230.825	51.01	40.28	-10.73	83.54	43.26	150	185	Vertical
5	21116.95	50.25	40.27	-9.98	83.54	43.27	150	282	Vertical
6	22597.65	47.28	38.26	-9.02	83.54	45.28	150	26	Vertical

----- The following blanks -----

Right earbuds

18GHz to 26.5GHz

According to C63.10, if the peak (or quasi-peak) measured value complies with the average limit, it is unnecessary to perform an average measurement, so AV emission value did not show in below table if the peak value complies with average limit.

Mode: TX/ BLE_1M
 Lowest Frequency (2402MHz)
 Environment: 24.8°C/54%RH/101.0kPa
 Tested By: Zhang Zishan

Voltage: DC 3.8V
 Date: 2022-10-18

Suspected Data List									
NO.	Freq. [MHz]	Reading [dBμV/m]	Level [dBμV/m]	Factor [dB]	Limit [dBμV/m]	Margin [dB]	Height [cm]	Angle [°]	Polarity
1	18444.55	52.10	39.84	-12.26	83.54	43.70	150	55	Horizontal
2	19594.175	51.97	40.65	-11.32	83.54	42.89	150	344	Horizontal
3	20382.975	51.53	40.89	-10.64	83.54	42.65	150	8	Horizontal
4	21175.175	50.41	40.34	-10.07	83.54	43.20	150	153	Horizontal
5	21884.5	47.46	37.69	-9.77	83.54	45.85	150	200	Horizontal
6	23229.625	44.52	35.81	-8.71	83.54	47.73	150	249	Horizontal

Suspected Data List									
NO.	Freq. [MHz]	Reading [dBμV/m]	Level [dBμV/m]	Factor [dB]	Limit [dBμV/m]	Margin [dB]	Height [cm]	Angle [°]	Polarity
1	18365.5	52.14	39.88	-12.26	83.54	43.66	150	255	Vertical
2	19439.475	51.15	39.68	-11.47	83.54	43.86	150	304	Vertical
3	20362.15	51.53	40.96	-10.57	83.54	42.58	150	111	Vertical
4	21154.775	50.32	40.35	-9.97	83.54	43.19	150	111	Vertical
5	22190.925	46.90	37.43	-9.47	83.54	46.11	150	191	Vertical
6	23704.35	43.46	34.92	-8.54	83.54	48.62	150	320	Vertical

----- The following blanks -----

Mode: TX/ BLE_1M
 Middle Frequency (2440MHz)
 Environment: 24.8°C/54%RH/101.0kPa
 Tested By: Zhang Zishan

Voltage: DC 3.8V
 Date: 2022-10-18

Suspected Data List									
NO.	Freq. [MHz]	Reading [dBμV/m]	Level [dBμV/m]	Factor [dB]	Limit [dBμV/m]	Margin [dB]	Height [cm]	Angle [°]	Polarity
1	18492.15	52.97	40.75	-12.22	83.54	42.79	150	22	Horizontal
2	18990.675	52.69	40.89	-11.80	83.54	42.65	150	186	Horizontal
3	19500.675	52.00	40.58	-11.42	83.54	42.96	150	344	Horizontal
4	20174.3	50.83	39.94	-10.89	83.54	43.60	150	266	Horizontal
5	20824.55	49.26	39.05	-10.21	83.54	44.49	150	22	Horizontal
6	21953.35	47.84	38.07	-9.77	83.54	45.47	150	120	Horizontal

Suspected Data List									
NO.	Freq. [MHz]	Reading [dBμV/m]	Level [dBμV/m]	Factor [dB]	Limit [dBμV/m]	Margin [dB]	Height [cm]	Angle [°]	Polarity
1	18453.475	52.67	40.50	-12.17	83.54	43.04	150	354	Vertical
2	19529.575	51.97	40.59	-11.38	83.54	42.95	150	322	Vertical
3	20213.4	51.33	40.58	-10.75	83.54	42.96	150	226	Vertical
4	21174.75	50.12	40.15	-9.97	83.54	43.39	150	193	Vertical
5	21635.025	48.17	38.51	-9.66	83.54	45.03	150	291	Vertical
6	22597.65	47.31	38.29	-9.02	83.54	45.25	150	163	Vertical

----- The following blanks -----

Mode: TX/ BLE_1M

Highest Frequency (2480MHz)

Environment: 24.8°C/54%RH/101.0kPa

Tested By: Zhang Zishan

Voltage: DC 3.8V

Date: 2022-10-18

Suspected Data List									
NO.	Freq. [MHz]	Reading [dB μ V/m]	Level [dB μ V/m]	Factor [dB]	Limit [dB μ V/m]	Margin [dB]	Height [cm]	Angle [°]	Polarity
1	18451.775	52.08	39.83	-12.25	83.54	43.71	150	135	Horizontal
2	19496	52.24	40.81	-11.43	83.54	42.73	150	297	Horizontal
3	20318.375	50.88	40.16	-10.72	83.54	43.38	150	233	Horizontal
4	21145.425	49.98	39.91	-10.07	83.54	43.63	150	55	Horizontal
5	21694.1	48.11	38.35	-9.76	83.54	45.19	150	135	Horizontal
6	22598.075	48.01	38.99	-9.02	83.54	44.55	150	8	Horizontal

Suspected Data List									
NO.	Freq. [MHz]	Reading [dB μ V/m]	Level [dB μ V/m]	Factor [dB]	Limit [dB μ V/m]	Margin [dB]	Height [cm]	Angle [°]	Polarity
1	18486.2	52.31	40.18	-12.13	83.54	43.36	150	143	Vertical
2	19029.35	52.14	40.36	-11.78	83.54	43.18	150	111	Vertical
3	19581.425	52.05	40.75	-11.30	83.54	42.79	150	321	Vertical
4	20173.025	51.53	40.74	-10.79	83.54	42.80	150	15	Vertical
5	21155.2	50.40	40.43	-9.97	83.54	43.11	150	305	Vertical
6	21756.15	47.69	38.03	-9.66	83.54	45.51	150	290	Vertical

----- The following blanks -----

8. 6dB BANDWIDTH

8.1 LIMITS

Systems using digital modulation techniques may operate in the 902–928MHz, 2400–2483.5MHz, and 5725–5850MHz bands. The minimum 6dB bandwidth shall be at least 500kHz.

8.2 TEST PROCEDURES

- 1) Remove the antenna from the EUT, and then connect a low loss RF cable from antenna port to the spectrum analyzer.
- 2) Set resolution bandwidth (RBW) = 100kHz. Set the video bandwidth (VBW) ≥ 3 x RBW. Detector = Peak. Trace mode = max hold. Sweep = auto couple. Allow the trace to stabilize, record 6dB bandwidth value.
- 3) Repeat above procedures until all frequencies measured were complete.

8.3 TEST SETUP



8.4 TEST RESULTS

Environment: 25.0°C/45%RH/101.0kPa
 Tested By: Qin Tingting

Voltage: DC 3.8V
 Date: 2022-10-12

Left earbuds

BLE_1M

Channel	Frequency (MHz)	Bandwidth (kHz)	Limit (kHz)	Test Result
Lowest	2402	656	≥500	PASS
Middle	2440	660		PASS
Highest	2480	660		PASS

Right earbuds

BLE_1M

Channel	Frequency (MHz)	Bandwidth (kHz)	Limit (kHz)	Test Result
Lowest	2402	656	≥500	PASS
Middle	2440	656		PASS
Highest	2480	656		PASS

Left earbuds

BLE_1M

Lowest Frequency (2402MHz)

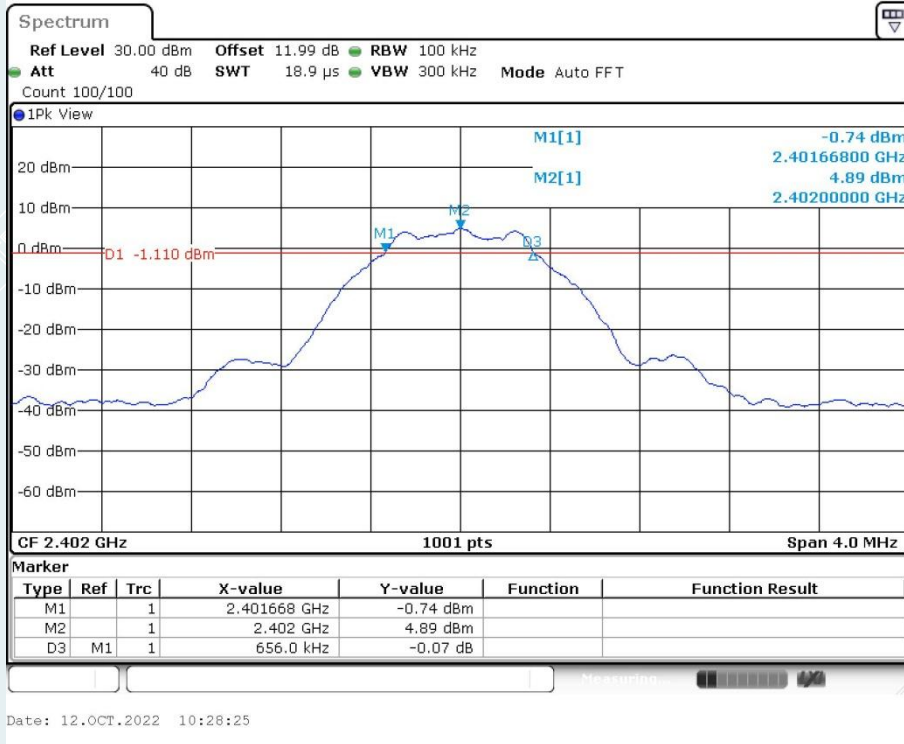

Middle Frequency (2440 MHz)

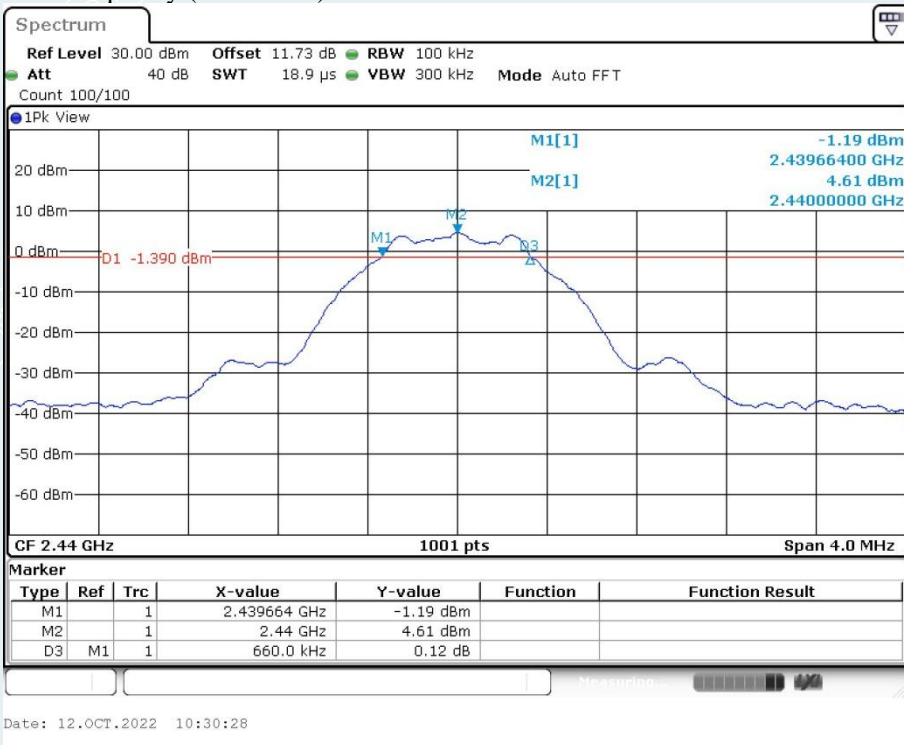

Highest Frequency (2480MHz)

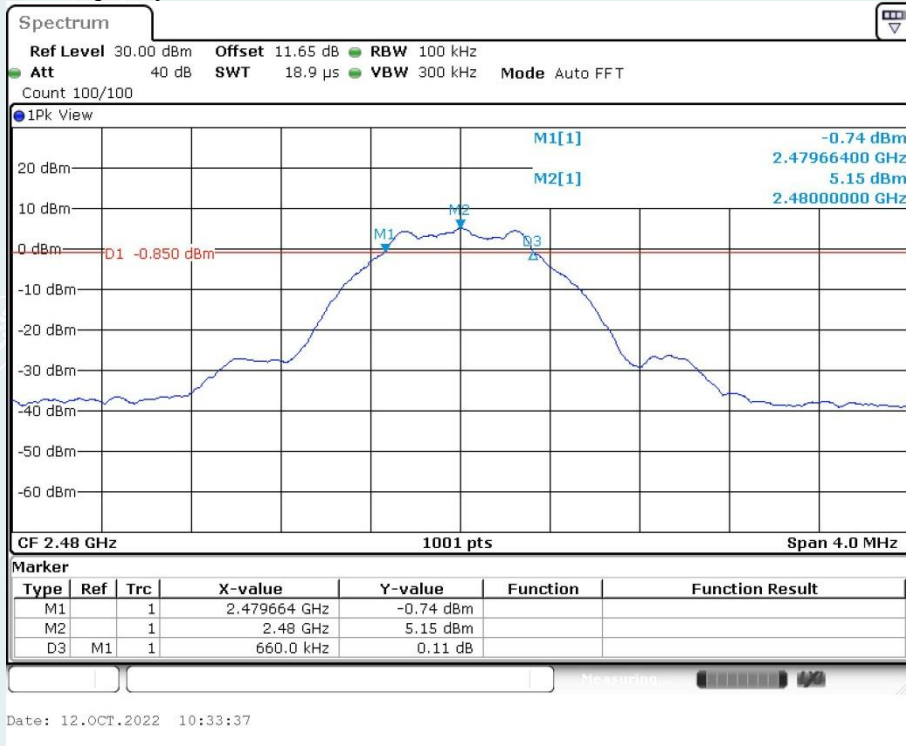

Right earbuds

BLE_1M

Lowest Frequency (2402MHz)

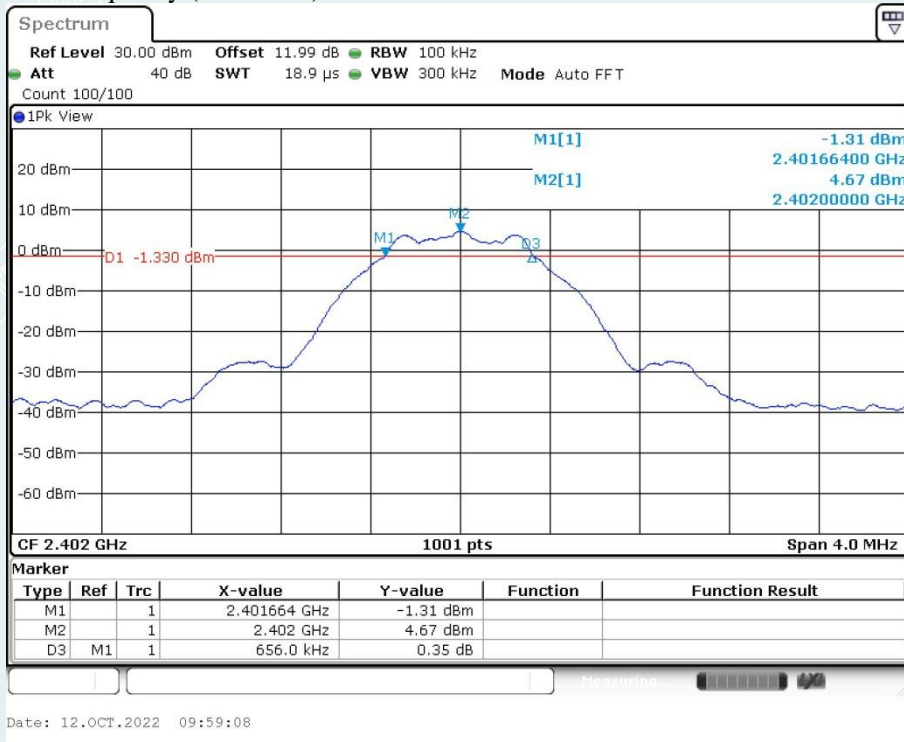

Middle Frequency (2440 MHz)

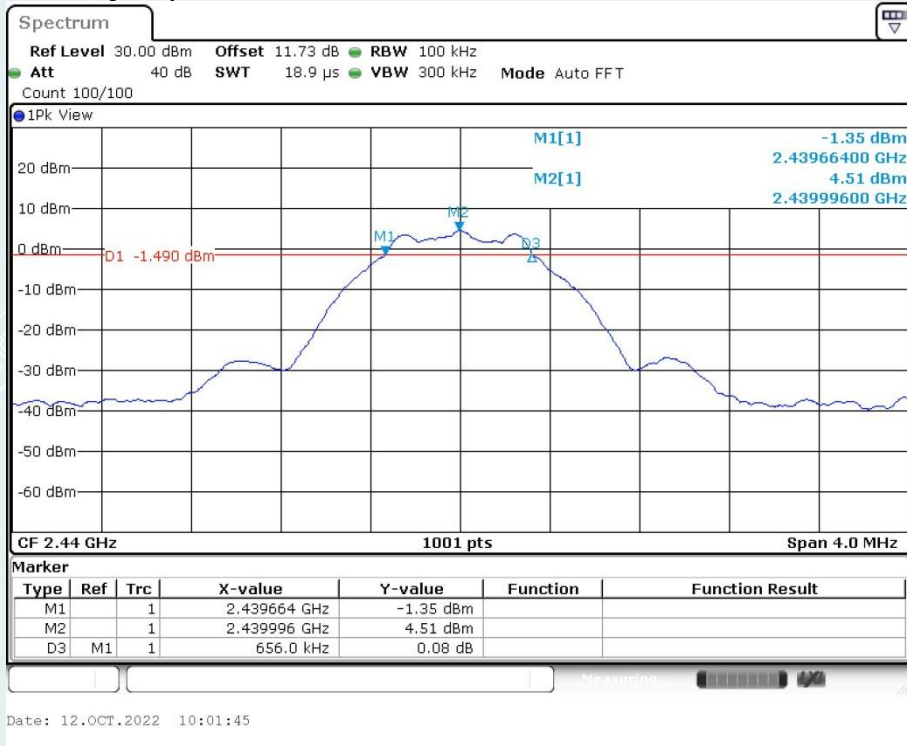

Highest Frequency (2480MHz)

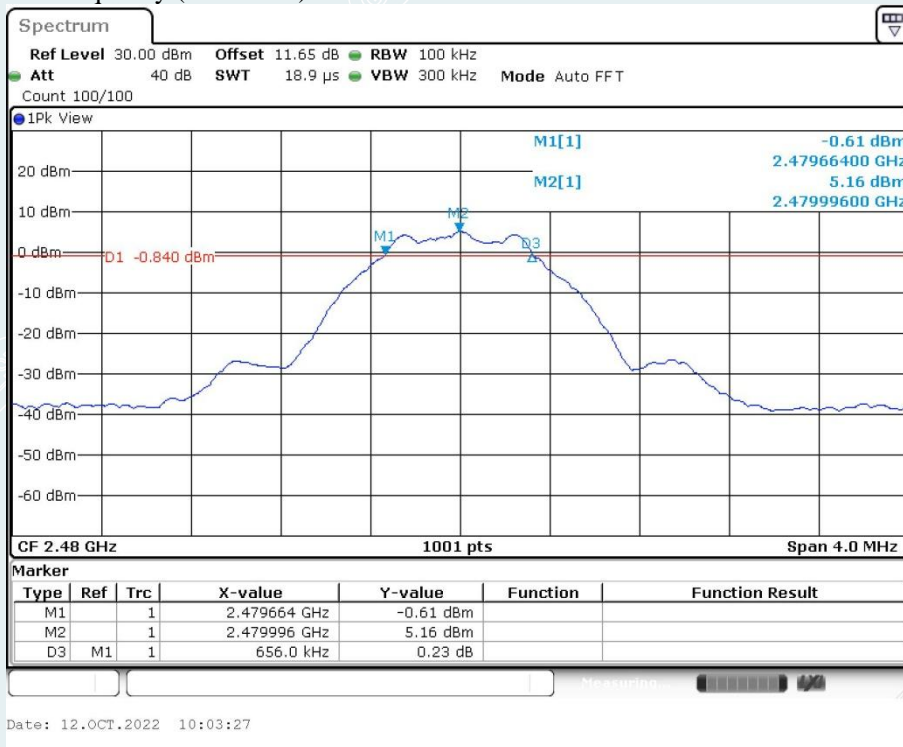

9. MAXIMUM PEAK OUTPUT POWER

9.1 LIMITS

The maximum Peak output power measurement is 1W

9.2 TEST PROCEDURES

- 1) RF output of EUT was connected to the broadband peak RF power meter by RF cable. The path loss was compensated to the results for each measurement.
- 2) Set to the maximum power setting and enable the EUT transmit continuously.
- 3) Measure the conducted output power and record the results in the test report.

9.3 TEST SETUP

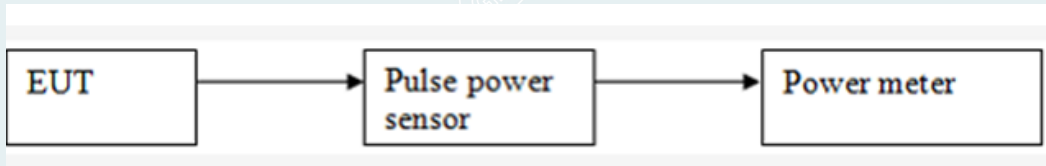

9.4 TEST RESULTS

Environment: 25.0°C/45%RH/101.0kPa
 Tested By: Qin Tingting

Voltage: DC 3.8V
 Date: 2022-10-13

Left earbuds

BLE_1M

Channel	Frequency (MHz)	Measured Channel Power (dBm)	Limit	Peak/Average	Result
Lowest	2402	4.87	1W (30dBm)	Peak	Pass
Middle	2440	5.27			Pass
Highest	2480	5.65			Pass

Right earbuds

BLE_1M

Channel	Frequency (MHz)	Measured Channel Power (dBm)	Limit	Peak/Average	Result
Lowest	2402	4.21	1W (30dBm)	Peak	Pass
Middle	2440	4.72			Pass
Highest	2480	5.16			Pass

10. POWER SPECTRAL DENSITY

10.1 LIMITS

For digitally modulated systems, the power spectral density conducted from the intentional radiator to the antenna shall not be greater than 8dBm in any 3kHz band during any time interval of continuous transmission. This power spectral density shall be determined in accordance with the provisions of paragraph (b) of this section. The same method of determining the conducted output power shall be used to determine the power spectral density.

10.2 TEST PROCEDURES

- 1) Remove the antenna from the EUT, and then connect a low loss RF cable from antenna port to the spectrum analyzer.
- 2) Position the EUT was set without connection to measurement instrument. Turn on the EUT and connect its antenna terminal to measurement instrument via a low loss cable. Then set it to any one measured frequency within its operating range, and make sure the instrument is operated in its linear range.
- 3) Set the analyzer span to 1.5 times the DTS bandwidth. Set the RBW to $3\text{ kHz} \leq \text{RBW} \leq 100\text{ kHz}$. Set the $\text{VBW} \geq [3 \times \text{RBW}]$. Detector = peak. Sweep time = auto couple. Trace mode = max hold. Allow trace to fully stabilize. Use the peak marker function to determine the maximum amplitude level within the RBW. If measured value exceeds requirement, then reduce RBW (but no less than 3kHz) and repeat.
- 4) Repeat above procedures until all frequencies measured were complete.

10.3 TEST SETUP



10.4 TEST RESULTS

Environment: 25.0°C/45%RH/101.0kPa
 Tested By: Qin Tingting

Voltage: DC 3.8V
 Date: 2022-10-12

Left earbuds

BLE_1M

Channel	Frequency (MHz)	PSD (dBm/3kHz)	Limit (dBm/3kHz)	Test Result
Lowest	2402	-10.85	8.00	PASS
Middle	2440	-11.03		PASS
Highest	2480	-10.30		PASS

Right earbuds

BLE_1M

Channel	Frequency (MHz)	PSD (dBm/3kHz)	Limit (dBm/3kHz)	Test Result
Lowest	2402	-11.20	8.00	PASS
Middle	2440	-11.09		PASS
Highest	2480	-10.40		PASS

Left earbuds

BLE_1M

Lowest Frequency (2402MHz)

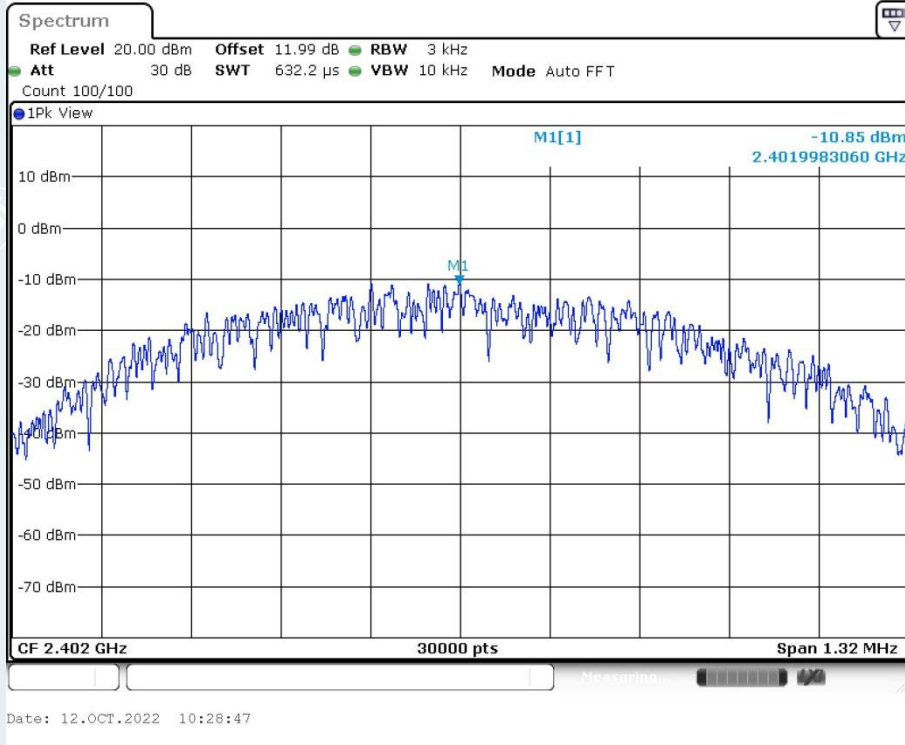

Middle Frequency (2440 MHz)

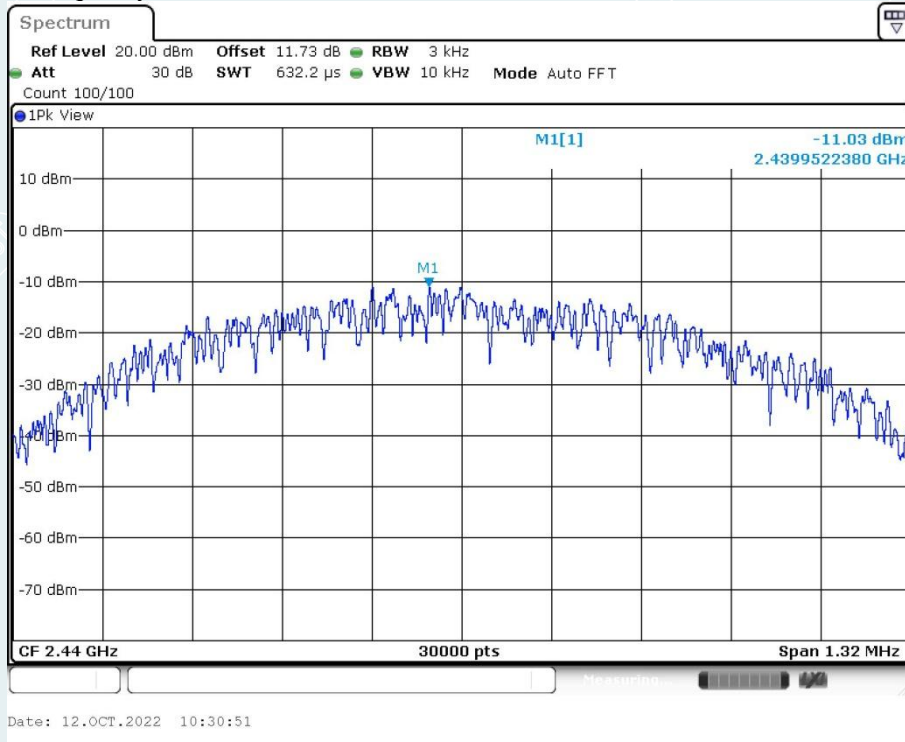

Highest Frequency (2480MHz)

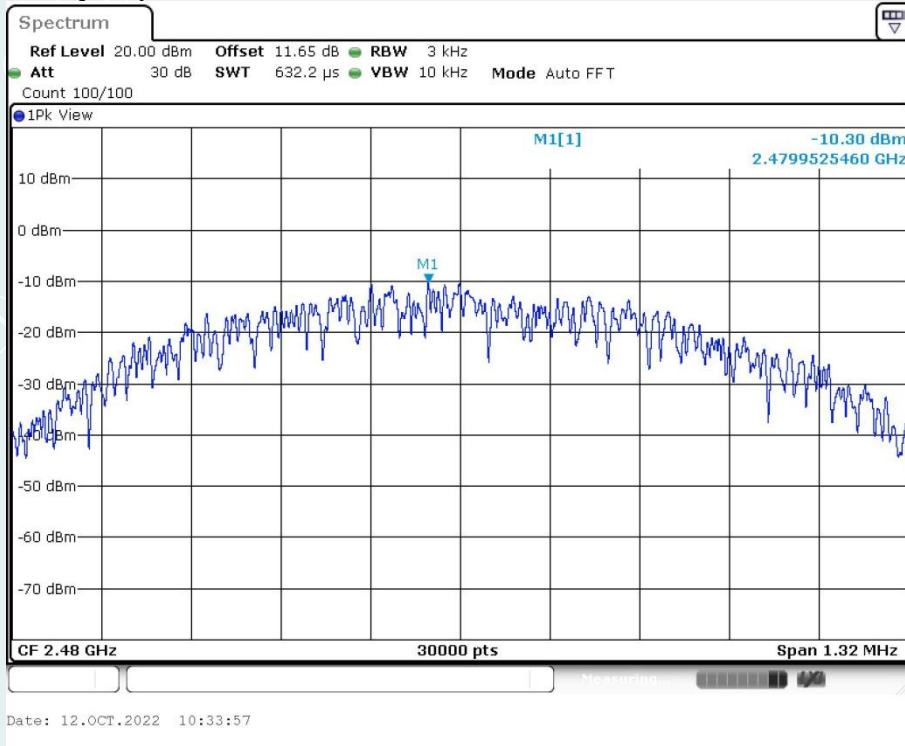

Right earbuds

BLE_1M

Lowest Frequency (2402MHz)

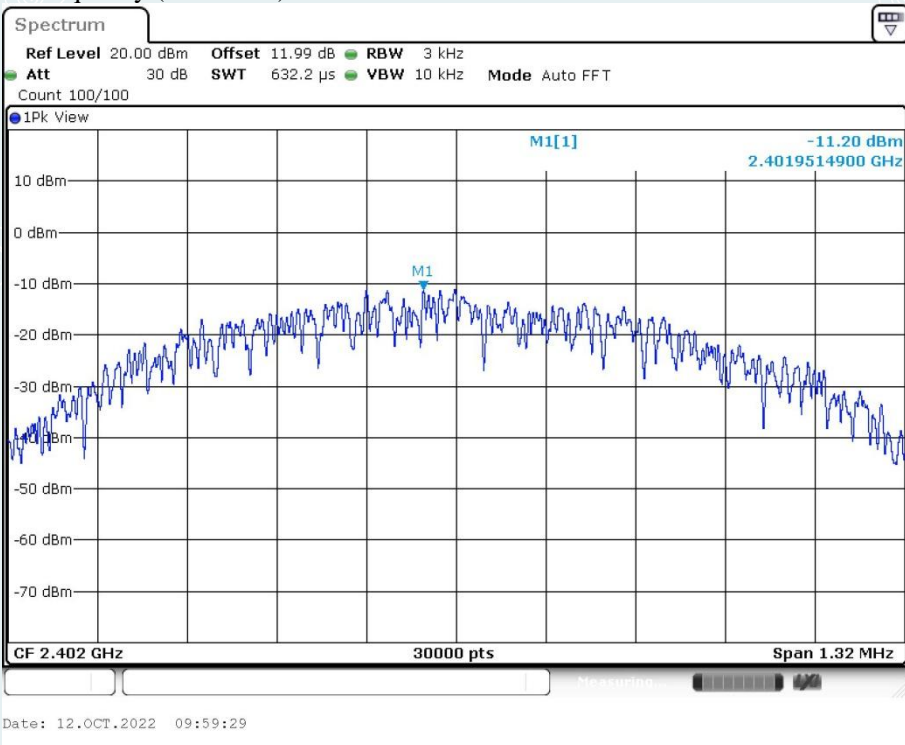

Middle Frequency (2440 MHz)

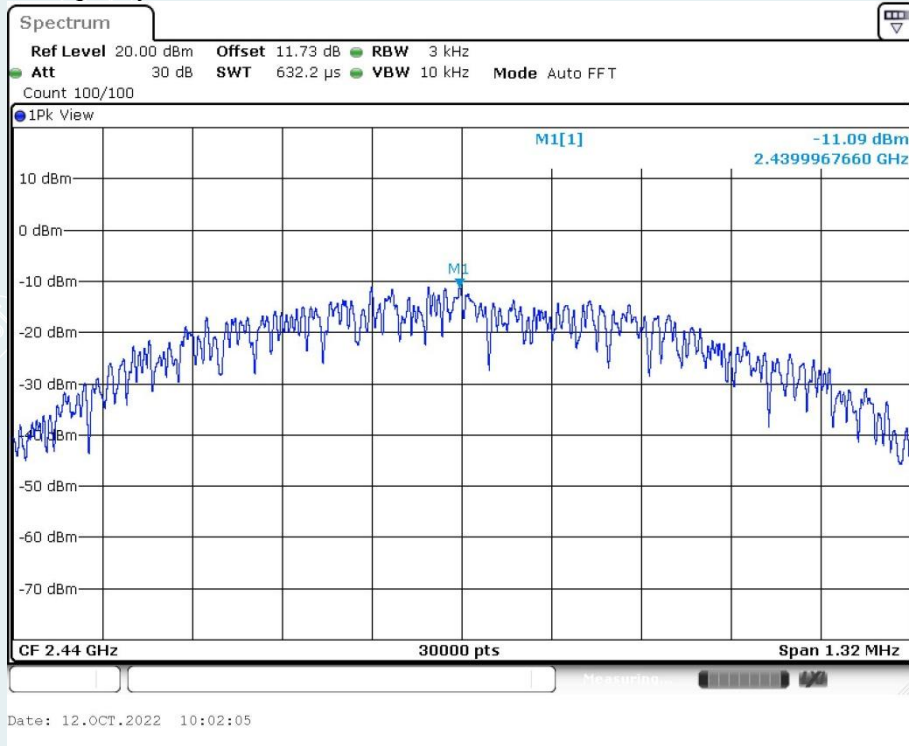

Highest Frequency (2480MHz)

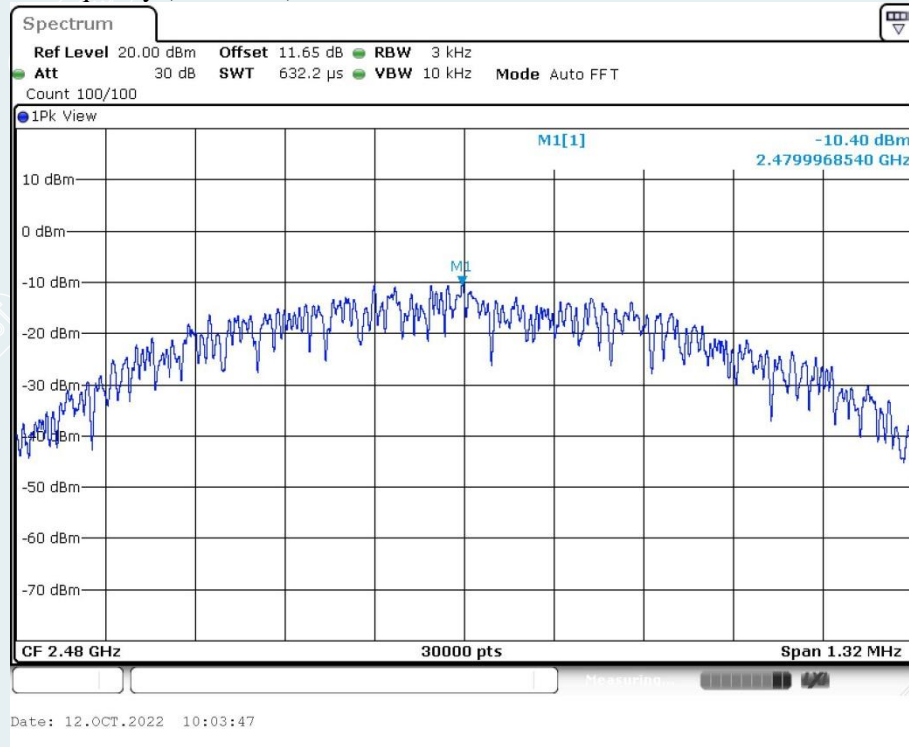

11. CONDUCTED BAND EDGES AND SPURIOUS EMISSIONS

11.1 LIMITS

In any 100kHz bandwidth outside the frequency band in which the spread spectrum or digitally modulated intentional radiator is operating, the radio frequency power that is produced by the intentional radiator shall be at least 20dB below that in the 100kHz bandwidth within the band that contains the highest level of the desired power, based on either an RF conducted or a radiated measurement, provided the transmitter demonstrates compliance with the peak conducted power limits. If the transmitter complies with the conducted power limits based on the use of RMS averaging over a time interval, as permitted under paragraph (b)(3) of this section, the attenuation required under this paragraph shall be 30dB instead of 20dB.

11.2 TEST PROCEDURES

Test procedures follow KDB 558074 D01 15.247 Measurement Guidance v05r02.

Remove the antenna from the EUT and then connect a low attenuation cable from the antenna port to the spectrum.

- 1) Remove the antenna from the EUT and then connect a low attenuation cable from the antenna port to the spectrum.
- 2) Set the spectrum analyzer: RBW =100kHz; VBW =300kHz, Frequency range = 30MHz to 26.5GHz; Sweep = auto; Detector Function = Peak. Trace = Max, hold.
- 3) Measure and record the results in the test report.
- 4) The RF fundamental frequency should be excluded against the limit line in the operating frequency band.

11.3 TEST SETUP



11.4 TEST RESULTS

Environment: 25.0°C/45%RH/101.0kPa
Tested By: Qin Tingting

Voltage: DC 3.8V
Date: 2022-10-12

Left earbuds

Band edge measurements

BLE_1M

Lowest Frequency (2402MHz)
2.35GHz-2.405GHz

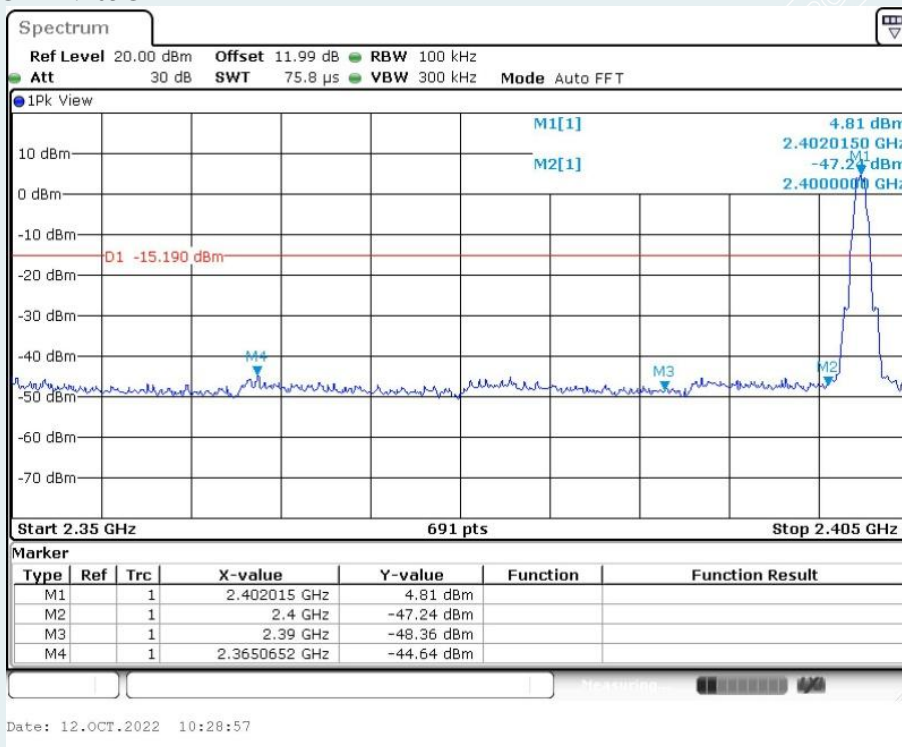

----- The following blanks -----

Highest Frequency (2480MHz)
2.47GHz-2.55GHz

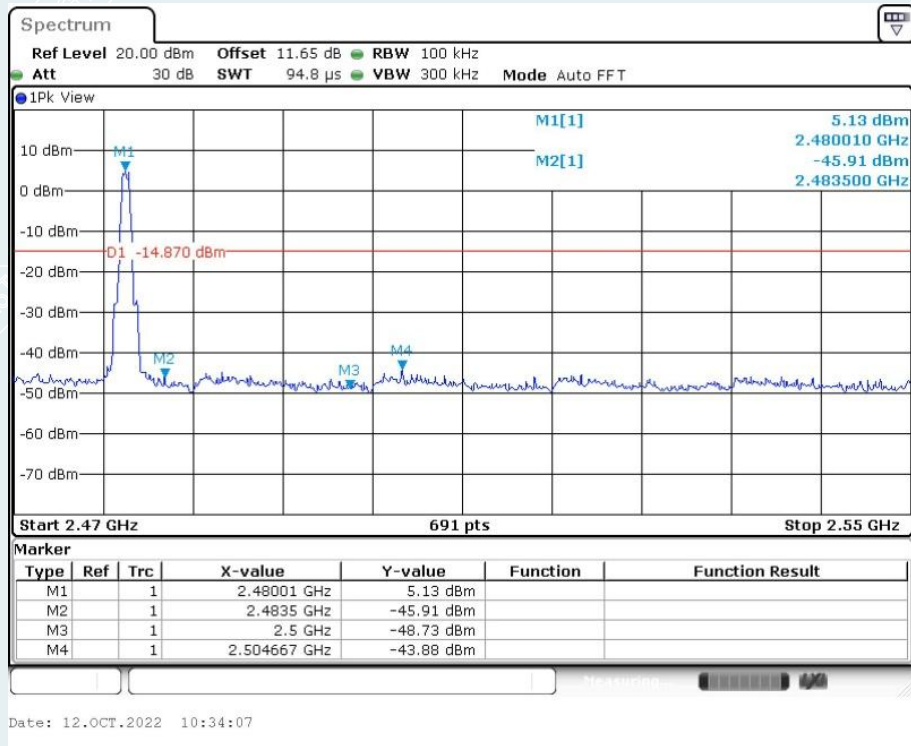

----- The following blanks -----

Conducted Spurious Emission BLE_1M

Lowest Frequency (2402MHz)

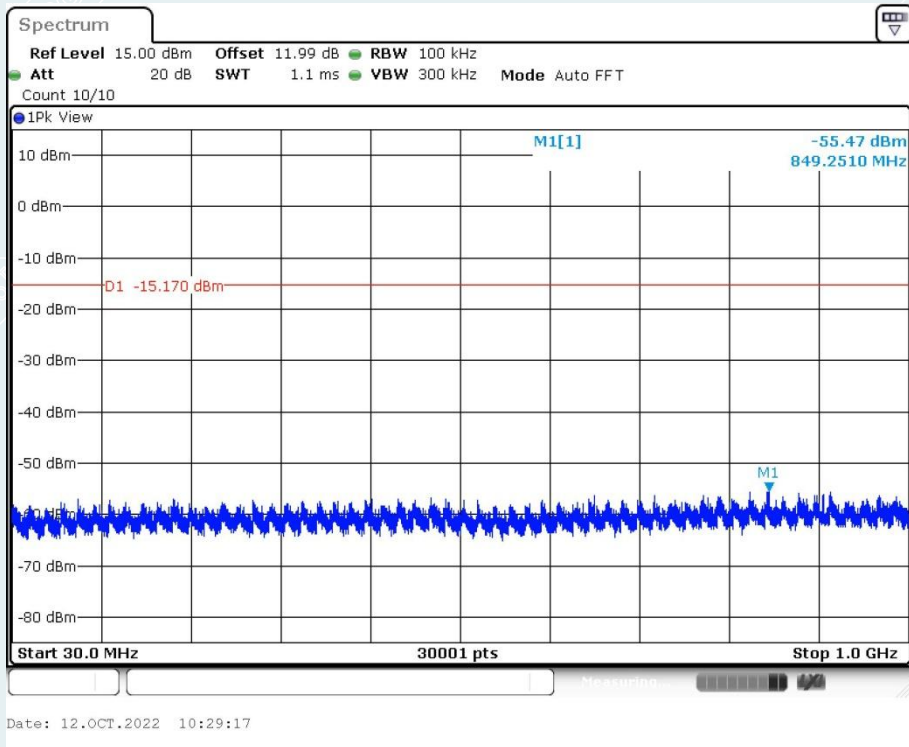
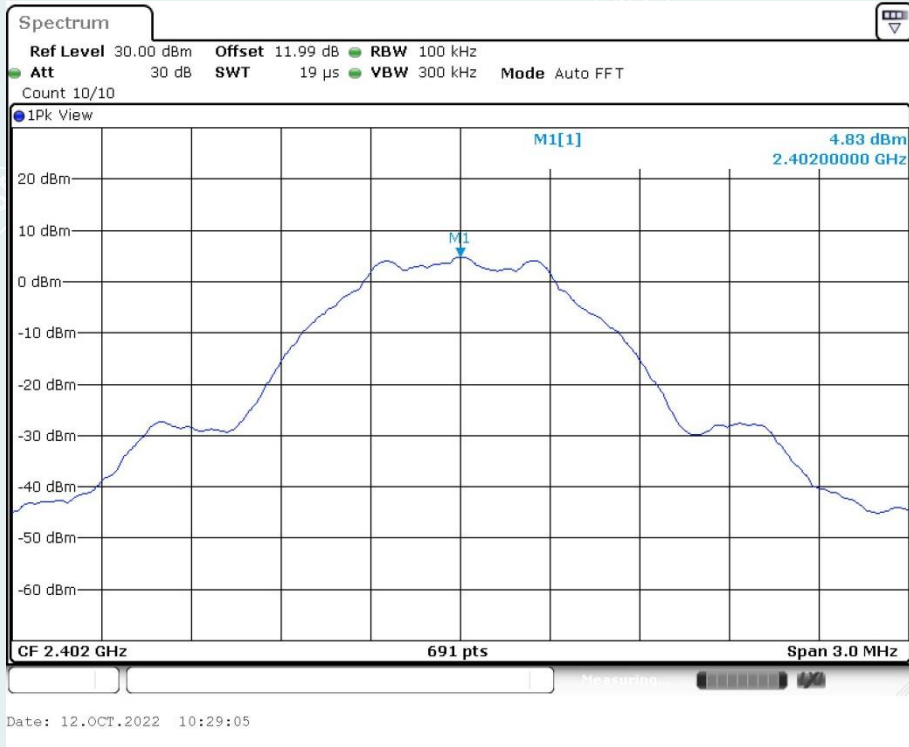

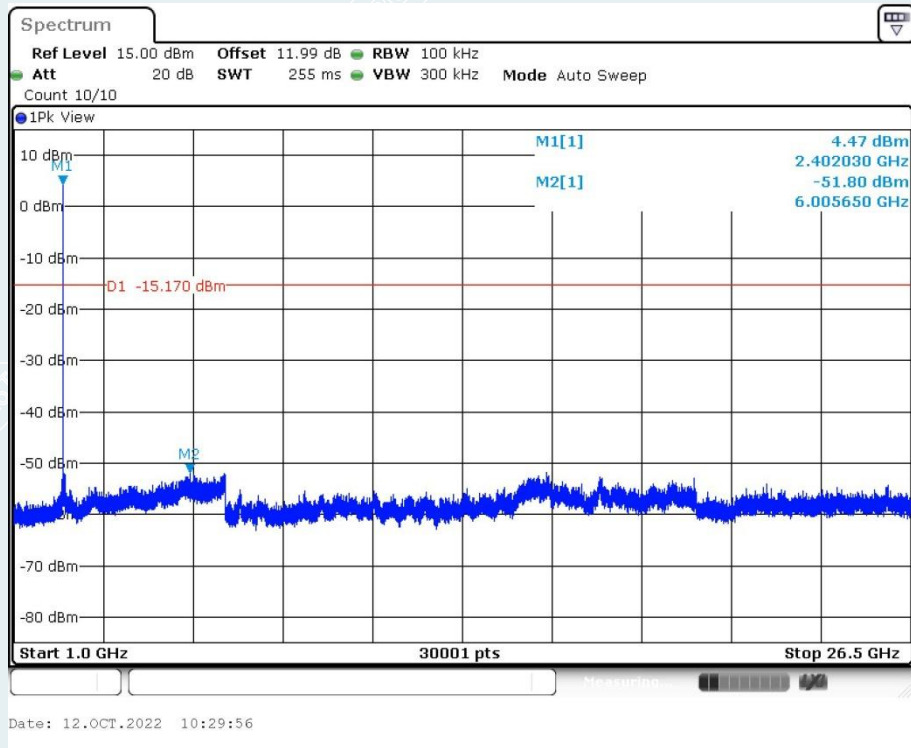

Middle Frequency (2440MHz)

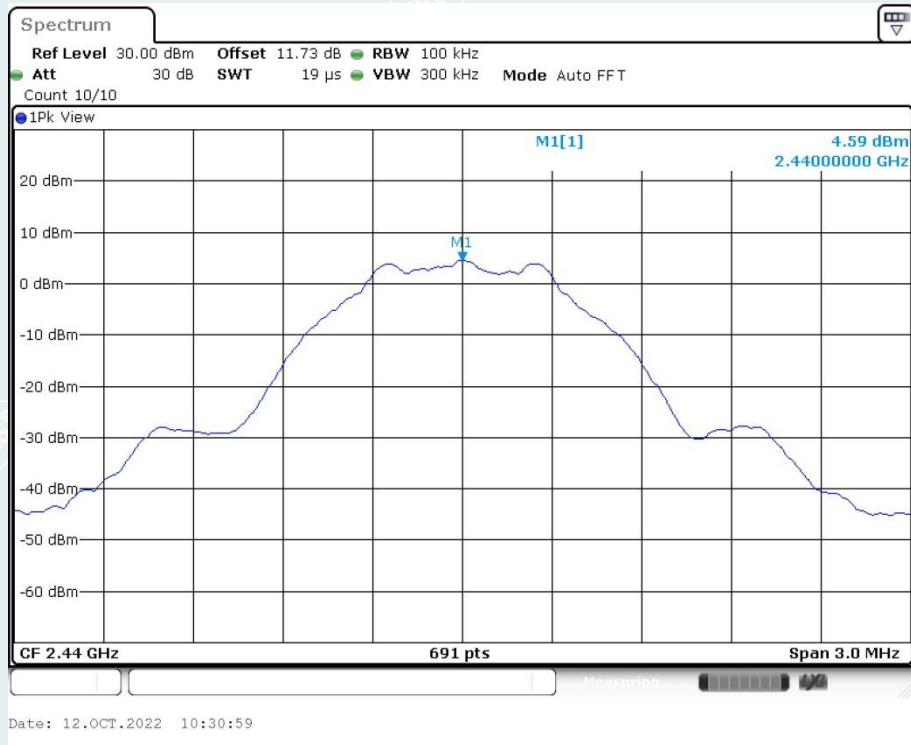

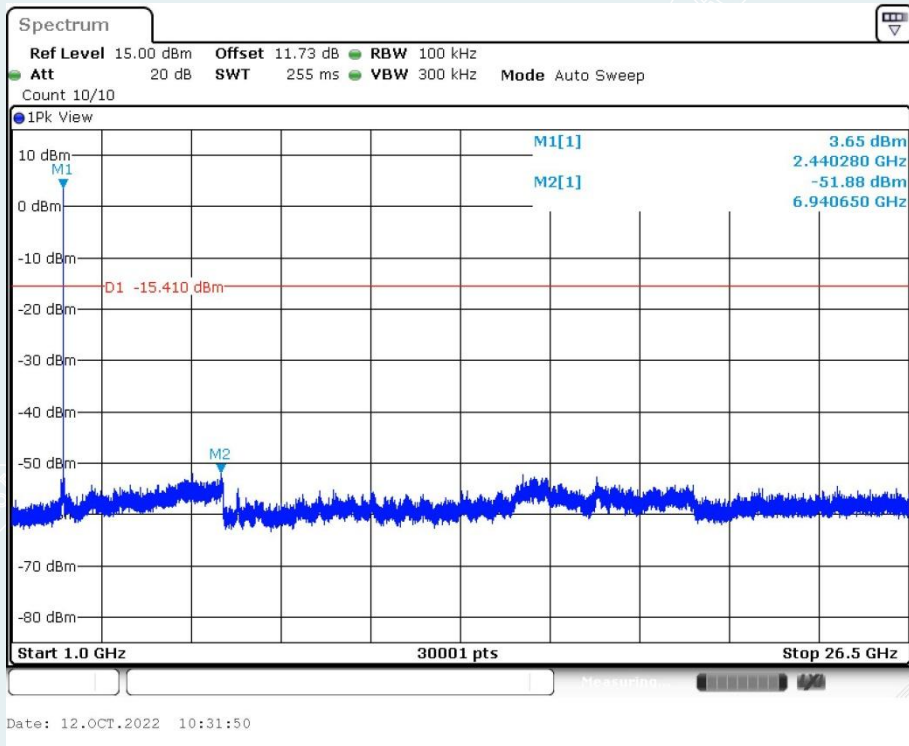
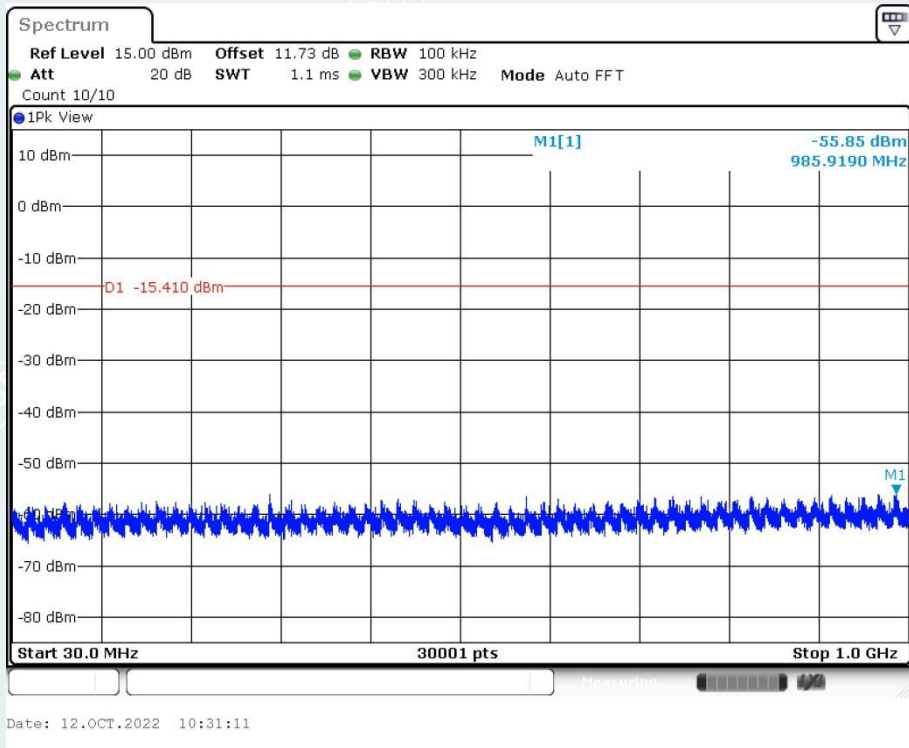

Highest Frequency (2480MHz)

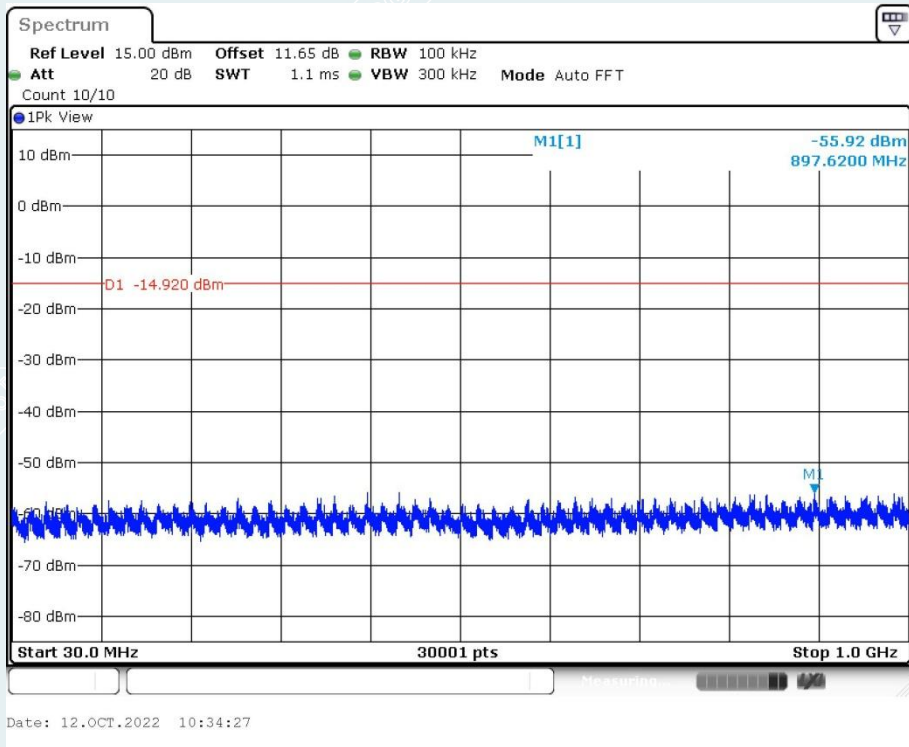
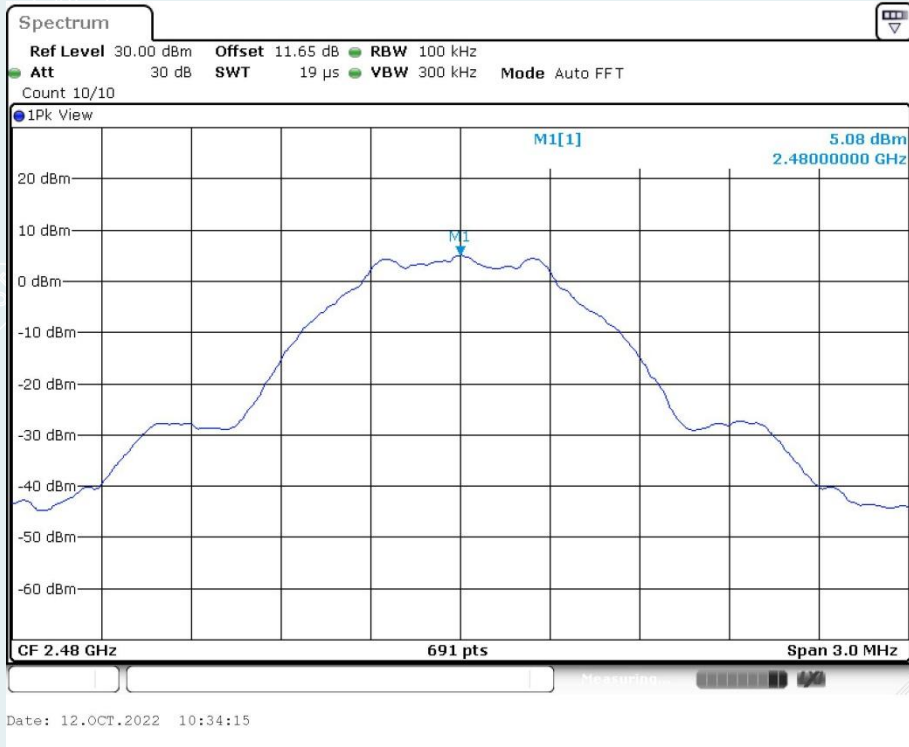

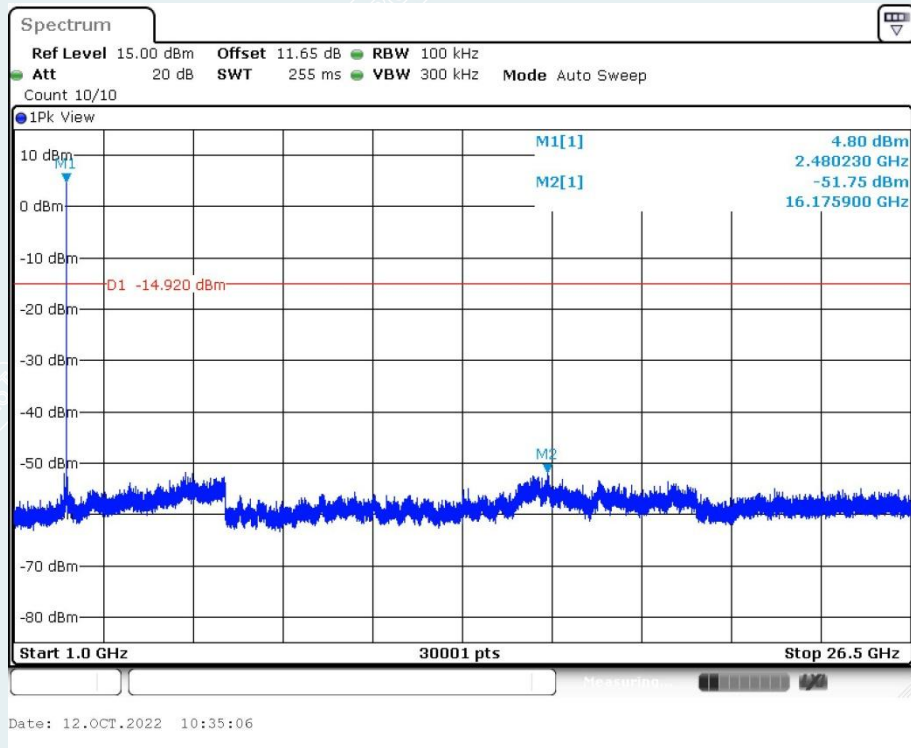

----- The following blanks -----

Right earbuds

BLE_1M

Lowest Frequency (2402MHz)
2.35GHz-2.405GHz

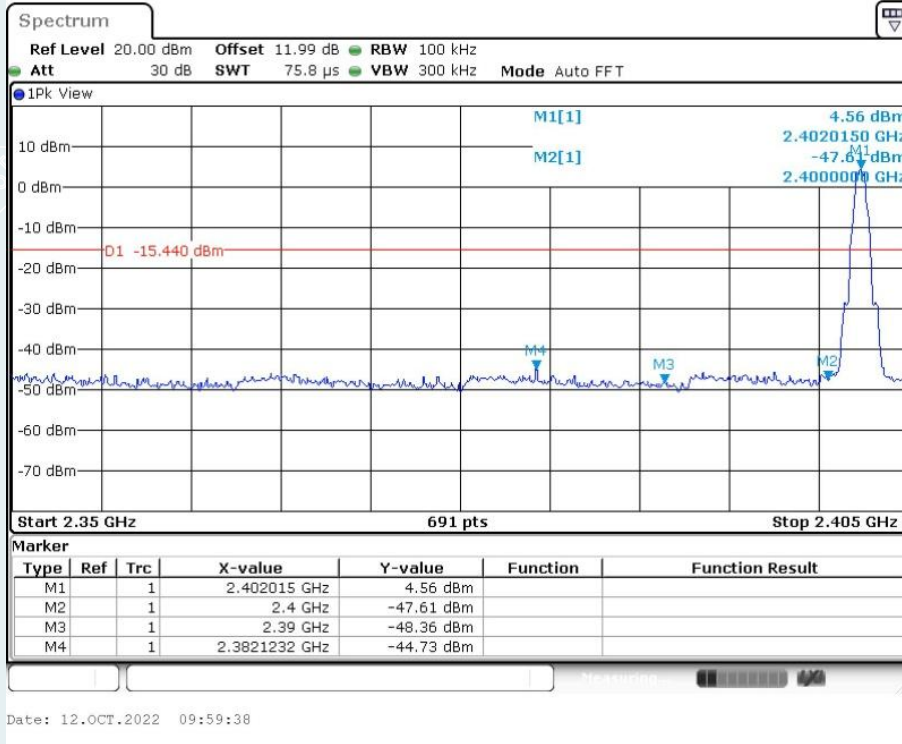

Highest Frequency (2480MHz)
2.47GHz-2.55GHz

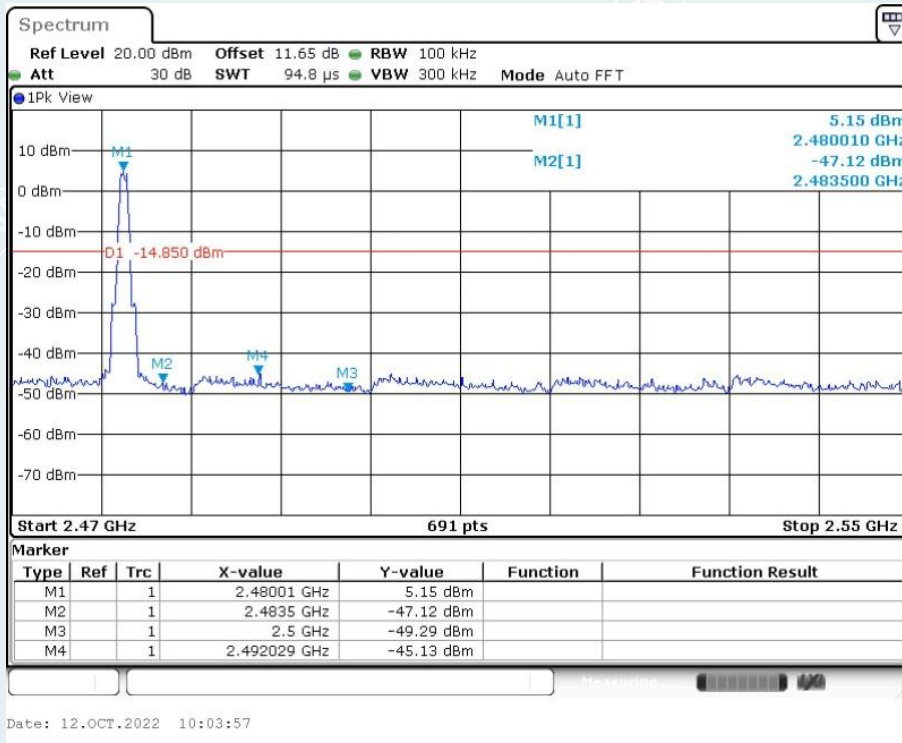

Conducted Spurious Emission BLE_1M

Lowest Frequency (2402MHz)

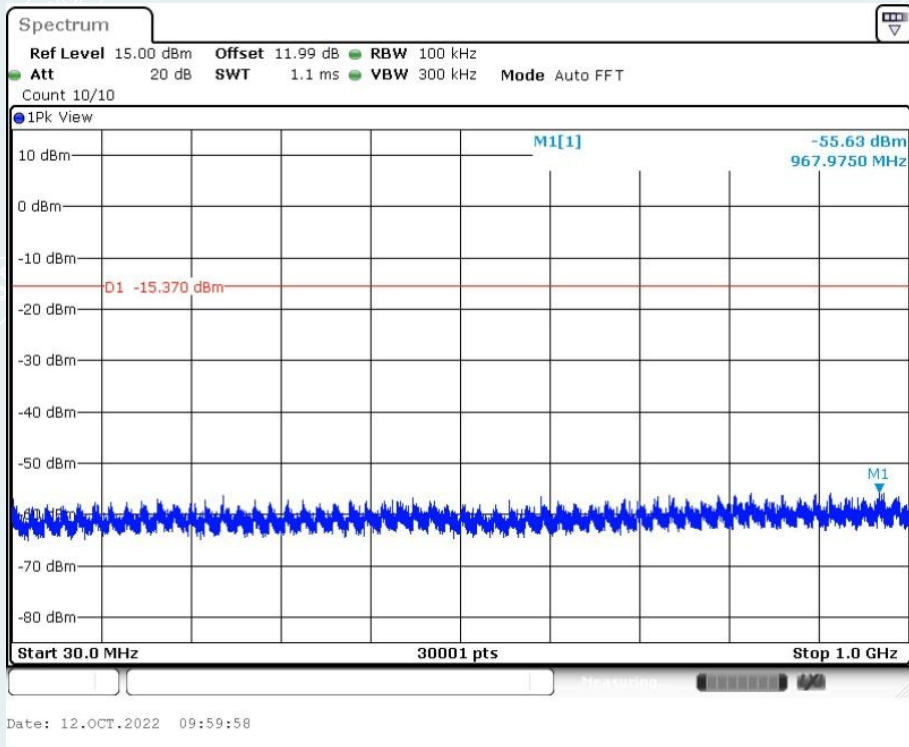
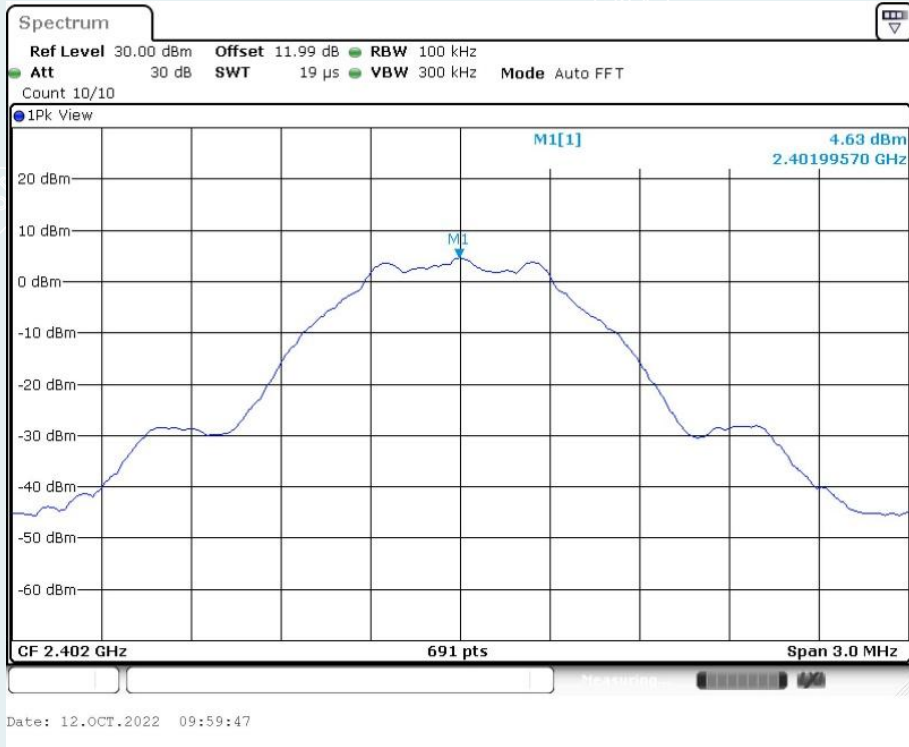

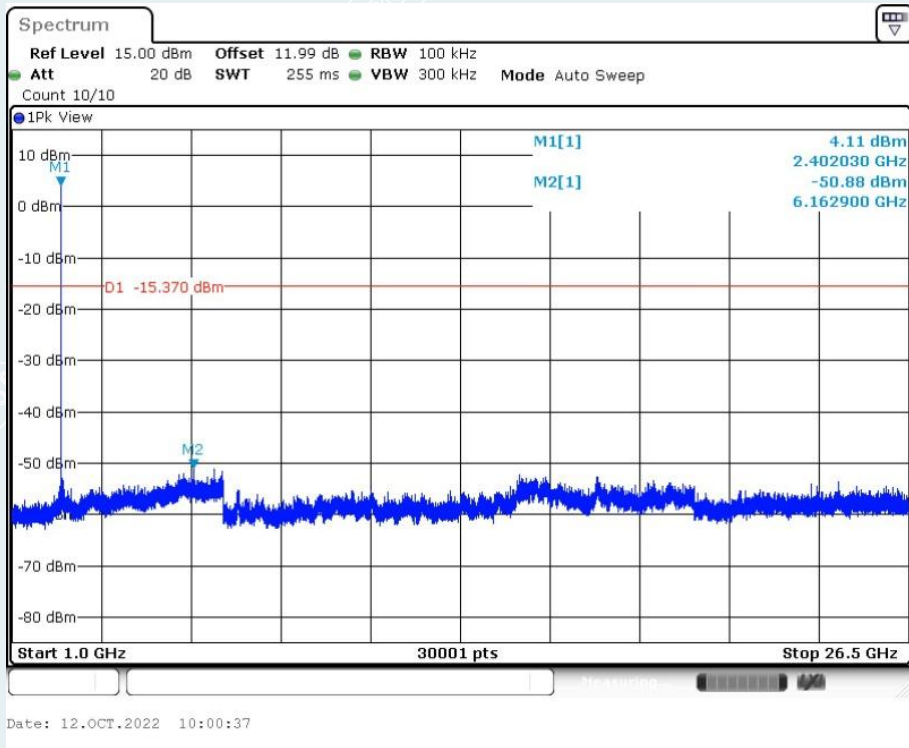

Middle Frequency (2440MHz)

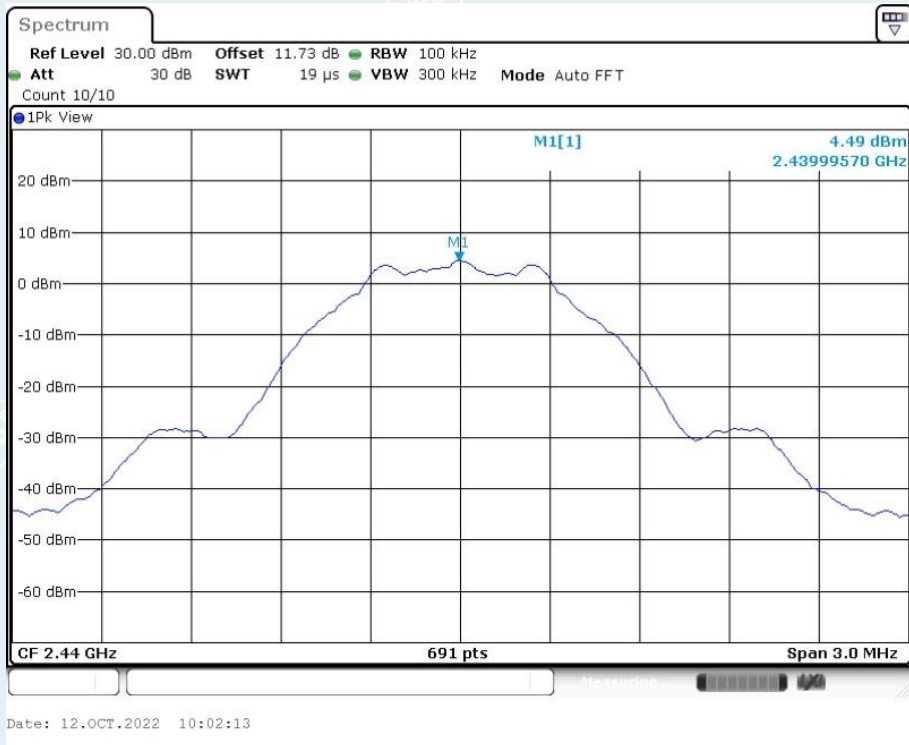

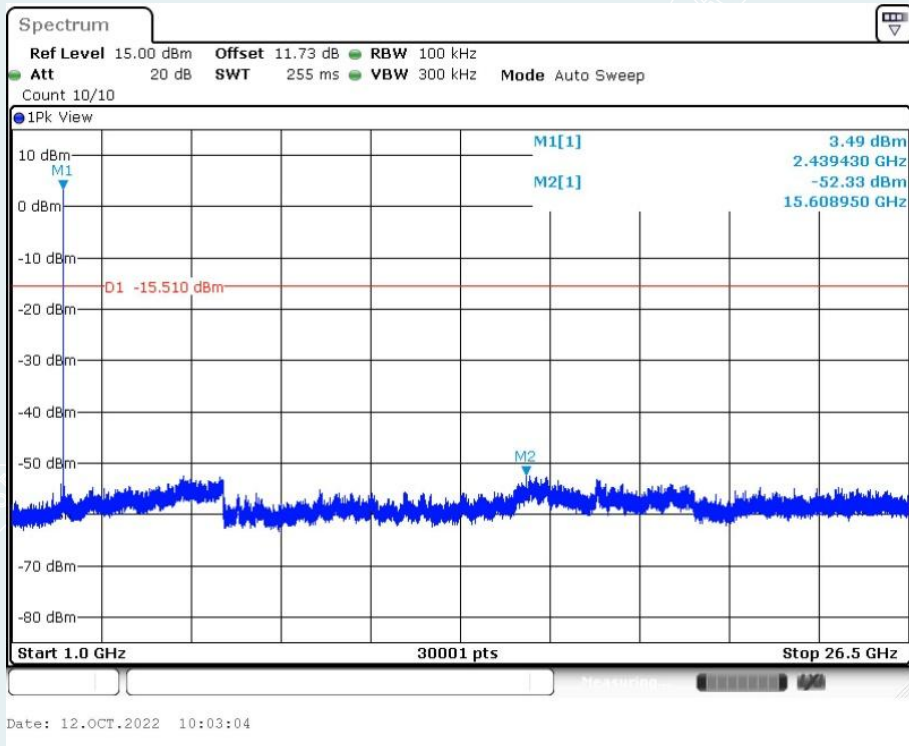
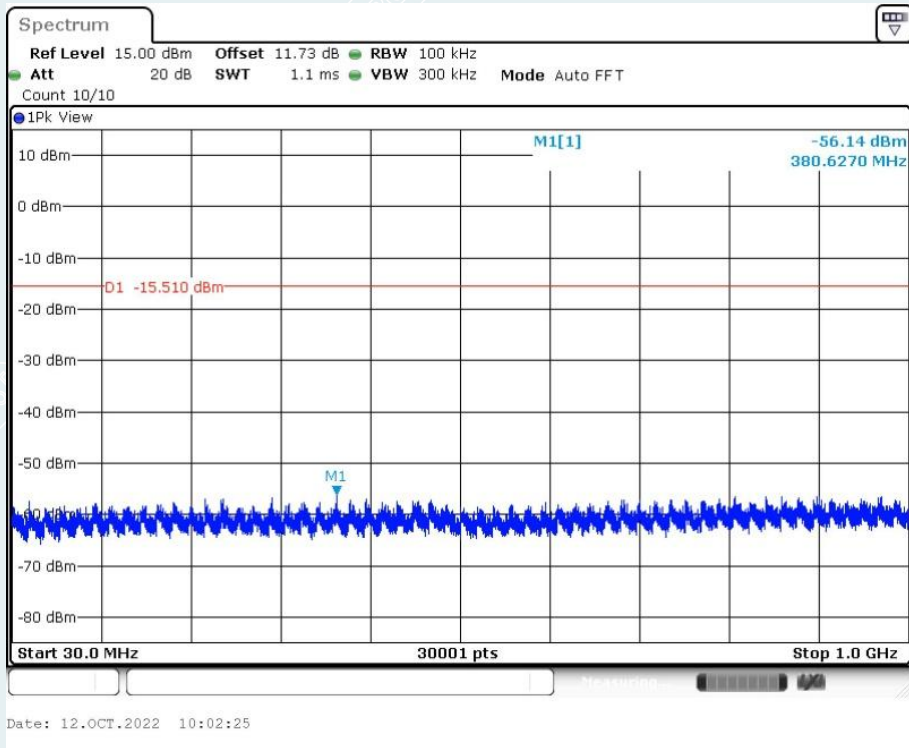

Highest Frequency (2480MHz)

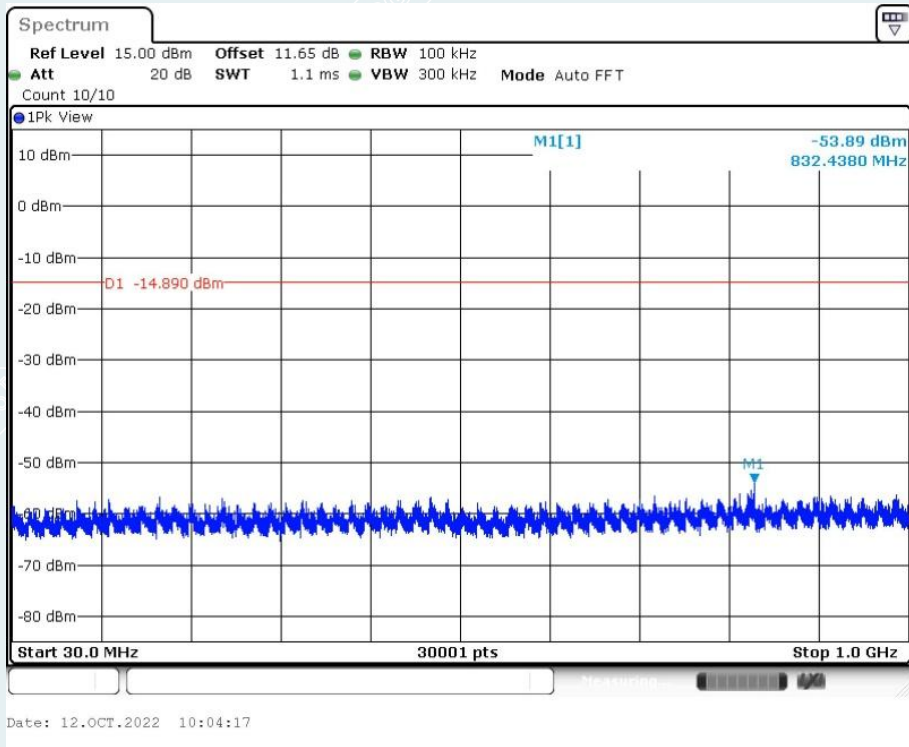
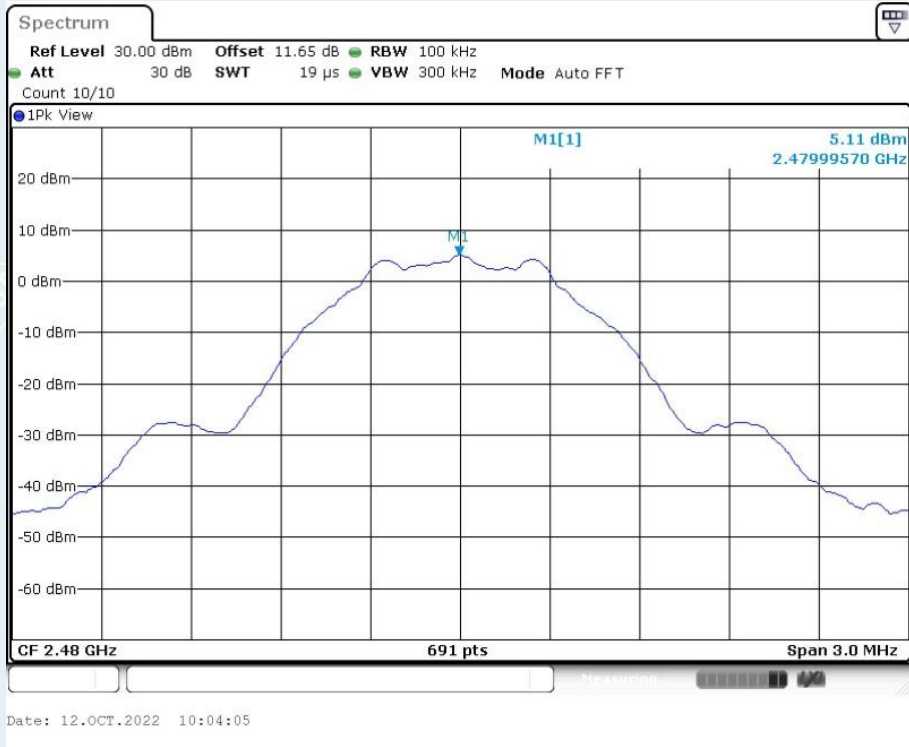

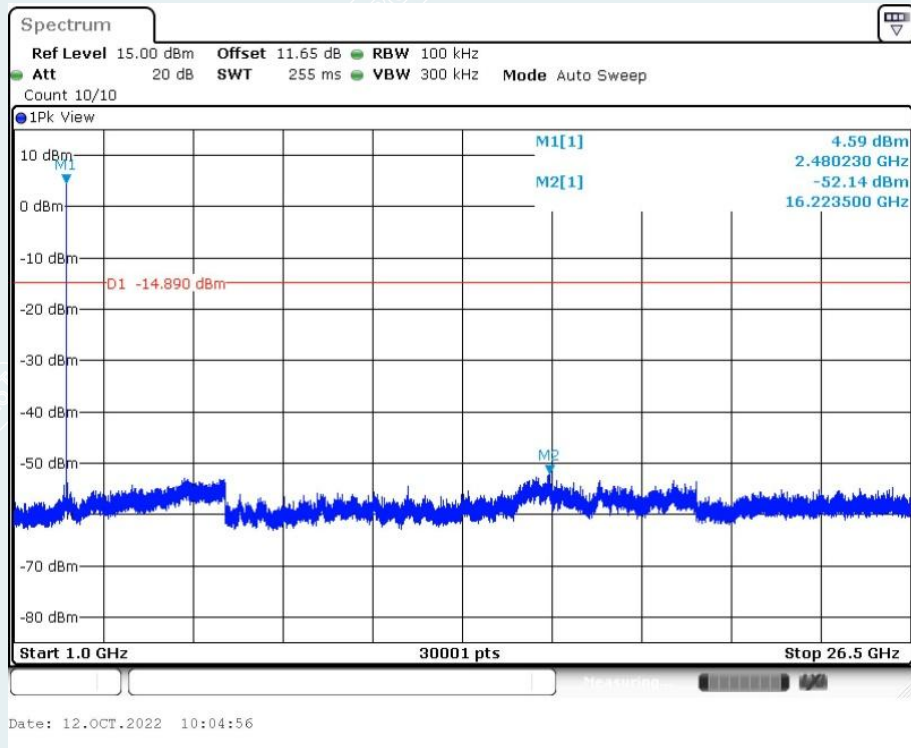

----- The following blanks -----

12. RESTRICTED BANDS OF OPERATION

12.1 LIMITS

Section 15.247(d) In addition, Radiated emissions which fall in the restricted bands, as defined in §15.205(a), must also comply with the radiated emission limits specified in §15.209(a) (see §15.205(c)).

MHz	MHz	MHz	GHz
0.090 - 0.110	16.42 - 16.423	399.9 - 410	4.5 - 5.15
¹ 0.495 - 0.505	16.69475 - 16.69525	608 - 614	5.35 - 5.46
2.1735 - 2.1905	16.80425 - 16.80475	960 - 1240	7.25 - 7.75
4.125 - 4.128	25.5 - 25.67	1300 - 1427	8.025 - 8.5
4.17725 - 4.17775	37.5 - 38.25	1435 - 1626.5	9.0 - 9.2
4.20725 - 4.20775	73 - 74.6	1645.5 - 1646.5	9.3 - 9.5
6.215 - 6.218	74.8 - 75.2	1660 - 1710	10.6 - 12.7
6.26775 - 6.26825	108 - 121.94	1718.8 - 1722.2	13.25 - 13.4
6.31175 - 6.31225	123 - 138	2200 - 2300	14.47 - 14.5
8.291 - 8.294	149.9 - 150.05	2310 - 2390	15.35 - 16.2
8.362 - 8.366	156.52475 - 156.52525	2483.5 - 2500	17.7 - 21.4
8.37625 - 8.38675	156.7 - 156.9	2655 - 2900	22.01 - 23.12
8.41425 - 8.41475	162.0125 - 167.17	3260 - 3267	23.6 - 24.0
12.29 - 12.293	167.72 - 173.2	3332 - 3339	31.2 - 31.8
12.51975 - 12.52025	240 - 285	3345.8 - 3358	36.43 - 36.5
12.57675 - 12.57725	322 - 335.4	3600 - 4400	
13.36 - 13.41			

Frequency (MHz)	Quasi-peak($\mu\text{V}/\text{m}$)	Measurement distance(m)	Quasi-peak($\text{dB}\mu\text{V}/\text{m}$)@distance 3m
0.009-0.490	2400/F(kHz)	300	128.5~93.8
0.490-1.705	24000/F(kHz)	30	73.8~63
1.705-30.0	30	30	69.5
30 ~ 88	100	3	40
88~216	150	3	43.5
216 ~ 960	200	3	46
Above 960	500	3	54

12.2 TEST PROCEDURES

Test procedures follow KDB 558074 D01 15.247 Meas Guidance v05r02.

- 1) The EUT is placed on a turntable, which is 1.5m above the ground plane.
- 2) The turntable shall be rotated for 360 degrees to determine the position of maximum emission level.
- 3) EUT is set 3m away from the receiving antenna, which is varied from 1m to 4m to find out the highest emission.
- 4) Set the spectrum analyzer in the following setting in order to capture the lower and upper band-edges of the emission:
 - a) PEAK: RBW=1MHz / VBW=1MHz / Sweep=AUTO.
 - b) AVERAGE: RBW=1MHz / VBW=1/T / Sweep=AUTO.

If the EUT is configured to transmit with duty cycle $\geq 98\%$, set $VBW \leq RBW/100$ (i.e., 10kHz) but not less than 10 Hz. If the EUT duty cycle is $< 98\%$, set $VBW \geq 1/T$, Where T is defined in section 2.9.
- 5) Repeat the procedures until all the PEAK and AVERAGE versus polarization are measured.

12.3 TEST SETUP

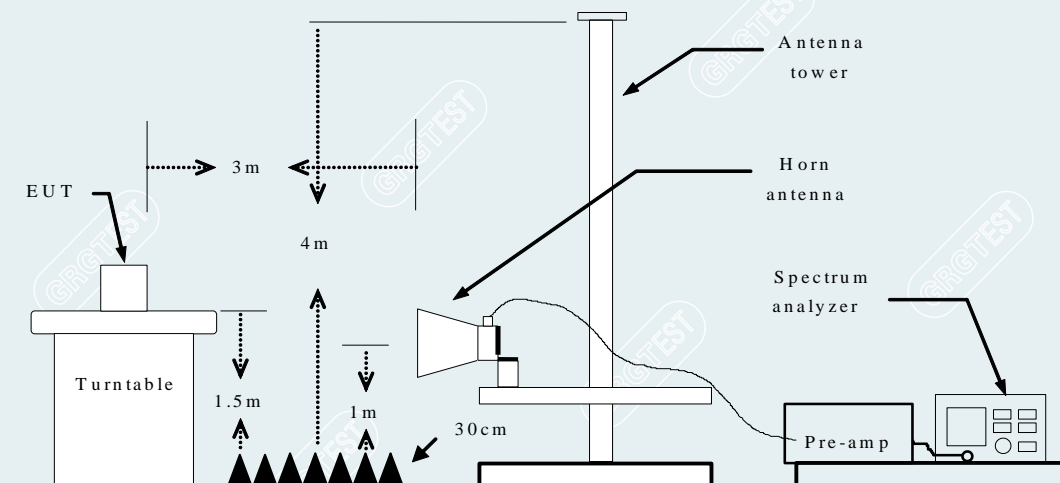

12.4 TEST RESULTS

Left earbuds

Equipment:	Wireless Earbuds	Test Date	2022-10-13
Model No.:	E508A	Test Engineer:	Chen Xiacong
Test Voltage:	DC 3.8V	Environmental Conditions	25.0°C/45%RH/101.0kPa

BLE 1M

Lowest Frequency

Frequency 2402MHz

Detector mode: Peak

Polarity: Horizontal

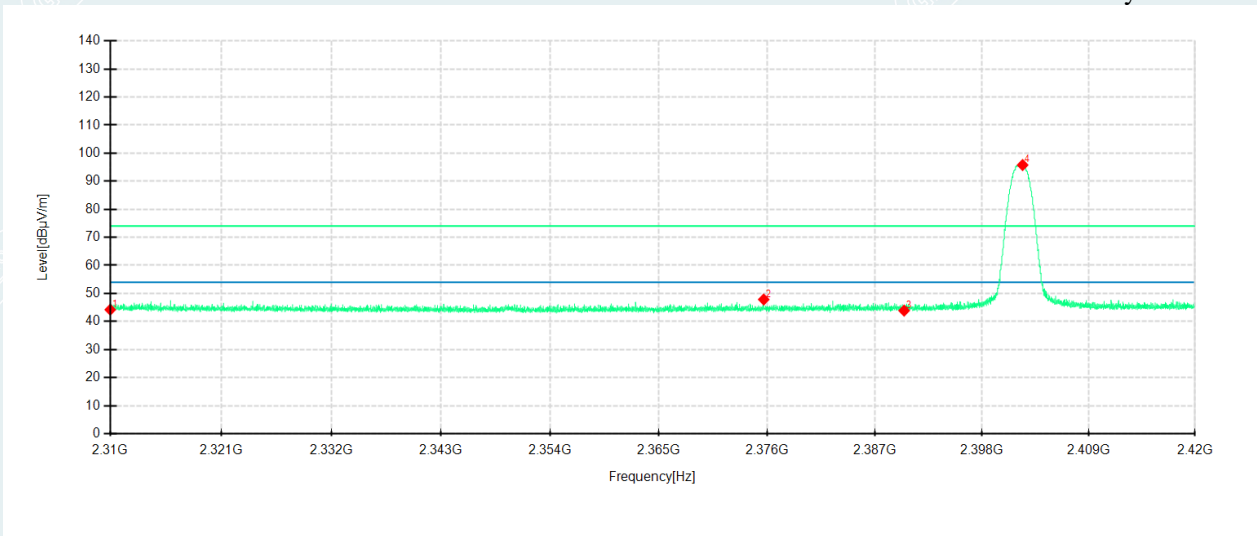

Detector mode: Peak

Polarity: Vertical

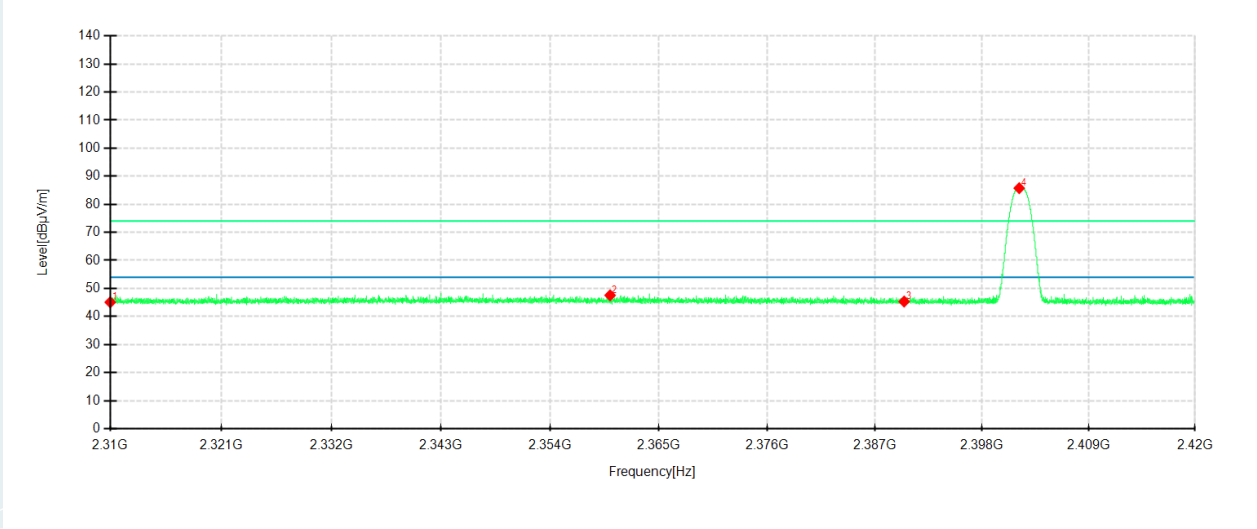

No.	Frequency MHz	Reading dB μ V/m	Level dB μ V/m	Factor dB	Limit dB μ V/m	Margin dB	Height cm	Angle °	Pole	Remark
1	2310	44.49	44.20	-0.29	74.00	29.80	100	278	Horizontal	/
2	2375.6546	48.79	47.83	-0.96	74.00	26.17	100	172	Horizontal	/
3	2390	44.73	43.88	-0.85	74.00	30.12	100	205	Horizontal	/
4	2402.1782	96.53	95.78	-0.75	74.00	-21.78	100	172	Horizontal	No limit
1	2310	44.78	45.07	0.29	74.00	28.93	200	290	Vertical	/
2	2360.055	47.06	47.54	0.48	74.00	26.46	100	41	Vertical	/
3	2390	45.04	45.33	0.29	74.00	28.67	200	172	Vertical	/
4	2401.8262	85.55	85.75	0.20	74.00	-11.75	200	195	Vertical	No limit

----- The following blanks -----

Lowest Frequency

Frequency 2402MHz

Detector mode: Average

Polarity: Horizontal

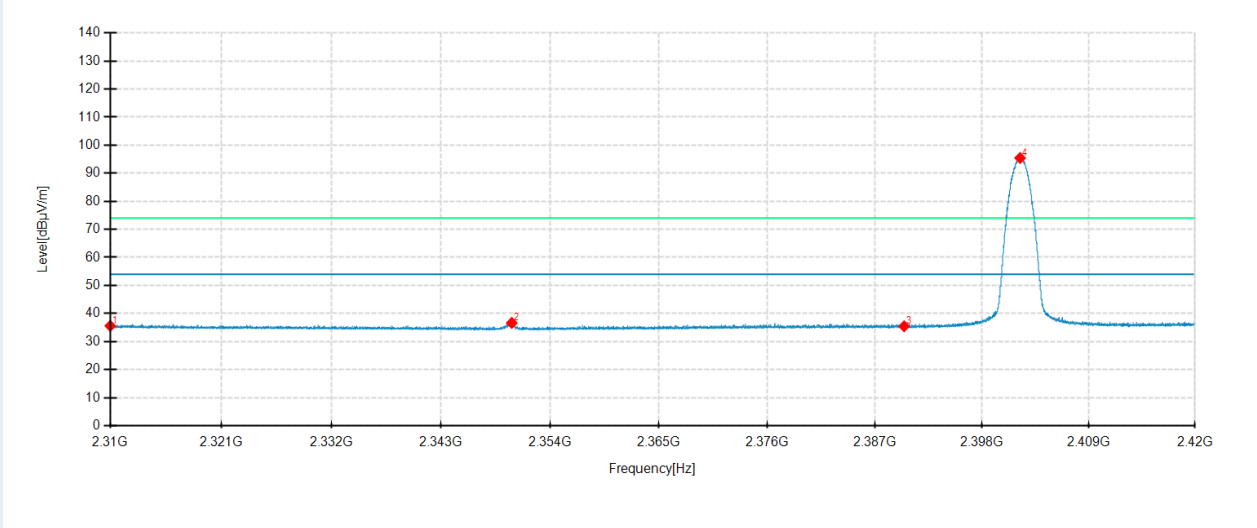

Detector mode: Average

Polarity: Vertical

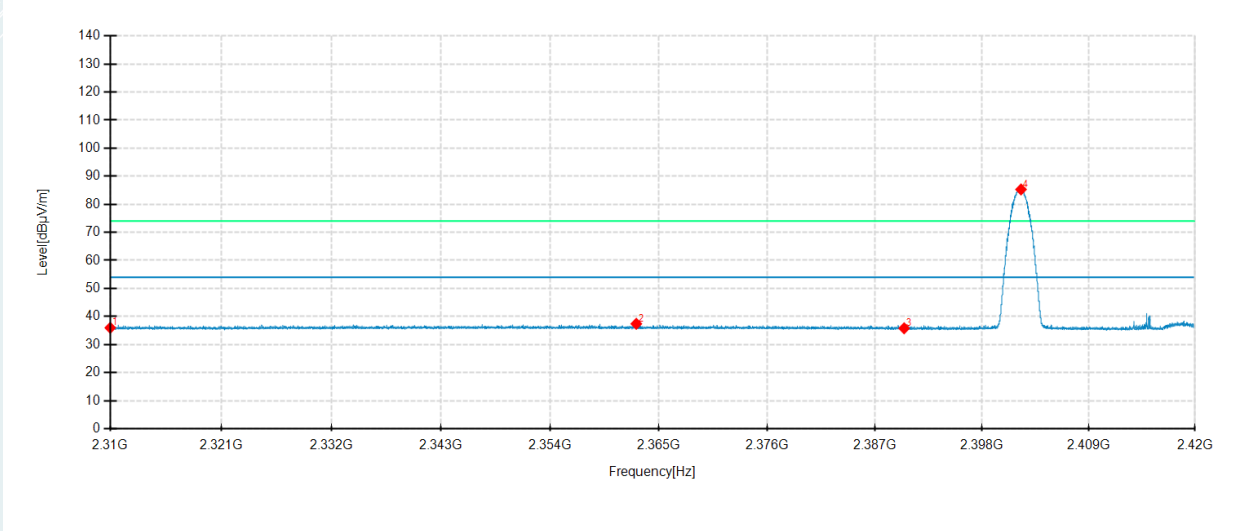

No.	Frequency MHz	Reading dBμV/m	Level dBμV/m	Factor dB	Limit dBμV/m	Margin dB	Height cm	Angle °	Pole	Remark
1	2310	35.87	35.58	-0.29	54.00	18.42	200	187	Horizontal	/
2	2350.121	37.79	36.63	-1.16	54.00	17.37	200	82	Horizontal	/
3	2390	36.30	35.45	-0.85	54.00	18.55	200	187	Horizontal	/
4	2401.9142	96.19	95.44	-0.75	54.00	-41.44	100	173	Horizontal	No limit
1	2310	35.68	35.97	0.29	54.00	18.03	100	188	Vertical	/
2	2362.7063	36.92	37.38	0.46	54.00	16.62	200	244	Vertical	/
3	2390	35.50	35.79	0.29	54.00	18.21	100	188	Vertical	/
4	2402.0132	85.09	85.29	0.20	54.00	-31.29	200	204	Vertical	No limit

Highest Frequency
 Frequency 2480MHz
 Detector mode: Peak

Polarity: Horizontal

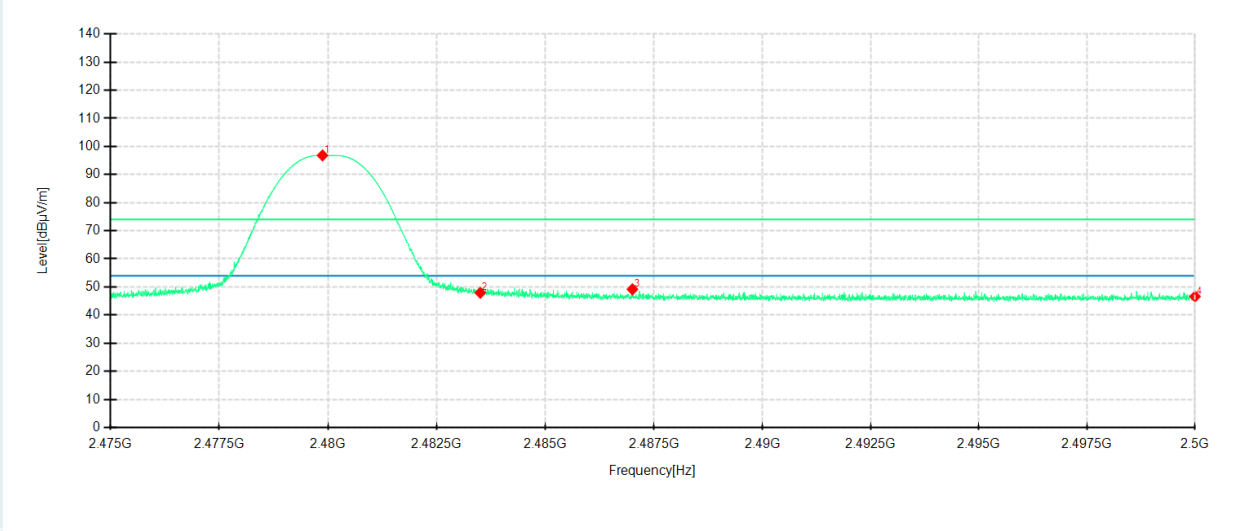

Detector mode: Peak

Polarity: Vertical

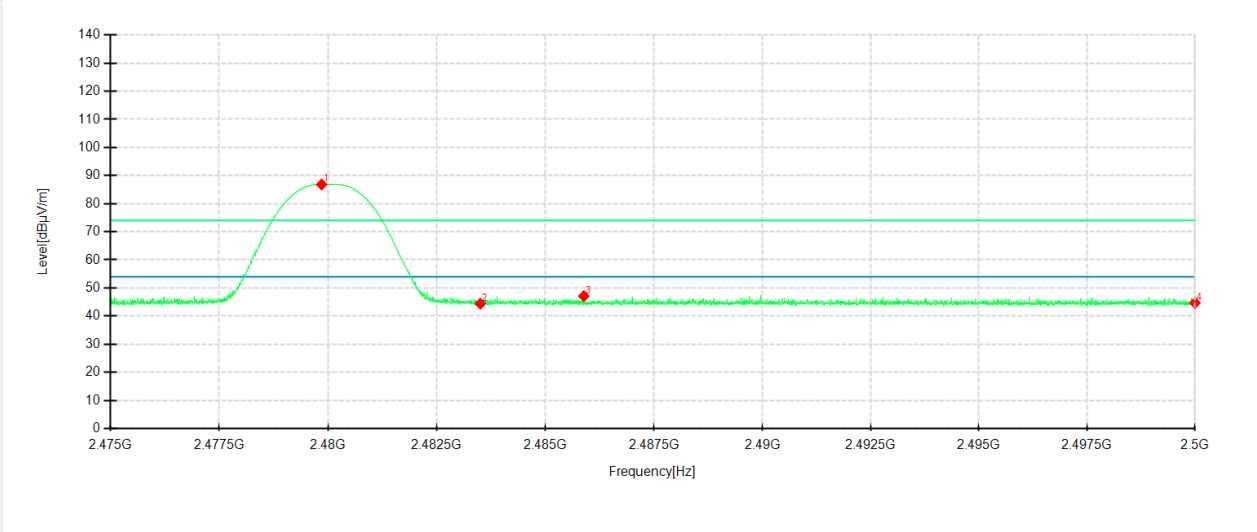

No.	Frequency MHz	Reading dBµV/m	Level dBµV/m	Factor dB	Limit dBµV/m	Margin dB	Height cm	Angle °	Pole	Remark
1	2479.873	96.63	96.82	0.19	74.00	-22.82	100	172	Horizontal	No limit
2	2483.5	47.65	47.91	0.26	74.00	26.09	200	188	Horizontal	/
3	2487.0037	48.84	49.17	0.33	74.00	24.83	100	172	Horizontal	/
4	2500	46.03	46.61	0.58	74.00	27.39	200	188	Horizontal	/
1	2479.853	87.21	86.82	-0.39	74.00	-12.82	200	182	Vertical	No limit
2	2483.5	44.79	44.41	-0.38	74.00	29.59	200	193	Vertical	/
3	2485.8836	47.48	47.11	-0.37	74.00	26.89	100	188	Vertical	/
4	2500	45.02	44.70	-0.32	74.00	29.30	100	188	Vertical	/

Highest Frequency

Frequency 2480MHz

Detector mode: Average

Polarity: Horizontal

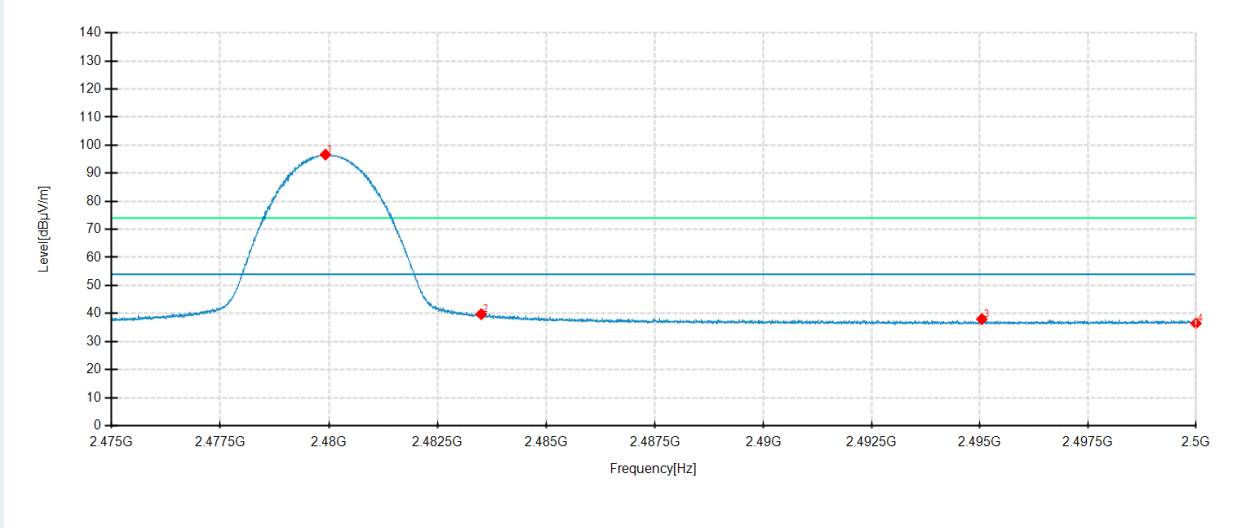

Detector mode: Average

Polarity: Vertical

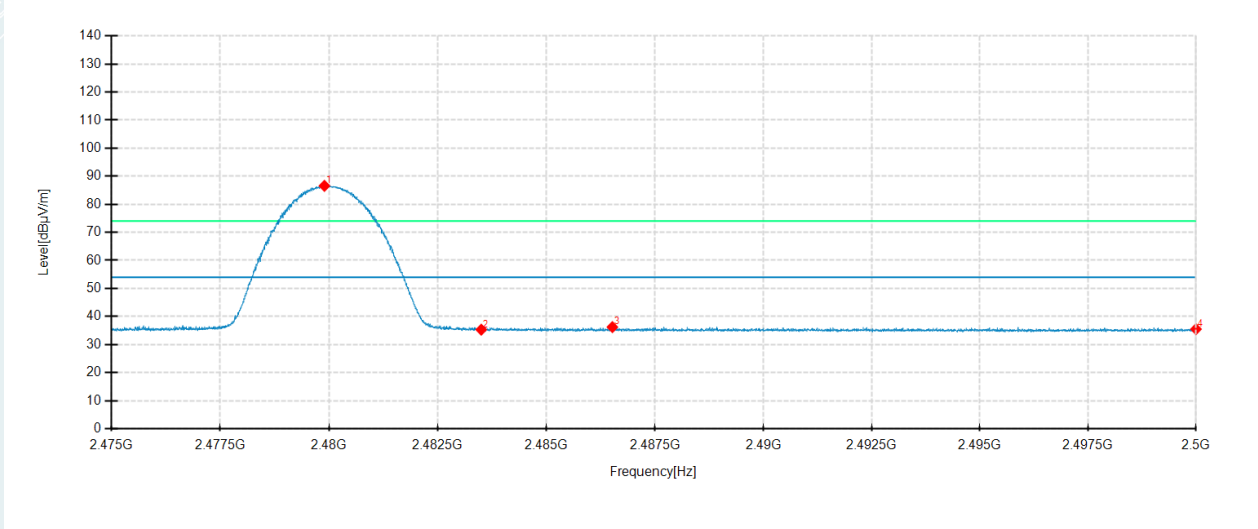

No.	Frequency MHz	Reading dBµV/m	Level dBµV/m	Factor dB	Limit dBµV/m	Margin dB	Height cm	Angle °	Pole	Remark
1	2479.918	96.44	96.63	0.19	54.00	-42.63	100	172	Horizontal	No limit
2	2483.5	39.49	39.75	0.26	54.00	14.25	100	172	Horizontal	/
3	2495.0445	37.49	37.97	0.48	54.00	16.03	200	188	Horizontal	/
4	2500	35.87	36.45	0.58	54.00	17.55	100	172	Horizontal	/
1	2479.893	86.97	86.58	-0.39	54.00	-32.58	200	184	Vertical	No limit
2	2483.5	35.67	35.29	-0.38	54.00	18.71	100	187	Vertical	/
3	2486.5187	36.59	36.22	-0.37	54.00	17.78	100	42	Vertical	/
4	2500	35.81	35.49	-0.32	54.00	18.51	200	184	Vertical	/

Remark: Max field strength in 3m distance. No any other emission which falls in restricted bands can be detected and be reported.

Right earbuds

Equipment:	Wireless Earbuds	Test Date	2022-10-13
Model No.:	E508A	Test Engineer:	Chen Xiaocong
Test Voltage:	DC 3.8V	Environmental Conditions	25.0°C/45%RH/101.0kPa

BLE 1M

Lowest Frequency

Frequency 2402MHz

Detector mode: Peak

Polarity: Horizontal

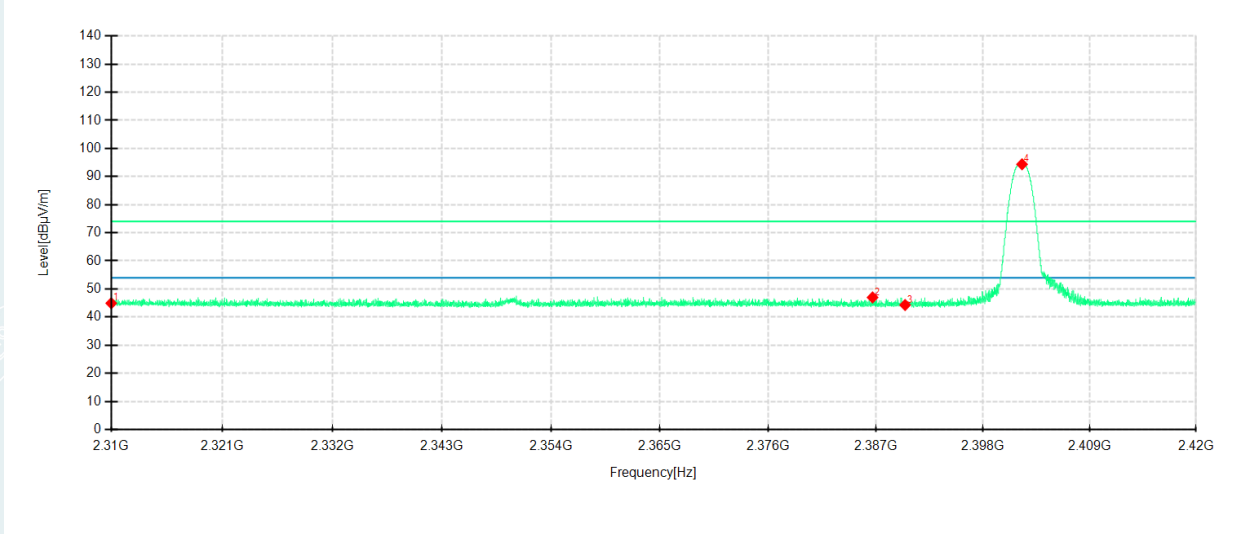

Detector mode: Peak

Polarity: Vertical

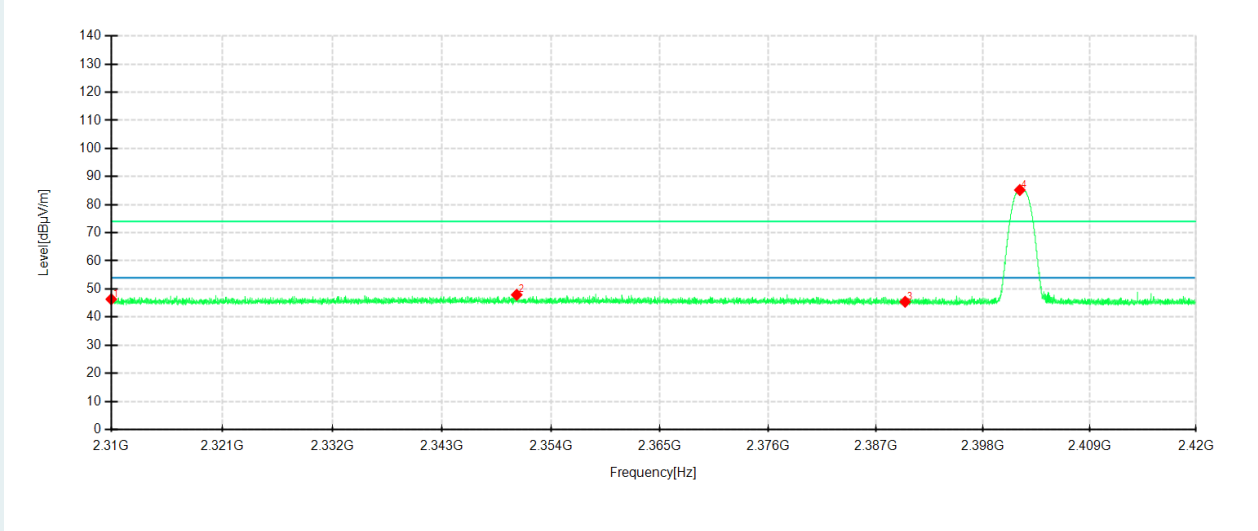

No.	Frequency MHz	Reading dB μ V/m	Level dB μ V/m	Factor dB	Limit dB μ V/m	Margin dB	Height cm	Angle °	Pole	Remark
1	2310	45.22	44.93	-0.29	74.00	29.07	200	187	Horizontal	/
2	2386.6667	47.85	46.98	-0.87	74.00	27.02	100	174	Horizontal	/
3	2390	45.14	44.29	-0.85	74.00	29.71	100	174	Horizontal	/
4	2402.0132	95.13	94.38	-0.75	74.00	-20.38	100	174	Horizontal	No limit
1	2310	46.06	46.35	0.29	74.00	27.65	200	172	Vertical	/
2	2350.5171	47.38	47.91	0.53	74.00	26.09	200	334	Vertical	/
3	2390	45.15	45.44	0.29	74.00	28.56	200	312	Vertical	/
4	2401.7822	84.99	85.20	0.21	74.00	-11.20	200	172	Vertical	No limit

----- The following blanks -----

Lowest Frequency

Frequency 2402MHz

Detector mode: Average

Polarity: Horizontal

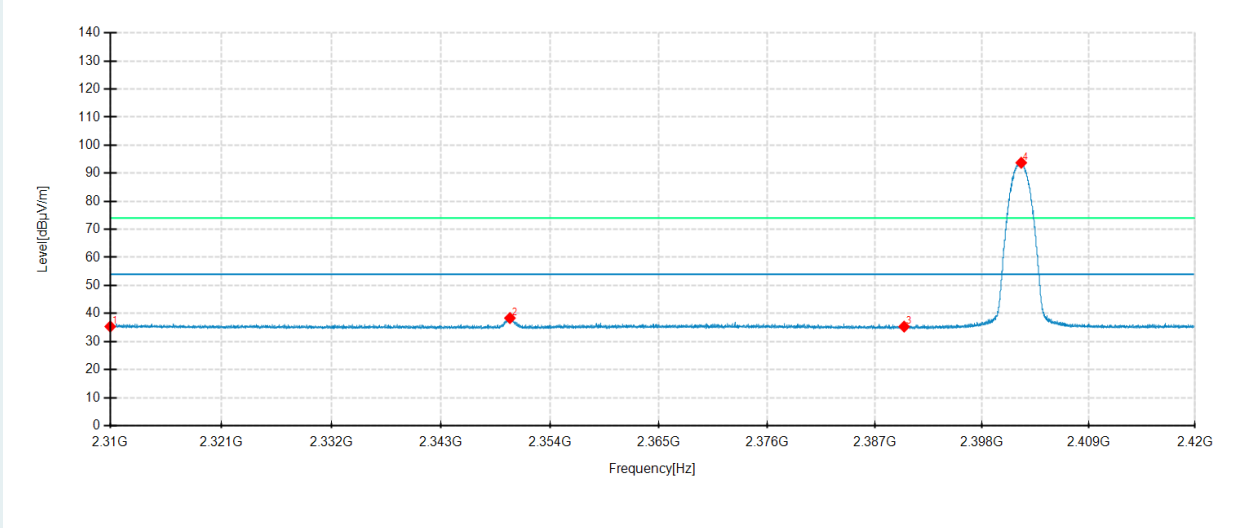

Detector mode: Average

Polarity: Vertical

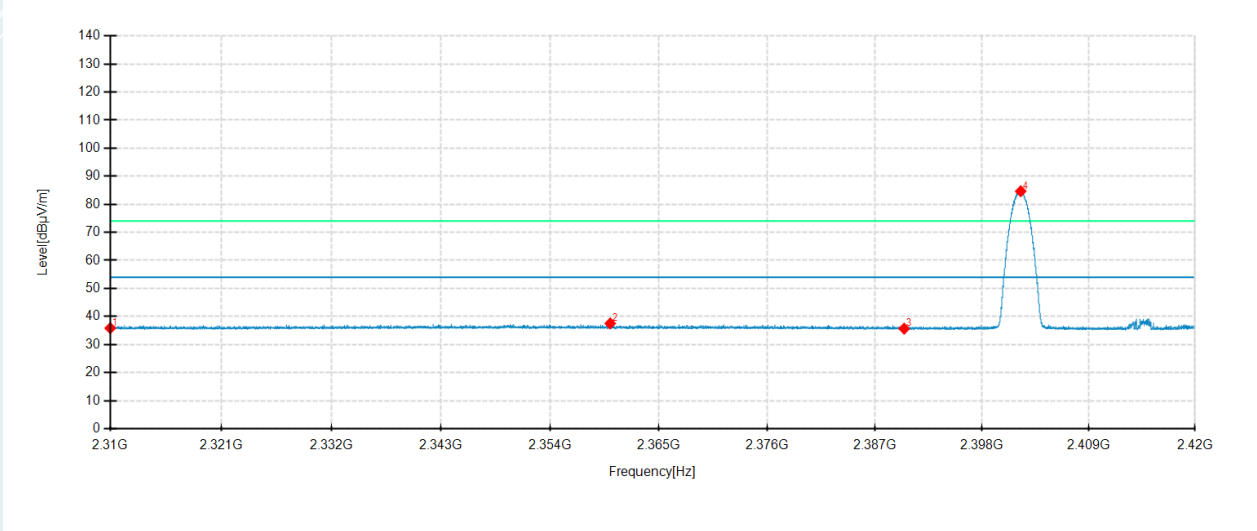

No.	Frequency MHz	Reading dBμV/m	Level dBμV/m	Factor dB	Limit dBμV/m	Margin dB	Height cm	Angle °	Pole	Remark
1	2310	35.63	35.34	-0.29	54.00	18.66	100	172	Horizontal	/
2	2349.934	39.52	38.36	-1.16	54.00	15.64	200	81	Horizontal	/
3	2390	36.17	35.32	-0.85	54.00	18.68	200	188	Horizontal	/
4	2402.0352	94.49	93.74	-0.75	54.00	-39.74	100	172	Horizontal	No limit
1	2310	35.55	35.84	0.29	54.00	18.16	200	344	Vertical	/
2	2360.066	37.05	37.53	0.48	54.00	16.47	100	187	Vertical	/
3	2390	35.37	35.66	0.29	54.00	18.34	200	204	Vertical	/
4	2401.9802	84.45	84.65	0.20	54.00	-30.65	200	173	Vertical	No limit

Highest Frequency

Frequency 2480MHz

Detector mode: Peak

Polarity: Horizontal

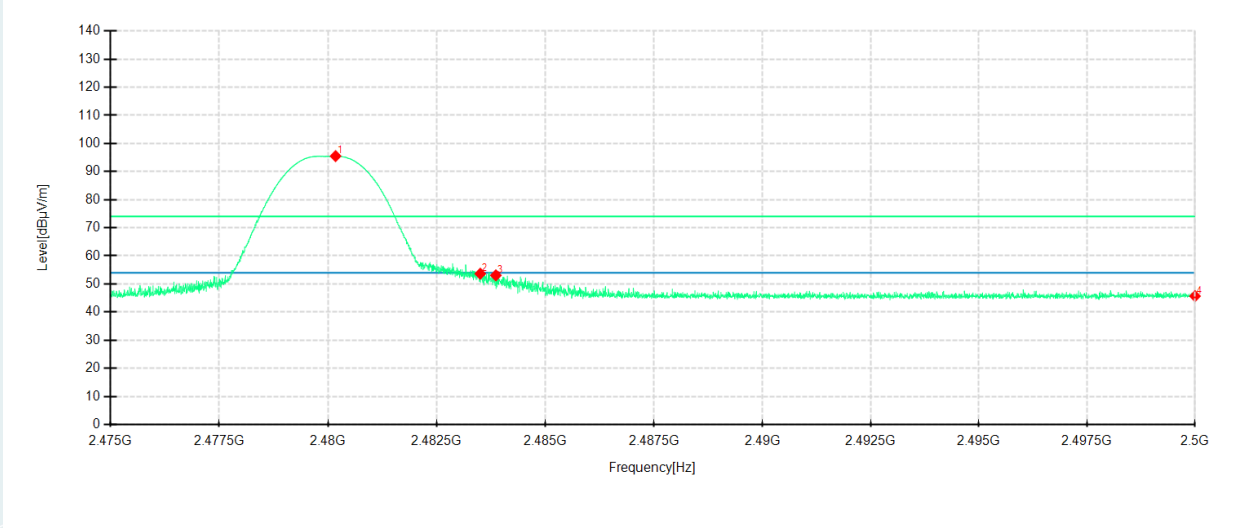

Detector mode: Peak

Polarity: Vertical

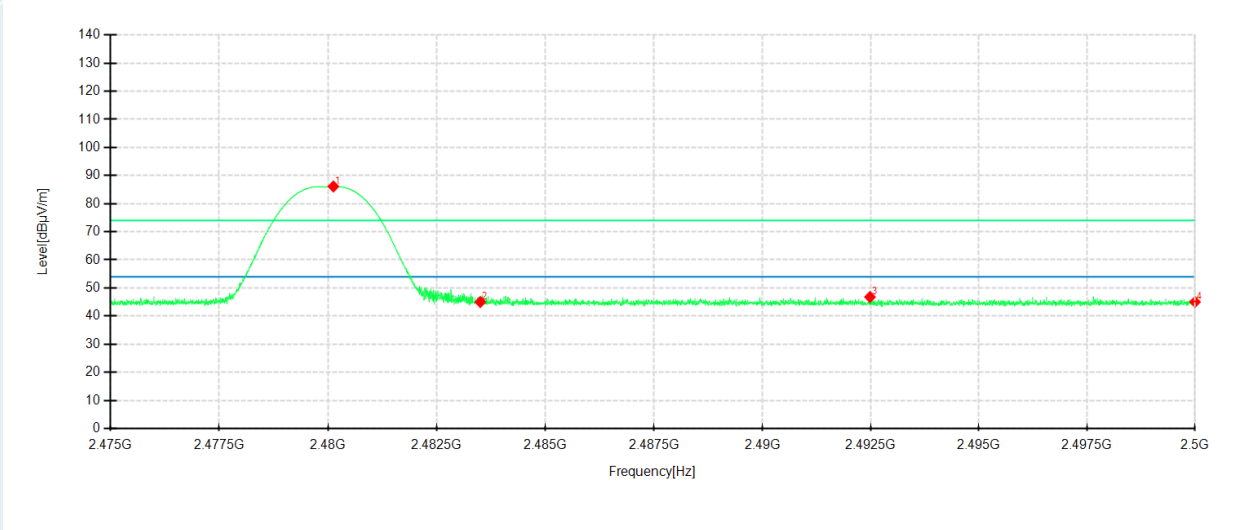

No.	Frequency MHz	Reading dBµV/m	Level dBµV/m	Factor dB	Limit dBµV/m	Margin dB	Height cm	Angle °	Pole	Remark
1	2480.173	95.32	95.51	0.19	74.00	-21.51	100	299	Horizontal	No limit
2	2483.5	53.40	53.66	0.26	74.00	20.34	100	311	Horizontal	/
3	2483.8584	52.80	53.07	0.27	74.00	20.93	100	173	Horizontal	/
4	2500	45.10	45.68	0.58	74.00	28.32	100	322	Horizontal	/
1	2480.123	86.51	86.12	-0.39	74.00	-12.12	200	182	Vertical	No limit
2	2483.5	45.38	45.00	-0.38	74.00	29.00	200	182	Vertical	/
3	2492.4842	47.13	46.78	-0.35	74.00	27.22	100	16	Vertical	/
4	2500	45.36	45.04	-0.32	74.00	28.96	100	91	Vertical	/

Highest Frequency

Frequency 2480MHz

Detector mode: Average

Polarity: Horizontal

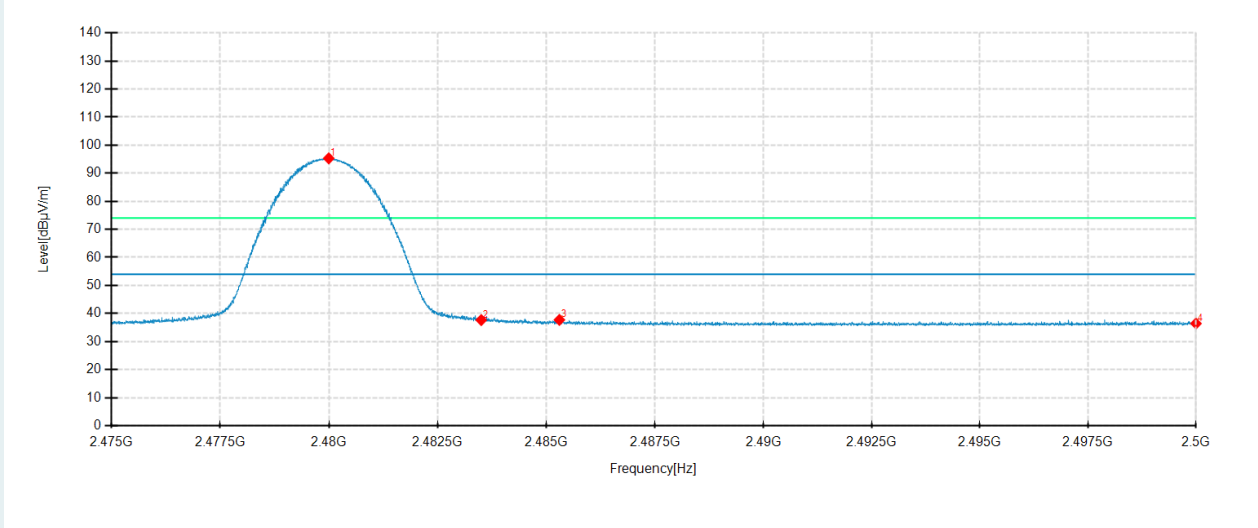

Detector mode: Average

Polarity: Vertical

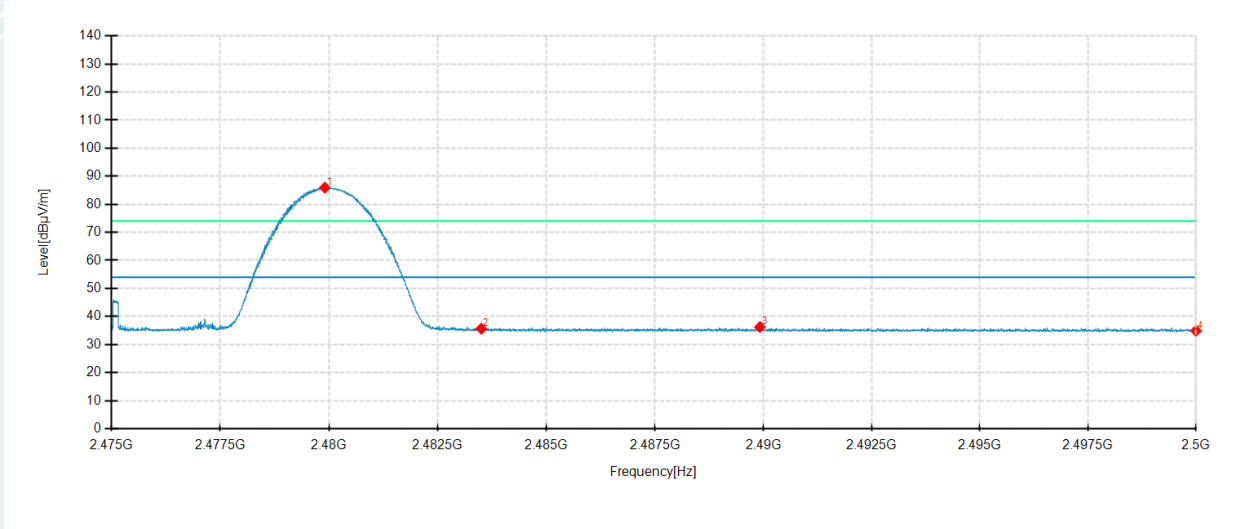

No.	Frequency MHz	Reading dBµV/m	Level dBµV/m	Factor dB	Limit dBµV/m	Margin dB	Height cm	Angle °	Pole	Remark
1	2479.993	95.11	95.30	0.19	54.00	-41.30	100	310	Horizontal	No limit
2	2483.5	37.39	37.65	0.26	54.00	16.35	100	310	Horizontal	/
3	2485.2985	37.43	37.72	0.29	54.00	16.28	100	287	Horizontal	/
4	2500	35.84	36.42	0.58	54.00	17.58	100	299	Horizontal	/
1	2479.903	86.31	85.92	-0.39	54.00	-31.92	200	184	Vertical	No limit
2	2483.5	36.01	35.63	-0.38	54.00	18.37	100	136	Vertical	/
3	2489.919	36.58	36.23	-0.35	54.00	17.77	100	187	Vertical	/
4	2500	35.21	34.89	-0.32	54.00	19.11	200	299	Vertical	/

Remark: Max field strength in 3m distance. No any other emission which falls in restricted bands can be detected and be reported.

APPENDIX A. PHOTOGRAPH OF THE TEST CONNECTION DIAGRAM

Please refer to the attached document E20220927529001-9-Test Photo.

APPENDIX B. PHOTOGRAPH OF THE EUT

Please refer to the attached document E20220927529001-10-EUT Photo.

----- End of Report -----